



中华人民共和国第十二届运动会
2013年 辽宁



男子手球预赛暨 2013 年全国男子手球锦标赛

成绩册

柳州

二〇一三年四月



中华人民共和国第十二届运动会 2013年 辽宁



男子手球预赛暨 2013 年全国男子手球锦标赛 比赛名次

- 第一名： 江苏
- 第二名： 广东
- 第三名： 山东
- 第四名： 上海
- 第五名： 解放军
- 第六名： 北京
- 第七名： 天津
- 第八名： 香港
- 第九名： 安徽
- 第十名： 西藏
- 第十一名： 四川
- 第十二名： 山西
- 第十三名： 澳门



中华人民共和国第十二届运动会 2013年 辽宁



男子手球预赛暨 2013 年全国男子手球锦标赛 单项技术奖

最佳位置

最佳中卫	张志宇（江苏）
最佳左卫	赵 晨（江苏）
最佳右卫	王旭东（山东）
最佳底线	王 伟（广东）
最佳左锋	李 安（江苏）
最佳右锋	李语庆（山东）
最佳守门员	王 权（江苏）

最有价值球员

王 权（江苏）



中华人民共和国第十二届运动会 2013年 辽宁



男子手球预赛暨 2013 年全国男子手球锦标赛 第一阶段积分表

A 组

队名	江苏	北京	山东	安徽	西藏	香港	澳门	积分	相互间			全部		名次
									积分	净胜球	总进球数	净胜球	总进球数	
江苏		<u>37:22</u> 2	<u>34:20</u> 2	<u>31:27</u> 2	<u>46:18</u> 2	<u>36:20</u> 2	<u>46:13</u> 2	12						1
北京	<u>22:37</u> 0		<u>14:34</u> 0	<u>27:21</u> 2	<u>36:25</u> 2	<u>33:29</u> 2	<u>48:16</u> 2	8						3
山东	<u>20:34</u> 0	<u>34:14</u> 2		<u>34:29</u> 2	<u>31:15</u> 2	<u>36:26</u> 2	<u>48:18</u> 2	10						2
安徽	<u>27:31</u> 0	<u>21:27</u> 0	<u>29:34</u> 0		<u>35:22</u> 2	<u>27:30</u> 0	<u>44:21</u> 2	4						5
西藏	<u>18:46</u> 0	<u>25:36</u> 0	<u>15:31</u> 0	<u>22:35</u> 0		<u>25:32</u> 0	<u>38:22</u> 2	2						6
香港	<u>00:00</u> 0	<u>29:33</u> 0	<u>26:36</u> 0	<u>30:27</u> 2	<u>32:25</u> 2		<u>25:17</u> 2	6						4
澳门	<u>13:46</u> 0	<u>16:48</u> 0	<u>18:48</u> 0	<u>21:44</u> 0	<u>22:38</u> 0	<u>17:25</u> 0		0						7

B 组

队名	广东	解放军	上海	天津	四川	山西	积分	相互间			全部		名次
								积分	净胜球	总进球数	净胜球	总进球数	
广东		<u>17:15</u> 2	<u>24:17</u> 2	<u>26:19</u> 2	<u>48:19</u> 2	<u>42:24</u> 2	10						1
解放军	<u>15:17</u> 0		<u>16:18</u> 0	<u>21:17</u> 2	<u>47:20</u> 2	<u>36:19</u> 2	6						3
上海	<u>17:24</u> 0	<u>18:16</u> 2		<u>24:22</u> 2	<u>45:15</u> 2	<u>32:22</u> 2	8						2
天津	<u>19:26</u> 0	<u>17:21</u> 0	<u>22:24</u> 0		<u>48:20</u> 2	<u>39:23</u> 2	4						4
四川	<u>19:48</u> 0	<u>20:47</u> 0	<u>15:45</u> 0	<u>20:48</u> 0		<u>28:33</u> 0	0						6
山西	<u>24:42</u> 0	<u>19:36</u> 0	<u>22:32</u> 0	<u>23:39</u> 0	<u>33:28</u> 2		2						5



中华人民共和国第十二届运动会 2013年 辽宁



男子手球预赛暨 2013 年全国男子手球锦标赛 第二阶段成绩表

日期	时间	场次	组别	比 赛 队	成绩	备注
4月27日 (六)	1300	37	E	安徽 — 四川	52:22(25:10)	
	1440	38	E	山西 — 西藏	23:35(11:19)	
	1620	39	D	北京 — 天津	26:23(12:10)	
	1800	40	D	解放军 — 香港	40:22(20:11)	
	1940	41	C	江苏 — 上海	33:23(21:11)	
	2120	42	C	广东 — 山东	24:22(9:12)	
4月28日 (日)	0900	43		四川 — 山西	36:33(18:14)	11/12名
	1040	44		安徽 — 西藏	39:24(18:12)	9/10名
	1440	45		天津 — 香港	45:30(24:19)	7/8名
	1620	46		北京 — 解放军	24:26(13:11)	5/6名
	1800	47		上海 — 山东	21:27(11:14)	3/4名
	1940	48		江苏 — 广东	32:24(17:11)	1/2名



中华人民共和国第十二届运动会 2013年 辽宁



男子手球预赛暨 2013 年全国男子手球锦标赛 体育道德风尚奖

运动队： 广东 江苏

运动员：

江苏： 张志宇 李 安

广东： 王 伟 张广建

山东： 宋朋强 赵 鑫

上海： 吴 璟 李和鑫

解放军： 丛 霖 吴龙瑞

北京： 郑永利 杜龙飞

天津： 李 军 张俊岭

香港： 许文邦 叶冠英

安徽： 王 超 袁 龙

西藏： 任 野 徐奕飞

山西： 李晋尧 朱涛涛

四川： 宋 涛 刘彦坤

澳门： 莫家进 冯国政

裁判员： 李 典 陈晓波



中华人民共和国第十二届运动会 2013年 辽宁



男子手球预赛暨 2013 年全国男子手球锦标赛 名单变更通知

- 四川队： 删除 13 号李瀛洲， 15 号张斌， 20 号付俊雄， 37 号黑耕晨； 增加 32 号逯明松
- 安徽队： 删除教练沈强， 队医钱忠东， 27 号史小帆， 增加 8 号董智景
- 山东队： 增加官员徐强
- 山西队： 领队邢俊杰更改为张晓东，
- 江苏队： 增加教练 NENADZ vonarek
- 广东队： 17 号李中渊更改为李中洲
- 天津队： 删除 6 号李志成， 增加 11 号王毅
- 解放军： 1 号苗青改为 6 号
- 西藏队： 7 号许奕飞更改为徐奕飞
- 澳门队： 队员号码变更为： 36 号陈嘉聪， 5 号何建成， 27 号徐展业， 81 号梁梓康， 33 号欧永健， 15 号黄俊勇， 29 号叶响俊， 21 号麦锦聪， 18 号卓伟杰， 2 号李翘臻， 24 号刘登宇， 93 号罗咪高， 16 号冯国政， 4 号刘家声， 22 号陈学敏， 28 号莫家进
- 香港队： 删除主教练苏大智； 运动员号码如下： 1 号萧智庭， 2 号叶冠英， 5 号黄胜业， 6 号谢伟希， 7 号许文邦， 8 号何伟杰， 9 号张建国， 10 号陈国兴， 11 号陈允文， 12 号叶冠雄， 13 号叶仕仁， 14 号李鑫豪， 15 号黄嘉愉， 25 号曾铭谦， 29 号练明辉



第十二届全国运动会男子手球预赛
排名表

正式表
手球
男子

截止至第 48场

2013010481204
China
2013-4-28 19:40:00

奖牌	排名	编码	队名
Gold	1	江苏	江苏
Silver	2	广东	广东
Bronze	3	山东	山东
	4	上海	上海
	5	解放军	解放军
	6	北京	北京
	7	天津	天津
	8	香港	香港
	9	安徽	安徽
	10	西藏	西藏
	11	四川	四川
	12	山西	山西
	13	澳门	澳门



第十二届全国运动会男子手球预赛

正式表
手球
男子

分组成绩

201301-1202-1/1

柳州

截止至第 48 场

2013-04-18

组别: A 预赛

名次	球队	积	场	胜	平	负	得分	失分	净胜
1	江苏	12	6	6	0	0	230	120	110
2	山东	10	6	5	0	1	203	136	67
3	北京	8	6	4	0	2	180	162	18
4	香港	6	6	3	0	3	162	174	-12
5	安徽	4	6	2	0	4	183	165	18
6	西藏	2	6	1	0	5	143	202	-59
7	澳门	0	6	0	0	6	107	249	-142

球队	江苏	山东	北京	香港	安徽	西藏	澳门
江苏		34-20	37-22	36-20	31-27	46-18	46-13
山东	20-34		34-14	36-26	34-29	31-15	48-18
北京	22-37	14-34		33-29	27-21	36-25	48-16
香港	20-36	26-36	29-33		30-27	32-25	25-17
安徽	27-31	29-34	21-27	27-30		35-22	44-21
西藏	18-46	15-31	25-36	25-32	22-35		38-22
澳门	13-46	18-48	16-48	17-25	21-44	22-38	

组别: B 预赛

名次	球队	积	场	胜	平	负	得分	失分	净胜
1	广东	10	5	5	0	0	157	94	63
2	上海	8	5	4	0	1	136	99	37
3	解放军	6	5	3	0	2	135	91	44
4	天津	4	5	2	0	3	145	114	31
5	山西	2	5	1	0	4	121	177	-56
6	四川	0	5	0	0	5	102	221	-119

球队	广东	上海	解放军	天津	山西	四川
广东		24-17	17-15	26-19	42-24	48-19
上海	17-24		18-16	24-22	32-22	45-15
解放军	15-17	16-18		21-17	36-19	47-20
天津	19-26	22-24	17-21		39-23	48-20
山西	24-42	22-32	19-36	23-39		33-28
四川	19-48	15-45	20-47	20-48	28-33	

名次	球队	积	场	胜	平	负	得分	失分	净胜

球队						

名次	球队	积	场	胜	平	负	得分	失分	净胜

球队						

Legend: 积 = 积分 场 = 已比赛场次 胜 = 胜场 平 = 平场 负 = 负场
 得分 = 得分累计 失分 = 失分累计 净胜 = 净胜分



第十二届全国运动会男子手球预赛
场次成绩正式表
手球
男子

截止至第48场

201301048-1203-1/1
柳州
2013-4-28 19:40:00

日期	场次	球队	成绩 (半时)	阶段
27-04-13	37	安徽-四川	52-22 (25-10)	复赛
	38	山西-西藏	23-35 (11-19)	复赛
	39	北京-天津	26-23 (12-10)	复赛
	40	解放军-香港	40-22 (20-11)	复赛
	41	江苏-上海	33-23 (21-11)	复赛
	42	广东-山东	24-22 (9-12)	复赛



第十二届全国运动会男子手球预赛
场次成绩正式表
手球
男子

截止至第48场

201301048-1203-1/1
柳州
2013-4-28 19:40:00

日期	场次	球队	成绩 (半时)	阶段
28-04-13	43	四川-山西	36-33 (18-14)	11-12名
	44	安徽-西藏	39-24 (18-12)	9-10名
	45	天津-香港	45-30 (24-19)	7-8名
	46	北京-解放军	24-26 (13-11)	5-6名
	47	上海-山东	21-27 (11-14)	3-4名
	48	江苏-广东	32-24 (17-11)	决赛



第十二届全国运动会男子手球预赛
场次成绩正式表
手球
男子

截止至第48场

201301048-1203-1/2
柳州
2013-4-28 19:40:00

日期	场次	球队	成绩 (半时)	阶段
18-04-13	1	江苏-西藏	46-18 (20-9)	预赛
	2	安徽-香港	27-30 (11-15)	预赛
	3	澳门-山东	18-48 (7-23)	预赛
19-04-13	4	江苏-香港	36-20 (20-10)	预赛
	5	北京-安徽	27-21 (11-10)	预赛
	6	西藏-澳门	38-22 (16-8)	预赛
	7	广东-天津	26-19 (13-9)	预赛
	8	解放军-山西	36-19 (20-7)	预赛
	9	上海-四川	45-15 (20-9)	预赛
20-04-13	10	山东-北京	34-14 (14-4)	预赛
	11	安徽-西藏	35-22 (18-8)	预赛
	12	澳门-江苏	13-46 (3-22)	预赛
	13	天津-解放军	17-21 (9-11)	预赛
	14	四川-广东	19-48 (8-27)	预赛
	15	山西-上海	22-32 (13-15)	预赛
21-04-13	16	山东-香港	36-26 (19-13)	预赛
	17	安徽-江苏	27-31 (7-16)	预赛
	18	北京-澳门	48-16 (25-6)	预赛
22-04-13	19	广东-山西	42-24 (22-12)	预赛
	20	解放军-上海	16-18 (6-7)	预赛
	21	天津-四川	48-20 (24-12)	预赛
23-04-13	22	澳门-安徽	21-44 (10-21)	预赛
	23	香港-北京	29-33 (15-18)	预赛
	24	西藏-山东	15-31 (8-12)	预赛
	25	解放军-四川	47-20 (23-9)	预赛
	26	上海-广东	17-24 (8-11)	预赛
	27	山西-天津	23-39 (12-22)	预赛
24-04-13	28	北京-西藏	36-25 (20-12)	预赛



第十二届全国运动会男子手球预赛
场次成绩

正式表
手球
男子

截止至第48场

201301048-1203-2/2
柳州
2013-4-28 19:40:00

日期	场次	球队	成绩 (半时)	阶段
	29	香港-澳门	25-17 (12-7)	预赛
	30	山东-江苏	20-34 (9-18)	预赛
25-04-13	31	四川-山西	28-33 (14-17)	预赛
	32	上海-天津	24-22 (13-11)	预赛
	33	广东-解放军	17-15 (6-4)	预赛
	34	西藏-香港	25-32 (12-15)	预赛
	35	山东-安徽	34-29 (19-12)	预赛
	36	江苏-北京	37-22 (20-8)	预赛
27-04-13	37	安徽-四川	52-22 (25-10)	复赛
	38	山西-西藏	23-35 (11-19)	复赛
	39	北京-天津	26-23 (12-10)	复赛
	40	解放军-香港	40-22 (20-11)	复赛
	41	江苏-上海	33-23 (21-11)	复赛
	42	广东-山东	24-22 (9-12)	复赛
28-04-13	43	四川-山西	36-33 (18-14)	11-12名
	44	安徽-西藏	39-24 (18-12)	9-10名
	45	天津-香港	45-30 (24-19)	7-8名
	46	北京-解放军	24-26 (13-11)	5-6名
	47	上海-山东	21-27 (11-14)	3-4名
	48	江苏-广东	32-24 (17-11)	决赛



第十二届全国运动会男子手球预赛
球队名单(媒体表)

江苏

201301000-53-1/1

号码	姓名	位置	生日	年龄	俱乐部	身高 (CM)	体重 (KG)	总场次	总进球
1	丁大伟	守门员	06/02/1984	29		189	92		
2	杨彦威	右边锋	20/01/1988	25		194	90		
3	李旭东	右边锋	09/01/1995	18		190	86		
4	沈庆	底线	11/10/1983	29		191	80		
5	闫亮	右后卫	23/01/1985	28		196	100		
6	赵晨	右后卫	24/06/1989	23		186	87		
8	周小坚	底线	13/01/1985	28		200	100		
9	叶强	守门员	16/06/1978	34		190	88		
10	郝可鑫	左后卫	15/01/1986	27		193	89		
11	姚仁剑	右后卫	01/02/1992	21		200	88		
12	王权	守门员	21/11/1992	20		194	80		
14	丛海航	右边锋	13/04/1985	28		190	90		
15	李安	左后卫	20/03/1987	26		197	98		
17	陈灵峰	右后卫	01/01/1989	24		196	90		
19	张志宇	中后卫	16/06/1986	26		189	90		
20	张星	中后卫	13/06/1986	26		195	100		
	平均			25.8		193.1	90.5		

替换队员

编码	姓名	职务
A	闫威名	主教练
C	NENADz vonarek	教练
D	王建国	医生
E	贾淑君	助理教练
B	钱红	领队





第十二届全国运动会男子手球预赛
球队名单(媒体表)

广东

201301000-53-1/1

号码	姓名	位置	生日	年龄	俱乐部	身高 (CM)	体重 (KG)	总场次	总进球
1	王旭兴	守门员	16/02/1990	23		191	80		
2	孙江山	底线	23/01/1991	22		198	90		
3	曲汝洋	右边锋	07/01/1989	24		191	70		
4	李卓洋	左后卫	05/02/1990	23		190	80		
5	候生升	左边锋	25/10/1989	23		190	75		
6	邓志贵	左边锋	25/05/1990	22		193	80		
7	付云博	后卫	14/12/1990	22		188	75		
8	于彦江	右后卫	09/06/1990	22		195	70		
9	徐庆	底线	25/01/1991	22		196	70		
10	陈超	右后卫	18/02/1990	23		197	85		
12	温杰	守门员	05/01/1987	26		199	78		
16	张广建	守门员	18/08/1980	32		197	80		
17	李中洲	中后卫	10/03/1989	24		198	75		
18	张腾	右边锋	25/09/1990	22		192	80		
19	马跃	守门员	04/12/1993	19		196	80		
20	王伟	底线	18/11/1985	27		199	85		
	平均			23.5		194.4	78.3		

替换队员

编码	姓名	职务
A	王锋	主教练
B	李晓忠	领队
C	郭艳辉	助理教练
E	薛良成	医生
D	黄炳春	助理教练





第十二届全国运动会男子手球预赛
球队名单(媒体表)

山东

201301000-53-1/1

号码	姓名	位置	生日	年龄	俱乐部	身高 (CM)	体重 (KG)	总场次	总进球
1	于性哲	守门员	25/06/1993	19		196	85		
4	田瑞	左边锋	01/03/1993	20		195	80		
5	潘翔	左边锋	04/10/1986	26		190	90		
6	李朝鹏	左边锋	01/12/1992	20		185	90		
8	王炳华	左后卫	10/05/1991	21		195	80		
9	赵鑫	左后卫	10/04/1987	26		180	80		
11	宋朋强	中后卫	12/02/1987	26		192	85		
13	刘晓	右边锋	30/03/1992	21		195	85		
15	陈鹏波	底线	20/07/1984	28		194	85		
16	王帅	守门员	01/04/1991	22		190	95		
17	王旭东	右边锋	06/12/1989	23		189	90		
18	于亚男	左后卫	25/11/1990	22		190	90		
19	李语庆	右边锋	07/03/1990	23		180	85		
20	杜在超	右后卫	01/07/1998	14		190	85		
21	翟乾坤	左边锋	29/08/1986	26		190	85		
22	刘正松	守门员	20/09/1987	25		193	85		
	平均			22.6		190.3	85.9		

替换队员

编码	姓名	职务
A	王鸿斌	主教练
B	王志峰	领队
C	邢建刚	医生
D	徐强	官员





第十二届全国运动会男子手球预赛
球队名单(媒体表)

上海

201301000-53-1/1

号码	姓名	位置	生日	年龄	俱乐部	身高 (CM)	体重 (KG)	总场次	总进球
1	张峥	守门员	01/04/1988	25		189	88		
2	胡辰	右边锋	01/06/1988	24		190	92		
3	赵时俊	右边锋	07/10/1991	21		185	88		
5	朱世杰	右后卫	01/06/1995	17		188	85		
6	李和鑫	右后卫	16/09/1985	27		194	97		
8	钱为玮	左边锋	17/11/1988	24		195	85		
9	朱礼彬	后卫	09/03/1991	22		194	97		
10	吴璟	底线	01/08/1983	29		190	108		
12	周哲韬	守门员	01/09/1995	17		191	88		
13	孟宇超	右边锋	01/02/1996	17		185	82		
14	王子阳	右边锋	01/01/1993	20		190	79		
15	徐俊吉	底线	23/05/1989	23		198	97		
16	朱春雷	守门员	19/04/1984	29		192	84		
18	马麟晓	中后卫	01/06/1989	23		191	83		
19	蒋承骅	左后卫	20/01/1991	22		198	100		
20	程云飞	底线	28/03/1991	22		195	120		
	平均			22.6		191.6	92.1		

替换队员

编码	姓名	职务
A	吴龙基	主教练
B	陆钦忠	领队
C	徐耀忠	助理教练
E	黄韡	医生
D	金迪琦	助理教练





第十二届全国运动会男子手球预赛
球队名单(媒体表)

解放军

201301000-53-1/1

号码	姓名	位置	生日	年龄	俱乐部	身高 (CM)	体重 (KG)	总场次	总进球
4	曹作亮	左后卫	28/08/1986	26		196	90		
5	吴龙瑞	右边锋	02/10/1990	22		186	86		
6	苗青	右后卫	04/02/1983	30		203	105		
7	陈昊	底线	27/01/1988	25		195	110		
8	王烁	左边锋	29/07/1988	24		185	80		
9	丁超	右后卫	04/06/1990	22		193	85		
10	师龙	右后卫	01/09/1990	22		196	108		
11	李想	底线	18/06/1985	27		196	110		
12	丛霖	守门员	03/07/1989	23		200	105		
13	王世杰	边锋	07/01/1991	22		185	80		
14	曲学博	底线	22/04/1990	23		198	115		
15	杨帆	中后卫	24/08/1984	28		195	95		
16	郎俊夫	守门员	28/08/1988	24		198	115		
17	王勇	右后卫	30/07/1989	23		198	110		
18	董宏斐	右边锋	31/01/1990	23		180	90		
20	谷浩	底线	29/10/1986	26		185	95		
	平均			24.4		193.1	98.7		

替换队员

编码	姓名	职务
A	张敬敏	主教练
B	张彬华	领队
C	刘捷	助理教练
D	刘军	医生





第十二届全国运动会男子手球预赛
球队名单(媒体表)

北京

201301000-53-1/1

号码	姓名	位置	生日	年龄	俱乐部	身高 (CM)	体重 (KG)	总场次	总进球
1	王泷	守门员	01/11/1985	27		195	93	130	
2	杜龙飞	右边锋	29/03/1990	23		190	95	20	
4	成亚	后卫	14/06/1990	22		187	87	60	
5	杨昆	底线	18/10/1990	22		195	95	60	
6	刘伟	右边锋	01/04/1987	26		184	87	160	
7	胡瀛	右后卫	21/07/1987	25		189	93	80	
8	王鹏	底线	01/11/1989	23		193	95	50	
9	刘振	左后卫	14/02/1988	25		182	90	80	
11	蒋维一	底线	01/06/1987	25		195	99	80	
13	白洁	左后卫	19/08/1987	25		190	105	40	
14	解建飞	底线	10/09/1989	23		198	100	30	
16	孟辉	守门员	10/10/1981	31		183	95	280	
17	姜冰峰	左边锋	12/05/1990	22		190	80	20	
18	张骥	后卫	05/11/1978	34		189	95	380	
20	郑永利	后卫	20/09/1978	34		194	85	280	
23	冯宁	右后卫	28/02/1984	29		196	92	120	
	平均			26.0		190.6	92.9	116.9	

替换队员

编码	姓名	职务
A	郑康旭	主教练
B	蔡建国	领队
C	吴健	助理教练
D	石锋	医生
E	郑永利	助理教练





第十二届全国运动会男子手球预赛
球队名单(媒体表)

天津

201301000-53-1/1

号码	姓名	位置	生日	年龄	俱乐部	身高 (CM)	体重 (KG)	总场次	总进球
1	刘宗其	守门员	31/03/1991	22		190	86		
2	李岳朋	左边锋	04/12/1986	26		194	90		
3	李军	中后卫	21/07/1988	24		190	92		
4	李松浩	右边锋	25/01/1993	20		191	80		
7	张青	右后卫	16/04/1989	24		192	100		
8	曹悦	左后卫	23/05/1993	19		200	100		
9	孟凡钢	左边锋	26/07/1979	33		190	88		
10	李帅	右边锋	14/07/1989	23		193	89		
11	王毅	左后卫	28/02/1995	18		193	89		
13	许松	右后卫	02/04/1992	21		183	77		
14	田剑侠	右后卫	01/09/1986	26		192	85		
15	张俊岭	右后卫	29/12/1986	26		197	98		
16	刘海亮	守门员	07/08/1990	22		194	86		
17	周群	底线	04/04/1994	19		192	100		
18	孙永	底线	04/01/1985	28		189	92		
19	梁堂亮	右边锋	30/03/1987	26		189	90		
	平均			23.6		191.8	90.1		

替换队员

编码	姓名	职务
A	尚喜	主教练
B	贾守信	领队
C	刘伟成	助理教练
D	冀谦	医生
E	杜瑞军	助理教练





第十二届全国运动会男子手球预赛
球队名单(媒体表)

香港

201301000-53-1/1

号码	姓名	位置	生日	年龄	俱乐部	身高 (CM)	体重 (KG)	总场次	总进球
1	萧智庭	守门员	01/04/1992	21		180	80		
2	叶冠英	守门员	01/04/1992	21		184	80		
5	黄胜业	右边锋	01/06/1991	21		172	72		
6	谢伟希	底线	01/01/1985	28		190	85		
7	许文邦	左后卫	01/03/1986	27		174	75		
8	何伟杰	右后卫	01/05/1989	23		182	88		
9	张建国	右边锋	01/07/1984	28		178	74		
10	陈国兴	中后卫	01/09/1987	25		174	72		
11	陈允文	右边锋	01/01/1986	27		174	75		
12	叶冠雄	中后卫	01/04/1992	21		183	74		
13	叶仕仁	中后卫	01/06/1986	26		184	84		
14	李鑫豪	底线	01/04/1987	26		187	81		
15	黄嘉愉	底线	01/11/1988	24		192	92		
25	曾铭谦	左边锋	02/10/1995	17		171	70		
29	练明辉	右边锋	01/04/1984	29		180	75		
平均				24.3		180.3	78.5		

替换队员

编码	姓名	职务
A	陈广裕	主教练
B	杨开将	领队
D	张军	医生





第十二届全国运动会男子手球预赛
球队名单(媒体表)

安徽

201301000-53-1/1

号码	姓名	位置	生日	年龄	俱乐部	身高 (CM)	体重 (KG)	总场次	总进球
1	高逸凡	守门员	10/05/1987	25		197	94		
2	周兰骏	左后卫	08/03/1990	23		199	100		
5	马鹏	左边锋	25/05/1989	23		185	80		
6	田耕	左边锋	17/10/1990	22		180	75		
7	姚雄敏	右后卫	01/02/1993	20		182	75		
8	董智景	左边锋	15/03/1995	18					
10	陈强龙	底线	11/11/1995	17		195	86		
11	黎涛	右边锋	02/10/1994	18		187	87		
12	曾献辰	守门员	29/06/1990	22		190	92		
15	邵青	右后卫	16/01/1990	23		193	86		
17	解维维	边锋	30/01/1989	24		183	76		
18	郭赛	底线	11/01/1989	24		186	80		
28	袁龙	中后卫	09/09/1989	23		189	80		
29	顾先亮	右边锋	11/08/1995	17		184	82		
32	王超	右后卫	09/01/1986	27		190	90		
33	曹振吉	底线	30/07/1989	23		195	90		
	平均			21.8		189.0	84.9		

替换队员

编码	姓名	职务
A	王来黔	主教练
B	刘晓蓓	领队
C	高恒勤	助理教练





第十二届全国运动会男子手球预赛
球队名单(媒体表)

西藏

201301000-53-1/1

号码	姓名	位置	生日	年龄	俱乐部	身高 (CM)	体重 (KG)	总场次	总进球
2	王龙	中后卫	01/04/1988	25		184	90		
4	张家纬	右后卫	01/09/1992	20		193	88		
5	冯祥龙	左边锋	01/01/1995	18		183	80		
6	任启双	底线	01/03/1993	20		192	89		
7	徐奕飞	右边锋	01/03/1993	20		181	80		
9	王博	底线	01/08/1992	20		192	98		
10	刘江	左后卫	01/03/1993	20		196	89		
11	朱治宇	左边锋	01/03/1993	20		181	80		
12	张帅	守门员	01/05/1995	17		187	80		
15	刘劲松	底线	01/12/1993	19		200	92		
16	徐畅	守门员	01/03/1994	19		200	92		
18	赵楠	右后卫	01/05/1993	19		186	90		
19	任野	右边锋	01/05/1991	21		182	75		
20	顾艳超		01/01/1993	20					
21	马光	左后卫	01/12/1993	19		196	85		
23	王伟强	左边锋	01/01/1993	20		176	80		
	平均			19.8		188.6	85.9		

替换队员

编码	姓名	职务
A	张文韬	主教练
B	殷永军	领队
C	瓮勇	医生





第十二届全国运动会男子手球预赛
球队名单(媒体表)

四川

201301000-53-1/1

号码	姓名	位置	生日	年龄	俱乐部	身高 (CM)	体重 (KG)	总场次	总进球
16	王松	守门员	01/11/1990	22		190	90		
18	杨洋	底线	01/08/1996	16		192	99		
19	杨洁	边锋	01/02/1997	16		188	80		
21	池培俊	后卫	01/07/1994	18		193	95		
22	刘彦坤	边锋	01/02/1982	31		186	80		
23	王震	后卫	01/06/1991	21		195	91		
25	李峥	后卫	01/04/1994	19		185	85		
27	于洪泉	后卫	01/01/1970	43		190	95		
28	宋涛	后卫	01/11/1985	27		180	73		
32	逯明松	右后卫	02/01/1998	15		190	81		
33	朱晓龙	后卫	01/11/1989	23		192	95		
35	仇振勇	边锋	01/10/1992	20		191	81		
36	刘琢	守门员	01/02/1995	18		185	82		
平均				22.2		189.0	86.7		

替换队员

编码	姓名	职务
A	李太平	主教练
B	李清	领队
C	黄承	助理教练
E	何明阳	助理教练





第十二届全国运动会男子手球预赛
球队名单(媒体表)

山西

201301000-53-1/1

号码	姓名	位置	生日	年龄	俱乐部	身高 (CM)	体重 (KG)	总场次	总进球
1	李晋尧	守门员	01/08/1993	19		196	96		
2	马健	边锋	01/07/1995	17		190	93		
3	王晋	底线	01/05/1993	19		196	97		
4	李鹏程	后卫	01/06/1992	20		188	86		
5	王志超	后卫	01/04/1994	19		196	90		
6	范帅	中后卫	01/03/1993	20		180	86		
7	白宇飞	后卫	01/01/1993	20		185	84		
8	崔钰	底线	01/11/1992	20		187	102		
9	朱涛涛	边锋	01/12/1992	20		188	92		
10	任海阳	边锋	01/06/1993	19		188	89		
12	侯乃章	守门员	01/04/1993	20		196	94		
13	侯建涛		01/07/1992	20		196	108		
14	刘明华	后卫	01/04/1994	19		187	98		
15	景新江	底线	01/05/1995	17		187	110		
18	朱榎	中后卫	01/12/1994	18		187	89		
平均				19.1		189.8	94.3		

替换队员

编码	姓名	职务
A	王喜和	主教练
B	张晓东	领队
D	石岩	助理教练
C	孙少波	助理教练





第十二届全国运动会男子手球预赛
球队名单(媒体表)

澳门

201301000-53-1/1

号码	姓名	位置	生日	年龄	俱乐部	身高 (CM)	体重 (KG)	总场次	总进球
2	李翘臻	后卫	01/05/1985	27		173	90		
4	刘家声	右后卫	01/04/1986	27		170	73		
5	何建成	右后卫	02/05/1986	26		183	70		
15	黄俊勇	底线	01/05/1988	24		181	75		
16	冯国政	守门员	01/10/1984	28		175	130		
18	卓伟杰	边锋	01/12/1991	21		170	70		
21	麦锦聪	边锋	01/09/1991	21		172	70		
22	陈学敏	底线	01/06/1994	18		179	82		
24	刘登宇	左后卫	01/08/1993	19		175	73		
27	徐展业	底线	01/07/1989	23		178	72		
28	莫家进	底线	01/07/1987	25		180	76		
29	叶响俊	边锋	01/11/1991	21		178	67		
33	欧永健	右后卫	01/10/1990	22		179	68		
36	陈嘉聪	守门员	01/12/1986	26		182	120		
81	梁梓康	中后卫	01/09/1989	23		171	68		
93	罗咪高	中后卫	01/08/1993	19		172	68		
	平均			23.1		176.1	79.5		

替换队员

编码	姓名	职务
A	卢永明	主教练
B	高光明	领队
C	黄宇豪	助理教练





第十二届全国运动会男子手球预赛

个人/全队技术累计表

正式表
手球
男子

截至第 48场

201301048-15-1/1
柳州市李宁体育馆
28/04/2013 19:40

号码	姓名	远射	近射	边射	快攻	突破	任意	7M	合计	%	助攻	失误	警告	2'	取消	场次	时间
江苏																	
<i>(场上队员)</i>																	
1	丁大伟									0.0%	3	1				8	04:15:01
2	杨彦威		3/3	1/3	10/16	1/1		0/1	15/24	62.5%		4	1			8	02:38:54
3	李旭东									0.0%						8	00:00:00
4	沈庆		13/17	1/1	4/6				18/24	75.0%	1	8	2			8	03:24:30
5	闫亮	4/9	8/9	0/3	5/10	3/9	2/2		22/42	52.4%	11	13	3			8	04:54:46
6	赵晨	15/30	7/10		5/8	3/5			30/53	56.6%	16	14	4	4		8	04:56:32
8	周小坚	1/2	18/20	1/2	8/9	1/2			29/35	82.9%	5	11	1			8	04:50:41
9	叶强	1/6	3/5	3/13	7/7	3/4	1/2	0/1	18/38	47.4%	8	14	1	3		8	03:31:56
10	郝可鑫	15/27	2/4		7/9	1/2	2/2		27/44	61.4%	5	7	2	2		8	03:34:12
11	姚仁剑									0.0%						8	00:00:00
12	王权	0/2					1/1		1/3	33.3%	3					8	03:44:59
14	丛海航		2/6	6/9	10/14	3/4			21/33	63.6%	2	12	2			8	05:02:56
15	李安	0/1	6/7	10/13	27/33	5/5		6/8	54/67	80.6%	3	12				8	05:03:15
17	陈灵峰	16/35	4/8	2/3	6/9			6/8	34/63	54.0%	5	18	4	3		8	04:07:04
19	张志宇	7/14	4/5	0/1	7/10	8/10	0/1		26/41	63.4%	18	16	2	3		8	05:26:49
20	张星									0.0%						8	00:00:00
合计																	
		59/126	70/94	24/48	96/13	28/42	6/8	12/18	295/467	63.2%	80	130	22	15			
<i>(守门员)</i>																	
1																	
1	丁大伟	45/70	11/25	12/25		3/13	3/4	3/7	93/189	49.2%	3	1				8	04:15:01
12	王权	31/58	8/17	10/22	16/45	0/2	1/2	0/2	60/131	45.8%	3					8	03:44:59
10/28																	
合计																	
		76/128	19/42	22/47		3/15	4/6	3/9	153/320	47.8%	6	1					

场上队员：得分/射门

守门员：救球/射门

已打比赛

全队合计	进球	被救	射失	击柱	封球	合计	%
远射	59	40	7	13	7	126	46.8%
近射	70	14	3	7		94	74.5%
边射	24	18	2	4		48	50.0%
快攻	96	25	1	7	2	131	73.3%
突破	28	6	4	4		42	66.7%
任意	6		2			8	75.0%
7M	12	5		1		18	66.7%

阶段	场次	对手	比分
预赛	1	西藏	46:18 (20:9)
预赛	4	香港	36:20 (20:10)
预赛	12	澳门	46:13 (22:3)
预赛	17	安徽	31:27 (16:7)
预赛	30	山东	34:20 (18:9)
预赛	36	北京	37:22 (20:8)
复赛	41	上海	33:23 (21:11)
决赛	48	广东	32:24 (17:11)





第十二届全国运动会男子手球预赛
图式射门区域累计

截止至第48场

201301048-42-1/1

江苏

1 丁大伟	2 杨彦威	3 李旭东	4 沈庆	5 闫亮	6 赵晨	8 周小坚	9 叶强																																																																								
<table border="1"><tr><td></td><td></td><td></td></tr><tr><td></td><td></td><td></td></tr><tr><td></td><td></td><td></td></tr></table>										<table border="1"><tr><td></td><td>1</td><td>2</td></tr><tr><td>2</td><td></td><td>1</td></tr><tr><td>3</td><td>2</td><td>4</td></tr></table>		1	2	2		1	3	2	4	<table border="1"><tr><td></td><td></td><td></td></tr><tr><td></td><td></td><td></td></tr><tr><td></td><td></td><td></td></tr></table>										<table border="1"><tr><td>1</td><td></td><td>1</td></tr><tr><td>4</td><td></td><td>3</td></tr><tr><td>4</td><td>1</td><td>4</td></tr></table>	1		1	4		3	4	1	4	<table border="1"><tr><td>2</td><td>1</td><td>2</td></tr><tr><td>2</td><td>1</td><td></td></tr><tr><td>8</td><td>2</td><td>4</td></tr></table>	2	1	2	2	1		8	2	4	<table border="1"><tr><td>2</td><td>1</td><td>3</td></tr><tr><td>4</td><td></td><td>5</td></tr><tr><td>12</td><td>1</td><td>2</td></tr></table>	2	1	3	4		5	12	1	2	<table border="1"><tr><td></td><td>1</td><td>4</td></tr><tr><td>2</td><td></td><td>5</td></tr><tr><td>9</td><td></td><td>8</td></tr></table>		1	4	2		5	9		8	<table border="1"><tr><td>2</td><td></td><td>3</td></tr><tr><td>3</td><td></td><td>2</td></tr><tr><td>5</td><td></td><td>3</td></tr></table>	2		3	3		2	5		3
	1	2																																																																													
2		1																																																																													
3	2	4																																																																													
1		1																																																																													
4		3																																																																													
4	1	4																																																																													
2	1	2																																																																													
2	1																																																																														
8	2	4																																																																													
2	1	3																																																																													
4		5																																																																													
12	1	2																																																																													
	1	4																																																																													
2		5																																																																													
9		8																																																																													
2		3																																																																													
3		2																																																																													
5		3																																																																													
Post - 0 Miss - 0 Block - 0	Post - 2 Miss - 2 Block - 0	Post - 0 Miss - 0 Block - 0	Post - 0 Miss - 0 Block - 0	Post - 6 Miss - 1 Block - 0	Post - 6 Miss - 0 Block - 3	Post - 0 Miss - 2 Block - 0	Post - 4 Miss - 2 Block - 1																																																																								
10 郝可鑫	11 姚仁剑	12 王权	14 丛海航	15 李安	17 陈灵峰	19 张志宇	20 张星																																																																								
<table border="1"><tr><td>5</td><td></td><td>2</td></tr><tr><td>5</td><td></td><td>1</td></tr><tr><td>8</td><td>1</td><td>5</td></tr></table>	5		2	5		1	8	1	5	<table border="1"><tr><td></td><td></td><td></td></tr><tr><td></td><td></td><td></td></tr><tr><td></td><td></td><td></td></tr></table>										<table border="1"><tr><td>1</td><td></td><td></td></tr><tr><td></td><td></td><td></td></tr><tr><td></td><td></td><td></td></tr></table>	1									<table border="1"><tr><td>4</td><td></td><td>2</td></tr><tr><td>5</td><td></td><td>1</td></tr><tr><td>6</td><td></td><td>3</td></tr></table>	4		2	5		1	6		3	<table border="1"><tr><td>6</td><td></td><td>5</td></tr><tr><td>12</td><td></td><td></td></tr><tr><td>11</td><td></td><td></td></tr></table>	6		5	12			11			<table border="1"><tr><td>5</td><td></td><td>8</td></tr><tr><td>6</td><td></td><td>7</td></tr><tr><td>6</td><td></td><td>2</td></tr></table>	5		8	6		7	6		2	<table border="1"><tr><td>3</td><td></td><td>3</td></tr><tr><td>5</td><td></td><td>3</td></tr><tr><td>9</td><td></td><td>3</td></tr></table>	3		3	5		3	9		3	<table border="1"><tr><td></td><td></td><td></td></tr><tr><td></td><td></td><td></td></tr><tr><td></td><td></td><td></td></tr></table>									
5		2																																																																													
5		1																																																																													
8	1	5																																																																													
1																																																																															
4		2																																																																													
5		1																																																																													
6		3																																																																													
6		5																																																																													
12																																																																															
11																																																																															
5		8																																																																													
6		7																																																																													
6		2																																																																													
3		3																																																																													
5		3																																																																													
9		3																																																																													
Post - 1 Miss - 1 Block - 3	Post - 0 Miss - 0 Block - 0	Post - 1 Miss - 1 Block - 0	Post - 2 Miss - 2 Block - 0	Post - 2 Miss - 2 Block - 0	Post - 6 Miss - 2 Block - 2	Post - 6 Miss - 4 Block - 0	Post - 0 Miss - 0 Block - 0																																																																								

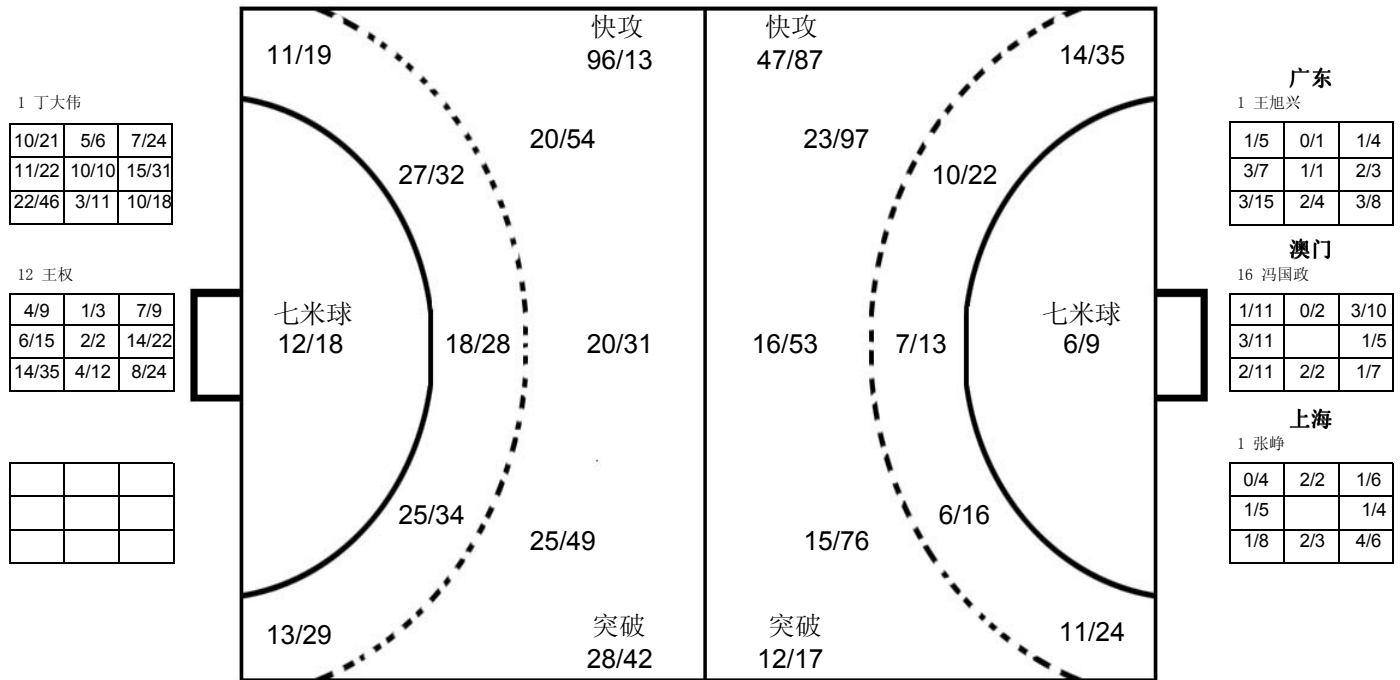

对手

32 王超	4 李卓洋	19 李语庆	9 朱礼彬	23 王伟强	2 周兰骏	21 翟乾坤	8 董智景																																																																								
<table border="1"><tr><td></td><td></td><td>1</td></tr><tr><td>2</td><td></td><td></td></tr><tr><td>1</td><td></td><td>4</td></tr></table>			1	2			1		4	<table border="1"><tr><td></td><td></td><td></td></tr><tr><td></td><td></td><td></td></tr><tr><td></td><td></td><td></td></tr></table>										<table border="1"><tr><td></td><td></td><td></td></tr><tr><td>1</td><td></td><td>1</td></tr><tr><td>1</td><td></td><td>3</td></tr></table>				1		1	1		3	<table border="1"><tr><td></td><td></td><td>1</td></tr><tr><td>1</td><td></td><td>1</td></tr><tr><td>1</td><td>1</td><td>1</td></tr></table>			1	1		1	1	1	1	<table border="1"><tr><td>1</td><td></td><td></td></tr><tr><td></td><td></td><td>1</td></tr><tr><td>1</td><td>2</td><td>1</td></tr></table>	1					1	1	2	1	<table border="1"><tr><td>1</td><td></td><td></td></tr><tr><td></td><td></td><td></td></tr><tr><td>4</td><td></td><td></td></tr></table>	1						4			<table border="1"><tr><td></td><td>1</td><td>1</td></tr><tr><td></td><td></td><td>1</td></tr><tr><td>2</td><td></td><td></td></tr></table>		1	1			1	2			<table border="1"><tr><td></td><td></td><td></td></tr><tr><td></td><td></td><td></td></tr><tr><td></td><td></td><td></td></tr></table>									
		1																																																																													
2																																																																															
1		4																																																																													
1		1																																																																													
1		3																																																																													
		1																																																																													
1		1																																																																													
1	1	1																																																																													
1																																																																															
		1																																																																													
1	2	1																																																																													
1																																																																															
4																																																																															
	1	1																																																																													
		1																																																																													
2																																																																															
Post - 1 Miss - 0 Block - 2	Post - 0 Miss - 2 Block - 1	Post - 0 Miss - 1 Block - 3	Post - 1 Miss - 3 Block - 4	Post - 0 Miss - 0 Block - 1	Post - 1 Miss - 1 Block - 2	Post - 0 Miss - 2 Block - 1	Post - 0 Miss - 0 Block - 0																																																																								
2 杜龙飞	11 蒋维一	3 曲汝洋	5 候生升	14 王子阳	18 马麟晓	28 袁龙	29 顾先亮																																																																								
<table border="1"><tr><td>3</td><td></td><td></td></tr><tr><td></td><td></td><td></td></tr><tr><td>1</td><td></td><td></td></tr></table>	3						1			<table border="1"><tr><td></td><td></td><td></td></tr><tr><td>2</td><td></td><td></td></tr><tr><td>2</td><td></td><td></td></tr></table>				2			2			<table border="1"><tr><td></td><td></td><td>1</td></tr><tr><td></td><td></td><td>1</td></tr><tr><td></td><td>2</td><td></td></tr></table>			1			1		2		<table border="1"><tr><td></td><td></td><td></td></tr><tr><td>1</td><td></td><td></td></tr><tr><td>1</td><td>1</td><td>1</td></tr></table>				1			1	1	1	<table border="1"><tr><td></td><td></td><td>2</td></tr><tr><td></td><td></td><td></td></tr><tr><td></td><td>2</td><td></td></tr></table>			2					2		<table border="1"><tr><td>1</td><td></td><td></td></tr><tr><td></td><td></td><td>1</td></tr><tr><td>2</td><td></td><td></td></tr></table>	1					1	2			<table border="1"><tr><td></td><td></td><td></td></tr><tr><td></td><td></td><td></td></tr><tr><td>3</td><td></td><td></td></tr></table>							3			<table border="1"><tr><td>1</td><td></td><td>1</td></tr><tr><td></td><td></td><td></td></tr><tr><td>1</td><td></td><td></td></tr></table>	1		1				1		
3																																																																															
1																																																																															
2																																																																															
2																																																																															
		1																																																																													
		1																																																																													
	2																																																																														
1																																																																															
1	1	1																																																																													
		2																																																																													
	2																																																																														
1																																																																															
		1																																																																													
2																																																																															
3																																																																															
1		1																																																																													
1																																																																															
Post - 0 Miss - 0 Block - 0	Post - 0 Miss - 0 Block - 0	Post - 0 Miss - 1 Block - 0	Post - 1 Miss - 0 Block - 0	Post - 0 Miss - 1 Block - 0	Post - 0 Miss - 2 Block - 1	Post - 2 Miss - 2 Block - 1	Post - 0 Miss - 0 Block - 0																																																																								

注释: Post=击柱 Miss=射失 Block=被封





第十二届全国运动会男子手球预赛

个人/全队技术累计表

正式表
手球
男子

截至第 48场

201301048-15-1/1
柳州市李宁体育馆
28/04/2013 19:40

号码	姓名	远射	近射	边射	快攻	突破	任意	7M	合计	%	助攻	失误	警告	2'	取消	场次	时间
广东																	
<i>(场上队员)</i>																	
1	王旭兴									0.0%	1	2				7	04:48:06
2	孙江山	1/1		3/6	9/11				13/18	72.2%	1	3	1	1		7	01:24:59
3	曲汝洋	1/4	0/1	3/3	11/13			1/1	16/22	72.7%	3	9				7	05:44:03
4	李卓洋	19/42	6/10	1/2	3/5	0/1	1/1		30/61	49.2%	5	11	2	1		7	04:02:52
5	候生升	0/2	4/4	0/2	13/13				17/21	81.0%	4	7				7	02:13:35
6	邓志贵		2/2	3/7	5/5	0/1			10/15	66.7%	1	4	4	1		7	03:49:52
7	付云博	7/24	4/7		5/9	5/6	0/1	5/6	26/53	49.1%	12	25	3	1		7	06:07:27
8	于彦江	7/18	2/6	2/3	3/4	3/5		2/2	19/38	50.0%	6	12	1	1		7	04:22:11
9	徐庆		2/5		0/1			1/1	3/7	42.9%	1	6	1			7	01:26:27
10	陈超	3/6	1/1	2/3	5/6	4/5			15/21	71.4%	1	6				7	01:48:36
12	温杰									0.0%	1					7	01:11:54
16	张广建									0.0%	1					7	01:00:00
17	李中洲	8/26	7/10	1/2	7/9	2/3	1/1	1/2	27/53	50.9%	7	22	3	4		7	05:24:54
18	张腾		1/2	3/4					4/6	66.7%	2	5	3	2		7	01:58:14
19	马跃									0.0%	1	1				7	00:30:00
20	王伟	2/3	10/16	0/3	8/11	4/4		1/1	25/38	65.8%	2	16	2	1		7	05:37:33
合计																	
		48/126	39/64	18/35	69/87	18/25	2/3	11/13	205/353	58.1%	49	129	20	12			
<i>(守门员)</i>																	
1	王旭兴	21/48	6/27	14/24	7/32	4/14	0/1	2/8	54/154	35.1%	1	2				7	04:48:06
12	温杰	7/8	3/8	2/5	4/13	2/7	3/3	0/2	21/46	45.7%	1					7	01:11:54
16	张广建	5/9	2/2	0/1	1/4	0/1		2/5	10/22	45.5%	1					7	01:00:00
19	合计	7/12	1/2	1/2	0/2	0/2	2/2		11/22	50.0%	1	1					00:30:00

场上队员：得分/射门

守门员：救球/射门

全队合计	进球	被救	射失	击柱	封球	合计	%
远射	48	45	11	7	15	126	38.1%
近射	39	19	3	2	1	64	60.9%
边射	18	9	2	6		35	51.4%
快攻	69	14	2	2		87	79.3%
突破	18	7				25	72.0%
任意	2		1			3	66.7%
7M	11	1		1		13	84.6%

已打比赛

阶段	场次	对手	比分
预赛	7	天津	26:19 (13:9)
预赛	14	四川	48:19 (27:8)
预赛	19	山西	42:24 (22:12)
预赛	26	上海	24:17 (11:8)
预赛	33	解放军	17:15 (6:4)
复赛	42	山东	24:22 (9:12)
决赛	48	江苏	24:32 (11:17)





第十二届全国运动会男子手球预赛
图式射门区域累计

截止至第48场

201301048-42-1/1

广东

1 王旭兴 Post - 0 Miss - 0 Block - 0	2 孙江山 Post - 2 Miss - 0 Block - 0	3 曲汝洋 Post - 1 Miss - 2 Block - 0	4 李卓洋 Post - 3 Miss - 6 Block - 2	5 候生升 Post - 1 Miss - 0 Block - 0	6 邓志贵 Post - 2 Miss - 0 Block - 0	7 付云博 Post - 3 Miss - 4 Block - 5	8 于彦江 Post - 1 Miss - 3 Block - 2
9 徐庆 Post - 1 Miss - 0 Block - 0	10 陈超 Post - 0 Miss - 0 Block - 1	12 温杰 Post - 0 Miss - 0 Block - 0	16 张广建 Post - 0 Miss - 0 Block - 0	17 李中洲 Post - 3 Miss - 2 Block - 5	18 张腾 Post - 0 Miss - 0 Block - 0	19 马跃 Post - 0 Miss - 0 Block - 0	20 王伟 Post - 1 Miss - 2 Block - 1

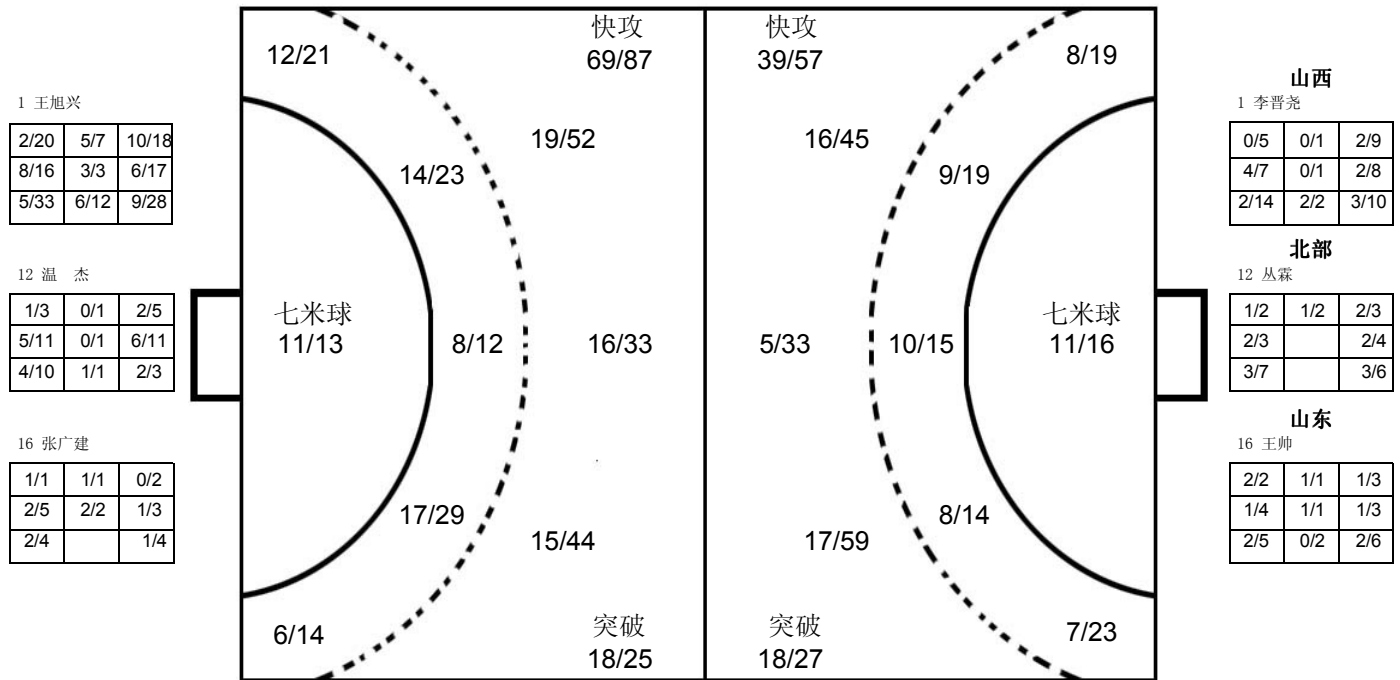

对手

江苏 15 李安 Post - 1 Miss - 1 Block - 0	山东 17 王旭东 Post - 0 Miss - 2 Block - 0	山西 7 白宇飞 Post - 0 Miss - 2 Block - 2	江苏 8 周小坚 Post - 0 Miss - 0 Block - 0	四川 23 王震 Post - 0 Miss - 0 Block - 1	北部 4 曹作亮 Post - 0 Miss - 2 Block - 2	江苏 6 赵晨 Post - 1 Miss - 0 Block - 0	四川 33 朱晓龙 Post - 1 Miss - 0 Block - 2
天津 7 张青 Post - 1 Miss - 0 Block - 1	天津 8 曹悦 Post - 1 Miss - 2 Block - 0	北部 5 吴龙瑞 Post - 1 Miss - 0 Block - 0	北部 8 王烁 Post - 0 Miss - 0 Block - 1	江苏 5 闫亮 Post - 1 Miss - 0 Block - 0	江苏 19 张志宇 Post - 1 Miss - 0 Block - 0	山东 9 赵鑫 Post - 0 Miss - 1 Block - 1	山东 20 杜在超 Post - 0 Miss - 1 Block - 1

注释: Post=击柱 Miss=射失 Block=被封





第十二届全国运动会男子手球预赛

个人/全队技术累计表

正式表
手球
男子

截至第 47场

201301047-15-1/1
柳州市李宁体育馆
28/04/2013 18:00

号码	姓名	远射	近射	边射	快攻	突破	任意	7M	合计	%	助攻	失误	警告	2'	取消	场次	时间
山东																	
<i>(场上队员)</i>																	
1	于性哲									0.0%	4	1	1			8	02:04:45
4	田瑞			1/3	2/3				3/6	50.0%		1				8	00:32:48
5	潘翔	1/1	16/20		8/8	3/4			28/33	84.8%	2	13	6	3	1	7	04:43:46
6	李朝鹏	2/4	4/4	1/1	4/7				11/16	68.8%		8			4	8	02:14:42
8	王炳华	2/9			5/6	1/1	0/1		8/17	47.1%	1	5		2		8	01:22:50
9	赵鑫	16/35	3/7	0/1	4/5	6/9	0/2		29/59	49.2%	10	13	2			8	04:16:20
11	宋朋强	3/14	1/2		6/12	2/2	0/1		12/31	38.7%	9	5	3	6		8	05:29:45
13	刘晓	3/7	1/6	4/4	1/2	2/3		1/2	12/24	50.0%	3	3				8	02:32:24
15	陈鹏波	0/3	6/9	1/4	0/2	1/1	1/1		9/20	45.0%	2	5	1	2		8	03:03:45
16	王帅	0/1							0/1	0.0%	4	2				8	03:15:31
17	王旭东	6/14	5/5	4/8	13/16	3/5	0/1		31/49	63.3%	3	15	4	5		8	05:14:58
18	于亚男	2/3	0/1		8/10	2/2			12/16	75.0%	4	3	3	1		8	02:04:28
19	李语庆	5/15	4/7	7/8	23/33	1/2		7/8	47/73	64.4%	3	10		1		8	04:31:59
20	杜在超	4/11	2/5	0/1	3/7	5/7	0/3		14/34	41.2%	7	20	3	1		8	04:38:38
21	翟乾坤	5/14	8/10	15/23	7/10	1/1		0/1	36/59	61.0%	6	16	1	1		8	06:45:55
22	刘正松									0.0%	4	1				8	02:39:42
合计																	
		49/131	50/76	33/53	84/12	27/37	1/9	8/11	252/438	57.5%	62	121	24	26	1		
<i>(守门员)</i>																	
																1	
1	于性哲	13/25	4/12	3/8		3/12	1/1	2/8	33/91	36.3%	4	1	1			8	02:04:45
16	王帅	23/45	7/24	6/11	7/25	1/11	2/3	0/3	49/125	39.2%	4	2				8	03:15:31
22	刘正松	23/40	4/13	2/7	10/28	2/12	1/1		40/87	46.0%	4	1				8	02:39:42
合计																	
		59/110	15/49	11/26	8/14	6/35	4/5	2/11	122/303	40.3%	12	4	1				

场上队员：得分/射门

守门员：救球/射门

已打比赛

全队合计	进球	被救	射失	击柱	封球	合计	%
远射	49	44	14	6	18	131	37.4%
近射	50	20	2	4		76	65.8%
边射	33	11	7	2		53	62.3%
快攻	84	24	7	6		121	69.4%
突破	27	6	2	2		37	73.0%
任意	1	5	3			9	11.1%
7M	8	3				11	72.7%

阶段	场次	对手	比分
预赛	3	澳门	48:18 (23:7)
预赛	10	北京	34:14 (14:4)
预赛	16	香港	36:26 (19:13)
预赛	24	西藏	31:15 (12:8)
预赛	30	江苏	20:34 (9:18)
预赛	35	安徽	34:29 (19:12)
复赛	42	广东	22:24 (12:9)
3-4名	47	上海	27:21 (14:11)





第十二届全国运动会男子手球预赛
图式射门区域累计

截止至第48场

201301048-42-1/1

山东

Table with 14 columns representing players (1 于性哲, 4 田瑞, 5 潘翔, 6 李朝鹏, 8 王炳华, 9 赵鑫, 11 宋朋强, 13 刘晓, 15 陈鹏波, 16 王帅, 17 王旭东, 18 于亚男, 19 李语庆, 20 杜在超, 21 翟乾坤, 22 刘正松) and their statistics in a grid format.

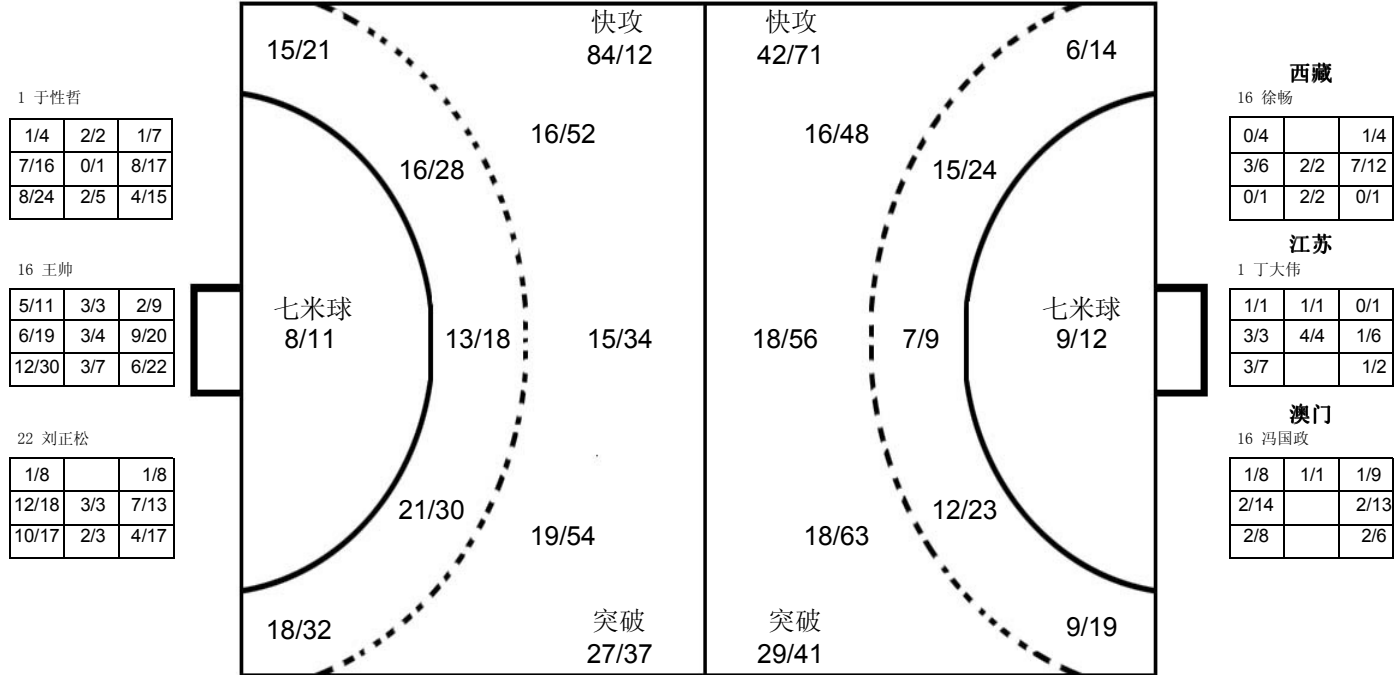

对手

Table with 14 columns representing opponents (15 李安, 32 王超, 7 许文邦, 20 王伟, 6 李和鑫, 9 朱礼彬, 5 黄胜业, 23 冯宁, 10 郝可鑫, 19 张志宇, 23 王伟强, 13 叶仕仁, 5 马鹏, 10 陈强龙, 33 欧永健, 93 罗味高) and their statistics in a grid format.

注释: Post=击柱 Miss=射失 Block=被封



第十二届全国运动会男子手球预赛

个人/全队技术累计表

正式表
手球
男子

截至第 47场

201301047-15-1/1
柳州市李宁体育馆
28/04/2013 18:00

号码	姓名	远射	近射	边射	快攻	突破	任意	7M	合计	%	助攻	失误	警告	2'	取消	场次	时间
上海																	
<i>(场上队员)</i>																	
1	张崢									0.0%	2					7	02:29:05
2	胡辰			0/1	2/3				2/4	50.0%					1	7	00:40:10
3	赵时俊	0/2		3/10	2/8				5/20	25.0%	3	6		3	7	05:04:12	
5	朱世杰	1/2	2/4		1/1	1/1			5/8	62.5%	3	5			7	00:26:45	
6	李和鑫	17/35	1/3	1/1	2/2	3/5	1/2	3/3	28/51	54.9%	6	19	5	1	7	04:52:07	
8	钱为玮	0/1	3/3	6/9	11/13	1/2			21/28	75.0%	1	8	3	1	7	04:32:39	
9	朱礼彬	9/36	4/4	0/1	5/5	5/10	1/2		24/58	41.4%	5	26	1	2	7	05:32:55	
10	吴璟	0/1	10/12	2/5	2/5	2/2		8/8	24/33	72.7%	2	6	2	2	7	04:15:29	
12	周哲韬	0/1							0/1	0.0%	2	3			7	01:21:22	
13	孟宇超	1/2	0/1	3/5	3/3	0/1	1/1		8/13	61.5%		2			7	01:07:02	
14	王子阳			4/13	11/15	2/3			17/31	54.8%		4		1	7	02:59:01	
15	徐俊吉		5/9		1/2			2/2	8/13	61.5%		3	2	2	7	03:10:11	
16	朱春雷									0.0%	1	1			7	03:39:33	
18	马麟晓	10/29	3/6		4/5	4/6	1/1	1/1	23/48	47.9%	19	21	1	1	7	06:20:24	
19	蒋承骅	0/2	2/5	1/1	3/5	1/1		1/1	8/15	53.3%	4	9	4	3	7	04:47:53	
20	程云飞		4/6		3/4				7/10	70.0%		1		1	7	00:31:48	

合计		38/111	34/53	20/46	50/71	19/31	4/6	15/15	180/333	54.1%	48	114	18	18			
<i>(守门员)</i>																	
1	张崢	16/31	5/29	7/15	1/13	2/6		0/6	31/100	31.0%	2					7	02:29:05
12	周哲韬	23/29	1/10	4/7	3/6	1/2		0/1	32/55	58.2%	2	3				7	01:21:22
16	朱春雷	9/19	7/18	5/11	1/22	1/10	2/5	2/9	27/94	28.7%	1	1				7	03:39:33
合计		48/79	13/57	16/33	5/41	4/18	2/5	2/16	90/249	36.1%	5	4					

场上队员：得分/射门

守门员：救球/射门

全队合计	进球	被救	射失	击柱	封球	合计	%
远射	38	40	13	4	16	111	34.2%
近射	34	12	5	2		53	64.2%
边射	20	18	4	4		46	43.5%
快攻	50	17	2	2		71	70.4%
突破	19	9	2	1		31	61.3%
任意	4		2			6	66.7%
7M	15					15	100.0%

已打比赛

阶段	场次	对手	比分
预赛	9	四川	45:15 (20:9)
预赛	15	山西	32:22 (15:13)
预赛	20	解放军	18:16 (7:6)
预赛	26	广东	17:24 (8:11)
预赛	32	天津	24:22 (13:11)
复赛	41	江苏	23:33 (11:21)
3-4名	47	山东	21:27 (11:14)





第十二届全国运动会男子手球预赛
图式射门区域累计

截止至第48场

201301048-42-1/1

上海

1 张峥	2 胡辰	3 赵时俊	5 朱世杰	6 李和鑫	8 钱为玮	9 朱礼彬	10 吴璟																																																																								
<table border="1"><tr><td></td><td></td><td></td></tr><tr><td></td><td></td><td></td></tr><tr><td></td><td></td><td></td></tr></table>										<table border="1"><tr><td>1</td><td></td><td></td></tr><tr><td></td><td></td><td></td></tr><tr><td></td><td></td><td>1</td></tr></table>	1								1	<table border="1"><tr><td>1</td><td></td><td>1</td></tr><tr><td>1</td><td></td><td>1</td></tr><tr><td></td><td></td><td>1</td></tr></table>	1		1	1		1			1	<table border="1"><tr><td></td><td></td><td></td></tr><tr><td>1</td><td>1</td><td>1</td></tr><tr><td>2</td><td></td><td></td></tr></table>				1	1	1	2			<table border="1"><tr><td>3</td><td></td><td></td></tr><tr><td>10</td><td></td><td>3</td></tr><tr><td>4</td><td>1</td><td>7</td></tr></table>	3			10		3	4	1	7	<table border="1"><tr><td>3</td><td></td><td>3</td></tr><tr><td>1</td><td></td><td>6</td></tr><tr><td>5</td><td>1</td><td>2</td></tr></table>	3		3	1		6	5	1	2	<table border="1"><tr><td>1</td><td></td><td>4</td></tr><tr><td>1</td><td></td><td>7</td></tr><tr><td>5</td><td>1</td><td>5</td></tr></table>	1		4	1		7	5	1	5	<table border="1"><tr><td>4</td><td>1</td><td>4</td></tr><tr><td>5</td><td></td><td>2</td></tr><tr><td>4</td><td></td><td>4</td></tr></table>	4	1	4	5		2	4		4
1																																																																															
		1																																																																													
1		1																																																																													
1		1																																																																													
		1																																																																													
1	1	1																																																																													
2																																																																															
3																																																																															
10		3																																																																													
4	1	7																																																																													
3		3																																																																													
1		6																																																																													
5	1	2																																																																													
1		4																																																																													
1		7																																																																													
5	1	5																																																																													
4	1	4																																																																													
5		2																																																																													
4		4																																																																													
Post - 0 Miss - 0 Block - 0	Post - 0 Miss - 0 Block - 0	Post - 2 Miss - 1 Block - 0	Post - 0 Miss - 1 Block - 0	Post - 1 Miss - 2 Block - 2	Post - 0 Miss - 1 Block - 0	Post - 3 Miss - 8 Block - 8	Post - 3 Miss - 2 Block - 0																																																																								
12 周哲韬	13 孟宇超	14 王子阳	15 徐俊吉	16 朱春雷	18 马麟晓	19 蒋承骅	20 程云飞																																																																								
<table border="1"><tr><td></td><td></td><td></td></tr><tr><td></td><td></td><td></td></tr><tr><td></td><td></td><td></td></tr></table>										<table border="1"><tr><td>1</td><td></td><td>2</td></tr><tr><td>1</td><td></td><td>1</td></tr><tr><td>3</td><td></td><td></td></tr></table>	1		2	1		1	3			<table border="1"><tr><td>3</td><td>2</td><td>4</td></tr><tr><td></td><td>1</td><td>2</td></tr><tr><td>1</td><td>3</td><td>1</td></tr></table>	3	2	4		1	2	1	3	1	<table border="1"><tr><td>2</td><td>1</td><td></td></tr><tr><td>2</td><td></td><td></td></tr><tr><td>3</td><td></td><td></td></tr></table>	2	1		2			3			<table border="1"><tr><td></td><td></td><td></td></tr><tr><td></td><td></td><td></td></tr><tr><td></td><td></td><td></td></tr></table>										<table border="1"><tr><td>4</td><td>1</td><td>1</td></tr><tr><td></td><td></td><td>4</td></tr><tr><td>8</td><td></td><td>5</td></tr></table>	4	1	1			4	8		5	<table border="1"><tr><td></td><td></td><td>1</td></tr><tr><td>2</td><td></td><td>2</td></tr><tr><td>1</td><td>1</td><td>1</td></tr></table>			1	2		2	1	1	1	<table border="1"><tr><td></td><td></td><td></td></tr><tr><td>2</td><td></td><td>1</td></tr><tr><td>1</td><td></td><td>3</td></tr></table>				2		1	1		3
1		2																																																																													
1		1																																																																													
3																																																																															
3	2	4																																																																													
	1	2																																																																													
1	3	1																																																																													
2	1																																																																														
2																																																																															
3																																																																															
4	1	1																																																																													
		4																																																																													
8		5																																																																													
		1																																																																													
2		2																																																																													
1	1	1																																																																													
2		1																																																																													
1		3																																																																													
Post - 0 Miss - 1 Block - 0	Post - 0 Miss - 2 Block - 1	Post - 1 Miss - 2 Block - 0	Post - 0 Miss - 3 Block - 0	Post - 0 Miss - 0 Block - 0	Post - 3 Miss - 3 Block - 5	Post - 0 Miss - 2 Block - 0	Post - 0 Miss - 0 Block - 0																																																																								

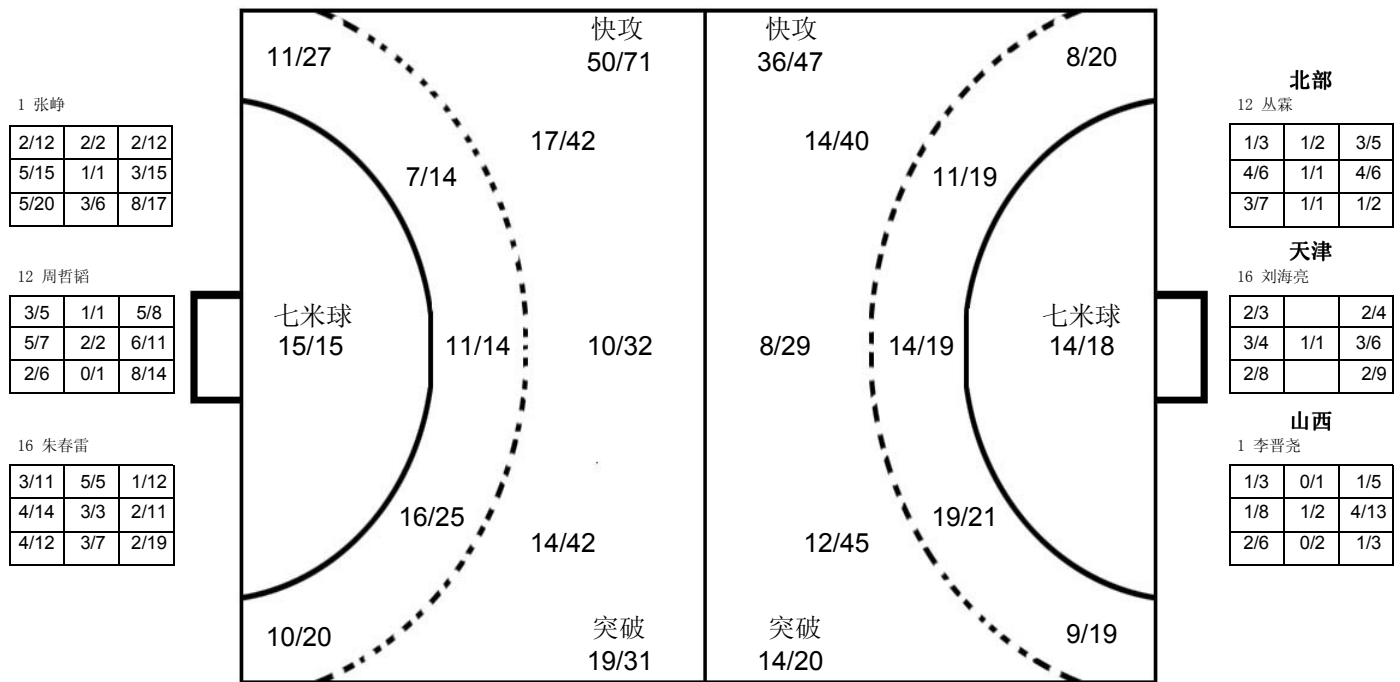

对手

7 付文博	17 王旭东	22 刘彦坤	19 张志宇	5 潘翔	7 白宇飞	8 曹锐	4 曹作亮																																																																								
<table border="1"><tr><td>2</td><td></td><td>1</td></tr><tr><td>1</td><td></td><td></td></tr><tr><td>1</td><td>1</td><td>1</td></tr></table>	2		1	1			1	1	1	<table border="1"><tr><td>1</td><td></td><td>4</td></tr><tr><td>2</td><td></td><td></td></tr><tr><td></td><td></td><td></td></tr></table>	1		4	2						<table border="1"><tr><td></td><td></td><td>2</td></tr><tr><td></td><td></td><td>3</td></tr><tr><td></td><td></td><td>2</td></tr></table>			2			3			2	<table border="1"><tr><td>1</td><td></td><td></td></tr><tr><td>2</td><td></td><td>2</td></tr><tr><td>1</td><td></td><td></td></tr></table>	1			2		2	1			<table border="1"><tr><td>1</td><td></td><td>1</td></tr><tr><td></td><td></td><td>3</td></tr><tr><td>1</td><td></td><td></td></tr></table>	1		1			3	1			<table border="1"><tr><td></td><td></td><td>1</td></tr><tr><td>1</td><td></td><td>1</td></tr><tr><td>2</td><td></td><td>1</td></tr></table>			1	1		1	2		1	<table border="1"><tr><td></td><td></td><td></td></tr><tr><td></td><td></td><td>1</td></tr><tr><td>1</td><td>2</td><td>2</td></tr></table>						1	1	2	2	<table border="1"><tr><td></td><td></td><td>1</td></tr><tr><td>2</td><td></td><td>1</td></tr><tr><td></td><td></td><td>1</td></tr></table>			1	2		1			1
2		1																																																																													
1																																																																															
1	1	1																																																																													
1		4																																																																													
2																																																																															
		2																																																																													
		3																																																																													
		2																																																																													
1																																																																															
2		2																																																																													
1																																																																															
1		1																																																																													
		3																																																																													
1																																																																															
		1																																																																													
1		1																																																																													
2		1																																																																													
		1																																																																													
1	2	2																																																																													
		1																																																																													
2		1																																																																													
		1																																																																													
Post - 0 Miss - 0 Block - 0	Post - 0 Miss - 1 Block - 0	Post - 1 Miss - 1 Block - 0	Post - 0 Miss - 1 Block - 0	Post - 0 Miss - 0 Block - 0	Post - 0 Miss - 0 Block - 0	Post - 0 Miss - 0 Block - 0	Post - 0 Miss - 3 Block - 0																																																																								
20 王伟	8 周小坚	10 郝可鑫	19 李语庆	7 张青	14 田剑侠	17 李中洲	9 赵鑫																																																																								
<table border="1"><tr><td>1</td><td></td><td></td></tr><tr><td></td><td></td><td>2</td></tr><tr><td>1</td><td></td><td>1</td></tr></table>	1					2	1		1	<table border="1"><tr><td></td><td></td><td>1</td></tr><tr><td>1</td><td></td><td></td></tr><tr><td>1</td><td></td><td>2</td></tr></table>			1	1			1		2	<table border="1"><tr><td>1</td><td></td><td></td></tr><tr><td>1</td><td></td><td></td></tr><tr><td>1</td><td>1</td><td>1</td></tr></table>	1			1			1	1	1	<table border="1"><tr><td></td><td></td><td></td></tr><tr><td></td><td></td><td></td></tr><tr><td>2</td><td></td><td>3</td></tr></table>							2		3	<table border="1"><tr><td></td><td></td><td></td></tr><tr><td></td><td></td><td>1</td></tr><tr><td>2</td><td>1</td><td>1</td></tr></table>						1	2	1	1	<table border="1"><tr><td>1</td><td></td><td>3</td></tr><tr><td>1</td><td></td><td></td></tr><tr><td></td><td></td><td></td></tr></table>	1		3	1						<table border="1"><tr><td>1</td><td></td><td>1</td></tr><tr><td>1</td><td></td><td></td></tr><tr><td></td><td>1</td><td></td></tr></table>	1		1	1				1		<table border="1"><tr><td></td><td></td><td></td></tr><tr><td></td><td></td><td>1</td></tr><tr><td>1</td><td></td><td>2</td></tr></table>						1	1		2
1																																																																															
		2																																																																													
1		1																																																																													
		1																																																																													
1																																																																															
1		2																																																																													
1																																																																															
1																																																																															
1	1	1																																																																													
2		3																																																																													
		1																																																																													
2	1	1																																																																													
1		3																																																																													
1																																																																															
1		1																																																																													
1																																																																															
	1																																																																														
		1																																																																													
1		2																																																																													
Post - 0 Miss - 0 Block - 0	Post - 0 Miss - 0 Block - 0	Post - 1 Miss - 0 Block - 1	Post - 1 Miss - 1 Block - 0	Post - 0 Miss - 0 Block - 0	Post - 2 Miss - 0 Block - 0	Post - 0 Miss - 0 Block - 0	Post - 0 Miss - 0 Block - 0																																																																								

注释: Post=击柱 Miss=射失 Block=被封





第十二届全国运动会男子手球预赛

个人/全队技术累计表

正式表
手球
男子

截至第 46场

201301046-15-1/1
柳州市李宁体育馆
28/04/2013 16:20

号码	姓名	远射	近射	边射	快攻	突破	任意	7M	合计	%	助攻	失误	警告	2'	取消	场次	时间
解放军																	
<i>(场上队员)</i>																	
4	曹作亮	10/29	1/2		9/9	2/5	4/10	1/1	27/56	48.2%	7	27	3	2		7	05:49:23
5	吴龙瑞	0/4	2/6	2/7	19/20	3/5		1/1	27/43	62.8%	1	10	3			7	05:51:26
6	苗青	3/15	3/3	0/2	3/3		0/1	3/5	12/29	41.4%	3	7	2	2		7	03:27:53
7	陈昊		11/13	1/1	4/5	1/1			17/20	85.0%		4		1		7	01:19:45
8	王烁	0/2	3/3	11/16	8/11	0/1		8/13	30/46	65.2%	5	8				7	07:04:48
9	丁超	1/6	2/2	0/2	0/1	5/7			8/18	44.4%	9	9	1			7	05:08:47
10	师龙	7/16	0/1		3/3	2/2		1/1	13/23	56.5%	7	5	2	1		7	01:49:47
11	李想	0/1	3/4		0/1			1/1	4/7	57.1%	1	3	1	2		7	02:39:40
12	丛霖									0.0%	1					7	03:39:01
13	王世杰	0/1	1/1		7/9			1/1	9/12	75.0%	3	4		1		7	01:07:11
14	曲学博		7/11	3/3	4/4	2/3			16/21	76.2%	2	8	7	4		7	03:00:30
15	杨帆	0/1	0/1		3/3	1/1			4/6	66.7%	3	8		1		7	02:22:27
16	郎俊夫									0.0%	10					7	04:21:29
17	王勇	12/30	3/3	3/4	7/10	1/2		0/1	26/50	52.0%	8	11	1			7	04:28:27
18	董宏斐	1/3		0/1	5/6				6/10	60.0%		2				7	01:03:45
20	谷浩	1/2	1/2		0/2				2/6	33.3%	2	1				7	01:10:15

合计		35/110	37/52	20/36	72/87	17/27	4/11	16/24	201/347	57.9%	62	107	20	14			
-----------	--	--------	-------	-------	-------	-------	------	-------	---------	-------	----	-----	----	----	--	--	--

(守门员)

12	丛霖	32/46	9/22	11/18	9/18	6/13	5/8	0/3	72/128	56.3%	1					7	03:39:01
16	郎俊夫	42/61	4/17	10/18	4/20	1/10	2/5	3/16	66/147	44.9%	10					7	04:21:29

合计		74/107	13/39	21/36	13/38	7/23	7/13	3/19	138/275	50.2%	11						
-----------	--	--------	-------	-------	-------	------	------	------	---------	-------	----	--	--	--	--	--	--

场上队员：得分/射门

守门员：救球/射门

全队合计	进球	被救	射失	击柱	封球	合计	%
远射	35	38	15	9	13	110	31.8%
近射	37	12	2	1		52	71.2%
边射	20	12	2	2		36	55.6%
快攻	72	13	1	1		87	82.8%
突破	17	7	2	1		27	63.0%
任意	4	4	3			11	36.4%
7M	16	6	1	1		24	66.7%

已打比赛

阶段	场次	对手	比分
预赛	8	山西	36:19 (20:7)
预赛	13	天津	21:17 (11:9)
预赛	20	上海	16:18 (6:7)
预赛	25	四川	47:20 (23:9)
预赛	33	广东	15:17 (4:6)
复赛	40	香港	40:22 (20:11)
5-6名	46	北京	26:24 (11:13)





第十二届全国运动会男子手球预赛
图式射门区域累计

截止至第48场

201301048-42-1/1

解放军

4 曹作亮 2 6 4 3 5 2 5 Post - 1 Miss - 8 Block - 6	5 吴龙瑞 7 4 4 1 4 1 6 Post - 4 Miss - 4 Block - 0	6 苗青 3 1 3 1 1 4 Post - 1 Miss - 6 Block - 2	7 陈昊 1 1 2 1 5 3 4 Post - 0 Miss - 0 Block - 0	8 王烁 1 1 11 4 5 2 6 Post - 1 Miss - 1 Block - 1	9 丁超 2 2 3 1 2 Post - 1 Miss - 0 Block - 1	10 师龙 4 2 2 1 2 2 Post - 2 Miss - 1 Block - 1	11 李想 2 2 2 Post - 0 Miss - 1 Block - 0
12 丛霖 Post - 0 Miss - 0 Block - 0	13 王世杰 1 3 1 1 2 1 Post - 0 Miss - 0 Block - 0	14 曲学博 1 1 1 2 1 5 1 5 Post - 1 Miss - 0 Block - 0	15 杨帆 1 1 2 Post - 0 Miss - 0 Block - 0	16 郎俊夫 Post - 0 Miss - 0 Block - 0	17 王勇 6 4 3 3 8 2 Post - 4 Miss - 2 Block - 2	18 董宏斐 1 1 2 1 1 Post - 0 Miss - 2 Block - 0	20 谷浩 2 2 Post - 0 Miss - 1 Block - 0

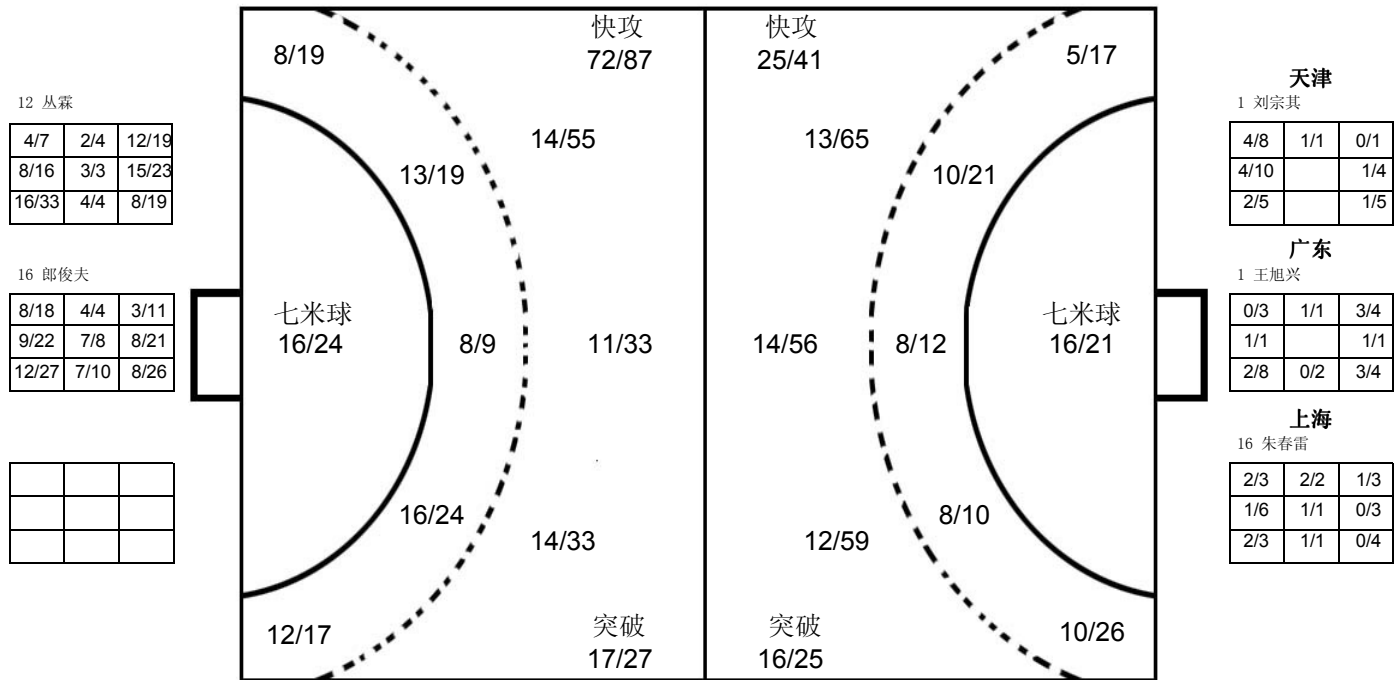

12 丛霖 4/7 2/4 12/19 8/16 3/3 15/23 16/33 4/4 8/19 Post - 0 Miss - 0 Block - 0	16 郎俊夫 8/18 4/4 3/11 9/22 7/8 8/21 12/27 7/10 8/26 Post - 0 Miss - 0 Block - 0	18 张骥 1 1 2 2 2 2 Post - 0 Miss - 3 Block - 2	7 许文邦 1 3 2 2 1 Post - 0 Miss - 1 Block - 2	14 刘明华 1 1 3 2 Post - 0 Miss - 3 Block - 1	3 李军 1 1 2 1 2 Post - 0 Miss - 2 Block - 3	13 侯建涛 1 1 2 1 Post - 0 Miss - 2 Block - 1	10 吴璟 1 1 2 1 Post - 1 Miss - 1 Block - 0	35 仇振勇 1 1 1 2 Post - 0 Miss - 1 Block - 3	9 刘振 2 2 2 Post - 0 Miss - 1 Block - 1
11 蒋维一 1 2 1 Post - 0 Miss - 0 Block - 0	17 姜冰峰 1 1 2 Post - 0 Miss - 0 Block - 0	7 付云博 2 1 1 1 Post - 0 Miss - 0 Block - 0	20 王伟 1 3 Post - 1 Miss - 0 Block - 0	21 池培俊 1 1 2 Post - 0 Miss - 1 Block - 0	14 田剑侠 1 1 2 1 Post - 1 Miss - 1 Block - 2	7 胡瀛 1 1 1 1 Post - 0 Miss - 0 Block - 1	3 曲汝洋 2 1 1 Post - 0 Miss - 0 Block - 0		

注释: Post=击柱 Miss=射失 Block=被封





第十二届全国运动会男子手球预赛

个人/全队技术累计表

正式表
手球
男子

截至第 46场

201301046-15-1/1
柳州市李宁体育馆
28/04/2013 16:20

号码	姓名	远射	近射	边射	快攻	突破	任意	7M	合计	%	助攻	失误	警告	2'	取消	场次	时间
北京																	
<i>(场上队员)</i>																	
1	王澍									0.0%	1	1				8	03:59:51
2	杜龙飞	2/4	0/1	4/12	12/16	2/2		3/4	23/39	59.0%	3	6	1	2		8	03:26:26
4	成亚	2/9	0/4	1/2	5/7				8/22	36.4%	2	9		2		8	02:06:47
5	杨昆				1/1				1/1	100%	1		3	3		8	01:56:04
6	刘伟	0/1	0/1	3/6	12/15	0/1	0/1		15/25	60.0%	2	5		1		8	03:05:16
7	胡瀛	3/9	3/6	2/3	6/10	3/3	1/1		18/32	56.3%	4	14	1	1		8	04:36:13
8	王鹏		3/3		2/2	1/1			6/6	100%		2	2	5		8	02:30:36
9	刘振	4/19	4/6	3/6	7/10	2/3	0/2	3/3	23/49	46.9%	3	14	2			8	05:33:40
11	蒋维一	2/3	14/17		9/10	1/2	1/2		27/34	79.4%	1	12	6	1		8	04:51:58
13	白洁	2/6	0/2	1/3	1/1	1/1	2/2	1/1	8/16	50.0%	2	11	1			8	02:07:28
14	解建飞	1/2	5/8	4/7	5/6		0/1		15/24	62.5%		3	1	1		8	01:46:57
16	孟辉	0/1						2/2	2/3	66.7%	9	3				8	04:00:09
17	姜冰峰	1/2	2/2	4/9	5/5	1/1			13/19	68.4%	2	8	4	4		8	05:24:00
18	张骥	15/45	6/12	3/3	12/15	3/5	0/1	11/12	50/93	53.8%	8	20				8	05:04:37
20	郑永利	3/7	1/1	0/3	2/3		0/1		6/15	40.0%	3	5		2		8	01:42:11
23	冯宁	7/16	4/6		0/1	4/5	0/1		15/29	51.7%	1	8		3		8	03:28:44
合计																	
		42/124	42/69	25/54	79/10	18/24	4/12	20/22	230/407	56.5%	42	121	21	25			
<i>(守门员)</i>																	
						2											
1	王澍	24/36	10/26	5/16		7/17	2/6	4/10	62/156	39.7%	1	1				8	03:59:51
16	孟辉	33/59	6/24	10/19	10/45	4/16	0/2	1/4	67/184	36.4%	9	3				8	04:00:09
合计																	
		57/95	16/50	15/35		11/33	2/8	5/14	129/340	37.9%	10	4					

场上队员：得分/射门

守门员：救球/射门

已打比赛

全队合计	进球	被救	射失	击柱	封球	合计	%
远射	42	39	16	12	15	124	33.9%
近射	42	17	6	3	1	69	60.9%
边射	25	16	7	6		54	46.3%
快攻	79	15	2	2	4	102	77.5%
突破	18	2	2	2		24	75.0%
任意	4	5	3			12	33.3%
7M	20	2				22	90.9%

阶段	场次	对手	比分
预赛	5	安徽	27:21 (11:10)
预赛	10	山东	14:34 (4:14)
预赛	18	澳门	48:16 (25:6)
预赛	23	香港	33:29 (18:15)
预赛	28	西藏	36:25 (20:12)
预赛	36	江苏	22:37 (8:20)
复赛	39	天津	26:23 (12:10)
5-6名	46	解放军	24:26 (13:11)





第十二届全国运动会男子手球预赛
图式射门区域累计

截止至第48场

201301048-42-1/1

北京

Table with 9 columns representing players (1 王澍, 2 杜龙飞, 4 成亚, 5 杨昆, 6 刘伟, 7 胡瀛, 8 王鹏, 9 刘振) and 3 rows of statistics for each player.

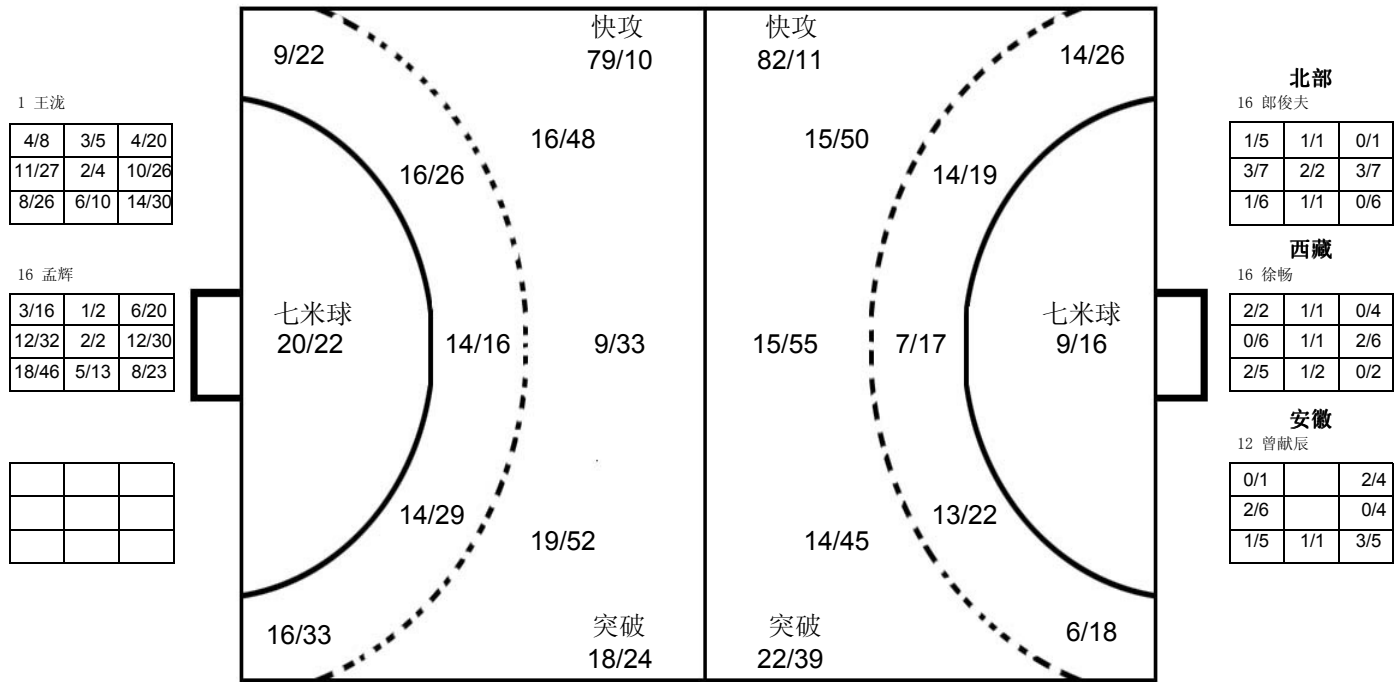

Table with 8 columns representing opponents (江苏, 安徽, 山东, 北部, 香港, 江苏, 山东, 天津) and 3 rows of statistics for each opponent.

注释: Post=击柱 Miss=射失 Block=被封





第十二届全国运动会男子手球预赛

个人/全队技术累计表

正式表
手球
男子

截至第 45场

201301045-15-1/1
柳州市李宁体育馆
28/04/2013 14:40

号码	姓名	远射	近射	边射	快攻	突破	任意	7M	合计	%	助攻	失误	警告	2'	取消	场次	时间
天津																	
<i>(场上队员)</i>																	
1	刘宗其									0.0%	3	3				7	03:48:47
2	李岳朋	5/12	2/5		3/4	0/1			10/22	45.5%	2	4	2	4		7	02:55:28
3	李军	6/22	4/6	0/2	11/13	4/5	0/1	5/9	30/58	51.7%	11	14	1	3		7	05:07:05
4	李松浩		2/2	0/1	8/8			0/1	10/12	83.3%		4		2		7	00:42:51
7	张青	9/15	15/20		10/10	4/5	0/1		38/51	74.5%	6	14	3	3		7	06:02:44
8	曹悦	7/13	5/11	2/2	12/15	6/6		1/1	33/48	68.8%	3	15	1	1		7	03:18:45
9	孟凡钢				0/1	1/1			1/2	50.0%	1	1		1		7	00:56:26
10	李帅		3/4	6/9	7/11				16/24	66.7%	1	5		2		7	02:57:20
11	王毅			2/4	2/2				4/6	66.7%		4		1		7	00:36:09
13	许松	0/1	0/1	8/16	12/15			1/1	21/34	61.8%		8	2	1		7	05:19:13
14	田剑侠	7/22	6/6	0/2	3/5	5/7	1/4	1/2	23/48	47.9%	18	19	2			7	04:29:54
15	张俊岭	0/1		3/8	2/4				5/13	38.5%		2	3	3		7	03:33:00
16	刘海亮									0.0%	4					7	03:11:11
17	周群		11/20		6/10	1/2			18/32	56.3%	1	9	6	4		7	04:17:32
18	孙永		2/2						2/2	100%		2		1		7	00:44:56
19	梁堂亮	1/2		1/1					2/3	66.7%		4				7	00:36:40
合计																	
		35/88	50/77	22/45	76/98	21/27	1/6	8/14	213/355	60.0%	50	108	20	26			
<i>(守门员)</i>																	
1	刘宗其	36/62	10/23	10/21	7/30	2/8	4/4	2/10	71/158	44.9%	3	3				7	03:48:47
16	刘海亮	26/57	10/23	8/18	6/20	1/4	0/3	3/12	54/137	39.4%	4					7	03:11:11
合计																	
		62/119	20/46	18/39	13/50	3/12	4/7	5/22	125/295	42.4%	7	3					

场上队员：得分/射门

守门员：救球/射门

已打比赛

全队合计	进球	被救	射失	击柱	封球	合计	%
远射	35	26	8	6	13	88	39.8%
近射	50	17	4	6		77	64.9%
边射	22	13	4	6		45	48.9%
快攻	76	17	3	2		98	77.6%
突破	21	2	2	2		27	77.8%
任意	1	4		1		6	16.7%
7M	8	4	1	1		14	57.1%

阶段	场次	对手	比分
预赛	7	广东	19:26 (9:13)
预赛	13	解放军	17:21 (9:11)
预赛	21	四川	48:20 (24:12)
预赛	27	山西	39:23 (22:12)
预赛	32	上海	22:24 (11:13)
复赛	39	北京	23:26 (10:12)
7-8名	45	香港	45:30 (24:19)





第十二届全国运动会男子手球预赛
图式射门区域累计

截止至第48场

201301048-42-1/1

天津

Table with 19 columns representing players (刘宗其, 李岳朋, 李军, 李松浩, 张青, 曹悦, 孟凡钢, 李帅, 王毅, 许松, 田剑侠, 张俊岭, 刘海亮, 周群, 孙永, 梁堂亮) and 3 rows of statistics (Goals, Misses, Blocks).

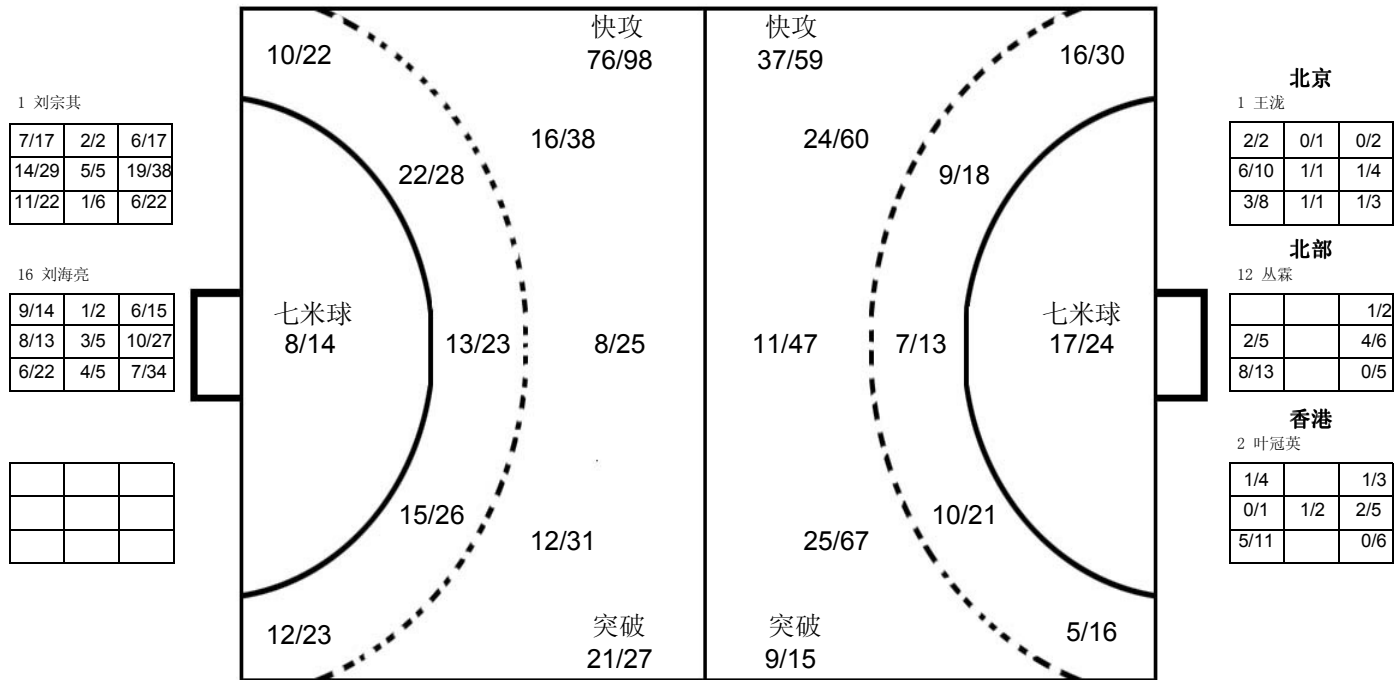

对手

Table with 14 columns representing opponents (北京, 上海, 香港, 北部, 北京, 广东, 北部, 广东, 山西, 香港, 北部, 广东, 上海, 上海, 四川, 香港) and 3 rows of statistics.

注释: Post=击柱 Miss=射失 Block=被封





第十二届全国运动会男子手球预赛

个人/全队技术累计表

正式表
手球
男子

截至第 45场

201301045-15-1/1
柳州市李宁体育馆
28/04/2013 14:40

号码	姓名	远射	近射	边射	快攻	突破	任意	7M	合计	%	助攻	失误	警告	2'	取消	场次	时间
香港																	
<i>(场上队员)</i>																	
1	萧智庭	0/1							0/1	0.0%		1				8	02:26:18
2	叶冠英							0/1	0/1	0.0%	9	4				8	05:34:16
5	黄胜业		1/2	6/13	4/7	1/1			12/23	52.2%	1	5	1			8	03:13:37
6	谢伟希	0/1	9/12		11/17	0/1			20/31	64.5%	1	7	2	2		8	03:58:45
7	许文邦	20/57	2/5	4/9	11/16	3/6	1/5	5/5	46/103	44.7%	8	24	1			8	05:26:26
8	何伟杰				0/1				0/1	0.0%			1			3	00:11:21
9	张建国	2/10	0/2	4/13	11/13	2/5		1/2	20/45	44.4%	6	13	3	3		8	05:10:11
10	陈国兴	1/2	1/2	1/2	3/6	5/5			11/17	64.7%	2	6	1			5	01:49:03
11	陈允文		1/3	3/8	2/4	0/1			6/16	37.5%		7	1	2		8	03:01:08
12	叶冠雄	9/30	0/1		4/8	3/3			16/42	38.1%	4	10	1			8	04:22:09
13	叶仕仁	8/24	4/5	1/1	4/6	7/8			24/44	54.5%	10	23	1			7	04:27:08
14	李鑫豪	0/2	1/3		4/4				5/9	55.6%	1	5				8	02:40:10
15	黄嘉愉		4/7	1/1	1/4				6/12	50.0%		3	3			8	02:50:45
25	曾铭谦	2/4	1/2	7/25	6/11			3/4	19/46	41.3%		2	2	1		8	04:29:49
29	练明辉	6/32	4/6	2/5	4/9	5/12	1/1	7/12	29/77	37.7%	5	19	2	3		8	05:52:22

合计	48/163	28/50	29/77	65/10	26/42	2/6	16/24	214/468	45.7%	47	129	19	11				
-----------	--------	-------	-------	-------	-------	-----	-------	---------	-------	----	-----	----	----	--	--	--	--

(守门员)

6

1	萧智庭	7/27	7/24	3/15		1/16	0/1	0/2	22/118	18.6%		1				8	02:26:18
2	叶冠英	33/64	18/50	11/28	4/33	7/29	3/7	4/10	90/252	35.7%	9	4				8	05:34:16

14/64

合计	40/91	25/74	14/43		8/45	3/8	4/12	112/370	30.3%	9	5						
-----------	-------	-------	-------	--	------	-----	------	---------	-------	---	---	--	--	--	--	--	--

场上队员：得分/射门

守门员：救球/射门

全队合计	进球	被救	射失	击柱	封球	合计	%
远射	48	52	32	9	22	163	29.4%
近射	28	17	4	1		50	56.0%
边射	29	35	10	3		77	37.7%
快攻	65	22	10	6	3	106	61.3%
突破	26	10	3	3		42	61.9%
任意	2	3	1			6	33.3%
7M	16	5	2	1		24	66.7%

已打比赛

阶段	场次	对手	比分
预赛	2	安徽	30:27 (15:11)
预赛	4	江苏	20:36 (10:20)
预赛	16	山东	26:36 (13:19)
预赛	23	北京	29:33 (15:18)
预赛	29	澳门	25:17 (12:7)
预赛	34	西藏	32:25 (15:12)
复赛	40	解放军	22:40 (11:20)
7-8名	45	天津	30:45 (19:24)





第十二届全国运动会男子手球预赛
图式射门区域累计

截止至第48场

201301048-42-1/1

香港

Table with 18 columns representing players (1-18) and 3 rows of statistics for each player, including Post, Miss, and Block counts.

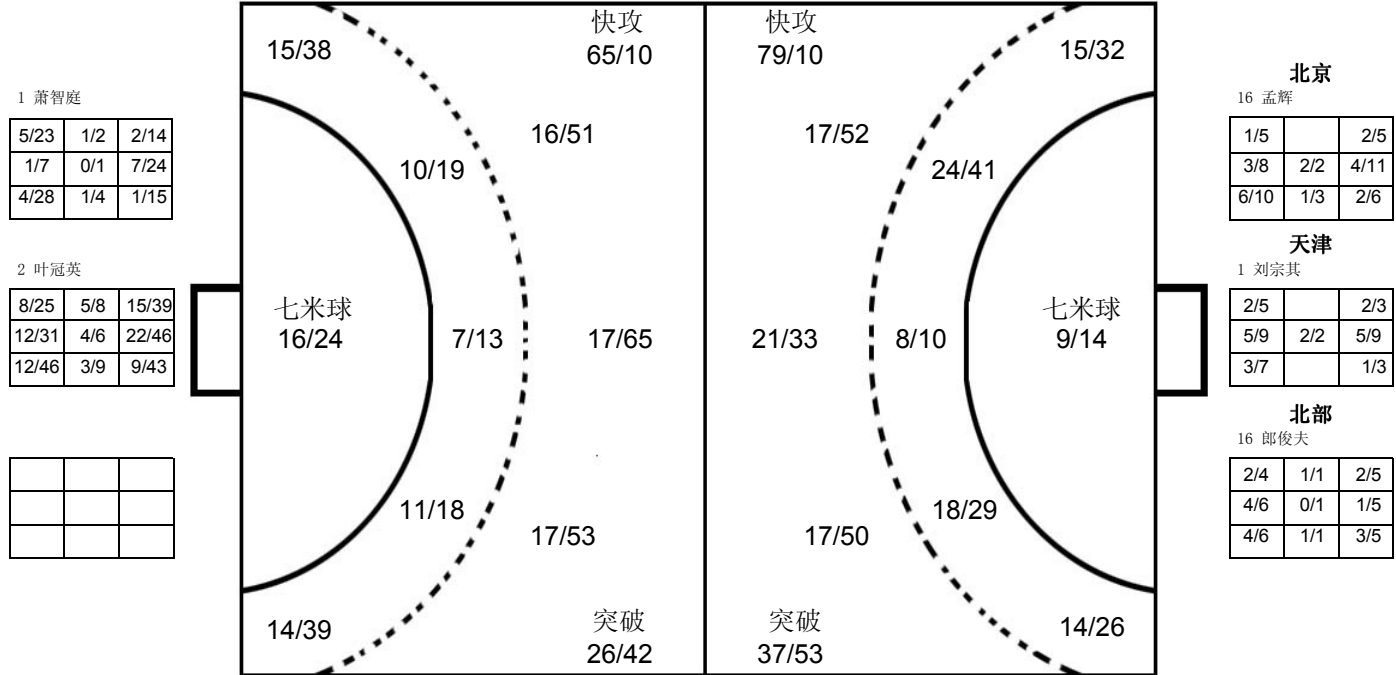

Table with 18 columns representing players from various teams (Tianjin, Anhui, North, Tibet, Jiangsu, Shandong, etc.) and 3 rows of statistics for each player.

注释: Post=击柱 Miss=射失 Block=被封



第十二届全国运动会男子手球预赛

个人/全队技术累计表

正式表
手球
男子

截至第 44场

201301044-15-1/1
柳州市李宁体育馆
28/04/2013 10:40

号码	姓名	远射	近射	边射	快攻	突破	任意	7M	合计	%	助攻	失误	警告	2'	取消	场次	时间
安徽																	
<i>(场上队员)</i>																	
1	高逸凡									0.0%	7					8	03:32:34
2	周兰骏	12/34	3/4		5/13	5/8	1/2	0/1	26/62	41.9%	3	15	1			8	03:04:45
5	马鹏	11/30	7/12	1/2	11/15	9/10	1/2	8/10	48/81	59.3%	10	16	2	4		8	05:08:56
6	田耕			1/1	3/4	0/1			4/6	66.7%		1		1		8	01:00:51
7	姚雄敏									0.0%						8	00:00:00
8	董智景	3/6		5/7	9/14	1/2		1/1	19/30	63.3%	1	3		1		8	02:13:39
10	陈强龙		8/13		15/21				23/34	67.6%	1	15	6	4		8	05:43:46
11	黎涛	0/3	1/1	8/9	6/8	3/3		2/4	20/28	71.4%	1	12		2		8	02:47:25
12	曾献辰									0.0%	3	3				8	04:27:47
15	邵青	2/8	2/6		6/10	2/2			12/26	46.2%	2	7	3	1		8	04:57:18
17	解维维		1/1	4/5	9/13				14/19	73.7%		1	1			8	02:11:23
18	郭赛		1/2		2/2				3/4	75.0%	2					8	01:31:26
28	袁龙	10/29	3/4	6/18	11/15	0/1		1/1	31/68	45.6%	5	11	3	3		8	05:41:25
29	顾先亮	6/6	1/1	7/12	8/13	0/4		1/1	23/37	62.2%	1	7	2	1		8	05:28:58
32	王超	19/48	4/7	1/1	8/9	8/8	3/4	0/1	43/78	55.1%	7	24	1	1		8	04:25:58
33	曹振吉		1/3	0/2	6/8	1/1			8/14	57.1%	3	8	3			8	03:16:35

合计	63/164	32/54	33/57	99/14	29/40	5/8	13/19	274/487	56.3%	46	123	22	18				
-----------	--------	-------	-------	-------	-------	-----	-------	---------	-------	----	-----	----	----	--	--	--	--

(守门员)

5

1	高逸凡	17/32	9/29	7/15		3/16	2/3	7/18	53/149	35.6%	7					8	03:32:34
12	曾献辰	30/57	15/30	11/28	8/36	4/21	4/7	2/7	72/187	38.5%	3	3				8	04:27:47

6/37

合计	47/89	24/59	18/43		7/37	6/10	9/25	125/336	37.2%	10	3						
-----------	-------	-------	-------	--	------	------	------	---------	-------	----	---	--	--	--	--	--	--

场上队员：得分/射门

守门员：救球/射门

全队合计	进球	被救	射失	击柱	封球	合计	%
远射	63	57	14	15	15	164	38.4%
近射	32	17	4	1		54	59.3%
边射	33	16	3	5		57	57.9%
快攻	99	32	9	4	1	145	68.3%
突破	29	7	3	1		40	72.5%
任意	5	2	1			8	62.5%
7M	13	4	1	1		19	68.4%

已打比赛

阶段	场次	对手	比分
预赛	2	香港	27:30 (11:15)
预赛	5	北京	21:27 (10:11)
预赛	11	西藏	35:22 (18:8)
预赛	17	江苏	27:31 (7:16)
预赛	22	澳门	44:21 (21:10)
预赛	35	山东	29:34 (12:19)
复赛	37	四川	52:22 (25:10)
9-10名	44	西藏	39:24 (18:12)





第十二届全国运动会男子手球预赛
图式射门区域累计

截止至第48场

201301048-42-1/1

安徽

Table with 15 columns representing players and their statistics. Each column includes a 3x3 grid for shot statistics and a line of text for Post, Miss, and Block counts.

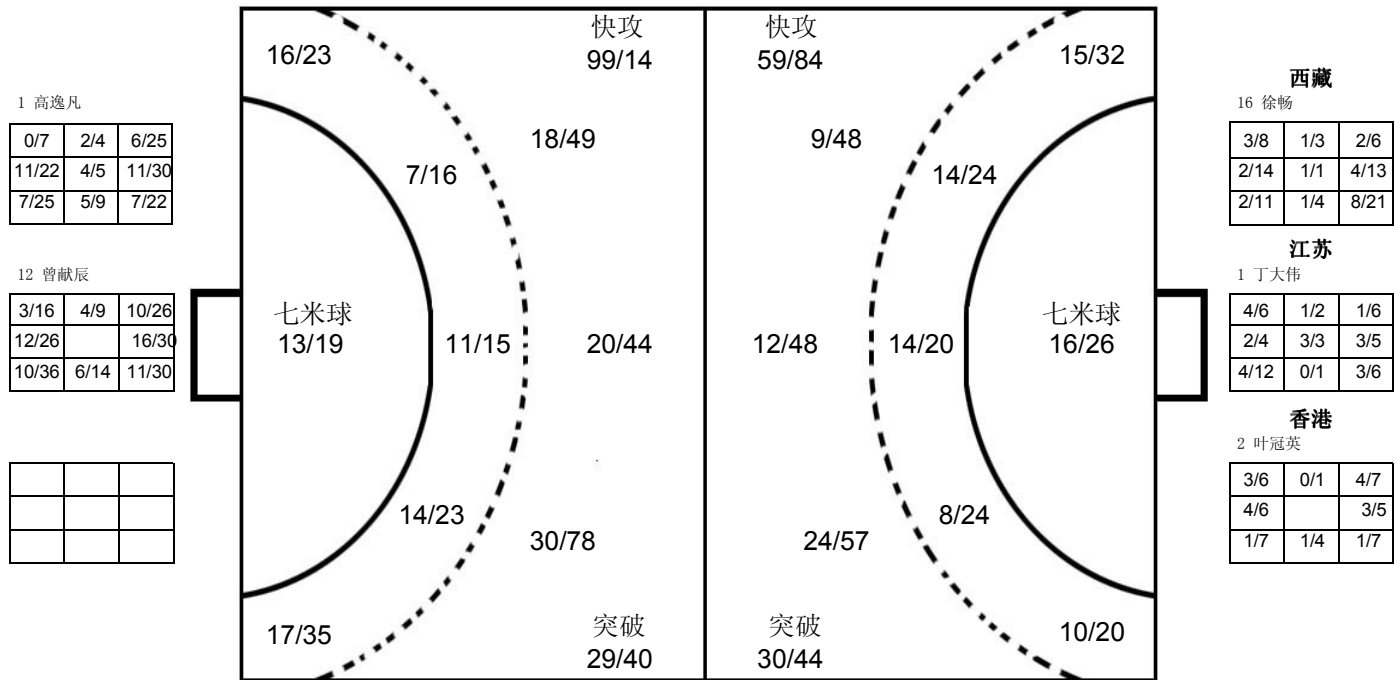

Table with 15 columns representing players from various teams (西藏, 北京, 江苏, 山东, 香港, 澳门, 江苏, 山东, 四川) and their statistics. Each column includes a 3x3 grid for shot statistics and a line of text for Post, Miss, and Block counts.

注释: Post=击柱 Miss=射失 Block=被封



第十二届全国运动会男子手球预赛

个人/全队技术累计表

正式表
手球
男子

截至第 44场

201301044-15-1/1
柳州市李宁体育馆
28/04/2013 10:40

号码	姓名	远射	近射	边射	快攻	突破	任意	7M	合计	%	助攻	失误	警告	2'	取消	场次	时间
西藏																	
<i>(场上队员)</i>																	
2	王龙	2/14	1/3		3/4	1/1		1/1	8/23	34.8%	4	16	1	1		8	02:28:14
4	张家纬	6/20	5/5	1/5	3/4	5/6	4/5		24/45	53.3%	3	24	2	1		8	06:01:43
5	冯祥龙									0.0%						8	00:49:13
6	任启双	0/1	4/6	1/1	3/5			1/1	9/14	64.3%	1	7	3	6		8	04:45:51
7	徐奕飞	1/5	2/4	4/8	8/11	0/1			15/29	51.7%		8	2	3		8	06:29:43
9	王博	0/3	7/12	1/1	8/11	1/2	0/1		17/30	56.7%	1	6				8	04:13:30
10	刘江	0/6	4/6	1/2	3/6	2/6	0/1	0/1	10/28	35.7%	5	6	2	1		8	04:31:23
11	朱治宇	0/4	2/3	7/12	1/4	3/4			13/27	48.1%	2	12	1	1		8	03:51:09
12	张帅									0.0%	1	3				8	02:19:58
15	刘劲松									0.0%						8	00:33:32
16	徐畅									0.0%	4	1				8	06:04:38
18	赵楠	10/32	2/4	3/4	5/10	2/5	0/2	5/8	27/65	41.5%	8	20	5	6		8	07:13:42
19	任野			0/1	3/4				3/5	60.0%	1	2	1			8	01:09:31
20	顾艳超	6/20	3/10	0/1	4/6	6/9	0/1		19/47	40.4%	4	31	1	1		8	05:17:13
21	马光	6/23	0/1		1/2	1/3			8/29	27.6%	1	19				8	02:06:08
23	王伟强	1/4	2/3	11/19	24/32	3/6	0/1	8/12	49/77	63.6%	3	14	2			8	05:24:45

合计

32/132 32/57 29/54 66/99 24/43 4/11 15/23 202/419 48.2% 38 169 20 20

(守门员)

2	王龙		0/2					0/2	0.0%	1	4	1				8	00:24:21
4	张家纬	0/2	0/1					0/3	0.0%		12					8	02:00:01
5	冯祥龙	0/1						0/1	0.0%							8	00:49:13
6	合计	0/1	0/1					0/2	0.0%			1	1				00:41:42

场上队员：得分/射门

守门员：救球/射门

全队合计	进球	被救	射失	击柱	封球	合计	%
远射	32	44	14	13	29	132	24.2%
近射	32	19		4	2	57	56.1%
边射	29	13	4	8		54	53.7%
快攻	66	23	5	5		99	66.7%
突破	24	11	6	2		43	55.8%
任意	4	5	1	1		11	36.4%
7M	15	7		1		23	65.2%

已打比赛

阶段	场次	对手	比分
预赛	1	江苏	18:46 (9:20)
预赛	6	澳门	38:22 (16:8)
预赛	11	安徽	22:35 (8:18)
预赛	24	山东	15:31 (8:12)
预赛	28	北京	25:36 (12:20)
预赛	34	香港	25:32 (12:15)
复赛	38	山西	35:23 (19:11)
9-10名	44	安徽	24:39 (12:18)





第十二届全国运动会男子手球预赛
图式射门区域累计

截止至第48场

201301048-42-1/1

西藏

Table with 18 columns representing players (e.g., 2 王龙, 4 张家纬) and 3 rows of statistics. Includes post, miss, and block counts for each player.

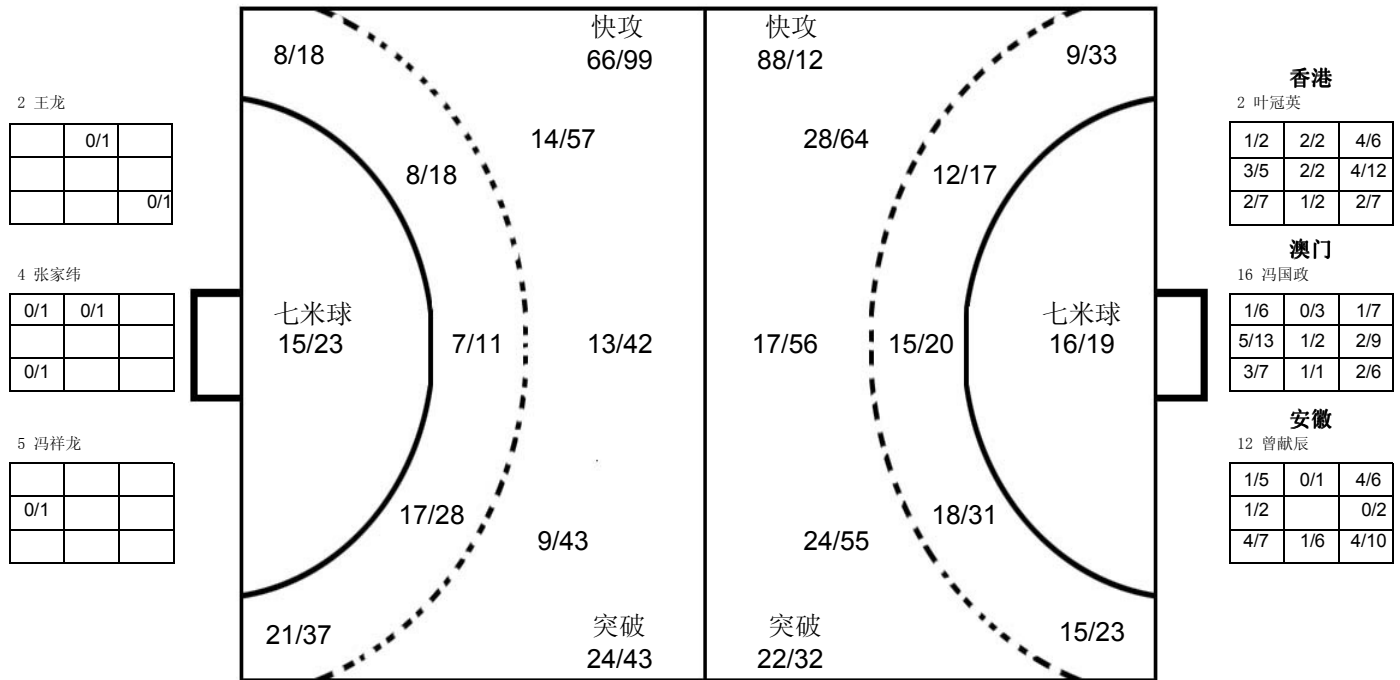

Table with 18 columns representing players from various teams (e.g., 5 马鹏, 32 王超) and 3 rows of statistics. Includes post, miss, and block counts for each player.

注释: Post=击柱 Miss=射失 Block=被封



第十二届全国运动会男子手球预赛

个人/全队技术累计表

正式表
手球
男子

截至第 43场

201301043-15-1/1
柳州市李宁体育馆
28/04/2013 09:00

号码	姓名	远射	近射	边射	快攻	突破	任意	7M	合计	%	助攻	失误	警告	2'	取消	场次	时间
四川																	
<i>(场上队员)</i>																	
16	王松									0.0%	3	5				7	04:51:14
18	杨洋		2/2		0/1				2/3	66.7%		2	1			7	00:27:18
19	杨洁	0/1	2/3	1/1	5/9	1/2			9/16	56.3%		8	2	3		7	03:32:01
21	池培俊	6/16	2/4	4/13	6/10				18/43	41.9%	1	23	2	3		7	06:30:01
22	刘彦坤	3/17	7/8	1/1	6/7	4/5	1/3	4/4	26/45	57.8%	1	23	4	1		7	04:03:35
23	王震	5/33	6/10	1/3	3/4		3/5	0/1	18/56	32.1%	4	16	4	4		7	05:37:50
25	李峥	3/12	3/7	2/4	5/7				13/30	43.3%		19	1			7	06:07:44
27	于洪泉	3/7		1/1	3/3	3/4		0/1	10/16	62.5%	1	7		1		7	00:51:23
28	宋涛	5/13	2/5	2/3	3/3	5/6		2/2	19/32	59.4%	9	37				7	04:06:57
32	逯明松	1/2		0/1	1/1				2/4	50.0%		9				7	01:41:27
33	朱晓龙	6/32	5/8	1/3	6/7		1/8		19/58	32.8%		14	1	1		7	04:13:02
35	仇振勇	7/28	5/7	4/10	7/9	1/1	0/4		24/59	40.7%	1	23			4	7	05:13:37
36	刘琢									0.0%	1	4				7	02:18:31
合计																	
		39/161	34/54	17/40	45/61	14/18	5/20	6/8	160/362	44.2%	21	190	15	17			
<i>(守门员)</i>																	
16	王松	17/45	10/46	5/24	16/10	1/15	2/2	2/11	53/252	21.0%	3	5				7	04:51:14
36	刘琢	17/30	5/29	3/14	9	2/9		2/3	40/147	27.2%	1	3				7	02:18:31
合计																	
		34/75	15/75	8/38		3/24	2/2	4/14	93/399	23.3%	4	8					

场上队员：得分/射门

守门员：救球/射门

已打比赛

全队合计	进球	被救	射失	击柱	封球	合计	%
远射	39	59	15	12	36	161	24.2%
近射	34	16	2	2		54	63.0%
边射	17	18	3	2		40	42.5%
快攻	45	6	4	6		61	73.8%
突破	14	3	1			18	77.8%
任意	5	9	4	2		20	25.0%
7M	6	1		1		8	75.0%

阶段	场次	对手	比分
预赛	9	上海	15:45 (9:20)
预赛	14	广东	19:48 (8:27)
预赛	21	天津	20:48 (12:24)
预赛	25	解放军	20:47 (9:23)
预赛	31	山西	28:33 (14:17)
复赛	37	安徽	22:52 (10:25)
11-12名	43	山西	36:33 (18:14)





第十二届全国运动会男子手球预赛
图式射门区域累计

截止至第48场

201301048-42-1/1

四川

Table with 16 columns representing players (16 王松, 18 杨洋, 19 杨洁, 21 池培俊, 22 刘彦坤, 23 王震, 25 李峥, 27 于洪泉, 28 宋涛, 32 逯明松, 33 朱晓龙, 35 仇振勇, 36 刘琢) and their statistics in a grid format.

Statistics for players 16 王松 and 36 刘琢, including a 3x3 grid for player 16 and a 3x3 grid for player 36.

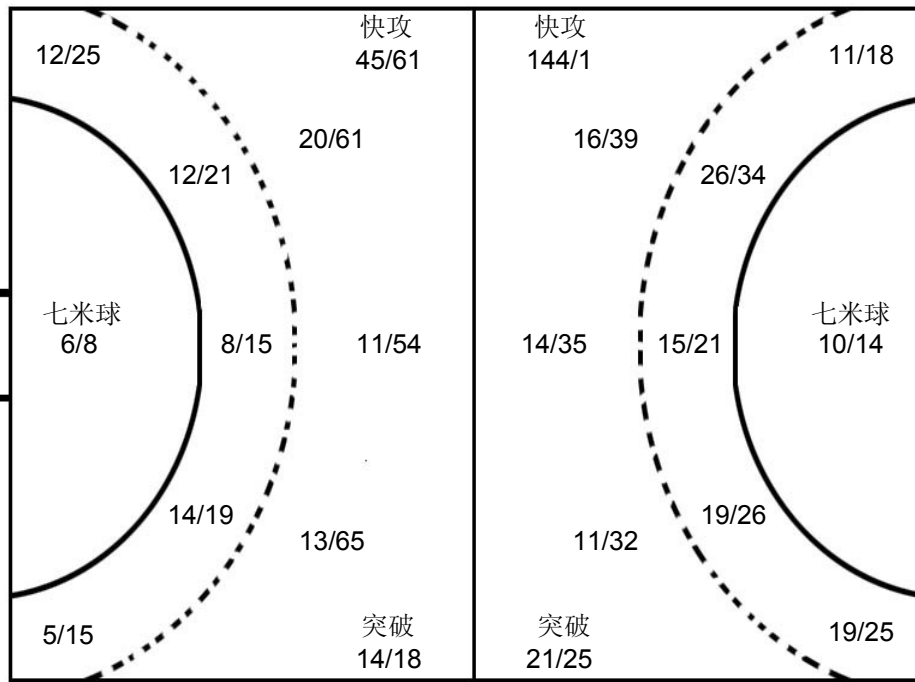

Statistics for players from '山西' (Shanxi), '北部' (North), and '安徽' (Anhui), including a 3x3 grid for player 1 李晋尧 and a 3x3 grid for player 12 曾献辰.

对手

Table with 16 columns representing opponents (7 白宇飞, 5 候生升, 4 李鹏程, 14 刘明华, 17 王勇, 10 陈超, 10 李帅, 17 解维维, 9 朱涛涛, 3 李军, 2 周兰骏, 10 陈强龙, 7 陈昊, 4 李卓洋, 3 王晋, 4 李松浩) and their statistics in a grid format.

注释: Post=击柱 Miss=射失 Block=被封





第十二届全国运动会男子手球预赛

个人/全队技术累计表

正式表
手球
男子

截至第 43场

201301043-15-1/1
柳州市李宁体育馆
28/04/2013 09:00

号码	姓名	远射	近射	边射	快攻	突破	任意	7M	合计	%	助攻	失误	警告	2'	取消	场次	时间
山西																	
<i>(场上队员)</i>																	
1	李晋尧									0.0%	3					7	06:21:35
2	马健	1/7	1/4	2/6	5/7	1/2			10/26	38.5%	1	4	2	1		7	04:02:06
3	王晋	1/3	9/12		3/4				13/19	68.4%		8	3			7	04:28:50
4	李鹏程	13/38	6/7	0/2	7/10	0/1	0/3	1/1	27/62	43.5%	2	23	1			7	06:09:46
5	王志超									0.0%						7	00:00:00
6	范帅	0/3	2/2	4/7	5/9				11/21	52.4%		7	1	1		7	01:42:09
7	白宇飞	10/48	2/7	0/1	7/9	2/4	0/3	9/10	30/82	36.6%	6	23	1	3		7	05:01:53
8	崔钰	1/5	2/3	2/2	0/1			1/2	6/13	46.2%		2				7	01:23:31
9	朱涛涛	2/3	1/3	9/15	4/6	1/1			17/28	60.7%	2	4	2	1		7	03:50:27
10	任海阳	0/2	1/2	0/3	5/6	3/3			9/16	56.3%	1	9	1	1		7	03:38:37
12	侯乃章									0.0%						7	00:43:55
13	侯建涛	10/27	1/3	1/3	3/3	0/1	1/2	1/1	17/40	42.5%	1	14	2			7	02:43:13
14	刘明华	9/33	2/2	4/7	1/3	7/9	1/2	0/1	24/57	42.1%	6	21	2	2		7	03:52:15
15	景新江		2/3	0/1	2/2	1/1			5/7	71.4%		3	1	1		7	01:30:17
18	朱棣	2/13	2/3	0/1	3/11	1/3			8/31	25.8%		12	2	1		7	04:25:18
合计																	
		49/182	31/51	22/48	45/71	16/25	2/10	12/15	177/402	44.0%	22	130	18	11			
<i>(守门员)</i>																	
1	李晋尧	19/46	15/60	12/39	18/98	13/41	1/4	0/11	78/299	26.1%	3					7	06:21:35
12	侯乃章	0/4	0/9	2/6	3/10	0/1		0/2	5/32	15.6%						7	00:43:55
合计																	
		19/50	15/69	14/45	21/10	13/42	1/4	0/13	83/331	25.1%	3						

场上队员：得分/射门

守门员：救球/射门

已打比赛

全队合计	进球	被救	射失	击柱	封球	合计	%
远射	49	78	18	2	35	182	26.9%
近射	31	18	2			51	60.8%
边射	22	16	7	3		48	45.8%
快攻	45	22		2	2	71	63.4%
突破	16	5	2	2		25	64.0%
任意	2	7	1			10	20.0%
7M	12	3				15	80.0%

阶段	场次	对手	比分
预赛	8	解放军	19:36 (7:20)
预赛	15	上海	22:32 (13:15)
预赛	19	广东	24:42 (12:22)
预赛	27	天津	23:39 (12:22)
预赛	31	四川	33:28 (17:14)
复赛	38	西藏	23:35 (11:19)
11-12名	43	四川	33:36 (14:18)





第十二届全国运动会男子手球预赛
图式射门区域累计

截止至第48场

201301048-42-1/1

山西

Table with 18 columns representing players (1-18) and 3 rows of statistics for each player, including Post, Miss, and Block counts.

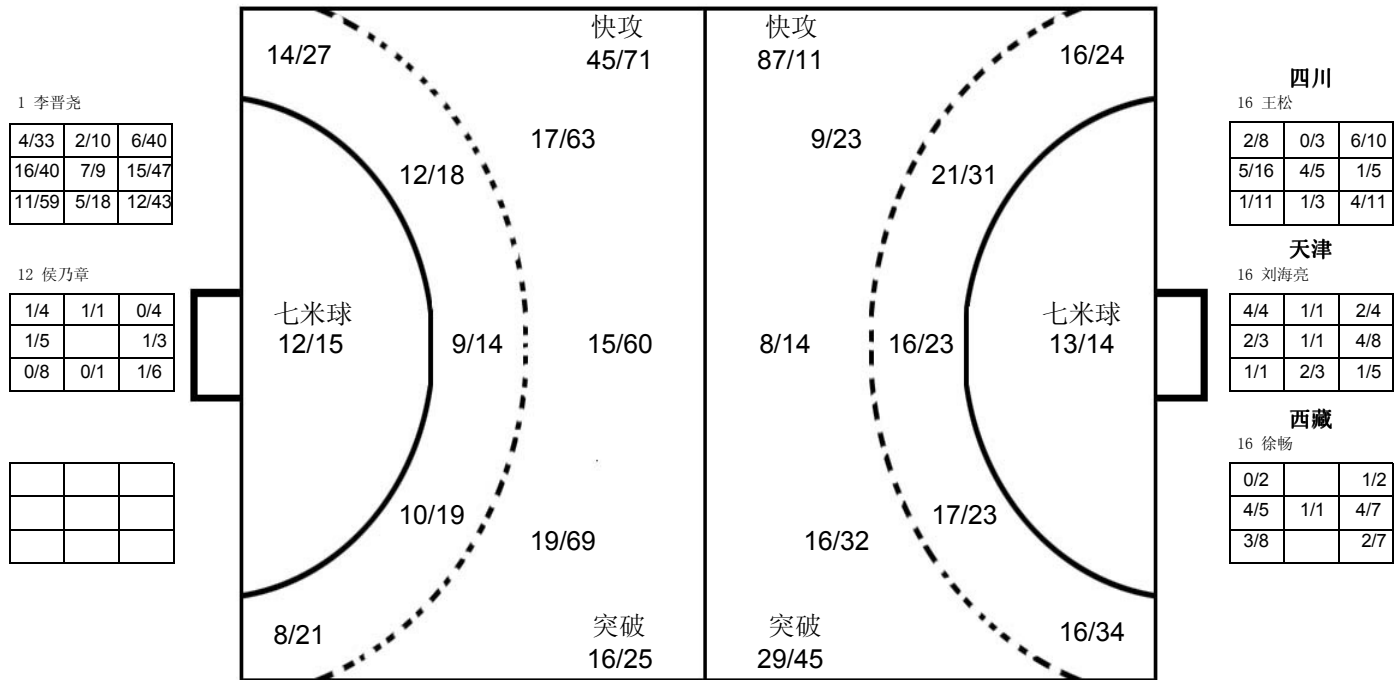

Table with 16 columns representing opponents (对手) and 3 rows of statistics for each opponent, including Post, Miss, and Block counts.

注释: Post=击柱 Miss=射失 Block=被封



第十二届全国运动会男子手球预赛

个人/全队技术累计表

正式表
手球
男子

截至第 46场

201301046-15-1/1
柳州市李宁体育馆
28/04/2013 16:20

号码	姓名	远射	近射	边射	快攻	突破	任意	7M	合计	%	助攻	失误	警告	2'	取消	场次	时间	
澳门																		
<i>(场上队员)</i>																		
2	李翘臻		0/1	0/1	0/2				0/4	0.0%	1	5	2	2		6	01:38:29	
4	刘家声	1/1							1/1	100%		5				6	00:31:55	
5	何建成	2/12	1/1		1/2	1/3			5/18	27.8%		17		1		6	02:25:24	
15	黄俊勇		1/2						1/2	50.0%		3				6	01:30:55	
16	冯国政									0.0%		1				6	04:02:44	
18	卓伟杰	0/1		1/4	1/1	1/2			3/8	37.5%		1	1			6	01:39:36	
21	麦锦聪	1/1	2/2		1/2	0/1			4/6	66.7%		3				6	00:55:08	
22	陈学敏	0/3	2/5		3/6				5/14	35.7%		10		3		6	01:24:30	
24	刘登宇	2/29	3/5	1/8	4/5	1/1	0/4	3/4	14/56	25.0%		28	1	2		6	04:02:51	
27	徐展业		2/2	2/2	2/4	3/4	0/1		9/13	69.2%		3	1			6	01:46:55	
28	莫家进	0/7	3/6	2/4	6/7	3/5	0/1	3/5	17/35	48.6%	1	18	3	5		6	04:16:38	
29	叶响俊	0/4	2/6	2/7	4/5	2/5			10/27	37.0%		9	2			6	04:19:45	
33	欧永健	3/20	1/4	2/4	2/4	3/4	1/3		12/39	30.8%	2	23	1			6	03:58:06	
36	陈嘉聪									0.0%							6	01:57:16
81	梁梓康	5/23	5/6	0/5	1/2	2/5	0/1	2/6	15/48	31.3%	1	21	4	3		6	04:00:12	
93	罗咪高	1/7	1/4	1/1	1/6	3/4		4/5	11/27	40.7%		15	1	2		6	03:05:04	
合计																		
		15/108	23/44	11/36	26/46	19/34	1/10	12/20	107/298	35.9%	5	162	16	18				
<i>(守门员)</i>																		
16	冯国政	8/22	6/41	8/32	16/10	4/11	3/6	2/16	47/229	20.5%		1				6	04:02:44	
36	陈嘉聪	3/11	3/13	8/20	1	5/15	0/1	1/5	27/94	28.7%						6	01:57:16	
合计																		
		11/33	9/54	16/52		9/26	3/7	3/21	74/323	22.9%		1						

场上队员：得分/射门

守门员：救球/射门

全队合计	进球	被救	射失	击柱	封球	合计	%
远射	15	49	13	5	26	108	13.9%
近射	23	16	2	1	2	44	52.3%
边射	11	17	5	3		36	30.6%
快攻	26	12	4	4		46	56.5%
突破	19	10	2	3		34	55.9%
任意	1	6	2	1		10	10.0%
7M	12	5		3		20	60.0%

已打比赛

阶段	场次	对手	比分
预赛	3	山东	18:48 (7:23)
预赛	6	西藏	22:38 (8:16)
预赛	12	江苏	13:46 (3:22)
预赛	18	北京	16:48 (6:25)
预赛	22	安徽	21:44 (10:21)
预赛	29	香港	17:25 (7:12)





第十二届全国运动会男子手球预赛
图式射门区域累计

截止至第48场

201301048-42-1/1

澳门

2 李翹珠	4 刘家声	5 何建成	15 黄俊勇	16 冯国政	18 卓伟杰	21 麦锦聪	22 陈学敏																																																																								
<table border="1"><tr><td></td><td></td><td></td></tr><tr><td></td><td></td><td></td></tr><tr><td></td><td></td><td></td></tr></table>										<table border="1"><tr><td></td><td></td><td>1</td></tr><tr><td></td><td></td><td></td></tr><tr><td></td><td></td><td></td></tr></table>			1							<table border="1"><tr><td></td><td></td><td></td></tr><tr><td></td><td></td><td>1</td></tr><tr><td>3</td><td></td><td>1</td></tr></table>						1	3		1	<table border="1"><tr><td></td><td></td><td></td></tr><tr><td></td><td></td><td>1</td></tr><tr><td></td><td></td><td></td></tr></table>						1				<table border="1"><tr><td></td><td></td><td></td></tr><tr><td></td><td></td><td></td></tr><tr><td></td><td></td><td></td></tr></table>										<table border="1"><tr><td></td><td></td><td>1</td></tr><tr><td></td><td></td><td></td></tr><tr><td></td><td></td><td>1</td></tr></table>			1						1	<table border="1"><tr><td></td><td></td><td></td></tr><tr><td></td><td>1</td><td></td></tr><tr><td></td><td>1</td><td>2</td></tr></table>					1			1	2	<table border="1"><tr><td></td><td></td><td></td></tr><tr><td></td><td></td><td>1</td></tr><tr><td>1</td><td></td><td>3</td></tr></table>						1	1		3
		1																																																																													
		1																																																																													
3		1																																																																													
		1																																																																													
		1																																																																													
		1																																																																													
	1																																																																														
	1	2																																																																													
		1																																																																													
1		3																																																																													
Post - 1 Miss - 0 Block - 0	Post - 0 Miss - 0 Block - 0	Post - 1 Miss - 2 Block - 4	Post - 1 Miss - 0 Block - 0	Post - 0 Miss - 0 Block - 0	Post - 0 Miss - 1 Block - 0	Post - 0 Miss - 0 Block - 0	Post - 0 Miss - 2 Block - 2																																																																								
24 刘登宇	27 徐展业	28 莫家进	29 叶响俊	33 欧永健	36 陈嘉聪	81 梁梓康	93 罗咪高																																																																								
<table border="1"><tr><td>2</td><td></td><td>6</td></tr><tr><td>4</td><td></td><td>2</td></tr><tr><td></td><td></td><td></td></tr></table>	2		6	4		2				<table border="1"><tr><td>1</td><td></td><td>3</td></tr><tr><td></td><td></td><td>1</td></tr><tr><td></td><td></td><td>4</td></tr></table>	1		3			1			4	<table border="1"><tr><td>4</td><td></td><td>2</td></tr><tr><td>4</td><td></td><td>1</td></tr><tr><td>4</td><td></td><td>2</td></tr></table>	4		2	4		1	4		2	<table border="1"><tr><td></td><td></td><td></td></tr><tr><td>1</td><td></td><td>2</td></tr><tr><td>6</td><td></td><td>1</td></tr></table>				1		2	6		1	<table border="1"><tr><td></td><td></td><td>3</td></tr><tr><td>2</td><td></td><td>1</td></tr><tr><td>3</td><td>3</td><td></td></tr></table>			3	2		1	3	3		<table border="1"><tr><td></td><td></td><td></td></tr><tr><td></td><td></td><td></td></tr><tr><td></td><td></td><td></td></tr></table>										<table border="1"><tr><td></td><td></td><td>1</td></tr><tr><td>2</td><td>1</td><td>5</td></tr><tr><td>5</td><td></td><td>1</td></tr></table>			1	2	1	5	5		1	<table border="1"><tr><td></td><td></td><td>5</td></tr><tr><td>1</td><td></td><td>1</td></tr><tr><td>3</td><td></td><td>1</td></tr></table>			5	1		1	3		1
2		6																																																																													
4		2																																																																													
1		3																																																																													
		1																																																																													
		4																																																																													
4		2																																																																													
4		1																																																																													
4		2																																																																													
1		2																																																																													
6		1																																																																													
		3																																																																													
2		1																																																																													
3	3																																																																														
		1																																																																													
2	1	5																																																																													
5		1																																																																													
		5																																																																													
1		1																																																																													
3		1																																																																													
Post - 7 Miss - 7 Block - 9	Post - 0 Miss - 1 Block - 0	Post - 3 Miss - 2 Block - 2	Post - 1 Miss - 3 Block - 1	Post - 0 Miss - 6 Block - 6	Post - 0 Miss - 0 Block - 0	Post - 4 Miss - 3 Block - 4	Post - 2 Miss - 1 Block - 0																																																																								

16 冯国政

4/29	1/9	5/35
14/53	2/3	6/34
7/36	3/4	5/26

36 陈嘉聪

5/15	1/5	3/16
6/14	3/4	3/13
3/13	1/1	2/13

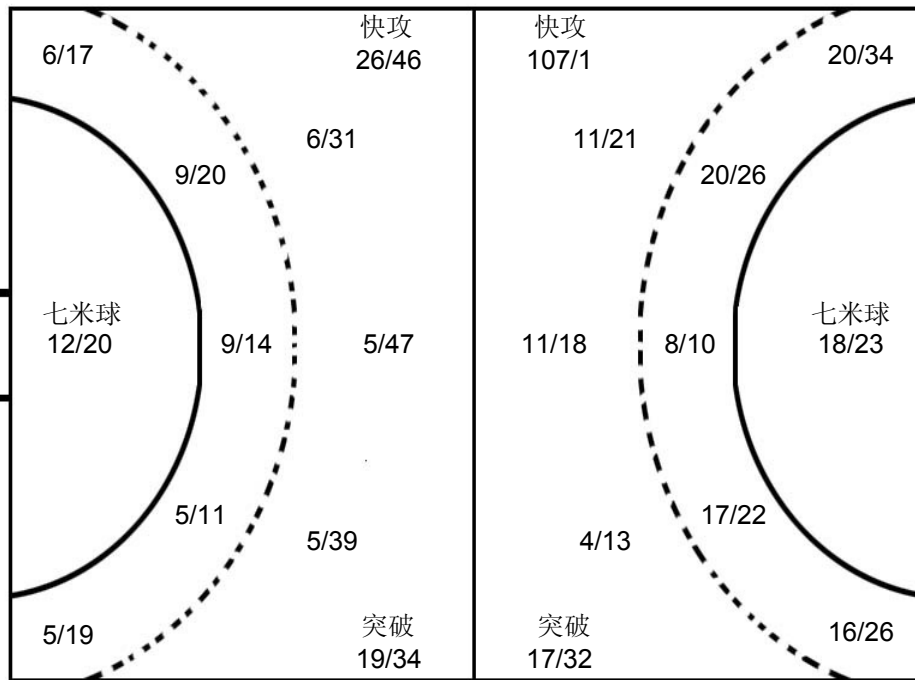

香港

2 叶冠英

1/2	2/2	3/8
2/4	1/1	5/5
2/8	1/1	0/3

江苏

1 丁大伟

1/2	2/2	2/3
1/3	1/1	2/5
1/3		2/3

西藏

16 徐畅

1/1		0/2
2/2	0/1	3/5
3/5	1/1	1/2

对手

19 李语庆	23 王伟强	2 周兰骏	2 杜龙飞	17 陈灵峰	2 杨彦威	29 练明辉	29 顾先亮																																																																								
<table border="1"><tr><td></td><td></td><td>2</td></tr><tr><td>4</td><td></td><td>4</td></tr><tr><td></td><td></td><td>2</td></tr></table>			2	4		4			2	<table border="1"><tr><td>1</td><td></td><td>3</td></tr><tr><td>2</td><td>1</td><td>2</td></tr><tr><td>2</td><td></td><td></td></tr></table>	1		3	2	1	2	2			<table border="1"><tr><td>1</td><td></td><td>1</td></tr><tr><td>1</td><td></td><td>2</td></tr><tr><td>4</td><td></td><td>1</td></tr></table>	1		1	1		2	4		1	<table border="1"><tr><td></td><td></td><td>1</td></tr><tr><td>2</td><td></td><td>1</td></tr><tr><td>4</td><td></td><td>2</td></tr></table>			1	2		1	4		2	<table border="1"><tr><td>3</td><td></td><td>3</td></tr><tr><td></td><td></td><td>2</td></tr><tr><td>1</td><td></td><td></td></tr></table>	3		3			2	1			<table border="1"><tr><td></td><td>1</td><td>1</td></tr><tr><td></td><td></td><td>1</td></tr><tr><td>2</td><td></td><td>3</td></tr></table>		1	1			1	2		3	<table border="1"><tr><td>2</td><td></td><td></td></tr><tr><td></td><td></td><td>1</td></tr><tr><td>4</td><td></td><td>1</td></tr></table>	2					1	4		1	<table border="1"><tr><td></td><td></td><td>2</td></tr><tr><td></td><td></td><td></td></tr><tr><td>1</td><td></td><td></td></tr></table>			2				1		
		2																																																																													
4		4																																																																													
		2																																																																													
1		3																																																																													
2	1	2																																																																													
2																																																																															
1		1																																																																													
1		2																																																																													
4		1																																																																													
		1																																																																													
2		1																																																																													
4		2																																																																													
3		3																																																																													
		2																																																																													
1																																																																															
	1	1																																																																													
		1																																																																													
2		3																																																																													
2																																																																															
		1																																																																													
4		1																																																																													
		2																																																																													
1																																																																															
Post - 0 Miss - 0 Block - 0	Post - 1 Miss - 1 Block - 0	Post - 0 Miss - 3 Block - 0	Post - 1 Miss - 0 Block - 0	Post - 2 Miss - 1 Block - 0	Post - 0 Miss - 0 Block - 0	Post - 2 Miss - 2 Block - 0	Post - 0 Miss - 0 Block - 0																																																																								
5 潘翔	14 解建飞	18 张骥	4 沈庆	15 李安	17 王旭东	4 张家纬	18 赵楠																																																																								
<table border="1"><tr><td>1</td><td></td><td>2</td></tr><tr><td>1</td><td></td><td>3</td></tr><tr><td></td><td></td><td></td></tr></table>	1		2	1		3				<table border="1"><tr><td></td><td></td><td>3</td></tr><tr><td></td><td></td><td>2</td></tr><tr><td></td><td></td><td>1</td></tr></table>			3			2			1	<table border="1"><tr><td>1</td><td></td><td>1</td></tr><tr><td>1</td><td></td><td></td></tr><tr><td>2</td><td></td><td>1</td></tr></table>	1		1	1			2		1	<table border="1"><tr><td></td><td></td><td></td></tr><tr><td>1</td><td></td><td>1</td></tr><tr><td>1</td><td></td><td>3</td></tr></table>				1		1	1		3	<table border="1"><tr><td>2</td><td></td><td>1</td></tr><tr><td>2</td><td></td><td></td></tr><tr><td>1</td><td></td><td></td></tr></table>	2		1	2			1			<table border="1"><tr><td>2</td><td></td><td></td></tr><tr><td>1</td><td></td><td></td></tr><tr><td>2</td><td></td><td>1</td></tr></table>	2			1			2		1	<table border="1"><tr><td>3</td><td>1</td><td></td></tr><tr><td>1</td><td></td><td>1</td></tr><tr><td></td><td></td><td></td></tr></table>	3	1		1		1				<table border="1"><tr><td></td><td>2</td><td></td></tr><tr><td></td><td></td><td></td></tr><tr><td>1</td><td></td><td>2</td></tr></table>		2					1		2
1		2																																																																													
1		3																																																																													
		3																																																																													
		2																																																																													
		1																																																																													
1		1																																																																													
1																																																																															
2		1																																																																													
1		1																																																																													
1		3																																																																													
2		1																																																																													
2																																																																															
1																																																																															
2																																																																															
1																																																																															
2		1																																																																													
3	1																																																																														
1		1																																																																													
	2																																																																														
1		2																																																																													
Post - 1 Miss - 0 Block - 0	Post - 0 Miss - 3 Block - 0	Post - 0 Miss - 1 Block - 0	Post - 0 Miss - 0 Block - 0	Post - 1 Miss - 0 Block - 0	Post - 0 Miss - 0 Block - 0	Post - 0 Miss - 1 Block - 0	Post - 0 Miss - 1 Block - 0																																																																								

注释: Post=击柱 Miss=射失 Block=被封





男子 国内比赛

第十二届全国运动会男子手球预赛

Team A		Team B		Match Number																	
A 江苏		B 西藏		1																	
played in		in the hall		on																	
China		柳州市李宁体育馆		18/04/2013																	
				at 14:40 hours																	
Spectators																					
Half-time (30')	A	B	End of playing time	A	B																
	20	9	46 18	1st extra time	2nd extra time																
				A	B																
				After penalty	throws																
				A	B																
Number of 7 m	A	Team time-out			Full name of players and officials			Team time-out			B	Number of 7 m									
	0/0	1	2	3				1	2	3	1/3										
	15:56	46:03						20:23													
No.	Team A					G	W	2'	D	DR	No.	Team B					G	W	2'	D	DR
1	丁大伟										2	王龙					1	1			
2	杨彦威					1	1				4	张家纬					2				
3	李旭东										5	冯祥龙									
4	沈庆					3	1				6	任启双						1	1		
5	闫亮					6					7	徐奕飞					3	1			
6	赵晨					5		1			9	王博									
8	周小坚					3					10	刘江					1				
9	叶强					4	1				11	朱治宇									
10	郝可鑫					5					12	张帅									
11	姚仁剑										15	刘劲松									
12	王权										16	徐畅									
14	丛海航					5					18	赵楠					2				
15	李安					2					19	任野									
17	陈灵峰					8					20	顾艳超					1		1		
19	张志宇					4					21	马光					2				
20	张星										23	王伟强					6				
A	闫威名										A	张文韬									
B	钱红										B	殷永军									
C	NENADz vonarek										C	瓮勇									
D	王建国																				
A	Signature of Responsible Official of the Teams (Off. A)																			B	
TP	Remarks of Referee / CHA Official																			TP	

Signatures

Referees	陈晓波 (CHN)	王锐 (CHN)		
Techn. Delegates	刘书勇 (CHN)	王锡祯 (CHN)		
CHA Official				

Note: Number of 7m Throws Awarded to Team A and B, Goals (G), Warnings (W), Suspensions (2'), Direct Disqualification (D), Disqualification with Report (DR) and Team Penalty (TP).

Table Officials:

Statisticians: 黄莉

朱伟平





第十二届全国运动会男子手球预赛 竞赛技术统计(媒体表)

Match header table with columns: 预赛, 组别, A, 轮次, 1, 场次, 1. Includes venue (柳州市李宁体育馆), date (18/04/2013), and match ID (201301001-51-1/1). Score: 江苏 46 vs 西藏 18.

Referee table: 裁判员 陈晓波 (CHN) / 王锐 (CHN)

Main statistics table for Jiangsu team. Columns: 远射, 近射, 边射, 快攻, 突破, 任意球, 7m球, 合计, %, 助攻, 失误, 警告, 2', D & DR. Rows include players like 丁大伟, 杨彦威, 李旭东, etc.

Main statistics table for Tibet team. Columns: 远射, 近射, 边射, 快攻, 突破, 任意球, 7m球, 合计, %, 助攻, 失误, 警告, 2', D & DR. Rows include players like 王龙, 张家纬, 冯祥龙, etc.

Match progression table (比赛进程) showing goals and assists for both teams across 1st and 2nd halves.

张帅 徐畅

场上队员: 得分 / 射门

守门员: 救球 / 射门

Summary table with columns: 快攻, Fast Break, 突破, Breakthrough, 任意球, Free Throw, 7M球, 7M Throw, 助攻, Assist, 警告, Warning, 失误, Error, 2', Suspension, D, 取消资格, DR, 取消资格+报告





第十二届全国运动会男子手球预赛 图式比赛技术统计表

轮次 1

场次 1

201301001-21-1/1

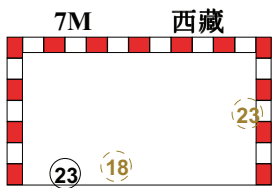
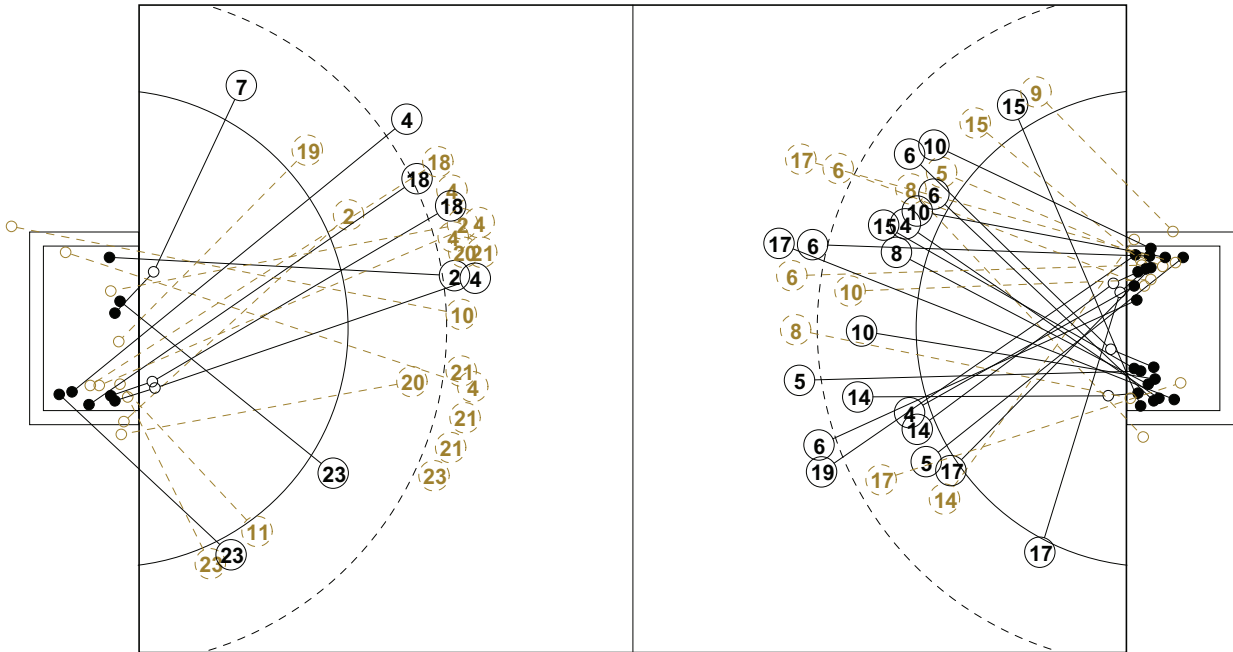

1st Half
9 : 20

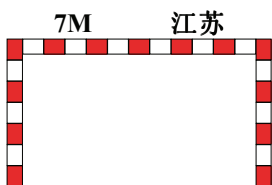
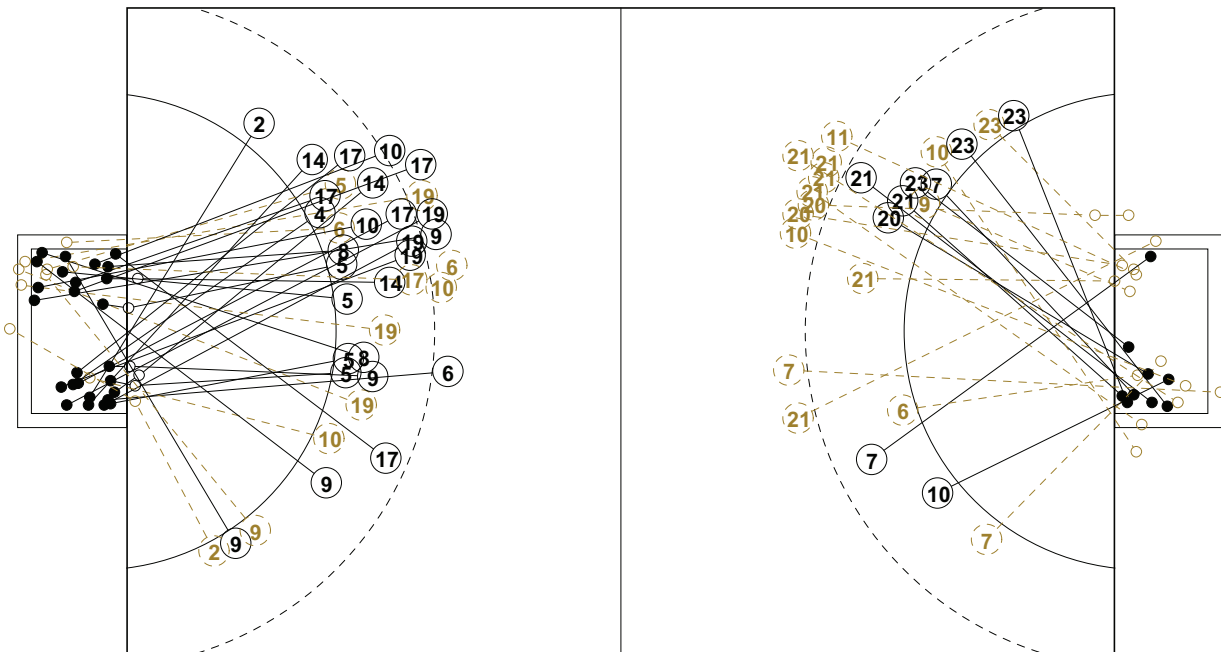
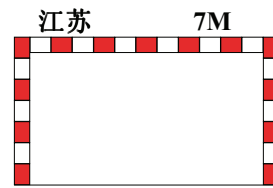

2nd Half
46 : 18

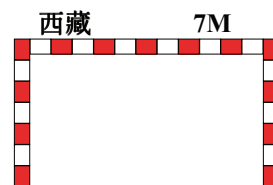



第十二届全国运动会男子手球预赛

个人/全队技术统计表

正式表
手球
男子预赛
轮次 1组别 A
场次 1201301001-14-1/2
柳州市李宁体院馆
18/04/2013 14:40

号码	姓名	远射	近射	边射	快攻	突破	任意	7M	合计	%	助攻	失误	警告	2'	取消	时间
江苏(江苏)																
<i>(场上队员)</i>																
1	丁大伟									0.0%						00:27:24
2	杨彦威			0/1	1/1				1/2	50.0%		2	1			00:27:28
3	李旭东									0.0%						00:00:00
4	沈庆		3/3						3/3	100%			1			00:27:30
5	闫亮		4/4		2/3	0/1			6/8	75.0%	2	2				00:39:16
6	赵晨	2/5	2/2		1/1	0/1			5/9	55.6%	2	1		1		00:52:50
8	周小坚		2/2		1/2	0/1			3/5	60.0%		1				00:32:18
9	叶强			1/3	2/2	1/1			4/6	66.7%	1	3	1			00:27:33
10	郝可鑫		0/2		4/5	1/1			5/8	62.5%	1	2				00:27:32
11	姚仁剑									0.0%						00:00:00
12	王权									0.0%						00:32:36
14	丛海航		1/2		2/2	2/2			5/6	83.3%		2				00:33:52
15	李安				1/2	1/1			2/3	66.7%		3				00:32:19
17	陈灵峰	3/6	2/2	1/1	2/2				8/11	72.7%	3					00:25:57
19	张志宇	4/5			0/2				4/7	57.1%	1	1				00:32:20
20	张星									0.0%						00:00:00
合计		9/16	14/17	2/5	16/22	5/8			46/68	67.6%	10	17	3	1		
<i>(守门员)</i>																
1	丁大伟	5/8	2/3		2/3		1/2	2/3	12/19	63.2%						00:27:24
12	王权	1/3	1/1	3/7	1/5	0/1			6/17	35.3%						00:32:36
合计		6/11	3/4	3/7	3/8	0/1	1/2	2/3	18/36	50.0%						

场上队员：得分/射门

守门员：救球/射门

全队合计	得分	被救	射失	击柱	封球	合计	%
远射	9	5		1	1	16	56.3%
近射	14	2		1		17	82.4%
边射	2	1	1	1		5	40.0%
快攻	16	3		2	1	22	72.7%
突破	5	1	1	1		8	62.5%
任意							0.0%
7M							0.0%





第十二届全国运动会男子手球预赛

个人/全队技术统计表

正式表
手球
男子预赛
轮次 1组别 A
场次 1201301001-14-2/2
柳州市李宁体院馆
18/04/2013 14:40

号码	姓名	远射	近射	边射	快攻	突破	任意	7M	合计	%	助攻	失误	警告	2'	取消	时间
西藏(西藏)																
<i>(上场队员)</i>																
2	王龙	1/2	0/1						1/3	33.3%	1	4	1			00:24:21
4	张家纬	1/4			0/1		1/1		2/6	33.3%		6				02:00:01
5	冯祥龙									0.0%						00:49:13
6	任启双		0/1						0/1	0.0%			1	1		00:41:42
7	徐奕飞	0/1		1/1	2/3				3/5	60.0%			1			01:31:35
9	王博		0/1						0/1	0.0%		3				00:32:11
10	刘江	0/1			1/1	0/1	0/1		1/4	25.0%		3				01:31:06
11	朱治宇	0/1		0/1					0/2	0.0%		1				01:29:57
12	张帅									0.0%						00:30:00
15	刘劲松									0.0%						00:33:32
16	徐畅									0.0%	1					00:54:36
18	赵楠	2/3						0/1	2/4	50.0%		1				00:59:44
19	任野				0/1				0/1	0.0%	1					00:15:09
20	顾艳超	0/3	1/1			0/1			1/5	20.0%	1	3		1		00:39:04
21	马光	1/10	0/1			1/1			2/12	16.7%		4				00:33:22
23	王伟强	0/1		3/5	2/2			1/2	6/10	60.0%		3				01:06:05
合计		5/26	1/5	4/7	5/8	1/3	1/2	1/3	18/54	33.3%	4	28	3	2		
<i>(守门员)</i>																
2	王龙		0/2						0/2	0.0%	1	4	1			00:24:21
4	张家纬	0/2	0/1						0/3	0.0%		12				02:00:01
5	冯祥龙	0/1							0/1	0.0%						00:49:13
6	任启双	合计	0/1	0/1					0/2	0.0%			1	1		00:41:42

场上队员：得分/射门

守门员：救球/射门

全队合计	得分	被救	射失	击柱	封球	合计	%
远射	5	6	2	3	10	26	19.2%
近射	1	3		1		5	20.0%
边射	4	3				7	57.1%
快攻	5	3				8	62.5%
突破	1		2			3	33.3%
任意	1	1				2	50.0%
7M	1	2				3	33.3%





第十二届全国运动会男子手球预赛

图式射门区域统计

轮次 1 场次 1

201301001-41-1/1

江苏

1 丁大伟	2 杨彦威	3 李旭东	4 沈庆	5 闫亮	6 赵晨	8 周小坚	9 叶强																																																																								
<table border="1"><tr><td></td><td></td><td></td></tr><tr><td></td><td></td><td></td></tr><tr><td></td><td></td><td></td></tr></table>										<table border="1"><tr><td></td><td></td><td></td></tr><tr><td>1</td><td></td><td></td></tr><tr><td></td><td></td><td></td></tr></table>				1						<table border="1"><tr><td></td><td></td><td></td></tr><tr><td></td><td></td><td></td></tr><tr><td></td><td></td><td></td></tr></table>										<table border="1"><tr><td></td><td></td><td></td></tr><tr><td>1</td><td></td><td>1</td></tr><tr><td>1</td><td></td><td></td></tr></table>				1		1	1			<table border="1"><tr><td></td><td></td><td>1</td></tr><tr><td>1</td><td></td><td></td></tr><tr><td>2</td><td>1</td><td>1</td></tr></table>			1	1			2	1	1	<table border="1"><tr><td></td><td></td><td></td></tr><tr><td></td><td></td><td></td></tr><tr><td>2</td><td>1</td><td>2</td></tr></table>							2	1	2	<table border="1"><tr><td></td><td></td><td>1</td></tr><tr><td></td><td></td><td></td></tr><tr><td></td><td></td><td>2</td></tr></table>			1						2	<table border="1"><tr><td></td><td></td><td>2</td></tr><tr><td>1</td><td></td><td></td></tr><tr><td></td><td></td><td></td></tr></table>			2	1					
1																																																																															
1		1																																																																													
1																																																																															
		1																																																																													
1																																																																															
2	1	1																																																																													
2	1	2																																																																													
		1																																																																													
		2																																																																													
		2																																																																													
1																																																																															
Post - 0 Miss - 0 Block - 0	Post - 0 Miss - 1 Block - 0	Post - 0 Miss - 0 Block - 0	Post - 0 Miss - 0 Block - 0	Post - 0 Miss - 0 Block - 0	Post - 1 Miss - 0 Block - 1	Post - 0 Miss - 1 Block - 0	Post - 1 Miss - 0 Block - 0																																																																								
10 郝可鑫	11 姚仁剑	12 王权	14 丛海航	15 李安	17 陈灵峰	19 张志宇	20 张星																																																																								
<table border="1"><tr><td></td><td></td><td>1</td></tr><tr><td>1</td><td></td><td>1</td></tr><tr><td>1</td><td></td><td>1</td></tr></table>			1	1		1	1		1	<table border="1"><tr><td></td><td></td><td></td></tr><tr><td></td><td></td><td></td></tr><tr><td></td><td></td><td></td></tr></table>										<table border="1"><tr><td></td><td></td><td></td></tr><tr><td></td><td></td><td></td></tr><tr><td></td><td></td><td></td></tr></table>										<table border="1"><tr><td></td><td></td><td></td></tr><tr><td>1</td><td></td><td></td></tr><tr><td>2</td><td></td><td>2</td></tr></table>				1			2		2	<table border="1"><tr><td></td><td></td><td></td></tr><tr><td></td><td></td><td></td></tr><tr><td></td><td></td><td>2</td></tr></table>									2	<table border="1"><tr><td></td><td></td><td></td></tr><tr><td>2</td><td></td><td>3</td></tr><tr><td>2</td><td></td><td>1</td></tr></table>				2		3	2		1	<table border="1"><tr><td></td><td></td><td>1</td></tr><tr><td>1</td><td></td><td></td></tr><tr><td>2</td><td></td><td></td></tr></table>			1	1			2			<table border="1"><tr><td></td><td></td><td></td></tr><tr><td></td><td></td><td></td></tr><tr><td></td><td></td><td></td></tr></table>									
		1																																																																													
1		1																																																																													
1		1																																																																													
1																																																																															
2		2																																																																													
		2																																																																													
2		3																																																																													
2		1																																																																													
		1																																																																													
1																																																																															
2																																																																															
Post - 0 Miss - 0 Block - 1	Post - 0 Miss - 0 Block - 0	Post - 0 Miss - 0 Block - 0	Post - 1 Miss - 0 Block - 0	Post - 0 Miss - 0 Block - 0	Post - 0 Miss - 0 Block - 0	Post - 3 Miss - 0 Block - 0	Post - 0 Miss - 0 Block - 0																																																																								

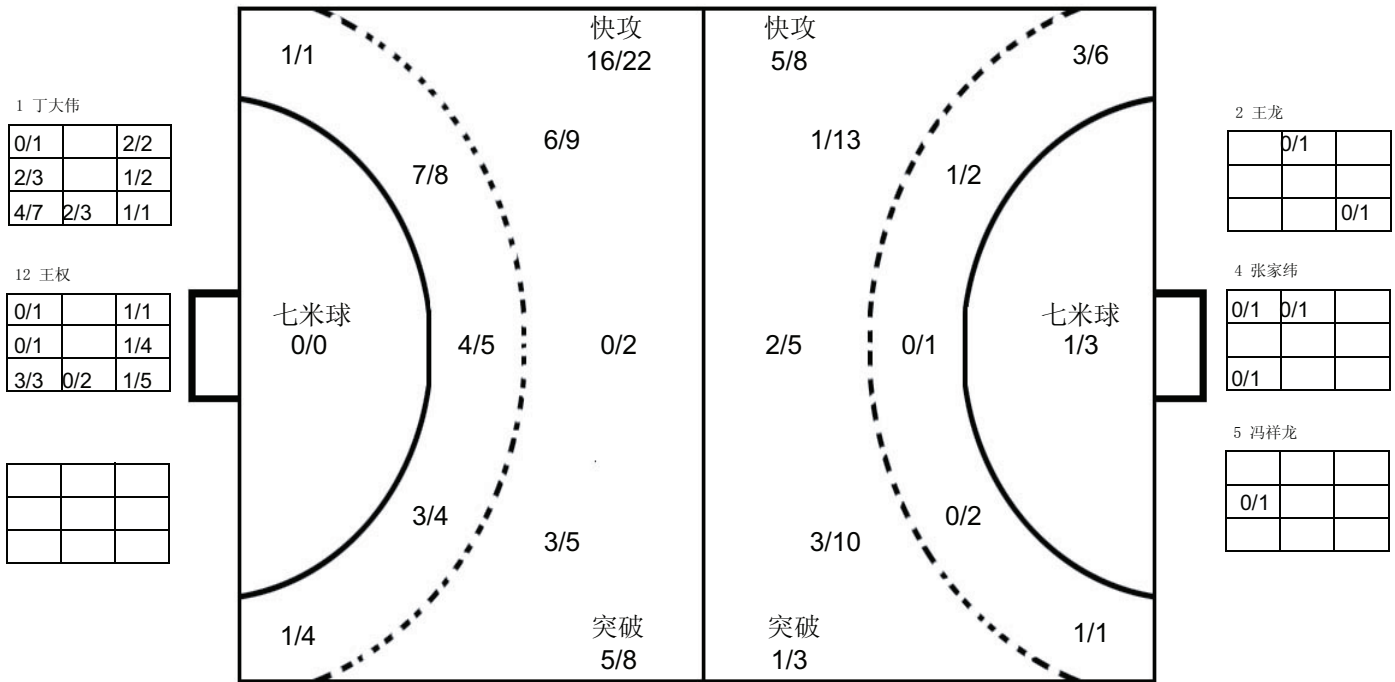

西藏

2 王龙	4 张家纬	5 冯祥龙	6 任启双	7 徐奕飞	9 王博	10 刘江	11 朱治宇																																																																								
<table border="1"><tr><td></td><td></td><td></td></tr><tr><td></td><td></td><td></td></tr><tr><td></td><td></td><td>1</td></tr></table>									1	<table border="1"><tr><td></td><td></td><td>1</td></tr><tr><td></td><td></td><td></td></tr><tr><td>1</td><td></td><td></td></tr></table>			1				1			<table border="1"><tr><td></td><td></td><td></td></tr><tr><td></td><td></td><td></td></tr><tr><td></td><td></td><td></td></tr></table>										<table border="1"><tr><td></td><td></td><td></td></tr><tr><td></td><td></td><td></td></tr><tr><td></td><td></td><td></td></tr></table>										<table border="1"><tr><td></td><td></td><td></td></tr><tr><td>1</td><td></td><td></td></tr><tr><td></td><td>1</td><td>1</td></tr></table>				1				1	1	<table border="1"><tr><td></td><td></td><td></td></tr><tr><td></td><td></td><td></td></tr><tr><td></td><td></td><td></td></tr></table>										<table border="1"><tr><td></td><td></td><td></td></tr><tr><td></td><td></td><td>1</td></tr><tr><td></td><td></td><td></td></tr></table>						1				<table border="1"><tr><td></td><td></td><td></td></tr><tr><td></td><td></td><td></td></tr><tr><td></td><td></td><td></td></tr></table>									
		1																																																																													
		1																																																																													
1																																																																															
1																																																																															
	1	1																																																																													
		1																																																																													
Post - 1 Miss - 0 Block - 0	Post - 0 Miss - 0 Block - 2	Post - 0 Miss - 0 Block - 0	Post - 0 Miss - 0 Block - 0	Post - 1 Miss - 0 Block - 0	Post - 0 Miss - 0 Block - 0	Post - 0 Miss - 2 Block - 0	Post - 0 Miss - 0 Block - 0																																																																								
12 张帅	15 刘劲松	16 徐畅	18 赵楠	19 任野	20 顾艳超	21 马光	23 王伟强																																																																								
<table border="1"><tr><td></td><td></td><td></td></tr><tr><td></td><td></td><td></td></tr><tr><td></td><td></td><td></td></tr></table>										<table border="1"><tr><td></td><td></td><td></td></tr><tr><td></td><td></td><td></td></tr><tr><td></td><td></td><td></td></tr></table>										<table border="1"><tr><td></td><td></td><td></td></tr><tr><td></td><td></td><td></td></tr><tr><td></td><td></td><td></td></tr></table>										<table border="1"><tr><td></td><td></td><td></td></tr><tr><td>1</td><td></td><td></td></tr><tr><td>1</td><td></td><td></td></tr></table>				1			1			<table border="1"><tr><td></td><td></td><td></td></tr><tr><td></td><td></td><td></td></tr><tr><td></td><td></td><td></td></tr></table>										<table border="1"><tr><td></td><td></td><td></td></tr><tr><td></td><td></td><td>1</td></tr><tr><td></td><td></td><td></td></tr></table>						1				<table border="1"><tr><td></td><td></td><td></td></tr><tr><td></td><td></td><td>1</td></tr><tr><td></td><td></td><td>1</td></tr></table>						1			1	<table border="1"><tr><td></td><td></td><td>1</td></tr><tr><td>1</td><td>2</td><td>1</td></tr><tr><td></td><td></td><td></td></tr></table>			1	1	2	1			
1																																																																															
1																																																																															
		1																																																																													
		1																																																																													
		1																																																																													
		1																																																																													
1	2	1																																																																													
Post - 0 Miss - 0 Block - 0	Post - 0 Miss - 0 Block - 0	Post - 0 Miss - 0 Block - 0	Post - 0 Miss - 0 Block - 0	Post - 0 Miss - 0 Block - 0	Post - 0 Miss - 2 Block - 1	Post - 2 Miss - 0 Block - 6	Post - 0 Miss - 0 Block - 1																																																																								

注释: Post=击柱 Miss=射失 Block=被封





男子 国内比赛

第十二届全国运动会男子手球预赛

Team A A 安徽		Team B B 香港		Match Number 2												
played in China		in the hall		on 18/04/2013												
				at 16:20 hours												
Spectators																
Half-time (30')	A 11	B 15	End of playing time	A 27	B 30											
1st extra time				2nd extra time												
				After penalty throws												
Number of 7 m	A 2/2	Team time-out			Full name of players and officials			Team time-out			B 1/2	Number of 7 m				
		1 11:02	2 52:47	3 56:25				1 19:09	2 49:10	3						
No.	Team A					G	W	2'	D	DR	No.	Team B				
1	高逸凡										1	萧智庭				
2	周兰骏					1					2	叶冠英				
5	马鹏					11		1			5	黄胜业				
6	田耕										6	谢伟希				
7	姚雄敏										7	许文邦				
8	董智景										8	何伟杰				
10	陈强龙					3	1	2			9	张建国				
11	黎涛					1					10	陈国兴				
12	曾献辰										11	陈允文				
15	邵青					1	1	1			12	叶冠雄				
17	解维维					1	1				13	叶仕仁				
18	郭赛										14	李鑫豪				
28	袁龙					2		1			15	黄嘉愉				
29	顾先亮					2					25	曾铭谦				
32	王超					5					29	练明辉				
33	曹振吉															
A	王来黔										A	陈广裕				
B	刘晓蓓										B	杨开捋				
C	高恒勤										D	张军				
Signature of Responsible Official of the Teams (Off. A)													Signature of Responsible Official of the Teams (Off. B)			
TP	Remarks of Referee / CHA Official											TP				

Signatures

Referees	李刚 (CHN)	王科 (CHN)		
Techn. Delegates	刘书勇 (CHN)	许宜扬 (CHN)		
CHA Official				

Note: Number of 7m Throws Awarded to Team A and B, Goals (G), Warnings (W), Suspensions (2'), Direct Disqualification (D), Disqualification with Report (DR) and Team Penalty (TP).

Table Officials: 黄思华 谭云东 Statisticians: 黄莉 朱伟平





第十二届全国运动会男子手球预赛 图式比赛技术统计表

轮次 1

场次 2

201301002-21-1/1

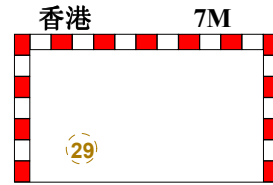
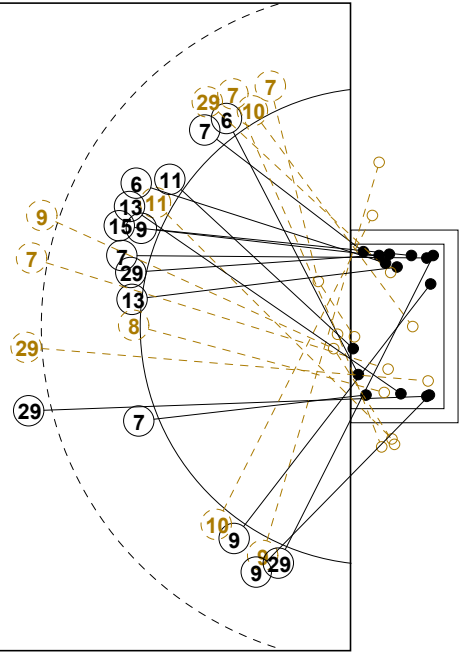
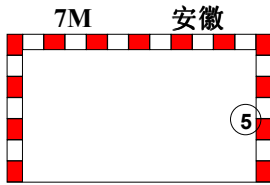
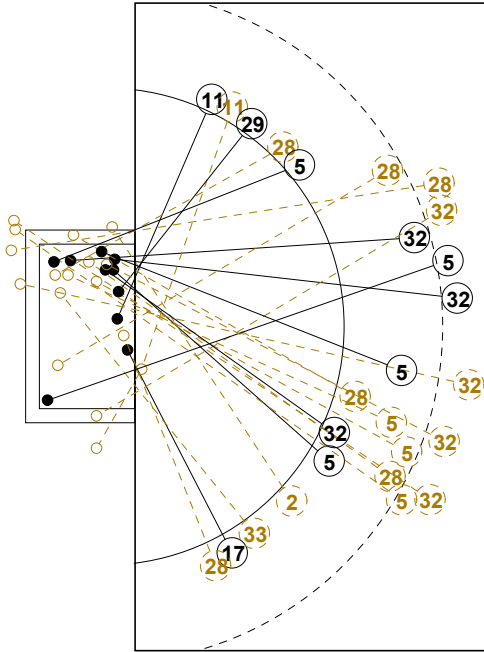

1st Half
11 : 15

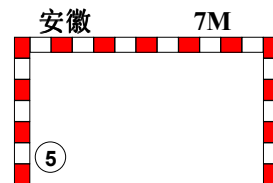
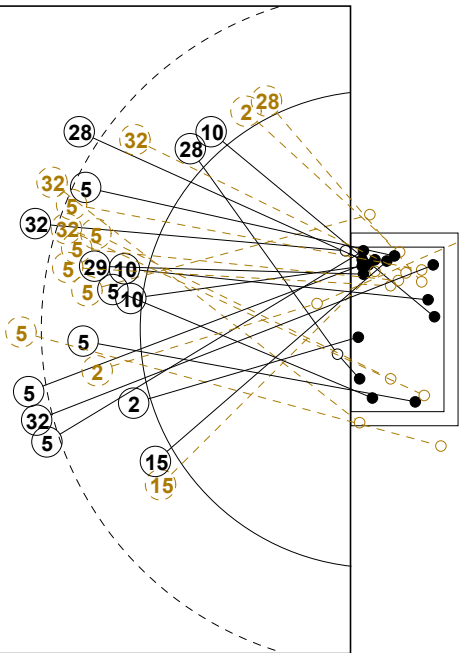
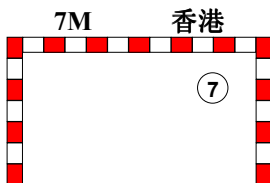
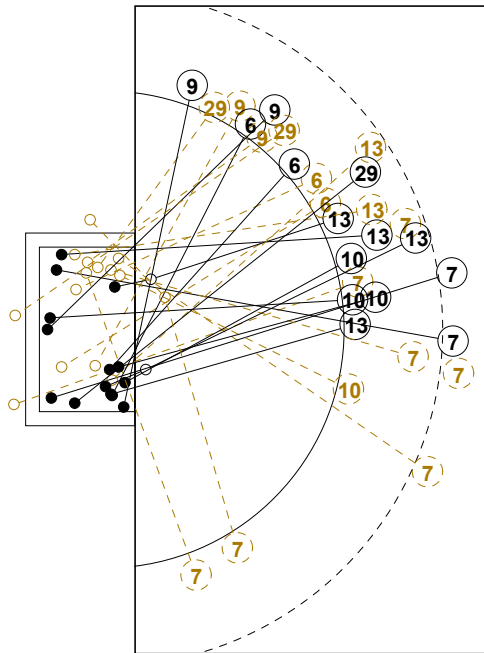

2nd Half
30 : 27



第十二届全国运动会男子手球预赛

个人/全队技术统计表

正式表
手球
男子预赛
轮次 1组别 A
场次 2

201301002-14-1/2

18/04/2013 16:20

号码	姓名	远射	近射	边射	快攻	突破	任意	7M	合计	%	助攻	失误	警告	2'	取消	时间
安徽(安徽)																
<i>(场上队员)</i>																
1	高逸凡									0.0%						00:00:34
2	周兰骏				1/3		0/1		1/4	25.0%						00:16:20
5	马鹏	4/10	2/4		3/3	0/1		2/2	11/20	55.0%	1	1		1		00:46:24
6	田耕									0.0%						00:00:00
7	姚雄敏									0.0%						00:00:00
8	董智景									0.0%						00:00:00
10	陈强龙				3/3				3/3	100%		2	1	2		00:56:58
11	黎涛			1/2					1/2	50.0%		2				00:18:22
12	曾献辰									0.0%	1					00:59:47
15	邵青		1/2						1/2	50.0%		2	1	1		00:43:25
17	解维维			1/1					1/1	100%			1			00:21:49
18	郭赛									0.0%						00:00:28
28	袁龙	1/4	0/1	0/2	1/1	0/1			2/9	22.2%	1			1		00:55:24
29	顾先亮		1/1	1/1					2/2	100%		1				00:37:49
32	王超	2/8			1/1	1/1	1/2		5/12	41.7%	2	5				00:38:47
33	曹振吉			0/1					0/1	0.0%	2	1				00:04:56
合计		7/22	4/8	3/7	9/11	1/3	1/3	2/2	27/56	48.2%	7	14	3	5		
<i>(守门员)</i>																
1	高逸凡		0/1					1/2	1/3	33.3%						00:00:34
12	曾献辰	4/8	2/6	7/10	3/14	0/6	1/1		17/45	37.8%	1					00:59:47
合计		4/8	2/7	7/10	3/14	0/6	1/1	1/2	18/48	37.5%	1					

场上队员：得分/射门

守门员：救球/射门

全队合计	得分	被救	射失	击柱	封球	合计	%
远射	7	9	4	2		22	31.8%
近射	4	4				8	50.0%
边射	3	3	1			7	42.9%
快攻	9		1	1		11	81.8%
突破	1		1	1		3	33.3%
任意	1	1	1			3	33.3%
7M	2					2	100.0%





第十二届全国运动会男子手球预赛

个人/全队技术统计表

正式表
手球
男子预赛
轮次 1组别 A
场次 2

201301002-14-2/2

18/04/2013 16:20

号码	姓名	远射	近射	边射	快攻	突破	任意	7M	合计	%	助攻	失误	警告	2'	取消	时间
香港(香港)																
<i>(上场队员)</i>																
1	萧智庭									0.0%						00:02:05
2	叶冠英									0.0%	1	1				00:58:29
5	黄胜业									0.0%						00:00:00
6	谢伟希				4/6				4/6	66.7%		1		2		00:29:22
7	许文邦	2/6	1/2	1/5	1/1		0/1	1/1	6/16	37.5%		4				00:47:23
8	何伟杰				0/1				0/1	0.0%			1			00:11:21
9	张建国	0/1		2/4	3/4				5/9	55.6%			1			00:52:07
10	陈国兴		0/1	0/1	1/2	2/2			3/6	50.0%		1	1			00:24:37
11	陈允文				1/2				1/2	50.0%				2		00:26:02
12	叶冠雄									0.0%						00:12:55
13	叶仕仁	1/2	2/3			3/3			6/8	75.0%	1	3				00:55:08
14	李鑫豪									0.0%						00:01:46
15	黄嘉愉				1/1				1/1	100%						00:30:03
25	曾铭谦									0.0%						00:00:00
29	练明辉	1/2	2/2	0/2		1/2		0/1	4/9	44.4%	2	4				00:49:16
合计		4/11	5/8	3/12	11/17	6/7	0/1	1/2	30/58	51.7%	4	14	3	4		
<i>(守门员)</i>																
1	萧智庭							0/1	0/1	0.0%						00:02:05
2	叶冠英	9/16	4/8	3/6	0/9	0/1	1/2	0/1	17/43	39.5%	1	1				00:58:29
合计		9/16	4/8	3/6	0/9	0/1	1/2	0/2	17/44	38.6%	1	1				

场上队员：得分/射门

守门员：救球/射门

全队合计	得分	被救	射失	击柱	封球	合计	%
远射	4	4	1		2	11	36.4%
近射	5	2	1			8	62.5%
边射	3	7	2			12	25.0%
快攻	11	3	3			17	64.7%
突破	6		1			7	85.7%
任意		1				1	0.0%
7M	1	1				2	50.0%





第十二届全国运动会男子手球预赛

图式射门区域统计

轮次 1 场次 2

201301002-41-1/1

安徽

1 高逸凡	2 周兰骏	5 马鹏	6 田耕	7 姚雄敏	8 董智景	10 陈强龙	11 黎涛																																																																								
<table border="1"><tr><td></td><td></td><td></td></tr><tr><td></td><td></td><td></td></tr><tr><td></td><td></td><td></td></tr></table>										<table border="1"><tr><td></td><td></td><td></td></tr><tr><td></td><td></td><td></td></tr><tr><td></td><td>1</td><td></td></tr></table>								1		<table border="1"><tr><td>1</td><td></td><td>2</td></tr><tr><td>1</td><td></td><td>2</td></tr><tr><td>3</td><td></td><td>2</td></tr></table>	1		2	1		2	3		2	<table border="1"><tr><td></td><td></td><td></td></tr><tr><td></td><td></td><td></td></tr><tr><td></td><td></td><td></td></tr></table>										<table border="1"><tr><td></td><td></td><td></td></tr><tr><td></td><td></td><td></td></tr><tr><td></td><td></td><td></td></tr></table>										<table border="1"><tr><td></td><td></td><td></td></tr><tr><td></td><td></td><td></td></tr><tr><td></td><td></td><td></td></tr></table>										<table border="1"><tr><td>1</td><td>1</td><td></td></tr><tr><td></td><td></td><td></td></tr><tr><td>1</td><td></td><td></td></tr></table>	1	1					1			<table border="1"><tr><td></td><td></td><td></td></tr><tr><td></td><td></td><td></td></tr><tr><td></td><td>1</td><td></td></tr></table>								1	
	1																																																																														
1		2																																																																													
1		2																																																																													
3		2																																																																													
1	1																																																																														
1																																																																															
	1																																																																														
Post - 0 Miss - 0 Block - 0	Post - 1 Miss - 1 Block - 0	Post - 0 Miss - 3 Block - 0	Post - 0 Miss - 0 Block - 0	Post - 0 Miss - 0 Block - 0	Post - 0 Miss - 0 Block - 0	Post - 0 Miss - 0 Block - 0	Post - 0 Miss - 1 Block - 0																																																																								
12 曾献辰	15 邵青	17 解维维	18 郭赛	28 袁龙	29 顾先亮	32 王超	33 曹振吉																																																																								
<table border="1"><tr><td></td><td></td><td></td></tr><tr><td></td><td></td><td></td></tr><tr><td></td><td></td><td></td></tr></table>										<table border="1"><tr><td></td><td></td><td></td></tr><tr><td>1</td><td></td><td></td></tr><tr><td></td><td></td><td></td></tr></table>				1						<table border="1"><tr><td></td><td></td><td></td></tr><tr><td></td><td></td><td></td></tr><tr><td></td><td>1</td><td></td></tr></table>								1		<table border="1"><tr><td></td><td></td><td></td></tr><tr><td></td><td></td><td></td></tr><tr><td></td><td></td><td></td></tr></table>										<table border="1"><tr><td></td><td></td><td></td></tr><tr><td></td><td></td><td></td></tr><tr><td>1</td><td></td><td>1</td></tr></table>							1		1	<table border="1"><tr><td></td><td></td><td></td></tr><tr><td></td><td></td><td></td></tr><tr><td>1</td><td></td><td>1</td></tr></table>							1		1	<table border="1"><tr><td>1</td><td></td><td>1</td></tr><tr><td></td><td></td><td></td></tr><tr><td>1</td><td></td><td>2</td></tr></table>	1		1				1		2	<table border="1"><tr><td></td><td></td><td></td></tr><tr><td></td><td></td><td></td></tr><tr><td></td><td></td><td></td></tr></table>									
1																																																																															
	1																																																																														
1		1																																																																													
1		1																																																																													
1		1																																																																													
1		2																																																																													
Post - 0 Miss - 0 Block - 0	Post - 0 Miss - 0 Block - 0	Post - 0 Miss - 0 Block - 0	Post - 0 Miss - 0 Block - 0	Post - 1 Miss - 1 Block - 0	Post - 0 Miss - 0 Block - 0	Post - 2 Miss - 2 Block - 0	Post - 0 Miss - 0 Block - 0																																																																								

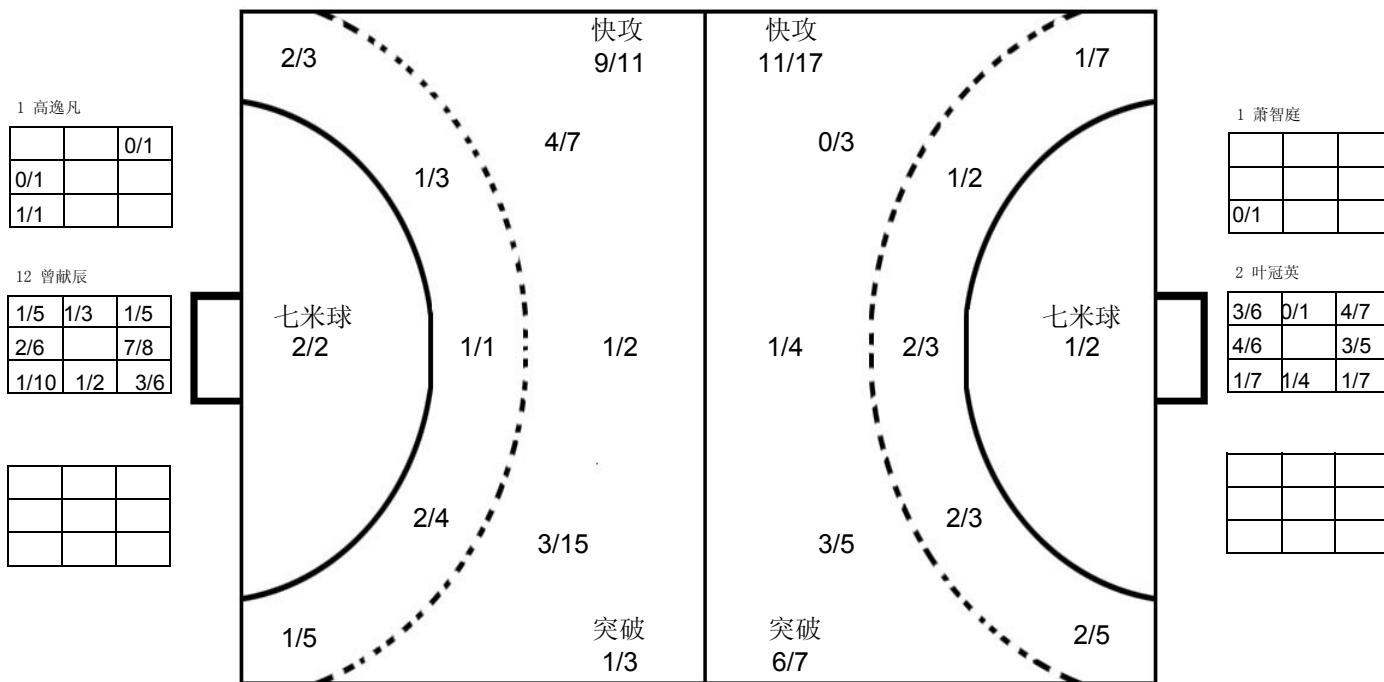

香港

1 萧智庭	2 叶冠英	5 黄胜业	6 谢伟希	7 许文邦	8 何伟杰	9 张建国	10 陈国兴																																																																								
<table border="1"><tr><td></td><td></td><td></td></tr><tr><td></td><td></td><td></td></tr><tr><td></td><td></td><td></td></tr></table>										<table border="1"><tr><td></td><td></td><td></td></tr><tr><td></td><td></td><td></td></tr><tr><td></td><td></td><td></td></tr></table>										<table border="1"><tr><td></td><td></td><td></td></tr><tr><td></td><td></td><td></td></tr><tr><td></td><td></td><td></td></tr></table>										<table border="1"><tr><td></td><td></td><td></td></tr><tr><td>1</td><td></td><td></td></tr><tr><td>2</td><td></td><td>1</td></tr></table>				1			2		1	<table border="1"><tr><td>2</td><td></td><td>2</td></tr><tr><td></td><td></td><td></td></tr><tr><td>1</td><td></td><td>1</td></tr></table>	2		2				1		1	<table border="1"><tr><td></td><td></td><td></td></tr><tr><td></td><td></td><td></td></tr><tr><td></td><td></td><td></td></tr></table>										<table border="1"><tr><td>1</td><td>1</td><td>1</td></tr><tr><td>1</td><td></td><td></td></tr><tr><td>1</td><td></td><td></td></tr></table>	1	1	1	1			1			<table border="1"><tr><td></td><td></td><td></td></tr><tr><td></td><td></td><td></td></tr><tr><td>2</td><td></td><td></td></tr></table>							2		
1																																																																															
2		1																																																																													
2		2																																																																													
1		1																																																																													
1	1	1																																																																													
1																																																																															
1																																																																															
2																																																																															
Post - 0 Miss - 0 Block - 0	Post - 0 Miss - 0 Block - 0	Post - 0 Miss - 0 Block - 0	Post - 0 Miss - 0 Block - 0	Post - 0 Miss - 3 Block - 2	Post - 0 Miss - 0 Block - 0	Post - 0 Miss - 2 Block - 0	Post - 0 Miss - 1 Block - 0																																																																								
11 陈允文	12 叶冠雄	13 叶仕仁	14 李鑫豪	15 黄嘉愉	25 曾铭谦	29 练明辉																																																																									
<table border="1"><tr><td></td><td></td><td></td></tr><tr><td></td><td></td><td></td></tr><tr><td>1</td><td></td><td></td></tr></table>							1			<table border="1"><tr><td></td><td></td><td></td></tr><tr><td></td><td></td><td></td></tr><tr><td></td><td></td><td></td></tr></table>										<table border="1"><tr><td></td><td></td><td>1</td></tr><tr><td>1</td><td></td><td>1</td></tr><tr><td>2</td><td></td><td>1</td></tr></table>			1	1		1	2		1	<table border="1"><tr><td></td><td></td><td></td></tr><tr><td></td><td></td><td></td></tr><tr><td></td><td></td><td></td></tr></table>										<table border="1"><tr><td></td><td></td><td></td></tr><tr><td></td><td></td><td></td></tr><tr><td>1</td><td></td><td></td></tr></table>							1			<table border="1"><tr><td></td><td></td><td></td></tr><tr><td></td><td></td><td></td></tr><tr><td></td><td></td><td></td></tr></table>										<table border="1"><tr><td>1</td><td></td><td>1</td></tr><tr><td>2</td><td></td><td></td></tr><tr><td></td><td></td><td></td></tr></table>	1		1	2						<table border="1"><tr><td></td><td></td><td></td></tr><tr><td></td><td></td><td></td></tr><tr><td></td><td></td><td></td></tr></table>									
1																																																																															
		1																																																																													
1		1																																																																													
2		1																																																																													
1																																																																															
1		1																																																																													
2																																																																															
Post - 0 Miss - 1 Block - 0	Post - 0 Miss - 0 Block - 0	Post - 0 Miss - 0 Block - 0	Post - 0 Miss - 0 Block - 0	Post - 0 Miss - 0 Block - 0	Post - 0 Miss - 0 Block - 0	Post - 0 Miss - 1 Block - 0																																																																									

注释: Post=击柱 Miss=射失 Block=被封



男子 国内比赛

第十二届全国运动会男子手球预赛

Team A										Team B										Match Number									
A 澳门					B 山东					3																			
played in China										in the hall 柳州市李宁体育馆					on 18/04/2013		at 18:00 hours		Spectators										
Half-time (30')		A 7		B 23		End of playing time		A 18		B 48		1st extra time		A		B		2nd extra time		A		B		After penalty		A		B	
Number of 7 m		A 2/4		Team time-out			Full name of players and officials										Team time-out			B 1/1		Number of 7 m							
		1	2	3	08:46	46:53																							
No.	Team A								G	W	2'	D	DR	No.	Team B								G	W	2'	D	DR		
2	李翹臻													1	于性哲														
4	刘家声													4	田瑞														
5	何建成								1					5	潘翔								7		1				
15	黄俊勇								1					6	李朝鹏								4		1				
16	冯国政													8	王炳华								1		1				
18	卓伟杰													9	赵鑫								3	1					
21	麦锦聪								2					11	宋朋强								2	1					
22	陈学敏								2					13	刘晓								4						
24	刘登宇								2	1	1			15	陈鹏波								3		1				
27	徐展业													16	王帅														
28	莫家进										1			17	王旭东								6	1					
29	叶响俊								1	1				18	于亚男								2		1				
33	欧永健								4					19	李语庆								12						
36	陈嘉聪													20	杜在超								1						
81	梁梓康								1		1			21	翟乾坤								3						
93	罗咪高								4					22	刘正松														
A	卢永明													A	王鸿斌														
B	高光明													B	王志峰														
C	黄宇豪													C	邢建刚														
														D	徐强														
A	Signature of Responsible Official of the Teams (Off. A)										Signature of Responsible Official of the Teams (Off. B)																		
TP	Remarks of Referee / CHA Official										TP																		

Signatures

Referees	李典 (CHN)	倪震 (CHN)		
Techn. Delegates	许宜扬 (CHN)	刘书勇 (CHN)		
CHA Official				

Note: Number of 7m Throws Awarded to Team A and B, Goals (G), Warnings (W), Suspensions (2), Direct Disqualification (D), Disqualification with Report (DR) and Team Penalty (TP).





第十二届全国运动会男子手球预赛
竞赛技术统计(媒体表)

Table with match details: 预赛, 组别 A, 轮次 1, 场次 3

柳州市李宁体育馆

18/04/2013

201301003-51-1/1

Match score table: 澳门 18 vs 48 山东, 7:23

Referee table: 裁判员 李典 (CHN) / 倪震 (CHN)

Main statistics table for Macao team, including player names, goals, assists, and percentages.

Main statistics table for Shandong team, including player names, goals, assists, and percentages.

Match progression table (比赛进程) showing time intervals and player actions.

场上队员: 得分 / 射门

守门员: 救球 / 射门

Legend table for abbreviations: 快攻, 警告, 突破, 任意球, 7m球, 助攻





第十二届全国运动会男子手球预赛 图式比赛技术统计表

轮次 1

场次 3

201301003-21-1/1

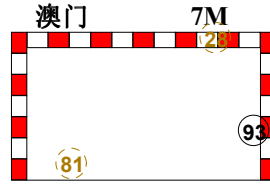
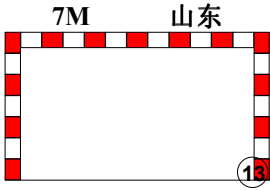
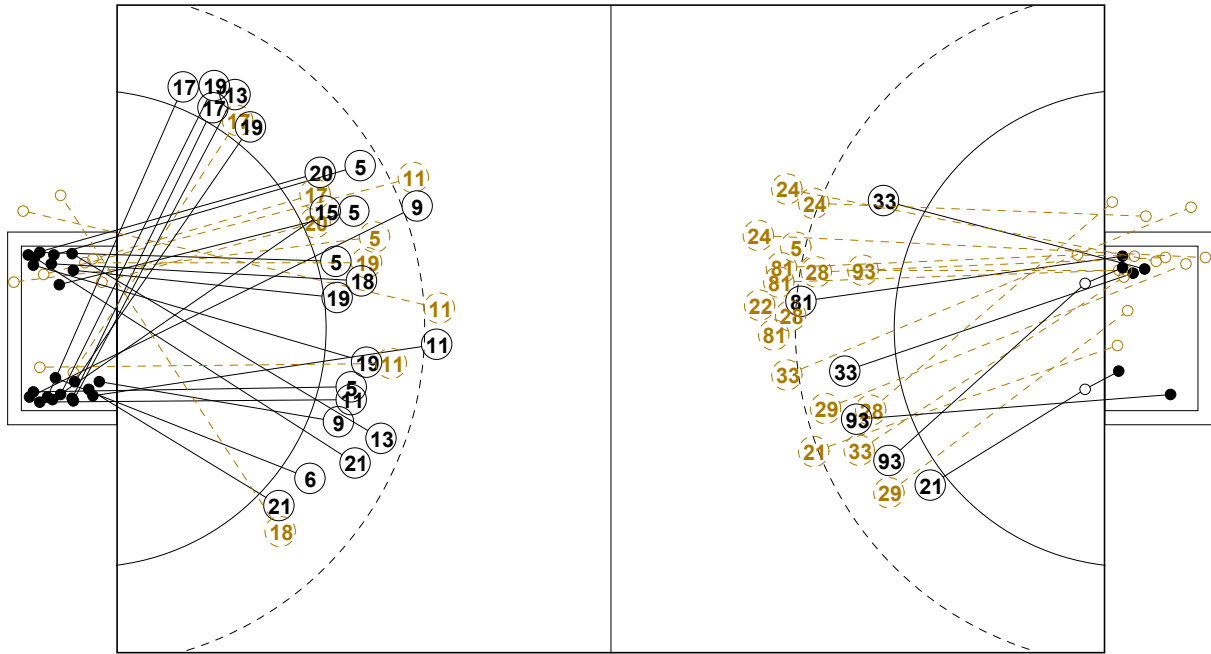

1st Half
23 : 7

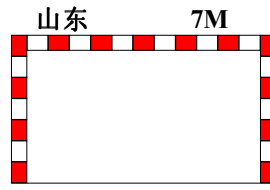
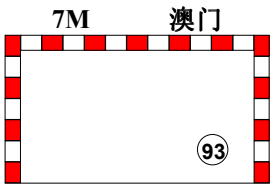
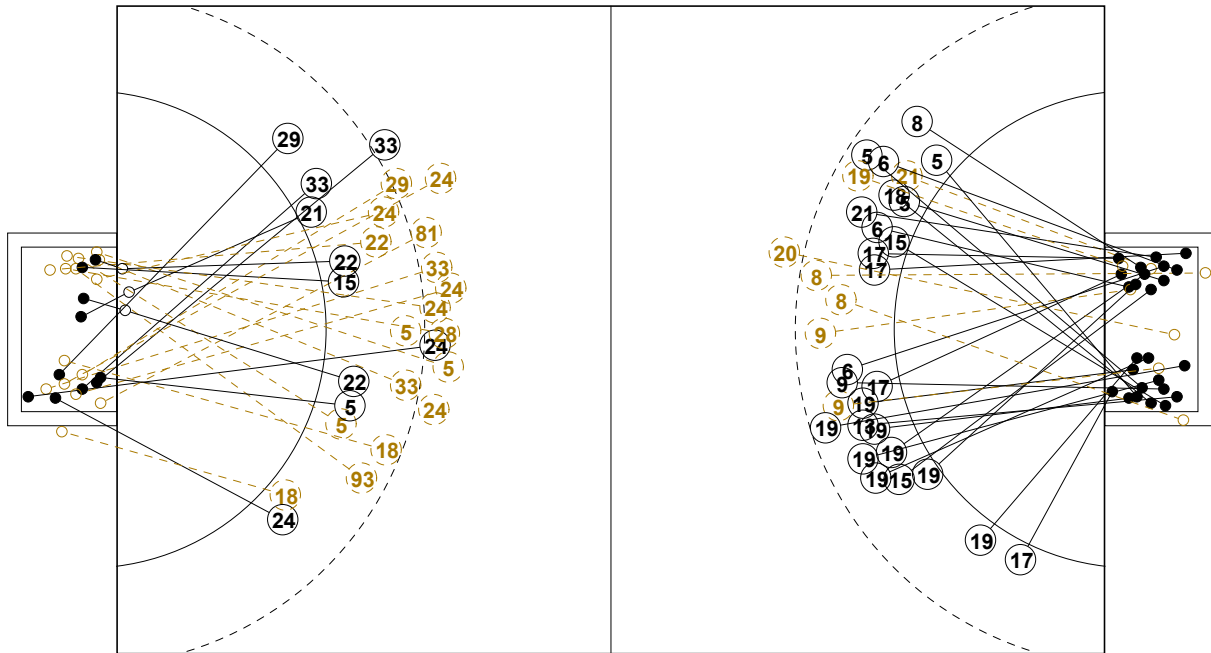

2nd Half
18 : 48



第十二届全国运动会男子手球预赛

个人/全队技术统计表

正式表
手球
男子预赛
轮次 1组别 A
场次 3201301003-14-1/2
柳州市李宁体院馆
18/04/2013 18:00

号码	姓名	远射	近射	边射	快攻	突破	任意	7M	合计	%	助攻	失误	警告	2'	取消	时间
澳门(澳门)																
<i>(场上队员)</i>																
2	李翹臻									0.0%						00:00:00
4	刘家声									0.0%		2				00:08:25
5	何建成	0/3			0/1	1/1			1/5	20.0%		2				00:19:57
15	黄俊勇		1/1						1/1	100%		1				00:22:08
16	冯国政									0.0%						01:00:00
18	卓伟杰	0/1				0/1			0/2	0.0%						00:30:42
21	麦锦聪		2/2		0/1				2/3	66.7%						00:10:52
22	陈学敏	0/1	0/1		2/2				2/4	50.0%		3				00:17:17
24	刘登宇	1/8	1/1				0/1		2/10	20.0%		6	1	1		00:45:14
27	徐展业									0.0%						00:00:00
28	莫家进	0/2	0/1				0/1	0/1	0/5	0.0%		3		1		00:27:15
29	叶响俊	0/2	1/2						1/4	25.0%		1	1			00:45:57
33	欧永健	1/3	1/2		0/1	2/2			4/8	50.0%	1	3				00:39:42
36	陈嘉聪									0.0%						00:00:00
81	梁梓康	1/5						0/1	1/6	16.7%		5		1		00:39:56
93	罗咪高	0/1	0/1			2/2		2/2	4/6	66.7%		4				00:48:37
合计		3/26	6/11		2/5	5/6	0/2	2/4	18/54	33.3%	1	30	2	3		
<i>(守门员)</i>																
16	冯国政	3/7	3/16	1/7	3/26	0/1	1/1	0/1	11/59	18.6%						01:00:00
合计		3/7	3/16	1/7	3/26	0/1	1/1	0/1	11/59	18.6%						

场上队员：得分/射门

守门员：救球/射门

全队合计	得分	被救	射失	击柱	封球	合计	%
远射	3	14	2	1	6	26	11.5%
近射	6	4	1			11	54.5%
边射							0.0%
快攻	2	3				5	40.0%
突破	5		1			6	83.3%
任意		2				2	0.0%
7M	2	1		1		4	50.0%





第十二届全国运动会男子手球预赛

个人/全队技术统计表

正式表
手球
男子预赛
轮次 1组别 A
场次 3201301003-14-2/2
柳州市李宁体院馆
18/04/2013 18:00

号码	姓名	远射	近射	边射	快攻	突破	任意	7M	合计	%	助攻	失误	警告	2'	取消	时间
山东(山东)																
<i>(上场队员)</i>																
1	于性哲									0.0%						00:18:09
4	田瑞									0.0%						00:00:00
5	潘翔	1/1	3/4		3/3				7/8	87.5%	1	2		1		00:44:36
6	李朝鹏		2/2		2/2				4/4	100%		2		1		00:23:15
8	王炳华	0/1			1/2				1/3	33.3%	1	1		1		00:06:55
9	赵鑫	1/2	1/2		1/1				3/5	60.0%				1		00:37:44
11	宋朋强	0/1	0/1		2/3				2/5	40.0%	2			1		00:30:00
13	刘晓	1/1		1/1	1/1			1/1	4/4	100%						00:00:00
15	陈鹏波		3/3						3/3	100%				1		00:18:54
16	王帅									0.0%	1	1				00:20:32
17	王旭东			2/3	3/4	1/1			6/8	75.0%		2		1		00:30:30
18	于亚男				2/3				2/3	66.7%	1	1		1		00:26:43
19	李语庆	1/2	2/2	3/3	6/7				12/14	85.7%	1	3				00:28:11
20	杜在超		0/1		1/1		0/1		1/3	33.3%	1	5				00:49:27
21	翟乾坤		2/2		1/2				3/4	75.0%	2					01:00:00
22	刘正松									0.0%						00:21:19
合计		4/8	13/17	6/7	23/29	1/1	0/1	1/1	48/64	75.0%	10	17	3	5		
<i>(守门员)</i>																
1	于性哲	5/5	3/4		0/2	0/2	1/1	1/3	10/17	58.8%						00:18:09
16	王帅	6/8	0/3		2/2	0/1	1/1		9/15	60.0%	1	1				00:20:32
22	刘正松	3/4	1/3		1/1	0/2			5/10	50.0%						00:21:19
合计		14/17	4/10		3/5	0/5	2/2	1/3	24/42	57.1%	1	1				

场上队员：得分/射门

守门员：救球/射门

全队合计	得分	被救	射失	击柱	封球	合计	%
远射	4	3		1		8	50.0%
近射	13	3		1		17	76.5%
边射	6	1				7	85.7%
快攻	23	3	2	1		29	79.3%
突破	1					1	100.0%
任意		1				1	0.0%
7M	1					1	100.0%





第十二届全国运动会男子手球预赛

图式射门区域统计

轮次 1 场次 3

201301003-41-1/1

澳门

2 李翹臻	4 刘家声	5 何建成	15 黄俊勇	16 冯国政	18 卓伟杰	21 麦锦聪	22 陈学敏																																																																								
<table border="1"><tr><td></td><td></td><td></td></tr><tr><td></td><td></td><td></td></tr><tr><td></td><td></td><td></td></tr></table>										<table border="1"><tr><td></td><td></td><td></td></tr><tr><td></td><td></td><td></td></tr><tr><td></td><td></td><td></td></tr></table>										<table border="1"><tr><td></td><td></td><td></td></tr><tr><td></td><td></td><td></td></tr><tr><td>1</td><td></td><td></td></tr></table>							1			<table border="1"><tr><td></td><td></td><td>1</td></tr><tr><td></td><td></td><td></td></tr><tr><td></td><td></td><td></td></tr></table>			1							<table border="1"><tr><td></td><td></td><td></td></tr><tr><td></td><td></td><td></td></tr><tr><td></td><td></td><td></td></tr></table>										<table border="1"><tr><td></td><td></td><td></td></tr><tr><td></td><td></td><td></td></tr><tr><td></td><td></td><td></td></tr></table>										<table border="1"><tr><td></td><td></td><td>1</td></tr><tr><td></td><td></td><td></td></tr><tr><td></td><td></td><td>1</td></tr></table>			1						1	<table border="1"><tr><td></td><td></td><td>1</td></tr><tr><td></td><td></td><td></td></tr><tr><td></td><td></td><td>1</td></tr></table>			1						1
1																																																																															
		1																																																																													
		1																																																																													
		1																																																																													
		1																																																																													
		1																																																																													
Post - 0 Miss - 0 Block - 0	Post - 0 Miss - 0 Block - 0	Post - 0 Miss - 0 Block - 2	Post - 0 Miss - 0 Block - 0	Post - 0 Miss - 0 Block - 0	Post - 0 Miss - 1 Block - 0	Post - 0 Miss - 0 Block - 0	Post - 0 Miss - 0 Block - 1																																																																								
24 刘登宇	27 徐展业	28 莫家进	29 叶响俊	33 欧永健	36 陈嘉聪	81 梁梓康	93 罗味高																																																																								
<table border="1"><tr><td>1</td><td></td><td></td></tr><tr><td>1</td><td></td><td></td></tr><tr><td></td><td></td><td></td></tr></table>	1			1						<table border="1"><tr><td></td><td></td><td></td></tr><tr><td></td><td></td><td></td></tr><tr><td></td><td></td><td></td></tr></table>										<table border="1"><tr><td></td><td></td><td></td></tr><tr><td></td><td></td><td></td></tr><tr><td></td><td></td><td></td></tr></table>										<table border="1"><tr><td></td><td></td><td>1</td></tr><tr><td></td><td></td><td></td></tr><tr><td></td><td></td><td></td></tr></table>			1							<table border="1"><tr><td></td><td></td><td>2</td></tr><tr><td></td><td></td><td></td></tr><tr><td>2</td><td></td><td></td></tr></table>			2				2			<table border="1"><tr><td></td><td></td><td></td></tr><tr><td></td><td></td><td></td></tr><tr><td></td><td></td><td></td></tr></table>										<table border="1"><tr><td></td><td></td><td>1</td></tr><tr><td></td><td></td><td></td></tr><tr><td></td><td></td><td></td></tr></table>			1							<table border="1"><tr><td></td><td></td><td>1</td></tr><tr><td></td><td></td><td></td></tr><tr><td>1</td><td></td><td>1</td></tr></table>			1				1		1
1																																																																															
1																																																																															
		1																																																																													
		2																																																																													
2																																																																															
		1																																																																													
		1																																																																													
1		1																																																																													
Post - 1 Miss - 1 Block - 1	Post - 0 Miss - 0 Block - 0	Post - 1 Miss - 1 Block - 1	Post - 0 Miss - 0 Block - 0	Post - 0 Miss - 1 Block - 0	Post - 0 Miss - 0 Block - 0	Post - 0 Miss - 0 Block - 1	Post - 0 Miss - 0 Block - 0																																																																								

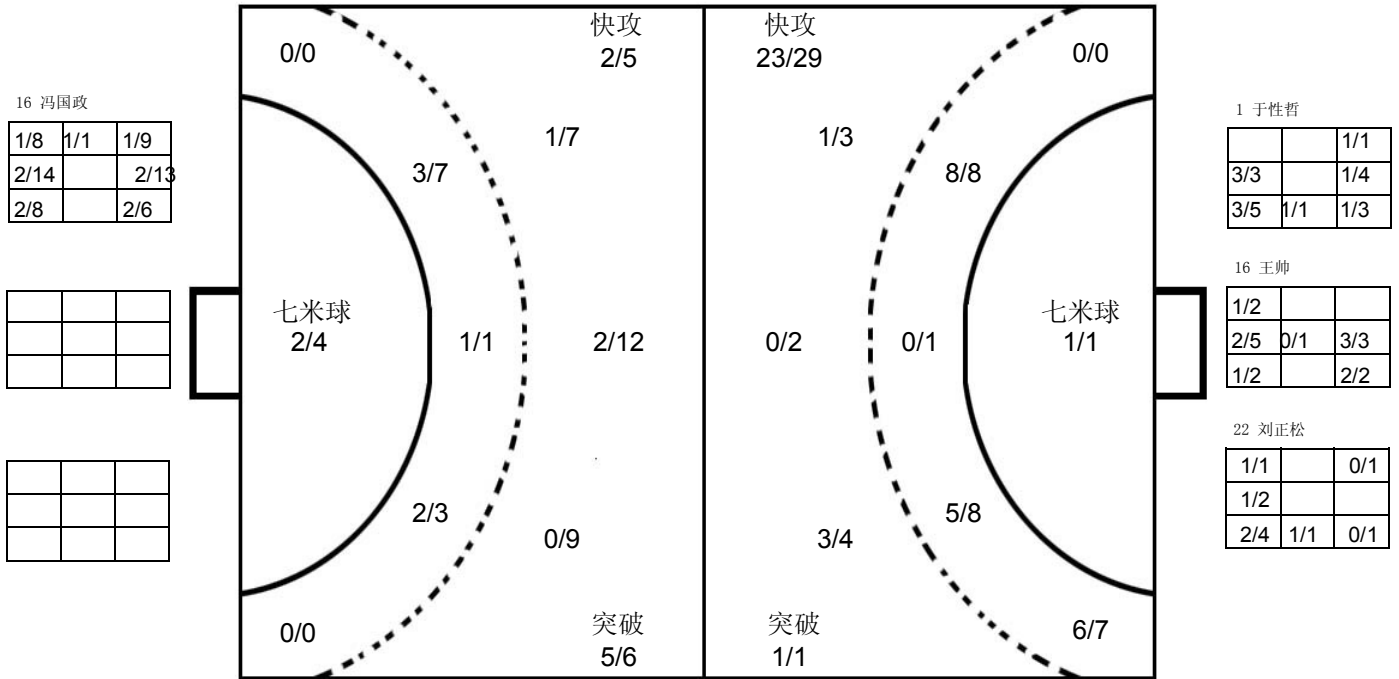

山东

1 于性哲	4 田瑞	5 潘翔	6 李朝鹏	8 王炳华	9 赵鑫	11 宋朋强	13 刘晓																																																																								
<table border="1"><tr><td></td><td></td><td></td></tr><tr><td></td><td></td><td></td></tr><tr><td></td><td></td><td></td></tr></table>										<table border="1"><tr><td></td><td></td><td></td></tr><tr><td></td><td></td><td></td></tr><tr><td></td><td></td><td></td></tr></table>										<table border="1"><tr><td>1</td><td></td><td>2</td></tr><tr><td>1</td><td></td><td>3</td></tr><tr><td></td><td></td><td></td></tr></table>	1		2	1		3				<table border="1"><tr><td>1</td><td></td><td></td></tr><tr><td>2</td><td></td><td></td></tr><tr><td>1</td><td></td><td></td></tr></table>	1			2			1			<table border="1"><tr><td>1</td><td></td><td></td></tr><tr><td></td><td></td><td></td></tr><tr><td></td><td></td><td></td></tr></table>	1									<table border="1"><tr><td>1</td><td></td><td></td></tr><tr><td></td><td></td><td>1</td></tr><tr><td>1</td><td></td><td></td></tr></table>	1					1	1			<table border="1"><tr><td>1</td><td></td><td></td></tr><tr><td></td><td></td><td></td></tr><tr><td>1</td><td></td><td></td></tr></table>	1						1			<table border="1"><tr><td></td><td></td><td>1</td></tr><tr><td>1</td><td></td><td></td></tr><tr><td></td><td></td><td></td></tr></table>			1	1					
1		2																																																																													
1		3																																																																													
1																																																																															
2																																																																															
1																																																																															
1																																																																															
1																																																																															
		1																																																																													
1																																																																															
1																																																																															
1																																																																															
		1																																																																													
1																																																																															
Post - 0 Miss - 0 Block - 0	Post - 0 Miss - 0 Block - 0	Post - 1 Miss - 0 Block - 0	Post - 0 Miss - 0 Block - 0	Post - 2 Miss - 0 Block - 0	Post - 0 Miss - 0 Block - 0	Post - 0 Miss - 1 Block - 0	Post - 0 Miss - 0 Block - 0																																																																								
15 陈鹏波	16 王帅	17 王旭东	18 于亚男	19 李语庆	20 杜在超	21 翟乾坤	22 刘正松																																																																								
<table border="1"><tr><td>1</td><td></td><td></td></tr><tr><td>1</td><td></td><td>1</td></tr><tr><td></td><td></td><td></td></tr></table>	1			1		1				<table border="1"><tr><td></td><td></td><td></td></tr><tr><td></td><td></td><td></td></tr><tr><td></td><td></td><td></td></tr></table>										<table border="1"><tr><td>2</td><td></td><td></td></tr><tr><td>1</td><td></td><td></td></tr><tr><td>2</td><td></td><td>1</td></tr></table>	2			1			2		1	<table border="1"><tr><td></td><td></td><td>1</td></tr><tr><td></td><td></td><td>1</td></tr><tr><td></td><td></td><td></td></tr></table>			1			1				<table border="1"><tr><td></td><td></td><td>2</td></tr><tr><td>4</td><td></td><td>4</td></tr><tr><td></td><td></td><td>2</td></tr></table>			2	4		4			2	<table border="1"><tr><td></td><td></td><td>1</td></tr><tr><td></td><td></td><td></td></tr><tr><td></td><td></td><td></td></tr></table>			1							<table border="1"><tr><td></td><td></td><td>1</td></tr><tr><td>1</td><td></td><td></td></tr><tr><td>1</td><td></td><td></td></tr></table>			1	1			1			<table border="1"><tr><td></td><td></td><td></td></tr><tr><td></td><td></td><td></td></tr><tr><td></td><td></td><td></td></tr></table>									
1																																																																															
1		1																																																																													
2																																																																															
1																																																																															
2		1																																																																													
		1																																																																													
		1																																																																													
		2																																																																													
4		4																																																																													
		2																																																																													
		1																																																																													
		1																																																																													
1																																																																															
1																																																																															
Post - 0 Miss - 0 Block - 0	Post - 0 Miss - 0 Block - 0	Post - 0 Miss - 0 Block - 0	Post - 0 Miss - 1 Block - 0	Post - 0 Miss - 0 Block - 0	Post - 0 Miss - 0 Block - 0	Post - 0 Miss - 0 Block - 0	Post - 0 Miss - 0 Block - 0																																																																								

注释: Post=击柱 Miss=射失 Block=被封





男子 国内比赛

第十二届全国运动会男子手球预赛

Team A										Team B										Match Number											
A 江苏					B 香港					4																					
played in China										in the hall 柳州市李宁体育馆										on 19/04/2013		at 13:00 hours		Spectators							
Half-time (30')		A 20		B 10		End of playing time		A 36		B 20		1st extra time		A		B		2nd extra time		A		B		After penalty throws		A		B			
Number of 7 m		A 1/2		Team time-out			Full name of players and officials										Team time-out			B 1/1		Number of 7 m									
		1	2	3	08:46	47:15																									
No.	Team A										G	W	2'	D	DR	No.	Team B										G	W	2'	D	DR
1	丁大伟															1	萧智庭														
2	杨彦威															2	叶冠英														
3	李旭东															5	黄胜业										3				
4	沈庆															6	谢伟希										1				
5	闫亮										2					7	许文邦										3				
6	赵晨										6	1				9	张建国										2				
8	周小坚										4					10	陈国兴														
9	叶强										2					11	陈允文														
10	郝可鑫										2					12	叶冠雄										2				
11	姚仁剑															13	叶仕仁										3				
12	王权															14	李鑫豪														
14	丛海航										4					15	黄嘉愉										1	1			
15	李安										7					25	曾铭谦										3				
17	陈灵峰										5	1				29	练明辉										2				
19	张志宇										4		1																		
20	张星																														
A	闫威名															A	陈广裕														
C	NENADz vonarek															B	杨开捋														
D	王建国															D	张军														
E	贾淑君																														
A										Signature of Responsible Official of the Teams (Off. A)										B											
TP	Remarks of Referee / CHA Official																				TP										

Signatures

Referees	朱昆宏 (CHN)	刘建鹏 (CHN)		
Techn. Delegates	李之文 (CHN)	王锡祯 (CHN)		
CHA Official				

Note: Number of 7m Throws Awarded to Team A and B, Goals (G), Warnings (W), Suspensions (2'), Direct Disqualification (D), Disqualification with Report (DR) and Team Penalty (TP).

Table Officials:

Statisticians: 黄莉

朱伟平





第十二届全国运动会男子手球预赛
竞赛技术统计(媒体表)

预赛 组别 A 轮次 2 场次 4

柳州市李宁体育馆

19/04/2013

201301004-51-1/1

江苏 江苏 36 vs 20 香港 香港 20:10

裁判员 朱昆宏 (CHN) / 刘建鹏 (CHN)

Main statistics table for Jiangsu vs Hong Kong, including player names, goals, assists, and penalties.

场上队员: 得分 / 射门

守门员: 救球 / 射门

Summary table for Fast Break, Breakthrough, Free Throw, 7m Throw, Assist, Warning, Error, 2', Suspension, D, and DR.





第十二届全国运动会男子手球预赛 图式比赛技术统计表

轮次 2

场次 4

201301004-21-1/1

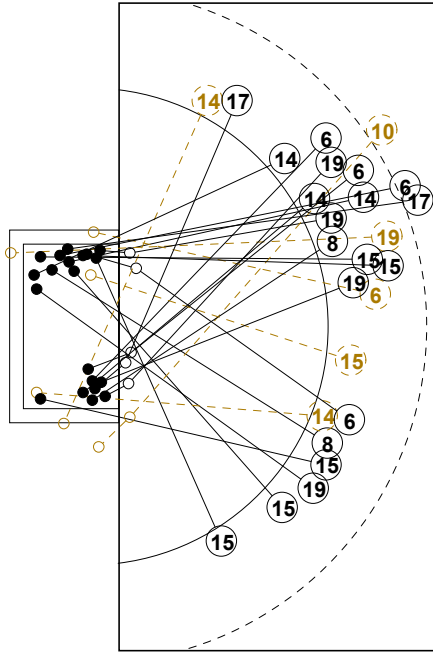

7M 江苏

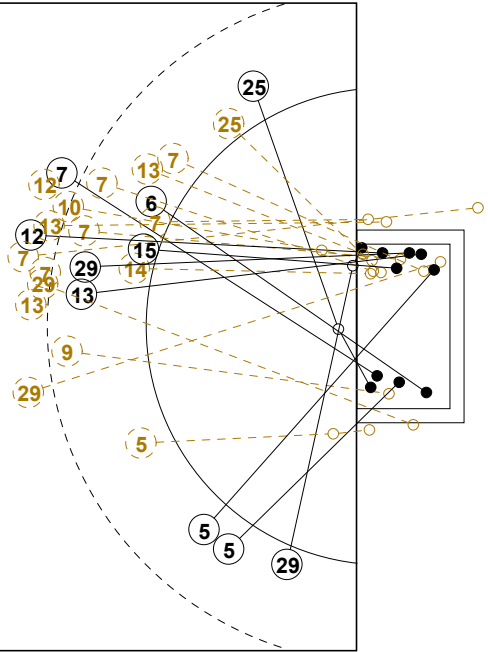
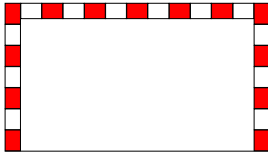

香港 7M

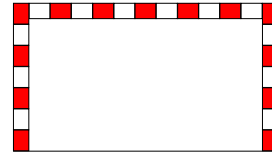

1st Half
20 : 10

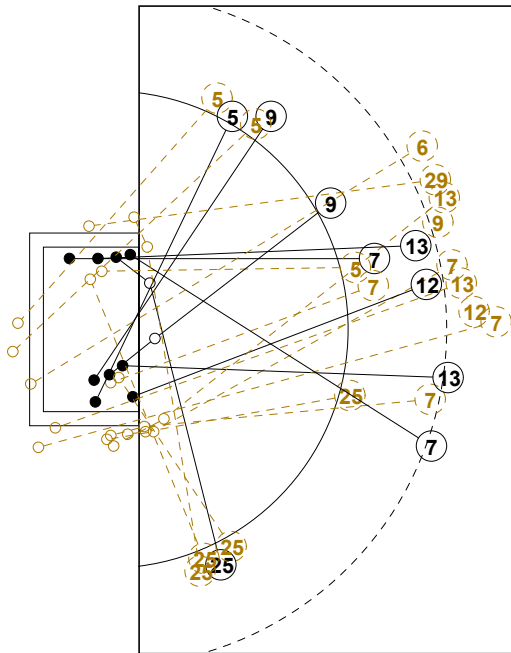

7M 香港

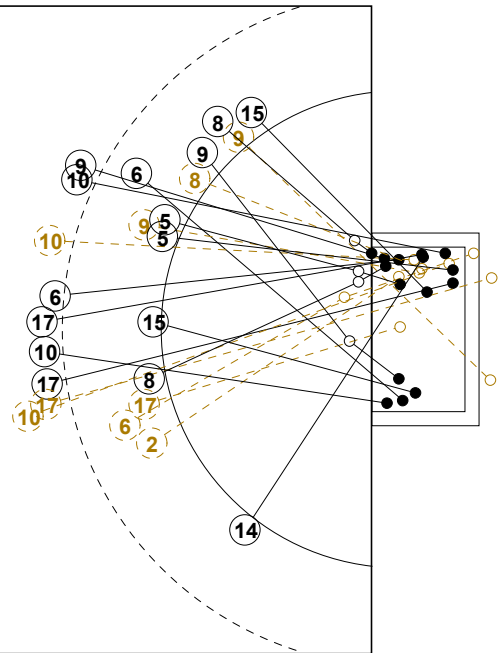
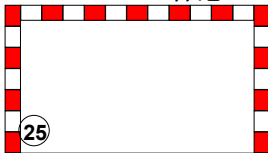

江苏 7M

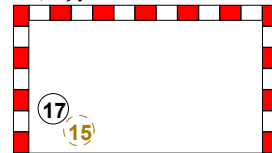

2nd Half
20 : 36



第十二届全国运动会男子手球预赛

个人/全队技术统计表

正式表
手球
男子预赛
轮次 2组别 A
场次 4201301004-14-1/2
柳州市李宁体院馆
19/04/2013 13:00

号码	姓名	远射	近射	边射	快攻	突破	任意	7M	合计	%	助攻	失误	警告	2'	取消	时间
江苏(江苏)																
<i>(场上队员)</i>																
1	丁大伟									0.0%	1					00:33:59
2	杨彦威				0/1				0/1	0.0%						00:18:00
3	李旭东									0.0%						00:00:00
4	沈庆									0.0%						00:17:14
5	闫亮		2/2						2/2	100%	1	3				00:19:52
6	赵晨	2/2	0/1		1/1	3/4			6/8	75.0%	4	2	1			00:41:07
8	周小坚		2/3	1/1		1/1			4/5	80.0%	1	3				00:41:59
9	叶强		0/1			1/2	1/1		2/4	50.0%		2				00:17:27
10	郝可鑫	2/4			0/1				2/5	40.0%	3	1				00:50:02
11	姚仁剑									0.0%						00:00:00
12	王权									0.0%						00:26:01
14	丛海航		1/2	1/2	1/1	1/1			4/6	66.7%		2				00:46:30
15	李安		2/2	2/2	3/4			0/1	7/9	77.8%		1				00:42:21
17	陈灵峰	2/3		1/1	1/2			1/1	5/7	71.4%		3	1			00:22:44
19	张志宇	0/1	1/1			3/3			4/5	80.0%	2	2		1		00:41:53
20	张星									0.0%						00:00:00
合计		6/10	8/12	5/6	6/10	9/11	1/1	1/2	36/52	69.2%	12	19	2	1		
<i>(守门员)</i>																
1	丁大伟	3/5	1/3	3/5	0/1	2/4			9/18	50.0%	1					00:33:59
12	王权	2/6		0/3	2/5			0/1	4/15	26.7%						00:26:01
合计		5/11	1/3	3/8	2/6	2/4		0/1	13/33	39.4%	1					

场上队员：得分/射门

守门员：救球/射门

全队合计	得分	被救	射失	击柱	封球	合计	%
远射	6	1	2	1		10	60.0%
近射	8	3		1		12	66.7%
边射	5			1		6	83.3%
快攻	6	4				10	60.0%
突破	9		1	1		11	81.8%
任意	1					1	100.0%
7M	1	1				2	50.0%





第十二届全国运动会男子手球预赛

个人/全队技术统计表

正式表
手球
男子预赛
轮次 2组别 A
场次 4201301004-14-2/2
柳州市李宁体院馆
19/04/2013 13:00

号码	姓名	远射	近射	边射	快攻	突破	任意	7M	合计	%	助攻	失误	警告	2'	取消	时间
香港(香港)																
<i>(上场队员)</i>																
1	萧智庭									0.0%						00:38:10
2	叶冠英									0.0%						00:21:50
5	黄胜业			2/4	1/3				3/7	42.9%	1					00:53:30
6	谢伟希	0/1	1/1						1/2	50.0%						00:24:04
7	许文邦	2/9	0/1		1/2	0/1			3/13	23.1%	2	2				00:30:51
9	张建国	0/2			2/2				2/4	50.0%		4				00:33:09
10	陈国兴	0/1							0/1	0.0%	2	2				00:24:26
11	陈允文									0.0%						00:00:00
12	叶冠雄	2/4							2/4	50.0%	1					00:23:07
13	叶仕仁	2/6				1/2			3/8	37.5%	2	3				00:41:00
14	李鑫豪		0/1						0/1	0.0%		2				00:26:25
15	黄嘉榆		1/1						1/1	100%			1			00:16:15
25	曾铭谦			2/6	0/1			1/1	3/8	37.5%						01:00:00
29	练明辉	0/3		1/1		1/1			2/5	40.0%		2				00:28:19
合计		6/26	2/4	5/11	4/8	2/4		1/1	20/54	37.0%	8	15	1			
<i>(守门员)</i>																
1	萧智庭	0/3	2/7	0/4	2/6	0/5			4/25	16.0%						00:38:10
2	叶冠英	1/4	1/4	0/1	2/4	0/4	0/1	1/2	5/20	25.0%						00:21:50
合计		1/7	3/11	0/5	4/10	0/9	0/1	1/2	9/45	20.0%						

场上队员：得分/射门

守门员：救球/射门

全队合计	得分	被救	射失	击柱	封球	合计	%
远射	6	5	7	3	5	26	23.1%
近射	2	1	1			4	50.0%
边射	5	3	3			11	45.5%
快攻	4	2	2			8	50.0%
突破	2	2				4	50.0%
任意							0.0%
7M	1					1	100.0%





第十二届全国运动会男子手球预赛

图式射门区域统计

轮次 2 场次 4

201301004-41-1/1

江苏

1 丁大伟	2 杨彦威	3 李旭东	4 沈庆	5 闫亮	6 赵晨	8 周小坚	9 叶强																																																																								
<table border="1"><tr><td></td><td></td><td></td></tr><tr><td></td><td></td><td></td></tr><tr><td></td><td></td><td></td></tr></table>										<table border="1"><tr><td></td><td></td><td></td></tr><tr><td></td><td></td><td></td></tr><tr><td></td><td></td><td></td></tr></table>										<table border="1"><tr><td></td><td></td><td></td></tr><tr><td></td><td></td><td></td></tr><tr><td></td><td></td><td></td></tr></table>										<table border="1"><tr><td></td><td></td><td></td></tr><tr><td></td><td></td><td></td></tr><tr><td></td><td></td><td></td></tr></table>										<table border="1"><tr><td>1</td><td></td><td></td></tr><tr><td></td><td></td><td></td></tr><tr><td>1</td><td></td><td></td></tr></table>	1						1			<table border="1"><tr><td></td><td></td><td></td></tr><tr><td></td><td></td><td>3</td></tr><tr><td>3</td><td></td><td></td></tr></table>						3	3			<table border="1"><tr><td></td><td></td><td>1</td></tr><tr><td></td><td></td><td></td></tr><tr><td>3</td><td></td><td></td></tr></table>			1				3			<table border="1"><tr><td></td><td></td><td></td></tr><tr><td></td><td></td><td></td></tr><tr><td>1</td><td></td><td>1</td></tr></table>							1		1
1																																																																															
1																																																																															
		3																																																																													
3																																																																															
		1																																																																													
3																																																																															
1		1																																																																													
Post - 0 Miss - 0 Block - 0	Post - 0 Miss - 0 Block - 0	Post - 0 Miss - 0 Block - 0	Post - 0 Miss - 0 Block - 0	Post - 0 Miss - 0 Block - 0	Post - 2 Miss - 0 Block - 0	Post - 0 Miss - 0 Block - 0	Post - 0 Miss - 1 Block - 0																																																																								
10 郝可鑫	11 姚仁剑	12 王权	14 丛海航	15 李安	17 陈灵峰	19 张志宇	20 张星																																																																								
<table border="1"><tr><td>1</td><td></td><td></td></tr><tr><td></td><td></td><td></td></tr><tr><td></td><td></td><td>1</td></tr></table>	1								1	<table border="1"><tr><td></td><td></td><td></td></tr><tr><td></td><td></td><td></td></tr><tr><td></td><td></td><td></td></tr></table>										<table border="1"><tr><td></td><td></td><td></td></tr><tr><td></td><td></td><td></td></tr><tr><td></td><td></td><td></td></tr></table>										<table border="1"><tr><td></td><td></td><td>1</td></tr><tr><td>2</td><td></td><td>1</td></tr><tr><td></td><td></td><td></td></tr></table>			1	2		1				<table border="1"><tr><td>1</td><td></td><td>1</td></tr><tr><td>1</td><td></td><td>3</td></tr><tr><td></td><td></td><td>1</td></tr></table>	1		1	1		3			1	<table border="1"><tr><td>1</td><td></td><td></td></tr><tr><td>2</td><td></td><td>1</td></tr><tr><td>1</td><td></td><td></td></tr></table>	1			2		1	1			<table border="1"><tr><td></td><td></td><td>1</td></tr><tr><td></td><td></td><td></td></tr><tr><td>2</td><td></td><td>1</td></tr></table>			1				2		1	<table border="1"><tr><td></td><td></td><td></td></tr><tr><td></td><td></td><td></td></tr><tr><td></td><td></td><td></td></tr></table>									
1																																																																															
		1																																																																													
		1																																																																													
2		1																																																																													
1		1																																																																													
1		3																																																																													
		1																																																																													
1																																																																															
2		1																																																																													
1																																																																															
		1																																																																													
2		1																																																																													
Post - 0 Miss - 1 Block - 0	Post - 0 Miss - 0 Block - 0	Post - 0 Miss - 0 Block - 0	Post - 1 Miss - 0 Block - 0	Post - 0 Miss - 0 Block - 0	Post - 0 Miss - 1 Block - 0	Post - 1 Miss - 0 Block - 0	Post - 0 Miss - 0 Block - 0																																																																								

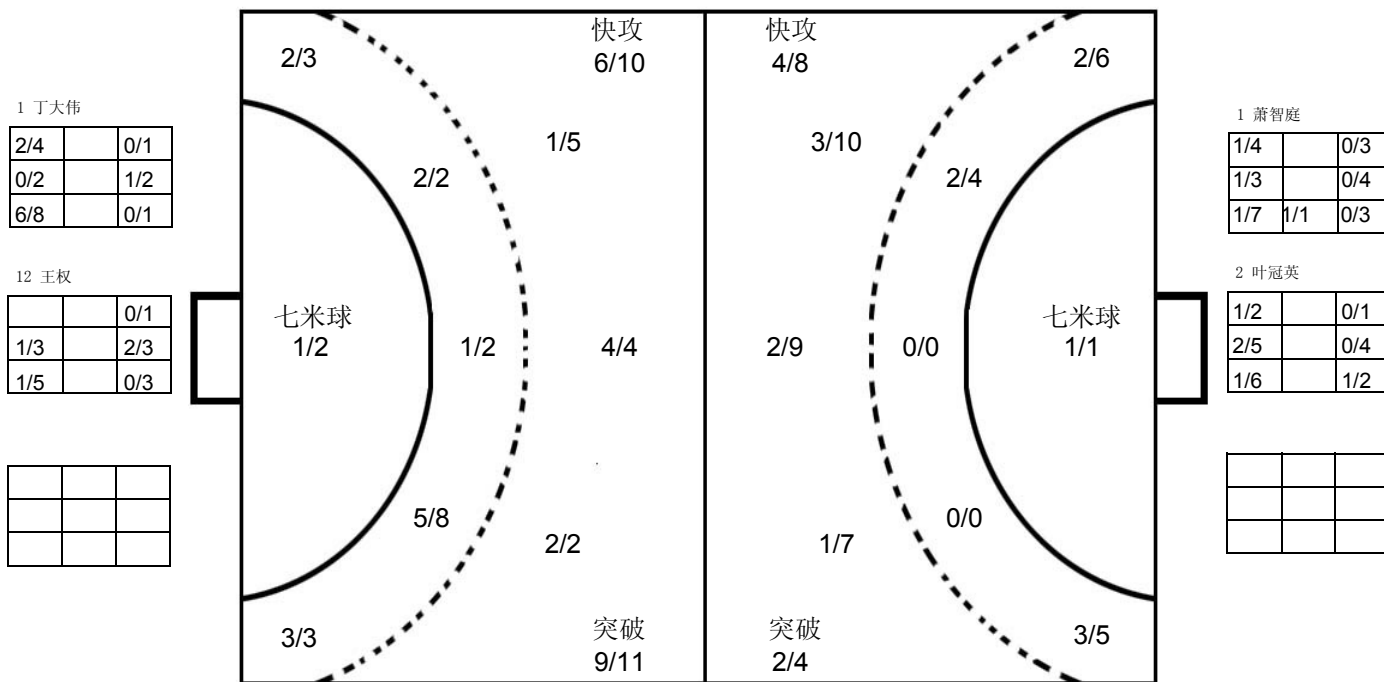

香港

1 萧智庭	2 叶冠英	5 黄胜业	6 谢伟希	7 许文邦	9 张建国	10 陈国兴	11 陈允文																																																																								
<table border="1"><tr><td></td><td></td><td></td></tr><tr><td></td><td></td><td></td></tr><tr><td></td><td></td><td></td></tr></table>										<table border="1"><tr><td></td><td></td><td></td></tr><tr><td></td><td></td><td></td></tr><tr><td></td><td></td><td></td></tr></table>										<table border="1"><tr><td>1</td><td></td><td></td></tr><tr><td>1</td><td></td><td>1</td></tr><tr><td></td><td></td><td></td></tr></table>	1			1		1				<table border="1"><tr><td></td><td></td><td>1</td></tr><tr><td></td><td></td><td></td></tr><tr><td></td><td></td><td></td></tr></table>			1							<table border="1"><tr><td></td><td></td><td>1</td></tr><tr><td></td><td></td><td></td></tr><tr><td></td><td></td><td>2</td></tr></table>			1						2	<table border="1"><tr><td></td><td></td><td></td></tr><tr><td>1</td><td></td><td></td></tr><tr><td>1</td><td></td><td></td></tr></table>				1			1			<table border="1"><tr><td></td><td></td><td></td></tr><tr><td></td><td></td><td></td></tr><tr><td></td><td></td><td></td></tr></table>										<table border="1"><tr><td></td><td></td><td></td></tr><tr><td></td><td></td><td></td></tr><tr><td></td><td></td><td></td></tr></table>									
1																																																																															
1		1																																																																													
		1																																																																													
		1																																																																													
		2																																																																													
1																																																																															
1																																																																															
Post - 0 Miss - 0 Block - 0	Post - 0 Miss - 0 Block - 0	Post - 0 Miss - 3 Block - 0	Post - 1 Miss - 0 Block - 0	Post - 0 Miss - 5 Block - 1	Post - 0 Miss - 0 Block - 1	Post - 0 Miss - 0 Block - 0	Post - 0 Miss - 0 Block - 0																																																																								
12 叶冠雄	13 叶仕仁	14 李鑫豪	15 黄嘉愉	25 曾铭谦	29 练明辉																																																																										
<table border="1"><tr><td></td><td></td><td></td></tr><tr><td></td><td></td><td></td></tr><tr><td>2</td><td></td><td></td></tr></table>							2			<table border="1"><tr><td></td><td>1</td><td></td></tr><tr><td></td><td></td><td>1</td></tr><tr><td>1</td><td></td><td></td></tr></table>		1				1	1			<table border="1"><tr><td></td><td></td><td></td></tr><tr><td></td><td></td><td></td></tr><tr><td></td><td></td><td></td></tr></table>										<table border="1"><tr><td></td><td></td><td></td></tr><tr><td>1</td><td></td><td></td></tr><tr><td></td><td></td><td></td></tr></table>				1						<table border="1"><tr><td></td><td></td><td></td></tr><tr><td></td><td></td><td></td></tr><tr><td>1</td><td></td><td>2</td></tr></table>							1		2	<table border="1"><tr><td></td><td></td><td></td></tr><tr><td>1</td><td></td><td></td></tr><tr><td>1</td><td></td><td></td></tr></table>				1			1			<table border="1"><tr><td></td><td></td><td></td></tr><tr><td></td><td></td><td></td></tr><tr><td></td><td></td><td></td></tr></table>										<table border="1"><tr><td></td><td></td><td></td></tr><tr><td></td><td></td><td></td></tr><tr><td></td><td></td><td></td></tr></table>									
2																																																																															
	1																																																																														
		1																																																																													
1																																																																															
1																																																																															
1		2																																																																													
1																																																																															
1																																																																															
Post - 0 Miss - 0 Block - 2	Post - 1 Miss - 2 Block - 1	Post - 0 Miss - 0 Block - 0	Post - 0 Miss - 0 Block - 0	Post - 0 Miss - 2 Block - 0	Post - 1 Miss - 1 Block - 0																																																																										

注释: Post=击柱 Miss=射失 Block=被封





男子 国内比赛

第十二届全国运动会男子手球预赛

Team A A 北京		Team B B 安徽		Match Number 5							
played in China		in the hall 柳州市李宁体育馆		on 19/04/2013							
				at 14:40 hours							
Spectators											
Half-time (30')	A 11	B 10	End of playing time	A 27	B 21						
			1st extra time	A	B						
			2nd extra time	A	B						
			After penalty throws	A	B						
Number of 7 m	A 3/4	Team time-out		Full name of players and officials							
	1 29:49	2 57:18	3	1 21:06	2 43:09						
				3							
					B 3/5						
					Number of 7 m						
No.	Team A					No.	Team B				
	G	W	2'	D	DR		G	W	2'	D	DR
1						1					
2	2	1	1			2					
4						5	9		1		
5						6					
6	2					7					
7	3	1				8					
8			2			10	1	1			
9	4					11					
11	3	1				12					
13	1					15					
14	1					17	1				
16						18					
17	1		1			28	5	1			
18	8					29	2		1		
20			1			32	3	1			
23	2					33					
A	郑康旭					A	王来黔				
B	蔡建国					B	刘晓蓓				
C	吴健					C	高恒勤				
D	石锋										
A	Signature of Responsible Official of the Teams (Off. A)										B
TP	Remarks of Referee / CHA Official										TP

Signatures

Referees	Andreas Bethmann	Michael Tzaferopoulos		
Techn. Delegates	王锡祯 (CHN)	刘书勇 (CHN)		
CHA Official				

Note: Number of 7m Throws Awarded to Team A and B, Goals (G), Warnings (W), Suspensions (2'), Direct Disqualification (D), Disqualification with Report (DR) and Team Penalty (TP).

Table Officials:

Statisticians: 黄莉

朱伟平





第十二届全国运动会男子手球预赛
竞赛技术统计(媒体表)

预赛	组别	A	轮次	2	场次	5
柳州市李宁体院馆		19/04/2013			201301005-51-1/1	
北京	北京	27	vs	21	安徽	安徽
11 : 10						

裁判员	Andreas Bethmann (GRE)			/	Michael Tzaferopoulos (GRE)		
-----	------------------------	--	--	---	-----------------------------	--	--

北京		远射	近射	边射	快攻	突破	任意球	7m球	合计	%	助攻	失误	警告	2'	D & DR	北京		比赛进程	安徽		
主教练：郑康旭																		1st Half			
1	王澍															11	蒋维一	0	02:57	1	29 顾先亮
2	杜龙飞	1/1	0/1	1/1	0/1				2/4	50.0			1	1		1	蒋维一	1	03:35	1	
4	成亚															18	张骥	2	05:10	1	
5	杨昆															17	姜冰峰	3	06:02	1	
6	刘伟				2/2			2/2	100							3	姜冰峰	3	06:28	2	5 马鹏
7	胡瀛	0/2		1/1		1/1	1/1	3/5	60.0	1	3	1				3	姜冰峰	3	08:10	3	28 袁龙
8	王鹏													2		4	姜冰峰	4	09:24	3	
9	刘振	1/2	1/2		1/3		0/1	1/1	4/9	44.4						7	胡瀛	5	13:19	4	
11	蒋维一		2/3				1/1	3/4	75.0		2	1				7	胡瀛	6	14:54	4	
13	白洁	0/1	0/1					1/1	1/3	33.3		4				9	刘振	7	19:00	4	
14	解建飞		1/1					1/1	100			1				7	胡瀛	7	19:24	5	28 袁龙
16	孟辉										2					18	张骥	8	20:11	5	
17	姜冰峰		1/1	0/1				1/2	50.0	1	1			1		8	张骥	8	21:05	6	5 马鹏
18	张骥	3/8	0/1	1/1	3/3		0/1	1/2	8/16	50.0	1	4				8	张骥	8	23:27	7	29 顾先亮
20	郑永利						0/1	0/1	0.0	1	1			1		9	刘振	9	24:11	7	
23	冯宁	2/2	0/1			0/1		2/4	50.0							9	刘振	9	24:40	8	28 袁龙
运动员 合计	7/16	5/11	3/4	6/9	1/2	2/5	3/4	27/51	52.9	6	16	3	5	5		9	刘振	9	25:59	9	28 袁龙
1	王澍	7/10	1/3	1/4	4/9	1/2	0/1	1/3	15/32	46.9						11	蒋维一	10	28:53	10	
16	孟辉	1/1	0/1		1/3		0/1	2/6	33.3	2						23	冯宁	11	30:00	10	
守门员 合计	8/11	1/4	1/4	5/12	1/2	0/1	1/4	17/38	44.7	2						2nd Half					
安徽		远射	近射	边射	快攻	突破	任意球	7m球	合计	%	助攻	失误	警告	2'	D & DR						
教练：王来黔																					
1	高逸凡																				
2	周兰骏	0/1			0/2	0/1		0/1	0/5	0.0		1									
5	马鹏	2/8	2/2		2/3		1/1	2/3	9/17	52.9	2	2		1							
6	田耕																				
7	姚雄敏																				
8	董智景																				
10	陈强龙		0/1		1/2				1/3	33.3		1	1								
11	黎涛																				
12	曾献辰												1								
15	邵青										2										
17	解维维				1/1			1/1	100												
18	郭赛																				
28	袁龙	0/2		3/3	1/4			1/1	5/10	50.0		2	1								
29	顾先亮	1/1		0/2	1/2				2/5	40.0		1		1							
32	王超	0/5	1/1		1/1	1/1			3/8	37.5	1	5	1								
33	曹振吉				0/1				0/1	0.0											
运动员 合计	3/17	3/4	3/5	7/16	1/2	1/1	3/5	21/50	42.0	5	13	3	2	2							
1	高逸凡	0/1	3/4	1/1	1/6	0/1		1/3	6/16	37.5											
12	曾献辰	3/9	3/7	0/3	1/2	1/1	1/3	0/1	9/26	34.6		1									
守门员 合计	3/10	6/11	1/4	2/8	1/2	1/3	1/4	15/42	35.7		1										

场上队员：得分 / 射门

守门员：救球 / 射门

快攻	Fast Break		突破	Breakthrough		任意球	Free Throw		7M球	7M Throw		助攻	Assist
警告	Warning		失误	Error		2'	Suspension		D	取消资格		DR	取消资格+报告





第十二届全国运动会男子手球预赛 图式比赛技术统计表

轮次 2

场次 5

201301005-21-1/1

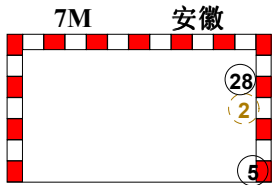
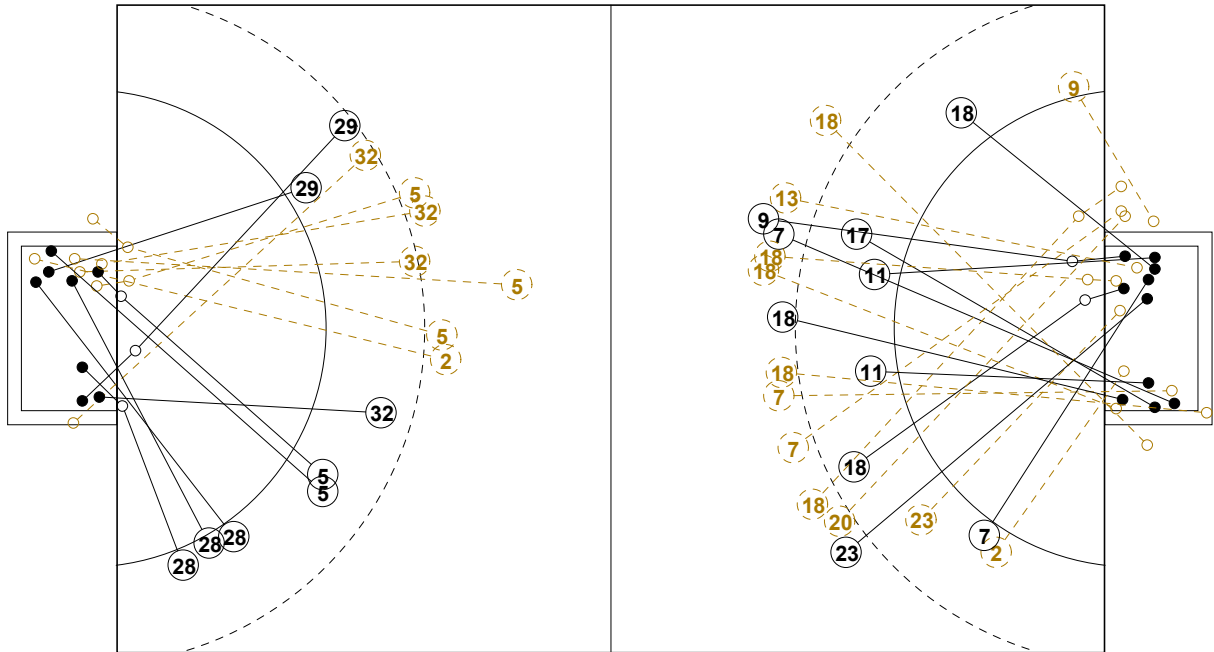

5
1st Half
10 : 11

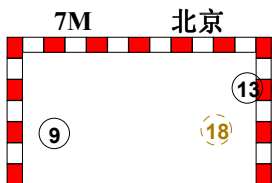
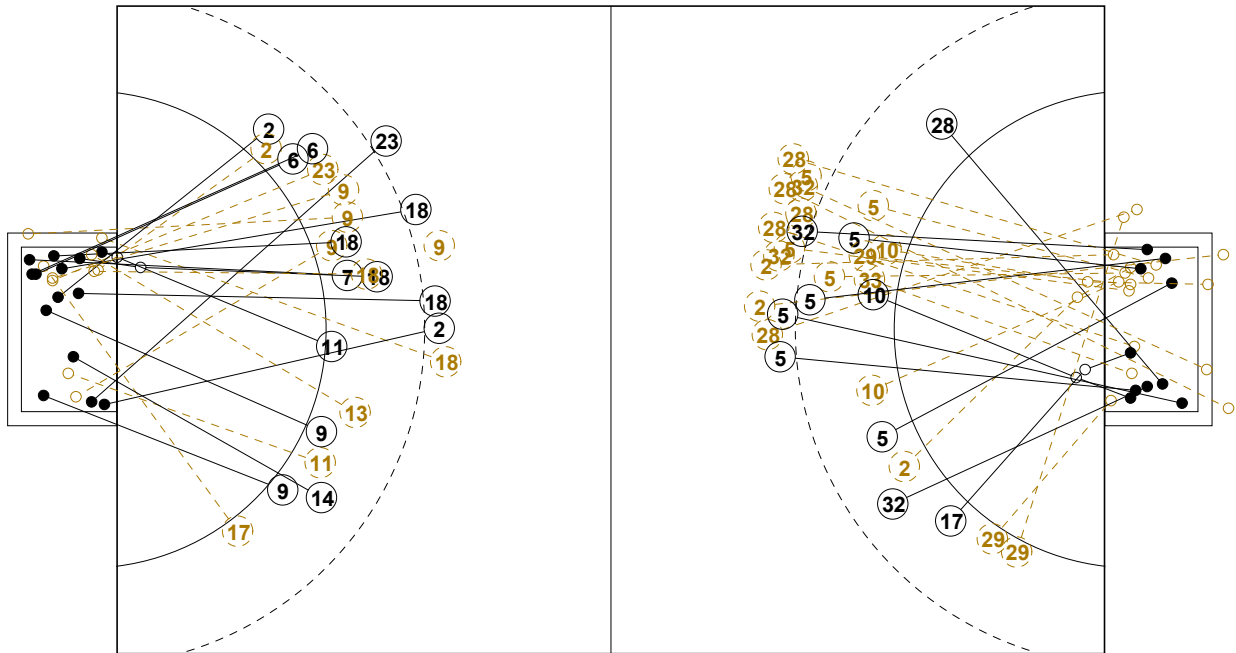
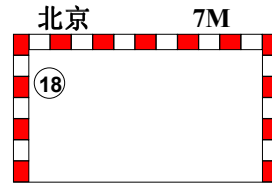

2nd Half
27 : 21

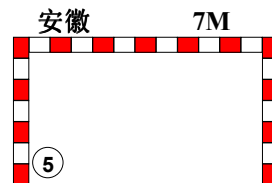



第十二届全国运动会男子手球预赛

个人/全队技术统计表

正式表
手球
男子预赛
轮次 2组别 A
场次 5201301005-14-1/2
柳州市李宁体院馆
19/04/2013 14:40

号码	姓名	远射	近射	边射	快攻	突破	任意	7M	合计	%	助攻	失误	警告	2'	取消	时间
北京(北京)																
<i>(场上队员)</i>																
1	王泷									0.0%						00:52:27
2	杜龙飞	1/1	0/1	1/1	0/1				2/4	50.0%			1	1		00:48:28
4	成亚									0.0%						00:00:00
5	杨昆									0.0%						00:03:14
6	刘伟				2/2				2/2	100%						00:09:50
7	胡瀛	0/2		1/1		1/1	1/1		3/5	60.0%	1	3	1			00:36:22
8	王鹏									0.0%				2		00:33:08
9	刘振	1/2	1/2		1/3		0/1	1/1	4/9	44.4%						00:46:21
11	蒋维一		2/3				1/1		3/4	75.0%		2	1			00:23:56
13	白洁	0/1	0/1					1/1	1/3	33.3%		4				00:32:31
14	解建飞		1/1						1/1	100%		1				00:02:19
16	孟辉									0.0%	2					00:07:33
17	姜冰峰		1/1	0/1					1/2	50.0%	1	1		1		00:46:26
18	张骥	3/8	0/1	1/1	3/3		0/1	1/2	8/16	50.0%	1	4				00:39:16
20	郑永利						0/1		0/1	0.0%	1	1		1		00:07:16
23	冯宁	2/2	0/1			0/1			2/4	50.0%						00:23:19
合计		7/16	5/11	3/4	6/9	1/2	2/5	3/4	27/51	52.9%	6	16	3	5		
<i>(守门员)</i>																
1	王泷	7/10	1/3	1/4	4/9	1/2	0/1	1/3	15/32	46.9%						00:52:27
16	孟辉	1/1	0/1		1/3			0/1	2/6	33.3%	2					00:07:33
合计		8/11	1/4	1/4	5/12	1/2	0/1	1/4	17/38	44.7%	2					

场上队员：得分/射门

守门员：救球/射门

全队合计	得分	被救	射失	击柱	封球	合计	%
远射	7	3	3	2	1	16	43.8%
近射	5	6				11	45.5%
边射	3	1				4	75.0%
快攻	6	2		1		9	66.7%
突破	1	1				2	50.0%
任意	2	1	2			5	40.0%
7M	3	1				4	75.0%





第十二届全国运动会男子手球预赛

个人/全队技术统计表

正式表
手球
男子预赛
轮次 2组别 A
场次 5201301005-14-2/2
柳州市李宁体育馆
19/04/2013 14:40

号码	姓名	远射	近射	边射	快攻	突破	任意	7M	合计	%	助攻	失误	警告	2'	取消	时间
安徽(安徽)																
<i>(上场队员)</i>																
1	高逸凡									0.0%						00:18:35
2	周兰骏	0/1			0/2	0/1		0/1	0/5	0.0%		1				00:18:28
5	马鹏	2/8	2/2		2/3		1/1	2/3	9/17	52.9%	2	2		1		00:52:32
6	田耕									0.0%						00:00:00
7	姚雄敏									0.0%						00:00:00
8	董智景									0.0%						00:00:00
10	陈强龙		0/1		1/2				1/3	33.3%		1	1			00:48:45
11	黎涛									0.0%						00:00:00
12	曾献辰									0.0%		1				00:41:25
15	邵青									0.0%	2					00:51:54
17	解维维				1/1				1/1	100%						00:06:10
18	郭赛									0.0%						00:01:55
28	袁龙	0/2		3/3	1/4			1/1	5/10	50.0%		2	1			00:55:08
29	顾先亮	1/1		0/2	1/2				2/5	40.0%		1		1		01:00:00
32	王超	0/5	1/1		1/1	1/1			3/8	37.5%	1	5	1			00:20:44
33	曹振吉				0/1				0/1	0.0%						00:43:09
合计		3/17	3/4	3/5	7/16	1/2	1/1	3/5	21/50	42.0%	5	13	3	2		
<i>(守门员)</i>																
1	高逸凡	0/1	3/4	1/1	1/6	0/1		1/3	6/16	37.5%						00:18:35
12	曾献辰	3/9	3/7	0/3	1/2	1/1	1/3	0/1	9/26	34.6%		1				00:41:25
合计		3/10	6/11	1/4	2/8	1/2	1/3	1/4	15/42	35.7%		1				

场上队员：得分/射门

守门员：救球/射门

全队合计	得分	被救	射失	击柱	封球	合计	%
远射	3	8	2	2	2	17	17.6%
近射	3	1				4	75.0%
边射	3	1	1			5	60.0%
快攻	7	5	2	1	1	16	43.8%
突破	1	1				2	50.0%
任意	1					1	100.0%
7M	3	1	1			5	60.0%





第十二届全国运动会男子手球预赛

图式射门区域统计

轮次 2 场次 5

201301005-41-1/1

北京

1 王澐	2 杜龙飞	4 成亚	5 杨昆	6 刘伟	7 胡瀛	8 王鹏	9 刘振																																																																								
<table border="1"><tr><td></td><td></td><td></td></tr><tr><td></td><td></td><td></td></tr><tr><td></td><td></td><td></td></tr></table>										<table border="1"><tr><td></td><td></td><td></td></tr><tr><td></td><td></td><td>1</td></tr><tr><td>1</td><td></td><td></td></tr></table>						1	1			<table border="1"><tr><td></td><td></td><td></td></tr><tr><td></td><td></td><td></td></tr><tr><td></td><td></td><td></td></tr></table>										<table border="1"><tr><td></td><td></td><td></td></tr><tr><td></td><td></td><td></td></tr><tr><td></td><td></td><td></td></tr></table>										<table border="1"><tr><td></td><td></td><td>2</td></tr><tr><td></td><td></td><td></td></tr><tr><td></td><td></td><td></td></tr></table>			2							<table border="1"><tr><td></td><td></td><td>2</td></tr><tr><td>1</td><td></td><td></td></tr><tr><td></td><td></td><td></td></tr></table>			2	1						<table border="1"><tr><td></td><td></td><td></td></tr><tr><td></td><td></td><td></td></tr><tr><td></td><td></td><td></td></tr></table>										<table border="1"><tr><td></td><td>1</td><td>1</td></tr><tr><td></td><td>1</td><td></td></tr><tr><td></td><td>1</td><td></td></tr></table>		1	1		1			1	
		1																																																																													
1																																																																															
		2																																																																													
		2																																																																													
1																																																																															
	1	1																																																																													
	1																																																																														
	1																																																																														
Post - 0 Miss - 0 Block - 0	Post - 0 Miss - 0 Block - 0	Post - 0 Miss - 0 Block - 0	Post - 0 Miss - 0 Block - 0	Post - 0 Miss - 0 Block - 0	Post - 0 Miss - 1 Block - 0	Post - 0 Miss - 0 Block - 0	Post - 1 Miss - 1 Block - 1																																																																								
11 蒋维一	13 白洁	14 解建飞	16 孟辉	17 姜冰峰	18 张骥	20 郑永利	23 冯宁																																																																								
<table border="1"><tr><td></td><td></td><td></td></tr><tr><td>1</td><td></td><td>1</td></tr><tr><td></td><td></td><td>1</td></tr></table>				1		1			1	<table border="1"><tr><td></td><td></td><td>1</td></tr><tr><td></td><td></td><td></td></tr><tr><td></td><td></td><td></td></tr></table>			1							<table border="1"><tr><td></td><td></td><td></td></tr><tr><td></td><td>1</td><td></td></tr><tr><td></td><td></td><td></td></tr></table>					1					<table border="1"><tr><td></td><td></td><td></td></tr><tr><td></td><td></td><td></td></tr><tr><td></td><td></td><td></td></tr></table>										<table border="1"><tr><td></td><td></td><td></td></tr><tr><td></td><td></td><td>1</td></tr><tr><td></td><td></td><td></td></tr></table>						1				<table border="1"><tr><td></td><td>1</td><td>1</td></tr><tr><td></td><td>1</td><td>3</td></tr><tr><td></td><td>1</td><td>1</td></tr></table>		1	1		1	3		1	1	<table border="1"><tr><td></td><td></td><td></td></tr><tr><td></td><td></td><td></td></tr><tr><td></td><td></td><td></td></tr></table>										<table border="1"><tr><td></td><td></td><td></td></tr><tr><td></td><td>1</td><td></td></tr><tr><td></td><td>1</td><td></td></tr></table>					1			1	
1		1																																																																													
		1																																																																													
		1																																																																													
	1																																																																														
		1																																																																													
	1	1																																																																													
	1	3																																																																													
	1	1																																																																													
	1																																																																														
	1																																																																														
Post - 0 Miss - 0 Block - 0	Post - 0 Miss - 0 Block - 0	Post - 0 Miss - 0 Block - 0	Post - 0 Miss - 0 Block - 0	Post - 0 Miss - 0 Block - 0	Post - 2 Miss - 2 Block - 0	Post - 0 Miss - 1 Block - 0	Post - 0 Miss - 0 Block - 0																																																																								

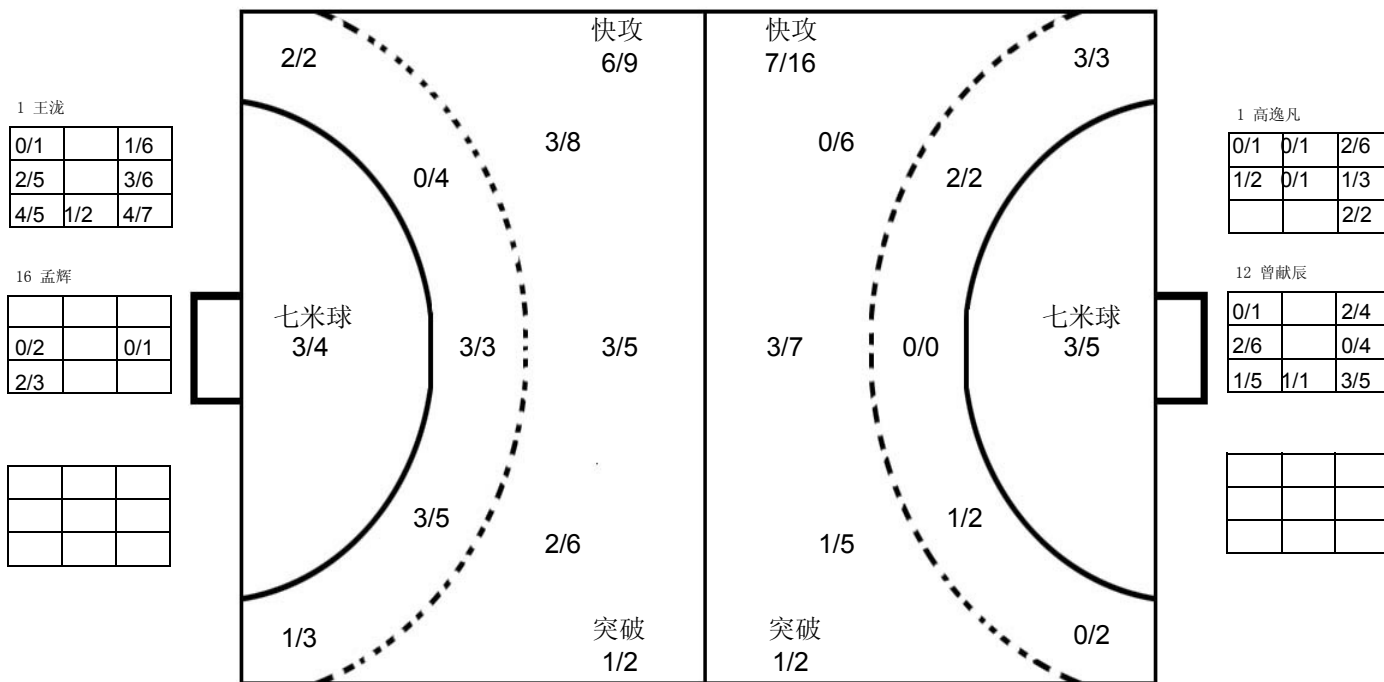

安徽

1 高逸凡	2 周兰骏	5 马鹏	6 田耕	7 姚雄敏	8 董智景	10 陈强龙	11 黎涛																																																																								
<table border="1"><tr><td></td><td></td><td></td></tr><tr><td></td><td></td><td></td></tr><tr><td></td><td></td><td></td></tr></table>										<table border="1"><tr><td></td><td></td><td></td></tr><tr><td></td><td></td><td></td></tr><tr><td></td><td></td><td></td></tr></table>										<table border="1"><tr><td>1</td><td></td><td>2</td></tr><tr><td>2</td><td></td><td>1</td></tr><tr><td>1</td><td></td><td>2</td></tr></table>	1		2	2		1	1		2	<table border="1"><tr><td></td><td></td><td></td></tr><tr><td></td><td></td><td></td></tr><tr><td></td><td></td><td></td></tr></table>										<table border="1"><tr><td></td><td></td><td></td></tr><tr><td></td><td></td><td></td></tr><tr><td></td><td></td><td></td></tr></table>										<table border="1"><tr><td></td><td></td><td></td></tr><tr><td></td><td></td><td></td></tr><tr><td></td><td></td><td></td></tr></table>										<table border="1"><tr><td></td><td></td><td></td></tr><tr><td></td><td></td><td></td></tr><tr><td></td><td></td><td>1</td></tr></table>									1	<table border="1"><tr><td></td><td></td><td></td></tr><tr><td></td><td></td><td></td></tr><tr><td></td><td></td><td></td></tr></table>									
1		2																																																																													
2		1																																																																													
1		2																																																																													
		1																																																																													
Post - 0 Miss - 0 Block - 0	Post - 0 Miss - 1 Block - 0	Post - 0 Miss - 2 Block - 1	Post - 0 Miss - 0 Block - 0	Post - 0 Miss - 0 Block - 0	Post - 0 Miss - 0 Block - 0	Post - 1 Miss - 0 Block - 0	Post - 0 Miss - 0 Block - 0																																																																								
12 曾献辰	15 邵青	17 解维维	18 郭赛	28 袁龙	29 顾先亮	32 王超	33 曹振吉																																																																								
<table border="1"><tr><td></td><td></td><td></td></tr><tr><td></td><td></td><td></td></tr><tr><td></td><td></td><td></td></tr></table>										<table border="1"><tr><td></td><td></td><td></td></tr><tr><td></td><td></td><td></td></tr><tr><td></td><td></td><td></td></tr></table>										<table border="1"><tr><td></td><td></td><td></td></tr><tr><td></td><td></td><td></td></tr><tr><td></td><td>1</td><td></td></tr></table>								1		<table border="1"><tr><td></td><td></td><td></td></tr><tr><td></td><td></td><td></td></tr><tr><td></td><td></td><td></td></tr></table>										<table border="1"><tr><td></td><td></td><td>2</td></tr><tr><td>1</td><td></td><td>2</td></tr><tr><td></td><td></td><td></td></tr></table>			2	1		2				<table border="1"><tr><td></td><td></td><td>1</td></tr><tr><td></td><td></td><td></td></tr><tr><td></td><td></td><td></td></tr></table>			1							<table border="1"><tr><td></td><td></td><td></td></tr><tr><td></td><td>1</td><td>1</td></tr><tr><td></td><td>1</td><td></td></tr></table>					1	1		1		<table border="1"><tr><td></td><td></td><td></td></tr><tr><td></td><td></td><td></td></tr><tr><td></td><td></td><td></td></tr></table>									
	1																																																																														
		2																																																																													
1		2																																																																													
		1																																																																													
	1	1																																																																													
	1																																																																														
Post - 0 Miss - 0 Block - 0	Post - 0 Miss - 0 Block - 0	Post - 0 Miss - 0 Block - 0	Post - 0 Miss - 0 Block - 0	Post - 0 Miss - 2 Block - 1	Post - 0 Miss - 1 Block - 0	Post - 2 Miss - 0 Block - 1	Post - 0 Miss - 0 Block - 0																																																																								

注释: Post=击柱 Miss=射失 Block=被封





男子 国内比赛

第十二届全国运动会男子手球预赛

Team A		Team B		Match Number							
A 西藏		B 澳门		6							
played in		in the hall		on							
China		柳州市李宁体育馆		19/04/2013							
				at 16:20 hours							
Spectators											
Half-time (30')	A	B	End of playing time	A	B						
	16	8	38 22	1st extra time	2nd extra time						
				A	B						
				After penalty							
				throws							
Number of 7 m	A	Team time-out			B						
	4 / 4	1	2	3	4 / 5						
		Full name of players and officials									
		1	2	3							
		10:35	49:03								
No.	Team A					No.	Team B				
	G	W	2'	D	DR		G	W	2'	D	DR
2	王龙	1		1		2	李翹臻	1			
4	张家纬	6				4	刘家声				
5	冯祥龙					5	何建成				
6	任启双			1		15	黄俊勇				
7	徐奕飞	2				16	冯国政				
9	王博	3				18	卓伟杰	3			
10	刘江	4	1			21	麦锦聪				
11	朱治宇	1		1		22	陈学敏				
12	张帅					24	刘登宇	1			
15	刘劲松					27	徐展业				
16	徐畅					28	莫家进	3	1	1	
18	赵楠	6		1		29	叶响俊				
19	任野	2	1			33	欧永健	2			
20	顾艳超	2				36	陈嘉聪				
21	马光					81	梁梓康	8	1		
23	王伟强	11	1			93	罗咪高	5			
A	张文韬					A	卢永明				
B	殷永军					B	高光明				
C	瓮勇					C	黄宇豪				
A	Signature of Responsible Official of the Teams (Off. A)										B
TP	Remarks of Referee / CHA Official										TP

Signatures

Referees	邓军 (CHN)	谭雷 (CHN)		
Techn. Delegates	许宜扬 (CHN)	刘书勇 (CHN)		
CHA Official				

Note: Number of 7m Throws Awarded to Team A and B, Goals (G), Warnings (W), Suspensions (2'), Direct Disqualification (D), Disqualification with Report (DR) and Team Penalty (TP).

Table Officials:

Statisticians: 黄莉

朱伟平



第十二届全国运动会男子手球预赛
竞赛技术统计(媒体表)

预赛	组别	A	轮次	2	场次	6
柳州市李宁体院馆		19/04/2013			201301006-51-1/1	
西藏	西藏	38	vs	22	澳门	澳门
				16 : 8		

裁判员		邓军 (CHN)													/	谭雷 (CHN)												
西藏		远射	近射	边射	快攻	突破	任意球	7m球	合计	%	助攻	失误	警告	2'	D & DR	西藏	比赛进程	澳门										
主教练：张文韬																1st Half												
2	王龙				1/1			1/1	100	3				1		9	王博	1	03:38	0								
4	张家纬	1/1	2/2	1/4			2/3	6/10	60.0	2	3					23	王伟强	2	04:36	0								
5	冯祥龙															10	刘江	3	05:59	1	93	罗咪高						
6	任启双	0/1						0/1	0.0					1		23	王伟强	4	07:18	1								
7	徐奕飞				2/2	0/1		2/3	66.7							4	顾艳超	5	08:08	2	93	罗咪高						
9	王博		1/1		2/4	0/1		3/6	50.0	1						20	任野	6	10:36	2								
10	刘江		1/2	1/1	1/2	1/3		4/8	50.0	2			1			10	刘江	7	11:06	2								
11	朱治宇			1/1	0/2			1/3	33.3	1				1		7	任野	7	12:02	3	93	罗咪高						
12	张帅									1						2	王龙	8	13:44	4	28	莫家进						
15	刘劲松															19	任野	9	14:50	4								
16	徐畅															10	刘江	10	15:35	4								
18	赵楠		2/2	1/1	1/3	1/1	0/1	1/1	6/9	66.7				1		7	徐奕飞	10	16:05	5	81	梁梓康						
19	任野				2/2			2/2	100				1			11	王博	11	17:31	5								
20	顾艳超				1/1	1/1		2/2	100		2					18	赵楠	12	19:28	6	81	梁梓康						
21	马光	0/1			0/1	0/1		0/3	0.0							11	朱治宇	13	21:42	6								
23	王伟强			1/1	7/11	0/1		3/3	11/16	68.8	2	2	1			18	赵楠	14	23:47	6								
运动员 合计		1/3	6/7	5/8	17/29	3/9	2/4	4/4	38/64	59.4	13	10	3	4		18	赵楠	14	23:58	7	81	梁梓康						
12	张帅	0/3	2/3	3/5	2/6	0/3		1/2	8/22	36.4	1					18	赵楠	15	24:38	7								
16	徐畅	5/6	3/6	1/2	1/1	1/1		0/3	11/19	57.9	1					15	朱治宇	15	25:15	8	81	梁梓康						
守门员 合计		5/9	5/9	4/7	3/7	1/4		1/5	19/41	46.3	2					7	徐奕飞	16	29:22	8								
2nd Half																												
教练：卢永明																4	张家纬	16	01:05	9	81	梁梓康						
2	李翹臻															17	任野	17	01:25	9								
4	刘家声															20	顾艳超	18	02:23	10	28	莫家进						
5	何建成	0/2				0/1		0/3	0.0							18	赵楠	19	03:09	10								
15	黄俊勇															18	赵楠	19	04:31	10								
16	冯国政															23	王伟强	19	05:24	11	93	罗咪高						
18	卓伟杰		1/2	1/1	1/1			3/4	75.0							20	顾艳超	20	06:08	11								
21	麦锦聪															20	任野	20	06:39	12	81	梁梓康						
22	陈学敏	0/1						0/1	0.0							20	任野	20	06:54	13	33	欧永健						
24	刘登宇	0/4		0/2	0/1	1/1	0/1	1/9	11.1							20	任野	20	07:30	14	18	卓伟杰						
27	徐展业															4	张家纬	21	07:58	14								
28	莫家进		1/2	1/1	1/1			3/4	75.0							21	任野	21	08:31	15	81	梁梓康						
29	叶响俊		0/3		0/1			0/4	0.0							18	赵楠	22	08:42	15								
33	欧永健	0/3	0/1	1/1	1/1		0/1	2/7	28.6							22	任野	22	09:10	16	81	梁梓康						
36	陈嘉聪															4	张家纬	23	09:46	16								
81	梁梓康	3/6	2/2	0/1	0/1	1/2		2/2	8/14	57.1	1	1	1			23	王伟强	23	10:33	17	24	刘登宇						
93	罗咪高	1/4	1/2	1/1	0/3			2/3	5/13	38.5						23	王伟强	24	11:19	17								
运动员 合计		4/20	4/10	3/7	4/10	3/5	0/2	4/5	22/59	37.3	1	21	3	1		4	张家纬	25	12:58	17								
16	冯国政	1/2	1/7	3/8	7/24	3/6	1/3	0/4	16/54	29.6						23	王伟强	26	13:39	17								
守门员 合计		1/2	1/7	3/8	7/24	3/6	1/3	0/4	16/54	29.6						26	任野	26	14:23	18	28	莫家进						

场上队员：得分 / 射门

守门员：救球 / 射门

快攻	Fast Break		突破	Breakthrough		任意球	Free Throw		7M球	7M Throw		助攻	Assist
警告	Warning		失误	Error		2'	Suspension		D	取消资格		DR	取消资格+报告





第十二届全国运动会男子手球预赛 图式比赛技术统计表

轮次 2

场次 6

201301006-21-1/1

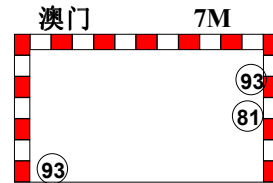
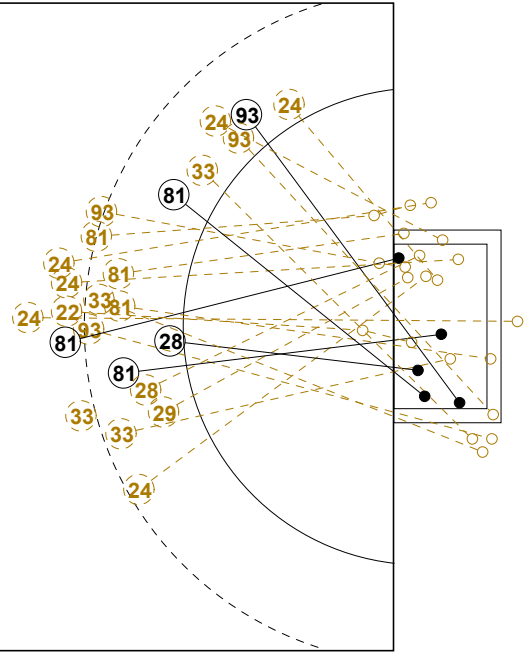
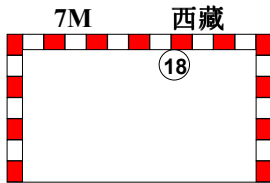
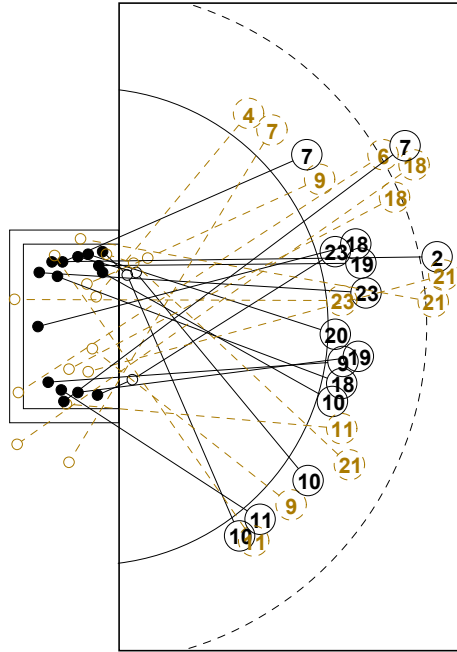

1st Half
16 : 8

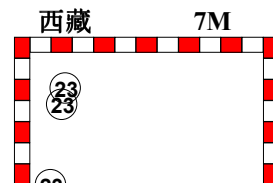
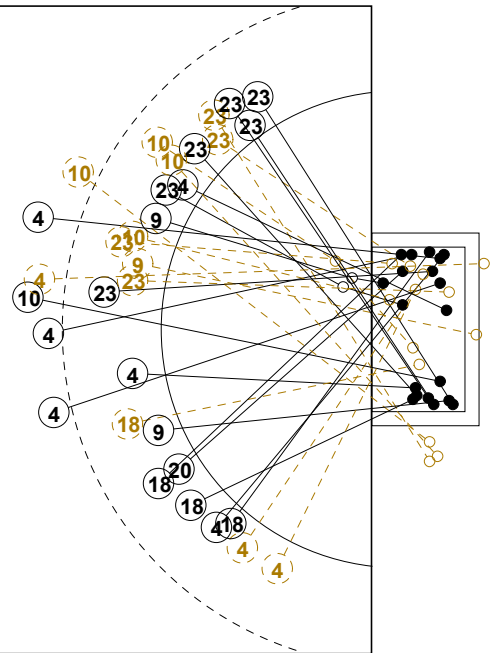
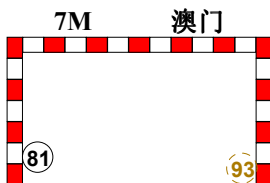
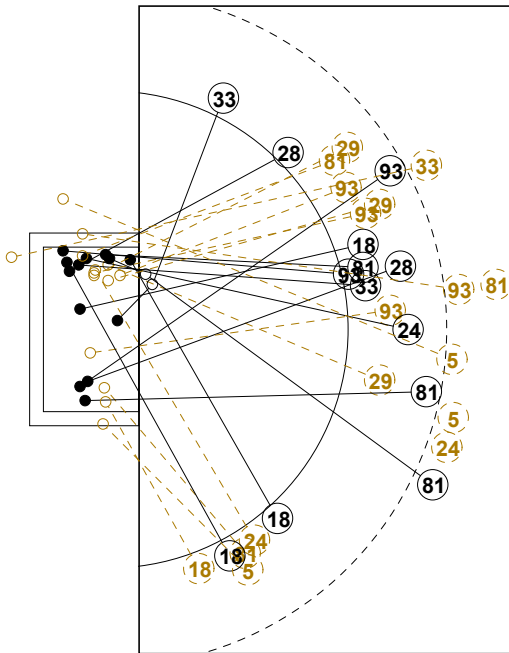

2nd Half
22 : 38



第十二届全国运动会男子手球预赛

个人/全队技术统计表

正式表
手球
男子预赛
轮次 2组别 A
场次 6201301006-14-1/2
柳州市李宁体院馆
19/04/2013 16:20

号码	姓名	远射	近射	边射	快攻	突破	任意	7M	合计	%	助攻	失误	警告	2'	取消	时间
西藏(西藏)																
<i>(场上队员)</i>																
2	王龙				1/1				1/1	100%	3			1		00:22:09
4	张家纬	1/1	2/2	1/4			2/3		6/10	60.0%	2	3				00:47:36
5	冯祥龙									0.0%						00:00:00
6	任启双	0/1							0/1	0.0%				1		00:13:47
7	徐奕飞				2/2	0/1			2/3	66.7%						00:11:36
9	王博		1/1		2/4	0/1			3/6	50.0%	1					00:46:45
10	刘江		1/2	1/1	1/2	1/3			4/8	50.0%	2		1			00:47:40
11	朱治宇			1/1	0/2				1/3	33.3%	1			1		00:17:56
12	张帅									0.0%	1					00:20:22
15	刘劲松									0.0%						00:00:00
16	徐畅									0.0%	1					00:39:38
18	赵楠		2/2	1/1	1/3	1/1	0/1	1/1	6/9	66.7%				1		00:41:27
19	任野				2/2				2/2	100%				1		00:17:40
20	顾艳超				1/1	1/1			2/2	100%		2				00:32:38
21	马光	0/1			0/1	0/1			0/3	0.0%		3				00:12:44
23	王伟强			1/1	7/11	0/1		3/3	11/16	68.8%	2	2	1			00:45:13
合计		1/3	6/7	5/8	17/29	3/9	2/4	4/4	38/64	59.4%	13	10	3	4		
<i>(守门员)</i>																
12	张帅	0/3	2/3	3/5	2/6	0/3		1/2	8/22	36.4%	1					00:20:22
16	徐畅	5/6	3/6	1/2	1/1	1/1		0/3	11/19	57.9%	1					00:39:38
合计		5/9	5/9	4/7	3/7	1/4		1/5	19/41	46.3%	2					

场上队员：得分/射门

守门员：救球/射门

全队合计	得分	被救	射失	击柱	封球	合计	%
远射	1	1		1		3	33.3%
近射	6	1				7	85.7%
边射	5	3				8	62.5%
快攻	17	7	2	3		29	58.6%
突破	3	3	3			9	33.3%
任意	2	1	1			4	50.0%
7M	4					4	100.0%



第十二届全国运动会男子手球预赛

个人/全队技术统计表

正式表
手球
男子预赛
轮次 2组别 A
场次 6201301006-14-2/2
柳州市李宁体院馆
19/04/2013 16:20

号码	姓名	远射	近射	边射	快攻	突破	任意	7M	合计	%	助攻	失误	警告	2'	取消	时间
澳门(澳门)																
<i>(上场队员)</i>																
2	李翹臻									0.0%		1	1			00:14:31
4	刘家声									0.0%						00:09:44
5	何建成	0/2				0/1			0/3	0.0%		3				00:21:14
15	黄俊勇									0.0%						00:17:47
16	冯国政									0.0%						01:00:00
18	卓伟杰			1/2	1/1	1/1			3/4	75.0%		1				00:44:39
21	麦锦聪									0.0%						00:00:00
22	陈学敏	0/1							0/1	0.0%		1				00:02:38
24	刘登宇	0/4		0/2	0/1	1/1	0/1		1/9	11.1%		2				00:27:32
27	徐展业									0.0%						00:00:00
28	莫家进		1/2		2/2				3/4	75.0%		1	1	1		00:41:28
29	叶响俊		0/3		0/1				0/4	0.0%		1				00:43:04
33	欧永健	0/3	0/1	1/1	1/1		0/1		2/7	28.6%		7				00:49:19
36	陈嘉聪									0.0%						00:00:00
81	梁梓康	3/6	2/2	0/1	0/1	1/2		2/2	8/14	57.1%	1	1	1			00:36:31
93	罗咪高	1/4	1/2	1/1	0/3			2/3	5/13	38.5%		3				00:49:03
合计		4/20	4/10	3/7	4/10	3/5	0/2	4/5	22/59	37.3%	1	21	3	1		
<i>(守门员)</i>																
16	冯国政	1/2	1/7	3/8	7/24	3/6	1/3	0/4	16/54	29.6%						01:00:00
合计		1/2	1/7	3/8	7/24	3/6	1/3	0/4	16/54	29.6%						

场上队员：得分/射门

守门员：救球/射门

全队合计	得分	被救	射失	击柱	封球	合计	%
远射	4	5	5	2	4	20	20.0%
近射	4	5	1			10	40.0%
边射	3	4				7	42.9%
快攻	4	3		3		10	40.0%
突破	3	1		1		5	60.0%
任意			2			2	0.0%
7M	4	1				5	80.0%





第十二届全国运动会男子手球预赛

图式射门区域统计

轮次 2 场次 6

201301006-41-1/1

西藏

2 王龙	4 张家纬	5 冯祥龙	6 任启双	7 徐奕飞	9 王博	10 刘江	11 朱治宇																																																																								
<table border="1"><tr><td></td><td></td><td>1</td></tr><tr><td></td><td></td><td></td></tr><tr><td></td><td></td><td></td></tr></table>			1							<table border="1"><tr><td>3</td><td>1</td><td></td></tr><tr><td>1</td><td></td><td>1</td></tr><tr><td></td><td></td><td></td></tr></table>	3	1		1		1				<table border="1"><tr><td></td><td></td><td></td></tr><tr><td></td><td></td><td></td></tr><tr><td></td><td></td><td></td></tr></table>										<table border="1"><tr><td></td><td></td><td></td></tr><tr><td></td><td></td><td></td></tr><tr><td></td><td></td><td></td></tr></table>										<table border="1"><tr><td></td><td></td><td></td></tr><tr><td>1</td><td></td><td>1</td></tr><tr><td></td><td></td><td></td></tr></table>				1		1				<table border="1"><tr><td>1</td><td></td><td>1</td></tr><tr><td></td><td></td><td></td></tr><tr><td>1</td><td></td><td></td></tr></table>	1		1				1			<table border="1"><tr><td></td><td></td><td>1</td></tr><tr><td></td><td></td><td>1</td></tr><tr><td></td><td></td><td>2</td></tr></table>			1			1			2	<table border="1"><tr><td></td><td></td><td></td></tr><tr><td>1</td><td></td><td></td></tr><tr><td></td><td></td><td></td></tr></table>				1					
		1																																																																													
3	1																																																																														
1		1																																																																													
1		1																																																																													
1		1																																																																													
1																																																																															
		1																																																																													
		1																																																																													
		2																																																																													
1																																																																															
Post - 0 Miss - 0 Block - 0	Post - 0 Miss - 1 Block - 0	Post - 0 Miss - 0 Block - 0	Post - 1 Miss - 0 Block - 0	Post - 0 Miss - 1 Block - 0	Post - 1 Miss - 0 Block - 0	Post - 0 Miss - 2 Block - 0	Post - 0 Miss - 0 Block - 0																																																																								
12 张帅	15 刘劲松	16 徐畅	18 赵楠	19 任野	20 顾艳超	21 马光	23 王伟强																																																																								
<table border="1"><tr><td></td><td></td><td></td></tr><tr><td></td><td></td><td></td></tr><tr><td></td><td></td><td></td></tr></table>										<table border="1"><tr><td></td><td></td><td></td></tr><tr><td></td><td></td><td></td></tr><tr><td></td><td></td><td></td></tr></table>										<table border="1"><tr><td></td><td></td><td></td></tr><tr><td></td><td></td><td></td></tr><tr><td></td><td></td><td></td></tr></table>										<table border="1"><tr><td></td><td>2</td><td></td></tr><tr><td>1</td><td></td><td>2</td></tr><tr><td>1</td><td></td><td></td></tr></table>		2		1		2	1			<table border="1"><tr><td></td><td></td><td></td></tr><tr><td>1</td><td></td><td></td></tr><tr><td></td><td></td><td>1</td></tr></table>				1					1	<table border="1"><tr><td></td><td></td><td></td></tr><tr><td>1</td><td></td><td></td></tr><tr><td></td><td></td><td>1</td></tr></table>				1					1	<table border="1"><tr><td></td><td></td><td></td></tr><tr><td></td><td></td><td></td></tr><tr><td></td><td></td><td></td></tr></table>										<table border="1"><tr><td></td><td>1</td><td>3</td></tr><tr><td>2</td><td>1</td><td>2</td></tr><tr><td>2</td><td></td><td></td></tr></table>		1	3	2	1	2	2		
	2																																																																														
1		2																																																																													
1																																																																															
1																																																																															
		1																																																																													
1																																																																															
		1																																																																													
	1	3																																																																													
2	1	2																																																																													
2																																																																															
Post - 0 Miss - 0 Block - 0	Post - 0 Miss - 0 Block - 0	Post - 0 Miss - 0 Block - 0	Post - 0 Miss - 1 Block - 0	Post - 0 Miss - 0 Block - 0	Post - 0 Miss - 0 Block - 0	Post - 1 Miss - 0 Block - 0	Post - 1 Miss - 1 Block - 0																																																																								

12 张帅

		0/3
2/5	1/2	2/5
0/1	0/1	3/5

16 徐畅

1/1		0/2
2/2	0/1	3/5
3/5	1/1	1/2

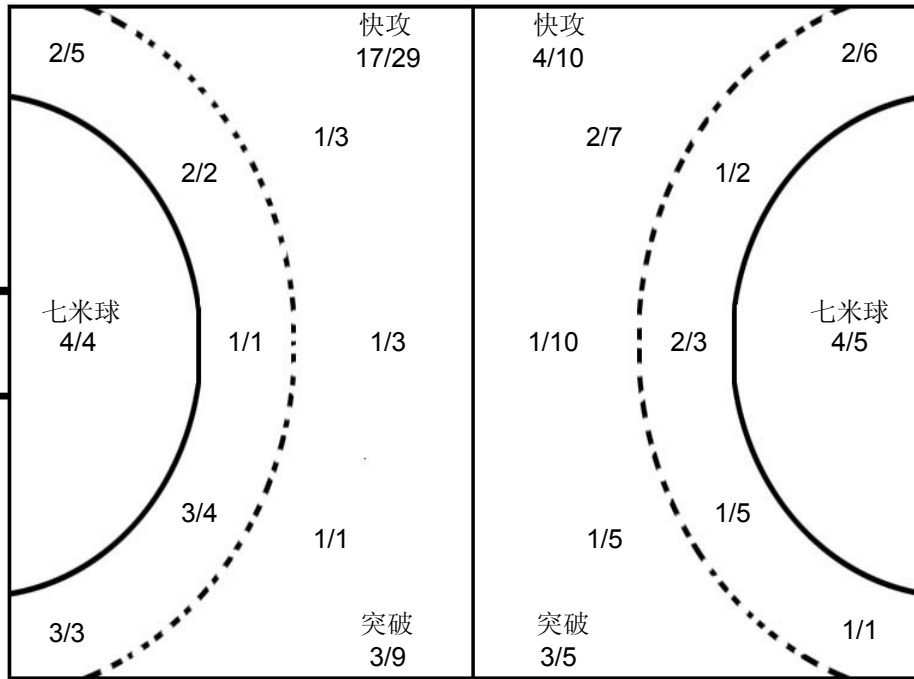

16 冯国政

1/6	0/3	1/7
5/13	1/2	2/9
3/7	1/1	2/6

澳门

2 李翹臻	4 刘家声	5 何建成	15 黄俊勇	16 冯国政	18 卓伟杰	21 麦锦聪	22 陈学敏																																																																														
<table border="1"><tr><td></td><td></td><td></td></tr><tr><td></td><td></td><td></td></tr><tr><td></td><td></td><td></td></tr></table>										<table border="1"><tr><td></td><td></td><td></td></tr><tr><td></td><td></td><td></td></tr><tr><td></td><td></td><td></td></tr></table>										<table border="1"><tr><td></td><td></td><td></td></tr><tr><td></td><td></td><td></td></tr><tr><td></td><td></td><td></td></tr></table>										<table border="1"><tr><td></td><td></td><td></td></tr><tr><td></td><td></td><td></td></tr><tr><td></td><td></td><td></td></tr></table>										<table border="1"><tr><td></td><td></td><td></td></tr><tr><td></td><td></td><td></td></tr><tr><td></td><td></td><td></td></tr></table>										<table border="1"><tr><td></td><td></td><td>1</td></tr><tr><td></td><td>1</td><td></td></tr><tr><td></td><td></td><td>1</td></tr></table>			1		1				1	<table border="1"><tr><td></td><td></td><td></td></tr><tr><td></td><td></td><td></td></tr><tr><td></td><td></td><td></td></tr></table>										<table border="1"><tr><td></td><td></td><td></td></tr><tr><td></td><td></td><td></td></tr><tr><td></td><td></td><td></td></tr></table>															
		1																																																																																			
	1																																																																																				
		1																																																																																			
Post - 0 Miss - 0 Block - 0	Post - 0 Miss - 0 Block - 0	Post - 1 Miss - 1 Block - 1	Post - 0 Miss - 0 Block - 0	Post - 0 Miss - 0 Block - 0	Post - 0 Miss - 0 Block - 0	Post - 0 Miss - 0 Block - 0	Post - 0 Miss - 0 Block - 0																																																																														
24 刘登宇	27 徐展业	28 莫家进	29 叶响俊	33 欧永健	36 陈嘉聪	81 梁梓康	93 罗味高																																																																														
<table border="1"><tr><td></td><td></td><td></td></tr><tr><td></td><td>1</td><td></td></tr><tr><td></td><td></td><td></td></tr></table>					1					<table border="1"><tr><td></td><td></td><td></td></tr><tr><td></td><td></td><td></td></tr><tr><td></td><td></td><td></td></tr></table>										<table border="1"><tr><td></td><td></td><td>1</td></tr><tr><td>1</td><td></td><td></td></tr><tr><td></td><td></td><td>1</td></tr></table>			1	1					1	<table border="1"><tr><td></td><td></td><td></td></tr><tr><td></td><td></td><td></td></tr><tr><td></td><td></td><td></td></tr></table>										<table border="1"><tr><td></td><td></td><td></td></tr><tr><td></td><td></td><td>1</td></tr><tr><td></td><td></td><td></td></tr></table>						1				<table border="1"><tr><td></td><td></td><td></td></tr><tr><td></td><td></td><td></td></tr><tr><td></td><td></td><td></td></tr></table>										<table border="1"><tr><td></td><td>1</td><td>1</td><td>3</td></tr><tr><td>2</td><td></td><td>1</td><td></td></tr><tr><td></td><td></td><td></td><td></td></tr></table>		1	1	3	2		1						<table border="1"><tr><td></td><td></td><td></td><td>3</td></tr><tr><td>1</td><td></td><td></td><td></td></tr><tr><td>1</td><td></td><td></td><td></td></tr></table>				3	1				1			
	1																																																																																				
		1																																																																																			
1																																																																																					
		1																																																																																			
		1																																																																																			
	1	1	3																																																																																		
2		1																																																																																			
			3																																																																																		
1																																																																																					
1																																																																																					
Post - 1 Miss - 2 Block - 1	Post - 0 Miss - 0 Block - 0	Post - 0 Miss - 0 Block - 0	Post - 0 Miss - 0 Block - 0	Post - 0 Miss - 3 Block - 1	Post - 0 Miss - 0 Block - 0	Post - 2 Miss - 1 Block - 1	Post - 2 Miss - 1 Block - 0																																																																														

注释: Post=击柱 Miss=射失 Block=被封





男子 国内比赛

第十二届全国运动会男子手球预赛

Team A A 广东		Team B B 天津		Match Number 7																	
played in China		in the hall 柳州市李宁体育馆		on 19/04/2013																	
				at 18:00 hours																	
Spectators																					
Half-time (30')	A 13	B 9	End of playing time	A 26	B 19																
1st extra time		2nd extra time		After penalty throws																	
Number of 7 m A 1/2		Team time-out 1 11:56 2 49:04 3 59:01		Full name of players and officials																	
				Team time-out 1 24:19 2 3																	
				B 1/3																	
Number of 7 m				Number of 7 m																	
No.	Team A					G	W	2'	D	DR	No.	Team B					G	W	2'	D	DR
1	王旭兴										1	刘宗其									
2	孙江山										2	李岳朋									
3	曲汝洋					2					3	李军					3				
4	李卓洋					3					4	李松浩									
5	候生升										7	张青					4	1	2		
6	邓志贵					1	1				8	曹悦					4				
7	付文博					6	1				9	孟凡钢									
8	于彦江					7		1			10	李帅									
9	徐庆										11	王毅									
10	陈超										13	许松					3		1		
12	温杰										14	田剑侠					3	1			
16	张广建										15	张俊岭							1		
17	李中洲					4	1	1			16	刘海亮									
18	张腾					1		2			17	周群					2	1			
19	马跃										18	孙永									
20	王伟					2					19	梁堂亮									
A	王锋										A	尚喜									
B	李晓忠										B	贾守信									
C	郭艳辉										C	刘伟成									
E	薛良成										D	冀谦									
A	Signature of Responsible Official of the Teams (Off. A)																			B	
TP	Remarks of Referee / CHA Official																			TP	

Signatures

Referees	Jan Eric Klaus	Mikael Engelbert		
Techn. Delegates	许宜扬 (CHN)	刘书勇 (CHN)		
CHA Official				

Note: Number of 7m Throws Awarded to Team A and B, Goals (G), Warnings (W), Suspensions (2'), Direct Disqualification (D), Disqualification with Report (DR) and Team Penalty (TP).

Table Officials: 黄思华

谭云东

Statisticians: 黄莉

朱伟平

Printed by PHMS Copyright: IHF / CHA 19/04/2013 20:04:01

Longman Sportsoft



handball@126.com

第十二届全国运动会男子手球预赛
竞赛技术统计(媒体表)

预赛	组别	B	轮次	2	场次	7
柳州市李宁体院馆			19/04/2013		201301007-51-1/1	
广东	广东	26	vs	19	天津	天津
13 : 9						

裁判员	Jan Eric Klaus Leandersson (NED)	/	Mikael Engelbert Lindroos (NED)
-----	----------------------------------	---	---------------------------------

广东		远射	近射	边射	快攻	突破	任意球	7m球	合计	%	助攻	失误	警告	2'	D & DR	广东	比赛进程	天津
主教练：王锋																		
1	王旭兴																8 于彦江	1 01:11 0
2	孙江山																7 付云博	2 03:10 0
3	曲汝洋			1/1	1/1				2/2	100		2					17 李中洲	3 04:56 1 13 许松
4	李卓洋	2/4	1/1						3/5	60.0	1						8 于彦江	3 07:02 3 14 田剑侠
5	候生升	0/1		0/1					0/2	0.0							8 于彦江	4 07:30 3
6	邓志贵				1/1				1/1	100		2	1				5	5 08:37 3
7	付文博	2/7			1/1	3/3			6/11	54.5	2	3	1				18 张腾	5 12:02 5 13 许松
8	于彦江	5/8	0/1		1/1			1/1	7/11	63.6	1	1		1			8 于彦江	5 09:07 4 7 张青
9	徐庆																5	5 12:02 5 13 许松
10	陈超			0/1					0/1	0.0							18 张腾	6 12:25 5
12	温杰																7	7 13:06 5
16	张广建																7	7 14:54 6 14 田剑侠
17	李中洲	3/4			1/2			0/1	4/7	57.1	1	5	1	1			7	7 17:35 7 17 周群
18	张腾			1/2					1/2	50.0							7	8 18:21 8 7 张青
19	马跃																7	8 18:21 8 7 张青
20	王伟		1/2	0/1	1/1				2/4	50.0		2					7	9 19:25 8
运动员 合计		12/24	2/4	2/6	6/7	3/3		1/2	26/46	56.5	5	15	3	4			20 王伟	10 20:53 8
1	王旭兴	2/7	2/7	2/4	0/4	0/2		1/1	7/25	28.0							17 李中洲	11 26:39 8
12	温杰							0/1	0/1	0.0							3	11 27:08 9 7 张青
守门员 合计		2/7	2/7	2/4	0/4	0/2		1/2	7/26	26.9							20 王伟	12 28:29 9
天津		远射	近射	边射	快攻	突破	任意球	7m球	合计	%	助攻	失误	警告	2'	D & DR			
教练：尚喜																		
1	刘宗其																	
2	李岳朋																	
3	李军	0/2			1/1	1/1		1/3	3/7	42.9	3	4						
4	李松浩																	
7	张青	1/2	3/4						4/6	66.7	3	6	1	2				
8	曹悦	3/4	0/2	1/1					4/7	57.1		1						
9	孟凡钢																	
10	李帅			0/1					0/1	0.0								
11	王毅																	
13	许松				1/2	2/2			3/4	75.0		1		1				
14	田剑侠	1/3	1/1	0/1		1/1			3/6	50.0	6	3	1					
15	张俊岭			0/1					0/1	0.0		1		1				
16	刘海亮																	
17	周群		1/4		1/1				2/5	40.0	1	2	1					
18	孙永																	
19	梁堂亮																	
运动员 合计		5/11	5/11	2/6	4/4	2/2		1/3	19/37	51.4	13	18	3	4				
1	刘宗其	5/11	0/1	4/5	0/3	0/1			9/21	42.9								
16	刘海亮	2/8	2/3	0/1	1/4	0/2		0/1	5/19	26.3								
守门员 合计		7/19	2/4	4/6	1/7	0/3		0/1	14/40	35.0								

场上队员：得分 / 射门

守门员：救球 / 射门

快攻	Fast Break	突破	Breakthrough	任意球	Free Throw	7M球	7M Throw	助攻	Assist
警告	Warning	失误	Error	2'	Suspension	D	取消资格	DR	取消资格+报告





第十二届全国运动会男子手球预赛 图式比赛技术统计表

轮次 2

场次 7

201301007-21-1/1

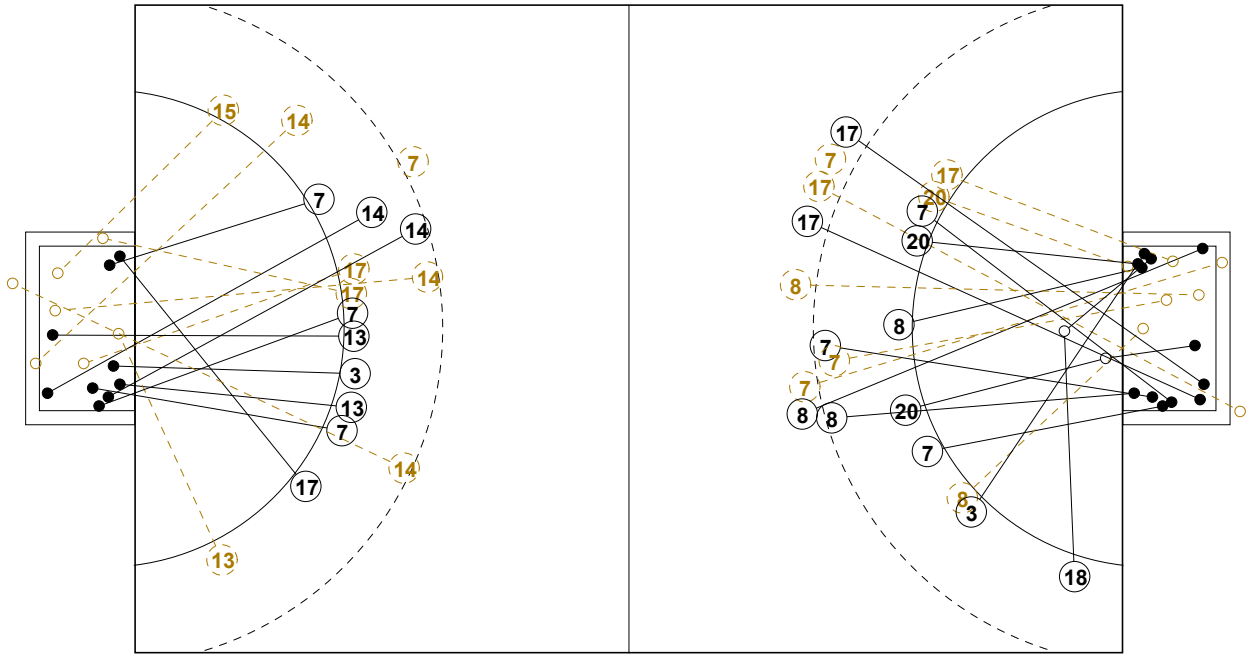

7M 天津

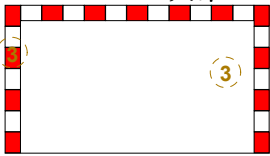

广东 7M

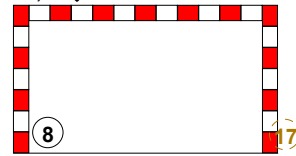

1st Half
9 : 13

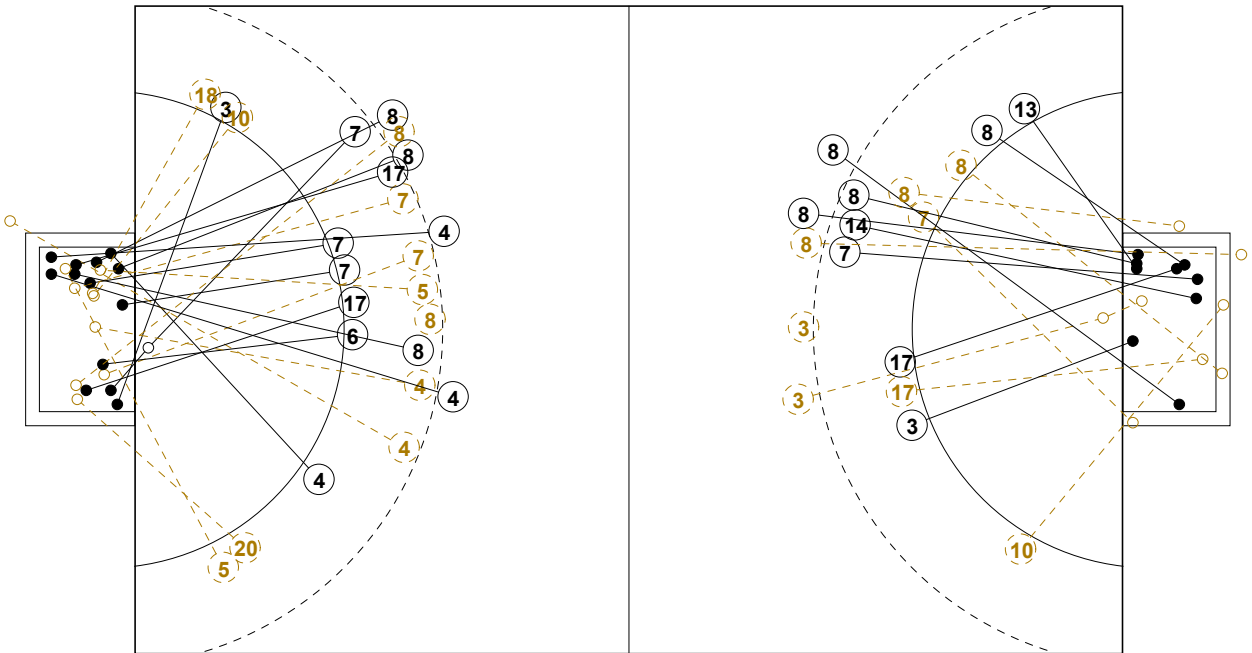

7M 广东

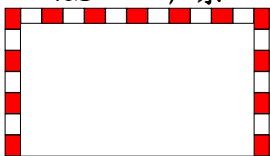

天津 7M

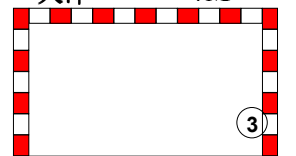

2nd Half
26 : 19



第十二届全国运动会男子手球预赛

个人/全队技术统计表

正式表
手球
男子预赛
轮次 2组别 B
场次 7201301007-14-1/2
柳州市李宁体院馆
19/04/2013 18:00

号码	姓名	远射	近射	边射	快攻	突破	任意	7M	合计	%	助攻	失误	警告	2'	取消	时间
广东(广东)																
<i>(场上队员)</i>																
1	王旭兴									0.0%						00:58:26
2	孙江山									0.0%						00:02:22
3	曲汝洋			1/1	1/1				2/2	100%		2				00:57:10
4	李卓洋	2/4	1/1						3/5	60.0%	1					00:19:08
5	候生升	0/1		0/1					0/2	0.0%						00:07:01
6	邓志贵				1/1				1/1	100%		2	1			00:30:29
7	付云博	2/7			1/1	3/3			6/11	54.5%	2	3	1			00:56:02
8	于彦江	5/8	0/1		1/1			1/1	7/11	63.6%	1	1		1		00:48:49
9	徐庆									0.0%						00:00:00
10	陈超			0/1					0/1	0.0%						00:03:57
12	温杰									0.0%						00:01:34
16	张广建									0.0%						00:00:00
17	李中洲	3/4			1/2			0/1	4/7	57.1%	1	5	1	1		00:54:57
18	张腾			1/2					1/2	50.0%				2		00:25:15
19	马跃									0.0%						00:00:00
20	王伟		1/2	0/1	1/1				2/4	50.0%		2				00:54:34
合计		12/24	2/4	2/6	6/7	3/3		1/2	26/46	56.5%	5	15	3	4		
<i>(守门员)</i>																
1	王旭兴	2/7	2/7	2/4	0/4	0/2		1/1	7/25	28.0%						00:58:26
12	温杰							0/1	0/1	0.0%						00:01:34
合计		2/7	2/7	2/4	0/4	0/2		1/2	7/26	26.9%						

场上队员：得分/射门

守门员：救球/射门

全队合计	得分	被救	射失	击柱	封球	合计	%
远射	12	7	2	1	2	24	50.0%
近射	2	2				4	50.0%
边射	2	4				6	33.3%
快攻	6	1				7	85.7%
突破	3					3	100.0%
任意							0.0%
7M	1			1		2	50.0%





第十二届全国运动会男子手球预赛

个人/全队技术统计表

正式表
手球
男子预赛
轮次 2组别 B
场次 7201301007-14-2/2
柳州市李宁体院馆
19/04/2013 18:00

号码	姓名	远射	近射	边射	快攻	突破	任意	7M	合计	%	助攻	失误	警告	2'	取消	时间
天津(天津)																
<i>(上场队员)</i>																
1	刘宗其									0.0%						00:28:57
2	李岳朋									0.0%						00:12:51
3	李军	0/2			1/1	1/1		1/3	3/7	42.9%	3	4				00:48:38
4	李松浩									0.0%						00:00:00
7	张青	1/2	3/4						4/6	66.7%	3	6	1	2		00:59:55
8	曹悦	3/4	0/2	1/1					4/7	57.1%		1				00:23:05
9	孟凡钢									0.0%						00:00:00
10	李帅			0/1					0/1	0.0%						00:30:00
11	王毅									0.0%						00:00:00
13	许松			1/2	2/2				3/4	75.0%		1		1		00:59:57
14	田剑侠	1/3	1/1	0/1		1/1			3/6	50.0%	6	3	1			00:40:26
15	张俊岭			0/1					0/1	0.0%		1		1		00:28:26
16	刘海亮									0.0%						00:31:03
17	周群		1/4		1/1				2/5	40.0%	1	2	1			00:55:33
18	孙永									0.0%						00:00:00
19	梁堂亮									0.0%						00:00:00
合计		5/11	5/11	2/6	4/4	2/2		1/3	19/37	51.4%	13	18	3	4		
<i>(守门员)</i>																
1	刘宗其	5/11	0/1	4/5	0/3	0/1			9/21	42.9%						00:28:57
16	刘海亮	2/8	2/3	0/1	1/4	0/2		0/1	5/19	26.3%						00:31:03
合计		7/19	2/4	4/6	1/7	0/3		0/1	14/40	35.0%						

场上队员：得分/射门

守门员：救球/射门

全队合计	得分	被救	射失	击柱	封球	合计	%
远射	5	2	2		2	11	45.5%
近射	5	2	1	3		11	45.5%
边射	2	2		2		6	33.3%
快攻	4					4	100.0%
突破	2					2	100.0%
任意							0.0%
7M	1	1		1		3	33.3%





第十二届全国运动会男子手球预赛

图式射门区域统计

轮次 2 场次 7

201301007-41-1/1

广东

1 王旭兴	2 孙江山	3 曲汝洋	4 李卓洋	5 候生升	6 邓志贵	7 付文博	8 于彦江																																																																								
<table border="1"><tr><td></td><td></td><td></td></tr><tr><td></td><td></td><td></td></tr><tr><td></td><td></td><td></td></tr></table>										<table border="1"><tr><td></td><td></td><td></td></tr><tr><td></td><td></td><td></td></tr><tr><td></td><td></td><td></td></tr></table>										<table border="1"><tr><td></td><td></td><td></td></tr><tr><td></td><td></td><td></td></tr><tr><td>2</td><td></td><td></td></tr></table>							2			<table border="1"><tr><td></td><td></td><td>2</td></tr><tr><td></td><td></td><td></td></tr><tr><td></td><td></td><td>1</td></tr></table>			2						1	<table border="1"><tr><td></td><td></td><td></td></tr><tr><td></td><td></td><td></td></tr><tr><td></td><td></td><td></td></tr></table>										<table border="1"><tr><td></td><td></td><td></td></tr><tr><td>1</td><td></td><td></td></tr><tr><td></td><td></td><td></td></tr></table>				1						<table border="1"><tr><td></td><td></td><td></td></tr><tr><td></td><td></td><td>3</td></tr><tr><td>1</td><td>1</td><td>1</td></tr></table>						3	1	1	1	<table border="1"><tr><td></td><td></td><td>1</td></tr><tr><td></td><td></td><td></td></tr><tr><td>2</td><td></td><td>2</td></tr></table>			1				2		2
2																																																																															
		2																																																																													
		1																																																																													
1																																																																															
		3																																																																													
1	1	1																																																																													
		1																																																																													
2		2																																																																													
Post - 0 Miss - 0 Block - 0	Post - 0 Miss - 0 Block - 0	Post - 0 Miss - 0 Block - 0	Post - 0 Miss - 1 Block - 0	Post - 0 Miss - 0 Block - 0	Post - 0 Miss - 0 Block - 0	Post - 1 Miss - 0 Block - 1	Post - 0 Miss - 0 Block - 1																																																																								
9 徐庆	10 陈超	12 温杰	16 张广建	17 李中洲	18 张腾	19 马跃	20 王伟																																																																								
<table border="1"><tr><td></td><td></td><td></td></tr><tr><td></td><td></td><td></td></tr><tr><td></td><td></td><td></td></tr></table>										<table border="1"><tr><td></td><td></td><td></td></tr><tr><td></td><td></td><td></td></tr><tr><td></td><td></td><td></td></tr></table>										<table border="1"><tr><td></td><td></td><td></td></tr><tr><td></td><td></td><td></td></tr><tr><td></td><td></td><td></td></tr></table>										<table border="1"><tr><td></td><td></td><td></td></tr><tr><td></td><td></td><td></td></tr><tr><td></td><td></td><td></td></tr></table>										<table border="1"><tr><td></td><td></td><td>2</td></tr><tr><td>1</td><td></td><td>1</td></tr><tr><td></td><td></td><td></td></tr></table>			2	1		1				<table border="1"><tr><td></td><td></td><td></td></tr><tr><td></td><td></td><td></td></tr><tr><td>1</td><td></td><td></td></tr></table>							1			<table border="1"><tr><td></td><td></td><td></td></tr><tr><td></td><td></td><td></td></tr><tr><td></td><td></td><td></td></tr></table>										<table border="1"><tr><td></td><td></td><td>1</td></tr><tr><td></td><td></td><td></td></tr><tr><td>1</td><td></td><td></td></tr></table>			1				1		
		2																																																																													
1		1																																																																													
1																																																																															
		1																																																																													
1																																																																															
Post - 0 Miss - 0 Block - 0	Post - 0 Miss - 0 Block - 0	Post - 0 Miss - 0 Block - 0	Post - 0 Miss - 0 Block - 0	Post - 1 Miss - 1 Block - 0	Post - 0 Miss - 0 Block - 0	Post - 0 Miss - 0 Block - 0	Post - 0 Miss - 0 Block - 0																																																																								

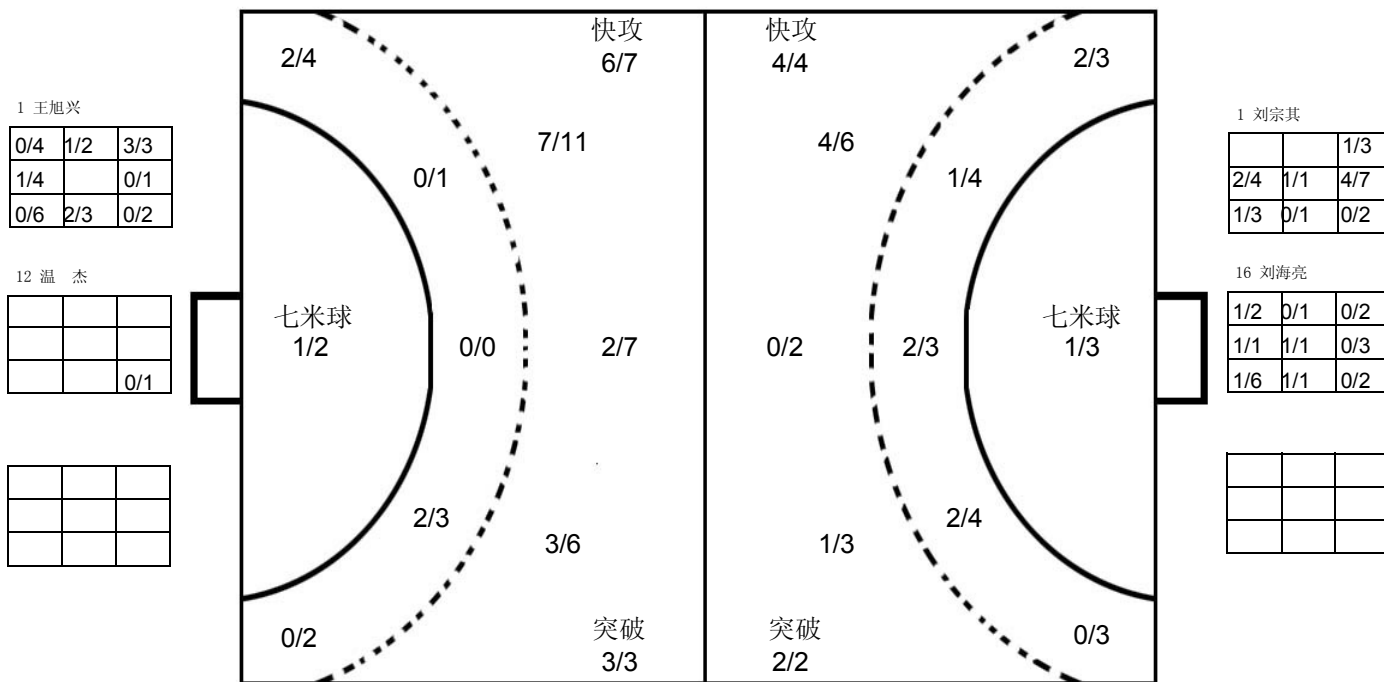

天津

1 刘宗其	2 李岳朋	3 李军	4 李松浩	7 张青	8 曹悦	9 孟凡钢	10 李帅																																																																								
<table border="1"><tr><td></td><td></td><td></td></tr><tr><td></td><td></td><td></td></tr><tr><td></td><td></td><td></td></tr></table>										<table border="1"><tr><td></td><td></td><td></td></tr><tr><td></td><td></td><td></td></tr><tr><td></td><td></td><td></td></tr></table>										<table border="1"><tr><td></td><td></td><td></td></tr><tr><td>1</td><td>1</td><td>1</td></tr><tr><td></td><td></td><td></td></tr></table>				1	1	1				<table border="1"><tr><td></td><td></td><td></td></tr><tr><td></td><td></td><td></td></tr><tr><td></td><td></td><td></td></tr></table>										<table border="1"><tr><td>1</td><td></td><td></td></tr><tr><td>2</td><td></td><td></td></tr><tr><td></td><td></td><td>1</td></tr></table>	1			2					1	<table border="1"><tr><td>1</td><td></td><td></td></tr><tr><td></td><td></td><td>1</td></tr><tr><td>2</td><td></td><td></td></tr></table>	1					1	2			<table border="1"><tr><td></td><td></td><td></td></tr><tr><td></td><td></td><td></td></tr><tr><td></td><td></td><td></td></tr></table>										<table border="1"><tr><td></td><td></td><td></td></tr><tr><td></td><td></td><td></td></tr><tr><td></td><td></td><td></td></tr></table>									
1	1	1																																																																													
1																																																																															
2																																																																															
		1																																																																													
1																																																																															
		1																																																																													
2																																																																															
Post - 0 Miss - 0 Block - 0	Post - 0 Miss - 0 Block - 0	Post - 1 Miss - 0 Block - 1	Post - 0 Miss - 0 Block - 0	Post - 1 Miss - 0 Block - 1	Post - 1 Miss - 2 Block - 0	Post - 0 Miss - 0 Block - 0	Post - 1 Miss - 0 Block - 0																																																																								
11 王毅	13 许松	14 田剑侠	15 张俊岭	16 刘海亮	17 周群	18 孙永	19 梁堂亮																																																																								
<table border="1"><tr><td></td><td></td><td></td></tr><tr><td></td><td></td><td></td></tr><tr><td></td><td></td><td></td></tr></table>										<table border="1"><tr><td></td><td>1</td><td></td></tr><tr><td></td><td></td><td></td></tr><tr><td>2</td><td></td><td></td></tr></table>		1					2			<table border="1"><tr><td></td><td>2</td><td></td></tr><tr><td></td><td></td><td></td></tr><tr><td>1</td><td></td><td></td></tr></table>		2					1			<table border="1"><tr><td></td><td></td><td></td></tr><tr><td></td><td></td><td></td></tr><tr><td></td><td></td><td></td></tr></table>										<table border="1"><tr><td></td><td></td><td></td></tr><tr><td></td><td></td><td></td></tr><tr><td></td><td></td><td></td></tr></table>										<table border="1"><tr><td></td><td></td><td></td></tr><tr><td>1</td><td></td><td></td></tr><tr><td></td><td></td><td>1</td></tr></table>				1					1	<table border="1"><tr><td></td><td></td><td></td></tr><tr><td></td><td></td><td></td></tr><tr><td></td><td></td><td></td></tr></table>										<table border="1"><tr><td></td><td></td><td></td></tr><tr><td></td><td></td><td></td></tr><tr><td></td><td></td><td></td></tr></table>									
	1																																																																														
2																																																																															
	2																																																																														
1																																																																															
1																																																																															
		1																																																																													
Post - 0 Miss - 0 Block - 0	Post - 0 Miss - 0 Block - 0	Post - 1 Miss - 1 Block - 0	Post - 0 Miss - 0 Block - 0	Post - 0 Miss - 0 Block - 0	Post - 1 Miss - 0 Block - 0	Post - 0 Miss - 0 Block - 0	Post - 0 Miss - 0 Block - 0																																																																								

注释: Post=击柱 Miss=射失 Block=被封





男子 国内比赛

第十二届全国运动会男子手球预赛

Team A										Team B										Match Number											
A 解放军										B 山西										8											
played in					in the hall					on					at					Spectators											
China					柳州市李宁体育馆					19/04/2013					19:40 hours																
Half-time (30')		A		B		End of playing time		A		B		1st extra time		A		B		2nd extra time		A		B		After penalty throws		A		B			
		20		7		36		19																							
Number of 7 m		A		Team time-out			Full name of players and officials										Team time-out			B		Number of 7 m									
3 / 3				1 2 3													1 2 3			1 / 1											
No.	Team A										G	W	2'	D	DR	No.	Team B										G	W	2'	D	DR
4	曹作亮										3	1				1	李晋尧														
5	吴龙瑞										5					2	马健										2	1			
6	苗青										2					3	王晋														
7	陈昊										3		1			4	李鹏程										1	1			
8	王烁										6					5	王志超														
9	丁超										1					6	范帅														
10	师龙										2					7	白宇飞														
11	李想										2					8	崔钰														
12	丛霖															9	朱涛涛										1				
13	王世杰										1		1			10	任海阳										3				
14	曲学博										2	1	2			12	侯乃章														
15	杨帆										1					13	侯建涛										5				
16	郎俊夫															14	刘明华										6	1	1		
17	王勇										6	1				15	景新江										1				
18	董宏斐										2					18	朱楔														
20	谷浩																														
A	张敬敏															A	王喜和														
B	张彬华															B	张晓东														
C	刘捷															D	石岩														
D	刘军																														
A		Signature of Responsible Official of the Teams (Off. A)										B										B									
TP	Remarks of Referee / CHA Official																				TP										

Signatures

Referees	姜涛 (CHN)	徐健 (CHN)		
Techn. Delegates	许宜扬 (CHN)	刘书勇 (CHN)		
CHA Official				

Note: Number of 7m Throws Awarded to Team A and B, Goals (G), Warnings (W), Suspensions (2), Direct Disqualification (D), Disqualification with Report (DR) and Team Penalty (TP).

Table Officials:

Statisticians: 黄莉

朱伟平



第十二届全国运动会男子手球预赛
竞赛技术统计(媒体表)

预赛	组别	B	轮次	2	场次	8
----	----	---	----	---	----	---

柳州市李宁体育馆

19/04/2013

201301008-51-1/1

解放军	解放军	36	vs	19	山西	山西
				20 : 7		

裁判员	姜涛 (CHN)	/	徐健 (CHN)
-----	----------	---	----------

解放军		远射	近射	边射	快攻	突破	任意球	7m球	合计	%	助攻	失误	警告	2'	D & DR	山西	
主教练:	张敬敏																
4	曹作亮				3/3				3/3	100		5	1				
5	吴龙瑞		1/1	0/1	4/5	0/1			5/8	62.5	1	3					14 刘明华
6	苗青	0/2	1/1		1/1				2/4	50.0	3	1					
7	陈昊		1/1	1/1	1/1				3/3	100				1			
8	王烁			3/3	1/2			2/2	6/7	85.7	1	2					
9	丁超				0/1	1/1			1/2	50.0	2	1					
10	师龙					1/1		1/1	2/2	100		1					
11	李想		2/3						2/3	66.7							
12	丛霖																
13	王世杰				1/2				1/2	50.0	1			1			
14	曲学博		2/2						2/2	100	1	3	1	2			
15	杨帆				1/1				1/1	100	1	3					
16	郎俊夫										2						
17	王勇	2/3		3/3		1/1			6/7	85.7	3	4	1				
18	董宏斐				2/2				2/2	100							
20	谷浩				0/2				0/2	0.0							
运动员	合计	2/5	7/8	7/8	14/20	3/4		3/3	36/48	75.0	15	23	3	4			
12	丛霖	6/9	1/1	3/4	2/3	0/1	2/3		14/21	66.7							
16	郎俊夫	8/12	2/4	1/1	1/3	0/3		0/1	12/24	50.0	2						
守门员	合计	14/21	3/5	4/5	3/6	0/4	2/3	0/1	26/45	57.8	2						
山西		远射	近射	边射	快攻	突破	任意球	7m球	合计	%	助攻	失误	警告	2'	D & DR	比赛进程	
教练:	王喜和																
1	李晋尧																
2	马健			0/1	2/2				2/3	66.7		1	1				
3	王晋											2					
4	李鹏程	1/3		0/1	0/1				1/5	20.0		3	1				
5	王志超																
6	范帅																
7	白宇飞	0/8	0/1				0/1		0/10	0.0		2					
8	崔钰																
9	朱涛涛		1/1	0/1					1/2	50.0							
10	任海阳		0/1		1/1	2/2			3/4	75.0							
12	侯乃章																
13	侯建涛	3/11	0/1	1/2				1/1	5/15	33.3	1	2					
14	刘明华	3/11			0/1	2/2	1/2		6/16	37.5		4	1	1			
15	景新江		1/1						1/1	100							
18	朱榭	0/1			0/1				0/2	0.0		3					
运动员	合计	7/34	2/5	1/5	3/6	4/4	1/3	1/1	19/58	32.8	1	17	3	1			
1	李晋尧	2/2	1/4	0/4	6/16	0/2		0/1	9/29	31.0							
12	侯乃章	0/2	0/4	1/4	0/4	0/1		0/2	1/17	5.9							
守门员	合计	2/4	1/8	1/8	6/20	0/3		0/3	10/46	21.7							

场上队员: 得分 / 射门

守门员: 救球 / 射门

快攻	Fast Break		突破	Breakthrough		任意球	Free Throw		7m球	7M Throw		助攻	Assist
警告	Warning		失误	Error		2'	Suspension		D	取消资格		DR	取消资格+报告





第十二届全国运动会男子手球预赛 图式比赛技术统计表

轮次 2

场次 8

201301008-21-1/1

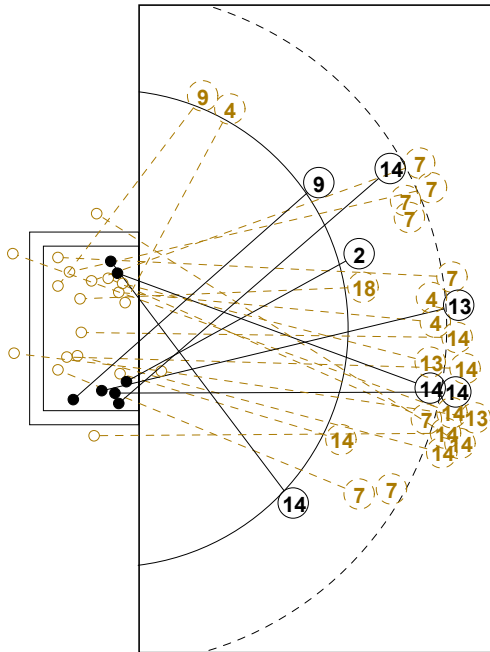

7M 山西

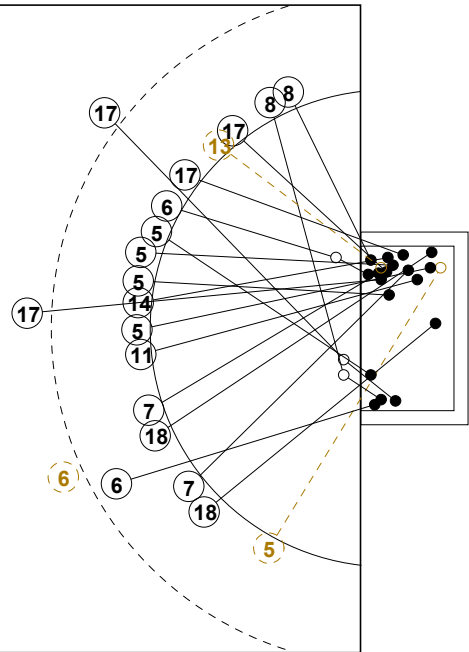
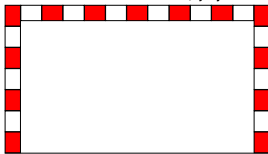

解放军 7M

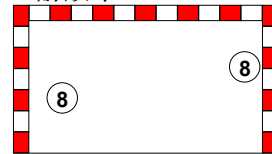

1st Half
7 : 20

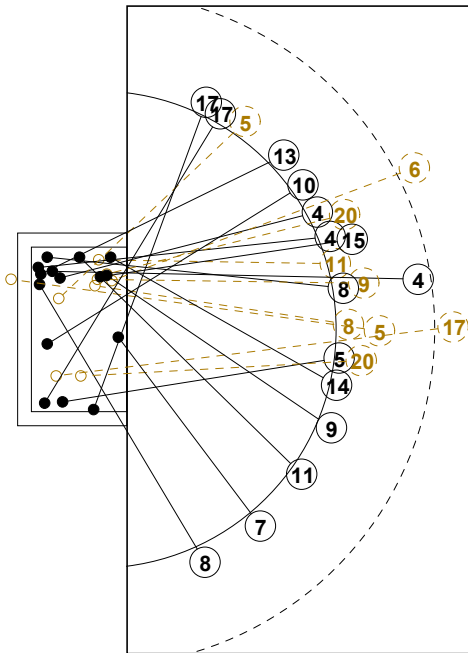

7M 解放军

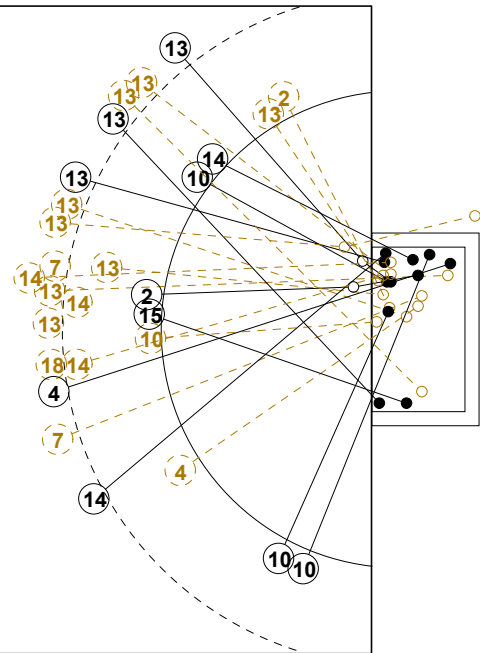
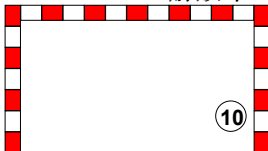

山西 7M

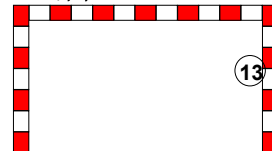

2nd Half
36 : 19



第十二届全国运动会男子手球预赛

个人/全队技术统计表

正式表
手球
男子预赛
轮次 2组别 B
场次 8201301008-14-1/2
柳州市李宁体院馆
19/04/2013 19:40

号码	姓名	远射	近射	边射	快攻	突破	任意	7M	合计	%	助攻	失误	警告	2'	取消	时间
解放军(解放军)																
<i>(场上队员)</i>																
4	曹作亮				3/3				3/3	100%		5	1			00:40:56
5	吴龙瑞		1/1	0/1	4/5	0/1			5/8	62.5%	1	3				00:48:56
6	苗青	0/2	1/1		1/1				2/4	50.0%	3	1				00:26:18
7	陈昊		1/1	1/1	1/1				3/3	100%				1		00:10:56
8	王烁			3/3	1/2			2/2	6/7	85.7%	1	2				00:48:31
9	丁超				0/1	1/1			1/2	50.0%	2	1				00:26:33
10	师龙					1/1		1/1	2/2	100%		1				00:10:04
11	李想		2/3						2/3	66.7%						00:38:30
12	丛霖									0.0%						00:21:58
13	王世杰				1/2				1/2	50.0%	1			1		00:11:27
14	曲学博		2/2						2/2	100%	1	3	1	2		00:26:09
15	杨帆				1/1				1/1	100%	1	3				00:05:03
16	郎俊夫									0.0%	2					00:38:02
17	王勇	2/3		3/3		1/1			6/7	85.7%	3	4	1			00:49:55
18	董宏斐				2/2				2/2	100%						00:11:02
20	谷浩				0/2				0/2	0.0%						00:05:26
合计		2/5	7/8	7/8	14/20	3/4		3/3	36/48	75.0%	15	23	3	4		
<i>(守门员)</i>																
12	丛霖	6/9	1/1	3/4	2/3	0/1	2/3		14/21	66.7%						00:21:58
16	郎俊夫	8/12	2/4	1/1	1/3	0/3		0/1	12/24	50.0%	2					00:38:02
合计		14/21	3/5	4/5	3/6	0/4	2/3	0/1	26/45	57.8%	2					

场上队员：得分/射门

守门员：救球/射门

全队合计	得分	被救	射失	击柱	封球	合计	%
远射	2	2			1	5	40.0%
近射	7	1				8	87.5%
边射	7	1				8	87.5%
快攻	14	6				20	70.0%
突破	3		1			4	75.0%
任意							0.0%
7M	3					3	100.0%





第十二届全国运动会男子手球预赛

个人/全队技术统计表

正式表
手球
男子预赛
轮次 2组别 B
场次 8201301008-14-2/2
柳州市李宁体院馆
19/04/2013 19:40

号码	姓名	远射	近射	边射	快攻	突破	任意	7M	合计	%	助攻	失误	警告	2'	取消	时间
山西(山西)																
<i>(上场队员)</i>																
1	李晋尧									0.0%						00:34:01
2	马健			0/1	2/2				2/3	66.7%		1	1			00:25:28
3	王晋									0.0%		2				00:45:58
4	李鹏程	1/3		0/1	0/1				1/5	20.0%		3	1			00:54:04
5	王志超									0.0%						00:00:00
6	范帅									0.0%						00:03:20
7	白宇飞	0/8	0/1				0/1		0/10	0.0%		2				00:27:37
8	崔钰									0.0%						00:11:16
9	朱涛涛		1/1	0/1					1/2	50.0%						00:28:40
10	任海阳		0/1		1/1	2/2			3/4	75.0%						00:37:14
12	侯乃章									0.0%						00:25:59
13	侯建涛	3/11	0/1	1/2				1/1	5/15	33.3%	1	2				00:39:15
14	刘明华	3/11			0/1	2/2	1/2		6/16	37.5%		4	1	1		00:40:00
15	景新江		1/1						1/1	100%						00:05:23
18	朱棣	0/1			0/1				0/2	0.0%		3				00:40:12
合计		7/34	2/5	1/5	3/6	4/4	1/3	1/1	19/58	32.8%	1	17	3	1		
<i>(守门员)</i>																
1	李晋尧	2/2	1/4	0/4	6/16	0/2		0/1	9/29	31.0%						00:34:01
12	侯乃章	0/2	0/4	1/4	0/4	0/1		0/2	1/17	5.9%						00:25:59
合计		2/4	1/8	1/8	6/20	0/3		0/3	10/46	21.7%						

场上队员：得分/射门

守门员：救球/射门

全队合计	得分	被救	射失	击柱	封球	合计	%
远射	7	14	5		8	34	20.6%
近射	2	3				5	40.0%
边射	1	4				5	20.0%
快攻	3	3				6	50.0%
突破	4					4	100.0%
任意	1	2				3	33.3%
7M	1					1	100.0%





第十二届全国运动会男子手球预赛

图式射门区域统计

轮次 2 场次 8

201301008-41-1/1

解放军

4 曹作亮	5 吴龙瑞	6 苗青	7 陈昊	8 王烁	9 丁超	10 师龙	11 李想																																																																								
<table border="1"><tr><td></td><td></td><td>3</td></tr><tr><td></td><td></td><td></td></tr><tr><td></td><td></td><td></td></tr></table>			3							<table border="1"><tr><td>2</td><td></td><td></td></tr><tr><td>1</td><td></td><td></td></tr><tr><td>1</td><td></td><td>1</td></tr></table>	2			1			1		1	<table border="1"><tr><td></td><td></td><td></td></tr><tr><td></td><td></td><td></td></tr><tr><td>1</td><td></td><td>1</td></tr></table>							1		1	<table border="1"><tr><td></td><td></td><td></td></tr><tr><td>1</td><td></td><td></td></tr><tr><td>1</td><td>1</td><td></td></tr></table>				1			1	1		<table border="1"><tr><td></td><td></td><td>3</td></tr><tr><td>1</td><td></td><td></td></tr><tr><td>1</td><td></td><td>1</td></tr></table>			3	1			1		1	<table border="1"><tr><td></td><td></td><td></td></tr><tr><td></td><td></td><td></td></tr><tr><td></td><td></td><td>1</td></tr></table>									1	<table border="1"><tr><td></td><td>1</td><td></td></tr><tr><td></td><td></td><td></td></tr><tr><td></td><td></td><td>1</td></tr></table>		1							1	<table border="1"><tr><td></td><td></td><td></td></tr><tr><td>1</td><td></td><td></td></tr><tr><td></td><td></td><td>1</td></tr></table>				1					1
		3																																																																													
2																																																																															
1																																																																															
1		1																																																																													
1		1																																																																													
1																																																																															
1	1																																																																														
		3																																																																													
1																																																																															
1		1																																																																													
		1																																																																													
	1																																																																														
		1																																																																													
1																																																																															
		1																																																																													
Post - 0 Miss - 0 Block - 0	Post - 0 Miss - 1 Block - 0	Post - 0 Miss - 0 Block - 1	Post - 0 Miss - 0 Block - 0	Post - 0 Miss - 0 Block - 0	Post - 0 Miss - 0 Block - 0	Post - 0 Miss - 0 Block - 0	Post - 0 Miss - 0 Block - 0																																																																								
12 丛霖	13 王世杰	14 曲学博	15 杨帆	16 郎俊夫	17 王勇	18 董宏斐	20 谷浩																																																																								
<table border="1"><tr><td></td><td></td><td></td></tr><tr><td></td><td></td><td></td></tr><tr><td></td><td></td><td></td></tr></table>										<table border="1"><tr><td></td><td></td><td>1</td></tr><tr><td></td><td></td><td></td></tr><tr><td></td><td></td><td></td></tr></table>			1							<table border="1"><tr><td></td><td></td><td></td></tr><tr><td></td><td></td><td></td></tr><tr><td>1</td><td></td><td>1</td></tr></table>							1		1	<table border="1"><tr><td></td><td></td><td></td></tr><tr><td></td><td></td><td></td></tr><tr><td></td><td></td><td>1</td></tr></table>									1	<table border="1"><tr><td></td><td></td><td></td></tr><tr><td></td><td></td><td></td></tr><tr><td></td><td></td><td></td></tr></table>										<table border="1"><tr><td>1</td><td></td><td></td></tr><tr><td>2</td><td></td><td>1</td></tr><tr><td>2</td><td></td><td></td></tr></table>	1			2		1	2			<table border="1"><tr><td>1</td><td>1</td><td></td></tr><tr><td></td><td></td><td></td></tr><tr><td></td><td></td><td></td></tr></table>	1	1								<table border="1"><tr><td></td><td></td><td></td></tr><tr><td></td><td></td><td></td></tr><tr><td></td><td></td><td></td></tr></table>									
		1																																																																													
1		1																																																																													
		1																																																																													
1																																																																															
2		1																																																																													
2																																																																															
1	1																																																																														
Post - 0 Miss - 0 Block - 0	Post - 0 Miss - 0 Block - 0	Post - 0 Miss - 0 Block - 0	Post - 0 Miss - 0 Block - 0	Post - 0 Miss - 0 Block - 0	Post - 0 Miss - 0 Block - 0	Post - 0 Miss - 0 Block - 0	Post - 0 Miss - 0 Block - 0																																																																								

12 丛霖

2/2		3/3
0/1	2/2	2/2
1/5	2/2	2/4

16 郎俊夫

1/3		0/1
1/4	2/2	1/2
5/8	1/2	1/2

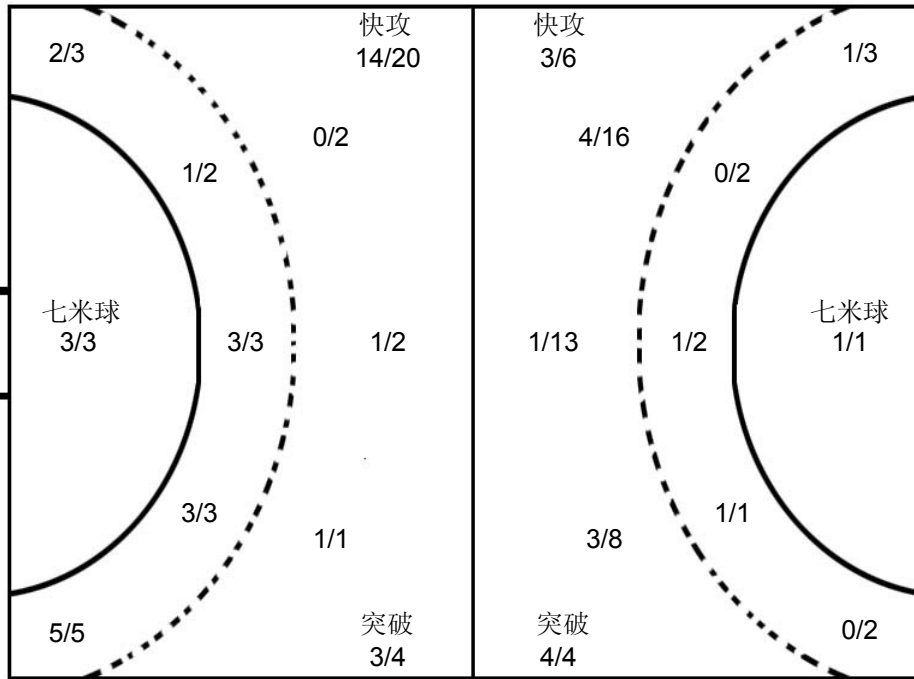

1 李晋尧

1/4	0/2	1/7
1/4		1/3
1/1	0/1	4/7

12 侯乃章

1/2		0/1
0/3		0/1
0/7		0/3

山西

1 李晋尧	2 马健	3 王晋	4 李鹏程	5 王志超	6 范帅	7 白宇飞	8 崔钰																																																																								
<table border="1"><tr><td></td><td></td><td></td></tr><tr><td></td><td></td><td></td></tr><tr><td></td><td></td><td></td></tr></table>										<table border="1"><tr><td></td><td></td><td></td></tr><tr><td>1</td><td></td><td></td></tr><tr><td>1</td><td></td><td></td></tr></table>				1			1			<table border="1"><tr><td></td><td></td><td></td></tr><tr><td></td><td></td><td></td></tr><tr><td></td><td></td><td></td></tr></table>										<table border="1"><tr><td>1</td><td></td><td></td></tr><tr><td></td><td></td><td></td></tr><tr><td></td><td></td><td></td></tr></table>	1									<table border="1"><tr><td></td><td></td><td></td></tr><tr><td></td><td></td><td></td></tr><tr><td></td><td></td><td></td></tr></table>										<table border="1"><tr><td></td><td></td><td></td></tr><tr><td></td><td></td><td></td></tr><tr><td></td><td></td><td></td></tr></table>										<table border="1"><tr><td></td><td></td><td></td></tr><tr><td></td><td></td><td></td></tr><tr><td></td><td></td><td></td></tr></table>										<table border="1"><tr><td></td><td></td><td></td></tr><tr><td></td><td></td><td></td></tr><tr><td></td><td></td><td></td></tr></table>									
1																																																																															
1																																																																															
1																																																																															
Post - 0 Miss - 0 Block - 0	Post - 0 Miss - 0 Block - 0	Post - 0 Miss - 0 Block - 0	Post - 0 Miss - 0 Block - 1	Post - 0 Miss - 0 Block - 0	Post - 0 Miss - 0 Block - 0	Post - 0 Miss - 0 Block - 4	Post - 0 Miss - 0 Block - 0																																																																								
9 朱涛涛	10 任海阳	12 侯乃章	13 侯建涛	14 刘明华	15 景新江	18 朱棣																																																																									
<table border="1"><tr><td>1</td><td></td><td></td></tr><tr><td></td><td></td><td></td></tr><tr><td></td><td></td><td></td></tr></table>	1									<table border="1"><tr><td></td><td></td><td></td></tr><tr><td>1</td><td></td><td></td></tr><tr><td>1</td><td>1</td><td></td></tr></table>				1			1	1		<table border="1"><tr><td></td><td></td><td></td></tr><tr><td></td><td></td><td></td></tr><tr><td></td><td></td><td></td></tr></table>										<table border="1"><tr><td></td><td></td><td>1</td></tr><tr><td>1</td><td></td><td></td></tr><tr><td>2</td><td></td><td>1</td></tr></table>			1	1			2		1	<table border="1"><tr><td></td><td></td><td></td></tr><tr><td>1</td><td></td><td></td></tr><tr><td>3</td><td></td><td>2</td></tr></table>				1			3		2	<table border="1"><tr><td></td><td></td><td></td></tr><tr><td></td><td></td><td></td></tr><tr><td></td><td></td><td>1</td></tr></table>									1	<table border="1"><tr><td></td><td></td><td></td></tr><tr><td></td><td></td><td></td></tr><tr><td></td><td></td><td></td></tr></table>										<table border="1"><tr><td></td><td></td><td></td></tr><tr><td></td><td></td><td></td></tr><tr><td></td><td></td><td></td></tr></table>									
1																																																																															
1																																																																															
1	1																																																																														
		1																																																																													
1																																																																															
2		1																																																																													
1																																																																															
3		2																																																																													
		1																																																																													
Post - 0 Miss - 0 Block - 0	Post - 0 Miss - 0 Block - 0	Post - 0 Miss - 0 Block - 0	Post - 0 Miss - 2 Block - 1	Post - 0 Miss - 3 Block - 1	Post - 0 Miss - 0 Block - 0	Post - 0 Miss - 0 Block - 1																																																																									

注释: Post=击柱 Miss=射失 Block=被封





男子 国内比赛

第十二届全国运动会男子手球预赛

Team A										Team B										Match Number													
A 上海					B 四川					9																							
played in China										in the hall 柳州市李宁体育馆					on 19/04/2013		at 21:20 hours		Spectators														
Half-time (30')		A 20		B 9		End of playing time		A 45		B 15		1st extra time		A		B		2nd extra time		A		B		After penalty		A		B					
Number of 7 m		A 3/3		Team time-out		1 14:21		2		3		Full name of players and officials										Team time-out		1		2		3		B 2/2		Number of 7 m	
No.	Team A									G	W	2'	D	DR	No.	Team B									G	W	2'	D	DR				
1	张崢														16	王松																	
2	胡辰									2					18	杨洋									1								
3	赵时俊									1					19	杨洁										1							
5	朱世杰									3					21	池培俊									1		2						
6	李和鑫									2	1				22	刘彦坤									7	1	1						
8	钱为玮									6	1				23	王震										1	1						
9	朱礼彬									3					25	李崢									1								
10	吴璟									3	1	1			27	于洪泉																	
12	周哲韬														28	宋涛									3								
13	孟宇超									4					32	逯明松																	
14	王子阳									6		1			33	朱晓龙									1		1						
15	徐俊吉									3					35	仇振勇									1		1						
16	朱春雷														36	刘琢																	
18	马麟晓									5																							
19	蒋承骅									2		1																					
20	程云飞									5		1																					
A	吴龙基														A	李太平																	
B	陆钦忠														B	李清																	
C	徐耀忠														C	黄承																	
E	黄韡														E	何明阳																	
A										Signature of Responsible Official of the Teams (Off. A)										B													
TP	Remarks of Referee / CHA Official																										TP						

Signatures

Referees	李典 (CHN)	倪震 (CHN)		
Techn. Delegates	李之文 (CHN)	许宜扬 (CHN)		
CHA Official				

Note: Number of 7m Throws Awarded to Team A and B, Goals (G), Warnings (W), Suspensions (2'), Direct Disqualification (D), Disqualification with Report (DR) and Team Penalty (TP).





第十二届全国运动会男子手球预赛
竞赛技术统计(媒体表)

Table with match details: 预赛, 组别 B, 轮次 2, 场次 9, 柳州市李宁体育馆, 19/04/2013, 201301009-51-1/1, 上海 vs 四川, 45 vs 15, 20:9

Table with referees: 裁判员 李典 (CHN) / 倪震 (CHN)

Main statistics table for Shanghai team, including columns for player name, distance, position, attack, breakthrough, free throw, 7m, total, %, assists, errors, warnings, 2', and D & DR.

Main statistics table for Sichuan team, including columns for player name, distance, position, attack, breakthrough, free throw, 7m, total, %, assists, errors, warnings, 2', and D & DR.

Match progress table (比赛进程) showing time, score, and player actions for both teams.

Summary table for on-court players (场上队员) and goalkeepers (守门员), including statistics for fast break, breakthrough, free throw, 7m, assists, and warnings.



第十二届全国运动会男子手球预赛 图式比赛技术统计表

轮次 2

场次 9

201301009-21-1/1

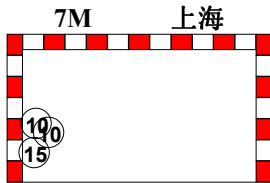
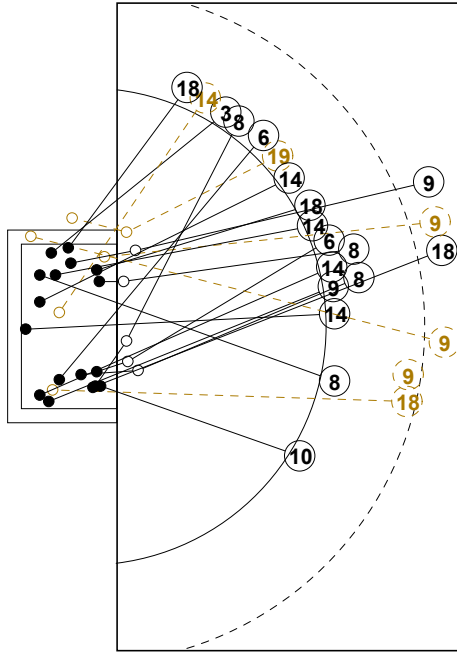

1st Half
20 : 9

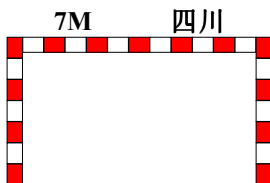
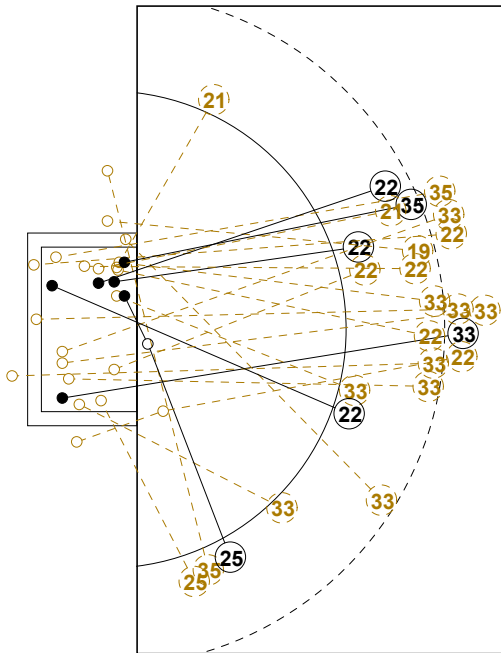
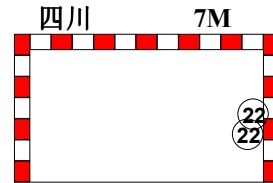
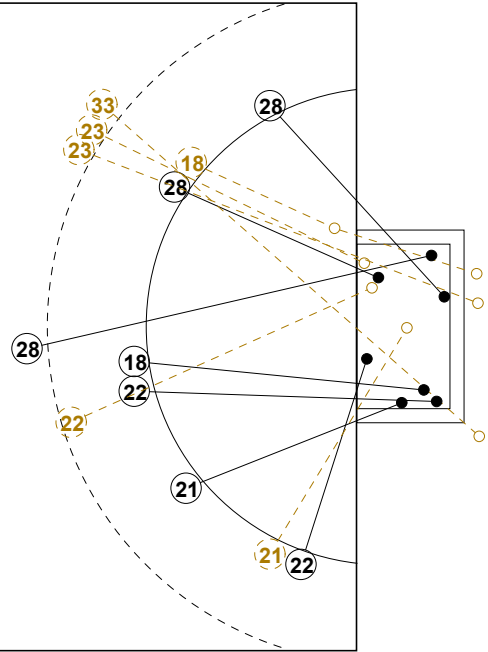

2nd Half
15 : 45

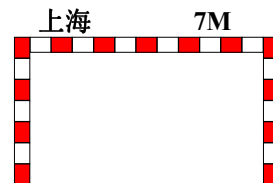
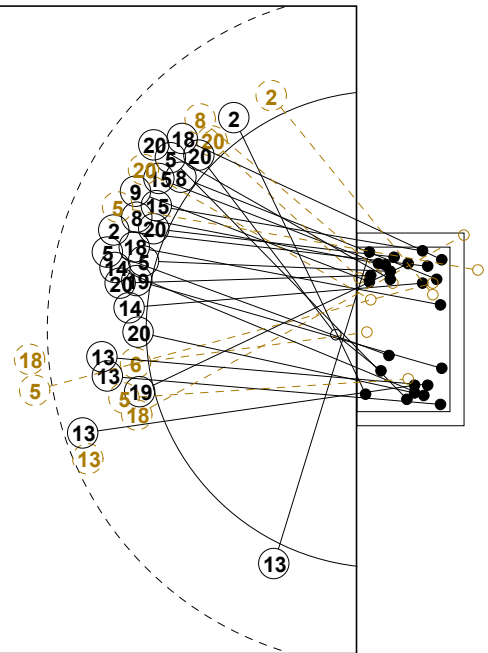



第十二届全国运动会男子手球预赛

个人/全队技术统计表

正式表
手球
男子预赛
轮次 2组别 B
场次 9201301009-14-1/2
柳州市李宁体院馆
19/04/2013 21:20

号码	姓名	远射	近射	边射	快攻	突破	任意	7M	合计	%	助攻	失误	警告	2'	取消	时间
上海(上海)																
<i>(场上队员)</i>																
1	张崢									0.0%	2					00:22:13
2	胡辰			0/1	2/2				2/3	66.7%						00:16:31
3	赵时俊				1/1				1/1	100%	1					00:11:29
5	朱世杰	0/1	1/3		1/1	1/1			3/6	50.0%	3	2				00:19:26
6	李和鑫			1/1	1/1	0/1			2/3	66.7%		3	1			00:33:07
8	钱为玮		1/1		5/6				6/7	85.7%	1	2	1			00:42:47
9	朱礼彬	1/4	1/1		1/1				3/6	50.0%	1	1				00:33:05
10	吴璟		1/1					2/2	3/3	100%	1	2	1	1		00:15:16
12	周哲韬									0.0%	2	2				00:19:36
13	孟宇超	1/2		1/1	2/2				4/5	80.0%						00:20:00
14	王子阳			0/1	6/6				6/7	85.7%		1		1		00:28:12
15	徐俊吉		2/2					1/1	3/3	100%		1				00:22:09
16	朱春雷									0.0%						00:18:11
18	马麟晓	1/3	2/2		2/3				5/8	62.5%		2				00:53:36
19	蒋承骅		1/2		1/1				2/3	66.7%	3			1		00:43:13
20	程云飞		2/3		3/4				5/7	71.4%				1		00:16:51
合计		3/10	11/15	2/4	25/28	1/2		3/3	45/62	72.6%	14	16	3	4		
<i>(守门员)</i>																
1	张崢	2/4	1/2	3/3	0/3	1/1		0/2	7/15	46.7%	2					00:22:13
12	周哲韬	7/9		1/2	0/1				8/12	66.7%	2	2				00:19:36
16	朱春雷	1/1		0/2		0/1			1/4	25.0%						00:18:11
合计		10/14	1/2	4/7	0/4	1/2		0/2	16/31	51.6%	4	2				

场上队员：得分/射门

守门员：救球/射门

全队合计	得分	被救	射失	击柱	封球	合计	%
远射	3	3		1	3	10	30.0%
近射	11	2	2			15	73.3%
边射	2	2				4	50.0%
快攻	25	2		1		28	89.3%
突破	1	1				2	50.0%
任意							0.0%
7M	3					3	100.0%



第十二届全国运动会男子手球预赛

个人/全队技术统计表

正式表
手球
男子预赛
轮次 2组别 B
场次 9201301009-14-2/2
柳州市李宁体院馆
19/04/2013 21:20

号码	姓名	远射	近射	边射	快攻	突破	任意	7M	合计	%	助攻	失误	警告	2'	取消	时间
四川(四川)																
<i>(上场队员)</i>																
16	王松									0.0%		1				00:30:00
18	杨洋		1/1		0/1				1/2	50.0%		2				00:20:50
19	杨洁	0/1							0/1	0.0%		2	1			00:23:29
21	池培俊	0/1		0/2	1/1				1/4	25.0%		3		2		00:59:03
22	刘彦坤	1/6		1/1	3/3	0/1		2/2	7/13	53.8%		12	1	1		00:59:32
23	王震	0/2							0/2	0.0%			1	1		00:30:00
25	李峥			1/2					1/2	50.0%		2				00:46:32
27	于洪泉									0.0%						00:00:00
28	宋涛	1/1		1/1		1/1			3/3	100%	2	8				00:30:00
32	逯明松									0.0%						00:00:00
33	朱晓龙	1/9	0/1	0/1					1/11	9.1%		2		1		00:41:46
35	仇振勇	1/2		0/1					1/3	33.3%		3		1		00:44:28
36	刘琢									0.0%						00:29:58
合计																
<i>(守门员)</i>																
16	王松	2/4	0/2	1/2	0/12			0/3	3/23	13.0%		1				00:30:00
36	刘琢	1/2	2/11	1/2	2/15	1/2			7/32	21.9%						00:29:58
合计																

场上队员：得分/射门

守门员：救球/射门

全队合计	得分	被救	射失	击柱	封球	合计	%
远射	4	10	5	3		22	18.2%
近射	1	1				2	50.0%
边射	3	4	1			8	37.5%
快攻	4		1			5	80.0%
突破	1	1				2	50.0%
任意							0.0%
7M	2					2	100.0%





第十二届全国运动会男子手球预赛

图式射门区域统计

轮次 2 场次 9

201301009-41-1/1

上海

1 张峥	2 胡辰	3 赵时俊	5 朱世杰	6 李和鑫	8 钱为玮	9 朱礼彬	10 吴璟																																																																								
<table border="1"><tr><td></td><td></td><td></td></tr><tr><td></td><td></td><td></td></tr><tr><td></td><td></td><td></td></tr></table>										<table border="1"><tr><td>1</td><td></td><td></td></tr><tr><td></td><td></td><td></td></tr><tr><td></td><td></td><td>1</td></tr></table>	1								1	<table border="1"><tr><td></td><td></td><td>1</td></tr><tr><td></td><td></td><td></td></tr><tr><td></td><td></td><td></td></tr></table>			1							<table border="1"><tr><td>1</td><td>1</td><td>1</td></tr><tr><td></td><td></td><td></td></tr><tr><td></td><td></td><td></td></tr></table>	1	1	1							<table border="1"><tr><td>1</td><td></td><td></td></tr><tr><td></td><td></td><td></td></tr><tr><td>1</td><td></td><td></td></tr></table>	1						1			<table border="1"><tr><td>1</td><td></td><td>1</td></tr><tr><td>1</td><td></td><td></td></tr><tr><td>2</td><td></td><td>1</td></tr></table>	1		1	1			2		1	<table border="1"><tr><td>1</td><td></td><td></td></tr><tr><td></td><td></td><td>1</td></tr><tr><td>1</td><td></td><td></td></tr></table>	1					1	1			<table border="1"><tr><td></td><td></td><td></td></tr><tr><td></td><td></td><td></td></tr><tr><td>2</td><td></td><td></td></tr></table>							2		
1																																																																															
		1																																																																													
		1																																																																													
1	1	1																																																																													
1																																																																															
1																																																																															
1		1																																																																													
1																																																																															
2		1																																																																													
1																																																																															
		1																																																																													
1																																																																															
2																																																																															
Post - 0 Miss - 0 Block - 0	Post - 0 Miss - 0 Block - 0	Post - 0 Miss - 0 Block - 0	Post - 0 Miss - 1 Block - 0	Post - 0 Miss - 0 Block - 0	Post - 0 Miss - 0 Block - 0	Post - 1 Miss - 0 Block - 1	Post - 0 Miss - 0 Block - 0																																																																								
12 周哲韬	13 孟宇超	14 王子阳	15 徐俊吉	16 朱春雷	18 马麟晓	19 蒋承骅	20 程云飞																																																																								
<table border="1"><tr><td></td><td></td><td></td></tr><tr><td></td><td></td><td></td></tr><tr><td></td><td></td><td></td></tr></table>										<table border="1"><tr><td></td><td></td><td>2</td></tr><tr><td></td><td></td><td>1</td></tr><tr><td>1</td><td></td><td></td></tr></table>			2			1	1			<table border="1"><tr><td>2</td><td>2</td><td>1</td></tr><tr><td></td><td></td><td>1</td></tr><tr><td></td><td></td><td></td></tr></table>	2	2	1			1				<table border="1"><tr><td>1</td><td></td><td></td></tr><tr><td></td><td></td><td></td></tr><tr><td>2</td><td></td><td></td></tr></table>	1						2			<table border="1"><tr><td></td><td></td><td></td></tr><tr><td></td><td></td><td></td></tr><tr><td></td><td></td><td></td></tr></table>										<table border="1"><tr><td>1</td><td>1</td><td></td></tr><tr><td></td><td></td><td>1</td></tr><tr><td>1</td><td></td><td>1</td></tr></table>	1	1				1	1		1	<table border="1"><tr><td></td><td></td><td>1</td></tr><tr><td>1</td><td></td><td></td></tr><tr><td></td><td></td><td></td></tr></table>			1	1						<table border="1"><tr><td></td><td></td><td></td></tr><tr><td></td><td></td><td></td></tr><tr><td>2</td><td></td><td>1</td></tr></table>							2		1
		2																																																																													
		1																																																																													
1																																																																															
2	2	1																																																																													
		1																																																																													
1																																																																															
2																																																																															
1	1																																																																														
		1																																																																													
1		1																																																																													
		1																																																																													
1																																																																															
2		1																																																																													
Post - 0 Miss - 0 Block - 0	Post - 0 Miss - 0 Block - 1	Post - 0 Miss - 0 Block - 0	Post - 0 Miss - 0 Block - 0	Post - 0 Miss - 0 Block - 0	Post - 1 Miss - 0 Block - 1	Post - 0 Miss - 1 Block - 0	Post - 0 Miss - 0 Block - 0																																																																								

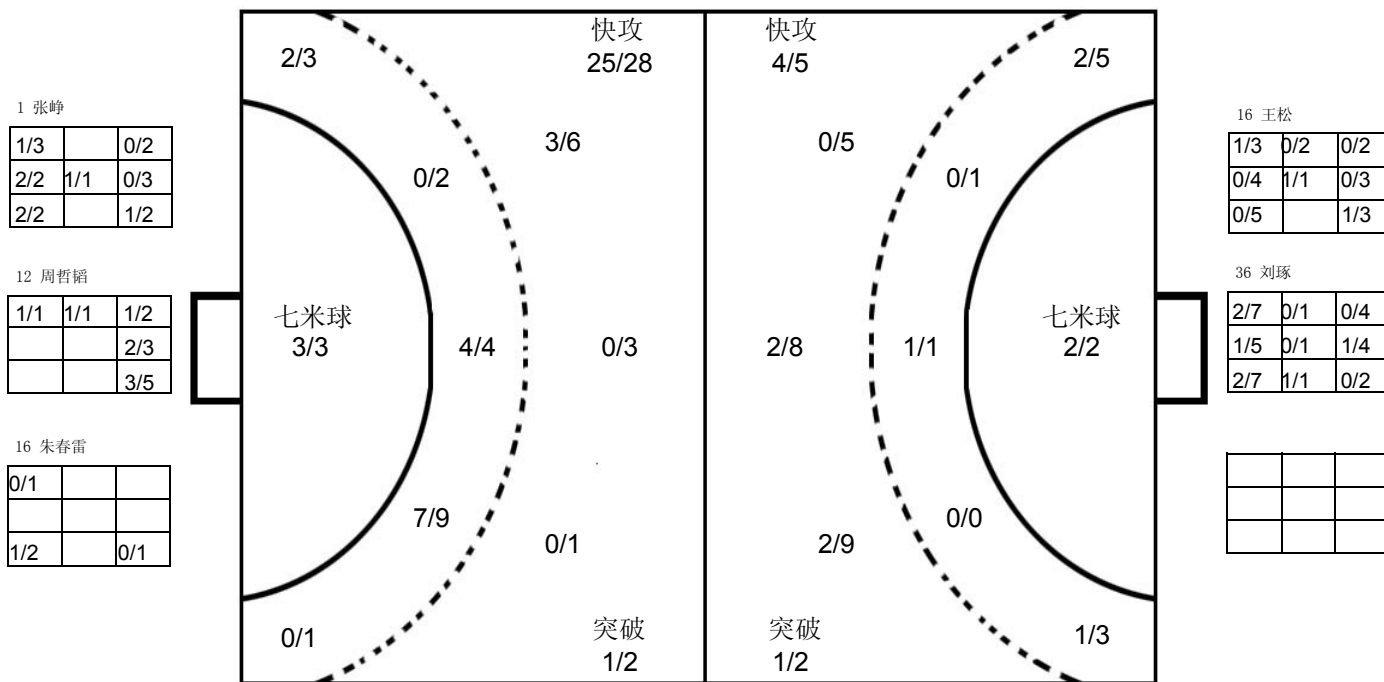

四川

16 王松	18 杨洋	19 杨洁	21 池培俊	22 刘彦坤	23 王震	25 李峥	27 于洪泉																																																																								
<table border="1"><tr><td></td><td></td><td></td></tr><tr><td></td><td></td><td></td></tr><tr><td></td><td></td><td></td></tr></table>										<table border="1"><tr><td></td><td></td><td>1</td></tr><tr><td></td><td></td><td></td></tr><tr><td></td><td></td><td></td></tr></table>			1							<table border="1"><tr><td></td><td></td><td></td></tr><tr><td></td><td></td><td></td></tr><tr><td></td><td></td><td></td></tr></table>										<table border="1"><tr><td></td><td></td><td></td></tr><tr><td></td><td></td><td>1</td></tr><tr><td></td><td></td><td></td></tr></table>						1				<table border="1"><tr><td></td><td></td><td>2</td></tr><tr><td></td><td></td><td>3</td></tr><tr><td></td><td></td><td>2</td></tr></table>			2			3			2	<table border="1"><tr><td></td><td></td><td></td></tr><tr><td></td><td></td><td></td></tr><tr><td></td><td></td><td></td></tr></table>										<table border="1"><tr><td></td><td></td><td></td></tr><tr><td></td><td></td><td></td></tr><tr><td></td><td></td><td>1</td></tr></table>									1	<table border="1"><tr><td></td><td></td><td></td></tr><tr><td></td><td></td><td></td></tr><tr><td></td><td></td><td></td></tr></table>									
		1																																																																													
		1																																																																													
		2																																																																													
		3																																																																													
		2																																																																													
		1																																																																													
Post - 0 Miss - 0 Block - 0	Post - 0 Miss - 1 Block - 0	Post - 0 Miss - 1 Block - 0	Post - 0 Miss - 0 Block - 0	Post - 1 Miss - 1 Block - 0	Post - 0 Miss - 1 Block - 0	Post - 0 Miss - 0 Block - 0	Post - 0 Miss - 0 Block - 0																																																																								
28 宋涛	32 逯明松	33 朱晓龙	35 仇振勇	36 刘琢																																																																											
<table border="1"><tr><td>2</td><td></td><td></td></tr><tr><td></td><td></td><td></td></tr><tr><td>1</td><td></td><td></td></tr></table>	2						1			<table border="1"><tr><td></td><td></td><td></td></tr><tr><td></td><td></td><td></td></tr><tr><td></td><td></td><td></td></tr></table>										<table border="1"><tr><td>1</td><td></td><td></td></tr><tr><td></td><td></td><td></td></tr><tr><td></td><td></td><td></td></tr></table>	1									<table border="1"><tr><td></td><td></td><td></td></tr><tr><td></td><td></td><td></td></tr><tr><td></td><td></td><td>1</td></tr></table>									1	<table border="1"><tr><td></td><td></td><td></td></tr><tr><td></td><td></td><td></td></tr><tr><td></td><td></td><td></td></tr></table>										<table border="1"><tr><td></td><td></td><td></td></tr><tr><td></td><td></td><td></td></tr><tr><td></td><td></td><td></td></tr></table>										<table border="1"><tr><td></td><td></td><td></td></tr><tr><td></td><td></td><td></td></tr><tr><td></td><td></td><td></td></tr></table>										<table border="1"><tr><td></td><td></td><td></td></tr><tr><td></td><td></td><td></td></tr><tr><td></td><td></td><td></td></tr></table>									
2																																																																															
1																																																																															
1																																																																															
		1																																																																													
Post - 0 Miss - 0 Block - 0	Post - 0 Miss - 0 Block - 0	Post - 2 Miss - 2 Block - 0	Post - 0 Miss - 1 Block - 0	Post - 0 Miss - 0 Block - 0																																																																											

注释: Post=击柱 Miss=射失 Block=被封



男子 国内比赛

第十二届全国运动会男子手球预赛

Team A		Team B		Match Number																	
A 山东		B 北京		10																	
played in		in the hall		on																	
China		柳州市李宁体育馆		20/04/2013																	
				at 13:00 hours																	
Spectators																					
Half-time (30')	A	B	End of playing time	A	B																
	14	4	34 14	1st extra time	2nd extra time																
				A	B																
				After penalty throws																	
				A	B																
Number of 7 m	A	Team time-out			Full name of players and officials			Team time-out			B	Number of 7 m									
	1/3	1	2	3				1	2	3	2/2										
	20:18							44:01													
No.	Team A					G	W	2'	D	DR	No.	Team B					G	W	2'	D	DR
1	于性哲										1	王泷									
4	田瑞										2	杜龙飞					2				
5	潘翔					4	1				4	成亚									
6	李朝鹏										5	杨昆									
8	王炳华										6	刘伟									
9	赵鑫					4					7	胡瀛									
11	宋朋强					3		1			8	王鹏					1				
13	刘晓										9	刘振						1			
15	陈鹏波					1					11	蒋维一					1	1			
16	王帅										13	白洁					1				
17	王旭东					4	1	1			14	解建飞					1				
18	于亚男					2	1				16	孟辉									
19	李语庆					9					17	姜冰峰							1		
20	杜在超					1					18	张骥					3				
21	翟乾坤					6					20	郑永利									
22	刘正松										23	冯宁					5		2		
A	王鸿斌										A	郑康旭									
B	王志峰										B	蔡建国									
C	邢建刚										C	吴健									
D	徐强										D	石锋									
A	Signature of Responsible Official of the Teams (Off. A)																			B	
TP	Remarks of Referee / CHA Official																			TP	

Signatures

Referees	Jan Eric Klaus	Mikael Engelbert		
Techn. Delegates	李之文 (CHN)	王锡祯 (CHN)		
CHA Official				

Note: Number of 7m Throws Awarded to Team A and B, Goals (G), Warnings (W), Suspensions (2'), Direct Disqualification (D), Disqualification with Report (DR) and Team Penalty (TP).

Table Officials:

Statisticians:



第十二届全国运动会男子手球预赛 竞赛技术统计(媒体表)

预赛 组别 A 轮次 3 场次 10

柳州市李宁体育馆

20/04/2013

201301010-51-1/1

山东 34 vs 14 北京 14:4 北京

裁判员 Jan Eric Klaus Leandersson (NED) / Mikael Engelbert Lindroos (NED)

Main statistics table for Shandong and Beijing teams, including player names, goals, assists, and game progress.

场上队员: 得分 / 射门

守门员: 救球 / 射门

Legend table for abbreviations: 快攻, 警告, 突破, 失误, 任意球, 7M球, 助攻, 取消资格+报告.





第十二届全国运动会男子手球预赛 图式比赛技术统计表

轮次 3

场次 10

201301010-21-1/1

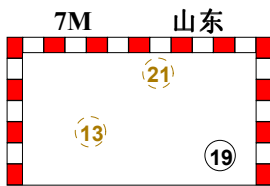
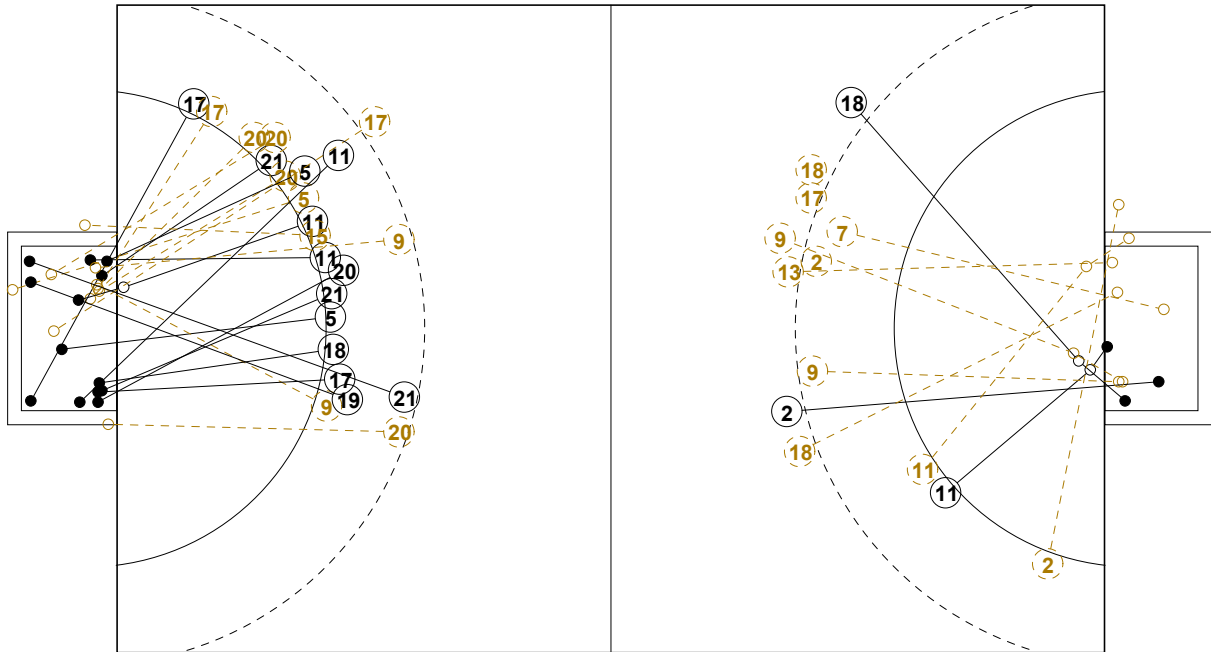

1st Half
14 : 4

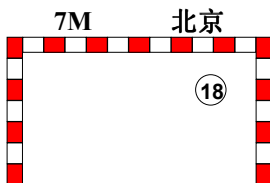
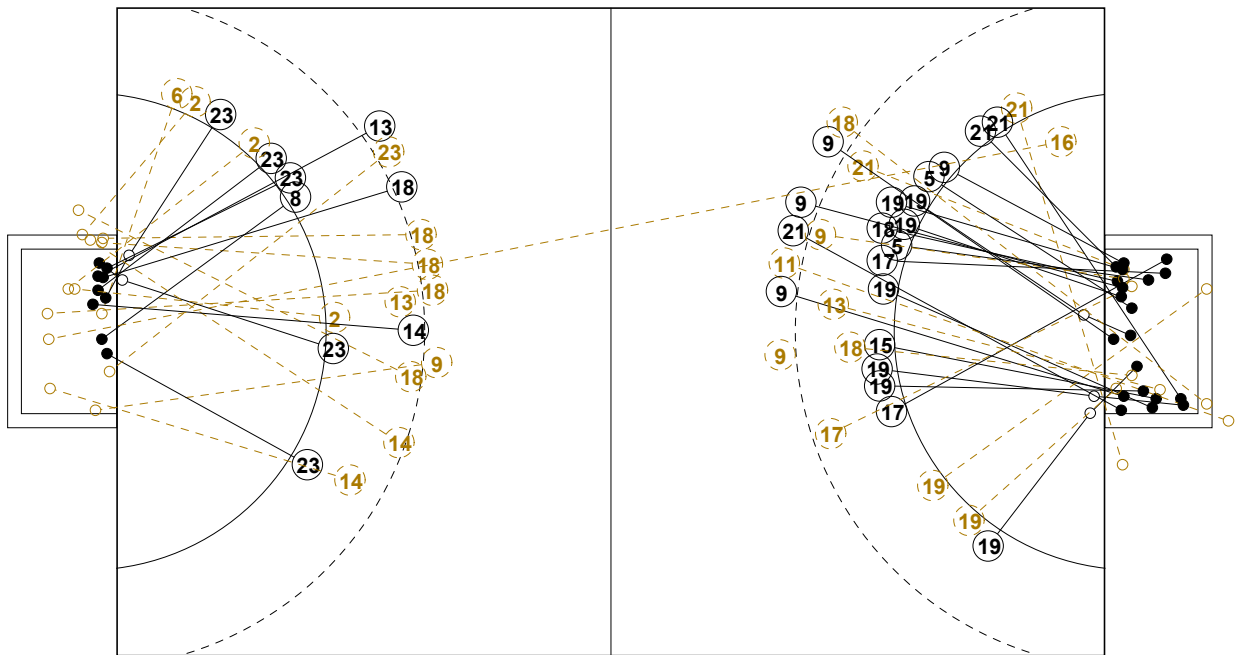
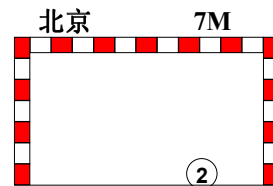

2nd Half
14 : 34

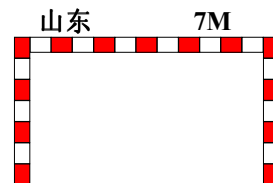



第十二届全国运动会男子手球预赛

个人/全队技术统计表

正式表
手球
男子预赛
轮次 3组别 A
场次 10201301010-14-1/2
柳州市李宁体院馆
20/04/2013 13:00

号码	姓名	远射	近射	边射	快攻	突破	任意	7M	合计	%	助攻	失误	警告	2'	取消	时间
山东(山东)																
<i>(场上队员)</i>																
1	于性哲									0.0%	2					00:09:20
4	田瑞									0.0%						00:00:00
5	潘翔		3/4		1/1				4/5	80.0%			1			00:47:48
6	李朝鹏									0.0%						00:05:42
8	王炳华									0.0%						00:00:27
9	赵鑫	3/6	1/1			0/1			4/8	50.0%	2					00:38:16
11	宋朋强				1/1	2/2	0/1		3/4	75.0%	2	1		1		00:51:46
13	刘晓		0/1					0/1	0/2	0.0%		1				00:07:25
15	陈鹏波		1/2						1/2	50.0%		1				00:12:04
16	王帅									0.0%	1					00:20:51
17	王旭东	0/2		0/1	3/3	1/1			4/7	57.1%	1	3	1	1		00:42:56
18	于亚男	0/1	0/1		2/2				2/4	50.0%			1			00:31:27
19	李语庆		1/1		7/9			1/1	9/11	81.8%						00:30:11
20	杜在超	0/1	1/3			0/1			1/5	20.0%	3	1				00:33:30
21	翟乾坤	2/3	2/2	2/3				0/1	6/9	66.7%						00:54:15
22	刘正松									0.0%	1					00:29:49
合计		5/13	9/15	2/4	14/16	3/5	0/1	1/3	34/57	59.6%	12	7	3	2		
<i>(守门员)</i>																
1	于性哲	2/4	1/2	1/1	1/1	0/1		0/1	5/10	50.0%	2					00:09:20
16	王帅	2/3	0/2	1/1		0/2		0/1	3/9	33.3%	1					00:20:51
22	刘正松	4/6	1/2						5/8	62.5%	1					00:29:49
合计		8/13	2/6	2/2	1/1	0/3		0/2	13/27	48.1%	4					

场上队员：得分/射门

守门员：救球/射门

全队合计	得分	被救	射失	击柱	封球	合计	%
远射	5	5		2	1	13	38.5%
近射	9	4	1	1		15	60.0%
边射	2	1	1			4	50.0%
快攻	14	1		1		16	87.5%
突破	3	2				5	60.0%
任意			1			1	0.0%
7M	1	2				3	33.3%





第十二届全国运动会男子手球预赛

个人/全队技术统计表

正式表
手球
男子预赛
轮次 3组别 A
场次 10201301010-14-2/2
柳州市李宁体院馆
20/04/2013 13:00

号码	姓名	远射	近射	边射	快攻	突破	任意	7M	合计	%	助攻	失误	警告	2'	取消	时间
北京(北京)																
<i>(上场队员)</i>																
1	王澍									0.0%						00:30:00
2	杜龙飞	1/2		0/3	0/1			1/1	2/7	28.6%	1	2				00:29:52
4	成亚									0.0%						00:00:00
5	杨昆									0.0%						00:07:14
6	刘伟			0/1					0/1	0.0%		2				00:19:15
7	胡瀛		0/1						0/1	0.0%		4				00:28:00
8	王鹏		1/1						1/1	100%		1				00:38:15
9	刘振	0/3							0/3	0.0%	1	4	1			00:43:34
11	蒋维一		1/1			0/1			1/2	50.0%		4	1			00:20:07
13	白洁	1/3							1/3	33.3%		1				00:25:49
14	解建飞	1/2	0/1						1/3	33.3%						00:08:34
16	孟辉	0/1							0/1	0.0%	1					00:30:00
17	姜冰峰	0/1							0/1	0.0%		1		1		01:00:00
18	张骥	2/8						1/1	3/9	33.3%	1	3				00:27:38
20	郑永利									0.0%						00:18:39
23	冯宁	0/1	2/2			3/3			5/6	83.3%		2		2		00:31:54
合计		5/21	4/6	0/4	0/1	3/4		2/2	14/38	36.8%	4	24	2	3		
<i>(守门员)</i>																
1	王澍	2/3	2/7	1/1	0/5	2/4		2/3	9/23	39.1%						00:30:00
16	孟辉	3/7	2/6	0/2	1/10	0/1			6/26	23.1%	1					00:30:00
合计		5/10	4/13	1/3	1/15	2/5		2/3	15/49	30.6%	1					

场上队员：得分/射门

守门员：救球/射门

全队合计	得分	被救	射失	击柱	封球	合计	%
远射	5	8	1	3	4	21	23.8%
近射	4	2				6	66.7%
边射		2	1	1		4	0.0%
快攻		1				1	0.0%
突破	3			1		4	75.0%
任意							0.0%
7M	2					2	100.0%





第十二届全国运动会男子手球预赛

图式射门区域统计

轮次 3 场次 10

201301010-41-1/1

山东

1 于性哲	4 田瑞	5 潘翔	6 李朝鹏	8 王炳华	9 赵鑫	11 宋朋强	13 刘晓																																																																											
<table border="1"><tr><td></td><td></td><td></td></tr><tr><td></td><td></td><td></td></tr><tr><td></td><td></td><td></td></tr></table>										<table border="1"><tr><td></td><td></td><td></td></tr><tr><td></td><td></td><td></td></tr><tr><td></td><td></td><td></td></tr></table>										<table border="1"><tr><td></td><td></td><td></td></tr><tr><td>1</td><td>1</td><td></td></tr><tr><td></td><td>1</td><td>1</td></tr></table>				1	1			1	1	<table border="1"><tr><td></td><td></td><td></td></tr><tr><td></td><td></td><td></td></tr><tr><td></td><td></td><td></td></tr></table>										<table border="1"><tr><td></td><td></td><td></td></tr><tr><td></td><td></td><td></td></tr><tr><td></td><td></td><td></td></tr></table>										<table border="1"><tr><td></td><td></td><td></td></tr><tr><td></td><td></td><td></td></tr><tr><td>2</td><td>1</td><td>1</td></tr></table>							2	1	1	<table border="1"><tr><td></td><td></td><td></td></tr><tr><td>1</td><td>1</td><td></td></tr><tr><td></td><td></td><td>1</td></tr></table>				1	1				1	<table border="1"><tr><td></td><td></td><td></td></tr><tr><td></td><td></td><td></td></tr><tr><td></td><td></td><td></td></tr></table>												
1	1																																																																																	
	1	1																																																																																
2	1	1																																																																																
1	1																																																																																	
		1																																																																																
Post - 0 Miss - 0 Block - 0	Post - 0 Miss - 0 Block - 0	Post - 1 Miss - 0 Block - 0	Post - 0 Miss - 0 Block - 0	Post - 0 Miss - 0 Block - 0	Post - 0 Miss - 0 Block - 1	Post - 0 Miss - 1 Block - 0	Post - 0 Miss - 0 Block - 0																																																																											
15 陈鹏波	16 王帅	17 王旭东	18 于亚男	19 李语庆	20 杜在超	21 翟乾坤	22 刘正松																																																																											
<table border="1"><tr><td></td><td></td><td></td></tr><tr><td></td><td></td><td>1</td></tr><tr><td></td><td></td><td></td></tr></table>						1				<table border="1"><tr><td></td><td></td><td></td></tr><tr><td></td><td></td><td></td></tr><tr><td></td><td></td><td></td></tr></table>										<table border="1"><tr><td></td><td></td><td></td></tr><tr><td>2</td><td></td><td></td></tr><tr><td>1</td><td></td><td></td></tr><tr><td>1</td><td></td><td></td></tr></table>				2			1			1			<table border="1"><tr><td></td><td></td><td></td></tr><tr><td></td><td></td><td></td></tr><tr><td>2</td><td></td><td></td></tr></table>							2			<table border="1"><tr><td></td><td></td><td></td></tr><tr><td></td><td></td><td>2</td></tr><tr><td></td><td></td><td>3</td></tr></table>						2			3	<table border="1"><tr><td></td><td></td><td></td></tr><tr><td></td><td></td><td></td></tr><tr><td>1</td><td></td><td></td></tr></table>							1			<table border="1"><tr><td></td><td></td><td></td></tr><tr><td></td><td></td><td>2</td></tr><tr><td>2</td><td></td><td>2</td></tr></table>						2	2		2	<table border="1"><tr><td></td><td></td><td></td></tr><tr><td></td><td></td><td></td></tr><tr><td></td><td></td><td></td></tr></table>									
		1																																																																																
2																																																																																		
1																																																																																		
1																																																																																		
2																																																																																		
		2																																																																																
		3																																																																																
1																																																																																		
		2																																																																																
2		2																																																																																
Post - 0 Miss - 1 Block - 0	Post - 0 Miss - 0 Block - 0	Post - 0 Miss - 0 Block - 0	Post - 1 Miss - 0 Block - 0	Post - 1 Miss - 0 Block - 0	Post - 1 Miss - 0 Block - 0	Post - 0 Miss - 1 Block - 0	Post - 0 Miss - 0 Block - 0																																																																											

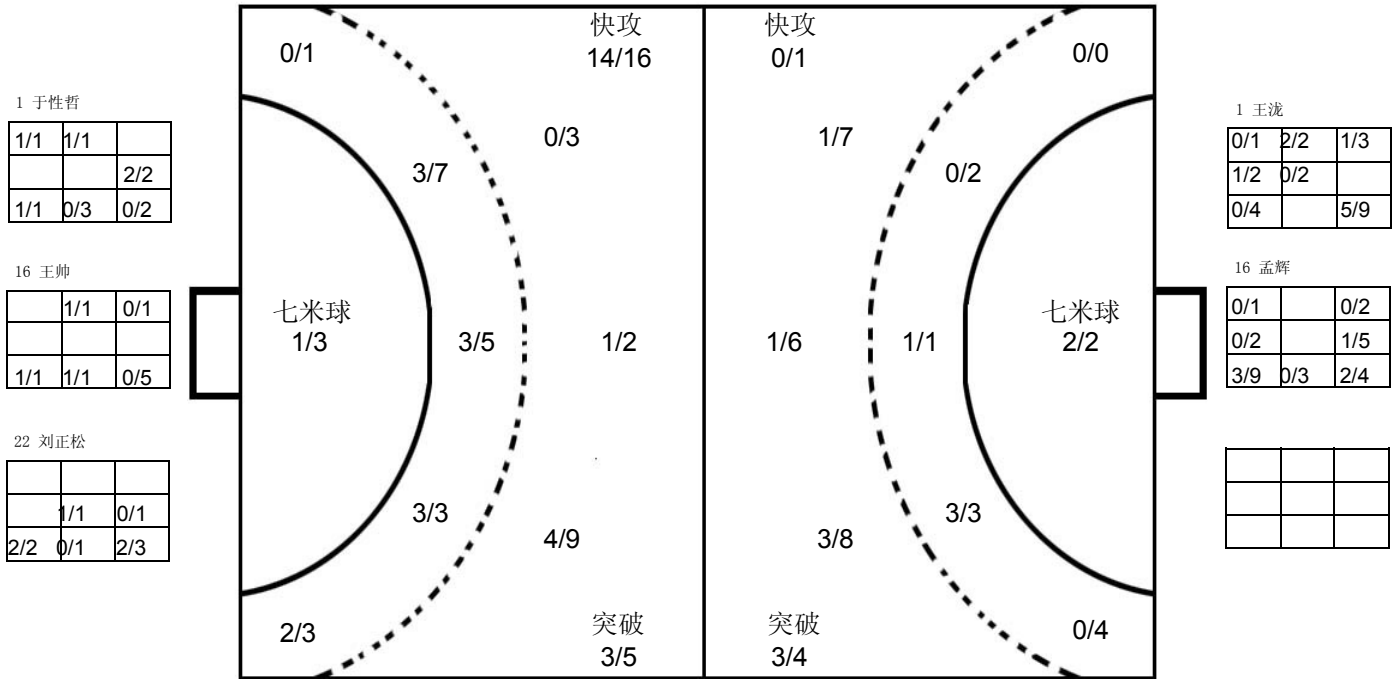

北京

1 王浣	2 杜龙飞	4 成亚	5 杨昆	6 刘伟	7 胡瀛	8 王鹏	9 刘振																																																																								
<table border="1"><tr><td></td><td></td><td></td></tr><tr><td></td><td></td><td></td></tr><tr><td></td><td></td><td></td></tr></table>										<table border="1"><tr><td></td><td></td><td></td></tr><tr><td></td><td></td><td>1</td></tr><tr><td></td><td></td><td>1</td></tr></table>						1			1	<table border="1"><tr><td></td><td></td><td></td></tr><tr><td></td><td></td><td></td></tr><tr><td></td><td></td><td></td></tr></table>										<table border="1"><tr><td></td><td></td><td></td></tr><tr><td></td><td></td><td></td></tr><tr><td></td><td></td><td></td></tr></table>										<table border="1"><tr><td></td><td></td><td></td></tr><tr><td></td><td></td><td></td></tr><tr><td></td><td></td><td></td></tr></table>										<table border="1"><tr><td></td><td></td><td></td></tr><tr><td></td><td></td><td></td></tr><tr><td></td><td></td><td></td></tr></table>										<table border="1"><tr><td></td><td></td><td></td></tr><tr><td></td><td></td><td></td></tr><tr><td></td><td></td><td></td></tr></table>										<table border="1"><tr><td></td><td></td><td></td></tr><tr><td></td><td></td><td></td></tr><tr><td></td><td></td><td></td></tr></table>									
		1																																																																													
		1																																																																													
Post - 0 Miss - 0 Block - 0	Post - 1 Miss - 1 Block - 1	Post - 0 Miss - 0 Block - 0	Post - 0 Miss - 0 Block - 0	Post - 0 Miss - 0 Block - 0	Post - 0 Miss - 0 Block - 0	Post - 0 Miss - 0 Block - 0	Post - 0 Miss - 0 Block - 0																																																																								
11 蒋维一	13 白洁	14 解建飞	16 孟辉	17 姜冰峰	18 张骥	20 郑永利	23 冯宁																																																																								
<table border="1"><tr><td></td><td></td><td></td></tr><tr><td></td><td></td><td></td></tr><tr><td>1</td><td></td><td></td></tr></table>							1			<table border="1"><tr><td></td><td></td><td></td></tr><tr><td></td><td></td><td></td></tr><tr><td></td><td></td><td>1</td></tr></table>									1	<table border="1"><tr><td></td><td></td><td></td></tr><tr><td></td><td></td><td></td></tr><tr><td></td><td></td><td>1</td></tr></table>									1	<table border="1"><tr><td></td><td></td><td></td></tr><tr><td></td><td></td><td></td></tr><tr><td></td><td></td><td></td></tr></table>										<table border="1"><tr><td></td><td></td><td></td></tr><tr><td></td><td></td><td></td></tr><tr><td></td><td></td><td></td></tr></table>										<table border="1"><tr><td></td><td></td><td></td></tr><tr><td></td><td></td><td>1</td></tr><tr><td></td><td></td><td>2</td></tr></table>						1			2	<table border="1"><tr><td></td><td></td><td></td></tr><tr><td></td><td></td><td></td></tr><tr><td></td><td></td><td></td></tr></table>										<table border="1"><tr><td></td><td></td><td></td></tr><tr><td></td><td></td><td></td></tr><tr><td></td><td>1</td><td>4</td></tr></table>								1	4
1																																																																															
		1																																																																													
		1																																																																													
		1																																																																													
		2																																																																													
	1	4																																																																													
Post - 1 Miss - 0 Block - 0	Post - 0 Miss - 0 Block - 1	Post - 1 Miss - 0 Block - 0	Post - 0 Miss - 0 Block - 0	Post - 0 Miss - 0 Block - 1	Post - 2 Miss - 1 Block - 1	Post - 0 Miss - 0 Block - 0	Post - 0 Miss - 0 Block - 0																																																																								

注释: Post=击柱 Miss=射失 Block=被封





男子 国内比赛

第十二届全国运动会男子手球预赛

Team A A 安徽				Team B B 西藏				Match Number 11													
played in China		in the hall 柳州市李宁体育馆		on 20/04/2013		at 14:40 hours		Spectators													
Half-time (30')	A 18	B 8	End of playing time	A 35	B 22	1st extra time	A	B	2nd extra time	A	B	After penalty throws	A	B							
Number of 7 m	A 1/2	Team time-out 1 2 3 39:45			Full name of players and officials				Team time-out 1 2 3			B 1/4	Number of 7 m								
No.	Team A					G	W	2'	D	DR	No.	Team B					G	W	2'	D	DR
1	高逸凡										2	王龙					3				
2	周兰骏					1					4	张家纬					5				
5	马鹏					5	1	1			5	冯祥龙									
6	田耕										6	任启双					1	2			
7	姚雄敏										7	徐奕飞					1				
8	董智景										9	王博									
10	陈强龙					1	1	1			10	刘江					3	1			
11	黎涛					4		1			11	朱治宇					2	1			
12	曾献辰										12	张帅									
15	邵青					3	1				15	刘劲松									
17	解维维					2					16	徐畅									
18	郭赛										18	赵楠					3	1	1		
28	袁龙					6					19	任野					1				
29	顾先亮					1					20	顾艳超					3				
32	王超					9					21	马光									
33	曹振吉					3					23	王伟强									
A	王来黔										A	张文韬									
B	刘晓蓓										B	殷永军									
C	高恒勤										C	瓮勇									
A	Signature of Responsible Official of the Teams (Off. A)										B										
TP	Remarks of Referee / CHA Official										TP										

Signatures

Referees	李刚 (CHN)	王科 (CHN)		
Techn. Delegates	王锡祯 (CHN)	刘书勇 (CHN)		
CHA Official				

Note: Number of 7m Throws Awarded to Team A and B, Goals (G), Warnings (W), Suspensions (2'), Direct Disqualification (D), Disqualification with Report (DR) and Team Penalty (TP).

Table Officials: 黄思华

谭云东

Statisticians: 黄莉

朱伟平

Printed by PHMS Copyright: IHF / CHA 20/04/2013 16:06:19

Longman Sportsoft



handball@126.com



第十二届全国运动会男子手球预赛
竞赛技术统计(媒体表)

预赛 组别 A 轮次 3 场次 11

柳州市李宁体育馆

20/04/2013

201301011-51-1/1

安徽 安徽 35 vs 22 西藏 西藏 18:8

裁判员 李刚 (CHN) / 王科 (CHN)

Main statistics table with columns for players, shots, goals, assists, etc. for both teams.

场上队员: 得分 / 射门

守门员: 救球 / 射门

Legend table for abbreviations like Fast Break, Breakthrough, Free Throw, etc.





第十二届全国运动会男子手球预赛 图式比赛技术统计表

轮次 3

场次 11

201301011-21-1/1

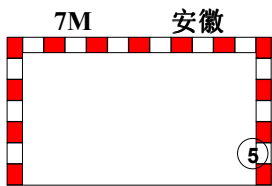
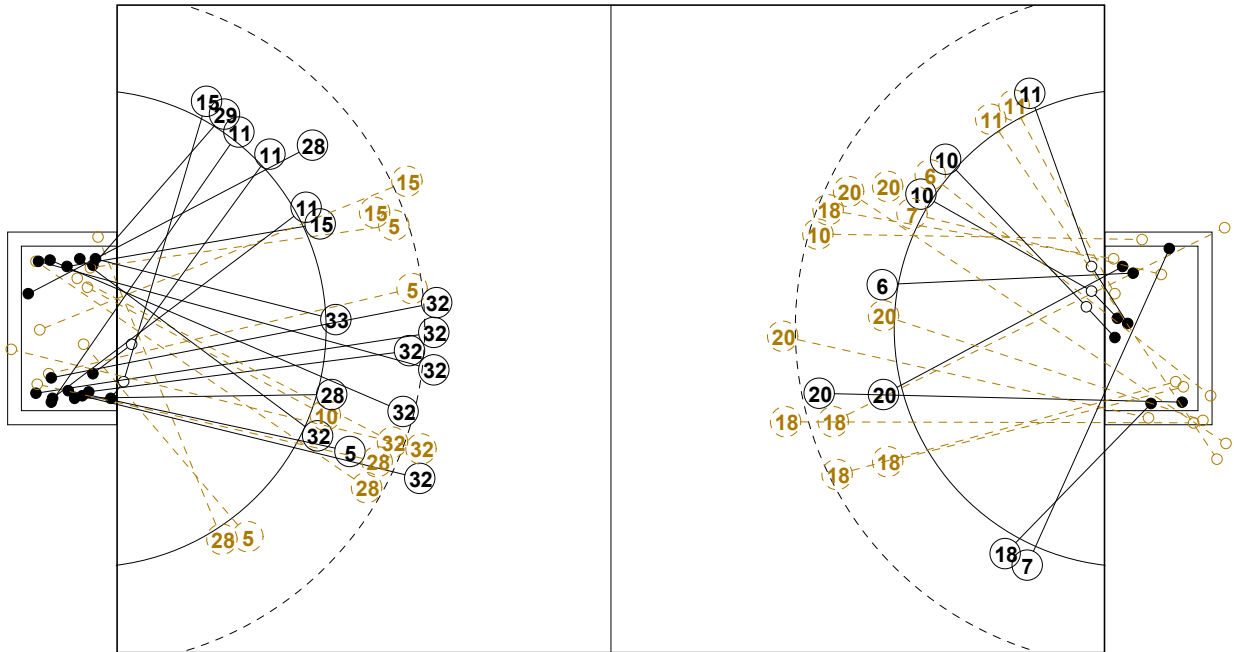

1st Half
18 : 8

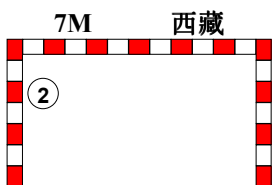
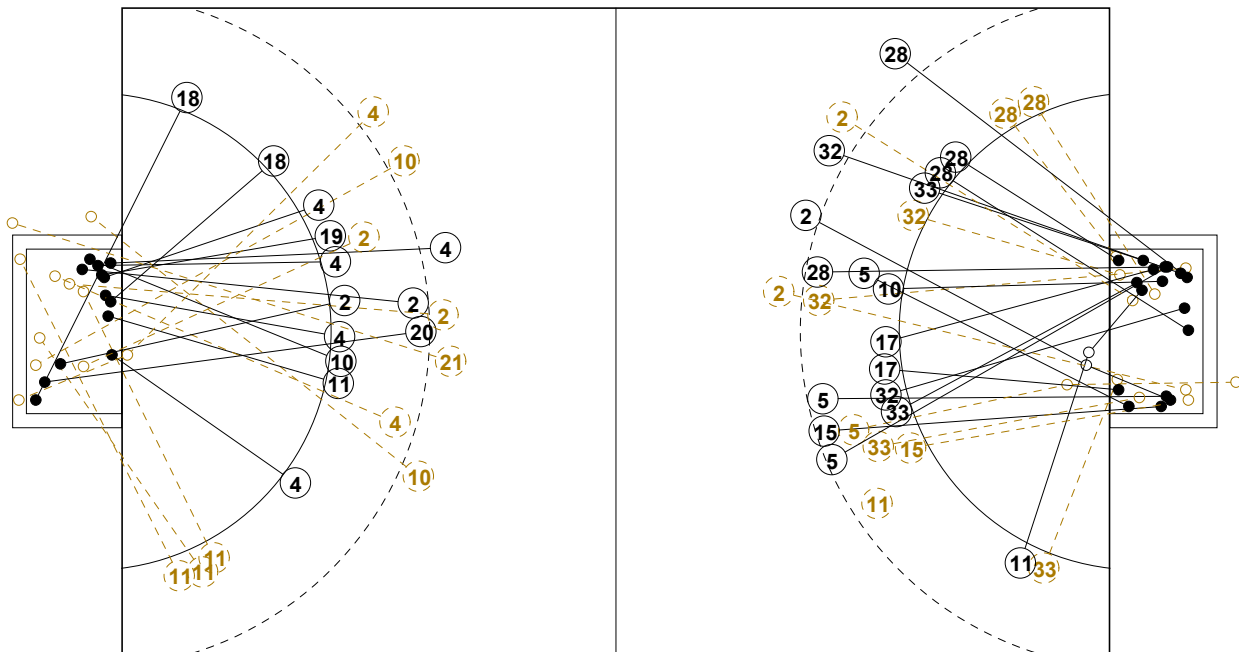
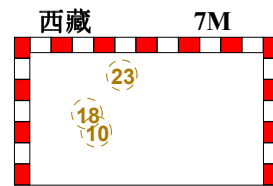

2nd Half
22 : 35

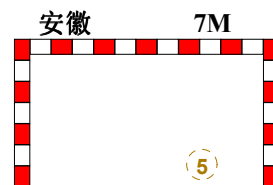



第十二届全国运动会男子手球预赛

个人/全队技术统计表

正式表
手球
男子预赛
轮次 3组别 A
场次 11201301011-14-1/2
柳州市李宁体院馆
20/04/2013 14:40

号码	姓名	远射	近射	边射	快攻	突破	任意	7M	合计	%	助攻	失误	警告	2'	取消	时间
安徽(安徽)																
<i>(场上队员)</i>																
1	高逸凡									0.0%	2					00:31:04
2	周兰骏	1/3							1/3	33.3%						00:06:38
5	马鹏	2/3	0/1	0/1	1/1	1/1	0/1	1/2	5/10	50.0%	1	3	1	1		00:46:56
6	田耕									0.0%						00:00:00
7	姚雄敏									0.0%						00:00:00
8	董智景									0.0%						00:00:00
10	陈强龙		1/1		0/1				1/2	50.0%		1	1	1		00:37:19
11	黎涛	0/1		1/1	3/3				4/5	80.0%		4		1		00:44:44
12	曾献辰									0.0%						00:28:56
15	邵青	1/3			2/3				3/6	50.0%			1			00:41:49
17	解维维				2/2				2/2	100%						00:13:12
18	郭赛									0.0%	1					00:03:12
28	袁龙	2/4	1/1	0/3	3/3				6/11	54.5%	1	1				00:59:52
29	顾先亮			1/1					1/1	100%						00:15:13
32	王超	5/8	0/1			2/2	2/2		9/13	69.2%		2				00:46:57
33	曹振吉		1/2	0/1	2/2				3/5	60.0%	1	2				00:42:46
合计		11/22	3/6	2/7	13/15	3/3	2/3	1/2	35/58	60.3%	6	13	3	3		
<i>(守门员)</i>																
1	高逸凡	2/4	2/4	2/3	0/2	0/2		3/4	9/19	47.4%	2					00:31:04
12	曾献辰	3/5	1/4	1/3	0/2	0/3			5/17	29.4%						00:28:56
合计		5/9	3/8	3/6	0/4	0/5		3/4	14/36	38.9%	2					

场上队员：得分/射门

守门员：救球/射门

全队合计	得分	被救	射失	击柱	封球	合计	%
远射	11	8		1	2	22	50.0%
近射	3	2	1			6	50.0%
边射	2	4		1		7	28.6%
快攻	13	2				15	86.7%
突破	3					3	100.0%
任意	2	1				3	66.7%
7M	1	1				2	50.0%





第十二届全国运动会男子手球预赛

个人/全队技术统计表

正式表
手球
男子预赛
轮次 3组别 A
场次 11201301011-14-2/2
柳州市李宁体院馆
20/04/2013 14:40

号码	姓名	远射	近射	边射	快攻	突破	任意	7M	合计	%	助攻	失误	警告	2'	取消	时间
西藏(西藏)																
<i>(上场队员)</i>																
2	王龙	1/2	1/2					1/1	3/5	60.0%		3				00:18:02
4	张家纬	1/3	1/1		1/1	2/2			5/7	71.4%	1	1				00:29:38
5	冯祥龙									0.0%						00:00:00
6	任启双		1/1		0/1				1/2	50.0%		2		2		00:48:17
7	徐奕飞		0/1	1/1					1/2	50.0%		1				00:30:00
9	王博									0.0%						00:11:18
10	刘江	0/3	2/2			1/1		0/1	3/7	42.9%	1	1	1			00:43:37
11	朱治宇			1/5		1/2			2/7	28.6%		2	1			00:59:42
12	张帅									0.0%						00:08:36
15	刘劲松									0.0%						00:00:00
16	徐畅									0.0%						00:51:24
18	赵楠	0/4	0/1	1/1	2/2			0/1	3/9	33.3%		2	1	1		00:41:05
19	任野				1/1				1/1	100%		1				00:13:33
20	顾艳超	2/3	0/1			1/2	0/1		3/7	42.9%		6				00:46:07
21	马光	0/1							0/1	0.0%		2				00:16:13
23	王伟强							0/1	0/1	0.0%						00:00:19
合计		4/16	5/9	3/7	4/5	5/7	0/1	1/4	22/49	44.9%	2	21	3	3		
<i>(守门员)</i>																
12	张帅	2/5			0/2				2/7	28.6%						00:08:36
16	徐畅	6/14	2/5	4/6	2/13	0/3	1/3	1/2	16/46	34.8%						00:51:24
合计		8/19	2/5	4/6	2/15	0/3	1/3	1/2	18/53	34.0%						

场上队员：得分/射门

守门员：救球/射门

全队合计	得分	被救	射失	击柱	封球	合计	%
远射	4	5	4	3		16	25.0%
近射	5	3			1	9	55.6%
边射	3	3	1			7	42.9%
快攻	4			1		5	80.0%
突破	5			2		7	71.4%
任意				1		1	0.0%
7M	1	3				4	25.0%





第十二届全国运动会男子手球预赛

图式射门区域统计

轮次 3 场次 11

201301011-41-1/1

安徽

1 高逸凡	2 周兰骏	5 马鹏	6 田耕	7 姚雄敏	8 董智景	10 陈强龙	11 黎涛																																																																								
<table border="1"><tr><td></td><td></td><td></td></tr><tr><td></td><td></td><td></td></tr><tr><td></td><td></td><td></td></tr></table>										<table border="1"><tr><td></td><td></td><td></td></tr><tr><td></td><td>1</td><td></td></tr><tr><td></td><td></td><td></td></tr></table>					1					<table border="1"><tr><td></td><td></td><td></td></tr><tr><td>2</td><td></td><td>1</td></tr><tr><td></td><td></td><td>2</td></tr></table>				2		1			2	<table border="1"><tr><td></td><td></td><td></td></tr><tr><td></td><td></td><td></td></tr><tr><td></td><td></td><td></td></tr></table>										<table border="1"><tr><td></td><td></td><td></td></tr><tr><td></td><td></td><td></td></tr><tr><td></td><td></td><td></td></tr></table>										<table border="1"><tr><td></td><td></td><td></td></tr><tr><td></td><td></td><td></td></tr><tr><td></td><td></td><td></td></tr></table>										<table border="1"><tr><td></td><td></td><td></td></tr><tr><td>1</td><td></td><td></td></tr><tr><td></td><td></td><td></td></tr></table>				1						<table border="1"><tr><td></td><td></td><td></td></tr><tr><td>2</td><td></td><td></td></tr><tr><td>1</td><td></td><td></td></tr></table>				2			1		
	1																																																																														
2		1																																																																													
		2																																																																													
1																																																																															
2																																																																															
1																																																																															
Post - 0 Miss - 0 Block - 0	Post - 0 Miss - 0 Block - 0	Post - 0 Miss - 1 Block - 0	Post - 0 Miss - 0 Block - 0	Post - 0 Miss - 0 Block - 0	Post - 0 Miss - 0 Block - 0	Post - 0 Miss - 0 Block - 0	Post - 0 Miss - 0 Block - 1																																																																								
12 曾献辰	15 邵青	17 解维维	18 郭赛	28 袁龙	29 顾先亮	32 王超	33 曹振吉																																																																								
<table border="1"><tr><td></td><td></td><td></td></tr><tr><td></td><td></td><td></td></tr><tr><td></td><td></td><td></td></tr></table>										<table border="1"><tr><td></td><td></td><td></td></tr><tr><td></td><td>2</td><td></td></tr><tr><td>1</td><td></td><td></td></tr></table>					2		1			<table border="1"><tr><td></td><td></td><td></td></tr><tr><td>1</td><td></td><td></td></tr><tr><td></td><td></td><td>1</td></tr></table>				1					1	<table border="1"><tr><td></td><td></td><td></td></tr><tr><td></td><td></td><td></td></tr><tr><td></td><td></td><td></td></tr></table>										<table border="1"><tr><td></td><td></td><td></td></tr><tr><td>1</td><td>1</td><td>1</td></tr><tr><td>2</td><td></td><td></td></tr></table>				1	1	1	2			<table border="1"><tr><td></td><td></td><td></td></tr><tr><td></td><td></td><td></td></tr><tr><td></td><td></td><td>1</td></tr></table>									1	<table border="1"><tr><td></td><td></td><td></td></tr><tr><td>3</td><td>1</td><td>2</td></tr><tr><td>1</td><td></td><td>1</td></tr></table>				3	1	2	1		1	<table border="1"><tr><td></td><td></td><td></td></tr><tr><td>1</td><td></td><td>1</td></tr><tr><td>1</td><td></td><td></td></tr></table>				1		1	1		
	2																																																																														
1																																																																															
1																																																																															
		1																																																																													
1	1	1																																																																													
2																																																																															
		1																																																																													
3	1	2																																																																													
1		1																																																																													
1		1																																																																													
1																																																																															
Post - 0 Miss - 0 Block - 0	Post - 0 Miss - 0 Block - 1	Post - 0 Miss - 0 Block - 0	Post - 0 Miss - 0 Block - 0	Post - 1 Miss - 0 Block - 0	Post - 0 Miss - 0 Block - 0	Post - 1 Miss - 0 Block - 0	Post - 0 Miss - 0 Block - 0																																																																								

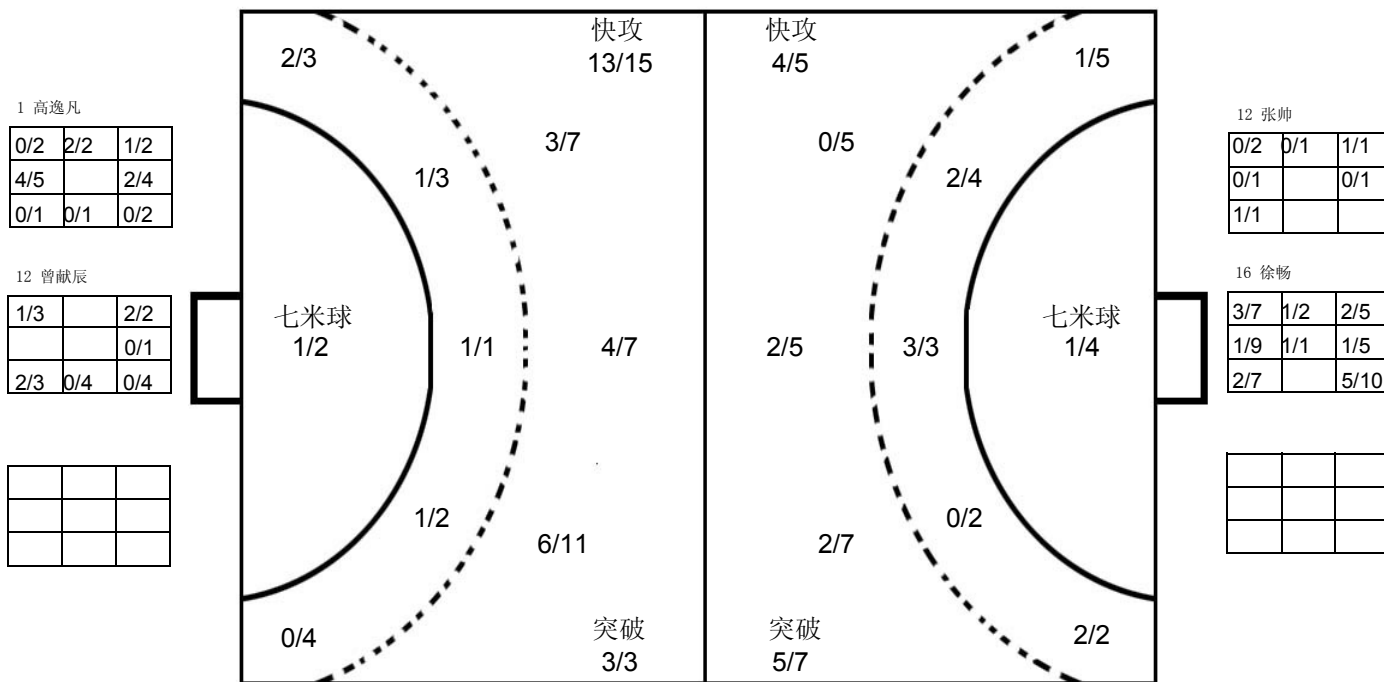

西藏

2 王龙	4 张家伟	5 冯祥龙	6 任启双	7 徐奕飞	9 王博	10 刘江	11 朱治宇																																																																								
<table border="1"><tr><td>1</td><td></td><td></td></tr><tr><td>1</td><td></td><td>1</td></tr><tr><td></td><td></td><td></td></tr></table>	1			1		1				<table border="1"><tr><td></td><td></td><td></td></tr><tr><td></td><td></td><td></td></tr><tr><td></td><td>1</td><td>4</td></tr></table>								1	4	<table border="1"><tr><td></td><td></td><td></td></tr><tr><td></td><td></td><td></td></tr><tr><td></td><td></td><td></td></tr></table>										<table border="1"><tr><td></td><td></td><td></td></tr><tr><td></td><td></td><td></td></tr><tr><td>1</td><td></td><td></td></tr></table>							1			<table border="1"><tr><td></td><td></td><td></td></tr><tr><td>1</td><td></td><td></td></tr><tr><td></td><td></td><td></td></tr></table>				1						<table border="1"><tr><td></td><td></td><td></td></tr><tr><td></td><td></td><td></td></tr><tr><td></td><td></td><td></td></tr></table>										<table border="1"><tr><td></td><td></td><td></td></tr><tr><td></td><td></td><td></td></tr><tr><td></td><td></td><td>1</td></tr></table>									1	<table border="1"><tr><td></td><td></td><td></td></tr><tr><td></td><td></td><td></td></tr><tr><td></td><td>2</td><td></td></tr></table>								2	
1																																																																															
1		1																																																																													
	1	4																																																																													
1																																																																															
1																																																																															
		1																																																																													
	2																																																																														
Post - 0 Miss - 0 Block - 0	Post - 1 Miss - 0 Block - 0	Post - 0 Miss - 0 Block - 0	Post - 1 Miss - 0 Block - 0	Post - 0 Miss - 0 Block - 0	Post - 0 Miss - 0 Block - 0	Post - 1 Miss - 1 Block - 0	Post - 1 Miss - 1 Block - 0																																																																								
12 张帅	15 刘劲松	16 徐畅	18 赵楠	19 任野	20 顾艳超	21 马光	23 王伟强																																																																								
<table border="1"><tr><td></td><td></td><td></td></tr><tr><td></td><td></td><td></td></tr><tr><td></td><td></td><td></td></tr></table>										<table border="1"><tr><td></td><td></td><td></td></tr><tr><td></td><td></td><td></td></tr><tr><td></td><td></td><td></td></tr></table>										<table border="1"><tr><td></td><td></td><td></td></tr><tr><td></td><td></td><td></td></tr><tr><td></td><td></td><td></td></tr></table>										<table border="1"><tr><td></td><td></td><td></td></tr><tr><td>1</td><td></td><td></td></tr><tr><td></td><td></td><td>1</td></tr></table>				1					1	<table border="1"><tr><td></td><td></td><td></td></tr><tr><td></td><td></td><td></td></tr><tr><td></td><td></td><td>1</td></tr></table>									1	<table border="1"><tr><td></td><td></td><td></td></tr><tr><td>1</td><td></td><td>1</td></tr><tr><td>1</td><td></td><td></td></tr></table>				1		1	1			<table border="1"><tr><td></td><td></td><td></td></tr><tr><td></td><td></td><td></td></tr><tr><td></td><td></td><td></td></tr></table>										<table border="1"><tr><td></td><td></td><td></td></tr><tr><td></td><td></td><td></td></tr><tr><td></td><td></td><td></td></tr></table>									
1																																																																															
		1																																																																													
		1																																																																													
1		1																																																																													
1																																																																															
Post - 0 Miss - 0 Block - 0	Post - 0 Miss - 0 Block - 0	Post - 0 Miss - 0 Block - 0	Post - 1 Miss - 1 Block - 0	Post - 0 Miss - 0 Block - 0	Post - 2 Miss - 1 Block - 1	Post - 0 Miss - 1 Block - 0	Post - 0 Miss - 0 Block - 0																																																																								

注释: Post=击柱 Miss=射失 Block=被封





男子 国内比赛



第十二届全国运动会男子手球预赛

Team A										Team B										Match Number									
A 澳门										B 江苏										12									
played in					in the hall					on					at					Spectators									
China					柳州市李宁体院馆					20/04/2013					16:20 hours														
Half-time (30')		A		B		End of playing time		A		B		1st extra time		A		B		2nd extra time		A		B		After penalty throws		A		B	
		3		22				13		46																			
Number of 7 m		A		Team time-out			Full name of players and officials										Team time-out			B		Number of 7 m							
		1 / 1		1	2	3											1	2	3	4 / 6									
No.	Team A					G	W	2'	D	DR	No.	Team B					G	W	2'	D	DR								
2	李翹臻										1	丁大伟																	
4	刘家声										2	杨彦威					8												
5	何建成					2					3	李旭东																	
15	黄俊勇										4	沈庆					6												
16	冯国政										5	闫亮					1												
18	卓伟杰						1				6	赵晨					4	1											
21	麦锦聪										8	周小坚																	
22	陈学敏					1					9	叶强					5		1										
24	刘登宇					2					10	郝可鑫					1												
27	徐展业										11	姚仁剑																	
28	莫家进					3		2			12	王权					1												
29	叶响俊					2					14	丛海航					4												
33	欧永健					1	1				15	李安					6												
36	陈嘉聪										17	陈灵峰					9	1	1										
81	梁梓康					2	1				19	张志宇					1												
93	罗咪高							1			20	张星																	
A	卢永明										A	闫威名																	
B	高光明										C	NENADz vonarek																	
C	黄宇豪										D	王建国																	
											E	贾淑君																	
A											Signature of Responsible Official of the Teams (Off. A)										B								
TP	Remarks of Referee / CHA Official																				TP								

Signatures

Referees	陈晓波 (CHN)	王锐 (CHN)		
Techn. Delegates	许宜扬 (CHN)	刘书勇 (CHN)		
CHA Official				

Note: Number of 7m Throws Awarded to Team A and B, Goals (G), Warnings (W), Suspensions (2), Direct Disqualification (D), Disqualification with Report (DR) and Team Penalty (TP).

Table Officials:

Statisticians: 黄莉

朱伟平





第十二届全国运动会男子手球预赛
竞赛技术统计(媒体表)

预赛 组别 A 轮次 3 场次 12

柳州市李宁体育馆

20/04/2013

201301012-51-1/1

澳门 13 vs 46 江苏 3:22

裁判员 陈晓波 (CHN) / 王锐 (CHN)

Main statistics table for the match between Macao and Jiangsu, including player performance, goals, and penalties.

场上队员: 得分 / 射门

守门员: 救球 / 射门

Legend table for abbreviations used in the statistics, such as Fast Break, Breakthrough, Free Throw, etc.





第十二届全国运动会男子手球预赛 图式比赛技术统计表

轮次 3

场次 12

201301012-21-1/1

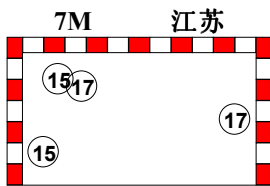
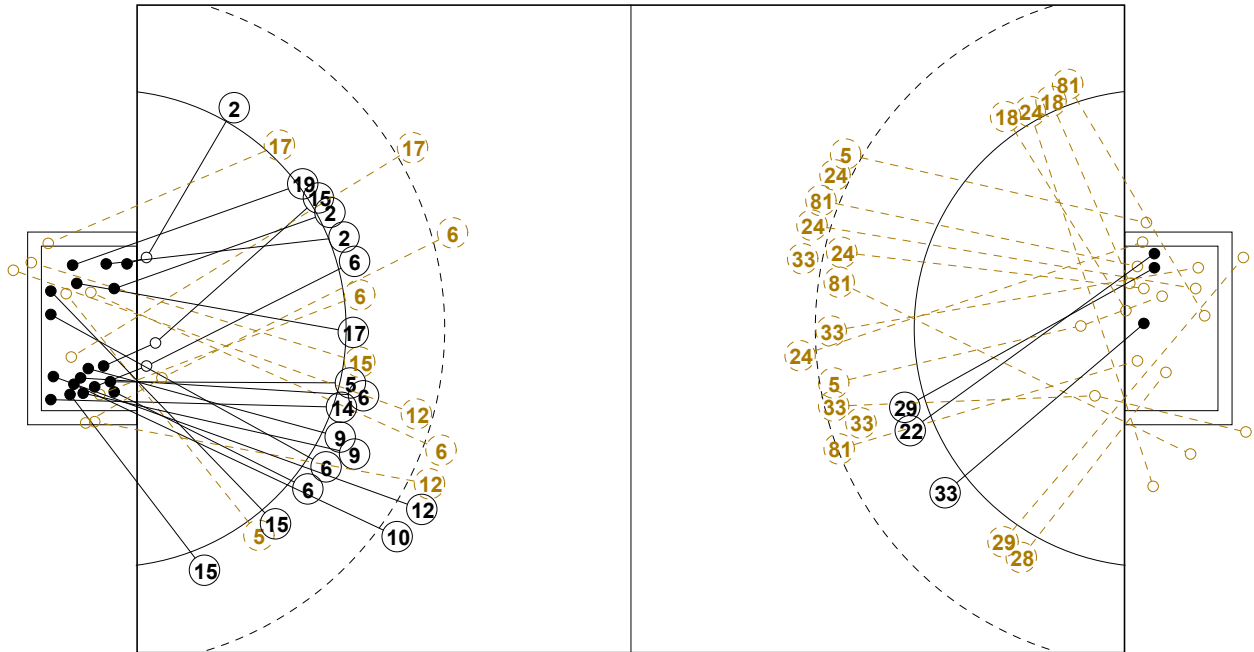

1st Half
22 : 3

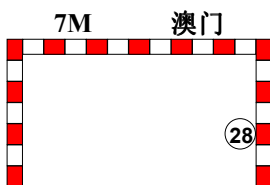
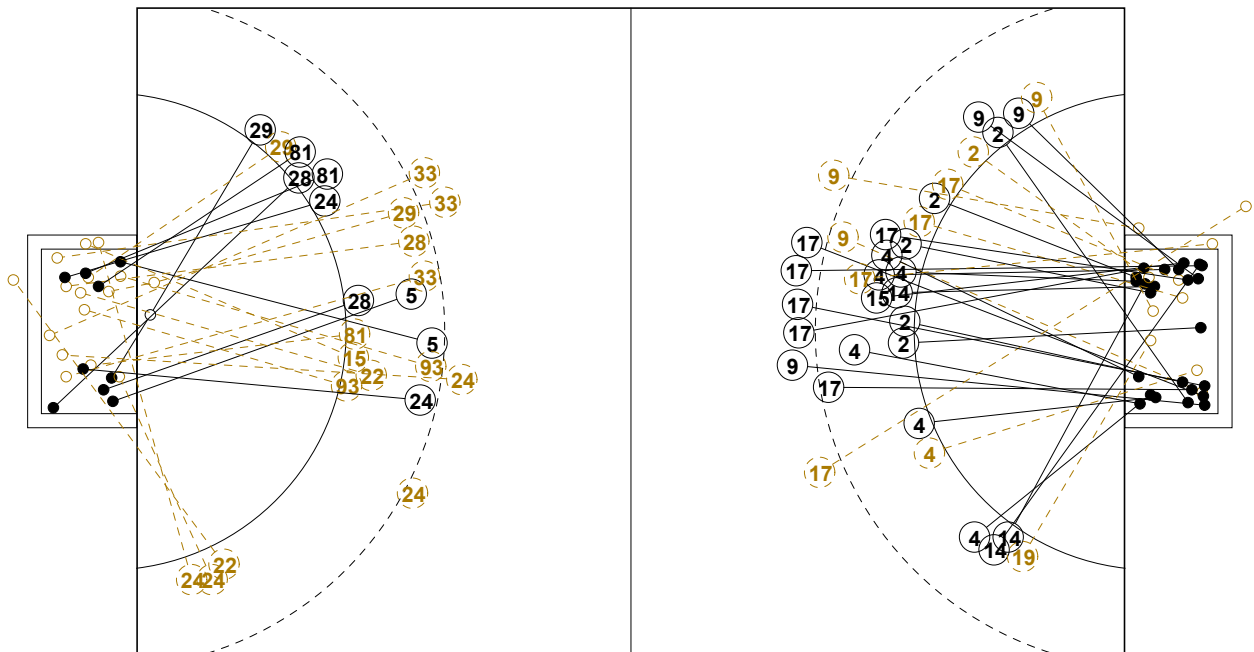
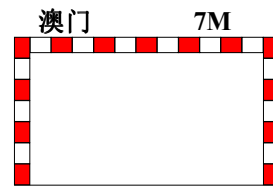

2nd Half
13 : 46

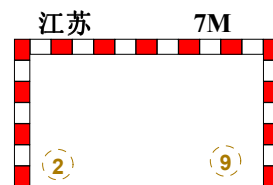



第十二届全国运动会男子手球预赛

个人/全队技术统计表

正式表
手球
男子预赛
轮次 3组别 A
场次 12201301012-14-1/2
柳州市李宁体院馆
20/04/2013 16:20

号码	姓名	远射	近射	边射	快攻	突破	任意	7M	合计	%	助攻	失误	警告	2'	取消	时间
澳门(澳门)																
<i>(场上队员)</i>																
2	李翹臻									0.0%		1				00:02:46
4	刘家声									0.0%		3				00:09:46
5	何建成	1/3	1/1						2/4	50.0%		3				00:30:43
15	黄俊勇		0/1						0/1	0.0%		2				00:17:29
16	冯国政									0.0%		1				01:00:00
18	卓伟杰			0/2					0/2	0.0%			1			00:24:15
21	麦锦聪									0.0%						00:00:00
22	陈学敏		1/2		0/1				1/3	33.3%		2				00:16:32
24	刘登宇	1/6		0/3	1/1		0/1		2/11	18.2%		8				00:45:53
27	徐展业									0.0%						00:00:00
28	莫家进	0/1	1/1	0/1	1/1			1/1	3/5	60.0%		3		2		00:51:13
29	叶响俊	0/1		1/3	1/1				2/5	40.0%		3				00:48:56
33	欧永健	0/6	0/1		1/1				1/8	12.5%		5	1			00:34:23
36	陈嘉聪									0.0%						00:00:00
81	梁梓康	0/3	2/3	0/1					2/7	28.6%		5	1			00:39:36
93	罗咪高	0/1			0/1				0/2	0.0%		4		1		00:35:36
合计		2/21	5/9	1/10	4/6		0/1	1/1	13/48	27.1%		40	3	3		
<i>(守门员)</i>																
16	冯国政	3/10	2/13	3/8	3/21		0/1	2/6	13/59	22.0%		1				01:00:00
合计		3/10	2/13	3/8	3/21		0/1	2/6	13/59	22.0%		1				

场上队员：得分/射门

守门员：救球/射门

全队合计	得分	被救	射失	击柱	封球	合计	%
远射	2	12	3	1	3	21	9.5%
近射	5	2		1	1	9	55.6%
边射	1	6	2	1		10	10.0%
快攻	4	1	1			6	66.7%
突破							0.0%
任意		1				1	0.0%
7M	1					1	100.0%





第十二届全国运动会男子手球预赛

个人/全队技术统计表

正式表
手球
男子预赛
轮次 3组别 A
场次 12201301012-14-2/2
柳州市李宁体院馆
20/04/2013 16:20

号码	姓名	远射	近射	边射	快攻	突破	任意	7M	合计	%	助攻	失误	警告	2'	取消	时间
江苏(江苏)																
<i>(上场队员)</i>																
1	丁大伟									0.0%						00:30:00
2	杨彦威		1/1		7/8			0/1	8/10	80.0%						00:43:12
3	李旭东									0.0%						00:00:00
4	沈庆		3/4	1/1	2/2				6/7	85.7%	1	1				00:33:21
5	闫亮		1/1	0/1					1/2	50.0%	1					00:17:04
6	赵晨	0/2	3/3		1/2				4/7	57.1%		3	1			00:34:09
8	周小坚									0.0%						00:21:56
9	叶强	1/2	1/1	0/1	3/3		0/1	0/1	5/9	55.6%	1	2		1		00:42:37
10	郝可鑫	1/1							1/1	100%						00:05:34
11	姚仁剑									0.0%						00:00:00
12	王权	0/2					1/1		1/3	33.3%	1					00:30:00
14	丛海航			2/2	2/2				4/4	100%	1	2				00:40:48
15	李安		1/1	2/2	1/2			2/2	6/7	85.7%	1					00:39:22
17	陈灵峰	5/7	0/2		2/4			2/2	9/15	60.0%		5	1	1		00:46:29
19	张志宇		1/1	0/1					1/2	50.0%		2				00:33:22
20	张星									0.0%						00:00:00
合计		7/14	11/14	5/8	18/23		1/2	4/6	46/67	68.7%	6	15	2	2		
<i>(守门员)</i>																
1	丁大伟	6/8	2/6	2/3	1/3		1/1	0/1	12/22	54.5%						00:30:00
12	王权	6/6	0/1	4/4	0/2				10/13	76.9%	1					00:30:00
合计		12/14	2/7	6/7	1/5		1/1	0/1	22/35	62.9%	1					

场上队员：得分/射门

守门员：救球/射门

全队合计	得分	被救	射失	击柱	封球	合计	%
远射	7	3	2	2		14	50.0%
近射	11	2		1		14	78.6%
边射	5	3				8	62.5%
快攻	18	3		2		23	78.3%
突破							0.0%
任意	1		1			2	50.0%
7M	4	2				6	66.7%





第十二届全国运动会男子手球预赛

图式射门区域统计

轮次 3 场次 12

201301012-41-1/1

澳门

2 李翹臻	4 刘家声	5 何建成	15 黄俊勇	16 冯国政	18 卓伟杰	21 麦锦聪	22 陈学敏																																																																								
<table border="1"><tr><td></td><td></td><td></td></tr><tr><td></td><td></td><td></td></tr><tr><td></td><td></td><td></td></tr></table>										<table border="1"><tr><td></td><td></td><td></td></tr><tr><td></td><td></td><td></td></tr><tr><td></td><td></td><td></td></tr></table>										<table border="1"><tr><td></td><td></td><td></td></tr><tr><td></td><td></td><td></td></tr><tr><td>1</td><td></td><td>1</td></tr></table>							1		1	<table border="1"><tr><td></td><td></td><td></td></tr><tr><td></td><td></td><td></td></tr><tr><td></td><td></td><td></td></tr></table>										<table border="1"><tr><td></td><td></td><td></td></tr><tr><td></td><td></td><td></td></tr><tr><td></td><td></td><td></td></tr></table>										<table border="1"><tr><td></td><td></td><td></td></tr><tr><td></td><td></td><td></td></tr><tr><td></td><td></td><td></td></tr></table>										<table border="1"><tr><td></td><td></td><td></td></tr><tr><td></td><td></td><td></td></tr><tr><td></td><td></td><td></td></tr></table>										<table border="1"><tr><td></td><td></td><td></td></tr><tr><td></td><td></td><td></td></tr><tr><td>1</td><td></td><td></td></tr></table>							1		
1		1																																																																													
1																																																																															
Post - 0 Miss - 0 Block - 0	Post - 0 Miss - 0 Block - 0	Post - 0 Miss - 1 Block - 0	Post - 1 Miss - 0 Block - 0	Post - 0 Miss - 0 Block - 0	Post - 0 Miss - 0 Block - 0	Post - 0 Miss - 0 Block - 0	Post - 0 Miss - 1 Block - 0																																																																								
24 刘登宇	27 徐展业	28 莫家进	29 叶响俊	33 欧永健	36 陈嘉聪	81 梁梓康	93 罗味高																																																																								
<table border="1"><tr><td></td><td></td><td>1</td></tr><tr><td>1</td><td></td><td></td></tr><tr><td></td><td></td><td></td></tr></table>			1	1						<table border="1"><tr><td></td><td></td><td></td></tr><tr><td></td><td></td><td></td></tr><tr><td></td><td></td><td></td></tr></table>										<table border="1"><tr><td>1</td><td></td><td></td></tr><tr><td>1</td><td></td><td>1</td></tr><tr><td></td><td></td><td></td></tr></table>	1			1		1				<table border="1"><tr><td></td><td></td><td></td></tr><tr><td></td><td></td><td></td></tr><tr><td>2</td><td></td><td></td></tr></table>							2			<table border="1"><tr><td></td><td></td><td></td></tr><tr><td></td><td></td><td></td></tr><tr><td>1</td><td></td><td></td></tr></table>							1			<table border="1"><tr><td></td><td></td><td></td></tr><tr><td></td><td></td><td></td></tr><tr><td></td><td></td><td></td></tr></table>										<table border="1"><tr><td></td><td></td><td></td></tr><tr><td></td><td></td><td></td></tr><tr><td></td><td>2</td><td></td></tr></table>								2		<table border="1"><tr><td></td><td></td><td></td></tr><tr><td></td><td></td><td></td></tr><tr><td></td><td></td><td></td></tr></table>									
		1																																																																													
1																																																																															
1																																																																															
1		1																																																																													
2																																																																															
1																																																																															
	2																																																																														
Post - 2 Miss - 1 Block - 2	Post - 0 Miss - 0 Block - 0	Post - 0 Miss - 0 Block - 0	Post - 0 Miss - 1 Block - 0	Post - 0 Miss - 1 Block - 2	Post - 0 Miss - 0 Block - 0	Post - 0 Miss - 1 Block - 0	Post - 0 Miss - 0 Block - 0																																																																								

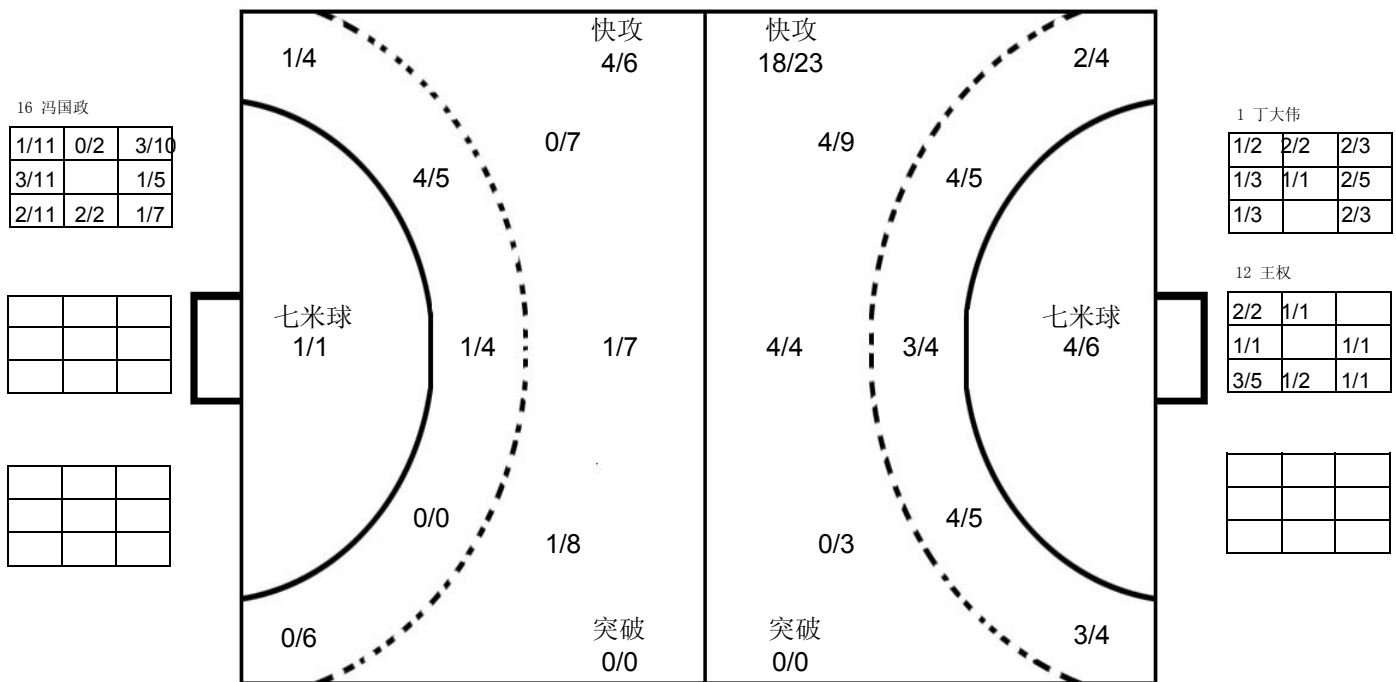

江苏

1 丁大伟	2 杨彦威	3 李旭东	4 沈庆	5 闫亮	6 赵晨	8 周小坚	9 叶强																																																																								
<table border="1"><tr><td></td><td></td><td></td></tr><tr><td></td><td></td><td></td></tr><tr><td></td><td></td><td></td></tr></table>										<table border="1"><tr><td></td><td>1</td><td>1</td></tr><tr><td></td><td></td><td>1</td></tr><tr><td>2</td><td></td><td>3</td></tr></table>		1	1			1	2		3	<table border="1"><tr><td></td><td></td><td></td></tr><tr><td></td><td></td><td></td></tr><tr><td></td><td></td><td></td></tr></table>										<table border="1"><tr><td></td><td></td><td></td></tr><tr><td>1</td><td></td><td>1</td></tr><tr><td></td><td></td><td>3</td></tr></table>				1		1			3	<table border="1"><tr><td></td><td></td><td></td></tr><tr><td></td><td></td><td></td></tr><tr><td>1</td><td></td><td></td></tr></table>							1			<table border="1"><tr><td></td><td>1</td><td></td></tr><tr><td>2</td><td></td><td></td></tr><tr><td>1</td><td></td><td></td></tr></table>		1		2			1			<table border="1"><tr><td></td><td></td><td></td></tr><tr><td></td><td></td><td></td></tr><tr><td></td><td></td><td></td></tr></table>										<table border="1"><tr><td>1</td><td></td><td>1</td></tr><tr><td></td><td></td><td></td></tr><tr><td>3</td><td></td><td></td></tr></table>	1		1				3		
	1	1																																																																													
		1																																																																													
2		3																																																																													
1		1																																																																													
		3																																																																													
1																																																																															
	1																																																																														
2																																																																															
1																																																																															
1		1																																																																													
3																																																																															
Post - 0 Miss - 0 Block - 0	Post - 0 Miss - 0 Block - 0	Post - 0 Miss - 0 Block - 0	Post - 0 Miss - 0 Block - 0	Post - 0 Miss - 0 Block - 0	Post - 1 Miss - 0 Block - 0	Post - 0 Miss - 0 Block - 0	Post - 0 Miss - 1 Block - 0																																																																								
10 郝可鑫	11 姚仁剑	12 王权	14 丛海航	15 李安	17 陈灵峰	19 张志宇	20 张星																																																																								
<table border="1"><tr><td>1</td><td></td><td></td></tr><tr><td></td><td></td><td></td></tr><tr><td></td><td></td><td></td></tr></table>	1									<table border="1"><tr><td></td><td></td><td></td></tr><tr><td></td><td></td><td></td></tr><tr><td></td><td></td><td></td></tr></table>										<table border="1"><tr><td>1</td><td></td><td></td></tr><tr><td></td><td></td><td></td></tr><tr><td></td><td></td><td></td></tr></table>	1									<table border="1"><tr><td>2</td><td></td><td></td></tr><tr><td></td><td></td><td></td></tr><tr><td>2</td><td></td><td></td></tr></table>	2						2			<table border="1"><tr><td>2</td><td></td><td>1</td></tr><tr><td>2</td><td></td><td></td></tr><tr><td>1</td><td></td><td></td></tr></table>	2		1	2			1			<table border="1"><tr><td>3</td><td></td><td>3</td></tr><tr><td></td><td></td><td>2</td></tr><tr><td>1</td><td></td><td></td></tr></table>	3		3			2	1			<table border="1"><tr><td></td><td></td><td></td></tr><tr><td></td><td></td><td></td></tr><tr><td></td><td>1</td><td></td></tr></table>								1		<table border="1"><tr><td></td><td></td><td></td></tr><tr><td></td><td></td><td></td></tr><tr><td></td><td></td><td></td></tr></table>									
1																																																																															
1																																																																															
2																																																																															
2																																																																															
2		1																																																																													
2																																																																															
1																																																																															
3		3																																																																													
		2																																																																													
1																																																																															
	1																																																																														
Post - 0 Miss - 0 Block - 0	Post - 0 Miss - 0 Block - 0	Post - 1 Miss - 1 Block - 0	Post - 0 Miss - 0 Block - 0	Post - 1 Miss - 0 Block - 0	Post - 2 Miss - 1 Block - 0	Post - 0 Miss - 0 Block - 0	Post - 0 Miss - 0 Block - 0																																																																								

注释: Post=击柱 Miss=射失 Block=被封





男子 国内比赛



第十二届全国运动会男子手球预赛

Team A				Team B				Match Number													
A 天津				B 解放军				13													
played in		in the hall		on		at		Spectators													
China		柳州市李宁体育馆		20/04/2013		18:00 hours															
Half-time (30')	A	B	End of playing time	A	B	1st extra time	A	B	2nd extra time	A	B	After penalty throws	A	B							
	9	11		17	21																
Number of 7 m	A	Team time-out			Full name of players and officials				Team time-out			B	Number of 7 m								
	1/3	1	2	3					1	2	3	4/5									
		26:02	27:42	36:23					50:51	58:44											
No.	Team A					G	W	2'	D	DR	No.	Team B					G	W	2'	D	DR
1	刘宗其										4	曹作亮					6	1	1		
2	李岳朋										5	吴龙瑞					1	1			
3	李军					6					6	苗青					8		2		
4	李松浩										7	陈昊									
7	张青					2	1				8	王烁					4				
8	曹悦					2		1			9	丁超					1				
9	孟凡钢										10	师龙									
10	李帅										11	李想					1				
11	王毅										12	丛霖									
13	许松					2					13	王世杰									
14	田剑侠					4					14	曲学博						1			
15	张俊岭					1	1	2			15	杨帆									
16	刘海亮										16	郎俊夫									
17	周群							1	1		17	王勇									
18	孙永										18	董宏斐									
19	梁堂亮										20	谷浩									
A	尚喜										A	张敬敏									
B	贾守信										B	张彬华									
C	刘伟成										C	刘捷									
D	冀谦										D	刘军									
A	Signature of Responsible Official of the Teams (Off. A)																		B		
TP	Remarks of Referee / CHA Official																		TP		

Signatures

Referees	Andreas Bethmann	Michael Tzaferopoulos		
Techn. Delegates	许宜扬 (CHN)	刘书勇 (CHN)		
CHA Official				

Note: Number of 7m Throws Awarded to Team A and B, Goals (G), Warnings (W), Suspensions (2'), Direct Disqualification (D), Disqualification with Report (DR) and Team Penalty (TP).

Table Officials: 黄思华 谭云东 Statisticians: 朱伟平 黄莉

Printed by PHMS Copyright: IHF / CHA 20/04/2013 19:29:46

Longman Sportsoft handball@126.com



第十二届全国运动会男子手球预赛
竞赛技术统计(媒体表)

预赛	组别	B	轮次	3	场次	13
柳州市李宁体院馆			20/04/2013		201301013-51-1/1	
天津	天津	17	vs	21	解放军	解放军
			9:11			

裁判员	Andreas Bethmann (GRE)	/	Michael Tzaferopoulos (GRE)
-----	------------------------	---	-----------------------------

天津		远射	近射	边射	快攻	突破	任意球	7m球	合计	%	助攻	失误	警告	2'	D & DR	天津	比赛进程	解放军			
主教练：尚喜																					
1	刘宗其																0	01:23	1	6	苗青
2	李岳朋																1	01:43	1		
3	李军	1/6	2/2	0/2	1/2	1/2	0/1	1/2	6/17	35.3		2				2	05:39	1			
4	李松浩																3	06:17	1		
7	张青		0/1		1/1	1/2	0/1		2/5	40.0			1			3	10:54	2	6	苗青	
8	曹悦				1/1	1/1			2/2	100	1	1		1		4	12:09	2			
9	孟凡钢															4	12:57	3	6	苗青	
10	李帅															4	13:44	4	4	曹作亮	
11	王毅															5	15:00	4			
13	许松		0/1	1/2	1/2				2/5	40.0		3				5	15:48	5	6	苗青	
14	田剑侠	2/7	1/1			0/1	1/2	0/1	4/12	33.3	2	5				6	18:09	6	6	苗青	
15	张俊岭			1/1	0/1				1/2	50.0			1	2		7	20:00	6			
16	刘海亮															7	20:40	6			
17	周群		0/1						0/1	0.0		3	1	1		7	23:07	7	4	曹作亮	
18	孙永															8	24:08	7			
19	梁堂亮															8	24:38	8	4	曹作亮	
运动员 合计		3/13	3/6	2/5	4/7	3/6	1/4	1/3	17/44	38.6	3	14	3	4		8	25:25	9	9	丁超	
1	刘宗其	6/11	1/4	1/2	1/6	2/5	1/1	1/5	13/34	38.2						8	26:08	10	5	吴龙瑞	
守门员 合计		6/11	1/4	1/2	1/6	2/5	1/1	1/5	13/34	38.2						9	26:40	10			
																9	28:39	11	11	李想	
																2nd Half					
																9	02:06	12	6	苗青	
																10	03:08	12			
																10	04:27	13	8	王烁	
																10	06:57	14	4	曹作亮	
																11	07:31	14			
																11	08:03	15	8	王烁	
																11	10:18	16	8	王烁	
																12	12:07	16			
																12	13:02	17	8	王烁	
																12	19:31	18	4	曹作亮	
																8	20:01	18			
																8	21:14	18			
																14	23:54	19	6	苗青	
																14	26:02	20	4	曹作亮	
																13	27:14	20			
																3	27:57	20			
																16	29:14	21	6	苗青	
																14	30:00	21			

场上队员：得分 / 射门																守门员：救球 / 射门			
快攻	Fast Break		突破	Breakthrough		任意球	Free Throw		7M球	7M Throw		助攻	Assist						
警告	Warning		失误	Error		2'	Suspension		D	取消资格		DR	取消资格+报告						





第十二届全国运动会男子手球预赛 图式比赛技术统计表

轮次 3

场次 13

201301013-21-1/1

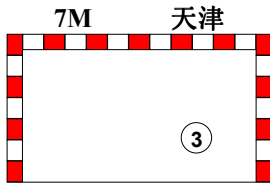
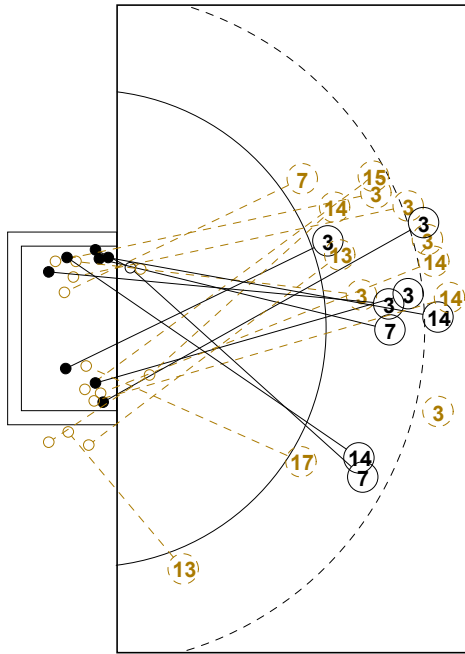

1st Half
9 : 11

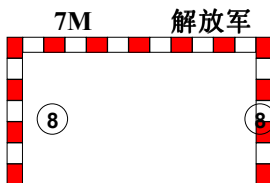
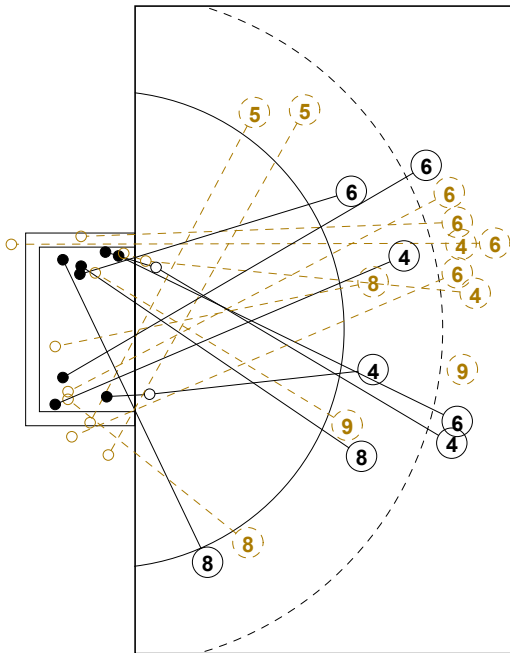
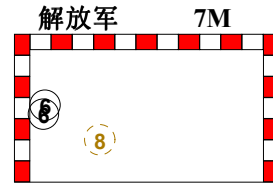
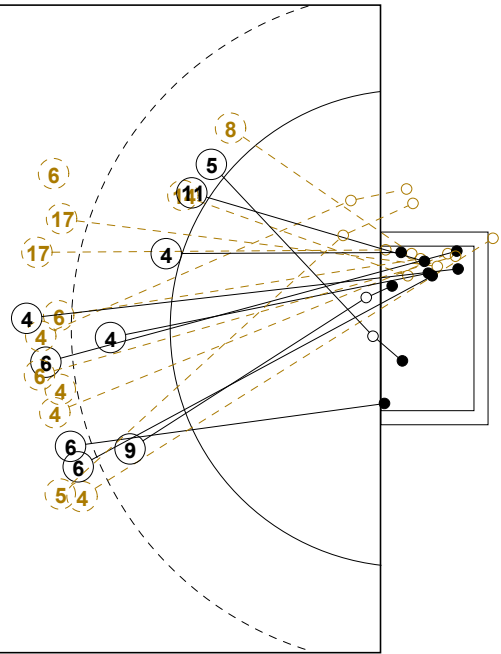

2nd Half
21 : 17

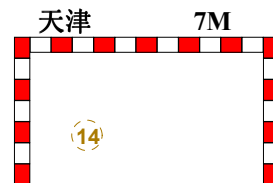
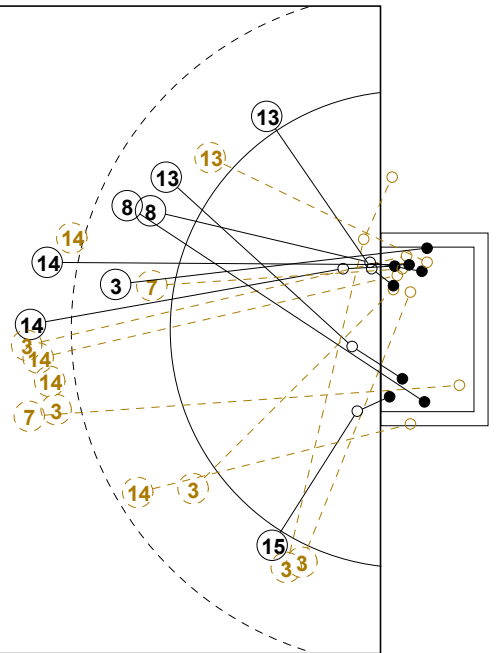



第十二届全国运动会男子手球预赛

个人/全队技术统计表

正式表
手球
男子预赛
轮次 3组别 B
场次 13201301013-14-1/2
柳州市李宁体院馆
20/04/2013 18:00

号码	姓名	远射	近射	边射	快攻	突破	任意	7M	合计	%	助攻	失误	警告	2'	取消	时间
天津(天津)																
<i>(场上队员)</i>																
1	刘宗其									0.0%						01:00:00
2	李岳朋									0.0%						00:16:03
3	李军	1/6	2/2	0/2	1/2	1/2	0/1	1/2	6/17	35.3%		2				01:00:00
4	李松浩									0.0%						00:00:00
7	张青		0/1		1/1	1/2	0/1		2/5	40.0%			1			00:58:51
8	曹悦				1/1	1/1			2/2	100%	1	1		1		00:13:36
9	孟凡钢									0.0%						00:00:00
10	李帅									0.0%						00:08:12
11	王毅									0.0%						00:00:00
13	许松		0/1	1/2	1/2				2/5	40.0%		3				00:59:26
14	田剑侠	2/7	1/1			0/1	1/2	0/1	4/12	33.3%	2	5				00:49:49
15	张俊岭			1/1	0/1				1/2	50.0%			1	2		00:44:10
16	刘海亮									0.0%						00:00:00
17	周群		0/1						0/1	0.0%		3	1	1		00:45:53
18	孙永									0.0%						00:00:00
19	梁堂亮									0.0%						00:00:00
合计		3/13	3/6	2/5	4/7	3/6	1/4	1/3	17/44	38.6%	3	14	3	4		
<i>(守门员)</i>																
1	刘宗其	6/11	1/4	1/2	1/6	2/5	1/1	1/5	13/34	38.2%						01:00:00
合计																
		6/11	1/4	1/2	1/6	2/5	1/1	1/5	13/34	38.2%						

场上队员：得分/射门

守门员：救球/射门

全队合计	得分	被救	射失	击柱	封球	合计	%
远射	3	4		1	5	13	23.1%
近射	3	2	1			6	50.0%
边射	2	1	2			5	40.0%
快攻	4	3				7	57.1%
突破	3	2	1			6	50.0%
任意	1	3				4	25.0%
7M	1	1	1			3	33.3%





第十二届全国运动会男子手球预赛

个人/全队技术统计表

正式表
手球
男子预赛
轮次 3组别 B
场次 13201301013-14-2/2
柳州市李宁体院馆
20/04/2013 18:00

号码	姓名	远射	近射	边射	快攻	突破	任意	7M	合计	%	助攻	失误	警告	2'	取消	时间
解放军(解放军)																
<i>(上场队员)</i>																
4	曹作亮	2/7			2/2	2/2	0/1		6/12	50.0%		3	1	1		00:59:44
5	吴龙瑞	0/1	0/1	0/1	1/1				1/4	25.0%		2	1			00:59:36
6	苗青	3/9	1/1		2/2		0/1	2/2	8/15	53.3%		2		2		00:59:36
7	陈昊									0.0%						00:09:37
8	王烁		1/1	1/2	0/1	0/1		2/3	4/8	50.0%	1					00:58:45
9	丁超	0/1				1/2			1/3	33.3%	3	1				00:40:37
10	师龙									0.0%						00:00:00
11	李想		1/1						1/1	100%		1				00:38:55
12	丛霖									0.0%	1					00:59:08
13	王世杰									0.0%						00:00:00
14	曲学博		0/1						0/1	0.0%			1			00:18:31
15	杨帆									0.0%						00:00:00
16	郎俊夫									0.0%						00:00:52
17	王勇	0/2							0/2	0.0%	1	1				00:13:18
18	董宏斐									0.0%						00:00:00
20	谷浩									0.0%						00:00:00
合计		5/20	3/5	1/3	5/6	3/5	0/2	4/5	21/46	45.7%	6	10	3	3		
<i>(守门员)</i>																
12	丛霖	4/7	2/5	1/3	3/7	2/5	3/4		15/31	48.4%	1					00:59:08
16	郎俊夫							1/2	1/2	50.0%						00:00:52
合计		4/7	2/5	1/3	3/7	2/5	3/4	1/2	16/33	48.5%	1					

场上队员：得分/射门

守门员：救球/射门

全队合计	得分	被救	射失	击柱	封球	合计	%
远射	5	6	4	1	4	20	25.0%
近射	3	1	1			5	60.0%
边射	1	1		1		3	33.3%
快攻	5	1				6	83.3%
突破	3	2				5	60.0%
任意		1	1			2	0.0%
7M	4	1				5	80.0%





第十二届全国运动会男子手球预赛

图式射门区域统计

轮次 3 场次 13

201301013-41-1/1

天津

1 刘宗其	2 李岳朋	3 李军	4 李松浩	7 张青	8 曹悦	9 孟凡钢	10 李帅																																																																								
<table border="1"><tr><td></td><td></td><td></td></tr><tr><td></td><td></td><td></td></tr><tr><td></td><td></td><td></td></tr></table>										<table border="1"><tr><td></td><td></td><td></td></tr><tr><td></td><td></td><td></td></tr><tr><td></td><td></td><td></td></tr></table>										<table border="1"><tr><td></td><td></td><td>1</td></tr><tr><td>2</td><td></td><td>1</td></tr><tr><td>2</td><td></td><td></td></tr></table>			1	2		1	2			<table border="1"><tr><td></td><td></td><td></td></tr><tr><td></td><td></td><td></td></tr><tr><td></td><td></td><td></td></tr></table>										<table border="1"><tr><td></td><td></td><td></td></tr><tr><td></td><td></td><td></td></tr><tr><td></td><td></td><td>2</td></tr></table>									2	<table border="1"><tr><td></td><td></td><td></td></tr><tr><td>1</td><td></td><td>1</td></tr><tr><td></td><td></td><td></td></tr></table>				1		1				<table border="1"><tr><td></td><td></td><td></td></tr><tr><td></td><td></td><td></td></tr><tr><td></td><td></td><td></td></tr></table>										<table border="1"><tr><td></td><td></td><td></td></tr><tr><td></td><td></td><td></td></tr><tr><td></td><td></td><td></td></tr></table>									
		1																																																																													
2		1																																																																													
2																																																																															
		2																																																																													
1		1																																																																													
Post - 0 Miss - 0 Block - 0	Post - 0 Miss - 0 Block - 0	Post - 0 Miss - 2 Block - 3	Post - 0 Miss - 0 Block - 0	Post - 0 Miss - 0 Block - 0	Post - 0 Miss - 0 Block - 0	Post - 0 Miss - 0 Block - 0	Post - 0 Miss - 0 Block - 0																																																																								
11 王毅	13 许松	14 田剑侠	15 张俊岭	16 刘海亮	17 周群	18 孙永	19 梁堂亮																																																																								
<table border="1"><tr><td></td><td></td><td></td></tr><tr><td></td><td></td><td></td></tr><tr><td></td><td></td><td></td></tr></table>										<table border="1"><tr><td></td><td></td><td></td></tr><tr><td>1</td><td></td><td>1</td></tr><tr><td></td><td></td><td></td></tr></table>				1		1				<table border="1"><tr><td></td><td></td><td>1</td></tr><tr><td>2</td><td></td><td>1</td></tr><tr><td></td><td></td><td></td></tr></table>			1	2		1				<table border="1"><tr><td></td><td></td><td></td></tr><tr><td></td><td></td><td>1</td></tr><tr><td></td><td></td><td></td></tr></table>						1				<table border="1"><tr><td></td><td></td><td></td></tr><tr><td></td><td></td><td></td></tr><tr><td></td><td></td><td></td></tr></table>										<table border="1"><tr><td></td><td></td><td></td></tr><tr><td></td><td></td><td></td></tr><tr><td></td><td></td><td></td></tr></table>										<table border="1"><tr><td></td><td></td><td></td></tr><tr><td></td><td></td><td></td></tr><tr><td></td><td></td><td></td></tr></table>										<table border="1"><tr><td></td><td></td><td></td></tr><tr><td></td><td></td><td></td></tr><tr><td></td><td></td><td></td></tr></table>									
1		1																																																																													
		1																																																																													
2		1																																																																													
		1																																																																													
Post - 0 Miss - 0 Block - 0	Post - 0 Miss - 2 Block - 0	Post - 1 Miss - 1 Block - 2	Post - 0 Miss - 0 Block - 0	Post - 0 Miss - 0 Block - 0	Post - 0 Miss - 0 Block - 0	Post - 0 Miss - 0 Block - 0	Post - 0 Miss - 0 Block - 0																																																																								

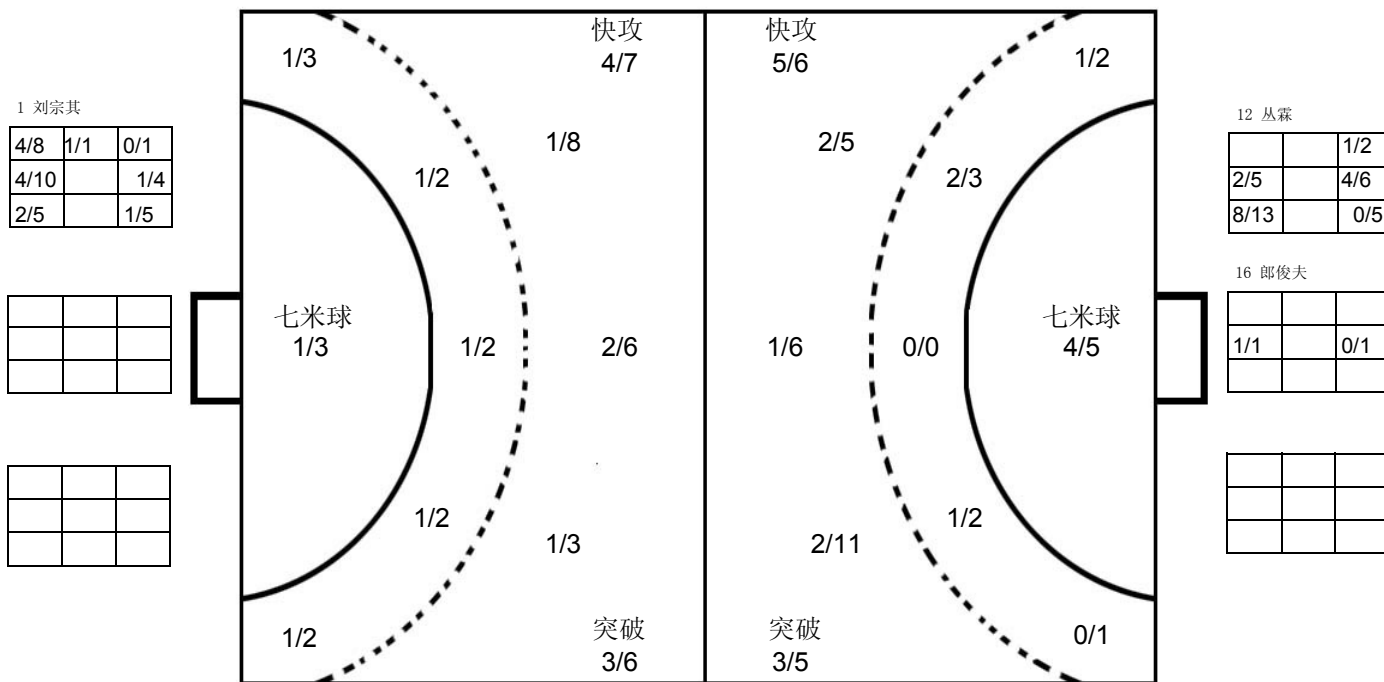

解放军

4 曹作亮	5 吴龙瑞	6 苗青	7 陈昊	8 王烁	9 丁超	10 师龙	11 李想																																																																								
<table border="1"><tr><td>2</td><td></td><td></td></tr><tr><td>1</td><td></td><td></td></tr><tr><td>2</td><td></td><td>1</td></tr></table>	2			1			2		1	<table border="1"><tr><td></td><td></td><td></td></tr><tr><td></td><td></td><td></td></tr><tr><td></td><td></td><td></td></tr></table>										<table border="1"><tr><td>2</td><td></td><td></td></tr><tr><td>3</td><td></td><td>1</td></tr><tr><td></td><td></td><td>2</td></tr></table>	2			3		1			2	<table border="1"><tr><td></td><td></td><td></td></tr><tr><td></td><td></td><td></td></tr><tr><td></td><td></td><td></td></tr></table>										<table border="1"><tr><td></td><td></td><td>1</td></tr><tr><td>1</td><td></td><td>2</td></tr><tr><td></td><td></td><td></td></tr></table>			1	1		2				<table border="1"><tr><td></td><td></td><td></td></tr><tr><td></td><td></td><td></td></tr><tr><td>1</td><td></td><td></td></tr></table>							1			<table border="1"><tr><td></td><td></td><td></td></tr><tr><td></td><td></td><td></td></tr><tr><td></td><td></td><td></td></tr></table>										<table border="1"><tr><td></td><td></td><td></td></tr><tr><td></td><td></td><td></td></tr><tr><td></td><td></td><td></td></tr></table>									
2																																																																															
1																																																																															
2		1																																																																													
2																																																																															
3		1																																																																													
		2																																																																													
		1																																																																													
1		2																																																																													
1																																																																															
Post - 0 Miss - 2 Block - 2	Post - 1 Miss - 2 Block - 0	Post - 1 Miss - 2 Block - 1	Post - 0 Miss - 0 Block - 0	Post - 0 Miss - 0 Block - 0	Post - 0 Miss - 0 Block - 1	Post - 0 Miss - 0 Block - 0	Post - 0 Miss - 0 Block - 0																																																																								
12 丛霖	13 王世杰	14 曲文博	15 杨帆	16 郎俊夫	17 王勇	18 董宏斐	20 谷浩																																																																								
<table border="1"><tr><td></td><td></td><td></td></tr><tr><td></td><td></td><td></td></tr><tr><td></td><td></td><td></td></tr></table>										<table border="1"><tr><td></td><td></td><td></td></tr><tr><td></td><td></td><td></td></tr><tr><td></td><td></td><td></td></tr></table>										<table border="1"><tr><td></td><td></td><td></td></tr><tr><td></td><td></td><td></td></tr><tr><td></td><td></td><td></td></tr></table>										<table border="1"><tr><td></td><td></td><td></td></tr><tr><td></td><td></td><td></td></tr><tr><td></td><td></td><td></td></tr></table>										<table border="1"><tr><td></td><td></td><td></td></tr><tr><td></td><td></td><td></td></tr><tr><td></td><td></td><td></td></tr></table>										<table border="1"><tr><td></td><td></td><td></td></tr><tr><td></td><td></td><td></td></tr><tr><td></td><td></td><td></td></tr></table>										<table border="1"><tr><td></td><td></td><td></td></tr><tr><td></td><td></td><td></td></tr><tr><td></td><td></td><td></td></tr></table>										<table border="1"><tr><td></td><td></td><td></td></tr><tr><td></td><td></td><td></td></tr><tr><td></td><td></td><td></td></tr></table>									
Post - 0 Miss - 0 Block - 0	Post - 0 Miss - 0 Block - 0	Post - 0 Miss - 0 Block - 0	Post - 0 Miss - 0 Block - 0	Post - 0 Miss - 0 Block - 0	Post - 0 Miss - 0 Block - 0	Post - 0 Miss - 0 Block - 0	Post - 0 Miss - 0 Block - 0																																																																								

注释: Post=击柱 Miss=射失 Block=被封





男子 国内比赛



第十二届全国运动会男子手球预赛

Team A										Team B										Match Number									
A 四川					B 广东					14																			
played in China					in the hall 柳州市李宁体育馆					on 20/04/2013		at 19:40 hours		Spectators															
Half-time (30')		A 8		B 27		End of playing time		A 19		B 48		1st extra time		A		B		2nd extra time		A		B		After penalty throws		A		B	
Number of 7 m		A 0/0		Team time-out			Full name of players and officials										Team time-out			B 0/0		Number of 7 m							
No.	Team A						G	W	2'	D	DR	No.	Team B						G	W	2'	D	DR						
16	王松											1	王旭兴																
18	杨洋						1	1				2	孙江山						6	1									
19	杨洁							1				3	曲汝洋																
21	池培俊						2					4	李卓洋						7	1									
22	刘彦坤						1					5	候生升						11										
23	王震						5					6	邓志贵						3										
25	李峥						2					7	付文博						4										
27	于洪泉											8	于彦江																
28	宋涛						1					9	徐庆						2	1									
32	逯明松						1					10	陈超						9										
33	朱晓龙						4	1				12	温杰																
35	仇振勇						2					16	张广建																
36	刘琢											17	李中洲						5										
												18	张腾						1	1									
												19	马跃																
												20	王伟																
A	李太平											A	王锋																
B	李清											B	李晓忠																
C	黄承											C	郭艳辉																
E	何明阳											E	薛良成																
A	Signature of Responsible Official of the Teams (Off. A)										Signature of Responsible Official of the Teams (Off. B)																		
TP	Remarks of Referee / CHA Official																												

Signatures

Referees	姜涛 (CHN)	徐健 (CHN)		
Techn. Delegates	许宜扬 (CHN)	刘书勇 (CHN)		
CHA Official				

Note: Number of 7m Throws Awarded to Team A and B, Goals (G), Warnings (W), Suspensions (2'), Direct Disqualification (D), Disqualification with Report (DR) and Team Penalty (TP).

Table Officials: 黄思华

谭云东

Statisticians: 朱伟平

黄莉





第十二届全国运动会男子手球预赛
竞赛技术统计(媒体表)

预赛 组别 B 轮次 3 场次 14

柳州市李宁体育馆

20/04/2013

201301014-51-1/1

四川 四川 19 vs 48 广东 广东 8:27

裁判员 姜涛 (CHN) / 徐健 (CHN)

Main statistics table with columns for player names, positions, and various performance metrics for both teams (四川 and 广东).

场上队员: 得分 / 射门

守门员: 救球 / 射门

Legend table for abbreviations used in the statistics, such as Fast Break, Breakthrough, Free Throw, etc.





第十二届全国运动会男子手球预赛 图式比赛技术统计表

轮次 3

场次 14

201301014-21-1/1

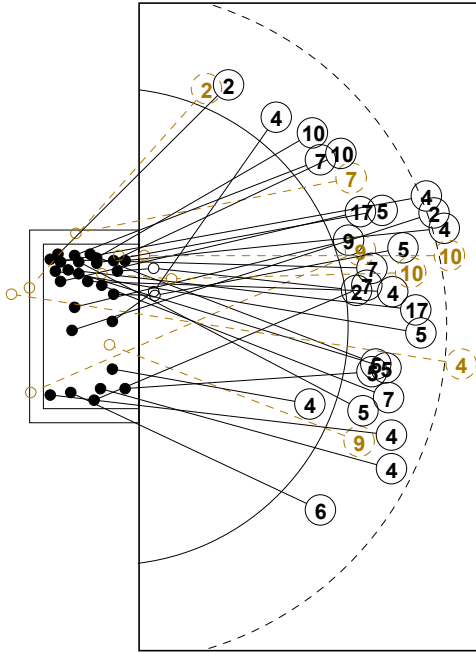

7M 广东

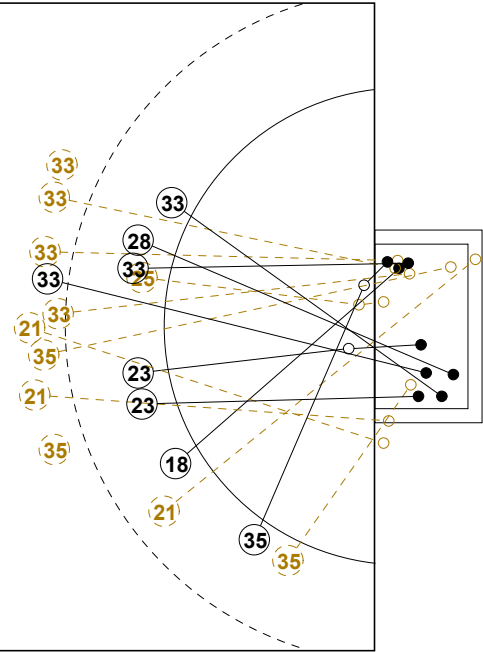
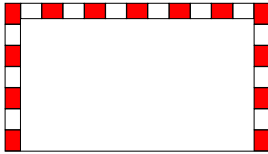

四川 7M

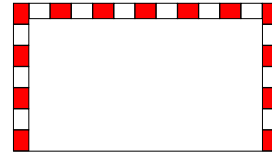

1st Half
27 : 8

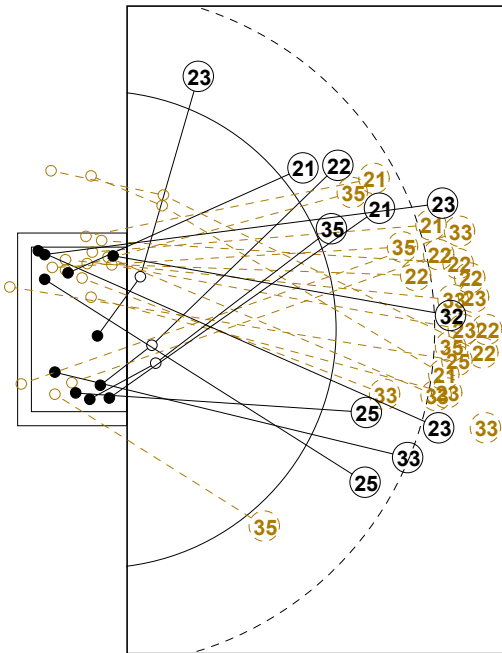

7M 四川

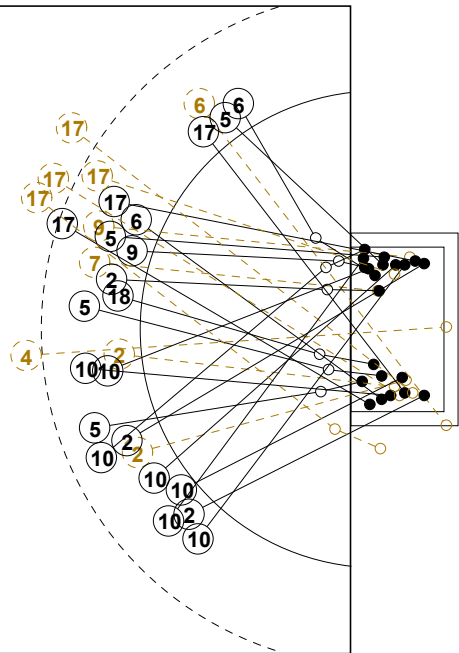
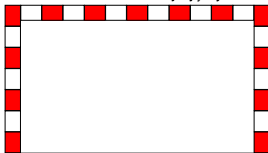

广东 7M



2nd Half
19 : 48



第十二届全国运动会男子手球预赛

个人/全队技术统计表

正式表
手球
男子预赛
轮次 3组别 B
场次 14201301014-14-1/2
柳州市李宁体育馆
20/04/2013 19:40

号码	姓名	远射	近射	边射	快攻	突破	任意	7M	合计	%	助攻	失误	警告	2'	取消	时间
四川(四川)																
<i>(场上队员)</i>																
16	王松									0.0%		1				00:41:57
18	杨洋		1/1						1/1	100%			1			00:06:28
19	杨洁									0.0%		2	1			00:29:25
21	池培俊	1/5			1/3				2/8	25.0%		1				00:58:58
22	刘彦坤	0/5				1/1	0/1		1/7	14.3%		3				00:29:17
23	王震	1/4	1/1	1/1	2/2				5/8	62.5%		2				00:52:49
25	李峥	1/2	1/2						2/4	50.0%		4				00:59:56
27	于洪泉									0.0%						00:00:00
28	宋涛					1/1			1/1	100%		4				00:30:00
32	逯明松	1/1							1/1	100%						00:00:00
33	朱晓龙	1/5	2/2		1/2		0/4		4/13	30.8%		3	1			00:46:15
35	仇振勇	0/4	0/1	1/2	0/1	1/1			2/9	22.2%		3				00:43:05
36	刘琢									0.0%		1				00:18:03
合计																
<i>(守门员)</i>																
16	王松	1/5	1/9	0/3	3/20	0/3			5/40	12.5%		1				00:41:57
36	刘琢	3/4	0/2		2/10	0/2			5/18	27.8%						00:18:03
合计																

场上队员：得分/射门

守门员：救球/射门

全队合计	得分	被救	射失	击柱	封球	合计	%
远射	5	8	3	3	7	26	19.2%
近射	5	2				7	71.4%
边射	2	1				3	66.7%
快攻	4	2	1	1		8	50.0%
突破	3					3	100.0%
任意		4		1		5	0.0%
7M							0.0%





第十二届全国运动会男子手球预赛

个人/全队技术统计表

正式表
手球
男子预赛
轮次 3组别 B
场次 14201301014-14-2/2
柳州市李宁体院馆
20/04/2013 19:40

号码	姓名	远射	近射	边射	快攻	突破	任意	7M	合计	%	助攻	失误	警告	2'	取消	时间
广东(广东)																
<i>(上场队员)</i>																
1	王旭兴									0.0%						00:00:00
2	孙江山	1/1		1/2	4/6				6/9	66.7%	1	2	1			00:35:17
3	曲汝洋									0.0%						00:00:00
4	李卓洋	2/4	2/2		3/3				7/9	77.8%		4	1			00:44:49
5	候生升		3/3		8/8				11/11	100%	1	3				00:59:28
6	邓志贵			1/2	2/2				3/4	75.0%						00:22:16
7	付云博		1/1		2/4	1/1			4/6	66.7%	1					00:31:21
8	于彦江									0.0%						00:00:00
9	徐庆		2/4		0/1				2/5	40.0%	1	4	1			00:39:43
10	陈超	0/1	1/1	1/1	3/4	4/4			9/11	81.8%	1	1				00:45:47
12	温杰									0.0%	1					00:30:00
16	张广建									0.0%						00:00:00
17	李中洲	2/6			3/3				5/9	55.6%		1				00:28:53
18	张腾		1/1						1/1	100%	1	2	1			00:28:04
19	马跃									0.0%	1	1				00:30:00
20	王伟									0.0%						00:00:00
合计		5/12	10/12	3/5	25/31	5/5			48/65	73.8%	8	18	4			
<i>(守门员)</i>																
12	温杰	1/1	1/5	0/1	2/4	0/1	2/2		6/14	42.9%	1					00:30:00
19	马跃	7/12	1/2	1/2	0/2	0/2	2/2		11/22	50.0%	1	1				00:30:00
合计		8/13	2/7	1/3	2/6	0/3	4/4		17/36	47.2%	2	1				

场上队员：得分/射门

守门员：救球/射门

全队合计	得分	被救	射失	击柱	封球	合计	%
远射	5	4	2	1		12	41.7%
近射	10	1		1		12	83.3%
边射	3			2		5	60.0%
快攻	25	5		1		31	80.6%
突破	5					5	100.0%
任意							0.0%
7M							0.0%





第十二届全国运动会男子手球预赛

图式射门区域统计

轮次 3 场次 14

201301014-41-1/1

四川

16 王松	18 杨洋	19 杨洁	21 池培俊	22 刘彦坤	23 王震	25 李峥	27 于洪泉																																																																																										
<table border="1"><tr><td></td><td></td><td></td></tr><tr><td></td><td></td><td></td></tr><tr><td></td><td></td><td></td></tr></table>										<table border="1"><tr><td></td><td></td><td></td></tr><tr><td>1</td><td></td><td></td></tr><tr><td></td><td></td><td></td></tr></table>				1						<table border="1"><tr><td></td><td></td><td></td></tr><tr><td></td><td></td><td></td></tr><tr><td></td><td></td><td></td></tr></table>										<table border="1"><tr><td></td><td></td><td></td></tr><tr><td></td><td></td><td>1</td></tr><tr><td>1</td><td></td><td></td></tr></table>						1	1			<table border="1"><tr><td></td><td></td><td></td></tr><tr><td></td><td></td><td></td></tr><tr><td>1</td><td></td><td></td></tr></table>							1			<table border="1"><tr><td></td><td></td><td>2</td></tr><tr><td></td><td>1</td><td>1</td></tr><tr><td></td><td>1</td><td></td></tr></table>			2		1	1		1		<table border="1"><tr><td></td><td></td><td></td></tr><tr><td>1</td><td></td><td></td></tr><tr><td></td><td></td><td></td></tr></table>				1						<table border="1"><tr><td></td><td></td><td></td></tr><tr><td></td><td></td><td></td></tr><tr><td></td><td></td><td></td></tr></table>																											
1																																																																																																	
		1																																																																																															
1																																																																																																	
1																																																																																																	
		2																																																																																															
	1	1																																																																																															
	1																																																																																																
1																																																																																																	
Post - 0 Miss - 0 Block - 0	Post - 0 Miss - 0 Block - 0	Post - 0 Miss - 0 Block - 0	Post - 3 Miss - 2 Block - 0	Post - 1 Miss - 1 Block - 2	Post - 0 Miss - 0 Block - 1	Post - 0 Miss - 1 Block - 0	Post - 0 Miss - 0 Block - 0																																																																																										
28 宋涛	32 逯明松	33 朱晓龙	35 仇振勇	36 刘琢																																																																																													
<table border="1"><tr><td></td><td></td><td>1</td></tr><tr><td></td><td></td><td></td></tr><tr><td></td><td></td><td></td></tr></table>			1							<table border="1"><tr><td></td><td></td><td></td></tr><tr><td></td><td></td><td></td></tr><tr><td></td><td></td><td>1</td></tr></table>									1	<table border="1"><tr><td></td><td>1</td><td></td><td>1</td></tr><tr><td></td><td>1</td><td></td><td>1</td></tr><tr><td></td><td></td><td></td><td></td></tr></table>		1		1		1		1					<table border="1"><tr><td></td><td></td><td></td><td></td></tr><tr><td>1</td><td></td><td></td><td></td></tr><tr><td>1</td><td></td><td></td><td></td></tr></table>					1				1				<table border="1"><tr><td></td><td></td><td></td><td></td></tr><tr><td></td><td></td><td></td><td></td></tr><tr><td></td><td></td><td></td><td></td></tr></table>													<table border="1"><tr><td></td><td></td><td></td><td></td></tr><tr><td></td><td></td><td></td><td></td></tr><tr><td></td><td></td><td></td><td></td></tr></table>													<table border="1"><tr><td></td><td></td><td></td><td></td></tr><tr><td></td><td></td><td></td><td></td></tr><tr><td></td><td></td><td></td><td></td></tr></table>													<table border="1"><tr><td></td><td></td><td></td><td></td></tr><tr><td></td><td></td><td></td><td></td></tr><tr><td></td><td></td><td></td><td></td></tr></table>												
		1																																																																																															
		1																																																																																															
	1		1																																																																																														
	1		1																																																																																														
1																																																																																																	
1																																																																																																	
Post - 0 Miss - 0 Block - 0	Post - 0 Miss - 0 Block - 0	Post - 1 Miss - 0 Block - 2	Post - 0 Miss - 0 Block - 2	Post - 0 Miss - 0 Block - 0																																																																																													

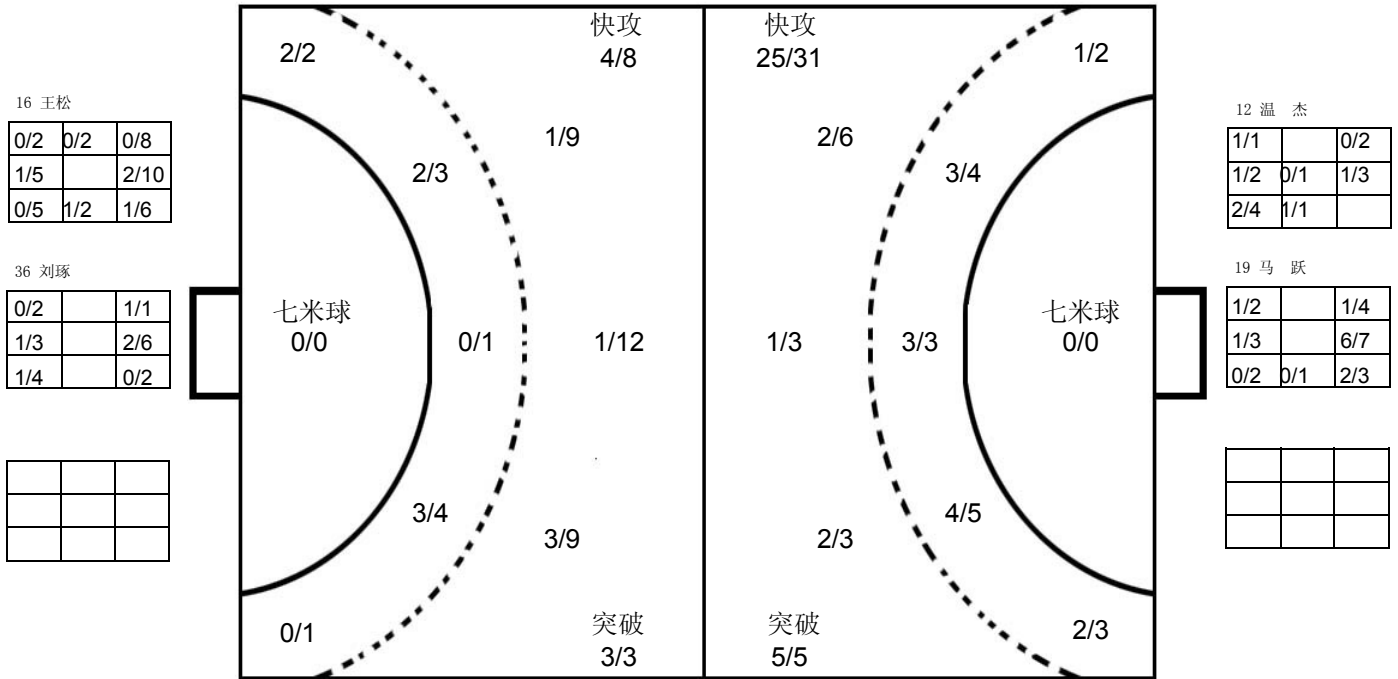

广东

1 王旭兴	2 孙江山	3 曲汝洋	4 李卓洋	5 候生升	6 邓志贵	7 付云博	8 于彦江																																																																								
<table border="1"><tr><td></td><td></td><td></td></tr><tr><td></td><td></td><td></td></tr><tr><td></td><td></td><td></td></tr></table>										<table border="1"><tr><td>1</td><td>1</td><td>2</td></tr><tr><td></td><td></td><td></td></tr><tr><td>1</td><td></td><td>1</td></tr></table>	1	1	2				1		1	<table border="1"><tr><td></td><td></td><td></td></tr><tr><td></td><td></td><td></td></tr><tr><td></td><td></td><td></td></tr></table>										<table border="1"><tr><td></td><td></td><td>1</td></tr><tr><td>1</td><td></td><td>1</td></tr><tr><td>1</td><td>1</td><td>1</td></tr></table>			1	1		1	1	1	1	<table border="1"><tr><td></td><td></td><td>1</td></tr><tr><td>2</td><td></td><td>5</td></tr><tr><td>1</td><td></td><td>2</td></tr></table>			1	2		5	1		2	<table border="1"><tr><td></td><td></td><td></td></tr><tr><td>1</td><td></td><td></td></tr><tr><td></td><td></td><td>1</td></tr></table>				1					1	<table border="1"><tr><td></td><td></td><td>2</td></tr><tr><td>1</td><td></td><td>1</td></tr><tr><td></td><td></td><td></td></tr></table>			2	1		1				<table border="1"><tr><td></td><td></td><td></td></tr><tr><td></td><td></td><td></td></tr><tr><td></td><td></td><td></td></tr></table>									
1	1	2																																																																													
1		1																																																																													
		1																																																																													
1		1																																																																													
1	1	1																																																																													
		1																																																																													
2		5																																																																													
1		2																																																																													
1																																																																															
		1																																																																													
		2																																																																													
1		1																																																																													
Post - 0 Miss - 0 Block - 0	Post - 1 Miss - 0 Block - 0	Post - 0 Miss - 0 Block - 0	Post - 1 Miss - 1 Block - 0	Post - 0 Miss - 0 Block - 0	Post - 1 Miss - 0 Block - 0	Post - 1 Miss - 0 Block - 0	Post - 0 Miss - 0 Block - 0																																																																								
9 徐庆	10 陈超	12 温杰	16 张广建	17 李中洲	18 张腾	19 马跃	20 王伟																																																																								
<table border="1"><tr><td></td><td>1</td><td></td></tr><tr><td></td><td></td><td></td></tr><tr><td>1</td><td></td><td></td></tr></table>		1					1			<table border="1"><tr><td></td><td></td><td></td></tr><tr><td>2</td><td></td><td>3</td></tr><tr><td>3</td><td></td><td>1</td></tr></table>				2		3	3		1	<table border="1"><tr><td></td><td></td><td></td></tr><tr><td></td><td></td><td></td></tr><tr><td></td><td></td><td></td></tr></table>										<table border="1"><tr><td></td><td></td><td></td></tr><tr><td></td><td></td><td></td></tr><tr><td></td><td></td><td></td></tr></table>										<table border="1"><tr><td></td><td></td><td>2</td></tr><tr><td></td><td></td><td>1</td></tr><tr><td></td><td></td><td>1</td></tr></table>			2			1			1	<table border="1"><tr><td></td><td></td><td></td></tr><tr><td></td><td></td><td></td></tr><tr><td></td><td></td><td>1</td></tr></table>									1	<table border="1"><tr><td></td><td></td><td></td></tr><tr><td></td><td></td><td></td></tr><tr><td></td><td></td><td></td></tr></table>										<table border="1"><tr><td></td><td></td><td></td></tr><tr><td></td><td></td><td></td></tr><tr><td></td><td></td><td></td></tr></table>									
	1																																																																														
1																																																																															
2		3																																																																													
3		1																																																																													
		2																																																																													
		1																																																																													
		1																																																																													
		1																																																																													
Post - 1 Miss - 0 Block - 0	Post - 0 Miss - 0 Block - 0	Post - 0 Miss - 0 Block - 0	Post - 0 Miss - 0 Block - 0	Post - 0 Miss - 1 Block - 0	Post - 0 Miss - 0 Block - 0	Post - 0 Miss - 0 Block - 0	Post - 0 Miss - 0 Block - 0																																																																								

注释: Post=击柱 Miss=射失 Block=被封





男子 国内比赛



第十二届全国运动会男子手球预赛

Team A		Team B		Match Number												
A 山西		B 上海		15												
played in		in the hall		on		at		Spectators								
China		柳州市李宁体育馆		20/04/2013		21:20 hours										
Half-time (30')	A	B	End of playing time	A	B	1st extra time	A	B	2nd extra time	A	B	After penalty throws	A	B		
	13	15	22 32													
Number of 7 m	A	Team time-out			Full name of players and officials	Team time-out			B	Number of 7 m						
		1	2	3		1	2	3								
	3 / 3	14:36	41:50			50:58			1 / 1							
No.	Team A					No.	Team B					G	W	2'	D	DR
1	李晋尧					1	张峥									
2	马健					2	胡辰									
3	王晋					3	赵时俊									
4	李鹏程					5	朱世杰									
5	王志超					6	李和鑫					5	1			
6	范帅					8	钱为玮					7	1			
7	白宇飞					9	朱礼彬					2		1		
8	崔钰					10	吴璟					6		1		
9	朱涛涛					12	周哲韬									
10	任海阳					13	孟宇超					1				
12	侯乃章					14	王子阳					4				
13	侯建涛					15	徐俊吉					2				
14	刘明华					16	朱春雷									
15	景新江					18	马麟晓					4				
18	朱棣					19	蒋承骅					1	1	1		
						20	程云飞									
A	王喜和					A	吴龙基									
B	张晓东					B	陆钦忠									
C	孙少波					C	徐耀忠									
D	石岩					E	黄韡									
A	Signature of Responsible Official of the Teams (Off. A)															B
TP	Remarks of Referee / CHA Official															TP

Signatures

Referees	邓军 (CHN)	谭雷 (CHN)		
Techn. Delegates	李之文 (CHN)	王锡祯 (CHN)		
CHA Official				

Note: Number of 7m Throws Awarded to Team A and B, Goals (G), Warnings (W), Suspensions (2'), Direct Disqualification (D), Disqualification with Report (DR) and Team Penalty (TP).

Table Officials: 黄思华 谭云东 Statisticians: 朱伟平 黄莉



第十二届全国运动会男子手球预赛
竞赛技术统计(媒体表)

预赛	组别	B	轮次	3	场次	15
柳州市李宁体院馆		20/04/2013			201301015-51-1/1	
山西		山西	22	vs	32	上海
			13 : 15			

裁判员	邓军 (CHN)	/	谭雷 (CHN)
-----	----------	---	----------

山西		远射	近射	边射	快攻	突破	任意球	7m球	合计	%	助攻	失误	警告	2'	D & DR	山西	比赛进程	上海
主教练:	王喜和																	
1	李晋尧																	
2	马健	0/2	1/1	0/1					1/4	25.0							18	马麟晓
3	王晋		2/3						2/3	66.7		1	1					
4	李鹏程	1/4	1/1		1/1			1/1	4/7	57.1		3					9	朱礼彬
5	王志超																	
6	范帅				0/1				0/1	0.0		1			1			
7	白宇飞	3/8			1/1			2/2	6/11	54.5	1	4						
8	崔钰																	
9	朱涛涛			2/2	1/1				3/3	100								
10	任海阳		1/1						1/1	100								
12	侯乃章																	
13	侯建涛	1/2	0/1			0/1	1/1		2/5	40.0		3	1					
14	刘明华	2/4			0/1				2/5	40.0	1	4			1			
15	景新江		0/1	0/1	1/1				1/3	33.3		1	1					
18	朱榭	0/1			0/2				0/3	0.0		2						
运动员	合计	7/21	5/8	2/4	4/8	0/1	1/1	3/3	22/46	47.8	2	19	3	2				
1	李晋尧	2/6	1/5	2/7	2/11	4/12	0/1	0/1	11/43	25.6								
守门员	合计	2/6	1/5	2/7	2/11	4/12	0/1	0/1	11/43	25.6								

上海		远射	近射	边射	快攻	突破	任意球	7m球	合计	%	助攻	失误	警告	2'	D & DR	比赛进程		
教练:	吴龙基																	
1	张峥																	
2	胡辰																	
3	赵时俊																	
5	朱世杰											2						
6	李和鑫	2/3	1/1			2/2			5/6	83.3	1	4	1					
8	钱为玮			3/3	3/3	1/2			7/8	87.5		1	1					
9	朱礼彬	0/1			2/2	0/1			2/4	50.0		2			1			
10	吴璟		2/3	1/1	1/3	1/1		1/1	6/9	66.7		1			1			
12	周哲韬											1						
13	孟宇超			0/1		0/1	1/1		1/3	33.3		1						
14	王子阳			1/5	1/2	2/3			4/10	40.0		2						
15	徐俊吉		1/1		1/1				2/2	100								
16	朱春雷																	
18	马麟晓	2/2				2/3			4/5	80.0	3	3						
19	蒋承骅				1/1				1/1	100	1		1	1				
20	程云飞																	
运动员	合计	4/6	4/5	5/10	9/12	8/13	1/1	1/1	32/48	66.7	5	17	3	3				
1	张峥	3/7	1/2	0/2	0/2	1/1			5/14	35.7								
12	周哲韬	9/10	0/4	1/1	2/2			0/1	12/18	66.7		1						
16	朱春雷	0/2	1/1		0/2		0/1	0/2	1/8	12.5								
守门员	合计	12/19	2/7	1/3	2/6	1/1	0/1	0/3	18/40	45.0		1						

场上队员: 得分 / 射门

守门员: 救球 / 射门

快攻	Fast Break		突破	Breakthrough		任意球	Free Throw		7m球	7M Throw		助攻	Assist
警告	Warning		失误	Error		2'	Suspension		D	取消资格		DR	取消资格+报告





第十二届全国运动会男子手球预赛 图式比赛技术统计表

轮次 3

场次 15

201301015-21-1/1

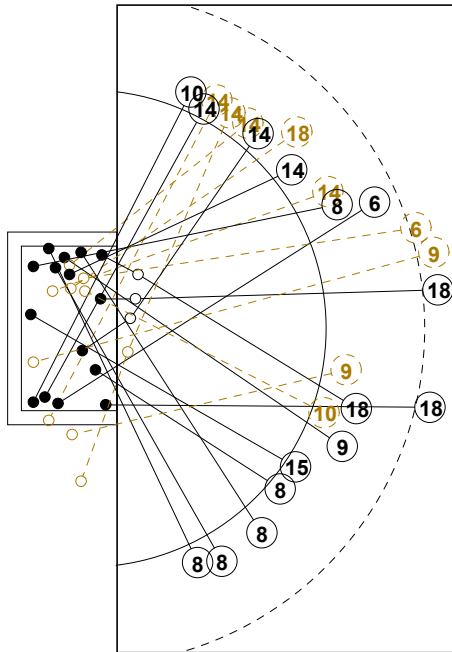

7M 上海

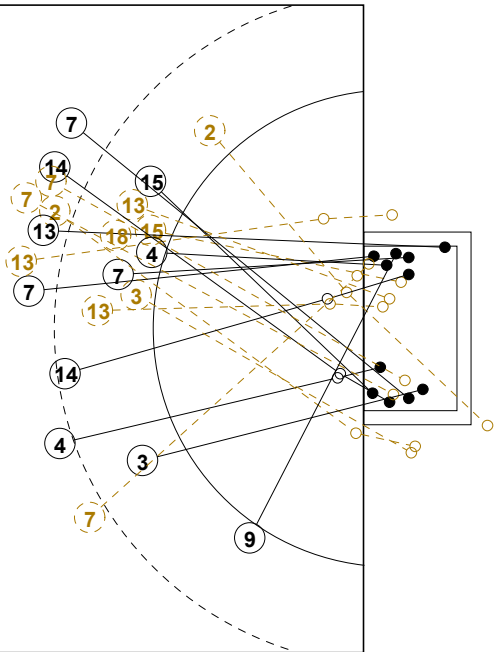
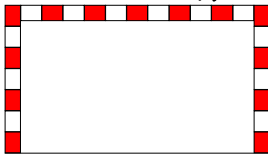

山西 7M

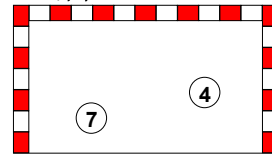

1st Half
15 : 13

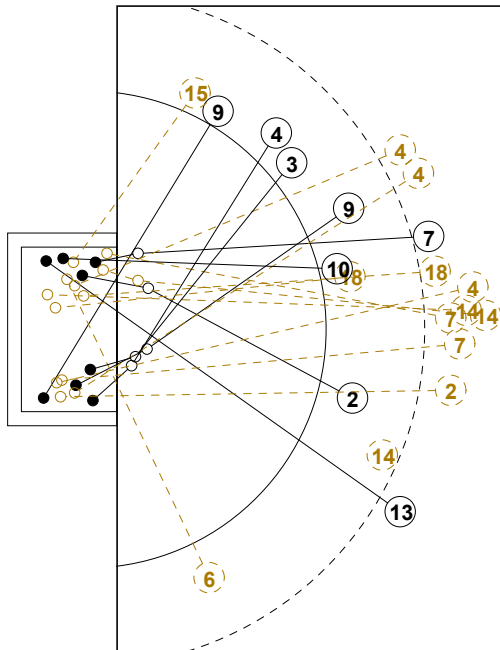

7M 山西

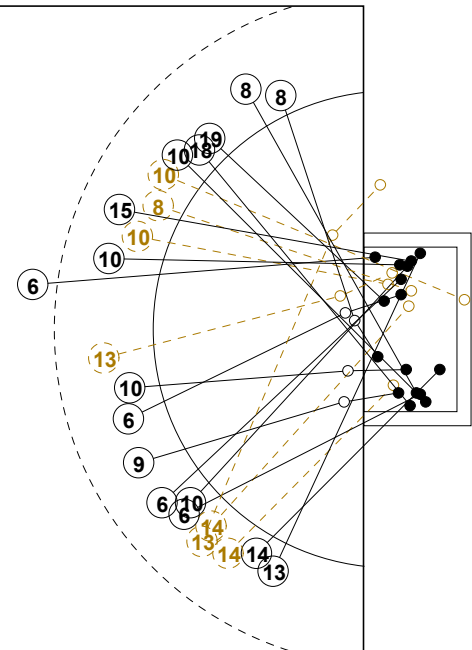
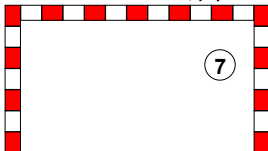

上海 7M

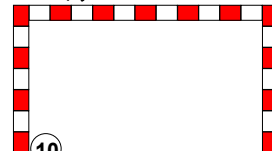

2nd Half
22 : 32



第十二届全国运动会男子手球预赛

个人/全队技术统计表

正式表
手球
男子预赛
轮次 3组别 B
场次 15201301015-14-1/2
柳州市李宁体院馆
20/04/2013 21:20

号码	姓名	远射	近射	边射	快攻	突破	任意	7M	合计	%	助攻	失误	警告	2'	取消	时间
山西(山西)																
<i>(场上队员)</i>																
1	李晋尧									0.0%						01:00:00
2	马健	0/2	1/1	0/1					1/4	25.0%						00:23:28
3	王晋		2/3						2/3	66.7%		1	1			00:21:59
4	李鹏程	1/4	1/1		1/1			1/1	4/7	57.1%		3				01:00:00
5	王志超									0.0%						00:00:00
6	范帅				0/1				0/1	0.0%		1		1		00:03:23
7	白宇飞	3/8			1/1			2/2	6/11	54.5%	1	4				00:56:04
8	崔钰									0.0%						00:04:45
9	朱涛涛			2/2	1/1				3/3	100%						00:28:10
10	任海阳		1/1						1/1	100%						00:31:37
12	侯乃章									0.0%						00:00:00
13	侯建涛	1/2	0/1			0/1	1/1		2/5	40.0%		3	1			00:32:33
14	刘明华	2/4			0/1				2/5	40.0%	1	4		1		00:26:42
15	景新江		0/1	0/1	1/1				1/3	33.3%		1	1			00:32:14
18	朱棣	0/1			0/2				0/3	0.0%		2				00:38:31
合计		7/21	5/8	2/4	4/8	0/1	1/1	3/3	22/46	47.8%	2	19	3	2		
<i>(守门员)</i>																
1	李晋尧	2/6	1/5	2/7	2/11	4/12	0/1	0/1	11/43	25.6%						01:00:00
合计		2/6	1/5	2/7	2/11	4/12	0/1	0/1	11/43	25.6%						

场上队员：得分/射门

守门员：救球/射门

全队合计	得分	被救	射失	击柱	封球	合计	%
远射	7	12	2			21	33.3%
近射	5	2	1			8	62.5%
边射	2	1	1			4	50.0%
快攻	4	2			2	8	50.0%
突破		1				1	0.0%
任意	1					1	100.0%
7M	3					3	100.0%





第十二届全国运动会男子手球预赛

个人/全队技术统计表

正式表
手球
男子预赛
轮次 3组别 B
场次 15201301015-14-2/2
柳州市李宁体院馆
20/04/2013 21:20

号码	姓名	远射	近射	边射	快攻	突破	任意	7M	合计	%	助攻	失误	警告	2'	取消	时间
上海(上海)																
<i>(上场队员)</i>																
1	张崢									0.0%						00:21:37
2	胡辰									0.0%						00:00:00
3	赵时俊									0.0%						00:00:00
5	朱世杰									0.0%		2				00:03:06
6	李和鑫	2/3	1/1			2/2			5/6	83.3%	1	4	1			00:49:37
8	钱为玮			3/3	3/3	1/2			7/8	87.5%		1	1			00:56:53
9	朱礼彬	0/1			2/2	0/1			2/4	50.0%		2		1		00:34:53
10	吴璟		2/3	1/1	1/3	1/1		1/1	6/9	66.7%		1		1		00:40:05
12	周哲韬									0.0%		1				00:25:59
13	孟宇超			0/1		0/1	1/1		1/3	33.3%		1				00:13:37
14	王子阳			1/5	1/2	2/3			4/10	40.0%		2				00:39:26
15	徐俊吉		1/1		1/1				2/2	100%						00:26:34
16	朱春雷									0.0%						00:12:24
18	马麟晓	2/2				2/3			4/5	80.0%	3	3				00:48:05
19	蒋承骅				1/1				1/1	100%	1		1	1		00:45:27
20	程云飞									0.0%						00:00:00
合计		4/6	4/5	5/10	9/12	8/13	1/1	1/1	32/48	66.7%	5	17	3	3		
<i>(守门员)</i>																
1	张崢	3/7	1/2	0/2	0/2	1/1			5/14	35.7%						00:21:37
12	周哲韬	9/10	0/4	1/1	2/2			0/1	12/18	66.7%		1				00:25:59
16	朱春雷	0/2	1/1		0/2		0/1	0/2	1/8	12.5%						00:12:24
合计		12/19	2/7	1/3	2/6	1/1	0/1	0/3	18/40	45.0%		1				

场上队员：得分/射门

守门员：救球/射门

全队合计	得分	被救	射失	击柱	封球	合计	%
远射	4	2				6	66.7%
近射	4	1				5	80.0%
边射	5	2	2	1		10	50.0%
快攻	9	2		1		12	75.0%
突破	8	4	1			13	61.5%
任意	1					1	100.0%
7M	1					1	100.0%





第十二届全国运动会男子手球预赛

图式射门区域统计

轮次 3 场次 15

201301015-41-1/1

山西

1 李晋尧	2 马健	3 王晋	4 李鹏程	5 王志超	6 范帅	7 白宇飞	8 崔钰																																																																								
<table border="1"><tr><td></td><td></td><td></td></tr><tr><td></td><td></td><td></td></tr><tr><td></td><td></td><td></td></tr></table>										<table border="1"><tr><td></td><td></td><td></td></tr><tr><td></td><td></td><td>1</td></tr><tr><td></td><td></td><td></td></tr></table>						1				<table border="1"><tr><td></td><td></td><td></td></tr><tr><td></td><td></td><td>1</td></tr><tr><td>1</td><td></td><td></td></tr></table>						1	1			<table border="1"><tr><td></td><td></td><td></td></tr><tr><td></td><td></td><td>1</td></tr><tr><td>2</td><td></td><td>1</td></tr></table>						1	2		1	<table border="1"><tr><td></td><td></td><td></td></tr><tr><td></td><td></td><td></td></tr><tr><td></td><td></td><td></td></tr></table>										<table border="1"><tr><td></td><td></td><td></td></tr><tr><td></td><td></td><td></td></tr><tr><td></td><td></td><td></td></tr></table>										<table border="1"><tr><td></td><td></td><td>1</td></tr><tr><td>1</td><td></td><td>1</td></tr><tr><td>2</td><td></td><td>1</td></tr></table>			1	1		1	2		1	<table border="1"><tr><td></td><td></td><td></td></tr><tr><td></td><td></td><td></td></tr><tr><td></td><td></td><td></td></tr></table>									
		1																																																																													
		1																																																																													
1																																																																															
		1																																																																													
2		1																																																																													
		1																																																																													
1		1																																																																													
2		1																																																																													
Post - 0 Miss - 0 Block - 0	Post - 0 Miss - 2 Block - 0	Post - 0 Miss - 1 Block - 0	Post - 0 Miss - 0 Block - 0	Post - 0 Miss - 0 Block - 0	Post - 0 Miss - 0 Block - 0	Post - 0 Miss - 0 Block - 0	Post - 0 Miss - 0 Block - 0																																																																								
9 朱涛涛	10 任海阳	12 侯乃章	13 侯建涛	14 刘明华	15 景新江	18 朱棣																																																																									
<table border="1"><tr><td>1</td><td></td><td></td></tr><tr><td>2</td><td></td><td></td></tr><tr><td></td><td></td><td></td></tr></table>	1			2						<table border="1"><tr><td></td><td></td><td></td></tr><tr><td></td><td></td><td>1</td></tr><tr><td></td><td></td><td></td></tr></table>						1				<table border="1"><tr><td></td><td></td><td></td></tr><tr><td></td><td></td><td></td></tr><tr><td></td><td></td><td></td></tr></table>										<table border="1"><tr><td>1</td><td></td><td>1</td></tr><tr><td></td><td></td><td></td></tr><tr><td></td><td></td><td></td></tr></table>	1		1							<table border="1"><tr><td></td><td></td><td></td></tr><tr><td>1</td><td></td><td></td></tr><tr><td></td><td></td><td>1</td></tr></table>				1					1	<table border="1"><tr><td></td><td></td><td></td></tr><tr><td></td><td></td><td></td></tr><tr><td></td><td></td><td>1</td></tr></table>									1	<table border="1"><tr><td></td><td></td><td></td></tr><tr><td></td><td></td><td></td></tr><tr><td></td><td></td><td></td></tr></table>										<table border="1"><tr><td></td><td></td><td></td></tr><tr><td></td><td></td><td></td></tr><tr><td></td><td></td><td></td></tr></table>									
1																																																																															
2																																																																															
		1																																																																													
1		1																																																																													
1																																																																															
		1																																																																													
		1																																																																													
Post - 0 Miss - 0 Block - 0	Post - 0 Miss - 0 Block - 0	Post - 0 Miss - 0 Block - 0	Post - 0 Miss - 1 Block - 0	Post - 0 Miss - 0 Block - 1	Post - 0 Miss - 0 Block - 0	Post - 0 Miss - 0 Block - 1																																																																									

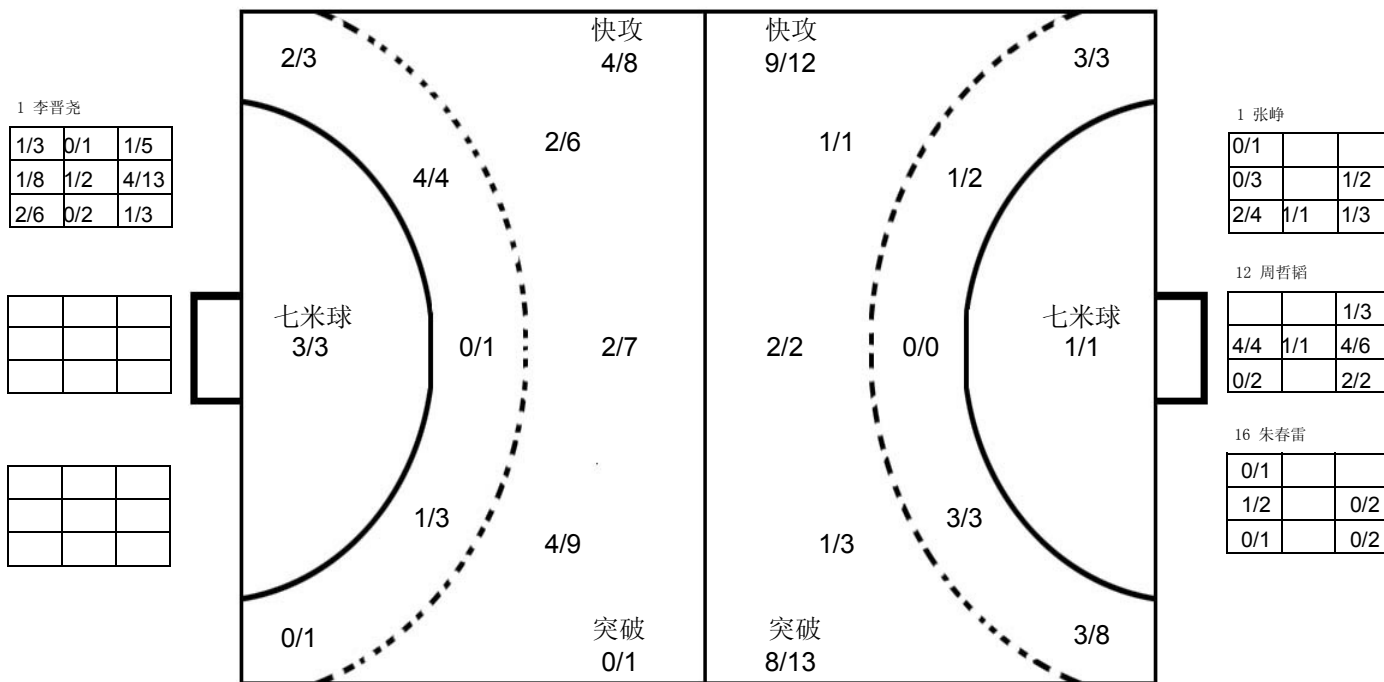

上海

1 张崢	2 胡辰	3 赵时俊	5 朱世杰	6 李和鑫	8 钱为玮	9 朱礼彬	10 吴璟																																																																								
<table border="1"><tr><td></td><td></td><td></td></tr><tr><td></td><td></td><td></td></tr><tr><td></td><td></td><td></td></tr></table>										<table border="1"><tr><td></td><td></td><td></td></tr><tr><td></td><td></td><td></td></tr><tr><td></td><td></td><td></td></tr></table>										<table border="1"><tr><td></td><td></td><td></td></tr><tr><td></td><td></td><td></td></tr><tr><td></td><td></td><td></td></tr></table>										<table border="1"><tr><td></td><td></td><td></td></tr><tr><td></td><td></td><td></td></tr><tr><td></td><td></td><td></td></tr></table>										<table border="1"><tr><td></td><td></td><td></td></tr><tr><td>3</td><td></td><td>1</td></tr><tr><td>1</td><td></td><td></td></tr></table>				3		1	1			<table border="1"><tr><td></td><td></td><td>2</td></tr><tr><td></td><td></td><td>3</td></tr><tr><td>1</td><td>1</td><td></td></tr></table>			2			3	1	1		<table border="1"><tr><td></td><td></td><td></td></tr><tr><td></td><td></td><td>2</td></tr><tr><td></td><td></td><td></td></tr></table>						2				<table border="1"><tr><td></td><td></td><td>1</td></tr><tr><td></td><td></td><td>1</td></tr><tr><td></td><td></td><td>1</td></tr></table>			1			1			1
3		1																																																																													
1																																																																															
		2																																																																													
		3																																																																													
1	1																																																																														
		2																																																																													
		1																																																																													
		1																																																																													
		1																																																																													
Post - 0 Miss - 0 Block - 0	Post - 0 Miss - 0 Block - 0	Post - 0 Miss - 0 Block - 0	Post - 0 Miss - 0 Block - 0	Post - 0 Miss - 0 Block - 0	Post - 0 Miss - 0 Block - 0	Post - 0 Miss - 1 Block - 0	Post - 1 Miss - 0 Block - 0																																																																								
12 周哲韬	13 孟宇超	14 王子阳	15 徐俊吉	16 朱春雷	18 马麟晓	19 蒋承骅	20 程云飞																																																																								
<table border="1"><tr><td></td><td></td><td></td></tr><tr><td></td><td></td><td></td></tr><tr><td></td><td></td><td></td></tr></table>										<table border="1"><tr><td></td><td></td><td></td></tr><tr><td>1</td><td></td><td></td></tr><tr><td></td><td></td><td></td></tr></table>				1						<table border="1"><tr><td></td><td></td><td>1</td></tr><tr><td></td><td>1</td><td>1</td></tr><tr><td></td><td></td><td></td></tr></table>			1		1	1				<table border="1"><tr><td></td><td></td><td>1</td></tr><tr><td></td><td></td><td></td></tr><tr><td></td><td></td><td></td></tr></table>			1							<table border="1"><tr><td></td><td></td><td></td></tr><tr><td></td><td></td><td></td></tr><tr><td></td><td></td><td></td></tr></table>										<table border="1"><tr><td></td><td></td><td></td></tr><tr><td></td><td></td><td>1</td></tr><tr><td>1</td><td></td><td>2</td></tr></table>						1	1		2	<table border="1"><tr><td></td><td></td><td></td></tr><tr><td></td><td></td><td>1</td></tr><tr><td></td><td></td><td></td></tr></table>						1				<table border="1"><tr><td></td><td></td><td></td></tr><tr><td></td><td></td><td></td></tr><tr><td></td><td></td><td></td></tr></table>									
1																																																																															
		1																																																																													
	1	1																																																																													
		1																																																																													
		1																																																																													
1		2																																																																													
		1																																																																													
Post - 0 Miss - 0 Block - 0	Post - 0 Miss - 1 Block - 0	Post - 1 Miss - 1 Block - 0	Post - 0 Miss - 0 Block - 0	Post - 0 Miss - 0 Block - 0	Post - 0 Miss - 0 Block - 0	Post - 0 Miss - 0 Block - 0	Post - 0 Miss - 0 Block - 0																																																																								

注释: Post=击柱 Miss=射失 Block=被封





男子 国内比赛



第十二届全国运动会男子手球预赛

Team A				Team B				Match Number													
A 山东				B 香港				16													
played in		in the hall		on		at		Spectators													
China		柳州市李宁体育馆		21/04/2013		14:40 hours															
Half-time (30')	A	B	End of playing time	A	B	1st extra time	A	B	2nd extra time	A	B	After penalty throws	A	B							
	19	13		36	26																
Number of 7 m	A	Team time-out			Full name of players and officials				Team time-out			B	Number of 7 m								
	0 / 0	1	2	3					1	2	3	2 / 2									
	16:53								51:53												
No.	Team A					G	W	2'	D	DR	No.	Team B					G	W	2'	D	DR
1	于性哲										1	萧智庭									
4	田瑞										2	叶冠英									
5	潘翔					2	1				5	黄胜业					6				
6	李朝鹏					2					6	谢伟希									
8	王炳华										7	许文邦					7	1			
9	赵鑫					5	1				9	张建国									
11	宋朋强					1		2			11	陈允文						1			
13	刘晓					3					12	叶冠雄					1				
15	陈鹏波					2					13	叶仕仁					5				
16	王帅										14	李鑫豪					1				
17	王旭东					3					15	黄嘉愉					1				
18	于亚男					4					25	曾铭谦					2				
19	李语庆					5		1			29	练明辉					3				
20	杜在超					2	1														
21	翟乾坤					7															
22	刘正松																				
A	王鸿斌										A	陈广裕									
B	王志峰										B	杨开捋									
C	邢建刚										D	张军									
D	徐强																				
A	Signature of Responsible Official of the Teams (Off. A)																			B	
TP	Remarks of Referee / IHFOfficial																			TP	

Signatures

Referees	Jan Eric Klaus	Mikael Engelbert		
Techn. Delegates	李之文 (CHN)	许宜扬 (CHN)		
IHF Official				

Note: Number of 7m Throws Awarded to Team A and B, Goals (G), Warnings (W), Suspensions (2'), Direct Disqualification (D), Disqualification with Report (DR) and Team Penalty (TP).

Table Officials: 黄思华 谭云东 Statisticians: 黄莉 朱伟平





第十二届全国运动会男子手球预赛
竞赛技术统计(媒体表)

预赛 组别 A 轮次 4 场次 16

柳州市李宁体育馆 21/04/2013 201301016-51-1/1
山东 36 vs 26 香港 香港
19 : 13

裁判员 Jan Eric Klaus Leandersson (FIN) / Mikael Engelbert Lindroos (FIN)

Main statistics table with columns for Player, Position, Shooting (远, 近, 边), Attacks (快, 突), Free Throws (任意), 7m, Total (合计), % Accuracy, Assists (助攻), Errors (失误), Warnings (警告), 2' suspensions, and D & DR. Includes sub-tables for 1st Half and 2nd Half.

场上队员： 得分 / 射门 守门员： 救球 / 射门

Legend table for abbreviations: 快攻 (Fast Break), 突破 (Breakthrough), 任意球 (Free Throw), 7M球 (7M Throw), 助攻 (Assist), 警告 (Warning), 失误 (Error), 2' (2' suspension), D (取消资格), DR (取消资格+报告).



第十二届全国运动会男子手球预赛 图式比赛技术统计表

轮次 4

场次 16

201301016-21-1/1

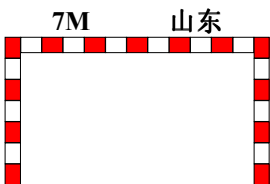
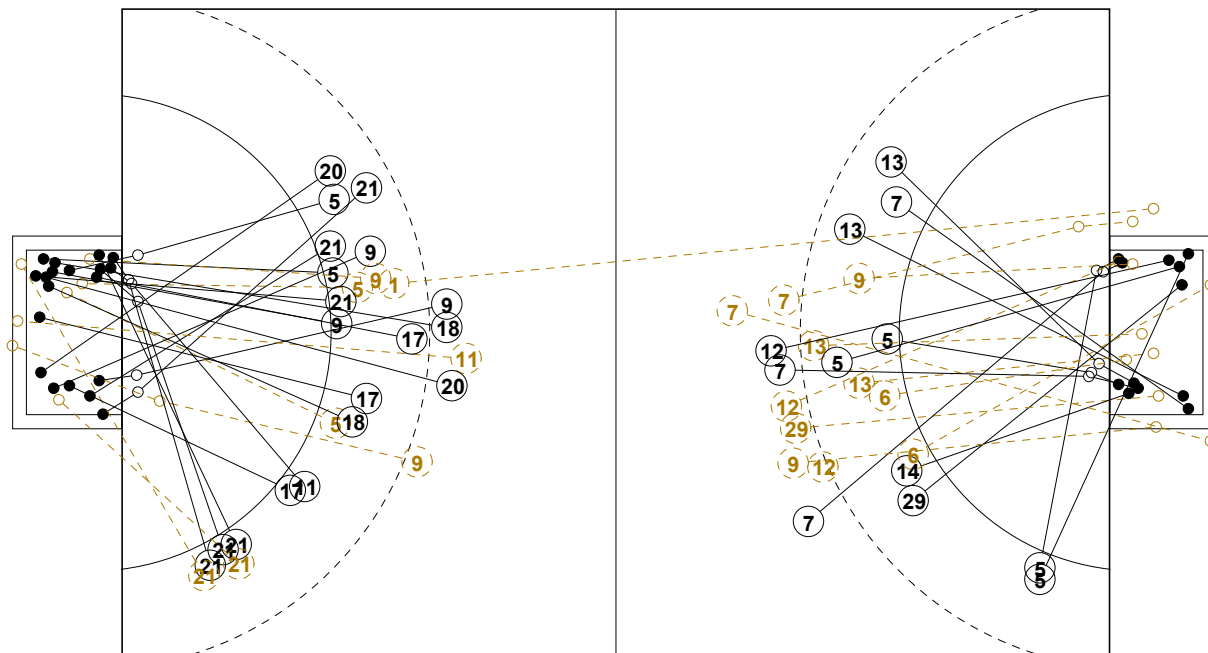

1st Half
19 : 13

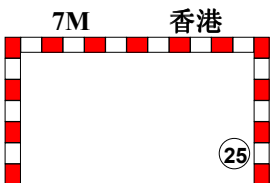
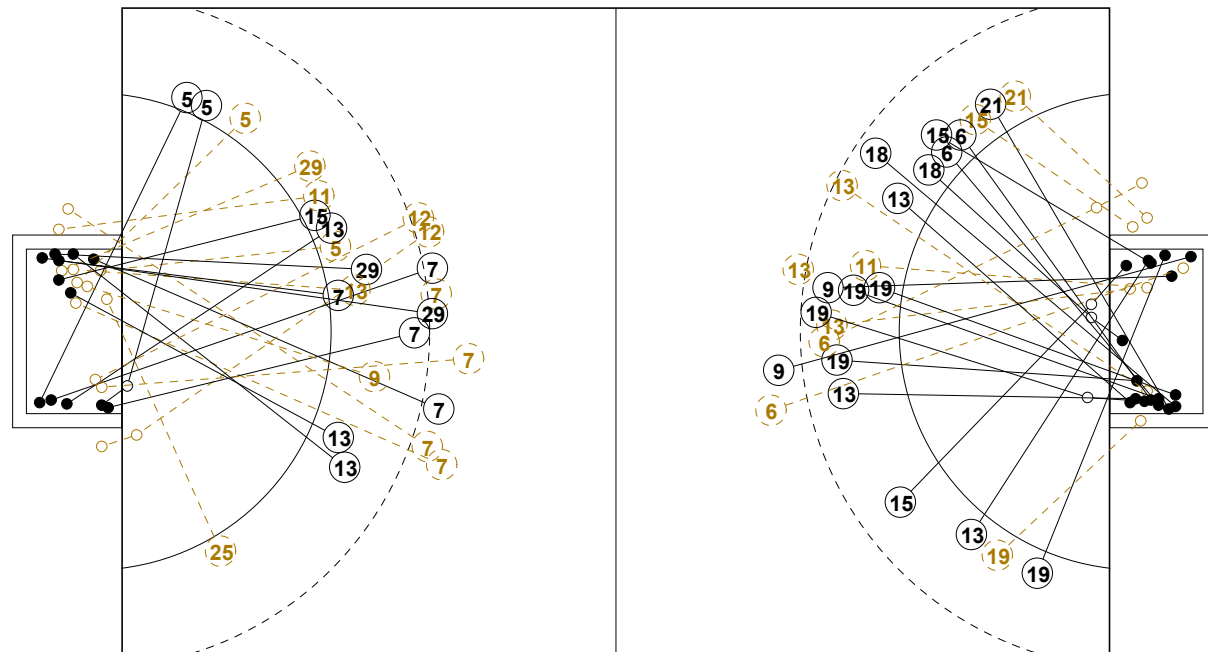
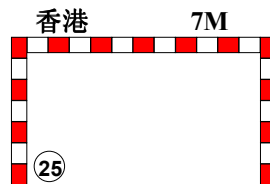

2nd Half
26 : 36

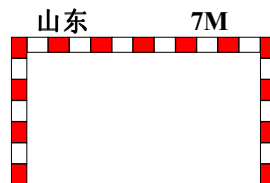



第十二届全国运动会男子手球预赛

个人/全队技术统计表

正式表
手球
男子

预赛
轮次 4

组别 A
场次 16

201301016-14-1/2
柳州市李宁体育馆
21/04/2013 14:40

号码	姓名	远射	近射	边射	快攻	突破	任意	7M	合计	%	助攻	失误	警告	2'	取消	时间
山东(山东)																
<i>(场上队员)</i>																
1	于性哲									0.0%						00:20:33
4	田瑞									0.0%						00:00:00
5	潘翔		1/2		1/1	0/1			2/4	50.0%		2	1			00:29:55
6	李朝鹏	0/1	1/1	1/1	0/1				2/4	50.0%		1				00:21:36
8	王炳华									0.0%						00:00:00
9	赵鑫	3/4			2/3				5/7	71.4%	1	3	1			00:31:43
11	宋朋强		1/1		0/2				1/3	33.3%	1			2		00:41:08
13	刘晓	0/2	1/1	1/1	0/1	1/1			3/6	50.0%						00:29:12
15	陈鹏波		2/2	0/1					2/3	66.7%		1				00:29:49
16	王帅									0.0%	1					00:19:40
17	王旭东	1/1	1/1		1/1				3/3	100%						00:29:53
18	于亚男	2/2				2/2			4/4	100%	2	2				00:28:12
19	李语庆			1/2	3/3	1/1			5/6	83.3%				1		00:30:00
20	杜在超	1/1				1/1			2/2	100%	3	2	1			00:30:00
21	翟乾坤		2/2	4/7		1/1			7/10	70.0%	2	1				00:54:49
22	刘正松									0.0%		1				00:19:47
合计		7/11	9/10	7/12	7/12	6/7			36/52	69.2%	10	13	3	3		
<i>(守门员)</i>																
1	于性哲	1/3	0/2	1/2	1/3	2/4		0/2	5/16	31.3%						00:20:33
16	王帅	1/4	1/3	1/2	1/1	1/2	1/1		6/13	46.2%	1					00:19:40
22	刘正松	3/4	0/1	0/2	1/2	0/3			4/12	33.3%		1				00:19:47
合计		5/11	1/6	2/6	3/6	3/9	1/1	0/2	15/41	36.6%	1	1				

场上队员：得分/射门

守门员：救球/射门

全队合计	得分	被救	射失	击柱	封球	合计	%
远射	7	2		1	1	11	63.6%
近射	9	1				10	90.0%
边射	7	1	2	2		12	58.3%
快攻	7	3	1	1		12	58.3%
突破	6	1				7	85.7%
任意							0.0%
7M							0.0%





第十二届全国运动会男子手球预赛

个人/全队技术统计表

正式表
手球
男子预赛
轮次 4组别 A
场次 16201301016-14-2/2
柳州市李宁体育馆
21/04/2013 14:40

号码	姓名	远射	近射	边射	快攻	突破	任意	7M	合计	%	助攻	失误	警告	2'	取消	时间
香港(香港)																
<i>(上场队员)</i>																
1	萧智庭	0/1							0/1	0.0%						00:26:23
2	叶冠英									0.0%						00:33:37
5	黄胜业		0/1	4/5	1/1	1/1			6/8	75.0%		1				00:48:03
6	谢伟希		0/1			0/1			0/2	0.0%						00:23:11
7	许文邦	4/8	1/1		1/2	1/1	0/1		7/13	53.8%		3	1			00:38:43
9	张建国	0/1			0/1	0/1			0/3	0.0%	3	2				00:24:23
11	陈允文		0/1						0/1	0.0%		2	1			00:33:38
12	叶冠雄	1/5							1/5	20.0%		3				00:34:31
13	叶仕仁	0/1	2/2		1/3	2/2			5/8	62.5%		5				00:31:40
14	李鑫豪		1/1						1/1	100%						00:19:43
15	黄嘉愉		1/1						1/1	100%		1				00:41:16
25	曾铭谦			0/1				2/2	2/3	66.7%						00:22:10
29	练明辉	1/2				2/3			3/5	60.0%		1				00:39:19
合计																
<i>(守门员)</i>																
1	萧智庭	0/4	0/5	1/4	1/4	0/3			2/20	10.0%						00:26:23
2	叶冠英	2/5	1/5	0/4	2/6	1/4			6/24	25.0%						00:33:37
合计																
2/9 1/10 1/8 3/10 1/7 8/44 18.2%																

场上队员：得分/射门

守门员：救球/射门

全队合计	得分	被救	射失	击柱	封球	合计	%
远射	6	5	5	1	1	18	33.3%
近射	5	1	1	1		8	62.5%
边射	4	2				6	66.7%
快攻	3	3			1	7	42.9%
突破	6	3				9	66.7%
任意		1				1	0.0%
7M	2					2	100.0%





第十二届全国运动会男子手球预赛

图式射门区域统计

轮次 4 场次 16

201301016-41-1/1

山东

1 于性哲	4 田瑞	5 潘翔	6 李朝鹏	8 王炳华	9 赵鑫	11 宋朋强	13 刘晓																																																																								
<table border="1"><tr><td></td><td></td><td></td></tr><tr><td></td><td></td><td></td></tr><tr><td></td><td></td><td></td></tr></table>										<table border="1"><tr><td></td><td></td><td></td></tr><tr><td></td><td></td><td></td></tr><tr><td></td><td></td><td></td></tr></table>										<table border="1"><tr><td></td><td></td><td>1</td></tr><tr><td></td><td></td><td>1</td></tr><tr><td></td><td></td><td></td></tr></table>			1			1				<table border="1"><tr><td></td><td></td><td></td></tr><tr><td></td><td></td><td>2</td></tr><tr><td></td><td></td><td></td></tr></table>						2				<table border="1"><tr><td></td><td></td><td></td></tr><tr><td></td><td></td><td></td></tr><tr><td></td><td></td><td></td></tr></table>										<table border="1"><tr><td>3</td><td></td><td>1</td></tr><tr><td></td><td></td><td></td></tr><tr><td>1</td><td></td><td></td></tr></table>	3		1				1			<table border="1"><tr><td></td><td></td><td></td></tr><tr><td></td><td></td><td></td></tr><tr><td></td><td></td><td>1</td></tr></table>									1	<table border="1"><tr><td></td><td></td><td></td></tr><tr><td>1</td><td></td><td></td></tr><tr><td></td><td></td><td>2</td></tr></table>				1					2
		1																																																																													
		1																																																																													
		2																																																																													
3		1																																																																													
1																																																																															
		1																																																																													
1																																																																															
		2																																																																													
Post - 0 Miss - 0 Block - 0	Post - 0 Miss - 0 Block - 0	Post - 0 Miss - 0 Block - 0	Post - 0 Miss - 1 Block - 0	Post - 0 Miss - 0 Block - 0	Post - 1 Miss - 0 Block - 0	Post - 1 Miss - 0 Block - 0	Post - 0 Miss - 0 Block - 1																																																																								
15 陈鹏波	16 王帅	17 王旭东	18 于亚男	19 李语庆	20 杜在超	21 翟乾坤	22 刘正松																																																																								
<table border="1"><tr><td></td><td></td><td></td></tr><tr><td>1</td><td></td><td></td></tr><tr><td>1</td><td></td><td></td></tr></table>				1			1			<table border="1"><tr><td></td><td></td><td></td></tr><tr><td></td><td></td><td></td></tr><tr><td></td><td></td><td></td></tr></table>										<table border="1"><tr><td></td><td>1</td><td></td></tr><tr><td>1</td><td></td><td></td></tr><tr><td></td><td></td><td>1</td></tr></table>		1		1					1	<table border="1"><tr><td></td><td></td><td>3</td></tr><tr><td></td><td></td><td></td></tr><tr><td></td><td>1</td><td></td></tr></table>			3					1		<table border="1"><tr><td></td><td></td><td>1</td></tr><tr><td>1</td><td></td><td>2</td></tr><tr><td></td><td></td><td>1</td></tr></table>			1	1		2			1	<table border="1"><tr><td>1</td><td></td><td>1</td></tr><tr><td></td><td></td><td></td></tr><tr><td></td><td></td><td></td></tr></table>	1		1							<table border="1"><tr><td></td><td></td><td>1</td></tr><tr><td>1</td><td></td><td>1</td></tr><tr><td>1</td><td></td><td>3</td></tr></table>			1	1		1	1		3	<table border="1"><tr><td></td><td></td><td></td></tr><tr><td></td><td></td><td></td></tr><tr><td></td><td></td><td></td></tr></table>									
1																																																																															
1																																																																															
	1																																																																														
1																																																																															
		1																																																																													
		3																																																																													
	1																																																																														
		1																																																																													
1		2																																																																													
		1																																																																													
1		1																																																																													
		1																																																																													
1		1																																																																													
1		3																																																																													
Post - 0 Miss - 1 Block - 0	Post - 0 Miss - 0 Block - 0	Post - 0 Miss - 0 Block - 0	Post - 0 Miss - 0 Block - 0	Post - 1 Miss - 0 Block - 0	Post - 0 Miss - 0 Block - 0	Post - 1 Miss - 1 Block - 0	Post - 0 Miss - 0 Block - 0																																																																								

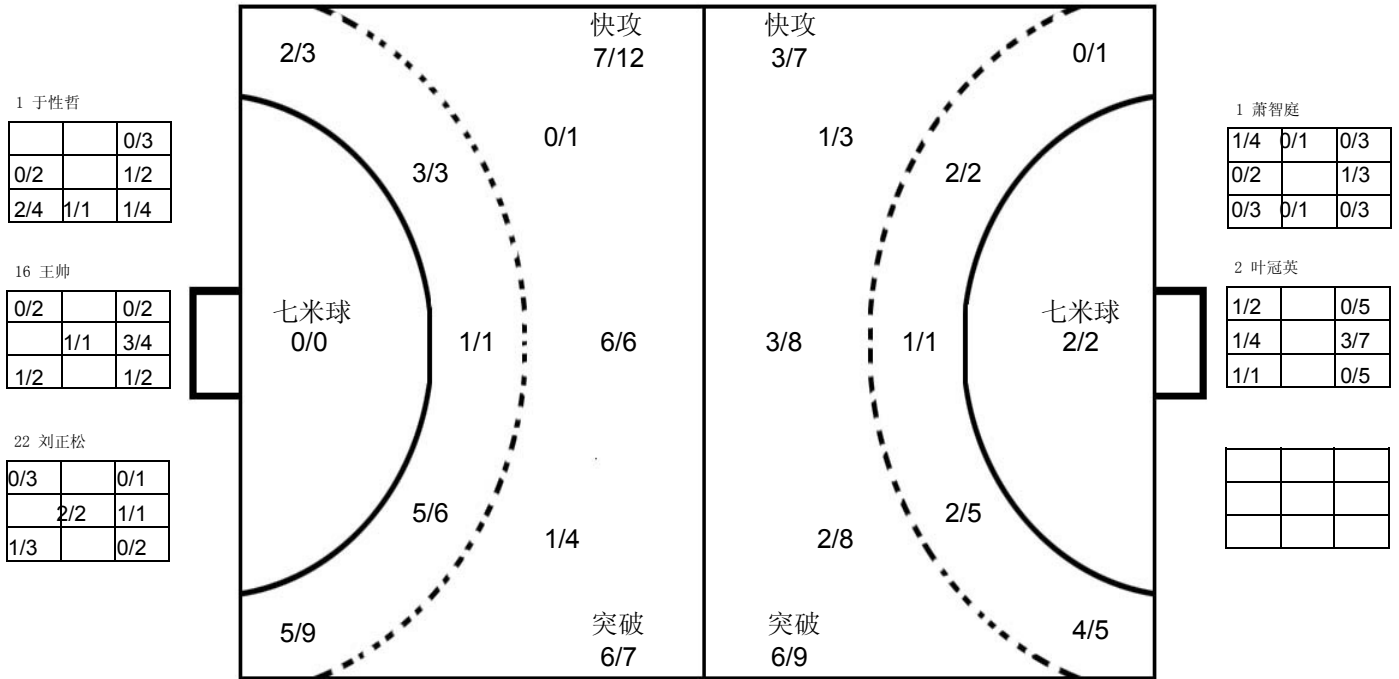

香港

1 萧智庭	2 叶冠英	5 黄胜业	6 谢伟希	7 许文邦	9 张建国	11 陈允文	12 叶冠雄																																																																								
<table border="1"><tr><td></td><td></td><td></td></tr><tr><td></td><td></td><td></td></tr><tr><td></td><td></td><td></td></tr></table>										<table border="1"><tr><td></td><td></td><td></td></tr><tr><td></td><td></td><td></td></tr><tr><td></td><td></td><td></td></tr></table>										<table border="1"><tr><td>3</td><td></td><td></td></tr><tr><td></td><td></td><td></td></tr><tr><td>2</td><td></td><td>1</td></tr></table>	3						2		1	<table border="1"><tr><td></td><td></td><td></td></tr><tr><td></td><td></td><td></td></tr><tr><td></td><td></td><td></td></tr></table>										<table border="1"><tr><td>1</td><td></td><td>2</td></tr><tr><td></td><td></td><td></td></tr><tr><td>2</td><td></td><td>2</td></tr></table>	1		2				2		2	<table border="1"><tr><td></td><td></td><td></td></tr><tr><td></td><td></td><td></td></tr><tr><td></td><td></td><td></td></tr></table>										<table border="1"><tr><td></td><td></td><td></td></tr><tr><td></td><td></td><td></td></tr><tr><td></td><td></td><td></td></tr></table>										<table border="1"><tr><td></td><td></td><td></td></tr><tr><td>1</td><td></td><td></td></tr><tr><td></td><td></td><td></td></tr></table>				1					
3																																																																															
2		1																																																																													
1		2																																																																													
2		2																																																																													
1																																																																															
Post - 0 Miss - 1 Block - 0	Post - 0 Miss - 0 Block - 0	Post - 0 Miss - 0 Block - 0	Post - 1 Miss - 0 Block - 0	Post - 0 Miss - 3 Block - 1	Post - 1 Miss - 0 Block - 0	Post - 0 Miss - 1 Block - 0	Post - 0 Miss - 1 Block - 1																																																																								
13 叶仕仁	14 李鑫豪	15 黄嘉愉	25 曾铭谦	29 练明辉																																																																											
<table border="1"><tr><td></td><td></td><td>1</td></tr><tr><td>1</td><td></td><td>2</td></tr><tr><td></td><td></td><td>1</td></tr></table>			1	1		2			1	<table border="1"><tr><td></td><td></td><td></td></tr><tr><td></td><td></td><td></td></tr><tr><td></td><td></td><td></td></tr></table>										<table border="1"><tr><td></td><td></td><td>1</td></tr><tr><td></td><td></td><td></td></tr><tr><td></td><td></td><td></td></tr></table>			1							<table border="1"><tr><td></td><td></td><td></td></tr><tr><td>1</td><td></td><td>1</td></tr><tr><td></td><td></td><td></td></tr></table>				1		1				<table border="1"><tr><td>1</td><td></td><td>2</td></tr><tr><td></td><td></td><td></td></tr><tr><td></td><td></td><td></td></tr></table>	1		2							<table border="1"><tr><td></td><td></td><td></td></tr><tr><td></td><td></td><td></td></tr><tr><td></td><td></td><td></td></tr></table>										<table border="1"><tr><td></td><td></td><td></td></tr><tr><td></td><td></td><td></td></tr><tr><td></td><td></td><td></td></tr></table>										<table border="1"><tr><td></td><td></td><td></td></tr><tr><td></td><td></td><td></td></tr><tr><td></td><td></td><td></td></tr></table>									
		1																																																																													
1		2																																																																													
		1																																																																													
		1																																																																													
1		1																																																																													
1		2																																																																													
Post - 0 Miss - 0 Block - 0	Post - 0 Miss - 0 Block - 0	Post - 0 Miss - 0 Block - 0	Post - 0 Miss - 0 Block - 0	Post - 0 Miss - 0 Block - 0																																																																											

注释: Post=击柱 Miss=射失 Block=被封





男子 国内比赛



第十二届全国运动会男子手球预赛

Team A A 安徽				Team B B 江苏				Match Number 17							
played in China		in the hall 柳州市李宁体育馆		on 21/04/2013		at 16:20 hours		Spectators							
Half-time (30')	A 7	B 16	End of playing time	A 27	B 31	1st extra time	A	B	2nd extra time	A	B	After penalty throws	A	B	
Number of 7 m	A 0 / 1	Team time-out			Full name of players and officials				Team time-out			B 2 / 3	Number of 7 m		
	10:45	2	3	1					2	3					
No.	Team A					Team B					G	W	2'	D	DR
1	高逸凡					1 丁大伟									
2	周兰骏					2 杨彦威					5				
5	马鹏					3 李旭东					1				
6	田耕					4 沈庆					2				
7	姚雄敏					5 闫亮					4				
8	董智景					6 赵晨					1				
10	陈强龙					8 周小坚					3				
11	黎涛					9 叶强					4	1			
12	曾献辰					10 郝可鑫					5				
15	邵青					11 姚仁剑					2	1			
17	解维维					12 王权					4	1	1		
18	郭赛					14 丛海航					1	1			
28	袁龙					15 李安					3				
29	顾先亮					17 陈灵峰					3				
32	王超					19 张志宇					8	1	1		
33	曹振吉					20 张星					1				
A	王来黔					A 闫威名									
B	刘晓蓓					C NENADz vonarek									
C	高恒勤					D 王建国									
						E 贾淑君									
A	Signature of Responsible Official of the Teams (Off. A)														B
TP	Remarks of Referee / IHFOfficial														TP

Signatures

Referees: 李典 (CHN) 倪震 (CHN)

Techn. Delegates: 王锡祯 (CHN) 刘书勇 (CHN)

IHF Official: _____

Note: Number of 7m Throws Awarded to Team A and B, Goals (G), Warnings (W), Suspensions (2'), Direct Disqualification (D), Disqualification with Report (DR) and Team Penalty (TP).

Table Officials: 黄思华 谭云东 Statisticians: 黄莉 朱伟平



第十二届全国运动会男子手球预赛
竞赛技术统计(媒体表)

预赛	组别	A	轮次	4	场次	17
柳州市李宁体育馆		21/04/2013			201301017-51-1/1	
安徽	安徽	27	vs	31	江苏	江苏
		7:16				

裁判员	李典 (CHN)	/	倪震 (CHN)
-----	----------	---	----------

安徽		远射	近射	边射	快攻	突破	任意球	7m球	合计	%	助攻	失误	警告	2'	D & DR	比赛进程	
主教练: 王来黔																安徽	江苏
1	高逸凡															32	王超
2	周兰骏	3/14			0/1	2/2			5/17	29.4		3				1	03:36
5	马鹏	0/4			1/2				1/6	16.7		3				1	04:57
6	田耕			1/1	1/1	0/1			2/3	66.7		1				1	06:52
7	姚雄敏															1	07:28
8	董智景	0/1		3/3	1/2				4/6	66.7		1				1	08:03
10	陈强龙															1	09:40
11	黎涛															2	09:52
12	曾献辰															2	10:26
15	邵青		0/1						0/1	0.0						2	11:14
17	解维维			0/1	0/1				0/2	0.0						2	13:19
18	郭赛		1/1						1/1	100						2	14:09
28	袁龙	1/7	1/1		1/2				3/10	30.0	1	2				3	15:19
29	顾先亮	3/3		0/1	0/2				3/6	50.0		2				4	18:58
32	王超	4/12	1/2		2/2	1/1		0/1	8/18	44.4		4		1		5	20:28
33	曹振吉											2				6	21:43
运动员 合计		11/41	3/5	4/6	6/13	3/4		0/1	27/70	38.6	2	22	3	1		6	22:50
1	高逸凡	2/6	3/9	1/1	4/11	0/3		1/3	11/33	33.3						6	23:27
12	曾献辰	3/7	1/3	2/3	0/1		0/1		6/15	40.0	1					6	24:26
守门员 合计		5/13	4/12	3/4	4/12	0/3	0/1	1/3	17/48	35.4	1					6	25:50
江苏		远射	近射	边射	快攻	突破	任意球	7m球	合计	%	助攻	失误	警告	2'	D & DR	7	29:58
教练: 闫威名																8	00:30
1	丁大伟															8	01:10
2	杨彦威		2/2	0/1	1/4	1/1			4/8	50.0		2				9	02:06
3	李旭东															9	02:30
4	沈庆		1/3		0/1				1/4	25.0		2				9	02:58
5	闫亮	1/1	0/1		1/1	1/1			3/4	75.0	2					9	03:18
6	赵晨	0/1							0/1	0.0	2	1				10	03:26
8	周小坚		3/4	0/1	2/2				5/7	71.4						10	04:26
9	叶强	0/2	0/1	1/3	1/1				2/7	28.6	2	3		1		10	05:26
10	郝可鑫	1/3	1/1		1/1		1/1		4/6	66.7		1	1	1		11	07:51
11	姚仁剑															11	08:30
12	王权															14	08:54
14	丛海航		0/1		1/1				1/2	50.0		2	1			14	09:58
15	李安				1/1	1/1		0/1	2/3	66.7	1	1				15	11:39
17	陈灵峰	5/7	1/2					2/2	8/11	72.7	1	6	1	1		15	12:13
19	张志宇	1/1	0/1		0/1		0/1		1/4	25.0	3	2				15	13:07
20	张星															15	14:08
运动员 合计		8/15	8/16	1/5	8/13	3/3	1/2	2/3	31/57	54.4	11	20	3	3		15	14:51
1	丁大伟	11/20	2/5	2/6	4/9	1/4		1/1	21/45	46.7						16	14:51
12	王权	6/8			1/2				7/10	70.0						16	14:51
守门员 合计		17/28	2/5	2/6	5/11	1/4		1/1	28/55	50.9						16	14:51

场上队员: 得分 / 射门

守门员: 救球 / 射门

快攻	Fast Break	突破	Breakthrough	任意球	Free Throw	7M球	7M Throw	助攻	Assist
警告	Warning	失误	Error	2'	Suspension	D	取消资格	DR	取消资格+报告



第十二届全国运动会男子手球预赛 图式比赛技术统计表

轮次 4

场次 17

201301017-21-1/1

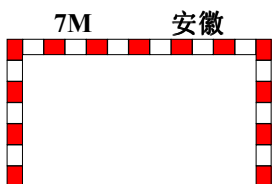
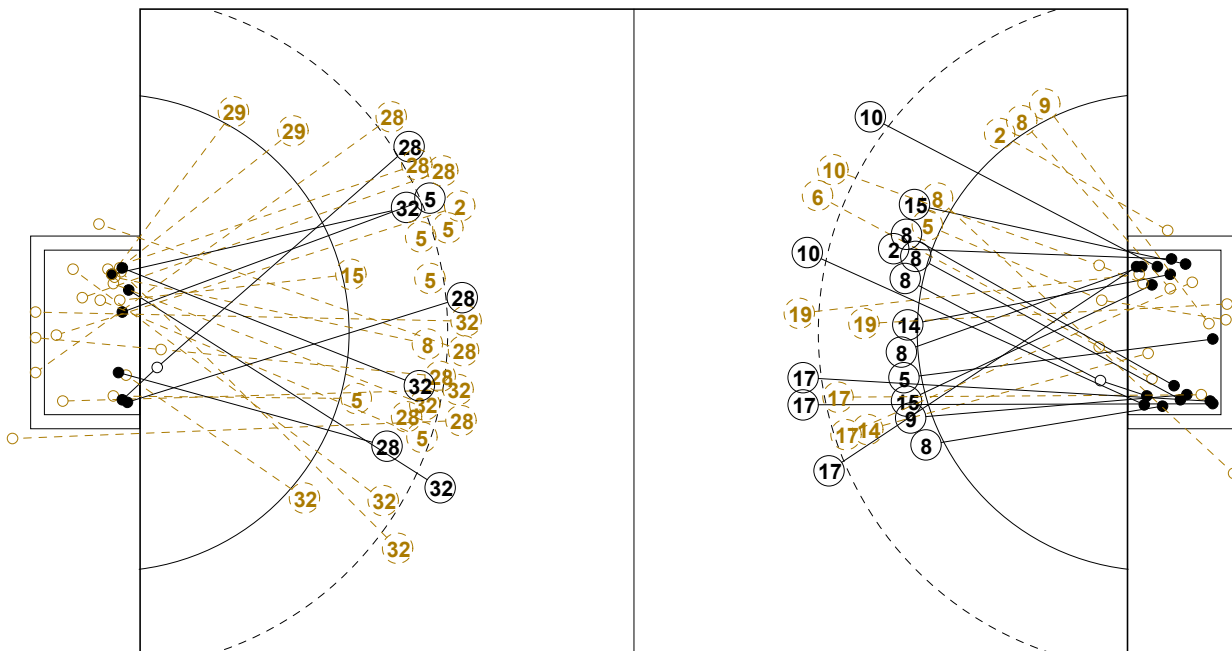

1st Half
7 : 16

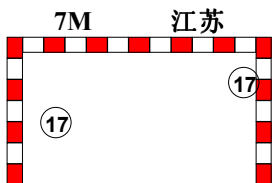
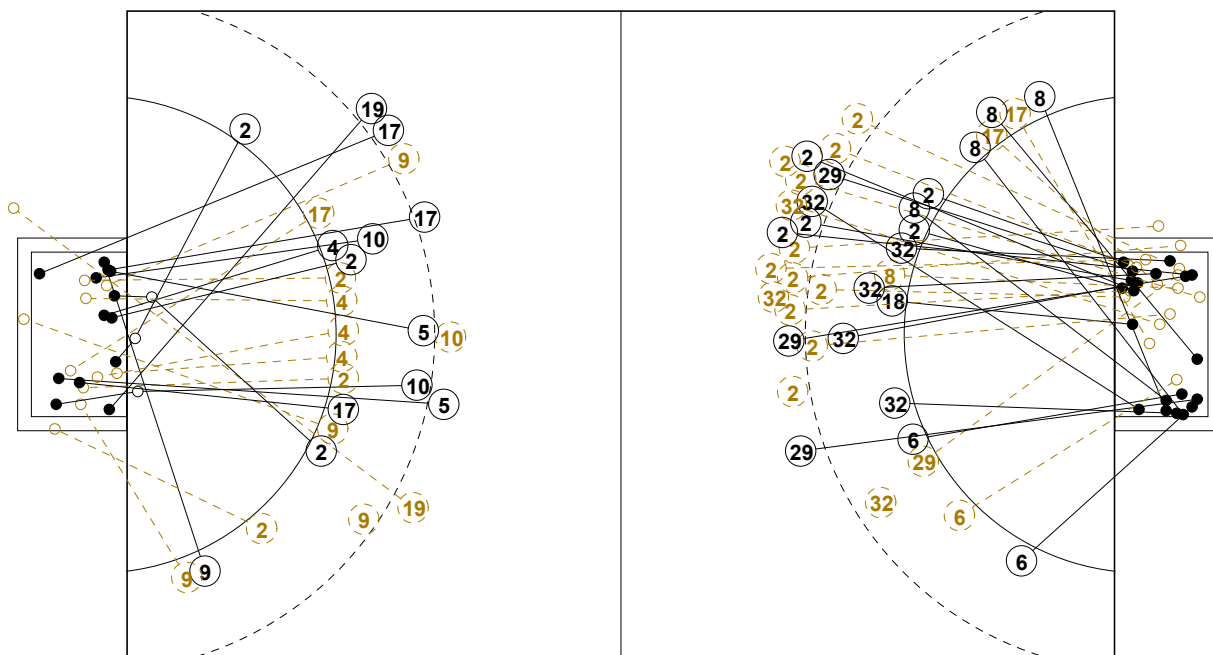
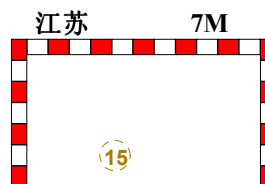

2nd Half
31 : 27

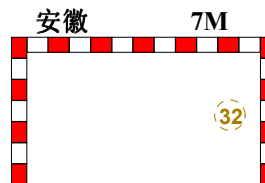



第十二届全国运动会男子手球预赛

个人/全队技术统计表

正式表
手球
男子

预赛
轮次 4

组别 A
场次 17

201301017-14-1/2
柳州市李宁体育馆
21/04/2013 16:20

号码	姓名	远射	近射	边射	快攻	突破	任意	7M	合计	%	助攻	失误	警告	2'	取消	时间
安徽(安徽)																
<i>(场上队员)</i>																
1	高逸凡									0.0%						00:40:37
2	周兰骏	3/14			0/1	2/2			5/17	29.4%		3				00:31:21
5	马鹏	0/4			1/2				1/6	16.7%		3				00:15:43
6	田耕			1/1	1/1	0/1			2/3	66.7%		1				00:17:08
7	姚雄敏									0.0%						00:00:00
8	董智景	0/1		3/3	1/2				4/6	66.7%		1				00:36:18
10	陈强龙									0.0%		2	1			00:30:00
11	黎涛									0.0%		2				00:05:14
12	曾献辰									0.0%	1					00:19:23
15	邵青		0/1						0/1	0.0%			1			00:30:00
17	解维维			0/1	0/1				0/2	0.0%						00:11:48
18	郭赛		1/1						1/1	100%						00:30:00
28	袁龙	1/7	1/1		1/2				3/10	30.0%	1	2				00:24:45
29	顾先亮	3/3		0/1	0/2				3/6	50.0%		2				00:45:44
32	王超	4/12	1/2		2/2	1/1		0/1	8/18	44.4%		4		1		00:40:05
33	曹振吉									0.0%		2	1			00:41:23
合计		11/41	3/5	4/6	6/13	3/4		0/1	27/70	38.6%	2	22	3	1		
<i>(守门员)</i>																
1	高逸凡	2/6	3/9	1/1	4/11	0/3		1/3	11/33	33.3%						00:40:37
12	曾献辰	3/7	1/3	2/3	0/1		0/1		6/15	40.0%	1					00:19:23
合计		5/13	4/12	3/4	4/12	0/3	0/1	1/3	17/48	35.4%	1					

场上队员：得分/射门

守门员：救球/射门

全队合计	得分	被救	射失	击柱	封球	合计	%
远射	11	17	1	4	8	41	26.8%
近射	3	2				5	60.0%
边射	4	2				6	66.7%
快攻	6	5	2			13	46.2%
突破	3	1				4	75.0%
任意							0.0%
7M		1				1	0.0%



第十二届全国运动会男子手球预赛

个人/全队技术统计表

正式表
手球
男子预赛
轮次 4组别 A
场次 17201301017-14-2/2
柳州市李宁体育馆
21/04/2013 16:20

号码	姓名	远射	近射	边射	快攻	突破	任意	7M	合计	%	助攻	失误	警告	2'	取消	时间
江苏(江苏)																
<i>(上场队员)</i>																
1	丁大伟									0.0%						00:44:33
2	杨彦威		2/2	0/1	1/4	1/1			4/8	50.0%		2				00:46:34
3	李旭东									0.0%						00:00:00
4	沈庆		1/3		0/1				1/4	25.0%		2				00:44:01
5	闫亮	1/1	0/1		1/1	1/1			3/4	75.0%	2					00:23:48
6	赵晨	0/1							0/1	0.0%	2	1				00:13:26
8	周小坚		3/4	0/1	2/2				5/7	71.4%						00:15:58
9	叶强	0/2	0/1	1/3	1/1				2/7	28.6%	2	3		1		00:42:32
10	郝可鑫	1/3	1/1		1/1		1/1		4/6	66.7%		1	1	1		00:38:32
11	姚仁剑									0.0%						00:00:00
12	王权									0.0%						00:15:27
14	丛海航		0/1		1/1				1/2	50.0%		2	1			00:22:24
15	李安				1/1	1/1		0/1	2/3	66.7%	1	1				00:13:24
17	陈灵峰	5/7	1/2					2/2	8/11	72.7%	1	6	1	1		00:47:19
19	张志宇	1/1	0/1		0/1		0/1		1/4	25.0%	3	2				00:51:49
20	张星									0.0%						00:00:00
合计		8/15	8/16	1/5	8/13	3/3	1/2	2/3	31/57	54.4%	11	20	3	3		
<i>(守门员)</i>																
1	丁大伟	11/20	2/5	2/6	4/9	1/4		1/1	21/45	46.7%						00:44:33
12	王权	6/8			1/2				7/10	70.0%						00:15:27
合计		17/28	2/5	2/6	5/11	1/4		1/1	28/55	50.9%						

场上队员：得分/射门

守门员：救球/射门

全队合计	得分	被救	射失	击柱	封球	合计	%
远射	8	5			2	15	53.3%
近射	8	4	1	3		16	50.0%
边射	1	3		1		5	20.0%
快攻	8	4	1			13	61.5%
突破	3					3	100.0%
任意	1		1			2	50.0%
7M	2	1				3	66.7%





第十二届全国运动会男子手球预赛

图式射门区域统计

轮次 4 场次 17

201301017-41-1/1

安徽

1 高逸凡	2 周兰骏	5 马鹏	6 田耕	7 姚雄敏	8 董智景	10 陈强龙	11 黎涛																																																																								
<table border="1"><tr><td></td><td></td><td></td></tr><tr><td></td><td></td><td></td></tr><tr><td></td><td></td><td></td></tr></table>										<table border="1"><tr><td>1</td><td></td><td></td></tr><tr><td></td><td></td><td></td></tr><tr><td>4</td><td></td><td></td></tr></table>	1						4			<table border="1"><tr><td></td><td></td><td></td></tr><tr><td></td><td></td><td></td></tr><tr><td></td><td>1</td><td></td></tr></table>								1		<table border="1"><tr><td></td><td></td><td>2</td></tr><tr><td></td><td></td><td></td></tr><tr><td></td><td></td><td></td></tr></table>			2							<table border="1"><tr><td></td><td></td><td></td></tr><tr><td></td><td></td><td></td></tr><tr><td></td><td></td><td></td></tr></table>										<table border="1"><tr><td></td><td>1</td><td>1</td></tr><tr><td></td><td></td><td></td></tr><tr><td></td><td></td><td>2</td></tr></table>		1	1						2	<table border="1"><tr><td></td><td></td><td></td></tr><tr><td></td><td></td><td></td></tr><tr><td></td><td></td><td></td></tr></table>										<table border="1"><tr><td></td><td></td><td></td></tr><tr><td></td><td></td><td></td></tr><tr><td></td><td></td><td></td></tr></table>									
1																																																																															
4																																																																															
	1																																																																														
		2																																																																													
	1	1																																																																													
		2																																																																													
Post - 0 Miss - 0 Block - 0	Post - 1 Miss - 1 Block - 2	Post - 0 Miss - 0 Block - 3	Post - 0 Miss - 0 Block - 0	Post - 0 Miss - 0 Block - 0	Post - 0 Miss - 0 Block - 0	Post - 0 Miss - 0 Block - 0	Post - 0 Miss - 0 Block - 0																																																																								
12 曾献辰	15 邵青	17 解维维	18 郭赛	28 袁龙	29 顾先亮	32 王超	33 曹振吉																																																																								
<table border="1"><tr><td></td><td></td><td></td></tr><tr><td></td><td></td><td></td></tr><tr><td></td><td></td><td></td></tr></table>										<table border="1"><tr><td></td><td></td><td></td></tr><tr><td></td><td></td><td></td></tr><tr><td></td><td></td><td></td></tr></table>										<table border="1"><tr><td></td><td></td><td></td></tr><tr><td></td><td></td><td></td></tr><tr><td></td><td></td><td></td></tr></table>										<table border="1"><tr><td></td><td></td><td></td></tr><tr><td></td><td></td><td></td></tr><tr><td></td><td>1</td><td></td></tr></table>								1		<table border="1"><tr><td></td><td></td><td></td></tr><tr><td></td><td></td><td></td></tr><tr><td>3</td><td></td><td></td></tr></table>							3			<table border="1"><tr><td>1</td><td></td><td>1</td></tr><tr><td></td><td></td><td></td></tr><tr><td>1</td><td></td><td></td></tr></table>	1		1				1			<table border="1"><tr><td></td><td></td><td>1</td></tr><tr><td></td><td></td><td></td></tr><tr><td>2</td><td></td><td></td></tr></table>			1				2			<table border="1"><tr><td></td><td></td><td></td></tr><tr><td></td><td></td><td></td></tr><tr><td>1</td><td></td><td>4</td></tr></table>							1		4
	1																																																																														
3																																																																															
1		1																																																																													
1																																																																															
		1																																																																													
2																																																																															
1		4																																																																													
Post - 0 Miss - 0 Block - 0	Post - 0 Miss - 0 Block - 0	Post - 0 Miss - 0 Block - 0	Post - 0 Miss - 0 Block - 0	Post - 2 Miss - 2 Block - 1	Post - 0 Miss - 0 Block - 0	Post - 1 Miss - 0 Block - 2	Post - 0 Miss - 0 Block - 0																																																																								

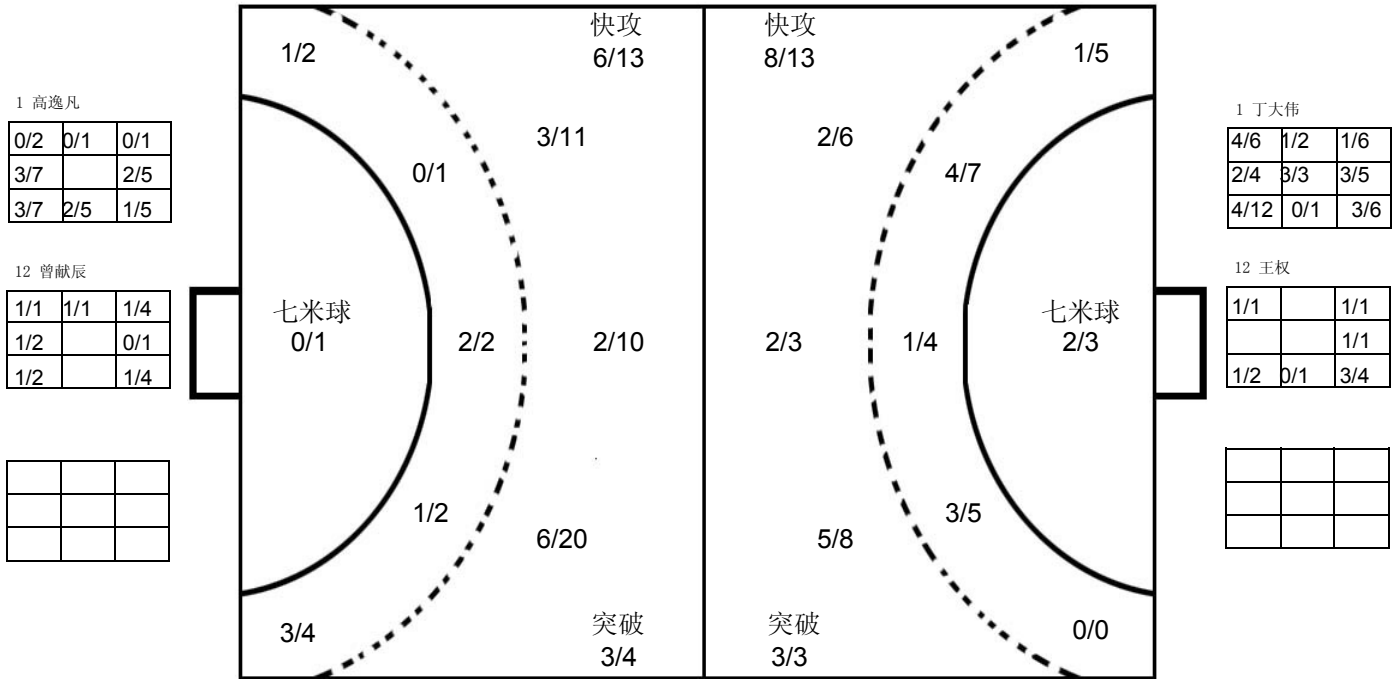

江苏

1 丁大伟	2 杨彦威	3 李旭东	4 沈庆	5 闫亮	6 赵晨	8 周小坚	9 叶强																																																																								
<table border="1"><tr><td></td><td></td><td></td></tr><tr><td></td><td></td><td></td></tr><tr><td></td><td></td><td></td></tr></table>										<table border="1"><tr><td>1</td><td></td><td></td></tr><tr><td></td><td></td><td></td></tr><tr><td>2</td><td>1</td><td></td></tr></table>	1						2	1		<table border="1"><tr><td></td><td></td><td></td></tr><tr><td></td><td></td><td></td></tr><tr><td></td><td></td><td></td></tr></table>										<table border="1"><tr><td></td><td></td><td></td></tr><tr><td></td><td></td><td></td></tr><tr><td></td><td>1</td><td></td></tr></table>								1		<table border="1"><tr><td>1</td><td>1</td><td></td></tr><tr><td></td><td></td><td></td></tr><tr><td></td><td></td><td>1</td></tr></table>	1	1							1	<table border="1"><tr><td></td><td></td><td></td></tr><tr><td></td><td></td><td></td></tr><tr><td></td><td></td><td></td></tr></table>										<table border="1"><tr><td></td><td></td><td></td></tr><tr><td></td><td></td><td></td></tr><tr><td>1</td><td></td><td>1</td></tr></table>							1		1	<table border="1"><tr><td></td><td></td><td></td></tr><tr><td></td><td></td><td></td></tr><tr><td></td><td></td><td>1</td></tr></table>									1
1																																																																															
2	1																																																																														
	1																																																																														
1	1																																																																														
		1																																																																													
1		1																																																																													
		1																																																																													
Post - 0 Miss - 0 Block - 0	Post - 1 Miss - 1 Block - 0	Post - 0 Miss - 0 Block - 0	Post - 0 Miss - 0 Block - 0	Post - 1 Miss - 0 Block - 0	Post - 0 Miss - 0 Block - 0	Post - 0 Miss - 1 Block - 0	Post - 1 Miss - 0 Block - 1																																																																								
10 郝可鑫	11 姚仁剑	12 王权	14 丛海航	15 李安	17 陈灵峰	19 张志宇	20 张星																																																																								
<table border="1"><tr><td>1</td><td></td><td></td></tr><tr><td></td><td></td><td></td></tr><tr><td>1</td><td></td><td>2</td></tr></table>	1						1		2	<table border="1"><tr><td></td><td></td><td></td></tr><tr><td></td><td></td><td></td></tr><tr><td></td><td></td><td></td></tr></table>										<table border="1"><tr><td></td><td></td><td></td></tr><tr><td></td><td></td><td></td></tr><tr><td></td><td></td><td></td></tr></table>										<table border="1"><tr><td></td><td></td><td></td></tr><tr><td></td><td></td><td></td></tr><tr><td>1</td><td></td><td></td></tr></table>							1			<table border="1"><tr><td></td><td></td><td></td></tr><tr><td></td><td></td><td></td></tr><tr><td>1</td><td></td><td></td></tr></table>							1			<table border="1"><tr><td></td><td></td><td></td></tr><tr><td></td><td></td><td></td></tr><tr><td>2</td><td></td><td>4</td></tr></table>							2		4	<table border="1"><tr><td></td><td></td><td></td></tr><tr><td></td><td></td><td></td></tr><tr><td>1</td><td></td><td>1</td></tr></table>							1		1	<table border="1"><tr><td></td><td></td><td></td></tr><tr><td></td><td></td><td></td></tr><tr><td></td><td></td><td></td></tr></table>									
1																																																																															
1		2																																																																													
1																																																																															
1																																																																															
2		4																																																																													
1		1																																																																													
Post - 0 Miss - 0 Block - 1	Post - 0 Miss - 0 Block - 0	Post - 0 Miss - 0 Block - 0	Post - 0 Miss - 0 Block - 0	Post - 0 Miss - 0 Block - 0	Post - 0 Miss - 0 Block - 0	Post - 1 Miss - 1 Block - 0	Post - 0 Miss - 0 Block - 0																																																																								

注释: Post=击柱 Miss=射失 Block=被封





男子 国内比赛



第十二届全国运动会男子手球预赛

Team A										Team B										Match Number									
A 北京										B 澳门										18									
played in					in the hall					on					at					Spectators									
China					柳州市李宁体育馆					21/04/2013					18:00 hours														
Half-time (30')		A		B		End of playing time		A		B		1st extra time		A		B		2nd extra time		A		B		After penalty throws		A		B	
		25		6		48		16																					
Number of 7 m		A		Team time-out			Full name of players and officials										Team time-out			B		Number of 7 m							
3 / 3				1 2 3													1 2 3			0 / 0									
																	19:25												
No.	Team A					G	W	2'	D	DR	No.	Team B					G	W	2'	D	DR								
1	王泷										2	李翹臻																	
2	杜龙飞					10					4	刘家声					1												
4	成亚					4					5	何建成					2												
5	杨昆						1	1			15	黄俊勇																	
6	刘伟					3		1			16	冯国政																	
7	胡瀛					3					18	卓伟杰																	
8	王鹏					3					21	麦锦聪					1												
9	刘振					3					22	陈学敏					1	1											
11	蒋维一					5	1				24	刘登宇					3												
13	白洁					1					27	徐展业																	
14	解建飞					6					28	莫家进					2												
16	孟辉										29	叶响俊					2	1											
17	姜冰峰					4	1	1			33	欧永健					3												
18	张骥					6					36	陈嘉聪																	
20	郑永利										81	梁梓康					1	1	1										
23	冯宁										93	罗咪高																	
A	郑康旭										A	卢永明																	
B	蔡建国										B	高光明																	
C	吴健										C	黄宇豪																	
D	石锋																												
A		Signature of Responsible Official of the Teams (Off. A)															B												
TP	Remarks of Referee / IHFOfficial																			TP									

Signatures

Referees	朱昆宏 (CHN)	刘建鹏 (CHN)		
Techn. Delegates	许宜扬 (CHN)	刘书勇 (CHN)		
IHF Official				

Note: Number of 7m Throws Awarded to Team A and B, Goals (G), Warnings (W), Suspensions (2'), Direct Disqualification (D), Disqualification with Report (DR) and Team Penalty (TP).





第十二届全国运动会男子手球预赛
竞赛技术统计(媒体表)

Table with match details: 预赛 (Pre-match), 组别 A (Group), 轮次 4 (Round), 场次 18 (Match), 柳州市李宁体育馆 (Venue), 21/04/2013 (Date), 201301018-51-1/1 (Match ID), 北京 (Beijing) vs 澳门 (Macau), 48 vs 16, 25:6 (Score)

裁判员 (Referee): 朱昆宏 (CHN) / 刘建鹏 (CHN)

Main statistics table for Beijing team. Columns include: 远射 (Distance), 近射 (Close), 边射 (Side), 快攻 (Fast break), 突破 (Breakthrough), 任意球 (Free throw), 7m球 (7m throw), 合计 (Total), %, 助攻 (Assist), 失误 (Error), 警告 (Warning), 2', D & DR. Rows list players like 王澍, 杜龙飞, etc.

Main statistics table for Macau team. Columns include: 远射 (Distance), 近射 (Close), 边射 (Side), 快攻 (Fast break), 突破 (Breakthrough), 任意球 (Free throw), 7m球 (7m throw), 合计 (Total), %, 助攻 (Assist), 失误 (Error), 警告 (Warning), 2', D & DR. Rows list players like 李翹臻, 刘家声, etc.

Summary table for on-court players (场上队员) and goalkeepers (守门员). Columns include: 快攻 (Fast Break), 突破 (Breakthrough), 任意球 (Free Throw), 7m球 (7M Throw), 助攻 (Assist).



第十二届全国运动会男子手球预赛 图式比赛技术统计表

轮次 4

场次 18

201301018-21-1/1

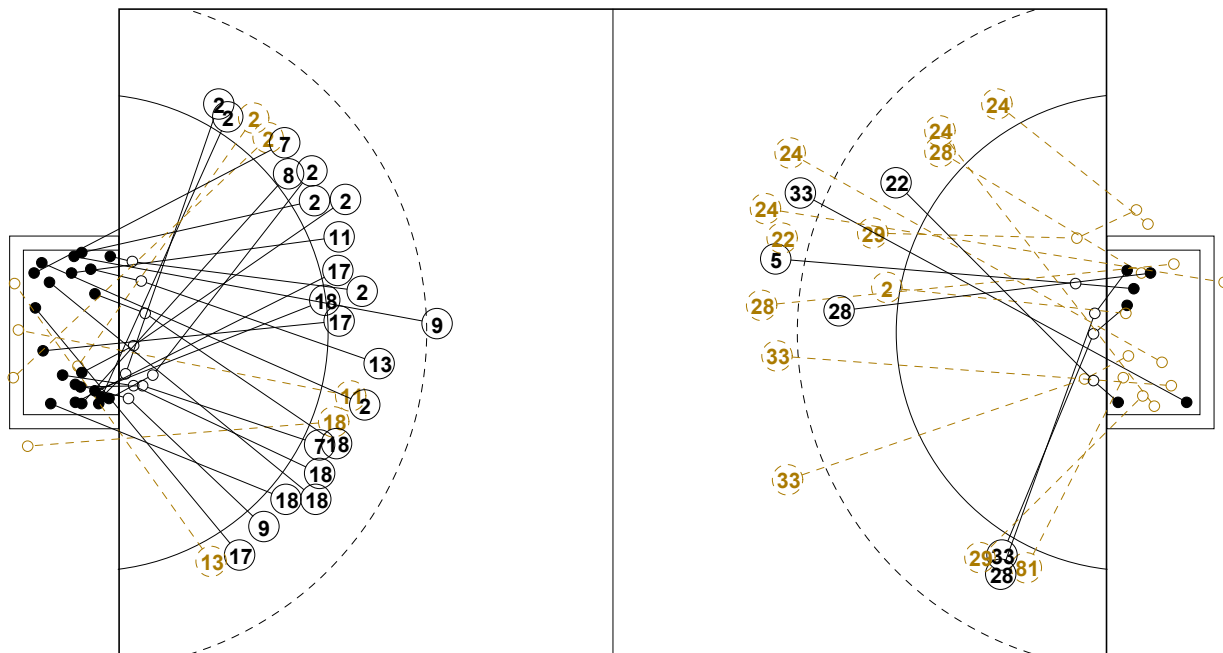

7M 北京

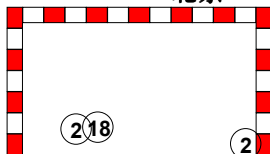

澳门 7M



1st Half
25 : 6

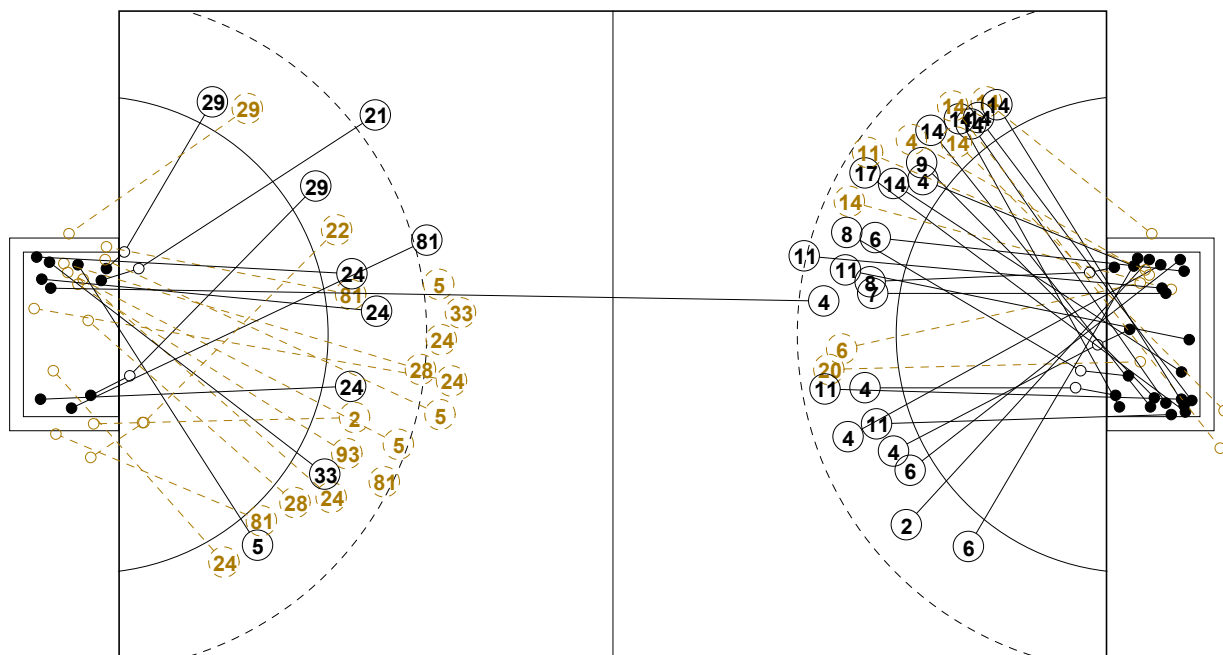

7M 澳门

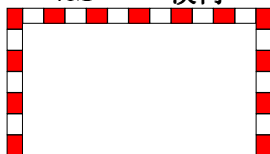

北京 7M



2nd Half
16 : 48



第十二届全国运动会男子手球预赛

个人/全队技术统计表

正式表
手球
男子预赛
轮次 4组别 A
场次 18201301018-14-1/2
柳州市李宁体育馆
21/04/2013 18:00

号码	姓名	远射	近射	边射	快攻	突破	任意	7M	合计	%	助攻	失误	警告	2'	取消	时间
北京(北京)																
<i>(场上队员)</i>																
1	王浣									0.0%	1					00:30:00
2	杜龙飞			2/4	4/4	2/2		2/2	10/12	83.3%	1	2				00:35:07
4	成亚				4/5				4/5	80.0%	1	1				00:15:20
5	杨昆									0.0%			1	1		00:08:17
6	刘伟			1/1	2/3				3/4	75.0%				1		00:21:26
7	胡瀛		1/1		2/2				3/3	100%		3				00:43:05
8	王鹏		1/1		2/2				3/3	100%		1				00:31:29
9	刘振				3/3				3/3	100%						00:39:04
11	蒋维一	1/1	1/2		3/3		0/1		5/7	71.4%			1			00:24:12
13	白洁			0/1	1/1				1/2	50.0%						00:11:20
14	解建飞			4/7	2/3				6/10	60.0%		1				00:29:17
16	孟辉									0.0%						00:30:00
17	姜冰峰	1/1	1/1	1/1	1/1				4/4	100%		1	1	1		00:42:03
18	张骥		1/2		3/3	1/1		1/1	6/7	85.7%	1					00:22:30
20	郑永利	0/1							0/1	0.0%	1	1				00:16:15
23	冯宁									0.0%						00:15:10
合计		2/3	5/7	8/14	27/30	3/3	0/1	3/3	48/61	78.7%	5	10	3	3		
<i>(守门员)</i>																
1	王浣	4/6	2/2	2/4	0/2	1/1			9/15	60.0%	1					00:30:00
16	孟辉	4/7	1/2	1/2	2/5	0/2			8/18	44.4%						00:30:00
合计		8/13	3/4	3/6	2/7	1/3			17/33	51.5%	1					

场上队员：得分/射门

守门员：救球/射门

全队合计	得分	被救	射失	击柱	封球	合计	%
远射	2	1				3	66.7%
近射	5		1	1		7	71.4%
边射	8	1	3	2		14	57.1%
快攻	27	3				30	90.0%
突破	3					3	100.0%
任意		1				1	0.0%
7M	3					3	100.0%





第十二届全国运动会男子手球预赛

个人/全队技术统计表

正式表
手球
男子预赛
轮次 4组别 A
场次 18201301018-14-2/2
柳州市李宁体育馆
21/04/2013 18:00

号码	姓名	远射	近射	边射	快攻	突破	任意	7M	合计	%	助攻	失误	警告	2'	取消	时间
澳门(澳门)																
<i>(上场队员)</i>																
2	李翹臻		0/1		0/1				0/2	0.0%	1	1				00:26:18
4	刘家声	1/1							1/1	100%						00:04:00
5	何建成	1/4			1/1				2/5	40.0%	1	1				00:27:59
15	黄俊勇									0.0%						00:33:31
16	冯国政									0.0%						01:00:00
18	卓伟杰									0.0%						00:00:00
21	麦锦聪	1/1							1/1	100%		1				00:16:11
22	陈学敏	0/1			1/2				1/3	33.3%		1		1		00:07:45
24	刘登宇	0/4	1/3	0/2	2/2				3/11	27.3%		2				00:59:03
27	徐展业									0.0%						00:00:00
28	莫家进	0/2		1/1	1/2	0/1			2/6	33.3%		4				00:43:34
29	叶响俊			1/3		1/2			2/5	40.0%		3		1		00:35:36
33	欧永健	1/4		1/1		1/1			3/6	50.0%		3				00:37:21
36	陈嘉聪									0.0%						00:00:00
81	梁梓康	1/2		0/2		0/1			1/5	20.0%		5		1	1	00:39:10
93	罗咪高				0/1				0/1	0.0%						00:17:24
合计		5/19	1/4	3/9	5/9	2/5			16/46	34.8%	1	21	2	2		
<i>(守门员)</i>																
16	冯国政	1/3	0/5	1/9	3/30	0/3	1/1	0/3	6/54	11.1%						01:00:00
合计		1/3	0/5	1/9	3/30	0/3	1/1	0/3	6/54	11.1%						

场上队员：得分/射门

守门员：救球/射门

全队合计	得分	被救	射失	击柱	封球	合计	%
远射	5	8	1		5	19	26.3%
近射	1	3				4	25.0%
边射	3	3	2	1		9	33.3%
快攻	5	2	1	1		9	55.6%
突破	2	1	1	1		5	40.0%
任意							0.0%
7M							0.0%





第十二届全国运动会男子手球预赛

图式射门区域统计

轮次 4 场次 18

201301018-41-1/1

北京

1 王澍	2 杜龙飞	4 成亚	5 杨昆	6 刘伟	7 胡瀛	8 王鹏	9 刘振																																																																								
<table border="1"><tr><td></td><td></td><td></td></tr><tr><td></td><td></td><td></td></tr><tr><td></td><td></td><td></td></tr></table>										<table border="1"><tr><td></td><td></td><td>1</td></tr><tr><td>2</td><td></td><td>1</td></tr><tr><td>4</td><td></td><td>2</td></tr></table>			1	2		1	4		2	<table border="1"><tr><td></td><td></td><td></td></tr><tr><td>1</td><td></td><td></td></tr><tr><td>1</td><td>1</td><td>1</td></tr></table>				1			1	1	1	<table border="1"><tr><td></td><td></td><td></td></tr><tr><td></td><td></td><td></td></tr><tr><td></td><td></td><td></td></tr></table>										<table border="1"><tr><td>2</td><td></td><td></td></tr><tr><td>1</td><td></td><td></td></tr><tr><td></td><td></td><td></td></tr></table>	2			1						<table border="1"><tr><td></td><td></td><td>1</td></tr><tr><td>2</td><td></td><td></td></tr><tr><td></td><td></td><td></td></tr></table>			1	2						<table border="1"><tr><td></td><td></td><td></td></tr><tr><td>1</td><td></td><td></td></tr><tr><td>1</td><td></td><td>1</td></tr></table>				1			1		1	<table border="1"><tr><td></td><td></td><td></td></tr><tr><td>1</td><td></td><td>2</td></tr><tr><td></td><td></td><td></td></tr></table>				1		2			
		1																																																																													
2		1																																																																													
4		2																																																																													
1																																																																															
1	1	1																																																																													
2																																																																															
1																																																																															
		1																																																																													
2																																																																															
1																																																																															
1		1																																																																													
1		2																																																																													
Post - 0 Miss - 0 Block - 0	Post - 1 Miss - 0 Block - 0	Post - 0 Miss - 0 Block - 0	Post - 0 Miss - 0 Block - 0	Post - 0 Miss - 0 Block - 0	Post - 0 Miss - 0 Block - 0	Post - 0 Miss - 0 Block - 0	Post - 0 Miss - 0 Block - 0																																																																								
11 蒋维一	13 白洁	14 解建飞	16 孟辉	17 姜冰峰	18 张骥	20 郑永利	23 冯宁																																																																								
<table border="1"><tr><td></td><td>1</td><td>2</td></tr><tr><td>1</td><td></td><td>1</td></tr><tr><td></td><td></td><td></td></tr></table>		1	2	1		1				<table border="1"><tr><td></td><td></td><td></td></tr><tr><td></td><td></td><td></td></tr><tr><td></td><td></td><td>1</td></tr></table>									1	<table border="1"><tr><td></td><td></td><td>3</td></tr><tr><td></td><td></td><td>2</td></tr><tr><td></td><td></td><td>1</td></tr></table>			3			2			1	<table border="1"><tr><td></td><td></td><td></td></tr><tr><td></td><td></td><td></td></tr><tr><td></td><td></td><td></td></tr></table>										<table border="1"><tr><td></td><td>2</td><td>1</td></tr><tr><td>1</td><td></td><td></td></tr><tr><td></td><td></td><td></td></tr></table>		2	1	1						<table border="1"><tr><td>1</td><td></td><td>1</td></tr><tr><td>1</td><td></td><td></td></tr><tr><td>2</td><td></td><td>1</td></tr></table>	1		1	1			2		1	<table border="1"><tr><td></td><td></td><td></td></tr><tr><td></td><td></td><td></td></tr><tr><td></td><td></td><td></td></tr></table>										<table border="1"><tr><td></td><td></td><td></td></tr><tr><td></td><td></td><td></td></tr><tr><td></td><td></td><td></td></tr></table>									
	1	2																																																																													
1		1																																																																													
		1																																																																													
		3																																																																													
		2																																																																													
		1																																																																													
	2	1																																																																													
1																																																																															
1		1																																																																													
1																																																																															
2		1																																																																													
Post - 1 Miss - 0 Block - 0	Post - 1 Miss - 0 Block - 0	Post - 0 Miss - 3 Block - 0	Post - 0 Miss - 0 Block - 0	Post - 0 Miss - 0 Block - 0	Post - 0 Miss - 1 Block - 0	Post - 0 Miss - 0 Block - 0	Post - 0 Miss - 0 Block - 0																																																																								

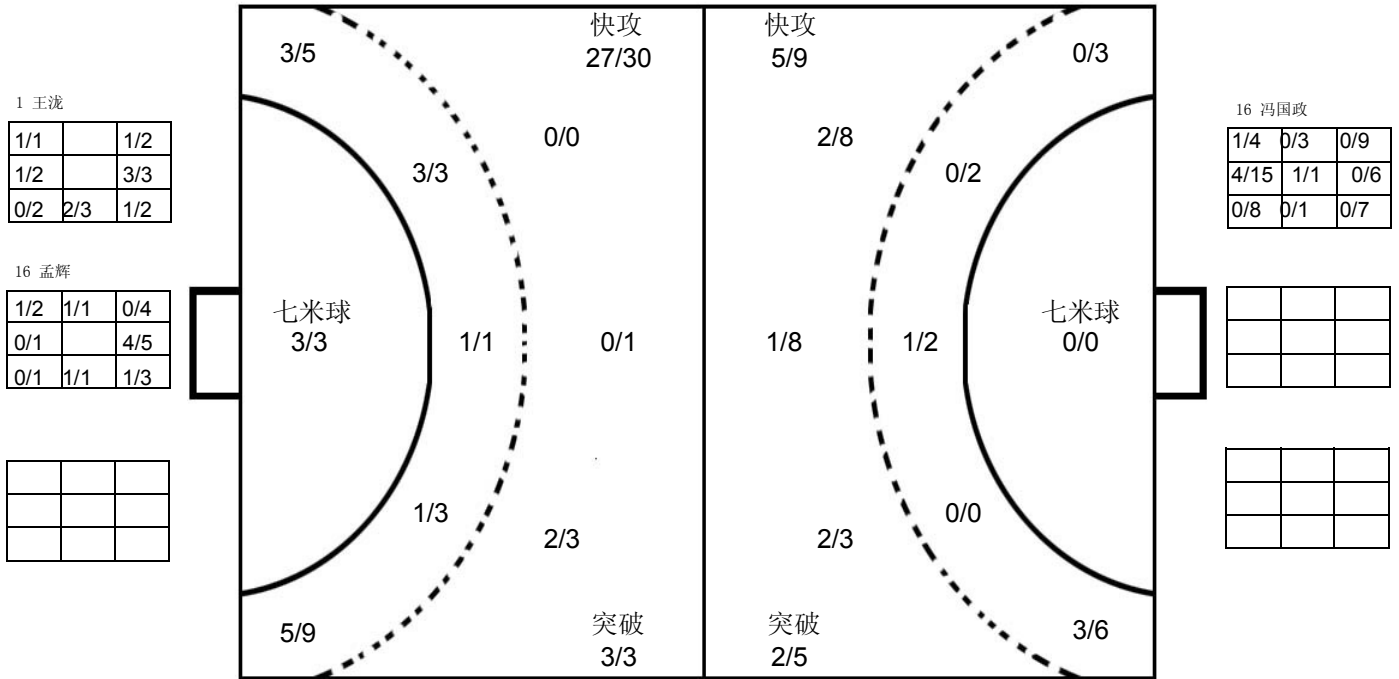

澳门

2 李翹臻	4 刘家声	5 何建成	15 黄俊勇	16 冯国政	18 卓伟杰	21 麦锦聪	22 陈学敏																																																																								
<table border="1"><tr><td></td><td></td><td></td></tr><tr><td></td><td></td><td></td></tr><tr><td></td><td></td><td></td></tr></table>										<table border="1"><tr><td></td><td></td><td>1</td></tr><tr><td></td><td></td><td></td></tr><tr><td></td><td></td><td></td></tr></table>			1							<table border="1"><tr><td></td><td></td><td></td></tr><tr><td></td><td></td><td>1</td></tr><tr><td>1</td><td></td><td></td></tr></table>						1	1			<table border="1"><tr><td></td><td></td><td></td></tr><tr><td></td><td></td><td></td></tr><tr><td></td><td></td><td></td></tr></table>										<table border="1"><tr><td></td><td></td><td></td></tr><tr><td></td><td></td><td></td></tr><tr><td></td><td></td><td></td></tr></table>										<table border="1"><tr><td></td><td></td><td></td></tr><tr><td></td><td></td><td></td></tr><tr><td></td><td></td><td></td></tr></table>										<table border="1"><tr><td></td><td></td><td></td></tr><tr><td></td><td></td><td></td></tr><tr><td></td><td></td><td>1</td></tr></table>									1	<table border="1"><tr><td></td><td></td><td></td></tr><tr><td></td><td></td><td></td></tr><tr><td></td><td></td><td>1</td></tr></table>									1
		1																																																																													
		1																																																																													
1																																																																															
		1																																																																													
		1																																																																													
Post - 1 Miss - 0 Block - 0	Post - 0 Miss - 0 Block - 0	Post - 0 Miss - 0 Block - 1	Post - 0 Miss - 0 Block - 0	Post - 0 Miss - 0 Block - 0	Post - 0 Miss - 0 Block - 0	Post - 0 Miss - 0 Block - 0	Post - 0 Miss - 1 Block - 1																																																																								
24 刘登宇	27 徐展业	28 莫家进	29 叶响俊	33 欧永健	36 陈嘉聪	81 梁梓康	93 罗咏高																																																																								
<table border="1"><tr><td>1</td><td></td><td>2</td></tr><tr><td></td><td></td><td></td></tr><tr><td></td><td></td><td></td></tr></table>	1		2							<table border="1"><tr><td></td><td></td><td></td></tr><tr><td></td><td></td><td></td></tr><tr><td></td><td></td><td></td></tr></table>										<table border="1"><tr><td></td><td></td><td></td></tr><tr><td>1</td><td></td><td></td></tr><tr><td>1</td><td></td><td></td></tr></table>				1			1			<table border="1"><tr><td></td><td></td><td></td></tr><tr><td></td><td></td><td></td></tr><tr><td>1</td><td></td><td>1</td></tr></table>							1		1	<table border="1"><tr><td></td><td></td><td>2</td></tr><tr><td></td><td></td><td></td></tr><tr><td>1</td><td></td><td></td></tr></table>			2				1			<table border="1"><tr><td></td><td></td><td></td></tr><tr><td></td><td></td><td></td></tr><tr><td></td><td></td><td></td></tr></table>										<table border="1"><tr><td></td><td></td><td></td></tr><tr><td>1</td><td></td><td></td></tr><tr><td></td><td></td><td></td></tr></table>				1						<table border="1"><tr><td></td><td></td><td></td></tr><tr><td></td><td></td><td></td></tr><tr><td></td><td></td><td></td></tr></table>									
1		2																																																																													
1																																																																															
1																																																																															
1		1																																																																													
		2																																																																													
1																																																																															
1																																																																															
Post - 0 Miss - 2 Block - 1	Post - 0 Miss - 0 Block - 0	Post - 0 Miss - 0 Block - 0	Post - 0 Miss - 2 Block - 0	Post - 0 Miss - 0 Block - 1	Post - 0 Miss - 0 Block - 0	Post - 2 Miss - 0 Block - 1	Post - 0 Miss - 0 Block - 0																																																																								

注释: Post=击柱 Miss=射失 Block=被封





男子 国内比赛



第十二届全国运动会男子手球预赛

Team A										Team B										Match Number											
A 广东										B 山西										19											
played in					in the hall					on					at					Spectators											
China					柳州市李宁体育馆					22/04/2013					14:40 hours																
Half-time (30')		A		B		End of playing time		A		B		1st extra time		A		B		2nd extra time		A		B		After penalty throws		A		B			
		22		12				42		24																					
Number of 7 m		A		Team time-out			Full name of players and officials										Team time-out			B		Number of 7 m									
1 / 1				1 2 3													1 2 3			3 / 3											
																	05:28														
No.	Team A										G	W	2'	D	DR	No.	Team B										G	W	2'	D	DR
1	王旭兴															1	李晋尧														
2	孙江山										6			1		2	马健										2	1			
3	曲汝洋										3					3	王晋										1				
4	李卓洋										5					4	李鹏程										2				
5	候生升										2					5	王志超														
6	邓志贵										2					6	范帅														
7	付云博										1					7	白宇飞										6	1			
8	于彦江										5					8	崔钰										1				
9	徐庆										1					9	朱涛涛										3				
10	陈超										4					10	任海阳														
12	温杰															12	侯乃章														
16	张广建															13	侯建涛										2				
17	李中洲										6					14	刘明华										2				
18	张腾										1	1				15	景新江										3				
19	马跃															18	朱楔										2				
20	王伟										6																				
A	王锋															A	王喜和														
B	李晓忠															B	张晓东														
C	郭艳辉															C	孙少波														
E	薛良成															D	石岩														
A		Signature of Responsible Official of the Teams (Off. A)										B																			
TP	Remarks of Referee / IHFOfficial										TP																				

Signatures

Referees	邓军 (CHN)	谭雷 (CHN)		
Techn. Delegates	王锡祯 (CHN)	刘书勇 (CHN)		
IHF Official				

Note: Number of 7m Throws Awarded to Team A and B, Goals (G), Warnings (W), Suspensions (2'), Direct Disqualification (D), Disqualification with Report (DR) and Team Penalty (TP).

Table Officials:

Statisticians: 黄莉

朱伟平





第十二届全国运动会男子手球预赛
竞赛技术统计(媒体表)

Table with match details: 预赛 (Pre-match), 组别 B (Group), 轮次 5 (Round), 场次 19 (Match), 柳州市李宁体育馆 (Venue), 22/04/2013 (Date), 201301019-51-1/1 (Match ID), 广东 42 vs 24 山西 (Score), 22:12 (Time)

裁判员 (Referee): 邓军 (CHN) / 谭雷 (CHN)

Main statistics table for Guangdong and Shanxi teams, including player names, positions, and various performance metrics like goals, assists, and suspensions.

场上队员: 得分 / 射门

守门员: 救球 / 射门

Legend table for abbreviations: 快攻 (Fast Break), 突破 (Breakthrough), 任意球 (Free Throw), 7m球 (7M Throw), 助攻 (Assist), 警告 (Warning), 失误 (Error), 2' (Suspension), D (取消资格 - Disqualification), DR (取消资格+报告 - Disqualification+Report)





第十二届全国运动会男子手球预赛 图式比赛技术统计表

轮次 5

场次 19

201301019-21-1/1

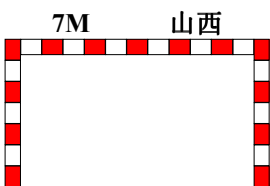
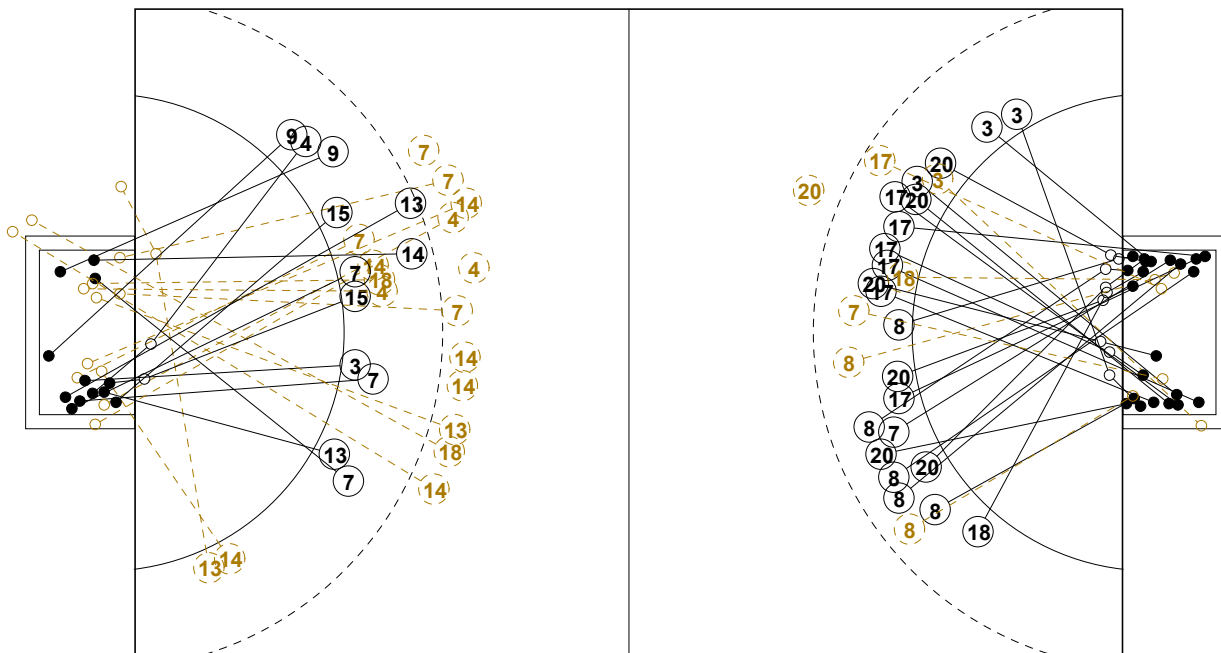

1st Half
12 : 22

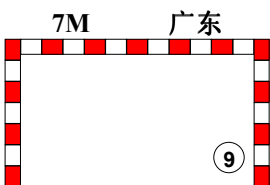
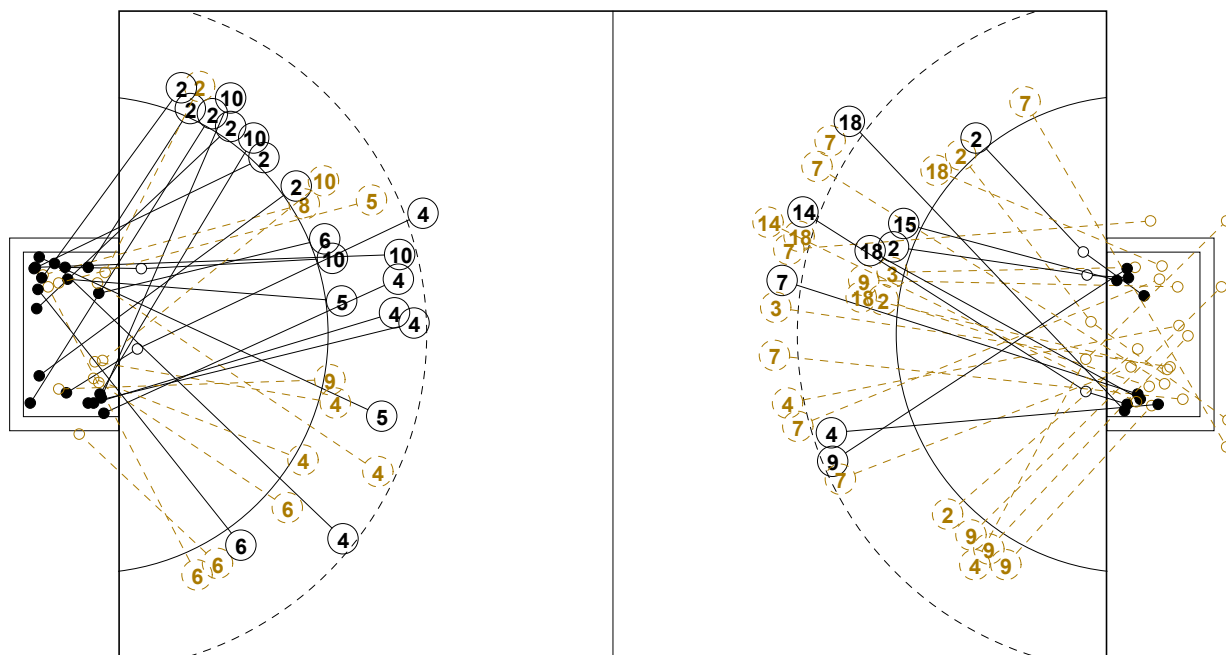
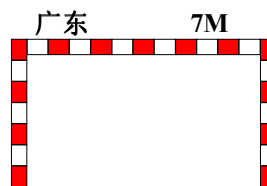

2nd Half
42 : 24

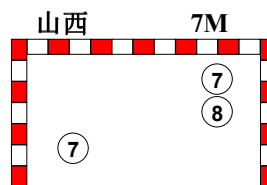



第十二届全国运动会男子手球预赛

个人/全队技术统计表

正式表
手球
男子预赛
轮次 5组别 B
场次 19201301019-14-1/2
柳州市李宁体育馆
22/04/2013 14:40

号码	姓名	远射	近射	边射	快攻	突破	任意	7M	合计	%	助攻	失误	警告	2'	取消	时间
广东(广东)																
<i>(场上队员)</i>																
1	王旭兴									0.0%	1					00:21:44
2	孙江山			2/3	4/4				6/7	85.7%				1		00:26:19
3	曲汝洋		0/1	1/1	2/2				3/4	75.0%		2			00:30:00	
4	李卓洋	3/4	1/2		0/1		1/1		5/8	62.5%		2			00:30:00	
5	候生升	0/1	1/1		1/1				2/3	66.7%	3	1			00:30:00	
6	邓志贵		1/1	1/3		0/1			2/5	40.0%	1				00:27:37	
7	付云博				0/1	1/1			1/2	50.0%	3	5			00:32:22	
8	于彦江		1/2		2/3	2/3			5/8	62.5%	2	2			00:32:59	
9	徐庆		0/1					1/1	1/2	50.0%		2			00:28:38	
10	陈超	1/1		1/1	2/2	0/1			4/5	80.0%		2			00:27:00	
12	温杰									0.0%					00:38:16	
16	张广建									0.0%					00:00:00	
17	李中洲		3/3		2/2	1/2			6/7	85.7%	2	2			00:30:00	
18	张腾		0/1	1/1					1/2	50.0%	1	3	1		00:33:39	
19	马跃									0.0%					00:00:00	
20	王伟	0/1	1/1		4/4	1/1			6/7	85.7%	2	2			00:31:20	
合计		4/7	8/13	6/9	17/20	5/9	1/1	1/1	42/60	70.0%	15	23	1	1		
<i>(守门员)</i>																
1	王旭兴	4/8	2/4	1/1	3/4			0/2	10/19	52.6%	1					00:21:44
12	温杰	6/7	2/3	1/2	2/9	2/6	1/1	0/1	14/29	48.3%						00:38:16
合计		10/15	4/7	2/3	5/13	2/6	1/1	0/3	24/48	50.0%	1					

场上队员：得分/射门

守门员：救球/射门

全队合计	得分	被救	射失	击柱	封球	合计	%
远射	4	2			1	7	57.1%
近射	8	4		1		13	61.5%
边射	6	2		1		9	66.7%
快攻	17	3				20	85.0%
突破	5	4				9	55.6%
任意	1					1	100.0%
7M	1					1	100.0%





第十二届全国运动会男子手球预赛

个人/全队技术统计表

正式表
手球
男子预赛
轮次 5组别 B
场次 19201301019-14-2/2
柳州市李宁体育馆
22/04/2013 14:40

号码	姓名	远射	近射	边射	快攻	突破	任意	7M	合计	%	助攻	失误	警告	2'	取消	时间
山西(山西)																
<i>(上场队员)</i>																
1	李晋尧									0.0%						01:00:00
2	马健		0/2	1/2	1/1				2/5	40.0%	1		1			00:36:52
3	王晋	0/1	1/2						1/3	33.3%			2			00:24:54
4	李鹏程	1/4			1/2	0/1			2/7	28.6%			6			00:34:04
5	王志超									0.0%						00:00:00
6	范帅									0.0%						00:06:58
7	白宇飞	1/9		0/1	2/3	1/2		2/2	6/17	35.3%	2	7	1			00:55:15
8	崔钰							1/1	1/1	100%			1			00:12:18
9	朱涛涛	1/1		0/2	1/3	1/1			3/7	42.9%	1					00:53:40
10	任海阳									0.0%						00:14:35
12	侯乃章									0.0%						00:00:00
13	侯建涛			0/1	2/2		0/1		2/4	50.0%			3			00:28:07
14	刘明华	1/6		0/1		1/2			2/9	22.2%			1			00:29:29
15	景新江		1/1		1/1	1/1			3/3	100%			1			00:37:19
18	朱棣	1/3	1/2		0/1	0/1			2/7	28.6%			1			00:26:08
合计		5/24	3/7	1/7	8/13	4/8	0/1	3/3	24/63	38.1%	4	22	2			
<i>(守门员)</i>																
1	李晋尧	2/6	4/12	2/8	3/20	4/9	0/1	0/1	15/57	26.3%						01:00:00
合计		2/6	4/12	2/8	3/20	4/9	0/1	0/1	15/57	26.3%						

场上队员：得分/射门

守门员：救球/射门

全队合计	得分	被救	射失	击柱	封球	合计	%
远射	5	10	3		6	24	20.8%
近射	3	4				7	42.9%
边射	1	2	4			7	14.3%
快攻	8	5				13	61.5%
突破	4	2	1	1		8	50.0%
任意		1				1	0.0%
7M	3					3	100.0%





第十二届全国运动会男子手球预赛

图式射门区域统计

轮次 5 场次 19

201301019-41-1/1

广东

1 王旭兴	2 孙江山	3 曲汝洋	4 李卓洋	5 候生升	6 邓志贵	7 付文博	8 于彦江																																																																								
<table border="1"><tr><td></td><td></td><td></td></tr><tr><td></td><td></td><td></td></tr><tr><td></td><td></td><td></td></tr></table>										<table border="1"><tr><td>2</td><td>1</td><td>2</td></tr><tr><td></td><td></td><td></td></tr><tr><td></td><td></td><td>1</td></tr></table>	2	1	2						1	<table border="1"><tr><td></td><td></td><td></td></tr><tr><td></td><td></td><td>1</td></tr><tr><td>1</td><td></td><td>1</td></tr></table>						1	1		1	<table border="1"><tr><td></td><td></td><td>1</td></tr><tr><td>1</td><td></td><td></td></tr><tr><td>3</td><td></td><td></td></tr></table>			1	1			3			<table border="1"><tr><td></td><td></td><td>1</td></tr><tr><td></td><td></td><td>1</td></tr><tr><td></td><td></td><td></td></tr></table>			1			1				<table border="1"><tr><td></td><td></td><td>1</td></tr><tr><td></td><td></td><td></td></tr><tr><td></td><td></td><td>1</td></tr></table>			1						1	<table border="1"><tr><td></td><td></td><td></td></tr><tr><td>1</td><td></td><td></td></tr><tr><td></td><td></td><td></td></tr></table>				1						<table border="1"><tr><td></td><td>1</td><td></td></tr><tr><td>1</td><td></td><td></td></tr><tr><td>2</td><td></td><td>1</td></tr></table>		1		1			2		1
2	1	2																																																																													
		1																																																																													
		1																																																																													
1		1																																																																													
		1																																																																													
1																																																																															
3																																																																															
		1																																																																													
		1																																																																													
		1																																																																													
		1																																																																													
1																																																																															
	1																																																																														
1																																																																															
2		1																																																																													
Post - 0 Miss - 0 Block - 0	Post - 0 Miss - 0 Block - 0	Post - 1 Miss - 0 Block - 0	Post - 0 Miss - 0 Block - 0	Post - 0 Miss - 0 Block - 0	Post - 1 Miss - 0 Block - 0	Post - 0 Miss - 0 Block - 0	Post - 0 Miss - 0 Block - 0																																																																								
9 徐庆	10 陈超	12 温杰	16 张广建	17 李中洲	18 张腾	19 马跃	20 王伟																																																																								
<table border="1"><tr><td></td><td></td><td></td></tr><tr><td></td><td></td><td></td></tr><tr><td></td><td></td><td>1</td></tr></table>									1	<table border="1"><tr><td></td><td></td><td>1</td></tr><tr><td></td><td></td><td>1</td></tr><tr><td>2</td><td></td><td></td></tr></table>			1			1	2			<table border="1"><tr><td></td><td></td><td></td></tr><tr><td></td><td></td><td></td></tr><tr><td></td><td></td><td></td></tr></table>										<table border="1"><tr><td></td><td></td><td></td></tr><tr><td></td><td></td><td></td></tr><tr><td></td><td></td><td></td></tr></table>										<table border="1"><tr><td>2</td><td></td><td>1</td></tr><tr><td></td><td></td><td>2</td></tr><tr><td></td><td></td><td>1</td></tr></table>	2		1			2			1	<table border="1"><tr><td></td><td></td><td></td></tr><tr><td></td><td></td><td></td></tr><tr><td>1</td><td></td><td></td></tr></table>							1			<table border="1"><tr><td></td><td></td><td></td></tr><tr><td></td><td></td><td></td></tr><tr><td></td><td></td><td></td></tr></table>										<table border="1"><tr><td></td><td></td><td></td></tr><tr><td></td><td>1</td><td>1</td></tr><tr><td>3</td><td></td><td>1</td></tr></table>					1	1	3		1
		1																																																																													
		1																																																																													
		1																																																																													
2																																																																															
2		1																																																																													
		2																																																																													
		1																																																																													
1																																																																															
	1	1																																																																													
3		1																																																																													
Post - 0 Miss - 0 Block - 0	Post - 0 Miss - 0 Block - 0	Post - 0 Miss - 0 Block - 0	Post - 0 Miss - 0 Block - 0	Post - 0 Miss - 0 Block - 0	Post - 0 Miss - 0 Block - 0	Post - 0 Miss - 0 Block - 0	Post - 0 Miss - 0 Block - 1																																																																								

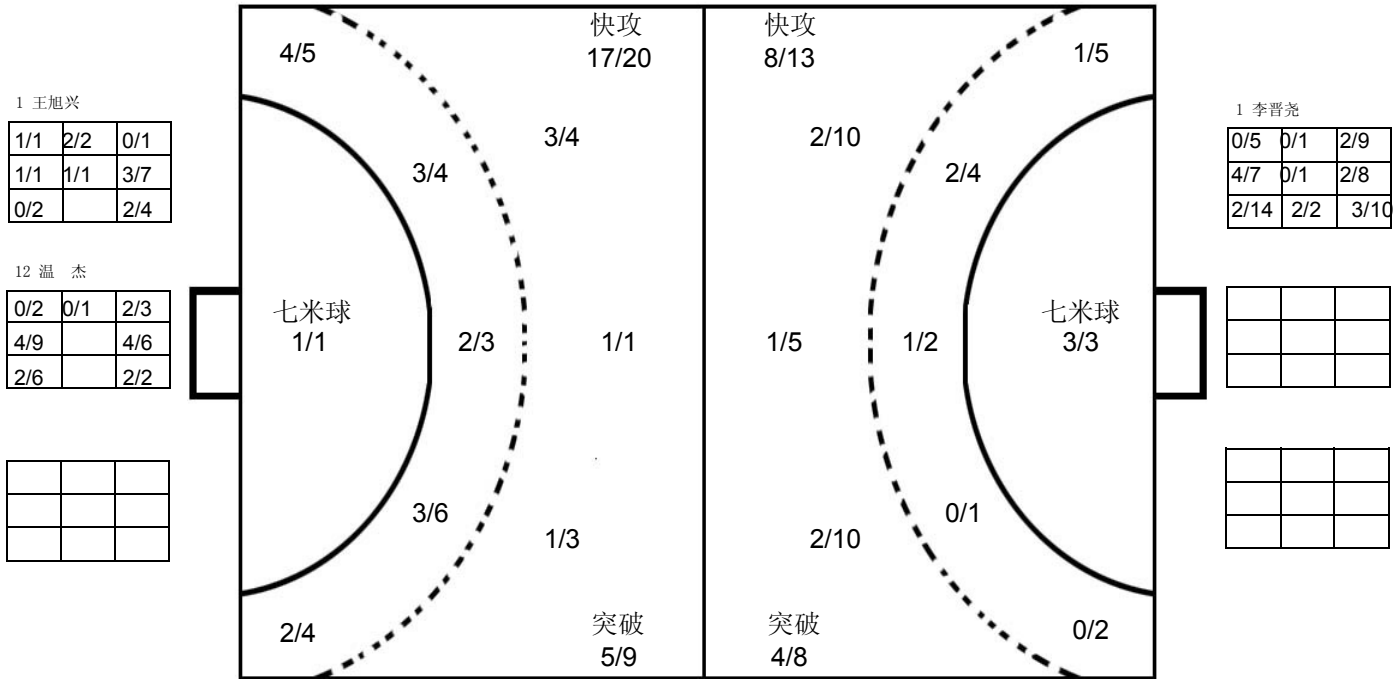

山西

1 李晋尧	2 马健	3 王晋	4 李鹏程	5 王志超	6 范帅	7 白宇飞	8 崔钰																																																																								
<table border="1"><tr><td></td><td></td><td></td></tr><tr><td></td><td></td><td></td></tr><tr><td></td><td></td><td></td></tr></table>										<table border="1"><tr><td></td><td></td><td></td></tr><tr><td>1</td><td></td><td></td></tr><tr><td>1</td><td></td><td></td></tr></table>				1			1			<table border="1"><tr><td></td><td></td><td></td></tr><tr><td>1</td><td></td><td></td></tr><tr><td></td><td></td><td></td></tr></table>				1						<table border="1"><tr><td></td><td></td><td></td></tr><tr><td>1</td><td></td><td>1</td></tr><tr><td></td><td></td><td></td></tr></table>				1		1				<table border="1"><tr><td></td><td></td><td></td></tr><tr><td></td><td></td><td></td></tr><tr><td></td><td></td><td></td></tr></table>										<table border="1"><tr><td></td><td></td><td></td></tr><tr><td></td><td></td><td></td></tr><tr><td></td><td></td><td></td></tr></table>										<table border="1"><tr><td></td><td>1</td><td>1</td></tr><tr><td></td><td>2</td><td>2</td></tr><tr><td></td><td></td><td></td></tr></table>		1	1		2	2				<table border="1"><tr><td></td><td></td><td></td></tr><tr><td></td><td></td><td>1</td></tr><tr><td></td><td></td><td></td></tr></table>						1			
1																																																																															
1																																																																															
1																																																																															
1		1																																																																													
	1	1																																																																													
	2	2																																																																													
		1																																																																													
Post - 0 Miss - 0 Block - 0	Post - 0 Miss - 1 Block - 0	Post - 0 Miss - 0 Block - 0	Post - 0 Miss - 1 Block - 1	Post - 0 Miss - 0 Block - 0	Post - 0 Miss - 0 Block - 0	Post - 0 Miss - 2 Block - 2	Post - 0 Miss - 0 Block - 0																																																																								
9 朱涛涛	10 任海阳	12 侯乃章	13 侯建涛	14 刘明华	15 景新江	18 朱棣																																																																									
<table border="1"><tr><td></td><td>1</td><td>1</td></tr><tr><td></td><td></td><td></td></tr><tr><td>1</td><td></td><td></td></tr></table>		1	1				1			<table border="1"><tr><td></td><td></td><td></td></tr><tr><td></td><td></td><td></td></tr><tr><td></td><td></td><td></td></tr></table>										<table border="1"><tr><td></td><td></td><td></td></tr><tr><td></td><td></td><td></td></tr><tr><td></td><td></td><td></td></tr></table>										<table border="1"><tr><td></td><td>1</td><td></td></tr><tr><td></td><td></td><td></td></tr><tr><td>1</td><td></td><td></td></tr></table>		1					1			<table border="1"><tr><td></td><td></td><td></td></tr><tr><td></td><td></td><td>1</td></tr><tr><td></td><td></td><td>1</td></tr></table>						1			1	<table border="1"><tr><td></td><td></td><td></td></tr><tr><td></td><td></td><td></td></tr><tr><td>3</td><td></td><td></td></tr></table>							3			<table border="1"><tr><td></td><td></td><td></td></tr><tr><td></td><td></td><td>1</td></tr><tr><td></td><td></td><td>1</td></tr></table>						1			1	<table border="1"><tr><td></td><td></td><td></td></tr><tr><td></td><td></td><td></td></tr><tr><td></td><td></td><td></td></tr></table>									
	1	1																																																																													
1																																																																															
	1																																																																														
1																																																																															
		1																																																																													
		1																																																																													
3																																																																															
		1																																																																													
		1																																																																													
Post - 0 Miss - 1 Block - 0	Post - 0 Miss - 0 Block - 0	Post - 0 Miss - 0 Block - 0	Post - 0 Miss - 1 Block - 0	Post - 1 Miss - 1 Block - 2	Post - 0 Miss - 0 Block - 0	Post - 0 Miss - 1 Block - 1																																																																									

注释: Post=击柱 Miss=射失 Block=被封





男子 国内比赛



第十二届全国运动会男子手球预赛

Team A		Team B		Match Number															
A 解放军		B 上海		20															
played in		in the hall		on															
China		柳州市李宁体育馆		22/04/2013															
				at 16:20 hours															
Spectators																			
Half-time (30')	A	B	End of playing time	A	B														
	6	7	14 14	14	14														
1st extra time		A		B															
2nd extra time		A		B															
After penalty		A		B															
throws		16		18															
Number of 7 m	A	Team time-out			Team time-out			B	Number of 7 m										
	3 / 6	1	2	3	1	2	3	5 / 5											
Full name of players and officials																			
23:15		46:51		57:18															
No.	Team A				G	W	2'	D	DR	No.	Team B				G	W	2'	D	DR
4	曹作亮				5					1	张峥								
5	吴龙瑞				3					2	胡辰								
6	苗青				1	1				3	赵时俊				2				
7	陈昊									5	朱世杰								
8	王烁				3					6	李和鑫				3				
9	丁超				2					8	钱为玮				2				
10	师龙									9	朱礼彬				1		1		
11	李想					1	2			10	吴璟				5	1			
12	丛霖									12	周哲韬								
13	王世杰									13	孟宇超								
14	曲学博					1				14	王子阳								
15	杨帆				2		1			15	徐俊吉				1				
16	郎俊夫									16	朱春雷								
17	王勇									18	马麟晓				1	1			
18	董宏斐									19	蒋承骅				3	1			
20	谷浩									20	程云飞								
A	张敬敏									A	吴龙基								
B	张彬华									B	陆钦忠								
C	刘捷									C	徐耀忠								
D	刘军									E	黄韡								
A		Signature of Responsible Official of the Teams (Off. A)														B			
TP	Remarks of Referee / IHFOfficial																TP		

Signatures

Referees	Andreas Bethmann	Michael Tzaferopoulos		
Techn. Delegates	许宜扬 (CHN)	刘书勇 (CHN)		
IHF Official				

Note: Number of 7m Throws Awarded to Team A and B, Goals (G), Warnings (W), Suspensions (2'), Direct Disqualification (D), Disqualification with Report (DR) and Team Penalty (TP).

Table Officials: 黄思华 谭云东 Statisticians: 黄莉 朱伟平



第十二届全国运动会男子手球预赛
竞赛技术统计(媒体表)

预赛	组别	B	轮次	5	场次	20
柳州市李宁体育馆			22/04/2013		201301020-51-1/1	
解放军	解放军	16	vs	18	上海	上海
			6:7			

裁判员	Andreas Bethmann (GRE)	/	Michael Tzaferopoulos (GRE)
-----	------------------------	---	-----------------------------

解放军		远	近	边	快	突	任意	7m	合计	%	助攻	失误	警告	2'	D & DR	解放军	比赛进程	上海
主教练: 张敬敏		射	射	射	攻	破	球	球										
4	曹作亮	0/5	1/1		1/1	0/1	2/4	1/1	5/13	38.5	1	4				4	曹作亮	1 00:54 0
5	吴龙瑞			0/3	3/3				3/6	50.0						9	丁超	2 09:31 1 18 马麟晓
6	苗青	0/2		0/1				1/2	1/5	20.0		1	1			4	曹作亮	2 10:10 2 3 赵时俊
7	陈昊																	
8	王烁			1/3	1/1			1/2	3/6	50.0		4						
9	丁超	1/1				1/1		2/2	2/2	100		2						
10	师龙																	
11	李想				0/1				0/1	0.0		2	1	2				
12	丛霖																	
13	王世杰																	
14	曲学博																	
15	杨帆				1/1	1/1		2/2	2/2	100		2		1				
16	郎俊夫																	
17	王勇							0/1	0/1	0.0								
18	董宏斐											2						
20	谷浩		0/1						0/1	0.0	1	1						
运动员 合计		1/8	1/2	1/7	6/7	2/3	2/4	3/6	16/37	43.2	2	18	3	3				
12	丛霖	12/13	2/8	2/5	1/2	2/3	0/1	0/1	19/33	57.6								
16	郎俊夫							0/4	0/4	0.0								
守门员 合计		12/13	2/8	2/5	1/2	2/3	0/1	0/5	19/37	51.4								
上海		远	近	边	快	突	任意	7m	合计	%	助攻	失误	警告	2'	D & DR			
教练: 吴龙基		射	射	射	攻	破	球	球										
1	张崢																	
2	胡辰																	
3	赵时俊	0/1		2/5	0/1			2/7	2/7	28.6								
5	朱世杰																	
6	李和鑫	1/6					0/1	2/2	3/9	33.3	3	4						
8	钱为玮		1/1	1/1				2/2	2/2	100		3						
9	朱礼彬	0/4	1/1	0/1		0/2		1/8	1/8	12.5		6		1				
10	吴璟	0/1	3/4			1/1		1/1	5/7	71.4		1	1					
12	周哲韬																	
13	孟宇超																	
14	王子阳																	
15	徐俊吉							1/1	1/1	100								
16	朱春雷										1							
18	马麟晓	0/6	0/2				1/1	1/9	1/9	11.1	1		1					
19	蒋承骅	0/1	1/1		1/1			1/1	3/4	75.0		1	1					
20	程云飞																	
运动员 合计		1/19	6/9	3/7	1/2	1/3	1/2	5/5	18/47	38.3	5	15	3	1				
16	朱春雷	3/4	0/1	3/4	0/6	0/2	2/4	2/5	10/26	38.5	1							
守门员 合计		3/4	0/1	3/4	0/6	0/2	2/4	2/5	10/26	38.5	1							

场上队员: 得分 / 射门

守门员: 救球 / 射门

快攻	Fast Break		突破	Breakthrough		任意球	Free Throw		7M球	7M Throw		助攻	Assist
警告	Warning		失误	Error		2'	Suspension		D	取消资格		DR	取消资格+报告





第十二届全国运动会男子手球预赛 图式比赛技术统计表

轮次 5

场次 20

201301020-21-1/1

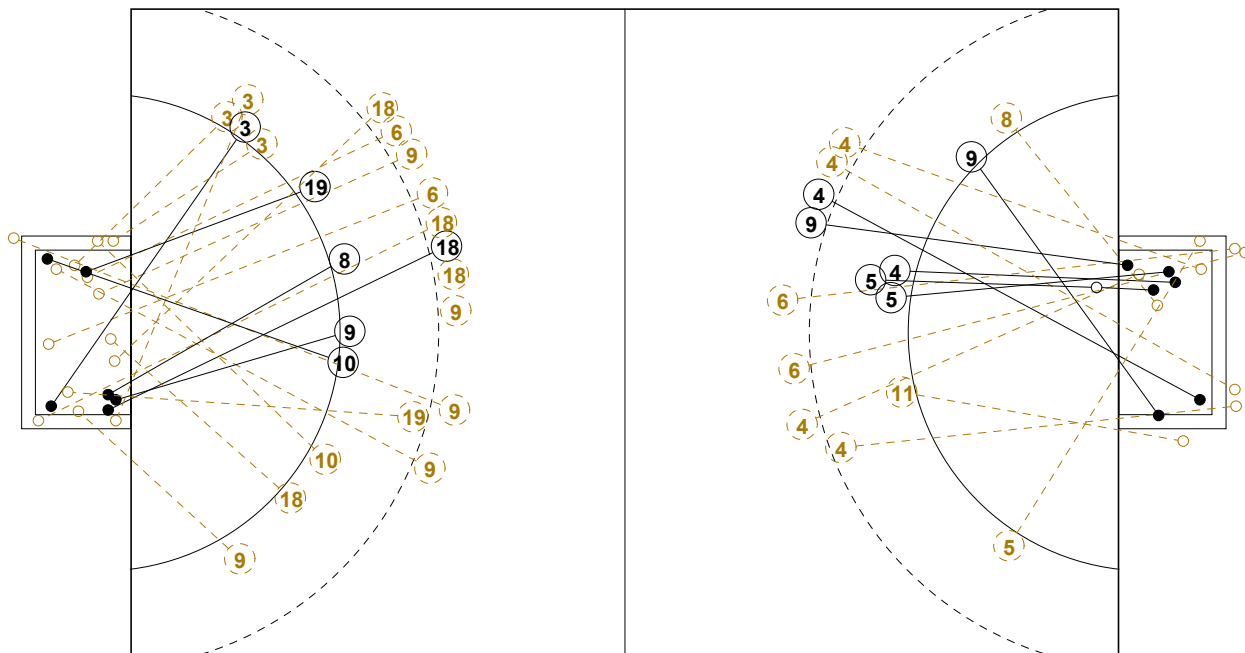

7M 上海

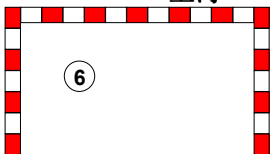

1st Half
7 : 6

解放军 7M

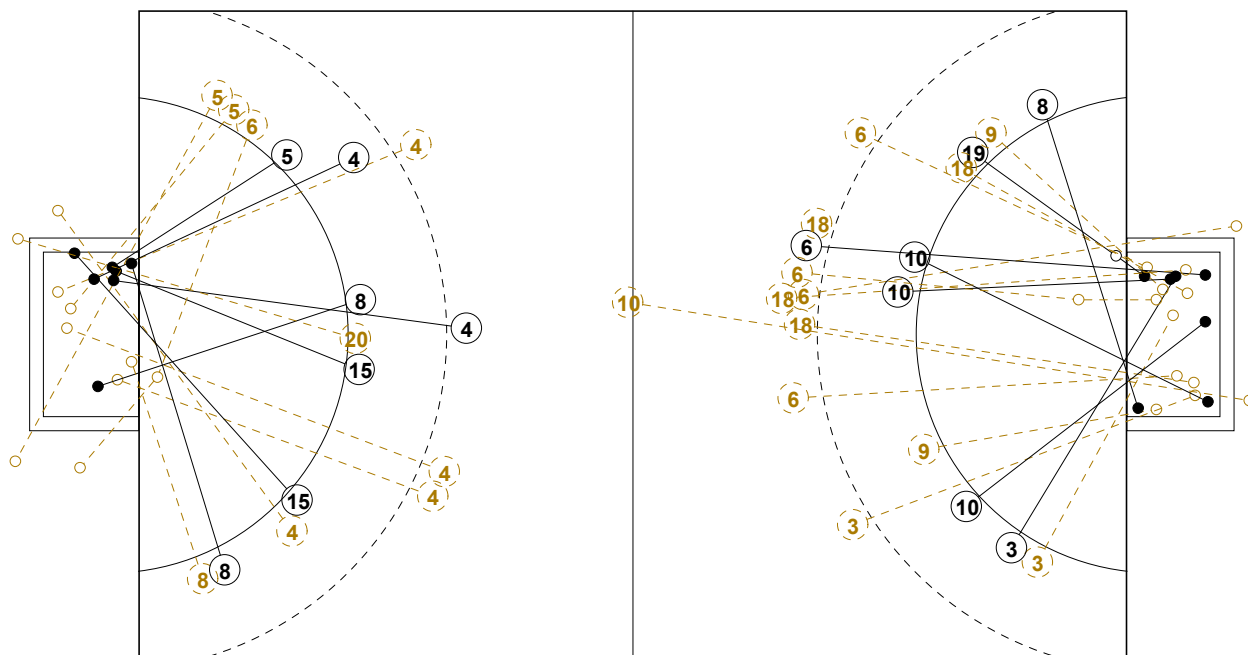
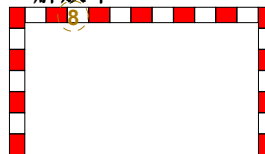

7M 解放军

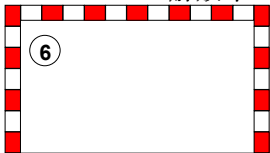

2nd Half
14 : 14

上海 7M





第十二届全国运动会男子手球预赛 图式比赛技术统计表

轮次 5

场次 20

201301020-21-1/1

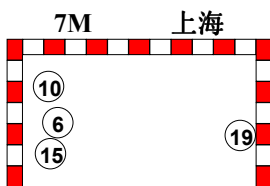
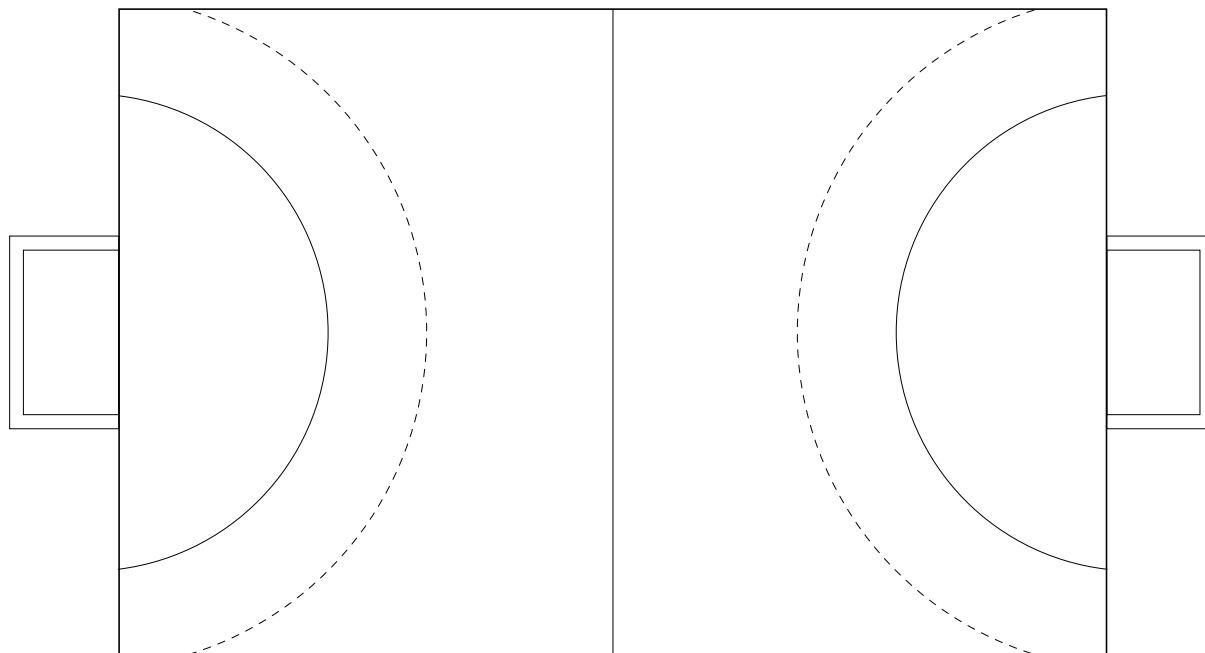

7M-Throw
18 : 16

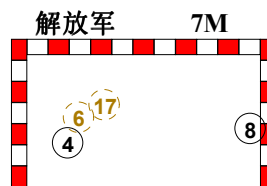



第十二届全国运动会男子手球预赛

个人/全队技术统计表

正式表
手球
男子预赛
轮次 5组别 B
场次 20201301020-14-1/2
柳州市李宁体育馆
22/04/2013 16:20

号码	姓名	远射	近射	边射	快攻	突破	任意	7M	合计	%	助攻	失误	警告	2'	取消	时间
解放军(解放军)																
<i>(场上队员)</i>																
4	曹作亮	0/5	1/1		1/1	0/1	2/4	1/1	5/13	38.5%	1	4				01:30:00
5	吴龙瑞			0/3	3/3				3/6	50.0%						00:50:48
6	苗青	0/2		0/1				1/2	1/5	20.0%		1	1		00:49:11	
7	陈昊									0.0%						00:00:00
8	王烁			1/3	1/1			1/2	3/6	50.0%		4			01:29:41	
9	丁超	1/1				1/1			2/2	100%		2			00:59:15	
10	师龙									0.0%						00:00:00
11	李想				0/1				0/1	0.0%		2	1	2	00:30:00	
12	丛霖									0.0%						01:00:21
13	王世杰									0.0%						00:00:00
14	曲文博									0.0%			1			00:13:00
15	杨帆				1/1	1/1			2/2	100%		2		1	01:08:10	
16	郎俊夫									0.0%						00:30:09
17	王勇							0/1	0/1	0.0%						00:30:43
18	董宏斐									0.0%		2				00:06:57
20	谷浩		0/1						0/1	0.0%	1	1				00:22:01
合计		1/8	1/2	1/7	6/7	2/3	2/4	3/6	16/37	43.2%	2	18	3	3		
<i>(守门员)</i>																
12	丛霖	12/13	2/8	2/5	1/2	2/3	0/1	0/1	19/33	57.6%						01:00:21
16	郎俊夫							0/4	0/4	0.0%						00:30:09
合计		12/13	2/8	2/5	1/2	2/3	0/1	0/5	19/37	51.4%						

场上队员：得分/射门

守门员：救球/射门

全队合计	得分	被救	射失	击柱	封球	合计	%
远射	1	3	4			8	12.5%
近射	1		1			2	50.0%
边射	1	3	2	1		7	14.3%
快攻	6		1			7	85.7%
突破	2		1			3	66.7%
任意	2	2				4	50.0%
7M	3	2		1		6	50.0%





第十二届全国运动会男子手球预赛

个人/全队技术统计表

正式表
手球
男子预赛
轮次 5组别 B
场次 20201301020-14-2/2
柳州市李宁体育馆
22/04/2013 16:20

号码	姓名	远射	近射	边射	快攻	突破	任意	7M	合计	%	助攻	失误	警告	2'	取消	时间
上海(上海)																
<i>(上场队员)</i>																
1	张崢									0.0%						00:00:00
2	胡辰									0.0%						00:00:00
3	赵时俊	0/1		2/5	0/1				2/7	28.6%						01:30:00
5	朱世杰									0.0%						00:00:00
6	李和鑫	1/6					0/1	2/2	3/9	33.3%	3	4				01:20:56
8	钱为玮		1/1	1/1					2/2	100%		3				00:48:55
9	朱礼彬	0/4	1/1	0/1		0/2			1/8	12.5%		6		1		00:55:32
10	吴璟	0/1	3/4			1/1		1/1	5/7	71.4%		1	1			01:30:00
12	周哲韬									0.0%						00:00:00
13	孟宇超									0.0%						00:00:00
14	王子阳									0.0%						00:11:05
15	徐俊吉							1/1	1/1	100%						00:30:00
16	朱春雷									0.0%	1					01:30:00
18	马麟晓	0/6	0/2				1/1		1/9	11.1%	1		1			00:56:55
19	蒋承骅	0/1	1/1		1/1			1/1	3/4	75.0%		1	1			00:46:19
20	程云飞									0.0%						00:00:00
合计		1/19	6/9	3/7	1/2	1/3	1/2	5/5	18/47	38.3%	5	15	3	1		
<i>(守门员)</i>																
16	朱春雷	3/4	0/1	3/4	0/6	0/2	2/4	2/5	10/26	38.5%	1					01:30:00
合计																
		3/4	0/1	3/4	0/6	0/2	2/4	2/5	10/26	38.5%	1					

场上队员：得分/射门

守门员：救球/射门

全队合计	得分	被救	射失	击柱	封球	合计	%
远射	1	12	2	1	3	19	5.3%
近射	6	2		1		9	66.7%
边射	3	2		2		7	42.9%
快攻	1	1				2	50.0%
突破	1	2				3	33.3%
任意	1		1			2	50.0%
7M	5					5	100.0%





第十二届全国运动会男子手球预赛

图式射门区域统计

轮次 5 场次 20

201301020-41-1/1

解放军

4 曹作亮	5 吴龙瑞	6 苗青	7 陈昊	8 王烁	9 丁超	10 师龙	11 李想																																																																								
<table border="1"><tr><td></td><td></td><td>1</td></tr><tr><td>2</td><td></td><td>1</td></tr><tr><td></td><td></td><td>1</td></tr></table>			1	2		1			1	<table border="1"><tr><td></td><td></td><td></td></tr><tr><td>2</td><td></td><td></td></tr><tr><td></td><td></td><td>1</td></tr></table>				2					1	<table border="1"><tr><td>1</td><td></td><td></td></tr><tr><td></td><td></td><td></td></tr><tr><td></td><td></td><td></td></tr></table>	1									<table border="1"><tr><td></td><td></td><td></td></tr><tr><td></td><td></td><td></td></tr><tr><td></td><td></td><td></td></tr></table>										<table border="1"><tr><td></td><td></td><td></td></tr><tr><td>1</td><td></td><td>1</td></tr><tr><td></td><td></td><td>1</td></tr></table>				1		1			1	<table border="1"><tr><td></td><td></td><td></td></tr><tr><td></td><td></td><td>1</td></tr><tr><td></td><td></td><td></td></tr></table>						1				<table border="1"><tr><td></td><td></td><td></td></tr><tr><td></td><td></td><td></td></tr><tr><td></td><td></td><td></td></tr></table>										<table border="1"><tr><td></td><td></td><td></td></tr><tr><td></td><td></td><td></td></tr><tr><td></td><td></td><td></td></tr></table>									
		1																																																																													
2		1																																																																													
		1																																																																													
2																																																																															
		1																																																																													
1																																																																															
1		1																																																																													
		1																																																																													
		1																																																																													
Post - 0 Miss - 3 Block - 0	Post - 1 Miss - 1 Block - 0	Post - 0 Miss - 3 Block - 0	Post - 0 Miss - 0 Block - 0	Post - 1 Miss - 0 Block - 0	Post - 0 Miss - 0 Block - 0	Post - 0 Miss - 0 Block - 0	Post - 0 Miss - 1 Block - 0																																																																								
12 丛霖	13 王世杰	14 曲学博	15 杨帆	16 郎俊夫	17 王勇	18 董宏斐	20 谷浩																																																																								
<table border="1"><tr><td></td><td></td><td></td></tr><tr><td></td><td></td><td></td></tr><tr><td></td><td></td><td></td></tr></table>										<table border="1"><tr><td></td><td></td><td></td></tr><tr><td></td><td></td><td></td></tr><tr><td></td><td></td><td></td></tr></table>										<table border="1"><tr><td></td><td></td><td></td></tr><tr><td></td><td></td><td></td></tr><tr><td></td><td></td><td></td></tr></table>										<table border="1"><tr><td></td><td></td><td>1</td></tr><tr><td></td><td></td><td></td></tr><tr><td></td><td></td><td>1</td></tr></table>			1						1	<table border="1"><tr><td></td><td></td><td></td></tr><tr><td></td><td></td><td></td></tr><tr><td></td><td></td><td></td></tr></table>										<table border="1"><tr><td></td><td></td><td></td></tr><tr><td></td><td></td><td></td></tr><tr><td></td><td></td><td></td></tr></table>										<table border="1"><tr><td></td><td></td><td></td></tr><tr><td></td><td></td><td></td></tr><tr><td></td><td></td><td></td></tr></table>										<table border="1"><tr><td></td><td></td><td></td></tr><tr><td></td><td></td><td></td></tr><tr><td></td><td></td><td></td></tr></table>									
		1																																																																													
		1																																																																													
Post - 0 Miss - 0 Block - 0	Post - 0 Miss - 0 Block - 0	Post - 0 Miss - 0 Block - 0	Post - 0 Miss - 0 Block - 0	Post - 0 Miss - 0 Block - 0	Post - 0 Miss - 0 Block - 0	Post - 0 Miss - 0 Block - 0	Post - 0 Miss - 1 Block - 0																																																																								

12 丛霖

1/3	1/2	3/5
4/6	1/1	4/6
3/7	1/1	1/2

16 郎俊夫

0/1		
0/2		
0/1		

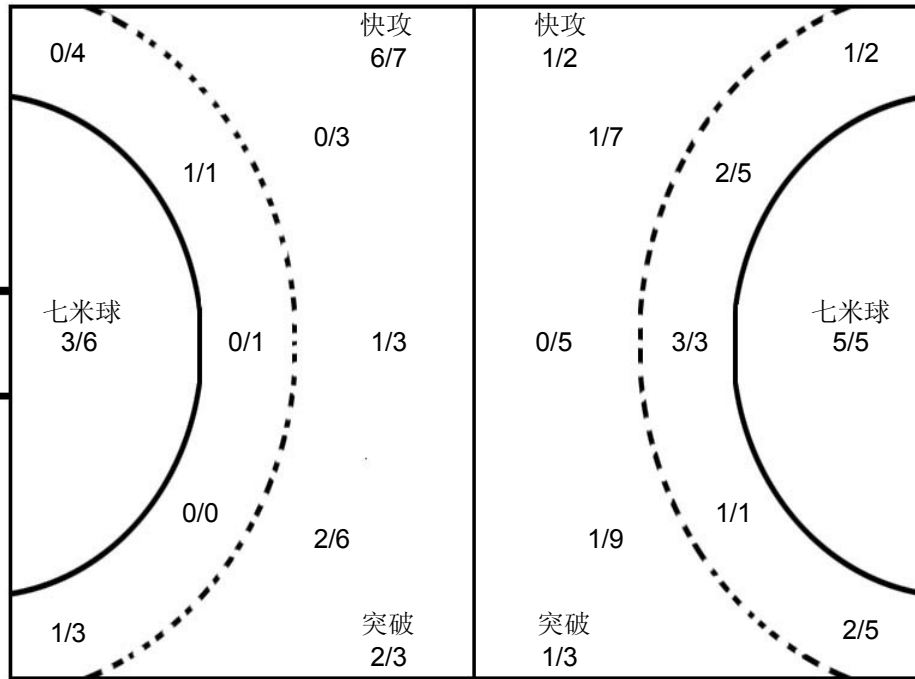

16 朱春雷

2/3	2/2	1/3
1/6	1/1	0/3
2/3	1/1	0/4

上海

1 张峥	2 胡辰	3 赵时俊	5 朱世杰	6 李和鑫	8 钱为玮	9 朱彬彬	10 吴璟																																																																								
<table border="1"><tr><td></td><td></td><td></td></tr><tr><td></td><td></td><td></td></tr><tr><td></td><td></td><td></td></tr></table>										<table border="1"><tr><td></td><td></td><td></td></tr><tr><td></td><td></td><td></td></tr><tr><td></td><td></td><td></td></tr></table>										<table border="1"><tr><td>1</td><td></td><td></td></tr><tr><td>1</td><td></td><td></td></tr><tr><td></td><td></td><td></td></tr></table>	1			1						<table border="1"><tr><td></td><td></td><td></td></tr><tr><td></td><td></td><td></td></tr><tr><td></td><td></td><td></td></tr></table>										<table border="1"><tr><td>1</td><td></td><td></td></tr><tr><td>2</td><td></td><td></td></tr><tr><td></td><td></td><td></td></tr></table>	1			2						<table border="1"><tr><td></td><td></td><td></td></tr><tr><td></td><td></td><td></td></tr><tr><td>1</td><td></td><td>1</td></tr></table>							1		1	<table border="1"><tr><td></td><td></td><td></td></tr><tr><td></td><td></td><td></td></tr><tr><td>1</td><td></td><td></td></tr></table>							1			<table border="1"><tr><td>1</td><td>1</td><td>2</td></tr><tr><td>1</td><td></td><td></td></tr><tr><td></td><td></td><td></td></tr></table>	1	1	2	1					
1																																																																															
1																																																																															
1																																																																															
2																																																																															
1		1																																																																													
1																																																																															
1	1	2																																																																													
1																																																																															
Post - 0 Miss - 0 Block - 0	Post - 0 Miss - 0 Block - 0	Post - 2 Miss - 0 Block - 0	Post - 0 Miss - 0 Block - 0	Post - 0 Miss - 1 Block - 0	Post - 0 Miss - 0 Block - 0	Post - 0 Miss - 1 Block - 1	Post - 1 Miss - 1 Block - 0																																																																								
12 周哲韬	13 孟宇超	14 王子阳	15 徐俊吉	16 朱春雷	18 马麟晓	19 蒋承骅	20 程云飞																																																																								
<table border="1"><tr><td></td><td></td><td></td></tr><tr><td></td><td></td><td></td></tr><tr><td></td><td></td><td></td></tr></table>										<table border="1"><tr><td></td><td></td><td></td></tr><tr><td></td><td></td><td></td></tr><tr><td></td><td></td><td></td></tr></table>										<table border="1"><tr><td></td><td></td><td></td></tr><tr><td></td><td></td><td></td></tr><tr><td></td><td></td><td></td></tr></table>										<table border="1"><tr><td></td><td></td><td></td></tr><tr><td></td><td></td><td></td></tr><tr><td>1</td><td></td><td></td></tr></table>							1			<table border="1"><tr><td></td><td></td><td></td></tr><tr><td></td><td></td><td></td></tr><tr><td></td><td></td><td></td></tr></table>										<table border="1"><tr><td></td><td></td><td></td></tr><tr><td></td><td></td><td></td></tr><tr><td>1</td><td></td><td></td></tr></table>							1			<table border="1"><tr><td></td><td></td><td></td></tr><tr><td></td><td></td><td></td></tr><tr><td>1</td><td></td><td>2</td></tr></table>							1		2	<table border="1"><tr><td></td><td></td><td></td></tr><tr><td></td><td></td><td></td></tr><tr><td></td><td></td><td></td></tr></table>									
1																																																																															
1																																																																															
1		2																																																																													
Post - 0 Miss - 0 Block - 0	Post - 0 Miss - 0 Block - 0	Post - 0 Miss - 0 Block - 0	Post - 0 Miss - 0 Block - 0	Post - 0 Miss - 0 Block - 0	Post - 1 Miss - 0 Block - 2	Post - 0 Miss - 0 Block - 0	Post - 0 Miss - 0 Block - 0																																																																								

注释: Post=击柱 Miss=射失 Block=被封





男子 国内比赛



第十二届全国运动会男子手球预赛

Team A A 天津				Team B B 四川				Match Number 21													
played in China		in the hall 柳州市李宁体育馆		on 22/04/2013		at 18:00 hours		Spectators													
Half-time (30')	A 24	B 12	End of playing time	A 48	B 20	1st extra time	A	B	2nd extra time	A	B	After penalty throws	A	B							
Number of 7 m	A 3 / 4	Team time-out			Full name of players and officials				Team time-out			B 0 / 1	Number of 7 m								
No.	Team A					G	W	2'	D	DR	No.	Team B					G	W	2'	D	DR
1	刘宗其										16	王松									
2	李岳朋										18	杨洋									
3	李军					8					19	杨洁					3				
4	李松浩					7		1			21	池培俊					3				
7	张青					5					22	刘彦坤					3	1			
8	曹悦					6					23	王震					2	1	1		
9	孟凡钢										25	李峥					1				
10	李帅					9					27	于洪泉					4				
11	王毅					3		1			28	宋涛					3				
13	许松					4	1				32	逯明松									
14	田剑侠					1	1				33	朱晓龙									
15	张俊岭										35	仇振勇					1				
16	刘海亮										36	刘琢									
17	周群					3	1														
18	孙永					2															
19	梁堂亮																				
A	尚喜										A	李太平									
B	贾守信										B	李清									
C	刘伟成										C	黄承									
D	冀谦										E	何明阳									
A	Signature of Responsible Official of the Teams (Off. A)										B										
TP	Remarks of Referee / IHFOfficial										TP										

Signatures

Referees	李刚 (CHN)	王科 (CHN)		
Techn. Delegates	李之文 (CHN)	许宜扬 (CHN)		
IHF Official				

Note: Number of 7m Throws Awarded to Team A and B, Goals (G), Warnings (W), Suspensions (2'), Direct Disqualification (D), Disqualification with Report (DR) and Team Penalty (TP).





第十二届全国运动会男子手球预赛
竞赛技术统计(媒体表)

预赛 组别 B 轮次 5 场次 21

柳州市李宁体育馆

22/04/2013

201301021-51-1/1

天津 48 vs 20 四川

24 : 12

裁判员 李刚 (CHN) / 王科 (CHN)

Main statistics table for Tianjin vs Sichuan match, including player performance, team totals, and game progression.

场上队员: 得分 / 射门

守门员: 救球 / 射门

Legend table for abbreviations: 快攻, 警告, 突破, 任意球, 7m球, 助攻, 失误, etc.





第十二届全国运动会男子手球预赛 图式比赛技术统计表

轮次 5

场次 21

201301021-21-1/1

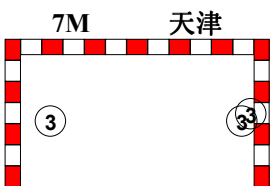
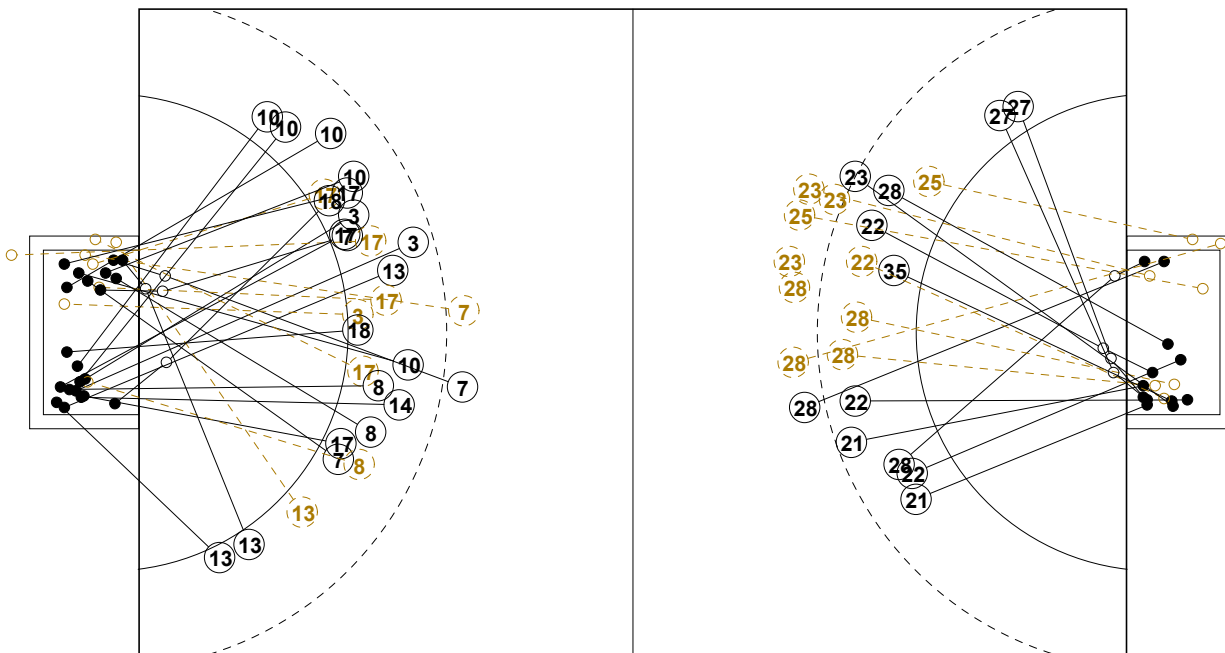

1st Half
24 : 12

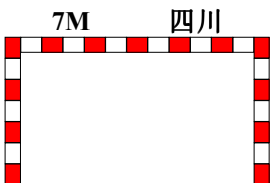
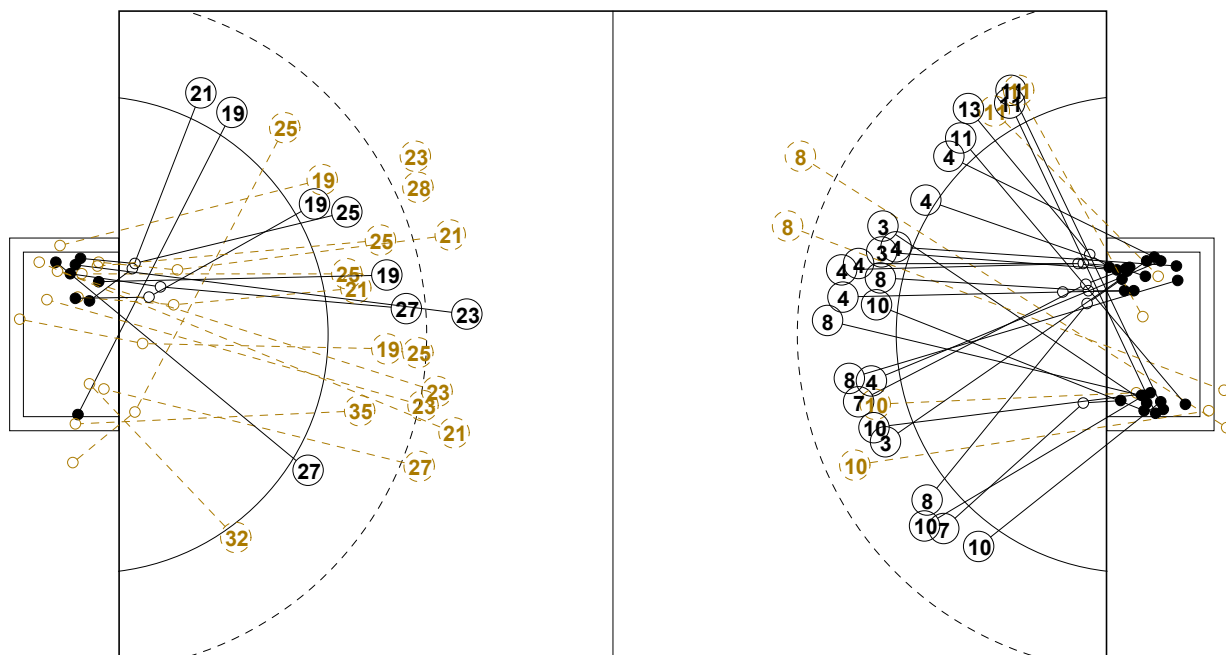
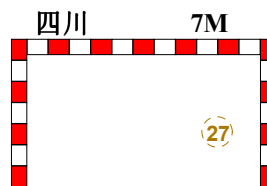

2nd Half
20 : 48

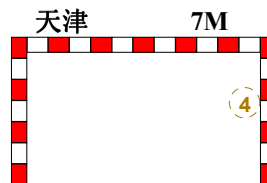



第十二届全国运动会男子手球预赛

个人/全队技术统计表

正式表
手球
男子预赛
轮次 5组别 B
场次 21201301021-14-1/2
柳州市李宁体育馆
22/04/2013 18:00

号码	姓名	远射	近射	边射	快攻	突破	任意	7M	合计	%	助攻	失误	警告	2'	取消	时间
天津(天津)																
<i>(场上队员)</i>																
1	刘宗其									0.0%	2					00:30:00
2	李岳朋									0.0%						00:14:52
3	李军	1/1	1/2		3/3			3/3	8/9	88.9%	3	1				00:50:15
4	李松浩		1/1		6/6			0/1	7/8	87.5%		3		1		00:14:48
7	张青	1/2	2/2			2/2			5/6	83.3%						00:43:06
8	曹悦	0/2			6/7				6/9	66.7%	1	1				00:39:26
9	孟凡钢									0.0%						00:00:00
10	李帅		2/2	2/2	5/7				9/11	81.8%		2				00:57:49
11	王毅			1/3	2/2				3/5	60.0%		1		1		00:21:39
13	许松			3/3	1/2				4/5	80.0%			1			00:36:16
14	田剑侠		1/1						1/1	100%	1		1			00:18:34
15	张俊岭									0.0%						00:00:00
16	刘海亮									0.0%						00:29:58
17	周群		2/3		1/3	0/1			3/7	42.9%		1	1			00:23:28
18	孙永		2/2						2/2	100%		1				00:19:32
19	梁堂亮									0.0%		1				00:07:39
合计		2/5	11/13	6/8	24/30	2/3		3/4	48/63	76.2%	7	11	3	2		
<i>(守门员)</i>																
1	刘宗其	4/6	3/4	1/3	0/2	0/1	1/1		9/17	52.9%	2					00:30:00
16	刘海亮	3/5	2/7	0/1	0/2	0/1	0/1	1/1	6/18	33.3%						00:29:58
合计		7/11	5/11	1/4	0/4	0/2	1/2	1/1	15/35	42.9%	2					

场上队员：得分/射门

守门员：救球/射门

全队合计	得分	被救	射失	击柱	封球	合计	%
远射	2	1	2			5	40.0%
近射	11	2				13	84.6%
边射	6	2				8	75.0%
快攻	24	3	1	2		30	80.0%
突破	2			1		3	66.7%
任意							0.0%
7M	3	1				4	75.0%





第十二届全国运动会男子手球预赛

个人/全队技术统计表

正式表
手球
男子预赛
轮次 5组别 B
场次 21201301021-14-2/2
柳州市李宁体育馆
22/04/2013 18:00

号码	姓名	远射	近射	边射	快攻	突破	任意	7M	合计	%	助攻	失误	警告	2'	取消	时间
四川(四川)																
<i>(上场队员)</i>																
16	王松									0.0%						00:59:58
18	杨洋									0.0%						00:00:00
19	杨洁		1/1	1/1	1/3				3/5	60.0%	1/3	2				00:29:48
21	池培俊	1/3	0/1	1/1	1/1				3/6	50.0%		7				00:52:52
22	刘彦坤		3/4						3/4	75.0%		2	1			00:41:54
23	王震	1/6					1/2		2/8	25.0%		4	1	1		00:43:50
25	李峥	0/2	0/3		1/2				1/7	14.3%		2				00:49:19
27	于洪泉	1/2		1/1	1/1	1/1		0/1	4/6	66.7%		1				00:17:56
28	宋涛	1/5	1/2			1/1			3/8	37.5%	3	7				00:42:12
32	逯明松			0/1					0/1	0.0%		1				00:17:49
33	朱晓龙									0.0%						00:08:34
35	仇振勇		1/1		0/1				1/2	50.0%						00:41:51
36	刘琢									0.0%						00:00:00
合计																
<i>(守门员)</i>																
16	王松	1/3	2/13	2/8	3/27	0/2		1/4	9/57	15.8%						00:59:58
合计																
1/3 2/13 2/8 3/27 0/2 1/4 9/57 15.8%																

场上队员：得分/射门

守门员：救球/射门

全队合计	得分	被救	射失	击柱	封球	合计	%
远射	4	7		1	6	18	22.2%
近射	6	5	1			12	50.0%
边射	3	1				4	75.0%
快攻	4			4		8	50.0%
突破	2					2	100.0%
任意	1	1				2	50.0%
7M		1				1	0.0%





第十二届全国运动会男子手球预赛

图式射门区域统计

轮次 5 场次 21

201301021-41-1/1

天津

1 刘宗其	2 李岳朋	3 李军	4 李松浩	7 张青	8 曹悦	9 孟凡钢	10 李帅																																																																								
<table border="1"><tr><td></td><td></td><td></td></tr><tr><td></td><td></td><td></td></tr><tr><td></td><td></td><td></td></tr></table>										<table border="1"><tr><td></td><td></td><td></td></tr><tr><td></td><td></td><td></td></tr><tr><td></td><td></td><td></td></tr></table>										<table border="1"><tr><td>1</td><td></td><td></td></tr><tr><td>3</td><td></td><td>3</td></tr><tr><td>1</td><td></td><td></td></tr></table>	1			3		3	1			<table border="1"><tr><td>1</td><td></td><td></td></tr><tr><td>3</td><td></td><td></td></tr><tr><td>3</td><td></td><td></td></tr></table>	1			3			3			<table border="1"><tr><td></td><td></td><td></td></tr><tr><td></td><td></td><td>2</td></tr><tr><td>1</td><td></td><td>2</td></tr></table>						2	1		2	<table border="1"><tr><td>2</td><td></td><td></td></tr><tr><td></td><td></td><td>1</td></tr><tr><td>2</td><td></td><td>1</td></tr></table>	2					1	2		1	<table border="1"><tr><td></td><td></td><td></td></tr><tr><td></td><td></td><td></td></tr><tr><td></td><td></td><td></td></tr></table>										<table border="1"><tr><td></td><td></td><td>1</td></tr><tr><td></td><td></td><td>6</td></tr><tr><td>2</td><td></td><td></td></tr></table>			1			6	2		
1																																																																															
3		3																																																																													
1																																																																															
1																																																																															
3																																																																															
3																																																																															
		2																																																																													
1		2																																																																													
2																																																																															
		1																																																																													
2		1																																																																													
		1																																																																													
		6																																																																													
2																																																																															
Post - 0 Miss - 0 Block - 0	Post - 0 Miss - 0 Block - 0	Post - 0 Miss - 0 Block - 0	Post - 0 Miss - 0 Block - 0	Post - 0 Miss - 0 Block - 0	Post - 0 Miss - 2 Block - 0	Post - 0 Miss - 0 Block - 0	Post - 1 Miss - 0 Block - 0																																																																								
11 王毅	13 许松	14 田剑侠	15 张俊岭	16 刘海亮	17 周群	18 孙永	19 梁堂亮																																																																								
<table border="1"><tr><td></td><td></td><td>1</td></tr><tr><td></td><td></td><td>2</td></tr><tr><td></td><td></td><td></td></tr></table>			1			2				<table border="1"><tr><td>2</td><td></td><td></td></tr><tr><td></td><td></td><td></td></tr><tr><td>1</td><td></td><td>1</td></tr></table>	2						1		1	<table border="1"><tr><td></td><td></td><td></td></tr><tr><td>1</td><td></td><td></td></tr><tr><td></td><td></td><td></td></tr></table>				1						<table border="1"><tr><td></td><td></td><td></td></tr><tr><td></td><td></td><td></td></tr><tr><td></td><td></td><td></td></tr></table>										<table border="1"><tr><td></td><td></td><td></td></tr><tr><td></td><td></td><td></td></tr><tr><td></td><td></td><td></td></tr></table>										<table border="1"><tr><td>1</td><td></td><td>1</td></tr><tr><td>1</td><td></td><td></td></tr><tr><td></td><td></td><td></td></tr></table>	1		1	1						<table border="1"><tr><td></td><td>1</td><td></td></tr><tr><td></td><td></td><td></td></tr><tr><td>1</td><td></td><td></td></tr></table>		1					1			<table border="1"><tr><td></td><td></td><td></td></tr><tr><td></td><td></td><td></td></tr><tr><td></td><td></td><td></td></tr></table>									
		1																																																																													
		2																																																																													
2																																																																															
1		1																																																																													
1																																																																															
1		1																																																																													
1																																																																															
	1																																																																														
1																																																																															
Post - 0 Miss - 0 Block - 0	Post - 1 Miss - 0 Block - 0	Post - 0 Miss - 0 Block - 0	Post - 0 Miss - 0 Block - 0	Post - 0 Miss - 0 Block - 0	Post - 1 Miss - 1 Block - 0	Post - 0 Miss - 0 Block - 0	Post - 0 Miss - 0 Block - 0																																																																								

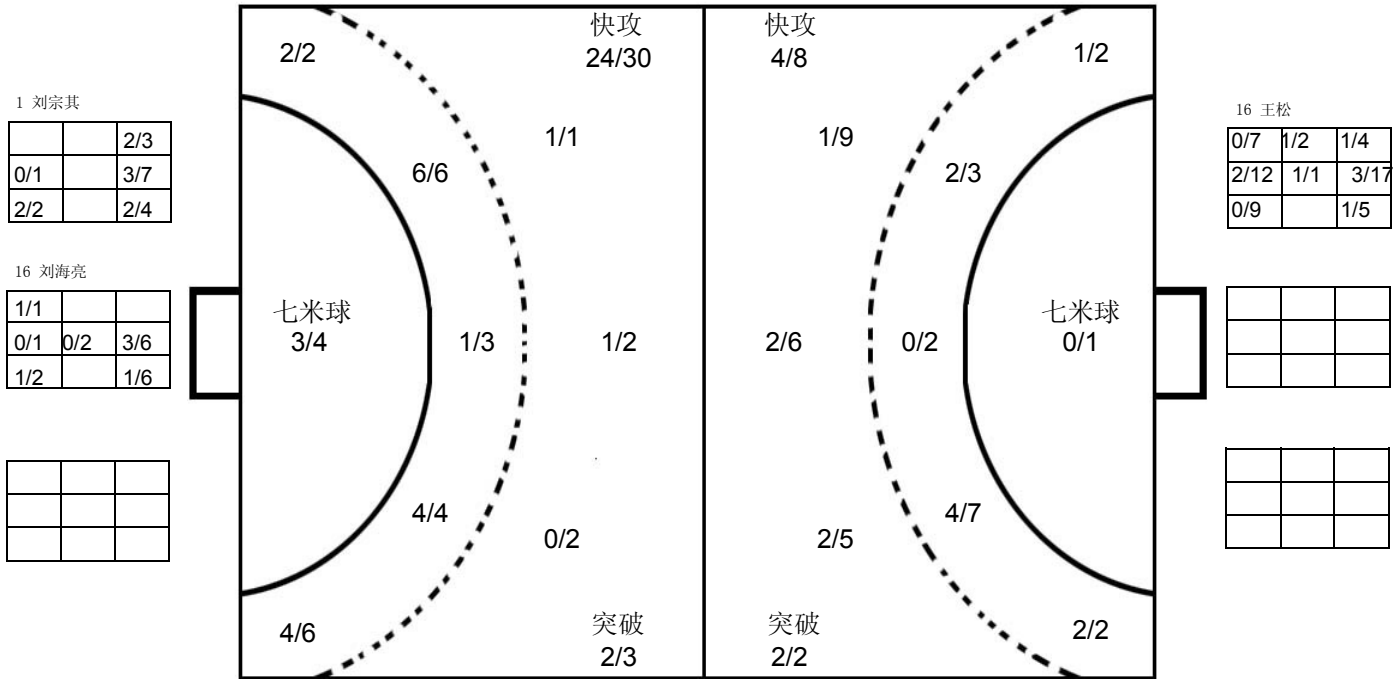

四川

16 王松	18 杨洋	19 杨洁	21 池培俊	22 刘彦坤	23 王震	25 李峥	27 于洪泉																																																																								
<table border="1"><tr><td></td><td></td><td></td></tr><tr><td></td><td></td><td></td></tr><tr><td></td><td></td><td></td></tr></table>										<table border="1"><tr><td></td><td></td><td></td></tr><tr><td></td><td></td><td></td></tr><tr><td></td><td></td><td></td></tr></table>										<table border="1"><tr><td>1</td><td></td><td>1</td></tr><tr><td></td><td></td><td>1</td></tr><tr><td></td><td></td><td></td></tr></table>	1		1			1				<table border="1"><tr><td></td><td></td><td></td></tr><tr><td></td><td></td><td>3</td></tr><tr><td></td><td></td><td></td></tr></table>						3				<table border="1"><tr><td></td><td>1</td><td>1</td></tr><tr><td></td><td></td><td>1</td></tr><tr><td></td><td></td><td></td></tr></table>		1	1			1				<table border="1"><tr><td></td><td></td><td>2</td></tr><tr><td></td><td></td><td></td></tr><tr><td></td><td></td><td></td></tr></table>			2							<table border="1"><tr><td></td><td></td><td>1</td></tr><tr><td></td><td></td><td></td></tr><tr><td></td><td></td><td></td></tr></table>			1							<table border="1"><tr><td></td><td></td><td>1</td></tr><tr><td></td><td></td><td>1</td></tr><tr><td></td><td></td><td>2</td></tr></table>			1			1			2
1		1																																																																													
		1																																																																													
		3																																																																													
	1	1																																																																													
		1																																																																													
		2																																																																													
		1																																																																													
		1																																																																													
		1																																																																													
		2																																																																													
Post - 0 Miss - 0 Block - 0	Post - 0 Miss - 0 Block - 0	Post - 2 Miss - 0 Block - 0	Post - 0 Miss - 0 Block - 0	Post - 0 Miss - 0 Block - 0	Post - 0 Miss - 0 Block - 3	Post - 1 Miss - 1 Block - 1	Post - 0 Miss - 0 Block - 0																																																																								
28 宋涛	32 逯明松	33 朱晓龙	35 仇振勇	36 刘琢																																																																											
<table border="1"><tr><td>1</td><td>1</td><td></td></tr><tr><td>1</td><td></td><td></td></tr><tr><td></td><td></td><td></td></tr></table>	1	1		1						<table border="1"><tr><td></td><td></td><td></td></tr><tr><td></td><td></td><td></td></tr><tr><td></td><td></td><td></td></tr></table>										<table border="1"><tr><td></td><td></td><td></td></tr><tr><td></td><td></td><td></td></tr><tr><td></td><td></td><td></td></tr></table>										<table border="1"><tr><td></td><td></td><td>1</td></tr><tr><td></td><td></td><td></td></tr><tr><td></td><td></td><td></td></tr></table>			1							<table border="1"><tr><td></td><td></td><td></td></tr><tr><td></td><td></td><td></td></tr><tr><td></td><td></td><td></td></tr></table>										<table border="1"><tr><td></td><td></td><td></td></tr><tr><td></td><td></td><td></td></tr><tr><td></td><td></td><td></td></tr></table>										<table border="1"><tr><td></td><td></td><td></td></tr><tr><td></td><td></td><td></td></tr><tr><td></td><td></td><td></td></tr></table>										<table border="1"><tr><td></td><td></td><td></td></tr><tr><td></td><td></td><td></td></tr><tr><td></td><td></td><td></td></tr></table>									
1	1																																																																														
1																																																																															
		1																																																																													
Post - 1 Miss - 0 Block - 2	Post - 0 Miss - 0 Block - 0	Post - 0 Miss - 0 Block - 0	Post - 1 Miss - 0 Block - 0	Post - 0 Miss - 0 Block - 0																																																																											

注释: Post=击柱 Miss=射失 Block=被封





男子 国内比赛



第十二届全国运动会男子手球预赛

Team A										Team B										Match Number											
A 澳门										B 安徽										22											
played in China										in the hall 柳州市李宁体育馆										on 23/04/2013		at 13:00 hours		Spectators							
Half-time (30')		A 10		B 21		End of playing time		A 21		B 44		1st extra time		A		B		2nd extra time		A		B		After penalty throws		A		B			
Number of 7 m		A 3/6		Team time-out			Full name of players and officials										Team time-out			B 2/2		Number of 7 m									
		1 11:47			2			3													1			2		3					
Team A										Team B																					
No.											G	W	2	D	DR	No.											G	W	2	D	DR
2	李翹臻												1			1	高逸凡														
4	刘家声															2	周兰骏										10	1			
5	何建成															5	马鹏										3		1		
15	黄俊勇															6	田耕												1		
16	冯国政															7	姚雄敏														
18	卓伟杰															8	董智景										5				
21	麦锦聪										1					10	陈强龙										2	1			
22	陈学敏												1			11	黎涛										4		1		
24	刘登宇										3					12	曾献辰														
27	徐展业										5	1				15	邵青										2				
28	莫家进										5	1				17	解维维										2				
29	叶响俊										3					18	郭赛														
33	欧永健										2					28	袁龙										3		1		
36	陈嘉聪															29	顾先亮										7	1			
81	梁梓康										2					32	王超										4				
93	罗咪高											1	1			33	曹振吉										2				
A	卢永明															A	王来黔														
B	高光明															B	刘晓蓓														
C	黄宇豪															C	高恒勤														
A										Signature of Responsible Official of the Teams (Off. A)										B											
TP	Remarks of Referee / IHFOfficial																				TP										

Signatures

Referees	姜涛 (CHN)	徐健 (CHN)		
Techn. Delegates	李之文 (CHN)	王锡祯 (CHN)		
IHF Official				

Note: Number of 7m Throws Awarded to Team A and B, Goals (G), Warnings (W), Suspensions (2), Direct Disqualification (D), Disqualification with Report (DR) and Team Penalty (TP).

Table Officials:

Statisticians: 黄莉

朱伟平





第十二届全国运动会男子手球预赛
竞赛技术统计(媒体表)

预赛 组别 A 轮次 6 场次 22

柳州市李宁体育馆

23/04/2013

201301022-51-1/1

澳门 21 vs 44 安徽 10:21

裁判员 姜涛 (CHN) / 徐健 (CHN)

Main statistics table with columns for players, goals (远, 近, 边, 快, 突, 任意, 7m), assists, errors, warnings, and suspensions for both teams.

场上队员: 得分 / 射门

守门员: 救球 / 射门

Legend table for abbreviations: 快攻 (Fast Break), 突破 (Breakthrough), 任意球 (Free Throw), 7m球 (7M Throw), 助攻 (Assist), 警告 (Warning), 失误 (Error), 2' (Suspension), D (取消资格 - Disqualification), DR (取消资格+报告 - Disqualification+Report)





第十二届全国运动会男子手球预赛 图式比赛技术统计表

轮次 6

场次 22

201301022-21-1/1

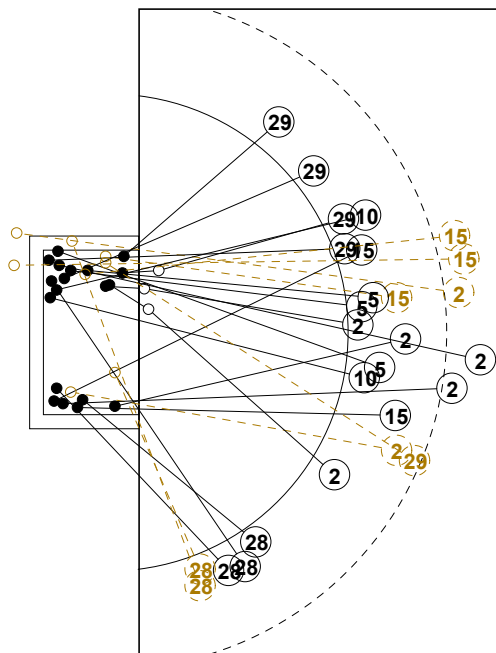

7M 安徽

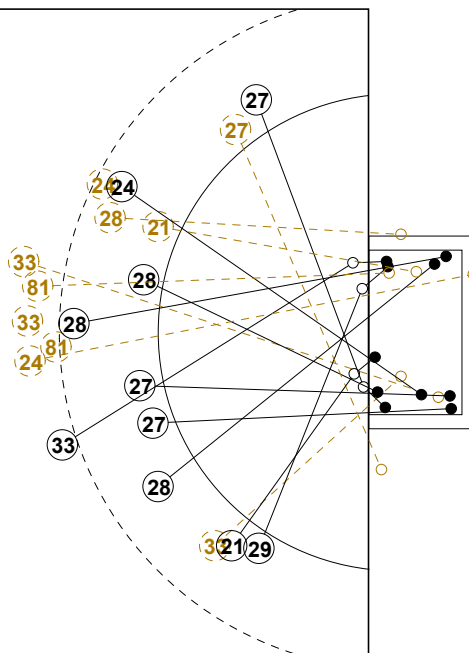
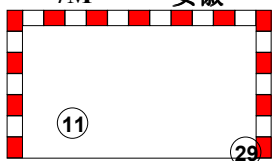

澳门 7M

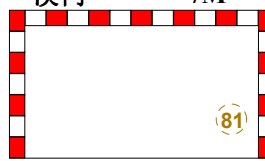

1st Half
21 : 10

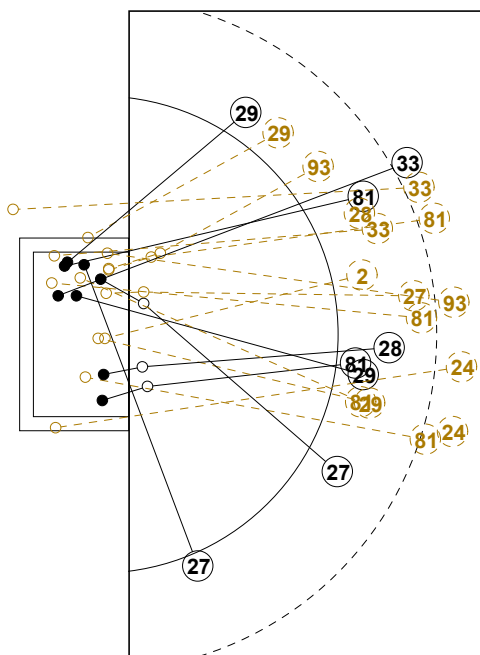

7M 澳门

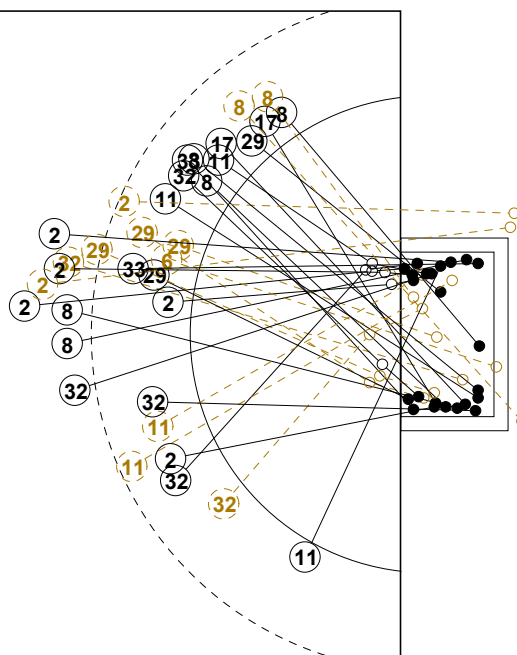
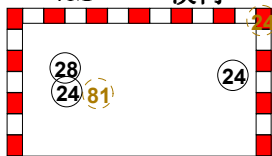

安徽 7M

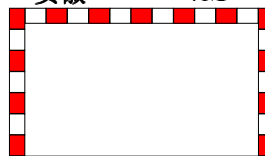

2nd Half
21 : 44



第十二届全国运动会男子手球预赛

个人/全队技术统计表

正式表
手球
男子预赛
轮次 6组别 A
场次 22201301022-14-1/2
柳州市李宁体育馆
23/04/2013 13:00

号码	姓名	远射	近射	边射	快攻	突破	任意	7M	合计	%	助攻	失误	警告	2'	取消	时间
澳门(澳门)																
<i>(场上队员)</i>																
2	李翹臻				0/1				0/1	0.0%		1		1		00:23:15
4	刘家声									0.0%						00:00:00
5	何建成									0.0%		3				00:20:21
15	黄俊勇									0.0%						00:00:00
16	冯国政									0.0%						00:02:29
18	卓伟杰									0.0%						00:00:00
21	麦锦聪				1/1	0/1			1/2	50.0%		1				00:21:26
22	陈学敏									0.0%		1		1		00:05:23
24	刘登宇	0/3			1/1		0/1	2/3	3/8	37.5%		8				00:37:09
27	徐展业			2/2	0/1	3/3	0/1		5/7	71.4%		1	1			00:59:55
28	莫家进		1/2		1/1	2/3		1/1	5/7	71.4%		3	1			00:53:40
29	叶响俊		1/1	0/1	2/2	0/1			3/5	60.0%		1				00:38:22
33	欧永健	1/3		0/1	0/1	0/1	1/1		2/7	28.6%	1	3				00:41:07
36	陈嘉聪									0.0%						00:57:31
81	梁梓康	0/5	1/1		1/1		0/1	0/2	2/10	20.0%		2				00:43:32
93	罗咪高	0/1				0/1			0/2	0.0%		1	1	1		00:14:12
合计		1/12	3/4	2/4	6/9	5/10	1/4	3/6	21/49	42.9%	1	25	3	3		
<i>(守门员)</i>																
16	冯国政					1/1		0/1	1/2	50.0%						00:02:29
36	陈嘉聪	2/8	0/5	2/9	5/19	3/12	0/1	0/1	12/55	21.8%						00:57:31
合计		2/8	0/5	2/9	5/19	4/13	0/1	0/2	13/57	22.8%						

场上队员：得分/射门

守门员：救球/射门

全队合计	得分	被救	射失	击柱	封球	合计	%
远射	1	6		1	4	12	8.3%
近射	3				1	4	75.0%
边射	2	1		1		4	50.0%
快攻	6	1	2			9	66.7%
突破	5	4		1		10	50.0%
任意	1	2		1		4	25.0%
7M	3	2		1		6	50.0%





第十二届全国运动会男子手球预赛

个人/全队技术统计表

正式表
手球
男子预赛
轮次 6组别 A
场次 22201301022-14-2/2
柳州市李宁体育馆
23/04/2013 13:00

号码	姓名	远射	近射	边射	快攻	突破	任意	7M	合计	%	助攻	失误	警告	2'	取消	时间
安徽(安徽)																
<i>(上场队员)</i>																
1	高逸凡									0.0%	2					00:35:21
2	周兰骏	3/4	3/3		2/4	1/2	1/1		10/14	71.4%	1	3	1			00:49:08
5	马鹏				1/1	2/2			3/3	100%	2	3		1		00:32:19
6	田耕				0/1				0/1	0.0%				1		00:13:43
7	姚雄敏									0.0%						00:00:00
8	董智景	2/2		0/1	2/2	1/2			5/7	71.4%	1					00:28:12
10	陈强龙				2/2				2/2	100%		2	1			00:30:00
11	黎涛	0/1		1/1	0/1	2/2		1/1	4/6	66.7%		1		1		00:30:00
12	曾献辰									0.0%						00:24:39
15	邵青	0/1			1/3	1/1			2/5	40.0%						00:30:00
17	解维维		1/1	1/1					2/2	100%						00:10:51
18	郭赛									0.0%						00:07:26
28	袁龙			3/5					3/5	60.0%		2		1		00:30:00
29	顾先亮			2/2	4/5	0/3		1/1	7/11	63.6%		1	1			00:40:24
32	王超	1/2	1/1		1/2	1/1			4/6	66.7%	2	2				00:30:00
33	曹振吉				1/1	1/1			2/2	100%		2				00:27:30
合计		6/10	5/5	7/10	14/22	9/14	1/1	2/2	44/64	68.8%	8	16	3	4		
<i>(守门员)</i>																
1	高逸凡	4/5	0/2	1/2	1/4	3/5	2/3	0/2	11/23	47.8%	2					00:35:21
12	曾献辰	2/2	0/1	0/1	0/3	1/4		2/3	5/14	35.7%						00:24:39
合计		6/7	0/3	1/3	1/7	4/9	2/3	2/5	16/37	43.2%	2					

场上队员：得分/射门

守门员：救球/射门

全队合计	得分	被救	射失	击柱	封球	合计	%
远射	6	2	2			10	60.0%
近射	5					5	100.0%
边射	7	2		1		10	70.0%
快攻	14	5	2	1		22	63.6%
突破	9	4	1			14	64.3%
任意	1					1	100.0%
7M	2					2	100.0%





第十二届全国运动会男子手球预赛

图式射门区域统计

轮次 6 场次 22

201301022-41-1/1

澳门

2 李翹臻	4 刘家声	5 何建成	15 黄俊勇	16 冯国政	18 卓伟杰	21 麦锦聪	22 陈学敏																																																																								
<table border="1"><tr><td></td><td></td><td></td></tr><tr><td></td><td></td><td></td></tr><tr><td></td><td></td><td></td></tr></table>										<table border="1"><tr><td></td><td></td><td></td></tr><tr><td></td><td></td><td></td></tr><tr><td></td><td></td><td></td></tr></table>										<table border="1"><tr><td></td><td></td><td></td></tr><tr><td></td><td></td><td></td></tr><tr><td></td><td></td><td></td></tr></table>										<table border="1"><tr><td></td><td></td><td></td></tr><tr><td></td><td></td><td></td></tr><tr><td></td><td></td><td></td></tr></table>										<table border="1"><tr><td></td><td></td><td></td></tr><tr><td></td><td></td><td></td></tr><tr><td></td><td></td><td></td></tr></table>										<table border="1"><tr><td></td><td></td><td></td></tr><tr><td></td><td></td><td></td></tr><tr><td></td><td></td><td></td></tr></table>										<table border="1"><tr><td></td><td></td><td></td></tr><tr><td></td><td></td><td></td></tr><tr><td></td><td>1</td><td></td></tr></table>								1		<table border="1"><tr><td></td><td></td><td></td></tr><tr><td></td><td></td><td></td></tr><tr><td></td><td></td><td></td></tr></table>									
	1																																																																														
Post - 0 Miss - 0 Block - 0	Post - 0 Miss - 0 Block - 0	Post - 0 Miss - 0 Block - 0	Post - 0 Miss - 0 Block - 0	Post - 0 Miss - 0 Block - 0	Post - 0 Miss - 0 Block - 0	Post - 0 Miss - 0 Block - 0	Post - 0 Miss - 0 Block - 0																																																																								
24 刘登宇	27 徐展业	28 莫家进	29 叶响俊	33 欧永健	36 陈嘉聪	81 梁梓康	93 罗咪高																																																																								
<table border="1"><tr><td></td><td></td><td>1</td></tr><tr><td>1</td><td></td><td>1</td></tr><tr><td></td><td></td><td></td></tr></table>			1	1		1				<table border="1"><tr><td></td><td></td><td>2</td></tr><tr><td></td><td></td><td>1</td></tr><tr><td></td><td></td><td>2</td></tr></table>			2			1			2	<table border="1"><tr><td>3</td><td></td><td></td></tr><tr><td></td><td></td><td></td></tr><tr><td>1</td><td></td><td>1</td></tr></table>	3						1		1	<table border="1"><tr><td></td><td></td><td></td></tr><tr><td></td><td></td><td>2</td></tr><tr><td>1</td><td></td><td></td></tr></table>						2	1			<table border="1"><tr><td></td><td></td><td>1</td></tr><tr><td></td><td></td><td></td></tr><tr><td>1</td><td></td><td></td></tr></table>			1				1			<table border="1"><tr><td></td><td></td><td></td></tr><tr><td></td><td></td><td></td></tr><tr><td></td><td></td><td></td></tr></table>										<table border="1"><tr><td></td><td></td><td>1</td></tr><tr><td></td><td></td><td></td></tr><tr><td>1</td><td></td><td></td></tr></table>			1				1			<table border="1"><tr><td></td><td></td><td></td></tr><tr><td></td><td></td><td></td></tr><tr><td></td><td></td><td></td></tr></table>									
		1																																																																													
1		1																																																																													
		2																																																																													
		1																																																																													
		2																																																																													
3																																																																															
1		1																																																																													
		2																																																																													
1																																																																															
		1																																																																													
1																																																																															
		1																																																																													
1																																																																															
Post - 3 Miss - 0 Block - 2	Post - 0 Miss - 1 Block - 0	Post - 1 Miss - 0 Block - 1	Post - 1 Miss - 0 Block - 0	Post - 0 Miss - 1 Block - 1	Post - 0 Miss - 0 Block - 0	Post - 0 Miss - 0 Block - 1	Post - 0 Miss - 0 Block - 0																																																																								

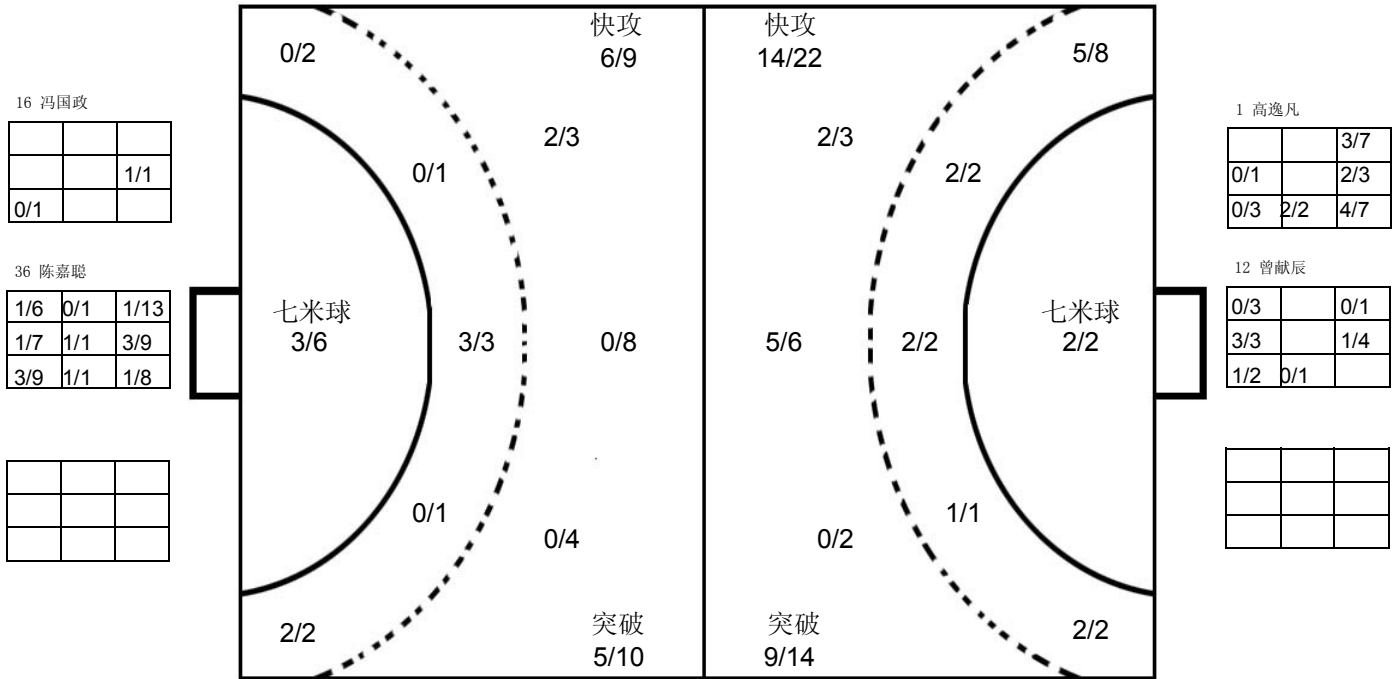

安徽

1 高逸凡	2 周兰骏	5 马鹏	6 田耕	7 姚雄敏	8 董智景	10 陈强龙	11 黎涛																																																																								
<table border="1"><tr><td></td><td></td><td></td></tr><tr><td></td><td></td><td></td></tr><tr><td></td><td></td><td></td></tr></table>										<table border="1"><tr><td>1</td><td></td><td>1</td></tr><tr><td>1</td><td></td><td>2</td></tr><tr><td>4</td><td></td><td>1</td></tr></table>	1		1	1		2	4		1	<table border="1"><tr><td></td><td></td><td>2</td></tr><tr><td></td><td></td><td>1</td></tr><tr><td></td><td></td><td></td></tr></table>			2			1				<table border="1"><tr><td></td><td></td><td></td></tr><tr><td></td><td></td><td></td></tr><tr><td></td><td></td><td></td></tr></table>										<table border="1"><tr><td></td><td></td><td></td></tr><tr><td></td><td></td><td></td></tr><tr><td></td><td></td><td></td></tr></table>										<table border="1"><tr><td>1</td><td>1</td><td>1</td></tr><tr><td></td><td></td><td>2</td></tr><tr><td></td><td></td><td></td></tr></table>	1	1	1			2				<table border="1"><tr><td></td><td></td><td>2</td></tr><tr><td></td><td></td><td></td></tr><tr><td></td><td></td><td></td></tr></table>			2							<table border="1"><tr><td></td><td></td><td>1</td></tr><tr><td></td><td></td><td></td></tr><tr><td>1</td><td></td><td></td></tr></table>			1				1		
1		1																																																																													
1		2																																																																													
4		1																																																																													
		2																																																																													
		1																																																																													
1	1	1																																																																													
		2																																																																													
		2																																																																													
		1																																																																													
1																																																																															
Post - 0 Miss - 0 Block - 0	Post - 0 Miss - 3 Block - 0	Post - 0 Miss - 0 Block - 0	Post - 1 Miss - 0 Block - 0	Post - 0 Miss - 0 Block - 0	Post - 0 Miss - 1 Block - 0	Post - 0 Miss - 0 Block - 0	Post - 0 Miss - 0 Block - 0																																																																								
12 曾献辰	15 邵青	17 解维维	18 郭赛	28 袁龙	29 顾先亮	32 王超	33 曹振吉																																																																								
<table border="1"><tr><td></td><td></td><td></td></tr><tr><td></td><td></td><td></td></tr><tr><td></td><td></td><td></td></tr></table>										<table border="1"><tr><td>1</td><td></td><td></td></tr><tr><td>1</td><td></td><td></td></tr><tr><td></td><td></td><td></td></tr></table>	1			1						<table border="1"><tr><td></td><td></td><td>1</td></tr><tr><td></td><td></td><td>1</td></tr><tr><td></td><td></td><td></td></tr></table>			1			1				<table border="1"><tr><td></td><td></td><td></td></tr><tr><td></td><td></td><td></td></tr><tr><td></td><td></td><td></td></tr></table>										<table border="1"><tr><td>1</td><td></td><td>1</td></tr><tr><td>1</td><td></td><td></td></tr><tr><td></td><td></td><td></td></tr></table>	1		1	1						<table border="1"><tr><td></td><td></td><td>2</td></tr><tr><td>1</td><td></td><td></td></tr><tr><td></td><td></td><td>4</td></tr></table>			2	1					4	<table border="1"><tr><td></td><td></td><td>1</td></tr><tr><td>1</td><td></td><td></td></tr><tr><td>1</td><td></td><td>1</td></tr></table>			1	1			1		1	<table border="1"><tr><td>1</td><td></td><td></td></tr><tr><td></td><td></td><td></td></tr><tr><td></td><td></td><td>1</td></tr></table>	1								1
1																																																																															
1																																																																															
		1																																																																													
		1																																																																													
1		1																																																																													
1																																																																															
		2																																																																													
1																																																																															
		4																																																																													
		1																																																																													
1																																																																															
1		1																																																																													
1																																																																															
		1																																																																													
Post - 0 Miss - 0 Block - 0	Post - 0 Miss - 1 Block - 0	Post - 0 Miss - 0 Block - 0	Post - 0 Miss - 0 Block - 0	Post - 1 Miss - 0 Block - 0	Post - 0 Miss - 0 Block - 0	Post - 0 Miss - 0 Block - 0	Post - 0 Miss - 0 Block - 0																																																																								

注释: Post=击柱 Miss=射失 Block=被封





男子 国内比赛



第十二届全国运动会男子手球预赛

Team A A 香港										Team B B 北京										Match Number 23									
played in China					in the hall 柳州市李宁体育馆					on 23/04/2013		at 14:40 hours		Spectators															
Half-time (30')		A 15		B 18		End of playing time		A 29		B 33		1st extra time		A		B		2nd extra time		A		B		After penalty throws		A		B	
Number of 7 m		A 1/2		Team time-out			Full name of players and officials										Team time-out			B 2/2		Number of 7 m							
		1	2	3	19:53	46:57																							
No.	Team A								G	W	2'	D	DR	No.	Team B								G	W	2'	D	DR		
1	萧智庭													1	王浣														
2	叶冠英													2	杜龙飞														
5	黄胜业								2					4	成亚														
6	谢伟希								6	1				5	杨昆														
7	许文邦								7					6	刘伟								5						
8	何伟杰													7	胡瀛								2						
9	张建国								3	1	1			8	王鹏								1	1	2				
10	陈国兴													9	刘振								1						
11	陈允文													11	蒋维一								3	1					
12	叶冠雄								2					13	白洁								5	1					
13	叶仕仁								2					14	解建飞								2						
14	李鑫豪								1					16	孟辉														
15	黄嘉愉								1	1				17	姜冰峰								3						
25	曾铭谦								3		1			18	张骥								5						
29	练明辉								2					20	郑永利								3						
														23	冯宁								3		1				
A	陈广裕													A	郑康旭														
B	杨开将													B	蔡建国														
D	张军													C	吴健														
														D	石锋														
A	Signature of Responsible Official of the Teams (Off. A)										B																		
TP	Remarks of Referee / CHA Official																										TP		

Signatures

Referees	Andreas Bethmann	Michael Tzaferopoulos		
Techn. Delegates	李之文 (CHN)	王锡祯 (CHN)		
CHA Official				

Note: Number of 7m Throws Awarded to Team A and B, Goals (G), Warnings (W), Suspensions (2), Direct Disqualification (D), Disqualification with Report (DR) and Team Penalty (TP).

Table Officials:

Statisticians: 黄莉

朱伟平





第十二届全国运动会男子手球预赛
竞赛技术统计(媒体表)

Table with match details: 预赛, 组别 A, 轮次 6, 场次 23

柳州市李宁体育馆

23/04/2013

201301023-51-1/1

Table with team names: 香港 vs 北京, score 29 vs 33, and final score 15:18

Table with referees: 裁判员 Andreas Bethmann (GRE) / Michael Tzaferopoulos (GRE)

Main statistics table for Hong Kong team, including player names, goals, assists, and percentages.

Main statistics table for Beijing team, including player names, goals, assists, and percentages.

Summary table for on-court players and goalkeepers, including fast break, breakthrough, and free throw statistics.



第十二届全国运动会男子手球预赛 图式比赛技术统计表

轮次 6

场次 23

201301023-21-1/1

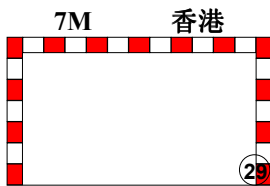
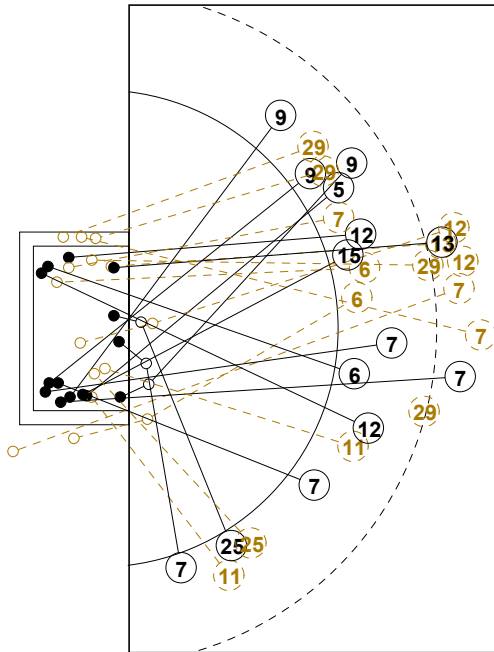

1st Half
15 : 18

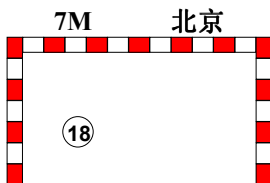
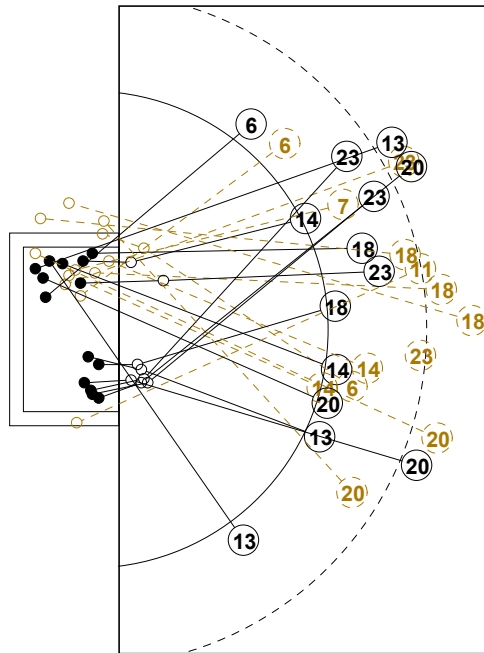
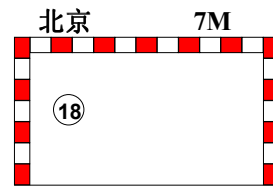
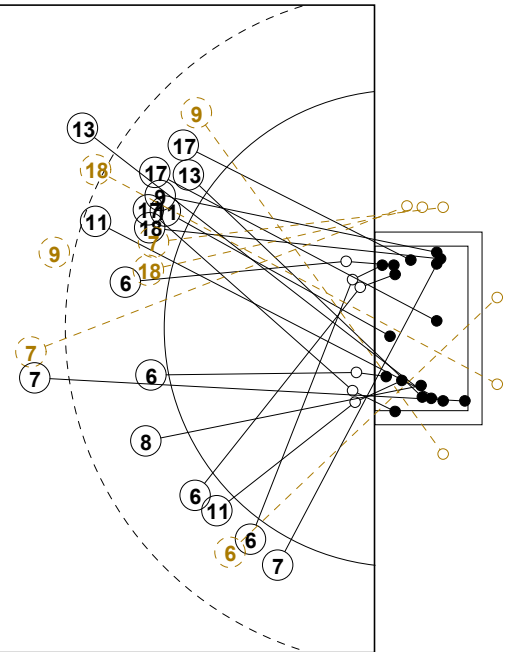

2nd Half
33 : 29

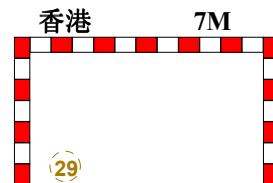
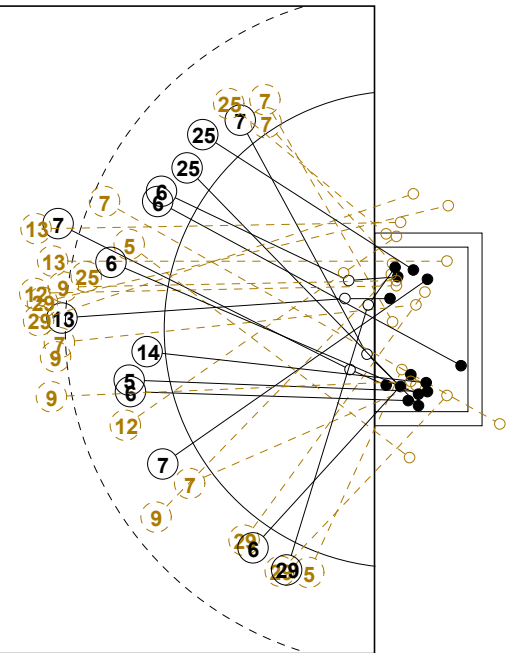



第十二届全国运动会男子手球预赛

个人/全队技术统计表

正式表
手球
男子预赛
轮次 6组别 A
场次 23201301023-14-1/2
柳州市李宁体育馆
23/04/2013 14:40

号码	姓名	远射	近射	边射	快攻	突破	任意	7M	合计	%	助攻	失误	警告	2'	取消	时间
香港(香港)																
<i>(场上队员)</i>																
1	萧智庭									0.0%						00:23:19
2	叶冠英									0.0%	4	1				00:36:41
5	黄胜业			0/1	2/3				2/4	50.0%		1				00:49:36
6	谢伟希		1/2		5/6				6/8	75.0%		1	1			00:29:00
7	许文邦	1/5	0/1	1/2	3/4	1/2	1/1		7/15	46.7%		3				00:28:21
8	何伟杰									0.0%						00:00:00
9	张建国	0/3			1/1	2/3			3/7	42.9%		1	1	1		00:43:15
10	陈国兴									0.0%						00:00:00
11	陈允文				0/1	0/1			0/2	0.0%		1				00:33:00
12	叶冠雄	0/2			1/3	1/1			2/6	33.3%		2				00:34:31
13	叶仕仁	2/5							2/5	40.0%	4	6				00:37:44
14	李鑫豪				1/1				1/1	100%						00:29:49
15	黄嘉愉		1/1						1/1	100%			1			00:10:46
25	曾铭谦			1/3	2/3				3/6	50.0%				1		00:32:38
29	练明辉	0/3		0/1	1/3	0/2		1/2	2/11	18.2%		2				00:29:43
合计		3/18	2/4	2/7	16/25	4/9	1/1	1/2	29/66	43.9%	8	18	3	2		
<i>(守门员)</i>																
1	萧智庭	1/3	1/3	0/2	0/3	0/3	0/1		2/15	13.3%						00:23:19
2	叶冠英	2/6	2/5	0/1	1/8	0/2	0/1	0/2	5/25	20.0%	4	1				00:36:41
合计		3/9	3/8	0/3	1/11	0/5	0/2	0/2	7/40	17.5%	4	1				

场上队员：得分/射门

守门员：救球/射门

全队合计	得分	被救	射失	击柱	封球	合计	%
远射	3	7	5	1	2	18	16.7%
近射	2	1	1			4	50.0%
边射	2	4		1		7	28.6%
快攻	16	5	1	1	2	25	64.0%
突破	4	3		2		9	44.4%
任意	1					1	100.0%
7M	1	1				2	50.0%





第十二届全国运动会男子手球预赛

个人/全队技术统计表

正式表
手球
男子预赛
轮次 6组别 A
场次 23201301023-14-2/2
柳州市李宁体育馆
23/04/2013 14:40

号码	姓名	远射	近射	边射	快攻	突破	任意	7M	合计	%	助攻	失误	警告	2'	取消	时间
北京(北京)																
<i>(上场队员)</i>																
1	王澍									0.0%						00:00:00
2	杜龙飞									0.0%						00:00:00
4	成亚									0.0%		1				00:13:03
5	杨昆									0.0%	1					00:13:43
6	刘伟		0/1	1/2	4/4	0/1			5/8	62.5%	1	3				00:46:55
7	胡瀛	1/1	0/1	1/1	0/2				2/5	40.0%		1				00:42:43
8	王鹏					1/1			1/1	100%			1	2		00:20:18
9	刘振	0/1	1/1			0/1			1/3	33.3%		1				00:20:31
11	蒋维一	1/2			2/2				3/4	75.0%	1	1	1			00:31:00
13	白洁	1/1		1/1		1/1	2/2		5/5	100%		3	1			00:30:09
14	解建飞		2/4						2/4	50.0%						00:25:05
16	孟辉									0.0%	3					01:00:00
17	姜冰峰				3/3				3/3	100%	1	4				00:46:12
18	张骥	0/4	0/1		1/1	2/2		2/2	5/10	50.0%		3				00:26:32
20	郑永利	2/4	1/1						3/5	60.0%	1	2				00:19:52
23	冯宁	1/3	1/1			1/1			3/5	60.0%				1		00:22:44
合计		6/16	5/10	3/4	10/12	5/7	2/2	2/2	33/53	62.3%	8	19	3	3		
<i>(守门员)</i>																
16	孟辉	7/10	1/3	4/6	5/21	3/7	0/1	1/2	21/50	42.0%	3					01:00:00
合计		7/10	1/3	4/6	5/21	3/7	0/1	1/2	21/50	42.0%	3					

场上队员：得分/射门

守门员：救球/射门

全队合计	得分	被救	射失	击柱	封球	合计	%
远射	6	3	4	1	2	16	37.5%
近射	5	3	2			10	50.0%
边射	3		1			4	75.0%
快攻	10	1	1			12	83.3%
突破	5		1	1		7	71.4%
任意	2					2	100.0%
7M	2					2	100.0%





第十二届全国运动会男子手球预赛

图式射门区域统计

轮次 6 场次 23

201301023-41-1/1

香港

Table with 16 columns representing players (1-16) and 3 rows for statistics. Includes post, miss, and block counts for each player.

Player 1 statistics table

Player 2 statistics table

Empty statistics table

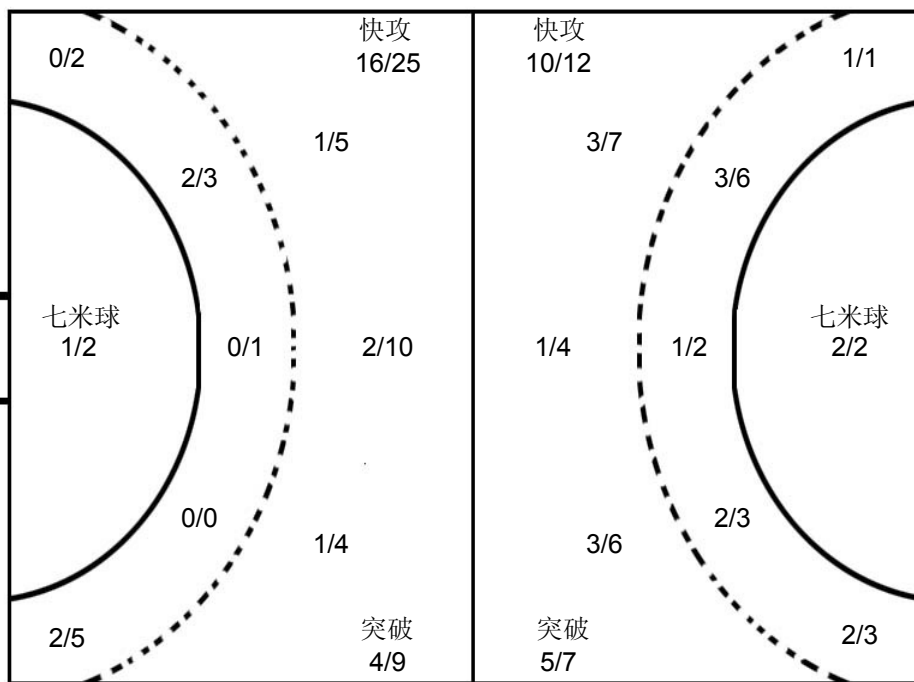

Player 16 statistics table

Empty statistics table

Empty statistics table

北京

Table with 16 columns representing players (1-16) and 3 rows for statistics. Includes post, miss, and block counts for each player.

注释: Post=击柱 Miss=射失 Block=被封





男子 国内比赛



第十二届全国运动会男子手球预赛

Team A										Team B										Match Number											
A 西藏										B 山东										24											
played in					in the hall					on					at					Spectators											
China					柳州市李宁体育馆					23/04/2013					16:20 hours																
Half-time (30')		A		B		End of playing time		A		B		1st extra time		A		B		2nd extra time		A		B		After penalty throws		A		B			
		8		12				15		31																					
Number of 7 m		A		Team time-out			Full name of players and officials										Team time-out			B		Number of 7 m									
0/0				1	2	3											1	2	3	0/0											
				05:19	39:37												50:58														
No.	Team A										G	W	2'	D	DR	No.	Team B										G	W	2'	D	DR
2	王龙															1	于性哲														
4	张家纬															4	田瑞										3				
5	冯祥龙															5	潘翔										1	1		1	
6	任启双											1	1			6	李朝鹏										3				
7	徐奕飞											1				8	王炳华										4				
9	王博															9	赵鑫										7				
10	刘江															11	宋朋强										1	1	2		
11	朱治宇															13	刘晓										1				
12	张帅															15	陈鹏波										1				
15	刘劲松															16	王帅														
16	徐畅															17	王旭东											1			
18	赵楠										3		1			18	于亚男										2				
19	任野															19	李语庆										3				
20	顾艳超										3					20	杜在超										2				
21	马光										4					21	翟乾坤										3				
23	王伟强										5					22	刘正松														
A	张文韬															A	王鸿斌														
B	殷永军															B	王志峰														
C	瓮勇															C	邢建刚														
																D	徐强														
A											Signature of Responsible Official of the Teams (Off. A)																				B
TP	Remarks of Referee / CHA Official																														TP

Signatures

Referees	朱昆宏 (CHN)	刘建鹏 (CHN)		
Techn. Delegates	王锡祯 (CHN)	刘书勇 (CHN)		
CHA Official				

Note: Number of 7m Throws Awarded to Team A and B, Goals (G), Warnings (W), Suspensions (2), Direct Disqualification (D), Disqualification with Report (DR) and Team Penalty (TP).

Table Officials:

Statisticians: 黄莉

朱伟平

Printed by PHMS Copyright: IHF / CHA 23/04/2013 17:40:53

Longman Sportsoft



handball@126.com

第十二届全国运动会男子手球预赛
竞赛技术统计(媒体表)

预赛	组别	A	轮次	6	场次	24
----	----	---	----	---	----	----

柳州市李宁体育馆

23/04/2013

201301024-51-1/1

西藏	西藏	15	vs	31	山东	山东
		8 : 12				

裁判员	朱昆宏 (CHN)	/	刘建鹏 (CHN)
-----	-----------	---	-----------

西藏		远射	近射	边射	快攻	突破	任意球	7m球	合计	%	助攻	失误	警告	2'	D & DR	比赛进程	
主教练:	张文韬																
2	王龙	0/3							0/3	0.0		2					0 01:58 1 20 杜在超
4	张家纬											2					0 02:44 2 20 杜在超
5	冯祥龙																1 03:11 2 2 杜在超
6	任启双		0/1		0/1			0/2	0.0			3	1	1			1 03:56 3 9 赵鑫
7	徐奕飞	0/1			0/1			0/2	0.0			3	1				1 04:13 4 21 翟乾坤
9	王博																1 05:15 5 11 宋朋强
10	刘江																2 05:39 5 5 宋朋强
11	朱洽宇																2 06:19 5 5 宋朋强
12	张帅												1				3 07:35 6 21 翟乾坤
15	刘劲松																4 08:10 6 6 翟乾坤
16	徐畅																4 10:29 7 9 赵鑫
18	赵楠	3/8			0/1	0/1	0/1	3/11	27.3		4			1			4 11:55 8 18 于亚男
19	任野																5 13:18 8 8 于亚男
20	顾艳超	0/4			3/4			3/8	37.5	2	3						6 15:33 8 8 于亚男
21	马光	3/7			1/1	0/1		4/9	44.4	1	8						6 19:26 9 9 赵鑫
23	王伟强		1/2	3/5	1/3			5/10	50.0		2						6 21:35 10 21 翟乾坤
运动员 合计		6/23	1/3	3/5	5/11	0/2	0/1	15/45	33.3	3	29	2	2	2			7 24:53 10 21 翟乾坤
12	张帅	1/3	0/1	0/2	2/8	0/3		3/17	17.6		1						7 25:18 11 9 赵鑫
16	徐畅	5/10	0/2	2/3	5/13	1/2	2/2	15/32	46.9		1						7 29:02 12 9 赵鑫
守门员 合计		6/13	0/3	2/5	7/21	1/5	2/2	18/49	36.7		2						8 29:24 12 12 翟乾坤
山东		远射	近射	边射	快攻	突破	任意球	7m球	合计	%	助攻	失误	警告	2'	D & DR	比赛进程	
教练:	王鸿斌																
1	于性哲										2	1					8 01:23 13 9 赵鑫
4	田瑞			1/2	2/2			3/4	75.0		1						8 03:06 14 18 于亚男
5	潘翔		1/1					1/1	100		2	1		1			8 04:18 15 5 潘翔
6	李朝鹏	1/2	1/1		1/2			3/5	60.0		1						8 05:54 16 19 李语庆
8	王炳华	1/4			2/2	1/1		4/7	57.1								8 09:34 17 19 李语庆
9	赵鑫	4/6		0/1	1/1	2/2	0/1	7/11	63.6	2	1						9 10:02 17 17 李朝鹏
11	宋朋强	0/2			1/2			1/4	25.0	3	1	1	2				10 10:49 17 17 李朝鹏
13	刘晓	0/1	0/1	1/1		0/1		1/4	25.0	3	2						10 11:13 18 6 李朝鹏
15	陈鹏波	0/2				1/1		1/3	33.3	1	1						10 12:09 19 6 李朝鹏
16	王帅																11 12:57 19 9 赵鑫
17	王旭东				0/2			0/2	0.0				1				11 13:30 20 9 赵鑫
18	于亚男				2/2			2/2	100								12 13:59 20 20 刘朝
19	李语庆	1/2		1/1	1/4	0/1		3/8	37.5		2						12 15:49 21 13 刘晓
20	杜在超				2/4		0/1	2/5	40.0		2						12 17:49 22 8 王炳华
21	翟乾坤	0/1	1/1	0/1	2/2			3/5	60.0		2						12 18:44 23 6 李朝鹏
22	刘正松										2						12 19:43 24 8 王炳华
运动员 合计		7/20	3/4	3/6	14/23	4/6	0/2	31/61	50.8	13	16	3	2	1			13 20:41 24 24 田瑞
1	于性哲	3/5	0/1	1/3	1/3			5/12	41.7	2	1						14 21:30 24 24 田瑞
22	刘正松	6/10	2/2	0/1	3/6	2/2	1/1	14/22	63.6	2							14 23:17 25 4 田瑞
守门员 合计		9/15	2/3	1/4	4/9	2/2	1/1	19/34	55.9	4	1						15 23:40 25 8 王炳华

场上队员: 得分 / 射门

守门员: 救球 / 射门

快攻	Fast Break		突破	Breakthrough		任意球	Free Throw		7m球	7M Throw		助攻	Assist
警告	Warning		失误	Error		2'	Suspension		D	取消资格		DR	取消资格+报告





第十二届全国运动会男子手球预赛 图式比赛技术统计表

轮次 6

场次 24

201301024-21-1/1

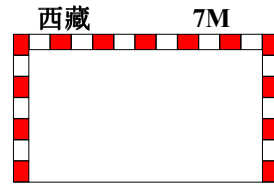
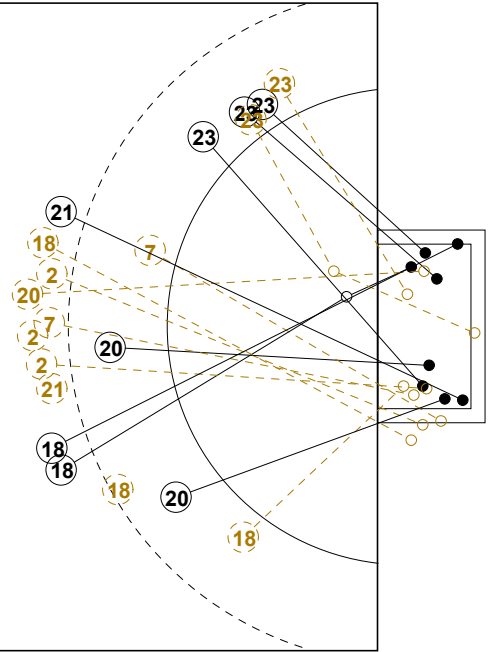
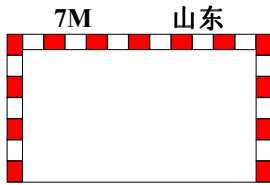
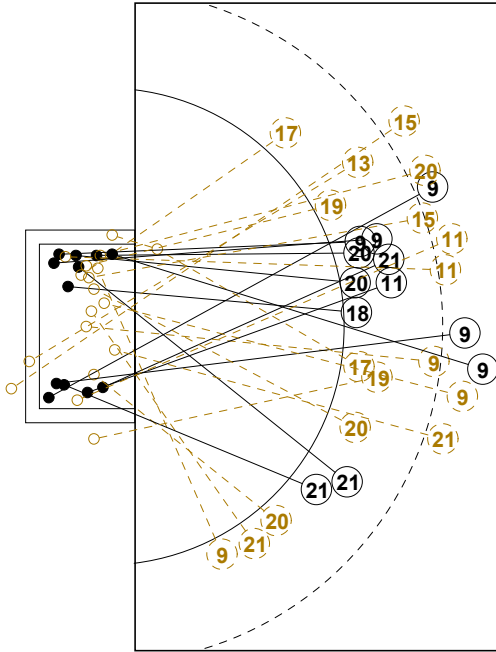

1st Half
12 : 8

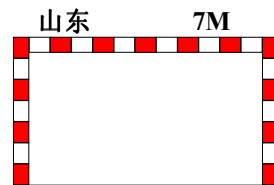
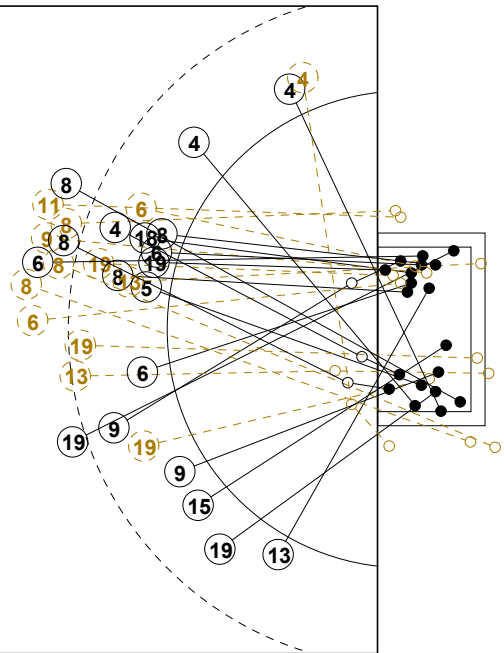
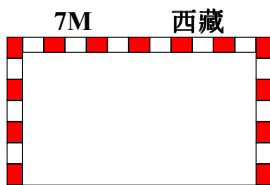
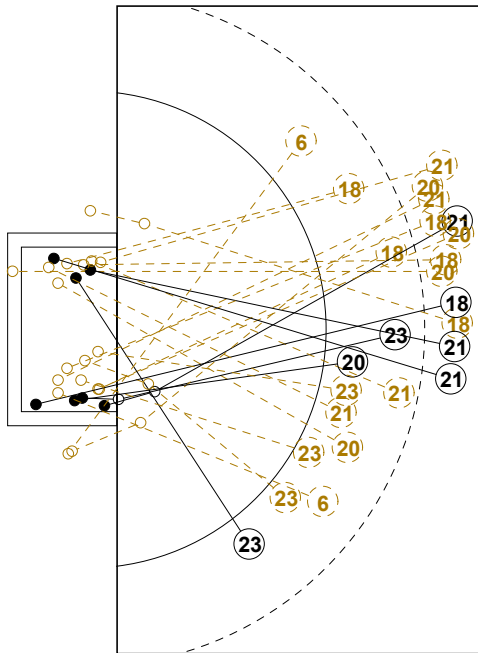

2nd Half
15 : 31



第十二届全国运动会男子手球预赛

个人/全队技术统计表

正式表
手球
男子预赛
轮次 6组别 A
场次 24201301024-14-1/2
柳州市李宁体育馆
23/04/2013 16:20

号码	姓名	远射	近射	边射	快攻	突破	任意	7M	合计	%	助攻	失误	警告	2'	取消	时间
西藏(西藏)																
<i>(场上队员)</i>																
2	王龙	0/3							0/3	0.0%		2				00:10:18
4	张家纬									0.0%		2				00:05:46
5	冯祥龙									0.0%						00:00:00
6	任启双		0/1		0/1				0/2	0.0%		3	1	1		01:00:00
7	徐奕飞	0/1			0/1				0/2	0.0%		3	1			00:54:07
9	王博									0.0%						00:00:00
10	刘江									0.0%						00:00:00
11	朱治宇									0.0%						00:02:31
12	张帅									0.0%		1				00:20:23
15	刘劲松									0.0%						00:00:00
16	徐畅									0.0%		1				00:39:37
18	赵楠	3/8			0/1	0/1	0/1		3/11	27.3%		4		1		00:59:37
19	任野									0.0%						00:00:00
20	顾艳超	0/4			3/4				3/8	37.5%	2	3				00:56:03
21	马光	3/7			1/1	0/1			4/9	44.4%	1	8				00:50:55
23	王伟强		1/2	3/5	1/3				5/10	50.0%		2				00:59:53
合计		6/23	1/3	3/5	5/11	0/2	0/1		15/45	33.3%	3	29	2	2		
<i>(守门员)</i>																
12	张帅	1/3	0/1	0/2	2/8	0/3			3/17	17.6%		1				00:20:23
16	徐畅	5/10	0/2	2/3	5/13	1/2	2/2		15/32	46.9%		1				00:39:37
合计		6/13	0/3	2/5	7/21	1/5	2/2		18/49	36.7%		2				

场上队员：得分/射门

守门员：救球/射门

全队合计	得分	被救	射失	击柱	封球	合计	%
远射	6	9	3	2	3	23	26.1%
近射	1	2				3	33.3%
边射	3	1		1		5	60.0%
快攻	5	4	1	1		11	45.5%
突破		2				2	0.0%
任意		1				1	0.0%
7M							0.0%





第十二届全国运动会男子手球预赛

个人/全队技术统计表

正式表
手球
男子预赛
轮次 6组别 A
场次 24201301024-14-2/2
柳州市李宁体育馆
23/04/2013 16:20

号码	姓名	远射	近射	边射	快攻	突破	任意	7M	合计	%	助攻	失误	警告	2'	取消	时间
山东(山东)																
<i>(上场队员)</i>																
1	于性哲									0.0%	2	1				00:25:20
4	田瑞			1/2	2/2				3/4	75.0%		1				00:07:08
5	潘翔		1/1						1/1	100%		2	1	1		00:30:10
6	李朝鹏	1/2	1/1		1/2				3/5	60.0%		1				00:22:11
8	王炳华	1/4			2/2	1/1			4/7	57.1%						00:16:25
9	赵鑫	4/6		0/1	1/1	2/2	0/1		7/11	63.6%	2	1				00:24:23
11	宋朋强	0/2			1/2				1/4	25.0%	3	1	1	2		00:52:39
13	刘晓	0/1	0/1	1/1		0/1			1/4	25.0%	3	2				00:39:37
15	陈鹏波	0/2				1/1			1/3	33.3%	1	1				00:28:52
16	王帅									0.0%						00:00:00
17	王旭东				0/2				0/2	0.0%			1			00:22:46
18	于亚男				2/2				2/2	100%						00:14:43
19	李语庆	1/2		1/1	1/4	0/1			3/8	37.5%		2				00:39:52
20	杜在超				2/4		0/1		2/5	40.0%		2				00:19:31
21	翟乾坤	0/1	1/1	0/1	2/2				3/5	60.0%		2				00:36:42
22	刘正松									0.0%	2					00:34:40
合计		7/20	3/4	3/6	14/23	4/6	0/2		31/61	50.8%	13	16	3	2	1	
<i>(守门员)</i>																
1	于性哲	3/5	0/1	1/3	1/3				5/12	41.7%	2	1				00:25:20
22	刘正松	6/10	2/2	0/1	3/6	2/2	1/1		14/22	63.6%	2					00:34:40
合计		9/15	2/3	1/4	4/9	2/2	1/1		19/34	55.9%	4	1				

场上队员：得分/射门

守门员：救球/射门

全队合计	得分	被救	射失	击柱	封球	合计	%
远射	7	6	6	1		20	35.0%
近射	3			1		4	75.0%
边射	3	2	1			6	50.0%
快攻	14	7	1	1		23	60.9%
突破	4	1		1		6	66.7%
任意		2				2	0.0%
7M							0.0%





第十二届全国运动会男子手球预赛

图式射门区域统计

轮次 6 场次 24

201301024-41-1/1

西藏

2 王龙	4 张家纬	5 冯祥龙	6 任启双	7 徐奕飞	9 王博	10 刘江	11 朱治宇
Post - 1 Miss - 0 Block - 1	Post - 0 Miss - 0 Block - 0	Post - 0 Miss - 0 Block - 0	Post - 0 Miss - 1 Block - 0	Post - 1 Miss - 0 Block - 0	Post - 0 Miss - 0 Block - 0	Post - 0 Miss - 0 Block - 0	Post - 0 Miss - 0 Block - 0
12 张帅	15 刘劲松	16 徐畅	18 赵楠	19 任野	20 顾艳超	21 马光	23 王伟强
Post - 0 Miss - 0 Block - 0	Post - 0 Miss - 0 Block - 0	Post - 0 Miss - 0 Block - 0	Post - 0 Miss - 2 Block - 1	Post - 0 Miss - 0 Block - 0	Post - 1 Miss - 1 Block - 0	Post - 0 Miss - 0 Block - 1	Post - 1 Miss - 0 Block - 0

0/1	0/2
1/6	0/2
2/4	0/2

0/4	1/4
3/6	2/2
0/1	2/2
0/1	0/1

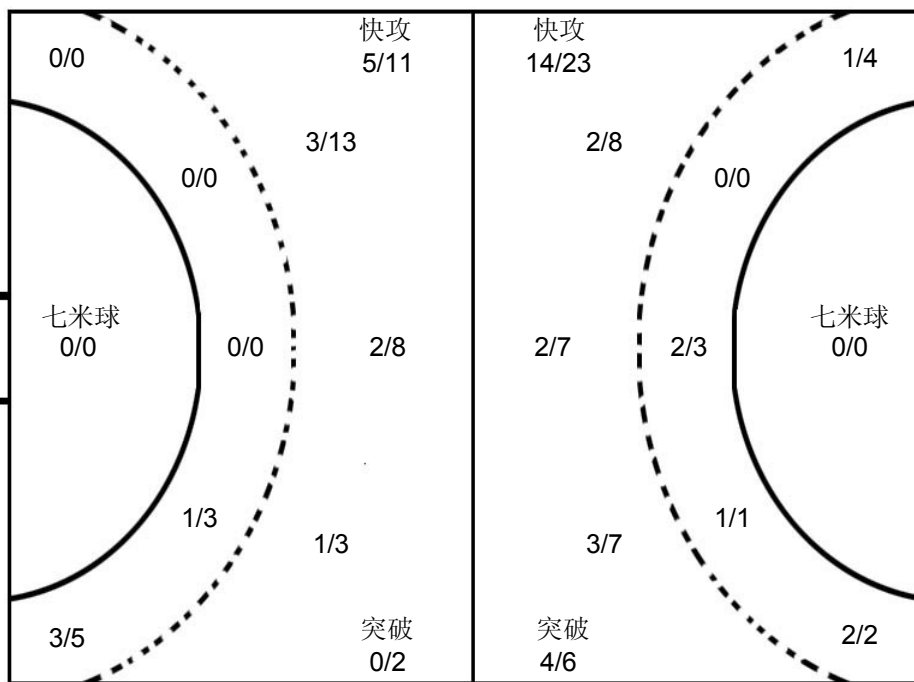

0/2
1/4
1/1

0/2	1/2
5/7	3/4
2/3	1/1
2/3	2/3

山东

1 于性哲	4 田瑞	5 潘翔	6 李朝鹏	8 王炳华	9 赵鑫	11 宋朋强	13 刘晓
Post - 0 Miss - 0 Block - 0	Post - 0 Miss - 1 Block - 0	Post - 0 Miss - 0 Block - 0	Post - 0 Miss - 0 Block - 0	Post - 0 Miss - 3 Block - 0	Post - 0 Miss - 0 Block - 0	Post - 0 Miss - 1 Block - 0	Post - 2 Miss - 1 Block - 0
15 陈鹏波	16 王帅	17 王旭东	18 于亚男	19 李语庆	20 杜在超	21 翟乾坤	22 刘正松
Post - 0 Miss - 1 Block - 0	Post - 0 Miss - 0 Block - 0	Post - 1 Miss - 0 Block - 0	Post - 0 Miss - 0 Block - 0	Post - 1 Miss - 1 Block - 0	Post - 0 Miss - 0 Block - 0	Post - 0 Miss - 0 Block - 0	Post - 0 Miss - 0 Block - 0

注释: Post=击柱 Miss=射失 Block=被封





男子 国内比赛



第十二届全国运动会男子手球预赛

Team A A 解放军				Team B B 四川				Match Number 25													
played in China		in the hall 柳州市李宁体育馆		on 23/04/2013		at 18:00 hours		Spectators													
Half-time (30')	A 23	B 9	End of playing time	A 47	B 20	1st extra time	A	B	2nd extra time	A	B	After penalty throws	A	B							
Number of 7 m	A 2 / 2	Team time-out			Full name of players and officials				Team time-out			B 0 / 1	Number of 7 m								
No.	Team A					G	W	2'	D	DR	No.	Team B					G	W	2'	D	DR
4	曹作亮					1					16	王松									
5	吴龙瑞					4					18	杨洋									
6	苗青										19	杨洁									
7	陈昊					7					21	池培俊					4	1			
8	王烁					5					22	刘彦坤					2	1			
9	丁超						1				23	王震					3				
10	师龙					4	1				25	李峥					3				
11	李想										27	于洪泉					1				
12	丛霖										28	宋涛					2				
13	王世杰					6					32	逯明松									
14	曲学博					4	1				33	朱晓龙									
15	杨帆										35	仇振勇					5	2			
16	郎俊夫										36	刘琢									
17	王勇					10															
18	董宏斐					4															
20	谷浩					2															
A	张敬敏										A	李太平									
B	张彬华										B	李清									
C	刘捷										C	黄承									
D	刘军										E	何明阳									
A	Signature of Responsible Official of the Teams (Off. A)										B										
TP	Remarks of Referee / CHA Official										TP										

Signatures

Referees	王锐 (CHN)	陈晓波 (CHN)		
Techn. Delegates	许宜扬 (CHN)	刘书勇 (CHN)		
CHA Official				

Note: Number of 7m Throws Awarded to Team A and B, Goals (G), Warnings (W), Suspensions (2'), Direct Disqualification (D), Disqualification with Report (DR) and Team Penalty (TP).

Table Officials: 黄思华 谭云东 Statisticians: 黄莉 朱伟平

Printed by PHMS Copyright: IHF / CHA 23/04/2013 19:29:01

Longman Sportsoft handball@126.com





第十二届全国运动会男子手球预赛 竞赛技术统计(媒体表)

预赛 组别 B 轮次 6 场次 25

柳州市李宁体育馆

23/04/2013

201301025-51-1/1

解放军 47 vs 20 四川 23:9

裁判员 王锐 (CHN) / 陈晓波 (CHN)

Main statistics table with columns for players, shots, goals, assists, etc. for both teams.

场上队员: 得分 / 射门

守门员: 救球 / 射门

Summary table for Fast Break, Breakthrough, Free Throw, 7M Throw, Assist, Warning, Error, 2', Suspension, D, DR.





第十二届全国运动会男子手球预赛 图式比赛技术统计表

轮次 6

场次 25

201301025-21-1/1

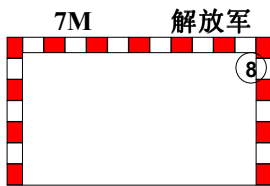
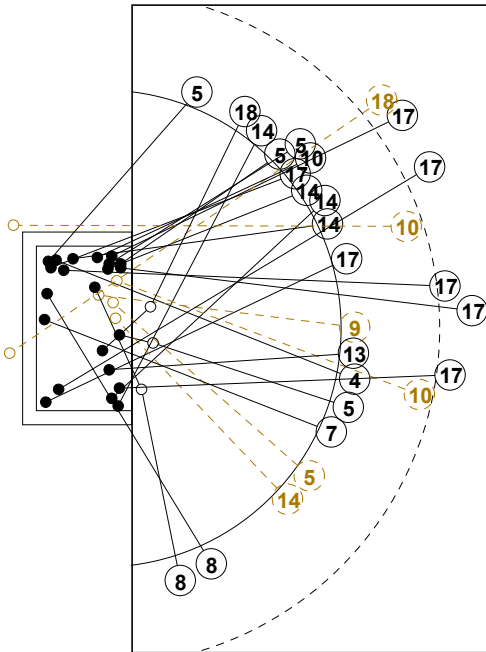

1st Half
23 : 9

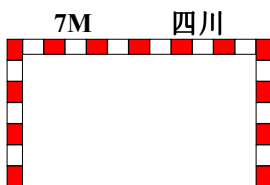
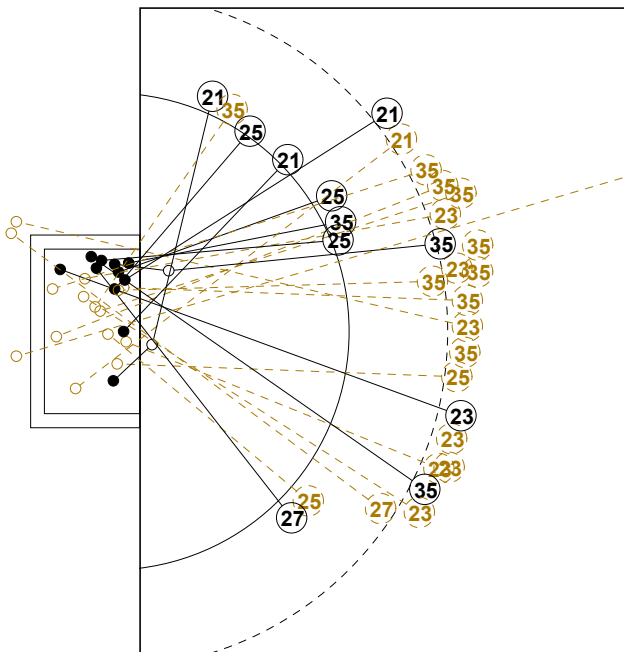
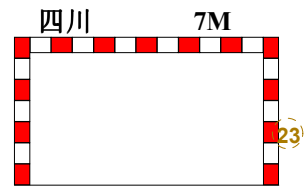
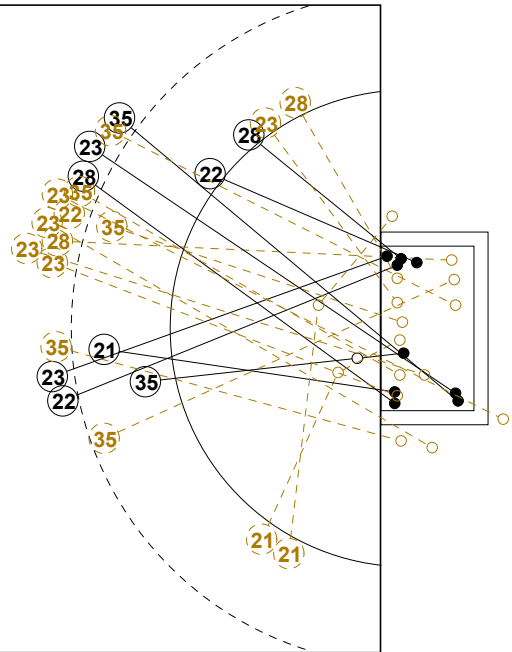

2nd Half
20 : 47

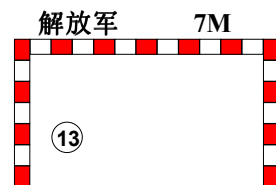
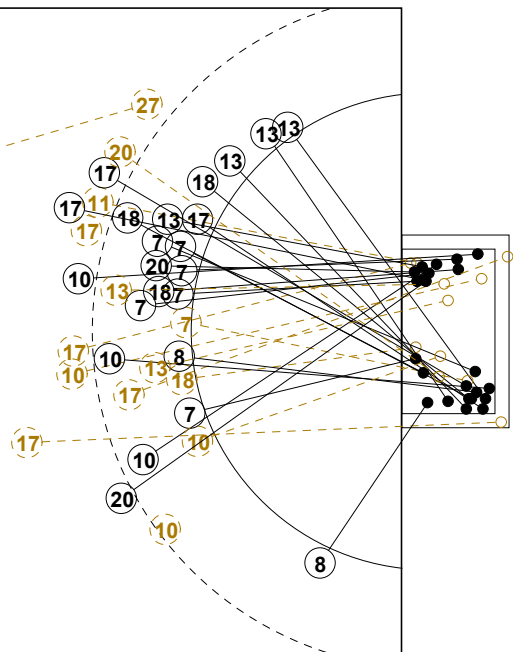



第十二届全国运动会男子手球预赛

个人/全队技术统计表

正式表
手球
男子预赛
轮次 6组别 B
场次 25201301025-14-1/2
柳州市李宁体育馆
23/04/2013 18:00

号码	姓名	远射	近射	边射	快攻	突破	任意	7M	合计	%	助攻	失误	警告	2'	取消	时间
解放军(解放军)																
<i>(场上队员)</i>																
4	曹作亮				1/1				1/1	100%	1	2				00:13:15
5	吴龙瑞		1/2	1/1	2/2				4/5	80.0%						00:18:20
6	苗青									0.0%						00:00:00
7	陈昊		5/5		2/3				7/8	87.5%		3				00:31:58
8	王烁			3/3	1/1			1/1	5/5	100%	1					00:38:17
9	丁超					0/1			0/1	0.0%	2		1			00:30:00
10	师龙	2/6	0/1		1/1	1/1			4/9	44.4%	4	4	1			00:46:44
11	李想	0/1							0/1	0.0%	1					00:18:48
12	丛霖									0.0%						00:00:00
13	王世杰	0/1			5/6			1/1	6/8	75.0%		3				00:35:48
14	曲学博		2/3	1/1	1/1				4/5	80.0%	1		1			00:24:09
15	杨帆									0.0%	1	1				00:12:14
16	郎俊夫									0.0%	4					01:00:00
17	王勇	6/9	2/2		2/3				10/14	71.4%	3	2				00:47:44
18	董宏斐	1/2			3/4				4/6	66.7%						00:31:22
20	谷浩	1/2	1/1						2/3	66.7%	1					00:11:11
合计		10/21	11/14	5/5	18/22	1/2		2/2	47/66	71.2%	19	15	3			
<i>(守门员)</i>																
16	郎俊夫	15/21	0/3	4/6	1/5	0/2	2/5		22/42	52.4%	4					01:00:00
合计																
		15/21	0/3	4/6	1/5	0/2	2/5		22/42	52.4%	4					

场上队员：得分/射门

守门员：救球/射门

全队合计	得分	被救	射失	击柱	封球	合计	%
远射	10	6	2	1	2	21	47.6%
近射	11	3				14	78.6%
边射	5					5	100.0%
快攻	18	3		1		22	81.8%
突破	1	1				2	50.0%
任意							0.0%
7M	2					2	100.0%





第十二届全国运动会男子手球预赛

个人/全队技术统计表

正式表
手球
男子预赛
轮次 6组别 B
场次 25201301025-14-2/2
柳州市李宁体育馆
23/04/2013 18:00

号码	姓名	远射	近射	边射	快攻	突破	任意	7M	合计	%	助攻	失误	警告	2'	取消	时间
四川(四川)																
<i>(上场队员)</i>																
16	王松									0.0%						00:30:00
18	杨洋									0.0%						00:00:00
19	杨洁									0.0%						01:00:00
21	池培俊	1/2	2/2	1/2	0/1				4/7	57.1%	1	6	1			01:00:00
22	刘彦坤	0/1				1/1	1/1		2/3	66.7%			1			00:10:54
23	王震	1/10		0/1	0/1		2/3	0/1	3/16	18.8%		3				01:00:00
25	李峥	0/1	1/1	1/1	1/2				3/5	60.0%		1				01:00:00
27	于洪泉	0/2			1/1				1/3	33.3%		3				00:10:31
28	宋涛	1/2		0/1		1/1			2/4	50.0%		1				00:10:16
32	逯明松									0.0%		3				00:39:08
33	朱晓龙									0.0%						00:00:00
35	仇振勇	3/14		0/1	2/2		0/2		5/19	26.3%		4		2		00:49:05
36	刘琢									0.0%	1	2				00:30:00
合计																
<i>(守门员)</i>																
16	王松	1/5	2/7	0/4	0/9	1/1		0/1	4/27	14.8%						00:30:00
36	刘琢	5/11	1/7	0/1	3/12	0/1		0/1	9/33	27.3%	1	2				00:30:00
合计																
		6/16	3/14	0/5	3/21	1/2		0/2	13/60	21.7%	1	2				

场上队员：得分/射门

守门员：救球/射门

全队合计	得分	被救	射失	击柱	封球	合计	%
远射	6	15	4		7	32	18.8%
近射	3					3	100.0%
边射	2	4				6	33.3%
快攻	4	1	2			7	57.1%
突破	2					2	100.0%
任意	3	2	1			6	50.0%
7M				1		1	0.0%





第十二届全国运动会男子手球预赛

图式射门区域统计

轮次 6 场次 25

201301025-41-1/1

解放军

4 曹作亮	5 吴龙瑞	6 苗青	7 陈昊	8 王烁	9 丁超	10 师龙	11 李想																																																																								
<table border="1"><tr><td></td><td></td><td>1</td></tr><tr><td></td><td></td><td></td></tr><tr><td></td><td></td><td></td></tr></table>			1							<table border="1"><tr><td></td><td></td><td>1</td></tr><tr><td></td><td></td><td></td></tr><tr><td></td><td>1</td><td>2</td></tr></table>			1					1	2	<table border="1"><tr><td></td><td></td><td></td></tr><tr><td></td><td></td><td></td></tr><tr><td></td><td></td><td></td></tr></table>										<table border="1"><tr><td></td><td>1</td><td>1</td></tr><tr><td>1</td><td></td><td></td></tr><tr><td>2</td><td>1</td><td>1</td></tr></table>		1	1	1			2	1	1	<table border="1"><tr><td></td><td></td><td>3</td></tr><tr><td></td><td></td><td>1</td></tr><tr><td></td><td></td><td>1</td></tr></table>			3			1			1	<table border="1"><tr><td></td><td></td><td></td></tr><tr><td></td><td></td><td></td></tr><tr><td></td><td></td><td></td></tr></table>										<table border="1"><tr><td>1</td><td></td><td>1</td></tr><tr><td>1</td><td></td><td>1</td></tr><tr><td></td><td></td><td></td></tr></table>	1		1	1		1				<table border="1"><tr><td></td><td></td><td></td></tr><tr><td></td><td></td><td></td></tr><tr><td></td><td></td><td></td></tr></table>									
		1																																																																													
		1																																																																													
	1	2																																																																													
	1	1																																																																													
1																																																																															
2	1	1																																																																													
		3																																																																													
		1																																																																													
		1																																																																													
1		1																																																																													
1		1																																																																													
Post - 0 Miss - 0 Block - 0	Post - 0 Miss - 0 Block - 0	Post - 0 Miss - 0 Block - 0	Post - 0 Miss - 0 Block - 0	Post - 0 Miss - 0 Block - 0	Post - 0 Miss - 0 Block - 0	Post - 0 Miss - 1 Block - 1	Post - 0 Miss - 0 Block - 0																																																																								
12 丛霖	13 王世杰	14 曲学博	15 杨帆	16 郎俊夫	17 王勇	18 董宏斐	20 谷浩																																																																								
<table border="1"><tr><td></td><td></td><td></td></tr><tr><td></td><td></td><td></td></tr><tr><td></td><td></td><td></td></tr></table>										<table border="1"><tr><td></td><td></td><td>2</td></tr><tr><td>1</td><td></td><td>1</td></tr><tr><td>2</td><td></td><td></td></tr></table>			2	1		1	2			<table border="1"><tr><td></td><td></td><td></td></tr><tr><td></td><td></td><td>1</td></tr><tr><td>2</td><td></td><td>1</td></tr></table>						1	2		1	<table border="1"><tr><td></td><td></td><td></td></tr><tr><td></td><td></td><td></td></tr><tr><td></td><td></td><td></td></tr></table>										<table border="1"><tr><td></td><td></td><td></td></tr><tr><td></td><td></td><td></td></tr><tr><td></td><td></td><td></td></tr></table>										<table border="1"><tr><td>2</td><td></td><td>4</td></tr><tr><td></td><td></td><td></td></tr><tr><td>2</td><td></td><td>2</td></tr></table>	2		4				2		2	<table border="1"><tr><td></td><td></td><td>2</td></tr><tr><td>1</td><td></td><td></td></tr><tr><td></td><td>1</td><td></td></tr></table>			2	1				1		<table border="1"><tr><td></td><td></td><td></td></tr><tr><td></td><td></td><td></td></tr><tr><td>2</td><td></td><td></td></tr></table>							2		
		2																																																																													
1		1																																																																													
2																																																																															
		1																																																																													
2		1																																																																													
2		4																																																																													
2		2																																																																													
		2																																																																													
1																																																																															
	1																																																																														
2																																																																															
Post - 0 Miss - 0 Block - 0	Post - 0 Miss - 0 Block - 0	Post - 0 Miss - 0 Block - 0	Post - 0 Miss - 0 Block - 0	Post - 0 Miss - 0 Block - 0	Post - 2 Miss - 0 Block - 1	Post - 0 Miss - 1 Block - 0	Post - 0 Miss - 0 Block - 0																																																																								

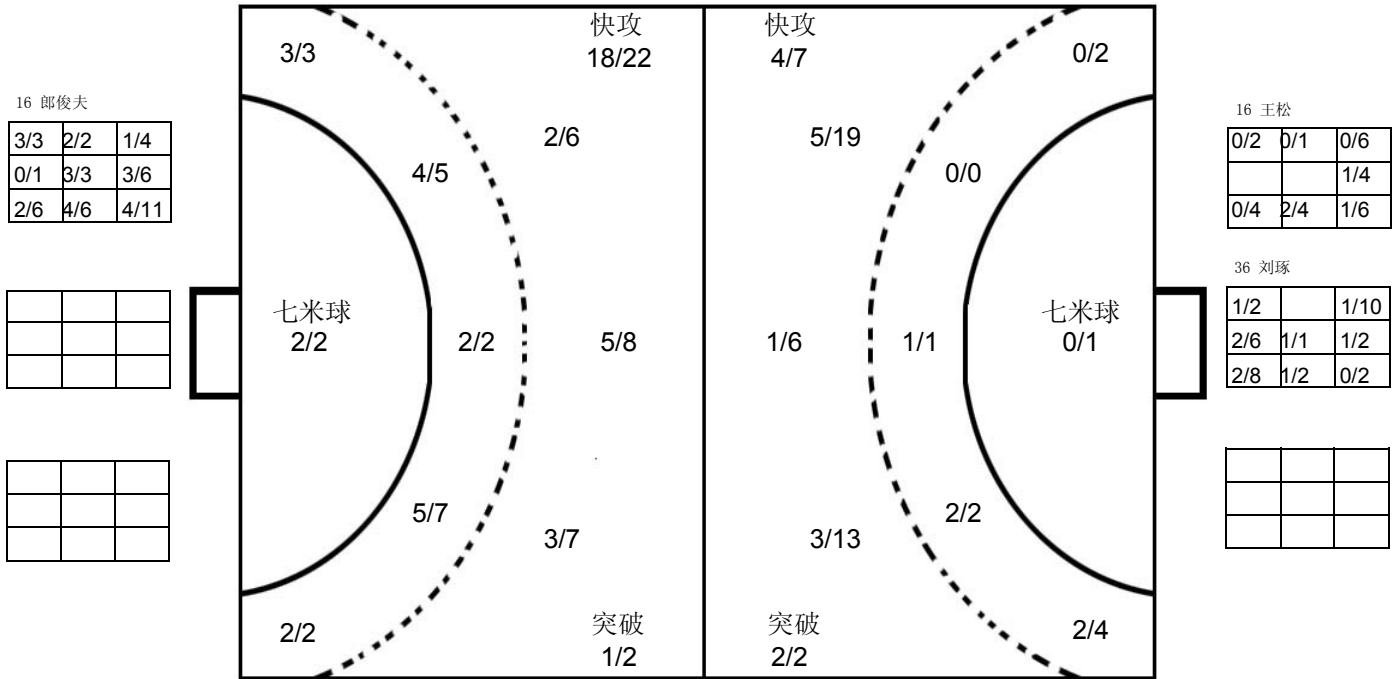

四川

16 王松	18 杨洋	19 杨洁	21 池培俊	22 刘彦坤	23 王震	25 李峥	27 于洪泉																																																																								
<table border="1"><tr><td></td><td></td><td></td></tr><tr><td></td><td></td><td></td></tr><tr><td></td><td></td><td></td></tr></table>										<table border="1"><tr><td></td><td></td><td></td></tr><tr><td></td><td></td><td></td></tr><tr><td></td><td></td><td></td></tr></table>										<table border="1"><tr><td></td><td></td><td></td></tr><tr><td></td><td></td><td></td></tr><tr><td></td><td></td><td></td></tr></table>										<table border="1"><tr><td></td><td></td><td></td></tr><tr><td>1</td><td>1</td><td>2</td></tr><tr><td></td><td></td><td></td></tr></table>				1	1	2				<table border="1"><tr><td></td><td></td><td></td></tr><tr><td>1</td><td></td><td></td></tr><tr><td>1</td><td></td><td></td></tr></table>				1			1			<table border="1"><tr><td></td><td></td><td>2</td></tr><tr><td></td><td></td><td></td></tr><tr><td>1</td><td></td><td></td></tr></table>			2				1			<table border="1"><tr><td></td><td></td><td></td></tr><tr><td></td><td></td><td>1</td></tr><tr><td></td><td></td><td>2</td></tr></table>						1			2	<table border="1"><tr><td></td><td></td><td></td></tr><tr><td></td><td></td><td>1</td></tr><tr><td></td><td></td><td></td></tr></table>						1			
1	1	2																																																																													
1																																																																															
1																																																																															
		2																																																																													
1																																																																															
		1																																																																													
		2																																																																													
		1																																																																													
Post - 0 Miss - 0 Block - 0	Post - 0 Miss - 0 Block - 0	Post - 0 Miss - 0 Block - 0	Post - 0 Miss - 1 Block - 0	Post - 0 Miss - 0 Block - 1	Post - 1 Miss - 3 Block - 3	Post - 0 Miss - 0 Block - 0	Post - 0 Miss - 2 Block - 0																																																																								
28 宋涛	32 逯明松	33 朱晓龙	35 仇振勇	36 刘琢																																																																											
<table border="1"><tr><td></td><td></td><td></td></tr><tr><td></td><td></td><td></td></tr><tr><td>1</td><td></td><td>1</td></tr></table>							1		1	<table border="1"><tr><td></td><td></td><td></td></tr><tr><td></td><td></td><td></td></tr><tr><td></td><td></td><td></td></tr></table>										<table border="1"><tr><td></td><td></td><td></td></tr><tr><td></td><td></td><td></td></tr><tr><td></td><td></td><td></td></tr></table>										<table border="1"><tr><td></td><td></td><td>1</td></tr><tr><td></td><td></td><td>1</td></tr><tr><td></td><td>1</td><td>2</td></tr></table>			1			1		1	2	<table border="1"><tr><td></td><td></td><td></td></tr><tr><td></td><td></td><td></td></tr><tr><td></td><td></td><td></td></tr></table>										<table border="1"><tr><td></td><td></td><td></td></tr><tr><td></td><td></td><td></td></tr><tr><td></td><td></td><td></td></tr></table>										<table border="1"><tr><td></td><td></td><td></td></tr><tr><td></td><td></td><td></td></tr><tr><td></td><td></td><td></td></tr></table>										<table border="1"><tr><td></td><td></td><td></td></tr><tr><td></td><td></td><td></td></tr><tr><td></td><td></td><td></td></tr></table>									
1		1																																																																													
		1																																																																													
		1																																																																													
	1	2																																																																													
Post - 0 Miss - 0 Block - 0	Post - 0 Miss - 0 Block - 0	Post - 0 Miss - 0 Block - 0	Post - 0 Miss - 1 Block - 3	Post - 0 Miss - 0 Block - 0																																																																											

注释: Post=击柱 Miss=射失 Block=被封





男子 国内比赛



第十二届全国运动会男子手球预赛

Team A		Team B		Match Number							
A 上海		B 广东		26							
played in		in the hall		on							
China		柳州市李宁体育馆		23/04/2013							
				at							
				19:40 hours							
Spectators											
Half-time (30')	A	B	End of playing time	A	B						
	8	11	17	24							
1st extra time		2nd extra time		After penalty throws							
Number of 7 m	A	Team time-out			B						
	1 / 1	1	2	3	3 / 3						
		Full name of players and officials									
		28:49			54:38						
No.	Team A					No.	Team B				
	G	W	2'	D	DR		G	W	2'	D	DR
1						1					
2						2					
3	2		2			3	2				
5						4	3	1			
6	3	1				5					
8	3		1			6					
9	2					7	7	1			
10	3					8	3	1			
12						9					
13						10					
14						12					
15		1				16					
16						17	4				
18	3		1			18		1			
19	1	1	1			19					
20						20	5	1			
A	吴龙基					A	王锋				
B	陆钦忠					B	李晓忠				
C	徐耀忠					C	郭艳辉				
E	黄韡					E	薛良成				
A	Signature of Responsible Official of the Teams (Off. A)										B
TP	Remarks of Referee / CHA Official										TP

Signatures

Referees	Jan Eric Klaus	Mikael Engelbert		
Techn. Delegates	许宜扬 (CHN)	刘书勇 (CHN)		
CHA Official				

Note: Number of 7m Throws Awarded to Team A and B, Goals (G), Warnings (W), Suspensions (2'), Direct Disqualification (D), Disqualification with Report (DR) and Team Penalty (TP).

Table Officials:

Statisticians: 黄莉

朱伟平

Printed by PHMS Copyright: IHF / CHA 23/04/2013 21:16:24

Longman Sportsoft



handball@126.com



第十二届全国运动会男子手球预赛
竞赛技术统计(媒体表)

预赛 组别 B 轮次 6 场次 26

柳州市李宁体育馆

23/04/2013

201301026-51-1/1

上海 17 vs 24 广东 8:11

裁判员 Jan Eric Klaus Leandersson (FIN) / Mikael Engelbert Lindroos (FIN)

Main statistics table for the match between Shanghai and Guangdong, including player performance, goals, and game progress.

Summary table for on-court statistics: Fast Break, Breakthrough, Free Throw, 7M Throw, Assist, Warning, Error, Suspension, D, and DR.



第十二届全国运动会男子手球预赛 图式比赛技术统计表

轮次 6

场次 26

201301026-21-1/1

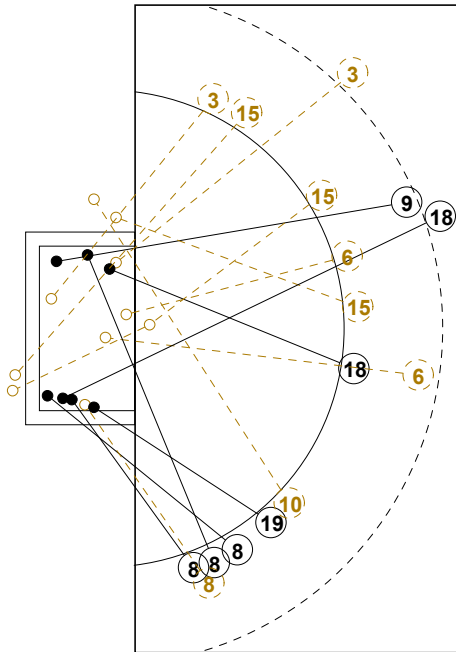

7M 上海

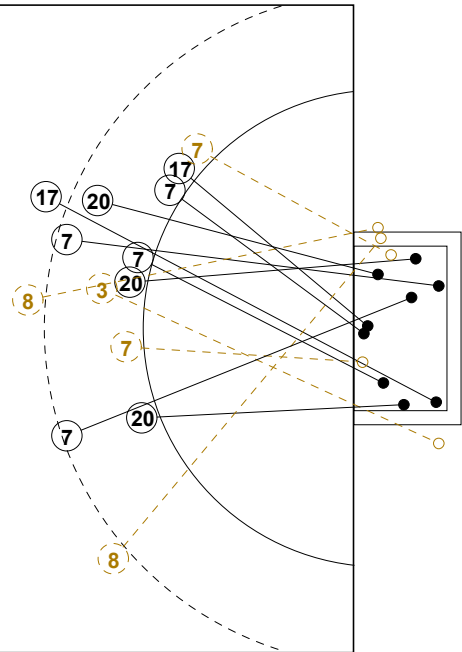
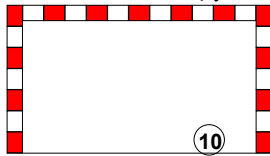

广东 7M

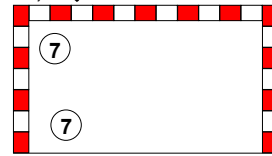

1st Half
8 : 11

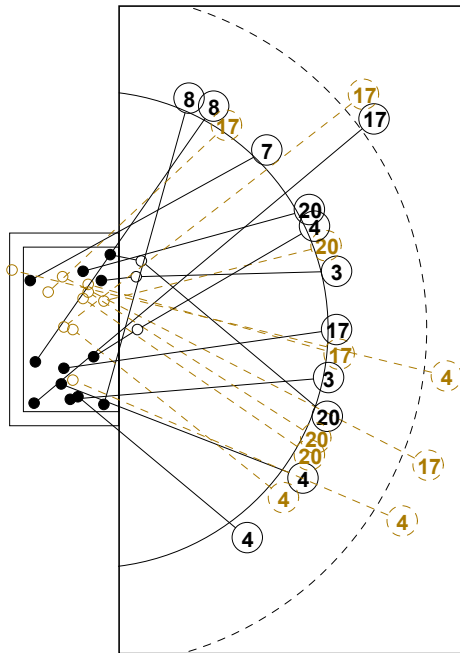

7M 广东

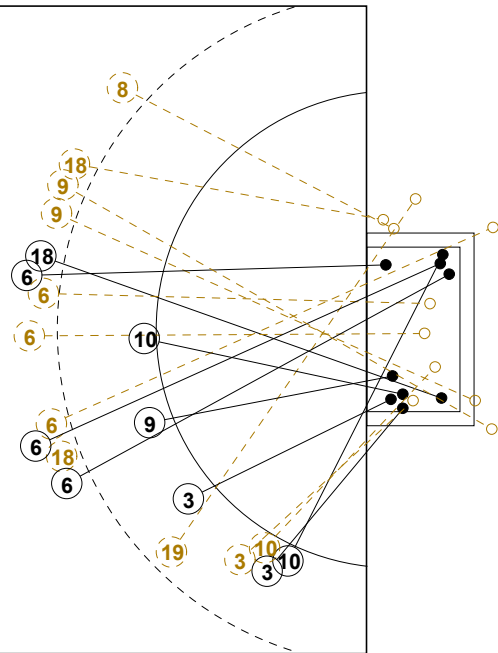
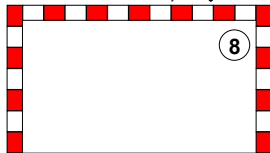

上海 7M



2nd Half
24 : 17



第十二届全国运动会男子手球预赛

个人/全队技术统计表

正式表
手球
男子预赛
轮次 6组别 B
场次 26201301026-14-1/2
柳州市李宁体育馆
23/04/2013 19:40

号码	姓名	远射	近射	边射	快攻	突破	任意	7M	合计	%	助攻	失误	警告	2'	取消	时间
上海(上海)																
<i>(场上队员)</i>																
1	张崢									0.0%						00:32:40
2	胡辰									0.0%						00:00:00
3	赵时俊	0/1		1/2	1/2				2/5	40.0%	1	4		2		01:00:00
5	朱世杰									0.0%						00:00:00
6	李和鑫	3/7				0/1			3/8	37.5%	1	2	1			00:41:54
8	钱为玮	0/1		1/2	2/2				3/5	60.0%				1		00:50:10
9	朱礼彬	1/3				1/1			2/4	50.0%		5				00:51:52
10	吴璟		1/1	1/2	0/1			1/1	3/5	60.0%		1				00:13:34
12	周哲韬									0.0%						00:03:34
13	孟宇超									0.0%						00:00:00
14	王子阳									0.0%						00:09:48
15	徐俊吉		0/2		0/1				0/3	0.0%		1	1			00:46:13
16	朱春雷									0.0%		1				00:23:46
18	马麟晓	1/3			1/1	1/1			3/5	60.0%	4	3		1		00:55:26
19	蒋承骅	0/1		1/1					1/2	50.0%			1	1		00:30:25
20	程云飞									0.0%						00:00:00
合计		5/16	1/3	4/7	4/7	2/3		1/1	17/37	45.9%	6	17	3	5		
<i>(守门员)</i>																
1	张崢	1/3	1/6	0/1	1/2			0/2	3/14	21.4%						00:32:40
12	周哲韬	1/1	0/1	1/1					2/3	66.7%						00:03:34
16	朱春雷	1/4	3/5	0/2	1/5	1/1		0/1	6/18	33.3%		1				00:23:46
合计		3/8	4/12	1/4	2/7	1/1		0/3	11/35	31.4%		1				

场上队员：得分/射门

守门员：救球/射门

全队合计	得分	被救	射失	击柱	封球	合计	%
远射	5	4	5	1	1	16	31.3%
近射	1		2			3	33.3%
边射	4	3				7	57.1%
快攻	4	1	2			7	57.1%
突破	2	1				3	66.7%
任意							0.0%
7M	1					1	100.0%





第十二届全国运动会男子手球预赛

个人/全队技术统计表

正式表
手球
男子预赛
轮次 6组别 B
场次 26201301026-14-2/2
柳州市李宁体育馆
23/04/2013 19:40

号码	姓名	远射	近射	边射	快攻	突破	任意	7M	合计	%	助攻	失误	警告	2'	取消	时间
广东(广东)																
<i>(上场队员)</i>																
1	王旭兴									0.0%						00:57:56
2	孙江山									0.0%						00:00:00
3	曲汝洋				2/3				2/3	66.7%	2	2				00:57:21
4	李卓洋	0/2	2/2	1/1		0/1			3/6	50.0%	1	1		1		00:26:13
5	候生升									0.0%						00:02:38
6	邓志贵									0.0%		1		1		00:40:49
7	付云博	2/2	2/3		1/2			2/2	7/9	77.8%	2	1		1		00:59:09
8	于彦江	0/2		2/2				1/1	3/5	60.0%	2	4	1			00:56:55
9	徐庆									0.0%						00:00:00
10	陈超									0.0%						00:02:04
12	温杰									0.0%						00:02:04
16	张广建									0.0%						00:00:00
17	李中洲	2/4	1/2	0/1	1/1				4/8	50.0%	3	6				00:45:49
18	张腾									0.0%			1			00:11:32
19	马跃									0.0%						00:00:00
20	王伟	1/1	3/5		1/2				5/8	62.5%		2	1			00:57:17
合计		5/11	8/12	3/4	5/8	0/1		3/3	24/39	61.5%	10	17	3	3		
<i>(守门员)</i>																
1	王旭兴	4/9	0/1	2/5	1/5	1/3		0/1	8/24	33.3%						00:57:56
12	温杰			1/2					1/2	50.0%						00:02:04
合计		4/9	0/1	3/7	1/5	1/3		0/1	9/26	34.6%						

场上队员：得分/射门

守门员：救球/射门

全队合计	得分	被救	射失	击柱	封球	合计	%
远射	5	3	1	2		11	45.5%
近射	8	4				12	66.7%
边射	3	1				4	75.0%
快攻	5	2	1			8	62.5%
突破		1				1	0.0%
任意							0.0%
7M	3					3	100.0%





第十二届全国运动会男子手球预赛

图式射门区域统计

轮次 6 场次 26

201301026-41-1/1

上海

1 张峥	2 胡辰	3 赵时俊	5 朱世杰	6 李和鑫	8 钱为玮	9 朱礼彬	10 吴璟																																																																								
<table border="1"><tr><td></td><td></td><td></td></tr><tr><td></td><td></td><td></td></tr><tr><td></td><td></td><td></td></tr></table>										<table border="1"><tr><td></td><td></td><td></td></tr><tr><td></td><td></td><td></td></tr><tr><td></td><td></td><td></td></tr></table>										<table border="1"><tr><td></td><td></td><td></td></tr><tr><td></td><td></td><td>1</td></tr><tr><td></td><td></td><td>1</td></tr></table>						1			1	<table border="1"><tr><td></td><td></td><td></td></tr><tr><td></td><td></td><td></td></tr><tr><td></td><td></td><td></td></tr></table>										<table border="1"><tr><td>2</td><td></td><td></td></tr><tr><td></td><td></td><td></td></tr><tr><td>1</td><td></td><td></td></tr></table>	2						1			<table border="1"><tr><td>2</td><td></td><td></td></tr><tr><td></td><td></td><td></td></tr><tr><td></td><td></td><td>1</td></tr></table>	2								1	<table border="1"><tr><td></td><td></td><td>1</td></tr><tr><td></td><td></td><td></td></tr><tr><td></td><td></td><td>1</td></tr></table>			1						1	<table border="1"><tr><td></td><td>1</td><td></td></tr><tr><td></td><td></td><td></td></tr><tr><td></td><td></td><td>1</td></tr></table>		1							1
		1																																																																													
		1																																																																													
2																																																																															
1																																																																															
2																																																																															
		1																																																																													
		1																																																																													
		1																																																																													
	1																																																																														
		1																																																																													
Post - 0 Miss - 0 Block - 0	Post - 0 Miss - 0 Block - 0	Post - 0 Miss - 0 Block - 0	Post - 0 Miss - 0 Block - 0	Post - 0 Miss - 1 Block - 0	Post - 0 Miss - 1 Block - 0	Post - 1 Miss - 1 Block - 0	Post - 0 Miss - 1 Block - 0																																																																								
12 周哲韬	13 孟宇超	14 王子阳	15 徐俊吉	16 朱春雷	18 马麟晓	19 蒋承骅	20 程云飞																																																																								
<table border="1"><tr><td></td><td></td><td></td></tr><tr><td></td><td></td><td></td></tr><tr><td></td><td></td><td></td></tr></table>										<table border="1"><tr><td></td><td></td><td></td></tr><tr><td></td><td></td><td></td></tr><tr><td></td><td></td><td></td></tr></table>										<table border="1"><tr><td></td><td></td><td></td></tr><tr><td></td><td></td><td></td></tr><tr><td></td><td></td><td></td></tr></table>										<table border="1"><tr><td></td><td></td><td></td></tr><tr><td></td><td></td><td></td></tr><tr><td></td><td></td><td></td></tr></table>										<table border="1"><tr><td></td><td></td><td></td></tr><tr><td></td><td></td><td></td></tr><tr><td></td><td></td><td></td></tr></table>										<table border="1"><tr><td>1</td><td></td><td>1</td></tr><tr><td></td><td></td><td></td></tr><tr><td></td><td></td><td>1</td></tr></table>	1		1						1	<table border="1"><tr><td></td><td>1</td><td></td></tr><tr><td></td><td></td><td></td></tr><tr><td></td><td></td><td></td></tr></table>		1								<table border="1"><tr><td></td><td></td><td></td></tr><tr><td></td><td></td><td></td></tr><tr><td></td><td></td><td></td></tr></table>									
1		1																																																																													
		1																																																																													
	1																																																																														
Post - 0 Miss - 0 Block - 0	Post - 0 Miss - 0 Block - 0	Post - 0 Miss - 0 Block - 0	Post - 0 Miss - 3 Block - 0	Post - 0 Miss - 0 Block - 0	Post - 0 Miss - 1 Block - 1	Post - 0 Miss - 1 Block - 0	Post - 0 Miss - 0 Block - 0																																																																								

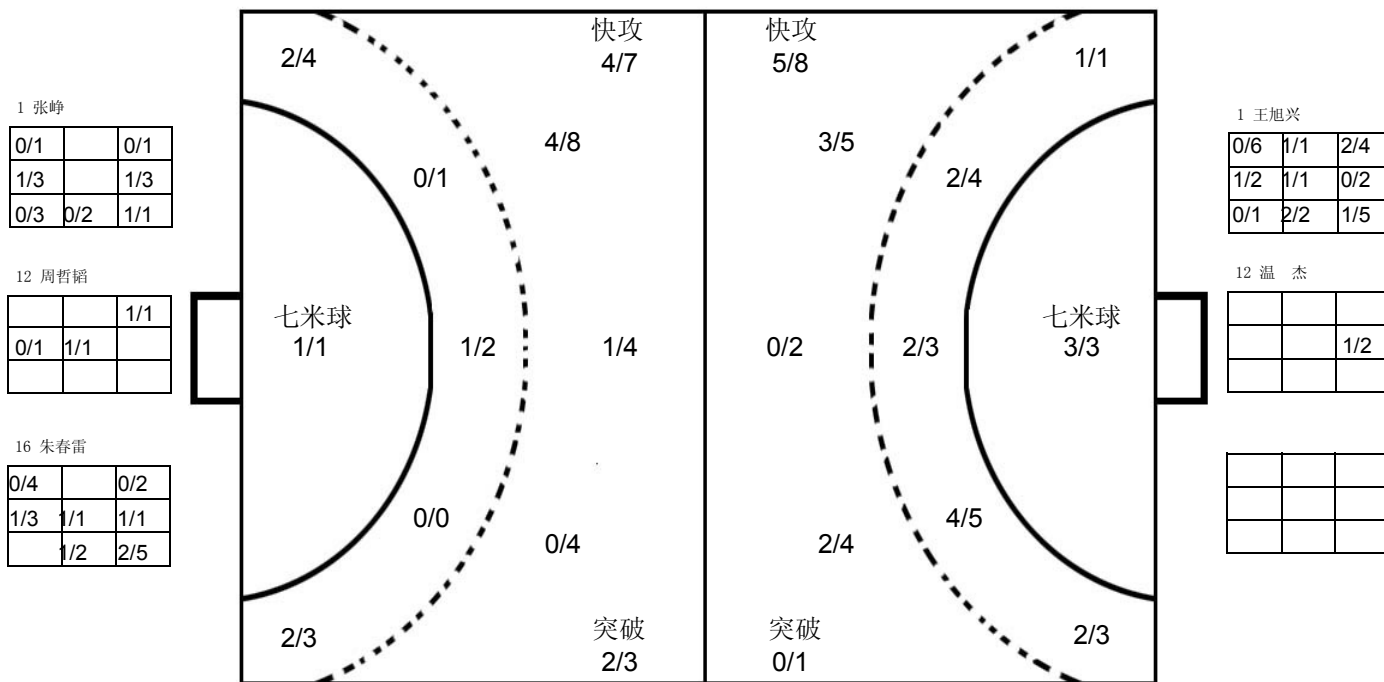

广东

1 王旭兴	2 孙江山	3 曲汝洋	4 李卓洋	5 候生升	6 邓志贵	7 付云博	8 于彦江																																																																								
<table border="1"><tr><td></td><td></td><td></td></tr><tr><td></td><td></td><td></td></tr><tr><td></td><td></td><td></td></tr></table>										<table border="1"><tr><td></td><td></td><td></td></tr><tr><td></td><td></td><td></td></tr><tr><td></td><td></td><td></td></tr></table>										<table border="1"><tr><td></td><td></td><td></td></tr><tr><td>1</td><td></td><td></td></tr><tr><td></td><td></td><td>1</td></tr></table>				1					1	<table border="1"><tr><td></td><td></td><td></td></tr><tr><td>2</td><td></td><td></td></tr><tr><td></td><td>1</td><td></td></tr></table>				2				1		<table border="1"><tr><td></td><td></td><td></td></tr><tr><td></td><td></td><td></td></tr><tr><td></td><td></td><td></td></tr></table>										<table border="1"><tr><td></td><td></td><td></td></tr><tr><td></td><td></td><td></td></tr><tr><td></td><td></td><td></td></tr></table>										<table border="1"><tr><td>2</td><td></td><td>1</td></tr><tr><td>1</td><td></td><td></td></tr><tr><td>1</td><td>1</td><td>1</td></tr></table>	2		1	1			1	1	1	<table border="1"><tr><td>1</td><td></td><td>1</td></tr><tr><td></td><td></td><td></td></tr><tr><td>1</td><td></td><td></td></tr></table>	1		1				1		
1																																																																															
		1																																																																													
2																																																																															
	1																																																																														
2		1																																																																													
1																																																																															
1	1	1																																																																													
1		1																																																																													
1																																																																															
Post - 0 Miss - 0 Block - 0	Post - 0 Miss - 0 Block - 0	Post - 0 Miss - 1 Block - 0	Post - 1 Miss - 0 Block - 0	Post - 0 Miss - 0 Block - 0	Post - 0 Miss - 0 Block - 0	Post - 0 Miss - 0 Block - 0	Post - 1 Miss - 1 Block - 0																																																																								
9 徐庆	10 陈超	12 温杰	16 张广建	17 李中洲	18 张腾	19 马跃	20 王伟																																																																								
<table border="1"><tr><td></td><td></td><td></td></tr><tr><td></td><td></td><td></td></tr><tr><td></td><td></td><td></td></tr></table>										<table border="1"><tr><td></td><td></td><td></td></tr><tr><td></td><td></td><td></td></tr><tr><td></td><td></td><td></td></tr></table>										<table border="1"><tr><td></td><td></td><td></td></tr><tr><td></td><td></td><td></td></tr><tr><td></td><td></td><td></td></tr></table>										<table border="1"><tr><td></td><td></td><td></td></tr><tr><td></td><td></td><td></td></tr><tr><td></td><td></td><td></td></tr></table>										<table border="1"><tr><td>1</td><td></td><td>1</td></tr><tr><td>1</td><td></td><td></td></tr><tr><td></td><td>1</td><td></td></tr></table>	1		1	1				1		<table border="1"><tr><td></td><td></td><td></td></tr><tr><td></td><td></td><td></td></tr><tr><td></td><td></td><td></td></tr></table>										<table border="1"><tr><td></td><td></td><td></td></tr><tr><td></td><td></td><td></td></tr><tr><td></td><td></td><td></td></tr></table>										<table border="1"><tr><td></td><td>1</td><td></td></tr><tr><td></td><td></td><td>2</td></tr><tr><td>1</td><td></td><td>1</td></tr></table>		1				2	1		1
1		1																																																																													
1																																																																															
	1																																																																														
	1																																																																														
		2																																																																													
1		1																																																																													
Post - 0 Miss - 0 Block - 0	Post - 0 Miss - 0 Block - 0	Post - 0 Miss - 0 Block - 0	Post - 0 Miss - 0 Block - 0	Post - 0 Miss - 0 Block - 0	Post - 0 Miss - 0 Block - 0	Post - 0 Miss - 0 Block - 0	Post - 0 Miss - 0 Block - 0																																																																								

注释: Post=击柱 Miss=射失 Block=被封





男子 国内比赛



第十二届全国运动会男子手球预赛

Team A				Team B				Match Number													
A 山西				B 天津				27													
played in		in the hall		on		at		Spectators													
China		柳州市李宁体育馆		23/04/2013		21:20 hours															
Half-time (30')	A	B	End of playing time	A	B	1st extra time	A	B	2nd extra time	A	B	After penalty throws	A	B							
	12	22		23	39																
Number of 7 m	A	Team time-out			Full name of players and officials						Team time-out			B	Number of 7 m						
		1	2	3							1	2	3								
	1/2	09:59	38:07	56:19							2/2										
No.	Team A					G	W	2'	D	DR	No.	Team B					G	W	2'	D	DR
1	李晋尧										1	刘宗其									
2	马健					1					2	李岳朋					2		1		
3	王晋					2					3	李军					3	1	1		
4	李鹏程					3					4	李松浩					3				
5	王志超										7	张青					3				
6	范帅					6					8	曹悦					5				
7	白宇飞					1		1			9	孟凡钢					1				
8	崔钰					2					10	李帅					6		1		
9	朱涛涛					2	1	1			11	王毅					1				
10	任海阳					1	1				13	许松					4	1			
12	侯乃章										14	田剑侠					2				
13	侯建涛										15	张俊岭									
14	刘明华					3					16	刘海亮									
15	景新江										17	周群					7		1		
18	朱棣					2		1			18	孙永									
											19	梁堂亮					2				
A	王喜和										A	尚喜									
B	张晓东										B	贾守信									
D	石岩										C	刘伟成									
											D	冀谦									
A	Signature of Responsible Official of the Teams (Off. A)																		B		
TP	Remarks of Referee / CHA Official																		TP		

Signatures

Referees: 李典 (CHN) 倪震 (CHN)

Techn. Delegates: 许宜扬 (CHN) 刘书勇 (CHN)

CHA Official:

Note: Number of 7m Throws Awarded to Team A and B, Goals (G), Warnings (W), Suspensions (2'), Direct Disqualification (D), Disqualification with Report (DR) and Team Penalty (TP).

Table Officials:

Statisticians: 黄莉

朱伟平

Printed by PHMS Copyright: IHF / CHA 23/04/2013 22:57:23

Longman Sportsoft



handball@126.com

第十二届全国运动会男子手球预赛
竞赛技术统计(媒体表)

预赛	组别	B	轮次	6	场次	27
柳州市李宁体育馆			23/04/2013		201301027-51-1/1	
山西	山西	23	vs	39	天津	天津
12 : 22						

裁判员	李典 (CHN)	/	倪震 (CHN)
-----	----------	---	----------

山西		远射	近射	边射	快攻	突破	任意球	7m球	合计	%	助攻	失误	警告	2'	D & DR	山西	比赛进程	天津
主教练: 王喜和																	1st Half	
1	李晋尧										1					4	00:34	1 13 许松
2	马健	0/1	0/1	1/1	0/1				1/4	25.0						1	01:09	1 7 张青
3	王晋		2/2						2/2	100						2	02:24	2 3 李军
4	李鹏程	3/12							3/12	25.0	1	5				2	03:21	2 3 周群
5	王志超															2	04:35	4 17 许松
6	范帅	0/1	2/2	3/3	1/1				6/7	85.7		1				2	05:27	5 13 周群
7	白宇飞	0/3	0/2					1/1	1/6	16.7		2		1		2	06:08	6 17 田剑侠
8	崔钰	1/3	1/1		0/1			0/1	2/6	33.3						2	07:56	7 14 李帅
9	朱涛涛	1/2	0/2	0/1	1/1				2/6	33.3			1	1		3	08:33	7 10 李帅
10	任海阳			0/1	1/1				1/2	50.0	1	3	1			4	09:50	8 10 田剑侠
12	侯乃章															4	10:25	8 10 田剑侠
13	侯建涛	0/2							0/2	0.0		3				4	11:11	9 14 田剑侠
14	刘明华	1/6		2/4		0/1			3/11	27.3	3	3				4	11:56	10 13 田剑侠
15	景新江											1				4	12:52	11 13 田剑侠
18	朱棣	0/3			2/4				2/7	28.6		2		1		4	13:09	12 3 李军
运动员 合计		6/33	5/10	6/10	5/9	0/1		1/2	23/65	35.4	6	20	2	3		3	13:39	12 3 李军
1	李晋尧	3/5	3/10	1/6	2/13	0/3		0/2	9/39	23.1	1					5	15:19	12 3 李军
12	侯乃章	0/1	0/4	1/2	3/6				4/13	30.8						6	15:54	13 7 张青
守门员 合计		3/6	3/14	2/8	5/19	0/3		0/2	13/52	25.0	1					6	16:51	14 3 李军
天津		远射	近射	边射	快攻	突破	任意球	7m球	合计	%	助攻	失误	警告	2'	D & DR	7	17:56	15 17 周群
教练: 尚喜																8	20:16	15 17 周群
1	刘宗其											2				8	20:43	16 8 曹悦
2	李岳朋	1/3	1/3						2/6	33.3		2		1		8	22:19	17 7 张青
3	李军				3/3				3/3	100	2	2	1	1		8	23:04	18 8 曹悦
4	李松浩		1/1	0/1	2/2				3/4	75.0		1				9	23:36	18 17 周群
7	张青	0/1	1/1		2/2				3/4	75.0		1				10	24:46	19 17 周群
8	曹悦	1/2	2/4		1/3			1/1	5/10	50.0		5				10	25:23	19 17 周群
9	孟凡钢					1/1			1/1	100	1					10	26:48	20 10 李帅
10	李帅		1/2	3/5	2/4				6/11	54.5	1	3		1		10	27:48	21 17 周群
11	王毅			1/1					1/1	100		1				11	28:12	21 10 李帅
13	许松			1/2	2/2			1/1	4/5	80.0			1			11	28:24	22 10 李帅
14	田剑侠		1/1			1/2			2/3	66.7		1				12	28:49	22 10 李帅
15	张俊岭															12	00:22	23 17 周群
16	刘海亮										1					12	00:22	23 17 周群
17	周群		4/5		2/3	1/1			7/9	77.8		1		1		13	03:00	23 17 周群
18	孙永															14	04:08	24 19 梁堂亮
19	梁堂亮	1/1		1/1					2/2	100		2				14	05:13	24 19 梁堂亮
运动员 合计		3/7	11/17	6/10	14/19	3/4		2/2	39/59	66.1	5	21	2	4		15	05:13	24 19 梁堂亮
1	刘宗其	10/11	1/4	0/3	3/7				14/25	56.0		2				16	06:36	24 19 梁堂亮
16	刘海亮	10/15	3/5	3/6	1/2			1/2	18/30	60.0	1					16	06:36	24 19 梁堂亮
守门员 合计		20/26	4/9	3/9	4/9			1/2	32/55	58.2	1	2				17	07:17	24 19 梁堂亮

场上队员: 得分 / 射门

守门员: 救球 / 射门

快攻	Fast Break	突破	Breakthrough	任意球	Free Throw	7M球	7M Throw	助攻	Assist
警告	Warning	失误	Error	2'	Suspension	D	取消资格	DR	取消资格+报告





第十二届全国运动会男子手球预赛 图式比赛技术统计表

轮次 6

场次 27

201301027-21-1/1

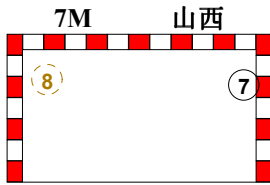
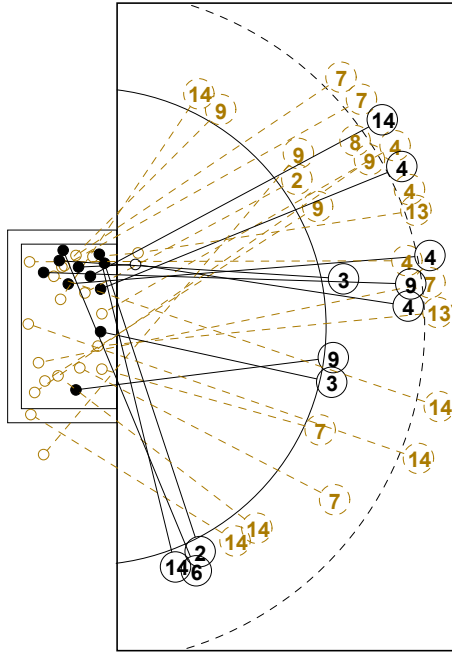

1st Half
12 : 22

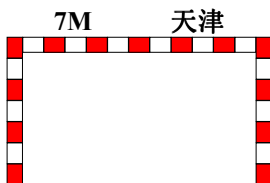
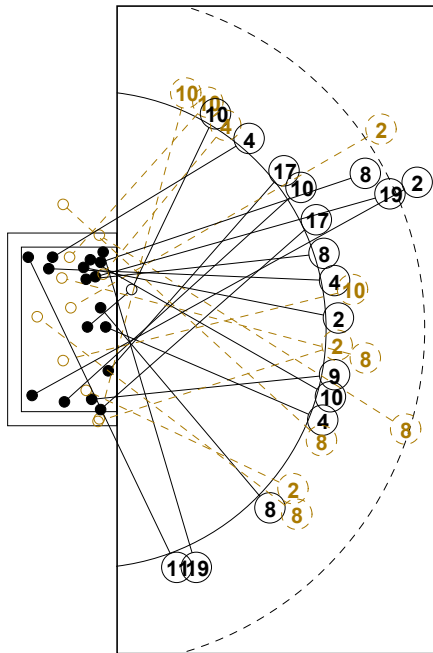
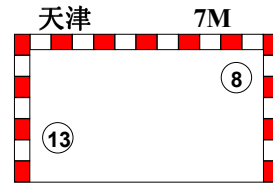
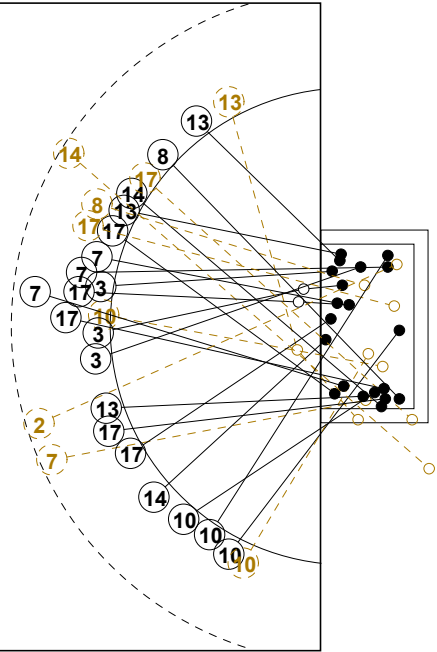

2nd Half
39 : 23

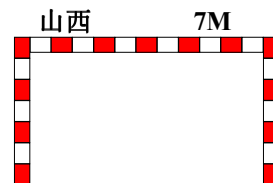
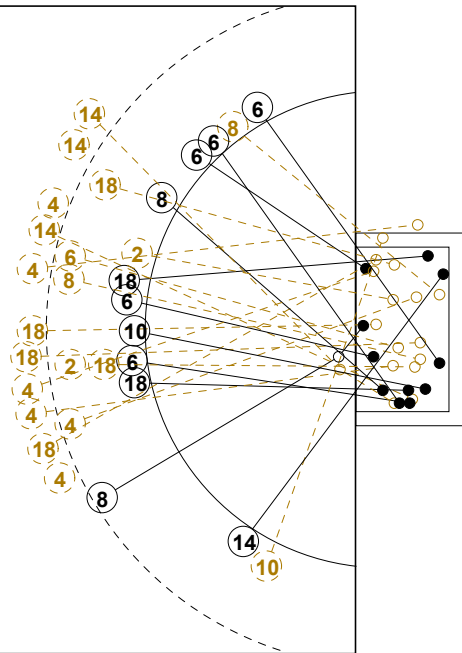



第十二届全国运动会男子手球预赛

个人/全队技术统计表

正式表
手球
男子预赛
轮次 6组别 B
场次 27201301027-14-1/2
柳州市李宁体育馆
23/04/2013 21:20

号码	姓名	远射	近射	边射	快攻	突破	任意	7M	合计	%	助攻	失误	警告	2'	取消	时间
山西(山西)																
<i>(场上队员)</i>																
1	李晋尧									0.0%	1					00:45:40
2	马健	0/1	0/1	1/1	0/1				1/4	25.0%						00:27:05
3	王晋		2/2						2/2	100%						00:20:25
4	李鹏程	3/12							3/12	25.0%	1	5				00:43:31
5	王志超									0.0%						00:00:00
6	范帅	0/1	2/2	3/3	1/1				6/7	85.7%		1				00:32:58
7	白宇飞	0/3	0/2					1/1	1/6	16.7%		2		1		00:23:17
8	崔钰	1/3	1/1		0/1			0/1	2/6	33.3%						00:29:40
9	朱涛涛	1/2	0/2	0/1	1/1				2/6	33.3%			1	1		00:26:34
10	任海阳			0/1	1/1				1/2	50.0%	1	3	1			00:47:38
12	侯乃章									0.0%						00:14:20
13	侯建涛	0/2							0/2	0.0%		3				00:19:03
14	刘明华	1/6		2/4		0/1			3/11	27.3%	3	3				00:46:21
15	景新江									0.0%		1				00:05:02
18	朱棣	0/3			2/4				2/7	28.6%		2		1		00:35:23
合计		6/33	5/10	6/10	5/9	0/1		1/2	23/65	35.4%	6	20	2	3		
<i>(守门员)</i>																
1	李晋尧	3/5	3/10	1/6	2/13	0/3		0/2	9/39	23.1%	1					00:45:40
12	侯乃章	0/1	0/4	1/2	3/6				4/13	30.8%						00:14:20
合计		3/6	3/14	2/8	5/19	0/3		0/2	13/52	25.0%	1					

场上队员：得分/射门

守门员：救球/射门

全队合计	得分	被救	射失	击柱	封球	合计	%
远射	6	20	1		6	33	18.2%
近射	5	4	1			10	50.0%
边射	6	3		1		10	60.0%
快攻	5	4				9	55.6%
突破				1		1	0.0%
任意							0.0%
7M	1	1				2	50.0%





第十二届全国运动会男子手球预赛

个人/全队技术统计表

正式表
手球
男子预赛
轮次 6组别 B
场次 27201301027-14-2/2
柳州市李宁体育馆
23/04/2013 21:20

号码	姓名	远射	近射	边射	快攻	突破	任意	7M	合计	%	助攻	失误	警告	2'	取消	时间
天津(天津)																
<i>(上场队员)</i>																
1	刘宗其									0.0%		2				00:30:00
2	李岳朋	1/3	1/3						2/6	33.3%		2		1		00:30:27
3	李军				3/3				3/3	100%	2	2	1	1		00:29:27
4	李松浩		1/1	0/1	2/2				3/4	75.0%		1				00:15:46
7	张青	0/1	1/1		2/2				3/4	75.0%		1				00:44:19
8	曹悦	1/2	2/4		1/3			1/1	5/10	50.0%		5				00:43:01
9	孟凡钢					1/1			1/1	100%	1					00:22:45
10	李帅		1/2	3/5	2/4				6/11	54.5%	1	3		1		00:59:50
11	王毅			1/1					1/1	100%		1				00:07:08
13	许松			1/2	2/2			1/1	4/5	80.0%			1			00:30:00
14	田剑侠		1/1			1/2			2/3	66.7%		1				00:16:53
15	张俊岭									0.0%						00:00:00
16	刘海亮									0.0%	1					00:30:00
17	周群		4/5		2/3	1/1			7/9	77.8%		1		1		00:44:05
18	孙永									0.0%						00:00:00
19	梁堂亮	1/1		1/1					2/2	100%		2				00:15:31
合计		3/7	11/17	6/10	14/19	3/4		2/2	39/59	66.1%	5	21	2	4		
<i>(守门员)</i>																
1	刘宗其	10/11	1/4	0/3	3/7				14/25	56.0%		2				00:30:00
16	刘海亮	10/15	3/5	3/6	1/2			1/2	18/30	60.0%	1					00:30:00
合计		20/26	4/9	3/9	4/9			1/2	32/55	58.2%	1	2				

场上队员：得分/射门

守门员：救球/射门

全队合计	得分	被救	射失	击柱	封球	合计	%
远射	3	3		1		7	42.9%
近射	11	3	1	2		17	64.7%
边射	6	2		2		10	60.0%
快攻	14	5				19	73.7%
突破	3		1			4	75.0%
任意							0.0%
7M	2					2	100.0%





第十二届全国运动会男子手球预赛

图式射门区域统计

轮次 6 场次 27

201301027-41-1/1

山西

1 李晋尧	2 马健	3 王晋	4 李鹏程	5 王志超	6 范帅	7 白宇飞	8 崔钰																																																																								
<table border="1"><tr><td></td><td></td><td></td></tr><tr><td></td><td></td><td></td></tr><tr><td></td><td></td><td></td></tr></table>										<table border="1"><tr><td></td><td></td><td></td></tr><tr><td></td><td></td><td></td></tr><tr><td></td><td></td><td>1</td></tr></table>									1	<table border="1"><tr><td></td><td></td><td></td></tr><tr><td></td><td></td><td>1</td></tr><tr><td></td><td></td><td></td></tr></table>						1				<table border="1"><tr><td></td><td></td><td></td></tr><tr><td></td><td></td><td>2</td></tr><tr><td></td><td></td><td>1</td></tr></table>						2			1	<table border="1"><tr><td></td><td></td><td></td></tr><tr><td></td><td></td><td></td></tr><tr><td></td><td></td><td></td></tr></table>										<table border="1"><tr><td></td><td></td><td>1</td></tr><tr><td></td><td></td><td>3</td></tr><tr><td>1</td><td>1</td><td></td></tr></table>			1			3	1	1		<table border="1"><tr><td></td><td></td><td></td></tr><tr><td></td><td></td><td>1</td></tr><tr><td></td><td></td><td></td></tr></table>						1				<table border="1"><tr><td></td><td></td><td></td></tr><tr><td></td><td></td><td></td></tr><tr><td></td><td>1</td><td>1</td></tr></table>								1	1
		1																																																																													
		1																																																																													
		2																																																																													
		1																																																																													
		1																																																																													
		3																																																																													
1	1																																																																														
		1																																																																													
	1	1																																																																													
Post - 0 Miss - 0 Block - 0	Post - 0 Miss - 0 Block - 1	Post - 0 Miss - 0 Block - 0	Post - 0 Miss - 1 Block - 3	Post - 0 Miss - 0 Block - 0	Post - 0 Miss - 0 Block - 0	Post - 0 Miss - 0 Block - 0	Post - 0 Miss - 0 Block - 1																																																																								
9 朱涛涛	10 任海阳	12 侯乃章	13 侯建涛	14 刘明华	15 景新江	18 朱棣																																																																									
<table border="1"><tr><td></td><td></td><td>1</td></tr><tr><td>1</td><td></td><td></td></tr><tr><td></td><td></td><td></td></tr></table>			1	1						<table border="1"><tr><td></td><td></td><td>1</td></tr><tr><td></td><td></td><td></td></tr><tr><td></td><td></td><td></td></tr></table>			1							<table border="1"><tr><td></td><td></td><td></td></tr><tr><td></td><td></td><td></td></tr><tr><td></td><td></td><td></td></tr></table>										<table border="1"><tr><td></td><td></td><td></td></tr><tr><td></td><td></td><td></td></tr><tr><td></td><td></td><td></td></tr></table>										<table border="1"><tr><td>1</td><td></td><td></td></tr><tr><td></td><td></td><td></td></tr><tr><td></td><td></td><td>2</td></tr></table>	1								2	<table border="1"><tr><td></td><td></td><td></td></tr><tr><td></td><td></td><td></td></tr><tr><td></td><td></td><td></td></tr></table>										<table border="1"><tr><td></td><td></td><td></td></tr><tr><td>1</td><td></td><td></td></tr><tr><td></td><td></td><td>1</td></tr></table>				1					1	<table border="1"><tr><td></td><td></td><td></td></tr><tr><td></td><td></td><td></td></tr><tr><td></td><td></td><td></td></tr></table>									
		1																																																																													
1																																																																															
		1																																																																													
1																																																																															
		2																																																																													
1																																																																															
		1																																																																													
Post - 0 Miss - 1 Block - 0	Post - 1 Miss - 0 Block - 0	Post - 0 Miss - 0 Block - 0	Post - 0 Miss - 0 Block - 0	Post - 1 Miss - 0 Block - 1	Post - 0 Miss - 0 Block - 0	Post - 0 Miss - 0 Block - 0																																																																									

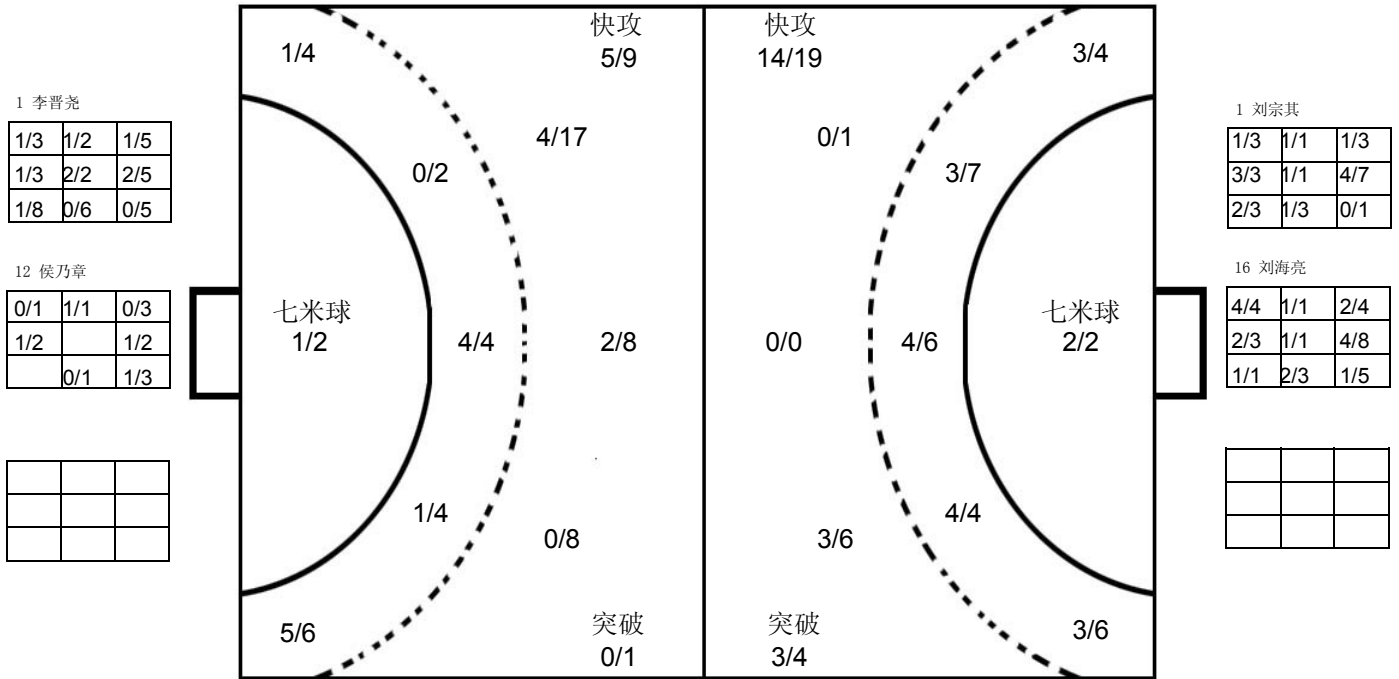

天津

1 刘宗其	2 李岳朋	3 李军	4 李松浩	7 张青	8 曹悦	9 孟凡钢	10 李帅																																																																								
<table border="1"><tr><td></td><td></td><td></td></tr><tr><td></td><td></td><td></td></tr><tr><td></td><td></td><td></td></tr></table>										<table border="1"><tr><td>1</td><td></td><td></td></tr><tr><td></td><td></td><td>1</td></tr><tr><td></td><td></td><td></td></tr></table>	1					1				<table border="1"><tr><td></td><td></td><td></td></tr><tr><td>1</td><td></td><td></td></tr><tr><td>2</td><td></td><td></td></tr></table>				1			2			<table border="1"><tr><td></td><td></td><td>2</td></tr><tr><td></td><td></td><td></td></tr><tr><td></td><td></td><td></td></tr></table>			2							<table border="1"><tr><td>1</td><td></td><td></td></tr><tr><td></td><td></td><td></td></tr><tr><td></td><td>1</td><td>1</td></tr></table>	1							1	1	<table border="1"><tr><td></td><td></td><td>2</td></tr><tr><td></td><td></td><td></td></tr><tr><td></td><td>1</td><td>2</td></tr></table>			2					1	2	<table border="1"><tr><td></td><td></td><td></td></tr><tr><td></td><td></td><td></td></tr><tr><td>1</td><td></td><td></td></tr></table>							1			<table border="1"><tr><td></td><td>1</td><td>1</td></tr><tr><td></td><td></td><td></td></tr><tr><td></td><td>1</td><td>1</td></tr></table>		1	1					1	1
1																																																																															
		1																																																																													
1																																																																															
2																																																																															
		2																																																																													
1																																																																															
	1	1																																																																													
		2																																																																													
	1	2																																																																													
1																																																																															
	1	1																																																																													
	1	1																																																																													
Post - 0 Miss - 0 Block - 0	Post - 1 Miss - 0 Block - 0	Post - 0 Miss - 0 Block - 0	Post - 0 Miss - 0 Block - 0	Post - 0 Miss - 0 Block - 0	Post - 1 Miss - 1 Block - 0	Post - 0 Miss - 0 Block - 0	Post - 1 Miss - 0 Block - 0																																																																								
11 王毅	13 许松	14 田剑侠	15 张俊岭	16 刘海亮	17 周群	18 孙永	19 梁堂亮																																																																								
<table border="1"><tr><td></td><td></td><td>1</td></tr><tr><td></td><td></td><td></td></tr><tr><td></td><td></td><td></td></tr></table>			1							<table border="1"><tr><td></td><td></td><td></td></tr><tr><td>1</td><td></td><td>1</td></tr><tr><td>2</td><td></td><td></td></tr></table>				1		1	2			<table border="1"><tr><td></td><td></td><td></td></tr><tr><td></td><td></td><td>1</td></tr><tr><td></td><td></td><td></td></tr></table>						1				<table border="1"><tr><td></td><td></td><td></td></tr><tr><td></td><td></td><td></td></tr><tr><td></td><td></td><td></td></tr></table>										<table border="1"><tr><td></td><td></td><td></td></tr><tr><td></td><td></td><td></td></tr><tr><td></td><td></td><td></td></tr></table>										<table border="1"><tr><td></td><td></td><td>2</td></tr><tr><td></td><td></td><td></td></tr><tr><td>2</td><td>2</td><td>1</td></tr></table>			2				2	2	1	<table border="1"><tr><td></td><td></td><td></td></tr><tr><td></td><td></td><td></td></tr><tr><td></td><td></td><td></td></tr></table>										<table border="1"><tr><td></td><td></td><td></td></tr><tr><td></td><td></td><td></td></tr><tr><td></td><td></td><td>2</td></tr></table>									2
		1																																																																													
1		1																																																																													
2																																																																															
		1																																																																													
		2																																																																													
2	2	1																																																																													
		2																																																																													
Post - 0 Miss - 0 Block - 0	Post - 1 Miss - 0 Block - 0	Post - 0 Miss - 1 Block - 0	Post - 0 Miss - 0 Block - 0	Post - 0 Miss - 0 Block - 0	Post - 1 Miss - 0 Block - 0	Post - 0 Miss - 0 Block - 0	Post - 0 Miss - 0 Block - 0																																																																								

注释: Post=击柱 Miss=射失 Block=被封





男子 国内比赛



第十二届全国运动会男子手球预赛

Team A		Team B		Match Number							
A 北京		B 西藏		28							
played in		in the hall		on							
China		柳州市李宁体育馆		24/04/2013							
				at							
				14:40 hours							
Spectators											
Half-time (30')	A	B	End of playing time	A	B						
	20	12	36 25	1st extra time							
				2nd extra time							
				After penalty throws							
Number of 7 m	A	Team time-out			B						
	2 / 2	1	2	3	0 / 0						
		22:00	45:01								
Full name of players and officials											
		1	2	3							
		14:36	48:59								
No.	Team A					No.	Team B				
	G	W	2'	D	DR		G	W	2'	D	DR
1	王泷					2	王龙	1			
2	杜龙飞	4		1		4	张家纬				
4	成亚					5	冯祥龙				
5	杨昆	1	1			6	任启双	3	1		
6	刘伟	4				7	徐奕飞	2			
7	胡瀛	5				9	王博				
8	王鹏		1	1		10	刘江				
9	刘振	2				11	朱治宇	4			
11	蒋维一	5				12	张帅				
13	白洁					15	刘劲松				
14	解建飞	3				16	徐畅				
16	孟辉	1				18	赵楠	3	1	1	
17	姜冰峰		1			19	任野				
18	张骥	9				20	顾艳超	5			
20	郑永利	2				21	马光	2			
23	冯宁					23	王伟强	5			
A	郑康旭					A	张文韬				
B	蔡建国					B	殷永军				
C	吴健					C	瓮勇				
D	石锋										
A	Signature of Responsible Official of the Teams (Off. A)										B
TP	Remarks of Referee / CHA Official										TP

Signatures

Referees	邓军 (CHN)	谭雷 (CHN)		
Techn. Delegates	许宜扬 (CHN)	刘书勇 (CHN)		
CHA Official				

Note: Number of 7m Throws Awarded to Team A and B, Goals (G), Warnings (W), Suspensions (2'), Direct Disqualification (D), Disqualification with Report (DR) and Team Penalty (TP).

Table Officials: 黄思华

谭云东

Statisticians: 黄莉

朱伟平

Printed by PHMS Copyright: IHF / CHA 24/04/2013 16:03:02

Longman Sportsoft



handball@126.com



第十二届全国运动会男子手球预赛 竞赛技术统计(媒体表)

预赛 组别 A 轮次 7 场次 28

柳州市李宁体育馆

24/04/2013

201301028-51-1/1

北京 北京 36 vs 25 西藏 西藏 20:12

裁判员 邓军 (CHN) / 谭雷 (CHN)

Main statistics table for Beijing and Tibet teams, including player names, goals, assists, and penalties.

场上队员: 得分 / 射门

守门员: 救球 / 射门

Legend table for abbreviations: 快攻, 警告, 突破, 失误, 任意球, 7M球, 助攻, 取消资格+报告





第十二届全国运动会男子手球预赛 图式比赛技术统计表

轮次 7

场次 28

201301028-21-1/1

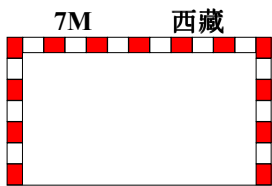
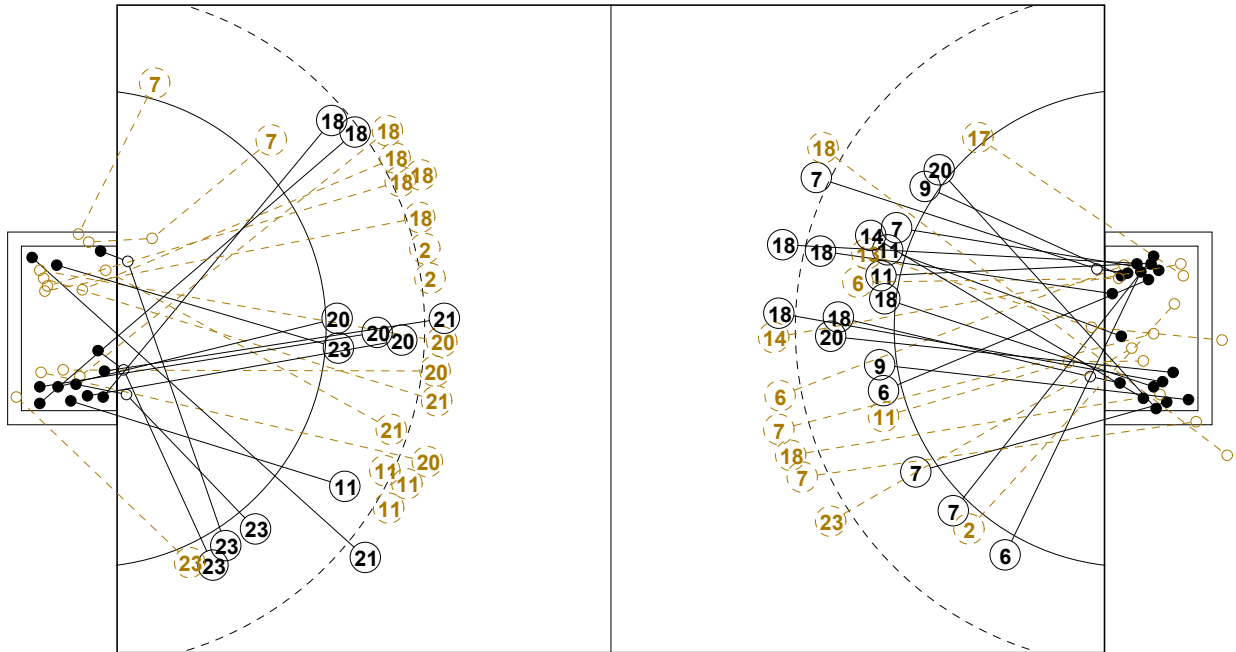

1st Half
12 : 20

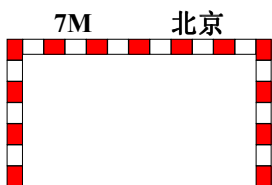
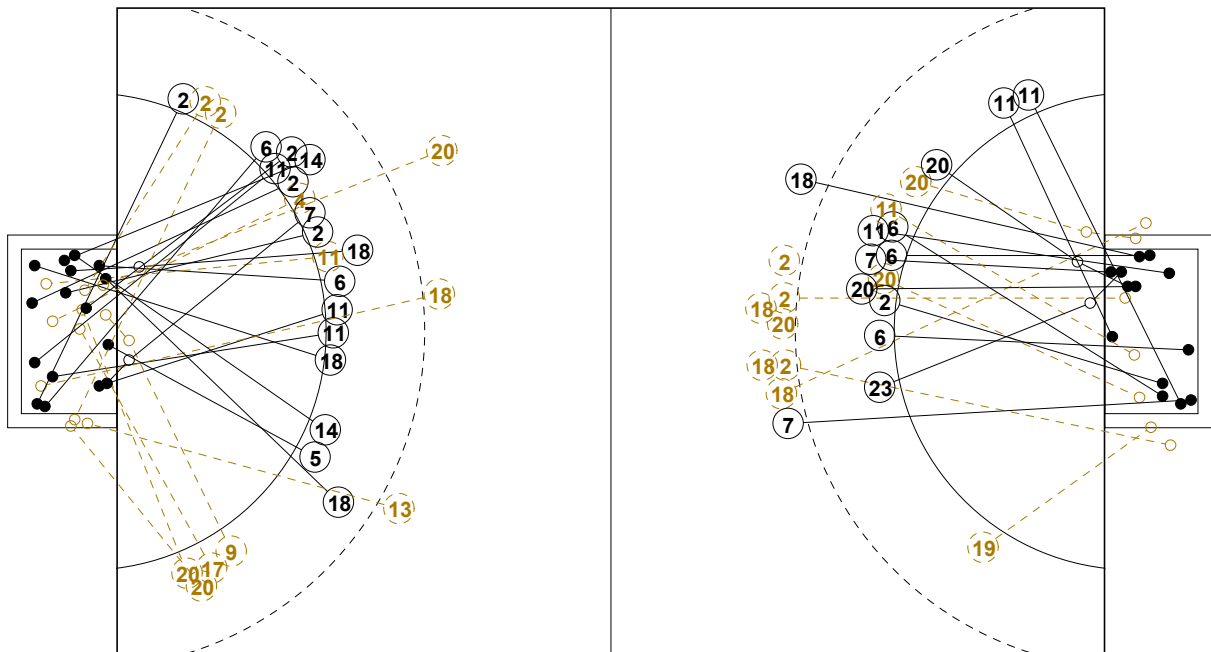
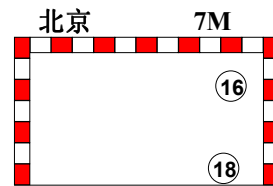

2nd Half
36 : 25

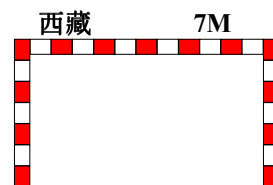



第十二届全国运动会男子手球预赛

个人/全队技术统计表

正式表
手球
男子预赛
轮次 7组别 A
场次 28201301028-14-1/2
柳州市李宁体育馆
24/04/2013 14:40

号码	姓名	远射	近射	边射	快攻	突破	任意	7M	合计	%	助攻	失误	警告	2'	取消	时间
北京(北京)																
<i>(场上队员)</i>																
1	王泷									0.0%		1				00:21:46
2	杜龙飞			0/1	4/6				4/7	57.1%		1		1		00:20:53
4	成亚		0/1						0/1	0.0%						00:05:16
5	杨昆				1/1				1/1	100%			1			00:25:22
6	刘伟				4/5		0/1		4/6	66.7%	1					00:40:04
7	胡瀛	1/3	1/1		2/2	1/1			5/7	71.4%	3	1				00:38:05
8	王鹏									0.0%			1	1		00:17:52
9	刘振		1/1	0/1	1/1				2/3	66.7%	1	4				00:39:24
11	蒋维一		4/5		1/2				5/7	71.4%		2				00:40:06
13	白洁	0/1	0/1						0/2	0.0%	2	2				00:22:39
14	解建飞		1/1		2/2		0/1		3/4	75.0%						00:07:50
16	孟辉							1/1	1/1	100%	3	1				00:38:14
17	姜冰峰			0/2					0/2	0.0%			1			00:38:01
18	张骥	3/6	4/4		1/1			1/1	9/12	75.0%	2	1				00:21:42
20	郑永利	0/1		0/2	2/2				2/5	40.0%						00:19:47
23	冯宁	0/1							0/1	0.0%						00:22:11
合计		4/12	11/14	0/6	18/22	1/1	0/2	2/2	36/59	61.0%	12	13	3	2		
<i>(守门员)</i>																
1	王泷	1/3	1/3	0/1	0/3	0/1			2/11	18.2%		1				00:21:46
16	孟辉	9/14	1/3	0/3	0/4	0/2			10/26	38.5%	3	1				00:38:14
合计		10/17	2/6	0/4	0/7	0/3			12/37	32.4%	3	2				

场上队员：得分/射门

守门员：救球/射门

全队合计	得分	被救	射失	击柱	封球	合计	%
远射	4	5	1	2		12	33.3%
近射	11	2	1			14	78.6%
边射		5		1		6	0.0%
快攻	18	3		1		22	81.8%
突破	1					1	100.0%
任意		2				2	0.0%
7M	2					2	100.0%





第十二届全国运动会男子手球预赛

个人/全队技术统计表

正式表
手球
男子预赛
轮次 7组别 A
场次 28201301028-14-2/2
柳州市李宁体育馆
24/04/2013 14:40

号码	姓名	远射	近射	边射	快攻	突破	任意	7M	合计	%	助攻	失误	警告	2'	取消	时间
西藏(西藏)																
<i>(上场队员)</i>																
2	王龙	0/5			1/1				1/6	16.7%		3				00:17:15
4	张家纬									0.0%						00:00:00
5	冯祥龙									0.0%						00:00:00
6	任启双		1/1		2/2				3/3	100%	1	1	1			01:00:00
7	徐奕飞	1/1	1/2	0/1					2/4	50.0%		1				00:59:57
9	王博									0.0%						00:00:00
10	刘江									0.0%						00:00:00
11	朱治宇	0/3	1/2	2/2	1/1				4/8	50.0%		4				00:36:37
12	张帅									0.0%		1				00:30:00
15	刘劲松									0.0%						00:00:00
16	徐畅									0.0%	1					00:30:00
18	赵楠	3/11							3/11	27.3%	4	2	1	1		01:00:00
19	任野			0/1					0/1	0.0%		1				00:23:09
20	顾艳超	1/5	1/3			3/3			5/11	45.5%		8				00:56:13
21	马光	2/4							2/4	50.0%		2				00:12:54
23	王伟强			2/3	3/3				5/6	83.3%		1				00:33:47
合计		7/29	4/8	4/7	7/7	3/3			25/54	46.3%	6	24	2	1		
<i>(守门员)</i>																
12	张帅	2/2	1/8	4/4	1/10				8/24	33.3%		1				00:30:00
16	徐畅	3/7	1/5	1/1	2/11	0/1	2/2	0/2	9/29	31.0%	1					00:30:00
合计		5/9	2/13	5/5	3/21	0/1	2/2	0/2	17/53	32.1%	1	1				

场上队员：得分/射门

守门员：救球/射门

全队合计	得分	被救	射失	击柱	封球	合计	%
远射	7	10	2		10	29	24.1%
近射	4	2		2		8	50.0%
边射	4			3		7	57.1%
快攻	7					7	100.0%
突破	3					3	100.0%
任意							0.0%
7M							0.0%





第十二届全国运动会男子手球预赛

图式射门区域统计

轮次 7 场次 28

201301028-41-1/1

北京

1 王澍	2 杜龙飞	4 成亚	5 杨昆	6 刘伟	7 胡瀛	8 王鹏	9 刘振																																																																								
<table border="1"><tr><td></td><td></td><td></td></tr><tr><td></td><td></td><td></td></tr><tr><td></td><td></td><td></td></tr></table>										<table border="1"><tr><td>1</td><td>1</td><td></td></tr><tr><td></td><td></td><td>1</td></tr><tr><td></td><td>1</td><td></td></tr></table>	1	1				1		1		<table border="1"><tr><td></td><td></td><td></td></tr><tr><td></td><td></td><td></td></tr><tr><td></td><td></td><td></td></tr></table>										<table border="1"><tr><td></td><td></td><td></td></tr><tr><td></td><td></td><td></td></tr><tr><td></td><td>1</td><td></td></tr></table>								1		<table border="1"><tr><td>1</td><td></td><td></td></tr><tr><td>2</td><td></td><td></td></tr><tr><td></td><td></td><td>1</td></tr></table>	1			2					1	<table border="1"><tr><td></td><td></td><td>1</td></tr><tr><td>2</td><td></td><td></td></tr><tr><td>2</td><td></td><td></td></tr></table>			1	2			2			<table border="1"><tr><td></td><td></td><td></td></tr><tr><td></td><td></td><td></td></tr><tr><td></td><td></td><td></td></tr></table>										<table border="1"><tr><td></td><td></td><td>1</td></tr><tr><td></td><td></td><td></td></tr><tr><td>1</td><td></td><td></td></tr></table>			1				1		
1	1																																																																														
		1																																																																													
	1																																																																														
	1																																																																														
1																																																																															
2																																																																															
		1																																																																													
		1																																																																													
2																																																																															
2																																																																															
		1																																																																													
1																																																																															
Post - 0 Miss - 0 Block - 0	Post - 1 Miss - 0 Block - 0	Post - 0 Miss - 0 Block - 0	Post - 0 Miss - 0 Block - 0	Post - 0 Miss - 0 Block - 0	Post - 1 Miss - 0 Block - 0	Post - 0 Miss - 0 Block - 0	Post - 0 Miss - 0 Block - 0																																																																								
11 蒋维一	13 白洁	14 解建飞	16 孟辉	17 姜冰峰	18 张骥	20 郑永利	23 冯宁																																																																								
<table border="1"><tr><td>2</td><td></td><td></td></tr><tr><td>1</td><td></td><td></td></tr><tr><td>1</td><td>1</td><td></td></tr></table>	2			1			1	1		<table border="1"><tr><td></td><td></td><td></td></tr><tr><td></td><td></td><td></td></tr><tr><td></td><td></td><td></td></tr></table>										<table border="1"><tr><td></td><td></td><td></td></tr><tr><td></td><td></td><td>3</td></tr><tr><td></td><td></td><td></td></tr></table>						3				<table border="1"><tr><td></td><td></td><td>1</td></tr><tr><td></td><td></td><td></td></tr><tr><td></td><td></td><td></td></tr></table>			1							<table border="1"><tr><td></td><td></td><td></td></tr><tr><td></td><td></td><td></td></tr><tr><td></td><td></td><td></td></tr></table>										<table border="1"><tr><td></td><td></td><td>1</td></tr><tr><td>1</td><td></td><td>3</td></tr><tr><td>1</td><td></td><td>3</td></tr></table>			1	1		3	1		3	<table border="1"><tr><td></td><td></td><td>1</td></tr><tr><td></td><td></td><td>1</td></tr><tr><td></td><td></td><td></td></tr></table>			1			1				<table border="1"><tr><td></td><td></td><td></td></tr><tr><td></td><td></td><td></td></tr><tr><td></td><td></td><td></td></tr></table>									
2																																																																															
1																																																																															
1	1																																																																														
		3																																																																													
		1																																																																													
		1																																																																													
1		3																																																																													
1		3																																																																													
		1																																																																													
		1																																																																													
Post - 0 Miss - 0 Block - 0	Post - 1 Miss - 1 Block - 0	Post - 0 Miss - 0 Block - 0	Post - 0 Miss - 0 Block - 0	Post - 0 Miss - 0 Block - 0	Post - 0 Miss - 1 Block - 0	Post - 1 Miss - 0 Block - 0	Post - 0 Miss - 0 Block - 0																																																																								

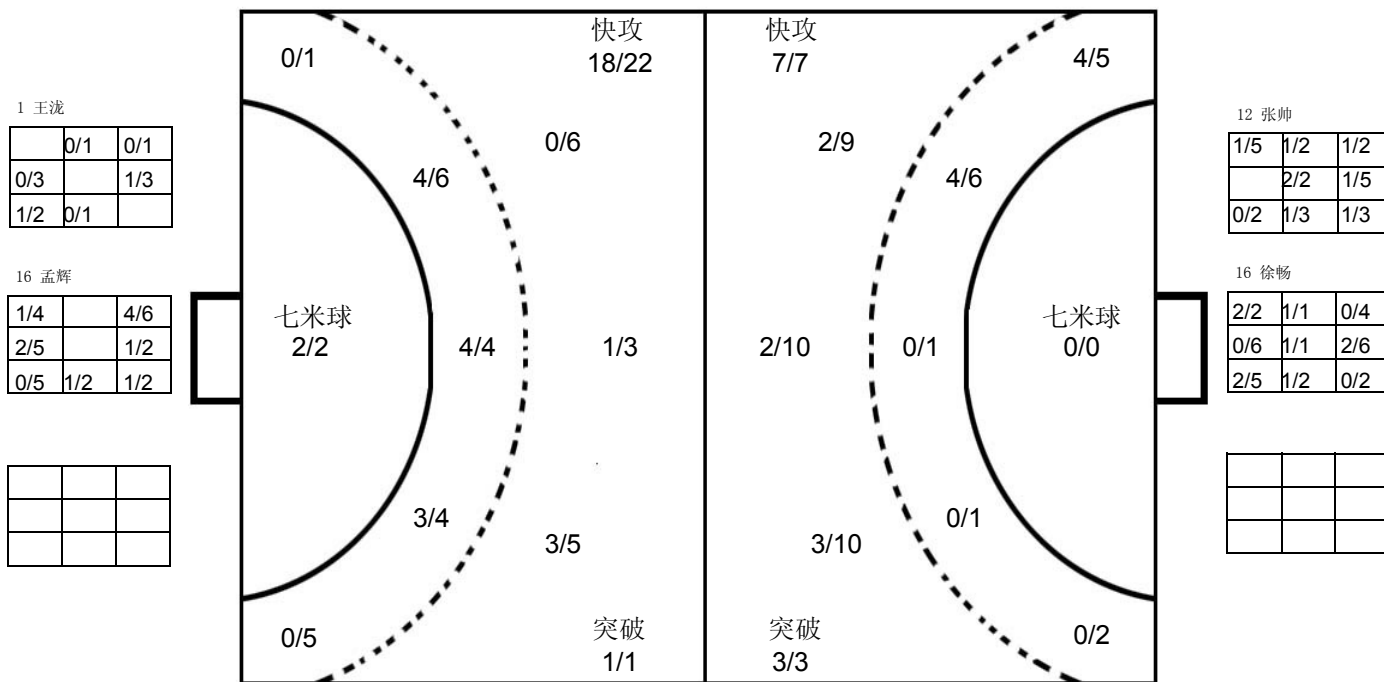

西藏

2 王龙	4 张家伟	5 冯祥龙	6 任启双	7 徐奕飞	9 王博	10 刘江	11 朱治宇																																																																								
<table border="1"><tr><td></td><td></td><td></td></tr><tr><td></td><td></td><td>1</td></tr><tr><td></td><td></td><td></td></tr></table>						1				<table border="1"><tr><td></td><td></td><td></td></tr><tr><td></td><td></td><td></td></tr><tr><td></td><td></td><td></td></tr></table>										<table border="1"><tr><td></td><td></td><td></td></tr><tr><td></td><td></td><td></td></tr><tr><td></td><td></td><td></td></tr></table>										<table border="1"><tr><td></td><td>1</td><td></td></tr><tr><td>1</td><td></td><td>1</td></tr><tr><td></td><td></td><td></td></tr></table>		1		1		1				<table border="1"><tr><td></td><td></td><td>1</td></tr><tr><td></td><td></td><td></td></tr><tr><td>1</td><td></td><td></td></tr></table>			1				1			<table border="1"><tr><td></td><td></td><td></td></tr><tr><td></td><td></td><td></td></tr><tr><td></td><td></td><td></td></tr></table>										<table border="1"><tr><td></td><td></td><td></td></tr><tr><td></td><td></td><td></td></tr><tr><td></td><td></td><td></td></tr></table>										<table border="1"><tr><td>1</td><td></td><td>1</td></tr><tr><td>1</td><td></td><td></td></tr><tr><td></td><td>1</td><td></td></tr></table>	1		1	1				1	
		1																																																																													
	1																																																																														
1		1																																																																													
		1																																																																													
1																																																																															
1		1																																																																													
1																																																																															
	1																																																																														
Post - 0 Miss - 1 Block - 3	Post - 0 Miss - 0 Block - 0	Post - 0 Miss - 0 Block - 0	Post - 0 Miss - 0 Block - 0	Post - 2 Miss - 0 Block - 0	Post - 0 Miss - 0 Block - 0	Post - 0 Miss - 0 Block - 0	Post - 0 Miss - 0 Block - 3																																																																								
12 张帅	15 刘劲松	16 徐畅	18 赵楠	19 任野	20 顾艳超	21 马光	23 王伟强																																																																								
<table border="1"><tr><td></td><td></td><td></td></tr><tr><td></td><td></td><td></td></tr><tr><td></td><td></td><td></td></tr></table>										<table border="1"><tr><td></td><td></td><td></td></tr><tr><td></td><td></td><td></td></tr><tr><td></td><td></td><td></td></tr></table>										<table border="1"><tr><td></td><td></td><td></td></tr><tr><td></td><td></td><td></td></tr><tr><td></td><td></td><td></td></tr></table>										<table border="1"><tr><td>1</td><td></td><td></td></tr><tr><td>1</td><td></td><td></td></tr><tr><td>1</td><td></td><td></td></tr></table>	1			1			1			<table border="1"><tr><td></td><td></td><td></td></tr><tr><td></td><td></td><td></td></tr><tr><td></td><td></td><td></td></tr></table>										<table border="1"><tr><td>1</td><td></td><td></td></tr><tr><td>2</td><td></td><td></td></tr><tr><td>2</td><td></td><td></td></tr></table>	1			2			2			<table border="1"><tr><td></td><td></td><td>1</td></tr><tr><td>1</td><td></td><td></td></tr><tr><td></td><td></td><td></td></tr></table>			1	1						<table border="1"><tr><td>1</td><td></td><td>1</td></tr><tr><td>1</td><td>1</td><td>1</td></tr><tr><td></td><td></td><td></td></tr></table>	1		1	1	1	1			
1																																																																															
1																																																																															
1																																																																															
1																																																																															
2																																																																															
2																																																																															
		1																																																																													
1																																																																															
1		1																																																																													
1	1	1																																																																													
Post - 0 Miss - 0 Block - 0	Post - 0 Miss - 0 Block - 0	Post - 0 Miss - 0 Block - 0	Post - 0 Miss - 1 Block - 3	Post - 1 Miss - 0 Block - 0	Post - 1 Miss - 0 Block - 1	Post - 0 Miss - 0 Block - 0	Post - 1 Miss - 0 Block - 0																																																																								

注释: Post=击柱 Miss=射失 Block=被封





男子 国内比赛



第十二届全国运动会男子手球预赛

Team A										Team B										Match Number											
A 香港										B 澳门										29											
played in China										in the hall 柳州市李宁体育馆										on 24/04/2013		at 16:20 hours		Spectators							
Half-time (30')		A 12		B 7		End of playing time		A 25		B 17		1st extra time		A		B		2nd extra time		A		B		After penalty throws		A		B			
Number of 7 m		A 4 / 7		Team time-out			Full name of players and officials										Team time-out			B 2 / 4		Number of 7 m									
		1	2	3	26:35	55:08																									
No.	Team A										G	W	2'	D	DR	No.	Team B										G	W	2'	D	DR
1	1 萧智庭															2	2 李翹臻											1	1		
2	2 叶冠英															4	4 刘家声														
5	5 黄胜业										1	1				5	5 何建成												1		
6	6 谢伟希										3	1				15	15 黄俊勇														
7	7 许文邦										1					16	16 冯国政														
9	9 张建国												1			18	18 卓伟杰														
11	11 陈允文										1					21	21 麦锦聪														
12	12 叶冠雄										4					22	22 陈学敏										1		1		
13	13 叶仕仁										3					24	24 刘登宇										3		1		
14	14 李鑫豪															27	27 徐展业										4				
15	15 黄嘉愉															28	28 莫家进										4	1	1		
25	25 曾铭谦										4	1				29	29 叶响俊										2				
29	29 练明辉										8					33	33 欧永健														
																36	36 陈嘉聪														
																81	81 梁梓康										1	1	1		
																93	93 罗咪高										2				
A	A 陈广裕															A	A 卢永明														
B	B 杨开将															B	B 高光明														
D	D 张军															C	C 黄宇豪														
A										Signature of Responsible Official of the Teams (Off. A)										B											
TP	Remarks of Referee / CHA Official																				TP										

Signatures

Referees: 朱昆宏 (CHN) 刘建鹏 (CHN)

Techn. Delegates: 许宜扬 (CHN) 刘书勇 (CHN)

CHA Official:

Note: Number of 7m Throws Awarded to Team A and B, Goals (G), Warnings (W), Suspensions (2'), Direct Disqualification (D), Disqualification with Report (DR) and Team Penalty (TP).

Table Officials: 黄思华

谭云东

Statisticians: 黄莉

朱伟平



第十二届全国运动会男子手球预赛
竞赛技术统计(媒体表)

预赛	组别	A	轮次	7	场次	29
----	----	---	----	---	----	----

柳州市李宁体育馆

24/04/2013

201301029-51-1/1

香港	香港	25	vs	17	澳门	澳门
12:7						

裁判员	朱昆宏 (CHN)	/	刘建鹏 (CHN)
-----	-----------	---	-----------

香港		远射	近射	边射	快攻	突破	任意球	7m球	合计	%	助攻	失误	警告	2'	D & DR	香港	比赛进程	澳门
主教练: 陈广裕																		
1	萧智庭																	
2	叶冠英										2							
5	黄胜业		1/1	0/2					1/3	33.3		2	1					
6	谢伟希		2/2		1/1				3/3	100	1	1	1					
7	许文邦	1/1				0/1	0/1		1/3	33.3	1	2						
9	张建国			0/1				0/1	0/2	0.0	1	2		1				
11	陈允文		0/1	1/1					1/2	50.0		2						
12	叶冠雄	1/1	0/1		2/4	1/1			4/7	57.1	1							
13	叶仕仁	0/1		1/1	2/2				3/4	75.0	1	2						
14	李鑫豪											1	1					
15	黄嘉愉		0/1		0/2				0/3	0.0								
25	曾铭谦		1/1	3/8	0/1				4/10	40.0		1	1					24 刘登宇
29	练明辉		1/1		3/3	0/3		4/6	8/14	57.1								93 罗咪高
运动员 合计		2/4	5/8	5/13	8/13	1/5	0/1	4/7	25/51	49.0	8	15	3	1				
2	叶冠英	4/4	2/6	3/5	2/7	4/8	1/1	1/2	17/33	51.5	2							
守门员 合计		4/4	2/6	3/5	2/7	4/8	1/1	1/2	17/33	51.5	2							
澳门		远射	近射	边射	快攻	突破	任意球	7m球	合计	%	助攻	失误	警告	2'	D & DR			
教练: 卢永明																		
2	李翘臻			0/1					0/1	0.0		1	1	1				
4	刘家声																	
5	何建成					0/1			0/1	0.0		5		1				
15	黄俊勇																	
16	冯国政																	
18	卓伟杰																	
21	麦锦聪											1						
22	陈学敏		1/2		0/1				1/3	33.3		2		1				
24	刘登宇	0/4	1/1	1/1				1/1	3/7	42.9		2		1				
27	徐展业		2/2		2/3	0/1			4/6	66.7		2						
28	莫家进	0/2		1/2	1/1	1/1		1/2	4/8	50.0	1	4	1	1				
29	叶响俊	0/1			1/1	1/2			2/4	50.0								
33	欧永健	0/1		0/1			0/1		0/3	0.0		2						
36	陈嘉聪																	
81	梁梓康	0/2		0/1		1/2		0/1	1/6	16.7		3	1	1				
93	罗咪高		0/1		1/1	1/1			2/3	66.7		3						
运动员 合计		0/10	4/6	2/6	5/7	4/8	0/1	2/4	17/42	40.5	1	25	3	6				
16	冯国政							0/1	0/1	0.0								
36	陈嘉聪	1/3	3/8	6/11	2/10	2/3		1/4	15/39	38.5								
守门员 合计		1/3	3/8	6/11	2/10	2/3		1/5	15/40	37.5								

场上队员: 得分 / 射门

守门员: 救球 / 射门

快攻	Fast Break		突破	Breakthrough		任意球	Free Throw		7m球	7M Throw		助攻	Assist
警告	Warning		失误	Error		2'	Suspension		D	取消资格		DR	取消资格+报告





第十二届全国运动会男子手球预赛 图式比赛技术统计表

轮次 7

场次 29

201301029-21-1/1

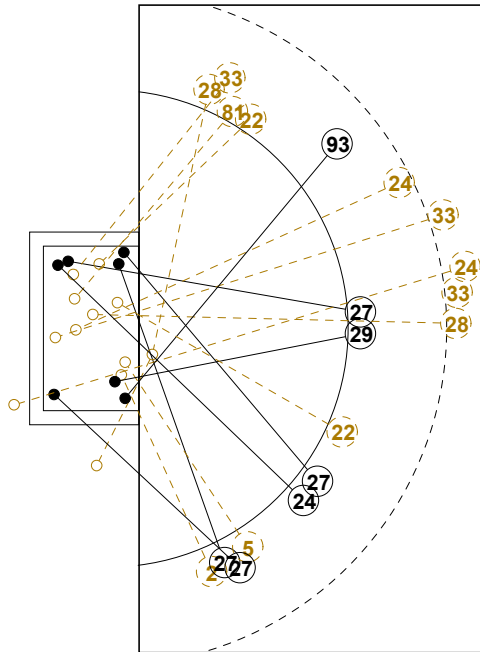

1st Half
7 : 12

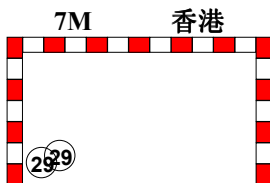
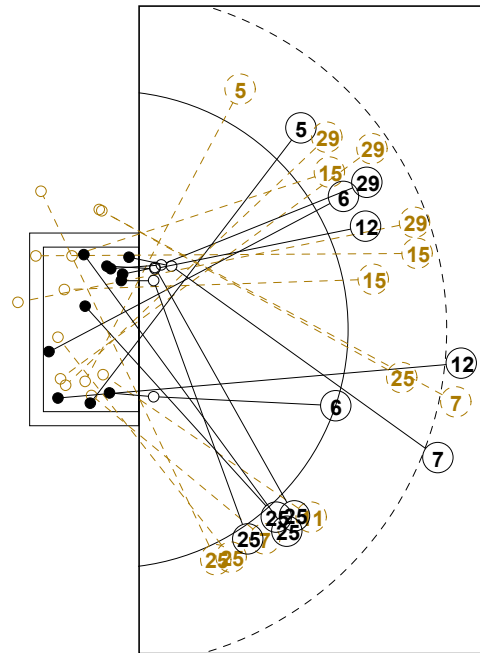
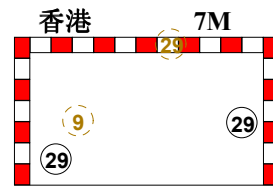
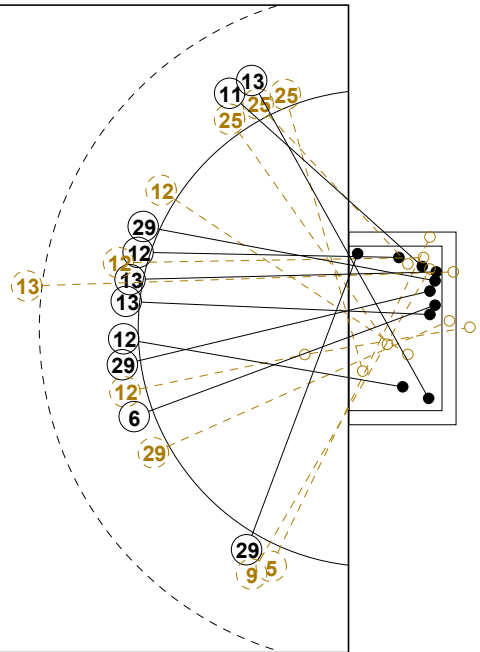

2nd Half
25 : 17

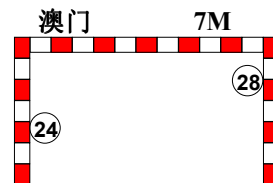
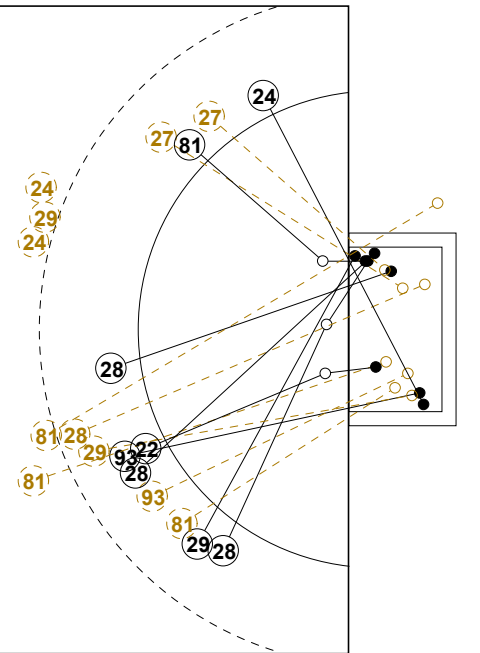



第十二届全国运动会男子手球预赛

个人/全队技术统计表

正式表
手球
男子预赛
轮次 7组别 A
场次 29201301029-14-1/2
柳州市李宁体育馆
24/04/2013 16:20

号码	姓名	远射	近射	边射	快攻	突破	任意	7M	合计	%	助攻	失误	警告	2'	取消	时间
香港(香港)																
<i>(场上队员)</i>																
1	萧智庭									0.0%						00:00:00
2	叶冠英									0.0%	2					01:00:00
5	黄胜业		1/1	0/2					1/3	33.3%		2	1			00:32:38
6	谢伟希		2/2		1/1				3/3	100%	1	1	1			00:31:54
7	许文邦	1/1				0/1	0/1		1/3	33.3%	1	2				00:19:16
9	张建国			0/1				0/1	0/2	0.0%	1	2		1		00:41:16
11	陈允文		0/1	1/1					1/2	50.0%		2				00:24:03
12	叶冠雄	1/1	0/1		2/4	1/1			4/7	57.1%	1					00:40:22
13	叶仕仁	0/1		1/1	2/2				3/4	75.0%	1	2				00:49:35
14	李鑫豪									0.0%	1	1				00:24:22
15	黄嘉愉		0/1		0/2				0/3	0.0%						00:14:34
25	曾铭谦		1/1	3/8	0/1				4/10	40.0%		1	1			00:35:55
29	练明辉	0/1	1/1		3/3	0/3		4/6	8/14	57.1%		2				00:45:54
合计																
<i>(守门员)</i>																
2	叶冠英	4/4	2/6	3/5	2/7	4/8	1/1	1/2	17/33	51.5%	2					01:00:00
合计																
4/4 2/6 3/5 2/7 4/8 1/1 1/2 17/33 51.5% 2																

场上队员：得分/射门

守门员：救球/射门

全队合计	得分	被救	射失	击柱	封球	合计	%
远射	2	1		1		4	50.0%
近射	5	3				8	62.5%
边射	5	6	1	1		13	38.5%
快攻	8	2	2	1		13	61.5%
突破	1	2	1	1		5	20.0%
任意			1			1	0.0%
7M	4	1	1	1		7	57.1%





第十二届全国运动会男子手球预赛

个人/全队技术统计表

正式表
手球
男子预赛
轮次 7组别 A
场次 29201301029-14-2/2
柳州市李宁体育馆
24/04/2013 16:20

号码	姓名	远射	近射	边射	快攻	突破	任意	7M	合计	%	助攻	失误	警告	2'	取消	时间
澳门(澳门)																
<i>(上场队员)</i>																
2	李翹臻			0/1					0/1	0.0%		1	1	1		00:31:39
4	刘家声									0.0%						00:00:00
5	何建成					0/1			0/1	0.0%		5		1		00:25:10
15	黄俊勇									0.0%						00:00:00
16	冯国政									0.0%						00:00:15
18	卓伟杰									0.0%						00:00:00
21	麦锦聪									0.0%		1				00:06:39
22	陈学敏		1/2		0/1				1/3	33.3%		2		1		00:34:55
24	刘登宇	0/4	1/1	1/1				1/1	3/7	42.9%		2		1		00:28:00
27	徐展业		2/2		2/3	0/1			4/6	66.7%		2				00:47:00
28	莫家进	0/2		1/2	1/1	1/1		1/2	4/8	50.0%	1	4	1	1		00:39:28
29	叶响俊	0/1			1/1	1/2			2/4	50.0%						00:47:50
33	欧永健	0/1		0/1			0/1		0/3	0.0%		2				00:36:14
36	陈嘉聪									0.0%						00:59:45
81	梁梓康	0/2		0/1		1/2		0/1	1/6	16.7%		3	1	1		00:41:27
93	罗咪高		0/1		1/1	1/1			2/3	66.7%		3				00:20:12
合计		0/10	4/6	2/6	5/7	4/8	0/1	2/4	17/42	40.5%	1	25	3	6		
<i>(守门员)</i>																
16	冯国政							0/1	0/1	0.0%						00:00:15
36	陈嘉聪	1/3	3/8	6/11	2/10	2/3		1/4	15/39	38.5%						00:59:45
合计		1/3	3/8	6/11	2/10	2/3		1/5	15/40	37.5%						

场上队员：得分/射门

守门员：救球/射门

全队合计	得分	被救	射失	击柱	封球	合计	%
远射		4	2		4	10	0.0%
近射	4	2				6	66.7%
边射	2	3	1			6	33.3%
快攻	5	2				7	71.4%
突破	4	4				8	50.0%
任意		1				1	0.0%
7M	2	1		1		4	50.0%





第十二届全国运动会男子手球预赛

图式射门区域统计

轮次 7 场次 29

201301029-41-1/1

香港

1 萧智庭	2 叶冠英	5 黄胜业	6 谢伟希	7 许文邦	9 张建国	11 陈允文	12 叶冠雄																																																																								
<table border="1"><tr><td></td><td></td><td></td></tr><tr><td></td><td></td><td></td></tr><tr><td></td><td></td><td></td></tr></table>										<table border="1"><tr><td></td><td></td><td></td></tr><tr><td></td><td></td><td></td></tr><tr><td></td><td></td><td></td></tr></table>										<table border="1"><tr><td></td><td></td><td></td></tr><tr><td>1</td><td></td><td></td></tr><tr><td></td><td></td><td></td></tr></table>				1						<table border="1"><tr><td></td><td>2</td><td></td></tr><tr><td></td><td></td><td></td></tr><tr><td>1</td><td></td><td></td></tr></table>		2					1			<table border="1"><tr><td></td><td></td><td></td></tr><tr><td></td><td></td><td></td></tr><tr><td></td><td></td><td>1</td></tr></table>									1	<table border="1"><tr><td></td><td></td><td></td></tr><tr><td></td><td></td><td></td></tr><tr><td></td><td></td><td></td></tr></table>										<table border="1"><tr><td>1</td><td></td><td></td></tr><tr><td></td><td></td><td></td></tr><tr><td></td><td></td><td></td></tr></table>	1									<table border="1"><tr><td>1</td><td></td><td></td></tr><tr><td></td><td></td><td></td></tr><tr><td>1</td><td></td><td>2</td></tr></table>	1						1		2
1																																																																															
	2																																																																														
1																																																																															
		1																																																																													
1																																																																															
1																																																																															
1		2																																																																													
Post - 0 Miss - 0 Block - 0	Post - 0 Miss - 0 Block - 0	Post - 1 Miss - 0 Block - 0	Post - 0 Miss - 0 Block - 0	Post - 0 Miss - 1 Block - 0	Post - 0 Miss - 0 Block - 0	Post - 0 Miss - 0 Block - 0	Post - 0 Miss - 1 Block - 0																																																																								
13 叶仕仁	14 李鑫豪	15 黄嘉愉	25 曾铭谦	29 练明辉																																																																											
<table border="1"><tr><td>1</td><td>1</td><td>1</td></tr><tr><td></td><td></td><td></td></tr><tr><td></td><td></td><td></td></tr></table>	1	1	1							<table border="1"><tr><td></td><td></td><td></td></tr><tr><td></td><td></td><td></td></tr><tr><td></td><td></td><td></td></tr></table>										<table border="1"><tr><td></td><td></td><td></td></tr><tr><td></td><td></td><td></td></tr><tr><td></td><td></td><td></td></tr></table>										<table border="1"><tr><td></td><td></td><td></td></tr><tr><td></td><td>1</td><td>1</td></tr><tr><td></td><td></td><td>2</td></tr></table>					1	1			2	<table border="1"><tr><td>2</td><td></td><td></td></tr><tr><td></td><td></td><td>1</td></tr><tr><td>4</td><td></td><td>1</td></tr></table>	2					1	4		1	<table border="1"><tr><td></td><td></td><td></td></tr><tr><td></td><td></td><td></td></tr><tr><td></td><td></td><td></td></tr></table>										<table border="1"><tr><td></td><td></td><td></td></tr><tr><td></td><td></td><td></td></tr><tr><td></td><td></td><td></td></tr></table>										<table border="1"><tr><td></td><td></td><td></td></tr><tr><td></td><td></td><td></td></tr><tr><td></td><td></td><td></td></tr></table>									
1	1	1																																																																													
	1	1																																																																													
		2																																																																													
2																																																																															
		1																																																																													
4		1																																																																													
Post - 1 Miss - 0 Block - 0	Post - 0 Miss - 0 Block - 0	Post - 1 Miss - 0 Block - 0	Post - 0 Miss - 2 Block - 0	Post - 2 Miss - 2 Block - 0																																																																											

2 叶冠英

1/2	2/2	3/8
2/4	1/1	5/5
2/8	1/1	0/3

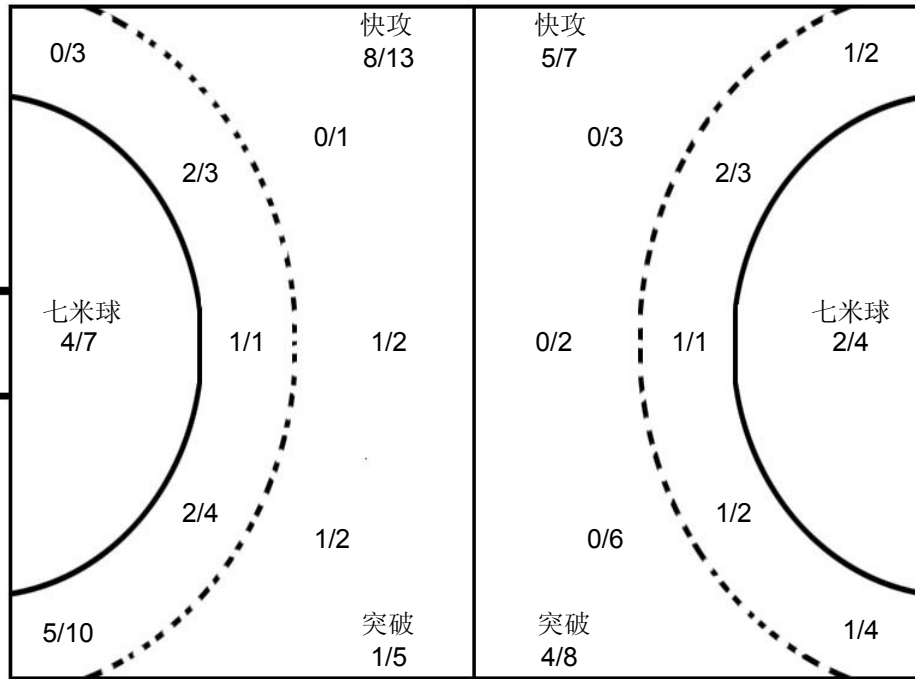

16 冯国政

0/1		

36 陈嘉聪

4/9	1/4	2/3
5/7	2/3	0/4
0/4		1/5

澳门

2 李翹臻	4 刘家声	5 何建成	15 黄俊勇	16 冯国政	18 卓伟杰	21 麦锦聪	22 陈学敏																																																																								
<table border="1"><tr><td></td><td></td><td></td></tr><tr><td></td><td></td><td></td></tr><tr><td></td><td></td><td></td></tr></table>										<table border="1"><tr><td></td><td></td><td></td></tr><tr><td></td><td></td><td></td></tr><tr><td></td><td></td><td></td></tr></table>										<table border="1"><tr><td></td><td></td><td></td></tr><tr><td></td><td></td><td></td></tr><tr><td></td><td></td><td></td></tr></table>										<table border="1"><tr><td></td><td></td><td></td></tr><tr><td></td><td></td><td></td></tr><tr><td></td><td></td><td></td></tr></table>										<table border="1"><tr><td></td><td></td><td></td></tr><tr><td></td><td></td><td></td></tr><tr><td></td><td></td><td></td></tr></table>										<table border="1"><tr><td></td><td></td><td></td></tr><tr><td></td><td></td><td></td></tr><tr><td></td><td></td><td></td></tr></table>										<table border="1"><tr><td></td><td></td><td></td></tr><tr><td></td><td></td><td></td></tr><tr><td></td><td></td><td></td></tr></table>										<table border="1"><tr><td></td><td></td><td>1</td></tr><tr><td></td><td></td><td></td></tr><tr><td></td><td></td><td></td></tr></table>			1						
		1																																																																													
Post - 0 Miss - 0 Block - 0	Post - 0 Miss - 0 Block - 0	Post - 0 Miss - 0 Block - 0	Post - 0 Miss - 0 Block - 0	Post - 0 Miss - 0 Block - 0	Post - 0 Miss - 0 Block - 0	Post - 0 Miss - 0 Block - 0	Post - 0 Miss - 0 Block - 0																																																																								
24 刘登宇	27 徐展业	28 莫家进	29 叶响俊	33 欧永健	36 陈嘉聪	81 梁梓康	93 罗咏高																																																																								
<table border="1"><tr><td></td><td></td><td>2</td></tr><tr><td>1</td><td></td><td></td></tr><tr><td></td><td></td><td></td></tr></table>			2	1						<table border="1"><tr><td>1</td><td></td><td>1</td></tr><tr><td></td><td></td><td></td></tr><tr><td></td><td></td><td>2</td></tr></table>	1		1						2	<table border="1"><tr><td></td><td></td><td>1</td></tr><tr><td>1</td><td></td><td></td></tr><tr><td>2</td><td></td><td></td></tr></table>			1	1			2			<table border="1"><tr><td></td><td></td><td></td></tr><tr><td></td><td></td><td></td></tr><tr><td>2</td><td></td><td></td></tr></table>							2			<table border="1"><tr><td></td><td></td><td></td></tr><tr><td></td><td></td><td></td></tr><tr><td></td><td></td><td></td></tr></table>										<table border="1"><tr><td></td><td></td><td></td></tr><tr><td></td><td></td><td></td></tr><tr><td></td><td></td><td></td></tr></table>										<table border="1"><tr><td></td><td></td><td></td></tr><tr><td>1</td><td></td><td></td></tr><tr><td></td><td></td><td></td></tr></table>				1						<table border="1"><tr><td></td><td></td><td>1</td></tr><tr><td></td><td></td><td></td></tr><tr><td>1</td><td></td><td></td></tr></table>			1				1		
		2																																																																													
1																																																																															
1		1																																																																													
		2																																																																													
		1																																																																													
1																																																																															
2																																																																															
2																																																																															
1																																																																															
		1																																																																													
1																																																																															
Post - 0 Miss - 1 Block - 2	Post - 0 Miss - 0 Block - 0	Post - 1 Miss - 1 Block - 0	Post - 0 Miss - 0 Block - 1	Post - 0 Miss - 0 Block - 1	Post - 0 Miss - 0 Block - 0	Post - 0 Miss - 1 Block - 0	Post - 0 Miss - 0 Block - 0																																																																								

注释: Post=击柱 Miss=射失 Block=被封





男子 国内比赛



第十二届全国运动会男子手球预赛

Team A				Team B				Match Number													
A 山东				B 江苏				30													
played in		in the hall		on		at		Spectators													
China		柳州市李宁体育馆		24/04/2013		18:00 hours															
Half-time (30')	A	B	End of playing time	A	B	1st extra time	A	B	2nd extra time	A	B	After penalty throws	A	B							
	9	18		20	34																
Number of 7 m	A	Team time-out			Full name of players and officials						Team time-out			B	Number of 7 m						
		1	2	3							1	2	3								
	1 / 1	16:38	53:08							23:36	43:56		1 / 2								
No.	Team A					G	W	2'	D	DR	No.	Team B					G	W	2'	D	DR
1	于性哲										1	丁大伟									
4	田瑞										2	杨彦威									
6	李朝鹏					1		1			3	李旭东									
8	王炳华					3					4	沈庆					3				
9	赵鑫										5	闫亮					3	1			
11	宋朋强					1		1			6	赵晨					2		1		
13	刘晓					2					8	周小坚					4				
15	陈鹏波					2	1				9	叶强					1				
16	王帅										10	郝可鑫					5	1			
17	王旭东							1			11	姚仁剑									
18	于亚男										12	王权									
19	李语庆					6					14	丛海航					2	1			
20	杜在超										15	李安					9				
21	翟乾坤					5					17	陈灵峰									
22	刘正松										19	张志宇					5				
											20	张星									
A	王鸿斌										A	闫威名									
B	王志峰										C	NENADz vonarek									
C	邢建刚										D	王建国									
D	徐强										E	贾淑君									
A	Signature of Responsible Official of the Teams (Off. A)																		B		
TP	Remarks of Referee / CHA Official																		TP		

Signatures

Referees	李刚 (CHN)	王科 (CHN)		
Techn. Delegates	李之文 (CHN)	王锡祯 (CHN)		
CHA Official				

Note: Number of 7m Throws Awarded to Team A and B, Goals (G), Warnings (W), Suspensions (2'), Direct Disqualification (D), Disqualification with Report (DR) and Team Penalty (TP).

Table Officials: 谭云东

Statisticians: 朱伟平

黄莉





第十二届全国运动会男子手球预赛
竞赛技术统计(媒体表)

Table with match details: 预赛 (Pre-match), 组别 A (Group), 轮次 7 (Round), 场次 30 (Match), 柳州市李宁体育馆 (Venue), 24/04/2013 (Date), 201301030-51-1/1 (Match ID), 山东 20 vs 江苏 34, 9:18 (Score)

裁判员 (Referee): 李刚 (CHN) / 王科 (CHN)

Table for Shandong team statistics, including player names, positions, and performance metrics like goals, assists, and errors.

Table for Jiangsu team statistics, including player names, positions, and performance metrics like goals, assists, and errors.

Table for match progression (比赛进程) showing time intervals and player actions for both teams.

Summary table for on-court statistics: 场上队员 (On-court players), 得分 / 射门 (Points / Shots), 守门员 (Goalkeepers), 救球 / 射门 (Saves / Shots), and various technical categories like Fast Break, Breakthrough, Free Throw, etc.



第十二届全国运动会男子手球预赛 图式比赛技术统计表

轮次 7

场次 30

201301030-21-1/1

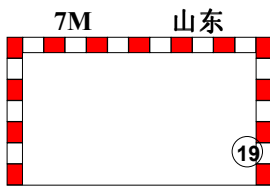
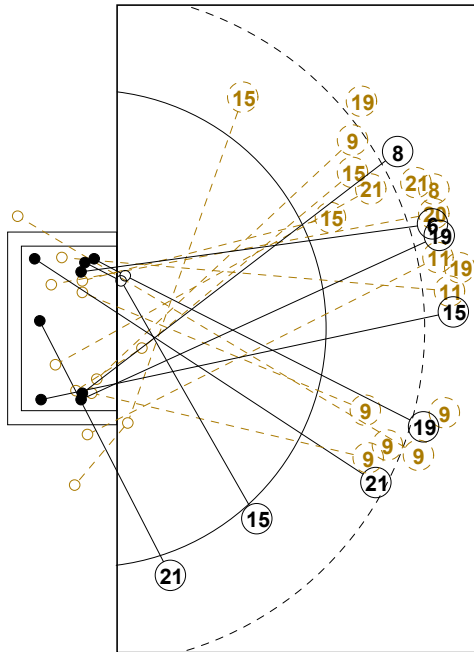

1st Half
9 : 18

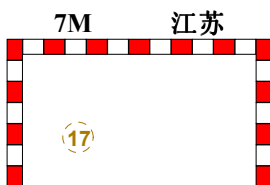
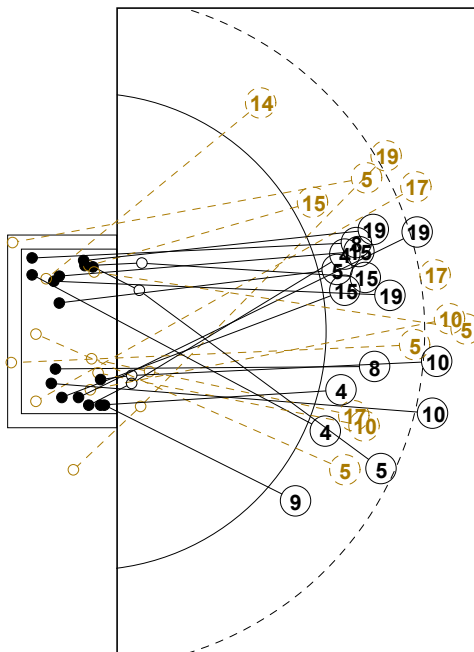
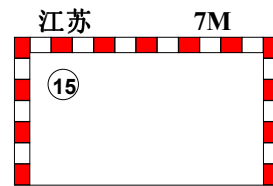
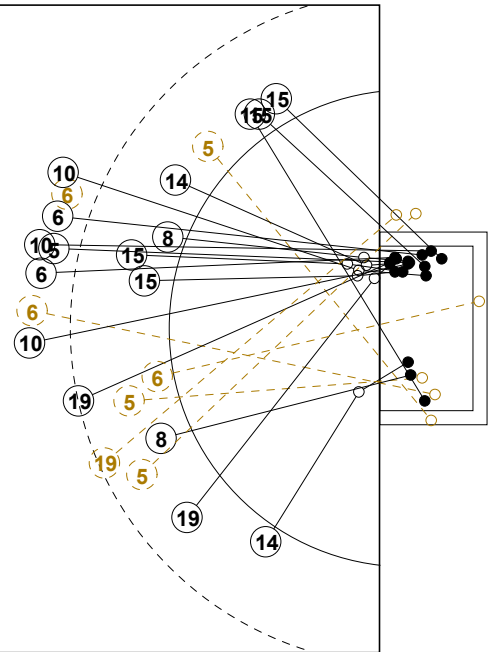

2nd Half
34 : 20

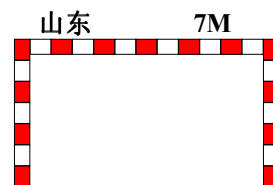
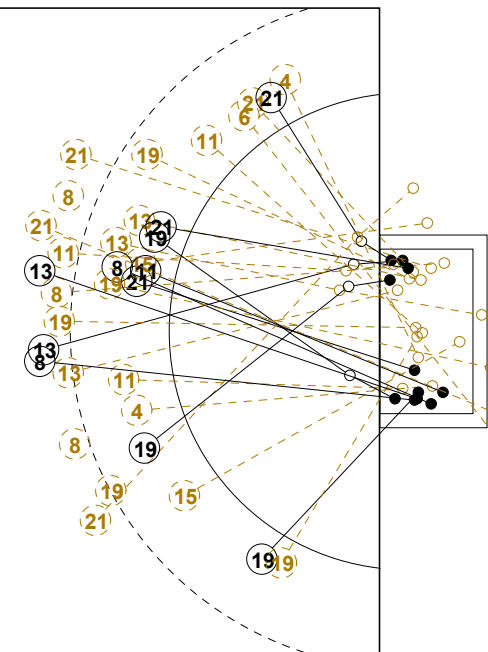



第十二届全国运动会男子手球预赛

个人/全队技术统计表

正式表
手球
男子预赛
轮次 7组别 A
场次 30201301030-14-1/2
柳州市李宁体育馆
24/04/2013 18:00

号码	姓名	远射	近射	边射	快攻	突破	任意	7M	合计	%	助攻	失误	警告	2'	取消	时间
山东(山东)																
<i>(场上队员)</i>																
1	于性哲									0.0%			1			00:37:50
4	田瑞			0/1	0/1				0/2	0.0%						00:25:40
6	李朝鹏	1/1			0/1				1/2	50.0%		4		1		00:43:20
8	王炳华	1/4			2/2		0/1		3/7	42.9%		3				00:41:10
9	赵鑫	0/5	0/1						0/6	0.0%						00:13:32
11	宋朋强	0/3			1/3				1/6	16.7%		2		1		00:41:38
13	刘晓	2/3	0/2						2/5	40.0%						00:46:46
15	陈鹏波	0/1	0/1	1/2	0/2		1/1		2/7	28.6%	1	1	1			00:42:07
16	王帅									0.0%	1	1				00:22:10
17	王旭东									0.0%			1			00:16:38
18	于亚男									0.0%						00:00:00
19	李语庆	2/7		1/1	2/4			1/1	6/13	46.2%	2	2				00:43:13
20	杜在超						0/1		0/1	0.0%		1				00:12:16
21	翟乾坤	1/5		2/3	2/3				5/11	45.5%	2	2				00:34:41
22	刘正松									0.0%						00:00:00
合计		7/29	0/4	4/7	7/16		1/3	1/1	20/60	33.3%	6	16	3	2		
<i>(守门员)</i>																
1	于性哲	2/7	0/2	0/2	2/10	1/3		1/2	6/26	23.1%			1			00:37:50
16	王帅	2/6	1/4		2/9				5/19	26.3%	1	1				00:22:10
合计		4/13	1/6	0/2	4/19	1/3		1/2	11/45	24.4%	1	1	1			

场上队员：得分/射门

守门员：救球/射门

全队合计	得分	被救	射失	击柱	封球	合计	%
远射	7	9	4		9	29	24.1%
近射		3		1		4	0.0%
边射	4	2	1			7	57.1%
快攻	7	6	3			16	43.8%
突破							0.0%
任意	1	2				3	33.3%
7M	1					1	100.0%





第十二届全国运动会男子手球预赛

个人/全队技术统计表

正式表
手球
男子预赛
轮次 7组别 A
场次 30201301030-14-2/2
柳州市李宁体育馆
24/04/2013 18:00

号码	姓名	远射	近射	边射	快攻	突破	任意	7M	合计	%	助攻	失误	警告	2'	取消	时间
江苏(江苏)																
<i>(上场队员)</i>																
1	丁大伟									0.0%	2	1				00:30:00
2	杨彦威									0.0%						00:00:00
3	李旭东									0.0%						00:00:00
4	沈庆		1/1		2/2				3/3	100%		2				00:24:43
5	闫亮	1/3			1/4	1/3			3/10	30.0%		3	1			00:44:12
6	赵晨	2/4	0/1						2/5	40.0%		1		1		00:19:51
8	周小坚		2/2		2/2				4/4	100%	2	3				00:47:03
9	叶强		1/1						1/1	100%	3	2				00:20:42
10	郝可鑫	5/6				0/1			5/7	71.4%			1			00:39:20
11	姚仁剑									0.0%						00:00:00
12	王权									0.0%	1					00:30:00
14	丛海航			1/1	1/2				2/3	66.7%	1	2	1			00:49:57
15	李安		1/1	1/1	6/7			1/1	9/10	90.0%		2				00:47:59
17	陈灵峰	0/2	0/1					0/1	0/4	0.0%		2				00:29:51
19	张志宇	1/3			3/3	1/1			5/7	71.4%	3	1				00:35:56
20	张星									0.0%						00:00:00
合计		9/18	5/7	2/2	15/20	2/5		1/2	34/54	63.0%	12	19	3	1		
<i>(守门员)</i>																
1	丁大伟	4/7	1/1	2/4	6/12		1/1		14/25	56.0%	2	1				00:30:00
12	王权	5/9	2/2	0/2	0/1		1/2	0/1	8/17	47.1%	1					00:30:00
合计		9/16	3/3	2/6	6/13		2/3	0/1	22/42	52.4%	3	1				

场上队员：得分/射门

守门员：救球/射门

全队合计	得分	被救	射失	击柱	封球	合计	%
远射	9	4	2	1	2	18	50.0%
近射	5	1		1		7	71.4%
边射	2					2	100.0%
快攻	15	4		1		20	75.0%
突破	2	1	1	1		5	40.0%
任意							0.0%
7M	1	1				2	50.0%





第十二届全国运动会男子手球预赛

图式射门区域统计

轮次 7 场次 30

201301030-41-1/1

山东

1 于性哲	4 田瑞	6 李朝鹏	8 王炳华	9 赵鑫	11 宋朋强	13 刘晓	15 陈鹏波																																																																								
<table border="1"><tr><td></td><td></td><td></td></tr><tr><td></td><td></td><td></td></tr><tr><td></td><td></td><td></td></tr></table>										<table border="1"><tr><td></td><td></td><td></td></tr><tr><td></td><td></td><td></td></tr><tr><td></td><td></td><td></td></tr></table>										<table border="1"><tr><td></td><td></td><td>1</td></tr><tr><td></td><td></td><td></td></tr><tr><td></td><td></td><td></td></tr></table>			1							<table border="1"><tr><td>1</td><td></td><td>2</td></tr><tr><td></td><td></td><td></td></tr><tr><td></td><td></td><td></td></tr></table>	1		2							<table border="1"><tr><td></td><td></td><td></td></tr><tr><td></td><td></td><td></td></tr><tr><td></td><td></td><td></td></tr></table>										<table border="1"><tr><td></td><td></td><td>1</td></tr><tr><td></td><td></td><td></td></tr><tr><td></td><td></td><td></td></tr></table>			1							<table border="1"><tr><td></td><td></td><td>1</td></tr><tr><td></td><td></td><td></td></tr><tr><td></td><td></td><td></td></tr></table>			1							<table border="1"><tr><td>1</td><td></td><td></td></tr><tr><td></td><td></td><td>1</td></tr><tr><td></td><td></td><td></td></tr></table>	1					1			
		1																																																																													
1		2																																																																													
		1																																																																													
		1																																																																													
1																																																																															
		1																																																																													
Post - 0 Miss - 0 Block - 0	Post - 0 Miss - 0 Block - 0	Post - 0 Miss - 1 Block - 0	Post - 0 Miss - 0 Block - 3	Post - 0 Miss - 1 Block - 2	Post - 0 Miss - 1 Block - 0	Post - 1 Miss - 0 Block - 0	Post - 0 Miss - 2 Block - 0																																																																								
16 王帅	17 王旭东	18 于亚男	19 李语庆	20 杜在超	21 翟乾坤	22 刘正松																																																																									
<table border="1"><tr><td></td><td></td><td></td></tr><tr><td></td><td></td><td></td></tr><tr><td></td><td></td><td></td></tr></table>										<table border="1"><tr><td></td><td></td><td></td></tr><tr><td></td><td></td><td></td></tr><tr><td></td><td></td><td></td></tr></table>										<table border="1"><tr><td></td><td></td><td></td></tr><tr><td></td><td></td><td></td></tr><tr><td></td><td></td><td></td></tr></table>										<table border="1"><tr><td>1</td><td></td><td>1</td></tr><tr><td></td><td></td><td></td></tr><tr><td>1</td><td></td><td>3</td></tr></table>	1		1				1		3	<table border="1"><tr><td></td><td></td><td></td></tr><tr><td></td><td></td><td></td></tr><tr><td></td><td></td><td></td></tr></table>										<table border="1"><tr><td></td><td>1</td><td>1</td></tr><tr><td></td><td></td><td>1</td></tr><tr><td>2</td><td></td><td></td></tr></table>		1	1			1	2			<table border="1"><tr><td></td><td></td><td></td></tr><tr><td></td><td></td><td></td></tr><tr><td></td><td></td><td></td></tr></table>										<table border="1"><tr><td></td><td></td><td></td></tr><tr><td></td><td></td><td></td></tr><tr><td></td><td></td><td></td></tr></table>									
1		1																																																																													
1		3																																																																													
	1	1																																																																													
		1																																																																													
2																																																																															
Post - 0 Miss - 0 Block - 0	Post - 0 Miss - 0 Block - 0	Post - 0 Miss - 0 Block - 0	Post - 0 Miss - 1 Block - 3	Post - 0 Miss - 0 Block - 0	Post - 0 Miss - 2 Block - 1	Post - 0 Miss - 0 Block - 0																																																																									

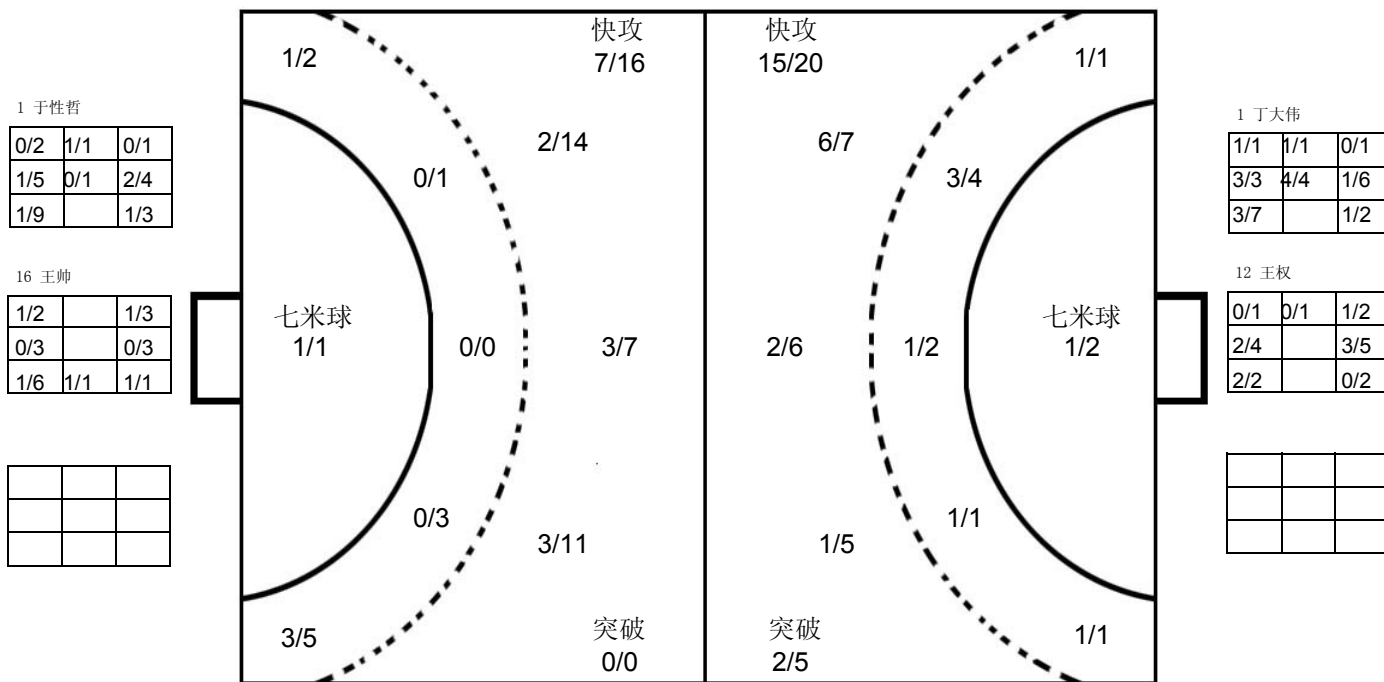

江苏

1 丁大伟	2 杨彦威	3 李旭东	4 沈庆	5 闫亮	6 赵晨	8 周小坚	9 叶强																																																																								
<table border="1"><tr><td></td><td></td><td></td></tr><tr><td></td><td></td><td></td></tr><tr><td></td><td></td><td></td></tr></table>										<table border="1"><tr><td></td><td></td><td></td></tr><tr><td></td><td></td><td></td></tr><tr><td></td><td></td><td></td></tr></table>										<table border="1"><tr><td></td><td></td><td></td></tr><tr><td></td><td></td><td></td></tr><tr><td></td><td></td><td></td></tr></table>										<table border="1"><tr><td></td><td></td><td>1</td></tr><tr><td></td><td></td><td></td></tr><tr><td>2</td><td></td><td></td></tr></table>			1				2			<table border="1"><tr><td></td><td></td><td></td></tr><tr><td></td><td></td><td></td></tr><tr><td>1</td><td></td><td>1</td></tr></table>							1		1	<table border="1"><tr><td></td><td></td><td></td></tr><tr><td></td><td></td><td></td></tr><tr><td>1</td><td></td><td></td></tr></table>							1			<table border="1"><tr><td></td><td></td><td>1</td></tr><tr><td></td><td></td><td>1</td></tr><tr><td></td><td></td><td></td></tr></table>			1			1				<table border="1"><tr><td></td><td></td><td></td></tr><tr><td></td><td></td><td></td></tr><tr><td></td><td></td><td></td></tr></table>									
		1																																																																													
2																																																																															
1		1																																																																													
1																																																																															
		1																																																																													
		1																																																																													
Post - 0 Miss - 0 Block - 0	Post - 0 Miss - 0 Block - 0	Post - 0 Miss - 0 Block - 0	Post - 0 Miss - 0 Block - 0	Post - 3 Miss - 1 Block - 0	Post - 1 Miss - 0 Block - 1	Post - 0 Miss - 0 Block - 0	Post - 0 Miss - 0 Block - 0																																																																								
10 郝可鑫	11 姚仁剑	12 王权	14 丛海航	15 李安	17 陈灵峰	19 张志宇	20 张星																																																																								
<table border="1"><tr><td>1</td><td></td><td></td></tr><tr><td>2</td><td></td><td></td></tr><tr><td>2</td><td></td><td></td></tr></table>	1			2			2			<table border="1"><tr><td></td><td></td><td></td></tr><tr><td></td><td></td><td></td></tr><tr><td></td><td></td><td></td></tr></table>										<table border="1"><tr><td></td><td></td><td></td></tr><tr><td></td><td></td><td></td></tr><tr><td></td><td></td><td></td></tr></table>										<table border="1"><tr><td></td><td></td><td></td></tr><tr><td></td><td></td><td></td></tr><tr><td>1</td><td></td><td>1</td></tr></table>							1		1	<table border="1"><tr><td>2</td><td></td><td></td></tr><tr><td>2</td><td></td><td>3</td></tr><tr><td>2</td><td></td><td></td></tr></table>	2			2		3	2			<table border="1"><tr><td></td><td></td><td></td></tr><tr><td></td><td></td><td></td></tr><tr><td></td><td></td><td></td></tr></table>										<table border="1"><tr><td></td><td></td><td>1</td></tr><tr><td>1</td><td></td><td>1</td></tr><tr><td>2</td><td></td><td></td></tr></table>			1	1		1	2			<table border="1"><tr><td></td><td></td><td></td></tr><tr><td></td><td></td><td></td></tr><tr><td></td><td></td><td></td></tr></table>									
1																																																																															
2																																																																															
2																																																																															
1		1																																																																													
2																																																																															
2		3																																																																													
2																																																																															
		1																																																																													
1		1																																																																													
2																																																																															
Post - 0 Miss - 0 Block - 0	Post - 0 Miss - 0 Block - 0	Post - 0 Miss - 0 Block - 0	Post - 0 Miss - 0 Block - 0	Post - 0 Miss - 0 Block - 0	Post - 0 Miss - 0 Block - 1	Post - 0 Miss - 2 Block - 0	Post - 0 Miss - 0 Block - 0																																																																								

注释: Post=击柱 Miss=射失 Block=被封





男子 国内比赛



第十二届全国运动会男子手球预赛

Team A		Team B		Match Number																	
A 四川		B 山西		31																	
played in		in the hall		on																	
China		柳州市李宁体育馆		25/04/2013																	
				at 13:00 hours																	
Spectators																					
Half-time (30')	A	B	End of playing time	A	B																
	14	17	28 33	1st extra time	2nd extra time																
				A	B																
				After penalty throws	A B																
Number of 7 m	A	Team time-out		Full name of players and officials																	
3 / 3	1	2	3																		
		50:13																			
				Team time-out																	
				1	2																
				07:15																	
				B																	
				1 / 2																	
				Number of 7 m																	
No.	Team A					G	W	2'	D	DR	No.	Team B					G	W	2'	D	DR
16	王松										1	李晋尧									
18	杨洋										2	马健									
19	杨洁					1		1			3	王晋					7	1			
21	池培俊					3		1			4	李鹏程					5				
22	刘彦坤					3					5	王志超									
23	王震					2	1				6	范帅									
25	李峥					1	1				7	白宇飞					8		1		
27	于洪泉					5		1			8	崔钰									
28	宋涛					2					9	朱涛涛									
32	逯明松										10	任海阳					2		1		
33	朱晓龙					6					12	侯乃章									
35	仇振勇					5		1			13	侯建涛					4	1			
36	刘琢										14	刘明华					7				
											15	景新江									
											18	朱棣						1			
A	李太平										A	王喜和									
B	李清										B	张晓东									
C	黄承										D	石岩									
E	何明阳																				
A	Signature of Responsible Official of the Teams (Off. A)										B										
TP	Remarks of Referee / CHA Official										TP										

Signatures

Referees	王科 (CHN)	李刚 (CHN)		
Techn. Delegates	许宜扬 (CHN)	刘书勇 (CHN)		
CHA Official				

Note: Number of 7m Throws Awarded to Team A and B, Goals (G), Warnings (W), Suspensions (2'), Direct Disqualification (D), Disqualification with Report (DR) and Team Penalty (TP).

Table Officials: 黄思华

谭云东

Statisticians: 黄莉

朱伟平

Printed by PHMS Copyright: IHF / CHA 25/04/2013 14:31:24

Longman Sportsoft



handball@126.com



第十二届全国运动会男子手球预赛
竞赛技术统计(媒体表)

预赛 组别 B 轮次 8 场次 31

柳州市李宁体育馆 25/04/2013 201301031-51-1/1

四川 33 山西 14:17

裁判员 王科 (CHN) / 李刚 (CHN)

Main statistics table with columns for players, shots, goals, assists, etc. for both teams.

场上队员: 得分 / 射门

守门员: 救球 / 射门

Summary table for Fast Break, Warning, Breakthrough, Free Throw, 7M Throw, Assist.





第十二届全国运动会男子手球预赛 图式比赛技术统计表

轮次 8

场次 31

201301031-21-1/1

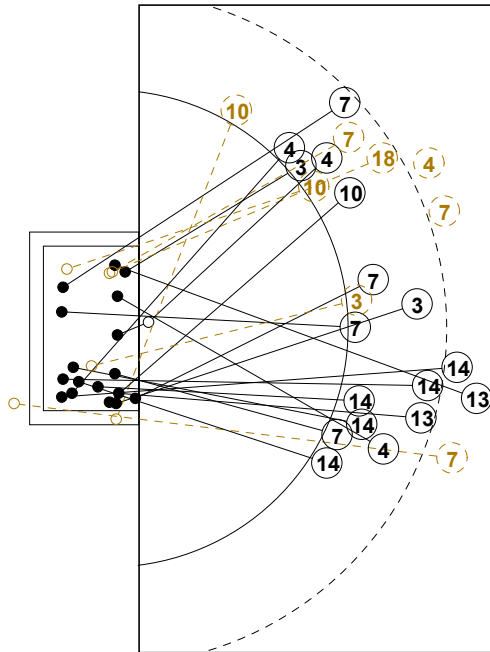

7M 山西

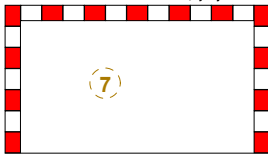

1st Half
17 : 14

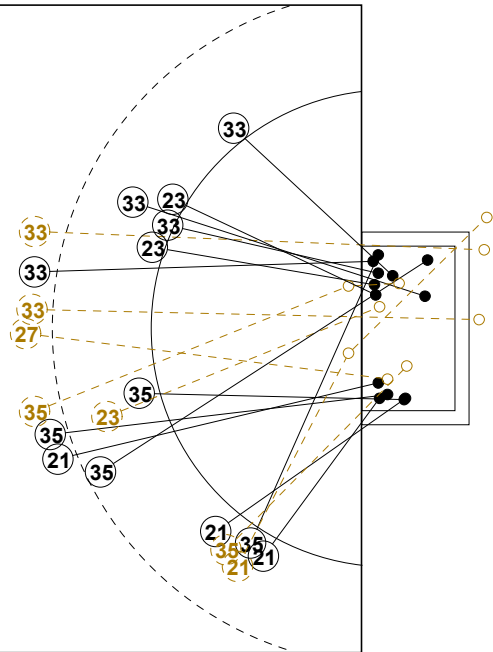

四川 7M

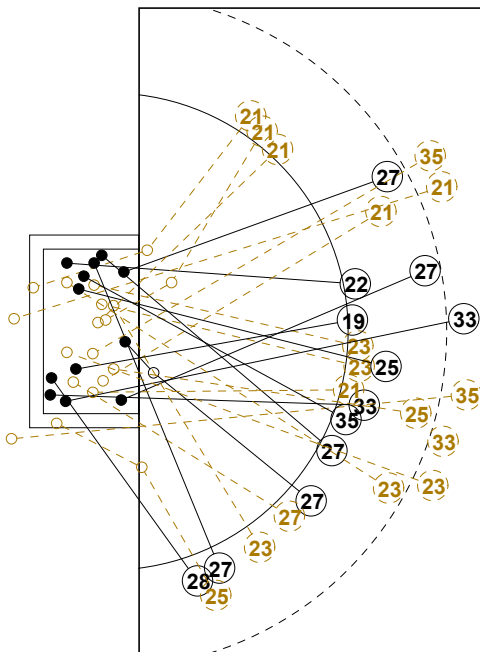
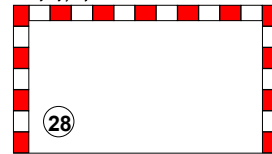

7M 四川

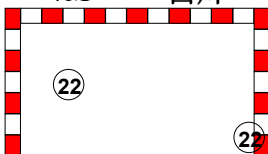

2nd Half
28 : 33

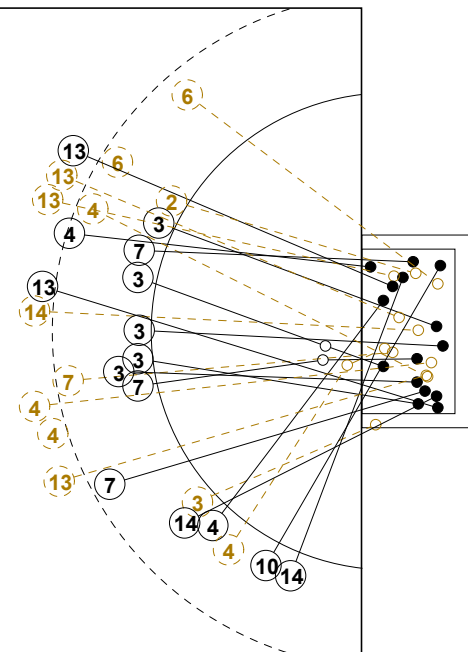

山西 7M

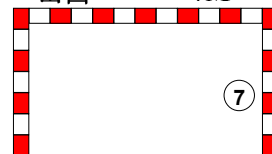



第十二届全国运动会男子手球预赛

个人/全队技术统计表

正式表
手球
男子预赛
轮次 8组别 B
场次 31201301031-14-1/2
柳州市李宁体育馆
25/04/2013 13:00

号码	姓名	远射	近射	边射	快攻	突破	任意	7M	合计	%	助攻	失误	警告	2'	取消	时间
四川(四川)																
<i>(场上队员)</i>																
16	王松									0.0%	1	3				01:00:00
18	杨洋									0.0%						00:00:00
19	杨洁				1/1				1/1	100%		1		1		00:09:47
21	池培俊	1/2	0/1	1/5	1/2				3/10	30.0%		2		1		00:59:29
22	刘彦坤					1/1		2/2	3/3	100%						00:20:05
23	王震	0/2	2/5	0/1					2/8	25.0%	1	1	1			00:57:31
25	李峥	0/1		0/1	1/1				1/3	33.3%		2	1			00:38:05
27	于洪泉	2/3			1/1	2/3			5/7	71.4%	1	3		1		00:22:56
28	宋涛			1/1				1/1	2/2	100%	4	8				00:51:27
32	逯明松									0.0%		1				00:09:47
33	朱晓龙	1/2	2/2	1/1	1/1		1/3		6/9	66.7%		1				00:49:21
35	仇振勇	2/3	1/1	1/2	1/1		0/2		5/9	55.6%	1	2		1		00:37:39
36	刘琢									0.0%						00:00:00
合计																
<i>(守门员)</i>																
16	王松	8/17	2/8	2/3	2/15	0/3		1/2	15/48	31.3%	1	3				01:00:00
合计																
8/17 2/8 2/3 2/15 0/3 1/2 15/48 31.3% 1 3																

场上队员：得分/射门

守门员：救球/射门

全队合计	得分	被救	射失	击柱	封球	合计	%
远射	6	5	1		1	13	46.2%
近射	5	4				9	55.6%
边射	4	4	1	2		11	36.4%
快攻	6	1				7	85.7%
突破	3	1				4	75.0%
任意	1	1	3			5	20.0%
7M	3					3	100.0%





第十二届全国运动会男子手球预赛

个人/全队技术统计表

正式表
手球
男子预赛
轮次 8组别 B
场次 31201301031-14-2/2
柳州市李宁体育馆
25/04/2013 13:00

号码	姓名	远射	近射	边射	快攻	突破	任意	7M	合计	%	助攻	失误	警告	2'	取消	时间
山西(山西)																
<i>(上场队员)</i>																
1	李晋尧									0.0%	1					00:56:24
2	马健				0/1				0/1	0.0%						00:57:16
3	王晋	1/1	3/4		3/4				7/9	77.8%		1	1			00:59:35
4	李鹏程	1/5	1/1	0/1	3/3				5/10	50.0%		3				00:59:26
5	王志超									0.0%						00:00:00
6	范帅	0/1		0/1					0/2	0.0%		1				00:01:08
7	白宇飞	1/3	1/2		4/4	1/1	0/1	1/2	8/13	61.5%	2	1		1		00:48:47
8	崔钰									0.0%						00:00:00
9	朱涛涛									0.0%						00:00:00
10	任海阳			0/1	2/3				2/4	50.0%		3		1		00:47:42
12	侯乃章									0.0%						00:03:36
13	侯建涛	4/7							4/7	57.1%		2	1			00:27:48
14	刘明华	2/3	1/1	1/1	1/1	2/2			7/8	87.5%	2	5				00:34:19
15	景新江									0.0%						00:00:00
18	朱椽	0/1							0/1	0.0%		1	1			00:19:44
合计		9/21	6/8	1/4	13/16	3/3	0/1	1/2	33/55	60.0%	5	17	3	2		
<i>(守门员)</i>																
1	李晋尧	5/10	4/8	4/8	1/7	1/4	1/2	0/3	16/42	38.1%	1					00:56:24
12	侯乃章	0/1	0/1						0/2	0.0%						00:03:36
合计		5/11	4/9	4/8	1/7	1/4	1/2	0/3	16/44	36.4%	1					

场上队员：得分/射门

守门员：救球/射门

全队合计	得分	被救	射失	击柱	封球	合计	%
远射	9	8			4	21	42.9%
近射	6	2				8	75.0%
边射	1	2		1		4	25.0%
快攻	13	2		1		16	81.3%
突破	3					3	100.0%
任意			1			1	0.0%
7M	1	1				2	50.0%





第十二届全国运动会男子手球预赛

图式射门区域统计

轮次 8 场次 31

201301031-41-1/1

四川

16 王松	18 杨洋	19 杨洁	21 池培俊	22 刘彦坤	23 王震	25 李峥	27 于洪泉																																																																								
<table border="1"><tr><td></td><td></td><td></td></tr><tr><td></td><td></td><td></td></tr><tr><td></td><td></td><td></td></tr></table>										<table border="1"><tr><td></td><td></td><td></td></tr><tr><td></td><td></td><td></td></tr><tr><td></td><td></td><td></td></tr></table>										<table border="1"><tr><td>1</td><td></td><td></td></tr><tr><td></td><td></td><td></td></tr><tr><td></td><td></td><td></td></tr></table>	1									<table border="1"><tr><td></td><td></td><td></td></tr><tr><td></td><td></td><td>1</td></tr><tr><td></td><td></td><td>2</td></tr></table>						1			2	<table border="1"><tr><td></td><td></td><td>1</td></tr><tr><td></td><td></td><td></td></tr><tr><td></td><td></td><td>1</td></tr></table>			1						1	<table border="1"><tr><td></td><td></td><td></td></tr><tr><td></td><td></td><td></td></tr><tr><td>2</td><td></td><td></td></tr></table>							2			<table border="1"><tr><td></td><td></td><td></td></tr><tr><td></td><td></td><td>1</td></tr><tr><td></td><td></td><td></td></tr></table>						1				<table border="1"><tr><td></td><td></td><td></td></tr><tr><td></td><td></td><td>2</td></tr><tr><td>1</td><td>1</td><td>1</td></tr></table>						2	1	1	1
1																																																																															
		1																																																																													
		2																																																																													
		1																																																																													
		1																																																																													
2																																																																															
		1																																																																													
		2																																																																													
1	1	1																																																																													
Post - 0 Miss - 0 Block - 0	Post - 0 Miss - 0 Block - 0	Post - 0 Miss - 0 Block - 0	Post - 1 Miss - 2 Block - 0	Post - 0 Miss - 0 Block - 0	Post - 0 Miss - 0 Block - 0	Post - 1 Miss - 0 Block - 0	Post - 0 Miss - 0 Block - 0																																																																								
28 宋涛	32 逯明松	33 朱晓龙	35 仇振勇	36 刘琢																																																																											
<table border="1"><tr><td>1</td><td></td><td></td></tr><tr><td></td><td></td><td></td></tr><tr><td>1</td><td></td><td></td></tr></table>	1						1			<table border="1"><tr><td></td><td></td><td></td></tr><tr><td></td><td></td><td></td></tr><tr><td></td><td></td><td></td></tr></table>										<table border="1"><tr><td>3</td><td></td><td></td></tr><tr><td>1</td><td></td><td></td></tr><tr><td>2</td><td></td><td></td></tr></table>	3			1			2			<table border="1"><tr><td>1</td><td></td><td></td></tr><tr><td></td><td></td><td>2</td></tr><tr><td>1</td><td></td><td>1</td></tr></table>	1					2	1		1	<table border="1"><tr><td></td><td></td><td></td></tr><tr><td></td><td></td><td></td></tr><tr><td></td><td></td><td></td></tr></table>																																							
1																																																																															
1																																																																															
3																																																																															
1																																																																															
2																																																																															
1																																																																															
		2																																																																													
1		1																																																																													
Post - 0 Miss - 0 Block - 0	Post - 0 Miss - 0 Block - 0	Post - 0 Miss - 2 Block - 1	Post - 0 Miss - 1 Block - 0	Post - 0 Miss - 0 Block - 0																																																																											

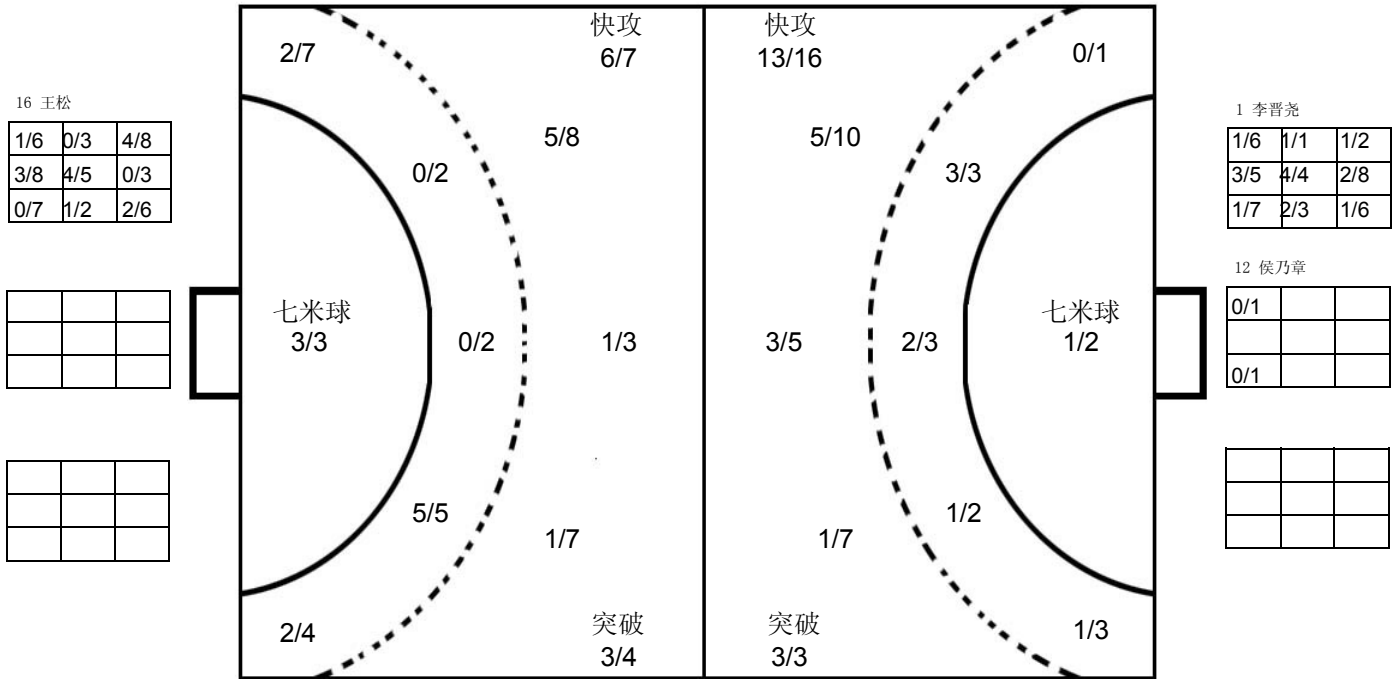

山西

1 李晋尧	2 马健	3 王晋	4 李鹏程	5 王志超	6 范帅	7 白宇飞	8 崔钰																																																																								
<table border="1"><tr><td></td><td></td><td></td></tr><tr><td></td><td></td><td></td></tr><tr><td></td><td></td><td></td></tr></table>										<table border="1"><tr><td></td><td></td><td></td></tr><tr><td></td><td></td><td></td></tr><tr><td></td><td></td><td></td></tr></table>										<table border="1"><tr><td></td><td>2</td><td></td></tr><tr><td></td><td></td><td>2</td></tr><tr><td>1</td><td></td><td>2</td></tr></table>		2				2	1		2	<table border="1"><tr><td>1</td><td></td><td></td></tr><tr><td></td><td></td><td></td></tr><tr><td>2</td><td>1</td><td>1</td></tr></table>	1						2	1	1	<table border="1"><tr><td></td><td></td><td></td></tr><tr><td></td><td></td><td></td></tr><tr><td></td><td></td><td></td></tr></table>										<table border="1"><tr><td></td><td></td><td></td></tr><tr><td></td><td></td><td></td></tr><tr><td></td><td></td><td></td></tr></table>										<table border="1"><tr><td></td><td>1</td><td>2</td></tr><tr><td>1</td><td>1</td><td>1</td></tr><tr><td>2</td><td></td><td></td></tr></table>		1	2	1	1	1	2			<table border="1"><tr><td></td><td></td><td></td></tr><tr><td></td><td></td><td></td></tr><tr><td></td><td></td><td></td></tr></table>									
	2																																																																														
		2																																																																													
1		2																																																																													
1																																																																															
2	1	1																																																																													
	1	2																																																																													
1	1	1																																																																													
2																																																																															
Post - 0 Miss - 0 Block - 0	Post - 0 Miss - 0 Block - 0	Post - 1 Miss - 0 Block - 0	Post - 0 Miss - 0 Block - 2	Post - 0 Miss - 0 Block - 0	Post - 0 Miss - 0 Block - 1	Post - 0 Miss - 1 Block - 1	Post - 0 Miss - 0 Block - 0																																																																								
9 朱涛涛	10 任海阳	12 侯乃章	13 侯建涛	14 刘明华	15 景新江	18 朱棣																																																																									
<table border="1"><tr><td></td><td></td><td></td></tr><tr><td></td><td></td><td></td></tr><tr><td></td><td></td><td></td></tr></table>										<table border="1"><tr><td>1</td><td></td><td></td></tr><tr><td></td><td></td><td></td></tr><tr><td>1</td><td></td><td></td></tr></table>	1						1			<table border="1"><tr><td></td><td></td><td></td></tr><tr><td></td><td></td><td></td></tr><tr><td></td><td></td><td></td></tr></table>										<table border="1"><tr><td></td><td></td><td>1</td></tr><tr><td>1</td><td></td><td></td></tr><tr><td>1</td><td></td><td>1</td></tr></table>			1	1			1		1	<table border="1"><tr><td>3</td><td></td><td>1</td></tr><tr><td>3</td><td></td><td></td></tr><tr><td></td><td></td><td></td></tr></table>	3		1	3						<table border="1"><tr><td></td><td></td><td></td></tr><tr><td></td><td></td><td></td></tr><tr><td></td><td></td><td></td></tr></table>										<table border="1"><tr><td></td><td></td><td></td></tr><tr><td></td><td></td><td></td></tr><tr><td></td><td></td><td></td></tr></table>										<table border="1"><tr><td></td><td></td><td></td></tr><tr><td></td><td></td><td></td></tr><tr><td></td><td></td><td></td></tr></table>									
1																																																																															
1																																																																															
		1																																																																													
1																																																																															
1		1																																																																													
3		1																																																																													
3																																																																															
Post - 0 Miss - 0 Block - 0	Post - 1 Miss - 0 Block - 0	Post - 0 Miss - 0 Block - 0	Post - 0 Miss - 0 Block - 0	Post - 0 Miss - 0 Block - 0	Post - 0 Miss - 0 Block - 0	Post - 0 Miss - 0 Block - 0																																																																									

注释: Post=击柱 Miss=射失 Block=被封





男子 国内比赛



第十二届全国运动会男子手球预赛

Team A A 上海				Team B B 天津				Match Number 32													
played in China		in the hall 柳州市李宁体育馆		on 25/04/2013		at 14:40 hours		Spectators													
Half-time (30')	A 13	B 11	End of playing time	A 24	B 22	1st extra time	A	B	2nd extra time	A	B	After penalty throws	A	B							
Number of 7 m	A 3/3	Team time-out			Full name of players and officials				Team time-out			B 0/0	Number of 7 m								
		1 28:13	2 48:04	3 58:30					1 14:26	2 57:25	3										
No.	Team A					G	W	2'	D	DR	No.	Team B					G	W	2'	D	DR
1	张崢										1	刘宗其									
2	胡辰										2	李岳朋					1	1	2		
3	赵时俊										3	李军					4		1		
5	朱世杰										4	李松浩									
6	李和鑫					9	1	1			7	张青					5				
8	钱为玮					2	1				8	曹悦					6				
9	朱礼彬					4					9	孟凡钢									
10	吴璟					4					10	李帅									
12	周哲韬										11	王毅									
13	孟宇超										13	许松					1				
14	王子阳					2					14	田剑侠					5				
15	徐俊吉										15	张俊岭						1			
16	朱春雷										16	刘海亮									
18	马麟晓					3					17	周群						1			
19	蒋承骅										18	孙永								1	
20	程云飞										19	梁堂亮									
A	吴龙基										A	尚喜									
B	陆钦忠										B	贾守信									
C	徐耀忠					1					C	刘伟成									
E	黄韡										D	冀谦									
A	Signature of Responsible Official of the Teams (Off. A)																			B	
TP	Remarks of Referee / CHA Official																			TP	

Signatures

Referees	邓军 (CHN)	谭雷 (CHN)		
Techn. Delegates	许宜扬 (CHN)	刘书勇 (CHN)		
CHA Official				

Note: Number of 7m Throws Awarded to Team A and B, Goals (G), Warnings (W), Suspensions (2'), Direct Disqualification (D), Disqualification with Report (DR) and Team Penalty (TP).

Table Officials:

Statisticians: 黄莉

朱伟平



第十二届全国运动会男子手球预赛
竞赛技术统计(媒体表)

预赛	组别	B	轮次	8	场次	32
柳州市李宁体育馆			25/04/2013		201301032-51-1/1	
上海		上海	24	vs	22	天津
			13 : 11			

裁判员		邓军 (CHN)											谭雷 (CHN)										
上海		远射	近射	边射	快攻	突破	任意球	7m球	合计	%	助攻	失误	警告	2'	D & DR	上海	比赛进程	天津					
主教练: 吴龙基																							
1	张峥																						
2	胡辰																						
3	赵时俊			0/1	0/1			0/2	0.0		1												
5	朱世杰																						
6	李和鑫	7/11	0/2				1/1	1/1	9/15	60.0		2	1	1									
8	钱为玮		1/1	1/3				2/4	50.0				1										
9	朱礼彬	3/6				0/1	1/1	4/8	50.0		1												
10	吴璟		1/1		1/1			2/2	4/4	100	1	1											
12	周哲韬																						
13	孟宇超																						
14	王子阳			2/4	0/1			2/5	40.0														
15	徐俊吉																						
16	朱春雷																						
18	马麟晓	3/6	0/1			0/1		3/8	37.5		3	1											
19	蒋承骅																						
20	程云飞																						
运动员 合计		13/23	2/5	3/8	1/3	0/2	2/2	3/3	24/46	52.2	4	6	2	1									
1	张峥	0/2	0/2	1/2	0/1			1/7	14.3														
16	朱春雷	2/5	1/7	1/1	0/4	0/3		4/20	20.0														
守门员 合计		2/7	1/9	2/3	0/4	0/4		5/27	18.5														
天津		远射	近射	边射	快攻	突破	任意球	7m球	合计	%	助攻	失误	警告	2'	D & DR								
教练: 尚喜																							
1	刘宗其																						
2	李岳朋	1/1						1/1	100		1		1	2									
3	李军	2/5	1/1		1/1			4/7	57.1		2	1		1									
4	李松浩																						
7	张青		4/4		1/1			5/5	100														
8	曹悦	1/1	2/3	1/1	1/1	1/1		6/7	85.7		1	4											
9	孟凡钢																						
10	李帅																						
11	王毅																						
13	许松	0/1		0/1	1/1			1/3	33.3			1											
14	田剑侠	1/3	1/1	0/1		3/3	0/1	5/9	55.6		2	6											
15	张俊岭			0/1				0/1	0.0			1	1										
16	刘海亮																						
17	周群												1										
18	孙永											1		1									
19	梁堂亮																						
运动员 合计		5/11	8/9	1/4	4/4	4/4	0/1	22/33	66.7		6	14	3	4									
1	刘宗其	1/5		1/1				2/6	33.3														
16	刘海亮	6/15	2/4	4/7	2/3	1/1	0/2	0/3	15/35	42.9													
守门员 合计		7/20	2/4	5/8	2/3	1/1	0/2	0/3	17/41	41.5													

场上队员: 得分 / 射门

守门员: 救球 / 射门

快攻	Fast Break	突破	Breakthrough	任意球	Free Throw	7M球	7M Throw	助攻	Assist
警告	Warning	失误	Error	2'	Suspension	D	取消资格	DR	取消资格+报告





第十二届全国运动会男子手球预赛 图式比赛技术统计表

轮次 8

场次 32

201301032-21-1/1

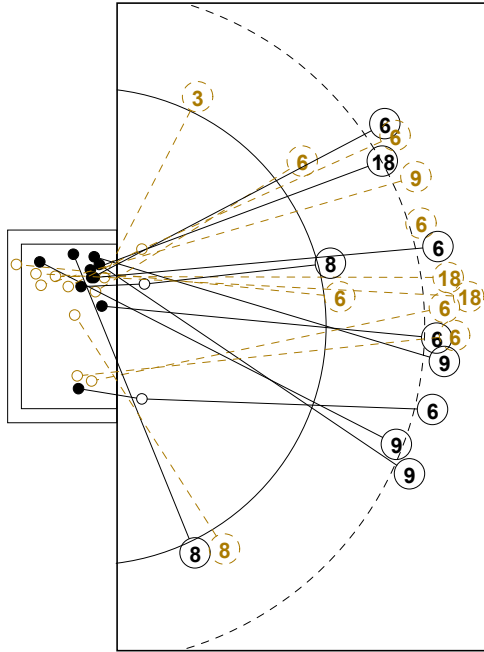

7M 上海

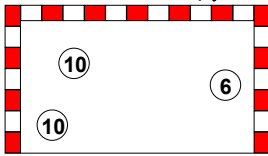

1st Half
13 : 11

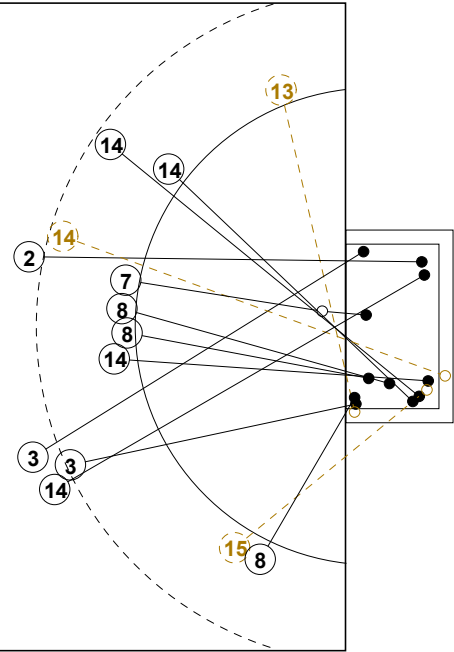

天津 7M

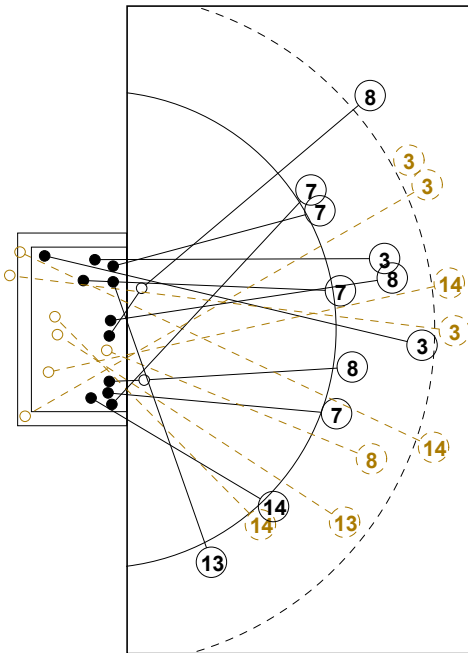

7M 天津

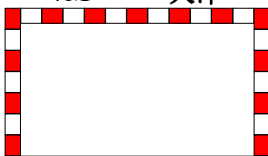

2nd Half
22 : 24

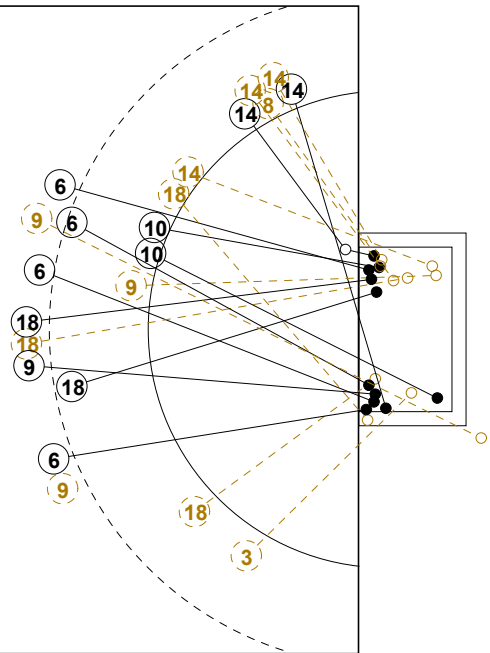

上海 7M

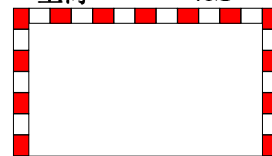



第十二届全国运动会男子手球预赛

个人/全队技术统计表

正式表
手球
男子预赛
轮次 8组别 B
场次 32201301032-14-1/2
柳州市李宁体育馆
25/04/2013 14:40

号码	姓名	远射	近射	边射	快攻	突破	任意	7M	合计	%	助攻	失误	警告	2'	取消	时间
上海(上海)																
<i>(场上队员)</i>																
1	张崢									0.0%						00:14:11
2	胡辰									0.0%						00:00:00
3	赵时俊			0/1	0/1				0/2	0.0%		1				00:57:51
5	朱世杰									0.0%						00:00:00
6	李和鑫	7/11	0/2				1/1	1/1	9/15	60.0%		2	1	1		00:51:07
8	钱为玮		1/1	1/3					2/4	50.0%			1			00:42:42
9	朱礼彬	3/6				0/1	1/1		4/8	50.0%		1				00:52:46
10	吴璟		1/1		1/1			2/2	4/4	100%	1	1				01:00:00
12	周哲韬									0.0%						00:00:00
13	孟宇超									0.0%						00:00:00
14	王子阳			2/4	0/1				2/5	40.0%						00:17:17
15	徐俊吉									0.0%						00:00:00
16	朱春雷									0.0%						00:45:49
18	马麟晓	3/6	0/1			0/1			3/8	37.5%	3	1				00:56:45
19	蒋承骅									0.0%						00:20:52
20	程云飞									0.0%						00:00:00
合计		13/23	2/5	3/8	1/3	0/2	2/2	3/3	24/46	52.2%	4	6	2	1		
<i>(守门员)</i>																
1	张崢	0/2	0/2	1/2		0/1			1/7	14.3%						00:14:11
16	朱春雷	2/5	1/7	1/1	0/4	0/3			4/20	20.0%						00:45:49
合计		2/7	1/9	2/3	0/4	0/4			5/27	18.5%						

场上队员：得分/射门

守门员：救球/射门

全队合计	得分	被救	射失	击柱	封球	合计	%
远射	13	7	1		2	23	56.5%
近射	2	2		1		5	40.0%
边射	3	5				8	37.5%
快攻	1	2				3	33.3%
突破		1		1		2	0.0%
任意	2					2	100.0%
7M	3					3	100.0%





第十二届全国运动会男子手球预赛

个人/全队技术统计表

正式表
手球
男子预赛
轮次 8组别 B
场次 32201301032-14-2/2
柳州市李宁体育馆
25/04/2013 14:40

号码	姓名	远射	近射	边射	快攻	突破	任意	7M	合计	%	助攻	失误	警告	2'	取消	时间
天津(天津)																
<i>(上场队员)</i>																
1	刘宗其									0.0%						00:07:25
2	李岳朋	1/1							1/1	100%	1		1	2		00:27:01
3	李军	2/5	1/1		1/1				4/7	57.1%	2	1		1		00:59:57
4	李松浩									0.0%						00:00:00
7	张青		4/4		1/1				5/5	100%						00:36:38
8	曹悦	1/1	2/3	1/1	1/1	1/1			6/7	85.7%	1	4				00:30:52
9	孟凡钢									0.0%						00:00:01
10	李帅									0.0%						00:00:00
11	王毅									0.0%						00:00:00
13	许松	0/1		0/1	1/1				1/3	33.3%		1				00:59:50
14	田剑侠	1/3	1/1	0/1		3/3	0/1		5/9	55.6%	2	6				00:59:49
15	张俊岭			0/1					0/1	0.0%		1	1			00:55:39
16	刘海亮									0.0%						00:52:35
17	周群									0.0%			1			00:08:08
18	孙永									0.0%		1		1		00:20:10
19	梁堂亮									0.0%						00:00:00
合计		5/11	8/9	1/4	4/4	4/4	0/1		22/33	66.7%	6	14	3	4		
<i>(守门员)</i>																
1	刘宗其	1/5		1/1					2/6	33.3%						00:07:25
16	刘海亮	6/15	2/4	4/7	2/3	1/1	0/2	0/3	15/35	42.9%						00:52:35
合计		7/20	2/4	5/8	2/3	1/1	0/2	0/3	17/41	41.5%						

场上队员：得分/射门

守门员：救球/射门

全队合计	得分	被救	射失	击柱	封球	合计	%
远射	5	2	1	2	1	11	45.5%
近射	8	1				9	88.9%
边射	1	2		1		4	25.0%
快攻	4					4	100.0%
突破	4					4	100.0%
任意				1		1	0.0%
7M							0.0%





第十二届全国运动会男子手球预赛

图式射门区域统计

轮次 8 场次 32

201301032-41-1/1

上海

1 张峥	2 胡辰	3 赵时俊	5 朱世杰	6 李和鑫	8 钱为玮	9 朱礼彬	10 吴璟																																																																								
<table border="1"><tr><td></td><td></td><td></td></tr><tr><td></td><td></td><td></td></tr><tr><td></td><td></td><td></td></tr></table>										<table border="1"><tr><td></td><td></td><td></td></tr><tr><td></td><td></td><td></td></tr><tr><td></td><td></td><td></td></tr></table>										<table border="1"><tr><td></td><td></td><td></td></tr><tr><td></td><td></td><td></td></tr><tr><td></td><td></td><td></td></tr></table>										<table border="1"><tr><td></td><td></td><td></td></tr><tr><td></td><td></td><td></td></tr><tr><td></td><td></td><td></td></tr></table>										<table border="1"><tr><td></td><td></td><td></td></tr><tr><td>1</td><td></td><td>1</td></tr><tr><td>1</td><td>1</td><td>5</td></tr></table>				1		1	1	1	5	<table border="1"><tr><td></td><td></td><td></td></tr><tr><td></td><td></td><td>2</td></tr><tr><td></td><td></td><td></td></tr></table>						2				<table border="1"><tr><td></td><td></td><td>1</td></tr><tr><td></td><td></td><td></td></tr><tr><td></td><td></td><td>3</td></tr></table>			1						3	<table border="1"><tr><td></td><td>1</td><td></td></tr><tr><td></td><td></td><td></td></tr><tr><td>2</td><td></td><td></td></tr></table>		1					2		
1		1																																																																													
1	1	5																																																																													
		2																																																																													
		1																																																																													
		3																																																																													
	1																																																																														
2																																																																															
Post - 0 Miss - 0 Block - 0	Post - 0 Miss - 0 Block - 0	Post - 0 Miss - 0 Block - 0	Post - 0 Miss - 0 Block - 0	Post - 1 Miss - 0 Block - 1	Post - 0 Miss - 0 Block - 0	Post - 0 Miss - 1 Block - 1	Post - 0 Miss - 0 Block - 0																																																																								
12 周哲韬	13 孟宇超	14 王子阳	15 徐俊吉	16 朱春雷	18 马麟晓	19 蒋承骅	20 程云飞																																																																								
<table border="1"><tr><td></td><td></td><td></td></tr><tr><td></td><td></td><td></td></tr><tr><td></td><td></td><td></td></tr></table>										<table border="1"><tr><td></td><td></td><td></td></tr><tr><td></td><td></td><td></td></tr><tr><td></td><td></td><td></td></tr></table>										<table border="1"><tr><td></td><td></td><td></td></tr><tr><td></td><td></td><td></td></tr><tr><td>1</td><td></td><td>1</td></tr></table>							1		1	<table border="1"><tr><td></td><td></td><td></td></tr><tr><td></td><td></td><td></td></tr><tr><td></td><td></td><td></td></tr></table>										<table border="1"><tr><td></td><td></td><td></td></tr><tr><td></td><td></td><td></td></tr><tr><td></td><td></td><td></td></tr></table>										<table border="1"><tr><td></td><td></td><td></td></tr><tr><td></td><td></td><td></td></tr><tr><td>2</td><td></td><td>1</td></tr></table>							2		1	<table border="1"><tr><td></td><td></td><td></td></tr><tr><td></td><td></td><td></td></tr><tr><td></td><td></td><td></td></tr></table>										<table border="1"><tr><td></td><td></td><td></td></tr><tr><td></td><td></td><td></td></tr><tr><td></td><td></td><td></td></tr></table>									
1		1																																																																													
2		1																																																																													
Post - 0 Miss - 0 Block - 0	Post - 0 Miss - 0 Block - 0	Post - 0 Miss - 0 Block - 0	Post - 0 Miss - 0 Block - 0	Post - 0 Miss - 0 Block - 0	Post - 1 Miss - 0 Block - 0	Post - 0 Miss - 0 Block - 0	Post - 0 Miss - 0 Block - 0																																																																								

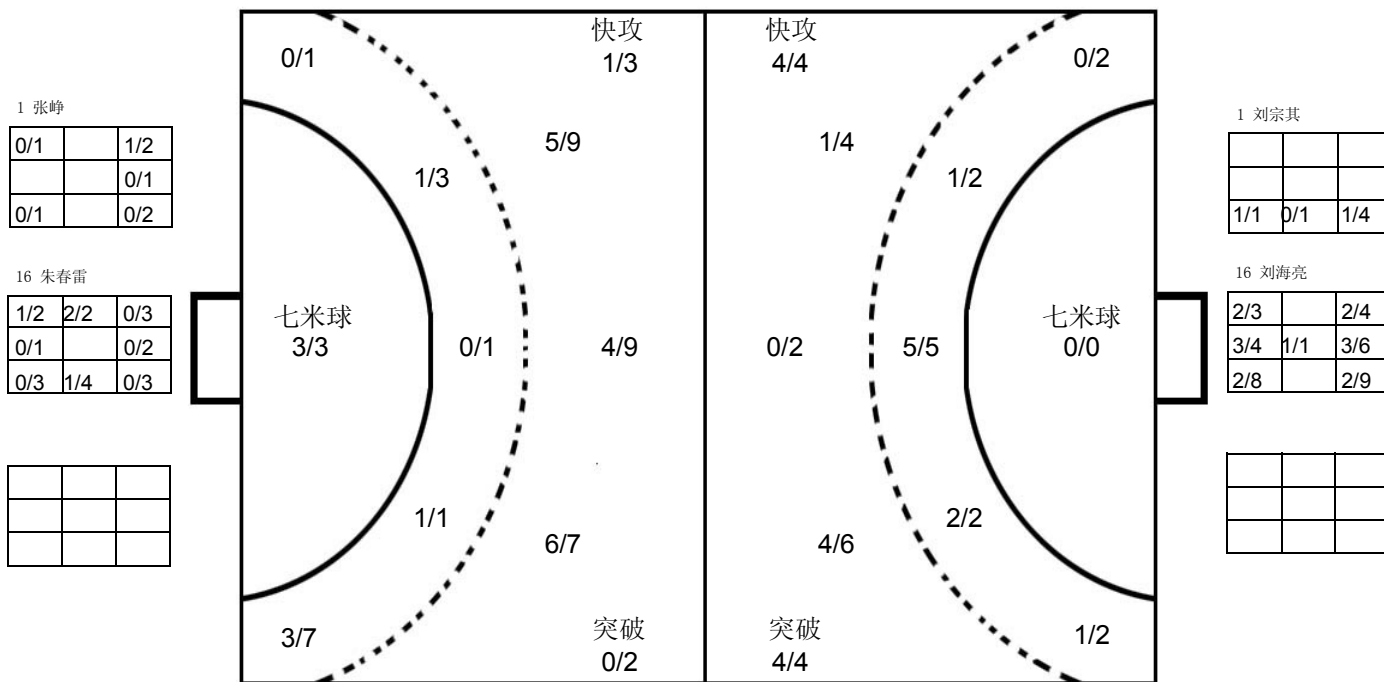

天津

1 刘宗其	2 李岳朋	3 李军	4 李松浩	7 张青	8 曹悦	9 孟凡钢	10 李帅																																																																								
<table border="1"><tr><td></td><td></td><td></td></tr><tr><td></td><td></td><td></td></tr><tr><td></td><td></td><td></td></tr></table>										<table border="1"><tr><td>1</td><td></td><td></td></tr><tr><td></td><td></td><td></td></tr><tr><td></td><td></td><td></td></tr></table>	1									<table border="1"><tr><td></td><td></td><td></td></tr><tr><td></td><td></td><td>1</td></tr><tr><td></td><td></td><td>1</td></tr></table>						1			1	<table border="1"><tr><td></td><td></td><td></td></tr><tr><td></td><td></td><td></td></tr><tr><td></td><td></td><td></td></tr></table>										<table border="1"><tr><td></td><td></td><td></td></tr><tr><td></td><td></td><td>1</td></tr><tr><td>2</td><td>1</td><td>1</td></tr></table>						1	2	1	1	<table border="1"><tr><td></td><td></td><td></td></tr><tr><td></td><td></td><td>1</td></tr><tr><td>1</td><td>2</td><td>2</td></tr></table>						1	1	2	2	<table border="1"><tr><td></td><td></td><td></td></tr><tr><td></td><td></td><td></td></tr><tr><td></td><td></td><td></td></tr></table>										<table border="1"><tr><td></td><td></td><td></td></tr><tr><td></td><td></td><td></td></tr><tr><td></td><td></td><td></td></tr></table>									
1																																																																															
		1																																																																													
		1																																																																													
		1																																																																													
2	1	1																																																																													
		1																																																																													
1	2	2																																																																													
Post - 0 Miss - 0 Block - 0	Post - 0 Miss - 0 Block - 0	Post - 1 Miss - 1 Block - 1	Post - 0 Miss - 0 Block - 0	Post - 0 Miss - 0 Block - 0	Post - 0 Miss - 0 Block - 0	Post - 0 Miss - 0 Block - 0	Post - 0 Miss - 0 Block - 0																																																																								
11 王毅	13 许松	14 田剑侠	15 张俊岭	16 刘海亮	17 周群	18 孙永	19 梁堂亮																																																																								
<table border="1"><tr><td></td><td></td><td></td></tr><tr><td></td><td></td><td></td></tr><tr><td></td><td></td><td></td></tr></table>										<table border="1"><tr><td></td><td></td><td></td></tr><tr><td></td><td></td><td></td></tr><tr><td></td><td></td><td>1</td></tr></table>									1	<table border="1"><tr><td></td><td></td><td></td></tr><tr><td>1</td><td></td><td>3</td></tr><tr><td>1</td><td></td><td></td></tr></table>				1		3	1			<table border="1"><tr><td></td><td></td><td></td></tr><tr><td></td><td></td><td></td></tr><tr><td></td><td></td><td></td></tr></table>										<table border="1"><tr><td></td><td></td><td></td></tr><tr><td></td><td></td><td></td></tr><tr><td></td><td></td><td></td></tr></table>										<table border="1"><tr><td></td><td></td><td></td></tr><tr><td></td><td></td><td></td></tr><tr><td></td><td></td><td></td></tr></table>										<table border="1"><tr><td></td><td></td><td></td></tr><tr><td></td><td></td><td></td></tr><tr><td></td><td></td><td></td></tr></table>										<table border="1"><tr><td></td><td></td><td></td></tr><tr><td></td><td></td><td></td></tr><tr><td></td><td></td><td></td></tr></table>									
		1																																																																													
1		3																																																																													
1																																																																															
Post - 0 Miss - 0 Block - 0	Post - 1 Miss - 0 Block - 0	Post - 2 Miss - 0 Block - 0	Post - 0 Miss - 0 Block - 0	Post - 0 Miss - 0 Block - 0	Post - 0 Miss - 0 Block - 0	Post - 0 Miss - 0 Block - 0	Post - 0 Miss - 0 Block - 0																																																																								

注释: Post=击柱 Miss=射失 Block=被封





男子 国内比赛



第十二届全国运动会男子手球预赛

Team A		Team B		Match Number																	
A 广东		B 解放军		33																	
played in		in the hall		on																	
China		柳州市李宁体育馆		25/04/2013																	
				at 16:20 hours																	
Spectators																					
Half-time (30')	A	B	End of playing time	A	B																
	6	4	13 13	13	13																
1st extra time		A		B																	
2nd extra time		A		B																	
After penalty		A		B																	
throws		17		15																	
Number of 7 m	A	Team time-out			Team time-out			B	Number of 7 m												
	5 / 6	1	2	3	1	2	3	3 / 6													
Full name of players and officials																					
26:08		53:58																			
No.	Team A					G	W	2'	D	DR	No.	Team B					G	W	2'	D	DR
1	王旭兴										4	曹作亮					4	1	1		
2	孙江山										5	吴龙瑞					3				
3	曲汝洋					3					6	苗青						1			
4	李卓洋					2					7	陈昊									
5	候生升										8	王烁					3				
6	邓志贵					1	1				9	丁超					1				
7	付文博					4	1				10	师龙									
8	于彦江					1					11	李想					1				
9	徐庆										12	丛霖									
10	陈超										13	王世杰									
12	温杰										14	曲学博						1	1		
16	张广建										15	杨帆					1				
17	李中洲					2	1				16	郎俊夫									
18	张腾										17	王勇					2				
19	马跃										18	董宏斐									
20	王伟					4		1			20	谷浩									
A	王锋										A	张敬敏					1				
B	李晓忠										B	张彬华									
C	郭艳辉										C	刘捷									
E	薛良成										D	刘军									
A		Signature of Responsible Official of the Teams (Off. A)																		B	
TP	Remarks of Referee / CHA Official																			TP	

Signatures

Referees	Jan Eric Klaus	Mikael Engelbert		
Techn. Delegates	许宜扬 (CHN)	刘书勇 (CHN)		
CHA Official				

Note: Number of 7m Throws Awarded to Team A and B, Goals (G), Warnings (W), Suspensions (2'), Direct Disqualification (D), Disqualification with Report (DR) and Team Penalty (TP).

Table Officials:

Statisticians: 黄莉

朱伟平



第十二届全国运动会男子手球预赛
竞赛技术统计(媒体表)

预赛	组别	B	轮次	8	场次	33
柳州市李宁体育馆			25/04/2013		201301033-51-1/1	
广东	广东	17	vs	15	解放军	解放军
			6:4			

裁判员	Jan Eric Klaus Leandersson (FIN)	/	Mikael Engelbert Lindroos (FIN)
-----	----------------------------------	---	---------------------------------

广东		远射	近射	边射	快攻	突破	任意球	7m球	合计	%	助攻	失误	警告	2'	D & DR	广东	比赛进程	解放军
主教练: 王锋																		
1	王旭兴											1						
2	孙江山																	
3	曲汝洋	0/1		1/1	1/2			1/1	3/5	60.0								
4	李卓洋	2/6						2/6	33.3		1							
5	候生升																	
6	邓志贵		1/1	0/1				1/2	50.0				1					
7	付文博	1/1	1/1			0/1		2/3	4/6	66.7		11	1					
8	于彦江	1/4	0/1			0/1		1/6	16.7		1							
9	徐庆																	
10	陈超																	
12	温杰																	
16	张广建																	
17	李中洲	0/2	1/2					1/1	2/5	40.0		4	1					
18	张腾																	
19	马跃																	
20	王伟	1/1	1/2	0/1	0/1	1/1		1/1	4/7	57.1		5		1				
运动员 合计		5/15	4/7	1/3	1/3	1/3		5/6	17/37	45.9		23	3	1				
1	王旭兴	5/9	1/3	2/2	1/5	1/2	0/1	1/2	11/24	45.8		1						
16	张广建							2/4	2/4	50.0								
守门员 合计		5/9	1/3	2/2	1/5	1/2	0/1	3/6	13/28	46.4		1						
解放军		远射	近射	边射	快攻	突破	任意球	7m球	合计	%	助攻	失误	警告	2'	D & DR	广东	比赛进程	解放军
教练: 张敬敏																		
4	曹作亮	3/6				0/1	1/3	4/10	40.0		1	8	1	1				
5	吴龙瑞	0/1	0/1		1/1	1/1		1/1	3/5	60.0		4						
6	苗青	0/1		0/1				0/1	0/3	0.0		3	1					
7	陈昊																	
8	王烁	0/1	1/1		1/1			1/3	3/6	50.0	1	2						
9	丁超	0/1	1/1					1/2	50.0			1						
10	师龙																	
11	李想							1/1	1/1	100								
12	丛霖																	
13	王世杰																	
14	曲学博											1	1	1				
15	杨帆	0/1	0/1		1/1			1/3	33.3		1	2						
16	郎俊夫																	
17	王勇	1/5		0/1	1/2			2/8	25.0			2						
18	董宏斐																	
20	谷浩																	
运动员 合计		4/16	2/4	0/2	4/5	1/2	1/3	3/6	15/38	39.5	3	23	3	2				
12	丛霖	6/11	3/7	1/2	2/3	2/3		0/1	14/27	51.9								
16	郎俊夫							1/5	1/5	20.0								
守门员 合计		6/11	3/7	1/2	2/3	2/3		1/6	15/32	46.9								

场上队员: 得分 / 射门

守门员: 救球 / 射门

快攻	Fast Break		突破	Breakthrough		任意球	Free Throw		7M球	7M Throw		助攻	Assist
警告	Warning		失误	Error		2'	Suspension		D	取消资格		DR	取消资格+报告





第十二届全国运动会男子手球预赛 图式比赛技术统计表

轮次 8

场次 33

201301033-21-1/1

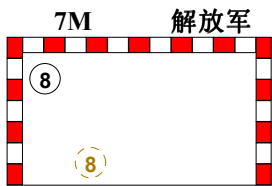
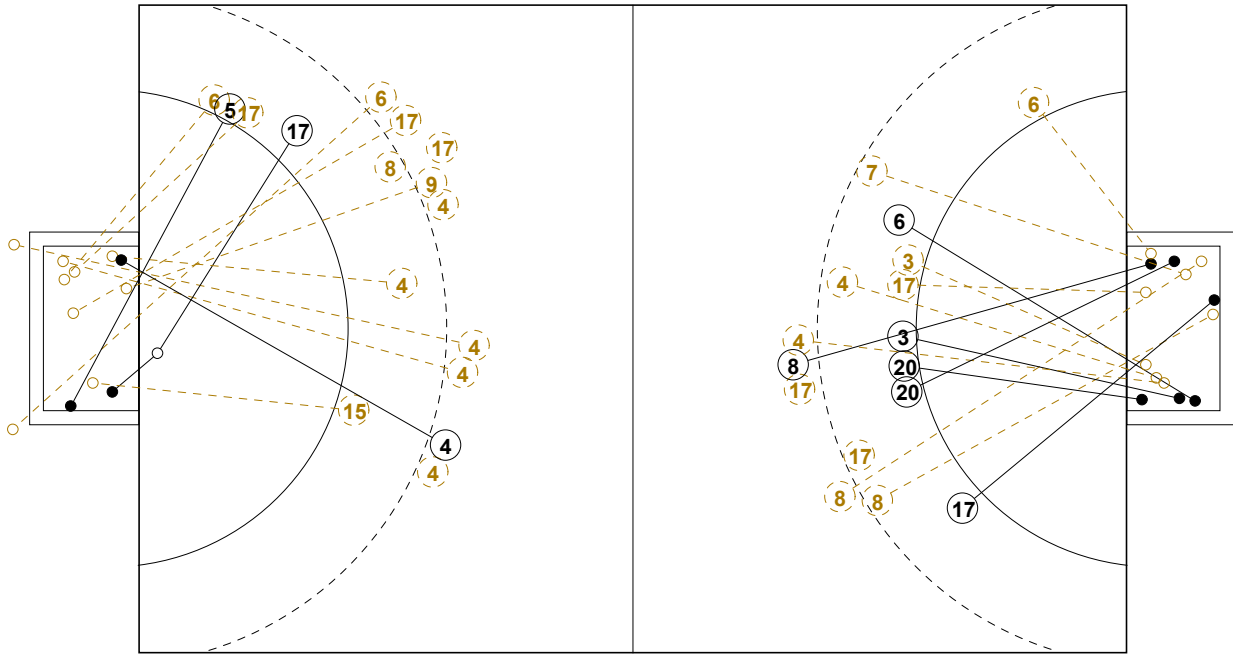

1st Half
4 : 6

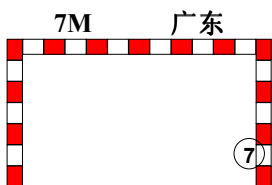
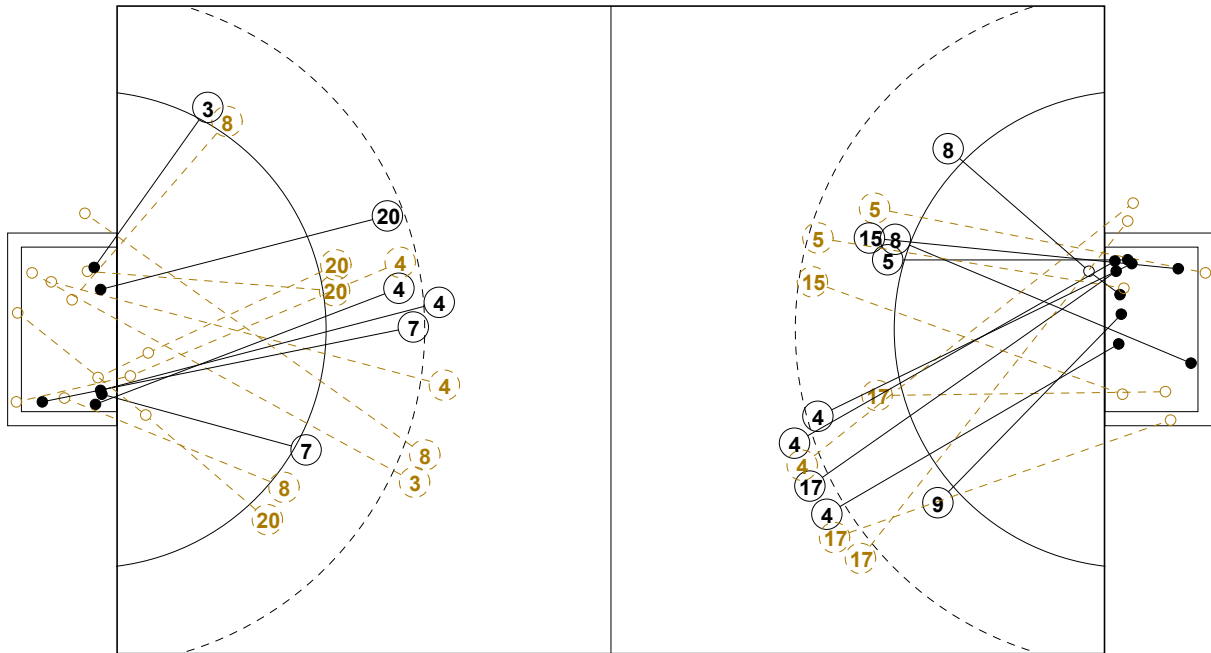
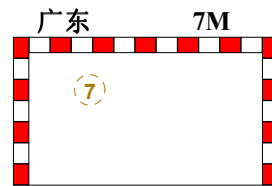

2nd Half
13 : 13

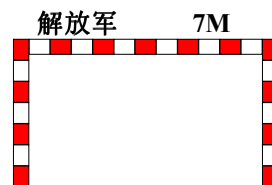



第十二届全国运动会男子手球预赛 图式比赛技术统计表

轮次 8

场次 33

201301033-21-1/1

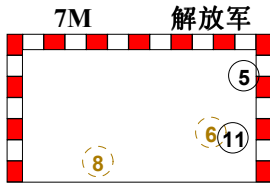
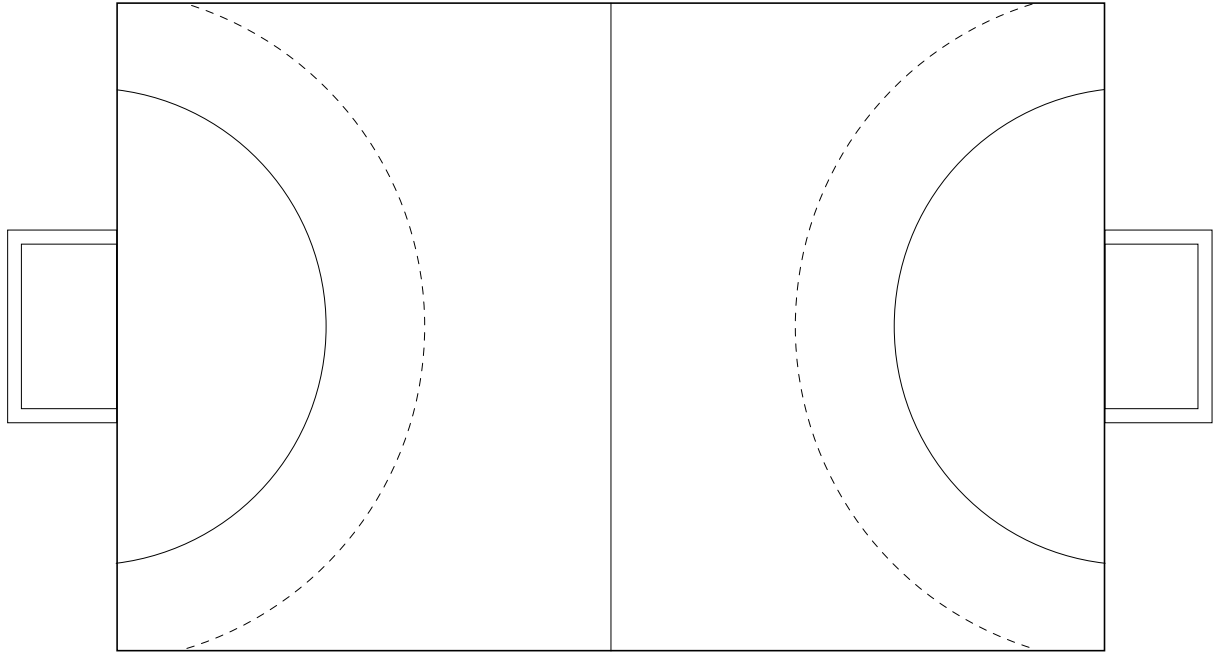

7M-Throw
15 : 17

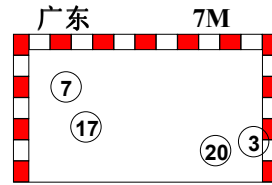



第十二届全国运动会男子手球预赛

个人/全队技术统计表

正式表
手球
男子预赛
轮次 8组别 B
场次 33201301033-14-1/2
柳州市李宁体育馆
25/04/2013 16:20

号码	姓名	远射	近射	边射	快攻	突破	任意	7M	合计	%	助攻	失误	警告	2'	取消	时间
广东(广东)																
<i>(场上队员)</i>																
1	王旭兴									0.0%		1				01:00:00
2	孙江山									0.0%						00:00:00
3	曲汝洋	0/1		1/1	1/2			1/1	3/5	60.0%						01:24:20
4	李卓洋	2/6							2/6	33.3%		1				00:33:39
5	候生升									0.0%						00:00:00
6	邓志贵		1/1	0/1					1/2	50.0%			1			00:52:29
7	付文博	1/1	1/1			0/1		2/3	4/6	66.7%		11	1			01:30:00
8	于彦江	1/4	0/1			0/1			1/6	16.7%		1				01:21:30
9	徐庆									0.0%						00:00:00
10	陈超									0.0%						00:00:00
12	温杰									0.0%						00:00:00
16	张广建									0.0%						00:30:00
17	李中洲	0/2	1/2					1/1	2/5	40.0%		4	1			01:17:38
18	张腾									0.0%						00:00:00
19	马跃									0.0%						00:00:00
20	王伟	1/1	1/2	0/1	0/1	1/1		1/1	4/7	57.1%		5		1		01:30:00
合计		5/15	4/7	1/3	1/3	1/3		5/6	17/37	45.9%		23	3	1		
<i>(守门员)</i>																
1	王旭兴	5/9	1/3	2/2	1/5	1/2	0/1	1/2	11/24	45.8%		1				01:00:00
16	张广建							2/4	2/4	50.0%						00:30:00
合计		5/9	1/3	2/2	1/5	1/2	0/1	3/6	13/28	46.4%		1				

场上队员：得分/射门

守门员：救球/射门

全队合计	得分	被救	射失	击柱	封球	合计	%
远射	5	6	1	1	2	15	33.3%
近射	4	3				7	57.1%
边射	1	1		1		3	33.3%
快攻	1	2				3	33.3%
突破	1	2				3	33.3%
任意							0.0%
7M	5	1				6	83.3%





第十二届全国运动会男子手球预赛

个人/全队技术统计表

正式表
手球
男子预赛
轮次 8组别 B
场次 33201301033-14-2/2
柳州市李宁体育馆
25/04/2013 16:20

号码	姓名	远射	近射	边射	快攻	突破	任意	7M	合计	%	助攻	失误	警告	2'	取消	时间
解放军(解放军)																
<i>(上场队员)</i>																
4	曹作亮	3/6				0/1	1/3		4/10	40.0%	1	8	1	1		01:00:00
5	吴龙瑞	0/1	0/1		1/1	1/1		1/1	3/5	60.0%		4				01:08:47
6	苗青	0/1		0/1				0/1	0/3	0.0%		3	1			00:54:47
7	陈昊									0.0%						00:00:00
8	王烁	0/1	1/1		1/1			1/3	3/6	50.0%	1	2				01:30:00
9	丁超	0/1	1/1						1/2	50.0%		1				00:45:52
10	师龙									0.0%						00:00:00
11	李想							1/1	1/1	100%						00:33:27
12	丛霖									0.0%						00:59:34
13	王世杰									0.0%						00:00:00
14	曲学博									0.0%		1	1	1		00:12:54
15	杨帆	0/1	0/1		1/1				1/3	33.3%	1	2				00:57:00
16	郎俊夫									0.0%						00:30:26
17	王勇	1/5		0/1	1/2				2/8	25.0%		2				00:43:36
18	董宏斐									0.0%						00:00:00
20	谷浩									0.0%						00:13:03
合计		4/16	2/4	0/2	4/5	1/2	1/3	3/6	15/38	39.5%	3	23	3	2		
<i>(守门员)</i>																
12	丛霖	6/11	3/7	1/2	2/3	2/3		0/1	14/27	51.9%						00:59:34
16	郎俊夫							1/5	1/5	20.0%						00:30:26
合计		6/11	3/7	1/2	2/3	2/3		1/6	15/32	46.9%						

场上队员：得分/射门

守门员：救球/射门

全队合计	得分	被救	射失	击柱	封球	合计	%
远射	4	5	2	1	4	16	25.0%
近射	2	1		1		4	50.0%
边射		2				2	0.0%
快攻	4	1				5	80.0%
突破	1	1				2	50.0%
任意	1		2			3	33.3%
7M	3	3				6	50.0%





第十二届全国运动会男子手球预赛

图式射门区域统计

轮次 8 场次 33

201301033-41-1/1

广东

1 王旭兴	2 孙江山	3 曲汝洋	4 李卓洋	5 候生升	6 邓志贵	7 付文博	8 于彦江																																																																								
<table border="1"><tr><td></td><td></td><td></td></tr><tr><td></td><td></td><td></td></tr><tr><td></td><td></td><td></td></tr></table>										<table border="1"><tr><td></td><td></td><td></td></tr><tr><td></td><td></td><td></td></tr><tr><td></td><td></td><td></td></tr></table>										<table border="1"><tr><td></td><td></td><td></td></tr><tr><td></td><td></td><td>2</td></tr><tr><td></td><td></td><td>1</td></tr></table>						2			1	<table border="1"><tr><td></td><td></td><td></td></tr><tr><td></td><td></td><td></td></tr><tr><td>2</td><td></td><td></td></tr></table>							2			<table border="1"><tr><td></td><td></td><td></td></tr><tr><td></td><td></td><td></td></tr><tr><td></td><td></td><td></td></tr></table>										<table border="1"><tr><td></td><td></td><td>1</td></tr><tr><td></td><td></td><td></td></tr><tr><td></td><td></td><td></td></tr></table>			1							<table border="1"><tr><td></td><td>2</td><td></td></tr><tr><td></td><td></td><td></td></tr><tr><td>1</td><td></td><td>1</td></tr></table>		2					1		1	<table border="1"><tr><td></td><td></td><td></td></tr><tr><td></td><td></td><td></td></tr><tr><td>1</td><td></td><td></td></tr></table>							1		
		2																																																																													
		1																																																																													
2																																																																															
		1																																																																													
	2																																																																														
1		1																																																																													
1																																																																															
Post - 0 Miss - 0 Block - 0	Post - 0 Miss - 0 Block - 0	Post - 0 Miss - 0 Block - 0	Post - 1 Miss - 0 Block - 0	Post - 0 Miss - 0 Block - 0	Post - 0 Miss - 0 Block - 0	Post - 0 Miss - 0 Block - 0	Post - 0 Miss - 1 Block - 0																																																																								
9 徐庆	10 陈超	12 温杰	16 张广建	17 李中洲	18 张腾	19 马跃	20 王伟																																																																								
<table border="1"><tr><td></td><td></td><td></td></tr><tr><td></td><td></td><td></td></tr><tr><td></td><td></td><td></td></tr></table>										<table border="1"><tr><td></td><td></td><td></td></tr><tr><td></td><td></td><td></td></tr><tr><td></td><td></td><td></td></tr></table>										<table border="1"><tr><td></td><td></td><td></td></tr><tr><td></td><td></td><td></td></tr><tr><td></td><td></td><td></td></tr></table>										<table border="1"><tr><td></td><td></td><td></td></tr><tr><td></td><td></td><td></td></tr><tr><td></td><td></td><td></td></tr></table>										<table border="1"><tr><td></td><td>1</td><td></td></tr><tr><td>1</td><td></td><td></td></tr><tr><td></td><td></td><td></td></tr></table>		1		1						<table border="1"><tr><td></td><td></td><td></td></tr><tr><td></td><td></td><td></td></tr><tr><td></td><td></td><td></td></tr></table>										<table border="1"><tr><td></td><td></td><td></td></tr><tr><td></td><td></td><td></td></tr><tr><td></td><td></td><td></td></tr></table>										<table border="1"><tr><td></td><td></td><td></td></tr><tr><td></td><td></td><td></td></tr><tr><td>1</td><td></td><td></td></tr></table>							1		
	1																																																																														
1																																																																															
1																																																																															
Post - 0 Miss - 0 Block - 0	Post - 0 Miss - 0 Block - 0	Post - 0 Miss - 0 Block - 0	Post - 0 Miss - 0 Block - 0	Post - 0 Miss - 0 Block - 2	Post - 0 Miss - 0 Block - 0	Post - 0 Miss - 0 Block - 0	Post - 1 Miss - 0 Block - 0																																																																								

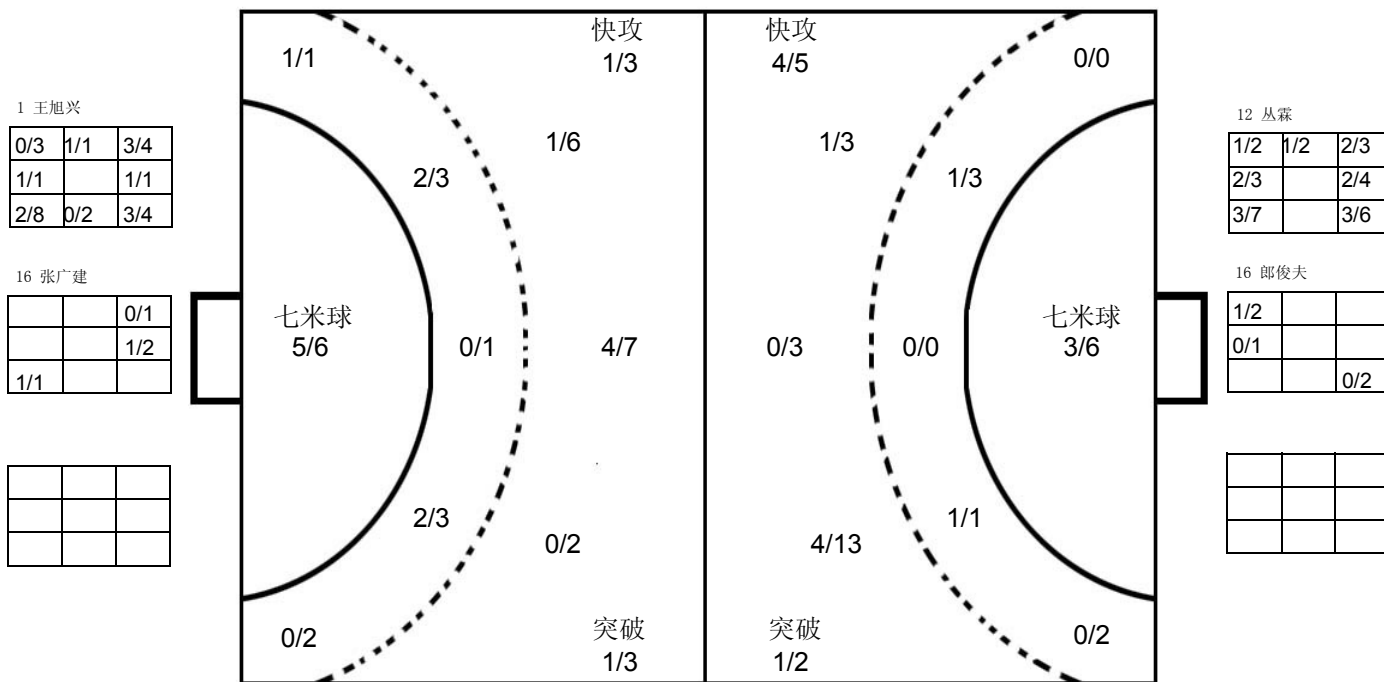

解放军

4 曹作亮	5 吴龙瑞	6 苗青	7 陈昊	8 王烁	9 丁超	10 师龙	11 李想																																																																								
<table border="1"><tr><td></td><td></td><td></td></tr><tr><td></td><td></td><td></td></tr><tr><td>2</td><td>1</td><td>1</td></tr></table>							2	1	1	<table border="1"><tr><td>1</td><td></td><td>1</td></tr><tr><td></td><td></td><td></td></tr><tr><td>1</td><td></td><td></td></tr></table>	1		1				1			<table border="1"><tr><td></td><td></td><td></td></tr><tr><td></td><td></td><td></td></tr><tr><td></td><td></td><td></td></tr></table>										<table border="1"><tr><td></td><td></td><td></td></tr><tr><td></td><td></td><td></td></tr><tr><td></td><td></td><td></td></tr></table>										<table border="1"><tr><td>1</td><td></td><td>1</td></tr><tr><td></td><td></td><td></td></tr><tr><td>1</td><td></td><td></td></tr></table>	1		1				1			<table border="1"><tr><td></td><td></td><td></td></tr><tr><td></td><td></td><td></td></tr><tr><td></td><td>1</td><td></td></tr></table>								1		<table border="1"><tr><td></td><td></td><td></td></tr><tr><td></td><td></td><td></td></tr><tr><td></td><td></td><td></td></tr></table>										<table border="1"><tr><td></td><td></td><td></td></tr><tr><td></td><td></td><td></td></tr><tr><td></td><td></td><td>1</td></tr></table>									1
2	1	1																																																																													
1		1																																																																													
1																																																																															
1		1																																																																													
1																																																																															
	1																																																																														
		1																																																																													
Post - 0 Miss - 2 Block - 2	Post - 1 Miss - 0 Block - 0	Post - 0 Miss - 1 Block - 0	Post - 0 Miss - 0 Block - 0	Post - 0 Miss - 0 Block - 1	Post - 0 Miss - 0 Block - 0	Post - 0 Miss - 0 Block - 0	Post - 0 Miss - 0 Block - 0																																																																								
12 丛霖	13 王世杰	14 曲学博	15 杨帆	16 郎俊夫	17 王勇	18 董宏斐	20 谷浩																																																																								
<table border="1"><tr><td></td><td></td><td></td></tr><tr><td></td><td></td><td></td></tr><tr><td></td><td></td><td></td></tr></table>										<table border="1"><tr><td></td><td></td><td></td></tr><tr><td></td><td></td><td></td></tr><tr><td></td><td></td><td></td></tr></table>										<table border="1"><tr><td></td><td></td><td></td></tr><tr><td></td><td></td><td></td></tr><tr><td></td><td></td><td></td></tr></table>										<table border="1"><tr><td>1</td><td></td><td></td></tr><tr><td></td><td></td><td></td></tr><tr><td></td><td></td><td></td></tr></table>	1									<table border="1"><tr><td></td><td></td><td></td></tr><tr><td></td><td></td><td></td></tr><tr><td></td><td></td><td></td></tr></table>										<table border="1"><tr><td></td><td></td><td></td></tr><tr><td></td><td></td><td></td></tr><tr><td>2</td><td></td><td></td></tr></table>							2			<table border="1"><tr><td></td><td></td><td></td></tr><tr><td></td><td></td><td></td></tr><tr><td></td><td></td><td></td></tr></table>										<table border="1"><tr><td></td><td></td><td></td></tr><tr><td></td><td></td><td></td></tr><tr><td></td><td></td><td></td></tr></table>									
1																																																																															
2																																																																															
Post - 0 Miss - 0 Block - 0	Post - 0 Miss - 0 Block - 0	Post - 0 Miss - 0 Block - 0	Post - 0 Miss - 0 Block - 0	Post - 0 Miss - 0 Block - 0	Post - 1 Miss - 1 Block - 1	Post - 0 Miss - 0 Block - 0	Post - 0 Miss - 0 Block - 0																																																																								

注释: Post=击柱 Miss=射失 Block=被封





男子 国内比赛



第十二届全国运动会男子手球预赛

Team A				Team B				Match Number																					
A 西藏				B 香港				34																					
played in		in the hall		on		at		Spectators																					
China		柳州市李宁体育馆		25/04/2013		18:00 hours																							
Half-time (30')	A	B	End of playing time	A	B	1st extra time	A	B	2nd extra time	A	B	After penalty throws	A	B															
	12	15		25	32																								
Number of 7 m	A	Team time-out			Full name of players and officials				Team time-out			B	Number of 7 m																
	2 / 4	1	2	3					1	2	3	2 / 2																	
No.	Team A					G	W	2'	D	DR	No.	Team B					G	W	2'	D	DR								
2	王龙					1					1	萧智庭																	
4	张家纬					3	1				2	叶冠英																	
5	冯祥龙										5	黄胜业																	
6	任启双							1			6	谢伟希					1												
7	徐奕飞										7	许文邦					6												
9	王博					7					8	何伟杰																	
10	刘江					2		1			9	张建国					7		1										
11	朱治宇										10	陈国兴					8												
12	张帅										11	陈允文																	
15	刘劲松										12	叶冠雄						1											
16	徐畅										13	叶仕仁					5	1											
18	赵楠					1	1	2			14	李鑫豪					1												
19	任野										15	黄嘉愉																	
20	顾艳超					3					25	曾铭谦																	
21	马光										29	练明辉					4	1	2										
23	王伟强					8	1																						
A	张文韬										A	陈广裕																	
B	殷永军										B	杨开将																	
C	瓮勇										D	张军																	
A										Signature of Responsible Official of the Teams (Off. A)										B									
TP	Remarks of Referee / CHA Official																			TP									

Signatures

Referees	Andreas Bethmann	Michael Tzaferopoulos		
Techn. Delegates	李之文 (CHN)	许宜扬 (CHN)		
CHA Official				

Note: Number of 7m Throws Awarded to Team A and B, Goals (G), Warnings (W), Suspensions (2'), Direct Disqualification (D), Disqualification with Report (DR) and Team Penalty (TP).

Table Officials:

Statisticians: 黄莉

朱伟平



第十二届全国运动会男子手球预赛
竞赛技术统计(媒体表)

预赛	组别	A	轮次	8	场次	34
----	----	---	----	---	----	----

柳州市李宁体育馆

25/04/2013

201301034-51-1/1

西藏	西藏	25	vs	32	香港	香港
12 : 15						

裁判员	Andreas Bethmann (GRE)	/	Michael Tzaferopoulos (GRE)
-----	------------------------	---	-----------------------------

西藏		远射	近射	边射	快攻	突破	任意球	7m球	合计	%	助攻	失误	警告	2'	D & DR	西藏	比赛进程	香港				
主教练: 张文韬																						
2	王龙	0/1			1/1				1/2	50.0		1					0	00:25	1	7	许文邦	
4	张家纬	0/1		0/1		2/3	1/1		3/6	50.0		4	1				1	00:49	1			
5	冯祥龙																1	01:54	2	10	陈国兴	
6	任启双													1			2	02:17	2			
7	徐奕飞																3	04:33	2			
9	王博		5/5		1/2	1/1		7/8	87.5			1					3	05:14	3	13	叶仕仁	
10	刘江	0/1	1/2	0/1	1/2	0/1		2/7	28.6		1	2		1			4	07:29	4	9	张建国	
11	朱治宇																4	08:33	5	9	张建国	
12	张帅																4	09:07	6	6	谢伟希	
15	刘劲松																4	10:28	7	13	叶仕仁	
16	徐畅																5	10:51	7			
18	赵楠	0/2		1/1		0/1		0/1	1/5	20.0	1	2	1	2			5	11:17	8	7	许文邦	
19	任野																6	14:47	8			
20	顾艳超	2/3	0/4	0/1	0/1	1/1		3/10	30.0		1	7					6	16:37	9	13	叶仕仁	
21	马光																7	18:26	9			
23	王伟强	0/1		1/2	4/6	1/1	0/1	2/3	8/14	57.1		3	1				7	18:53	10	10	陈国兴	
运动员 合计		2/9	6/11	2/6	7/12	5/8	1/2	2/4	25/52	48.1	4	21	3	4			8	19:12	10			
16	徐畅	4/15	3/4	2/7	1/9	0/4	0/1	0/2	10/42	23.8	1						9	21:07	10			
守门员 合计		4/15	3/4	2/7	1/9	0/4	0/1	0/2	10/42	23.8	1						9	21:45	11	29	练明辉	
香港		远射	近射	边射	快攻	突破	任意球	7m球	合计	%	助攻	失误	警告	2'	D & DR	2nd Half						
教练: 陈广裕																9	王博	13	00:21	15		
1	萧智庭															23	王伟强	14	02:34	15		
2	叶冠英															4	张家纬	14	04:29	16	10	陈国兴
5	黄胜业			0/1				0/1	0.0			1				9	王博	15	05:44	16		
6	谢伟希				1/1			1/1	100			1				16	顾艳超	16	07:22	16		
7	许文邦	4/8		2/2				6/10	60.0		1	4				16	王博	16	07:48	17	29	练明辉
8	何伟杰															16	顾艳超	16	08:38	18	13	叶仕仁
9	张建国	1/1	0/1	2/4	3/3			1/1	7/10	70.0	1	2		1		17	王龙	17	08:51	18		
10	陈国兴	1/1	1/1	1/1	2/4	3/3		8/10	80.0			3				17	王伟强	17	10:15	19	29	练明辉
11	陈允文															18	王博	18	10:37	19		
12	叶冠雄															18	顾艳超	18	12:00	20	9	张建国
13	叶仕仁	3/9			1/1	1/1		5/11	45.5		2	4	1			18	王博	18	12:34	21	9	张建国
14	李鑫豪				1/1			1/1	100							18	顾艳超	18	13:04	22	10	陈国兴
15	黄嘉愉		0/1					0/1	0.0							10	刘江	19	13:39	22		
25	曾铭谦															20	顾艳超	19	14:06	23	10	陈国兴
29	练明辉	2/4	0/1				1/1	1/1	4/7	57.1	1	2	1	2		20	顾艳超	20	15:47	23		
运动员 合计		11/23	1/4	5/8	8/10	4/4	1/1	2/2	32/52	61.5	5	18	3	3		21	顾艳超	21	16:25	23		
1	萧智庭							0/1	0/1	0.0						21	王博	21	18:01	24	29	练明辉
2	叶冠英	5/7	4/10	2/4	5/12	2/7	1/2	2/3	21/45	46.7		1				21	王伟强	21	18:21	25	9	张建国
守门员 合计		5/7	4/10	2/4	5/12	2/7	1/2	2/4	21/46	45.7		1				22	王博	22	19:31	25		
																22	王博	22	20:21	26	9	张建国
																23	王伟强	23	23:08	26		
																23	王博	23	23:30	27	7	许文邦
																10	刘江	24	23:40	27		
																24	王博	24	25:15	28	7	许文邦
																24	王伟强	24	25:35	29	10	陈国兴
																24	王博	24	26:42	30	13	叶仕仁
																9	王博	24	27:58	31	7	许文邦
																25	王伟强	25	28:27	31		
																25	王博	25	29:24	32	9	张建国

场上队员: 得分 / 射门

守门员: 救球 / 射门

快攻	Fast Break	突破	Breakthrough	任意球	Free Throw	7M球	7M Throw	助攻	Assist
警告	Warning	失误	Error	2'	Suspension	D	取消资格	DR	取消资格+报告





第十二届全国运动会男子手球预赛 图式比赛技术统计表

轮次 8

场次 34

201301034-21-1/1

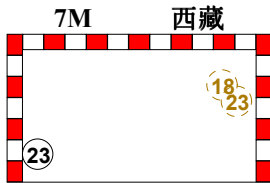
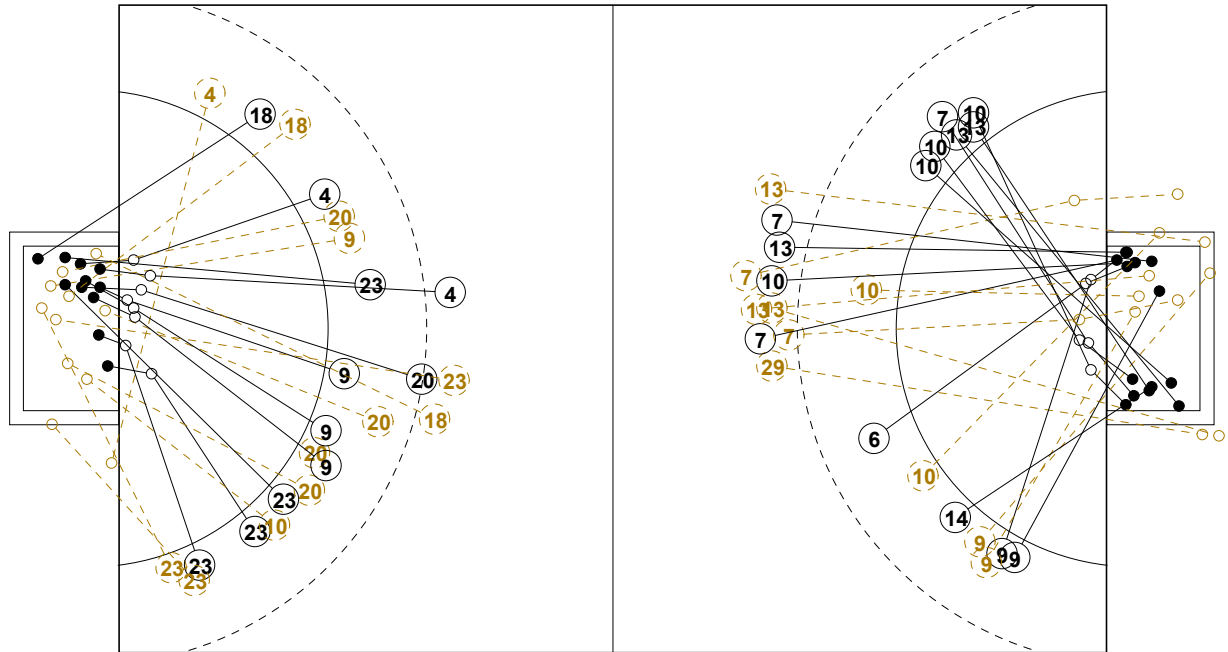

1st Half
12 : 15

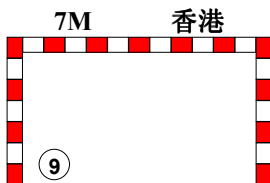
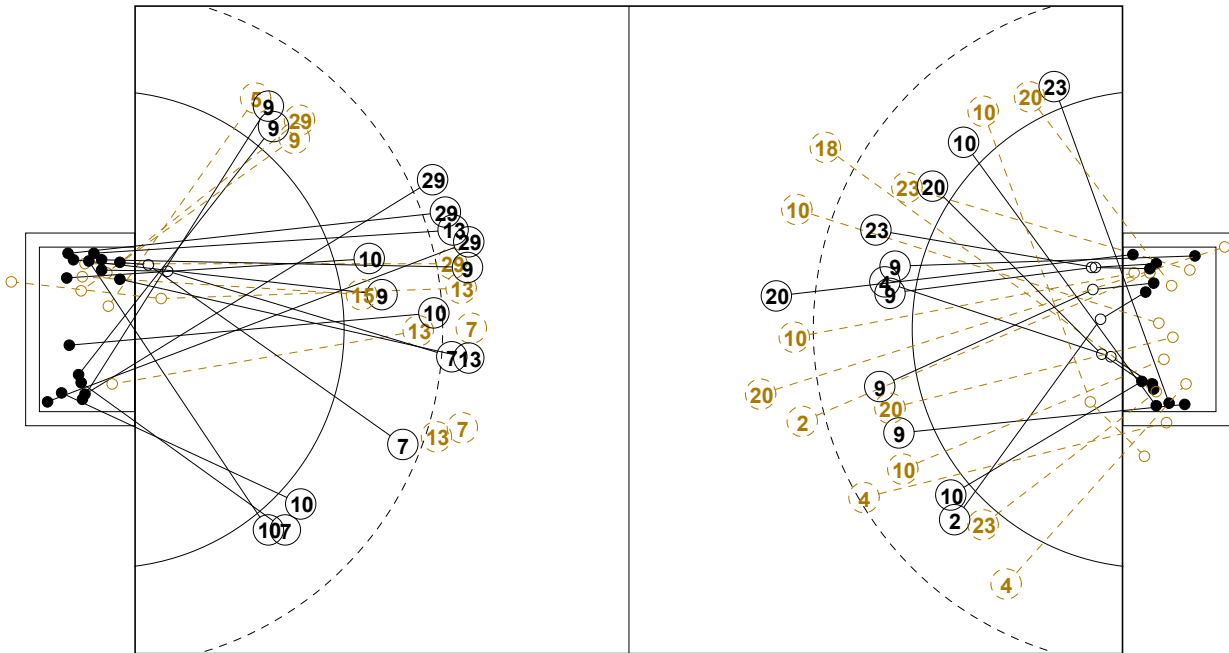

2nd Half
32 : 25

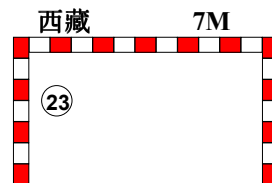



第十二届全国运动会男子手球预赛

个人/全队技术统计表

正式表
手球
男子预赛
轮次 8组别 A
场次 34201301034-14-1/2
柳州市李宁体育馆
25/04/2013 18:00

号码	姓名	远射	近射	边射	快攻	突破	任意	7M	合计	%	助攻	失误	警告	2'	取消	时间
西藏(西藏)																
<i>(场上队员)</i>																
2	王龙	0/1			1/1				1/2	50.0%		1				00:11:58
4	张家纬	0/1		0/1		2/3	1/1		3/6	50.0%		4	1			00:45:45
5	冯祥龙									0.0%						00:00:00
6	任启双									0.0%				1		00:04:12
7	徐奕飞									0.0%		1				00:29:36
9	王博		5/5		1/2	1/1			7/8	87.5%		1				00:55:45
10	刘江	0/1	1/2	0/1	1/2	0/1			2/7	28.6%	1	2		1		00:45:38
11	朱治宇									0.0%						00:00:00
12	张帅									0.0%						00:00:00
15	刘劲松									0.0%						00:00:00
16	徐畅									0.0%	1					01:00:00
18	赵楠	0/2		1/1		0/1		0/1	1/5	20.0%	1	2	1	2		00:57:44
19	任野									0.0%						00:00:00
20	顾艳超	2/3	0/4	0/1	0/1	1/1			3/10	30.0%	1	7				00:48:56
21	马光									0.0%						00:00:00
23	王伟强	0/1		1/2	4/6	1/1	0/1	2/3	8/14	57.1%		3	1			01:00:00
合计		2/9	6/11	2/6	7/12	5/8	1/2	2/4	25/52	48.1%	4	21	3	4		
<i>(守门员)</i>																
16	徐畅	4/15	3/4	2/7	1/9	0/4	0/1	0/2	10/42	23.8%	1					01:00:00
合计																
		4/15	3/4	2/7	1/9	0/4	0/1	0/2	10/42	23.8%	1					

场上队员：得分/射门

守门员：救球/射门

全队合计	得分	被救	射失	击柱	封球	合计	%
远射	2	5		2		9	22.2%
近射	6	4			1	11	54.5%
边射	2	2	1	1		6	33.3%
快攻	7	5				12	58.3%
突破	5	2	1			8	62.5%
任意	1	1				2	50.0%
7M	2	2				4	50.0%





第十二届全国运动会男子手球预赛

个人/全队技术统计表

正式表
手球
男子预赛
轮次 8组别 A
场次 34201301034-14-2/2
柳州市李宁体育馆
25/04/2013 18:00

号码	姓名	远射	近射	边射	快攻	突破	任意	7M	合计	%	助攻	失误	警告	2'	取消	时间
香港(香港)																
<i>(上场队员)</i>																
1	萧智庭									0.0%						00:00:10
2	叶冠英									0.0%		1				00:59:50
5	黄胜业			0/1					0/1	0.0%		1				00:09:50
6	谢伟希				1/1				1/1	100%		1				00:40:57
7	许文邦	4/8		2/2					6/10	60.0%	1	4				00:50:36
8	何伟杰									0.0%						00:00:00
9	张建国	1/1	0/1	2/4	3/3			1/1	7/10	70.0%	1	2		1		00:50:05
10	陈国兴	1/1	1/1	1/1	2/4	3/3			8/10	80.0%		3				01:00:00
11	陈允文									0.0%						00:00:16
12	叶冠雄									0.0%			1			00:11:55
13	叶仕仁	3/9			1/1	1/1			5/11	45.5%	2	4	1			00:52:01
14	李鑫豪				1/1				1/1	100%						00:07:17
15	黄嘉愉		0/1						0/1	0.0%						00:21:53
25	曾铭谦									0.0%						00:00:00
29	练明辉	2/4	0/1				1/1	1/1	4/7	57.1%	1	2	1	2		00:56:49
合计		11/23	1/4	5/8	8/10	4/4	1/1	2/2	32/52	61.5%	5	18	3	3		
<i>(守门员)</i>																
1	萧智庭							0/1	0/1	0.0%						00:00:10
2	叶冠英	5/7	4/10	2/4	5/12	2/7	1/2	2/3	21/45	46.7%		1				00:59:50
合计		5/7	4/10	2/4	5/12	2/7	1/2	2/4	21/46	45.7%		1				

场上队员：得分/射门

守门员：救球/射门

全队合计	得分	被救	射失	击柱	封球	合计	%
远射	11	4	4	1	3	23	47.8%
近射	1	3				4	25.0%
边射	5	2		1		8	62.5%
快攻	8	1		1		10	80.0%
突破	4					4	100.0%
任意	1					1	100.0%
7M	2					2	100.0%





第十二届全国运动会男子手球预赛

图式射门区域统计

轮次 8 场次 34

201301034-41-1/1

西藏

2 王龙	4 张家纬	5 冯祥龙	6 任启双	7 徐奕飞	9 王博	10 刘江	11 朱治宇																																																																								
<table border="1"><tr><td></td><td></td><td></td></tr><tr><td></td><td></td><td></td></tr><tr><td>1</td><td></td><td></td></tr></table>							1			<table border="1"><tr><td></td><td></td><td></td></tr><tr><td></td><td></td><td>1</td></tr><tr><td></td><td></td><td>2</td></tr></table>						1			2	<table border="1"><tr><td></td><td></td><td></td></tr><tr><td></td><td></td><td></td></tr><tr><td></td><td></td><td></td></tr></table>										<table border="1"><tr><td></td><td></td><td></td></tr><tr><td></td><td></td><td></td></tr><tr><td></td><td></td><td></td></tr></table>										<table border="1"><tr><td></td><td></td><td></td></tr><tr><td></td><td></td><td></td></tr><tr><td></td><td></td><td></td></tr></table>										<table border="1"><tr><td>1</td><td></td><td>1</td></tr><tr><td>1</td><td></td><td>1</td></tr><tr><td>1</td><td></td><td>2</td></tr></table>	1		1	1		1	1		2	<table border="1"><tr><td></td><td></td><td></td></tr><tr><td></td><td></td><td>1</td></tr><tr><td></td><td></td><td>1</td></tr></table>						1			1	<table border="1"><tr><td></td><td></td><td></td></tr><tr><td></td><td></td><td></td></tr><tr><td></td><td></td><td></td></tr></table>									
1																																																																															
		1																																																																													
		2																																																																													
1		1																																																																													
1		1																																																																													
1		2																																																																													
		1																																																																													
		1																																																																													
Post - 0 Miss - 0 Block - 0	Post - 1 Miss - 1 Block - 0	Post - 0 Miss - 0 Block - 0	Post - 0 Miss - 0 Block - 0	Post - 0 Miss - 0 Block - 0	Post - 0 Miss - 0 Block - 0	Post - 0 Miss - 1 Block - 0	Post - 0 Miss - 0 Block - 0																																																																								
12 张帅	15 刘劲松	16 徐畅	18 赵楠	19 任野	20 顾艳超	21 马光	23 王伟强																																																																								
<table border="1"><tr><td></td><td></td><td></td></tr><tr><td></td><td></td><td></td></tr><tr><td></td><td></td><td></td></tr></table>										<table border="1"><tr><td></td><td></td><td></td></tr><tr><td></td><td></td><td></td></tr><tr><td></td><td></td><td></td></tr></table>										<table border="1"><tr><td></td><td></td><td></td></tr><tr><td></td><td></td><td></td></tr><tr><td></td><td></td><td></td></tr></table>										<table border="1"><tr><td></td><td></td><td>1</td></tr><tr><td></td><td></td><td></td></tr><tr><td></td><td></td><td></td></tr></table>			1							<table border="1"><tr><td></td><td></td><td></td></tr><tr><td></td><td></td><td></td></tr><tr><td></td><td></td><td></td></tr></table>										<table border="1"><tr><td></td><td></td><td></td></tr><tr><td></td><td></td><td>2</td></tr><tr><td>1</td><td></td><td></td></tr></table>						2	1			<table border="1"><tr><td></td><td></td><td></td></tr><tr><td></td><td></td><td></td></tr><tr><td></td><td></td><td></td></tr></table>										<table border="1"><tr><td></td><td></td><td>1</td></tr><tr><td></td><td></td><td>3</td></tr><tr><td>2</td><td>1</td><td></td></tr></table>			1			3	2	1	
		1																																																																													
		2																																																																													
1																																																																															
		1																																																																													
		3																																																																													
2	1																																																																														
Post - 0 Miss - 0 Block - 0	Post - 0 Miss - 0 Block - 0	Post - 0 Miss - 0 Block - 0	Post - 0 Miss - 0 Block - 0	Post - 0 Miss - 0 Block - 0	Post - 1 Miss - 0 Block - 1	Post - 0 Miss - 0 Block - 0	Post - 1 Miss - 0 Block - 0																																																																								

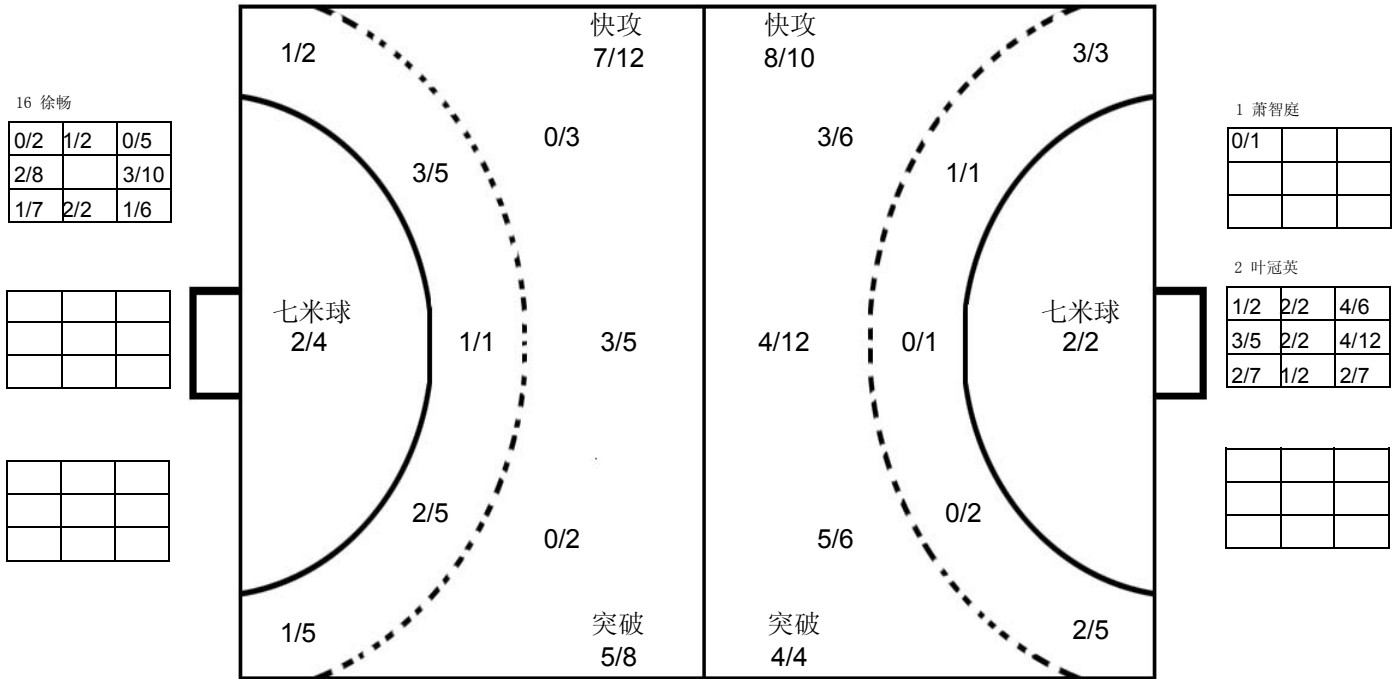

香港

1 萧智庭	2 叶冠英	5 黄胜业	6 谢伟希	7 许文邦	8 何伟杰	9 张建国	10 陈国兴																																																																								
<table border="1"><tr><td></td><td></td><td></td></tr><tr><td></td><td></td><td></td></tr><tr><td></td><td></td><td></td></tr></table>										<table border="1"><tr><td></td><td></td><td></td></tr><tr><td></td><td></td><td></td></tr><tr><td></td><td></td><td></td></tr></table>										<table border="1"><tr><td></td><td></td><td></td></tr><tr><td></td><td></td><td></td></tr><tr><td></td><td></td><td></td></tr></table>										<table border="1"><tr><td></td><td></td><td></td></tr><tr><td></td><td></td><td></td></tr><tr><td>1</td><td></td><td></td></tr></table>							1			<table border="1"><tr><td></td><td></td><td></td></tr><tr><td>2</td><td></td><td>1</td></tr><tr><td>1</td><td></td><td>2</td></tr></table>				2		1	1		2	<table border="1"><tr><td></td><td></td><td></td></tr><tr><td></td><td></td><td></td></tr><tr><td></td><td></td><td></td></tr></table>										<table border="1"><tr><td></td><td></td><td></td></tr><tr><td>3</td><td></td><td>2</td></tr><tr><td>2</td><td></td><td></td></tr></table>				3		2	2			<table border="1"><tr><td></td><td></td><td>1</td></tr><tr><td></td><td></td><td>1</td></tr><tr><td>1</td><td></td><td>2</td></tr></table>			1			1	1		2
1																																																																															
2		1																																																																													
1		2																																																																													
3		2																																																																													
2																																																																															
		1																																																																													
		1																																																																													
1		2																																																																													
Post - 0 Miss - 0 Block - 0	Post - 0 Miss - 0 Block - 0	Post - 0 Miss - 0 Block - 0	Post - 0 Miss - 0 Block - 0	Post - 0 Miss - 1 Block - 2	Post - 0 Miss - 0 Block - 0	Post - 1 Miss - 0 Block - 0	Post - 1 Miss - 0 Block - 0																																																																								
11 陈允文	12 叶冠雄	13 叶仕仁	14 李鑫豪	15 黄嘉榆	25 曾铭谦	29 练明辉																																																																									
<table border="1"><tr><td></td><td></td><td></td></tr><tr><td></td><td></td><td></td></tr><tr><td></td><td></td><td></td></tr></table>										<table border="1"><tr><td></td><td></td><td></td></tr><tr><td></td><td></td><td></td></tr><tr><td></td><td></td><td></td></tr></table>										<table border="1"><tr><td></td><td></td><td>1</td></tr><tr><td></td><td></td><td>2</td></tr><tr><td>1</td><td></td><td>1</td></tr></table>			1			2	1		1	<table border="1"><tr><td></td><td></td><td></td></tr><tr><td></td><td></td><td>1</td></tr><tr><td></td><td></td><td></td></tr></table>						1				<table border="1"><tr><td></td><td></td><td></td></tr><tr><td></td><td></td><td></td></tr><tr><td></td><td></td><td></td></tr></table>										<table border="1"><tr><td></td><td></td><td></td></tr><tr><td></td><td></td><td></td></tr><tr><td></td><td></td><td></td></tr></table>										<table border="1"><tr><td></td><td></td><td></td></tr><tr><td>1</td><td></td><td>2</td></tr><tr><td>1</td><td></td><td></td></tr></table>				1		2	1			<table border="1"><tr><td></td><td></td><td></td></tr><tr><td></td><td></td><td></td></tr><tr><td></td><td></td><td></td></tr></table>									
		1																																																																													
		2																																																																													
1		1																																																																													
		1																																																																													
1		2																																																																													
1																																																																															
Post - 0 Miss - 0 Block - 0	Post - 0 Miss - 0 Block - 0	Post - 1 Miss - 2 Block - 1	Post - 0 Miss - 0 Block - 0	Post - 0 Miss - 0 Block - 0	Post - 0 Miss - 0 Block - 0	Post - 0 Miss - 1 Block - 0																																																																									

注释: Post=击柱 Miss=射失 Block=被封





男子 国内比赛



第十二届全国运动会男子手球预赛

Team A				Team B				Match Number													
A 山东				B 安徽				35													
played in		in the hall		on		at		Spectators													
China		柳州市李宁体育馆		25/04/2013		19:40 hours															
Half-time (30')	A	B	End of playing time	A	B	1st extra time	A	B	2nd extra time	A	B	After penalty throws	A	B							
	19	12		34	29																
Number of 7 m	A	Team time-out			Full name of players and officials						Team time-out			B	Number of 7 m						
		1	2	3							1	2	3								
	1/2	22:34	33:28							18:40			0/0								
No.	Team A					G	W	2'	D	DR	No.	Team B					G	W	2'	D	DR
1	于性哲										1	高逸凡									
4	田瑞										2	周兰骏					2				
5	潘翔					6	1	1			5	马鹏					4	1			
6	李朝鹏					1		2			6	田耕									
8	王炳华							1			7	姚雄敏									
9	赵鑫					3					8	董智景					3				
11	宋朋强										10	陈强龙					4				
13	刘晓					1					11	黎涛									
15	陈鹏波							1			12	曾献辰									
16	王帅										15	邵青					2				
17	王旭东					5		1			17	解维维									
18	于亚男						1				18	郭赛									
19	李语庆					5					28	袁龙					3		1		
20	杜在超					5					29	顾先亮					3	1			
21	翟乾坤					8	1				32	王超					8				
22	刘正松										33	曹振吉									
A	王鸿斌										A	王来黔									
B	王志峰										B	刘晓蓓									
C	邢建刚										C	高恒勤									
D	徐强																				
A	Signature of Responsible Official of the Teams (Off. A)																		B		
TP	Remarks of Referee / CHA Official																		TP		

Signatures

Referees	李典 (CHN)	倪震 (CHN)		
Techn. Delegates	李之文 (CHN)	王锡祯 (CHN)		
CHA Official				

Note: Number of 7m Throws Awarded to Team A and B, Goals (G), Warnings (W), Suspensions (2'), Direct Disqualification (D), Disqualification with Report (DR) and Team Penalty (TP).

Table Officials:

Statisticians: 黄莉

朱伟平

Printed by PHMS Copyright: IHF / CHA 25/04/2013 21:23:29

Longman Sportsoft



handball@126.com

第十二届全国运动会男子手球预赛
竞赛技术统计(媒体表)

预赛	组别	A	轮次	8	场次	35
柳州市李宁体育馆			25/04/2013		201301035-51-1/1	
山东	34	vs	29	安徽	安徽	
19 : 12						

裁判员		李典 (CHN)											倪震 (CHN)																			
山东		远射	近射	边射	快攻	突破	任意球	7m球	合计	%	助攻	失误	警告	2'	D & DR	山东		比赛进程	安徽													
主教练: 王鸿斌															1st Half																	
1	于性哲															21	翟乾坤	1	00:34	0												
4	田瑞															1		1	01:24	1	29	顾先亮										
5	潘翔		3/3		1/1	2/2		6/6	100	1	3	1	1		20	杜在超	2	02:42	1													
6	李朝鹏				1/1			1/1	100						9	赵鑫	3	05:04	1													
8	王炳华										1				13	刘晓	4	07:29	2													
9	赵鑫	2/5	0/1			1/2		3/8	37.5	1	4				20	杜在超	5	08:16	2													
11	宋朋强														17	王旭东	6	08:53	2													
13	刘晓		0/1			1/1		1/2	50.0						20	杜在超	7	09:53	2													
15	陈鹏波											1		1	7		7	10:59	3	15	邵青											
16	王帅														5	潘翔	8	11:24	3													
17	王旭东	4/5		1/2		0/2		5/9	55.6	1				1	8		8	11:49	4	15	邵青											
18	于亚男				0/1			0/1	0.0				1		19	李语庆	9	13:04	4													
19	李语庆	0/2	1/2		3/4		1/2	5/10	50.0		2				9		9	13:10	5	32	王超											
20	杜在超	2/6			0/1	3/3		5/10	50.0		4				9		9	13:57	6	5	马鹏											
21	翟乾坤	1/1	1/1	4/4	2/2			8/8	100		5	1			21	翟乾坤	10	15:26	6													
22	刘正松														21	翟乾坤	11	16:28	6													
运动员 合计		9/19	5/8	5/6	7/10	7/10	1/2	34/55	61.8	4	20	3	6		21	翟乾坤	12	17:29	7	5	马鹏											
1	于性哲	0/1	0/1		2/6	0/2		2/10	20.0						21	翟乾坤	13	18:29	7													
16	王帅	1/4	2/3	2/4	1/4			6/15	40.0						19	李语庆	13	19:16	8	5	马鹏											
22	刘正松	3/7	0/2	0/1	3/4	0/4		6/18	33.3	1					14		14	20:24	8													
守门员 合计		4/12	2/6	2/5	6/14	0/6		14/43	32.6	1					14		14	21:51	9	32	王超											
安徽		远射	近射	边射	快攻	突破	任意球	7m球	合计	%	助攻	失误	警告	2'	D & DR	2nd Half																
教练: 王来黔															5		潘翔	20	01:16	12												
1	高逸凡														20		20	01:40	13	2	周兰骏											
2	周兰骏	1/5	0/1		0/1	1/2		2/9	22.2		5				20		20	02:48	14	29	顾先亮											
5	马鹏	1/2	0/1		0/2	3/3		4/8	50.0	1	3	1			21	翟乾坤	21	04:38	14													
6	田耕														17	王旭东	22	05:21	14													
7	姚雄敏														17	王旭东	23	06:30	14													
8	董智景				3/4			3/4	75.0						23		23	06:45	15	32	王超											
10	陈强龙		1/1		3/4			4/5	80.0		1				20	杜在超	24	08:22	15													
11	黎涛														19	李语庆	25	08:40	15													
12	曾献辰														20	杜在超	25	08:50	16	28	袁龙											
15	邵青		1/2			1/1		2/3	66.7		2				26		26	09:17	16													
17	解维维				0/1			0/1	0.0						26		26	11:32	17	32	王超											
18	郭赛														26		26	12:26	18	28	袁龙											
28	袁龙	1/1	1/1	0/3	1/1			3/6	50.0		1			1	26		26	14:09	19	28	袁龙											
29	顾先亮	1/1		2/2				3/3	100		1	1			17	王旭东	27	14:50	19													
32	王超	4/8	1/1	1/1	1/1	1/1		8/12	66.7		3				27		27	15:46	20	10	陈强龙											
33	曹振吉														17	王旭东	28	16:41	20													
运动员 合计		8/17	4/7	3/6	8/14	6/7		29/51	56.9	1	16	2	1		5	潘翔	28	17:13	21	32	王超											
1	高逸凡	6/11	1/6	1/4	1/8	0/4	1/2	10/35	28.6						21	翟乾坤	29	17:44	21													
12	曾献辰	1/5	2/2	0/2	1/1	1/4		5/14	35.7						5	潘翔	29	18:23	22	2	周兰骏											
守门员 合计		7/16	3/8	1/6	2/9	1/8	1/2	15/49	30.6						5	潘翔	30	19:13	22													

场上队员: 得分 / 射门

守门员: 救球 / 射门

快攻	Fast Break	突破	Breakthrough	任意球	Free Throw	7M球	7M Throw	助攻	Assist
警告	Warning	失误	Error	2'	Suspension	D	取消资格	DR	取消资格+报告





第十二届全国运动会男子手球预赛 图式比赛技术统计表

轮次 8

场次 35

201301035-21-1/1

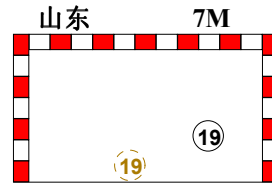
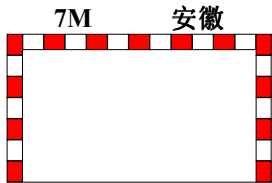
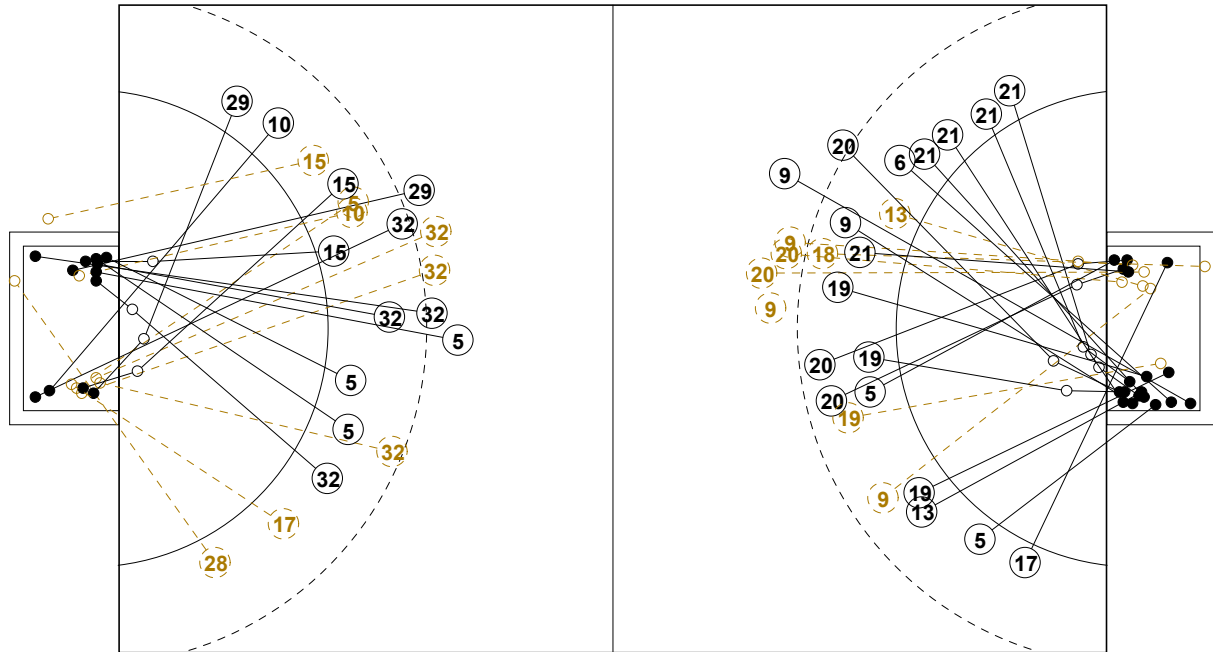

1st Half
12 : 19

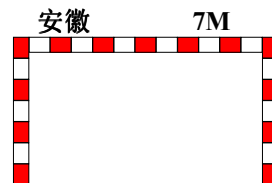
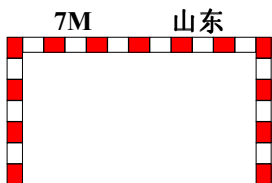
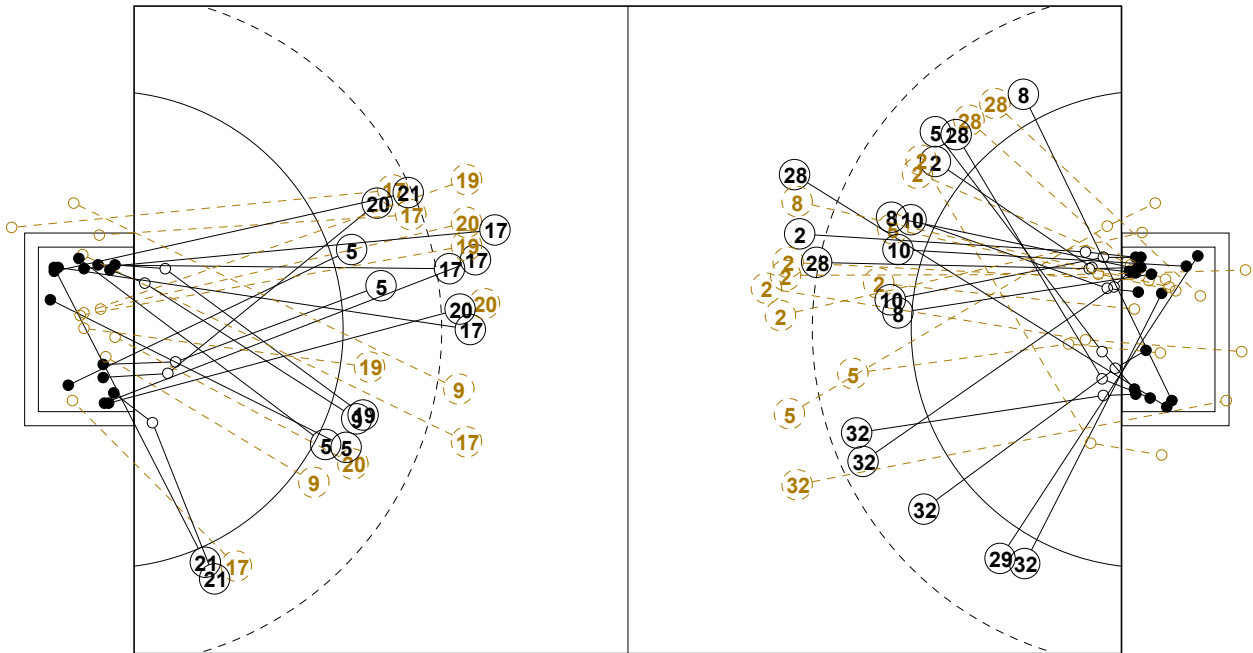

2nd Half
34 : 29



第十二届全国运动会男子手球预赛

个人/全队技术统计表

正式表
手球
男子预赛
轮次 8组别 A
场次 35201301035-14-1/2
柳州市李宁体育馆
25/04/2013 19:40

号码	姓名	远射	近射	边射	快攻	突破	任意	7M	合计	%	助攻	失误	警告	2'	取消	时间
山东(山东)																
<i>(场上队员)</i>																
1	于性哲									0.0%						00:13:33
4	田瑞									0.0%						00:00:00
5	潘翔		3/3		1/1	2/2			6/6	100%	1	3	1	1		00:50:31
6	李朝鹏				1/1				1/1	100%				2		00:18:38
8	王炳华									0.0%		1		1		00:17:53
9	赵鑫	2/5	0/1			1/2			3/8	37.5%	1	4				00:33:18
11	宋朋强									0.0%						00:00:00
13	刘晓		0/1			1/1			1/2	50.0%						00:11:35
15	陈鹏波									0.0%		1		1		00:15:34
16	王帅									0.0%						00:17:17
17	王旭东	4/5		1/2		0/2			5/9	55.6%	1			1		00:58:24
18	于亚男				0/1				0/1	0.0%				1		00:03:58
19	李语庆	0/2	1/2		3/4			1/2	5/10	50.0%		2				00:45:20
20	杜在超	2/6			0/1	3/3			5/10	50.0%		4				00:55:39
21	翟乾坤	1/1	1/1	4/4	2/2				8/8	100%		5	1			00:45:28
22	刘正松									0.0%	1					00:29:10
合计		9/19	5/8	5/6	7/10	7/10		1/2	34/55	61.8%	4	20	3	6		
<i>(守门员)</i>																
1	于性哲	0/1	0/1		2/6	0/2			2/10	20.0%						00:13:33
16	王帅	1/4	2/3	2/4	1/4				6/15	40.0%						00:17:17
22	刘正松	3/7	0/2	0/1	3/4	0/4			6/18	33.3%	1					00:29:10
合计		4/12	2/6	2/5	6/14	0/6			14/43	32.6%	1					

场上队员：得分/射门

守门员：救球/射门

全队合计	得分	被救	射失	击柱	封球	合计	%
远射	9	7	1		2	19	47.4%
近射	5	3				8	62.5%
边射	5	1				6	83.3%
快攻	7	2		1		10	70.0%
突破	7	1	1	1		10	70.0%
任意							0.0%
7M	1	1				2	50.0%





第十二届全国运动会男子手球预赛

个人/全队技术统计表

正式表
手球
男子预赛
轮次 8组别 A
场次 35201301035-14-2/2
柳州市李宁体育馆
25/04/2013 19:40

号码	姓名	远射	近射	边射	快攻	突破	任意	7M	合计	%	助攻	失误	警告	2'	取消	时间
安徽(安徽)																
<i>(上场队员)</i>																
1	高逸凡									0.0%						00:43:26
2	周兰骏	1/5	0/1		0/1	1/2			2/9	22.2%		5				00:30:00
5	马鹏	1/2	0/1		0/2	3/3			4/8	50.0%	1	3	1			00:40:58
6	田耕									0.0%						00:00:00
7	姚雄敏									0.0%						00:00:00
8	董智景				3/4				3/4	75.0%						00:10:30
10	陈强龙		1/1		3/4				4/5	80.0%		1				00:41:57
11	黎涛									0.0%						00:00:00
12	曾献辰									0.0%						00:16:34
15	邵青		1/2			1/1			2/3	66.7%		2				00:30:00
17	解维维				0/1				0/1	0.0%						00:37:38
18	郭赛									0.0%						00:18:25
28	袁龙	1/1	1/1	0/3	1/1				3/6	50.0%		1		1		00:48:03
29	顾先亮	1/1		2/2					3/3	100%		1	1			00:59:40
32	王超	4/8	1/1	1/1	1/1	1/1			8/12	66.7%		3				00:19:24
33	曹振吉									0.0%						00:20:14
合计		8/17	4/7	3/6	8/14	6/7			29/51	56.9%	1	16	2	1		
<i>(守门员)</i>																
1	高逸凡	6/11	1/6	1/4	1/8	0/4		1/2	10/35	28.6%						00:43:26
12	曾献辰	1/5	2/2	0/2	1/1	1/4			5/14	35.7%						00:16:34
合计		7/16	3/8	1/6	2/9	1/8		1/2	15/49	30.6%						

场上队员：得分/射门

守门员：救球/射门

全队合计	得分	被救	射失	击柱	封球	合计	%
远射	8	4	3	2		17	47.1%
近射	4	2	1			7	57.1%
边射	3	2		1		6	50.0%
快攻	8	6				14	57.1%
突破	6		1			7	85.7%
任意							0.0%
7M							0.0%





第十二届全国运动会男子手球预赛

图式射门区域统计

轮次 8 场次 35

201301035-41-1/1

山东

1 于性哲	4 田瑞	5 潘翔	6 李朝鹏	8 王炳华	9 赵鑫	11 宋朋强	13 刘晓																																																																								
<table border="1"><tr><td></td><td></td><td></td></tr><tr><td></td><td></td><td></td></tr><tr><td></td><td></td><td></td></tr></table>										<table border="1"><tr><td></td><td></td><td></td></tr><tr><td></td><td></td><td></td></tr><tr><td></td><td></td><td></td></tr></table>										<table border="1"><tr><td>1</td><td></td><td>1</td></tr><tr><td></td><td></td><td>2</td></tr><tr><td>2</td><td></td><td></td></tr></table>	1		1			2	2			<table border="1"><tr><td></td><td></td><td>1</td></tr><tr><td></td><td></td><td></td></tr><tr><td></td><td></td><td></td></tr></table>			1							<table border="1"><tr><td></td><td></td><td></td></tr><tr><td></td><td></td><td></td></tr><tr><td></td><td></td><td></td></tr></table>										<table border="1"><tr><td></td><td></td><td>1</td></tr><tr><td></td><td></td><td></td></tr><tr><td></td><td></td><td>2</td></tr></table>			1						2	<table border="1"><tr><td></td><td></td><td></td></tr><tr><td></td><td></td><td></td></tr><tr><td></td><td></td><td></td></tr></table>										<table border="1"><tr><td></td><td></td><td></td></tr><tr><td></td><td></td><td></td></tr><tr><td></td><td></td><td>1</td></tr></table>									1
1		1																																																																													
		2																																																																													
2																																																																															
		1																																																																													
		1																																																																													
		2																																																																													
		1																																																																													
Post - 0 Miss - 0 Block - 0	Post - 0 Miss - 0 Block - 0	Post - 0 Miss - 0 Block - 0	Post - 0 Miss - 0 Block - 0	Post - 0 Miss - 0 Block - 0	Post - 0 Miss - 1 Block - 1	Post - 0 Miss - 0 Block - 0	Post - 0 Miss - 0 Block - 0																																																																								
15 陈鹏波	16 王帅	17 王旭东	18 于亚男	19 李语庆	20 杜在超	21 翟乾坤	22 刘正松																																																																								
<table border="1"><tr><td></td><td></td><td></td></tr><tr><td></td><td></td><td></td></tr><tr><td></td><td></td><td></td></tr></table>										<table border="1"><tr><td></td><td></td><td></td></tr><tr><td></td><td></td><td></td></tr><tr><td></td><td></td><td></td></tr></table>										<table border="1"><tr><td></td><td></td><td>1</td></tr><tr><td>1</td><td></td><td>2</td></tr><tr><td>1</td><td></td><td></td></tr></table>			1	1		2	1			<table border="1"><tr><td></td><td></td><td></td></tr><tr><td></td><td></td><td></td></tr><tr><td></td><td></td><td></td></tr></table>										<table border="1"><tr><td></td><td></td><td>1</td></tr><tr><td></td><td></td><td>2</td></tr><tr><td></td><td></td><td>2</td></tr></table>			1			2			2	<table border="1"><tr><td></td><td></td><td></td></tr><tr><td></td><td></td><td></td></tr><tr><td>4</td><td></td><td>1</td></tr></table>							4		1	<table border="1"><tr><td></td><td></td><td>2</td></tr><tr><td></td><td></td><td>2</td></tr><tr><td>2</td><td></td><td>2</td></tr></table>			2			2	2		2	<table border="1"><tr><td></td><td></td><td></td></tr><tr><td></td><td></td><td></td></tr><tr><td></td><td></td><td></td></tr></table>									
		1																																																																													
1		2																																																																													
1																																																																															
		1																																																																													
		2																																																																													
		2																																																																													
4		1																																																																													
		2																																																																													
		2																																																																													
2		2																																																																													
Post - 0 Miss - 0 Block - 0	Post - 0 Miss - 0 Block - 0	Post - 1 Miss - 1 Block - 0	Post - 1 Miss - 0 Block - 0	Post - 0 Miss - 0 Block - 0	Post - 0 Miss - 0 Block - 1	Post - 0 Miss - 0 Block - 0	Post - 0 Miss - 0 Block - 0																																																																								

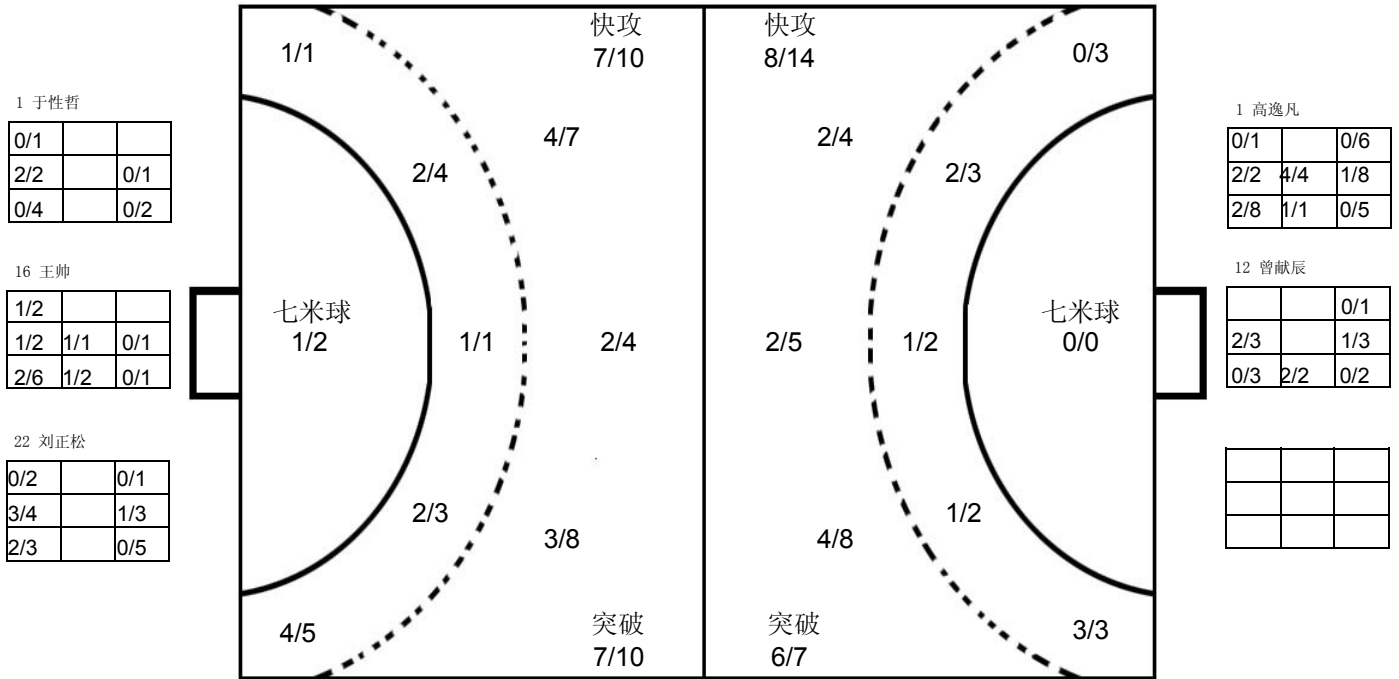

安徽

1 高逸凡	2 周兰骏	5 马鹏	6 田耕	7 姚雄敏	8 董智景	10 陈强龙	11 黎涛																																																																								
<table border="1"><tr><td></td><td></td><td></td></tr><tr><td></td><td></td><td></td></tr><tr><td></td><td></td><td></td></tr></table>										<table border="1"><tr><td></td><td></td><td></td></tr><tr><td>2</td><td></td><td></td></tr><tr><td></td><td></td><td></td></tr></table>				2						<table border="1"><tr><td></td><td></td><td></td></tr><tr><td></td><td></td><td>4</td></tr><tr><td></td><td></td><td></td></tr></table>						4				<table border="1"><tr><td></td><td></td><td></td></tr><tr><td></td><td></td><td></td></tr><tr><td></td><td></td><td></td></tr></table>										<table border="1"><tr><td></td><td></td><td></td></tr><tr><td></td><td></td><td></td></tr><tr><td></td><td></td><td></td></tr></table>										<table border="1"><tr><td></td><td></td><td></td></tr><tr><td></td><td></td><td>1</td></tr><tr><td>2</td><td></td><td></td></tr></table>						1	2			<table border="1"><tr><td>2</td><td></td><td></td></tr><tr><td></td><td></td><td></td></tr><tr><td>2</td><td></td><td></td></tr></table>	2						2			<table border="1"><tr><td></td><td></td><td></td></tr><tr><td></td><td></td><td></td></tr><tr><td></td><td></td><td></td></tr></table>									
2																																																																															
		4																																																																													
		1																																																																													
2																																																																															
2																																																																															
2																																																																															
Post - 0 Miss - 0 Block - 0	Post - 1 Miss - 3 Block - 0	Post - 0 Miss - 1 Block - 0	Post - 0 Miss - 0 Block - 0	Post - 0 Miss - 0 Block - 0	Post - 0 Miss - 0 Block - 0	Post - 0 Miss - 0 Block - 0	Post - 0 Miss - 0 Block - 0																																																																								
12 曾献辰	15 邵青	17 解维维	18 郭赛	28 袁龙	29 顾先亮	32 王超	33 曹振吉																																																																								
<table border="1"><tr><td></td><td></td><td></td></tr><tr><td></td><td></td><td></td></tr><tr><td></td><td></td><td></td></tr></table>										<table border="1"><tr><td></td><td></td><td></td></tr><tr><td>1</td><td></td><td>1</td></tr><tr><td></td><td></td><td></td></tr></table>				1		1				<table border="1"><tr><td></td><td></td><td></td></tr><tr><td></td><td></td><td></td></tr><tr><td></td><td></td><td></td></tr></table>										<table border="1"><tr><td></td><td></td><td></td></tr><tr><td></td><td></td><td></td></tr><tr><td></td><td></td><td></td></tr></table>										<table border="1"><tr><td></td><td></td><td></td></tr><tr><td></td><td></td><td>1</td></tr><tr><td>1</td><td></td><td>1</td></tr></table>						1	1		1	<table border="1"><tr><td>1</td><td></td><td></td></tr><tr><td></td><td></td><td>1</td></tr><tr><td>1</td><td></td><td></td></tr></table>	1					1	1			<table border="1"><tr><td>1</td><td></td><td>1</td></tr><tr><td>1</td><td></td><td></td></tr><tr><td>1</td><td>1</td><td>3</td></tr></table>	1		1	1			1	1	3	<table border="1"><tr><td></td><td></td><td></td></tr><tr><td></td><td></td><td></td></tr><tr><td></td><td></td><td></td></tr></table>									
1		1																																																																													
		1																																																																													
1		1																																																																													
1																																																																															
		1																																																																													
1																																																																															
1		1																																																																													
1																																																																															
1	1	3																																																																													
Post - 0 Miss - 0 Block - 0	Post - 0 Miss - 1 Block - 0	Post - 0 Miss - 0 Block - 0	Post - 0 Miss - 0 Block - 0	Post - 1 Miss - 0 Block - 0	Post - 0 Miss - 0 Block - 0	Post - 1 Miss - 0 Block - 0	Post - 0 Miss - 0 Block - 0																																																																								

注释: Post=击柱 Miss=射失 Block=被封





男子 国内比赛



第十二届全国运动会男子手球预赛

Team A A 江苏				Team B B 北京				Match Number 36													
played in China		in the hall 柳州市李宁体育馆		on 25/04/2013		at 21:20 hours		Spectators													
Half-time (30')	A 20	B 8	End of playing time	A 37	B 22	1st extra time	A	B	2nd extra time	A	B	After penalty throws	A	B							
Number of 7 m	A 2 / 2	Team time-out			Full name of players and officials				Team time-out			B 1 / 1	Number of 7 m								
		1	2	3					1	2	3										
No.	Team A					G	W	2'	D	DR	No.	Team B					G	W	2'	D	DR
1	丁大伟										1	王洸									
2	杨彦威										2	杜龙飞					4				
3	李旭东										4	成亚							1		
4	沈庆					2					5	杨昆									
5	闫亮					3	1				6	刘伟					1				
6	赵晨					6	1	1			7	胡瀛					2				
8	周小坚					3					8	王鹏									
9	叶强					1		1			9	刘振					2				
10	郝可鑫					5					11	蒋维一					4	1			
11	姚仁剑										13	白洁									
12	王权										14	解建飞					2		1		
14	丛海航					1					16	孟辉					1				
15	李安					13					17	姜冰峰					1	1	1		
17	陈灵峰					1					18	张骥					1				
19	张志宇					2	1	1			20	郑永利					1		1		
20	张星										23	冯宁					3				
A	闫威名										A	郑康旭									
C	NENADz vonarek										B	蔡建国									
D	王建国										C	吴健									
E	贾淑君										D	石锋									
A	Signature of Responsible Official of the Teams (Off. A)																		B		
TP	Remarks of Referee / CHA Official																		TP		

Signatures

Referees	王锐 (CHN)	陈晓波 (CHN)		
Techn. Delegates	王锡祯 (CHN)	刘书勇 (CHN)		
CHA Official				

Note: Number of 7m Throws Awarded to Team A and B, Goals (G), Warnings (W), Suspensions (2'), Direct Disqualification (D), Disqualification with Report (DR) and Team Penalty (TP).

Table Officials:

Statisticians: 黄莉

朱伟平

Printed by PHMS Copyright: IHF / CHA 25/04/2013 22:54:41

Longman Sportsoft



handball@126.com



第十二届全国运动会男子手球预赛 图式比赛技术统计表

轮次 8

场次 36

201301036-21-1/1

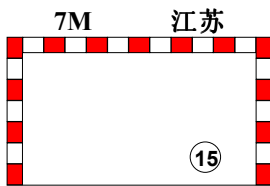
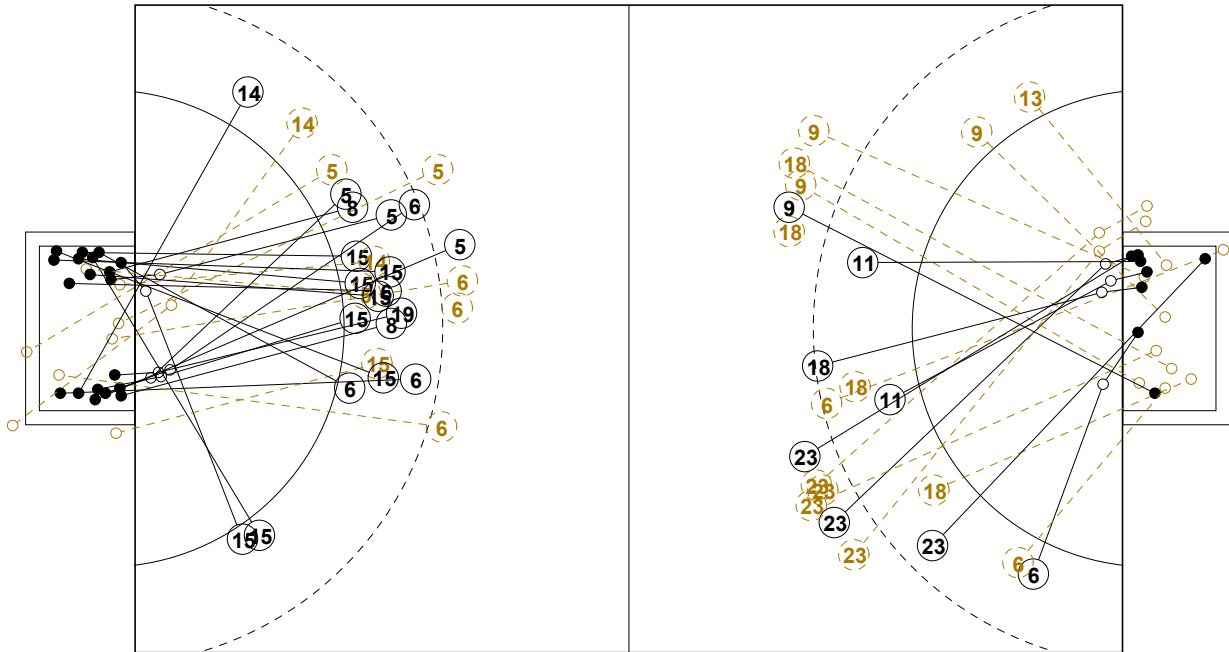

1st Half
20 : 8

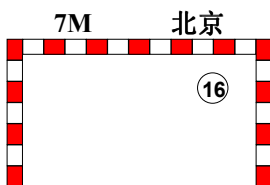
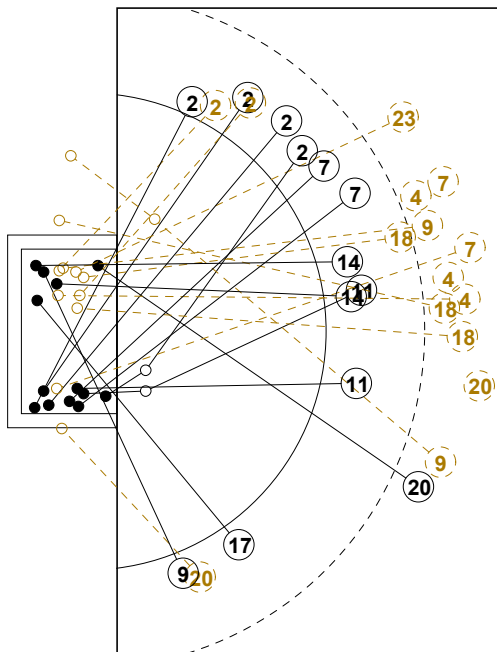
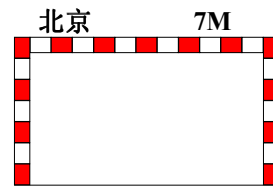

2nd Half
22 : 37

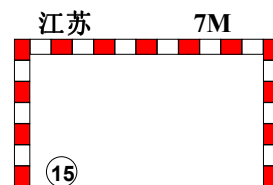



第十二届全国运动会男子手球预赛

个人/全队技术统计表

正式表
手球
男子预赛
轮次 8组别 A
场次 36201301036-14-1/2
柳州市李宁体育馆
25/04/2013 21:20

号码	姓名	远射	近射	边射	快攻	突破	任意	7M	合计	%	助攻	失误	警告	2'	取消	时间
江苏(江苏)																
<i>(场上队员)</i>																
1	丁大伟									0.0%						00:30:00
2	杨彦威									0.0%						00:00:00
3	李旭东									0.0%						00:00:00
4	沈庆		2/2		0/1				2/3	66.7%		1				00:16:15
5	闫亮				0/1	1/3	2/2		3/6	50.0%	1	1	1			00:46:24
6	赵晨	3/4	1/1		2/4				6/9	66.7%		1	1	1		00:37:36
8	周小坚	0/1			3/3				3/4	75.0%						00:50:04
9	叶强	0/2		0/2	1/1				1/5	20.0%				1		00:17:49
10	郝可鑫	3/4			1/1		1/1		5/6	83.3%		2				00:06:17
11	姚仁剑									0.0%						00:00:00
12	王权									0.0%	1					00:30:00
14	丛海航		0/1		1/3				1/4	25.0%		1				00:52:56
15	李安		0/1	2/2	8/8	1/1		2/2	13/14	92.9%	1	2				00:46:21
17	陈灵峰	1/2							1/2	50.0%	1					00:12:42
19	张志宇	1/2			1/1	0/1			2/4	50.0%	2	3	1	1		00:51:06
20	张星									0.0%						00:00:00
合计		8/15	3/5	2/4	17/23	2/5	3/3	2/2	37/57	64.9%	6	11	3	3		
<i>(守门员)</i>																
1	丁大伟	3/4	0/2	2/5	3/8	0/2		0/1	8/22	36.4%						00:30:00
12	王权	4/9	1/3	3/4					8/16	50.0%	1					00:30:00
合计		7/13	1/5	5/9	3/8	0/2		0/1	16/38	42.1%	1					

场上队员：得分/射门

守门员：救球/射门

全队合计	得分	被救	射失	击柱	封球	合计	%
远射	8	5		2		15	53.3%
近射	3		2			5	60.0%
边射	2	2				4	50.0%
快攻	17	5			1	23	73.9%
突破	2	2		1		5	40.0%
任意	3					3	100.0%
7M	2					2	100.0%





第十二届全国运动会男子手球预赛

个人/全队技术统计表

正式表
手球
男子预赛
轮次 8组别 A
场次 36201301036-14-2/2
柳州市李宁体育馆
25/04/2013 21:20

号码	姓名	远射	近射	边射	快攻	突破	任意	7M	合计	%	助攻	失误	警告	2'	取消	时间
北京(北京)																
<i>(上场队员)</i>																
1	王澍									0.0%						00:30:00
2	杜龙飞			1/3	3/3				4/6	66.7%	1	1				00:29:46
4	成亚	0/2			0/1				0/3	0.0%	1	2		1		00:10:12
5	杨昆									0.0%						00:10:40
6	刘伟	0/1		1/2					1/3	33.3%						00:30:00
7	胡瀛	0/1			1/2	1/1			2/4	50.0%		1				00:20:35
8	王鹏									0.0%						00:00:00
9	刘振	1/3		1/2	0/1		0/1		2/7	28.6%		1				00:56:23
11	蒋维一		3/3			1/1			4/4	100%		2	1			00:44:43
13	白洁			0/1					0/1	0.0%		1				00:05:00
14	解建飞		1/1		1/1				2/2	100%				1		00:13:11
16	孟辉							1/1	1/1	100%		1				00:30:00
17	姜冰峰			1/1					1/1	100%		1	1	1		00:29:44
18	张骥	1/4	0/2		0/2				1/8	12.5%	1	2				00:47:05
20	郑永利	1/1		0/1	0/1				1/3	33.3%		1		1		00:20:22
23	冯宁	3/7			0/1				3/8	37.5%	1	2				00:40:36
合计		6/19	4/6	4/10	5/12	2/2	0/1	1/1	22/51	43.1%	4	15	2	4		
<i>(守门员)</i>																
1	王澍	1/2	0/1	0/1	3/15	1/3	0/2	0/1	5/25	20.0%						00:30:00
16	孟辉	4/11	0/2	2/3	2/7	1/1	0/1	0/1	9/26	34.6%		1				00:30:00
合计		5/13	0/3	2/4	5/22	2/4	0/3	0/2	14/51	27.5%		1				

场上队员：得分/射门

守门员：救球/射门

全队合计	得分	被救	射失	击柱	封球	合计	%
远射	6	7	2	1	3	19	31.6%
近射	4	1			1	6	66.7%
边射	4	5		1		10	40.0%
快攻	5	3	1		3	12	41.7%
突破	2					2	100.0%
任意			1			1	0.0%
7M	1					1	100.0%





第十二届全国运动会男子手球预赛

图式射门区域统计

轮次 8 场次 36

201301036-41-1/1

江苏

1 丁大伟	2 杨彦威	3 李旭东	4 沈庆	5 闫亮	6 赵晨	8 周小坚	9 叶强																																																																								
<table border="1"><tr><td></td><td></td><td></td></tr><tr><td></td><td></td><td></td></tr><tr><td></td><td></td><td></td></tr></table>										<table border="1"><tr><td></td><td></td><td></td></tr><tr><td></td><td></td><td></td></tr><tr><td></td><td></td><td></td></tr></table>										<table border="1"><tr><td></td><td></td><td></td></tr><tr><td></td><td></td><td></td></tr><tr><td></td><td></td><td></td></tr></table>										<table border="1"><tr><td>1</td><td></td><td></td></tr><tr><td>1</td><td></td><td></td></tr><tr><td></td><td></td><td></td></tr></table>	1			1						<table border="1"><tr><td></td><td></td><td></td></tr><tr><td>1</td><td></td><td></td></tr><tr><td>1</td><td></td><td>1</td></tr></table>				1			1		1	<table border="1"><tr><td>1</td><td></td><td>1</td></tr><tr><td></td><td></td><td>1</td></tr><tr><td>3</td><td></td><td></td></tr></table>	1		1			1	3			<table border="1"><tr><td></td><td></td><td></td></tr><tr><td></td><td></td><td>1</td></tr><tr><td>1</td><td></td><td>1</td></tr></table>						1	1		1	<table border="1"><tr><td></td><td></td><td></td></tr><tr><td></td><td></td><td></td></tr><tr><td></td><td></td><td></td></tr></table>									
1																																																																															
1																																																																															
1																																																																															
1		1																																																																													
1		1																																																																													
		1																																																																													
3																																																																															
		1																																																																													
1		1																																																																													
Post - 0 Miss - 0 Block - 0	Post - 0 Miss - 0 Block - 0	Post - 0 Miss - 0 Block - 0	Post - 0 Miss - 0 Block - 0	Post - 1 Miss - 0 Block - 0	Post - 0 Miss - 0 Block - 1	Post - 0 Miss - 0 Block - 0	Post - 2 Miss - 0 Block - 0																																																																								
10 郝可鑫	11 姚仁剑	12 王权	14 丛海航	15 李安	17 陈灵峰	19 张志宇	20 张星																																																																								
<table border="1"><tr><td></td><td></td><td>1</td></tr><tr><td>1</td><td></td><td></td></tr><tr><td>3</td><td></td><td></td></tr></table>			1	1			3			<table border="1"><tr><td></td><td></td><td></td></tr><tr><td></td><td></td><td></td></tr><tr><td></td><td></td><td></td></tr></table>										<table border="1"><tr><td></td><td></td><td></td></tr><tr><td></td><td></td><td></td></tr><tr><td></td><td></td><td></td></tr></table>										<table border="1"><tr><td></td><td></td><td></td></tr><tr><td>1</td><td></td><td></td></tr><tr><td></td><td></td><td></td></tr></table>				1						<table border="1"><tr><td></td><td></td><td>2</td></tr><tr><td>3</td><td></td><td>4</td></tr><tr><td>1</td><td></td><td>3</td></tr></table>			2	3		4	1		3	<table border="1"><tr><td></td><td></td><td></td></tr><tr><td></td><td></td><td></td></tr><tr><td>1</td><td></td><td></td></tr></table>							1			<table border="1"><tr><td></td><td></td><td></td></tr><tr><td>1</td><td></td><td></td></tr><tr><td>1</td><td></td><td></td></tr></table>				1			1			<table border="1"><tr><td></td><td></td><td></td></tr><tr><td></td><td></td><td></td></tr><tr><td></td><td></td><td></td></tr></table>									
		1																																																																													
1																																																																															
3																																																																															
1																																																																															
		2																																																																													
3		4																																																																													
1		3																																																																													
1																																																																															
1																																																																															
1																																																																															
Post - 0 Miss - 0 Block - 0	Post - 0 Miss - 0 Block - 0	Post - 0 Miss - 0 Block - 0	Post - 0 Miss - 1 Block - 0	Post - 0 Miss - 1 Block - 0	Post - 0 Miss - 0 Block - 0	Post - 0 Miss - 0 Block - 0	Post - 0 Miss - 0 Block - 0																																																																								

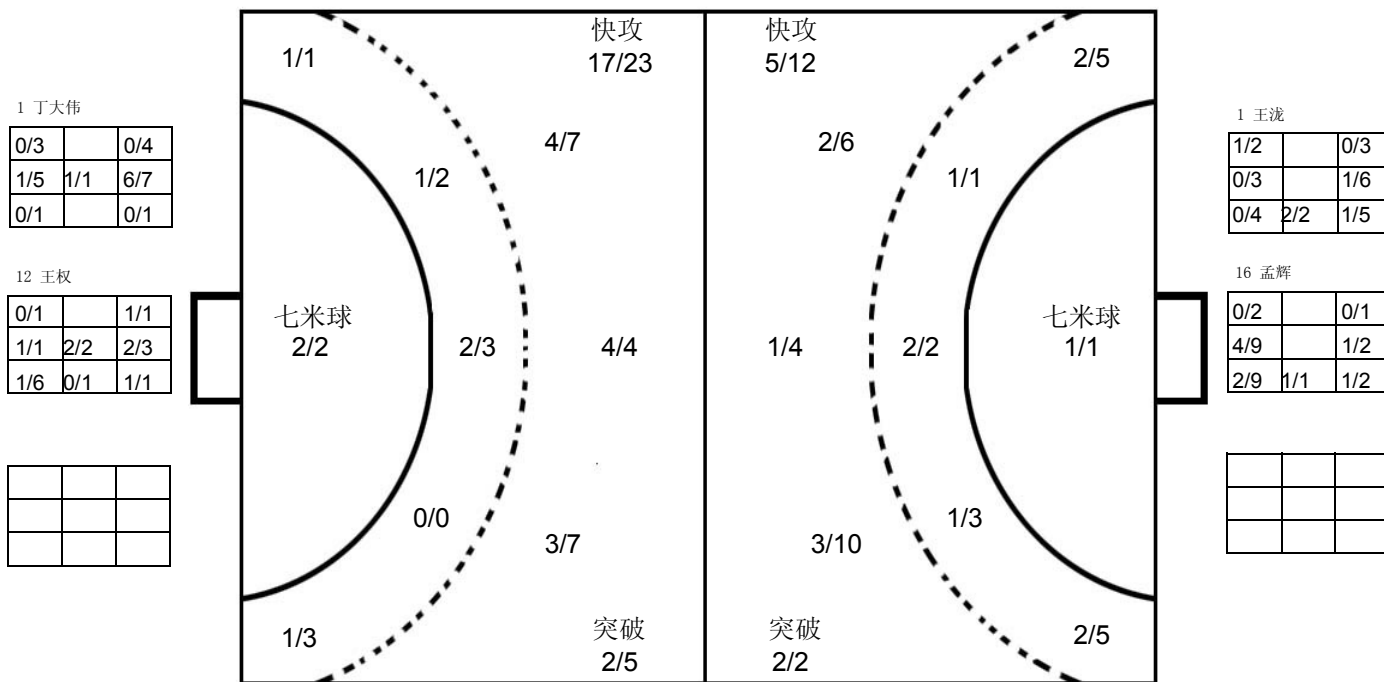

北京

1 王浣	2 杜龙飞	4 成亚	5 杨昆	6 刘伟	7 胡灏	8 王鹏	9 刘振																																																																								
<table border="1"><tr><td></td><td></td><td></td></tr><tr><td></td><td></td><td></td></tr><tr><td></td><td></td><td></td></tr></table>										<table border="1"><tr><td>3</td><td></td><td></td></tr><tr><td></td><td></td><td></td></tr><tr><td>1</td><td></td><td></td></tr></table>	3						1			<table border="1"><tr><td></td><td></td><td></td></tr><tr><td></td><td></td><td></td></tr><tr><td></td><td></td><td></td></tr></table>										<table border="1"><tr><td></td><td></td><td></td></tr><tr><td></td><td></td><td></td></tr><tr><td></td><td></td><td></td></tr></table>										<table border="1"><tr><td></td><td></td><td></td></tr><tr><td></td><td></td><td></td></tr><tr><td>1</td><td></td><td></td></tr></table>							1			<table border="1"><tr><td></td><td></td><td></td></tr><tr><td>2</td><td></td><td></td></tr><tr><td></td><td></td><td></td></tr></table>				2						<table border="1"><tr><td></td><td></td><td></td></tr><tr><td></td><td></td><td></td></tr><tr><td></td><td></td><td></td></tr></table>										<table border="1"><tr><td></td><td></td><td>1</td></tr><tr><td></td><td></td><td>1</td></tr><tr><td></td><td></td><td></td></tr></table>			1			1			
3																																																																															
1																																																																															
1																																																																															
2																																																																															
		1																																																																													
		1																																																																													
Post - 0 Miss - 0 Block - 0	Post - 0 Miss - 0 Block - 0	Post - 0 Miss - 0 Block - 2	Post - 0 Miss - 0 Block - 0	Post - 1 Miss - 0 Block - 0	Post - 0 Miss - 0 Block - 1	Post - 0 Miss - 0 Block - 0	Post - 0 Miss - 1 Block - 0																																																																								
11 蒋维一	13 白洁	14 解建飞	16 孟辉	17 姜冰峰	18 张骥	20 郑永利	23 冯宁																																																																								
<table border="1"><tr><td></td><td></td><td></td></tr><tr><td>2</td><td></td><td></td></tr><tr><td>2</td><td></td><td></td></tr></table>				2			2			<table border="1"><tr><td></td><td></td><td></td></tr><tr><td></td><td></td><td></td></tr><tr><td></td><td></td><td></td></tr></table>										<table border="1"><tr><td></td><td></td><td>1</td></tr><tr><td></td><td></td><td>1</td></tr><tr><td></td><td></td><td></td></tr></table>			1			1				<table border="1"><tr><td></td><td></td><td>1</td></tr><tr><td></td><td></td><td></td></tr><tr><td></td><td></td><td></td></tr></table>			1							<table border="1"><tr><td></td><td></td><td>1</td></tr><tr><td></td><td></td><td></td></tr><tr><td></td><td></td><td></td></tr></table>			1							<table border="1"><tr><td></td><td></td><td></td></tr><tr><td>1</td><td></td><td></td></tr><tr><td></td><td></td><td></td></tr></table>				1						<table border="1"><tr><td></td><td></td><td></td></tr><tr><td></td><td></td><td>1</td></tr><tr><td></td><td></td><td></td></tr></table>						1				<table border="1"><tr><td></td><td></td><td>1</td></tr><tr><td></td><td></td><td></td></tr><tr><td>2</td><td></td><td></td></tr></table>			1				2		
2																																																																															
2																																																																															
		1																																																																													
		1																																																																													
		1																																																																													
		1																																																																													
1																																																																															
		1																																																																													
		1																																																																													
2																																																																															
Post - 0 Miss - 0 Block - 0	Post - 0 Miss - 0 Block - 0	Post - 0 Miss - 0 Block - 0	Post - 0 Miss - 0 Block - 0	Post - 0 Miss - 0 Block - 0	Post - 0 Miss - 1 Block - 2	Post - 1 Miss - 0 Block - 1	Post - 0 Miss - 2 Block - 1																																																																								

注释: Post=击柱 Miss=射失 Block=被封





男子 国内比赛



第十二届全国运动会男子手球预赛

Team A										Team B										Match Number	
A 安徽					B 四川					37											
played in		in the hall			on		at		Spectators												
China		柳州市李宁体育馆			27/04/2013		13:00 hours														
Half-time (30')	A	B	End of playing time		A	B	1st extra time		A	B	2nd extra time		A	B	After penalty throws		A	B			
	25	10	52	22																	
Number of 7 m	A	Team time-out			Full name of players and officials						Team time-out			B	Number of 7 m						
	0 / 1	1	2	3							1	2	3	0 / 0							
No.	Team A					G	W	2'	D	DR	No.	Team B					G	W	2'	D	DR
1	高逸凡										16	王松									
2	周兰骏					7					18	杨洋									
5	马鹏					4					19	杨洁					5		2		
6	田耕					2					21	池培俊					2				
7	姚雄敏										22	刘彦坤									
8	董智景					5		1			23	王震					1				
10	陈强龙					7					25	李峥					4				
11	黎涛					6					27	于洪泉									
12	曾献辰										28	宋涛									
15	邵青					1					32	逯明松					1				
17	解维维					8					33	朱晓龙					3				
18	郭赛					2					35	仇振勇					6				
28	袁龙					5	1				36	刘琢									
29	顾先亮					2															
32	王超					2															
33	曹振吉					1	1														
A	王来黔										A	李太平									
B	刘晓蓓										B	李清									
C	高恒勤										C	黄承									
											E	何明阳									
A	Signature of Responsible Official of the Teams (Off. A)																	B			
TP	Remarks of Referee / CHA Official																	TP			

Signatures

Referees	姜涛 (CHN)	徐健 (CHN)		
Techn. Delegates	王锡祯 (CHN)	刘书勇 (CHN)		
CHA Official				

Note: Number of 7m Throws Awarded to Team A and B, Goals (G), Warnings (W), Suspensions (2'), Direct Disqualification (D), Disqualification with Report (DR) and Team Penalty (TP).

Table Officials:

Statisticians: 黄莉

朱伟平





第十二届全国运动会男子手球预赛
竞赛技术统计(媒体表)

复赛 组别 E 轮次 9 场次 37

柳州市李宁体育馆

27/04/2013

201301037-51-1/1

安徽 安徽 52 vs 22 四川 四川 25 : 10

裁判员 姜涛 (CHN) / 徐健 (CHN)

安徽 主教练: 王来黔. 统计表格: 远射, 近射, 边射, 快攻, 突破, 任意球, 7m球, 合计, %, 助攻, 失误, 警告, 2', D & DR.

四川 教练: 李太平. 统计表格: 远射, 近射, 边射, 快攻, 突破, 任意球, 7m球, 合计, %, 助攻, 失误, 警告, 2', D & DR.

比赛进程. 安徽 vs 四川. 1st Half and 2nd Half. 球员得分和犯规记录.

场上队员: 得分 / 射门

守门员: 救球 / 射门

快攻 Fast Break, 突破 Breakthrough, 任意球 Free Throw, 7m球 7M Throw, 助攻 Assist, 警告 Warning, 失误 Error, 2', Suspension, D, 取消资格, DR, 取消资格+报告





第十二届全国运动会男子手球预赛 图式比赛技术统计表

轮次 9

场次 37

201301037-21-1/1

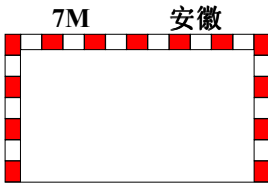
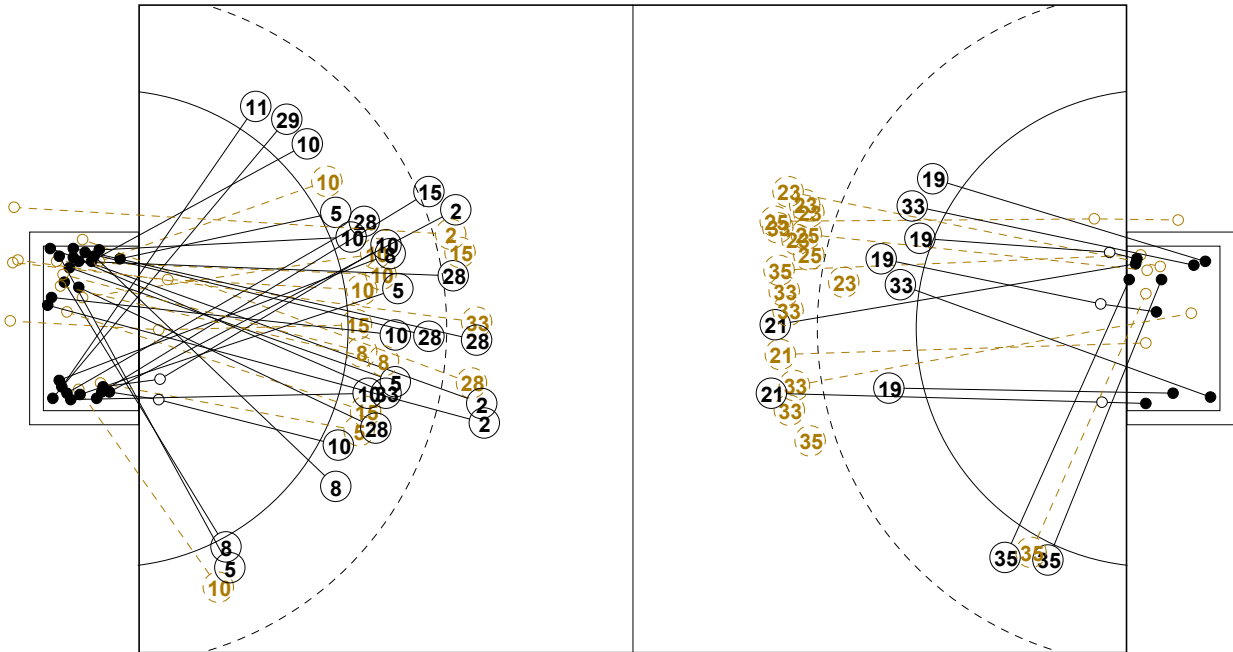

1st Half
25 : 10

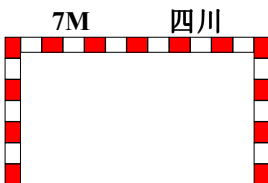
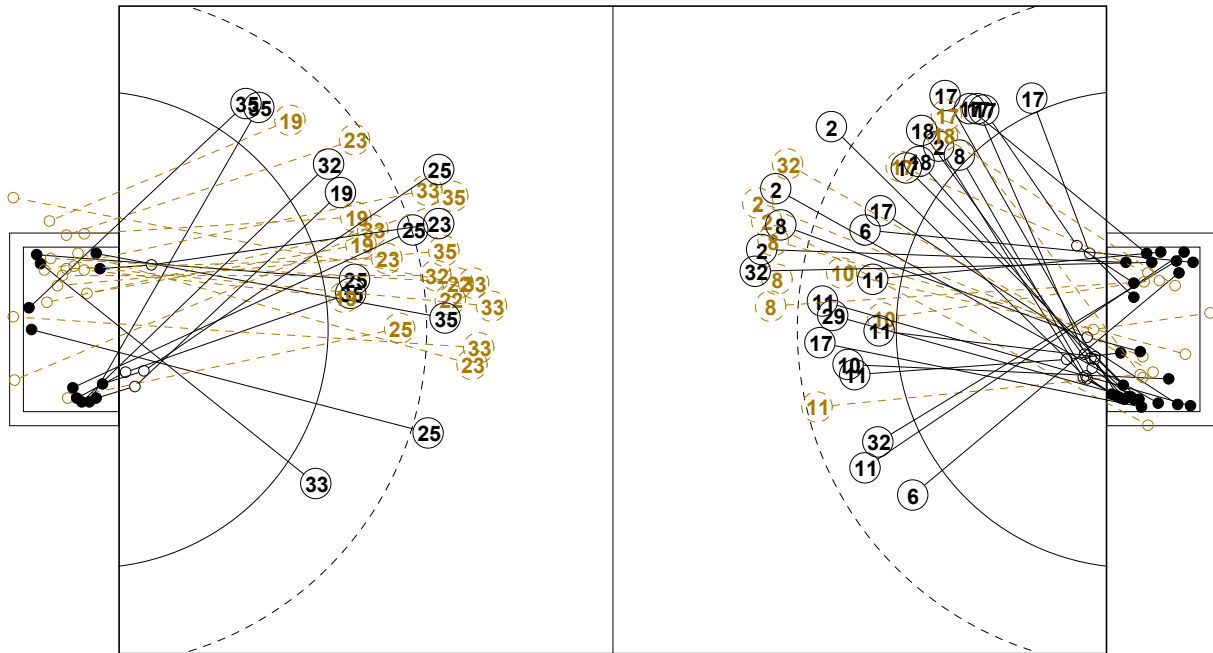
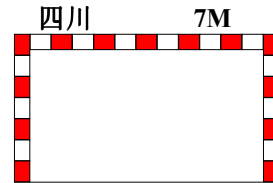

2nd Half
22 : 52

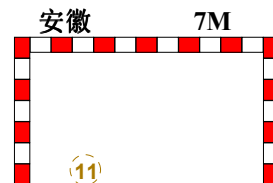



第十二届全国运动会男子手球预赛

个人/全队技术统计表

正式表
手球
男子复赛
轮次 9组别 E
场次 37201301037-14-1/2
柳州市李宁体育馆
27/04/2013 13:00

号码	姓名	远射	近射	边射	快攻	突破	任意	7M	合计	%	助攻	失误	警告	2'	取消	时间
安徽(安徽)																
<i>(场上队员)</i>																
1	高逸凡									0.0%	2					00:12:57
2	周兰骏	4/7			2/2	1/1			7/10	70.0%	2	3				00:32:50
5	马鹏		0/1	1/1	1/1	2/2			4/5	80.0%	2	1				00:14:09
6	田耕				2/2				2/2	100%						00:30:00
7	姚雄敏									0.0%						00:00:00
8	董智景	1/3		1/1	3/6				5/10	50.0%		2		1		00:39:11
10	陈强龙		3/7		4/7				7/14	50.0%	1	2				00:38:47
11	黎涛	0/1	1/1	1/1	3/3	1/1		0/1	6/8	75.0%	1	1				00:27:54
12	曾献辰									0.0%	1	2				00:47:03
15	邵青	0/1	0/1		1/2				1/4	25.0%		1				00:23:05
17	解维维			2/2	6/8				8/10	80.0%		1				00:29:55
18	郭赛		0/1		2/2				2/3	66.7%	1					00:30:00
28	袁龙	2/3			3/3				5/6	83.3%	2	1	1			00:27:48
29	顾先亮				2/2				2/2	100%						00:38:31
32	王超	1/2				1/1			2/3	66.7%	2	1				00:19:04
33	曹振吉				1/2				1/2	50.0%				1		00:07:52
合计		8/17	4/11	5/5	30/40	5/5		0/1	52/79	65.8%	14	15	2	1		
<i>(守门员)</i>																
1	高逸凡	2/3	0/1	0/1					2/5	40.0%	2					00:12:57
12	曾献辰	9/14	3/4	1/2	1/12	0/1	1/1		15/34	44.1%	1	2				00:47:03
合计		11/17	3/5	1/3	1/12	0/1	1/1		17/39	43.6%	3	2				

场上队员：得分/射门

守门员：救球/射门

全队合计	得分	被救	射失	击柱	封球	合计	%
远射	8	4	1	2	2	17	47.1%
近射	4	4	2	1		11	36.4%
边射	5					5	100.0%
快攻	30	9	1			40	75.0%
突破	5					5	100.0%
任意							0.0%
7M		1				1	0.0%





第十二届全国运动会男子手球预赛

个人/全队技术统计表

正式表
手球
男子复赛
轮次 9组别 E
场次 37201301037-14-2/2
柳州市李宁体育馆
27/04/2013 13:00

号码	姓名	远射	近射	边射	快攻	突破	任意	7M	合计	%	助攻	失误	警告	2'	取消	时间
四川(四川)																
<i>(上场队员)</i>																
16	王松									0.0%	2					00:30:00
18	杨洋									0.0%						00:00:00
19	杨洁		1/2		3/5	1/2			5/9	55.6%		1		2		00:59:32
21	池培俊	2/3							2/3	66.7%		2				00:30:30
22	刘彦坤	0/2							0/2	0.0%						00:12:28
23	王震	1/8	0/1						1/9	11.1%		5				00:40:55
25	李峥	2/6			2/2				4/8	50.0%		7				00:58:09
27	于洪泉									0.0%						00:00:00
28	宋涛									0.0%		4				00:13:36
32	逯明松	0/1			1/1				1/2	50.0%		4				00:34:43
33	朱晓龙	0/8	0/1		3/3		0/1		3/13	23.1%		5				00:46:45
35	仇振勇	1/5	1/1	2/3	2/2				6/11	54.5%		9				00:58:31
36	刘琢									0.0%		1				00:30:00
合计																
<i>(守门员)</i>																
16	王松	0/5	2/4	0/3	6/19	0/2			8/33	24.2%	2					00:30:00
36	刘琢	4/7	2/4	0/2	3/20	0/3		1/1	10/37	27.0%		1				00:30:00
合计																
		4/12	4/8	0/5	9/39	0/5		1/1	18/70	25.7%	2	1				

场上队员：得分/射门

守门员：救球/射门

全队合计	得分	被救	射失	击柱	封球	合计	%
远射	6	11	2	3	11	33	18.2%
近射	2	3				5	40.0%
边射	2	1				3	66.7%
快攻	11	1		1		13	84.6%
突破	1		1			2	50.0%
任意		1				1	0.0%
7M							0.0%





第十二届全国运动会男子手球预赛

图式射门区域统计

轮次 9 场次 37

201301037-41-1/1

安徽

1 高逸凡	2 周兰骏	5 马鹏	6 田耕	7 姚雄敏	8 董智景	10 陈强龙	11 黎涛																																																																								
<table border="1"><tr><td></td><td></td><td></td></tr><tr><td></td><td></td><td></td></tr><tr><td></td><td></td><td></td></tr></table>										<table border="1"><tr><td></td><td>1</td><td>1</td></tr><tr><td>1</td><td></td><td>1</td></tr><tr><td>1</td><td></td><td>2</td></tr></table>		1	1	1		1	1		2	<table border="1"><tr><td></td><td></td><td>2</td></tr><tr><td>1</td><td></td><td></td></tr><tr><td></td><td></td><td>1</td></tr></table>			2	1					1	<table border="1"><tr><td>2</td><td></td><td></td></tr><tr><td></td><td></td><td></td></tr><tr><td></td><td></td><td></td></tr></table>	2									<table border="1"><tr><td></td><td></td><td></td></tr><tr><td></td><td></td><td></td></tr><tr><td></td><td></td><td></td></tr></table>										<table border="1"><tr><td>1</td><td></td><td>1</td></tr><tr><td></td><td>1</td><td>1</td></tr><tr><td></td><td></td><td>1</td></tr></table>	1		1		1	1			1	<table border="1"><tr><td>1</td><td></td><td>2</td></tr><tr><td>1</td><td></td><td>2</td></tr><tr><td>1</td><td></td><td></td></tr></table>	1		2	1		2	1			<table border="1"><tr><td>2</td><td></td><td>1</td></tr><tr><td>1</td><td></td><td></td></tr><tr><td></td><td>1</td><td>1</td></tr></table>	2		1	1				1	1
	1	1																																																																													
1		1																																																																													
1		2																																																																													
		2																																																																													
1																																																																															
		1																																																																													
2																																																																															
1		1																																																																													
	1	1																																																																													
		1																																																																													
1		2																																																																													
1		2																																																																													
1																																																																															
2		1																																																																													
1																																																																															
	1	1																																																																													
Post - 0 Miss - 0 Block - 0	Post - 1 Miss - 1 Block - 0	Post - 0 Miss - 0 Block - 0	Post - 0 Miss - 0 Block - 0	Post - 0 Miss - 0 Block - 0	Post - 0 Miss - 0 Block - 1	Post - 1 Miss - 1 Block - 0	Post - 0 Miss - 0 Block - 0																																																																								
12 曾献辰	15 邵青	17 解维维	18 郭赛	28 袁龙	29 顾先亮	32 王超	33 曹振吉																																																																								
<table border="1"><tr><td></td><td></td><td></td></tr><tr><td></td><td></td><td></td></tr><tr><td></td><td></td><td></td></tr></table>										<table border="1"><tr><td>1</td><td></td><td></td></tr><tr><td></td><td></td><td></td></tr><tr><td></td><td></td><td></td></tr></table>	1									<table border="1"><tr><td></td><td></td><td>1</td></tr><tr><td>1</td><td></td><td>2</td></tr><tr><td>2</td><td></td><td>2</td></tr></table>			1	1		2	2		2	<table border="1"><tr><td></td><td></td><td></td></tr><tr><td></td><td></td><td>2</td></tr><tr><td></td><td></td><td></td></tr></table>						2				<table border="1"><tr><td>1</td><td></td><td>1</td></tr><tr><td></td><td></td><td>3</td></tr><tr><td></td><td></td><td></td></tr></table>	1		1			3				<table border="1"><tr><td>1</td><td></td><td></td></tr><tr><td></td><td></td><td></td></tr><tr><td></td><td></td><td>1</td></tr></table>	1								1	<table border="1"><tr><td>1</td><td></td><td></td></tr><tr><td>1</td><td></td><td></td></tr><tr><td></td><td></td><td></td></tr></table>	1			1						<table border="1"><tr><td></td><td></td><td>1</td></tr><tr><td></td><td></td><td></td></tr><tr><td></td><td></td><td></td></tr></table>			1						
1																																																																															
		1																																																																													
1		2																																																																													
2		2																																																																													
		2																																																																													
1		1																																																																													
		3																																																																													
1																																																																															
		1																																																																													
1																																																																															
1																																																																															
		1																																																																													
Post - 0 Miss - 0 Block - 0	Post - 0 Miss - 1 Block - 1	Post - 0 Miss - 0 Block - 0	Post - 0 Miss - 0 Block - 0	Post - 1 Miss - 0 Block - 0	Post - 0 Miss - 0 Block - 0	Post - 0 Miss - 0 Block - 0	Post - 0 Miss - 1 Block - 0																																																																								

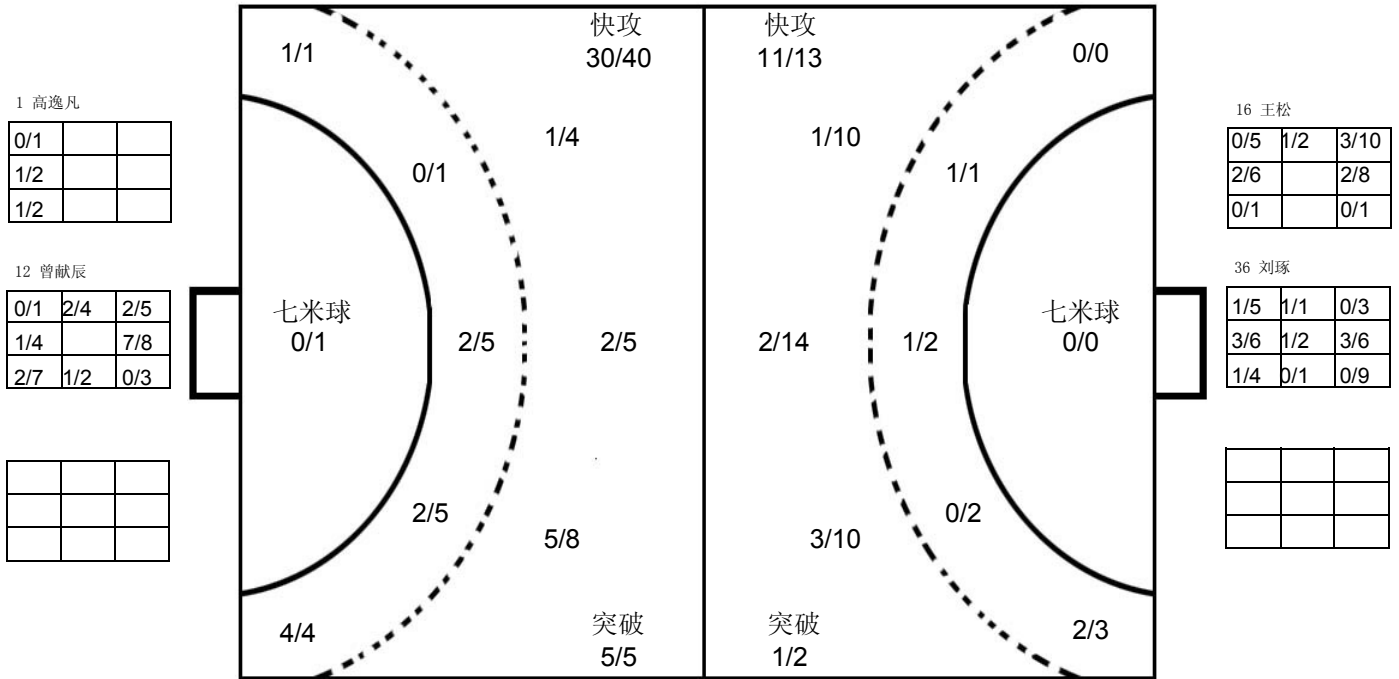

四川

16 王松	18 杨洋	19 杨洁	21 池培俊	22 刘彦坤	23 王震	25 李峥	27 于洪泉																																																																								
<table border="1"><tr><td></td><td></td><td></td></tr><tr><td></td><td></td><td></td></tr><tr><td></td><td></td><td></td></tr></table>										<table border="1"><tr><td></td><td></td><td></td></tr><tr><td></td><td></td><td></td></tr><tr><td></td><td></td><td></td></tr></table>										<table border="1"><tr><td>1</td><td></td><td></td></tr><tr><td></td><td></td><td>1</td></tr><tr><td>2</td><td>1</td><td></td></tr></table>	1					1	2	1		<table border="1"><tr><td></td><td></td><td></td></tr><tr><td>1</td><td></td><td>1</td></tr><tr><td></td><td></td><td></td></tr></table>				1		1				<table border="1"><tr><td></td><td></td><td></td></tr><tr><td></td><td></td><td></td></tr><tr><td></td><td></td><td></td></tr></table>										<table border="1"><tr><td></td><td></td><td></td></tr><tr><td></td><td></td><td></td></tr><tr><td></td><td></td><td>1</td></tr></table>									1	<table border="1"><tr><td></td><td>1</td><td>1</td></tr><tr><td>1</td><td></td><td></td></tr><tr><td>1</td><td></td><td></td></tr></table>		1	1	1			1			<table border="1"><tr><td></td><td></td><td></td></tr><tr><td></td><td></td><td></td></tr><tr><td></td><td></td><td></td></tr></table>									
1																																																																															
		1																																																																													
2	1																																																																														
1		1																																																																													
		1																																																																													
	1	1																																																																													
1																																																																															
1																																																																															
Post - 0 Miss - 0 Block - 0	Post - 0 Miss - 0 Block - 0	Post - 1 Miss - 1 Block - 0	Post - 0 Miss - 0 Block - 0	Post - 0 Miss - 1 Block - 1	Post - 1 Miss - 0 Block - 4	Post - 0 Miss - 1 Block - 1	Post - 0 Miss - 0 Block - 0																																																																								
28 宋涛	32 逯明松	33 朱晓龙	35 仇振勇	36 刘琢																																																																											
<table border="1"><tr><td></td><td></td><td></td></tr><tr><td></td><td></td><td></td></tr><tr><td></td><td></td><td></td></tr></table>										<table border="1"><tr><td></td><td></td><td></td></tr><tr><td>1</td><td></td><td></td></tr><tr><td></td><td></td><td></td></tr></table>				1						<table border="1"><tr><td>1</td><td></td><td>2</td></tr><tr><td></td><td></td><td></td></tr><tr><td></td><td></td><td></td></tr></table>	1		2							<table border="1"><tr><td></td><td>1</td><td></td></tr><tr><td>2</td><td></td><td></td></tr><tr><td>2</td><td></td><td>1</td></tr></table>		1		2			2		1	<table border="1"><tr><td></td><td></td><td></td></tr><tr><td></td><td></td><td></td></tr><tr><td></td><td></td><td></td></tr></table>										<table border="1"><tr><td></td><td></td><td></td></tr><tr><td></td><td></td><td></td></tr><tr><td></td><td></td><td></td></tr></table>										<table border="1"><tr><td></td><td></td><td></td></tr><tr><td></td><td></td><td></td></tr><tr><td></td><td></td><td></td></tr></table>										<table border="1"><tr><td></td><td></td><td></td></tr><tr><td></td><td></td><td></td></tr><tr><td></td><td></td><td></td></tr></table>									
1																																																																															
1		2																																																																													
	1																																																																														
2																																																																															
2		1																																																																													
Post - 0 Miss - 0 Block - 0	Post - 0 Miss - 0 Block - 0	Post - 1 Miss - 0 Block - 4	Post - 1 Miss - 0 Block - 1	Post - 0 Miss - 0 Block - 0																																																																											

注释: Post=击柱 Miss=射失 Block=被封





男子 国内比赛



第十二届全国运动会男子手球预赛

Team A										Team B										Match Number										
A 山西										B 西藏										38										
played in China										in the hall 柳州市李宁体育馆										on 27/04/2013		at 14:40 hours		Spectators						
Half-time (30')		A 11		B 19		End of playing time			A 23		B 35		1st extra time		A		B		2nd extra time		A		B		After penalty throws		A		B	
Number of 7 m		A 2/2		Team time-out			Full name of players and officials										Team time-out			B 2/3		Number of 7 m								
				1 11:53	2 24:31	3 58:30																								
No.	Team A									G	W	2'	D	DR	No.	Team B									G	W	2'	D	DR	
1	李晋尧														2	王龙														
2	马健									2					4	张家纬									4	1				
3	王晋									1	1				5	冯祥龙														
4	李鹏程									6					6	任启双									2					
5	王志超														7	徐奕飞									4		1			
6	范帅									1					9	王博									4					
7	白宇飞									5					10	刘江														
8	崔钰									3					11	朱治宇									1					
9	朱涛涛										1				12	张帅														
10	任海阳									1					15	刘劲松														
12	侯乃章														16	徐畅														
13	侯建涛									4					18	赵楠									4	1				
14	刘明华														19	任野														
15	景新江											1			20	顾艳超									2	1				
18	朱棣										1				21	马光														
															23	王伟强									14					
A	王喜和														A	张文韬														
B	张晓东														B	殷永军														
D	石岩														C	瓮勇														
A										Signature of Responsible Official of the Teams (Off. A)										B										
TP	Remarks of Referee / CHA Official																				TP									

Signatures

Referees	李典 (CHN)	倪震 (CHN)		
Techn. Delegates	王锡祯 (CHN)	刘书勇 (CHN)		
CHA Official				

Note: Number of 7m Throws Awarded to Team A and B, Goals (G), Warnings (W), Suspensions (2), Direct Disqualification (D), Disqualification with Report (DR) and Team Penalty (TP).

Table Officials:

Statisticians: 黄莉

朱伟平



Printed by PHMS Copyright: IHF / CHA 27/04/2013 15:57:41

Longman Sportsoft handball@126.com



第十二届全国运动会男子手球预赛
竞赛技术统计(媒体表)

Table with match details: 复赛, 组别 E, 轮次 9, 场次 38

柳州市李宁体育馆

27/04/2013

201301038-51-1/1

Table with team names: 山西 vs 西藏, scores 23 vs 35, and final score 11:19

Table with referee names: 裁判员 李典 (CHN) / 倪震 (CHN)

Main statistics table for Shanxi and Tibet teams, including player names, positions, and various performance metrics like goals, assists, and suspensions.

场上队员: 得分 / 射门

守门员: 救球 / 射门

Legend table for abbreviations: 快攻, 警告, 突破, 失误, 任意球, 7m球, 助攻, 取消资格+报告





第十二届全国运动会男子手球预赛 图式比赛技术统计表

轮次 9

场次 38

201301038-21-1/1

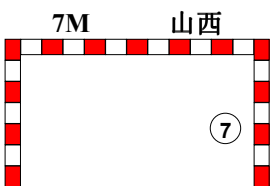
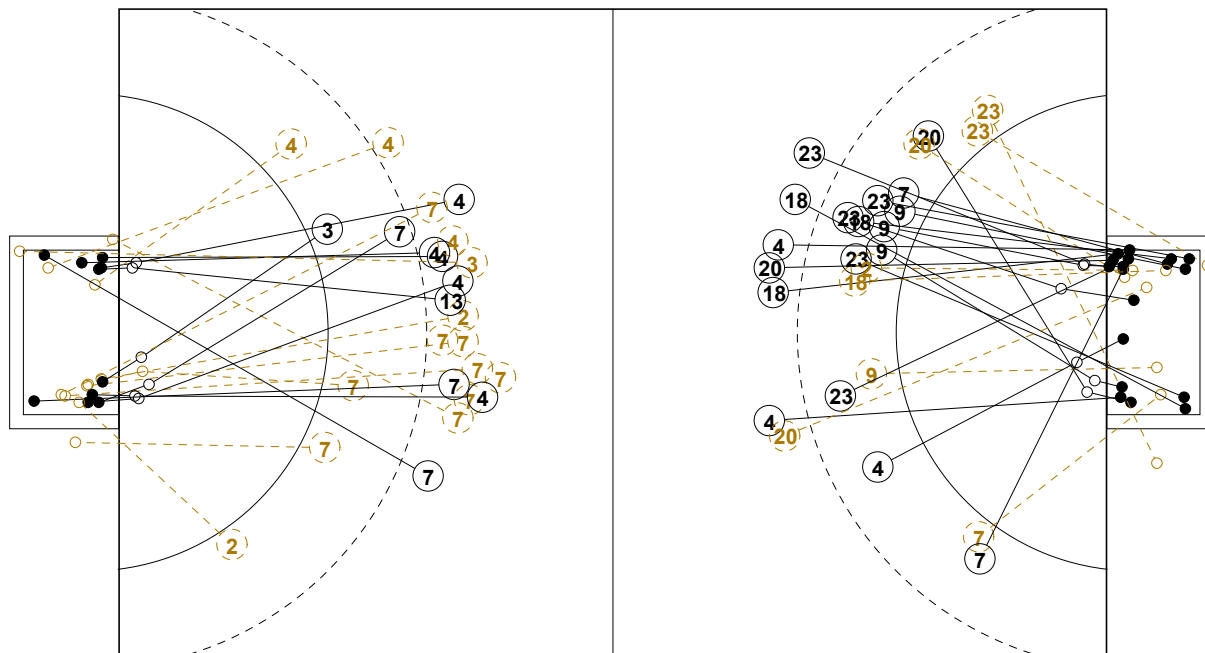

1st Half
11 : 19

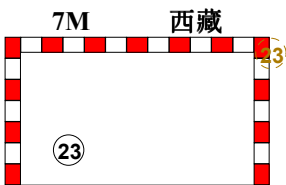
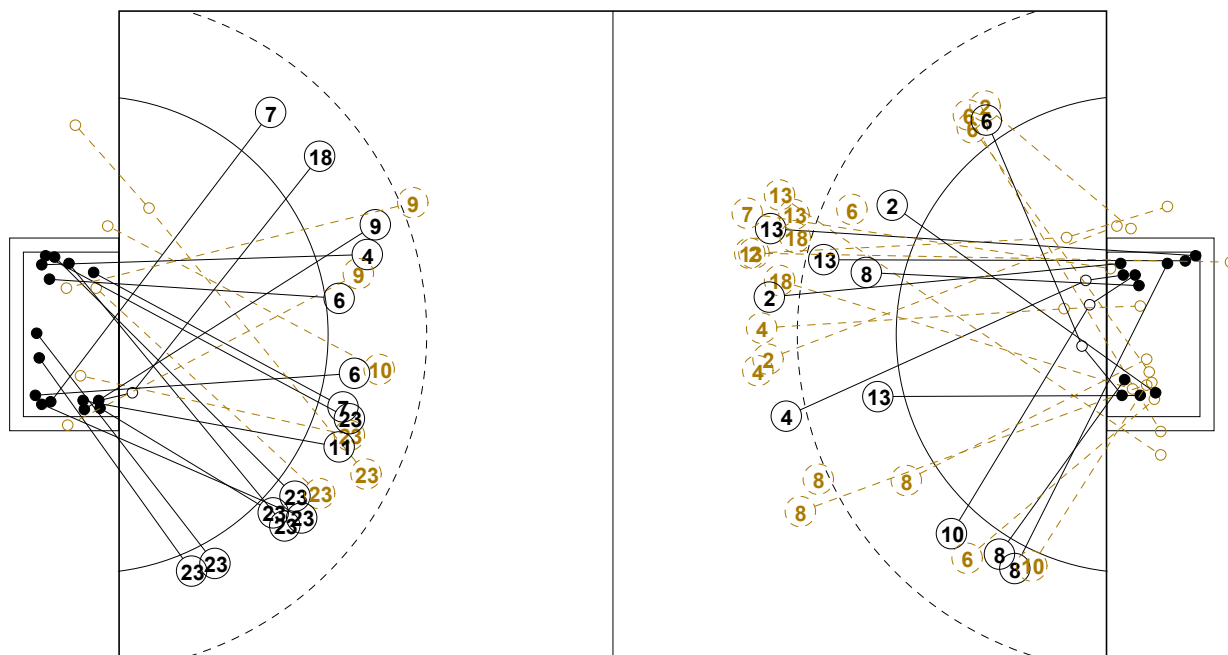
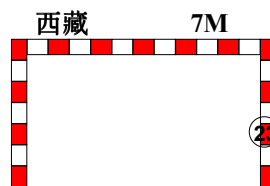

2nd Half
35 : 23

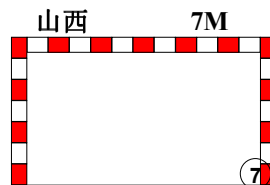



第十二届全国运动会男子手球预赛

个人/全队技术统计表

正式表
手球
男子复赛
轮次 9组别 E
场次 38201301038-14-1/2
柳州市李宁体育馆
27/04/2013 14:40

号码	姓名	远射	近射	边射	快攻	突破	任意	7M	合计	%	助攻	失误	警告	2'	取消	时间
山西(山西)																
<i>(场上队员)</i>																
1	李晋尧									0.0%						01:00:00
2	马健	1/4		0/1	1/1	0/1			2/7	28.6%		1				00:41:00
3	王晋	0/1	1/1						1/2	50.0%			1			00:41:26
4	李鹏程	5/8			1/2		0/1		6/11	54.5%		1				00:48:41
5	王志超									0.0%						00:00:00
6	范帅	0/1		1/2	0/2				1/5	20.0%		2				00:30:00
7	白宇飞	3/9	0/1		0/1	0/1	0/1	2/2	5/15	33.3%		3				00:34:46
8	崔钰	0/2	1/2	2/2					3/6	50.0%		1				00:25:32
9	朱涛涛									0.0%			1			00:23:29
10	任海阳			0/1		1/1			1/2	50.0%		2				00:36:25
12	侯乃章									0.0%						00:00:00
13	侯建涛	2/5	1/1		1/1				4/7	57.1%		1				00:16:27
14	刘明华									0.0%		1				00:02:37
15	景新江									0.0%				1		00:10:19
18	朱棣	0/2							0/2	0.0%			1			00:47:58
合计		11/32	3/5	3/6	3/7	1/3	0/2	2/2	23/57	40.4%		12	3	1		
<i>(守门员)</i>																
1	李晋尧	2/6	1/8	0/2	3/18	3/8		0/2	9/44	20.5%						01:00:00
合计		2/6	1/8	0/2	3/18	3/8		0/2	9/44	20.5%						

场上队员：得分/射门

守门员：救球/射门

全队合计	得分	被救	射失	击柱	封球	合计	%
远射	11	6	4	2	9	32	34.4%
近射	3	2				5	60.0%
边射	3	2	1			6	50.0%
快攻	3	3		1		7	42.9%
突破	1	1	1			3	33.3%
任意		2				2	0.0%
7M	2					2	100.0%





第十二届全国运动会男子手球预赛

个人/全队技术统计表

正式表
手球
男子复赛
轮次 9组别 E
场次 38201301038-14-2/2
柳州市李宁体育馆
27/04/2013 14:40

号码	姓名	远射	近射	边射	快攻	突破	任意	7M	合计	%	助攻	失误	警告	2'	取消	时间
西藏(西藏)																
<i>(上场队员)</i>																
2	王龙				0/1				0/1	0.0%		1				00:22:45
4	张家纬		1/1		2/2	1/1			4/4	100%		6	1			00:59:42
5	冯祥龙									0.0%						00:00:00
6	任启双		2/2						2/2	100%						00:11:12
7	徐奕飞		1/1	1/1	2/3				4/5	80.0%		1		1		00:53:06
9	王博	0/1	1/3		3/3				4/7	57.1%						00:47:42
10	刘江				0/1				0/1	0.0%						00:16:36
11	朱治宇					1/1			1/1	100%		1				00:00:00
12	张帅									0.0%						00:11:37
15	刘劲松									0.0%						00:00:00
16	徐畅									0.0%						00:48:23
18	赵楠	2/2			1/2	1/1			4/5	80.0%	3	2	1			00:59:19
19	任野									0.0%						00:00:00
20	顾艳超	1/2	1/1			0/1			2/4	50.0%		1	1			00:26:44
21	马光									0.0%						00:00:00
23	王伟强	1/2	1/1	1/3	7/7	2/4		2/3	14/20	70.0%	1	3				00:59:28
合计		4/7	7/9	2/4	15/19	5/8		2/3	35/50	70.0%	4	15	3	1		
<i>(守门员)</i>																
12	张帅	0/1	0/1	0/1	0/1	0/1	1/1	0/1	1/7	14.3%						00:11:37
16	徐畅	6/16	2/4	2/4	3/5	1/1	1/1	0/1	15/32	46.9%						00:48:23
合计		6/17	2/5	2/5	3/6	1/2	2/2	0/2	16/39	41.0%						

场上队员：得分/射门

守门员：救球/射门

全队合计	得分	被救	射失	击柱	封球	合计	%
远射	4	2	1			7	57.1%
近射	7	1		1		9	77.8%
边射	2		1	1		4	50.0%
快攻	15	3	1			19	78.9%
突破	5	3				8	62.5%
任意							0.0%
7M	2			1		3	66.7%





第十二届全国运动会男子手球预赛

图式射门区域统计

轮次 9 场次 38

201301038-41-1/1

山西

1 李晋尧	2 马健	3 王晋	4 李鹏程	5 王志超	6 范帅	7 白宇飞	8 崔钰																																																																								
<table border="1"><tr><td></td><td></td><td></td></tr><tr><td></td><td></td><td></td></tr><tr><td></td><td></td><td></td></tr></table>										<table border="1"><tr><td></td><td></td><td>1</td></tr><tr><td></td><td></td><td></td></tr><tr><td>1</td><td></td><td></td></tr></table>			1				1			<table border="1"><tr><td></td><td></td><td></td></tr><tr><td></td><td></td><td></td></tr><tr><td>1</td><td></td><td></td></tr></table>							1			<table border="1"><tr><td></td><td></td><td></td></tr><tr><td></td><td></td><td>1</td></tr><tr><td>3</td><td></td><td>2</td></tr></table>						1	3		2	<table border="1"><tr><td></td><td></td><td></td></tr><tr><td></td><td></td><td></td></tr><tr><td></td><td></td><td></td></tr></table>										<table border="1"><tr><td></td><td></td><td></td></tr><tr><td></td><td></td><td></td></tr><tr><td></td><td></td><td>1</td></tr></table>									1	<table border="1"><tr><td>1</td><td></td><td>1</td></tr><tr><td></td><td></td><td>1</td></tr><tr><td>1</td><td></td><td>1</td></tr></table>	1		1			1	1		1	<table border="1"><tr><td></td><td></td><td></td></tr><tr><td></td><td></td><td></td></tr><tr><td></td><td></td><td>1</td></tr></table>									1
		1																																																																													
1																																																																															
1																																																																															
		1																																																																													
3		2																																																																													
		1																																																																													
1		1																																																																													
		1																																																																													
1		1																																																																													
		1																																																																													
Post - 0 Miss - 0 Block - 0	Post - 0 Miss - 3 Block - 0	Post - 1 Miss - 0 Block - 0	Post - 0 Miss - 0 Block - 2	Post - 0 Miss - 0 Block - 0	Post - 1 Miss - 0 Block - 1	Post - 1 Miss - 1 Block - 3	Post - 0 Miss - 0 Block - 1																																																																								
9 朱涛涛	10 任海阳	12 侯乃章	13 侯建涛	14 刘明华	15 景新江	18 朱棣																																																																									
<table border="1"><tr><td></td><td></td><td></td></tr><tr><td></td><td></td><td></td></tr><tr><td></td><td></td><td></td></tr></table>										<table border="1"><tr><td></td><td></td><td></td></tr><tr><td></td><td></td><td></td></tr><tr><td>1</td><td></td><td></td></tr></table>							1			<table border="1"><tr><td></td><td></td><td></td></tr><tr><td></td><td></td><td></td></tr><tr><td></td><td></td><td></td></tr></table>										<table border="1"><tr><td>2</td><td></td><td></td></tr><tr><td></td><td></td><td>1</td></tr><tr><td></td><td></td><td>1</td></tr></table>	2					1			1	<table border="1"><tr><td></td><td></td><td></td></tr><tr><td></td><td></td><td></td></tr><tr><td></td><td></td><td></td></tr></table>										<table border="1"><tr><td></td><td></td><td></td></tr><tr><td></td><td></td><td></td></tr><tr><td></td><td></td><td></td></tr></table>										<table border="1"><tr><td></td><td></td><td></td></tr><tr><td></td><td></td><td></td></tr><tr><td></td><td></td><td></td></tr></table>										<table border="1"><tr><td></td><td></td><td></td></tr><tr><td></td><td></td><td></td></tr><tr><td></td><td></td><td></td></tr></table>									
1																																																																															
2																																																																															
		1																																																																													
		1																																																																													
Post - 0 Miss - 0 Block - 0	Post - 0 Miss - 0 Block - 0	Post - 0 Miss - 0 Block - 0	Post - 0 Miss - 2 Block - 1	Post - 0 Miss - 0 Block - 0	Post - 0 Miss - 0 Block - 0	Post - 0 Miss - 0 Block - 1																																																																									

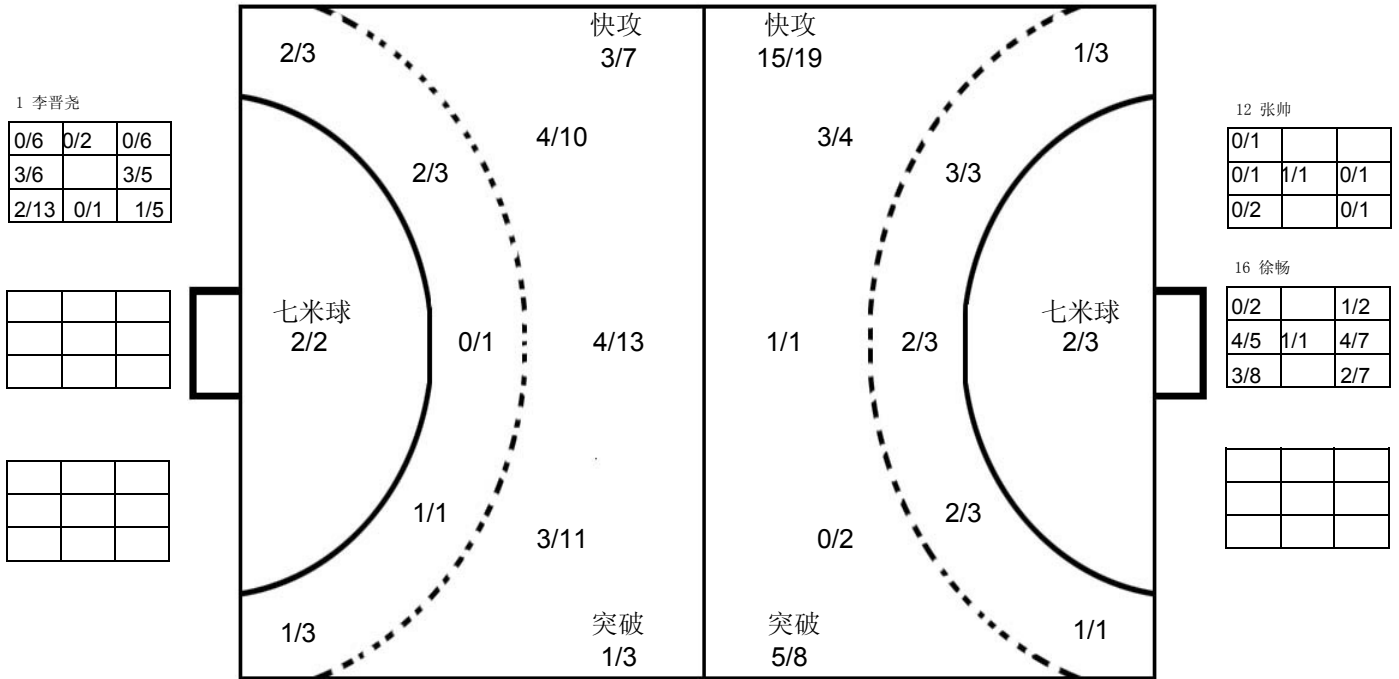

西藏

2 王龙	4 张家伟	5 冯祥龙	6 任启双	7 徐奕飞	9 王博	10 刘江	11 朱治宇																																																																								
<table border="1"><tr><td></td><td></td><td></td></tr><tr><td></td><td></td><td></td></tr><tr><td></td><td></td><td></td></tr></table>										<table border="1"><tr><td></td><td></td><td>1</td></tr><tr><td></td><td></td><td></td></tr><tr><td>1</td><td>1</td><td>1</td></tr></table>			1				1	1	1	<table border="1"><tr><td></td><td></td><td></td></tr><tr><td></td><td></td><td></td></tr><tr><td></td><td></td><td></td></tr></table>										<table border="1"><tr><td>1</td><td></td><td>1</td></tr><tr><td></td><td></td><td></td></tr><tr><td></td><td></td><td></td></tr></table>	1		1							<table border="1"><tr><td>1</td><td></td><td></td></tr><tr><td>1</td><td></td><td></td></tr><tr><td>1</td><td></td><td>1</td></tr></table>	1			1			1		1	<table border="1"><tr><td>1</td><td></td><td></td></tr><tr><td>1</td><td></td><td></td></tr><tr><td>1</td><td></td><td>1</td></tr></table>	1			1			1		1	<table border="1"><tr><td></td><td></td><td></td></tr><tr><td></td><td></td><td></td></tr><tr><td></td><td></td><td></td></tr></table>										<table border="1"><tr><td></td><td></td><td></td></tr><tr><td></td><td></td><td></td></tr><tr><td></td><td></td><td></td></tr></table>									
		1																																																																													
1	1	1																																																																													
1		1																																																																													
1																																																																															
1																																																																															
1		1																																																																													
1																																																																															
1																																																																															
1		1																																																																													
Post - 0 Miss - 0 Block - 0	Post - 0 Miss - 0 Block - 0	Post - 0 Miss - 0 Block - 0	Post - 0 Miss - 0 Block - 0	Post - 0 Miss - 0 Block - 0	Post - 1 Miss - 0 Block - 0	Post - 0 Miss - 1 Block - 0	Post - 0 Miss - 0 Block - 0																																																																								
12 张帅	15 刘劲松	16 徐畅	18 赵楠	19 任野	20 顾艳超	21 马光	23 王伟强																																																																								
<table border="1"><tr><td></td><td></td><td></td></tr><tr><td></td><td></td><td></td></tr><tr><td></td><td></td><td></td></tr></table>										<table border="1"><tr><td></td><td></td><td></td></tr><tr><td></td><td></td><td></td></tr><tr><td></td><td></td><td></td></tr></table>										<table border="1"><tr><td></td><td></td><td></td></tr><tr><td></td><td></td><td></td></tr><tr><td></td><td></td><td></td></tr></table>										<table border="1"><tr><td>1</td><td></td><td>1</td></tr><tr><td></td><td></td><td></td></tr><tr><td>2</td><td></td><td></td></tr></table>	1		1				2			<table border="1"><tr><td></td><td></td><td></td></tr><tr><td></td><td></td><td></td></tr><tr><td></td><td></td><td></td></tr></table>										<table border="1"><tr><td></td><td></td><td></td></tr><tr><td></td><td></td><td></td></tr><tr><td>1</td><td></td><td>1</td></tr></table>							1		1	<table border="1"><tr><td></td><td></td><td></td></tr><tr><td></td><td></td><td></td></tr><tr><td></td><td></td><td></td></tr></table>										<table border="1"><tr><td>2</td><td>2</td><td>3</td></tr><tr><td></td><td></td><td>2</td></tr><tr><td>5</td><td></td><td></td></tr></table>	2	2	3			2	5		
1		1																																																																													
2																																																																															
1		1																																																																													
2	2	3																																																																													
		2																																																																													
5																																																																															
Post - 0 Miss - 0 Block - 0	Post - 0 Miss - 0 Block - 0	Post - 0 Miss - 0 Block - 0	Post - 0 Miss - 0 Block - 0	Post - 0 Miss - 0 Block - 0	Post - 0 Miss - 0 Block - 0	Post - 0 Miss - 0 Block - 0	Post - 2 Miss - 2 Block - 0																																																																								

注释: Post=击柱 Miss=射失 Block=被封





男子 国内比赛



第十二届全国运动会男子手球预赛

Team A A 解放军				Team B B 香港				Match Number 40											
played in China		in the hall 柳州市李宁体育馆		on 27/04/2013		at 18:00 hours		Spectators											
Half-time (30')	A 20	B 11	End of playing time	A 40	B 22	1st extra time	A	B	2nd extra time	A	B	After penalty throws	A	B					
Number of 7 m	A 0 / 0	Team time-out			Full name of players and officials				Team time-out			B 2 / 3	Number of 7 m						
No.	Team A				G	W	2'	D	DR	No.	Team B				G	W	2'	D	DR
4	曹作亮				4					1	萧智庭								
5	吴龙瑞				8	1				2	叶冠英								
6	苗青									5	黄胜业								
7	陈昊				5					6	谢伟希				2				
8	王烁				1					7	许文邦				7				
9	丁超				2					9	张建国				1				
10	师龙				6	1				10	陈国兴								
11	李想									11	陈允文				2				
12	丛霖									12	叶冠雄				3				
13	王世杰				2					13	叶仕仁								
14	曲学博				7	1				14	李鑫豪				1				
15	杨帆									15	黄嘉愉				1	1			
16	郎俊夫									25	曾铭谦				2	1			
17	王勇				5					29	练明辉				3				
18	董宏斐																		
20	谷浩																		
A	张敬敏									A	陈广裕								
B	张彬华									B	杨开将								
C	刘捷									D	张军								
D	刘军																		
A	Signature of Responsible Official of the Teams (Off. A)																B		
TP	Remarks of Referee / CHA Official																TP		

Signatures

Referees	王锐 (CHN)	陈晓波 (CHN)		
Techn. Delegates	许宜扬 (CHN)	刘书勇 (CHN)		
CHA Official				

Note: Number of 7m Throws Awarded to Team A and B, Goals (G), Warnings (W), Suspensions (2'), Direct Disqualification (D), Disqualification with Report (DR) and Team Penalty (TP).

Table Officials:

Statisticians: 黄莉

朱伟平



第十二届全国运动会男子手球预赛
竞赛技术统计(媒体表)

复赛	组别	D	轮次	9	场次	40
柳州市李宁体育馆			27/04/2013		201301040-51-1/1	
解放军		解放军	40	vs	22	香港
			20 : 11			

裁判员	王锐 (CHN)		/	陈晓波 (CHN)	
-----	----------	--	---	-----------	--

解放军														香港			
主教练	远射	近射	边射	快攻	突破	任意球	7m球	合计	%	助攻	失误	警告	2'	D & DR	比赛进程		
张敬敏															1st Half		
4 曹作亮	2/4	0/1		2/2				4/7	57.1	2	1				4 曹作亮	1 00:33	0
5 吴龙瑞	0/1	0/1	1/1	6/6	1/2			8/11	72.7		1	1			14 曲学博	2 01:45	0
6 苗青															14 曲学博	3 02:33	0
7 陈昊		3/5		1/1	1/1			5/7	71.4		1				14 曲学博	3 04:19	1 25 曾铭谦
8 王烁			1/2					1/2	50.0	1					14 曲学博	4 05:44	1
9 丁超	0/1				2/2			2/3	66.7	1	1				14 曲学博	4 06:13	2 7 许文邦
10 师龙	5/9			1/1				6/10	60.0	3		1			4 曲学博	4 08:51	3 9 张建国
11 李想															14 曲学博	5 09:35	3
12 丛霖															17 王勇	6 10:33	3
13 王世杰		1/1		1/1				2/2	100	2					6 王勇	6 11:23	4 7 许文邦
14 曲学博		2/3	2/2	2/2	1/1			7/8	87.5		2	1			14 曲学博	7 11:49	4
15 杨帆															17 王勇	8 12:55	4
16 郎俊夫										2					5 吴龙瑞	9 14:01	4
17 王勇	2/9	1/1		2/3				5/13	38.5	1	2				4 曹作亮	10 14:51	4
18 董宏斐	0/1		0/1					0/2	0.0						10 15:22	5 12 叶冠雄	
20 谷浩															10 17:08	6 7 许文邦	
运动员 合计	9/25	7/12	4/6	15/16	5/6			40/65	61.5	12	8	3			4 曹作亮	11 18:15	6
12 丛霖	4/6	1/1	4/4	1/3	0/1		0/1	10/16	62.5						5 吴龙瑞	12 19:30	6
16 郎俊夫	12/15	1/3	3/7	1/5	0/2		1/2	18/34	52.9	2					4 曹作亮	13 20:02	6
守门员 合计	16/21	2/4	7/11	2/8	0/3		1/3	28/50	56.0	2					5 吴龙瑞	14 20:34	6
															8 王烁	15 22:00	6
															5 吴龙瑞	16 23:21	6
															9 丁超	17 24:30	6
															17 25:05	7 11 陈允文	
															17 26:05	8 15 黄嘉榆	
															10 师龙	18 26:36	8
															18 26:48	9 12 叶冠雄	
															18 27:28	10 12 叶冠雄	
															17 王勇	19 28:02	10
															10 师龙	19 28:50	11 29 练明辉
															10 师龙	20 29:22	11
															2nd Half		
															14 曲学博	21 02:03	11
															5 吴龙瑞	22 02:39	11
															10 师龙	23 03:16	11
															10 师龙	24 03:58	11
															24 04:57	12 7 许文邦	
															24 05:52	13 29 练明辉	
															7 陈昊	25 07:54	13
															5 吴龙瑞	26 10:13	13
															13 王世杰	27 11:06	13
															17 王勇	27 12:04	14 25 曾铭谦
															10 师龙	28 12:43	14
															10 师龙	28 13:11	15 11 陈允文
															10 师龙	29 13:51	15
															29 14:18	16 7 许文邦	
															9 丁超	30 14:50	16
															7 陈昊	31 15:28	16
															31 15:36	17 7 许文邦	
															31 16:42	18 14 李鑫豪	
															10 师龙	32 17:15	18
															32 17:27	19 29 练明辉	
															32 18:16	20 6 谢伟希	
															7 陈昊	33 20:26	20
															33 20:53	21 6 谢伟希	
															5 吴龙瑞	34 22:07	21
															5 吴龙瑞	35 23:01	21
															7 陈昊	36 24:05	21
															17 王勇	37 24:56	21
															7 陈昊	38 26:10	21
															13 王世杰	39 27:10	21
															39 28:16	22 7 许文邦	
															14 曲学博	40 28:38	22

场上队员: 得分 / 射门

守门员: 救球 / 射门

快攻	Fast Break	突破	Breakthrough	任意球	Free Throw	7M球	7M Throw	助攻	Assist
警告	Warning	失误	Error	2'	Suspension	D	取消资格	DR	取消资格+报告



第十二届全国运动会男子手球预赛 图式比赛技术统计表

轮次 9

场次 40

201301040-21-1/1

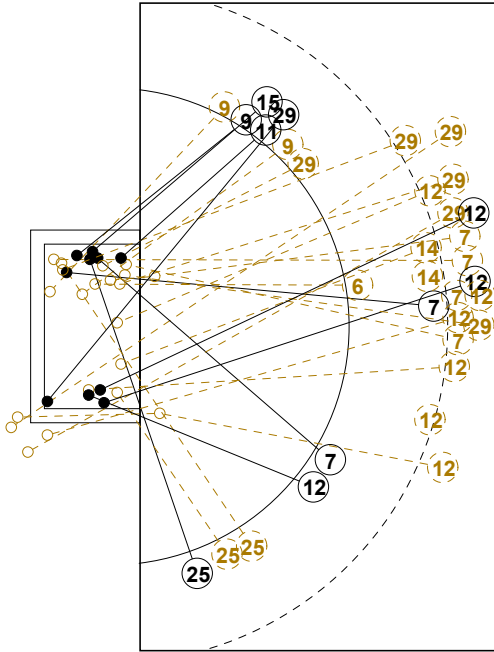

7M 香港

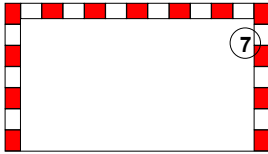

1st Half
11 : 20

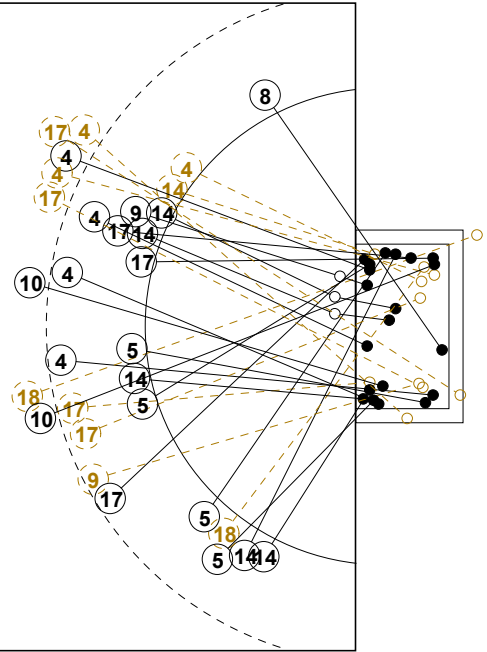

解放军 7M

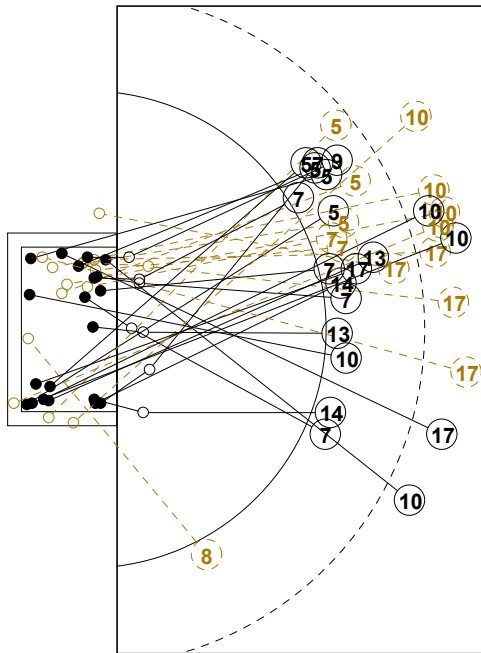
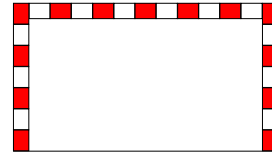

7M 解放军

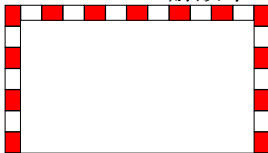

2nd Half
40 : 22

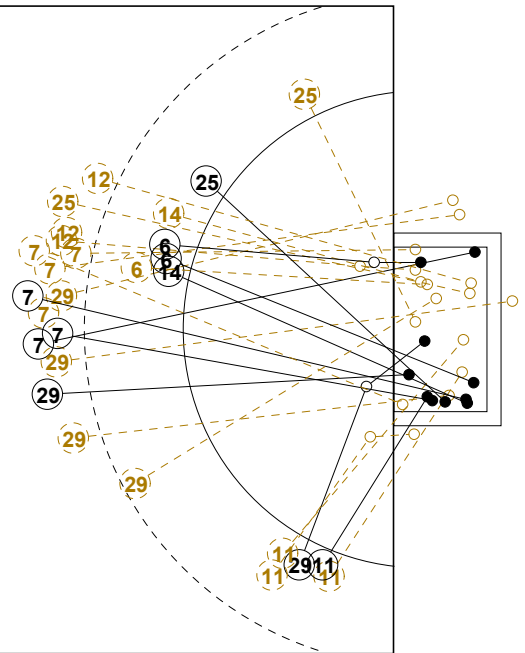

香港 7M

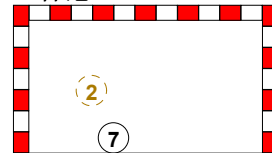



第十二届全国运动会男子手球预赛

个人/全队技术统计表

正式表
手球
男子复赛
轮次 9组别 D
场次 40201301040-14-1/2
柳州市李宁体育馆
27/04/2013 18:00

号码	姓名	远射	近射	边射	快攻	突破	任意	7M	合计	%	助攻	失误	警告	2'	取消	时间
解放军(解放军)																
<i>(场上队员)</i>																
4	曹作亮	2/4	0/1		2/2				4/7	57.1%	2	1				00:25:28
5	吴龙瑞	0/1	0/1	1/1	6/6	1/2			8/11	72.7%		1	1			00:44:59
6	苗青									0.0%						00:00:00
7	陈昊		3/5		1/1	1/1			5/7	71.4%		1				00:24:57
8	王烁			1/2					1/2	50.0%	1					00:40:47
9	丁超	0/1				2/2			2/3	66.7%	1	1				00:59:30
10	师龙	5/9			1/1				6/10	60.0%	3		1			00:33:57
11	李想									0.0%						00:00:00
12	丛霖									0.0%						00:18:00
13	王世杰		1/1		1/1				2/2	100%	2					00:18:44
14	曲学博		2/3	2/2	2/2	1/1			7/8	87.5%		2	1			00:39:06
15	杨帆									0.0%						00:00:00
16	郎俊夫									0.0%	2					00:42:00
17	王勇	2/9	1/1		2/3				5/13	38.5%	1	2				00:54:56
18	董宏斐	0/1		0/1					0/2	0.0%						00:14:24
20	谷浩									0.0%						00:00:00
合计		9/25	7/12	4/6	15/16	5/6			40/65	61.5%	12	8	3			
<i>(守门员)</i>																
12	丛霖	4/6	1/1	4/4	1/3	0/1		0/1	10/16	62.5%						00:18:00
16	郎俊夫	12/15	1/3	3/7	1/5	0/2		1/2	18/34	52.9%	2					00:42:00
合计		16/21	2/4	7/11	2/8	0/3		1/3	28/50	56.0%	2					

场上队员：得分/射门

守门员：救球/射门

全队合计	得分	被救	射失	击柱	封球	合计	%
远射	9	9	2	5		25	36.0%
近射	7	5				12	58.3%
边射	4	2				6	66.7%
快攻	15	1				16	93.8%
突破	5	1				6	83.3%
任意							0.0%
7M							0.0%





第十二届全国运动会男子手球预赛

个人/全队技术统计表

正式表
手球
男子复赛
轮次 9组别 D
场次 40201301040-14-2/2
柳州市李宁体育馆
27/04/2013 18:00

号码	姓名	远射	近射	边射	快攻	突破	任意	7M	合计	%	助攻	失误	警告	2'	取消	时间
香港(香港)																
<i>(上场队员)</i>																
1	萧智庭									0.0%						00:31:22
2	叶冠英							0/1	0/1	0.0%						00:28:38
5	黄胜业									0.0%						00:00:00
6	谢伟希		2/3		0/1				2/4	50.0%		1				00:25:14
7	许文邦	3/11			1/1	1/1		2/2	7/15	46.7%	2	5				00:55:01
9	张建国			0/2	1/1				1/3	33.3%	1					00:24:19
10	陈国兴									0.0%						00:00:00
11	陈允文			2/5					2/5	40.0%		1				00:34:40
12	叶冠雄	1/10			1/1	1/1			3/12	25.0%		4				00:59:52
13	叶仕仁									0.0%						00:00:00
14	李鑫豪	0/2	0/1		1/1				1/4	25.0%		1				00:23:49
15	黄嘉榆			1/1					1/1	100%			1			00:20:54
25	曾铭谦	0/1		0/3	2/2				2/6	33.3%		1	1			00:59:44
29	练明辉	1/10		1/1	0/1	1/1			3/13	23.1%	1	3				00:55:16
合计																
<i>(守门员)</i>																
1	萧智庭	5/10	2/5	1/2	0/7	1/4			9/28	32.1%						00:31:22
2	叶冠英	4/8	3/7	1/4	1/9	0/2			9/30	30.0%						00:28:38
合计																
		9/18	5/12	2/6	1/16	1/6			18/58	31.0%						

场上队员：得分/射门

守门员：救球/射门

全队合计	得分	被救	射失	击柱	封球	合计	%
远射	5	16	7		6	34	14.7%
近射	2	2				4	50.0%
边射	4	7	1			12	33.3%
快攻	6	2				8	75.0%
突破	3					3	100.0%
任意							0.0%
7M	2	1				3	66.7%





第十二届全国运动会男子手球预赛

图式射门区域统计

轮次 9 场次 40

201301040-41-1/1

解放军

4 曹作亮 1 1 1 Post - 1 Miss - 0 Block - 0	5 吴龙瑞 2 2 1 2 1 Post - 1 Miss - 0 Block - 0	6 苗青 Post - 0 Miss - 0 Block - 0	7 陈昊 1 3 Post - 0 Miss - 0 Block - 0	8 王烁 1 Post - 0 Miss - 0 Block - 0	9 丁超 1 1 Post - 0 Miss - 0 Block - 0	10 师龙 3 1 2 Post - 2 Miss - 0 Block - 0	11 李想 Post - 0 Miss - 0 Block - 0
12 丛霖 Post - 0 Miss - 0 Block - 0	13 王世杰 1 1 Post - 0 Miss - 0 Block - 0	14 曲学博 1 2 2 Post - 0 Miss - 0 Block - 0	15 杨帆 Post - 0 Miss - 0 Block - 0	16 郎俊夫 Post - 0 Miss - 0 Block - 0	17 王勇 2 1 1 1 Post - 1 Miss - 1 Block - 0	18 董宏斐 Post - 0 Miss - 1 Block - 0	20 谷浩 Post - 0 Miss - 0 Block - 0

12 丛霖
3/6
0/1 3/5
1/1 1/1 2/2

16 郎俊夫
2/4 1/1 2/5
4/6 0/1 1/5
4/6 1/1 3/5

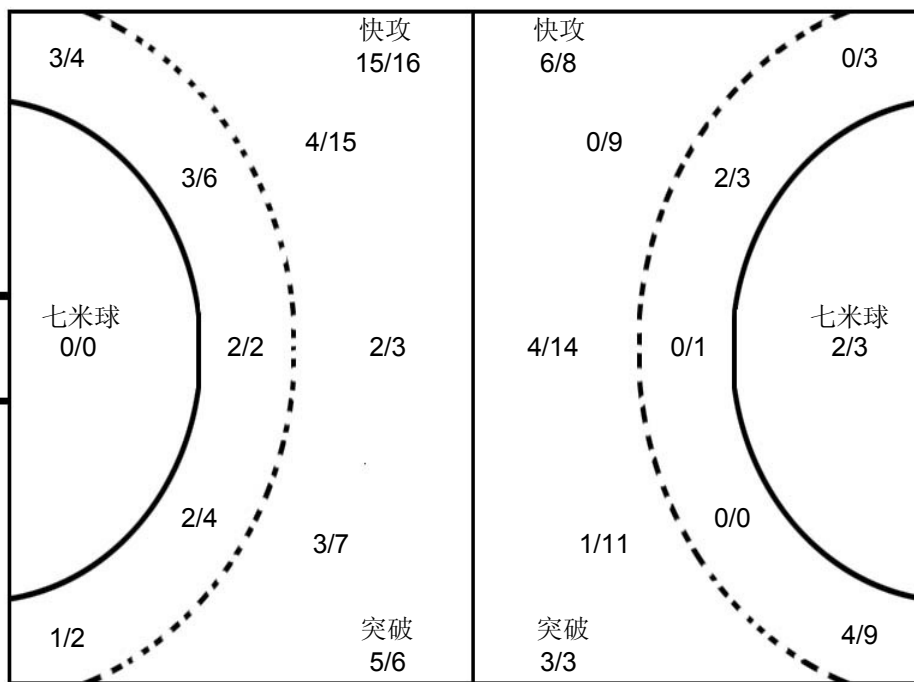

1 萧智庭
3/6 1/1 2/4
0/1 1/3
1/5 0/1 1/7

2 叶冠英
0/5 1/2 2/4
0/2 0/1 3/4
0/4 0/1 3/7

香港

1 萧智庭 Post - 0 Miss - 0 Block - 0	2 叶冠英 Post - 0 Miss - 0 Block - 0	5 黄胜业 Post - 0 Miss - 0 Block - 0	6 谢伟希 1 1 Post - 0 Miss - 0 Block - 0	7 许文邦 1 3 2 1 Post - 0 Miss - 1 Block - 2	9 张建国 1 Post - 0 Miss - 0 Block - 0	10 陈国兴 Post - 0 Miss - 0 Block - 0	11 陈允文 1 1 Post - 0 Miss - 1 Block - 0
12 叶冠雄 3 Post - 0 Miss - 2 Block - 3	13 叶仕仁 Post - 0 Miss - 0 Block - 0	14 李鑫豪 1 Post - 0 Miss - 0 Block - 1	15 黄嘉愉 1 Post - 0 Miss - 0 Block - 0	25 曾铭谦 2 Post - 0 Miss - 0 Block - 0	29 练明辉 1 1 1 Post - 0 Miss - 4 Block - 0		

注释: Post=击柱 Miss=射失 Block=被封





男子 国内比赛



第十二届全国运动会男子手球预赛

Team A										Team B										Match Number									
A 江苏										B 上海										41									
played in					in the hall					on					at					Spectators									
China					柳州市李宁体育馆					27/04/2013					19:40 hours														
Half-time (30')		A		B		End of playing time		A		B		1st extra time		A		B		2nd extra time		A		B		After penalty throws		A		B	
		21		11		33		23																					
Number of 7 m		A		Team time-out			Full name of players and officials										Team time-out			B		Number of 7 m							
1/2		1		45:41													10:21			51:12		1/1							
No.	Team A					G	W	2'	D	DR	No.	Team B					G	W	2'	D	DR								
1	丁大伟										1	张峥																	
2	杨彦威					1					2	胡辰								1									
3	李旭东										3	赵时俊																	
4	沈庆					3	1				5	朱世杰					2												
5	闫亮					1					6	李和鑫																	
6	赵晨					3					8	钱为玮																	
8	周小坚					5	1				9	朱礼彬					6												
9	叶强					2					10	吴璟																	
10	郝可鑫					5		1			12	周哲韬																	
11	姚仁剑										13	孟宇超					3												
12	王权										14	王子阳					4												
14	丛海航					2					15	徐俊吉					2	1	1										
15	李安					2					16	朱春雷																	
17	陈灵峰					3	1	1			18	马麟晓					4												
19	张志宇					6					19	蒋承骅																	
20	张星										20	程云飞					2												
A	闫威名										A	吴龙基																	
C	NENADz vonarek						1				B	陆钦忠																	
D	王建国										C	徐耀忠																	
E	贾淑君										E	黄韡																	
A										Signature of Responsible Official of the Teams (Off. A)										B									
TP	Remarks of Referee / CHA Official																				TP								

Signatures

Referees	朱昆宏 (CHN)	刘建鹏 (CHN)		
Techn. Delegates	许宜扬 (CHN)	李之文 (CHN)		
CHA Official				

Note: Number of 7m Throws Awarded to Team A and B, Goals (G), Warnings (W), Suspensions (2'), Direct Disqualification (D), Disqualification with Report (DR) and Team Penalty (TP).

Table Officials:

Statisticians: 黄莉

朱伟平





第十二届全国运动会男子手球预赛
竞赛技术统计(媒体表)

Table with match details: 复赛, 组别 C, 轮次 9, 场次 41

柳州市李宁体育馆

27/04/2013

201301041-51-1/1

Match score table: 江苏 33 vs 23 上海, 21:11

Referee table: 裁判员 朱昆宏 (CHN) / 刘建鹏 (CHN)

Main statistics table for Jiangsu team, including columns for distance, near, side, fast, breakthrough, free ball, 7m, total, %, assists, errors, warnings, 2', D & DR.

Main statistics table for Shanghai team, including columns for distance, near, side, fast, breakthrough, free ball, 7m, total, %, assists, errors, warnings, 2', D & DR.

Match progression table (比赛进程) showing player names, numbers, and scores for both teams across different halves.

场上队员: 得分 / 射门

守门员: 救球 / 射门

Legend table for abbreviations: 快攻, 突破, 任意球, 警告, etc.





第十二届全国运动会男子手球预赛 图式比赛技术统计表

轮次 9

场次 41

201301041-21-1/1

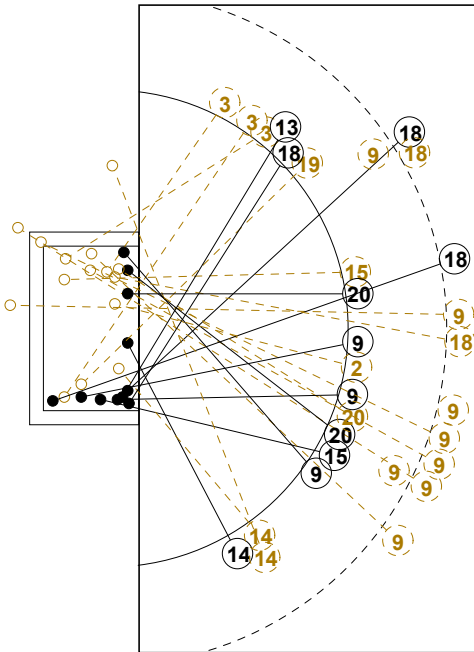

7M 上海

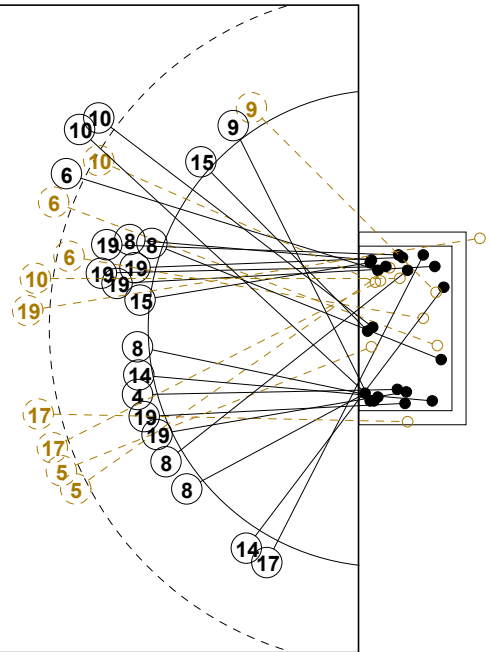
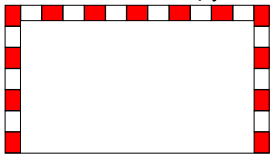

江苏 7M

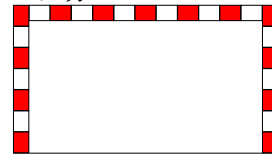

1st Half
11 : 21

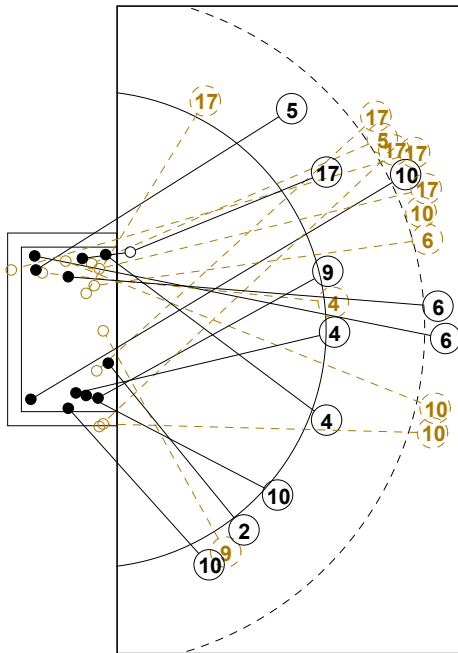

7M 江苏

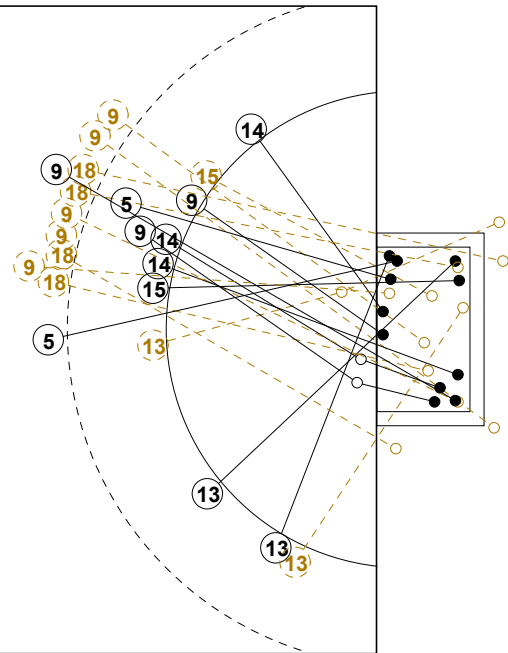
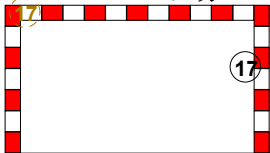

上海 7M



2nd Half
33 : 23



第十二届全国运动会男子手球预赛

个人/全队技术统计表

正式表
手球
男子复赛
轮次 9组别 C
场次 41201301041-14-1/2
柳州市李宁体育馆
27/04/2013 19:40

号码	姓名	远射	近射	边射	快攻	突破	任意	7M	合计	%	助攻	失误	警告	2'	取消	时间
江苏(江苏)																
<i>(场上队员)</i>																
1	丁大伟									0.0%						00:30:00
2	杨彦威			1/1					1/1	100%						00:13:12
3	李旭东									0.0%						00:00:00
4	沈庆		3/4						3/4	75.0%	2	1				00:32:26
5	闫亮	0/3	1/1						1/4	25.0%	1	2				00:56:16
6	赵晨	3/6							3/6	50.0%	3	3				00:56:01
8	周小坚		5/5						5/5	100%	1	1	1			00:21:29
9	叶强		1/1	1/3					2/4	50.0%	1	2				00:38:05
10	郝可鑫	3/8	1/1		1/1				5/10	50.0%	1			1		00:30:25
11	姚仁剑									0.0%						00:00:00
12	王权									0.0%						00:30:00
14	丛海航			1/1	1/1				2/2	100%						00:11:57
15	李安		1/1		1/1				2/2	100%	1					00:21:47
17	陈灵峰	0/6	1/1	0/1	1/1			1/2	3/11	27.3%	1	1	1			00:47:58
19	张志宇	0/1	1/1		3/3	2/2			6/7	85.7%	3	2				00:30:00
20	张星									0.0%						00:00:00
合计		6/24	14/15	3/6	7/7	2/2		1/2	33/56	58.9%	10	14	3	2		
<i>(守门员)</i>																
1	丁大伟	5/7	1/3	1/2	0/4	0/2		0/1	7/19	36.8%						00:30:00
12	王权	3/5	3/8	0/2	5/6	0/1			11/22	50.0%						00:30:00
合计		8/12	4/11	1/4	5/10	0/3		0/1	18/41	43.9%						

场上队员：得分/射门

守门员：救球/射门

全队合计	得分	被救	射失	击柱	封球	合计	%
远射	6	12	1	4	1	24	25.0%
近射	14	1				15	93.3%
边射	3	3				6	50.0%
快攻	7					7	100.0%
突破	2					2	100.0%
任意							0.0%
7M	1			1		2	50.0%





第十二届全国运动会男子手球预赛

个人/全队技术统计表

正式表
手球
男子复赛
轮次 9组别 C
场次 41201301041-14-2/2
柳州市李宁体育馆
27/04/2013 19:40

号码	姓名	远射	近射	边射	快攻	突破	任意	7M	合计	%	助攻	失误	警告	2'	取消	时间
上海(上海)																
<i>(上场队员)</i>																
1	张崢									0.0%						00:43:10
2	胡辰				0/1				0/1	0.0%				1		00:23:39
3	赵时俊				0/3				0/3	0.0%	1	1				00:26:30
5	朱世杰	1/1	1/1						2/2	100%		1				00:04:13
6	李和鑫									0.0%						00:00:00
8	钱为玮									0.0%						00:00:00
9	朱礼彬	1/13	1/1		1/1	3/3	0/1		6/19	31.6%	4	5				01:00:00
10	吴璟									0.0%						00:00:00
12	周哲韬									0.0%						00:16:50
13	孟宇超		0/1	2/3	1/1				3/5	60.0%		1				00:33:25
14	王子阳			1/2	3/4				4/6	66.7%		1				00:36:19
15	徐俊吉		2/4						2/4	50.0%		1	1	1		00:44:58
16	朱春雷									0.0%						00:00:00
18	马麟晓	2/8	1/1					1/1	4/10	40.0%	8	5				00:55:46
19	蒋承骅		0/1						0/1	0.0%		4				01:00:00
20	程云飞		2/3						2/3	66.7%		1				00:14:57
合计		4/22	7/12	3/5	5/10	3/3	0/1	1/1	23/54	42.6%	13	20	1	2		
<i>(守门员)</i>																
1	张崢	9/13	1/12	2/4	0/6	0/2		0/1	12/38	31.6%						00:43:10
12	周哲韬	3/5	0/3	1/2	0/1				4/11	36.4%						00:16:50
合计		12/18	1/15	3/6	0/7	0/2		0/1	16/49	32.7%						

场上队员：得分/射门

守门员：救球/射门

全队合计	得分	被救	射失	击柱	封球	合计	%
远射	4	8	4	1	5	22	18.2%
近射	7	4	1			12	58.3%
边射	3	1	1			5	60.0%
快攻	5	5				10	50.0%
突破	3					3	100.0%
任意			1			1	0.0%
7M	1					1	100.0%





第十二届全国运动会男子手球预赛

图式射门区域统计

轮次 9 场次 41

201301041-41-1/1

江苏

1 丁大伟	2 杨彦威	3 李旭东	4 沈庆	5 闫亮	6 赵晨	8 周小坚	9 叶强																																																																								
<table border="1"><tr><td></td><td></td><td></td></tr><tr><td></td><td></td><td></td></tr><tr><td></td><td></td><td></td></tr></table>										<table border="1"><tr><td></td><td></td><td></td></tr><tr><td></td><td></td><td></td></tr><tr><td>1</td><td></td><td></td></tr></table>							1			<table border="1"><tr><td></td><td></td><td></td></tr><tr><td></td><td></td><td></td></tr><tr><td></td><td></td><td></td></tr></table>										<table border="1"><tr><td></td><td></td><td></td></tr><tr><td>1</td><td></td><td>1</td></tr><tr><td></td><td></td><td>1</td></tr></table>				1		1			1	<table border="1"><tr><td></td><td></td><td>1</td></tr><tr><td></td><td></td><td></td></tr><tr><td></td><td></td><td></td></tr></table>			1							<table border="1"><tr><td></td><td></td><td>1</td></tr><tr><td></td><td></td><td></td></tr><tr><td>1</td><td></td><td></td></tr></table>			1				1			<table border="1"><tr><td></td><td></td><td>1</td></tr><tr><td></td><td></td><td></td></tr><tr><td>1</td><td></td><td>2</td></tr></table>			1				1		2	<table border="1"><tr><td></td><td></td><td></td></tr><tr><td></td><td></td><td></td></tr><tr><td>1</td><td></td><td>1</td></tr></table>							1		1
1																																																																															
1		1																																																																													
		1																																																																													
		1																																																																													
		1																																																																													
1																																																																															
		1																																																																													
1		2																																																																													
1		1																																																																													
Post - 0 Miss - 0 Block - 0	Post - 0 Miss - 0 Block - 0	Post - 0 Miss - 0 Block - 0	Post - 0 Miss - 0 Block - 0	Post - 0 Miss - 0 Block - 0	Post - 0 Miss - 0 Block - 0	Post - 0 Miss - 0 Block - 0	Post - 0 Miss - 0 Block - 0																																																																								
10 郝可鑫	11 姚仁剑	12 王权	14 丛海航	15 李安	17 陈灵峰	19 张志宇	20 张星																																																																								
<table border="1"><tr><td>1</td><td></td><td></td></tr><tr><td>1</td><td></td><td></td></tr><tr><td>1</td><td>1</td><td>1</td></tr></table>	1			1			1	1	1	<table border="1"><tr><td></td><td></td><td></td></tr><tr><td></td><td></td><td></td></tr><tr><td></td><td></td><td></td></tr></table>										<table border="1"><tr><td></td><td></td><td></td></tr><tr><td></td><td></td><td></td></tr><tr><td></td><td></td><td></td></tr></table>										<table border="1"><tr><td>1</td><td></td><td>1</td></tr><tr><td></td><td></td><td></td></tr><tr><td></td><td></td><td></td></tr></table>	1		1							<table border="1"><tr><td></td><td></td><td></td></tr><tr><td></td><td></td><td></td></tr><tr><td>1</td><td>1</td><td></td></tr></table>							1	1		<table border="1"><tr><td>1</td><td></td><td>1</td></tr><tr><td></td><td></td><td>1</td></tr><tr><td></td><td></td><td></td></tr></table>	1		1			1				<table border="1"><tr><td>1</td><td></td><td></td></tr><tr><td>2</td><td></td><td>2</td></tr><tr><td>1</td><td></td><td></td></tr></table>	1			2		2	1			<table border="1"><tr><td></td><td></td><td></td></tr><tr><td></td><td></td><td></td></tr><tr><td></td><td></td><td></td></tr></table>									
1																																																																															
1																																																																															
1	1	1																																																																													
1		1																																																																													
1	1																																																																														
1		1																																																																													
		1																																																																													
1																																																																															
2		2																																																																													
1																																																																															
Post - 1 Miss - 0 Block - 1	Post - 0 Miss - 0 Block - 0	Post - 0 Miss - 0 Block - 0	Post - 0 Miss - 0 Block - 0	Post - 0 Miss - 0 Block - 0	Post - 4 Miss - 0 Block - 0	Post - 0 Miss - 1 Block - 0	Post - 0 Miss - 0 Block - 0																																																																								

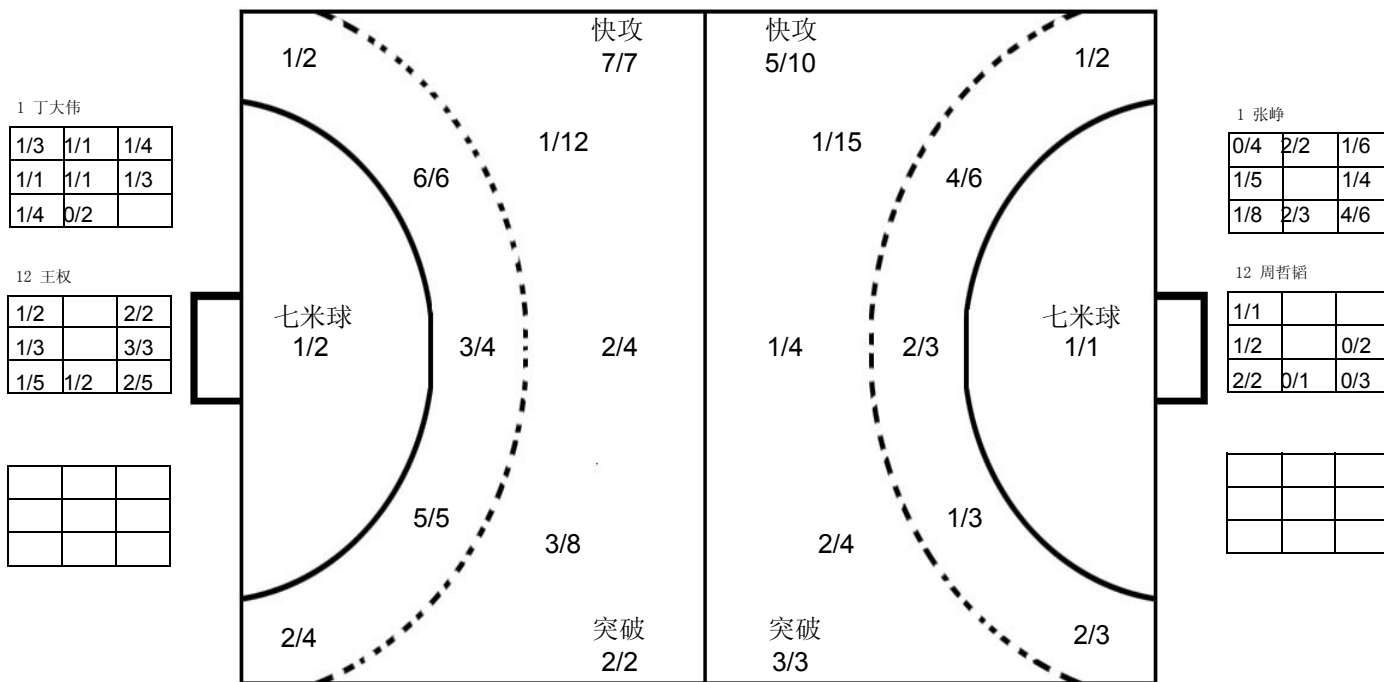

上海

1 张崢	2 胡辰	3 赵时俊	5 朱世杰	6 李和鑫	8 钱为玮	9 朱礼彬	10 吴璟																																																																								
<table border="1"><tr><td></td><td></td><td></td></tr><tr><td></td><td></td><td></td></tr><tr><td></td><td></td><td></td></tr></table>										<table border="1"><tr><td></td><td></td><td></td></tr><tr><td></td><td></td><td></td></tr><tr><td></td><td></td><td></td></tr></table>										<table border="1"><tr><td></td><td></td><td></td></tr><tr><td></td><td></td><td></td></tr><tr><td></td><td></td><td></td></tr></table>										<table border="1"><tr><td></td><td></td><td></td></tr><tr><td>2</td><td></td><td></td></tr><tr><td></td><td></td><td></td></tr></table>				2						<table border="1"><tr><td></td><td></td><td></td></tr><tr><td></td><td></td><td></td></tr><tr><td></td><td></td><td></td></tr></table>										<table border="1"><tr><td></td><td></td><td></td></tr><tr><td></td><td></td><td></td></tr><tr><td></td><td></td><td></td></tr></table>										<table border="1"><tr><td></td><td></td><td>1</td></tr><tr><td>1</td><td></td><td>1</td></tr><tr><td>1</td><td>1</td><td>1</td></tr></table>			1	1		1	1	1	1	<table border="1"><tr><td></td><td></td><td></td></tr><tr><td></td><td></td><td></td></tr><tr><td></td><td></td><td></td></tr></table>									
2																																																																															
		1																																																																													
1		1																																																																													
1	1	1																																																																													
Post - 0 Miss - 0 Block - 0	Post - 0 Miss - 0 Block - 0	Post - 0 Miss - 0 Block - 0	Post - 0 Miss - 0 Block - 0	Post - 0 Miss - 0 Block - 0	Post - 0 Miss - 0 Block - 0	Post - 1 Miss - 3 Block - 4	Post - 0 Miss - 0 Block - 0																																																																								
12 周哲韬	13 孟宇超	14 王子阳	15 徐俊吉	16 朱春雷	18 马麟晓	19 蒋承骅	20 程云飞																																																																								
<table border="1"><tr><td></td><td></td><td></td></tr><tr><td></td><td></td><td></td></tr><tr><td></td><td></td><td></td></tr></table>										<table border="1"><tr><td>1</td><td></td><td></td></tr><tr><td></td><td></td><td></td></tr><tr><td>2</td><td></td><td></td></tr></table>	1						2			<table border="1"><tr><td></td><td></td><td>2</td></tr><tr><td></td><td></td><td></td></tr><tr><td></td><td></td><td>2</td></tr></table>			2						2	<table border="1"><tr><td>1</td><td></td><td></td></tr><tr><td>1</td><td></td><td></td></tr><tr><td></td><td></td><td></td></tr></table>	1			1						<table border="1"><tr><td></td><td></td><td></td></tr><tr><td></td><td></td><td></td></tr><tr><td></td><td></td><td></td></tr></table>										<table border="1"><tr><td>1</td><td></td><td></td></tr><tr><td></td><td></td><td>1</td></tr><tr><td>2</td><td></td><td></td></tr></table>	1					1	2			<table border="1"><tr><td></td><td></td><td></td></tr><tr><td></td><td></td><td></td></tr><tr><td></td><td></td><td></td></tr></table>										<table border="1"><tr><td></td><td></td><td>2</td></tr><tr><td></td><td></td><td></td></tr><tr><td></td><td></td><td></td></tr></table>			2						
1																																																																															
2																																																																															
		2																																																																													
		2																																																																													
1																																																																															
1																																																																															
1																																																																															
		1																																																																													
2																																																																															
		2																																																																													
Post - 0 Miss - 0 Block - 0	Post - 0 Miss - 1 Block - 0	Post - 0 Miss - 1 Block - 0	Post - 0 Miss - 0 Block - 0	Post - 0 Miss - 0 Block - 0	Post - 0 Miss - 2 Block - 1	Post - 0 Miss - 0 Block - 0	Post - 0 Miss - 0 Block - 0																																																																								

注释: Post=击柱 Miss=射失 Block=被封





男子 国内比赛



第十二届全国运动会男子手球预赛

Team A A 广东				Team B B 山东				Match Number 42													
played in China		in the hall 柳州市李宁体育馆		on 27/04/2013		at 21:20 hours		Spectators													
Half-time (30')	A 9	B 12	End of playing time	A 24	B 22	1st extra time	A	B	2nd extra time	A	B	After penalty throws	A	B							
Number of 7 m	A 1/1	Team time-out			Full name of players and officials				Team time-out			B 2/2	Number of 7 m								
		1 18:57	2 35:08	3 47:48					1 28:01	2 45:07	3										
No.	Team A					G	W	2'	D	DR	No.	Team B					G	W	2'	D	DR
1	王旭兴										1	于性哲									
2	孙江山										4	田瑞									
3	曲汝洋					2					5	潘翔					2	1	1		
4	李卓洋					3	1				6	李朝鹏									
5	候生升										8	王炳华									
6	邓志贵					2	1				9	赵鑫					3				
7	付文博					3					11	宋朋强					2				
8	于彦江					3					13	刘晓									
9	徐庆										15	陈鹏波									
10	陈超										16	王帅									
12	温杰										17	王旭东					6		1		
16	张广建										18	于亚男					2	1			
17	李中洲					4	1	3			19	李语庆					2				
18	张腾					1					20	杜在超					3	1	1		
19	马跃										21	翟乾坤					2				
20	王伟					6					22	刘正松									
A	王锋										A	王鸿斌									
B	李晓忠										B	王志峰									
C	郭艳辉										C	邢建刚									
E	薛良成										D	徐强									
A	Signature of Responsible Official of the Teams (Off. A)																			B	
TP	Remarks of Referee / CHA Official																			TP	

Signatures

Referees	Andreas Bethmann	Michael Tzaferopoulos		
Techn. Delegates	许宜扬 (CHN)	李之文 (CHN)		
CHA Official				

Note: Number of 7m Throws Awarded to Team A and B, Goals (G), Warnings (W), Suspensions (2'), Direct Disqualification (D), Disqualification with Report (DR) and Team Penalty (TP).

Table Officials:

Statisticians: 黄莉

朱伟平

Printed by PHMS Copyright: IHF / CHA 27/04/2013 22:52:41

Longman Sportsoft



handball@126.com



第十二届全国运动会男子手球预赛 竞赛技术统计(媒体表)

Match header table with columns: 复赛, 组别 C, 轮次 9, 场次 42, 柳州市李宁体育馆, 27/04/2013, 201301042-51-1/1, 广东 vs 山东, 9:12

Referee table: 裁判员 Andreas Bethmann (GRE) / Michael Tzaferopoulos (GRE)

Main statistics table for Guangdong and Shandong teams, including player names, goals, assists, and game progress.

场上队员: 得分 / 射门

守门员: 救球 / 射门

Legend table for abbreviations: 快攻, 突破, 任意球, 7m球, 助攻, 警告, 失误, 取消资格+报告





第十二届全国运动会男子手球预赛 图式比赛技术统计表

轮次 9

场次 42

201301042-21-1/1

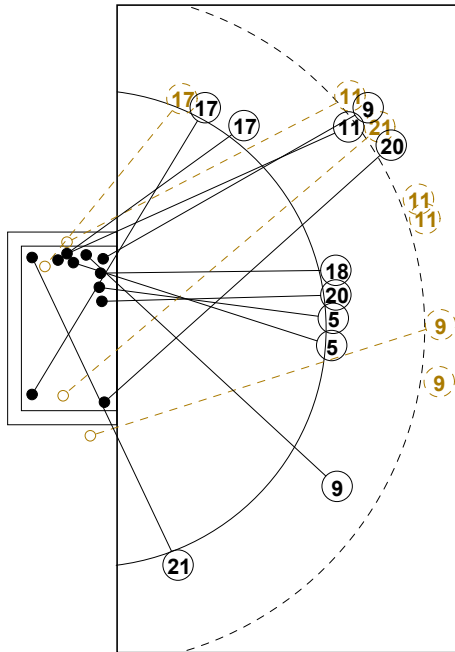

7M 山东

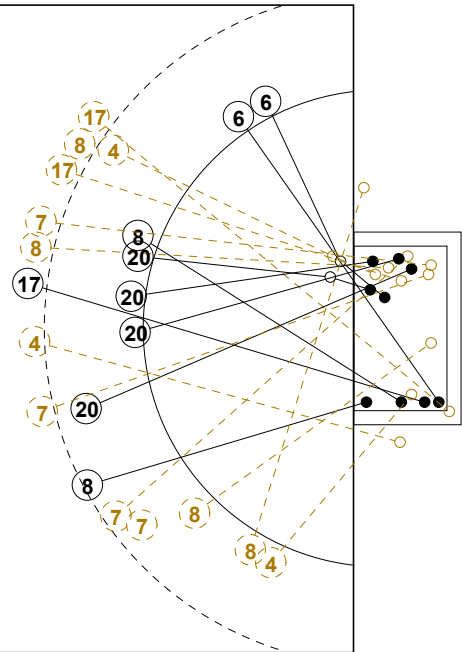
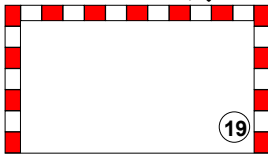

广东 7M



1st Half
12 : 9

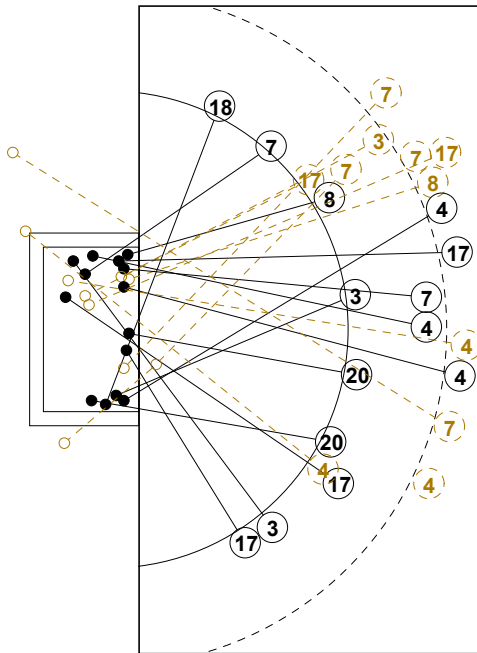

7M 广东

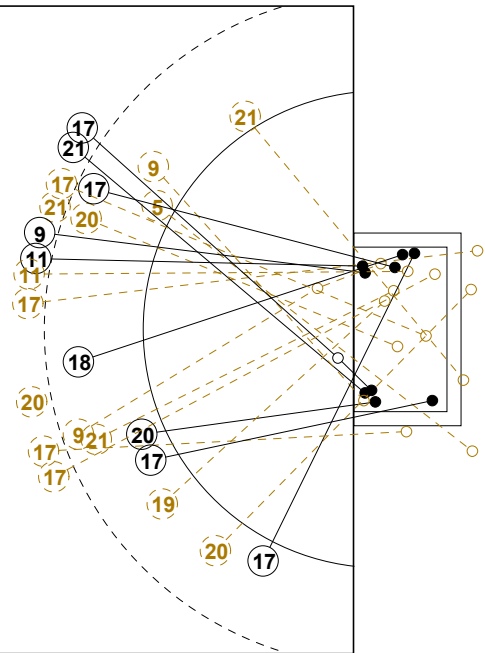
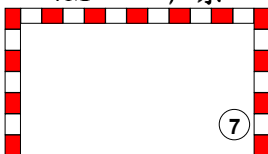

山东 7M



2nd Half
24 : 22



第十二届全国运动会男子手球预赛

个人/全队技术统计表

正式表
手球
男子复赛
轮次 9组别 C
场次 42201301042-14-1/2
柳州市李宁体育馆
27/04/2013 21:20

号码	姓名	远射	近射	边射	快攻	突破	任意	7M	合计	%	助攻	失误	警告	2'	取消	时间
广东(广东)																
<i>(场上队员)</i>																
1	王旭兴									0.0%						00:30:00
2	孙江山									0.0%						00:00:00
3	曲汝洋	0/1			2/2				2/3	66.7%	1					00:59:41
4	李卓洋	3/7	0/1	0/1					3/9	33.3%	1		1			00:37:19
5	候生升									0.0%						00:00:00
6	邓志贵			1/1	1/1				2/2	100%		1	1			00:30:50
7	付文博	1/7	0/1		1/1		0/1	1/1	3/11	27.3%	3	4				00:58:44
8	于彦江	1/4	1/2	0/1		1/1			3/8	37.5%	1	4				00:41:58
9	徐庆									0.0%						00:00:00
10	陈超									0.0%						00:00:00
12	温杰									0.0%						00:00:00
16	张广建									0.0%	1					00:30:00
17	李中洲	1/4	1/2	1/1			1/1		4/8	50.0%		2	1	3		00:49:32
18	张腾			1/1					1/1	100%						00:19:44
19	马跃									0.0%						00:00:00
20	王伟		4/4			2/2			6/6	100%		2				00:59:32
合计		6/23	6/10	3/5	4/4	3/3	1/2	1/1	24/48	50.0%	7	13	3	3		
<i>(守门员)</i>																
1	王旭兴	1/4	0/4	1/2	0/3			0/1	2/14	14.3%						00:30:00
16	张广建	5/9	2/2	0/1	1/4	0/1		0/1	8/18	44.4%	1					00:30:00
合计		6/13	2/6	1/3	1/7	0/1		0/2	10/32	31.3%	1					

场上队员：得分/射门

守门员：救球/射门

全队合计	得分	被救	射失	击柱	封球	合计	%
远射	6	11	1	1	4	23	26.1%
近射	6	2	2			10	60.0%
边射	3	1	1			5	60.0%
快攻	4					4	100.0%
突破	3					3	100.0%
任意	1		1			2	50.0%
7M	1					1	100.0%





第十二届全国运动会男子手球预赛

个人/全队技术统计表

正式表
手球
男子复赛
轮次 9组别 C
场次 42201301042-14-2/2
柳州市李宁体育馆
27/04/2013 21:20

号码	姓名	远射	近射	边射	快攻	突破	任意	7M	合计	%	助攻	失误	警告	2'	取消	时间
山东(山东)																
<i>(上场队员)</i>																
1	于性哲									0.0%						00:00:00
4	田瑞									0.0%						00:00:00
5	潘翔		2/3						2/3	66.7%		1	1	1		00:41:00
6	李朝鹏									0.0%						00:00:00
8	王炳华									0.0%						00:00:00
9	赵鑫	2/4	1/2				0/1		3/7	42.9%	1	1				00:40:02
11	宋朋强	2/6							2/6	33.3%		1				00:58:18
13	刘晓									0.0%						00:00:00
15	陈鹏波									0.0%						00:17:41
16	王帅									0.0%						00:42:10
17	王旭东	1/4		1/2	4/4		0/1		6/11	54.5%	1	3		1		00:57:06
18	于亚男				2/2				2/2	100%	1		1			00:19:25
19	李语庆		0/1					2/2	2/3	66.7%						00:10:13
20	杜在超	1/3	1/1	0/1		1/1			3/6	50.0%		5	1	1		00:52:44
21	翟乾坤	1/3		1/2	0/1				2/6	33.3%		3				01:00:00
22	刘正松									0.0%						00:17:48
合计		7/20	4/7	2/5	6/7	1/1	0/2	2/2	22/44	50.0%	3	14	3	3		
<i>(守门员)</i>																
16	王帅	9/12	2/5	0/2	0/3	0/3	0/1	0/1	11/27	40.7%						00:42:10
22	刘正松	2/5	0/3	1/2	0/1				3/11	27.3%						00:17:48
合计		11/17	2/8	1/4	0/4	0/3	0/1	0/1	14/38	36.8%						

场上队员：得分/射门

守门员：救球/射门

全队合计	得分	被救	射失	击柱	封球	合计	%
远射	7	6	1	1	5	20	35.0%
近射	4	2	1			7	57.1%
边射	2	1	2			5	40.0%
快攻	6	1				7	85.7%
突破	1					1	100.0%
任意			2			2	0.0%
7M	2					2	100.0%





第十二届全国运动会男子手球预赛

图式射门区域统计

轮次 9 场次 42

201301042-41-1/1

广东

1 王旭兴	2 孙江山	3 曲汝洋	4 李卓洋	5 候生升	6 邓志贵	7 付云博	8 于彦江																																																																								
<table border="1"><tr><td></td><td></td><td></td></tr><tr><td></td><td></td><td></td></tr><tr><td></td><td></td><td></td></tr></table>										<table border="1"><tr><td></td><td></td><td></td></tr><tr><td></td><td></td><td></td></tr><tr><td></td><td></td><td></td></tr></table>										<table border="1"><tr><td></td><td></td><td>1</td></tr><tr><td></td><td></td><td></td></tr><tr><td>1</td><td></td><td></td></tr></table>			1				1			<table border="1"><tr><td></td><td></td><td></td></tr><tr><td></td><td></td><td>1</td></tr><tr><td>1</td><td></td><td>1</td></tr></table>						1	1		1	<table border="1"><tr><td></td><td></td><td></td></tr><tr><td></td><td></td><td></td></tr><tr><td></td><td></td><td></td></tr></table>										<table border="1"><tr><td></td><td></td><td>1</td></tr><tr><td>1</td><td></td><td></td></tr><tr><td></td><td></td><td></td></tr></table>			1	1						<table border="1"><tr><td></td><td></td><td></td></tr><tr><td></td><td></td><td>1</td></tr><tr><td></td><td></td><td>2</td></tr></table>						1			2	<table border="1"><tr><td></td><td></td><td></td></tr><tr><td></td><td></td><td>1</td></tr><tr><td></td><td></td><td>2</td></tr></table>						1			2
		1																																																																													
1																																																																															
		1																																																																													
1		1																																																																													
		1																																																																													
1																																																																															
		1																																																																													
		2																																																																													
		1																																																																													
		2																																																																													
Post - 0 Miss - 0 Block - 0	Post - 0 Miss - 0 Block - 0	Post - 0 Miss - 0 Block - 0	Post - 0 Miss - 2 Block - 1	Post - 0 Miss - 0 Block - 0	Post - 0 Miss - 0 Block - 0	Post - 0 Miss - 2 Block - 2	Post - 0 Miss - 1 Block - 1																																																																								
9 徐庆	10 陈超	12 温杰	16 张广建	17 李中洲	18 张腾	19 马跃	20 王伟																																																																								
<table border="1"><tr><td></td><td></td><td></td></tr><tr><td></td><td></td><td></td></tr><tr><td></td><td></td><td></td></tr></table>										<table border="1"><tr><td></td><td></td><td></td></tr><tr><td></td><td></td><td></td></tr><tr><td></td><td></td><td></td></tr></table>										<table border="1"><tr><td></td><td></td><td></td></tr><tr><td></td><td></td><td></td></tr><tr><td></td><td></td><td></td></tr></table>										<table border="1"><tr><td></td><td></td><td></td></tr><tr><td></td><td></td><td></td></tr><tr><td></td><td></td><td></td></tr></table>										<table border="1"><tr><td></td><td></td><td>2</td></tr><tr><td></td><td></td><td></td></tr><tr><td>1</td><td></td><td>1</td></tr></table>			2				1		1	<table border="1"><tr><td></td><td></td><td></td></tr><tr><td>1</td><td></td><td></td></tr><tr><td></td><td></td><td></td></tr></table>				1						<table border="1"><tr><td></td><td></td><td></td></tr><tr><td></td><td></td><td></td></tr><tr><td></td><td></td><td></td></tr></table>										<table border="1"><tr><td></td><td></td><td></td></tr><tr><td></td><td></td><td>3</td></tr><tr><td>2</td><td></td><td>1</td></tr></table>						3	2		1
		2																																																																													
1		1																																																																													
1																																																																															
		3																																																																													
2		1																																																																													
Post - 0 Miss - 0 Block - 0	Post - 0 Miss - 0 Block - 0	Post - 0 Miss - 0 Block - 0	Post - 0 Miss - 0 Block - 0	Post - 1 Miss - 0 Block - 0	Post - 0 Miss - 0 Block - 0	Post - 0 Miss - 0 Block - 0	Post - 0 Miss - 0 Block - 0																																																																								

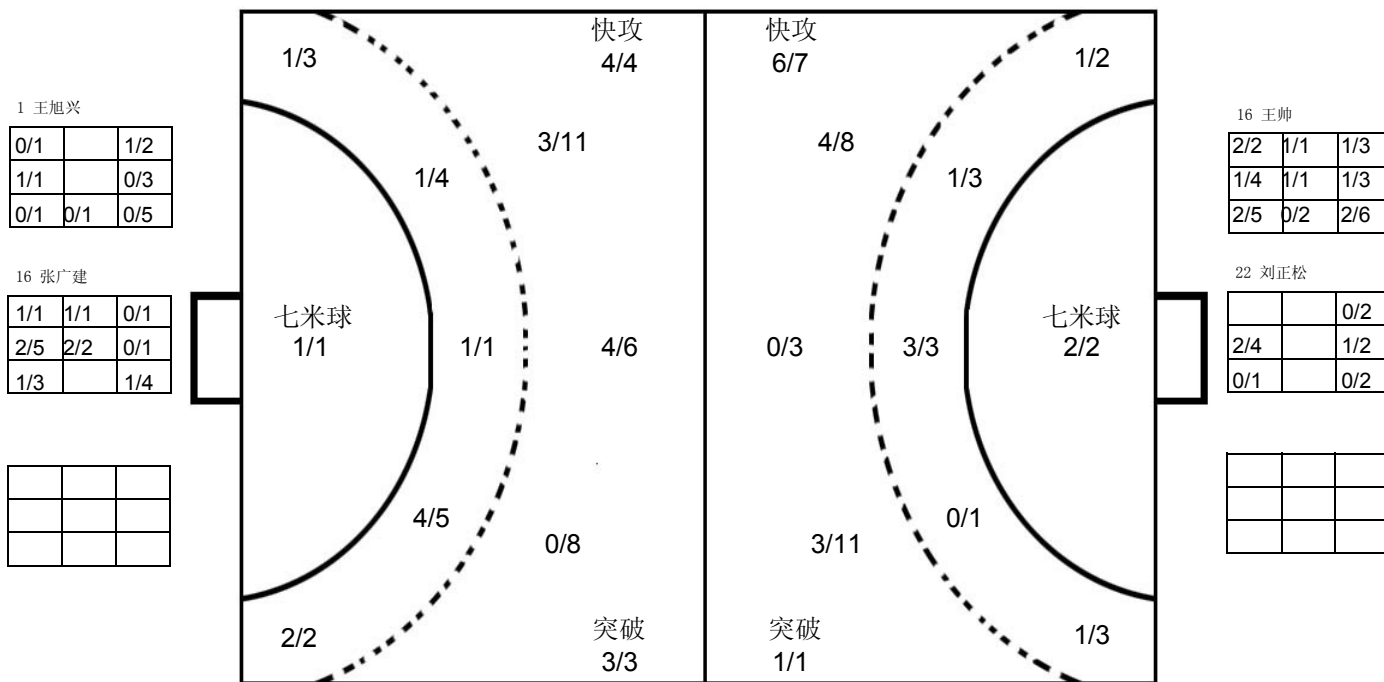

山东

1 于性哲	4 田瑞	5 潘翔	6 李朝鹏	8 王炳华	9 赵鑫	11 宋朋强	13 刘晓																																																																								
<table border="1"><tr><td></td><td></td><td></td></tr><tr><td></td><td></td><td></td></tr><tr><td></td><td></td><td></td></tr></table>										<table border="1"><tr><td></td><td></td><td></td></tr><tr><td></td><td></td><td></td></tr><tr><td></td><td></td><td></td></tr></table>										<table border="1"><tr><td></td><td></td><td>1</td></tr><tr><td></td><td></td><td>1</td></tr><tr><td></td><td></td><td></td></tr></table>			1			1				<table border="1"><tr><td></td><td></td><td></td></tr><tr><td></td><td></td><td></td></tr><tr><td></td><td></td><td></td></tr></table>										<table border="1"><tr><td></td><td></td><td></td></tr><tr><td></td><td></td><td></td></tr><tr><td></td><td></td><td></td></tr></table>										<table border="1"><tr><td></td><td></td><td></td></tr><tr><td></td><td></td><td></td></tr><tr><td>1</td><td></td><td>2</td></tr></table>							1		2	<table border="1"><tr><td></td><td></td><td></td></tr><tr><td></td><td></td><td></td></tr><tr><td>1</td><td></td><td></td></tr></table>							1			<table border="1"><tr><td></td><td></td><td></td></tr><tr><td></td><td></td><td></td></tr><tr><td></td><td></td><td></td></tr></table>									
		1																																																																													
		1																																																																													
1		2																																																																													
1																																																																															
Post - 0 Miss - 0 Block - 0	Post - 0 Miss - 0 Block - 0	Post - 0 Miss - 1 Block - 0	Post - 0 Miss - 0 Block - 0	Post - 0 Miss - 0 Block - 0	Post - 0 Miss - 1 Block - 1	Post - 1 Miss - 0 Block - 2	Post - 0 Miss - 0 Block - 0																																																																								
15 陈鹏波	16 王帅	17 王旭东	18 于亚男	19 李语庆	20 杜在超	21 翟乾坤	22 刘正松																																																																								
<table border="1"><tr><td></td><td></td><td></td></tr><tr><td></td><td></td><td></td></tr><tr><td></td><td></td><td></td></tr></table>										<table border="1"><tr><td></td><td></td><td></td></tr><tr><td></td><td></td><td></td></tr><tr><td></td><td></td><td></td></tr></table>										<table border="1"><tr><td>1</td><td></td><td>1</td></tr><tr><td>2</td><td></td><td>1</td></tr><tr><td></td><td></td><td>1</td></tr></table>	1		1	2		1			1	<table border="1"><tr><td></td><td></td><td></td></tr><tr><td>1</td><td></td><td></td></tr><tr><td></td><td></td><td>1</td></tr></table>				1					1	<table border="1"><tr><td></td><td></td><td></td></tr><tr><td></td><td></td><td></td></tr><tr><td></td><td></td><td>1</td></tr></table>									1	<table border="1"><tr><td></td><td></td><td></td></tr><tr><td></td><td></td><td></td></tr><tr><td>1</td><td>1</td><td>1</td></tr></table>							1	1	1	<table border="1"><tr><td></td><td></td><td></td></tr><tr><td></td><td></td><td>1</td></tr><tr><td></td><td></td><td>1</td></tr></table>						1			1	<table border="1"><tr><td></td><td></td><td></td></tr><tr><td></td><td></td><td></td></tr><tr><td></td><td></td><td></td></tr></table>									
1		1																																																																													
2		1																																																																													
		1																																																																													
1																																																																															
		1																																																																													
		1																																																																													
1	1	1																																																																													
		1																																																																													
		1																																																																													
Post - 0 Miss - 0 Block - 0	Post - 0 Miss - 0 Block - 0	Post - 0 Miss - 2 Block - 0	Post - 0 Miss - 0 Block - 0	Post - 0 Miss - 0 Block - 0	Post - 0 Miss - 1 Block - 1	Post - 0 Miss - 1 Block - 1	Post - 0 Miss - 0 Block - 0																																																																								

注释: Post=击柱 Miss=射失 Block=被封





男子 国内比赛



第十二届全国运动会男子手球预赛

Team A				Team B				Match Number													
A 四川				B 山西				43													
played in		in the hall		on		at		Spectators													
China		柳州市李宁体育馆		28/04/2013		09:00 hours															
Half-time (30')	A	B	End of playing time	A	B	1st extra time	A	B	2nd extra time	A	B	After penalty throws	A	B							
	18	14	32	32		36	33														
Number of 7 m	A	Team time-out			Full name of players and officials						Team time-out			B	Number of 7 m						
	1/1	1	2	3							1	2	3	1/2							
		15:43	49:38	59:58							40:27	54:34	1/2								
No.	Team A					G	W	2'	D	DR	No.	Team B					G	W	2'	D	DR
16	王松										1	李晋尧									
18	杨洋										2	马健					2		1		
19	杨洁										3	王晋									
21	池培俊					3	1				4	李鹏程					6				
22	刘彦坤					10	1				5	王志超									
23	王震					5	1	2			6	范帅					4	1			
25	李峥					1					7	白宇飞					4		1		
27	于洪泉										8	崔钰									
28	宋涛					8					9	朱涛涛					8				
32	逯明松										10	任海阳					1				
33	朱晓龙					5					12	侯乃章									
35	仇振勇					4					13	侯建涛									
36	刘琢										14	刘明华					4	1			
											15	景新江									
											18	朱棣					4				
A	李太平										A	王喜和									
B	李清										B	张晓东									
C	黄承										C	孙少波									
E	何明阳										D	石岩									
A	Signature of Responsible Official of the Teams (Off. A)																	B			
TP	Remarks of Referee / CHA Official																	TP			

Signatures

Referees	朱昆宏 (CHN)	刘建鹏 (CHN)		
Techn. Delegates	许宜扬 (CHN)	刘书勇 (CHN)		
CHA Official				

Note: Number of 7m Throws Awarded to Team A and B, Goals (G), Warnings (W), Suspensions (2'), Direct Disqualification (D), Disqualification with Report (DR) and Team Penalty (TP).

Table Officials:

Statisticians: 黄莉

朱伟平



第十二届全国运动会男子手球预赛
竞赛技术统计(媒体表)

11-12名	组别	X	轮次	10	场次	43
柳州市李宁体育馆		28/04/2013			201301043-51-1/1	
四川	四川	36	vs	33	山西	山西
			18 : 14			

裁判员		朱昆宏 (CHN)											刘建鹏 (CHN)																
四川		远射	近射	边射	快攻	突破	任意球	7m球	合计	%	助攻	失误	警告	2'	D & DR	四川		比赛进程		山西									
主教练: 李太平																1st Half													
16	王松														23	王震	1	00:43	0										
18	杨洋														1		1	01:12	1	4	李鹏程								
19	杨洁														21	池培俊	2	02:19	1										
21	池培俊			1/3	2/2			3/5	60.0		2	1			33	朱晓龙	3	03:06	1										
22	刘彦坤	2/3	4/4		3/4	1/1	0/1	10/13	76.9	1	6	1			4		4	05:11	2	4	李鹏程								
23	王震	1/1	3/3		1/1			5/5	100	3	1	1	2		23	王震	5	05:31	2										
25	李峥		1/1					1/1	100		1				28	宋涛	6	06:14	2										
27	于洪泉														22	刘彦坤	7	09:11	2										
28	宋涛	2/5	1/3		3/3	1/2	1/1	8/14	57.1		5				28	宋涛	8	11:28	2										
32	透明松														8		8	11:49	3	18	朱栎								
33	朱晓龙	3/8	1/2	0/1	1/1			5/12	41.7		3				8		8	13:08	4	2	马健								
35	仇振勇		2/3	0/1	2/2			4/6	66.7		2				33	朱晓龙	9	13:33	4										
36	刘琢														9		9	15:40	5	7	白宇飞								
运动员 合计		8/17	12/16	1/5	12/13	2/3	0/1	1/1	36/56	64.3	4	20	3	2	21	池培俊	10	15:57	5										
16	王松	4/6	1/3	0/1	2/7	0/4	2/2	0/1	9/24	37.5					10		10	16:39	6	18	朱栎								
36	刘琢	4/6	0/5	2/9	1/5	1/1	1/1	9/27	33.3						10		10	17:28	7	2	马健								
守门员 合计		8/12	1/8	2/10	3/12	1/5	2/2	1/2	18/51	35.3					10		10	18:41	8	4	李鹏程								
山西																2nd Half													
教练: 王喜和																19		01:51		14									
1	李晋尧														28	宋涛	20	05:12	16										
2	马健				1/1	1/1		2/2	100		1			1	22	刘彦坤	20	05:42	17	9	朱涛涛								
3	王晋														22	刘彦坤	21	06:15	17										
4	李鹏程	1/2	4/5		1/1		0/2	6/10	60.0	1	2				35	仇振勇	21	07:01	18	9	朱涛涛								
5	王志超														33	朱晓龙	22	08:45	19	4	李鹏程								
6	范帅			0/1	4/5			4/6	66.7		2	1			22	刘彦坤	23	09:02	19										
7	白宇飞	2/8	1/1					1/1	4/10	40.0	1	4		1	22	刘彦坤	23	09:57	20	14	刘明华								
8	崔钰														24		24	10:23	20										
9	朱涛涛			7/9	1/1			8/10	80.0	1	4				24		24	10:49	21	18	朱栎								
10	任海阳	0/2			1/1			1/3	33.3		1				24		24	11:37	22	4	李鹏程								
12	侯乃章														23	王震	25	11:58	22										
13	侯建涛														25		25	14:26	23	6	范帅								
14	刘明华	0/3	1/1	1/1		2/2	0/1	4/8	50.0		3	1			25		25	15:19	24	6	范帅								
15	景新江														23	王震	26	16:41	24										
18	朱栎	1/2	1/1	0/1	1/3	1/2		4/9	44.4		3				23	王震	26	17:17	25	9	朱涛涛								
运动员 合计		4/17	7/8	8/12	9/12	4/5	0/2	1/2	33/58	56.9	4	23	2	2	26		26	18:10	26	6	范帅								
1	李晋尧	3/11	1/13	3/4	1/13	1/3	0/1	9/45	20.0	1					27		27	18:36	26										
守门员 合计		3/11	1/13	3/4	1/13	1/3	0/1	9/45	20.0	1					27		27	19:23	27	7	白宇飞								
场上队员: 得分 / 射门																22		21:02		28		6		范帅					
守门员: 救球 / 射门																22		21:44		28									
																22		23:02		28									
																29		23:29		29		9		朱涛涛					
																30		24:27		29									
																30		24:56		30		9		朱涛涛					
																31		25:19		30									
																31		27:46		31		9		朱涛涛					
																31		28:29		32		7		白宇飞					
																32		29:09		32									
																Ext. 1-1													
																28		宋涛		33		01:31		32					
																22		刘彦坤		34		02:42		32					
																Ext. 1-2													
																22		刘彦坤		35		01:00		32					
																22		刘彦坤		35		04:22		33		9		朱涛涛	
																22		刘彦坤		36		04:46		33					

快攻	Fast Break	突破	Breakthrough	任意球	Free Throw	7M球	7M Throw	助攻	Assist
警告	Warning	失误	Error	2'	Suspension	D	取消资格	DR	取消资格+报告





第十二届全国运动会男子手球预赛 图式比赛技术统计表

轮次 10

场次 43

201301043-21-1/1

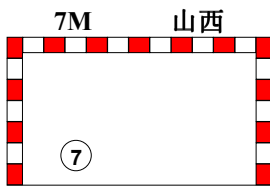
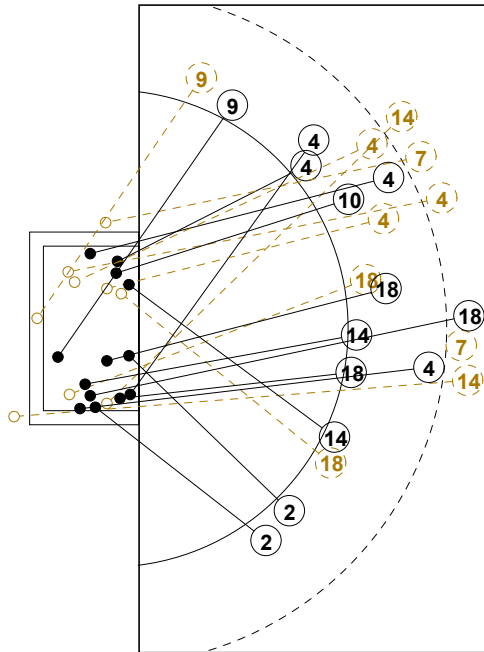

1st Half
14 : 18

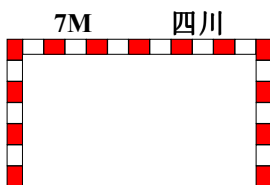
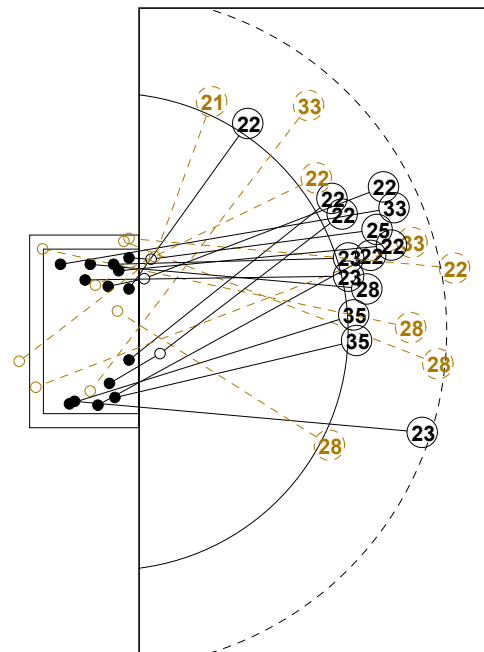
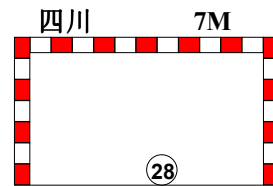
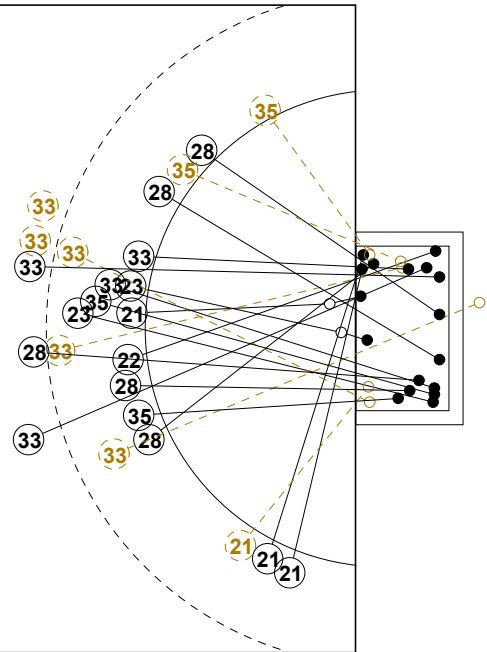

2nd Half
32 : 32

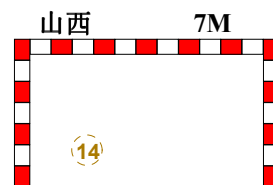
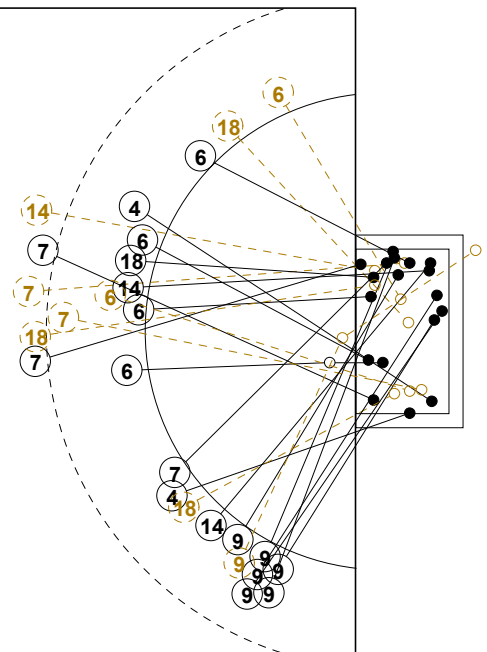



第十二届全国运动会男子手球预赛 图式比赛技术统计表

轮次 10

场次 43

201301043-21-1/1

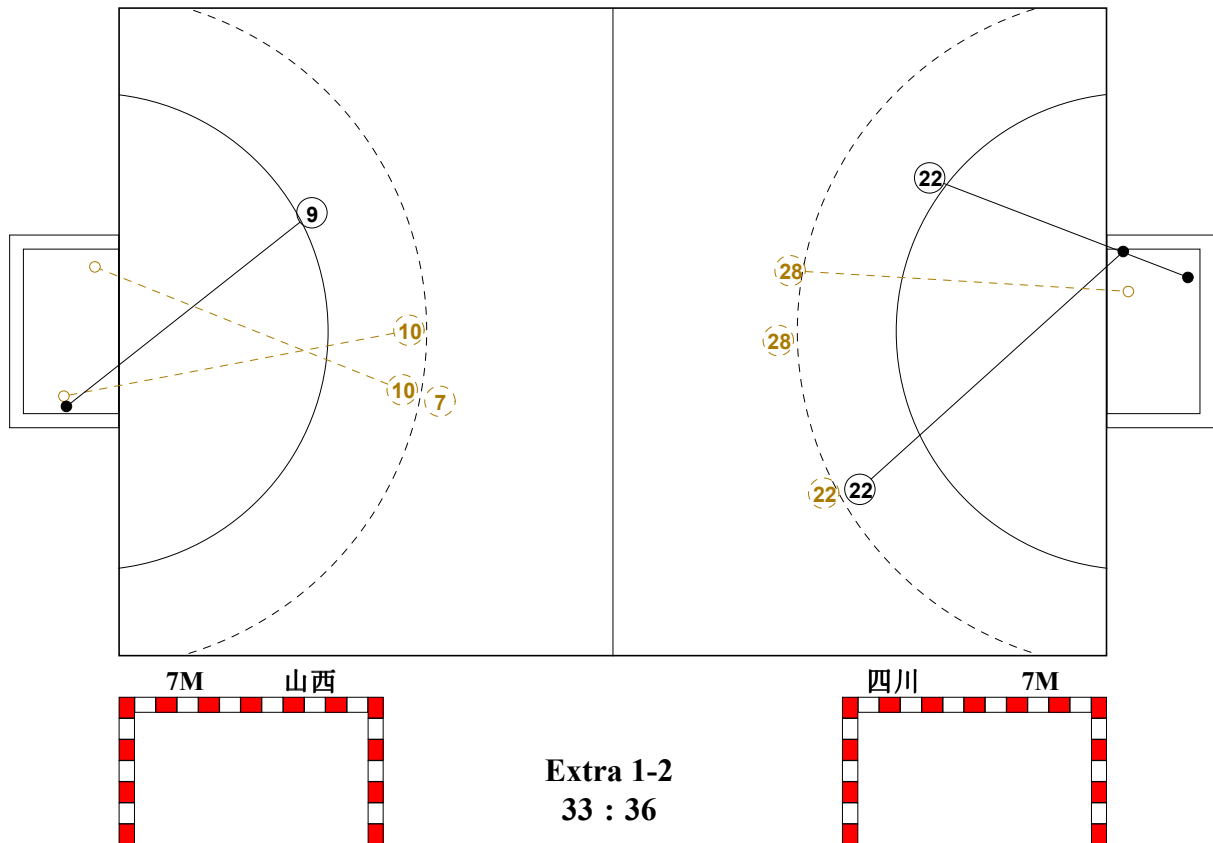
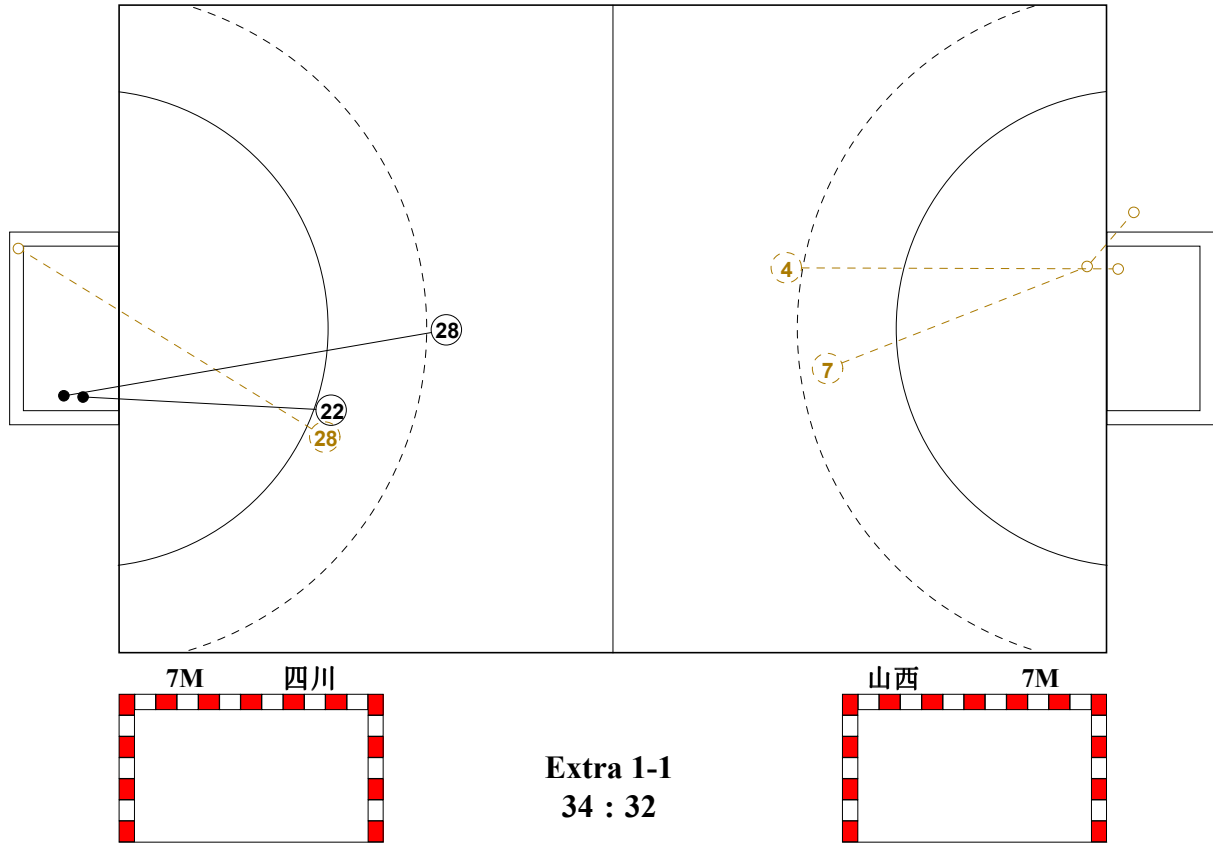



第十二届全国运动会男子手球预赛

个人/全队技术统计表

正式表
手球
男子11-12名
轮次 10组别 X
场次 43201301043-14-1/2
柳州市李宁体育馆
28/04/2013 09:00

号码	姓名	远射	近射	边射	快攻	突破	任意	7M	合计	%	助攻	失误	警告	2'	取消	时间
四川(四川)																
<i>(场上队员)</i>																
16	王松									0.0%						00:39:19
18	杨洋									0.0%						00:00:00
19	杨洁									0.0%						00:00:00
21	池培俊			1/3	2/2				3/5	60.0%	2	1				01:09:09
22	刘彦坤	2/3	4/4		3/4	1/1	0/1		10/13	76.9%	1	6	1			01:09:25
23	王震	1/1	3/3		1/1				5/5	100%	3	1	1	2		00:52:45
25	李峥		1/1						1/1	100%		1				00:55:43
27	于洪泉									0.0%						00:00:00
28	宋涛	2/5	1/3		3/3	1/2		1/1	8/14	57.1%		5				01:09:26
32	逯明松									0.0%						00:00:00
33	朱晓龙	3/8	1/2	0/1	1/1				5/12	41.7%		3				01:00:21
35	仇振勇		2/3	0/1	2/2				4/6	66.7%		2				00:38:58
36	刘琢									0.0%						00:30:30
合计																
<i>(守门员)</i>																
16	王松	4/6	1/3	0/1	2/7	0/4	2/2	0/1	9/24	37.5%						00:39:19
36	刘琢	4/6	0/5	2/9	1/5	1/1		1/1	9/27	33.3%						00:30:30
合计																
		8/12	1/8	2/10	3/12	1/5	2/2	1/2	18/51	35.3%						

场上队员：得分/射门

守门员：救球/射门

全队合计	得分	被救	射失	击柱	封球	合计	%
远射	8	3		2	4	17	47.1%
近射	12	1	1	2		16	75.0%
边射	1	3	1			5	20.0%
快攻	12	1				13	92.3%
突破	2	1				3	66.7%
任意				1		1	0.0%
7M	1					1	100.0%





第十二届全国运动会男子手球预赛

个人/全队技术统计表

正式表
手球
男子11-12名
轮次 10组别 X
场次 43201301043-14-2/2
柳州市李宁体育馆
28/04/2013 09:00

号码	姓名	远射	近射	边射	快攻	突破	任意	7M	合计	%	助攻	失误	警告	2'	取消	时间
山西(山西)																
<i>(上场队员)</i>																
1	李晋尧									0.0%	1					01:05:30
2	马健				1/1	1/1			2/2	100%		2		1		00:30:57
3	王晋									0.0%		2				00:54:33
4	李鹏程	1/2	4/5		1/1		0/2		6/10	60.0%	1	2				01:10:00
5	王志超									0.0%						00:00:00
6	范帅			0/1	4/5				4/6	66.7%		2	1			00:24:22
7	白宇飞	2/8	1/1					1/1	4/10	40.0%	1	4		1		00:56:07
8	崔钰									0.0%						00:00:00
9	朱涛涛			7/9	1/1				8/10	80.0%	1	4				01:09:54
10	任海阳	0/2			1/1				1/3	33.3%		1				00:03:26
12	侯乃章									0.0%						00:00:00
13	侯建涛									0.0%						00:00:00
14	刘明华	0/3	1/1	1/1		2/2		0/1	4/8	50.0%		3	1			00:52:47
15	景新江									0.0%						00:00:00
18	朱棣	1/2	1/1	0/1	1/3	1/2			4/9	44.4%		3				00:57:22
合计		4/17	7/8	8/12	9/12	4/5	0/2	1/2	33/58	56.9%	4	23	2	2		
<i>(守门员)</i>																
1	李晋尧	3/11	1/13	3/4	1/13	1/3		0/1	9/45	20.0%	1					01:05:30
合计		3/11	1/13	3/4	1/13	1/3		0/1	9/45	20.0%	1					

场上队员：得分/射门

守门员：救球/射门

全队合计	得分	被救	射失	击柱	封球	合计	%
远射	4	8	3		2	17	23.5%
近射	7	1				8	87.5%
边射	8	2	1	1		12	66.7%
快攻	9	3				12	75.0%
突破	4	1				5	80.0%
任意		2				2	0.0%
7M	1	1				2	50.0%





第十二届全国运动会男子手球预赛

图式射门区域统计

轮次 10 场次 43

201301043-41-1/1

四川

16 王松	18 杨洋	19 杨洁	21 池培俊	22 刘彦坤	23 王震	25 李峥	27 于洪泉																																																																								
<table border="1"><tr><td></td><td></td><td></td></tr><tr><td></td><td></td><td></td></tr><tr><td></td><td></td><td></td></tr></table>										<table border="1"><tr><td></td><td></td><td></td></tr><tr><td></td><td></td><td></td></tr><tr><td></td><td></td><td></td></tr></table>										<table border="1"><tr><td></td><td></td><td></td></tr><tr><td></td><td></td><td></td></tr><tr><td></td><td></td><td></td></tr></table>										<table border="1"><tr><td></td><td></td><td></td></tr><tr><td></td><td></td><td></td></tr><tr><td>3</td><td></td><td></td></tr></table>							3			<table border="1"><tr><td>2</td><td></td><td></td></tr><tr><td>2</td><td></td><td></td></tr><tr><td>3</td><td></td><td>3</td></tr></table>	2			2			3		3	<table border="1"><tr><td>1</td><td></td><td>1</td></tr><tr><td></td><td></td><td>1</td></tr><tr><td></td><td>1</td><td>1</td></tr></table>	1		1			1		1	1	<table border="1"><tr><td></td><td></td><td></td></tr><tr><td></td><td></td><td></td></tr><tr><td></td><td></td><td>1</td></tr></table>									1	<table border="1"><tr><td></td><td></td><td></td></tr><tr><td></td><td></td><td></td></tr><tr><td></td><td></td><td></td></tr></table>									
3																																																																															
2																																																																															
2																																																																															
3		3																																																																													
1		1																																																																													
		1																																																																													
	1	1																																																																													
		1																																																																													
Post - 0 Miss - 0 Block - 0	Post - 0 Miss - 0 Block - 0	Post - 0 Miss - 0 Block - 0	Post - 0 Miss - 1 Block - 0	Post - 1 Miss - 0 Block - 1	Post - 0 Miss - 0 Block - 0	Post - 0 Miss - 0 Block - 0	Post - 0 Miss - 0 Block - 0																																																																								
28 宋涛	32 逯明松	33 朱晓龙	35 仇振勇	36 刘琢																																																																											
<table border="1"><tr><td></td><td>1</td><td>2</td></tr><tr><td>1</td><td></td><td>2</td></tr><tr><td>1</td><td>1</td><td></td></tr></table>		1	2	1		2	1	1		<table border="1"><tr><td></td><td></td><td></td></tr><tr><td></td><td></td><td></td></tr><tr><td></td><td></td><td></td></tr></table>										<table border="1"><tr><td>2</td><td></td><td>2</td></tr><tr><td>1</td><td></td><td></td></tr><tr><td></td><td></td><td></td></tr></table>	2		2	1						<table border="1"><tr><td>1</td><td></td><td>1</td></tr><tr><td></td><td></td><td>1</td></tr><tr><td>1</td><td></td><td></td></tr></table>	1		1			1	1			<table border="1"><tr><td></td><td></td><td></td></tr><tr><td></td><td></td><td></td></tr><tr><td></td><td></td><td></td></tr></table>										<table border="1"><tr><td></td><td></td><td></td></tr><tr><td></td><td></td><td></td></tr><tr><td></td><td></td><td></td></tr></table>										<table border="1"><tr><td></td><td></td><td></td></tr><tr><td></td><td></td><td></td></tr><tr><td></td><td></td><td></td></tr></table>										<table border="1"><tr><td></td><td></td><td></td></tr><tr><td></td><td></td><td></td></tr><tr><td></td><td></td><td></td></tr></table>									
	1	2																																																																													
1		2																																																																													
1	1																																																																														
2		2																																																																													
1																																																																															
1		1																																																																													
		1																																																																													
1																																																																															
Post - 3 Miss - 0 Block - 1	Post - 0 Miss - 0 Block - 0	Post - 1 Miss - 1 Block - 2	Post - 0 Miss - 0 Block - 0	Post - 0 Miss - 0 Block - 0																																																																											

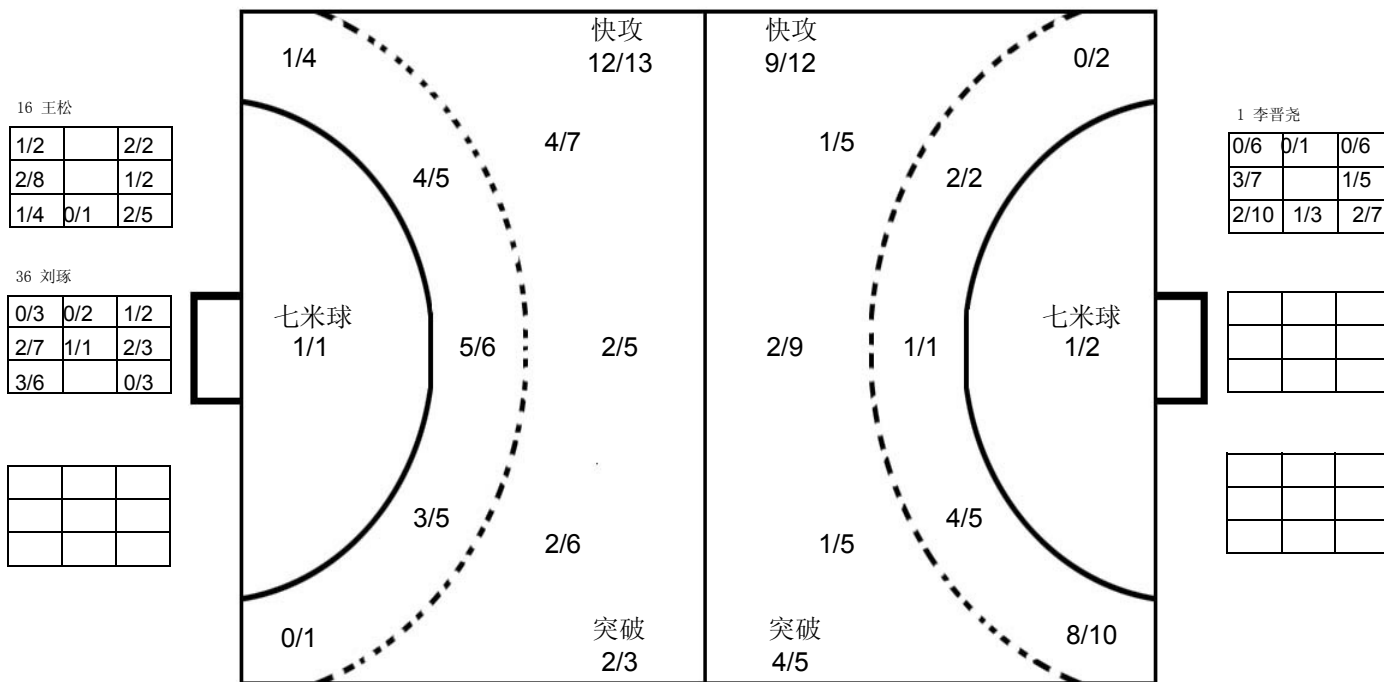

山西

1 李晋尧	2 马健	3 王晋	4 李鹏程	5 王志超	6 范帅	7 白宇飞	8 崔钰																																																																								
<table border="1"><tr><td></td><td></td><td></td></tr><tr><td></td><td></td><td></td></tr><tr><td></td><td></td><td></td></tr></table>										<table border="1"><tr><td></td><td></td><td></td></tr><tr><td>1</td><td></td><td></td></tr><tr><td></td><td>1</td><td></td></tr></table>				1				1		<table border="1"><tr><td></td><td></td><td></td></tr><tr><td></td><td></td><td></td></tr><tr><td></td><td></td><td></td></tr></table>										<table border="1"><tr><td></td><td></td><td>1</td></tr><tr><td>1</td><td></td><td>2</td></tr><tr><td>1</td><td></td><td>1</td></tr></table>			1	1		2	1		1	<table border="1"><tr><td></td><td></td><td></td></tr><tr><td></td><td></td><td></td></tr><tr><td></td><td></td><td></td></tr></table>										<table border="1"><tr><td></td><td></td><td></td></tr><tr><td>1</td><td></td><td></td></tr><tr><td>1</td><td></td><td>2</td></tr></table>				1			1		2	<table border="1"><tr><td></td><td></td><td></td></tr><tr><td>1</td><td></td><td></td></tr><tr><td>2</td><td></td><td>1</td></tr></table>				1			2		1	<table border="1"><tr><td></td><td></td><td></td></tr><tr><td></td><td></td><td></td></tr><tr><td></td><td></td><td></td></tr></table>									
1																																																																															
	1																																																																														
		1																																																																													
1		2																																																																													
1		1																																																																													
1																																																																															
1		2																																																																													
1																																																																															
2		1																																																																													
Post - 0 Miss - 0 Block - 0	Post - 0 Miss - 0 Block - 0	Post - 0 Miss - 0 Block - 0	Post - 0 Miss - 0 Block - 0	Post - 0 Miss - 0 Block - 0	Post - 0 Miss - 0 Block - 0	Post - 0 Miss - 2 Block - 2	Post - 0 Miss - 0 Block - 0																																																																								
9 朱涛涛	10 任海阳	12 侯乃章	13 侯建涛	14 刘明华	15 景新江	18 朱棣																																																																									
<table border="1"><tr><td>2</td><td>2</td><td></td></tr><tr><td>4</td><td></td><td></td></tr><tr><td></td><td></td><td></td></tr></table>	2	2		4						<table border="1"><tr><td></td><td></td><td></td></tr><tr><td></td><td></td><td></td></tr><tr><td></td><td></td><td>1</td></tr></table>									1	<table border="1"><tr><td></td><td></td><td></td></tr><tr><td></td><td></td><td></td></tr><tr><td></td><td></td><td></td></tr></table>										<table border="1"><tr><td></td><td></td><td></td></tr><tr><td></td><td></td><td></td></tr><tr><td></td><td></td><td></td></tr></table>										<table border="1"><tr><td>2</td><td></td><td></td></tr><tr><td>1</td><td></td><td></td></tr><tr><td></td><td></td><td>1</td></tr></table>	2			1					1	<table border="1"><tr><td></td><td></td><td></td></tr><tr><td></td><td></td><td></td></tr><tr><td></td><td></td><td></td></tr></table>										<table border="1"><tr><td></td><td></td><td></td></tr><tr><td>2</td><td></td><td></td></tr><tr><td>2</td><td></td><td></td></tr></table>				2			2			<table border="1"><tr><td></td><td></td><td></td></tr><tr><td></td><td></td><td></td></tr><tr><td></td><td></td><td></td></tr></table>									
2	2																																																																														
4																																																																															
		1																																																																													
2																																																																															
1																																																																															
		1																																																																													
2																																																																															
2																																																																															
Post - 1 Miss - 1 Block - 0	Post - 0 Miss - 0 Block - 0	Post - 0 Miss - 0 Block - 0	Post - 0 Miss - 0 Block - 0	Post - 0 Miss - 1 Block - 0	Post - 0 Miss - 0 Block - 0	Post - 0 Miss - 0 Block - 0																																																																									

注释: Post=击柱 Miss=射失 Block=被封





男子 国内比赛



第十二届全国运动会男子手球预赛

Team A A 安徽										Team B B 西藏										Match Number 44									
played in China					in the hall 柳州市李宁体育馆					on 28/04/2013		at 10:40 hours		Spectators															
Half-time (30')		A 18		B 12		End of playing time		A 39		B 24		1st extra time		A		B		2nd extra time		A		B		After penalty throws		A		B	
Number of 7 m		A 5 / 6		Team time-out			Full name of players and officials										Team time-out			B 5 / 5		Number of 7 m							
No.	Team A							G	W	2'	D	DR	No.	Team B							G	W	2'	D	DR				
1	高逸凡												2	王龙							1								
2	周兰骏												4	张家纬							4		1						
5	马鹏							11					5	冯祥龙															
6	田耕												6	任启双							3								
7	姚雄敏												7	徐奕飞							3		2						
8	董智景							2					9	王博							3								
10	陈强龙							5	1	1			10	刘江															
11	黎涛							5					11	朱治宇							5								
12	曾献辰												12	张帅															
15	邵青							3					15	刘劲松															
17	解维维												16	徐畅															
18	郭赛												18	赵楠							5	1							
28	袁龙							4	1				19	任野															
29	顾先亮							3					20	顾艳超															
32	王超							4					21	马光															
33	曹振吉							2	1				23	王伟强															
A	王来黔												A	张文韬															
B	刘晓蓓												B	殷永军															
C	高恒勤												C	瓮勇															
A		Signature of Responsible Official of the Teams (Off. A)										B																	
TP	Remarks of Referee / CHA Official										TP																		

Signatures

Referees: 李刚 (CHN) 王科 (CHN)

Techn. Delegates: 许宜扬 (CHN) 刘书勇 (CHN)

CHA Official: _____

Note: Number of 7m Throws Awarded to Team A and B, Goals (G), Warnings (W), Suspensions (2), Direct Disqualification (D), Disqualification with Report (DR) and Team Penalty (TP).

Table Officials:

Statisticians: 黄莉

朱伟平





第十二届全国运动会男子手球预赛
竞赛技术统计(媒体表)

Match header table with columns: 9-10名, 组别, X, 轮次, 10, 场次, 44. Includes date 28/04/2013 and venue 柳州市李宁体育馆.

Referee table: 裁判员 李刚 (CHN) / 王科 (CHN)

Main statistics table for 安徽 team, including columns for shooting (远, 近, 边), attacks (快, 突, 任意), and totals (合计, %).

Main statistics table for 西藏 team, including columns for shooting (远, 近, 边), attacks (快, 突, 任意), and totals (合计, %).

Match progression table (比赛进程) showing player names and numbers for both teams across different time intervals.

Summary table for on-court players (场上队员) and goalkeepers (守门员), listing statistics like Fast Break, Breakthrough, Free Throw, 7M Throw, and Assist.



第十二届全国运动会男子手球预赛 图式比赛技术统计表

轮次 10

场次 44

201301044-21-1/1

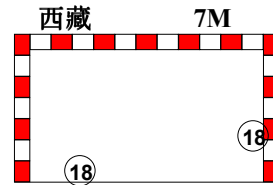
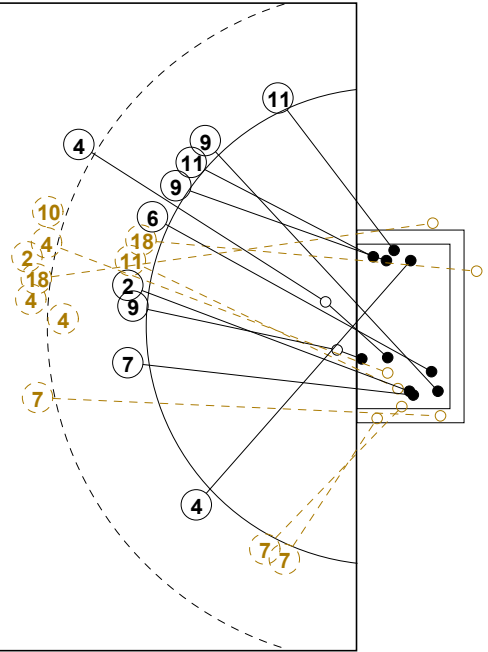
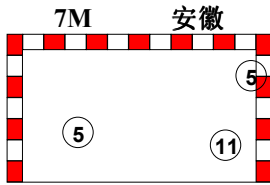
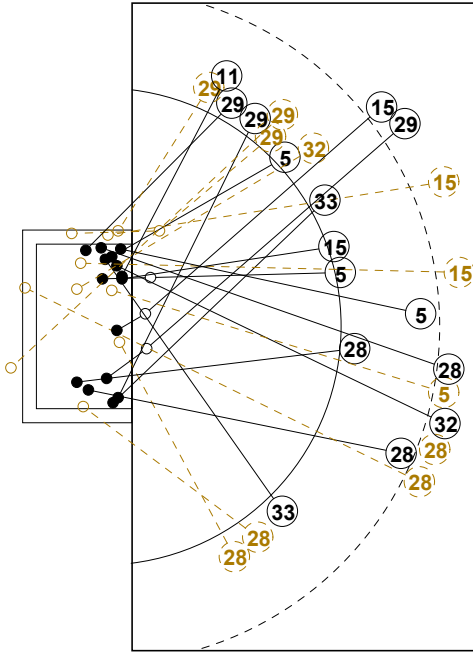

1st Half
18 : 12

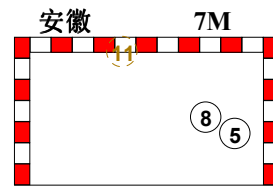
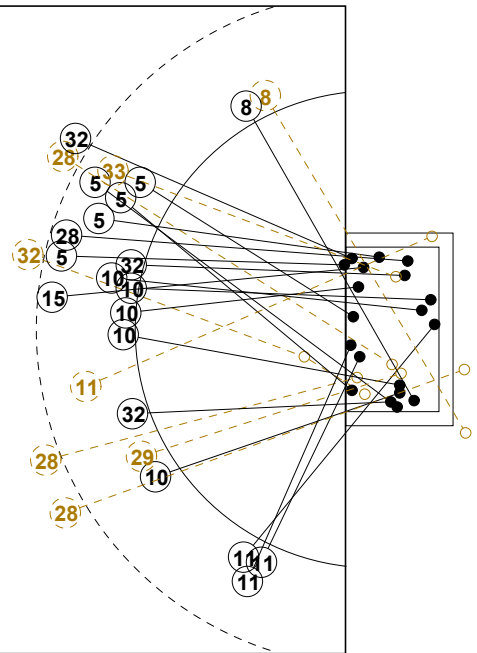
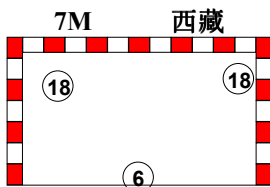
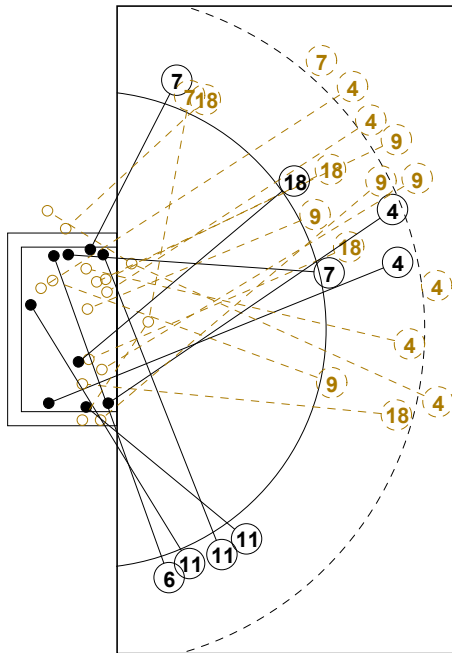

2nd Half
24 : 39



第十二届全国运动会男子手球预赛

个人/全队技术统计表

正式表
手球
男子9-10名
轮次 10组别 X
场次 44201301044-14-1/2
柳州市李宁体育馆
28/04/2013 10:40

号码	姓名	远射	近射	边射	快攻	突破	任意	7M	合计	%	助攻	失误	警告	2'	取消	时间
安徽(安徽)																
<i>(场上队员)</i>																
1	高逸凡									0.0%	1					00:30:00
2	周兰骏									0.0%						00:00:00
5	马鹏	2/3	3/3		2/2	1/1		3/3	11/12	91.7%	1					00:59:55
6	田耕									0.0%						00:00:00
7	姚雄敏									0.0%						00:00:00
8	董智景			1/2				1/1	2/3	66.7%						00:19:28
10	陈强龙		3/3		2/2				5/5	100%		4	1	1		01:00:00
11	黎涛			4/4	0/1			1/2	5/7	71.4%		2				00:41:11
12	曾献辰									0.0%						00:30:00
15	邵青	1/3			2/2				3/5	60.0%		2				00:47:05
17	解维维									0.0%						00:00:00
18	郭赛									0.0%						00:00:00
28	袁龙	3/8		0/2	1/1				4/11	36.4%		2	1			00:40:25
29	顾先亮	1/1		1/3	1/2	0/1			3/7	42.9%	1	1				00:31:37
32	王超	2/3	0/1		2/2				4/6	66.7%		2				00:50:57
33	曹振吉		0/1		2/2				2/3	66.7%		1	1			00:08:45
合计		9/18	6/8	6/11	12/14	1/2		5/6	39/59	66.1%	3	14	3	1		
<i>(守门员)</i>																
1	高逸凡	1/2	0/2	1/3	1/5	0/1		0/2	3/15	20.0%	1					00:30:00
12	曾献辰	5/7	3/3	0/4	0/2	1/2	1/1	0/3	10/22	45.5%						00:30:00
合计		6/9	3/5	1/7	1/7	1/3	1/1	0/5	13/37	35.1%	1					

场上队员：得分/射门

守门员：救球/射门

全队合计	得分	被救	射失	击柱	封球	合计	%
远射	9	5	1	2	1	18	50.0%
近射	6	2				8	75.0%
边射	6	2	1	2		11	54.5%
快攻	12		1	1		14	85.7%
突破	1	1				2	50.0%
任意							0.0%
7M	5			1		6	83.3%





第十二届全国运动会男子手球预赛

个人/全队技术统计表

正式表
手球
男子9-10名
轮次 10组别 X
场次 44201301044-14-2/2
柳州市李宁体育馆
28/04/2013 10:40

号码	姓名	远射	近射	边射	快攻	突破	任意	7M	合计	%	助攻	失误	警告	2'	取消	时间
西藏(西藏)																
<i>(上场队员)</i>																
2	王龙	0/1				1/1			1/2	50.0%		2				00:21:26
4	张家纬	3/11	1/1						4/12	33.3%		2		1		00:53:15
5	冯祥龙									0.0%						00:00:00
6	任启双			1/1	1/1			1/1	3/3	100%		1				00:46:41
7	徐奕飞	0/2		1/4	2/2				3/8	37.5%		1		2		00:59:46
9	王博	0/2	0/2	1/1	2/2		0/1		3/8	37.5%		2				00:59:49
10	刘江	0/1							0/1	0.0%	1					00:26:46
11	朱治宇		1/1	3/3	0/1	1/1			5/6	83.3%	1	4				00:24:26
12	张帅									0.0%		1				00:19:00
15	刘劲松									0.0%						00:00:00
16	徐畅									0.0%						00:41:00
18	赵楠	0/2	0/1	0/1	1/2	0/1		4/4	5/11	45.5%		7	1			00:54:46
19	任野									0.0%						00:00:00
20	顾艳超									0.0%		1				00:11:28
21	马光									0.0%						00:00:00
23	王伟强									0.0%						00:00:00
合计		3/19	2/5	6/10	6/8	2/3	0/1	5/5	24/51	47.1%	2	21	1	3		
<i>(守门员)</i>																
12	张帅	0/2	1/5	0/1	0/3	1/1		0/2	2/14	14.3%						00:19:00
16	徐畅	5/12	1/3	2/7	0/9	0/1		0/3	8/35	22.9%						00:41:00
合计		5/14	2/8	2/8	0/12	1/2		0/5	10/49	20.4%						

场上队员：得分/射门

守门员：救球/射门

全队合计	得分	被救	射失	击柱	封球	合计	%
远射	3	6	2	2	6	19	15.8%
近射	2	3				5	40.0%
边射	6	1	1	2		10	60.0%
快攻	6	1	1			8	75.0%
突破	2	1				3	66.7%
任意		1				1	0.0%
7M	5					5	100.0%





第十二届全国运动会男子手球预赛

图式射门区域统计

轮次 10 场次 44

201301044-41-1/1

安徽

Table with 8 columns of player statistics for Anhui province, including names like 高逸凡, 周兰骏, 马鹏, etc., and their respective goal counts in different positions.

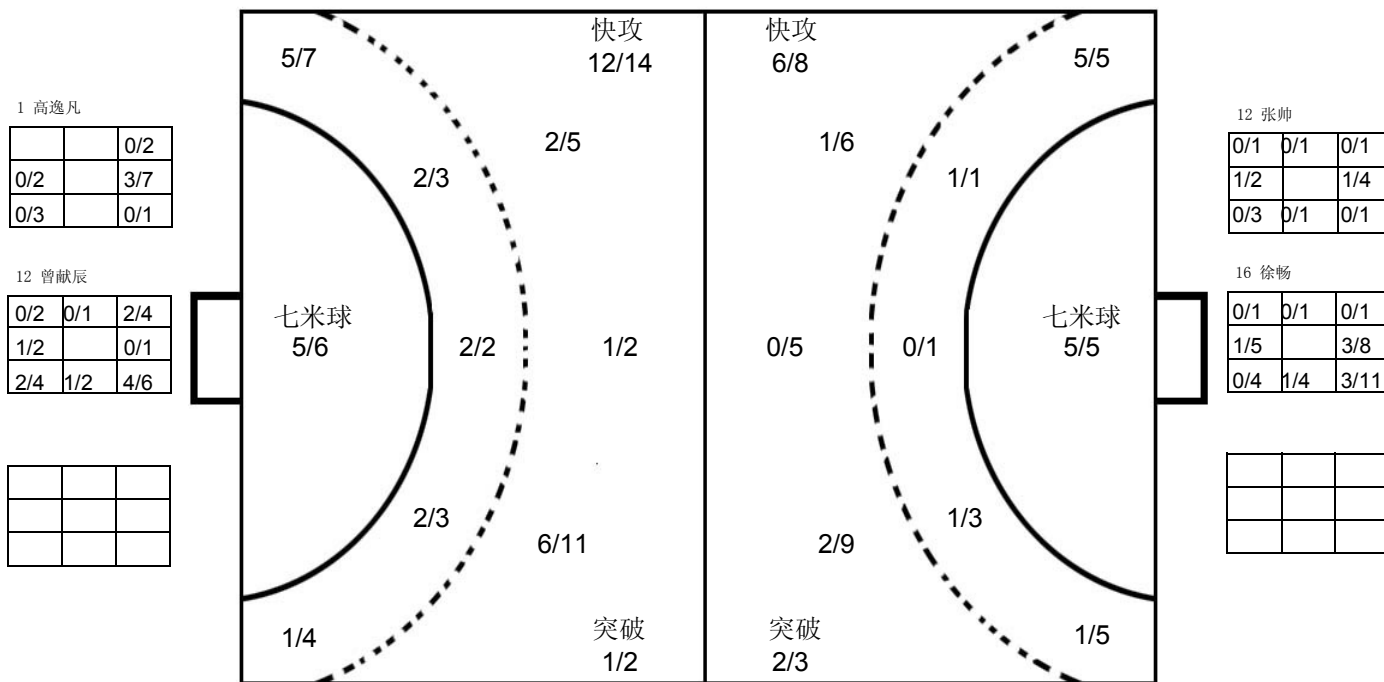

西藏

Table with 8 columns of player statistics for Tibet province, including names like 王龙, 张家伟, 冯祥龙, etc., and their respective goal counts.

注释: Post=击柱 Miss=射失 Block=被封





男子 国内比赛



第十二届全国运动会男子手球预赛

Team A										Team B										Match Number									
A 天津										B 香港										45									
played in					in the hall					on					at					Spectators									
China					柳州市李宁体育馆					28/04/2013					14:40 hours														
Half-time (30')		A		B		End of playing time		A		B		1st extra time		A		B		2nd extra time		A		B		After penalty throws		A		B	
		24		19		45		30																					
Number of 7 m		A		Team time-out			Full name of players and officials										Team time-out			B		Number of 7 m							
0/0		12:22															27:49			3/5									
No.	Team A					G	W	2'	D	DR	No.	Team B					G	W	2'	D	DR								
1	刘宗其										1	萧智庭																	
2	李岳朋					7					2	叶冠英																	
3	李军										5	黄胜业																	
4	李松浩							1			6	谢伟希					3												
7	张青					13					7	许文邦					9												
8	曹悦					7	1				9	张建国					2	1											
9	孟凡钢										11	陈允文					2												
10	李帅					1		1			12	叶冠雄					4												
11	王毅										14	李鑫豪					1												
13	许松					6					15	黄嘉愉					1												
14	田剑侠					5					25	曾铭谦					5												
15	张俊岭					2	1				29	练明辉					3	1	1										
16	刘海亮																												
17	周群					4	1	1																					
18	孙永																												
19	梁堂亮																												
A	尚喜										A	陈广裕																	
B	贾守信										B	杨开将																	
C	刘伟成										D	张军																	
D	冀谦																												
A										Signature of Responsible Official of the Teams (Off. A)										B									
TP	Remarks of Referee / CHA Official																				TP								

Signatures

Referees	邓军 (CHN)	谭雷 (CHN)		
Techn. Delegates	李之文 (CHN)	许宜扬 (CHN)		
CHA Official				

Note: Number of 7m Throws Awarded to Team A and B, Goals (G), Warnings (W), Suspensions (2'), Direct Disqualification (D), Disqualification with Report (DR) and Team Penalty (TP).

Table Officials:

Statisticians: 朱伟平

黄莉





第十二届全国运动会男子手球预赛
竞赛技术统计(媒体表)

7-8名 组别 X 轮次 10 场次 45

柳州市李宁体育馆

28/04/2013

201301045-51-1/1

天津 45 vs 30 香港 24 : 19

裁判员 邓军 (CHN) / 谭雷 (CHN)

Main statistics table for Tianjin vs Hong Kong handball match, including player performance, goals, and technical stats.

场上队员: 得分 / 射门

守门员: 救球 / 射门

Legend table for technical terms: 快攻, 突破, 任意球, 7m球, 助攻, 警告, etc.





第十二届全国运动会男子手球预赛 图式比赛技术统计表

轮次 10

场次 45

201301045-21-1/1

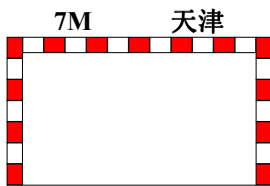
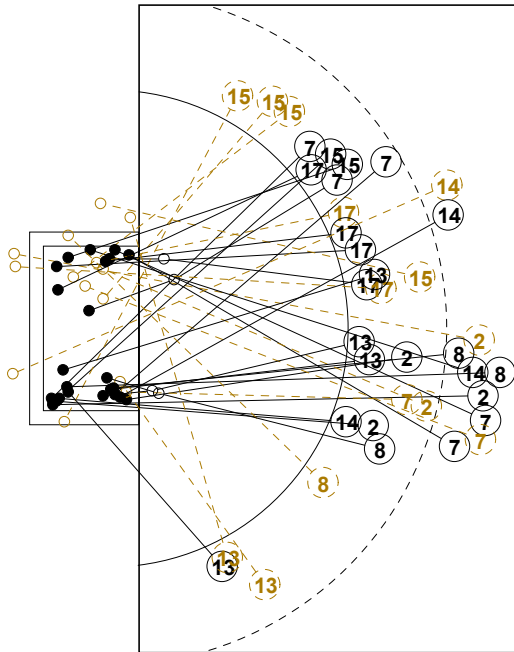

1st Half
24 : 19

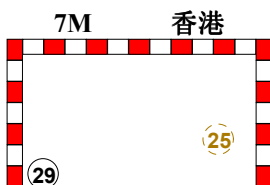
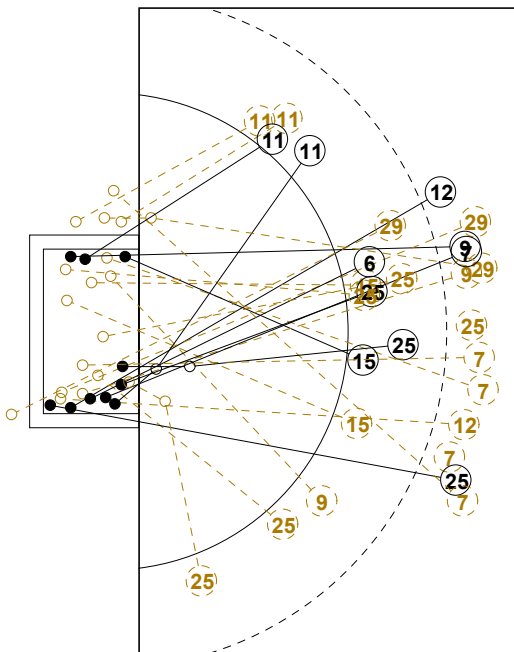
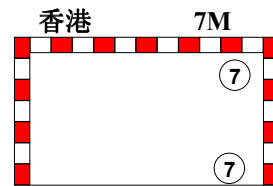
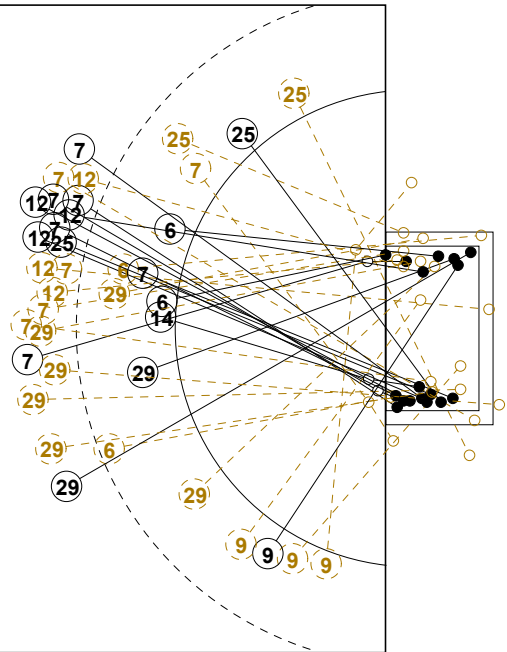

2nd Half
30 : 45

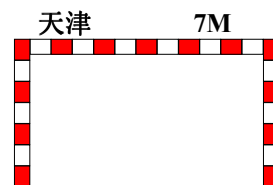
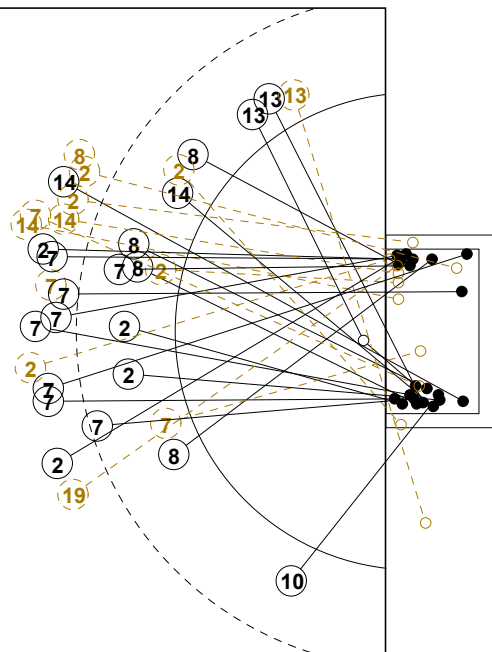



第十二届全国运动会男子手球预赛

个人/全队技术统计表

正式表
手球
男子7-8名
轮次 10组别 X
场次 45201301045-14-1/2
柳州市李宁体育馆
28/04/2013 14:40

号码	姓名	远射	近射	边射	快攻	突破	任意	7M	合计	%	助攻	失误	警告	2'	取消	时间
天津(天津)																
<i>(场上队员)</i>																
1	刘宗其									0.0%	1	1				00:42:40
2	李岳朋	3/8	1/1		3/4	0/1			7/14	50.0%	1	2				00:51:26
3	李军									0.0%						00:00:00
4	李松浩									0.0%				1		00:12:17
7	张青	7/10	1/3		5/5				13/18	72.2%	3	5				00:59:55
8	曹悦	2/3	1/2		2/2	2/2			7/9	77.8%			1			00:16:43
9	孟凡钢									0.0%						00:00:00
10	李帅			1/1					1/1	100%				1		00:21:29
11	王毅									0.0%		2				00:07:22
13	许松			2/5	4/4				6/9	66.7%		2				00:52:30
14	田剑侠	2/4	1/1		2/3				5/8	62.5%	2	1				00:46:22
15	张俊岭			0/3	2/3				2/6	33.3%			1			00:24:45
16	刘海亮									0.0%	1					00:17:20
17	周群		2/3		2/3				4/6	66.7%		1	1	1		00:47:26
18	孙永									0.0%						00:05:14
19	梁堂亮	0/1							0/1	0.0%		1				00:13:30
合计		14/26	6/10	3/9	20/24	2/3			45/72	62.5%	8	15	3	3		
<i>(守门员)</i>																
1	刘宗其	9/15	4/8	3/4	2/8		1/1	1/2	20/38	52.6%	1	1				00:42:40
16	刘海亮	1/6	0/2	1/1	2/5			0/2	4/16	25.0%	1					00:17:20
合计		10/21	4/10	4/5	4/13		1/1	1/4	24/54	44.4%	2	1				

场上队员：得分/射门

守门员：救球/射门

全队合计	得分	被救	射失	击柱	封球	合计	%
远射	14	7	2	1	2	26	53.8%
近射	6	3		1		10	60.0%
边射	3	3	2	1		9	33.3%
快攻	20	2	2			24	83.3%
突破	2			1		3	66.7%
任意							0.0%
7M							0.0%





第十二届全国运动会男子手球预赛

个人/全队技术统计表

正式表
手球
男子7-8名
轮次 10组别 X
场次 45201301045-14-2/2
柳州市李宁体育馆
28/04/2013 14:40

号码	姓名	远射	近射	边射	快攻	突破	任意	7M	合计	%	助攻	失误	警告	2'	取消	时间
香港(香港)																
<i>(上场队员)</i>																
1	萧智庭									0.0%		1				00:24:49
2	叶冠英									0.0%	2	1				00:35:11
5	黄胜业									0.0%						00:00:00
6	谢伟希		3/3		0/2				3/5	60.0%		2				00:35:03
7	许文邦	3/9			4/6		0/1	2/2	9/18	50.0%	2	1				00:56:15
9	张建国	1/2	0/1	0/2	1/1	0/1			2/7	28.6%		2	1			00:41:37
11	陈允文		1/1	0/2	1/1				2/4	50.0%		1				00:29:29
12	叶冠雄	4/8							4/8	50.0%	2	1				00:44:56
14	李鑫豪				1/1				1/1	100%		1				00:26:59
15	黄嘉愉		1/2		0/1				1/3	33.3%		2				00:15:04
25	曾铭谦	2/3	0/1	1/4	2/4			0/1	5/13	38.5%						00:59:22
29	练明辉	1/7	1/2		0/2			1/2	3/13	23.1%	1	3	1	1		00:47:46
合计																
<i>(守门员)</i>																
1	萧智庭	1/7	2/4	1/3	1/13	0/1			5/28	17.9%		1				00:24:49
2	叶冠英	6/14	1/5	2/3	1/9	0/1			10/32	31.3%	2	1				00:35:11
合计																

场上队员：得分/射门

守门员：救球/射门

全队合计	得分	被救	射失	击柱	封球	合计	%
远射	11	10	3	2	3	29	37.9%
近射	6	4				10	60.0%
边射	1	4	3			8	12.5%
快攻	9	4	2	3		18	50.0%
突破			1			1	0.0%
任意		1				1	0.0%
7M	3	1	1			5	60.0%





第十二届全国运动会男子手球预赛

图式射门区域统计

轮次 10 场次 45

201301045-41-1/1

天津

1 刘宗其	2 李岳朋	3 李军	4 李松浩	7 张青	8 曹悦	9 孟凡钢	10 李帅																																																																								
<table border="1"><tr><td></td><td></td><td></td></tr><tr><td></td><td></td><td></td></tr><tr><td></td><td></td><td></td></tr></table>										<table border="1"><tr><td>2</td><td></td><td></td></tr><tr><td></td><td></td><td>1</td></tr><tr><td>3</td><td></td><td>1</td></tr></table>	2					1	3		1	<table border="1"><tr><td></td><td></td><td></td></tr><tr><td></td><td></td><td></td></tr><tr><td></td><td></td><td></td></tr></table>										<table border="1"><tr><td></td><td></td><td></td></tr><tr><td></td><td></td><td></td></tr><tr><td></td><td></td><td></td></tr></table>										<table border="1"><tr><td>3</td><td></td><td></td></tr><tr><td></td><td>1</td><td></td></tr><tr><td>4</td><td></td><td>5</td></tr></table>	3				1		4		5	<table border="1"><tr><td>1</td><td></td><td></td></tr><tr><td>2</td><td></td><td>2</td></tr><tr><td>2</td><td></td><td></td></tr></table>	1			2		2	2			<table border="1"><tr><td></td><td></td><td></td></tr><tr><td></td><td></td><td></td></tr><tr><td></td><td></td><td></td></tr></table>										<table border="1"><tr><td></td><td></td><td></td></tr><tr><td></td><td></td><td></td></tr><tr><td></td><td></td><td>1</td></tr></table>									1
2																																																																															
		1																																																																													
3		1																																																																													
3																																																																															
	1																																																																														
4		5																																																																													
1																																																																															
2		2																																																																													
2																																																																															
		1																																																																													
Post - 0 Miss - 0 Block - 0	Post - 2 Miss - 1 Block - 0	Post - 0 Miss - 0 Block - 0	Post - 0 Miss - 0 Block - 0	Post - 0 Miss - 0 Block - 1	Post - 1 Miss - 0 Block - 1	Post - 0 Miss - 0 Block - 0	Post - 0 Miss - 0 Block - 0																																																																								
11 王毅	13 许松	14 田剑侠	15 张俊岭	16 刘海亮	17 周群	18 孙永	19 梁堂亮																																																																								
<table border="1"><tr><td></td><td></td><td></td></tr><tr><td></td><td></td><td></td></tr><tr><td></td><td></td><td></td></tr></table>										<table border="1"><tr><td>2</td><td></td><td></td></tr><tr><td>1</td><td></td><td>1</td></tr><tr><td>1</td><td></td><td>1</td></tr></table>	2			1		1	1		1	<table border="1"><tr><td>1</td><td></td><td>1</td></tr><tr><td></td><td></td><td>2</td></tr><tr><td>1</td><td></td><td></td></tr></table>	1		1			2	1			<table border="1"><tr><td>1</td><td></td><td>1</td></tr><tr><td></td><td></td><td></td></tr><tr><td></td><td></td><td></td></tr></table>	1		1							<table border="1"><tr><td></td><td></td><td></td></tr><tr><td></td><td></td><td></td></tr><tr><td></td><td></td><td></td></tr></table>										<table border="1"><tr><td></td><td></td><td>2</td></tr><tr><td></td><td></td><td>1</td></tr><tr><td></td><td></td><td>1</td></tr></table>			2			1			1	<table border="1"><tr><td></td><td></td><td></td></tr><tr><td></td><td></td><td></td></tr><tr><td></td><td></td><td></td></tr></table>										<table border="1"><tr><td></td><td></td><td></td></tr><tr><td></td><td></td><td></td></tr><tr><td></td><td></td><td></td></tr></table>									
2																																																																															
1		1																																																																													
1		1																																																																													
1		1																																																																													
		2																																																																													
1																																																																															
1		1																																																																													
		2																																																																													
		1																																																																													
		1																																																																													
Post - 0 Miss - 0 Block - 0	Post - 0 Miss - 2 Block - 0	Post - 0 Miss - 1 Block - 0	Post - 1 Miss - 1 Block - 0	Post - 0 Miss - 0 Block - 0	Post - 0 Miss - 1 Block - 0	Post - 0 Miss - 0 Block - 0	Post - 0 Miss - 0 Block - 0																																																																								

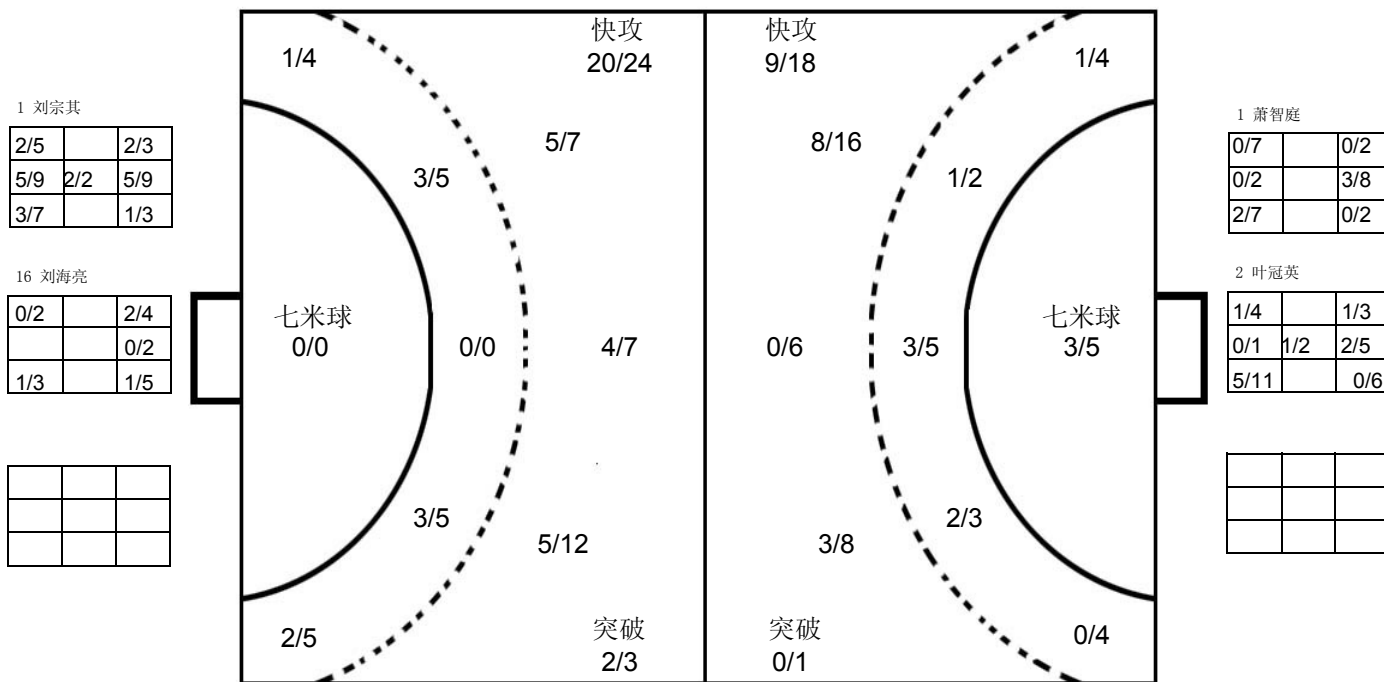

香港

1 萧智庭	2 叶冠英	5 黄胜业	6 谢伟希	7 许文邦	9 张建国	11 陈允文	12 叶冠雄																																																																								
<table border="1"><tr><td></td><td></td><td></td></tr><tr><td></td><td></td><td></td></tr><tr><td></td><td></td><td></td></tr></table>										<table border="1"><tr><td></td><td></td><td></td></tr><tr><td></td><td></td><td></td></tr><tr><td></td><td></td><td></td></tr></table>										<table border="1"><tr><td></td><td></td><td></td></tr><tr><td></td><td></td><td></td></tr><tr><td></td><td></td><td></td></tr></table>										<table border="1"><tr><td></td><td></td><td></td></tr><tr><td>2</td><td></td><td></td></tr><tr><td>1</td><td></td><td></td></tr></table>				2			1			<table border="1"><tr><td></td><td></td><td>2</td></tr><tr><td>1</td><td></td><td>1</td></tr><tr><td>1</td><td></td><td>4</td></tr></table>			2	1		1	1		4	<table border="1"><tr><td>1</td><td></td><td>1</td></tr><tr><td></td><td></td><td></td></tr><tr><td></td><td></td><td></td></tr></table>	1		1							<table border="1"><tr><td></td><td></td><td></td></tr><tr><td></td><td></td><td>1</td></tr><tr><td>1</td><td></td><td></td></tr></table>						1	1			<table border="1"><tr><td>1</td><td></td><td></td></tr><tr><td>1</td><td></td><td>1</td></tr><tr><td></td><td></td><td>1</td></tr></table>	1			1		1			1
2																																																																															
1																																																																															
		2																																																																													
1		1																																																																													
1		4																																																																													
1		1																																																																													
		1																																																																													
1																																																																															
1																																																																															
1		1																																																																													
		1																																																																													
Post - 0 Miss - 0 Block - 0	Post - 0 Miss - 0 Block - 0	Post - 0 Miss - 0 Block - 0	Post - 1 Miss - 0 Block - 0	Post - 1 Miss - 2 Block - 2	Post - 0 Miss - 1 Block - 0	Post - 0 Miss - 2 Block - 0	Post - 1 Miss - 0 Block - 0																																																																								
14 李鑫豪	15 黄嘉愉	25 曾铭谦	29 练明辉																																																																												
<table border="1"><tr><td></td><td></td><td></td></tr><tr><td></td><td></td><td>1</td></tr><tr><td></td><td></td><td></td></tr></table>						1				<table border="1"><tr><td></td><td></td><td></td></tr><tr><td></td><td></td><td></td></tr><tr><td></td><td></td><td>1</td></tr></table>									1	<table border="1"><tr><td>1</td><td></td><td></td></tr><tr><td></td><td></td><td>2</td></tr><tr><td>2</td><td></td><td></td></tr></table>	1					2	2			<table border="1"><tr><td>2</td><td></td><td></td></tr><tr><td></td><td></td><td></td></tr><tr><td>1</td><td></td><td></td></tr></table>	2						1			<table border="1"><tr><td></td><td></td><td></td></tr><tr><td></td><td></td><td></td></tr><tr><td></td><td></td><td></td></tr></table>										<table border="1"><tr><td></td><td></td><td></td></tr><tr><td></td><td></td><td></td></tr><tr><td></td><td></td><td></td></tr></table>										<table border="1"><tr><td></td><td></td><td></td></tr><tr><td></td><td></td><td></td></tr><tr><td></td><td></td><td></td></tr></table>										<table border="1"><tr><td></td><td></td><td></td></tr><tr><td></td><td></td><td></td></tr><tr><td></td><td></td><td></td></tr></table>									
		1																																																																													
		1																																																																													
1																																																																															
		2																																																																													
2																																																																															
2																																																																															
1																																																																															
Post - 0 Miss - 0 Block - 0	Post - 0 Miss - 0 Block - 0	Post - 1 Miss - 1 Block - 1	Post - 1 Miss - 4 Block - 0																																																																												

注释: Post=击柱 Miss=射失 Block=被封





男子 国内比赛



第十二届全国运动会男子手球预赛

Team A A 北京		Team B B 解放军		Match Number 46							
played in China		in the hall 柳州市李宁体育馆		on 28/04/2013							
				at 16:20 hours							
Spectators											
Half-time (30')	A 13	B 11	End of playing time	A 24	B 26						
1st extra time		2nd extra time		After penalty throws							
Number of 7 m A 2/2		Team time-out 1 23:18 2 3 3		Full name of players and officials							
		Team time-out 1 29:39 2 48:18 3 59:16		B 1/2							
Number of 7 m		Number of 7 m		Number of 7 m							
No.	Team A				No.	Team B					
	G	W	2'	D	DR		G	W	2'	D	DR
1						4					
2						5					
4	1					6					
5			1			7					
6						8					
7	3		1			9					
8	1					10					
9	4					11					
11	4					12					
13						13					
14		1				14					
16						15					
17	4	1				16					
18	7					17					
20						18					
23						20					
A	郑康旭					A	张敬敏				
B	蔡建国					B	张彬华				
C	吴健					C	刘捷				
D	石锋					D	刘军				
A	Signature of Responsible Official of the Teams (Off. A)										B
TP	Remarks of Referee / CHA Official										TP

Signatures

Referees	Andreas Bethmann	Michael Tzaferopoulos		
Techn. Delegates	王锡祯 (CHN)	刘书勇 (CHN)		
CHA Official				

Note: Number of 7m Throws Awarded to Team A and B, Goals (G), Warnings (W), Suspensions (2'), Direct Disqualification (D), Disqualification with Report (DR) and Team Penalty (TP).

Table Officials:

Statisticians: 朱伟平

黄莉



第十二届全国运动会男子手球预赛
竞赛技术统计(媒体表)

5-6名	组别	X	轮次	10	场次	46
柳州市李宁体育馆			28/04/2013		201301046-51-1/1	
北京		北京	24	vs	26	解放军
		13 : 11				

裁判员	Andreas Bethmann (GRE)	/	Michael Tzaferopoulos (GRE)
-----	------------------------	---	-----------------------------

北京		远射	近射	边射	快攻	突破	任意球	7m球	合计	%	助攻	失误	警告	2'	D & DR	北京	比赛进程	解放军
主教练：郑康旭																		
1	王澍															18	张骥	1 02:16 0
2	杜龙飞															18	张骥	2 03:50 0
4	成亚	1/2	0/1	0/1					1/4	25.0		2				17	姜冰峰	3 04:51 0
5	杨昆													1				3 05:32 1 4 曹作亮
6	刘伟																	3 07:54 2 8 王烁
7	胡瀛	1/2	1/2	0/1	1/2				3/7	42.9						11	蒋维一	3 08:45 3 17 王勇
8	王鹏		1/1						1/1	100								4 09:37 3
9	刘振	1/7	1/1		1/1	1/1			4/10	40.0	1	2				7	胡瀛	4 10:12 4 8 王烁
11	蒋维一		2/2		2/2				4/4	100		1				4	刘振	4 10:50 5 8 王烁
13	白洁															9	刘振	5 11:21 5
14	解建飞												1	1		17	姜冰峰	6 12:21 5
16	孟辉															6	姜冰峰	6 12:56 6 8 王烁
17	姜冰峰			2/3	1/1	1/1			4/5	80.0			1			9	刘振	7 15:59 6
18	张骥	3/7	1/2		1/2	0/2		2/2	7/15	46.7	1	4				9	刘振	8 17:08 6
20	郑永利															11	蒋维一	9 17:54 6
23	冯宁															9	蒋维一	9 18:16 7 14 曲学博
运动员 合计		6/18	6/9	2/5	6/8	2/4		2/2	24/46	52.2	2	10	2	2		9	蒋维一	9 19:49 8 8 王烁
1	王澍	3/3	0/2	1/3	0/5	2/2	1/2	0/1	7/18	38.9						7	胡瀛	10 21:17 8
16	孟辉	4/8	1/5	2/2	1/6	0/2			8/23	34.8						10	胡瀛	10 23:15 9 9 丁超
守门员 合计		7/11	1/7	3/5	1/11	2/4	1/2	0/1	15/41	36.6						18	张骥	11 23:24 9
解放军																9	刘振	11 24:28 10 5 吴龙瑞
教练：张敬敏																13	张骥	12 25:23 10
4	曹作亮	3/7				0/1	1/2		4/10	40.0	2	4				12	张骥	12 27:56 11 14 曲学博
5	吴龙瑞	0/1			2/2	1/1			3/4	75.0						13	张骥	13 01:01 12 8 王烁
6	苗青	0/1	1/1						1/2	50.0						13	张骥	13 03:37 13 8 王烁
7	陈昊		2/2						2/2	100						13	张骥	13 04:17 14 10 师龙
8	王烁	0/1	1/1	2/3	4/5			1/2	8/12	66.7						11	蒋维一	14 06:22 14
9	丁超	0/2	1/1	0/2					1/5	20.0	1	3				15	张骥	15 07:18 14
10	师龙	0/1			1/1				1/2	50.0						15	张骥	15 07:46 15 14 曲学博
11	李想															16	张骥	16 10:39 15
12	丛霖															16	张骥	16 11:05 16 4 曹作亮
13	王世杰												1			16	张骥	16 12:28 17 8 王烁
14	曲学博		1/2		1/1	1/2			3/5	60.0			2	1	1	17	姜冰峰	17 13:38 17
15	杨帆															18	张骥	18 15:05 17
16	郎俊夫											2				8	王鹏	19 16:33 17
17	王勇	1/2			2/2	0/1			3/5	60.0						17	姜冰峰	20 18:12 17
18	董宏斐															20	姜冰峰	20 18:51 18 7 陈昊
20	谷浩															9	刘振	21 20:12 18
运动员 合计		4/15	6/7	2/5	10/11	2/5	1/2	1/2	26/47	55.3	5	10	2	2		21	姜冰峰	21 20:46 19 6 苗青
16	郎俊夫	7/13	1/7	2/4	1/7	1/3	0/2	0/2	12/36	33.3	2					21	姜冰峰	21 22:10 20 5 吴龙瑞
守门员 合计		7/13	1/7	2/4	1/7	1/3	0/2	0/2	12/36	33.3	2					21	姜冰峰	21 22:56 21 7 陈昊
																21	姜冰峰	21 24:20 22 5 吴龙瑞
																21	姜冰峰	21 24:42 23 17 王勇
																21	姜冰峰	21 25:39 24 4 曹作亮
																18	张骥	22 26:27 24
																17	姜冰峰	22 27:00 25 17 王勇
																23	姜冰峰	23 27:30 25
																23	姜冰峰	23 28:14 26 4 曹作亮
																11	蒋维一	24 29:37 26

场上队员：得分 / 射门

守门员：救球 / 射门

快攻	Fast Break		突破	Breakthrough		任意球	Free Throw		7M球	7M Throw		助攻	Assist
警告	Warning		失误	Error		2'	Suspension		D	取消资格		DR	取消资格+报告





第十二届全国运动会男子手球预赛 图式比赛技术统计表

轮次 10

场次 46

201301046-21-1/1

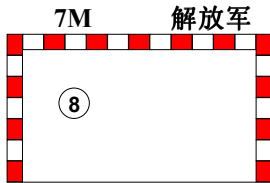
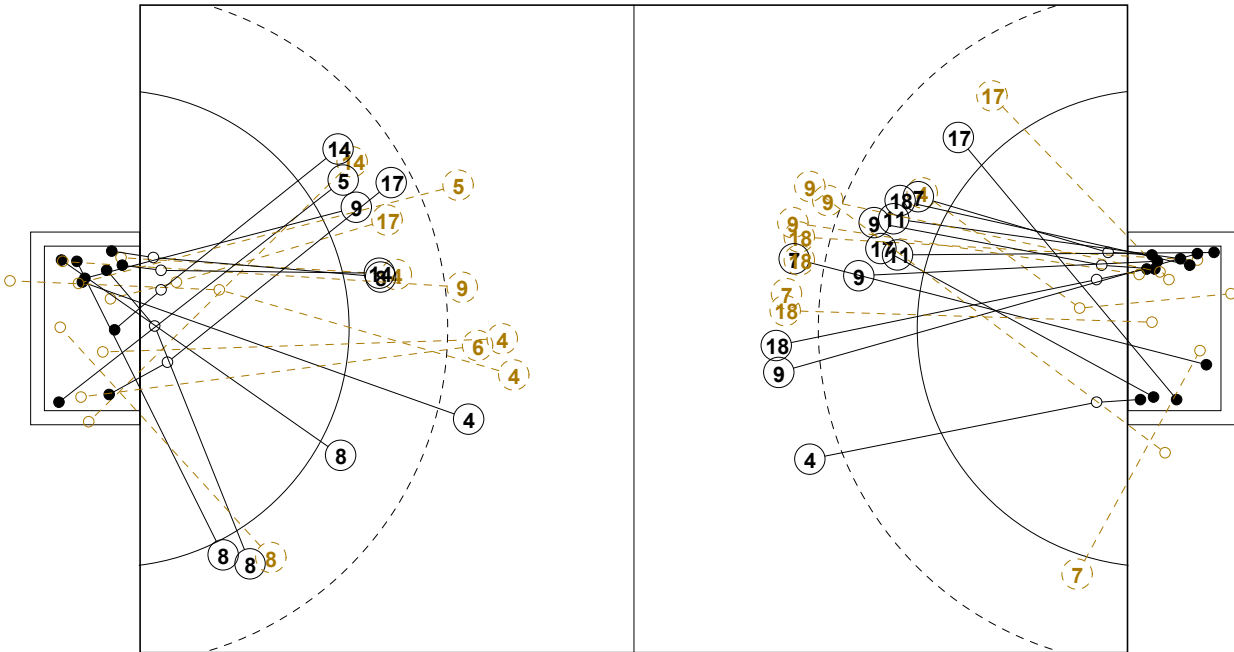

1st Half
11 : 13

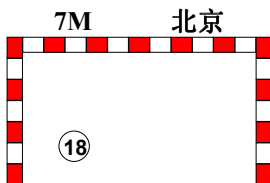
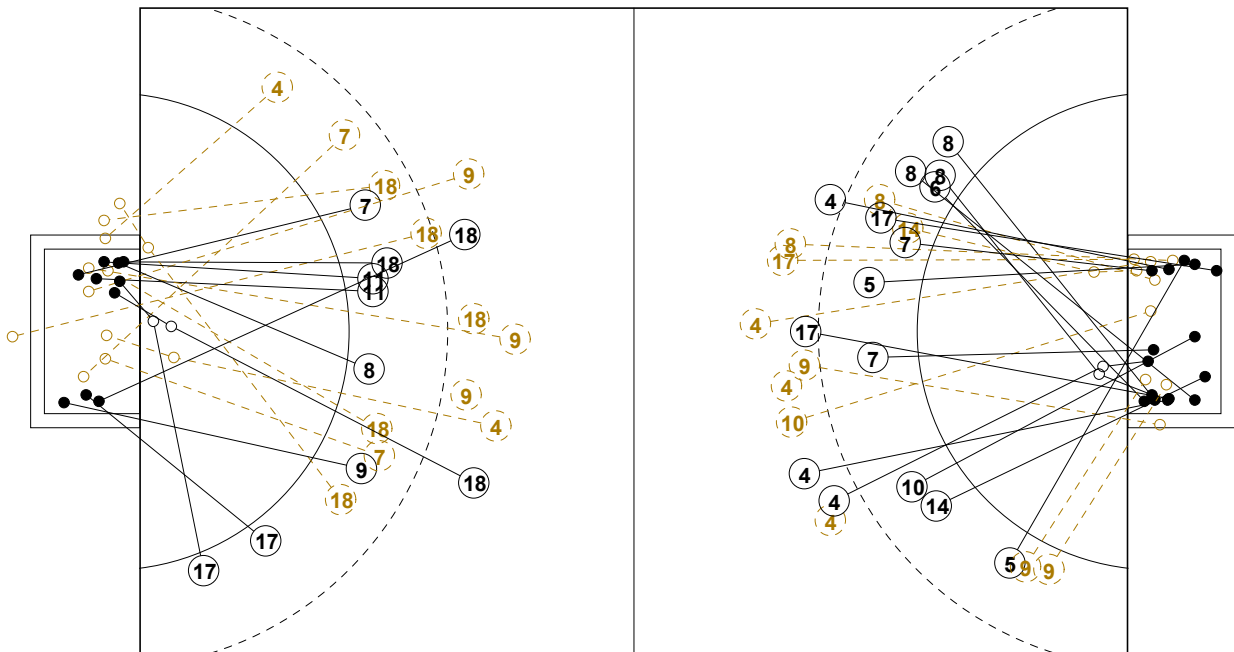
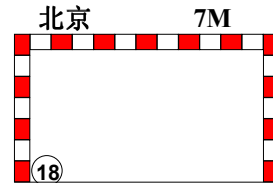

2nd Half
24 : 26

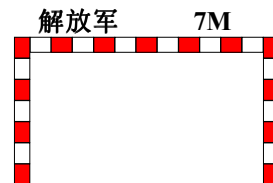



第十二届全国运动会男子手球预赛

个人/全队技术统计表

正式表
手球
男子5-6名
轮次 10组别 X
场次 46201301046-14-1/2
柳州市李宁体育馆
28/04/2013 16:20

号码	姓名	远射	近射	边射	快攻	突破	任意	7M	合计	%	助攻	失误	警告	2'	取消	时间
北京(北京)																
<i>(场上队员)</i>																
1	王泷									0.0%						00:30:00
2	杜龙飞									0.0%						00:00:00
4	成亚	1/2	0/1	0/1					1/4	25.0%		2				00:40:47
5	杨昆									0.0%				1		00:28:17
6	刘伟									0.0%						00:00:00
7	胡瀛	1/2	1/2	0/1	1/2				3/7	42.9%				1		01:00:00
8	王鹏		1/1						1/1	100%						00:06:29
9	刘振	1/7	1/1		1/1	1/1			4/10	40.0%	1	2				00:30:00
11	蒋维一		2/2		2/2				4/4	100%		1				00:53:29
13	白洁									0.0%						00:00:00
14	解建飞									0.0%		1	1			00:20:41
16	孟辉									0.0%						00:30:00
17	姜冰峰			2/3	1/1	1/1			4/5	80.0%				1		01:00:00
18	张骥	3/7	1/2		1/2	0/2		2/2	7/15	46.7%	1	4				01:00:00
20	郑永利									0.0%						00:00:00
23	冯宁									0.0%						00:00:00
合计		6/18	6/9	2/5	6/8	2/4		2/2	24/46	52.2%	2	10	2	2		
<i>(守门员)</i>																
1	王泷	3/3	0/2	1/3	0/5	2/2	1/2	0/1	7/18	38.9%						00:30:00
16	孟辉	4/8	1/5	2/2	1/6	0/2			8/23	34.8%						00:30:00
合计		7/11	1/7	3/5	1/11	2/4	1/2	0/1	15/41	36.6%						

场上队员：得分/射门

守门员：救球/射门

全队合计	得分	被救	射失	击柱	封球	合计	%
远射	6	7	2		3	18	33.3%
近射	6	1	1	1		9	66.7%
边射	2	2		1		5	40.0%
快攻	6	1			1	8	75.0%
突破	2	1	1			4	50.0%
任意							0.0%
7M	2					2	100.0%





第十二届全国运动会男子手球预赛

个人/全队技术统计表

正式表
手球
男子5-6名
轮次 10组别 X
场次 46201301046-14-2/2
柳州市李宁体育馆
28/04/2013 16:20

号码	姓名	远射	近射	边射	快攻	突破	任意	7M	合计	%	助攻	失误	警告	2'	取消	时间
解放军(解放军)																
<i>(上场队员)</i>																
4	曹作亮	3/7				0/1	1/2		4/10	40.0%	2	4				01:00:00
5	吴龙瑞	0/1			2/2	1/1			3/4	75.0%			1			01:00:00
6	苗青	0/1	1/1						1/2	50.0%						00:18:01
7	陈昊		2/2						2/2	100%						00:02:17
8	王烁	0/1	1/1	2/3	4/5			1/2	8/12	66.7%						00:58:47
9	丁超	0/2	1/1	0/2					1/5	20.0%	1	3				00:47:00
10	师龙	0/1			1/1				1/2	50.0%				1		00:19:02
11	李想									0.0%						00:00:00
12	丛霖									0.0%						00:00:00
13	王世杰									0.0%		1				00:01:12
14	曲学博		1/2		1/1	1/2			3/5	60.0%		2	1	1		00:46:41
15	杨帆									0.0%						00:00:00
16	郎俊夫									0.0%	2					01:00:00
17	王勇	1/2			2/2	0/1			3/5	60.0%						00:28:15
18	董宏斐									0.0%						00:00:00
20	谷浩									0.0%						00:18:34
合计		4/15	6/7	2/5	10/11	2/5	1/2	1/2	26/47	55.3%	5	10	2	2		
<i>(守门员)</i>																
16	郎俊夫	7/13	1/7	2/4	1/7	1/3		0/2	12/36	33.3%	2					01:00:00
合计		7/13	1/7	2/4	1/7	1/3		0/2	12/36	33.3%	2					

场上队员：得分/射门

守门员：救球/射门

全队合计	得分	被救	射失	击柱	封球	合计	%
远射	4	7	1	1	2	15	26.7%
近射	6	1				7	85.7%
边射	2	3				5	40.0%
快攻	10	1				11	90.9%
突破	2	2		1		5	40.0%
任意	1	1				2	50.0%
7M	1		1			2	50.0%





第十二届全国运动会男子手球预赛

图式射门区域统计

轮次 10 场次 46

201301046-41-1/1

北京

1 王澍	2 杜龙飞	4 成亚	5 杨昆	6 刘伟	7 胡瀛	8 王鹏	9 刘振																																																																								
<table border="1"><tr><td></td><td></td><td></td></tr><tr><td></td><td></td><td></td></tr><tr><td></td><td></td><td></td></tr></table>										<table border="1"><tr><td></td><td></td><td></td></tr><tr><td></td><td></td><td></td></tr><tr><td></td><td></td><td></td></tr></table>										<table border="1"><tr><td></td><td></td><td></td></tr><tr><td></td><td></td><td></td></tr><tr><td></td><td></td><td>1</td></tr></table>									1	<table border="1"><tr><td></td><td></td><td></td></tr><tr><td></td><td></td><td></td></tr><tr><td></td><td></td><td></td></tr></table>										<table border="1"><tr><td></td><td></td><td></td></tr><tr><td></td><td></td><td></td></tr><tr><td></td><td></td><td></td></tr></table>										<table border="1"><tr><td></td><td></td><td>1</td></tr><tr><td></td><td></td><td>1</td></tr><tr><td>1</td><td></td><td></td></tr></table>			1			1	1			<table border="1"><tr><td></td><td></td><td></td></tr><tr><td></td><td></td><td></td></tr><tr><td></td><td></td><td>1</td></tr></table>									1	<table border="1"><tr><td></td><td></td><td></td></tr><tr><td></td><td></td><td></td></tr><tr><td></td><td></td><td>2</td></tr></table>									2
		1																																																																													
		1																																																																													
		1																																																																													
1																																																																															
		1																																																																													
		2																																																																													
Post - 0 Miss - 0 Block - 0	Post - 0 Miss - 0 Block - 0	Post - 2 Miss - 0 Block - 0	Post - 0 Miss - 0 Block - 0	Post - 0 Miss - 0 Block - 0	Post - 0 Miss - 0 Block - 1	Post - 0 Miss - 0 Block - 0	Post - 0 Miss - 1 Block - 1																																																																								
11 蒋维一	13 白洁	14 解建飞	16 孟辉	17 姜冰峰	18 张骥	20 郑永利	23 冯宁																																																																								
<table border="1"><tr><td>1</td><td></td><td></td></tr><tr><td>1</td><td></td><td>2</td></tr><tr><td></td><td></td><td></td></tr></table>	1			1		2				<table border="1"><tr><td></td><td></td><td></td></tr><tr><td></td><td></td><td></td></tr><tr><td></td><td></td><td></td></tr></table>										<table border="1"><tr><td></td><td></td><td></td></tr><tr><td></td><td></td><td></td></tr><tr><td></td><td></td><td></td></tr></table>										<table border="1"><tr><td></td><td></td><td></td></tr><tr><td></td><td></td><td></td></tr><tr><td></td><td></td><td></td></tr></table>										<table border="1"><tr><td></td><td></td><td></td></tr><tr><td>1</td><td></td><td>1</td></tr><tr><td></td><td></td><td>2</td></tr></table>				1		1			2	<table border="1"><tr><td>1</td><td></td><td></td></tr><tr><td>2</td><td></td><td></td></tr><tr><td>2</td><td></td><td>2</td></tr></table>	1			2			2		2	<table border="1"><tr><td></td><td></td><td></td></tr><tr><td></td><td></td><td></td></tr><tr><td></td><td></td><td></td></tr></table>										<table border="1"><tr><td></td><td></td><td></td></tr><tr><td></td><td></td><td></td></tr><tr><td></td><td></td><td></td></tr></table>									
1																																																																															
1		2																																																																													
1		1																																																																													
		2																																																																													
1																																																																															
2																																																																															
2		2																																																																													
Post - 0 Miss - 0 Block - 0	Post - 0 Miss - 0 Block - 0	Post - 0 Miss - 0 Block - 0	Post - 0 Miss - 0 Block - 0	Post - 0 Miss - 0 Block - 0	Post - 0 Miss - 3 Block - 2	Post - 0 Miss - 0 Block - 0	Post - 0 Miss - 0 Block - 0																																																																								

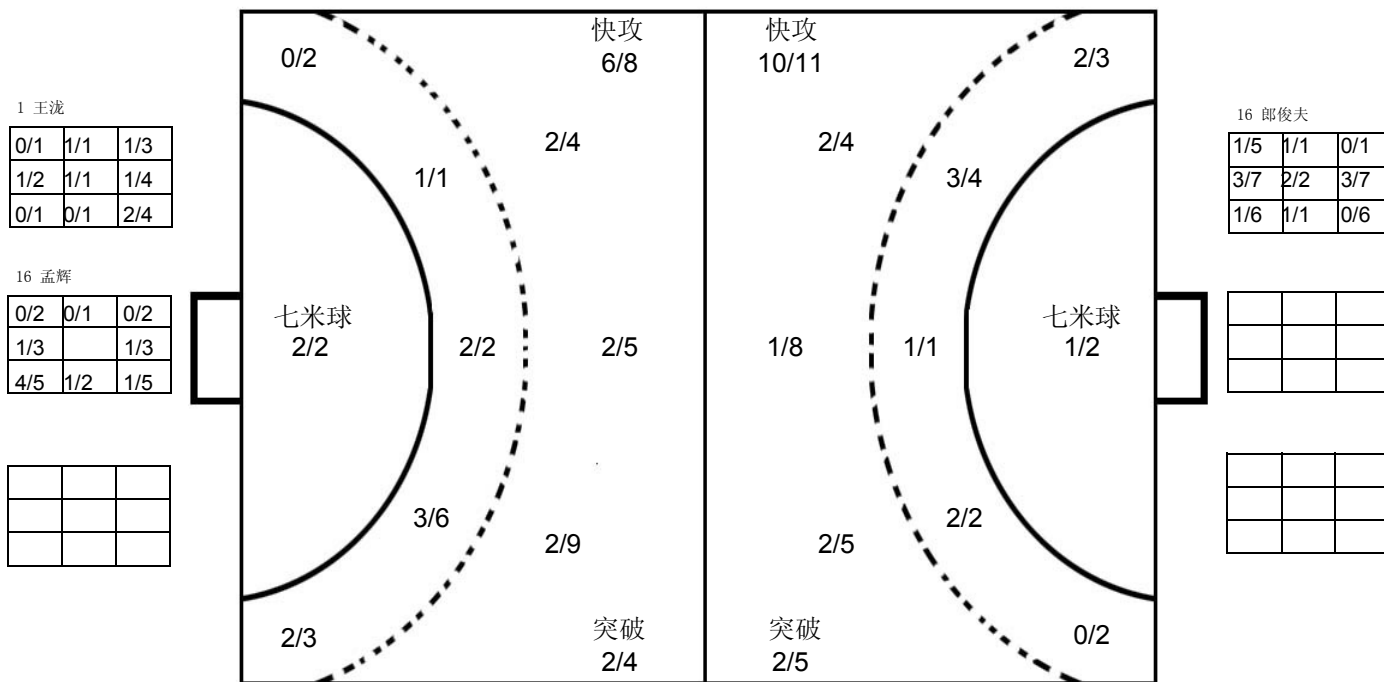

解放军

4 曹作亮	5 吴龙瑞	6 苗青	7 陈昊	8 王烁	9 丁超	10 师龙	11 李想																																																																								
<table border="1"><tr><td></td><td></td><td></td></tr><tr><td>1</td><td></td><td>2</td></tr><tr><td></td><td></td><td>1</td></tr></table>				1		2			1	<table border="1"><tr><td>2</td><td></td><td></td></tr><tr><td>1</td><td></td><td></td></tr><tr><td></td><td></td><td></td></tr></table>	2			1						<table border="1"><tr><td></td><td></td><td></td></tr><tr><td></td><td></td><td></td></tr><tr><td></td><td></td><td>1</td></tr></table>									1	<table border="1"><tr><td></td><td></td><td></td></tr><tr><td></td><td></td><td></td></tr><tr><td>1</td><td>1</td><td></td></tr></table>							1	1		<table border="1"><tr><td></td><td></td><td>3</td></tr><tr><td>1</td><td></td><td>1</td></tr><tr><td></td><td></td><td>3</td></tr></table>			3	1		1			3	<table border="1"><tr><td></td><td></td><td></td></tr><tr><td></td><td></td><td>1</td></tr><tr><td></td><td></td><td></td></tr></table>						1				<table border="1"><tr><td></td><td></td><td></td></tr><tr><td></td><td>1</td><td></td></tr><tr><td></td><td></td><td></td></tr></table>					1					<table border="1"><tr><td></td><td></td><td></td></tr><tr><td></td><td></td><td></td></tr><tr><td></td><td></td><td></td></tr></table>									
1		2																																																																													
		1																																																																													
2																																																																															
1																																																																															
		1																																																																													
1	1																																																																														
		3																																																																													
1		1																																																																													
		3																																																																													
		1																																																																													
	1																																																																														
Post - 0 Miss - 1 Block - 2	Post - 0 Miss - 0 Block - 0	Post - 0 Miss - 0 Block - 0	Post - 0 Miss - 0 Block - 0	Post - 0 Miss - 1 Block - 0	Post - 1 Miss - 0 Block - 0	Post - 0 Miss - 0 Block - 0	Post - 0 Miss - 0 Block - 0																																																																								
12 丛霖	13 王世杰	14 曲文博	15 杨帆	16 郎俊夫	17 王勇	18 董宏斐	20 谷浩																																																																								
<table border="1"><tr><td></td><td></td><td></td></tr><tr><td></td><td></td><td></td></tr><tr><td></td><td></td><td></td></tr></table>										<table border="1"><tr><td></td><td></td><td></td></tr><tr><td></td><td></td><td></td></tr><tr><td></td><td></td><td></td></tr></table>										<table border="1"><tr><td></td><td></td><td>1</td></tr><tr><td></td><td></td><td></td></tr><tr><td></td><td>1</td><td>1</td></tr></table>			1					1	1	<table border="1"><tr><td></td><td></td><td></td></tr><tr><td></td><td></td><td></td></tr><tr><td></td><td></td><td></td></tr></table>										<table border="1"><tr><td></td><td></td><td></td></tr><tr><td></td><td></td><td></td></tr><tr><td></td><td></td><td></td></tr></table>										<table border="1"><tr><td></td><td></td><td></td></tr><tr><td>1</td><td></td><td></td></tr><tr><td></td><td></td><td>1</td></tr></table>				1					1	<table border="1"><tr><td></td><td></td><td></td></tr><tr><td></td><td></td><td></td></tr><tr><td></td><td></td><td></td></tr></table>										<table border="1"><tr><td></td><td></td><td></td></tr><tr><td></td><td></td><td></td></tr><tr><td></td><td></td><td></td></tr></table>									
		1																																																																													
	1	1																																																																													
1																																																																															
		1																																																																													
Post - 0 Miss - 0 Block - 0	Post - 0 Miss - 0 Block - 0	Post - 1 Miss - 0 Block - 0	Post - 0 Miss - 0 Block - 0	Post - 0 Miss - 0 Block - 0	Post - 0 Miss - 0 Block - 0	Post - 0 Miss - 0 Block - 0	Post - 0 Miss - 0 Block - 0																																																																								

注释: Post=击柱 Miss=射失 Block=被封





男子 国内比赛



第十二届全国运动会男子手球预赛

Team A										Team B										Match Number									
A 上海					B 山东									47															
played in				in the hall				on				at				Spectators													
China				柳州市李宁体育馆				28/04/2013				18:00 hours																	
Half-time (30')		A		B		End of playing time		A		B		1st extra time		A		B		2nd extra time		A		B		After penalty throws		A		B	
		11		14				21		27																			
Number of 7 m		A		Team time-out			Full name of players and officials										Team time-out			B		Number of 7 m							
1 / 1				1	2	3											1	2	3	2 / 2									
				15:56	36:33												10:12	50:48											
No.	Team A					G	W	2'	D	DR	No.	Team B					G	W	2'	D	DR								
1	张崢										1	于性哲																	
2	胡辰										4	田瑞																	
3	赵时俊							1			5	潘翔					6	1											
5	朱世杰										6	李朝鹏																	
6	李和鑫					6	1				8	王炳华																	
8	钱为玮					1					9	赵鑫					4												
9	朱礼彬					6	1				11	宋朋强					2	1											
10	吴璟					3					13	刘晓					1												
12	周哲韬										15	陈鹏波																	
13	孟宇超										16	王帅																	
14	王子阳					1					17	王旭东					7		2										
15	徐俊吉							1			18	于亚男																	
16	朱春雷										19	李语庆					5												
18	马麟晓					3					20	杜在超						1											
19	蒋承骅					1	1				21	翟乾坤					2		1										
20	程云飞										22	刘正松																	
A	吴龙基										A	王鸿斌																	
B	陆钦忠										B	王志峰																	
C	徐耀忠										C	邢建刚																	
E	黄韡										D	徐强																	
A											Signature of Responsible Official of the Teams (Off. A)										B								
TP	Remarks of Referee / CHA Official																				TP								

Signatures

Referees	Jan Eric Klaus	Mikael Engelbert		
Techn. Delegates	李之文 (CHN)	王锡祯 (CHN)		
CHA Official				

Note: Number of 7m Throws Awarded to Team A and B, Goals (G), Warnings (W), Suspensions (2), Direct Disqualification (D), Disqualification with Report (DR) and Team Penalty (TP).

Table Officials:

Statisticians: 朱伟平

黄莉

Printed by PHMS Copyright: IHF / CHA 28/04/2013 19:57:15

Longman Sportsoft



handball@126.com



第十二届全国运动会男子手球预赛
竞赛技术统计(媒体表)

Match header table with columns: 3-4名, 组别, X, 轮次, 10, 场次, 47, 柳州市李宁体育馆, 28/04/2013, 201301047-51-1/1, 上海, 上海, 21, vs, 27, 山东, 山东, 11:14

Referee table: 裁判员, Jan Eric Klaus Leandersson (FIN), /, Mikael Engelbert Lindroos (FIN)

Main statistics table with columns for players (上海, 山东), statistics (远射, 近射, 边射, 快攻, 突破, 任意球, 7m球, 合计, %, 助攻, 失误, 警告, 2', D & DR), and game progress (1st Half, 2nd Half).

Summary table with columns: 快攻, Fast Break, 突破, Breakthrough, 任意球, Free Throw, 7m球, 7M Throw, 助攻, Assist, 警告, Warning, 失误, Error, 2', Suspension, D, 取消资格, DR, 取消资格+报告



第十二届全国运动会男子手球预赛 图式比赛技术统计表

轮次 10

场次 47

201301047-21-1/1

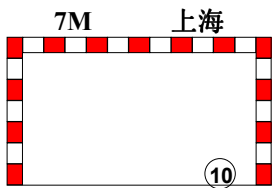
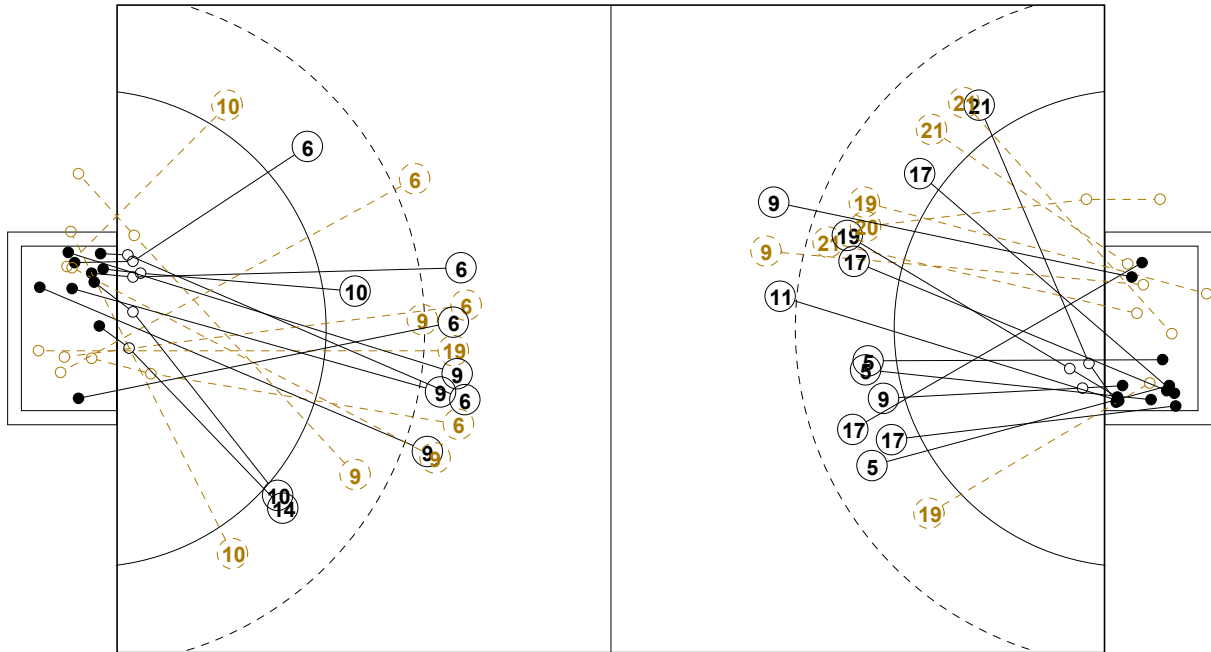

1st Half
11 : 14

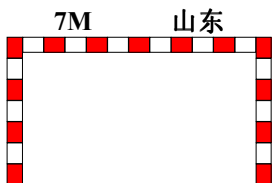
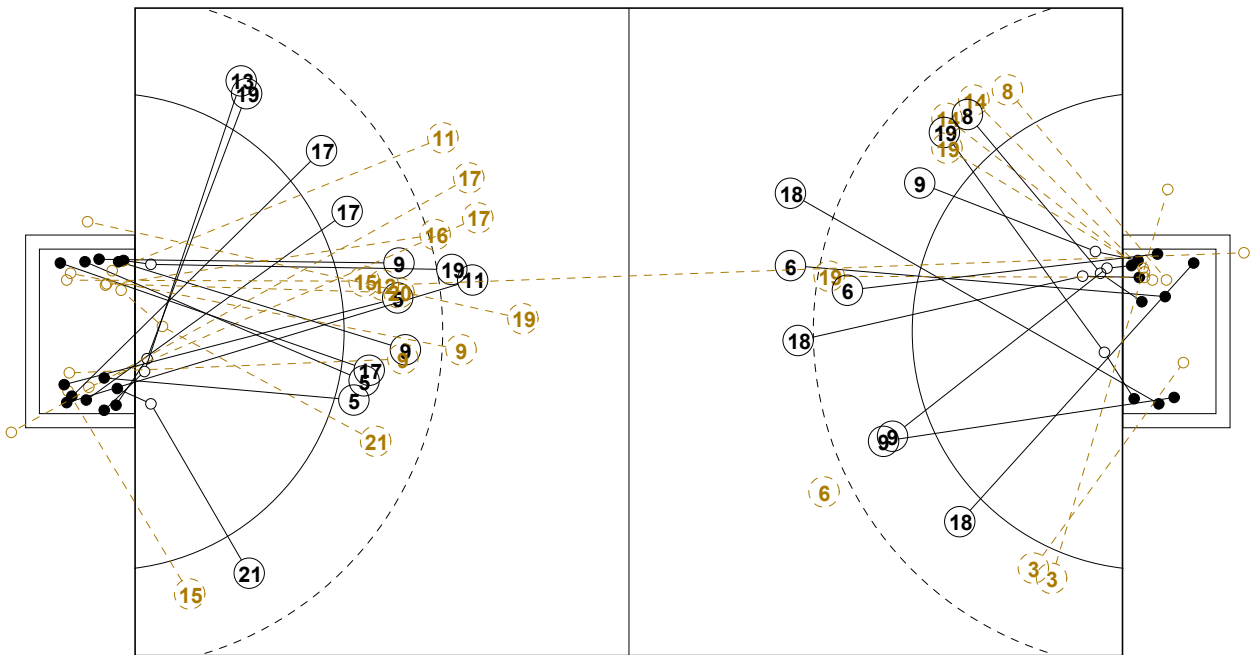
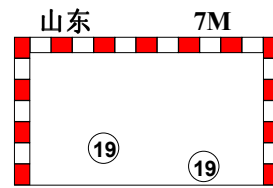

2nd Half
27 : 21

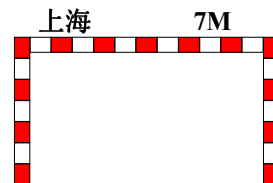



第十二届全国运动会男子手球预赛

个人/全队技术统计表

正式表
手球
男子3-4名
轮次 10组别 X
场次 47201301047-14-1/2
柳州市李宁体育馆
28/04/2013 18:00

号码	姓名	远射	近射	边射	快攻	突破	任意	7M	合计	%	助攻	失误	警告	2'	取消	时间
上海(上海)																
<i>(场上队员)</i>																
1	张崢									0.0%						00:15:14
2	胡辰									0.0%						00:00:00
3	赵时俊			0/2					0/2	0.0%				1		00:58:22
5	朱世杰									0.0%						00:00:00
6	李和鑫	4/8			1/1	1/1			6/10	60.0%	1	4	1			00:35:26
8	钱为玮				1/2				1/2	50.0%		2				00:31:12
9	朱礼彬	3/5	1/1		1/1	1/2			6/9	66.7%		6	1			00:44:47
10	吴璟		2/2	0/2				1/1	3/5	60.0%						00:36:34
12	周哲韬	0/1							0/1	0.0%						00:15:23
13	孟宇超									0.0%						00:00:00
14	王子阳			0/1	1/2				1/3	33.3%						00:36:54
15	徐俊吉									0.0%				1		00:20:17
16	朱春雷									0.0%						00:29:23
18	马麟晓	1/1			1/1	1/1			3/3	100%		7				00:53:51
19	蒋承骅		0/1		0/2	1/1			1/4	25.0%		4	1			00:41:37
20	程云飞									0.0%						00:00:00
合计		8/15	3/4	0/5	5/9	4/5		1/1	21/39	53.8%	1	23	3	2		
<i>(守门员)</i>																
1	张崢	1/2	1/5	1/3		0/1		0/1	3/12	25.0%						00:15:14
12	周哲韬	3/4	1/2	0/1	1/2	1/2			6/11	54.5%						00:15:23
16	朱春雷	2/3	2/4	1/2	0/5	0/3		0/1	5/18	27.8%						00:29:23
合计		6/9	4/11	2/6	1/7	1/6		0/2	14/41	34.1%						

场上队员：得分/射门

守门员：救球/射门

全队合计	得分	被救	射失	击柱	封球	合计	%
远射	8	4	1		2	15	53.3%
近射	3	1				4	75.0%
边射		3	1	1		5	0.0%
快攻	5	4				9	55.6%
突破	4		1			5	80.0%
任意							0.0%
7M	1					1	100.0%





第十二届全国运动会男子手球预赛

个人/全队技术统计表

正式表
手球
男子3-4名
轮次 10组别 X
场次 47201301047-14-2/2
柳州市李宁体育馆
28/04/2013 18:00

号码	姓名	远射	近射	边射	快攻	突破	任意	7M	合计	%	助攻	失误	警告	2'	取消	时间
山东(山东)																
<i>(上场队员)</i>																
1	于性哲									0.0%						00:00:00
4	田瑞									0.0%						00:00:00
5	潘翔		3/3		2/2	1/1			6/6	100%		3	1			00:39:46
6	李朝鹏									0.0%						00:00:00
8	王炳华									0.0%						00:00:00
9	赵鑫	1/3				3/4			4/7	57.1%	3	4				00:37:22
11	宋朋强	1/2			1/1				2/3	66.7%	1		1			00:54:16
13	刘晓			1/1					1/1	100%						00:17:49
15	陈鹏波		0/1	0/1					0/2	0.0%						00:18:44
16	王帅	0/1							0/1	0.0%						00:52:51
17	王旭东	0/2	4/4		2/2	1/1			7/9	77.8%		7		2		00:56:45
18	于亚男									0.0%						00:00:00
19	李语庆	1/2	0/1	1/1	1/2			2/2	5/8	62.5%		1				00:44:59
20	杜在超				0/1	0/1			0/2	0.0%			1			00:25:31
21	翟乾坤	0/1	0/2	2/3					2/6	33.3%		3		1		01:00:00
22	刘正松									0.0%						00:07:09
合计		3/11	7/11	4/6	6/8	5/7		2/2	27/45	60.0%	4	18	3	3		
<i>(守门员)</i>																
16	王帅	2/8	1/4	2/2	4/9	0/3		0/1	9/27	33.3%						00:52:51
22	刘正松	2/4		1/1		0/1			3/6	50.0%						00:07:09
合计		4/12	1/4	3/3	4/9	0/4		0/1	12/33	36.4%						

场上队员：得分/射门

守门员：救球/射门

全队合计	得分	被救	射失	击柱	封球	合计	%
远射	3	6	2			11	27.3%
近射	7	4				11	63.6%
边射	4	2				6	66.7%
快攻	6	1		1		8	75.0%
突破	5	1	1			7	71.4%
任意							0.0%
7M	2					2	100.0%





第十二届全国运动会男子手球预赛

图式射门区域统计

轮次 10 场次 47

201301047-41-1/1

上海

1 张峥	2 胡辰	3 赵时俊	5 朱世杰	6 李和鑫	8 钱为玮	9 朱礼彬	10 吴璟																																																																								
<table border="1"><tr><td></td><td></td><td></td></tr><tr><td></td><td></td><td></td></tr><tr><td></td><td></td><td></td></tr></table>										<table border="1"><tr><td></td><td></td><td></td></tr><tr><td></td><td></td><td></td></tr><tr><td></td><td></td><td></td></tr></table>										<table border="1"><tr><td></td><td></td><td></td></tr><tr><td></td><td></td><td></td></tr><tr><td></td><td></td><td></td></tr></table>										<table border="1"><tr><td></td><td></td><td></td></tr><tr><td></td><td></td><td></td></tr><tr><td></td><td></td><td></td></tr></table>										<table border="1"><tr><td></td><td></td><td></td></tr><tr><td>3</td><td></td><td>1</td></tr><tr><td></td><td></td><td>2</td></tr></table>				3		1			2	<table border="1"><tr><td></td><td></td><td></td></tr><tr><td></td><td></td><td></td></tr><tr><td>1</td><td></td><td></td></tr></table>							1			<table border="1"><tr><td></td><td></td><td>1</td></tr><tr><td></td><td></td><td>3</td></tr><tr><td></td><td></td><td></td></tr></table>			1			3				<table border="1"><tr><td></td><td></td><td></td></tr><tr><td></td><td></td><td></td></tr><tr><td></td><td></td><td>3</td></tr></table>									3
3		1																																																																													
		2																																																																													
1																																																																															
		1																																																																													
		3																																																																													
		3																																																																													
Post - 0 Miss - 0 Block - 0	Post - 0 Miss - 0 Block - 0	Post - 0 Miss - 1 Block - 0	Post - 0 Miss - 0 Block - 0	Post - 0 Miss - 0 Block - 1	Post - 0 Miss - 0 Block - 0	Post - 0 Miss - 1 Block - 1	Post - 1 Miss - 0 Block - 0																																																																								
12 周哲韬	13 孟宇超	14 王子阳	15 徐俊吉	16 朱春雷	18 马麟晓	19 蒋承骅	20 程云飞																																																																								
<table border="1"><tr><td></td><td></td><td></td></tr><tr><td></td><td></td><td></td></tr><tr><td></td><td></td><td></td></tr></table>										<table border="1"><tr><td></td><td></td><td></td></tr><tr><td></td><td></td><td></td></tr><tr><td></td><td></td><td></td></tr></table>										<table border="1"><tr><td></td><td></td><td></td></tr><tr><td></td><td></td><td></td></tr><tr><td></td><td>1</td><td></td></tr></table>								1		<table border="1"><tr><td></td><td></td><td></td></tr><tr><td></td><td></td><td></td></tr><tr><td></td><td></td><td></td></tr></table>										<table border="1"><tr><td></td><td></td><td></td></tr><tr><td></td><td></td><td></td></tr><tr><td></td><td></td><td></td></tr></table>										<table border="1"><tr><td></td><td></td><td></td></tr><tr><td>1</td><td></td><td></td></tr><tr><td></td><td></td><td>1</td></tr></table>				1					1	<table border="1"><tr><td></td><td></td><td></td></tr><tr><td></td><td></td><td></td></tr><tr><td></td><td></td><td>1</td></tr></table>									1	<table border="1"><tr><td></td><td></td><td></td></tr><tr><td></td><td></td><td></td></tr><tr><td></td><td></td><td></td></tr></table>									
	1																																																																														
1																																																																															
		1																																																																													
		1																																																																													
Post - 0 Miss - 1 Block - 0	Post - 0 Miss - 0 Block - 0	Post - 0 Miss - 0 Block - 0	Post - 0 Miss - 0 Block - 0	Post - 0 Miss - 0 Block - 0	Post - 0 Miss - 0 Block - 0	Post - 0 Miss - 0 Block - 0	Post - 0 Miss - 0 Block - 0																																																																								

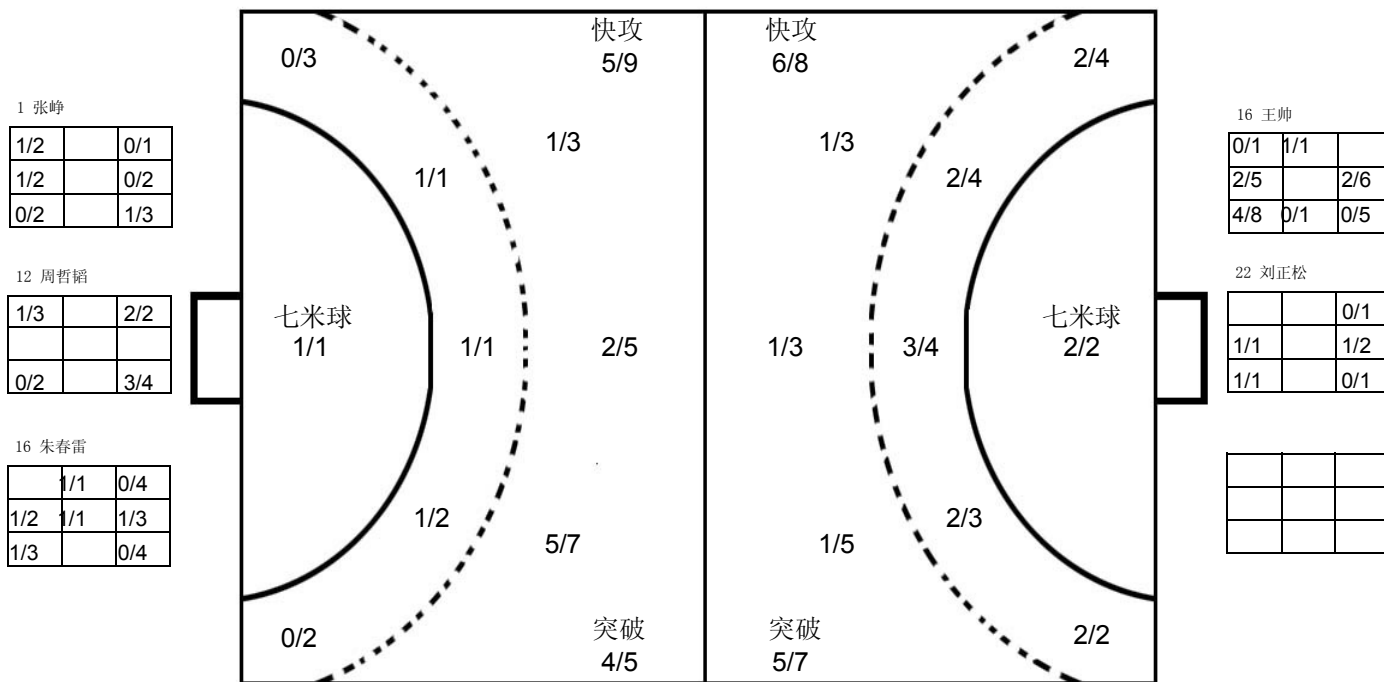

山东

1 于性哲	4 田瑞	5 潘翔	6 李朝鹏	8 王炳华	9 赵鑫	11 宋朋强	13 刘晓																																																																								
<table border="1"><tr><td></td><td></td><td></td></tr><tr><td></td><td></td><td></td></tr><tr><td></td><td></td><td></td></tr></table>										<table border="1"><tr><td></td><td></td><td></td></tr><tr><td></td><td></td><td></td></tr><tr><td></td><td></td><td></td></tr></table>										<table border="1"><tr><td>1</td><td></td><td>1</td></tr><tr><td></td><td></td><td>3</td></tr><tr><td>1</td><td></td><td></td></tr></table>	1		1			3	1			<table border="1"><tr><td></td><td></td><td></td></tr><tr><td></td><td></td><td></td></tr><tr><td></td><td></td><td></td></tr></table>										<table border="1"><tr><td></td><td></td><td></td></tr><tr><td></td><td></td><td></td></tr><tr><td></td><td></td><td></td></tr></table>										<table border="1"><tr><td></td><td></td><td></td></tr><tr><td></td><td></td><td></td></tr><tr><td></td><td></td><td>1</td></tr></table>									1	<table border="1"><tr><td></td><td></td><td></td></tr><tr><td></td><td></td><td></td></tr><tr><td></td><td></td><td>1</td></tr></table>									1	<table border="1"><tr><td></td><td></td><td></td></tr><tr><td></td><td></td><td></td></tr><tr><td></td><td></td><td>1</td></tr></table>									1
1		1																																																																													
		3																																																																													
1																																																																															
		1																																																																													
		1																																																																													
		1																																																																													
Post - 0 Miss - 0 Block - 0	Post - 0 Miss - 0 Block - 0	Post - 0 Miss - 0 Block - 0	Post - 0 Miss - 0 Block - 0	Post - 0 Miss - 0 Block - 0	Post - 0 Miss - 0 Block - 0	Post - 0 Miss - 0 Block - 0	Post - 0 Miss - 0 Block - 0																																																																								
15 陈鹏波	16 王帅	17 王旭东	18 于亚男	19 李语庆	20 杜在超	21 翟乾坤	22 刘正松																																																																								
<table border="1"><tr><td></td><td></td><td></td></tr><tr><td></td><td></td><td></td></tr><tr><td></td><td></td><td></td></tr></table>										<table border="1"><tr><td></td><td></td><td></td></tr><tr><td></td><td></td><td></td></tr><tr><td></td><td></td><td></td></tr></table>										<table border="1"><tr><td>1</td><td></td><td>4</td></tr><tr><td>2</td><td></td><td></td></tr><tr><td></td><td></td><td></td></tr></table>	1		4	2						<table border="1"><tr><td></td><td></td><td></td></tr><tr><td></td><td></td><td></td></tr><tr><td></td><td></td><td></td></tr></table>										<table border="1"><tr><td></td><td></td><td></td></tr><tr><td></td><td></td><td></td></tr><tr><td>2</td><td></td><td>3</td></tr></table>							2		3	<table border="1"><tr><td></td><td></td><td></td></tr><tr><td></td><td></td><td></td></tr><tr><td></td><td></td><td></td></tr></table>										<table border="1"><tr><td></td><td></td><td></td></tr><tr><td></td><td></td><td></td></tr><tr><td>1</td><td></td><td>1</td></tr></table>							1		1	<table border="1"><tr><td></td><td></td><td></td></tr><tr><td></td><td></td><td></td></tr><tr><td></td><td></td><td></td></tr></table>									
1		4																																																																													
2																																																																															
2		3																																																																													
1		1																																																																													
Post - 0 Miss - 0 Block - 0	Post - 0 Miss - 0 Block - 0	Post - 0 Miss - 1 Block - 0	Post - 0 Miss - 0 Block - 0	Post - 1 Miss - 1 Block - 0	Post - 0 Miss - 1 Block - 0	Post - 0 Miss - 0 Block - 0	Post - 0 Miss - 0 Block - 0																																																																								

注释: Post=击柱 Miss=射失 Block=被封





男子 国内比赛



第十二届全国运动会男子手球预赛

Team A A 江苏				Team B B 广东				Match Number 48													
played in China		in the hall 柳州市李宁体育馆		on 28/04/2013		at 19:40 hours		Spectators													
Half-time (30')	A 17	B 11	End of playing time	A 32	B 24	1st extra time	A	B	2nd extra time	A	B	After penalty throws	A	B							
Number of 7 m	A 1/1	Team time-out			Full name of players and officials				Team time-out			B 0/0	Number of 7 m								
No.	Team A					G	W	2'	D	DR	No.	Team B					G	W	2'	D	DR
1	丁大伟										1	王旭兴									
2	杨彦威					1					2	孙江山					1				
3	李旭东										3	曲汝洋					4				
4	沈庆										4	李卓洋					7				
5	闫亮					3	1				5	候生升					4				
6	赵晨					4	1	1			6	邓志贵					1	1			
8	周小坚					5					7	付文博					1	1			
9	叶强					1					8	于彦江									
10	郝可鑫										9	徐庆									
11	姚仁剑										10	陈超					2				
12	王权										12	温杰									
14	丛海航					2					16	张广建									
15	李安					13					17	李中洲					2				
17	陈灵峰										18	张腾									
19	张志宇					3	1	1			19	马跃									
20	张星										20	王伟					2	1			
A	闫威名										A	王锋									
C	NENADz vonarek										B	李晓忠									
D	王建国										C	郭艳辉									
E	贾淑君										E	薛良成									
A	Signature of Responsible Official of the Teams (Off. A)																		B		
TP	Remarks of Referee / CHA Official																		TP		

Signatures

Referees: 王锐 (CHN) 陈晓波 (CHN)

Techn. Delegates: 王锡祯 (CHN) 刘书勇 (CHN)

CHA Official:

Note: Number of 7m Throws Awarded to Team A and B, Goals (G), Warnings (W), Suspensions (2'), Direct Disqualification (D), Disqualification with Report (DR) and Team Penalty (TP).

Table Officials:

Statisticians: 黄莉

朱伟平



第十二届全国运动会男子手球预赛
竞赛技术统计(媒体表)

决赛	组别	X	轮次	10	场次	48
----	----	---	----	----	----	----

柳州市李宁体育馆

28/04/2013

201301048-51-1/1

江苏	江苏	32	vs	24	广东	广东
17 : 11						

裁判员	王锐 (CHN)	/	陈晓波 (CHN)
-----	----------	---	-----------

江苏		远射	近射	边射	快攻	突破	任意球	7m球	合计	%	助攻	失误	警告	2'	D & DR	江苏	比赛进程	广东
主教练:	闫威名																	
1	丁大伟				1/2				1/2	50.0								
2	杨彦威																	
3	李旭东																	
4	沈庆																	
5	闫亮	2/2		0/2	1/1	0/1			3/6	50.0	3	2	1					
6	赵晨	3/6	1/2						4/8	50.0	5	2	1	1				
8	周小坚	1/1	4/4						5/5	100	1	3						
9	叶强			0/1		1/1			1/2	50.0								
10	郝可鑫	0/1							0/1	0.0		1						
11	姚仁剑																	
12	王权																	
14	丛海航			1/3	1/2	0/1			2/6	33.3		1						
15	李安	0/1	1/1	3/6	6/8	2/2		1/1	13/19	68.4		2						
17	陈灵峰	0/2							0/2	0.0		1						
19	张志宇	0/1	1/1			2/3			3/5	60.0	4	3	1	1				
20	张星																	
运动员 合计		6/14	7/8	4/12	9/13	5/8		1/1	32/56	57.1	13	15	3	2				
1	丁大伟	8/11	2/2		0/5	0/1			10/19	52.6								
12	王权	4/12	1/2		1/7				6/21	28.6								
守门员 合计		12/23	3/4		1/12	0/1			16/40	40.0								
广东		远射	近射	边射	快攻	突破	任意球	7m球	合计	%	助攻	失误	警告	2'	D & DR			
教练:	王锋																	
1	王旭兴											1						
2	孙江山			0/1	1/1				1/2	50.0		1						
3	曲汝洋	1/2			3/3				4/5	80.0		3						
4	李卓洋	7/15	0/2		0/1				7/18	38.9	2	3						
5	候生升			0/1	4/4				4/5	80.0		3						
6	邓志贵				1/1				1/1	100			1					
7	付云博	1/7	0/1						1/8	12.5	1	1	1					
8	于彦江																	
9	徐庆																	
10	陈超	2/4							2/4	50.0		3						
12	温杰																	
16	张广建																	
17	李中洲	0/6	1/1		0/1	1/1			2/9	22.2	1	2						
18	张腾																	
19	马跃																	
20	王伟		0/2	0/1	2/3				2/6	33.3		3	1					
运动员 合计		11/34	1/6	0/3	11/14	1/1			24/58	41.4	4	20	3					
1	王旭兴	5/11	1/8	6/10	2/11	2/7		0/1	16/48	33.3		1						
守门员 合计		5/11	1/8	6/10	2/11	2/7		0/1	16/48	33.3		1						

场上队员: 得分 / 射门

守门员: 救球 / 射门

快攻	Fast Break		突破	Breakthrough		任意球	Free Throw		7M球	7M Throw		助攻	Assist
警告	Warning		失误	Error		2'	Suspension		D	取消资格		DR	取消资格+报告





第十二届全国运动会男子手球预赛 图式比赛技术统计表

轮次 10

场次 48

201301048-21-1/1

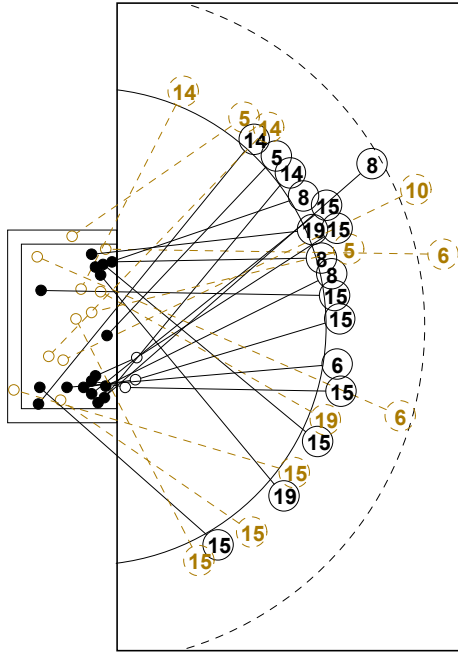

7M 江苏

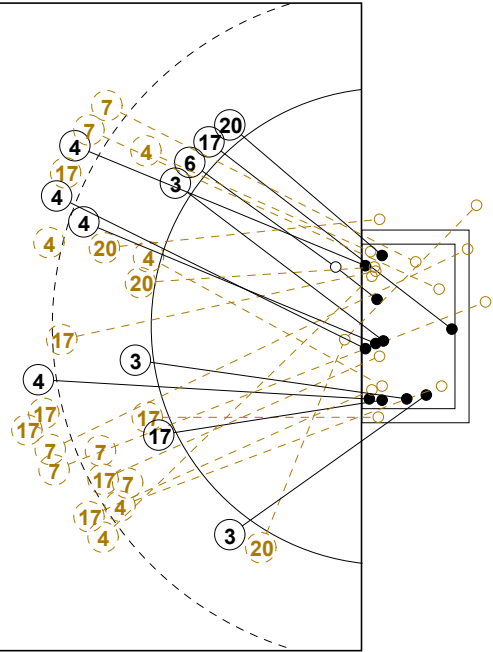
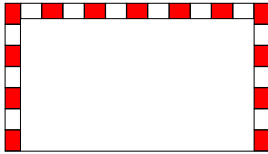

广东 7M

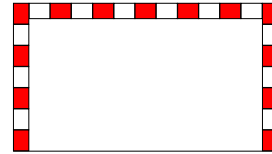

1st Half
17 : 11

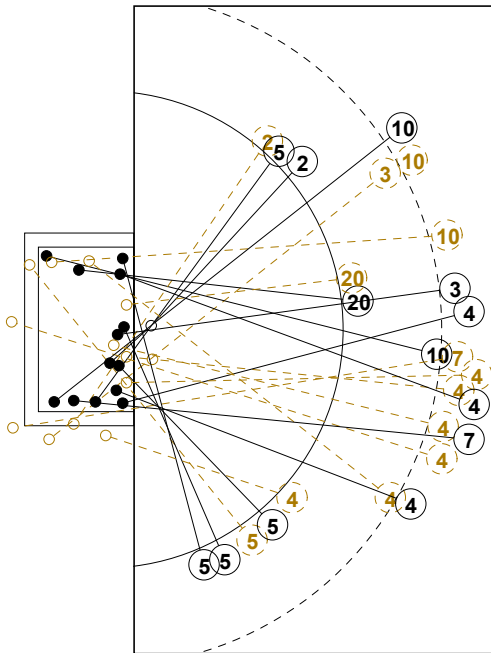

7M 广东

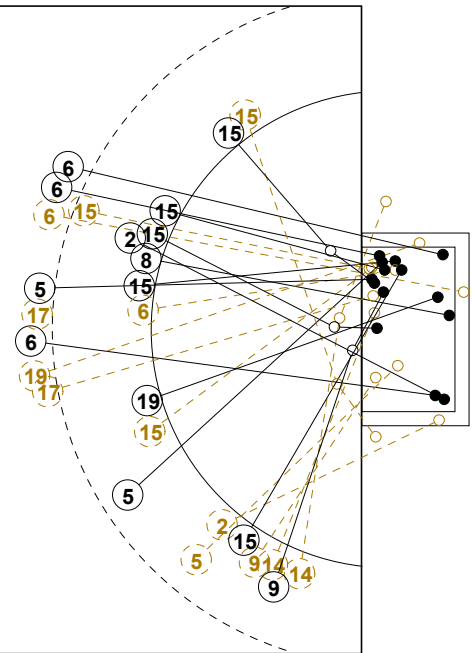
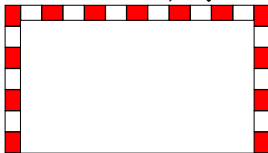

江苏 7M

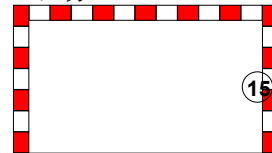

2nd Half
24 : 32



第十二届全国运动会男子手球预赛

个人/全队技术统计表

正式表
手球
男子决赛
轮次 10组别 X
场次 48201301048-14-1/2
柳州市李宁体育馆
28/04/2013 19:40

号码	姓名	远射	近射	边射	快攻	突破	任意	7M	合计	%	助攻	失误	警告	2'	取消	时间
江苏(江苏)																
<i>(场上队员)</i>																
1	丁大伟									0.0%						00:29:05
2	杨彦威				1/2				1/2	50.0%						00:10:28
3	李旭东									0.0%						00:00:00
4	沈庆									0.0%						00:09:00
5	闫亮	2/2		0/2	1/1	0/1			3/6	50.0%	3	2	1			00:47:54
6	赵晨	3/6	1/2						4/8	50.0%	5	2	1	1		00:41:32
8	周小坚	1/1	4/4						5/5	100%	1	3				00:59:54
9	叶强			0/1		1/1			1/2	50.0%						00:05:11
10	郝可鑫	0/1							0/1	0.0%		1				00:16:30
11	姚仁剑									0.0%						00:00:00
12	王权									0.0%						00:30:55
14	丛海航			1/3	1/2	0/1			2/6	33.3%		1				00:44:32
15	李安	0/1	1/1	3/6	6/8	2/2		1/1	13/19	68.4%		2				00:59:42
17	陈灵峰	0/2							0/2	0.0%		1				00:14:04
19	张志宇	0/1	1/1			2/3			3/5	60.0%	4	3	1	1		00:50:23
20	张星									0.0%						00:00:00
合计		6/14	7/8	4/12	9/13	5/8		1/1	32/56	57.1%	13	15	3	2		
<i>(守门员)</i>																
1	丁大伟	8/11	2/2		0/5	0/1			10/19	52.6%						00:29:05
12	王权	4/12	1/2		1/7				6/21	28.6%						00:30:55
合计		12/23	3/4		1/12	0/1			16/40	40.0%						

场上队员：得分/射门

守门员：救球/射门

全队合计	得分	被救	射失	击柱	封球	合计	%
远射	6	5		2	1	14	42.9%
近射	7	1				8	87.5%
边射	4	6	1	1		12	33.3%
快攻	9	2		2		13	69.2%
突破	5	2	1			8	62.5%
任意							0.0%
7M	1					1	100.0%





第十二届全国运动会男子手球预赛

个人/全队技术统计表

正式表
手球
男子决赛
轮次 10组别 X
场次 48201301048-14-2/2
柳州市李宁体育馆
28/04/2013 19:40

号码	姓名	远射	近射	边射	快攻	突破	任意	7M	合计	%	助攻	失误	警告	2'	取消	时间
广东(广东)																
<i>(上场队员)</i>																
1	王旭兴									0.0%		1				01:00:00
2	孙江山			0/1	1/1				1/2	50.0%		1				00:21:01
3	曲汝洋	1/2			3/3				4/5	80.0%		3				00:55:31
4	李卓洋	7/15	0/2		0/1				7/18	38.9%	2	3				00:51:44
5	候生升			0/1	4/4				4/5	80.0%		3				00:34:28
6	邓志贵				1/1				1/1	100%			1			00:25:22
7	付云博	1/7	0/1						1/8	12.5%	1	1	1			00:39:49
8	于彦江									0.0%						00:00:00
9	徐庆									0.0%						00:18:06
10	陈超	2/4							2/4	50.0%		3				00:29:48
12	温杰									0.0%						00:00:00
16	张广建									0.0%						00:00:00
17	李中洲	0/6	1/1		0/1	1/1			2/9	22.2%	1	2				00:38:05
18	张腾									0.0%						00:00:00
19	马跃									0.0%						00:00:00
20	王伟		0/2	0/1	2/3				2/6	33.3%		3	1			00:44:50
合计		11/34	1/6	0/3	11/14	1/1			24/58	41.4%	4	20	3			
<i>(守门员)</i>																
1	王旭兴	5/11	1/8	6/10	2/11	2/7		0/1	16/48	33.3%		1				01:00:00
合计		5/11	1/8	6/10	2/11	2/7		0/1	16/48	33.3%		1				

场上队员：得分/射门

守门员：救球/射门

全队合计	得分	被救	射失	击柱	封球	合计	%
远射	11	12	4	1	6	34	32.4%
近射	1	3	1		1	6	16.7%
边射			1	2		3	0.0%
快攻	11	1	1	1		14	78.6%
突破	1					1	100.0%
任意							0.0%
7M							0.0%





第十二届全国运动会男子手球预赛

图式射门区域统计

轮次 10 场次 48

201301048-41-1/1

江苏

1 丁大伟	2 杨彦威	3 李旭东	4 沈庆	5 闫亮	6 赵晨	8 周小坚	9 叶强																																																																								
<table border="1"><tr><td></td><td></td><td></td></tr><tr><td></td><td></td><td></td></tr><tr><td></td><td></td><td></td></tr></table>										<table border="1"><tr><td></td><td></td><td>1</td></tr><tr><td></td><td></td><td></td></tr><tr><td></td><td></td><td></td></tr></table>			1							<table border="1"><tr><td></td><td></td><td></td></tr><tr><td></td><td></td><td></td></tr><tr><td></td><td></td><td></td></tr></table>										<table border="1"><tr><td></td><td></td><td></td></tr><tr><td></td><td></td><td></td></tr><tr><td></td><td></td><td></td></tr></table>										<table border="1"><tr><td></td><td></td><td></td></tr><tr><td></td><td></td><td></td></tr><tr><td>2</td><td>1</td><td></td></tr></table>							2	1		<table border="1"><tr><td>1</td><td></td><td>1</td></tr><tr><td>1</td><td></td><td></td></tr><tr><td>1</td><td></td><td></td></tr></table>	1		1	1			1			<table border="1"><tr><td></td><td>1</td><td></td></tr><tr><td></td><td></td><td></td></tr><tr><td>2</td><td></td><td>2</td></tr></table>		1					2		2	<table border="1"><tr><td></td><td></td><td></td></tr><tr><td></td><td></td><td></td></tr><tr><td>1</td><td></td><td></td></tr></table>							1		
		1																																																																													
2	1																																																																														
1		1																																																																													
1																																																																															
1																																																																															
	1																																																																														
2		2																																																																													
1																																																																															
Post - 0 Miss - 0 Block - 0	Post - 1 Miss - 0 Block - 0	Post - 0 Miss - 0 Block - 0	Post - 0 Miss - 0 Block - 0	Post - 1 Miss - 0 Block - 0	Post - 1 Miss - 0 Block - 0	Post - 0 Miss - 0 Block - 0	Post - 0 Miss - 0 Block - 0																																																																								
10 郝可鑫	11 姚仁剑	12 王权	14 丛海航	15 李安	17 陈灵峰	19 张志宇	20 张星																																																																								
<table border="1"><tr><td></td><td></td><td></td></tr><tr><td></td><td></td><td></td></tr><tr><td></td><td></td><td></td></tr></table>										<table border="1"><tr><td></td><td></td><td></td></tr><tr><td></td><td></td><td></td></tr><tr><td></td><td></td><td></td></tr></table>										<table border="1"><tr><td></td><td></td><td></td></tr><tr><td></td><td></td><td></td></tr><tr><td></td><td></td><td></td></tr></table>										<table border="1"><tr><td>1</td><td></td><td></td></tr><tr><td></td><td></td><td></td></tr><tr><td>1</td><td></td><td></td></tr></table>	1						1			<table border="1"><tr><td>1</td><td></td><td>1</td></tr><tr><td>3</td><td></td><td>1</td></tr><tr><td>5</td><td>1</td><td>1</td></tr></table>	1		1	3		1	5	1	1	<table border="1"><tr><td></td><td></td><td></td></tr><tr><td></td><td></td><td></td></tr><tr><td></td><td></td><td></td></tr></table>										<table border="1"><tr><td>1</td><td></td><td></td></tr><tr><td></td><td></td><td></td></tr><tr><td></td><td></td><td>2</td></tr></table>	1								2	<table border="1"><tr><td></td><td></td><td></td></tr><tr><td></td><td></td><td></td></tr><tr><td></td><td></td><td></td></tr></table>									
1																																																																															
1																																																																															
1		1																																																																													
3		1																																																																													
5	1	1																																																																													
1																																																																															
		2																																																																													
Post - 0 Miss - 0 Block - 0	Post - 0 Miss - 0 Block - 0	Post - 0 Miss - 0 Block - 0	Post - 0 Miss - 1 Block - 0	Post - 1 Miss - 1 Block - 0	Post - 0 Miss - 0 Block - 1	Post - 1 Miss - 0 Block - 0	Post - 0 Miss - 0 Block - 0																																																																								

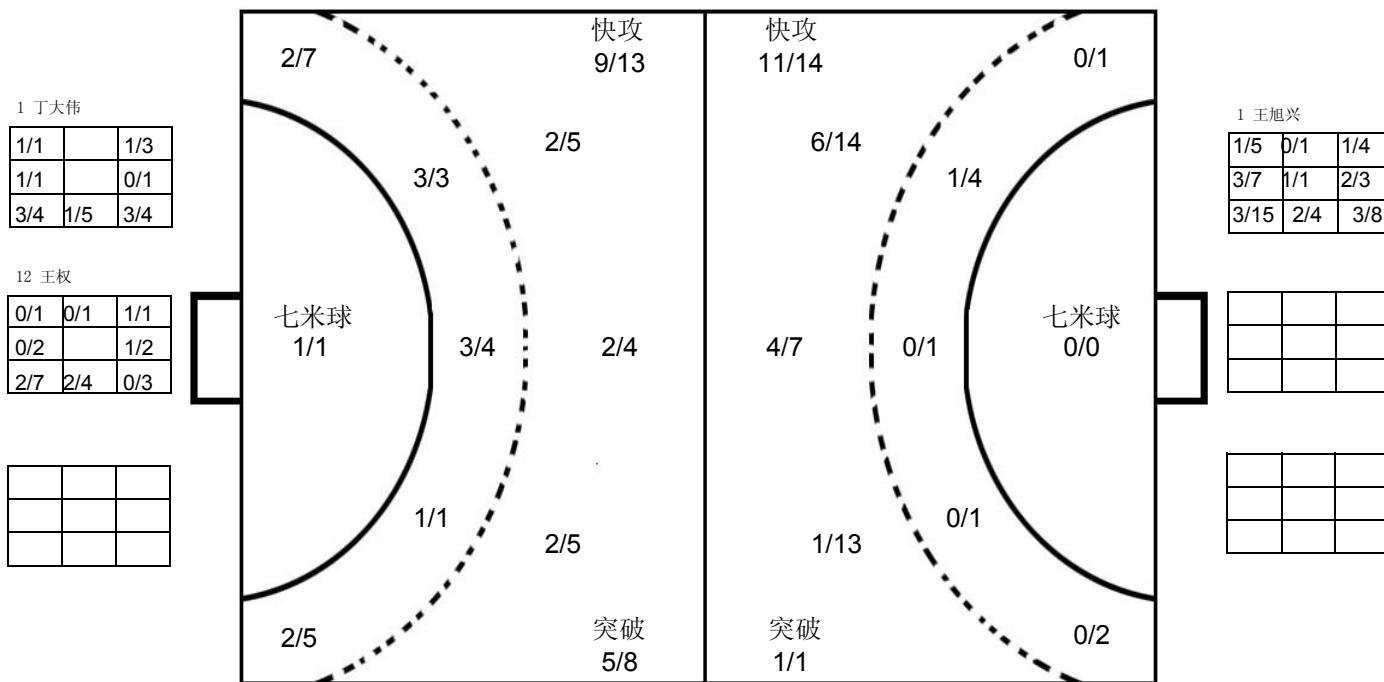

广东

1 王旭兴	2 孙江山	3 曲汝洋	4 李卓洋	5 候生升	6 邓志贵	7 付云博	8 于彦江																																																																								
<table border="1"><tr><td></td><td></td><td></td></tr><tr><td></td><td></td><td></td></tr><tr><td></td><td></td><td></td></tr></table>										<table border="1"><tr><td></td><td></td><td></td></tr><tr><td>1</td><td></td><td></td></tr><tr><td></td><td></td><td></td></tr></table>				1						<table border="1"><tr><td></td><td></td><td>1</td></tr><tr><td></td><td></td><td>1</td></tr><tr><td>2</td><td></td><td></td></tr></table>			1			1	2			<table border="1"><tr><td></td><td></td><td></td></tr><tr><td>3</td><td>2</td><td>2</td></tr><tr><td></td><td></td><td></td></tr></table>				3	2	2				<table border="1"><tr><td>1</td><td></td><td></td></tr><tr><td>1</td><td>1</td><td>1</td></tr><tr><td></td><td></td><td></td></tr></table>	1			1	1	1				<table border="1"><tr><td></td><td></td><td></td></tr><tr><td></td><td></td><td></td></tr><tr><td>1</td><td></td><td></td></tr></table>							1			<table border="1"><tr><td></td><td></td><td></td></tr><tr><td>1</td><td></td><td></td></tr><tr><td></td><td></td><td></td></tr></table>				1						<table border="1"><tr><td></td><td></td><td></td></tr><tr><td></td><td></td><td></td></tr><tr><td></td><td></td><td></td></tr></table>									
1																																																																															
		1																																																																													
		1																																																																													
2																																																																															
3	2	2																																																																													
1																																																																															
1	1	1																																																																													
1																																																																															
1																																																																															
Post - 0 Miss - 0 Block - 0	Post - 1 Miss - 0 Block - 0	Post - 0 Miss - 1 Block - 0	Post - 0 Miss - 2 Block - 1	Post - 1 Miss - 0 Block - 0	Post - 0 Miss - 0 Block - 0	Post - 1 Miss - 2 Block - 2	Post - 0 Miss - 0 Block - 0																																																																								
9 徐庆	10 陈超	12 温杰	16 张广建	17 李中洲	18 张腾	19 马跃	20 王伟																																																																								
<table border="1"><tr><td></td><td></td><td></td></tr><tr><td></td><td></td><td></td></tr><tr><td></td><td></td><td></td></tr></table>										<table border="1"><tr><td>1</td><td></td><td>1</td></tr><tr><td></td><td></td><td></td></tr><tr><td></td><td></td><td></td></tr></table>	1		1							<table border="1"><tr><td></td><td></td><td></td></tr><tr><td></td><td></td><td></td></tr><tr><td></td><td></td><td></td></tr></table>										<table border="1"><tr><td></td><td></td><td></td></tr><tr><td></td><td></td><td></td></tr><tr><td></td><td></td><td></td></tr></table>										<table border="1"><tr><td></td><td>1</td><td></td></tr><tr><td></td><td></td><td></td></tr><tr><td></td><td>1</td><td></td></tr></table>		1						1		<table border="1"><tr><td></td><td></td><td></td></tr><tr><td></td><td></td><td></td></tr><tr><td></td><td></td><td></td></tr></table>										<table border="1"><tr><td></td><td></td><td></td></tr><tr><td></td><td></td><td></td></tr><tr><td></td><td></td><td></td></tr></table>										<table border="1"><tr><td></td><td></td><td>1</td></tr><tr><td></td><td></td><td></td></tr><tr><td>1</td><td></td><td></td></tr></table>			1				1		
1		1																																																																													
	1																																																																														
	1																																																																														
		1																																																																													
1																																																																															
Post - 0 Miss - 0 Block - 0	Post - 0 Miss - 0 Block - 1	Post - 0 Miss - 0 Block - 0	Post - 0 Miss - 0 Block - 0	Post - 1 Miss - 0 Block - 3	Post - 0 Miss - 0 Block - 0	Post - 0 Miss - 0 Block - 0	Post - 0 Miss - 2 Block - 0																																																																								

注释: Post=击柱 Miss=射失 Block=被封

