

2016年全国青年男子手球锦标赛

成绩册

2016年3月20日至3月29日

重庆万州

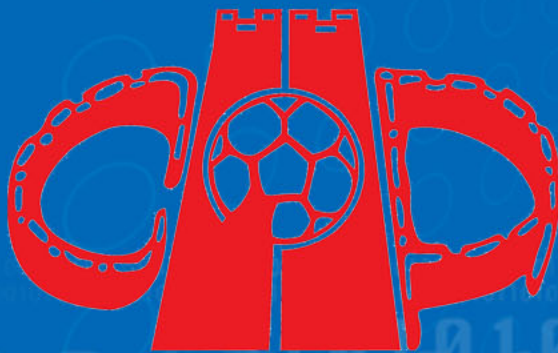

数据由PHMS收集生成
PHMS国际手球联合会官方技术统计系统



成绩与技术统计数据册目录

1 比赛结果

- 1) 名次
- 2) 场次成绩
- 3) 分组成绩

2 运动员排名

- 1) 得分
- 2) 助攻
- 3) 封球
- 4) 防守
- 5) 失误
- 6) 受罚

3 守门员排名

- 1) 救球
- 2) 救 7M 球

4 球队累计表

5 球队受罚表

6 球队信息

- 1) 球队名单
- 2) 个人/全队技术累计表
- 3) 球队射门区域累计

7 比赛统计数据

- 1) 比赛记录表
- 2) 比赛统计(媒体表)
- 3) 每场个人/全队技术统计表
- 4) 图式统计表
- 5) 每场射门区域统计
- 6) 比赛进程表(决赛场次)

注：如需更多比赛统计数据，请通过以下电邮联络：handball@126.com



2016年"体彩杯"全国手球男子青年锦标赛

OFFICIAL
HANDBALL
青年 男子

Final Standings

201313020-1204-1/1

重庆万州

UP TO MATCH 46

2016/3/29 17:51

| Medal | Rank | Code | Team |
|--------|------|------|------|
| Gold | 1 | 新疆 | 新疆队 |
| Silver | 2 | 四川 | 四川队 |
| Bronze | 3 | 安徽 | 安徽队 |
| | 4 | 山东 | 山东队 |
| | 5 | 广东 | 广东队 |
| | 6 | 北京 | 北京队 |
| | 7 | 解放军 | 解放军队 |
| | 8 | 江苏 | 江苏队 |
| | 9 | 辽宁 | 辽宁队 |
| | 10 | 浙江 | 浙江队 |

因天津、上海报名人数不足赛制要求，不计成绩。



2016年“体彩杯”全国手球男子青年锦标赛 场次成绩

正式表
手球
青年男子

截止至第46场

201602046-1203-1/1
重庆万州
2016/3/29 16:00:00

| 日期 | 时间 | 场次 | 体育馆 | 组别 | 球队 | 成绩 (半时) | 阶段 |
|----------|-------|----|------|----|--------|---------------|--------|
| 26/03/16 | 08:30 | 31 | 重庆万州 | C | 浙江-天津 | 12-27 (11-19) | 9-12名 |
| | 10:00 | 32 | 重庆万州 | C | 上海-辽宁 | 12-27 (12-25) | 9-12名 |
| | 13:00 | 33 | 重庆万州 | X | 山东-北京 | 41-39 (18-18) | 四分之一决赛 |
| | 14:30 | 34 | 重庆万州 | X | 新疆-解放军 | 40-36 (23-15) | 四分之一决赛 |
| | 16:00 | 35 | 重庆万州 | X | 广东-四川 | 30-39 (13-20) | 四分之一决赛 |
| | 17:30 | 36 | 重庆万州 | X | 安徽-江苏 | 41-27 (22-10) | 四分之一决赛 |
| 28/03/16 | 08:30 | 37 | 重庆万州 | C | 上海-天津 | 25-29 (12-15) | 11-12名 |
| | 10:00 | 38 | 重庆万州 | C | 浙江-辽宁 | 14-29 (12-19) | 9-10名 |
| | 13:00 | 39 | 重庆万州 | X | 北京-解放军 | 32-31 (18-14) | 5-8名 |
| | 14:30 | 40 | 重庆万州 | X | 广东-江苏 | 45-35 (26-16) | 5-8名 |
| | 16:00 | 41 | 重庆万州 | X | 山东-新疆 | 30-38 (11-19) | 半决赛 |
| | 17:30 | 42 | 重庆万州 | X | 四川-安徽 | 36-35 (20-15) | 半决赛 |
| 29/03/16 | 10:00 | 43 | 重庆万州 | X | 解放军-江苏 | 45-33 (21-15) | 7-8名 |
| | 13:00 | 44 | 重庆万州 | X | 北京-广东 | 27-38 (11-16) | 5-6名 |
| | 14:30 | 45 | 重庆万州 | X | 山东-安徽 | 35-42 (19-26) | 3-4名 |
| | 16:00 | 46 | 重庆万州 | X | 新疆-四川 | 28-27 (18-16) | 决赛 |





2016年“体彩杯”全国手球男子青年锦标赛

正式表
手球
青年男子

分组成绩

201602-1202-1/1

重庆万州

截止至第 42 场

2016-03-20

组别: C 9-12名

| 名次 | 球队 | 积 | 场 | 胜 | 平 | 负 | 得分 | 失分 | 净胜 |
|----|----|---|---|---|---|---|----|----|-----|
| 1 | 辽宁 | 2 | 1 | 1 | 0 | 0 | 27 | 12 | 15 |
| 2 | 天津 | 2 | 1 | 1 | 0 | 0 | 27 | 12 | 15 |
| 3 | 上海 | 0 | 1 | 0 | 0 | 1 | 12 | 27 | -15 |
| 4 | 浙江 | 0 | 1 | 0 | 0 | 1 | 12 | 27 | -15 |

| 球队 | 辽宁 | 天津 | 上海 | 浙江 |
|----|-------|-------|-------|-------|
| 辽宁 | | 30-31 | 27-12 | 29-14 |
| 天津 | 31-30 | | 29-25 | 27-12 |
| 上海 | 12-27 | 25-29 | | 25-4 |
| 浙江 | 14-29 | 12-27 | 4-25 | |

| 名次 | 球队 | 积 | 场 | 胜 | 平 | 负 | 得分 | 失分 | 净胜 |
|----|----|---|---|---|---|---|----|----|----|
| | | | | | | | | | |
| | | | | | | | | | |
| | | | | | | | | | |
| | | | | | | | | | |

| 球队 | | | | |
|----|--|--|--|--|
| | | | | |
| | | | | |
| | | | | |
| | | | | |

| 名次 | 球队 | 积 | 场 | 胜 | 平 | 负 | 得分 | 失分 | 净胜 |
|----|----|---|---|---|---|---|----|----|----|
| | | | | | | | | | |
| | | | | | | | | | |
| | | | | | | | | | |
| | | | | | | | | | |

| 球队 | | | | |
|----|--|--|--|--|
| | | | | |
| | | | | |
| | | | | |
| | | | | |

| 名次 | 球队 | 积 | 场 | 胜 | 平 | 负 | 得分 | 失分 | 净胜 |
|----|----|---|---|---|---|---|----|----|----|
| | | | | | | | | | |
| | | | | | | | | | |
| | | | | | | | | | |
| | | | | | | | | | |

| 球队 | | | | |
|----|--|--|--|--|
| | | | | |
| | | | | |
| | | | | |
| | | | | |

Legend: 积 = 积分 场 = 已比赛场次 胜 = 胜场 平 = 平场 负 = 负场
得分 = 得分累计 失分 = 失分累计 净胜 = 净胜分





2016年“体彩杯”全国手球男子青年锦标赛

正式表
手球
青年男子

分组成绩

201602-1202-1/1

重庆万州

截止至第 30 场

2016/03/20

组别：A 预赛

| 名次 | 球队 | 积 | 场 | 胜 | 平 | 负 | 得分 | 失分 | 净胜 |
|----|-----|----|---|---|---|---|-----|-----|-----|
| 1 | 山东 | 10 | 5 | 5 | 0 | 0 | 179 | 142 | 37 |
| 2 | 广东 | 8 | 5 | 4 | 0 | 1 | 162 | 125 | 37 |
| 3 | 解放军 | 6 | 5 | 3 | 0 | 2 | 154 | 119 | 35 |
| 4 | 江苏 | 2 | 4 | 1 | 0 | 3 | 111 | 129 | -18 |
| 5 | 浙江 | 0 | 5 | 0 | 0 | 5 | 72 | 154 | -82 |
| 6 | 上海 | 2 | 4 | 1 | 0 | 3 | 99 | 108 | -9 |

| 球队 | 山东 | 广东 | 解放军 | 江苏 | 浙江 | 上海 |
|-----|-------|-------|-------|-------|-------|-------|
| 山东 | | 42-33 | 35-33 | 33-26 | 37-22 | 32-28 |
| 广东 | 33-42 | | 29-24 | 33-18 | 30-15 | 37-26 |
| 解放军 | 33-35 | 24-29 | | 37-30 | 25-5 | 35-20 |
| 江苏 | 26-33 | 18-33 | 30-37 | | 37-26 | 32-29 |
| 浙江 | 22-37 | 15-30 | 5-25 | 26-37 | | 4-25 |
| 上海 | 28-32 | 26-37 | 20-35 | 29-32 | 25-4 | |

因上海队报名人数不足赛制要求，不计成绩。

组别：B 预赛

| 名次 | 球队 | 积 | 场 | 胜 | 平 | 负 | 得分 | 失分 | 净胜 |
|----|----|---|---|---|---|---|-----|-----|-----|
| 1 | 安徽 | 8 | 5 | 4 | 0 | 1 | 167 | 143 | 24 |
| 2 | 新疆 | 8 | 5 | 4 | 0 | 1 | 176 | 136 | 40 |
| 3 | 四川 | 8 | 5 | 4 | 0 | 1 | 150 | 113 | 37 |
| 4 | 北京 | 4 | 5 | 2 | 0 | 3 | 146 | 159 | -13 |
| 5 | 辽宁 | 0 | 5 | 0 | 0 | 5 | 129 | 167 | -38 |
| 6 | 天津 | 2 | 5 | 1 | 0 | 4 | 105 | 155 | -50 |

| 球队 | 安徽 | 新疆 | 四川 | 北京 | 辽宁 | 天津 |
|----|-------|-------|-------|-------|-------|-------|
| 安徽 | | 32-39 | 32-31 | 38-26 | 40-37 | 25-10 |
| 新疆 | 39-32 | | 28-29 | 33-26 | 32-17 | 44-32 |
| 四川 | 31-32 | 29-28 | | 35-29 | 31-16 | 24-8 |
| 北京 | 26-38 | 26-33 | 29-35 | | 33-29 | 32-24 |
| 辽宁 | 37-40 | 17-32 | 16-31 | 29-33 | | 30-31 |
| 天津 | 10-25 | 32-44 | 8-24 | 24-32 | 31-30 | |

因天津队报名人数不足赛制要求，不计成绩。

| 名次 | 球队 | 积 | 场 | 胜 | 平 | 负 | 得分 | 失分 | 净胜 |
|----|----|---|---|---|---|---|----|----|----|
| | | | | | | | | | |
| | | | | | | | | | |
| | | | | | | | | | |
| | | | | | | | | | |
| | | | | | | | | | |
| | | | | | | | | | |
| | | | | | | | | | |
| | | | | | | | | | |

| 球队 | | | | | | |
|----|--|--|--|--|--|--|
| | | | | | | |
| | | | | | | |
| | | | | | | |
| | | | | | | |
| | | | | | | |
| | | | | | | |
| | | | | | | |
| | | | | | | |

| 名次 | 球队 | 积 | 场 | 胜 | 平 | 负 | 得分 | 失分 | 净胜 |
|----|----|---|---|---|---|---|----|----|----|
| | | | | | | | | | |
| | | | | | | | | | |
| | | | | | | | | | |
| | | | | | | | | | |
| | | | | | | | | | |
| | | | | | | | | | |
| | | | | | | | | | |
| | | | | | | | | | |

| 球队 | | | | | | |
|----|--|--|--|--|--|--|
| | | | | | | |
| | | | | | | |
| | | | | | | |
| | | | | | | |
| | | | | | | |
| | | | | | | |
| | | | | | | |
| | | | | | | |

Legend: 积 = 积分 场 = 已比赛场次 胜 = 胜场 平 = 平场 负 = 负场
得分 = 得分累计 失分 = 失分累计 净胜 = 净胜分





2016年“体彩杯”全国手球男子青年锦标赛

得分排名表(场上队员)

正式表
手球
青年截止至第 46场
按总得分201602046-1601-1/4
重庆万州
20/03/2016 8:30

| 排序 | 号码 | 姓名 | 球队 | 远射 | 近射 | 边射 | 快攻 | 突破 | 任意 | 7M | 合计 | % | 助攻 | 场数 |
|----|----|-----|-----|-------|-------|-------|-------|-------|-------|-------|--------|------|----|----|
| 1 | 11 | 周傲 | 江苏 | 22-61 | 28-55 | 5-10 | 4-12 | 6-11 | 4-7 | 6-9 | 75-165 | 45.5 | 41 | 8 |
| 2 | 8 | 罗尧尧 | 四川 | 16-30 | 12-19 | 2-2 | 14-16 | 4-5 | 2-4 | 19-24 | 69-100 | 69.0 | 26 | 8 |
| 3 | 5 | 王晓峰 | 山东 | 38-86 | 7-15 | 0-2 | 7-7 | 0-0 | 10-12 | 1-1 | 63-123 | 51.2 | 8 | 8 |
| 4 | 18 | 李双 | 安徽 | 14-31 | 23-29 | 1-6 | 6-6 | 7-9 | 4-4 | 3-4 | 58-89 | 65.2 | 20 | 8 |
| 5 | 10 | 孙芳伟 | 山东 | 21-61 | 15-27 | 4-6 | 5-7 | 7-8 | 0-0 | 4-5 | 56-114 | 49.1 | 14 | 8 |
| 6 | 7 | 姜钦 | 解放军 | 15-35 | 21-37 | 1-2 | 2-4 | 7-7 | 5-9 | 1-1 | 52-95 | 54.7 | 33 | 8 |
| 7 | 10 | 王柏淇 | 辽宁 | 11-41 | 9-23 | 1-2 | 8-11 | 14-16 | 1-6 | 7-8 | 51-107 | 47.7 | 19 | 7 |
| 8 | 14 | 孙耀琦 | 解放军 | 1-2 | 37-50 | 0-0 | 4-6 | 0-0 | 0-0 | 7-9 | 49-67 | 73.1 | 5 | 8 |
| 9 | 4 | 朱广刚 | 北京 | 13-28 | 12-25 | 0-0 | 5-5 | 10-14 | 6-7 | 2-5 | 48-84 | 57.1 | 21 | 8 |
| 10 | 3 | 张昌轲 | 解放军 | 16-33 | 13-22 | 0-1 | 3-3 | 9-11 | 3-6 | 3-5 | 47-81 | 58.0 | 43 | 8 |
| 11 | 17 | 王巨柱 | 安徽 | 27-58 | 6-17 | 0-1 | 8-10 | 4-4 | 2-5 | 0-1 | 47-96 | 49.0 | 26 | 8 |
| 12 | 15 | 张建杰 | 广东 | 14-42 | 17-30 | 1-1 | 1-1 | 9-12 | 5-11 | 0-0 | 47-97 | 48.5 | 14 | 8 |
| 13 | 19 | 李龙吉 | 新疆 | 4-9 | 16-32 | 1-1 | 11-13 | 8-12 | 0-1 | 6-9 | 46-77 | 59.7 | 13 | 8 |
| 14 | 7 | 林豪文 | 新疆 | 20-50 | 8-13 | 2-3 | 3-4 | 3-4 | 4-6 | 6-7 | 46-87 | 52.9 | 26 | 8 |
| 15 | 13 | 尹吉祥 | 江苏 | 21-73 | 13-25 | 0-1 | 2-6 | 5-8 | 2-2 | 3-8 | 46-123 | 37.4 | 11 | 8 |
| 16 | 1 | 郭世伟 | 安徽 | 14-31 | 14-21 | 2-4 | 7-11 | 8-9 | 0-0 | 0-1 | 45-77 | 58.4 | 5 | 7 |
| 17 | 3 | 刘赵梁 | 四川 | 0-4 | 9-18 | 17-29 | 14-18 | 4-5 | 0-0 | 0-0 | 44-74 | 59.5 | 3 | 8 |
| 18 | 5 | 黄培杰 | 广东 | 2-11 | 8-17 | 7-11 | 11-15 | 11-13 | 0-0 | 5-10 | 44-77 | 57.1 | 31 | 8 |
| 19 | 9 | 陈开勇 | 安徽 | 3-5 | 22-30 | 0-0 | 16-20 | 0-0 | 1-1 | 1-1 | 43-57 | 75.4 | 2 | 8 |
| 20 | 11 | 王誌汉 | 解放军 | 2-5 | 14-16 | 15-23 | 12-16 | 0-0 | 0-0 | 0-0 | 43-60 | 71.7 | 4 | 8 |
| 21 | 10 | 董凯 | 上海 | 10-26 | 21-29 | 1-1 | 3-3 | 1-2 | 1-2 | 6-7 | 43-70 | 61.4 | 6 | 7 |
| 22 | 22 | 魏雨童 | 天津 | 4-11 | 21-28 | 0-1 | 5-6 | 8-11 | 0-0 | 4-5 | 42-62 | 67.7 | 4 | 7 |
| 23 | 6 | 赵一涵 | 北京 | 8-22 | 16-28 | 2-2 | 1-1 | 15-19 | 0-1 | 0-0 | 42-73 | 57.5 | 15 | 8 |
| 24 | 11 | 胡国富 | 广东 | 4-8 | 13-18 | 4-7 | 14-20 | 4-4 | 0-1 | 2-3 | 41-61 | 67.2 | 9 | 8 |
| 25 | 10 | 王钟彬 | 新疆 | 12-35 | 15-23 | 0-1 | 6-9 | 7-9 | 1-3 | 0-1 | 41-81 | 50.6 | 9 | 8 |
| 26 | 10 | 周仲坤 | 广东 | 5-13 | 15-26 | 5-6 | 8-9 | 3-7 | 1-1 | 1-1 | 38-63 | 60.3 | 9 | 8 |
| 27 | 5 | 徐伟 | 新疆 | 0-0 | 10-13 | 17-27 | 9-15 | 0-1 | 0-0 | 1-1 | 37-57 | 64.9 | 5 | 8 |
| 28 | 2 | 姚雪岩 | 广东 | 3-10 | 20-28 | 0-0 | 2-2 | 4-4 | 3-7 | 3-3 | 35-54 | 64.8 | 15 | 8 |
| 29 | 9 | 吴明远 | 天津 | 13-27 | 15-21 | 0-0 | 1-4 | 5-6 | 1-1 | 0-0 | 35-59 | 59.3 | 6 | 7 |
| 30 | 6 | 吴昊 | 解放军 | 6-29 | 18-27 | 0-0 | 3-5 | 4-5 | 1-1 | 3-5 | 35-72 | 48.6 | 17 | 8 |
| 31 | 18 | 吴双 | 上海 | 5-30 | 10-19 | 1-2 | 8-10 | 6-9 | 2-5 | 2-3 | 34-78 | 43.6 | 6 | 7 |
| 32 | 26 | 吴锐樊 | 北京 | 1-4 | 14-19 | 9-11 | 6-10 | 3-3 | 0-0 | 0-0 | 33-47 | 70.2 | 2 | 8 |
| 33 | 1 | 林先方 | 浙江 | 2-10 | 8-17 | 3-16 | 4-8 | 5-5 | 0-1 | 11-14 | 33-71 | 46.5 | 10 | 7 |
| 34 | 17 | 马益奎 | 江苏 | 1-5 | 25-34 | 2-6 | 3-4 | 0-0 | 0-1 | 1-1 | 32-51 | 62.7 | 5 | 8 |
| 35 | 6 | 陈庆港 | 辽宁 | 2-12 | 8-14 | 11-15 | 6-7 | 3-5 | 0-0 | 1-1 | 31-54 | 57.4 | 14 | 7 |
| 36 | 18 | 耿畅 | 江苏 | 4-20 | 12-25 | 4-6 | 10-13 | 1-2 | 0-0 | 0-1 | 31-67 | 46.3 | 4 | 8 |
| 37 | 18 | 王晓琪 | 天津 | 19-44 | 7-18 | 0-0 | 0-0 | 2-3 | 0-1 | 3-4 | 31-70 | 44.3 | 12 | 6 |
| 38 | 15 | 王维东 | 新疆 | 3-8 | 6-11 | 8-15 | 8-10 | 4-4 | 0-0 | 1-1 | 30-49 | 61.2 | 4 | 8 |
| 39 | 2 | 金勇峰 | 安徽 | 9-16 | 10-13 | 3-11 | 3-3 | 4-4 | 0-0 | 0-1 | 29-48 | 60.4 | 10 | 8 |
| 40 | 3 | 郑尧俊 | 浙江 | 2-10 | 6-13 | 1-2 | 8-9 | 12-14 | 0-0 | 0-0 | 29-48 | 60.4 | 9 | 7 |
| 41 | 11 | 庞东阳 | 辽宁 | 10-21 | 8-10 | 1-5 | 6-7 | 3-5 | 0-1 | 1-1 | 29-50 | 58.0 | 14 | 7 |
| 42 | 36 | 王鹏皓 | 北京 | 1-2 | 8-19 | 7-15 | 8-9 | 1-1 | 0-0 | 4-5 | 29-51 | 56.9 | 2 | 8 |
| 43 | 10 | 徐彦昊 | 四川 | 8-18 | 8-12 | 2-4 | 10-15 | 1-3 | 0-1 | 0-2 | 29-55 | 52.7 | 10 | 8 |
| 44 | 3 | 高天伦 | 上海 | 12-28 | 11-19 | 2-3 | 1-2 | 0-0 | 0-0 | 3-3 | 29-55 | 52.7 | 12 | 7 |
| 45 | 3 | 王铁林 | 山东 | 3-16 | 6-17 | 11-18 | 8-9 | 0-0 | 0-0 | 0-0 | 28-60 | 46.7 | 5 | 8 |
| 46 | 2 | 冯鑫宇 | 山东 | 3-10 | 9-22 | 1-1 | 7-8 | 4-5 | 0-0 | 3-6 | 27-52 | 51.9 | 4 | 8 |
| 47 | 6 | 王军鸣 | 山东 | 4-17 | 10-20 | 2-4 | 4-8 | 0-0 | 2-5 | 5-6 | 27-60 | 45.0 | 8 | 8 |





2016年“体彩杯”全国手球男子青年锦标赛

得分排名表(场上队员)

正式表
手球
青年截止至第 46场
按总得分201602046-1601-2/4
重庆万州
20/03/2016 8:30

| 排序 | 号码 | 姓名 | 球队 | 远射 | 近射 | 边射 | 快攻 | 突破 | 任意 | 7M | 合计 | % | 助攻 | 场数 |
|----|----|-----|-----|-------|-------|-------|------|-----|------|-----|-------|------|----|----|
| 48 | 17 | 胡晋铭 | 新疆 | 0-2 | 25-29 | 0-1 | 1-1 | 0-0 | 0-0 | 0-0 | 26-33 | 78.8 | 2 | 8 |
| 49 | 5 | 王凯 | 四川 | 0-1 | 14-22 | 5-14 | 7-11 | 0-0 | 0-0 | 0-2 | 26-50 | 52.0 | 6 | 8 |
| 50 | 13 | 徐峻清 | 解放军 | 0-2 | 12-22 | 7-18 | 7-10 | 0-0 | 0-0 | 0-0 | 26-52 | 50.0 | 4 | 8 |
| 51 | 21 | 潘玉帅 | 天津 | 7-24 | 4-8 | 1-3 | 9-9 | 3-5 | 0-0 | 2-4 | 26-53 | 49.1 | 12 | 7 |
| 52 | 19 | 陈旭 | 北京 | 11-39 | 6-16 | 1-2 | 3-4 | 3-3 | 0-0 | 2-3 | 26-67 | 38.8 | 8 | 8 |
| 53 | 19 | 庞连康 | 四川 | 7-15 | 8-14 | 1-2 | 4-4 | 2-2 | 1-1 | 0-1 | 23-39 | 59.0 | 9 | 8 |
| 54 | 17 | 谢庆龙 | 四川 | 0-0 | 20-30 | 0-0 | 1-1 | 0-0 | 0-0 | 1-1 | 22-32 | 68.8 | 2 | 8 |
| 55 | 7 | 任超凡 | 江苏 | 3-5 | 10-17 | 4-16 | 4-5 | 0-0 | 0-1 | 0-0 | 21-44 | 47.7 | 5 | 8 |
| 56 | 18 | 李文金 | 广东 | 3-6 | 15-21 | 0-0 | 2-2 | 0-0 | 0-1 | 0-0 | 20-30 | 66.7 | 1 | 8 |
| 57 | 7 | 段飞宇 | 广东 | 0-2 | 7-9 | 6-14 | 5-6 | 0-0 | 0-0 | 1-1 | 19-32 | 59.4 | 4 | 8 |
| 58 | 17 | 薛盼龙 | 山东 | 0-4 | 13-16 | 0-1 | 4-4 | 0-0 | 0-0 | 1-1 | 18-26 | 69.2 | 0 | 8 |
| 59 | 11 | 李旭 | 北京 | 1-3 | 12-19 | 0-0 | 0-0 | 0-0 | 0-0 | 5-6 | 18-28 | 64.3 | 3 | 8 |
| 60 | 19 | 何山 | 安徽 | 0-0 | 3-4 | 11-20 | 4-4 | 0-1 | 0-0 | 0-0 | 18-29 | 62.1 | 0 | 8 |
| 61 | 26 | 程浩然 | 安徽 | 1-2 | 5-9 | 4-10 | 6-9 | 2-3 | 0-1 | 0-0 | 18-34 | 52.9 | 0 | 8 |
| 62 | 18 | 倪陈辉 | 浙江 | 8-43 | 5-9 | 0-1 | 0-0 | 0-0 | 4-12 | 1-1 | 18-66 | 27.3 | 5 | 7 |
| 63 | 4 | 高玉杰 | 广东 | 1-4 | 3-6 | 5-11 | 6-8 | 2-3 | 0-0 | 0-0 | 17-32 | 53.1 | 2 | 8 |
| 64 | 8 | 庄旭杰 | 上海 | 0-1 | 3-4 | 5-20 | 7-7 | 2-2 | 0-0 | 0-0 | 17-34 | 50.0 | 1 | 7 |
| 65 | 14 | 吴佳兵 | 上海 | 9-20 | 7-14 | 0-0 | 0-0 | 1-1 | 0-0 | 0-0 | 17-35 | 48.6 | 2 | 7 |
| 66 | 9 | 许翔宇 | 四川 | 4-15 | 6-11 | 2-4 | 2-2 | 1-2 | 1-1 | 1-3 | 17-38 | 44.7 | 16 | 8 |
| 67 | 13 | 于欣君 | 山东 | 6-14 | 7-14 | 1-4 | 1-5 | 2-2 | 0-2 | 0-1 | 17-42 | 40.5 | 5 | 8 |
| 68 | 7 | 孙义广 | 辽宁 | 0-0 | 7-7 | 4-6 | 5-8 | 0-0 | 0-0 | 0-0 | 16-21 | 76.2 | 1 | 7 |
| 69 | 5 | 曹磊 | 上海 | 8-19 | 2-9 | 0-2 | 2-2 | 3-3 | 0-0 | 1-1 | 16-36 | 44.4 | 5 | 7 |
| 70 | 7 | 卞友山 | 北京 | 0-0 | 13-16 | 1-1 | 1-1 | 0-0 | 0-0 | 0-1 | 15-19 | 78.9 | 0 | 8 |
| 71 | 26 | 刘思远 | 天津 | 0-1 | 4-6 | 5-14 | 4-5 | 2-2 | 0-0 | 0-0 | 15-28 | 53.6 | 0 | 7 |
| 72 | 27 | 王长旭 | 安徽 | 1-3 | 1-1 | 2-4 | 6-8 | 1-1 | 0-0 | 3-3 | 14-20 | 70.0 | 2 | 8 |
| 73 | 13 | 苏兴伟 | 新疆 | 3-10 | 4-5 | 0-1 | 5-7 | 1-1 | 1-1 | 0-0 | 14-25 | 56.0 | 4 | 8 |
| 74 | 13 | 杨洁 | 辽宁 | 5-16 | 3-10 | 1-2 | 3-4 | 1-1 | 0-0 | 1-1 | 14-34 | 41.2 | 1 | 7 |
| 75 | 3 | 李星浩 | 辽宁 | 0-0 | 13-21 | 0-0 | 0-0 | 0-0 | 0-0 | 0-0 | 13-21 | 61.9 | 3 | 7 |
| 76 | 10 | 范保坤 | 解放军 | 1-1 | 3-5 | 7-14 | 2-4 | 0-0 | 0-0 | 0-0 | 13-24 | 54.2 | 3 | 8 |
| 77 | 2 | 李恩铭 | 浙江 | 0-4 | 8-17 | 2-12 | 3-7 | 0-0 | 0-0 | 0-0 | 13-40 | 32.5 | 1 | 7 |
| 78 | 2 | 王泽川 | 新疆 | 0-0 | 8-11 | 0-0 | 2-2 | 0-0 | 0-0 | 2-2 | 12-15 | 80.0 | 0 | 8 |
| 79 | 8 | 姜童耀 | 江苏 | 2-3 | 4-8 | 4-6 | 1-1 | 0-0 | 0-0 | 1-1 | 12-19 | 63.2 | 0 | 8 |
| 80 | 13 | 尹文珂 | 四川 | 1-2 | 5-8 | 4-6 | 1-3 | 0-0 | 0-1 | 1-1 | 12-21 | 57.1 | 0 | 8 |
| 81 | 23 | 李荣健 | 山东 | 0-0 | 4-8 | 4-9 | 1-3 | 0-0 | 0-0 | 3-3 | 12-23 | 52.2 | 7 | 8 |
| 82 | 25 | 王一雄 | 天津 | 4-7 | 4-8 | 3-9 | 1-1 | 0-0 | 0-0 | 0-0 | 12-25 | 48.0 | 0 | 7 |
| 83 | 7 | 徐勇林 | 山东 | 3-7 | 5-11 | 1-8 | 2-3 | 1-1 | 0-0 | 0-0 | 12-30 | 40.0 | 7 | 8 |
| 84 | 18 | 李明远 | 北京 | 1-8 | 3-11 | 0-0 | 3-4 | 4-5 | 1-2 | 0-0 | 12-30 | 40.0 | 7 | 8 |
| 85 | 24 | 徐安格 | 安徽 | 0-2 | 10-13 | 0-0 | 1-1 | 0-0 | 0-0 | 0-0 | 11-16 | 68.8 | 0 | 8 |
| 86 | 11 | 王洋 | 山东 | 2-3 | 3-5 | 5-7 | 1-2 | 0-0 | 0-0 | 0-0 | 11-17 | 64.7 | 1 | 8 |
| 87 | 14 | 吕昊臻 | 辽宁 | 3-7 | 6-7 | 0-1 | 0-1 | 1-1 | 0-1 | 1-1 | 11-19 | 57.9 | 0 | 7 |
| 88 | 24 | 陈伟华 | 新疆 | 2-5 | 4-4 | 1-4 | 2-2 | 1-1 | 0-0 | 0-1 | 10-17 | 58.8 | 3 | 8 |
| 89 | 4 | 谷通金 | 新疆 | 0-2 | 5-6 | 1-2 | 3-5 | 0-1 | 0-0 | 0-0 | 9-16 | 56.3 | 2 | 8 |
| 90 | 2 | 王司雨 | 辽宁 | 2-2 | 6-8 | 0-0 | 0-0 | 0-0 | 0-0 | 0-0 | 8-10 | 80.0 | 2 | 6 |
| 91 | 12 | 李壮 | 广东 | 0-0 | 3-6 | 1-1 | 0-0 | 0-0 | 1-3 | 3-5 | 8-15 | 53.3 | 0 | 8 |
| 92 | 3 | 王哲一 | 北京 | 1-2 | 3-5 | 0-3 | 4-5 | 0-0 | 0-0 | 0-0 | 8-15 | 53.3 | 3 | 8 |
| 93 | 3 | 赵韦光 | 江苏 | 0-1 | 5-10 | 1-7 | 1-3 | 1-1 | 0-0 | 0-0 | 8-22 | 36.4 | 2 | 8 |
| 94 | 15 | 逯明松 | 北京 | 0-8 | 4-9 | 3-8 | 1-2 | 0-0 | 0-0 | 0-0 | 8-27 | 29.6 | 1 | 8 |





2016年“体彩杯”全国手球男子青年锦标赛

得分排名表(场上队员)

正式表
手球
青年截止至第 46场
按总得分201602046-1601-3/4
重庆万州
20/03/2016 8:30

| 排序 | 号码 | 姓名 | 球队 | 远射 | 近射 | 边射 | 快攻 | 突破 | 任意 | 7M | 合计 | % | 助攻 | 场数 |
|-----|----|-----|-----|------|-----|-----|-----|-----|-----|-----|------|-------|----|----|
| 95 | 21 | 王腾达 | 山东 | 0-0 | 2-2 | 1-2 | 4-4 | 0-0 | 0-0 | 0-0 | 7-8 | 87.5 | 1 | 8 |
| 96 | 18 | 李万兴 | 新疆 | 2-3 | 1-2 | 1-1 | 2-3 | 1-1 | 0-0 | 0-0 | 7-10 | 70.0 | 2 | 8 |
| 97 | 5 | 余昊锦 | 辽宁 | 1-12 | 3-3 | 1-1 | 2-2 | 0-0 | 0-0 | 0-0 | 7-18 | 38.9 | 3 | 7 |
| 98 | 7 | 蒋家敏 | 上海 | 0-3 | 3-7 | 3-4 | 0-0 | 0-0 | 0-0 | 0-0 | 6-14 | 42.9 | 0 | 7 |
| 99 | 9 | 王俊威 | 江苏 | 0-0 | 2-3 | 1-3 | 1-1 | 1-1 | 0-1 | 0-0 | 5-9 | 55.6 | 3 | 8 |
| 100 | 11 | 张天豪 | 四川 | 0-0 | 1-4 | 0-3 | 3-3 | 0-0 | 0-0 | 1-1 | 5-11 | 45.5 | 1 | 8 |
| 101 | 1 | 王帅 | 广东 | 3-4 | 1-1 | 0-0 | 0-1 | 0-0 | 0-0 | 0-0 | 4-6 | 66.7 | 10 | 8 |
| 102 | 6 | 白光宇 | 新疆 | 1-1 | 3-4 | 0-2 | 0-0 | 0-0 | 0-1 | 0-0 | 4-8 | 50.0 | 0 | 8 |
| 103 | 7 | 仇瑞祥 | 四川 | 0-2 | 2-2 | 1-2 | 0-1 | 1-1 | 0-0 | 0-1 | 4-9 | 44.4 | 5 | 8 |
| 104 | 4 | 高震东 | 上海 | 0-2 | 1-1 | 0-0 | 1-1 | 0-0 | 0-0 | 1-1 | 3-5 | 60.0 | 1 | 7 |
| 105 | 18 | 李玮 | 山东 | 0-1 | 2-2 | 1-4 | 0-0 | 0-0 | 0-0 | 0-0 | 3-7 | 42.9 | 6 | 8 |
| 106 | 23 | 刘帅 | 北京 | 3-5 | 0-0 | 0-0 | 0-0 | 0-0 | 0-3 | 0-0 | 3-8 | 37.5 | 1 | 8 |
| 107 | 15 | 阎冠中 | 江苏 | 0-0 | 0-1 | 0-4 | 0-0 | 0-0 | 0-0 | 3-6 | 3-11 | 27.3 | 0 | 8 |
| 108 | 8 | 王鑫鹏 | 辽宁 | 0-0 | 1-6 | 2-5 | 0-1 | 0-0 | 0-0 | 0-0 | 3-12 | 25.0 | 0 | 7 |
| 109 | 22 | 李子跃 | 山东 | 1-9 | 0-1 | 1-3 | 0-0 | 0-0 | 0-0 | 1-2 | 3-15 | 20.0 | 0 | 8 |
| 110 | 6 | 季雨 | 江苏 | 0-0 | 1-2 | 1-1 | 0-0 | 0-0 | 0-0 | 0-0 | 2-3 | 66.7 | 2 | 8 |
| 111 | 10 | 徐正飞 | 浙江 | 0-1 | 1-1 | 1-1 | 0-0 | 0-0 | 0-0 | 0-0 | 2-3 | 66.7 | 0 | 7 |
| 112 | 25 | 张斌 | 北京 | 0-0 | 1-1 | 0-1 | 1-1 | 0-0 | 0-0 | 0-0 | 2-3 | 66.7 | 0 | 7 |
| 113 | 9 | 周凯峰 | 广东 | 0-0 | 1-2 | 1-2 | 0-0 | 0-0 | 0-0 | 0-0 | 2-4 | 50.0 | 0 | 8 |
| 114 | 14 | 罗中熠 | 江苏 | 0-0 | 1-3 | 1-1 | 0-0 | 0-0 | 0-0 | 0-0 | 2-4 | 50.0 | 0 | 7 |
| 115 | 28 | 丁浩然 | 安徽 | 0-0 | 0-0 | 1-4 | 1-1 | 0-0 | 0-0 | 0-0 | 2-5 | 40.0 | 0 | 8 |
| 116 | 9 | 李家乐 | 浙江 | 0-0 | 0-3 | 2-4 | 0-0 | 0-0 | 0-0 | 0-0 | 2-7 | 28.6 | 1 | 7 |
| 117 | 1 | 刘继超 | 山东 | 1-1 | 0-0 | 0-0 | 0-0 | 0-0 | 0-0 | 0-0 | 1-1 | 100.0 | 2 | 8 |
| 118 | 4 | 张洋 | 解放军 | 0-0 | 1-1 | 0-0 | 0-0 | 0-0 | 0-0 | 0-0 | 1-1 | 100.0 | 0 | 8 |
| 119 | 16 | 吴阳 | 辽宁 | 0-0 | 0-0 | 1-1 | 0-0 | 0-0 | 0-0 | 0-0 | 1-1 | 100.0 | 0 | 7 |
| 120 | 1 | 高尚君 | 辽宁 | 1-1 | 0-0 | 0-0 | 0-0 | 0-0 | 0-0 | 0-0 | 1-1 | 100.0 | 5 | 7 |
| 121 | 15 | 徐逸 | 四川 | 0-0 | 0-0 | 0-0 | 0-1 | 0-0 | 0-0 | 1-1 | 1-2 | 50.0 | 1 | 8 |
| 122 | 4 | 张瑞恒 | 江苏 | 0-0 | 1-2 | 0-0 | 0-0 | 0-0 | 0-0 | 0-0 | 1-2 | 50.0 | 0 | 8 |
| 123 | 17 | 罗明杰 | 浙江 | 0-1 | 1-3 | 0-0 | 0-0 | 0-0 | 0-0 | 0-0 | 1-4 | 25.0 | 1 | 7 |
| 124 | 9 | 李天枢 | 解放军 | 0-0 | 0-0 | 0-0 | 0-0 | 0-0 | 0-0 | 0-0 | 0-0 | 0.0 | 0 | 8 |
| 125 | 25 | 李文哲 | 安徽 | 0-0 | 0-0 | 0-0 | 0-0 | 0-0 | 0-0 | 0-0 | 0-0 | 0.0 | 0 | 8 |
| 126 | 41 | 刘润民 | 安徽 | 0-0 | 0-0 | 0-0 | 0-0 | 0-0 | 0-0 | 0-0 | 0-0 | 0.0 | 0 | 8 |
| 127 | 8 | 邹峻楠 | 解放军 | 0-0 | 0-0 | 0-0 | 0-0 | 0-0 | 0-0 | 0-0 | 0-0 | 0.0 | 0 | 8 |
| 128 | 12 | 王金鑫 | 新疆 | 0-0 | 0-0 | 0-0 | 0-0 | 0-0 | 0-0 | 0-0 | 0-0 | 0.0 | 0 | 8 |
| 129 | 33 | 姚紫祥 | 安徽 | 0-0 | 0-0 | 0-0 | 0-0 | 0-0 | 0-0 | 0-0 | 0-0 | 0.0 | 0 | 8 |
| 130 | 16 | 李佳懿 | 新疆 | 0-0 | 0-0 | 0-0 | 0-0 | 0-0 | 0-0 | 0-0 | 0-0 | 0.0 | 1 | 8 |
| 131 | 17 | 刘安宁 | 解放军 | 0-0 | 0-0 | 0-0 | 0-0 | 0-0 | 0-0 | 0-0 | 0-0 | 0.0 | 0 | 8 |
| 132 | 16 | 池猛 | 解放军 | 0-0 | 0-0 | 0-0 | 0-0 | 0-0 | 0-0 | 0-0 | 0-0 | 0.0 | 0 | 8 |
| 133 | 12 | 左子健 | 解放军 | 0-0 | 0-0 | 0-0 | 0-0 | 0-0 | 0-0 | 0-0 | 0-0 | 0.0 | 0 | 8 |
| 134 | 12 | 刘道林 | 山东 | 0-0 | 0-0 | 0-0 | 0-0 | 0-0 | 0-0 | 0-0 | 0-0 | 0.0 | 0 | 8 |
| 135 | 5 | 尹一楠 | 解放军 | 0-0 | 0-0 | 0-0 | 0-0 | 0-0 | 0-0 | 0-0 | 0-0 | 0.0 | 0 | 8 |
| 136 | 16 | 马佳鹏 | 北京 | 0-0 | 0-0 | 0-0 | 0-0 | 0-0 | 0-0 | 0-0 | 0-0 | 0.0 | 0 | 8 |
| 137 | 12 | 刘树豪 | 四川 | 0-0 | 0-0 | 0-0 | 0-0 | 0-0 | 0-0 | 0-0 | 0-0 | 0.0 | 8 | 8 |
| 138 | 1 | 宋晓晨 | 新疆 | 0-0 | 0-0 | 0-0 | 0-0 | 0-0 | 0-0 | 0-0 | 0-0 | 0.0 | 11 | 8 |
| 139 | 1 | 宋继强 | 四川 | 0-0 | 0-0 | 0-0 | 0-0 | 0-0 | 0-0 | 0-0 | 0-0 | 0.0 | 2 | 8 |
| 140 | 35 | 高云健 | 北京 | 0-0 | 0-0 | 0-0 | 0-0 | 0-0 | 0-0 | 0-0 | 0-0 | 0.0 | 1 | 8 |
| 141 | 1 | 潘博琦 | 江苏 | 0-0 | 0-0 | 0-0 | 0-0 | 0-0 | 0-0 | 0-0 | 0-0 | 0.0 | 0 | 8 |





2016年“体彩杯”全国手球男子青年锦标赛

得分排名表(场上队员)

正式表
手球
青年截止至第 46场
按总得分201602046-1601-4/4
重庆万州
20/03/2016 8:30

| 排序 | 号码 | 姓名 | 球队 | 远射 | 近射 | 边射 | 快攻 | 突破 | 任意 | 7M | 合计 | % | 助攻 | 场数 |
|-----|----|-----|-----|-----|-----|-----|-----|-----|-----|-----|-----|-----|----|----|
| 142 | 20 | 张文健 | 四川 | 0-0 | 0-0 | 0-0 | 0-0 | 0-0 | 0-0 | 0-0 | 0-0 | 0.0 | 0 | 8 |
| 143 | 21 | 曹修庆 | 四川 | 0-0 | 0-0 | 0-0 | 0-0 | 0-0 | 0-0 | 0-0 | 0-0 | 0.0 | 0 | 8 |
| 144 | 16 | 王猛 | 广东 | 0-0 | 0-0 | 0-0 | 0-0 | 0-0 | 0-0 | 0-0 | 0-0 | 0.0 | 3 | 8 |
| 145 | 14 | 王泽润 | 广东 | 0-0 | 0-0 | 0-0 | 0-0 | 0-0 | 0-0 | 0-0 | 0-0 | 0.0 | 0 | 8 |
| 146 | 12 | 张润民 | 上海 | 0-0 | 0-0 | 0-0 | 0-0 | 0-0 | 0-0 | 0-0 | 0-0 | 0.0 | 0 | 7 |
| 147 | 14 | 虞勇灿 | 浙江 | 0-0 | 0-0 | 0-0 | 0-0 | 0-0 | 0-0 | 0-0 | 0-0 | 0.0 | 2 | 7 |
| 148 | 15 | 张佩力 | 浙江 | 0-0 | 0-0 | 0-0 | 0-0 | 0-0 | 0-0 | 0-0 | 0-0 | 0.0 | 0 | 7 |
| 149 | 18 | 梅凯博 | 辽宁 | 0-0 | 0-0 | 0-0 | 0-0 | 0-0 | 0-0 | 0-0 | 0-0 | 0.0 | 0 | 7 |
| 150 | 16 | 陈辰 | 上海 | 0-0 | 0-0 | 0-0 | 0-0 | 0-0 | 0-0 | 0-0 | 0-0 | 0.0 | 0 | 7 |
| 151 | 2 | 谢智超 | 上海 | 0-0 | 0-0 | 0-0 | 0-0 | 0-0 | 0-0 | 0-0 | 0-0 | 0.0 | 0 | 7 |
| 152 | 17 | 李傲 | 辽宁 | 0-0 | 0-0 | 0-0 | 0-0 | 0-0 | 0-0 | 0-0 | 0-0 | 0.0 | 0 | 7 |
| 153 | 19 | 王浩 | 浙江 | 0-0 | 0-0 | 0-0 | 0-0 | 0-0 | 0-0 | 0-0 | 0-0 | 0.0 | 0 | 7 |
| 154 | 24 | 刘子健 | 天津 | 0-0 | 0-0 | 0-0 | 0-0 | 0-0 | 0-0 | 0-0 | 0-0 | 0.0 | 0 | 7 |
| 155 | 20 | 赵佛赐 | 辽宁 | 0-0 | 0-0 | 0-0 | 0-0 | 0-0 | 0-0 | 0-0 | 0-0 | 0.0 | 0 | 7 |
| 156 | 28 | 何喜年 | 天津 | 0-0 | 0-0 | 0-0 | 0-0 | 0-0 | 0-0 | 0-0 | 0-0 | 0.0 | 2 | 7 |
| 157 | 19 | 赵鑫 | 辽宁 | 0-0 | 0-0 | 0-0 | 0-0 | 0-0 | 0-0 | 0-0 | 0-0 | 0.0 | 0 | 7 |
| 158 | 6 | 季晨旭 | 上海 | 0-0 | 0-0 | 0-0 | 0-0 | 0-0 | 0-0 | 0-0 | 0-0 | 0.0 | 0 | 6 |
| 159 | 1 | 郭梦雨 | 解放军 | 0-1 | 0-0 | 0-0 | 0-0 | 0-0 | 0-0 | 0-0 | 0-1 | 0.0 | 2 | 8 |
| 160 | 42 | 王成龙 | 安徽 | 0-0 | 0-0 | 0-1 | 0-0 | 0-0 | 0-0 | 0-0 | 0-1 | 0.0 | 0 | 8 |
| 161 | 32 | 许浩翔 | 安徽 | 0-1 | 0-0 | 0-0 | 0-0 | 0-0 | 0-0 | 0-0 | 0-1 | 0.0 | 1 | 8 |
| 162 | 18 | 张睿梁 | 四川 | 0-0 | 0-1 | 0-0 | 0-0 | 0-0 | 0-0 | 0-0 | 0-1 | 0.0 | 0 | 8 |
| 163 | 27 | 左金龙 | 天津 | 0-0 | 0-0 | 0-1 | 0-0 | 0-0 | 0-0 | 0-0 | 0-1 | 0.0 | 0 | 7 |
| 164 | 21 | 李明 | 安徽 | 0-0 | 0-2 | 0-0 | 0-0 | 0-0 | 0-0 | 0-0 | 0-2 | 0.0 | 14 | 8 |
| 165 | 13 | 蔡杰 | 广东 | 0-0 | 0-1 | 0-1 | 0-0 | 0-0 | 0-0 | 0-0 | 0-2 | 0.0 | 0 | 8 |
| 166 | 5 | 高家南 | 浙江 | 0-1 | 0-1 | 0-0 | 0-0 | 0-0 | 0-0 | 0-0 | 0-2 | 0.0 | 0 | 7 |





2016年“体彩杯”全国手球男子青年锦标赛

得分排名表(场上队员)

正式表
手球
青年截止至第 46场
按助攻201602046-1610-1/4
重庆万州
20/03/2016 8:30

| 排序 | 号码 | 姓名 | 球队 | 远射 | 近射 | 边射 | 快攻 | 突破 | 任意 | 7M | 合计 | % | 助攻 | 场数 |
|----|----|-----|-----|-------|-------|-------|-------|-------|-------|-------|--------|------|----|----|
| 1 | 3 | 张昌轲 | 解放军 | 16-33 | 13-22 | 0-1 | 3-3 | 9-11 | 3-6 | 3-5 | 47-81 | 58.0 | 43 | 8 |
| 2 | 11 | 周傲 | 江苏 | 22-61 | 28-55 | 5-10 | 4-12 | 6-11 | 4-7 | 6-9 | 75-165 | 45.5 | 41 | 8 |
| 3 | 7 | 姜钦 | 解放军 | 15-35 | 21-37 | 1-2 | 2-4 | 7-7 | 5-9 | 1-1 | 52-95 | 54.7 | 33 | 8 |
| 4 | 5 | 黄培杰 | 广东 | 2-11 | 8-17 | 7-11 | 11-15 | 11-13 | 0-0 | 5-10 | 44-77 | 57.1 | 31 | 8 |
| 5 | 8 | 罗尧尧 | 四川 | 16-30 | 12-19 | 2-2 | 14-16 | 4-5 | 2-4 | 19-24 | 69-100 | 69.0 | 26 | 8 |
| 6 | 17 | 王巨柱 | 安徽 | 27-58 | 6-17 | 0-1 | 8-10 | 4-4 | 2-5 | 0-1 | 47-96 | 49.0 | 26 | 8 |
| 7 | 7 | 林豪文 | 新疆 | 20-50 | 8-13 | 2-3 | 3-4 | 3-4 | 4-6 | 6-7 | 46-87 | 52.9 | 26 | 8 |
| 8 | 4 | 朱广刚 | 北京 | 13-28 | 12-25 | 0-0 | 5-5 | 10-14 | 6-7 | 2-5 | 48-84 | 57.1 | 21 | 8 |
| 9 | 18 | 李双 | 安徽 | 14-31 | 23-29 | 1-6 | 6-6 | 7-9 | 4-4 | 3-4 | 58-89 | 65.2 | 20 | 8 |
| 10 | 10 | 王柏淇 | 辽宁 | 11-41 | 9-23 | 1-2 | 8-11 | 14-16 | 1-6 | 7-8 | 51-107 | 47.7 | 19 | 7 |
| 11 | 6 | 吴昊 | 解放军 | 6-29 | 18-27 | 0-0 | 3-5 | 4-5 | 1-1 | 3-5 | 35-72 | 48.6 | 17 | 8 |
| 12 | 9 | 许翔宇 | 四川 | 4-15 | 6-11 | 2-4 | 2-2 | 1-2 | 1-1 | 1-3 | 17-38 | 44.7 | 16 | 8 |
| 13 | 6 | 赵一涵 | 北京 | 8-22 | 16-28 | 2-2 | 1-1 | 15-19 | 0-1 | 0-0 | 42-73 | 57.5 | 15 | 8 |
| 14 | 2 | 姚雪岩 | 广东 | 3-10 | 20-28 | 0-0 | 2-2 | 4-4 | 3-7 | 3-3 | 35-54 | 64.8 | 15 | 8 |
| 15 | 10 | 孙芳伟 | 山东 | 21-61 | 15-27 | 4-6 | 5-7 | 7-8 | 0-0 | 4-5 | 56-114 | 49.1 | 14 | 8 |
| 16 | 15 | 张建杰 | 广东 | 14-42 | 17-30 | 1-1 | 1-1 | 9-12 | 5-11 | 0-0 | 47-97 | 48.5 | 14 | 8 |
| 17 | 6 | 陈庆港 | 辽宁 | 2-12 | 8-14 | 11-15 | 6-7 | 3-5 | 0-0 | 1-1 | 31-54 | 57.4 | 14 | 7 |
| 18 | 11 | 庞东阳 | 辽宁 | 10-21 | 8-10 | 1-5 | 6-7 | 3-5 | 0-1 | 1-1 | 29-50 | 58.0 | 14 | 7 |
| 19 | 21 | 李明 | 安徽 | 0-0 | 0-2 | 0-0 | 0-0 | 0-0 | 0-0 | 0-0 | 0-2 | 0.0 | 14 | 8 |
| 20 | 19 | 李龙吉 | 新疆 | 4-9 | 16-32 | 1-1 | 11-13 | 8-12 | 0-1 | 6-9 | 46-77 | 59.7 | 13 | 8 |
| 21 | 18 | 王晓琪 | 天津 | 19-44 | 7-18 | 0-0 | 0-0 | 2-3 | 0-1 | 3-4 | 31-70 | 44.3 | 12 | 6 |
| 22 | 3 | 高天伦 | 上海 | 12-28 | 11-19 | 2-3 | 1-2 | 0-0 | 0-0 | 3-3 | 29-55 | 52.7 | 12 | 7 |
| 23 | 21 | 潘玉帅 | 天津 | 7-24 | 4-8 | 1-3 | 9-9 | 3-5 | 0-0 | 2-4 | 26-53 | 49.1 | 12 | 7 |
| 24 | 13 | 尹吉祥 | 江苏 | 21-73 | 13-25 | 0-1 | 2-6 | 5-8 | 2-2 | 3-8 | 46-123 | 37.4 | 11 | 8 |
| 25 | 1 | 宋晓晨 | 新疆 | 0-0 | 0-0 | 0-0 | 0-0 | 0-0 | 0-0 | 0-0 | 0-0 | 0.0 | 11 | 8 |
| 26 | 1 | 林先方 | 浙江 | 2-10 | 8-17 | 3-16 | 4-8 | 5-5 | 0-1 | 11-14 | 33-71 | 46.5 | 10 | 7 |
| 27 | 2 | 金勇峰 | 安徽 | 9-16 | 10-13 | 3-11 | 3-3 | 4-4 | 0-0 | 0-1 | 29-48 | 60.4 | 10 | 8 |
| 28 | 10 | 徐彦昊 | 四川 | 8-18 | 8-12 | 2-4 | 10-15 | 1-3 | 0-1 | 0-2 | 29-55 | 52.7 | 10 | 8 |
| 29 | 1 | 王帅 | 广东 | 3-4 | 1-1 | 0-0 | 0-1 | 0-0 | 0-0 | 0-0 | 4-6 | 66.7 | 10 | 8 |
| 30 | 11 | 胡国富 | 广东 | 4-8 | 13-18 | 4-7 | 14-20 | 4-4 | 0-1 | 2-3 | 41-61 | 67.2 | 9 | 8 |
| 31 | 10 | 王钟彬 | 新疆 | 12-35 | 15-23 | 0-1 | 6-9 | 7-9 | 1-3 | 0-1 | 41-81 | 50.6 | 9 | 8 |
| 32 | 10 | 周仲坤 | 广东 | 5-13 | 15-26 | 5-6 | 8-9 | 3-7 | 1-1 | 1-1 | 38-63 | 60.3 | 9 | 8 |
| 33 | 3 | 郑尧俊 | 浙江 | 2-10 | 6-13 | 1-2 | 8-9 | 12-14 | 0-0 | 0-0 | 29-48 | 60.4 | 9 | 7 |
| 34 | 19 | 庞连康 | 四川 | 7-15 | 8-14 | 1-2 | 4-4 | 2-2 | 1-1 | 0-1 | 23-39 | 59.0 | 9 | 8 |
| 35 | 5 | 王晓峰 | 山东 | 38-86 | 7-15 | 0-2 | 7-7 | 0-0 | 10-12 | 1-1 | 63-123 | 51.2 | 8 | 8 |
| 36 | 6 | 王军鸣 | 山东 | 4-17 | 10-20 | 2-4 | 4-8 | 0-0 | 2-5 | 5-6 | 27-60 | 45.0 | 8 | 8 |
| 37 | 19 | 陈旭 | 北京 | 11-39 | 6-16 | 1-2 | 3-4 | 3-3 | 0-0 | 2-3 | 26-67 | 38.8 | 8 | 8 |
| 38 | 12 | 刘树豪 | 四川 | 0-0 | 0-0 | 0-0 | 0-0 | 0-0 | 0-0 | 0-0 | 0-0 | 0.0 | 8 | 8 |
| 39 | 23 | 李荣健 | 山东 | 0-0 | 4-8 | 4-9 | 1-3 | 0-0 | 0-0 | 3-3 | 12-23 | 52.2 | 7 | 8 |
| 40 | 7 | 徐勇林 | 山东 | 3-7 | 5-11 | 1-8 | 2-3 | 1-1 | 0-0 | 0-0 | 12-30 | 40.0 | 7 | 8 |
| 41 | 18 | 李明远 | 北京 | 1-8 | 3-11 | 0-0 | 3-4 | 4-5 | 1-2 | 0-0 | 12-30 | 40.0 | 7 | 8 |
| 42 | 10 | 董凯 | 上海 | 10-26 | 21-29 | 1-1 | 3-3 | 1-2 | 1-2 | 6-7 | 43-70 | 61.4 | 6 | 7 |
| 43 | 9 | 吴明远 | 天津 | 13-27 | 15-21 | 0-0 | 1-4 | 5-6 | 1-1 | 0-0 | 35-59 | 59.3 | 6 | 7 |
| 44 | 18 | 吴双 | 上海 | 5-30 | 10-19 | 1-2 | 8-10 | 6-9 | 2-5 | 2-3 | 34-78 | 43.6 | 6 | 7 |
| 45 | 5 | 王凯 | 四川 | 0-1 | 14-22 | 5-14 | 7-11 | 0-0 | 0-0 | 0-2 | 26-50 | 52.0 | 6 | 8 |
| 46 | 18 | 李玮 | 山东 | 0-1 | 2-2 | 1-4 | 0-0 | 0-0 | 0-0 | 0-0 | 3-7 | 42.9 | 6 | 8 |
| 47 | 14 | 孙耀琦 | 解放军 | 1-2 | 37-50 | 0-0 | 4-6 | 0-0 | 0-0 | 7-9 | 49-67 | 73.1 | 5 | 8 |





2016年“体彩杯”全国手球男子青年锦标赛

得分排名表(场上队员)

正式表
手球
青年截止至第 46场
按助攻201602046-1610-2/4
重庆万州
20/03/2016 8:30

| 排序 | 号码 | 姓名 | 球队 | 远射 | 近射 | 边射 | 快攻 | 突破 | 任意 | 7M | 合计 | % | 助攻 | 场数 |
|----|----|-----|-----|-------|-------|-------|-------|------|------|-----|-------|-------|----|----|
| 48 | 1 | 郭世伟 | 安徽 | 14-31 | 14-21 | 2-4 | 7-11 | 8-9 | 0-0 | 0-1 | 45-77 | 58.4 | 5 | 7 |
| 49 | 5 | 徐伟 | 新疆 | 0-0 | 10-13 | 17-27 | 9-15 | 0-1 | 0-0 | 1-1 | 37-57 | 64.9 | 5 | 8 |
| 50 | 17 | 马益奎 | 江苏 | 1-5 | 25-34 | 2-6 | 3-4 | 0-0 | 0-1 | 1-1 | 32-51 | 62.7 | 5 | 8 |
| 51 | 3 | 王铁林 | 山东 | 3-16 | 6-17 | 11-18 | 8-9 | 0-0 | 0-0 | 0-0 | 28-60 | 46.7 | 5 | 8 |
| 52 | 7 | 任超凡 | 江苏 | 3-5 | 10-17 | 4-16 | 4-5 | 0-0 | 0-1 | 0-0 | 21-44 | 47.7 | 5 | 8 |
| 53 | 18 | 倪陈辉 | 浙江 | 8-43 | 5-9 | 0-1 | 0-0 | 0-0 | 4-12 | 1-1 | 18-66 | 27.3 | 5 | 7 |
| 54 | 13 | 于欣君 | 山东 | 6-14 | 7-14 | 1-4 | 1-5 | 2-2 | 0-2 | 0-1 | 17-42 | 40.5 | 5 | 8 |
| 55 | 5 | 曹磊 | 上海 | 8-19 | 2-9 | 0-2 | 2-2 | 3-3 | 0-0 | 1-1 | 16-36 | 44.4 | 5 | 7 |
| 56 | 7 | 仇瑞祥 | 四川 | 0-2 | 2-2 | 1-2 | 0-1 | 1-1 | 0-0 | 0-1 | 4-9 | 44.4 | 5 | 8 |
| 57 | 1 | 高尚君 | 辽宁 | 1-1 | 0-0 | 0-0 | 0-0 | 0-0 | 0-0 | 0-0 | 1-1 | 100.0 | 5 | 7 |
| 58 | 11 | 王誌汉 | 解放军 | 2-5 | 14-16 | 15-23 | 12-16 | 0-0 | 0-0 | 0-0 | 43-60 | 71.7 | 4 | 8 |
| 59 | 22 | 魏雨童 | 天津 | 4-11 | 21-28 | 0-1 | 5-6 | 8-11 | 0-0 | 4-5 | 42-62 | 67.7 | 4 | 7 |
| 60 | 18 | 耿畅 | 江苏 | 4-20 | 12-25 | 4-6 | 10-13 | 1-2 | 0-0 | 0-1 | 31-67 | 46.3 | 4 | 8 |
| 61 | 15 | 王维东 | 新疆 | 3-8 | 6-11 | 8-15 | 8-10 | 4-4 | 0-0 | 1-1 | 30-49 | 61.2 | 4 | 8 |
| 62 | 2 | 冯鑫宇 | 山东 | 3-10 | 9-22 | 1-1 | 7-8 | 4-5 | 0-0 | 3-6 | 27-52 | 51.9 | 4 | 8 |
| 63 | 13 | 徐峻清 | 解放军 | 0-2 | 12-22 | 7-18 | 7-10 | 0-0 | 0-0 | 0-0 | 26-52 | 50.0 | 4 | 8 |
| 64 | 7 | 段飞宇 | 广东 | 0-2 | 7-9 | 6-14 | 5-6 | 0-0 | 0-0 | 1-1 | 19-32 | 59.4 | 4 | 8 |
| 65 | 13 | 苏兴伟 | 新疆 | 3-10 | 4-5 | 0-1 | 5-7 | 1-1 | 1-1 | 0-0 | 14-25 | 56.0 | 4 | 8 |
| 66 | 3 | 刘赵梁 | 四川 | 0-4 | 9-18 | 17-29 | 14-18 | 4-5 | 0-0 | 0-0 | 44-74 | 59.5 | 3 | 8 |
| 67 | 11 | 李旭 | 北京 | 1-3 | 12-19 | 0-0 | 0-0 | 0-0 | 0-0 | 5-6 | 18-28 | 64.3 | 3 | 8 |
| 68 | 3 | 李星浩 | 辽宁 | 0-0 | 13-21 | 0-0 | 0-0 | 0-0 | 0-0 | 0-0 | 13-21 | 61.9 | 3 | 7 |
| 69 | 10 | 范保坤 | 解放军 | 1-1 | 3-5 | 7-14 | 2-4 | 0-0 | 0-0 | 0-0 | 13-24 | 54.2 | 3 | 8 |
| 70 | 24 | 陈伟华 | 新疆 | 2-5 | 4-4 | 1-4 | 2-2 | 1-1 | 0-0 | 0-1 | 10-17 | 58.8 | 3 | 8 |
| 71 | 3 | 王哲一 | 北京 | 1-2 | 3-5 | 0-3 | 4-5 | 0-0 | 0-0 | 0-0 | 8-15 | 53.3 | 3 | 8 |
| 72 | 5 | 余昊锦 | 辽宁 | 1-12 | 3-3 | 1-1 | 2-2 | 0-0 | 0-0 | 0-0 | 7-18 | 38.9 | 3 | 7 |
| 73 | 9 | 王俊威 | 江苏 | 0-0 | 2-3 | 1-3 | 1-1 | 1-1 | 0-1 | 0-0 | 5-9 | 55.6 | 3 | 8 |
| 74 | 16 | 王猛 | 广东 | 0-0 | 0-0 | 0-0 | 0-0 | 0-0 | 0-0 | 0-0 | 0-0 | 0.0 | 3 | 8 |
| 75 | 9 | 陈开勇 | 安徽 | 3-5 | 22-30 | 0-0 | 16-20 | 0-0 | 1-1 | 1-1 | 43-57 | 75.4 | 2 | 8 |
| 76 | 26 | 吴锐樊 | 北京 | 1-4 | 14-19 | 9-11 | 6-10 | 3-3 | 0-0 | 0-0 | 33-47 | 70.2 | 2 | 8 |
| 77 | 36 | 王鹏皓 | 北京 | 1-2 | 8-19 | 7-15 | 8-9 | 1-1 | 0-0 | 4-5 | 29-51 | 56.9 | 2 | 8 |
| 78 | 17 | 胡晋铭 | 新疆 | 0-2 | 25-29 | 0-1 | 1-1 | 0-0 | 0-0 | 0-0 | 26-33 | 78.8 | 2 | 8 |
| 79 | 17 | 谢庆龙 | 四川 | 0-0 | 20-30 | 0-0 | 1-1 | 0-0 | 0-0 | 1-1 | 22-32 | 68.8 | 2 | 8 |
| 80 | 4 | 高玉杰 | 广东 | 1-4 | 3-6 | 5-11 | 6-8 | 2-3 | 0-0 | 0-0 | 17-32 | 53.1 | 2 | 8 |
| 81 | 14 | 吴佳兵 | 上海 | 9-20 | 7-14 | 0-0 | 0-0 | 1-1 | 0-0 | 0-0 | 17-35 | 48.6 | 2 | 7 |
| 82 | 27 | 王长旭 | 安徽 | 1-3 | 1-1 | 2-4 | 6-8 | 1-1 | 0-0 | 3-3 | 14-20 | 70.0 | 2 | 8 |
| 83 | 4 | 谷通金 | 新疆 | 0-2 | 5-6 | 1-2 | 3-5 | 0-1 | 0-0 | 0-0 | 9-16 | 56.3 | 2 | 8 |
| 84 | 2 | 王司雨 | 辽宁 | 2-2 | 6-8 | 0-0 | 0-0 | 0-0 | 0-0 | 0-0 | 8-10 | 80.0 | 2 | 6 |
| 85 | 3 | 赵韦光 | 江苏 | 0-1 | 5-10 | 1-7 | 1-3 | 1-1 | 0-0 | 0-0 | 8-22 | 36.4 | 2 | 8 |
| 86 | 18 | 李万兴 | 新疆 | 2-3 | 1-2 | 1-1 | 2-3 | 1-1 | 0-0 | 0-0 | 7-10 | 70.0 | 2 | 8 |
| 87 | 6 | 季雨 | 江苏 | 0-0 | 1-2 | 1-1 | 0-0 | 0-0 | 0-0 | 0-0 | 2-3 | 66.7 | 2 | 8 |
| 88 | 1 | 刘继超 | 山东 | 1-1 | 0-0 | 0-0 | 0-0 | 0-0 | 0-0 | 0-0 | 1-1 | 100.0 | 2 | 8 |
| 89 | 1 | 宋继强 | 四川 | 0-0 | 0-0 | 0-0 | 0-0 | 0-0 | 0-0 | 0-0 | 0-0 | 0.0 | 2 | 8 |
| 90 | 28 | 何喜年 | 天津 | 0-0 | 0-0 | 0-0 | 0-0 | 0-0 | 0-0 | 0-0 | 0-0 | 0.0 | 2 | 7 |
| 91 | 14 | 虞勇灿 | 浙江 | 0-0 | 0-0 | 0-0 | 0-0 | 0-0 | 0-0 | 0-0 | 0-0 | 0.0 | 2 | 7 |
| 92 | 1 | 郭梦雨 | 解放军 | 0-1 | 0-0 | 0-0 | 0-0 | 0-0 | 0-0 | 0-0 | 0-1 | 0.0 | 2 | 8 |
| 93 | 18 | 李文金 | 广东 | 3-6 | 15-21 | 0-0 | 2-2 | 0-0 | 0-1 | 0-0 | 20-30 | 66.7 | 1 | 8 |
| 94 | 8 | 庄旭杰 | 上海 | 0-1 | 3-4 | 5-20 | 7-7 | 2-2 | 0-0 | 0-0 | 17-34 | 50.0 | 1 | 7 |





2016年“体彩杯”全国手球男子青年锦标赛

得分排名表(场上队员)

正式表
手球
青年截止至第 46场
按助攻201602046-1610-3/4
重庆万州
20/03/2016 8:30

| 排序 | 号码 | 姓名 | 球队 | 远射 | 近射 | 边射 | 快攻 | 突破 | 任意 | 7M | 合计 | % | 助攻 | 场数 |
|-----|----|-----|-----|------|-------|-------|-----|-----|-----|-----|-------|-------|----|----|
| 95 | 7 | 孙义广 | 辽宁 | 0-0 | 7-7 | 4-6 | 5-8 | 0-0 | 0-0 | 0-0 | 16-21 | 76.2 | 1 | 7 |
| 96 | 13 | 杨洁 | 辽宁 | 5-16 | 3-10 | 1-2 | 3-4 | 1-1 | 0-0 | 1-1 | 14-34 | 41.2 | 1 | 7 |
| 97 | 2 | 李恩铭 | 浙江 | 0-4 | 8-17 | 2-12 | 3-7 | 0-0 | 0-0 | 0-0 | 13-40 | 32.5 | 1 | 7 |
| 98 | 11 | 王洋 | 山东 | 2-3 | 3-5 | 5-7 | 1-2 | 0-0 | 0-0 | 0-0 | 11-17 | 64.7 | 1 | 8 |
| 99 | 15 | 逯明松 | 北京 | 0-8 | 4-9 | 3-8 | 1-2 | 0-0 | 0-0 | 0-0 | 8-27 | 29.6 | 1 | 8 |
| 100 | 21 | 王腾达 | 山东 | 0-0 | 2-2 | 1-2 | 4-4 | 0-0 | 0-0 | 0-0 | 7-8 | 87.5 | 1 | 8 |
| 101 | 11 | 张天豪 | 四川 | 0-0 | 1-4 | 0-3 | 3-3 | 0-0 | 0-0 | 1-1 | 5-11 | 45.5 | 1 | 8 |
| 102 | 4 | 高震东 | 上海 | 0-2 | 1-1 | 0-0 | 1-1 | 0-0 | 0-0 | 1-1 | 3-5 | 60.0 | 1 | 7 |
| 103 | 23 | 刘帅 | 北京 | 3-5 | 0-0 | 0-0 | 0-0 | 0-0 | 0-3 | 0-0 | 3-8 | 37.5 | 1 | 8 |
| 104 | 9 | 李家乐 | 浙江 | 0-0 | 0-3 | 2-4 | 0-0 | 0-0 | 0-0 | 0-0 | 2-7 | 28.6 | 1 | 7 |
| 105 | 15 | 徐逸 | 四川 | 0-0 | 0-0 | 0-0 | 0-1 | 0-0 | 0-0 | 1-1 | 1-2 | 50.0 | 1 | 8 |
| 106 | 17 | 罗明杰 | 浙江 | 0-1 | 1-3 | 0-0 | 0-0 | 0-0 | 0-0 | 0-0 | 1-4 | 25.0 | 1 | 7 |
| 107 | 16 | 李佳懿 | 新疆 | 0-0 | 0-0 | 0-0 | 0-0 | 0-0 | 0-0 | 0-0 | 0-0 | 0.0 | 1 | 8 |
| 108 | 35 | 高云健 | 北京 | 0-0 | 0-0 | 0-0 | 0-0 | 0-0 | 0-0 | 0-0 | 0-0 | 0.0 | 1 | 8 |
| 109 | 32 | 许浩翔 | 安徽 | 0-1 | 0-0 | 0-0 | 0-0 | 0-0 | 0-0 | 0-0 | 0-1 | 0.0 | 1 | 8 |
| 110 | 17 | 薛盼龙 | 山东 | 0-4 | 13-16 | 0-1 | 4-4 | 0-0 | 0-0 | 1-1 | 18-26 | 69.2 | 0 | 8 |
| 111 | 19 | 何山 | 安徽 | 0-0 | 3-4 | 11-20 | 4-4 | 0-1 | 0-0 | 0-0 | 18-29 | 62.1 | 0 | 8 |
| 112 | 26 | 程浩然 | 安徽 | 1-2 | 5-9 | 4-10 | 6-9 | 2-3 | 0-1 | 0-0 | 18-34 | 52.9 | 0 | 8 |
| 113 | 7 | 卞友山 | 北京 | 0-0 | 13-16 | 1-1 | 1-1 | 0-0 | 0-0 | 0-1 | 15-19 | 78.9 | 0 | 8 |
| 114 | 26 | 刘思远 | 天津 | 0-1 | 4-6 | 5-14 | 4-5 | 2-2 | 0-0 | 0-0 | 15-28 | 53.6 | 0 | 7 |
| 115 | 2 | 王泽川 | 新疆 | 0-0 | 8-11 | 0-0 | 2-2 | 0-0 | 0-0 | 2-2 | 12-15 | 80.0 | 0 | 8 |
| 116 | 8 | 姜童耀 | 江苏 | 2-3 | 4-8 | 4-6 | 1-1 | 0-0 | 0-0 | 1-1 | 12-19 | 63.2 | 0 | 8 |
| 117 | 13 | 尹文珂 | 四川 | 1-2 | 5-8 | 4-6 | 1-3 | 0-0 | 0-1 | 1-1 | 12-21 | 57.1 | 0 | 8 |
| 118 | 25 | 王一雄 | 天津 | 4-7 | 4-8 | 3-9 | 1-1 | 0-0 | 0-0 | 0-0 | 12-25 | 48.0 | 0 | 7 |
| 119 | 24 | 徐安格 | 安徽 | 0-2 | 10-13 | 0-0 | 1-1 | 0-0 | 0-0 | 0-0 | 11-16 | 68.8 | 0 | 8 |
| 120 | 14 | 吕昊臻 | 辽宁 | 3-7 | 6-7 | 0-1 | 0-1 | 1-1 | 0-1 | 1-1 | 11-19 | 57.9 | 0 | 7 |
| 121 | 12 | 李壮 | 广东 | 0-0 | 3-6 | 1-1 | 0-0 | 0-0 | 1-3 | 3-5 | 8-15 | 53.3 | 0 | 8 |
| 122 | 7 | 蒋家敏 | 上海 | 0-3 | 3-7 | 3-4 | 0-0 | 0-0 | 0-0 | 0-0 | 6-14 | 42.9 | 0 | 7 |
| 123 | 6 | 白光宇 | 新疆 | 1-1 | 3-4 | 0-2 | 0-0 | 0-0 | 0-1 | 0-0 | 4-8 | 50.0 | 0 | 8 |
| 124 | 15 | 阎冠中 | 江苏 | 0-0 | 0-1 | 0-4 | 0-0 | 0-0 | 0-0 | 3-6 | 3-11 | 27.3 | 0 | 8 |
| 125 | 8 | 王鑫鹏 | 辽宁 | 0-0 | 1-6 | 2-5 | 0-1 | 0-0 | 0-0 | 0-0 | 3-12 | 25.0 | 0 | 7 |
| 126 | 22 | 李子跃 | 山东 | 1-9 | 0-1 | 1-3 | 0-0 | 0-0 | 0-0 | 1-2 | 3-15 | 20.0 | 0 | 8 |
| 127 | 10 | 徐正飞 | 浙江 | 0-1 | 1-1 | 1-1 | 0-0 | 0-0 | 0-0 | 0-0 | 2-3 | 66.7 | 0 | 7 |
| 128 | 25 | 张斌 | 北京 | 0-0 | 1-1 | 0-1 | 1-1 | 0-0 | 0-0 | 0-0 | 2-3 | 66.7 | 0 | 7 |
| 129 | 9 | 周凯峰 | 广东 | 0-0 | 1-2 | 1-2 | 0-0 | 0-0 | 0-0 | 0-0 | 2-4 | 50.0 | 0 | 8 |
| 130 | 14 | 罗中熠 | 江苏 | 0-0 | 1-3 | 1-1 | 0-0 | 0-0 | 0-0 | 0-0 | 2-4 | 50.0 | 0 | 7 |
| 131 | 28 | 丁浩然 | 安徽 | 0-0 | 0-0 | 1-4 | 1-1 | 0-0 | 0-0 | 0-0 | 2-5 | 40.0 | 0 | 8 |
| 132 | 4 | 张洋 | 解放军 | 0-0 | 1-1 | 0-0 | 0-0 | 0-0 | 0-0 | 0-0 | 1-1 | 100.0 | 0 | 8 |
| 133 | 16 | 吴阳 | 辽宁 | 0-0 | 0-0 | 1-1 | 0-0 | 0-0 | 0-0 | 0-0 | 1-1 | 100.0 | 0 | 7 |
| 134 | 4 | 张瑞恒 | 江苏 | 0-0 | 1-2 | 0-0 | 0-0 | 0-0 | 0-0 | 0-0 | 1-2 | 50.0 | 0 | 8 |
| 135 | 12 | 刘道林 | 山东 | 0-0 | 0-0 | 0-0 | 0-0 | 0-0 | 0-0 | 0-0 | 0-0 | 0.0 | 0 | 8 |
| 136 | 20 | 张文健 | 四川 | 0-0 | 0-0 | 0-0 | 0-0 | 0-0 | 0-0 | 0-0 | 0-0 | 0.0 | 0 | 8 |
| 137 | 33 | 姚紫祥 | 安徽 | 0-0 | 0-0 | 0-0 | 0-0 | 0-0 | 0-0 | 0-0 | 0-0 | 0.0 | 0 | 8 |
| 138 | 12 | 王金鑫 | 新疆 | 0-0 | 0-0 | 0-0 | 0-0 | 0-0 | 0-0 | 0-0 | 0-0 | 0.0 | 0 | 8 |
| 139 | 41 | 刘润民 | 安徽 | 0-0 | 0-0 | 0-0 | 0-0 | 0-0 | 0-0 | 0-0 | 0-0 | 0.0 | 0 | 8 |
| 140 | 25 | 李文哲 | 安徽 | 0-0 | 0-0 | 0-0 | 0-0 | 0-0 | 0-0 | 0-0 | 0-0 | 0.0 | 0 | 8 |
| 141 | 21 | 曹修庆 | 四川 | 0-0 | 0-0 | 0-0 | 0-0 | 0-0 | 0-0 | 0-0 | 0-0 | 0.0 | 0 | 8 |





2016年“体彩杯”全国手球男子青年锦标赛

得分排名表(场上队员)

正式表
手球
青年截止至第 46场
按助攻201602046-1610-4/4
重庆万州
20/03/2016 8:30

| 排序 | 号码 | 姓名 | 球队 | 远射 | 近射 | 边射 | 快攻 | 突破 | 任意 | 7M | 合计 | % | 助攻 | 场数 |
|-----|----|-----|-----|-----|-----|-----|-----|-----|-----|-----|-----|-----|----|----|
| 142 | 17 | 刘安宁 | 解放军 | 0-0 | 0-0 | 0-0 | 0-0 | 0-0 | 0-0 | 0-0 | 0-0 | 0.0 | 0 | 8 |
| 143 | 1 | 潘博琦 | 江苏 | 0-0 | 0-0 | 0-0 | 0-0 | 0-0 | 0-0 | 0-0 | 0-0 | 0.0 | 0 | 8 |
| 144 | 16 | 马佳鹏 | 北京 | 0-0 | 0-0 | 0-0 | 0-0 | 0-0 | 0-0 | 0-0 | 0-0 | 0.0 | 0 | 8 |
| 145 | 5 | 尹一楠 | 解放军 | 0-0 | 0-0 | 0-0 | 0-0 | 0-0 | 0-0 | 0-0 | 0-0 | 0.0 | 0 | 8 |
| 146 | 9 | 李天枢 | 解放军 | 0-0 | 0-0 | 0-0 | 0-0 | 0-0 | 0-0 | 0-0 | 0-0 | 0.0 | 0 | 8 |
| 147 | 12 | 左子健 | 解放军 | 0-0 | 0-0 | 0-0 | 0-0 | 0-0 | 0-0 | 0-0 | 0-0 | 0.0 | 0 | 8 |
| 148 | 16 | 池猛 | 解放军 | 0-0 | 0-0 | 0-0 | 0-0 | 0-0 | 0-0 | 0-0 | 0-0 | 0.0 | 0 | 8 |
| 149 | 14 | 王泽润 | 广东 | 0-0 | 0-0 | 0-0 | 0-0 | 0-0 | 0-0 | 0-0 | 0-0 | 0.0 | 0 | 8 |
| 150 | 8 | 邹峻楠 | 解放军 | 0-0 | 0-0 | 0-0 | 0-0 | 0-0 | 0-0 | 0-0 | 0-0 | 0.0 | 0 | 8 |
| 151 | 15 | 张佩力 | 浙江 | 0-0 | 0-0 | 0-0 | 0-0 | 0-0 | 0-0 | 0-0 | 0-0 | 0.0 | 0 | 7 |
| 152 | 19 | 王浩 | 浙江 | 0-0 | 0-0 | 0-0 | 0-0 | 0-0 | 0-0 | 0-0 | 0-0 | 0.0 | 0 | 7 |
| 153 | 19 | 赵鑫 | 辽宁 | 0-0 | 0-0 | 0-0 | 0-0 | 0-0 | 0-0 | 0-0 | 0-0 | 0.0 | 0 | 7 |
| 154 | 24 | 刘子健 | 天津 | 0-0 | 0-0 | 0-0 | 0-0 | 0-0 | 0-0 | 0-0 | 0-0 | 0.0 | 0 | 7 |
| 155 | 20 | 赵佛赐 | 辽宁 | 0-0 | 0-0 | 0-0 | 0-0 | 0-0 | 0-0 | 0-0 | 0-0 | 0.0 | 0 | 7 |
| 156 | 16 | 陈辰 | 上海 | 0-0 | 0-0 | 0-0 | 0-0 | 0-0 | 0-0 | 0-0 | 0-0 | 0.0 | 0 | 7 |
| 157 | 2 | 谢智超 | 上海 | 0-0 | 0-0 | 0-0 | 0-0 | 0-0 | 0-0 | 0-0 | 0-0 | 0.0 | 0 | 7 |
| 158 | 12 | 张润民 | 上海 | 0-0 | 0-0 | 0-0 | 0-0 | 0-0 | 0-0 | 0-0 | 0-0 | 0.0 | 0 | 7 |
| 159 | 17 | 李傲 | 辽宁 | 0-0 | 0-0 | 0-0 | 0-0 | 0-0 | 0-0 | 0-0 | 0-0 | 0.0 | 0 | 7 |
| 160 | 18 | 梅凯博 | 辽宁 | 0-0 | 0-0 | 0-0 | 0-0 | 0-0 | 0-0 | 0-0 | 0-0 | 0.0 | 0 | 7 |
| 161 | 6 | 季晨旭 | 上海 | 0-0 | 0-0 | 0-0 | 0-0 | 0-0 | 0-0 | 0-0 | 0-0 | 0.0 | 0 | 6 |
| 162 | 18 | 张睿梁 | 四川 | 0-0 | 0-1 | 0-0 | 0-0 | 0-0 | 0-0 | 0-0 | 0-1 | 0.0 | 0 | 8 |
| 163 | 42 | 王成龙 | 安徽 | 0-0 | 0-0 | 0-1 | 0-0 | 0-0 | 0-0 | 0-0 | 0-1 | 0.0 | 0 | 8 |
| 164 | 27 | 左金龙 | 天津 | 0-0 | 0-0 | 0-1 | 0-0 | 0-0 | 0-0 | 0-0 | 0-1 | 0.0 | 0 | 7 |
| 165 | 13 | 蔡杰 | 广东 | 0-0 | 0-1 | 0-1 | 0-0 | 0-0 | 0-0 | 0-0 | 0-2 | 0.0 | 0 | 8 |
| 166 | 5 | 高家南 | 浙江 | 0-1 | 0-1 | 0-0 | 0-0 | 0-0 | 0-0 | 0-0 | 0-2 | 0.0 | 0 | 7 |





2016年“体彩杯”全国手球男子青年锦标赛

得分排名表(场上队员)

正式表
手球
青年男子

截止至第 46场
按封球

201602046-1611-1/4
重庆万州
20/03/2016 8:30

| 名次 | 号码 | 姓名 | 球队 | 抢球 | 断球 | 造失误 | 造犯规 | 合计 | 封球 | 场数 |
|----|----|-----|-----|----|----|-----|-----|----|----|----|
| 1 | 17 | 薛盼龙 | 山东 | 2 | 2 | 3 | 0 | 7 | 15 | 8 |
| 2 | 17 | 马益奎 | 江苏 | 4 | 5 | 0 | 0 | 9 | 13 | 8 |
| 3 | 17 | 胡晋铭 | 新疆 | 0 | 4 | 0 | 1 | 5 | 12 | 8 |
| 4 | 17 | 谢庆龙 | 四川 | 2 | 9 | 0 | 4 | 15 | 11 | 8 |
| 5 | 10 | 孙芳伟 | 山东 | 1 | 12 | 3 | 0 | 16 | 11 | 8 |
| 6 | 14 | 孙耀琦 | 解放军 | 2 | 3 | 2 | 1 | 8 | 10 | 8 |
| 7 | 2 | 姚雪岩 | 广东 | 0 | 4 | 0 | 0 | 4 | 10 | 8 |
| 8 | 18 | 李文金 | 广东 | 0 | 2 | 1 | 0 | 3 | 7 | 8 |
| 9 | 7 | 林豪文 | 新疆 | 1 | 9 | 0 | 2 | 12 | 7 | 8 |
| 10 | 19 | 庞连康 | 四川 | 2 | 14 | 1 | 1 | 18 | 6 | 8 |
| 11 | 10 | 周仲坤 | 广东 | 1 | 8 | 1 | 2 | 12 | 6 | 8 |
| 12 | 15 | 张建杰 | 广东 | 0 | 2 | 0 | 1 | 3 | 6 | 8 |
| 13 | 22 | 魏雨童 | 天津 | 1 | 5 | 1 | 0 | 7 | 5 | 7 |
| 14 | 5 | 王晓峰 | 山东 | 1 | 10 | 1 | 0 | 12 | 5 | 8 |
| 15 | 6 | 吴昊 | 解放军 | 0 | 7 | 0 | 1 | 8 | 5 | 8 |
| 16 | 18 | 李双 | 安徽 | 2 | 12 | 3 | 2 | 19 | 5 | 8 |
| 17 | 7 | 卞友山 | 北京 | 0 | 1 | 0 | 1 | 2 | 5 | 8 |
| 18 | 2 | 王司雨 | 辽宁 | 0 | 2 | 0 | 0 | 2 | 4 | 6 |
| 19 | 21 | 潘玉帅 | 天津 | 0 | 4 | 3 | 0 | 7 | 4 | 7 |
| 20 | 10 | 董凯 | 上海 | 3 | 0 | 0 | 2 | 5 | 4 | 7 |
| 21 | 3 | 张昌轲 | 解放军 | 2 | 5 | 6 | 1 | 14 | 4 | 8 |
| 22 | 8 | 罗尧尧 | 四川 | 2 | 8 | 3 | 7 | 20 | 4 | 8 |
| 23 | 1 | 郭世伟 | 安徽 | 5 | 6 | 1 | 5 | 17 | 3 | 7 |
| 24 | 3 | 高天伦 | 上海 | 0 | 8 | 1 | 1 | 10 | 3 | 7 |
| 25 | 10 | 徐正飞 | 浙江 | 0 | 1 | 0 | 0 | 1 | 3 | 7 |
| 26 | 9 | 陈开勇 | 安徽 | 5 | 3 | 0 | 0 | 8 | 3 | 8 |
| 27 | 7 | 姜钦 | 解放军 | 5 | 10 | 1 | 1 | 17 | 3 | 8 |
| 28 | 11 | 李旭 | 北京 | 0 | 1 | 0 | 1 | 2 | 3 | 8 |
| 29 | 17 | 王巨柱 | 安徽 | 4 | 12 | 1 | 1 | 18 | 3 | 8 |
| 30 | 4 | 朱广刚 | 北京 | 2 | 8 | 1 | 3 | 14 | 3 | 8 |
| 31 | 6 | 王军鸣 | 山东 | 0 | 4 | 1 | 0 | 5 | 3 | 8 |
| 32 | 2 | 金勇峰 | 安徽 | 4 | 0 | 1 | 1 | 6 | 3 | 8 |
| 33 | 6 | 赵一涵 | 北京 | 1 | 1 | 1 | 3 | 6 | 3 | 8 |
| 34 | 18 | 王晓琪 | 天津 | 2 | 2 | 1 | 0 | 5 | 2 | 6 |
| 35 | 14 | 吴佳兵 | 上海 | 0 | 4 | 0 | 0 | 4 | 2 | 7 |
| 36 | 19 | 陈旭 | 北京 | 0 | 8 | 2 | 0 | 10 | 2 | 8 |
| 37 | 13 | 尹吉祥 | 江苏 | 1 | 11 | 2 | 0 | 14 | 2 | 8 |
| 38 | 9 | 许翔宇 | 四川 | 0 | 2 | 0 | 4 | 6 | 2 | 8 |
| 39 | 24 | 徐安格 | 安徽 | 0 | 0 | 0 | 0 | 0 | 2 | 8 |
| 40 | 18 | 李玮 | 山东 | 1 | 0 | 1 | 0 | 2 | 2 | 8 |
| 41 | 13 | 杨洁 | 辽宁 | 0 | 1 | 1 | 1 | 3 | 1 | 7 |
| 42 | 3 | 李星浩 | 辽宁 | 2 | 4 | 0 | 0 | 6 | 1 | 7 |
| 43 | 7 | 孙义广 | 辽宁 | 1 | 1 | 2 | 0 | 4 | 1 | 7 |
| 44 | 1 | 林先方 | 浙江 | 0 | 9 | 1 | 0 | 10 | 1 | 7 |
| 45 | 11 | 庞东阳 | 辽宁 | 1 | 3 | 1 | 1 | 6 | 1 | 7 |
| 46 | 5 | 高家南 | 浙江 | 0 | 3 | 0 | 0 | 3 | 1 | 7 |
| 47 | 9 | 吴明远 | 天津 | 1 | 5 | 3 | 0 | 9 | 1 | 7 |
| 48 | 7 | 徐勇林 | 山东 | 2 | 9 | 1 | 0 | 12 | 1 | 8 |





2016年“体彩杯”全国手球男子青年锦标赛
得分排名表(场上队员)

正式表
手球
青年男子

截止至第 46场
按封球

201602046-1611-2/4
重庆万州
20/03/2016 8:30

| 名次 | 号码 | 姓名 | 球队 | 抢球 | 断球 | 造失误 | 造犯规 | 合计 | 封球 | 场数 |
|----|----|-----|-----|----|----|-----|-----|----|----|----|
| 49 | 11 | 王洋 | 山东 | 1 | 0 | 0 | 0 | 1 | 1 | 8 |
| 50 | 23 | 李荣健 | 山东 | 0 | 3 | 0 | 0 | 3 | 1 | 8 |
| 51 | 3 | 刘赵梁 | 四川 | 4 | 5 | 0 | 1 | 10 | 1 | 8 |
| 52 | 15 | 逯明松 | 北京 | 0 | 1 | 1 | 1 | 3 | 1 | 8 |
| 53 | 5 | 王凯 | 四川 | 1 | 4 | 0 | 1 | 6 | 1 | 8 |
| 54 | 10 | 王钟彬 | 新疆 | 2 | 10 | 3 | 1 | 16 | 1 | 8 |
| 55 | 5 | 黄培杰 | 广东 | 4 | 16 | 2 | 0 | 22 | 1 | 8 |
| 56 | 3 | 王哲一 | 北京 | 1 | 1 | 0 | 0 | 2 | 1 | 8 |
| 57 | 13 | 苏兴伟 | 新疆 | 0 | 1 | 1 | 0 | 2 | 1 | 8 |
| 58 | 2 | 冯鑫宇 | 山东 | 1 | 5 | 4 | 0 | 10 | 1 | 8 |
| 59 | 11 | 王誌汉 | 解放军 | 0 | 0 | 0 | 0 | 0 | 1 | 8 |
| 60 | 15 | 王维东 | 新疆 | 2 | 5 | 1 | 1 | 9 | 1 | 8 |
| 61 | 19 | 李龙吉 | 新疆 | 3 | 8 | 2 | 0 | 13 | 1 | 8 |
| 62 | 23 | 刘帅 | 北京 | 0 | 0 | 0 | 0 | 0 | 1 | 8 |
| 63 | 7 | 任超凡 | 江苏 | 1 | 4 | 1 | 0 | 6 | 1 | 8 |
| 64 | 6 | 季晨旭 | 上海 | 0 | 0 | 0 | 0 | 0 | 0 | 6 |
| 65 | 17 | 李傲 | 辽宁 | 0 | 0 | 0 | 1 | 1 | 0 | 7 |
| 66 | 20 | 赵佛赐 | 辽宁 | 0 | 0 | 0 | 0 | 0 | 0 | 7 |
| 67 | 19 | 赵鑫 | 辽宁 | 0 | 0 | 0 | 1 | 1 | 0 | 7 |
| 68 | 18 | 梅凯博 | 辽宁 | 0 | 0 | 0 | 0 | 0 | 0 | 7 |
| 69 | 16 | 吴阳 | 辽宁 | 0 | 0 | 0 | 0 | 0 | 0 | 7 |
| 70 | 25 | 张斌 | 北京 | 0 | 0 | 0 | 0 | 0 | 0 | 7 |
| 71 | 10 | 王柏淇 | 辽宁 | 0 | 9 | 1 | 0 | 10 | 0 | 7 |
| 72 | 14 | 罗中熠 | 江苏 | 0 | 1 | 0 | 0 | 1 | 0 | 7 |
| 73 | 6 | 陈庆港 | 辽宁 | 4 | 5 | 1 | 1 | 11 | 0 | 7 |
| 74 | 8 | 王鑫鹏 | 辽宁 | 0 | 2 | 0 | 0 | 2 | 0 | 7 |
| 75 | 5 | 余昊锦 | 辽宁 | 1 | 3 | 3 | 0 | 7 | 0 | 7 |
| 76 | 1 | 高尚君 | 辽宁 | 0 | 0 | 0 | 0 | 0 | 0 | 7 |
| 77 | 9 | 李家乐 | 浙江 | 0 | 1 | 0 | 0 | 1 | 0 | 7 |
| 78 | 8 | 庄旭杰 | 上海 | 1 | 1 | 1 | 0 | 3 | 0 | 7 |
| 79 | 25 | 王一雄 | 天津 | 3 | 1 | 0 | 0 | 4 | 0 | 7 |
| 80 | 3 | 郑尧俊 | 浙江 | 6 | 2 | 1 | 0 | 9 | 0 | 7 |
| 81 | 17 | 罗明杰 | 浙江 | 1 | 1 | 0 | 1 | 3 | 0 | 7 |
| 82 | 19 | 王浩 | 浙江 | 0 | 0 | 0 | 0 | 0 | 0 | 7 |
| 83 | 15 | 张佩力 | 浙江 | 0 | 0 | 0 | 0 | 0 | 0 | 7 |
| 84 | 18 | 倪陈辉 | 浙江 | 1 | 5 | 0 | 1 | 7 | 0 | 7 |
| 85 | 2 | 李恩铭 | 浙江 | 0 | 4 | 0 | 0 | 4 | 0 | 7 |
| 86 | 26 | 刘思远 | 天津 | 0 | 5 | 3 | 1 | 9 | 0 | 7 |
| 87 | 5 | 曹磊 | 上海 | 0 | 4 | 0 | 0 | 4 | 0 | 7 |
| 88 | 24 | 刘子健 | 天津 | 0 | 0 | 0 | 0 | 0 | 0 | 7 |
| 89 | 16 | 陈辰 | 上海 | 0 | 0 | 0 | 0 | 0 | 0 | 7 |
| 90 | 2 | 谢智超 | 上海 | 0 | 0 | 0 | 0 | 0 | 0 | 7 |
| 91 | 12 | 张润民 | 上海 | 0 | 0 | 0 | 0 | 0 | 0 | 7 |
| 92 | 7 | 蒋家敏 | 上海 | 0 | 0 | 0 | 1 | 1 | 0 | 7 |
| 93 | 18 | 吴双 | 上海 | 4 | 8 | 1 | 0 | 13 | 0 | 7 |
| 94 | 14 | 吕昊臻 | 辽宁 | 0 | 2 | 0 | 1 | 3 | 0 | 7 |
| 95 | 28 | 何喜年 | 天津 | 0 | 0 | 0 | 0 | 0 | 0 | 7 |
| 96 | 27 | 左金龙 | 天津 | 1 | 2 | 0 | 0 | 3 | 0 | 7 |





2016年“体彩杯”全国手球男子青年锦标赛

得分排名表(场上队员)

正式表
手球
青年男子

截止至第 46场
按封球

201602046-1611-3/4
重庆万州
20/03/2016 8:30

| 名次 | 号码 | 姓名 | 球队 | 抢球 | 断球 | 造失误 | 造犯规 | 合计 | 封球 | 场数 |
|-----|----|-----|-----|----|----|-----|-----|----|----|----|
| 97 | 14 | 虞勇灿 | 浙江 | 0 | 0 | 0 | 0 | 0 | 0 | 7 |
| 98 | 4 | 高震东 | 上海 | 0 | 3 | 0 | 0 | 3 | 0 | 7 |
| 99 | 4 | 谷通金 | 新疆 | 0 | 4 | 0 | 0 | 4 | 0 | 8 |
| 100 | 16 | 马佳鹏 | 北京 | 0 | 0 | 0 | 0 | 0 | 0 | 8 |
| 101 | 18 | 李明远 | 北京 | 0 | 4 | 1 | 1 | 6 | 0 | 8 |
| 102 | 35 | 高云健 | 北京 | 0 | 0 | 0 | 0 | 0 | 0 | 8 |
| 103 | 1 | 王帅 | 广东 | 0 | 1 | 2 | 0 | 3 | 0 | 8 |
| 104 | 16 | 王猛 | 广东 | 0 | 0 | 0 | 0 | 0 | 0 | 8 |
| 105 | 5 | 徐伟 | 新疆 | 1 | 1 | 2 | 0 | 4 | 0 | 8 |
| 106 | 2 | 王泽川 | 新疆 | 0 | 1 | 0 | 0 | 1 | 0 | 8 |
| 107 | 4 | 高玉杰 | 广东 | 1 | 5 | 1 | 3 | 10 | 0 | 8 |
| 108 | 1 | 宋晓晨 | 新疆 | 0 | 0 | 0 | 0 | 0 | 0 | 8 |
| 109 | 14 | 王泽润 | 广东 | 0 | 0 | 0 | 0 | 0 | 0 | 8 |
| 110 | 33 | 姚紫祥 | 安徽 | 0 | 0 | 0 | 0 | 0 | 0 | 8 |
| 111 | 19 | 何山 | 安徽 | 0 | 2 | 1 | 0 | 3 | 0 | 8 |
| 112 | 25 | 李文哲 | 安徽 | 0 | 0 | 0 | 0 | 0 | 0 | 8 |
| 113 | 27 | 王长旭 | 安徽 | 0 | 2 | 0 | 0 | 2 | 0 | 8 |
| 114 | 32 | 许浩翔 | 安徽 | 0 | 0 | 0 | 0 | 0 | 0 | 8 |
| 115 | 41 | 刘润民 | 安徽 | 0 | 0 | 0 | 0 | 0 | 0 | 8 |
| 116 | 28 | 丁浩然 | 安徽 | 0 | 0 | 0 | 0 | 0 | 0 | 8 |
| 117 | 36 | 王鹏皓 | 北京 | 2 | 7 | 1 | 0 | 10 | 0 | 8 |
| 118 | 42 | 王成龙 | 安徽 | 0 | 0 | 0 | 0 | 0 | 0 | 8 |
| 119 | 6 | 白光宇 | 新疆 | 0 | 0 | 0 | 0 | 0 | 0 | 8 |
| 120 | 26 | 程浩然 | 安徽 | 1 | 3 | 0 | 1 | 5 | 0 | 8 |
| 121 | 26 | 吴锐樊 | 北京 | 3 | 6 | 0 | 1 | 10 | 0 | 8 |
| 122 | 12 | 王金鑫 | 新疆 | 0 | 0 | 0 | 0 | 0 | 0 | 8 |
| 123 | 16 | 李佳懿 | 新疆 | 0 | 0 | 0 | 0 | 0 | 0 | 8 |
| 124 | 18 | 李万兴 | 新疆 | 1 | 1 | 1 | 0 | 3 | 0 | 8 |
| 125 | 24 | 陈伟华 | 新疆 | 0 | 1 | 0 | 0 | 1 | 0 | 8 |
| 126 | 21 | 李明 | 安徽 | 0 | 0 | 0 | 0 | 0 | 0 | 8 |
| 127 | 8 | 邹峻楠 | 解放军 | 0 | 0 | 0 | 0 | 0 | 0 | 8 |
| 128 | 12 | 李壮 | 广东 | 0 | 0 | 1 | 0 | 1 | 0 | 8 |
| 129 | 10 | 范保坤 | 解放军 | 0 | 2 | 0 | 0 | 2 | 0 | 8 |
| 130 | 7 | 仇瑞祥 | 四川 | 0 | 0 | 0 | 0 | 0 | 0 | 8 |
| 131 | 12 | 左子健 | 解放军 | 0 | 0 | 0 | 0 | 0 | 0 | 8 |
| 132 | 13 | 徐峻清 | 解放军 | 1 | 1 | 0 | 1 | 3 | 0 | 8 |
| 133 | 12 | 刘树豪 | 四川 | 0 | 0 | 0 | 0 | 0 | 0 | 8 |
| 134 | 16 | 池猛 | 解放军 | 0 | 0 | 0 | 0 | 0 | 0 | 8 |
| 135 | 13 | 尹文珂 | 四川 | 0 | 2 | 0 | 2 | 4 | 0 | 8 |
| 136 | 1 | 宋继强 | 四川 | 0 | 0 | 0 | 0 | 0 | 0 | 8 |
| 137 | 5 | 尹一楠 | 解放军 | 0 | 1 | 0 | 0 | 1 | 0 | 8 |
| 138 | 11 | 张天豪 | 四川 | 1 | 2 | 0 | 0 | 3 | 0 | 8 |
| 139 | 15 | 徐逸 | 四川 | 0 | 0 | 1 | 0 | 1 | 0 | 8 |
| 140 | 18 | 张睿梁 | 四川 | 1 | 0 | 0 | 1 | 2 | 0 | 8 |
| 141 | 22 | 李子跃 | 山东 | 0 | 0 | 0 | 1 | 1 | 0 | 8 |
| 142 | 21 | 王腾达 | 山东 | 0 | 1 | 0 | 0 | 1 | 0 | 8 |
| 143 | 13 | 于欣君 | 山东 | 0 | 5 | 0 | 0 | 5 | 0 | 8 |
| 144 | 12 | 刘道林 | 山东 | 0 | 0 | 0 | 0 | 0 | 0 | 8 |





2016年“体彩杯”全国手球男子青年锦标赛

得分排名表(场上队员)

正式表
手球
青年男子

截止至第 46场
按封球

201602046-1611-4/4
重庆万州
20/03/2016 8:30

| 名次 | 号码 | 姓名 | 球队 | 抢球 | 断球 | 造失误 | 造犯规 | 合计 | 封球 | 场数 |
|-----|----|-----|-----|----|----|-----|-----|----|----|----|
| 145 | 3 | 王铁林 | 山东 | 6 | 5 | 0 | 1 | 12 | 0 | 8 |
| 146 | 17 | 刘安宁 | 解放军 | 0 | 0 | 0 | 0 | 0 | 0 | 8 |
| 147 | 6 | 季雨 | 江苏 | 0 | 5 | 0 | 0 | 5 | 0 | 8 |
| 148 | 7 | 段飞宇 | 广东 | 0 | 5 | 0 | 1 | 6 | 0 | 8 |
| 149 | 9 | 周凯峰 | 广东 | 0 | 1 | 0 | 0 | 1 | 0 | 8 |
| 150 | 13 | 蔡杰 | 广东 | 0 | 1 | 0 | 0 | 1 | 0 | 8 |
| 151 | 9 | 王俊威 | 江苏 | 2 | 5 | 0 | 0 | 7 | 0 | 8 |
| 152 | 1 | 刘继超 | 山东 | 0 | 0 | 0 | 0 | 0 | 0 | 8 |
| 153 | 8 | 姜童耀 | 江苏 | 0 | 1 | 0 | 1 | 2 | 0 | 8 |
| 154 | 3 | 赵韦光 | 江苏 | 0 | 0 | 0 | 0 | 0 | 0 | 8 |
| 155 | 9 | 李天枢 | 解放军 | 0 | 0 | 0 | 0 | 0 | 0 | 8 |
| 156 | 18 | 耿畅 | 江苏 | 1 | 13 | 0 | 2 | 16 | 0 | 8 |
| 157 | 11 | 胡国富 | 广东 | 4 | 5 | 1 | 0 | 10 | 0 | 8 |
| 158 | 15 | 阎冠中 | 江苏 | 0 | 1 | 0 | 0 | 1 | 0 | 8 |
| 159 | 21 | 曹修庆 | 四川 | 0 | 0 | 0 | 0 | 0 | 0 | 8 |
| 160 | 20 | 张文健 | 四川 | 0 | 0 | 0 | 0 | 0 | 0 | 8 |
| 161 | 11 | 周傲 | 江苏 | 4 | 13 | 1 | 1 | 19 | 0 | 8 |
| 162 | 1 | 潘博琦 | 江苏 | 0 | 0 | 0 | 0 | 0 | 0 | 8 |
| 163 | 1 | 郭梦雨 | 解放军 | 0 | 0 | 0 | 0 | 0 | 0 | 8 |
| 164 | 10 | 徐彦昊 | 四川 | 2 | 8 | 0 | 0 | 10 | 0 | 8 |
| 165 | 4 | 张洋 | 解放军 | 0 | 0 | 1 | 0 | 1 | 0 | 8 |
| 166 | 4 | 张瑞恒 | 江苏 | 0 | 0 | 0 | 0 | 0 | 0 | 8 |





2016年“体彩杯”全国手球男子青年锦标赛 得分排名表(场上队员)

正式表
手球
青年男子

截止至第 46场
按防守

201602046-1612-1/4
重庆万州
20/03/2016 8:30

| 名次 | 号码 | 姓名 | 球队 | 抢球 | 断球 | 造失误 | 造犯规 | 合计 | 封球 | 场数 |
|----|----|-----|-----|----|----|-----|-----|----|----|----|
| 1 | 5 | 黄培杰 | 广东 | 4 | 16 | 2 | 0 | 22 | 1 | 8 |
| 2 | 8 | 罗尧尧 | 四川 | 2 | 8 | 3 | 7 | 20 | 4 | 8 |
| 3 | 18 | 李双 | 安徽 | 2 | 12 | 3 | 2 | 19 | 5 | 8 |
| 4 | 11 | 周傲 | 江苏 | 4 | 13 | 1 | 1 | 19 | 0 | 8 |
| 5 | 19 | 庞连康 | 四川 | 2 | 14 | 1 | 1 | 18 | 6 | 8 |
| 6 | 17 | 王巨柱 | 安徽 | 4 | 12 | 1 | 1 | 18 | 3 | 8 |
| 7 | 7 | 姜钦 | 解放军 | 5 | 10 | 1 | 1 | 17 | 3 | 8 |
| 8 | 1 | 郭世伟 | 安徽 | 5 | 6 | 1 | 5 | 17 | 3 | 7 |
| 9 | 10 | 王钟彬 | 新疆 | 2 | 10 | 3 | 1 | 16 | 1 | 8 |
| 10 | 18 | 耿畅 | 江苏 | 1 | 13 | 0 | 2 | 16 | 0 | 8 |
| 11 | 10 | 孙芳伟 | 山东 | 1 | 12 | 3 | 0 | 16 | 11 | 8 |
| 12 | 17 | 谢庆龙 | 四川 | 2 | 9 | 0 | 4 | 15 | 11 | 8 |
| 13 | 3 | 张昌轲 | 解放军 | 2 | 5 | 6 | 1 | 14 | 4 | 8 |
| 14 | 13 | 尹吉祥 | 江苏 | 1 | 11 | 2 | 0 | 14 | 2 | 8 |
| 15 | 4 | 朱广刚 | 北京 | 2 | 8 | 1 | 3 | 14 | 3 | 8 |
| 16 | 19 | 李龙吉 | 新疆 | 3 | 8 | 2 | 0 | 13 | 1 | 8 |
| 17 | 18 | 吴双 | 上海 | 4 | 8 | 1 | 0 | 13 | 0 | 7 |
| 18 | 5 | 王晓峰 | 山东 | 1 | 10 | 1 | 0 | 12 | 5 | 8 |
| 19 | 3 | 王铁林 | 山东 | 6 | 5 | 0 | 1 | 12 | 0 | 8 |
| 20 | 7 | 徐勇林 | 山东 | 2 | 9 | 1 | 0 | 12 | 1 | 8 |
| 21 | 10 | 周仲坤 | 广东 | 1 | 8 | 1 | 2 | 12 | 6 | 8 |
| 22 | 7 | 林豪文 | 新疆 | 1 | 9 | 0 | 2 | 12 | 7 | 8 |
| 23 | 6 | 陈庆港 | 辽宁 | 4 | 5 | 1 | 1 | 11 | 0 | 7 |
| 24 | 26 | 吴锐樊 | 北京 | 3 | 6 | 0 | 1 | 10 | 0 | 8 |
| 25 | 36 | 王鹏皓 | 北京 | 2 | 7 | 1 | 0 | 10 | 0 | 8 |
| 26 | 2 | 冯鑫宇 | 山东 | 1 | 5 | 4 | 0 | 10 | 1 | 8 |
| 27 | 3 | 刘赵梁 | 四川 | 4 | 5 | 0 | 1 | 10 | 1 | 8 |
| 28 | 10 | 徐彦昊 | 四川 | 2 | 8 | 0 | 0 | 10 | 0 | 8 |
| 29 | 4 | 高玉杰 | 广东 | 1 | 5 | 1 | 3 | 10 | 0 | 8 |
| 30 | 19 | 陈旭 | 北京 | 0 | 8 | 2 | 0 | 10 | 2 | 8 |
| 31 | 11 | 胡国富 | 广东 | 4 | 5 | 1 | 0 | 10 | 0 | 8 |
| 32 | 10 | 王柏淇 | 辽宁 | 0 | 9 | 1 | 0 | 10 | 0 | 7 |
| 33 | 1 | 林先方 | 浙江 | 0 | 9 | 1 | 0 | 10 | 1 | 7 |
| 34 | 3 | 高天伦 | 上海 | 0 | 8 | 1 | 1 | 10 | 3 | 7 |
| 35 | 17 | 马益奎 | 江苏 | 4 | 5 | 0 | 0 | 9 | 13 | 8 |
| 36 | 15 | 王维东 | 新疆 | 2 | 5 | 1 | 1 | 9 | 1 | 8 |
| 37 | 3 | 郑尧俊 | 浙江 | 6 | 2 | 1 | 0 | 9 | 0 | 7 |
| 38 | 9 | 吴明远 | 天津 | 1 | 5 | 3 | 0 | 9 | 1 | 7 |
| 39 | 26 | 刘思远 | 天津 | 0 | 5 | 3 | 1 | 9 | 0 | 7 |
| 40 | 14 | 孙耀琦 | 解放军 | 2 | 3 | 2 | 1 | 8 | 10 | 8 |
| 41 | 6 | 吴昊 | 解放军 | 0 | 7 | 0 | 1 | 8 | 5 | 8 |
| 42 | 9 | 陈开勇 | 安徽 | 5 | 3 | 0 | 0 | 8 | 3 | 8 |
| 43 | 17 | 薛盼龙 | 山东 | 2 | 2 | 3 | 0 | 7 | 15 | 8 |
| 44 | 9 | 王俊威 | 江苏 | 2 | 5 | 0 | 0 | 7 | 0 | 8 |
| 45 | 22 | 魏雨童 | 天津 | 1 | 5 | 1 | 0 | 7 | 5 | 7 |
| 46 | 21 | 潘玉帅 | 天津 | 0 | 4 | 3 | 0 | 7 | 4 | 7 |
| 47 | 5 | 余昊锦 | 辽宁 | 1 | 3 | 3 | 0 | 7 | 0 | 7 |
| 48 | 18 | 倪陈辉 | 浙江 | 1 | 5 | 0 | 1 | 7 | 0 | 7 |





2016年“体彩杯”全国手球男子青年锦标赛

得分排名表(场上队员)

正式表
手球
青年男子截止至第 46场
按防守201602046-1612-2/4
重庆万州
20/03/2016 8:30

| 名次 | 号码 | 姓名 | 球队 | 抢球 | 断球 | 造失误 | 造犯规 | 合计 | 封球 | 场数 |
|----|----|-----|-----|----|----|-----|-----|----|----|----|
| 49 | 18 | 李明远 | 北京 | 0 | 4 | 1 | 1 | 6 | 0 | 8 |
| 50 | 2 | 金勇峰 | 安徽 | 4 | 0 | 1 | 1 | 6 | 3 | 8 |
| 51 | 7 | 段飞宇 | 广东 | 0 | 5 | 0 | 1 | 6 | 0 | 8 |
| 52 | 5 | 王凯 | 四川 | 1 | 4 | 0 | 1 | 6 | 1 | 8 |
| 53 | 9 | 许翔宇 | 四川 | 0 | 2 | 0 | 4 | 6 | 2 | 8 |
| 54 | 7 | 任超凡 | 江苏 | 1 | 4 | 1 | 0 | 6 | 1 | 8 |
| 55 | 6 | 赵一涵 | 北京 | 1 | 1 | 1 | 3 | 6 | 3 | 8 |
| 56 | 11 | 庞东阳 | 辽宁 | 1 | 3 | 1 | 1 | 6 | 1 | 7 |
| 57 | 3 | 李星浩 | 辽宁 | 2 | 4 | 0 | 0 | 6 | 1 | 7 |
| 58 | 17 | 胡晋铭 | 新疆 | 0 | 4 | 0 | 1 | 5 | 12 | 8 |
| 59 | 13 | 于欣君 | 山东 | 0 | 5 | 0 | 0 | 5 | 0 | 8 |
| 60 | 6 | 王军鸣 | 山东 | 0 | 4 | 1 | 0 | 5 | 3 | 8 |
| 61 | 26 | 程浩然 | 安徽 | 1 | 3 | 0 | 1 | 5 | 0 | 8 |
| 62 | 6 | 季雨 | 江苏 | 0 | 5 | 0 | 0 | 5 | 0 | 8 |
| 63 | 10 | 董凯 | 上海 | 3 | 0 | 0 | 2 | 5 | 4 | 7 |
| 64 | 18 | 王晓琪 | 天津 | 2 | 2 | 1 | 0 | 5 | 2 | 6 |
| 65 | 4 | 谷通金 | 新疆 | 0 | 4 | 0 | 0 | 4 | 0 | 8 |
| 66 | 5 | 徐伟 | 新疆 | 1 | 1 | 2 | 0 | 4 | 0 | 8 |
| 67 | 2 | 姚雪岩 | 广东 | 0 | 4 | 0 | 0 | 4 | 10 | 8 |
| 68 | 13 | 尹文珂 | 四川 | 0 | 2 | 0 | 2 | 4 | 0 | 8 |
| 69 | 7 | 孙义广 | 辽宁 | 1 | 1 | 2 | 0 | 4 | 1 | 7 |
| 70 | 2 | 李恩铭 | 浙江 | 0 | 4 | 0 | 0 | 4 | 0 | 7 |
| 71 | 25 | 王一雄 | 天津 | 3 | 1 | 0 | 0 | 4 | 0 | 7 |
| 72 | 5 | 曹磊 | 上海 | 0 | 4 | 0 | 0 | 4 | 0 | 7 |
| 73 | 14 | 吴佳兵 | 上海 | 0 | 4 | 0 | 0 | 4 | 2 | 7 |
| 74 | 15 | 张建杰 | 广东 | 0 | 2 | 0 | 1 | 3 | 6 | 8 |
| 75 | 23 | 李荣健 | 山东 | 0 | 3 | 0 | 0 | 3 | 1 | 8 |
| 76 | 18 | 李文金 | 广东 | 0 | 2 | 1 | 0 | 3 | 7 | 8 |
| 77 | 11 | 张天豪 | 四川 | 1 | 2 | 0 | 0 | 3 | 0 | 8 |
| 78 | 15 | 逯明松 | 北京 | 0 | 1 | 1 | 1 | 3 | 1 | 8 |
| 79 | 18 | 李万兴 | 新疆 | 1 | 1 | 1 | 0 | 3 | 0 | 8 |
| 80 | 19 | 何山 | 安徽 | 0 | 2 | 1 | 0 | 3 | 0 | 8 |
| 81 | 13 | 徐峻清 | 解放军 | 1 | 1 | 0 | 1 | 3 | 0 | 8 |
| 82 | 1 | 王帅 | 广东 | 0 | 1 | 2 | 0 | 3 | 0 | 8 |
| 83 | 13 | 杨洁 | 辽宁 | 0 | 1 | 1 | 1 | 3 | 1 | 7 |
| 84 | 27 | 左金龙 | 天津 | 1 | 2 | 0 | 0 | 3 | 0 | 7 |
| 85 | 8 | 庄旭杰 | 上海 | 1 | 1 | 1 | 0 | 3 | 0 | 7 |
| 86 | 17 | 罗明杰 | 浙江 | 1 | 1 | 0 | 1 | 3 | 0 | 7 |
| 87 | 5 | 高家南 | 浙江 | 0 | 3 | 0 | 0 | 3 | 1 | 7 |
| 88 | 4 | 高震东 | 上海 | 0 | 3 | 0 | 0 | 3 | 0 | 7 |
| 89 | 14 | 吕昊臻 | 辽宁 | 0 | 2 | 0 | 1 | 3 | 0 | 7 |
| 90 | 10 | 范保坤 | 解放军 | 0 | 2 | 0 | 0 | 2 | 0 | 8 |
| 91 | 8 | 姜童耀 | 江苏 | 0 | 1 | 0 | 1 | 2 | 0 | 8 |
| 92 | 18 | 张睿梁 | 四川 | 1 | 0 | 0 | 1 | 2 | 0 | 8 |
| 93 | 18 | 李玮 | 山东 | 1 | 0 | 1 | 0 | 2 | 2 | 8 |
| 94 | 7 | 卞友山 | 北京 | 0 | 1 | 0 | 1 | 2 | 5 | 8 |
| 95 | 3 | 王哲一 | 北京 | 1 | 1 | 0 | 0 | 2 | 1 | 8 |
| 96 | 13 | 苏兴伟 | 新疆 | 0 | 1 | 1 | 0 | 2 | 1 | 8 |





2016年“体彩杯”全国手球男子青年锦标赛 得分排名表(场上队员)

正式表
手球
青年男子

截止至第 46场
按防守

201602046-1612-3/4
重庆万州
20/03/2016 8:30

| 名次 | 号码 | 姓名 | 球队 | 抢球 | 断球 | 造失误 | 造犯规 | 合计 | 封球 | 场数 |
|-----|----|-----|-----|----|----|-----|-----|----|----|----|
| 97 | 11 | 李旭 | 北京 | 0 | 1 | 0 | 1 | 2 | 3 | 8 |
| 98 | 27 | 王长旭 | 安徽 | 0 | 2 | 0 | 0 | 2 | 0 | 8 |
| 99 | 8 | 王鑫鹏 | 辽宁 | 0 | 2 | 0 | 0 | 2 | 0 | 7 |
| 100 | 2 | 王司雨 | 辽宁 | 0 | 2 | 0 | 0 | 2 | 4 | 6 |
| 101 | 13 | 蔡杰 | 广东 | 0 | 1 | 0 | 0 | 1 | 0 | 8 |
| 102 | 15 | 阎冠中 | 江苏 | 0 | 1 | 0 | 0 | 1 | 0 | 8 |
| 103 | 9 | 周凯峰 | 广东 | 0 | 1 | 0 | 0 | 1 | 0 | 8 |
| 104 | 12 | 李壮 | 广东 | 0 | 0 | 1 | 0 | 1 | 0 | 8 |
| 105 | 24 | 陈伟华 | 新疆 | 0 | 1 | 0 | 0 | 1 | 0 | 8 |
| 106 | 2 | 王泽川 | 新疆 | 0 | 1 | 0 | 0 | 1 | 0 | 8 |
| 107 | 22 | 李子跃 | 山东 | 0 | 0 | 0 | 1 | 1 | 0 | 8 |
| 108 | 21 | 王腾达 | 山东 | 0 | 1 | 0 | 0 | 1 | 0 | 8 |
| 109 | 4 | 张洋 | 解放军 | 0 | 0 | 1 | 0 | 1 | 0 | 8 |
| 110 | 11 | 王洋 | 山东 | 1 | 0 | 0 | 0 | 1 | 1 | 8 |
| 111 | 5 | 尹一楠 | 解放军 | 0 | 1 | 0 | 0 | 1 | 0 | 8 |
| 112 | 15 | 徐逸 | 四川 | 0 | 0 | 1 | 0 | 1 | 0 | 8 |
| 113 | 9 | 李家乐 | 浙江 | 0 | 1 | 0 | 0 | 1 | 0 | 7 |
| 114 | 17 | 李傲 | 辽宁 | 0 | 0 | 0 | 1 | 1 | 0 | 7 |
| 115 | 14 | 罗中熠 | 江苏 | 0 | 1 | 0 | 0 | 1 | 0 | 7 |
| 116 | 10 | 徐正飞 | 浙江 | 0 | 1 | 0 | 0 | 1 | 3 | 7 |
| 117 | 19 | 赵鑫 | 辽宁 | 0 | 0 | 0 | 1 | 1 | 0 | 7 |
| 118 | 7 | 蒋家敏 | 上海 | 0 | 0 | 0 | 1 | 1 | 0 | 7 |
| 119 | 1 | 宋晓晨 | 新疆 | 0 | 0 | 0 | 0 | 0 | 0 | 8 |
| 120 | 8 | 邹峻楠 | 解放军 | 0 | 0 | 0 | 0 | 0 | 0 | 8 |
| 121 | 24 | 徐安格 | 安徽 | 0 | 0 | 0 | 0 | 0 | 2 | 8 |
| 122 | 1 | 刘继超 | 山东 | 0 | 0 | 0 | 0 | 0 | 0 | 8 |
| 123 | 16 | 马佳鹏 | 北京 | 0 | 0 | 0 | 0 | 0 | 0 | 8 |
| 124 | 6 | 白光宇 | 新疆 | 0 | 0 | 0 | 0 | 0 | 0 | 8 |
| 125 | 23 | 刘帅 | 北京 | 0 | 0 | 0 | 0 | 0 | 1 | 8 |
| 126 | 16 | 李佳懿 | 新疆 | 0 | 0 | 0 | 0 | 0 | 0 | 8 |
| 127 | 33 | 姚紫祥 | 安徽 | 0 | 0 | 0 | 0 | 0 | 0 | 8 |
| 128 | 35 | 高云健 | 北京 | 0 | 0 | 0 | 0 | 0 | 0 | 8 |
| 129 | 42 | 王成龙 | 安徽 | 0 | 0 | 0 | 0 | 0 | 0 | 8 |
| 130 | 21 | 李明 | 安徽 | 0 | 0 | 0 | 0 | 0 | 0 | 8 |
| 131 | 28 | 丁浩然 | 安徽 | 0 | 0 | 0 | 0 | 0 | 0 | 8 |
| 132 | 41 | 刘润民 | 安徽 | 0 | 0 | 0 | 0 | 0 | 0 | 8 |
| 133 | 32 | 许浩翔 | 安徽 | 0 | 0 | 0 | 0 | 0 | 0 | 8 |
| 134 | 25 | 李文哲 | 安徽 | 0 | 0 | 0 | 0 | 0 | 0 | 8 |
| 135 | 12 | 王金鑫 | 新疆 | 0 | 0 | 0 | 0 | 0 | 0 | 8 |
| 136 | 1 | 宋继强 | 四川 | 0 | 0 | 0 | 0 | 0 | 0 | 8 |
| 137 | 4 | 张瑞恒 | 江苏 | 0 | 0 | 0 | 0 | 0 | 0 | 8 |
| 138 | 3 | 赵韦光 | 江苏 | 0 | 0 | 0 | 0 | 0 | 0 | 8 |
| 139 | 11 | 王誌汉 | 解放军 | 0 | 0 | 0 | 0 | 0 | 1 | 8 |
| 140 | 1 | 潘博琦 | 江苏 | 0 | 0 | 0 | 0 | 0 | 0 | 8 |
| 141 | 16 | 王猛 | 广东 | 0 | 0 | 0 | 0 | 0 | 0 | 8 |
| 142 | 12 | 左子健 | 解放军 | 0 | 0 | 0 | 0 | 0 | 0 | 8 |
| 143 | 9 | 李天枢 | 解放军 | 0 | 0 | 0 | 0 | 0 | 0 | 8 |
| 144 | 17 | 刘安宁 | 解放军 | 0 | 0 | 0 | 0 | 0 | 0 | 8 |





2016年“体彩杯”全国手球男子青年锦标赛
得分排名表(场上队员)

正式表
手球
青年男子

截止至第 46场
按防守

201602046-1612-4/4
重庆万州
20/03/2016 8:30

| 名次 | 号码 | 姓名 | 球队 | 抢球 | 断球 | 造失误 | 造犯规 | 合计 | 封球 | 场数 |
|-----|----|-----|-----|----|----|-----|-----|----|----|----|
| 145 | 12 | 刘树豪 | 四川 | 0 | 0 | 0 | 0 | 0 | 0 | 8 |
| 146 | 7 | 仇瑞祥 | 四川 | 0 | 0 | 0 | 0 | 0 | 0 | 8 |
| 147 | 20 | 张文健 | 四川 | 0 | 0 | 0 | 0 | 0 | 0 | 8 |
| 148 | 1 | 郭梦雨 | 解放军 | 0 | 0 | 0 | 0 | 0 | 0 | 8 |
| 149 | 21 | 曹修庆 | 四川 | 0 | 0 | 0 | 0 | 0 | 0 | 8 |
| 150 | 12 | 刘道林 | 山东 | 0 | 0 | 0 | 0 | 0 | 0 | 8 |
| 151 | 14 | 王泽润 | 广东 | 0 | 0 | 0 | 0 | 0 | 0 | 8 |
| 152 | 16 | 池猛 | 解放军 | 0 | 0 | 0 | 0 | 0 | 0 | 8 |
| 153 | 20 | 赵佛赐 | 辽宁 | 0 | 0 | 0 | 0 | 0 | 0 | 7 |
| 154 | 15 | 张佩力 | 浙江 | 0 | 0 | 0 | 0 | 0 | 0 | 7 |
| 155 | 12 | 张润民 | 上海 | 0 | 0 | 0 | 0 | 0 | 0 | 7 |
| 156 | 2 | 谢智超 | 上海 | 0 | 0 | 0 | 0 | 0 | 0 | 7 |
| 157 | 14 | 虞勇灿 | 浙江 | 0 | 0 | 0 | 0 | 0 | 0 | 7 |
| 158 | 16 | 陈辰 | 上海 | 0 | 0 | 0 | 0 | 0 | 0 | 7 |
| 159 | 19 | 王浩 | 浙江 | 0 | 0 | 0 | 0 | 0 | 0 | 7 |
| 160 | 16 | 吴阳 | 辽宁 | 0 | 0 | 0 | 0 | 0 | 0 | 7 |
| 161 | 28 | 何喜年 | 天津 | 0 | 0 | 0 | 0 | 0 | 0 | 7 |
| 162 | 18 | 梅凯博 | 辽宁 | 0 | 0 | 0 | 0 | 0 | 0 | 7 |
| 163 | 1 | 高尚君 | 辽宁 | 0 | 0 | 0 | 0 | 0 | 0 | 7 |
| 164 | 25 | 张斌 | 北京 | 0 | 0 | 0 | 0 | 0 | 0 | 7 |
| 165 | 24 | 刘子健 | 天津 | 0 | 0 | 0 | 0 | 0 | 0 | 7 |
| 166 | 6 | 季晨旭 | 上海 | 0 | 0 | 0 | 0 | 0 | 0 | 6 |





2016年“体彩杯”全国手球男子青年锦标赛

得分排名表(场上队员)

正式表
手球
青年男子截止至第 46场
失误排名表201602046-1613-1/4
重庆万州
20/03/2016 8:30

| 排序 | 号码 | 姓名 | 球队 | 传失 | 接失 | 两次 | 四步 | 侵区 | 撞人 | 其它 | 合计 | 场数 |
|----|----|-----|-----|----|----|----|----|----|----|----|----|----|
| 1 | 18 | 倪陈辉 | 浙江 | 24 | 8 | 14 | 7 | 3 | 1 | 2 | 59 | 7 |
| 2 | 11 | 周傲 | 江苏 | 31 | 3 | 4 | 4 | 3 | 1 | 0 | 46 | 8 |
| 3 | 1 | 林先方 | 浙江 | 21 | 8 | 9 | 0 | 2 | 0 | 5 | 45 | 7 |
| 4 | 3 | 郑尧俊 | 浙江 | 19 | 3 | 9 | 3 | 2 | 2 | 4 | 42 | 7 |
| 5 | 19 | 李龙吉 | 新疆 | 20 | 5 | 2 | 7 | 2 | 5 | 0 | 41 | 8 |
| 6 | 3 | 张昌轲 | 解放军 | 18 | 3 | 6 | 12 | 2 | 0 | 0 | 41 | 8 |
| 7 | 4 | 朱广刚 | 北京 | 19 | 4 | 2 | 8 | 0 | 2 | 1 | 36 | 8 |
| 8 | 13 | 尹吉祥 | 江苏 | 15 | 4 | 8 | 6 | 0 | 0 | 3 | 36 | 8 |
| 9 | 21 | 潘玉帅 | 天津 | 15 | 5 | 4 | 4 | 4 | 2 | 1 | 35 | 7 |
| 10 | 18 | 吴双 | 上海 | 18 | 3 | 6 | 4 | 2 | 0 | 2 | 35 | 7 |
| 11 | 19 | 陈旭 | 北京 | 16 | 5 | 5 | 5 | 0 | 1 | 2 | 34 | 8 |
| 12 | 10 | 王柏淇 | 辽宁 | 23 | 4 | 4 | 1 | 1 | 0 | 1 | 34 | 7 |
| 13 | 6 | 赵一涵 | 北京 | 11 | 5 | 8 | 2 | 1 | 3 | 1 | 31 | 8 |
| 14 | 5 | 黄培杰 | 广东 | 15 | 2 | 1 | 4 | 3 | 1 | 2 | 28 | 8 |
| 15 | 14 | 吴佳兵 | 上海 | 12 | 4 | 0 | 10 | 1 | 0 | 1 | 28 | 7 |
| 16 | 6 | 吴昊 | 解放军 | 12 | 5 | 4 | 3 | 1 | 0 | 2 | 27 | 8 |
| 17 | 18 | 李明远 | 北京 | 14 | 8 | 2 | 2 | 0 | 1 | 0 | 27 | 8 |
| 18 | 9 | 吴明远 | 天津 | 5 | 10 | 3 | 6 | 0 | 2 | 1 | 27 | 7 |
| 19 | 11 | 胡国富 | 广东 | 11 | 2 | 1 | 4 | 6 | 1 | 1 | 26 | 8 |
| 20 | 3 | 高天伦 | 上海 | 14 | 0 | 3 | 6 | 2 | 1 | 0 | 26 | 7 |
| 21 | 11 | 庞东阳 | 辽宁 | 10 | 5 | 4 | 4 | 0 | 1 | 1 | 25 | 7 |
| 22 | 18 | 李双 | 安徽 | 10 | 3 | 5 | 0 | 1 | 3 | 2 | 24 | 8 |
| 23 | 9 | 许翔宇 | 四川 | 15 | 1 | 2 | 3 | 2 | 0 | 1 | 24 | 8 |
| 24 | 17 | 王巨柱 | 安徽 | 18 | 2 | 3 | 0 | 0 | 0 | 0 | 23 | 8 |
| 25 | 3 | 刘赵梁 | 四川 | 3 | 7 | 2 | 3 | 8 | 0 | 0 | 23 | 8 |
| 26 | 22 | 魏雨童 | 天津 | 5 | 1 | 4 | 2 | 6 | 5 | 0 | 23 | 7 |
| 27 | 19 | 庞连康 | 四川 | 11 | 1 | 1 | 2 | 3 | 4 | 0 | 22 | 8 |
| 28 | 10 | 董凯 | 上海 | 18 | 3 | 0 | 0 | 0 | 1 | 0 | 22 | 7 |
| 29 | 15 | 张建杰 | 广东 | 11 | 5 | 4 | 1 | 0 | 0 | 0 | 21 | 8 |
| 30 | 7 | 姜钦 | 解放军 | 12 | 3 | 1 | 1 | 2 | 1 | 0 | 20 | 8 |
| 31 | 2 | 金勇峰 | 安徽 | 7 | 9 | 1 | 1 | 2 | 0 | 0 | 20 | 8 |
| 32 | 8 | 罗尧尧 | 四川 | 7 | 5 | 4 | 2 | 1 | 0 | 1 | 20 | 8 |
| 33 | 10 | 王钟彬 | 新疆 | 12 | 1 | 2 | 3 | 1 | 1 | 0 | 20 | 8 |
| 34 | 10 | 孙芳伟 | 山东 | 12 | 3 | 0 | 1 | 0 | 1 | 2 | 19 | 8 |
| 35 | 10 | 徐彦昊 | 四川 | 14 | 1 | 1 | 2 | 0 | 0 | 1 | 19 | 8 |
| 36 | 1 | 郭世伟 | 安徽 | 10 | 1 | 7 | 1 | 0 | 0 | 0 | 19 | 7 |
| 37 | 6 | 陈庆港 | 辽宁 | 13 | 4 | 1 | 1 | 0 | 0 | 0 | 19 | 7 |
| 38 | 2 | 姚雪岩 | 广东 | 5 | 5 | 2 | 2 | 2 | 1 | 1 | 18 | 8 |
| 39 | 17 | 谢庆龙 | 四川 | 1 | 7 | 2 | 1 | 4 | 2 | 1 | 18 | 8 |
| 40 | 18 | 王晓琪 | 天津 | 12 | 4 | 0 | 2 | 0 | 0 | 0 | 18 | 6 |
| 41 | 18 | 耿畅 | 江苏 | 10 | 2 | 2 | 1 | 0 | 0 | 2 | 17 | 8 |
| 42 | 2 | 李恩铭 | 浙江 | 8 | 3 | 0 | 0 | 4 | 1 | 1 | 17 | 7 |
| 43 | 15 | 王维东 | 新疆 | 7 | 2 | 1 | 2 | 4 | 0 | 0 | 16 | 8 |
| 44 | 10 | 周仲坤 | 广东 | 8 | 2 | 1 | 3 | 1 | 1 | 0 | 16 | 8 |
| 45 | 2 | 冯鑫宇 | 山东 | 5 | 3 | 3 | 0 | 1 | 2 | 2 | 16 | 8 |
| 46 | 7 | 林豪文 | 新疆 | 8 | 1 | 2 | 4 | 0 | 0 | 0 | 15 | 8 |
| 47 | 6 | 王军鸣 | 山东 | 4 | 3 | 1 | 2 | 2 | 2 | 1 | 15 | 8 |
| 48 | 7 | 任超凡 | 江苏 | 5 | 2 | 1 | 1 | 5 | 0 | 1 | 15 | 8 |



2016年“体彩杯”全国手球男子青年锦标赛

得分排名表(场上队员)

正式表
手球
青年男子截止至第 46场
失误排名表201602046-1613-2/4
重庆万州
20/03/2016 8:30

| 排序 | 号码 | 姓名 | 球队 | 传失 | 接失 | 两次 | 四步 | 侵区 | 撞人 | 其它 | 合计 | 场数 |
|----|----|-----|-----|----|----|----|----|----|----|----|----|----|
| 49 | 26 | 刘思远 | 天津 | 3 | 5 | 1 | 1 | 5 | 0 | 0 | 15 | 7 |
| 50 | 5 | 王晓峰 | 山东 | 10 | 2 | 0 | 1 | 0 | 1 | 0 | 14 | 8 |
| 51 | 15 | 阎冠中 | 江苏 | 3 | 1 | 1 | 2 | 5 | 0 | 1 | 13 | 8 |
| 52 | 7 | 段飞宇 | 广东 | 3 | 0 | 0 | 5 | 3 | 0 | 2 | 13 | 8 |
| 53 | 11 | 王誌汉 | 解放军 | 6 | 3 | 1 | 2 | 1 | 0 | 0 | 13 | 8 |
| 54 | 13 | 徐崧清 | 解放军 | 5 | 2 | 0 | 1 | 4 | 1 | 0 | 13 | 8 |
| 55 | 3 | 王铁林 | 山东 | 5 | 2 | 2 | 1 | 3 | 0 | 0 | 13 | 8 |
| 56 | 8 | 庄旭杰 | 上海 | 6 | 3 | 1 | 0 | 1 | 0 | 2 | 13 | 7 |
| 57 | 11 | 李旭 | 北京 | 7 | 1 | 0 | 0 | 2 | 1 | 1 | 12 | 8 |
| 58 | 26 | 程浩然 | 安徽 | 3 | 2 | 2 | 1 | 2 | 2 | 0 | 12 | 8 |
| 59 | 17 | 马益奎 | 江苏 | 4 | 2 | 1 | 0 | 3 | 1 | 1 | 12 | 8 |
| 60 | 36 | 王鹏皓 | 北京 | 4 | 1 | 4 | 0 | 1 | 0 | 1 | 11 | 8 |
| 61 | 18 | 李文金 | 广东 | 0 | 1 | 0 | 3 | 6 | 0 | 1 | 11 | 8 |
| 62 | 4 | 高玉杰 | 广东 | 3 | 3 | 0 | 3 | 1 | 1 | 0 | 11 | 8 |
| 63 | 5 | 曹磊 | 上海 | 5 | 1 | 2 | 0 | 1 | 1 | 1 | 11 | 7 |
| 64 | 9 | 陈开勇 | 安徽 | 3 | 4 | 0 | 0 | 1 | 2 | 0 | 10 | 8 |
| 65 | 14 | 孙耀琦 | 解放军 | 2 | 4 | 2 | 0 | 1 | 1 | 0 | 10 | 8 |
| 66 | 17 | 薛盼龙 | 山东 | 4 | 3 | 1 | 0 | 1 | 1 | 0 | 10 | 8 |
| 67 | 2 | 王司雨 | 辽宁 | 3 | 1 | 1 | 0 | 4 | 1 | 0 | 10 | 6 |
| 68 | 6 | 季雨 | 江苏 | 3 | 3 | 1 | 2 | 0 | 0 | 0 | 9 | 8 |
| 69 | 5 | 徐伟 | 新疆 | 2 | 3 | 0 | 0 | 0 | 2 | 2 | 9 | 8 |
| 70 | 18 | 李万兴 | 新疆 | 2 | 3 | 2 | 0 | 0 | 0 | 2 | 9 | 8 |
| 71 | 26 | 吴锐樊 | 北京 | 4 | 1 | 2 | 1 | 0 | 1 | 0 | 9 | 8 |
| 72 | 17 | 胡晋铭 | 新疆 | 0 | 1 | 0 | 0 | 2 | 4 | 1 | 8 | 8 |
| 73 | 13 | 苏兴伟 | 新疆 | 3 | 1 | 0 | 2 | 1 | 0 | 1 | 8 | 8 |
| 74 | 3 | 王哲一 | 北京 | 3 | 1 | 1 | 1 | 2 | 0 | 0 | 8 | 8 |
| 75 | 18 | 李玮 | 山东 | 2 | 2 | 0 | 1 | 3 | 0 | 0 | 8 | 8 |
| 76 | 19 | 何山 | 安徽 | 3 | 1 | 0 | 2 | 2 | 0 | 0 | 8 | 8 |
| 77 | 5 | 余昊锦 | 辽宁 | 5 | 0 | 2 | 0 | 1 | 0 | 0 | 8 | 7 |
| 78 | 24 | 陈伟华 | 新疆 | 3 | 1 | 0 | 0 | 2 | 1 | 0 | 7 | 8 |
| 79 | 21 | 李明 | 安徽 | 7 | 0 | 0 | 0 | 0 | 0 | 0 | 7 | 8 |
| 80 | 7 | 徐勇林 | 山东 | 3 | 3 | 0 | 0 | 1 | 0 | 0 | 7 | 8 |
| 81 | 15 | 逯明松 | 北京 | 2 | 2 | 0 | 1 | 1 | 0 | 1 | 7 | 8 |
| 82 | 12 | 李壮 | 广东 | 1 | 4 | 0 | 0 | 2 | 0 | 0 | 7 | 8 |
| 83 | 13 | 杨洁 | 辽宁 | 2 | 4 | 0 | 0 | 0 | 0 | 1 | 7 | 7 |
| 84 | 17 | 罗明杰 | 浙江 | 1 | 2 | 0 | 0 | 4 | 0 | 0 | 7 | 7 |
| 85 | 11 | 王洋 | 山东 | 3 | 1 | 0 | 2 | 0 | 0 | 0 | 6 | 8 |
| 86 | 27 | 王长旭 | 安徽 | 1 | 1 | 1 | 1 | 2 | 0 | 0 | 6 | 8 |
| 87 | 24 | 徐安格 | 安徽 | 3 | 0 | 1 | 0 | 1 | 1 | 0 | 6 | 8 |
| 88 | 25 | 王一雄 | 天津 | 1 | 0 | 2 | 1 | 2 | 0 | 0 | 6 | 7 |
| 89 | 7 | 蒋家敏 | 上海 | 4 | 1 | 0 | 1 | 0 | 0 | 0 | 6 | 7 |
| 90 | 4 | 张瑞恒 | 江苏 | 0 | 0 | 0 | 1 | 3 | 0 | 1 | 5 | 8 |
| 91 | 8 | 姜童耀 | 江苏 | 2 | 1 | 0 | 0 | 2 | 0 | 0 | 5 | 8 |
| 92 | 9 | 王俊威 | 江苏 | 1 | 1 | 0 | 0 | 1 | 1 | 1 | 5 | 8 |
| 93 | 5 | 王凯 | 四川 | 2 | 1 | 0 | 0 | 2 | 0 | 0 | 5 | 8 |
| 94 | 13 | 于欣君 | 山东 | 1 | 1 | 0 | 2 | 0 | 1 | 0 | 5 | 8 |
| 95 | 5 | 高家南 | 浙江 | 1 | 1 | 0 | 0 | 2 | 1 | 0 | 5 | 7 |
| 96 | 7 | 孙义广 | 辽宁 | 0 | 1 | 2 | 0 | 1 | 0 | 1 | 5 | 7 |





2016年“体彩杯”全国手球男子青年锦标赛

得分排名表(场上队员)

正式表
手球
青年男子截止至第 46场
失误排名表201602046-1613-3/4
重庆万州
20/03/2016 8:30

| 排序 | 号码 | 姓名 | 球队 | 传失 | 接失 | 两次 | 四步 | 侵区 | 撞人 | 其它 | 合计 | 场数 |
|-----|----|-----|-----|----|----|----|----|----|----|----|----|----|
| 97 | 10 | 徐正飞 | 浙江 | 3 | 1 | 0 | 0 | 0 | 1 | 0 | 5 | 7 |
| 98 | 1 | 王帅 | 广东 | 3 | 1 | 0 | 0 | 0 | 0 | 0 | 4 | 8 |
| 99 | 1 | 郭梦雨 | 解放军 | 4 | 0 | 0 | 0 | 0 | 0 | 0 | 4 | 8 |
| 100 | 1 | 宋晓晨 | 新疆 | 4 | 0 | 0 | 0 | 0 | 0 | 0 | 4 | 8 |
| 101 | 2 | 王泽川 | 新疆 | 0 | 2 | 1 | 0 | 1 | 0 | 0 | 4 | 8 |
| 102 | 14 | 吕昊臻 | 辽宁 | 3 | 0 | 1 | 0 | 0 | 0 | 0 | 4 | 7 |
| 103 | 8 | 王鑫鹏 | 辽宁 | 3 | 1 | 0 | 0 | 0 | 0 | 0 | 4 | 7 |
| 104 | 23 | 李荣健 | 山东 | 1 | 0 | 0 | 1 | 0 | 0 | 1 | 3 | 8 |
| 105 | 7 | 仇瑞祥 | 四川 | 1 | 0 | 1 | 1 | 0 | 0 | 0 | 3 | 8 |
| 106 | 10 | 范保坤 | 解放军 | 1 | 1 | 0 | 1 | 0 | 0 | 0 | 3 | 8 |
| 107 | 28 | 丁浩然 | 安徽 | 0 | 2 | 0 | 0 | 1 | 0 | 0 | 3 | 8 |
| 108 | 9 | 周凯峰 | 广东 | 1 | 1 | 1 | 0 | 0 | 0 | 0 | 3 | 8 |
| 109 | 13 | 尹文珂 | 四川 | 0 | 1 | 0 | 1 | 1 | 0 | 0 | 3 | 8 |
| 110 | 14 | 罗中熠 | 江苏 | 3 | 0 | 0 | 0 | 0 | 0 | 0 | 3 | 7 |
| 111 | 1 | 高尚君 | 辽宁 | 3 | 0 | 0 | 0 | 0 | 0 | 0 | 3 | 7 |
| 112 | 12 | 张润民 | 上海 | 3 | 0 | 0 | 0 | 0 | 0 | 0 | 3 | 7 |
| 113 | 28 | 何喜年 | 天津 | 3 | 0 | 0 | 0 | 0 | 0 | 0 | 3 | 7 |
| 114 | 4 | 高震东 | 上海 | 1 | 0 | 1 | 0 | 0 | 1 | 0 | 3 | 7 |
| 115 | 3 | 李星浩 | 辽宁 | 1 | 1 | 0 | 0 | 1 | 0 | 0 | 3 | 7 |
| 116 | 7 | 卞友山 | 北京 | 0 | 0 | 1 | 0 | 1 | 0 | 0 | 2 | 8 |
| 117 | 1 | 潘博琦 | 江苏 | 2 | 0 | 0 | 0 | 0 | 0 | 0 | 2 | 8 |
| 118 | 6 | 白光宇 | 新疆 | 0 | 0 | 0 | 0 | 0 | 2 | 0 | 2 | 8 |
| 119 | 5 | 尹一楠 | 解放军 | 0 | 0 | 1 | 0 | 1 | 0 | 0 | 2 | 8 |
| 120 | 4 | 谷通金 | 新疆 | 0 | 1 | 0 | 0 | 0 | 0 | 1 | 2 | 8 |
| 121 | 13 | 蔡杰 | 广东 | 0 | 2 | 0 | 0 | 0 | 0 | 0 | 2 | 8 |
| 122 | 23 | 刘帅 | 北京 | 1 | 0 | 0 | 0 | 0 | 0 | 1 | 2 | 8 |
| 123 | 12 | 刘树豪 | 四川 | 1 | 0 | 0 | 0 | 0 | 0 | 1 | 2 | 8 |
| 124 | 1 | 刘继超 | 山东 | 2 | 0 | 0 | 0 | 0 | 0 | 0 | 2 | 8 |
| 125 | 14 | 虞勇灿 | 浙江 | 2 | 0 | 0 | 0 | 0 | 0 | 0 | 2 | 7 |
| 126 | 15 | 徐逸 | 四川 | 0 | 1 | 0 | 0 | 0 | 0 | 0 | 1 | 8 |
| 127 | 11 | 张天豪 | 四川 | 0 | 0 | 0 | 0 | 1 | 0 | 0 | 1 | 8 |
| 128 | 21 | 王腾达 | 山东 | 0 | 0 | 0 | 0 | 1 | 0 | 0 | 1 | 8 |
| 129 | 35 | 高云健 | 北京 | 1 | 0 | 0 | 0 | 0 | 0 | 0 | 1 | 8 |
| 130 | 4 | 张洋 | 解放军 | 1 | 0 | 0 | 0 | 0 | 0 | 0 | 1 | 8 |
| 131 | 12 | 左子健 | 解放军 | 1 | 0 | 0 | 0 | 0 | 0 | 0 | 1 | 8 |
| 132 | 16 | 李佳懿 | 新疆 | 1 | 0 | 0 | 0 | 0 | 0 | 0 | 1 | 8 |
| 133 | 32 | 许浩翔 | 安徽 | 1 | 0 | 0 | 0 | 0 | 0 | 0 | 1 | 8 |
| 134 | 22 | 李子跃 | 山东 | 0 | 0 | 0 | 1 | 0 | 0 | 0 | 1 | 8 |
| 135 | 3 | 赵韦光 | 江苏 | 0 | 0 | 0 | 0 | 0 | 0 | 1 | 1 | 8 |
| 136 | 24 | 刘子健 | 天津 | 1 | 0 | 0 | 0 | 0 | 0 | 0 | 1 | 7 |
| 137 | 25 | 张斌 | 北京 | 0 | 0 | 0 | 0 | 1 | 0 | 0 | 1 | 7 |
| 138 | 17 | 李傲 | 辽宁 | 0 | 1 | 0 | 0 | 0 | 0 | 0 | 1 | 7 |
| 139 | 19 | 赵鑫 | 辽宁 | 0 | 0 | 0 | 0 | 1 | 0 | 0 | 1 | 7 |
| 140 | 27 | 左金龙 | 天津 | 1 | 0 | 0 | 0 | 0 | 0 | 0 | 1 | 7 |
| 141 | 20 | 赵佛赐 | 辽宁 | 0 | 1 | 0 | 0 | 0 | 0 | 0 | 1 | 7 |
| 142 | 33 | 姚紫祥 | 安徽 | 0 | 0 | 0 | 0 | 0 | 0 | 0 | 0 | 8 |
| 143 | 12 | 王金鑫 | 新疆 | 0 | 0 | 0 | 0 | 0 | 0 | 0 | 0 | 8 |
| 144 | 21 | 曹修庆 | 四川 | 0 | 0 | 0 | 0 | 0 | 0 | 0 | 0 | 8 |



2016年“体彩杯”全国手球男子青年锦标赛

得分排名表(场上队员)

正式表
手球
青年男子

截止至第 46场
失误排名表

201602046-1613-4/4
重庆万州
20/03/2016 8:30

| 排序 | 号码 | 姓名 | 球队 | 传失 | 接失 | 两次 | 四步 | 侵区 | 撞人 | 其它 | 合计 | 场数 |
|-----|----|-----|-----|----|----|----|----|----|----|----|----|----|
| 145 | 25 | 李文哲 | 安徽 | 0 | 0 | 0 | 0 | 0 | 0 | 0 | 0 | 8 |
| 146 | 42 | 王成龙 | 安徽 | 0 | 0 | 0 | 0 | 0 | 0 | 0 | 0 | 8 |
| 147 | 20 | 张文健 | 四川 | 0 | 0 | 0 | 0 | 0 | 0 | 0 | 0 | 8 |
| 148 | 41 | 刘润民 | 安徽 | 0 | 0 | 0 | 0 | 0 | 0 | 0 | 0 | 8 |
| 149 | 18 | 张睿梁 | 四川 | 0 | 0 | 0 | 0 | 0 | 0 | 0 | 0 | 8 |
| 150 | 16 | 马佳鹏 | 北京 | 0 | 0 | 0 | 0 | 0 | 0 | 0 | 0 | 8 |
| 151 | 9 | 李天枢 | 解放军 | 0 | 0 | 0 | 0 | 0 | 0 | 0 | 0 | 8 |
| 152 | 16 | 王猛 | 广东 | 0 | 0 | 0 | 0 | 0 | 0 | 0 | 0 | 8 |
| 153 | 14 | 王泽润 | 广东 | 0 | 0 | 0 | 0 | 0 | 0 | 0 | 0 | 8 |
| 154 | 12 | 刘道林 | 山东 | 0 | 0 | 0 | 0 | 0 | 0 | 0 | 0 | 8 |
| 155 | 1 | 宋继强 | 四川 | 0 | 0 | 0 | 0 | 0 | 0 | 0 | 0 | 8 |
| 156 | 16 | 池猛 | 解放军 | 0 | 0 | 0 | 0 | 0 | 0 | 0 | 0 | 8 |
| 157 | 8 | 邹峻楠 | 解放军 | 0 | 0 | 0 | 0 | 0 | 0 | 0 | 0 | 8 |
| 158 | 17 | 刘安宁 | 解放军 | 0 | 0 | 0 | 0 | 0 | 0 | 0 | 0 | 8 |
| 159 | 18 | 梅凯博 | 辽宁 | 0 | 0 | 0 | 0 | 0 | 0 | 0 | 0 | 7 |
| 160 | 15 | 张佩力 | 浙江 | 0 | 0 | 0 | 0 | 0 | 0 | 0 | 0 | 7 |
| 161 | 19 | 王浩 | 浙江 | 0 | 0 | 0 | 0 | 0 | 0 | 0 | 0 | 7 |
| 162 | 16 | 吴阳 | 辽宁 | 0 | 0 | 0 | 0 | 0 | 0 | 0 | 0 | 7 |
| 163 | 2 | 谢智超 | 上海 | 0 | 0 | 0 | 0 | 0 | 0 | 0 | 0 | 7 |
| 164 | 16 | 陈辰 | 上海 | 0 | 0 | 0 | 0 | 0 | 0 | 0 | 0 | 7 |
| 165 | 9 | 李家乐 | 浙江 | 0 | 0 | 0 | 0 | 0 | 0 | 0 | 0 | 7 |
| 166 | 6 | 季晨旭 | 上海 | 0 | 0 | 0 | 0 | 0 | 0 | 0 | 0 | 6 |



2016年“体彩杯”全国手球男子青年锦标赛

得分排名表(场上队员)

正式表
手球
青年男子截止至第 46场
受罚排名表201602046-1614-1/4
重庆万州
20/03/2016 8:30

| 排序 | 号码 | 姓名 | 球队 | 警告 | 罚2分钟 | D+DR | 场数 |
|----|----|-----|-----|----|------|------|----|
| 1 | 18 | 王晓琪 | 天津 | 2 | 4 | 1 | 6 |
| 2 | 2 | 王司雨 | 辽宁 | 2 | 2 | 1 | 6 |
| 3 | 14 | 罗中熠 | 江苏 | 0 | 0 | 1 | 7 |
| 4 | 6 | 吴昊 | 解放军 | 6 | 11 | 0 | 8 |
| 5 | 4 | 朱广刚 | 北京 | 3 | 8 | 0 | 8 |
| 6 | 10 | 王钟彬 | 新疆 | 2 | 8 | 0 | 8 |
| 7 | 17 | 马益奎 | 江苏 | 6 | 6 | 0 | 8 |
| 8 | 18 | 李双 | 安徽 | 5 | 6 | 0 | 8 |
| 9 | 22 | 魏雨童 | 天津 | 5 | 6 | 0 | 7 |
| 10 | 6 | 王军鸣 | 山东 | 3 | 6 | 0 | 8 |
| 11 | 3 | 王铁林 | 山东 | 3 | 6 | 0 | 8 |
| 12 | 19 | 庞连康 | 四川 | 6 | 5 | 0 | 8 |
| 13 | 6 | 赵一涵 | 北京 | 5 | 5 | 0 | 8 |
| 14 | 7 | 林豪文 | 新疆 | 5 | 5 | 0 | 8 |
| 15 | 17 | 胡晋铭 | 新疆 | 5 | 5 | 0 | 8 |
| 16 | 3 | 张昌轲 | 解放军 | 3 | 5 | 0 | 8 |
| 17 | 18 | 倪陈辉 | 浙江 | 5 | 4 | 0 | 7 |
| 18 | 14 | 孙耀琦 | 解放军 | 4 | 4 | 0 | 8 |
| 19 | 5 | 王晓峰 | 山东 | 3 | 4 | 0 | 8 |
| 20 | 3 | 郑尧俊 | 浙江 | 3 | 4 | 0 | 7 |
| 21 | 13 | 杨洁 | 辽宁 | 2 | 4 | 0 | 7 |
| 22 | 24 | 徐安格 | 安徽 | 1 | 4 | 0 | 8 |
| 23 | 10 | 孙芳伟 | 山东 | 4 | 3 | 0 | 8 |
| 24 | 17 | 谢庆龙 | 四川 | 3 | 3 | 0 | 8 |
| 25 | 2 | 金勇峰 | 安徽 | 3 | 3 | 0 | 8 |
| 26 | 11 | 周傲 | 江苏 | 3 | 3 | 0 | 8 |
| 27 | 18 | 耿畅 | 江苏 | 3 | 3 | 0 | 8 |
| 28 | 10 | 周仲坤 | 广东 | 2 | 3 | 0 | 8 |
| 29 | 3 | 高天伦 | 上海 | 2 | 3 | 0 | 7 |
| 30 | 1 | 郭世伟 | 安徽 | 2 | 3 | 0 | 7 |
| 31 | 36 | 王鹏皓 | 北京 | 1 | 3 | 0 | 8 |
| 32 | 2 | 王泽川 | 新疆 | 1 | 3 | 0 | 8 |
| 33 | 10 | 范保坤 | 解放军 | 1 | 3 | 0 | 8 |
| 34 | 26 | 程浩然 | 安徽 | 1 | 3 | 0 | 8 |
| 35 | 11 | 胡国富 | 广东 | 0 | 3 | 0 | 8 |
| 36 | 9 | 吴明远 | 天津 | 0 | 3 | 0 | 7 |
| 37 | 15 | 张建杰 | 广东 | 7 | 2 | 0 | 8 |
| 38 | 11 | 李旭 | 北京 | 4 | 2 | 0 | 8 |
| 39 | 11 | 王誌汉 | 解放军 | 4 | 2 | 0 | 8 |
| 40 | 1 | 林先方 | 浙江 | 4 | 2 | 0 | 7 |
| 41 | 5 | 黄培杰 | 广东 | 3 | 2 | 0 | 8 |
| 42 | 9 | 许翔宇 | 四川 | 3 | 2 | 0 | 8 |
| 43 | 9 | 陈开勇 | 安徽 | 3 | 2 | 0 | 8 |
| 44 | 17 | 薛盼龙 | 山东 | 2 | 2 | 0 | 8 |
| 45 | 19 | 何山 | 安徽 | 2 | 2 | 0 | 8 |
| 46 | 4 | 高玉杰 | 广东 | 2 | 2 | 0 | 8 |
| 47 | 3 | 赵韦光 | 江苏 | 2 | 2 | 0 | 8 |
| 48 | 10 | 徐彦昊 | 四川 | 2 | 2 | 0 | 8 |





2016年“体彩杯”全国手球男子青年锦标赛

得分排名表(场上队员)

正式表
手球
青年男子截止至第 46场
受罚排名表201602046-1614-2/4
重庆万州
20/03/2016 8:30

| 排序 | 号码 | 姓名 | 球队 | 警告 | 罚2分钟 | D+DR | 场数 |
|----|----|-----|-----|----|------|------|----|
| 49 | 19 | 陈旭 | 北京 | 2 | 2 | 0 | 8 |
| 50 | 7 | 姜钦 | 解放军 | 2 | 2 | 0 | 8 |
| 51 | 13 | 尹吉祥 | 江苏 | 2 | 2 | 0 | 8 |
| 52 | 11 | 庞东阳 | 辽宁 | 2 | 2 | 0 | 7 |
| 53 | 2 | 李恩铭 | 浙江 | 2 | 2 | 0 | 7 |
| 54 | 7 | 孙义广 | 辽宁 | 2 | 2 | 0 | 7 |
| 55 | 27 | 王长旭 | 安徽 | 1 | 2 | 0 | 8 |
| 56 | 18 | 张睿梁 | 四川 | 1 | 2 | 0 | 8 |
| 57 | 21 | 王腾达 | 山东 | 1 | 2 | 0 | 8 |
| 58 | 15 | 阎冠中 | 江苏 | 1 | 2 | 0 | 8 |
| 59 | 7 | 蒋家敏 | 上海 | 1 | 2 | 0 | 7 |
| 60 | 8 | 庄旭杰 | 上海 | 1 | 2 | 0 | 7 |
| 61 | 11 | 张天豪 | 四川 | 0 | 2 | 0 | 8 |
| 62 | 13 | 苏兴伟 | 新疆 | 0 | 2 | 0 | 8 |
| 63 | 13 | 尹文珂 | 四川 | 0 | 2 | 0 | 8 |
| 64 | 19 | 李龙吉 | 新疆 | 4 | 1 | 0 | 8 |
| 65 | 10 | 董凯 | 上海 | 4 | 1 | 0 | 7 |
| 66 | 21 | 潘玉帅 | 天津 | 4 | 1 | 0 | 7 |
| 67 | 3 | 李星浩 | 辽宁 | 4 | 1 | 0 | 7 |
| 68 | 26 | 吴锐樊 | 北京 | 3 | 1 | 0 | 8 |
| 69 | 24 | 陈伟华 | 新疆 | 2 | 1 | 0 | 8 |
| 70 | 8 | 罗尧尧 | 四川 | 2 | 1 | 0 | 8 |
| 71 | 5 | 曹磊 | 上海 | 2 | 1 | 0 | 7 |
| 72 | 18 | 吴双 | 上海 | 2 | 1 | 0 | 7 |
| 73 | 7 | 任超凡 | 江苏 | 1 | 1 | 0 | 8 |
| 74 | 2 | 冯鑫宇 | 山东 | 1 | 1 | 0 | 8 |
| 75 | 5 | 徐伟 | 新疆 | 1 | 1 | 0 | 8 |
| 76 | 15 | 逯明松 | 北京 | 1 | 1 | 0 | 8 |
| 77 | 10 | 徐正飞 | 浙江 | 1 | 1 | 0 | 7 |
| 78 | 21 | 李明 | 安徽 | 0 | 1 | 0 | 8 |
| 79 | 18 | 李明远 | 北京 | 0 | 1 | 0 | 8 |
| 80 | 4 | 张瑞恒 | 江苏 | 0 | 1 | 0 | 8 |
| 81 | 15 | 王维东 | 新疆 | 0 | 1 | 0 | 8 |
| 82 | 7 | 卞友山 | 北京 | 0 | 1 | 0 | 8 |
| 83 | 16 | 池猛 | 解放军 | 0 | 1 | 0 | 8 |
| 84 | 13 | 于欣君 | 山东 | 0 | 1 | 0 | 8 |
| 85 | 6 | 季雨 | 江苏 | 0 | 1 | 0 | 8 |
| 86 | 10 | 王柏淇 | 辽宁 | 0 | 1 | 0 | 7 |
| 87 | 16 | 吴阳 | 辽宁 | 0 | 1 | 0 | 7 |
| 88 | 18 | 梅凯博 | 辽宁 | 0 | 1 | 0 | 7 |
| 89 | 19 | 赵鑫 | 辽宁 | 0 | 1 | 0 | 7 |
| 90 | 16 | 陈辰 | 上海 | 0 | 1 | 0 | 7 |
| 91 | 2 | 姚雪岩 | 广东 | 3 | 0 | 0 | 8 |
| 92 | 13 | 徐峻清 | 解放军 | 3 | 0 | 0 | 8 |
| 93 | 14 | 吴佳兵 | 上海 | 3 | 0 | 0 | 7 |
| 94 | 5 | 余昊锦 | 辽宁 | 3 | 0 | 0 | 7 |
| 95 | 17 | 王巨柱 | 安徽 | 2 | 0 | 0 | 8 |
| 96 | 8 | 姜童耀 | 江苏 | 2 | 0 | 0 | 8 |





2016年“体彩杯”全国手球男子青年锦标赛

得分排名表(场上队员)

正式表
手球
青年男子截止至第 46场
受罚排名表201602046-1614-3/4
重庆万州
20/03/2016 8:30

| 排序 | 号码 | 姓名 | 球队 | 警告 | 罚2分钟 | D+DR | 场数 |
|-----|----|-----|-----|----|------|------|----|
| 97 | 11 | 王洋 | 山东 | 2 | 0 | 0 | 8 |
| 98 | 25 | 王一雄 | 天津 | 2 | 0 | 0 | 7 |
| 99 | 5 | 高家南 | 浙江 | 2 | 0 | 0 | 7 |
| 100 | 4 | 谷通金 | 新疆 | 1 | 0 | 0 | 8 |
| 101 | 3 | 刘赵梁 | 四川 | 1 | 0 | 0 | 8 |
| 102 | 9 | 周凯峰 | 广东 | 1 | 0 | 0 | 8 |
| 103 | 7 | 仇瑞祥 | 四川 | 1 | 0 | 0 | 8 |
| 104 | 1 | 王帅 | 广东 | 1 | 0 | 0 | 8 |
| 105 | 22 | 李子跃 | 山东 | 1 | 0 | 0 | 8 |
| 106 | 18 | 李文金 | 广东 | 1 | 0 | 0 | 8 |
| 107 | 5 | 王凯 | 四川 | 1 | 0 | 0 | 8 |
| 108 | 17 | 罗明杰 | 浙江 | 1 | 0 | 0 | 7 |
| 109 | 6 | 陈庆港 | 辽宁 | 1 | 0 | 0 | 7 |
| 110 | 17 | 李傲 | 辽宁 | 1 | 0 | 0 | 7 |
| 111 | 26 | 刘思远 | 天津 | 1 | 0 | 0 | 7 |
| 112 | 27 | 左金龙 | 天津 | 1 | 0 | 0 | 7 |
| 113 | 6 | 白光宇 | 新疆 | 0 | 0 | 0 | 8 |
| 114 | 4 | 张洋 | 解放军 | 0 | 0 | 0 | 8 |
| 115 | 16 | 马佳鹏 | 北京 | 0 | 0 | 0 | 8 |
| 116 | 15 | 徐逸 | 四川 | 0 | 0 | 0 | 8 |
| 117 | 1 | 宋继强 | 四川 | 0 | 0 | 0 | 8 |
| 118 | 12 | 刘树豪 | 四川 | 0 | 0 | 0 | 8 |
| 119 | 20 | 张文健 | 四川 | 0 | 0 | 0 | 8 |
| 120 | 3 | 王哲一 | 北京 | 0 | 0 | 0 | 8 |
| 121 | 21 | 曹修庆 | 四川 | 0 | 0 | 0 | 8 |
| 122 | 23 | 刘帅 | 北京 | 0 | 0 | 0 | 8 |
| 123 | 16 | 王猛 | 广东 | 0 | 0 | 0 | 8 |
| 124 | 33 | 姚紫祥 | 安徽 | 0 | 0 | 0 | 8 |
| 125 | 35 | 高云健 | 北京 | 0 | 0 | 0 | 8 |
| 126 | 18 | 李万兴 | 新疆 | 0 | 0 | 0 | 8 |
| 127 | 16 | 李佳懿 | 新疆 | 0 | 0 | 0 | 8 |
| 128 | 12 | 王金鑫 | 新疆 | 0 | 0 | 0 | 8 |
| 129 | 42 | 王成龙 | 安徽 | 0 | 0 | 0 | 8 |
| 130 | 28 | 丁浩然 | 安徽 | 0 | 0 | 0 | 8 |
| 131 | 41 | 刘润民 | 安徽 | 0 | 0 | 0 | 8 |
| 132 | 32 | 许浩翔 | 安徽 | 0 | 0 | 0 | 8 |
| 133 | 25 | 李文哲 | 安徽 | 0 | 0 | 0 | 8 |
| 134 | 1 | 宋晓晨 | 新疆 | 0 | 0 | 0 | 8 |
| 135 | 7 | 徐勇林 | 山东 | 0 | 0 | 0 | 8 |
| 136 | 17 | 刘安宁 | 解放军 | 0 | 0 | 0 | 8 |
| 137 | 12 | 左子健 | 解放军 | 0 | 0 | 0 | 8 |
| 138 | 9 | 李天枢 | 解放军 | 0 | 0 | 0 | 8 |
| 139 | 14 | 王泽润 | 广东 | 0 | 0 | 0 | 8 |
| 140 | 12 | 李壮 | 广东 | 0 | 0 | 0 | 8 |
| 141 | 13 | 蔡杰 | 广东 | 0 | 0 | 0 | 8 |
| 142 | 1 | 刘继超 | 山东 | 0 | 0 | 0 | 8 |
| 143 | 8 | 邹峻楠 | 解放军 | 0 | 0 | 0 | 8 |
| 144 | 7 | 段飞宇 | 广东 | 0 | 0 | 0 | 8 |





2016年“体彩杯”全国手球男子青年锦标赛

得分排名表(场上队员)

正式表
手球
青年男子截止至第 46场
受罚排名表201602046-1614-4/4
重庆万州
20/03/2016 8:30

| 排序 | 号码 | 姓名 | 球队 | 警告 | 罚2分钟 | D+DR | 场数 |
|-----|----|-----|-----|----|------|------|----|
| 145 | 9 | 王俊威 | 江苏 | 0 | 0 | 0 | 8 |
| 146 | 12 | 刘道林 | 山东 | 0 | 0 | 0 | 8 |
| 147 | 18 | 李玮 | 山东 | 0 | 0 | 0 | 8 |
| 148 | 1 | 潘博琦 | 江苏 | 0 | 0 | 0 | 8 |
| 149 | 23 | 李荣健 | 山东 | 0 | 0 | 0 | 8 |
| 150 | 1 | 郭梦雨 | 解放军 | 0 | 0 | 0 | 8 |
| 151 | 5 | 尹一楠 | 解放军 | 0 | 0 | 0 | 8 |
| 152 | 19 | 王浩 | 浙江 | 0 | 0 | 0 | 7 |
| 153 | 15 | 张佩力 | 浙江 | 0 | 0 | 0 | 7 |
| 154 | 14 | 虞勇灿 | 浙江 | 0 | 0 | 0 | 7 |
| 155 | 1 | 高尚君 | 辽宁 | 0 | 0 | 0 | 7 |
| 156 | 8 | 王鑫鹏 | 辽宁 | 0 | 0 | 0 | 7 |
| 157 | 9 | 李家乐 | 浙江 | 0 | 0 | 0 | 7 |
| 158 | 28 | 何喜年 | 天津 | 0 | 0 | 0 | 7 |
| 159 | 24 | 刘子健 | 天津 | 0 | 0 | 0 | 7 |
| 160 | 25 | 张斌 | 北京 | 0 | 0 | 0 | 7 |
| 161 | 12 | 张润民 | 上海 | 0 | 0 | 0 | 7 |
| 162 | 14 | 吕昊臻 | 辽宁 | 0 | 0 | 0 | 7 |
| 163 | 2 | 谢智超 | 上海 | 0 | 0 | 0 | 7 |
| 164 | 4 | 高震东 | 上海 | 0 | 0 | 0 | 7 |
| 165 | 20 | 赵佛赐 | 辽宁 | 0 | 0 | 0 | 7 |
| 166 | 6 | 季晨旭 | 上海 | 0 | 0 | 0 | 6 |





2016年“体彩杯”全国手球男子青年锦标赛

排名表(守门员)

正式表
手球
青年男子截止至第 46场
得分排名表201602046-1701-1/1
重庆万州
20/03/2016 8:30

| 排序 | 号码 | 姓名 | 球队 | 远射 | 近射 | 边射 | 快攻 | 突破 | 任意 | 7M | 合计 | % | 助攻 | 场数 |
|----|----|-----|-----|--------|--------|-------|-------|------|------|------|---------|------|----|----|
| 1 | 21 | 李明 | 安徽 | 57-115 | 46-109 | 16-51 | 10-30 | 5-25 | 3-5 | 2-23 | 139-358 | 38.8 | 14 | 8 |
| 2 | 1 | 刘继超 | 山东 | 49-94 | 47-148 | 19-38 | 11-37 | 4-30 | 3-9 | 4-12 | 137-368 | 37.2 | 2 | 8 |
| 3 | 1 | 王帅 | 广东 | 49-77 | 43-113 | 23-40 | 12-35 | 3-15 | 2-8 | 3-11 | 135-299 | 45.2 | 10 | 8 |
| 4 | 1 | 郭梦雨 | 解放军 | 46-100 | 45-111 | 17-27 | 9-34 | 4-25 | 3-12 | 5-24 | 129-333 | 38.7 | 2 | 8 |
| 5 | 1 | 宋晓晨 | 新疆 | 37-67 | 50-125 | 19-45 | 4-33 | 3-17 | 6-10 | 7-23 | 126-320 | 39.4 | 11 | 8 |
| 6 | 16 | 马佳鹏 | 北京 | 30-69 | 33-105 | 23-45 | 10-42 | 9-34 | 3-10 | 4-12 | 112-317 | 35.3 | 0 | 8 |
| 7 | 12 | 张润民 | 上海 | 19-50 | 39-109 | 14-33 | 10-50 | 3-18 | 3-7 | 2-13 | 90-280 | 32.1 | 0 | 7 |
| 8 | 1 | 高尚君 | 辽宁 | 27-61 | 27-93 | 14-36 | 6-48 | 2-24 | 1-2 | 3-9 | 80-273 | 29.3 | 5 | 7 |
| 9 | 12 | 刘树豪 | 四川 | 39-69 | 18-70 | 8-23 | 1-13 | 3-11 | 3-5 | 4-15 | 76-206 | 36.9 | 8 | 8 |
| 10 | 1 | 潘博琦 | 江苏 | 19-39 | 23-65 | 6-13 | 6-32 | 0-9 | 2-10 | 1-10 | 57-178 | 32.0 | 0 | 8 |
| 11 | 1 | 宋继强 | 四川 | 17-38 | 10-38 | 8-13 | 4-15 | 1-6 | 1-3 | 1-5 | 42-118 | 35.6 | 2 | 8 |
| 12 | 24 | 刘子健 | 天津 | 8-25 | 14-55 | 5-12 | 2-25 | 3-14 | 2-5 | 1-5 | 35-141 | 24.8 | 0 | 7 |
| 13 | 14 | 虞勇灿 | 浙江 | 12-38 | 8-42 | 6-16 | 3-23 | 0-7 | 1-2 | 0-5 | 30-133 | 22.6 | 2 | 7 |
| 14 | 15 | 张佩力 | 浙江 | 9-31 | 13-53 | 6-14 | 1-25 | 0-9 | 1-2 | 0-3 | 30-137 | 21.9 | 0 | 7 |
| 15 | 28 | 何喜年 | 天津 | 9-24 | 8-33 | 5-10 | 2-27 | 1-12 | 3-4 | 1-5 | 29-115 | 25.2 | 2 | 7 |
| 16 | 35 | 高云健 | 北京 | 7-20 | 8-27 | 3-17 | 3-12 | 1-5 | 0-1 | 0-4 | 22-86 | 25.6 | 1 | 8 |
| 17 | 16 | 王猛 | 广东 | 3-7 | 6-12 | 4-9 | 2-8 | 2-8 | 1-2 | 2-7 | 20-53 | 37.7 | 3 | 8 |
| 18 | 14 | 罗中熠 | 江苏 | 2-15 | 9-46 | 7-14 | 1-12 | 0-7 | 1-4 | 0-5 | 20-103 | 19.4 | 0 | 7 |
| 19 | 12 | 左子健 | 解放军 | 4-9 | 4-10 | 2-4 | 5-9 | 1-1 | 0-0 | 0-3 | 16-36 | 44.4 | 0 | 8 |
| 20 | 16 | 李佳懿 | 新疆 | 3-5 | 7-20 | 2-8 | 1-4 | 0-0 | 2-3 | 1-3 | 16-43 | 37.2 | 1 | 8 |
| 21 | 4 | 张瑞恒 | 江苏 | 2-13 | 4-23 | 3-7 | 2-15 | 4-14 | 1-6 | 0-1 | 16-79 | 20.3 | 0 | 8 |
| 22 | 14 | 王泽润 | 广东 | 4-9 | 5-18 | 1-3 | 1-2 | 2-5 | 0-0 | 1-6 | 14-43 | 32.6 | 0 | 8 |
| 23 | 32 | 许浩翔 | 安徽 | 4-10 | 0-9 | 4-6 | 2-6 | 0-0 | 1-1 | 1-2 | 12-34 | 35.3 | 1 | 8 |
| 24 | 13 | 尹吉祥 | 江苏 | 3-9 | 2-11 | 4-7 | 0-3 | 0-1 | 2-2 | 0-0 | 11-33 | 33.3 | 1 | 8 |
| 25 | 12 | 刘道林 | 山东 | 2-6 | 1-10 | 4-8 | 1-6 | 0-5 | 0-1 | 0-2 | 8-38 | 21.1 | 0 | 8 |
| 26 | 16 | 陈辰 | 上海 | 2-3 | 0-2 | 2-4 | 1-2 | 0-0 | 0-0 | 1-1 | 6-12 | 50.0 | 0 | 7 |
| 27 | 12 | 王金鑫 | 新疆 | 1-2 | 3-5 | 0-1 | 0-0 | 1-3 | 0-1 | 0-1 | 5-13 | 38.5 | 0 | 8 |
| 28 | 16 | 池猛 | 解放军 | 0-0 | 0-0 | 0-0 | 0-0 | 0-0 | 0-0 | 0-0 | 0-0 | 0.0 | 0 | 8 |
| 29 | 3 | 王铁林 | 山东 | 0-0 | 0-0 | 0-0 | 0-0 | 0-0 | 0-0 | 0-0 | 0-0 | 0.0 | 0 | 8 |
| 30 | 3 | 王哲一 | 北京 | 0-0 | 0-0 | 0-0 | 0-0 | 0-0 | 0-0 | 0-0 | 0-0 | 0.0 | 0 | 8 |
| 31 | 11 | 张天豪 | 四川 | 0-0 | 0-0 | 0-0 | 0-0 | 0-0 | 0-0 | 0-0 | 0-0 | 0.0 | 0 | 8 |
| 32 | 2 | 金勇峰 | 安徽 | 0-0 | 0-0 | 0-0 | 0-0 | 0-0 | 0-0 | 0-0 | 0-0 | 0.0 | 0 | 8 |
| 33 | 9 | 吴明远 | 天津 | 0-0 | 0-0 | 0-0 | 0-0 | 0-0 | 0-0 | 0-0 | 0-0 | 0.0 | 0 | 7 |
| 34 | 1 | 郭世伟 | 安徽 | 0-0 | 0-0 | 0-0 | 0-0 | 0-0 | 0-0 | 0-0 | 0-0 | 0.0 | 0 | 7 |
| 35 | 1 | 林先方 | 浙江 | 0-0 | 0-0 | 0-0 | 0-0 | 0-0 | 0-0 | 0-0 | 0-0 | 0.0 | 3 | 7 |



2016年“体彩杯”全国手球男子青年锦标赛

排名表(守门员)

正式表
手球
青年男子截止至第 46场
7M球得分排名表201602046-1703-1/1
重庆万州
20/03/2016 8:30

| 排序 | 号码 | 姓名 | 球队 | 远射 | 近射 | 边射 | 快攻 | 突破 | 任意 | 7M | 合计 | % | 助攻 | 场数 |
|----|----|-----|-----|--------|--------|-------|-------|------|------|------|---------|-------|----|----|
| 1 | 1 | 宋晓晨 | 新疆 | 37-67 | 50-125 | 19-45 | 4-33 | 3-17 | 6-10 | 7-23 | 126-320 | 30.4 | 11 | 8 |
| 2 | 1 | 郭梦雨 | 解放军 | 46-100 | 45-111 | 17-27 | 9-34 | 4-25 | 3-12 | 5-24 | 129-333 | 20.8 | 2 | 8 |
| 3 | 1 | 刘继超 | 山东 | 49-94 | 47-148 | 19-38 | 11-37 | 4-30 | 3-9 | 4-12 | 137-368 | 33.3 | 2 | 8 |
| 4 | 16 | 马佳鹏 | 北京 | 30-69 | 33-105 | 23-45 | 10-42 | 9-34 | 3-10 | 4-12 | 112-317 | 33.3 | 0 | 8 |
| 5 | 12 | 刘树豪 | 四川 | 39-69 | 18-70 | 8-23 | 1-13 | 3-11 | 3-5 | 4-15 | 76-206 | 26.7 | 8 | 8 |
| 6 | 1 | 高尚君 | 辽宁 | 27-61 | 27-93 | 14-36 | 6-48 | 2-24 | 1-2 | 3-9 | 80-273 | 33.3 | 5 | 7 |
| 7 | 1 | 王帅 | 广东 | 49-77 | 43-113 | 23-40 | 12-35 | 3-15 | 2-8 | 3-11 | 135-299 | 27.3 | 10 | 8 |
| 8 | 16 | 王猛 | 广东 | 3-7 | 6-12 | 4-9 | 2-8 | 2-8 | 1-2 | 2-7 | 20-53 | 28.6 | 3 | 8 |
| 9 | 12 | 张润民 | 上海 | 19-50 | 39-109 | 14-33 | 10-50 | 3-18 | 3-7 | 2-13 | 90-280 | 15.4 | 0 | 7 |
| 10 | 21 | 李明 | 安徽 | 57-115 | 46-109 | 16-51 | 10-30 | 5-25 | 3-5 | 2-23 | 139-358 | 8.7 | 14 | 8 |
| 11 | 16 | 陈辰 | 上海 | 2-3 | 0-2 | 2-4 | 1-2 | 0-0 | 0-0 | 1-1 | 6-12 | 100.0 | 0 | 7 |
| 12 | 32 | 许浩翔 | 安徽 | 4-10 | 0-9 | 4-6 | 2-6 | 0-0 | 1-1 | 1-2 | 12-34 | 50.0 | 1 | 8 |
| 13 | 16 | 李佳懿 | 新疆 | 3-5 | 7-20 | 2-8 | 1-4 | 0-0 | 2-3 | 1-3 | 16-43 | 33.3 | 1 | 8 |
| 14 | 1 | 宋继强 | 四川 | 17-38 | 10-38 | 8-13 | 4-15 | 1-6 | 1-3 | 1-5 | 42-118 | 20.0 | 2 | 8 |
| 15 | 24 | 刘子健 | 天津 | 8-25 | 14-55 | 5-12 | 2-25 | 3-14 | 2-5 | 1-5 | 35-141 | 20.0 | 0 | 7 |
| 16 | 28 | 何喜年 | 天津 | 9-24 | 8-33 | 5-10 | 2-27 | 1-12 | 3-4 | 1-5 | 29-115 | 20.0 | 2 | 7 |
| 17 | 14 | 王泽润 | 广东 | 4-9 | 5-18 | 1-3 | 1-2 | 2-5 | 0-0 | 1-6 | 14-43 | 16.7 | 0 | 8 |
| 18 | 1 | 潘博琦 | 江苏 | 19-39 | 23-65 | 6-13 | 6-32 | 0-9 | 2-10 | 1-10 | 57-178 | 10.0 | 0 | 8 |
| 19 | 13 | 尹吉祥 | 江苏 | 3-9 | 2-11 | 4-7 | 0-3 | 0-1 | 2-2 | 0-0 | 11-33 | 0.0 | 1 | 8 |
| 20 | 11 | 张天豪 | 四川 | 0-0 | 0-0 | 0-0 | 0-0 | 0-0 | 0-0 | 0-0 | 0-0 | 0.0 | 0 | 8 |
| 21 | 3 | 王哲一 | 北京 | 0-0 | 0-0 | 0-0 | 0-0 | 0-0 | 0-0 | 0-0 | 0-0 | 0.0 | 0 | 8 |
| 22 | 2 | 金勇峰 | 安徽 | 0-0 | 0-0 | 0-0 | 0-0 | 0-0 | 0-0 | 0-0 | 0-0 | 0.0 | 0 | 8 |
| 23 | 16 | 池猛 | 解放军 | 0-0 | 0-0 | 0-0 | 0-0 | 0-0 | 0-0 | 0-0 | 0-0 | 0.0 | 0 | 8 |
| 24 | 3 | 王铁林 | 山东 | 0-0 | 0-0 | 0-0 | 0-0 | 0-0 | 0-0 | 0-0 | 0-0 | 0.0 | 0 | 8 |
| 25 | 1 | 林先方 | 浙江 | 0-0 | 0-0 | 0-0 | 0-0 | 0-0 | 0-0 | 0-0 | 0-0 | 0.0 | 3 | 7 |
| 26 | 1 | 郭世伟 | 安徽 | 0-0 | 0-0 | 0-0 | 0-0 | 0-0 | 0-0 | 0-0 | 0-0 | 0.0 | 0 | 7 |
| 27 | 9 | 吴明远 | 天津 | 0-0 | 0-0 | 0-0 | 0-0 | 0-0 | 0-0 | 0-0 | 0-0 | 0.0 | 0 | 7 |
| 28 | 4 | 张瑞恒 | 江苏 | 2-13 | 4-23 | 3-7 | 2-15 | 4-14 | 1-6 | 0-1 | 16-79 | 0.0 | 0 | 8 |
| 29 | 12 | 王金鑫 | 新疆 | 1-2 | 3-5 | 0-1 | 0-0 | 1-3 | 0-1 | 0-1 | 5-13 | 0.0 | 0 | 8 |
| 30 | 12 | 刘道林 | 山东 | 2-6 | 1-10 | 4-8 | 1-6 | 0-5 | 0-1 | 0-2 | 8-38 | 0.0 | 0 | 8 |
| 31 | 15 | 张佩力 | 浙江 | 9-31 | 13-53 | 6-14 | 1-25 | 0-9 | 1-2 | 0-3 | 30-137 | 0.0 | 0 | 7 |
| 32 | 12 | 左子健 | 解放军 | 4-9 | 4-10 | 2-4 | 5-9 | 1-1 | 0-0 | 0-3 | 16-36 | 0.0 | 0 | 8 |
| 33 | 35 | 高云健 | 北京 | 7-20 | 8-27 | 3-17 | 3-12 | 1-5 | 0-1 | 0-4 | 22-86 | 0.0 | 1 | 8 |
| 34 | 14 | 虞勇灿 | 浙江 | 12-38 | 8-42 | 6-16 | 3-23 | 0-7 | 1-2 | 0-5 | 30-133 | 0.0 | 2 | 7 |
| 35 | 14 | 罗中熠 | 江苏 | 2-15 | 9-46 | 7-14 | 1-12 | 0-7 | 1-4 | 0-5 | 20-103 | 0.0 | 0 | 7 |



2016年“体彩杯”全国手球男子青年锦标赛

攻防成功率统计总表

20160246-3102-1/1

29-03-16

重庆万州

| 序号 | 球队 | 比分 | 进攻成功率 | | | | | | | | | | | | 助攻 | 防守成功率 | | | | | | | | | | | |
|----|-----|-----------|-------|-----|------|------|----|------|------|----|------|-----|-----|------|----|-------|------|-----|----|------|-----|------|------|----|----|-----|------|
| | | | 阵地进攻 | | | 一传快攻 | | | 短传快攻 | | | 合计 | | | | 多打少 | | 少打多 | | 封打抢断 | 守门员 | 对方射失 | 对方失误 | 合计 | % | | |
| | | | 得分 | 进攻 | % | 得分 | 进攻 | % | 得分 | 进攻 | % | 得分 | 进攻 | % | | 得分 | 进攻 | % | 得分 | | | | | | | 进攻 | % |
| 1 | 安徽 | 285 : 241 | 227 | 505 | 45.0 | 40 | 50 | 80.0 | 18 | 59 | 30.5 | 285 | 614 | 46.4 | 35 | 56 | 62.5 | 24 | 48 | 50.0 | 80 | 97 | 151 | 64 | 59 | 371 | 58.8 |
| 2 | 北京 | 244 : 269 | 211 | 571 | 37.0 | 19 | 22 | 86.4 | 14 | 40 | 35.0 | 244 | 633 | 38.5 | 30 | 62 | 48.4 | 17 | 37 | 45.9 | 64 | 84 | 134 | 64 | 64 | 346 | 54.6 |
| 3 | 广东 | 275 : 226 | 226 | 547 | 41.3 | 31 | 40 | 77.5 | 18 | 46 | 39.1 | 275 | 633 | 43.4 | 30 | 43 | 69.8 | 9 | 18 | 50.0 | 98 | 106 | 169 | 54 | 54 | 383 | 59.9 |
| 4 | 江苏 | 238 : 289 | 212 | 612 | 34.6 | 16 | 25 | 64.0 | 10 | 52 | 19.2 | 238 | 689 | 34.5 | 35 | 55 | 63.6 | 16 | 35 | 45.7 | 73 | 96 | 104 | 50 | 83 | 333 | 52.2 |
| 5 | 解放军 | 266 : 224 | 233 | 522 | 44.6 | 15 | 21 | 71.4 | 18 | 45 | 40.0 | 266 | 588 | 45.2 | 28 | 37 | 75.7 | 20 | 44 | 45.5 | 111 | 77 | 145 | 63 | 63 | 348 | 58.5 |
| 6 | 辽宁 | 185 : 193 | 155 | 413 | 37.5 | 20 | 28 | 71.4 | 10 | 32 | 31.3 | 185 | 473 | 39.1 | 15 | 28 | 53.6 | 8 | 23 | 34.8 | 62 | 64 | 80 | 40 | 81 | 265 | 56.9 |
| 7 | 山东 | 285 : 261 | 241 | 617 | 39.1 | 29 | 37 | 78.4 | 15 | 43 | 34.9 | 285 | 698 | 40.8 | 20 | 36 | 55.6 | 20 | 40 | 50.0 | 68 | 127 | 145 | 66 | 63 | 401 | 57.1 |
| 8 | 上海 | 165 : 196 | 143 | 437 | 32.7 | 15 | 16 | 93.8 | 7 | 21 | 33.3 | 165 | 474 | 34.8 | 18 | 32 | 56.3 | 11 | 25 | 44.0 | 33 | 52 | 96 | 72 | 51 | 271 | 56.9 |
| 9 | 四川 | 252 : 206 | 196 | 481 | 40.7 | 38 | 51 | 74.5 | 18 | 41 | 43.9 | 252 | 573 | 44.0 | 30 | 51 | 58.8 | 16 | 36 | 44.4 | 89 | 120 | 118 | 65 | 51 | 354 | 60.5 |
| 10 | 天津 | 161 : 192 | 141 | 390 | 36.2 | 11 | 12 | 91.7 | 9 | 25 | 36.0 | 161 | 427 | 37.7 | 18 | 25 | 72.0 | 9 | 22 | 40.9 | 36 | 56 | 64 | 52 | 63 | 235 | 53.5 |
| 11 | 新疆 | 282 : 229 | 230 | 532 | 43.2 | 38 | 47 | 80.9 | 14 | 42 | 33.3 | 282 | 621 | 45.4 | 32 | 66 | 48.5 | 19 | 40 | 47.5 | 82 | 93 | 147 | 68 | 66 | 374 | 59.7 |
| 12 | 浙江 | 98 : 210 | 83 | 374 | 22.2 | 9 | 13 | 69.2 | 6 | 36 | 16.7 | 98 | 423 | 23.2 | 9 | 17 | 52.9 | 4 | 14 | 28.6 | 29 | 43 | 60 | 36 | 61 | 200 | 48.2 |

注释： 进攻 = 进攻次数（射门 + 进攻失误） 对方射失 = 对方射门失误（射失 + 击柱） 防守成功率% = 本方防守合计 / 对方进攻合计



2016年“体彩杯”全国手球男子青年锦标赛

防守技术统计总表

20160246-3402-1/1

29-03-2016

重庆万州

| 场次 | 球队 | 比分 | 防守成功 | | | | | | 防守（成功：失误） | | | | | | | 处罚 | | | | 守门员 | | | |
|----|-----|---------|------|----|----|----|----|-----|-----------|------|-----|------|-----|-----|------|-------|----|----|----|-----|-----|-----|-------|
| | | | 封球 | 抢球 | 断球 | 造失 | 造犯 | 合计 | 选位 | 顶贴 | 观察 | 移动 | 换防 | 其他 | 合计 | 警告 2' | 取消 | DR | 合计 | 救球 | 射门 | % | |
| 1 | 安徽 | 285:241 | 19 | 21 | 40 | 7 | 10 | 97 | 0:0 | 0:9 | 0:0 | 0:9 | 0:0 | 0:0 | 0:20 | 20 | 26 | 0 | 0 | 46 | 151 | 392 | 38.52 |
| 2 | 北京 | 244:269 | 19 | 9 | 38 | 7 | 11 | 84 | 0:0 | 0:30 | 0:1 | 0:6 | 0:0 | 0:0 | 0:42 | 19 | 24 | 0 | 0 | 43 | 134 | 403 | 33.25 |
| 3 | 广东 | 275:226 | 30 | 10 | 50 | 9 | 7 | 106 | 0:0 | 0:13 | 0:0 | 0:7 | 0:0 | 0:0 | 0:26 | 20 | 12 | 0 | 0 | 32 | 169 | 395 | 42.78 |
| 4 | 江苏 | 238:289 | 16 | 13 | 59 | 4 | 4 | 96 | 0:0 | 0:19 | 0:1 | 0:8 | 0:0 | 0:0 | 0:33 | 20 | 21 | 1 | 0 | 42 | 104 | 393 | 26.46 |
| 5 | 解放军 | 266:224 | 23 | 10 | 29 | 10 | 5 | 77 | 0:0 | 0:18 | 0:0 | 0:5 | 0:0 | 0:0 | 0:29 | 23 | 28 | 0 | 0 | 51 | 145 | 369 | 39.30 |
| 6 | 辽宁 | 185:193 | 8 | 9 | 32 | 9 | 6 | 64 | 0:0 | 0:17 | 0:0 | 0:5 | 0:0 | 0:0 | 0:28 | 17 | 15 | 1 | 0 | 33 | 80 | 273 | 29.30 |
| 7 | 山东 | 285:261 | 40 | 15 | 56 | 14 | 2 | 127 | 0:0 | 0:32 | 0:0 | 0:6 | 0:2 | 0:0 | 0:51 | 20 | 25 | 0 | 0 | 45 | 145 | 406 | 35.71 |
| 8 | 上海 | 165:196 | 9 | 8 | 28 | 3 | 4 | 52 | 0:0 | 0:14 | 0:0 | 0:5 | 0:0 | 0:0 | 0:22 | 15 | 11 | 0 | 0 | 26 | 96 | 292 | 32.88 |
| 9 | 四川 | 252:206 | 25 | 15 | 54 | 5 | 21 | 120 | 0:0 | 0:11 | 0:0 | 0:6 | 0:0 | 0:0 | 0:18 | 20 | 19 | 0 | 0 | 39 | 118 | 324 | 36.42 |
| 10 | 天津 | 161:192 | 12 | 8 | 24 | 11 | 1 | 56 | 0:0 | 0:25 | 0:0 | 0:9 | 0:0 | 0:0 | 0:41 | 15 | 14 | 1 | 0 | 30 | 64 | 256 | 25.00 |
| 11 | 新疆 | 282:229 | 23 | 10 | 45 | 10 | 5 | 93 | 0:0 | 0:7 | 0:0 | 0:1 | 0:0 | 0:0 | 0:12 | 21 | 27 | 0 | 0 | 48 | 147 | 376 | 39.10 |
| 12 | 浙江 | 98:210 | 5 | 8 | 26 | 2 | 2 | 43 | 0:0 | 0:16 | 0:2 | 0:12 | 0:0 | 0:0 | 0:31 | 18 | 13 | 0 | 0 | 31 | 60 | 270 | 22.22 |

注释：造失 = 造对方失误 造犯 = 造对方犯规 DR = 取消资格+报告



2016年“体彩杯”全国手球男子青年锦标赛
球队名单(媒体表)

新疆队

201602000-53-1/1

| 号码 | 姓名 | 位置 | 生日 | 年龄 | 俱乐部 | 身高 (CM) | 体重 (KG) | 总场次 | 总进球 |
|----|-----|-----|------------|------|-----|------------|------------|-----|-----|
| 1 | 宋晓晨 | 守门员 | 12/03/1996 | 20 | 新疆队 | 186 | 85 | | |
| 2 | 王泽川 | 边锋 | 30/01/1999 | 17 | 新疆队 | 176 | 70 | | |
| 4 | 谷通金 | 中后卫 | 23/07/1999 | 16 | 新疆队 | 184 | 83 | | |
| 5 | 徐伟 | 边锋 | 13/03/1996 | 20 | 新疆队 | 187 | 85 | | |
| 6 | 白光宇 | 底线 | 16/02/1999 | 17 | 新疆队 | 189 | 88 | | |
| 7 | 林豪文 | 左后卫 | 21/12/1997 | 18 | 新疆队 | 190 | 85 | | |
| 10 | 王钟彬 | 左后卫 | 29/11/1996 | 19 | 新疆队 | 193 | 84 | | |
| 12 | 王金鑫 | | | | | | | | |
| 13 | 苏兴伟 | 底线 | 01/06/1999 | 16 | 新疆队 | 186 | 88 | | |
| 15 | 王维东 | 左边锋 | 08/10/1998 | 17 | 新疆队 | 187 | 80 | | |
| 16 | 李佳懿 | 守门员 | 17/04/1999 | 16 | 新疆队 | 185 | 75 | | |
| 17 | 胡晋铭 | 底线 | 09/02/1997 | 19 | 新疆队 | 190 | 90 | | |
| 18 | 李万兴 | 右边锋 | 25/02/2000 | 16 | 新疆队 | 180 | 78 | | |
| 19 | 李龙吉 | 中后卫 | 04/08/1997 | 18 | 新疆队 | 188 | 87 | | |
| 24 | 陈伟华 | 右后卫 | 17/12/1999 | 16 | 新疆队 | 192 | 90 | | |
| 平均 | | | | 17.5 | | 186.6 | 83.4 | | |

替换队员

| | | | | | | | | | |
|--|--|--|--|--|--|--|--|--|--|
| | | | | | | | | | |
| | | | | | | | | | |

| 编码 | 姓名 | 职务 |
|----|-----|-----|
| A | 孔德宾 | 主教练 |
| B | 陈鹏波 | 教练 |
| C | 李楠 | 领队 |
| | | |
| | | |



2016年“体彩杯”全国手球男子青年锦标赛
球队名单(媒体表)

四川队

201602000-53-1/1

| 号码 | 姓名 | 位置 | 生日 | 年龄 | 俱乐部 | 身高 (CM) | 体重 (KG) | 总场次 | 总进球 |
|----|-----|-----|------------|------|-----|------------|------------|-----|-----|
| 1 | 宋继强 | 守门员 | 22/03/1997 | 19 | 四川队 | 192 | 81 | | |
| 3 | 刘赵梁 | 右边锋 | 04/07/1997 | 18 | 四川队 | 188 | 75 | | |
| 5 | 王凯 | 右边锋 | 29/10/1997 | 18 | 四川队 | 180 | 84 | | |
| 7 | 仇瑞祥 | 右边锋 | 23/07/1999 | 16 | 四川队 | 177 | 71 | | |
| 8 | 罗尧尧 | 中后卫 | 28/07/1996 | 19 | 四川队 | 190 | 90 | | |
| 9 | 许翔宇 | 左后卫 | 20/01/1997 | 19 | 四川队 | 190 | 85 | | |
| 10 | 徐彦昊 | 后卫 | 24/01/1996 | 20 | 四川队 | 180 | 85 | | |
| 11 | 张天豪 | 左边锋 | 02/06/1998 | 17 | 四川队 | 182 | 80 | | |
| 12 | 刘树豪 | 守门员 | 16/02/1998 | 18 | 四川队 | 191 | 95 | | |
| 13 | 尹文珂 | 左边锋 | 02/04/1999 | 16 | 四川队 | 187 | 89 | | |
| 15 | 徐逸 | 左边锋 | 24/05/1999 | 16 | 四川队 | 182 | 80 | | |
| 17 | 谢庆龙 | 底线 | 24/10/2000 | 15 | 四川队 | 192 | 100 | | |
| 18 | 张睿梁 | 底线 | 09/06/1998 | 17 | 四川队 | 192 | 120 | | |
| 19 | 庞连康 | 左后卫 | 02/07/1996 | 19 | 四川队 | 191 | 88 | | |
| 20 | 张文健 | 中后卫 | 22/08/1999 | 16 | 四川队 | 182 | 80 | | |
| 21 | 曹修庆 | 底线 | 15/04/1997 | 18 | 四川队 | 180 | 90 | | |
| 平均 | | | | 17.6 | | 186.0 | 87.1 | | |

替换队员

| | | | | | | | | | |
|--|--|--|--|--|--|--|--|--|--|
| | | | | | | | | | |
| | | | | | | | | | |

| 编码 | 姓名 | 职务 |
|----|-----|-----|
| B | 张文韬 | 主教练 |
| | | |
| | | |
| | | |



2016年“体彩杯”全国手球男子青年锦标赛
球队名单(媒体表)

安徽队

201602000-53-1/1

| 号码 | 姓名 | 位置 | 生日 | 年龄 | 俱乐部 | 身高 (CM) | 体重 (KG) | 总场次 | 总进球 |
|----|-----|-----|------------|------|-----|------------|------------|-----|-----|
| 1 | 郭世伟 | 守门员 | 18/02/1997 | 19 | | 191 | 90 | | |
| 2 | 金勇峰 | 左边锋 | 06/06/1999 | 16 | | 180 | 75 | | |
| 9 | 陈开勇 | 底线 | 18/02/1996 | 20 | | 192 | 100 | | |
| 17 | 王巨柱 | 左后卫 | 17/08/1997 | 18 | | 194 | 85 | | |
| 18 | 李双 | 右后卫 | 10/02/1997 | 19 | | 193 | 85 | | |
| 19 | 何山 | 后卫 | 04/04/1999 | 16 | | 183 | 75 | | |
| 21 | 李明 | 守门员 | 04/05/1997 | 18 | | 195 | 90 | | |
| 24 | 徐安格 | | 05/02/1998 | 18 | | 190 | 95 | | |
| 25 | 李文哲 | 左边锋 | 28/03/1997 | 18 | | 190 | 86 | | |
| 26 | 程浩然 | 边锋 | 20/02/1999 | 17 | 替补 | 185 | 80 | | |
| 27 | 王长旭 | 右边锋 | 05/01/1999 | 17 | | 190 | 86 | | |
| 28 | 丁浩然 | 右后卫 | 28/10/1999 | 16 | | 187 | 86 | | |
| 32 | 许浩翔 | 底线 | 22/12/1999 | 16 | | 195 | 90 | | |
| 33 | 姚紫祥 | 底线 | 25/04/1999 | 16 | | 188 | 85 | | |
| 41 | 刘润民 | 后卫 | 12/11/1998 | 17 | | 187 | 80 | | |
| 42 | 王成龙 | 守门员 | 09/05/2000 | 15 | | 191 | 90 | | |
| 平均 | | | | 17.3 | | 189.4 | 86.1 | | |

替换队员

| | | | | | | | | | |
|--|--|--|--|--|--|--|--|--|--|
| | | | | | | | | | |
| | | | | | | | | | |

| 编码 | 姓名 | 职务 |
|----|-----|-----|
| A | 王来黔 | 主教练 |
| B | 陆万红 | 教练 |
| C | 吴翔 | 领队 |
| | | |
| | | |



2016年“体彩杯”全国手球男子青年锦标赛
球队名单(媒体表)

山东队

201602000-53-1/1

| 号码 | 姓名 | 位置 | 生日 | 年龄 | 俱乐部 | 身高 (CM) | 体重 (KG) | 总场次 | 总进球 |
|----|-----|----|------------|------|-----|------------|------------|-----|-----|
| 1 | 刘继超 | | 30/10/1998 | 17 | 山东队 | 186 | 85 | | |
| 2 | 冯鑫宇 | | 24/11/1997 | 18 | 山东队 | 176 | 70 | | |
| 3 | 王铁林 | | 18/03/1999 | 17 | 山东队 | 181 | 76 | | |
| 5 | 王晓峰 | | 27/09/1998 | 17 | 山东队 | 184 | 83 | | |
| 6 | 王军鸣 | | 19/02/1999 | 17 | 山东队 | 187 | 85 | | |
| 7 | 徐勇林 | | 24/02/1999 | 17 | 山东队 | 189 | 88 | | |
| 10 | 孙芳伟 | | 01/09/1998 | 17 | 山东队 | 190 | 85 | | |
| 11 | 王洋 | | 06/02/2000 | 16 | 山东队 | 192 | 90 | | |
| 12 | 刘道林 | | 02/10/1999 | 16 | 山东队 | 180 | 78 | | |
| 13 | 于欣君 | | 22/07/1997 | 18 | 山东队 | 193 | 84 | | |
| 17 | 薛盼龙 | | 23/10/1999 | 16 | 山东队 | 178 | 70 | | |
| 18 | 李玮 | | 28/02/2000 | 16 | 山东队 | 190 | 87 | | |
| 21 | 王腾达 | | 02/06/2000 | 15 | 山东队 | 186 | 88 | | |
| 22 | 李子跃 | | 18/11/2000 | 15 | 山东队 | 187 | 80 | | |
| 23 | 李荣健 | | 16/04/1997 | 18 | 山东队 | 185 | 75 | | |
| 平均 | | | | 16.7 | | 185.6 | 81.6 | | |

替换队员

| | | | | | | | | | |
|--|--|--|--|--|--|--|--|--|--|
| | | | | | | | | | |
| | | | | | | | | | |
| | | | | | | | | | |

| 编码 | 姓名 | 职务 |
|----|-----|-----|
| B | 王莉莉 | 主教练 |
| A | 赵洋 | 领队 |
| | | |
| | | |
| | | |



2016年“体彩杯”全国手球男子青年锦标赛
球队名单(媒体表)

广东队

201602000-53-1/1

| 号码 | 姓名 | 位置 | 生日 | 年龄 | 俱乐部 | 身高 (CM) | 体重 (KG) | 总场次 | 总进球 |
|----|-----|-----|------------|------|-------------|------------|------------|-----|-----|
| 1 | 王帅 | 守门员 | 03/09/1997 | 18 | 广东省黄村体育训练中心 | 197 | 90 | | |
| 2 | 姚雪岩 | 底线 | 19/11/1996 | 19 | 广东省黄村体育训练中心 | 205 | 95 | | |
| 4 | 高玉杰 | 左边锋 | 16/10/1998 | 17 | 广东省黄村体育训练中心 | 195 | 87 | | |
| 5 | 黄培杰 | 中后卫 | 15/01/1998 | 18 | 广东省黄村体育训练中心 | 182 | 82 | | |
| 7 | 段飞宇 | 边锋 | 13/05/1997 | 18 | 广东省黄村体育训练中心 | 184 | 81 | | |
| 9 | 周凯峰 | 中后卫 | 31/05/2000 | 15 | 广东省黄村体育训练中心 | 185 | 81 | | |
| 10 | 周仲坤 | 左后卫 | 02/01/1997 | 19 | 广东省黄村体育训练中心 | 195 | 88 | | |
| 11 | 胡国富 | 底线 | 17/10/1997 | 18 | 广东省黄村体育训练中心 | 185 | 80 | | |
| 12 | 李壮 | 后卫 | 16/01/2000 | 16 | 广东省黄村体育训练中心 | 185 | 81 | | |
| 13 | 蔡杰 | 左边锋 | 12/05/2000 | 15 | 广东省黄村体育训练中心 | 195 | 90 | | |
| 14 | 王泽润 | 守门员 | 19/02/1998 | 18 | 广东省黄村体育训练中心 | 192 | 85 | | |
| 15 | 张建杰 | 中后卫 | 29/10/1997 | 18 | 广东省黄村体育训练中心 | 195 | 86 | | |
| 16 | 王猛 | 守门员 | 06/07/1997 | 18 | 广东省黄村体育训练中心 | 187 | 77 | | |
| 18 | 李文金 | 右边锋 | 15/03/1998 | 18 | 广东省黄村体育训练中心 | 200 | 92 | | |
| 平均 | | | | 17.5 | | 191.6 | 85.4 | | |

替换队员

| | | | | | | | | | |
|--|--|--|--|--|--|--|--|--|--|
| | | | | | | | | | |
| | | | | | | | | | |

| 编码 | 姓名 | 职务 |
|----|-----|-----|
| B | 刘康伶 | 主教练 |
| C | 刘文宁 | 教练 |
| D | 王永存 | 医生 |
| | | |
| | | |



2016年“体彩杯”全国手球男子青年锦标赛
球队名单(媒体表)

北京队

201602000-53-1/1

| 号码 | 姓名 | 位置 | 生日 | 年龄 | 俱乐部 | 身高 (CM) | 体重 (KG) | 总场次 | 总进球 |
|----|-----|-----|------------|------|---------|------------|------------|-----|-----|
| 3 | 王哲一 | 边锋 | 14/06/1999 | 16 | 北京男子手球队 | 180 | 70 | | |
| 4 | 朱广刚 | 中后卫 | 05/10/1996 | 19 | 北京男子手球队 | 178 | 67 | | |
| 6 | 赵一涵 | 右后卫 | 23/10/1997 | 18 | 北京男子手球队 | 195 | 101 | | |
| 7 | 卞友山 | 底线 | 15/03/1999 | 17 | 北京男子手球队 | 192 | 92 | | |
| 11 | 李旭 | 底线 | 16/02/1997 | 19 | 北京男子手球队 | 191 | 78 | | |
| 15 | 逯明松 | 右后卫 | 11/02/1998 | 18 | 北京男子手球队 | 194 | 87 | | |
| 16 | 马佳鹏 | 守门员 | 04/03/1999 | 17 | 北京男子手球队 | 190 | 80 | | |
| 18 | 李明远 | 中后卫 | 24/01/1998 | 18 | 北京男子手球队 | 193 | 75 | | |
| 19 | 陈旭 | 左后卫 | 22/03/1998 | 18 | 北京男子手球队 | 193 | 90 | | |
| 23 | 刘帅 | 左后卫 | 06/01/1997 | 19 | 北京男子手球队 | 201 | 80 | | |
| 25 | 张斌 | 左边锋 | 25/05/1996 | 19 | 北京男子手球队 | 185 | 76 | | |
| 26 | 吴锐樊 | 左边锋 | 11/01/2000 | 16 | 北京男子手球队 | 175 | 60 | | |
| 35 | 高云健 | 守门员 | 26/11/1999 | 16 | 北京男子手球队 | 194 | 83 | | |
| 36 | 王鹏皓 | 右边锋 | 03/09/1999 | 16 | 北京男子手球队 | 193 | 74 | | |
| 平均 | | | | 17.6 | | 189.6 | 79.5 | | |

替换队员

| | | | | | | | | | |
|--|--|--|--|--|--|--|--|--|--|
| | | | | | | | | | |
| | | | | | | | | | |

| 编码 | 姓名 | 职务 |
|----|----|-----|
| B | 吴健 | 主教练 |
| C | 宋刚 | 教练 |
| D | 陈璇 | 医生 |
| A | 孙铁 | 领队 |
| | | |



2016年“体彩杯”全国手球男子青年锦标赛
球队名单(媒体表)

解放军队

201602000-53-1/1

| 号码 | 姓名 | 位置 | 生日 | 年龄 | 俱乐部 | 身高 (CM) | 体重 (KG) | 总场次 | 总进球 |
|----|-----|-----|------------|------|-----|------------|------------|-----|-----|
| 1 | 郭梦雨 | 守门员 | 21/08/1999 | 16 | | 185 | 80 | | |
| 3 | 张昌轲 | 中后卫 | 13/03/1999 | 17 | | 185 | 70 | | |
| 4 | 张洋 | 左后卫 | 10/08/1998 | 17 | | 190 | 95 | | |
| 5 | 尹一楠 | 右边锋 | 19/12/1996 | 19 | | 180 | 90 | | |
| 6 | 吴昊 | 右后卫 | 26/03/1998 | 18 | | 192 | 90 | | |
| 7 | 姜钦 | 左后卫 | 20/07/1998 | 17 | | 190 | 90 | | |
| 8 | 邹峻楠 | 左边锋 | 25/11/2001 | 14 | | 175 | 75 | | |
| 9 | 李天枢 | 左后卫 | 09/02/1999 | 17 | | 190 | 90 | | |
| 10 | 范保坤 | 左边锋 | 01/01/1999 | 17 | | 185 | 80 | | |
| 11 | 王誌汉 | 左边锋 | 21/05/2000 | 15 | | 180 | 75 | | |
| 12 | 左子健 | 守门员 | 06/01/1999 | 17 | | 185 | 80 | | |
| 13 | 徐崧清 | 左边锋 | 18/01/1999 | 17 | | 185 | 80 | | |
| 14 | 孙耀琦 | 底线 | 24/01/1996 | 20 | | 190 | 100 | | |
| 16 | 池猛 | 守门员 | 21/08/1998 | 17 | | 190 | 100 | | |
| 17 | 刘安宁 | 右边锋 | 02/05/1999 | 16 | | 180 | 75 | | |
| 平均 | | | | 16.9 | | 185.5 | 84.7 | | |

替换队员

| | | | | | | | | | |
|--|--|--|--|--|--|--|--|--|--|
| | | | | | | | | | |
| | | | | | | | | | |

| 编码 | 姓名 | 职务 |
|----|-----|-----|
| A | 杜长义 | 主教练 |
| B | 刘捷 | 教练 |
| C | 王学力 | 教练 |
| | | |
| | | |



2016年“体彩杯”全国手球男子青年锦标赛
球队名单(媒体表)

江苏队

201602000-53-1/1

| 号码 | 姓名 | 位置 | 生日 | 年龄 | 俱乐部 | 身高 (CM) | 体重 (KG) | 总场次 | 总进球 |
|----|-----|-----|------------|------|-----|------------|------------|-----|-----|
| 1 | 潘博琦 | 守门员 | | | | 186 | 75 | | |
| 3 | 赵韦光 | 左边锋 | 14/10/1999 | 16 | | 185 | 80 | | |
| 4 | 张瑞恒 | 底线 | 05/04/1997 | 18 | | 193 | 92 | | |
| 6 | 季雨 | 右后卫 | 25/12/2000 | 15 | | 182 | 78 | | |
| 7 | 任超凡 | 左后卫 | 05/03/1998 | 18 | | 183 | 80 | | |
| 8 | 姜童耀 | 左边锋 | 05/04/1998 | 17 | | 186 | 82 | | |
| 9 | 王俊威 | 左后卫 | 24/05/1997 | 18 | | 184 | 80 | | |
| 11 | 周傲 | 左后卫 | 08/09/1999 | 16 | | 187 | 70 | | |
| 13 | 尹吉祥 | 中后卫 | 01/10/1999 | 16 | | 185 | 70 | | |
| 14 | 罗中熠 | 右边锋 | 25/11/1998 | 17 | | 80 | 85 | | |
| 15 | 阎冠中 | 后卫 | 12/06/1996 | 19 | | 175 | 75 | | |
| 17 | 马益奎 | 后卫 | 22/09/1999 | 16 | | 175 | 70 | | |
| 18 | 耿畅 | 右后卫 | 19/10/1999 | 16 | | 180 | 87 | | |
| 平均 | | | | 16.8 | | 175.5 | 78.8 | | |

替换队员

| | | | | | | | | | |
|--|--|--|--|--|--|--|--|--|--|
| | | | | | | | | | |
| | | | | | | | | | |

| 编码 | 姓名 | 职务 |
|----|-----|-----|
| B | 贾淑君 | 主教练 |
| | | |
| | | |



2016年“体彩杯”全国手球男子青年锦标赛
球队名单(媒体表)

辽宁队

201602000-53-1/1

| 号码 | 姓名 | 位置 | 生日 | 年龄 | 俱乐部 | 身高 (CM) | 体重 (KG) | 总场次 | 总进球 |
|----|-----|-----|------------|------|-----|------------|------------|-----|-----|
| 1 | 高尚君 | 守门员 | 06/06/2000 | 15 | 辽宁 | 187 | 80 | | |
| 2 | 王司雨 | 底线 | 08/02/1997 | 19 | 辽宁 | 189 | 85 | | |
| 3 | 李星浩 | 左边锋 | 26/08/1997 | 18 | 辽宁 | 181 | 65 | | |
| 5 | 余昊锦 | 左后卫 | 23/02/1997 | 19 | 辽宁 | 185 | 72 | | |
| 6 | 陈庆港 | 右边锋 | 20/05/1997 | 18 | 辽宁 | 178 | 65 | | |
| 7 | 孙义广 | 中后卫 | 23/02/1996 | 20 | 辽宁 | 183 | 70 | | |
| 8 | 王鑫鹏 | 左边锋 | 01/11/1996 | 19 | 辽宁 | 183 | 70 | | |
| 10 | 王柏淇 | 左后卫 | 11/09/1996 | 19 | 辽宁 | 184 | 70 | | |
| 11 | 庞东阳 | 左后卫 | 01/05/1997 | 18 | 辽宁 | 187 | 76 | | |
| 13 | 杨洁 | 右边锋 | 20/02/1997 | 19 | 辽宁 | 184 | 75 | | |
| 14 | 吕昊臻 | 右后卫 | 11/05/1999 | 16 | 辽宁 | 190 | 85 | | |
| 16 | 吴阳 | 右后卫 | 13/03/1999 | 17 | 辽宁 | 187 | 70 | | |
| 17 | 李傲 | 左边锋 | 14/05/1999 | 16 | 辽宁 | 178 | 60 | | |
| 18 | 梅凯博 | 左边锋 | 01/03/2000 | 16 | 辽宁 | 175 | 60 | | |
| 19 | 赵鑫 | 底线 | 11/08/1999 | 16 | 辽宁 | 184 | 70 | | |
| 20 | 赵佛赐 | 左后卫 | 14/10/1998 | 17 | 辽宁 | 185 | 70 | | |
| 平均 | | | | 17.6 | | 183.8 | 71.4 | | |

替换队员

| | | | | | | | | | |
|--|--|--|--|--|--|--|--|--|--|
| | | | | | | | | | |
| | | | | | | | | | |

| 编码 | 姓名 | 职务 |
|----|-----|-----|
| B | 赵影 | 主教练 |
| C | 刘启迪 | 教练 |
| A | 于泉海 | 领队 |
| | | |
| | | |



2016年“体彩杯”全国手球男子青年锦标赛
球队名单(媒体表)

浙江队

201602000-53-1/1

| 号码 | 姓名 | 位置 | 生日 | 年龄 | 俱乐部 | 身高 (CM) | 体重 (KG) | 总场次 | 总进球 |
|----|-----|-----|------------|------|---------------|------------|------------|-----|-----|
| 1 | 林先方 | 右后卫 | 09/10/1998 | 17 | 临海市桃渚青少年体育俱乐部 | 180 | 70 | | |
| 2 | 李恩铭 | 右边锋 | 24/01/1999 | 17 | 临海市桃渚青少年体育俱乐部 | 179 | 62 | | |
| 3 | 郑尧俊 | 后卫 | 15/03/1999 | 17 | 临海市桃渚青少年体育俱乐部 | 172 | 70 | | |
| 5 | 高家南 | 底线 | 17/08/1999 | 16 | 临海市桃渚青少年体育俱乐部 | 173 | 70 | | |
| 9 | 李家乐 | 底线 | 30/12/1998 | 17 | 临海市桃渚青少年体育俱乐部 | 175 | 65 | | |
| 10 | 徐正飞 | 右边锋 | 07/03/1999 | 17 | 临海市桃渚青少年体育俱乐部 | 172 | 60 | | |
| 14 | 虞勇灿 | 守门员 | 14/12/1998 | 17 | 临海市桃渚青少年体育俱乐部 | 195 | 82 | | |
| 15 | 张佩力 | 守门员 | 25/12/1999 | 16 | 临海市桃渚青少年体育俱乐部 | 196 | 95 | | |
| 17 | 罗明杰 | 左边锋 | 18/02/1999 | 17 | 临海市桃渚青少年体育俱乐部 | 171 | 64 | | |
| 18 | 倪陈辉 | 左后卫 | 19/10/1996 | 19 | 临海市桃渚青少年体育俱乐部 | 180 | 68 | | |
| 19 | 王浩 | 左边锋 | 01/02/1999 | 17 | 临海市桃渚青少年体育俱乐部 | 177 | 62 | | |
| 平均 | | | | 17.0 | | 179.1 | 69.8 | | |

替换队员

| | | | | | | | | | |
|--|--|--|--|--|--|--|--|--|--|
| | | | | | | | | | |
| | | | | | | | | | |

| 编码 | 姓名 | 职务 |
|----|-----|----|
| D | 项建生 | 教练 |
| E | 刘晓辉 | 医生 |
| C | 柳佳 | 教练 |
| F | 沈伟林 | 领队 |
| | | |



2016年“体彩杯”全国手球男子青年锦标赛
球队名单(媒体表)

天津队

201602000-53-1/1

| 号码 | 姓名 | 位置 | 生日 | 年龄 | 俱乐部 | 身高 (CM) | 体重 (KG) | 总场次 | 总进球 |
|----|-----|-----|------------|------|-----|------------|------------|-----|-----|
| 9 | 吴明远 | 右后卫 | 21/03/1996 | 20 | 天津 | 188 | 85 | | |
| 18 | 王晓琪 | 中后卫 | 20/03/1997 | 19 | 天津 | 192 | 88 | | |
| 21 | 潘玉帅 | 左后卫 | 20/11/1997 | 18 | 天津 | 195 | 85 | | |
| 22 | 魏雨童 | 底线 | 05/10/1996 | 19 | 天津 | 199 | 95 | | |
| 24 | 刘子健 | 守门员 | 22/08/1998 | 17 | 天津 | 193 | 92 | | |
| 25 | 王一雄 | 左边锋 | 07/01/1999 | 17 | 天津 | 186 | 83 | | |
| 26 | 刘思远 | 右边锋 | 22/02/1999 | 17 | 天津 | 182 | 79 | | |
| 27 | 左金龙 | 底线 | 18/06/2000 | 15 | 天津 | 187 | 85 | | |
| 28 | 何喜年 | 守门员 | 02/01/2000 | 16 | 天津 | 200 | 100 | | |
| 平均 | | | | 17.6 | | 191.3 | 88.0 | | |

替换队员

| | | | | | | | | | |
|--|--|--|--|--|--|--|--|--|--|
| | | | | | | | | | |
| | | | | | | | | | |

| 编码 | 姓名 | 职务 |
|----|-----|----|
| A | 李志成 | 领队 |
| B | 潘玉强 | 教练 |
| | | |
| | | |



2016年“体彩杯”全国手球男子青年锦标赛
球队名单(媒体表)

上海队

201602000-53-1/1

| 号码 | 姓名 | 位置 | 生日 | 年龄 | 俱乐部 | 身高 (CM) | 体重 (KG) | 总场次 | 总进球 |
|----|-----|-----|------------|------|-----|------------|------------|-----|-----|
| 2 | 谢智超 | 右后卫 | 21/03/1998 | 18 | | 185 | 70 | | |
| 3 | 高天伦 | 右边锋 | 15/04/1997 | 18 | | 178 | 75 | | |
| 4 | 高震东 | 中后卫 | 05/02/2000 | 16 | | 184 | 88 | | |
| 5 | 曹磊 | 后卫 | 14/01/1999 | 17 | | 188 | 70 | | |
| 6 | 季晨旭 | 中后卫 | 23/04/1999 | 16 | | 188 | 82 | | |
| 7 | 蒋家敏 | 左边锋 | 02/02/1997 | 19 | | 185 | 84 | | |
| 8 | 庄旭杰 | 边锋 | 21/02/1999 | 17 | | 184 | 70 | | |
| 10 | 董凯 | 底线 | 08/01/1996 | 20 | | 188 | 90 | | |
| 12 | 张润民 | 守门员 | 23/03/1996 | 20 | | 180 | 76 | | |
| 14 | 吴佳兵 | 右后卫 | 09/12/1996 | 19 | | 185 | 85 | | |
| 16 | 陈辰 | 守门员 | 09/09/2000 | 15 | | 189 | 75 | | |
| 18 | 吴双 | 右后卫 | 06/02/1999 | 17 | | 193 | 70 | | |
| 平均 | | | | 17.7 | | 185.6 | 77.9 | | |

替换队员

| | | | | | | | | | |
|--|--|--|--|--|--|--|--|--|--|
| | | | | | | | | | |
| | | | | | | | | | |

| 编码 | 姓名 | 职务 |
|----|-----|------|
| A | 马仲顺 | 工作人员 |
| | | |
| | | |
| | | |



2016年“体彩杯”全国手球男子青年锦标赛

个人/全队技术累计表

正式表
手球
青年201602046-15-1/1
重庆万州
29/03/2016 16:00

截至第 46场

| 号码 | 姓名 | 远射 | 近射 | 边射 | 快攻 | 突破 | 任意 | 7M | 合计 | % | 助攻 | 失误 | 警告 | 2' | 取消 | 场次 | 时间 |
|---------------|-----|-------|-------|-------|-------|------|-----|-----|-------|-------|----|----|----|----|----|----|----------|
| 新疆队 | | | | | | | | | | | | | | | | | |
| <i>(场上队员)</i> | | | | | | | | | | | | | | | | | |
| 1 | 宋晓晨 | | | | | | | | | 0.0% | 11 | 4 | | | | 8 | 06:43:09 |
| 2 | 王泽川 | | 8/11 | | 2/2 | | | 2/2 | 12/15 | 80.0% | | 4 | 1 | 3 | | 8 | 01:46:49 |
| 4 | 谷通金 | 0/2 | 5/6 | 1/2 | 3/5 | 0/1 | | | 9/16 | 56.3% | 2 | 2 | 1 | | | 8 | 02:29:25 |
| 5 | 徐伟 | | 10/13 | 17/27 | 9/15 | 0/1 | | 1/1 | 37/57 | 64.9% | 5 | 9 | 1 | 1 | | 8 | 06:05:32 |
| 6 | 白光宇 | 1/1 | 3/4 | 0/2 | | | 0/1 | | 4/8 | 50.0% | | 2 | | | | 8 | 00:50:03 |
| 7 | 林豪文 | 20/50 | 8/13 | 2/3 | 3/4 | 3/4 | 4/6 | 6/7 | 46/87 | 52.9% | 26 | 15 | 5 | 5 | | 8 | 06:22:24 |
| 10 | 王钟彬 | 12/35 | 15/23 | 0/1 | 6/9 | 7/9 | 1/3 | 0/1 | 41/81 | 50.6% | 9 | 20 | 2 | 8 | | 8 | 06:00:45 |
| 12 | 王金鑫 | | | | | | | | | 0.0% | | | | | | 8 | 00:15:01 |
| 13 | 苏兴伟 | 3/10 | 4/5 | 0/1 | 5/7 | 1/1 | 1/1 | | 14/25 | 56.0% | 4 | 8 | | 2 | | 8 | 01:26:13 |
| 15 | 王维东 | 3/8 | 6/11 | 8/15 | 8/10 | 4/4 | | 1/1 | 30/49 | 61.2% | 4 | 16 | | 1 | | 8 | 06:02:34 |
| 16 | 李佳懿 | | | | | | | | | 0.0% | 1 | 1 | | | | 8 | 00:47:45 |
| 17 | 胡晋铭 | 0/2 | 25/29 | 0/1 | 1/1 | | | | 26/33 | 78.8% | 2 | 8 | 5 | 5 | | 8 | 06:07:43 |
| 18 | 李万兴 | 2/3 | 1/2 | 1/1 | 2/3 | 1/1 | | | 7/10 | 70.0% | 2 | 9 | | | | 8 | 01:26:33 |
| 19 | 李龙吉 | 4/9 | 16/32 | 1/1 | 11/13 | 8/12 | 0/1 | 6/9 | 46/77 | 59.7% | 13 | 41 | 4 | 1 | | 8 | 06:12:39 |
| 24 | 陈伟华 | 2/5 | 4/4 | 1/4 | 2/2 | 1/1 | | 0/1 | 10/17 | 58.8% | 3 | 7 | 2 | 1 | | 8 | 01:49:35 |

| | | | | | | | | | | | | | | | | | |
|--------------|-----|--------|---------|-------|-------|-------|------|-------|---------|-------|----|-----|----|----|--|-----|----------|
| 合计 | | 47/125 | 105/153 | 31/58 | 52/71 | 25/34 | 6/12 | 16/22 | 282/475 | 59.4% | 82 | 146 | 21 | 27 | | 120 | |
| <i>(守门员)</i> | | | | | | | | | | | | | | | | | |
| 1 | 宋晓晨 | 37/67 | 50/125 | 19/45 | 4/33 | 3/17 | 6/10 | 7/23 | 126/320 | 39.4% | 11 | 4 | | | | 8 | 06:43:09 |
| 12 | 王金鑫 | 1/2 | 3/5 | 0/1 | | 1/3 | 0/1 | 0/1 | 5/13 | 38.5% | | | | | | 8 | 00:15:01 |
| 16 | 李佳懿 | 3/5 | 7/20 | 2/8 | 1/4 | | 2/3 | 1/3 | 16/43 | 37.2% | 1 | 1 | | | | 8 | 00:47:45 |

| | | | | | | | | | | | | | | | | | |
|-----------|--|-------|--------|-------|------|------|------|------|---------|-------|----|---|--|--|--|----|--|
| 合计 | | 41/74 | 60/150 | 21/54 | 5/37 | 4/20 | 8/14 | 8/27 | 147/376 | 39.1% | 12 | 5 | | | | 24 | |
|-----------|--|-------|--------|-------|------|------|------|------|---------|-------|----|---|--|--|--|----|--|

场上队员：得分/射门

守门员：救球/射门

| 全队合计 | 进球 | 被救 | 射失 | 击柱 | 封球 | 合计 | % |
|------|-----|----|----|----|----|-----|-------|
| 远射 | 47 | 44 | 10 | 7 | 17 | 125 | 37.6% |
| 近射 | 105 | 36 | 5 | 7 | | 153 | 68.6% |
| 边射 | 31 | 18 | 6 | 3 | | 58 | 53.4% |
| 快攻 | 52 | 13 | 2 | 4 | | 71 | 73.2% |
| 突破 | 25 | 6 | 2 | 1 | | 34 | 73.5% |
| 任意 | 6 | 4 | 2 | | | 12 | 50.0% |
| 7M | 16 | 4 | 1 | 1 | | 22 | 72.7% |

已打比赛

| 阶段 | 场次 | 对手 | 比分 |
|--------|----|-----|---------------|
| 预赛 | 6 | 天津 | 44:32 (24:13) |
| 预赛 | 11 | 安徽 | 39:32 (15:15) |
| 预赛 | 18 | 北京 | 33:26 (17:13) |
| 预赛 | 21 | 四川 | 28:29 (17:15) |
| 预赛 | 25 | 辽宁 | 32:17 (19:10) |
| 四分之一决赛 | 34 | 解放军 | 40:36 (23:15) |
| 半决赛 | 41 | 山东 | 38:30 (19:11) |
| 决赛 | 46 | 四川 | 28:27 (18:16) |





2016年“体彩杯”全国手球男子青年锦标赛
图式射门区域累计

截止至第46场

201602046-42-1/1

新疆队

Player statistics for Xinjiang team including names like 宋晓晨, 王泽川, 谷通金, etc., with corresponding performance metrics in a grid format.

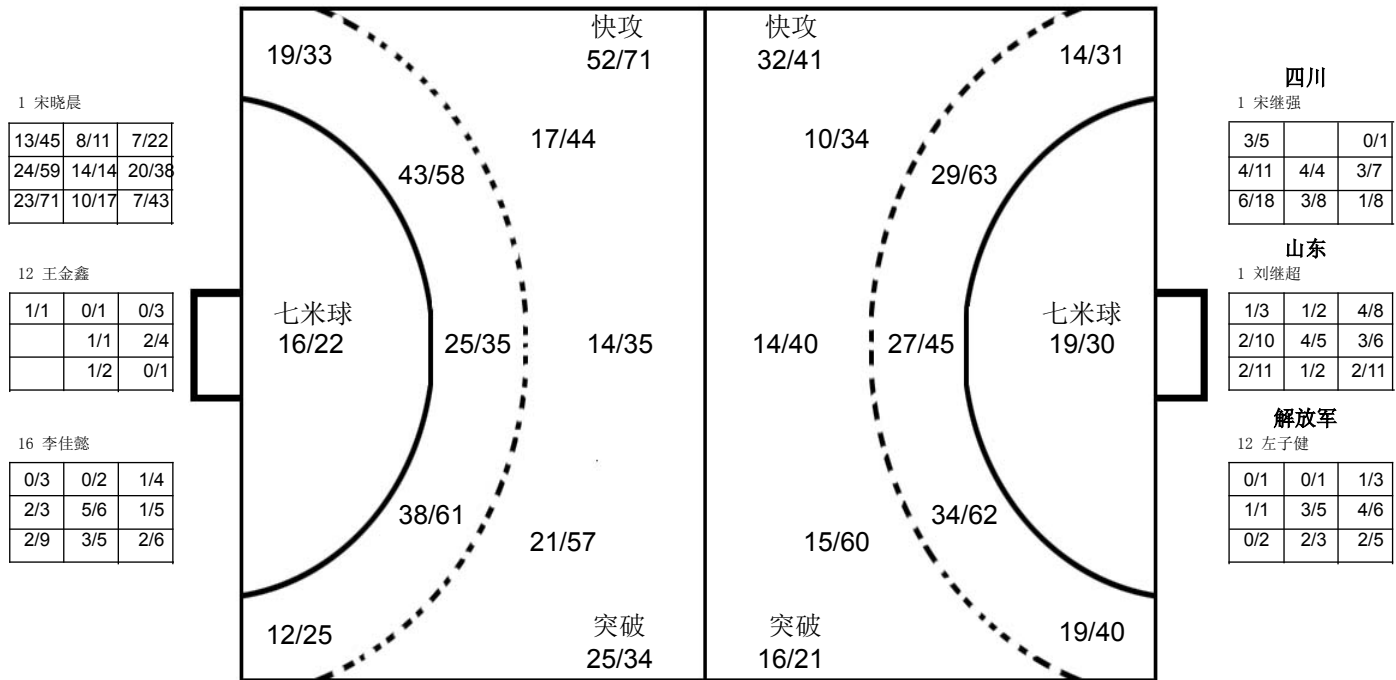

对手

Opponent statistics for teams like 四川, 山东, 安徽, 解放军, 天津, 辽宁, etc., with player names and performance metrics.

注释: Post=击柱 Miss=射失 Block=被封





2016年“体彩杯”全国手球男子青年锦标赛

个人/全队技术累计表

正式表
手球
青年

截至第 46场

201602046-15-1/1
重庆万州
29/03/2016 16:00

| 号码 | 姓名 | 远射 | 近射 | 边射 | 快攻 | 突破 | 任意 | 7M | 合计 | % | 助攻 | 失误 | 警告 | 2' | 取消 | 场次 | 时间 |
|---------------|-----|-------|-------|-------|-------|-----|-----|-------|--------|-------|----|----|----|----|----|----|----------|
| 四川队 | | | | | | | | | | | | | | | | | |
| <i>(场上队员)</i> | | | | | | | | | | | | | | | | | |
| 1 | 宋继强 | | | | | | | | | 0.0% | 2 | | | | | 8 | 02:44:12 |
| 3 | 刘赵梁 | 0/4 | 9/18 | 17/29 | 14/18 | 4/5 | | | 44/74 | 59.5% | 3 | 23 | 1 | | | 8 | 05:52:05 |
| 5 | 王凯 | 0/1 | 14/22 | 5/14 | 7/11 | | | 0/2 | 26/50 | 52.0% | 6 | 5 | 1 | | | 8 | 06:13:42 |
| 7 | 仇瑞祥 | 0/2 | 2/2 | 1/2 | 0/1 | 1/1 | | 0/1 | 4/9 | 44.4% | 5 | 3 | 1 | | | 8 | 00:37:49 |
| 8 | 罗尧尧 | 16/30 | 12/19 | 2/2 | 14/16 | 4/5 | 2/4 | 19/24 | 69/100 | 69.0% | 26 | 20 | 2 | 1 | | 8 | 06:13:34 |
| 9 | 许翔宇 | 4/15 | 6/11 | 2/4 | 2/2 | 1/2 | 1/1 | 1/3 | 17/38 | 44.7% | 16 | 24 | 3 | 2 | | 8 | 03:52:48 |
| 10 | 徐彦昊 | 8/18 | 8/12 | 2/4 | 10/15 | 1/3 | 0/1 | 0/2 | 29/55 | 52.7% | 10 | 19 | 2 | 2 | | 8 | 04:20:47 |
| 11 | 张天豪 | | 1/4 | 0/3 | 3/3 | | | 1/1 | 5/11 | 45.5% | 1 | 1 | | 2 | | 8 | 00:40:34 |
| 12 | 刘树豪 | | | | | | | | | 0.0% | 8 | 2 | | | | 8 | 04:23:18 |
| 13 | 尹文珂 | 1/2 | 5/8 | 4/6 | 1/3 | | 0/1 | 1/1 | 12/21 | 57.1% | | 3 | | 2 | | 8 | 01:15:11 |
| 15 | 徐逸 | | | | 0/1 | | | 1/1 | 1/2 | 50.0% | 1 | 1 | | | | 8 | 00:15:13 |
| 17 | 谢庆龙 | | 20/30 | | 1/1 | | | 1/1 | 22/32 | 68.8% | 2 | 18 | 3 | 3 | | 8 | 06:58:02 |
| 18 | 张睿梁 | | 0/1 | | | | | | 0/1 | 0.0% | | | 1 | 2 | | 8 | 00:33:41 |
| 19 | 庞连康 | 7/15 | 8/14 | 1/2 | 4/4 | 2/2 | 1/1 | 0/1 | 23/39 | 59.0% | 9 | 22 | 6 | 5 | | 8 | 06:46:47 |
| 20 | 张文健 | | | | | | | | | 0.0% | | | | | | 8 | 00:00:00 |
| 21 | 曹修庆 | | | | | | | | | 0.0% | | | | | | 8 | 00:00:00 |

| | | | | | | | | | | | | | | | | | |
|-----------|--|-------|--------|-------|-------|-------|-----|-------|---------|-------|----|-----|----|----|--|-----|--|
| 合计 | | 36/87 | 85/141 | 34/66 | 56/75 | 13/18 | 4/8 | 24/37 | 252/432 | 58.3% | 89 | 141 | 20 | 19 | | 128 | |
|-----------|--|-------|--------|-------|-------|-------|-----|-------|---------|-------|----|-----|----|----|--|-----|--|

(守门员)

| | | | | | | | | | | | | | | | | | |
|----|-----|-------|-------|------|------|------|-----|------|--------|-------|---|---|--|--|--|---|----------|
| 1 | 宋继强 | 17/38 | 10/38 | 8/13 | 4/15 | 1/6 | 1/3 | 1/5 | 42/118 | 35.6% | 2 | | | | | 8 | 02:44:12 |
| 11 | 张天豪 | | | | | | | | | 0.0% | | | | | | 8 | 00:00:00 |
| 12 | 刘树豪 | 39/69 | 18/70 | 8/23 | 1/13 | 3/11 | 3/5 | 4/15 | 76/206 | 36.9% | 8 | 2 | | | | 8 | 04:23:18 |

| | | | | | | | | | | | | | | | | | |
|-----------|--|--------|--------|-------|------|------|-----|------|---------|-------|----|---|--|--|--|----|--|
| 合计 | | 56/107 | 28/108 | 16/36 | 5/28 | 4/17 | 4/8 | 5/20 | 118/324 | 36.4% | 10 | 2 | | | | 24 | |
|-----------|--|--------|--------|-------|------|------|-----|------|---------|-------|----|---|--|--|--|----|--|

场上队员：得分/射门

守门员：救球/射门

| 全队合计 | 进球 | 被救 | 射失 | 击柱 | 封球 | 合计 | % |
|------|----|----|----|----|----|-----|-------|
| 远射 | 36 | 22 | 9 | | 20 | 87 | 41.4% |
| 近射 | 85 | 38 | 7 | 11 | | 141 | 60.3% |
| 边射 | 34 | 20 | 6 | 6 | | 66 | 51.5% |
| 快攻 | 56 | 14 | 4 | 1 | | 75 | 74.7% |
| 突破 | 13 | 4 | | 1 | | 18 | 72.2% |
| 任意 | 4 | 3 | 1 | | | 8 | 50.0% |
| 7M | 24 | 9 | 4 | | | 37 | 64.9% |

已打比赛

| 阶段 | 场次 | 对手 | 比分 |
|--------|----|----|---------------|
| 预赛 | 5 | 辽宁 | 31:16 (20:14) |
| 预赛 | 10 | 北京 | 35:29 (12:14) |
| 预赛 | 17 | 天津 | 24:8 (24:8) |
| 预赛 | 21 | 新疆 | 29:28 (15:17) |
| 预赛 | 27 | 安徽 | 31:32 (12:14) |
| 四分之一决赛 | 35 | 广东 | 39:30 (20:13) |
| 半决赛 | 42 | 安徽 | 36:35 (20:15) |
| 决赛 | 46 | 新疆 | 27:28 (16:18) |





2016年“体彩杯”全国手球男子青年锦标赛

图式射门区域累计

截止至第46场

201602046-42-1/1

四川队

Table of player statistics for Sichuan team, including names like 宋继强, 刘树豪, etc., and their respective performance metrics in a grid format.

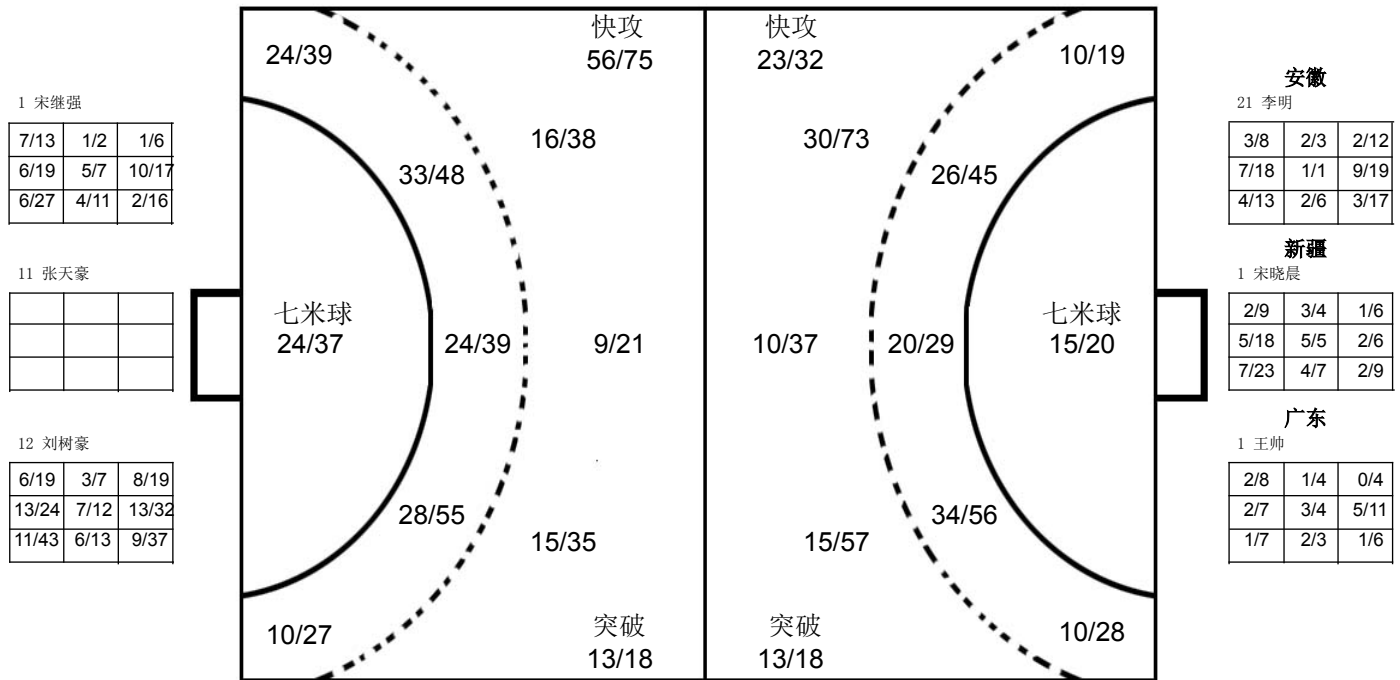

对手

Table of player statistics for the opponent team, including names like 王巨柱, 郭世伟, etc., and their performance metrics.

注释: Post=击柱 Miss=射失 Block=被封



2016年“体彩杯”全国手球男子青年锦标赛

个人/全队技术累计表

正式表
手球
青年

截至第 46场

201602046-15-1/1
重庆万州
29/03/2016 16:00

| 号码 | 姓名 | 远射 | 近射 | 边射 | 快攻 | 突破 | 任意 | 7M | 合计 | % | 助攻 | 失误 | 警告 | 2' | 取消 | 场次 | 时间 |
|---------------|-----|-------|-------|-------|-------|-----|-----|-----|-------|-------|----|----|----|----|----|----|----------|
| 安徽队 | | | | | | | | | | | | | | | | | |
| <i>(场上队员)</i> | | | | | | | | | | | | | | | | | |
| 1 | 郭世伟 | 14/31 | 14/21 | 2/4 | 7/11 | 8/9 | | 0/1 | 45/77 | 58.4% | 5 | 19 | 2 | 3 | | 7 | 07:31:11 |
| 2 | 金勇峰 | 9/16 | 10/13 | 3/11 | 3/3 | 4/4 | | 0/1 | 29/48 | 60.4% | 10 | 20 | 3 | 3 | | 8 | 06:37:54 |
| 9 | 陈开勇 | 3/5 | 22/30 | | 16/20 | | 1/1 | 1/1 | 43/57 | 75.4% | 2 | 10 | 3 | 2 | | 8 | 04:53:40 |
| 17 | 王巨柱 | 27/58 | 6/17 | 0/1 | 8/10 | 4/4 | 2/5 | 0/1 | 47/96 | 49.0% | 26 | 23 | 2 | | | 8 | 06:28:25 |
| 18 | 李双 | 14/31 | 23/29 | 1/6 | 6/6 | 7/9 | 4/4 | 3/4 | 58/89 | 65.2% | 20 | 24 | 5 | 6 | | 8 | 06:44:04 |
| 19 | 何山 | | 3/4 | 11/20 | 4/4 | 0/1 | | | 18/29 | 62.1% | | 8 | 2 | 2 | | 8 | 04:59:07 |
| 21 | 李明 | | 0/2 | | | | | | 0/2 | 0.0% | 14 | 7 | | 1 | | 8 | 07:05:05 |
| 24 | 徐安格 | 0/2 | 10/13 | | 1/1 | | | | 11/16 | 68.8% | | 6 | 1 | 4 | | 8 | 03:22:53 |
| 25 | 李文哲 | | | | | | | | | 0.0% | | | | | | 8 | 00:06:56 |
| 26 | 程浩然 | 1/2 | 5/9 | 4/10 | 6/9 | 2/3 | 0/1 | | 18/34 | 52.9% | | 12 | 1 | 3 | | 8 | 03:51:00 |
| 27 | 王长旭 | 1/3 | 1/1 | 2/4 | 6/8 | 1/1 | | 3/3 | 14/20 | 70.0% | 2 | 6 | 1 | 2 | | 8 | 01:44:33 |
| 28 | 丁浩然 | | | 1/4 | 1/1 | | | | 2/5 | 40.0% | | 3 | | | | 8 | 00:21:46 |
| 32 | 许浩翔 | 0/1 | | | | | | | 0/1 | 0.0% | 1 | 1 | | | | 8 | 00:27:15 |
| 33 | 姚紫祥 | | | | | | | | | 0.0% | | | | | | 8 | 00:05:42 |
| 41 | 刘润民 | | | | | | | | | 0.0% | | | | | | 8 | 00:13:20 |
| 42 | 王成龙 | | | 0/1 | | | | | 0/1 | 0.0% | | | | | | 8 | 00:03:39 |

| | | | | | | | | | | | | | | | | | |
|--------------|-----|--------|--------|-------|-------|-------|------|------|---------|-------|----|-----|----|----|--|-----|----------|
| 合计 | | 69/149 | 94/139 | 24/61 | 58/73 | 26/31 | 7/11 | 7/11 | 285/475 | 60.0% | 80 | 139 | 20 | 26 | | 127 | |
| <i>(守门员)</i> | | | | | | | | | | | | | | | | | |
| 1 | 郭世伟 | | | | | | | | | 0.0% | | | | 1 | | 7 | 02:32:50 |
| 2 | 金勇峰 | | | | | | | | | 0.0% | | | | | | 8 | 01:00:00 |
| 21 | 李明 | 57/115 | 46/109 | 16/51 | 10/30 | 5/25 | 3/5 | 2/23 | 139/358 | 38.8% | 14 | 7 | | 1 | | 8 | 07:05:05 |
| 32 | 许浩翔 | 4/10 | 0/9 | 4/6 | 2/6 | | 1/1 | 1/2 | 12/34 | 35.3% | 1 | 1 | | | | 8 | 00:27:15 |
| 合计 | | 61/125 | 46/118 | 20/57 | 12/36 | 5/25 | 4/6 | 3/25 | 151/392 | 38.5% | 15 | 8 | | 2 | | 31 | |

场上队员：得分/射门

守门员：救球/射门

| 全队合计 | 进球 | 被救 | 射失 | 击柱 | 封球 | 合计 | % |
|------|----|----|----|----|----|-----|-------|
| 远射 | 69 | 36 | 18 | 12 | 14 | 149 | 46.3% |
| 近射 | 94 | 31 | 3 | 10 | 1 | 139 | 67.6% |
| 边射 | 24 | 25 | 5 | 7 | | 61 | 39.3% |
| 快攻 | 58 | 11 | 2 | 2 | | 73 | 79.5% |
| 突破 | 26 | 3 | 2 | | | 31 | 83.9% |
| 任意 | 7 | 2 | 1 | 1 | | 11 | 63.6% |
| 7M | 7 | 3 | | 1 | | 11 | 63.6% |

已打比赛

| 阶段 | 场次 | 对手 | 比分 |
|--------|----|----|---------------|
| 预赛 | 4 | 北京 | 38:26 (18:12) |
| 预赛 | 11 | 新疆 | 32:39 (15:15) |
| 预赛 | 16 | 辽宁 | 40:37 (17:23) |
| 预赛 | 20 | 天津 | 25:10 (22:10) |
| 预赛 | 27 | 四川 | 32:31 (14:12) |
| 四分之一决赛 | 36 | 江苏 | 41:27 (22:10) |
| 半决赛 | 42 | 四川 | 35:36 (15:20) |
| 3-4名 | 45 | 山东 | 42:35 (26:19) |





2016年“体彩杯”全国手球男子青年锦标赛

图式射门区域累计

截止至第46场

201602046-42-1/1

安徽队

| | | | | | | | |
|-----------------------------|-----------------------------|-----------------------------|------------------------------|-----------------------------|-----------------------------|-----------------------------|-----------------------------|
| 1 郭世伟 | 2 金勇峰 | 9 陈开勇 | 17 王巨柱 | 18 李双 | 19 何山 | 21 李明 | 24 徐安格 |
| 12 2 4 | 3 1 4 | 10 3 7 | 4 2 11 | 5 1 7 | 5 1 | | 2 |
| 8 | 3 1 5 | 9 | 5 | 10 2 | 3 1 2 | | 1 |
| 13 1 2 | 2 1 9 | 8 1 3 | 4 2 8 | 14 | 1 2 3 | | 3 1 3 |
| Post - 5 Miss - 6 Block - 4 | Post - 6 Miss - 4 Block - 0 | Post - 1 Miss - 3 Block - 0 | Post - 13 Miss - 6 Block - 7 | Post - 3 Miss - 8 Block - 2 | Post - 1 Miss - 2 Block - 0 | Post - 1 Miss - 0 Block - 0 | Post - 2 Miss - 0 Block - 0 |
| 25 李文哲 | 26 程浩然 | 27 王长旭 | 28 丁浩然 | 32 许浩翔 | 33 姚紫祥 | 41 刘润民 | 42 王成龙 |
| | 1 | 1 | | | | | |
| | 4 1 3 | 1 1 1 | 1 | | | | |
| | 5 | 5 | | | | | |
| Post - 0 Miss - 0 Block - 0 | Post - 1 Miss - 0 Block - 0 | Post - 0 Miss - 1 Block - 2 | Post - 0 Miss - 0 Block - 0 | Post - 0 Miss - 1 Block - 0 | Post - 0 Miss - 0 Block - 0 | Post - 0 Miss - 0 Block - 0 | Post - 0 Miss - 0 Block - 0 |

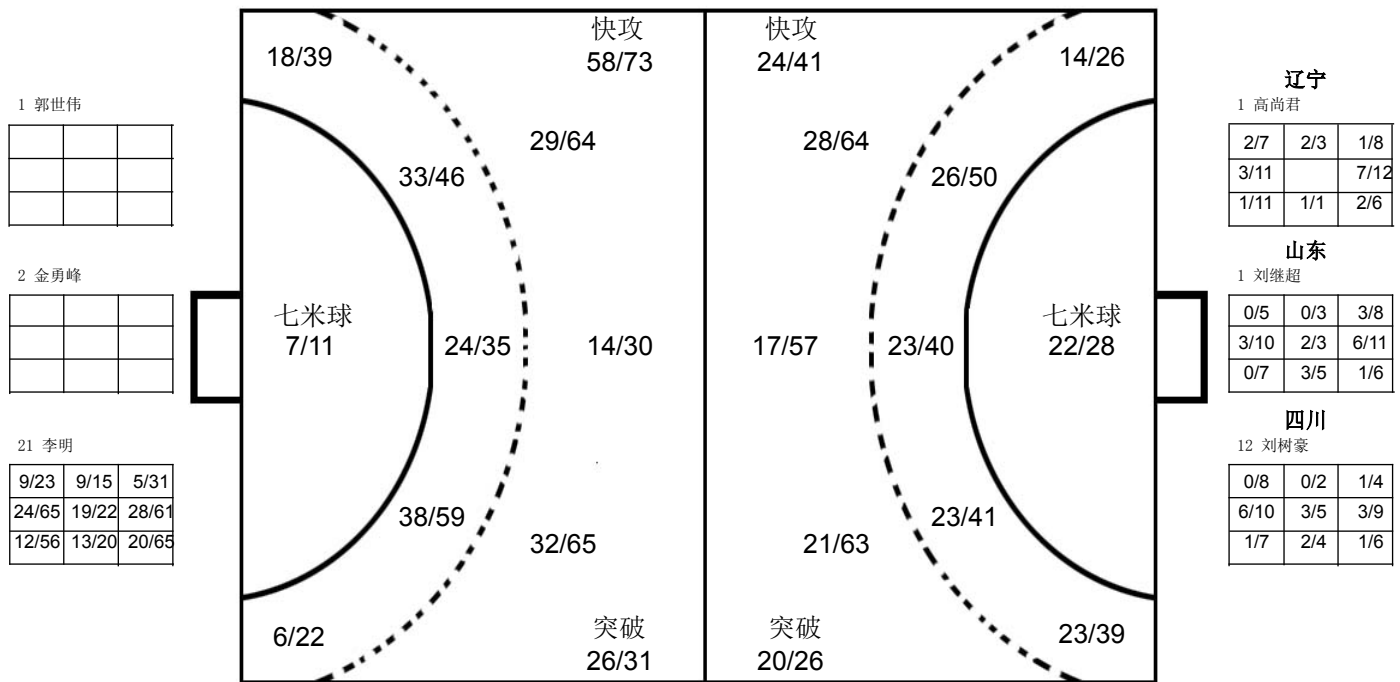

对手

| | | | | | | | |
|-----------------------------|-----------------------------|-----------------------------|-----------------------------|-----------------------------|-----------------------------|-----------------------------|-----------------------------|
| 四川 8 罗尧尧 | 辽宁 10 王柏淇 | 四川 3 刘赵梁 | 山东 6 王军鸣 | 四川 10 徐彦昊 | 新疆 5 徐伟 | 新疆 7 林豪文 | 辽宁 6 陈庆港 |
| 2 | 1 1 1 | | | | | | |
| 5 | 2 | 2 | 1 | 4 | 5 | 2 | 2 |
| 4 1 4 | 2 | 2 1 4 | 1 | 3 | | 4 1 1 | 1 1 1 |
| Post - 0 Miss - 3 Block - 5 | Post - 1 Miss - 3 Block - 0 | Post - 0 Miss - 3 Block - 0 | Post - 0 Miss - 1 Block - 1 | Post - 1 Miss - 2 Block - 2 | Post - 2 Miss - 0 Block - 0 | Post - 1 Miss - 0 Block - 1 | Post - 0 Miss - 0 Block - 0 |
| 江苏 11 周傲 | 山东 10 孙芳伟 | 新疆 19 李龙吉 | 四川 19 庞连康 | 新疆 10 王钟彬 | 辽宁 13 杨洁 | 山东 5 王晓峰 | 北京 4 朱广刚 |
| 2 | 1 | 1 1 | 2 | | | 1 | |
| 1 3 | 1 | 2 | | 2 | | 1 | 1 |
| 1 | 1 1 3 | 1 | | 3 | 2 1 1 | 1 | 2 |
| Post - 0 Miss - 5 Block - 1 | Post - 0 Miss - 1 Block - 2 | Post - 0 Miss - 1 Block - 0 | Post - 0 Miss - 0 Block - 1 | Post - 0 Miss - 1 Block - 0 | Post - 4 Miss - 0 Block - 0 | Post - 1 Miss - 1 Block - 2 | Post - 1 Miss - 1 Block - 0 |

注释: Post=击柱 Miss=射失 Block=被封





2016年“体彩杯”全国手球男子青年锦标赛

个人/全队技术累计表

正式表
手球
青年

截至第 46场

201602046-15-1/1
重庆万州
29/03/2016 16:00

| 号码 | 姓名 | 远射 | 近射 | 边射 | 快攻 | 突破 | 任意 | 7M | 合计 | % | 助攻 | 失误 | 警告 | 2' | 取消 | 场次 | 时间 |
|---------------|-----|-------|-------|-------|-----|-----|-------|-----|--------|-------|----|----|----|----|----|----|----------|
| 山东队 | | | | | | | | | | | | | | | | | |
| <i>(场上队员)</i> | | | | | | | | | | | | | | | | | |
| 1 | 刘继超 | 1/1 | | | | | | | 1/1 | 100% | 2 | 2 | | | | 8 | 06:51:48 |
| 2 | 冯鑫宇 | 3/10 | 9/22 | 1/1 | 7/8 | 4/5 | | 3/6 | 27/52 | 51.9% | 4 | 16 | 1 | 1 | | 8 | 05:06:37 |
| 3 | 王铁林 | 3/16 | 6/17 | 11/18 | 8/9 | | | | 28/60 | 46.7% | 5 | 13 | 3 | 6 | | 8 | 06:25:52 |
| 5 | 王晓峰 | 38/86 | 7/15 | 0/2 | 7/7 | | 10/12 | 1/1 | 63/123 | 51.2% | 8 | 14 | 3 | 4 | | 8 | 06:30:16 |
| 6 | 王军鸣 | 4/17 | 10/20 | 2/4 | 4/8 | | 2/5 | 5/6 | 27/60 | 45.0% | 8 | 15 | 3 | 6 | | 8 | 04:48:27 |
| 7 | 徐勇林 | 3/7 | 5/11 | 1/8 | 2/3 | 1/1 | | | 12/30 | 40.0% | 7 | 7 | | | | 8 | 03:02:14 |
| 10 | 孙芳伟 | 21/61 | 15/27 | 4/6 | 5/7 | 7/8 | | 4/5 | 56/114 | 49.1% | 14 | 19 | 4 | 3 | | 8 | 06:44:45 |
| 11 | 王洋 | 2/3 | 3/5 | 5/7 | 1/2 | | | | 11/17 | 64.7% | 1 | 6 | 2 | | | 8 | 03:41:20 |
| 12 | 刘道林 | | | | | | | | | 0.0% | | | | | | 8 | 01:04:11 |
| 13 | 于欣君 | 6/14 | 7/14 | 1/4 | 1/5 | 2/2 | 0/2 | 0/1 | 17/42 | 40.5% | 5 | 5 | | 1 | | 8 | 02:45:02 |
| 17 | 薛盼龙 | 0/4 | 13/16 | 0/1 | 4/4 | | | 1/1 | 18/26 | 69.2% | | 10 | 2 | 2 | | 8 | 04:11:38 |
| 18 | 李玮 | 0/1 | 2/2 | 1/4 | | | | | 3/7 | 42.9% | 6 | 8 | | | | 8 | 01:21:12 |
| 21 | 王腾达 | | 2/2 | 1/2 | 4/4 | | | | 7/8 | 87.5% | 1 | 1 | 1 | 2 | | 8 | 01:01:48 |
| 22 | 李子跃 | 1/9 | 0/1 | 1/3 | | | | 1/2 | 3/15 | 20.0% | | 1 | 1 | | | 8 | 00:49:52 |
| 23 | 李荣健 | | 4/8 | 4/9 | 1/3 | | | 3/3 | 12/23 | 52.2% | 7 | 3 | | | | 8 | 02:48:01 |

| | | | | | | | | | | | | | | | | | |
|--------------|-----|--------|--------|-------|-------|-------|-------|-------|---------|-------|----|-----|----|----|--|-----|----------|
| 合计 | | 82/229 | 83/160 | 32/69 | 44/60 | 14/16 | 12/19 | 18/25 | 285/578 | 49.3% | 68 | 120 | 20 | 25 | | 120 | |
| <i>(守门员)</i> | | | | | | | | | | | | | | | | | |
| 1 | 刘继超 | 49/94 | 47/148 | 19/38 | 11/37 | 4/30 | 3/9 | 4/12 | 137/368 | 37.2% | 2 | 2 | | | | 8 | 06:51:48 |
| 3 | 王铁林 | | | | | | | | | 0.0% | | | | | | 8 | 00:09:35 |
| 12 | 刘道林 | 2/6 | 1/10 | 4/8 | 1/6 | 0/5 | 0/1 | 0/2 | 8/38 | 21.1% | | | | | | 8 | 01:04:11 |

| | | | | | | | | | | | | | | | | | |
|-----------|--|--------|--------|-------|-------|------|------|------|---------|-------|---|---|--|--|--|----|--|
| 合计 | | 51/100 | 48/158 | 23/46 | 12/43 | 4/35 | 3/10 | 4/14 | 145/406 | 35.7% | 2 | 2 | | | | 24 | |
|-----------|--|--------|--------|-------|-------|------|------|------|---------|-------|---|---|--|--|--|----|--|

场上队员：得分/射门

守门员：救球/射门

| 全队合计 | 进球 | 被救 | 射失 | 击柱 | 封球 | 合计 | % |
|------|----|----|----|----|----|-----|-------|
| 远射 | 82 | 65 | 36 | 21 | 25 | 229 | 35.8% |
| 近射 | 83 | 57 | 10 | 8 | 2 | 160 | 51.9% |
| 边射 | 32 | 29 | 5 | 3 | | 69 | 46.4% |
| 快攻 | 44 | 12 | 1 | 2 | 1 | 60 | 73.3% |
| 突破 | 14 | 2 | | | | 16 | 87.5% |
| 任意 | 12 | 5 | 1 | 1 | | 19 | 63.2% |
| 7M | 18 | 4 | 2 | 1 | | 25 | 72.0% |

已打比赛

| 阶段 | 场次 | 对手 | 比分 |
|--------|----|-----|---------------|
| 预赛 | 3 | 解放军 | 35:33 (15:15) |
| 预赛 | 8 | 上海 | 32:28 (14:15) |
| 预赛 | 13 | 江苏 | 33:26 (16:10) |
| 预赛 | 22 | 广东 | 42:33 (24:17) |
| 预赛 | 28 | 浙江 | 37:22 (23:9) |
| 四分之一决赛 | 33 | 北京 | 41:39 (18:18) |
| 半决赛 | 41 | 新疆 | 30:38 (11:19) |
| 3-4名 | 45 | 安徽 | 35:42 (19:26) |





2016年“体彩杯”全国手球男子青年锦标赛

图式射门区域累计

截止至第46场

201602046-42-1/1

山东队

Table listing player statistics for Shandong team, including names like 刘继超, 冯鑫宇, 王铁林, etc., and their respective performance metrics in a grid format.

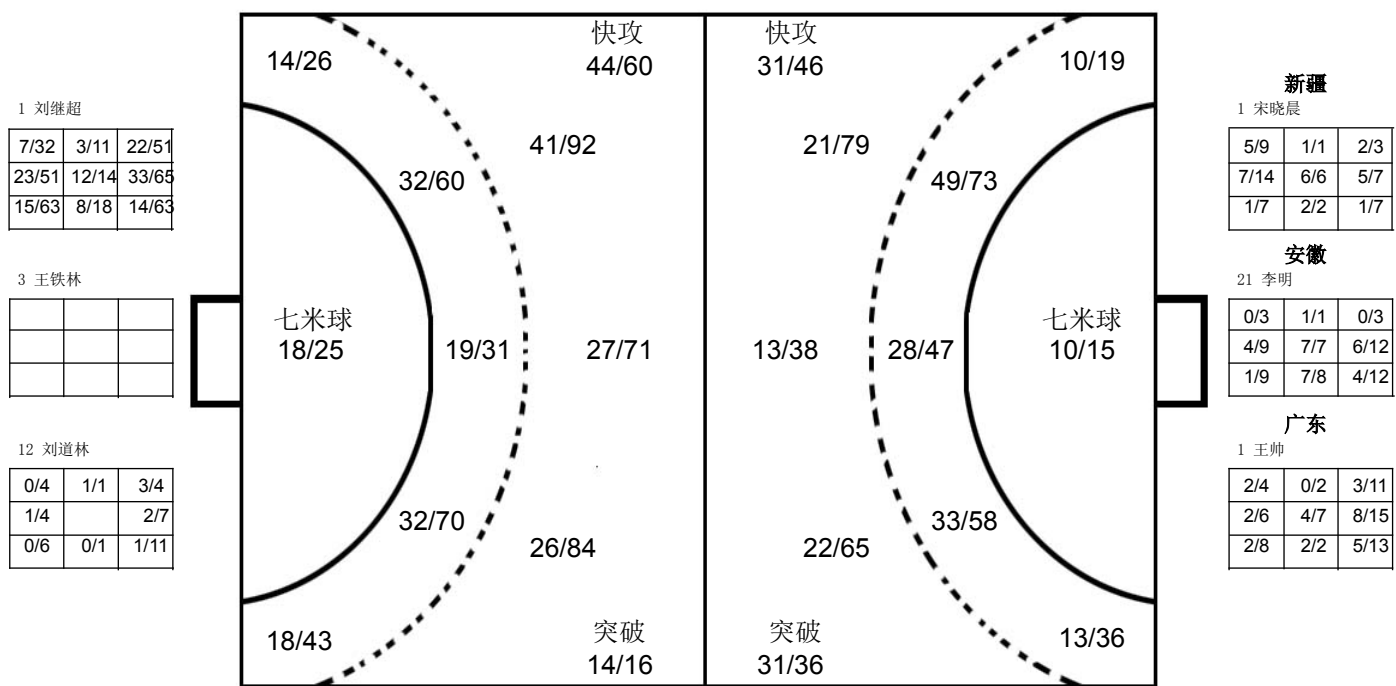

Table listing player statistics for the opponent team (对手), including names like 李双, 赵一涵, 郭世伟, etc., and their performance metrics.

注释: Post=击柱 Miss=射失 Block=被封



2016年“体彩杯”全国手球男子青年锦标赛

个人/全队技术累计表

正式表
手球
青年

截至第 46场

201602046-15-1/1
重庆万州
29/03/2016 16:00

| 号码 | 姓名 | 远射 | 近射 | 边射 | 快攻 | 突破 | 任意 | 7M | 合计 | % | 助攻 | 失误 | 警告 | 2' | 取消 | 场次 | 时间 |
|---------------|-----|-------|-------|------|-------|-------|------|------|-------|-------|----|----|----|----|----|----|----------|
| 广东队 | | | | | | | | | | | | | | | | | |
| <i>(场上队员)</i> | | | | | | | | | | | | | | | | | |
| 1 | 王帅 | 3/4 | 1/1 | | 0/1 | | | | 4/6 | 66.7% | 10 | 4 | 1 | | | 8 | 05:30:36 |
| 2 | 姚雪岩 | 3/10 | 20/28 | | 2/2 | 4/4 | 3/7 | 3/3 | 35/54 | 64.8% | 15 | 18 | 3 | | | 8 | 06:53:17 |
| 4 | 高玉杰 | 1/4 | 3/6 | 5/11 | 6/8 | 2/3 | | | 17/32 | 53.1% | 2 | 11 | 2 | 2 | | 8 | 03:13:23 |
| 5 | 黄培杰 | 2/11 | 8/17 | 7/11 | 11/15 | 11/13 | | 5/10 | 44/77 | 57.1% | 31 | 28 | 3 | 2 | | 8 | 07:27:18 |
| 7 | 段飞宇 | 0/2 | 7/9 | 6/14 | 5/6 | | | 1/1 | 19/32 | 59.4% | 4 | 13 | | | | 8 | 04:34:45 |
| 9 | 周凯峰 | | 1/2 | 1/2 | | | | | 2/4 | 50.0% | | 3 | 1 | | | 8 | 00:14:30 |
| 10 | 周仲坤 | 5/13 | 15/26 | 5/6 | 8/9 | 3/7 | 1/1 | 1/1 | 38/63 | 60.3% | 9 | 16 | 2 | 3 | | 8 | 07:27:16 |
| 11 | 胡国富 | 4/8 | 13/18 | 4/7 | 14/20 | 4/4 | 0/1 | 2/3 | 41/61 | 67.2% | 9 | 26 | | 3 | | 8 | 05:21:48 |
| 12 | 李壮 | | 3/6 | 1/1 | | | 1/3 | 3/5 | 8/15 | 53.3% | | 7 | | | | 8 | 01:22:38 |
| 13 | 蔡杰 | | 0/1 | 0/1 | | | | | 0/2 | 0.0% | | 2 | | | | 8 | 00:27:26 |
| 14 | 王泽润 | | | | | | | | | 0.0% | | | | | | 8 | 00:45:19 |
| 15 | 张建杰 | 14/42 | 17/30 | 1/1 | 1/1 | 9/12 | 5/11 | | 47/97 | 48.5% | 14 | 21 | 7 | 2 | | 8 | 06:08:05 |
| 16 | 王猛 | | | | | | | | | 0.0% | 3 | | | | | 8 | 00:54:48 |
| 18 | 李文金 | 3/6 | 15/21 | | 2/2 | | 0/1 | | 20/30 | 66.7% | 1 | 11 | 1 | | | 8 | 04:28:54 |

| | | | | | | | | | | | | | | | | | |
|--------------|-----|--------|---------|-------|-------|-------|-------|-------|---------|-------|----|-----|----|----|--|-----|----------|
| 合计 | | 35/100 | 103/165 | 30/54 | 49/64 | 33/43 | 10/24 | 15/23 | 275/473 | 58.1% | 98 | 160 | 20 | 12 | | 112 | |
| <i>(守门员)</i> | | | | | | | | | | | | | | | | | |
| 1 | 王帅 | 49/77 | 43/113 | 23/40 | 12/35 | 3/15 | 2/8 | 3/11 | 135/299 | 45.2% | 10 | 4 | 1 | | | 8 | 05:30:36 |
| 14 | 王泽润 | 4/9 | 5/18 | 1/3 | 1/2 | 2/5 | | 1/6 | 14/43 | 32.6% | | | | | | 8 | 00:45:19 |
| 16 | 王猛 | 3/7 | 6/12 | 4/9 | 2/8 | 2/8 | 1/2 | 2/7 | 20/53 | 37.7% | 3 | | | | | 8 | 00:54:48 |

| | | | | | | | | | | | | | | | | |
|-----------|--|-------|--------|-------|-------|------|------|------|---------|-------|----|---|---|--|--|----|
| 合计 | | 56/93 | 54/143 | 28/52 | 15/45 | 7/28 | 3/10 | 6/24 | 169/395 | 42.8% | 13 | 4 | 1 | | | 24 |
|-----------|--|-------|--------|-------|-------|------|------|------|---------|-------|----|---|---|--|--|----|

场上队员：得分/射门

守门员：救球/射门

| 全队合计 | 进球 | 被救 | 射失 | 击柱 | 封球 | 合计 | % |
|------|-----|----|----|----|----|-----|-------|
| 远射 | 35 | 32 | 11 | 9 | 13 | 100 | 35.0% |
| 近射 | 103 | 39 | 10 | 13 | | 165 | 62.4% |
| 边射 | 30 | 16 | 4 | 4 | | 54 | 55.6% |
| 快攻 | 49 | 10 | 3 | 2 | | 64 | 76.6% |
| 突破 | 33 | 8 | 1 | 1 | | 43 | 76.7% |
| 任意 | 10 | 11 | 3 | | | 24 | 41.7% |
| 7M | 15 | 4 | 3 | 1 | | 23 | 65.2% |

已打比赛

| 阶段 | 场次 | 对手 | 比分 |
|--------|----|-----|---------------|
| 预赛 | 2 | 浙江 | 30:15 (20:9) |
| 预赛 | 9 | 江苏 | 33:18 (22:11) |
| 预赛 | 14 | 解放军 | 29:24 (12:8) |
| 预赛 | 22 | 山东 | 33:42 (17:24) |
| 预赛 | 30 | 上海 | 37:26 (19:10) |
| 四分之一决赛 | 35 | 四川 | 30:39 (13:20) |
| 5-8名 | 40 | 江苏 | 45:35 (26:16) |
| 5-6名 | 44 | 北京 | 38:27 (16:11) |





2016年“体彩杯”全国手球男子青年锦标赛

图式射门区域累计

截止至第46场

201602046-42-1/1

广东队

Table with 11 columns representing players (1 王帅 to 11 胡国富) and 3 rows of statistics (Goals, Misses, Blocks) for each player.

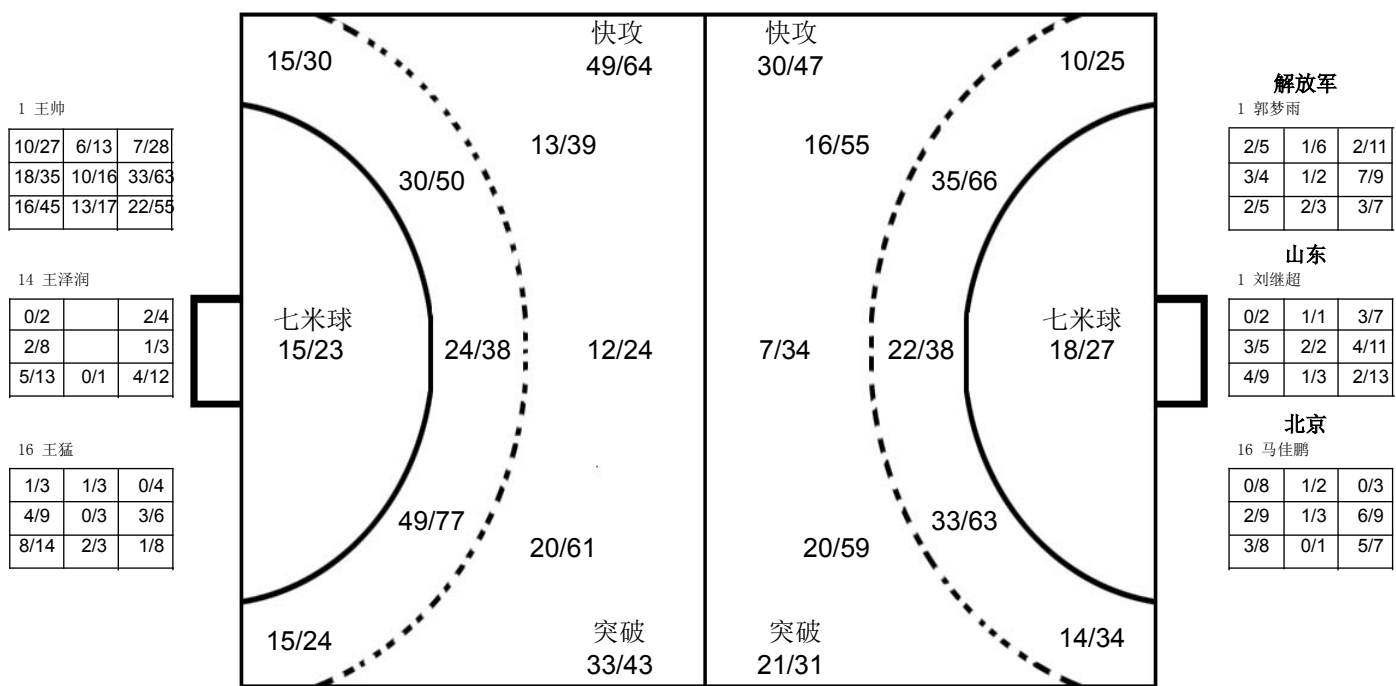

Table with 11 columns representing opponents (江苏, 山东, 北京, 四川, 上海, etc.) and 3 rows of statistics for each opponent.

注释: Post=击柱 Miss=射失 Block=被封



2016年“体彩杯”全国手球男子青年锦标赛

个人/全队技术累计表

正式表
手球
青年

截至第 46场

201602046-15-1/1
重庆万州
29/03/2016 16:00

| 号码 | 姓名 | 远射 | 近射 | 边射 | 快攻 | 突破 | 任意 | 7M | 合计 | % | 助攻 | 失误 | 警告 | 2' | 取消 | 场次 | 时间 |
|---------------|-----|-------|-------|------|------|-------|-----|-----|-------|-------|----|----|----|----|----|----|----------|
| 北京队 | | | | | | | | | | | | | | | | | |
| <i>(场上队员)</i> | | | | | | | | | | | | | | | | | |
| 3 | 王哲一 | 1/2 | 3/5 | 0/3 | 4/5 | | | | 8/15 | 53.3% | 3 | 8 | | | | 8 | 02:07:16 |
| 4 | 朱广刚 | 13/28 | 12/25 | | 5/5 | 10/14 | 6/7 | 2/5 | 48/84 | 57.1% | 21 | 36 | 3 | 8 | | 8 | 07:36:03 |
| 6 | 赵一涵 | 8/22 | 16/28 | 2/2 | 1/1 | 15/19 | 0/1 | | 42/73 | 57.5% | 15 | 31 | 5 | 5 | | 8 | 06:56:47 |
| 7 | 卞友山 | | 13/16 | 1/1 | 1/1 | | | 0/1 | 15/19 | 78.9% | | 2 | | 1 | | 8 | 02:30:58 |
| 11 | 李旭 | 1/3 | 12/19 | | | | | 5/6 | 18/28 | 64.3% | 3 | 12 | 4 | 2 | | 8 | 05:36:11 |
| 15 | 逯明松 | 0/8 | 4/9 | 3/8 | 1/2 | | | | 8/27 | 29.6% | 1 | 7 | 1 | 1 | | 8 | 04:11:23 |
| 16 | 马佳鹏 | | | | | | | | | 0.0% | | | | | | 8 | 06:27:05 |
| 18 | 李明远 | 1/8 | 3/11 | | 3/4 | 4/5 | 1/2 | | 12/30 | 40.0% | 7 | 27 | | 1 | | 8 | 02:58:06 |
| 19 | 陈旭 | 11/39 | 6/16 | 1/2 | 3/4 | 3/3 | | 2/3 | 26/67 | 38.8% | 8 | 34 | 2 | 2 | | 8 | 04:47:04 |
| 23 | 刘帅 | 3/5 | | | | | 0/3 | | 3/8 | 37.5% | 1 | 2 | | | | 8 | 00:23:44 |
| 25 | 张斌 | | 1/1 | 0/1 | 1/1 | | | | 2/3 | 66.7% | | 1 | | | | 7 | 00:42:24 |
| 26 | 吴锐樊 | 1/4 | 14/19 | 9/11 | 6/10 | 3/3 | | | 33/47 | 70.2% | 2 | 9 | 3 | 1 | | 8 | 05:41:26 |
| 35 | 高云健 | | | | | | | | | 0.0% | 1 | 1 | | | | 8 | 01:32:55 |
| 36 | 王鹏皓 | 1/2 | 8/19 | 7/15 | 8/9 | 1/1 | | 4/5 | 29/51 | 56.9% | 2 | 11 | 1 | 3 | | 8 | 04:42:34 |

| | | | | | | | | | | | | | | | | | |
|--------------|-----|--------|--------|-------|-------|-------|------|-------|---------|-------|----|-----|----|----|--|-----|----------|
| 合计 | | 40/121 | 92/168 | 23/43 | 33/42 | 36/45 | 7/13 | 13/20 | 244/452 | 54.0% | 64 | 181 | 19 | 24 | | 111 | |
| <i>(守门员)</i> | | | | | | | | | | | | | | | | | |
| 3 | 王哲一 | | | | | | | | | 0.0% | | | | | | 8 | 00:07:34 |
| 16 | 马佳鹏 | 30/69 | 33/105 | 23/45 | 10/42 | 9/34 | 3/10 | 4/12 | 112/317 | 35.3% | | | | | | 8 | 06:27:05 |
| 35 | 高云健 | 7/20 | 8/27 | 3/17 | 3/12 | 1/5 | 0/1 | 0/4 | 22/86 | 25.6% | 1 | 1 | | | | 8 | 01:32:55 |

| | | | | | | | | | | | | | | | | | |
|-----------|-------|--------|-------|-------|-------|------|------|---------|-------|---|---|--|--|--|--|----|--|
| 合计 | 37/89 | 41/132 | 26/62 | 13/54 | 10/39 | 3/11 | 4/16 | 134/403 | 33.3% | 1 | 1 | | | | | 24 | |
|-----------|-------|--------|-------|-------|-------|------|------|---------|-------|---|---|--|--|--|--|----|--|

场上队员：得分/射门

守门员：救球/射门

| 全队合计 | 进球 | 被救 | 射失 | 击柱 | 封球 | 合计 | % |
|------|----|----|----|----|----|-----|-------|
| 远射 | 40 | 41 | 16 | 7 | 17 | 121 | 33.1% |
| 近射 | 92 | 62 | 5 | 8 | 1 | 168 | 54.8% |
| 边射 | 23 | 12 | 2 | 6 | | 43 | 53.5% |
| 快攻 | 33 | 8 | 1 | | | 42 | 78.6% |
| 突破 | 36 | 6 | 1 | 2 | | 45 | 80.0% |
| 任意 | 7 | 3 | 2 | 1 | | 13 | 53.8% |
| 7M | 13 | 5 | | 2 | | 20 | 65.0% |

已打比赛

| 阶段 | 场次 | 对手 | 比分 |
|--------|----|-----|---------------|
| 预赛 | 4 | 安徽 | 26:38 (12:18) |
| 预赛 | 10 | 四川 | 29:35 (14:12) |
| 预赛 | 18 | 新疆 | 26:33 (13:17) |
| 预赛 | 19 | 辽宁 | 33:29 (18:11) |
| 预赛 | 26 | 天津 | 32:24 (14:15) |
| 四分之一决赛 | 33 | 山东 | 39:41 (18:18) |
| 5-8名 | 39 | 解放军 | 32:31 (18:14) |
| 5-6名 | 44 | 广东 | 27:38 (11:16) |





2016年“体彩杯”全国手球男子青年锦标赛
图式射门区域累计

截止至第46场

201602046-42-1/1

北京队

Player statistics for Beijing team including names like 王哲一, 朱广刚, 赵一涵, etc., with corresponding goalkeeping and shooting data.

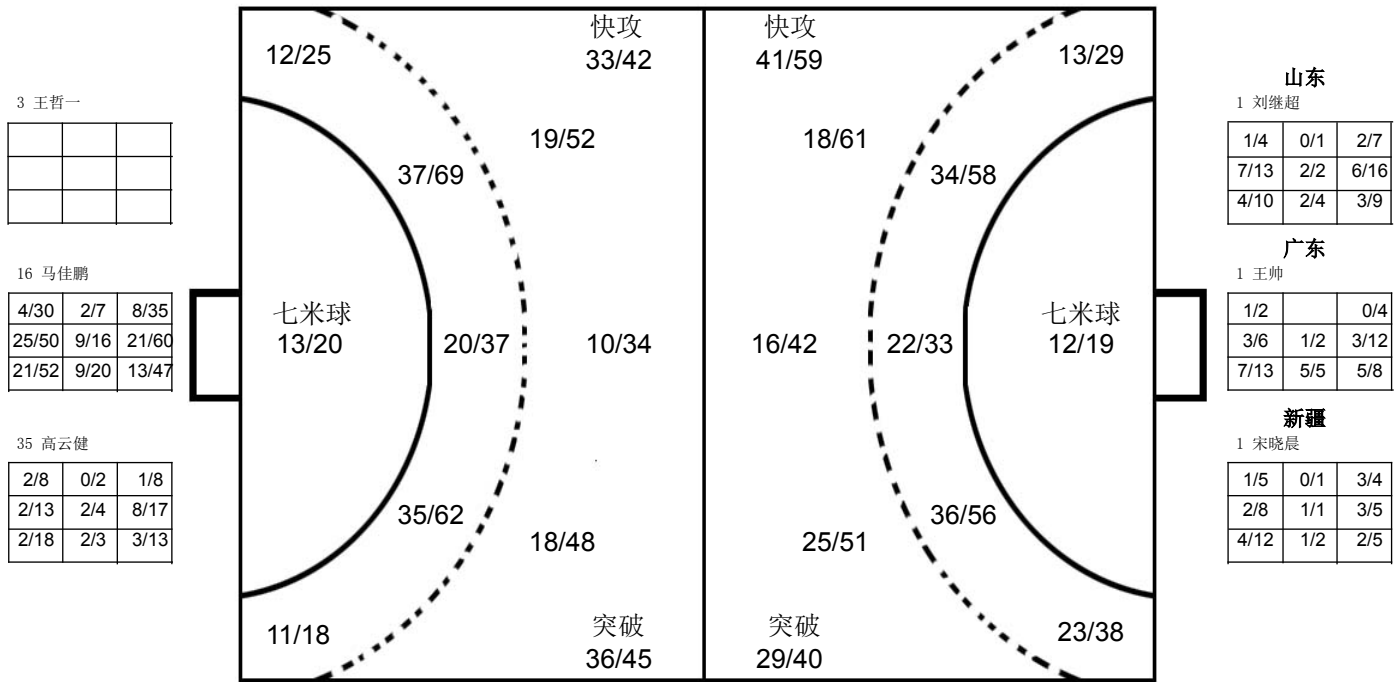

对手

Player statistics for the opponent team including names like 王柏淇, 刘赵梁, 孙芳伟, etc., with corresponding goalkeeping and shooting data.

注释: Post=击柱 Miss=射失 Block=被封





2016年“体彩杯”全国手球男子青年锦标赛

个人/全队技术累计表

正式表
手球
青年

截至第 46场

201602046-15-1/1
重庆万州
29/03/2016 16:00

| 号码 | 姓名 | 远射 | 近射 | 边射 | 快攻 | 突破 | 任意 | 7M | 合计 | % | 助攻 | 失误 | 警告 | 2' | 取消 | 场次 | 时间 |
|---------------|-----|-------|-------|-------|-------|------|-----|-----|-------|-------|----|----|----|----|----|----|----------|
| 解放军队 | | | | | | | | | | | | | | | | | |
| <i>(场上队员)</i> | | | | | | | | | | | | | | | | | |
| 1 | 郭梦雨 | 0/1 | | | | | | | 0/1 | 0.0% | 2 | 4 | | | | 8 | 06:26:01 |
| 3 | 张昌轲 | 16/33 | 13/22 | 0/1 | 3/3 | 9/11 | 3/6 | 3/5 | 47/81 | 58.0% | 43 | 41 | 3 | 5 | | 8 | 07:54:09 |
| 4 | 张洋 | | 1/1 | | | | | | 1/1 | 100% | | 1 | | | | 8 | 00:07:37 |
| 5 | 尹一楠 | | | | | | | | | 0.0% | | 2 | | | | 8 | 00:03:06 |
| 6 | 吴昊 | 6/29 | 18/27 | | 3/5 | 4/5 | 1/1 | 3/5 | 35/72 | 48.6% | 17 | 27 | 6 | 11 | | 8 | 07:34:48 |
| 7 | 姜钦 | 15/35 | 21/37 | 1/2 | 2/4 | 7/7 | 5/9 | 1/1 | 52/95 | 54.7% | 33 | 20 | 2 | 2 | | 8 | 07:55:36 |
| 8 | 邹峻楠 | | | | | | | | | 0.0% | | | | | | 8 | 00:00:00 |
| 9 | 李天枢 | | | | | | | | | 0.0% | | | | | | 8 | 00:00:00 |
| 10 | 范保坤 | 1/1 | 3/5 | 7/14 | 2/4 | | | | 13/24 | 54.2% | 3 | 3 | 1 | 3 | | 8 | 04:51:20 |
| 11 | 王誌汉 | 2/5 | 14/16 | 15/23 | 12/16 | | | | 43/60 | 71.7% | 4 | 13 | 4 | 2 | | 8 | 06:10:40 |
| 12 | 左子健 | | | | | | | | | 0.0% | | 1 | | | | 8 | 00:33:47 |
| 13 | 徐峻清 | 0/2 | 12/22 | 7/18 | 7/10 | | | | 26/52 | 50.0% | 4 | 13 | 3 | | | 8 | 05:23:49 |
| 14 | 孙耀琦 | 1/2 | 37/50 | | 4/6 | | | 7/9 | 49/67 | 73.1% | 5 | 10 | 4 | 4 | | 8 | 07:44:35 |
| 16 | 池猛 | | | | | | | | | 0.0% | | | | 1 | | 8 | 00:03:07 |
| 17 | 刘安宁 | | | | | | | | | 0.0% | | | | | | 8 | 00:05:54 |

| 合计 | | 41/108 | 119/180 | 30/58 | 33/48 | 20/23 | 9/16 | 14/20 | 266/453 | 58.7% | 111 | 135 | 23 | 28 | 120 | | |
|--------------|-----|--------|---------|-------|-------|-------|------|-------|---------|-------|-----|-----|----|----|-----|---|----------|
| <i>(守门员)</i> | | | | | | | | | | | | | | | | | |
| 1 | 郭梦雨 | 46/100 | 45/111 | 17/27 | 9/34 | 4/25 | 3/12 | 5/24 | 129/333 | 38.7% | 2 | 4 | | | | 8 | 06:26:01 |
| 12 | 左子健 | 4/9 | 4/10 | 2/4 | 5/9 | 1/1 | | 0/3 | 16/36 | 44.4% | | 1 | | | | 8 | 00:33:47 |
| 16 | 池猛 | | | | | | | | | 0.0% | | | | 1 | | 8 | 00:03:07 |

| 合计 | 50/109 | 49/121 | 19/31 | 14/43 | 5/26 | 3/12 | 5/27 | 145/369 | 39.3% | 2 | 5 | 1 | 24 |
|----|--------|--------|-------|-------|------|------|------|---------|-------|---|---|---|----|
|----|--------|--------|-------|-------|------|------|------|---------|-------|---|---|---|----|

场上队员：得分/射门

守门员：救球/射门

| 全队合计 | 进球 | 被救 | 射失 | 击柱 | 封球 | 合计 | % |
|------|-----|----|----|----|----|-----|-------|
| 远射 | 41 | 30 | 11 | 5 | 21 | 108 | 38.0% |
| 近射 | 119 | 46 | 9 | 6 | | 180 | 66.1% |
| 边射 | 30 | 24 | 3 | 1 | | 58 | 51.7% |
| 快攻 | 33 | 11 | 3 | 1 | | 48 | 68.8% |
| 突破 | 20 | 2 | 1 | | | 23 | 87.0% |
| 任意 | 9 | 2 | 3 | 2 | | 16 | 56.3% |
| 7M | 14 | 4 | | 2 | | 20 | 70.0% |

已打比赛

| 阶段 | 场次 | 对手 | 比分 |
|--------|----|----|---------------|
| 预赛 | 3 | 山东 | 33:35 (15:15) |
| 预赛 | 7 | 浙江 | 25:5 (25:5) |
| 预赛 | 14 | 广东 | 24:29 (8:12) |
| 预赛 | 23 | 上海 | 35:20 (16:10) |
| 预赛 | 29 | 江苏 | 37:30 (17:19) |
| 四分之一决赛 | 34 | 新疆 | 36:40 (15:23) |
| 5-8名 | 39 | 北京 | 31:32 (14:18) |
| 7-8名 | 43 | 江苏 | 45:33 (21:15) |





2016年“体彩杯”全国手球男子青年锦标赛
图式射门区域累计

截止至第46场

201602046-42-1/1

解放军队

Table with 18 columns representing players (1-18) and 3 rows of statistics (Goals, Misses, Blocks) for each player.

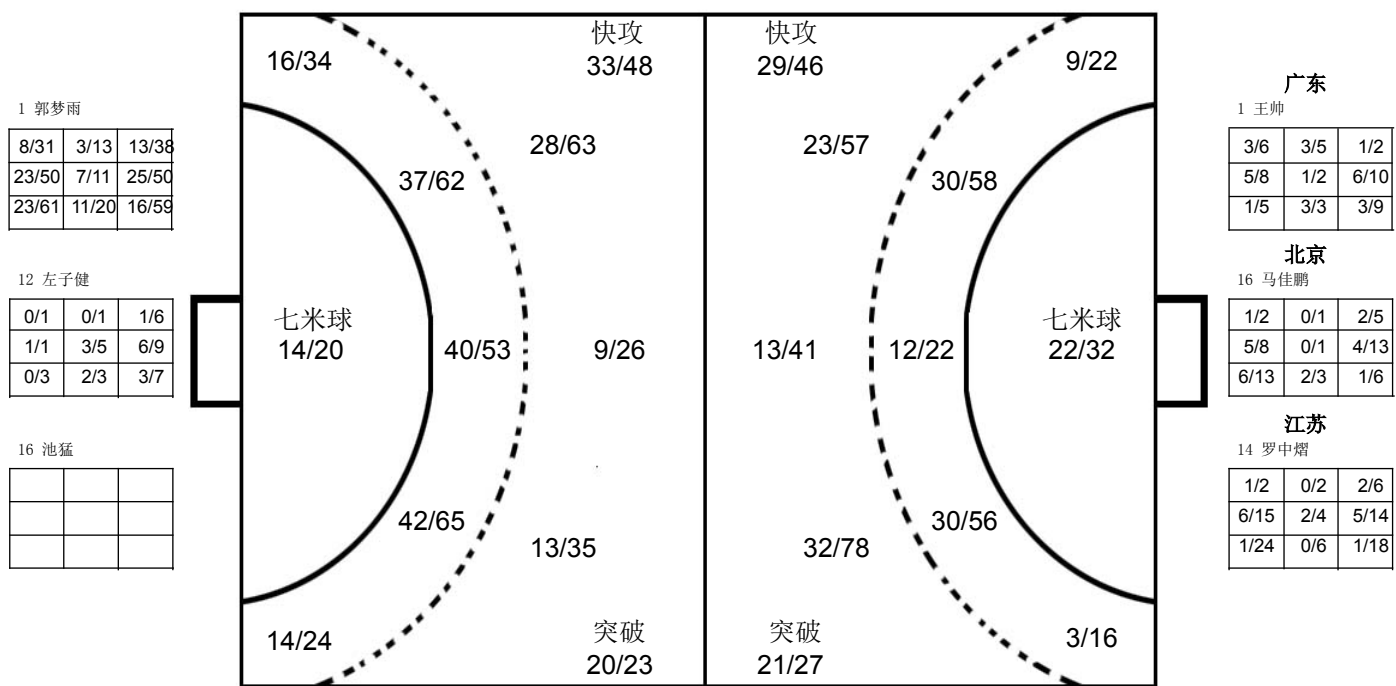

Table with 18 columns representing opponents (1-18) and 3 rows of statistics (Goals, Misses, Blocks) for each opponent.

注释: Post=击柱 Miss=射失 Block=被封



2016年“体彩杯”全国手球男子青年锦标赛

个人/全队技术累计表

正式表
手球
青年201602046-15-1/1
重庆万州
29/03/2016 16:00

截至第 46场

| 号码 | 姓名 | 远射 | 近射 | 边射 | 快攻 | 突破 | 任意 | 7M | 合计 | % | 助攻 | 失误 | 警告 | 2' | 取消 | 场次 | 时间 |
|---------------|-----|--------|---------|-------|-------|-------|------|-------|---------|-------|----|-----|----|----|----|-----|----------|
| 江苏队 | | | | | | | | | | | | | | | | | |
| <i>(场上队员)</i> | | | | | | | | | | | | | | | | | |
| 1 | 潘博琦 | | | | | | | | | 0.0% | | 2 | | | | 8 | 03:42:18 |
| 3 | 赵韦光 | 0/1 | 5/10 | 1/7 | 1/3 | 1/1 | | | 8/22 | 36.4% | 2 | 1 | 2 | 2 | | 8 | 01:55:52 |
| 4 | 张瑞恒 | | 1/2 | | | | | | 1/2 | 50.0% | | 5 | | 1 | | 8 | 01:57:25 |
| 6 | 季雨 | | 1/2 | 1/1 | | | | | 2/3 | 66.7% | 2 | 9 | | 1 | | 8 | 01:53:14 |
| 7 | 任超凡 | 3/5 | 10/17 | 4/16 | 4/5 | | 0/1 | | 21/44 | 47.7% | 5 | 15 | 1 | 1 | | 8 | 06:34:41 |
| 8 | 姜童耀 | 2/3 | 4/8 | 4/6 | 1/1 | | | 1/1 | 12/19 | 63.2% | | 5 | 2 | | | 8 | 02:45:17 |
| 9 | 王俊威 | | 2/3 | 1/3 | 1/1 | 1/1 | 0/1 | | 5/9 | 55.6% | 3 | 5 | | | | 8 | 03:23:56 |
| 11 | 周傲 | 22/61 | 28/55 | 5/10 | 4/12 | 6/11 | 4/7 | 6/9 | 75/165 | 45.5% | 41 | 46 | 3 | 3 | | 8 | 07:28:19 |
| 13 | 尹吉祥 | 21/73 | 13/25 | 0/1 | 2/6 | 5/8 | 2/2 | 3/8 | 46/123 | 37.4% | 11 | 36 | 2 | 2 | | 8 | 06:56:56 |
| 14 | 罗中熠 | | 1/3 | 1/1 | | | | | 2/4 | 50.0% | | 3 | | | 1 | 7 | 02:33:49 |
| 15 | 阎冠中 | | 0/1 | 0/4 | | | | 3/6 | 3/11 | 27.3% | | 13 | 1 | 2 | | 8 | 02:12:24 |
| 17 | 马益奎 | 1/5 | 25/34 | 2/6 | 3/4 | | 0/1 | 1/1 | 32/51 | 62.7% | 5 | 12 | 6 | 6 | | 8 | 07:23:56 |
| 18 | 耿畅 | 4/20 | 12/25 | 4/6 | 10/13 | 1/2 | | 0/1 | 31/67 | 46.3% | 4 | 17 | 3 | 3 | | 8 | 06:11:05 |
| 合计 | | 53/168 | 102/185 | 23/61 | 26/45 | 14/23 | 6/12 | 14/26 | 238/520 | 45.8% | 73 | 169 | 20 | 21 | 1 | 103 | |
| <i>(守门员)</i> | | | | | | | | | | | | | | | | | |
| 1 | 潘博琦 | 19/39 | 23/65 | 6/13 | 6/32 | 0/9 | 2/10 | 1/10 | 57/178 | 32.0% | | 2 | | | | 8 | 03:42:18 |
| 4 | 张瑞恒 | 2/13 | 4/23 | 3/7 | 2/15 | 4/14 | 1/6 | 0/1 | 16/79 | 20.3% | | | | | | 8 | 01:24:53 |
| 13 | 尹吉祥 | 3/9 | 2/11 | 4/7 | 0/3 | 0/1 | 2/2 | | 11/33 | 33.3% | 1 | | | | | 8 | 02:47:51 |
| 14 | 罗中熠 | 2/15 | 9/46 | 7/14 | 1/12 | 0/7 | 1/4 | 0/5 | 20/103 | 19.4% | | | | | 1 | 7 | 01:55:38 |
| 合计 | | 26/76 | 38/145 | 20/41 | 9/62 | 4/31 | 6/22 | 1/16 | 104/393 | 26.5% | 1 | 2 | | | 1 | 31 | |

场上队员：得分/射门

守门员：救球/射门

| 全队合计 | 进球 | 被救 | 射失 | 击柱 | 封球 | 合计 | % |
|------|-----|----|----|----|----|-----|-------|
| 远射 | 53 | 57 | 16 | 8 | 34 | 168 | 31.5% |
| 近射 | 102 | 59 | 13 | 9 | 2 | 185 | 55.1% |
| 边射 | 23 | 29 | 6 | 3 | | 61 | 37.7% |
| 快攻 | 26 | 15 | 2 | 2 | | 45 | 57.8% |
| 突破 | 14 | 8 | | 1 | | 23 | 60.9% |
| 任意 | 6 | 2 | 3 | 1 | | 12 | 50.0% |
| 7M | 14 | 6 | 4 | 2 | | 26 | 53.8% |

已打比赛

| 阶段 | 场次 | 对手 | 比分 |
|--------|----|-----|---------------|
| 预赛 | 1 | 上海 | 32:29 (20:12) |
| 预赛 | 9 | 广东 | 18:33 (11:22) |
| 预赛 | 13 | 山东 | 26:33 (10:16) |
| 预赛 | 24 | 浙江 | 37:26 (19:8) |
| 预赛 | 29 | 解放军 | 30:37 (19:17) |
| 四分之一决赛 | 36 | 安徽 | 27:41 (10:22) |
| 5-8名 | 40 | 广东 | 35:45 (16:26) |
| 7-8名 | 43 | 解放军 | 33:45 (15:21) |





2016年“体彩杯”全国手球男子青年锦标赛

图式射门区域累计

截止至第46场

201602046-42-1/1

江苏队

Player statistics for Jiangsu team including names like 潘博琦, 赵韦光, 张瑞恒, etc., and their respective goal counts in different areas.

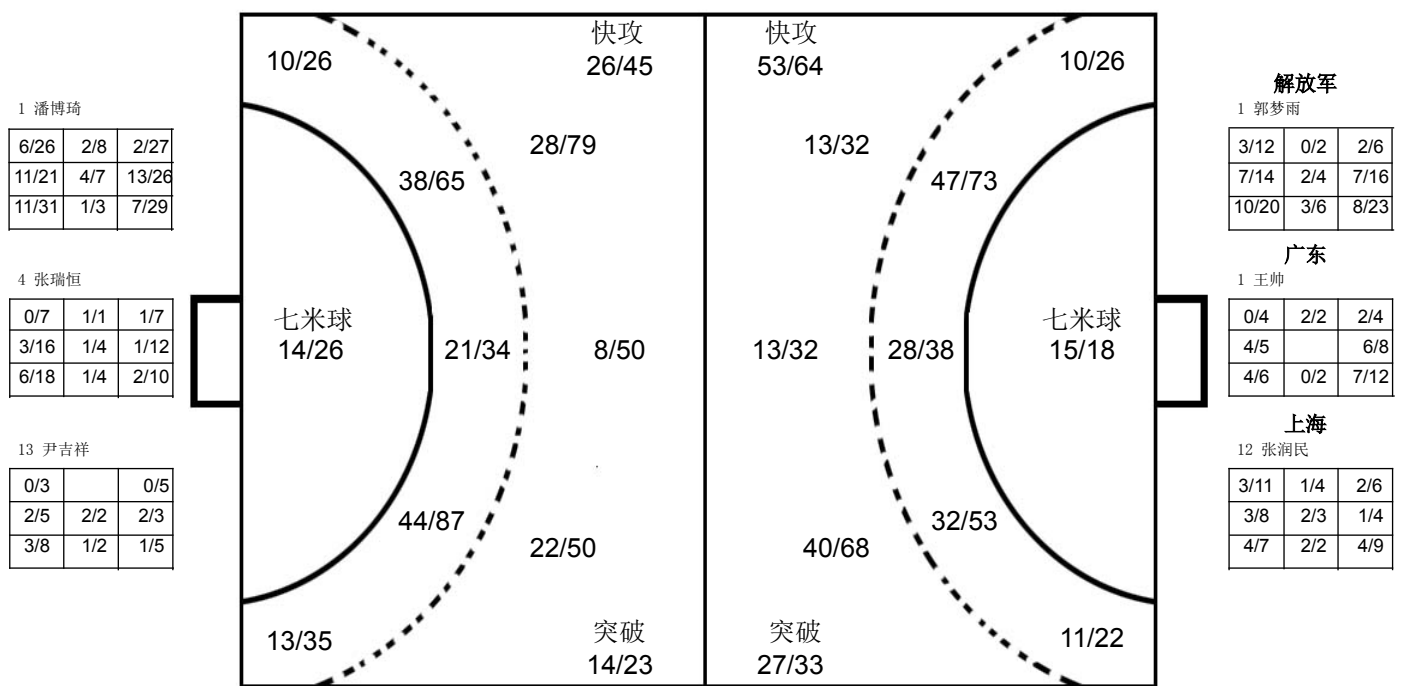

Opponent statistics table for 对手 (Opponent) listing players from teams like 解放军, 广东, 上海, etc., and their performance metrics.

注释: Post=击柱 Miss=射失 Block=被封



2016年“体彩杯”全国手球男子青年锦标赛

个人/全队技术累计表

正式表
手球
青年

截至第 46场

201602046-15-1/1
重庆万州
29/03/2016 16:00

| 号码 | 姓名 | 远射 | 近射 | 边射 | 快攻 | 突破 | 任意 | 7M | 合计 | % | 助攻 | 失误 | 警告 | 2' | 取消 | 场次 | 时间 |
|---------------|-----|-------|-------|-------|------|-------|-----|-----|--------|-------|----|----|----|----|----|----|----------|
| 辽宁队 | | | | | | | | | | | | | | | | | |
| <i>(场上队员)</i> | | | | | | | | | | | | | | | | | |
| 1 | 高尚君 | 1/1 | | | | | | | 1/1 | 100% | 5 | 3 | | | | 7 | 05:36:00 |
| 2 | 王司雨 | 2/2 | 6/8 | | | | | | 8/10 | 80.0% | 2 | 10 | 2 | 2 | 1 | 6 | 02:28:00 |
| 3 | 李星浩 | | 13/21 | | | | | | 13/21 | 61.9% | 3 | 3 | 4 | 1 | | 7 | 02:53:34 |
| 5 | 余昊锦 | 1/12 | 3/3 | 1/1 | 2/2 | | | | 7/18 | 38.9% | 3 | 8 | 3 | | | 7 | 02:30:32 |
| 6 | 陈庆港 | 2/12 | 8/14 | 11/15 | 6/7 | 3/5 | | 1/1 | 31/54 | 57.4% | 14 | 19 | 1 | | | 7 | 05:09:13 |
| 7 | 孙义广 | | 7/7 | 4/6 | 5/8 | | | | 16/21 | 76.2% | 1 | 5 | 2 | 2 | | 7 | 03:44:18 |
| 8 | 王鑫鹏 | | 1/6 | 2/5 | 0/1 | | | | 3/12 | 25.0% | | 4 | | | | 7 | 02:29:53 |
| 10 | 王柏淇 | 11/41 | 9/23 | 1/2 | 8/11 | 14/16 | 1/6 | 7/8 | 51/107 | 47.7% | 19 | 34 | | 1 | | 7 | 04:01:16 |
| 11 | 庞东阳 | 10/21 | 8/10 | 1/5 | 6/7 | 3/5 | 0/1 | 1/1 | 29/50 | 58.0% | 14 | 25 | 2 | 2 | | 7 | 04:42:01 |
| 13 | 杨洁 | 5/16 | 3/10 | 1/2 | 3/4 | 1/1 | | 1/1 | 14/34 | 41.2% | 1 | 7 | 2 | 4 | | 7 | 03:08:27 |
| 14 | 吕昊臻 | 3/7 | 6/7 | 0/1 | 0/1 | 1/1 | 0/1 | 1/1 | 11/19 | 57.9% | | 4 | | | | 7 | 01:15:10 |
| 16 | 吴阳 | | | 1/1 | | | | | 1/1 | 100% | | | | 1 | | 7 | 00:32:05 |
| 17 | 李傲 | | | | | | | | 0.0% | 0.0% | 1 | 1 | | | | 7 | 00:16:10 |
| 18 | 梅凯博 | | | | | | | | 0.0% | 0.0% | | | | 1 | | 7 | 00:10:14 |
| 19 | 赵鑫 | | | | | | | | 0.0% | 0.0% | 1 | | | 1 | | 7 | 00:13:50 |
| 20 | 赵佛赐 | | | | | | | | 0.0% | 0.0% | 1 | | | | | 7 | 00:13:50 |

| | | | | | | | | | | | | | | | | | |
|-----------|--|--------|--------|-------|-------|-------|-----|-------|---------|-------|----|-----|----|----|---|-----|--|
| 合计 | | 35/112 | 64/109 | 22/38 | 30/41 | 22/28 | 1/8 | 11/12 | 185/348 | 53.2% | 62 | 125 | 17 | 15 | 1 | 111 | |
|-----------|--|--------|--------|-------|-------|-------|-----|-------|---------|-------|----|-----|----|----|---|-----|--|

(守门员)

| | | | | | | | | | | | | | | | | | |
|---|-----|-------|-------|-------|------|------|-----|-----|--------|-------|---|---|--|--|--|---|----------|
| 1 | 高尚君 | 27/61 | 27/93 | 14/36 | 6/48 | 2/24 | 1/2 | 3/9 | 80/273 | 29.3% | 5 | 3 | | | | 7 | 05:36:00 |
|---|-----|-------|-------|-------|------|------|-----|-----|--------|-------|---|---|--|--|--|---|----------|

| | | | | | | | | | | | | | | | | | |
|-----------|--|-------|-------|-------|------|------|-----|-----|--------|-------|---|---|--|--|--|---|--|
| 合计 | | 27/61 | 27/93 | 14/36 | 6/48 | 2/24 | 1/2 | 3/9 | 80/273 | 29.3% | 5 | 3 | | | | 7 | |
|-----------|--|-------|-------|-------|------|------|-----|-----|--------|-------|---|---|--|--|--|---|--|

场上队员：得分/射门

守门员：救球/射门

| 全队合计 | 进球 | 被救 | 射失 | 击柱 | 封球 | 合计 | % |
|------|----|----|----|----|----|-----|-------|
| 远射 | 35 | 38 | 23 | 5 | 11 | 112 | 31.3% |
| 近射 | 64 | 30 | 9 | 6 | | 109 | 58.7% |
| 边射 | 22 | 8 | 2 | 6 | | 38 | 57.9% |
| 快攻 | 30 | 5 | 3 | 3 | | 41 | 73.2% |
| 突破 | 22 | 4 | 2 | | | 28 | 78.6% |
| 任意 | 1 | 6 | | 1 | | 8 | 12.5% |
| 7M | 11 | | | 1 | | 12 | 91.7% |

已打比赛

| 阶段 | 场次 | 对手 | 比分 |
|-------|----|----|---------------|
| 预赛 | 5 | 四川 | 16:31 (14:20) |
| 预赛 | 12 | 天津 | 30:31 (18:14) |
| 预赛 | 16 | 安徽 | 37:40 (23:17) |
| 预赛 | 19 | 北京 | 29:33 (11:18) |
| 预赛 | 25 | 新疆 | 17:32 (10:19) |
| 9-12名 | 32 | 上海 | 27:12 (25:12) |
| 9-10名 | 38 | 浙江 | 29:14 (19:12) |





2016年“体彩杯”全国手球男子青年锦标赛 图式射门区域累计

截止至第46场

201602046-42-1/1

辽宁队

| | | | | | | | | | | | | | | | | | |
|-----------------------------|-----------------------------|-----------------------------|-----------------------------|-----------------------------|-----------------------------|-----------------------------|------------------------------|---|---|---|---|---|---|----|---|---|---|
| 1 高尚君 | 2 王司雨 | 3 李星浩 | 5 余昊锦 | 6 陈庆港 | 7 孙义广 | 8 王鑫鹏 | 10 王柏淇 | | | | | | | | | | |
| 1 | | | 3 | | 1 | | | | 5 | 2 | 5 | | | | | | |
| | | | 3 | | | 2 | 1 | 2 | 3 | | | 7 | | 12 | | | |
| | | | 3 | | 2 | 2 | | | 6 | 3 | 6 | 1 | 1 | 1 | 9 | 4 | 7 |
| Post - 0 Miss - 0 Block - 0 | Post - 1 Miss - 0 Block - 0 | Post - 0 Miss - 1 Block - 0 | Post - 0 Miss - 2 Block - 2 | Post - 2 Miss - 7 Block - 1 | Post - 2 Miss - 1 Block - 0 | Post - 2 Miss - 3 Block - 0 | Post - 6 Miss - 13 Block - 5 | | | | | | | | | | |
| 11 庞东阳 | 13 杨洁 | 14 吴昊臻 | 16 吴阳 | 17 李傲 | 18 梅凯博 | 19 赵鑫 | 20 赵佛赐 | | | | | | | | | | |
| 2 | 1 | | 2 | 1 | 1 | 1 | 1 | 2 | | | | | | | | | |
| 3 | 1 | 2 | 1 | | 2 | 1 | | 1 | | | | | | | | | |
| 8 | 1 | 11 | 4 | 1 | 2 | 1 | 1 | 3 | | | | | | | | | |
| Post - 3 Miss - 7 Block - 1 | Post - 6 Miss - 5 Block - 2 | Post - 0 Miss - 0 Block - 0 | Post - 0 Miss - 0 Block - 0 | Post - 0 Miss - 0 Block - 0 | Post - 0 Miss - 0 Block - 0 | Post - 0 Miss - 0 Block - 0 | Post - 0 Miss - 0 Block - 0 | | | | | | | | | | |

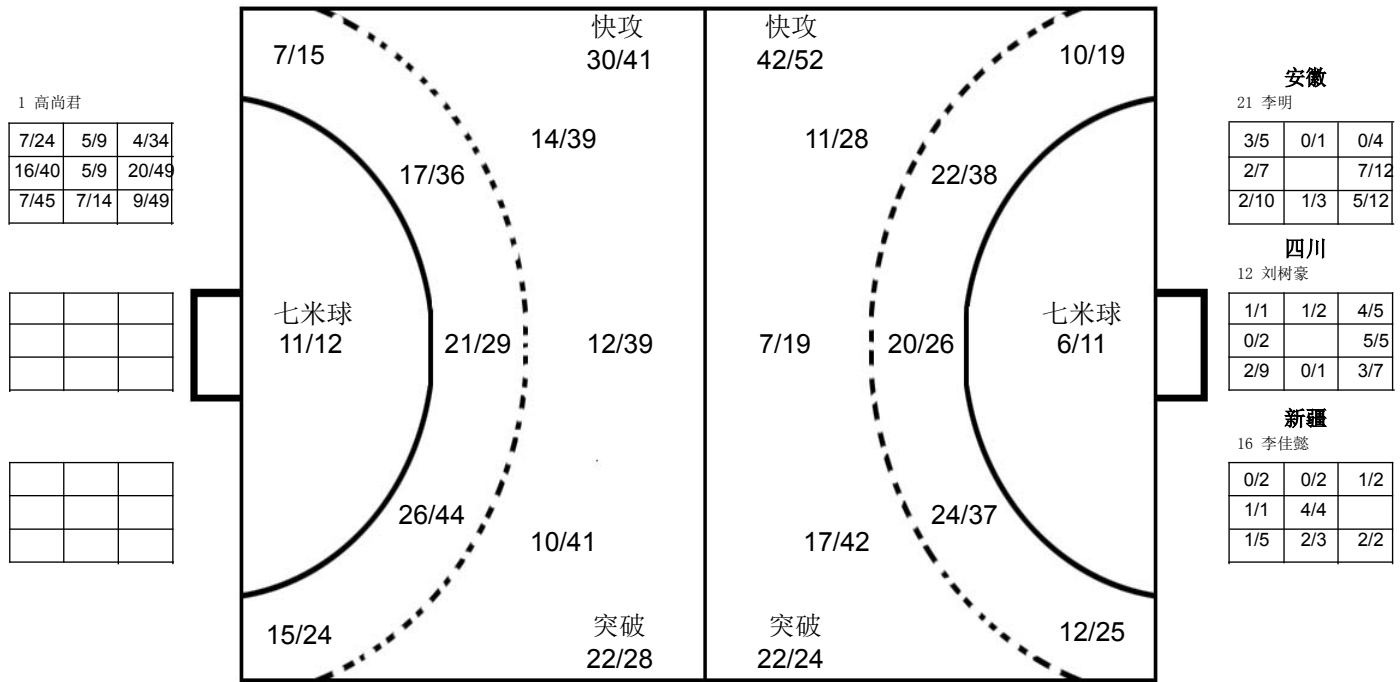

1 高尚君

| | | |
|-------|------|-------|
| 7/24 | 5/9 | 4/34 |
| 16/40 | 5/9 | 20/49 |
| 7/45 | 7/14 | 9/49 |

| | | |
|--|--|--|
| | | |
| | | |
| | | |

| | | |
|--|--|--|
| | | |
| | | |
| | | |

安徽

21 李明

| | | |
|------|-----|------|
| 3/5 | 0/1 | 0/4 |
| 2/7 | | 7/12 |
| 2/10 | 1/3 | 5/12 |

四川

12 刘树豪

| | | |
|-----|-----|-----|
| 1/1 | 1/2 | 4/5 |
| 0/2 | | 5/5 |
| 2/9 | 0/1 | 3/7 |

新疆

16 李佳懿

| | | |
|-----|-----|-----|
| 0/2 | 0/2 | 1/2 |
| 1/1 | 4/4 | |
| 1/5 | 2/3 | 2/2 |

对手

| | | | | | | | | |
|-----------------------------|-----------------------------|-----------------------------|-----------------------------|-----------------------------|-----------------------------|-----------------------------|-----------------------------|---|
| 安徽 | 浙江 | 北京 | 四川 | 安徽 | 北京 | 四川 | 四川 | |
| 9 陈开勇 | 3 郑尧俊 | 26 吴锐樊 | 8 罗尧尧 | 17 王巨柱 | 4 朱广刚 | 5 王凯 | 10 徐彦昊 | |
| 4 | 1 | 1 | | | | 1 | 1 | 1 |
| 3 | | | 1 | | | | | |
| 3 | | 1 | 2 | | 3 | 2 | 1 | 2 |
| 3 | 1 | 3 | 1 | 1 | 2 | 3 | 1 | 3 |
| Post - 0 Miss - 1 Block - 0 | Post - 0 Miss - 0 Block - 0 | Post - 0 Miss - 2 Block - 1 | Post - 0 Miss - 1 Block - 0 | Post - 2 Miss - 1 Block - 1 | Post - 0 Miss - 0 Block - 0 | Post - 0 Miss - 0 Block - 0 | Post - 0 Miss - 1 Block - 0 | |
| 天津 | 天津 | 新疆 | 安徽 | 上海 | 天津 | 新疆 | 安徽 | |
| 18 王晓琪 | 22 魏雨童 | 13 苏兴伟 | 18 李双 | 10 董凯 | 9 吴明远 | 2 王泽川 | 26 程浩然 | |
| 1 | | 2 | | | 1 | | | |
| 1 | | 1 | | | 1 | | | |
| 1 | 1 | | 1 | | 2 | 1 | 2 | |
| 1 | | 3 | 3 | | 1 | 1 | 2 | 1 |
| 1 | 1 | 1 | 1 | 1 | 1 | 1 | 1 | 2 |
| 2 | 1 | 1 | 2 | 1 | 1 | 1 | 1 | 2 |
| Post - 0 Miss - 2 Block - 0 | Post - 1 Miss - 3 Block - 0 | Post - 0 Miss - 1 Block - 0 | Post - 0 Miss - 2 Block - 0 | Post - 0 Miss - 0 Block - 1 | Post - 1 Miss - 0 Block - 0 | Post - 0 Miss - 0 Block - 0 | Post - 1 Miss - 0 Block - 0 | |

注释: Post=击柱 Miss=射失 Block=被封





2016年“体彩杯”全国手球男子青年锦标赛

个人/全队技术累计表

正式表
手球
青年

截至第 46场

201602046-15-1/1
重庆万州
29/03/2016 16:00

| 号码 | 姓名 | 远射 | 近射 | 边射 | 快攻 | 突破 | 任意 | 7M | 合计 | % | 助攻 | 失误 | 警告 | 2' | 取消 | 场次 | 时间 |
|---------------|-----|-------|-------|-------|-------|-------|------|-------|--------|-------|----|-----|----|----|----|----|----------|
| 浙江队 | | | | | | | | | | | | | | | | | |
| <i>(场上队员)</i> | | | | | | | | | | | | | | | | | |
| 1 | 林先方 | 2/10 | 8/17 | 3/16 | 4/8 | 5/5 | 0/1 | 11/14 | 33/71 | 46.5% | 10 | 45 | 4 | 2 | | 7 | 05:21:15 |
| 2 | 李恩铭 | 0/4 | 8/17 | 2/12 | 3/7 | | | | 13/40 | 32.5% | 1 | 17 | 2 | 2 | | 7 | 04:54:30 |
| 3 | 郑尧俊 | 2/10 | 6/13 | 1/2 | 8/9 | 12/14 | | | 29/48 | 60.4% | 9 | 42 | 3 | 4 | | 7 | 05:19:17 |
| 5 | 高家南 | 0/1 | 0/1 | | | | | | 0/2 | 0.0% | | 5 | 2 | | | 7 | 02:43:32 |
| 9 | 李家乐 | | 0/3 | 2/4 | | | | | 2/7 | 28.6% | 1 | | | | | 7 | 02:10:00 |
| 10 | 徐正飞 | 0/1 | 1/1 | 1/1 | | | | | 2/3 | 66.7% | | 5 | 1 | 1 | | 7 | 02:46:02 |
| 14 | 虞勇灿 | | | | | | | | | 0.0% | 2 | 2 | | | | 7 | 02:30:21 |
| 15 | 张佩力 | | | | | | | | | 0.0% | | | | | | 7 | 02:48:57 |
| 17 | 罗明杰 | 0/1 | 1/3 | | | | | | 1/4 | 25.0% | 1 | 7 | 1 | | | 7 | 03:30:15 |
| 18 | 倪陈辉 | 8/43 | 5/9 | 0/1 | | | 4/12 | 1/1 | 18/66 | 27.3% | 5 | 59 | 5 | 4 | | 7 | 05:10:33 |
| 19 | 王浩 | | | | | | | | | 0.0% | | | | | | 7 | 00:18:59 |
| 合计 | | 12/70 | 29/64 | 9/36 | 15/24 | 17/19 | 4/13 | 12/15 | 98/241 | 40.7% | 29 | 182 | 18 | 13 | | 77 | |
| <i>(守门员)</i> | | | | | | | | | | | | | | | | | |
| 1 | 林先方 | | | | | | | | | 0.0% | 3 | 7 | | 1 | | 7 | 01:53:20 |
| 14 | 虞勇灿 | 12/38 | 8/42 | 6/16 | 3/23 | 0/7 | 1/2 | 0/5 | 30/133 | 22.6% | 2 | 2 | | | | 7 | 02:30:21 |
| 15 | 张佩力 | 9/31 | 13/53 | 6/14 | 1/25 | 0/9 | 1/2 | 0/3 | 30/137 | 21.9% | | | | | | 7 | 02:48:57 |
| 合计 | | 21/69 | 21/95 | 12/30 | 4/48 | 0/16 | 2/4 | 0/8 | 60/270 | 22.2% | 5 | 9 | | 1 | | 21 | |

场上队员：得分/射门

守门员：救球/射门

| 全队合计 | 进球 | 被救 | 射失 | 击柱 | 封球 | 合计 | % |
|------|----|----|----|----|----|----|-------|
| 远射 | 12 | 30 | 6 | 2 | 20 | 70 | 17.1% |
| 近射 | 29 | 23 | 7 | 5 | 64 | 64 | 45.3% |
| 边射 | 9 | 16 | 10 | 1 | 36 | 36 | 25.0% |
| 快攻 | 15 | 6 | 2 | 1 | 24 | 24 | 62.5% |
| 突破 | 17 | 1 | 1 | | 19 | 19 | 89.5% |
| 任意 | 4 | 3 | 3 | 3 | 13 | 13 | 30.8% |
| 7M | 12 | 3 | | | 15 | 15 | 80.0% |

已打比赛

| 阶段 | 场次 | 对手 | 比分 |
|-------|----|-----|---------------|
| 预赛 | 2 | 广东 | 15:30 (9:20) |
| 预赛 | 7 | 解放军 | 5:25 (5:25) |
| 预赛 | 15 | 上海 | 4:25 (4:25) |
| 预赛 | 24 | 江苏 | 26:37 (8:19) |
| 预赛 | 28 | 山东 | 22:37 (9:23) |
| 9-12名 | 31 | 天津 | 12:27 (11:19) |
| 9-10名 | 38 | 辽宁 | 14:29 (12:19) |





2016年“体彩杯”全国手球男子青年锦标赛

图式射门区域累计

截止至第46场

201602046-42-1/1

浙江队

Player statistics for Zhejiang team including names like 林先方, 李恩铭, 郑尧俊, etc., with corresponding goal counts in a grid format.

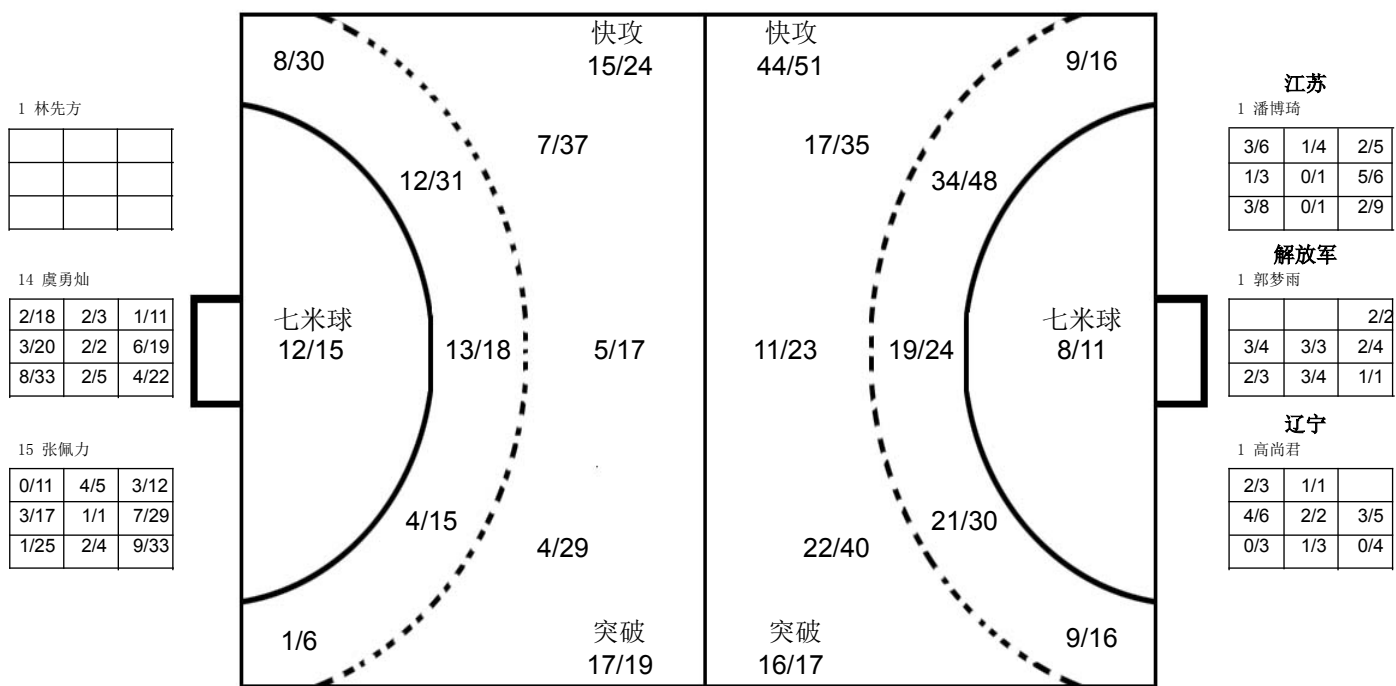

对手

Opponent statistics for various teams including Jiangsu, Tianjin, Liaoning, Shandong, and Guangdong, with player names and goal counts.

注释: Post=击柱 Miss=射失 Block=被封



2016年“体彩杯”全国手球男子青年锦标赛

个人/全队技术累计表

正式表
手球
青年201602046-15-1/1
重庆万州
29/03/2016 16:00

截至第 46场

| 号码 | 姓名 | 远射 | 近射 | 边射 | 快攻 | 突破 | 任意 | 7M | 合计 | % | 助攻 | 失误 | 警告 | 2' | 取消 | 场次 | 时间 |
|---------------|-----|-------|-------|-------|-------|------|-----|-----|-------|-------|----|----|----|----|----|----|----------|
| 新疆队 | | | | | | | | | | | | | | | | | |
| <i>(场上队员)</i> | | | | | | | | | | | | | | | | | |
| 1 | 宋晓晨 | | | | | | | | | 0.0% | 11 | 4 | | | | 8 | 06:43:09 |
| 2 | 王泽川 | | 8/11 | | 2/2 | | | 2/2 | 12/15 | 80.0% | | 4 | 1 | 3 | | 8 | 01:46:49 |
| 4 | 谷通金 | 0/2 | 5/6 | 1/2 | 3/5 | 0/1 | | | 9/16 | 56.3% | 2 | 2 | 1 | | | 8 | 02:29:25 |
| 5 | 徐伟 | | 10/13 | 17/27 | 9/15 | 0/1 | | 1/1 | 37/57 | 64.9% | 5 | 9 | 1 | 1 | | 8 | 06:05:32 |
| 6 | 白光宇 | 1/1 | 3/4 | 0/2 | | | 0/1 | | 4/8 | 50.0% | | 2 | | | | 8 | 00:50:03 |
| 7 | 林豪文 | 20/50 | 8/13 | 2/3 | 3/4 | 3/4 | 4/6 | 6/7 | 46/87 | 52.9% | 26 | 15 | 5 | 5 | | 8 | 06:22:24 |
| 10 | 王钟彬 | 12/35 | 15/23 | 0/1 | 6/9 | 7/9 | 1/3 | 0/1 | 41/81 | 50.6% | 9 | 20 | 2 | 8 | | 8 | 06:00:45 |
| 12 | 王金鑫 | | | | | | | | | 0.0% | | | | | | 8 | 00:15:01 |
| 13 | 苏兴伟 | 3/10 | 4/5 | 0/1 | 5/7 | 1/1 | 1/1 | | 14/25 | 56.0% | 4 | 8 | | 2 | | 8 | 01:26:13 |
| 15 | 王维东 | 3/8 | 6/11 | 8/15 | 8/10 | 4/4 | | 1/1 | 30/49 | 61.2% | 4 | 16 | | 1 | | 8 | 06:02:34 |
| 16 | 李佳懿 | | | | | | | | | 0.0% | 1 | 1 | | | | 8 | 00:47:45 |
| 17 | 胡晋铭 | 0/2 | 25/29 | 0/1 | 1/1 | | | | 26/33 | 78.8% | 2 | 8 | 5 | 5 | | 8 | 06:07:43 |
| 18 | 李万兴 | 2/3 | 1/2 | 1/1 | 2/3 | 1/1 | | | 7/10 | 70.0% | 2 | 9 | | | | 8 | 01:26:33 |
| 19 | 李龙吉 | 4/9 | 16/32 | 1/1 | 11/13 | 8/12 | 0/1 | 6/9 | 46/77 | 59.7% | 13 | 41 | 4 | 1 | | 8 | 06:12:39 |
| 24 | 陈伟华 | 2/5 | 4/4 | 1/4 | 2/2 | 1/1 | | 0/1 | 10/17 | 58.8% | 3 | 7 | 2 | 1 | | 8 | 01:49:35 |

| | | | | | | | | | | | | | | | | | |
|--------------|-----|--------|---------|-------|-------|-------|------|-------|---------|-------|----|-----|----|----|--|-----|----------|
| 合计 | | 47/125 | 105/153 | 31/58 | 52/71 | 25/34 | 6/12 | 16/22 | 282/475 | 59.4% | 82 | 146 | 21 | 27 | | 120 | |
| <i>(守门员)</i> | | | | | | | | | | | | | | | | | |
| 1 | 宋晓晨 | 37/67 | 50/125 | 19/45 | 4/33 | 3/17 | 6/10 | 7/23 | 126/320 | 39.4% | 11 | 4 | | | | 8 | 06:43:09 |
| 12 | 王金鑫 | 1/2 | 3/5 | 0/1 | | 1/3 | 0/1 | 0/1 | 5/13 | 38.5% | | | | | | 8 | 00:15:01 |
| 16 | 李佳懿 | 3/5 | 7/20 | 2/8 | 1/4 | | 2/3 | 1/3 | 16/43 | 37.2% | 1 | 1 | | | | 8 | 00:47:45 |

| | | | | | | | | | | | | | | | | | |
|-----------|--|-------|--------|-------|------|------|------|------|---------|-------|----|---|--|--|--|----|--|
| 合计 | | 41/74 | 60/150 | 21/54 | 5/37 | 4/20 | 8/14 | 8/27 | 147/376 | 39.1% | 12 | 5 | | | | 24 | |
|-----------|--|-------|--------|-------|------|------|------|------|---------|-------|----|---|--|--|--|----|--|

场上队员：得分/射门

守门员：救球/射门

| 全队合计 | 进球 | 被救 | 射失 | 击柱 | 封球 | 合计 | % |
|------|-----|----|----|----|----|-----|-------|
| 远射 | 47 | 44 | 10 | 7 | 17 | 125 | 37.6% |
| 近射 | 105 | 36 | 5 | 7 | | 153 | 68.6% |
| 边射 | 31 | 18 | 6 | 3 | | 58 | 53.4% |
| 快攻 | 52 | 13 | 2 | 4 | | 71 | 73.2% |
| 突破 | 25 | 6 | 2 | 1 | | 34 | 73.5% |
| 任意 | 6 | 4 | 2 | | | 12 | 50.0% |
| 7M | 16 | 4 | 1 | 1 | | 22 | 72.7% |

已打比赛

| 阶段 | 场次 | 对手 | 比分 |
|--------|----|-----|---------------|
| 预赛 | 6 | 天津 | 44:32 (24:13) |
| 预赛 | 11 | 安徽 | 39:32 (15:15) |
| 预赛 | 18 | 北京 | 33:26 (17:13) |
| 预赛 | 21 | 四川 | 28:29 (17:15) |
| 预赛 | 25 | 辽宁 | 32:17 (19:10) |
| 四分之一决赛 | 34 | 解放军 | 40:36 (23:15) |
| 半决赛 | 41 | 山东 | 38:30 (19:11) |
| 决赛 | 46 | 四川 | 28:27 (18:16) |





2016年“体彩杯”全国手球男子青年锦标赛 图式射门区域累计

截止至第46场

201602046-42-1/1

天津队

| | | | | | | | | | | | | | | | | | | | | | | | |
|-----------------------------|---|---|------------------------------|---|---|-----------------------------|---|----|-----------------------------|---|----|-----------------------------|--|--|-----------------------------|--|---|-----------------------------|--|---|-----------------------------|--|--|
| 9 吴明远 | | | 18 王晓琪 | | | 21 潘玉帅 | | | 22 魏雨童 | | | 24 刘子健 | | | 25 王一雄 | | | 26 刘思远 | | | 27 左金龙 | | |
| 4 | 1 | 9 | 8 | | 8 | 4 | | 4 | 1 | 1 | 3 | | | | 2 | | | 2 | | 3 | | | |
| 2 | | 4 | 4 | | 1 | | | 11 | 3 | | 10 | | | | 2 | | 1 | 2 | | 2 | | | |
| 8 | | 7 | 3 | 1 | 6 | 2 | 1 | 4 | 7 | | 17 | | | | 2 | | 5 | 3 | | 3 | | | |
| Post - 4 Miss - 2 Block - 0 | | | Post - 6 Miss - 10 Block - 2 | | | Post - 7 Miss - 8 Block - 0 | | | Post - 5 Miss - 6 Block - 0 | | | Post - 0 Miss - 0 Block - 0 | | | Post - 2 Miss - 0 Block - 0 | | | Post - 0 Miss - 1 Block - 0 | | | Post - 0 Miss - 0 Block - 0 | | |
| 28 何喜年 | | | | | | | | | | | | | | | | | | | | | | | |
| | | | | | | | | | | | | | | | | | | | | | | | |
| Post - 0 Miss - 0 Block - 0 | | | | | | | | | | | | | | | | | | | | | | | |

| | | |
|--------|-----|------|
| 9 吴明远 | | |
| | | |
| | | |
| 24 刘子健 | | |
| 1/18 | 1/4 | 2/14 |
| 11/28 | 1/3 | 7/17 |
| 3/19 | 3/6 | 6/32 |
| 28 何喜年 | | |
| 2/11 | 1/3 | 2/10 |
| 5/18 | 2/3 | 8/24 |
| 3/19 | 1/4 | 5/23 |

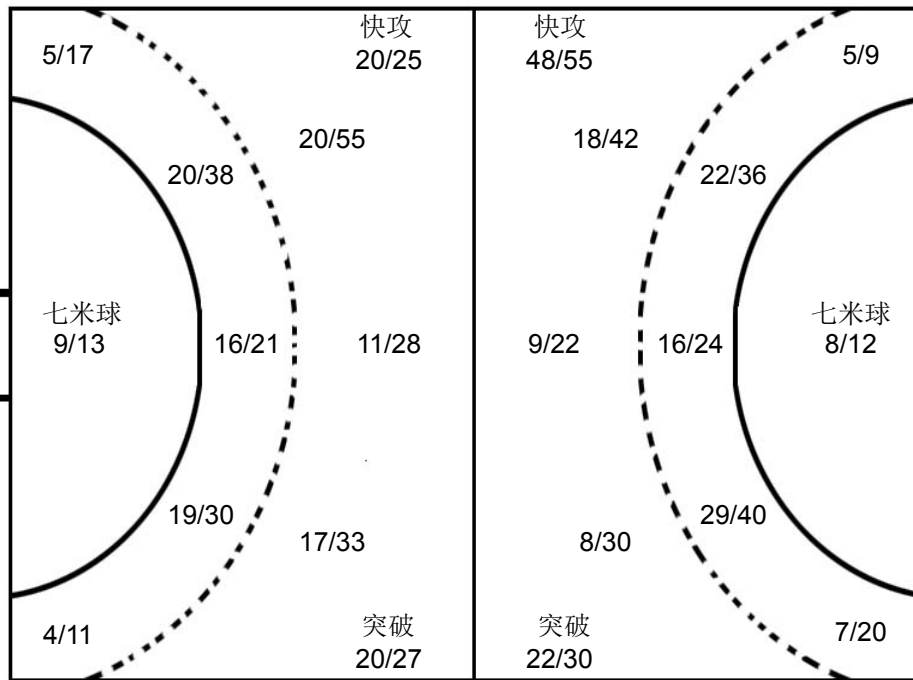

| | | |
|-----------|-----|------|
| 新疆 | | |
| 1 宋晓晨 | | |
| 1/7 | 2/2 | 0/4 |
| 6/9 | | 7/11 |
| 4/7 | 0/1 | 1/10 |
| 北京 | | |
| 16 马佳鹏 | | |
| 1/4 | 0/1 | 2/6 |
| 4/4 | 2/2 | 5/11 |
| 3/6 | | 1/8 |
| 辽宁 | | |
| 1 高尚君 | | |
| 0/3 | | 1/7 |
| 2/5 | | 4/11 |
| 0/4 | 0/1 | 4/11 |

对手

| | | | | | | | | | | | | | | | | | | | | | | | |
|-----------------------------|---|---|-----------------------------|--|---|-----------------------------|--|---|-----------------------------|---|---|-----------------------------|---|---|-----------------------------|---|---|-----------------------------|---|---|-----------------------------|--|---|
| 新疆 | | | 北京 | | | 北京 | | | 辽宁 | | | 上海 | | | 浙江 | | | 辽宁 | | | 安徽 | | |
| 19 李龙吉 | | | 7 卞友山 | | | 4 朱广刚 | | | 6 陈庆港 | | | 3 高天伦 | | | 1 林先方 | | | 11 庞东阳 | | | 9 陈开勇 | | |
| 3 | 2 | 1 | 1 | | | | | 1 | 1 | | 2 | | 1 | 1 | | | | | | | 2 | | 2 |
| | | | | | 1 | 4 | | 1 | | | | 4 | | | 2 | 1 | 3 | | 1 | 1 | 1 | | 1 |
| 1 | | 3 | 4 | | 3 | | | 2 | 1 | 1 | 3 | | | 2 | 1 | | 1 | 1 | | 4 | | | |
| Post - 0 Miss - 0 Block - 0 | | | Post - 0 Miss - 0 Block - 0 | | | Post - 1 Miss - 1 Block - 4 | | | Post - 1 Miss - 4 Block - 1 | | | Post - 0 Miss - 2 Block - 0 | | | Post - 1 Miss - 0 Block - 0 | | | Post - 0 Miss - 2 Block - 0 | | | Post - 0 Miss - 0 Block - 0 | | |
| 新疆 | | | 新疆 | | | 安徽 | | | 上海 | | | 上海 | | | 四川 | | | 新疆 | | | 安徽 | | |
| 7 林豪文 | | | 10 王钟彬 | | | 1 郭世伟 | | | 8 庄旭杰 | | | 10 董凯 | | | 3 刘赵梁 | | | 24 陈伟华 | | | 17 王巨柱 | | |
| 2 | 1 | | | | 1 | 1 | | | 1 | | 1 | | | | | | 1 | 1 | | 1 | 2 | | 1 |
| | | 1 | 2 | | 1 | 2 | | 1 | | | 1 | | | 1 | | | 3 | | | 3 | | | |
| 2 | | | | | 2 | 1 | | | 1 | | 1 | 2 | | 2 | 1 | | 3 | | | | | | 1 |
| Post - 2 Miss - 0 Block - 0 | | | Post - 0 Miss - 1 Block - 1 | | | Post - 0 Miss - 1 Block - 0 | | | Post - 1 Miss - 0 Block - 0 | | | Post - 1 Miss - 0 Block - 0 | | | Post - 1 Miss - 2 Block - 0 | | | Post - 0 Miss - 1 Block - 1 | | | Post - 0 Miss - 0 Block - 0 | | |

注释: Post=击柱 Miss=射失 Block=被封





2016年“体彩杯”全国手球男子青年锦标赛

个人/全队技术累计表

正式表
手球
青年

截至第 46场

201602046-15-1/1
重庆万州
29/03/2016 16:00

| 号码 | 姓名 | 远射 | 近射 | 边射 | 快攻 | 突破 | 任意 | 7M | 合计 | % | 助攻 | 失误 | 警告 | 2' | 取消 | 场次 | 时间 | |
|---------------|-----|-------|-------|------|------|-----|-----|-----|-------|-------|----|----|----|----|----|----|----------|----------|
| 上海队 | | | | | | | | | | | | | | | | | | |
| <i>(场上队员)</i> | | | | | | | | | | | | | | | | | | |
| 2 | 谢智超 | | | | | | | | | 0.0% | | | | | | 7 | 00:14:04 | |
| 3 | 高天伦 | 12/28 | 11/19 | 2/3 | 1/2 | | | 3/3 | 29/55 | 52.7% | 12 | 26 | 2 | 3 | | 7 | 05:51:59 | |
| 4 | 高震东 | 0/2 | 1/1 | | 1/1 | | | 1/1 | 3/5 | 60.0% | 1 | 3 | | | | 7 | 00:18:39 | |
| 5 | 曹磊 | 8/19 | 2/9 | 0/2 | 2/2 | 3/3 | | 1/1 | 16/36 | 44.4% | 5 | 11 | 2 | 1 | | 7 | 01:57:13 | |
| 6 | 季晨旭 | | | | | | | | | 0.0% | | | | | | 6 | 00:00:00 | |
| 7 | 蒋家敏 | 0/3 | 3/7 | 3/4 | | | | | 6/14 | 42.9% | | 6 | 1 | 2 | | 7 | 05:43:46 | |
| 8 | 庄旭杰 | 0/1 | 3/4 | 5/20 | 7/7 | 2/2 | | | 17/34 | 50.0% | 1 | 13 | 1 | 2 | | 7 | 05:50:43 | |
| 10 | 董凯 | 10/26 | 21/29 | 1/1 | 3/3 | 1/2 | 1/2 | 6/7 | 43/70 | 61.4% | 6 | 22 | 4 | 1 | | 7 | 05:56:14 | |
| 12 | 张润民 | | | | | | | | | 0.0% | | 3 | | | | 7 | 05:46:16 | |
| 14 | 吴佳兵 | 9/20 | 7/14 | | | 1/1 | | | 17/35 | 48.6% | 2 | 28 | 3 | | | 7 | 05:02:38 | |
| 16 | 陈辰 | | | | | | | | | 0.0% | | | | | 1 | | 7 | 00:17:54 |
| 18 | 吴双 | 5/30 | 10/19 | 1/2 | 8/10 | 6/9 | 2/5 | 2/3 | 34/78 | 43.6% | 6 | 35 | 2 | 1 | | 7 | 05:13:54 | |

| | | | | | | | | | | | | | | | | | |
|--------------|-----|--------|--------|-------|-------|-------|-----|-------|---------|-------|----|-----|----|----|--|----|----------|
| 合计 | | 44/129 | 58/102 | 12/32 | 22/25 | 13/17 | 3/7 | 13/15 | 165/327 | 50.5% | 33 | 147 | 15 | 11 | | 83 | |
| <i>(守门员)</i> | | | | | | | | | | | | | | | | | |
| 12 | 张润民 | 19/50 | 39/109 | 14/33 | 10/50 | 3/18 | 3/7 | 2/13 | 90/280 | 32.1% | | 3 | | | | 7 | 05:46:16 |
| 16 | 陈辰 | 2/3 | 0/2 | 2/4 | 1/2 | | | 1/1 | 6/12 | 50.0% | | | | | | 7 | 00:17:54 |

| | | | | | | | | | | | | | | | | | |
|-----------|--|-------|--------|-------|-------|------|-----|------|--------|-------|--|---|--|--|--|----|--|
| 合计 | | 21/53 | 39/111 | 16/37 | 11/52 | 3/18 | 3/7 | 3/14 | 96/292 | 32.9% | | 3 | | | | 14 | |
|-----------|--|-------|--------|-------|-------|------|-----|------|--------|-------|--|---|--|--|--|----|--|

场上队员：得分/射门

守门员：救球/射门

| 全队合计 | 进球 | 被救 | 射失 | 击柱 | 封球 | 合计 | % |
|------|----|----|----|----|----|-----|-------|
| 远射 | 44 | 36 | 16 | 7 | 26 | 129 | 34.1% |
| 近射 | 58 | 26 | 9 | 7 | 2 | 102 | 56.9% |
| 边射 | 12 | 14 | 3 | 3 | | 32 | 37.5% |
| 快攻 | 22 | 2 | | 1 | | 25 | 88.0% |
| 突破 | 13 | 2 | | 2 | | 17 | 76.5% |
| 任意 | 3 | 3 | 1 | | | 7 | 42.9% |
| 7M | 13 | 1 | 1 | | | 15 | 86.7% |

已打比赛

| 阶段 | 场次 | 对手 | 比分 |
|--------|----|-----|---------------|
| 预赛 | 1 | 江苏 | 29:32 (12:20) |
| 预赛 | 8 | 山东 | 28:32 (15:14) |
| 预赛 | 15 | 浙江 | 25:4 (25:4) |
| 预赛 | 23 | 解放军 | 20:35 (10:16) |
| 预赛 | 30 | 广东 | 26:37 (10:19) |
| 9-12名 | 32 | 辽宁 | 12:27 (12:25) |
| 11-12名 | 37 | 天津 | 25:29 (12:15) |





2016年“体彩杯”全国手球男子青年锦标赛

图式射门区域累计

截止至第46场

201602046-42-1/1

上海队

Player statistics for Shanghai team including names like 谢智超, 高天伦, 高震东, etc., with goal counts in a grid format.

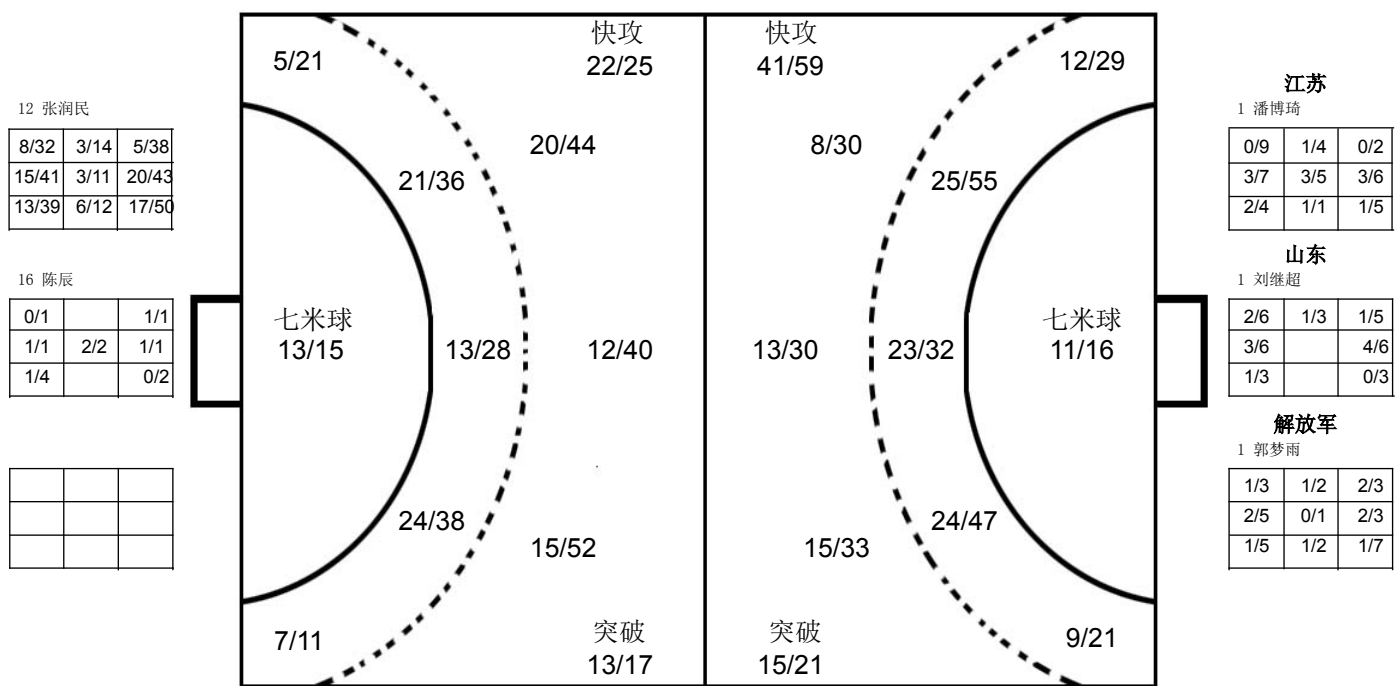

Opponent statistics (对手) for various teams like 辽宁, 天津, 山东, 江苏, 广东, 解放军, including player names and goal counts.

注释: Post=击柱 Miss=射失 Block=被封



预赛 Group A
青年男子 全国比赛

2016年“体彩杯”全国手球男子青年锦标赛

| | | | | | | | | | | | | | | | | | | | | | |
|--------------------|---|------------------------------|---------------------|------------------|------------------------------------|-------------------|---|--------------------------|------------------------------------|----|-----|----------------------|---------------|---|--|--|---|---|----|---|----|
| Team A A 上海队 | | | | Team B B 江苏队 | | | | Match Number 1 | | | | | | | | | | | | | |
| played in China | | in the hall 重庆万州 | | on 20/03/2016 | | at 08:30 hours | | Spectators | | | | | | | | | | | | | |
| Half-time (30') | A 12 | B 20 | End of playing time | A 29 | B 32 | 1st extra time | A | B | 2nd extra time | A | B | After penalty throws | A | B | | | | | | | |
| Number of 7 m | A 3 / 3 | Team time-out 1 12:48 2 3 | | | Full name of players and officials | | | | Team time-out 1 19:20 2 49:57 3 | | | B 0 / 1 | Number of 7 m | | | | | | | | |
| No. | Team A | | | | | G | W | 2' | D | DR | No. | Team B | | | | | G | W | 2' | D | DR |
| 2 | 谢智超 | | | | | | | | | | 1 | 潘博琦 | | | | | | | | | |
| 3 | 高天伦 | | | | | 7 | 1 | | | | 3 | 赵韦光 | | | | | 1 | | 1 | | |
| 4 | 高震东 | | | | | | | | | | 4 | 张瑞恒 | | | | | | | | | |
| 5 | 曹磊 | | | | | 1 | 1 | | | | 6 | 季雨 | | | | | | | | | |
| 6 | 季晨旭 | | | | | | | | | | 7 | 任超凡 | | | | | 6 | 1 | | | |
| 7 | 蒋家敏 | | | | | 1 | | | | | 8 | 姜童耀 | | | | | | | | | |
| 8 | 庄旭杰 | | | | | | 1 | | | | 9 | 王俊威 | | | | | | | | | |
| 9 | 彭天阳 | | | | | | | | | | 11 | 周傲 | | | | | 9 | | 2 | | |
| 10 | 董凯 | | | | | 7 | | 1 | | | 13 | 尹吉祥 | | | | | 6 | 1 | | | |
| 12 | 张润民 | | | | | | | | | | 14 | 罗中熠 | | | | | | | | | |
| 14 | 吴佳兵 | | | | | 4 | | | | | 15 | 阎冠中 | | | | | | | | | |
| 16 | 陈辰 | | | | | | | | | | 17 | 马益奎 | | | | | 1 | 1 | | | |
| 17 | 贺政 | | | | | | | | | | 18 | 耿畅 | | | | | 9 | | | | |
| 18 | 吴双 | | | | | 9 | | 1 | | | | | | | | | | | | | |
| A | 马仲顺 | | | | | | | | | | A | 钱红 | | | | | | | | | |
| B | 张勇军 | | | | | | | | | | B | 贾淑君 (主教练) | | | | | | | | | |
| C | 朱春雷 | | | | | | | | | | C | 李家昌 | | | | | | | | | |
| | | | | | | | | | | | D | 王建国 | | | | | | | | | |
| A | Signature of Responsible Official of the Teams (Off. A) | | | | | | | | | | B | | | | | | | | | | |
| TP | Remarks of Referee / CHA Official | | | | | | | | | | TP | | | | | | | | | | |

Signatures

Referees: 倪震 (CHN) 王洋 (CHN)

Techn. Delegates: 张春生

CHA Official: 许宜扬 (CHN)

Note: Number of 7m Throws Awarded to Team A and B, Goals (G), Warnings (W), Suspensions (2'), Direct Disqualification (D), Disqualification with Report (DR) and Team Penalty (TP).

Table Officials:

Statisticians: 李双

刘永欢





2016年“体彩杯”全国手球男子青年锦标赛 竞赛技术统计(媒体表)

| | | | | | | |
|----------------|-----------|------------|----|-----------|------------------|----------|
| 预赛 | 组别 | A | 轮次 | 1 | 场次 | 1 |
| 重庆万州 | | 20/03/2016 | | | 201602001-51-1/1 | |
| 上海队 | 上海 | 29 | vs | 32 | 江苏 | 江苏队 |
| 12 : 20 | | | | | | |

| 裁判员 | | 倪震 (CHN) | | | | | | | | | | | 王洋 (CHN) | | | | | | | | | | | | | | | | | |
|---------------|-----|-------------|--------------|-------------|------------|------------|------------|--------------|--------------|-------------|----------|-----------|----------|----------|----------|-----------|-------|-------|-------|-----|-----|-----|--|--|--|--|--|--|-----------|--|
| 上海 | | 远射 | 近射 | 边射 | 快攻 | 突破 | 任意球 | 7m球 | 合计 | % | 助攻 | 失误 | 警告 | 2' | D & DR | 上海 | | 比赛进程 | | | | | | | | | | | 江苏 | |
| 主教练：朱春雷 | | | | | | | | | | | | | | | 1st Half | | | | | | | | | | | | | | | |
| 2 | 谢智超 | | | | | | | | | | | | | | | 0 | 00:27 | 1 | 18 | 耿畅 | | | | | | | | | | |
| 3 | 高天伦 | 0/2 | 4/6 | 1/1 | 0/1 | | | 2/2 | 7/12 | 58.3 | 1 | | 1 | | | 0 | 01:04 | 2 | 7 | 任超凡 | | | | | | | | | | |
| 4 | 高震东 | | | | | | | | | | | | | | | 0 | 01:32 | 3 | 18 | 耿畅 | | | | | | | | | | |
| 5 | 曹磊 | 1/2 | 0/3 | | | | | 1/5 | 20.0 | | 3 | 1 | | | 10 | 董凯 | 1 | 02:08 | 3 | | | | | | | | | | | |
| 6 | 季晨旭 | | | | | | | | | | | | | | 10 | 董凯 | 2 | 02:59 | 3 | | | | | | | | | | | |
| 7 | 蒋家敏 | 0/1 | 1/2 | | | | | 1/3 | 33.3 | | 1 | | | | 2 | 高天伦 | 3 | 03:26 | 4 | 11 | 周傲 | | | | | | | | | |
| 8 | 庄旭杰 | | | 0/2 | | | | 0/2 | 0.0 | | 1 | 1 | | | 3 | 高天伦 | 3 | 03:53 | 4 | | | | | | | | | | | |
| 9 | 彭天阳 | | | | | | | | | | | | | | 3 | 高天伦 | 3 | 04:15 | 5 | 11 | 周傲 | | | | | | | | | |
| 10 | 董凯 | 2/4 | 3/5 | | | | 1/1 | 1/1 | 7/11 | 63.6 | 1 | 5 | | 1 | 3 | 高天伦 | 3 | 04:44 | 6 | 11 | 周傲 | | | | | | | | | |
| 12 | 张润民 | | | | | | | | | | | | | | 3 | 高天伦 | 3 | 05:27 | 7 | 18 | 耿畅 | | | | | | | | | |
| 14 | 吴佳兵 | 1/1 | 2/4 | | | 1/1 | | 4/6 | 66.7 | 1 | 6 | | | | 4 | 吴佳兵 | 4 | 06:27 | 7 | | | | | | | | | | | |
| 16 | 陈辰 | | | | | | | | | | | | | | 4 | 高天伦 | 4 | 07:22 | 8 | 18 | 耿畅 | | | | | | | | | |
| 17 | 贺政 | | | | | | | | | | | | | | 4 | 高天伦 | 4 | 08:54 | 9 | 18 | 耿畅 | | | | | | | | | |
| 18 | 吴双 | 0/4 | 4/7 | | 2/2 | 2/2 | 1/2 | 9/17 | 52.9 | 1 | 5 | | 1 | | 4 | 高天伦 | 4 | 10:26 | 10 | 18 | 耿畅 | | | | | | | | | |
| 运动员 合计 | | 4/14 | 14/27 | 1/3 | 2/3 | 3/3 | 2/3 | 3/3 | 29/56 | 51.8 | 4 | 21 | 3 | 2 | 4 | 高天伦 | 4 | 11:09 | 11 | 13 | 尹吉祥 | | | | | | | | | |
| 12 | 张润民 | 4/12 | 11/24 | 5/10 | 2/7 | 0/1 | | 22/54 | 40.7 | | | | | | 5 | 曹磊 | 5 | 11:56 | 11 | | | | | | | | | | | |
| 守门员 合计 | | 4/12 | 11/24 | 5/10 | 2/7 | 0/1 | | 22/54 | 40.7 | | | | | | 5 | 曹磊 | 5 | 12:26 | 12 | 17 | 马益奎 | | | | | | | | | |
| 江苏 | | 远射 | 近射 | 边射 | 快攻 | 突破 | 任意球 | 7m球 | 合计 | % | 助攻 | 失误 | 警告 | 2' | D & DR | 5 | 曹磊 | 5 | 14:57 | 13 | 7 | 任超凡 | | | | | | | | |
| 教练：贾淑君 | | | | | | | | | | | | | | | 2nd Half | | | | | | | | | | | | | | | |
| 1 | 潘博琦 | | | | | | | | | | | | | | | 6 | 蒋家敏 | 6 | 17:12 | 14 | | | | | | | | | | |
| 3 | 赵韦光 | | 1/2 | 0/2 | 0/1 | | | | | | | | | | | 7 | 吴双 | 7 | 17:43 | 14 | | | | | | | | | | |
| 4 | 张瑞恒 | | | | | | | | | | | | | | | 3 | 高天伦 | 8 | 20:12 | 14 | | | | | | | | | | |
| 6 | 季雨 | | | | | | | | | | | | | | | 8 | 高天伦 | 8 | 20:42 | 15 | 13 | 尹吉祥 | | | | | | | | |
| 7 | 任超凡 | | 3/3 | 2/4 | 1/2 | | | | | | | | | | | 10 | 董凯 | 9 | 21:23 | 15 | | | | | | | | | | |
| 8 | 姜童耀 | | | | | | | | | | | | | | | 9 | 董凯 | 9 | 21:58 | 16 | 11 | 周傲 | | | | | | | | |
| 9 | 王俊威 | | 0/1 | 0/1 | | | | 0/2 | 0.0 | | 3 | | | | 10 | 董凯 | 10 | 22:44 | 16 | | | | | | | | | | | |
| 11 | 周傲 | 3/4 | 3/9 | 2/2 | | 1/1 | | 0/1 | 9/17 | 52.9 | 2 | 5 | | 2 | 10 | 董凯 | 10 | 26:00 | 17 | 7 | 任超凡 | | | | | | | | | |
| 13 | 尹吉祥 | 3/7 | 2/6 | 0/1 | 1/2 | | | | 6/16 | 37.5 | 1 | 4 | 1 | | 3 | 高天伦 | 11 | 26:39 | 17 | | | | | | | | | | | |
| 14 | 罗中熠 | | | | | | | | | | | | | | | 11 | 吴双 | 11 | 26:51 | 18 | 18 | 耿畅 | | | | | | | | |
| 15 | 阎冠中 | | | | | | | | | | | | | | | 11 | 吴双 | 11 | 28:14 | 19 | 18 | 耿畅 | | | | | | | | |
| 17 | 马益奎 | | 1/2 | 0/1 | | | | 1/3 | 33.3 | | 1 | 1 | | | 18 | 吴双 | 11 | 29:00 | 20 | 13 | 尹吉祥 | | | | | | | | | |
| 18 | 耿畅 | 2/4 | 3/6 | 1/1 | 3/3 | | | 9/14 | 64.3 | | 2 | | | | 18 | 吴双 | 12 | 29:33 | 20 | | | | | | | | | | | |
| 运动员 合计 | | 8/15 | 13/29 | 5/12 | 5/8 | 1/1 | | 0/1 | 32/66 | 48.5 | 3 | 17 | 3 | 3 | 2nd Half | | | | | | | | | | | | | | | |
| 1 | 潘博琦 | 3/7 | 8/22 | 1/2 | 1/3 | 0/3 | 1/3 | 0/3 | 14/43 | 32.6 | | | | | | 13 | 吴双 | 13 | 00:53 | 20 | | | | | | | | | | |
| 守门员 合计 | | 3/7 | 8/22 | 1/2 | 1/3 | 0/3 | 1/3 | 0/3 | 14/43 | 32.6 | | | | | | 13 | 吴双 | 13 | 03:00 | 21 | 11 | 周傲 | | | | | | | | |

场上队员：得分 / 射门

守门员：救球 / 射门

| | | | | | | | | | |
|----|------------|----|--------------|-----|------------|-----|----------|----|---------|
| 快攻 | Fast Break | 突破 | Breakthrough | 任意球 | Free Throw | 7M球 | 7M Throw | 助攻 | Assist |
| 警告 | Warning | 失误 | Error | 2' | Suspension | D | 取消资格 | DR | 取消资格+报告 |





2016年“体彩杯”全国手球男子青年锦标赛 图式比赛技术统计表

轮次 1

场次 1

201602001-21-1/1

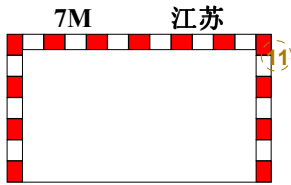
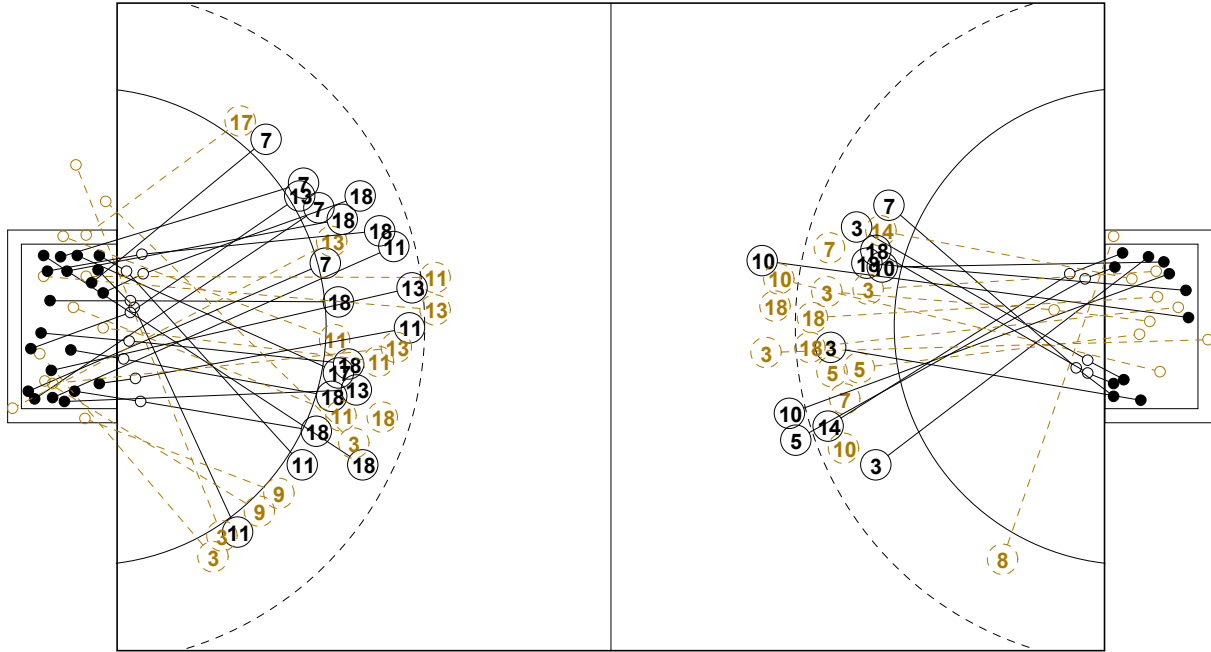

1st Half
20 : 12

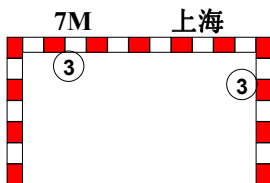
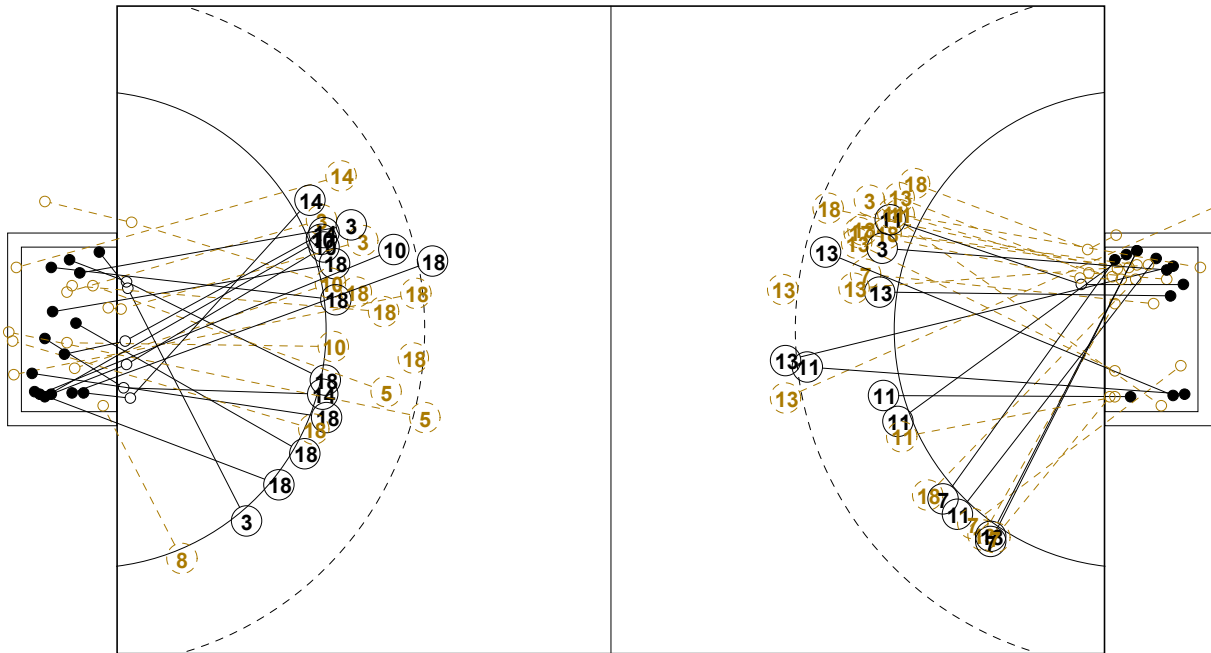
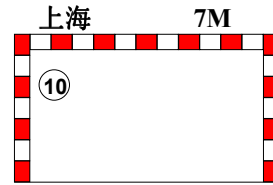

2nd Half
29 : 32

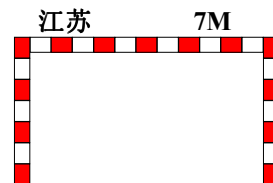



2016年“体彩杯”全国手球男子青年锦标赛

个人/全队技术统计表

正式表
手球
青年男子预赛
轮次 1组别 A
场次 1201602001-14-1/2
重庆万州
20/03/2016 08:30

| 号码 | 姓名 | 远射 | 近射 | 边射 | 快攻 | 突破 | 任意 | 7M | 合计 | % | 助攻 | 失误 | 警告 | 2' | 取消 | 时间 |
|----------------|-----|------|-------|------|-----|-----|-----|-----|-------|-------|----|----|----|----|----|----------|
| 上海队(上海) | | | | | | | | | | | | | | | | |
| <i>(场上队员)</i> | | | | | | | | | | | | | | | | |
| 2 | 谢智超 | | | | | | | | | 0.0% | | | | | | 00:00:00 |
| 3 | 高天伦 | 0/2 | 4/6 | 1/1 | 0/1 | | | 2/2 | 7/12 | 58.3% | 1 | | 1 | | | 01:00:00 |
| 4 | 高震东 | | | | | | | | | 0.0% | | | | | | 00:00:00 |
| 5 | 曹磊 | 1/2 | 0/3 | | | | | | 1/5 | 20.0% | | 3 | 1 | | | 00:16:23 |
| 6 | 季晨旭 | | | | | | | | | 0.0% | | | | | | 00:00:00 |
| 7 | 蒋家敏 | 0/1 | 1/2 | | | | | | 1/3 | 33.3% | | 1 | | | | 01:00:00 |
| 8 | 庄旭杰 | | | 0/2 | | | | | 0/2 | 0.0% | | 1 | 1 | | | 01:00:00 |
| 9 | 彭天阳 | | | | | | | | | 0.0% | | | | | | 00:00:00 |
| 10 | 董凯 | 2/4 | 3/5 | | | | 1/1 | 1/1 | 7/11 | 63.6% | 1 | 5 | | 1 | | 01:00:00 |
| 12 | 张润民 | | | | | | | | | 0.0% | | | | | | 01:00:00 |
| 14 | 吴佳兵 | 1/1 | 2/4 | | | 1/1 | | | 4/6 | 66.7% | 1 | 6 | | | | 00:56:31 |
| 16 | 陈辰 | | | | | | | | | 0.0% | | | | | | 00:00:00 |
| 17 | 贺政 | | | | | | | | | 0.0% | | | | | | 00:00:00 |
| 18 | 吴双 | 0/4 | 4/7 | | 2/2 | 2/2 | 1/2 | | 9/17 | 52.9% | 1 | 5 | | 1 | | 00:46:55 |
| 合计 | | | | | | | | | | | | | | | | |
| <i>(守门员)</i> | | | | | | | | | | | | | | | | |
| 12 | 张润民 | 4/12 | 11/24 | 5/10 | 2/7 | 0/1 | | | 22/54 | 40.7% | | | | | | 01:00:00 |
| 合计 | | | | | | | | | | | | | | | | |

场上队员：得分/射门

守门员：救球/射门

| 全队合计 | 得分 | 被救 | 射失 | 击柱 | 封球 | 合计 | % |
|------|----|----|----|----|----|----|--------|
| 远射 | 4 | 3 | | 3 | 4 | 14 | 28.6% |
| 近射 | 14 | 8 | 1 | 2 | 2 | 27 | 51.9% |
| 边射 | 1 | 1 | | 1 | | 3 | 33.3% |
| 快攻 | 2 | 1 | | | | 3 | 66.7% |
| 突破 | 3 | | | | | 3 | 100.0% |
| 任意 | 2 | 1 | | | | 3 | 66.7% |
| 7M | 3 | | | | | 3 | 100.0% |





2016年“体彩杯”全国手球男子青年锦标赛

个人/全队技术统计表

正式表
手球
青年男子预赛
轮次 1组别 A
场次 1201602001-14-2/2
重庆万州
20/03/2016 08:30

| 号码 | 姓名 | 远射 | 近射 | 边射 | 快攻 | 突破 | 任意 | 7M | 合计 | % | 助攻 | 失误 | 警告 | 2' | 取消 | 时间 |
|--|-----|-----|------|-----|-----|-----|-----|-----|-------|-------|----|----|----|----|----|----------|
| 江苏队(江苏) | | | | | | | | | | | | | | | | |
| <i>(上场队员)</i> | | | | | | | | | | | | | | | | |
| 1 | 潘博琦 | | | | | | | | | 0.0% | | | | | | 01:00:00 |
| 3 | 赵韦光 | | 1/2 | 0/2 | 0/1 | | | | 1/5 | 20.0% | | | | 1 | | 00:16:47 |
| 4 | 张瑞恒 | | | | | | | | | 0.0% | | | | | | 00:00:00 |
| 6 | 季雨 | | | | | | | | | 0.0% | | | | | | 00:00:00 |
| 7 | 任超凡 | | 3/3 | 2/4 | 1/2 | | | | 6/9 | 66.7% | | 2 | 1 | | | 01:15:52 |
| 8 | 姜童耀 | | | | | | | | | 0.0% | | | | | | 00:07:01 |
| 9 | 王俊威 | | 0/1 | 0/1 | | | | | 0/2 | 0.0% | | 3 | | | | 00:50:32 |
| 11 | 周傲 | 3/4 | 3/9 | 2/2 | | 1/1 | | 0/1 | 9/17 | 52.9% | 2 | 5 | | 2 | | 00:58:11 |
| 13 | 尹吉祥 | 3/7 | 2/6 | 0/1 | 1/2 | | | | 6/16 | 37.5% | 1 | 4 | 1 | | | 01:00:00 |
| 14 | 罗中熠 | | | | | | | | | 0.0% | | | | | | 00:00:00 |
| 15 | 阎冠中 | | | | | | | | | 0.0% | | | | | | 00:00:00 |
| 17 | 马益奎 | | 1/2 | 0/1 | | | | | 1/3 | 33.3% | | 1 | 1 | | | 01:00:00 |
| 18 | 耿畅 | 2/4 | 3/6 | 1/1 | 3/3 | | | | 9/14 | 64.3% | | 2 | | | | 00:45:28 |
| 合计 | | | | | | | | | | | | | | | | |
| <i>(守门员)</i> | | | | | | | | | | | | | | | | |
| 1 | 潘博琦 | 3/7 | 8/22 | 1/2 | 1/3 | 0/3 | 1/3 | 0/3 | 14/43 | 32.6% | | | | | | 01:00:00 |
| 合计 | | | | | | | | | | | | | | | | |
| 3/7 8/22 1/2 1/3 0/3 1/3 0/3 14/43 32.6% | | | | | | | | | | | | | | | | |

场上队员：得分/射门

守门员：救球/射门

| 全队合计 | 得分 | 被救 | 射失 | 击柱 | 封球 | 合计 | % |
|------|----|----|----|----|----|----|--------|
| 远射 | 8 | 4 | 1 | | 2 | 15 | 53.3% |
| 近射 | 13 | 11 | 1 | 4 | | 29 | 44.8% |
| 边射 | 5 | 5 | 1 | 1 | | 12 | 41.7% |
| 快攻 | 5 | 2 | | 1 | | 8 | 62.5% |
| 突破 | 1 | | | | | 1 | 100.0% |
| 任意 | | | | | | | 0.0% |
| 7M | | | | 1 | | 1 | 0.0% |





2016年“体彩杯”全国手球男子青年锦标赛

图式射门区域统计

轮次 1 场次 1

201602001-41-1/1

上海队

| | | | | | | | | | | | | | | | | | | | | | | | | | | | | | | | | | | | | | | | | | | | | | | | | | | | | | | | | | | | | | | | | | | | | | | | | | | | | | | | |
|---|-----------------------------|-----------------------------|-----------------------------|-----------------------------|-----------------------------|-----------------------------|-----------------------------|--|--|---|---|--|---|---|--|---|--|--|---|--|--|---|--|---|---|--|---|--|--|---|--|--|--|--|--|--|---|--|--|--|--|--|--|--|--|--|--|--|--|---|---|---|---|---|---|---|--|--|---|--|--|--|--|--|--|--|--|--|--|--|--|--|--|--|--|--|--|--|--|
| 2 谢智超 | 3 高天伦 | 4 高震东 | 5 曹磊 | 6 季晨旭 | 7 蒋家敏 | 8 庄旭杰 | 9 彭天阳 | | | | | | | | | | | | | | | | | | | | | | | | | | | | | | | | | | | | | | | | | | | | | | | | | | | | | | | | | | | | | | | | | | | | | | | | |
| <table border="1"><tr><td></td><td></td><td></td></tr><tr><td></td><td></td><td></td></tr><tr><td></td><td></td><td></td></tr></table> | | | | | | | | | | <table border="1"><tr><td>1</td><td></td><td>1</td></tr><tr><td>1</td><td></td><td>2</td></tr><tr><td></td><td></td><td>2</td></tr></table> | 1 | | 1 | 1 | | 2 | | | 2 | <table border="1"><tr><td></td><td></td><td></td></tr><tr><td></td><td></td><td></td></tr><tr><td></td><td></td><td></td></tr></table> | | | | | | | | | | <table border="1"><tr><td></td><td></td><td></td></tr><tr><td></td><td></td><td></td></tr><tr><td>1</td><td></td><td></td></tr></table> | | | | | | | 1 | | | <table border="1"><tr><td></td><td></td><td></td></tr><tr><td></td><td></td><td></td></tr><tr><td></td><td></td><td></td></tr></table> | | | | | | | | | | <table border="1"><tr><td></td><td></td><td></td></tr><tr><td></td><td></td><td></td></tr><tr><td></td><td></td><td>1</td></tr></table> | | | | | | | | | 1 | <table border="1"><tr><td></td><td></td><td></td></tr><tr><td></td><td></td><td></td></tr><tr><td></td><td></td><td></td></tr></table> | | | | | | | | | | <table border="1"><tr><td></td><td></td><td></td></tr><tr><td></td><td></td><td></td></tr><tr><td></td><td></td><td></td></tr></table> | | | | | | | | | |
| | | | | | | | | | | | | | | | | | | | | | | | | | | | | | | | | | | | | | | | | | | | | | | | | | | | | | | | | | | | | | | | | | | | | | | | | | | | | | | | |
| | | | | | | | | | | | | | | | | | | | | | | | | | | | | | | | | | | | | | | | | | | | | | | | | | | | | | | | | | | | | | | | | | | | | | | | | | | | | | | | |
| | | | | | | | | | | | | | | | | | | | | | | | | | | | | | | | | | | | | | | | | | | | | | | | | | | | | | | | | | | | | | | | | | | | | | | | | | | | | | | | |
| 1 | | 1 | | | | | | | | | | | | | | | | | | | | | | | | | | | | | | | | | | | | | | | | | | | | | | | | | | | | | | | | | | | | | | | | | | | | | | | | | | | | | |
| 1 | | 2 | | | | | | | | | | | | | | | | | | | | | | | | | | | | | | | | | | | | | | | | | | | | | | | | | | | | | | | | | | | | | | | | | | | | | | | | | | | | | |
| | | 2 | | | | | | | | | | | | | | | | | | | | | | | | | | | | | | | | | | | | | | | | | | | | | | | | | | | | | | | | | | | | | | | | | | | | | | | | | | | | | |
| | | | | | | | | | | | | | | | | | | | | | | | | | | | | | | | | | | | | | | | | | | | | | | | | | | | | | | | | | | | | | | | | | | | | | | | | | | | | | | | |
| | | | | | | | | | | | | | | | | | | | | | | | | | | | | | | | | | | | | | | | | | | | | | | | | | | | | | | | | | | | | | | | | | | | | | | | | | | | | | | | |
| | | | | | | | | | | | | | | | | | | | | | | | | | | | | | | | | | | | | | | | | | | | | | | | | | | | | | | | | | | | | | | | | | | | | | | | | | | | | | | | |
| | | | | | | | | | | | | | | | | | | | | | | | | | | | | | | | | | | | | | | | | | | | | | | | | | | | | | | | | | | | | | | | | | | | | | | | | | | | | | | | |
| | | | | | | | | | | | | | | | | | | | | | | | | | | | | | | | | | | | | | | | | | | | | | | | | | | | | | | | | | | | | | | | | | | | | | | | | | | | | | | | |
| 1 | | | | | | | | | | | | | | | | | | | | | | | | | | | | | | | | | | | | | | | | | | | | | | | | | | | | | | | | | | | | | | | | | | | | | | | | | | | | | | | |
| | | | | | | | | | | | | | | | | | | | | | | | | | | | | | | | | | | | | | | | | | | | | | | | | | | | | | | | | | | | | | | | | | | | | | | | | | | | | | | | |
| | | | | | | | | | | | | | | | | | | | | | | | | | | | | | | | | | | | | | | | | | | | | | | | | | | | | | | | | | | | | | | | | | | | | | | | | | | | | | | | |
| | | | | | | | | | | | | | | | | | | | | | | | | | | | | | | | | | | | | | | | | | | | | | | | | | | | | | | | | | | | | | | | | | | | | | | | | | | | | | | | |
| | | | | | | | | | | | | | | | | | | | | | | | | | | | | | | | | | | | | | | | | | | | | | | | | | | | | | | | | | | | | | | | | | | | | | | | | | | | | | | | |
| | | | | | | | | | | | | | | | | | | | | | | | | | | | | | | | | | | | | | | | | | | | | | | | | | | | | | | | | | | | | | | | | | | | | | | | | | | | | | | | |
| | | 1 | | | | | | | | | | | | | | | | | | | | | | | | | | | | | | | | | | | | | | | | | | | | | | | | | | | | | | | | | | | | | | | | | | | | | | | | | | | | | |
| | | | | | | | | | | | | | | | | | | | | | | | | | | | | | | | | | | | | | | | | | | | | | | | | | | | | | | | | | | | | | | | | | | | | | | | | | | | | | | | |
| | | | | | | | | | | | | | | | | | | | | | | | | | | | | | | | | | | | | | | | | | | | | | | | | | | | | | | | | | | | | | | | | | | | | | | | | | | | | | | | |
| | | | | | | | | | | | | | | | | | | | | | | | | | | | | | | | | | | | | | | | | | | | | | | | | | | | | | | | | | | | | | | | | | | | | | | | | | | | | | | | |
| | | | | | | | | | | | | | | | | | | | | | | | | | | | | | | | | | | | | | | | | | | | | | | | | | | | | | | | | | | | | | | | | | | | | | | | | | | | | | | | |
| | | | | | | | | | | | | | | | | | | | | | | | | | | | | | | | | | | | | | | | | | | | | | | | | | | | | | | | | | | | | | | | | | | | | | | | | | | | | | | | |
| | | | | | | | | | | | | | | | | | | | | | | | | | | | | | | | | | | | | | | | | | | | | | | | | | | | | | | | | | | | | | | | | | | | | | | | | | | | | | | | |
| Post - 0 Miss - 0 Block - 0 | Post - 1 Miss - 0 Block - 0 | Post - 0 Miss - 0 Block - 0 | Post - 1 Miss - 0 Block - 1 | Post - 0 Miss - 0 Block - 0 | Post - 0 Miss - 0 Block - 2 | Post - 1 Miss - 0 Block - 0 | Post - 0 Miss - 0 Block - 0 | | | | | | | | | | | | | | | | | | | | | | | | | | | | | | | | | | | | | | | | | | | | | | | | | | | | | | | | | | | | | | | | | | | | | | | | |
| 10 董凯 | 12 张润民 | 14 吴佳兵 | 16 陈辰 | 17 贺政 | 18 吴双 | | | | | | | | | | | | | | | | | | | | | | | | | | | | | | | | | | | | | | | | | | | | | | | | | | | | | | | | | | | | | | | | | | | | | | | | | | |
| <table border="1"><tr><td>5</td><td>1</td><td></td></tr><tr><td>1</td><td></td><td></td></tr><tr><td></td><td></td><td></td></tr></table> | 5 | 1 | | 1 | | | | | | <table border="1"><tr><td></td><td></td><td></td></tr><tr><td></td><td></td><td></td></tr><tr><td></td><td></td><td></td></tr></table> | | | | | | | | | | <table border="1"><tr><td></td><td>1</td><td></td></tr><tr><td>1</td><td>1</td><td></td></tr><tr><td>1</td><td></td><td></td></tr></table> | | 1 | | 1 | 1 | | 1 | | | <table border="1"><tr><td></td><td></td><td></td></tr><tr><td></td><td></td><td></td></tr><tr><td></td><td></td><td></td></tr></table> | | | | | | | | | | <table border="1"><tr><td></td><td></td><td></td></tr><tr><td></td><td></td><td></td></tr><tr><td></td><td></td><td></td></tr></table> | | | | | | | | | | <table border="1"><tr><td>3</td><td>1</td><td>1</td></tr><tr><td>1</td><td>1</td><td>1</td></tr><tr><td></td><td></td><td>1</td></tr></table> | 3 | 1 | 1 | 1 | 1 | 1 | | | 1 | <table border="1"><tr><td></td><td></td><td></td></tr><tr><td></td><td></td><td></td></tr><tr><td></td><td></td><td></td></tr></table> | | | | | | | | | | <table border="1"><tr><td></td><td></td><td></td></tr><tr><td></td><td></td><td></td></tr><tr><td></td><td></td><td></td></tr></table> | | | | | | | | | |
| 5 | 1 | | | | | | | | | | | | | | | | | | | | | | | | | | | | | | | | | | | | | | | | | | | | | | | | | | | | | | | | | | | | | | | | | | | | | | | | | | | | | | |
| 1 | | | | | | | | | | | | | | | | | | | | | | | | | | | | | | | | | | | | | | | | | | | | | | | | | | | | | | | | | | | | | | | | | | | | | | | | | | | | | | | |
| | | | | | | | | | | | | | | | | | | | | | | | | | | | | | | | | | | | | | | | | | | | | | | | | | | | | | | | | | | | | | | | | | | | | | | | | | | | | | | | |
| | | | | | | | | | | | | | | | | | | | | | | | | | | | | | | | | | | | | | | | | | | | | | | | | | | | | | | | | | | | | | | | | | | | | | | | | | | | | | | | |
| | | | | | | | | | | | | | | | | | | | | | | | | | | | | | | | | | | | | | | | | | | | | | | | | | | | | | | | | | | | | | | | | | | | | | | | | | | | | | | | |
| | | | | | | | | | | | | | | | | | | | | | | | | | | | | | | | | | | | | | | | | | | | | | | | | | | | | | | | | | | | | | | | | | | | | | | | | | | | | | | | |
| | 1 | | | | | | | | | | | | | | | | | | | | | | | | | | | | | | | | | | | | | | | | | | | | | | | | | | | | | | | | | | | | | | | | | | | | | | | | | | | | | | |
| 1 | 1 | | | | | | | | | | | | | | | | | | | | | | | | | | | | | | | | | | | | | | | | | | | | | | | | | | | | | | | | | | | | | | | | | | | | | | | | | | | | | | |
| 1 | | | | | | | | | | | | | | | | | | | | | | | | | | | | | | | | | | | | | | | | | | | | | | | | | | | | | | | | | | | | | | | | | | | | | | | | | | | | | | | |
| | | | | | | | | | | | | | | | | | | | | | | | | | | | | | | | | | | | | | | | | | | | | | | | | | | | | | | | | | | | | | | | | | | | | | | | | | | | | | | | |
| | | | | | | | | | | | | | | | | | | | | | | | | | | | | | | | | | | | | | | | | | | | | | | | | | | | | | | | | | | | | | | | | | | | | | | | | | | | | | | | |
| | | | | | | | | | | | | | | | | | | | | | | | | | | | | | | | | | | | | | | | | | | | | | | | | | | | | | | | | | | | | | | | | | | | | | | | | | | | | | | | |
| | | | | | | | | | | | | | | | | | | | | | | | | | | | | | | | | | | | | | | | | | | | | | | | | | | | | | | | | | | | | | | | | | | | | | | | | | | | | | | | |
| | | | | | | | | | | | | | | | | | | | | | | | | | | | | | | | | | | | | | | | | | | | | | | | | | | | | | | | | | | | | | | | | | | | | | | | | | | | | | | | |
| | | | | | | | | | | | | | | | | | | | | | | | | | | | | | | | | | | | | | | | | | | | | | | | | | | | | | | | | | | | | | | | | | | | | | | | | | | | | | | | |
| 3 | 1 | 1 | | | | | | | | | | | | | | | | | | | | | | | | | | | | | | | | | | | | | | | | | | | | | | | | | | | | | | | | | | | | | | | | | | | | | | | | | | | | | |
| 1 | 1 | 1 | | | | | | | | | | | | | | | | | | | | | | | | | | | | | | | | | | | | | | | | | | | | | | | | | | | | | | | | | | | | | | | | | | | | | | | | | | | | | |
| | | 1 | | | | | | | | | | | | | | | | | | | | | | | | | | | | | | | | | | | | | | | | | | | | | | | | | | | | | | | | | | | | | | | | | | | | | | | | | | | | | |
| | | | | | | | | | | | | | | | | | | | | | | | | | | | | | | | | | | | | | | | | | | | | | | | | | | | | | | | | | | | | | | | | | | | | | | | | | | | | | | | |
| | | | | | | | | | | | | | | | | | | | | | | | | | | | | | | | | | | | | | | | | | | | | | | | | | | | | | | | | | | | | | | | | | | | | | | | | | | | | | | | |
| | | | | | | | | | | | | | | | | | | | | | | | | | | | | | | | | | | | | | | | | | | | | | | | | | | | | | | | | | | | | | | | | | | | | | | | | | | | | | | | |
| | | | | | | | | | | | | | | | | | | | | | | | | | | | | | | | | | | | | | | | | | | | | | | | | | | | | | | | | | | | | | | | | | | | | | | | | | | | | | | | |
| | | | | | | | | | | | | | | | | | | | | | | | | | | | | | | | | | | | | | | | | | | | | | | | | | | | | | | | | | | | | | | | | | | | | | | | | | | | | | | | |
| | | | | | | | | | | | | | | | | | | | | | | | | | | | | | | | | | | | | | | | | | | | | | | | | | | | | | | | | | | | | | | | | | | | | | | | | | | | | | | | |
| Post - 0 Miss - 0 Block - 1 | Post - 0 Miss - 0 Block - 0 | Post - 1 Miss - 0 Block - 0 | Post - 0 Miss - 0 Block - 0 | Post - 0 Miss - 0 Block - 0 | Post - 2 Miss - 1 Block - 2 | | | | | | | | | | | | | | | | | | | | | | | | | | | | | | | | | | | | | | | | | | | | | | | | | | | | | | | | | | | | | | | | | | | | | | | | | | |

12 张润民

| | | |
|------|-----|-----|
| 3/11 | 1/4 | 2/6 |
| 3/8 | 2/3 | 1/4 |
| 4/7 | 2/2 | 4/9 |

| | | |
|--|--|--|
| | | |
| | | |
| | | |

| | | |
|--|--|--|
| | | |
| | | |
| | | |

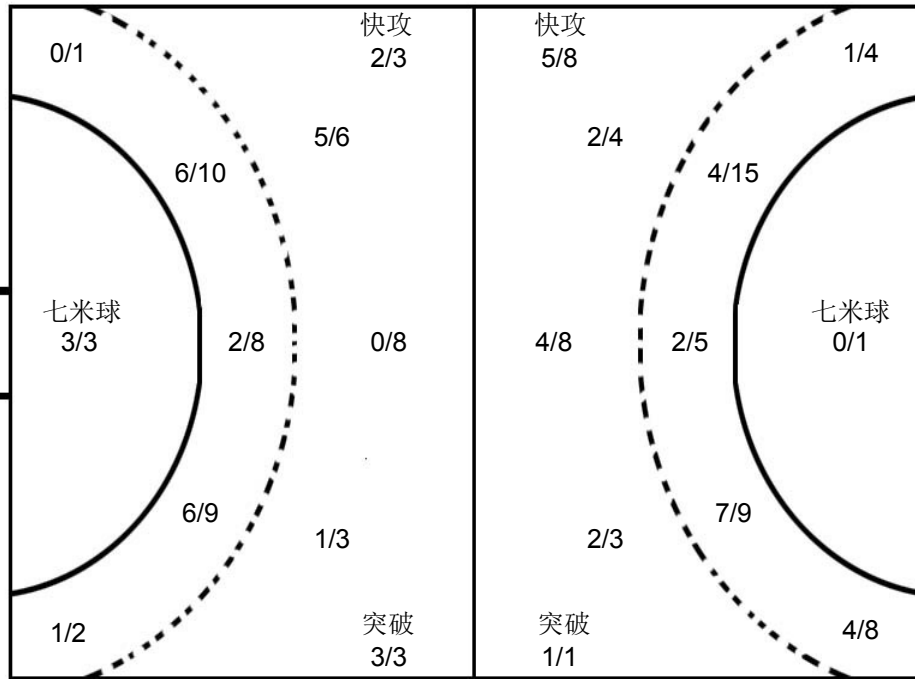

1 潘博琦

| | | |
|-----|-----|-----|
| 0/9 | 1/4 | 0/2 |
| 3/7 | 3/5 | 3/6 |
| 2/4 | 1/1 | 1/5 |

| | | |
|--|--|--|
| | | |
| | | |
| | | |

| | | |
|--|--|--|
| | | |
| | | |
| | | |

江苏队

| | | | | | | | | | | | | | | | | | | | | | | | | | | | | | | | | | | | | | | | | | | | | | | | | | | | | | | | | | | | | | | | | | | | | | | | | | | | | | | | |
|--|-----------------------------|-----------------------------|-----------------------------|-----------------------------|-----------------------------|-----------------------------|-----------------------------|--|--|---|---|--|--|--|--|--|--|--|--|--|--|--|--|--|--|--|--|--|--|---|--|--|--|--|--|---|--|--|--|--|---|---|---|---|---|---|---|--|---|--|--|--|--|--|--|--|--|--|--|--|--|--|--|--|--|--|--|--|--|---|---|--|---|---|--|--|---|--|---|
| 1 潘博琦 | 3 赵韦光 | 4 张瑞恒 | 6 季雨 | 7 任超凡 | 8 姜童耀 | 9 王俊威 | 11 周傲 | | | | | | | | | | | | | | | | | | | | | | | | | | | | | | | | | | | | | | | | | | | | | | | | | | | | | | | | | | | | | | | | | | | | | | | | |
| <table border="1"><tr><td></td><td></td><td></td></tr><tr><td></td><td></td><td></td></tr><tr><td></td><td></td><td></td></tr></table> | | | | | | | | | | <table border="1"><tr><td>1</td><td></td><td></td></tr><tr><td></td><td></td><td></td></tr><tr><td></td><td></td><td></td></tr></table> | 1 | | | | | | | | | <table border="1"><tr><td></td><td></td><td></td></tr><tr><td></td><td></td><td></td></tr><tr><td></td><td></td><td></td></tr></table> | | | | | | | | | | <table border="1"><tr><td></td><td></td><td></td></tr><tr><td></td><td></td><td></td></tr><tr><td></td><td></td><td></td></tr></table> | | | | | | | | | | <table border="1"><tr><td>2</td><td></td><td></td></tr><tr><td>1</td><td></td><td>1</td></tr><tr><td>1</td><td></td><td>1</td></tr></table> | 2 | | | 1 | | 1 | 1 | | 1 | <table border="1"><tr><td></td><td></td><td></td></tr><tr><td></td><td></td><td></td></tr><tr><td></td><td></td><td></td></tr></table> | | | | | | | | | | <table border="1"><tr><td></td><td></td><td></td></tr><tr><td></td><td></td><td></td></tr><tr><td></td><td></td><td></td></tr></table> | | | | | | | | | | <table border="1"><tr><td>2</td><td></td><td>1</td></tr><tr><td>1</td><td></td><td></td></tr><tr><td>2</td><td></td><td>3</td></tr></table> | 2 | | 1 | 1 | | | 2 | | 3 |
| | | | | | | | | | | | | | | | | | | | | | | | | | | | | | | | | | | | | | | | | | | | | | | | | | | | | | | | | | | | | | | | | | | | | | | | | | | | | | | | |
| | | | | | | | | | | | | | | | | | | | | | | | | | | | | | | | | | | | | | | | | | | | | | | | | | | | | | | | | | | | | | | | | | | | | | | | | | | | | | | | |
| | | | | | | | | | | | | | | | | | | | | | | | | | | | | | | | | | | | | | | | | | | | | | | | | | | | | | | | | | | | | | | | | | | | | | | | | | | | | | | | |
| 1 | | | | | | | | | | | | | | | | | | | | | | | | | | | | | | | | | | | | | | | | | | | | | | | | | | | | | | | | | | | | | | | | | | | | | | | | | | | | | | | |
| | | | | | | | | | | | | | | | | | | | | | | | | | | | | | | | | | | | | | | | | | | | | | | | | | | | | | | | | | | | | | | | | | | | | | | | | | | | | | | | |
| | | | | | | | | | | | | | | | | | | | | | | | | | | | | | | | | | | | | | | | | | | | | | | | | | | | | | | | | | | | | | | | | | | | | | | | | | | | | | | | |
| | | | | | | | | | | | | | | | | | | | | | | | | | | | | | | | | | | | | | | | | | | | | | | | | | | | | | | | | | | | | | | | | | | | | | | | | | | | | | | | |
| | | | | | | | | | | | | | | | | | | | | | | | | | | | | | | | | | | | | | | | | | | | | | | | | | | | | | | | | | | | | | | | | | | | | | | | | | | | | | | | |
| | | | | | | | | | | | | | | | | | | | | | | | | | | | | | | | | | | | | | | | | | | | | | | | | | | | | | | | | | | | | | | | | | | | | | | | | | | | | | | | |
| | | | | | | | | | | | | | | | | | | | | | | | | | | | | | | | | | | | | | | | | | | | | | | | | | | | | | | | | | | | | | | | | | | | | | | | | | | | | | | | |
| | | | | | | | | | | | | | | | | | | | | | | | | | | | | | | | | | | | | | | | | | | | | | | | | | | | | | | | | | | | | | | | | | | | | | | | | | | | | | | | |
| | | | | | | | | | | | | | | | | | | | | | | | | | | | | | | | | | | | | | | | | | | | | | | | | | | | | | | | | | | | | | | | | | | | | | | | | | | | | | | | |
| 2 | | | | | | | | | | | | | | | | | | | | | | | | | | | | | | | | | | | | | | | | | | | | | | | | | | | | | | | | | | | | | | | | | | | | | | | | | | | | | | | |
| 1 | | 1 | | | | | | | | | | | | | | | | | | | | | | | | | | | | | | | | | | | | | | | | | | | | | | | | | | | | | | | | | | | | | | | | | | | | | | | | | | | | | |
| 1 | | 1 | | | | | | | | | | | | | | | | | | | | | | | | | | | | | | | | | | | | | | | | | | | | | | | | | | | | | | | | | | | | | | | | | | | | | | | | | | | | | |
| | | | | | | | | | | | | | | | | | | | | | | | | | | | | | | | | | | | | | | | | | | | | | | | | | | | | | | | | | | | | | | | | | | | | | | | | | | | | | | | |
| | | | | | | | | | | | | | | | | | | | | | | | | | | | | | | | | | | | | | | | | | | | | | | | | | | | | | | | | | | | | | | | | | | | | | | | | | | | | | | | |
| | | | | | | | | | | | | | | | | | | | | | | | | | | | | | | | | | | | | | | | | | | | | | | | | | | | | | | | | | | | | | | | | | | | | | | | | | | | | | | | |
| | | | | | | | | | | | | | | | | | | | | | | | | | | | | | | | | | | | | | | | | | | | | | | | | | | | | | | | | | | | | | | | | | | | | | | | | | | | | | | | |
| | | | | | | | | | | | | | | | | | | | | | | | | | | | | | | | | | | | | | | | | | | | | | | | | | | | | | | | | | | | | | | | | | | | | | | | | | | | | | | | |
| | | | | | | | | | | | | | | | | | | | | | | | | | | | | | | | | | | | | | | | | | | | | | | | | | | | | | | | | | | | | | | | | | | | | | | | | | | | | | | | |
| 2 | | 1 | | | | | | | | | | | | | | | | | | | | | | | | | | | | | | | | | | | | | | | | | | | | | | | | | | | | | | | | | | | | | | | | | | | | | | | | | | | | | |
| 1 | | | | | | | | | | | | | | | | | | | | | | | | | | | | | | | | | | | | | | | | | | | | | | | | | | | | | | | | | | | | | | | | | | | | | | | | | | | | | | | |
| 2 | | 3 | | | | | | | | | | | | | | | | | | | | | | | | | | | | | | | | | | | | | | | | | | | | | | | | | | | | | | | | | | | | | | | | | | | | | | | | | | | | | |
| Post - 0 Miss - 0 Block - 0 | Post - 0 Miss - 2 Block - 0 | Post - 0 Miss - 0 Block - 0 | Post - 0 Miss - 0 Block - 0 | Post - 0 Miss - 0 Block - 0 | Post - 0 Miss - 0 Block - 0 | Post - 1 Miss - 0 Block - 0 | Post - 3 Miss - 0 Block - 0 | | | | | | | | | | | | | | | | | | | | | | | | | | | | | | | | | | | | | | | | | | | | | | | | | | | | | | | | | | | | | | | | | | | | | | | | |
| 13 尹吉祥 | 14 罗中熠 | 15 阎冠中 | 17 马益奎 | 18 耿畅 | | | | | | | | | | | | | | | | | | | | | | | | | | | | | | | | | | | | | | | | | | | | | | | | | | | | | | | | | | | | | | | | | | | | | | | | | | | |
| <table border="1"><tr><td>3</td><td>1</td><td>1</td></tr><tr><td>1</td><td></td><td></td></tr><tr><td></td><td></td><td></td></tr></table> | 3 | 1 | 1 | 1 | | | | | | <table border="1"><tr><td></td><td></td><td></td></tr><tr><td></td><td></td><td></td></tr><tr><td></td><td></td><td></td></tr></table> | | | | | | | | | | <table border="1"><tr><td></td><td></td><td></td></tr><tr><td></td><td></td><td></td></tr><tr><td></td><td></td><td></td></tr></table> | | | | | | | | | | <table border="1"><tr><td></td><td></td><td></td></tr><tr><td></td><td></td><td>1</td></tr><tr><td></td><td></td><td></td></tr></table> | | | | | | 1 | | | | <table border="1"><tr><td></td><td>2</td><td>2</td></tr><tr><td>2</td><td>1</td><td>1</td></tr><tr><td></td><td></td><td>1</td></tr></table> | | 2 | 2 | 2 | 1 | 1 | | | 1 | <table border="1"><tr><td></td><td></td><td></td></tr><tr><td></td><td></td><td></td></tr><tr><td></td><td></td><td></td></tr></table> | | | | | | | | | | <table border="1"><tr><td></td><td></td><td></td></tr><tr><td></td><td></td><td></td></tr><tr><td></td><td></td><td></td></tr></table> | | | | | | | | | | <table border="1"><tr><td></td><td></td><td></td></tr><tr><td></td><td></td><td></td></tr><tr><td></td><td></td><td></td></tr></table> | | | | | | | | | |
| 3 | 1 | 1 | | | | | | | | | | | | | | | | | | | | | | | | | | | | | | | | | | | | | | | | | | | | | | | | | | | | | | | | | | | | | | | | | | | | | | | | | | | | | |
| 1 | | | | | | | | | | | | | | | | | | | | | | | | | | | | | | | | | | | | | | | | | | | | | | | | | | | | | | | | | | | | | | | | | | | | | | | | | | | | | | | |
| | | | | | | | | | | | | | | | | | | | | | | | | | | | | | | | | | | | | | | | | | | | | | | | | | | | | | | | | | | | | | | | | | | | | | | | | | | | | | | | |
| | | | | | | | | | | | | | | | | | | | | | | | | | | | | | | | | | | | | | | | | | | | | | | | | | | | | | | | | | | | | | | | | | | | | | | | | | | | | | | | |
| | | | | | | | | | | | | | | | | | | | | | | | | | | | | | | | | | | | | | | | | | | | | | | | | | | | | | | | | | | | | | | | | | | | | | | | | | | | | | | | |
| | | | | | | | | | | | | | | | | | | | | | | | | | | | | | | | | | | | | | | | | | | | | | | | | | | | | | | | | | | | | | | | | | | | | | | | | | | | | | | | |
| | | | | | | | | | | | | | | | | | | | | | | | | | | | | | | | | | | | | | | | | | | | | | | | | | | | | | | | | | | | | | | | | | | | | | | | | | | | | | | | |
| | | | | | | | | | | | | | | | | | | | | | | | | | | | | | | | | | | | | | | | | | | | | | | | | | | | | | | | | | | | | | | | | | | | | | | | | | | | | | | | |
| | | | | | | | | | | | | | | | | | | | | | | | | | | | | | | | | | | | | | | | | | | | | | | | | | | | | | | | | | | | | | | | | | | | | | | | | | | | | | | | |
| | | | | | | | | | | | | | | | | | | | | | | | | | | | | | | | | | | | | | | | | | | | | | | | | | | | | | | | | | | | | | | | | | | | | | | | | | | | | | | | |
| | | 1 | | | | | | | | | | | | | | | | | | | | | | | | | | | | | | | | | | | | | | | | | | | | | | | | | | | | | | | | | | | | | | | | | | | | | | | | | | | | | |
| | | | | | | | | | | | | | | | | | | | | | | | | | | | | | | | | | | | | | | | | | | | | | | | | | | | | | | | | | | | | | | | | | | | | | | | | | | | | | | | |
| | 2 | 2 | | | | | | | | | | | | | | | | | | | | | | | | | | | | | | | | | | | | | | | | | | | | | | | | | | | | | | | | | | | | | | | | | | | | | | | | | | | | | |
| 2 | 1 | 1 | | | | | | | | | | | | | | | | | | | | | | | | | | | | | | | | | | | | | | | | | | | | | | | | | | | | | | | | | | | | | | | | | | | | | | | | | | | | | |
| | | 1 | | | | | | | | | | | | | | | | | | | | | | | | | | | | | | | | | | | | | | | | | | | | | | | | | | | | | | | | | | | | | | | | | | | | | | | | | | | | | |
| | | | | | | | | | | | | | | | | | | | | | | | | | | | | | | | | | | | | | | | | | | | | | | | | | | | | | | | | | | | | | | | | | | | | | | | | | | | | | | | |
| | | | | | | | | | | | | | | | | | | | | | | | | | | | | | | | | | | | | | | | | | | | | | | | | | | | | | | | | | | | | | | | | | | | | | | | | | | | | | | | |
| | | | | | | | | | | | | | | | | | | | | | | | | | | | | | | | | | | | | | | | | | | | | | | | | | | | | | | | | | | | | | | | | | | | | | | | | | | | | | | | |
| | | | | | | | | | | | | | | | | | | | | | | | | | | | | | | | | | | | | | | | | | | | | | | | | | | | | | | | | | | | | | | | | | | | | | | | | | | | | | | | |
| | | | | | | | | | | | | | | | | | | | | | | | | | | | | | | | | | | | | | | | | | | | | | | | | | | | | | | | | | | | | | | | | | | | | | | | | | | | | | | | |
| | | | | | | | | | | | | | | | | | | | | | | | | | | | | | | | | | | | | | | | | | | | | | | | | | | | | | | | | | | | | | | | | | | | | | | | | | | | | | | | |
| | | | | | | | | | | | | | | | | | | | | | | | | | | | | | | | | | | | | | | | | | | | | | | | | | | | | | | | | | | | | | | | | | | | | | | | | | | | | | | | |
| | | | | | | | | | | | | | | | | | | | | | | | | | | | | | | | | | | | | | | | | | | | | | | | | | | | | | | | | | | | | | | | | | | | | | | | | | | | | | | | |
| | | | | | | | | | | | | | | | | | | | | | | | | | | | | | | | | | | | | | | | | | | | | | | | | | | | | | | | | | | | | | | | | | | | | | | | | | | | | | | | |
| Post - 1 Miss - 1 Block - 1 | Post - 0 Miss - 0 Block - 0 | Post - 0 Miss - 0 Block - 0 | Post - 1 Miss - 0 Block - 0 | Post - 1 Miss - 0 Block - 1 | | | | | | | | | | | | | | | | | | | | | | | | | | | | | | | | | | | | | | | | | | | | | | | | | | | | | | | | | | | | | | | | | | | | | | | | | | | |

注释: Post=击柱 Miss=射失 Block=被封





预赛 Group A
青年男子 全国比赛

2016年“体彩杯”全国手球男子青年锦标赛

| | | | | | | | | | | | | | | | | | | | | | | | | | | | | | | | | | | | | | | | |
|---------------------------|-----------------------------------|--------------------------------|---------------------|------------------------------------|---------|---|---|----|---|----|-----|--------|--|--|--|--|---|---|----|---|----|--|--|--|--|--|--|--|--|---|--|--|--|--|--|--|--|--|--|
| Team A A 广东队 | | Team B B 浙江队 | | Match Number 2 | | | | | | | | | | | | | | | | | | | | | | | | | | | | | | | | | | | |
| played in China | | in the hall 重庆万州 | | on 20/03/2016 | | | | | | | | | | | | | | | | | | | | | | | | | | | | | | | | | | | |
| | | | | at 10:00 hours | | | | | | | | | | | | | | | | | | | | | | | | | | | | | | | | | | | |
| Spectators | | | | | | | | | | | | | | | | | | | | | | | | | | | | | | | | | | | | | | | |
| Half-time (30') | A 20 | B 9 | End of playing time | A 30 | B 15 | | | | | | | | | | | | | | | | | | | | | | | | | | | | | | | | | | |
| 1st extra time | | 2nd extra time | | After penalty throws | | | | | | | | | | | | | | | | | | | | | | | | | | | | | | | | | | | |
| Number of 7 m A 0/0 | | Team time-out 1 16:38 2 3 3 | | Full name of players and officials | | | | | | | | | | | | | | | | | | | | | | | | | | | | | | | | | | | |
| | | | | Team time-out 1 09:49 2 37:43 3 | | | | | | | | | | | | | | | | | | | | | | | | | | | | | | | | | | | |
| Number of 7 m B 4/5 | | | | | | | | | | | | | | | | | | | | | | | | | | | | | | | | | | | | | | | |
| No. | Team A | | | | | G | W | 2' | D | DR | No. | Team B | | | | | G | W | 2' | D | DR | | | | | | | | | | | | | | | | | | |
| 1 | 王帅 | | | | | 3 | | | | | 1 | 林先方 | | | | | 6 | | | | | | | | | | | | | | | | | | | | | | |
| 2 | 姚雪岩 | | | | | 2 | | | | | 2 | 李恩铭 | | | | | 2 | | | | | | | | | | | | | | | | | | | | | | |
| 4 | 高玉杰 | | | | | 1 | 1 | | | | 3 | 郑尧俊 | | | | | 3 | 1 | 1 | | | | | | | | | | | | | | | | | | | | |
| 5 | 黄培杰 | | | | | 5 | | | | | 5 | 高家南 | | | | | | 1 | | | | | | | | | | | | | | | | | | | | | |
| 7 | 段飞宇 | | | | | 2 | | | | | 9 | 李家乐 | | | | | | | | | | | | | | | | | | | | | | | | | | | |
| 9 | 周凯峰 | | | | | | 1 | | | | 10 | 徐正飞 | | | | | | | | | | | | | | | | | | | | | | | | | | | |
| 10 | 周仲坤 | | | | | 4 | | | | | 11 | 陈渝天 | | | | | | | | | | | | | | | | | | | | | | | | | | | |
| 11 | 胡国富 | | | | | 2 | | | | | 14 | 虞勇灿 | | | | | | | | | | | | | | | | | | | | | | | | | | | |
| 12 | 李壮 | | | | | 4 | | | | | 15 | 张佩力 | | | | | | | | | | | | | | | | | | | | | | | | | | | |
| 13 | 蔡杰 | | | | | | | | | | 17 | 罗明杰 | | | | | | | | | | | | | | | | | | | | | | | | | | | |
| 14 | 王泽润 | | | | | | | | | | 18 | 倪陈辉 | | | | | 4 | 1 | | | | | | | | | | | | | | | | | | | | | |
| 15 | 张建杰 | | | | | 2 | 1 | 1 | | | 19 | 王浩 | | | | | | | | | | | | | | | | | | | | | | | | | | | |
| 16 | 王猛 | | | | | | | | | | | | | | | | | | | | | | | | | | | | | | | | | | | | | | |
| 18 | 李文金 | | | | | 5 | | | | | | | | | | | | | | | | | | | | | | | | | | | | | | | | | |
| B | 刘康伶 (主教练) | | | | | | | | | | C | 柳佳 | | | | | | | | | | | | | | | | | | | | | | | | | | | |
| C | 刘文宁 | | | | | | | | | | D | 项建生 | | | | | | | | | | | | | | | | | | | | | | | | | | | |
| D | 王永存 | | | | | | | | | | E | 刘晓辉 | | | | | | | | | | | | | | | | | | | | | | | | | | | |
| A | | | | | | | | | | | | | | | | | | | | Signature of Responsible Official of the Teams (Off. A) | | | | | | | | | | B | | | | | | | | | |
| TP | Remarks of Referee / CHA Official | | | | | | | | | | | | | | | | | | | TP | | | | | | | | | | | | | | | | | | | |

Signatures

| | | | | |
|------------------|-----------|-----------|--|--|
| Referees | 许翔 (CHN) | 王雨洋 (CHN) | | |
| Techn. Delegates | 张春生 (CHN) | | | |
| CHA Official | 许宜扬 (CHN) | | | |

Note: Number of 7m Throws Awarded to Team A and B, Goals (G), Warnings (W), Suspensions (2'), Direct Disqualification (D), Disqualification with Report (DR) and Team Penalty (TP).

Table Officials:

Statisticians: 刘永欢

李双





2016年“体彩杯”全国手球男子青年锦标赛
竞赛技术统计(媒体表)

Table with match details: 预赛, 组别 A, 轮次 1, 场次 2, 重庆万州, 20/03/2016, 201602002-51-1/1, 广东队 vs 浙江队, 30 vs 15, 20:9

裁判员: 许翔 (CHN) / 王雨洋 (CHN)

Main statistics table for Guangdong and Zhejiang teams, including player names, goals, assists, and penalties.

场上队员: 得分 / 射门

守门员: 救球 / 射门

Legend table for abbreviations: 快攻, 突破, 任意球, 警告, etc.





2016年“体彩杯”全国手球男子青年锦标赛 图式比赛技术统计表

轮次 1

场次 2

201602002-21-1/1

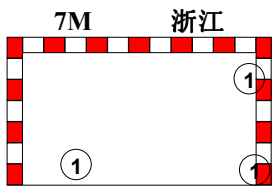
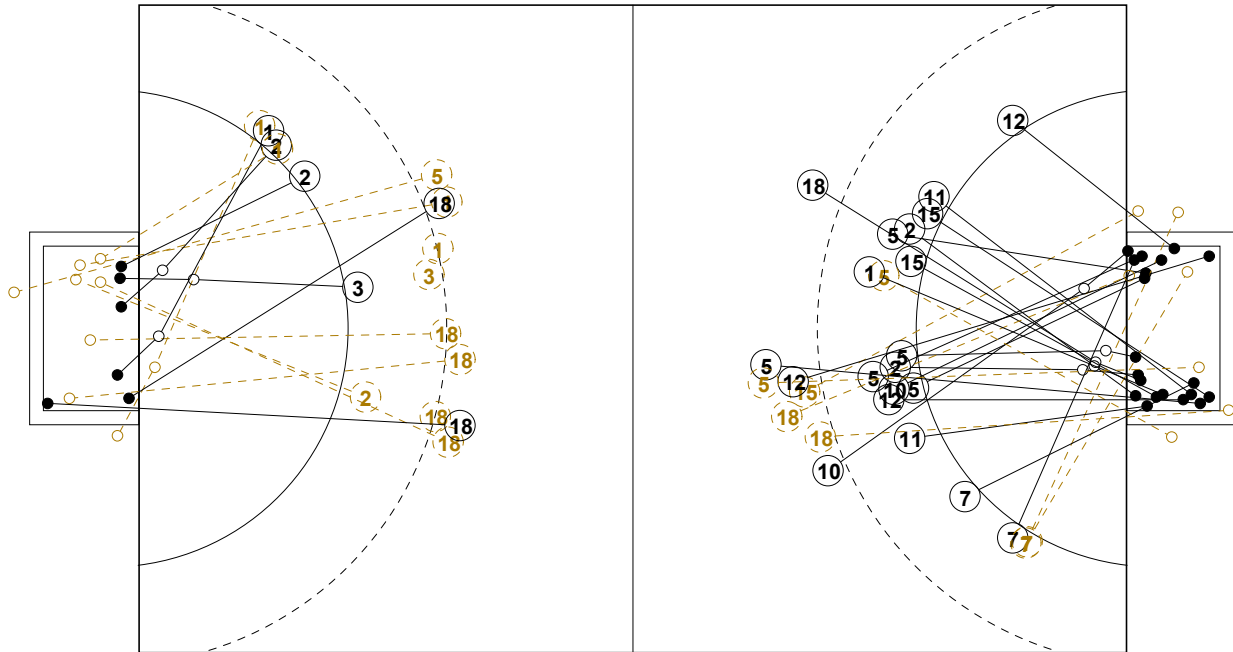

1st Half
9 : 20

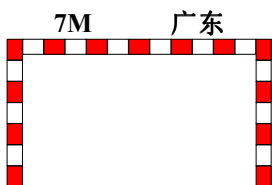
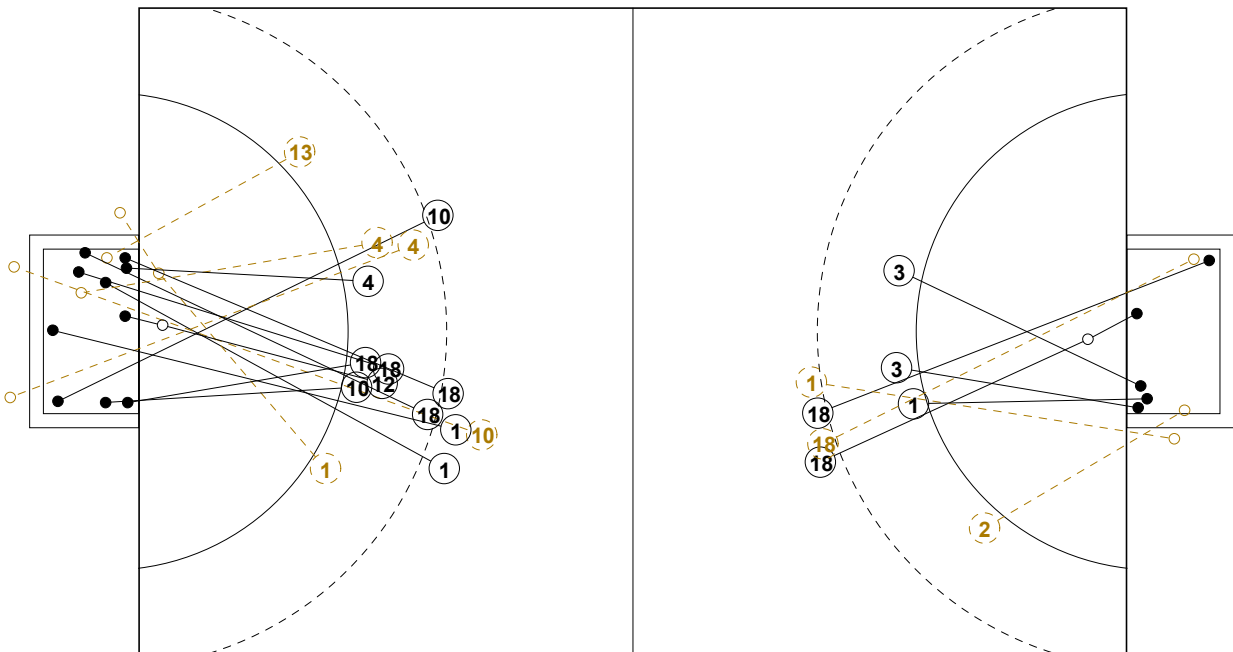
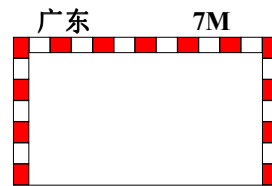

2nd Half
30 : 15

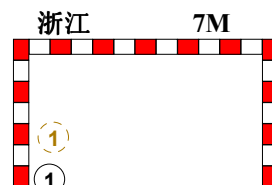



2016年“体彩杯”全国手球男子青年锦标赛

个人/全队技术统计表

正式表
手球
青年男子预赛
轮次 1组别 A
场次 2201602002-14-1/2
重庆万州
20/03/2016 10:00

| 号码 | 姓名 | 远射 | 近射 | 边射 | 快攻 | 突破 | 任意 | 7M | 合计 | % | 助攻 | 失误 | 警告 | 2' | 取消 | 时间 |
|----------------|-----|-----|-----|-----|-----|-----|-----|-----|------|-------|----|----|----|----|----|----------|
| 广东队(广东) | | | | | | | | | | | | | | | | |
| <i>(场上队员)</i> | | | | | | | | | | | | | | | | |
| 1 | 王帅 | 2/2 | 1/1 | | 0/1 | | | | 3/4 | 75.0% | 3 | 2 | | | | 00:43:03 |
| 2 | 姚雪岩 | | 2/2 | | | | | | 2/2 | 100% | | | | | | 00:14:28 |
| 4 | 高玉杰 | 0/1 | 0/1 | | 1/1 | | | | 1/3 | 33.3% | 1 | 4 | 1 | | | 00:24:13 |
| 5 | 黄培杰 | 1/2 | 1/2 | | 1/1 | 2/2 | | | 5/7 | 71.4% | 4 | 3 | | | | 00:30:00 |
| 7 | 段飞宇 | | | 0/2 | 2/2 | | | | 2/4 | 50.0% | | 1 | | | | 00:22:27 |
| 9 | 周凯峰 | | | | | | | | | 0.0% | | | 1 | | | 00:06:49 |
| 10 | 周仲坤 | 2/3 | | | 2/2 | | | | 4/5 | 80.0% | 1 | 1 | | | | 00:32:32 |
| 11 | 胡国富 | | 1/1 | | 1/1 | | | | 2/2 | 100% | 1 | 3 | | | | 00:20:08 |
| 12 | 李壮 | 2/2 | | 1/1 | | | 1/1 | | 4/4 | 100% | | 3 | | | | 00:29:46 |
| 13 | 蔡杰 | | 0/1 | | | | | | 0/1 | 0.0% | | 1 | | | | 00:20:41 |
| 14 | 王泽润 | | | | | | | | | 0.0% | | | | | | 00:01:47 |
| 15 | 张建杰 | 0/1 | 2/2 | | | | | | 2/3 | 66.7% | 1 | | 1 | 1 | | 00:19:37 |
| 16 | 王猛 | | | | | | | | | 0.0% | | | | | | 00:13:05 |
| 18 | 李文金 | 3/4 | 1/1 | | 1/1 | | 0/1 | | 5/7 | 71.4% | | 3 | | | | 00:23:27 |
| 合计 | | | | | | | | | | | | | | | | |
| <i>(守门员)</i> | | | | | | | | | | | | | | | | |
| 1 | 王帅 | 4/6 | 0/2 | 1/3 | | | | 0/2 | 5/13 | 38.5% | 3 | 2 | | | | 00:43:03 |
| 14 | 王泽润 | | 1/1 | | | | | 0/1 | 1/2 | 50.0% | | | | | | 00:01:47 |
| 16 | 王猛 | 0/2 | | 1/1 | 0/1 | 0/2 | 1/1 | 1/2 | 3/9 | 33.3% | | | | | | 00:13:05 |
| 合计 | | | | | | | | | | | | | | | | |

场上队员：得分/射门

守门员：救球/射门

| 全队合计 | 得分 | 被救 | 射失 | 击柱 | 封球 | 合计 | % |
|------|----|----|----|----|----|----|--------|
| 远射 | 8 | 1 | 3 | 1 | | 13 | 61.5% |
| 近射 | 10 | 2 | 1 | | | 13 | 76.9% |
| 边射 | 1 | 1 | 1 | | | 3 | 33.3% |
| 快攻 | 8 | | 1 | | | 9 | 88.9% |
| 突破 | 2 | | | | | 2 | 100.0% |
| 任意 | 1 | 1 | | | | 2 | 50.0% |
| 7M | | | | | | | 0.0% |





2016年“体彩杯”全国手球男子青年锦标赛

个人/全队技术统计表

正式表
手球
青年男子预赛
轮次 1组别 A
场次 2201602002-14-2/2
重庆万州
20/03/2016 10:00

| 号码 | 姓名 | 远射 | 近射 | 边射 | 快攻 | 突破 | 任意 | 7M | 合计 | % | 助攻 | 失误 | 警告 | 2' | 取消 | 时间 |
|----------------|-----|-----|------|-----|-----|-----|-----|-----|------|-------|----|----|----|----|----|----------|
| 浙江队(浙江) | | | | | | | | | | | | | | | | |
| <i>(上场队员)</i> | | | | | | | | | | | | | | | | |
| 1 | 林先方 | 0/3 | | 1/3 | 1/1 | | | 4/5 | 6/12 | 50.0% | 1 | 7 | | | | 00:43:05 |
| 2 | 李恩铭 | | 1/2 | 1/2 | | | | | 2/4 | 50.0% | | 2 | | | | 00:43:05 |
| 3 | 郑尧俊 | 0/1 | 1/1 | | | 2/2 | | | 3/4 | 75.0% | | 9 | 1 | 1 | | 00:43:05 |
| 5 | 高家南 | 0/1 | | | | | | | 0/1 | 0.0% | | 1 | 1 | | | 00:40:17 |
| 9 | 李家乐 | | | | | | | | | 0.0% | | | | | | 00:36:55 |
| 10 | 徐正飞 | | | | | | | | | 0.0% | | | | | | 00:02:35 |
| 11 | 陈渝天 | | | | | | | | | 0.0% | | | | | | 00:00:00 |
| 14 | 虞勇灿 | | | | | | | | | 0.0% | | | | | | 00:13:16 |
| 15 | 张佩力 | | | | | | | | | 0.0% | | | | | | 00:29:49 |
| 17 | 罗明杰 | | | | | | | | | 0.0% | | | | | | 00:06:09 |
| 18 | 倪陈辉 | 4/8 | | | | | 0/1 | | 4/9 | 44.4% | 2 | 10 | 1 | | | 00:43:05 |
| 19 | 王浩 | | | | | | | | | 0.0% | | | | | | 00:00:00 |
| 合计 | | | | | | | | | | | | | | | | |
| <i>(守门员)</i> | | | | | | | | | | | | | | | | |
| 14 | 虞勇灿 | 0/1 | 0/2 | | 0/3 | | 1/2 | | 1/8 | 12.5% | | | | | | 00:13:16 |
| 15 | 张佩力 | 1/8 | 2/10 | 1/2 | 0/5 | 0/2 | | | 4/27 | 14.8% | | | | | | 00:29:49 |
| 合计 | | | | | | | | | | | | | | | | |
| | | 1/9 | 2/12 | 1/2 | 0/8 | 0/2 | 1/2 | | 5/35 | 14.3% | | | | | | |

场上队员：得分/射门

守门员：救球/射门

| 全队合计 | 得分 | 被救 | 射失 | 击柱 | 封球 | 合计 | % |
|------|----|----|----|----|----|----|--------|
| 远射 | 4 | 4 | 2 | | 3 | 13 | 30.8% |
| 近射 | 2 | 1 | | | | 3 | 66.7% |
| 边射 | 2 | 2 | 1 | | | 5 | 40.0% |
| 快攻 | 1 | | | | | 1 | 100.0% |
| 突破 | 2 | | | | | 2 | 100.0% |
| 任意 | | 1 | | | | 1 | 0.0% |
| 7M | 4 | 1 | | | | 5 | 80.0% |





2016年“体彩杯”全国手球男子青年锦标赛

图式射门区域统计

轮次 1 场次 2

201602002-41-1/1

广东队

| | | | | | | | | | | | | | | | | | | | | | | | | | | | | | | | | | | | | | | | | | | | | | | | | | | | | | | | | | | | | | | | | | | | | | | | | | | | | | | | |
|--|-----------------------------|-----------------------------|-----------------------------|-----------------------------|-----------------------------|-----------------------------|-----------------------------|---|--|---|--|--|--|--|--|---|--|--|--|---|--|--|--|--|--|---|--|--|--|---|--|--|---|--|--|--|---|--|---|--|--|--|---|--|--|--|---|--|--|---|--|--|--|--|--|---|---|--|---|---|---|--|--|---|--|--|---|--|--|--|--|--|---|--|--|--|--|--|---|
| 1 王帅 | 2 姚雪岩 | 4 高玉杰 | 5 黄培杰 | 7 段飞宇 | 9 周凯峰 | 10 周仲坤 | 11 胡国富 | | | | | | | | | | | | | | | | | | | | | | | | | | | | | | | | | | | | | | | | | | | | | | | | | | | | | | | | | | | | | | | | | | | | | | | | |
| <table border="1"><tr><td></td><td>1</td><td></td></tr><tr><td></td><td></td><td>2</td></tr><tr><td></td><td></td><td></td></tr></table> | | 1 | | | | 2 | | | | <table border="1"><tr><td></td><td></td><td></td></tr><tr><td></td><td></td><td>2</td></tr><tr><td></td><td></td><td></td></tr></table> | | | | | | 2 | | | | <table border="1"><tr><td></td><td></td><td></td></tr><tr><td></td><td></td><td>1</td></tr><tr><td></td><td></td><td></td></tr></table> | | | | | | 1 | | | | <table border="1"><tr><td></td><td></td><td>1</td></tr><tr><td></td><td></td><td></td></tr><tr><td>3</td><td></td><td>1</td></tr></table> | | | 1 | | | | 3 | | 1 | <table border="1"><tr><td></td><td></td><td>1</td></tr><tr><td></td><td></td><td></td></tr><tr><td>1</td><td></td><td></td></tr></table> | | | 1 | | | | 1 | | | <table border="1"><tr><td></td><td></td><td></td></tr><tr><td></td><td></td><td></td></tr><tr><td></td><td></td><td></td></tr></table> | | | | | | | | | | <table border="1"><tr><td>1</td><td></td><td></td></tr><tr><td>2</td><td></td><td></td></tr><tr><td>1</td><td></td><td></td></tr></table> | 1 | | | 2 | | | 1 | | | <table border="1"><tr><td></td><td></td><td>1</td></tr><tr><td></td><td></td><td></td></tr><tr><td></td><td></td><td>1</td></tr></table> | | | 1 | | | | | | 1 |
| | 1 | | | | | | | | | | | | | | | | | | | | | | | | | | | | | | | | | | | | | | | | | | | | | | | | | | | | | | | | | | | | | | | | | | | | | | | | | | | | | | |
| | | 2 | | | | | | | | | | | | | | | | | | | | | | | | | | | | | | | | | | | | | | | | | | | | | | | | | | | | | | | | | | | | | | | | | | | | | | | | | | | | | |
| | | | | | | | | | | | | | | | | | | | | | | | | | | | | | | | | | | | | | | | | | | | | | | | | | | | | | | | | | | | | | | | | | | | | | | | | | | | | | | | |
| | | | | | | | | | | | | | | | | | | | | | | | | | | | | | | | | | | | | | | | | | | | | | | | | | | | | | | | | | | | | | | | | | | | | | | | | | | | | | | | |
| | | 2 | | | | | | | | | | | | | | | | | | | | | | | | | | | | | | | | | | | | | | | | | | | | | | | | | | | | | | | | | | | | | | | | | | | | | | | | | | | | | |
| | | | | | | | | | | | | | | | | | | | | | | | | | | | | | | | | | | | | | | | | | | | | | | | | | | | | | | | | | | | | | | | | | | | | | | | | | | | | | | | |
| | | | | | | | | | | | | | | | | | | | | | | | | | | | | | | | | | | | | | | | | | | | | | | | | | | | | | | | | | | | | | | | | | | | | | | | | | | | | | | | |
| | | 1 | | | | | | | | | | | | | | | | | | | | | | | | | | | | | | | | | | | | | | | | | | | | | | | | | | | | | | | | | | | | | | | | | | | | | | | | | | | | | |
| | | | | | | | | | | | | | | | | | | | | | | | | | | | | | | | | | | | | | | | | | | | | | | | | | | | | | | | | | | | | | | | | | | | | | | | | | | | | | | | |
| | | 1 | | | | | | | | | | | | | | | | | | | | | | | | | | | | | | | | | | | | | | | | | | | | | | | | | | | | | | | | | | | | | | | | | | | | | | | | | | | | | |
| | | | | | | | | | | | | | | | | | | | | | | | | | | | | | | | | | | | | | | | | | | | | | | | | | | | | | | | | | | | | | | | | | | | | | | | | | | | | | | | |
| 3 | | 1 | | | | | | | | | | | | | | | | | | | | | | | | | | | | | | | | | | | | | | | | | | | | | | | | | | | | | | | | | | | | | | | | | | | | | | | | | | | | | |
| | | 1 | | | | | | | | | | | | | | | | | | | | | | | | | | | | | | | | | | | | | | | | | | | | | | | | | | | | | | | | | | | | | | | | | | | | | | | | | | | | | |
| | | | | | | | | | | | | | | | | | | | | | | | | | | | | | | | | | | | | | | | | | | | | | | | | | | | | | | | | | | | | | | | | | | | | | | | | | | | | | | | |
| 1 | | | | | | | | | | | | | | | | | | | | | | | | | | | | | | | | | | | | | | | | | | | | | | | | | | | | | | | | | | | | | | | | | | | | | | | | | | | | | | | |
| | | | | | | | | | | | | | | | | | | | | | | | | | | | | | | | | | | | | | | | | | | | | | | | | | | | | | | | | | | | | | | | | | | | | | | | | | | | | | | | |
| | | | | | | | | | | | | | | | | | | | | | | | | | | | | | | | | | | | | | | | | | | | | | | | | | | | | | | | | | | | | | | | | | | | | | | | | | | | | | | | |
| | | | | | | | | | | | | | | | | | | | | | | | | | | | | | | | | | | | | | | | | | | | | | | | | | | | | | | | | | | | | | | | | | | | | | | | | | | | | | | | |
| 1 | | | | | | | | | | | | | | | | | | | | | | | | | | | | | | | | | | | | | | | | | | | | | | | | | | | | | | | | | | | | | | | | | | | | | | | | | | | | | | | |
| 2 | | | | | | | | | | | | | | | | | | | | | | | | | | | | | | | | | | | | | | | | | | | | | | | | | | | | | | | | | | | | | | | | | | | | | | | | | | | | | | | |
| 1 | | | | | | | | | | | | | | | | | | | | | | | | | | | | | | | | | | | | | | | | | | | | | | | | | | | | | | | | | | | | | | | | | | | | | | | | | | | | | | | |
| | | 1 | | | | | | | | | | | | | | | | | | | | | | | | | | | | | | | | | | | | | | | | | | | | | | | | | | | | | | | | | | | | | | | | | | | | | | | | | | | | | |
| | | | | | | | | | | | | | | | | | | | | | | | | | | | | | | | | | | | | | | | | | | | | | | | | | | | | | | | | | | | | | | | | | | | | | | | | | | | | | | | |
| | | 1 | | | | | | | | | | | | | | | | | | | | | | | | | | | | | | | | | | | | | | | | | | | | | | | | | | | | | | | | | | | | | | | | | | | | | | | | | | | | | |
| Post - 0 Miss - 1 Block - 0 | Post - 0 Miss - 0 Block - 0 | Post - 0 Miss - 1 Block - 0 | Post - 0 Miss - 1 Block - 0 | Post - 0 Miss - 1 Block - 0 | Post - 0 Miss - 0 Block - 0 | Post - 0 Miss - 1 Block - 0 | Post - 0 Miss - 0 Block - 0 | | | | | | | | | | | | | | | | | | | | | | | | | | | | | | | | | | | | | | | | | | | | | | | | | | | | | | | | | | | | | | | | | | | | | | | | |
| 12 李壮 | 13 蔡杰 | 14 王泽润 | 15 张建杰 | 16 王猛 | 18 李文金 | | | | | | | | | | | | | | | | | | | | | | | | | | | | | | | | | | | | | | | | | | | | | | | | | | | | | | | | | | | | | | | | | | | | | | | | | | |
| <table border="1"><tr><td>1</td><td></td><td></td></tr><tr><td>1</td><td></td><td>1</td></tr><tr><td></td><td>1</td><td></td></tr></table> | 1 | | | 1 | | 1 | | 1 | | <table border="1"><tr><td></td><td></td><td></td></tr><tr><td></td><td></td><td></td></tr><tr><td></td><td></td><td></td></tr></table> | | | | | | | | | | <table border="1"><tr><td></td><td></td><td></td></tr><tr><td></td><td></td><td></td></tr><tr><td></td><td></td><td></td></tr></table> | | | | | | | | | | <table border="1"><tr><td></td><td></td><td>1</td></tr><tr><td></td><td></td><td></td></tr><tr><td></td><td></td><td>1</td></tr></table> | | | 1 | | | | | | 1 | <table border="1"><tr><td></td><td></td><td></td></tr><tr><td></td><td></td><td></td></tr><tr><td></td><td></td><td></td></tr></table> | | | | | | | | | | <table border="1"><tr><td></td><td></td><td></td></tr><tr><td></td><td></td><td>2</td></tr><tr><td>1</td><td></td><td>2</td></tr></table> | | | | | | 2 | 1 | | 2 | | | | | | | | | | | | | | | | | | | | |
| 1 | | | | | | | | | | | | | | | | | | | | | | | | | | | | | | | | | | | | | | | | | | | | | | | | | | | | | | | | | | | | | | | | | | | | | | | | | | | | | | | |
| 1 | | 1 | | | | | | | | | | | | | | | | | | | | | | | | | | | | | | | | | | | | | | | | | | | | | | | | | | | | | | | | | | | | | | | | | | | | | | | | | | | | | |
| | 1 | | | | | | | | | | | | | | | | | | | | | | | | | | | | | | | | | | | | | | | | | | | | | | | | | | | | | | | | | | | | | | | | | | | | | | | | | | | | | | |
| | | | | | | | | | | | | | | | | | | | | | | | | | | | | | | | | | | | | | | | | | | | | | | | | | | | | | | | | | | | | | | | | | | | | | | | | | | | | | | | |
| | | | | | | | | | | | | | | | | | | | | | | | | | | | | | | | | | | | | | | | | | | | | | | | | | | | | | | | | | | | | | | | | | | | | | | | | | | | | | | | |
| | | | | | | | | | | | | | | | | | | | | | | | | | | | | | | | | | | | | | | | | | | | | | | | | | | | | | | | | | | | | | | | | | | | | | | | | | | | | | | | |
| | | | | | | | | | | | | | | | | | | | | | | | | | | | | | | | | | | | | | | | | | | | | | | | | | | | | | | | | | | | | | | | | | | | | | | | | | | | | | | | |
| | | | | | | | | | | | | | | | | | | | | | | | | | | | | | | | | | | | | | | | | | | | | | | | | | | | | | | | | | | | | | | | | | | | | | | | | | | | | | | | |
| | | | | | | | | | | | | | | | | | | | | | | | | | | | | | | | | | | | | | | | | | | | | | | | | | | | | | | | | | | | | | | | | | | | | | | | | | | | | | | | |
| | | 1 | | | | | | | | | | | | | | | | | | | | | | | | | | | | | | | | | | | | | | | | | | | | | | | | | | | | | | | | | | | | | | | | | | | | | | | | | | | | | |
| | | | | | | | | | | | | | | | | | | | | | | | | | | | | | | | | | | | | | | | | | | | | | | | | | | | | | | | | | | | | | | | | | | | | | | | | | | | | | | | |
| | | 1 | | | | | | | | | | | | | | | | | | | | | | | | | | | | | | | | | | | | | | | | | | | | | | | | | | | | | | | | | | | | | | | | | | | | | | | | | | | | | |
| | | | | | | | | | | | | | | | | | | | | | | | | | | | | | | | | | | | | | | | | | | | | | | | | | | | | | | | | | | | | | | | | | | | | | | | | | | | | | | | |
| | | | | | | | | | | | | | | | | | | | | | | | | | | | | | | | | | | | | | | | | | | | | | | | | | | | | | | | | | | | | | | | | | | | | | | | | | | | | | | | |
| | | | | | | | | | | | | | | | | | | | | | | | | | | | | | | | | | | | | | | | | | | | | | | | | | | | | | | | | | | | | | | | | | | | | | | | | | | | | | | | |
| | | | | | | | | | | | | | | | | | | | | | | | | | | | | | | | | | | | | | | | | | | | | | | | | | | | | | | | | | | | | | | | | | | | | | | | | | | | | | | | |
| | | 2 | | | | | | | | | | | | | | | | | | | | | | | | | | | | | | | | | | | | | | | | | | | | | | | | | | | | | | | | | | | | | | | | | | | | | | | | | | | | | |
| 1 | | 2 | | | | | | | | | | | | | | | | | | | | | | | | | | | | | | | | | | | | | | | | | | | | | | | | | | | | | | | | | | | | | | | | | | | | | | | | | | | | | |
| Post - 0 Miss - 0 Block - 0 | Post - 0 Miss - 0 Block - 0 | Post - 0 Miss - 0 Block - 0 | Post - 0 Miss - 1 Block - 0 | Post - 0 Miss - 0 Block - 0 | Post - 1 Miss - 0 Block - 0 | | | | | | | | | | | | | | | | | | | | | | | | | | | | | | | | | | | | | | | | | | | | | | | | | | | | | | | | | | | | | | | | | | | | | | | | | | |

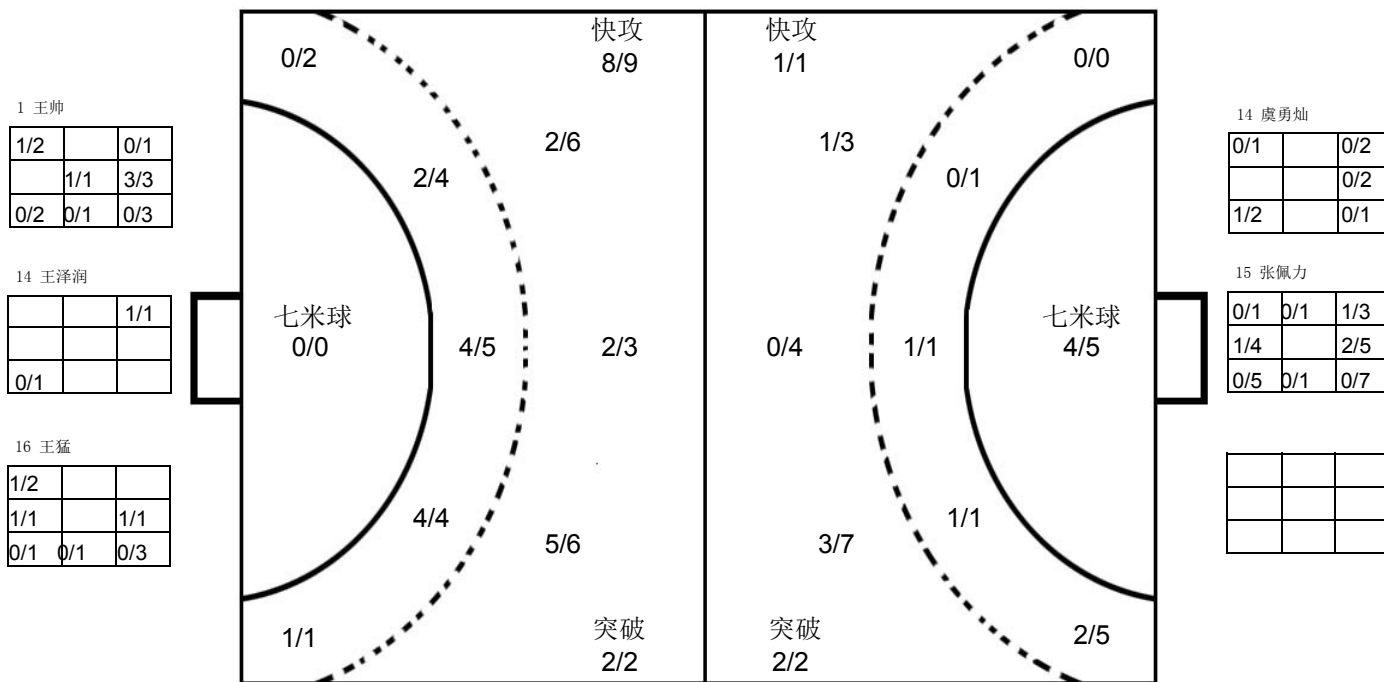

浙江队

| | | | | | | | | | | | | | | | | | | | | | | | | | | | | | | | | | | | | | | | | | | | | | | | | | | | | | | | | | | | | | | | | | | | | | | | | | | | | | | | |
|---|-----------------------------|-----------------------------|-----------------------------|-----------------------------|-----------------------------|-----------------------------|-----------------------------|--|---|--|--|--|--|--|---|---|--|--|--|---|---|--|--|--|--|--|---|---|---|--|--|--|--|--|--|--|--|--|--|--|--|--|--|--|--|--|--|--|--|--|--|--|--|--|--|--|--|--|--|--|--|--|--|--|--|--|--|--|--|--|--|--|--|--|--|--|--|--|--|
| 1 林先方 | 2 李恩铭 | 3 郑尧俊 | 5 高家南 | 9 李家乐 | 10 徐正飞 | 11 陈渝天 | 14 虞勇灿 | | | | | | | | | | | | | | | | | | | | | | | | | | | | | | | | | | | | | | | | | | | | | | | | | | | | | | | | | | | | | | | | | | | | | | | | |
| <table border="1"><tr><td></td><td></td><td>1</td></tr><tr><td></td><td></td><td></td></tr><tr><td>3</td><td></td><td>2</td></tr></table> | | | 1 | | | | 3 | | 2 | <table border="1"><tr><td></td><td></td><td></td></tr><tr><td></td><td>1</td><td>1</td></tr><tr><td></td><td></td><td></td></tr></table> | | | | | 1 | 1 | | | | <table border="1"><tr><td></td><td></td><td></td></tr><tr><td></td><td></td><td></td></tr><tr><td></td><td></td><td>3</td></tr></table> | | | | | | | | | 3 | <table border="1"><tr><td></td><td></td><td></td></tr><tr><td></td><td></td><td></td></tr><tr><td></td><td></td><td></td></tr></table> | | | | | | | | | | <table border="1"><tr><td></td><td></td><td></td></tr><tr><td></td><td></td><td></td></tr><tr><td></td><td></td><td></td></tr></table> | | | | | | | | | | <table border="1"><tr><td></td><td></td><td></td></tr><tr><td></td><td></td><td></td></tr><tr><td></td><td></td><td></td></tr></table> | | | | | | | | | | <table border="1"><tr><td></td><td></td><td></td></tr><tr><td></td><td></td><td></td></tr><tr><td></td><td></td><td></td></tr></table> | | | | | | | | | | <table border="1"><tr><td></td><td></td><td></td></tr><tr><td></td><td></td><td></td></tr><tr><td></td><td></td><td></td></tr></table> | | | | | | | | | |
| | | 1 | | | | | | | | | | | | | | | | | | | | | | | | | | | | | | | | | | | | | | | | | | | | | | | | | | | | | | | | | | | | | | | | | | | | | | | | | | | | | |
| | | | | | | | | | | | | | | | | | | | | | | | | | | | | | | | | | | | | | | | | | | | | | | | | | | | | | | | | | | | | | | | | | | | | | | | | | | | | | | | |
| 3 | | 2 | | | | | | | | | | | | | | | | | | | | | | | | | | | | | | | | | | | | | | | | | | | | | | | | | | | | | | | | | | | | | | | | | | | | | | | | | | | | | |
| | | | | | | | | | | | | | | | | | | | | | | | | | | | | | | | | | | | | | | | | | | | | | | | | | | | | | | | | | | | | | | | | | | | | | | | | | | | | | | | |
| | 1 | 1 | | | | | | | | | | | | | | | | | | | | | | | | | | | | | | | | | | | | | | | | | | | | | | | | | | | | | | | | | | | | | | | | | | | | | | | | | | | | | |
| | | | | | | | | | | | | | | | | | | | | | | | | | | | | | | | | | | | | | | | | | | | | | | | | | | | | | | | | | | | | | | | | | | | | | | | | | | | | | | | |
| | | | | | | | | | | | | | | | | | | | | | | | | | | | | | | | | | | | | | | | | | | | | | | | | | | | | | | | | | | | | | | | | | | | | | | | | | | | | | | | |
| | | | | | | | | | | | | | | | | | | | | | | | | | | | | | | | | | | | | | | | | | | | | | | | | | | | | | | | | | | | | | | | | | | | | | | | | | | | | | | | |
| | | 3 | | | | | | | | | | | | | | | | | | | | | | | | | | | | | | | | | | | | | | | | | | | | | | | | | | | | | | | | | | | | | | | | | | | | | | | | | | | | | |
| | | | | | | | | | | | | | | | | | | | | | | | | | | | | | | | | | | | | | | | | | | | | | | | | | | | | | | | | | | | | | | | | | | | | | | | | | | | | | | | |
| | | | | | | | | | | | | | | | | | | | | | | | | | | | | | | | | | | | | | | | | | | | | | | | | | | | | | | | | | | | | | | | | | | | | | | | | | | | | | | | |
| | | | | | | | | | | | | | | | | | | | | | | | | | | | | | | | | | | | | | | | | | | | | | | | | | | | | | | | | | | | | | | | | | | | | | | | | | | | | | | | |
| | | | | | | | | | | | | | | | | | | | | | | | | | | | | | | | | | | | | | | | | | | | | | | | | | | | | | | | | | | | | | | | | | | | | | | | | | | | | | | | |
| | | | | | | | | | | | | | | | | | | | | | | | | | | | | | | | | | | | | | | | | | | | | | | | | | | | | | | | | | | | | | | | | | | | | | | | | | | | | | | | |
| | | | | | | | | | | | | | | | | | | | | | | | | | | | | | | | | | | | | | | | | | | | | | | | | | | | | | | | | | | | | | | | | | | | | | | | | | | | | | | | |
| | | | | | | | | | | | | | | | | | | | | | | | | | | | | | | | | | | | | | | | | | | | | | | | | | | | | | | | | | | | | | | | | | | | | | | | | | | | | | | | |
| | | | | | | | | | | | | | | | | | | | | | | | | | | | | | | | | | | | | | | | | | | | | | | | | | | | | | | | | | | | | | | | | | | | | | | | | | | | | | | | |
| | | | | | | | | | | | | | | | | | | | | | | | | | | | | | | | | | | | | | | | | | | | | | | | | | | | | | | | | | | | | | | | | | | | | | | | | | | | | | | | |
| | | | | | | | | | | | | | | | | | | | | | | | | | | | | | | | | | | | | | | | | | | | | | | | | | | | | | | | | | | | | | | | | | | | | | | | | | | | | | | | |
| | | | | | | | | | | | | | | | | | | | | | | | | | | | | | | | | | | | | | | | | | | | | | | | | | | | | | | | | | | | | | | | | | | | | | | | | | | | | | | | |
| | | | | | | | | | | | | | | | | | | | | | | | | | | | | | | | | | | | | | | | | | | | | | | | | | | | | | | | | | | | | | | | | | | | | | | | | | | | | | | | |
| | | | | | | | | | | | | | | | | | | | | | | | | | | | | | | | | | | | | | | | | | | | | | | | | | | | | | | | | | | | | | | | | | | | | | | | | | | | | | | | |
| | | | | | | | | | | | | | | | | | | | | | | | | | | | | | | | | | | | | | | | | | | | | | | | | | | | | | | | | | | | | | | | | | | | | | | | | | | | | | | | |
| | | | | | | | | | | | | | | | | | | | | | | | | | | | | | | | | | | | | | | | | | | | | | | | | | | | | | | | | | | | | | | | | | | | | | | | | | | | | | | | |
| Post - 0 Miss - 2 Block - 1 | Post - 0 Miss - 0 Block - 0 | Post - 0 Miss - 0 Block - 1 | Post - 0 Miss - 1 Block - 0 | Post - 0 Miss - 0 Block - 0 | Post - 0 Miss - 0 Block - 0 | Post - 0 Miss - 0 Block - 0 | Post - 0 Miss - 0 Block - 0 | | | | | | | | | | | | | | | | | | | | | | | | | | | | | | | | | | | | | | | | | | | | | | | | | | | | | | | | | | | | | | | | | | | | | | | | |
| 15 张佩力 | 17 罗明杰 | 18 倪陈辉 | 19 王浩 | | | | | | | | | | | | | | | | | | | | | | | | | | | | | | | | | | | | | | | | | | | | | | | | | | | | | | | | | | | | | | | | | | | | | | | | | | | | |
| <table border="1"><tr><td></td><td></td><td></td></tr><tr><td></td><td></td><td></td></tr><tr><td></td><td></td><td></td></tr></table> | | | | | | | | | | <table border="1"><tr><td></td><td></td><td></td></tr><tr><td></td><td></td><td></td></tr><tr><td></td><td></td><td></td></tr></table> | | | | | | | | | | <table border="1"><tr><td>2</td><td></td><td></td></tr><tr><td></td><td></td><td></td></tr><tr><td>1</td><td>1</td><td></td></tr></table> | 2 | | | | | | 1 | 1 | | <table border="1"><tr><td></td><td></td><td></td></tr><tr><td></td><td></td><td></td></tr><tr><td></td><td></td><td></td></tr></table> | | | | | | | | | | | | | | | | | | | | | | | | | | | | | | | | | | | | | | | | | | | | | | | | | |
| | | | | | | | | | | | | | | | | | | | | | | | | | | | | | | | | | | | | | | | | | | | | | | | | | | | | | | | | | | | | | | | | | | | | | | | | | | | | | | | |
| | | | | | | | | | | | | | | | | | | | | | | | | | | | | | | | | | | | | | | | | | | | | | | | | | | | | | | | | | | | | | | | | | | | | | | | | | | | | | | | |
| | | | | | | | | | | | | | | | | | | | | | | | | | | | | | | | | | | | | | | | | | | | | | | | | | | | | | | | | | | | | | | | | | | | | | | | | | | | | | | | |
| | | | | | | | | | | | | | | | | | | | | | | | | | | | | | | | | | | | | | | | | | | | | | | | | | | | | | | | | | | | | | | | | | | | | | | | | | | | | | | | |
| | | | | | | | | | | | | | | | | | | | | | | | | | | | | | | | | | | | | | | | | | | | | | | | | | | | | | | | | | | | | | | | | | | | | | | | | | | | | | | | |
| | | | | | | | | | | | | | | | | | | | | | | | | | | | | | | | | | | | | | | | | | | | | | | | | | | | | | | | | | | | | | | | | | | | | | | | | | | | | | | | |
| 2 | | | | | | | | | | | | | | | | | | | | | | | | | | | | | | | | | | | | | | | | | | | | | | | | | | | | | | | | | | | | | | | | | | | | | | | | | | | | | | | |
| | | | | | | | | | | | | | | | | | | | | | | | | | | | | | | | | | | | | | | | | | | | | | | | | | | | | | | | | | | | | | | | | | | | | | | | | | | | | | | | |
| 1 | 1 | | | | | | | | | | | | | | | | | | | | | | | | | | | | | | | | | | | | | | | | | | | | | | | | | | | | | | | | | | | | | | | | | | | | | | | | | | | | | | |
| | | | | | | | | | | | | | | | | | | | | | | | | | | | | | | | | | | | | | | | | | | | | | | | | | | | | | | | | | | | | | | | | | | | | | | | | | | | | | | | |
| | | | | | | | | | | | | | | | | | | | | | | | | | | | | | | | | | | | | | | | | | | | | | | | | | | | | | | | | | | | | | | | | | | | | | | | | | | | | | | | |
| | | | | | | | | | | | | | | | | | | | | | | | | | | | | | | | | | | | | | | | | | | | | | | | | | | | | | | | | | | | | | | | | | | | | | | | | | | | | | | | |
| Post - 0 Miss - 0 Block - 0 | Post - 0 Miss - 0 Block - 0 | Post - 0 Miss - 0 Block - 1 | Post - 0 Miss - 0 Block - 0 | | | | | | | | | | | | | | | | | | | | | | | | | | | | | | | | | | | | | | | | | | | | | | | | | | | | | | | | | | | | | | | | | | | | | | | | | | | | |

注释: Post=击柱 Miss=射失 Block=被封





预赛 Group A
青年男子 全国比赛

2016年“体彩杯”全国手球男子青年锦标赛

| | | | | | | | | | | | | | | | | | | | | | |
|-------------------------|---|---------------------|---------------------|------------------------|------------------------------------|-------------------|----------|--------------------------|----------------|------------|----------|----------------------|---------------|----------|--|--|----|---|----|----------|----|
| Team A A 解放军队 | | | | Team B B 山东队 | | | | Match Number 3 | | | | | | | | | | | | | |
| played in China | | in the hall 重庆万州 | | on 19/03/2016 | | at 13:00 hours | | Spectators | | | | | | | | | | | | | |
| Half-time (30') | A 15 | B 15 | End of playing time | A 33 | B 35 | 1st extra time | A | B | 2nd extra time | A | B | After penalty throws | A | B | | | | | | | |
| Number of 7 m | A 0/2 | Team time-out | | | Full name of players and officials | | | | Team time-out | | | B 3/4 | Number of 7 m | | | | | | | | |
| | | 1 17:15 | 2 38:20 | 3 56:48 | | | | | 1 14:48 | 2 43:11 | 3 | | | | | | | | | | |
| No. | Team A | | | | | G | W | 2' | D | DR | No. | Team B | | | | | G | W | 2' | D | DR |
| 1 | 郭梦雨 | | | | | | | | | | 1 | 刘继超 | | | | | 1 | | | | |
| 3 | 张昌轲 | | | | | 4 | 1 | 2 | | | 2 | 冯鑫宇 | | | | | 2 | | | | |
| 4 | 张洋 | | | | | | | | | | 3 | 王铁林 | | | | | 2 | | 1 | | |
| 5 | 尹一楠 | | | | | | | | | | 5 | 王晓峰 | | | | | 13 | | 2 | | |
| 6 | 吴昊 | | | | | 4 | | 3 | | | 6 | 王军鸣 | | | | | 3 | | 1 | | |
| 7 | 姜钦 | | | | | 8 | 1 | 1 | | | 7 | 徐勇林 | | | | | | | | | |
| 8 | 邹峻楠 | | | | | | | | | | 10 | 孙芳伟 | | | | | 8 | | 1 | | |
| 9 | 李天枢 | | | | | | | | | | 11 | 王洋 | | | | | | 1 | | | |
| 10 | 范保坤 | | | | | 1 | | | | | 12 | 刘道林 | | | | | | | | | |
| 11 | 王誌汉 | | | | | 8 | 1 | | | | 13 | 于欣君 | | | | | 4 | | | | |
| 12 | 左子健 | | | | | | | | | | 17 | 薛盼龙 | | | | | | | 1 | | |
| 13 | 徐崧清 | | | | | 1 | | | | | 18 | 李玮 | | | | | | | | | |
| 14 | 孙耀琦 | | | | | 7 | | 1 | | | 21 | 王腾达 | | | | | | | | | |
| 16 | 池猛 | | | | | | | 1 | | | 22 | 李子跃 | | | | | | | | | |
| 17 | 刘安宁 | | | | | | | | | | 23 | 李荣健 | | | | | 2 | | | | |
| A | 杜长义 (主教练) | | | | | | | | | | A | 赵洋 | | | | | | | | | |
| B | 刘捷 | | | | | | | | | | B | 王莉莉 (主教练) | | | | | | | | | |
| C | 王学力 | | | | | | | | | | C | 曲铭锟 | | | | | | | | | |
| A | Signature of Responsible Official of the Teams (Off. A) | | | | | | | | | | | | | | | | | | | B | |
| TP | Remarks of Referee / CHA Official | | | | | | | | | | | | | | | | | | | TP | |

Signatures

| | | | | |
|------------------|-----------|-----------|--|--|
| Referees | 梅丹 (CHN) | 尹静阳 (CHN) | | |
| Techn. Delegates | 许宜扬 (CHN) | | | |
| CHA Official | 吴瑞亭 (CHN) | | | |

Note: Number of 7m Throws Awarded to Team A and B, Goals (G), Warnings (W), Suspensions (2'), Direct Disqualification (D), Disqualification with Report (DR) and Team Penalty (TP).

Table Officials:

Statisticians: 李双

刘永欢





2016年“体彩杯”全国手球男子青年锦标赛 竞赛技术统计(媒体表)

| | | | | | | |
|----------------|-----|------------|----|----|------------------|-----|
| 预赛 | 组别 | A | 轮次 | 1 | 场次 | 3 |
| 重庆万州 | | 19/03/2016 | | | 201602003-51-1/1 | |
| 解放军队 | 解放军 | 33 | vs | 35 | 山东 | 山东队 |
| 15 : 15 | | | | | | |

| | | | |
|-----|----------|---|-----------|
| 裁判员 | 梅丹 (CHN) | / | 尹静阳 (CHN) |
|-----|----------|---|-----------|

| 解放军 | | 远 | 近 | 边 | 快 | 突 | 任意 | 7m | 合计 | % | 助攻 | 失误 | 警告 | 2' | D & DR | 比赛进程 | |
|---------------|-----|-------|-------|-----|-----|-----|-----|-----|-------|------|----|----|----|----|--------|--------------------|--------------------|
| 主教练：杜长义 | | 射 | 射 | 射 | 攻 | 破 | 球 | 球 | | | | | | | | 解放军 | 山东 |
| 1 | 郭梦雨 | | | | | | | | | | | 1 | | | | 14 孙耀琦 | 1st Half 00:46 0 |
| 3 | 张昌轲 | 3/9 | 0/1 | | | 1/1 | | | 4/11 | 36.4 | 10 | 9 | 1 | 2 | | 7 姜钦 | 1 02:14 1 10 孙芳伟 |
| 4 | 张洋 | | | | | | | | | | | | | | | 11 王誌汉 | 2 02:37 1 10 孙芳伟 |
| 5 | 尹一楠 | | | | | | | | | | | 1 | | | | 14 孙耀琦 | 2 03:59 2 10 孙芳伟 |
| 6 | 吴昊 | 0/4 | 3/3 | | | 1/2 | | 0/1 | 4/10 | 40.0 | 2 | 6 | | 3 | | 6 吴昊 | 3 05:17 2 5 王晓峰 |
| 7 | 姜钦 | 3/6 | 1/4 | | 0/1 | 2/2 | 2/2 | | 8/15 | 53.3 | 5 | 4 | 1 | 1 | | 14 孙耀琦 | 4 06:52 2 10 孙芳伟 |
| 8 | 邹峻楠 | | | | | | | | | | | | | | | 6 吴昊 | 4 07:37 3 5 王晓峰 |
| 9 | 李天枢 | | | | | | | | | | | | | | | 14 孙耀琦 | 5 07:51 3 10 孙芳伟 |
| 10 | 范保坤 | | 1/2 | | | | | | 1/2 | 50.0 | 2 | | | | | 6 吴昊 | 5 08:27 4 10 孙芳伟 |
| 11 | 王誌汉 | 1/1 | 3/3 | 3/3 | 1/1 | | | | 8/8 | 100 | 1 | 1 | 1 | | | 7 姜钦 | 6 08:54 4 10 孙芳伟 |
| 12 | 左子健 | | | | | | | | | | | | | | | 6 吴昊 | 7 11:12 4 4 冯鑫宇 |
| 13 | 徐峻清 | | | 1/4 | | | | | 1/4 | 25.0 | | 1 | | | | 7 姜钦 | 7 12:05 5 2 冯鑫宇 |
| 14 | 孙耀琦 | | 7/7 | | 0/1 | | | 0/1 | 7/9 | 77.8 | | | | | | 7 姜钦 | 8 15:28 6 6 13 于欣君 |
| 16 | 池猛 | | | | | | | | | | | | | | | 7 姜钦 | 8 16:31 7 2 冯鑫宇 |
| 17 | 刘安宁 | | | | | | | | | | | | | | | 7 姜钦 | 9 17:23 7 2 冯鑫宇 |
| 运动员 合计 | | 7/20 | 15/20 | 4/7 | 1/3 | 4/5 | 2/2 | 0/2 | 33/59 | 55.9 | 20 | 23 | 3 | 8 | | 10 王誌汉 | 10 18:56 8 5 王晓峰 |
| 1 | 郭梦雨 | 7/22 | 5/10 | 1/1 | 2/4 | 0/3 | 0/4 | 0/2 | 15/46 | 32.6 | | 1 | | | | 10 王誌汉 | 10 21:16 9 13 于欣君 |
| 12 | 左子健 | 0/3 | | | | | | 0/1 | 0/4 | 0.0 | | | | | | 14 孙耀琦 | 10 22:01 10 5 王晓峰 |
| 16 | 池猛 | | | | | | | | | | | | | | | 14 孙耀琦 | 11 22:25 10 10 孙芳伟 |
| 守门员 合计 | | 7/25 | 5/10 | 1/1 | 2/4 | 0/3 | 0/4 | 0/3 | 15/50 | 30.0 | | 1 | | 1 | | 14 孙耀琦 | 12 24:18 11 6 王军鸣 |
| | | | | | | | | | | | | | | | | | |
| 山东 | | 远 | 近 | 边 | 快 | 突 | 任意 | 7m | 合计 | % | 助攻 | 失误 | 警告 | 2' | D & DR | 比赛进程 | |
| 教练：王莉莉 | | 射 | 射 | 射 | 攻 | 破 | 球 | 球 | | | | | | | | 解放军 | 山东 |
| 1 | 刘继超 | 1/1 | | | | | | | 1/1 | 100 | | | | | | 3 张昌轲 | 2nd Half 00:47 15 |
| 2 | 冯鑫宇 | 1/2 | 0/1 | | | | | 1/1 | 2/4 | 50.0 | 1 | 3 | | | | 16 01:26 16 10 孙芳伟 | |
| 3 | 王铁林 | 0/5 | 0/2 | | 2/2 | | | | 2/9 | 22.2 | 1 | 1 | | 1 | | 16 03:36 17 23 李荣健 | |
| 5 | 王晓峰 | 10/22 | 0/4 | | | | 3/3 | | 13/29 | 44.8 | 1 | 3 | | 2 | | 16 04:32 18 10 孙芳伟 | |
| 6 | 王军鸣 | 1/2 | 1/1 | | 0/2 | | 1/2 | | 3/7 | 42.9 | 1 | 1 | | 1 | | 6 吴昊 | 17 04:55 18 |
| 7 | 徐勇林 | | 0/1 | | | | | | 0/1 | 0.0 | | | | | | 17 05:29 19 23 李荣健 | |
| 10 | 孙芳伟 | 2/5 | 2/2 | | | 3/3 | | 1/1 | 8/11 | 72.7 | 1 | 4 | | 1 | | 17 05:54 20 1 刘继超 | |
| 11 | 王洋 | | | | | | | | | | | | | | | 18 07:09 20 | |
| 12 | 刘道林 | | | | | | | | | | | | | | | 18 09:10 21 5 王晓峰 | |
| 13 | 于欣君 | 3/3 | 1/1 | 0/1 | | | | 0/1 | 4/6 | 66.7 | | 1 | | | | 18 09:47 22 13 于欣君 | |
| 17 | 薛盼龙 | | | | | | | | | | | | | | | 3 张昌轲 | 19 10:05 22 |
| 18 | 李玮 | | | | | | | | | | | | | | | 19 10:27 23 6 王军鸣 | |
| 21 | 王腾达 | | | | | | | | | | | | | | | 6 吴昊 | 20 10:43 23 |
| 22 | 李子跃 | | | | | | | | | | | | | | | 20 11:14 24 5 王晓峰 | |
| 23 | 李荣健 | | 1/1 | 0/1 | 0/1 | | | 1/1 | 2/4 | 50.0 | | | | | | 7 姜钦 | 21 11:23 24 |
| 运动员 合计 | | 18/40 | 5/13 | 0/2 | 2/5 | 3/3 | 4/5 | 3/4 | 35/72 | 48.6 | 5 | 13 | 1 | 6 | | 11 王誌汉 | 22 11:58 24 |
| 1 | 刘继超 | 6/13 | 2/17 | 3/7 | 2/3 | 1/5 | 0/2 | 2/2 | 16/49 | 32.7 | | | | | | 11 王誌汉 | 22 13:56 25 10 孙芳伟 |
| 守门员 合计 | | 6/13 | 2/17 | 3/7 | 2/3 | 1/5 | 0/2 | 2/2 | 16/49 | 32.7 | | | | | | 14 孙耀琦 | 24 14:51 25 |

场上队员：得分 / 射门

守门员：救球 / 射门

| | | | | | | | | | |
|----|------------|----|--------------|-----|------------|-----|----------|----|---------|
| 快攻 | Fast Break | 突破 | Breakthrough | 任意球 | Free Throw | 7M球 | 7M Throw | 助攻 | Assist |
| 警告 | Warning | 失误 | Error | 2' | Suspension | D | 取消资格 | DR | 取消资格+报告 |





2016年“体彩杯”全国手球男子青年锦标赛 图式比赛技术统计表

轮次 1

场次 3

201602003-21-1/1

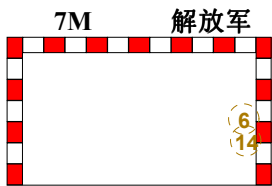
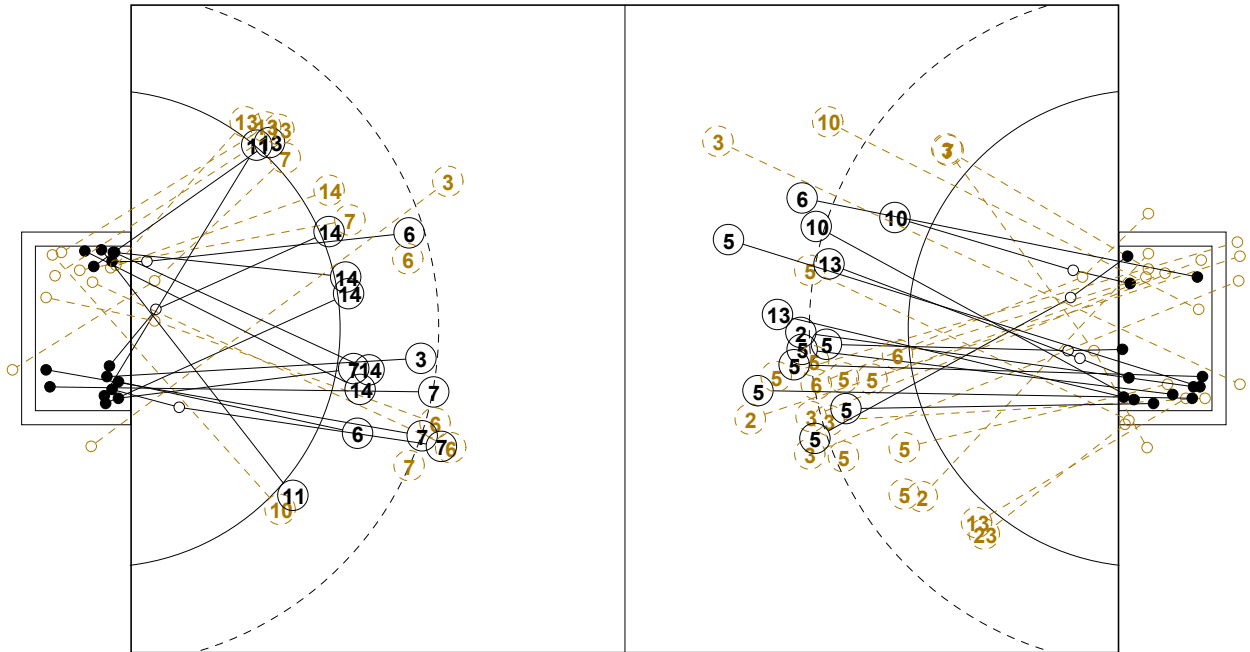

1st Half
15 : 15

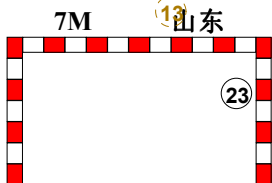
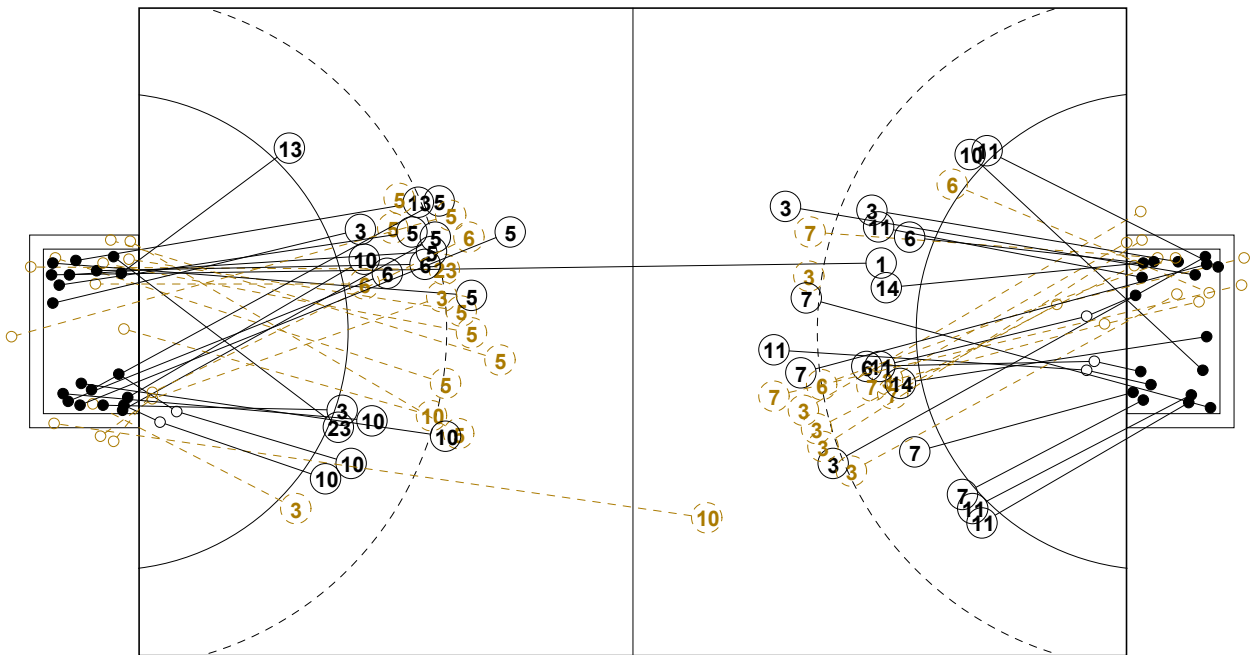
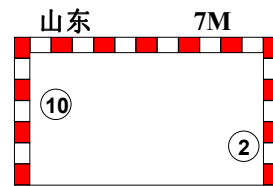

2nd Half
35 : 33

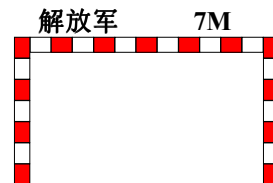



2016年“体彩杯”全国手球男子青年锦标赛

个人/全队技术统计表

正式表
手球
青年男子预赛
轮次 1组别 A
场次 3201602003-14-1/2
重庆万州
19/03/2016 13:00

| 号码 | 姓名 | 远射 | 近射 | 边射 | 快攻 | 突破 | 任意 | 7M | 合计 | % | 助攻 | 失误 | 警告 | 2' | 取消 | 时间 |
|------------------|-----|------|-------|-----|-----|-----|-----|-----|-------|-------|----|----|----|----|----|----------|
| 解放军队(解放军) | | | | | | | | | | | | | | | | |
| <i>(场上队员)</i> | | | | | | | | | | | | | | | | |
| 1 | 郭梦雨 | | | | | | | | | 0.0% | | 1 | | | | 00:55:48 |
| 3 | 张昌轲 | 3/9 | 0/1 | | | 1/1 | | | 4/11 | 36.4% | 10 | 9 | 1 | 2 | | 00:57:45 |
| 4 | 张洋 | | | | | | | | | 0.0% | | | | | | 00:00:00 |
| 5 | 尹一楠 | | | | | | | | | 0.0% | | 1 | | | | 00:00:08 |
| 6 | 吴昊 | 0/4 | 3/3 | | | 1/2 | | 0/1 | 4/10 | 40.0% | 2 | 6 | | 3 | | 00:56:03 |
| 7 | 姜钦 | 3/6 | 1/4 | | 0/1 | 2/2 | 2/2 | | 8/15 | 53.3% | 5 | 4 | 1 | 1 | | 00:57:24 |
| 8 | 邹峻楠 | | | | | | | | | 0.0% | | | | | | 00:00:00 |
| 9 | 李天枢 | | | | | | | | | 0.0% | | | | | | 00:00:00 |
| 10 | 范保坤 | | 1/2 | | | | | | 1/2 | 50.0% | 2 | | | | | 00:51:56 |
| 11 | 王誌汉 | 1/1 | 3/3 | 3/3 | 1/1 | | | | 8/8 | 100% | 1 | 1 | 1 | | | 00:48:24 |
| 12 | 左子健 | | | | | | | | | 0.0% | | | | | | 00:03:52 |
| 13 | 徐峻清 | | | 1/4 | | | | | 1/4 | 25.0% | | 1 | | | | 00:30:39 |
| 14 | 孙耀琦 | | 7/7 | | 0/1 | | | 0/1 | 7/9 | 77.8% | | | | 1 | | 00:55:41 |
| 16 | 池猛 | | | | | | | | | 0.0% | | | | 1 | | 00:03:07 |
| 17 | 刘安宁 | | | | | | | | | 0.0% | | | | | | 00:00:00 |
| 合计 | | 7/20 | 15/20 | 4/7 | 1/3 | 4/5 | 2/2 | 0/2 | 33/59 | 55.9% | 20 | 23 | 3 | 8 | | |
| <i>(守门员)</i> | | | | | | | | | | | | | | | | |
| 1 | 郭梦雨 | 7/22 | 5/10 | 1/1 | 2/4 | 0/3 | 0/4 | 0/2 | 15/46 | 32.6% | | 1 | | | | 00:55:48 |
| 12 | 左子健 | 0/3 | | | | | | 0/1 | 0/4 | 0.0% | | | | | | 00:03:52 |
| 16 | 池猛 | | | | | | | | | 0.0% | | | | 1 | | 00:03:07 |
| 合计 | | 7/25 | 5/10 | 1/1 | 2/4 | 0/3 | 0/4 | 0/3 | 15/50 | 30.0% | | 1 | | 1 | | |

场上队员：得分/射门

守门员：救球/射门

| 全队合计 | 得分 | 被救 | 射失 | 击柱 | 封球 | 合计 | % |
|------|----|----|----|----|----|----|--------|
| 远射 | 7 | 6 | 3 | 1 | 3 | 20 | 35.0% |
| 近射 | 15 | 2 | 2 | 1 | | 20 | 75.0% |
| 边射 | 4 | 3 | | | | 7 | 57.1% |
| 快攻 | 1 | 2 | | | | 3 | 33.3% |
| 突破 | 4 | 1 | | | | 5 | 80.0% |
| 任意 | 2 | | | | | 2 | 100.0% |
| 7M | | 2 | | | | 2 | 0.0% |





2016年“体彩杯”全国手球男子青年锦标赛

个人/全队技术统计表

正式表
手球
青年男子预赛
轮次 1组别 A
场次 3201602003-14-2/2
重庆万州
19/03/2016 13:00

| 号码 | 姓名 | 远射 | 近射 | 边射 | 快攻 | 突破 | 任意 | 7M | 合计 | % | 助攻 | 失误 | 警告 | 2' | 取消 | 时间 |
|----------------|-----|-------|------|-----|-----|-----|-----|-----|-------|-------|----|----|----|----|----|----------|
| 山东队(山东) | | | | | | | | | | | | | | | | |
| <i>(上场队员)</i> | | | | | | | | | | | | | | | | |
| 1 | 刘继超 | 1/1 | | | | | | | 1/1 | 100% | | | | | | 01:00:00 |
| 2 | 冯鑫宇 | 1/2 | 0/1 | | | | | 1/1 | 2/4 | 50.0% | 1 | 3 | | | | 00:48:16 |
| 3 | 王铁林 | 0/5 | 0/2 | | 2/2 | | | | 2/9 | 22.2% | 1 | 1 | | 1 | | 00:50:24 |
| 5 | 王晓峰 | 10/22 | 0/4 | | | | 3/3 | | 13/29 | 44.8% | 1 | 3 | | 2 | | 01:18:40 |
| 6 | 王军鸣 | 1/2 | 1/1 | | 0/2 | | 1/2 | | 3/7 | 42.9% | 1 | 1 | | 1 | | 00:39:56 |
| 7 | 徐勇林 | | 0/1 | | | | | | 0/1 | 0.0% | | | | | | 00:19:33 |
| 10 | 孙芳伟 | 2/5 | 2/2 | | | 3/3 | | 1/1 | 8/11 | 72.7% | 1 | 4 | | 1 | | 01:00:00 |
| 11 | 王洋 | | | | | | | | | 0.0% | | | 1 | | | 00:13:57 |
| 12 | 刘道林 | | | | | | | | | 0.0% | | | | | | 00:00:00 |
| 13 | 于欣君 | 3/3 | 1/1 | 0/1 | | | | 0/1 | 4/6 | 66.7% | | 1 | | | | 00:22:08 |
| 17 | 薛盼龙 | | | | | | | | | 0.0% | | | | 1 | | 00:20:03 |
| 18 | 李玮 | | | | | | | | | 0.0% | | | | | | 00:00:00 |
| 21 | 王腾达 | | | | | | | | | 0.0% | | | | | | 00:00:00 |
| 22 | 李子跃 | | | | | | | | | 0.0% | | | | | | 00:00:00 |
| 23 | 李荣健 | | 1/1 | 0/1 | 0/1 | | | 1/1 | 2/4 | 50.0% | | | | | | 00:25:38 |
| 合计 | | 18/40 | 5/13 | 0/2 | 2/5 | 3/3 | 4/5 | 3/4 | 35/72 | 48.6% | 5 | 13 | 1 | 6 | | |
| <i>(守门员)</i> | | | | | | | | | | | | | | | | |
| 1 | 刘继超 | 6/13 | 2/17 | 3/7 | 2/3 | 1/5 | 0/2 | 2/2 | 16/49 | 32.7% | | | | | | 01:00:00 |
| 合计 | | 6/13 | 2/17 | 3/7 | 2/3 | 1/5 | 0/2 | 2/2 | 16/49 | 32.7% | | | | | | |

场上队员：得分/射门

守门员：救球/射门

| 全队合计 | 得分 | 被救 | 射失 | 击柱 | 封球 | 合计 | % |
|------|----|----|----|----|----|----|--------|
| 远射 | 18 | 7 | 7 | 4 | 4 | 40 | 45.0% |
| 近射 | 5 | 5 | 1 | | 2 | 13 | 38.5% |
| 边射 | | 1 | | 1 | | 2 | 0.0% |
| 快攻 | 2 | 2 | | 1 | | 5 | 40.0% |
| 突破 | 3 | | | | | 3 | 100.0% |
| 任意 | 4 | | 1 | | | 5 | 80.0% |
| 7M | 3 | | 1 | | | 4 | 75.0% |





2016年“体彩杯”全国手球男子青年锦标赛

图式射门区域统计

轮次 1 场次 3

201602003-41-1/1

解放军队

| | | | | | | | | | | | | | | | | | | | | | | | | | | | | | | | | | | | | | | | | | | | | | | | | | | | | | | | | | | | | | | | | | | | | | | | | | | | | | | | |
|---|-----------------------------|-----------------------------|-----------------------------|-----------------------------|-----------------------------|-----------------------------|-----------------------------|--|--|--|---|--|---|---|--|--|---|--|---|--|--|--|--|--|--|--|--|--|--|---|--|--|--|--|--|---|--|--|--|--|--|---|--|--|--|---|---|--|---|--|---|--|---|--|--|--|---|--|---|--|--|--|--|--|--|--|--|--|--|--|--|--|--|--|--|--|--|--|--|
| 1 郭梦雨 | 3 张昌轲 | 4 张洋 | 5 尹一楠 | 6 吴昊 | 7 姜钦 | 8 邹峻楠 | 9 李天枢 | | | | | | | | | | | | | | | | | | | | | | | | | | | | | | | | | | | | | | | | | | | | | | | | | | | | | | | | | | | | | | | | | | | | | | | | |
| <table border="1"><tr><td></td><td></td><td></td></tr><tr><td></td><td></td><td></td></tr><tr><td></td><td></td><td></td></tr></table> | | | | | | | | | | <table border="1"><tr><td>2</td><td></td><td></td></tr><tr><td>1</td><td></td><td></td></tr><tr><td>1</td><td></td><td></td></tr></table> | 2 | | | 1 | | | 1 | | | <table border="1"><tr><td></td><td></td><td></td></tr><tr><td></td><td></td><td></td></tr><tr><td></td><td></td><td></td></tr></table> | | | | | | | | | | <table border="1"><tr><td></td><td></td><td></td></tr><tr><td></td><td></td><td></td></tr><tr><td></td><td></td><td></td></tr></table> | | | | | | | | | | <table border="1"><tr><td></td><td></td><td></td></tr><tr><td></td><td></td><td></td></tr><tr><td>2</td><td></td><td>2</td></tr></table> | | | | | | | 2 | | 2 | <table border="1"><tr><td>3</td><td></td><td>1</td></tr><tr><td></td><td></td><td></td></tr><tr><td>2</td><td></td><td>2</td></tr></table> | 3 | | 1 | | | | 2 | | 2 | <table border="1"><tr><td></td><td></td><td></td></tr><tr><td></td><td></td><td></td></tr><tr><td></td><td></td><td></td></tr></table> | | | | | | | | | | <table border="1"><tr><td></td><td></td><td></td></tr><tr><td></td><td></td><td></td></tr><tr><td></td><td></td><td></td></tr></table> | | | | | | | | | |
| | | | | | | | | | | | | | | | | | | | | | | | | | | | | | | | | | | | | | | | | | | | | | | | | | | | | | | | | | | | | | | | | | | | | | | | | | | | | | | | |
| | | | | | | | | | | | | | | | | | | | | | | | | | | | | | | | | | | | | | | | | | | | | | | | | | | | | | | | | | | | | | | | | | | | | | | | | | | | | | | | |
| | | | | | | | | | | | | | | | | | | | | | | | | | | | | | | | | | | | | | | | | | | | | | | | | | | | | | | | | | | | | | | | | | | | | | | | | | | | | | | | |
| 2 | | | | | | | | | | | | | | | | | | | | | | | | | | | | | | | | | | | | | | | | | | | | | | | | | | | | | | | | | | | | | | | | | | | | | | | | | | | | | | | |
| 1 | | | | | | | | | | | | | | | | | | | | | | | | | | | | | | | | | | | | | | | | | | | | | | | | | | | | | | | | | | | | | | | | | | | | | | | | | | | | | | | |
| 1 | | | | | | | | | | | | | | | | | | | | | | | | | | | | | | | | | | | | | | | | | | | | | | | | | | | | | | | | | | | | | | | | | | | | | | | | | | | | | | | |
| | | | | | | | | | | | | | | | | | | | | | | | | | | | | | | | | | | | | | | | | | | | | | | | | | | | | | | | | | | | | | | | | | | | | | | | | | | | | | | | |
| | | | | | | | | | | | | | | | | | | | | | | | | | | | | | | | | | | | | | | | | | | | | | | | | | | | | | | | | | | | | | | | | | | | | | | | | | | | | | | | |
| | | | | | | | | | | | | | | | | | | | | | | | | | | | | | | | | | | | | | | | | | | | | | | | | | | | | | | | | | | | | | | | | | | | | | | | | | | | | | | | |
| | | | | | | | | | | | | | | | | | | | | | | | | | | | | | | | | | | | | | | | | | | | | | | | | | | | | | | | | | | | | | | | | | | | | | | | | | | | | | | | |
| | | | | | | | | | | | | | | | | | | | | | | | | | | | | | | | | | | | | | | | | | | | | | | | | | | | | | | | | | | | | | | | | | | | | | | | | | | | | | | | |
| | | | | | | | | | | | | | | | | | | | | | | | | | | | | | | | | | | | | | | | | | | | | | | | | | | | | | | | | | | | | | | | | | | | | | | | | | | | | | | | |
| | | | | | | | | | | | | | | | | | | | | | | | | | | | | | | | | | | | | | | | | | | | | | | | | | | | | | | | | | | | | | | | | | | | | | | | | | | | | | | | |
| | | | | | | | | | | | | | | | | | | | | | | | | | | | | | | | | | | | | | | | | | | | | | | | | | | | | | | | | | | | | | | | | | | | | | | | | | | | | | | | |
| 2 | | 2 | | | | | | | | | | | | | | | | | | | | | | | | | | | | | | | | | | | | | | | | | | | | | | | | | | | | | | | | | | | | | | | | | | | | | | | | | | | | | |
| 3 | | 1 | | | | | | | | | | | | | | | | | | | | | | | | | | | | | | | | | | | | | | | | | | | | | | | | | | | | | | | | | | | | | | | | | | | | | | | | | | | | | |
| | | | | | | | | | | | | | | | | | | | | | | | | | | | | | | | | | | | | | | | | | | | | | | | | | | | | | | | | | | | | | | | | | | | | | | | | | | | | | | | |
| 2 | | 2 | | | | | | | | | | | | | | | | | | | | | | | | | | | | | | | | | | | | | | | | | | | | | | | | | | | | | | | | | | | | | | | | | | | | | | | | | | | | | |
| | | | | | | | | | | | | | | | | | | | | | | | | | | | | | | | | | | | | | | | | | | | | | | | | | | | | | | | | | | | | | | | | | | | | | | | | | | | | | | | |
| | | | | | | | | | | | | | | | | | | | | | | | | | | | | | | | | | | | | | | | | | | | | | | | | | | | | | | | | | | | | | | | | | | | | | | | | | | | | | | | |
| | | | | | | | | | | | | | | | | | | | | | | | | | | | | | | | | | | | | | | | | | | | | | | | | | | | | | | | | | | | | | | | | | | | | | | | | | | | | | | | |
| | | | | | | | | | | | | | | | | | | | | | | | | | | | | | | | | | | | | | | | | | | | | | | | | | | | | | | | | | | | | | | | | | | | | | | | | | | | | | | | |
| | | | | | | | | | | | | | | | | | | | | | | | | | | | | | | | | | | | | | | | | | | | | | | | | | | | | | | | | | | | | | | | | | | | | | | | | | | | | | | | |
| | | | | | | | | | | | | | | | | | | | | | | | | | | | | | | | | | | | | | | | | | | | | | | | | | | | | | | | | | | | | | | | | | | | | | | | | | | | | | | | |
| Post - 0 Miss - 0 Block - 0 | Post - 2 Miss - 2 Block - 1 | Post - 0 Miss - 0 Block - 0 | Post - 0 Miss - 0 Block - 0 | Post - 0 Miss - 0 Block - 1 | Post - 0 Miss - 3 Block - 1 | Post - 0 Miss - 0 Block - 0 | Post - 0 Miss - 0 Block - 0 | | | | | | | | | | | | | | | | | | | | | | | | | | | | | | | | | | | | | | | | | | | | | | | | | | | | | | | | | | | | | | | | | | | | | | | | |
| 10 范保坤 | 11 王誌汉 | 12 左子健 | 13 徐崧清 | 14 孙耀琦 | 16 池猛 | 17 刘安宇 | | | | | | | | | | | | | | | | | | | | | | | | | | | | | | | | | | | | | | | | | | | | | | | | | | | | | | | | | | | | | | | | | | | | | | | | | |
| <table border="1"><tr><td></td><td></td><td>1</td></tr><tr><td></td><td></td><td></td></tr><tr><td></td><td></td><td></td></tr></table> | | | 1 | | | | | | | <table border="1"><tr><td>1</td><td></td><td>2</td></tr><tr><td></td><td></td><td></td></tr><tr><td>3</td><td></td><td>2</td></tr></table> | 1 | | 2 | | | | 3 | | 2 | <table border="1"><tr><td></td><td></td><td></td></tr><tr><td></td><td></td><td></td></tr><tr><td></td><td></td><td></td></tr></table> | | | | | | | | | | <table border="1"><tr><td></td><td></td><td></td></tr><tr><td></td><td></td><td>1</td></tr><tr><td></td><td></td><td></td></tr></table> | | | | | | 1 | | | | <table border="1"><tr><td></td><td>1</td><td></td></tr><tr><td></td><td></td><td>1</td></tr><tr><td>3</td><td></td><td>2</td></tr></table> | | 1 | | | | 1 | 3 | | 2 | <table border="1"><tr><td></td><td></td><td></td></tr><tr><td></td><td></td><td></td></tr><tr><td></td><td></td><td></td></tr></table> | | | | | | | | | | <table border="1"><tr><td></td><td></td><td></td></tr><tr><td></td><td></td><td></td></tr><tr><td></td><td></td><td></td></tr></table> | | | | | | | | | | <table border="1"><tr><td></td><td></td><td></td></tr><tr><td></td><td></td><td></td></tr><tr><td></td><td></td><td></td></tr></table> | | | | | | | | | |
| | | 1 | | | | | | | | | | | | | | | | | | | | | | | | | | | | | | | | | | | | | | | | | | | | | | | | | | | | | | | | | | | | | | | | | | | | | | | | | | | | | |
| | | | | | | | | | | | | | | | | | | | | | | | | | | | | | | | | | | | | | | | | | | | | | | | | | | | | | | | | | | | | | | | | | | | | | | | | | | | | | | | |
| | | | | | | | | | | | | | | | | | | | | | | | | | | | | | | | | | | | | | | | | | | | | | | | | | | | | | | | | | | | | | | | | | | | | | | | | | | | | | | | |
| 1 | | 2 | | | | | | | | | | | | | | | | | | | | | | | | | | | | | | | | | | | | | | | | | | | | | | | | | | | | | | | | | | | | | | | | | | | | | | | | | | | | | |
| | | | | | | | | | | | | | | | | | | | | | | | | | | | | | | | | | | | | | | | | | | | | | | | | | | | | | | | | | | | | | | | | | | | | | | | | | | | | | | | |
| 3 | | 2 | | | | | | | | | | | | | | | | | | | | | | | | | | | | | | | | | | | | | | | | | | | | | | | | | | | | | | | | | | | | | | | | | | | | | | | | | | | | | |
| | | | | | | | | | | | | | | | | | | | | | | | | | | | | | | | | | | | | | | | | | | | | | | | | | | | | | | | | | | | | | | | | | | | | | | | | | | | | | | | |
| | | | | | | | | | | | | | | | | | | | | | | | | | | | | | | | | | | | | | | | | | | | | | | | | | | | | | | | | | | | | | | | | | | | | | | | | | | | | | | | |
| | | | | | | | | | | | | | | | | | | | | | | | | | | | | | | | | | | | | | | | | | | | | | | | | | | | | | | | | | | | | | | | | | | | | | | | | | | | | | | | |
| | | | | | | | | | | | | | | | | | | | | | | | | | | | | | | | | | | | | | | | | | | | | | | | | | | | | | | | | | | | | | | | | | | | | | | | | | | | | | | | |
| | | 1 | | | | | | | | | | | | | | | | | | | | | | | | | | | | | | | | | | | | | | | | | | | | | | | | | | | | | | | | | | | | | | | | | | | | | | | | | | | | | |
| | | | | | | | | | | | | | | | | | | | | | | | | | | | | | | | | | | | | | | | | | | | | | | | | | | | | | | | | | | | | | | | | | | | | | | | | | | | | | | | |
| | 1 | | | | | | | | | | | | | | | | | | | | | | | | | | | | | | | | | | | | | | | | | | | | | | | | | | | | | | | | | | | | | | | | | | | | | | | | | | | | | | |
| | | 1 | | | | | | | | | | | | | | | | | | | | | | | | | | | | | | | | | | | | | | | | | | | | | | | | | | | | | | | | | | | | | | | | | | | | | | | | | | | | | |
| 3 | | 2 | | | | | | | | | | | | | | | | | | | | | | | | | | | | | | | | | | | | | | | | | | | | | | | | | | | | | | | | | | | | | | | | | | | | | | | | | | | | | |
| | | | | | | | | | | | | | | | | | | | | | | | | | | | | | | | | | | | | | | | | | | | | | | | | | | | | | | | | | | | | | | | | | | | | | | | | | | | | | | | |
| | | | | | | | | | | | | | | | | | | | | | | | | | | | | | | | | | | | | | | | | | | | | | | | | | | | | | | | | | | | | | | | | | | | | | | | | | | | | | | | |
| | | | | | | | | | | | | | | | | | | | | | | | | | | | | | | | | | | | | | | | | | | | | | | | | | | | | | | | | | | | | | | | | | | | | | | | | | | | | | | | |
| | | | | | | | | | | | | | | | | | | | | | | | | | | | | | | | | | | | | | | | | | | | | | | | | | | | | | | | | | | | | | | | | | | | | | | | | | | | | | | | |
| | | | | | | | | | | | | | | | | | | | | | | | | | | | | | | | | | | | | | | | | | | | | | | | | | | | | | | | | | | | | | | | | | | | | | | | | | | | | | | | |
| | | | | | | | | | | | | | | | | | | | | | | | | | | | | | | | | | | | | | | | | | | | | | | | | | | | | | | | | | | | | | | | | | | | | | | | | | | | | | | | |
| | | | | | | | | | | | | | | | | | | | | | | | | | | | | | | | | | | | | | | | | | | | | | | | | | | | | | | | | | | | | | | | | | | | | | | | | | | | | | | | |
| | | | | | | | | | | | | | | | | | | | | | | | | | | | | | | | | | | | | | | | | | | | | | | | | | | | | | | | | | | | | | | | | | | | | | | | | | | | | | | | |
| | | | | | | | | | | | | | | | | | | | | | | | | | | | | | | | | | | | | | | | | | | | | | | | | | | | | | | | | | | | | | | | | | | | | | | | | | | | | | | | |
| Post - 0 Miss - 0 Block - 0 | Post - 0 Miss - 0 Block - 0 | Post - 0 Miss - 0 Block - 0 | Post - 0 Miss - 0 Block - 0 | Post - 0 Miss - 0 Block - 0 | Post - 0 Miss - 0 Block - 0 | Post - 0 Miss - 0 Block - 0 | | | | | | | | | | | | | | | | | | | | | | | | | | | | | | | | | | | | | | | | | | | | | | | | | | | | | | | | | | | | | | | | | | | | | | | | | |

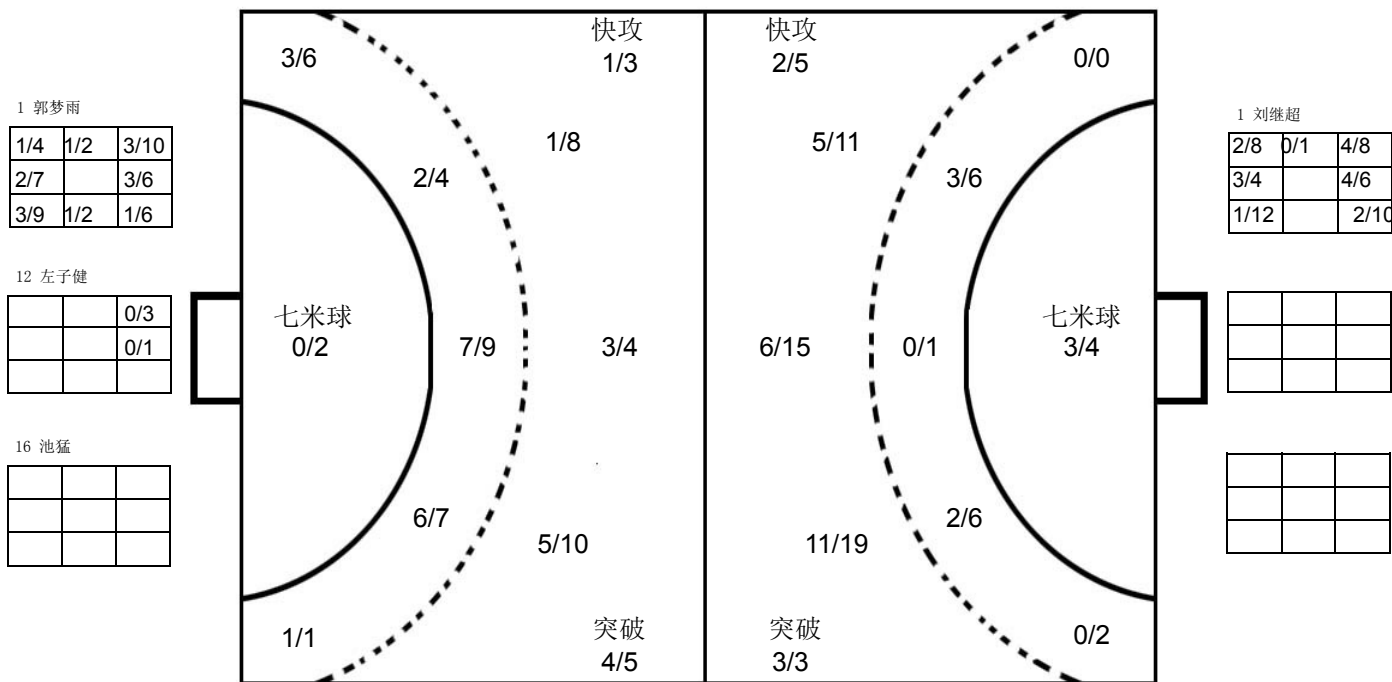

山东队

| | | | | | | | | | | | | | | | | | | | | | | | | | | | | | | | | | | | | | | | | | | | | | | | | | | | | | | | | | | | | | | | | | | | | | | | | | | | | | | | |
|---|-----------------------------|-----------------------------|-----------------------------|-----------------------------|-----------------------------|-----------------------------|-----------------------------|--|--|--|--|--|---|--|--|---|--|--|---|--|--|---|--|---|--|--|--|--|--|---|--|--|---|---|--|---|---|---|--|--|---|--|--|--|--|---|--|--|--|--|--|--|--|--|--|--|--|--|--|--|---|--|---|---|--|--|---|--|---|--|--|--|--|--|--|--|--|--|--|
| 1 刘继超 | 2 冯鑫宇 | 3 王铁林 | 5 王晓峰 | 6 王军鸣 | 7 徐勇林 | 10 孙芳伟 | 11 王洋 | | | | | | | | | | | | | | | | | | | | | | | | | | | | | | | | | | | | | | | | | | | | | | | | | | | | | | | | | | | | | | | | | | | | | | | | |
| <table border="1"><tr><td></td><td></td><td>1</td></tr><tr><td></td><td></td><td></td></tr><tr><td></td><td></td><td></td></tr></table> | | | 1 | | | | | | | <table border="1"><tr><td></td><td></td><td>1</td></tr><tr><td></td><td></td><td>1</td></tr><tr><td></td><td></td><td></td></tr></table> | | | 1 | | | 1 | | | | <table border="1"><tr><td></td><td>1</td><td></td></tr><tr><td>1</td><td></td><td></td></tr><tr><td></td><td></td><td></td></tr></table> | | 1 | | 1 | | | | | | <table border="1"><tr><td></td><td></td><td>6</td></tr><tr><td>2</td><td></td><td>2</td></tr><tr><td>2</td><td>1</td><td></td></tr></table> | | | 6 | 2 | | 2 | 2 | 1 | | <table border="1"><tr><td>2</td><td></td><td></td></tr><tr><td></td><td></td><td>1</td></tr><tr><td></td><td></td><td></td></tr></table> | 2 | | | | | 1 | | | | <table border="1"><tr><td></td><td></td><td></td></tr><tr><td></td><td></td><td></td></tr><tr><td></td><td></td><td></td></tr></table> | | | | | | | | | | <table border="1"><tr><td>1</td><td></td><td></td></tr><tr><td>2</td><td></td><td></td></tr><tr><td>4</td><td></td><td>1</td></tr></table> | 1 | | | 2 | | | 4 | | 1 | <table border="1"><tr><td></td><td></td><td></td></tr><tr><td></td><td></td><td></td></tr><tr><td></td><td></td><td></td></tr></table> | | | | | | | | | |
| | | 1 | | | | | | | | | | | | | | | | | | | | | | | | | | | | | | | | | | | | | | | | | | | | | | | | | | | | | | | | | | | | | | | | | | | | | | | | | | | | | |
| | | | | | | | | | | | | | | | | | | | | | | | | | | | | | | | | | | | | | | | | | | | | | | | | | | | | | | | | | | | | | | | | | | | | | | | | | | | | | | | |
| | | | | | | | | | | | | | | | | | | | | | | | | | | | | | | | | | | | | | | | | | | | | | | | | | | | | | | | | | | | | | | | | | | | | | | | | | | | | | | | |
| | | 1 | | | | | | | | | | | | | | | | | | | | | | | | | | | | | | | | | | | | | | | | | | | | | | | | | | | | | | | | | | | | | | | | | | | | | | | | | | | | | |
| | | 1 | | | | | | | | | | | | | | | | | | | | | | | | | | | | | | | | | | | | | | | | | | | | | | | | | | | | | | | | | | | | | | | | | | | | | | | | | | | | | |
| | | | | | | | | | | | | | | | | | | | | | | | | | | | | | | | | | | | | | | | | | | | | | | | | | | | | | | | | | | | | | | | | | | | | | | | | | | | | | | | |
| | 1 | | | | | | | | | | | | | | | | | | | | | | | | | | | | | | | | | | | | | | | | | | | | | | | | | | | | | | | | | | | | | | | | | | | | | | | | | | | | | | |
| 1 | | | | | | | | | | | | | | | | | | | | | | | | | | | | | | | | | | | | | | | | | | | | | | | | | | | | | | | | | | | | | | | | | | | | | | | | | | | | | | | |
| | | | | | | | | | | | | | | | | | | | | | | | | | | | | | | | | | | | | | | | | | | | | | | | | | | | | | | | | | | | | | | | | | | | | | | | | | | | | | | | |
| | | 6 | | | | | | | | | | | | | | | | | | | | | | | | | | | | | | | | | | | | | | | | | | | | | | | | | | | | | | | | | | | | | | | | | | | | | | | | | | | | | |
| 2 | | 2 | | | | | | | | | | | | | | | | | | | | | | | | | | | | | | | | | | | | | | | | | | | | | | | | | | | | | | | | | | | | | | | | | | | | | | | | | | | | | |
| 2 | 1 | | | | | | | | | | | | | | | | | | | | | | | | | | | | | | | | | | | | | | | | | | | | | | | | | | | | | | | | | | | | | | | | | | | | | | | | | | | | | | |
| 2 | | | | | | | | | | | | | | | | | | | | | | | | | | | | | | | | | | | | | | | | | | | | | | | | | | | | | | | | | | | | | | | | | | | | | | | | | | | | | | | |
| | | 1 | | | | | | | | | | | | | | | | | | | | | | | | | | | | | | | | | | | | | | | | | | | | | | | | | | | | | | | | | | | | | | | | | | | | | | | | | | | | | |
| | | | | | | | | | | | | | | | | | | | | | | | | | | | | | | | | | | | | | | | | | | | | | | | | | | | | | | | | | | | | | | | | | | | | | | | | | | | | | | | |
| | | | | | | | | | | | | | | | | | | | | | | | | | | | | | | | | | | | | | | | | | | | | | | | | | | | | | | | | | | | | | | | | | | | | | | | | | | | | | | | |
| | | | | | | | | | | | | | | | | | | | | | | | | | | | | | | | | | | | | | | | | | | | | | | | | | | | | | | | | | | | | | | | | | | | | | | | | | | | | | | | |
| | | | | | | | | | | | | | | | | | | | | | | | | | | | | | | | | | | | | | | | | | | | | | | | | | | | | | | | | | | | | | | | | | | | | | | | | | | | | | | | |
| 1 | | | | | | | | | | | | | | | | | | | | | | | | | | | | | | | | | | | | | | | | | | | | | | | | | | | | | | | | | | | | | | | | | | | | | | | | | | | | | | | |
| 2 | | | | | | | | | | | | | | | | | | | | | | | | | | | | | | | | | | | | | | | | | | | | | | | | | | | | | | | | | | | | | | | | | | | | | | | | | | | | | | | |
| 4 | | 1 | | | | | | | | | | | | | | | | | | | | | | | | | | | | | | | | | | | | | | | | | | | | | | | | | | | | | | | | | | | | | | | | | | | | | | | | | | | | | |
| | | | | | | | | | | | | | | | | | | | | | | | | | | | | | | | | | | | | | | | | | | | | | | | | | | | | | | | | | | | | | | | | | | | | | | | | | | | | | | | |
| | | | | | | | | | | | | | | | | | | | | | | | | | | | | | | | | | | | | | | | | | | | | | | | | | | | | | | | | | | | | | | | | | | | | | | | | | | | | | | | |
| | | | | | | | | | | | | | | | | | | | | | | | | | | | | | | | | | | | | | | | | | | | | | | | | | | | | | | | | | | | | | | | | | | | | | | | | | | | | | | | |
| Post - 0 Miss - 0 Block - 0 | Post - 0 Miss - 1 Block - 0 | Post - 0 Miss - 4 Block - 0 | Post - 3 Miss - 2 Block - 6 | Post - 0 Miss - 2 Block - 0 | Post - 0 Miss - 0 Block - 0 | Post - 1 Miss - 0 Block - 0 | Post - 0 Miss - 0 Block - 0 | | | | | | | | | | | | | | | | | | | | | | | | | | | | | | | | | | | | | | | | | | | | | | | | | | | | | | | | | | | | | | | | | | | | | | | | |
| 12 刘道林 | 13 于欣君 | 17 薛盼龙 | 18 李玮 | 21 王腾达 | 22 李子跃 | 23 李荣健 | | | | | | | | | | | | | | | | | | | | | | | | | | | | | | | | | | | | | | | | | | | | | | | | | | | | | | | | | | | | | | | | | | | | | | | | | |
| <table border="1"><tr><td></td><td></td><td></td></tr><tr><td></td><td></td><td></td></tr><tr><td></td><td></td><td></td></tr></table> | | | | | | | | | | <table border="1"><tr><td></td><td></td><td>1</td></tr><tr><td></td><td></td><td></td></tr><tr><td></td><td></td><td>3</td></tr></table> | | | 1 | | | | | | 3 | <table border="1"><tr><td></td><td></td><td></td></tr><tr><td></td><td></td><td></td></tr><tr><td></td><td></td><td></td></tr></table> | | | | | | | | | | <table border="1"><tr><td></td><td></td><td></td></tr><tr><td></td><td></td><td></td></tr><tr><td></td><td></td><td></td></tr></table> | | | | | | | | | | <table border="1"><tr><td></td><td></td><td></td></tr><tr><td></td><td></td><td></td></tr><tr><td></td><td></td><td></td></tr></table> | | | | | | | | | | <table border="1"><tr><td></td><td></td><td></td></tr><tr><td></td><td></td><td></td></tr><tr><td></td><td></td><td></td></tr></table> | | | | | | | | | | <table border="1"><tr><td></td><td></td><td>1</td></tr><tr><td></td><td></td><td></td></tr><tr><td></td><td></td><td>1</td></tr></table> | | | 1 | | | | | | 1 | <table border="1"><tr><td></td><td></td><td></td></tr><tr><td></td><td></td><td></td></tr><tr><td></td><td></td><td></td></tr></table> | | | | | | | | | |
| | | | | | | | | | | | | | | | | | | | | | | | | | | | | | | | | | | | | | | | | | | | | | | | | | | | | | | | | | | | | | | | | | | | | | | | | | | | | | | | |
| | | | | | | | | | | | | | | | | | | | | | | | | | | | | | | | | | | | | | | | | | | | | | | | | | | | | | | | | | | | | | | | | | | | | | | | | | | | | | | | |
| | | | | | | | | | | | | | | | | | | | | | | | | | | | | | | | | | | | | | | | | | | | | | | | | | | | | | | | | | | | | | | | | | | | | | | | | | | | | | | | |
| | | 1 | | | | | | | | | | | | | | | | | | | | | | | | | | | | | | | | | | | | | | | | | | | | | | | | | | | | | | | | | | | | | | | | | | | | | | | | | | | | | |
| | | | | | | | | | | | | | | | | | | | | | | | | | | | | | | | | | | | | | | | | | | | | | | | | | | | | | | | | | | | | | | | | | | | | | | | | | | | | | | | |
| | | 3 | | | | | | | | | | | | | | | | | | | | | | | | | | | | | | | | | | | | | | | | | | | | | | | | | | | | | | | | | | | | | | | | | | | | | | | | | | | | | |
| | | | | | | | | | | | | | | | | | | | | | | | | | | | | | | | | | | | | | | | | | | | | | | | | | | | | | | | | | | | | | | | | | | | | | | | | | | | | | | | |
| | | | | | | | | | | | | | | | | | | | | | | | | | | | | | | | | | | | | | | | | | | | | | | | | | | | | | | | | | | | | | | | | | | | | | | | | | | | | | | | |
| | | | | | | | | | | | | | | | | | | | | | | | | | | | | | | | | | | | | | | | | | | | | | | | | | | | | | | | | | | | | | | | | | | | | | | | | | | | | | | | |
| | | | | | | | | | | | | | | | | | | | | | | | | | | | | | | | | | | | | | | | | | | | | | | | | | | | | | | | | | | | | | | | | | | | | | | | | | | | | | | | |
| | | | | | | | | | | | | | | | | | | | | | | | | | | | | | | | | | | | | | | | | | | | | | | | | | | | | | | | | | | | | | | | | | | | | | | | | | | | | | | | |
| | | | | | | | | | | | | | | | | | | | | | | | | | | | | | | | | | | | | | | | | | | | | | | | | | | | | | | | | | | | | | | | | | | | | | | | | | | | | | | | |
| | | | | | | | | | | | | | | | | | | | | | | | | | | | | | | | | | | | | | | | | | | | | | | | | | | | | | | | | | | | | | | | | | | | | | | | | | | | | | | | |
| | | | | | | | | | | | | | | | | | | | | | | | | | | | | | | | | | | | | | | | | | | | | | | | | | | | | | | | | | | | | | | | | | | | | | | | | | | | | | | | |
| | | | | | | | | | | | | | | | | | | | | | | | | | | | | | | | | | | | | | | | | | | | | | | | | | | | | | | | | | | | | | | | | | | | | | | | | | | | | | | | |
| | | | | | | | | | | | | | | | | | | | | | | | | | | | | | | | | | | | | | | | | | | | | | | | | | | | | | | | | | | | | | | | | | | | | | | | | | | | | | | | |
| | | | | | | | | | | | | | | | | | | | | | | | | | | | | | | | | | | | | | | | | | | | | | | | | | | | | | | | | | | | | | | | | | | | | | | | | | | | | | | | |
| | | | | | | | | | | | | | | | | | | | | | | | | | | | | | | | | | | | | | | | | | | | | | | | | | | | | | | | | | | | | | | | | | | | | | | | | | | | | | | | |
| | | 1 | | | | | | | | | | | | | | | | | | | | | | | | | | | | | | | | | | | | | | | | | | | | | | | | | | | | | | | | | | | | | | | | | | | | | | | | | | | | | |
| | | | | | | | | | | | | | | | | | | | | | | | | | | | | | | | | | | | | | | | | | | | | | | | | | | | | | | | | | | | | | | | | | | | | | | | | | | | | | | | |
| | | 1 | | | | | | | | | | | | | | | | | | | | | | | | | | | | | | | | | | | | | | | | | | | | | | | | | | | | | | | | | | | | | | | | | | | | | | | | | | | | | |
| | | | | | | | | | | | | | | | | | | | | | | | | | | | | | | | | | | | | | | | | | | | | | | | | | | | | | | | | | | | | | | | | | | | | | | | | | | | | | | | |
| | | | | | | | | | | | | | | | | | | | | | | | | | | | | | | | | | | | | | | | | | | | | | | | | | | | | | | | | | | | | | | | | | | | | | | | | | | | | | | | |
| | | | | | | | | | | | | | | | | | | | | | | | | | | | | | | | | | | | | | | | | | | | | | | | | | | | | | | | | | | | | | | | | | | | | | | | | | | | | | | | |
| Post - 0 Miss - 0 Block - 0 | Post - 0 Miss - 1 Block - 0 | Post - 0 Miss - 0 Block - 0 | Post - 0 Miss - 0 Block - 0 | Post - 0 Miss - 0 Block - 0 | Post - 0 Miss - 0 Block - 0 | Post - 2 Miss - 0 Block - 0 | | | | | | | | | | | | | | | | | | | | | | | | | | | | | | | | | | | | | | | | | | | | | | | | | | | | | | | | | | | | | | | | | | | | | | | | | |

注释: Post=击柱 Miss=射失 Block=被封





预赛 Group B
青年男子 全国比赛

2016年“体彩杯”全国手球男子青年锦标赛

| | | | | | | | | | | | | | | | | | | | | | |
|--------------------|---|---------------------|---------------------|------------------|------------------------------------|-------------------|---|-------------------|----------------|-------|-------|----------------------|---------------|---|--|--|---|---|----|---|----|
| Team A A 安徽队 | | | | Team B B 北京队 | | | | Match Number 4 | | | | | | | | | | | | | |
| played in China | | in the hall 重庆万州 | | on 19/03/2016 | | at 14:30 hours | | Spectators | | | | | | | | | | | | | |
| Half-time (30') | A 18 | B 12 | End of playing time | A 38 | B 26 | 1st extra time | A | B | 2nd extra time | A | B | After penalty throws | A | B | | | | | | | |
| Number of 7 m | A 1/2 | Team time-out | | | Full name of players and officials | | | | Team time-out | | | B 1/2 | Number of 7 m | | | | | | | | |
| | | 1 | 2 | 3 | | | | | 1 | 2 | 3 | | | | | | | | | | |
| | | 50:38 | | | | | | | 04:34 | 35:05 | 48:37 | | | | | | | | | | |
| No. | Team A | | | | | G | W | 2' | D | DR | No. | Team B | | | | | G | W | 2' | D | DR |
| 2 | 金勇峰 | | | | | 7 | | | | | 3 | 王哲一 | | | | | 2 | | | | |
| 9 | 陈开勇 | | | | | 1 | | 2 | | | 4 | 朱广刚 | | | | | 5 | | 2 | | |
| 17 | 王巨柱 | | | | | 8 | | | | | 6 | 赵一涵 | | | | | 3 | 1 | 1 | | |
| 18 | 李双 | | | | | 9 | 1 | | | | 7 | 卞友山 | | | | | 1 | | | | |
| 19 | 何山 | | | | | 4 | 1 | | | | 11 | 李旭 | | | | | 2 | 1 | | | |
| 21 | 李明 | | | | | | | | | | 15 | 逯明松 | | | | | | | | | |
| 24 | 徐安格 | | | | | 3 | | 1 | | | 16 | 马佳鹏 | | | | | | | | | |
| 25 | 李文哲 | | | | | | | | | | 18 | 李明远 | | | | | 2 | | | | |
| 26 | 程浩然 | | | | | 4 | | 1 | | | 19 | 陈旭 | | | | | 4 | | 1 | | |
| 27 | 王长旭 | | | | | 2 | 1 | | | | 23 | 刘帅 | | | | | 2 | | | | |
| 28 | 丁浩然 | | | | | | | | | | 25 | 张斌 | | | | | | | | | |
| 32 | 许浩翔 | | | | | | | | | | 26 | 吴锐樊 | | | | | 2 | | | | |
| 33 | 姚紫祥 | | | | | | | | | | 29 | 赵文宣 | | | | | | | | | |
| 41 | 刘润民 | | | | | | | | | | 35 | 高云健 | | | | | | | | | |
| 42 | 王成龙 | | | | | | | | | | 36 | 王鹏皓 | | | | | 3 | | 1 | | |
| A | 王来黔 (主教练) | | | | | | | | | | A | 孙铁 | | | | | | | | | |
| B | 陆万红 | | | | | | | | | | B | 吴健 (主教练) | | | | | | | | | |
| C | 吴翔 | | | | | | | | | | C | 宋刚 | | | | | | | | | |
| | | | | | | | | | | | D | 陈璇 | | | | | | | | | |
| A | Signature of Responsible Official of the Teams (Off. A) | | | | | | | | | | | | | | | | | | B | | |
| TP | Remarks of Referee / CHA Official | | | | | | | | | | | | | | | | | | TP | | |

Signatures

| | | | | |
|------------------|-----------|-----------|--|--|
| Referees | 程钰峰 (CHN) | 周云磊 (CHN) | | |
| Techn. Delegates | 徐健 (CHN) | | | |
| CHA Official | 李英才 (CHN) | | | |

Note: Number of 7m Throws Awarded to Team A and B, Goals (G), Warnings (W), Suspensions (2'), Direct Disqualification (D), Disqualification with Report (DR) and Team Penalty (TP).

Table Officials:

Statisticians: 刘永欢

李双





2016年“体彩杯”全国手球男子青年锦标赛 竞赛技术统计(媒体表)

| | | | | | | |
|----------------|----|----|------------|----|------------------|-----|
| 预赛 | 组别 | B | 轮次 | 1 | 场次 | 4 |
| 重庆万州 | | | 19/03/2016 | | 201602004-51-1/1 | |
| 安徽队 | 安徽 | 38 | vs | 26 | 北京 | 北京队 |
| 18 : 12 | | | | | | |

| | | | |
|-----|-----------|---|-----------|
| 裁判员 | 程钰峰 (CHN) | / | 周云磊 (CHN) |
|-----|-----------|---|-----------|

| 安徽 | | | | | | | | | | | | | | 安徽 | | 北京 | | | |
|---------------|-----|------|------|-----|-----|-----|------|------|-------|------|----|----|--------|-----------------|-----|----------|----|----|-----|
| 主教练：王来黔 | | | | | | | | | | | | | | 比赛进程 | | | | | |
| 远射 | 近射 | 边射 | 快攻 | 突破 | 任意球 | 7m球 | 合计 | % | 助攻 | 失误 | 警告 | 2' | D & DR | 安徽 | 北京 | | | | |
| 2 | 金勇峰 | 2/3 | 3/3 | 1/1 | 1/1 | 0/1 | 7/9 | 77.8 | 1 | 4 | | | | 18 | 李双 | 0 01:32 | 1 | 19 | 陈旭 |
| 9 | 陈开勇 | | 1/1 | | 0/1 | | 1/2 | 50.0 | | | | 2 | | 17 | 王巨柱 | 1 01:48 | 1 | | |
| 17 | 王巨柱 | 5/8 | 1/4 | | 2/2 | 0/1 | 8/15 | 53.3 | | 3 | | | | 2 | 金勇峰 | 2 02:44 | 1 | | |
| 18 | 李双 | 3/4 | 4/5 | | 1/1 | 1/1 | 9/11 | 81.8 | 3 | 5 | 1 | | | 3 | 金勇峰 | 3 03:57 | 1 | | |
| 19 | 何山 | | | 2/2 | 2/2 | | 4/4 | 100 | | 2 | 1 | | | 4 | 何山 | 4 04:27 | 1 | | |
| 21 | 李明 | | 0/2 | | | | 0/2 | 0.0 | 2 | | | | | 5 | 李双 | 5 05:50 | 2 | 36 | 王鹏皓 |
| 24 | 徐安格 | | 3/3 | | | | 3/3 | 100 | | 3 | | 1 | | 6 | 李双 | 6 08:27 | 2 | | |
| 25 | 李文哲 | | | | | | | | | | | | | 7 | 李双 | 7 10:53 | 3 | 4 | 朱广刚 |
| 26 | 程浩然 | | 2/3 | 0/1 | 2/2 | | 4/6 | 66.7 | | 2 | | 1 | | 8 | 李双 | 8 14:34 | 3 | | |
| 27 | 王长旭 | 0/2 | | | 1/1 | | 1/1 | 2/4 | 50.0 | | 1 | 1 | | 9 | 王巨柱 | 9 15:19 | 4 | | |
| 28 | 丁浩然 | | | | | | | | | | | | | 10 | 李双 | 10 14:58 | 4 | 6 | 赵一涵 |
| 32 | 许浩翔 | | | | | | | | | | | | | 11 | 王巨柱 | 11 20:27 | 7 | | |
| 33 | 姚紫祥 | | | | | | | | | | | | | 12 | 程浩然 | 12 21:03 | 7 | | |
| 41 | 刘润民 | | | | | | | | | | | | | 13 | 李双 | 13 21:35 | 7 | | |
| 42 | 王成龙 | | | 0/1 | | | 0/1 | 0.0 | | | | | | 14 | 李双 | 14 22:12 | 8 | 19 | 陈旭 |
| 运动员 合计 | | | | | | | | | | | | | | 15 | 何山 | 15 22:44 | 9 | 4 | 朱广刚 |
| 21 | 李明 | 5/11 | 5/15 | 0/2 | 1/5 | 1/4 | 1/1 | 1/2 | 14/40 | 35.0 | 2 | | | 16 | 徐安格 | 16 24:17 | 9 | | |
| 守门员 合计 | | | | | | | | | | | | | | 17 | 王巨柱 | 17 24:55 | 10 | 11 | 李旭 |
| | | | | | | | | | | | | | | 18 | 李双 | 18 27:10 | 10 | | |
| | | | | | | | | | | | | | | 26 | 程浩然 | 17 27:33 | 10 | | |
| | | | | | | | | | | | | | | 9 | 陈开勇 | 17 28:20 | 11 | 11 | 李旭 |
| | | | | | | | | | | | | | | 18 | 李双 | 18 29:07 | 11 | | |
| | | | | | | | | | | | | | | 18 | 李双 | 18 29:19 | 12 | 36 | 王鹏皓 |
| | | | | | | | | | | | | | | 2nd Half | | | | | |
| | | | | | | | | | | | | | | 17 | 王巨柱 | 19 00:18 | 12 | | |
| | | | | | | | | | | | | | | 19 | 何山 | 19 00:29 | 13 | 26 | 吴锐樊 |
| | | | | | | | | | | | | | | 24 | 徐安格 | 20 01:13 | 13 | | |
| | | | | | | | | | | | | | | 2 | 金勇峰 | 21 02:10 | 13 | | |
| | | | | | | | | | | | | | | 17 | 王巨柱 | 22 02:42 | 13 | | |
| | | | | | | | | | | | | | | 24 | 徐安格 | 22 03:00 | 14 | 4 | 朱广刚 |
| | | | | | | | | | | | | | | 18 | 李双 | 23 04:57 | 14 | | |
| | | | | | | | | | | | | | | 17 | 王巨柱 | 24 07:34 | 14 | | |
| | | | | | | | | | | | | | | 24 | 徐安格 | 24 08:31 | 15 | 19 | 陈旭 |
| | | | | | | | | | | | | | | 24 | 徐安格 | 24 09:17 | 16 | 4 | 朱广刚 |
| | | | | | | | | | | | | | | 27 | 王长旭 | 24 10:30 | 17 | 6 | 赵一涵 |
| | | | | | | | | | | | | | | 27 | 王长旭 | 25 12:36 | 17 | | |
| | | | | | | | | | | | | | | 19 | 何山 | 26 13:21 | 17 | | |
| | | | | | | | | | | | | | | 17 | 王巨柱 | 27 14:05 | 17 | | |
| | | | | | | | | | | | | | | 28 | 徐安格 | 28 14:40 | 17 | | |
| | | | | | | | | | | | | | | 18 | 李双 | 28 15:07 | 18 | 23 | 刘帅 |
| | | | | | | | | | | | | | | 17 | 王巨柱 | 29 15:29 | 18 | | |
| | | | | | | | | | | | | | | 17 | 王巨柱 | 30 16:16 | 18 | | |
| | | | | | | | | | | | | | | 17 | 王巨柱 | 31 16:35 | 18 | | |
| | | | | | | | | | | | | | | 26 | 程浩然 | 31 19:05 | 19 | 23 | 刘帅 |
| | | | | | | | | | | | | | | 24 | 徐安格 | 32 19:33 | 19 | | |
| | | | | | | | | | | | | | | 2 | 金勇峰 | 33 19:58 | 19 | | |
| | | | | | | | | | | | | | | 2 | 金勇峰 | 33 21:58 | 20 | 26 | 吴锐樊 |
| | | | | | | | | | | | | | | 2 | 金勇峰 | 34 22:38 | 20 | | |
| | | | | | | | | | | | | | | 2 | 金勇峰 | 34 22:56 | 21 | 6 | 赵一涵 |
| | | | | | | | | | | | | | | 2 | 金勇峰 | 35 23:55 | 21 | | |
| | | | | | | | | | | | | | | 2 | 金勇峰 | 35 24:30 | 22 | 7 | 卞友山 |
| | | | | | | | | | | | | | | 2 | 金勇峰 | 36 24:51 | 22 | | |
| | | | | | | | | | | | | | | 36 | 张斌 | 36 25:11 | 23 | 18 | 李明远 |
| | | | | | | | | | | | | | | 36 | 张斌 | 36 26:01 | 24 | 3 | 王哲一 |
| | | | | | | | | | | | | | | 26 | 程浩然 | 36 26:53 | 25 | 18 | 李明远 |
| | | | | | | | | | | | | | | 2 | 金勇峰 | 37 27:33 | 25 | | |
| | | | | | | | | | | | | | | 2 | 金勇峰 | 38 28:52 | 25 | | |
| | | | | | | | | | | | | | | 2 | 金勇峰 | 38 29:59 | 26 | 3 | 王哲一 |

场上队员：得分 / 射门

守门员：救球 / 射门

| | | | | | | | | | |
|----|------------|----|--------------|-----|------------|-----|----------|----|---------|
| 快攻 | Fast Break | 突破 | Breakthrough | 任意球 | Free Throw | 7M球 | 7M Throw | 助攻 | Assist |
| 警告 | Warning | 失误 | Error | 2' | Suspension | D | 取消资格 | DR | 取消资格+报告 |





2016年“体彩杯”全国手球男子青年锦标赛 图式比赛技术统计表

轮次 1

场次 4

201602004-21-1/1

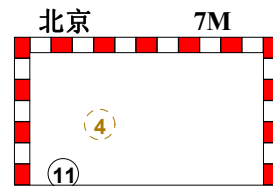
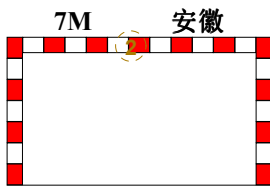
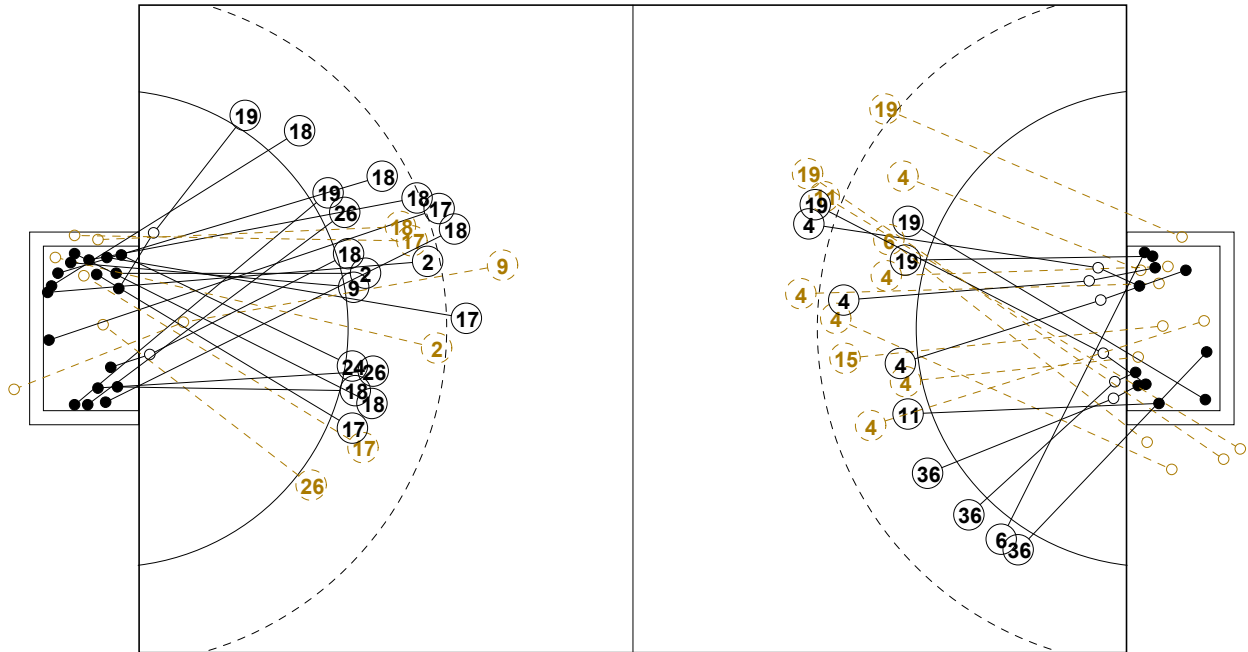

1st Half
18 : 12

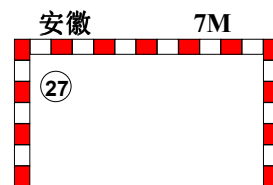
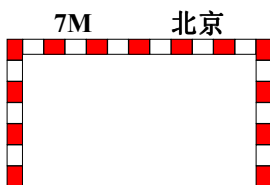
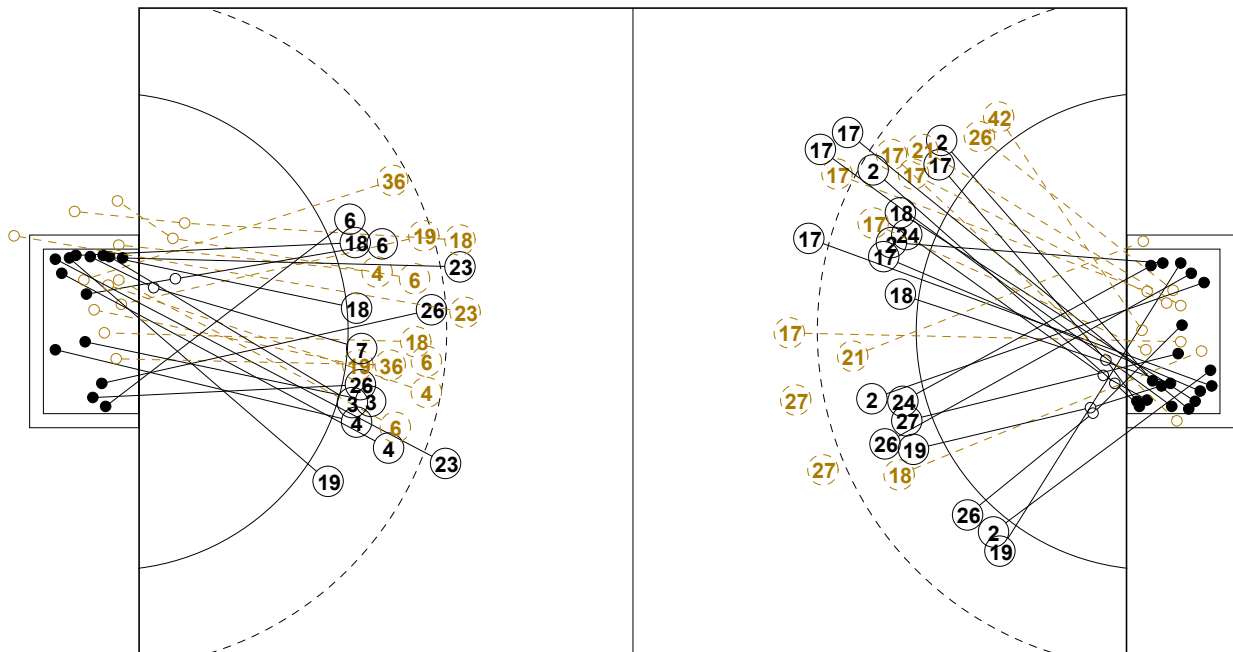

2nd Half
26 : 38



2016年“体彩杯”全国手球男子青年锦标赛

个人/全队技术统计表

正式表
手球
青年男子预赛
轮次 1组别 B
场次 4201602004-14-1/2
重庆万州
19/03/2016 14:30

| 号码 | 姓名 | 远射 | 近射 | 边射 | 快攻 | 突破 | 任意 | 7M | 合计 | % | 助攻 | 失误 | 警告 | 2' | 取消 | 时间 |
|----------------|-----|-------|-------|-----|-----|-----|-----|-----|-------|-------|----|----|----|----|----|----------|
| 安徽队(安徽) | | | | | | | | | | | | | | | | |
| <i>(场上队员)</i> | | | | | | | | | | | | | | | | |
| 2 | 金勇峰 | 2/3 | 3/3 | 1/1 | | 1/1 | | 0/1 | 7/9 | 77.8% | 1 | 4 | | | | 01:00:00 |
| 9 | 陈开勇 | | 1/1 | | 0/1 | | | | 1/2 | 50.0% | | | | 2 | | 00:15:02 |
| 17 | 王巨柱 | 5/8 | 1/4 | | 2/2 | | 0/1 | | 8/15 | 53.3% | | 3 | | | | 00:50:48 |
| 18 | 李双 | 3/4 | 4/5 | | 1/1 | | 1/1 | | 9/11 | 81.8% | 3 | 5 | 1 | | | 00:49:13 |
| 19 | 何山 | | | 2/2 | 2/2 | | | | 4/4 | 100% | | 2 | 1 | | | 01:00:00 |
| 21 | 李明 | | 0/2 | | | | | | 0/2 | 0.0% | 2 | | | | | 01:00:00 |
| 24 | 徐安格 | | 3/3 | | | | | | 3/3 | 100% | | 3 | | 1 | | 00:44:38 |
| 25 | 李文哲 | | | | | | | | | 0.0% | | | | | | 00:00:00 |
| 26 | 程浩然 | | 2/3 | 0/1 | 2/2 | | | | 4/6 | 66.7% | | 2 | | 1 | | 01:00:32 |
| 27 | 王长旭 | 0/2 | | | 1/1 | | | 1/1 | 2/4 | 50.0% | | 1 | 1 | | | 00:17:50 |
| 28 | 丁浩然 | | | | | | | | | 0.0% | | | | | | 00:00:00 |
| 32 | 许浩翔 | | | | | | | | | 0.0% | | | | | | 00:00:00 |
| 33 | 姚紫祥 | | | | | | | | | 0.0% | | | | | | 00:05:42 |
| 41 | 刘润民 | | | | | | | | | 0.0% | | | | | | 00:00:00 |
| 42 | 王成龙 | | | 0/1 | | | | | 0/1 | 0.0% | | | | | | 00:03:39 |
| 合计 | | 10/17 | 14/21 | 3/5 | 8/9 | 1/1 | 1/2 | 1/2 | 38/57 | 66.7% | 6 | 20 | 3 | 4 | | |
| <i>(守门员)</i> | | | | | | | | | | | | | | | | |
| 21 | 李明 | 5/11 | 5/15 | 0/2 | 1/5 | 1/4 | 1/1 | 1/2 | 14/40 | 35.0% | 2 | | | | | 01:00:00 |
| 合计 | | 5/11 | 5/15 | 0/2 | 1/5 | 1/4 | 1/1 | 1/2 | 14/40 | 35.0% | 2 | | | | | |

场上队员：得分/射门

守门员：救球/射门

| 全队合计 | 得分 | 被救 | 射失 | 击柱 | 封球 | 合计 | % |
|------|----|----|----|----|----|----|--------|
| 远射 | 10 | 2 | | 3 | 2 | 17 | 58.8% |
| 近射 | 14 | 6 | | 1 | | 21 | 66.7% |
| 边射 | 3 | 2 | | | | 5 | 60.0% |
| 快攻 | 8 | | 1 | | | 9 | 88.9% |
| 突破 | 1 | | | | | 1 | 100.0% |
| 任意 | 1 | 1 | | | | 2 | 50.0% |
| 7M | 1 | | | 1 | | 2 | 50.0% |





2016年“体彩杯”全国手球男子青年锦标赛

个人/全队技术统计表

正式表
手球
青年男子预赛
轮次 1组别 B
场次 4201602004-14-2/2
重庆万州
19/03/2016 14:30

| 号码 | 姓名 | 远射 | 近射 | 边射 | 快攻 | 突破 | 任意 | 7M | 合计 | % | 助攻 | 失误 | 警告 | 2' | 取消 | 时间 |
|----------------|-----|------|-------|-----|-----|-----|-----|-----|-------|-------|----|----|----|----|----|----------|
| 北京队(北京) | | | | | | | | | | | | | | | | |
| <i>(上场队员)</i> | | | | | | | | | | | | | | | | |
| 3 | 王哲一 | | 1/1 | | 1/1 | | | | 2/2 | 100% | | 2 | | | | 00:24:08 |
| 4 | 朱广刚 | 2/4 | 1/5 | | 1/1 | 1/2 | 0/1 | 0/1 | 5/14 | 35.7% | 1 | 6 | | 2 | | 00:47:27 |
| 6 | 赵一涵 | 0/2 | 2/4 | 1/1 | | | | | 3/7 | 42.9% | 1 | 1 | 1 | 1 | | 00:52:33 |
| 7 | 卞友山 | | 1/1 | | | | | | 1/1 | 100% | | | | | | 00:15:05 |
| 11 | 李旭 | 0/1 | 1/1 | | | | | 1/1 | 2/3 | 66.7% | | 4 | 1 | | | 00:43:04 |
| 15 | 逯明松 | 0/1 | | | | | | | 0/1 | 0.0% | | | | | | 00:07:23 |
| 16 | 马佳鹏 | | | | | | | | | 0.0% | | | | | | 00:36:16 |
| 18 | 李明远 | 0/2 | | | 1/1 | 1/1 | | | 2/4 | 50.0% | | 3 | | | | 00:14:20 |
| 19 | 陈旭 | 1/4 | 1/1 | | 1/2 | 1/1 | | | 4/8 | 50.0% | | 6 | | 1 | | 00:43:35 |
| 23 | 刘帅 | 2/2 | | | | | 0/1 | | 2/3 | 66.7% | 1 | 1 | | | | 00:16:24 |
| 25 | 张斌 | | | | | | | | | 0.0% | | | | | | 00:24:29 |
| 26 | 吴锐樊 | 1/1 | 1/1 | | | | | | 2/2 | 100% | | | | | | 00:19:28 |
| 29 | 赵文宣 | | | | | | | | | 0.0% | | | | | | 00:00:00 |
| 35 | 高云健 | | | | | | | | | 0.0% | | | | | | 00:23:44 |
| 36 | 王鹏皓 | 0/1 | 2/3 | 1/1 | | | | | 3/5 | 60.0% | | 2 | | 1 | | 00:51:52 |
| 合计 | | 6/18 | 10/17 | 2/2 | 4/5 | 3/4 | 0/2 | 1/2 | 26/50 | 52.0% | 3 | 25 | 2 | 5 | | |
| <i>(守门员)</i> | | | | | | | | | | | | | | | | |
| 16 | 马佳鹏 | 1/8 | 4/11 | 2/2 | 0/5 | 0/1 | 1/2 | 0/1 | 8/30 | 26.7% | | | | | | 00:36:16 |
| 35 | 高云健 | 1/4 | 2/9 | 0/3 | 0/3 | | | | 3/19 | 15.8% | | | | | | 00:23:44 |
| 合计 | | 2/12 | 6/20 | 2/5 | 0/8 | 0/1 | 1/2 | 0/1 | 11/49 | 22.4% | | | | | | |

场上队员：得分/射门

守门员：救球/射门

| 全队合计 | 得分 | 被救 | 射失 | 击柱 | 封球 | 合计 | % |
|------|----|----|----|----|----|----|--------|
| 远射 | 6 | 5 | 5 | 1 | 1 | 18 | 33.3% |
| 近射 | 10 | 5 | 1 | 1 | | 17 | 58.8% |
| 边射 | 2 | | | | | 2 | 100.0% |
| 快攻 | 4 | 1 | | | | 5 | 80.0% |
| 突破 | 3 | 1 | | | | 4 | 75.0% |
| 任意 | | 1 | 1 | | | 2 | 0.0% |
| 7M | 1 | 1 | | | | 2 | 50.0% |





2016年“体彩杯”全国手球男子青年锦标赛

图式射门区域统计

轮次 1 场次 4

201602004-41-1/1

安徽队

| | | | | | | | |
|-----------------------------|-----------------------------|-----------------------------|-----------------------------|-----------------------------|-----------------------------|-----------------------------|-----------------------------|
| 2 金勇峰 | 9 陈开勇 | 17 王巨柱 | 18 李双 | 19 何山 | 21 李明 | 24 徐安格 | 25 李文哲 |
| 1 1 3 | 1 1 | 1 1 3 | 1 2 4 | 1 1 1 | 1 2 | | |
| Post - 1 Miss - 0 Block - 0 | Post - 0 Miss - 1 Block - 0 | Post - 2 Miss - 0 Block - 0 | Post - 1 Miss - 0 Block - 0 | Post - 0 Miss - 0 Block - 0 | Post - 1 Miss - 0 Block - 0 | Post - 0 Miss - 0 Block - 0 | Post - 0 Miss - 0 Block - 0 |
| 26 程浩然 | 27 王长旭 | 28 丁浩然 | 32 许浩翔 | 33 姚紫祥 | 41 刘润民 | 42 王成龙 | |
| 1 2 1 | 1 1 | | | | | | |
| Post - 0 Miss - 0 Block - 0 | Post - 0 Miss - 0 Block - 2 | Post - 0 Miss - 0 Block - 0 | Post - 0 Miss - 0 Block - 0 | Post - 0 Miss - 0 Block - 0 | Post - 0 Miss - 0 Block - 0 | Post - 0 Miss - 0 Block - 0 | |

| |
|-------------|
| 21 李明 |
| 1/3 0/5 |
| 3/7 3/4 1/5 |
| 1/6 2/2 3/8 |

| | | |
|--|--|--|
| | | |
| | | |
| | | |

| | | |
|--|--|--|
| | | |
| | | |
| | | |

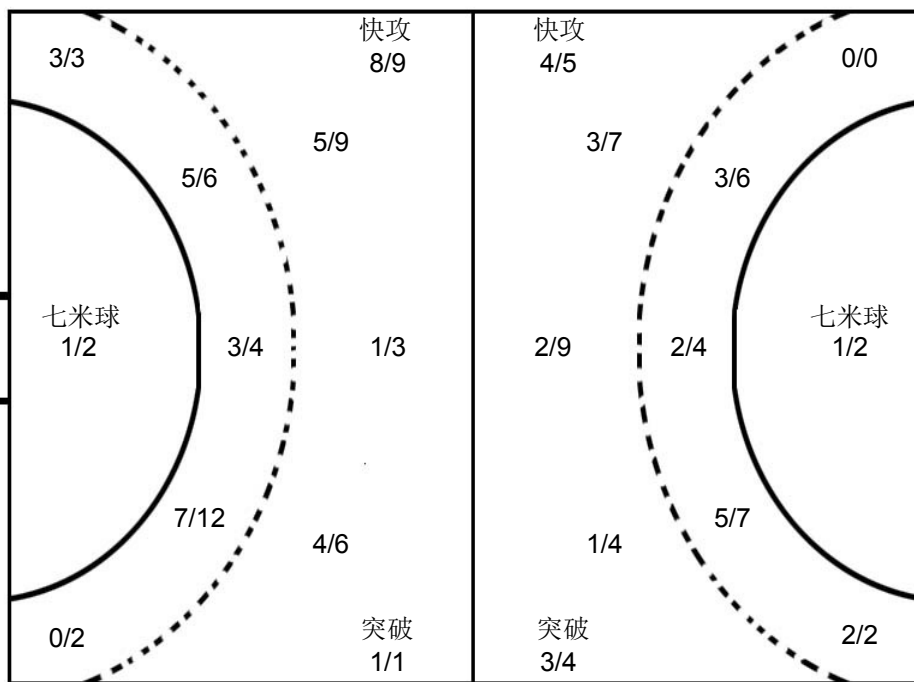

| |
|-------------|
| 16 马佳鹏 |
| 0/4 1/1 0/5 |
| 1/2 3/5 0/5 |
| 1/2 2/2 0/4 |

| |
|-------------|
| 35 高云健 |
| 0/1 1/6 |
| 0/4 1/1 1/2 |
| 0/2 0/3 |

| | | |
|--|--|--|
| | | |
| | | |
| | | |

北京队

| | | | | | | | |
|-----------------------------|-----------------------------|-----------------------------|-----------------------------|-----------------------------|-----------------------------|-----------------------------|-----------------------------|
| 3 王哲一 | 4 朱广刚 | 6 赵一涵 | 7 卞友山 | 11 李旭 | 15 逯明松 | 16 马佳鹏 | 18 李明远 |
| 1 1 | 1 1 1 | 1 1 | 1 | 1 | | | 1 1 |
| Post - 0 Miss - 0 Block - 0 | Post - 1 Miss - 1 Block - 0 | Post - 0 Miss - 2 Block - 1 | Post - 0 Miss - 0 Block - 0 | Post - 0 Miss - 1 Block - 0 | Post - 0 Miss - 0 Block - 0 | Post - 0 Miss - 0 Block - 0 | Post - 0 Miss - 1 Block - 0 |
| 19 陈旭 | 23 刘帅 | 25 张斌 | 26 吴锐樊 | 29 赵文宣 | 35 高云健 | 36 王鹏皓 | |
| 2 1 1 | 1 1 | | 2 | | | 1 2 | |
| Post - 1 Miss - 1 Block - 0 | Post - 0 Miss - 1 Block - 0 | Post - 0 Miss - 0 Block - 0 | Post - 0 Miss - 0 Block - 0 | Post - 0 Miss - 0 Block - 0 | Post - 0 Miss - 0 Block - 0 | Post - 0 Miss - 0 Block - 0 | |

注释: Post=击柱 Miss=射失 Block=被封





预赛 Group B
青年男子 全国比赛

2016年“体彩杯”全国手球男子青年锦标赛

| | | | | | | | | | | | | | | | | | | | | | | | | | | | | | | | |
|-----------------|-----------|---|--|---------------|-------------|------------------------------------|--|----|--|------------|---|----------------|---|----|-------|---------------|------------|----------------|--|---------------|--|---|--|---------------|--|---|---|---|---|---|----|
| Team A | | | | | | | | | | Team B | | | | | | | | | | Match Number | | | | | | | | | | | |
| A 四川队 | | | | | B 辽宁队 | | | | | 5 | | | | | | | | | | | | | | | | | | | | | |
| played in | | | | | in the hall | | | | | on | | | | | at | | Spectators | | | | | | | | | | | | | | |
| China | | | | | 重庆万州 | | | | | 19/03/2016 | | | | | 16:00 | | hours | | | | | | | | | | | | | | |
| Half-time (30') | | A | | B | | End of playing time | | A | | B | | 1st extra time | | A | | B | | 2nd extra time | | A | | B | | After penalty | | A | | B | | | |
| | | 20 | | 14 | | 31 | | 16 | | | | | | | | | | | | | | | | | | | | | | | |
| Number of 7 m | | A | | Team time-out | | Full name of players and officials | | | | | | | | | | Team time-out | | B | | Number of 7 m | | | | | | | | | | | |
| 1/4 | | 1 | | 2 | | 3 | | | | | | | | | | | | 2/2 | | | | | | | | | | | | | |
| | | 11:09 | | 21:16 | | | | | | | | | | | | | | | | | | | | | | | | | | | |
| No. | Team A | | | | | | | | | | G | W | 2 | D | DR | No. | Team B | | | | | | | | | | G | W | 2 | D | DR |
| 1 | 宋继强 | | | | | | | | | | | | | | | 1 | 高尚君 | | | | | | | | | | | | | | |
| 3 | 刘赵梁 | | | | | | | | | | 5 | | | | | 2 | 王司雨 | | | | | | | | | | 2 | 1 | 1 | | |
| 5 | 王凯 | | | | | | | | | | 7 | | | | | 3 | 李星浩 | | | | | | | | | | | | | | |
| 7 | 仇瑞祥 | | | | | | | | | | | | | | | 5 | 余昊锦 | | | | | | | | | | | 1 | | | |
| 8 | 罗尧尧 | | | | | | | | | | 8 | 1 | | | | 6 | 陈庆港 | | | | | | | | | | 2 | | | | |
| 9 | 许翔宇 | | | | | | | | | | | | | | | 7 | 孙义广 | | | | | | | | | | 2 | | 1 | | |
| 10 | 徐彦昊 | | | | | | | | | | 7 | 1 | 1 | | | 8 | 王鑫鹏 | | | | | | | | | | | | | | |
| 11 | 张天豪 | | | | | | | | | | | | | | | 10 | 王柏淇 | | | | | | | | | | 5 | | | | |
| 12 | 刘树豪 | | | | | | | | | | | | | | | 11 | 庞东阳 | | | | | | | | | | 5 | | | | |
| 13 | 尹文珂 | | | | | | | | | | 1 | | | | | 13 | 杨洁 | | | | | | | | | | | | | | |
| 15 | 徐逸 | | | | | | | | | | | | | | | 14 | 吕昊臻 | | | | | | | | | | | | | | |
| 17 | 谢庆龙 | | | | | | | | | | 2 | | | | | 16 | 吴阳 | | | | | | | | | | | | | | |
| 18 | 张睿梁 | | | | | | | | | | | | | | | 17 | 李傲 | | | | | | | | | | | | | | |
| 19 | 庞连康 | | | | | | | | | | 1 | 1 | | | | 18 | 梅凯博 | | | | | | | | | | | | | | |
| 20 | 张文健 | | | | | | | | | | | | | | | 19 | 赵鑫 | | | | | | | | | | | | | | |
| 21 | 曹修庆 | | | | | | | | | | | | | | | 20 | 赵佛赐 | | | | | | | | | | | | | | |
| A | 郑倩 | | | | | | | | | | | | | | | B | 赵影 (主教练) | | | | | | | | | | | | | | |
| B | 张文韬 (主教练) | | | | | | | | | | | | | | | C | 刘启迪 | | | | | | | | | | | | | | |
| C | 丁大伟 | | | | | | | | | | | | | | | | | | | | | | | | | | | | | | |
| D | 王建国 | | | | | | | | | | | | | | | | | | | | | | | | | | | | | | |
| A | | Signature of Responsible Official of the Teams (Off. A) | | | | | | | | | | | | B | | | | | | | | | | | | | | | | | |
| TP | | Remarks of Referee / CHA Official | | | | | | | | | | | | TP | | | | | | | | | | | | | | | | | |

Signatures

| | | | | |
|------------------|-----------|----------|--|--|
| Referees | 汤怡 (CHN) | 缪俊 (CHN) | | |
| Techn. Delegates | 张春生 (CHN) | | | |
| CHA Official | 许宜扬 (CHN) | | | |

Note: Number of 7m Throws Awarded to Team A and B, Goals (G), Warnings (W), Suspensions (2), Direct Disqualification (D), Disqualification with Report (DR) and Team Penalty (TP).

Table Officials:

Statisticians: 刘永欢

李双





2016年“体彩杯”全国手球男子青年锦标赛 竞赛技术统计(媒体表)

| | | | | | | |
|------|----|----------------|-----------|----------|------------------|-----------|
| 预赛 | 组别 | B | 轮次 | 1 | 场次 | 5 |
| 重庆万州 | | 19/03/2016 | | | 201602005-51-1/1 | |
| 四川队 | | <i>四川</i> | 31 | vs | 16 | <i>辽宁</i> |
| | | 20 : 14 | | | | 辽宁队 |

| | | | |
|-----|----------|---|----------|
| 裁判员 | 汤怡 (CHN) | / | 缪俊 (CHN) |
|-----|----------|---|----------|

| <i>四川</i> | | 远射 | 近射 | 边射 | 快攻 | 突破 | 任意球 | 7m球 | 合计 | % | 助攻 | 失误 | 警告 | 2' | D & DR | <i>四川</i> | 比赛 进程 | <i>辽宁</i> |
|---------------|-----|--------------|--------------|------------|--------------|------------|------------|------------|--------------|-------------|-----------|-----------|----------|----------|--------|-----------|----------|-----------|
| 主教练：张文韬 | | | | | | | | | | | | | | | | | | |
| 1 | 宋继强 | | | | | | | | | | | | | | | | | |
| 3 | 刘赵梁 | 0/1 | 1/1 | 1/2 | 2/2 | 1/1 | | | 5/7 | 71.4 | | 1 | | | | | | |
| 5 | 王凯 | 0/1 | 3/3 | 1/1 | 3/3 | | | 0/1 | 7/9 | 77.8 | | 1 | | | | | | |
| 7 | 仇瑞祥 | | | | | | | | | | | | | | | | | |
| 8 | 罗尧尧 | 2/3 | 2/2 | | 2/2 | 1/1 | | 1/1 | 8/9 | 88.9 | 3 | 1 | 1 | | | | | |
| 9 | 许翔宇 | | | | | | | | | | | | | | | | | |
| 10 | 徐彦昊 | 1/1 | 2/2 | | 4/5 | | | 0/1 | 7/9 | 77.8 | 2 | 3 | 1 | 1 | | | | |
| 11 | 张天豪 | | | | | | | | | | | | | | | | | |
| 12 | 刘树豪 | | | | | | | | | | 5 | 1 | | | | | | |
| 13 | 尹文珂 | | 1/1 | | | | | | 1/1 | 100 | | 1 | | | | | | |
| 15 | 徐逸 | | | | | | | | | | | | | | | | | |
| 17 | 谢庆龙 | | 2/2 | | | | | | 2/2 | 100 | 1 | 3 | | | | | | |
| 18 | 张睿梁 | | | | | | | | | | | | | | | | | |
| 19 | 庞连康 | 1/3 | 0/1 | | | | | 0/1 | 1/5 | 20.0 | 2 | 2 | 1 | | | | | |
| 20 | 张文健 | | | | | | | | | | | | | | | | | |
| 21 | 曹修庆 | | | | | | | | | | | | | | | | | |
| 运动员 合计 | | 4/9 | 11/12 | 2/3 | 11/12 | 2/2 | | 1/4 | 31/42 | 73.8 | 13 | 13 | 3 | 1 | | | | |
| 12 | 刘树豪 | 11/13 | 4/14 | 0/2 | | | 1/1 | 0/2 | 16/32 | 50.0 | 5 | 1 | | | | | | |
| 守门员 合计 | | 11/13 | 4/14 | 0/2 | | | 1/1 | 0/2 | 16/32 | 50.0 | 5 | 1 | | | | | | |
| <i>辽宁</i> | | 远射 | 近射 | 边射 | 快攻 | 突破 | 任意球 | 7m球 | 合计 | % | 助攻 | 失误 | 警告 | 2' | D & DR | | | |
| 教练：赵影 | | | | | | | | | | | | | | | | | | |
| 1 | 高尚君 | | | | | | | | | | | | | | | | | |
| 2 | 王司雨 | | 2/3 | | | | | | 2/3 | 66.7 | | | | | | | | |
| 3 | 李星浩 | | | | | | | | | | | | | | | | | |
| 5 | 余昊锦 | 0/1 | | | | | | | 0/1 | 0.0 | | | 1 | | | | | |
| 6 | 陈庆港 | | 1/2 | 1/1 | | | | | 2/3 | 66.7 | 1 | 1 | | | | | | |
| 7 | 孙义广 | | 2/2 | 0/1 | | | | | 2/3 | 66.7 | | | | | | | | |
| 8 | 王鑫鹏 | | | | | | | | | | | | | | | | | |
| 10 | 王柏淇 | 0/10 | 3/5 | | | | 0/1 | 2/2 | 5/18 | 27.8 | 1 | 5 | | | | | | |
| 11 | 庞东阳 | 2/4 | 2/2 | 1/2 | | | | | 5/8 | 62.5 | 2 | 5 | | | | | | |
| 13 | 杨洁 | 0/2 | 0/2 | | | | | | 0/4 | 0.0 | | 1 | | | | | | |
| 14 | 吕昊臻 | | | | | | | | | | | | | | | | | |
| 16 | 吴阳 | | | | | | | | | | | | | | | | | |
| 17 | 李傲 | | | | | | | | | | | | | | | | | |
| 18 | 梅凯博 | | | | | | | | | | | | | | | | | |
| 19 | 赵鑫 | | | | | | | | | | | | | | | | | |
| 20 | 赵佛赐 | | | | | | | | | | | | | | | | | |
| 运动员 合计 | | 2/17 | 10/16 | 2/4 | | | 0/1 | 2/2 | 16/40 | 40.0 | 4 | 16 | 2 | 2 | | | | |
| 1 | 高尚君 | 2/6 | 1/12 | 0/2 | 1/12 | 0/2 | | 2/3 | 6/37 | 16.2 | | 1 | | | | | | |
| 守门员 合计 | | 2/6 | 1/12 | 0/2 | 1/12 | 0/2 | | 2/3 | 6/37 | 16.2 | | 1 | | | | | | |

场上队员：得分 / 射门

守门员：救球 / 射门

| | | | | | | | | | | | | | |
|----|------------|--|----|--------------|--|-----|------------|--|-----|----------|--|----|---------|
| 快攻 | Fast Break | | 突破 | Breakthrough | | 任意球 | Free Throw | | 7M球 | 7M Throw | | 助攻 | Assist |
| 警告 | Warning | | 失误 | Error | | 2' | Suspension | | D | 取消资格 | | DR | 取消资格+报告 |



2016年“体彩杯”全国手球男子青年锦标赛

个人/全队技术统计表

正式表
手球
青年男子预赛
轮次 1组别 B
场次 5201602005-14-1/2
重庆万州
19/03/2016 16:00

| 号码 | 姓名 | 远射 | 近射 | 边射 | 快攻 | 突破 | 任意 | 7M | 合计 | % | 助攻 | 失误 | 警告 | 2' | 取消 | 时间 |
|----------------|-----|-------|-------|-----|-------|-----|-----|-----|-------|-------|----|----|----|----|----|----------|
| 四川队(四川) | | | | | | | | | | | | | | | | |
| <i>(场上队员)</i> | | | | | | | | | | | | | | | | |
| 1 | 宋继强 | | | | | | | | | 0.0% | | | | | | 00:00:00 |
| 3 | 刘赵梁 | 0/1 | 1/1 | 1/2 | 2/2 | 1/1 | | | 5/7 | 71.4% | | 1 | | | | 00:28:52 |
| 5 | 王凯 | 0/1 | 3/3 | 1/1 | 3/3 | | | 0/1 | 7/9 | 77.8% | | 1 | | | | 00:37:30 |
| 7 | 仇瑞祥 | | | | | | | | | 0.0% | | | | | | 00:00:00 |
| 8 | 罗尧尧 | 2/3 | 2/2 | | 2/2 | 1/1 | | 1/1 | 8/9 | 88.9% | 3 | 1 | 1 | | | 00:37:30 |
| 9 | 许翔宇 | | | | | | | | | 0.0% | | | | | | 00:02:59 |
| 10 | 徐彦昊 | 1/1 | 2/2 | | 4/5 | | | 0/1 | 7/9 | 77.8% | 2 | 3 | 1 | 1 | | 00:37:30 |
| 11 | 张天豪 | | | | | | | | | 0.0% | | | | | | 00:00:00 |
| 12 | 刘树豪 | | | | | | | | | 0.0% | 5 | 1 | | | | 00:37:30 |
| 13 | 尹文珂 | | 1/1 | | | | | | 1/1 | 100% | | 1 | | | | 00:08:37 |
| 15 | 徐逸 | | | | | | | | | 0.0% | | | | | | 00:00:00 |
| 17 | 谢庆龙 | | 2/2 | | | | | | 2/2 | 100% | 1 | 3 | | | | 00:37:30 |
| 18 | 张睿梁 | | | | | | | | | 0.0% | | | | | | 00:00:00 |
| 19 | 庞连康 | 1/3 | 0/1 | | | | | 0/1 | 1/5 | 20.0% | 2 | 2 | 1 | | | 00:34:30 |
| 20 | 张文健 | | | | | | | | | 0.0% | | | | | | 00:00:00 |
| 21 | 曹修庆 | | | | | | | | | 0.0% | | | | | | 00:00:00 |
| 合计 | | 4/9 | 11/12 | 2/3 | 11/12 | 2/2 | | 1/4 | 31/42 | 73.8% | 13 | 13 | 3 | 1 | | |
| <i>(守门员)</i> | | | | | | | | | | | | | | | | |
| 12 | 刘树豪 | 11/13 | 4/14 | 0/2 | | | 1/1 | 0/2 | 16/32 | 50.0% | 5 | 1 | | | | 00:37:30 |
| 合计 | | 11/13 | 4/14 | 0/2 | | | 1/1 | 0/2 | 16/32 | 50.0% | 5 | 1 | | | | |

场上队员：得分/射门

守门员：救球/射门

| 全队合计 | 得分 | 被救 | 射失 | 击柱 | 封球 | 合计 | % |
|------|----|----|----|----|----|----|--------|
| 远射 | 4 | 2 | 2 | | 1 | 9 | 44.4% |
| 近射 | 11 | 1 | | | | 12 | 91.7% |
| 边射 | 2 | | 1 | | | 3 | 66.7% |
| 快攻 | 11 | 1 | | | | 12 | 91.7% |
| 突破 | 2 | | | | | 2 | 100.0% |
| 任意 | | | | | | | 0.0% |
| 7M | 1 | 2 | 1 | | | 4 | 25.0% |





2016年“体彩杯”全国手球男子青年锦标赛

个人/全队技术统计表

正式表
手球
青年男子预赛
轮次 1组别 B
场次 5201602005-14-2/2
重庆万州
19/03/2016 16:00

| 号码 | 姓名 | 远射 | 近射 | 边射 | 快攻 | 突破 | 任意 | 7M | 合计 | % | 助攻 | 失误 | 警告 | 2' | 取消 | 时间 |
|----------------|-----|------|-------|-----|------|-----|-----|-----|-------|-------|----|----|----|----|----|----------|
| 辽宁队(辽宁) | | | | | | | | | | | | | | | | |
| <i>(上场队员)</i> | | | | | | | | | | | | | | | | |
| 1 | 高尚君 | | | | | | | | | 0.0% | | 1 | | | | 00:37:30 |
| 2 | 王司雨 | | 2/3 | | | | | | 2/3 | 66.7% | | 2 | 1 | 1 | | 00:37:30 |
| 3 | 李星浩 | | | | | | | | | 0.0% | | | | | | 00:00:00 |
| 5 | 余昊锦 | 0/1 | | | | | | | 0/1 | 0.0% | | | 1 | | | 00:16:45 |
| 6 | 陈庆港 | | 1/2 | 1/1 | | | | | 2/3 | 66.7% | 1 | 1 | | | | 00:31:05 |
| 7 | 孙义广 | | 2/2 | 0/1 | | | | | 2/3 | 66.7% | | | | 1 | | 00:33:28 |
| 8 | 王鑫鹏 | | | | | | | | | 0.0% | | 1 | | | | 00:01:57 |
| 10 | 王柏淇 | 0/10 | 3/5 | | | | 0/1 | 2/2 | 5/18 | 27.8% | 1 | 5 | | | | 00:37:30 |
| 11 | 庞东阳 | 2/4 | 2/2 | 1/2 | | | | | 5/8 | 62.5% | 2 | 5 | | | | 00:37:30 |
| 13 | 杨洁 | 0/2 | 0/2 | | | | | | 0/4 | 0.0% | | 1 | | | | 00:29:11 |
| 14 | 吕昊臻 | | | | | | | | | 0.0% | | | | | | 00:00:00 |
| 16 | 吴阳 | | | | | | | | | 0.0% | | | | | | 00:00:00 |
| 17 | 李傲 | | | | | | | | | 0.0% | | | | | | 00:00:00 |
| 18 | 梅凯博 | | | | | | | | | 0.0% | | | | | | 00:00:00 |
| 19 | 赵鑫 | | | | | | | | | 0.0% | | | | | | 00:00:00 |
| 20 | 赵佛赐 | | | | | | | | | 0.0% | | | | | | 00:00:00 |
| 合计 | | 2/17 | 10/16 | 2/4 | | | 0/1 | 2/2 | 16/40 | 40.0% | 4 | 16 | 2 | 2 | | |
| <i>(守门员)</i> | | | | | | | | | | | | | | | | |
| 1 | 高尚君 | 2/6 | 1/12 | 0/2 | 1/12 | 0/2 | | 2/3 | 6/37 | 16.2% | | 1 | | | | 00:37:30 |
| 合计 | | 2/6 | 1/12 | 0/2 | 1/12 | 0/2 | | 2/3 | 6/37 | 16.2% | | 1 | | | | |

场上队员：得分/射门

守门员：救球/射门

| 全队合计 | 得分 | 被救 | 射失 | 击柱 | 封球 | 合计 | % |
|------|----|----|----|----|----|----|--------|
| 远射 | 2 | 11 | | 1 | 3 | 17 | 11.8% |
| 近射 | 10 | 4 | 2 | | | 16 | 62.5% |
| 边射 | 2 | | 1 | 1 | | 4 | 50.0% |
| 快攻 | | | | | | | 0.0% |
| 突破 | | | | | | | 0.0% |
| 任意 | | 1 | | | | 1 | 0.0% |
| 7M | 2 | | | | | 2 | 100.0% |





2016年“体彩杯”全国手球男子青年锦标赛

图式射门区域统计

轮次 1 场次 5

201602005-41-1/1

四川队

| | | | | | | | | | | | | | | | | | | | | | | | | | | | | | | | | | | | | | | | | | | | | | | | | | | | | | | | | | | | | | | | | | | | | | | | | | | | | | | | |
|--|-----------------------------|-----------------------------|-----------------------------|-----------------------------|-----------------------------|-----------------------------|-----------------------------|--|--|---|--|--|--|---|--|--|---|--|---|---|---|--|---|--|--|---|---|--|---|--|--|--|---|--|--|--|---|--|--|--|---|--|--|---|--|---|---|---|---|---|--|--|--|--|--|--|--|--|---|--|---|---|---|--|--|---|---|--|---|--|--|--|--|--|--|--|--|--|--|
| 1 宋继强 | 3 刘赵梁 | 5 王凯 | 7 仇瑞祥 | 8 罗尧尧 | 9 许翔宇 | 10 徐彦昊 | 11 张天豪 | | | | | | | | | | | | | | | | | | | | | | | | | | | | | | | | | | | | | | | | | | | | | | | | | | | | | | | | | | | | | | | | | | | | | | | | |
| <table border="1"><tr><td></td><td></td><td></td></tr><tr><td></td><td></td><td></td></tr><tr><td></td><td></td><td></td></tr></table> | | | | | | | | | | <table border="1"><tr><td></td><td></td><td></td></tr><tr><td>1</td><td></td><td></td></tr><tr><td>1</td><td></td><td>3</td></tr></table> | | | | 1 | | | 1 | | 3 | <table border="1"><tr><td>1</td><td></td><td>1</td></tr><tr><td></td><td></td><td>1</td></tr><tr><td>1</td><td></td><td>3</td></tr></table> | 1 | | 1 | | | 1 | 1 | | 3 | <table border="1"><tr><td></td><td></td><td></td></tr><tr><td></td><td></td><td></td></tr><tr><td></td><td></td><td></td></tr></table> | | | | | | | | | | <table border="1"><tr><td>1</td><td></td><td></td></tr><tr><td>2</td><td></td><td>1</td></tr><tr><td>1</td><td>1</td><td>2</td></tr></table> | 1 | | | 2 | | 1 | 1 | 1 | 2 | <table border="1"><tr><td></td><td></td><td></td></tr><tr><td></td><td></td><td></td></tr><tr><td></td><td></td><td></td></tr></table> | | | | | | | | | | <table border="1"><tr><td>1</td><td>1</td><td>1</td></tr><tr><td></td><td></td><td>2</td></tr><tr><td>1</td><td></td><td>1</td></tr></table> | 1 | 1 | 1 | | | 2 | 1 | | 1 | <table border="1"><tr><td></td><td></td><td></td></tr><tr><td></td><td></td><td></td></tr><tr><td></td><td></td><td></td></tr></table> | | | | | | | | | |
| | | | | | | | | | | | | | | | | | | | | | | | | | | | | | | | | | | | | | | | | | | | | | | | | | | | | | | | | | | | | | | | | | | | | | | | | | | | | | | | |
| | | | | | | | | | | | | | | | | | | | | | | | | | | | | | | | | | | | | | | | | | | | | | | | | | | | | | | | | | | | | | | | | | | | | | | | | | | | | | | | |
| | | | | | | | | | | | | | | | | | | | | | | | | | | | | | | | | | | | | | | | | | | | | | | | | | | | | | | | | | | | | | | | | | | | | | | | | | | | | | | | |
| | | | | | | | | | | | | | | | | | | | | | | | | | | | | | | | | | | | | | | | | | | | | | | | | | | | | | | | | | | | | | | | | | | | | | | | | | | | | | | | |
| 1 | | | | | | | | | | | | | | | | | | | | | | | | | | | | | | | | | | | | | | | | | | | | | | | | | | | | | | | | | | | | | | | | | | | | | | | | | | | | | | | |
| 1 | | 3 | | | | | | | | | | | | | | | | | | | | | | | | | | | | | | | | | | | | | | | | | | | | | | | | | | | | | | | | | | | | | | | | | | | | | | | | | | | | | |
| 1 | | 1 | | | | | | | | | | | | | | | | | | | | | | | | | | | | | | | | | | | | | | | | | | | | | | | | | | | | | | | | | | | | | | | | | | | | | | | | | | | | | |
| | | 1 | | | | | | | | | | | | | | | | | | | | | | | | | | | | | | | | | | | | | | | | | | | | | | | | | | | | | | | | | | | | | | | | | | | | | | | | | | | | | |
| 1 | | 3 | | | | | | | | | | | | | | | | | | | | | | | | | | | | | | | | | | | | | | | | | | | | | | | | | | | | | | | | | | | | | | | | | | | | | | | | | | | | | |
| | | | | | | | | | | | | | | | | | | | | | | | | | | | | | | | | | | | | | | | | | | | | | | | | | | | | | | | | | | | | | | | | | | | | | | | | | | | | | | | |
| | | | | | | | | | | | | | | | | | | | | | | | | | | | | | | | | | | | | | | | | | | | | | | | | | | | | | | | | | | | | | | | | | | | | | | | | | | | | | | | |
| | | | | | | | | | | | | | | | | | | | | | | | | | | | | | | | | | | | | | | | | | | | | | | | | | | | | | | | | | | | | | | | | | | | | | | | | | | | | | | | |
| 1 | | | | | | | | | | | | | | | | | | | | | | | | | | | | | | | | | | | | | | | | | | | | | | | | | | | | | | | | | | | | | | | | | | | | | | | | | | | | | | | |
| 2 | | 1 | | | | | | | | | | | | | | | | | | | | | | | | | | | | | | | | | | | | | | | | | | | | | | | | | | | | | | | | | | | | | | | | | | | | | | | | | | | | | |
| 1 | 1 | 2 | | | | | | | | | | | | | | | | | | | | | | | | | | | | | | | | | | | | | | | | | | | | | | | | | | | | | | | | | | | | | | | | | | | | | | | | | | | | | |
| | | | | | | | | | | | | | | | | | | | | | | | | | | | | | | | | | | | | | | | | | | | | | | | | | | | | | | | | | | | | | | | | | | | | | | | | | | | | | | | |
| | | | | | | | | | | | | | | | | | | | | | | | | | | | | | | | | | | | | | | | | | | | | | | | | | | | | | | | | | | | | | | | | | | | | | | | | | | | | | | | |
| | | | | | | | | | | | | | | | | | | | | | | | | | | | | | | | | | | | | | | | | | | | | | | | | | | | | | | | | | | | | | | | | | | | | | | | | | | | | | | | |
| 1 | 1 | 1 | | | | | | | | | | | | | | | | | | | | | | | | | | | | | | | | | | | | | | | | | | | | | | | | | | | | | | | | | | | | | | | | | | | | | | | | | | | | | |
| | | 2 | | | | | | | | | | | | | | | | | | | | | | | | | | | | | | | | | | | | | | | | | | | | | | | | | | | | | | | | | | | | | | | | | | | | | | | | | | | | | |
| 1 | | 1 | | | | | | | | | | | | | | | | | | | | | | | | | | | | | | | | | | | | | | | | | | | | | | | | | | | | | | | | | | | | | | | | | | | | | | | | | | | | | |
| | | | | | | | | | | | | | | | | | | | | | | | | | | | | | | | | | | | | | | | | | | | | | | | | | | | | | | | | | | | | | | | | | | | | | | | | | | | | | | | |
| | | | | | | | | | | | | | | | | | | | | | | | | | | | | | | | | | | | | | | | | | | | | | | | | | | | | | | | | | | | | | | | | | | | | | | | | | | | | | | | |
| | | | | | | | | | | | | | | | | | | | | | | | | | | | | | | | | | | | | | | | | | | | | | | | | | | | | | | | | | | | | | | | | | | | | | | | | | | | | | | | |
| Post - 0 Miss - 0 Block - 0 | Post - 0 Miss - 1 Block - 0 | Post - 0 Miss - 0 Block - 0 | Post - 0 Miss - 0 Block - 0 | Post - 0 Miss - 1 Block - 0 | Post - 0 Miss - 0 Block - 0 | Post - 0 Miss - 1 Block - 0 | Post - 0 Miss - 0 Block - 0 | | | | | | | | | | | | | | | | | | | | | | | | | | | | | | | | | | | | | | | | | | | | | | | | | | | | | | | | | | | | | | | | | | | | | | | | |
| 12 刘树豪 | 13 尹文珂 | 15 徐逸 | 17 谢庆龙 | 18 张睿梁 | 19 庞连康 | 20 张文健 | 21 曹修庆 | | | | | | | | | | | | | | | | | | | | | | | | | | | | | | | | | | | | | | | | | | | | | | | | | | | | | | | | | | | | | | | | | | | | | | | | |
| <table border="1"><tr><td></td><td></td><td></td></tr><tr><td></td><td></td><td></td></tr><tr><td></td><td></td><td></td></tr></table> | | | | | | | | | | <table border="1"><tr><td></td><td></td><td></td></tr><tr><td></td><td></td><td></td></tr><tr><td></td><td></td><td>1</td></tr></table> | | | | | | | | | 1 | <table border="1"><tr><td></td><td></td><td></td></tr><tr><td></td><td></td><td></td></tr><tr><td></td><td></td><td></td></tr></table> | | | | | | | | | | <table border="1"><tr><td></td><td></td><td>1</td></tr><tr><td></td><td></td><td></td></tr><tr><td>1</td><td></td><td></td></tr></table> | | | 1 | | | | 1 | | | <table border="1"><tr><td></td><td></td><td></td></tr><tr><td></td><td></td><td></td></tr><tr><td></td><td></td><td></td></tr></table> | | | | | | | | | | <table border="1"><tr><td></td><td></td><td></td></tr><tr><td></td><td></td><td></td></tr><tr><td></td><td></td><td>1</td></tr></table> | | | | | | | | | 1 | <table border="1"><tr><td></td><td></td><td></td></tr><tr><td></td><td></td><td></td></tr><tr><td></td><td></td><td></td></tr></table> | | | | | | | | | | <table border="1"><tr><td></td><td></td><td></td></tr><tr><td></td><td></td><td></td></tr><tr><td></td><td></td><td></td></tr></table> | | | | | | | | | |
| | | | | | | | | | | | | | | | | | | | | | | | | | | | | | | | | | | | | | | | | | | | | | | | | | | | | | | | | | | | | | | | | | | | | | | | | | | | | | | | |
| | | | | | | | | | | | | | | | | | | | | | | | | | | | | | | | | | | | | | | | | | | | | | | | | | | | | | | | | | | | | | | | | | | | | | | | | | | | | | | | |
| | | | | | | | | | | | | | | | | | | | | | | | | | | | | | | | | | | | | | | | | | | | | | | | | | | | | | | | | | | | | | | | | | | | | | | | | | | | | | | | |
| | | | | | | | | | | | | | | | | | | | | | | | | | | | | | | | | | | | | | | | | | | | | | | | | | | | | | | | | | | | | | | | | | | | | | | | | | | | | | | | |
| | | | | | | | | | | | | | | | | | | | | | | | | | | | | | | | | | | | | | | | | | | | | | | | | | | | | | | | | | | | | | | | | | | | | | | | | | | | | | | | |
| | | 1 | | | | | | | | | | | | | | | | | | | | | | | | | | | | | | | | | | | | | | | | | | | | | | | | | | | | | | | | | | | | | | | | | | | | | | | | | | | | | |
| | | | | | | | | | | | | | | | | | | | | | | | | | | | | | | | | | | | | | | | | | | | | | | | | | | | | | | | | | | | | | | | | | | | | | | | | | | | | | | | |
| | | | | | | | | | | | | | | | | | | | | | | | | | | | | | | | | | | | | | | | | | | | | | | | | | | | | | | | | | | | | | | | | | | | | | | | | | | | | | | | |
| | | | | | | | | | | | | | | | | | | | | | | | | | | | | | | | | | | | | | | | | | | | | | | | | | | | | | | | | | | | | | | | | | | | | | | | | | | | | | | | |
| | | 1 | | | | | | | | | | | | | | | | | | | | | | | | | | | | | | | | | | | | | | | | | | | | | | | | | | | | | | | | | | | | | | | | | | | | | | | | | | | | | |
| | | | | | | | | | | | | | | | | | | | | | | | | | | | | | | | | | | | | | | | | | | | | | | | | | | | | | | | | | | | | | | | | | | | | | | | | | | | | | | | |
| 1 | | | | | | | | | | | | | | | | | | | | | | | | | | | | | | | | | | | | | | | | | | | | | | | | | | | | | | | | | | | | | | | | | | | | | | | | | | | | | | | |
| | | | | | | | | | | | | | | | | | | | | | | | | | | | | | | | | | | | | | | | | | | | | | | | | | | | | | | | | | | | | | | | | | | | | | | | | | | | | | | | |
| | | | | | | | | | | | | | | | | | | | | | | | | | | | | | | | | | | | | | | | | | | | | | | | | | | | | | | | | | | | | | | | | | | | | | | | | | | | | | | | |
| | | | | | | | | | | | | | | | | | | | | | | | | | | | | | | | | | | | | | | | | | | | | | | | | | | | | | | | | | | | | | | | | | | | | | | | | | | | | | | | |
| | | | | | | | | | | | | | | | | | | | | | | | | | | | | | | | | | | | | | | | | | | | | | | | | | | | | | | | | | | | | | | | | | | | | | | | | | | | | | | | |
| | | | | | | | | | | | | | | | | | | | | | | | | | | | | | | | | | | | | | | | | | | | | | | | | | | | | | | | | | | | | | | | | | | | | | | | | | | | | | | | |
| | | 1 | | | | | | | | | | | | | | | | | | | | | | | | | | | | | | | | | | | | | | | | | | | | | | | | | | | | | | | | | | | | | | | | | | | | | | | | | | | | | |
| | | | | | | | | | | | | | | | | | | | | | | | | | | | | | | | | | | | | | | | | | | | | | | | | | | | | | | | | | | | | | | | | | | | | | | | | | | | | | | | |
| | | | | | | | | | | | | | | | | | | | | | | | | | | | | | | | | | | | | | | | | | | | | | | | | | | | | | | | | | | | | | | | | | | | | | | | | | | | | | | | |
| | | | | | | | | | | | | | | | | | | | | | | | | | | | | | | | | | | | | | | | | | | | | | | | | | | | | | | | | | | | | | | | | | | | | | | | | | | | | | | | |
| | | | | | | | | | | | | | | | | | | | | | | | | | | | | | | | | | | | | | | | | | | | | | | | | | | | | | | | | | | | | | | | | | | | | | | | | | | | | | | | |
| | | | | | | | | | | | | | | | | | | | | | | | | | | | | | | | | | | | | | | | | | | | | | | | | | | | | | | | | | | | | | | | | | | | | | | | | | | | | | | | |
| | | | | | | | | | | | | | | | | | | | | | | | | | | | | | | | | | | | | | | | | | | | | | | | | | | | | | | | | | | | | | | | | | | | | | | | | | | | | | | | |
| Post - 0 Miss - 0 Block - 0 | Post - 0 Miss - 0 Block - 0 | Post - 0 Miss - 0 Block - 0 | Post - 0 Miss - 0 Block - 0 | Post - 0 Miss - 0 Block - 0 | Post - 0 Miss - 1 Block - 1 | Post - 0 Miss - 0 Block - 0 | Post - 0 Miss - 0 Block - 0 | | | | | | | | | | | | | | | | | | | | | | | | | | | | | | | | | | | | | | | | | | | | | | | | | | | | | | | | | | | | | | | | | | | | | | | | |

12 刘树豪

| | | |
|-----|-----|-----|
| 1/1 | 1/2 | 4/5 |
| 0/2 | | 5/5 |
| 2/9 | 0/1 | 3/7 |

| | | |
|--|--|--|
| | | |
| | | |
| | | |

| | | |
|--|--|--|
| | | |
| | | |
| | | |

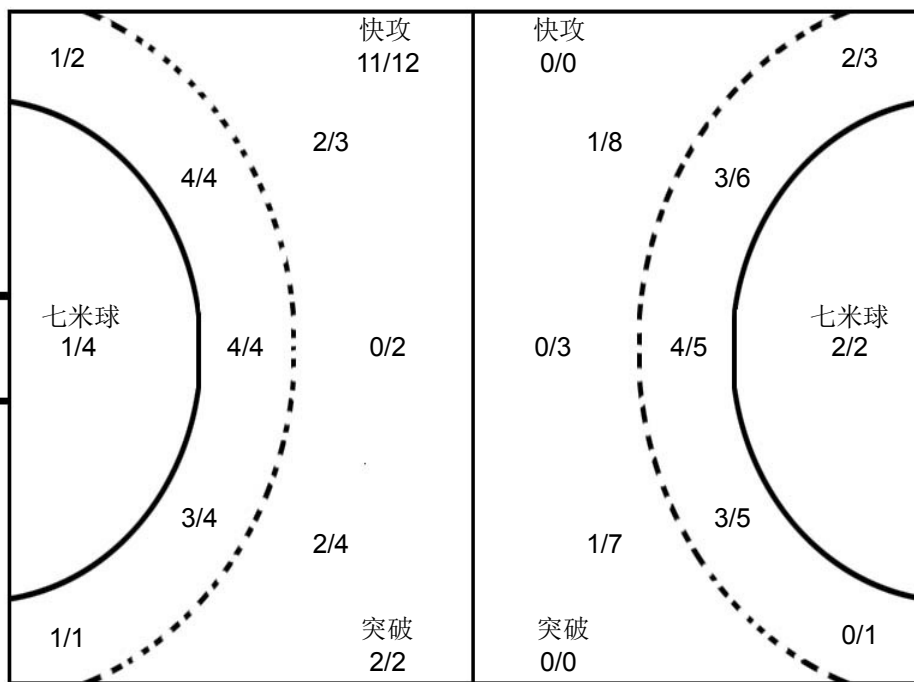

1 高尚君

| | | |
|-----|-----|------|
| 1/4 | 0/1 | 0/4 |
| 1/4 | 1/1 | 2/6 |
| 1/6 | 0/1 | 0/10 |

| | | |
|--|--|--|
| | | |
| | | |
| | | |

| | | |
|--|--|--|
| | | |
| | | |
| | | |

辽宁队

| | | | | | | | | | | | | | | | | | | | | | | | | | | | | | | | | | | | | | | | | | | | | | | | | | | | | | | | | | | | | | | | | | | | | | | | | | | | | | | | |
|--|-----------------------------|-----------------------------|-----------------------------|-----------------------------|-----------------------------|-----------------------------|-----------------------------|--|--|---|--|--|--|---|--|--|--|--|--|--|--|--|--|--|--|--|--|--|--|--|--|--|--|--|--|--|--|--|--|--|--|---|--|---|--|--|--|--|--|--|--|--|--|---|--|--|--|--|---|--|--|--|--|--|--|--|--|--|--|---|--|--|---|---|--|--|---|---|---|
| 1 高尚君 | 2 王司雨 | 3 李星浩 | 5 余昊锦 | 6 陈庆港 | 7 孙义广 | 8 王鑫鹏 | 10 王柏淇 | | | | | | | | | | | | | | | | | | | | | | | | | | | | | | | | | | | | | | | | | | | | | | | | | | | | | | | | | | | | | | | | | | | | | | | | |
| <table border="1"><tr><td></td><td></td><td></td></tr><tr><td></td><td></td><td></td></tr><tr><td></td><td></td><td></td></tr></table> | | | | | | | | | | <table border="1"><tr><td></td><td></td><td></td></tr><tr><td>2</td><td></td><td></td></tr><tr><td></td><td></td><td></td></tr></table> | | | | 2 | | | | | | <table border="1"><tr><td></td><td></td><td></td></tr><tr><td></td><td></td><td></td></tr><tr><td></td><td></td><td></td></tr></table> | | | | | | | | | | <table border="1"><tr><td></td><td></td><td></td></tr><tr><td></td><td></td><td></td></tr><tr><td></td><td></td><td></td></tr></table> | | | | | | | | | | <table border="1"><tr><td></td><td>1</td><td></td></tr><tr><td>1</td><td></td><td></td></tr><tr><td></td><td></td><td></td></tr></table> | | 1 | | 1 | | | | | | <table border="1"><tr><td></td><td></td><td></td></tr><tr><td>1</td><td></td><td></td></tr><tr><td></td><td></td><td>1</td></tr></table> | | | | 1 | | | | | 1 | <table border="1"><tr><td></td><td></td><td></td></tr><tr><td></td><td></td><td></td></tr><tr><td></td><td></td><td></td></tr></table> | | | | | | | | | | <table border="1"><tr><td></td><td></td><td>1</td></tr><tr><td>1</td><td></td><td></td></tr><tr><td>1</td><td>1</td><td>1</td></tr></table> | | | 1 | 1 | | | 1 | 1 | 1 |
| | | | | | | | | | | | | | | | | | | | | | | | | | | | | | | | | | | | | | | | | | | | | | | | | | | | | | | | | | | | | | | | | | | | | | | | | | | | | | | | |
| | | | | | | | | | | | | | | | | | | | | | | | | | | | | | | | | | | | | | | | | | | | | | | | | | | | | | | | | | | | | | | | | | | | | | | | | | | | | | | | |
| | | | | | | | | | | | | | | | | | | | | | | | | | | | | | | | | | | | | | | | | | | | | | | | | | | | | | | | | | | | | | | | | | | | | | | | | | | | | | | | |
| | | | | | | | | | | | | | | | | | | | | | | | | | | | | | | | | | | | | | | | | | | | | | | | | | | | | | | | | | | | | | | | | | | | | | | | | | | | | | | | |
| 2 | | | | | | | | | | | | | | | | | | | | | | | | | | | | | | | | | | | | | | | | | | | | | | | | | | | | | | | | | | | | | | | | | | | | | | | | | | | | | | | |
| | | | | | | | | | | | | | | | | | | | | | | | | | | | | | | | | | | | | | | | | | | | | | | | | | | | | | | | | | | | | | | | | | | | | | | | | | | | | | | | |
| | | | | | | | | | | | | | | | | | | | | | | | | | | | | | | | | | | | | | | | | | | | | | | | | | | | | | | | | | | | | | | | | | | | | | | | | | | | | | | | |
| | | | | | | | | | | | | | | | | | | | | | | | | | | | | | | | | | | | | | | | | | | | | | | | | | | | | | | | | | | | | | | | | | | | | | | | | | | | | | | | |
| | | | | | | | | | | | | | | | | | | | | | | | | | | | | | | | | | | | | | | | | | | | | | | | | | | | | | | | | | | | | | | | | | | | | | | | | | | | | | | | |
| | | | | | | | | | | | | | | | | | | | | | | | | | | | | | | | | | | | | | | | | | | | | | | | | | | | | | | | | | | | | | | | | | | | | | | | | | | | | | | | |
| | | | | | | | | | | | | | | | | | | | | | | | | | | | | | | | | | | | | | | | | | | | | | | | | | | | | | | | | | | | | | | | | | | | | | | | | | | | | | | | |
| | | | | | | | | | | | | | | | | | | | | | | | | | | | | | | | | | | | | | | | | | | | | | | | | | | | | | | | | | | | | | | | | | | | | | | | | | | | | | | | |
| | 1 | | | | | | | | | | | | | | | | | | | | | | | | | | | | | | | | | | | | | | | | | | | | | | | | | | | | | | | | | | | | | | | | | | | | | | | | | | | | | | |
| 1 | | | | | | | | | | | | | | | | | | | | | | | | | | | | | | | | | | | | | | | | | | | | | | | | | | | | | | | | | | | | | | | | | | | | | | | | | | | | | | | |
| | | | | | | | | | | | | | | | | | | | | | | | | | | | | | | | | | | | | | | | | | | | | | | | | | | | | | | | | | | | | | | | | | | | | | | | | | | | | | | | |
| | | | | | | | | | | | | | | | | | | | | | | | | | | | | | | | | | | | | | | | | | | | | | | | | | | | | | | | | | | | | | | | | | | | | | | | | | | | | | | | |
| 1 | | | | | | | | | | | | | | | | | | | | | | | | | | | | | | | | | | | | | | | | | | | | | | | | | | | | | | | | | | | | | | | | | | | | | | | | | | | | | | | |
| | | 1 | | | | | | | | | | | | | | | | | | | | | | | | | | | | | | | | | | | | | | | | | | | | | | | | | | | | | | | | | | | | | | | | | | | | | | | | | | | | | |
| | | | | | | | | | | | | | | | | | | | | | | | | | | | | | | | | | | | | | | | | | | | | | | | | | | | | | | | | | | | | | | | | | | | | | | | | | | | | | | | |
| | | | | | | | | | | | | | | | | | | | | | | | | | | | | | | | | | | | | | | | | | | | | | | | | | | | | | | | | | | | | | | | | | | | | | | | | | | | | | | | |
| | | | | | | | | | | | | | | | | | | | | | | | | | | | | | | | | | | | | | | | | | | | | | | | | | | | | | | | | | | | | | | | | | | | | | | | | | | | | | | | |
| | | 1 | | | | | | | | | | | | | | | | | | | | | | | | | | | | | | | | | | | | | | | | | | | | | | | | | | | | | | | | | | | | | | | | | | | | | | | | | | | | | |
| 1 | | | | | | | | | | | | | | | | | | | | | | | | | | | | | | | | | | | | | | | | | | | | | | | | | | | | | | | | | | | | | | | | | | | | | | | | | | | | | | | |
| 1 | 1 | 1 | | | | | | | | | | | | | | | | | | | | | | | | | | | | | | | | | | | | | | | | | | | | | | | | | | | | | | | | | | | | | | | | | | | | | | | | | | | | | |
| Post - 0 Miss - 0 Block - 0 | Post - 0 Miss - 0 Block - 0 | Post - 0 Miss - 0 Block - 0 | Post - 0 Miss - 0 Block - 0 | Post - 0 Miss - 0 Block - 0 | Post - 0 Miss - 1 Block - 0 | Post - 0 Miss - 0 Block - 0 | Post - 1 Miss - 1 Block - 2 | | | | | | | | | | | | | | | | | | | | | | | | | | | | | | | | | | | | | | | | | | | | | | | | | | | | | | | | | | | | | | | | | | | | | | | | |
| 11 庞东阳 | 13 杨洁 | 14 吕昊臻 | 16 吴阳 | 17 李傲 | 18 梅凯博 | 19 赵鑫 | 20 赵佛赐 | | | | | | | | | | | | | | | | | | | | | | | | | | | | | | | | | | | | | | | | | | | | | | | | | | | | | | | | | | | | | | | | | | | | | | | | |
| <table border="1"><tr><td></td><td></td><td></td></tr><tr><td>3</td><td></td><td>2</td></tr><tr><td></td><td></td><td></td></tr></table> | | | | 3 | | 2 | | | | <table border="1"><tr><td></td><td></td><td></td></tr><tr><td></td><td></td><td></td></tr><tr><td></td><td></td><td></td></tr></table> | | | | | | | | | | <table border="1"><tr><td></td><td></td><td></td></tr><tr><td></td><td></td><td></td></tr><tr><td></td><td></td><td></td></tr></table> | | | | | | | | | | <table border="1"><tr><td></td><td></td><td></td></tr><tr><td></td><td></td><td></td></tr><tr><td></td><td></td><td></td></tr></table> | | | | | | | | | | <table border="1"><tr><td></td><td></td><td></td></tr><tr><td></td><td></td><td></td></tr><tr><td></td><td></td><td></td></tr></table> | | | | | | | | | | <table border="1"><tr><td></td><td></td><td></td></tr><tr><td></td><td></td><td></td></tr><tr><td></td><td></td><td></td></tr></table> | | | | | | | | | | <table border="1"><tr><td></td><td></td><td></td></tr><tr><td></td><td></td><td></td></tr><tr><td></td><td></td><td></td></tr></table> | | | | | | | | | | <table border="1"><tr><td></td><td></td><td></td></tr><tr><td></td><td></td><td></td></tr><tr><td></td><td></td><td></td></tr></table> | | | | | | | | | |
| | | | | | | | | | | | | | | | | | | | | | | | | | | | | | | | | | | | | | | | | | | | | | | | | | | | | | | | | | | | | | | | | | | | | | | | | | | | | | | | |
| 3 | | 2 | | | | | | | | | | | | | | | | | | | | | | | | | | | | | | | | | | | | | | | | | | | | | | | | | | | | | | | | | | | | | | | | | | | | | | | | | | | | | |
| | | | | | | | | | | | | | | | | | | | | | | | | | | | | | | | | | | | | | | | | | | | | | | | | | | | | | | | | | | | | | | | | | | | | | | | | | | | | | | | |
| | | | | | | | | | | | | | | | | | | | | | | | | | | | | | | | | | | | | | | | | | | | | | | | | | | | | | | | | | | | | | | | | | | | | | | | | | | | | | | | |
| | | | | | | | | | | | | | | | | | | | | | | | | | | | | | | | | | | | | | | | | | | | | | | | | | | | | | | | | | | | | | | | | | | | | | | | | | | | | | | | |
| | | | | | | | | | | | | | | | | | | | | | | | | | | | | | | | | | | | | | | | | | | | | | | | | | | | | | | | | | | | | | | | | | | | | | | | | | | | | | | | |
| | | | | | | | | | | | | | | | | | | | | | | | | | | | | | | | | | | | | | | | | | | | | | | | | | | | | | | | | | | | | | | | | | | | | | | | | | | | | | | | |
| | | | | | | | | | | | | | | | | | | | | | | | | | | | | | | | | | | | | | | | | | | | | | | | | | | | | | | | | | | | | | | | | | | | | | | | | | | | | | | | |
| | | | | | | | | | | | | | | | | | | | | | | | | | | | | | | | | | | | | | | | | | | | | | | | | | | | | | | | | | | | | | | | | | | | | | | | | | | | | | | | |
| | | | | | | | | | | | | | | | | | | | | | | | | | | | | | | | | | | | | | | | | | | | | | | | | | | | | | | | | | | | | | | | | | | | | | | | | | | | | | | | |
| | | | | | | | | | | | | | | | | | | | | | | | | | | | | | | | | | | | | | | | | | | | | | | | | | | | | | | | | | | | | | | | | | | | | | | | | | | | | | | | |
| | | | | | | | | | | | | | | | | | | | | | | | | | | | | | | | | | | | | | | | | | | | | | | | | | | | | | | | | | | | | | | | | | | | | | | | | | | | | | | | |
| | | | | | | | | | | | | | | | | | | | | | | | | | | | | | | | | | | | | | | | | | | | | | | | | | | | | | | | | | | | | | | | | | | | | | | | | | | | | | | | |
| | | | | | | | | | | | | | | | | | | | | | | | | | | | | | | | | | | | | | | | | | | | | | | | | | | | | | | | | | | | | | | | | | | | | | | | | | | | | | | | |
| | | | | | | | | | | | | | | | | | | | | | | | | | | | | | | | | | | | | | | | | | | | | | | | | | | | | | | | | | | | | | | | | | | | | | | | | | | | | | | | |
| | | | | | | | | | | | | | | | | | | | | | | | | | | | | | | | | | | | | | | | | | | | | | | | | | | | | | | | | | | | | | | | | | | | | | | | | | | | | | | | |
| | | | | | | | | | | | | | | | | | | | | | | | | | | | | | | | | | | | | | | | | | | | | | | | | | | | | | | | | | | | | | | | | | | | | | | | | | | | | | | | |
| | | | | | | | | | | | | | | | | | | | | | | | | | | | | | | | | | | | | | | | | | | | | | | | | | | | | | | | | | | | | | | | | | | | | | | | | | | | | | | | |
| | | | | | | | | | | | | | | | | | | | | | | | | | | | | | | | | | | | | | | | | | | | | | | | | | | | | | | | | | | | | | | | | | | | | | | | | | | | | | | | |
| | | | | | | | | | | | | | | | | | | | | | | | | | | | | | | | | | | | | | | | | | | | | | | | | | | | | | | | | | | | | | | | | | | | | | | | | | | | | | | | |
| | | | | | | | | | | | | | | | | | | | | | | | | | | | | | | | | | | | | | | | | | | | | | | | | | | | | | | | | | | | | | | | | | | | | | | | | | | | | | | | |
| | | | | | | | | | | | | | | | | | | | | | | | | | | | | | | | | | | | | | | | | | | | | | | | | | | | | | | | | | | | | | | | | | | | | | | | | | | | | | | | |
| | | | | | | | | | | | | | | | | | | | | | | | | | | | | | | | | | | | | | | | | | | | | | | | | | | | | | | | | | | | | | | | | | | | | | | | | | | | | | | | |
| | | | | | | | | | | | | | | | | | | | | | | | | | | | | | | | | | | | | | | | | | | | | | | | | | | | | | | | | | | | | | | | | | | | | | | | | | | | | | | | |
| Post - 1 Miss - 0 Block - 0 | Post - 0 Miss - 1 Block - 1 | Post - 0 Miss - 0 Block - 0 | Post - 0 Miss - 0 Block - 0 | Post - 0 Miss - 0 Block - 0 | Post - 0 Miss - 0 Block - 0 | Post - 0 Miss - 0 Block - 0 | Post - 0 Miss - 0 Block - 0 | | | | | | | | | | | | | | | | | | | | | | | | | | | | | | | | | | | | | | | | | | | | | | | | | | | | | | | | | | | | | | | | | | | | | | | | |

注释: Post=击柱 Miss=射失 Block=被封





预赛 Group B
青年男子 全国比赛

2016年“体彩杯”全国手球男子青年锦标赛

| | | | | | | | | | | | | | | | | | | | | | |
|--------------------|---|---------------------|---------------------|------------------|------------------------------------|-------------------|---|--------------------------|----------------|----|-----|----------------------|---------------|---|--|--|----|---|----|---|----|
| Team A A 天津队 | | | | Team B B 新疆队 | | | | Match Number 6 | | | | | | | | | | | | | |
| played in China | | in the hall 重庆万州 | | on 20/03/2016 | | at 17:30 hours | | Spectators | | | | | | | | | | | | | |
| Half-time (30') | A 13 | B 24 | End of playing time | A 32 | B 44 | 1st extra time | A | B | 2nd extra time | A | B | After penalty throws | A | B | | | | | | | |
| Number of 7 m | A 0/2 | Team time-out | | | Full name of players and officials | | | | Team time-out | | | B 2/4 | Number of 7 m | | | | | | | | |
| No. | Team A | | | | | G | W | 2' | D | DR | No. | Team B | | | | | G | W | 2' | D | DR |
| 9 | 吴明远 | | | | | 7 | | 1 | | | 1 | 宋晓晨 | | | | | | | | | |
| 18 | 王晓琪 | | | | | 6 | | 1 | | | 2 | 王泽川 | | | | | 1 | | 2 | | |
| 21 | 潘玉帅 | | | | | 4 | 1 | | | | 4 | 谷通金 | | | | | 1 | | | | |
| 22 | 魏雨童 | | | | | 7 | | 1 | | | 5 | 徐伟 | | | | | 3 | | | | |
| 24 | 刘子健 | | | | | | | | | | 6 | 白光宇 | | | | | | | | | |
| 25 | 王一雄 | | | | | 4 | 1 | | | | 7 | 林豪文 | | | | | 6 | | 1 | | |
| 26 | 刘思远 | | | | | 4 | | | | | 10 | 王钟彬 | | | | | 6 | 1 | | | |
| 27 | 左金龙 | | | | | | | 1 | | | 12 | 王金鑫 | | | | | | | | | |
| 28 | 何喜年 | | | | | | | | | | 13 | 苏兴伟 | | | | | 4 | | | | |
| | | | | | | | | | | | 15 | 王维东 | | | | | 4 | | | | |
| | | | | | | | | | | | 16 | 李佳懿 | | | | | | | | | |
| | | | | | | | | | | | 17 | 胡晋铭 | | | | | 3 | | | | |
| | | | | | | | | | | | 18 | 李万兴 | | | | | 1 | | | | |
| | | | | | | | | | | | 19 | 李龙吉 | | | | | 10 | 1 | | | |
| | | | | | | | | | | | 24 | 陈伟华 | | | | | 5 | 1 | | | |
| A | 李志成 | | | | | | | | | | A | 孔德斌 (主教练) | | | | | 1 | | | | |
| B | 潘玉强 | | | | | | | | | | B | 陈鹏波 | | | | | | | | | |
| | | | | | | | | | | | C | 李楠 | | | | | | | | | |
| | | | | | | | | | | | | | | | | | | | | | |
| | | | | | | | | | | | | | | | | | | | | | |
| A | Signature of Responsible Official of the Teams (Off. A) | | | | | | | | | | B | | | | | | | | | | |
| TP | Remarks of Referee / CHA Official | | | | | | | | | | TP | | | | | | | | | | |

Signatures

| | | | | |
|------------------|-----------|----------|--|--|
| Referees | 马晓晔 (CHN) | 王羚 (CHN) | | |
| Techn. Delegates | 吴瑞亭 (CHN) | | | |
| CHA Official | 张春生 (CHN) | | | |

Note: Number of 7m Throws Awarded to Team A and B, Goals (G), Warnings (W), Suspensions (2), Direct Disqualification (D), Disqualification with Report (DR) and Team Penalty (TP).

Table Officials:

Statisticians: 李双

刘永欢





2016年“体彩杯”全国手球男子青年锦标赛 竞赛技术统计(媒体表)

| | | | | | | |
|----------------|-----------|------------|----|-----------|------------------|----------|
| 预赛 | 组别 | B | 轮次 | 1 | 场次 | 6 |
| 重庆万州 | | 20/03/2016 | | | 201602006-51-1/1 | |
| 天津队 | 天津 | 32 | vs | 44 | 新疆 | 新疆队 |
| 13 : 24 | | | | | | |

| | | | |
|-----|-----------|---|----------|
| 裁判员 | 马晓晔 (CHN) | / | 王羚 (CHN) |
|-----|-----------|---|----------|

| 天津 | | | | | | | | | | | | | | 天津 | | 新疆 | |
|---------------|--------------|--------------|--------------|-------------|------------|------------|--------------|--------------|-------------|-----------|-----------|----------|----------|----------|-----------|----|--|
| 主教练：潘玉强 | | | | | | | | | | | | | | 比赛进程 | | 新疆 | |
| 远射 | 近射 | 边射 | 快攻 | 突破 | 任意球 | 7m球 | 合计 | % | 助攻 | 失误 | 警告 | 2' | D & DR | 1st Half | 2nd Half | | |
| 9 吴明远 | 3/7 | 4/5 | | | | | 7/12 | 58.3 | 1 | 5 | | 1 | | 0 00:28 | 1 19 李龙吉 | | |
| 18 王晓琪 | 4/9 | 1/3 | | | 1/1 | 0/1 | 6/14 | 42.9 | 5 | 4 | | 1 | | 1 00:38 | 1 1 王钟彬 | | |
| 21 潘玉帅 | 1/4 | 2/2 | | 1/1 | | 0/1 | 4/8 | 50.0 | 5 | 5 | 1 | | | 2 02:37 | 2 10 王钟彬 | | |
| 22 魏雨童 | | 7/9 | | | | 0/1 | 7/10 | 70.0 | | 2 | | 1 | | 3 03:49 | 3 10 王钟彬 | | |
| 24 刘子健 | | | | | | | | | | 1 | | | | 3 04:09 | 4 19 李龙吉 | | |
| 25 王一雄 | 1/2 | 2/2 | 0/2 | 1/1 | | | 4/7 | 57.1 | | | | 1 | | 3 04:59 | 5 4 谷通金 | | |
| 26 刘思远 | | 0/1 | 1/3 | 2/2 | 1/1 | | 4/7 | 57.1 | | 1 | | | | 4 05:40 | 6 17 胡晋铭 | | |
| 27 左金龙 | | | 0/1 | | | | 0/1 | 0.0 | | | | | | 4 05:31 | 6 17 胡晋铭 | | |
| 28 何喜年 | | | | | | | | | | | | | | 4 05:40 | 7 19 李龙吉 | | |
| 运动员 合计 | 9/22 | 16/22 | 1/6 | 4/4 | 2/2 | 0/1 | 0/2 | 32/59 | 54.2 | 11 | 18 | 3 | 3 | 5 06:35 | 7 17 胡晋铭 | | |
| 24 刘子健 | 2/5 | 0/12 | | 0/6 | 1/2 | 0/1 | 3/26 | 11.5 | | 1 | | | | 6 07:05 | 8 24 陈伟华 | | |
| 28 何喜年 | 1/4 | 3/10 | | 0/6 | 0/2 | 2/3 | 1/3 | 7/28 | 25.0 | | | | | 6 08:00 | 9 24 陈伟华 | | |
| 守门员 合计 | 3/9 | 3/22 | | 0/12 | 1/4 | 2/4 | 1/3 | 10/54 | 18.5 | | 1 | | | 7 08:45 | 9 24 陈伟华 | | |
| 新疆 | | | | | | | | | | | | | | 天津 | | 新疆 | |
| 教练：孔德斌 | | | | | | | | | | | | | | 比赛进程 | | 新疆 | |
| 远射 | 近射 | 边射 | 快攻 | 突破 | 任意球 | 7m球 | 合计 | % | 助攻 | 失误 | 警告 | 2' | D & DR | 1st Half | 2nd Half | | |
| 1 宋晓晨 | | | | | | | | | | | | | | 8 09:26 | 10 7 林豪文 | | |
| 2 王泽川 | | | | | | 1/1 | 1/1 | 100 | | | | 2 | | 8 09:37 | 10 7 林豪文 | | |
| 4 谷通金 | | | 1/1 | | | | 1/1 | 100 | | | | | | 8 11:52 | 11 24 陈伟华 | | |
| 5 徐伟 | | 2/3 | 1/1 | | | | 3/4 | 75.0 | 2 | 1 | | | | 8 12:51 | 12 10 王钟彬 | | |
| 6 白光宇 | | | | | | | | | | | | | | 9 14:19 | 12 10 王钟彬 | | |
| 7 林豪文 | 2/6 | 2/2 | 1/1 | | 1/2 | | 6/11 | 54.5 | 5 | 2 | | 1 | | 9 14:45 | 13 7 林豪文 | | |
| 10 王钟彬 | 1/3 | 2/2 | 2/2 | 1/3 | 0/1 | | 6/11 | 54.5 | 3 | | | | | 9 15:04 | 14 10 王钟彬 | | |
| 11 陶丛龙 | | | | | | | | | | | | | | 9 16:21 | 15 19 李龙吉 | | |
| 12 王金鑫 | | | | | | | | | | | | | | 9 16:59 | 16 19 李龙吉 | | |
| 13 苏兴伟 | 1/2 | 1/1 | 1/1 | | 1/1 | | 4/5 | 80.0 | 1 | 1 | | | | 9 17:42 | 17 7 林豪文 | | |
| 15 王维东 | 1/1 | 1/1 | 1/1 | | | | 1/1 | 100 | 1 | 2 | | | | 9 18:44 | 18 24 陈伟华 | | |
| 16 李佳懿 | | | | | | | | | | | | | | 9 20:14 | 19 7 林豪文 | | |
| 17 胡晋铭 | 0/1 | 3/3 | | | | | 3/4 | 75.0 | 1 | 1 | | | | 9 23:46 | 20 19 李龙吉 | | |
| 18 李万兴 | | 0/1 | | 1/1 | | | 1/2 | 50.0 | | 2 | | | | 9 23:46 | 20 19 李龙吉 | | |
| 19 李龙吉 | | 5/7 | 4/4 | 1/1 | | 0/1 | 10/13 | 76.9 | | 1 | 1 | | | 10 24:28 | 20 19 李龙吉 | | |
| 24 陈伟华 | 1/2 | 3/3 | 1/1 | | | 0/1 | 5/7 | 71.4 | | 2 | 1 | | | 10 25:10 | 21 17 胡晋铭 | | |
| 运动员 合计 | 6/15 | 19/23 | 12/12 | 3/5 | 2/4 | 2/4 | 44/63 | 69.8 | 16 | 13 | 3 | 3 | | 10 25:26 | 21 17 胡晋铭 | | |
| 1 宋晓晨 | 9/17 | 6/21 | 4/5 | 0/4 | 0/2 | 1/1 | 1/1 | 21/51 | 41.2 | 3 | 1 | | | 12 26:01 | 21 13 苏兴伟 | | |
| 12 王金鑫 | 1/2 | 0/1 | | | | | 1/3 | 33.3 | | | | | | 12 26:27 | 22 13 苏兴伟 | | |
| 守门员 合计 | 10/19 | 6/22 | 4/5 | 0/4 | 0/2 | 1/1 | 1/1 | 22/54 | 40.7 | 3 | 1 | | | 13 27:13 | 22 13 苏兴伟 | | |

场上队员：得分 / 射门

守门员：救球 / 射门

| | | | | | | | | | |
|----|------------|----|--------------|-----|------------|-----|----------|----|---------|
| 快攻 | Fast Break | 突破 | Breakthrough | 任意球 | Free Throw | 7M球 | 7M Throw | 助攻 | Assist |
| 警告 | Warning | 失误 | Error | 2' | Suspension | D | 取消资格 | DR | 取消资格+报告 |





2016年“体彩杯”全国手球男子青年锦标赛 图式比赛技术统计表

轮次 1

场次 6

201602006-21-1/1

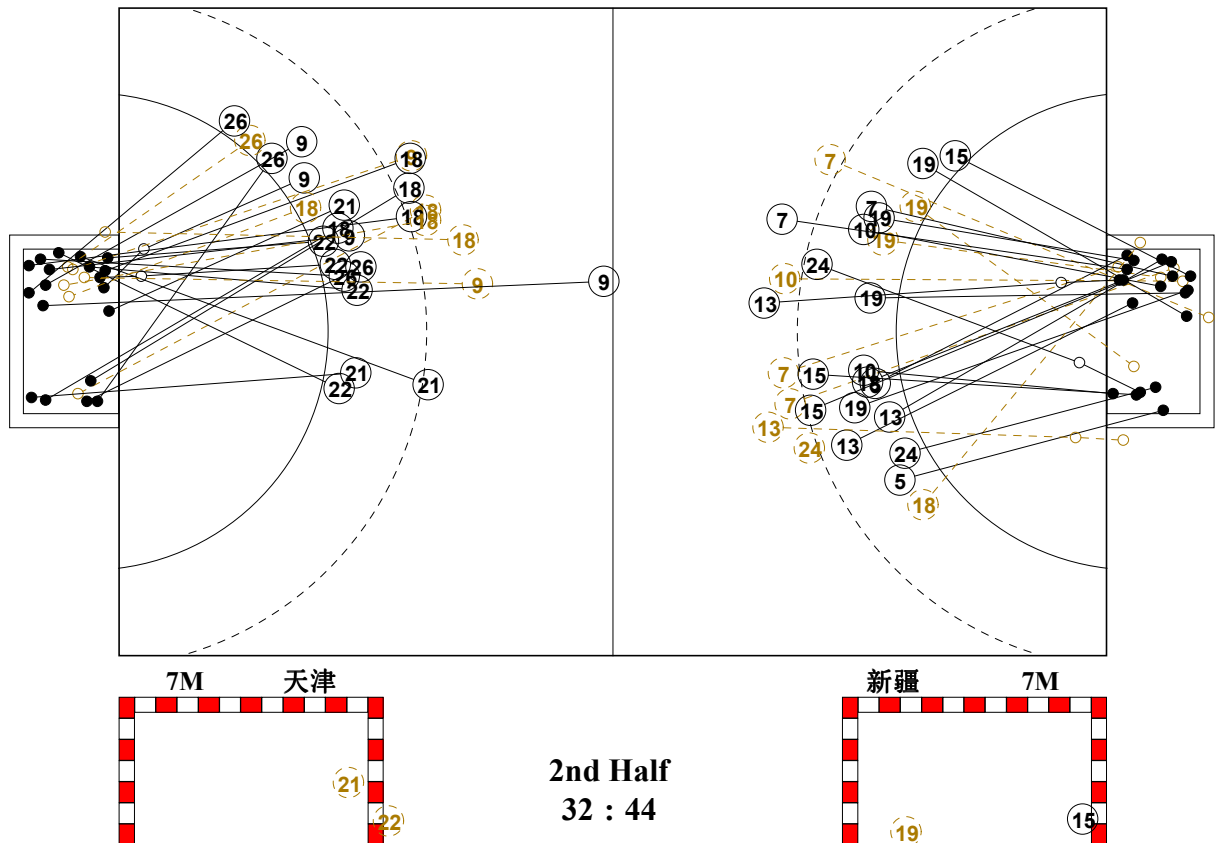
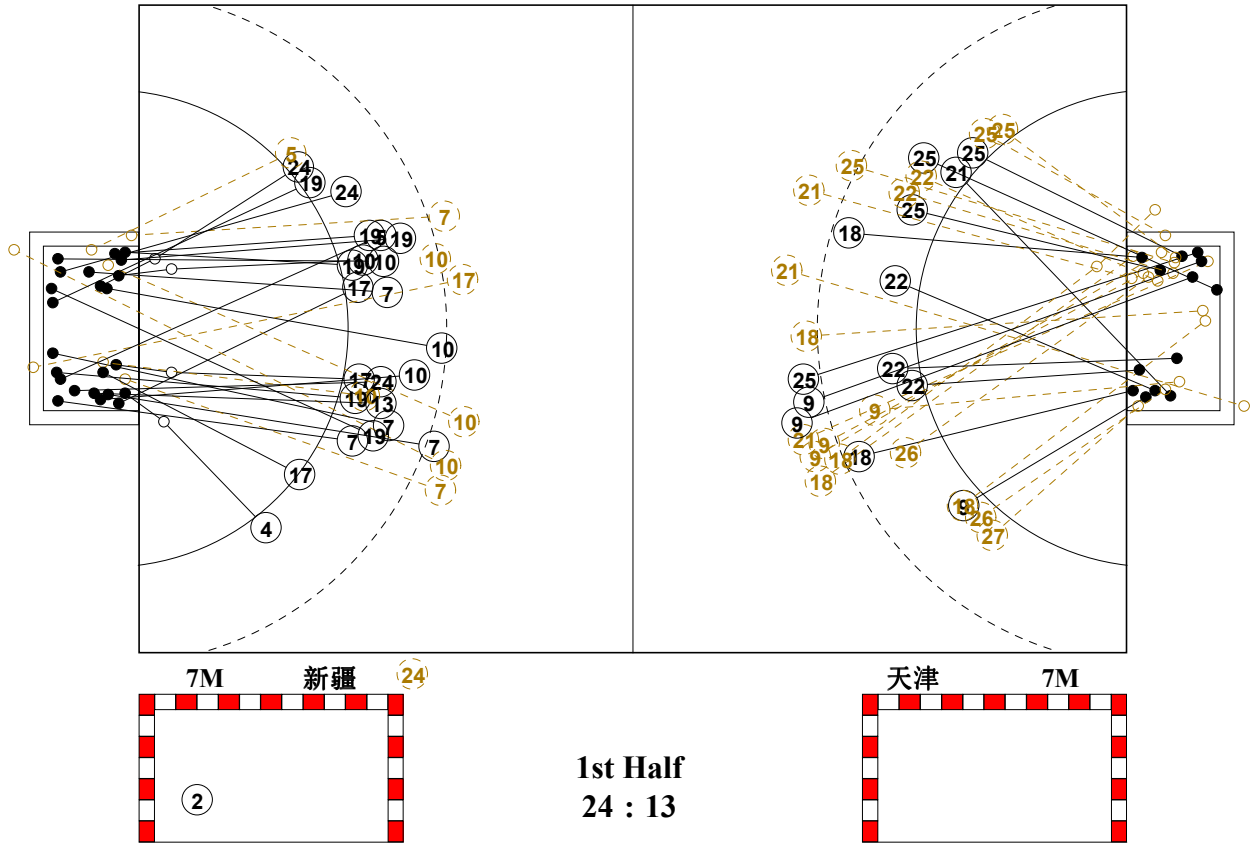



2016年“体彩杯”全国手球男子青年锦标赛

个人/全队技术统计表

正式表
手球
青年男子预赛
轮次 1组别 B
场次 6201602006-14-1/2
重庆万州
20/03/2016 17:30

| 号码 | 姓名 | 远射 | 近射 | 边射 | 快攻 | 突破 | 任意 | 7M | 合计 | % | 助攻 | 失误 | 警告 | 2' | 取消 | 时间 |
|---|-----|-----|------|-----|-----|-----|-----|-----|------|-------|----|----|----|----|----|----------|
| 天津队(天津) | | | | | | | | | | | | | | | | |
| <i>(场上队员)</i> | | | | | | | | | | | | | | | | |
| 9 | 吴明远 | 3/7 | 4/5 | | | | | | 7/12 | 58.3% | 1 | 5 | | 1 | | 01:00:00 |
| 18 | 王晓琪 | 4/9 | 1/3 | | | 1/1 | 0/1 | | 6/14 | 42.9% | 5 | 4 | | 1 | | 00:55:20 |
| 21 | 潘玉帅 | 1/4 | 2/2 | | 1/1 | | | 0/1 | 4/8 | 50.0% | 5 | 5 | 1 | | | 00:57:07 |
| 22 | 魏雨童 | | 7/9 | | | | | 0/1 | 7/10 | 70.0% | | 2 | | 1 | | 01:00:00 |
| 24 | 刘子健 | | | | | | | | | 0.0% | | 1 | | | | 00:25:50 |
| 25 | 王一雄 | 1/2 | 2/2 | 0/2 | 1/1 | | | | 4/7 | 57.1% | | | | 1 | | 01:00:00 |
| 26 | 刘思远 | | 0/1 | 1/3 | 2/2 | 1/1 | | | 4/7 | 57.1% | | 1 | | | | 00:54:02 |
| 27 | 左金龙 | | | 0/1 | | | | | 0/1 | 0.0% | | | | 1 | | 00:13:27 |
| 28 | 何喜年 | | | | | | | | | 0.0% | | | | | | 00:34:10 |
| 合计 | | | | | | | | | | | | | | | | |
| <i>(守门员)</i> | | | | | | | | | | | | | | | | |
| 24 | | 2/5 | 0/12 | | 0/6 | 1/2 | 0/1 | | 3/26 | 11.5% | | 1 | | | | 00:25:50 |
| 28 | | 1/4 | 3/10 | | 0/6 | 0/2 | 2/3 | 1/3 | 7/28 | 25.0% | | | | | | 00:34:10 |
| 合计 | | | | | | | | | | | | | | | | |
| 3/9 3/22 0/12 1/4 2/4 1/3 10/54 18.5% 1 | | | | | | | | | | | | | | | | |

场上队员：得分/射门

守门员：救球/射门

| 全队合计 | 得分 | 被救 | 射失 | 击柱 | 封球 | 合计 | % |
|------|----|----|----|----|----|----|--------|
| 远射 | 9 | 10 | 2 | 1 | | 22 | 40.9% |
| 近射 | 16 | 6 | | | | 22 | 72.7% |
| 边射 | 1 | 4 | | 1 | | 6 | 16.7% |
| 快攻 | 4 | | | | | 4 | 100.0% |
| 突破 | 2 | | | | | 2 | 100.0% |
| 任意 | | 1 | | | | 1 | 0.0% |
| 7M | | 1 | | 1 | | 2 | 0.0% |





2016年“体彩杯”全国手球男子青年锦标赛

个人/全队技术统计表

正式表
手球
青年男子预赛
轮次 1组别 B
场次 6201602006-14-2/2
重庆万州
20/03/2016 17:30

| 号码 | 姓名 | 远射 | 近射 | 边射 | 快攻 | 突破 | 任意 | 7M | 合计 | % | 助攻 | 失误 | 警告 | 2' | 取消 | 时间 |
|----------------|-----|-------|-------|-----|-------|-----|-----|-----|-------|-------|----|----|----|----|----|----------|
| 新疆队(新疆) | | | | | | | | | | | | | | | | |
| <i>(上场队员)</i> | | | | | | | | | | | | | | | | |
| 1 | 宋晓晨 | | | | | | | | | 0.0% | 3 | 1 | | | | 00:56:44 |
| 2 | 王泽川 | | | | | | | 1/1 | 1/1 | 100% | | | | 2 | | 00:21:07 |
| 4 | 谷通金 | | | | 1/1 | | | | 1/1 | 100% | | | | | | 00:41:55 |
| 5 | 徐伟 | | 2/3 | | 1/1 | | | | 3/4 | 75.0% | 2 | 1 | | | | 00:33:35 |
| 6 | 白光宇 | | | | | | | | | 0.0% | | | | | | 00:00:00 |
| 7 | 林豪文 | 2/6 | 2/2 | | 1/1 | | 1/2 | | 6/11 | 54.5% | 5 | 2 | | 1 | | 00:41:12 |
| 10 | 王钟彬 | 1/3 | 2/2 | | 2/2 | 1/3 | 0/1 | | 6/11 | 54.5% | 3 | | 1 | | | 00:47:55 |
| 11 | 陶丛龙 | | | | | | | | | 0.0% | | | | | | 00:00:00 |
| 12 | 王金鑫 | | | | | | | | | 0.0% | | | | | | 00:03:16 |
| 13 | 苏兴伟 | 1/2 | 1/1 | | 1/1 | | 1/1 | | 4/5 | 80.0% | 1 | 1 | | | | 00:15:21 |
| 15 | 王维东 | 1/1 | 1/1 | | 1/1 | | | 1/1 | 4/4 | 100% | 1 | 2 | | | | 00:35:23 |
| 16 | 李佳懿 | | | | | | | | | 0.0% | | | | | | 00:00:00 |
| 17 | 胡晋铭 | 0/1 | 3/3 | | | | | | 3/4 | 75.0% | 1 | 1 | | | | 00:44:12 |
| 18 | 李万兴 | | 0/1 | | | 1/1 | | | 1/2 | 50.0% | | 2 | | | | 00:14:03 |
| 19 | 李龙吉 | | 5/7 | | 4/4 | 1/1 | | 0/1 | 10/13 | 76.9% | | 1 | 1 | | | 00:39:51 |
| 24 | 陈伟华 | 1/2 | 3/3 | | 1/1 | | | 0/1 | 5/7 | 71.4% | | 2 | 1 | | | 00:31:29 |
| 合计 | | 6/15 | 19/23 | | 12/12 | 3/5 | 2/4 | 2/4 | 44/63 | 69.8% | 16 | 13 | 3 | 3 | | |
| <i>(守门员)</i> | | | | | | | | | | | | | | | | |
| 1 | 宋晓晨 | 9/17 | 6/21 | 4/5 | 0/4 | 0/2 | 1/1 | 1/1 | 21/51 | 41.2% | 3 | 1 | | | | 00:56:44 |
| 12 | 王金鑫 | 1/2 | 0/1 | | | | | | 1/3 | 33.3% | | | | | | 00:03:16 |
| 合计 | | 10/19 | 6/22 | 4/5 | 0/4 | 0/2 | 1/1 | 1/1 | 22/54 | 40.7% | 3 | 1 | | | | |

场上队员：得分/射门

守门员：救球/射门

| 全队合计 | 得分 | 被救 | 射失 | 击柱 | 封球 | 合计 | % |
|------|----|----|----|----|----|----|--------|
| 远射 | 6 | 3 | 1 | 3 | 2 | 15 | 40.0% |
| 近射 | 19 | 3 | | 1 | | 23 | 82.6% |
| 边射 | | | | | | | 0.0% |
| 快攻 | 12 | | | | | 12 | 100.0% |
| 突破 | 3 | 1 | 1 | | | 5 | 60.0% |
| 任意 | 2 | 2 | | | | 4 | 50.0% |
| 7M | 2 | 1 | 1 | | | 4 | 50.0% |





2016年“体彩杯”全国手球男子青年锦标赛

图式射门区域统计

轮次 1 场次 6

201602006-41-1/1

天津队

| | | | | | | | |
|-------|--------|--------|--------|--------|--------|--------|--------|
| 9 吴明远 | 18 王晓琪 | 21 潘玉帅 | 22 魏雨童 | 24 刘子健 | 25 王一雄 | 26 刘思远 | 27 左金龙 |
| 2 1 2 | 1 1 | 1 2 | 2 | | 2 2 | 1 2 | |
| | 2 2 | 1 | 5 | | | 1 | |
| | | | | | | | |

Post - 0 Miss - 0 Block - 0 Post - 1 Miss - 1 Block - 0 Post - 0 Miss - 1 Block - 0 Post - 1 Miss - 0 Block - 0 Post - 0 Miss - 0 Block - 0 Post - 1 Miss - 0 Block - 0 Post - 0 Miss - 0 Block - 0 Post - 0 Miss - 0 Block - 0

| | | | | | | | |
|--------|--|--|--|--|--|--|--|
| 28 何喜年 | | | | | | | |
| | | | | | | | |
| | | | | | | | |

Post - 0 Miss - 0 Block - 0

24 刘子健

| | | |
|-----|-----|-----|
| 0/5 | 0/3 | 0/2 |
| 1/3 | | 0/2 |
| 2/7 | | 0/4 |

28 何喜年

| | | |
|-----|-----|-----|
| 2/6 | | 0/1 |
| 1/5 | | 1/5 |
| 1/5 | 0/1 | 2/5 |

| | | |
|--|--|--|
| | | |
| | | |
| | | |

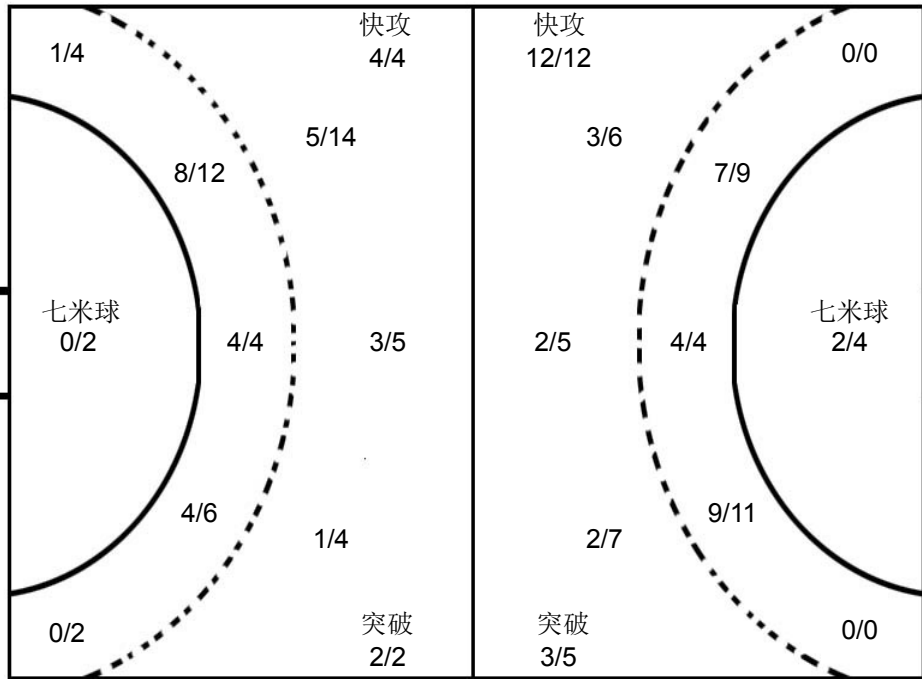

1 宋晓晨

| | | |
|-----|-----|------|
| 1/7 | 2/2 | 0/4 |
| 6/9 | | 7/11 |
| 4/7 | 0/1 | 1/10 |

12 王金鑫

| | | |
|--|-----|-----|
| | 0/1 | 0/1 |
| | | 1/1 |
| | | |

| | | |
|--|--|--|
| | | |
| | | |
| | | |

新疆队

| | | | | | | | |
|-------|-------|-------|------|-------|-------|--------|--------|
| 1 宋晓晨 | 2 王泽川 | 4 谷通金 | 5 徐伟 | 6 白光宇 | 7 林豪文 | 10 王钟彬 | 11 陶丛龙 |
| | 1 | 1 | 1 1 | | 2 1 1 | 2 1 2 | |
| | | | | | | | |

Post - 0 Miss - 0 Block - 0 Post - 0 Miss - 0 Block - 0 Post - 0 Miss - 0 Block - 0 Post - 0 Miss - 0 Block - 0 Post - 0 Miss - 0 Block - 0 Post - 2 Miss - 0 Block - 0 Post - 0 Miss - 1 Block - 1 Post - 0 Miss - 0 Block - 0

| | | | | | | | |
|--------|--------|--------|--------|--------|--------|--------|--------|
| 12 王金鑫 | 13 苏兴伟 | 15 王维东 | 16 李佳懿 | 17 胡晋铭 | 18 李万兴 | 19 李龙吉 | 24 陈伟华 |
| | 2 1 1 | 2 | | 1 2 | 1 | 3 2 1 | 1 1 3 |
| | | | | | | | |

Post - 0 Miss - 0 Block - 0 Post - 0 Miss - 1 Block - 0 Post - 0 Miss - 0 Block - 0 Post - 0 Miss - 0 Block - 0 Post - 1 Miss - 0 Block - 0 Post - 1 Miss - 0 Block - 0 Post - 0 Miss - 0 Block - 0 Post - 0 Miss - 1 Block - 1

注释: Post=击柱 Miss=射失 Block=被封



预赛 Group A
青年男子 全国比赛

2016年“体彩杯”全国手球男子青年锦标赛

| | | | | | | | | | | | | | | | | | | | | | |
|--------------------|---|------------------------------|---------------------|------------------|------------------------------------|-------------------|---|-------------------|------------------------|----|-----|----------------------|---------------|---|--|--|---|---|----|----|----|
| Team A A 浙江队 | | | | Team B B 解放军队 | | | | Match Number 7 | | | | | | | | | | | | | |
| played in China | | in the hall 重庆万州 | | on 21/03/2016 | | at 08:30 hours | | Spectators | | | | | | | | | | | | | |
| Half-time (30') | A 5 | B 25 | End of playing time | A 5 | B 25 | 1st extra time | A | B | 2nd extra time | A | B | After penalty throws | A | B | | | | | | | |
| Number of 7 m | A 2/3 | Team time-out 1 13:24 2 3 | | | Full name of players and officials | | | | Team time-out 1 2 3 | | | B 0/0 | Number of 7 m | | | | | | | | |
| No. | Team A | | | | | G | W | 2' | D | DR | No. | Team B | | | | | G | W | 2' | D | DR |
| 1 | 林先方 | | | | | 3 | 1 | | | | 1 | 郭梦雨 | | | | | | | | | |
| 2 | 李恩铭 | | | | | | | | | | 3 | 张昌轲 | | | | | 8 | | | | |
| 3 | 郑尧俊 | | | | | 1 | 1 | | | | 4 | 张洋 | | | | | | | | | |
| 5 | 高家南 | | | | | | | | | | 5 | 尹一楠 | | | | | | | | | |
| 9 | 李家乐 | | | | | | | | | | 6 | 吴昊 | | | | | 2 | 1 | 2 | | |
| 10 | 徐正飞 | | | | | | | | | | 7 | 姜钦 | | | | | 3 | | | | |
| 14 | 虞勇灿 | | | | | | | | | | 8 | 邹峻楠 | | | | | | | | | |
| 15 | 张佩力 | | | | | | | | | | 9 | 李天枢 | | | | | | | | | |
| 17 | 罗明杰 | | | | | | | | | | 10 | 范保坤 | | | | | 1 | | | | |
| 18 | 倪陈辉 | | | | | 1 | | | | | 11 | 王誌汉 | | | | | 6 | | | | |
| 19 | 王浩 | | | | | | | | | | 12 | 左子健 | | | | | | | | | |
| | | | | | | | | | | | 13 | 徐峻清 | | | | | 3 | 1 | | | |
| | | | | | | | | | | | 14 | 孙耀琦 | | | | | 2 | 1 | | | |
| | | | | | | | | | | | 16 | 池猛 | | | | | | | | | |
| | | | | | | | | | | | 17 | 刘安宁 | | | | | | | | | |
| C | 柳佳 | | | | | | | | | | A | 杜长义 (主教练) | | | | | | | | | |
| D | 项建生 | | | | | | | | | | B | 刘捷 | | | | | | | | | |
| E | 刘晓辉 | | | | | | | | | | C | 王学力 | | | | | | | | | |
| A | Signature of Responsible Official of the Teams (Off. A) | | | | | | | | | | | | | | | | | | | B | |
| TP | Remarks of Referee / CHA Official | | | | | | | | | | | | | | | | | | | TP | |

Signatures

Referees: 陈炳威 (CHN) 张智伟 (CHN)

Techn. Delegates: 徐健 (CHN)

CHA Official: 张春生 (CHN)

Note: Number of 7m Throws Awarded to Team A and B, Goals (G), Warnings (W), Suspensions (2'), Direct Disqualification (D), Disqualification with Report (DR) and Team Penalty (TP).

Table Officials:

Statisticians: 李双

刘永欢





2016年“体彩杯”全国手球男子青年锦标赛
竞赛技术统计(媒体表)

| | | | | | | | | | | | | | |
|------|--|----|---|------------|----|-----|------|--|--|------------------|---|--|--|
| 预赛 | | 组别 | A | | | 轮次 | 2 | | | 场次 | 7 | | |
| 重庆万州 | | | | 21/03/2016 | | | | | | 201602007-51-1/1 | | | |
| 浙江队 | | 浙江 | 5 | vs | 25 | 解放军 | 解放军队 | | | | | | |
| | | | | 5 : 25 | | | | | | | | | |

| | | | | | | | | | | | | |
|-----|-----------|--|--|---|-----------|--|--|--|--|--|--|--|
| 裁判员 | 陈炳威 (CHN) | | | / | 张智伟 (CHN) | | | | | | | |
|-----|-----------|--|--|---|-----------|--|--|--|--|--|--|--|

| 浙江 | | | | | | | | | | | | | | | | 浙江 | | 比赛进程 | | 解放军 | | |
|----------|-----|------|-----|-----|-----|-----|-----|------|-------|------|----|----|----|----|--------|----|----|------|-------|-----|----|-----|
| 主教练: 柳日祥 | | 远射 | 近射 | 边射 | 快攻 | 突破 | 任意球 | 7m球 | 合计 | % | 助攻 | 失误 | 警告 | 2' | D & DR | 浙江 | 浙江 | 浙江 | 解放军 | | | |
| 1 | 林先方 | 1/4 | 0/3 | 0/2 | 0/1 | | | 2/3 | 3/13 | 23.1 | | 3 | 1 | | | | | 0 | 01:20 | 1 | 6 | 吴昊 |
| 2 | 李恩铭 | | 0/1 | 0/2 | 0/1 | | | | 0/4 | 0.0 | | 1 | | | | | | 0 | 02:03 | 2 | 3 | 张昌柯 |
| 3 | 郑尧俊 | 1/2 | 0/1 | | | | | | 1/3 | 33.3 | 1 | 3 | 1 | | | | | 0 | 03:25 | 3 | 11 | 王誌汉 |
| 5 | 高家南 | | | | | | | | | | | | | | | | | 0 | 04:24 | 4 | 10 | 范保坤 |
| 9 | 李家乐 | | | | | | | | | | | | | | | | | 0 | 05:10 | 5 | 7 | 姜钦 |
| 10 | 徐正飞 | | | | | | | | | | | | | | | | | 0 | 05:54 | 6 | 13 | 徐峻清 |
| 14 | 虞勇灿 | | | | | | | | | | 1 | 1 | | | | | | 1 | 07:16 | 6 | | |
| 15 | 张佩力 | | | | | | | | | | | | | | | | | 1 | 07:49 | 7 | 3 | 张昌柯 |
| 17 | 罗明杰 | | | | | | | | | | | | | | | | | 2 | 09:25 | 7 | | |
| 18 | 倪陈辉 | | | | | | | | | | | | | | | | | 2 | 09:46 | 8 | 3 | 张昌柯 |
| 19 | 王浩 | 0/5 | 1/2 | | | | 0/1 | 1/8 | 12.5 | | | 5 | | | | | | 2 | 10:11 | 9 | 11 | 王誌汉 |
| | | | | | | | | | | | | | | | | | | 2 | 11:18 | 10 | 3 | 张昌柯 |
| | | | | | | | | | | | | | | | | | | 2 | 12:04 | 11 | 3 | 张昌柯 |
| | | | | | | | | | | | | | | | | | | 2 | 13:17 | 12 | 11 | 王誌汉 |
| | | | | | | | | | | | | | | | | | | 3 | 15:17 | 12 | | |
| | | | | | | | | | | | | | | | | | | 3 | 15:40 | 13 | 3 | 张昌柯 |
| | | | | | | | | | | | | | | | | | | 4 | 16:58 | 13 | | |
| | | | | | | | | | | | | | | | | | | 4 | 17:15 | 14 | 13 | 徐峻清 |
| | | | | | | | | | | | | | | | | | | 4 | 20:02 | 15 | 13 | 徐峻清 |
| | | | | | | | | | | | | | | | | | | 4 | 20:43 | 16 | 14 | 孙耀琦 |
| | | | | | | | | | | | | | | | | | | 5 | 22:18 | 16 | | |
| | | | | | | | | | | | | | | | | | | 5 | 22:42 | 17 | 7 | 姜钦 |
| | | | | | | | | | | | | | | | | | | 5 | 23:34 | 18 | 3 | 张昌柯 |
| | | | | | | | | | | | | | | | | | | 5 | 24:28 | 19 | 14 | 孙耀琦 |
| | | | | | | | | | | | | | | | | | | 5 | 25:29 | 20 | 11 | 王誌汉 |
| | | | | | | | | | | | | | | | | | | 5 | 25:58 | 21 | 11 | 王誌汉 |
| | | | | | | | | | | | | | | | | | | 5 | 26:35 | 22 | 7 | 姜钦 |
| | | | | | | | | | | | | | | | | | | 5 | 28:27 | 23 | 3 | 张昌柯 |
| | | | | | | | | | | | | | | | | | | 5 | 28:56 | 24 | 6 | 吴昊 |
| | | | | | | | | | | | | | | | | | | 5 | 29:21 | 25 | 11 | 王誌汉 |
| 运动员 | 合计 | 2/11 | 1/7 | 0/4 | 0/2 | | 0/1 | 2/3 | 5/28 | 17.9 | 2 | 13 | 2 | | | | | | | | | |
| 14 | 虞勇灿 | 2/5 | 1/5 | 1/3 | 2/4 | 0/1 | | | 6/18 | 33.3 | 1 | 1 | | | | | | | | | | |
| 15 | 张佩力 | 1/6 | 1/4 | 0/2 | 0/3 | | | | 2/15 | 13.3 | | | | | | | | | | | | |
| 守门员 | 合计 | 3/11 | 2/9 | 1/5 | 2/7 | 0/1 | | 8/33 | 24.2 | | 1 | 1 | | | | | | | | | | |
| 解放军 | | | | | | | | | | | | | | | | | | | | | | |
| 教练: 杜长义 | | 远射 | 近射 | 边射 | 快攻 | 突破 | 任意球 | 7m球 | 合计 | % | 助攻 | 失误 | 警告 | 2' | D & DR | | | | | | | |
| 1 | 郭梦雨 | | | | | | | | | | 1 | | | | | | | | | | | |
| 3 | 张昌柯 | 4/4 | 3/3 | | | 1/1 | | | 8/8 | 100 | 2 | 2 | | | | | | | | | | |
| 4 | 张洋 | | | | | | | | | | | | | | | | | | | | | |
| 5 | 尹一楠 | | | | | | | | | | | | | | | | | | | | | |
| 6 | 吴昊 | 1/3 | 0/1 | | 1/2 | | | | 2/6 | 33.3 | 1 | | 1 | 2 | | | | | | | | |
| 7 | 姜钦 | 1/2 | 2/2 | | | | | | 3/4 | 75.0 | 2 | | | | | | | | | | | |
| 8 | 邹峻楠 | | | | | | | | | | | | | | | | | | | | | |
| 9 | 李天枢 | | | | | | | | | | | | | | | | | | | | | |
| 10 | 范保坤 | 1/1 | | 0/1 | | | | | 1/2 | 50.0 | | | | | | | | | | | | |
| 11 | 王誌汉 | 1/1 | | 2/2 | 3/3 | | | | 6/6 | 100 | | | | | | | | | | | | |
| 12 | 左子健 | | | | | | | | | | | | | | | | | | | | | |
| 13 | 徐峻清 | | | 2/2 | 0/1 | | | | 3/4 | 75.0 | 1 | 1 | 1 | | | | | | | | | |
| 14 | 孙耀琦 | | 1/2 | | 1/1 | | | | 2/3 | 66.7 | | 2 | 1 | | | | | | | | | |
| 16 | 池猛 | | | | | | | | | | | | | | | | | | | | | |
| 17 | 刘安宁 | | | | | | | | | | | | | | | | | | | | | |
| 运动员 | 合计 | 8/11 | 7/9 | 4/5 | 5/7 | 1/1 | | | 25/33 | 75.8 | 7 | 5 | 3 | 2 | | | | | | | | |
| 1 | 郭梦雨 | 6/8 | 4/5 | 4/4 | 1/1 | | | 1/3 | 16/21 | 76.2 | 1 | | | | | | | | | | | |
| 守门员 | 合计 | 6/8 | 4/5 | 4/4 | 1/1 | | | 1/3 | 16/21 | 76.2 | 1 | | | | | | | | | | | |

场上队员: 得分 / 射门 守门员: 救球 / 射门

| | | | | | | | | | |
|----|------------|----|--------------|-----|------------|-----|----------|----|---------|
| 快攻 | Fast Break | 突破 | Breakthrough | 任意球 | Free Throw | 7M球 | 7M Throw | 助攻 | Assist |
| 警告 | Warning | 失误 | Error | 2' | Suspension | D | 取消资格 | DR | 取消资格+报告 |



2016年“体彩杯”全国手球男子青年锦标赛 图式比赛技术统计表

轮次 2

场次 7

201602007-21-1/1

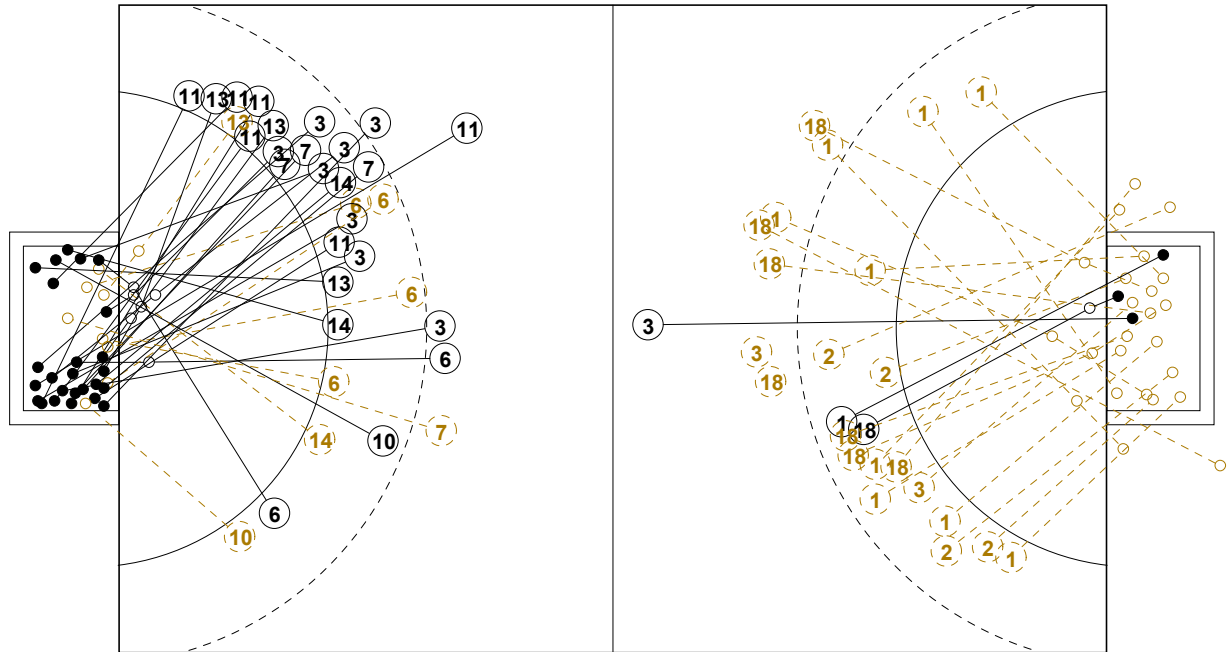

7M 解放军

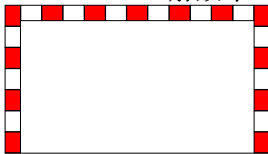

浙江 7M

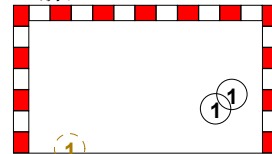

1st Half
25 : 5

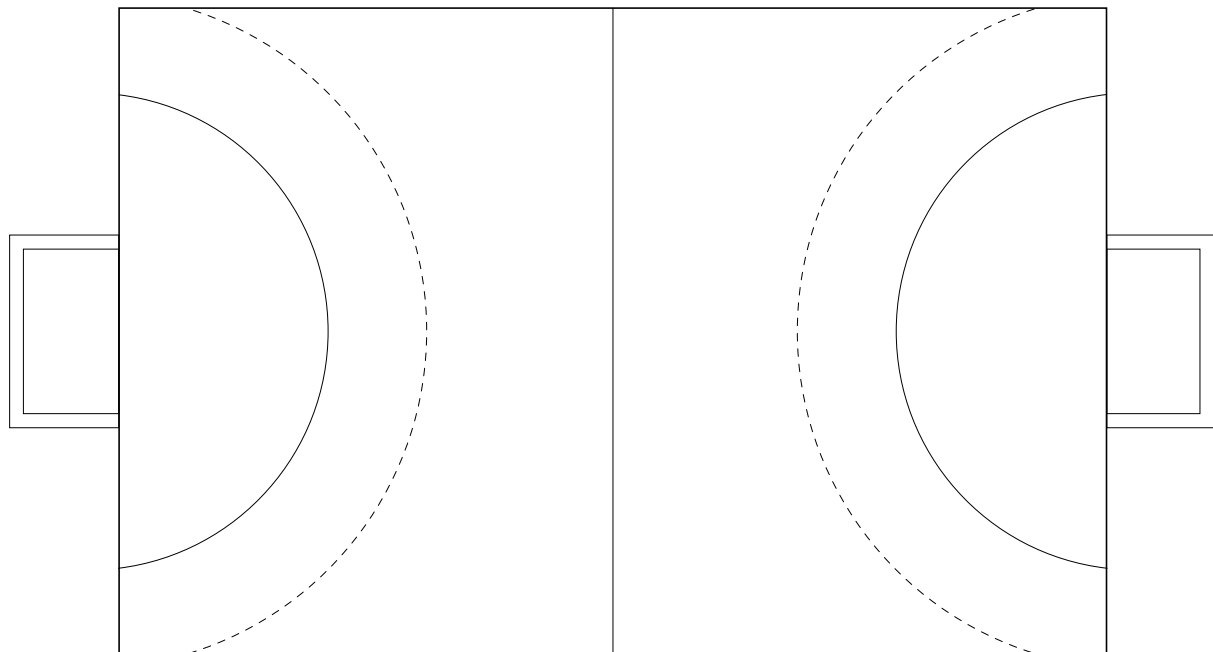

7M 浙江

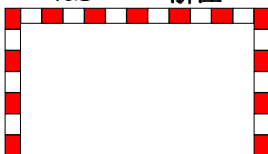

解放军 7M

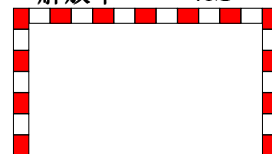

2nd Half
5 : 25



2016年“体彩杯”全国手球男子青年锦标赛

个人/全队技术统计表

正式表
手球
青年男子预赛
轮次 2组别 A
场次 7201602007-14-1/2
重庆万州
21/03/2016 08:30

| 号码 | 姓名 | 远射 | 近射 | 边射 | 快攻 | 突破 | 任意 | 7M | 合计 | % | 助攻 | 失误 | 警告 | 2' | 取消 | 时间 |
|----------------|-----|-----|-----|-----|-----|-----|-----|-----|------|-------|----|----|----|----|----|----------|
| 浙江队(浙江) | | | | | | | | | | | | | | | | |
| <i>(场上队员)</i> | | | | | | | | | | | | | | | | |
| 1 | 林先方 | 1/4 | 0/3 | 0/2 | 0/1 | | | 2/3 | 3/13 | 23.1% | | 3 | 1 | | | 00:30:00 |
| 2 | 李恩铭 | | 0/1 | 0/2 | 0/1 | | | | 0/4 | 0.0% | | 1 | | | | 00:30:00 |
| 3 | 郑尧俊 | 1/2 | 0/1 | | | | | | 1/3 | 33.3% | 1 | 3 | 1 | | | 00:30:00 |
| 5 | 高家南 | | | | | | | | | 0.0% | | | | | | 00:11:23 |
| 9 | 李家乐 | | | | | | | | | 0.0% | | | | | | 00:05:39 |
| 10 | 徐正飞 | | | | | | | | | 0.0% | | | | | | 00:18:35 |
| 14 | 虞勇灿 | | | | | | | | | 0.0% | 1 | 1 | | | | 00:17:03 |
| 15 | 张佩力 | | | | | | | | | 0.0% | | | | | | 00:12:57 |
| 17 | 罗明杰 | | | | | | | | | 0.0% | | | | | | 00:19:56 |
| 18 | 倪陈辉 | 0/5 | 1/2 | | | | 0/1 | | 1/8 | 12.5% | | 5 | | | | 00:30:00 |
| 19 | 王浩 | | | | | | | | | 0.0% | | | | | | 00:04:21 |
| 合计 | | | | | | | | | | | | | | | | |
| <i>(守门员)</i> | | | | | | | | | | | | | | | | |
| 14 | 虞勇灿 | 2/5 | 1/5 | 1/3 | 2/4 | 0/1 | | | 6/18 | 33.3% | 1 | 1 | | | | 00:17:03 |
| 15 | 张佩力 | 1/6 | 1/4 | 0/2 | 0/3 | | | | 2/15 | 13.3% | | | | | | 00:12:57 |
| 合计 | | | | | | | | | | | | | | | | |

场上队员：得分/射门

守门员：救球/射门

| 全队合计 | 得分 | 被救 | 射失 | 击柱 | 封球 | 合计 | % |
|------|----|----|----|----|----|----|-------|
| 远射 | 2 | 6 | 1 | | 2 | 11 | 18.2% |
| 近射 | 1 | 4 | 2 | | | 7 | 14.3% |
| 边射 | | 4 | | | | 4 | 0.0% |
| 快攻 | | 1 | 1 | | | 2 | 0.0% |
| 突破 | | | | | | | 0.0% |
| 任意 | | | 1 | | | 1 | 0.0% |
| 7M | 2 | 1 | | | | 3 | 66.7% |





2016年“体彩杯”全国手球男子青年锦标赛

个人/全队技术统计表

正式表
手球
青年男子预赛
轮次 2组别 A
场次 7201602007-14-2/2
重庆万州
21/03/2016 08:30

| 号码 | 姓名 | 远射 | 近射 | 边射 | 快攻 | 突破 | 任意 | 7M | 合计 | % | 助攻 | 失误 | 警告 | 2' | 取消 | 时间 |
|------------------|-----|------|-----|-----|-----|-----|----|-----|-------|-------|----|----|----|----|----|----------|
| 解放军队(解放军) | | | | | | | | | | | | | | | | |
| <i>(上场队员)</i> | | | | | | | | | | | | | | | | |
| 1 | 郭梦雨 | | | | | | | | | 0.0% | 1 | | | | | 00:30:00 |
| 3 | 张昌轲 | 4/4 | 3/3 | | | 1/1 | | | 8/8 | 100% | 2 | 2 | | | | 00:30:00 |
| 4 | 张洋 | | | | | | | | | 0.0% | | | | | | 00:00:00 |
| 5 | 尹一楠 | | | | | | | | | 0.0% | | | | | | 00:00:00 |
| 6 | 吴昊 | 1/3 | 0/1 | | 1/2 | | | | 2/6 | 33.3% | 1 | | 1 | 2 | | 00:26:02 |
| 7 | 姜钦 | 1/2 | 2/2 | | | | | | 3/4 | 75.0% | 2 | | | | | 00:30:00 |
| 8 | 邹峻楠 | | | | | | | | | 0.0% | | | | | | 00:00:00 |
| 9 | 李天枢 | | | | | | | | | 0.0% | | | | | | 00:00:00 |
| 10 | 范保坤 | 1/1 | | 0/1 | | | | | 1/2 | 50.0% | | | | | | 00:30:00 |
| 11 | 王誌汉 | 1/1 | | 2/2 | 3/3 | | | | 6/6 | 100% | | | | | | 00:23:54 |
| 12 | 左子健 | | | | | | | | | 0.0% | | | | | | 00:00:00 |
| 13 | 徐崧清 | | 1/1 | 2/2 | 0/1 | | | | 3/4 | 75.0% | 1 | 1 | 1 | | | 00:09:52 |
| 14 | 孙耀琦 | | 1/2 | | 1/1 | | | | 2/3 | 66.7% | | 2 | 1 | | | 00:30:00 |
| 16 | 池猛 | | | | | | | | | 0.0% | | | | | | 00:00:00 |
| 17 | 刘安宁 | | | | | | | | | 0.0% | | | | | | 00:00:00 |
| 合计 | | 8/11 | 7/9 | 4/5 | 5/7 | 1/1 | | | 25/33 | 75.8% | 7 | 5 | 3 | 2 | | |
| <i>(守门员)</i> | | | | | | | | | | | | | | | | |
| 1 | 郭梦雨 | 6/8 | 4/5 | 4/4 | 1/1 | | | 1/3 | 16/21 | 76.2% | 1 | | | | | 00:30:00 |
| 合计 | | 6/8 | 4/5 | 4/4 | 1/1 | | | 1/3 | 16/21 | 76.2% | 1 | | | | | |

场上队员：得分/射门

守门员：救球/射门

| 全队合计 | 得分 | 被救 | 射失 | 击柱 | 封球 | 合计 | % |
|------|----|----|----|----|----|----|--------|
| 远射 | 8 | 3 | | | | 11 | 72.7% |
| 近射 | 7 | 2 | | | | 9 | 77.8% |
| 边射 | 4 | 1 | | | | 5 | 80.0% |
| 快攻 | 5 | 2 | | | | 7 | 71.4% |
| 突破 | 1 | | | | | 1 | 100.0% |
| 任意 | | | | | | | 0.0% |
| 7M | | | | | | | 0.0% |





2016年“体彩杯”全国手球男子青年锦标赛

图式射门区域统计

轮次 2 场次 7

201602007-41-1/1

浙江队

| | | | | | | | | | | | | | | | | | | | | | | | | | | | | | | | | | | | | | | | | | | | | | | | | | | | | | | | | | | | | | | | | | | | | | | | | | | | | | | | |
|--|-----------------------------|-----------------------------|-----------------------------|-----------------------------|-----------------------------|-----------------------------|-----------------------------|--|--|---|--|--|---|--|--|--|--|--|--|---|--|--|---|--|--|--|--|--|--|--|--|--|--|--|--|--|--|--|--|--|--|--|--|--|--|--|--|--|--|--|--|--|--|--|--|--|--|--|--|--|--|--|--|--|--|--|--|--|--|--|--|--|--|--|--|--|--|--|--|
| 1 林先方 | 2 李恩铭 | 3 郑尧俊 | 5 高家南 | 9 李家乐 | 10 徐正飞 | 14 虞勇灿 | 15 张佩力 | | | | | | | | | | | | | | | | | | | | | | | | | | | | | | | | | | | | | | | | | | | | | | | | | | | | | | | | | | | | | | | | | | | | | | | | |
| <table border="1"><tr><td>1</td><td></td><td>2</td></tr><tr><td></td><td></td><td></td></tr><tr><td></td><td></td><td></td></tr></table> | 1 | | 2 | | | | | | | <table border="1"><tr><td></td><td></td><td></td></tr><tr><td></td><td></td><td></td></tr><tr><td></td><td></td><td></td></tr></table> | | | | | | | | | | <table border="1"><tr><td></td><td></td><td>1</td></tr><tr><td></td><td></td><td></td></tr><tr><td></td><td></td><td></td></tr></table> | | | 1 | | | | | | | <table border="1"><tr><td></td><td></td><td></td></tr><tr><td></td><td></td><td></td></tr><tr><td></td><td></td><td></td></tr></table> | | | | | | | | | | <table border="1"><tr><td></td><td></td><td></td></tr><tr><td></td><td></td><td></td></tr><tr><td></td><td></td><td></td></tr></table> | | | | | | | | | | <table border="1"><tr><td></td><td></td><td></td></tr><tr><td></td><td></td><td></td></tr><tr><td></td><td></td><td></td></tr></table> | | | | | | | | | | <table border="1"><tr><td></td><td></td><td></td></tr><tr><td></td><td></td><td></td></tr><tr><td></td><td></td><td></td></tr></table> | | | | | | | | | | <table border="1"><tr><td></td><td></td><td></td></tr><tr><td></td><td></td><td></td></tr><tr><td></td><td></td><td></td></tr></table> | | | | | | | | | |
| 1 | | 2 | | | | | | | | | | | | | | | | | | | | | | | | | | | | | | | | | | | | | | | | | | | | | | | | | | | | | | | | | | | | | | | | | | | | | | | | | | | | | |
| | | | | | | | | | | | | | | | | | | | | | | | | | | | | | | | | | | | | | | | | | | | | | | | | | | | | | | | | | | | | | | | | | | | | | | | | | | | | | | | |
| | | | | | | | | | | | | | | | | | | | | | | | | | | | | | | | | | | | | | | | | | | | | | | | | | | | | | | | | | | | | | | | | | | | | | | | | | | | | | | | |
| | | | | | | | | | | | | | | | | | | | | | | | | | | | | | | | | | | | | | | | | | | | | | | | | | | | | | | | | | | | | | | | | | | | | | | | | | | | | | | | |
| | | | | | | | | | | | | | | | | | | | | | | | | | | | | | | | | | | | | | | | | | | | | | | | | | | | | | | | | | | | | | | | | | | | | | | | | | | | | | | | |
| | | | | | | | | | | | | | | | | | | | | | | | | | | | | | | | | | | | | | | | | | | | | | | | | | | | | | | | | | | | | | | | | | | | | | | | | | | | | | | | |
| | | 1 | | | | | | | | | | | | | | | | | | | | | | | | | | | | | | | | | | | | | | | | | | | | | | | | | | | | | | | | | | | | | | | | | | | | | | | | | | | | | |
| | | | | | | | | | | | | | | | | | | | | | | | | | | | | | | | | | | | | | | | | | | | | | | | | | | | | | | | | | | | | | | | | | | | | | | | | | | | | | | | |
| | | | | | | | | | | | | | | | | | | | | | | | | | | | | | | | | | | | | | | | | | | | | | | | | | | | | | | | | | | | | | | | | | | | | | | | | | | | | | | | |
| | | | | | | | | | | | | | | | | | | | | | | | | | | | | | | | | | | | | | | | | | | | | | | | | | | | | | | | | | | | | | | | | | | | | | | | | | | | | | | | |
| | | | | | | | | | | | | | | | | | | | | | | | | | | | | | | | | | | | | | | | | | | | | | | | | | | | | | | | | | | | | | | | | | | | | | | | | | | | | | | | |
| | | | | | | | | | | | | | | | | | | | | | | | | | | | | | | | | | | | | | | | | | | | | | | | | | | | | | | | | | | | | | | | | | | | | | | | | | | | | | | | |
| | | | | | | | | | | | | | | | | | | | | | | | | | | | | | | | | | | | | | | | | | | | | | | | | | | | | | | | | | | | | | | | | | | | | | | | | | | | | | | | |
| | | | | | | | | | | | | | | | | | | | | | | | | | | | | | | | | | | | | | | | | | | | | | | | | | | | | | | | | | | | | | | | | | | | | | | | | | | | | | | | |
| | | | | | | | | | | | | | | | | | | | | | | | | | | | | | | | | | | | | | | | | | | | | | | | | | | | | | | | | | | | | | | | | | | | | | | | | | | | | | | | |
| | | | | | | | | | | | | | | | | | | | | | | | | | | | | | | | | | | | | | | | | | | | | | | | | | | | | | | | | | | | | | | | | | | | | | | | | | | | | | | | |
| | | | | | | | | | | | | | | | | | | | | | | | | | | | | | | | | | | | | | | | | | | | | | | | | | | | | | | | | | | | | | | | | | | | | | | | | | | | | | | | |
| | | | | | | | | | | | | | | | | | | | | | | | | | | | | | | | | | | | | | | | | | | | | | | | | | | | | | | | | | | | | | | | | | | | | | | | | | | | | | | | |
| | | | | | | | | | | | | | | | | | | | | | | | | | | | | | | | | | | | | | | | | | | | | | | | | | | | | | | | | | | | | | | | | | | | | | | | | | | | | | | | |
| | | | | | | | | | | | | | | | | | | | | | | | | | | | | | | | | | | | | | | | | | | | | | | | | | | | | | | | | | | | | | | | | | | | | | | | | | | | | | | | |
| | | | | | | | | | | | | | | | | | | | | | | | | | | | | | | | | | | | | | | | | | | | | | | | | | | | | | | | | | | | | | | | | | | | | | | | | | | | | | | | |
| | | | | | | | | | | | | | | | | | | | | | | | | | | | | | | | | | | | | | | | | | | | | | | | | | | | | | | | | | | | | | | | | | | | | | | | | | | | | | | | |
| | | | | | | | | | | | | | | | | | | | | | | | | | | | | | | | | | | | | | | | | | | | | | | | | | | | | | | | | | | | | | | | | | | | | | | | | | | | | | | | |
| | | | | | | | | | | | | | | | | | | | | | | | | | | | | | | | | | | | | | | | | | | | | | | | | | | | | | | | | | | | | | | | | | | | | | | | | | | | | | | | |
| Post - 0 Miss - 2 Block - 0 | Post - 0 Miss - 1 Block - 0 | Post - 0 Miss - 0 Block - 1 | Post - 0 Miss - 0 Block - 0 | Post - 0 Miss - 0 Block - 0 | Post - 0 Miss - 0 Block - 0 | Post - 0 Miss - 0 Block - 0 | Post - 0 Miss - 0 Block - 0 | | | | | | | | | | | | | | | | | | | | | | | | | | | | | | | | | | | | | | | | | | | | | | | | | | | | | | | | | | | | | | | | | | | | | | | | |
| 17 罗明杰 | 18 倪陈辉 | 19 王浩 | | | | | | | | | | | | | | | | | | | | | | | | | | | | | | | | | | | | | | | | | | | | | | | | | | | | | | | | | | | | | | | | | | | | | | | | | | | | | |
| <table border="1"><tr><td></td><td></td><td></td></tr><tr><td></td><td></td><td></td></tr><tr><td></td><td></td><td></td></tr></table> | | | | | | | | | | <table border="1"><tr><td></td><td></td><td>1</td></tr><tr><td></td><td></td><td></td></tr><tr><td></td><td></td><td></td></tr></table> | | | 1 | | | | | | | <table border="1"><tr><td></td><td></td><td></td></tr><tr><td></td><td></td><td></td></tr><tr><td></td><td></td><td></td></tr></table> | | | | | | | | | | <table border="1"><tr><td></td><td></td><td></td></tr><tr><td></td><td></td><td></td></tr><tr><td></td><td></td><td></td></tr></table> | | | | | | | | | | <table border="1"><tr><td></td><td></td><td></td></tr><tr><td></td><td></td><td></td></tr><tr><td></td><td></td><td></td></tr></table> | | | | | | | | | | <table border="1"><tr><td></td><td></td><td></td></tr><tr><td></td><td></td><td></td></tr><tr><td></td><td></td><td></td></tr></table> | | | | | | | | | | <table border="1"><tr><td></td><td></td><td></td></tr><tr><td></td><td></td><td></td></tr><tr><td></td><td></td><td></td></tr></table> | | | | | | | | | | <table border="1"><tr><td></td><td></td><td></td></tr><tr><td></td><td></td><td></td></tr><tr><td></td><td></td><td></td></tr></table> | | | | | | | | | |
| | | | | | | | | | | | | | | | | | | | | | | | | | | | | | | | | | | | | | | | | | | | | | | | | | | | | | | | | | | | | | | | | | | | | | | | | | | | | | | | |
| | | | | | | | | | | | | | | | | | | | | | | | | | | | | | | | | | | | | | | | | | | | | | | | | | | | | | | | | | | | | | | | | | | | | | | | | | | | | | | | |
| | | | | | | | | | | | | | | | | | | | | | | | | | | | | | | | | | | | | | | | | | | | | | | | | | | | | | | | | | | | | | | | | | | | | | | | | | | | | | | | |
| | | 1 | | | | | | | | | | | | | | | | | | | | | | | | | | | | | | | | | | | | | | | | | | | | | | | | | | | | | | | | | | | | | | | | | | | | | | | | | | | | | |
| | | | | | | | | | | | | | | | | | | | | | | | | | | | | | | | | | | | | | | | | | | | | | | | | | | | | | | | | | | | | | | | | | | | | | | | | | | | | | | | |
| | | | | | | | | | | | | | | | | | | | | | | | | | | | | | | | | | | | | | | | | | | | | | | | | | | | | | | | | | | | | | | | | | | | | | | | | | | | | | | | |
| | | | | | | | | | | | | | | | | | | | | | | | | | | | | | | | | | | | | | | | | | | | | | | | | | | | | | | | | | | | | | | | | | | | | | | | | | | | | | | | |
| | | | | | | | | | | | | | | | | | | | | | | | | | | | | | | | | | | | | | | | | | | | | | | | | | | | | | | | | | | | | | | | | | | | | | | | | | | | | | | | |
| | | | | | | | | | | | | | | | | | | | | | | | | | | | | | | | | | | | | | | | | | | | | | | | | | | | | | | | | | | | | | | | | | | | | | | | | | | | | | | | |
| | | | | | | | | | | | | | | | | | | | | | | | | | | | | | | | | | | | | | | | | | | | | | | | | | | | | | | | | | | | | | | | | | | | | | | | | | | | | | | | |
| | | | | | | | | | | | | | | | | | | | | | | | | | | | | | | | | | | | | | | | | | | | | | | | | | | | | | | | | | | | | | | | | | | | | | | | | | | | | | | | |
| | | | | | | | | | | | | | | | | | | | | | | | | | | | | | | | | | | | | | | | | | | | | | | | | | | | | | | | | | | | | | | | | | | | | | | | | | | | | | | | |
| | | | | | | | | | | | | | | | | | | | | | | | | | | | | | | | | | | | | | | | | | | | | | | | | | | | | | | | | | | | | | | | | | | | | | | | | | | | | | | | |
| | | | | | | | | | | | | | | | | | | | | | | | | | | | | | | | | | | | | | | | | | | | | | | | | | | | | | | | | | | | | | | | | | | | | | | | | | | | | | | | |
| | | | | | | | | | | | | | | | | | | | | | | | | | | | | | | | | | | | | | | | | | | | | | | | | | | | | | | | | | | | | | | | | | | | | | | | | | | | | | | | |
| | | | | | | | | | | | | | | | | | | | | | | | | | | | | | | | | | | | | | | | | | | | | | | | | | | | | | | | | | | | | | | | | | | | | | | | | | | | | | | | |
| | | | | | | | | | | | | | | | | | | | | | | | | | | | | | | | | | | | | | | | | | | | | | | | | | | | | | | | | | | | | | | | | | | | | | | | | | | | | | | | |
| | | | | | | | | | | | | | | | | | | | | | | | | | | | | | | | | | | | | | | | | | | | | | | | | | | | | | | | | | | | | | | | | | | | | | | | | | | | | | | | |
| | | | | | | | | | | | | | | | | | | | | | | | | | | | | | | | | | | | | | | | | | | | | | | | | | | | | | | | | | | | | | | | | | | | | | | | | | | | | | | | |
| | | | | | | | | | | | | | | | | | | | | | | | | | | | | | | | | | | | | | | | | | | | | | | | | | | | | | | | | | | | | | | | | | | | | | | | | | | | | | | | |
| | | | | | | | | | | | | | | | | | | | | | | | | | | | | | | | | | | | | | | | | | | | | | | | | | | | | | | | | | | | | | | | | | | | | | | | | | | | | | | | |
| | | | | | | | | | | | | | | | | | | | | | | | | | | | | | | | | | | | | | | | | | | | | | | | | | | | | | | | | | | | | | | | | | | | | | | | | | | | | | | | |
| | | | | | | | | | | | | | | | | | | | | | | | | | | | | | | | | | | | | | | | | | | | | | | | | | | | | | | | | | | | | | | | | | | | | | | | | | | | | | | | |
| | | | | | | | | | | | | | | | | | | | | | | | | | | | | | | | | | | | | | | | | | | | | | | | | | | | | | | | | | | | | | | | | | | | | | | | | | | | | | | | |
| Post - 0 Miss - 0 Block - 0 | Post - 0 Miss - 2 Block - 1 | Post - 0 Miss - 0 Block - 0 | | | | | | | | | | | | | | | | | | | | | | | | | | | | | | | | | | | | | | | | | | | | | | | | | | | | | | | | | | | | | | | | | | | | | | | | | | | | | |

14 虞勇灿

| | | |
|-----|-----|-----|
| 0/2 | | 0/2 |
| 1/4 | 1/1 | 1/2 |
| 1/3 | 1/2 | 1/2 |

15 张佩力

| | | |
|-----|-----|-----|
| 0/4 | | 0/1 |
| 0/3 | | 0/1 |
| 0/4 | 1/1 | 1/1 |

| | | |
|--|--|--|
| | | |
| | | |
| | | |

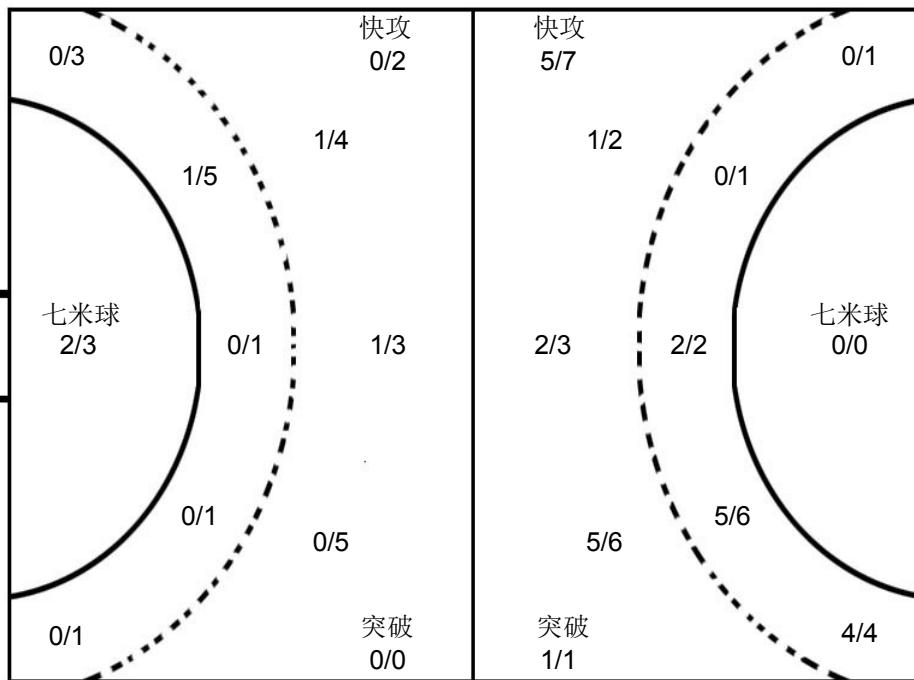

1 郭梦雨

| | | |
|-----|-----|-----|
| | | 2/2 |
| 3/4 | 3/3 | 2/4 |
| 2/3 | 3/4 | 1/1 |

| | | |
|--|--|--|
| | | |
| | | |
| | | |

| | | |
|--|--|--|
| | | |
| | | |
| | | |

解放军队

| | | | | | | | | | | | | | | | | | | | | | | | | | | | | | | | | | | | | | | | | | | | | | | | | | | | | | | | | | | | | | | | | | | | | | | | | | | | | | | | |
|---|-----------------------------|-----------------------------|-----------------------------|-----------------------------|-----------------------------|-----------------------------|-----------------------------|--|--|---|---|--|---|---|--|---|---|---|--|--|--|--|--|--|--|--|--|--|--|--|--|--|---|--|--|--|---|--|--|--|---|--|--|--|--|---|--|--|---|--|--|--|--|---|--|--|---|--|--|--|--|--|--|--|--|--|--|--|--|--|--|--|--|--|--|--|--|--|--|
| 1 郭梦雨 | 3 张昌柯 | 4 张洋 | 5 尹一楠 | 6 吴昊 | 7 姜钦 | 8 邹峻楠 | 9 李天枢 | | | | | | | | | | | | | | | | | | | | | | | | | | | | | | | | | | | | | | | | | | | | | | | | | | | | | | | | | | | | | | | | | | | | | | | | |
| <table border="1"><tr><td></td><td></td><td></td></tr><tr><td></td><td></td><td></td></tr><tr><td></td><td></td><td></td></tr></table> | | | | | | | | | | <table border="1"><tr><td>3</td><td></td><td></td></tr><tr><td>2</td><td></td><td>1</td></tr><tr><td>1</td><td>1</td><td></td></tr></table> | 3 | | | 2 | | 1 | 1 | 1 | | <table border="1"><tr><td></td><td></td><td></td></tr><tr><td></td><td></td><td></td></tr><tr><td></td><td></td><td></td></tr></table> | | | | | | | | | | <table border="1"><tr><td></td><td></td><td></td></tr><tr><td></td><td></td><td></td></tr><tr><td></td><td></td><td></td></tr></table> | | | | | | | | | | <table border="1"><tr><td>1</td><td></td><td></td></tr><tr><td></td><td></td><td></td></tr><tr><td></td><td></td><td>1</td></tr></table> | 1 | | | | | | | | 1 | <table border="1"><tr><td></td><td></td><td></td></tr><tr><td>2</td><td></td><td></td></tr><tr><td>1</td><td></td><td></td></tr></table> | | | | 2 | | | 1 | | | <table border="1"><tr><td></td><td></td><td></td></tr><tr><td></td><td></td><td></td></tr><tr><td></td><td></td><td></td></tr></table> | | | | | | | | | | <table border="1"><tr><td></td><td></td><td></td></tr><tr><td></td><td></td><td></td></tr><tr><td></td><td></td><td></td></tr></table> | | | | | | | | | |
| | | | | | | | | | | | | | | | | | | | | | | | | | | | | | | | | | | | | | | | | | | | | | | | | | | | | | | | | | | | | | | | | | | | | | | | | | | | | | | | |
| | | | | | | | | | | | | | | | | | | | | | | | | | | | | | | | | | | | | | | | | | | | | | | | | | | | | | | | | | | | | | | | | | | | | | | | | | | | | | | | |
| | | | | | | | | | | | | | | | | | | | | | | | | | | | | | | | | | | | | | | | | | | | | | | | | | | | | | | | | | | | | | | | | | | | | | | | | | | | | | | | |
| 3 | | | | | | | | | | | | | | | | | | | | | | | | | | | | | | | | | | | | | | | | | | | | | | | | | | | | | | | | | | | | | | | | | | | | | | | | | | | | | | | |
| 2 | | 1 | | | | | | | | | | | | | | | | | | | | | | | | | | | | | | | | | | | | | | | | | | | | | | | | | | | | | | | | | | | | | | | | | | | | | | | | | | | | | |
| 1 | 1 | | | | | | | | | | | | | | | | | | | | | | | | | | | | | | | | | | | | | | | | | | | | | | | | | | | | | | | | | | | | | | | | | | | | | | | | | | | | | | |
| | | | | | | | | | | | | | | | | | | | | | | | | | | | | | | | | | | | | | | | | | | | | | | | | | | | | | | | | | | | | | | | | | | | | | | | | | | | | | | | |
| | | | | | | | | | | | | | | | | | | | | | | | | | | | | | | | | | | | | | | | | | | | | | | | | | | | | | | | | | | | | | | | | | | | | | | | | | | | | | | | |
| | | | | | | | | | | | | | | | | | | | | | | | | | | | | | | | | | | | | | | | | | | | | | | | | | | | | | | | | | | | | | | | | | | | | | | | | | | | | | | | |
| | | | | | | | | | | | | | | | | | | | | | | | | | | | | | | | | | | | | | | | | | | | | | | | | | | | | | | | | | | | | | | | | | | | | | | | | | | | | | | | |
| | | | | | | | | | | | | | | | | | | | | | | | | | | | | | | | | | | | | | | | | | | | | | | | | | | | | | | | | | | | | | | | | | | | | | | | | | | | | | | | |
| | | | | | | | | | | | | | | | | | | | | | | | | | | | | | | | | | | | | | | | | | | | | | | | | | | | | | | | | | | | | | | | | | | | | | | | | | | | | | | | |
| 1 | | | | | | | | | | | | | | | | | | | | | | | | | | | | | | | | | | | | | | | | | | | | | | | | | | | | | | | | | | | | | | | | | | | | | | | | | | | | | | | |
| | | | | | | | | | | | | | | | | | | | | | | | | | | | | | | | | | | | | | | | | | | | | | | | | | | | | | | | | | | | | | | | | | | | | | | | | | | | | | | | |
| | | 1 | | | | | | | | | | | | | | | | | | | | | | | | | | | | | | | | | | | | | | | | | | | | | | | | | | | | | | | | | | | | | | | | | | | | | | | | | | | | | |
| | | | | | | | | | | | | | | | | | | | | | | | | | | | | | | | | | | | | | | | | | | | | | | | | | | | | | | | | | | | | | | | | | | | | | | | | | | | | | | | |
| 2 | | | | | | | | | | | | | | | | | | | | | | | | | | | | | | | | | | | | | | | | | | | | | | | | | | | | | | | | | | | | | | | | | | | | | | | | | | | | | | | |
| 1 | | | | | | | | | | | | | | | | | | | | | | | | | | | | | | | | | | | | | | | | | | | | | | | | | | | | | | | | | | | | | | | | | | | | | | | | | | | | | | | |
| | | | | | | | | | | | | | | | | | | | | | | | | | | | | | | | | | | | | | | | | | | | | | | | | | | | | | | | | | | | | | | | | | | | | | | | | | | | | | | | |
| | | | | | | | | | | | | | | | | | | | | | | | | | | | | | | | | | | | | | | | | | | | | | | | | | | | | | | | | | | | | | | | | | | | | | | | | | | | | | | | |
| | | | | | | | | | | | | | | | | | | | | | | | | | | | | | | | | | | | | | | | | | | | | | | | | | | | | | | | | | | | | | | | | | | | | | | | | | | | | | | | |
| | | | | | | | | | | | | | | | | | | | | | | | | | | | | | | | | | | | | | | | | | | | | | | | | | | | | | | | | | | | | | | | | | | | | | | | | | | | | | | | |
| | | | | | | | | | | | | | | | | | | | | | | | | | | | | | | | | | | | | | | | | | | | | | | | | | | | | | | | | | | | | | | | | | | | | | | | | | | | | | | | |
| | | | | | | | | | | | | | | | | | | | | | | | | | | | | | | | | | | | | | | | | | | | | | | | | | | | | | | | | | | | | | | | | | | | | | | | | | | | | | | | |
| Post - 0 Miss - 0 Block - 0 | Post - 0 Miss - 0 Block - 0 | Post - 0 Miss - 0 Block - 0 | Post - 0 Miss - 0 Block - 0 | Post - 0 Miss - 0 Block - 0 | Post - 0 Miss - 0 Block - 0 | Post - 0 Miss - 0 Block - 0 | Post - 0 Miss - 0 Block - 0 | | | | | | | | | | | | | | | | | | | | | | | | | | | | | | | | | | | | | | | | | | | | | | | | | | | | | | | | | | | | | | | | | | | | | | | | |
| 10 范保坤 | 11 王誌汉 | 12 左子健 | 13 徐峻清 | 14 孙耀琦 | 16 池猛 | 17 刘安宁 | | | | | | | | | | | | | | | | | | | | | | | | | | | | | | | | | | | | | | | | | | | | | | | | | | | | | | | | | | | | | | | | | | | | | | | | | |
| <table border="1"><tr><td></td><td></td><td>1</td></tr><tr><td></td><td></td><td></td></tr><tr><td></td><td></td><td></td></tr></table> | | | 1 | | | | | | | <table border="1"><tr><td>3</td><td></td><td>1</td></tr><tr><td>1</td><td></td><td></td></tr><tr><td>1</td><td></td><td></td></tr></table> | 3 | | 1 | 1 | | | 1 | | | <table border="1"><tr><td></td><td></td><td></td></tr><tr><td></td><td></td><td></td></tr><tr><td></td><td></td><td></td></tr></table> | | | | | | | | | | <table border="1"><tr><td></td><td></td><td>1</td></tr><tr><td></td><td></td><td></td></tr><tr><td>2</td><td></td><td></td></tr></table> | | | 1 | | | | 2 | | | <table border="1"><tr><td></td><td></td><td></td></tr><tr><td></td><td></td><td>1</td></tr><tr><td></td><td></td><td></td></tr></table> | | | | | | 1 | | | | <table border="1"><tr><td></td><td></td><td></td></tr><tr><td></td><td></td><td></td></tr><tr><td></td><td></td><td></td></tr></table> | | | | | | | | | | <table border="1"><tr><td></td><td></td><td></td></tr><tr><td></td><td></td><td></td></tr><tr><td></td><td></td><td></td></tr></table> | | | | | | | | | | <table border="1"><tr><td></td><td></td><td></td></tr><tr><td></td><td></td><td></td></tr><tr><td></td><td></td><td></td></tr></table> | | | | | | | | | |
| | | 1 | | | | | | | | | | | | | | | | | | | | | | | | | | | | | | | | | | | | | | | | | | | | | | | | | | | | | | | | | | | | | | | | | | | | | | | | | | | | | |
| | | | | | | | | | | | | | | | | | | | | | | | | | | | | | | | | | | | | | | | | | | | | | | | | | | | | | | | | | | | | | | | | | | | | | | | | | | | | | | | |
| | | | | | | | | | | | | | | | | | | | | | | | | | | | | | | | | | | | | | | | | | | | | | | | | | | | | | | | | | | | | | | | | | | | | | | | | | | | | | | | |
| 3 | | 1 | | | | | | | | | | | | | | | | | | | | | | | | | | | | | | | | | | | | | | | | | | | | | | | | | | | | | | | | | | | | | | | | | | | | | | | | | | | | | |
| 1 | | | | | | | | | | | | | | | | | | | | | | | | | | | | | | | | | | | | | | | | | | | | | | | | | | | | | | | | | | | | | | | | | | | | | | | | | | | | | | | |
| 1 | | | | | | | | | | | | | | | | | | | | | | | | | | | | | | | | | | | | | | | | | | | | | | | | | | | | | | | | | | | | | | | | | | | | | | | | | | | | | | | |
| | | | | | | | | | | | | | | | | | | | | | | | | | | | | | | | | | | | | | | | | | | | | | | | | | | | | | | | | | | | | | | | | | | | | | | | | | | | | | | | |
| | | | | | | | | | | | | | | | | | | | | | | | | | | | | | | | | | | | | | | | | | | | | | | | | | | | | | | | | | | | | | | | | | | | | | | | | | | | | | | | |
| | | | | | | | | | | | | | | | | | | | | | | | | | | | | | | | | | | | | | | | | | | | | | | | | | | | | | | | | | | | | | | | | | | | | | | | | | | | | | | | |
| | | 1 | | | | | | | | | | | | | | | | | | | | | | | | | | | | | | | | | | | | | | | | | | | | | | | | | | | | | | | | | | | | | | | | | | | | | | | | | | | | | |
| | | | | | | | | | | | | | | | | | | | | | | | | | | | | | | | | | | | | | | | | | | | | | | | | | | | | | | | | | | | | | | | | | | | | | | | | | | | | | | | |
| 2 | | | | | | | | | | | | | | | | | | | | | | | | | | | | | | | | | | | | | | | | | | | | | | | | | | | | | | | | | | | | | | | | | | | | | | | | | | | | | | | |
| | | | | | | | | | | | | | | | | | | | | | | | | | | | | | | | | | | | | | | | | | | | | | | | | | | | | | | | | | | | | | | | | | | | | | | | | | | | | | | | |
| | | 1 | | | | | | | | | | | | | | | | | | | | | | | | | | | | | | | | | | | | | | | | | | | | | | | | | | | | | | | | | | | | | | | | | | | | | | | | | | | | | |
| | | | | | | | | | | | | | | | | | | | | | | | | | | | | | | | | | | | | | | | | | | | | | | | | | | | | | | | | | | | | | | | | | | | | | | | | | | | | | | | |
| | | | | | | | | | | | | | | | | | | | | | | | | | | | | | | | | | | | | | | | | | | | | | | | | | | | | | | | | | | | | | | | | | | | | | | | | | | | | | | | |
| | | | | | | | | | | | | | | | | | | | | | | | | | | | | | | | | | | | | | | | | | | | | | | | | | | | | | | | | | | | | | | | | | | | | | | | | | | | | | | | |
| | | | | | | | | | | | | | | | | | | | | | | | | | | | | | | | | | | | | | | | | | | | | | | | | | | | | | | | | | | | | | | | | | | | | | | | | | | | | | | | |
| | | | | | | | | | | | | | | | | | | | | | | | | | | | | | | | | | | | | | | | | | | | | | | | | | | | | | | | | | | | | | | | | | | | | | | | | | | | | | | | |
| | | | | | | | | | | | | | | | | | | | | | | | | | | | | | | | | | | | | | | | | | | | | | | | | | | | | | | | | | | | | | | | | | | | | | | | | | | | | | | | |
| | | | | | | | | | | | | | | | | | | | | | | | | | | | | | | | | | | | | | | | | | | | | | | | | | | | | | | | | | | | | | | | | | | | | | | | | | | | | | | | |
| | | | | | | | | | | | | | | | | | | | | | | | | | | | | | | | | | | | | | | | | | | | | | | | | | | | | | | | | | | | | | | | | | | | | | | | | | | | | | | | |
| | | | | | | | | | | | | | | | | | | | | | | | | | | | | | | | | | | | | | | | | | | | | | | | | | | | | | | | | | | | | | | | | | | | | | | | | | | | | | | | |
| | | | | | | | | | | | | | | | | | | | | | | | | | | | | | | | | | | | | | | | | | | | | | | | | | | | | | | | | | | | | | | | | | | | | | | | | | | | | | | | |
| Post - 0 Miss - 0 Block - 0 | Post - 0 Miss - 0 Block - 0 | Post - 0 Miss - 0 Block - 0 | Post - 0 Miss - 0 Block - 0 | Post - 0 Miss - 0 Block - 0 | Post - 0 Miss - 0 Block - 0 | Post - 0 Miss - 0 Block - 0 | | | | | | | | | | | | | | | | | | | | | | | | | | | | | | | | | | | | | | | | | | | | | | | | | | | | | | | | | | | | | | | | | | | | | | | | | |

注释: Post=击柱 Miss=射失 Block=被封





预赛 Group A
青年男子 全国比赛

2016年“体彩杯”全国手球男子青年锦标赛

| | | | | | | | | | | | | | | | | | | | | | |
|----------------------|-----------------------------------|---|---------------------|------------------------------------|---------|----|---|----|---|----|-----|--------|--|--|--|--|---|---|----|---|----|
| Team A A 山东队 | | Team B B 上海队 | | Match Number 8 | | | | | | | | | | | | | | | | | |
| played in China | | in the hall 重庆万州 | | on 21/03/2016 | | | | | | | | | | | | | | | | | |
| | | | | at 10:00 hours | | | | | | | | | | | | | | | | | |
| Spectators | | | | | | | | | | | | | | | | | | | | | |
| Half-time (30') | A 14 | B 15 | End of playing time | A 32 | B 28 | | | | | | | | | | | | | | | | |
| 1st extra time | | A | | B | | | | | | | | | | | | | | | | | |
| 2nd extra time | | A | | B | | | | | | | | | | | | | | | | | |
| After penalty throws | | A | | B | | | | | | | | | | | | | | | | | |
| Number of 7 m | A 3 / 3 | Team time-out | | Full name of players and officials | | | | | | | | | | | | | | | | | |
| | | 45:16 | | | | | | | | | | | | | | | | | | | |
| | | | | Team time-out | | | | | | | | | | | | | | | | | |
| | | | | 12:34 50:56 | | | | | | | | | | | | | | | | | |
| | | | | B 3 / 4 | | | | | | | | | | | | | | | | | |
| | | | | Number of 7 m | | | | | | | | | | | | | | | | | |
| No. | Team A | | | | | G | W | 2' | D | DR | No. | Team B | | | | | G | W | 2' | D | DR |
| 1 | 刘继超 | | | | | | | | | | 2 | 谢智超 | | | | | | | | | |
| 2 | 冯鑫宇 | | | | | 1 | | | | | 3 | 高天伦 | | | | | 5 | | 1 | | |
| 3 | 王铁林 | | | | | 3 | | | | | 4 | 高震东 | | | | | | | | | |
| 5 | 王晓峰 | | | | | 10 | 1 | 1 | | | 5 | 曹磊 | | | | | 1 | | | | |
| 6 | 王军鸣 | | | | | 2 | | | | | 6 | 季晨旭 | | | | | | | | | |
| 7 | 徐勇林 | | | | | 1 | | | | | 7 | 蒋家敏 | | | | | 2 | | 1 | | |
| 10 | 孙芳伟 | | | | | 5 | | | | | 8 | 庄旭杰 | | | | | 4 | | | | |
| 11 | 王洋 | | | | | 3 | 1 | | | | 10 | 董凯 | | | | | 8 | | | | |
| 12 | 刘道林 | | | | | | | | | | 12 | 张润民 | | | | | | | | | |
| 13 | 于欣君 | | | | | 1 | | 1 | | | 14 | 吴佳兵 | | | | | 2 | | | | |
| 17 | 薛盼龙 | | | | | 4 | 1 | | | | 16 | 陈辰 | | | | | | | | | |
| 18 | 李玮 | | | | | | | | | | 18 | 吴双 | | | | | 6 | | | | |
| 21 | 王腾达 | | | | | | | | | | | | | | | | | | | | |
| 22 | 李子跃 | | | | | | | | | | | | | | | | | | | | |
| 23 | 李荣健 | | | | | 2 | | | | | | | | | | | | | | | |
| B | 王莉莉 (主教练) | | | | | | | | | | A | 马仲顺 | | | | | | | | | |
| A | | Signature of Responsible Official of the Teams (Off. A) | | | | | | | | | | | | | | | B | | | | |
| TP | Remarks of Referee / CHA Official | | | | | | | | | | | | | | | | | | TP | | |

Signatures

| | | | | |
|------------------|-----------|----------|--|--|
| Referees | 倪震 (CHN) | 严璐 (CHN) | | |
| Techn. Delegates | 张春生 (CHN) | | | |
| CHA Official | 徐健 (CHN) | | | |

Note: Number of 7m Throws Awarded to Team A and B, Goals (G), Warnings (W), Suspensions (2'), Direct Disqualification (D), Disqualification with Report (DR) and Team Penalty (TP).

Table Officials:

Statisticians: 刘永欢

李双





2016年“体彩杯”全国手球男子青年锦标赛 图式比赛技术统计表

轮次 2

场次 8

201602008-21-1/1

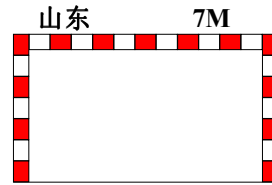
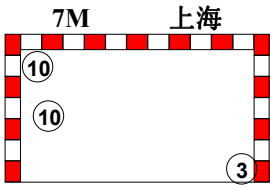
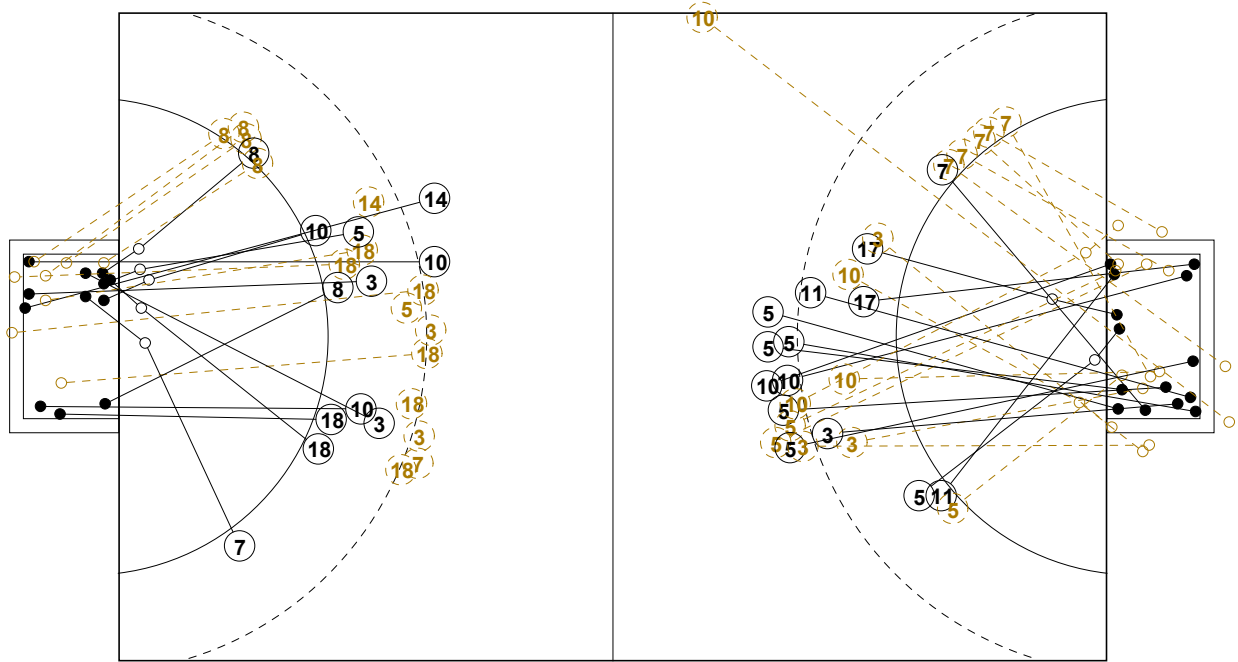

1st Half
15 : 14

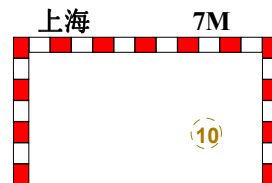
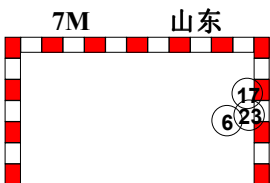
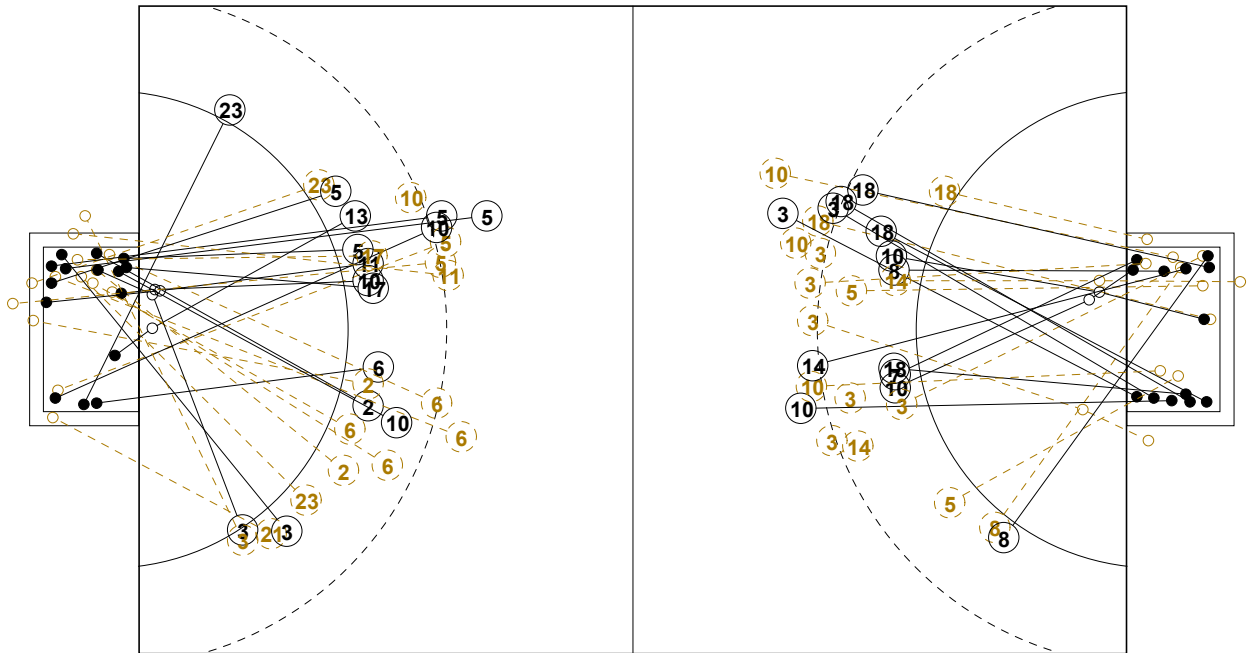

2nd Half
32 : 28



2016年“体彩杯”全国手球男子青年锦标赛

个人/全队技术统计表

正式表
手球
青年男子预赛
轮次 2组别 A
场次 8201602008-14-1/2
重庆万州
21/03/2016 10:00

| 号码 | 姓名 | 远射 | 近射 | 边射 | 快攻 | 突破 | 任意 | 7M | 合计 | % | 助攻 | 失误 | 警告 | 2' | 取消 | 时间 |
|----------------|-----|-------|-------|-----|-----|-----|-----|-----|-------|-------|----|----|----|----|----|----------|
| 山东队(山东) | | | | | | | | | | | | | | | | |
| <i>(场上队员)</i> | | | | | | | | | | | | | | | | |
| 1 | 刘继超 | | | | | | | | | 0.0% | 1 | | | | | 00:46:20 |
| 2 | 冯鑫宇 | | 0/1 | | 1/2 | | | | 1/3 | 33.3% | | 1 | | | | 00:15:17 |
| 3 | 王铁林 | 1/2 | 0/2 | 2/3 | | | | | 3/7 | 42.9% | 1 | 6 | | | | 00:44:42 |
| 5 | 王晓峰 | 6/10 | 3/4 | | | | 1/1 | | 10/15 | 66.7% | 2 | | 1 | 1 | | 00:43:19 |
| 6 | 王军鸣 | 0/2 | 0/1 | | 1/2 | | | 1/1 | 2/6 | 33.3% | 1 | | | | | 00:30:00 |
| 7 | 徐勇林 | | 1/1 | 0/4 | 0/1 | | | | 1/6 | 16.7% | | | | | | 00:30:00 |
| 10 | 孙芳伟 | 3/6 | 2/3 | | 0/1 | | | | 5/10 | 50.0% | 4 | 2 | | | | 00:43:44 |
| 11 | 王洋 | 1/2 | 1/1 | | 1/1 | | | | 3/4 | 75.0% | | 2 | 1 | | | 00:47:15 |
| 12 | 刘道林 | | | | | | | | | 0.0% | | | | | | 00:13:40 |
| 13 | 于欣君 | | 1/1 | | | | | | 1/1 | 100% | | 1 | | 1 | | 00:16:41 |
| 17 | 薛盼龙 | | 2/3 | | 1/1 | | | 1/1 | 4/5 | 80.0% | | 2 | 1 | | | 00:43:45 |
| 18 | 李玮 | | | | | | | | | 0.0% | 1 | 2 | | | | 00:16:14 |
| 21 | 王腾达 | | | 0/1 | | | | | 0/1 | 0.0% | | | | | | 00:12:41 |
| 22 | 李子跃 | | | | | | | | | 0.0% | | | | | | 00:00:00 |
| 23 | 李荣健 | | 0/2 | 1/1 | | | | 1/1 | 2/4 | 50.0% | 1 | 2 | | | | 00:16:16 |
| 合计 | | 11/22 | 10/19 | 3/9 | 4/8 | | 1/1 | 3/3 | 32/62 | 51.6% | 11 | 18 | 3 | 2 | | |
| <i>(守门员)</i> | | | | | | | | | | | | | | | | |
| 1 | 刘继超 | 4/11 | 3/9 | 3/4 | 0/4 | 0/1 | 1/1 | 1/2 | 12/32 | 37.5% | 1 | | | | | 00:46:20 |
| 12 | 刘道林 | | 0/2 | 2/4 | 1/3 | | | 0/2 | 3/11 | 27.3% | | | | | | 00:13:40 |
| 合计 | | 4/11 | 3/11 | 5/8 | 1/7 | 0/1 | 1/1 | 1/4 | 15/43 | 34.9% | 1 | | | | | |

场上队员：得分/射门

守门员：救球/射门

| 全队合计 | 得分 | 被救 | 射失 | 击柱 | 封球 | 合计 | % |
|------|----|----|----|----|----|----|--------|
| 远射 | 11 | 5 | 4 | 1 | 1 | 22 | 50.0% |
| 近射 | 10 | 6 | 1 | 2 | | 19 | 52.6% |
| 边射 | 3 | 3 | 2 | 1 | | 9 | 33.3% |
| 快攻 | 4 | 2 | 1 | 1 | | 8 | 50.0% |
| 突破 | | | | | | | 0.0% |
| 任意 | 1 | | | | | 1 | 100.0% |
| 7M | 3 | | | | | 3 | 100.0% |





2016年“体彩杯”全国手球男子青年锦标赛

个人/全队技术统计表

正式表
手球
青年男子预赛
轮次 2组别 A
场次 8201602008-14-2/2
重庆万州
21/03/2016 10:00

| 号码 | 姓名 | 远射 | 近射 | 边射 | 快攻 | 突破 | 任意 | 7M | 合计 | % | 助攻 | 失误 | 警告 | 2' | 取消 | 时间 |
|----------------|-----|------|------|-----|-----|-----|-----|-----|-------|-------|----|----|----|----|----|----------|
| 上海队(上海) | | | | | | | | | | | | | | | | |
| <i>(上场队员)</i> | | | | | | | | | | | | | | | | |
| 2 | 谢智超 | | | | | | | | | 0.0% | | | | | | 00:00:00 |
| 3 | 高天伦 | 2/9 | 1/2 | | 1/1 | | | 1/1 | 5/13 | 38.5% | 2 | 5 | | 1 | | 01:00:00 |
| 4 | 高震东 | | | | | | | | | 0.0% | | | | | | 00:00:00 |
| 5 | 曹磊 | 0/1 | 0/2 | | 1/1 | | | | 1/4 | 25.0% | 1 | 3 | | | | 00:22:39 |
| 6 | 季晨旭 | | | | | | | | | 0.0% | | | | | | 00:00:00 |
| 7 | 蒋家敏 | 0/1 | 1/1 | 1/1 | | | | | 2/3 | 66.7% | | | | 1 | | 00:58:00 |
| 8 | 庄旭杰 | | 1/1 | 2/7 | 1/1 | | | | 4/9 | 44.4% | | 4 | | | | 01:00:00 |
| 10 | 董凯 | 2/5 | 3/3 | | 1/1 | | | 2/3 | 8/12 | 66.7% | 2 | 5 | | | | 01:00:00 |
| 12 | 张润民 | | | | | | | | | 0.0% | | | | | | 01:00:00 |
| 14 | 吴佳兵 | 2/4 | 0/1 | | | | | | 2/5 | 40.0% | 1 | 3 | | | | 00:39:19 |
| 16 | 陈辰 | | | | | | | | | 0.0% | | | | | | 00:00:00 |
| 18 | 吴双 | 1/5 | 2/2 | | 2/4 | 1/2 | 0/1 | | 6/14 | 42.9% | 1 | 6 | | | | 01:00:00 |
| 合计 | | | | | | | | | | | | | | | | |
| <i>(守门员)</i> | | | | | | | | | | | | | | | | |
| 12 | 张润民 | 5/16 | 6/16 | 3/6 | 2/6 | | 0/1 | 0/3 | 16/48 | 33.3% | | | | | | 01:00:00 |
| 合计 | | | | | | | | | | | | | | | | |

场上队员：得分/射门

守门员：救球/射门

| 全队合计 | 得分 | 被救 | 射失 | 击柱 | 封球 | 合计 | % |
|------|----|----|----|----|----|----|-------|
| 远射 | 7 | 4 | 1 | 1 | 12 | 25 | 28.0% |
| 近射 | 8 | 3 | 1 | | | 12 | 66.7% |
| 边射 | 3 | 5 | | | | 8 | 37.5% |
| 快攻 | 6 | 1 | | 1 | | 8 | 75.0% |
| 突破 | 1 | | | 1 | | 2 | 50.0% |
| 任意 | | 1 | | | | 1 | 0.0% |
| 7M | 3 | 1 | | | | 4 | 75.0% |





2016年“体彩杯”全国手球男子青年锦标赛

图式射门区域统计

轮次 2 场次 8

201602008-41-1/1

山东队

| | | | | | | | | | | | | | | | | | | | | | | | | | | | | | | | | | | | | | | | | | | | | | | | | | | | | | | | | | | | | | | | | | | | | | | | | | | | | | | | |
|--|-----------------------------|-----------------------------|-----------------------------|-----------------------------|-----------------------------|-----------------------------|-----------------------------|--|--|---|--|--|--|--|---|---|--|--|--|--|---|--|---|--|--|---|--|---|---|---|--|---|---|--|--|---|--|---|---|--|--|--|--|---|--|---|--|--|--|---|--|--|--|--|--|---|--|--|--|---|---|--|--|---|--|---|---|--|---|---|--|--|---|--|--|---|---|--|--|
| 1 刘继超 | 2 冯鑫宇 | 3 王铁林 | 5 王晓峰 | 6 王军鸣 | 7 徐勇林 | 10 孙芳伟 | 11 王洋 | | | | | | | | | | | | | | | | | | | | | | | | | | | | | | | | | | | | | | | | | | | | | | | | | | | | | | | | | | | | | | | | | | | | | | | | |
| <table border="1"><tr><td></td><td></td><td></td></tr><tr><td></td><td></td><td></td></tr><tr><td></td><td></td><td></td></tr></table> | | | | | | | | | | <table border="1"><tr><td></td><td></td><td></td></tr><tr><td></td><td></td><td>1</td></tr><tr><td></td><td></td><td></td></tr></table> | | | | | | 1 | | | | <table border="1"><tr><td></td><td></td><td>2</td></tr><tr><td></td><td></td><td>1</td></tr><tr><td></td><td></td><td></td></tr></table> | | | 2 | | | 1 | | | | <table border="1"><tr><td></td><td>1</td><td>4</td></tr><tr><td></td><td></td><td>1</td></tr><tr><td></td><td>1</td><td>3</td></tr></table> | | 1 | 4 | | | 1 | | 1 | 3 | <table border="1"><tr><td></td><td></td><td></td></tr><tr><td>1</td><td></td><td>1</td></tr><tr><td></td><td></td><td></td></tr></table> | | | | 1 | | 1 | | | | <table border="1"><tr><td></td><td></td><td></td></tr><tr><td></td><td></td><td>1</td></tr><tr><td></td><td></td><td></td></tr></table> | | | | | | 1 | | | | <table border="1"><tr><td>2</td><td></td><td></td></tr><tr><td></td><td></td><td></td></tr><tr><td>1</td><td></td><td>2</td></tr></table> | 2 | | | | | | 1 | | 2 | <table border="1"><tr><td></td><td></td><td>1</td></tr><tr><td></td><td></td><td>1</td></tr><tr><td>1</td><td></td><td></td></tr></table> | | | 1 | | | 1 | 1 | | |
| | | | | | | | | | | | | | | | | | | | | | | | | | | | | | | | | | | | | | | | | | | | | | | | | | | | | | | | | | | | | | | | | | | | | | | | | | | | | | | | |
| | | | | | | | | | | | | | | | | | | | | | | | | | | | | | | | | | | | | | | | | | | | | | | | | | | | | | | | | | | | | | | | | | | | | | | | | | | | | | | | |
| | | | | | | | | | | | | | | | | | | | | | | | | | | | | | | | | | | | | | | | | | | | | | | | | | | | | | | | | | | | | | | | | | | | | | | | | | | | | | | | |
| | | | | | | | | | | | | | | | | | | | | | | | | | | | | | | | | | | | | | | | | | | | | | | | | | | | | | | | | | | | | | | | | | | | | | | | | | | | | | | | |
| | | 1 | | | | | | | | | | | | | | | | | | | | | | | | | | | | | | | | | | | | | | | | | | | | | | | | | | | | | | | | | | | | | | | | | | | | | | | | | | | | | |
| | | | | | | | | | | | | | | | | | | | | | | | | | | | | | | | | | | | | | | | | | | | | | | | | | | | | | | | | | | | | | | | | | | | | | | | | | | | | | | | |
| | | 2 | | | | | | | | | | | | | | | | | | | | | | | | | | | | | | | | | | | | | | | | | | | | | | | | | | | | | | | | | | | | | | | | | | | | | | | | | | | | | |
| | | 1 | | | | | | | | | | | | | | | | | | | | | | | | | | | | | | | | | | | | | | | | | | | | | | | | | | | | | | | | | | | | | | | | | | | | | | | | | | | | | |
| | | | | | | | | | | | | | | | | | | | | | | | | | | | | | | | | | | | | | | | | | | | | | | | | | | | | | | | | | | | | | | | | | | | | | | | | | | | | | | | |
| | 1 | 4 | | | | | | | | | | | | | | | | | | | | | | | | | | | | | | | | | | | | | | | | | | | | | | | | | | | | | | | | | | | | | | | | | | | | | | | | | | | | | |
| | | 1 | | | | | | | | | | | | | | | | | | | | | | | | | | | | | | | | | | | | | | | | | | | | | | | | | | | | | | | | | | | | | | | | | | | | | | | | | | | | | |
| | 1 | 3 | | | | | | | | | | | | | | | | | | | | | | | | | | | | | | | | | | | | | | | | | | | | | | | | | | | | | | | | | | | | | | | | | | | | | | | | | | | | | |
| | | | | | | | | | | | | | | | | | | | | | | | | | | | | | | | | | | | | | | | | | | | | | | | | | | | | | | | | | | | | | | | | | | | | | | | | | | | | | | | |
| 1 | | 1 | | | | | | | | | | | | | | | | | | | | | | | | | | | | | | | | | | | | | | | | | | | | | | | | | | | | | | | | | | | | | | | | | | | | | | | | | | | | | |
| | | | | | | | | | | | | | | | | | | | | | | | | | | | | | | | | | | | | | | | | | | | | | | | | | | | | | | | | | | | | | | | | | | | | | | | | | | | | | | | |
| | | | | | | | | | | | | | | | | | | | | | | | | | | | | | | | | | | | | | | | | | | | | | | | | | | | | | | | | | | | | | | | | | | | | | | | | | | | | | | | |
| | | 1 | | | | | | | | | | | | | | | | | | | | | | | | | | | | | | | | | | | | | | | | | | | | | | | | | | | | | | | | | | | | | | | | | | | | | | | | | | | | | |
| | | | | | | | | | | | | | | | | | | | | | | | | | | | | | | | | | | | | | | | | | | | | | | | | | | | | | | | | | | | | | | | | | | | | | | | | | | | | | | | |
| 2 | | | | | | | | | | | | | | | | | | | | | | | | | | | | | | | | | | | | | | | | | | | | | | | | | | | | | | | | | | | | | | | | | | | | | | | | | | | | | | | |
| | | | | | | | | | | | | | | | | | | | | | | | | | | | | | | | | | | | | | | | | | | | | | | | | | | | | | | | | | | | | | | | | | | | | | | | | | | | | | | | |
| 1 | | 2 | | | | | | | | | | | | | | | | | | | | | | | | | | | | | | | | | | | | | | | | | | | | | | | | | | | | | | | | | | | | | | | | | | | | | | | | | | | | | |
| | | 1 | | | | | | | | | | | | | | | | | | | | | | | | | | | | | | | | | | | | | | | | | | | | | | | | | | | | | | | | | | | | | | | | | | | | | | | | | | | | | |
| | | 1 | | | | | | | | | | | | | | | | | | | | | | | | | | | | | | | | | | | | | | | | | | | | | | | | | | | | | | | | | | | | | | | | | | | | | | | | | | | | | |
| 1 | | | | | | | | | | | | | | | | | | | | | | | | | | | | | | | | | | | | | | | | | | | | | | | | | | | | | | | | | | | | | | | | | | | | | | | | | | | | | | | |
| Post - 0 Miss - 0 Block - 0 | Post - 1 Miss - 0 Block - 0 | Post - 1 Miss - 2 Block - 0 | Post - 0 Miss - 1 Block - 0 | Post - 0 Miss - 0 Block - 0 | Post - 0 Miss - 2 Block - 0 | Post - 0 Miss - 3 Block - 1 | Post - 1 Miss - 0 Block - 0 | | | | | | | | | | | | | | | | | | | | | | | | | | | | | | | | | | | | | | | | | | | | | | | | | | | | | | | | | | | | | | | | | | | | | | | | |
| 12 刘道林 | 13 于欣君 | 17 薛盼龙 | 18 李玮 | 21 王腾达 | 22 李子跃 | 23 李荣健 | | | | | | | | | | | | | | | | | | | | | | | | | | | | | | | | | | | | | | | | | | | | | | | | | | | | | | | | | | | | | | | | | | | | | | | | | |
| <table border="1"><tr><td></td><td></td><td></td></tr><tr><td></td><td></td><td></td></tr><tr><td></td><td></td><td></td></tr></table> | | | | | | | | | | <table border="1"><tr><td></td><td></td><td></td></tr><tr><td></td><td>1</td><td></td></tr><tr><td></td><td></td><td></td></tr></table> | | | | | 1 | | | | | <table border="1"><tr><td>1</td><td></td><td>1</td></tr><tr><td></td><td></td><td></td></tr><tr><td></td><td>1</td><td>1</td></tr></table> | 1 | | 1 | | | | | 1 | 1 | <table border="1"><tr><td></td><td></td><td></td></tr><tr><td></td><td></td><td></td></tr><tr><td></td><td></td><td></td></tr></table> | | | | | | | | | | <table border="1"><tr><td></td><td></td><td></td></tr><tr><td></td><td></td><td></td></tr><tr><td></td><td></td><td></td></tr></table> | | | | | | | | | | <table border="1"><tr><td></td><td></td><td></td></tr><tr><td></td><td></td><td></td></tr><tr><td></td><td></td><td></td></tr></table> | | | | | | | | | | <table border="1"><tr><td></td><td></td><td></td></tr><tr><td>1</td><td></td><td>1</td></tr><tr><td></td><td></td><td></td></tr></table> | | | | 1 | | 1 | | | | <table border="1"><tr><td></td><td></td><td></td></tr><tr><td></td><td></td><td></td></tr><tr><td></td><td></td><td></td></tr></table> | | | | | | | | | |
| | | | | | | | | | | | | | | | | | | | | | | | | | | | | | | | | | | | | | | | | | | | | | | | | | | | | | | | | | | | | | | | | | | | | | | | | | | | | | | | |
| | | | | | | | | | | | | | | | | | | | | | | | | | | | | | | | | | | | | | | | | | | | | | | | | | | | | | | | | | | | | | | | | | | | | | | | | | | | | | | | |
| | | | | | | | | | | | | | | | | | | | | | | | | | | | | | | | | | | | | | | | | | | | | | | | | | | | | | | | | | | | | | | | | | | | | | | | | | | | | | | | |
| | | | | | | | | | | | | | | | | | | | | | | | | | | | | | | | | | | | | | | | | | | | | | | | | | | | | | | | | | | | | | | | | | | | | | | | | | | | | | | | |
| | 1 | | | | | | | | | | | | | | | | | | | | | | | | | | | | | | | | | | | | | | | | | | | | | | | | | | | | | | | | | | | | | | | | | | | | | | | | | | | | | | |
| | | | | | | | | | | | | | | | | | | | | | | | | | | | | | | | | | | | | | | | | | | | | | | | | | | | | | | | | | | | | | | | | | | | | | | | | | | | | | | | |
| 1 | | 1 | | | | | | | | | | | | | | | | | | | | | | | | | | | | | | | | | | | | | | | | | | | | | | | | | | | | | | | | | | | | | | | | | | | | | | | | | | | | | |
| | | | | | | | | | | | | | | | | | | | | | | | | | | | | | | | | | | | | | | | | | | | | | | | | | | | | | | | | | | | | | | | | | | | | | | | | | | | | | | | |
| | 1 | 1 | | | | | | | | | | | | | | | | | | | | | | | | | | | | | | | | | | | | | | | | | | | | | | | | | | | | | | | | | | | | | | | | | | | | | | | | | | | | | |
| | | | | | | | | | | | | | | | | | | | | | | | | | | | | | | | | | | | | | | | | | | | | | | | | | | | | | | | | | | | | | | | | | | | | | | | | | | | | | | | |
| | | | | | | | | | | | | | | | | | | | | | | | | | | | | | | | | | | | | | | | | | | | | | | | | | | | | | | | | | | | | | | | | | | | | | | | | | | | | | | | |
| | | | | | | | | | | | | | | | | | | | | | | | | | | | | | | | | | | | | | | | | | | | | | | | | | | | | | | | | | | | | | | | | | | | | | | | | | | | | | | | |
| | | | | | | | | | | | | | | | | | | | | | | | | | | | | | | | | | | | | | | | | | | | | | | | | | | | | | | | | | | | | | | | | | | | | | | | | | | | | | | | |
| | | | | | | | | | | | | | | | | | | | | | | | | | | | | | | | | | | | | | | | | | | | | | | | | | | | | | | | | | | | | | | | | | | | | | | | | | | | | | | | |
| | | | | | | | | | | | | | | | | | | | | | | | | | | | | | | | | | | | | | | | | | | | | | | | | | | | | | | | | | | | | | | | | | | | | | | | | | | | | | | | |
| | | | | | | | | | | | | | | | | | | | | | | | | | | | | | | | | | | | | | | | | | | | | | | | | | | | | | | | | | | | | | | | | | | | | | | | | | | | | | | | |
| | | | | | | | | | | | | | | | | | | | | | | | | | | | | | | | | | | | | | | | | | | | | | | | | | | | | | | | | | | | | | | | | | | | | | | | | | | | | | | | |
| | | | | | | | | | | | | | | | | | | | | | | | | | | | | | | | | | | | | | | | | | | | | | | | | | | | | | | | | | | | | | | | | | | | | | | | | | | | | | | | |
| | | | | | | | | | | | | | | | | | | | | | | | | | | | | | | | | | | | | | | | | | | | | | | | | | | | | | | | | | | | | | | | | | | | | | | | | | | | | | | | |
| 1 | | 1 | | | | | | | | | | | | | | | | | | | | | | | | | | | | | | | | | | | | | | | | | | | | | | | | | | | | | | | | | | | | | | | | | | | | | | | | | | | | | |
| | | | | | | | | | | | | | | | | | | | | | | | | | | | | | | | | | | | | | | | | | | | | | | | | | | | | | | | | | | | | | | | | | | | | | | | | | | | | | | | |
| | | | | | | | | | | | | | | | | | | | | | | | | | | | | | | | | | | | | | | | | | | | | | | | | | | | | | | | | | | | | | | | | | | | | | | | | | | | | | | | |
| | | | | | | | | | | | | | | | | | | | | | | | | | | | | | | | | | | | | | | | | | | | | | | | | | | | | | | | | | | | | | | | | | | | | | | | | | | | | | | | |
| | | | | | | | | | | | | | | | | | | | | | | | | | | | | | | | | | | | | | | | | | | | | | | | | | | | | | | | | | | | | | | | | | | | | | | | | | | | | | | | |
| Post - 0 Miss - 0 Block - 0 | Post - 0 Miss - 0 Block - 0 | Post - 0 Miss - 0 Block - 0 | Post - 0 Miss - 0 Block - 0 | Post - 1 Miss - 0 Block - 0 | Post - 0 Miss - 0 Block - 0 | Post - 1 Miss - 0 Block - 0 | | | | | | | | | | | | | | | | | | | | | | | | | | | | | | | | | | | | | | | | | | | | | | | | | | | | | | | | | | | | | | | | | | | | | | | | | |

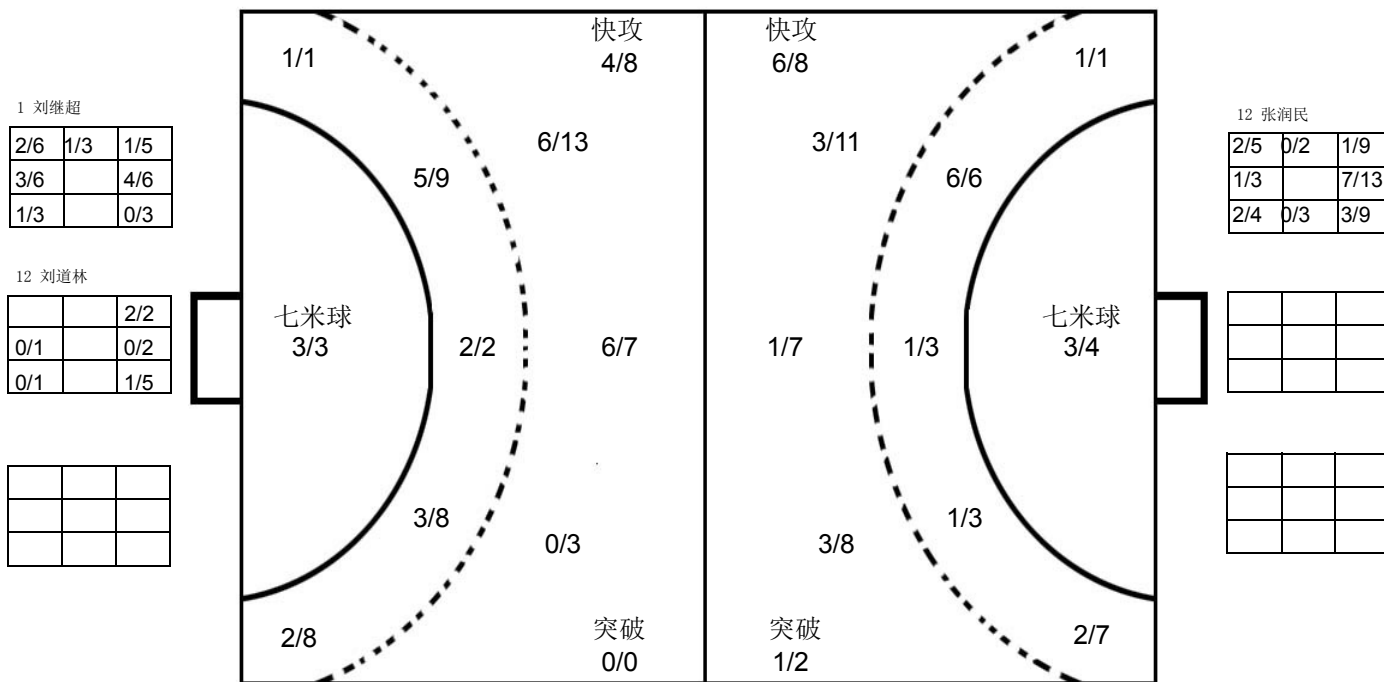

上海队

| | | | | | | | | | | | | | | | | | | | | | | | | | | | | | | | | | | | | | | | | | | | | | | | | | | | | | | | | | | | | | | | | | | | | | | | | | | | | | | | |
|--|-----------------------------|-----------------------------|-----------------------------|-----------------------------|-----------------------------|-----------------------------|-----------------------------|--|--|---|--|---|---|---|--|---|--|--|---|--|--|--|--|--|--|--|--|--|--|---|---|--|---|---|--|---|--|--|---|--|--|--|--|--|--|--|--|--|--|--|--|--|--|--|--|---|---|--|--|--|---|--|--|---|--|--|---|--|---|---|---|---|---|---|--|---|---|--|---|
| 2 谢智超 | 3 高天伦 | 4 高震东 | 5 曹磊 | 6 季晨旭 | 7 蒋家敏 | 8 庄旭杰 | 10 董凯 | | | | | | | | | | | | | | | | | | | | | | | | | | | | | | | | | | | | | | | | | | | | | | | | | | | | | | | | | | | | | | | | | | | | | | | | |
| <table border="1"><tr><td></td><td></td><td></td></tr><tr><td></td><td></td><td></td></tr><tr><td></td><td></td><td></td></tr></table> | | | | | | | | | | <table border="1"><tr><td></td><td></td><td>1</td></tr><tr><td></td><td></td><td>1</td></tr><tr><td></td><td></td><td>3</td></tr></table> | | | 1 | | | 1 | | | 3 | <table border="1"><tr><td></td><td></td><td></td></tr><tr><td></td><td></td><td></td></tr><tr><td></td><td></td><td></td></tr></table> | | | | | | | | | | <table border="1"><tr><td></td><td></td><td></td></tr><tr><td></td><td></td><td>1</td></tr><tr><td></td><td></td><td></td></tr></table> | | | | | | 1 | | | | <table border="1"><tr><td></td><td></td><td></td></tr><tr><td></td><td></td><td></td></tr><tr><td></td><td></td><td></td></tr></table> | | | | | | | | | | <table border="1"><tr><td></td><td></td><td></td></tr><tr><td></td><td></td><td>1</td></tr><tr><td>1</td><td></td><td></td></tr></table> | | | | | | 1 | 1 | | | <table border="1"><tr><td>1</td><td></td><td></td></tr><tr><td>1</td><td></td><td></td></tr><tr><td>1</td><td></td><td>1</td></tr></table> | 1 | | | 1 | | | 1 | | 1 | <table border="1"><tr><td>2</td><td>1</td><td>1</td></tr><tr><td>1</td><td></td><td>1</td></tr><tr><td>1</td><td></td><td>1</td></tr></table> | 2 | 1 | 1 | 1 | | 1 | 1 | | 1 |
| | | | | | | | | | | | | | | | | | | | | | | | | | | | | | | | | | | | | | | | | | | | | | | | | | | | | | | | | | | | | | | | | | | | | | | | | | | | | | | | |
| | | | | | | | | | | | | | | | | | | | | | | | | | | | | | | | | | | | | | | | | | | | | | | | | | | | | | | | | | | | | | | | | | | | | | | | | | | | | | | | |
| | | | | | | | | | | | | | | | | | | | | | | | | | | | | | | | | | | | | | | | | | | | | | | | | | | | | | | | | | | | | | | | | | | | | | | | | | | | | | | | |
| | | 1 | | | | | | | | | | | | | | | | | | | | | | | | | | | | | | | | | | | | | | | | | | | | | | | | | | | | | | | | | | | | | | | | | | | | | | | | | | | | | |
| | | 1 | | | | | | | | | | | | | | | | | | | | | | | | | | | | | | | | | | | | | | | | | | | | | | | | | | | | | | | | | | | | | | | | | | | | | | | | | | | | | |
| | | 3 | | | | | | | | | | | | | | | | | | | | | | | | | | | | | | | | | | | | | | | | | | | | | | | | | | | | | | | | | | | | | | | | | | | | | | | | | | | | | |
| | | | | | | | | | | | | | | | | | | | | | | | | | | | | | | | | | | | | | | | | | | | | | | | | | | | | | | | | | | | | | | | | | | | | | | | | | | | | | | | |
| | | | | | | | | | | | | | | | | | | | | | | | | | | | | | | | | | | | | | | | | | | | | | | | | | | | | | | | | | | | | | | | | | | | | | | | | | | | | | | | |
| | | | | | | | | | | | | | | | | | | | | | | | | | | | | | | | | | | | | | | | | | | | | | | | | | | | | | | | | | | | | | | | | | | | | | | | | | | | | | | | |
| | | | | | | | | | | | | | | | | | | | | | | | | | | | | | | | | | | | | | | | | | | | | | | | | | | | | | | | | | | | | | | | | | | | | | | | | | | | | | | | |
| | | 1 | | | | | | | | | | | | | | | | | | | | | | | | | | | | | | | | | | | | | | | | | | | | | | | | | | | | | | | | | | | | | | | | | | | | | | | | | | | | | |
| | | | | | | | | | | | | | | | | | | | | | | | | | | | | | | | | | | | | | | | | | | | | | | | | | | | | | | | | | | | | | | | | | | | | | | | | | | | | | | | |
| | | | | | | | | | | | | | | | | | | | | | | | | | | | | | | | | | | | | | | | | | | | | | | | | | | | | | | | | | | | | | | | | | | | | | | | | | | | | | | | |
| | | | | | | | | | | | | | | | | | | | | | | | | | | | | | | | | | | | | | | | | | | | | | | | | | | | | | | | | | | | | | | | | | | | | | | | | | | | | | | | |
| | | | | | | | | | | | | | | | | | | | | | | | | | | | | | | | | | | | | | | | | | | | | | | | | | | | | | | | | | | | | | | | | | | | | | | | | | | | | | | | |
| | | | | | | | | | | | | | | | | | | | | | | | | | | | | | | | | | | | | | | | | | | | | | | | | | | | | | | | | | | | | | | | | | | | | | | | | | | | | | | | |
| | | 1 | | | | | | | | | | | | | | | | | | | | | | | | | | | | | | | | | | | | | | | | | | | | | | | | | | | | | | | | | | | | | | | | | | | | | | | | | | | | | |
| 1 | | | | | | | | | | | | | | | | | | | | | | | | | | | | | | | | | | | | | | | | | | | | | | | | | | | | | | | | | | | | | | | | | | | | | | | | | | | | | | | |
| 1 | | | | | | | | | | | | | | | | | | | | | | | | | | | | | | | | | | | | | | | | | | | | | | | | | | | | | | | | | | | | | | | | | | | | | | | | | | | | | | | |
| 1 | | | | | | | | | | | | | | | | | | | | | | | | | | | | | | | | | | | | | | | | | | | | | | | | | | | | | | | | | | | | | | | | | | | | | | | | | | | | | | | |
| 1 | | 1 | | | | | | | | | | | | | | | | | | | | | | | | | | | | | | | | | | | | | | | | | | | | | | | | | | | | | | | | | | | | | | | | | | | | | | | | | | | | | |
| 2 | 1 | 1 | | | | | | | | | | | | | | | | | | | | | | | | | | | | | | | | | | | | | | | | | | | | | | | | | | | | | | | | | | | | | | | | | | | | | | | | | | | | | |
| 1 | | 1 | | | | | | | | | | | | | | | | | | | | | | | | | | | | | | | | | | | | | | | | | | | | | | | | | | | | | | | | | | | | | | | | | | | | | | | | | | | | | |
| 1 | | 1 | | | | | | | | | | | | | | | | | | | | | | | | | | | | | | | | | | | | | | | | | | | | | | | | | | | | | | | | | | | | | | | | | | | | | | | | | | | | | |
| Post - 0 Miss - 0 Block - 0 | Post - 0 Miss - 1 Block - 5 | Post - 0 Miss - 0 Block - 0 | Post - 0 Miss - 0 Block - 1 | Post - 0 Miss - 0 Block - 0 | Post - 0 Miss - 0 Block - 1 | Post - 0 Miss - 0 Block - 0 | Post - 0 Miss - 0 Block - 1 | | | | | | | | | | | | | | | | | | | | | | | | | | | | | | | | | | | | | | | | | | | | | | | | | | | | | | | | | | | | | | | | | | | | | | | | |
| 12 张润民 | 14 吴佳兵 | 16 陈辰 | 18 吴双 | | | | | | | | | | | | | | | | | | | | | | | | | | | | | | | | | | | | | | | | | | | | | | | | | | | | | | | | | | | | | | | | | | | | | | | | | | | | |
| <table border="1"><tr><td></td><td></td><td></td></tr><tr><td></td><td></td><td></td></tr><tr><td></td><td></td><td></td></tr></table> | | | | | | | | | | <table border="1"><tr><td></td><td>1</td><td></td></tr><tr><td>1</td><td></td><td></td></tr><tr><td></td><td></td><td></td></tr></table> | | 1 | | 1 | | | | | | <table border="1"><tr><td></td><td></td><td></td></tr><tr><td></td><td></td><td></td></tr><tr><td></td><td></td><td></td></tr></table> | | | | | | | | | | <table border="1"><tr><td>1</td><td></td><td>2</td></tr><tr><td>1</td><td></td><td>1</td></tr><tr><td></td><td></td><td>1</td></tr></table> | 1 | | 2 | 1 | | 1 | | | 1 | <table border="1"><tr><td></td><td></td><td></td></tr><tr><td></td><td></td><td></td></tr><tr><td></td><td></td><td></td></tr></table> | | | | | | | | | | <table border="1"><tr><td></td><td></td><td></td></tr><tr><td></td><td></td><td></td></tr><tr><td></td><td></td><td></td></tr></table> | | | | | | | | | | <table border="1"><tr><td></td><td></td><td></td></tr><tr><td></td><td></td><td></td></tr><tr><td></td><td></td><td></td></tr></table> | | | | | | | | | | <table border="1"><tr><td></td><td></td><td></td></tr><tr><td></td><td></td><td></td></tr><tr><td></td><td></td><td></td></tr></table> | | | | | | | | | |
| | | | | | | | | | | | | | | | | | | | | | | | | | | | | | | | | | | | | | | | | | | | | | | | | | | | | | | | | | | | | | | | | | | | | | | | | | | | | | | | |
| | | | | | | | | | | | | | | | | | | | | | | | | | | | | | | | | | | | | | | | | | | | | | | | | | | | | | | | | | | | | | | | | | | | | | | | | | | | | | | | |
| | | | | | | | | | | | | | | | | | | | | | | | | | | | | | | | | | | | | | | | | | | | | | | | | | | | | | | | | | | | | | | | | | | | | | | | | | | | | | | | |
| | 1 | | | | | | | | | | | | | | | | | | | | | | | | | | | | | | | | | | | | | | | | | | | | | | | | | | | | | | | | | | | | | | | | | | | | | | | | | | | | | | |
| 1 | | | | | | | | | | | | | | | | | | | | | | | | | | | | | | | | | | | | | | | | | | | | | | | | | | | | | | | | | | | | | | | | | | | | | | | | | | | | | | | |
| | | | | | | | | | | | | | | | | | | | | | | | | | | | | | | | | | | | | | | | | | | | | | | | | | | | | | | | | | | | | | | | | | | | | | | | | | | | | | | | |
| | | | | | | | | | | | | | | | | | | | | | | | | | | | | | | | | | | | | | | | | | | | | | | | | | | | | | | | | | | | | | | | | | | | | | | | | | | | | | | | |
| | | | | | | | | | | | | | | | | | | | | | | | | | | | | | | | | | | | | | | | | | | | | | | | | | | | | | | | | | | | | | | | | | | | | | | | | | | | | | | | |
| | | | | | | | | | | | | | | | | | | | | | | | | | | | | | | | | | | | | | | | | | | | | | | | | | | | | | | | | | | | | | | | | | | | | | | | | | | | | | | | |
| 1 | | 2 | | | | | | | | | | | | | | | | | | | | | | | | | | | | | | | | | | | | | | | | | | | | | | | | | | | | | | | | | | | | | | | | | | | | | | | | | | | | | |
| 1 | | 1 | | | | | | | | | | | | | | | | | | | | | | | | | | | | | | | | | | | | | | | | | | | | | | | | | | | | | | | | | | | | | | | | | | | | | | | | | | | | | |
| | | 1 | | | | | | | | | | | | | | | | | | | | | | | | | | | | | | | | | | | | | | | | | | | | | | | | | | | | | | | | | | | | | | | | | | | | | | | | | | | | | |
| | | | | | | | | | | | | | | | | | | | | | | | | | | | | | | | | | | | | | | | | | | | | | | | | | | | | | | | | | | | | | | | | | | | | | | | | | | | | | | | |
| | | | | | | | | | | | | | | | | | | | | | | | | | | | | | | | | | | | | | | | | | | | | | | | | | | | | | | | | | | | | | | | | | | | | | | | | | | | | | | | |
| | | | | | | | | | | | | | | | | | | | | | | | | | | | | | | | | | | | | | | | | | | | | | | | | | | | | | | | | | | | | | | | | | | | | | | | | | | | | | | | |
| | | | | | | | | | | | | | | | | | | | | | | | | | | | | | | | | | | | | | | | | | | | | | | | | | | | | | | | | | | | | | | | | | | | | | | | | | | | | | | | |
| | | | | | | | | | | | | | | | | | | | | | | | | | | | | | | | | | | | | | | | | | | | | | | | | | | | | | | | | | | | | | | | | | | | | | | | | | | | | | | | |
| | | | | | | | | | | | | | | | | | | | | | | | | | | | | | | | | | | | | | | | | | | | | | | | | | | | | | | | | | | | | | | | | | | | | | | | | | | | | | | | |
| | | | | | | | | | | | | | | | | | | | | | | | | | | | | | | | | | | | | | | | | | | | | | | | | | | | | | | | | | | | | | | | | | | | | | | | | | | | | | | | |
| | | | | | | | | | | | | | | | | | | | | | | | | | | | | | | | | | | | | | | | | | | | | | | | | | | | | | | | | | | | | | | | | | | | | | | | | | | | | | | | |
| | | | | | | | | | | | | | | | | | | | | | | | | | | | | | | | | | | | | | | | | | | | | | | | | | | | | | | | | | | | | | | | | | | | | | | | | | | | | | | | |
| | | | | | | | | | | | | | | | | | | | | | | | | | | | | | | | | | | | | | | | | | | | | | | | | | | | | | | | | | | | | | | | | | | | | | | | | | | | | | | | |
| | | | | | | | | | | | | | | | | | | | | | | | | | | | | | | | | | | | | | | | | | | | | | | | | | | | | | | | | | | | | | | | | | | | | | | | | | | | | | | | |
| | | | | | | | | | | | | | | | | | | | | | | | | | | | | | | | | | | | | | | | | | | | | | | | | | | | | | | | | | | | | | | | | | | | | | | | | | | | | | | | |
| Post - 0 Miss - 0 Block - 0 | Post - 0 Miss - 1 Block - 2 | Post - 0 Miss - 0 Block - 0 | Post - 3 Miss - 0 Block - 2 | | | | | | | | | | | | | | | | | | | | | | | | | | | | | | | | | | | | | | | | | | | | | | | | | | | | | | | | | | | | | | | | | | | | | | | | | | | | |

注释: Post=击柱 Miss=射失 Block=被封





预赛 Group A
青年男子 全国比赛

2016年“体彩杯”全国手球男子青年锦标赛

| | | | | | | | | | | | | | | | | | | | | | |
|--------------------|---|------------------------------|---------------------|------------------|------------------------------------|-------------------|---|-------------------|------------------------------|----|-----|----------------------|---------------|---|--|--|---|---|----|----|----|
| Team A A 江苏队 | | | | Team B B 广东队 | | | | Match Number 9 | | | | | | | | | | | | | |
| played in China | | in the hall 重庆万州 | | on 21/03/2016 | | at 13:00 hours | | Spectators | | | | | | | | | | | | | |
| Half-time (30') | A 11 | B 22 | End of playing time | A 18 | B 33 | 1st extra time | A | B | 2nd extra time | A | B | After penalty throws | A | B | | | | | | | |
| Number of 7 m | A 1/2 | Team time-out 1 11:11 2 3 | | | Full name of players and officials | | | | Team time-out 1 23:40 2 3 | | | B 3/4 | Number of 7 m | | | | | | | | |
| No. | Team A | | | | | G | W | 2' | D | DR | No. | Team B | | | | | G | W | 2' | D | DR |
| 1 | 潘博琦 | | | | | | | | | | 1 | 王帅 | | | | | 1 | 1 | | | |
| 3 | 赵韦光 | | | | | 2 | | 1 | | | 2 | 姚雪岩 | | | | | 4 | 1 | | | |
| 4 | 张瑞恒 | | | | | | | | | | 4 | 高玉杰 | | | | | 4 | | 1 | | |
| 6 | 季雨 | | | | | | | | | | 5 | 黄培杰 | | | | | 7 | | 1 | | |
| 7 | 任超凡 | | | | | 1 | | | | | 7 | 段飞宇 | | | | | 4 | | | | |
| 8 | 姜童耀 | | | | | | | | | | 9 | 周凯峰 | | | | | | | | | |
| 9 | 王俊威 | | | | | | | | | | 10 | 周仲坤 | | | | | 4 | | | | |
| 11 | 周傲 | | | | | 7 | 1 | | | | 11 | 胡国富 | | | | | | | | | |
| 13 | 尹吉祥 | | | | | 5 | 1 | | | | 12 | 李壮 | | | | | | | | | |
| 14 | 罗中熠 | | | | | | | | | | 13 | 蔡杰 | | | | | | | | | |
| 15 | 阎冠中 | | | | | | | | | | 14 | 王泽润 | | | | | | | | | |
| 17 | 马益奎 | | | | | 1 | 1 | | | | 15 | 张建杰 | | | | | 7 | | | | |
| 18 | 耿畅 | | | | | 2 | | | | | 16 | 王猛 | | | | | | | | | |
| | | | | | | | | | | | 18 | 李文金 | | | | | 2 | 1 | | | |
| B | 贾淑君 (主教练) | | | | | | | | | | B | 刘康伶 (主教练) | | | | | | | | | |
| | | | | | | | | | | | C | 刘文宁 | | | | | | | | | |
| | | | | | | | | | | | D | 王永存 | | | | | | | | | |
| A | Signature of Responsible Official of the Teams (Off. A) | | | | | | | | | | | | | | | | | | | B | |
| TP | Remarks of Referee / CHA Official | | | | | | | | | | | | | | | | | | | TP | |

Signatures

Referees: 马晓晔 (CHN) 王羚 (CHN)

Techn. Delegates: 许宜扬 (CHN)

CHA Official: 吴瑞亭 (CHN)

Note: Number of 7m Throws Awarded to Team A and B, Goals (G), Warnings (W), Suspensions (2'), Direct Disqualification (D), Disqualification with Report (DR) and Team Penalty (TP).

Table Officials:

Statisticians: 李双

刘永欢





2016年“体彩杯”全国手球男子青年锦标赛 竞赛技术统计(媒体表)

| | | | | | | |
|----------------|-----------|------------|----|-----------|------------------|----------|
| 预赛 | 组别 | A | 轮次 | 2 | 场次 | 9 |
| 重庆万州 | | 21/03/2016 | | | 201602009-51-1/1 | |
| 江苏队 | 江苏 | 18 | vs | 33 | 广东 | 广东队 |
| 11 : 22 | | | | | | |

| 裁判员 | | 马晓晔 (CHN) | | | | | | | | | | | / | 王羚 (CHN) | | | | | | | | | | |
|---------------|-----|-------------|-------|-----|-----|-----|-----|------|-------|------|----|----|----|----------|--------|-----------|-------|------|-----------|-----|--|--|--|--|
| 江苏 | | 远射 | 近射 | 边射 | 快攻 | 突破 | 任意球 | 7m球 | 合计 | % | 助攻 | 失误 | 警告 | 2' | D & DR | 江苏 | | 比赛进程 | 广东 | | | | | |
| 主教练：贾淑君 | | | | | | | | | | | | | | | | 1st Half | | | | | | | | |
| 1 | 潘博琦 | | | | | | | | | | | | | | | 3 | 赵韦光 | 1 | 00:24 | 0 | | | | |
| 3 | 赵韦光 | | 2/3 | 0/1 | 0/1 | | | 2/5 | 40.0 | | | | | 1 | | 1 | 00:36 | 1 | 2 | 姚雪岩 | | | | |
| 4 | 张瑞恒 | | | | | | | | | | | | | | | 2 | 01:22 | 1 | | | | | | |
| 6 | 季雨 | | | | | | | | | | | | | | | 2 | 02:17 | 2 | 5 | 黄培杰 | | | | |
| 7 | 任超凡 | 0/1 | 1/1 | 0/1 | | | | 1/3 | 33.3 | | 2 | | | | | 3 | 05:02 | 2 | | | | | | |
| 8 | 姜童耀 | | 0/2 | | | | | 0/2 | 0.0 | | 1 | | | | | 3 | 05:48 | 3 | 5 | 黄培杰 | | | | |
| 9 | 王俊威 | | | | | | | | | | | | | | | 3 | 06:22 | 4 | 10 | 周仲坤 | | | | |
| 11 | 周傲 | 3/8 | 2/3 | 0/2 | 1/2 | 0/1 | 1/1 | 7/17 | 41.2 | 2 | 7 | 1 | | | 4 | 07:01 | 4 | | | | | | | |
| 13 | 尹吉祥 | 4/11 | | | 0/1 | 0/1 | | 1/2 | 5/15 | 33.3 | 1 | 2 | 1 | | 4 | 07:24 | 5 | 18 | 李文金 | | | | | |
| 14 | 罗中熠 | | | | | | | | | | | | | | | 4 | 08:40 | 6 | 7 | 段飞宇 | | | | |
| 15 | 阎冠中 | | | | | | | | | | | | | | | 5 | 09:04 | 6 | | | | | | |
| 17 | 马益奎 | 0/1 | 1/1 | | | | | 1/2 | 50.0 | 1 | | 1 | | | 5 | 09:49 | 7 | 5 | 黄培杰 | | | | | |
| 18 | 耿畅 | 0/4 | 2/4 | | 0/1 | | | 2/9 | 22.2 | 1 | | | | | 5 | 10:42 | 8 | 15 | 张建杰 | | | | | |
| 运动员 合计 | | 7/25 | 8/14 | 0/4 | 1/5 | 0/2 | 1/1 | 1/2 | 18/53 | 34.0 | 5 | 12 | 3 | 1 | | 6 | 11:30 | 8 | | | | | | |
| 1 | 潘博琦 | 3/6 | 4/15 | 0/2 | 0/7 | 0/3 | 0/4 | 0/3 | 7/40 | 17.5 | | | | | | 6 | 11:48 | 9 | 2 | 姚雪岩 | | | | |
| 守门员 合计 | | 3/6 | 4/15 | 0/2 | 0/7 | 0/3 | 0/4 | 0/3 | 7/40 | 17.5 | | | | | | 6 | 12:09 | 10 | 15 | 张建杰 | | | | |
| 广东 | | 远射 | 近射 | 边射 | 快攻 | 突破 | 任意球 | 7m球 | 合计 | % | 助攻 | 失误 | 警告 | 2' | D & DR | 6 | 12:52 | 11 | 7 | 段飞宇 | | | | |
| 教练：刘康伶 | | | | | | | | | | | | | | | | 6 | 13:25 | 12 | 2 | 姚雪岩 | | | | |
| 1 | 王帅 | 1/1 | | | | | | 1/1 | 100 | | | 1 | 1 | | | 6 | 15:29 | 13 | 15 | 张建杰 | | | | |
| 2 | 姚雪岩 | 0/1 | 1/2 | | | 1/1 | 2/2 | 4/6 | 66.7 | 3 | 2 | 1 | | | 6 | 16:13 | 14 | 10 | 周仲坤 | | | | | |
| 4 | 高玉杰 | | 2/2 | 1/1 | 1/1 | | | 4/4 | 100 | | | | | 1 | | 6 | 16:50 | 15 | 10 | 周仲坤 | | | | |
| 5 | 黄培杰 | 1/2 | 1/1 | | 2/2 | 1/2 | | 2/3 | 7/10 | 70.0 | 5 | 1 | | 1 | | 6 | 16:50 | 16 | 4 | 高玉杰 | | | | |
| 7 | 段飞宇 | | 1/1 | 1/1 | 2/2 | | | 4/4 | 100 | 1 | 2 | | | | | 6 | 19:21 | 16 | 18 | 李文金 | | | | |
| 9 | 周凯峰 | | | | | | | | | | | | | | | 6 | 20:54 | 17 | 5 | 黄培杰 | | | | |
| 10 | 周仲坤 | 0/1 | 1/2 | | 2/2 | | | 1/1 | 4/6 | 66.7 | 1 | 2 | | | | 7 | 21:27 | 17 | | | | | | |
| 11 | 胡国富 | | | | | | | | | | | | | | | 8 | 22:43 | 17 | | | | | | |
| 12 | 李壮 | | | | | | | | | | | | | | | 9 | 25:01 | 17 | | | | | | |
| 13 | 蔡杰 | | | | | | | | | | | | | | | 9 | 25:21 | 18 | 15 | 张建杰 | | | | |
| 14 | 王泽润 | | | | | | | | | | | | | | | 9 | 26:09 | 19 | 7 | 段飞宇 | | | | |
| 15 | 张建杰 | 1/3 | 3/6 | | | 1/1 | 2/2 | 7/12 | 58.3 | 3 | 4 | | | | 9 | 26:39 | 20 | 15 | 张建杰 | | | | | |
| 16 | 王猛 | | | | | | | | | | | | | | | 10 | 26:59 | 20 | | | | | | |
| 18 | 李文金 | 0/1 | 2/3 | | | | | 2/4 | 50.0 | | 1 | 1 | | | 10 | 28:50 | 20 | | | | | | | |
| 运动员 合计 | | 3/9 | 11/17 | 2/2 | 7/7 | 3/4 | 4/4 | 3/4 | 33/47 | 70.2 | 13 | 13 | 3 | 2 | | 10 | 29:05 | 21 | 10 | 周仲坤 | | | | |
| 1 | 王帅 | 12/19 | 5/13 | 3/3 | 3/4 | 1/1 | 0/1 | 1/2 | 25/43 | 58.1 | | 1 | 1 | | | 11 | 30:00 | 22 | 2 | 姚雪岩 | | | | |
| 守门员 合计 | | 12/19 | 5/13 | 3/3 | 3/4 | 1/1 | 0/1 | 1/2 | 25/43 | 58.1 | | 1 | 1 | | | 2nd Half | | | | | | | | |
| 场上队员：得分 / 射门 | | 守门员：救球 / 射门 | | | | | | | | | | | | | | | | | | | | | | |

| | | | | | | | | | |
|----|------------|----|--------------|-----|------------|-----|----------|----|---------|
| 快攻 | Fast Break | 突破 | Breakthrough | 任意球 | Free Throw | 7M球 | 7M Throw | 助攻 | Assist |
| 警告 | Warning | 失误 | Error | 2' | Suspension | D | 取消资格 | DR | 取消资格+报告 |





2016年“体彩杯”全国手球男子青年锦标赛

个人/全队技术统计表

正式表
手球
青年男子预赛
轮次 2组别 A
场次 9201602009-14-1/2
重庆万州
21/03/2016 13:00

| 号码 | 姓名 | 远射 | 近射 | 边射 | 快攻 | 突破 | 任意 | 7M | 合计 | % | 助攻 | 失误 | 警告 | 2' | 取消 | 时间 |
|----------------|-----|------|------|-----|-----|-----|-----|-----|-------|-------|----|----|----|----|----|----------|
| 江苏队(江苏) | | | | | | | | | | | | | | | | |
| <i>(场上队员)</i> | | | | | | | | | | | | | | | | |
| 1 | 潘博琦 | | | | | | | | | 0.0% | | | | | | 00:42:18 |
| 3 | 赵韦光 | | 2/3 | 0/1 | 0/1 | | | | 2/5 | 40.0% | | | | 1 | | 00:34:11 |
| 4 | 张瑞恒 | | | | | | | | | 0.0% | | | | | | 00:00:00 |
| 6 | 季雨 | | | | | | | | | 0.0% | | | | | | 00:00:00 |
| 7 | 任超凡 | 0/1 | 1/1 | 0/1 | | | | | 1/3 | 33.3% | | 2 | | | | 00:42:17 |
| 8 | 姜童耀 | | 0/2 | | | | | | 0/2 | 0.0% | | 1 | | | | 00:12:17 |
| 9 | 王俊威 | | | | | | | | | 0.0% | | | | | | 00:08:05 |
| 11 | 周傲 | 3/8 | 2/3 | 0/2 | 1/2 | 0/1 | 1/1 | | 7/17 | 41.2% | 2 | 7 | 1 | | | 00:42:18 |
| 13 | 尹吉祥 | 4/11 | | | 0/1 | 0/1 | | 1/2 | 5/15 | 33.3% | 1 | 2 | 1 | | | 00:40:25 |
| 14 | 罗中熠 | | | | | | | | | 0.0% | | | | | | 00:00:00 |
| 15 | 阎冠中 | | | | | | | | | 0.0% | | | | | | 00:00:00 |
| 17 | 马益奎 | 0/1 | 1/1 | | | | | | 1/2 | 50.0% | 1 | | 1 | | | 00:42:18 |
| 18 | 耿畅 | 0/4 | 2/4 | | 0/1 | | | | 2/9 | 22.2% | 1 | | | | | 00:31:52 |
| 合计 | | | | | | | | | | | | | | | | |
| <i>(守门员)</i> | | | | | | | | | | | | | | | | |
| | | 7/25 | 8/14 | 0/4 | 1/5 | 0/2 | 1/1 | 1/2 | 18/53 | 34.0% | 5 | 12 | 3 | 1 | | |
| 1 | 潘博琦 | 3/6 | 4/15 | 0/2 | 0/7 | 0/3 | 0/4 | 0/3 | 7/40 | 17.5% | | | | | | 00:42:18 |
| 合计 | | | | | | | | | | | | | | | | |
| | | 3/6 | 4/15 | 0/2 | 0/7 | 0/3 | 0/4 | 0/3 | 7/40 | 17.5% | | | | | | |

场上队员：得分/射门

守门员：救球/射门

| 全队合计 | 得分 | 被救 | 射失 | 击柱 | 封球 | 合计 | % |
|------|----|----|----|----|----|----|--------|
| 远射 | 7 | 12 | | | 6 | 25 | 28.0% |
| 近射 | 8 | 5 | 1 | | | 14 | 57.1% |
| 边射 | | 3 | | 1 | | 4 | 0.0% |
| 快攻 | 1 | 3 | 1 | | | 5 | 20.0% |
| 突破 | | 1 | | 1 | | 2 | 0.0% |
| 任意 | 1 | | | | | 1 | 100.0% |
| 7M | 1 | 1 | | | | 2 | 50.0% |





2016年“体彩杯”全国手球男子青年锦标赛

个人/全队技术统计表

正式表
手球
青年男子预赛
轮次 2组别 A
场次 9201602009-14-2/2
重庆万州
21/03/2016 13:00

| 号码 | 姓名 | 远射 | 近射 | 边射 | 快攻 | 突破 | 任意 | 7M | 合计 | % | 助攻 | 失误 | 警告 | 2' | 取消 | 时间 |
|----------------|-----|-------|------|-----|-----|-----|-----|-----|-------|-------|----|----|----|----|----|----------|
| 广东队(广东) | | | | | | | | | | | | | | | | |
| <i>(上场队员)</i> | | | | | | | | | | | | | | | | |
| 1 | 王帅 | 1/1 | | | | | | | 1/1 | 100% | | 1 | 1 | | | 00:42:18 |
| 2 | 姚雪岩 | 0/1 | 1/2 | | | 1/1 | 2/2 | | 4/6 | 66.7% | 3 | 2 | 1 | | | 00:42:17 |
| 4 | 高玉杰 | | 2/2 | 1/1 | 1/1 | | | | 4/4 | 100% | | | | 1 | | 00:13:26 |
| 5 | 黄培杰 | 1/2 | 1/1 | | 2/2 | 1/2 | | 2/3 | 7/10 | 70.0% | 5 | 1 | | 1 | | 00:42:17 |
| 7 | 段飞宇 | | 1/1 | 1/1 | 2/2 | | | | 4/4 | 100% | 1 | 2 | | | | 00:42:18 |
| 9 | 周凯峰 | | | | | | | | | 0.0% | | | | | | 00:00:00 |
| 10 | 周仲坤 | 0/1 | 1/2 | | 2/2 | | | 1/1 | 4/6 | 66.7% | 1 | 2 | | | | 00:42:18 |
| 11 | 胡国富 | | | | | | | | | 0.0% | | | | | | 00:00:00 |
| 12 | 李壮 | | | | | | | | | 0.0% | | | | | | 00:00:00 |
| 13 | 蔡杰 | | | | | | | | | 0.0% | | | | | | 00:00:00 |
| 14 | 王泽润 | | | | | | | | | 0.0% | | | | | | 00:00:00 |
| 15 | 张建杰 | 1/3 | 3/6 | | | 1/1 | 2/2 | | 7/12 | 58.3% | 3 | 4 | | | | 00:42:18 |
| 16 | 王猛 | | | | | | | | | 0.0% | | | | | | 00:00:00 |
| 18 | 李文金 | 0/1 | 2/3 | | | | | | 2/4 | 50.0% | | 1 | 1 | | | 00:48:04 |
| 合计 | | | | | | | | | | | | | | | | |
| <i>(守门员)</i> | | | | | | | | | | | | | | | | |
| 1 | 王帅 | 12/19 | 5/13 | 3/3 | 3/4 | 1/1 | 0/1 | 1/2 | 25/43 | 58.1% | | 1 | 1 | | | 00:42:18 |
| 合计 | | | | | | | | | | | | | | | | |

场上队员：得分/射门

守门员：救球/射门

| 全队合计 | 得分 | 被救 | 射失 | 击柱 | 封球 | 合计 | % |
|------|----|----|----|----|----|----|--------|
| 远射 | 3 | 3 | 1 | 2 | | 9 | 33.3% |
| 近射 | 11 | 4 | 1 | 1 | | 17 | 64.7% |
| 边射 | 2 | | | | | 2 | 100.0% |
| 快攻 | 7 | | | | | 7 | 100.0% |
| 突破 | 3 | | | 1 | | 4 | 75.0% |
| 任意 | 4 | | | | | 4 | 100.0% |
| 7M | 3 | | 1 | | | 4 | 75.0% |





2016年“体彩杯”全国手球男子青年锦标赛

图式射门区域统计

轮次 2 场次 9

201602009-41-1/1

江苏队

| | | | | | | | | | | | | | | | | | | | | | | | | | | | | | | | | | | | | | | | | | | | | | | | | | | | | | | | | | | | | | | | | | | | | | | | | | | | | | | | |
|--|-----------------------------|-----------------------------|-----------------------------|-----------------------------|-----------------------------|-----------------------------|-----------------------------|--|---|--|--|--|---|--|--|--|--|--|---|--|--|--|--|--|--|--|--|--|--|---|--|--|---|--|--|--|--|--|--|---|--|---|--|--|--|--|--|--|---|--|--|--|--|--|--|--|--|--|--|--|--|--|--|--|--|--|--|--|--|--|--|---|--|--|--|--|---|---|---|
| 1 潘博琦 | 3 赵韦光 | 4 张瑞恒 | 6 季雨 | 7 任超凡 | 8 姜童耀 | 9 王俊威 | 11 周傲 | | | | | | | | | | | | | | | | | | | | | | | | | | | | | | | | | | | | | | | | | | | | | | | | | | | | | | | | | | | | | | | | | | | | | | | | |
| <table border="1"><tr><td></td><td></td><td></td></tr><tr><td></td><td></td><td></td></tr><tr><td></td><td></td><td></td></tr></table> | | | | | | | | | | <table border="1"><tr><td></td><td></td><td>1</td></tr><tr><td></td><td></td><td></td></tr><tr><td></td><td></td><td>1</td></tr></table> | | | 1 | | | | | | 1 | <table border="1"><tr><td></td><td></td><td></td></tr><tr><td></td><td></td><td></td></tr><tr><td></td><td></td><td></td></tr></table> | | | | | | | | | | <table border="1"><tr><td></td><td></td><td></td></tr><tr><td></td><td></td><td></td></tr><tr><td></td><td></td><td></td></tr></table> | | | | | | | | | | <table border="1"><tr><td></td><td></td><td></td></tr><tr><td></td><td></td><td></td></tr><tr><td></td><td></td><td>1</td></tr></table> | | | | | | | | | 1 | <table border="1"><tr><td></td><td></td><td></td></tr><tr><td></td><td></td><td></td></tr><tr><td></td><td></td><td></td></tr></table> | | | | | | | | | | <table border="1"><tr><td></td><td></td><td></td></tr><tr><td></td><td></td><td></td></tr><tr><td></td><td></td><td></td></tr></table> | | | | | | | | | | <table border="1"><tr><td></td><td>2</td><td></td></tr><tr><td></td><td></td><td></td></tr><tr><td>1</td><td>2</td><td>1</td></tr></table> | | 2 | | | | | 1 | 2 | 1 |
| | | | | | | | | | | | | | | | | | | | | | | | | | | | | | | | | | | | | | | | | | | | | | | | | | | | | | | | | | | | | | | | | | | | | | | | | | | | | | | | |
| | | | | | | | | | | | | | | | | | | | | | | | | | | | | | | | | | | | | | | | | | | | | | | | | | | | | | | | | | | | | | | | | | | | | | | | | | | | | | | | |
| | | | | | | | | | | | | | | | | | | | | | | | | | | | | | | | | | | | | | | | | | | | | | | | | | | | | | | | | | | | | | | | | | | | | | | | | | | | | | | | |
| | | 1 | | | | | | | | | | | | | | | | | | | | | | | | | | | | | | | | | | | | | | | | | | | | | | | | | | | | | | | | | | | | | | | | | | | | | | | | | | | | | |
| | | | | | | | | | | | | | | | | | | | | | | | | | | | | | | | | | | | | | | | | | | | | | | | | | | | | | | | | | | | | | | | | | | | | | | | | | | | | | | | |
| | | 1 | | | | | | | | | | | | | | | | | | | | | | | | | | | | | | | | | | | | | | | | | | | | | | | | | | | | | | | | | | | | | | | | | | | | | | | | | | | | | |
| | | | | | | | | | | | | | | | | | | | | | | | | | | | | | | | | | | | | | | | | | | | | | | | | | | | | | | | | | | | | | | | | | | | | | | | | | | | | | | | |
| | | | | | | | | | | | | | | | | | | | | | | | | | | | | | | | | | | | | | | | | | | | | | | | | | | | | | | | | | | | | | | | | | | | | | | | | | | | | | | | |
| | | | | | | | | | | | | | | | | | | | | | | | | | | | | | | | | | | | | | | | | | | | | | | | | | | | | | | | | | | | | | | | | | | | | | | | | | | | | | | | |
| | | | | | | | | | | | | | | | | | | | | | | | | | | | | | | | | | | | | | | | | | | | | | | | | | | | | | | | | | | | | | | | | | | | | | | | | | | | | | | | |
| | | | | | | | | | | | | | | | | | | | | | | | | | | | | | | | | | | | | | | | | | | | | | | | | | | | | | | | | | | | | | | | | | | | | | | | | | | | | | | | |
| | | | | | | | | | | | | | | | | | | | | | | | | | | | | | | | | | | | | | | | | | | | | | | | | | | | | | | | | | | | | | | | | | | | | | | | | | | | | | | | |
| | | | | | | | | | | | | | | | | | | | | | | | | | | | | | | | | | | | | | | | | | | | | | | | | | | | | | | | | | | | | | | | | | | | | | | | | | | | | | | | |
| | | | | | | | | | | | | | | | | | | | | | | | | | | | | | | | | | | | | | | | | | | | | | | | | | | | | | | | | | | | | | | | | | | | | | | | | | | | | | | | |
| | | 1 | | | | | | | | | | | | | | | | | | | | | | | | | | | | | | | | | | | | | | | | | | | | | | | | | | | | | | | | | | | | | | | | | | | | | | | | | | | | | |
| | | | | | | | | | | | | | | | | | | | | | | | | | | | | | | | | | | | | | | | | | | | | | | | | | | | | | | | | | | | | | | | | | | | | | | | | | | | | | | | |
| | | | | | | | | | | | | | | | | | | | | | | | | | | | | | | | | | | | | | | | | | | | | | | | | | | | | | | | | | | | | | | | | | | | | | | | | | | | | | | | |
| | | | | | | | | | | | | | | | | | | | | | | | | | | | | | | | | | | | | | | | | | | | | | | | | | | | | | | | | | | | | | | | | | | | | | | | | | | | | | | | |
| | | | | | | | | | | | | | | | | | | | | | | | | | | | | | | | | | | | | | | | | | | | | | | | | | | | | | | | | | | | | | | | | | | | | | | | | | | | | | | | |
| | | | | | | | | | | | | | | | | | | | | | | | | | | | | | | | | | | | | | | | | | | | | | | | | | | | | | | | | | | | | | | | | | | | | | | | | | | | | | | | |
| | | | | | | | | | | | | | | | | | | | | | | | | | | | | | | | | | | | | | | | | | | | | | | | | | | | | | | | | | | | | | | | | | | | | | | | | | | | | | | | |
| | 2 | | | | | | | | | | | | | | | | | | | | | | | | | | | | | | | | | | | | | | | | | | | | | | | | | | | | | | | | | | | | | | | | | | | | | | | | | | | | | | |
| | | | | | | | | | | | | | | | | | | | | | | | | | | | | | | | | | | | | | | | | | | | | | | | | | | | | | | | | | | | | | | | | | | | | | | | | | | | | | | | |
| 1 | 2 | 1 | | | | | | | | | | | | | | | | | | | | | | | | | | | | | | | | | | | | | | | | | | | | | | | | | | | | | | | | | | | | | | | | | | | | | | | | | | | | | |
| Post - 0 Miss - 0 Block - 0 | Post - 0 Miss - 0 Block - 0 | Post - 0 Miss - 0 Block - 0 | Post - 0 Miss - 0 Block - 0 | Post - 0 Miss - 0 Block - 1 | Post - 0 Miss - 0 Block - 0 | Post - 0 Miss - 0 Block - 0 | Post - 2 Miss - 1 Block - 2 | | | | | | | | | | | | | | | | | | | | | | | | | | | | | | | | | | | | | | | | | | | | | | | | | | | | | | | | | | | | | | | | | | | | | | | | |
| 13 尹吉祥 | 14 罗中耀 | 15 阎冠中 | 17 马益奎 | 18 耿畅 | | | | | | | | | | | | | | | | | | | | | | | | | | | | | | | | | | | | | | | | | | | | | | | | | | | | | | | | | | | | | | | | | | | | | | | | | | | |
| <table border="1"><tr><td></td><td></td><td></td></tr><tr><td>1</td><td></td><td>1</td></tr><tr><td>1</td><td></td><td>2</td></tr></table> | | | | 1 | | 1 | 1 | | 2 | <table border="1"><tr><td></td><td></td><td></td></tr><tr><td></td><td></td><td></td></tr><tr><td></td><td></td><td></td></tr></table> | | | | | | | | | | <table border="1"><tr><td></td><td></td><td></td></tr><tr><td></td><td></td><td></td></tr><tr><td></td><td></td><td></td></tr></table> | | | | | | | | | | <table border="1"><tr><td></td><td></td><td>1</td></tr><tr><td></td><td></td><td></td></tr><tr><td></td><td></td><td></td></tr></table> | | | 1 | | | | | | | <table border="1"><tr><td></td><td>2</td><td></td></tr><tr><td></td><td></td><td></td></tr><tr><td></td><td></td><td></td></tr></table> | | 2 | | | | | | | | <table border="1"><tr><td></td><td></td><td></td></tr><tr><td></td><td></td><td></td></tr><tr><td></td><td></td><td></td></tr></table> | | | | | | | | | | <table border="1"><tr><td></td><td></td><td></td></tr><tr><td></td><td></td><td></td></tr><tr><td></td><td></td><td></td></tr></table> | | | | | | | | | | <table border="1"><tr><td></td><td></td><td></td></tr><tr><td></td><td></td><td></td></tr><tr><td></td><td></td><td></td></tr></table> | | | | | | | | | |
| | | | | | | | | | | | | | | | | | | | | | | | | | | | | | | | | | | | | | | | | | | | | | | | | | | | | | | | | | | | | | | | | | | | | | | | | | | | | | | | |
| 1 | | 1 | | | | | | | | | | | | | | | | | | | | | | | | | | | | | | | | | | | | | | | | | | | | | | | | | | | | | | | | | | | | | | | | | | | | | | | | | | | | | |
| 1 | | 2 | | | | | | | | | | | | | | | | | | | | | | | | | | | | | | | | | | | | | | | | | | | | | | | | | | | | | | | | | | | | | | | | | | | | | | | | | | | | | |
| | | | | | | | | | | | | | | | | | | | | | | | | | | | | | | | | | | | | | | | | | | | | | | | | | | | | | | | | | | | | | | | | | | | | | | | | | | | | | | | |
| | | | | | | | | | | | | | | | | | | | | | | | | | | | | | | | | | | | | | | | | | | | | | | | | | | | | | | | | | | | | | | | | | | | | | | | | | | | | | | | |
| | | | | | | | | | | | | | | | | | | | | | | | | | | | | | | | | | | | | | | | | | | | | | | | | | | | | | | | | | | | | | | | | | | | | | | | | | | | | | | | |
| | | | | | | | | | | | | | | | | | | | | | | | | | | | | | | | | | | | | | | | | | | | | | | | | | | | | | | | | | | | | | | | | | | | | | | | | | | | | | | | |
| | | | | | | | | | | | | | | | | | | | | | | | | | | | | | | | | | | | | | | | | | | | | | | | | | | | | | | | | | | | | | | | | | | | | | | | | | | | | | | | |
| | | | | | | | | | | | | | | | | | | | | | | | | | | | | | | | | | | | | | | | | | | | | | | | | | | | | | | | | | | | | | | | | | | | | | | | | | | | | | | | |
| | | 1 | | | | | | | | | | | | | | | | | | | | | | | | | | | | | | | | | | | | | | | | | | | | | | | | | | | | | | | | | | | | | | | | | | | | | | | | | | | | | |
| | | | | | | | | | | | | | | | | | | | | | | | | | | | | | | | | | | | | | | | | | | | | | | | | | | | | | | | | | | | | | | | | | | | | | | | | | | | | | | | |
| | | | | | | | | | | | | | | | | | | | | | | | | | | | | | | | | | | | | | | | | | | | | | | | | | | | | | | | | | | | | | | | | | | | | | | | | | | | | | | | |
| | 2 | | | | | | | | | | | | | | | | | | | | | | | | | | | | | | | | | | | | | | | | | | | | | | | | | | | | | | | | | | | | | | | | | | | | | | | | | | | | | | |
| | | | | | | | | | | | | | | | | | | | | | | | | | | | | | | | | | | | | | | | | | | | | | | | | | | | | | | | | | | | | | | | | | | | | | | | | | | | | | | | |
| | | | | | | | | | | | | | | | | | | | | | | | | | | | | | | | | | | | | | | | | | | | | | | | | | | | | | | | | | | | | | | | | | | | | | | | | | | | | | | | |
| | | | | | | | | | | | | | | | | | | | | | | | | | | | | | | | | | | | | | | | | | | | | | | | | | | | | | | | | | | | | | | | | | | | | | | | | | | | | | | | |
| | | | | | | | | | | | | | | | | | | | | | | | | | | | | | | | | | | | | | | | | | | | | | | | | | | | | | | | | | | | | | | | | | | | | | | | | | | | | | | | |
| | | | | | | | | | | | | | | | | | | | | | | | | | | | | | | | | | | | | | | | | | | | | | | | | | | | | | | | | | | | | | | | | | | | | | | | | | | | | | | | |
| | | | | | | | | | | | | | | | | | | | | | | | | | | | | | | | | | | | | | | | | | | | | | | | | | | | | | | | | | | | | | | | | | | | | | | | | | | | | | | | |
| | | | | | | | | | | | | | | | | | | | | | | | | | | | | | | | | | | | | | | | | | | | | | | | | | | | | | | | | | | | | | | | | | | | | | | | | | | | | | | | |
| | | | | | | | | | | | | | | | | | | | | | | | | | | | | | | | | | | | | | | | | | | | | | | | | | | | | | | | | | | | | | | | | | | | | | | | | | | | | | | | |
| | | | | | | | | | | | | | | | | | | | | | | | | | | | | | | | | | | | | | | | | | | | | | | | | | | | | | | | | | | | | | | | | | | | | | | | | | | | | | | | |
| | | | | | | | | | | | | | | | | | | | | | | | | | | | | | | | | | | | | | | | | | | | | | | | | | | | | | | | | | | | | | | | | | | | | | | | | | | | | | | | |
| | | | | | | | | | | | | | | | | | | | | | | | | | | | | | | | | | | | | | | | | | | | | | | | | | | | | | | | | | | | | | | | | | | | | | | | | | | | | | | | |
| Post - 0 Miss - 0 Block - 3 | Post - 0 Miss - 0 Block - 0 | Post - 0 Miss - 0 Block - 0 | Post - 0 Miss - 0 Block - 0 | Post - 0 Miss - 1 Block - 0 | | | | | | | | | | | | | | | | | | | | | | | | | | | | | | | | | | | | | | | | | | | | | | | | | | | | | | | | | | | | | | | | | | | | | | | | | | | |

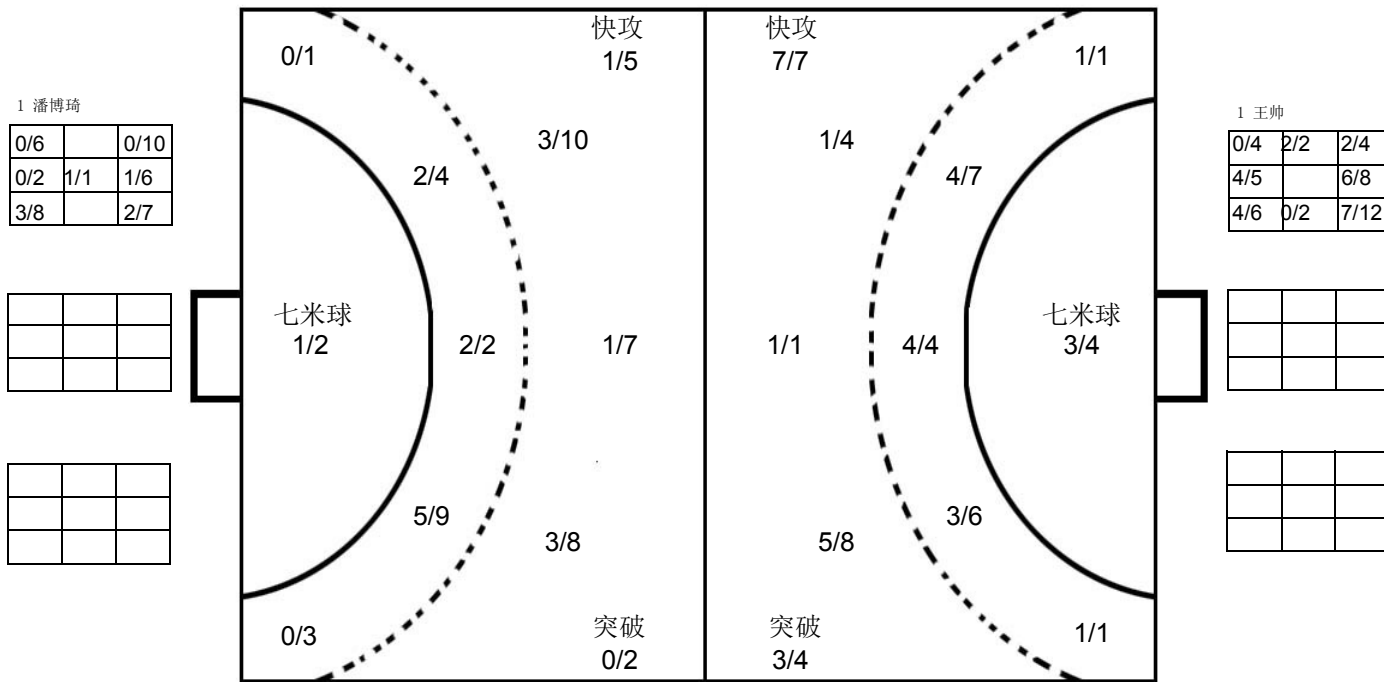

广东队

| | | | | | | | | | | | | | | | | | | | | | | | | | | | | | | | | | | | | | | | | | | | | | | | | | | | | | | | | | | | | | | | | | | | | | | | | | | | | |
|---|-----------------------------|-----------------------------|-----------------------------|-----------------------------|-----------------------------|-----------------------------|-----------------------------|--|--|---|--|--|---|--|--|--|--|--|--|--|---|--|---|--|--|--|--|--|--|--|---|---|---|---|---|---|--|---|---|--|---|--|--|--|--|--|---|--|--|--|--|--|--|--|--|---|--|--|--|---|---|--|---|--|--|--|--|--|--|--|--|--|--|--|--|--|
| 1 王帅 | 2 姚雪岩 | 4 高玉杰 | 5 黄培杰 | 7 段飞宇 | 9 周凯峰 | 10 周仲坤 | 11 胡国富 | | | | | | | | | | | | | | | | | | | | | | | | | | | | | | | | | | | | | | | | | | | | | | | | | | | | | | | | | | | | | | | | | | | | | |
| <table border="1"><tr><td></td><td></td><td></td></tr><tr><td></td><td></td><td></td></tr><tr><td>1</td><td></td><td></td></tr></table> | | | | | | | 1 | | | <table border="1"><tr><td></td><td></td><td>4</td></tr><tr><td></td><td></td><td></td></tr><tr><td></td><td></td><td></td></tr></table> | | | 4 | | | | | | | <table border="1"><tr><td>3</td><td></td><td>1</td></tr><tr><td></td><td></td><td></td></tr><tr><td></td><td></td><td></td></tr></table> | 3 | | 1 | | | | | | | <table border="1"><tr><td>1</td><td>2</td></tr><tr><td>1</td><td>1</td></tr><tr><td>2</td><td></td></tr></table> | 1 | 2 | 1 | 1 | 2 | | <table border="1"><tr><td>2</td><td>1</td></tr><tr><td></td><td>1</td></tr><tr><td></td><td></td></tr></table> | 2 | 1 | | 1 | | | <table border="1"><tr><td></td><td></td><td></td></tr><tr><td></td><td></td><td></td></tr><tr><td></td><td></td><td></td></tr></table> | | | | | | | | | | <table border="1"><tr><td></td><td></td><td>1</td></tr><tr><td></td><td></td><td>1</td></tr><tr><td>1</td><td></td><td>1</td></tr></table> | | | 1 | | | 1 | 1 | | 1 | <table border="1"><tr><td></td><td></td><td></td></tr><tr><td></td><td></td><td></td></tr><tr><td></td><td></td><td></td></tr></table> | | | | | | | | | | | | |
| | | | | | | | | | | | | | | | | | | | | | | | | | | | | | | | | | | | | | | | | | | | | | | | | | | | | | | | | | | | | | | | | | | | | | | | | | | | | |
| | | | | | | | | | | | | | | | | | | | | | | | | | | | | | | | | | | | | | | | | | | | | | | | | | | | | | | | | | | | | | | | | | | | | | | | | | | | | |
| 1 | | | | | | | | | | | | | | | | | | | | | | | | | | | | | | | | | | | | | | | | | | | | | | | | | | | | | | | | | | | | | | | | | | | | | | | | | | | | |
| | | 4 | | | | | | | | | | | | | | | | | | | | | | | | | | | | | | | | | | | | | | | | | | | | | | | | | | | | | | | | | | | | | | | | | | | | | | | | | | |
| | | | | | | | | | | | | | | | | | | | | | | | | | | | | | | | | | | | | | | | | | | | | | | | | | | | | | | | | | | | | | | | | | | | | | | | | | | | | |
| | | | | | | | | | | | | | | | | | | | | | | | | | | | | | | | | | | | | | | | | | | | | | | | | | | | | | | | | | | | | | | | | | | | | | | | | | | | | |
| 3 | | 1 | | | | | | | | | | | | | | | | | | | | | | | | | | | | | | | | | | | | | | | | | | | | | | | | | | | | | | | | | | | | | | | | | | | | | | | | | | |
| | | | | | | | | | | | | | | | | | | | | | | | | | | | | | | | | | | | | | | | | | | | | | | | | | | | | | | | | | | | | | | | | | | | | | | | | | | | | |
| | | | | | | | | | | | | | | | | | | | | | | | | | | | | | | | | | | | | | | | | | | | | | | | | | | | | | | | | | | | | | | | | | | | | | | | | | | | | |
| 1 | 2 | | | | | | | | | | | | | | | | | | | | | | | | | | | | | | | | | | | | | | | | | | | | | | | | | | | | | | | | | | | | | | | | | | | | | | | | | | | |
| 1 | 1 | | | | | | | | | | | | | | | | | | | | | | | | | | | | | | | | | | | | | | | | | | | | | | | | | | | | | | | | | | | | | | | | | | | | | | | | | | | |
| 2 | | | | | | | | | | | | | | | | | | | | | | | | | | | | | | | | | | | | | | | | | | | | | | | | | | | | | | | | | | | | | | | | | | | | | | | | | | | | |
| 2 | 1 | | | | | | | | | | | | | | | | | | | | | | | | | | | | | | | | | | | | | | | | | | | | | | | | | | | | | | | | | | | | | | | | | | | | | | | | | | | |
| | 1 | | | | | | | | | | | | | | | | | | | | | | | | | | | | | | | | | | | | | | | | | | | | | | | | | | | | | | | | | | | | | | | | | | | | | | | | | | | |
| | | | | | | | | | | | | | | | | | | | | | | | | | | | | | | | | | | | | | | | | | | | | | | | | | | | | | | | | | | | | | | | | | | | | | | | | | | | | |
| | | | | | | | | | | | | | | | | | | | | | | | | | | | | | | | | | | | | | | | | | | | | | | | | | | | | | | | | | | | | | | | | | | | | | | | | | | | | |
| | | | | | | | | | | | | | | | | | | | | | | | | | | | | | | | | | | | | | | | | | | | | | | | | | | | | | | | | | | | | | | | | | | | | | | | | | | | | |
| | | | | | | | | | | | | | | | | | | | | | | | | | | | | | | | | | | | | | | | | | | | | | | | | | | | | | | | | | | | | | | | | | | | | | | | | | | | | |
| | | 1 | | | | | | | | | | | | | | | | | | | | | | | | | | | | | | | | | | | | | | | | | | | | | | | | | | | | | | | | | | | | | | | | | | | | | | | | | | |
| | | 1 | | | | | | | | | | | | | | | | | | | | | | | | | | | | | | | | | | | | | | | | | | | | | | | | | | | | | | | | | | | | | | | | | | | | | | | | | | |
| 1 | | 1 | | | | | | | | | | | | | | | | | | | | | | | | | | | | | | | | | | | | | | | | | | | | | | | | | | | | | | | | | | | | | | | | | | | | | | | | | | |
| | | | | | | | | | | | | | | | | | | | | | | | | | | | | | | | | | | | | | | | | | | | | | | | | | | | | | | | | | | | | | | | | | | | | | | | | | | | | |
| | | | | | | | | | | | | | | | | | | | | | | | | | | | | | | | | | | | | | | | | | | | | | | | | | | | | | | | | | | | | | | | | | | | | | | | | | | | | |
| | | | | | | | | | | | | | | | | | | | | | | | | | | | | | | | | | | | | | | | | | | | | | | | | | | | | | | | | | | | | | | | | | | | | | | | | | | | | |
| Post - 0 Miss - 0 Block - 0 | Post - 0 Miss - 1 Block - 0 | Post - 0 Miss - 0 Block - 0 | Post - 1 Miss - 2 Block - 0 | Post - 0 Miss - 0 Block - 0 | Post - 0 Miss - 0 Block - 0 | Post - 2 Miss - 0 Block - 0 | Post - 0 Miss - 0 Block - 0 | | | | | | | | | | | | | | | | | | | | | | | | | | | | | | | | | | | | | | | | | | | | | | | | | | | | | | | | | | | | | | | | | | | | | |
| 12 李壮 | 13 蔡杰 | 14 王泽润 | 15 张建杰 | 16 王猛 | 18 李文金 | | | | | | | | | | | | | | | | | | | | | | | | | | | | | | | | | | | | | | | | | | | | | | | | | | | | | | | | | | | | | | | | | | | | | | | |
| <table border="1"><tr><td></td><td></td><td></td></tr><tr><td></td><td></td><td></td></tr><tr><td></td><td></td><td></td></tr></table> | | | | | | | | | | <table border="1"><tr><td></td><td></td><td></td></tr><tr><td></td><td></td><td></td></tr><tr><td></td><td></td><td></td></tr></table> | | | | | | | | | | <table border="1"><tr><td></td><td></td><td></td></tr><tr><td></td><td></td><td></td></tr><tr><td></td><td></td><td></td></tr></table> | | | | | | | | | | <table border="1"><tr><td></td><td>1</td></tr><tr><td>1</td><td>2</td></tr><tr><td>1</td><td>2</td></tr></table> | | 1 | 1 | 2 | 1 | 2 | <table border="1"><tr><td></td><td></td><td></td></tr><tr><td></td><td></td><td></td></tr><tr><td></td><td></td><td></td></tr></table> | | | | | | | | | | <table border="1"><tr><td></td><td></td><td></td></tr><tr><td></td><td></td><td></td></tr><tr><td></td><td></td><td>2</td></tr></table> | | | | | | | | | 2 | <table border="1"><tr><td></td><td></td><td></td></tr><tr><td></td><td></td><td></td></tr><tr><td></td><td></td><td></td></tr></table> | | | | | | | | | | <table border="1"><tr><td></td><td></td><td></td></tr><tr><td></td><td></td><td></td></tr><tr><td></td><td></td><td></td></tr></table> | | | | | | | | | |
| | | | | | | | | | | | | | | | | | | | | | | | | | | | | | | | | | | | | | | | | | | | | | | | | | | | | | | | | | | | | | | | | | | | | | | | | | | | | |
| | | | | | | | | | | | | | | | | | | | | | | | | | | | | | | | | | | | | | | | | | | | | | | | | | | | | | | | | | | | | | | | | | | | | | | | | | | | | |
| | | | | | | | | | | | | | | | | | | | | | | | | | | | | | | | | | | | | | | | | | | | | | | | | | | | | | | | | | | | | | | | | | | | | | | | | | | | | |
| | | | | | | | | | | | | | | | | | | | | | | | | | | | | | | | | | | | | | | | | | | | | | | | | | | | | | | | | | | | | | | | | | | | | | | | | | | | | |
| | | | | | | | | | | | | | | | | | | | | | | | | | | | | | | | | | | | | | | | | | | | | | | | | | | | | | | | | | | | | | | | | | | | | | | | | | | | | |
| | | | | | | | | | | | | | | | | | | | | | | | | | | | | | | | | | | | | | | | | | | | | | | | | | | | | | | | | | | | | | | | | | | | | | | | | | | | | |
| | | | | | | | | | | | | | | | | | | | | | | | | | | | | | | | | | | | | | | | | | | | | | | | | | | | | | | | | | | | | | | | | | | | | | | | | | | | | |
| | | | | | | | | | | | | | | | | | | | | | | | | | | | | | | | | | | | | | | | | | | | | | | | | | | | | | | | | | | | | | | | | | | | | | | | | | | | | |
| | | | | | | | | | | | | | | | | | | | | | | | | | | | | | | | | | | | | | | | | | | | | | | | | | | | | | | | | | | | | | | | | | | | | | | | | | | | | |
| | 1 | | | | | | | | | | | | | | | | | | | | | | | | | | | | | | | | | | | | | | | | | | | | | | | | | | | | | | | | | | | | | | | | | | | | | | | | | | | |
| 1 | 2 | | | | | | | | | | | | | | | | | | | | | | | | | | | | | | | | | | | | | | | | | | | | | | | | | | | | | | | | | | | | | | | | | | | | | | | | | | | |
| 1 | 2 | | | | | | | | | | | | | | | | | | | | | | | | | | | | | | | | | | | | | | | | | | | | | | | | | | | | | | | | | | | | | | | | | | | | | | | | | | | |
| | | | | | | | | | | | | | | | | | | | | | | | | | | | | | | | | | | | | | | | | | | | | | | | | | | | | | | | | | | | | | | | | | | | | | | | | | | | | |
| | | | | | | | | | | | | | | | | | | | | | | | | | | | | | | | | | | | | | | | | | | | | | | | | | | | | | | | | | | | | | | | | | | | | | | | | | | | | |
| | | | | | | | | | | | | | | | | | | | | | | | | | | | | | | | | | | | | | | | | | | | | | | | | | | | | | | | | | | | | | | | | | | | | | | | | | | | | |
| | | | | | | | | | | | | | | | | | | | | | | | | | | | | | | | | | | | | | | | | | | | | | | | | | | | | | | | | | | | | | | | | | | | | | | | | | | | | |
| | | | | | | | | | | | | | | | | | | | | | | | | | | | | | | | | | | | | | | | | | | | | | | | | | | | | | | | | | | | | | | | | | | | | | | | | | | | | |
| | | 2 | | | | | | | | | | | | | | | | | | | | | | | | | | | | | | | | | | | | | | | | | | | | | | | | | | | | | | | | | | | | | | | | | | | | | | | | | | |
| | | | | | | | | | | | | | | | | | | | | | | | | | | | | | | | | | | | | | | | | | | | | | | | | | | | | | | | | | | | | | | | | | | | | | | | | | | | | |
| | | | | | | | | | | | | | | | | | | | | | | | | | | | | | | | | | | | | | | | | | | | | | | | | | | | | | | | | | | | | | | | | | | | | | | | | | | | | |
| | | | | | | | | | | | | | | | | | | | | | | | | | | | | | | | | | | | | | | | | | | | | | | | | | | | | | | | | | | | | | | | | | | | | | | | | | | | | |
| | | | | | | | | | | | | | | | | | | | | | | | | | | | | | | | | | | | | | | | | | | | | | | | | | | | | | | | | | | | | | | | | | | | | | | | | | | | | |
| | | | | | | | | | | | | | | | | | | | | | | | | | | | | | | | | | | | | | | | | | | | | | | | | | | | | | | | | | | | | | | | | | | | | | | | | | | | | |
| | | | | | | | | | | | | | | | | | | | | | | | | | | | | | | | | | | | | | | | | | | | | | | | | | | | | | | | | | | | | | | | | | | | | | | | | | | | | |
| Post - 0 Miss - 0 Block - 0 | Post - 0 Miss - 0 Block - 0 | Post - 0 Miss - 0 Block - 0 | Post - 1 Miss - 0 Block - 0 | Post - 0 Miss - 0 Block - 0 | Post - 0 Miss - 0 Block - 0 | | | | | | | | | | | | | | | | | | | | | | | | | | | | | | | | | | | | | | | | | | | | | | | | | | | | | | | | | | | | | | | | | | | | | | | |

注释: Post=击柱 Miss=射失 Block=被封





预赛 Group B
青年男子 全国比赛

2016年“体彩杯”全国手球男子青年锦标赛

| | | | | | | | | | | | | | | | | | | | | | |
|-----------------|-----------------------------------|---------------|---------------------|------------|------------------------------------|-------------|----------------|--------------|---|----|---|-----------|---|---|---------------|---|----|-----|---------------|---|----|
| Team A | | | | Team B | | | | Match Number | | | | | | | | | | | | | |
| A 北京队 | | | | B 四川队 | | | | 10 | | | | | | | | | | | | | |
| played in | | in the hall | | on | | at | | Spectators | | | | | | | | | | | | | |
| China | | 重庆万州 | | 21/03/2016 | | 14:30 hours | | | | | | | | | | | | | | | |
| Half-time (30') | A | B | End of playing time | | A | B | 1st extra time | | A | B | 2nd extra time | | A | B | After penalty | | A | B | | | |
| | 14 | 12 | | | 29 | 35 | | | | | | | | | | | | | | | |
| Number of 7 m | A | Team time-out | | | Full name of players and officials | | | | | | | | | | Team time-out | | | B | Number of 7 m | | |
| | | 1 | 2 | 3 | | | | | | | | | | | 1 | 2 | 3 | | | | |
| | 1/1 | 14:12 | 36:10 | 53:16 | | | | | | | | | | | 10:33 | | | 0/3 | | | |
| No. | Team A | | | | | G | W | 2 | D | DR | No. | Team B | | | | | G | W | 2 | D | DR |
| 3 | 王哲一 | | | | | | | | | | 1 | 宋继强 | | | | | | | | | |
| 4 | 朱广刚 | | | | | 6 | 1 | 1 | | | 3 | 刘赵梁 | | | | | 11 | 1 | | | |
| 6 | 赵一涵 | | | | | 2 | | | | | 5 | 王凯 | | | | | 2 | | | | |
| 7 | 卞友山 | | | | | | | | | | 7 | 仇瑞祥 | | | | | | | | | |
| 11 | 李旭 | | | | | 4 | | | | | 8 | 罗尧尧 | | | | | 10 | | | | |
| 15 | 逯明松 | | | | | 1 | | | | | 9 | 许翔宇 | | | | | | 1 | | | |
| 16 | 马佳鹏 | | | | | | | | | | 10 | 徐彦昊 | | | | | 4 | | 1 | | |
| 18 | 李明远 | | | | | | | | | | 11 | 张天豪 | | | | | | | | | |
| 19 | 陈旭 | | | | | 8 | | | | | 12 | 刘树豪 | | | | | | | | | |
| 23 | 刘帅 | | | | | | | | | | 13 | 尹文珂 | | | | | | | | | |
| 26 | 吴锐樊 | | | | | 3 | 1 | | | | 15 | 徐逸 | | | | | | | | | |
| 35 | 高云健 | | | | | | | | | | 17 | 谢庆龙 | | | | | 6 | | | | |
| 36 | 王鹏皓 | | | | | 5 | 1 | | | | 18 | 张睿梁 | | | | | | | | | |
| | | | | | | | | | | | 19 | 庞连康 | | | | | 2 | 1 | 1 | | |
| | | | | | | | | | | | 20 | 张文健 | | | | | | | | | |
| | | | | | | | | | | | 21 | 曹修庆 | | | | | | | | | |
| B | 吴健 (主教练) | | | | | | | | | | B | 张文韬 (主教练) | | | | | | | | | |
| C | 宋刚 | | | | | | | | | | | | | | | | | | | | |
| D | 陈璇 | | | | | | | | | | | | | | | | | | | | |
| | | | | | | | | | | | | | | | | | | | | | |
| | | | | | | | | | | | | | | | | | | | | | |
| A | | | | | | | | | | | Signature of Responsible Official of the Teams (Off. A) | | | | | | | | | | B |
| TP | Remarks of Referee / CHA Official | | | | | | | | | | | | | | | | | | | | TP |
| | | | | | | | | | | | | | | | | | | | | | |
| | | | | | | | | | | | | | | | | | | | | | |

Signatures

| | | | | |
|------------------|-----------|-----------|--|--|
| Referees | 许翔 (CHN) | 王雨洋 (CHN) | | |
| Techn. Delegates | 许宣扬 (CHN) | | | |
| CHA Official | 张春生 (CHN) | | | |

Note: Number of 7m Throws Awarded to Team A and B, Goals (G), Warnings (W), Suspensions (2), Direct Disqualification (D), Disqualification with Report (DR) and Team Penalty (TP).

Table Officials:

Statisticians: 刘永欢

李双





2016年“体彩杯”全国手球男子青年锦标赛 竞赛技术统计(媒体表)

| | | | | | | |
|---------|----|----|------------|----|----|------------------|
| 预赛 | 组别 | B | 轮次 | 2 | 场次 | 10 |
| 重庆万州 | | | 21/03/2016 | | | 201602010-51-1/1 |
| 北京队 | 北京 | 29 | vs | 35 | 四川 | 四川队 |
| 14 : 12 | | | | | | |

| | | | |
|-----|----------|---|-----------|
| 裁判员 | 许翔 (CHN) | / | 王雨洋 (CHN) |
|-----|----------|---|-----------|

| 北京 | | | | | | | | | | | | | | 北京 | | 四川 | |
|---------------|-------------|--------------|-------------|------------|------------|------------|--------------|--------------|-------------|----------|-----------|----------|----------|----------|----------|----------|--------|
| 主教练： 吴健 | | | | | | | | | | | | | | 比赛进程 | | | |
| 远射 | 近射 | 边射 | 快攻 | 突破 | 任意球 | 7m球 | 合计 | % | 助攻 | 失误 | 警告 | 2' | D & DR | | | | |
| 3 王哲一 | | | | | | | | | | 2 | | | | | 4 朱广刚 | 1 02:14 | 0 |
| 4 朱广刚 | 2/3 | 4/5 | | | | | 6/8 | 75.0 | 2 | 8 | 1 | 1 | | | 1 03:41 | 1 | 8 罗尧尧 |
| 6 赵一涵 | 0/2 | 1/1 | | | 1/2 | 0/1 | 2/6 | 33.3 | 1 | 1 | | | | | 19 陈旭 | 2 05:33 | 1 |
| 7 卞友山 | | | | | | | | | | | | | | | 19 陈旭 | 3 06:16 | 1 |
| 11 李旭 | | 4/6 | | | | | 4/6 | 66.7 | | 1 | | | | | 26 吴锐樊 | 4 07:02 | 1 |
| 15 逯明松 | 0/2 | 1/1 | | | | | 1/3 | 33.3 | 1 | 3 | | | | | 11 李旭 | 5 07:33 | 1 |
| 16 马佳鹏 | | | | | | | | | | | | | | | 5 08:07 | 2 | 8 罗尧尧 |
| 18 李明远 | | | | | | | | | | | | | | | 6 09:43 | 2 | 2 |
| 19 陈旭 | 3/11 | 3/6 | 1/1 | | | 1/1 | 8/19 | 42.1 | 4 | 8 | | | | | 19 陈旭 | 7 10:23 | 2 |
| 23 刘帅 | | | | | | | | | | | | | | | 4 朱广刚 | 8 11:19 | 3 |
| 26 吴锐樊 | | 1/2 | | 2/2 | | | 3/4 | 75.0 | | 1 | 1 | | | | 8 11:48 | 4 | 17 谢庆龙 |
| 35 高云健 | | | | | | | | | | | | | | | 15 逯明松 | 9 13:14 | 4 |
| 36 王鹏皓 | | 3/5 | 1/3 | 1/1 | | | 5/9 | 55.6 | | 2 | 1 | | | | 26 吴锐樊 | 10 13:36 | 4 |
| 运动员 合计 | 5/18 | 17/26 | 2/4 | 3/3 | 1/2 | 0/1 | 1/1 | 29/55 | 52.7 | 8 | 26 | 3 | 1 | | 10 14:07 | 5 | 10 徐彦昊 |
| 16 马佳鹏 | 1/5 | 2/14 | 5/10 | 1/8 | 0/2 | | 3/3 | 12/42 | 28.6 | | | | | | 10 16:40 | 6 | 10 徐彦昊 |
| 35 高云健 | 0/1 | 1/2 | 1/3 | | | 0/1 | 2/7 | 28.6 | | | | | | | 10 18:12 | 7 | 8 罗尧尧 |
| 守门员 合计 | 1/6 | 3/16 | 6/13 | 1/8 | 0/2 | 0/1 | 3/3 | 14/49 | 28.6 | | | | | | 11 李旭 | 11 18:38 | 7 |
| 四川 | | | | | | | | | | | | | | 北京 | | 四川 | |
| 教练： 张文韬 | | | | | | | | | | | | | | 1st Half | | | |
| 远射 | 近射 | 边射 | 快攻 | 突破 | 任意球 | 7m球 | 合计 | % | 助攻 | 失误 | 警告 | 2' | D & DR | | | | |
| 1 宋继强 | | | | | | | | | | | | | | | 4 朱广刚 | 8 11:19 | 3 |
| 3 刘赵梁 | 0/1 | 0/1 | 6/8 | 3/3 | 2/2 | | 11/15 | 73.3 | | 7 | 1 | | | | 8 11:48 | 4 | 17 谢庆龙 |
| 5 王凯 | | 2/2 | 0/4 | | | | 0/1 | 2/7 | 28.6 | 1 | 1 | | | | 15 逯明松 | 9 13:14 | 4 |
| 7 仇瑞祥 | | | 0/1 | | | | 0/1 | 0/2 | 0.0 | | | | | | 26 吴锐樊 | 10 13:36 | 4 |
| 8 罗尧尧 | 4/4 | 2/4 | 1/1 | 3/4 | | | 10/13 | 76.9 | 3 | 1 | | | | | 10 14:07 | 5 | 10 徐彦昊 |
| 9 许翔宇 | 0/1 | | | | | | 0/1 | 0.0 | | 2 | 1 | | | | 10 16:40 | 6 | 10 徐彦昊 |
| 10 徐彦昊 | 0/2 | 3/3 | 0/1 | 1/1 | | | 0/1 | 4/8 | 50.0 | 3 | 3 | | 1 | | 10 18:12 | 7 | 8 罗尧尧 |
| 11 张天豪 | | | | | | | | | | | | | | | 11 18:47 | 8 | 3 刘赵梁 |
| 12 刘树豪 | | | | | | | | | | | | | | | 12 19:42 | 8 | |
| 13 尹文珂 | | | | | | | | | | | | | | | 12 20:54 | 9 | 17 谢庆龙 |
| 15 徐逸 | | | | | | | | | | | | | | | 12 24:36 | 10 | 3 刘赵梁 |
| 17 谢庆龙 | | 6/9 | | | | | 6/9 | 66.7 | | 2 | | | | | 13 26:00 | 10 | |
| 18 张春梁 | | | | | | | | | | | | | | | 13 28:17 | 11 | 3 刘赵梁 |
| 19 庞连康 | 1/1 | | | | | 1/1 | 2/2 | 100 | | 2 | 1 | 1 | | | 13 28:32 | 12 | 3 刘赵梁 |
| 20 张文健 | | | | | | | | | | | | | | | 14 28:49 | 12 | |
| 21 曹修庆 | | | | | | | | | | | | | | | | | |
| 运动员 合计 | 5/9 | 13/19 | 7/15 | 7/8 | 2/2 | 1/1 | 0/3 | 35/57 | 61.4 | 7 | 19 | 3 | 2 | | 14 01:59 | 13 | 10 徐彦昊 |
| 1 宋继强 | 2/3 | 5/11 | | | | | 7/14 | 50.0 | | | | | | | 15 02:30 | 13 | |
| 12 刘树豪 | 5/9 | 3/14 | 1/3 | 0/3 | 1/2 | | 10/32 | 31.3 | | | | | | | 15 02:38 | 14 | 5 王凯 |
| 守门员 合计 | 7/12 | 8/25 | 1/3 | 0/3 | 1/2 | 0/1 | 17/46 | 37.0 | | | | | | | 16 03:28 | 14 | |

场上队员： 得分 / 射门

守门员： 救球 / 射门

| | | | | | | | | | |
|----|------------|----|--------------|-----|------------|-----|----------|----|---------|
| 快攻 | Fast Break | 突破 | Breakthrough | 任意球 | Free Throw | 7M球 | 7M Throw | 助攻 | Assist |
| 警告 | Warning | 失误 | Error | 2' | Suspension | D | 取消资格 | DR | 取消资格+报告 |





2016年“体彩杯”全国手球男子青年锦标赛 图式比赛技术统计表

轮次 2

场次 10

201602010-21-1/1

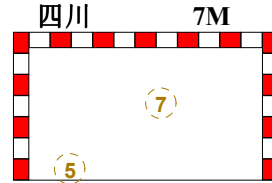
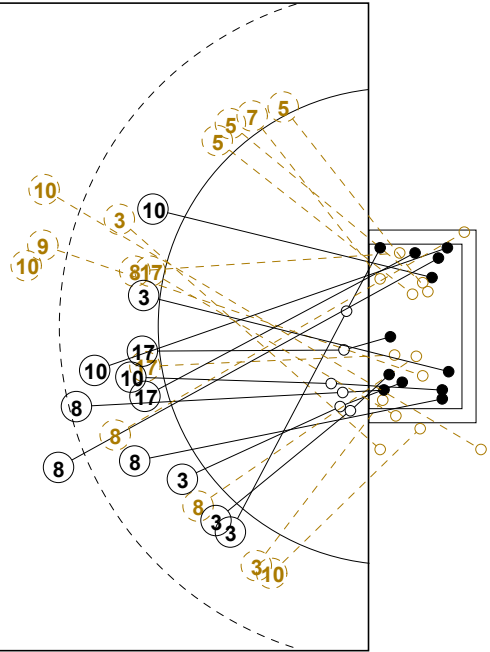
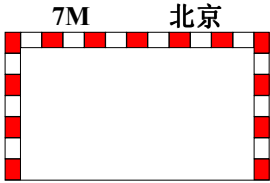
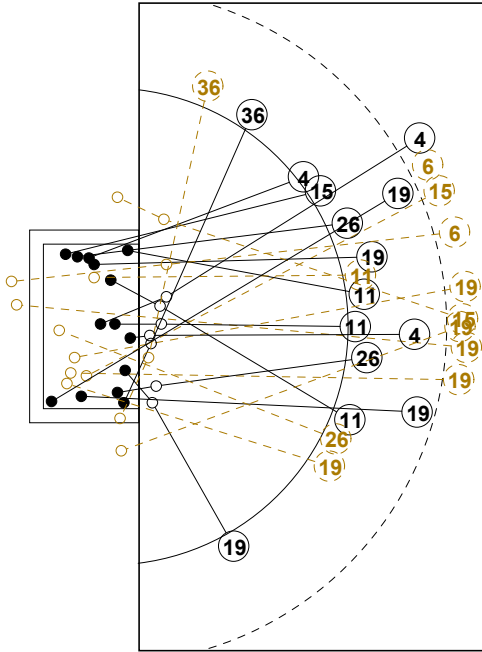

1st Half
14 : 12

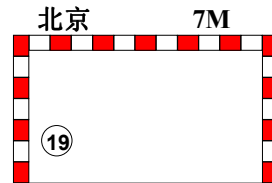
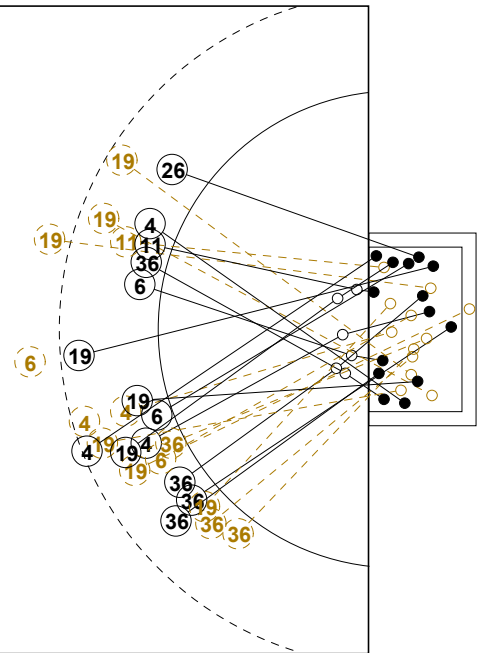
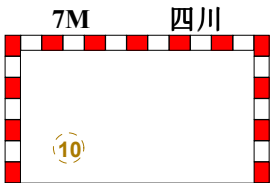
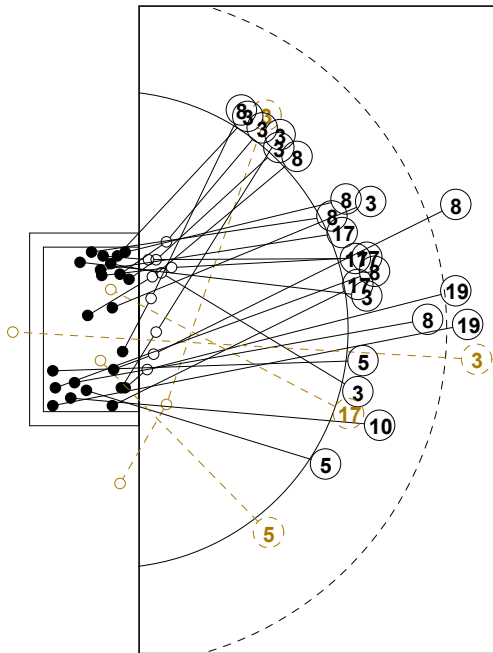

2nd Half
35 : 29



2016年“体彩杯”全国手球男子青年锦标赛

个人/全队技术统计表

正式表
手球
青年男子预赛
轮次 2组别 B
场次 10201602010-14-1/2
重庆万州
21/03/2016 14:30

| 号码 | 姓名 | 远射 | 近射 | 边射 | 快攻 | 突破 | 任意 | 7M | 合计 | % | 助攻 | 失误 | 警告 | 2' | 取消 | 时间 |
|----------------|-----|------|------|------|-----|-----|-----|-----|-------|-------|----|----|----|----|----|----------|
| 北京队(北京) | | | | | | | | | | | | | | | | |
| <i>(场上队员)</i> | | | | | | | | | | | | | | | | |
| 3 | 王哲一 | | | | | | | | | 0.0% | | 2 | | | | 00:12:53 |
| 4 | 朱广刚 | 2/3 | 4/5 | | | | | | 6/8 | 75.0% | 2 | 8 | 1 | 1 | | 01:00:00 |
| 6 | 赵一涵 | 0/2 | 1/1 | | | 1/2 | 0/1 | | 2/6 | 33.3% | 1 | 1 | | | | 00:35:20 |
| 7 | 卞友山 | | | | | | | | | 0.0% | | | | | | 00:05:09 |
| 11 | 李旭 | | 4/6 | | | | | | 4/6 | 66.7% | | 1 | | | | 00:54:50 |
| 15 | 逯明松 | 0/2 | 1/1 | | | | | | 1/3 | 33.3% | 1 | 3 | | | | 00:24:36 |
| 16 | 马佳鹏 | | | | | | | | | 0.0% | | | | | | 00:52:42 |
| 18 | 李明远 | | | | | | | | | 0.0% | | | | | | 00:00:00 |
| 19 | 陈旭 | 3/11 | 3/6 | 1/1 | | | | 1/1 | 8/19 | 42.1% | 4 | 8 | | | | 01:00:00 |
| 23 | 刘帅 | | | | | | | | | 0.0% | | | | | | 00:00:00 |
| 26 | 吴锐樊 | | 1/2 | | 2/2 | | | | 3/4 | 75.0% | | 1 | 1 | | | 00:51:08 |
| 35 | 高云健 | | | | | | | | | 0.0% | | | | | | 00:07:18 |
| 36 | 王鹏皓 | | 3/5 | 1/3 | 1/1 | | | | 5/9 | 55.6% | | 2 | 1 | | | 00:55:56 |
| 合计 | | | | | | | | | | | | | | | | |
| <i>(守门员)</i> | | | | | | | | | | | | | | | | |
| 16 | 马佳鹏 | 1/5 | 2/14 | 5/10 | 1/8 | 0/2 | | 3/3 | 12/42 | 28.6% | | | | | | 00:52:42 |
| 35 | 高云健 | 0/1 | 1/2 | 1/3 | | | 0/1 | | 2/7 | 28.6% | | | | | | 00:07:18 |
| 合计 | | | | | | | | | | | | | | | | |

场上队员：得分/射门

守门员：救球/射门

| 全队合计 | 得分 | 被救 | 射失 | 击柱 | 封球 | 合计 | % |
|------|----|----|----|----|----|----|--------|
| 远射 | 5 | 7 | 3 | | 3 | 18 | 27.8% |
| 近射 | 17 | 8 | | 1 | | 26 | 65.4% |
| 边射 | 2 | 1 | | 1 | | 4 | 50.0% |
| 快攻 | 3 | | | | | 3 | 100.0% |
| 突破 | 1 | 1 | | | | 2 | 50.0% |
| 任意 | | | 1 | | | 1 | 0.0% |
| 7M | 1 | | | | | 1 | 100.0% |





2016年“体彩杯”全国手球男子青年锦标赛

个人/全队技术统计表

正式表
手球
青年男子预赛
轮次 2组别 B
场次 10201602010-14-2/2
重庆万州
21/03/2016 14:30

| 号码 | 姓名 | 远射 | 近射 | 边射 | 快攻 | 突破 | 任意 | 7M | 合计 | % | 助攻 | 失误 | 警告 | 2' | 取消 | 时间 |
|----------------|-----|------|-------|------|-----|-----|-----|-----|-------|-------|----|----|----|----|----|----------|
| 四川队(四川) | | | | | | | | | | | | | | | | |
| <i>(上场队员)</i> | | | | | | | | | | | | | | | | |
| 1 | 宋继强 | | | | | | | | | 0.0% | | | | | | 00:21:33 |
| 3 | 刘赵梁 | 0/1 | 0/1 | 6/8 | 3/3 | 2/2 | | | 11/15 | 73.3% | | 7 | 1 | | | 01:00:00 |
| 5 | 王凯 | | 2/2 | 0/4 | | | | 0/1 | 2/7 | 28.6% | 1 | 1 | | | | 00:56:18 |
| 7 | 仇瑞祥 | | | 0/1 | | | | 0/1 | 0/2 | 0.0% | | | | | | 00:04:01 |
| 8 | 罗尧尧 | 4/4 | 2/4 | 1/1 | 3/4 | | | | 10/13 | 76.9% | 3 | 1 | | | | 01:00:00 |
| 9 | 许翔宇 | 0/1 | | | | | | | 0/1 | 0.0% | | 2 | 1 | | | 00:06:48 |
| 10 | 徐彦昊 | 0/2 | 3/3 | 0/1 | 1/1 | | | 0/1 | 4/8 | 50.0% | 3 | 3 | | 1 | | 00:53:09 |
| 11 | 张天豪 | | | | | | | | | 0.0% | | | | | | 00:00:00 |
| 12 | 刘树豪 | | | | | | | | | 0.0% | | 1 | | | | 00:38:27 |
| 13 | 尹文珂 | | | | | | | | | 0.0% | | | | | | 00:00:00 |
| 15 | 徐逸 | | | | | | | | | 0.0% | | | | | | 00:00:00 |
| 17 | 谢庆龙 | | 6/9 | | | | | | 6/9 | 66.7% | | 2 | | | | 00:54:46 |
| 18 | 张睿梁 | | | | | | | | | 0.0% | | | | | | 00:04:48 |
| 19 | 庞连康 | 1/1 | | | | | 1/1 | | 2/2 | 100% | | 2 | 1 | 1 | | 01:00:00 |
| 20 | 张文健 | | | | | | | | | 0.0% | | | | | | 00:00:00 |
| 21 | 曹修庆 | | | | | | | | | 0.0% | | | | | | 00:00:00 |
| 合计 | | 5/9 | 13/19 | 7/15 | 7/8 | 2/2 | 1/1 | 0/3 | 35/57 | 61.4% | 7 | 19 | 3 | 2 | | |
| <i>(守门员)</i> | | | | | | | | | | | | | | | | |
| 1 | 宋继强 | 2/3 | 5/11 | | | | | | 7/14 | 50.0% | | | | | | 00:21:33 |
| 12 | 刘树豪 | 5/9 | 3/14 | 1/3 | 0/3 | 1/2 | | 0/1 | 10/32 | 31.3% | | 1 | | | | 00:38:27 |
| 合计 | | 7/12 | 8/25 | 1/3 | 0/3 | 1/2 | | 0/1 | 17/46 | 37.0% | | 1 | | | | |

场上队员：得分/射门

守门员：救球/射门

| 全队合计 | 得分 | 被救 | 射失 | 击柱 | 封球 | 合计 | % |
|------|----|----|----|----|----|----|--------|
| 远射 | 5 | 1 | 2 | | 1 | 9 | 55.6% |
| 近射 | 13 | 3 | 1 | 2 | | 19 | 68.4% |
| 边射 | 7 | 6 | 2 | | | 15 | 46.7% |
| 快攻 | 7 | 1 | | | | 8 | 87.5% |
| 突破 | 2 | | | | | 2 | 100.0% |
| 任意 | 1 | | | | | 1 | 100.0% |
| 7M | | 3 | | | | 3 | 0.0% |





2016年“体彩杯”全国手球男子青年锦标赛

图式射门区域统计

轮次 2 场次 10

201602010-41-1/1

北京队

| | | | | | | | | | | | | | | | | | | | | | | | | | | | | | | | | | | | | | | | | | | | | | | | | | | | | | | | | | | | | | | | | | | | | | | | | | | | | | | | |
|--|-----------------------------|-----------------------------|-----------------------------|-----------------------------|-----------------------------|-----------------------------|-----------------------------|--|--|--|--|--|--|--|---|---|---|---|--|--|--|--|--|--|--|--|---|--|---|--|--|--|--|--|--|--|--|--|--|--|--|---|--|---|--|--|---|---|---|---|--|--|---|--|--|--|--|--|--|--|--|--|--|--|--|--|--|--|--|--|--|--|--|--|--|--|--|--|--|
| 3 王哲一 | 4 朱广刚 | 6 赵一涵 | 7 卞友山 | 11 李旭 | 15 逯明松 | 16 马佳鹏 | 18 李明远 | | | | | | | | | | | | | | | | | | | | | | | | | | | | | | | | | | | | | | | | | | | | | | | | | | | | | | | | | | | | | | | | | | | | | | | | |
| <table border="1"><tr><td></td><td></td><td></td></tr><tr><td></td><td></td><td></td></tr><tr><td></td><td></td><td></td></tr></table> | | | | | | | | | | <table border="1"><tr><td></td><td></td><td></td></tr><tr><td></td><td>2</td><td>2</td></tr><tr><td>1</td><td>1</td><td></td></tr></table> | | | | | 2 | 2 | 1 | 1 | | <table border="1"><tr><td></td><td></td><td></td></tr><tr><td></td><td></td><td></td></tr><tr><td></td><td></td><td>1</td></tr></table> | | | | | | | | | 1 | <table border="1"><tr><td></td><td></td><td></td></tr><tr><td></td><td></td><td></td></tr><tr><td></td><td></td><td></td></tr></table> | | | | | | | | | | <table border="1"><tr><td></td><td></td><td></td></tr><tr><td></td><td></td><td></td></tr><tr><td>1</td><td>1</td><td>2</td></tr></table> | | | | | | | 1 | 1 | 2 | <table border="1"><tr><td></td><td></td><td>1</td></tr><tr><td></td><td></td><td></td></tr><tr><td></td><td></td><td></td></tr></table> | | | 1 | | | | | | | <table border="1"><tr><td></td><td></td><td></td></tr><tr><td></td><td></td><td></td></tr><tr><td></td><td></td><td></td></tr></table> | | | | | | | | | | <table border="1"><tr><td></td><td></td><td></td></tr><tr><td></td><td></td><td></td></tr><tr><td></td><td></td><td></td></tr></table> | | | | | | | | | |
| | | | | | | | | | | | | | | | | | | | | | | | | | | | | | | | | | | | | | | | | | | | | | | | | | | | | | | | | | | | | | | | | | | | | | | | | | | | | | | | |
| | | | | | | | | | | | | | | | | | | | | | | | | | | | | | | | | | | | | | | | | | | | | | | | | | | | | | | | | | | | | | | | | | | | | | | | | | | | | | | | |
| | | | | | | | | | | | | | | | | | | | | | | | | | | | | | | | | | | | | | | | | | | | | | | | | | | | | | | | | | | | | | | | | | | | | | | | | | | | | | | | |
| | | | | | | | | | | | | | | | | | | | | | | | | | | | | | | | | | | | | | | | | | | | | | | | | | | | | | | | | | | | | | | | | | | | | | | | | | | | | | | | |
| | 2 | 2 | | | | | | | | | | | | | | | | | | | | | | | | | | | | | | | | | | | | | | | | | | | | | | | | | | | | | | | | | | | | | | | | | | | | | | | | | | | | | |
| 1 | 1 | | | | | | | | | | | | | | | | | | | | | | | | | | | | | | | | | | | | | | | | | | | | | | | | | | | | | | | | | | | | | | | | | | | | | | | | | | | | | | |
| | | | | | | | | | | | | | | | | | | | | | | | | | | | | | | | | | | | | | | | | | | | | | | | | | | | | | | | | | | | | | | | | | | | | | | | | | | | | | | | |
| | | | | | | | | | | | | | | | | | | | | | | | | | | | | | | | | | | | | | | | | | | | | | | | | | | | | | | | | | | | | | | | | | | | | | | | | | | | | | | | |
| | | 1 | | | | | | | | | | | | | | | | | | | | | | | | | | | | | | | | | | | | | | | | | | | | | | | | | | | | | | | | | | | | | | | | | | | | | | | | | | | | | |
| | | | | | | | | | | | | | | | | | | | | | | | | | | | | | | | | | | | | | | | | | | | | | | | | | | | | | | | | | | | | | | | | | | | | | | | | | | | | | | | |
| | | | | | | | | | | | | | | | | | | | | | | | | | | | | | | | | | | | | | | | | | | | | | | | | | | | | | | | | | | | | | | | | | | | | | | | | | | | | | | | |
| | | | | | | | | | | | | | | | | | | | | | | | | | | | | | | | | | | | | | | | | | | | | | | | | | | | | | | | | | | | | | | | | | | | | | | | | | | | | | | | |
| | | | | | | | | | | | | | | | | | | | | | | | | | | | | | | | | | | | | | | | | | | | | | | | | | | | | | | | | | | | | | | | | | | | | | | | | | | | | | | | |
| | | | | | | | | | | | | | | | | | | | | | | | | | | | | | | | | | | | | | | | | | | | | | | | | | | | | | | | | | | | | | | | | | | | | | | | | | | | | | | | |
| 1 | 1 | 2 | | | | | | | | | | | | | | | | | | | | | | | | | | | | | | | | | | | | | | | | | | | | | | | | | | | | | | | | | | | | | | | | | | | | | | | | | | | | | |
| | | 1 | | | | | | | | | | | | | | | | | | | | | | | | | | | | | | | | | | | | | | | | | | | | | | | | | | | | | | | | | | | | | | | | | | | | | | | | | | | | | |
| | | | | | | | | | | | | | | | | | | | | | | | | | | | | | | | | | | | | | | | | | | | | | | | | | | | | | | | | | | | | | | | | | | | | | | | | | | | | | | | |
| | | | | | | | | | | | | | | | | | | | | | | | | | | | | | | | | | | | | | | | | | | | | | | | | | | | | | | | | | | | | | | | | | | | | | | | | | | | | | | | |
| | | | | | | | | | | | | | | | | | | | | | | | | | | | | | | | | | | | | | | | | | | | | | | | | | | | | | | | | | | | | | | | | | | | | | | | | | | | | | | | |
| | | | | | | | | | | | | | | | | | | | | | | | | | | | | | | | | | | | | | | | | | | | | | | | | | | | | | | | | | | | | | | | | | | | | | | | | | | | | | | | |
| | | | | | | | | | | | | | | | | | | | | | | | | | | | | | | | | | | | | | | | | | | | | | | | | | | | | | | | | | | | | | | | | | | | | | | | | | | | | | | | |
| | | | | | | | | | | | | | | | | | | | | | | | | | | | | | | | | | | | | | | | | | | | | | | | | | | | | | | | | | | | | | | | | | | | | | | | | | | | | | | | |
| | | | | | | | | | | | | | | | | | | | | | | | | | | | | | | | | | | | | | | | | | | | | | | | | | | | | | | | | | | | | | | | | | | | | | | | | | | | | | | | |
| | | | | | | | | | | | | | | | | | | | | | | | | | | | | | | | | | | | | | | | | | | | | | | | | | | | | | | | | | | | | | | | | | | | | | | | | | | | | | | | |
| Post - 0 Miss - 0 Block - 0 | Post - 0 Miss - 0 Block - 1 | Post - 0 Miss - 1 Block - 2 | Post - 0 Miss - 0 Block - 0 | Post - 0 Miss - 0 Block - 0 | Post - 0 Miss - 1 Block - 0 | Post - 0 Miss - 0 Block - 0 | Post - 0 Miss - 0 Block - 0 | | | | | | | | | | | | | | | | | | | | | | | | | | | | | | | | | | | | | | | | | | | | | | | | | | | | | | | | | | | | | | | | | | | | | | | | |
| 19 陈旭 | 23 刘帅 | 26 吴锐樊 | 35 高云健 | 36 王鹏皓 | | | | | | | | | | | | | | | | | | | | | | | | | | | | | | | | | | | | | | | | | | | | | | | | | | | | | | | | | | | | | | | | | | | | | | | | | | | |
| <table border="1"><tr><td>2</td><td></td><td></td></tr><tr><td>2</td><td></td><td>2</td></tr><tr><td>2</td><td></td><td></td></tr></table> | 2 | | | 2 | | 2 | 2 | | | <table border="1"><tr><td></td><td></td><td></td></tr><tr><td></td><td></td><td></td></tr><tr><td></td><td></td><td></td></tr></table> | | | | | | | | | | <table border="1"><tr><td></td><td></td><td></td></tr><tr><td></td><td></td><td></td></tr><tr><td>1</td><td></td><td>1</td></tr></table> | | | | | | | 1 | | 1 | <table border="1"><tr><td></td><td></td><td></td></tr><tr><td></td><td></td><td></td></tr><tr><td></td><td></td><td></td></tr></table> | | | | | | | | | | <table border="1"><tr><td></td><td>1</td><td></td></tr><tr><td>1</td><td></td><td></td></tr><tr><td>1</td><td></td><td>2</td></tr></table> | | 1 | | 1 | | | 1 | | 2 | <table border="1"><tr><td></td><td></td><td></td></tr><tr><td></td><td></td><td></td></tr><tr><td></td><td></td><td></td></tr></table> | | | | | | | | | | <table border="1"><tr><td></td><td></td><td></td></tr><tr><td></td><td></td><td></td></tr><tr><td></td><td></td><td></td></tr></table> | | | | | | | | | | <table border="1"><tr><td></td><td></td><td></td></tr><tr><td></td><td></td><td></td></tr><tr><td></td><td></td><td></td></tr></table> | | | | | | | | | |
| 2 | | | | | | | | | | | | | | | | | | | | | | | | | | | | | | | | | | | | | | | | | | | | | | | | | | | | | | | | | | | | | | | | | | | | | | | | | | | | | | | |
| 2 | | 2 | | | | | | | | | | | | | | | | | | | | | | | | | | | | | | | | | | | | | | | | | | | | | | | | | | | | | | | | | | | | | | | | | | | | | | | | | | | | | |
| 2 | | | | | | | | | | | | | | | | | | | | | | | | | | | | | | | | | | | | | | | | | | | | | | | | | | | | | | | | | | | | | | | | | | | | | | | | | | | | | | | |
| | | | | | | | | | | | | | | | | | | | | | | | | | | | | | | | | | | | | | | | | | | | | | | | | | | | | | | | | | | | | | | | | | | | | | | | | | | | | | | | |
| | | | | | | | | | | | | | | | | | | | | | | | | | | | | | | | | | | | | | | | | | | | | | | | | | | | | | | | | | | | | | | | | | | | | | | | | | | | | | | | |
| | | | | | | | | | | | | | | | | | | | | | | | | | | | | | | | | | | | | | | | | | | | | | | | | | | | | | | | | | | | | | | | | | | | | | | | | | | | | | | | |
| | | | | | | | | | | | | | | | | | | | | | | | | | | | | | | | | | | | | | | | | | | | | | | | | | | | | | | | | | | | | | | | | | | | | | | | | | | | | | | | |
| | | | | | | | | | | | | | | | | | | | | | | | | | | | | | | | | | | | | | | | | | | | | | | | | | | | | | | | | | | | | | | | | | | | | | | | | | | | | | | | |
| 1 | | 1 | | | | | | | | | | | | | | | | | | | | | | | | | | | | | | | | | | | | | | | | | | | | | | | | | | | | | | | | | | | | | | | | | | | | | | | | | | | | | |
| | | | | | | | | | | | | | | | | | | | | | | | | | | | | | | | | | | | | | | | | | | | | | | | | | | | | | | | | | | | | | | | | | | | | | | | | | | | | | | | |
| | | | | | | | | | | | | | | | | | | | | | | | | | | | | | | | | | | | | | | | | | | | | | | | | | | | | | | | | | | | | | | | | | | | | | | | | | | | | | | | |
| | | | | | | | | | | | | | | | | | | | | | | | | | | | | | | | | | | | | | | | | | | | | | | | | | | | | | | | | | | | | | | | | | | | | | | | | | | | | | | | |
| | 1 | | | | | | | | | | | | | | | | | | | | | | | | | | | | | | | | | | | | | | | | | | | | | | | | | | | | | | | | | | | | | | | | | | | | | | | | | | | | | | |
| 1 | | | | | | | | | | | | | | | | | | | | | | | | | | | | | | | | | | | | | | | | | | | | | | | | | | | | | | | | | | | | | | | | | | | | | | | | | | | | | | | |
| 1 | | 2 | | | | | | | | | | | | | | | | | | | | | | | | | | | | | | | | | | | | | | | | | | | | | | | | | | | | | | | | | | | | | | | | | | | | | | | | | | | | | |
| | | | | | | | | | | | | | | | | | | | | | | | | | | | | | | | | | | | | | | | | | | | | | | | | | | | | | | | | | | | | | | | | | | | | | | | | | | | | | | | |
| | | | | | | | | | | | | | | | | | | | | | | | | | | | | | | | | | | | | | | | | | | | | | | | | | | | | | | | | | | | | | | | | | | | | | | | | | | | | | | | |
| | | | | | | | | | | | | | | | | | | | | | | | | | | | | | | | | | | | | | | | | | | | | | | | | | | | | | | | | | | | | | | | | | | | | | | | | | | | | | | | |
| | | | | | | | | | | | | | | | | | | | | | | | | | | | | | | | | | | | | | | | | | | | | | | | | | | | | | | | | | | | | | | | | | | | | | | | | | | | | | | | |
| | | | | | | | | | | | | | | | | | | | | | | | | | | | | | | | | | | | | | | | | | | | | | | | | | | | | | | | | | | | | | | | | | | | | | | | | | | | | | | | |
| | | | | | | | | | | | | | | | | | | | | | | | | | | | | | | | | | | | | | | | | | | | | | | | | | | | | | | | | | | | | | | | | | | | | | | | | | | | | | | | |
| | | | | | | | | | | | | | | | | | | | | | | | | | | | | | | | | | | | | | | | | | | | | | | | | | | | | | | | | | | | | | | | | | | | | | | | | | | | | | | | |
| | | | | | | | | | | | | | | | | | | | | | | | | | | | | | | | | | | | | | | | | | | | | | | | | | | | | | | | | | | | | | | | | | | | | | | | | | | | | | | | |
| | | | | | | | | | | | | | | | | | | | | | | | | | | | | | | | | | | | | | | | | | | | | | | | | | | | | | | | | | | | | | | | | | | | | | | | | | | | | | | | |
| Post - 1 Miss - 2 Block - 0 | Post - 0 Miss - 0 Block - 0 | Post - 0 Miss - 0 Block - 0 | Post - 0 Miss - 0 Block - 0 | Post - 1 Miss - 0 Block - 0 | | | | | | | | | | | | | | | | | | | | | | | | | | | | | | | | | | | | | | | | | | | | | | | | | | | | | | | | | | | | | | | | | | | | | | | | | | | |

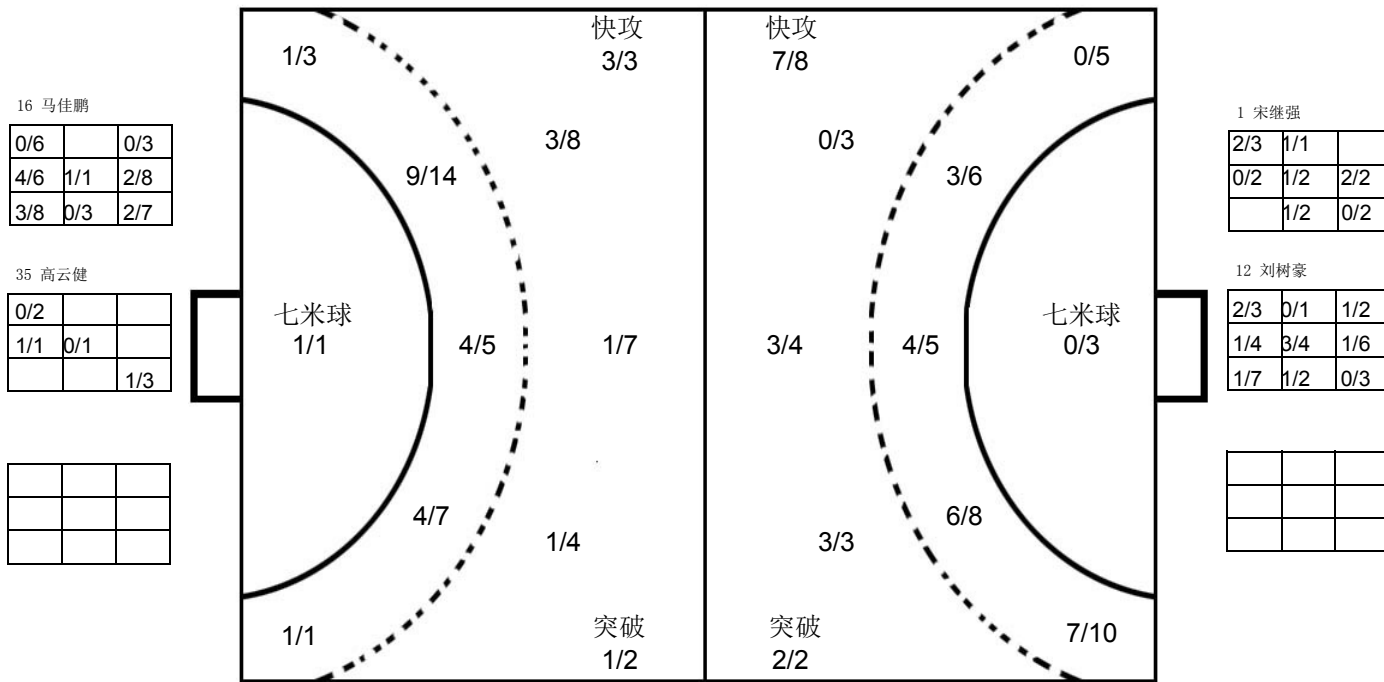

四川队

| | | | | | | | | | | | | | | | | | | | | | | | | | | | | | | | | | | | | | | | | | | | | | | | | | | | | | | | | | | | | | | | | | | | | | | | | | | | | | | | |
|--|-----------------------------|-----------------------------|-----------------------------|-----------------------------|-----------------------------|-----------------------------|-----------------------------|--|--|---|--|--|---|--|--|---|---|---|---|--|---|--|--|---|--|--|--|--|--|--|--|--|--|---|--|---|---|---|--|---|---|--|---|--|---|---|---|---|---|--|--|---|--|--|--|--|---|--|--|--|--|--|--|--|--|--|---|--|---|--|--|--|--|--|--|--|--|--|--|
| 1 宋继强 | 3 刘赵梁 | 5 王凯 | 7 仇瑞祥 | 8 罗尧尧 | 9 许翔宇 | 10 徐彦昊 | 11 张天豪 | | | | | | | | | | | | | | | | | | | | | | | | | | | | | | | | | | | | | | | | | | | | | | | | | | | | | | | | | | | | | | | | | | | | | | | | |
| <table border="1"><tr><td></td><td></td><td></td></tr><tr><td></td><td></td><td></td></tr><tr><td></td><td></td><td></td></tr></table> | | | | | | | | | | <table border="1"><tr><td></td><td></td><td>1</td></tr><tr><td></td><td></td><td>2</td></tr><tr><td>2</td><td>1</td><td>5</td></tr></table> | | | 1 | | | 2 | 2 | 1 | 5 | <table border="1"><tr><td>1</td><td></td><td></td></tr><tr><td>1</td><td></td><td></td></tr><tr><td></td><td></td><td></td></tr></table> | 1 | | | 1 | | | | | | <table border="1"><tr><td></td><td></td><td></td></tr><tr><td></td><td></td><td></td></tr><tr><td></td><td></td><td></td></tr></table> | | | | | | | | | | <table border="1"><tr><td>3</td><td></td><td>1</td></tr><tr><td></td><td>1</td><td>1</td></tr><tr><td>1</td><td>1</td><td>2</td></tr></table> | 3 | | 1 | | 1 | 1 | 1 | 1 | 2 | <table border="1"><tr><td></td><td></td><td></td></tr><tr><td></td><td></td><td></td></tr><tr><td></td><td></td><td></td></tr></table> | | | | | | | | | | <table border="1"><tr><td></td><td></td><td></td></tr><tr><td></td><td></td><td></td></tr><tr><td>3</td><td></td><td>1</td></tr></table> | | | | | | | 3 | | 1 | <table border="1"><tr><td></td><td></td><td></td></tr><tr><td></td><td></td><td></td></tr><tr><td></td><td></td><td></td></tr></table> | | | | | | | | | |
| | | | | | | | | | | | | | | | | | | | | | | | | | | | | | | | | | | | | | | | | | | | | | | | | | | | | | | | | | | | | | | | | | | | | | | | | | | | | | | | |
| | | | | | | | | | | | | | | | | | | | | | | | | | | | | | | | | | | | | | | | | | | | | | | | | | | | | | | | | | | | | | | | | | | | | | | | | | | | | | | | |
| | | | | | | | | | | | | | | | | | | | | | | | | | | | | | | | | | | | | | | | | | | | | | | | | | | | | | | | | | | | | | | | | | | | | | | | | | | | | | | | |
| | | 1 | | | | | | | | | | | | | | | | | | | | | | | | | | | | | | | | | | | | | | | | | | | | | | | | | | | | | | | | | | | | | | | | | | | | | | | | | | | | | |
| | | 2 | | | | | | | | | | | | | | | | | | | | | | | | | | | | | | | | | | | | | | | | | | | | | | | | | | | | | | | | | | | | | | | | | | | | | | | | | | | | | |
| 2 | 1 | 5 | | | | | | | | | | | | | | | | | | | | | | | | | | | | | | | | | | | | | | | | | | | | | | | | | | | | | | | | | | | | | | | | | | | | | | | | | | | | | |
| 1 | | | | | | | | | | | | | | | | | | | | | | | | | | | | | | | | | | | | | | | | | | | | | | | | | | | | | | | | | | | | | | | | | | | | | | | | | | | | | | | |
| 1 | | | | | | | | | | | | | | | | | | | | | | | | | | | | | | | | | | | | | | | | | | | | | | | | | | | | | | | | | | | | | | | | | | | | | | | | | | | | | | | |
| | | | | | | | | | | | | | | | | | | | | | | | | | | | | | | | | | | | | | | | | | | | | | | | | | | | | | | | | | | | | | | | | | | | | | | | | | | | | | | | |
| | | | | | | | | | | | | | | | | | | | | | | | | | | | | | | | | | | | | | | | | | | | | | | | | | | | | | | | | | | | | | | | | | | | | | | | | | | | | | | | |
| | | | | | | | | | | | | | | | | | | | | | | | | | | | | | | | | | | | | | | | | | | | | | | | | | | | | | | | | | | | | | | | | | | | | | | | | | | | | | | | |
| | | | | | | | | | | | | | | | | | | | | | | | | | | | | | | | | | | | | | | | | | | | | | | | | | | | | | | | | | | | | | | | | | | | | | | | | | | | | | | | |
| 3 | | 1 | | | | | | | | | | | | | | | | | | | | | | | | | | | | | | | | | | | | | | | | | | | | | | | | | | | | | | | | | | | | | | | | | | | | | | | | | | | | | |
| | 1 | 1 | | | | | | | | | | | | | | | | | | | | | | | | | | | | | | | | | | | | | | | | | | | | | | | | | | | | | | | | | | | | | | | | | | | | | | | | | | | | | |
| 1 | 1 | 2 | | | | | | | | | | | | | | | | | | | | | | | | | | | | | | | | | | | | | | | | | | | | | | | | | | | | | | | | | | | | | | | | | | | | | | | | | | | | | |
| | | | | | | | | | | | | | | | | | | | | | | | | | | | | | | | | | | | | | | | | | | | | | | | | | | | | | | | | | | | | | | | | | | | | | | | | | | | | | | | |
| | | | | | | | | | | | | | | | | | | | | | | | | | | | | | | | | | | | | | | | | | | | | | | | | | | | | | | | | | | | | | | | | | | | | | | | | | | | | | | | |
| | | | | | | | | | | | | | | | | | | | | | | | | | | | | | | | | | | | | | | | | | | | | | | | | | | | | | | | | | | | | | | | | | | | | | | | | | | | | | | | |
| | | | | | | | | | | | | | | | | | | | | | | | | | | | | | | | | | | | | | | | | | | | | | | | | | | | | | | | | | | | | | | | | | | | | | | | | | | | | | | | |
| | | | | | | | | | | | | | | | | | | | | | | | | | | | | | | | | | | | | | | | | | | | | | | | | | | | | | | | | | | | | | | | | | | | | | | | | | | | | | | | |
| 3 | | 1 | | | | | | | | | | | | | | | | | | | | | | | | | | | | | | | | | | | | | | | | | | | | | | | | | | | | | | | | | | | | | | | | | | | | | | | | | | | | | |
| | | | | | | | | | | | | | | | | | | | | | | | | | | | | | | | | | | | | | | | | | | | | | | | | | | | | | | | | | | | | | | | | | | | | | | | | | | | | | | | |
| | | | | | | | | | | | | | | | | | | | | | | | | | | | | | | | | | | | | | | | | | | | | | | | | | | | | | | | | | | | | | | | | | | | | | | | | | | | | | | | |
| | | | | | | | | | | | | | | | | | | | | | | | | | | | | | | | | | | | | | | | | | | | | | | | | | | | | | | | | | | | | | | | | | | | | | | | | | | | | | | | |
| Post - 0 Miss - 0 Block - 0 | Post - 0 Miss - 3 Block - 0 | Post - 0 Miss - 0 Block - 0 | Post - 0 Miss - 0 Block - 0 | Post - 1 Miss - 0 Block - 0 | Post - 0 Miss - 0 Block - 0 | Post - 0 Miss - 2 Block - 1 | Post - 0 Miss - 0 Block - 0 | | | | | | | | | | | | | | | | | | | | | | | | | | | | | | | | | | | | | | | | | | | | | | | | | | | | | | | | | | | | | | | | | | | | | | | | |
| 12 刘树豪 | 13 尹文珂 | 15 徐逸 | 17 谢庆龙 | 18 张睿梁 | 19 庞连康 | 20 张文健 | 21 曹修庆 | | | | | | | | | | | | | | | | | | | | | | | | | | | | | | | | | | | | | | | | | | | | | | | | | | | | | | | | | | | | | | | | | | | | | | | | |
| <table border="1"><tr><td></td><td></td><td></td></tr><tr><td></td><td></td><td></td></tr><tr><td></td><td></td><td></td></tr></table> | | | | | | | | | | <table border="1"><tr><td></td><td></td><td></td></tr><tr><td></td><td></td><td></td></tr><tr><td></td><td></td><td></td></tr></table> | | | | | | | | | | <table border="1"><tr><td></td><td></td><td></td></tr><tr><td></td><td></td><td></td></tr><tr><td></td><td></td><td></td></tr></table> | | | | | | | | | | <table border="1"><tr><td></td><td></td><td></td></tr><tr><td>1</td><td></td><td>3</td></tr><tr><td>1</td><td>1</td><td></td></tr></table> | | | | 1 | | 3 | 1 | 1 | | <table border="1"><tr><td></td><td></td><td></td></tr><tr><td></td><td></td><td></td></tr><tr><td></td><td></td><td></td></tr></table> | | | | | | | | | | <table border="1"><tr><td></td><td>1</td><td></td></tr><tr><td></td><td></td><td></td></tr><tr><td>1</td><td></td><td></td></tr></table> | | 1 | | | | | 1 | | | <table border="1"><tr><td></td><td></td><td></td></tr><tr><td></td><td></td><td></td></tr><tr><td></td><td></td><td></td></tr></table> | | | | | | | | | | <table border="1"><tr><td></td><td></td><td></td></tr><tr><td></td><td></td><td></td></tr><tr><td></td><td></td><td></td></tr></table> | | | | | | | | | |
| | | | | | | | | | | | | | | | | | | | | | | | | | | | | | | | | | | | | | | | | | | | | | | | | | | | | | | | | | | | | | | | | | | | | | | | | | | | | | | | |
| | | | | | | | | | | | | | | | | | | | | | | | | | | | | | | | | | | | | | | | | | | | | | | | | | | | | | | | | | | | | | | | | | | | | | | | | | | | | | | | |
| | | | | | | | | | | | | | | | | | | | | | | | | | | | | | | | | | | | | | | | | | | | | | | | | | | | | | | | | | | | | | | | | | | | | | | | | | | | | | | | |
| | | | | | | | | | | | | | | | | | | | | | | | | | | | | | | | | | | | | | | | | | | | | | | | | | | | | | | | | | | | | | | | | | | | | | | | | | | | | | | | |
| | | | | | | | | | | | | | | | | | | | | | | | | | | | | | | | | | | | | | | | | | | | | | | | | | | | | | | | | | | | | | | | | | | | | | | | | | | | | | | | |
| | | | | | | | | | | | | | | | | | | | | | | | | | | | | | | | | | | | | | | | | | | | | | | | | | | | | | | | | | | | | | | | | | | | | | | | | | | | | | | | |
| | | | | | | | | | | | | | | | | | | | | | | | | | | | | | | | | | | | | | | | | | | | | | | | | | | | | | | | | | | | | | | | | | | | | | | | | | | | | | | | |
| | | | | | | | | | | | | | | | | | | | | | | | | | | | | | | | | | | | | | | | | | | | | | | | | | | | | | | | | | | | | | | | | | | | | | | | | | | | | | | | |
| | | | | | | | | | | | | | | | | | | | | | | | | | | | | | | | | | | | | | | | | | | | | | | | | | | | | | | | | | | | | | | | | | | | | | | | | | | | | | | | |
| | | | | | | | | | | | | | | | | | | | | | | | | | | | | | | | | | | | | | | | | | | | | | | | | | | | | | | | | | | | | | | | | | | | | | | | | | | | | | | | |
| 1 | | 3 | | | | | | | | | | | | | | | | | | | | | | | | | | | | | | | | | | | | | | | | | | | | | | | | | | | | | | | | | | | | | | | | | | | | | | | | | | | | | |
| 1 | 1 | | | | | | | | | | | | | | | | | | | | | | | | | | | | | | | | | | | | | | | | | | | | | | | | | | | | | | | | | | | | | | | | | | | | | | | | | | | | | | |
| | | | | | | | | | | | | | | | | | | | | | | | | | | | | | | | | | | | | | | | | | | | | | | | | | | | | | | | | | | | | | | | | | | | | | | | | | | | | | | | |
| | | | | | | | | | | | | | | | | | | | | | | | | | | | | | | | | | | | | | | | | | | | | | | | | | | | | | | | | | | | | | | | | | | | | | | | | | | | | | | | |
| | | | | | | | | | | | | | | | | | | | | | | | | | | | | | | | | | | | | | | | | | | | | | | | | | | | | | | | | | | | | | | | | | | | | | | | | | | | | | | | |
| | 1 | | | | | | | | | | | | | | | | | | | | | | | | | | | | | | | | | | | | | | | | | | | | | | | | | | | | | | | | | | | | | | | | | | | | | | | | | | | | | | |
| | | | | | | | | | | | | | | | | | | | | | | | | | | | | | | | | | | | | | | | | | | | | | | | | | | | | | | | | | | | | | | | | | | | | | | | | | | | | | | | |
| 1 | | | | | | | | | | | | | | | | | | | | | | | | | | | | | | | | | | | | | | | | | | | | | | | | | | | | | | | | | | | | | | | | | | | | | | | | | | | | | | | |
| | | | | | | | | | | | | | | | | | | | | | | | | | | | | | | | | | | | | | | | | | | | | | | | | | | | | | | | | | | | | | | | | | | | | | | | | | | | | | | | |
| | | | | | | | | | | | | | | | | | | | | | | | | | | | | | | | | | | | | | | | | | | | | | | | | | | | | | | | | | | | | | | | | | | | | | | | | | | | | | | | |
| | | | | | | | | | | | | | | | | | | | | | | | | | | | | | | | | | | | | | | | | | | | | | | | | | | | | | | | | | | | | | | | | | | | | | | | | | | | | | | | |
| | | | | | | | | | | | | | | | | | | | | | | | | | | | | | | | | | | | | | | | | | | | | | | | | | | | | | | | | | | | | | | | | | | | | | | | | | | | | | | | |
| | | | | | | | | | | | | | | | | | | | | | | | | | | | | | | | | | | | | | | | | | | | | | | | | | | | | | | | | | | | | | | | | | | | | | | | | | | | | | | | |
| | | | | | | | | | | | | | | | | | | | | | | | | | | | | | | | | | | | | | | | | | | | | | | | | | | | | | | | | | | | | | | | | | | | | | | | | | | | | | | | |
| Post - 0 Miss - 0 Block - 0 | Post - 0 Miss - 0 Block - 0 | Post - 0 Miss - 0 Block - 0 | Post - 1 Miss - 0 Block - 0 | Post - 0 Miss - 0 Block - 0 | Post - 0 Miss - 0 Block - 0 | Post - 0 Miss - 0 Block - 0 | Post - 0 Miss - 0 Block - 0 | | | | | | | | | | | | | | | | | | | | | | | | | | | | | | | | | | | | | | | | | | | | | | | | | | | | | | | | | | | | | | | | | | | | | | | | |

注释: Post=击柱 Miss=射失 Block=被封



预赛 Group B
青年男子 全国比赛

2016年“体彩杯”全国手球男子青年锦标赛

| | | | | | | | | | | | | | | | | | | | | | |
|------------------------|---|---------------------|---------------------|------------------------|------------------------------------|-------------------|----------|---------------------------|----------------|----------|----------|----------------------|---------------|----------|--|--|---|---|----|----------|----|
| Team A A 新疆队 | | | | Team B B 安徽队 | | | | Match Number 11 | | | | | | | | | | | | | |
| played in China | | in the hall 重庆万州 | | on 21/03/2016 | | at 16:00 hours | | Spectators | | | | | | | | | | | | | |
| Half-time (30') | A 15 | B 15 | End of playing time | A 39 | B 32 | 1st extra time | A | B | 2nd extra time | A | B | After penalty throws | A | B | | | | | | | |
| Number of 7 m | A 3 / 3 | Team time-out | | | Full name of players and officials | | | | Team time-out | | | B 0 / 1 | Number of 7 m | | | | | | | | |
| | | 1 | 2 | 3 | | | | | 1 | 2 | 3 | | | | | | | | | | |
| | | 50:11 57:49 | | | | | | | 27:18 45:00 | | | | | | | | | | | | |
| No. | Team A | | | | | G | W | 2' | D | DR | No. | Team B | | | | | G | W | 2' | D | DR |
| 1 | 宋晓晨 | | | | | | | | | | 1 | 郭世伟 | | | | | 5 | | 1 | | |
| 2 | 王泽川 | | | | | | | | | | 2 | 金勇峰 | | | | | 1 | | 2 | | |
| 4 | 谷通金 | | | | | | | | | | 9 | 陈开勇 | | | | | | | | | |
| 5 | 徐伟 | | | | | 10 | | | | | 17 | 王巨柱 | | | | | 8 | | | | |
| 6 | 白光宇 | | | | | | | | | | 18 | 李双 | | | | | 9 | 1 | 1 | | |
| 7 | 林豪文 | | | | | 10 | 1 | 2 | | | 19 | 何山 | | | | | 1 | | | | |
| 10 | 王钟彬 | | | | | 7 | 1 | 2 | | | 21 | 李明 | | | | | | | | | |
| 12 | 王金鑫 | | | | | | | | | | 24 | 徐安格 | | | | | 4 | 1 | 1 | | |
| 13 | 苏兴伟 | | | | | | | | | | 25 | 李文哲 | | | | | | | | | |
| 15 | 王维东 | | | | | 3 | | | | | 26 | 程浩然 | | | | | 3 | | | | |
| 16 | 李佳懿 | | | | | | | | | | 27 | 王长旭 | | | | | 1 | | | | |
| 17 | 胡晋铭 | | | | | 1 | 1 | | | | 28 | 丁浩然 | | | | | | | | | |
| 18 | 李万兴 | | | | | | | | | | 32 | 许浩翔 | | | | | | | | | |
| 19 | 李龙吉 | | | | | 8 | | | | | 33 | 姚紫祥 | | | | | | | | | |
| 24 | 陈伟华 | | | | | | | | | | 41 | 刘润民 | | | | | | | | | |
| | | | | | | | | | | | 42 | 王成龙 | | | | | | | | | |
| A | 孔德斌 (主教练) | | | | | | | | | | A | 王来黔 (主教练) | | | | | 1 | 1 | | | |
| B | 陈鹏波 | | | | | | | | | | B | 陆万红 | | | | | | | | | |
| C | 李楠 | | | | | | | | | | C | 吴翔 | | | | | | | | | |
| A | Signature of Responsible Official of the Teams (Off. A) | | | | | | | | | | | | | | | | | | | B | |
| TP | Remarks of Referee / CHA Official | | | | | | | | | | | | | | | | | | | TP | |

Signatures

| | | | | |
|------------------|-----------|----------|--|--|
| Referees | 汤怡 (CHN) | 缪俊 (CHN) | | |
| Techn. Delegates | 徐健 (CHN) | | | |
| CHA Official | 吴瑞亭 (CHN) | | | |

Note: Number of 7m Throws Awarded to Team A and B, Goals (G), Warnings (W), Suspensions (2'), Direct Disqualification (D), Disqualification with Report (DR) and Team Penalty (TP).

Table Officials:

Statisticians: 李双

刘永欢





2016年“体彩杯”全国手球男子青年锦标赛
竞赛技术统计(媒体表)

| | | | | | | |
|----------------|----|----|------------|----|----|------------------|
| 预赛 | 组别 | B | 轮次 | 2 | 场次 | 11 |
| 重庆万州 | | | 21/03/2016 | | | 201602011-51-1/1 |
| 新疆队 | 新疆 | 39 | vs | 32 | 安徽 | 安徽队 |
| 15 : 15 | | | | | | |

| | | | |
|-----|----------|---|----------|
| 裁判员 | 汤怡 (CHN) | / | 缪俊 (CHN) |
|-----|----------|---|----------|

| 新疆 | | 远射 | 近射 | 边射 | 快攻 | 突破 | 任意球 | 7m球 | 合计 | % | 助攻 | 失误 | 警告 | 2' | D & DR | 新疆 | 比赛进程 | 安徽 |
|----------|-----|------|------|------|-----|-----|-----|-------|-------|------|----|----|----|----|--------|----|----------|-----------|
| 主教练: 孔德斌 | | | | | | | | | | | | | | | | | 1st Half | |
| 1 | 宋晓晨 | | | | | | | | | | 1 | | | | | 10 | 00:47 | 1 郭世伟 |
| 2 | 王泽川 | | | | | | | | | | | | | | | 1 | 01:15 | 1 |
| 4 | 谷通金 | | | | | | | | | | | | | | | 15 | 01:57 | 1 |
| 5 | 徐伟 | | 1/1 | 8/11 | 1/2 | | | 10/14 | 71.4 | 1 | 1 | | | | | 7 | 03:20 | 1 |
| 6 | 白光宇 | | | | | | | | | | | | | | | 3 | 04:07 | 2 19 何山 |
| 7 | 林豪文 | 6/11 | 1/2 | | | 1/2 | | 2/2 | 10/17 | 58.8 | 5 | 3 | 1 | 2 | | 3 | 05:54 | 3 17 王巨柱 |
| 10 | 王钟彬 | 1/2 | 3/5 | | 1/2 | 2/2 | | 7/11 | 63.6 | 1 | 2 | 1 | 2 | | | 4 | 08:36 | 4 24 徐安格 |
| 12 | 王金鑫 | | | | | | | | | | | | | | | 4 | 09:13 | 5 1 郭世伟 |
| 13 | 苏兴伟 | | | | | | | | | | | | | | | 5 | 10:44 | 5 |
| 15 | 王维东 | | 1/1 | 1/2 | | 1/1 | | 3/4 | 75.0 | | | | | | | 6 | 11:45 | 6 24 徐安格 |
| 16 | 李佳懿 | | | | | | | | | | | | | | | 10 | 12:31 | 6 |
| 17 | 胡晋铭 | | 1/3 | | | | | 1/3 | 33.3 | | 2 | 1 | | | | 7 | 14:20 | 7 17 王巨柱 |
| 18 | 李万兴 | | | | | | | | | | | | | | | 5 | 14:28 | 7 |
| 19 | 李龙吉 | | 2/4 | | 1/2 | 4/4 | 1/1 | 8/11 | 72.7 | 1 | 7 | | | | | 9 | 16:09 | 7 |
| 24 | 陈伟华 | | | | | | | | | | | | | | | 5 | 16:38 | 8 18 李双 |
| 运动员 合计 | | 7/13 | 9/16 | 9/13 | 3/6 | 8/9 | 3/3 | 39/60 | 65.0 | 9 | 15 | 3 | 4 | | | 7 | 17:14 | 8 |
| 1 | 宋晓晨 | 5/9 | 3/12 | 3/9 | 0/5 | 2/7 | 0/3 | 1/1 | 14/46 | 30.4 | 1 | | | | | 10 | 17:38 | 9 17 王巨柱 |
| 守门员 合计 | | 5/9 | 3/12 | 3/9 | 0/5 | 2/7 | 0/3 | 1/1 | 14/46 | 30.4 | 1 | | | | | 19 | 18:12 | 9 |
| 安徽 | | | | | | | | | | | | | | | | 11 | 19:23 | 10 24 徐安格 |
| 教练: 王来黔 | | | | | | | | | | | | | | | | 11 | 20:49 | 11 郭世伟 |
| 1 | 郭世伟 | 2/7 | 1/2 | 1/1 | 1/1 | | | 0/1 | 5/12 | 41.7 | 2 | 1 | | 1 | | 12 | 21:49 | 11 |
| 2 | 金勇峰 | 0/1 | 1/1 | 0/4 | | | | 1/6 | 16.7 | | | | | 2 | | 12 | 22:27 | 12 1 郭世伟 |
| 9 | 陈开勇 | | | | | | | | | | | | | | | 13 | 23:16 | 12 |
| 17 | 王巨柱 | 2/7 | 0/2 | | 2/2 | 3/3 | 1/1 | 8/15 | 53.3 | 3 | 4 | | | | | 10 | 27:07 | 12 |
| 18 | 李双 | 0/2 | 3/3 | 1/2 | 1/1 | 2/4 | 2/2 | 9/14 | 64.3 | 2 | 3 | 1 | 1 | | | 14 | 27:39 | 13 17 王巨柱 |
| 19 | 何山 | | | 1/2 | | | | 1/2 | 50.0 | | | | | | | 5 | 28:08 | 13 |
| 24 | 徐安格 | 0/1 | 3/5 | | 1/1 | | | 4/7 | 57.1 | | 2 | 1 | 1 | | | 15 | 28:19 | 14 18 李双 |
| 25 | 李文哲 | | | | | | | | | | | | | | | 15 | 28:29 | 14 18 李双 |
| 26 | 程浩然 | | 1/1 | 2/3 | | 0/1 | | 3/5 | 60.0 | | 2 | | | | | 15 | 29:32 | 15 24 徐安格 |
| 27 | 王长旭 | | | 1/1 | | | | 1/1 | 100 | | | | | | | | | |
| 28 | 丁浩然 | | | | | | | | | | | | | | | | | |
| 32 | 许浩翔 | | | | | | | | | | | | | | | | | |
| 33 | 姚紫祥 | | | | | | | | | | | | | | | | | |
| 41 | 刘润民 | | | | | | | | | | | | | | | | | |
| 42 | 王成龙 | | | | | | | | | | | | | | | | | |
| 运动员 合计 | | 4/18 | 9/14 | 6/13 | 5/5 | 5/8 | 3/3 | 0/1 | 32/62 | 51.6 | 7 | 15 | 2 | 5 | | | | |
| 21 | 李明 | 3/8 | 6/14 | 2/11 | 2/4 | 0/8 | | 0/2 | 13/47 | 27.7 | | | | | | | | |
| 32 | 许浩翔 | 1/3 | 0/1 | | 0/1 | | | 0/1 | 1/6 | 16.7 | | | | | | | | |
| 守门员 合计 | | 4/11 | 6/15 | 2/11 | 2/5 | 0/8 | | 0/3 | 14/53 | 26.4 | | | | | | | | |

场上队员: 得分 / 射门

守门员: 救球 / 射门

| | | | | | | | | | |
|----|------------|----|--------------|-----|------------|-----|----------|----|---------|
| 快攻 | Fast Break | 突破 | Breakthrough | 任意球 | Free Throw | 7M球 | 7M Throw | 助攻 | Assist |
| 警告 | Warning | 失误 | Error | 2' | Suspension | D | 取消资格 | DR | 取消资格+报告 |





2016年“体彩杯”全国手球男子青年锦标赛 图式比赛技术统计表

轮次 2

场次 11

201602011-21-1/1

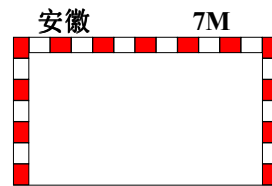
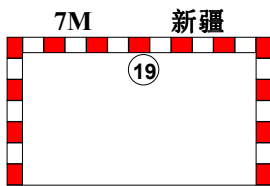
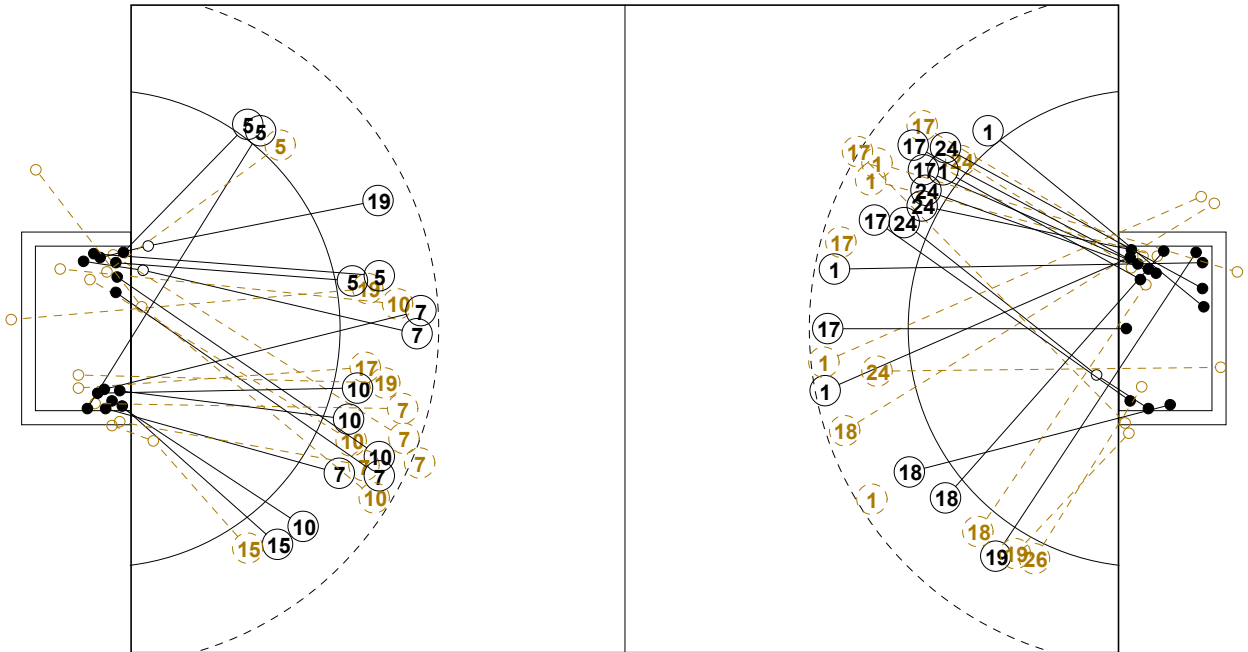

1st Half
15 : 15

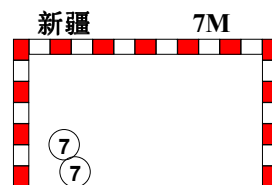
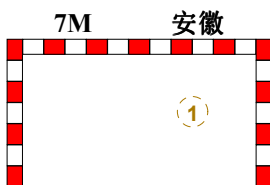
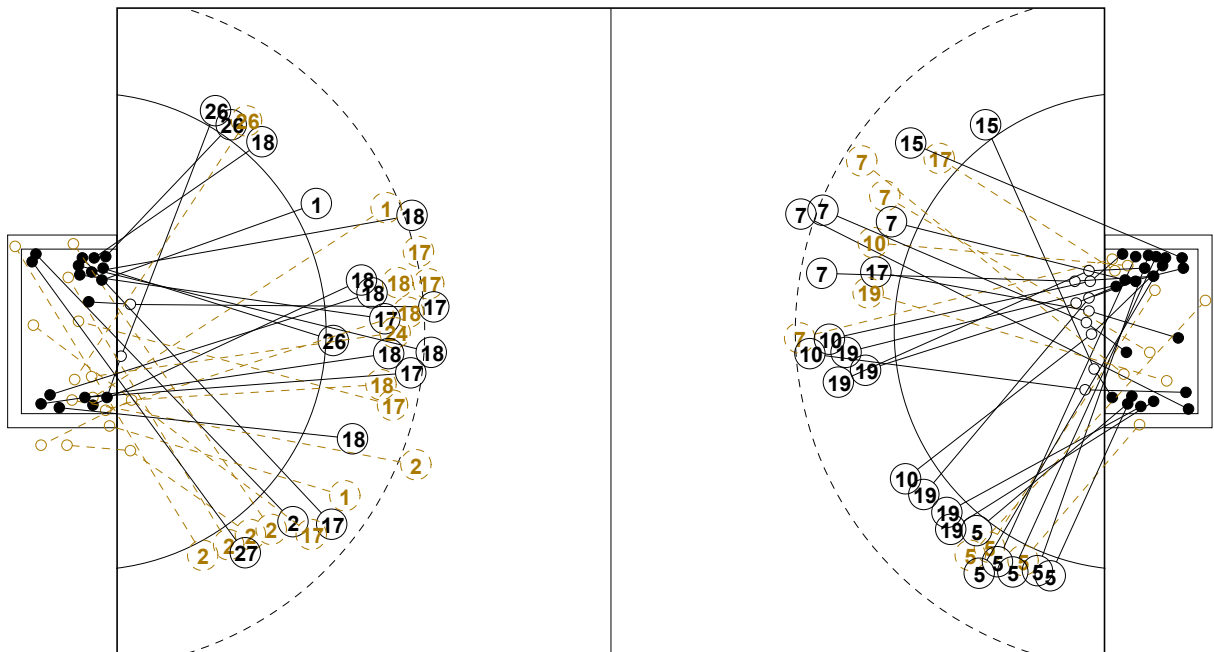

2nd Half
32 : 39



2016年“体彩杯”全国手球男子青年锦标赛

个人/全队技术统计表

正式表
手球
青年男子预赛
轮次 2组别 B
场次 11201602011-14-1/2
重庆万州
21/03/2016 16:00

| 号码 | 姓名 | 远射 | 近射 | 边射 | 快攻 | 突破 | 任意 | 7M | 合计 | % | 助攻 | 失误 | 警告 | 2' | 取消 | 时间 |
|----------------|-----|------|------|------|-----|-----|-----|-----|-------|-------|----|----|----|----|----|----------|
| 新疆队(新疆) | | | | | | | | | | | | | | | | |
| <i>(场上队员)</i> | | | | | | | | | | | | | | | | |
| 1 | 宋晓晨 | | | | | | | | | 0.0% | 1 | | | | | 01:00:00 |
| 2 | 王泽川 | | | | | | | | | 0.0% | | | | | | 00:00:00 |
| 4 | 谷通金 | | | | | | | | | 0.0% | | | | | | 00:04:36 |
| 5 | 徐伟 | | 1/1 | 8/11 | 1/2 | | | | 10/14 | 71.4% | 1 | 1 | | | | 01:00:00 |
| 6 | 白光宇 | | | | | | | | | 0.0% | | | | | | 00:00:00 |
| 7 | 林豪文 | 6/11 | 1/2 | | | 1/2 | | 2/2 | 10/17 | 58.8% | 5 | 3 | 1 | 2 | | 01:00:00 |
| 10 | 王钟彬 | 1/2 | 3/5 | | 1/2 | 2/2 | | | 7/11 | 63.6% | 1 | 2 | 1 | 2 | | 00:59:10 |
| 12 | 王金鑫 | | | | | | | | | 0.0% | | | | | | 00:00:00 |
| 13 | 苏兴伟 | | | | | | | | | 0.0% | | | | | | 00:00:00 |
| 15 | 王维东 | | 1/1 | 1/2 | | 1/1 | | | 3/4 | 75.0% | | | | | | 00:56:11 |
| 16 | 李佳懿 | | | | | | | | | 0.0% | | | | | | 00:00:00 |
| 17 | 胡晋铭 | | 1/3 | | | | | | 1/3 | 33.3% | | 2 | 1 | | | 01:00:00 |
| 18 | 李万兴 | | | | | | | | | 0.0% | | | | | | 00:00:00 |
| 19 | 李龙吉 | | 2/4 | | 1/2 | 4/4 | | 1/1 | 8/11 | 72.7% | 1 | 7 | | | | 01:00:00 |
| 24 | 陈伟华 | | | | | | | | | 0.0% | | | | | | 00:00:00 |
| 合计 | | 7/13 | 9/16 | 9/13 | 3/6 | 8/9 | | 3/3 | 39/60 | 65.0% | 9 | 15 | 3 | 4 | | |
| <i>(守门员)</i> | | | | | | | | | | | | | | | | |
| 1 | 宋晓晨 | 5/9 | 3/12 | 3/9 | 0/5 | 2/7 | 0/3 | 1/1 | 14/46 | 30.4% | 1 | | | | | 01:00:00 |
| 合计 | | 5/9 | 3/12 | 3/9 | 0/5 | 2/7 | 0/3 | 1/1 | 14/46 | 30.4% | 1 | | | | | |

场上队员：得分/射门

守门员：救球/射门

| 全队合计 | 得分 | 被救 | 射失 | 击柱 | 封球 | 合计 | % |
|------|----|----|----|----|----|----|--------|
| 远射 | 7 | 4 | 1 | | 1 | 13 | 53.8% |
| 近射 | 9 | 6 | 1 | | | 16 | 56.3% |
| 边射 | 9 | 2 | | 2 | | 13 | 69.2% |
| 快攻 | 3 | 2 | | 1 | | 6 | 50.0% |
| 突破 | 8 | | | 1 | | 9 | 88.9% |
| 任意 | | | | | | | 0.0% |
| 7M | 3 | | | | | 3 | 100.0% |





2016年“体彩杯”全国手球男子青年锦标赛

个人/全队技术统计表

正式表
手球
青年男子预赛
轮次 2组别 B
场次 11201602011-14-2/2
重庆万州
21/03/2016 16:00

| 号码 | 姓名 | 远射 | 近射 | 边射 | 快攻 | 突破 | 任意 | 7M | 合计 | % | 助攻 | 失误 | 警告 | 2' | 取消 | 时间 |
|----------------|-----|------|------|------|-----|-----|-----|-----|-------|-------|----|----|----|----|----|----------|
| 安徽队(安徽) | | | | | | | | | | | | | | | | |
| <i>(上场队员)</i> | | | | | | | | | | | | | | | | |
| 1 | 郭世伟 | 2/7 | 1/2 | 1/1 | 1/1 | | | 0/1 | 5/12 | 41.7% | 2 | 1 | | 1 | | 00:59:30 |
| 2 | 金勇峰 | 0/1 | 1/1 | 0/4 | | | | | 1/6 | 16.7% | | 2 | | 2 | | 00:57:57 |
| 9 | 陈开勇 | | | | | | | | | 0.0% | | | | | | 00:00:00 |
| 17 | 王巨柱 | 2/7 | 0/2 | | 2/2 | 3/3 | 1/1 | | 8/15 | 53.3% | 3 | 4 | | | | 01:00:00 |
| 18 | 李双 | 0/2 | 3/3 | 1/2 | 1/1 | 2/4 | 2/2 | | 9/14 | 64.3% | 2 | 3 | 1 | 1 | | 01:00:00 |
| 19 | 何山 | | | 1/2 | | | | | 1/2 | 50.0% | | 1 | | | | 00:09:33 |
| 21 | 李明 | | | | | | | | | 0.0% | | | | | | 00:57:12 |
| 24 | 徐安格 | 0/1 | 3/5 | | 1/1 | | | | 4/7 | 57.1% | | 2 | 1 | 1 | | 01:00:00 |
| 25 | 李文哲 | | | | | | | | | 0.0% | | | | | | 00:00:00 |
| 26 | 程浩然 | | 1/1 | 2/3 | | 0/1 | | | 3/5 | 60.0% | | 2 | | | | 00:48:20 |
| 27 | 王长旭 | | | 1/1 | | | | | 1/1 | 100% | | | | | | 00:02:03 |
| 28 | 丁浩然 | | | | | | | | | 0.0% | | | | | | 00:00:20 |
| 32 | 许浩翔 | | | | | | | | | 0.0% | | | | | | 00:02:48 |
| 33 | 姚紫祥 | | | | | | | | | 0.0% | | | | | | 00:00:00 |
| 41 | 刘润民 | | | | | | | | | 0.0% | | | | | | 00:00:00 |
| 42 | 王成龙 | | | | | | | | | 0.0% | | | | | | 00:00:00 |
| 合计 | | 4/18 | 9/14 | 6/13 | 5/5 | 5/8 | 3/3 | 0/1 | 32/62 | 51.6% | 7 | 15 | 2 | 5 | | |
| <i>(守门员)</i> | | | | | | | | | | | | | | | | |
| 21 | 李明 | 3/8 | 6/14 | 2/11 | 2/4 | 0/8 | | 0/2 | 13/47 | 27.7% | | | | | | 00:57:12 |
| 32 | 许浩翔 | 1/3 | 0/1 | | 0/1 | | | 0/1 | 1/6 | 16.7% | | | | | | 00:02:48 |
| 合计 | | 4/11 | 6/15 | 2/11 | 2/5 | 0/8 | | 0/3 | 14/53 | 26.4% | | | | | | |

场上队员：得分/射门

守门员：救球/射门

| 全队合计 | 得分 | 被救 | 射失 | 击柱 | 封球 | 合计 | % |
|------|----|----|----|----|----|----|--------|
| 远射 | 4 | 5 | 3 | 1 | 5 | 18 | 22.2% |
| 近射 | 9 | 3 | | 2 | | 14 | 64.3% |
| 边射 | 6 | 3 | 2 | 2 | | 13 | 46.2% |
| 快攻 | 5 | | | | | 5 | 100.0% |
| 突破 | 5 | 2 | 1 | | | 8 | 62.5% |
| 任意 | 3 | | | | | 3 | 100.0% |
| 7M | | 1 | | | | 1 | 0.0% |





2016年“体彩杯”全国手球男子青年锦标赛

图式射门区域统计

轮次 2 场次 11

201602011-41-1/1

新疆队

| | | | | | | | | | | | | | | | | | | | | | | | | | | | | | | | | | | | | | | | | | | | | | | | | | | | | | | | | | | | | | | | | | | | | | | | | | | | | | | | |
|--|-----------------------------|-----------------------------|-----------------------------|-----------------------------|-----------------------------|-----------------------------|-----------------------------|--|--|---|---|--|--|--|--|--|---|--|---|--|--|--|--|--|--|--|--|--|--|---|--|---|--|---|--|---|--|--|---|--|--|--|--|--|--|--|--|--|--|--|---|---|---|---|--|---|---|---|---|--|--|--|---|---|--|--|---|--|---|--|--|--|--|--|--|--|--|--|--|
| 1 宋晓晨 | 2 王泽川 | 4 谷通金 | 5 徐伟 | 6 白光宇 | 7 林豪文 | 10 王钟彬 | 12 王金鑫 | | | | | | | | | | | | | | | | | | | | | | | | | | | | | | | | | | | | | | | | | | | | | | | | | | | | | | | | | | | | | | | | | | | | | | | | |
| <table border="1"><tr><td></td><td></td><td></td></tr><tr><td></td><td></td><td></td></tr><tr><td></td><td></td><td></td></tr></table> | | | | | | | | | | <table border="1"><tr><td></td><td></td><td></td></tr><tr><td></td><td></td><td></td></tr><tr><td></td><td></td><td></td></tr></table> | | | | | | | | | | <table border="1"><tr><td></td><td></td><td></td></tr><tr><td></td><td></td><td></td></tr><tr><td></td><td></td><td></td></tr></table> | | | | | | | | | | <table border="1"><tr><td></td><td></td><td></td></tr><tr><td>5</td><td></td><td>1</td></tr><tr><td></td><td></td><td>4</td></tr></table> | | | | 5 | | 1 | | | 4 | <table border="1"><tr><td></td><td></td><td></td></tr><tr><td></td><td></td><td></td></tr><tr><td></td><td></td><td></td></tr></table> | | | | | | | | | | <table border="1"><tr><td></td><td></td><td>1</td></tr><tr><td>2</td><td></td><td>1</td></tr><tr><td>4</td><td>1</td><td>1</td></tr></table> | | | 1 | 2 | | 1 | 4 | 1 | 1 | <table border="1"><tr><td></td><td></td><td>1</td></tr><tr><td>2</td><td></td><td></td></tr><tr><td>3</td><td></td><td>1</td></tr></table> | | | 1 | 2 | | | 3 | | 1 | <table border="1"><tr><td></td><td></td><td></td></tr><tr><td></td><td></td><td></td></tr><tr><td></td><td></td><td></td></tr></table> | | | | | | | | | |
| | | | | | | | | | | | | | | | | | | | | | | | | | | | | | | | | | | | | | | | | | | | | | | | | | | | | | | | | | | | | | | | | | | | | | | | | | | | | | | | |
| | | | | | | | | | | | | | | | | | | | | | | | | | | | | | | | | | | | | | | | | | | | | | | | | | | | | | | | | | | | | | | | | | | | | | | | | | | | | | | | |
| | | | | | | | | | | | | | | | | | | | | | | | | | | | | | | | | | | | | | | | | | | | | | | | | | | | | | | | | | | | | | | | | | | | | | | | | | | | | | | | |
| | | | | | | | | | | | | | | | | | | | | | | | | | | | | | | | | | | | | | | | | | | | | | | | | | | | | | | | | | | | | | | | | | | | | | | | | | | | | | | | |
| | | | | | | | | | | | | | | | | | | | | | | | | | | | | | | | | | | | | | | | | | | | | | | | | | | | | | | | | | | | | | | | | | | | | | | | | | | | | | | | |
| | | | | | | | | | | | | | | | | | | | | | | | | | | | | | | | | | | | | | | | | | | | | | | | | | | | | | | | | | | | | | | | | | | | | | | | | | | | | | | | |
| | | | | | | | | | | | | | | | | | | | | | | | | | | | | | | | | | | | | | | | | | | | | | | | | | | | | | | | | | | | | | | | | | | | | | | | | | | | | | | | |
| | | | | | | | | | | | | | | | | | | | | | | | | | | | | | | | | | | | | | | | | | | | | | | | | | | | | | | | | | | | | | | | | | | | | | | | | | | | | | | | |
| | | | | | | | | | | | | | | | | | | | | | | | | | | | | | | | | | | | | | | | | | | | | | | | | | | | | | | | | | | | | | | | | | | | | | | | | | | | | | | | |
| | | | | | | | | | | | | | | | | | | | | | | | | | | | | | | | | | | | | | | | | | | | | | | | | | | | | | | | | | | | | | | | | | | | | | | | | | | | | | | | |
| 5 | | 1 | | | | | | | | | | | | | | | | | | | | | | | | | | | | | | | | | | | | | | | | | | | | | | | | | | | | | | | | | | | | | | | | | | | | | | | | | | | | | |
| | | 4 | | | | | | | | | | | | | | | | | | | | | | | | | | | | | | | | | | | | | | | | | | | | | | | | | | | | | | | | | | | | | | | | | | | | | | | | | | | | | |
| | | | | | | | | | | | | | | | | | | | | | | | | | | | | | | | | | | | | | | | | | | | | | | | | | | | | | | | | | | | | | | | | | | | | | | | | | | | | | | | |
| | | | | | | | | | | | | | | | | | | | | | | | | | | | | | | | | | | | | | | | | | | | | | | | | | | | | | | | | | | | | | | | | | | | | | | | | | | | | | | | |
| | | | | | | | | | | | | | | | | | | | | | | | | | | | | | | | | | | | | | | | | | | | | | | | | | | | | | | | | | | | | | | | | | | | | | | | | | | | | | | | |
| | | 1 | | | | | | | | | | | | | | | | | | | | | | | | | | | | | | | | | | | | | | | | | | | | | | | | | | | | | | | | | | | | | | | | | | | | | | | | | | | | | |
| 2 | | 1 | | | | | | | | | | | | | | | | | | | | | | | | | | | | | | | | | | | | | | | | | | | | | | | | | | | | | | | | | | | | | | | | | | | | | | | | | | | | | |
| 4 | 1 | 1 | | | | | | | | | | | | | | | | | | | | | | | | | | | | | | | | | | | | | | | | | | | | | | | | | | | | | | | | | | | | | | | | | | | | | | | | | | | | | |
| | | 1 | | | | | | | | | | | | | | | | | | | | | | | | | | | | | | | | | | | | | | | | | | | | | | | | | | | | | | | | | | | | | | | | | | | | | | | | | | | | | |
| 2 | | | | | | | | | | | | | | | | | | | | | | | | | | | | | | | | | | | | | | | | | | | | | | | | | | | | | | | | | | | | | | | | | | | | | | | | | | | | | | | |
| 3 | | 1 | | | | | | | | | | | | | | | | | | | | | | | | | | | | | | | | | | | | | | | | | | | | | | | | | | | | | | | | | | | | | | | | | | | | | | | | | | | | | |
| | | | | | | | | | | | | | | | | | | | | | | | | | | | | | | | | | | | | | | | | | | | | | | | | | | | | | | | | | | | | | | | | | | | | | | | | | | | | | | | |
| | | | | | | | | | | | | | | | | | | | | | | | | | | | | | | | | | | | | | | | | | | | | | | | | | | | | | | | | | | | | | | | | | | | | | | | | | | | | | | | |
| | | | | | | | | | | | | | | | | | | | | | | | | | | | | | | | | | | | | | | | | | | | | | | | | | | | | | | | | | | | | | | | | | | | | | | | | | | | | | | | |
| Post - 0 Miss - 0 Block - 0 | Post - 0 Miss - 0 Block - 0 | Post - 0 Miss - 0 Block - 0 | Post - 2 Miss - 0 Block - 0 | Post - 0 Miss - 0 Block - 0 | Post - 1 Miss - 0 Block - 1 | Post - 0 Miss - 1 Block - 0 | Post - 0 Miss - 0 Block - 0 | | | | | | | | | | | | | | | | | | | | | | | | | | | | | | | | | | | | | | | | | | | | | | | | | | | | | | | | | | | | | | | | | | | | | | | | |
| 13 苏兴伟 | 15 王维东 | 16 李佳懿 | 17 胡晋铭 | 18 李万兴 | 19 李龙吉 | 24 陈伟华 | | | | | | | | | | | | | | | | | | | | | | | | | | | | | | | | | | | | | | | | | | | | | | | | | | | | | | | | | | | | | | | | | | | | | | | | | |
| <table border="1"><tr><td></td><td></td><td></td></tr><tr><td></td><td></td><td></td></tr><tr><td></td><td></td><td></td></tr></table> | | | | | | | | | | <table border="1"><tr><td>1</td><td></td><td></td></tr><tr><td></td><td></td><td></td></tr><tr><td>1</td><td></td><td>1</td></tr></table> | 1 | | | | | | 1 | | 1 | <table border="1"><tr><td></td><td></td><td></td></tr><tr><td></td><td></td><td></td></tr><tr><td></td><td></td><td></td></tr></table> | | | | | | | | | | <table border="1"><tr><td></td><td>1</td><td></td></tr><tr><td></td><td></td><td></td></tr><tr><td></td><td></td><td></td></tr></table> | | 1 | | | | | | | | <table border="1"><tr><td></td><td></td><td></td></tr><tr><td></td><td></td><td></td></tr><tr><td></td><td></td><td></td></tr></table> | | | | | | | | | | <table border="1"><tr><td>1</td><td>1</td><td></td></tr><tr><td>2</td><td></td><td>2</td></tr><tr><td>1</td><td></td><td>1</td></tr></table> | 1 | 1 | | 2 | | 2 | 1 | | 1 | <table border="1"><tr><td></td><td></td><td></td></tr><tr><td></td><td></td><td></td></tr><tr><td></td><td></td><td></td></tr></table> | | | | | | | | | | <table border="1"><tr><td></td><td></td><td></td></tr><tr><td></td><td></td><td></td></tr><tr><td></td><td></td><td></td></tr></table> | | | | | | | | | |
| | | | | | | | | | | | | | | | | | | | | | | | | | | | | | | | | | | | | | | | | | | | | | | | | | | | | | | | | | | | | | | | | | | | | | | | | | | | | | | | |
| | | | | | | | | | | | | | | | | | | | | | | | | | | | | | | | | | | | | | | | | | | | | | | | | | | | | | | | | | | | | | | | | | | | | | | | | | | | | | | | |
| | | | | | | | | | | | | | | | | | | | | | | | | | | | | | | | | | | | | | | | | | | | | | | | | | | | | | | | | | | | | | | | | | | | | | | | | | | | | | | | |
| 1 | | | | | | | | | | | | | | | | | | | | | | | | | | | | | | | | | | | | | | | | | | | | | | | | | | | | | | | | | | | | | | | | | | | | | | | | | | | | | | | |
| | | | | | | | | | | | | | | | | | | | | | | | | | | | | | | | | | | | | | | | | | | | | | | | | | | | | | | | | | | | | | | | | | | | | | | | | | | | | | | | |
| 1 | | 1 | | | | | | | | | | | | | | | | | | | | | | | | | | | | | | | | | | | | | | | | | | | | | | | | | | | | | | | | | | | | | | | | | | | | | | | | | | | | | |
| | | | | | | | | | | | | | | | | | | | | | | | | | | | | | | | | | | | | | | | | | | | | | | | | | | | | | | | | | | | | | | | | | | | | | | | | | | | | | | | |
| | | | | | | | | | | | | | | | | | | | | | | | | | | | | | | | | | | | | | | | | | | | | | | | | | | | | | | | | | | | | | | | | | | | | | | | | | | | | | | | |
| | | | | | | | | | | | | | | | | | | | | | | | | | | | | | | | | | | | | | | | | | | | | | | | | | | | | | | | | | | | | | | | | | | | | | | | | | | | | | | | |
| | 1 | | | | | | | | | | | | | | | | | | | | | | | | | | | | | | | | | | | | | | | | | | | | | | | | | | | | | | | | | | | | | | | | | | | | | | | | | | | | | | |
| | | | | | | | | | | | | | | | | | | | | | | | | | | | | | | | | | | | | | | | | | | | | | | | | | | | | | | | | | | | | | | | | | | | | | | | | | | | | | | | |
| | | | | | | | | | | | | | | | | | | | | | | | | | | | | | | | | | | | | | | | | | | | | | | | | | | | | | | | | | | | | | | | | | | | | | | | | | | | | | | | |
| | | | | | | | | | | | | | | | | | | | | | | | | | | | | | | | | | | | | | | | | | | | | | | | | | | | | | | | | | | | | | | | | | | | | | | | | | | | | | | | |
| | | | | | | | | | | | | | | | | | | | | | | | | | | | | | | | | | | | | | | | | | | | | | | | | | | | | | | | | | | | | | | | | | | | | | | | | | | | | | | | |
| | | | | | | | | | | | | | | | | | | | | | | | | | | | | | | | | | | | | | | | | | | | | | | | | | | | | | | | | | | | | | | | | | | | | | | | | | | | | | | | |
| 1 | 1 | | | | | | | | | | | | | | | | | | | | | | | | | | | | | | | | | | | | | | | | | | | | | | | | | | | | | | | | | | | | | | | | | | | | | | | | | | | | | | |
| 2 | | 2 | | | | | | | | | | | | | | | | | | | | | | | | | | | | | | | | | | | | | | | | | | | | | | | | | | | | | | | | | | | | | | | | | | | | | | | | | | | | | |
| 1 | | 1 | | | | | | | | | | | | | | | | | | | | | | | | | | | | | | | | | | | | | | | | | | | | | | | | | | | | | | | | | | | | | | | | | | | | | | | | | | | | | |
| | | | | | | | | | | | | | | | | | | | | | | | | | | | | | | | | | | | | | | | | | | | | | | | | | | | | | | | | | | | | | | | | | | | | | | | | | | | | | | | |
| | | | | | | | | | | | | | | | | | | | | | | | | | | | | | | | | | | | | | | | | | | | | | | | | | | | | | | | | | | | | | | | | | | | | | | | | | | | | | | | |
| | | | | | | | | | | | | | | | | | | | | | | | | | | | | | | | | | | | | | | | | | | | | | | | | | | | | | | | | | | | | | | | | | | | | | | | | | | | | | | | |
| | | | | | | | | | | | | | | | | | | | | | | | | | | | | | | | | | | | | | | | | | | | | | | | | | | | | | | | | | | | | | | | | | | | | | | | | | | | | | | | |
| | | | | | | | | | | | | | | | | | | | | | | | | | | | | | | | | | | | | | | | | | | | | | | | | | | | | | | | | | | | | | | | | | | | | | | | | | | | | | | | |
| | | | | | | | | | | | | | | | | | | | | | | | | | | | | | | | | | | | | | | | | | | | | | | | | | | | | | | | | | | | | | | | | | | | | | | | | | | | | | | | |
| Post - 0 Miss - 0 Block - 0 | Post - 1 Miss - 0 Block - 0 | Post - 0 Miss - 0 Block - 0 | Post - 0 Miss - 0 Block - 0 | Post - 0 Miss - 0 Block - 0 | Post - 0 Miss - 1 Block - 0 | Post - 0 Miss - 0 Block - 0 | | | | | | | | | | | | | | | | | | | | | | | | | | | | | | | | | | | | | | | | | | | | | | | | | | | | | | | | | | | | | | | | | | | | | | | | | |

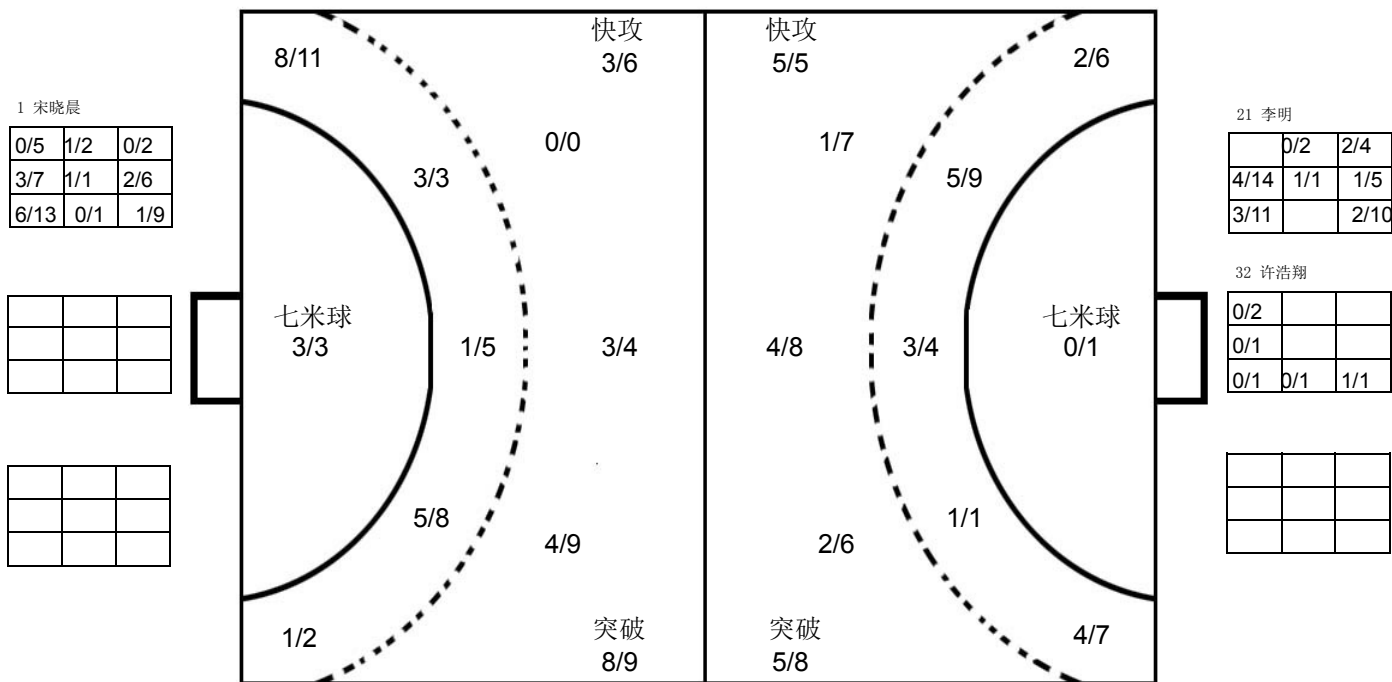

安徽队

| | | | | | | | | | | | | | | | | | | | | | | | | | | | | | | | | | | | | | | | | | | | | | | | | | | | | | | | | | | | | | | | | | | | | | | | | | | | | | | | |
|--|-----------------------------|-----------------------------|-----------------------------|-----------------------------|-----------------------------|-----------------------------|-----------------------------|--|---|--|--|--|---|---|--|---|--|--|--|---|--|--|---|--|--|--|--|--|--|---|--|--|--|---|--|---|---|---|---|---|---|--|--|---|--|---|---|--|---|---|---|--|--|--|--|--|--|--|--|--|--|--|--|--|--|--|--|--|--|--|---|--|--|---|--|--|---|--|---|
| 1 郭世伟 | 2 金勇峰 | 9 陈开勇 | 17 王巨柱 | 18 李双 | 19 何山 | 21 李明 | 24 徐安格 | | | | | | | | | | | | | | | | | | | | | | | | | | | | | | | | | | | | | | | | | | | | | | | | | | | | | | | | | | | | | | | | | | | | | | | | |
| <table border="1"><tr><td>1</td><td>1</td><td></td></tr><tr><td></td><td></td><td></td></tr><tr><td>2</td><td></td><td>1</td></tr></table> | 1 | 1 | | | | | 2 | | 1 | <table border="1"><tr><td></td><td></td><td>1</td></tr><tr><td></td><td></td><td></td></tr><tr><td></td><td></td><td></td></tr></table> | | | 1 | | | | | | | <table border="1"><tr><td></td><td></td><td></td></tr><tr><td></td><td></td><td></td></tr><tr><td></td><td></td><td></td></tr></table> | | | | | | | | | | <table border="1"><tr><td></td><td></td><td></td></tr><tr><td>1</td><td></td><td>2</td></tr><tr><td>2</td><td>1</td><td>2</td></tr></table> | | | | 1 | | 2 | 2 | 1 | 2 | <table border="1"><tr><td>2</td><td></td><td></td></tr><tr><td>2</td><td></td><td>2</td></tr><tr><td>1</td><td></td><td>2</td></tr></table> | 2 | | | 2 | | 2 | 1 | | 2 | <table border="1"><tr><td>1</td><td></td><td></td></tr><tr><td></td><td></td><td></td></tr><tr><td></td><td></td><td></td></tr></table> | 1 | | | | | | | | | <table border="1"><tr><td></td><td></td><td></td></tr><tr><td></td><td></td><td></td></tr><tr><td></td><td></td><td></td></tr></table> | | | | | | | | | | <table border="1"><tr><td>1</td><td></td><td></td></tr><tr><td>1</td><td></td><td></td></tr><tr><td>1</td><td></td><td>1</td></tr></table> | 1 | | | 1 | | | 1 | | 1 |
| 1 | 1 | | | | | | | | | | | | | | | | | | | | | | | | | | | | | | | | | | | | | | | | | | | | | | | | | | | | | | | | | | | | | | | | | | | | | | | | | | | | | | |
| | | | | | | | | | | | | | | | | | | | | | | | | | | | | | | | | | | | | | | | | | | | | | | | | | | | | | | | | | | | | | | | | | | | | | | | | | | | | | | | |
| 2 | | 1 | | | | | | | | | | | | | | | | | | | | | | | | | | | | | | | | | | | | | | | | | | | | | | | | | | | | | | | | | | | | | | | | | | | | | | | | | | | | | |
| | | 1 | | | | | | | | | | | | | | | | | | | | | | | | | | | | | | | | | | | | | | | | | | | | | | | | | | | | | | | | | | | | | | | | | | | | | | | | | | | | | |
| | | | | | | | | | | | | | | | | | | | | | | | | | | | | | | | | | | | | | | | | | | | | | | | | | | | | | | | | | | | | | | | | | | | | | | | | | | | | | | | |
| | | | | | | | | | | | | | | | | | | | | | | | | | | | | | | | | | | | | | | | | | | | | | | | | | | | | | | | | | | | | | | | | | | | | | | | | | | | | | | | |
| | | | | | | | | | | | | | | | | | | | | | | | | | | | | | | | | | | | | | | | | | | | | | | | | | | | | | | | | | | | | | | | | | | | | | | | | | | | | | | | |
| | | | | | | | | | | | | | | | | | | | | | | | | | | | | | | | | | | | | | | | | | | | | | | | | | | | | | | | | | | | | | | | | | | | | | | | | | | | | | | | |
| | | | | | | | | | | | | | | | | | | | | | | | | | | | | | | | | | | | | | | | | | | | | | | | | | | | | | | | | | | | | | | | | | | | | | | | | | | | | | | | |
| | | | | | | | | | | | | | | | | | | | | | | | | | | | | | | | | | | | | | | | | | | | | | | | | | | | | | | | | | | | | | | | | | | | | | | | | | | | | | | | |
| 1 | | 2 | | | | | | | | | | | | | | | | | | | | | | | | | | | | | | | | | | | | | | | | | | | | | | | | | | | | | | | | | | | | | | | | | | | | | | | | | | | | | |
| 2 | 1 | 2 | | | | | | | | | | | | | | | | | | | | | | | | | | | | | | | | | | | | | | | | | | | | | | | | | | | | | | | | | | | | | | | | | | | | | | | | | | | | | |
| 2 | | | | | | | | | | | | | | | | | | | | | | | | | | | | | | | | | | | | | | | | | | | | | | | | | | | | | | | | | | | | | | | | | | | | | | | | | | | | | | | |
| 2 | | 2 | | | | | | | | | | | | | | | | | | | | | | | | | | | | | | | | | | | | | | | | | | | | | | | | | | | | | | | | | | | | | | | | | | | | | | | | | | | | | |
| 1 | | 2 | | | | | | | | | | | | | | | | | | | | | | | | | | | | | | | | | | | | | | | | | | | | | | | | | | | | | | | | | | | | | | | | | | | | | | | | | | | | | |
| 1 | | | | | | | | | | | | | | | | | | | | | | | | | | | | | | | | | | | | | | | | | | | | | | | | | | | | | | | | | | | | | | | | | | | | | | | | | | | | | | | |
| | | | | | | | | | | | | | | | | | | | | | | | | | | | | | | | | | | | | | | | | | | | | | | | | | | | | | | | | | | | | | | | | | | | | | | | | | | | | | | | |
| | | | | | | | | | | | | | | | | | | | | | | | | | | | | | | | | | | | | | | | | | | | | | | | | | | | | | | | | | | | | | | | | | | | | | | | | | | | | | | | |
| | | | | | | | | | | | | | | | | | | | | | | | | | | | | | | | | | | | | | | | | | | | | | | | | | | | | | | | | | | | | | | | | | | | | | | | | | | | | | | | |
| | | | | | | | | | | | | | | | | | | | | | | | | | | | | | | | | | | | | | | | | | | | | | | | | | | | | | | | | | | | | | | | | | | | | | | | | | | | | | | | |
| | | | | | | | | | | | | | | | | | | | | | | | | | | | | | | | | | | | | | | | | | | | | | | | | | | | | | | | | | | | | | | | | | | | | | | | | | | | | | | | |
| 1 | | | | | | | | | | | | | | | | | | | | | | | | | | | | | | | | | | | | | | | | | | | | | | | | | | | | | | | | | | | | | | | | | | | | | | | | | | | | | | | |
| 1 | | | | | | | | | | | | | | | | | | | | | | | | | | | | | | | | | | | | | | | | | | | | | | | | | | | | | | | | | | | | | | | | | | | | | | | | | | | | | | | |
| 1 | | 1 | | | | | | | | | | | | | | | | | | | | | | | | | | | | | | | | | | | | | | | | | | | | | | | | | | | | | | | | | | | | | | | | | | | | | | | | | | | | | |
| Post - 1 Miss - 2 Block - 1 | Post - 2 Miss - 1 Block - 0 | Post - 0 Miss - 0 Block - 0 | Post - 1 Miss - 0 Block - 3 | Post - 0 Miss - 2 Block - 1 | Post - 0 Miss - 1 Block - 0 | Post - 0 Miss - 0 Block - 0 | Post - 1 Miss - 0 Block - 0 | | | | | | | | | | | | | | | | | | | | | | | | | | | | | | | | | | | | | | | | | | | | | | | | | | | | | | | | | | | | | | | | | | | | | | | | |
| 25 李文哲 | 26 程浩然 | 27 王长旭 | 28 丁浩然 | 32 许浩翔 | 33 姚紫祥 | 41 刘润民 | 42 王成龙 | | | | | | | | | | | | | | | | | | | | | | | | | | | | | | | | | | | | | | | | | | | | | | | | | | | | | | | | | | | | | | | | | | | | | | | | |
| <table border="1"><tr><td></td><td></td><td></td></tr><tr><td></td><td></td><td></td></tr><tr><td></td><td></td><td></td></tr></table> | | | | | | | | | | <table border="1"><tr><td></td><td></td><td></td></tr><tr><td>1</td><td></td><td>2</td></tr><tr><td></td><td></td><td></td></tr></table> | | | | 1 | | 2 | | | | <table border="1"><tr><td></td><td></td><td>1</td></tr><tr><td></td><td></td><td></td></tr><tr><td></td><td></td><td></td></tr></table> | | | 1 | | | | | | | <table border="1"><tr><td></td><td></td><td></td></tr><tr><td></td><td></td><td></td></tr><tr><td></td><td></td><td></td></tr></table> | | | | | | | | | | <table border="1"><tr><td></td><td></td><td></td></tr><tr><td></td><td></td><td></td></tr><tr><td></td><td></td><td></td></tr></table> | | | | | | | | | | <table border="1"><tr><td></td><td></td><td></td></tr><tr><td></td><td></td><td></td></tr><tr><td></td><td></td><td></td></tr></table> | | | | | | | | | | <table border="1"><tr><td></td><td></td><td></td></tr><tr><td></td><td></td><td></td></tr><tr><td></td><td></td><td></td></tr></table> | | | | | | | | | | <table border="1"><tr><td></td><td></td><td></td></tr><tr><td></td><td></td><td></td></tr><tr><td></td><td></td><td></td></tr></table> | | | | | | | | | |
| | | | | | | | | | | | | | | | | | | | | | | | | | | | | | | | | | | | | | | | | | | | | | | | | | | | | | | | | | | | | | | | | | | | | | | | | | | | | | | | |
| | | | | | | | | | | | | | | | | | | | | | | | | | | | | | | | | | | | | | | | | | | | | | | | | | | | | | | | | | | | | | | | | | | | | | | | | | | | | | | | |
| | | | | | | | | | | | | | | | | | | | | | | | | | | | | | | | | | | | | | | | | | | | | | | | | | | | | | | | | | | | | | | | | | | | | | | | | | | | | | | | |
| | | | | | | | | | | | | | | | | | | | | | | | | | | | | | | | | | | | | | | | | | | | | | | | | | | | | | | | | | | | | | | | | | | | | | | | | | | | | | | | |
| 1 | | 2 | | | | | | | | | | | | | | | | | | | | | | | | | | | | | | | | | | | | | | | | | | | | | | | | | | | | | | | | | | | | | | | | | | | | | | | | | | | | | |
| | | | | | | | | | | | | | | | | | | | | | | | | | | | | | | | | | | | | | | | | | | | | | | | | | | | | | | | | | | | | | | | | | | | | | | | | | | | | | | | |
| | | 1 | | | | | | | | | | | | | | | | | | | | | | | | | | | | | | | | | | | | | | | | | | | | | | | | | | | | | | | | | | | | | | | | | | | | | | | | | | | | | |
| | | | | | | | | | | | | | | | | | | | | | | | | | | | | | | | | | | | | | | | | | | | | | | | | | | | | | | | | | | | | | | | | | | | | | | | | | | | | | | | |
| | | | | | | | | | | | | | | | | | | | | | | | | | | | | | | | | | | | | | | | | | | | | | | | | | | | | | | | | | | | | | | | | | | | | | | | | | | | | | | | |
| | | | | | | | | | | | | | | | | | | | | | | | | | | | | | | | | | | | | | | | | | | | | | | | | | | | | | | | | | | | | | | | | | | | | | | | | | | | | | | | |
| | | | | | | | | | | | | | | | | | | | | | | | | | | | | | | | | | | | | | | | | | | | | | | | | | | | | | | | | | | | | | | | | | | | | | | | | | | | | | | | |
| | | | | | | | | | | | | | | | | | | | | | | | | | | | | | | | | | | | | | | | | | | | | | | | | | | | | | | | | | | | | | | | | | | | | | | | | | | | | | | | |
| | | | | | | | | | | | | | | | | | | | | | | | | | | | | | | | | | | | | | | | | | | | | | | | | | | | | | | | | | | | | | | | | | | | | | | | | | | | | | | | |
| | | | | | | | | | | | | | | | | | | | | | | | | | | | | | | | | | | | | | | | | | | | | | | | | | | | | | | | | | | | | | | | | | | | | | | | | | | | | | | | |
| | | | | | | | | | | | | | | | | | | | | | | | | | | | | | | | | | | | | | | | | | | | | | | | | | | | | | | | | | | | | | | | | | | | | | | | | | | | | | | | |
| | | | | | | | | | | | | | | | | | | | | | | | | | | | | | | | | | | | | | | | | | | | | | | | | | | | | | | | | | | | | | | | | | | | | | | | | | | | | | | | |
| | | | | | | | | | | | | | | | | | | | | | | | | | | | | | | | | | | | | | | | | | | | | | | | | | | | | | | | | | | | | | | | | | | | | | | | | | | | | | | | |
| | | | | | | | | | | | | | | | | | | | | | | | | | | | | | | | | | | | | | | | | | | | | | | | | | | | | | | | | | | | | | | | | | | | | | | | | | | | | | | | |
| | | | | | | | | | | | | | | | | | | | | | | | | | | | | | | | | | | | | | | | | | | | | | | | | | | | | | | | | | | | | | | | | | | | | | | | | | | | | | | | |
| | | | | | | | | | | | | | | | | | | | | | | | | | | | | | | | | | | | | | | | | | | | | | | | | | | | | | | | | | | | | | | | | | | | | | | | | | | | | | | | |
| | | | | | | | | | | | | | | | | | | | | | | | | | | | | | | | | | | | | | | | | | | | | | | | | | | | | | | | | | | | | | | | | | | | | | | | | | | | | | | | |
| | | | | | | | | | | | | | | | | | | | | | | | | | | | | | | | | | | | | | | | | | | | | | | | | | | | | | | | | | | | | | | | | | | | | | | | | | | | | | | | |
| | | | | | | | | | | | | | | | | | | | | | | | | | | | | | | | | | | | | | | | | | | | | | | | | | | | | | | | | | | | | | | | | | | | | | | | | | | | | | | | |
| | | | | | | | | | | | | | | | | | | | | | | | | | | | | | | | | | | | | | | | | | | | | | | | | | | | | | | | | | | | | | | | | | | | | | | | | | | | | | | | |
| Post - 0 Miss - 0 Block - 0 | Post - 0 Miss - 0 Block - 0 | Post - 0 Miss - 0 Block - 0 | Post - 0 Miss - 0 Block - 0 | Post - 0 Miss - 0 Block - 0 | Post - 0 Miss - 0 Block - 0 | Post - 0 Miss - 0 Block - 0 | Post - 0 Miss - 0 Block - 0 | | | | | | | | | | | | | | | | | | | | | | | | | | | | | | | | | | | | | | | | | | | | | | | | | | | | | | | | | | | | | | | | | | | | | | | | |

注释: Post=击柱 Miss=射失 Block=被封





预赛 Group B
青年男子 全国比赛

2016年“体彩杯”全国手球男子青年锦标赛

| | | | | | | | | | | | | | | | | | | | | | | |
|------------------------|---|------------------------------------|---------------------|------------------------|------------------------------------|-------------------|----------|---------------------------|--|----------|----------|----------------------|---------------|----------|--|--|---|---|----------|---|----|--|
| Team A A 辽宁队 | | | | Team B B 天津队 | | | | Match Number 12 | | | | | | | | | | | | | | |
| played in China | | in the hall 重庆万州 | | on 21/03/2016 | | at 17:30 hours | | Spectators | | | | | | | | | | | | | | |
| Half-time (30') | A 18 | B 14 | End of playing time | A 30 | B 31 | 1st extra time | A | B | 2nd extra time | A | B | After penalty throws | A | B | | | | | | | | |
| Number of 7 m | A 1/1 | Team time-out 1 27:00 2 44:27 3 | | | Full name of players and officials | | | | Team time-out 1 17:05 2 25:00 3 59:51 | | | B 1/2 | Number of 7 m | | | | | | | | | |
| No. | Team A | | | | | G | W | 2' | D | DR | No. | Team B | | | | | G | W | 2' | D | DR | |
| 1 | 高尚君 | | | | | | | | | | 9 | 吴明远 | | | | | 6 | | | 1 | | |
| 2 | 王司雨 | | | | | 3 | 1 | | 1 | | 18 | 王晓琪 | | | | | 7 | | | 2 | | |
| 3 | 李星浩 | | | | | | | | | | 21 | 潘玉帅 | | | | | 4 | 1 | | | | |
| 5 | 余昊锦 | | | | | 4 | 1 | | | | 22 | 魏雨童 | | | | | 7 | 1 | 2 | | | |
| 6 | 陈庆港 | | | | | 8 | | | | | 24 | 刘子健 | | | | | | | | | | |
| 7 | 孙义广 | | | | | 2 | 1 | | | | 25 | 王一雄 | | | | | 4 | | | | | |
| 8 | 王鑫鹏 | | | | | 2 | | | | | 26 | 刘思远 | | | | | 3 | | | | | |
| 10 | 王柏淇 | | | | | 2 | | 1 | | | 27 | 左金龙 | | | | | | | | | | |
| 11 | 庞东阳 | | | | | 7 | | 1 | | | 28 | 何喜年 | | | | | | | | | | |
| 13 | 杨洁 | | | | | 2 | | | | | | | | | | | | | | | | |
| 14 | 吕昊臻 | | | | | | | | | | | | | | | | | | | | | |
| 16 | 吴阳 | | | | | | | | | | | | | | | | | | | | | |
| 17 | 李傲 | | | | | | | | | | | | | | | | | | | | | |
| 18 | 梅凯博 | | | | | | | | | | | | | | | | | | | | | |
| 19 | 赵鑫 | | | | | | | | | | | | | | | | | | | | | |
| 20 | 赵佛赐 | | | | | | | | | | | | | | | | | | | | | |
| A | 于泉海 | | | | | 1 | | | | | A | 李志成 | | | | | | | | | | |
| B | 赵影 (主教练) | | | | | | | | | | B | 潘玉强 | | | | | | | | | | |
| C | 刘启迪 | | | | | | | | | | | | | | | | | | | | | |
| A | Signature of Responsible Official of the Teams (Off. A) | | | | | | | | | | | | | | | | | | B | | | |
| TP | Remarks of Referee / CHA Official | | | | | | | | | | | | | | | | | | TP | | | |

Signatures

Referees: 程钰峰 (CHN) 周云磊 (CHN)

Techn. Delegates: 许宜扬 (CHN)

CHA Official: 徐健 (CHN)

Note: Number of 7m Throws Awarded to Team A and B, Goals (G), Warnings (W), Suspensions (2'), Direct Disqualification (D), Disqualification with Report (DR) and Team Penalty (TP).

Table Officials:

Statisticians: 李双

刘永欢





2016年“体彩杯”全国手球男子青年锦标赛
竞赛技术统计(媒体表)

| | | | | | | |
|----|----|---|----|---|----|----|
| 预赛 | 组别 | B | 轮次 | 2 | 场次 | 12 |
|----|----|---|----|---|----|----|

重庆万州

21/03/2016

201602012-51-1/1

| | | | | | | |
|---------|----|----|----|----|----|-----|
| 辽宁队 | 辽宁 | 30 | vs | 31 | 天津 | 天津队 |
| 18 : 14 | | | | | | |

| | | | |
|-----|-----------|---|-----------|
| 裁判员 | 程钰峰 (CHN) | / | 周云磊 (CHN) |
|-----|-----------|---|-----------|

| 辽宁 | | 远 | 近 | 边 | 快 | 突 | 任意 | 7m | 合计 | % | 助攻 | 失误 | 警告 | 2' | D & DR | 辽宁 | 比赛进程 | 天津 |
|--------|-----|-------|-------|-----|-----|-----|-----|-----|-------|------|----|----|----|----|--------|----|-------------------|---------------------|
| 主教练：赵影 | | 射 | 射 | 射 | 攻 | 破 | 球 | 球 | | | | | | | | | | |
| 1 | 高尚君 | | | | | | | | | | | | | | | | 6 陈庆港 | 1st Half 01:45 0 |
| 2 | 王司雨 | 1/1 | 2/3 | | | | | | 3/4 | 75.0 | 1 | 6 | 1 | | 1 | | 1 02:05 1 9 吴明远 | |
| 3 | 李星浩 | | | | | | | | | | | | | | | | 1 02:23 2 21 潘玉帅 | |
| 5 | 余昊锦 | | | | | | | | | | | | | | | | 2 02:45 2 2 魏雨童 | |
| 6 | 陈庆港 | 0/5 | 3/4 | 1/1 | 3/3 | 0/1 | | 1/1 | 8/15 | 53.3 | 5 | 5 | | | | | 2 04:19 3 9 吴明远 | |
| 7 | 孙义广 | | 1/1 | | 1/2 | | | | 2/3 | 66.7 | | 1 | 1 | | | | 3 08:23 3 3 潘玉帅 | |
| 8 | 王鑫鹏 | | 1/1 | 1/3 | | | | | 2/4 | 50.0 | | 2 | | | | | 3 09:26 5 22 魏雨童 | |
| 10 | 王柏淇 | 0/2 | 2/4 | | | | | | 2/6 | 33.3 | | 2 | | | 1 | | 3 10:13 6 22 魏雨童 | |
| 11 | 庞东阳 | 3/5 | 1/2 | 0/1 | 1/1 | 2/2 | 0/1 | | 7/12 | 58.3 | 2 | 4 | | | 1 | | 4 11:29 6 6 王尧 | |
| 13 | 杨洁 | 0/2 | | 1/2 | | 1/1 | | | 2/5 | 40.0 | | 1 | | | | | 4 11:56 7 18 王晓琪 | |
| 14 | 吕昊臻 | | | | | | | | | | | | | | | | 5 14:02 7 7 魏雨童 | |
| 16 | 吴阳 | | | | | | | | | | | | | | | | 5 15:32 8 26 刘思远 | |
| 17 | 李傲 | | | | | | | | | | | | | | | | 6 15:46 8 8 魏雨童 | |
| 18 | 梅凯博 | | | | | | | | | | | | | | | | 6 16:17 9 25 王一雄 | |
| 19 | 赵鑫 | | | | | | | | | | | | | | | | 7 16:40 9 9 魏雨童 | |
| 20 | 赵佛赐 | | | | | | | | | | | | | | | | 7 17:23 10 18 王晓琪 | |
| 运动员 合计 | | 5/19 | 12/17 | 3/7 | 6/7 | 3/4 | 0/1 | 1/1 | 30/56 | 53.6 | 10 | 23 | 3 | 2 | 1 | | 8 17:53 10 10 魏雨童 | |
| 1 | 高尚君 | 5/15 | 3/14 | 1/5 | 2/5 | 0/2 | | 0/1 | 11/42 | 26.2 | | | | | | | 8 20:10 11 9 吴明远 | |
| 守门员 合计 | | 5/15 | 3/14 | 1/5 | 2/5 | 0/2 | | 0/1 | 11/42 | 26.2 | | | | | | | | 9 20:45 11 11 魏雨童 |
| 天津 | | 远 | 近 | 边 | 快 | 突 | 任意 | 7m | 合计 | % | 助攻 | 失误 | 警告 | 2' | D & DR | | | |
| 教练：潘玉强 | | 射 | 射 | 射 | 攻 | 破 | 球 | 球 | | | | | | | | | | |
| 9 | 吴明远 | 2/4 | 4/5 | | 0/1 | | | | 6/10 | 60.0 | 1 | 4 | | | 1 | | | |
| 18 | 王晓琪 | 4/8 | 2/4 | | | | | 1/2 | 7/14 | 50.0 | | 5 | | | 2 | | | |
| 21 | 潘玉帅 | 1/2 | | | 2/2 | 1/1 | | | 4/5 | 80.0 | 1 | 8 | 1 | | | | | |
| 22 | 魏雨童 | 1/2 | 4/5 | 0/1 | 1/2 | 1/1 | | | 7/11 | 63.6 | | 4 | 1 | 2 | | | | |
| 24 | 刘子健 | | | | | | | | | | | | | | | | | |
| 25 | 王一雄 | 2/3 | 1/1 | 1/2 | | | | | 4/6 | 66.7 | | 2 | | | | | | |
| 26 | 刘思远 | | | 3/3 | 0/1 | | | | 3/4 | 75.0 | | 2 | | | | | | |
| 27 | 左金龙 | | | | | | | | | | | | | | | | | |
| 28 | 何喜年 | | | | | | | | | | | 1 | | | | | | |
| 运动员 合计 | | 10/19 | 11/15 | 4/6 | 3/6 | 2/2 | | 1/2 | 31/50 | 62.0 | 2 | 26 | 2 | 5 | | | | |
| 24 | 刘子健 | 1/4 | 0/6 | 1/2 | 0/2 | 0/2 | 1/1 | 0/1 | 3/18 | 16.7 | | | | | | | | |
| 28 | 何喜年 | 2/4 | 2/8 | 1/3 | 0/4 | 0/1 | | | 5/20 | 25.0 | | 1 | | | | | | |
| 守门员 合计 | | 3/8 | 2/14 | 2/5 | 0/6 | 0/3 | 1/1 | 0/1 | 8/38 | 21.1 | | 1 | | | | | | |

场上队员：得分 / 射门

守门员：救球 / 射门

| | | | | | | | | | | | | | |
|----|------------|--|----|--------------|--|-----|------------|--|-----|----------|--|----|---------|
| 快攻 | Fast Break | | 突破 | Breakthrough | | 任意球 | Free Throw | | 7M球 | 7M Throw | | 助攻 | Assist |
| 警告 | Warning | | 失误 | Error | | 2' | Suspension | | D | 取消资格 | | DR | 取消资格+报告 |





2016年“体彩杯”全国手球男子青年锦标赛 图式比赛技术统计表

轮次 2

场次 12

201602012-21-1/1

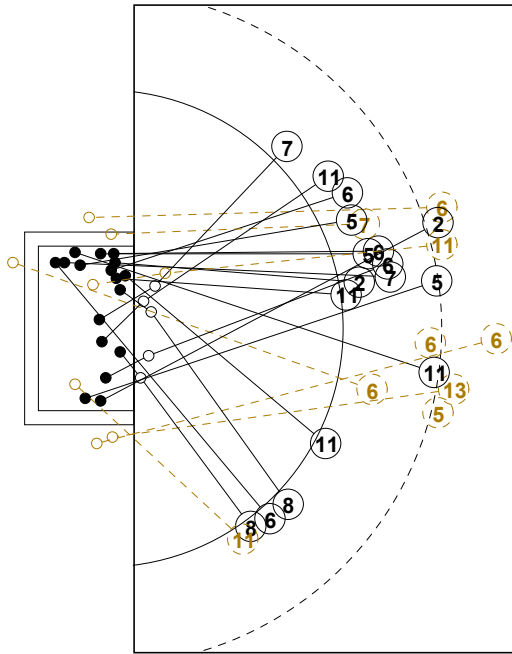

7M 辽宁

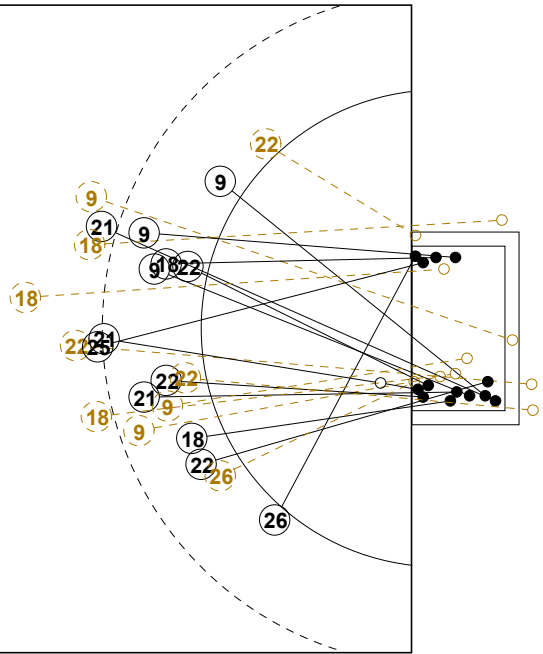
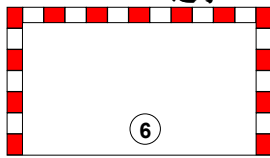

天津 7M

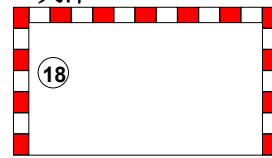

1st Half
18 : 14

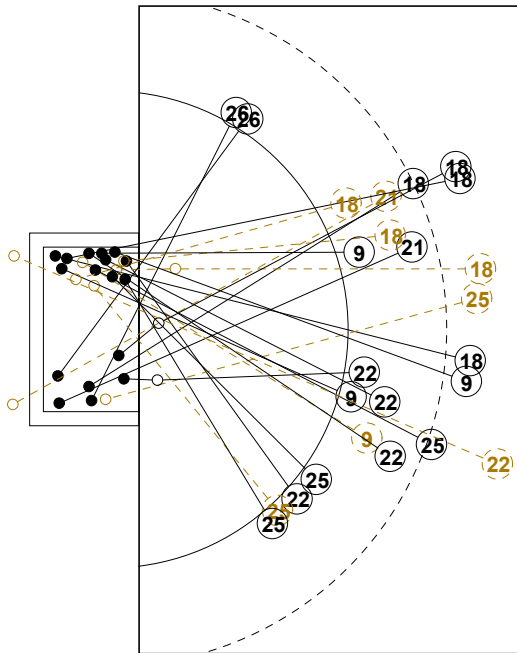

7M 天津

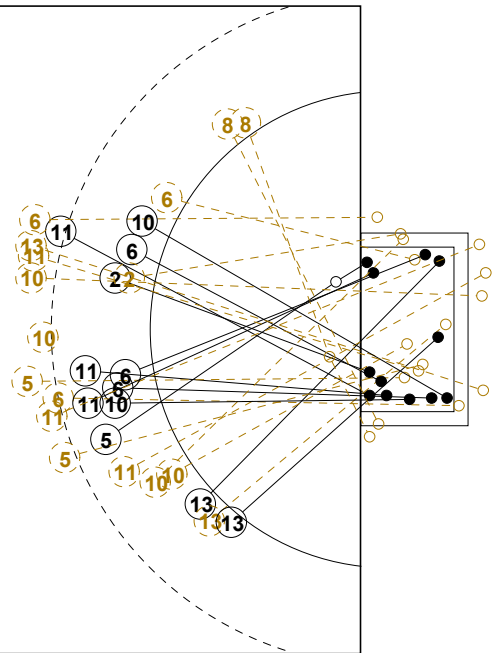

辽宁 7M



2nd Half
31 : 30



2016年“体彩杯”全国手球男子青年锦标赛

个人/全队技术统计表

正式表
手球
青年男子预赛
轮次 2组别 B
场次 12201602012-14-1/2
重庆万州
21/03/2016 17:30

| 号码 | 姓名 | 远射 | 近射 | 边射 | 快攻 | 突破 | 任意 | 7M | 合计 | % | 助攻 | 失误 | 警告 | 2' | 取消 | 时间 |
|----------------|-----|------|-------|-----|-----|-----|-----|-----|-------|-------|----|----|----|----|----|----------|
| 辽宁队(辽宁) | | | | | | | | | | | | | | | | |
| <i>(场上队员)</i> | | | | | | | | | | | | | | | | |
| 1 | 高尚君 | | | | | | | | | 0.0% | | | | | | 01:00:00 |
| 2 | 王司雨 | 1/1 | 2/3 | | | | | | 3/4 | 75.0% | 1 | 6 | 1 | 1 | | 00:58:31 |
| 3 | 李星浩 | | | | | | | | | 0.0% | | | | | | 00:00:00 |
| 5 | 余昊锦 | 1/4 | 2/2 | | 1/1 | | | | 4/7 | 57.1% | 2 | 2 | 1 | | | 00:55:27 |
| 6 | 陈庆港 | 0/5 | 3/4 | 1/1 | 3/3 | 0/1 | | 1/1 | 8/15 | 53.3% | 5 | 5 | | | | 01:00:00 |
| 7 | 孙义广 | | 1/1 | | 1/2 | | | | 2/3 | 66.7% | | 1 | 1 | | | 00:30:00 |
| 8 | 王鑫鹏 | | 1/1 | 1/3 | | | | | 2/4 | 50.0% | | 2 | | | | 00:47:58 |
| 10 | 王柏淇 | 0/2 | 2/4 | | | | | | 2/6 | 33.3% | | 2 | | 1 | | 00:15:33 |
| 11 | 庞东阳 | 3/5 | 1/2 | 0/1 | 1/1 | 2/2 | 0/1 | | 7/12 | 58.3% | 2 | 4 | | 1 | | 01:00:00 |
| 13 | 杨洁 | 0/2 | | 1/2 | | 1/1 | | | 2/5 | 40.0% | | 1 | | | | 00:32:26 |
| 14 | 吕昊臻 | | | | | | | | | 0.0% | | | | | | 00:00:00 |
| 16 | 吴阳 | | | | | | | | | 0.0% | | | | | | 00:00:00 |
| 17 | 李傲 | | | | | | | | | 0.0% | | | | | | 00:00:00 |
| 18 | 梅凯博 | | | | | | | | | 0.0% | | | | | | 00:00:00 |
| 19 | 赵鑫 | | | | | | | | | 0.0% | | | | | | 00:00:00 |
| 20 | 赵佛赐 | | | | | | | | | 0.0% | | | | | | 00:00:00 |
| 合计 | | 5/19 | 12/17 | 3/7 | 6/7 | 3/4 | 0/1 | 1/1 | 30/56 | 53.6% | 10 | 23 | 3 | 2 | 1 | |
| <i>(守门员)</i> | | | | | | | | | | | | | | | | |
| 1 | 高尚君 | 5/15 | 3/14 | 1/5 | 2/5 | 0/2 | | 0/1 | 11/42 | 26.2% | | | | | | 01:00:00 |
| 合计 | | 5/15 | 3/14 | 1/5 | 2/5 | 0/2 | | 0/1 | 11/42 | 26.2% | | | | | | |

场上队员：得分/射门

守门员：救球/射门

| 全队合计 | 得分 | 被救 | 射失 | 击柱 | 封球 | 合计 | % |
|------|----|----|----|----|----|----|--------|
| 远射 | 5 | 3 | 7 | 1 | 3 | 19 | 26.3% |
| 近射 | 12 | 2 | 1 | 2 | | 17 | 70.6% |
| 边射 | 3 | 2 | 1 | 1 | | 7 | 42.9% |
| 快攻 | 6 | | | 1 | | 7 | 85.7% |
| 突破 | 3 | | 1 | | | 4 | 75.0% |
| 任意 | | 1 | | | | 1 | 0.0% |
| 7M | 1 | | | | | 1 | 100.0% |





2016年“体彩杯”全国手球男子青年锦标赛

个人/全队技术统计表

正式表
手球
青年男子预赛
轮次 2组别 B
场次 12201602012-14-2/2
重庆万州
21/03/2016 17:30

| 号码 | 姓名 | 远射 | 近射 | 边射 | 快攻 | 突破 | 任意 | 7M | 合计 | % | 助攻 | 失误 | 警告 | 2' | 取消 | 时间 |
|--|-----|-----|-----|-----|-----|-----|-----|-----|------|-------|----|----|----|----|----|----------|
| 天津队(天津) | | | | | | | | | | | | | | | | |
| <i>(上场队员)</i> | | | | | | | | | | | | | | | | |
| 9 | 吴明远 | 2/4 | 4/5 | | 0/1 | | | | 6/10 | 60.0% | 1 | 4 | | 1 | | 01:00:00 |
| 18 | 王晓琪 | 4/8 | 2/4 | | | | | 1/2 | 7/14 | 50.0% | | 5 | | 2 | | 01:00:00 |
| 21 | 潘玉帅 | 1/2 | | | 2/2 | 1/1 | | | 4/5 | 80.0% | 1 | 8 | 1 | | | 00:58:49 |
| 22 | 魏雨童 | 1/2 | 4/5 | 0/1 | 1/2 | 1/1 | | | 7/11 | 63.6% | | 4 | 1 | 2 | | 01:09:14 |
| 24 | 刘子健 | | | | | | | | | 0.0% | | | | | | 00:29:59 |
| 25 | 王一雄 | 2/3 | 1/1 | 1/2 | | | | | 4/6 | 66.7% | | 2 | | | | 01:14:44 |
| 26 | 刘思远 | | | 3/3 | 0/1 | | | | 3/4 | 75.0% | | 2 | | | | 01:00:00 |
| 27 | 左金龙 | | | | | | | | | 0.0% | | | | | | 00:01:10 |
| 28 | 何喜年 | | | | | | | | | 0.0% | | 1 | | | | 00:30:01 |
| 合计 | | | | | | | | | | | | | | | | |
| <i>(守门员)</i> | | | | | | | | | | | | | | | | |
| 24 | | 1/4 | 0/6 | 1/2 | 0/2 | 0/2 | 1/1 | 0/1 | 3/18 | 16.7% | | | | | | 00:29:59 |
| 28 | | 2/4 | 2/8 | 1/3 | 0/4 | 0/1 | | | 5/20 | 25.0% | | 1 | | | | 00:30:01 |
| 合计 | | | | | | | | | | | | | | | | |
| 3/8 2/14 2/5 0/6 0/3 1/1 0/1 8/38 21.1% 1 | | | | | | | | | | | | | | | | |

场上队员：得分/射门

守门员：救球/射门

| 全队合计 | 得分 | 被救 | 射失 | 击柱 | 封球 | 合计 | % |
|------|----|----|----|----|----|----|--------|
| 远射 | 10 | 5 | 3 | 1 | | 19 | 52.6% |
| 近射 | 11 | 3 | 1 | | | 15 | 73.3% |
| 边射 | 4 | 1 | | 1 | | 6 | 66.7% |
| 快攻 | 3 | 2 | 1 | | | 6 | 50.0% |
| 突破 | 2 | | | | | 2 | 100.0% |
| 任意 | | | | | | | 0.0% |
| 7M | 1 | | 1 | | | 2 | 50.0% |





2016年“体彩杯”全国手球男子青年锦标赛

图式射门区域统计

轮次 2 场次 12

201602012-41-1/1

辽宁队

| | | | | | | | | | | | | | | | | | | | | | | | | | | | | | | | | | | | | | | | | | | | | | | | | | | | | | | | | | | | | | | | | | | | | | | | | | | | | | | | |
|--|-----------------------------|-----------------------------|-----------------------------|-----------------------------|-----------------------------|-----------------------------|-----------------------------|--|---|--|---|---|--|---|--|--|--|--|---|--|--|--|--|--|--|--|--|--|--|---|--|--|--|---|--|---|---|--|--|---|---|--|---|--|--|--|---|---|---|---|--|--|---|--|--|--|--|--|--|--|--|--|--|--|--|--|--|---|---|--|--|--|---|--|--|--|--|--|---|
| 1 高尚君 | 2 王司雨 | 3 李星浩 | 5 余昊锦 | 6 陈庆港 | 7 孙义广 | 8 王鑫鹏 | 10 王柏淇 | | | | | | | | | | | | | | | | | | | | | | | | | | | | | | | | | | | | | | | | | | | | | | | | | | | | | | | | | | | | | | | | | | | | | | | | |
| <table border="1"><tr><td></td><td></td><td></td></tr><tr><td></td><td></td><td></td></tr><tr><td></td><td></td><td></td></tr></table> | | | | | | | | | | <table border="1"><tr><td></td><td></td><td></td></tr><tr><td>1</td><td></td><td></td></tr><tr><td></td><td></td><td>2</td></tr></table> | | | | 1 | | | | | 2 | <table border="1"><tr><td></td><td></td><td></td></tr><tr><td></td><td></td><td></td></tr><tr><td></td><td></td><td></td></tr></table> | | | | | | | | | | <table border="1"><tr><td></td><td></td><td></td></tr><tr><td>1</td><td></td><td>2</td></tr><tr><td>1</td><td></td><td></td></tr></table> | | | | 1 | | 2 | 1 | | | <table border="1"><tr><td>1</td><td></td><td>2</td></tr><tr><td></td><td></td><td></td></tr><tr><td>1</td><td>1</td><td>3</td></tr></table> | 1 | | 2 | | | | 1 | 1 | 3 | <table border="1"><tr><td></td><td></td><td>1</td></tr><tr><td></td><td></td><td></td></tr><tr><td></td><td></td><td></td></tr></table> | | | 1 | | | | | | | <table border="1"><tr><td></td><td></td><td></td></tr><tr><td></td><td></td><td></td></tr><tr><td></td><td>1</td><td>1</td></tr></table> | | | | | | | | 1 | 1 | <table border="1"><tr><td></td><td></td><td>1</td></tr><tr><td></td><td></td><td></td></tr><tr><td></td><td></td><td>1</td></tr></table> | | | 1 | | | | | | 1 |
| | | | | | | | | | | | | | | | | | | | | | | | | | | | | | | | | | | | | | | | | | | | | | | | | | | | | | | | | | | | | | | | | | | | | | | | | | | | | | | | |
| | | | | | | | | | | | | | | | | | | | | | | | | | | | | | | | | | | | | | | | | | | | | | | | | | | | | | | | | | | | | | | | | | | | | | | | | | | | | | | | |
| | | | | | | | | | | | | | | | | | | | | | | | | | | | | | | | | | | | | | | | | | | | | | | | | | | | | | | | | | | | | | | | | | | | | | | | | | | | | | | | |
| | | | | | | | | | | | | | | | | | | | | | | | | | | | | | | | | | | | | | | | | | | | | | | | | | | | | | | | | | | | | | | | | | | | | | | | | | | | | | | | |
| 1 | | | | | | | | | | | | | | | | | | | | | | | | | | | | | | | | | | | | | | | | | | | | | | | | | | | | | | | | | | | | | | | | | | | | | | | | | | | | | | | |
| | | 2 | | | | | | | | | | | | | | | | | | | | | | | | | | | | | | | | | | | | | | | | | | | | | | | | | | | | | | | | | | | | | | | | | | | | | | | | | | | | | |
| | | | | | | | | | | | | | | | | | | | | | | | | | | | | | | | | | | | | | | | | | | | | | | | | | | | | | | | | | | | | | | | | | | | | | | | | | | | | | | | |
| | | | | | | | | | | | | | | | | | | | | | | | | | | | | | | | | | | | | | | | | | | | | | | | | | | | | | | | | | | | | | | | | | | | | | | | | | | | | | | | |
| | | | | | | | | | | | | | | | | | | | | | | | | | | | | | | | | | | | | | | | | | | | | | | | | | | | | | | | | | | | | | | | | | | | | | | | | | | | | | | | |
| | | | | | | | | | | | | | | | | | | | | | | | | | | | | | | | | | | | | | | | | | | | | | | | | | | | | | | | | | | | | | | | | | | | | | | | | | | | | | | | |
| 1 | | 2 | | | | | | | | | | | | | | | | | | | | | | | | | | | | | | | | | | | | | | | | | | | | | | | | | | | | | | | | | | | | | | | | | | | | | | | | | | | | | |
| 1 | | | | | | | | | | | | | | | | | | | | | | | | | | | | | | | | | | | | | | | | | | | | | | | | | | | | | | | | | | | | | | | | | | | | | | | | | | | | | | | |
| 1 | | 2 | | | | | | | | | | | | | | | | | | | | | | | | | | | | | | | | | | | | | | | | | | | | | | | | | | | | | | | | | | | | | | | | | | | | | | | | | | | | | |
| | | | | | | | | | | | | | | | | | | | | | | | | | | | | | | | | | | | | | | | | | | | | | | | | | | | | | | | | | | | | | | | | | | | | | | | | | | | | | | | |
| 1 | 1 | 3 | | | | | | | | | | | | | | | | | | | | | | | | | | | | | | | | | | | | | | | | | | | | | | | | | | | | | | | | | | | | | | | | | | | | | | | | | | | | | |
| | | 1 | | | | | | | | | | | | | | | | | | | | | | | | | | | | | | | | | | | | | | | | | | | | | | | | | | | | | | | | | | | | | | | | | | | | | | | | | | | | | |
| | | | | | | | | | | | | | | | | | | | | | | | | | | | | | | | | | | | | | | | | | | | | | | | | | | | | | | | | | | | | | | | | | | | | | | | | | | | | | | | |
| | | | | | | | | | | | | | | | | | | | | | | | | | | | | | | | | | | | | | | | | | | | | | | | | | | | | | | | | | | | | | | | | | | | | | | | | | | | | | | | |
| | | | | | | | | | | | | | | | | | | | | | | | | | | | | | | | | | | | | | | | | | | | | | | | | | | | | | | | | | | | | | | | | | | | | | | | | | | | | | | | |
| | | | | | | | | | | | | | | | | | | | | | | | | | | | | | | | | | | | | | | | | | | | | | | | | | | | | | | | | | | | | | | | | | | | | | | | | | | | | | | | |
| | 1 | 1 | | | | | | | | | | | | | | | | | | | | | | | | | | | | | | | | | | | | | | | | | | | | | | | | | | | | | | | | | | | | | | | | | | | | | | | | | | | | | |
| | | 1 | | | | | | | | | | | | | | | | | | | | | | | | | | | | | | | | | | | | | | | | | | | | | | | | | | | | | | | | | | | | | | | | | | | | | | | | | | | | | |
| | | | | | | | | | | | | | | | | | | | | | | | | | | | | | | | | | | | | | | | | | | | | | | | | | | | | | | | | | | | | | | | | | | | | | | | | | | | | | | | |
| | | 1 | | | | | | | | | | | | | | | | | | | | | | | | | | | | | | | | | | | | | | | | | | | | | | | | | | | | | | | | | | | | | | | | | | | | | | | | | | | | | |
| Post - 0 Miss - 0 Block - 0 | Post - 1 Miss - 0 Block - 0 | Post - 0 Miss - 0 Block - 0 | Post - 0 Miss - 0 Block - 1 | Post - 1 Miss - 4 Block - 1 | Post - 1 Miss - 0 Block - 0 | Post - 1 Miss - 1 Block - 0 | Post - 1 Miss - 1 Block - 1 | | | | | | | | | | | | | | | | | | | | | | | | | | | | | | | | | | | | | | | | | | | | | | | | | | | | | | | | | | | | | | | | | | | | | | | | |
| 11 庞东阳 | 13 杨洁 | 14 吕昊臻 | 16 吴阳 | 17 李傲 | 18 梅凯博 | 19 赵鑫 | 20 赵佛赐 | | | | | | | | | | | | | | | | | | | | | | | | | | | | | | | | | | | | | | | | | | | | | | | | | | | | | | | | | | | | | | | | | | | | | | | | |
| <table border="1"><tr><td></td><td></td><td></td></tr><tr><td></td><td>1</td><td>1</td></tr><tr><td>1</td><td></td><td>4</td></tr></table> | | | | | 1 | 1 | 1 | | 4 | <table border="1"><tr><td>1</td><td>1</td><td></td></tr><tr><td></td><td></td><td></td></tr><tr><td></td><td></td><td></td></tr></table> | 1 | 1 | | | | | | | | <table border="1"><tr><td></td><td></td><td></td></tr><tr><td></td><td></td><td></td></tr><tr><td></td><td></td><td></td></tr></table> | | | | | | | | | | <table border="1"><tr><td></td><td></td><td></td></tr><tr><td></td><td></td><td></td></tr><tr><td></td><td></td><td></td></tr></table> | | | | | | | | | | <table border="1"><tr><td></td><td></td><td></td></tr><tr><td></td><td></td><td></td></tr><tr><td></td><td></td><td></td></tr></table> | | | | | | | | | | <table border="1"><tr><td></td><td></td><td></td></tr><tr><td></td><td></td><td></td></tr><tr><td></td><td></td><td></td></tr></table> | | | | | | | | | | <table border="1"><tr><td></td><td></td><td></td></tr><tr><td></td><td></td><td></td></tr><tr><td></td><td></td><td></td></tr></table> | | | | | | | | | | <table border="1"><tr><td></td><td></td><td></td></tr><tr><td></td><td></td><td></td></tr><tr><td></td><td></td><td></td></tr></table> | | | | | | | | | |
| | | | | | | | | | | | | | | | | | | | | | | | | | | | | | | | | | | | | | | | | | | | | | | | | | | | | | | | | | | | | | | | | | | | | | | | | | | | | | | | |
| | 1 | 1 | | | | | | | | | | | | | | | | | | | | | | | | | | | | | | | | | | | | | | | | | | | | | | | | | | | | | | | | | | | | | | | | | | | | | | | | | | | | | |
| 1 | | 4 | | | | | | | | | | | | | | | | | | | | | | | | | | | | | | | | | | | | | | | | | | | | | | | | | | | | | | | | | | | | | | | | | | | | | | | | | | | | | |
| 1 | 1 | | | | | | | | | | | | | | | | | | | | | | | | | | | | | | | | | | | | | | | | | | | | | | | | | | | | | | | | | | | | | | | | | | | | | | | | | | | | | | |
| | | | | | | | | | | | | | | | | | | | | | | | | | | | | | | | | | | | | | | | | | | | | | | | | | | | | | | | | | | | | | | | | | | | | | | | | | | | | | | | |
| | | | | | | | | | | | | | | | | | | | | | | | | | | | | | | | | | | | | | | | | | | | | | | | | | | | | | | | | | | | | | | | | | | | | | | | | | | | | | | | |
| | | | | | | | | | | | | | | | | | | | | | | | | | | | | | | | | | | | | | | | | | | | | | | | | | | | | | | | | | | | | | | | | | | | | | | | | | | | | | | | |
| | | | | | | | | | | | | | | | | | | | | | | | | | | | | | | | | | | | | | | | | | | | | | | | | | | | | | | | | | | | | | | | | | | | | | | | | | | | | | | | |
| | | | | | | | | | | | | | | | | | | | | | | | | | | | | | | | | | | | | | | | | | | | | | | | | | | | | | | | | | | | | | | | | | | | | | | | | | | | | | | | |
| | | | | | | | | | | | | | | | | | | | | | | | | | | | | | | | | | | | | | | | | | | | | | | | | | | | | | | | | | | | | | | | | | | | | | | | | | | | | | | | |
| | | | | | | | | | | | | | | | | | | | | | | | | | | | | | | | | | | | | | | | | | | | | | | | | | | | | | | | | | | | | | | | | | | | | | | | | | | | | | | | |
| | | | | | | | | | | | | | | | | | | | | | | | | | | | | | | | | | | | | | | | | | | | | | | | | | | | | | | | | | | | | | | | | | | | | | | | | | | | | | | | |
| | | | | | | | | | | | | | | | | | | | | | | | | | | | | | | | | | | | | | | | | | | | | | | | | | | | | | | | | | | | | | | | | | | | | | | | | | | | | | | | |
| | | | | | | | | | | | | | | | | | | | | | | | | | | | | | | | | | | | | | | | | | | | | | | | | | | | | | | | | | | | | | | | | | | | | | | | | | | | | | | | |
| | | | | | | | | | | | | | | | | | | | | | | | | | | | | | | | | | | | | | | | | | | | | | | | | | | | | | | | | | | | | | | | | | | | | | | | | | | | | | | | |
| | | | | | | | | | | | | | | | | | | | | | | | | | | | | | | | | | | | | | | | | | | | | | | | | | | | | | | | | | | | | | | | | | | | | | | | | | | | | | | | |
| | | | | | | | | | | | | | | | | | | | | | | | | | | | | | | | | | | | | | | | | | | | | | | | | | | | | | | | | | | | | | | | | | | | | | | | | | | | | | | | |
| | | | | | | | | | | | | | | | | | | | | | | | | | | | | | | | | | | | | | | | | | | | | | | | | | | | | | | | | | | | | | | | | | | | | | | | | | | | | | | | |
| | | | | | | | | | | | | | | | | | | | | | | | | | | | | | | | | | | | | | | | | | | | | | | | | | | | | | | | | | | | | | | | | | | | | | | | | | | | | | | | |
| | | | | | | | | | | | | | | | | | | | | | | | | | | | | | | | | | | | | | | | | | | | | | | | | | | | | | | | | | | | | | | | | | | | | | | | | | | | | | | | |
| | | | | | | | | | | | | | | | | | | | | | | | | | | | | | | | | | | | | | | | | | | | | | | | | | | | | | | | | | | | | | | | | | | | | | | | | | | | | | | | |
| | | | | | | | | | | | | | | | | | | | | | | | | | | | | | | | | | | | | | | | | | | | | | | | | | | | | | | | | | | | | | | | | | | | | | | | | | | | | | | | |
| | | | | | | | | | | | | | | | | | | | | | | | | | | | | | | | | | | | | | | | | | | | | | | | | | | | | | | | | | | | | | | | | | | | | | | | | | | | | | | | |
| | | | | | | | | | | | | | | | | | | | | | | | | | | | | | | | | | | | | | | | | | | | | | | | | | | | | | | | | | | | | | | | | | | | | | | | | | | | | | | | |
| Post - 0 Miss - 2 Block - 0 | Post - 0 Miss - 2 Block - 0 | Post - 0 Miss - 0 Block - 0 | Post - 0 Miss - 0 Block - 0 | Post - 0 Miss - 0 Block - 0 | Post - 0 Miss - 0 Block - 0 | Post - 0 Miss - 0 Block - 0 | Post - 0 Miss - 0 Block - 0 | | | | | | | | | | | | | | | | | | | | | | | | | | | | | | | | | | | | | | | | | | | | | | | | | | | | | | | | | | | | | | | | | | | | | | | | |

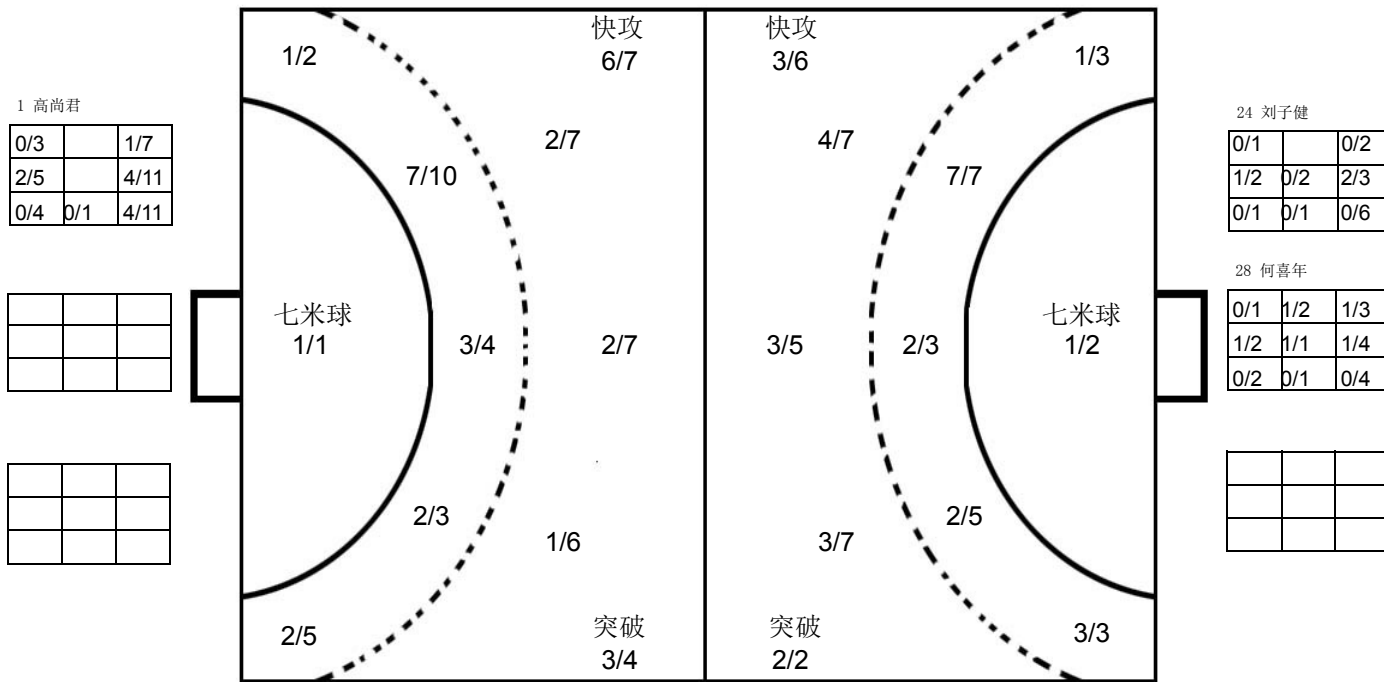

天津队

| | | | | | | | | | | | | | | | | | | | | | | | | | | | | | | | | | | | | | | | | | | | | | | | | | | | | | | | | | | | | | | | | | | | | | | | | | | | | | | | |
|--|-----------------------------|-----------------------------|-----------------------------|-----------------------------|-----------------------------|-----------------------------|-----------------------------|--|---|--|---|--|---|---|--|---|---|---|--|--|---|--|---|--|--|---|--|--|---|--|--|--|---|--|--|---|---|--|---|--|--|--|--|--|--|--|--|--|--|---|--|--|--|--|--|---|---|--|---|---|---|--|--|---|--|--|---|--|--|--|--|--|--|--|--|--|--|--|--|
| 9 吴明远 | 18 王晓琪 | 21 潘玉帅 | 22 魏雨童 | 24 刘子健 | 25 王一雄 | 26 刘思远 | 27 左金龙 | | | | | | | | | | | | | | | | | | | | | | | | | | | | | | | | | | | | | | | | | | | | | | | | | | | | | | | | | | | | | | | | | | | | | | | | |
| <table border="1"><tr><td></td><td></td><td>2</td></tr><tr><td>1</td><td></td><td>2</td></tr><tr><td></td><td></td><td>1</td></tr></table> | | | 2 | 1 | | 2 | | | 1 | <table border="1"><tr><td>1</td><td></td><td>2</td></tr><tr><td>1</td><td></td><td>1</td></tr><tr><td>1</td><td>1</td><td></td></tr></table> | 1 | | 2 | 1 | | 1 | 1 | 1 | | <table border="1"><tr><td>1</td><td></td><td>1</td></tr><tr><td></td><td></td><td>1</td></tr><tr><td></td><td></td><td>1</td></tr></table> | 1 | | 1 | | | 1 | | | 1 | <table border="1"><tr><td></td><td></td><td>1</td></tr><tr><td></td><td></td><td>2</td></tr><tr><td>1</td><td></td><td>3</td></tr></table> | | | 1 | | | 2 | 1 | | 3 | <table border="1"><tr><td></td><td></td><td></td></tr><tr><td></td><td></td><td></td></tr><tr><td></td><td></td><td></td></tr></table> | | | | | | | | | | <table border="1"><tr><td></td><td></td><td></td></tr><tr><td></td><td></td><td>1</td></tr><tr><td>1</td><td></td><td>2</td></tr></table> | | | | | | 1 | 1 | | 2 | <table border="1"><tr><td>1</td><td></td><td></td></tr><tr><td>1</td><td></td><td></td></tr><tr><td>1</td><td></td><td></td></tr></table> | 1 | | | 1 | | | 1 | | | <table border="1"><tr><td></td><td></td><td></td></tr><tr><td></td><td></td><td></td></tr><tr><td></td><td></td><td></td></tr></table> | | | | | | | | | |
| | | 2 | | | | | | | | | | | | | | | | | | | | | | | | | | | | | | | | | | | | | | | | | | | | | | | | | | | | | | | | | | | | | | | | | | | | | | | | | | | | | |
| 1 | | 2 | | | | | | | | | | | | | | | | | | | | | | | | | | | | | | | | | | | | | | | | | | | | | | | | | | | | | | | | | | | | | | | | | | | | | | | | | | | | | |
| | | 1 | | | | | | | | | | | | | | | | | | | | | | | | | | | | | | | | | | | | | | | | | | | | | | | | | | | | | | | | | | | | | | | | | | | | | | | | | | | | | |
| 1 | | 2 | | | | | | | | | | | | | | | | | | | | | | | | | | | | | | | | | | | | | | | | | | | | | | | | | | | | | | | | | | | | | | | | | | | | | | | | | | | | | |
| 1 | | 1 | | | | | | | | | | | | | | | | | | | | | | | | | | | | | | | | | | | | | | | | | | | | | | | | | | | | | | | | | | | | | | | | | | | | | | | | | | | | | |
| 1 | 1 | | | | | | | | | | | | | | | | | | | | | | | | | | | | | | | | | | | | | | | | | | | | | | | | | | | | | | | | | | | | | | | | | | | | | | | | | | | | | | |
| 1 | | 1 | | | | | | | | | | | | | | | | | | | | | | | | | | | | | | | | | | | | | | | | | | | | | | | | | | | | | | | | | | | | | | | | | | | | | | | | | | | | | |
| | | 1 | | | | | | | | | | | | | | | | | | | | | | | | | | | | | | | | | | | | | | | | | | | | | | | | | | | | | | | | | | | | | | | | | | | | | | | | | | | | | |
| | | 1 | | | | | | | | | | | | | | | | | | | | | | | | | | | | | | | | | | | | | | | | | | | | | | | | | | | | | | | | | | | | | | | | | | | | | | | | | | | | | |
| | | 1 | | | | | | | | | | | | | | | | | | | | | | | | | | | | | | | | | | | | | | | | | | | | | | | | | | | | | | | | | | | | | | | | | | | | | | | | | | | | | |
| | | 2 | | | | | | | | | | | | | | | | | | | | | | | | | | | | | | | | | | | | | | | | | | | | | | | | | | | | | | | | | | | | | | | | | | | | | | | | | | | | | |
| 1 | | 3 | | | | | | | | | | | | | | | | | | | | | | | | | | | | | | | | | | | | | | | | | | | | | | | | | | | | | | | | | | | | | | | | | | | | | | | | | | | | | |
| | | | | | | | | | | | | | | | | | | | | | | | | | | | | | | | | | | | | | | | | | | | | | | | | | | | | | | | | | | | | | | | | | | | | | | | | | | | | | | | |
| | | | | | | | | | | | | | | | | | | | | | | | | | | | | | | | | | | | | | | | | | | | | | | | | | | | | | | | | | | | | | | | | | | | | | | | | | | | | | | | |
| | | | | | | | | | | | | | | | | | | | | | | | | | | | | | | | | | | | | | | | | | | | | | | | | | | | | | | | | | | | | | | | | | | | | | | | | | | | | | | | |
| | | | | | | | | | | | | | | | | | | | | | | | | | | | | | | | | | | | | | | | | | | | | | | | | | | | | | | | | | | | | | | | | | | | | | | | | | | | | | | | |
| | | 1 | | | | | | | | | | | | | | | | | | | | | | | | | | | | | | | | | | | | | | | | | | | | | | | | | | | | | | | | | | | | | | | | | | | | | | | | | | | | | |
| 1 | | 2 | | | | | | | | | | | | | | | | | | | | | | | | | | | | | | | | | | | | | | | | | | | | | | | | | | | | | | | | | | | | | | | | | | | | | | | | | | | | | |
| 1 | | | | | | | | | | | | | | | | | | | | | | | | | | | | | | | | | | | | | | | | | | | | | | | | | | | | | | | | | | | | | | | | | | | | | | | | | | | | | | | |
| 1 | | | | | | | | | | | | | | | | | | | | | | | | | | | | | | | | | | | | | | | | | | | | | | | | | | | | | | | | | | | | | | | | | | | | | | | | | | | | | | | |
| 1 | | | | | | | | | | | | | | | | | | | | | | | | | | | | | | | | | | | | | | | | | | | | | | | | | | | | | | | | | | | | | | | | | | | | | | | | | | | | | | | |
| | | | | | | | | | | | | | | | | | | | | | | | | | | | | | | | | | | | | | | | | | | | | | | | | | | | | | | | | | | | | | | | | | | | | | | | | | | | | | | | |
| | | | | | | | | | | | | | | | | | | | | | | | | | | | | | | | | | | | | | | | | | | | | | | | | | | | | | | | | | | | | | | | | | | | | | | | | | | | | | | | |
| | | | | | | | | | | | | | | | | | | | | | | | | | | | | | | | | | | | | | | | | | | | | | | | | | | | | | | | | | | | | | | | | | | | | | | | | | | | | | | | |
| Post - 1 Miss - 0 Block - 0 | Post - 0 Miss - 2 Block - 0 | Post - 0 Miss - 1 Block - 0 | Post - 1 Miss - 3 Block - 0 | Post - 0 Miss - 0 Block - 0 | Post - 0 Miss - 0 Block - 0 | Post - 0 Miss - 0 Block - 0 | Post - 0 Miss - 0 Block - 0 | | | | | | | | | | | | | | | | | | | | | | | | | | | | | | | | | | | | | | | | | | | | | | | | | | | | | | | | | | | | | | | | | | | | | | | | |
| 28 何喜年 | | | | | | | | | | | | | | | | | | | | | | | | | | | | | | | | | | | | | | | | | | | | | | | | | | | | | | | | | | | | | | | | | | | | | | | | | | | | | | | |
| <table border="1"><tr><td></td><td></td><td></td></tr><tr><td></td><td></td><td></td></tr><tr><td></td><td></td><td></td></tr></table> | | | | | | | | | | <table border="1"><tr><td></td><td></td><td></td></tr><tr><td></td><td></td><td></td></tr><tr><td></td><td></td><td></td></tr></table> | | | | | | | | | | <table border="1"><tr><td></td><td></td><td></td></tr><tr><td></td><td></td><td></td></tr><tr><td></td><td></td><td></td></tr></table> | | | | | | | | | | <table border="1"><tr><td></td><td></td><td></td></tr><tr><td></td><td></td><td></td></tr><tr><td></td><td></td><td></td></tr></table> | | | | | | | | | | <table border="1"><tr><td></td><td></td><td></td></tr><tr><td></td><td></td><td></td></tr><tr><td></td><td></td><td></td></tr></table> | | | | | | | | | | <table border="1"><tr><td></td><td></td><td></td></tr><tr><td></td><td></td><td></td></tr><tr><td></td><td></td><td></td></tr></table> | | | | | | | | | | <table border="1"><tr><td></td><td></td><td></td></tr><tr><td></td><td></td><td></td></tr><tr><td></td><td></td><td></td></tr></table> | | | | | | | | | | <table border="1"><tr><td></td><td></td><td></td></tr><tr><td></td><td></td><td></td></tr><tr><td></td><td></td><td></td></tr></table> | | | | | | | | | |
| | | | | | | | | | | | | | | | | | | | | | | | | | | | | | | | | | | | | | | | | | | | | | | | | | | | | | | | | | | | | | | | | | | | | | | | | | | | | | | | |
| | | | | | | | | | | | | | | | | | | | | | | | | | | | | | | | | | | | | | | | | | | | | | | | | | | | | | | | | | | | | | | | | | | | | | | | | | | | | | | | |
| | | | | | | | | | | | | | | | | | | | | | | | | | | | | | | | | | | | | | | | | | | | | | | | | | | | | | | | | | | | | | | | | | | | | | | | | | | | | | | | |
| | | | | | | | | | | | | | | | | | | | | | | | | | | | | | | | | | | | | | | | | | | | | | | | | | | | | | | | | | | | | | | | | | | | | | | | | | | | | | | | |
| | | | | | | | | | | | | | | | | | | | | | | | | | | | | | | | | | | | | | | | | | | | | | | | | | | | | | | | | | | | | | | | | | | | | | | | | | | | | | | | |
| | | | | | | | | | | | | | | | | | | | | | | | | | | | | | | | | | | | | | | | | | | | | | | | | | | | | | | | | | | | | | | | | | | | | | | | | | | | | | | | |
| | | | | | | | | | | | | | | | | | | | | | | | | | | | | | | | | | | | | | | | | | | | | | | | | | | | | | | | | | | | | | | | | | | | | | | | | | | | | | | | |
| | | | | | | | | | | | | | | | | | | | | | | | | | | | | | | | | | | | | | | | | | | | | | | | | | | | | | | | | | | | | | | | | | | | | | | | | | | | | | | | |
| | | | | | | | | | | | | | | | | | | | | | | | | | | | | | | | | | | | | | | | | | | | | | | | | | | | | | | | | | | | | | | | | | | | | | | | | | | | | | | | |
| | | | | | | | | | | | | | | | | | | | | | | | | | | | | | | | | | | | | | | | | | | | | | | | | | | | | | | | | | | | | | | | | | | | | | | | | | | | | | | | |
| | | | | | | | | | | | | | | | | | | | | | | | | | | | | | | | | | | | | | | | | | | | | | | | | | | | | | | | | | | | | | | | | | | | | | | | | | | | | | | | |
| | | | | | | | | | | | | | | | | | | | | | | | | | | | | | | | | | | | | | | | | | | | | | | | | | | | | | | | | | | | | | | | | | | | | | | | | | | | | | | | |
| | | | | | | | | | | | | | | | | | | | | | | | | | | | | | | | | | | | | | | | | | | | | | | | | | | | | | | | | | | | | | | | | | | | | | | | | | | | | | | | |
| | | | | | | | | | | | | | | | | | | | | | | | | | | | | | | | | | | | | | | | | | | | | | | | | | | | | | | | | | | | | | | | | | | | | | | | | | | | | | | | |
| | | | | | | | | | | | | | | | | | | | | | | | | | | | | | | | | | | | | | | | | | | | | | | | | | | | | | | | | | | | | | | | | | | | | | | | | | | | | | | | |
| | | | | | | | | | | | | | | | | | | | | | | | | | | | | | | | | | | | | | | | | | | | | | | | | | | | | | | | | | | | | | | | | | | | | | | | | | | | | | | | |
| | | | | | | | | | | | | | | | | | | | | | | | | | | | | | | | | | | | | | | | | | | | | | | | | | | | | | | | | | | | | | | | | | | | | | | | | | | | | | | | |
| | | | | | | | | | | | | | | | | | | | | | | | | | | | | | | | | | | | | | | | | | | | | | | | | | | | | | | | | | | | | | | | | | | | | | | | | | | | | | | | |
| | | | | | | | | | | | | | | | | | | | | | | | | | | | | | | | | | | | | | | | | | | | | | | | | | | | | | | | | | | | | | | | | | | | | | | | | | | | | | | | |
| | | | | | | | | | | | | | | | | | | | | | | | | | | | | | | | | | | | | | | | | | | | | | | | | | | | | | | | | | | | | | | | | | | | | | | | | | | | | | | | |
| | | | | | | | | | | | | | | | | | | | | | | | | | | | | | | | | | | | | | | | | | | | | | | | | | | | | | | | | | | | | | | | | | | | | | | | | | | | | | | | |
| | | | | | | | | | | | | | | | | | | | | | | | | | | | | | | | | | | | | | | | | | | | | | | | | | | | | | | | | | | | | | | | | | | | | | | | | | | | | | | | |
| | | | | | | | | | | | | | | | | | | | | | | | | | | | | | | | | | | | | | | | | | | | | | | | | | | | | | | | | | | | | | | | | | | | | | | | | | | | | | | | |
| | | | | | | | | | | | | | | | | | | | | | | | | | | | | | | | | | | | | | | | | | | | | | | | | | | | | | | | | | | | | | | | | | | | | | | | | | | | | | | | |
| Post - 0 Miss - 0 Block - 0 | | | | | | | | | | | | | | | | | | | | | | | | | | | | | | | | | | | | | | | | | | | | | | | | | | | | | | | | | | | | | | | | | | | | | | | | | | | | | | | |

注释: Post=击柱 Miss=射失 Block=被封





预赛 Group A
青年男子 全国比赛

2016年“体彩杯”全国手球男子青年锦标赛

| | | | | | | | | | | | | | | | | | | | | | |
|------------------------|---|------------------------------------|---------------------|------------------------|------------------------------------|-------------------|----------|---------------------------|------------------------------|----------|----------|----------------------|---------------|----------|--|--|----|---|----|----------|----|
| Team A A 江苏队 | | | | Team B B 山东队 | | | | Match Number 13 | | | | | | | | | | | | | |
| played in China | | in the hall 重庆万州 | | on 22/03/2016 | | at 08:30 hours | | Spectators | | | | | | | | | | | | | |
| Half-time (30') | A 10 | B 16 | End of playing time | A 26 | B 33 | 1st extra time | A | B | 2nd extra time | A | B | After penalty throws | A | B | | | | | | | |
| Number of 7 m | A 1/2 | Team time-out 1 14:36 2 42:03 3 | | | Full name of players and officials | | | | Team time-out 1 22:28 2 3 | | | B 1/2 | Number of 7 m | | | | | | | | |
| No. | Team A | | | | | G | W | 2' | D | DR | No. | Team B | | | | | G | W | 2' | D | DR |
| 1 | 潘博琦 | | | | | | | | | | 1 | 刘继超 | | | | | | | | | |
| 3 | 赵韦光 | | | | | 3 | 1 | | | | 2 | 冯鑫宇 | | | | | 1 | | | | |
| 4 | 张瑞恒 | | | | | | | | | | 3 | 王铁林 | | | | | 6 | 1 | | | |
| 6 | 季雨 | | | | | | | | | | 5 | 王晓峰 | | | | | 10 | 1 | 1 | | |
| 7 | 任超凡 | | | | | | | | | | 6 | 王军鸣 | | | | | | | | | |
| 8 | 姜童耀 | | | | | | | | | | 7 | 徐勇林 | | | | | 3 | | | | |
| 9 | 王俊威 | | | | | | | | | | 10 | 孙芳伟 | | | | | 6 | 1 | | | |
| 11 | 周傲 | | | | | 9 | 1 | 1 | | | 11 | 王洋 | | | | | | | | | |
| 13 | 尹吉祥 | | | | | 7 | | 1 | | | 12 | 刘道林 | | | | | | | | | |
| 14 | 罗中熠 | | | | | | | | | | 13 | 于欣君 | | | | | 2 | | | | |
| 15 | 阎冠中 | | | | | | | | | | 17 | 薛盼龙 | | | | | 3 | | | | |
| 17 | 马益奎 | | | | | 1 | | | | | 18 | 李玮 | | | | | | | | | |
| 18 | 耿畅 | | | | | 6 | 1 | | | | 21 | 王腾达 | | | | | | | 2 | | |
| | | | | | | | | | | | 22 | 李子跃 | | | | | | | | | |
| | | | | | | | | | | | 23 | 李荣健 | | | | | 2 | | | | |
| B | 贾淑君 (主教练) | | | | | | | | | | B | 王莉莉 (主教练) | | | | | | | | | |
| A | Signature of Responsible Official of the Teams (Off. A) | | | | | | | | | | | | | | | | | | | B | |
| TP | Remarks of Referee / CHA Official | | | | | | | | | | | | | | | | | | | TP | |

Signatures

Referees: 王洋 (CHN) 严璐 (CHN)

Techn. Delegates: 许宜扬 (CHN)

CHA Official: 张春生 (CHN)

Note: Number of 7m Throws Awarded to Team A and B, Goals (G), Warnings (W), Suspensions (2'), Direct Disqualification (D), Disqualification with Report (DR) and Team Penalty (TP).

Table Officials:

Statisticians: 李双

刘永欢





2016年“体彩杯”全国手球男子青年锦标赛 竞赛技术统计(媒体表)

| | | | | | | |
|------|----|------------|----|---------|------------------|-----|
| 预赛 | 组别 | A | 轮次 | 3 | 场次 | 13 |
| 重庆万州 | | 22/03/2016 | | | 201602013-51-1/1 | |
| 江苏队 | | 江苏 | 26 | vs | 33 | 山东队 |
| | | | | 10 : 16 | | |

| | | | |
|-----|----------|---|----------|
| 裁判员 | 王洋 (CHN) | / | 严璐 (CHN) |
|-----|----------|---|----------|

| 江苏 | | 远射 | 近射 | 边射 | 快攻 | 突破 | 任意球 | 7m球 | 合计 | % | 助攻 | 失误 | 警告 | 2' | D & DR | 比赛进程 | |
|---------------|-----|--------------|--------------|------------|-------------|------------|------------|------------|--------------|-------------|-----------|-----------|----------|----------|--------|------|--------------------|
| 主教练：贾淑君 | | | | | | | | | | | | | | | | | |
| 1 | 潘博琦 | | | | | | | | | | | | | | | | 0 02:39 1 5 王晓峰 |
| 3 | 赵韦光 | 0/1 | 2/5 | 0/3 | 1/1 | | | | 3/10 | 30.0 | | | 1 | | | | 1 03:11 1 17 薛盼龙 |
| 4 | 张瑞恒 | | | | | | | | | | | | | | | | 1 07:27 3 3 王铁林 |
| 6 | 季雨 | | | | | | | | | | | | | | | | 2 07:50 3 3 王铁林 |
| 7 | 任超凡 | 0/1 | 0/2 | 0/2 | | | | | 0/5 | 0.0 | 2 | | | | | | 3 08:25 3 4 王铁林 |
| 8 | 姜童耀 | | | | | | | | | | | | | | | | 3 09:22 4 5 王晓峰 |
| 9 | 王俊威 | | | | | | | | | | | | | | | | 4 09:39 4 4 王铁林 |
| 11 | 周傲 | 5/13 | 2/4 | 0/1 | | | 2/2 | | 9/20 | 45.0 | 6 | 7 | 1 | 1 | | | 4 10:55 5 5 王晓峰 |
| 13 | 尹吉祥 | 1/11 | 2/3 | | | 2/2 | 1/1 | 1/1 | 7/18 | 38.9 | | 7 | | | | | 4 12:52 6 5 王晓峰 |
| 14 | 罗中熠 | | | | | | | | | | | | | | | | 5 14:44 6 6 王铁林 |
| 15 | 阎冠中 | | | | | | | | | | | | | | | | 5 15:19 7 5 王晓峰 |
| 17 | 马益奎 | | 1/3 | | | | 0/1 | | 1/4 | 25.0 | 1 | 4 | | | | | 5 15:55 8 17 薛盼龙 |
| 18 | 耿畅 | 0/4 | 3/5 | 1/1 | 2/2 | | | 0/1 | 6/13 | 46.2 | | 3 | 1 | | | | 5 16:33 9 3 王铁林 |
| 运动员 合计 | | 6/30 | 10/22 | 1/7 | 3/3 | 2/2 | 3/4 | 1/2 | 26/70 | 37.1 | 9 | 22 | 3 | 2 | | | 6 16:58 9 9 王铁林 |
| 1 | 潘博琦 | 6/17 | 6/17 | 4/5 | 2/10 | 0/1 | | 1/2 | 19/52 | 36.5 | | | | | | | 7 17:33 9 10 孙芳伟 |
| 守门员 合计 | | 6/17 | 6/17 | 4/5 | 2/10 | 0/1 | | 1/2 | 19/52 | 36.5 | | | | | | | 7 18:13 10 10 孙芳伟 |
| 山东 | | 远射 | 近射 | 边射 | 快攻 | 突破 | 任意球 | 7m球 | 合计 | % | 助攻 | 失误 | 警告 | 2' | D & DR | 比赛进程 | |
| 教练：王莉莉 | | | | | | | | | | | | | | | | | |
| 1 | 刘继超 | | | | | | | | | | | | | | | | 8 20:20 10 5 王晓峰 |
| 2 | 冯鑫宇 | | 0/2 | | 1/1 | | | | 1/3 | 33.3 | 2 | 2 | | | | | 8 21:59 11 5 王晓峰 |
| 3 | 王铁林 | 1/4 | 3/4 | | 2/2 | | | | 6/10 | 60.0 | 2 | | 1 | | | | 8 22:38 12 5 王晓峰 |
| 5 | 王晓峰 | 6/12 | 1/1 | | 2/2 | | | 1/1 | 10/16 | 62.5 | 2 | | 1 | 1 | | | 9 25:00 12 10 孙芳伟 |
| 6 | 王军鸣 | | | 0/1 | | | | | 0/1 | 0.0 | 1 | | | | | | 9 26:58 13 10 孙芳伟 |
| 7 | 徐勇林 | 1/2 | 1/4 | 0/1 | 1/1 | | | | 3/8 | 37.5 | 2 | 2 | | | | | 9 28:04 14 3 王铁林 |
| 10 | 孙芳伟 | 2/4 | 1/2 | 1/2 | 1/1 | 1/1 | | 0/1 | 6/11 | 54.5 | 1 | 1 | 1 | | | | 10 28:34 14 3 王铁林 |
| 11 | 王洋 | | | 0/1 | 0/1 | | | | 0/2 | 0.0 | | 1 | | | | | 10 28:54 15 10 孙芳伟 |
| 12 | 刘道林 | | | | | | | | | | | | | | | | 10 29:45 16 17 薛盼龙 |
| 13 | 于欣君 | 1/4 | 1/1 | | | | | | 2/5 | 40.0 | 1 | 1 | | | | | 10 00:19 17 3 王铁林 |
| 17 | 薛盼龙 | | 3/3 | | | | | | 3/3 | 100 | | | | | | | 10 03:51 18 5 王晓峰 |
| 18 | 李玮 | | | 0/1 | | | | | 0/1 | 0.0 | | 1 | | | | | 10 04:17 18 10 孙芳伟 |
| 21 | 王腾达 | | | | | | | | | | | | | | | | 11 04:51 19 10 孙芳伟 |
| 22 | 李子跃 | 0/2 | | | | | | | 0/2 | 0.0 | | 1 | | | | | 12 06:03 19 10 孙芳伟 |
| 23 | 李荣健 | | 1/2 | | 1/2 | | | | 2/4 | 50.0 | | | | | | | 12 07:13 20 10 孙芳伟 |
| 运动员 合计 | | 11/28 | 11/19 | 1/6 | 8/10 | 1/1 | | 1/2 | 33/66 | 50.0 | 11 | 10 | 3 | 3 | | | 13 07:33 20 10 孙芳伟 |
| 1 | 刘继超 | 8/14 | 8/18 | 4/5 | 0/3 | 0/2 | 0/3 | 0/1 | 20/46 | 43.5 | | 1 | | | | | 14 08:12 20 10 孙芳伟 |
| 守门员 合计 | | 8/14 | 8/18 | 4/5 | 0/3 | 0/2 | 0/3 | 0/1 | 20/46 | 43.5 | | | | | | | 14 09:19 21 5 王晓峰 |

场上队员：得分 / 射门

守门员：救球 / 射门

| | | | | | | | | | |
|----|------------|----|--------------|-----|------------|-----|----------|----|---------|
| 快攻 | Fast Break | 突破 | Breakthrough | 任意球 | Free Throw | 7M球 | 7M Throw | 助攻 | Assist |
| 警告 | Warning | 失误 | Error | 2' | Suspension | D | 取消资格 | DR | 取消资格+报告 |





2016年“体彩杯”全国手球男子青年锦标赛 图式比赛技术统计表

轮次 3

场次 13

201602013-21-1/1

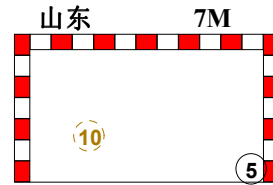
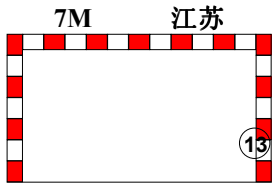
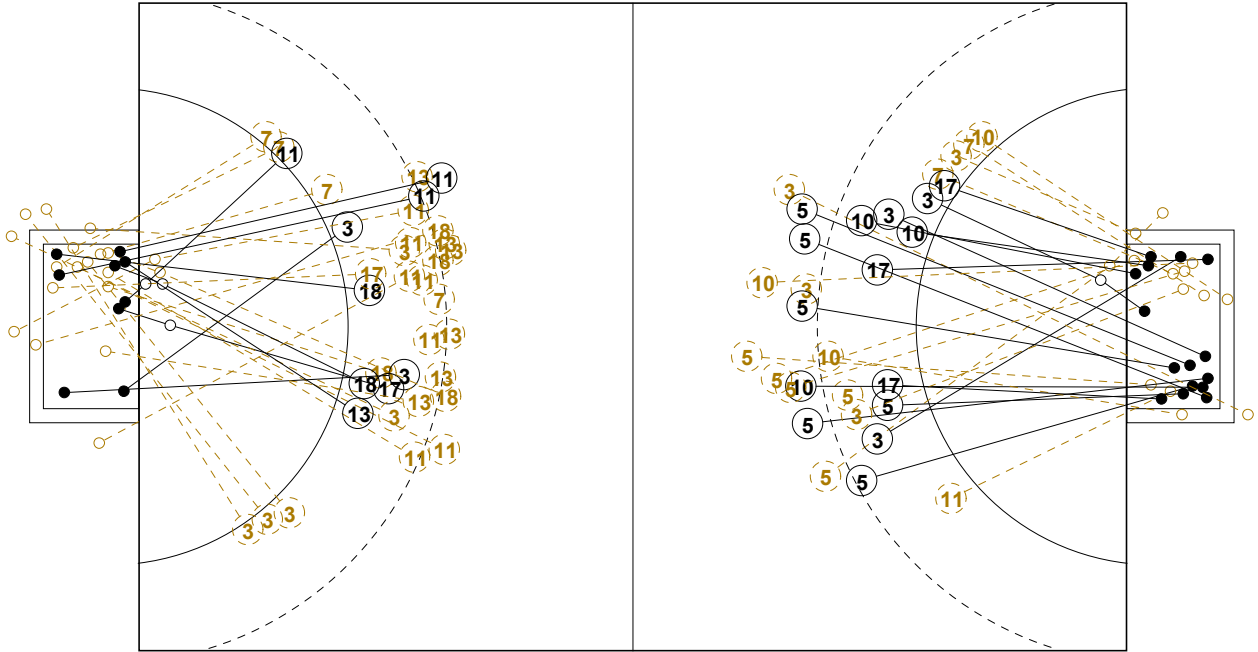

1st Half
10 : 16

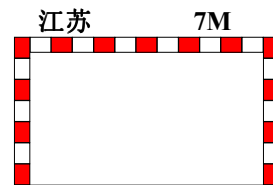
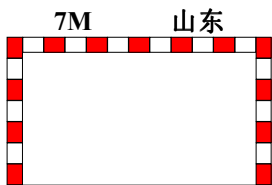
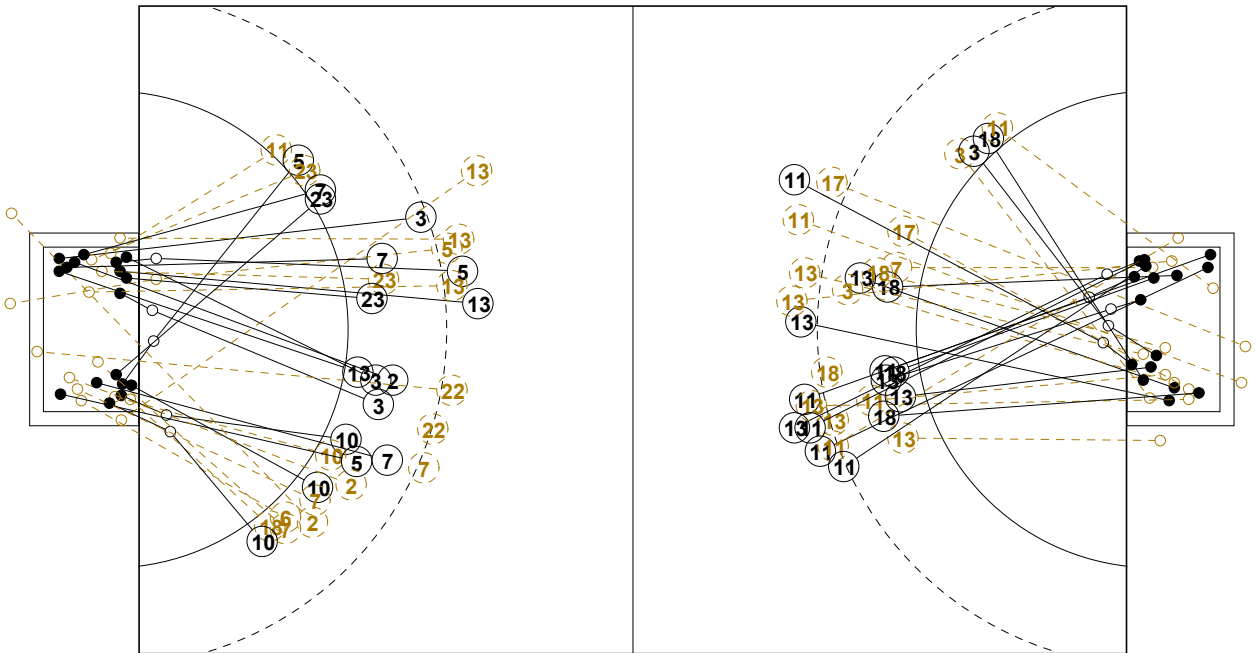

2nd Half
33 : 26



2016年“体彩杯”全国手球男子青年锦标赛

个人/全队技术统计表

正式表
手球
青年男子预赛
轮次 3组别 A
场次 13201602013-14-1/2
重庆万州
22/03/2016 08:30

| 号码 | 姓名 | 远射 | 近射 | 边射 | 快攻 | 突破 | 任意 | 7M | 合计 | % | 助攻 | 失误 | 警告 | 2' | 取消 | 时间 |
|----------------|-----|------|-----|-----|-----|-----|-----|-----|------|-------|----|----|----|----|----|----------|
| 江苏队(江苏) | | | | | | | | | | | | | | | | |
| <i>(场上队员)</i> | | | | | | | | | | | | | | | | |
| 1 | 潘博琦 | | | | | | | | | 0.0% | | | | | | 01:00:00 |
| 3 | 赵韦光 | 0/1 | 2/5 | 0/3 | 1/1 | | | | 3/10 | 30.0% | | | 1 | | | 00:50:25 |
| 4 | 张瑞恒 | | | | | | | | | 0.0% | | | | | | 00:00:00 |
| 6 | 季雨 | | | | | | | | | 0.0% | | | | | | 00:00:00 |
| 7 | 任超凡 | 0/1 | 0/2 | 0/2 | | | | | 0/5 | 0.0% | 2 | | | | | 00:46:46 |
| 8 | 姜童耀 | | | | | | | | | 0.0% | | | | | | 00:05:51 |
| 9 | 王俊威 | | | | | | | | | 0.0% | | | | | | 00:09:35 |
| 11 | 周傲 | 5/13 | 2/4 | 0/1 | | | 2/2 | | 9/20 | 45.0% | 6 | 7 | 1 | 1 | | 01:00:00 |
| 13 | 尹吉祥 | 1/11 | 2/3 | | | 2/2 | 1/1 | 1/1 | 7/18 | 38.9% | | 7 | | 1 | | 01:00:00 |
| 14 | 罗中熠 | | | | | | | | | 0.0% | | | | | | 00:00:00 |
| 15 | 阎冠中 | | | | | | | | | 0.0% | | 1 | | | | 00:13:13 |
| 17 | 马益奎 | | 1/3 | | | | 0/1 | | 1/4 | 25.0% | 1 | 4 | | | | 01:00:00 |
| 18 | 耿畅 | 0/4 | 3/5 | 1/1 | 2/2 | | | 0/1 | 6/13 | 46.2% | | 3 | 1 | | | 00:54:08 |

| | | | | | | | | | | | | | | | | |
|--------------|-----|------|-------|-----|------|-----|-----|-----|-------|-------|---|----|---|---|--|----------|
| 合计 | | 6/30 | 10/22 | 1/7 | 3/3 | 2/2 | 3/4 | 1/2 | 26/70 | 37.1% | 9 | 22 | 3 | 2 | | |
| <i>(守门员)</i> | | | | | | | | | | | | | | | | |
| 1 | 潘博琦 | 6/17 | 6/17 | 4/5 | 2/10 | 0/1 | | 1/2 | 19/52 | 36.5% | | | | | | 01:00:00 |

| | | | | | | | | | | | | | | | | |
|-----------|--|------|------|-----|------|-----|--|-----|-------|-------|--|--|--|--|--|--|
| 合计 | | 6/17 | 6/17 | 4/5 | 2/10 | 0/1 | | 1/2 | 19/52 | 36.5% | | | | | | |
|-----------|--|------|------|-----|------|-----|--|-----|-------|-------|--|--|--|--|--|--|

场上队员：得分/射门

守门员：救球/射门

| 全队合计 | 得分 | 被救 | 射失 | 击柱 | 封球 | 合计 | % |
|------|----|----|----|----|----|----|--------|
| 远射 | 6 | 8 | 2 | 2 | 12 | 30 | 20.0% |
| 近射 | 10 | 8 | 3 | 1 | | 22 | 45.5% |
| 边射 | 1 | 4 | 2 | | | 7 | 14.3% |
| 快攻 | 3 | | | | | 3 | 100.0% |
| 突破 | 2 | | | | | 2 | 100.0% |
| 任意 | 3 | | 1 | | | 4 | 75.0% |
| 7M | 1 | | 1 | | | 2 | 50.0% |





2016年“体彩杯”全国手球男子青年锦标赛

个人/全队技术统计表

正式表
手球
青年男子预赛
轮次 3组别 A
场次 13201602013-14-2/2
重庆万州
22/03/2016 08:30

| 号码 | 姓名 | 远射 | 近射 | 边射 | 快攻 | 突破 | 任意 | 7M | 合计 | % | 助攻 | 失误 | 警告 | 2' | 取消 | 时间 |
|----------------|-----|-------|-------|-----|------|-----|-----|-----|-------|-------|----|----|----|----|----|----------|
| 山东队(山东) | | | | | | | | | | | | | | | | |
| <i>(上场队员)</i> | | | | | | | | | | | | | | | | |
| 1 | 刘继超 | | | | | | | | | 0.0% | | 1 | | | | 01:00:00 |
| 2 | 冯鑫宇 | | 0/2 | | 1/1 | | | | 1/3 | 33.3% | 2 | 2 | | | | 00:17:08 |
| 3 | 王铁林 | 1/4 | 3/4 | | 2/2 | | | | 6/10 | 60.0% | 2 | | 1 | | | 00:53:53 |
| 5 | 王晓峰 | 6/12 | 1/1 | | 2/2 | | | 1/1 | 10/16 | 62.5% | 2 | | 1 | 1 | | 00:43:53 |
| 6 | 王军鸣 | | | 0/1 | | | | | 0/1 | 0.0% | 1 | | | | | 00:13:19 |
| 7 | 徐勇林 | 1/2 | 1/4 | 0/1 | 1/1 | | | | 3/8 | 37.5% | 2 | 2 | | | | 00:46:32 |
| 10 | 孙芳伟 | 2/4 | 1/2 | 1/2 | 1/1 | 1/1 | | 0/1 | 6/11 | 54.5% | 1 | 1 | 1 | | | 00:43:36 |
| 11 | 王洋 | | | 0/1 | 0/1 | | | | 0/2 | 0.0% | | 1 | | | | 00:43:27 |
| 12 | 刘道林 | | | | | | | | | 0.0% | | | | | | 00:00:00 |
| 13 | 于欣君 | 1/4 | 1/1 | | | | | | 2/5 | 40.0% | 1 | 1 | | | | 00:16:03 |
| 17 | 薛盼龙 | | 3/3 | | | | | | 3/3 | 100% | | | | | | 00:30:00 |
| 18 | 李玮 | | | 0/1 | | | | | 0/1 | 0.0% | | 1 | | | | 00:13:30 |
| 21 | 王腾达 | | | | | | | | | 0.0% | | | | 2 | | 00:10:47 |
| 22 | 李子跃 | 0/2 | | | | | | | 0/2 | 0.0% | | 1 | | | | 00:16:24 |
| 23 | 李荣健 | | 1/2 | | 1/2 | | | | 2/4 | 50.0% | | | | | | 00:16:40 |
| 合计 | | 11/28 | 11/19 | 1/6 | 8/10 | 1/1 | | 1/2 | 33/66 | 50.0% | 11 | 10 | 3 | 3 | | |
| <i>(守门员)</i> | | | | | | | | | | | | | | | | |
| 1 | 刘继超 | 8/14 | 8/18 | 4/5 | 0/3 | 0/2 | 0/3 | 0/1 | 20/46 | 43.5% | | 1 | | | | 01:00:00 |
| 合计 | | 8/14 | 8/18 | 4/5 | 0/3 | 0/2 | 0/3 | 0/1 | 20/46 | 43.5% | | 1 | | | | |

场上队员：得分/射门

守门员：救球/射门

| 全队合计 | 得分 | 被救 | 射失 | 击柱 | 封球 | 合计 | % |
|------|----|----|----|----|----|----|--------|
| 远射 | 11 | 6 | 3 | 4 | 4 | 28 | 39.3% |
| 近射 | 11 | 6 | 1 | 1 | | 19 | 57.9% |
| 边射 | 1 | 4 | | 1 | | 6 | 16.7% |
| 快攻 | 8 | 2 | | | | 10 | 80.0% |
| 突破 | 1 | | | | | 1 | 100.0% |
| 任意 | | | | | | | 0.0% |
| 7M | 1 | 1 | | | | 2 | 50.0% |





2016年“体彩杯”全国手球男子青年锦标赛

图式射门区域统计

轮次 3 场次 13

201602013-41-1/1

江苏队

| | | | | | | | | | | | | | | | | | | | | | | | | | | | | | | | | | | | | | | | | | | | | | | | | | | | | | | | | | | | | | | | | | | | | | | | | | | | | | | | |
|---|-----------------------------|-----------------------------|-----------------------------|-----------------------------|-----------------------------|-----------------------------|-----------------------------|--|---|---|---|--|--|--|--|--|---|---|--|--|--|--|--|--|--|--|--|--|--|---|--|--|--|--|--|---|--|--|--|--|--|--|---|---|--|--|---|--|---|--|--|--|--|--|--|--|--|--|--|--|--|--|--|--|--|--|--|--|--|---|---|--|---|--|--|--|---|---|---|
| 1 潘博琦 | 3 赵韦光 | 4 张瑞恒 | 6 季雨 | 7 任超凡 | 8 姜童耀 | 9 王俊威 | 11 周傲 | | | | | | | | | | | | | | | | | | | | | | | | | | | | | | | | | | | | | | | | | | | | | | | | | | | | | | | | | | | | | | | | | | | | | | | | |
| <table border="1"><tr><td></td><td></td><td></td></tr><tr><td></td><td></td><td></td></tr><tr><td></td><td></td><td></td></tr></table> | | | | | | | | | | <table border="1"><tr><td>1</td><td></td><td></td></tr><tr><td></td><td></td><td></td></tr><tr><td>1</td><td>1</td><td></td></tr></table> | 1 | | | | | | 1 | 1 | | <table border="1"><tr><td></td><td></td><td></td></tr><tr><td></td><td></td><td></td></tr><tr><td></td><td></td><td></td></tr></table> | | | | | | | | | | <table border="1"><tr><td></td><td></td><td></td></tr><tr><td></td><td></td><td></td></tr><tr><td></td><td></td><td></td></tr></table> | | | | | | | | | | <table border="1"><tr><td></td><td></td><td></td></tr><tr><td></td><td></td><td></td></tr><tr><td></td><td></td><td></td></tr></table> | | | | | | | | | | <table border="1"><tr><td></td><td></td><td></td></tr><tr><td></td><td></td><td></td></tr><tr><td></td><td></td><td></td></tr></table> | | | | | | | | | | <table border="1"><tr><td></td><td></td><td></td></tr><tr><td></td><td></td><td></td></tr><tr><td></td><td></td><td></td></tr></table> | | | | | | | | | | <table border="1"><tr><td>2</td><td></td><td>1</td></tr><tr><td></td><td></td><td></td></tr><tr><td>3</td><td>1</td><td>2</td></tr></table> | 2 | | 1 | | | | 3 | 1 | 2 |
| | | | | | | | | | | | | | | | | | | | | | | | | | | | | | | | | | | | | | | | | | | | | | | | | | | | | | | | | | | | | | | | | | | | | | | | | | | | | | | | |
| | | | | | | | | | | | | | | | | | | | | | | | | | | | | | | | | | | | | | | | | | | | | | | | | | | | | | | | | | | | | | | | | | | | | | | | | | | | | | | | |
| | | | | | | | | | | | | | | | | | | | | | | | | | | | | | | | | | | | | | | | | | | | | | | | | | | | | | | | | | | | | | | | | | | | | | | | | | | | | | | | |
| 1 | | | | | | | | | | | | | | | | | | | | | | | | | | | | | | | | | | | | | | | | | | | | | | | | | | | | | | | | | | | | | | | | | | | | | | | | | | | | | | | |
| | | | | | | | | | | | | | | | | | | | | | | | | | | | | | | | | | | | | | | | | | | | | | | | | | | | | | | | | | | | | | | | | | | | | | | | | | | | | | | | |
| 1 | 1 | | | | | | | | | | | | | | | | | | | | | | | | | | | | | | | | | | | | | | | | | | | | | | | | | | | | | | | | | | | | | | | | | | | | | | | | | | | | | | |
| | | | | | | | | | | | | | | | | | | | | | | | | | | | | | | | | | | | | | | | | | | | | | | | | | | | | | | | | | | | | | | | | | | | | | | | | | | | | | | | |
| | | | | | | | | | | | | | | | | | | | | | | | | | | | | | | | | | | | | | | | | | | | | | | | | | | | | | | | | | | | | | | | | | | | | | | | | | | | | | | | |
| | | | | | | | | | | | | | | | | | | | | | | | | | | | | | | | | | | | | | | | | | | | | | | | | | | | | | | | | | | | | | | | | | | | | | | | | | | | | | | | |
| | | | | | | | | | | | | | | | | | | | | | | | | | | | | | | | | | | | | | | | | | | | | | | | | | | | | | | | | | | | | | | | | | | | | | | | | | | | | | | | |
| | | | | | | | | | | | | | | | | | | | | | | | | | | | | | | | | | | | | | | | | | | | | | | | | | | | | | | | | | | | | | | | | | | | | | | | | | | | | | | | |
| | | | | | | | | | | | | | | | | | | | | | | | | | | | | | | | | | | | | | | | | | | | | | | | | | | | | | | | | | | | | | | | | | | | | | | | | | | | | | | | |
| | | | | | | | | | | | | | | | | | | | | | | | | | | | | | | | | | | | | | | | | | | | | | | | | | | | | | | | | | | | | | | | | | | | | | | | | | | | | | | | |
| | | | | | | | | | | | | | | | | | | | | | | | | | | | | | | | | | | | | | | | | | | | | | | | | | | | | | | | | | | | | | | | | | | | | | | | | | | | | | | | |
| | | | | | | | | | | | | | | | | | | | | | | | | | | | | | | | | | | | | | | | | | | | | | | | | | | | | | | | | | | | | | | | | | | | | | | | | | | | | | | | |
| | | | | | | | | | | | | | | | | | | | | | | | | | | | | | | | | | | | | | | | | | | | | | | | | | | | | | | | | | | | | | | | | | | | | | | | | | | | | | | | |
| | | | | | | | | | | | | | | | | | | | | | | | | | | | | | | | | | | | | | | | | | | | | | | | | | | | | | | | | | | | | | | | | | | | | | | | | | | | | | | | |
| | | | | | | | | | | | | | | | | | | | | | | | | | | | | | | | | | | | | | | | | | | | | | | | | | | | | | | | | | | | | | | | | | | | | | | | | | | | | | | | |
| | | | | | | | | | | | | | | | | | | | | | | | | | | | | | | | | | | | | | | | | | | | | | | | | | | | | | | | | | | | | | | | | | | | | | | | | | | | | | | | |
| | | | | | | | | | | | | | | | | | | | | | | | | | | | | | | | | | | | | | | | | | | | | | | | | | | | | | | | | | | | | | | | | | | | | | | | | | | | | | | | |
| | | | | | | | | | | | | | | | | | | | | | | | | | | | | | | | | | | | | | | | | | | | | | | | | | | | | | | | | | | | | | | | | | | | | | | | | | | | | | | | |
| 2 | | 1 | | | | | | | | | | | | | | | | | | | | | | | | | | | | | | | | | | | | | | | | | | | | | | | | | | | | | | | | | | | | | | | | | | | | | | | | | | | | | |
| | | | | | | | | | | | | | | | | | | | | | | | | | | | | | | | | | | | | | | | | | | | | | | | | | | | | | | | | | | | | | | | | | | | | | | | | | | | | | | | |
| 3 | 1 | 2 | | | | | | | | | | | | | | | | | | | | | | | | | | | | | | | | | | | | | | | | | | | | | | | | | | | | | | | | | | | | | | | | | | | | | | | | | | | | | |
| Post - 0 Miss - 0 Block - 0 | Post - 1 Miss - 3 Block - 0 | Post - 0 Miss - 0 Block - 0 | Post - 0 Miss - 0 Block - 0 | Post - 0 Miss - 0 Block - 1 | Post - 0 Miss - 0 Block - 0 | Post - 0 Miss - 0 Block - 0 | Post - 1 Miss - 3 Block - 3 | | | | | | | | | | | | | | | | | | | | | | | | | | | | | | | | | | | | | | | | | | | | | | | | | | | | | | | | | | | | | | | | | | | | | | | | |
| 13 尹吉祥 | 14 罗中耀 | 15 阎冠中 | 17 马益奎 | 18 耿畅 | | | | | | | | | | | | | | | | | | | | | | | | | | | | | | | | | | | | | | | | | | | | | | | | | | | | | | | | | | | | | | | | | | | | | | | | | | | |
| <table border="1"><tr><td></td><td></td><td></td></tr><tr><td></td><td></td><td>3</td></tr><tr><td>2</td><td></td><td>2</td></tr></table> | | | | | | 3 | 2 | | 2 | <table border="1"><tr><td></td><td></td><td></td></tr><tr><td></td><td></td><td></td></tr><tr><td></td><td></td><td></td></tr></table> | | | | | | | | | | <table border="1"><tr><td></td><td></td><td></td></tr><tr><td></td><td></td><td></td></tr><tr><td></td><td></td><td></td></tr></table> | | | | | | | | | | <table border="1"><tr><td></td><td></td><td></td></tr><tr><td></td><td></td><td>1</td></tr><tr><td></td><td></td><td></td></tr></table> | | | | | | 1 | | | | <table border="1"><tr><td></td><td></td><td>2</td></tr><tr><td>1</td><td></td><td></td></tr><tr><td>1</td><td></td><td>2</td></tr></table> | | | 2 | 1 | | | 1 | | 2 | <table border="1"><tr><td></td><td></td><td></td></tr><tr><td></td><td></td><td></td></tr><tr><td></td><td></td><td></td></tr></table> | | | | | | | | | | <table border="1"><tr><td></td><td></td><td></td></tr><tr><td></td><td></td><td></td></tr><tr><td></td><td></td><td></td></tr></table> | | | | | | | | | | <table border="1"><tr><td></td><td></td><td></td></tr><tr><td></td><td></td><td></td></tr><tr><td></td><td></td><td></td></tr></table> | | | | | | | | | |
| | | | | | | | | | | | | | | | | | | | | | | | | | | | | | | | | | | | | | | | | | | | | | | | | | | | | | | | | | | | | | | | | | | | | | | | | | | | | | | | |
| | | 3 | | | | | | | | | | | | | | | | | | | | | | | | | | | | | | | | | | | | | | | | | | | | | | | | | | | | | | | | | | | | | | | | | | | | | | | | | | | | | |
| 2 | | 2 | | | | | | | | | | | | | | | | | | | | | | | | | | | | | | | | | | | | | | | | | | | | | | | | | | | | | | | | | | | | | | | | | | | | | | | | | | | | | |
| | | | | | | | | | | | | | | | | | | | | | | | | | | | | | | | | | | | | | | | | | | | | | | | | | | | | | | | | | | | | | | | | | | | | | | | | | | | | | | | |
| | | | | | | | | | | | | | | | | | | | | | | | | | | | | | | | | | | | | | | | | | | | | | | | | | | | | | | | | | | | | | | | | | | | | | | | | | | | | | | | |
| | | | | | | | | | | | | | | | | | | | | | | | | | | | | | | | | | | | | | | | | | | | | | | | | | | | | | | | | | | | | | | | | | | | | | | | | | | | | | | | |
| | | | | | | | | | | | | | | | | | | | | | | | | | | | | | | | | | | | | | | | | | | | | | | | | | | | | | | | | | | | | | | | | | | | | | | | | | | | | | | | |
| | | | | | | | | | | | | | | | | | | | | | | | | | | | | | | | | | | | | | | | | | | | | | | | | | | | | | | | | | | | | | | | | | | | | | | | | | | | | | | | |
| | | | | | | | | | | | | | | | | | | | | | | | | | | | | | | | | | | | | | | | | | | | | | | | | | | | | | | | | | | | | | | | | | | | | | | | | | | | | | | | |
| | | | | | | | | | | | | | | | | | | | | | | | | | | | | | | | | | | | | | | | | | | | | | | | | | | | | | | | | | | | | | | | | | | | | | | | | | | | | | | | |
| | | 1 | | | | | | | | | | | | | | | | | | | | | | | | | | | | | | | | | | | | | | | | | | | | | | | | | | | | | | | | | | | | | | | | | | | | | | | | | | | | | |
| | | | | | | | | | | | | | | | | | | | | | | | | | | | | | | | | | | | | | | | | | | | | | | | | | | | | | | | | | | | | | | | | | | | | | | | | | | | | | | | |
| | | 2 | | | | | | | | | | | | | | | | | | | | | | | | | | | | | | | | | | | | | | | | | | | | | | | | | | | | | | | | | | | | | | | | | | | | | | | | | | | | | |
| 1 | | | | | | | | | | | | | | | | | | | | | | | | | | | | | | | | | | | | | | | | | | | | | | | | | | | | | | | | | | | | | | | | | | | | | | | | | | | | | | | |
| 1 | | 2 | | | | | | | | | | | | | | | | | | | | | | | | | | | | | | | | | | | | | | | | | | | | | | | | | | | | | | | | | | | | | | | | | | | | | | | | | | | | | |
| | | | | | | | | | | | | | | | | | | | | | | | | | | | | | | | | | | | | | | | | | | | | | | | | | | | | | | | | | | | | | | | | | | | | | | | | | | | | | | | |
| | | | | | | | | | | | | | | | | | | | | | | | | | | | | | | | | | | | | | | | | | | | | | | | | | | | | | | | | | | | | | | | | | | | | | | | | | | | | | | | |
| | | | | | | | | | | | | | | | | | | | | | | | | | | | | | | | | | | | | | | | | | | | | | | | | | | | | | | | | | | | | | | | | | | | | | | | | | | | | | | | |
| | | | | | | | | | | | | | | | | | | | | | | | | | | | | | | | | | | | | | | | | | | | | | | | | | | | | | | | | | | | | | | | | | | | | | | | | | | | | | | | |
| | | | | | | | | | | | | | | | | | | | | | | | | | | | | | | | | | | | | | | | | | | | | | | | | | | | | | | | | | | | | | | | | | | | | | | | | | | | | | | | |
| | | | | | | | | | | | | | | | | | | | | | | | | | | | | | | | | | | | | | | | | | | | | | | | | | | | | | | | | | | | | | | | | | | | | | | | | | | | | | | | |
| | | | | | | | | | | | | | | | | | | | | | | | | | | | | | | | | | | | | | | | | | | | | | | | | | | | | | | | | | | | | | | | | | | | | | | | | | | | | | | | |
| | | | | | | | | | | | | | | | | | | | | | | | | | | | | | | | | | | | | | | | | | | | | | | | | | | | | | | | | | | | | | | | | | | | | | | | | | | | | | | | |
| | | | | | | | | | | | | | | | | | | | | | | | | | | | | | | | | | | | | | | | | | | | | | | | | | | | | | | | | | | | | | | | | | | | | | | | | | | | | | | | |
| Post - 0 Miss - 1 Block - 6 | Post - 0 Miss - 0 Block - 0 | Post - 0 Miss - 0 Block - 0 | Post - 0 Miss - 1 Block - 0 | Post - 1 Miss - 1 Block - 2 | | | | | | | | | | | | | | | | | | | | | | | | | | | | | | | | | | | | | | | | | | | | | | | | | | | | | | | | | | | | | | | | | | | | | | | | | | | |

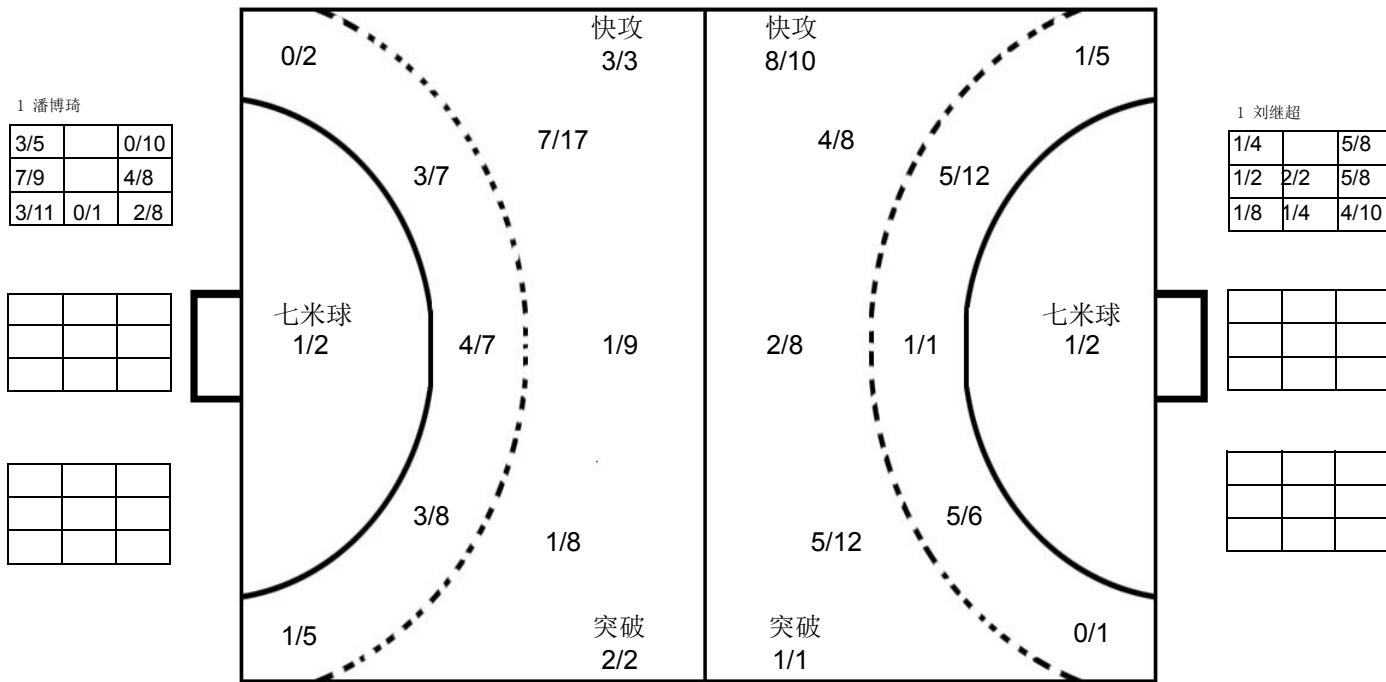

山东队

| | | | | | | | | | | | | | | | | | | | | | | | | | | | | | | | | | | | | | | | | | | | | | | | | | | | | | | | | | | | | | | | | | | | | | | | | | | | | | | | |
|--|-----------------------------|-----------------------------|-----------------------------|-----------------------------|-----------------------------|-----------------------------|-----------------------------|--|--|--|--|--|---|--|--|--|--|--|---|--|---|--|---|---|--|---|---|---|---|---|---|--|---|--|--|---|---|--|---|--|--|--|--|--|--|--|--|--|--|---|--|--|---|---|--|---|--|--|--|--|--|--|---|--|--|--|---|--|---|--|--|--|--|--|--|--|--|--|--|
| 1 刘继超 | 2 冯鑫宇 | 3 王铁林 | 5 王晓峰 | 6 王军鸣 | 7 徐勇林 | 10 孙芳伟 | 11 王洋 | | | | | | | | | | | | | | | | | | | | | | | | | | | | | | | | | | | | | | | | | | | | | | | | | | | | | | | | | | | | | | | | | | | | | | | | |
| <table border="1"><tr><td></td><td></td><td></td></tr><tr><td></td><td></td><td></td></tr><tr><td></td><td></td><td></td></tr></table> | | | | | | | | | | <table border="1"><tr><td></td><td></td><td>1</td></tr><tr><td></td><td></td><td></td></tr><tr><td></td><td></td><td></td></tr></table> | | | 1 | | | | | | | <table border="1"><tr><td></td><td></td><td>2</td></tr><tr><td>1</td><td></td><td></td></tr><tr><td></td><td>1</td><td>2</td></tr></table> | | | 2 | 1 | | | | 1 | 2 | <table border="1"><tr><td>1</td><td></td><td>4</td></tr><tr><td></td><td></td><td>2</td></tr><tr><td>1</td><td></td><td>2</td></tr></table> | 1 | | 4 | | | 2 | 1 | | 2 | <table border="1"><tr><td></td><td></td><td></td></tr><tr><td></td><td></td><td></td></tr><tr><td></td><td></td><td></td></tr></table> | | | | | | | | | | <table border="1"><tr><td></td><td></td><td>1</td></tr><tr><td>1</td><td></td><td>1</td></tr><tr><td></td><td></td><td></td></tr></table> | | | 1 | 1 | | 1 | | | | <table border="1"><tr><td></td><td></td><td>1</td></tr><tr><td></td><td></td><td></td></tr><tr><td></td><td></td><td></td></tr></table> | | | 1 | | | | | | | <table border="1"><tr><td></td><td></td><td></td></tr><tr><td></td><td></td><td></td></tr><tr><td></td><td></td><td></td></tr></table> | | | | | | | | | |
| | | | | | | | | | | | | | | | | | | | | | | | | | | | | | | | | | | | | | | | | | | | | | | | | | | | | | | | | | | | | | | | | | | | | | | | | | | | | | | | |
| | | | | | | | | | | | | | | | | | | | | | | | | | | | | | | | | | | | | | | | | | | | | | | | | | | | | | | | | | | | | | | | | | | | | | | | | | | | | | | | |
| | | | | | | | | | | | | | | | | | | | | | | | | | | | | | | | | | | | | | | | | | | | | | | | | | | | | | | | | | | | | | | | | | | | | | | | | | | | | | | | |
| | | 1 | | | | | | | | | | | | | | | | | | | | | | | | | | | | | | | | | | | | | | | | | | | | | | | | | | | | | | | | | | | | | | | | | | | | | | | | | | | | | |
| | | | | | | | | | | | | | | | | | | | | | | | | | | | | | | | | | | | | | | | | | | | | | | | | | | | | | | | | | | | | | | | | | | | | | | | | | | | | | | | |
| | | | | | | | | | | | | | | | | | | | | | | | | | | | | | | | | | | | | | | | | | | | | | | | | | | | | | | | | | | | | | | | | | | | | | | | | | | | | | | | |
| | | 2 | | | | | | | | | | | | | | | | | | | | | | | | | | | | | | | | | | | | | | | | | | | | | | | | | | | | | | | | | | | | | | | | | | | | | | | | | | | | | |
| 1 | | | | | | | | | | | | | | | | | | | | | | | | | | | | | | | | | | | | | | | | | | | | | | | | | | | | | | | | | | | | | | | | | | | | | | | | | | | | | | | |
| | 1 | 2 | | | | | | | | | | | | | | | | | | | | | | | | | | | | | | | | | | | | | | | | | | | | | | | | | | | | | | | | | | | | | | | | | | | | | | | | | | | | | |
| 1 | | 4 | | | | | | | | | | | | | | | | | | | | | | | | | | | | | | | | | | | | | | | | | | | | | | | | | | | | | | | | | | | | | | | | | | | | | | | | | | | | | |
| | | 2 | | | | | | | | | | | | | | | | | | | | | | | | | | | | | | | | | | | | | | | | | | | | | | | | | | | | | | | | | | | | | | | | | | | | | | | | | | | | | |
| 1 | | 2 | | | | | | | | | | | | | | | | | | | | | | | | | | | | | | | | | | | | | | | | | | | | | | | | | | | | | | | | | | | | | | | | | | | | | | | | | | | | | |
| | | | | | | | | | | | | | | | | | | | | | | | | | | | | | | | | | | | | | | | | | | | | | | | | | | | | | | | | | | | | | | | | | | | | | | | | | | | | | | | |
| | | | | | | | | | | | | | | | | | | | | | | | | | | | | | | | | | | | | | | | | | | | | | | | | | | | | | | | | | | | | | | | | | | | | | | | | | | | | | | | |
| | | | | | | | | | | | | | | | | | | | | | | | | | | | | | | | | | | | | | | | | | | | | | | | | | | | | | | | | | | | | | | | | | | | | | | | | | | | | | | | |
| | | 1 | | | | | | | | | | | | | | | | | | | | | | | | | | | | | | | | | | | | | | | | | | | | | | | | | | | | | | | | | | | | | | | | | | | | | | | | | | | | | |
| 1 | | 1 | | | | | | | | | | | | | | | | | | | | | | | | | | | | | | | | | | | | | | | | | | | | | | | | | | | | | | | | | | | | | | | | | | | | | | | | | | | | | |
| | | | | | | | | | | | | | | | | | | | | | | | | | | | | | | | | | | | | | | | | | | | | | | | | | | | | | | | | | | | | | | | | | | | | | | | | | | | | | | | |
| | | 1 | | | | | | | | | | | | | | | | | | | | | | | | | | | | | | | | | | | | | | | | | | | | | | | | | | | | | | | | | | | | | | | | | | | | | | | | | | | | | |
| | | | | | | | | | | | | | | | | | | | | | | | | | | | | | | | | | | | | | | | | | | | | | | | | | | | | | | | | | | | | | | | | | | | | | | | | | | | | | | | |
| | | | | | | | | | | | | | | | | | | | | | | | | | | | | | | | | | | | | | | | | | | | | | | | | | | | | | | | | | | | | | | | | | | | | | | | | | | | | | | | |
| | | | | | | | | | | | | | | | | | | | | | | | | | | | | | | | | | | | | | | | | | | | | | | | | | | | | | | | | | | | | | | | | | | | | | | | | | | | | | | | |
| | | | | | | | | | | | | | | | | | | | | | | | | | | | | | | | | | | | | | | | | | | | | | | | | | | | | | | | | | | | | | | | | | | | | | | | | | | | | | | | |
| | | | | | | | | | | | | | | | | | | | | | | | | | | | | | | | | | | | | | | | | | | | | | | | | | | | | | | | | | | | | | | | | | | | | | | | | | | | | | | | |
| Post - 0 Miss - 0 Block - 0 | Post - 0 Miss - 1 Block - 0 | Post - 1 Miss - 1 Block - 1 | Post - 0 Miss - 2 Block - 1 | Post - 0 Miss - 0 Block - 0 | Post - 0 Miss - 0 Block - 1 | Post - 2 Miss - 0 Block - 0 | Post - 0 Miss - 0 Block - 0 | | | | | | | | | | | | | | | | | | | | | | | | | | | | | | | | | | | | | | | | | | | | | | | | | | | | | | | | | | | | | | | | | | | | | | | | |
| 12 刘道林 | 13 于欣君 | 17 薛盼龙 | 18 李玮 | 21 王腾达 | 22 李子跃 | 23 李荣健 | | | | | | | | | | | | | | | | | | | | | | | | | | | | | | | | | | | | | | | | | | | | | | | | | | | | | | | | | | | | | | | | | | | | | | | | | |
| <table border="1"><tr><td></td><td></td><td></td></tr><tr><td></td><td></td><td></td></tr><tr><td></td><td></td><td></td></tr></table> | | | | | | | | | | <table border="1"><tr><td></td><td></td><td>1</td></tr><tr><td></td><td></td><td></td></tr><tr><td></td><td></td><td>1</td></tr></table> | | | 1 | | | | | | 1 | <table border="1"><tr><td>1</td><td></td><td></td></tr><tr><td></td><td></td><td>1</td></tr><tr><td>1</td><td></td><td></td></tr></table> | 1 | | | | | 1 | 1 | | | <table border="1"><tr><td></td><td></td><td></td></tr><tr><td></td><td></td><td></td></tr><tr><td></td><td></td><td></td></tr></table> | | | | | | | | | | <table border="1"><tr><td></td><td></td><td></td></tr><tr><td></td><td></td><td></td></tr><tr><td></td><td></td><td></td></tr></table> | | | | | | | | | | <table border="1"><tr><td></td><td></td><td></td></tr><tr><td></td><td></td><td></td></tr><tr><td></td><td></td><td></td></tr></table> | | | | | | | | | | <table border="1"><tr><td></td><td></td><td></td></tr><tr><td></td><td></td><td></td></tr><tr><td>1</td><td></td><td>1</td></tr></table> | | | | | | | 1 | | 1 | <table border="1"><tr><td></td><td></td><td></td></tr><tr><td></td><td></td><td></td></tr><tr><td></td><td></td><td></td></tr></table> | | | | | | | | | |
| | | | | | | | | | | | | | | | | | | | | | | | | | | | | | | | | | | | | | | | | | | | | | | | | | | | | | | | | | | | | | | | | | | | | | | | | | | | | | | | |
| | | | | | | | | | | | | | | | | | | | | | | | | | | | | | | | | | | | | | | | | | | | | | | | | | | | | | | | | | | | | | | | | | | | | | | | | | | | | | | | |
| | | | | | | | | | | | | | | | | | | | | | | | | | | | | | | | | | | | | | | | | | | | | | | | | | | | | | | | | | | | | | | | | | | | | | | | | | | | | | | | |
| | | 1 | | | | | | | | | | | | | | | | | | | | | | | | | | | | | | | | | | | | | | | | | | | | | | | | | | | | | | | | | | | | | | | | | | | | | | | | | | | | | |
| | | | | | | | | | | | | | | | | | | | | | | | | | | | | | | | | | | | | | | | | | | | | | | | | | | | | | | | | | | | | | | | | | | | | | | | | | | | | | | | |
| | | 1 | | | | | | | | | | | | | | | | | | | | | | | | | | | | | | | | | | | | | | | | | | | | | | | | | | | | | | | | | | | | | | | | | | | | | | | | | | | | | |
| 1 | | | | | | | | | | | | | | | | | | | | | | | | | | | | | | | | | | | | | | | | | | | | | | | | | | | | | | | | | | | | | | | | | | | | | | | | | | | | | | | |
| | | 1 | | | | | | | | | | | | | | | | | | | | | | | | | | | | | | | | | | | | | | | | | | | | | | | | | | | | | | | | | | | | | | | | | | | | | | | | | | | | | |
| 1 | | | | | | | | | | | | | | | | | | | | | | | | | | | | | | | | | | | | | | | | | | | | | | | | | | | | | | | | | | | | | | | | | | | | | | | | | | | | | | | |
| | | | | | | | | | | | | | | | | | | | | | | | | | | | | | | | | | | | | | | | | | | | | | | | | | | | | | | | | | | | | | | | | | | | | | | | | | | | | | | | |
| | | | | | | | | | | | | | | | | | | | | | | | | | | | | | | | | | | | | | | | | | | | | | | | | | | | | | | | | | | | | | | | | | | | | | | | | | | | | | | | |
| | | | | | | | | | | | | | | | | | | | | | | | | | | | | | | | | | | | | | | | | | | | | | | | | | | | | | | | | | | | | | | | | | | | | | | | | | | | | | | | |
| | | | | | | | | | | | | | | | | | | | | | | | | | | | | | | | | | | | | | | | | | | | | | | | | | | | | | | | | | | | | | | | | | | | | | | | | | | | | | | | |
| | | | | | | | | | | | | | | | | | | | | | | | | | | | | | | | | | | | | | | | | | | | | | | | | | | | | | | | | | | | | | | | | | | | | | | | | | | | | | | | |
| | | | | | | | | | | | | | | | | | | | | | | | | | | | | | | | | | | | | | | | | | | | | | | | | | | | | | | | | | | | | | | | | | | | | | | | | | | | | | | | |
| | | | | | | | | | | | | | | | | | | | | | | | | | | | | | | | | | | | | | | | | | | | | | | | | | | | | | | | | | | | | | | | | | | | | | | | | | | | | | | | |
| | | | | | | | | | | | | | | | | | | | | | | | | | | | | | | | | | | | | | | | | | | | | | | | | | | | | | | | | | | | | | | | | | | | | | | | | | | | | | | | |
| | | | | | | | | | | | | | | | | | | | | | | | | | | | | | | | | | | | | | | | | | | | | | | | | | | | | | | | | | | | | | | | | | | | | | | | | | | | | | | | |
| | | | | | | | | | | | | | | | | | | | | | | | | | | | | | | | | | | | | | | | | | | | | | | | | | | | | | | | | | | | | | | | | | | | | | | | | | | | | | | | |
| | | | | | | | | | | | | | | | | | | | | | | | | | | | | | | | | | | | | | | | | | | | | | | | | | | | | | | | | | | | | | | | | | | | | | | | | | | | | | | | |
| 1 | | 1 | | | | | | | | | | | | | | | | | | | | | | | | | | | | | | | | | | | | | | | | | | | | | | | | | | | | | | | | | | | | | | | | | | | | | | | | | | | | | |
| | | | | | | | | | | | | | | | | | | | | | | | | | | | | | | | | | | | | | | | | | | | | | | | | | | | | | | | | | | | | | | | | | | | | | | | | | | | | | | | |
| | | | | | | | | | | | | | | | | | | | | | | | | | | | | | | | | | | | | | | | | | | | | | | | | | | | | | | | | | | | | | | | | | | | | | | | | | | | | | | | |
| | | | | | | | | | | | | | | | | | | | | | | | | | | | | | | | | | | | | | | | | | | | | | | | | | | | | | | | | | | | | | | | | | | | | | | | | | | | | | | | |
| Post - 0 Miss - 0 Block - 0 | Post - 2 Miss - 0 Block - 0 | Post - 0 Miss - 0 Block - 0 | Post - 0 Miss - 0 Block - 0 | Post - 0 Miss - 0 Block - 0 | Post - 1 Miss - 0 Block - 1 | Post - 0 Miss - 0 Block - 0 | | | | | | | | | | | | | | | | | | | | | | | | | | | | | | | | | | | | | | | | | | | | | | | | | | | | | | | | | | | | | | | | | | | | | | | | | |

注释: Post=击柱 Miss=射失 Block=被封



预赛 Group A
青年男子 全国比赛

2016年“体彩杯”全国手球男子青年锦标赛

| | | | | | | | | | | | | | | | | | | | | | |
|--------------------|---|------------------------------------|---------------------|------------------|------------------------------------|-------------------|---|---------------------------|------------------------------------|----|-----|----------------------|---------------|---|--|--|---|---|----|---|----|
| Team A A 广东队 | | | | Team B B 解放军队 | | | | Match Number 14 | | | | | | | | | | | | | |
| played in China | | in the hall 重庆万州 | | on 22/03/2016 | | at 10:00 hours | | Spectators | | | | | | | | | | | | | |
| Half-time (30') | A 12 | B 8 | End of playing time | A 29 | B 24 | 1st extra time | A | B | 2nd extra time | A | B | After penalty throws | A | B | | | | | | | |
| Number of 7 m | A 3/5 | Team time-out 1 13:28 2 55:23 3 | | | Full name of players and officials | | | | Team time-out 1 21:00 2 42:34 3 | | | B 1/3 | Number of 7 m | | | | | | | | |
| No. | Team A | | | | | G | W | 2' | D | DR | No. | Team B | | | | | G | W | 2' | D | DR |
| 1 | 王帅 | | | | | | | | | | 1 | 郭梦雨 | | | | | | | | | |
| 2 | 姚雪岩 | | | | | 2 | | | | | 3 | 张昌轲 | | | | | 7 | 1 | | | |
| 3 | 胡祥鹏 | | | | | | | | | | 4 | 张洋 | | | | | | | | | |
| 4 | 高玉杰 | | | | | | | | | | 5 | 尹一楠 | | | | | | | | | |
| 5 | 黄培杰 | | | | | 6 | | | | | 6 | 吴昊 | | | | | 3 | 1 | 2 | | |
| 7 | 段飞宇 | | | | | 7 | | | | | 7 | 姜钦 | | | | | 4 | | | | |
| 9 | 周凯峰 | | | | | | | | | | 8 | 邹峻楠 | | | | | | | | | |
| 10 | 周仲坤 | | | | | 4 | | | | | 9 | 李天枢 | | | | | | | | | |
| 11 | 胡国富 | | | | | 6 | | | | | 10 | 范保坤 | | | | | | | | | |
| 12 | 李壮 | | | | | | | | | | 11 | 王誌汉 | | | | | 4 | 1 | | | |
| 13 | 蔡杰 | | | | | | | | | | 12 | 左子健 | | | | | | | | | |
| 14 | 王泽润 | | | | | | | | | | 13 | 徐峻清 | | | | | 2 | | | | |
| 15 | 张建杰 | | | | | 3 | 1 | | | | 14 | 孙耀琦 | | | | | 4 | | 1 | | |
| 16 | 王猛 | | | | | | | | | | 16 | 池猛 | | | | | | | | | |
| 18 | 李文金 | | | | | 1 | | | | | 17 | 刘安宁 | | | | | | | | | |
| B | 刘康伶 (主教练) | | | | | | | | | | A | 杜长义 (主教练) | | | | | | | | | |
| C | 刘文宁 | | | | | | | | | | B | 刘捷 | | | | | | | | | |
| D | 王永存 | | | | | | | | | | C | 王学力 | | | | | | | | | |
| A | Signature of Responsible Official of the Teams (Off. A) | | | | | | | | | | | | | | | | | | B | | |
| TP | Remarks of Referee / CHA Official | | | | | | | | | | | | | | | | | | TP | | |

Signatures

Referees: 梅丹 (CHN) 尹静阳 (CHN)

Techn. Delegates: 张春生 (CHN)

CHA Official: 许宜扬 (CHN)

Note: Number of 7m Throws Awarded to Team A and B, Goals (G), Warnings (W), Suspensions (2'), Direct Disqualification (D), Disqualification with Report (DR) and Team Penalty (TP).

Table Officials:

Statisticians: 刘永欢

李双





2016年“体彩杯”全国手球男子青年锦标赛 竞赛技术统计(媒体表)

| | | | | | | |
|-----------|----|---------------|-----------|----------|------------------|-------------|
| 预赛 | 组别 | A | 轮次 | 3 | 场次 | 14 |
| 重庆万州 | | 22/03/2016 | | | 201602014-51-1/1 | |
| 广东队 | | 广东 | 29 | vs | 24 | 解放军 |
| | | 12 : 8 | | | | 解放军队 |

| | | | |
|-----|----------|---|-----------|
| 裁判员 | 梅丹 (CHN) | / | 尹静阳 (CHN) |
|-----|----------|---|-----------|

| 广东 | | 远 | 近 | 边 | 快 | 突 | 任意 | 7m | 合计 | % | 助攻 | 失误 | 警告 | 2' | D & DR | 广东 | | 比赛进程 | | 解放军 | | | | | | |
|---------------|-----|-------------|--------------|------------|------------|------------|------------|------------|--------------|-------------|----------|-----------|----------|----|--------|----|-----|----------|-------|-----|----|-----|--|--|--|--|
| 主教练：刘康伶 | | 射 | 射 | 射 | 攻 | 破 | 球 | 球 | | | | | | | | | | | | | | | | | | |
| 1 | 王帅 | 0/1 | | | | | | | 0/1 | 0.0 | 1 | | | | | | | 1st Half | | | | | | | | |
| 2 | 姚雪岩 | 1/2 | 1/2 | | | | 0/1 | | 2/5 | 40.0 | 2 | 3 | | | | 5 | 黄培杰 | 0 | 00:31 | 1 | 3 | 张昌柯 | | | | |
| 3 | 胡祥鹏 | | | | | | | | | | | | | | | 18 | 李文金 | 1 | 01:23 | 1 | | | | | | |
| 4 | 高玉杰 | | | | | | | | | | | | | | | 5 | 黄培杰 | 2 | 01:59 | 1 | | | | | | |
| 5 | 黄培杰 | 0/1 | 1/3 | 2/2 | | 1/1 | | 2/4 | 6/11 | 54.5 | 3 | 5 | | | | 7 | 段飞宇 | 3 | 03:48 | 1 | | | | | | |
| 7 | 段飞宇 | 0/2 | 5/5 | 1/3 | | | | 1/1 | 7/11 | 63.6 | | 3 | | | | 5 | 黄培杰 | 3 | 08:51 | 2 | 3 | 张昌柯 | | | | |
| 9 | 周凯峰 | | | | | | | | | | | | | | | 7 | 段飞宇 | 4 | 10:51 | 2 | | | | | | |
| 10 | 周仲坤 | 1/1 | 2/5 | 1/2 | 0/1 | | | | 4/9 | 44.4 | 1 | 2 | | | | 5 | 黄培杰 | 4 | 13:14 | 3 | 11 | 王誌汉 | | | | |
| 11 | 胡国富 | 0/2 | 1/2 | 1/1 | 1/1 | 3/3 | | | 6/9 | 66.7 | | 1 | | | | 2 | 姚雪岩 | 5 | 14:23 | 3 | | | | | | |
| 12 | 李壮 | | | | | | | | | | | | | | | 7 | 段飞宇 | 6 | 16:22 | 3 | | | | | | |
| 13 | 蔡杰 | | | | | | | | | | | | | | | 15 | 张建杰 | 7 | 17:50 | 3 | | | | | | |
| 14 | 王泽润 | | | | | | | | | | | | | | | 15 | 张建杰 | 8 | 22:17 | 4 | 14 | 孙耀琦 | | | | |
| 15 | 张建杰 | 1/4 | 1/5 | | | 1/1 | 0/1 | | 3/11 | 27.3 | 1 | 1 | 1 | | | 8 | 王猛 | 9 | 22:17 | 4 | | | | | | |
| 16 | 王猛 | | | | | | | | | | | | | | | 8 | 王猛 | 10 | 23:08 | 5 | 6 | 吴昊 | | | | |
| 18 | 李文金 | | 1/5 | | | | | | 1/5 | 20.0 | | 1 | | | | 8 | 王猛 | 11 | 24:14 | 6 | 7 | 姜钦 | | | | |
| 运动员 合计 | | 3/13 | 12/27 | 5/8 | 1/2 | 5/5 | 0/2 | 3/5 | 29/62 | 46.8 | 8 | 16 | 1 | | | 5 | 黄培杰 | 12 | 25:22 | 6 | | | | | | |
| 1 | 王帅 | 5/8 | 13/26 | 5/7 | 2/4 | 0/2 | 0/1 | 1/2 | 26/50 | 52.0 | 1 | | | | | 9 | 黄培杰 | 9 | 25:51 | 7 | 7 | 姜钦 | | | | |
| 守门员 合计 | | 5/8 | 13/26 | 5/7 | 2/4 | 0/2 | 0/1 | 1/2 | 26/50 | 52.0 | 1 | | | | | 15 | 张建杰 | 10 | 26:02 | 7 | | | | | | |
| | | | | | | | | | | | | | | | | 15 | 张建杰 | 11 | 28:16 | 7 | | | | | | |
| | | | | | | | | | | | | | | | | 10 | 周仲坤 | 11 | 28:46 | 8 | 3 | 张昌柯 | | | | |
| | | | | | | | | | | | | | | | | 10 | 周仲坤 | 12 | 29:28 | 8 | | | | | | |
| | | | | | | | | | | | | | | | | | | 2nd Half | | | | | | | | |
| | | | | | | | | | | | | | | | | 12 | 王泽润 | 12 | 01:20 | 9 | 13 | 徐峻清 | | | | |
| | | | | | | | | | | | | | | | | 12 | 王泽润 | 12 | 01:44 | 10 | 13 | 徐峻清 | | | | |
| | | | | | | | | | | | | | | | | 12 | 王泽润 | 12 | 01:58 | 11 | 3 | 张昌柯 | | | | |
| | | | | | | | | | | | | | | | | 10 | 周仲坤 | 13 | 02:25 | 11 | | | | | | |
| | | | | | | | | | | | | | | | | 10 | 周仲坤 | 13 | 03:05 | 12 | 3 | 张昌柯 | | | | |
| | | | | | | | | | | | | | | | | 10 | 周仲坤 | 13 | 04:48 | 13 | 11 | 王誌汉 | | | | |
| | | | | | | | | | | | | | | | | 10 | 周仲坤 | 13 | 06:12 | 14 | 6 | 吴昊 | | | | |
| | | | | | | | | | | | | | | | | 7 | 段飞宇 | 14 | 06:32 | 14 | | | | | | |
| | | | | | | | | | | | | | | | | 5 | 黄培杰 | 15 | 08:08 | 14 | | | | | | |
| | | | | | | | | | | | | | | | | 10 | 周仲坤 | 16 | 10:03 | 14 | | | | | | |
| | | | | | | | | | | | | | | | | 11 | 胡国富 | 17 | 11:59 | 14 | | | | | | |
| | | | | | | | | | | | | | | | | 11 | 胡国富 | 17 | 13:20 | 15 | 14 | 孙耀琦 | | | | |
| | | | | | | | | | | | | | | | | 11 | 胡国富 | 18 | 13:39 | 15 | | | | | | |
| | | | | | | | | | | | | | | | | 7 | 段飞宇 | 19 | 14:50 | 15 | | | | | | |
| | | | | | | | | | | | | | | | | 11 | 胡国富 | 19 | 14:53 | 16 | 6 | 吴昊 | | | | |
| | | | | | | | | | | | | | | | | 7 | 段飞宇 | 20 | 15:00 | 16 | | | | | | |
| | | | | | | | | | | | | | | | | 11 | 胡国富 | 20 | 15:53 | 17 | 11 | 王誌汉 | | | | |
| | | | | | | | | | | | | | | | | 11 | 胡国富 | 21 | 16:20 | 17 | | | | | | |
| | | | | | | | | | | | | | | | | 5 | 黄培杰 | 22 | 17:02 | 17 | | | | | | |
| | | | | | | | | | | | | | | | | 7 | 段飞宇 | 22 | 17:22 | 18 | 3 | 张昌柯 | | | | |
| | | | | | | | | | | | | | | | | 7 | 段飞宇 | 23 | 18:22 | 18 | | | | | | |
| | | | | | | | | | | | | | | | | 7 | 段飞宇 | 23 | 18:49 | 19 | 7 | 姜钦 | | | | |
| | | | | | | | | | | | | | | | | 7 | 段飞宇 | 24 | 19:38 | 19 | | | | | | |
| | | | | | | | | | | | | | | | | 11 | 胡国富 | 25 | 20:24 | 19 | | | | | | |
| | | | | | | | | | | | | | | | | 7 | 段飞宇 | 26 | 21:28 | 19 | | | | | | |
| | | | | | | | | | | | | | | | | 10 | 周仲坤 | 26 | 21:55 | 20 | 14 | 孙耀琦 | | | | |
| | | | | | | | | | | | | | | | | 10 | 周仲坤 | 27 | 22:14 | 20 | | | | | | |
| | | | | | | | | | | | | | | | | 11 | 胡国富 | 27 | 23:57 | 21 | 3 | 张昌柯 | | | | |
| | | | | | | | | | | | | | | | | 11 | 胡国富 | 27 | 25:05 | 22 | 7 | 姜钦 | | | | |
| | | | | | | | | | | | | | | | | 11 | 胡国富 | 27 | 25:55 | 23 | 14 | 孙耀琦 | | | | |
| | | | | | | | | | | | | | | | | 2 | 姚雪岩 | 28 | 27:12 | 23 | | | | | | |
| | | | | | | | | | | | | | | | | 2 | 姚雪岩 | 28 | 28:09 | 24 | 11 | 王誌汉 | | | | |
| | | | | | | | | | | | | | | | | 2 | 姚雪岩 | 29 | 29:32 | 24 | | | | | | |

场上队员：得分 / 射门

守门员：救球 / 射门

| | | | | | | | | | |
|----|------------|----|--------------|-----|------------|-----|----------|----|---------|
| 快攻 | Fast Break | 突破 | Breakthrough | 任意球 | Free Throw | 7M球 | 7M Throw | 助攻 | Assist |
| 警告 | Warning | 失误 | Error | 2' | Suspension | D | 取消资格 | DR | 取消资格+报告 |





2016年“体彩杯”全国手球男子青年锦标赛 图式比赛技术统计表

轮次 3

场次 14

201602014-21-1/1

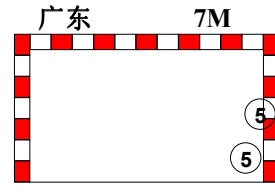
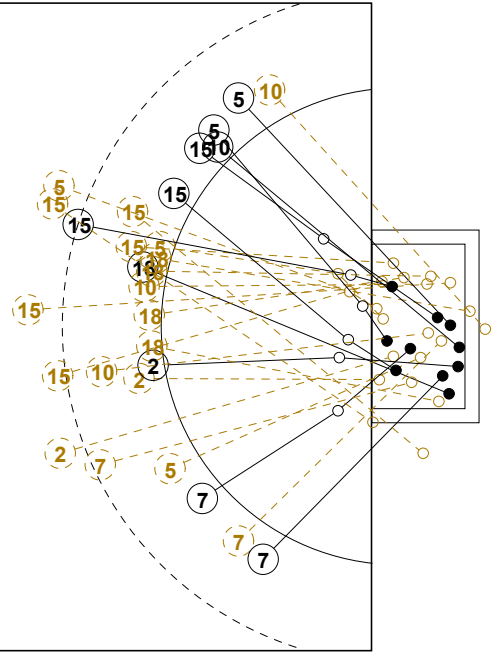
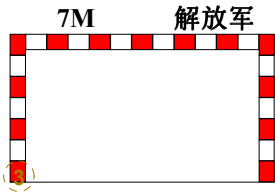
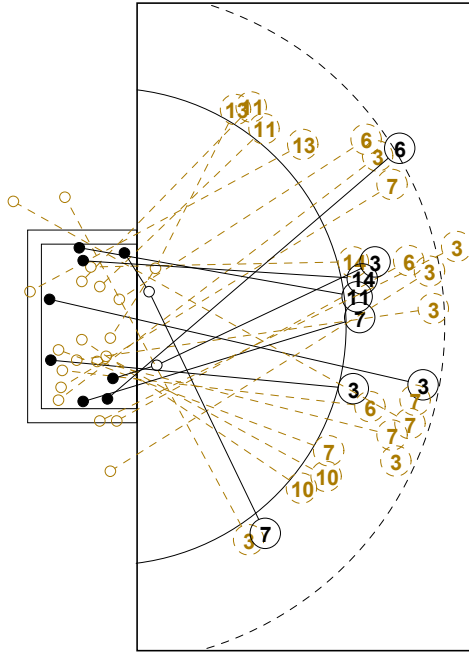

1st Half
8 : 12

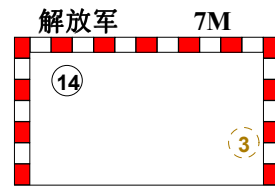
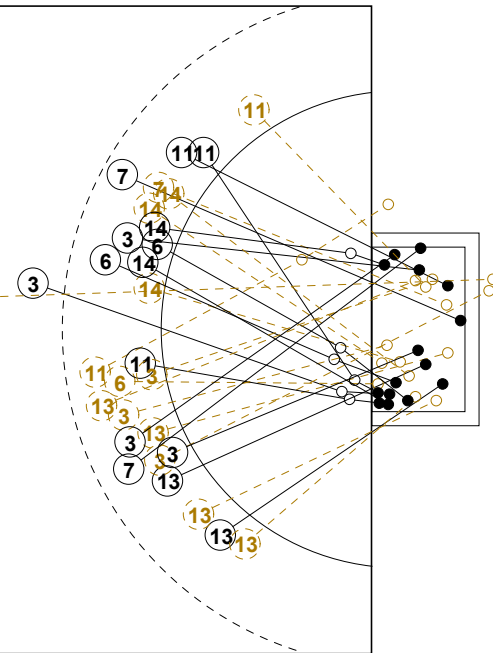
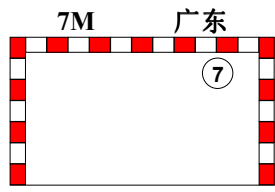
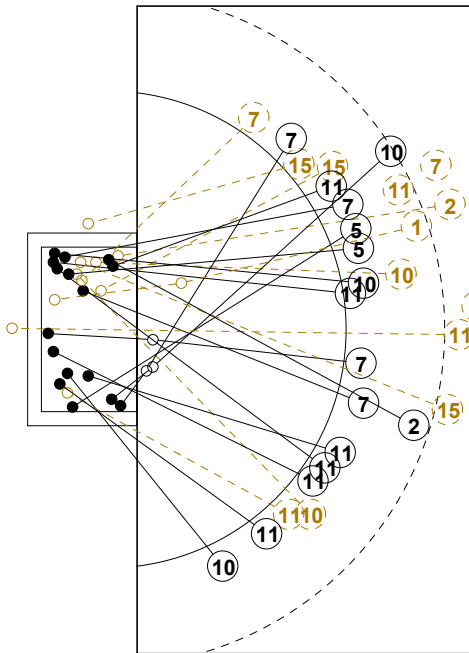

2nd Half (5)
29 : 24



2016年“体彩杯”全国手球男子青年锦标赛

个人/全队技术统计表

正式表
手球
青年男子预赛
轮次 3组别 A
场次 14201602014-14-1/2
重庆万州
22/03/2016 10:00

| 号码 | 姓名 | 远射 | 近射 | 边射 | 快攻 | 突破 | 任意 | 7M | 合计 | % | 助攻 | 失误 | 警告 | 2' | 取消 | 时间 |
|----------------|-----|------|-------|-----|-----|-----|-----|-----|-------|-------|----|----|----|----|----|----------|
| 广东队(广东) | | | | | | | | | | | | | | | | |
| <i>(场上队员)</i> | | | | | | | | | | | | | | | | |
| 1 | 王帅 | 0/1 | | | | | | | 0/1 | 0.0% | 1 | | | | | 00:30:30 |
| 2 | 姚雪岩 | 1/2 | 1/2 | | | | 0/1 | | 2/5 | 40.0% | 2 | 3 | | | | 01:28:44 |
| 3 | 胡祥鹏 | | | | | | | | | 0.0% | | | | | | 00:00:00 |
| 4 | 高玉杰 | | | | | | | | | 0.0% | | | | | | 00:00:58 |
| 5 | 黄培杰 | 0/1 | 1/3 | 2/2 | | 1/1 | | 2/4 | 6/11 | 54.5% | 3 | 5 | | | | 01:23:56 |
| 7 | 段飞宇 | 0/2 | 5/5 | 1/3 | | | | 1/1 | 7/11 | 63.6% | | 3 | | | | 01:27:45 |
| 9 | 周凯峰 | | | | | | | | | 0.0% | | | | | | 00:00:00 |
| 10 | 周仲坤 | 1/1 | 2/5 | 1/2 | 0/1 | | | | 4/9 | 44.4% | 1 | 2 | | | | 01:28:43 |
| 11 | 胡国富 | 0/2 | 1/2 | 1/1 | 1/1 | 3/3 | | | 6/9 | 66.7% | | 1 | | | | 00:29:16 |
| 12 | 李壮 | | | | | | | | | 0.0% | | | | | | 00:00:00 |
| 13 | 蔡杰 | | | | | | | | | 0.0% | | | | | | 00:00:00 |
| 14 | 王泽润 | | | | | | | | | 0.0% | | | | | | 00:00:00 |
| 15 | 张建杰 | 1/4 | 1/5 | | | 1/1 | 0/1 | | 3/11 | 27.3% | 1 | 1 | 1 | | | 01:28:43 |
| 16 | 王猛 | | | | | | | | | 0.0% | | | | | | 00:00:00 |
| 18 | 李文金 | | 1/5 | | | | | | 1/5 | 20.0% | | 1 | | | | 01:04:09 |
| 合计 | | 3/13 | 12/27 | 5/8 | 1/2 | 5/5 | 0/2 | 3/5 | 29/62 | 46.8% | 8 | 16 | 1 | | | |
| <i>(守门员)</i> | | | | | | | | | | | | | | | | |
| 1 | 王帅 | 5/8 | 13/26 | 5/7 | 2/4 | 0/2 | 0/1 | 1/2 | 26/50 | 52.0% | 1 | | | | | 00:30:30 |
| 合计 | | 5/8 | 13/26 | 5/7 | 2/4 | 0/2 | 0/1 | 1/2 | 26/50 | 52.0% | 1 | | | | | |

场上队员：得分/射门

守门员：救球/射门

| 全队合计 | 得分 | 被救 | 射失 | 击柱 | 封球 | 合计 | % |
|------|----|----|----|----|----|----|--------|
| 远射 | 3 | 6 | 1 | 1 | 2 | 13 | 23.1% |
| 近射 | 12 | 12 | 2 | 1 | | 27 | 44.4% |
| 边射 | 5 | 2 | 1 | | | 8 | 62.5% |
| 快攻 | 1 | 1 | | | | 2 | 50.0% |
| 突破 | 5 | | | | | 5 | 100.0% |
| 任意 | | 2 | | | | 2 | 0.0% |
| 7M | 3 | | 2 | | | 5 | 60.0% |





2016年“体彩杯”全国手球男子青年锦标赛

个人/全队技术统计表

正式表
手球
青年男子预赛
轮次 3组别 A
场次 14201602014-14-2/2
重庆万州
22/03/2016 10:00

| 号码 | 姓名 | 远射 | 近射 | 边射 | 快攻 | 突破 | 任意 | 7M | 合计 | % | 助攻 | 失误 | 警告 | 2' | 取消 | 时间 |
|------------------|-----|------|-------|-----|-----|-----|-----|-----|-------|-------|----|----|----|----|----|----------|
| 解放军队(解放军) | | | | | | | | | | | | | | | | |
| <i>(上场队员)</i> | | | | | | | | | | | | | | | | |
| 1 | 郭梦雨 | 0/1 | | | | | | | 0/1 | 0.0% | | | | | | 00:30:30 |
| 3 | 张昌轲 | 1/5 | 3/6 | 0/1 | | 2/2 | 1/2 | 0/2 | 7/18 | 38.9% | 2 | 4 | 1 | | | 01:28:45 |
| 4 | 张洋 | | | | | | | | | 0.0% | | | | | | 00:06:19 |
| 5 | 尹一楠 | | | | | | | | | 0.0% | | | | | | 00:00:00 |
| 6 | 吴昊 | 1/3 | 2/3 | | 0/1 | | | | 3/7 | 42.9% | 3 | 6 | 1 | 2 | | 01:28:45 |
| 7 | 姜钦 | 1/4 | 1/4 | 1/1 | 1/1 | | | | 4/10 | 40.0% | 4 | 3 | | | | 01:26:01 |
| 8 | 邹峻楠 | | | | | | | | | 0.0% | | | | | | 00:00:00 |
| 9 | 李天枢 | | | | | | | | | 0.0% | | | | | | 00:00:00 |
| 10 | 范保坤 | | 0/1 | | 0/1 | | | | 0/2 | 0.0% | | | | | | 00:18:00 |
| 11 | 王誌汉 | 0/1 | 3/3 | 0/3 | 1/1 | | | | 4/8 | 50.0% | | 1 | 1 | | | 01:25:15 |
| 12 | 左子健 | | | | | | | | | 0.0% | | | | | | 00:00:00 |
| 13 | 徐崧清 | 0/1 | 1/4 | 1/3 | | | | | 2/8 | 25.0% | 2 | 1 | | | | 01:10:58 |
| 14 | 孙耀琦 | | 3/7 | | | | | 1/1 | 4/8 | 50.0% | | 2 | | 1 | | 01:22:25 |
| 16 | 池猛 | | | | | | | | | 0.0% | | | | | | 00:00:00 |
| 17 | 刘安宁 | | | | | | | | | 0.0% | | | | | | 00:05:54 |
| 合计 | | 3/15 | 13/28 | 2/8 | 2/4 | 2/2 | 1/2 | 1/3 | 24/62 | 38.7% | 11 | 17 | 3 | 3 | | |
| <i>(守门员)</i> | | | | | | | | | | | | | | | | |
| 1 | 郭梦雨 | 6/9 | 12/24 | 2/7 | 1/2 | 0/5 | 2/2 | 0/3 | 23/52 | 44.2% | | | | | | 00:30:30 |
| 合计 | | 6/9 | 12/24 | 2/7 | 1/2 | 0/5 | 2/2 | 0/3 | 23/52 | 44.2% | | | | | | |

场上队员：得分/射门

守门员：救球/射门

| 全队合计 | 得分 | 被救 | 射失 | 击柱 | 封球 | 合计 | % |
|------|----|----|----|----|----|----|--------|
| 远射 | 3 | 5 | 4 | 1 | 2 | 15 | 20.0% |
| 近射 | 13 | 13 | 1 | 1 | | 28 | 46.4% |
| 边射 | 2 | 5 | 1 | | | 8 | 25.0% |
| 快攻 | 2 | 2 | | | | 4 | 50.0% |
| 突破 | 2 | | | | | 2 | 100.0% |
| 任意 | 1 | | | 1 | | 2 | 50.0% |
| 7M | 1 | 1 | | 1 | | 3 | 33.3% |





2016年“体彩杯”全国手球男子青年锦标赛

图式射门区域统计

轮次 3 场次 14

201602014-41-1/1

广东队

| | | | | | | | | | | | | | | | | | | | | | | | | | | | | | | | | | | | | | | | | | | | | | | | | | | | | | | | | | | | | | | | | | | | | | | | | | | | | | | | |
|---|-----------------------------|-----------------------------|-----------------------------|-----------------------------|-----------------------------|-----------------------------|-----------------------------|--|---|--|--|--|---|--|--|--|--|--|---|--|--|--|--|--|--|--|--|--|--|--|--|--|--|--|--|--|--|--|--|--|---|---|---|--|--|---|---|---|---|---|--|---|---|--|---|---|---|--|--|---|--|--|---|--|--|--|--|--|--|--|---|---|---|--|--|--|---|--|--|
| 1 王帅 | 2 姚雪岩 | 3 胡祥鹏 | 4 高玉杰 | 5 黄培杰 | 7 段飞宇 | 9 周凯峰 | 10 周仲坤 | | | | | | | | | | | | | | | | | | | | | | | | | | | | | | | | | | | | | | | | | | | | | | | | | | | | | | | | | | | | | | | | | | | | | | | | |
| <table border="1"><tr><td></td><td></td><td></td></tr><tr><td></td><td></td><td></td></tr><tr><td></td><td></td><td></td></tr></table> | | | | | | | | | | <table border="1"><tr><td></td><td></td><td>1</td></tr><tr><td></td><td></td><td></td></tr><tr><td></td><td></td><td>1</td></tr></table> | | | 1 | | | | | | 1 | <table border="1"><tr><td></td><td></td><td></td></tr><tr><td></td><td></td><td></td></tr><tr><td></td><td></td><td></td></tr></table> | | | | | | | | | | <table border="1"><tr><td></td><td></td><td></td></tr><tr><td></td><td></td><td></td></tr><tr><td></td><td></td><td></td></tr></table> | | | | | | | | | | <table border="1"><tr><td>1</td><td>1</td><td>1</td></tr><tr><td></td><td></td><td>1</td></tr><tr><td></td><td>1</td><td>1</td></tr></table> | 1 | 1 | 1 | | | 1 | | 1 | 1 | <table border="1"><tr><td></td><td>1</td><td>3</td></tr><tr><td></td><td>1</td><td>1</td></tr><tr><td>1</td><td></td><td></td></tr></table> | | 1 | 3 | | 1 | 1 | 1 | | | <table border="1"><tr><td></td><td></td><td></td></tr><tr><td></td><td></td><td></td></tr><tr><td></td><td></td><td></td></tr></table> | | | | | | | | | | <table border="1"><tr><td>1</td><td>1</td><td>1</td></tr><tr><td></td><td></td><td></td></tr><tr><td>1</td><td></td><td></td></tr></table> | 1 | 1 | 1 | | | | 1 | | |
| | | | | | | | | | | | | | | | | | | | | | | | | | | | | | | | | | | | | | | | | | | | | | | | | | | | | | | | | | | | | | | | | | | | | | | | | | | | | | | | |
| | | | | | | | | | | | | | | | | | | | | | | | | | | | | | | | | | | | | | | | | | | | | | | | | | | | | | | | | | | | | | | | | | | | | | | | | | | | | | | | |
| | | | | | | | | | | | | | | | | | | | | | | | | | | | | | | | | | | | | | | | | | | | | | | | | | | | | | | | | | | | | | | | | | | | | | | | | | | | | | | | |
| | | 1 | | | | | | | | | | | | | | | | | | | | | | | | | | | | | | | | | | | | | | | | | | | | | | | | | | | | | | | | | | | | | | | | | | | | | | | | | | | | | |
| | | | | | | | | | | | | | | | | | | | | | | | | | | | | | | | | | | | | | | | | | | | | | | | | | | | | | | | | | | | | | | | | | | | | | | | | | | | | | | | |
| | | 1 | | | | | | | | | | | | | | | | | | | | | | | | | | | | | | | | | | | | | | | | | | | | | | | | | | | | | | | | | | | | | | | | | | | | | | | | | | | | | |
| | | | | | | | | | | | | | | | | | | | | | | | | | | | | | | | | | | | | | | | | | | | | | | | | | | | | | | | | | | | | | | | | | | | | | | | | | | | | | | | |
| | | | | | | | | | | | | | | | | | | | | | | | | | | | | | | | | | | | | | | | | | | | | | | | | | | | | | | | | | | | | | | | | | | | | | | | | | | | | | | | |
| | | | | | | | | | | | | | | | | | | | | | | | | | | | | | | | | | | | | | | | | | | | | | | | | | | | | | | | | | | | | | | | | | | | | | | | | | | | | | | | |
| | | | | | | | | | | | | | | | | | | | | | | | | | | | | | | | | | | | | | | | | | | | | | | | | | | | | | | | | | | | | | | | | | | | | | | | | | | | | | | | |
| | | | | | | | | | | | | | | | | | | | | | | | | | | | | | | | | | | | | | | | | | | | | | | | | | | | | | | | | | | | | | | | | | | | | | | | | | | | | | | | |
| | | | | | | | | | | | | | | | | | | | | | | | | | | | | | | | | | | | | | | | | | | | | | | | | | | | | | | | | | | | | | | | | | | | | | | | | | | | | | | | |
| 1 | 1 | 1 | | | | | | | | | | | | | | | | | | | | | | | | | | | | | | | | | | | | | | | | | | | | | | | | | | | | | | | | | | | | | | | | | | | | | | | | | | | | | |
| | | 1 | | | | | | | | | | | | | | | | | | | | | | | | | | | | | | | | | | | | | | | | | | | | | | | | | | | | | | | | | | | | | | | | | | | | | | | | | | | | | |
| | 1 | 1 | | | | | | | | | | | | | | | | | | | | | | | | | | | | | | | | | | | | | | | | | | | | | | | | | | | | | | | | | | | | | | | | | | | | | | | | | | | | | |
| | 1 | 3 | | | | | | | | | | | | | | | | | | | | | | | | | | | | | | | | | | | | | | | | | | | | | | | | | | | | | | | | | | | | | | | | | | | | | | | | | | | | | |
| | 1 | 1 | | | | | | | | | | | | | | | | | | | | | | | | | | | | | | | | | | | | | | | | | | | | | | | | | | | | | | | | | | | | | | | | | | | | | | | | | | | | | |
| 1 | | | | | | | | | | | | | | | | | | | | | | | | | | | | | | | | | | | | | | | | | | | | | | | | | | | | | | | | | | | | | | | | | | | | | | | | | | | | | | | |
| | | | | | | | | | | | | | | | | | | | | | | | | | | | | | | | | | | | | | | | | | | | | | | | | | | | | | | | | | | | | | | | | | | | | | | | | | | | | | | | |
| | | | | | | | | | | | | | | | | | | | | | | | | | | | | | | | | | | | | | | | | | | | | | | | | | | | | | | | | | | | | | | | | | | | | | | | | | | | | | | | |
| | | | | | | | | | | | | | | | | | | | | | | | | | | | | | | | | | | | | | | | | | | | | | | | | | | | | | | | | | | | | | | | | | | | | | | | | | | | | | | | |
| 1 | 1 | 1 | | | | | | | | | | | | | | | | | | | | | | | | | | | | | | | | | | | | | | | | | | | | | | | | | | | | | | | | | | | | | | | | | | | | | | | | | | | | | |
| | | | | | | | | | | | | | | | | | | | | | | | | | | | | | | | | | | | | | | | | | | | | | | | | | | | | | | | | | | | | | | | | | | | | | | | | | | | | | | | |
| 1 | | | | | | | | | | | | | | | | | | | | | | | | | | | | | | | | | | | | | | | | | | | | | | | | | | | | | | | | | | | | | | | | | | | | | | | | | | | | | | | |
| Post - 0 Miss - 0 Block - 0 | Post - 0 Miss - 0 Block - 0 | Post - 0 Miss - 0 Block - 0 | Post - 0 Miss - 0 Block - 0 | Post - 0 Miss - 2 Block - 0 | Post - 0 Miss - 0 Block - 1 | Post - 0 Miss - 0 Block - 0 | Post - 0 Miss - 1 Block - 0 | | | | | | | | | | | | | | | | | | | | | | | | | | | | | | | | | | | | | | | | | | | | | | | | | | | | | | | | | | | | | | | | | | | | | | | | |
| 11 胡国富 | 12 李壮 | 13 蔡杰 | 14 王泽润 | 15 张建杰 | 16 王猛 | 18 李文金 | | | | | | | | | | | | | | | | | | | | | | | | | | | | | | | | | | | | | | | | | | | | | | | | | | | | | | | | | | | | | | | | | | | | | | | | | |
| <table border="1"><tr><td>1</td><td>1</td><td>2</td></tr><tr><td>1</td><td></td><td></td></tr><tr><td></td><td></td><td>1</td></tr></table> | 1 | 1 | 2 | 1 | | | | | 1 | <table border="1"><tr><td></td><td></td><td></td></tr><tr><td></td><td></td><td></td></tr><tr><td></td><td></td><td></td></tr></table> | | | | | | | | | | <table border="1"><tr><td></td><td></td><td></td></tr><tr><td></td><td></td><td></td></tr><tr><td></td><td></td><td></td></tr></table> | | | | | | | | | | <table border="1"><tr><td></td><td></td><td></td></tr><tr><td></td><td></td><td></td></tr><tr><td></td><td></td><td></td></tr></table> | | | | | | | | | | <table border="1"><tr><td></td><td>1</td><td></td></tr><tr><td></td><td></td><td></td></tr><tr><td>1</td><td></td><td>1</td></tr></table> | | 1 | | | | | 1 | | 1 | <table border="1"><tr><td></td><td></td><td></td></tr><tr><td></td><td></td><td></td></tr><tr><td></td><td></td><td></td></tr></table> | | | | | | | | | | <table border="1"><tr><td></td><td></td><td>1</td></tr><tr><td></td><td></td><td></td></tr><tr><td></td><td></td><td></td></tr></table> | | | 1 | | | | | | | <table border="1"><tr><td></td><td></td><td></td></tr><tr><td></td><td></td><td></td></tr><tr><td></td><td></td><td></td></tr></table> | | | | | | | | | |
| 1 | 1 | 2 | | | | | | | | | | | | | | | | | | | | | | | | | | | | | | | | | | | | | | | | | | | | | | | | | | | | | | | | | | | | | | | | | | | | | | | | | | | | | |
| 1 | | | | | | | | | | | | | | | | | | | | | | | | | | | | | | | | | | | | | | | | | | | | | | | | | | | | | | | | | | | | | | | | | | | | | | | | | | | | | | | |
| | | 1 | | | | | | | | | | | | | | | | | | | | | | | | | | | | | | | | | | | | | | | | | | | | | | | | | | | | | | | | | | | | | | | | | | | | | | | | | | | | | |
| | | | | | | | | | | | | | | | | | | | | | | | | | | | | | | | | | | | | | | | | | | | | | | | | | | | | | | | | | | | | | | | | | | | | | | | | | | | | | | | |
| | | | | | | | | | | | | | | | | | | | | | | | | | | | | | | | | | | | | | | | | | | | | | | | | | | | | | | | | | | | | | | | | | | | | | | | | | | | | | | | |
| | | | | | | | | | | | | | | | | | | | | | | | | | | | | | | | | | | | | | | | | | | | | | | | | | | | | | | | | | | | | | | | | | | | | | | | | | | | | | | | |
| | | | | | | | | | | | | | | | | | | | | | | | | | | | | | | | | | | | | | | | | | | | | | | | | | | | | | | | | | | | | | | | | | | | | | | | | | | | | | | | |
| | | | | | | | | | | | | | | | | | | | | | | | | | | | | | | | | | | | | | | | | | | | | | | | | | | | | | | | | | | | | | | | | | | | | | | | | | | | | | | | |
| | | | | | | | | | | | | | | | | | | | | | | | | | | | | | | | | | | | | | | | | | | | | | | | | | | | | | | | | | | | | | | | | | | | | | | | | | | | | | | | |
| | | | | | | | | | | | | | | | | | | | | | | | | | | | | | | | | | | | | | | | | | | | | | | | | | | | | | | | | | | | | | | | | | | | | | | | | | | | | | | | |
| | | | | | | | | | | | | | | | | | | | | | | | | | | | | | | | | | | | | | | | | | | | | | | | | | | | | | | | | | | | | | | | | | | | | | | | | | | | | | | | |
| | | | | | | | | | | | | | | | | | | | | | | | | | | | | | | | | | | | | | | | | | | | | | | | | | | | | | | | | | | | | | | | | | | | | | | | | | | | | | | | |
| | 1 | | | | | | | | | | | | | | | | | | | | | | | | | | | | | | | | | | | | | | | | | | | | | | | | | | | | | | | | | | | | | | | | | | | | | | | | | | | | | | |
| | | | | | | | | | | | | | | | | | | | | | | | | | | | | | | | | | | | | | | | | | | | | | | | | | | | | | | | | | | | | | | | | | | | | | | | | | | | | | | | |
| 1 | | 1 | | | | | | | | | | | | | | | | | | | | | | | | | | | | | | | | | | | | | | | | | | | | | | | | | | | | | | | | | | | | | | | | | | | | | | | | | | | | | |
| | | | | | | | | | | | | | | | | | | | | | | | | | | | | | | | | | | | | | | | | | | | | | | | | | | | | | | | | | | | | | | | | | | | | | | | | | | | | | | | |
| | | | | | | | | | | | | | | | | | | | | | | | | | | | | | | | | | | | | | | | | | | | | | | | | | | | | | | | | | | | | | | | | | | | | | | | | | | | | | | | |
| | | | | | | | | | | | | | | | | | | | | | | | | | | | | | | | | | | | | | | | | | | | | | | | | | | | | | | | | | | | | | | | | | | | | | | | | | | | | | | | |
| | | 1 | | | | | | | | | | | | | | | | | | | | | | | | | | | | | | | | | | | | | | | | | | | | | | | | | | | | | | | | | | | | | | | | | | | | | | | | | | | | | |
| | | | | | | | | | | | | | | | | | | | | | | | | | | | | | | | | | | | | | | | | | | | | | | | | | | | | | | | | | | | | | | | | | | | | | | | | | | | | | | | |
| | | | | | | | | | | | | | | | | | | | | | | | | | | | | | | | | | | | | | | | | | | | | | | | | | | | | | | | | | | | | | | | | | | | | | | | | | | | | | | | |
| | | | | | | | | | | | | | | | | | | | | | | | | | | | | | | | | | | | | | | | | | | | | | | | | | | | | | | | | | | | | | | | | | | | | | | | | | | | | | | | |
| | | | | | | | | | | | | | | | | | | | | | | | | | | | | | | | | | | | | | | | | | | | | | | | | | | | | | | | | | | | | | | | | | | | | | | | | | | | | | | | |
| | | | | | | | | | | | | | | | | | | | | | | | | | | | | | | | | | | | | | | | | | | | | | | | | | | | | | | | | | | | | | | | | | | | | | | | | | | | | | | | |
| Post - 0 Miss - 1 Block - 1 | Post - 0 Miss - 0 Block - 0 | Post - 0 Miss - 0 Block - 0 | Post - 0 Miss - 0 Block - 0 | Post - 1 Miss - 2 Block - 0 | Post - 0 Miss - 0 Block - 0 | Post - 1 Miss - 0 Block - 0 | | | | | | | | | | | | | | | | | | | | | | | | | | | | | | | | | | | | | | | | | | | | | | | | | | | | | | | | | | | | | | | | | | | | | | | | | |

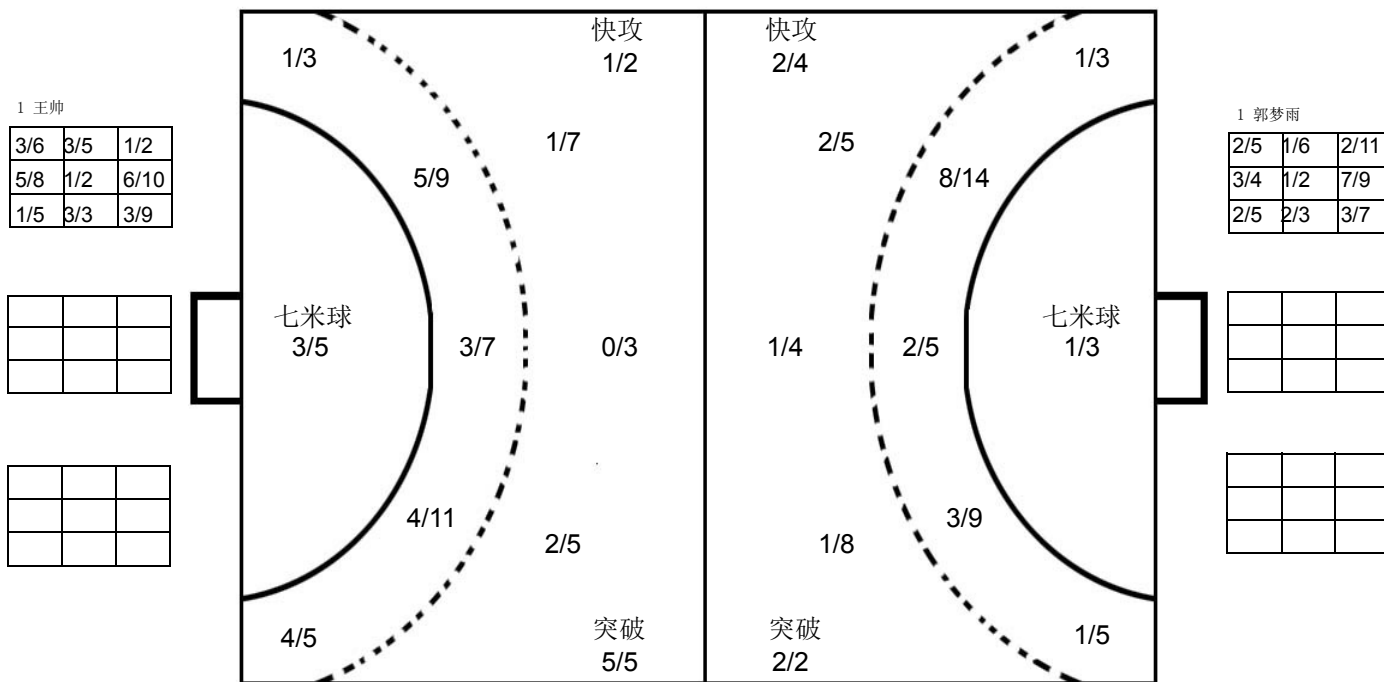

解放军队

| | | | | | | | | | | | | | | | | | | | | | | | | | | | | | | | | | | | | | | | | | | | | | | | | | | | | | | | | | | | | | | | | | | | | | | | | | | | | | | | |
|--|-----------------------------|-----------------------------|-----------------------------|-----------------------------|-----------------------------|-----------------------------|-----------------------------|--|--|--|---|---|--|---|---|---|---|--|---|--|--|--|--|--|--|--|--|--|--|--|--|--|---|--|--|---|--|--|--|--|---|--|---|--|--|---|---|--|---|---|--|---|--|---|--|--|--|--|---|--|--|--|--|--|--|--|--|--|--|--|--|--|--|--|--|--|--|--|--|
| 1 郭梦雨 | 3 张昌柯 | 4 张洋 | 5 尹一楠 | 6 吴昊 | 7 姜钦 | 8 邹峻楠 | 9 李天枢 | | | | | | | | | | | | | | | | | | | | | | | | | | | | | | | | | | | | | | | | | | | | | | | | | | | | | | | | | | | | | | | | | | | | | | | | |
| <table border="1"><tr><td></td><td></td><td></td></tr><tr><td></td><td></td><td></td></tr><tr><td></td><td></td><td></td></tr></table> | | | | | | | | | | <table border="1"><tr><td>1</td><td>1</td><td></td></tr><tr><td>1</td><td>1</td><td></td></tr><tr><td>2</td><td></td><td>1</td></tr></table> | 1 | 1 | | 1 | 1 | | 2 | | 1 | <table border="1"><tr><td></td><td></td><td></td></tr><tr><td></td><td></td><td></td></tr><tr><td></td><td></td><td></td></tr></table> | | | | | | | | | | <table border="1"><tr><td></td><td></td><td></td></tr><tr><td></td><td></td><td></td></tr><tr><td></td><td></td><td></td></tr></table> | | | | | | | | | | <table border="1"><tr><td></td><td></td><td>1</td></tr><tr><td></td><td></td><td></td></tr><tr><td>1</td><td></td><td>1</td></tr></table> | | | 1 | | | | 1 | | 1 | <table border="1"><tr><td></td><td>1</td><td></td></tr><tr><td>2</td><td></td><td></td></tr><tr><td></td><td></td><td>1</td></tr></table> | | 1 | | 2 | | | | | 1 | <table border="1"><tr><td></td><td></td><td></td></tr><tr><td></td><td></td><td></td></tr><tr><td></td><td></td><td></td></tr></table> | | | | | | | | | | <table border="1"><tr><td></td><td></td><td></td></tr><tr><td></td><td></td><td></td></tr><tr><td></td><td></td><td></td></tr></table> | | | | | | | | | |
| | | | | | | | | | | | | | | | | | | | | | | | | | | | | | | | | | | | | | | | | | | | | | | | | | | | | | | | | | | | | | | | | | | | | | | | | | | | | | | | |
| | | | | | | | | | | | | | | | | | | | | | | | | | | | | | | | | | | | | | | | | | | | | | | | | | | | | | | | | | | | | | | | | | | | | | | | | | | | | | | | |
| | | | | | | | | | | | | | | | | | | | | | | | | | | | | | | | | | | | | | | | | | | | | | | | | | | | | | | | | | | | | | | | | | | | | | | | | | | | | | | | |
| 1 | 1 | | | | | | | | | | | | | | | | | | | | | | | | | | | | | | | | | | | | | | | | | | | | | | | | | | | | | | | | | | | | | | | | | | | | | | | | | | | | | | |
| 1 | 1 | | | | | | | | | | | | | | | | | | | | | | | | | | | | | | | | | | | | | | | | | | | | | | | | | | | | | | | | | | | | | | | | | | | | | | | | | | | | | | |
| 2 | | 1 | | | | | | | | | | | | | | | | | | | | | | | | | | | | | | | | | | | | | | | | | | | | | | | | | | | | | | | | | | | | | | | | | | | | | | | | | | | | | |
| | | | | | | | | | | | | | | | | | | | | | | | | | | | | | | | | | | | | | | | | | | | | | | | | | | | | | | | | | | | | | | | | | | | | | | | | | | | | | | | |
| | | | | | | | | | | | | | | | | | | | | | | | | | | | | | | | | | | | | | | | | | | | | | | | | | | | | | | | | | | | | | | | | | | | | | | | | | | | | | | | |
| | | | | | | | | | | | | | | | | | | | | | | | | | | | | | | | | | | | | | | | | | | | | | | | | | | | | | | | | | | | | | | | | | | | | | | | | | | | | | | | |
| | | | | | | | | | | | | | | | | | | | | | | | | | | | | | | | | | | | | | | | | | | | | | | | | | | | | | | | | | | | | | | | | | | | | | | | | | | | | | | | |
| | | | | | | | | | | | | | | | | | | | | | | | | | | | | | | | | | | | | | | | | | | | | | | | | | | | | | | | | | | | | | | | | | | | | | | | | | | | | | | | |
| | | | | | | | | | | | | | | | | | | | | | | | | | | | | | | | | | | | | | | | | | | | | | | | | | | | | | | | | | | | | | | | | | | | | | | | | | | | | | | | |
| | | 1 | | | | | | | | | | | | | | | | | | | | | | | | | | | | | | | | | | | | | | | | | | | | | | | | | | | | | | | | | | | | | | | | | | | | | | | | | | | | | |
| | | | | | | | | | | | | | | | | | | | | | | | | | | | | | | | | | | | | | | | | | | | | | | | | | | | | | | | | | | | | | | | | | | | | | | | | | | | | | | | |
| 1 | | 1 | | | | | | | | | | | | | | | | | | | | | | | | | | | | | | | | | | | | | | | | | | | | | | | | | | | | | | | | | | | | | | | | | | | | | | | | | | | | | |
| | 1 | | | | | | | | | | | | | | | | | | | | | | | | | | | | | | | | | | | | | | | | | | | | | | | | | | | | | | | | | | | | | | | | | | | | | | | | | | | | | | |
| 2 | | | | | | | | | | | | | | | | | | | | | | | | | | | | | | | | | | | | | | | | | | | | | | | | | | | | | | | | | | | | | | | | | | | | | | | | | | | | | | | |
| | | 1 | | | | | | | | | | | | | | | | | | | | | | | | | | | | | | | | | | | | | | | | | | | | | | | | | | | | | | | | | | | | | | | | | | | | | | | | | | | | | |
| | | | | | | | | | | | | | | | | | | | | | | | | | | | | | | | | | | | | | | | | | | | | | | | | | | | | | | | | | | | | | | | | | | | | | | | | | | | | | | | |
| | | | | | | | | | | | | | | | | | | | | | | | | | | | | | | | | | | | | | | | | | | | | | | | | | | | | | | | | | | | | | | | | | | | | | | | | | | | | | | | |
| | | | | | | | | | | | | | | | | | | | | | | | | | | | | | | | | | | | | | | | | | | | | | | | | | | | | | | | | | | | | | | | | | | | | | | | | | | | | | | | |
| | | | | | | | | | | | | | | | | | | | | | | | | | | | | | | | | | | | | | | | | | | | | | | | | | | | | | | | | | | | | | | | | | | | | | | | | | | | | | | | |
| | | | | | | | | | | | | | | | | | | | | | | | | | | | | | | | | | | | | | | | | | | | | | | | | | | | | | | | | | | | | | | | | | | | | | | | | | | | | | | | |
| | | | | | | | | | | | | | | | | | | | | | | | | | | | | | | | | | | | | | | | | | | | | | | | | | | | | | | | | | | | | | | | | | | | | | | | | | | | | | | | |
| Post - 0 Miss - 1 Block - 0 | Post - 2 Miss - 3 Block - 1 | Post - 0 Miss - 0 Block - 0 | Post - 0 Miss - 0 Block - 0 | Post - 1 Miss - 0 Block - 0 | Post - 0 Miss - 1 Block - 1 | Post - 0 Miss - 0 Block - 0 | Post - 0 Miss - 0 Block - 0 | | | | | | | | | | | | | | | | | | | | | | | | | | | | | | | | | | | | | | | | | | | | | | | | | | | | | | | | | | | | | | | | | | | | | | | | |
| 10 范保坤 | 11 王誌汉 | 12 左子健 | 13 徐峻清 | 14 孙耀琦 | 16 池猛 | 17 刘安宁 | | | | | | | | | | | | | | | | | | | | | | | | | | | | | | | | | | | | | | | | | | | | | | | | | | | | | | | | | | | | | | | | | | | | | | | | | |
| <table border="1"><tr><td></td><td></td><td></td></tr><tr><td></td><td></td><td></td></tr><tr><td></td><td></td><td></td></tr></table> | | | | | | | | | | <table border="1"><tr><td>1</td><td></td><td></td></tr><tr><td></td><td></td><td>1</td></tr><tr><td></td><td></td><td>2</td></tr></table> | 1 | | | | | 1 | | | 2 | <table border="1"><tr><td></td><td></td><td></td></tr><tr><td></td><td></td><td></td></tr><tr><td></td><td></td><td></td></tr></table> | | | | | | | | | | <table border="1"><tr><td></td><td></td><td>1</td></tr><tr><td></td><td></td><td>1</td></tr><tr><td></td><td></td><td></td></tr></table> | | | 1 | | | 1 | | | | <table border="1"><tr><td>1</td><td></td><td></td></tr><tr><td></td><td></td><td>1</td></tr><tr><td>1</td><td></td><td>1</td></tr></table> | 1 | | | | | 1 | 1 | | 1 | <table border="1"><tr><td></td><td></td><td></td></tr><tr><td></td><td></td><td></td></tr><tr><td></td><td></td><td></td></tr></table> | | | | | | | | | | <table border="1"><tr><td></td><td></td><td></td></tr><tr><td></td><td></td><td></td></tr><tr><td></td><td></td><td></td></tr></table> | | | | | | | | | | <table border="1"><tr><td></td><td></td><td></td></tr><tr><td></td><td></td><td></td></tr><tr><td></td><td></td><td></td></tr></table> | | | | | | | | | |
| | | | | | | | | | | | | | | | | | | | | | | | | | | | | | | | | | | | | | | | | | | | | | | | | | | | | | | | | | | | | | | | | | | | | | | | | | | | | | | | |
| | | | | | | | | | | | | | | | | | | | | | | | | | | | | | | | | | | | | | | | | | | | | | | | | | | | | | | | | | | | | | | | | | | | | | | | | | | | | | | | |
| | | | | | | | | | | | | | | | | | | | | | | | | | | | | | | | | | | | | | | | | | | | | | | | | | | | | | | | | | | | | | | | | | | | | | | | | | | | | | | | |
| 1 | | | | | | | | | | | | | | | | | | | | | | | | | | | | | | | | | | | | | | | | | | | | | | | | | | | | | | | | | | | | | | | | | | | | | | | | | | | | | | | |
| | | 1 | | | | | | | | | | | | | | | | | | | | | | | | | | | | | | | | | | | | | | | | | | | | | | | | | | | | | | | | | | | | | | | | | | | | | | | | | | | | | |
| | | 2 | | | | | | | | | | | | | | | | | | | | | | | | | | | | | | | | | | | | | | | | | | | | | | | | | | | | | | | | | | | | | | | | | | | | | | | | | | | | | |
| | | | | | | | | | | | | | | | | | | | | | | | | | | | | | | | | | | | | | | | | | | | | | | | | | | | | | | | | | | | | | | | | | | | | | | | | | | | | | | | |
| | | | | | | | | | | | | | | | | | | | | | | | | | | | | | | | | | | | | | | | | | | | | | | | | | | | | | | | | | | | | | | | | | | | | | | | | | | | | | | | |
| | | | | | | | | | | | | | | | | | | | | | | | | | | | | | | | | | | | | | | | | | | | | | | | | | | | | | | | | | | | | | | | | | | | | | | | | | | | | | | | |
| | | 1 | | | | | | | | | | | | | | | | | | | | | | | | | | | | | | | | | | | | | | | | | | | | | | | | | | | | | | | | | | | | | | | | | | | | | | | | | | | | | |
| | | 1 | | | | | | | | | | | | | | | | | | | | | | | | | | | | | | | | | | | | | | | | | | | | | | | | | | | | | | | | | | | | | | | | | | | | | | | | | | | | | |
| | | | | | | | | | | | | | | | | | | | | | | | | | | | | | | | | | | | | | | | | | | | | | | | | | | | | | | | | | | | | | | | | | | | | | | | | | | | | | | | |
| 1 | | | | | | | | | | | | | | | | | | | | | | | | | | | | | | | | | | | | | | | | | | | | | | | | | | | | | | | | | | | | | | | | | | | | | | | | | | | | | | | |
| | | 1 | | | | | | | | | | | | | | | | | | | | | | | | | | | | | | | | | | | | | | | | | | | | | | | | | | | | | | | | | | | | | | | | | | | | | | | | | | | | | |
| 1 | | 1 | | | | | | | | | | | | | | | | | | | | | | | | | | | | | | | | | | | | | | | | | | | | | | | | | | | | | | | | | | | | | | | | | | | | | | | | | | | | | |
| | | | | | | | | | | | | | | | | | | | | | | | | | | | | | | | | | | | | | | | | | | | | | | | | | | | | | | | | | | | | | | | | | | | | | | | | | | | | | | | |
| | | | | | | | | | | | | | | | | | | | | | | | | | | | | | | | | | | | | | | | | | | | | | | | | | | | | | | | | | | | | | | | | | | | | | | | | | | | | | | | |
| | | | | | | | | | | | | | | | | | | | | | | | | | | | | | | | | | | | | | | | | | | | | | | | | | | | | | | | | | | | | | | | | | | | | | | | | | | | | | | | |
| | | | | | | | | | | | | | | | | | | | | | | | | | | | | | | | | | | | | | | | | | | | | | | | | | | | | | | | | | | | | | | | | | | | | | | | | | | | | | | | |
| | | | | | | | | | | | | | | | | | | | | | | | | | | | | | | | | | | | | | | | | | | | | | | | | | | | | | | | | | | | | | | | | | | | | | | | | | | | | | | | |
| | | | | | | | | | | | | | | | | | | | | | | | | | | | | | | | | | | | | | | | | | | | | | | | | | | | | | | | | | | | | | | | | | | | | | | | | | | | | | | | |
| | | | | | | | | | | | | | | | | | | | | | | | | | | | | | | | | | | | | | | | | | | | | | | | | | | | | | | | | | | | | | | | | | | | | | | | | | | | | | | | |
| | | | | | | | | | | | | | | | | | | | | | | | | | | | | | | | | | | | | | | | | | | | | | | | | | | | | | | | | | | | | | | | | | | | | | | | | | | | | | | | |
| | | | | | | | | | | | | | | | | | | | | | | | | | | | | | | | | | | | | | | | | | | | | | | | | | | | | | | | | | | | | | | | | | | | | | | | | | | | | | | | |
| Post - 0 Miss - 0 Block - 0 | Post - 0 Miss - 1 Block - 0 | Post - 0 Miss - 0 Block - 0 | Post - 1 Miss - 0 Block - 0 | Post - 0 Miss - 0 Block - 0 | Post - 0 Miss - 0 Block - 0 | Post - 0 Miss - 0 Block - 0 | | | | | | | | | | | | | | | | | | | | | | | | | | | | | | | | | | | | | | | | | | | | | | | | | | | | | | | | | | | | | | | | | | | | | | | | | |

注释: Post=击柱 Miss=射失 Block=被封





预赛 Group A
青年男子 全国比赛

2016年“体彩杯”全国手球男子青年锦标赛

| | | | | | | | | | | | | | | | | | | | | | |
|--------------------|---|------------------------|---------------------|------------------|------------------------------------|-------------------|---|---------------------------|------------------------|----|-----|----------------------|---------------|---|--|--|---|---|----|---|----|
| Team A A 上海队 | | | | Team B B 浙江队 | | | | Match Number 15 | | | | | | | | | | | | | |
| played in China | | in the hall 重庆万州 | | on 22/03/2016 | | at 13:00 hours | | Spectators | | | | | | | | | | | | | |
| Half-time (30') | A 25 | B 4 | End of playing time | A 25 | B 4 | 1st extra time | A | B | 2nd extra time | A | B | After penalty throws | A | B | | | | | | | |
| Number of 7 m | A 2 / 2 | Team time-out 1 2 3 | | | Full name of players and officials | | | | Team time-out 1 2 3 | | | B 0 / 1 | Number of 7 m | | | | | | | | |
| No. | Team A | | | | | G | W | 2' | D | DR | No. | Team B | | | | | G | W | 2' | D | DR |
| 2 | 谢智超 | | | | | | | | | | 1 | 林先方 | | | | | 2 | | | | |
| 3 | 高天伦 | | | | | 4 | | | | | 2 | 李恩铭 | | | | | 1 | 1 | | | |
| 4 | 高震东 | | | | | 3 | | | | | 3 | 郑尧俊 | | | | | | 1 | | | |
| 5 | 曹磊 | | | | | 3 | | | | | 5 | 高家南 | | | | | | | | | |
| 7 | 蒋家敏 | | | | | | | | | | 9 | 李家乐 | | | | | | | | | |
| 8 | 庄旭杰 | | | | | 4 | | | | | 10 | 徐正飞 | | | | | | | | | |
| 10 | 董凯 | | | | | 2 | | | | | 14 | 虞勇灿 | | | | | | | | | |
| 12 | 张润民 | | | | | | | | | | 15 | 张佩力 | | | | | | | | | |
| 14 | 吴佳兵 | | | | | 7 | 1 | | | | 17 | 罗明杰 | | | | | | | | | |
| 16 | 陈辰 | | | | | | | 1 | | | 18 | 倪陈辉 | | | | | 1 | 1 | 2 | | |
| 18 | 吴双 | | | | | 2 | | | | | 19 | 王浩 | | | | | | | | | |
| A | 马仲顺 | | | | | | | | | | C | 柳佳 | | | | | | | | | |
| | | | | | | | | | | | D | 项建生 | | | | | | | | | |
| | | | | | | | | | | | E | 刘晓辉 | | | | | | | | | |
| A | Signature of Responsible Official of the Teams (Off. A) | | | | | | | | | | B | | | | | | | | | | |
| TP | Remarks of Referee / CHA Official | | | | | | | | | | TP | | | | | | | | | | |

Signatures

| | | | | |
|------------------|-----------|-----------|--|--|
| Referees | 张智伟 (CHN) | 陈炳威 (CHN) | | |
| Techn. Delegates | 徐健 (CHN) | | | |
| CHA Official | 吴瑞亭 (CHN) | | | |

Note: Number of 7m Throws Awarded to Team A and B, Goals (G), Warnings (W), Suspensions (2'), Direct Disqualification (D), Disqualification with Report (DR) and Team Penalty (TP).

Table Officials:

Statisticians: 刘永欢

李双





2016年“体彩杯”全国手球男子青年锦标赛
竞赛技术统计(媒体表)

| | | | | | | |
|------|----|------------|----|--------|------------------|-----|
| 预赛 | 组别 | A | 轮次 | 3 | 场次 | 15 |
| 重庆万州 | | 22/03/2016 | | | 201602015-51-1/1 | |
| 上海队 | | 上海 | 25 | vs | 4 | 浙江队 |
| | | | | 25 : 4 | | |

| | | | | | |
|-----|-----------|--|---|-----------|--|
| 裁判员 | 张智伟 (CHN) | | / | 陈炳威 (CHN) | |
|-----|-----------|--|---|-----------|--|

| 上海 | | 远射 | 近射 | 边射 | 快攻 | 突破 | 任意球 | 7m球 | 合计 | % | 助攻 | 失误 | 警告 | 2' | D & DR | 上海 | 比赛进程 | 浙江 |
|----------|-----|-------|------|-----|-----|-----|-----|------|-------|------|----|----|----|----|--------|----|------|----|
| 主教练: 朱春雷 | | | | | | | | | | | | | | | | | | |
| 2 | 谢智超 | | | | | | | | | | | | | | | | | |
| 3 | 高天伦 | 3/4 | 1/1 | | | | | 4/5 | 80.0 | 1 | 1 | | | | | | | |
| 4 | 高震东 | 0/2 | 1/1 | | 1/1 | | | 3/5 | 60.0 | 1 | 3 | | | | | | | |
| 5 | 曹磊 | 3/5 | | | | | | 3/5 | 60.0 | 1 | 1 | | | | | | | |
| 7 | 蒋家敏 | | | | | | | | | | | | | | | | | |
| 8 | 庄旭杰 | 0/1 | 2/3 | | 2/2 | | | 4/6 | 66.7 | | | | | | | | | |
| 10 | 董凯 | | 1/1 | | 1/1 | | | 2/2 | 100 | | 2 | | | | | | | |
| 12 | 张润民 | | | | | | | | | | | | | | | | | |
| 14 | 吴佳兵 | 5/7 | 2/3 | | | | | 7/10 | 70.0 | | 3 | 1 | | | | | | |
| 16 | 陈辰 | | | | | | | | | | | | | 1 | | | | |
| 18 | 吴双 | | 1/1 | | | | | 1/1 | 2/2 | 100 | | | | | | | | |
| 运动员 合计 | | 11/19 | 8/10 | | 4/4 | | | 2/2 | 25/35 | 71.4 | 3 | 10 | 1 | 1 | | | | |
| 12 | 张润民 | 1/1 | 6/8 | 1/1 | 1/1 | | 0/1 | 9/12 | 75.0 | | | | | | | | | |
| 16 | 陈辰 | 2/2 | 0/1 | 2/2 | 1/1 | | | 1/1 | 6/7 | 85.7 | | | | | | | | |
| 守门员 合计 | | 3/3 | 6/9 | 3/3 | 2/2 | | 0/1 | 1/1 | 15/19 | 78.9 | | | | | | | | |
| 浙江 | | 远射 | 近射 | 边射 | 快攻 | 突破 | 任意球 | 7m球 | 合计 | % | 助攻 | 失误 | 警告 | 2' | D & DR | | | |
| 教练: 柳日祥 | | | | | | | | | | | | | | | | | | |
| 1 | 林先方 | 0/1 | 2/2 | 0/4 | 0/2 | | | 0/1 | 2/10 | 20.0 | 1 | 3 | | | | | | |
| 2 | 李恩铭 | 0/1 | 1/6 | 0/1 | | | | | 1/8 | 12.5 | | 3 | 1 | | | | | |
| 3 | 郑尧俊 | 0/2 | 0/1 | | 0/1 | 0/1 | | | 0/5 | 0.0 | 4 | 5 | 1 | | | | | |
| 5 | 高家南 | | 0/1 | | | | | | 0/1 | 0.0 | | | | | | | | |
| 9 | 李家乐 | | 0/1 | 0/1 | | | | | 0/2 | 0.0 | 1 | | | | | | | |
| 10 | 徐正飞 | 0/1 | | | | | | | 0/1 | 0.0 | | 1 | | | | | | |
| 14 | 虞勇灿 | | | | | | | | | | | 1 | | | | | | |
| 15 | 张佩力 | | | | | | | | | | | | | | | | | |
| 17 | 罗明杰 | | 0/2 | | | | | | 0/2 | 0.0 | | 1 | | | | | | |
| 18 | 倪陈辉 | 0/1 | | 0/1 | | | 1/2 | 1/4 | 25.0 | | 1 | 1 | 1 | 2 | | | | |
| 19 | 王浩 | | | | | | | | | | | | | | | | | |
| 运动员 合计 | | 0/6 | 3/13 | 0/7 | 0/3 | 0/1 | 1/2 | 0/1 | 4/33 | 12.1 | 7 | 15 | 3 | 2 | | | | |
| 14 | 虞勇灿 | 2/10 | 1/5 | | 0/2 | | | 0/1 | 3/18 | 16.7 | | 1 | | | | | | |
| 15 | 张佩力 | 1/4 | 0/4 | | 0/2 | | | 0/1 | 1/11 | 9.1 | | | | | | | | |
| 守门员 合计 | | 3/14 | 1/9 | | 0/4 | | | 0/2 | 4/29 | 13.8 | | 1 | | | | | | |

| 上海 | 比赛进程 | 浙江 |
|----------|----------|----------|
| 1st Half | | |
| 14 吴佳兵 | 1 01:17 | 0 |
| 3 高天伦 | 2 01:57 | 0 |
| 18 吴双 | 3 03:25 | 0 |
| 3 高天伦 | 4 04:03 | 0 |
| 8 庄旭杰 | 5 05:07 | 0 |
| 3 高天伦 | 6 06:24 | 0 |
| 6 高天伦 | 6 07:42 | 1 18 倪陈辉 |
| 14 吴佳兵 | 7 08:35 | 1 林先方 |
| 7 高天伦 | 7 09:10 | 2 |
| 14 吴佳兵 | 8 09:25 | 2 |
| 14 吴佳兵 | 9 09:52 | 2 |
| 18 吴双 | 10 10:57 | 2 |
| 10 董凯 | 11 11:19 | 2 |
| 14 吴佳兵 | 12 11:49 | 2 |
| 8 庄旭杰 | 13 13:29 | 2 |
| 4 高震东 | 14 15:47 | 2 |
| 14 吴佳兵 | 14 16:32 | 3 1 林先方 |
| 8 庄旭杰 | 15 17:37 | 3 |
| 3 高天伦 | 16 19:05 | 3 |
| 14 吴佳兵 | 17 20:03 | 3 |
| 17 高天伦 | 17 22:08 | 4 2 李恩铭 |
| 4 高震东 | 18 22:25 | 4 |
| 10 董凯 | 19 22:53 | 4 |
| 5 曹磊 | 20 23:55 | 4 |
| 5 曹磊 | 21 24:51 | 4 |
| 8 庄旭杰 | 22 25:36 | 4 |
| 14 吴佳兵 | 23 26:33 | 4 |
| 5 曹磊 | 24 28:15 | 4 |
| 4 高震东 | 25 29:45 | 4 |

场上队员: 得分 / 射门

守门员: 救球 / 射门

| | | | | | | | | | | | | | |
|----|------------|--|----|--------------|--|-----|------------|--|-----|----------|--|----|---------|
| 快攻 | Fast Break | | 突破 | Breakthrough | | 任意球 | Free Throw | | 7m球 | 7M Throw | | 助攻 | Assist |
| 警告 | Warning | | 失误 | Error | | 2' | Suspension | | D | 取消资格 | | DR | 取消资格+报告 |





2016年“体彩杯”全国手球男子青年锦标赛 图式比赛技术统计表

轮次 3

场次 15

201602015-21-1/1

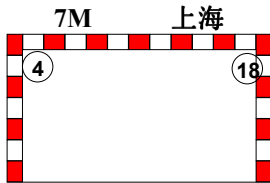
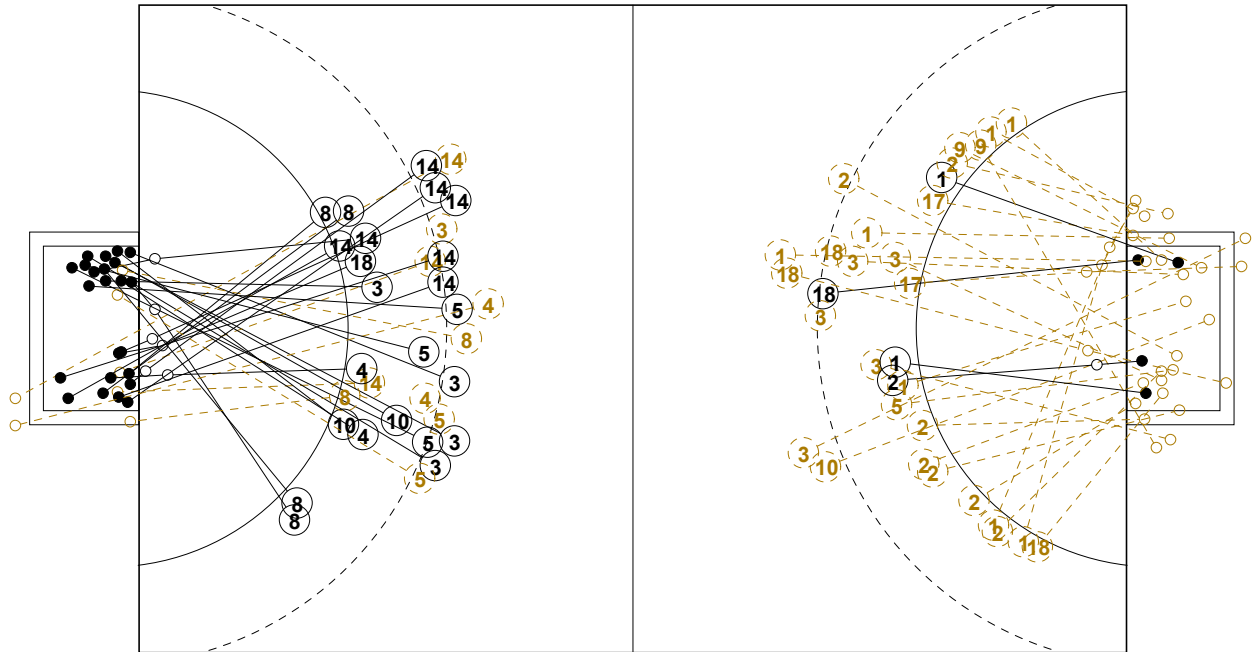

1st Half
25 : 4

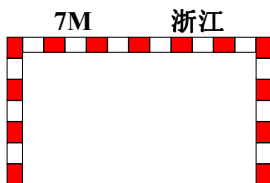
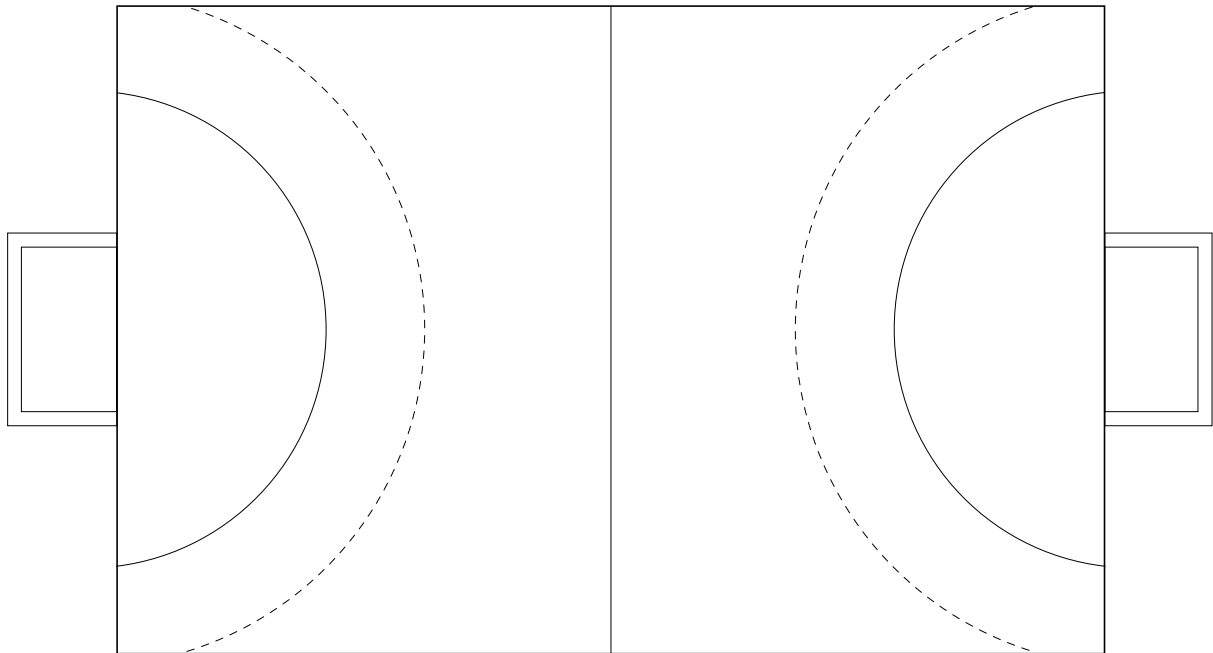
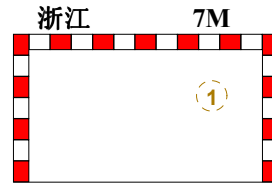

2nd Half
4 : 25

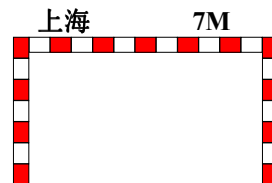



2016年“体彩杯”全国手球男子青年锦标赛

个人/全队技术统计表

正式表
手球
青年男子预赛
轮次 3组别 A
场次 15201602015-14-1/2
重庆万州
22/03/2016 13:00

| 号码 | 姓名 | 远射 | 近射 | 边射 | 快攻 | 突破 | 任意 | 7M | 合计 | % | 助攻 | 失误 | 警告 | 2' | 取消 | 时间 |
|--|-----|-----|-----|-----|-----|----|-----|-----|------|-------|----|----|----|----|----|----------|
| 上海队(上海) | | | | | | | | | | | | | | | | |
| <i>(场上队员)</i> | | | | | | | | | | | | | | | | |
| 2 | 谢智超 | | | | | | | | | 0.0% | | | | | | 00:14:04 |
| 3 | 高天伦 | 3/4 | 1/1 | | | | | | 4/5 | 80.0% | 1 | 1 | | | | 00:23:23 |
| 4 | 高震东 | 0/2 | 1/1 | | 1/1 | | | 1/1 | 3/5 | 60.0% | 1 | 3 | | | | 00:18:39 |
| 5 | 曹磊 | 3/5 | | | | | | | 3/5 | 60.0% | 1 | 1 | | | | 00:06:36 |
| 7 | 蒋家敏 | | | | | | | | | 0.0% | | | | | | 00:13:48 |
| 8 | 庄旭杰 | 0/1 | 2/3 | | 2/2 | | | | 4/6 | 66.7% | | | | | | 00:30:00 |
| 10 | 董凯 | | 1/1 | | 1/1 | | | | 2/2 | 100% | | 2 | | | | 00:26:10 |
| 12 | 张润民 | | | | | | | | | 0.0% | | | | | | 00:21:06 |
| 14 | 吴佳兵 | 5/7 | 2/3 | | | | | | 7/10 | 70.0% | | 3 | 1 | | | 00:30:00 |
| 16 | 陈辰 | | | | | | | | | 0.0% | | | | 1 | | 00:11:05 |
| 18 | 吴双 | | 1/1 | | | | | 1/1 | 2/2 | 100% | | | | | | 00:15:10 |
| 合计 | | | | | | | | | | | | | | | | |
| <i>(守门员)</i> | | | | | | | | | | | | | | | | |
| 12 | 张润民 | 1/1 | 6/8 | 1/1 | 1/1 | | 0/1 | | 9/12 | 75.0% | | | | | | 00:21:06 |
| 16 | 陈辰 | 2/2 | 0/1 | 2/2 | 1/1 | | | 1/1 | 6/7 | 85.7% | | | | | | 00:11:05 |
| 合计 | | | | | | | | | | | | | | | | |
| 3/3 6/9 3/3 2/2 0/1 1/1 15/19 78.9% | | | | | | | | | | | | | | | | |

场上队员：得分/射门

守门员：救球/射门

| 全队合计 | 得分 | 被救 | 射失 | 击柱 | 封球 | 合计 | % |
|------|----|----|----|----|----|----|--------|
| 远射 | 11 | 3 | 2 | | 3 | 19 | 57.9% |
| 近射 | 8 | 1 | | 1 | | 10 | 80.0% |
| 边射 | | | | | | | 0.0% |
| 快攻 | 4 | | | | | 4 | 100.0% |
| 突破 | | | | | | | 0.0% |
| 任意 | | | | | | | 0.0% |
| 7M | 2 | | | | | 2 | 100.0% |





2016年“体彩杯”全国手球男子青年锦标赛

个人/全队技术统计表

正式表
手球
青年男子预赛
轮次 3组别 A
场次 15201602015-14-2/2
重庆万州
22/03/2016 13:00

| 号码 | 姓名 | 远射 | 近射 | 边射 | 快攻 | 突破 | 任意 | 7M | 合计 | % | 助攻 | 失误 | 警告 | 2' | 取消 | 时间 |
|----------------|-----|------|-----|-----|-----|-----|-----|-----|------|-------|----|----|----|----|----|----------|
| 浙江队(浙江) | | | | | | | | | | | | | | | | |
| <i>(上场队员)</i> | | | | | | | | | | | | | | | | |
| 1 | 林先方 | 0/1 | 2/2 | 0/4 | 0/2 | | | 0/1 | 2/10 | 20.0% | 1 | 3 | | | | 00:30:00 |
| 2 | 李恩铭 | 0/1 | 1/6 | 0/1 | | | | | 1/8 | 12.5% | | 3 | 1 | | | 00:30:00 |
| 3 | 郑尧俊 | 0/2 | 0/1 | | 0/1 | 0/1 | | | 0/5 | 0.0% | 4 | 5 | 1 | | | 00:30:00 |
| 5 | 高家南 | | 0/1 | | | | | | 0/1 | 0.0% | | | | | | 00:23:23 |
| 9 | 李家乐 | | 0/1 | 0/1 | | | | | 0/2 | 0.0% | 1 | | | | | 00:16:16 |
| 10 | 徐正飞 | 0/1 | | | | | | | 0/1 | 0.0% | | 1 | | | | 00:16:45 |
| 14 | 虞勇灿 | | | | | | | | | 0.0% | | 1 | | | | 00:17:04 |
| 15 | 张佩力 | | | | | | | | | 0.0% | | | | | | 00:12:56 |
| 17 | 罗明杰 | | 0/2 | | | | | | 0/2 | 0.0% | | 1 | | | | 00:17:18 |
| 18 | 倪陈辉 | 0/1 | | 0/1 | | | 1/2 | | 1/4 | 25.0% | 1 | 1 | 1 | 2 | | 00:26:19 |
| 19 | 王浩 | | | | | | | | | 0.0% | | | | | | 00:00:00 |
| 合计 | | | | | | | | | | | | | | | | |
| <i>(守门员)</i> | | | | | | | | | | | | | | | | |
| 14 | 虞勇灿 | 2/10 | 1/5 | | 0/2 | | | 0/1 | 3/18 | 16.7% | | 1 | | | | 00:17:04 |
| 15 | 张佩力 | 1/4 | 0/4 | | 0/2 | | | 0/1 | 1/11 | 9.1% | | | | | | 00:12:56 |
| 合计 | | | | | | | | | | | | | | | | |

场上队员：得分/射门

守门员：救球/射门

| 全队合计 | 得分 | 被救 | 射失 | 击柱 | 封球 | 合计 | % |
|------|----|----|----|----|----|----|-------|
| 远射 | | 3 | 1 | | 2 | 6 | 0.0% |
| 近射 | 3 | 6 | 2 | 2 | | 13 | 23.1% |
| 边射 | | 3 | 4 | | | 7 | 0.0% |
| 快攻 | | 2 | | 1 | | 3 | 0.0% |
| 突破 | | | 1 | | | 1 | 0.0% |
| 任意 | 1 | | | 1 | | 2 | 50.0% |
| 7M | | 1 | | | | 1 | 0.0% |





2016年“体彩杯”全国手球男子青年锦标赛

图式射门区域统计

轮次 3 场次 15

201602015-41-1/1

上海队

| | | | | | | | | | | | | | | | | | | | | | | | | | | | | | | | | | | | | | | | | | | | | | | | | | | | | | | | | | | | | | | | | | | | | | | | | | | | | | | | |
|--|-----------------------------|-----------------------------|-----------------------------|-----------------------------|-----------------------------|-----------------------------|-----------------------------|---|--|--|--|--|--|--|--|---|--|--|---|---|---|--|---|--|--|--|---|---|---|--|--|--|---|--|--|---|--|--|--|--|--|--|--|--|--|--|--|--|--|--|--|--|--|---|--|---|---|--|---|--|--|--|--|--|--|---|--|--|---|--|--|--|--|--|--|--|--|--|--|
| 2 谢智超 | 3 高天伦 | 4 高震东 | 5 曹磊 | 7 蒋家敏 | 8 庄旭杰 | 10 董凯 | 12 张润民 | | | | | | | | | | | | | | | | | | | | | | | | | | | | | | | | | | | | | | | | | | | | | | | | | | | | | | | | | | | | | | | | | | | | | | | | |
| <table border="1"><tr><td></td><td></td><td></td></tr><tr><td></td><td></td><td></td></tr><tr><td></td><td></td><td></td></tr></table> | | | | | | | | | | <table border="1"><tr><td></td><td></td><td></td></tr><tr><td></td><td></td><td>2</td></tr><tr><td></td><td></td><td>2</td></tr></table> | | | | | | 2 | | | 2 | <table border="1"><tr><td>1</td><td></td><td></td></tr><tr><td></td><td></td><td></td></tr><tr><td>1</td><td></td><td>1</td></tr></table> | 1 | | | | | | 1 | | 1 | <table border="1"><tr><td></td><td></td><td>1</td></tr><tr><td></td><td></td><td>2</td></tr><tr><td></td><td></td><td></td></tr></table> | | | 1 | | | 2 | | | | <table border="1"><tr><td></td><td></td><td></td></tr><tr><td></td><td></td><td></td></tr><tr><td></td><td></td><td></td></tr></table> | | | | | | | | | | <table border="1"><tr><td></td><td></td><td></td></tr><tr><td>1</td><td></td><td>1</td></tr><tr><td>1</td><td></td><td>1</td></tr></table> | | | | 1 | | 1 | 1 | | 1 | <table border="1"><tr><td></td><td></td><td></td></tr><tr><td></td><td></td><td>1</td></tr><tr><td></td><td></td><td>1</td></tr></table> | | | | | | 1 | | | 1 | <table border="1"><tr><td></td><td></td><td></td></tr><tr><td></td><td></td><td></td></tr><tr><td></td><td></td><td></td></tr></table> | | | | | | | | | |
| | | | | | | | | | | | | | | | | | | | | | | | | | | | | | | | | | | | | | | | | | | | | | | | | | | | | | | | | | | | | | | | | | | | | | | | | | | | | | | | |
| | | | | | | | | | | | | | | | | | | | | | | | | | | | | | | | | | | | | | | | | | | | | | | | | | | | | | | | | | | | | | | | | | | | | | | | | | | | | | | | |
| | | | | | | | | | | | | | | | | | | | | | | | | | | | | | | | | | | | | | | | | | | | | | | | | | | | | | | | | | | | | | | | | | | | | | | | | | | | | | | | |
| | | | | | | | | | | | | | | | | | | | | | | | | | | | | | | | | | | | | | | | | | | | | | | | | | | | | | | | | | | | | | | | | | | | | | | | | | | | | | | | |
| | | 2 | | | | | | | | | | | | | | | | | | | | | | | | | | | | | | | | | | | | | | | | | | | | | | | | | | | | | | | | | | | | | | | | | | | | | | | | | | | | | |
| | | 2 | | | | | | | | | | | | | | | | | | | | | | | | | | | | | | | | | | | | | | | | | | | | | | | | | | | | | | | | | | | | | | | | | | | | | | | | | | | | | |
| 1 | | | | | | | | | | | | | | | | | | | | | | | | | | | | | | | | | | | | | | | | | | | | | | | | | | | | | | | | | | | | | | | | | | | | | | | | | | | | | | | |
| | | | | | | | | | | | | | | | | | | | | | | | | | | | | | | | | | | | | | | | | | | | | | | | | | | | | | | | | | | | | | | | | | | | | | | | | | | | | | | | |
| 1 | | 1 | | | | | | | | | | | | | | | | | | | | | | | | | | | | | | | | | | | | | | | | | | | | | | | | | | | | | | | | | | | | | | | | | | | | | | | | | | | | | |
| | | 1 | | | | | | | | | | | | | | | | | | | | | | | | | | | | | | | | | | | | | | | | | | | | | | | | | | | | | | | | | | | | | | | | | | | | | | | | | | | | | |
| | | 2 | | | | | | | | | | | | | | | | | | | | | | | | | | | | | | | | | | | | | | | | | | | | | | | | | | | | | | | | | | | | | | | | | | | | | | | | | | | | | |
| | | | | | | | | | | | | | | | | | | | | | | | | | | | | | | | | | | | | | | | | | | | | | | | | | | | | | | | | | | | | | | | | | | | | | | | | | | | | | | | |
| | | | | | | | | | | | | | | | | | | | | | | | | | | | | | | | | | | | | | | | | | | | | | | | | | | | | | | | | | | | | | | | | | | | | | | | | | | | | | | | |
| | | | | | | | | | | | | | | | | | | | | | | | | | | | | | | | | | | | | | | | | | | | | | | | | | | | | | | | | | | | | | | | | | | | | | | | | | | | | | | | |
| | | | | | | | | | | | | | | | | | | | | | | | | | | | | | | | | | | | | | | | | | | | | | | | | | | | | | | | | | | | | | | | | | | | | | | | | | | | | | | | |
| | | | | | | | | | | | | | | | | | | | | | | | | | | | | | | | | | | | | | | | | | | | | | | | | | | | | | | | | | | | | | | | | | | | | | | | | | | | | | | | |
| 1 | | 1 | | | | | | | | | | | | | | | | | | | | | | | | | | | | | | | | | | | | | | | | | | | | | | | | | | | | | | | | | | | | | | | | | | | | | | | | | | | | | |
| 1 | | 1 | | | | | | | | | | | | | | | | | | | | | | | | | | | | | | | | | | | | | | | | | | | | | | | | | | | | | | | | | | | | | | | | | | | | | | | | | | | | | |
| | | | | | | | | | | | | | | | | | | | | | | | | | | | | | | | | | | | | | | | | | | | | | | | | | | | | | | | | | | | | | | | | | | | | | | | | | | | | | | | |
| | | 1 | | | | | | | | | | | | | | | | | | | | | | | | | | | | | | | | | | | | | | | | | | | | | | | | | | | | | | | | | | | | | | | | | | | | | | | | | | | | | |
| | | 1 | | | | | | | | | | | | | | | | | | | | | | | | | | | | | | | | | | | | | | | | | | | | | | | | | | | | | | | | | | | | | | | | | | | | | | | | | | | | | |
| | | | | | | | | | | | | | | | | | | | | | | | | | | | | | | | | | | | | | | | | | | | | | | | | | | | | | | | | | | | | | | | | | | | | | | | | | | | | | | | |
| | | | | | | | | | | | | | | | | | | | | | | | | | | | | | | | | | | | | | | | | | | | | | | | | | | | | | | | | | | | | | | | | | | | | | | | | | | | | | | | |
| | | | | | | | | | | | | | | | | | | | | | | | | | | | | | | | | | | | | | | | | | | | | | | | | | | | | | | | | | | | | | | | | | | | | | | | | | | | | | | | |
| Post - 0 Miss - 0 Block - 0 | Post - 0 Miss - 0 Block - 1 | Post - 0 Miss - 1 Block - 1 | Post - 0 Miss - 0 Block - 1 | Post - 0 Miss - 0 Block - 0 | Post - 1 Miss - 0 Block - 0 | Post - 0 Miss - 0 Block - 0 | Post - 0 Miss - 0 Block - 0 | | | | | | | | | | | | | | | | | | | | | | | | | | | | | | | | | | | | | | | | | | | | | | | | | | | | | | | | | | | | | | | | | | | | | | | | |
| 14 吴佳兵 | 16 陈辰 | 18 吴双 | | | | | | | | | | | | | | | | | | | | | | | | | | | | | | | | | | | | | | | | | | | | | | | | | | | | | | | | | | | | | | | | | | | | | | | | | | | | | |
| <table border="1"><tr><td>2</td><td></td><td></td></tr><tr><td></td><td></td><td>1</td></tr><tr><td>3</td><td>1</td><td></td></tr></table> | 2 | | | | | 1 | 3 | 1 | | <table border="1"><tr><td></td><td></td><td></td></tr><tr><td></td><td></td><td></td></tr><tr><td></td><td></td><td></td></tr></table> | | | | | | | | | | <table border="1"><tr><td></td><td></td><td>1</td></tr><tr><td></td><td></td><td></td></tr><tr><td></td><td>1</td><td></td></tr></table> | | | 1 | | | | | 1 | | <table border="1"><tr><td></td><td></td><td></td></tr><tr><td></td><td></td><td></td></tr><tr><td></td><td></td><td></td></tr></table> | | | | | | | | | | <table border="1"><tr><td></td><td></td><td></td></tr><tr><td></td><td></td><td></td></tr><tr><td></td><td></td><td></td></tr></table> | | | | | | | | | | <table border="1"><tr><td></td><td></td><td></td></tr><tr><td></td><td></td><td></td></tr><tr><td></td><td></td><td></td></tr></table> | | | | | | | | | | <table border="1"><tr><td></td><td></td><td></td></tr><tr><td></td><td></td><td></td></tr><tr><td></td><td></td><td></td></tr></table> | | | | | | | | | | <table border="1"><tr><td></td><td></td><td></td></tr><tr><td></td><td></td><td></td></tr><tr><td></td><td></td><td></td></tr></table> | | | | | | | | | |
| 2 | | | | | | | | | | | | | | | | | | | | | | | | | | | | | | | | | | | | | | | | | | | | | | | | | | | | | | | | | | | | | | | | | | | | | | | | | | | | | | | |
| | | 1 | | | | | | | | | | | | | | | | | | | | | | | | | | | | | | | | | | | | | | | | | | | | | | | | | | | | | | | | | | | | | | | | | | | | | | | | | | | | | |
| 3 | 1 | | | | | | | | | | | | | | | | | | | | | | | | | | | | | | | | | | | | | | | | | | | | | | | | | | | | | | | | | | | | | | | | | | | | | | | | | | | | | | |
| | | | | | | | | | | | | | | | | | | | | | | | | | | | | | | | | | | | | | | | | | | | | | | | | | | | | | | | | | | | | | | | | | | | | | | | | | | | | | | | |
| | | | | | | | | | | | | | | | | | | | | | | | | | | | | | | | | | | | | | | | | | | | | | | | | | | | | | | | | | | | | | | | | | | | | | | | | | | | | | | | |
| | | | | | | | | | | | | | | | | | | | | | | | | | | | | | | | | | | | | | | | | | | | | | | | | | | | | | | | | | | | | | | | | | | | | | | | | | | | | | | | |
| | | 1 | | | | | | | | | | | | | | | | | | | | | | | | | | | | | | | | | | | | | | | | | | | | | | | | | | | | | | | | | | | | | | | | | | | | | | | | | | | | | |
| | | | | | | | | | | | | | | | | | | | | | | | | | | | | | | | | | | | | | | | | | | | | | | | | | | | | | | | | | | | | | | | | | | | | | | | | | | | | | | | |
| | 1 | | | | | | | | | | | | | | | | | | | | | | | | | | | | | | | | | | | | | | | | | | | | | | | | | | | | | | | | | | | | | | | | | | | | | | | | | | | | | | |
| | | | | | | | | | | | | | | | | | | | | | | | | | | | | | | | | | | | | | | | | | | | | | | | | | | | | | | | | | | | | | | | | | | | | | | | | | | | | | | | |
| | | | | | | | | | | | | | | | | | | | | | | | | | | | | | | | | | | | | | | | | | | | | | | | | | | | | | | | | | | | | | | | | | | | | | | | | | | | | | | | |
| | | | | | | | | | | | | | | | | | | | | | | | | | | | | | | | | | | | | | | | | | | | | | | | | | | | | | | | | | | | | | | | | | | | | | | | | | | | | | | | |
| | | | | | | | | | | | | | | | | | | | | | | | | | | | | | | | | | | | | | | | | | | | | | | | | | | | | | | | | | | | | | | | | | | | | | | | | | | | | | | | |
| | | | | | | | | | | | | | | | | | | | | | | | | | | | | | | | | | | | | | | | | | | | | | | | | | | | | | | | | | | | | | | | | | | | | | | | | | | | | | | | |
| | | | | | | | | | | | | | | | | | | | | | | | | | | | | | | | | | | | | | | | | | | | | | | | | | | | | | | | | | | | | | | | | | | | | | | | | | | | | | | | |
| | | | | | | | | | | | | | | | | | | | | | | | | | | | | | | | | | | | | | | | | | | | | | | | | | | | | | | | | | | | | | | | | | | | | | | | | | | | | | | | |
| | | | | | | | | | | | | | | | | | | | | | | | | | | | | | | | | | | | | | | | | | | | | | | | | | | | | | | | | | | | | | | | | | | | | | | | | | | | | | | | |
| | | | | | | | | | | | | | | | | | | | | | | | | | | | | | | | | | | | | | | | | | | | | | | | | | | | | | | | | | | | | | | | | | | | | | | | | | | | | | | | |
| | | | | | | | | | | | | | | | | | | | | | | | | | | | | | | | | | | | | | | | | | | | | | | | | | | | | | | | | | | | | | | | | | | | | | | | | | | | | | | | |
| | | | | | | | | | | | | | | | | | | | | | | | | | | | | | | | | | | | | | | | | | | | | | | | | | | | | | | | | | | | | | | | | | | | | | | | | | | | | | | | |
| | | | | | | | | | | | | | | | | | | | | | | | | | | | | | | | | | | | | | | | | | | | | | | | | | | | | | | | | | | | | | | | | | | | | | | | | | | | | | | | |
| | | | | | | | | | | | | | | | | | | | | | | | | | | | | | | | | | | | | | | | | | | | | | | | | | | | | | | | | | | | | | | | | | | | | | | | | | | | | | | | |
| | | | | | | | | | | | | | | | | | | | | | | | | | | | | | | | | | | | | | | | | | | | | | | | | | | | | | | | | | | | | | | | | | | | | | | | | | | | | | | | |
| | | | | | | | | | | | | | | | | | | | | | | | | | | | | | | | | | | | | | | | | | | | | | | | | | | | | | | | | | | | | | | | | | | | | | | | | | | | | | | | |
| Post - 0 Miss - 1 Block - 0 | Post - 0 Miss - 0 Block - 0 | Post - 0 Miss - 0 Block - 0 | | | | | | | | | | | | | | | | | | | | | | | | | | | | | | | | | | | | | | | | | | | | | | | | | | | | | | | | | | | | | | | | | | | | | | | | | | | | | |

12 张润民

| | | |
|-----|-----|-----|
| 1/1 | 1/1 | |
| 1/2 | | 4/4 |
| 0/1 | | 2/3 |

16 陈辰

| | | |
|-----|-----|-----|
| | | 1/1 |
| 1/1 | 2/2 | 1/1 |
| 1/1 | | 0/1 |

| | | |
|--|--|--|
| | | |
| | | |
| | | |

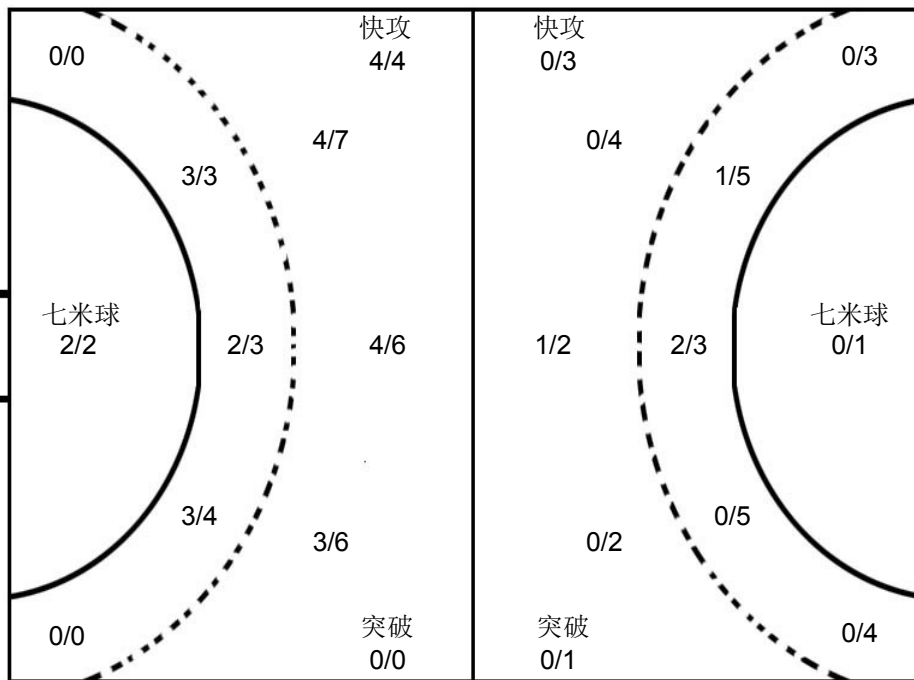

14 虞勇灿

| | | |
|-----|-----|-----|
| 0/1 | | 0/1 |
| 0/1 | | 0/4 |
| 2/4 | 0/2 | 1/5 |

15 张佩力

| | | |
|-----|--|-----|
| 0/2 | | 0/1 |
| | | 0/3 |
| 0/3 | | 1/2 |

| | | |
|--|--|--|
| | | |
| | | |
| | | |

浙江队

| | | | | | | | | | | | | | | | | | | | | | | | | | | | | | | | | | | | | | | | | | | | | | | | | | | | | | | | | | | | | | | | | | | | | | | | | | | | | | | | |
|--|-----------------------------|-----------------------------|-----------------------------|-----------------------------|-----------------------------|-----------------------------|-----------------------------|--|---|---|--|--|--|--|--|--|--|---|---|--|--|--|--|--|--|--|--|--|--|--|--|--|--|--|--|--|--|--|--|--|--|--|--|--|--|--|--|--|--|--|--|--|--|--|--|--|--|--|--|--|--|--|--|--|--|--|--|--|--|--|--|--|--|--|--|--|--|--|--|
| 1 林先方 | 2 李恩铭 | 3 郑尧俊 | 5 高家南 | 9 李家乐 | 10 徐正飞 | 14 虞勇灿 | 15 张佩力 | | | | | | | | | | | | | | | | | | | | | | | | | | | | | | | | | | | | | | | | | | | | | | | | | | | | | | | | | | | | | | | | | | | | | | | | |
| <table border="1"><tr><td>1</td><td></td><td></td></tr><tr><td></td><td></td><td></td></tr><tr><td></td><td></td><td>1</td></tr></table> | 1 | | | | | | | | 1 | <table border="1"><tr><td></td><td></td><td></td></tr><tr><td></td><td></td><td></td></tr><tr><td></td><td></td><td>1</td></tr></table> | | | | | | | | | 1 | <table border="1"><tr><td></td><td></td><td></td></tr><tr><td></td><td></td><td></td></tr><tr><td></td><td></td><td></td></tr></table> | | | | | | | | | | <table border="1"><tr><td></td><td></td><td></td></tr><tr><td></td><td></td><td></td></tr><tr><td></td><td></td><td></td></tr></table> | | | | | | | | | | <table border="1"><tr><td></td><td></td><td></td></tr><tr><td></td><td></td><td></td></tr><tr><td></td><td></td><td></td></tr></table> | | | | | | | | | | <table border="1"><tr><td></td><td></td><td></td></tr><tr><td></td><td></td><td></td></tr><tr><td></td><td></td><td></td></tr></table> | | | | | | | | | | <table border="1"><tr><td></td><td></td><td></td></tr><tr><td></td><td></td><td></td></tr><tr><td></td><td></td><td></td></tr></table> | | | | | | | | | | <table border="1"><tr><td></td><td></td><td></td></tr><tr><td></td><td></td><td></td></tr><tr><td></td><td></td><td></td></tr></table> | | | | | | | | | |
| 1 | | | | | | | | | | | | | | | | | | | | | | | | | | | | | | | | | | | | | | | | | | | | | | | | | | | | | | | | | | | | | | | | | | | | | | | | | | | | | | | |
| | | | | | | | | | | | | | | | | | | | | | | | | | | | | | | | | | | | | | | | | | | | | | | | | | | | | | | | | | | | | | | | | | | | | | | | | | | | | | | | |
| | | 1 | | | | | | | | | | | | | | | | | | | | | | | | | | | | | | | | | | | | | | | | | | | | | | | | | | | | | | | | | | | | | | | | | | | | | | | | | | | | | |
| | | | | | | | | | | | | | | | | | | | | | | | | | | | | | | | | | | | | | | | | | | | | | | | | | | | | | | | | | | | | | | | | | | | | | | | | | | | | | | | |
| | | | | | | | | | | | | | | | | | | | | | | | | | | | | | | | | | | | | | | | | | | | | | | | | | | | | | | | | | | | | | | | | | | | | | | | | | | | | | | | |
| | | 1 | | | | | | | | | | | | | | | | | | | | | | | | | | | | | | | | | | | | | | | | | | | | | | | | | | | | | | | | | | | | | | | | | | | | | | | | | | | | | |
| | | | | | | | | | | | | | | | | | | | | | | | | | | | | | | | | | | | | | | | | | | | | | | | | | | | | | | | | | | | | | | | | | | | | | | | | | | | | | | | |
| | | | | | | | | | | | | | | | | | | | | | | | | | | | | | | | | | | | | | | | | | | | | | | | | | | | | | | | | | | | | | | | | | | | | | | | | | | | | | | | |
| | | | | | | | | | | | | | | | | | | | | | | | | | | | | | | | | | | | | | | | | | | | | | | | | | | | | | | | | | | | | | | | | | | | | | | | | | | | | | | | |
| | | | | | | | | | | | | | | | | | | | | | | | | | | | | | | | | | | | | | | | | | | | | | | | | | | | | | | | | | | | | | | | | | | | | | | | | | | | | | | | |
| | | | | | | | | | | | | | | | | | | | | | | | | | | | | | | | | | | | | | | | | | | | | | | | | | | | | | | | | | | | | | | | | | | | | | | | | | | | | | | | |
| | | | | | | | | | | | | | | | | | | | | | | | | | | | | | | | | | | | | | | | | | | | | | | | | | | | | | | | | | | | | | | | | | | | | | | | | | | | | | | | |
| | | | | | | | | | | | | | | | | | | | | | | | | | | | | | | | | | | | | | | | | | | | | | | | | | | | | | | | | | | | | | | | | | | | | | | | | | | | | | | | |
| | | | | | | | | | | | | | | | | | | | | | | | | | | | | | | | | | | | | | | | | | | | | | | | | | | | | | | | | | | | | | | | | | | | | | | | | | | | | | | | |
| | | | | | | | | | | | | | | | | | | | | | | | | | | | | | | | | | | | | | | | | | | | | | | | | | | | | | | | | | | | | | | | | | | | | | | | | | | | | | | | |
| | | | | | | | | | | | | | | | | | | | | | | | | | | | | | | | | | | | | | | | | | | | | | | | | | | | | | | | | | | | | | | | | | | | | | | | | | | | | | | | |
| | | | | | | | | | | | | | | | | | | | | | | | | | | | | | | | | | | | | | | | | | | | | | | | | | | | | | | | | | | | | | | | | | | | | | | | | | | | | | | | |
| | | | | | | | | | | | | | | | | | | | | | | | | | | | | | | | | | | | | | | | | | | | | | | | | | | | | | | | | | | | | | | | | | | | | | | | | | | | | | | | |
| | | | | | | | | | | | | | | | | | | | | | | | | | | | | | | | | | | | | | | | | | | | | | | | | | | | | | | | | | | | | | | | | | | | | | | | | | | | | | | | |
| | | | | | | | | | | | | | | | | | | | | | | | | | | | | | | | | | | | | | | | | | | | | | | | | | | | | | | | | | | | | | | | | | | | | | | | | | | | | | | | |
| | | | | | | | | | | | | | | | | | | | | | | | | | | | | | | | | | | | | | | | | | | | | | | | | | | | | | | | | | | | | | | | | | | | | | | | | | | | | | | | |
| | | | | | | | | | | | | | | | | | | | | | | | | | | | | | | | | | | | | | | | | | | | | | | | | | | | | | | | | | | | | | | | | | | | | | | | | | | | | | | | |
| | | | | | | | | | | | | | | | | | | | | | | | | | | | | | | | | | | | | | | | | | | | | | | | | | | | | | | | | | | | | | | | | | | | | | | | | | | | | | | | |
| | | | | | | | | | | | | | | | | | | | | | | | | | | | | | | | | | | | | | | | | | | | | | | | | | | | | | | | | | | | | | | | | | | | | | | | | | | | | | | | |
| Post - 1 Miss - 3 Block - 0 | Post - 1 Miss - 1 Block - 0 | Post - 0 Miss - 2 Block - 1 | Post - 0 Miss - 0 Block - 0 | Post - 0 Miss - 1 Block - 0 | Post - 0 Miss - 0 Block - 0 | Post - 0 Miss - 0 Block - 0 | Post - 0 Miss - 0 Block - 0 | | | | | | | | | | | | | | | | | | | | | | | | | | | | | | | | | | | | | | | | | | | | | | | | | | | | | | | | | | | | | | | | | | | | | | | | |
| 17 罗明杰 | 18 倪陈辉 | 19 王浩 | | | | | | | | | | | | | | | | | | | | | | | | | | | | | | | | | | | | | | | | | | | | | | | | | | | | | | | | | | | | | | | | | | | | | | | | | | | | | |
| <table border="1"><tr><td></td><td></td><td></td></tr><tr><td></td><td></td><td></td></tr><tr><td></td><td></td><td></td></tr></table> | | | | | | | | | | <table border="1"><tr><td></td><td></td><td></td></tr><tr><td></td><td></td><td></td></tr><tr><td></td><td>1</td><td></td></tr></table> | | | | | | | | 1 | | <table border="1"><tr><td></td><td></td><td></td></tr><tr><td></td><td></td><td></td></tr><tr><td></td><td></td><td></td></tr></table> | | | | | | | | | | <table border="1"><tr><td></td><td></td><td></td></tr><tr><td></td><td></td><td></td></tr><tr><td></td><td></td><td></td></tr></table> | | | | | | | | | | <table border="1"><tr><td></td><td></td><td></td></tr><tr><td></td><td></td><td></td></tr><tr><td></td><td></td><td></td></tr></table> | | | | | | | | | | <table border="1"><tr><td></td><td></td><td></td></tr><tr><td></td><td></td><td></td></tr><tr><td></td><td></td><td></td></tr></table> | | | | | | | | | | <table border="1"><tr><td></td><td></td><td></td></tr><tr><td></td><td></td><td></td></tr><tr><td></td><td></td><td></td></tr></table> | | | | | | | | | | <table border="1"><tr><td></td><td></td><td></td></tr><tr><td></td><td></td><td></td></tr><tr><td></td><td></td><td></td></tr></table> | | | | | | | | | |
| | | | | | | | | | | | | | | | | | | | | | | | | | | | | | | | | | | | | | | | | | | | | | | | | | | | | | | | | | | | | | | | | | | | | | | | | | | | | | | | |
| | | | | | | | | | | | | | | | | | | | | | | | | | | | | | | | | | | | | | | | | | | | | | | | | | | | | | | | | | | | | | | | | | | | | | | | | | | | | | | | |
| | | | | | | | | | | | | | | | | | | | | | | | | | | | | | | | | | | | | | | | | | | | | | | | | | | | | | | | | | | | | | | | | | | | | | | | | | | | | | | | |
| | | | | | | | | | | | | | | | | | | | | | | | | | | | | | | | | | | | | | | | | | | | | | | | | | | | | | | | | | | | | | | | | | | | | | | | | | | | | | | | |
| | | | | | | | | | | | | | | | | | | | | | | | | | | | | | | | | | | | | | | | | | | | | | | | | | | | | | | | | | | | | | | | | | | | | | | | | | | | | | | | |
| | 1 | | | | | | | | | | | | | | | | | | | | | | | | | | | | | | | | | | | | | | | | | | | | | | | | | | | | | | | | | | | | | | | | | | | | | | | | | | | | | | |
| | | | | | | | | | | | | | | | | | | | | | | | | | | | | | | | | | | | | | | | | | | | | | | | | | | | | | | | | | | | | | | | | | | | | | | | | | | | | | | | |
| | | | | | | | | | | | | | | | | | | | | | | | | | | | | | | | | | | | | | | | | | | | | | | | | | | | | | | | | | | | | | | | | | | | | | | | | | | | | | | | |
| | | | | | | | | | | | | | | | | | | | | | | | | | | | | | | | | | | | | | | | | | | | | | | | | | | | | | | | | | | | | | | | | | | | | | | | | | | | | | | | |
| | | | | | | | | | | | | | | | | | | | | | | | | | | | | | | | | | | | | | | | | | | | | | | | | | | | | | | | | | | | | | | | | | | | | | | | | | | | | | | | |
| | | | | | | | | | | | | | | | | | | | | | | | | | | | | | | | | | | | | | | | | | | | | | | | | | | | | | | | | | | | | | | | | | | | | | | | | | | | | | | | |
| | | | | | | | | | | | | | | | | | | | | | | | | | | | | | | | | | | | | | | | | | | | | | | | | | | | | | | | | | | | | | | | | | | | | | | | | | | | | | | | |
| | | | | | | | | | | | | | | | | | | | | | | | | | | | | | | | | | | | | | | | | | | | | | | | | | | | | | | | | | | | | | | | | | | | | | | | | | | | | | | | |
| | | | | | | | | | | | | | | | | | | | | | | | | | | | | | | | | | | | | | | | | | | | | | | | | | | | | | | | | | | | | | | | | | | | | | | | | | | | | | | | |
| | | | | | | | | | | | | | | | | | | | | | | | | | | | | | | | | | | | | | | | | | | | | | | | | | | | | | | | | | | | | | | | | | | | | | | | | | | | | | | | |
| | | | | | | | | | | | | | | | | | | | | | | | | | | | | | | | | | | | | | | | | | | | | | | | | | | | | | | | | | | | | | | | | | | | | | | | | | | | | | | | |
| | | | | | | | | | | | | | | | | | | | | | | | | | | | | | | | | | | | | | | | | | | | | | | | | | | | | | | | | | | | | | | | | | | | | | | | | | | | | | | | |
| | | | | | | | | | | | | | | | | | | | | | | | | | | | | | | | | | | | | | | | | | | | | | | | | | | | | | | | | | | | | | | | | | | | | | | | | | | | | | | | |
| | | | | | | | | | | | | | | | | | | | | | | | | | | | | | | | | | | | | | | | | | | | | | | | | | | | | | | | | | | | | | | | | | | | | | | | | | | | | | | | |
| | | | | | | | | | | | | | | | | | | | | | | | | | | | | | | | | | | | | | | | | | | | | | | | | | | | | | | | | | | | | | | | | | | | | | | | | | | | | | | | |
| | | | | | | | | | | | | | | | | | | | | | | | | | | | | | | | | | | | | | | | | | | | | | | | | | | | | | | | | | | | | | | | | | | | | | | | | | | | | | | | |
| | | | | | | | | | | | | | | | | | | | | | | | | | | | | | | | | | | | | | | | | | | | | | | | | | | | | | | | | | | | | | | | | | | | | | | | | | | | | | | | |
| | | | | | | | | | | | | | | | | | | | | | | | | | | | | | | | | | | | | | | | | | | | | | | | | | | | | | | | | | | | | | | | | | | | | | | | | | | | | | | | |
| | | | | | | | | | | | | | | | | | | | | | | | | | | | | | | | | | | | | | | | | | | | | | | | | | | | | | | | | | | | | | | | | | | | | | | | | | | | | | | | |
| Post - 1 Miss - 1 Block - 0 | Post - 1 Miss - 0 Block - 1 | Post - 0 Miss - 0 Block - 0 | | | | | | | | | | | | | | | | | | | | | | | | | | | | | | | | | | | | | | | | | | | | | | | | | | | | | | | | | | | | | | | | | | | | | | | | | | | | | |

注释: Post=击柱 Miss=射失 Block=被封





预赛 Group B
青年男子 全国比赛

2016年“体彩杯”全国手球男子青年锦标赛

| | | | | | | | | | | | | | | | | | | | | | |
|--------------------|---|---------------------|---------------------|------------------|------------------------------------|-------------------|---|---------------------------|----------------|------------|------------|----------------------|---------------|---|--|--|----|---|----|----|----|
| Team A A 安徽队 | | | | Team B B 辽宁队 | | | | Match Number 16 | | | | | | | | | | | | | |
| played in China | | in the hall 重庆万州 | | on 22/03/2016 | | at 14:30 hours | | Spectators | | | | | | | | | | | | | |
| Half-time (30') | A 17 | B 23 | End of playing time | A 40 | B 37 | 1st extra time | A | B | 2nd extra time | A | B | After penalty throws | A | B | | | | | | | |
| Number of 7 m | A 1/2 | Team time-out | | | Full name of players and officials | | | | Team time-out | | | B 2/2 | Number of 7 m | | | | | | | | |
| | | 1 15:20 | 2 22:50 | 3 | | | | | 1 26:28 | 2 41:23 | 3 49:43 | | | | | | | | | | |
| No. | Team A | | | | | G | W | 2' | D | DR | No. | Team B | | | | | G | W | 2' | D | DR |
| 1 | 郭世伟 | | | | | 3 | 1 | | | | 1 | 高尚君 | | | | | | | | | |
| 2 | 金勇峰 | | | | | 4 | 1 | | | | 3 | 李星浩 | | | | | 2 | 1 | 1 | | |
| 9 | 陈开勇 | | | | | 13 | | | | | 5 | 余昊锦 | | | | | | | | | |
| 17 | 王巨柱 | | | | | 7 | 1 | | | | 6 | 陈庆港 | | | | | 9 | | | | |
| 18 | 李双 | | | | | 6 | | | | | 7 | 孙义广 | | | | | | | | | |
| 19 | 何山 | | | | | | | 1 | | | 8 | 王鑫鹏 | | | | | 1 | | | | |
| 21 | 李明 | | | | | | | | | | 10 | 王柏淇 | | | | | 14 | | | | |
| 24 | 徐安格 | | | | | | | | | | 11 | 庞东阳 | | | | | 5 | 1 | 1 | | |
| 25 | 李文哲 | | | | | | | | | | 13 | 杨洁 | | | | | 6 | 1 | 3 | | |
| 26 | 程浩然 | | | | | 5 | | | | | 14 | 吕昊臻 | | | | | | | | | |
| 27 | 王长旭 | | | | | 2 | | | | | 16 | 吴阳 | | | | | | | | | |
| 28 | 丁浩然 | | | | | | | | | | 17 | 李傲 | | | | | | | | | |
| 32 | 许浩翔 | | | | | | | | | | 18 | 梅凯博 | | | | | | | | | |
| 33 | 姚紫祥 | | | | | | | | | | 19 | 赵鑫 | | | | | | | | | |
| 41 | 刘润民 | | | | | | | | | | 20 | 赵佛赐 | | | | | | | | | |
| 42 | 王成龙 | | | | | | | | | | | | | | | | | | | | |
| A | 王来黔 (主教练) | | | | | 1 | | | | | B | 赵影 (主教练) | | | | | 1 | | | | |
| B | 陆万红 | | | | | | | | | | C | 刘启迪 | | | | | | | | | |
| C | 吴翔 | | | | | | | | | | | | | | | | | | | | |
| A | Signature of Responsible Official of the Teams (Off. A) | | | | | | | | | | | | | | | | | | | B | |
| TP | Remarks of Referee / CHA Official | | | | | | | | | | | | | | | | | | | TP | |

Signatures

| | | | | |
|------------------|-----------|----------|--|--|
| Referees | 马晓晔 (CHN) | 王羚 (CHN) | | |
| Techn. Delegates | 徐健 (CHN) | | | |
| CHA Official | 吴瑞亭 (CHN) | | | |

Note: Number of 7m Throws Awarded to Team A and B, Goals (G), Warnings (W), Suspensions (2'), Direct Disqualification (D), Disqualification with Report (DR) and Team Penalty (TP).

Table Officials:

Statisticians: 刘永欢

李双





2016年“体彩杯”全国手球男子青年锦标赛 竞赛技术统计(媒体表)

| | | | | | | |
|----------------|-----------|------------|----|-----------|------------------|-----------|
| 预赛 | 组别 | B | 轮次 | 3 | 场次 | 16 |
| 重庆万州 | | 22/03/2016 | | | 201602016-51-1/1 | |
| 安徽队 | 安徽 | 40 | vs | 37 | 辽宁 | 辽宁队 |
| 17 : 23 | | | | | | |

| 裁判员 | | 马晓晔 (CHN) | | | | | | | | | | | / | 王羚 (CHN) | | | | | | | | | | | | | | | | | | |
|---------------|-----|-----------|-------|------|------|-----|-----|-------|------|----|----|----|----|----------|--------|-----------|----|-------|----|--|--|--|--|--|--|--|--|--|--|-----------|----|-----|
| 安徽 | | 远射 | 近射 | 边射 | 快攻 | 突破 | 任意球 | 7m球 | 合计 | % | 助攻 | 失误 | 警告 | 2' | D & DR | 安徽 | | 比赛进程 | | | | | | | | | | | | 辽宁 | | |
| 主教练：王来黔 | | | | | | | | | | | | | | | | 1st Half | | | | | | | | | | | | | | | | |
| 1 | 郭世伟 | | 2/3 | 1/1 | | | | 3/4 | 75.0 | 1 | 2 | 1 | | | 2 | 金勇峰 | 1 | 01:22 | 0 | | | | | | | | | | | | | |
| 2 | 金勇峰 | 1/1 | 1/2 | 1/1 | 1/1 | | | 4/5 | 80.0 | 1 | 5 | 1 | | | 2 | 金勇峰 | 2 | 02:39 | 0 | | | | | | | | | | | | 8 | 王鑫鹏 |
| 9 | 陈开勇 | 3/4 | 7/11 | | 2/2 | | | 13/18 | 72.2 | | | | | | 3 | 金勇峰 | 3 | 04:50 | 1 | | | | | | | | | | | | | |
| 17 | 王巨柱 | 3/11 | 2/2 | | 1/1 | 1/1 | | 7/16 | 43.8 | 5 | 3 | 1 | | | 4 | 陈开勇 | 3 | 05:37 | 2 | | | | | | | | | | | | 11 | 庞东阳 |
| 18 | 李双 | 1/6 | 2/3 | | | 3/3 | | 6/12 | 50.0 | 3 | 3 | | | | 4 | 陈开勇 | 4 | 06:02 | 2 | | | | | | | | | | | | | |
| 19 | 何山 | | | | | | | | | | | | 1 | | 5 | 王巨柱 | 5 | 06:33 | 3 | | | | | | | | | | | | 11 | 庞东阳 |
| 21 | 李明 | | | | | | | | | | | | | | 5 | 王巨柱 | 6 | 07:28 | 4 | | | | | | | | | | | | 6 | 陈庆港 |
| 24 | 徐安格 | | | | | | | | | | | | | | 6 | 郭世伟 | 6 | 07:58 | 4 | | | | | | | | | | | | | |
| 25 | 李文哲 | | | | | | | | | | | | | | 6 | 郭世伟 | 7 | 08:42 | 5 | | | | | | | | | | | | 11 | 庞东阳 |
| 26 | 程浩然 | | 0/1 | 2/5 | 3/4 | | | 5/10 | 50.0 | | | 3 | | | 7 | 郭世伟 | 8 | 09:00 | 5 | | | | | | | | | | | | | |
| 27 | 王长旭 | | | | 2/2 | | | 2/2 | 100 | | | | | | 8 | 陈开勇 | 8 | 10:27 | 5 | | | | | | | | | | | | | |
| 28 | 丁浩然 | | | | | | | | | | | | | | 8 | 陈开勇 | 9 | 10:45 | 6 | | | | | | | | | | | | 10 | 王柏淇 |
| 32 | 许浩翔 | | | | | | | | | | | | | | 9 | 陈开勇 | 9 | 11:33 | 6 | | | | | | | | | | | | | |
| 33 | 姚紫祥 | | | | | | | | | | | | | | 9 | 陈开勇 | 9 | 11:33 | 6 | | | | | | | | | | | | | |
| 41 | 刘润民 | | | | | | | | | | | | | | 9 | 陈开勇 | 10 | 12:23 | 7 | | | | | | | | | | | | 10 | 王柏淇 |
| 42 | 王成龙 | | | | | | | | | | | | | | 9 | 陈开勇 | 10 | 12:23 | 7 | | | | | | | | | | | | 10 | 王柏淇 |
| 运动员 合计 | | 8/22 | 14/22 | 4/7 | 9/10 | 4/4 | 1/2 | 40/67 | 59.7 | 15 | 16 | 3 | 1 | | 9 | 陈开勇 | 10 | 13:17 | 8 | | | | | | | | | | | | 10 | 王柏淇 |
| 21 | 李明 | 9/18 | 8/18 | 2/8 | 1/4 | 0/4 | 0/2 | 20/54 | 37.0 | 5 | | | | | 9 | 陈开勇 | 10 | 13:17 | 8 | | | | | | | | | | | | 10 | 王柏淇 |
| 32 | 许浩翔 | 0/2 | | | 0/1 | | | 0/3 | 0.0 | | | | | | 9 | 陈开勇 | 10 | 13:17 | 8 | | | | | | | | | | | | 10 | 王柏淇 |
| 守门员 合计 | | 9/20 | 8/18 | 2/8 | 1/5 | 0/4 | 0/2 | 20/57 | 35.1 | 5 | | | | | 9 | 陈开勇 | 10 | 14:24 | 9 | | | | | | | | | | | | 10 | 王柏淇 |
| 辽宁 | | 远射 | 近射 | 边射 | 快攻 | 突破 | 任意球 | 7m球 | 合计 | % | 助攻 | 失误 | 警告 | 2' | D & DR | 2nd Half | | | | | | | | | | | | | | | | |
| 教练：赵影 | | | | | | | | | | | | | | | 17 | 程浩然 | 11 | 16:26 | 11 | | | | | | | | | | | | | |
| 1 | 高尚君 | | | | | | | | | | | | | | 11 | 程浩然 | 11 | 17:24 | 12 | | | | | | | | | | | | 13 | 杨洁 |
| 3 | 李星浩 | | 2/5 | | | | | | | | | | | | 11 | 程浩然 | 11 | 18:08 | 13 | | | | | | | | | | | | 6 | 陈庆港 |
| 5 | 余昊锦 | | | | | | | | | | | | | | 11 | 程浩然 | 11 | 18:57 | 14 | | | | | | | | | | | | 11 | 庞东阳 |
| 6 | 陈庆港 | 0/2 | 4/6 | 5/6 | | | | | | | | | | | 11 | 程浩然 | 12 | 19:22 | 14 | | | | | | | | | | | | | |
| 7 | 孙义广 | | | | | | | | | | | | | | 11 | 程浩然 | 12 | 19:22 | 14 | | | | | | | | | | | | | |
| 8 | 王鑫鹏 | | 0/2 | 1/2 | 0/1 | | | 1/5 | 20.0 | | | 1 | | | 11 | 程浩然 | 12 | 19:56 | 15 | | | | | | | | | | | | 3 | 李星浩 |
| 10 | 王柏淇 | 6/11 | 2/3 | 0/1 | 1/1 | 3/3 | 2/2 | 14/21 | 66.7 | 2 | 10 | | | | 11 | 程浩然 | 12 | 21:02 | 16 | | | | | | | | | | | | 6 | 陈庆港 |
| 11 | 庞东阳 | 1/3 | 1/2 | 0/1 | 2/2 | 1/1 | | 5/9 | 55.6 | 4 | 4 | 1 | 1 | | 11 | 程浩然 | 12 | 21:40 | 17 | | | | | | | | | | | | 10 | 王柏淇 |
| 13 | 杨洁 | 4/8 | 1/3 | | 1/2 | | | 6/13 | 46.2 | | | 2 | 1 | 3 | 11 | 程浩然 | 12 | 22:12 | 18 | | | | | | | | | | | | 13 | 杨洁 |
| 14 | 吕昊臻 | | | | | | | | | | | | | | 11 | 程浩然 | 12 | 22:43 | 19 | | | | | | | | | | | | 6 | 陈庆港 |
| 16 | 吴阳 | | | | | | | | | | | | | | 11 | 程浩然 | 12 | 22:43 | 19 | | | | | | | | | | | | | |
| 17 | 李傲 | | | | | | | | | | | | | | 11 | 程浩然 | 12 | 22:43 | 19 | | | | | | | | | | | | | |
| 18 | 梅凯博 | | | | | | | | | | | | | | 11 | 程浩然 | 12 | 22:43 | 19 | | | | | | | | | | | | | |
| 19 | 赵鑫 | | | | | | | | | | | | | | 11 | 程浩然 | 12 | 22:43 | 19 | | | | | | | | | | | | | |
| 20 | 赵佛赐 | | | | | | | | | | | | | | 11 | 程浩然 | 12 | 22:43 | 19 | | | | | | | | | | | | | |
| 运动员 合计 | | 11/24 | 10/21 | 6/10 | 4/6 | 4/4 | 2/2 | 37/67 | 55.2 | 10 | 20 | 3 | 5 | | 11 | 程浩然 | 12 | 22:43 | 19 | | | | | | | | | | | | | |
| 1 | 高尚君 | 8/16 | 7/21 | 3/7 | 0/9 | 0/4 | 1/2 | 19/59 | 32.2 | | | | | | 11 | 程浩然 | 12 | 22:43 | 19 | | | | | | | | | | | | | |
| 守门员 合计 | | 8/16 | 7/21 | 3/7 | 0/9 | 0/4 | 1/2 | 19/59 | 32.2 | | | | | | 11 | 程浩然 | 12 | 22:43 | 19 | | | | | | | | | | | | | |

场上队员：得分 / 射门

守门员：救球 / 射门

| | | | | | | | | | | | | | |
|----|------------|--|----|--------------|--|-----|------------|--|-----|----------|--|----|---------|
| 快攻 | Fast Break | | 突破 | Breakthrough | | 任意球 | Free Throw | | 7M球 | 7M Throw | | 助攻 | Assist |
| 警告 | Warning | | 失误 | Error | | 2' | Suspension | | D | 取消资格 | | DR | 取消资格+报告 |





2016年“体彩杯”全国手球男子青年锦标赛 图式比赛技术统计表

轮次 3

场次 16

201602016-21-1/1

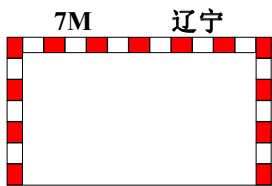
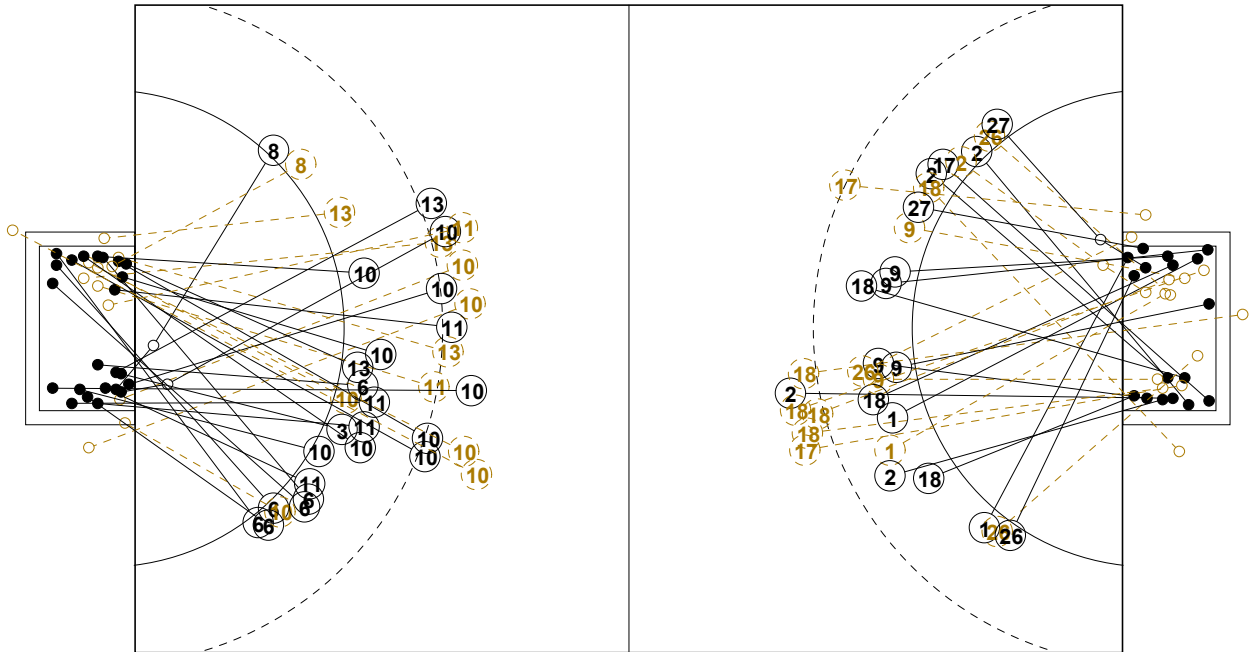

1st Half
23 : 17

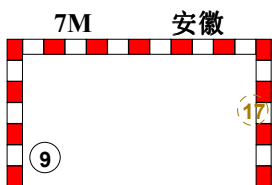
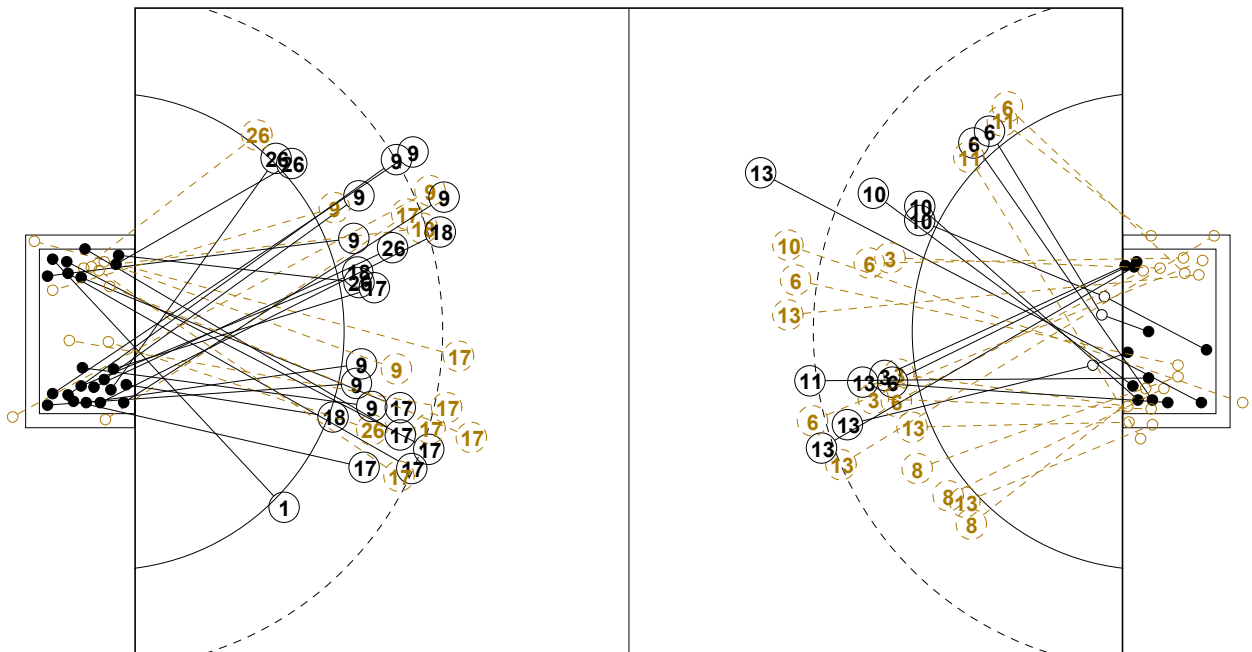
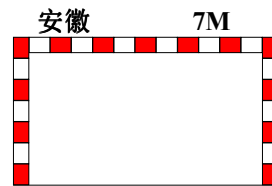

2nd Half
40 : 37

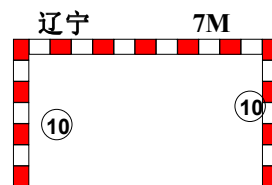



2016年“体彩杯”全国手球男子青年锦标赛

个人/全队技术统计表

正式表
手球
青年男子预赛
轮次 3组别 B
场次 16201602016-14-1/2
重庆万州
22/03/2016 14:30

| 号码 | 姓名 | 远射 | 近射 | 边射 | 快攻 | 突破 | 任意 | 7M | 合计 | % | 助攻 | 失误 | 警告 | 2' | 取消 | 时间 |
|----------------|-----|------|-------|-----|------|-----|----|-----|-------|-------|----|----|----|----|----|----------|
| 安徽队(安徽) | | | | | | | | | | | | | | | | |
| <i>(场上队员)</i> | | | | | | | | | | | | | | | | |
| 1 | 郭世伟 | | 2/3 | 1/1 | | | | | 3/4 | 75.0% | 1 | 2 | 1 | | | 00:47:28 |
| 2 | 金勇峰 | 1/1 | 1/2 | 1/1 | 1/1 | | | | 4/5 | 80.0% | 1 | 5 | 1 | | | 00:34:31 |
| 9 | 陈开勇 | 3/4 | 7/11 | | 2/2 | | | 1/1 | 13/18 | 72.2% | | | | | | 01:00:00 |
| 17 | 王巨柱 | 3/11 | 2/2 | | 1/1 | 1/1 | | 0/1 | 7/16 | 43.8% | 5 | 3 | 1 | | | 01:00:00 |
| 18 | 李双 | 1/6 | 2/3 | | | 3/3 | | | 6/12 | 50.0% | 3 | 3 | | | | 01:00:00 |
| 19 | 何山 | | | | | | | | | 0.0% | | | | 1 | | 00:22:56 |
| 21 | 李明 | | | | | | | | | 0.0% | 5 | | | | | 00:56:22 |
| 24 | 徐安格 | | | | | | | | | 0.0% | | | | | | 00:19:37 |
| 25 | 李文哲 | | | | | | | | | 0.0% | | | | | | 00:00:00 |
| 26 | 程浩然 | | 0/1 | 2/5 | 3/4 | | | | 5/10 | 50.0% | | 3 | | | | 00:48:22 |
| 27 | 王长旭 | | | | 2/2 | | | | 2/2 | 100% | | | | | | 00:07:02 |
| 28 | 丁浩然 | | | | | | | | | 0.0% | | | | | | 00:00:00 |
| 32 | 许浩翔 | | | | | | | | | 0.0% | | | | | | 00:03:38 |
| 33 | 姚紫祥 | | | | | | | | | 0.0% | | | | | | 00:00:00 |
| 41 | 刘润民 | | | | | | | | | 0.0% | | | | | | 00:00:00 |
| 42 | 王成龙 | | | | | | | | | 0.0% | | | | | | 00:00:00 |
| 合计 | | 8/22 | 14/22 | 4/7 | 9/10 | 4/4 | | 1/2 | 40/67 | 59.7% | 15 | 16 | 3 | 1 | | |
| <i>(守门员)</i> | | | | | | | | | | | | | | | | |
| 21 | 李明 | 9/18 | 8/18 | 2/8 | 1/4 | 0/4 | | 0/2 | 20/54 | 37.0% | 5 | | | | | 00:56:22 |
| 32 | 许浩翔 | 0/2 | | | 0/1 | | | | 0/3 | 0.0% | | | | | | 00:03:38 |
| 合计 | | 9/20 | 8/18 | 2/8 | 1/5 | 0/4 | | 0/2 | 20/57 | 35.1% | 5 | | | | | |

场上队员：得分/射门

守门员：救球/射门

| 全队合计 | 得分 | 被救 | 射失 | 击柱 | 封球 | 合计 | % |
|------|----|----|----|----|----|----|--------|
| 远射 | 8 | 8 | 3 | 2 | 1 | 22 | 36.4% |
| 近射 | 14 | 7 | 1 | | | 22 | 63.6% |
| 边射 | 4 | 3 | | | | 7 | 57.1% |
| 快攻 | 9 | | | 1 | | 10 | 90.0% |
| 突破 | 4 | | | | | 4 | 100.0% |
| 任意 | | | | | | | 0.0% |
| 7M | 1 | 1 | | | | 2 | 50.0% |





2016年“体彩杯”全国手球男子青年锦标赛

个人/全队技术统计表

正式表
手球
青年男子预赛
轮次 3组别 B
场次 16201602016-14-2/2
重庆万州
22/03/2016 14:30

| 号码 | 姓名 | 远射 | 近射 | 边射 | 快攻 | 突破 | 任意 | 7M | 合计 | % | 助攻 | 失误 | 警告 | 2' | 取消 | 时间 |
|----------------|-----|-------|-------|------|-----|-----|----|-----|-------|-------|----|----|----|----|----|----------|
| 辽宁队(辽宁) | | | | | | | | | | | | | | | | |
| <i>(上场队员)</i> | | | | | | | | | | | | | | | | |
| 1 | 高尚君 | | | | | | | | | 0.0% | | | | | | 01:00:00 |
| 3 | 李星浩 | | 2/5 | | | | | | 2/5 | 40.0% | 1 | 1 | 1 | 1 | | 01:00:00 |
| 5 | 余昊锦 | | | | | | | | | 0.0% | | | | | | 00:00:00 |
| 6 | 陈庆港 | 0/2 | 4/6 | 5/6 | | | | | 9/14 | 64.3% | 2 | 2 | | | | 01:00:00 |
| 7 | 孙义广 | | | | | | | | | 0.0% | 1 | | | | | 00:08:45 |
| 8 | 王鑫鹏 | | 0/2 | 1/2 | 0/1 | | | | 1/5 | 20.0% | | 1 | | | | 00:51:13 |
| 10 | 王柏淇 | 6/11 | 2/3 | 0/1 | 1/1 | 3/3 | | 2/2 | 14/21 | 66.7% | 2 | 10 | | | | 01:00:00 |
| 11 | 庞东阳 | 1/3 | 1/2 | 0/1 | 2/2 | 1/1 | | | 5/9 | 55.6% | 4 | 4 | 1 | 1 | | 01:00:00 |
| 13 | 杨洁 | 4/8 | 1/3 | | 1/2 | | | | 6/13 | 46.2% | | 2 | 1 | 3 | | 01:00:00 |
| 14 | 吕昊臻 | | | | | | | | | 0.0% | | | | | | 00:00:00 |
| 16 | 吴阳 | | | | | | | | | 0.0% | | | | | | 00:00:00 |
| 17 | 李傲 | | | | | | | | | 0.0% | | | | | | 00:00:00 |
| 18 | 梅凯博 | | | | | | | | | 0.0% | | | | | | 00:00:00 |
| 19 | 赵鑫 | | | | | | | | | 0.0% | | | | | | 00:00:00 |
| 20 | 赵佛赐 | | | | | | | | | 0.0% | | | | | | 00:00:00 |
| 合计 | | 11/24 | 10/21 | 6/10 | 4/6 | 4/4 | | 2/2 | 37/67 | 55.2% | 10 | 20 | 3 | 5 | | |
| <i>(守门员)</i> | | | | | | | | | | | | | | | | |
| 1 | 高尚君 | 8/16 | 7/21 | 3/7 | 0/9 | 0/4 | | 1/2 | 19/59 | 32.2% | | | | | | 01:00:00 |
| 合计 | | 8/16 | 7/21 | 3/7 | 0/9 | 0/4 | | 1/2 | 19/59 | 32.2% | | | | | | |

场上队员：得分/射门

守门员：救球/射门

| 全队合计 | 得分 | 被救 | 射失 | 击柱 | 封球 | 合计 | % |
|------|----|----|----|----|----|----|--------|
| 远射 | 11 | 9 | 3 | 1 | | 24 | 45.8% |
| 近射 | 10 | 8 | 1 | 2 | | 21 | 47.6% |
| 边射 | 6 | 2 | | 2 | | 10 | 60.0% |
| 快攻 | 4 | 1 | | 1 | | 6 | 66.7% |
| 突破 | 4 | | | | | 4 | 100.0% |
| 任意 | | | | | | | 0.0% |
| 7M | 2 | | | | | 2 | 100.0% |





2016年“体彩杯”全国手球男子青年锦标赛

图式射门区域统计

轮次 3 场次 16

201602016-41-1/1

安徽队

| | | | | | | | | |
|-----------------------------|-----------------------------|-----------------------------|-----------------------------|-----------------------------|-----------------------------|-----------------------------|-----------------------------|--|
| 1 郭世伟 | 2 金勇峰 | 9 陈开勇 | 17 王巨柱 | 18 李双 | 19 何山 | 21 李明 | 24 徐安格 | |
| 1 | | 1 | | | 1 | | | |
| | | 1 | | | 3 | | | |
| | | 3 | | | 2 | | | |
| 1 | | | | | 1 | | | |
| | | 3 | | | 1 | | | |
| | | 1 | | | 1 | | | |
| Post - 0 Miss - 0 Block - 0 | Post - 0 Miss - 0 Block - 0 | Post - 0 Miss - 1 Block - 0 | Post - 2 Miss - 1 Block - 1 | Post - 0 Miss - 2 Block - 0 | Post - 0 Miss - 0 Block - 0 | Post - 0 Miss - 0 Block - 0 | Post - 0 Miss - 0 Block - 0 | |
| 25 李文哲 | 26 程浩然 | 27 王长旭 | 28 丁浩然 | 32 许浩翔 | 33 姚紫祥 | 41 刘润民 | 42 王成龙 | |
| | | | | | | | | |
| | | | | | | | | |
| | 1 | | | | | | | |
| | 2 | 2 | | | | | | |
| | | 2 | | | | | | |
| | | | | | | | | |
| Post - 0 Miss - 0 Block - 0 | Post - 1 Miss - 0 Block - 0 | Post - 0 Miss - 0 Block - 0 | Post - 0 Miss - 0 Block - 0 | Post - 0 Miss - 0 Block - 0 | Post - 0 Miss - 0 Block - 0 | Post - 0 Miss - 0 Block - 0 | Post - 0 Miss - 0 Block - 0 | |

| |
|---------------|
| 21 李明 |
| 3/5 0/1 0/4 |
| 2/7 7/12 |
| 2/10 1/3 5/12 |

| |
|---------|
| 32 许浩翔 |
| 0/1 |
| 0/1 0/1 |

| |
|--|
| |
| |
| |

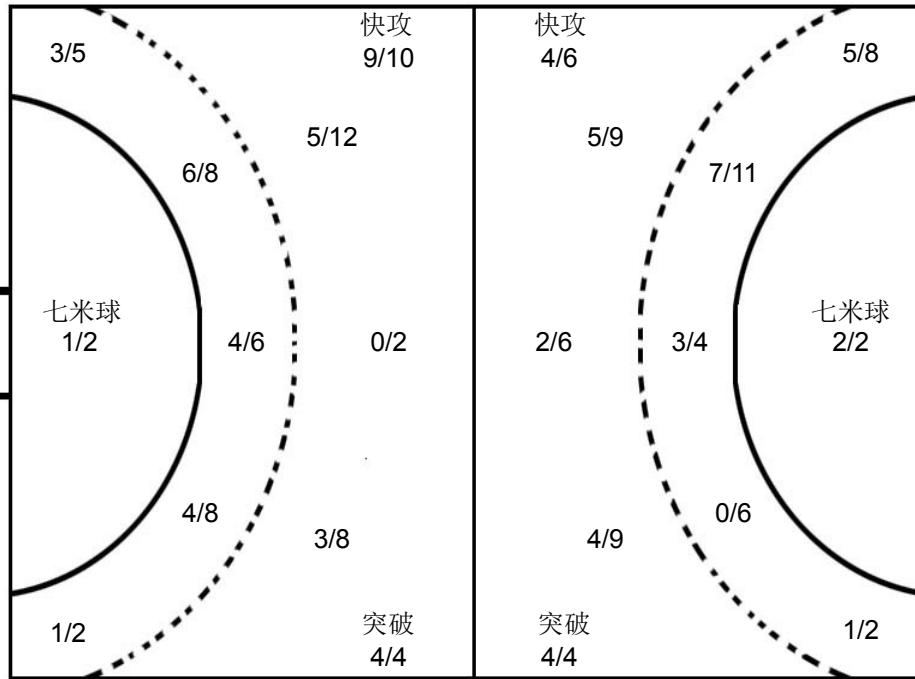

| |
|--------------|
| 1 高尚君 |
| 2/7 2/3 1/8 |
| 3/11 7/12 |
| 1/11 1/1 2/6 |

| |
|--|
| |
| |

| |
|--|
| |
| |
| |

辽宁队

| | | | | | | | |
|-----------------------------|-----------------------------|-----------------------------|-----------------------------|-----------------------------|-----------------------------|-----------------------------|-----------------------------|
| 1 高尚君 | 3 李星浩 | 5 余昊锦 | 6 陈庆港 | 7 孙义广 | 8 王鑫鹏 | 10 王柏淇 | 11 庞东阳 |
| | | | | | | | |
| | | | 3 | | | 1 1 1 | 1 |
| | | | 2 1 | | | 2 3 | 1 |
| | | | 1 1 1 | | | 2 4 | 1 2 |
| | | | | | 1 | | |
| Post - 0 Miss - 0 Block - 0 | Post - 0 Miss - 0 Block - 0 | Post - 0 Miss - 0 Block - 0 | Post - 0 Miss - 0 Block - 0 | Post - 0 Miss - 0 Block - 0 | Post - 0 Miss - 0 Block - 0 | Post - 1 Miss - 3 Block - 0 | Post - 1 Miss - 1 Block - 0 |
| 13 杨洁 | 14 吕昊臻 | 16 吴阳 | 17 李傲 | 18 梅凯博 | 19 赵鑫 | 20 赵佛赐 | |
| | | | | | | | |
| | | | | | | | |
| | | | | | | | |
| 2 1 1 | | | | | | | |
| | | | | | | | |
| Post - 4 Miss - 0 Block - 0 | Post - 0 Miss - 0 Block - 0 | Post - 0 Miss - 0 Block - 0 | Post - 0 Miss - 0 Block - 0 | Post - 0 Miss - 0 Block - 0 | Post - 0 Miss - 0 Block - 0 | Post - 0 Miss - 0 Block - 0 | |

注释: Post=击柱 Miss=射失 Block=被封





预赛 Group B
青年男子 全国比赛

2016年“体彩杯”全国手球男子青年锦标赛

| | | | | | | | | | | | | | |
|------------------------------------|---|---------------------|---------------------|---------------------------|------------|--|--|--|---|---|----|---|----|
| Team A A 四川队 | | Team B B 天津队 | | Match Number 17 | | | | | | | | | |
| played in China | | in the hall 重庆万州 | | on 22/03/2016 | | | | | | | | | |
| | | | | at 14:00 hours | | | | | | | | | |
| Spectators | | | | | | | | | | | | | |
| Half-time (30') | A 24 | B 8 | End of playing time | A 24 | B 8 | | | | | | | | |
| 1st extra time | | A | | B | | | | | | | | | |
| 2nd extra time | | A | | B | | | | | | | | | |
| After penalty throws | | A | | B | | | | | | | | | |
| Number of 7 m | A 2 / 2 | Team time-out | | | B 1 / 1 | | | | | | | | |
| 1 | | 2 | | 3 | | | | | | | | | |
| Full name of players and officials | | 1 | | 2 | | | | | | | | | |
| 07:33 | | 15:39 | | 3 | | | | | | | | | |
| No. | Team A | | | | Team B | | | | G | W | 2' | D | DR |
| 1 | 宋继强 | | | | 9 吴明远 | | | | 2 | | | | |
| 3 | 刘赵梁 | | | | 18 王晓琪 | | | | 2 | 1 | | | |
| 5 | 王凯 | | | | 21 潘玉帅 | | | | 1 | 1 | | | |
| 7 | 仇瑞祥 | | | | 22 魏雨童 | | | | 1 | 1 | | | |
| 8 | 罗尧尧 | | | | 24 刘子健 | | | | | | | | |
| 9 | 许翔宇 | | | | 25 王一雄 | | | | 1 | | | | |
| 10 | 徐彦昊 | | | | 26 刘思远 | | | | 1 | | | | |
| 11 | 张天豪 | | | | 27 左金龙 | | | | | | | | |
| 12 | 刘树豪 | | | | 28 何喜年 | | | | | | | | |
| 13 | 尹文珂 | | | | | | | | | | | | |
| 15 | 徐逸 | | | | | | | | | | | | |
| 17 | 谢庆龙 | | | | | | | | | | | | |
| 18 | 张睿梁 | | | | | | | | | | | | |
| 19 | 庞连康 | | | | | | | | | | | | |
| 20 | 张文健 | | | | | | | | | | | | |
| 21 | 曹修庆 | | | | | | | | | | | | |
| B | 张文韬 (主教练) | | | | A 李志成 | | | | | | | | |
| | | | | | B 潘玉强 | | | | | | | | |
| | | | | | | | | | | | | | |
| | | | | | | | | | | | | | |
| | | | | | | | | | | | | | |
| A | Signature of Responsible Official of the Teams (Off. A) | | | | | | | | | | | | B |
| TP | Remarks of Referee / CHA Official | | | | | | | | | | | | TP |

Signatures

| | | | | |
|------------------|-----------|-----------|--|--|
| Referees | 许翔 (CHN) | 王雨洋 (CHN) | | |
| Techn. Delegates | 张春生 (CHN) | | | |
| CHA Official | 吴瑞亭 (CHN) | | | |

Note: Number of 7m Throws Awarded to Team A and B, Goals (G), Warnings (W), Suspensions (2'), Direct Disqualification (D), Disqualification with Report (DR) and Team Penalty (TP).

Table Officials:

Statisticians: 刘永欢

李双





2016年“体彩杯”全国手球男子青年锦标赛 竞赛技术统计(媒体表)

| | | | | | | |
|--------|----|----|------------|---|----|------------------|
| 预赛 | 组别 | B | 轮次 | 3 | 场次 | 17 |
| 重庆万州 | | | 22/03/2016 | | | 201602017-51-1/1 |
| 四川队 | 四川 | 24 | vs | 8 | 天津 | 天津队 |
| 24 : 8 | | | | | | |

| | | | |
|-----|----------|---|-----------|
| 裁判员 | 许翔 (CHN) | / | 王雨洋 (CHN) |
|-----|----------|---|-----------|

| 四川 | | 远射 | 近射 | 边射 | 快攻 | 突破 | 任意球 | 7m球 | 合计 | % | 助攻 | 失误 | 警告 | 2' | D & DR | 四川 | 比赛进程 | 天津 |
|---------------|-----|-----|------|-----|-------|-----|-----|-----|-------|------|----|----|----|----|--------|----|------|------------|
| 主教练：张文韬 | | | | | | | | | | | | | | | | | | |
| 1 | 宋继强 | | | | | | | | | | 1 | | | | | 3 | 刘赵梁 | 1 00:46 0 |
| 3 | 刘赵梁 | | 1/2 | 2/4 | 1/3 | 1/1 | | | 5/10 | 50.0 | 1 | 2 | | | | 19 | 庞连康 | 2 01:10 0 |
| 5 | 王凯 | | 1/1 | | 2/2 | | | | 3/3 | 100 | 1 | | | | | 9 | 许翔宇 | 3 02:44 1 |
| 7 | 仇瑞祥 | | | | | | | | | | 1 | 1 | 1 | | | 3 | 刘赵梁 | 4 03:15 2 |
| 8 | 罗尧尧 | | | | 1/1 | | | 1/1 | 2/2 | 100 | 3 | | | | | 5 | 王凯 | 5 03:52 2 |
| 9 | 许翔宇 | | 2/2 | 1/1 | 1/1 | 0/1 | | | 4/5 | 80.0 | 2 | 1 | 1 | | | 3 | 刘赵梁 | 6 04:28 3 |
| 10 | 徐彦昊 | | 0/1 | | 2/2 | | | | 2/3 | 66.7 | | | | | | 9 | 许翔宇 | 7 06:59 3 |
| 11 | 张天豪 | | | 0/1 | 2/2 | | | 1/1 | 3/4 | 75.0 | | | | | | 17 | 谢庆龙 | 8 07:27 3 |
| 12 | 刘树豪 | | | | | | | | | | | | | | | 3 | 刘赵梁 | 9 09:35 3 |
| 13 | 尹文珂 | | | | 1/1 | | 0/1 | | 1/2 | 50.0 | | | | | | 19 | 庞连康 | 10 13:27 4 |
| 15 | 徐逸 | | | | | | | | | | 1 | 1 | | | | 3 | 刘赵梁 | 10 13:50 5 |
| 17 | 谢庆龙 | | 1/3 | | | | | | 1/3 | 33.3 | | 2 | | | | 3 | 刘赵梁 | 11 14:00 5 |
| 18 | 张睿梁 | | 0/1 | | | | | | 0/1 | 0.0 | | | 1 | | | 9 | 许翔宇 | 12 15:10 5 |
| 19 | 庞连康 | | 1/2 | | 2/2 | | | | 3/4 | 75.0 | | 3 | | | | 9 | 许翔宇 | 13 15:37 5 |
| 20 | 张文健 | | | | | | | | | | | | | | | 5 | 王凯 | 13 16:49 6 |
| 21 | 曹修庆 | | | | | | | | | | | | | | | 19 | 庞连康 | 14 17:29 6 |
| 运动员 合计 | | | 6/12 | 3/6 | 12/14 | 1/2 | 0/1 | 2/2 | 24/37 | 64.9 | 10 | 10 | 3 | | | 5 | 罗尧尧 | 15 19:16 6 |
| 1 | 宋继强 | | 0/1 | 1/1 | | | | 0/1 | 1/3 | 33.3 | 1 | | | | | 5 | 王凯 | 16 19:46 6 |
| 12 | 刘树豪 | 3/5 | 4/6 | 1/3 | | 1/1 | | | 9/15 | 60.0 | | | | | | 19 | 庞连康 | 17 20:06 6 |
| 守门员 合计 | | 3/5 | 4/7 | 2/4 | | 1/1 | | 0/1 | 10/18 | 55.6 | 1 | | | | | 8 | 罗尧尧 | 18 20:42 6 |

| 天津 | | 远射 | 近射 | 边射 | 快攻 | 突破 | 任意球 | 7m球 | 合计 | % | 助攻 | 失误 | 警告 | 2' | D & DR |
|---------------|-----|-----|------|-----|------|-----|-----|-----|------|------|----|----|----|----|--------|
| 教练：潘玉强 | | | | | | | | | | | | | | | |
| 9 | 吴明远 | 2/3 | | | | 0/1 | | | 2/4 | 50.0 | | 5 | | | |
| 18 | 王晓琪 | 0/4 | 2/6 | | | | | | 2/10 | 20.0 | 1 | 3 | 1 | | |
| 21 | 潘玉帅 | 0/1 | | | | | | 1/1 | 1/2 | 50.0 | | 6 | 1 | | |
| 22 | 魏雨童 | | 1/3 | | | | | | 1/3 | 33.3 | | 5 | 1 | | |
| 24 | 刘子健 | | | | | | | | | | | | | | |
| 25 | 王一雄 | | 0/1 | 1/2 | | | | | 1/3 | 33.3 | | 1 | | | |
| 26 | 刘思远 | | | 1/3 | | | | | 1/3 | 33.3 | | 2 | | | |
| 27 | 左金龙 | | | | | | | | | | | | | | |
| 28 | 何喜年 | | | | | | | | | | | | | | |
| 运动员 合计 | | 2/8 | 3/10 | 2/5 | | 0/1 | | 1/1 | 8/25 | 32.0 | 1 | 22 | 3 | | |
| 24 | 刘子健 | | 3/9 | 1/4 | 1/7 | 1/2 | | 0/1 | 6/23 | 26.1 | | | | | |
| 28 | 何喜年 | | 1/1 | 1/1 | 0/6 | | | 0/1 | 2/9 | 22.2 | | | | | |
| 守门员 合计 | | | 4/10 | 2/5 | 1/13 | 1/2 | | 0/2 | 8/32 | 25.0 | | | | | |

场上队员：得分 / 射门

守门员：救球 / 射门

| | | | | | | | | | |
|----|------------|----|--------------|-----|------------|-----|----------|----|---------|
| 快攻 | Fast Break | 突破 | Breakthrough | 任意球 | Free Throw | 7M球 | 7M Throw | 助攻 | Assist |
| 警告 | Warning | 失误 | Error | 2' | Suspension | D | 取消资格 | DR | 取消资格+报告 |



2016年“体彩杯”全国手球男子青年锦标赛 图式比赛技术统计表

轮次 3

场次 17

201602017-21-1/1

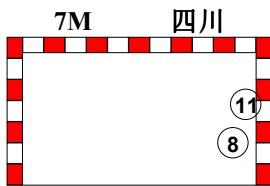
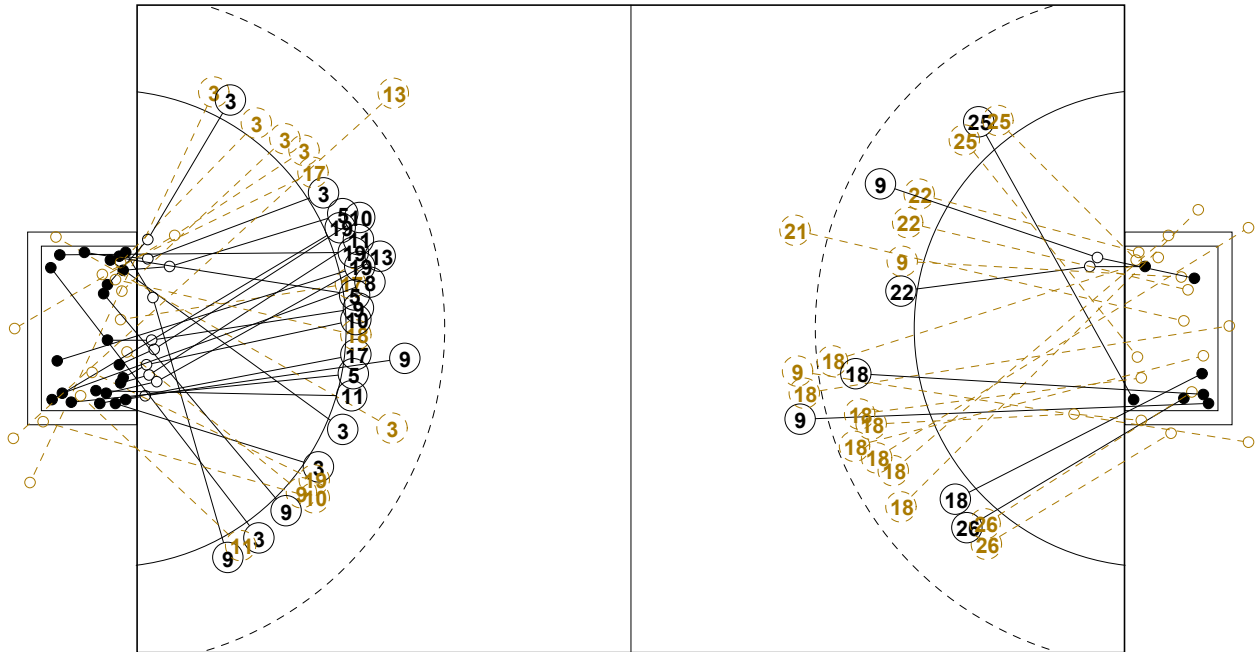

1st Half
24 : 8

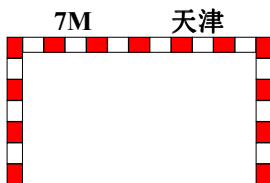
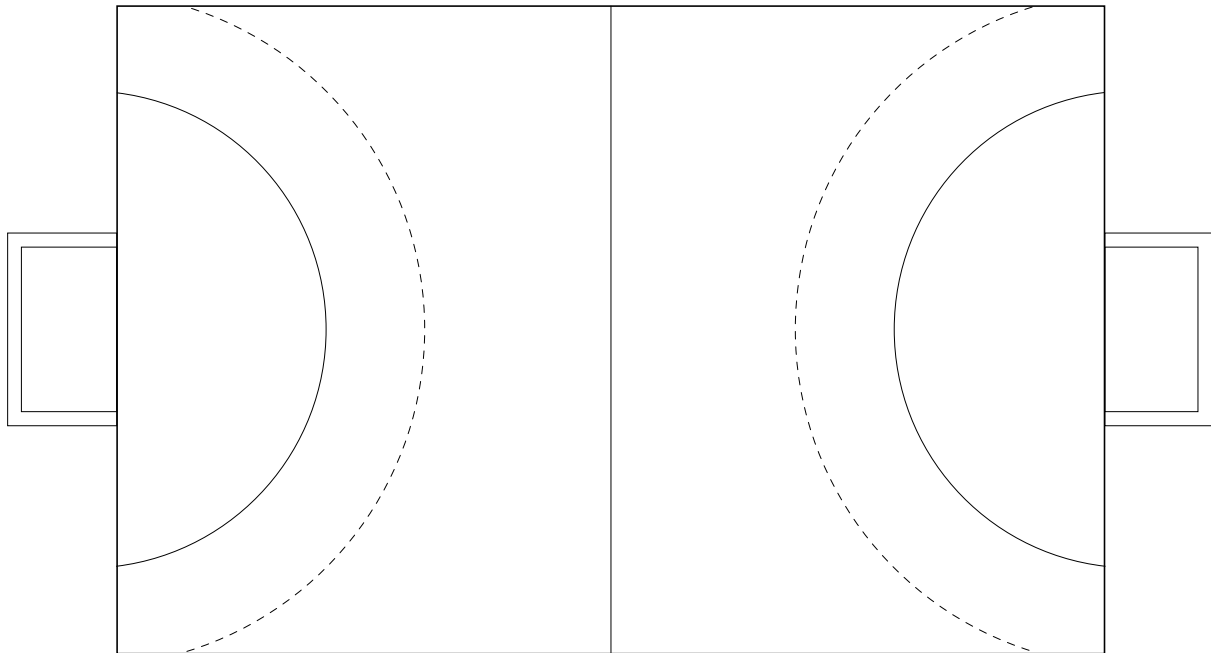
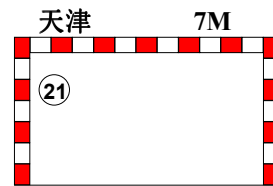

2nd Half
8 : 24

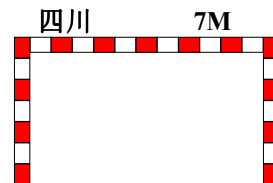



2016年“体彩杯”全国手球男子青年锦标赛

个人/全队技术统计表

正式表
手球
青年男子预赛
轮次 3组别 B
场次 17201602017-14-1/2
重庆万州
22/03/2016 14:00

| 号码 | 姓名 | 远射 | 近射 | 边射 | 快攻 | 突破 | 任意 | 7M | 合计 | % | 助攻 | 失误 | 警告 | 2' | 取消 | 时间 |
|----------------|-----|----|------|-----|-------|-----|-----|-----|-------|-------|----|----|----|----|----|----------|
| 四川队(四川) | | | | | | | | | | | | | | | | |
| <i>(场上队员)</i> | | | | | | | | | | | | | | | | |
| 1 | 宋继强 | | | | | | | | | 0.0% | 1 | | | | | 00:08:57 |
| 3 | 刘赵梁 | | 1/2 | 2/4 | 1/3 | 1/1 | | | 5/10 | 50.0% | 1 | 2 | | | | 00:21:03 |
| 5 | 王凯 | | 1/1 | | 2/2 | | | | 3/3 | 100% | 1 | | | | | 00:21:03 |
| 7 | 仇瑞祥 | | | | | | | | | 0.0% | 1 | 1 | 1 | | | 00:08:57 |
| 8 | 罗尧尧 | | | | 1/1 | | | 1/1 | 2/2 | 100% | 3 | | | | | 00:21:03 |
| 9 | 许翔宇 | | 2/2 | 1/1 | 1/1 | 0/1 | | | 4/5 | 80.0% | 2 | 1 | 1 | | | 00:24:51 |
| 10 | 徐彦昊 | | 0/1 | | 2/2 | | | | 2/3 | 66.7% | | | | | | 00:08:57 |
| 11 | 张天豪 | | | 0/1 | 2/2 | | | 1/1 | 3/4 | 75.0% | | | | | | 00:08:57 |
| 12 | 刘树豪 | | | | | | | | | 0.0% | | | | | | 00:21:03 |
| 13 | 尹文珂 | | | | 1/1 | | 0/1 | | 1/2 | 50.0% | | | | | | 00:08:57 |
| 15 | 徐逸 | | | | | | | | | 0.0% | 1 | 1 | | | | 00:05:07 |
| 17 | 谢庆龙 | | 1/3 | | | | | | 1/3 | 33.3% | | 2 | | | | 00:21:03 |
| 18 | 张睿梁 | | 0/1 | | | | | | 0/1 | 0.0% | | | 1 | | | 00:08:57 |
| 19 | 庞连康 | | 1/2 | | 2/2 | | | | 3/4 | 75.0% | | 3 | | | | 00:21:03 |
| 20 | 张文健 | | | | | | | | | 0.0% | | | | | | 00:00:00 |
| 21 | 曹修庆 | | | | | | | | | 0.0% | | | | | | 00:00:00 |
| 合计 | | | 6/12 | 3/6 | 12/14 | 1/2 | 0/1 | 2/2 | 24/37 | 64.9% | 10 | 10 | 3 | | | |
| <i>(守门员)</i> | | | | | | | | | | | | | | | | |
| 1 | 宋继强 | | 0/1 | 1/1 | | | | 0/1 | 1/3 | 33.3% | 1 | | | | | 00:08:57 |
| 12 | 刘树豪 | | 3/5 | 4/6 | 1/3 | 1/1 | | | 9/15 | 60.0% | | | | | | 00:21:03 |
| 合计 | | | 3/5 | 4/7 | 2/4 | 1/1 | | 0/1 | 10/18 | 55.6% | 1 | | | | | |

场上队员：得分/射门

守门员：救球/射门

| 全队合计 | 得分 | 被救 | 射失 | 击柱 | 封球 | 合计 | % |
|------|----|----|----|----|----|----|--------|
| 远射 | | | | | | | 0.0% |
| 近射 | 6 | 4 | | 2 | | 12 | 50.0% |
| 边射 | 3 | 2 | 1 | | | 6 | 50.0% |
| 快攻 | 12 | 1 | 1 | | | 14 | 85.7% |
| 突破 | 1 | 1 | | | | 2 | 50.0% |
| 任意 | | | 1 | | | 1 | 0.0% |
| 7M | 2 | | | | | 2 | 100.0% |





2016年“体彩杯”全国手球男子青年锦标赛

个人/全队技术统计表

正式表
手球
青年男子预赛
轮次 3组别 B
场次 17201602017-14-2/2
重庆万州
22/03/2016 14:00

| 号码 | 姓名 | 远射 | 近射 | 边射 | 快攻 | 突破 | 任意 | 7M | 合计 | % | 助攻 | 失误 | 警告 | 2' | 取消 | 时间 |
|----------------|-----|-----|-----|-----|----|-----|----|-----|------|-------|----|----|----|----|----|----------|
| 天津队(天津) | | | | | | | | | | | | | | | | |
| <i>(上场队员)</i> | | | | | | | | | | | | | | | | |
| 9 | 吴明远 | 2/3 | | | | 0/1 | | | 2/4 | 50.0% | | 5 | | | | 00:30:00 |
| 18 | 王晓琪 | 0/4 | 2/6 | | | | | | 2/10 | 20.0% | 1 | 3 | 1 | | | 00:30:00 |
| 21 | 潘玉帅 | 0/1 | | | | | | 1/1 | 1/2 | 50.0% | | 6 | 1 | | | 00:30:00 |
| 22 | 魏雨童 | | 1/3 | | | | | | 1/3 | 33.3% | | 5 | 1 | | | 00:30:00 |
| 24 | 刘子健 | | | | | | | | | 0.0% | | | | | | 00:20:20 |
| 25 | 王一雄 | | 0/1 | 1/2 | | | | | 1/3 | 33.3% | | 1 | | | | 00:30:00 |
| 26 | 刘思远 | | | 1/3 | | | | | 1/3 | 33.3% | | 2 | | | | 00:30:00 |
| 27 | 左金龙 | | | | | | | | | 0.0% | | | | | | 00:00:00 |
| 28 | 何喜年 | | | | | | | | | 0.0% | | | | | | 00:09:40 |

| | | | | | | | | | | | | | | | | |
|--------------|--|-----|------|-----|-----|-----|--|-----|------|-------|---|----|---|--|--|----------|
| 合计 | | 2/8 | 3/10 | 2/5 | | 0/1 | | 1/1 | 8/25 | 32.0% | 1 | 22 | 3 | | | |
| <i>(守门员)</i> | | | | | | | | | | | | | | | | |
| 24 | | | 3/9 | 1/4 | 1/7 | 1/2 | | 0/1 | 6/23 | 26.1% | | | | | | 00:20:20 |
| 28 | | | 1/1 | 1/1 | 0/6 | | | 0/1 | 2/9 | 22.2% | | | | | | 00:09:40 |

| | | | | | | | | | | | | | | | | |
|-----------|--|--|------|-----|------|-----|--|-----|------|-------|--|--|--|--|--|--|
| 合计 | | | 4/10 | 2/5 | 1/13 | 1/2 | | 0/2 | 8/32 | 25.0% | | | | | | |
|-----------|--|--|------|-----|------|-----|--|-----|------|-------|--|--|--|--|--|--|

场上队员：得分/射门

守门员：救球/射门

| 全队合计 | 得分 | 被救 | 射失 | 击柱 | 封球 | 合计 | % |
|------|----|----|----|----|----|----|--------|
| 远射 | 2 | 3 | 2 | 1 | | 8 | 25.0% |
| 近射 | 3 | 4 | 1 | 2 | | 10 | 30.0% |
| 边射 | 2 | 2 | 1 | | | 5 | 40.0% |
| 快攻 | | | | | | | 0.0% |
| 突破 | | 1 | | | | 1 | 0.0% |
| 任意 | | | | | | | 0.0% |
| 7M | 1 | | | | | 1 | 100.0% |





2016年“体彩杯”全国手球男子青年锦标赛

图式射门区域统计

轮次 3 场次 17

201602017-41-1/1

四川队

| | | | | | | | | | | | | | | | | | | | | | | | | | | | | | | | | | | | | | | | | | | | | | | | | | | | | | | | | | | | | | | | | | | | | | | | | | | | | | | | |
|--|-----------------------------|-----------------------------|-----------------------------|-----------------------------|-----------------------------|-----------------------------|-----------------------------|--|--|---|--|--|---|--|--|--|---|--|---|---|---|--|--|--|--|---|--|--|---|---|--|--|--|--|--|--|---|--|--|--|---|--|--|--|--|---|--|--|--|--|--|--|--|--|--|---|---|---|---|---|--|--|--|--|--|--|---|--|--|--|--|--|--|--|--|---|---|--|--|
| 1 宋继强 | 3 刘赵梁 | 5 王凯 | 7 仇瑞祥 | 8 罗尧尧 | 9 许翔宇 | 10 徐彦昊 | 11 张天豪 | | | | | | | | | | | | | | | | | | | | | | | | | | | | | | | | | | | | | | | | | | | | | | | | | | | | | | | | | | | | | | | | | | | | | | | | |
| <table border="1"><tr><td></td><td></td><td></td></tr><tr><td></td><td></td><td></td></tr><tr><td></td><td></td><td></td></tr></table> | | | | | | | | | | <table border="1"><tr><td></td><td></td><td>1</td></tr><tr><td></td><td></td><td></td></tr><tr><td>1</td><td></td><td>3</td></tr></table> | | | 1 | | | | 1 | | 3 | <table border="1"><tr><td>1</td><td></td><td></td></tr><tr><td></td><td></td><td>1</td></tr><tr><td></td><td></td><td>1</td></tr></table> | 1 | | | | | 1 | | | 1 | <table border="1"><tr><td></td><td></td><td></td></tr><tr><td></td><td></td><td></td></tr><tr><td></td><td></td><td></td></tr></table> | | | | | | | | | | <table border="1"><tr><td>1</td><td></td><td></td></tr><tr><td></td><td></td><td>1</td></tr><tr><td></td><td></td><td></td></tr></table> | 1 | | | | | 1 | | | | <table border="1"><tr><td></td><td></td><td></td></tr><tr><td></td><td></td><td>1</td></tr><tr><td>1</td><td>1</td><td>1</td></tr></table> | | | | | | 1 | 1 | 1 | 1 | <table border="1"><tr><td></td><td></td><td></td></tr><tr><td></td><td></td><td></td></tr><tr><td>2</td><td></td><td></td></tr></table> | | | | | | | 2 | | | <table border="1"><tr><td></td><td></td><td></td></tr><tr><td></td><td></td><td>1</td></tr><tr><td>1</td><td></td><td></td></tr></table> | | | | | | 1 | 1 | | |
| | | | | | | | | | | | | | | | | | | | | | | | | | | | | | | | | | | | | | | | | | | | | | | | | | | | | | | | | | | | | | | | | | | | | | | | | | | | | | | | |
| | | | | | | | | | | | | | | | | | | | | | | | | | | | | | | | | | | | | | | | | | | | | | | | | | | | | | | | | | | | | | | | | | | | | | | | | | | | | | | | |
| | | | | | | | | | | | | | | | | | | | | | | | | | | | | | | | | | | | | | | | | | | | | | | | | | | | | | | | | | | | | | | | | | | | | | | | | | | | | | | | |
| | | 1 | | | | | | | | | | | | | | | | | | | | | | | | | | | | | | | | | | | | | | | | | | | | | | | | | | | | | | | | | | | | | | | | | | | | | | | | | | | | | |
| | | | | | | | | | | | | | | | | | | | | | | | | | | | | | | | | | | | | | | | | | | | | | | | | | | | | | | | | | | | | | | | | | | | | | | | | | | | | | | | |
| 1 | | 3 | | | | | | | | | | | | | | | | | | | | | | | | | | | | | | | | | | | | | | | | | | | | | | | | | | | | | | | | | | | | | | | | | | | | | | | | | | | | | |
| 1 | | | | | | | | | | | | | | | | | | | | | | | | | | | | | | | | | | | | | | | | | | | | | | | | | | | | | | | | | | | | | | | | | | | | | | | | | | | | | | | |
| | | 1 | | | | | | | | | | | | | | | | | | | | | | | | | | | | | | | | | | | | | | | | | | | | | | | | | | | | | | | | | | | | | | | | | | | | | | | | | | | | | |
| | | 1 | | | | | | | | | | | | | | | | | | | | | | | | | | | | | | | | | | | | | | | | | | | | | | | | | | | | | | | | | | | | | | | | | | | | | | | | | | | | | |
| | | | | | | | | | | | | | | | | | | | | | | | | | | | | | | | | | | | | | | | | | | | | | | | | | | | | | | | | | | | | | | | | | | | | | | | | | | | | | | | |
| | | | | | | | | | | | | | | | | | | | | | | | | | | | | | | | | | | | | | | | | | | | | | | | | | | | | | | | | | | | | | | | | | | | | | | | | | | | | | | | |
| | | | | | | | | | | | | | | | | | | | | | | | | | | | | | | | | | | | | | | | | | | | | | | | | | | | | | | | | | | | | | | | | | | | | | | | | | | | | | | | |
| 1 | | | | | | | | | | | | | | | | | | | | | | | | | | | | | | | | | | | | | | | | | | | | | | | | | | | | | | | | | | | | | | | | | | | | | | | | | | | | | | | |
| | | 1 | | | | | | | | | | | | | | | | | | | | | | | | | | | | | | | | | | | | | | | | | | | | | | | | | | | | | | | | | | | | | | | | | | | | | | | | | | | | | |
| | | | | | | | | | | | | | | | | | | | | | | | | | | | | | | | | | | | | | | | | | | | | | | | | | | | | | | | | | | | | | | | | | | | | | | | | | | | | | | | |
| | | | | | | | | | | | | | | | | | | | | | | | | | | | | | | | | | | | | | | | | | | | | | | | | | | | | | | | | | | | | | | | | | | | | | | | | | | | | | | | |
| | | 1 | | | | | | | | | | | | | | | | | | | | | | | | | | | | | | | | | | | | | | | | | | | | | | | | | | | | | | | | | | | | | | | | | | | | | | | | | | | | | |
| 1 | 1 | 1 | | | | | | | | | | | | | | | | | | | | | | | | | | | | | | | | | | | | | | | | | | | | | | | | | | | | | | | | | | | | | | | | | | | | | | | | | | | | | |
| | | | | | | | | | | | | | | | | | | | | | | | | | | | | | | | | | | | | | | | | | | | | | | | | | | | | | | | | | | | | | | | | | | | | | | | | | | | | | | | |
| | | | | | | | | | | | | | | | | | | | | | | | | | | | | | | | | | | | | | | | | | | | | | | | | | | | | | | | | | | | | | | | | | | | | | | | | | | | | | | | |
| 2 | | | | | | | | | | | | | | | | | | | | | | | | | | | | | | | | | | | | | | | | | | | | | | | | | | | | | | | | | | | | | | | | | | | | | | | | | | | | | | | |
| | | | | | | | | | | | | | | | | | | | | | | | | | | | | | | | | | | | | | | | | | | | | | | | | | | | | | | | | | | | | | | | | | | | | | | | | | | | | | | | |
| | | 1 | | | | | | | | | | | | | | | | | | | | | | | | | | | | | | | | | | | | | | | | | | | | | | | | | | | | | | | | | | | | | | | | | | | | | | | | | | | | | |
| 1 | | | | | | | | | | | | | | | | | | | | | | | | | | | | | | | | | | | | | | | | | | | | | | | | | | | | | | | | | | | | | | | | | | | | | | | | | | | | | | | |
| Post - 0 Miss - 0 Block - 0 | Post - 1 Miss - 2 Block - 0 | Post - 0 Miss - 0 Block - 0 | Post - 0 Miss - 0 Block - 0 | Post - 0 Miss - 0 Block - 0 | Post - 0 Miss - 0 Block - 0 | Post - 1 Miss - 0 Block - 0 | Post - 0 Miss - 0 Block - 0 | | | | | | | | | | | | | | | | | | | | | | | | | | | | | | | | | | | | | | | | | | | | | | | | | | | | | | | | | | | | | | | | | | | | | | | | |
| 12 刘树豪 | 13 尹文珂 | 15 徐逸 | 17 谢庆龙 | 18 张睿梁 | 19 庞连康 | 20 张文健 | 21 曹修庆 | | | | | | | | | | | | | | | | | | | | | | | | | | | | | | | | | | | | | | | | | | | | | | | | | | | | | | | | | | | | | | | | | | | | | | | | |
| <table border="1"><tr><td></td><td></td><td></td></tr><tr><td></td><td></td><td></td></tr><tr><td></td><td></td><td></td></tr></table> | | | | | | | | | | <table border="1"><tr><td></td><td></td><td></td></tr><tr><td></td><td></td><td></td></tr><tr><td>1</td><td></td><td></td></tr></table> | | | | | | | 1 | | | <table border="1"><tr><td></td><td></td><td></td></tr><tr><td></td><td></td><td></td></tr><tr><td></td><td></td><td></td></tr></table> | | | | | | | | | | <table border="1"><tr><td></td><td></td><td></td></tr><tr><td></td><td></td><td></td></tr><tr><td>1</td><td></td><td></td></tr></table> | | | | | | | 1 | | | <table border="1"><tr><td></td><td></td><td></td></tr><tr><td></td><td></td><td></td></tr><tr><td></td><td></td><td></td></tr></table> | | | | | | | | | | <table border="1"><tr><td></td><td></td><td></td></tr><tr><td></td><td></td><td></td></tr><tr><td>2</td><td></td><td>1</td></tr></table> | | | | | | | 2 | | 1 | <table border="1"><tr><td></td><td></td><td></td></tr><tr><td></td><td></td><td></td></tr><tr><td></td><td></td><td></td></tr></table> | | | | | | | | | | <table border="1"><tr><td></td><td></td><td></td></tr><tr><td></td><td></td><td></td></tr><tr><td></td><td></td><td></td></tr></table> | | | | | | | | | |
| | | | | | | | | | | | | | | | | | | | | | | | | | | | | | | | | | | | | | | | | | | | | | | | | | | | | | | | | | | | | | | | | | | | | | | | | | | | | | | | |
| | | | | | | | | | | | | | | | | | | | | | | | | | | | | | | | | | | | | | | | | | | | | | | | | | | | | | | | | | | | | | | | | | | | | | | | | | | | | | | | |
| | | | | | | | | | | | | | | | | | | | | | | | | | | | | | | | | | | | | | | | | | | | | | | | | | | | | | | | | | | | | | | | | | | | | | | | | | | | | | | | |
| | | | | | | | | | | | | | | | | | | | | | | | | | | | | | | | | | | | | | | | | | | | | | | | | | | | | | | | | | | | | | | | | | | | | | | | | | | | | | | | |
| | | | | | | | | | | | | | | | | | | | | | | | | | | | | | | | | | | | | | | | | | | | | | | | | | | | | | | | | | | | | | | | | | | | | | | | | | | | | | | | |
| 1 | | | | | | | | | | | | | | | | | | | | | | | | | | | | | | | | | | | | | | | | | | | | | | | | | | | | | | | | | | | | | | | | | | | | | | | | | | | | | | | |
| | | | | | | | | | | | | | | | | | | | | | | | | | | | | | | | | | | | | | | | | | | | | | | | | | | | | | | | | | | | | | | | | | | | | | | | | | | | | | | | |
| | | | | | | | | | | | | | | | | | | | | | | | | | | | | | | | | | | | | | | | | | | | | | | | | | | | | | | | | | | | | | | | | | | | | | | | | | | | | | | | |
| | | | | | | | | | | | | | | | | | | | | | | | | | | | | | | | | | | | | | | | | | | | | | | | | | | | | | | | | | | | | | | | | | | | | | | | | | | | | | | | |
| | | | | | | | | | | | | | | | | | | | | | | | | | | | | | | | | | | | | | | | | | | | | | | | | | | | | | | | | | | | | | | | | | | | | | | | | | | | | | | | |
| | | | | | | | | | | | | | | | | | | | | | | | | | | | | | | | | | | | | | | | | | | | | | | | | | | | | | | | | | | | | | | | | | | | | | | | | | | | | | | | |
| 1 | | | | | | | | | | | | | | | | | | | | | | | | | | | | | | | | | | | | | | | | | | | | | | | | | | | | | | | | | | | | | | | | | | | | | | | | | | | | | | | |
| | | | | | | | | | | | | | | | | | | | | | | | | | | | | | | | | | | | | | | | | | | | | | | | | | | | | | | | | | | | | | | | | | | | | | | | | | | | | | | | |
| | | | | | | | | | | | | | | | | | | | | | | | | | | | | | | | | | | | | | | | | | | | | | | | | | | | | | | | | | | | | | | | | | | | | | | | | | | | | | | | |
| | | | | | | | | | | | | | | | | | | | | | | | | | | | | | | | | | | | | | | | | | | | | | | | | | | | | | | | | | | | | | | | | | | | | | | | | | | | | | | | |
| | | | | | | | | | | | | | | | | | | | | | | | | | | | | | | | | | | | | | | | | | | | | | | | | | | | | | | | | | | | | | | | | | | | | | | | | | | | | | | | |
| | | | | | | | | | | | | | | | | | | | | | | | | | | | | | | | | | | | | | | | | | | | | | | | | | | | | | | | | | | | | | | | | | | | | | | | | | | | | | | | |
| 2 | | 1 | | | | | | | | | | | | | | | | | | | | | | | | | | | | | | | | | | | | | | | | | | | | | | | | | | | | | | | | | | | | | | | | | | | | | | | | | | | | | |
| | | | | | | | | | | | | | | | | | | | | | | | | | | | | | | | | | | | | | | | | | | | | | | | | | | | | | | | | | | | | | | | | | | | | | | | | | | | | | | | |
| | | | | | | | | | | | | | | | | | | | | | | | | | | | | | | | | | | | | | | | | | | | | | | | | | | | | | | | | | | | | | | | | | | | | | | | | | | | | | | | |
| | | | | | | | | | | | | | | | | | | | | | | | | | | | | | | | | | | | | | | | | | | | | | | | | | | | | | | | | | | | | | | | | | | | | | | | | | | | | | | | |
| | | | | | | | | | | | | | | | | | | | | | | | | | | | | | | | | | | | | | | | | | | | | | | | | | | | | | | | | | | | | | | | | | | | | | | | | | | | | | | | |
| | | | | | | | | | | | | | | | | | | | | | | | | | | | | | | | | | | | | | | | | | | | | | | | | | | | | | | | | | | | | | | | | | | | | | | | | | | | | | | | |
| | | | | | | | | | | | | | | | | | | | | | | | | | | | | | | | | | | | | | | | | | | | | | | | | | | | | | | | | | | | | | | | | | | | | | | | | | | | | | | | |
| Post - 0 Miss - 0 Block - 0 | Post - 0 Miss - 1 Block - 0 | Post - 0 Miss - 0 Block - 0 | Post - 0 Miss - 0 Block - 0 | Post - 0 Miss - 0 Block - 0 | Post - 0 Miss - 0 Block - 0 | Post - 0 Miss - 0 Block - 0 | Post - 0 Miss - 0 Block - 0 | | | | | | | | | | | | | | | | | | | | | | | | | | | | | | | | | | | | | | | | | | | | | | | | | | | | | | | | | | | | | | | | | | | | | | | | |

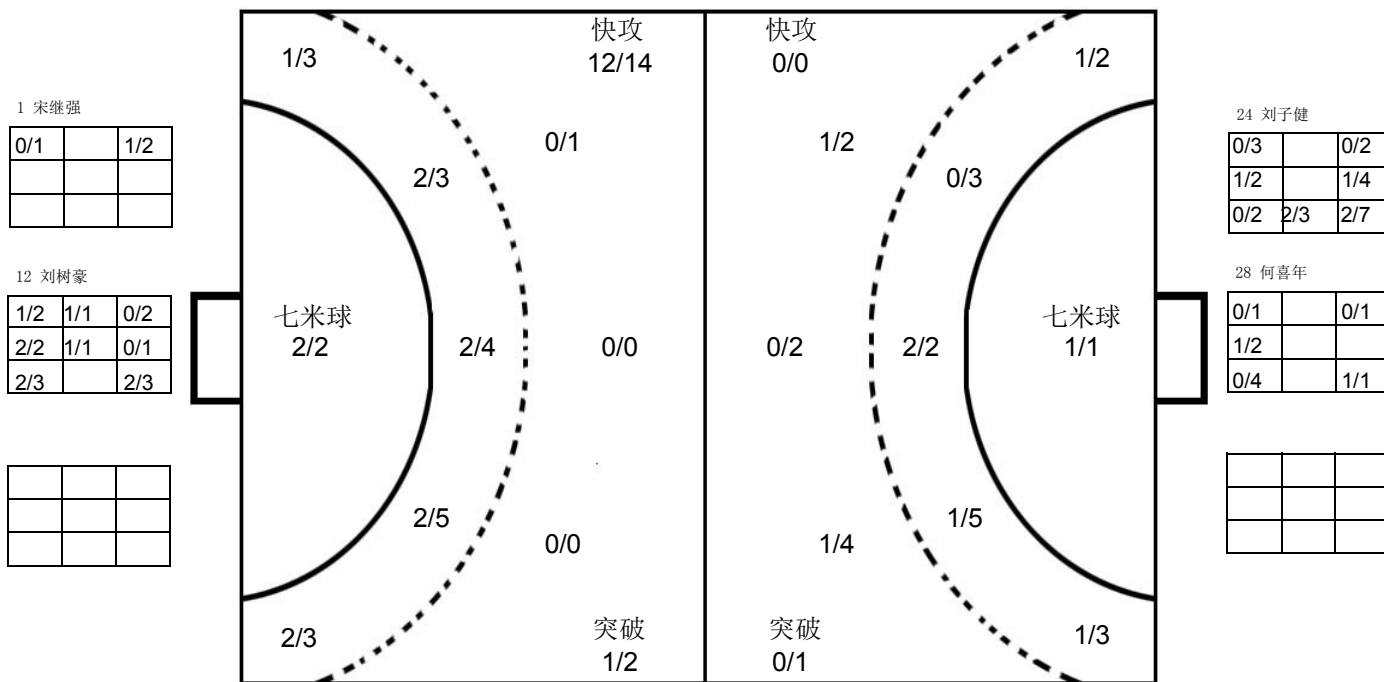

天津队

| | | | | | | | | | | | | | | | | | | | | | | | | | | | | | | | | | | | | | | | | | | | | | | | | | | | | | | | | | | | | | | | | | | | | | | | | | | | | | | | |
|--|-----------------------------|-----------------------------|-----------------------------|-----------------------------|-----------------------------|-----------------------------|-----------------------------|--|--|---|--|--|---|--|--|--|--|--|--|---|---|--|--|--|--|--|--|--|--|---|--|--|--|--|--|--|---|--|--|--|--|--|--|--|--|--|--|--|--|---|--|--|--|--|--|--|--|--|---|--|--|--|--|--|--|--|--|--|--|--|--|--|--|--|--|--|--|--|--|
| 9 吴明远 | 18 王晓琪 | 21 潘玉帅 | 22 魏雨童 | 24 刘子健 | 25 王一雄 | 26 刘思远 | 27 左金龙 | | | | | | | | | | | | | | | | | | | | | | | | | | | | | | | | | | | | | | | | | | | | | | | | | | | | | | | | | | | | | | | | | | | | | | | | |
| <table border="1"><tr><td>1</td><td></td><td>1</td></tr><tr><td></td><td></td><td></td></tr><tr><td></td><td></td><td></td></tr></table> | 1 | | 1 | | | | | | | <table border="1"><tr><td></td><td></td><td>2</td></tr><tr><td></td><td></td><td></td></tr><tr><td></td><td></td><td></td></tr></table> | | | 2 | | | | | | | <table border="1"><tr><td>1</td><td></td><td></td></tr><tr><td></td><td></td><td></td></tr><tr><td></td><td></td><td></td></tr></table> | 1 | | | | | | | | | <table border="1"><tr><td></td><td></td><td></td></tr><tr><td></td><td></td><td></td></tr><tr><td>1</td><td></td><td></td></tr></table> | | | | | | | 1 | | | <table border="1"><tr><td></td><td></td><td></td></tr><tr><td></td><td></td><td></td></tr><tr><td></td><td></td><td></td></tr></table> | | | | | | | | | | <table border="1"><tr><td></td><td></td><td></td></tr><tr><td></td><td></td><td></td></tr><tr><td></td><td></td><td>1</td></tr></table> | | | | | | | | | 1 | <table border="1"><tr><td></td><td></td><td></td></tr><tr><td></td><td></td><td></td></tr><tr><td></td><td></td><td></td></tr></table> | | | | | | | | | | <table border="1"><tr><td></td><td></td><td></td></tr><tr><td></td><td></td><td></td></tr><tr><td></td><td></td><td></td></tr></table> | | | | | | | | | |
| 1 | | 1 | | | | | | | | | | | | | | | | | | | | | | | | | | | | | | | | | | | | | | | | | | | | | | | | | | | | | | | | | | | | | | | | | | | | | | | | | | | | | |
| | | | | | | | | | | | | | | | | | | | | | | | | | | | | | | | | | | | | | | | | | | | | | | | | | | | | | | | | | | | | | | | | | | | | | | | | | | | | | | | |
| | | | | | | | | | | | | | | | | | | | | | | | | | | | | | | | | | | | | | | | | | | | | | | | | | | | | | | | | | | | | | | | | | | | | | | | | | | | | | | | |
| | | 2 | | | | | | | | | | | | | | | | | | | | | | | | | | | | | | | | | | | | | | | | | | | | | | | | | | | | | | | | | | | | | | | | | | | | | | | | | | | | | |
| | | | | | | | | | | | | | | | | | | | | | | | | | | | | | | | | | | | | | | | | | | | | | | | | | | | | | | | | | | | | | | | | | | | | | | | | | | | | | | | |
| | | | | | | | | | | | | | | | | | | | | | | | | | | | | | | | | | | | | | | | | | | | | | | | | | | | | | | | | | | | | | | | | | | | | | | | | | | | | | | | |
| 1 | | | | | | | | | | | | | | | | | | | | | | | | | | | | | | | | | | | | | | | | | | | | | | | | | | | | | | | | | | | | | | | | | | | | | | | | | | | | | | | |
| | | | | | | | | | | | | | | | | | | | | | | | | | | | | | | | | | | | | | | | | | | | | | | | | | | | | | | | | | | | | | | | | | | | | | | | | | | | | | | | |
| | | | | | | | | | | | | | | | | | | | | | | | | | | | | | | | | | | | | | | | | | | | | | | | | | | | | | | | | | | | | | | | | | | | | | | | | | | | | | | | |
| | | | | | | | | | | | | | | | | | | | | | | | | | | | | | | | | | | | | | | | | | | | | | | | | | | | | | | | | | | | | | | | | | | | | | | | | | | | | | | | |
| | | | | | | | | | | | | | | | | | | | | | | | | | | | | | | | | | | | | | | | | | | | | | | | | | | | | | | | | | | | | | | | | | | | | | | | | | | | | | | | |
| 1 | | | | | | | | | | | | | | | | | | | | | | | | | | | | | | | | | | | | | | | | | | | | | | | | | | | | | | | | | | | | | | | | | | | | | | | | | | | | | | | |
| | | | | | | | | | | | | | | | | | | | | | | | | | | | | | | | | | | | | | | | | | | | | | | | | | | | | | | | | | | | | | | | | | | | | | | | | | | | | | | | |
| | | | | | | | | | | | | | | | | | | | | | | | | | | | | | | | | | | | | | | | | | | | | | | | | | | | | | | | | | | | | | | | | | | | | | | | | | | | | | | | |
| | | | | | | | | | | | | | | | | | | | | | | | | | | | | | | | | | | | | | | | | | | | | | | | | | | | | | | | | | | | | | | | | | | | | | | | | | | | | | | | |
| | | | | | | | | | | | | | | | | | | | | | | | | | | | | | | | | | | | | | | | | | | | | | | | | | | | | | | | | | | | | | | | | | | | | | | | | | | | | | | | |
| | | | | | | | | | | | | | | | | | | | | | | | | | | | | | | | | | | | | | | | | | | | | | | | | | | | | | | | | | | | | | | | | | | | | | | | | | | | | | | | |
| | | 1 | | | | | | | | | | | | | | | | | | | | | | | | | | | | | | | | | | | | | | | | | | | | | | | | | | | | | | | | | | | | | | | | | | | | | | | | | | | | | |
| | | | | | | | | | | | | | | | | | | | | | | | | | | | | | | | | | | | | | | | | | | | | | | | | | | | | | | | | | | | | | | | | | | | | | | | | | | | | | | | |
| | | | | | | | | | | | | | | | | | | | | | | | | | | | | | | | | | | | | | | | | | | | | | | | | | | | | | | | | | | | | | | | | | | | | | | | | | | | | | | | |
| | | | | | | | | | | | | | | | | | | | | | | | | | | | | | | | | | | | | | | | | | | | | | | | | | | | | | | | | | | | | | | | | | | | | | | | | | | | | | | | |
| | | | | | | | | | | | | | | | | | | | | | | | | | | | | | | | | | | | | | | | | | | | | | | | | | | | | | | | | | | | | | | | | | | | | | | | | | | | | | | | |
| | | | | | | | | | | | | | | | | | | | | | | | | | | | | | | | | | | | | | | | | | | | | | | | | | | | | | | | | | | | | | | | | | | | | | | | | | | | | | | | |
| | | | | | | | | | | | | | | | | | | | | | | | | | | | | | | | | | | | | | | | | | | | | | | | | | | | | | | | | | | | | | | | | | | | | | | | | | | | | | | | |
| Post - 0 Miss - 1 Block - 0 | Post - 3 Miss - 2 Block - 0 | Post - 0 Miss - 0 Block - 0 | Post - 0 Miss - 0 Block - 0 | Post - 0 Miss - 0 Block - 0 | Post - 0 Miss - 0 Block - 0 | Post - 0 Miss - 1 Block - 0 | Post - 0 Miss - 0 Block - 0 | | | | | | | | | | | | | | | | | | | | | | | | | | | | | | | | | | | | | | | | | | | | | | | | | | | | | | | | | | | | | | | | | | | | | | | | |
| 28 何喜年 | | | | | | | | | | | | | | | | | | | | | | | | | | | | | | | | | | | | | | | | | | | | | | | | | | | | | | | | | | | | | | | | | | | | | | | | | | | | | | | |
| <table border="1"><tr><td></td><td></td><td></td></tr><tr><td></td><td></td><td></td></tr><tr><td></td><td></td><td></td></tr></table> | | | | | | | | | | <table border="1"><tr><td></td><td></td><td></td></tr><tr><td></td><td></td><td></td></tr><tr><td></td><td></td><td></td></tr></table> | | | | | | | | | | <table border="1"><tr><td></td><td></td><td></td></tr><tr><td></td><td></td><td></td></tr><tr><td></td><td></td><td></td></tr></table> | | | | | | | | | | <table border="1"><tr><td></td><td></td><td></td></tr><tr><td></td><td></td><td></td></tr><tr><td></td><td></td><td></td></tr></table> | | | | | | | | | | <table border="1"><tr><td></td><td></td><td></td></tr><tr><td></td><td></td><td></td></tr><tr><td></td><td></td><td></td></tr></table> | | | | | | | | | | <table border="1"><tr><td></td><td></td><td></td></tr><tr><td></td><td></td><td></td></tr><tr><td></td><td></td><td></td></tr></table> | | | | | | | | | | <table border="1"><tr><td></td><td></td><td></td></tr><tr><td></td><td></td><td></td></tr><tr><td></td><td></td><td></td></tr></table> | | | | | | | | | | <table border="1"><tr><td></td><td></td><td></td></tr><tr><td></td><td></td><td></td></tr><tr><td></td><td></td><td></td></tr></table> | | | | | | | | | |
| | | | | | | | | | | | | | | | | | | | | | | | | | | | | | | | | | | | | | | | | | | | | | | | | | | | | | | | | | | | | | | | | | | | | | | | | | | | | | | | |
| | | | | | | | | | | | | | | | | | | | | | | | | | | | | | | | | | | | | | | | | | | | | | | | | | | | | | | | | | | | | | | | | | | | | | | | | | | | | | | | |
| | | | | | | | | | | | | | | | | | | | | | | | | | | | | | | | | | | | | | | | | | | | | | | | | | | | | | | | | | | | | | | | | | | | | | | | | | | | | | | | |
| | | | | | | | | | | | | | | | | | | | | | | | | | | | | | | | | | | | | | | | | | | | | | | | | | | | | | | | | | | | | | | | | | | | | | | | | | | | | | | | |
| | | | | | | | | | | | | | | | | | | | | | | | | | | | | | | | | | | | | | | | | | | | | | | | | | | | | | | | | | | | | | | | | | | | | | | | | | | | | | | | |
| | | | | | | | | | | | | | | | | | | | | | | | | | | | | | | | | | | | | | | | | | | | | | | | | | | | | | | | | | | | | | | | | | | | | | | | | | | | | | | | |
| | | | | | | | | | | | | | | | | | | | | | | | | | | | | | | | | | | | | | | | | | | | | | | | | | | | | | | | | | | | | | | | | | | | | | | | | | | | | | | | |
| | | | | | | | | | | | | | | | | | | | | | | | | | | | | | | | | | | | | | | | | | | | | | | | | | | | | | | | | | | | | | | | | | | | | | | | | | | | | | | | |
| | | | | | | | | | | | | | | | | | | | | | | | | | | | | | | | | | | | | | | | | | | | | | | | | | | | | | | | | | | | | | | | | | | | | | | | | | | | | | | | |
| | | | | | | | | | | | | | | | | | | | | | | | | | | | | | | | | | | | | | | | | | | | | | | | | | | | | | | | | | | | | | | | | | | | | | | | | | | | | | | | |
| | | | | | | | | | | | | | | | | | | | | | | | | | | | | | | | | | | | | | | | | | | | | | | | | | | | | | | | | | | | | | | | | | | | | | | | | | | | | | | | |
| | | | | | | | | | | | | | | | | | | | | | | | | | | | | | | | | | | | | | | | | | | | | | | | | | | | | | | | | | | | | | | | | | | | | | | | | | | | | | | | |
| | | | | | | | | | | | | | | | | | | | | | | | | | | | | | | | | | | | | | | | | | | | | | | | | | | | | | | | | | | | | | | | | | | | | | | | | | | | | | | | |
| | | | | | | | | | | | | | | | | | | | | | | | | | | | | | | | | | | | | | | | | | | | | | | | | | | | | | | | | | | | | | | | | | | | | | | | | | | | | | | | |
| | | | | | | | | | | | | | | | | | | | | | | | | | | | | | | | | | | | | | | | | | | | | | | | | | | | | | | | | | | | | | | | | | | | | | | | | | | | | | | | |
| | | | | | | | | | | | | | | | | | | | | | | | | | | | | | | | | | | | | | | | | | | | | | | | | | | | | | | | | | | | | | | | | | | | | | | | | | | | | | | | |
| | | | | | | | | | | | | | | | | | | | | | | | | | | | | | | | | | | | | | | | | | | | | | | | | | | | | | | | | | | | | | | | | | | | | | | | | | | | | | | | |
| | | | | | | | | | | | | | | | | | | | | | | | | | | | | | | | | | | | | | | | | | | | | | | | | | | | | | | | | | | | | | | | | | | | | | | | | | | | | | | | |
| | | | | | | | | | | | | | | | | | | | | | | | | | | | | | | | | | | | | | | | | | | | | | | | | | | | | | | | | | | | | | | | | | | | | | | | | | | | | | | | |
| | | | | | | | | | | | | | | | | | | | | | | | | | | | | | | | | | | | | | | | | | | | | | | | | | | | | | | | | | | | | | | | | | | | | | | | | | | | | | | | |
| | | | | | | | | | | | | | | | | | | | | | | | | | | | | | | | | | | | | | | | | | | | | | | | | | | | | | | | | | | | | | | | | | | | | | | | | | | | | | | | |
| | | | | | | | | | | | | | | | | | | | | | | | | | | | | | | | | | | | | | | | | | | | | | | | | | | | | | | | | | | | | | | | | | | | | | | | | | | | | | | | |
| | | | | | | | | | | | | | | | | | | | | | | | | | | | | | | | | | | | | | | | | | | | | | | | | | | | | | | | | | | | | | | | | | | | | | | | | | | | | | | | |
| | | | | | | | | | | | | | | | | | | | | | | | | | | | | | | | | | | | | | | | | | | | | | | | | | | | | | | | | | | | | | | | | | | | | | | | | | | | | | | | |
| Post - 0 Miss - 0 Block - 0 | | | | | | | | | | | | | | | | | | | | | | | | | | | | | | | | | | | | | | | | | | | | | | | | | | | | | | | | | | | | | | | | | | | | | | | | | | | | | | | |

注释: Post=击柱 Miss=射失 Block=被封



预赛 Group B
青年男子 全国比赛

2016年“体彩杯”全国手球男子青年锦标赛

| | | | | | | | | | | | |
|------------------------|---|------------------------|----------------------|------------------------------------|-----------------|-----|-----------|---|----|---|----------|
| Team A A 北京队 | | Team B B 新疆队 | | Match Number 18 | | | | | | | |
| played in China | | in the hall 重庆万州 | | on 22/03/2016 | | | | | | | |
| | | | | at 17:30 hours | | | | | | | |
| Spectators | | | | | | | | | | | |
| Half-time (30') | A 13 | B 17 | End of playing time | A 26 | B 33 | | | | | | |
| | | | 1st extra time | A | B | | | | | | |
| | | | 2nd extra time | A | B | | | | | | |
| | | | After penalty throws | A | B | | | | | | |
| Number of 7 m | A 3/4 | Team time-out | | Full name of players and officials | | | | | | | |
| | 1 14:21 | 2 39:15 | 3 | | | | | | | | |
| | | | Team time-out | | B 3/4 | | | | | | |
| | 1 25:04 | 2 51:49 | 3 56:32 | | | | | | | | |
| No. | Team A | | | | Team B | | | | | | |
| | G | W | 2' | D | DR | No. | G | W | 2' | D | DR |
| 3 | 王哲一 | | | | | 1 | 宋晓晨 | | | | |
| 4 | 朱广刚 | 3 | 1 | 1 | | 2 | 王泽川 | 1 | | | |
| 6 | 赵一涵 | 4 | | 1 | | 4 | 谷通金 | | | | |
| 7 | 卞友山 | | | | | 5 | 徐伟 | 3 | | | |
| 11 | 李旭 | 4 | 1 | | | 6 | 白光宇 | | | | |
| 15 | 逯明松 | 2 | | | | 7 | 林豪文 | 9 | 1 | | |
| 16 | 马佳鹏 | | | | | 10 | 王钟彬 | 6 | | | |
| 18 | 李明远 | 1 | | | | 12 | 王金鑫 | | | | |
| 19 | 陈旭 | 4 | 1 | | | 13 | 苏兴伟 | | | 1 | |
| 23 | 刘帅 | | | | | 15 | 王维东 | 3 | | | |
| 25 | 张斌 | | | | | 16 | 李佳懿 | | | | |
| 26 | 吴锐樊 | 5 | | 1 | | 17 | 胡晋铭 | 4 | | 3 | |
| 35 | 高云健 | | | | | 18 | 李万兴 | 1 | | | |
| 36 | 王鹏皓 | 3 | | 1 | | 19 | 李龙吉 | 6 | 1 | | |
| | | | | | | 24 | 陈伟华 | | | | |
| B | 吴健 (主教练) | | | | | A | 孔德宾 (主教练) | | | | |
| C | 宋刚 | | | | | B | 陈鹏波 | | | | |
| D | 陈璇 | | | | | C | 李楠 | | | | |
| | | | | | | | | | | | |
| | | | | | | | | | | | |
| A | Signature of Responsible Official of the Teams (Off. A) | | | | | | | | | | B |
| TP | Remarks of Referee / CHA Official | | | | | | | | | | TP |

Signatures

| | | | | |
|------------------|-----------|----------|--|--|
| Referees | 汤怡 (CHN) | 缪俊 (CHN) | | |
| Techn. Delegates | 徐健 (CHN) | | | |
| CHA Official | 许宜扬 (CHN) | | | |

Note: Number of 7m Throws Awarded to Team A and B, Goals (G), Warnings (W), Suspensions (2'), Direct Disqualification (D), Disqualification with Report (DR) and Team Penalty (TP).

Table Officials:

Statisticians:





2016年“体彩杯”全国手球男子青年锦标赛 竞赛技术统计(媒体表)

| | | | | | | | |
|-----------|--|------------|-----------|----------------|------------------|-----------|-----------|
| 预赛 | | 组别 | B | 轮次 | 3 | 场次 | 18 |
| 重庆万州 | | 22/03/2016 | | | 201602018-51-1/1 | | |
| 北京队 | | 北京 | 26 | vs | 33 | 新疆 | 新疆队 |
| | | | | 13 : 17 | | | |

| 裁判员 | | 汤怡 (CHN) | | | | | | | | | | | / | | | | | | | | | | | 缪俊 (CHN) | | | | | | | | | | |
|---------------|-----|----------|-------|-----|-----|-----|-----|-----|-------|------|----|----|----|----|--------|----|-----|----------|-------|-------|----|-----|----|----------|--|--|--|--|--|--|--|--|--|--|
| 北京 | | 远 | 近 | 边 | 快 | 突 | 任意 | 7m | 合计 | % | 助攻 | 失误 | 警告 | 2' | D & DR | 北京 | | 比赛进程 | | 新疆 | | | | | | | | | | | | | | |
| 主教练: 吴健 | | 射 | 射 | 射 | 攻 | 破 | 球 | 球 | | | | | | | | | | 1st Half | | | | | | | | | | | | | | | | |
| 3 | 王哲一 | | | | | | | | | | 1 | | | | | 26 | 吴锐樊 | 0 | 01:11 | 1 | 7 | 林豪文 | | | | | | | | | | | | |
| 4 | 朱广刚 | 1/5 | 1/4 | | | 1/1 | | | 3/10 | 30.0 | 4 | 7 | 1 | 1 | | | | 1 | 01:40 | 1 | | | | | | | | | | | | | | |
| 6 | 赵一涵 | 1/1 | 3/5 | | | | | | 4/6 | 66.7 | 1 | 5 | | 1 | | | | 1 | 02:14 | 2 | 10 | 王钟彬 | | | | | | | | | | | | |
| 7 | 卞友山 | | | | | | | | | | | | | | | | | 1 | 03:02 | 3 | 15 | 王维东 | | | | | | | | | | | | |
| 11 | 李旭 | | 2/3 | | | | | 2/2 | 4/5 | 80.0 | | 2 | 1 | | | 15 | 逯明松 | 2 | 04:05 | 3 | | | | | | | | | | | | | | |
| 15 | 逯明松 | 0/1 | 0/1 | 1/1 | 1/1 | | | | 2/4 | 50.0 | | 1 | | | | 19 | 陈旭 | 3 | 05:16 | 3 | | | | | | | | | | | | | | |
| 16 | 马佳鹏 | | | | | | | | | | | | | | | 4 | 朱广刚 | 4 | 06:35 | 3 | | | | | | | | | | | | | | |
| 18 | 李明远 | | | | 1/1 | | | | 1/1 | 100 | | | | | | 4 | 朱广刚 | 4 | 06:35 | 3 | | | | | | | | | | | | | | |
| 19 | 陈旭 | 3/5 | 0/3 | 0/1 | | | | 1/2 | 4/11 | 36.4 | | 5 | 1 | | | 19 | 陈旭 | 5 | 13:11 | 5 | | | | | | | | | | | | | | |
| 23 | 刘帅 | | | | | | 0/1 | | 0/1 | 0.0 | | | | | | 5 | | 5 | 13:29 | 6 | 5 | 徐伟 | | | | | | | | | | | | |
| 25 | 张斌 | | | | | | | | | | | | | | | 4 | | 5 | 14:12 | 7 | 10 | 王钟彬 | | | | | | | | | | | | |
| 26 | 吴锐樊 | | 2/2 | 3/4 | | | | | 5/6 | 83.3 | | 1 | | 1 | | 5 | | 5 | 15:24 | 8 | 7 | 林豪文 | | | | | | | | | | | | |
| 35 | 高云健 | | | | | | | | | | | | | | | 6 | | 6 | 16:03 | 8 | | | | | | | | | | | | | | |
| 36 | 王鹏皓 | | 1/2 | 2/3 | | | | | 3/5 | 60.0 | | 2 | | 1 | | 6 | | 6 | 16:50 | 9 | 19 | 李龙吉 | | | | | | | | | | | | |
| 运动员 合计 | | 5/12 | 9/20 | 6/9 | 2/2 | 1/1 | 0/1 | 3/4 | 26/49 | 53.1 | 6 | 23 | 3 | 4 | | 7 | | 7 | 18:54 | 9 | | | | | | | | | | | | | | |
| 16 | 马佳鹏 | 2/3 | 3/12 | 2/5 | 2/5 | 1/4 | | | 10/29 | 34.5 | | | | | | 8 | | 8 | 19:45 | 9 | | | | | | | | | | | | | | |
| 35 | 高云健 | 5/8 | 2/6 | 1/3 | 1/2 | 0/1 | | 0/3 | 9/23 | 39.1 | | | | | | 8 | | 8 | 20:09 | 10 | 7 | 林豪文 | | | | | | | | | | | | |
| 守门员 合计 | | 7/11 | 5/18 | 3/8 | 3/7 | 1/5 | | 0/3 | 19/52 | 36.5 | | | | | | 8 | | 8 | 21:06 | 11 | 17 | 胡晋铭 | | | | | | | | | | | | |
| 新疆 | | 远 | 近 | 边 | 快 | 突 | 任意 | 7m | 合计 | % | 助攻 | 失误 | 警告 | 2' | D & DR | | | 2nd Half | | | | | | | | | | | | | | | | |
| 教练: 孔德宾 | | 射 | 射 | 射 | 攻 | 破 | 球 | 球 | | | | | | | | | | 13 | | 00:22 | | 18 | 10 | 王钟彬 | | | | | | | | | | |
| 1 | 宋晓晨 | | | | | | | | | | | | | | | 11 | 李旭 | 13 | 00:22 | 18 | 10 | 王钟彬 | | | | | | | | | | | | |
| 2 | 王泽川 | | 1/2 | | | | | | 1/2 | 50.0 | | 1 | | | | 14 | | 14 | 01:39 | 18 | | | | | | | | | | | | | | |
| 4 | 谷通金 | | | | | | | | | | | | | | | 14 | | 14 | 02:31 | 19 | 19 | 李龙吉 | | | | | | | | | | | | |
| 5 | 徐伟 | | | 2/3 | 1/2 | | | | 3/5 | 60.0 | | 2 | | | | 6 | 赵一涵 | 15 | 03:21 | 19 | | | | | | | | | | | | | | |
| 6 | 白光宇 | | | | | | | | | | | | | | | 6 | 赵一涵 | 16 | 03:47 | 19 | | | | | | | | | | | | | | |
| 7 | 林豪文 | 2/7 | 2/5 | 1/1 | 1/1 | 1/1 | | 2/2 | 9/17 | 52.9 | 4 | 1 | 1 | | | 11 | 李旭 | 16 | 05:14 | 20 | 7 | 林豪文 | | | | | | | | | | | | |
| 10 | 王钟彬 | 1/3 | 3/4 | 0/1 | 0/2 | 2/2 | | | 6/12 | 50.0 | | | | | | 16 | | 16 | 06:42 | 21 | 19 | 李龙吉 | | | | | | | | | | | | |
| 12 | 王金鑫 | | | | | | | | | | | | | | | 17 | | 17 | 07:23 | 21 | | | | | | | | | | | | | | |
| 13 | 苏兴伟 | 0/1 | | | | | | | 0/1 | 0.0 | | | | | | 17 | | 17 | 07:47 | 22 | 17 | 胡晋铭 | | | | | | | | | | | | |
| 15 | 王维东 | | 1/1 | 1/2 | 1/2 | | | | 3/5 | 60.0 | | 4 | | | | 18 | | 18 | 08:34 | 22 | | | | | | | | | | | | | | |
| 16 | 李佳懿 | | | | | | | | | | | | | | | 18 | | 18 | 09:01 | 23 | 7 | 林豪文 | | | | | | | | | | | | |
| 17 | 胡晋铭 | | 4/4 | | | | | | 4/4 | 100 | | | | | | 18 | | 18 | 10:54 | 24 | 19 | 李龙吉 | | | | | | | | | | | | |
| 18 | 李万兴 | | | 1/1 | | | | | 1/1 | 100 | | 1 | | | | 19 | | 19 | 11:41 | 25 | 7 | 林豪文 | | | | | | | | | | | | |
| 19 | 李龙吉 | 1/1 | 2/6 | | 1/1 | 1/2 | | 1/2 | 6/12 | 50.0 | 3 | 5 | 1 | | | 36 | 王鹏皓 | 19 | 13:13 | 25 | | | | | | | | | | | | | | |
| 24 | 陈伟华 | 0/1 | | | | | | | 0/1 | 0.0 | | | | 1 | | 26 | 吴锐樊 | 19 | 13:46 | 26 | 7 | 林豪文 | | | | | | | | | | | | |
| 运动员 合计 | | 4/13 | 13/22 | 5/8 | 4/8 | 4/5 | | 3/4 | 33/60 | 55.0 | 7 | 14 | 2 | 4 | | 20 | | 20 | 15:24 | 26 | | | | | | | | | | | | | | |
| 1 | 宋晓晨 | 5/10 | 10/19 | 1/7 | 0/2 | 0/1 | 1/1 | 0/3 | 17/43 | 39.5 | | | | | | 20 | | 20 | 15:54 | 27 | 19 | 李龙吉 | | | | | | | | | | | | |
| 守门员 合计 | | 5/10 | 10/19 | 1/7 | 0/2 | 0/1 | 1/1 | 0/3 | 17/43 | 39.5 | | | | | | 20 | | 20 | 19:10 | 28 | 7 | 林豪文 | | | | | | | | | | | | |
| | | | | | | | | | | | | | | | | 19 | 陈旭 | 21 | 20:38 | 28 | | | | | | | | | | | | | | |
| | | | | | | | | | | | | | | | | 4 | 朱广刚 | 21 | 21:00 | 29 | 19 | 李龙吉 | | | | | | | | | | | | |
| | | | | | | | | | | | | | | | | 4 | 朱广刚 | 22 | 21:34 | 29 | | | | | | | | | | | | | | |
| | | | | | | | | | | | | | | | | 23 | | 23 | 22:24 | 29 | | | | | | | | | | | | | | |
| | | | | | | | | | | | | | | | | 23 | | 23 | 22:47 | 30 | 15 | 王维东 | | | | | | | | | | | | |
| | | | | | | | | | | | | | | | | 23 | | 23 | 24:08 | 31 | 2 | 王泽川 | | | | | | | | | | | | |
| | | | | | | | | | | | | | | | | 23 | | 23 | 24:20 | 32 | 5 | 徐伟 | | | | | | | | | | | | |
| | | | | | | | | | | | | | | | | 36 | 王鹏皓 | 24 | 26:55 | 32 | | | | | | | | | | | | | | |
| | | | | | | | | | | | | | | | | 18 | 李明远 | 24 | 27:09 | 33 | 18 | 李万兴 | | | | | | | | | | | | |
| | | | | | | | | | | | | | | | | 6 | 赵一涵 | 25 | 29:22 | 33 | | | | | | | | | | | | | | |
| | | | | | | | | | | | | | | | | 6 | 赵一涵 | 26 | 29:50 | 33 | | | | | | | | | | | | | | |

场上队员: 得分 / 射门

守门员: 救球 / 射门

| | | | | | | | | | |
|----|------------|----|--------------|-----|------------|-----|----------|----|---------|
| 快攻 | Fast Break | 突破 | Breakthrough | 任意球 | Free Throw | 7M球 | 7M Throw | 助攻 | Assist |
| 警告 | Warning | 失误 | Error | 2' | Suspension | D | 取消资格 | DR | 取消资格+报告 |





2016年“体彩杯”全国手球男子青年锦标赛 图式比赛技术统计表

轮次 3

场次 18

201602018-21-1/1

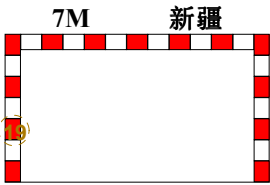
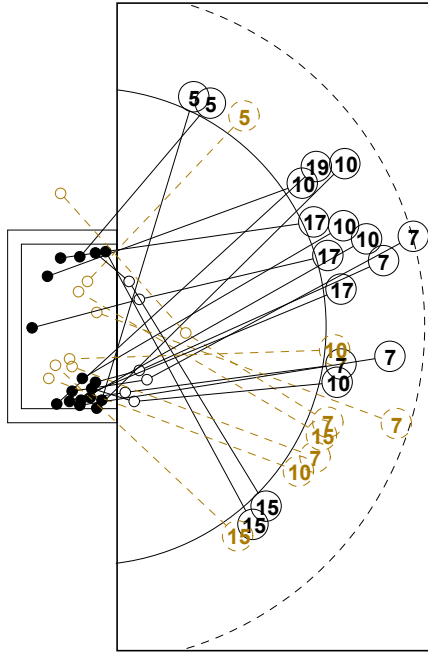

1st Half
17 : 13

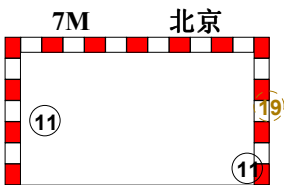
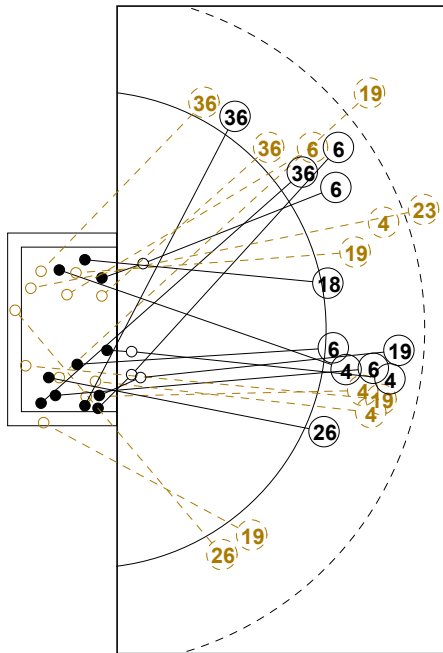
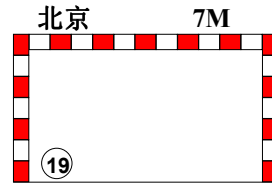
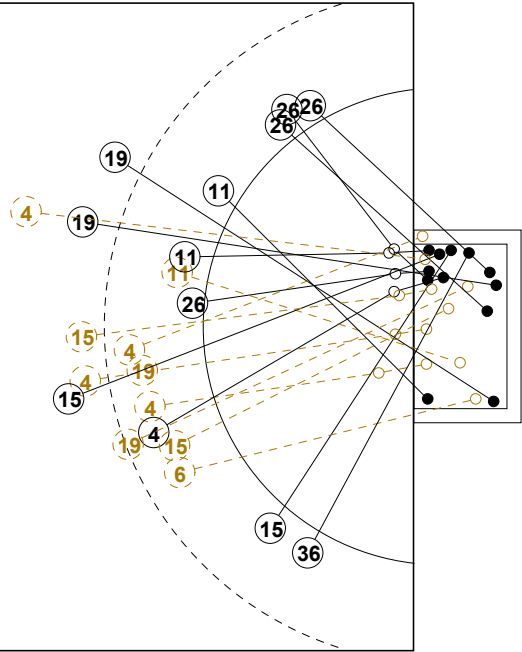

2nd Half
26 : 33

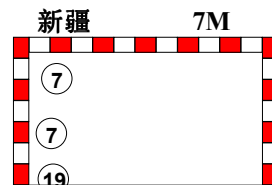
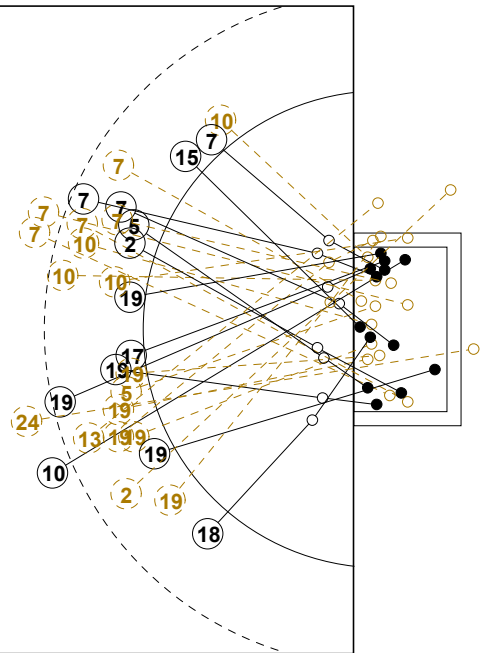



2016年“体彩杯”全国手球男子青年锦标赛

个人/全队技术统计表

正式表
手球
青年男子预赛
轮次 3组别 B
场次 18201602018-14-1/2
重庆万州
22/03/2016 17:30

| 号码 | 姓名 | 远射 | 近射 | 边射 | 快攻 | 突破 | 任意 | 7M | 合计 | % | 助攻 | 失误 | 警告 | 2' | 取消 | 时间 |
|----------------|-----|-----|------|-----|-----|-----|-----|-----|-------|-------|----|----|----|----|----|----------|
| 北京队(北京) | | | | | | | | | | | | | | | | |
| <i>(场上队员)</i> | | | | | | | | | | | | | | | | |
| 3 | 王哲一 | | | | | | | | | 0.0% | 1 | | | | | 00:08:55 |
| 4 | 朱广刚 | 1/5 | 1/4 | | | 1/1 | | | 3/10 | 30.0% | 4 | 7 | 1 | 1 | | 00:57:24 |
| 6 | 赵一涵 | 1/1 | 3/5 | | | | | | 4/6 | 66.7% | 1 | 5 | | 1 | | 00:45:45 |
| 7 | 卞友山 | | | | | | | | | 0.0% | | | | | | 00:05:03 |
| 11 | 李旭 | | 2/3 | | | | | 2/2 | 4/5 | 80.0% | | 2 | 1 | | | 00:54:55 |
| 15 | 逯明松 | 0/1 | 0/1 | 1/1 | 1/1 | | | | 2/4 | 50.0% | | 1 | | | | 00:29:41 |
| 16 | 马佳鹏 | | | | | | | | | 0.0% | | | | | | 00:37:07 |
| 18 | 李明远 | | | | | 1/1 | | | 1/1 | 100% | | | | | | 00:00:25 |
| 19 | 陈旭 | 3/5 | 0/3 | 0/1 | | | | 1/2 | 4/11 | 36.4% | | 5 | 1 | | | 01:00:00 |
| 23 | 刘帅 | | | | | | 0/1 | | 0/1 | 0.0% | | | | | | 00:02:34 |
| 25 | 张斌 | | | | | | | | | 0.0% | | | | | | 00:00:00 |
| 26 | 吴锐樊 | | 2/2 | 3/4 | | | | | 5/6 | 83.3% | | 1 | | 1 | | 00:51:04 |
| 35 | 高云健 | | | | | | | | | 0.0% | | | | | | 00:22:53 |
| 36 | 王鹏皓 | | 1/2 | 2/3 | | | | | 3/5 | 60.0% | | 2 | | 1 | | 00:44:32 |
| 合计 | | | | | | | | | | | | | | | | |
| <i>(守门员)</i> | | | | | | | | | | | | | | | | |
| 16 | 马佳鹏 | 2/3 | 3/12 | 2/5 | 2/5 | 1/4 | | | 10/29 | 34.5% | | | | | | 00:37:07 |
| 35 | 高云健 | 5/8 | 2/6 | 1/3 | 1/2 | 0/1 | | 0/3 | 9/23 | 39.1% | | | | | | 00:22:53 |
| 合计 | | | | | | | | | | | | | | | | |

场上队员：得分/射门

守门员：救球/射门

| 全队合计 | 得分 | 被救 | 射失 | 击柱 | 封球 | 合计 | % |
|------|----|----|----|----|----|----|--------|
| 远射 | 5 | 5 | | 1 | 1 | 12 | 41.7% |
| 近射 | 9 | 10 | | | 1 | 20 | 45.0% |
| 边射 | 6 | 1 | | 2 | | 9 | 66.7% |
| 快攻 | 2 | | | | | 2 | 100.0% |
| 突破 | 1 | | | | | 1 | 100.0% |
| 任意 | | 1 | | | | 1 | 0.0% |
| 7M | 3 | | | 1 | | 4 | 75.0% |





2016年“体彩杯”全国手球男子青年锦标赛

个人/全队技术统计表

正式表
手球
青年男子预赛
轮次 3组别 B
场次 18201602018-14-2/2
重庆万州
22/03/2016 17:30

| 号码 | 姓名 | 远射 | 近射 | 边射 | 快攻 | 突破 | 任意 | 7M | 合计 | % | 助攻 | 失误 | 警告 | 2' | 取消 | 时间 |
|----------------|-----|------|-------|-----|-----|-----|-----|-----|-------|-------|----|----|----|----|----|----------|
| 新疆队(新疆) | | | | | | | | | | | | | | | | |
| <i>(上场队员)</i> | | | | | | | | | | | | | | | | |
| 1 | 宋晓晨 | | | | | | | | | 0.0% | | | | | | 01:00:00 |
| 2 | 王泽川 | | 1/2 | | | | | | 1/2 | 50.0% | | 1 | | | | 00:10:42 |
| 4 | 谷通金 | | | | | | | | | 0.0% | | | | | | 00:03:28 |
| 5 | 徐伟 | | | 2/3 | 1/2 | | | | 3/5 | 60.0% | | 2 | | | | 00:56:19 |
| 6 | 白光宇 | | | | | | | | | 0.0% | | | | | | 00:12:47 |
| 7 | 林豪文 | 2/7 | 2/5 | 1/1 | 1/1 | 1/1 | | 2/2 | 9/17 | 52.9% | 4 | 1 | 1 | | | 00:56:32 |
| 10 | 王钟彬 | 1/3 | 3/4 | 0/1 | 0/2 | 2/2 | | | 6/12 | 50.0% | | | | | | 00:56:32 |
| 12 | 王金鑫 | | | | | | | | | 0.0% | | | | | | 00:00:00 |
| 13 | 苏兴伟 | 0/1 | | | | | | | 0/1 | 0.0% | | | | 1 | | 00:03:28 |
| 15 | 王维东 | | 1/1 | 1/2 | 1/2 | | | | 3/5 | 60.0% | | 4 | | | | 00:42:53 |
| 16 | 李佳懿 | | | | | | | | | 0.0% | | | | | | 00:00:00 |
| 17 | 胡晋铭 | | 4/4 | | | | | | 4/4 | 100% | | | | 3 | | 00:52:38 |
| 18 | 李万兴 | | | 1/1 | | | | | 1/1 | 100% | | 1 | | | | 00:03:28 |
| 19 | 李龙吉 | 1/1 | 2/6 | | 1/1 | 1/2 | | 1/2 | 6/12 | 50.0% | 3 | 5 | 1 | | | 00:56:32 |
| 24 | 陈伟华 | 0/1 | | | | | | | 0/1 | 0.0% | | | | | | 00:03:39 |
| 合计 | | 4/13 | 13/22 | 5/8 | 4/8 | 4/5 | | 3/4 | 33/60 | 55.0% | 7 | 14 | 2 | 4 | | |
| <i>(守门员)</i> | | | | | | | | | | | | | | | | |
| 1 | 宋晓晨 | 5/10 | 10/19 | 1/7 | 0/2 | 0/1 | 1/1 | 0/3 | 17/43 | 39.5% | | | | | | 01:00:00 |
| 合计 | | 5/10 | 10/19 | 1/7 | 0/2 | 0/1 | 1/1 | 0/3 | 17/43 | 39.5% | | | | | | |

场上队员：得分/射门

守门员：救球/射门

| 全队合计 | 得分 | 被救 | 射失 | 击柱 | 封球 | 合计 | % |
|------|----|----|----|----|----|----|-------|
| 远射 | 4 | 7 | 2 | | | 13 | 30.8% |
| 近射 | 13 | 5 | 2 | 2 | | 22 | 59.1% |
| 边射 | 5 | 3 | | | | 8 | 62.5% |
| 快攻 | 4 | 3 | | 1 | | 8 | 50.0% |
| 突破 | 4 | 1 | | | | 5 | 80.0% |
| 任意 | | | | | | | 0.0% |
| 7M | 3 | | | 1 | | 4 | 75.0% |





2016年“体彩杯”全国手球男子青年锦标赛

图式射门区域统计

轮次 3 场次 18

201602018-41-1/1

北京队

| | | | | | | | | | | | | | | | | | | | | | | | | | | | | | | | | | | | | | | | | | | | | | | | | | | | | | | | | | | | | | | | | | | | | | | | | | | | | | | | |
|---|-----------------------------|-----------------------------|-----------------------------|-----------------------------|-----------------------------|-----------------------------|-----------------------------|--|--|---|--|--|---|---|---|--|--|--|--|---|--|--|---|---|--|---|--|--|--|---|---|---|--|--|--|--|---|--|--|--|--|--|---|---|--|---|---|--|--|--|---|--|---|---|--|--|--|--|--|--|--|--|--|--|--|--|--|--|--|---|--|--|---|--|--|--|--|--|--|
| 3 王哲一 | 4 朱广刚 | 6 赵一涵 | 7 卞友山 | 11 李旭 | 15 逯明松 | 16 马佳鹏 | 18 李明远 | | | | | | | | | | | | | | | | | | | | | | | | | | | | | | | | | | | | | | | | | | | | | | | | | | | | | | | | | | | | | | | | | | | | | | | | |
| <table border="1"><tr><td></td><td></td><td></td></tr><tr><td></td><td></td><td></td></tr><tr><td></td><td></td><td></td></tr></table> | | | | | | | | | | <table border="1"><tr><td></td><td></td><td>1</td></tr><tr><td>1</td><td>1</td><td></td></tr><tr><td></td><td></td><td></td></tr></table> | | | 1 | 1 | 1 | | | | | <table border="1"><tr><td></td><td></td><td>2</td></tr><tr><td>1</td><td></td><td>1</td></tr><tr><td></td><td></td><td></td></tr></table> | | | 2 | 1 | | 1 | | | | <table border="1"><tr><td></td><td></td><td></td></tr><tr><td></td><td></td><td></td></tr><tr><td></td><td></td><td></td></tr></table> | | | | | | | | | | <table border="1"><tr><td></td><td></td><td>1</td></tr><tr><td>1</td><td></td><td>2</td></tr><tr><td>1</td><td></td><td></td></tr></table> | | | 1 | 1 | | 2 | 1 | | | <table border="1"><tr><td></td><td></td><td>1</td></tr><tr><td>1</td><td></td><td></td></tr><tr><td></td><td></td><td></td></tr></table> | | | 1 | 1 | | | | | | <table border="1"><tr><td></td><td></td><td></td></tr><tr><td></td><td></td><td></td></tr><tr><td></td><td></td><td></td></tr></table> | | | | | | | | | | <table border="1"><tr><td></td><td></td><td>1</td></tr><tr><td></td><td></td><td></td></tr><tr><td></td><td></td><td></td></tr></table> | | | 1 | | | | | | |
| | | | | | | | | | | | | | | | | | | | | | | | | | | | | | | | | | | | | | | | | | | | | | | | | | | | | | | | | | | | | | | | | | | | | | | | | | | | | | | | |
| | | | | | | | | | | | | | | | | | | | | | | | | | | | | | | | | | | | | | | | | | | | | | | | | | | | | | | | | | | | | | | | | | | | | | | | | | | | | | | | |
| | | | | | | | | | | | | | | | | | | | | | | | | | | | | | | | | | | | | | | | | | | | | | | | | | | | | | | | | | | | | | | | | | | | | | | | | | | | | | | | |
| | | 1 | | | | | | | | | | | | | | | | | | | | | | | | | | | | | | | | | | | | | | | | | | | | | | | | | | | | | | | | | | | | | | | | | | | | | | | | | | | | | |
| 1 | 1 | | | | | | | | | | | | | | | | | | | | | | | | | | | | | | | | | | | | | | | | | | | | | | | | | | | | | | | | | | | | | | | | | | | | | | | | | | | | | | |
| | | | | | | | | | | | | | | | | | | | | | | | | | | | | | | | | | | | | | | | | | | | | | | | | | | | | | | | | | | | | | | | | | | | | | | | | | | | | | | | |
| | | 2 | | | | | | | | | | | | | | | | | | | | | | | | | | | | | | | | | | | | | | | | | | | | | | | | | | | | | | | | | | | | | | | | | | | | | | | | | | | | | |
| 1 | | 1 | | | | | | | | | | | | | | | | | | | | | | | | | | | | | | | | | | | | | | | | | | | | | | | | | | | | | | | | | | | | | | | | | | | | | | | | | | | | | |
| | | | | | | | | | | | | | | | | | | | | | | | | | | | | | | | | | | | | | | | | | | | | | | | | | | | | | | | | | | | | | | | | | | | | | | | | | | | | | | | |
| | | | | | | | | | | | | | | | | | | | | | | | | | | | | | | | | | | | | | | | | | | | | | | | | | | | | | | | | | | | | | | | | | | | | | | | | | | | | | | | |
| | | | | | | | | | | | | | | | | | | | | | | | | | | | | | | | | | | | | | | | | | | | | | | | | | | | | | | | | | | | | | | | | | | | | | | | | | | | | | | | |
| | | | | | | | | | | | | | | | | | | | | | | | | | | | | | | | | | | | | | | | | | | | | | | | | | | | | | | | | | | | | | | | | | | | | | | | | | | | | | | | |
| | | 1 | | | | | | | | | | | | | | | | | | | | | | | | | | | | | | | | | | | | | | | | | | | | | | | | | | | | | | | | | | | | | | | | | | | | | | | | | | | | | |
| 1 | | 2 | | | | | | | | | | | | | | | | | | | | | | | | | | | | | | | | | | | | | | | | | | | | | | | | | | | | | | | | | | | | | | | | | | | | | | | | | | | | | |
| 1 | | | | | | | | | | | | | | | | | | | | | | | | | | | | | | | | | | | | | | | | | | | | | | | | | | | | | | | | | | | | | | | | | | | | | | | | | | | | | | | |
| | | 1 | | | | | | | | | | | | | | | | | | | | | | | | | | | | | | | | | | | | | | | | | | | | | | | | | | | | | | | | | | | | | | | | | | | | | | | | | | | | | |
| 1 | | | | | | | | | | | | | | | | | | | | | | | | | | | | | | | | | | | | | | | | | | | | | | | | | | | | | | | | | | | | | | | | | | | | | | | | | | | | | | | |
| | | | | | | | | | | | | | | | | | | | | | | | | | | | | | | | | | | | | | | | | | | | | | | | | | | | | | | | | | | | | | | | | | | | | | | | | | | | | | | | |
| | | | | | | | | | | | | | | | | | | | | | | | | | | | | | | | | | | | | | | | | | | | | | | | | | | | | | | | | | | | | | | | | | | | | | | | | | | | | | | | |
| | | | | | | | | | | | | | | | | | | | | | | | | | | | | | | | | | | | | | | | | | | | | | | | | | | | | | | | | | | | | | | | | | | | | | | | | | | | | | | | |
| | | | | | | | | | | | | | | | | | | | | | | | | | | | | | | | | | | | | | | | | | | | | | | | | | | | | | | | | | | | | | | | | | | | | | | | | | | | | | | | |
| | | 1 | | | | | | | | | | | | | | | | | | | | | | | | | | | | | | | | | | | | | | | | | | | | | | | | | | | | | | | | | | | | | | | | | | | | | | | | | | | | | |
| | | | | | | | | | | | | | | | | | | | | | | | | | | | | | | | | | | | | | | | | | | | | | | | | | | | | | | | | | | | | | | | | | | | | | | | | | | | | | | | |
| | | | | | | | | | | | | | | | | | | | | | | | | | | | | | | | | | | | | | | | | | | | | | | | | | | | | | | | | | | | | | | | | | | | | | | | | | | | | | | | |
| Post - 0 Miss - 0 Block - 0 | Post - 1 Miss - 0 Block - 1 | Post - 0 Miss - 0 Block - 0 | Post - 0 Miss - 0 Block - 0 | Post - 0 Miss - 0 Block - 0 | Post - 0 Miss - 0 Block - 0 | Post - 0 Miss - 0 Block - 0 | Post - 0 Miss - 0 Block - 0 | | | | | | | | | | | | | | | | | | | | | | | | | | | | | | | | | | | | | | | | | | | | | | | | | | | | | | | | | | | | | | | | | | | | | | | | |
| 19 陈旭 | 23 刘帅 | 25 张斌 | 26 吴锐樊 | 35 高云健 | 36 王鹏皓 | | | | | | | | | | | | | | | | | | | | | | | | | | | | | | | | | | | | | | | | | | | | | | | | | | | | | | | | | | | | | | | | | | | | | | | | | | |
| <table border="1"><tr><td>1</td><td></td><td>1</td></tr><tr><td></td><td></td><td></td></tr><tr><td>2</td><td></td><td></td></tr></table> | 1 | | 1 | | | | 2 | | | <table border="1"><tr><td></td><td></td><td></td></tr><tr><td></td><td></td><td></td></tr><tr><td></td><td></td><td></td></tr></table> | | | | | | | | | | <table border="1"><tr><td></td><td></td><td></td></tr><tr><td></td><td></td><td></td></tr><tr><td></td><td></td><td></td></tr></table> | | | | | | | | | | <table border="1"><tr><td>2</td><td>1</td><td></td></tr><tr><td></td><td></td><td></td></tr><tr><td>2</td><td></td><td></td></tr></table> | 2 | 1 | | | | | 2 | | | <table border="1"><tr><td></td><td></td><td></td></tr><tr><td></td><td></td><td></td></tr><tr><td></td><td></td><td></td></tr></table> | | | | | | | | | | <table border="1"><tr><td>1</td><td></td><td></td></tr><tr><td>2</td><td></td><td></td></tr><tr><td></td><td></td><td></td></tr></table> | 1 | | | 2 | | | | | | <table border="1"><tr><td></td><td></td><td></td></tr><tr><td></td><td></td><td></td></tr><tr><td></td><td></td><td></td></tr></table> | | | | | | | | | | <table border="1"><tr><td></td><td></td><td></td></tr><tr><td></td><td></td><td></td></tr><tr><td></td><td></td><td></td></tr></table> | | | | | | | | | |
| 1 | | 1 | | | | | | | | | | | | | | | | | | | | | | | | | | | | | | | | | | | | | | | | | | | | | | | | | | | | | | | | | | | | | | | | | | | | | | | | | | | | | |
| | | | | | | | | | | | | | | | | | | | | | | | | | | | | | | | | | | | | | | | | | | | | | | | | | | | | | | | | | | | | | | | | | | | | | | | | | | | | | | | |
| 2 | | | | | | | | | | | | | | | | | | | | | | | | | | | | | | | | | | | | | | | | | | | | | | | | | | | | | | | | | | | | | | | | | | | | | | | | | | | | | | | |
| | | | | | | | | | | | | | | | | | | | | | | | | | | | | | | | | | | | | | | | | | | | | | | | | | | | | | | | | | | | | | | | | | | | | | | | | | | | | | | | |
| | | | | | | | | | | | | | | | | | | | | | | | | | | | | | | | | | | | | | | | | | | | | | | | | | | | | | | | | | | | | | | | | | | | | | | | | | | | | | | | |
| | | | | | | | | | | | | | | | | | | | | | | | | | | | | | | | | | | | | | | | | | | | | | | | | | | | | | | | | | | | | | | | | | | | | | | | | | | | | | | | |
| | | | | | | | | | | | | | | | | | | | | | | | | | | | | | | | | | | | | | | | | | | | | | | | | | | | | | | | | | | | | | | | | | | | | | | | | | | | | | | | |
| | | | | | | | | | | | | | | | | | | | | | | | | | | | | | | | | | | | | | | | | | | | | | | | | | | | | | | | | | | | | | | | | | | | | | | | | | | | | | | | |
| | | | | | | | | | | | | | | | | | | | | | | | | | | | | | | | | | | | | | | | | | | | | | | | | | | | | | | | | | | | | | | | | | | | | | | | | | | | | | | | |
| 2 | 1 | | | | | | | | | | | | | | | | | | | | | | | | | | | | | | | | | | | | | | | | | | | | | | | | | | | | | | | | | | | | | | | | | | | | | | | | | | | | | | |
| | | | | | | | | | | | | | | | | | | | | | | | | | | | | | | | | | | | | | | | | | | | | | | | | | | | | | | | | | | | | | | | | | | | | | | | | | | | | | | | |
| 2 | | | | | | | | | | | | | | | | | | | | | | | | | | | | | | | | | | | | | | | | | | | | | | | | | | | | | | | | | | | | | | | | | | | | | | | | | | | | | | | |
| | | | | | | | | | | | | | | | | | | | | | | | | | | | | | | | | | | | | | | | | | | | | | | | | | | | | | | | | | | | | | | | | | | | | | | | | | | | | | | | |
| | | | | | | | | | | | | | | | | | | | | | | | | | | | | | | | | | | | | | | | | | | | | | | | | | | | | | | | | | | | | | | | | | | | | | | | | | | | | | | | |
| | | | | | | | | | | | | | | | | | | | | | | | | | | | | | | | | | | | | | | | | | | | | | | | | | | | | | | | | | | | | | | | | | | | | | | | | | | | | | | | |
| 1 | | | | | | | | | | | | | | | | | | | | | | | | | | | | | | | | | | | | | | | | | | | | | | | | | | | | | | | | | | | | | | | | | | | | | | | | | | | | | | | |
| 2 | | | | | | | | | | | | | | | | | | | | | | | | | | | | | | | | | | | | | | | | | | | | | | | | | | | | | | | | | | | | | | | | | | | | | | | | | | | | | | | |
| | | | | | | | | | | | | | | | | | | | | | | | | | | | | | | | | | | | | | | | | | | | | | | | | | | | | | | | | | | | | | | | | | | | | | | | | | | | | | | | |
| | | | | | | | | | | | | | | | | | | | | | | | | | | | | | | | | | | | | | | | | | | | | | | | | | | | | | | | | | | | | | | | | | | | | | | | | | | | | | | | |
| | | | | | | | | | | | | | | | | | | | | | | | | | | | | | | | | | | | | | | | | | | | | | | | | | | | | | | | | | | | | | | | | | | | | | | | | | | | | | | | |
| | | | | | | | | | | | | | | | | | | | | | | | | | | | | | | | | | | | | | | | | | | | | | | | | | | | | | | | | | | | | | | | | | | | | | | | | | | | | | | | |
| | | | | | | | | | | | | | | | | | | | | | | | | | | | | | | | | | | | | | | | | | | | | | | | | | | | | | | | | | | | | | | | | | | | | | | | | | | | | | | | |
| | | | | | | | | | | | | | | | | | | | | | | | | | | | | | | | | | | | | | | | | | | | | | | | | | | | | | | | | | | | | | | | | | | | | | | | | | | | | | | | |
| | | | | | | | | | | | | | | | | | | | | | | | | | | | | | | | | | | | | | | | | | | | | | | | | | | | | | | | | | | | | | | | | | | | | | | | | | | | | | | | |
| Post - 2 Miss - 0 Block - 1 | Post - 0 Miss - 0 Block - 0 | Post - 0 Miss - 0 Block - 0 | Post - 1 Miss - 0 Block - 0 | Post - 0 Miss - 0 Block - 0 | Post - 0 Miss - 0 Block - 0 | | | | | | | | | | | | | | | | | | | | | | | | | | | | | | | | | | | | | | | | | | | | | | | | | | | | | | | | | | | | | | | | | | | | | | | | | | |

16 马佳鹏

| | | |
|-----|-----|-----|
| | 0/1 | 0/1 |
| 4/9 | 0/1 | 1/3 |
| 0/4 | 4/6 | 1/4 |

35 高云健

| | | |
|-----|-----|-----|
| 1/2 | | 0/1 |
| 0/5 | 1/1 | 2/3 |
| 2/7 | 2/2 | 1/2 |

| | | |
|--|--|--|
| | | |
| | | |
| | | |

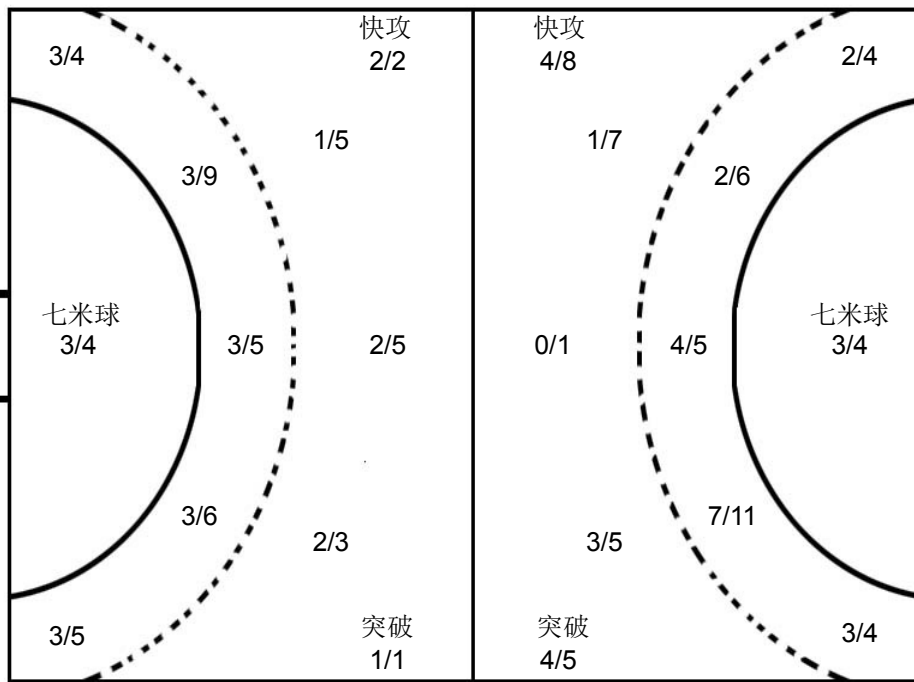

1 宋晓晨

| | | |
|------|-----|-----|
| 1/5 | 0/1 | 3/4 |
| 2/8 | 1/1 | 3/5 |
| 4/12 | 1/2 | 2/5 |

| | | |
|--|--|--|
| | | |
| | | |
| | | |

| | | |
|--|--|--|
| | | |
| | | |
| | | |

新疆队

| | | | | | | | | | | | | | | | | | | | | | | | | | | | | | | | | | | | | | | | | | | | | | | | | | | | | | | | | | | | | | | | | | | | | | | | | | | | | | | | |
|--|-----------------------------|-----------------------------|-----------------------------|-----------------------------|-----------------------------|-----------------------------|-----------------------------|--|--|--|--|--|---|--|---|---|--|--|--|--|--|--|--|--|--|--|--|--|--|---|--|---|---|---|--|---|--|--|--|--|--|--|--|--|--|--|--|--|--|--|---|--|---|---|---|--|---|--|---|---|--|--|---|---|--|--|---|--|--|--|--|--|--|--|--|--|--|--|--|
| 1 宋晓晨 | 2 王泽川 | 4 谷通金 | 5 徐伟 | 6 白光宇 | 7 林豪文 | 10 王钟彬 | 12 王金鑫 | | | | | | | | | | | | | | | | | | | | | | | | | | | | | | | | | | | | | | | | | | | | | | | | | | | | | | | | | | | | | | | | | | | | | | | | |
| <table border="1"><tr><td></td><td></td><td></td></tr><tr><td></td><td></td><td></td></tr><tr><td></td><td></td><td></td></tr></table> | | | | | | | | | | <table border="1"><tr><td></td><td></td><td>1</td></tr><tr><td></td><td></td><td></td></tr><tr><td></td><td></td><td></td></tr></table> | | | 1 | | | | | | | <table border="1"><tr><td></td><td></td><td></td></tr><tr><td></td><td></td><td></td></tr><tr><td></td><td></td><td></td></tr></table> | | | | | | | | | | <table border="1"><tr><td></td><td></td><td>1</td></tr><tr><td>1</td><td></td><td>1</td></tr><tr><td></td><td></td><td></td></tr></table> | | | 1 | 1 | | 1 | | | | <table border="1"><tr><td></td><td></td><td></td></tr><tr><td></td><td></td><td></td></tr><tr><td></td><td></td><td></td></tr></table> | | | | | | | | | | <table border="1"><tr><td>1</td><td></td><td></td></tr><tr><td>4</td><td>1</td><td></td></tr><tr><td>3</td><td></td><td></td></tr></table> | 1 | | | 4 | 1 | | 3 | | | <table border="1"><tr><td></td><td></td><td>1</td></tr><tr><td>3</td><td></td><td></td></tr><tr><td>2</td><td></td><td></td></tr></table> | | | 1 | 3 | | | 2 | | | <table border="1"><tr><td></td><td></td><td></td></tr><tr><td></td><td></td><td></td></tr><tr><td></td><td></td><td></td></tr></table> | | | | | | | | | |
| | | | | | | | | | | | | | | | | | | | | | | | | | | | | | | | | | | | | | | | | | | | | | | | | | | | | | | | | | | | | | | | | | | | | | | | | | | | | | | | |
| | | | | | | | | | | | | | | | | | | | | | | | | | | | | | | | | | | | | | | | | | | | | | | | | | | | | | | | | | | | | | | | | | | | | | | | | | | | | | | | |
| | | | | | | | | | | | | | | | | | | | | | | | | | | | | | | | | | | | | | | | | | | | | | | | | | | | | | | | | | | | | | | | | | | | | | | | | | | | | | | | |
| | | 1 | | | | | | | | | | | | | | | | | | | | | | | | | | | | | | | | | | | | | | | | | | | | | | | | | | | | | | | | | | | | | | | | | | | | | | | | | | | | | |
| | | | | | | | | | | | | | | | | | | | | | | | | | | | | | | | | | | | | | | | | | | | | | | | | | | | | | | | | | | | | | | | | | | | | | | | | | | | | | | | |
| | | | | | | | | | | | | | | | | | | | | | | | | | | | | | | | | | | | | | | | | | | | | | | | | | | | | | | | | | | | | | | | | | | | | | | | | | | | | | | | |
| | | | | | | | | | | | | | | | | | | | | | | | | | | | | | | | | | | | | | | | | | | | | | | | | | | | | | | | | | | | | | | | | | | | | | | | | | | | | | | | |
| | | | | | | | | | | | | | | | | | | | | | | | | | | | | | | | | | | | | | | | | | | | | | | | | | | | | | | | | | | | | | | | | | | | | | | | | | | | | | | | |
| | | | | | | | | | | | | | | | | | | | | | | | | | | | | | | | | | | | | | | | | | | | | | | | | | | | | | | | | | | | | | | | | | | | | | | | | | | | | | | | |
| | | 1 | | | | | | | | | | | | | | | | | | | | | | | | | | | | | | | | | | | | | | | | | | | | | | | | | | | | | | | | | | | | | | | | | | | | | | | | | | | | | |
| 1 | | 1 | | | | | | | | | | | | | | | | | | | | | | | | | | | | | | | | | | | | | | | | | | | | | | | | | | | | | | | | | | | | | | | | | | | | | | | | | | | | | |
| | | | | | | | | | | | | | | | | | | | | | | | | | | | | | | | | | | | | | | | | | | | | | | | | | | | | | | | | | | | | | | | | | | | | | | | | | | | | | | | |
| | | | | | | | | | | | | | | | | | | | | | | | | | | | | | | | | | | | | | | | | | | | | | | | | | | | | | | | | | | | | | | | | | | | | | | | | | | | | | | | |
| | | | | | | | | | | | | | | | | | | | | | | | | | | | | | | | | | | | | | | | | | | | | | | | | | | | | | | | | | | | | | | | | | | | | | | | | | | | | | | | |
| | | | | | | | | | | | | | | | | | | | | | | | | | | | | | | | | | | | | | | | | | | | | | | | | | | | | | | | | | | | | | | | | | | | | | | | | | | | | | | | |
| 1 | | | | | | | | | | | | | | | | | | | | | | | | | | | | | | | | | | | | | | | | | | | | | | | | | | | | | | | | | | | | | | | | | | | | | | | | | | | | | | | |
| 4 | 1 | | | | | | | | | | | | | | | | | | | | | | | | | | | | | | | | | | | | | | | | | | | | | | | | | | | | | | | | | | | | | | | | | | | | | | | | | | | | | | |
| 3 | | | | | | | | | | | | | | | | | | | | | | | | | | | | | | | | | | | | | | | | | | | | | | | | | | | | | | | | | | | | | | | | | | | | | | | | | | | | | | | |
| | | 1 | | | | | | | | | | | | | | | | | | | | | | | | | | | | | | | | | | | | | | | | | | | | | | | | | | | | | | | | | | | | | | | | | | | | | | | | | | | | | |
| 3 | | | | | | | | | | | | | | | | | | | | | | | | | | | | | | | | | | | | | | | | | | | | | | | | | | | | | | | | | | | | | | | | | | | | | | | | | | | | | | | |
| 2 | | | | | | | | | | | | | | | | | | | | | | | | | | | | | | | | | | | | | | | | | | | | | | | | | | | | | | | | | | | | | | | | | | | | | | | | | | | | | | | |
| | | | | | | | | | | | | | | | | | | | | | | | | | | | | | | | | | | | | | | | | | | | | | | | | | | | | | | | | | | | | | | | | | | | | | | | | | | | | | | | |
| | | | | | | | | | | | | | | | | | | | | | | | | | | | | | | | | | | | | | | | | | | | | | | | | | | | | | | | | | | | | | | | | | | | | | | | | | | | | | | | |
| | | | | | | | | | | | | | | | | | | | | | | | | | | | | | | | | | | | | | | | | | | | | | | | | | | | | | | | | | | | | | | | | | | | | | | | | | | | | | | | |
| Post - 0 Miss - 0 Block - 0 | Post - 0 Miss - 1 Block - 0 | Post - 0 Miss - 0 Block - 0 | Post - 0 Miss - 0 Block - 0 | Post - 0 Miss - 0 Block - 0 | Post - 0 Miss - 1 Block - 0 | Post - 1 Miss - 0 Block - 0 | Post - 0 Miss - 0 Block - 0 | | | | | | | | | | | | | | | | | | | | | | | | | | | | | | | | | | | | | | | | | | | | | | | | | | | | | | | | | | | | | | | | | | | | | | | | |
| 13 苏兴伟 | 15 王维东 | 16 李佳懿 | 17 胡晋铭 | 18 李万兴 | 19 李龙吉 | 24 陈伟华 | | | | | | | | | | | | | | | | | | | | | | | | | | | | | | | | | | | | | | | | | | | | | | | | | | | | | | | | | | | | | | | | | | | | | | | | | |
| <table border="1"><tr><td></td><td></td><td></td></tr><tr><td></td><td></td><td></td></tr><tr><td></td><td></td><td></td></tr></table> | | | | | | | | | | <table border="1"><tr><td></td><td></td><td></td></tr><tr><td></td><td>1</td><td>2</td></tr><tr><td></td><td></td><td></td></tr></table> | | | | | 1 | 2 | | | | <table border="1"><tr><td></td><td></td><td></td></tr><tr><td></td><td></td><td></td></tr><tr><td></td><td></td><td></td></tr></table> | | | | | | | | | | <table border="1"><tr><td></td><td>1</td><td></td></tr><tr><td>2</td><td></td><td>1</td></tr><tr><td></td><td></td><td></td></tr></table> | | 1 | | 2 | | 1 | | | | <table border="1"><tr><td></td><td></td><td></td></tr><tr><td></td><td></td><td></td></tr><tr><td></td><td></td><td></td></tr></table> | | | | | | | | | | <table border="1"><tr><td></td><td></td><td>1</td></tr><tr><td>1</td><td></td><td></td></tr><tr><td>3</td><td></td><td>1</td></tr></table> | | | 1 | 1 | | | 3 | | 1 | <table border="1"><tr><td></td><td></td><td></td></tr><tr><td></td><td></td><td></td></tr><tr><td></td><td></td><td></td></tr></table> | | | | | | | | | | <table border="1"><tr><td></td><td></td><td></td></tr><tr><td></td><td></td><td></td></tr><tr><td></td><td></td><td></td></tr></table> | | | | | | | | | |
| | | | | | | | | | | | | | | | | | | | | | | | | | | | | | | | | | | | | | | | | | | | | | | | | | | | | | | | | | | | | | | | | | | | | | | | | | | | | | | | |
| | | | | | | | | | | | | | | | | | | | | | | | | | | | | | | | | | | | | | | | | | | | | | | | | | | | | | | | | | | | | | | | | | | | | | | | | | | | | | | | |
| | | | | | | | | | | | | | | | | | | | | | | | | | | | | | | | | | | | | | | | | | | | | | | | | | | | | | | | | | | | | | | | | | | | | | | | | | | | | | | | |
| | | | | | | | | | | | | | | | | | | | | | | | | | | | | | | | | | | | | | | | | | | | | | | | | | | | | | | | | | | | | | | | | | | | | | | | | | | | | | | | |
| | 1 | 2 | | | | | | | | | | | | | | | | | | | | | | | | | | | | | | | | | | | | | | | | | | | | | | | | | | | | | | | | | | | | | | | | | | | | | | | | | | | | | |
| | | | | | | | | | | | | | | | | | | | | | | | | | | | | | | | | | | | | | | | | | | | | | | | | | | | | | | | | | | | | | | | | | | | | | | | | | | | | | | | |
| | | | | | | | | | | | | | | | | | | | | | | | | | | | | | | | | | | | | | | | | | | | | | | | | | | | | | | | | | | | | | | | | | | | | | | | | | | | | | | | |
| | | | | | | | | | | | | | | | | | | | | | | | | | | | | | | | | | | | | | | | | | | | | | | | | | | | | | | | | | | | | | | | | | | | | | | | | | | | | | | | |
| | | | | | | | | | | | | | | | | | | | | | | | | | | | | | | | | | | | | | | | | | | | | | | | | | | | | | | | | | | | | | | | | | | | | | | | | | | | | | | | |
| | 1 | | | | | | | | | | | | | | | | | | | | | | | | | | | | | | | | | | | | | | | | | | | | | | | | | | | | | | | | | | | | | | | | | | | | | | | | | | | | | | |
| 2 | | 1 | | | | | | | | | | | | | | | | | | | | | | | | | | | | | | | | | | | | | | | | | | | | | | | | | | | | | | | | | | | | | | | | | | | | | | | | | | | | | |
| | | | | | | | | | | | | | | | | | | | | | | | | | | | | | | | | | | | | | | | | | | | | | | | | | | | | | | | | | | | | | | | | | | | | | | | | | | | | | | | |
| | | | | | | | | | | | | | | | | | | | | | | | | | | | | | | | | | | | | | | | | | | | | | | | | | | | | | | | | | | | | | | | | | | | | | | | | | | | | | | | |
| | | | | | | | | | | | | | | | | | | | | | | | | | | | | | | | | | | | | | | | | | | | | | | | | | | | | | | | | | | | | | | | | | | | | | | | | | | | | | | | |
| | | | | | | | | | | | | | | | | | | | | | | | | | | | | | | | | | | | | | | | | | | | | | | | | | | | | | | | | | | | | | | | | | | | | | | | | | | | | | | | |
| | | 1 | | | | | | | | | | | | | | | | | | | | | | | | | | | | | | | | | | | | | | | | | | | | | | | | | | | | | | | | | | | | | | | | | | | | | | | | | | | | | |
| 1 | | | | | | | | | | | | | | | | | | | | | | | | | | | | | | | | | | | | | | | | | | | | | | | | | | | | | | | | | | | | | | | | | | | | | | | | | | | | | | | |
| 3 | | 1 | | | | | | | | | | | | | | | | | | | | | | | | | | | | | | | | | | | | | | | | | | | | | | | | | | | | | | | | | | | | | | | | | | | | | | | | | | | | | |
| | | | | | | | | | | | | | | | | | | | | | | | | | | | | | | | | | | | | | | | | | | | | | | | | | | | | | | | | | | | | | | | | | | | | | | | | | | | | | | | |
| | | | | | | | | | | | | | | | | | | | | | | | | | | | | | | | | | | | | | | | | | | | | | | | | | | | | | | | | | | | | | | | | | | | | | | | | | | | | | | | |
| | | | | | | | | | | | | | | | | | | | | | | | | | | | | | | | | | | | | | | | | | | | | | | | | | | | | | | | | | | | | | | | | | | | | | | | | | | | | | | | |
| | | | | | | | | | | | | | | | | | | | | | | | | | | | | | | | | | | | | | | | | | | | | | | | | | | | | | | | | | | | | | | | | | | | | | | | | | | | | | | | |
| | | | | | | | | | | | | | | | | | | | | | | | | | | | | | | | | | | | | | | | | | | | | | | | | | | | | | | | | | | | | | | | | | | | | | | | | | | | | | | | |
| | | | | | | | | | | | | | | | | | | | | | | | | | | | | | | | | | | | | | | | | | | | | | | | | | | | | | | | | | | | | | | | | | | | | | | | | | | | | | | | |
| Post - 0 Miss - 1 Block - 0 | Post - 0 Miss - 0 Block - 0 | Post - 0 Miss - 0 Block - 0 | Post - 0 Miss - 0 Block - 0 | Post - 0 Miss - 0 Block - 0 | Post - 3 Miss - 0 Block - 0 | Post - 0 Miss - 1 Block - 0 | | | | | | | | | | | | | | | | | | | | | | | | | | | | | | | | | | | | | | | | | | | | | | | | | | | | | | | | | | | | | | | | | | | | | | | | | |

注释: Post=击柱 Miss=射失 Block=被封



预赛 Group B
青年男子 全国比赛

2016年“体彩杯”全国手球男子青年锦标赛

| | | | | | | | | | | | | | | | | | | | | | |
|------------------------|---|---------------------|---------------------|------------------------|------------------------------------|-------------------|----------|---------------------------|----------------|----------|----------|----------------------|---------------|----------|--|--|---|---|----|----------|----|
| Team A A 辽宁队 | | | | Team B B 北京队 | | | | Match Number 19 | | | | | | | | | | | | | |
| played in China | | in the hall 重庆万州 | | on 24/03/2016 | | at 08:30 hours | | Spectators | | | | | | | | | | | | | |
| Half-time (30') | A 11 | B 18 | End of playing time | A 29 | B 33 | 1st extra time | A | B | 2nd extra time | A | B | After penalty throws | A | B | | | | | | | |
| Number of 7 m | A 3 / 4 | Team time-out | | | Full name of players and officials | | | | Team time-out | | | B 1 / 1 | Number of 7 m | | | | | | | | |
| | | 1 | 2 | 3 | | | | | 1 | 2 | 3 | | | | | | | | | | |
| | | 19:28 | 48:13 | | | | | | 39:46 | 53:02 | | | | | | | | | | | |
| No. | Team A | | | | | G | W | 2' | D | DR | No. | Team B | | | | | G | W | 2' | D | DR |
| 1 | 高尚君 | | | | | | | | | | 3 | 王哲一 | | | | | | | | | |
| 2 | 王司雨 | | | | | 1 | | | | | 4 | 朱广刚 | | | | | 7 | | | 1 | |
| 3 | 李星浩 | | | | | 1 | 1 | | | | 6 | 赵一涵 | | | | | 5 | 1 | | | |
| 5 | 余昊锦 | | | | | | | | | | 7 | 卞友山 | | | | | 2 | | | | |
| 6 | 陈庆港 | | | | | 5 | | | | | 11 | 李旭 | | | | | 1 | 1 | | 2 | |
| 7 | 孙义广 | | | | | 4 | | | | | 15 | 逯明松 | | | | | 1 | | | 1 | |
| 8 | 王鑫鹏 | | | | | | | | | | 16 | 马佳鹏 | | | | | | | | | |
| 10 | 王柏淇 | | | | | 11 | | | | | 18 | 李明远 | | | | | | | | | |
| 11 | 庞东阳 | | | | | 6 | | | | | 19 | 陈旭 | | | | | 5 | | | | |
| 13 | 杨洁 | | | | | 1 | 1 | 1 | | | 23 | 刘帅 | | | | | | | | | |
| 14 | 吕昊臻 | | | | | | | | | | 25 | 张斌 | | | | | | | | | |
| 16 | 吴阳 | | | | | | | | | | 26 | 吴锐樊 | | | | | 8 | 1 | | | |
| 17 | 李傲 | | | | | | | | | | 35 | 高云健 | | | | | | | | | |
| 18 | 梅凯博 | | | | | | | | | | 36 | 王鹏皓 | | | | | 4 | | | 1 | |
| 19 | 赵鑫 | | | | | | | | | | | | | | | | | | | | |
| 20 | 赵佛赐 | | | | | | | | | | | | | | | | | | | | |
| B | 赵影 (主教练) | | | | | | | | | | B | 吴健 (主教练) | | | | | | | | | |
| C | 刘启迪 | | | | | | | | | | C | 宋刚 | | | | | | | | | |
| | | | | | | | | | | | D | 陈璇 | | | | | | | | | |
| A | Signature of Responsible Official of the Teams (Off. A) | | | | | | | | | | | | | | | | | | | B | |
| TP | Remarks of Referee / CHA Official | | | | | | | | | | | | | | | | | | | TP | |

Signatures

| | | | | |
|------------------|-----------|----------|--|--|
| Referees | 倪震 (CHN) | 严璐 (CHN) | | |
| Techn. Delegates | 徐健 (CHN) | | | |
| CHA Official | 张春生 (CHN) | | | |

Note: Number of 7m Throws Awarded to Team A and B, Goals (G), Warnings (W), Suspensions (2'), Direct Disqualification (D), Disqualification with Report (DR) and Team Penalty (TP).

Table Officials:

Statisticians: 李双

刘永欢





2016年“体彩杯”全国手球男子青年锦标赛
竞赛技术统计(媒体表)

预赛 组别 B 轮次 4 场次 19

重庆万州

24/03/2016

201602019-51-1/1

辽宁队 辽宁 29 vs 33 北京队 北京队 11:18

裁判员 倪震 (CHN) / 严璐 (CHN)

Main statistics table for Liaoning and Beijing teams, including player names, positions, and performance metrics like goals, assists, and suspensions.

场上队员: 得分 / 射门

守门员: 救球 / 射门

Legend table for abbreviations: 快攻 (Fast Break), 突破 (Breakthrough), 任意球 (Free Throw), 7M球 (7M Throw), 助攻 (Assist), 警告 (Warning), 失误 (Error), 2' (Suspension), D (取消资格 - Disqualification), DR (取消资格+报告 - Disqualification+Report)





2016年“体彩杯”全国手球男子青年锦标赛 图式比赛技术统计表

轮次 4

场次 19

201602019-21-1/1

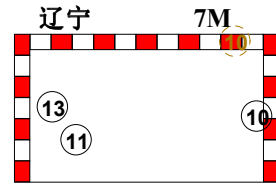
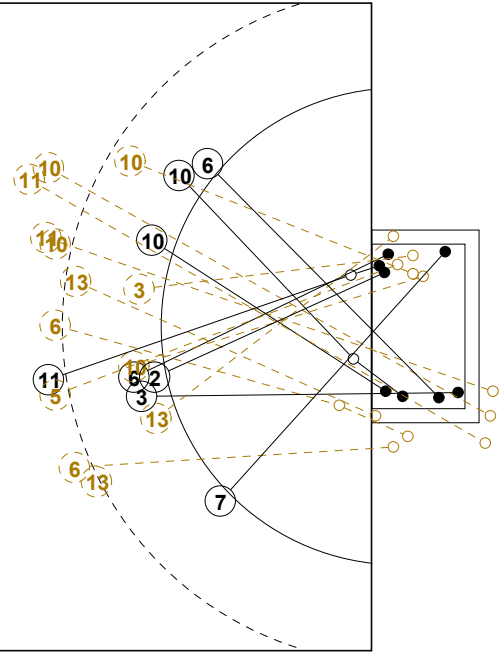
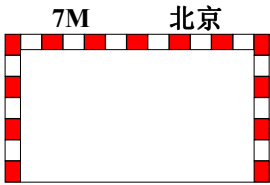
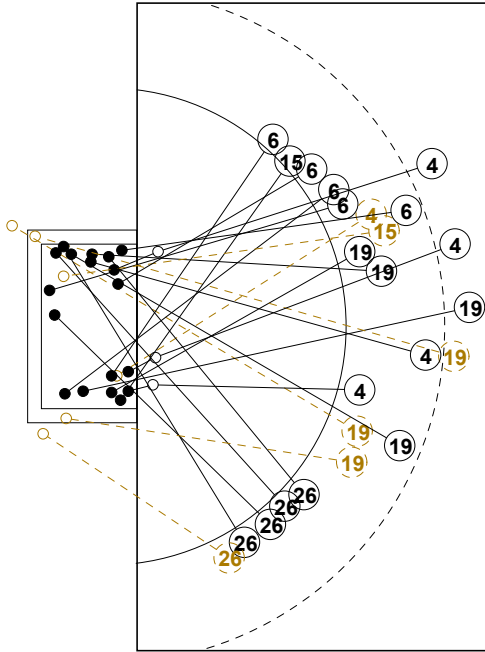

1st Half
18 : 11

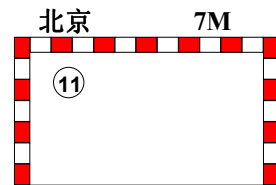
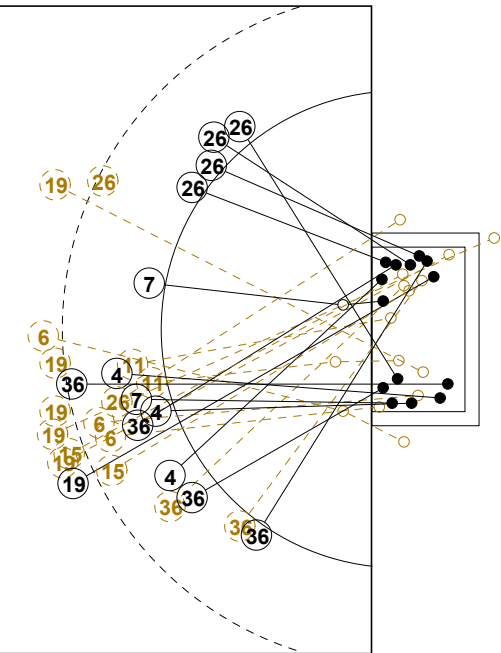
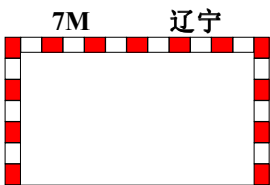
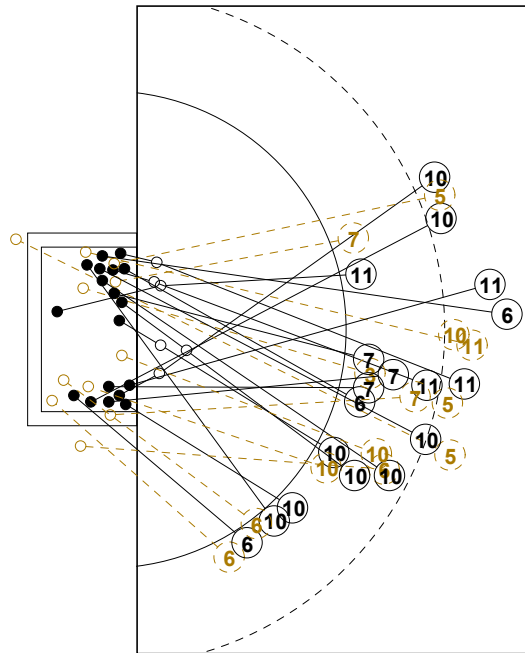

2nd Half
29 : 33



2016年“体彩杯”全国手球男子青年锦标赛

个人/全队技术统计表

正式表
手球
青年男子预赛
轮次 4组别 B
场次 19201602019-14-1/2
重庆万州
24/03/2016 08:30

| 号码 | 姓名 | 远射 | 近射 | 边射 | 快攻 | 突破 | 任意 | 7M | 合计 | % | 助攻 | 失误 | 警告 | 2' | 取消 | 时间 |
|----------------|-----|------|------|-----|-----|-----|-----|-----|-------|-------|----|----|----|----|----|----------|
| 辽宁队(辽宁) | | | | | | | | | | | | | | | | |
| <i>(场上队员)</i> | | | | | | | | | | | | | | | | |
| 1 | 高尚君 | | | | | | | | | 0.0% | | | | | | 01:00:00 |
| 2 | 王司雨 | | 1/1 | | | | | | 1/1 | 100% | 1 | 2 | | | | 00:24:30 |
| 3 | 李星浩 | | 1/3 | | | | | | 1/3 | 33.3% | 1 | | 1 | | | 00:35:29 |
| 5 | 余昊锦 | 0/4 | | | | | | | 0/4 | 0.0% | | 4 | | | | 00:40:59 |
| 6 | 陈庆港 | 1/4 | | 1/3 | 2/2 | 1/1 | | | 5/10 | 50.0% | | 3 | | | | 01:00:00 |
| 7 | 孙义广 | | 3/3 | | 1/3 | | | | 4/6 | 66.7% | | 1 | | | | 01:00:00 |
| 8 | 王鑫鹏 | | | | | | | | | 0.0% | | | | | | 00:08:31 |
| 10 | 王柏淇 | 3/7 | 1/2 | | | 6/8 | | 1/2 | 11/19 | 57.9% | 5 | 8 | | | | 00:46:56 |
| 11 | 庞东阳 | 4/7 | | | 1/1 | | | 1/1 | 6/9 | 66.7% | 3 | 8 | | | | 00:51:46 |
| 13 | 杨洁 | 0/2 | 0/1 | | | | | 1/1 | 1/4 | 25.0% | | 2 | 1 | 1 | | 00:31:36 |
| 14 | 吕昊臻 | | | | | | | | | 0.0% | | | | | | 00:00:00 |
| 16 | 吴阳 | | | | | | | | | 0.0% | | | | | | 00:00:00 |
| 17 | 李傲 | | | | | | | | | 0.0% | | | | | | 00:00:00 |
| 18 | 梅凯博 | | | | | | | | | 0.0% | | | | | | 00:00:00 |
| 19 | 赵鑫 | | | | | | | | | 0.0% | | | | | | 00:00:00 |
| 20 | 赵佛赐 | | | | | | | | | 0.0% | | | | | | 00:00:00 |
| 合计 | | 8/24 | 6/10 | 1/3 | 4/6 | 7/9 | | 3/4 | 29/56 | 51.8% | 10 | 28 | 2 | 1 | | |
| <i>(守门员)</i> | | | | | | | | | | | | | | | | |
| 1 | 高尚君 | 5/11 | 4/12 | 1/6 | 1/8 | 1/6 | 0/1 | 0/1 | 12/45 | 26.7% | | | | | | 01:00:00 |
| 合计 | | 5/11 | 4/12 | 1/6 | 1/8 | 1/6 | 0/1 | 0/1 | 12/45 | 26.7% | | | | | | |

场上队员：得分/射门

守门员：救球/射门

| 全队合计 | 得分 | 被救 | 射失 | 击柱 | 封球 | 合计 | % |
|------|----|----|----|----|----|----|-------|
| 远射 | 8 | 4 | 7 | 1 | 4 | 24 | 33.3% |
| 近射 | 6 | 3 | | 1 | | 10 | 60.0% |
| 边射 | 1 | 2 | | | | 3 | 33.3% |
| 快攻 | 4 | 1 | | 1 | | 6 | 66.7% |
| 突破 | 7 | 2 | | | | 9 | 77.8% |
| 任意 | | | | | | | 0.0% |
| 7M | 3 | | | 1 | | 4 | 75.0% |





2016年“体彩杯”全国手球男子青年锦标赛

个人/全队技术统计表

正式表
手球
青年男子预赛
轮次 4组别 B
场次 19201602019-14-2/2
重庆万州
24/03/2016 08:30

| 号码 | 姓名 | 远射 | 近射 | 边射 | 快攻 | 突破 | 任意 | 7M | 合计 | % | 助攻 | 失误 | 警告 | 2' | 取消 | 时间 |
|----------------|-----|------|------|-----|-----|-----|-----|-----|-------|-------|----|----|----|----|----|----------|
| 北京队(北京) | | | | | | | | | | | | | | | | |
| <i>(上场队员)</i> | | | | | | | | | | | | | | | | |
| 3 | 王哲一 | | | | | | | | | 0.0% | 1 | 2 | | | | 00:04:24 |
| 4 | 朱广刚 | 2/2 | 1/2 | | 2/2 | 1/1 | 1/1 | | 7/8 | 87.5% | 1 | 2 | | 1 | | 01:00:00 |
| 6 | 赵一涵 | 1/3 | 1/1 | 1/1 | 1/1 | 1/2 | | | 5/8 | 62.5% | 1 | 3 | 1 | | | 00:42:55 |
| 7 | 卞友山 | | 2/2 | | | | | | 2/2 | 100% | | | | | | 00:13:22 |
| 11 | 李旭 | | 0/2 | | | | | 1/1 | 1/3 | 33.3% | | 1 | 1 | 2 | | 00:47:41 |
| 15 | 逯明松 | 0/2 | 1/1 | | 0/1 | | | | 1/4 | 25.0% | | 2 | | 1 | | 01:00:00 |
| 16 | 马佳鹏 | | | | | | | | | 0.0% | | | | | | 00:37:50 |
| 18 | 李明远 | | | | | | | | | 0.0% | | | | | | 00:00:00 |
| 19 | 陈旭 | 3/9 | 0/2 | | 1/1 | 1/1 | | | 5/13 | 38.5% | 4 | 11 | | | | 00:58:55 |
| 23 | 刘帅 | | | | | | | | | 0.0% | | | | | | 00:00:00 |
| 25 | 张斌 | | | | | | | | | 0.0% | | | | | | 00:00:00 |
| 26 | 吴锐樊 | 0/1 | 3/4 | 3/4 | 1/1 | 1/1 | | | 8/11 | 72.7% | 2 | 1 | 1 | | | 00:55:36 |
| 35 | 高云健 | | | | | | | | | 0.0% | | 1 | | | | 00:22:10 |
| 36 | 王鹏皓 | | 0/1 | 1/2 | 2/2 | 1/1 | | | 4/6 | 66.7% | 1 | 3 | | 1 | | 00:17:04 |
| 合计 | | 6/17 | 8/15 | 5/7 | 7/8 | 5/6 | 1/1 | 1/1 | 33/55 | 60.0% | 10 | 26 | 3 | 5 | | |
| <i>(守门员)</i> | | | | | | | | | | | | | | | | |
| 16 | 马佳鹏 | 3/7 | 1/6 | 1/1 | 0/2 | 2/7 | | 0/2 | 7/25 | 28.0% | | | | | | 00:37:50 |
| 35 | 高云健 | 1/5 | 2/3 | 1/2 | 1/3 | 0/2 | | 0/1 | 5/16 | 31.3% | | 1 | | | | 00:22:10 |
| 合计 | | 4/12 | 3/9 | 2/3 | 1/5 | 2/9 | | 0/3 | 12/41 | 29.3% | | 1 | | | | |

场上队员：得分/射门

守门员：救球/射门

| 全队合计 | 得分 | 被救 | 射失 | 击柱 | 封球 | 合计 | % |
|------|----|----|----|----|----|----|--------|
| 远射 | 6 | 5 | 2 | 1 | 3 | 17 | 35.3% |
| 近射 | 8 | 4 | 2 | 1 | | 15 | 53.3% |
| 边射 | 5 | 1 | 1 | | | 7 | 71.4% |
| 快攻 | 7 | 1 | | | | 8 | 87.5% |
| 突破 | 5 | 1 | | | | 6 | 83.3% |
| 任意 | 1 | | | | | 1 | 100.0% |
| 7M | 1 | | | | | 1 | 100.0% |





2016年“体彩杯”全国手球男子青年锦标赛

图式射门区域统计

轮次 4 场次 19

201602019-41-1/1

辽宁队

| | | | | | | | | | | | | | | | | | | | | | | | | | | | | | | | | | | | | | | | | | | | | | | | | | | | | | | | | | | | | | | | | | | | | | | | | | | | | | | | |
|--|-----------------------------|-----------------------------|-----------------------------|-----------------------------|-----------------------------|-----------------------------|-----------------------------|--|---|---|--|--|--|---|--|--|--|--|--|---|--|--|---|--|--|--|--|--|--|--|--|--|--|--|--|--|--|--|--|---|---|--|---|--|--|---|---|--|---|---|---|--|--|--|--|--|---|--|---|--|--|--|--|--|--|--|--|--|--|---|--|--|--|---|--|---|---|---|---|
| 1 高尚君 | 2 王可雨 | 3 李星浩 | 5 余昊锦 | 6 陈庆港 | 7 孙义广 | 8 王鑫鹏 | 10 王柏淇 | | | | | | | | | | | | | | | | | | | | | | | | | | | | | | | | | | | | | | | | | | | | | | | | | | | | | | | | | | | | | | | | | | | | | | | | |
| <table border="1"><tr><td></td><td></td><td></td></tr><tr><td></td><td></td><td></td></tr><tr><td></td><td></td><td></td></tr></table> | | | | | | | | | | <table border="1"><tr><td></td><td></td><td></td></tr><tr><td>1</td><td></td><td></td></tr><tr><td></td><td></td><td></td></tr></table> | | | | 1 | | | | | | <table border="1"><tr><td></td><td></td><td>1</td></tr><tr><td></td><td></td><td></td></tr><tr><td></td><td></td><td></td></tr></table> | | | 1 | | | | | | | <table border="1"><tr><td></td><td></td><td></td></tr><tr><td></td><td></td><td></td></tr><tr><td></td><td></td><td></td></tr></table> | | | | | | | | | | <table border="1"><tr><td>1</td><td></td><td>1</td></tr><tr><td></td><td></td><td>1</td></tr><tr><td>1</td><td></td><td>1</td></tr></table> | 1 | | 1 | | | 1 | 1 | | 1 | <table border="1"><tr><td>1</td><td></td><td></td></tr><tr><td></td><td></td><td></td></tr><tr><td>2</td><td></td><td>1</td></tr></table> | 1 | | | | | | 2 | | 1 | <table border="1"><tr><td></td><td></td><td></td></tr><tr><td></td><td></td><td></td></tr><tr><td></td><td></td><td></td></tr></table> | | | | | | | | | | <table border="1"><tr><td></td><td></td><td></td></tr><tr><td>1</td><td></td><td>5</td></tr><tr><td>2</td><td>2</td><td>1</td></tr></table> | | | | 1 | | 5 | 2 | 2 | 1 |
| | | | | | | | | | | | | | | | | | | | | | | | | | | | | | | | | | | | | | | | | | | | | | | | | | | | | | | | | | | | | | | | | | | | | | | | | | | | | | | | |
| | | | | | | | | | | | | | | | | | | | | | | | | | | | | | | | | | | | | | | | | | | | | | | | | | | | | | | | | | | | | | | | | | | | | | | | | | | | | | | | |
| | | | | | | | | | | | | | | | | | | | | | | | | | | | | | | | | | | | | | | | | | | | | | | | | | | | | | | | | | | | | | | | | | | | | | | | | | | | | | | | |
| | | | | | | | | | | | | | | | | | | | | | | | | | | | | | | | | | | | | | | | | | | | | | | | | | | | | | | | | | | | | | | | | | | | | | | | | | | | | | | | |
| 1 | | | | | | | | | | | | | | | | | | | | | | | | | | | | | | | | | | | | | | | | | | | | | | | | | | | | | | | | | | | | | | | | | | | | | | | | | | | | | | | |
| | | | | | | | | | | | | | | | | | | | | | | | | | | | | | | | | | | | | | | | | | | | | | | | | | | | | | | | | | | | | | | | | | | | | | | | | | | | | | | | |
| | | 1 | | | | | | | | | | | | | | | | | | | | | | | | | | | | | | | | | | | | | | | | | | | | | | | | | | | | | | | | | | | | | | | | | | | | | | | | | | | | | |
| | | | | | | | | | | | | | | | | | | | | | | | | | | | | | | | | | | | | | | | | | | | | | | | | | | | | | | | | | | | | | | | | | | | | | | | | | | | | | | | |
| | | | | | | | | | | | | | | | | | | | | | | | | | | | | | | | | | | | | | | | | | | | | | | | | | | | | | | | | | | | | | | | | | | | | | | | | | | | | | | | |
| | | | | | | | | | | | | | | | | | | | | | | | | | | | | | | | | | | | | | | | | | | | | | | | | | | | | | | | | | | | | | | | | | | | | | | | | | | | | | | | |
| | | | | | | | | | | | | | | | | | | | | | | | | | | | | | | | | | | | | | | | | | | | | | | | | | | | | | | | | | | | | | | | | | | | | | | | | | | | | | | | |
| | | | | | | | | | | | | | | | | | | | | | | | | | | | | | | | | | | | | | | | | | | | | | | | | | | | | | | | | | | | | | | | | | | | | | | | | | | | | | | | |
| 1 | | 1 | | | | | | | | | | | | | | | | | | | | | | | | | | | | | | | | | | | | | | | | | | | | | | | | | | | | | | | | | | | | | | | | | | | | | | | | | | | | | |
| | | 1 | | | | | | | | | | | | | | | | | | | | | | | | | | | | | | | | | | | | | | | | | | | | | | | | | | | | | | | | | | | | | | | | | | | | | | | | | | | | | |
| 1 | | 1 | | | | | | | | | | | | | | | | | | | | | | | | | | | | | | | | | | | | | | | | | | | | | | | | | | | | | | | | | | | | | | | | | | | | | | | | | | | | | |
| 1 | | | | | | | | | | | | | | | | | | | | | | | | | | | | | | | | | | | | | | | | | | | | | | | | | | | | | | | | | | | | | | | | | | | | | | | | | | | | | | | |
| | | | | | | | | | | | | | | | | | | | | | | | | | | | | | | | | | | | | | | | | | | | | | | | | | | | | | | | | | | | | | | | | | | | | | | | | | | | | | | | |
| 2 | | 1 | | | | | | | | | | | | | | | | | | | | | | | | | | | | | | | | | | | | | | | | | | | | | | | | | | | | | | | | | | | | | | | | | | | | | | | | | | | | | |
| | | | | | | | | | | | | | | | | | | | | | | | | | | | | | | | | | | | | | | | | | | | | | | | | | | | | | | | | | | | | | | | | | | | | | | | | | | | | | | | |
| | | | | | | | | | | | | | | | | | | | | | | | | | | | | | | | | | | | | | | | | | | | | | | | | | | | | | | | | | | | | | | | | | | | | | | | | | | | | | | | |
| | | | | | | | | | | | | | | | | | | | | | | | | | | | | | | | | | | | | | | | | | | | | | | | | | | | | | | | | | | | | | | | | | | | | | | | | | | | | | | | |
| | | | | | | | | | | | | | | | | | | | | | | | | | | | | | | | | | | | | | | | | | | | | | | | | | | | | | | | | | | | | | | | | | | | | | | | | | | | | | | | |
| 1 | | 5 | | | | | | | | | | | | | | | | | | | | | | | | | | | | | | | | | | | | | | | | | | | | | | | | | | | | | | | | | | | | | | | | | | | | | | | | | | | | | |
| 2 | 2 | 1 | | | | | | | | | | | | | | | | | | | | | | | | | | | | | | | | | | | | | | | | | | | | | | | | | | | | | | | | | | | | | | | | | | | | | | | | | | | | | |
| Post - 0 Miss - 0 Block - 0 | Post - 0 Miss - 0 Block - 0 | Post - 0 Miss - 0 Block - 0 | Post - 0 Miss - 1 Block - 1 | Post - 0 Miss - 3 Block - 0 | Post - 1 Miss - 0 Block - 0 | Post - 0 Miss - 0 Block - 0 | Post - 1 Miss - 1 Block - 2 | | | | | | | | | | | | | | | | | | | | | | | | | | | | | | | | | | | | | | | | | | | | | | | | | | | | | | | | | | | | | | | | | | | | | | | | |
| 11 庞东阳 | 13 杨洁 | 14 吕昊臻 | 16 吴阳 | 17 李傲 | 18 梅凯博 | 19 赵鑫 | 20 赵佛赐 | | | | | | | | | | | | | | | | | | | | | | | | | | | | | | | | | | | | | | | | | | | | | | | | | | | | | | | | | | | | | | | | | | | | | | | | |
| <table border="1"><tr><td></td><td>1</td><td></td></tr><tr><td>1</td><td></td><td></td></tr><tr><td>2</td><td></td><td>2</td></tr></table> | | 1 | | 1 | | | 2 | | 2 | <table border="1"><tr><td></td><td></td><td></td></tr><tr><td>1</td><td></td><td></td></tr><tr><td></td><td></td><td></td></tr></table> | | | | 1 | | | | | | <table border="1"><tr><td></td><td></td><td></td></tr><tr><td></td><td></td><td></td></tr><tr><td></td><td></td><td></td></tr></table> | | | | | | | | | | <table border="1"><tr><td></td><td></td><td></td></tr><tr><td></td><td></td><td></td></tr><tr><td></td><td></td><td></td></tr></table> | | | | | | | | | | <table border="1"><tr><td></td><td></td><td></td></tr><tr><td></td><td></td><td></td></tr><tr><td></td><td></td><td></td></tr></table> | | | | | | | | | | <table border="1"><tr><td></td><td></td><td></td></tr><tr><td></td><td></td><td></td></tr><tr><td></td><td></td><td></td></tr></table> | | | | | | | | | | <table border="1"><tr><td></td><td></td><td></td></tr><tr><td></td><td></td><td></td></tr><tr><td></td><td></td><td></td></tr></table> | | | | | | | | | | <table border="1"><tr><td></td><td></td><td></td></tr><tr><td></td><td></td><td></td></tr><tr><td></td><td></td><td></td></tr></table> | | | | | | | | | |
| | 1 | | | | | | | | | | | | | | | | | | | | | | | | | | | | | | | | | | | | | | | | | | | | | | | | | | | | | | | | | | | | | | | | | | | | | | | | | | | | | | |
| 1 | | | | | | | | | | | | | | | | | | | | | | | | | | | | | | | | | | | | | | | | | | | | | | | | | | | | | | | | | | | | | | | | | | | | | | | | | | | | | | | |
| 2 | | 2 | | | | | | | | | | | | | | | | | | | | | | | | | | | | | | | | | | | | | | | | | | | | | | | | | | | | | | | | | | | | | | | | | | | | | | | | | | | | | |
| | | | | | | | | | | | | | | | | | | | | | | | | | | | | | | | | | | | | | | | | | | | | | | | | | | | | | | | | | | | | | | | | | | | | | | | | | | | | | | | |
| 1 | | | | | | | | | | | | | | | | | | | | | | | | | | | | | | | | | | | | | | | | | | | | | | | | | | | | | | | | | | | | | | | | | | | | | | | | | | | | | | | |
| | | | | | | | | | | | | | | | | | | | | | | | | | | | | | | | | | | | | | | | | | | | | | | | | | | | | | | | | | | | | | | | | | | | | | | | | | | | | | | | |
| | | | | | | | | | | | | | | | | | | | | | | | | | | | | | | | | | | | | | | | | | | | | | | | | | | | | | | | | | | | | | | | | | | | | | | | | | | | | | | | |
| | | | | | | | | | | | | | | | | | | | | | | | | | | | | | | | | | | | | | | | | | | | | | | | | | | | | | | | | | | | | | | | | | | | | | | | | | | | | | | | |
| | | | | | | | | | | | | | | | | | | | | | | | | | | | | | | | | | | | | | | | | | | | | | | | | | | | | | | | | | | | | | | | | | | | | | | | | | | | | | | | |
| | | | | | | | | | | | | | | | | | | | | | | | | | | | | | | | | | | | | | | | | | | | | | | | | | | | | | | | | | | | | | | | | | | | | | | | | | | | | | | | |
| | | | | | | | | | | | | | | | | | | | | | | | | | | | | | | | | | | | | | | | | | | | | | | | | | | | | | | | | | | | | | | | | | | | | | | | | | | | | | | | |
| | | | | | | | | | | | | | | | | | | | | | | | | | | | | | | | | | | | | | | | | | | | | | | | | | | | | | | | | | | | | | | | | | | | | | | | | | | | | | | | |
| | | | | | | | | | | | | | | | | | | | | | | | | | | | | | | | | | | | | | | | | | | | | | | | | | | | | | | | | | | | | | | | | | | | | | | | | | | | | | | | |
| | | | | | | | | | | | | | | | | | | | | | | | | | | | | | | | | | | | | | | | | | | | | | | | | | | | | | | | | | | | | | | | | | | | | | | | | | | | | | | | |
| | | | | | | | | | | | | | | | | | | | | | | | | | | | | | | | | | | | | | | | | | | | | | | | | | | | | | | | | | | | | | | | | | | | | | | | | | | | | | | | |
| | | | | | | | | | | | | | | | | | | | | | | | | | | | | | | | | | | | | | | | | | | | | | | | | | | | | | | | | | | | | | | | | | | | | | | | | | | | | | | | |
| | | | | | | | | | | | | | | | | | | | | | | | | | | | | | | | | | | | | | | | | | | | | | | | | | | | | | | | | | | | | | | | | | | | | | | | | | | | | | | | |
| | | | | | | | | | | | | | | | | | | | | | | | | | | | | | | | | | | | | | | | | | | | | | | | | | | | | | | | | | | | | | | | | | | | | | | | | | | | | | | | |
| | | | | | | | | | | | | | | | | | | | | | | | | | | | | | | | | | | | | | | | | | | | | | | | | | | | | | | | | | | | | | | | | | | | | | | | | | | | | | | | |
| | | | | | | | | | | | | | | | | | | | | | | | | | | | | | | | | | | | | | | | | | | | | | | | | | | | | | | | | | | | | | | | | | | | | | | | | | | | | | | | |
| | | | | | | | | | | | | | | | | | | | | | | | | | | | | | | | | | | | | | | | | | | | | | | | | | | | | | | | | | | | | | | | | | | | | | | | | | | | | | | | |
| | | | | | | | | | | | | | | | | | | | | | | | | | | | | | | | | | | | | | | | | | | | | | | | | | | | | | | | | | | | | | | | | | | | | | | | | | | | | | | | |
| | | | | | | | | | | | | | | | | | | | | | | | | | | | | | | | | | | | | | | | | | | | | | | | | | | | | | | | | | | | | | | | | | | | | | | | | | | | | | | | |
| | | | | | | | | | | | | | | | | | | | | | | | | | | | | | | | | | | | | | | | | | | | | | | | | | | | | | | | | | | | | | | | | | | | | | | | | | | | | | | | |
| Post - 0 Miss - 2 Block - 0 | Post - 2 Miss - 0 Block - 1 | Post - 0 Miss - 0 Block - 0 | Post - 0 Miss - 0 Block - 0 | Post - 0 Miss - 0 Block - 0 | Post - 0 Miss - 0 Block - 0 | Post - 0 Miss - 0 Block - 0 | Post - 0 Miss - 0 Block - 0 | | | | | | | | | | | | | | | | | | | | | | | | | | | | | | | | | | | | | | | | | | | | | | | | | | | | | | | | | | | | | | | | | | | | | | | | |

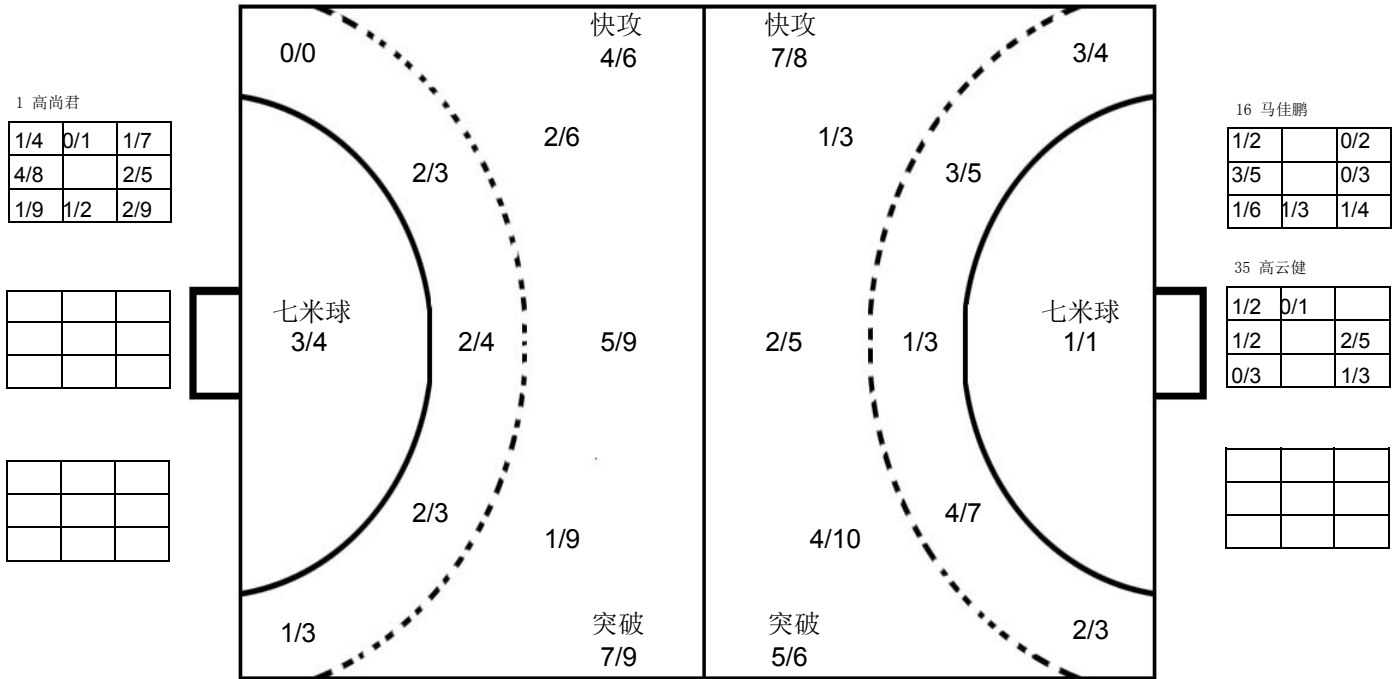

北京队

| | | | | | | | | | | | | | | | | | | | | | | | | | | | | | | | | | | | | | | | | | | | | | | | | | | | | | | | | | | | | | | | | | | | | | | | | | | | | | | | |
|---|-----------------------------|-----------------------------|-----------------------------|-----------------------------|-----------------------------|-----------------------------|-----------------------------|--|--|--|--|--|---|--|--|---|---|--|---|--|---|--|---|--|--|--|---|--|---|---|--|---|---|---|--|--|---|--|---|---|---|--|--|--|--|--|--|--|--|--|--|--|---|---|--|--|---|--|---|--|--|--|--|--|--|--|--|--|--|--|--|--|--|--|--|--|--|--|--|
| 3 王哲一 | 4 朱广刚 | 6 赵一涵 | 7 卞友山 | 11 李旭 | 15 逯明松 | 16 马佳鹏 | 18 李明远 | | | | | | | | | | | | | | | | | | | | | | | | | | | | | | | | | | | | | | | | | | | | | | | | | | | | | | | | | | | | | | | | | | | | | | | | |
| <table border="1"><tr><td></td><td></td><td></td></tr><tr><td></td><td></td><td></td></tr><tr><td></td><td></td><td></td></tr></table> | | | | | | | | | | <table border="1"><tr><td></td><td></td><td>1</td></tr><tr><td></td><td></td><td>2</td></tr><tr><td>3</td><td></td><td>1</td></tr></table> | | | 1 | | | 2 | 3 | | 1 | <table border="1"><tr><td>1</td><td></td><td>1</td></tr><tr><td></td><td></td><td></td></tr><tr><td>1</td><td></td><td>2</td></tr></table> | 1 | | 1 | | | | 1 | | 2 | <table border="1"><tr><td></td><td></td><td></td></tr><tr><td></td><td></td><td></td></tr><tr><td>1</td><td></td><td>1</td></tr></table> | | | | | | | 1 | | 1 | <table border="1"><tr><td>1</td><td></td><td></td></tr><tr><td></td><td></td><td></td></tr><tr><td></td><td></td><td></td></tr></table> | 1 | | | | | | | | | <table border="1"><tr><td></td><td></td><td></td></tr><tr><td></td><td></td><td></td></tr><tr><td>1</td><td></td><td></td></tr></table> | | | | | | | 1 | | | <table border="1"><tr><td></td><td></td><td></td></tr><tr><td></td><td></td><td></td></tr><tr><td></td><td></td><td></td></tr></table> | | | | | | | | | | <table border="1"><tr><td></td><td></td><td></td></tr><tr><td></td><td></td><td></td></tr><tr><td></td><td></td><td></td></tr></table> | | | | | | | | | |
| | | | | | | | | | | | | | | | | | | | | | | | | | | | | | | | | | | | | | | | | | | | | | | | | | | | | | | | | | | | | | | | | | | | | | | | | | | | | | | | |
| | | | | | | | | | | | | | | | | | | | | | | | | | | | | | | | | | | | | | | | | | | | | | | | | | | | | | | | | | | | | | | | | | | | | | | | | | | | | | | | |
| | | | | | | | | | | | | | | | | | | | | | | | | | | | | | | | | | | | | | | | | | | | | | | | | | | | | | | | | | | | | | | | | | | | | | | | | | | | | | | | |
| | | 1 | | | | | | | | | | | | | | | | | | | | | | | | | | | | | | | | | | | | | | | | | | | | | | | | | | | | | | | | | | | | | | | | | | | | | | | | | | | | | |
| | | 2 | | | | | | | | | | | | | | | | | | | | | | | | | | | | | | | | | | | | | | | | | | | | | | | | | | | | | | | | | | | | | | | | | | | | | | | | | | | | | |
| 3 | | 1 | | | | | | | | | | | | | | | | | | | | | | | | | | | | | | | | | | | | | | | | | | | | | | | | | | | | | | | | | | | | | | | | | | | | | | | | | | | | | |
| 1 | | 1 | | | | | | | | | | | | | | | | | | | | | | | | | | | | | | | | | | | | | | | | | | | | | | | | | | | | | | | | | | | | | | | | | | | | | | | | | | | | | |
| | | | | | | | | | | | | | | | | | | | | | | | | | | | | | | | | | | | | | | | | | | | | | | | | | | | | | | | | | | | | | | | | | | | | | | | | | | | | | | | |
| 1 | | 2 | | | | | | | | | | | | | | | | | | | | | | | | | | | | | | | | | | | | | | | | | | | | | | | | | | | | | | | | | | | | | | | | | | | | | | | | | | | | | |
| | | | | | | | | | | | | | | | | | | | | | | | | | | | | | | | | | | | | | | | | | | | | | | | | | | | | | | | | | | | | | | | | | | | | | | | | | | | | | | | |
| | | | | | | | | | | | | | | | | | | | | | | | | | | | | | | | | | | | | | | | | | | | | | | | | | | | | | | | | | | | | | | | | | | | | | | | | | | | | | | | |
| 1 | | 1 | | | | | | | | | | | | | | | | | | | | | | | | | | | | | | | | | | | | | | | | | | | | | | | | | | | | | | | | | | | | | | | | | | | | | | | | | | | | | |
| 1 | | | | | | | | | | | | | | | | | | | | | | | | | | | | | | | | | | | | | | | | | | | | | | | | | | | | | | | | | | | | | | | | | | | | | | | | | | | | | | | |
| | | | | | | | | | | | | | | | | | | | | | | | | | | | | | | | | | | | | | | | | | | | | | | | | | | | | | | | | | | | | | | | | | | | | | | | | | | | | | | | |
| | | | | | | | | | | | | | | | | | | | | | | | | | | | | | | | | | | | | | | | | | | | | | | | | | | | | | | | | | | | | | | | | | | | | | | | | | | | | | | | |
| | | | | | | | | | | | | | | | | | | | | | | | | | | | | | | | | | | | | | | | | | | | | | | | | | | | | | | | | | | | | | | | | | | | | | | | | | | | | | | | |
| | | | | | | | | | | | | | | | | | | | | | | | | | | | | | | | | | | | | | | | | | | | | | | | | | | | | | | | | | | | | | | | | | | | | | | | | | | | | | | | |
| 1 | | | | | | | | | | | | | | | | | | | | | | | | | | | | | | | | | | | | | | | | | | | | | | | | | | | | | | | | | | | | | | | | | | | | | | | | | | | | | | | |
| | | | | | | | | | | | | | | | | | | | | | | | | | | | | | | | | | | | | | | | | | | | | | | | | | | | | | | | | | | | | | | | | | | | | | | | | | | | | | | | |
| | | | | | | | | | | | | | | | | | | | | | | | | | | | | | | | | | | | | | | | | | | | | | | | | | | | | | | | | | | | | | | | | | | | | | | | | | | | | | | | |
| | | | | | | | | | | | | | | | | | | | | | | | | | | | | | | | | | | | | | | | | | | | | | | | | | | | | | | | | | | | | | | | | | | | | | | | | | | | | | | | |
| | | | | | | | | | | | | | | | | | | | | | | | | | | | | | | | | | | | | | | | | | | | | | | | | | | | | | | | | | | | | | | | | | | | | | | | | | | | | | | | |
| | | | | | | | | | | | | | | | | | | | | | | | | | | | | | | | | | | | | | | | | | | | | | | | | | | | | | | | | | | | | | | | | | | | | | | | | | | | | | | | |
| | | | | | | | | | | | | | | | | | | | | | | | | | | | | | | | | | | | | | | | | | | | | | | | | | | | | | | | | | | | | | | | | | | | | | | | | | | | | | | | |
| Post - 0 Miss - 0 Block - 0 | Post - 0 Miss - 0 Block - 0 | Post - 0 Miss - 1 Block - 0 | Post - 0 Miss - 0 Block - 0 | Post - 0 Miss - 0 Block - 0 | Post - 0 Miss - 0 Block - 0 | Post - 0 Miss - 0 Block - 0 | Post - 0 Miss - 0 Block - 0 | | | | | | | | | | | | | | | | | | | | | | | | | | | | | | | | | | | | | | | | | | | | | | | | | | | | | | | | | | | | | | | | | | | | | | | | |
| 19 陈旭 | 23 刘帅 | 25 张斌 | 26 吴锐樊 | 35 高云健 | 36 王鹏皓 | | | | | | | | | | | | | | | | | | | | | | | | | | | | | | | | | | | | | | | | | | | | | | | | | | | | | | | | | | | | | | | | | | | | | | | | | | |
| <table border="1"><tr><td>1</td><td></td><td>1</td></tr><tr><td>1</td><td></td><td>1</td></tr><tr><td>1</td><td></td><td></td></tr></table> | 1 | | 1 | 1 | | 1 | 1 | | | <table border="1"><tr><td></td><td></td><td></td></tr><tr><td></td><td></td><td></td></tr><tr><td></td><td></td><td></td></tr></table> | | | | | | | | | | <table border="1"><tr><td></td><td></td><td></td></tr><tr><td></td><td></td><td></td></tr><tr><td></td><td></td><td></td></tr></table> | | | | | | | | | | <table border="1"><tr><td></td><td>1</td><td>2</td></tr><tr><td>2</td><td></td><td></td></tr><tr><td>1</td><td></td><td>2</td></tr></table> | | 1 | 2 | 2 | | | 1 | | 2 | <table border="1"><tr><td></td><td></td><td></td></tr><tr><td></td><td></td><td></td></tr><tr><td></td><td></td><td></td></tr></table> | | | | | | | | | | <table border="1"><tr><td></td><td></td><td>1</td></tr><tr><td>1</td><td></td><td></td></tr><tr><td>1</td><td></td><td>1</td></tr></table> | | | 1 | 1 | | | 1 | | 1 | <table border="1"><tr><td></td><td></td><td></td></tr><tr><td></td><td></td><td></td></tr><tr><td></td><td></td><td></td></tr></table> | | | | | | | | | | <table border="1"><tr><td></td><td></td><td></td></tr><tr><td></td><td></td><td></td></tr><tr><td></td><td></td><td></td></tr></table> | | | | | | | | | |
| 1 | | 1 | | | | | | | | | | | | | | | | | | | | | | | | | | | | | | | | | | | | | | | | | | | | | | | | | | | | | | | | | | | | | | | | | | | | | | | | | | | | | |
| 1 | | 1 | | | | | | | | | | | | | | | | | | | | | | | | | | | | | | | | | | | | | | | | | | | | | | | | | | | | | | | | | | | | | | | | | | | | | | | | | | | | | |
| 1 | | | | | | | | | | | | | | | | | | | | | | | | | | | | | | | | | | | | | | | | | | | | | | | | | | | | | | | | | | | | | | | | | | | | | | | | | | | | | | | |
| | | | | | | | | | | | | | | | | | | | | | | | | | | | | | | | | | | | | | | | | | | | | | | | | | | | | | | | | | | | | | | | | | | | | | | | | | | | | | | | |
| | | | | | | | | | | | | | | | | | | | | | | | | | | | | | | | | | | | | | | | | | | | | | | | | | | | | | | | | | | | | | | | | | | | | | | | | | | | | | | | |
| | | | | | | | | | | | | | | | | | | | | | | | | | | | | | | | | | | | | | | | | | | | | | | | | | | | | | | | | | | | | | | | | | | | | | | | | | | | | | | | |
| | | | | | | | | | | | | | | | | | | | | | | | | | | | | | | | | | | | | | | | | | | | | | | | | | | | | | | | | | | | | | | | | | | | | | | | | | | | | | | | |
| | | | | | | | | | | | | | | | | | | | | | | | | | | | | | | | | | | | | | | | | | | | | | | | | | | | | | | | | | | | | | | | | | | | | | | | | | | | | | | | |
| | | | | | | | | | | | | | | | | | | | | | | | | | | | | | | | | | | | | | | | | | | | | | | | | | | | | | | | | | | | | | | | | | | | | | | | | | | | | | | | |
| | 1 | 2 | | | | | | | | | | | | | | | | | | | | | | | | | | | | | | | | | | | | | | | | | | | | | | | | | | | | | | | | | | | | | | | | | | | | | | | | | | | | | |
| 2 | | | | | | | | | | | | | | | | | | | | | | | | | | | | | | | | | | | | | | | | | | | | | | | | | | | | | | | | | | | | | | | | | | | | | | | | | | | | | | | |
| 1 | | 2 | | | | | | | | | | | | | | | | | | | | | | | | | | | | | | | | | | | | | | | | | | | | | | | | | | | | | | | | | | | | | | | | | | | | | | | | | | | | | |
| | | | | | | | | | | | | | | | | | | | | | | | | | | | | | | | | | | | | | | | | | | | | | | | | | | | | | | | | | | | | | | | | | | | | | | | | | | | | | | | |
| | | | | | | | | | | | | | | | | | | | | | | | | | | | | | | | | | | | | | | | | | | | | | | | | | | | | | | | | | | | | | | | | | | | | | | | | | | | | | | | |
| | | | | | | | | | | | | | | | | | | | | | | | | | | | | | | | | | | | | | | | | | | | | | | | | | | | | | | | | | | | | | | | | | | | | | | | | | | | | | | | |
| | | 1 | | | | | | | | | | | | | | | | | | | | | | | | | | | | | | | | | | | | | | | | | | | | | | | | | | | | | | | | | | | | | | | | | | | | | | | | | | | | | |
| 1 | | | | | | | | | | | | | | | | | | | | | | | | | | | | | | | | | | | | | | | | | | | | | | | | | | | | | | | | | | | | | | | | | | | | | | | | | | | | | | | |
| 1 | | 1 | | | | | | | | | | | | | | | | | | | | | | | | | | | | | | | | | | | | | | | | | | | | | | | | | | | | | | | | | | | | | | | | | | | | | | | | | | | | | |
| | | | | | | | | | | | | | | | | | | | | | | | | | | | | | | | | | | | | | | | | | | | | | | | | | | | | | | | | | | | | | | | | | | | | | | | | | | | | | | | |
| | | | | | | | | | | | | | | | | | | | | | | | | | | | | | | | | | | | | | | | | | | | | | | | | | | | | | | | | | | | | | | | | | | | | | | | | | | | | | | | |
| | | | | | | | | | | | | | | | | | | | | | | | | | | | | | | | | | | | | | | | | | | | | | | | | | | | | | | | | | | | | | | | | | | | | | | | | | | | | | | | |
| | | | | | | | | | | | | | | | | | | | | | | | | | | | | | | | | | | | | | | | | | | | | | | | | | | | | | | | | | | | | | | | | | | | | | | | | | | | | | | | |
| | | | | | | | | | | | | | | | | | | | | | | | | | | | | | | | | | | | | | | | | | | | | | | | | | | | | | | | | | | | | | | | | | | | | | | | | | | | | | | | |
| | | | | | | | | | | | | | | | | | | | | | | | | | | | | | | | | | | | | | | | | | | | | | | | | | | | | | | | | | | | | | | | | | | | | | | | | | | | | | | | |
| Post - 2 Miss - 2 Block - 2 | Post - 0 Miss - 0 Block - 0 | Post - 0 Miss - 0 Block - 0 | Post - 0 Miss - 2 Block - 1 | Post - 0 Miss - 0 Block - 0 | Post - 0 Miss - 0 Block - 0 | | | | | | | | | | | | | | | | | | | | | | | | | | | | | | | | | | | | | | | | | | | | | | | | | | | | | | | | | | | | | | | | | | | | | | | | | | |

注释: Post=击柱 Miss=射失 Block=被封





预赛 Group B
青年男子 全国比赛

2016年“体彩杯”全国手球男子青年锦标赛

| | | | | | | | | | | | | | | | | | | | | | |
|--------------------|---|------------------------------------|---------------------|------------------|------------------------------------|-------------------|---|--------------------|------------------------|----|-----|----------------------|---------------|---|--|--|---|---|----|---|----|
| Team A A 天津队 | | | | Team B B 安徽队 | | | | Match Number 20 | | | | | | | | | | | | | |
| played in China | | in the hall 重庆万州 | | on 24/03/2016 | | at 10:00 hours | | Spectators | | | | | | | | | | | | | |
| Half-time (30') | A 10 | B 22 | End of playing time | A 10 | B 25 | 1st extra time | A | B | 2nd extra time | A | B | After penalty throws | A | B | | | | | | | |
| Number of 7 m | A 1/2 | Team time-out 1 09:46 2 23:35 3 | | | Full name of players and officials | | | | Team time-out 1 2 3 | | | B 0/0 | Number of 7 m | | | | | | | | |
| No. | Team A | | | | | G | W | 2' | D | DR | No. | Team B | | | | | G | W | 2' | D | DR |
| 9 | 吴明远 | | | | | 1 | | | | | 1 | 郭世伟 | | | | | 5 | 1 | 1 | | |
| 18 | 王晓琪 | | | | | 4 | | | | | 2 | 金勇峰 | | | | | 2 | | | | |
| 21 | 潘玉帅 | | | | | 1 | | | | | 9 | 陈开勇 | | | | | 6 | 1 | | | |
| 22 | 魏雨童 | | | | | 3 | 1 | | | | 17 | 王巨柱 | | | | | 4 | 1 | | | |
| 24 | 刘子健 | | | | | | | | | | 18 | 李双 | | | | | 4 | | 1 | | |
| 25 | 王一雄 | | | | | | | | | | 19 | 何山 | | | | | 4 | | | | |
| 26 | 刘思远 | | | | | 1 | | | | | 21 | 李明 | | | | | | | | | |
| 27 | 左金龙 | | | | | | | | | | 24 | 徐安格 | | | | | | | | | |
| 28 | 何喜年 | | | | | | | | | | 25 | 李文哲 | | | | | | | | | |
| | | | | | | | | | | | 26 | 程浩然 | | | | | | | | | |
| | | | | | | | | | | | 27 | 王长旭 | | | | | | | | | |
| | | | | | | | | | | | 28 | 丁浩然 | | | | | | | | | |
| | | | | | | | | | | | 32 | 许浩翔 | | | | | | | | | |
| | | | | | | | | | | | 33 | 姚紫祥 | | | | | | | | | |
| | | | | | | | | | | | 41 | 刘润民 | | | | | | | | | |
| | | | | | | | | | | | 42 | 王成龙 | | | | | | | | | |
| A | 李志成 | | | | | | | | | | A | 王来黔 (主教练) | | | | | | | | | |
| B | 潘玉强 | | | | | | | | | | B | 陆万红 | | | | | | | | | |
| | | | | | | | | | | | C | 吴翔 | | | | | | | | | |
| | | | | | | | | | | | | | | | | | | | | | |
| A | Signature of Responsible Official of the Teams (Off. A) | | | | | | | | | | | | | | | | | | B | | |
| TP | Remarks of Referee / CHA Official | | | | | | | | | | | | | | | | | | TP | | |

Signatures

Referees: 马晓晔 (CHN) 王羚 (CHN)

Techn. Delegates: 徐健 (CHN)

CHA Official: 吴瑞亭 (CHN)

Note: Number of 7m Throws Awarded to Team A and B, Goals (G), Warnings (W), Suspensions (2'), Direct Disqualification (D), Disqualification with Report (DR) and Team Penalty (TP).

Table Officials:

Statisticians: 刘永欢

李双





2016年“体彩杯”全国手球男子青年锦标赛 竞赛技术统计(媒体表)

| | | | | | | |
|------|----|----------------|----|----|------------------|-----|
| 预赛 | 组别 | B | 轮次 | 4 | 场次 | 20 |
| 重庆万州 | | 24/03/2016 | | | 201602020-51-1/1 | |
| 天津队 | 天津 | 10 | vs | 25 | 安徽 | 安徽队 |
| | | 10 : 22 | | | | |

| | | | |
|-----|-----------|---|----------|
| 裁判员 | 马晓晔 (CHN) | / | 王羚 (CHN) |
|-----|-----------|---|----------|

| 天津 | | | | | | | | | | | | | | 天津 | | 比赛进程 | | 安徽 | |
|---------------|-----|-------------|------------|------------|-------------|------------|------------|--------------|-------------|----------|-----------|----------|----------|--------|--|------|--|----|--|
| 主教练: 潘玉强 | | | | | | | | | | | | | | | | | | | |
| | 远射 | 近射 | 边射 | 快攻 | 突破 | 任意球 | 7m球 | 合计 | % | 助攻 | 失误 | 警告 | 2' | D & DR | | | | | |
| 9 | 吴明远 | 1/2 | | | | | | 1/2 | 50.0 | 1 | 5 | | | | | | | | |
| 18 | 王晓琪 | 3/9 | 0/1 | | | | 1/1 | 4/11 | 36.4 | 1 | 5 | | | | | | | | |
| 21 | 潘玉帅 | 1/8 | | | | | 0/1 | 1/9 | 11.1 | | 4 | | | | | | | | |
| 22 | 魏雨童 | 1/1 | 2/2 | | | | | 3/3 | 100 | | | 1 | | | | | | | |
| 24 | 刘子健 | | | | | | | | | | | | | | | | | | |
| 25 | 王一雄 | | 0/1 | | | | | 0/1 | 0.0 | | | | | | | | | | |
| 26 | 刘思远 | 0/1 | 1/1 | 0/1 | | | | 1/3 | 33.3 | | 2 | | | | | | | | |
| 27 | 左金龙 | | | | | | | | | | | | | | | | | | |
| 28 | 何喜年 | | | | | | | | | | | | | | | | | | |
| 运动员 合计 | | 6/21 | 3/5 | 0/1 | | | 1/2 | 10/29 | 34.5 | 2 | 16 | 1 | | | | | | | |
| 24 | 刘子健 | 0/4 | 2/4 | 2/4 | 1/3 | 0/2 | | 5/17 | 29.4 | | | | | | | | | | |
| 28 | 何喜年 | 0/2 | 0/3 | 2/3 | 2/7 | 0/2 | | 4/17 | 23.5 | | | | | | | | | | |
| 守门员 合计 | | 0/6 | 2/7 | 4/7 | 3/10 | 0/4 | | 9/34 | 26.5 | | | | | | | | | | |
| 安徽 | | | | | | | | | | | | | | | | | | | |
| 教练: 王来黔 | | | | | | | | | | | | | | | | | | | |
| | 远射 | 近射 | 边射 | 快攻 | 突破 | 任意球 | 7m球 | 合计 | % | 助攻 | 失误 | 警告 | 2' | D & DR | | | | | |
| 1 | 郭世伟 | 1/2 | | | 1/4 | 3/3 | | 5/9 | 55.6 | 1 | 4 | 1 | 1 | | | | | | |
| 2 | 金勇峰 | 2/2 | | | | | | 2/2 | 100 | 1 | 1 | | | | | | | | |
| 9 | 陈开勇 | | 2/2 | | 4/4 | | | 6/6 | 100 | 1 | 1 | 1 | | | | | | | |
| 17 | 王巨柱 | 3/3 | | | 1/1 | | | 4/4 | 100 | 3 | 2 | 1 | | | | | | | |
| 18 | 李双 | 0/1 | 2/4 | 0/3 | 1/1 | 1/1 | | 4/10 | 40.0 | 2 | 2 | | 1 | | | | | | |
| 19 | 何山 | | 1/1 | 3/4 | | | | 4/5 | 80.0 | | | | | | | | | | |
| 21 | 李明 | | | | | | | | | | 1 | | | | | | | | |
| 24 | 徐安格 | | | | | | | | | | | | | | | | | | |
| 25 | 李文哲 | | | | | | | | | | | | | | | | | | |
| 26 | 程浩然 | | | | | | | | | | | | | | | | | | |
| 27 | 王长旭 | | | | | | | | | | | | | | | | | | |
| 28 | 丁浩然 | | | | | | | | | | | | | | | | | | |
| 32 | 许浩翔 | | | | | | | | | | | | | | | | | | |
| 33 | 姚紫祥 | | | | | | | | | | | | | | | | | | |
| 41 | 刘润民 | | | | | | | | | | | | | | | | | | |
| 42 | 王成龙 | | | | | | | | | | | | | | | | | | |
| 运动员 合计 | | 6/8 | 5/7 | 3/7 | 7/10 | 4/4 | | 25/36 | 69.4 | 8 | 11 | 3 | 2 | | | | | | |
| 1 | 郭世伟 | | | | | | | | | | | | | | | | | | |
| 21 | 李明 | 6/12 | 2/5 | 1/1 | | | 0/1 | 9/19 | 47.4 | | 1 | | | | | | | | |
| 守门员 合计 | | 6/12 | 2/5 | 1/1 | | | 0/1 | 9/19 | 47.4 | | 1 | | | | | | | | |

场上队员: 得分 / 射门

守门员: 救球 / 射门

| | | | | | | | | | | | | | |
|----|------------|--|----|--------------|--|-----|------------|--|-----|----------|--|----|---------|
| 快攻 | Fast Break | | 突破 | Breakthrough | | 任意球 | Free Throw | | 7M球 | 7M Throw | | 助攻 | Assist |
| 警告 | Warning | | 失误 | Error | | 2' | Suspension | | D | 取消资格 | | DR | 取消资格+报告 |





2016年“体彩杯”全国手球男子青年锦标赛 图式比赛技术统计表

轮次 4

场次 20

201602020-21-1/1

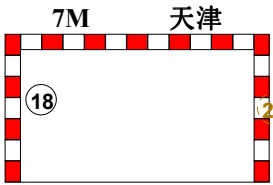
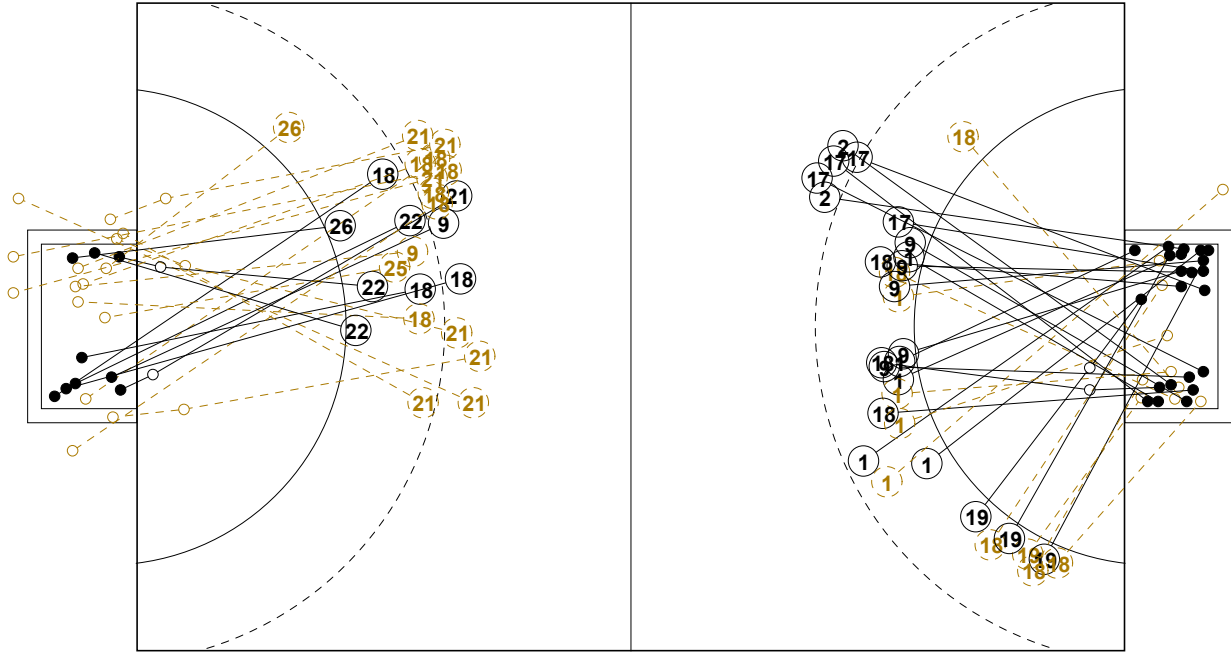

1st Half
10 : 22

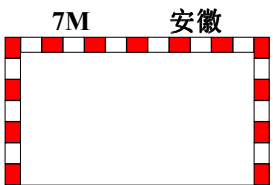
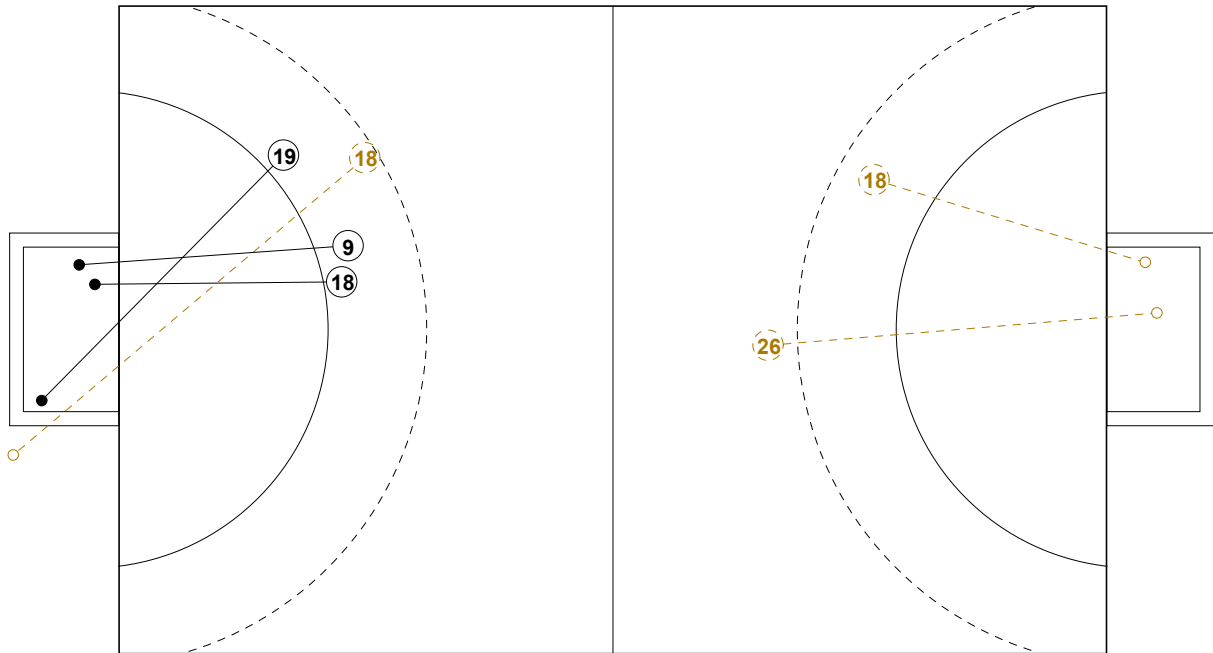
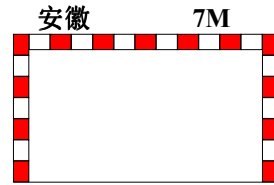

2nd Half
25 : 10

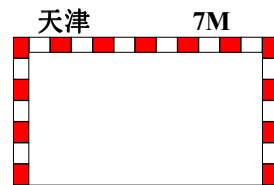



2016年“体彩杯”全国手球男子青年锦标赛

个人/全队技术统计表

正式表
手球
青年男子预赛
轮次 4组别 B
场次 20201602020-14-1/2
重庆万州
24/03/2016 10:00

| 号码 | 姓名 | 远射 | 近射 | 边射 | 快攻 | 突破 | 任意 | 7M | 合计 | % | 助攻 | 失误 | 警告 | 2' | 取消 | 时间 |
|---------------------------------|-----|-----|-----|-----|-----|-----|----|-----|------|-------|----|----|----|----|----|----------|
| 天津队(天津) | | | | | | | | | | | | | | | | |
| <i>(场上队员)</i> | | | | | | | | | | | | | | | | |
| 9 | 吴明远 | 1/2 | | | | | | | 1/2 | 50.0% | 1 | 5 | | | | 00:32:20 |
| 18 | 王晓琪 | 3/9 | 0/1 | | | | | 1/1 | 4/11 | 36.4% | 1 | 5 | | | | 00:32:20 |
| 21 | 潘玉帅 | 1/8 | | | | | | 0/1 | 1/9 | 11.1% | | 4 | | | | 00:28:31 |
| 22 | 魏雨童 | 1/1 | 2/2 | | | | | | 3/3 | 100% | | | 1 | | | 00:32:20 |
| 24 | 刘子健 | | | | | | | | | 0.0% | | | | | | 00:17:09 |
| 25 | 王一雄 | | 0/1 | | | | | | 0/1 | 0.0% | | | | | | 00:32:20 |
| 26 | 刘思远 | 0/1 | 1/1 | 0/1 | | | | | 1/3 | 33.3% | | 2 | | | | 00:30:09 |
| 27 | 左金龙 | | | | | | | | | 0.0% | | | | | | 00:05:56 |
| 28 | 何喜年 | | | | | | | | | 0.0% | | | | | | 00:15:11 |
| 合计 | | | | | | | | | | | | | | | | |
| <i>(守门员)</i> | | | | | | | | | | | | | | | | |
| 24 | | 0/4 | 2/4 | 2/4 | 1/3 | 0/2 | | | 5/17 | 29.4% | | | | | | 00:17:09 |
| 28 | | 0/2 | 0/3 | 2/3 | 2/7 | 0/2 | | | 4/17 | 23.5% | | | | | | 00:15:11 |
| 合计 | | | | | | | | | | | | | | | | |
| 0/6 2/7 4/7 3/10 0/4 9/34 26.5% | | | | | | | | | | | | | | | | |

场上队员：得分/射门

守门员：救球/射门

| 全队合计 | 得分 | 被救 | 射失 | 击柱 | 封球 | 合计 | % |
|------|----|----|----|----|----|----|-------|
| 远射 | 6 | 6 | 5 | 3 | 1 | 21 | 28.6% |
| 近射 | 3 | 2 | | | | 5 | 60.0% |
| 边射 | | 1 | | | | 1 | 0.0% |
| 快攻 | | | | | | | 0.0% |
| 突破 | | | | | | | 0.0% |
| 任意 | | | | | | | 0.0% |
| 7M | 1 | | | 1 | | 2 | 50.0% |





2016年“体彩杯”全国手球男子青年锦标赛

个人/全队技术统计表

正式表
手球
青年男子预赛
轮次 4组别 B
场次 20201602020-14-2/2
重庆万州
24/03/2016 10:00

| 号码 | 姓名 | 远射 | 近射 | 边射 | 快攻 | 突破 | 任意 | 7M | 合计 | % | 助攻 | 失误 | 警告 | 2' | 取消 | 时间 |
|----------------|-----|------|-----|-----|------|-----|----|-----|-------|-------|----|----|----|----|----|----------|
| 安徽队(安徽) | | | | | | | | | | | | | | | | |
| <i>(上场队员)</i> | | | | | | | | | | | | | | | | |
| 1 | 郭世伟 | 1/2 | | | 1/4 | 3/3 | | | 5/9 | 55.6% | 1 | 4 | 1 | 1 | | 00:32:50 |
| 2 | 金勇峰 | 2/2 | | | | | | | 2/2 | 100% | 1 | 1 | | | | 00:32:20 |
| 9 | 陈开勇 | | 2/2 | | 4/4 | | | | 6/6 | 100% | 1 | 1 | 1 | | | 00:32:20 |
| 17 | 王巨柱 | 3/3 | | | 1/1 | | | | 4/4 | 100% | 3 | 2 | 1 | | | 00:32:20 |
| 18 | 李双 | 0/1 | 2/4 | 0/3 | 1/1 | 1/1 | | | 4/10 | 40.0% | 2 | 2 | | 1 | | 00:32:20 |
| 19 | 何山 | | 1/1 | 3/4 | | | | | 4/5 | 80.0% | | | | | | 00:32:20 |
| 21 | 李明 | | | | | | | | | 0.0% | | 1 | | | | 00:32:20 |
| 24 | 徐安格 | | | | | | | | | 0.0% | | | | | | 00:00:00 |
| 25 | 李文哲 | | | | | | | | | 0.0% | | | | | | 00:00:00 |
| 26 | 程浩然 | | | | | | | | | 0.0% | | | | | | 00:00:00 |
| 27 | 王长旭 | | | | | | | | | 0.0% | | | | | | 00:00:00 |
| 28 | 丁浩然 | | | | | | | | | 0.0% | | | | | | 00:00:00 |
| 32 | 许浩翔 | | | | | | | | | 0.0% | | | | | | 00:00:00 |
| 33 | 姚紫祥 | | | | | | | | | 0.0% | | | | | | 00:00:00 |
| 41 | 刘润民 | | | | | | | | | 0.0% | | | | | | 00:00:00 |
| 42 | 王成龙 | | | | | | | | | 0.0% | | | | | | 00:00:00 |
| 合计 | | 6/8 | 5/7 | 3/7 | 7/10 | 4/4 | | | 25/36 | 69.4% | 8 | 11 | 3 | 2 | | |
| <i>(守门员)</i> | | | | | | | | | | | | | | | | |
| 1 | 郭世伟 | | | | | | | | | 0.0% | | | | | | 00:32:50 |
| 21 | 李明 | 6/12 | 2/5 | 1/1 | | | | 0/1 | 9/19 | 47.4% | | 1 | | | | 00:32:20 |
| 合计 | | 6/12 | 2/5 | 1/1 | | | | 0/1 | 9/19 | 47.4% | | 1 | | | | |

场上队员：得分/射门

守门员：救球/射门

| 全队合计 | 得分 | 被救 | 射失 | 击柱 | 封球 | 合计 | % |
|------|----|----|----|----|----|----|--------|
| 远射 | 6 | | 2 | | | 8 | 75.0% |
| 近射 | 5 | 2 | | | | 7 | 71.4% |
| 边射 | 3 | 4 | | | | 7 | 42.9% |
| 快攻 | 7 | 3 | | | | 10 | 70.0% |
| 突破 | 4 | | | | | 4 | 100.0% |
| 任意 | | | | | | | 0.0% |
| 7M | | | | | | | 0.0% |





2016年“体彩杯”全国手球男子青年锦标赛

图式射门区域统计

轮次 4 场次 20

201602020-41-1/1

天津队

| | | | | | | | | | | | | | | | | | | | | | | | | | | | | | | | | | | | | | | | | | | | | | | | | | | | | | | | | | | | | | | | | | | | | | | | | | | | | | | | |
|---|--------|--------|--------|--------|--------|--------|--------|--|--|--|---|--|--|---|--|--|--|--|--|---|--|--|--|--|--|--|---|--|--|---|--|--|--|---|--|---|--|--|---|--|--|--|--|--|--|--|--|--|--|--|--|--|--|--|--|--|--|--|--|---|--|--|---|--|--|--|--|--|--|--|--|--|--|--|--|--|--|--|--|
| 9 吴明远 | 18 王晓琪 | 21 潘玉帅 | 22 魏雨童 | 24 刘子健 | 25 王一雄 | 26 刘思远 | 27 左金龙 | | | | | | | | | | | | | | | | | | | | | | | | | | | | | | | | | | | | | | | | | | | | | | | | | | | | | | | | | | | | | | | | | | | | | | | | |
| <table border="1"><tr><td></td><td></td><td></td></tr><tr><td></td><td></td><td></td></tr><tr><td>1</td><td></td><td></td></tr></table> | | | | | | | 1 | | | <table border="1"><tr><td>3</td><td></td><td></td></tr><tr><td>1</td><td></td><td></td></tr><tr><td></td><td></td><td></td></tr></table> | 3 | | | 1 | | | | | | <table border="1"><tr><td></td><td></td><td></td></tr><tr><td></td><td></td><td></td></tr><tr><td>1</td><td></td><td></td></tr></table> | | | | | | | 1 | | | <table border="1"><tr><td></td><td></td><td></td></tr><tr><td>1</td><td></td><td>1</td></tr><tr><td></td><td></td><td>1</td></tr></table> | | | | 1 | | 1 | | | 1 | <table border="1"><tr><td></td><td></td><td></td></tr><tr><td></td><td></td><td></td></tr><tr><td></td><td></td><td></td></tr></table> | | | | | | | | | | <table border="1"><tr><td></td><td></td><td></td></tr><tr><td></td><td></td><td></td></tr><tr><td></td><td></td><td></td></tr></table> | | | | | | | | | | <table border="1"><tr><td></td><td></td><td>1</td></tr><tr><td></td><td></td><td></td></tr><tr><td></td><td></td><td></td></tr></table> | | | 1 | | | | | | | <table border="1"><tr><td></td><td></td><td></td></tr><tr><td></td><td></td><td></td></tr><tr><td></td><td></td><td></td></tr></table> | | | | | | | | | |
| | | | | | | | | | | | | | | | | | | | | | | | | | | | | | | | | | | | | | | | | | | | | | | | | | | | | | | | | | | | | | | | | | | | | | | | | | | | | | | | |
| | | | | | | | | | | | | | | | | | | | | | | | | | | | | | | | | | | | | | | | | | | | | | | | | | | | | | | | | | | | | | | | | | | | | | | | | | | | | | | | |
| 1 | | | | | | | | | | | | | | | | | | | | | | | | | | | | | | | | | | | | | | | | | | | | | | | | | | | | | | | | | | | | | | | | | | | | | | | | | | | | | | | |
| 3 | | | | | | | | | | | | | | | | | | | | | | | | | | | | | | | | | | | | | | | | | | | | | | | | | | | | | | | | | | | | | | | | | | | | | | | | | | | | | | | |
| 1 | | | | | | | | | | | | | | | | | | | | | | | | | | | | | | | | | | | | | | | | | | | | | | | | | | | | | | | | | | | | | | | | | | | | | | | | | | | | | | | |
| | | | | | | | | | | | | | | | | | | | | | | | | | | | | | | | | | | | | | | | | | | | | | | | | | | | | | | | | | | | | | | | | | | | | | | | | | | | | | | | |
| | | | | | | | | | | | | | | | | | | | | | | | | | | | | | | | | | | | | | | | | | | | | | | | | | | | | | | | | | | | | | | | | | | | | | | | | | | | | | | | |
| | | | | | | | | | | | | | | | | | | | | | | | | | | | | | | | | | | | | | | | | | | | | | | | | | | | | | | | | | | | | | | | | | | | | | | | | | | | | | | | |
| 1 | | | | | | | | | | | | | | | | | | | | | | | | | | | | | | | | | | | | | | | | | | | | | | | | | | | | | | | | | | | | | | | | | | | | | | | | | | | | | | | |
| | | | | | | | | | | | | | | | | | | | | | | | | | | | | | | | | | | | | | | | | | | | | | | | | | | | | | | | | | | | | | | | | | | | | | | | | | | | | | | | |
| 1 | | 1 | | | | | | | | | | | | | | | | | | | | | | | | | | | | | | | | | | | | | | | | | | | | | | | | | | | | | | | | | | | | | | | | | | | | | | | | | | | | | |
| | | 1 | | | | | | | | | | | | | | | | | | | | | | | | | | | | | | | | | | | | | | | | | | | | | | | | | | | | | | | | | | | | | | | | | | | | | | | | | | | | | |
| | | | | | | | | | | | | | | | | | | | | | | | | | | | | | | | | | | | | | | | | | | | | | | | | | | | | | | | | | | | | | | | | | | | | | | | | | | | | | | | |
| | | | | | | | | | | | | | | | | | | | | | | | | | | | | | | | | | | | | | | | | | | | | | | | | | | | | | | | | | | | | | | | | | | | | | | | | | | | | | | | |
| | | | | | | | | | | | | | | | | | | | | | | | | | | | | | | | | | | | | | | | | | | | | | | | | | | | | | | | | | | | | | | | | | | | | | | | | | | | | | | | |
| | | | | | | | | | | | | | | | | | | | | | | | | | | | | | | | | | | | | | | | | | | | | | | | | | | | | | | | | | | | | | | | | | | | | | | | | | | | | | | | |
| | | | | | | | | | | | | | | | | | | | | | | | | | | | | | | | | | | | | | | | | | | | | | | | | | | | | | | | | | | | | | | | | | | | | | | | | | | | | | | | |
| | | | | | | | | | | | | | | | | | | | | | | | | | | | | | | | | | | | | | | | | | | | | | | | | | | | | | | | | | | | | | | | | | | | | | | | | | | | | | | | |
| | | 1 | | | | | | | | | | | | | | | | | | | | | | | | | | | | | | | | | | | | | | | | | | | | | | | | | | | | | | | | | | | | | | | | | | | | | | | | | | | | | |
| | | | | | | | | | | | | | | | | | | | | | | | | | | | | | | | | | | | | | | | | | | | | | | | | | | | | | | | | | | | | | | | | | | | | | | | | | | | | | | | |
| | | | | | | | | | | | | | | | | | | | | | | | | | | | | | | | | | | | | | | | | | | | | | | | | | | | | | | | | | | | | | | | | | | | | | | | | | | | | | | | |
| | | | | | | | | | | | | | | | | | | | | | | | | | | | | | | | | | | | | | | | | | | | | | | | | | | | | | | | | | | | | | | | | | | | | | | | | | | | | | | | |
| | | | | | | | | | | | | | | | | | | | | | | | | | | | | | | | | | | | | | | | | | | | | | | | | | | | | | | | | | | | | | | | | | | | | | | | | | | | | | | | |
| | | | | | | | | | | | | | | | | | | | | | | | | | | | | | | | | | | | | | | | | | | | | | | | | | | | | | | | | | | | | | | | | | | | | | | | | | | | | | | | |

Post - 0 Miss - 0 Block - 0 Post - 0 Miss - 2 Block - 1 Post - 4 Miss - 3 Block - 0 Post - 0 Miss - 0 Block - 0 Post - 0 Miss - 0 Block - 0 Post - 0 Miss - 0 Block - 0 Post - 0 Miss - 0 Block - 0 Post - 0 Miss - 0 Block - 0

| | | | | | | | | | | | | | | | | | | | | | | | | | | | | | | | | | | | | | | | | | | | | | | | | | | | | | | | | | | | | | | | | | | | | | | | | | | | | | | | |
|--|--|--|--|--|--|--|--|--|--|--|--|--|--|--|--|--|--|--|--|--|--|--|--|--|--|--|--|--|--|--|--|--|--|--|--|--|--|--|--|--|--|--|--|--|--|--|--|--|--|--|--|--|--|--|--|--|--|--|--|--|--|--|--|--|--|--|--|--|--|--|--|--|--|--|--|--|--|--|--|
| 28 何喜年 | | | | | | | | | | | | | | | | | | | | | | | | | | | | | | | | | | | | | | | | | | | | | | | | | | | | | | | | | | | | | | | | | | | | | | | | | | | | | | | |
| <table border="1"><tr><td></td><td></td><td></td></tr><tr><td></td><td></td><td></td></tr><tr><td></td><td></td><td></td></tr></table> | | | | | | | | | | <table border="1"><tr><td></td><td></td><td></td></tr><tr><td></td><td></td><td></td></tr><tr><td></td><td></td><td></td></tr></table> | | | | | | | | | | <table border="1"><tr><td></td><td></td><td></td></tr><tr><td></td><td></td><td></td></tr><tr><td></td><td></td><td></td></tr></table> | | | | | | | | | | <table border="1"><tr><td></td><td></td><td></td></tr><tr><td></td><td></td><td></td></tr><tr><td></td><td></td><td></td></tr></table> | | | | | | | | | | <table border="1"><tr><td></td><td></td><td></td></tr><tr><td></td><td></td><td></td></tr><tr><td></td><td></td><td></td></tr></table> | | | | | | | | | | <table border="1"><tr><td></td><td></td><td></td></tr><tr><td></td><td></td><td></td></tr><tr><td></td><td></td><td></td></tr></table> | | | | | | | | | | <table border="1"><tr><td></td><td></td><td></td></tr><tr><td></td><td></td><td></td></tr><tr><td></td><td></td><td></td></tr></table> | | | | | | | | | | <table border="1"><tr><td></td><td></td><td></td></tr><tr><td></td><td></td><td></td></tr><tr><td></td><td></td><td></td></tr></table> | | | | | | | | | |
| | | | | | | | | | | | | | | | | | | | | | | | | | | | | | | | | | | | | | | | | | | | | | | | | | | | | | | | | | | | | | | | | | | | | | | | | | | | | | | | |
| | | | | | | | | | | | | | | | | | | | | | | | | | | | | | | | | | | | | | | | | | | | | | | | | | | | | | | | | | | | | | | | | | | | | | | | | | | | | | | | |
| | | | | | | | | | | | | | | | | | | | | | | | | | | | | | | | | | | | | | | | | | | | | | | | | | | | | | | | | | | | | | | | | | | | | | | | | | | | | | | | |
| | | | | | | | | | | | | | | | | | | | | | | | | | | | | | | | | | | | | | | | | | | | | | | | | | | | | | | | | | | | | | | | | | | | | | | | | | | | | | | | |
| | | | | | | | | | | | | | | | | | | | | | | | | | | | | | | | | | | | | | | | | | | | | | | | | | | | | | | | | | | | | | | | | | | | | | | | | | | | | | | | |
| | | | | | | | | | | | | | | | | | | | | | | | | | | | | | | | | | | | | | | | | | | | | | | | | | | | | | | | | | | | | | | | | | | | | | | | | | | | | | | | |
| | | | | | | | | | | | | | | | | | | | | | | | | | | | | | | | | | | | | | | | | | | | | | | | | | | | | | | | | | | | | | | | | | | | | | | | | | | | | | | | |
| | | | | | | | | | | | | | | | | | | | | | | | | | | | | | | | | | | | | | | | | | | | | | | | | | | | | | | | | | | | | | | | | | | | | | | | | | | | | | | | |
| | | | | | | | | | | | | | | | | | | | | | | | | | | | | | | | | | | | | | | | | | | | | | | | | | | | | | | | | | | | | | | | | | | | | | | | | | | | | | | | |
| | | | | | | | | | | | | | | | | | | | | | | | | | | | | | | | | | | | | | | | | | | | | | | | | | | | | | | | | | | | | | | | | | | | | | | | | | | | | | | | |
| | | | | | | | | | | | | | | | | | | | | | | | | | | | | | | | | | | | | | | | | | | | | | | | | | | | | | | | | | | | | | | | | | | | | | | | | | | | | | | | |
| | | | | | | | | | | | | | | | | | | | | | | | | | | | | | | | | | | | | | | | | | | | | | | | | | | | | | | | | | | | | | | | | | | | | | | | | | | | | | | | |
| | | | | | | | | | | | | | | | | | | | | | | | | | | | | | | | | | | | | | | | | | | | | | | | | | | | | | | | | | | | | | | | | | | | | | | | | | | | | | | | |
| | | | | | | | | | | | | | | | | | | | | | | | | | | | | | | | | | | | | | | | | | | | | | | | | | | | | | | | | | | | | | | | | | | | | | | | | | | | | | | | |
| | | | | | | | | | | | | | | | | | | | | | | | | | | | | | | | | | | | | | | | | | | | | | | | | | | | | | | | | | | | | | | | | | | | | | | | | | | | | | | | |
| | | | | | | | | | | | | | | | | | | | | | | | | | | | | | | | | | | | | | | | | | | | | | | | | | | | | | | | | | | | | | | | | | | | | | | | | | | | | | | | |
| | | | | | | | | | | | | | | | | | | | | | | | | | | | | | | | | | | | | | | | | | | | | | | | | | | | | | | | | | | | | | | | | | | | | | | | | | | | | | | | |
| | | | | | | | | | | | | | | | | | | | | | | | | | | | | | | | | | | | | | | | | | | | | | | | | | | | | | | | | | | | | | | | | | | | | | | | | | | | | | | | |
| | | | | | | | | | | | | | | | | | | | | | | | | | | | | | | | | | | | | | | | | | | | | | | | | | | | | | | | | | | | | | | | | | | | | | | | | | | | | | | | |
| | | | | | | | | | | | | | | | | | | | | | | | | | | | | | | | | | | | | | | | | | | | | | | | | | | | | | | | | | | | | | | | | | | | | | | | | | | | | | | | |
| | | | | | | | | | | | | | | | | | | | | | | | | | | | | | | | | | | | | | | | | | | | | | | | | | | | | | | | | | | | | | | | | | | | | | | | | | | | | | | | |
| | | | | | | | | | | | | | | | | | | | | | | | | | | | | | | | | | | | | | | | | | | | | | | | | | | | | | | | | | | | | | | | | | | | | | | | | | | | | | | | |
| | | | | | | | | | | | | | | | | | | | | | | | | | | | | | | | | | | | | | | | | | | | | | | | | | | | | | | | | | | | | | | | | | | | | | | | | | | | | | | | |
| | | | | | | | | | | | | | | | | | | | | | | | | | | | | | | | | | | | | | | | | | | | | | | | | | | | | | | | | | | | | | | | | | | | | | | | | | | | | | | | |

Post - 0 Miss - 0 Block - 0

24 刘子健

| | | |
|-----|--|-----|
| 0/5 | | 0/1 |
| 2/6 | | 2/3 |
| 0/1 | | 1/1 |

28 何喜年

| | | |
|-----|-----|-----|
| 0/2 | | 1/4 |
| 0/2 | 1/1 | 1/4 |
| | 0/1 | 1/3 |

| | | |
|--|--|--|
| | | |
| | | |
| | | |

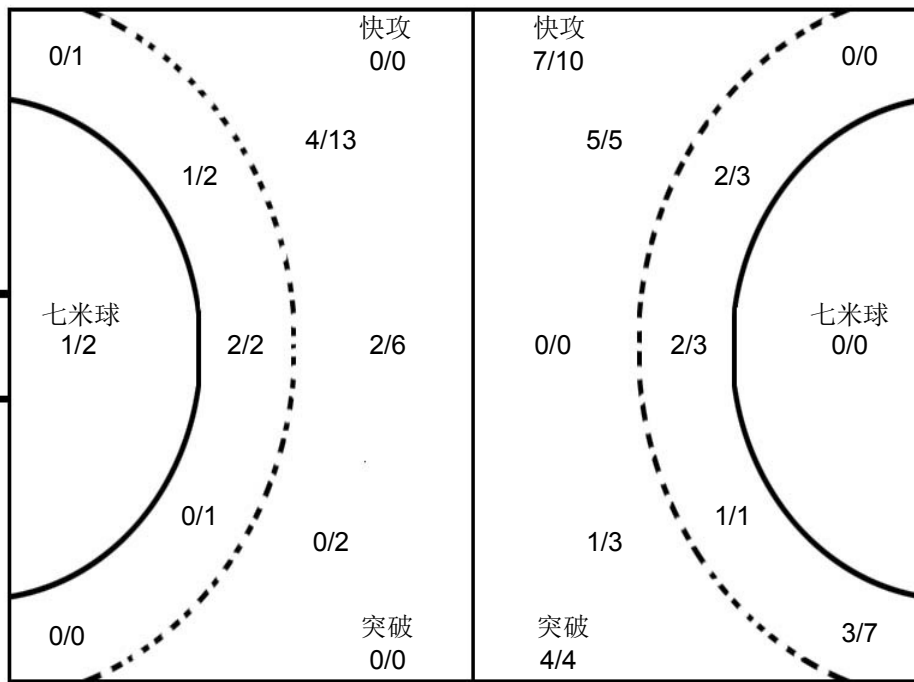

1 郭世伟

| | | |
|--|--|--|
| | | |
| | | |
| | | |

21 李明

| | | |
|-----|-----|-----|
| 0/3 | | 0/1 |
| 2/4 | 3/3 | 3/4 |
| 0/2 | | 1/2 |

| | | |
|--|--|--|
| | | |
| | | |
| | | |

安徽队

| | | | | | | | | | | | | | | | | | | | | | | | | | | | | | | | | | | | | | | | | | | | | | | | | | | | | | | | | | | | | | | | | | | | | | | | | | | | | | | | |
|--|-------|-------|--------|-------|-------|-------|--------|--|--|--|--|--|--|---|--|---|--|--|--|--|---|--|---|---|--|---|--|--|--|---|---|--|---|--|--|--|--|--|---|--|--|--|---|---|--|---|--|--|---|--|---|--|--|---|--|--|--|--|--|--|--|--|--|--|--|--|--|--|--|--|--|--|--|--|--|--|--|--|--|
| 1 郭世伟 | 2 金勇峰 | 9 陈开勇 | 17 王巨柱 | 18 李双 | 19 何山 | 21 李明 | 24 徐安格 | | | | | | | | | | | | | | | | | | | | | | | | | | | | | | | | | | | | | | | | | | | | | | | | | | | | | | | | | | | | | | | | | | | | | | | | |
| <table border="1"><tr><td>1</td><td></td><td></td></tr><tr><td>2</td><td></td><td>1</td></tr><tr><td>1</td><td></td><td></td></tr></table> | 1 | | | 2 | | 1 | 1 | | | <table border="1"><tr><td></td><td></td><td></td></tr><tr><td>1</td><td></td><td>1</td></tr><tr><td></td><td></td><td></td></tr></table> | | | | 1 | | 1 | | | | <table border="1"><tr><td>2</td><td></td><td>2</td></tr><tr><td>1</td><td></td><td>1</td></tr><tr><td></td><td></td><td></td></tr></table> | 2 | | 2 | 1 | | 1 | | | | <table border="1"><tr><td>2</td><td></td><td>1</td></tr><tr><td></td><td></td><td></td></tr><tr><td></td><td></td><td>1</td></tr></table> | 2 | | 1 | | | | | | 1 | <table border="1"><tr><td></td><td></td><td>1</td></tr><tr><td>1</td><td></td><td>1</td></tr><tr><td></td><td></td><td>1</td></tr></table> | | | 1 | 1 | | 1 | | | 1 | <table border="1"><tr><td>2</td><td></td><td></td></tr><tr><td>1</td><td></td><td></td></tr><tr><td></td><td></td><td></td></tr></table> | 2 | | | 1 | | | | | | <table border="1"><tr><td></td><td></td><td></td></tr><tr><td></td><td></td><td></td></tr><tr><td></td><td></td><td></td></tr></table> | | | | | | | | | | <table border="1"><tr><td></td><td></td><td></td></tr><tr><td></td><td></td><td></td></tr><tr><td></td><td></td><td></td></tr></table> | | | | | | | | | |
| 1 | | | | | | | | | | | | | | | | | | | | | | | | | | | | | | | | | | | | | | | | | | | | | | | | | | | | | | | | | | | | | | | | | | | | | | | | | | | | | | | |
| 2 | | 1 | | | | | | | | | | | | | | | | | | | | | | | | | | | | | | | | | | | | | | | | | | | | | | | | | | | | | | | | | | | | | | | | | | | | | | | | | | | | | |
| 1 | | | | | | | | | | | | | | | | | | | | | | | | | | | | | | | | | | | | | | | | | | | | | | | | | | | | | | | | | | | | | | | | | | | | | | | | | | | | | | | |
| | | | | | | | | | | | | | | | | | | | | | | | | | | | | | | | | | | | | | | | | | | | | | | | | | | | | | | | | | | | | | | | | | | | | | | | | | | | | | | | |
| 1 | | 1 | | | | | | | | | | | | | | | | | | | | | | | | | | | | | | | | | | | | | | | | | | | | | | | | | | | | | | | | | | | | | | | | | | | | | | | | | | | | | |
| | | | | | | | | | | | | | | | | | | | | | | | | | | | | | | | | | | | | | | | | | | | | | | | | | | | | | | | | | | | | | | | | | | | | | | | | | | | | | | | |
| 2 | | 2 | | | | | | | | | | | | | | | | | | | | | | | | | | | | | | | | | | | | | | | | | | | | | | | | | | | | | | | | | | | | | | | | | | | | | | | | | | | | | |
| 1 | | 1 | | | | | | | | | | | | | | | | | | | | | | | | | | | | | | | | | | | | | | | | | | | | | | | | | | | | | | | | | | | | | | | | | | | | | | | | | | | | | |
| | | | | | | | | | | | | | | | | | | | | | | | | | | | | | | | | | | | | | | | | | | | | | | | | | | | | | | | | | | | | | | | | | | | | | | | | | | | | | | | |
| 2 | | 1 | | | | | | | | | | | | | | | | | | | | | | | | | | | | | | | | | | | | | | | | | | | | | | | | | | | | | | | | | | | | | | | | | | | | | | | | | | | | | |
| | | | | | | | | | | | | | | | | | | | | | | | | | | | | | | | | | | | | | | | | | | | | | | | | | | | | | | | | | | | | | | | | | | | | | | | | | | | | | | | |
| | | 1 | | | | | | | | | | | | | | | | | | | | | | | | | | | | | | | | | | | | | | | | | | | | | | | | | | | | | | | | | | | | | | | | | | | | | | | | | | | | | |
| | | 1 | | | | | | | | | | | | | | | | | | | | | | | | | | | | | | | | | | | | | | | | | | | | | | | | | | | | | | | | | | | | | | | | | | | | | | | | | | | | | |
| 1 | | 1 | | | | | | | | | | | | | | | | | | | | | | | | | | | | | | | | | | | | | | | | | | | | | | | | | | | | | | | | | | | | | | | | | | | | | | | | | | | | | |
| | | 1 | | | | | | | | | | | | | | | | | | | | | | | | | | | | | | | | | | | | | | | | | | | | | | | | | | | | | | | | | | | | | | | | | | | | | | | | | | | | | |
| 2 | | | | | | | | | | | | | | | | | | | | | | | | | | | | | | | | | | | | | | | | | | | | | | | | | | | | | | | | | | | | | | | | | | | | | | | | | | | | | | | |
| 1 | | | | | | | | | | | | | | | | | | | | | | | | | | | | | | | | | | | | | | | | | | | | | | | | | | | | | | | | | | | | | | | | | | | | | | | | | | | | | | | |
| | | | | | | | | | | | | | | | | | | | | | | | | | | | | | | | | | | | | | | | | | | | | | | | | | | | | | | | | | | | | | | | | | | | | | | | | | | | | | | | |
| | | | | | | | | | | | | | | | | | | | | | | | | | | | | | | | | | | | | | | | | | | | | | | | | | | | | | | | | | | | | | | | | | | | | | | | | | | | | | | | |
| | | | | | | | | | | | | | | | | | | | | | | | | | | | | | | | | | | | | | | | | | | | | | | | | | | | | | | | | | | | | | | | | | | | | | | | | | | | | | | | |
| | | | | | | | | | | | | | | | | | | | | | | | | | | | | | | | | | | | | | | | | | | | | | | | | | | | | | | | | | | | | | | | | | | | | | | | | | | | | | | | |
| | | | | | | | | | | | | | | | | | | | | | | | | | | | | | | | | | | | | | | | | | | | | | | | | | | | | | | | | | | | | | | | | | | | | | | | | | | | | | | | |
| | | | | | | | | | | | | | | | | | | | | | | | | | | | | | | | | | | | | | | | | | | | | | | | | | | | | | | | | | | | | | | | | | | | | | | | | | | | | | | | |
| | | | | | | | | | | | | | | | | | | | | | | | | | | | | | | | | | | | | | | | | | | | | | | | | | | | | | | | | | | | | | | | | | | | | | | | | | | | | | | | |

Post - 0 Miss - 1 Block - 0 Post - 0 Miss - 0 Block - 0 Post - 0 Miss - 0 Block - 0 Post - 0 Miss - 0 Block - 0 Post - 0 Miss - 1 Block - 0 Post - 0 Miss - 0 Block - 0 Post - 0 Miss - 0 Block - 0 Post - 0 Miss - 0 Block - 0

| | | | | | | | | | | | | | | | | | | | | | | | | | | | | | | | | | | | | | | | | | | | | | | | | | | | | | | | | | | | | | | | | | | | | | | | | | | | | | | | |
|--|--------|--------|--------|--------|--------|--------|--------|--|--|--|--|--|--|--|--|--|--|--|--|--|--|--|--|--|--|--|--|--|--|--|--|--|--|--|--|--|--|--|--|--|--|--|--|--|--|--|--|--|--|--|--|--|--|--|--|--|--|--|--|--|--|--|--|--|--|--|--|--|--|--|--|--|--|--|--|--|--|--|--|
| 25 李文哲 | 26 程浩然 | 27 王长旭 | 28 丁浩然 | 32 许浩翔 | 33 姚紫祥 | 41 刘润民 | 42 王成龙 | | | | | | | | | | | | | | | | | | | | | | | | | | | | | | | | | | | | | | | | | | | | | | | | | | | | | | | | | | | | | | | | | | | | | | | | |
| <table border="1"><tr><td></td><td></td><td></td></tr><tr><td></td><td></td><td></td></tr><tr><td></td><td></td><td></td></tr></table> | | | | | | | | | | <table border="1"><tr><td></td><td></td><td></td></tr><tr><td></td><td></td><td></td></tr><tr><td></td><td></td><td></td></tr></table> | | | | | | | | | | <table border="1"><tr><td></td><td></td><td></td></tr><tr><td></td><td></td><td></td></tr><tr><td></td><td></td><td></td></tr></table> | | | | | | | | | | <table border="1"><tr><td></td><td></td><td></td></tr><tr><td></td><td></td><td></td></tr><tr><td></td><td></td><td></td></tr></table> | | | | | | | | | | <table border="1"><tr><td></td><td></td><td></td></tr><tr><td></td><td></td><td></td></tr><tr><td></td><td></td><td></td></tr></table> | | | | | | | | | | <table border="1"><tr><td></td><td></td><td></td></tr><tr><td></td><td></td><td></td></tr><tr><td></td><td></td><td></td></tr></table> | | | | | | | | | | <table border="1"><tr><td></td><td></td><td></td></tr><tr><td></td><td></td><td></td></tr><tr><td></td><td></td><td></td></tr></table> | | | | | | | | | | <table border="1"><tr><td></td><td></td><td></td></tr><tr><td></td><td></td><td></td></tr><tr><td></td><td></td><td></td></tr></table> | | | | | | | | | |
| | | | | | | | | | | | | | | | | | | | | | | | | | | | | | | | | | | | | | | | | | | | | | | | | | | | | | | | | | | | | | | | | | | | | | | | | | | | | | | | |
| | | | | | | | | | | | | | | | | | | | | | | | | | | | | | | | | | | | | | | | | | | | | | | | | | | | | | | | | | | | | | | | | | | | | | | | | | | | | | | | |
| | | | | | | | | | | | | | | | | | | | | | | | | | | | | | | | | | | | | | | | | | | | | | | | | | | | | | | | | | | | | | | | | | | | | | | | | | | | | | | | |
| | | | | | | | | | | | | | | | | | | | | | | | | | | | | | | | | | | | | | | | | | | | | | | | | | | | | | | | | | | | | | | | | | | | | | | | | | | | | | | | |
| | | | | | | | | | | | | | | | | | | | | | | | | | | | | | | | | | | | | | | | | | | | | | | | | | | | | | | | | | | | | | | | | | | | | | | | | | | | | | | | |
| | | | | | | | | | | | | | | | | | | | | | | | | | | | | | | | | | | | | | | | | | | | | | | | | | | | | | | | | | | | | | | | | | | | | | | | | | | | | | | | |
| | | | | | | | | | | | | | | | | | | | | | | | | | | | | | | | | | | | | | | | | | | | | | | | | | | | | | | | | | | | | | | | | | | | | | | | | | | | | | | | |
| | | | | | | | | | | | | | | | | | | | | | | | | | | | | | | | | | | | | | | | | | | | | | | | | | | | | | | | | | | | | | | | | | | | | | | | | | | | | | | | |
| | | | | | | | | | | | | | | | | | | | | | | | | | | | | | | | | | | | | | | | | | | | | | | | | | | | | | | | | | | | | | | | | | | | | | | | | | | | | | | | |
| | | | | | | | | | | | | | | | | | | | | | | | | | | | | | | | | | | | | | | | | | | | | | | | | | | | | | | | | | | | | | | | | | | | | | | | | | | | | | | | |
| | | | | | | | | | | | | | | | | | | | | | | | | | | | | | | | | | | | | | | | | | | | | | | | | | | | | | | | | | | | | | | | | | | | | | | | | | | | | | | | |
| | | | | | | | | | | | | | | | | | | | | | | | | | | | | | | | | | | | | | | | | | | | | | | | | | | | | | | | | | | | | | | | | | | | | | | | | | | | | | | | |
| | | | | | | | | | | | | | | | | | | | | | | | | | | | | | | | | | | | | | | | | | | | | | | | | | | | | | | | | | | | | | | | | | | | | | | | | | | | | | | | |
| | | | | | | | | | | | | | | | | | | | | | | | | | | | | | | | | | | | | | | | | | | | | | | | | | | | | | | | | | | | | | | | | | | | | | | | | | | | | | | | |
| | | | | | | | | | | | | | | | | | | | | | | | | | | | | | | | | | | | | | | | | | | | | | | | | | | | | | | | | | | | | | | | | | | | | | | | | | | | | | | | |
| | | | | | | | | | | | | | | | | | | | | | | | | | | | | | | | | | | | | | | | | | | | | | | | | | | | | | | | | | | | | | | | | | | | | | | | | | | | | | | | |
| | | | | | | | | | | | | | | | | | | | | | | | | | | | | | | | | | | | | | | | | | | | | | | | | | | | | | | | | | | | | | | | | | | | | | | | | | | | | | | | |
| | | | | | | | | | | | | | | | | | | | | | | | | | | | | | | | | | | | | | | | | | | | | | | | | | | | | | | | | | | | | | | | | | | | | | | | | | | | | | | | |
| | | | | | | | | | | | | | | | | | | | | | | | | | | | | | | | | | | | | | | | | | | | | | | | | | | | | | | | | | | | | | | | | | | | | | | | | | | | | | | | |
| | | | | | | | | | | | | | | | | | | | | | | | | | | | | | | | | | | | | | | | | | | | | | | | | | | | | | | | | | | | | | | | | | | | | | | | | | | | | | | | |
| | | | | | | | | | | | | | | | | | | | | | | | | | | | | | | | | | | | | | | | | | | | | | | | | | | | | | | | | | | | | | | | | | | | | | | | | | | | | | | | |
| | | | | | | | | | | | | | | | | | | | | | | | | | | | | | | | | | | | | | | | | | | | | | | | | | | | | | | | | | | | | | | | | | | | | | | | | | | | | | | | |
| | | | | | | | | | | | | | | | | | | | | | | | | | | | | | | | | | | | | | | | | | | | | | | | | | | | | | | | | | | | | | | | | | | | | | | | | | | | | | | | |
| | | | | | | | | | | | | | | | | | | | | | | | | | | | | | | | | | | | | | | | | | | | | | | | | | | | | | | | | | | | | | | | | | | | | | | | | | | | | | | | |

Post - 0 Miss - 0 Block - 0 Post - 0 Miss - 0 Block - 0 Post - 0 Miss - 0 Block - 0 Post - 0 Miss - 0 Block - 0 Post - 0 Miss - 0 Block - 0 Post - 0 Miss - 0 Block - 0 Post - 0 Miss - 0 Block - 0 Post - 0 Miss - 0 Block - 0

注释: Post=击柱 Miss=射失 Block=被封



预赛 Group B
青年男子 全国比赛

2016年“体彩杯”全国手球男子青年锦标赛

| | | | | | | | | | | | | | | | | | | | | | |
|--------------------|---|--|---------------------|------------------|------------------------------------|-------------------|---|--------------------|------------------------------------|----|-----|----------------------|---------------|---|--|--|---|---|----|----|----|
| Team A A 四川队 | | | | Team B B 新疆队 | | | | Match Number 21 | | | | | | | | | | | | | |
| played in China | | in the hall 重庆万州 | | on 24/03/2016 | | at 13:00 hours | | Spectators | | | | | | | | | | | | | |
| Half-time (30') | A 15 | B 17 | End of playing time | A 29 | B 28 | 1st extra time | A | B | 2nd extra time | A | B | After penalty throws | A | B | | | | | | | |
| Number of 7 m | A 3/4 | Team time-out 1 22:37 2 46:32 3 57:16 | | | Full name of players and officials | | | | Team time-out 1 13:17 2 41:54 3 | | | B 2/3 | Number of 7 m | | | | | | | | |
| No. | Team A | | | | | G | W | 2' | D | DR | No. | Team B | | | | | G | W | 2' | D | DR |
| 1 | 宋继强 | | | | | | | | | | 1 | 宋晓晨 | | | | | | | | | |
| 3 | 刘赵梁 | | | | | 5 | | | | | 2 | 王泽川 | | | | | | | | | |
| 5 | 王凯 | | | | | 4 | 1 | | | | 4 | 谷通金 | | | | | 1 | | | | |
| 7 | 仇瑞祥 | | | | | | | | | | 5 | 徐伟 | | | | | 5 | 1 | | | |
| 8 | 罗尧尧 | | | | | 8 | | 1 | | | 6 | 白光宇 | | | | | | | | | |
| 9 | 许翔宇 | | | | | 3 | | | | | 7 | 林豪文 | | | | | 4 | 1 | | | |
| 10 | 徐彦昊 | | | | | | | | | | 10 | 王钟彬 | | | | | 4 | | 3 | | |
| 11 | 张天豪 | | | | | | | 1 | | | 12 | 王金鑫 | | | | | | | | | |
| 12 | 刘树豪 | | | | | | | | | | 13 | 苏兴伟 | | | | | | | | | |
| 13 | 尹文珂 | | | | | | | | | | 15 | 王维东 | | | | | 7 | | 1 | | |
| 15 | 徐逸 | | | | | | | | | | 16 | 李佳懿 | | | | | | | | | |
| 17 | 谢庆龙 | | | | | 3 | 1 | 1 | | | 17 | 胡晋铭 | | | | | 4 | 1 | 1 | | |
| 18 | 张睿梁 | | | | | | | 1 | | | 18 | 李万兴 | | | | | | | | | |
| 19 | 庞连康 | | | | | 6 | 1 | 1 | | | 19 | 李龙吉 | | | | | 3 | | | | |
| 20 | 张文健 | | | | | | | | | | 24 | 陈伟华 | | | | | | | | | |
| 21 | 曹修庆 | | | | | | | | | | | | | | | | | | | | |
| B | 张文韬 (主教练) | | | | | | | | | | A | 孔德宾 (主教练) | | | | | | | | | |
| | | | | | | | | | | | B | 陈鹏波 | | | | | | | | | |
| | | | | | | | | | | | C | 李楠 | | | | | | | | | |
| A | Signature of Responsible Official of the Teams (Off. A) | | | | | | | | | | | | | | | | | | | B | |
| TP | Remarks of Referee / CHA Official | | | | | | | | | | | | | | | | | | | TP | |

Signatures

| | | | | |
|------------------|-----------|-----------|--|--|
| Referees | 许翔 (CHN) | 王雨洋 (CHN) | | |
| Techn. Delegates | 许宜扬 (CHN) | | | |
| CHA Official | 张春生 (CHN) | | | |

Note: Number of 7m Throws Awarded to Team A and B, Goals (G), Warnings (W), Suspensions (2'), Direct Disqualification (D), Disqualification with Report (DR) and Team Penalty (TP).

Table Officials:

Statisticians: 刘永欢

李双





2016年“体彩杯”全国手球男子青年锦标赛 竞赛技术统计(媒体表)

| | | | | | | |
|----------------|-----------|------------|----|-----------|------------------|-----------|
| 预赛 | 组别 | B | 轮次 | 4 | 场次 | 21 |
| 重庆万州 | | 24/03/2016 | | | 201602021-51-1/1 | |
| 四川队 | <i>四川</i> | 29 | vs | 28 | <i>新疆</i> | 新疆队 |
| 15 : 17 | | | | | | |

| | | | | | | | |
|-----|----------|--|--|---|-----------|--|--|
| 裁判员 | 许翔 (CHN) | | | / | 王雨洋 (CHN) | | |
|-----|----------|--|--|---|-----------|--|--|

| <i>四川</i> | | 远 | 近 | 边 | 快 | 突 | 任意 | 7m | 合计 | % | 助攻 | 失误 | 警告 | 2' | D & DR | 四川 | | 新疆 | |
|---------------|-----|-------------|-------------|-------------|------------|------------|------------|------------|--------------|-------------|-----------|-----------|----------|----------|--------|--------------|-------|----|--------|
| 主教练: 张文韬 | | 射 | 射 | 射 | 攻 | 破 | 球 | 球 | 球 | | | | | | | 比赛进程 | | | |
| 1 | 宋继强 | | | | | | | | | | 1 | | | | | 1st Half | | | |
| 3 | 刘赵梁 | | 0/3 | 3/5 | 2/3 | | | | 5/11 | 45.5 | | 3 | | | | 0 | 02:06 | 1 | 10 王钟彬 |
| 5 | 王凯 | | 3/6 | 1/2 | 0/1 | | | | 4/9 | 44.4 | 1 | 1 | 1 | | | 0 | 02:42 | 2 | 5 徐伟 |
| 7 | 仇瑞祥 | | | | | | | | | | | | | | | 1 | 03:12 | 2 | |
| 8 | 罗尧尧 | 2/5 | 0/1 | 1/1 | 2/2 | | 0/2 | 3/4 | 8/15 | 53.3 | 5 | 2 | | 1 | | 1 | 03:48 | 3 | 15 王维东 |
| 9 | 许翔宇 | 1/3 | 0/2 | 1/3 | 1/1 | | | | 3/9 | 33.3 | 2 | 10 | | | | 2 | 05:27 | 3 | |
| 10 | 徐彦昊 | | | | | | | | | | | | | | | 2 | 05:53 | 4 | 15 王维东 |
| 11 | 张天豪 | | | | | | | | | | | | | | | 3 | 07:00 | 4 | |
| 12 | 刘树豪 | | | | | | | | | | | | | | | 3 | 07:28 | 5 | 10 王钟彬 |
| 13 | 尹文珂 | | | | | | | | | | | | | | | 3 | 07:46 | 6 | 10 王钟彬 |
| 15 | 徐逸 | | | | | | | | | | | | | | | 4 | 09:15 | 6 | |
| 17 | 谢庆龙 | | 2/2 | | 1/1 | | | | 3/3 | 100 | | 4 | 1 | 1 | | 5 | 10:39 | 6 | |
| 18 | 张睿梁 | | | | | | | | | | | | | | | 5 | 10:39 | 6 | |
| 19 | 庞连康 | 1/3 | 3/4 | 0/1 | | 2/2 | | | 6/10 | 60.0 | 5 | 2 | 1 | 1 | | 6 | 12:42 | 6 | |
| 20 | 张文健 | | | | | | | | | | | | | | | 6 | 12:42 | 6 | |
| 21 | 曹修庆 | | | | | | | | | | | | | | | 7 | 13:51 | 6 | |
| 运动员 合计 | | 4/11 | 8/18 | 6/12 | 6/8 | 2/2 | 0/2 | 3/4 | 29/57 | 50.9 | 15 | 23 | 3 | 5 | | 8 | 15:59 | 6 | |
| 1 | 宋继强 | 8/13 | 2/8 | 2/5 | 2/7 | 1/3 | 1/1 | 1/3 | 17/40 | 42.5 | 1 | | | | | 8 | 16:20 | 7 | 7 林豪文 |
| 12 | 刘树豪 | 0/2 | 0/1 | 0/2 | | | | | 0/5 | 0.0 | | | | | | 9 | 16:46 | 7 | |
| 守门员 合计 | | 8/15 | 2/9 | 2/7 | 2/7 | 1/3 | 1/1 | 1/3 | 17/45 | 37.8 | 1 | | | | | 9 | 17:41 | 8 | 7 林豪文 |
| <i>新疆</i> | | 远 | 近 | 边 | 快 | 突 | 任意 | 7m | 合计 | % | 助攻 | 失误 | 警告 | 2' | D & DR | 四川 | | 新疆 | |
| 教练: 孔德宾 | | 射 | 射 | 射 | 攻 | 破 | 球 | 球 | 球 | | | | | | | 比赛进程 | | | |
| 1 | 宋晓晨 | | | | | | | | | | 2 | 1 | | | | 2nd Half | | | |
| 2 | 王泽川 | | | | | | | | | | | | | | | 16 | 01:14 | 17 | |
| 4 | 谷通金 | | | 1/1 | 0/1 | | | | 1/2 | 50.0 | | 2 | | | | 16 | 01:33 | 18 | 17 胡晋铭 |
| 5 | 徐伟 | | 1/1 | 2/4 | 1/1 | | | 1/1 | 5/7 | 71.4 | 1 | 1 | 1 | | | 17 | 01:56 | 18 | |
| 6 | 白光宇 | | | | | | | | | | | | | | | 17 | 02:41 | 19 | 7 林豪文 |
| 7 | 林豪文 | 3/9 | 0/1 | | 0/1 | | 0/1 | 1/1 | 4/13 | 30.8 | 3 | 3 | 1 | | | 18 | 03:44 | 19 | |
| 10 | 王钟彬 | 3/8 | | | 1/1 | | 0/1 | | 4/10 | 40.0 | 1 | 3 | | 3 | | 19 | 04:17 | 19 | |
| 12 | 王金鑫 | | | | | | | | | | | | | | | 19 | 04:17 | 19 | |
| 13 | 苏兴伟 | | | | | | | | | | | | | | | 9 | 05:29 | 19 | |
| 15 | 王维东 | 1/5 | 1/2 | 2/3 | 2/3 | 1/1 | | | 7/14 | 50.0 | 1 | 3 | | 1 | | 3 | 06:52 | 19 | |
| 16 | 李佳懿 | | | | | | | | | | | | | | | 5 | 08:23 | 19 | |
| 17 | 胡晋铭 | | 4/4 | | | | | | | | | | | | | 9 | 11:35 | 19 | |
| 18 | 李万兴 | | | | | | | | | | | | | | | 3 | 14:16 | 19 | |
| 19 | 李龙吉 | 0/1 | 1/2 | | 1/1 | 1/2 | 0/1 | 0/1 | 3/8 | 37.5 | 2 | 8 | | | | 24 | 15:46 | 20 | 19 李龙吉 |
| 24 | 陈伟华 | | | | | | | | | | | 1 | | | | 24 | 17:17 | 20 | |
| 运动员 合计 | | 7/23 | 7/10 | 5/8 | 5/8 | 2/3 | 0/3 | 2/3 | 28/58 | 48.3 | 10 | 23 | 3 | 5 | | 25 | 17:17 | 20 | |
| 1 | 宋晓晨 | 2/6 | 7/15 | 4/10 | 1/7 | 0/2 | 2/2 | 1/4 | 17/46 | 37.0 | 2 | 1 | | | | 25 | 18:08 | 21 | 7 林豪文 |
| 守门员 合计 | | 2/6 | 7/15 | 4/10 | 1/7 | 0/2 | 2/2 | 1/4 | 17/46 | 37.0 | 2 | 1 | | | | 25 | 19:11 | 22 | 5 徐伟 |
| 场上队员: 得分 / 射门 | | | | | | | | | | | | | | | | 守门员: 救球 / 射门 | | | |

| | | | | | | | | | | | | | |
|----|------------|--|----|--------------|--|-----|------------|--|-----|----------|--|----|---------|
| 快攻 | Fast Break | | 突破 | Breakthrough | | 任意球 | Free Throw | | 7M球 | 7M Throw | | 助攻 | Assist |
| 警告 | Warning | | 失误 | Error | | 2' | Suspension | | D | 取消资格 | | DR | 取消资格+报告 |





2016年“体彩杯”全国手球男子青年锦标赛

个人/全队技术统计表

正式表
手球
青年男子预赛
轮次 4组别 B
场次 21201602021-14-1/2
重庆万州
24/03/2016 13:00

| 号码 | 姓名 | 远射 | 近射 | 边射 | 快攻 | 突破 | 任意 | 7M | 合计 | % | 助攻 | 失误 | 警告 | 2' | 取消 | 时间 |
|----------------|-----|------|------|------|-----|-----|-----|-----|-------|-------|----|----|----|----|----|----------|
| 四川队(四川) | | | | | | | | | | | | | | | | |
| <i>(场上队员)</i> | | | | | | | | | | | | | | | | |
| 1 | 宋继强 | | | | | | | | | 0.0% | 1 | | | | | 00:53:25 |
| 3 | 刘赵梁 | | 0/3 | 3/5 | 2/3 | | | | 5/11 | 45.5% | | 3 | | | | 00:59:39 |
| 5 | 王凯 | | 3/6 | 1/2 | 0/1 | | | | 4/9 | 44.4% | 1 | 1 | 1 | | | 00:53:11 |
| 7 | 仇瑞祥 | | | | | | | | | 0.0% | | | | | | 00:00:00 |
| 8 | 罗尧尧 | 2/5 | 0/1 | 1/1 | 2/2 | | 0/2 | 3/4 | 8/15 | 53.3% | 5 | 2 | | 1 | | 00:58:42 |
| 9 | 许翔宇 | 1/3 | 0/2 | 1/3 | 1/1 | | | | 3/9 | 33.3% | 2 | 10 | | | | 00:53:24 |
| 10 | 徐彦昊 | | | | | | | | | 0.0% | | 1 | | | | 00:07:13 |
| 11 | 张天豪 | | | | | | | | | 0.0% | 1 | | | 1 | | 00:05:45 |
| 12 | 刘树豪 | | | | | | | | | 0.0% | | | | | | 00:06:35 |
| 13 | 尹文珂 | | | | | | | | | 0.0% | | | | | | 00:00:00 |
| 15 | 徐逸 | | | | | | | | | 0.0% | | | | | | 00:00:00 |
| 17 | 谢庆龙 | | 2/2 | | 1/1 | | | | 3/3 | 100% | | 4 | 1 | 1 | | 00:59:58 |
| 18 | 张睿梁 | | | | | | | | | 0.0% | | | | 1 | | 00:00:02 |
| 19 | 庞连康 | 1/3 | 3/4 | 0/1 | | 2/2 | | | 6/10 | 60.0% | 5 | 2 | 1 | 1 | | 01:00:00 |
| 20 | 张文健 | | | | | | | | | 0.0% | | | | | | 00:00:00 |
| 21 | 曹修庆 | | | | | | | | | 0.0% | | | | | | 00:00:00 |
| 合计 | | 4/11 | 8/18 | 6/12 | 6/8 | 2/2 | 0/2 | 3/4 | 29/57 | 50.9% | 15 | 23 | 3 | 5 | | |
| <i>(守门员)</i> | | | | | | | | | | | | | | | | |
| 1 | 宋继强 | 8/13 | 2/8 | 2/5 | 2/7 | 1/3 | 1/1 | 1/3 | 17/40 | 42.5% | 1 | | | | | 00:53:25 |
| 12 | 刘树豪 | 0/2 | 0/1 | 0/2 | | | | | 0/5 | 0.0% | | | | | | 00:06:35 |
| 合计 | | 8/15 | 2/9 | 2/7 | 2/7 | 1/3 | 1/1 | 1/3 | 17/45 | 37.8% | 1 | | | | | |

场上队员：得分/射门

守门员：救球/射门

| 全队合计 | 得分 | 被救 | 射失 | 击柱 | 封球 | 合计 | % |
|------|----|----|----|----|----|----|--------|
| 远射 | 4 | 2 | 3 | | 2 | 11 | 36.4% |
| 近射 | 8 | 7 | 1 | 2 | | 18 | 44.4% |
| 边射 | 6 | 4 | | 2 | | 12 | 50.0% |
| 快攻 | 6 | 1 | 1 | | | 8 | 75.0% |
| 突破 | 2 | | | | | 2 | 100.0% |
| 任意 | | 2 | | | | 2 | 0.0% |
| 7M | 3 | 1 | | | | 4 | 75.0% |





2016年“体彩杯”全国手球男子青年锦标赛

个人/全队技术统计表

正式表
手球
青年男子预赛
轮次 4组别 B
场次 21201602021-14-2/2
重庆万州
24/03/2016 13:00

| 号码 | 姓名 | 远射 | 近射 | 边射 | 快攻 | 突破 | 任意 | 7M | 合计 | % | 助攻 | 失误 | 警告 | 2' | 取消 | 时间 |
|----------------|-----|------|------|------|-----|-----|-----|-----|-------|-------|----|----|----|----|----|----------|
| 新疆队(新疆) | | | | | | | | | | | | | | | | |
| <i>(上场队员)</i> | | | | | | | | | | | | | | | | |
| 1 | 宋晓晨 | | | | | | | | | 0.0% | 2 | 1 | | | | 01:00:00 |
| 2 | 王泽川 | | | | | | | | | 0.0% | | | | | | 00:00:00 |
| 4 | 谷通金 | | | 1/1 | 0/1 | | | | 1/2 | 50.0% | | 2 | | | | 00:21:35 |
| 5 | 徐伟 | | 1/1 | 2/4 | 1/1 | | | 1/1 | 5/7 | 71.4% | 1 | 1 | 1 | | | 01:00:00 |
| 6 | 白光宇 | | | | | | | | | 0.0% | | | | | | 00:00:00 |
| 7 | 林豪文 | 3/9 | 0/1 | | 0/1 | | 0/1 | 1/1 | 4/13 | 30.8% | 3 | 3 | 1 | | | 01:00:00 |
| 10 | 王钟彬 | 3/8 | | | 1/1 | | 0/1 | | 4/10 | 40.0% | 1 | 3 | | 3 | | 00:40:25 |
| 12 | 王金鑫 | | | | | | | | | 0.0% | | | | | | 00:00:00 |
| 13 | 苏兴伟 | | | | | | | | | 0.0% | | | | | | 00:00:00 |
| 15 | 王维东 | 1/5 | 1/2 | 2/3 | 2/3 | 1/1 | | | 7/14 | 50.0% | 1 | 3 | | 1 | | 00:56:31 |
| 16 | 李佳懿 | | | | | | | | | 0.0% | | | | | | 00:00:00 |
| 17 | 胡晋铭 | | 4/4 | | | | | | 4/4 | 100% | | 1 | 1 | 1 | | 01:00:00 |
| 18 | 李万兴 | | | | | | | | | 0.0% | | | | | | 00:00:00 |
| 19 | 李龙吉 | 0/1 | 1/2 | | 1/1 | 1/2 | 0/1 | 0/1 | 3/8 | 37.5% | 2 | 8 | | | | 01:00:00 |
| 24 | 陈伟华 | | | | | | | | | 0.0% | | 1 | | | | 00:01:28 |
| 合计 | | 7/23 | 7/10 | 5/8 | 5/8 | 2/3 | 0/3 | 2/3 | 28/58 | 48.3% | 10 | 23 | 3 | 5 | | |
| <i>(守门员)</i> | | | | | | | | | | | | | | | | |
| 1 | 宋晓晨 | 2/6 | 7/15 | 4/10 | 1/7 | 0/2 | 2/2 | 1/4 | 17/46 | 37.0% | 2 | 1 | | | | 01:00:00 |
| 合计 | | 2/6 | 7/15 | 4/10 | 1/7 | 0/2 | 2/2 | 1/4 | 17/46 | 37.0% | 2 | 1 | | | | |

场上队员：得分/射门

守门员：救球/射门

| 全队合计 | 得分 | 被救 | 射失 | 击柱 | 封球 | 合计 | % |
|------|----|----|----|----|----|----|-------|
| 远射 | 7 | 8 | 3 | | 5 | 23 | 30.4% |
| 近射 | 7 | 2 | | 1 | | 10 | 70.0% |
| 边射 | 5 | 2 | 1 | | | 8 | 62.5% |
| 快攻 | 5 | 2 | | 1 | | 8 | 62.5% |
| 突破 | 2 | 1 | | | | 3 | 66.7% |
| 任意 | | 1 | 2 | | | 3 | 0.0% |
| 7M | 2 | 1 | | | | 3 | 66.7% |





2016年“体彩杯”全国手球男子青年锦标赛

图式射门区域统计

轮次 4 场次 21

201602021-41-1/1

四川队

| | | | | | | | | | | | | | | | | | | | | | | | | | | | | | | | | | | | | | | | | | | | | | | | | | | | | | | | | | | | | | | | | | | | | | | | | | | | | | | | |
|--|-----------------------------|-----------------------------|-----------------------------|-----------------------------|-----------------------------|-----------------------------|-----------------------------|--|--|--|---|---|---|---|--|--|--|--|--|--|--|--|---|--|--|--|--|---|--|---|--|--|--|--|--|--|---|--|--|---|---|--|---|---|--|--|---|---|--|--|---|--|--|---|--|---|---|--|---|--|--|--|--|--|--|--|--|--|--|--|--|--|--|--|--|--|--|--|--|
| 1 宋继强 | 3 刘赵梁 | 5 王凯 | 7 仇瑞祥 | 8 罗尧尧 | 9 许翔宇 | 10 徐彦昊 | 11 张天豪 | | | | | | | | | | | | | | | | | | | | | | | | | | | | | | | | | | | | | | | | | | | | | | | | | | | | | | | | | | | | | | | | | | | | | | | | |
| <table border="1"><tr><td></td><td></td><td></td></tr><tr><td></td><td></td><td></td></tr><tr><td></td><td></td><td></td></tr></table> | | | | | | | | | | <table border="1"><tr><td>1</td><td>1</td><td>1</td></tr><tr><td>2</td><td></td><td></td></tr><tr><td></td><td></td><td></td></tr></table> | 1 | 1 | 1 | 2 | | | | | | <table border="1"><tr><td></td><td></td><td>2</td></tr><tr><td></td><td></td><td></td></tr><tr><td></td><td>2</td><td></td></tr></table> | | | 2 | | | | | 2 | | <table border="1"><tr><td></td><td></td><td></td></tr><tr><td></td><td></td><td></td></tr><tr><td></td><td></td><td></td></tr></table> | | | | | | | | | | <table border="1"><tr><td>1</td><td></td><td>1</td></tr><tr><td>3</td><td></td><td></td></tr><tr><td>2</td><td>1</td><td></td></tr></table> | 1 | | 1 | 3 | | | 2 | 1 | | <table border="1"><tr><td></td><td></td><td></td></tr><tr><td></td><td></td><td>1</td></tr><tr><td></td><td></td><td></td></tr></table> | | | | | | 1 | | | | <table border="1"><tr><td></td><td></td><td></td></tr><tr><td></td><td></td><td></td></tr><tr><td></td><td></td><td></td></tr></table> | | | | | | | | | | <table border="1"><tr><td></td><td></td><td></td></tr><tr><td></td><td></td><td></td></tr><tr><td></td><td></td><td></td></tr></table> | | | | | | | | | |
| | | | | | | | | | | | | | | | | | | | | | | | | | | | | | | | | | | | | | | | | | | | | | | | | | | | | | | | | | | | | | | | | | | | | | | | | | | | | | | | |
| | | | | | | | | | | | | | | | | | | | | | | | | | | | | | | | | | | | | | | | | | | | | | | | | | | | | | | | | | | | | | | | | | | | | | | | | | | | | | | | |
| | | | | | | | | | | | | | | | | | | | | | | | | | | | | | | | | | | | | | | | | | | | | | | | | | | | | | | | | | | | | | | | | | | | | | | | | | | | | | | | |
| 1 | 1 | 1 | | | | | | | | | | | | | | | | | | | | | | | | | | | | | | | | | | | | | | | | | | | | | | | | | | | | | | | | | | | | | | | | | | | | | | | | | | | | | |
| 2 | | | | | | | | | | | | | | | | | | | | | | | | | | | | | | | | | | | | | | | | | | | | | | | | | | | | | | | | | | | | | | | | | | | | | | | | | | | | | | | |
| | | | | | | | | | | | | | | | | | | | | | | | | | | | | | | | | | | | | | | | | | | | | | | | | | | | | | | | | | | | | | | | | | | | | | | | | | | | | | | | |
| | | 2 | | | | | | | | | | | | | | | | | | | | | | | | | | | | | | | | | | | | | | | | | | | | | | | | | | | | | | | | | | | | | | | | | | | | | | | | | | | | | |
| | | | | | | | | | | | | | | | | | | | | | | | | | | | | | | | | | | | | | | | | | | | | | | | | | | | | | | | | | | | | | | | | | | | | | | | | | | | | | | | |
| | 2 | | | | | | | | | | | | | | | | | | | | | | | | | | | | | | | | | | | | | | | | | | | | | | | | | | | | | | | | | | | | | | | | | | | | | | | | | | | | | | |
| | | | | | | | | | | | | | | | | | | | | | | | | | | | | | | | | | | | | | | | | | | | | | | | | | | | | | | | | | | | | | | | | | | | | | | | | | | | | | | | |
| | | | | | | | | | | | | | | | | | | | | | | | | | | | | | | | | | | | | | | | | | | | | | | | | | | | | | | | | | | | | | | | | | | | | | | | | | | | | | | | |
| | | | | | | | | | | | | | | | | | | | | | | | | | | | | | | | | | | | | | | | | | | | | | | | | | | | | | | | | | | | | | | | | | | | | | | | | | | | | | | | |
| 1 | | 1 | | | | | | | | | | | | | | | | | | | | | | | | | | | | | | | | | | | | | | | | | | | | | | | | | | | | | | | | | | | | | | | | | | | | | | | | | | | | | |
| 3 | | | | | | | | | | | | | | | | | | | | | | | | | | | | | | | | | | | | | | | | | | | | | | | | | | | | | | | | | | | | | | | | | | | | | | | | | | | | | | | |
| 2 | 1 | | | | | | | | | | | | | | | | | | | | | | | | | | | | | | | | | | | | | | | | | | | | | | | | | | | | | | | | | | | | | | | | | | | | | | | | | | | | | | |
| | | | | | | | | | | | | | | | | | | | | | | | | | | | | | | | | | | | | | | | | | | | | | | | | | | | | | | | | | | | | | | | | | | | | | | | | | | | | | | | |
| | | 1 | | | | | | | | | | | | | | | | | | | | | | | | | | | | | | | | | | | | | | | | | | | | | | | | | | | | | | | | | | | | | | | | | | | | | | | | | | | | | |
| | | | | | | | | | | | | | | | | | | | | | | | | | | | | | | | | | | | | | | | | | | | | | | | | | | | | | | | | | | | | | | | | | | | | | | | | | | | | | | | |
| | | | | | | | | | | | | | | | | | | | | | | | | | | | | | | | | | | | | | | | | | | | | | | | | | | | | | | | | | | | | | | | | | | | | | | | | | | | | | | | |
| | | | | | | | | | | | | | | | | | | | | | | | | | | | | | | | | | | | | | | | | | | | | | | | | | | | | | | | | | | | | | | | | | | | | | | | | | | | | | | | |
| | | | | | | | | | | | | | | | | | | | | | | | | | | | | | | | | | | | | | | | | | | | | | | | | | | | | | | | | | | | | | | | | | | | | | | | | | | | | | | | |
| | | | | | | | | | | | | | | | | | | | | | | | | | | | | | | | | | | | | | | | | | | | | | | | | | | | | | | | | | | | | | | | | | | | | | | | | | | | | | | | |
| | | | | | | | | | | | | | | | | | | | | | | | | | | | | | | | | | | | | | | | | | | | | | | | | | | | | | | | | | | | | | | | | | | | | | | | | | | | | | | | |
| | | | | | | | | | | | | | | | | | | | | | | | | | | | | | | | | | | | | | | | | | | | | | | | | | | | | | | | | | | | | | | | | | | | | | | | | | | | | | | | |
| Post - 0 Miss - 0 Block - 0 | Post - 1 Miss - 1 Block - 0 | Post - 2 Miss - 0 Block - 0 | Post - 0 Miss - 0 Block - 0 | Post - 0 Miss - 1 Block - 0 | Post - 1 Miss - 2 Block - 1 | Post - 0 Miss - 0 Block - 0 | Post - 0 Miss - 0 Block - 0 | | | | | | | | | | | | | | | | | | | | | | | | | | | | | | | | | | | | | | | | | | | | | | | | | | | | | | | | | | | | | | | | | | | | | | | | |
| 12 刘树豪 | 13 尹文珂 | 15 徐逸 | 17 谢庆龙 | 18 张睿梁 | 19 庞连康 | 20 张文健 | 21 曹修庆 | | | | | | | | | | | | | | | | | | | | | | | | | | | | | | | | | | | | | | | | | | | | | | | | | | | | | | | | | | | | | | | | | | | | | | | | |
| <table border="1"><tr><td></td><td></td><td></td></tr><tr><td></td><td></td><td></td></tr><tr><td></td><td></td><td></td></tr></table> | | | | | | | | | | <table border="1"><tr><td></td><td></td><td></td></tr><tr><td></td><td></td><td></td></tr><tr><td></td><td></td><td></td></tr></table> | | | | | | | | | | <table border="1"><tr><td></td><td></td><td></td></tr><tr><td></td><td></td><td></td></tr><tr><td></td><td></td><td></td></tr></table> | | | | | | | | | | <table border="1"><tr><td></td><td></td><td></td></tr><tr><td></td><td></td><td></td></tr><tr><td>3</td><td></td><td></td></tr></table> | | | | | | | 3 | | | <table border="1"><tr><td></td><td></td><td></td></tr><tr><td></td><td></td><td></td></tr><tr><td></td><td></td><td></td></tr></table> | | | | | | | | | | <table border="1"><tr><td>3</td><td></td><td></td></tr><tr><td>1</td><td></td><td></td></tr><tr><td>1</td><td></td><td>1</td></tr></table> | 3 | | | 1 | | | 1 | | 1 | <table border="1"><tr><td></td><td></td><td></td></tr><tr><td></td><td></td><td></td></tr><tr><td></td><td></td><td></td></tr></table> | | | | | | | | | | <table border="1"><tr><td></td><td></td><td></td></tr><tr><td></td><td></td><td></td></tr><tr><td></td><td></td><td></td></tr></table> | | | | | | | | | |
| | | | | | | | | | | | | | | | | | | | | | | | | | | | | | | | | | | | | | | | | | | | | | | | | | | | | | | | | | | | | | | | | | | | | | | | | | | | | | | | |
| | | | | | | | | | | | | | | | | | | | | | | | | | | | | | | | | | | | | | | | | | | | | | | | | | | | | | | | | | | | | | | | | | | | | | | | | | | | | | | | |
| | | | | | | | | | | | | | | | | | | | | | | | | | | | | | | | | | | | | | | | | | | | | | | | | | | | | | | | | | | | | | | | | | | | | | | | | | | | | | | | |
| | | | | | | | | | | | | | | | | | | | | | | | | | | | | | | | | | | | | | | | | | | | | | | | | | | | | | | | | | | | | | | | | | | | | | | | | | | | | | | | |
| | | | | | | | | | | | | | | | | | | | | | | | | | | | | | | | | | | | | | | | | | | | | | | | | | | | | | | | | | | | | | | | | | | | | | | | | | | | | | | | |
| | | | | | | | | | | | | | | | | | | | | | | | | | | | | | | | | | | | | | | | | | | | | | | | | | | | | | | | | | | | | | | | | | | | | | | | | | | | | | | | |
| | | | | | | | | | | | | | | | | | | | | | | | | | | | | | | | | | | | | | | | | | | | | | | | | | | | | | | | | | | | | | | | | | | | | | | | | | | | | | | | |
| | | | | | | | | | | | | | | | | | | | | | | | | | | | | | | | | | | | | | | | | | | | | | | | | | | | | | | | | | | | | | | | | | | | | | | | | | | | | | | | |
| | | | | | | | | | | | | | | | | | | | | | | | | | | | | | | | | | | | | | | | | | | | | | | | | | | | | | | | | | | | | | | | | | | | | | | | | | | | | | | | |
| | | | | | | | | | | | | | | | | | | | | | | | | | | | | | | | | | | | | | | | | | | | | | | | | | | | | | | | | | | | | | | | | | | | | | | | | | | | | | | | |
| | | | | | | | | | | | | | | | | | | | | | | | | | | | | | | | | | | | | | | | | | | | | | | | | | | | | | | | | | | | | | | | | | | | | | | | | | | | | | | | |
| 3 | | | | | | | | | | | | | | | | | | | | | | | | | | | | | | | | | | | | | | | | | | | | | | | | | | | | | | | | | | | | | | | | | | | | | | | | | | | | | | | |
| | | | | | | | | | | | | | | | | | | | | | | | | | | | | | | | | | | | | | | | | | | | | | | | | | | | | | | | | | | | | | | | | | | | | | | | | | | | | | | | |
| | | | | | | | | | | | | | | | | | | | | | | | | | | | | | | | | | | | | | | | | | | | | | | | | | | | | | | | | | | | | | | | | | | | | | | | | | | | | | | | |
| | | | | | | | | | | | | | | | | | | | | | | | | | | | | | | | | | | | | | | | | | | | | | | | | | | | | | | | | | | | | | | | | | | | | | | | | | | | | | | | |
| 3 | | | | | | | | | | | | | | | | | | | | | | | | | | | | | | | | | | | | | | | | | | | | | | | | | | | | | | | | | | | | | | | | | | | | | | | | | | | | | | | |
| 1 | | | | | | | | | | | | | | | | | | | | | | | | | | | | | | | | | | | | | | | | | | | | | | | | | | | | | | | | | | | | | | | | | | | | | | | | | | | | | | | |
| 1 | | 1 | | | | | | | | | | | | | | | | | | | | | | | | | | | | | | | | | | | | | | | | | | | | | | | | | | | | | | | | | | | | | | | | | | | | | | | | | | | | | |
| | | | | | | | | | | | | | | | | | | | | | | | | | | | | | | | | | | | | | | | | | | | | | | | | | | | | | | | | | | | | | | | | | | | | | | | | | | | | | | | |
| | | | | | | | | | | | | | | | | | | | | | | | | | | | | | | | | | | | | | | | | | | | | | | | | | | | | | | | | | | | | | | | | | | | | | | | | | | | | | | | |
| | | | | | | | | | | | | | | | | | | | | | | | | | | | | | | | | | | | | | | | | | | | | | | | | | | | | | | | | | | | | | | | | | | | | | | | | | | | | | | | |
| | | | | | | | | | | | | | | | | | | | | | | | | | | | | | | | | | | | | | | | | | | | | | | | | | | | | | | | | | | | | | | | | | | | | | | | | | | | | | | | |
| | | | | | | | | | | | | | | | | | | | | | | | | | | | | | | | | | | | | | | | | | | | | | | | | | | | | | | | | | | | | | | | | | | | | | | | | | | | | | | | |
| | | | | | | | | | | | | | | | | | | | | | | | | | | | | | | | | | | | | | | | | | | | | | | | | | | | | | | | | | | | | | | | | | | | | | | | | | | | | | | | |
| Post - 0 Miss - 0 Block - 0 | Post - 0 Miss - 0 Block - 0 | Post - 0 Miss - 0 Block - 0 | Post - 0 Miss - 0 Block - 0 | Post - 0 Miss - 0 Block - 0 | Post - 0 Miss - 1 Block - 1 | Post - 0 Miss - 0 Block - 0 | Post - 0 Miss - 0 Block - 0 | | | | | | | | | | | | | | | | | | | | | | | | | | | | | | | | | | | | | | | | | | | | | | | | | | | | | | | | | | | | | | | | | | | | | | | | |

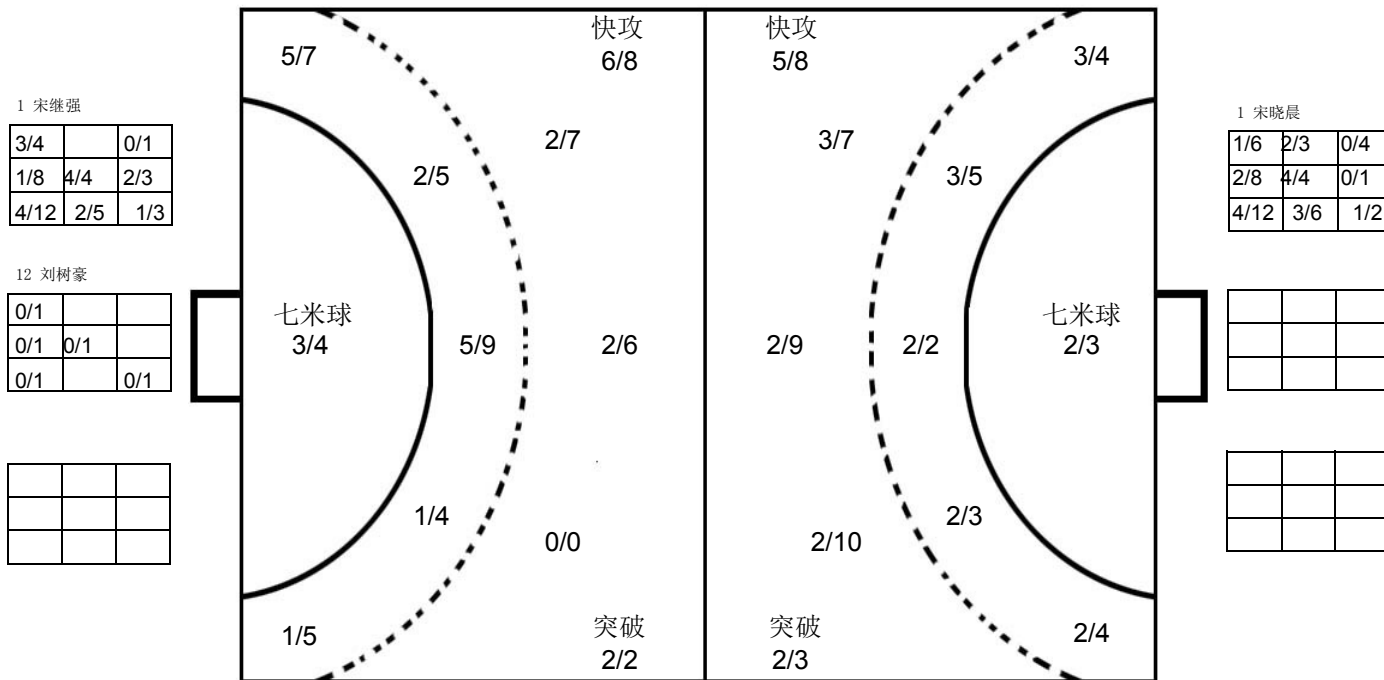

新疆队

| | | | | | | | | | | | | | | | | | | | | | | | | | | | | | | | | | | | | | | | | | | | | | | | | | | | | | | | | | | | | | | | | | | | | | | | | | | | | | | | |
|--|-----------------------------|-----------------------------|-----------------------------|-----------------------------|-----------------------------|-----------------------------|-----------------------------|--|--|--|---|--|---|---|--|--|---|---|---|---|---|--|--|--|--|--|--|--|--|--|---|--|--|---|---|--|--|---|---|--|--|--|--|--|--|--|--|--|--|---|---|--|--|---|---|--|---|--|--|---|---|--|---|---|--|--|--|--|--|--|--|--|--|--|--|--|--|--|--|
| 1 宋晓晨 | 2 王泽川 | 4 谷通金 | 5 徐伟 | 6 白光宇 | 7 林豪文 | 10 王钟彬 | 12 王金鑫 | | | | | | | | | | | | | | | | | | | | | | | | | | | | | | | | | | | | | | | | | | | | | | | | | | | | | | | | | | | | | | | | | | | | | | | | |
| <table border="1"><tr><td></td><td></td><td></td></tr><tr><td></td><td></td><td></td></tr><tr><td></td><td></td><td></td></tr></table> | | | | | | | | | | <table border="1"><tr><td></td><td></td><td></td></tr><tr><td></td><td></td><td></td></tr><tr><td></td><td></td><td></td></tr></table> | | | | | | | | | | <table border="1"><tr><td>1</td><td></td><td></td></tr><tr><td></td><td></td><td></td></tr><tr><td></td><td></td><td></td></tr></table> | 1 | | | | | | | | | <table border="1"><tr><td>2</td><td></td><td></td></tr><tr><td>3</td><td></td><td></td></tr><tr><td></td><td></td><td></td></tr></table> | 2 | | | 3 | | | | | | <table border="1"><tr><td></td><td></td><td></td></tr><tr><td></td><td></td><td></td></tr><tr><td></td><td></td><td></td></tr></table> | | | | | | | | | | <table border="1"><tr><td>1</td><td></td><td></td></tr><tr><td>2</td><td>1</td><td></td></tr><tr><td></td><td></td><td></td></tr></table> | 1 | | | 2 | 1 | | | | | <table border="1"><tr><td>2</td><td></td><td>1</td></tr><tr><td>1</td><td></td><td></td></tr><tr><td></td><td></td><td></td></tr></table> | 2 | | 1 | 1 | | | | | | <table border="1"><tr><td></td><td></td><td></td></tr><tr><td></td><td></td><td></td></tr><tr><td></td><td></td><td></td></tr></table> | | | | | | | | | |
| | | | | | | | | | | | | | | | | | | | | | | | | | | | | | | | | | | | | | | | | | | | | | | | | | | | | | | | | | | | | | | | | | | | | | | | | | | | | | | | |
| | | | | | | | | | | | | | | | | | | | | | | | | | | | | | | | | | | | | | | | | | | | | | | | | | | | | | | | | | | | | | | | | | | | | | | | | | | | | | | | |
| | | | | | | | | | | | | | | | | | | | | | | | | | | | | | | | | | | | | | | | | | | | | | | | | | | | | | | | | | | | | | | | | | | | | | | | | | | | | | | | |
| | | | | | | | | | | | | | | | | | | | | | | | | | | | | | | | | | | | | | | | | | | | | | | | | | | | | | | | | | | | | | | | | | | | | | | | | | | | | | | | |
| | | | | | | | | | | | | | | | | | | | | | | | | | | | | | | | | | | | | | | | | | | | | | | | | | | | | | | | | | | | | | | | | | | | | | | | | | | | | | | | |
| | | | | | | | | | | | | | | | | | | | | | | | | | | | | | | | | | | | | | | | | | | | | | | | | | | | | | | | | | | | | | | | | | | | | | | | | | | | | | | | |
| 1 | | | | | | | | | | | | | | | | | | | | | | | | | | | | | | | | | | | | | | | | | | | | | | | | | | | | | | | | | | | | | | | | | | | | | | | | | | | | | | | |
| | | | | | | | | | | | | | | | | | | | | | | | | | | | | | | | | | | | | | | | | | | | | | | | | | | | | | | | | | | | | | | | | | | | | | | | | | | | | | | | |
| | | | | | | | | | | | | | | | | | | | | | | | | | | | | | | | | | | | | | | | | | | | | | | | | | | | | | | | | | | | | | | | | | | | | | | | | | | | | | | | |
| 2 | | | | | | | | | | | | | | | | | | | | | | | | | | | | | | | | | | | | | | | | | | | | | | | | | | | | | | | | | | | | | | | | | | | | | | | | | | | | | | | |
| 3 | | | | | | | | | | | | | | | | | | | | | | | | | | | | | | | | | | | | | | | | | | | | | | | | | | | | | | | | | | | | | | | | | | | | | | | | | | | | | | | |
| | | | | | | | | | | | | | | | | | | | | | | | | | | | | | | | | | | | | | | | | | | | | | | | | | | | | | | | | | | | | | | | | | | | | | | | | | | | | | | | |
| | | | | | | | | | | | | | | | | | | | | | | | | | | | | | | | | | | | | | | | | | | | | | | | | | | | | | | | | | | | | | | | | | | | | | | | | | | | | | | | |
| | | | | | | | | | | | | | | | | | | | | | | | | | | | | | | | | | | | | | | | | | | | | | | | | | | | | | | | | | | | | | | | | | | | | | | | | | | | | | | | |
| | | | | | | | | | | | | | | | | | | | | | | | | | | | | | | | | | | | | | | | | | | | | | | | | | | | | | | | | | | | | | | | | | | | | | | | | | | | | | | | |
| 1 | | | | | | | | | | | | | | | | | | | | | | | | | | | | | | | | | | | | | | | | | | | | | | | | | | | | | | | | | | | | | | | | | | | | | | | | | | | | | | | |
| 2 | 1 | | | | | | | | | | | | | | | | | | | | | | | | | | | | | | | | | | | | | | | | | | | | | | | | | | | | | | | | | | | | | | | | | | | | | | | | | | | | | | |
| | | | | | | | | | | | | | | | | | | | | | | | | | | | | | | | | | | | | | | | | | | | | | | | | | | | | | | | | | | | | | | | | | | | | | | | | | | | | | | | |
| 2 | | 1 | | | | | | | | | | | | | | | | | | | | | | | | | | | | | | | | | | | | | | | | | | | | | | | | | | | | | | | | | | | | | | | | | | | | | | | | | | | | | |
| 1 | | | | | | | | | | | | | | | | | | | | | | | | | | | | | | | | | | | | | | | | | | | | | | | | | | | | | | | | | | | | | | | | | | | | | | | | | | | | | | | |
| | | | | | | | | | | | | | | | | | | | | | | | | | | | | | | | | | | | | | | | | | | | | | | | | | | | | | | | | | | | | | | | | | | | | | | | | | | | | | | | |
| | | | | | | | | | | | | | | | | | | | | | | | | | | | | | | | | | | | | | | | | | | | | | | | | | | | | | | | | | | | | | | | | | | | | | | | | | | | | | | | |
| | | | | | | | | | | | | | | | | | | | | | | | | | | | | | | | | | | | | | | | | | | | | | | | | | | | | | | | | | | | | | | | | | | | | | | | | | | | | | | | |
| | | | | | | | | | | | | | | | | | | | | | | | | | | | | | | | | | | | | | | | | | | | | | | | | | | | | | | | | | | | | | | | | | | | | | | | | | | | | | | | |
| Post - 0 Miss - 0 Block - 0 | Post - 0 Miss - 0 Block - 0 | Post - 1 Miss - 0 Block - 0 | Post - 0 Miss - 0 Block - 0 | Post - 0 Miss - 0 Block - 0 | Post - 0 Miss - 1 Block - 3 | Post - 0 Miss - 2 Block - 1 | Post - 0 Miss - 0 Block - 0 | | | | | | | | | | | | | | | | | | | | | | | | | | | | | | | | | | | | | | | | | | | | | | | | | | | | | | | | | | | | | | | | | | | | | | | | |
| 13 苏兴伟 | 15 王维东 | 16 李佳懿 | 17 胡晋铭 | 18 李万兴 | 19 李龙吉 | 24 陈伟华 | | | | | | | | | | | | | | | | | | | | | | | | | | | | | | | | | | | | | | | | | | | | | | | | | | | | | | | | | | | | | | | | | | | | | | | | | |
| <table border="1"><tr><td></td><td></td><td></td></tr><tr><td></td><td></td><td></td></tr><tr><td></td><td></td><td></td></tr></table> | | | | | | | | | | <table border="1"><tr><td>1</td><td></td><td>1</td></tr><tr><td>1</td><td></td><td></td></tr><tr><td>1</td><td>1</td><td>2</td></tr></table> | 1 | | 1 | 1 | | | 1 | 1 | 2 | <table border="1"><tr><td></td><td></td><td></td></tr><tr><td></td><td></td><td></td></tr><tr><td></td><td></td><td></td></tr></table> | | | | | | | | | | <table border="1"><tr><td>1</td><td></td><td></td></tr><tr><td></td><td>1</td><td></td></tr><tr><td></td><td>1</td><td>1</td></tr></table> | 1 | | | | 1 | | | 1 | 1 | <table border="1"><tr><td></td><td></td><td></td></tr><tr><td></td><td></td><td></td></tr><tr><td></td><td></td><td></td></tr></table> | | | | | | | | | | <table border="1"><tr><td></td><td></td><td></td></tr><tr><td>1</td><td></td><td></td></tr><tr><td>2</td><td></td><td></td></tr></table> | | | | 1 | | | 2 | | | <table border="1"><tr><td></td><td></td><td></td></tr><tr><td></td><td></td><td></td></tr><tr><td></td><td></td><td></td></tr></table> | | | | | | | | | | <table border="1"><tr><td></td><td></td><td></td></tr><tr><td></td><td></td><td></td></tr><tr><td></td><td></td><td></td></tr></table> | | | | | | | | | |
| | | | | | | | | | | | | | | | | | | | | | | | | | | | | | | | | | | | | | | | | | | | | | | | | | | | | | | | | | | | | | | | | | | | | | | | | | | | | | | | |
| | | | | | | | | | | | | | | | | | | | | | | | | | | | | | | | | | | | | | | | | | | | | | | | | | | | | | | | | | | | | | | | | | | | | | | | | | | | | | | | |
| | | | | | | | | | | | | | | | | | | | | | | | | | | | | | | | | | | | | | | | | | | | | | | | | | | | | | | | | | | | | | | | | | | | | | | | | | | | | | | | |
| 1 | | 1 | | | | | | | | | | | | | | | | | | | | | | | | | | | | | | | | | | | | | | | | | | | | | | | | | | | | | | | | | | | | | | | | | | | | | | | | | | | | | |
| 1 | | | | | | | | | | | | | | | | | | | | | | | | | | | | | | | | | | | | | | | | | | | | | | | | | | | | | | | | | | | | | | | | | | | | | | | | | | | | | | | |
| 1 | 1 | 2 | | | | | | | | | | | | | | | | | | | | | | | | | | | | | | | | | | | | | | | | | | | | | | | | | | | | | | | | | | | | | | | | | | | | | | | | | | | | | |
| | | | | | | | | | | | | | | | | | | | | | | | | | | | | | | | | | | | | | | | | | | | | | | | | | | | | | | | | | | | | | | | | | | | | | | | | | | | | | | | |
| | | | | | | | | | | | | | | | | | | | | | | | | | | | | | | | | | | | | | | | | | | | | | | | | | | | | | | | | | | | | | | | | | | | | | | | | | | | | | | | |
| | | | | | | | | | | | | | | | | | | | | | | | | | | | | | | | | | | | | | | | | | | | | | | | | | | | | | | | | | | | | | | | | | | | | | | | | | | | | | | | |
| 1 | | | | | | | | | | | | | | | | | | | | | | | | | | | | | | | | | | | | | | | | | | | | | | | | | | | | | | | | | | | | | | | | | | | | | | | | | | | | | | | |
| | 1 | | | | | | | | | | | | | | | | | | | | | | | | | | | | | | | | | | | | | | | | | | | | | | | | | | | | | | | | | | | | | | | | | | | | | | | | | | | | | | |
| | 1 | 1 | | | | | | | | | | | | | | | | | | | | | | | | | | | | | | | | | | | | | | | | | | | | | | | | | | | | | | | | | | | | | | | | | | | | | | | | | | | | | |
| | | | | | | | | | | | | | | | | | | | | | | | | | | | | | | | | | | | | | | | | | | | | | | | | | | | | | | | | | | | | | | | | | | | | | | | | | | | | | | | |
| | | | | | | | | | | | | | | | | | | | | | | | | | | | | | | | | | | | | | | | | | | | | | | | | | | | | | | | | | | | | | | | | | | | | | | | | | | | | | | | |
| | | | | | | | | | | | | | | | | | | | | | | | | | | | | | | | | | | | | | | | | | | | | | | | | | | | | | | | | | | | | | | | | | | | | | | | | | | | | | | | |
| | | | | | | | | | | | | | | | | | | | | | | | | | | | | | | | | | | | | | | | | | | | | | | | | | | | | | | | | | | | | | | | | | | | | | | | | | | | | | | | |
| 1 | | | | | | | | | | | | | | | | | | | | | | | | | | | | | | | | | | | | | | | | | | | | | | | | | | | | | | | | | | | | | | | | | | | | | | | | | | | | | | | |
| 2 | | | | | | | | | | | | | | | | | | | | | | | | | | | | | | | | | | | | | | | | | | | | | | | | | | | | | | | | | | | | | | | | | | | | | | | | | | | | | | | |
| | | | | | | | | | | | | | | | | | | | | | | | | | | | | | | | | | | | | | | | | | | | | | | | | | | | | | | | | | | | | | | | | | | | | | | | | | | | | | | | |
| | | | | | | | | | | | | | | | | | | | | | | | | | | | | | | | | | | | | | | | | | | | | | | | | | | | | | | | | | | | | | | | | | | | | | | | | | | | | | | | |
| | | | | | | | | | | | | | | | | | | | | | | | | | | | | | | | | | | | | | | | | | | | | | | | | | | | | | | | | | | | | | | | | | | | | | | | | | | | | | | | |
| | | | | | | | | | | | | | | | | | | | | | | | | | | | | | | | | | | | | | | | | | | | | | | | | | | | | | | | | | | | | | | | | | | | | | | | | | | | | | | | |
| | | | | | | | | | | | | | | | | | | | | | | | | | | | | | | | | | | | | | | | | | | | | | | | | | | | | | | | | | | | | | | | | | | | | | | | | | | | | | | | |
| | | | | | | | | | | | | | | | | | | | | | | | | | | | | | | | | | | | | | | | | | | | | | | | | | | | | | | | | | | | | | | | | | | | | | | | | | | | | | | | |
| Post - 0 Miss - 0 Block - 0 | Post - 1 Miss - 1 Block - 1 | Post - 0 Miss - 0 Block - 0 | Post - 0 Miss - 0 Block - 0 | Post - 0 Miss - 0 Block - 0 | Post - 0 Miss - 2 Block - 0 | Post - 0 Miss - 0 Block - 0 | | | | | | | | | | | | | | | | | | | | | | | | | | | | | | | | | | | | | | | | | | | | | | | | | | | | | | | | | | | | | | | | | | | | | | | | | |

注释: Post=击柱 Miss=射失 Block=被封



预赛 Group A
青年男子 全国比赛

2016年“体彩杯”全国手球男子青年锦标赛

| | | | | | | | | | | | | | | | | | | | | | |
|--------------------|---|--|---------------------|------------------|------------------------------------|-------------------|---|---------------------------|------------------------------------|----|-----|----------------------|---------------|---|--|--|----|---|----|---|----|
| Team A A 广东队 | | | | Team B B 山东队 | | | | Match Number 22 | | | | | | | | | | | | | |
| played in China | | in the hall 重庆万州 | | on 24/03/2016 | | at 14:30 hours | | Spectators | | | | | | | | | | | | | |
| Half-time (30') | A 17 | B 24 | End of playing time | A 33 | B 42 | 1st extra time | A | B | 2nd extra time | A | B | After penalty throws | A | B | | | | | | | |
| Number of 7 m | A 1 / 1 | Team time-out 1 14:53 2 27:58 3 47:25 | | | Full name of players and officials | | | | Team time-out 1 22:55 2 42:29 3 | | | B 2 / 3 | Number of 7 m | | | | | | | | |
| No. | Team A | | | | | G | W | 2' | D | DR | No. | Team B | | | | | G | W | 2' | D | DR |
| 1 | 王帅 | | | | | | | | | | 1 | 刘继超 | | | | | | | | | |
| 2 | 姚雪岩 | | | | | 6 | 1 | | | | 2 | 冯鑫宇 | | | | | 8 | 1 | 1 | | |
| 4 | 高玉杰 | | | | | | | | | | 3 | 王铁林 | | | | | 2 | | 1 | | |
| 5 | 黄培杰 | | | | | 5 | | | | | 5 | 王晓峰 | | | | | 12 | | | | |
| 7 | 段飞宇 | | | | | 1 | | | | | 6 | 王军鸣 | | | | | 4 | 1 | 2 | | |
| 9 | 周凯峰 | | | | | | | | | | 7 | 徐勇林 | | | | | | | | | |
| 10 | 周仲坤 | | | | | 3 | 1 | | | | 10 | 孙芳伟 | | | | | 6 | | 1 | | |
| 11 | 胡国富 | | | | | 7 | | | | | 11 | 王洋 | | | | | | | | | |
| 12 | 李壮 | | | | | | | | | | 12 | 刘道林 | | | | | | | | | |
| 13 | 蔡杰 | | | | | | | | | | 13 | 于欣君 | | | | | 6 | | | | |
| 14 | 王泽润 | | | | | | | | | | 17 | 薛盼龙 | | | | | 2 | | | | |
| 15 | 张建杰 | | | | | 10 | 1 | 1 | | | 18 | 李玮 | | | | | | | | | |
| 16 | 王猛 | | | | | | | | | | 21 | 王腾达 | | | | | | | | | |
| 18 | 李文金 | | | | | 1 | | | | | 22 | 李子跃 | | | | | | | | | |
| | | | | | | | | | | | 23 | 李荣健 | | | | | 2 | | | | |
| B | 刘康伶 (主教练) | | | | | | | | | | B | 王莉莉 (主教练) | | | | | | | | | |
| C | 刘文宁 | | | | | | | | | | | | | | | | | | | | |
| D | 王永存 | | | | | | | | | | | | | | | | | | | | |
| A | Signature of Responsible Official of the Teams (Off. A) | | | | | | | | | | B | | | | | | | | | | |
| TP | Remarks of Referee / CHA Official | | | | | | | | | | TP | | | | | | | | | | |

Signatures

| | | | | |
|------------------|-----------|----------|--|--|
| Referees | 尹静阳 (CHN) | 王洋 (CHN) | | |
| Techn. Delegates | 许宜扬 (CHN) | | | |
| CHA Official | 张春生 (CHN) | | | |

Note: Number of 7m Throws Awarded to Team A and B, Goals (G), Warnings (W), Suspensions (2'), Direct Disqualification (D), Disqualification with Report (DR) and Team Penalty (TP).

Table Officials:

Statisticians: 李双

刘永欢





2016年“体彩杯”全国手球男子青年锦标赛 竞赛技术统计(媒体表)

| | | | | | | |
|----------------|-----------|------------|----|-----------|------------------|-----------|
| 预赛 | 组别 | A | 轮次 | 4 | 场次 | 22 |
| 重庆万州 | | 24/03/2016 | | | 201602022-51-1/1 | |
| 广东队 | 广东 | 33 | vs | 42 | 山东 | 山东队 |
| 17 : 24 | | | | | | |

| | | | |
|-----|-----------|---|----------|
| 裁判员 | 尹静阳 (CHN) | / | 王洋 (CHN) |
|-----|-----------|---|----------|

| 广东 | | 远 | 近 | 边 | 快 | 突 | 任意 | 7m | 合计 | % | 助攻 | 失误 | 警告 | 2' | D & DR | 比赛进程 | |
|---------------|-----|--------------|--------------|-------------|------------|------------|------------|------------|--------------|-------------|-----------|-----------|----------|----------|--------|----------|-----------|
| 主教练：刘康伶 | | 射 | 射 | 射 | 攻 | 破 | 球 | 球 | | | | | | | | 广东 | 山东 |
| 1 | 王帅 | | | | | | | | | | 3 | 1 | | | | 00:40 | 1 5 王晓峰 |
| 2 | 姚雪岩 | 0/1 | 6/8 | | | | | | 6/9 | 66.7 | 3 | 4 | 1 | | | 01:10 | 2 5 王晓峰 |
| 4 | 高玉杰 | | | | 0/1 | | | | 0/1 | 0.0 | | | | | | 01:56 | 3 10 孙芳伟 |
| 5 | 黄培杰 | 0/2 | 0/5 | | 1/1 | 3/3 | | 1/1 | 5/12 | 41.7 | 2 | 2 | | | | 02:48 | 3 03:43 3 |
| 7 | 段飞宇 | | 1/2 | 0/1 | | | | | 1/3 | 33.3 | | 2 | | | | 03:03 | 4 4 5 王晓峰 |
| 9 | 周凯峰 | | | | | | | | | | | | | | | 04:45 | 4 4 王军鸣 |
| 10 | 周仲坤 | 0/4 | 1/3 | 2/2 | | | | | 3/9 | 33.3 | 3 | 3 | 1 | | | 05:38 | 5 6 孙芳伟 |
| 11 | 胡国富 | 2/2 | 3/3 | 1/1 | 1/3 | | | | 7/9 | 77.8 | 2 | 5 | | | | 06:00 | 6 10 孙芳伟 |
| 12 | 李壮 | | | | | | | | | | | | | | | 08:34 | 7 23 李荣健 |
| 13 | 蔡杰 | | | | | | | | | | | | | | | 09:58 | 7 3 王铁林 |
| 14 | 王泽润 | | | | | | | | | | | | | | | 10:23 | 8 8 孙芳伟 |
| 15 | 张建杰 | 5/12 | 5/8 | | | 0/2 | 0/2 | | 10/24 | 41.7 | 1 | 5 | 1 | 1 | | 11:05 | 9 10 孙芳伟 |
| 16 | 王猛 | | | | | | | | | | | | | | | 13:10 | 9 10 孙芳伟 |
| 18 | 李文金 | | 1/2 | | | | | | 1/2 | 50.0 | 1 | 1 | | | | 13:29 | 10 10 孙芳伟 |
| 运动员 合计 | | 7/21 | 17/31 | 3/4 | 2/5 | 3/5 | 0/2 | 1/1 | 33/69 | 47.8 | 15 | 23 | 3 | 1 | | | |
| 1 | 王帅 | 13/21 | 6/18 | 5/12 | 2/9 | 0/4 | 1/3 | 1/1 | 28/68 | 41.2 | 3 | 1 | | | | | |
| 16 | 王猛 | | | | | | | 0/2 | 0/2 | 0.0 | | | | | | | |
| 守门员 合计 | | 13/21 | 6/18 | 5/12 | 2/9 | 0/4 | 1/3 | 1/3 | 28/70 | 40.0 | 3 | 1 | | | | | |
| 山东 | | 远 | 近 | 边 | 快 | 突 | 任意 | 7m | 合计 | % | 助攻 | 失误 | 警告 | 2' | D & DR | 2nd Half | |
| 教练：王莉莉 | | 射 | 射 | 射 | 攻 | 破 | 球 | 球 | | | | | | | | 广东 | 山东 |
| 1 | 刘继超 | | | | | | | | | | 1 | | | | | 18 00:51 | 24 2 冯鑫宇 |
| 2 | 冯鑫宇 | 0/4 | 2/3 | 1/1 | 2/2 | 2/2 | | 1/1 | 8/13 | 61.5 | 1 | 2 | 1 | 1 | | 18 01:25 | 25 2 冯鑫宇 |
| 3 | 王铁林 | 0/2 | 0/2 | 2/4 | | | | | 2/8 | 25.0 | 1 | 2 | | 1 | | 19 01:56 | 25 5 王晓峰 |
| 5 | 王晓峰 | 6/14 | 1/2 | | 3/3 | | 2/2 | | 12/21 | 57.1 | 1 | 2 | | | | 20 02:16 | 26 5 王晓峰 |
| 6 | 王军鸣 | | 1/2 | 1/2 | 2/2 | | 0/1 | 0/1 | 4/8 | 50.0 | | 2 | 1 | 2 | | 20 02:48 | 26 5 王晓峰 |
| 7 | 徐勇林 | | 0/1 | | | | | | 0/1 | 0.0 | | 2 | | | | 21 03:03 | 26 13 于欣君 |
| 10 | 孙芳伟 | 1/4 | 3/5 | 1/1 | | 1/1 | | | 6/11 | 54.5 | 1 | 2 | | 1 | | 21 03:28 | 27 10 孙芳伟 |
| 11 | 王洋 | | | | | | | | | | | | | | | 22 04:54 | 27 10 孙芳伟 |
| 12 | 刘道林 | | | | | | | | | | | | | | | 22 05:26 | 28 10 孙芳伟 |
| 13 | 于欣君 | 1/4 | 3/6 | 1/2 | 0/2 | 1/1 | | | 6/15 | 40.0 | | 1 | | | | 23 06:01 | 28 13 于欣君 |
| 17 | 薛盼龙 | | 2/2 | | | | | | 2/2 | 100 | | 1 | | | | 24 06:42 | 28 13 于欣君 |
| 18 | 李玮 | | | | | | | | | | | | | | | 24 08:05 | 29 13 于欣君 |
| 21 | 王腾达 | | | | | | | | | | | | | | | 25 08:40 | 29 6 王军鸣 |
| 22 | 李子跃 | | | | | | | | | | | | | | | 25 10:19 | 30 6 王军鸣 |
| 23 | 李荣健 | | | 1/2 | | | | 1/1 | 2/3 | 66.7 | 2 | | | | | 26 12:06 | 30 2 姚雪岩 |
| 运动员 合计 | | 8/28 | 12/23 | 7/12 | 7/9 | 4/4 | 2/3 | 2/3 | 42/82 | 51.2 | 7 | 14 | 2 | 5 | | | |
| 1 | 刘继超 | 5/12 | 7/24 | 1/4 | 3/5 | 2/5 | 2/2 | 0/1 | 20/53 | 37.7 | 1 | | | | | | |
| 守门员 合计 | | 5/12 | 7/24 | 1/4 | 3/5 | 2/5 | 2/2 | 0/1 | 20/53 | 37.7 | 1 | | | | | | |

场上队员：得分 / 射门

守门员：救球 / 射门

| | | | | | | | | | |
|----|------------|----|--------------|-----|------------|-----|----------|----|---------|
| 快攻 | Fast Break | 突破 | Breakthrough | 任意球 | Free Throw | 7M球 | 7M Throw | 助攻 | Assist |
| 警告 | Warning | 失误 | Error | 2' | Suspension | D | 取消资格 | DR | 取消资格+报告 |





2016年“体彩杯”全国手球男子青年锦标赛 图式比赛技术统计表

轮次 4

场次 22

201602022-21-1/1

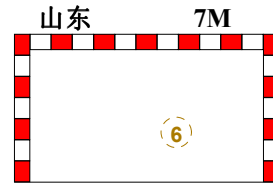
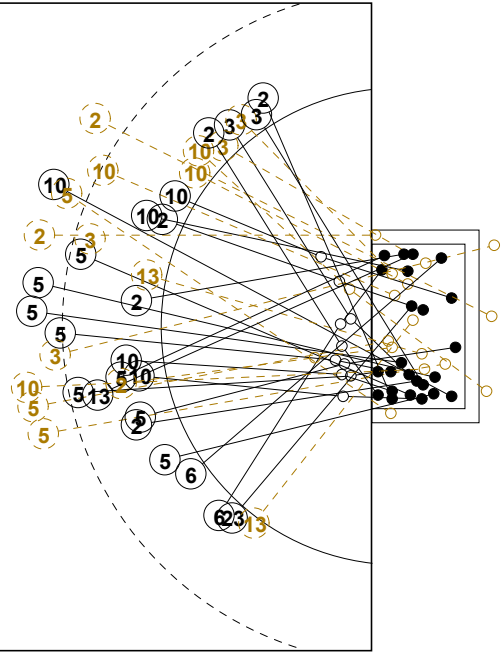
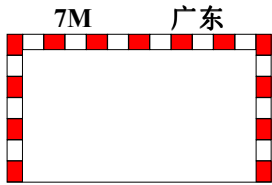
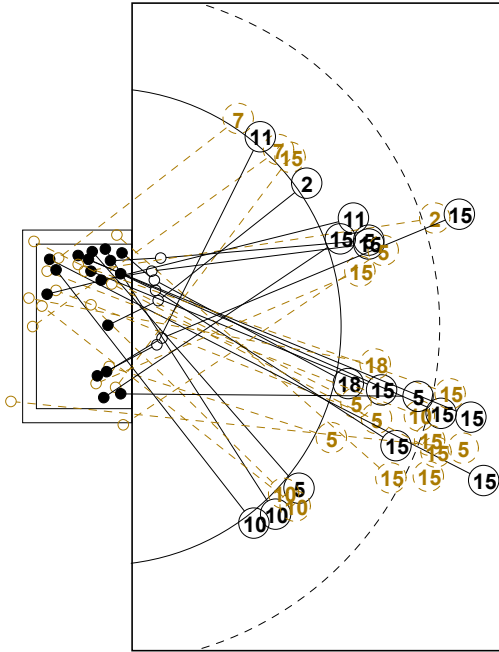

1st Half
17 : 24

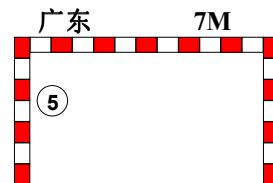
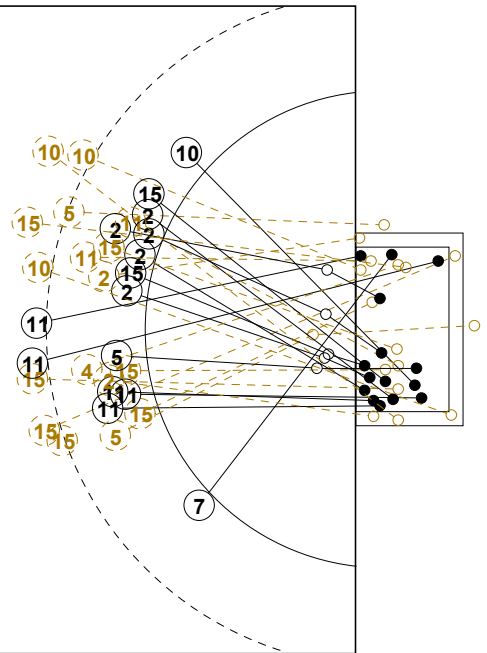
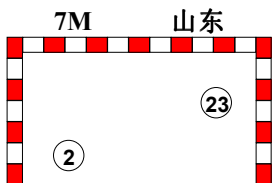
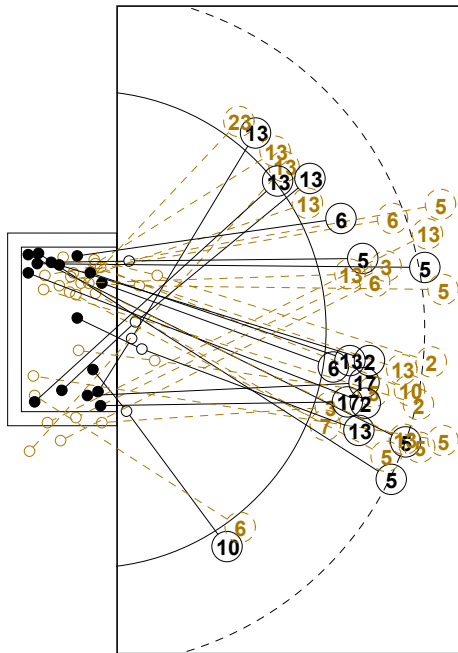

2nd Half
42 : 33



2016年“体彩杯”全国手球男子青年锦标赛

个人/全队技术统计表

正式表
手球
青年男子预赛
轮次 4组别 A
场次 22201602022-14-1/2
重庆万州
24/03/2016 14:30

| 号码 | 姓名 | 远射 | 近射 | 边射 | 快攻 | 突破 | 任意 | 7M | 合计 | % | 助攻 | 失误 | 警告 | 2' | 取消 | 时间 |
|----------------|-----|-------|-------|------|-----|-----|-----|-----|-------|-------|----|----|----|----|----|----------|
| 广东队(广东) | | | | | | | | | | | | | | | | |
| <i>(场上队员)</i> | | | | | | | | | | | | | | | | |
| 1 | 王帅 | | | | | | | | | 0.0% | 3 | 1 | | | | 00:59:41 |
| 2 | 姚雪岩 | 0/1 | 6/8 | | | | | | 6/9 | 66.7% | 3 | 4 | 1 | | | 01:00:00 |
| 4 | 高玉杰 | | | | 0/1 | | | | 0/1 | 0.0% | | | | | | 00:03:56 |
| 5 | 黄培杰 | 0/2 | 0/5 | | 1/1 | 3/3 | | 1/1 | 5/12 | 41.7% | 2 | 2 | | | | 01:00:00 |
| 7 | 段飞宇 | | 1/2 | 0/1 | | | | | 1/3 | 33.3% | | 2 | | | | 00:36:26 |
| 9 | 周凯峰 | | | | | | | | | 0.0% | | | | | | 00:00:00 |
| 10 | 周仲坤 | 0/4 | 1/3 | 2/2 | | | | | 3/9 | 33.3% | 3 | 3 | 1 | | | 01:00:00 |
| 11 | 胡国富 | 2/2 | 3/3 | 1/1 | 1/3 | | | | 7/9 | 77.8% | 2 | 5 | | | | 00:51:37 |
| 12 | 李壮 | | | | | | | | | 0.0% | | | | | | 00:00:00 |
| 13 | 蔡杰 | | | | | | | | | 0.0% | | | | | | 00:00:00 |
| 14 | 王泽润 | | | | | | | | | 0.0% | | | | | | 00:00:00 |
| 15 | 张建杰 | 5/12 | 5/8 | | | 0/2 | 0/2 | | 10/24 | 41.7% | 1 | 5 | 1 | 1 | | 01:00:00 |
| 16 | 王猛 | | | | | | | | | 0.0% | | | | | | 00:00:19 |
| 18 | 李文金 | | 1/2 | | | | | | 1/2 | 50.0% | 1 | 1 | | | | 00:27:59 |
| 合计 | | 7/21 | 17/31 | 3/4 | 2/5 | 3/5 | 0/2 | 1/1 | 33/69 | 47.8% | 15 | 23 | 3 | 1 | | |
| <i>(守门员)</i> | | | | | | | | | | | | | | | | |
| 1 | 王帅 | 13/21 | 6/18 | 5/12 | 2/9 | 0/4 | 1/3 | 1/1 | 28/68 | 41.2% | 3 | 1 | | | | 00:59:41 |
| 16 | 王猛 | | | | | | | 0/2 | 0/2 | 0.0% | | | | | | 00:00:19 |
| 合计 | | 13/21 | 6/18 | 5/12 | 2/9 | 0/4 | 1/3 | 1/3 | 28/70 | 40.0% | 3 | 1 | | | | |

场上队员：得分/射门

守门员：救球/射门

| 全队合计 | 得分 | 被救 | 射失 | 击柱 | 封球 | 合计 | % |
|------|----|----|----|----|----|----|--------|
| 远射 | 7 | 5 | 2 | 4 | 3 | 21 | 33.3% |
| 近射 | 17 | 7 | 1 | 6 | | 31 | 54.8% |
| 边射 | 3 | 1 | | | | 4 | 75.0% |
| 快攻 | 2 | 3 | | | | 5 | 40.0% |
| 突破 | 3 | 2 | | | | 5 | 60.0% |
| 任意 | | 2 | | | | 2 | 0.0% |
| 7M | 1 | | | | | 1 | 100.0% |





2016年“体彩杯”全国手球男子青年锦标赛

个人/全队技术统计表

正式表
手球
青年男子预赛
轮次 4组别 A
场次 22201602022-14-2/2
重庆万州
24/03/2016 14:30

| 号码 | 姓名 | 远射 | 近射 | 边射 | 快攻 | 突破 | 任意 | 7M | 合计 | % | 助攻 | 失误 | 警告 | 2' | 取消 | 时间 |
|----------------|-----|------|-------|------|-----|-----|-----|-----|-------|-------|----|----|----|----|----|----------|
| 山东队(山东) | | | | | | | | | | | | | | | | |
| <i>(上场队员)</i> | | | | | | | | | | | | | | | | |
| 1 | 刘继超 | | | | | | | | | 0.0% | 1 | | | | | 01:00:00 |
| 2 | 冯鑫宇 | 0/4 | 2/3 | 1/1 | 2/2 | 2/2 | | 1/1 | 8/13 | 61.5% | 1 | 2 | 1 | 1 | | 01:16:40 |
| 3 | 王铁林 | 0/2 | 0/2 | 2/4 | | | | | 2/8 | 25.0% | 1 | 2 | | 1 | | 00:46:44 |
| 5 | 王晓峰 | 6/14 | 1/2 | | 3/3 | | 2/2 | | 12/21 | 57.1% | 1 | 2 | | | | 00:56:56 |
| 6 | 王军鸣 | | 1/2 | 1/2 | 2/2 | | 0/1 | 0/1 | 4/8 | 50.0% | | 2 | 1 | 2 | | 00:48:53 |
| 7 | 徐勇林 | | 0/1 | | | | | | 0/1 | 0.0% | | 2 | | | | 00:07:29 |
| 10 | 孙芳伟 | 1/4 | 3/5 | 1/1 | | 1/1 | | | 6/11 | 54.5% | 1 | 2 | | 1 | | 01:00:00 |
| 11 | 王洋 | | | | | | | | | 0.0% | | | | | | 00:00:05 |
| 12 | 刘道林 | | | | | | | | | 0.0% | | | | | | 00:00:00 |
| 13 | 于欣君 | 1/4 | 3/6 | 1/2 | 0/2 | 1/1 | | | 6/15 | 40.0% | | 1 | | | | 00:37:51 |
| 17 | 薛盼龙 | | 2/2 | | | | | | 2/2 | 100% | | 1 | | | | 00:07:58 |
| 18 | 李玮 | | | | | | | | | 0.0% | | | | | | 00:00:00 |
| 21 | 王腾达 | | | | | | | | | 0.0% | | | | | | 00:00:00 |
| 22 | 李子跃 | | | | | | | | | 0.0% | | | | | | 00:00:00 |
| 23 | 李荣健 | | | 1/2 | | | | 1/1 | 2/3 | 66.7% | 2 | | | | | 00:39:32 |
| 合计 | | 8/28 | 12/23 | 7/12 | 7/9 | 4/4 | 2/3 | 2/3 | 42/82 | 51.2% | 7 | 14 | 2 | 5 | | |
| <i>(守门员)</i> | | | | | | | | | | | | | | | | |
| 1 | 刘继超 | 5/12 | 7/24 | 1/4 | 3/5 | 2/5 | 2/2 | 0/1 | 20/53 | 37.7% | 1 | | | | | 01:00:00 |
| 合计 | | 5/12 | 7/24 | 1/4 | 3/5 | 2/5 | 2/2 | 0/1 | 20/53 | 37.7% | 1 | | | | | |

场上队员：得分/射门

守门员：救球/射门

| 全队合计 | 得分 | 被救 | 射失 | 击柱 | 封球 | 合计 | % |
|------|----|----|----|----|----|----|--------|
| 远射 | 8 | 13 | 2 | 3 | 2 | 28 | 28.6% |
| 近射 | 12 | 6 | 3 | 2 | | 23 | 52.2% |
| 边射 | 7 | 5 | | | | 12 | 58.3% |
| 快攻 | 7 | 2 | | | | 9 | 77.8% |
| 突破 | 4 | | | | | 4 | 100.0% |
| 任意 | 2 | 1 | | | | 3 | 66.7% |
| 7M | 2 | 1 | | | | 3 | 66.7% |





2016年“体彩杯”全国手球男子青年锦标赛

图式射门区域统计

轮次 4 场次 22

201602022-41-1/1

广东队

| | | | | | | | | | | | | | | | | | | | | | | | | | | | | | | | | | | | | | | | | | | | | | | | | | | | | | | | | | | | | | | | | | | | | | | | | | | | | | | | |
|--|-----------------------------|-----------------------------|-----------------------------|-----------------------------|-----------------------------|-----------------------------|-----------------------------|--|--|--|--|--|---|--|--|--|---|---|---|--|--|--|--|--|--|--|--|--|--|--|---|--|---|--|--|---|---|--|---|--|--|--|--|--|--|--|--|--|--|---|--|--|--|--|--|--|--|--|---|--|--|--|---|--|--|--|--|--|---|--|--|--|---|--|--|--|--|--|---|
| 1 王帅 | 2 姚雪岩 | 4 高玉杰 | 5 黄培杰 | 7 段飞宇 | 9 周凯峰 | 10 周仲坤 | 11 胡国富 | | | | | | | | | | | | | | | | | | | | | | | | | | | | | | | | | | | | | | | | | | | | | | | | | | | | | | | | | | | | | | | | | | | | | | | | |
| <table border="1"><tr><td></td><td></td><td></td></tr><tr><td></td><td></td><td></td></tr><tr><td></td><td></td><td></td></tr></table> | | | | | | | | | | <table border="1"><tr><td></td><td></td><td>1</td></tr><tr><td></td><td></td><td></td></tr><tr><td>1</td><td>2</td><td>2</td></tr></table> | | | 1 | | | | 1 | 2 | 2 | <table border="1"><tr><td></td><td></td><td></td></tr><tr><td></td><td></td><td></td></tr><tr><td></td><td></td><td></td></tr></table> | | | | | | | | | | <table border="1"><tr><td>1</td><td></td><td></td></tr><tr><td></td><td></td><td>2</td></tr><tr><td>1</td><td></td><td>1</td></tr></table> | 1 | | | | | 2 | 1 | | 1 | <table border="1"><tr><td></td><td></td><td></td></tr><tr><td></td><td></td><td></td></tr><tr><td></td><td></td><td></td></tr></table> | | | | | | | | | | <table border="1"><tr><td></td><td></td><td></td></tr><tr><td></td><td></td><td></td></tr><tr><td></td><td></td><td></td></tr></table> | | | | | | | | | | <table border="1"><tr><td></td><td></td><td>1</td></tr><tr><td></td><td></td><td></td></tr><tr><td></td><td></td><td>1</td></tr></table> | | | 1 | | | | | | 1 | <table border="1"><tr><td></td><td></td><td>1</td></tr><tr><td></td><td></td><td></td></tr><tr><td></td><td></td><td>2</td></tr></table> | | | 1 | | | | | | 2 |
| | | | | | | | | | | | | | | | | | | | | | | | | | | | | | | | | | | | | | | | | | | | | | | | | | | | | | | | | | | | | | | | | | | | | | | | | | | | | | | | |
| | | | | | | | | | | | | | | | | | | | | | | | | | | | | | | | | | | | | | | | | | | | | | | | | | | | | | | | | | | | | | | | | | | | | | | | | | | | | | | | |
| | | | | | | | | | | | | | | | | | | | | | | | | | | | | | | | | | | | | | | | | | | | | | | | | | | | | | | | | | | | | | | | | | | | | | | | | | | | | | | | |
| | | 1 | | | | | | | | | | | | | | | | | | | | | | | | | | | | | | | | | | | | | | | | | | | | | | | | | | | | | | | | | | | | | | | | | | | | | | | | | | | | | |
| | | | | | | | | | | | | | | | | | | | | | | | | | | | | | | | | | | | | | | | | | | | | | | | | | | | | | | | | | | | | | | | | | | | | | | | | | | | | | | | |
| 1 | 2 | 2 | | | | | | | | | | | | | | | | | | | | | | | | | | | | | | | | | | | | | | | | | | | | | | | | | | | | | | | | | | | | | | | | | | | | | | | | | | | | | |
| | | | | | | | | | | | | | | | | | | | | | | | | | | | | | | | | | | | | | | | | | | | | | | | | | | | | | | | | | | | | | | | | | | | | | | | | | | | | | | | |
| | | | | | | | | | | | | | | | | | | | | | | | | | | | | | | | | | | | | | | | | | | | | | | | | | | | | | | | | | | | | | | | | | | | | | | | | | | | | | | | |
| | | | | | | | | | | | | | | | | | | | | | | | | | | | | | | | | | | | | | | | | | | | | | | | | | | | | | | | | | | | | | | | | | | | | | | | | | | | | | | | |
| 1 | | | | | | | | | | | | | | | | | | | | | | | | | | | | | | | | | | | | | | | | | | | | | | | | | | | | | | | | | | | | | | | | | | | | | | | | | | | | | | | |
| | | 2 | | | | | | | | | | | | | | | | | | | | | | | | | | | | | | | | | | | | | | | | | | | | | | | | | | | | | | | | | | | | | | | | | | | | | | | | | | | | | |
| 1 | | 1 | | | | | | | | | | | | | | | | | | | | | | | | | | | | | | | | | | | | | | | | | | | | | | | | | | | | | | | | | | | | | | | | | | | | | | | | | | | | | |
| | | | | | | | | | | | | | | | | | | | | | | | | | | | | | | | | | | | | | | | | | | | | | | | | | | | | | | | | | | | | | | | | | | | | | | | | | | | | | | | |
| | | | | | | | | | | | | | | | | | | | | | | | | | | | | | | | | | | | | | | | | | | | | | | | | | | | | | | | | | | | | | | | | | | | | | | | | | | | | | | | |
| | | | | | | | | | | | | | | | | | | | | | | | | | | | | | | | | | | | | | | | | | | | | | | | | | | | | | | | | | | | | | | | | | | | | | | | | | | | | | | | |
| | | | | | | | | | | | | | | | | | | | | | | | | | | | | | | | | | | | | | | | | | | | | | | | | | | | | | | | | | | | | | | | | | | | | | | | | | | | | | | | |
| | | | | | | | | | | | | | | | | | | | | | | | | | | | | | | | | | | | | | | | | | | | | | | | | | | | | | | | | | | | | | | | | | | | | | | | | | | | | | | | |
| | | | | | | | | | | | | | | | | | | | | | | | | | | | | | | | | | | | | | | | | | | | | | | | | | | | | | | | | | | | | | | | | | | | | | | | | | | | | | | | |
| | | 1 | | | | | | | | | | | | | | | | | | | | | | | | | | | | | | | | | | | | | | | | | | | | | | | | | | | | | | | | | | | | | | | | | | | | | | | | | | | | | |
| | | | | | | | | | | | | | | | | | | | | | | | | | | | | | | | | | | | | | | | | | | | | | | | | | | | | | | | | | | | | | | | | | | | | | | | | | | | | | | | |
| | | 1 | | | | | | | | | | | | | | | | | | | | | | | | | | | | | | | | | | | | | | | | | | | | | | | | | | | | | | | | | | | | | | | | | | | | | | | | | | | | | |
| | | 1 | | | | | | | | | | | | | | | | | | | | | | | | | | | | | | | | | | | | | | | | | | | | | | | | | | | | | | | | | | | | | | | | | | | | | | | | | | | | | |
| | | | | | | | | | | | | | | | | | | | | | | | | | | | | | | | | | | | | | | | | | | | | | | | | | | | | | | | | | | | | | | | | | | | | | | | | | | | | | | | |
| | | 2 | | | | | | | | | | | | | | | | | | | | | | | | | | | | | | | | | | | | | | | | | | | | | | | | | | | | | | | | | | | | | | | | | | | | | | | | | | | | | |
| Post - 0 Miss - 0 Block - 0 | Post - 2 Miss - 0 Block - 0 | Post - 0 Miss - 0 Block - 0 | Post - 2 Miss - 3 Block - 0 | Post - 1 Miss - 0 Block - 0 | Post - 0 Miss - 0 Block - 0 | Post - 2 Miss - 0 Block - 0 | Post - 0 Miss - 0 Block - 0 | | | | | | | | | | | | | | | | | | | | | | | | | | | | | | | | | | | | | | | | | | | | | | | | | | | | | | | | | | | | | | | | | | | | | | | | |
| 12 李壮 | 13 蔡杰 | 14 王泽润 | 15 张建杰 | 16 王猛 | 18 李文金 | | | | | | | | | | | | | | | | | | | | | | | | | | | | | | | | | | | | | | | | | | | | | | | | | | | | | | | | | | | | | | | | | | | | | | | | | | |
| <table border="1"><tr><td></td><td></td><td></td></tr><tr><td></td><td></td><td></td></tr><tr><td></td><td></td><td></td></tr></table> | | | | | | | | | | <table border="1"><tr><td></td><td></td><td></td></tr><tr><td></td><td></td><td></td></tr><tr><td></td><td></td><td></td></tr></table> | | | | | | | | | | <table border="1"><tr><td></td><td></td><td></td></tr><tr><td></td><td></td><td></td></tr><tr><td></td><td></td><td></td></tr></table> | | | | | | | | | | <table border="1"><tr><td></td><td></td><td>1</td></tr><tr><td></td><td></td><td>3</td></tr><tr><td>2</td><td></td><td>4</td></tr></table> | | | 1 | | | 3 | 2 | | 4 | <table border="1"><tr><td></td><td></td><td></td></tr><tr><td></td><td></td><td></td></tr><tr><td></td><td></td><td></td></tr></table> | | | | | | | | | | <table border="1"><tr><td></td><td></td><td></td></tr><tr><td></td><td></td><td></td></tr><tr><td></td><td></td><td>1</td></tr></table> | | | | | | | | | 1 | <table border="1"><tr><td></td><td></td><td></td></tr><tr><td></td><td></td><td></td></tr><tr><td></td><td></td><td></td></tr></table> | | | | | | | | | | <table border="1"><tr><td></td><td></td><td></td></tr><tr><td></td><td></td><td></td></tr><tr><td></td><td></td><td></td></tr></table> | | | | | | | | | |
| | | | | | | | | | | | | | | | | | | | | | | | | | | | | | | | | | | | | | | | | | | | | | | | | | | | | | | | | | | | | | | | | | | | | | | | | | | | | | | | |
| | | | | | | | | | | | | | | | | | | | | | | | | | | | | | | | | | | | | | | | | | | | | | | | | | | | | | | | | | | | | | | | | | | | | | | | | | | | | | | | |
| | | | | | | | | | | | | | | | | | | | | | | | | | | | | | | | | | | | | | | | | | | | | | | | | | | | | | | | | | | | | | | | | | | | | | | | | | | | | | | | |
| | | | | | | | | | | | | | | | | | | | | | | | | | | | | | | | | | | | | | | | | | | | | | | | | | | | | | | | | | | | | | | | | | | | | | | | | | | | | | | | |
| | | | | | | | | | | | | | | | | | | | | | | | | | | | | | | | | | | | | | | | | | | | | | | | | | | | | | | | | | | | | | | | | | | | | | | | | | | | | | | | |
| | | | | | | | | | | | | | | | | | | | | | | | | | | | | | | | | | | | | | | | | | | | | | | | | | | | | | | | | | | | | | | | | | | | | | | | | | | | | | | | |
| | | | | | | | | | | | | | | | | | | | | | | | | | | | | | | | | | | | | | | | | | | | | | | | | | | | | | | | | | | | | | | | | | | | | | | | | | | | | | | | |
| | | | | | | | | | | | | | | | | | | | | | | | | | | | | | | | | | | | | | | | | | | | | | | | | | | | | | | | | | | | | | | | | | | | | | | | | | | | | | | | |
| | | | | | | | | | | | | | | | | | | | | | | | | | | | | | | | | | | | | | | | | | | | | | | | | | | | | | | | | | | | | | | | | | | | | | | | | | | | | | | | |
| | | 1 | | | | | | | | | | | | | | | | | | | | | | | | | | | | | | | | | | | | | | | | | | | | | | | | | | | | | | | | | | | | | | | | | | | | | | | | | | | | | |
| | | 3 | | | | | | | | | | | | | | | | | | | | | | | | | | | | | | | | | | | | | | | | | | | | | | | | | | | | | | | | | | | | | | | | | | | | | | | | | | | | | |
| 2 | | 4 | | | | | | | | | | | | | | | | | | | | | | | | | | | | | | | | | | | | | | | | | | | | | | | | | | | | | | | | | | | | | | | | | | | | | | | | | | | | | |
| | | | | | | | | | | | | | | | | | | | | | | | | | | | | | | | | | | | | | | | | | | | | | | | | | | | | | | | | | | | | | | | | | | | | | | | | | | | | | | | |
| | | | | | | | | | | | | | | | | | | | | | | | | | | | | | | | | | | | | | | | | | | | | | | | | | | | | | | | | | | | | | | | | | | | | | | | | | | | | | | | |
| | | | | | | | | | | | | | | | | | | | | | | | | | | | | | | | | | | | | | | | | | | | | | | | | | | | | | | | | | | | | | | | | | | | | | | | | | | | | | | | |
| | | | | | | | | | | | | | | | | | | | | | | | | | | | | | | | | | | | | | | | | | | | | | | | | | | | | | | | | | | | | | | | | | | | | | | | | | | | | | | | |
| | | | | | | | | | | | | | | | | | | | | | | | | | | | | | | | | | | | | | | | | | | | | | | | | | | | | | | | | | | | | | | | | | | | | | | | | | | | | | | | |
| | | 1 | | | | | | | | | | | | | | | | | | | | | | | | | | | | | | | | | | | | | | | | | | | | | | | | | | | | | | | | | | | | | | | | | | | | | | | | | | | | | |
| | | | | | | | | | | | | | | | | | | | | | | | | | | | | | | | | | | | | | | | | | | | | | | | | | | | | | | | | | | | | | | | | | | | | | | | | | | | | | | | |
| | | | | | | | | | | | | | | | | | | | | | | | | | | | | | | | | | | | | | | | | | | | | | | | | | | | | | | | | | | | | | | | | | | | | | | | | | | | | | | | |
| | | | | | | | | | | | | | | | | | | | | | | | | | | | | | | | | | | | | | | | | | | | | | | | | | | | | | | | | | | | | | | | | | | | | | | | | | | | | | | | |
| | | | | | | | | | | | | | | | | | | | | | | | | | | | | | | | | | | | | | | | | | | | | | | | | | | | | | | | | | | | | | | | | | | | | | | | | | | | | | | | |
| | | | | | | | | | | | | | | | | | | | | | | | | | | | | | | | | | | | | | | | | | | | | | | | | | | | | | | | | | | | | | | | | | | | | | | | | | | | | | | | |
| | | | | | | | | | | | | | | | | | | | | | | | | | | | | | | | | | | | | | | | | | | | | | | | | | | | | | | | | | | | | | | | | | | | | | | | | | | | | | | | |
| Post - 0 Miss - 0 Block - 0 | Post - 0 Miss - 0 Block - 0 | Post - 0 Miss - 0 Block - 0 | Post - 2 Miss - 0 Block - 3 | Post - 0 Miss - 0 Block - 0 | Post - 1 Miss - 0 Block - 0 | | | | | | | | | | | | | | | | | | | | | | | | | | | | | | | | | | | | | | | | | | | | | | | | | | | | | | | | | | | | | | | | | | | | | | | | | | |

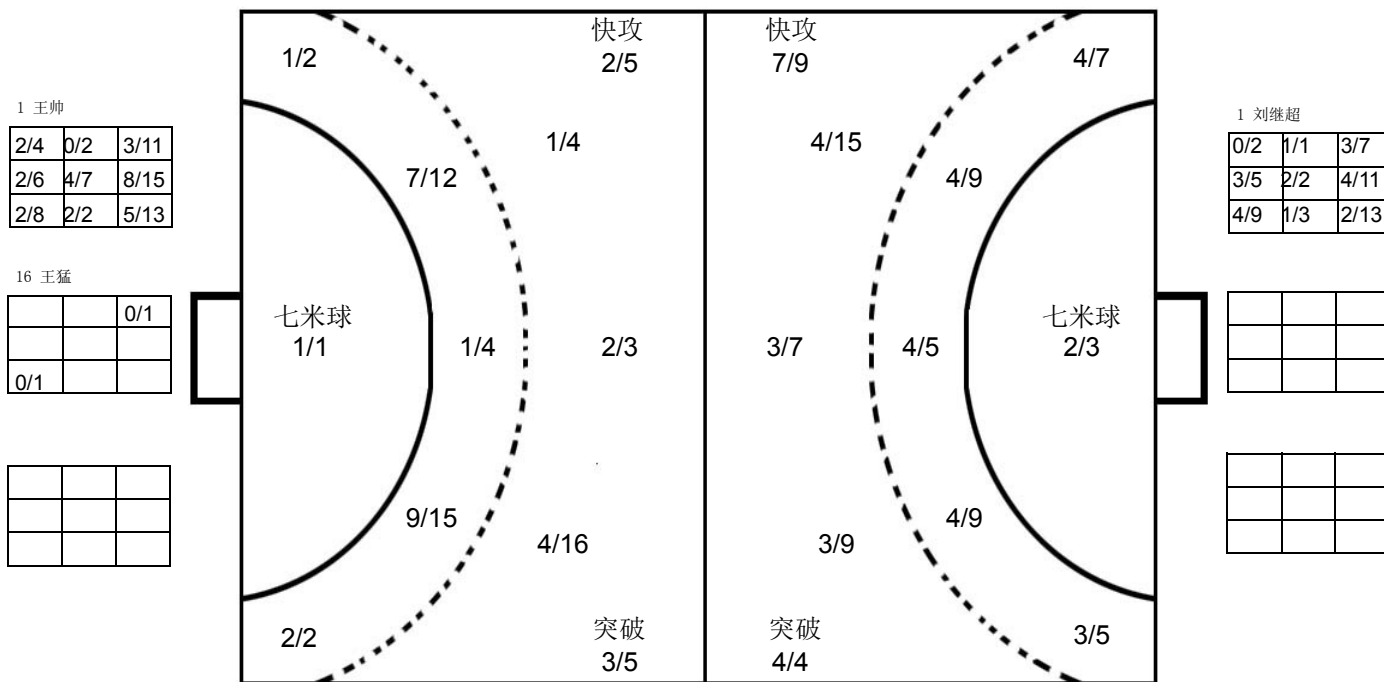

山东队

| | | | | | | | | | | | | | | | | | | | | | | | | | | | | | | | | | | | | | | | | | | | | | | | | | | | | | | | | | | | | | | | | | | | | | | | | | | | | | | | |
|--|-----------------------------|-----------------------------|-----------------------------|-----------------------------|-----------------------------|-----------------------------|-----------------------------|--|--|--|---|--|---|---|---|---|---|--|---|---|--|--|--|--|--|---|---|--|--|---|--|---|---|--|--|---|---|--|---|--|---|--|--|--|--|---|---|--|---|--|--|--|--|--|--|--|--|--|--|--|--|---|---|---|---|---|---|--|---|--|--|--|--|--|--|--|--|--|--|
| 1 刘继超 | 2 冯鑫宇 | 3 王铁林 | 5 王晓峰 | 6 王军鸣 | 7 徐勇林 | 10 孙芳伟 | 11 王洋 | | | | | | | | | | | | | | | | | | | | | | | | | | | | | | | | | | | | | | | | | | | | | | | | | | | | | | | | | | | | | | | | | | | | | | | | |
| <table border="1"><tr><td></td><td></td><td></td></tr><tr><td></td><td></td><td></td></tr><tr><td></td><td></td><td></td></tr></table> | | | | | | | | | | <table border="1"><tr><td></td><td></td><td>1</td></tr><tr><td>1</td><td>1</td><td>2</td></tr><tr><td>1</td><td></td><td>2</td></tr></table> | | | 1 | 1 | 1 | 2 | 1 | | 2 | <table border="1"><tr><td></td><td></td><td></td></tr><tr><td></td><td></td><td>2</td></tr><tr><td></td><td></td><td></td></tr></table> | | | | | | 2 | | | | <table border="1"><tr><td></td><td>1</td><td>6</td></tr><tr><td></td><td></td><td>1</td></tr><tr><td>1</td><td></td><td>3</td></tr></table> | | 1 | 6 | | | 1 | 1 | | 3 | <table border="1"><tr><td>1</td><td></td><td></td></tr><tr><td></td><td></td><td>1</td></tr><tr><td>1</td><td></td><td>1</td></tr></table> | 1 | | | | | 1 | 1 | | 1 | <table border="1"><tr><td></td><td></td><td></td></tr><tr><td></td><td></td><td></td></tr><tr><td></td><td></td><td></td></tr></table> | | | | | | | | | | <table border="1"><tr><td></td><td>1</td><td>1</td></tr><tr><td>1</td><td></td><td>1</td></tr><tr><td>1</td><td></td><td>1</td></tr></table> | | 1 | 1 | 1 | | 1 | 1 | | 1 | <table border="1"><tr><td></td><td></td><td></td></tr><tr><td></td><td></td><td></td></tr><tr><td></td><td></td><td></td></tr></table> | | | | | | | | | |
| | | | | | | | | | | | | | | | | | | | | | | | | | | | | | | | | | | | | | | | | | | | | | | | | | | | | | | | | | | | | | | | | | | | | | | | | | | | | | | | |
| | | | | | | | | | | | | | | | | | | | | | | | | | | | | | | | | | | | | | | | | | | | | | | | | | | | | | | | | | | | | | | | | | | | | | | | | | | | | | | | |
| | | | | | | | | | | | | | | | | | | | | | | | | | | | | | | | | | | | | | | | | | | | | | | | | | | | | | | | | | | | | | | | | | | | | | | | | | | | | | | | |
| | | 1 | | | | | | | | | | | | | | | | | | | | | | | | | | | | | | | | | | | | | | | | | | | | | | | | | | | | | | | | | | | | | | | | | | | | | | | | | | | | | |
| 1 | 1 | 2 | | | | | | | | | | | | | | | | | | | | | | | | | | | | | | | | | | | | | | | | | | | | | | | | | | | | | | | | | | | | | | | | | | | | | | | | | | | | | |
| 1 | | 2 | | | | | | | | | | | | | | | | | | | | | | | | | | | | | | | | | | | | | | | | | | | | | | | | | | | | | | | | | | | | | | | | | | | | | | | | | | | | | |
| | | | | | | | | | | | | | | | | | | | | | | | | | | | | | | | | | | | | | | | | | | | | | | | | | | | | | | | | | | | | | | | | | | | | | | | | | | | | | | | |
| | | 2 | | | | | | | | | | | | | | | | | | | | | | | | | | | | | | | | | | | | | | | | | | | | | | | | | | | | | | | | | | | | | | | | | | | | | | | | | | | | | |
| | | | | | | | | | | | | | | | | | | | | | | | | | | | | | | | | | | | | | | | | | | | | | | | | | | | | | | | | | | | | | | | | | | | | | | | | | | | | | | | |
| | 1 | 6 | | | | | | | | | | | | | | | | | | | | | | | | | | | | | | | | | | | | | | | | | | | | | | | | | | | | | | | | | | | | | | | | | | | | | | | | | | | | | |
| | | 1 | | | | | | | | | | | | | | | | | | | | | | | | | | | | | | | | | | | | | | | | | | | | | | | | | | | | | | | | | | | | | | | | | | | | | | | | | | | | | |
| 1 | | 3 | | | | | | | | | | | | | | | | | | | | | | | | | | | | | | | | | | | | | | | | | | | | | | | | | | | | | | | | | | | | | | | | | | | | | | | | | | | | | |
| 1 | | | | | | | | | | | | | | | | | | | | | | | | | | | | | | | | | | | | | | | | | | | | | | | | | | | | | | | | | | | | | | | | | | | | | | | | | | | | | | | |
| | | 1 | | | | | | | | | | | | | | | | | | | | | | | | | | | | | | | | | | | | | | | | | | | | | | | | | | | | | | | | | | | | | | | | | | | | | | | | | | | | | |
| 1 | | 1 | | | | | | | | | | | | | | | | | | | | | | | | | | | | | | | | | | | | | | | | | | | | | | | | | | | | | | | | | | | | | | | | | | | | | | | | | | | | | |
| | | | | | | | | | | | | | | | | | | | | | | | | | | | | | | | | | | | | | | | | | | | | | | | | | | | | | | | | | | | | | | | | | | | | | | | | | | | | | | | |
| | | | | | | | | | | | | | | | | | | | | | | | | | | | | | | | | | | | | | | | | | | | | | | | | | | | | | | | | | | | | | | | | | | | | | | | | | | | | | | | |
| | | | | | | | | | | | | | | | | | | | | | | | | | | | | | | | | | | | | | | | | | | | | | | | | | | | | | | | | | | | | | | | | | | | | | | | | | | | | | | | |
| | 1 | 1 | | | | | | | | | | | | | | | | | | | | | | | | | | | | | | | | | | | | | | | | | | | | | | | | | | | | | | | | | | | | | | | | | | | | | | | | | | | | | |
| 1 | | 1 | | | | | | | | | | | | | | | | | | | | | | | | | | | | | | | | | | | | | | | | | | | | | | | | | | | | | | | | | | | | | | | | | | | | | | | | | | | | | |
| 1 | | 1 | | | | | | | | | | | | | | | | | | | | | | | | | | | | | | | | | | | | | | | | | | | | | | | | | | | | | | | | | | | | | | | | | | | | | | | | | | | | | |
| | | | | | | | | | | | | | | | | | | | | | | | | | | | | | | | | | | | | | | | | | | | | | | | | | | | | | | | | | | | | | | | | | | | | | | | | | | | | | | | |
| | | | | | | | | | | | | | | | | | | | | | | | | | | | | | | | | | | | | | | | | | | | | | | | | | | | | | | | | | | | | | | | | | | | | | | | | | | | | | | | |
| | | | | | | | | | | | | | | | | | | | | | | | | | | | | | | | | | | | | | | | | | | | | | | | | | | | | | | | | | | | | | | | | | | | | | | | | | | | | | | | |
| Post - 0 Miss - 0 Block - 0 | Post - 1 Miss - 1 Block - 0 | Post - 2 Miss - 1 Block - 1 | Post - 1 Miss - 0 Block - 0 | Post - 0 Miss - 1 Block - 0 | Post - 0 Miss - 0 Block - 0 | Post - 0 Miss - 1 Block - 0 | Post - 0 Miss - 0 Block - 0 | | | | | | | | | | | | | | | | | | | | | | | | | | | | | | | | | | | | | | | | | | | | | | | | | | | | | | | | | | | | | | | | | | | | | | | | |
| 12 刘道林 | 13 于欣君 | 17 薛盼龙 | 18 李玮 | 21 王腾达 | 22 李子跃 | 23 李荣健 | | | | | | | | | | | | | | | | | | | | | | | | | | | | | | | | | | | | | | | | | | | | | | | | | | | | | | | | | | | | | | | | | | | | | | | | | |
| <table border="1"><tr><td></td><td></td><td></td></tr><tr><td></td><td></td><td></td></tr><tr><td></td><td></td><td></td></tr></table> | | | | | | | | | | <table border="1"><tr><td>1</td><td></td><td></td></tr><tr><td>2</td><td>1</td><td></td></tr><tr><td>1</td><td></td><td>1</td></tr></table> | 1 | | | 2 | 1 | | 1 | | 1 | <table border="1"><tr><td></td><td></td><td></td></tr><tr><td></td><td></td><td></td></tr><tr><td>2</td><td></td><td></td></tr></table> | | | | | | | 2 | | | <table border="1"><tr><td></td><td></td><td></td></tr><tr><td></td><td></td><td></td></tr><tr><td></td><td></td><td></td></tr></table> | | | | | | | | | | <table border="1"><tr><td></td><td></td><td></td></tr><tr><td></td><td></td><td></td></tr><tr><td></td><td></td><td></td></tr></table> | | | | | | | | | | <table border="1"><tr><td></td><td></td><td></td></tr><tr><td></td><td></td><td></td></tr><tr><td></td><td></td><td></td></tr></table> | | | | | | | | | | <table border="1"><tr><td></td><td></td><td>1</td></tr><tr><td></td><td>1</td><td></td></tr><tr><td></td><td></td><td></td></tr></table> | | | 1 | | 1 | | | | | <table border="1"><tr><td></td><td></td><td></td></tr><tr><td></td><td></td><td></td></tr><tr><td></td><td></td><td></td></tr></table> | | | | | | | | | |
| | | | | | | | | | | | | | | | | | | | | | | | | | | | | | | | | | | | | | | | | | | | | | | | | | | | | | | | | | | | | | | | | | | | | | | | | | | | | | | | |
| | | | | | | | | | | | | | | | | | | | | | | | | | | | | | | | | | | | | | | | | | | | | | | | | | | | | | | | | | | | | | | | | | | | | | | | | | | | | | | | |
| | | | | | | | | | | | | | | | | | | | | | | | | | | | | | | | | | | | | | | | | | | | | | | | | | | | | | | | | | | | | | | | | | | | | | | | | | | | | | | | |
| 1 | | | | | | | | | | | | | | | | | | | | | | | | | | | | | | | | | | | | | | | | | | | | | | | | | | | | | | | | | | | | | | | | | | | | | | | | | | | | | | | |
| 2 | 1 | | | | | | | | | | | | | | | | | | | | | | | | | | | | | | | | | | | | | | | | | | | | | | | | | | | | | | | | | | | | | | | | | | | | | | | | | | | | | | |
| 1 | | 1 | | | | | | | | | | | | | | | | | | | | | | | | | | | | | | | | | | | | | | | | | | | | | | | | | | | | | | | | | | | | | | | | | | | | | | | | | | | | | |
| | | | | | | | | | | | | | | | | | | | | | | | | | | | | | | | | | | | | | | | | | | | | | | | | | | | | | | | | | | | | | | | | | | | | | | | | | | | | | | | |
| | | | | | | | | | | | | | | | | | | | | | | | | | | | | | | | | | | | | | | | | | | | | | | | | | | | | | | | | | | | | | | | | | | | | | | | | | | | | | | | |
| 2 | | | | | | | | | | | | | | | | | | | | | | | | | | | | | | | | | | | | | | | | | | | | | | | | | | | | | | | | | | | | | | | | | | | | | | | | | | | | | | | |
| | | | | | | | | | | | | | | | | | | | | | | | | | | | | | | | | | | | | | | | | | | | | | | | | | | | | | | | | | | | | | | | | | | | | | | | | | | | | | | | |
| | | | | | | | | | | | | | | | | | | | | | | | | | | | | | | | | | | | | | | | | | | | | | | | | | | | | | | | | | | | | | | | | | | | | | | | | | | | | | | | |
| | | | | | | | | | | | | | | | | | | | | | | | | | | | | | | | | | | | | | | | | | | | | | | | | | | | | | | | | | | | | | | | | | | | | | | | | | | | | | | | |
| | | | | | | | | | | | | | | | | | | | | | | | | | | | | | | | | | | | | | | | | | | | | | | | | | | | | | | | | | | | | | | | | | | | | | | | | | | | | | | | |
| | | | | | | | | | | | | | | | | | | | | | | | | | | | | | | | | | | | | | | | | | | | | | | | | | | | | | | | | | | | | | | | | | | | | | | | | | | | | | | | |
| | | | | | | | | | | | | | | | | | | | | | | | | | | | | | | | | | | | | | | | | | | | | | | | | | | | | | | | | | | | | | | | | | | | | | | | | | | | | | | | |
| | | | | | | | | | | | | | | | | | | | | | | | | | | | | | | | | | | | | | | | | | | | | | | | | | | | | | | | | | | | | | | | | | | | | | | | | | | | | | | | |
| | | | | | | | | | | | | | | | | | | | | | | | | | | | | | | | | | | | | | | | | | | | | | | | | | | | | | | | | | | | | | | | | | | | | | | | | | | | | | | | |
| | | | | | | | | | | | | | | | | | | | | | | | | | | | | | | | | | | | | | | | | | | | | | | | | | | | | | | | | | | | | | | | | | | | | | | | | | | | | | | | |
| | | 1 | | | | | | | | | | | | | | | | | | | | | | | | | | | | | | | | | | | | | | | | | | | | | | | | | | | | | | | | | | | | | | | | | | | | | | | | | | | | | |
| | 1 | | | | | | | | | | | | | | | | | | | | | | | | | | | | | | | | | | | | | | | | | | | | | | | | | | | | | | | | | | | | | | | | | | | | | | | | | | | | | | |
| | | | | | | | | | | | | | | | | | | | | | | | | | | | | | | | | | | | | | | | | | | | | | | | | | | | | | | | | | | | | | | | | | | | | | | | | | | | | | | | |
| | | | | | | | | | | | | | | | | | | | | | | | | | | | | | | | | | | | | | | | | | | | | | | | | | | | | | | | | | | | | | | | | | | | | | | | | | | | | | | | |
| | | | | | | | | | | | | | | | | | | | | | | | | | | | | | | | | | | | | | | | | | | | | | | | | | | | | | | | | | | | | | | | | | | | | | | | | | | | | | | | |
| | | | | | | | | | | | | | | | | | | | | | | | | | | | | | | | | | | | | | | | | | | | | | | | | | | | | | | | | | | | | | | | | | | | | | | | | | | | | | | | |
| Post - 0 Miss - 0 Block - 0 | Post - 1 Miss - 1 Block - 1 | Post - 0 Miss - 0 Block - 0 | Post - 0 Miss - 0 Block - 0 | Post - 0 Miss - 0 Block - 0 | Post - 0 Miss - 0 Block - 0 | Post - 0 Miss - 0 Block - 0 | | | | | | | | | | | | | | | | | | | | | | | | | | | | | | | | | | | | | | | | | | | | | | | | | | | | | | | | | | | | | | | | | | | | | | | | | |

注释: Post=击柱 Miss=射失 Block=被封





预赛 Group A
青年男子 全国比赛

2016年“体彩杯”全国手球男子青年锦标赛

| | | | | | | | | | | | | | | | | | | | | | |
|--------------------|---|---------------------|---------------------|------------------------------------|---------|-------------------|---|---------------------------|----------------|-------|------------|----------------------|---|---|--|--|---|---|----|---|----|
| Team A A 解放军队 | | | | Team B B 上海队 | | | | Match Number 23 | | | | | | | | | | | | | |
| played in China | | in the hall 重庆万州 | | on 24/03/2016 | | at 16:00 hours | | Spectators | | | | | | | | | | | | | |
| Half-time (30') | A 16 | B 10 | End of playing time | A 35 | B 20 | 1st extra time | A | B | 2nd extra time | A | B | After penalty throws | A | B | | | | | | | |
| Number of 7 m | A 3 / 3 | Team time-out | | Full name of players and officials | | | | Team time-out | | | B 2 / 2 | Number of 7 m | | | | | | | | | |
| | | 1 | 2 | 3 | | | | 1 | 2 | 3 | | | | | | | | | | | |
| | | | 50:07 | | | | | 14:13 | 44:20 | 58:22 | | | | | | | | | | | |
| No. | Team A | | | | | G | W | 2' | D | DR | No. | Team B | | | | | G | W | 2' | D | DR |
| 1 | 郭梦雨 | | | | | | | | | | 2 | 谢智超 | | | | | | | | | |
| 3 | 张昌轲 | | | | | 5 | 1 | | | | 3 | 高天伦 | | | | | 2 | | 1 | | |
| 4 | 张洋 | | | | | 1 | | | | | 4 | 高震东 | | | | | | | | | |
| 5 | 尹一楠 | | | | | | | | | | 5 | 曹磊 | | | | | 1 | | | | |
| 6 | 吴昊 | | | | | 8 | | 1 | | | 6 | 季晨旭 | | | | | | | | | |
| 7 | 姜钦 | | | | | 7 | 1 | | | | 7 | 蒋家敏 | | | | | | | | | |
| 8 | 邹峻楠 | | | | | | | | | | 8 | 庄旭杰 | | | | | | | | 1 | |
| 9 | 李天枢 | | | | | | | | | | 10 | 董凯 | | | | | 7 | 1 | | | |
| 10 | 范保坤 | | | | | 2 | | 1 | | | 12 | 张润民 | | | | | | | | | |
| 11 | 王誌汉 | | | | | 4 | 1 | | | | 14 | 吴佳兵 | | | | | 1 | | | | |
| 12 | 左子健 | | | | | | | | | | 16 | 陈辰 | | | | | | | | | |
| 13 | 徐崧清 | | | | | 1 | | | | | 18 | 吴双 | | | | | 9 | 1 | | | |
| 14 | 孙耀琦 | | | | | 7 | | | | | | | | | | | | | | | |
| 16 | 池猛 | | | | | | | | | | | | | | | | | | | | |
| 17 | 刘安宁 | | | | | | | | | | | | | | | | | | | | |
| A | 杜长义 (主教练) | | | | | | | | | | A | 马仲顺 | | | | | 1 | | | | |
| A | Signature of Responsible Official of the Teams (Off. A) | | | | | | | | | | B | | | | | | | | | | |
| TP | Remarks of Referee / CHA Official | | | | | | | | | | TP | | | | | | | | | | |

Signatures

| | | | | |
|------------------|-----------|-----------|--|--|
| Referees | 程钰峰 (CHN) | 周云磊 (CHN) | | |
| Techn. Delegates | 徐健 (CHN) | | | |
| CHA Official | 吴瑞亭 (CHN) | | | |

Note: Number of 7m Throws Awarded to Team A and B, Goals (G), Warnings (W), Suspensions (2'), Direct Disqualification (D), Disqualification with Report (DR) and Team Penalty (TP).

Table Officials:

Statisticians: 刘永欢

李双





2016年“体彩杯”全国手球男子青年锦标赛 竞赛技术统计(媒体表)

| | | | | | | |
|----|----|---|----|---|----|----|
| 预赛 | 组别 | A | 轮次 | 4 | 场次 | 23 |
|----|----|---|----|---|----|----|

重庆万州

24/03/2016

201602023-51-1/1

| | | | | | | |
|----------------|------------|-----------|----|-----------|----|-----|
| 解放军队 | 解放军 | 35 | vs | 20 | 上海 | 上海队 |
| 16 : 10 | | | | | | |

| | | | |
|-----|-----------|---|-----------|
| 裁判员 | 程钰峰 (CHN) | / | 周云磊 (CHN) |
|-----|-----------|---|-----------|

| 解放军 | | 远 | 近 | 边 | 快 | 突 | 任意 | 7m | 合计 | % | 助攻 | 失误 | 警告 | 2' | D & DR | 解放军 | | 比赛 | 上海 | | |
|---------------|-----|------|-------|-----|------|-----|-----|-----|-------|------|----|----|----|----|--------|-----|-----|----------|----|----|-----|
| 主教练：杜长义 | | 射 | 射 | 射 | 攻 | 破 | 球 | 球 | | | | | | | | 进程 | | | | | |
| 1 | 郭梦雨 | | | | | | | | | | | | | | | 6 | 吴昊 | 1st Half | 0 | | |
| 3 | 张昌轲 | 0/1 | 1/2 | | 2/2 | 1/1 | | 1/1 | 5/7 | 71.4 | 10 | 4 | 1 | | | 1 | 董凯 | 01:28 | 1 | 10 | 董凯 |
| 4 | 张洋 | | 1/1 | | | | | | 1/1 | 100 | | | | | | 1 | 吴昊 | 03:26 | 2 | 18 | 吴昊 |
| 5 | 尹一楠 | | | | | | | | | | | | | | | 2 | 董凯 | 03:36 | 2 | | |
| 6 | 吴昊 | 1/4 | 3/7 | | 2/2 | | | 2/2 | 8/15 | 53.3 | 1 | 1 | | 1 | | 2 | 吴昊 | 05:36 | 3 | 18 | 吴昊 |
| 7 | 姜钦 | 0/2 | 5/7 | | 1/2 | 1/1 | | | 7/12 | 58.3 | 6 | 1 | 1 | | | 3 | 姜钦 | 07:44 | 3 | | |
| 8 | 邹峻楠 | | | | | | | | | | | | | | | 4 | 范保坤 | 09:08 | 3 | | |
| 9 | 李天枢 | | | | | | | | | | | | | | | 5 | 范保坤 | 11:06 | 3 | | |
| 10 | 范保坤 | | | 1/2 | 1/1 | | | | 2/3 | 66.7 | | 1 | | 1 | | 6 | 姜钦 | 11:33 | 4 | 10 | 董凯 |
| 11 | 王誌汉 | | 2/2 | 1/3 | 1/2 | | | | 4/7 | 57.1 | 1 | 2 | 1 | | | 7 | 王誌汉 | 13:16 | 4 | | |
| 12 | 左子健 | | | | | | | | | | | | | | | 8 | 王誌汉 | 15:00 | 5 | 10 | 董凯 |
| 13 | 徐峻清 | | 0/1 | | 1/1 | | | | 1/2 | 50.0 | 1 | 2 | | | | 9 | 吴昊 | 16:01 | 6 | 10 | 董凯 |
| 14 | 孙耀琦 | | 6/8 | | 1/2 | | | | 7/10 | 70.0 | 1 | 1 | | | | 10 | 孙耀琦 | 16:22 | 6 | | |
| 16 | 池猛 | | | | | | | | | | | | | | | 11 | 孙耀琦 | 17:22 | 6 | | |
| 17 | 刘安宁 | | | | | | | | | | | | | | | 12 | 孙耀琦 | 17:45 | 7 | 3 | 高天伦 |
| 运动员 合计 | | 1/7 | 18/28 | 2/5 | 9/12 | 2/2 | | 3/3 | 35/57 | 61.4 | 20 | 14 | 3 | 2 | | 13 | 吴昊 | 18:49 | 7 | | |
| 1 | 郭梦雨 | 8/15 | 2/7 | 1/1 | 0/2 | 0/3 | 0/1 | 0/2 | 11/31 | 35.5 | | 2 | | | | 14 | 姜钦 | 22:14 | 7 | | |
| 守门员 合计 | | 8/15 | 2/7 | 1/1 | 0/2 | 0/3 | 0/1 | 0/2 | 11/31 | 35.5 | | 2 | | | | 15 | 张昌轲 | 22:57 | 7 | | |
| 上海 | | 远 | 近 | 边 | 快 | 突 | 任意 | 7m | 合计 | % | 助攻 | 失误 | 警告 | 2' | D & DR | 上海 | | | | | |
| 教练：马仲顺 | | 射 | 射 | 射 | 攻 | 破 | 球 | 球 | | | | | | | | 进程 | | | | | |
| 2 | 谢智超 | | | | | | | | | | | | | | | 17 | 孙耀琦 | 00:21 | 10 | | |
| 3 | 高天伦 | 2/6 | 0/1 | | | | | | 2/7 | 28.6 | | 5 | | 1 | | 18 | 王誌汉 | 00:43 | 11 | 3 | 高天伦 |
| 4 | 高震东 | | | | | | | | | | | | | | | 19 | 王誌汉 | 01:13 | 11 | | |
| 5 | 曹磊 | 1/1 | | | | | | | 1/1 | 100 | | 2 | | | | 20 | 姜钦 | 02:46 | 12 | 10 | 董凯 |
| 6 | 季晨旭 | | | | | | | | | | | | | | | 21 | 姜钦 | 03:11 | 12 | | |
| 7 | 蒋家敏 | | | | | | | | | | | | | | | 22 | 吴昊 | 04:02 | 12 | | |
| 8 | 庄旭杰 | | | 0/1 | | | | | | | | | | | | 23 | 吴昊 | 07:24 | 13 | 18 | 吴昊 |
| 10 | 董凯 | 2/5 | 2/3 | | | 1/1 | 0/1 | 2/2 | 7/12 | 58.3 | 1 | 3 | 1 | 1 | | 24 | 姜钦 | 08:44 | 14 | 14 | 吴佳兵 |
| 12 | 张润民 | | | | | | | | | | | | | | | 25 | 吴昊 | 08:59 | 14 | | |
| 14 | 吴佳兵 | 1/5 | | | | | | | 1/5 | 20.0 | | 8 | | | | 26 | 吴昊 | 11:54 | 14 | | |
| 16 | 陈辰 | | | | | | | | | | | | | | | 27 | 姜钦 | 12:36 | 14 | | |
| 18 | 吴昊 | 1/7 | 3/3 | | 2/2 | 2/3 | 1/1 | | 9/16 | 56.3 | 1 | 6 | 1 | | | 28 | 姜钦 | 13:35 | 15 | 5 | 曹磊 |
| 运动员 合计 | | 7/24 | 5/7 | 0/1 | 2/2 | 3/4 | 1/2 | 2/2 | 20/42 | 47.6 | 2 | 25 | 2 | 2 | | 29 | 张昌轲 | 14:02 | 15 | | |
| 12 | 张润民 | 3/4 | 6/24 | 2/4 | 2/11 | 0/2 | | 0/3 | 13/48 | 27.1 | | | | | | 30 | 张昌轲 | 14:16 | 15 | | |
| 守门员 合计 | | 3/4 | 6/24 | 2/4 | 2/11 | 0/2 | | 0/3 | 13/48 | 27.1 | | | | | | 31 | 姜钦 | 15:57 | 15 | | |

场上队员：得分 / 射门

守门员：救球 / 射门

| | | | | | | | | | |
|----|------------|----|--------------|-----|------------|-----|----------|----|---------|
| 快攻 | Fast Break | 突破 | Breakthrough | 任意球 | Free Throw | 7M球 | 7M Throw | 助攻 | Assist |
| 警告 | Warning | 失误 | Error | 2' | Suspension | D | 取消资格 | DR | 取消资格+报告 |





2016年“体彩杯”全国手球男子青年锦标赛 图式比赛技术统计表

轮次 4

场次 23

201602023-21-1/1

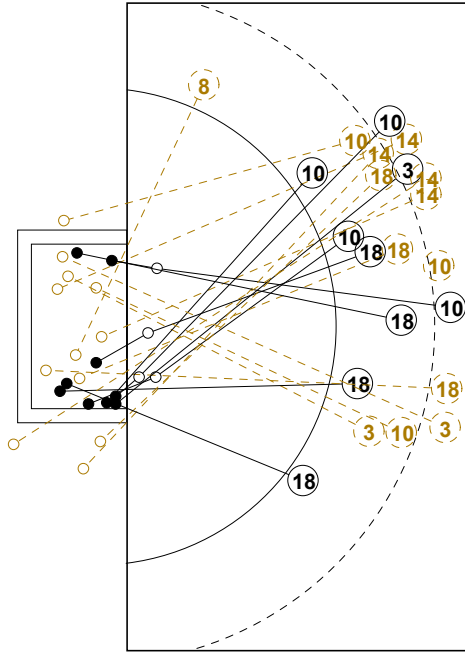

7M 上海

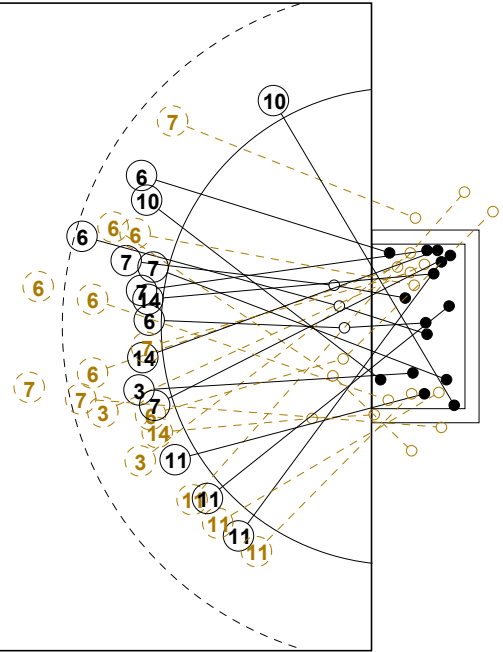
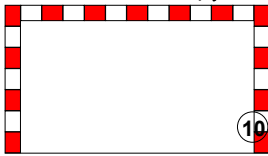

解放军 7M

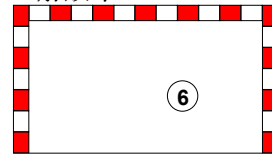

1st Half
10 : 16

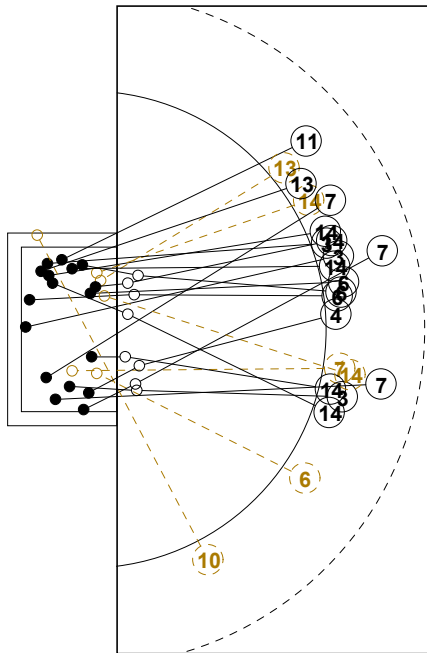

7M 解放军

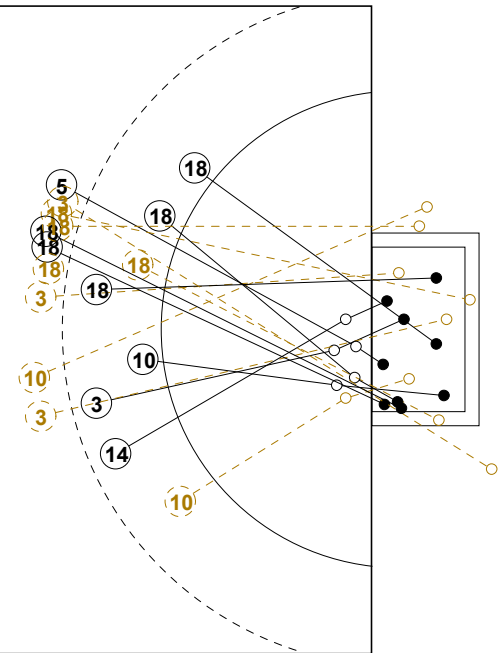
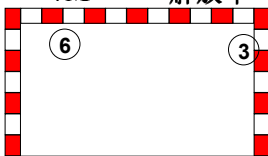

上海 7M

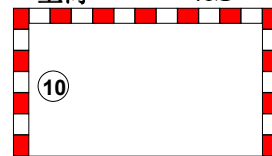

2nd Half
35 : 20



2016年“体彩杯”全国手球男子青年锦标赛

个人/全队技术统计表

正式表
手球
青年男子预赛
轮次 4组别 A
场次 23201602023-14-1/2
重庆万州
24/03/2016 16:00

| 号码 | 姓名 | 远射 | 近射 | 边射 | 快攻 | 突破 | 任意 | 7M | 合计 | % | 助攻 | 失误 | 警告 | 2' | 取消 | 时间 |
|------------------|-----|------|-------|-----|------|-----|-----|-----|-------|-------|----|----|----|----|----|----------|
| 解放军队(解放军) | | | | | | | | | | | | | | | | |
| <i>(场上队员)</i> | | | | | | | | | | | | | | | | |
| 1 | 郭梦雨 | | | | | | | | | 0.0% | | 2 | | | | 00:59:38 |
| 3 | 张昌轲 | 0/1 | 1/2 | | 2/2 | 1/1 | | 1/1 | 5/7 | 71.4% | 10 | 4 | 1 | | | 00:59:37 |
| 4 | 张洋 | | 1/1 | | | | | | 1/1 | 100% | | | | | | 00:00:12 |
| 5 | 尹一楠 | | | | | | | | | 0.0% | | | | | | 00:01:37 |
| 6 | 吴昊 | 1/4 | 3/7 | | 2/2 | | | 2/2 | 8/15 | 53.3% | 1 | 1 | | 1 | | 00:59:37 |
| 7 | 姜钦 | 0/2 | 5/7 | | 1/2 | 1/1 | | | 7/12 | 58.3% | 6 | 1 | 1 | | | 00:59:36 |
| 8 | 邹峻楠 | | | | | | | | | 0.0% | | | | | | 00:00:00 |
| 9 | 李天枢 | | | | | | | | | 0.0% | | | | | | 00:00:00 |
| 10 | 范保坤 | | | 1/2 | 1/1 | | | | 2/3 | 66.7% | | 1 | | 1 | | 00:57:57 |
| 11 | 王誌汉 | | 2/2 | 1/3 | 1/2 | | | | 4/7 | 57.1% | 1 | 2 | 1 | | | 00:35:55 |
| 12 | 左子健 | | | | | | | | | 0.0% | | | | | | 00:00:00 |
| 13 | 徐峻清 | | 0/1 | | 1/1 | | | | 1/2 | 50.0% | 1 | 2 | | | | 00:23:41 |
| 14 | 孙耀琦 | | 6/8 | | 1/2 | | | | 7/10 | 70.0% | 1 | 1 | | | | 00:59:24 |
| 16 | 池猛 | | | | | | | | | 0.0% | | | | | | 00:00:00 |
| 17 | 刘安宁 | | | | | | | | | 0.0% | | | | | | 00:00:00 |
| 合计 | | 1/7 | 18/28 | 2/5 | 9/12 | 2/2 | | 3/3 | 35/57 | 61.4% | 20 | 14 | 3 | 2 | | |
| <i>(守门员)</i> | | | | | | | | | | | | | | | | |
| 1 | 郭梦雨 | 8/15 | 2/7 | 1/1 | 0/2 | 0/3 | 0/1 | 0/2 | 11/31 | 35.5% | | 2 | | | | 00:59:38 |
| 合计 | | 8/15 | 2/7 | 1/1 | 0/2 | 0/3 | 0/1 | 0/2 | 11/31 | 35.5% | | 2 | | | | |

场上队员：得分/射门

守门员：救球/射门

| 全队合计 | 得分 | 被救 | 射失 | 击柱 | 封球 | 合计 | % |
|------|----|----|----|----|----|----|--------|
| 远射 | 1 | 3 | 1 | | 2 | 7 | 14.3% |
| 近射 | 18 | 6 | 3 | 1 | | 28 | 64.3% |
| 边射 | 2 | 2 | | 1 | | 5 | 40.0% |
| 快攻 | 9 | 2 | 1 | | | 12 | 75.0% |
| 突破 | 2 | | | | | 2 | 100.0% |
| 任意 | | | | | | | 0.0% |
| 7M | 3 | | | | | 3 | 100.0% |





2016年“体彩杯”全国手球男子青年锦标赛

个人/全队技术统计表

正式表
手球
青年男子预赛
轮次 4组别 A
场次 23201602023-14-2/2
重庆万州
24/03/2016 16:00

| 号码 | 姓名 | 远射 | 近射 | 边射 | 快攻 | 突破 | 任意 | 7M | 合计 | % | 助攻 | 失误 | 警告 | 2' | 取消 | 时间 |
|---------------------------------------|-----|-----|------|-----|------|-----|-----|-----|-------|-------|----|----|----|----|----|----------|
| 上海队(上海) | | | | | | | | | | | | | | | | |
| <i>(上场队员)</i> | | | | | | | | | | | | | | | | |
| 2 | 谢智超 | | | | | | | | | 0.0% | | | | | | 00:00:00 |
| 3 | 高天伦 | 2/6 | 0/1 | | | | | | 2/7 | 28.6% | | 5 | | 1 | | 00:59:37 |
| 4 | 高震东 | | | | | | | | | 0.0% | | | | | | 00:00:00 |
| 5 | 曹磊 | 1/1 | | | | | | | 1/1 | 100% | | 2 | | | | 00:03:47 |
| 6 | 季晨旭 | | | | | | | | | 0.0% | | | | | | 00:00:00 |
| 7 | 蒋家敏 | | | | | | | | | 0.0% | | 1 | | | | 00:59:37 |
| 8 | 庄旭杰 | | | 0/1 | | | | | 0/1 | 0.0% | 1 | | | 1 | | 00:59:37 |
| 10 | 董凯 | 2/5 | 2/3 | | | 1/1 | 0/1 | 2/2 | 7/12 | 58.3% | | 3 | | 1 | | 00:59:37 |
| 12 | 张润民 | | | | | | | | | 0.0% | | | | | | 00:59:38 |
| 14 | 吴佳兵 | 1/5 | | | | | | | 1/5 | 20.0% | | 8 | | | | 00:59:38 |
| 16 | 陈辰 | | | | | | | | | 0.0% | | | | | | 00:00:00 |
| 18 | 吴双 | 1/7 | 3/3 | | 2/2 | 2/3 | 1/1 | | 9/16 | 56.3% | 1 | 6 | | 1 | | 00:55:46 |
| 合计 | | | | | | | | | | | | | | | | |
| <i>(守门员)</i> | | | | | | | | | | | | | | | | |
| 12 | 张润民 | 3/4 | 6/24 | 2/4 | 2/11 | 0/2 | | 0/3 | 13/48 | 27.1% | | | | | | 00:59:38 |
| 合计 | | | | | | | | | | | | | | | | |
| 3/4 6/24 2/4 2/11 0/2 0/3 13/48 27.1% | | | | | | | | | | | | | | | | |

场上队员：得分/射门

守门员：救球/射门

| 全队合计 | 得分 | 被救 | 射失 | 击柱 | 封球 | 合计 | % |
|------|----|----|----|----|----|----|--------|
| 远射 | 7 | 8 | 6 | 1 | 2 | 24 | 29.2% |
| 近射 | 5 | 2 | | | | 7 | 71.4% |
| 边射 | | 1 | | | | 1 | 0.0% |
| 快攻 | 2 | | | | | 2 | 100.0% |
| 突破 | 3 | | | 1 | | 4 | 75.0% |
| 任意 | 1 | | 1 | | | 2 | 50.0% |
| 7M | 2 | | | | | 2 | 100.0% |





2016年“体彩杯”全国手球男子青年锦标赛

图式射门区域统计

轮次 4 场次 23

201602023-41-1/1

解放军队

Player statistics grid for the PLA team, listing 17 players with their respective goalkeeping statistics (Post, Miss, Block).

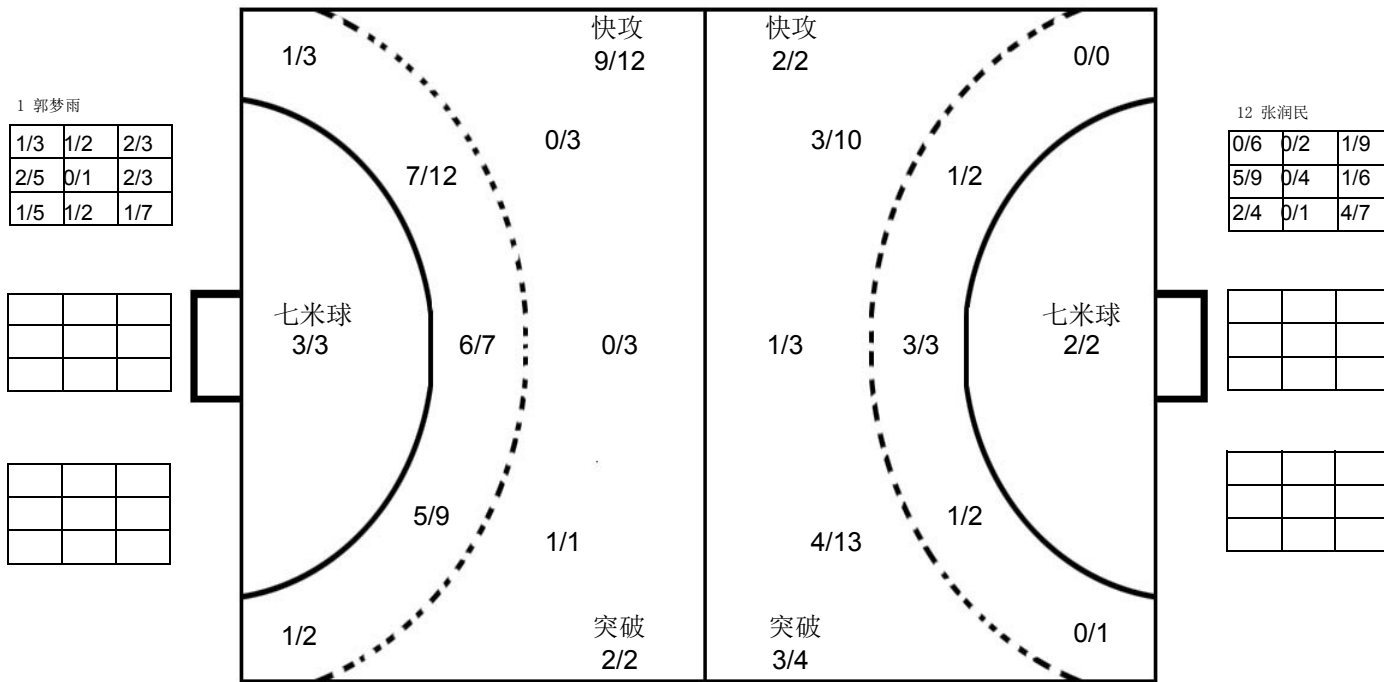

上海队

Player statistics grid for the Shanghai team, listing 12 players with their respective goalkeeping statistics (Post, Miss, Block).

注释: Post=击柱 Miss=射失 Block=被封





预赛 Group A
青年男子 全国比赛

2016年“体彩杯”全国手球男子青年锦标赛

| | | | | | | | | | | | | | | | | | | | | | |
|------------------------|---|--|---------------------|------------------------|------------------------------------|-------------------|----------|---------------------------|------------------------|----------|----------|----------------------|---------------|----------|--|--|----|---|----|---|----|
| Team A A 浙江队 | | | | Team B B 江苏队 | | | | Match Number 24 | | | | | | | | | | | | | |
| played in China | | in the hall 重庆万州 | | on 24/03/2016 | | at 17:30 hours | | Spectators | | | | | | | | | | | | | |
| Half-time (30') | A 8 | B 19 | End of playing time | A 26 | B 37 | 1st extra time | A | B | 2nd extra time | A | B | After penalty throws | A | B | | | | | | | |
| Number of 7 m | A 2/2 | Team time-out 1 08:36 2 23:54 3 47:11 | | | Full name of players and officials | | | | Team time-out 1 2 3 | | | B 2/3 | Number of 7 m | | | | | | | | |
| No. | Team A | | | | | G | W | 2' | D | DR | No. | Team B | | | | | G | W | 2' | D | DR |
| 1 | 林先方 | | | | | 8 | 1 | 1 | | | 1 | 潘博琦 | | | | | | | | | |
| 2 | 李恩铭 | | | | | 5 | 1 | 1 | | | 3 | 赵韦光 | | | | | 2 | 1 | | | |
| 3 | 郑尧俊 | | | | | 8 | | 2 | | | 4 | 张瑞恒 | | | | | 1 | | 1 | | |
| 5 | 高家南 | | | | | | | | | | 6 | 季雨 | | | | | 1 | | | | |
| 9 | 李家乐 | | | | | 1 | | | | | 7 | 任超凡 | | | | | | | | | |
| 10 | 徐正飞 | | | | | | | 1 | | | 8 | 姜童耀 | | | | | 10 | 1 | | | |
| 14 | 虞勇灿 | | | | | | | | | | 9 | 王俊威 | | | | | 3 | | | | |
| 15 | 张佩力 | | | | | | | | | | 11 | 周傲 | | | | | 11 | | | | |
| 17 | 罗明杰 | | | | | 1 | | | | | 13 | 尹吉祥 | | | | | 2 | | | | |
| 18 | 倪陈辉 | | | | | 3 | 1 | 1 | | | 14 | 罗中熠 | | | | | 2 | | | | |
| 19 | 王浩 | | | | | | | | | | 15 | 阎冠中 | | | | | | 1 | 2 | | |
| | | | | | | | | | | | 17 | 马益奎 | | | | | 5 | | 1 | | |
| | | | | | | | | | | | 18 | 耿畅 | | | | | | | | | |
| C | 柳佳 | | | | | | | | | | B | 贾淑君 (主教练) | | | | | 1 | | | | |
| D | 项建生 | | | | | | | | | | | | | | | | | | | | |
| E | 刘晓辉 | | | | | | | | | | | | | | | | | | | | |
| F | 沈伟林 | | | | | | | | | | | | | | | | | | | | |
| A | Signature of Responsible Official of the Teams (Off. A) | | | | | | | | | | B | | | | | | | | | | |
| TP | Remarks of Referee / CHA Official | | | | | | | | | | TP | | | | | | | | | | |

Signatures

| | | | | |
|------------------|-----------|----------|--|--|
| Referees | 缪俊 (CHN) | 汤怡 (CHN) | | |
| Techn. Delegates | 许宜扬 (CHN) | | | |
| CHA Official | 吴瑞亭 (CHN) | | | |

Note: Number of 7m Throws Awarded to Team A and B, Goals (G), Warnings (W), Suspensions (2'), Direct Disqualification (D), Disqualification with Report (DR) and Team Penalty (TP).

Table Officials:

Statisticians: 李双

刘永欢





2016年“体彩杯”全国手球男子青年锦标赛
竞赛技术统计(媒体表)

预赛 组别 A 轮次 4 场次 24

重庆万州

24/03/2016

201602024-51-1/1

浙江队 浙江 26 vs 37 江苏 江苏队
8:19

裁判员 缪俊 (CHN) / 汤怡 (CHN)

Main statistics table for Zhejiang and Jiangsu teams, including player names, positions, and various performance metrics like goals, assists, and suspensions.

场上队员: 得分 / 射门

守门员: 救球 / 射门

Legend table for abbreviations used in the statistics, such as Fast Break, Breakthrough, Free Throw, etc.





2016年“体彩杯”全国手球男子青年锦标赛 图式比赛技术统计表

轮次 4

场次 24

201602024-21-1/1

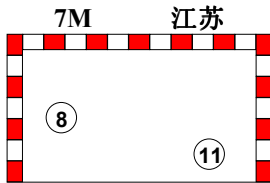
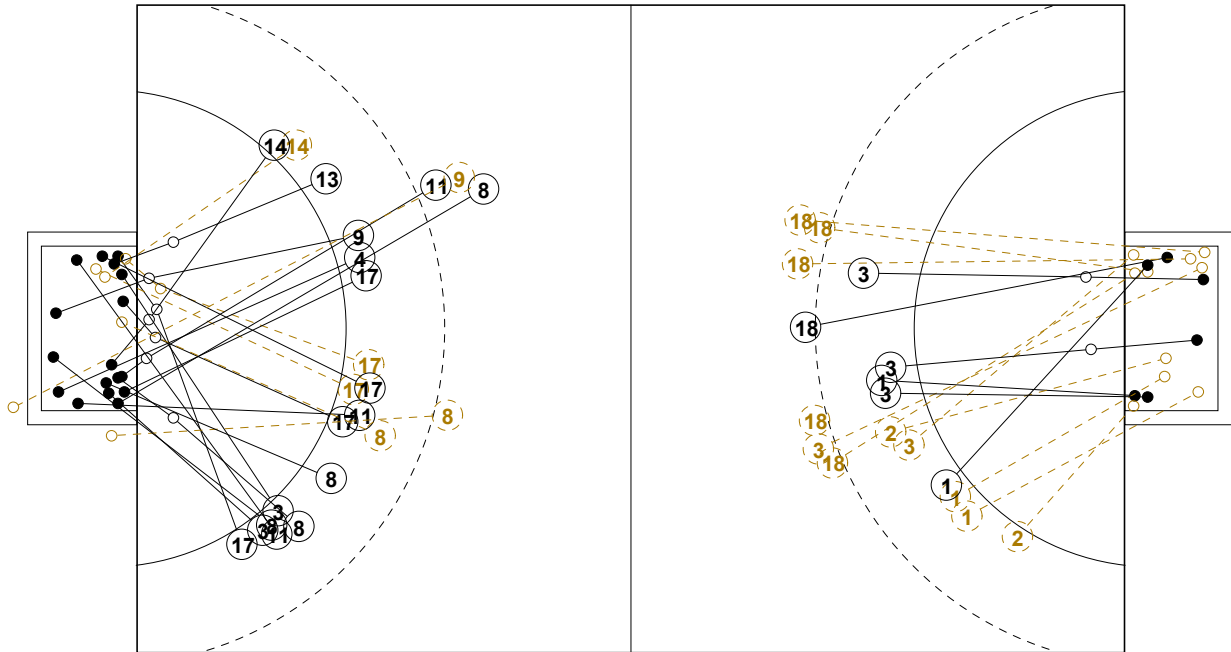

1st Half
19 : 8

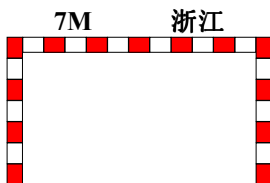
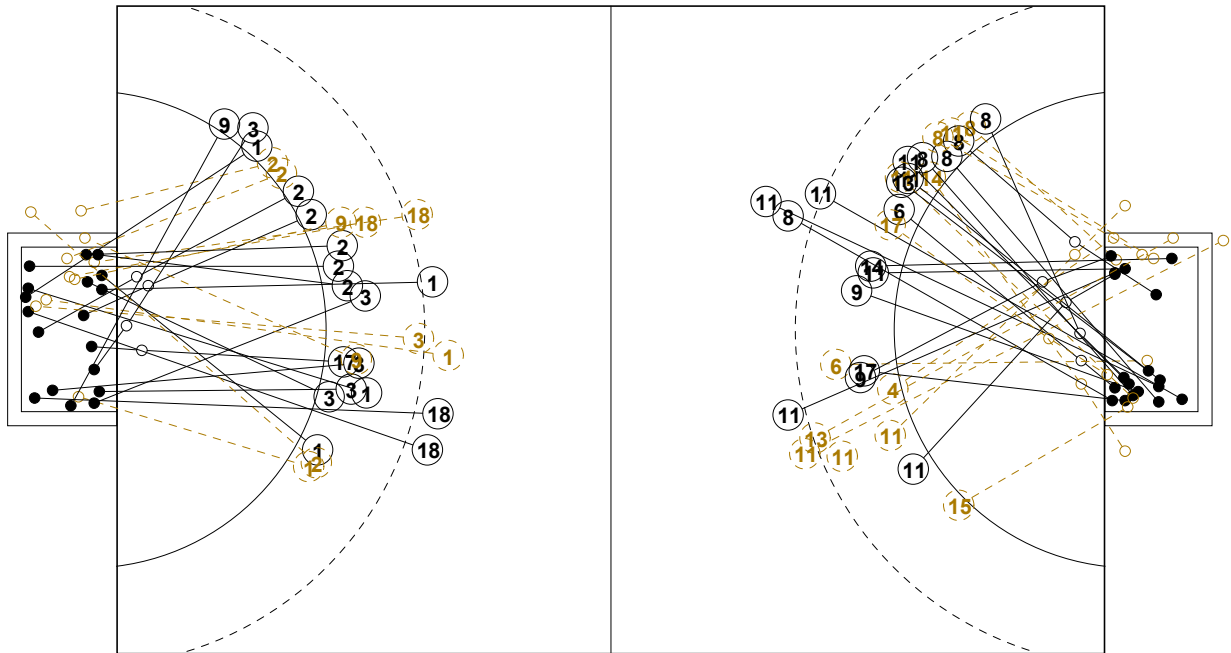
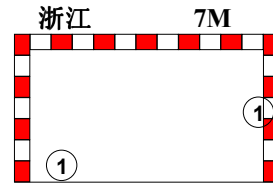

2nd Half
26 : 37

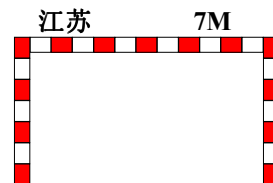



2016年“体彩杯”全国手球男子青年锦标赛

个人/全队技术统计表

正式表
手球
青年男子预赛
轮次 4组别 A
场次 24201602024-14-1/2
重庆万州
24/03/2016 17:30

| 号码 | 姓名 | 远射 | 近射 | 边射 | 快攻 | 突破 | 任意 | 7M | 合计 | % | 助攻 | 失误 | 警告 | 2' | 取消 | 时间 |
|----------------|-----|-----|-----|-----|-----|-----|-----|-----|------|-------|----|----|----|----|----|----------|
| 浙江队(浙江) | | | | | | | | | | | | | | | | |
| <i>(场上队员)</i> | | | | | | | | | | | | | | | | |
| 1 | 林先方 | 1/2 | 1/3 | 1/1 | 3/4 | | | 2/2 | 8/12 | 66.7% | 2 | 12 | 1 | 1 | | 00:57:22 |
| 2 | 李恩铭 | | 4/6 | 0/1 | 1/3 | | | | 5/10 | 50.0% | | 7 | 1 | 1 | | 01:00:00 |
| 3 | 郑尧俊 | 0/2 | 0/1 | 1/1 | 5/5 | 2/2 | | | 8/11 | 72.7% | 4 | 7 | | 2 | | 01:00:00 |
| 5 | 高家南 | | | | | | | | | 0.0% | | 1 | | | | 00:27:54 |
| 9 | 李家乐 | | 0/2 | 1/1 | | | | | 1/3 | 33.3% | | | | | | 00:08:38 |
| 10 | 徐正飞 | | | | | | | | | 0.0% | | 3 | | 1 | | 00:32:04 |
| 14 | 虞勇灿 | | | | | | | | | 0.0% | 1 | | | | | 00:40:47 |
| 15 | 张佩力 | | | | | | | | | 0.0% | | | | | | 00:19:13 |
| 17 | 罗明杰 | | 1/1 | | | | | | 1/1 | 100% | 1 | 2 | | | | 00:54:00 |
| 18 | 倪陈辉 | 1/6 | 0/1 | | | | 2/3 | | 3/10 | 30.0% | 1 | 16 | 1 | 1 | | 00:58:25 |
| 19 | 王浩 | | | | | | | | | 0.0% | | | | | | 00:01:34 |

| | | | | | | | | | | | | | | | | |
|--------------|-----|------|------|------|------|-----|-----|-----|-------|-------|---|----|---|---|--|----------|
| 合计 | | 2/10 | 6/14 | 3/4 | 9/12 | 2/2 | 2/3 | 2/2 | 26/47 | 55.3% | 9 | 48 | 3 | 6 | | |
| <i>(守门员)</i> | | | | | | | | | | | | | | | | |
| 1 | 林先方 | | | | | | | | | 0.0% | 1 | 4 | | 1 | | 00:57:22 |
| 14 | 虞勇灿 | 0/6 | 3/15 | 1/5 | 0/2 | 0/1 | | 0/2 | 4/31 | 12.9% | 1 | | | | | 00:40:47 |
| 15 | 张佩力 | | 4/8 | 2/5 | 1/2 | 0/2 | | | 7/17 | 41.2% | | | | | | 00:19:13 |
| 合计 | | 0/6 | 7/23 | 3/10 | 1/4 | 0/3 | | 0/2 | 11/48 | 22.9% | 2 | 4 | | 1 | | |

场上队员：得分/射门

守门员：救球/射门

| 全队合计 | 得分 | 被救 | 射失 | 击柱 | 封球 | 合计 | % |
|------|----|----|----|----|----|----|--------|
| 远射 | 2 | 7 | | | 1 | 10 | 20.0% |
| 近射 | 6 | 5 | 2 | 1 | | 14 | 42.9% |
| 边射 | 3 | 1 | | | | 4 | 75.0% |
| 快攻 | 9 | 3 | | | | 12 | 75.0% |
| 突破 | 2 | | | | | 2 | 100.0% |
| 任意 | 2 | 1 | | | | 3 | 66.7% |
| 7M | 2 | | | | | 2 | 100.0% |





2016年“体彩杯”全国手球男子青年锦标赛

个人/全队技术统计表

正式表
手球
青年男子预赛
轮次 4组别 A
场次 24201602024-14-2/2
重庆万州
24/03/2016 17:30

| 号码 | 姓名 | 远射 | 近射 | 边射 | 快攻 | 突破 | 任意 | 7M | 合计 | % | 助攻 | 失误 | 警告 | 2' | 取消 | 时间 |
|----------------|-----|-----|------|-----|------|-----|-----|-----|-------|-------|----|----|----|----|----|----------|
| 江苏队(江苏) | | | | | | | | | | | | | | | | |
| <i>(上场队员)</i> | | | | | | | | | | | | | | | | |
| 1 | 潘博琦 | | | | | | | | | 0.0% | | 2 | | | | 01:00:00 |
| 3 | 赵韦光 | | | 1/1 | | 1/1 | | | 2/2 | 100% | 2 | 1 | 1 | | | 00:12:55 |
| 4 | 张瑞恒 | | 1/2 | | | | | | 1/2 | 50.0% | | 5 | | 1 | | 00:32:32 |
| 6 | 季雨 | | 1/2 | | | | | | 1/2 | 50.0% | 1 | 7 | | | | 00:40:50 |
| 7 | 任超凡 | | | | | | | | | 0.0% | 1 | 1 | | | | 00:13:28 |
| 8 | 姜童耀 | 2/3 | 3/5 | 3/4 | 1/1 | | | 1/1 | 10/14 | 71.4% | | | 1 | | | 00:55:37 |
| 9 | 王俊威 | | 1/1 | | 1/1 | 1/1 | 0/1 | | 3/4 | 75.0% | 2 | 1 | | | | 00:31:43 |
| 11 | 周傲 | 4/5 | 3/4 | 1/2 | 1/2 | 1/1 | 0/1 | 1/1 | 11/16 | 68.8% | 8 | 3 | | | | 00:47:50 |
| 13 | 尹吉祥 | 0/1 | 2/2 | | | | | | 2/3 | 66.7% | 2 | 4 | | | | 00:28:40 |
| 14 | 罗中熠 | | 1/3 | 1/1 | | | | | 2/4 | 50.0% | | 3 | | | | 00:38:11 |
| 15 | 阎冠中 | | | 0/1 | | | | 0/1 | 0/2 | 0.0% | | 8 | 1 | 2 | | 00:43:49 |
| 17 | 马益奎 | | 4/7 | 1/1 | | | | | 5/8 | 62.5% | | | | 1 | | 00:23:22 |
| 18 | 耿畅 | | | | | | | | | 0.0% | | | | | | 00:00:00 |
| 合计 | | | | | | | | | | | | | | | | |
| <i>(守门员)</i> | | | | | | | | | | | | | | | | |
| 1 | 潘博琦 | 7/9 | 5/11 | 1/4 | 3/12 | 0/2 | 1/3 | 0/2 | 17/43 | 39.5% | | 2 | | | | 01:00:00 |
| 合计 | | | | | | | | | | | | | | | | |

场上队员：得分/射门

守门员：救球/射门

| 全队合计 | 得分 | 被救 | 射失 | 击柱 | 封球 | 合计 | % |
|------|----|----|----|----|----|----|--------|
| 远射 | 6 | | 1 | 1 | 1 | 9 | 66.7% |
| 近射 | 16 | 7 | 2 | 1 | | 26 | 61.5% |
| 边射 | 7 | 3 | | | | 10 | 70.0% |
| 快攻 | 3 | 1 | | | | 4 | 75.0% |
| 突破 | 3 | | | | | 3 | 100.0% |
| 任意 | | | 2 | | | 2 | 0.0% |
| 7M | 2 | | 1 | | | 3 | 66.7% |





2016年“体彩杯”全国手球男子青年锦标赛

图式射门区域统计

轮次 4 场次 24

201602024-41-1/1

浙江队

Player statistics for Zhejiang team including names like 林先方, 李恩铭, 郑尧俊, etc., with corresponding goalkeeping and shooting data.

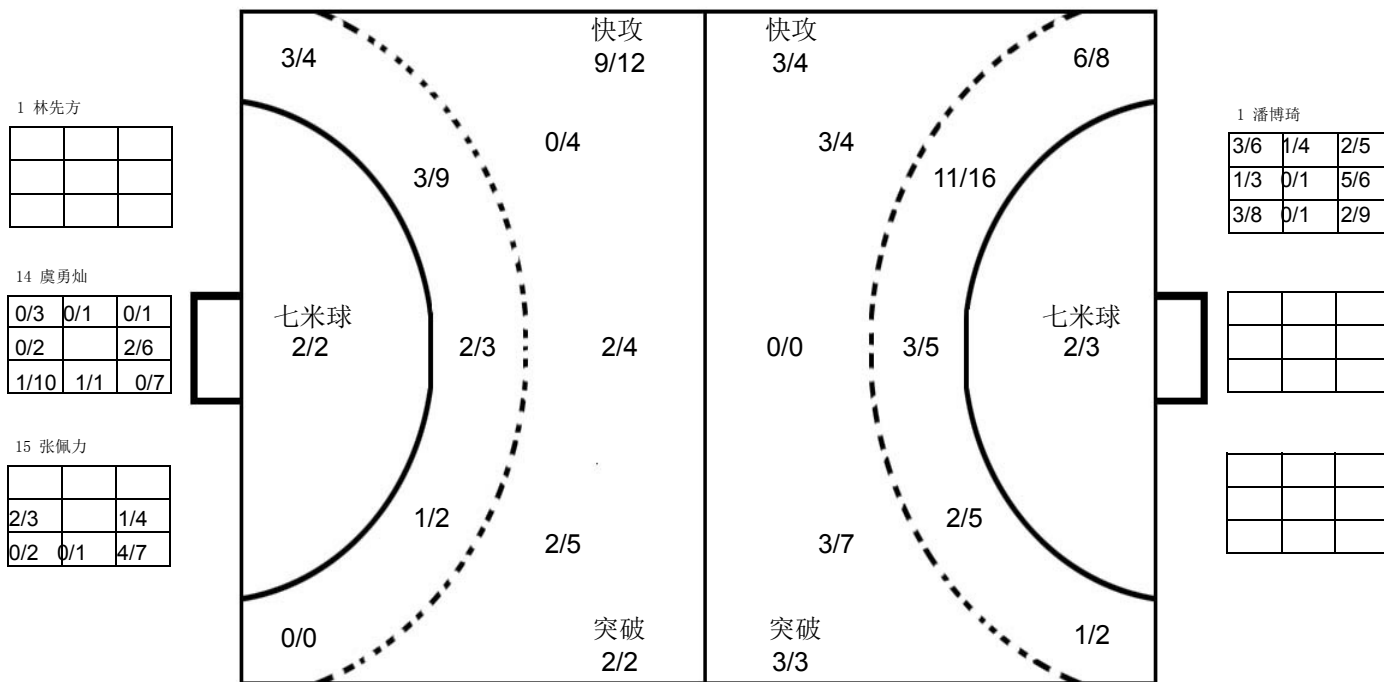

江苏队

Player statistics for Jiangsu team including names like 潘博琦, 赵韦光, 张瑞恒, etc., with corresponding goalkeeping and shooting data.

注释: Post=击柱 Miss=射失 Block=被封



预赛 Group B
青年男子 全国比赛

2016年“体彩杯”全国手球男子青年锦标赛

| | | | | | | | | | | | | | | | | | | | | | |
|------------------------|-----------------------------------|---|---------------------|---------------------------|------------------------------------|---|---|---------------|---|----|-------------------|---------------|--|--|--|--|---|----------|----|---|----|
| Team A A 新疆队 | | Team B B 辽宁队 | | Match Number 25 | | | | | | | | | | | | | | | | | |
| played in China | | in the hall 重庆万州 | | on 25/03/2016 | | | | | | | | | | | | | | | | | |
| | | | | at 08:30 hours | | | | | | | | | | | | | | | | | |
| Spectators | | | | | | | | | | | | | | | | | | | | | |
| Half-time (30') | A 19 | B 10 | End of playing time | A 32 | B 17 | | | | | | | | | | | | | | | | |
| 1st extra time | | | | 2nd extra time | | | | | | | | | | | | | | | | | |
| | | | | After penalty throws | | | | | | | | | | | | | | | | | |
| | | | | | | | | | | | | | | | | | | | | | |
| Number of 7 m | A 1 / 1 | Team time-out | | | Full name of players and officials | | | Team time-out | | | B 2 / 2 | Number of 7 m | | | | | | | | | |
| | | | | | | | | | | | | | | | | | | | | | |
| | | | | | | | | | | | | | | | | | | | | | |
| No. | Team A | | | | | G | W | 2' | D | DR | No. | Team B | | | | | G | W | 2' | D | DR |
| 1 | 宋晓晨 | | | | | | | | | | 1 | 高尚君 | | | | | | | | | |
| 2 | 王泽川 | | | | | 6 | 1 | | | | 2 | 王司雨 | | | | | | | | 1 | |
| 4 | 谷通金 | | | | | 5 | 1 | | | | 3 | 李星浩 | | | | | 3 | 1 | | | |
| 5 | 徐伟 | | | | | | | | | | 5 | 余昊锦 | | | | | | 1 | | | |
| 6 | 白光宇 | | | | | 2 | | | | | 6 | 陈庆港 | | | | | 2 | 1 | | | |
| 7 | 林豪文 | | | | | | | | | | 7 | 孙义广 | | | | | 2 | | | | |
| 10 | 王钟彬 | | | | | | | | | | 8 | 王鑫鹏 | | | | | | | | | |
| 12 | 王金鑫 | | | | | | | | | | 10 | 王柏淇 | | | | | 6 | | | | |
| 13 | 苏兴伟 | | | | | 7 | | 1 | | | 11 | 庞东阳 | | | | | | | | | |
| 15 | 王维东 | | | | | 3 | | | | | 13 | 杨洁 | | | | | | | | | |
| 16 | 李佳懿 | | | | | | | | | | 14 | 吕昊臻 | | | | | 3 | | | | |
| 17 | 胡晋铭 | | | | | | | | | | 16 | 吴阳 | | | | | 1 | | 1 | | |
| 18 | 李万兴 | | | | | 5 | | | | | 17 | 李傲 | | | | | | | | | |
| 19 | 李龙吉 | | | | | | | | | | 18 | 梅凯博 | | | | | | | | | |
| 24 | 陈伟华 | | | | | 4 | 1 | | | | 19 | 赵鑫 | | | | | | | | | |
| | | | | | | | | | | | 20 | 赵佛赐 | | | | | | | | | |
| A | 孔德宾 (主教练) | | | | | | | | | | B | 赵影 (主教练) | | | | | | | | | |
| B | 陈鹏波 | | | | | | | | | | C | 刘启迪 | | | | | | | | | |
| C | 李楠 | | | | | | | | | | | | | | | | | | | | |
| | | | | | | | | | | | | | | | | | | | | | |
| A | | Signature of Responsible Official of the Teams (Off. A) | | | | | | | | | | | | | | | | B | | | |
| TP | Remarks of Referee / CHA Official | | | | | | | | | | | | | | | | | | TP | | |
| | | | | | | | | | | | | | | | | | | | | | |

Signatures

| | | | | |
|------------------|-----------|----------|--|--|
| Referees | 汤怡 (CHN) | 缪俊 (CHN) | | |
| Techn. Delegates | 许宜扬 (CHN) | | | |
| CHA Official | 张春生 (CHN) | | | |

Note: Number of 7m Throws Awarded to Team A and B, Goals (G), Warnings (W), Suspensions (2'), Direct Disqualification (D), Disqualification with Report (DR) and Team Penalty (TP).

Table Officials:

Statisticians:





2016年“体彩杯”全国手球男子青年锦标赛
竞赛技术统计(媒体表)

Table with match details: 预赛, 组别 B, 轮次 5, 场次 25, 重庆万州, 25/03/2016, 201602025-51-1/1, 新疆队 vs 辽宁队, 19:10

Table with referee information: 裁判员 汤怡 (CHN) / 缪俊 (CHN)

Main statistics table for Xinjiang and Liaoning teams, including player names, positions, and various performance metrics like goals, assists, and suspensions.

场上队员: 得分 / 射门

守门员: 救球 / 射门

Legend table for abbreviations: 快攻, 突破, 任意球, 警告, 助攻, 失误, 7m球, 取消资格, 报告





2016年“体彩杯”全国手球男子青年锦标赛 图式比赛技术统计表

轮次 5

场次 25

201602025-21-1/1

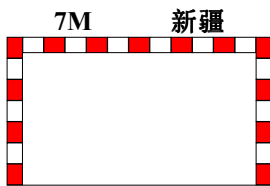
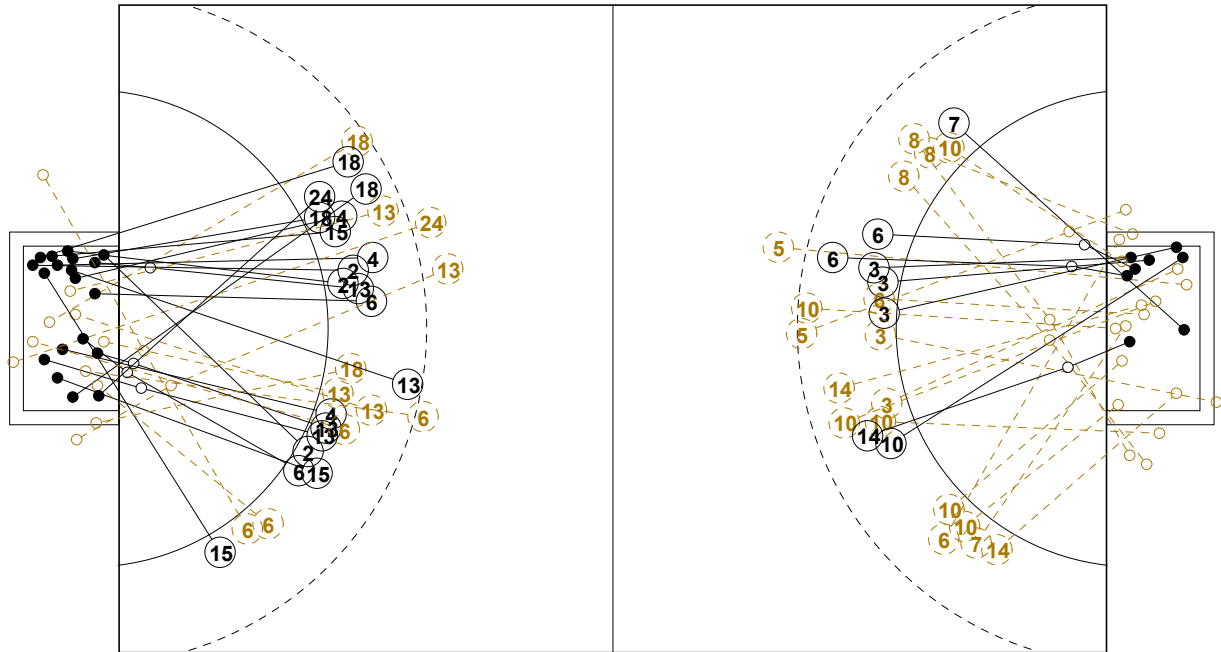

1st Half
19 : 10

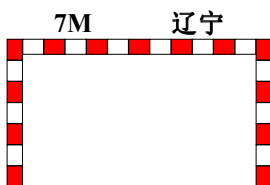
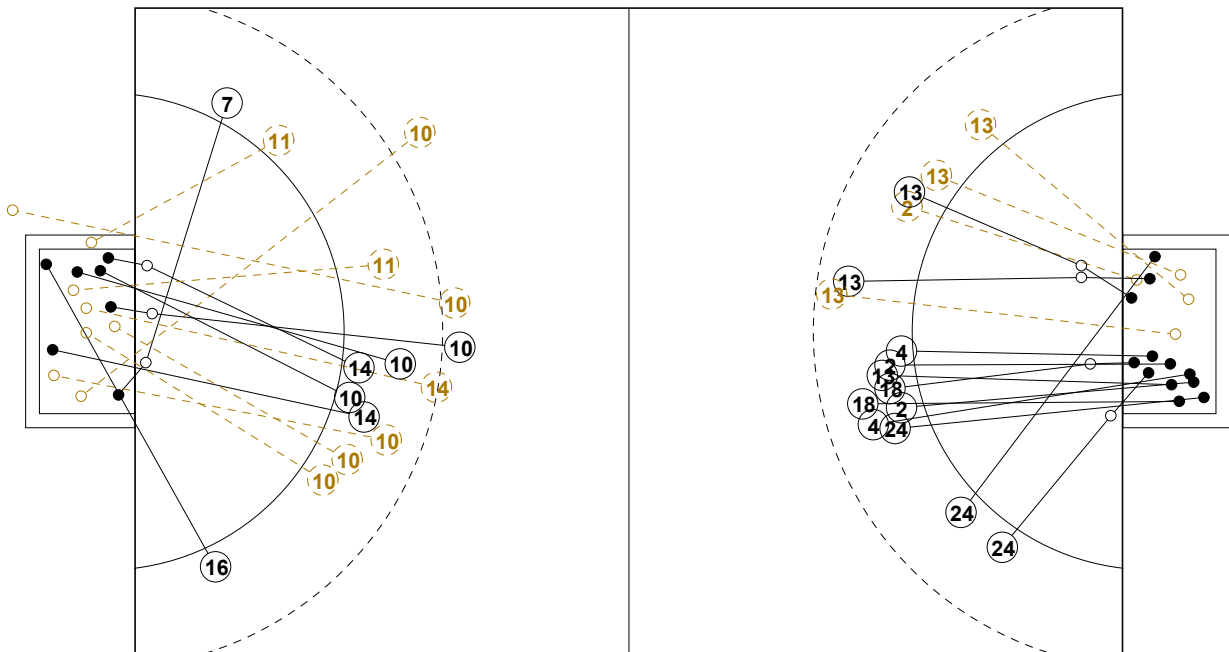
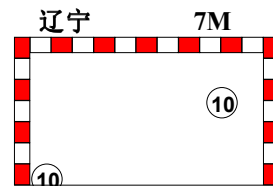

2nd Half
17 : 32

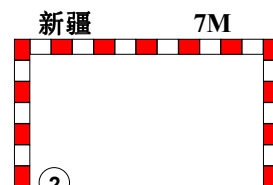



2016年“体彩杯”全国手球男子青年锦标赛

个人/全队技术统计表

正式表
手球
青年男子预赛
轮次 5组别 B
场次 25201602025-14-1/2
重庆万州
25/03/2016 08:30

| 号码 | 姓名 | 远射 | 近射 | 边射 | 快攻 | 突破 | 任意 | 7M | 合计 | % | 助攻 | 失误 | 警告 | 2' | 取消 | 时间 |
|----------------|-----|-----|-------|-----|-------|-----|-----|-----|-------|-------|----|----|----|----|----|----------|
| 新疆队(新疆) | | | | | | | | | | | | | | | | |
| <i>(场上队员)</i> | | | | | | | | | | | | | | | | |
| 1 | 宋晓晨 | | | | | | | | | 0.0% | | 1 | | | | 00:08:04 |
| 2 | 王泽川 | | 4/5 | | 1/1 | | | 1/1 | 6/7 | 85.7% | | 3 | 1 | | | 00:45:54 |
| 4 | 谷通金 | | 3/3 | | 2/2 | | | | 5/5 | 100% | 2 | | 1 | | | 00:45:54 |
| 5 | 徐伟 | | | | | | | | | 0.0% | | | | | | 00:00:00 |
| 6 | 白光宇 | | 2/3 | 0/2 | | | 0/1 | | 2/6 | 33.3% | | | | | | 00:22:40 |
| 7 | 林豪文 | | | | | | | | | 0.0% | | 1 | | | | 00:06:09 |
| 10 | 王钟彬 | | | | | | | | | 0.0% | | | | | | 00:00:00 |
| 12 | 王金鑫 | | | | | | | | | 0.0% | | | | | | 00:11:35 |
| 13 | 苏兴伟 | 1/4 | 1/2 | 0/1 | 4/6 | 1/1 | | | 7/14 | 50.0% | 2 | 6 | | 1 | | 00:45:55 |
| 15 | 王维东 | | 1/1 | 1/1 | | 1/1 | | | 3/3 | 100% | 1 | 1 | | | | 00:17:02 |
| 16 | 李佳懿 | | | | | | | | | 0.0% | 1 | 1 | | | | 00:26:16 |
| 17 | 胡晋铭 | | | | | | | | | 0.0% | | | | | | 00:00:00 |
| 18 | 李万兴 | 2/3 | 1/1 | | 2/3 | | | | 5/7 | 71.4% | 2 | 3 | | | | 00:45:55 |
| 19 | 李龙吉 | | | | | | | | | 0.0% | | | | | | 00:00:00 |
| 24 | 陈伟华 | 0/1 | 1/1 | 1/1 | 1/1 | 1/1 | | | 4/5 | 80.0% | 3 | 3 | 1 | | | 00:45:55 |
| 合计 | | 3/8 | 13/16 | 2/5 | 10/13 | 3/3 | 0/1 | 1/1 | 32/47 | 68.1% | 11 | 19 | 3 | 1 | | |
| <i>(守门员)</i> | | | | | | | | | | | | | | | | |
| 1 | 宋晓晨 | 1/1 | 1/2 | | | 0/1 | | | 2/4 | 50.0% | | 1 | | | | 00:08:04 |
| 12 | 王金鑫 | | 3/4 | 0/1 | | 1/3 | 0/1 | | 4/9 | 44.4% | | | | | | 00:11:35 |
| 16 | 李佳懿 | 2/3 | 4/8 | 2/4 | 1/2 | | 2/2 | 0/2 | 11/21 | 52.4% | 1 | 1 | | | | 00:26:16 |
| 合计 | | 3/4 | 8/14 | 2/5 | 1/2 | 1/4 | 2/3 | 0/2 | 17/34 | 50.0% | 1 | 2 | | | | |

场上队员：得分/射门

守门员：救球/射门

| 全队合计 | 得分 | 被救 | 射失 | 击柱 | 封球 | 合计 | % |
|------|----|----|----|----|----|----|--------|
| 远射 | 3 | 3 | 1 | 1 | | 8 | 37.5% |
| 近射 | 13 | 3 | | | | 16 | 81.3% |
| 边射 | 2 | 2 | 1 | | | 5 | 40.0% |
| 快攻 | 10 | 2 | | 1 | | 13 | 76.9% |
| 突破 | 3 | | | | | 3 | 100.0% |
| 任意 | | 1 | | | | 1 | 0.0% |
| 7M | 1 | | | | | 1 | 100.0% |





2016年“体彩杯”全国手球男子青年锦标赛

个人/全队技术统计表

正式表
手球
青年男子预赛
轮次 5组别 B
场次 25201602025-14-2/2
重庆万州
25/03/2016 08:30

| 号码 | 姓名 | 远射 | 近射 | 边射 | 快攻 | 突破 | 任意 | 7M | 合计 | % | 助攻 | 失误 | 警告 | 2' | 取消 | 时间 |
|----------------|-----|-----|------|-----|------|-----|-----|-----|-------|-------|----|----|----|----|----|----------|
| 辽宁队(辽宁) | | | | | | | | | | | | | | | | |
| <i>(上场队员)</i> | | | | | | | | | | | | | | | | |
| 1 | 高尚君 | | | | | | | | | 0.0% | | | | | | 00:45:55 |
| 2 | 王司雨 | | | | | | | | | 0.0% | | | | 1 | | 00:15:54 |
| 3 | 李星浩 | | 3/5 | | | | | | 3/5 | 60.0% | | 1 | 1 | | | 00:30:00 |
| 5 | 余昊锦 | 0/2 | | | | | | | 0/2 | 0.0% | | 2 | 1 | | | 00:15:27 |
| 6 | 陈庆港 | 1/1 | | 0/1 | 0/1 | 1/1 | | | 2/4 | 50.0% | 4 | 4 | 1 | | | 00:45:27 |
| 7 | 孙义广 | | | 2/3 | | | | | 2/3 | 66.7% | | 2 | | | | 00:45:54 |
| 8 | 王鑫鹏 | | 0/3 | | | | | | 0/3 | 0.0% | | | | | | 00:30:00 |
| 10 | 王柏淇 | 0/2 | 0/6 | | 1/2 | 2/2 | 1/3 | 2/2 | 6/17 | 35.3% | 5 | 4 | | | | 00:30:27 |
| 11 | 庞东阳 | | | 0/1 | | 0/1 | | | 0/2 | 0.0% | | 3 | | | | 00:15:55 |
| 13 | 杨洁 | | | | | | | | | 0.0% | | | | | | 00:00:00 |
| 14 | 吕昊臻 | 0/1 | 3/4 | 0/1 | | | | | 3/6 | 50.0% | | 3 | | | | 00:45:55 |
| 16 | 吴阳 | | | 1/1 | | | | | 1/1 | 100% | | | | 1 | | 00:15:55 |
| 17 | 李傲 | | | | | | | | | 0.0% | | | | | | 00:00:00 |
| 18 | 梅凯博 | | | | | | | | | 0.0% | | | | | | 00:00:00 |
| 19 | 赵鑫 | | | | | | | | | 0.0% | | | | | | 00:00:00 |
| 20 | 赵佛赐 | | | | | | | | | 0.0% | | | | | | 00:00:00 |
| 合计 | | 1/6 | 6/18 | 3/7 | 1/3 | 3/4 | 1/3 | 2/2 | 17/43 | 39.5% | 9 | 19 | 3 | 2 | | |
| <i>(守门员)</i> | | | | | | | | | | | | | | | | |
| 1 | 高尚君 | 3/6 | 3/16 | 2/4 | 2/12 | 0/3 | 1/1 | 0/1 | 11/43 | 25.6% | | | | | | 00:45:55 |
| 合计 | | 3/6 | 3/16 | 2/4 | 2/12 | 0/3 | 1/1 | 0/1 | 11/43 | 25.6% | | | | | | |

场上队员：得分/射门

守门员：救球/射门

| 全队合计 | 得分 | 被救 | 射失 | 击柱 | 封球 | 合计 | % |
|------|----|----|----|----|----|----|--------|
| 远射 | 1 | 3 | 2 | | | 6 | 16.7% |
| 近射 | 6 | 8 | 3 | 1 | | 18 | 33.3% |
| 边射 | 3 | 2 | | 2 | | 7 | 42.9% |
| 快攻 | 1 | 1 | 1 | | | 3 | 33.3% |
| 突破 | 3 | 1 | | | | 4 | 75.0% |
| 任意 | 1 | 2 | | | | 3 | 33.3% |
| 7M | 2 | | | | | 2 | 100.0% |





2016年“体彩杯”全国手球男子青年锦标赛

图式射门区域统计

轮次 5 场次 25

201602025-41-1/1

新疆队

| | | | | | | | | | | | | | | | | | | | | | | | | | | | | | | | | | | | | | | | | | | | | | | | | | | | | | | | | | | | | | | | | | | | | | | | | | | | | | | | |
|---|-----------------------------|-----------------------------|-----------------------------|-----------------------------|-----------------------------|-----------------------------|-----------------------------|---|---|--|--|--|---|---|--|---|---|--|---|--|--|--|---|--|---|---|--|---|--|--|--|--|--|--|--|--|--|--|--|--|--|--|---|---|---|---|--|--|---|--|--|--|--|--|--|--|--|--|--|--|--|--|---|---|--|--|---|--|---|--|--|--|--|--|--|--|--|--|--|
| 1 宋晓晨 | 2 王泽川 | 4 谷通金 | 5 徐伟 | 6 白光宇 | 7 林豪文 | 10 王钟彬 | 12 王金鑫 | | | | | | | | | | | | | | | | | | | | | | | | | | | | | | | | | | | | | | | | | | | | | | | | | | | | | | | | | | | | | | | | | | | | | | | | |
| <table border="1"><tr><td></td><td></td><td></td></tr><tr><td></td><td></td><td></td></tr><tr><td></td><td></td><td></td></tr></table> | | | | | | | | | | <table border="1"><tr><td></td><td></td><td>2</td></tr><tr><td></td><td></td><td>2</td></tr><tr><td>1</td><td></td><td>1</td></tr></table> | | | 2 | | | 2 | 1 | | 1 | <table border="1"><tr><td></td><td></td><td>1</td></tr><tr><td></td><td>1</td><td>2</td></tr><tr><td></td><td>1</td><td></td></tr></table> | | | 1 | | 1 | 2 | | 1 | | <table border="1"><tr><td></td><td></td><td></td></tr><tr><td></td><td></td><td></td></tr><tr><td></td><td></td><td></td></tr></table> | | | | | | | | | | <table border="1"><tr><td></td><td></td><td></td></tr><tr><td></td><td>1</td><td></td></tr><tr><td></td><td></td><td>1</td></tr></table> | | | | | 1 | | | | 1 | <table border="1"><tr><td></td><td></td><td></td></tr><tr><td></td><td></td><td></td></tr><tr><td></td><td></td><td></td></tr></table> | | | | | | | | | | <table border="1"><tr><td></td><td></td><td></td></tr><tr><td></td><td></td><td></td></tr><tr><td></td><td></td><td></td></tr></table> | | | | | | | | | | <table border="1"><tr><td></td><td></td><td></td></tr><tr><td></td><td></td><td></td></tr><tr><td></td><td></td><td></td></tr></table> | | | | | | | | | |
| | | | | | | | | | | | | | | | | | | | | | | | | | | | | | | | | | | | | | | | | | | | | | | | | | | | | | | | | | | | | | | | | | | | | | | | | | | | | | | | |
| | | | | | | | | | | | | | | | | | | | | | | | | | | | | | | | | | | | | | | | | | | | | | | | | | | | | | | | | | | | | | | | | | | | | | | | | | | | | | | | |
| | | | | | | | | | | | | | | | | | | | | | | | | | | | | | | | | | | | | | | | | | | | | | | | | | | | | | | | | | | | | | | | | | | | | | | | | | | | | | | | |
| | | 2 | | | | | | | | | | | | | | | | | | | | | | | | | | | | | | | | | | | | | | | | | | | | | | | | | | | | | | | | | | | | | | | | | | | | | | | | | | | | | |
| | | 2 | | | | | | | | | | | | | | | | | | | | | | | | | | | | | | | | | | | | | | | | | | | | | | | | | | | | | | | | | | | | | | | | | | | | | | | | | | | | | |
| 1 | | 1 | | | | | | | | | | | | | | | | | | | | | | | | | | | | | | | | | | | | | | | | | | | | | | | | | | | | | | | | | | | | | | | | | | | | | | | | | | | | | |
| | | 1 | | | | | | | | | | | | | | | | | | | | | | | | | | | | | | | | | | | | | | | | | | | | | | | | | | | | | | | | | | | | | | | | | | | | | | | | | | | | | |
| | 1 | 2 | | | | | | | | | | | | | | | | | | | | | | | | | | | | | | | | | | | | | | | | | | | | | | | | | | | | | | | | | | | | | | | | | | | | | | | | | | | | | |
| | 1 | | | | | | | | | | | | | | | | | | | | | | | | | | | | | | | | | | | | | | | | | | | | | | | | | | | | | | | | | | | | | | | | | | | | | | | | | | | | | | |
| | | | | | | | | | | | | | | | | | | | | | | | | | | | | | | | | | | | | | | | | | | | | | | | | | | | | | | | | | | | | | | | | | | | | | | | | | | | | | | | |
| | | | | | | | | | | | | | | | | | | | | | | | | | | | | | | | | | | | | | | | | | | | | | | | | | | | | | | | | | | | | | | | | | | | | | | | | | | | | | | | |
| | | | | | | | | | | | | | | | | | | | | | | | | | | | | | | | | | | | | | | | | | | | | | | | | | | | | | | | | | | | | | | | | | | | | | | | | | | | | | | | |
| | | | | | | | | | | | | | | | | | | | | | | | | | | | | | | | | | | | | | | | | | | | | | | | | | | | | | | | | | | | | | | | | | | | | | | | | | | | | | | | |
| | 1 | | | | | | | | | | | | | | | | | | | | | | | | | | | | | | | | | | | | | | | | | | | | | | | | | | | | | | | | | | | | | | | | | | | | | | | | | | | | | | |
| | | 1 | | | | | | | | | | | | | | | | | | | | | | | | | | | | | | | | | | | | | | | | | | | | | | | | | | | | | | | | | | | | | | | | | | | | | | | | | | | | | |
| | | | | | | | | | | | | | | | | | | | | | | | | | | | | | | | | | | | | | | | | | | | | | | | | | | | | | | | | | | | | | | | | | | | | | | | | | | | | | | | |
| | | | | | | | | | | | | | | | | | | | | | | | | | | | | | | | | | | | | | | | | | | | | | | | | | | | | | | | | | | | | | | | | | | | | | | | | | | | | | | | |
| | | | | | | | | | | | | | | | | | | | | | | | | | | | | | | | | | | | | | | | | | | | | | | | | | | | | | | | | | | | | | | | | | | | | | | | | | | | | | | | |
| | | | | | | | | | | | | | | | | | | | | | | | | | | | | | | | | | | | | | | | | | | | | | | | | | | | | | | | | | | | | | | | | | | | | | | | | | | | | | | | |
| | | | | | | | | | | | | | | | | | | | | | | | | | | | | | | | | | | | | | | | | | | | | | | | | | | | | | | | | | | | | | | | | | | | | | | | | | | | | | | | |
| | | | | | | | | | | | | | | | | | | | | | | | | | | | | | | | | | | | | | | | | | | | | | | | | | | | | | | | | | | | | | | | | | | | | | | | | | | | | | | | |
| | | | | | | | | | | | | | | | | | | | | | | | | | | | | | | | | | | | | | | | | | | | | | | | | | | | | | | | | | | | | | | | | | | | | | | | | | | | | | | | |
| | | | | | | | | | | | | | | | | | | | | | | | | | | | | | | | | | | | | | | | | | | | | | | | | | | | | | | | | | | | | | | | | | | | | | | | | | | | | | | | |
| | | | | | | | | | | | | | | | | | | | | | | | | | | | | | | | | | | | | | | | | | | | | | | | | | | | | | | | | | | | | | | | | | | | | | | | | | | | | | | | |
| Post - 0 Miss - 0 Block - 0 | Post - 0 Miss - 0 Block - 0 | Post - 0 Miss - 0 Block - 0 | Post - 0 Miss - 0 Block - 0 | Post - 0 Miss - 1 Block - 0 | Post - 0 Miss - 0 Block - 0 | Post - 0 Miss - 0 Block - 0 | Post - 0 Miss - 0 Block - 0 | | | | | | | | | | | | | | | | | | | | | | | | | | | | | | | | | | | | | | | | | | | | | | | | | | | | | | | | | | | | | | | | | | | | | | | | |
| 13 苏兴伟 | 15 王维东 | 16 李佳懿 | 17 胡晋铭 | 18 李万兴 | 19 李龙吉 | 24 陈伟华 | | | | | | | | | | | | | | | | | | | | | | | | | | | | | | | | | | | | | | | | | | | | | | | | | | | | | | | | | | | | | | | | | | | | | | | | | |
| <table border="1"><tr><td>1</td><td></td><td></td></tr><tr><td></td><td></td><td>2</td></tr><tr><td>2</td><td>1</td><td>1</td></tr></table> | 1 | | | | | 2 | 2 | 1 | 1 | <table border="1"><tr><td></td><td></td><td>2</td></tr><tr><td>1</td><td></td><td></td></tr><tr><td></td><td></td><td></td></tr></table> | | | 2 | 1 | | | | | | <table border="1"><tr><td></td><td></td><td></td></tr><tr><td></td><td></td><td></td></tr><tr><td></td><td></td><td></td></tr></table> | | | | | | | | | | <table border="1"><tr><td></td><td></td><td></td></tr><tr><td></td><td></td><td></td></tr><tr><td></td><td></td><td></td></tr></table> | | | | | | | | | | <table border="1"><tr><td></td><td></td><td>1</td></tr><tr><td>1</td><td></td><td>2</td></tr><tr><td></td><td></td><td>1</td></tr></table> | | | 1 | 1 | | 2 | | | 1 | <table border="1"><tr><td></td><td></td><td></td></tr><tr><td></td><td></td><td></td></tr><tr><td></td><td></td><td></td></tr></table> | | | | | | | | | | <table border="1"><tr><td></td><td></td><td>1</td></tr><tr><td>1</td><td></td><td></td></tr><tr><td>1</td><td></td><td>1</td></tr></table> | | | 1 | 1 | | | 1 | | 1 | <table border="1"><tr><td></td><td></td><td></td></tr><tr><td></td><td></td><td></td></tr><tr><td></td><td></td><td></td></tr></table> | | | | | | | | | |
| 1 | | | | | | | | | | | | | | | | | | | | | | | | | | | | | | | | | | | | | | | | | | | | | | | | | | | | | | | | | | | | | | | | | | | | | | | | | | | | | | | |
| | | 2 | | | | | | | | | | | | | | | | | | | | | | | | | | | | | | | | | | | | | | | | | | | | | | | | | | | | | | | | | | | | | | | | | | | | | | | | | | | | | |
| 2 | 1 | 1 | | | | | | | | | | | | | | | | | | | | | | | | | | | | | | | | | | | | | | | | | | | | | | | | | | | | | | | | | | | | | | | | | | | | | | | | | | | | | |
| | | 2 | | | | | | | | | | | | | | | | | | | | | | | | | | | | | | | | | | | | | | | | | | | | | | | | | | | | | | | | | | | | | | | | | | | | | | | | | | | | | |
| 1 | | | | | | | | | | | | | | | | | | | | | | | | | | | | | | | | | | | | | | | | | | | | | | | | | | | | | | | | | | | | | | | | | | | | | | | | | | | | | | | |
| | | | | | | | | | | | | | | | | | | | | | | | | | | | | | | | | | | | | | | | | | | | | | | | | | | | | | | | | | | | | | | | | | | | | | | | | | | | | | | | |
| | | | | | | | | | | | | | | | | | | | | | | | | | | | | | | | | | | | | | | | | | | | | | | | | | | | | | | | | | | | | | | | | | | | | | | | | | | | | | | | |
| | | | | | | | | | | | | | | | | | | | | | | | | | | | | | | | | | | | | | | | | | | | | | | | | | | | | | | | | | | | | | | | | | | | | | | | | | | | | | | | |
| | | | | | | | | | | | | | | | | | | | | | | | | | | | | | | | | | | | | | | | | | | | | | | | | | | | | | | | | | | | | | | | | | | | | | | | | | | | | | | | |
| | | | | | | | | | | | | | | | | | | | | | | | | | | | | | | | | | | | | | | | | | | | | | | | | | | | | | | | | | | | | | | | | | | | | | | | | | | | | | | | |
| | | | | | | | | | | | | | | | | | | | | | | | | | | | | | | | | | | | | | | | | | | | | | | | | | | | | | | | | | | | | | | | | | | | | | | | | | | | | | | | |
| | | | | | | | | | | | | | | | | | | | | | | | | | | | | | | | | | | | | | | | | | | | | | | | | | | | | | | | | | | | | | | | | | | | | | | | | | | | | | | | |
| | | 1 | | | | | | | | | | | | | | | | | | | | | | | | | | | | | | | | | | | | | | | | | | | | | | | | | | | | | | | | | | | | | | | | | | | | | | | | | | | | | |
| 1 | | 2 | | | | | | | | | | | | | | | | | | | | | | | | | | | | | | | | | | | | | | | | | | | | | | | | | | | | | | | | | | | | | | | | | | | | | | | | | | | | | |
| | | 1 | | | | | | | | | | | | | | | | | | | | | | | | | | | | | | | | | | | | | | | | | | | | | | | | | | | | | | | | | | | | | | | | | | | | | | | | | | | | | |
| | | | | | | | | | | | | | | | | | | | | | | | | | | | | | | | | | | | | | | | | | | | | | | | | | | | | | | | | | | | | | | | | | | | | | | | | | | | | | | | |
| | | | | | | | | | | | | | | | | | | | | | | | | | | | | | | | | | | | | | | | | | | | | | | | | | | | | | | | | | | | | | | | | | | | | | | | | | | | | | | | |
| | | | | | | | | | | | | | | | | | | | | | | | | | | | | | | | | | | | | | | | | | | | | | | | | | | | | | | | | | | | | | | | | | | | | | | | | | | | | | | | |
| | | 1 | | | | | | | | | | | | | | | | | | | | | | | | | | | | | | | | | | | | | | | | | | | | | | | | | | | | | | | | | | | | | | | | | | | | | | | | | | | | | |
| 1 | | | | | | | | | | | | | | | | | | | | | | | | | | | | | | | | | | | | | | | | | | | | | | | | | | | | | | | | | | | | | | | | | | | | | | | | | | | | | | | |
| 1 | | 1 | | | | | | | | | | | | | | | | | | | | | | | | | | | | | | | | | | | | | | | | | | | | | | | | | | | | | | | | | | | | | | | | | | | | | | | | | | | | | |
| | | | | | | | | | | | | | | | | | | | | | | | | | | | | | | | | | | | | | | | | | | | | | | | | | | | | | | | | | | | | | | | | | | | | | | | | | | | | | | | |
| | | | | | | | | | | | | | | | | | | | | | | | | | | | | | | | | | | | | | | | | | | | | | | | | | | | | | | | | | | | | | | | | | | | | | | | | | | | | | | | |
| | | | | | | | | | | | | | | | | | | | | | | | | | | | | | | | | | | | | | | | | | | | | | | | | | | | | | | | | | | | | | | | | | | | | | | | | | | | | | | | |
| Post - 0 Miss - 1 Block - 0 | Post - 0 Miss - 0 Block - 0 | Post - 0 Miss - 0 Block - 0 | Post - 0 Miss - 0 Block - 0 | Post - 1 Miss - 0 Block - 0 | Post - 0 Miss - 0 Block - 0 | Post - 1 Miss - 0 Block - 0 | | | | | | | | | | | | | | | | | | | | | | | | | | | | | | | | | | | | | | | | | | | | | | | | | | | | | | | | | | | | | | | | | | | | | | | | | |

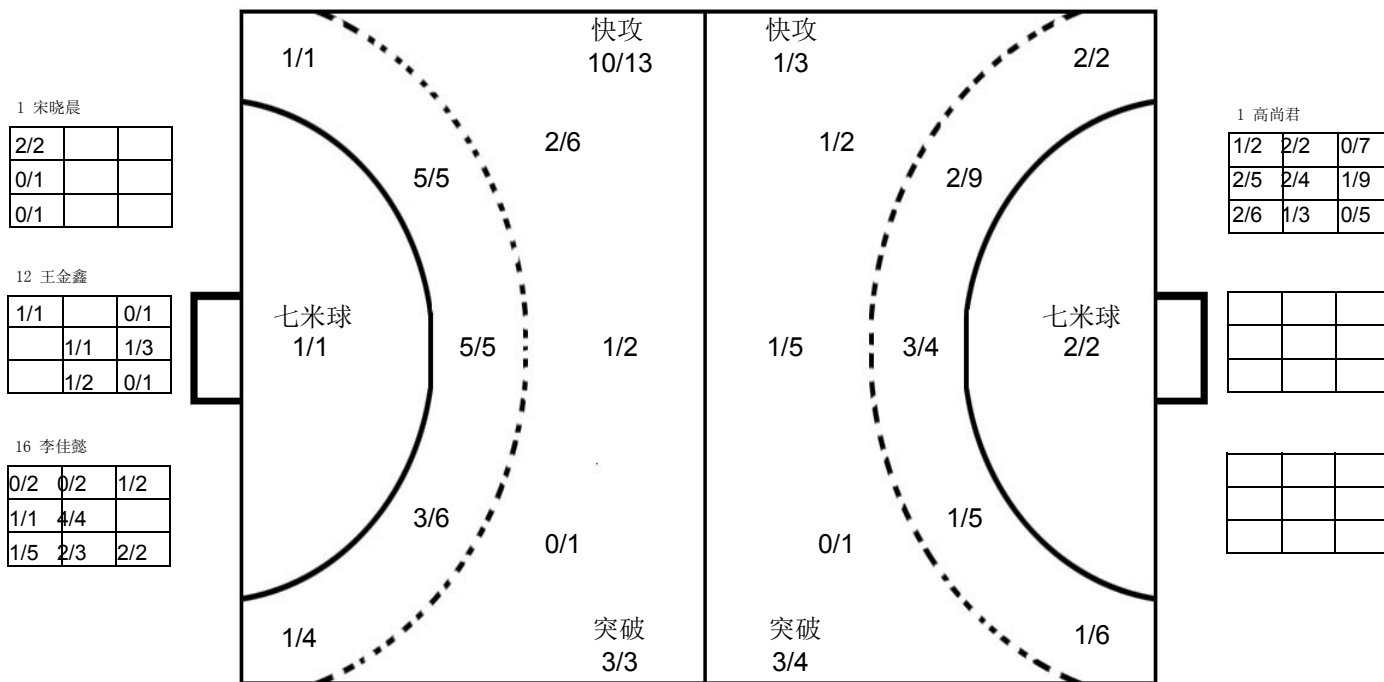

辽宁队

| | | | | | | | | | | | | | | | | | | | | | | | | | | | | | | | | | | | | | | | | | | | | | | | | | | | | | | | | | | | | | | | | | | | | | | | | | | | | | | | |
|--|-----------------------------|-----------------------------|-----------------------------|-----------------------------|-----------------------------|-----------------------------|-----------------------------|--|--|--|--|--|--|--|--|--|--|--|--|---|---|---|--|---|--|--|---|---|---|---|--|--|---|--|--|--|--|--|--|---|--|--|--|---|--|--|--|--|--|--|--|---|--|--|--|--|---|--|--|--|--|--|--|--|--|--|--|--|--|---|---|--|---|--|--|---|---|---|--|
| 1 高尚君 | 2 王司雨 | 3 李星浩 | 5 余昊锦 | 6 陈庆港 | 7 孙义广 | 8 王鑫鹏 | 10 王柏淇 | | | | | | | | | | | | | | | | | | | | | | | | | | | | | | | | | | | | | | | | | | | | | | | | | | | | | | | | | | | | | | | | | | | | | | | | |
| <table border="1"><tr><td></td><td></td><td></td></tr><tr><td></td><td></td><td></td></tr><tr><td></td><td></td><td></td></tr></table> | | | | | | | | | | <table border="1"><tr><td></td><td></td><td></td></tr><tr><td></td><td></td><td></td></tr><tr><td></td><td></td><td></td></tr></table> | | | | | | | | | | <table border="1"><tr><td>1</td><td></td><td></td></tr><tr><td>1</td><td></td><td></td></tr><tr><td>1</td><td></td><td></td></tr></table> | 1 | | | 1 | | | 1 | | | <table border="1"><tr><td></td><td></td><td></td></tr><tr><td></td><td></td><td></td></tr><tr><td></td><td></td><td></td></tr></table> | | | | | | | | | | <table border="1"><tr><td></td><td></td><td></td></tr><tr><td>2</td><td></td><td></td></tr><tr><td></td><td></td><td></td></tr></table> | | | | 2 | | | | | | <table border="1"><tr><td></td><td>1</td><td></td></tr><tr><td></td><td></td><td></td></tr><tr><td>1</td><td></td><td></td></tr></table> | | 1 | | | | | 1 | | | <table border="1"><tr><td></td><td></td><td></td></tr><tr><td></td><td></td><td></td></tr><tr><td></td><td></td><td></td></tr></table> | | | | | | | | | | <table border="1"><tr><td>1</td><td></td><td>1</td></tr><tr><td></td><td></td><td>2</td></tr><tr><td>1</td><td>1</td><td></td></tr></table> | 1 | | 1 | | | 2 | 1 | 1 | |
| | | | | | | | | | | | | | | | | | | | | | | | | | | | | | | | | | | | | | | | | | | | | | | | | | | | | | | | | | | | | | | | | | | | | | | | | | | | | | | | |
| | | | | | | | | | | | | | | | | | | | | | | | | | | | | | | | | | | | | | | | | | | | | | | | | | | | | | | | | | | | | | | | | | | | | | | | | | | | | | | | |
| | | | | | | | | | | | | | | | | | | | | | | | | | | | | | | | | | | | | | | | | | | | | | | | | | | | | | | | | | | | | | | | | | | | | | | | | | | | | | | | |
| | | | | | | | | | | | | | | | | | | | | | | | | | | | | | | | | | | | | | | | | | | | | | | | | | | | | | | | | | | | | | | | | | | | | | | | | | | | | | | | |
| | | | | | | | | | | | | | | | | | | | | | | | | | | | | | | | | | | | | | | | | | | | | | | | | | | | | | | | | | | | | | | | | | | | | | | | | | | | | | | | |
| | | | | | | | | | | | | | | | | | | | | | | | | | | | | | | | | | | | | | | | | | | | | | | | | | | | | | | | | | | | | | | | | | | | | | | | | | | | | | | | |
| 1 | | | | | | | | | | | | | | | | | | | | | | | | | | | | | | | | | | | | | | | | | | | | | | | | | | | | | | | | | | | | | | | | | | | | | | | | | | | | | | | |
| 1 | | | | | | | | | | | | | | | | | | | | | | | | | | | | | | | | | | | | | | | | | | | | | | | | | | | | | | | | | | | | | | | | | | | | | | | | | | | | | | | |
| 1 | | | | | | | | | | | | | | | | | | | | | | | | | | | | | | | | | | | | | | | | | | | | | | | | | | | | | | | | | | | | | | | | | | | | | | | | | | | | | | | |
| | | | | | | | | | | | | | | | | | | | | | | | | | | | | | | | | | | | | | | | | | | | | | | | | | | | | | | | | | | | | | | | | | | | | | | | | | | | | | | | |
| | | | | | | | | | | | | | | | | | | | | | | | | | | | | | | | | | | | | | | | | | | | | | | | | | | | | | | | | | | | | | | | | | | | | | | | | | | | | | | | |
| | | | | | | | | | | | | | | | | | | | | | | | | | | | | | | | | | | | | | | | | | | | | | | | | | | | | | | | | | | | | | | | | | | | | | | | | | | | | | | | |
| | | | | | | | | | | | | | | | | | | | | | | | | | | | | | | | | | | | | | | | | | | | | | | | | | | | | | | | | | | | | | | | | | | | | | | | | | | | | | | | |
| 2 | | | | | | | | | | | | | | | | | | | | | | | | | | | | | | | | | | | | | | | | | | | | | | | | | | | | | | | | | | | | | | | | | | | | | | | | | | | | | | | |
| | | | | | | | | | | | | | | | | | | | | | | | | | | | | | | | | | | | | | | | | | | | | | | | | | | | | | | | | | | | | | | | | | | | | | | | | | | | | | | | |
| | 1 | | | | | | | | | | | | | | | | | | | | | | | | | | | | | | | | | | | | | | | | | | | | | | | | | | | | | | | | | | | | | | | | | | | | | | | | | | | | | | |
| | | | | | | | | | | | | | | | | | | | | | | | | | | | | | | | | | | | | | | | | | | | | | | | | | | | | | | | | | | | | | | | | | | | | | | | | | | | | | | | |
| 1 | | | | | | | | | | | | | | | | | | | | | | | | | | | | | | | | | | | | | | | | | | | | | | | | | | | | | | | | | | | | | | | | | | | | | | | | | | | | | | | |
| | | | | | | | | | | | | | | | | | | | | | | | | | | | | | | | | | | | | | | | | | | | | | | | | | | | | | | | | | | | | | | | | | | | | | | | | | | | | | | | |
| | | | | | | | | | | | | | | | | | | | | | | | | | | | | | | | | | | | | | | | | | | | | | | | | | | | | | | | | | | | | | | | | | | | | | | | | | | | | | | | |
| | | | | | | | | | | | | | | | | | | | | | | | | | | | | | | | | | | | | | | | | | | | | | | | | | | | | | | | | | | | | | | | | | | | | | | | | | | | | | | | |
| 1 | | 1 | | | | | | | | | | | | | | | | | | | | | | | | | | | | | | | | | | | | | | | | | | | | | | | | | | | | | | | | | | | | | | | | | | | | | | | | | | | | | |
| | | 2 | | | | | | | | | | | | | | | | | | | | | | | | | | | | | | | | | | | | | | | | | | | | | | | | | | | | | | | | | | | | | | | | | | | | | | | | | | | | | |
| 1 | 1 | | | | | | | | | | | | | | | | | | | | | | | | | | | | | | | | | | | | | | | | | | | | | | | | | | | | | | | | | | | | | | | | | | | | | | | | | | | | | | |
| Post - 0 Miss - 0 Block - 0 | Post - 0 Miss - 0 Block - 0 | Post - 0 Miss - 1 Block - 0 | Post - 0 Miss - 1 Block - 0 | Post - 1 Miss - 0 Block - 0 | Post - 0 Miss - 0 Block - 0 | Post - 1 Miss - 2 Block - 0 | Post - 0 Miss - 2 Block - 0 | | | | | | | | | | | | | | | | | | | | | | | | | | | | | | | | | | | | | | | | | | | | | | | | | | | | | | | | | | | | | | | | | | | | | | | | |
| 11 庞东阳 | 13 杨洁 | 14 吕昊臻 | 16 吴阳 | 17 李傲 | 18 梅凯博 | 19 赵鑫 | 20 赵佛赐 | | | | | | | | | | | | | | | | | | | | | | | | | | | | | | | | | | | | | | | | | | | | | | | | | | | | | | | | | | | | | | | | | | | | | | | | |
| <table border="1"><tr><td></td><td></td><td></td></tr><tr><td></td><td></td><td></td></tr><tr><td></td><td></td><td></td></tr></table> | | | | | | | | | | <table border="1"><tr><td></td><td></td><td></td></tr><tr><td></td><td></td><td></td></tr><tr><td></td><td></td><td></td></tr></table> | | | | | | | | | | <table border="1"><tr><td></td><td>1</td><td></td></tr><tr><td></td><td></td><td></td></tr><tr><td></td><td>1</td><td>1</td></tr></table> | | 1 | | | | | | 1 | 1 | <table border="1"><tr><td></td><td></td><td>1</td></tr><tr><td></td><td></td><td></td></tr><tr><td></td><td></td><td></td></tr></table> | | | 1 | | | | | | | <table border="1"><tr><td></td><td></td><td></td></tr><tr><td></td><td></td><td></td></tr><tr><td></td><td></td><td></td></tr></table> | | | | | | | | | | <table border="1"><tr><td></td><td></td><td></td></tr><tr><td></td><td></td><td></td></tr><tr><td></td><td></td><td></td></tr></table> | | | | | | | | | | <table border="1"><tr><td></td><td></td><td></td></tr><tr><td></td><td></td><td></td></tr><tr><td></td><td></td><td></td></tr></table> | | | | | | | | | | <table border="1"><tr><td></td><td></td><td></td></tr><tr><td></td><td></td><td></td></tr><tr><td></td><td></td><td></td></tr></table> | | | | | | | | | |
| | | | | | | | | | | | | | | | | | | | | | | | | | | | | | | | | | | | | | | | | | | | | | | | | | | | | | | | | | | | | | | | | | | | | | | | | | | | | | | | |
| | | | | | | | | | | | | | | | | | | | | | | | | | | | | | | | | | | | | | | | | | | | | | | | | | | | | | | | | | | | | | | | | | | | | | | | | | | | | | | | |
| | | | | | | | | | | | | | | | | | | | | | | | | | | | | | | | | | | | | | | | | | | | | | | | | | | | | | | | | | | | | | | | | | | | | | | | | | | | | | | | |
| | | | | | | | | | | | | | | | | | | | | | | | | | | | | | | | | | | | | | | | | | | | | | | | | | | | | | | | | | | | | | | | | | | | | | | | | | | | | | | | |
| | | | | | | | | | | | | | | | | | | | | | | | | | | | | | | | | | | | | | | | | | | | | | | | | | | | | | | | | | | | | | | | | | | | | | | | | | | | | | | | |
| | | | | | | | | | | | | | | | | | | | | | | | | | | | | | | | | | | | | | | | | | | | | | | | | | | | | | | | | | | | | | | | | | | | | | | | | | | | | | | | |
| | 1 | | | | | | | | | | | | | | | | | | | | | | | | | | | | | | | | | | | | | | | | | | | | | | | | | | | | | | | | | | | | | | | | | | | | | | | | | | | | | | |
| | | | | | | | | | | | | | | | | | | | | | | | | | | | | | | | | | | | | | | | | | | | | | | | | | | | | | | | | | | | | | | | | | | | | | | | | | | | | | | | |
| | 1 | 1 | | | | | | | | | | | | | | | | | | | | | | | | | | | | | | | | | | | | | | | | | | | | | | | | | | | | | | | | | | | | | | | | | | | | | | | | | | | | | |
| | | 1 | | | | | | | | | | | | | | | | | | | | | | | | | | | | | | | | | | | | | | | | | | | | | | | | | | | | | | | | | | | | | | | | | | | | | | | | | | | | | |
| | | | | | | | | | | | | | | | | | | | | | | | | | | | | | | | | | | | | | | | | | | | | | | | | | | | | | | | | | | | | | | | | | | | | | | | | | | | | | | | |
| | | | | | | | | | | | | | | | | | | | | | | | | | | | | | | | | | | | | | | | | | | | | | | | | | | | | | | | | | | | | | | | | | | | | | | | | | | | | | | | |
| | | | | | | | | | | | | | | | | | | | | | | | | | | | | | | | | | | | | | | | | | | | | | | | | | | | | | | | | | | | | | | | | | | | | | | | | | | | | | | | |
| | | | | | | | | | | | | | | | | | | | | | | | | | | | | | | | | | | | | | | | | | | | | | | | | | | | | | | | | | | | | | | | | | | | | | | | | | | | | | | | |
| | | | | | | | | | | | | | | | | | | | | | | | | | | | | | | | | | | | | | | | | | | | | | | | | | | | | | | | | | | | | | | | | | | | | | | | | | | | | | | | |
| | | | | | | | | | | | | | | | | | | | | | | | | | | | | | | | | | | | | | | | | | | | | | | | | | | | | | | | | | | | | | | | | | | | | | | | | | | | | | | | |
| | | | | | | | | | | | | | | | | | | | | | | | | | | | | | | | | | | | | | | | | | | | | | | | | | | | | | | | | | | | | | | | | | | | | | | | | | | | | | | | |
| | | | | | | | | | | | | | | | | | | | | | | | | | | | | | | | | | | | | | | | | | | | | | | | | | | | | | | | | | | | | | | | | | | | | | | | | | | | | | | | |
| | | | | | | | | | | | | | | | | | | | | | | | | | | | | | | | | | | | | | | | | | | | | | | | | | | | | | | | | | | | | | | | | | | | | | | | | | | | | | | | |
| | | | | | | | | | | | | | | | | | | | | | | | | | | | | | | | | | | | | | | | | | | | | | | | | | | | | | | | | | | | | | | | | | | | | | | | | | | | | | | | |
| | | | | | | | | | | | | | | | | | | | | | | | | | | | | | | | | | | | | | | | | | | | | | | | | | | | | | | | | | | | | | | | | | | | | | | | | | | | | | | | |
| | | | | | | | | | | | | | | | | | | | | | | | | | | | | | | | | | | | | | | | | | | | | | | | | | | | | | | | | | | | | | | | | | | | | | | | | | | | | | | | |
| | | | | | | | | | | | | | | | | | | | | | | | | | | | | | | | | | | | | | | | | | | | | | | | | | | | | | | | | | | | | | | | | | | | | | | | | | | | | | | | |
| | | | | | | | | | | | | | | | | | | | | | | | | | | | | | | | | | | | | | | | | | | | | | | | | | | | | | | | | | | | | | | | | | | | | | | | | | | | | | | | |
| Post - 1 Miss - 0 Block - 0 | Post - 0 Miss - 0 Block - 0 | Post - 0 Miss - 0 Block - 0 | Post - 0 Miss - 0 Block - 0 | Post - 0 Miss - 0 Block - 0 | Post - 0 Miss - 0 Block - 0 | Post - 0 Miss - 0 Block - 0 | Post - 0 Miss - 0 Block - 0 | | | | | | | | | | | | | | | | | | | | | | | | | | | | | | | | | | | | | | | | | | | | | | | | | | | | | | | | | | | | | | | | | | | | | | | | |

注释: Post=击柱 Miss=射失 Block=被封





预赛 Group B
青年男子 全国比赛

2016年“体彩杯”全国手球男子青年锦标赛

| | | | | | | | | | | | | | | | | | | | | | |
|--------------------|---|---------------------------------------|---------------------|------------------|------------------------------------|-------------------|---|---------------------------|---------------------------------------|----|-----|----------------------|---------------|---|--|--|---|---|----|---|----|
| Team A A 天津队 | | | | Team B B 北京队 | | | | Match Number 26 | | | | | | | | | | | | | |
| played in China | | in the hall 重庆万州 | | on 25/03/2016 | | at 10:00 hours | | Spectators | | | | | | | | | | | | | |
| Half-time (30') | A 15 | B 14 | End of playing time | A 24 | B 32 | 1st extra time | A | B | 2nd extra time | A | B | After penalty throws | A | B | | | | | | | |
| Number of 7 m | A 2 / 2 | Team time-out 1 2 3 40:02 51:26 | | | Full name of players and officials | | | | Team time-out 1 2 3 23:02 54:40 | | | B 1 / 2 | Number of 7 m | | | | | | | | |
| No. | Team A | | | | | G | W | 2' | D | DR | No. | Team B | | | | | G | W | 2' | D | DR |
| 9 | 吴明远 | | | | | 2 | | 1 | | | 3 | 王哲一 | | | | | 2 | | | | |
| 18 | 王晓琪 | | | | | 7 | 1 | 1 | 1 | | 4 | 朱广刚 | | | | | 8 | | | | |
| 21 | 潘玉帅 | | | | | 7 | | | | | 6 | 赵一涵 | | | | | 4 | 1 | 1 | | |
| 22 | 魏雨童 | | | | | 7 | 1 | 1 | | | 7 | 卞友山 | | | | | 9 | | 1 | | |
| 24 | 刘子健 | | | | | | | | | | 11 | 李旭 | | | | | 1 | | | | |
| 25 | 王一雄 | | | | | | | | | | 15 | 逯明松 | | | | | 2 | 1 | | | |
| 26 | 刘思远 | | | | | 1 | 1 | | | | 16 | 马佳鹏 | | | | | | | | | |
| 27 | 左金龙 | | | | | | | | | | 18 | 李明远 | | | | | 1 | | 1 | | |
| 28 | 何喜年 | | | | | | | | | | 19 | 陈旭 | | | | | | | | | |
| | | | | | | | | | | | 23 | 刘帅 | | | | | 1 | | | | |
| | | | | | | | | | | | 25 | 张斌 | | | | | | | | | |
| | | | | | | | | | | | 26 | 吴锐樊 | | | | | 4 | 1 | | | |
| | | | | | | | | | | | 35 | 高云健 | | | | | | | | | |
| | | | | | | | | | | | 36 | 王鹏皓 | | | | | | | | | |
| A | 李志成 | | | | | | | | | | B | 吴健 (主教练) | | | | | 1 | | | | |
| B | 潘玉强 | | | | | | | | | | C | 宋刚 | | | | | | | | | |
| | | | | | | | | | | | D | 陈璇 | | | | | | | | | |
| | | | | | | | | | | | | | | | | | | | | | |
| A | Signature of Responsible Official of the Teams (Off. A) | | | | | | | | | | | | | | | | | | B | | |
| TP | Remarks of Referee / CHA Official | | | | | | | | | | | | | | | | | | TP | | |

Signatures

| | | | | |
|------------------|-----------|-----------|--|--|
| Referees | 程钰峰 (CHN) | 周云磊 (CHN) | | |
| Techn. Delegates | 许宜扬 (CHN) | | | |
| CHA Official | 张春生 (CHN) | | | |

Note: Number of 7m Throws Awarded to Team A and B, Goals (G), Warnings (W), Suspensions (2'), Direct Disqualification (D), Disqualification with Report (DR) and Team Penalty (TP).

Table Officials:

Statisticians: 李双

刘永欢





2016年“体彩杯”全国手球男子青年锦标赛 竞赛技术统计(媒体表)

| | | | | | | |
|----------------|-----------|------------|----|-----------|------------------|-----------|
| 预赛 | 组别 | B | 轮次 | 5 | 场次 | 26 |
| 重庆万州 | | 25/03/2016 | | | 201602026-51-1/1 | |
| 天津队 | 天津 | 24 | vs | 32 | 北京 | 北京队 |
| 15 : 14 | | | | | | |

| | | | |
|-----|-----------|---|-----------|
| 裁判员 | 程钰峰 (CHN) | / | 周云磊 (CHN) |
|-----|-----------|---|-----------|

| 天津 | | | | | | | | | | | | | | 天津 | | 北京 | |
|---------------|-------------|--------------|------------|------------|------------|------------|--------------|-------------|-------------|-----------|----------|----------|----------|----------|----|-----------------|--|
| 主教练：潘玉强 | | | | | | | | | | | | | | 比赛进程 | | | |
| 远射 | 近射 | 边射 | 快攻 | 突破 | 任意球 | 7m球 | 合计 | % | 助攻 | 失误 | 警告 | 2' | D & DR | | | | |
| 9 吴明远 | 2/5 | 0/2 | | 0/1 | | | 2/8 | 25.0 | 1 | 3 | | 1 | | 0 01:55 | 1 | 26 吴锐樊 | |
| 18 王晓琪 | 4/6 | 2/3 | | 0/1 | | 1/1 | 7/11 | 63.6 | 1 | | 1 | 1 | 1 | 0 03:17 | 2 | 7 卞友山 | |
| 21 潘玉帅 | 1/3 | 1/4 | 1/2 | 3/3 | 1/2 | | 7/14 | 50.0 | 1 | 4 | | | | 1 04:05 | 3 | 4 朱广刚 | |
| 22 魏雨童 | 1/4 | 3/4 | | | 2/5 | 1/1 | 7/14 | 50.0 | 2 | 9 | 1 | 1 | | 2 04:43 | 3 | 3 吴锐樊 | |
| 24 刘子健 | | | | | | | | | | | | | | 3 07:11 | 4 | 4 朱广刚 | |
| 25 王一雄 | 0/1 | | 0/1 | | | | 0/2 | 0.0 | | | | | | 4 09:46 | 4 | 4 朱广刚 | |
| 26 刘思远 | | | 0/1 | | 1/1 | | 1/2 | 50.0 | | 3 | 1 | | | 4 14:22 | 6 | 7 卞友山 | |
| 27 左金龙 | | | | | | | | | | 1 | | | | 4 15:23 | 7 | 26 吴锐樊 | |
| 28 何喜年 | | | | | | | | | 2 | | | | | 5 15:50 | 7 | | |
| 运动员 合计 | 8/19 | 6/13 | 1/4 | 3/4 | 4/9 | 2/2 | 24/51 | 47.1 | 7 | 20 | 3 | 3 | 1 | 6 16:30 | 8 | 6 赵一涵 | |
| 9 吴明远 | | | | | | | | | | | | | | 7 17:57 | 8 | | |
| 24 刘子健 | 0/2 | 6/14 | 0/1 | 0/3 | 0/2 | 0/2 | 1/2 | 7/26 | 26.9 | | | | | 8 18:58 | 8 | | |
| 28 何喜年 | 0/3 | 0/5 | 1/2 | | 0/4 | | 1/14 | 7.1 | 2 | | | | | 8 19:14 | 9 | 4 朱广刚 | |
| 守门员 合计 | 0/5 | 6/19 | 1/3 | 0/3 | 0/6 | 0/2 | 1/2 | 8/40 | 20.0 | 2 | | | | 9 19:32 | 9 | 20:35 10 15 逯明松 | |
| 北京 | | | | | | | | | | | | | | 2nd Half | | | |
| 教练：吴健 | | | | | | | | | | | | | | 15 00:37 | | 15 7 卞友山 | |
| 远射 | 近射 | 边射 | 快攻 | 突破 | 任意球 | 7m球 | 合计 | % | 助攻 | 失误 | 警告 | 2' | D & DR | | | | |
| 3 王哲一 | | 1/1 | | 1/1 | | | 2/2 | 100 | | | | | | 16 02:16 | 15 | 7 卞友山 | |
| 4 朱广刚 | 3/7 | 1/3 | | | 2/3 | 2/2 | 0/1 | 8/16 | 50.0 | 6 | 2 | | | 16 05:26 | 16 | 7 卞友山 | |
| 6 赵一涵 | 1/1 | 0/3 | | | 3/3 | | 4/7 | 57.1 | 4 | 7 | 1 | 1 | | 16 08:24 | 17 | 7 卞友山 | |
| 7 卞友山 | | 8/8 | 1/1 | | | | 9/9 | 100 | | 1 | | 1 | | 17 06:41 | 17 | | |
| 11 李旭 | | | | | | 1/1 | 1/1 | 100 | | | | | | 17 06:59 | 18 | 18 李明远 | |
| 15 逯明松 | | 1/1 | 1/4 | | | | 2/5 | 40.0 | | 1 | 1 | | | 18 10:45 | 18 | | |
| 16 马佳鹏 | | | | | | | | | | | | | | 18 11:30 | 19 | 7 卞友山 | |
| 18 李明远 | | 0/3 | | | 1/2 | | 1/5 | 20.0 | 4 | 6 | | 1 | | 19 11:55 | 19 | | |
| 19 陈旭 | | | | | | | | | | | | | | 19 12:53 | 20 | 7 卞友山 | |
| 23 刘帅 | 1/1 | | | | | | 1/1 | 100 | | | | | | 19 14:31 | 21 | 11 李旭 | |
| 25 张斌 | | | | | | | | | | | | | | 20 14:53 | 21 | | |
| 26 吴锐樊 | 0/1 | 2/2 | | 2/3 | | | 4/6 | 66.7 | | 1 | 1 | | | 20 16:20 | 22 | 7 卞友山 | |
| 35 高云健 | | | | | | | | | | | | | | 20 17:29 | 23 | 4 朱广刚 | |
| 36 王鹏皓 | | | | | | | | | | 1 | | | | 20 18:11 | 24 | 6 赵一涵 | |
| 运动员 合计 | 5/10 | 13/21 | 2/5 | 3/4 | 6/8 | 2/2 | 32/52 | 61.5 | 14 | 20 | 3 | 3 | | 21 19:09 | 24 | | |
| 3 王哲一 | | | | | | | | | | | | | | 21 19:35 | 25 | 6 赵一涵 | |
| 16 马佳鹏 | 3/11 | 7/13 | 2/3 | 1/4 | 5/9 | 0/2 | 18/42 | 42.9 | | | | | | 21 20:57 | 26 | 6 赵一涵 | |
| 守门员 合计 | 3/11 | 7/13 | 2/3 | 1/4 | 5/9 | 0/2 | 18/42 | 42.9 | | | | | | 21 21:25 | 27 | 26 吴锐樊 | |
| | | | | | | | | | | | | | | 21 21:52 | 28 | 26 吴锐樊 | |
| | | | | | | | | | | | | | | 22 23:08 | 28 | | |
| | | | | | | | | | | | | | | 22 23:34 | 29 | 7 卞友山 | |
| | | | | | | | | | | | | | | 22 23:57 | 29 | | |
| | | | | | | | | | | | | | | 23 25:26 | 30 | 3 王哲一 | |
| | | | | | | | | | | | | | | 24 27:16 | 30 | | |
| | | | | | | | | | | | | | | 24 27:58 | 31 | 3 王哲一 | |
| | | | | | | | | | | | | | | 24 28:48 | 32 | 23 刘帅 | |

场上队员：得分 / 射门

守门员：救球 / 射门

| | | | | | | | | | |
|----|------------|----|--------------|-----|------------|-----|----------|----|---------|
| 快攻 | Fast Break | 突破 | Breakthrough | 任意球 | Free Throw | 7M球 | 7M Throw | 助攻 | Assist |
| 警告 | Warning | 失误 | Error | 2' | Suspension | D | 取消资格 | DR | 取消资格+报告 |





2016年“体彩杯”全国手球男子青年锦标赛 图式比赛技术统计表

轮次 5

场次 26

201602026-21-1/1

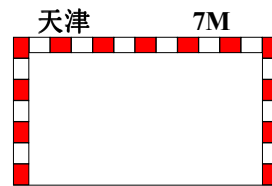
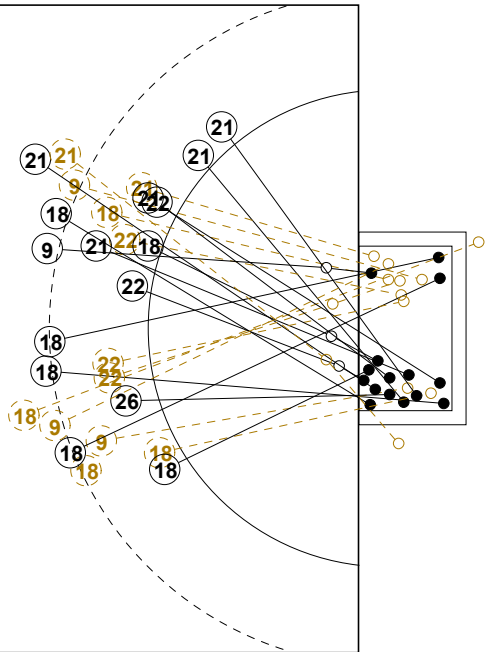
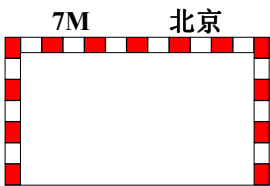
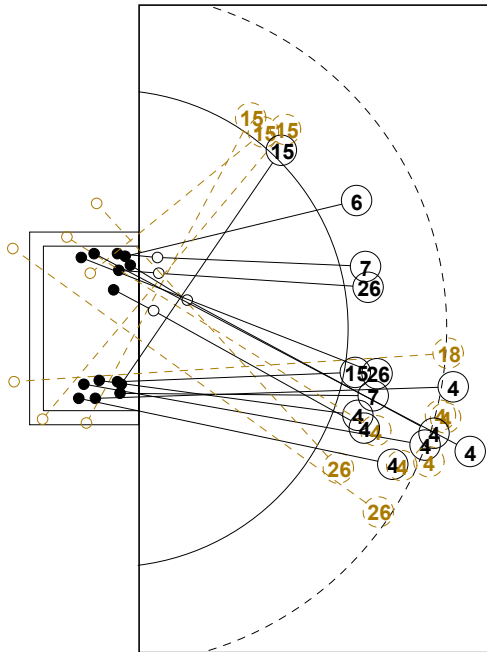

1st Half
14 : 15

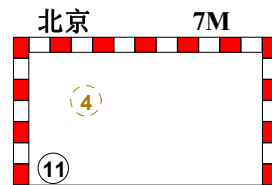
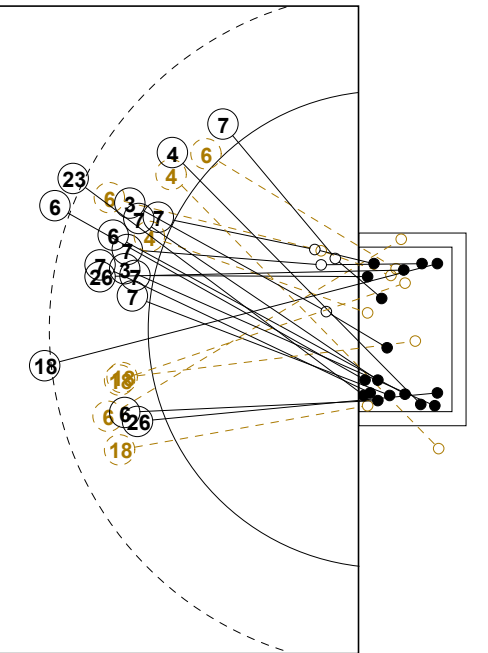
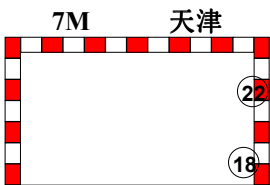
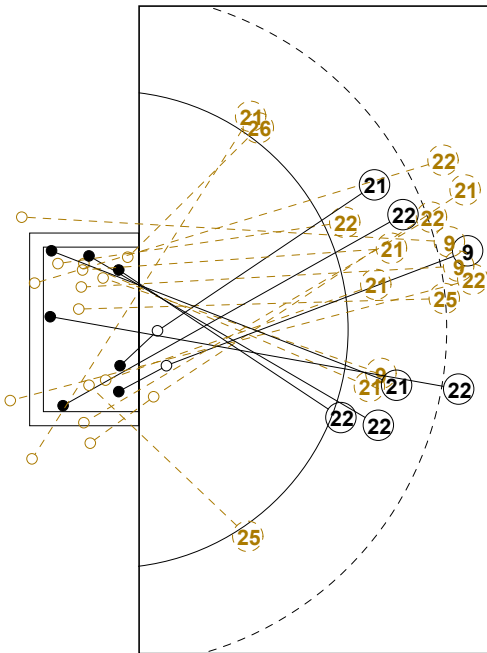

2nd Half
24 : 32



2016年“体彩杯”全国手球男子青年锦标赛

个人/全队技术统计表

正式表
手球
青年男子预赛
轮次 5组别 B
场次 26201602026-14-1/2
重庆万州
25/03/2016 10:00

| 号码 | 姓名 | 远射 | 近射 | 边射 | 快攻 | 突破 | 任意 | 7M | 合计 | % | 助攻 | 失误 | 警告 | 2' | 取消 | 时间 |
|----------------|-----|-----|------|-----|-----|-----|-----|-----|------|-------|----|----|----|----|----|----------|
| 天津队(天津) | | | | | | | | | | | | | | | | |
| <i>(场上队员)</i> | | | | | | | | | | | | | | | | |
| 9 | 吴明远 | 2/5 | 0/2 | | | 0/1 | | | 2/8 | 25.0% | 1 | 3 | | | 1 | 01:00:00 |
| 18 | 王晓琪 | 4/6 | 2/3 | | | 0/1 | | 1/1 | 7/11 | 63.6% | 1 | | 1 | 1 | 1 | 00:38:52 |
| 21 | 潘玉帅 | 1/3 | 1/4 | 1/2 | 3/3 | 1/2 | | | 7/14 | 50.0% | 1 | 4 | | | | 01:00:00 |
| 22 | 魏雨童 | 1/4 | 3/4 | | | 2/5 | | 1/1 | 7/14 | 50.0% | 2 | 9 | 1 | 1 | | 01:00:00 |
| 24 | 刘子健 | | | | | | | | | 0.0% | | | | | | 00:39:39 |
| 25 | 王一雄 | 0/1 | | 0/1 | | | | | 0/2 | 0.0% | | | | | | 00:30:00 |
| 26 | 刘思远 | | | 0/1 | | 1/1 | | | 1/2 | 50.0% | | 3 | 1 | | | 01:00:00 |
| 27 | 左金龙 | | | | | | | | | 0.0% | | 1 | | | | 00:51:03 |
| 28 | 何喜年 | | | | | | | | | 0.0% | 2 | | | | | 00:20:21 |
| 合计 | | | | | | | | | | | | | | | | |
| <i>(守门员)</i> | | | | | | | | | | | | | | | | |
| 9 | | | | | | | | | | 0.0% | | | | | | 01:00:00 |
| 24 | | 0/2 | 6/14 | 0/1 | 0/3 | 0/2 | 0/2 | 1/2 | 7/26 | 26.9% | | | | | | 00:39:39 |
| 28 | | 0/3 | 0/5 | 1/2 | | 0/4 | | | 1/14 | 7.1% | 2 | | | | | 00:20:21 |
| 合计 | | | | | | | | | | | | | | | | |
| | | 0/5 | 6/19 | 1/3 | 0/3 | 0/6 | 0/2 | 1/2 | 8/40 | 20.0% | 2 | | | | | |

场上队员：得分/射门

守门员：救球/射门

| 全队合计 | 得分 | 被救 | 射失 | 击柱 | 封球 | 合计 | % |
|------|----|----|----|----|----|----|--------|
| 远射 | 8 | 3 | 5 | 2 | 1 | 19 | 42.1% |
| 近射 | 6 | 7 | | | | 13 | 46.2% |
| 边射 | 1 | 2 | 1 | | | 4 | 25.0% |
| 快攻 | 3 | 1 | | | | 4 | 75.0% |
| 突破 | 4 | 5 | | | | 9 | 44.4% |
| 任意 | | | | | | | 0.0% |
| 7M | 2 | | | | | 2 | 100.0% |





2016年“体彩杯”全国手球男子青年锦标赛

个人/全队技术统计表

正式表
手球
青年男子预赛
轮次 5组别 B
场次 26201602026-14-2/2
重庆万州
25/03/2016 10:00

| 号码 | 姓名 | 远射 | 近射 | 边射 | 快攻 | 突破 | 任意 | 7M | 合计 | % | 助攻 | 失误 | 警告 | 2' | 取消 | 时间 |
|----------------|-----|-----|-----|-----|-----|-----|-----|-----|------|-------|----|----|----|----|----|----------|
| 北京队(北京) | | | | | | | | | | | | | | | | |
| <i>(上场队员)</i> | | | | | | | | | | | | | | | | |
| 3 | 王哲一 | | 1/1 | | 1/1 | | | | 2/2 | 100% | | | | | | 00:07:34 |
| 4 | 朱广刚 | 3/7 | 1/3 | | | 2/3 | 2/2 | 0/1 | 8/16 | 50.0% | 6 | 2 | | | | 00:56:44 |
| 6 | 赵一涵 | 1/1 | 0/3 | | | 3/3 | | | 4/7 | 57.1% | 4 | 7 | 1 | 1 | | 01:02:43 |
| 7 | 卞友山 | | 8/8 | 1/1 | | | | | 9/9 | 100% | | 1 | | 1 | | 01:00:00 |
| 11 | 李旭 | | | | | | | 1/1 | 1/1 | 100% | | 1 | | | | 00:10:32 |
| 15 | 逯明松 | | 1/1 | 1/4 | | | | | 2/5 | 40.0% | | 1 | 1 | | | 01:00:00 |
| 16 | 马佳鹏 | | | | | | | | | 0.0% | | | | | | 01:00:00 |
| 18 | 李明远 | | 0/3 | | | 1/2 | | | 1/5 | 20.0% | 4 | 6 | | 1 | | 00:49:34 |
| 19 | 陈旭 | | | | | | | | | 0.0% | | | | | | 00:00:00 |
| 23 | 刘帅 | 1/1 | | | | | | | 1/1 | 100% | | | | | | 00:03:15 |
| 25 | 张斌 | | | | | | | | | 0.0% | | | | | | 00:00:00 |
| 26 | 吴锐樊 | 0/1 | 2/2 | | 2/3 | | | | 4/6 | 66.7% | | 1 | 1 | | | 00:52:25 |
| 35 | 高云健 | | | | | | | | | 0.0% | | | | | | 00:00:00 |
| 36 | 王鹏皓 | | | | | | | | | 0.0% | | 1 | | | | 00:01:25 |

| | | | | | | | | | | | | | | | | |
|--------------|-----|------|-------|-----|-----|-----|-----|-----|-------|-------|----|----|---|---|--|----------|
| 合计 | | 5/10 | 13/21 | 2/5 | 3/4 | 6/8 | 2/2 | 1/2 | 32/52 | 61.5% | 14 | 20 | 3 | 3 | | |
| <i>(守门员)</i> | | | | | | | | | | | | | | | | |
| 3 | 王哲一 | | | | | | | | | 0.0% | | | | | | 00:07:34 |
| 16 | 马佳鹏 | 3/11 | 7/13 | 2/3 | 1/4 | 5/9 | | 0/2 | 18/42 | 42.9% | | | | | | 01:00:00 |

| | | | | | | | | | | | | | | | | |
|-----------|--|------|------|-----|-----|-----|--|-----|-------|-------|--|--|--|--|--|--|
| 合计 | | 3/11 | 7/13 | 2/3 | 1/4 | 5/9 | | 0/2 | 18/42 | 42.9% | | | | | | |
|-----------|--|------|------|-----|-----|-----|--|-----|-------|-------|--|--|--|--|--|--|

场上队员：得分/射门

守门员：救球/射门

| 全队合计 | 得分 | 被救 | 射失 | 击柱 | 封球 | 合计 | % |
|------|----|----|----|----|----|----|--------|
| 远射 | 5 | | 1 | | 4 | 10 | 50.0% |
| 近射 | 13 | 6 | 1 | 1 | | 21 | 61.9% |
| 边射 | 2 | 1 | | 2 | | 5 | 40.0% |
| 快攻 | 3 | | 1 | | | 4 | 75.0% |
| 突破 | 6 | | 1 | 1 | | 8 | 75.0% |
| 任意 | 2 | | | | | 2 | 100.0% |
| 7M | 1 | 1 | | | | 2 | 50.0% |





2016年“体彩杯”全国手球男子青年锦标赛

图式射门区域统计

轮次 5 场次 26

201602026-41-1/1

天津队

| | | | | | | | | | | | | | | | | | | | | | | | | | | | | | | | | | | | | | | | | | | | | | | | | | | | | | | | | | | | | | | | | | | | | | | | | | | | | | | | |
|---|-----------------------------|-----------------------------|-----------------------------|-----------------------------|-----------------------------|-----------------------------|-----------------------------|--|--|---|---|--|---|--|--|--|--|--|---|--|--|--|---|--|--|---|---|--|---|---|---|---|---|--|--|---|--|--|---|--|--|--|--|--|--|--|--|--|--|--|--|--|--|--|--|--|--|--|--|---|--|--|---|--|--|--|--|--|--|--|--|--|--|--|--|--|--|--|--|
| 9 吴明远 | 18 王晓琪 | 21 潘玉帅 | 22 魏雨童 | 24 刘子健 | 25 王一雄 | 26 刘思远 | 27 左金龙 | | | | | | | | | | | | | | | | | | | | | | | | | | | | | | | | | | | | | | | | | | | | | | | | | | | | | | | | | | | | | | | | | | | | | | | | |
| <table border="1"><tr><td></td><td></td><td></td></tr><tr><td></td><td></td><td></td></tr><tr><td>2</td><td></td><td></td></tr></table> | | | | | | | 2 | | | <table border="1"><tr><td>2</td><td></td><td>1</td></tr><tr><td></td><td></td><td></td></tr><tr><td></td><td></td><td>4</td></tr></table> | 2 | | 1 | | | | | | 4 | <table border="1"><tr><td></td><td></td><td>2</td></tr><tr><td></td><td></td><td>3</td></tr><tr><td>1</td><td></td><td>1</td></tr></table> | | | 2 | | | 3 | 1 | | 1 | <table border="1"><tr><td>1</td><td>1</td><td>1</td></tr><tr><td></td><td></td><td>2</td></tr><tr><td></td><td></td><td>2</td></tr></table> | 1 | 1 | 1 | | | 2 | | | 2 | <table border="1"><tr><td></td><td></td><td></td></tr><tr><td></td><td></td><td></td></tr><tr><td></td><td></td><td></td></tr></table> | | | | | | | | | | <table border="1"><tr><td></td><td></td><td></td></tr><tr><td></td><td></td><td></td></tr><tr><td></td><td></td><td></td></tr></table> | | | | | | | | | | <table border="1"><tr><td></td><td></td><td>1</td></tr><tr><td></td><td></td><td></td></tr><tr><td></td><td></td><td></td></tr></table> | | | 1 | | | | | | | <table border="1"><tr><td></td><td></td><td></td></tr><tr><td></td><td></td><td></td></tr><tr><td></td><td></td><td></td></tr></table> | | | | | | | | | |
| | | | | | | | | | | | | | | | | | | | | | | | | | | | | | | | | | | | | | | | | | | | | | | | | | | | | | | | | | | | | | | | | | | | | | | | | | | | | | | | |
| | | | | | | | | | | | | | | | | | | | | | | | | | | | | | | | | | | | | | | | | | | | | | | | | | | | | | | | | | | | | | | | | | | | | | | | | | | | | | | | |
| 2 | | | | | | | | | | | | | | | | | | | | | | | | | | | | | | | | | | | | | | | | | | | | | | | | | | | | | | | | | | | | | | | | | | | | | | | | | | | | | | | |
| 2 | | 1 | | | | | | | | | | | | | | | | | | | | | | | | | | | | | | | | | | | | | | | | | | | | | | | | | | | | | | | | | | | | | | | | | | | | | | | | | | | | | |
| | | | | | | | | | | | | | | | | | | | | | | | | | | | | | | | | | | | | | | | | | | | | | | | | | | | | | | | | | | | | | | | | | | | | | | | | | | | | | | | |
| | | 4 | | | | | | | | | | | | | | | | | | | | | | | | | | | | | | | | | | | | | | | | | | | | | | | | | | | | | | | | | | | | | | | | | | | | | | | | | | | | | |
| | | 2 | | | | | | | | | | | | | | | | | | | | | | | | | | | | | | | | | | | | | | | | | | | | | | | | | | | | | | | | | | | | | | | | | | | | | | | | | | | | | |
| | | 3 | | | | | | | | | | | | | | | | | | | | | | | | | | | | | | | | | | | | | | | | | | | | | | | | | | | | | | | | | | | | | | | | | | | | | | | | | | | | | |
| 1 | | 1 | | | | | | | | | | | | | | | | | | | | | | | | | | | | | | | | | | | | | | | | | | | | | | | | | | | | | | | | | | | | | | | | | | | | | | | | | | | | | |
| 1 | 1 | 1 | | | | | | | | | | | | | | | | | | | | | | | | | | | | | | | | | | | | | | | | | | | | | | | | | | | | | | | | | | | | | | | | | | | | | | | | | | | | | |
| | | 2 | | | | | | | | | | | | | | | | | | | | | | | | | | | | | | | | | | | | | | | | | | | | | | | | | | | | | | | | | | | | | | | | | | | | | | | | | | | | | |
| | | 2 | | | | | | | | | | | | | | | | | | | | | | | | | | | | | | | | | | | | | | | | | | | | | | | | | | | | | | | | | | | | | | | | | | | | | | | | | | | | | |
| | | | | | | | | | | | | | | | | | | | | | | | | | | | | | | | | | | | | | | | | | | | | | | | | | | | | | | | | | | | | | | | | | | | | | | | | | | | | | | | |
| | | | | | | | | | | | | | | | | | | | | | | | | | | | | | | | | | | | | | | | | | | | | | | | | | | | | | | | | | | | | | | | | | | | | | | | | | | | | | | | |
| | | | | | | | | | | | | | | | | | | | | | | | | | | | | | | | | | | | | | | | | | | | | | | | | | | | | | | | | | | | | | | | | | | | | | | | | | | | | | | | |
| | | | | | | | | | | | | | | | | | | | | | | | | | | | | | | | | | | | | | | | | | | | | | | | | | | | | | | | | | | | | | | | | | | | | | | | | | | | | | | | |
| | | | | | | | | | | | | | | | | | | | | | | | | | | | | | | | | | | | | | | | | | | | | | | | | | | | | | | | | | | | | | | | | | | | | | | | | | | | | | | | |
| | | | | | | | | | | | | | | | | | | | | | | | | | | | | | | | | | | | | | | | | | | | | | | | | | | | | | | | | | | | | | | | | | | | | | | | | | | | | | | | |
| | | 1 | | | | | | | | | | | | | | | | | | | | | | | | | | | | | | | | | | | | | | | | | | | | | | | | | | | | | | | | | | | | | | | | | | | | | | | | | | | | | |
| | | | | | | | | | | | | | | | | | | | | | | | | | | | | | | | | | | | | | | | | | | | | | | | | | | | | | | | | | | | | | | | | | | | | | | | | | | | | | | | |
| | | | | | | | | | | | | | | | | | | | | | | | | | | | | | | | | | | | | | | | | | | | | | | | | | | | | | | | | | | | | | | | | | | | | | | | | | | | | | | | |
| | | | | | | | | | | | | | | | | | | | | | | | | | | | | | | | | | | | | | | | | | | | | | | | | | | | | | | | | | | | | | | | | | | | | | | | | | | | | | | | |
| | | | | | | | | | | | | | | | | | | | | | | | | | | | | | | | | | | | | | | | | | | | | | | | | | | | | | | | | | | | | | | | | | | | | | | | | | | | | | | | |
| | | | | | | | | | | | | | | | | | | | | | | | | | | | | | | | | | | | | | | | | | | | | | | | | | | | | | | | | | | | | | | | | | | | | | | | | | | | | | | | |
| Post - 0 Miss - 1 Block - 0 | Post - 0 Miss - 1 Block - 1 | Post - 0 Miss - 3 Block - 0 | Post - 2 Miss - 1 Block - 0 | Post - 0 Miss - 0 Block - 0 | Post - 0 Miss - 0 Block - 0 | Post - 0 Miss - 0 Block - 0 | Post - 0 Miss - 0 Block - 0 | | | | | | | | | | | | | | | | | | | | | | | | | | | | | | | | | | | | | | | | | | | | | | | | | | | | | | | | | | | | | | | | | | | | | | | | |
| 28 何喜年 | | | | | | | | | | | | | | | | | | | | | | | | | | | | | | | | | | | | | | | | | | | | | | | | | | | | | | | | | | | | | | | | | | | | | | | | | | | | | | | |
| <table border="1"><tr><td></td><td></td><td></td></tr><tr><td></td><td></td><td></td></tr><tr><td></td><td></td><td></td></tr></table> | | | | | | | | | | <table border="1"><tr><td></td><td></td><td></td></tr><tr><td></td><td></td><td></td></tr><tr><td></td><td></td><td></td></tr></table> | | | | | | | | | | <table border="1"><tr><td></td><td></td><td></td></tr><tr><td></td><td></td><td></td></tr><tr><td></td><td></td><td></td></tr></table> | | | | | | | | | | <table border="1"><tr><td></td><td></td><td></td></tr><tr><td></td><td></td><td></td></tr><tr><td></td><td></td><td></td></tr></table> | | | | | | | | | | <table border="1"><tr><td></td><td></td><td></td></tr><tr><td></td><td></td><td></td></tr><tr><td></td><td></td><td></td></tr></table> | | | | | | | | | | <table border="1"><tr><td></td><td></td><td></td></tr><tr><td></td><td></td><td></td></tr><tr><td></td><td></td><td></td></tr></table> | | | | | | | | | | <table border="1"><tr><td></td><td></td><td></td></tr><tr><td></td><td></td><td></td></tr><tr><td></td><td></td><td></td></tr></table> | | | | | | | | | | <table border="1"><tr><td></td><td></td><td></td></tr><tr><td></td><td></td><td></td></tr><tr><td></td><td></td><td></td></tr></table> | | | | | | | | | |
| | | | | | | | | | | | | | | | | | | | | | | | | | | | | | | | | | | | | | | | | | | | | | | | | | | | | | | | | | | | | | | | | | | | | | | | | | | | | | | | |
| | | | | | | | | | | | | | | | | | | | | | | | | | | | | | | | | | | | | | | | | | | | | | | | | | | | | | | | | | | | | | | | | | | | | | | | | | | | | | | | |
| | | | | | | | | | | | | | | | | | | | | | | | | | | | | | | | | | | | | | | | | | | | | | | | | | | | | | | | | | | | | | | | | | | | | | | | | | | | | | | | |
| | | | | | | | | | | | | | | | | | | | | | | | | | | | | | | | | | | | | | | | | | | | | | | | | | | | | | | | | | | | | | | | | | | | | | | | | | | | | | | | |
| | | | | | | | | | | | | | | | | | | | | | | | | | | | | | | | | | | | | | | | | | | | | | | | | | | | | | | | | | | | | | | | | | | | | | | | | | | | | | | | |
| | | | | | | | | | | | | | | | | | | | | | | | | | | | | | | | | | | | | | | | | | | | | | | | | | | | | | | | | | | | | | | | | | | | | | | | | | | | | | | | |
| | | | | | | | | | | | | | | | | | | | | | | | | | | | | | | | | | | | | | | | | | | | | | | | | | | | | | | | | | | | | | | | | | | | | | | | | | | | | | | | |
| | | | | | | | | | | | | | | | | | | | | | | | | | | | | | | | | | | | | | | | | | | | | | | | | | | | | | | | | | | | | | | | | | | | | | | | | | | | | | | | |
| | | | | | | | | | | | | | | | | | | | | | | | | | | | | | | | | | | | | | | | | | | | | | | | | | | | | | | | | | | | | | | | | | | | | | | | | | | | | | | | |
| | | | | | | | | | | | | | | | | | | | | | | | | | | | | | | | | | | | | | | | | | | | | | | | | | | | | | | | | | | | | | | | | | | | | | | | | | | | | | | | |
| | | | | | | | | | | | | | | | | | | | | | | | | | | | | | | | | | | | | | | | | | | | | | | | | | | | | | | | | | | | | | | | | | | | | | | | | | | | | | | | |
| | | | | | | | | | | | | | | | | | | | | | | | | | | | | | | | | | | | | | | | | | | | | | | | | | | | | | | | | | | | | | | | | | | | | | | | | | | | | | | | |
| | | | | | | | | | | | | | | | | | | | | | | | | | | | | | | | | | | | | | | | | | | | | | | | | | | | | | | | | | | | | | | | | | | | | | | | | | | | | | | | |
| | | | | | | | | | | | | | | | | | | | | | | | | | | | | | | | | | | | | | | | | | | | | | | | | | | | | | | | | | | | | | | | | | | | | | | | | | | | | | | | |
| | | | | | | | | | | | | | | | | | | | | | | | | | | | | | | | | | | | | | | | | | | | | | | | | | | | | | | | | | | | | | | | | | | | | | | | | | | | | | | | |
| | | | | | | | | | | | | | | | | | | | | | | | | | | | | | | | | | | | | | | | | | | | | | | | | | | | | | | | | | | | | | | | | | | | | | | | | | | | | | | | |
| | | | | | | | | | | | | | | | | | | | | | | | | | | | | | | | | | | | | | | | | | | | | | | | | | | | | | | | | | | | | | | | | | | | | | | | | | | | | | | | |
| | | | | | | | | | | | | | | | | | | | | | | | | | | | | | | | | | | | | | | | | | | | | | | | | | | | | | | | | | | | | | | | | | | | | | | | | | | | | | | | |
| | | | | | | | | | | | | | | | | | | | | | | | | | | | | | | | | | | | | | | | | | | | | | | | | | | | | | | | | | | | | | | | | | | | | | | | | | | | | | | | |
| | | | | | | | | | | | | | | | | | | | | | | | | | | | | | | | | | | | | | | | | | | | | | | | | | | | | | | | | | | | | | | | | | | | | | | | | | | | | | | | |
| | | | | | | | | | | | | | | | | | | | | | | | | | | | | | | | | | | | | | | | | | | | | | | | | | | | | | | | | | | | | | | | | | | | | | | | | | | | | | | | |
| | | | | | | | | | | | | | | | | | | | | | | | | | | | | | | | | | | | | | | | | | | | | | | | | | | | | | | | | | | | | | | | | | | | | | | | | | | | | | | | |
| | | | | | | | | | | | | | | | | | | | | | | | | | | | | | | | | | | | | | | | | | | | | | | | | | | | | | | | | | | | | | | | | | | | | | | | | | | | | | | | |
| | | | | | | | | | | | | | | | | | | | | | | | | | | | | | | | | | | | | | | | | | | | | | | | | | | | | | | | | | | | | | | | | | | | | | | | | | | | | | | | |
| Post - 0 Miss - 0 Block - 0 | | | | | | | | | | | | | | | | | | | | | | | | | | | | | | | | | | | | | | | | | | | | | | | | | | | | | | | | | | | | | | | | | | | | | | | | | | | | | | | |

| | | | | | | | | | |
|--|--|--|--|--|--|--|--|--|--|
| 9 吴明远 | | | | | | | | | |
| <table border="1"><tr><td></td><td></td><td></td></tr><tr><td></td><td></td><td></td></tr><tr><td></td><td></td><td></td></tr></table> | | | | | | | | | |
| | | | | | | | | | |
| | | | | | | | | | |
| | | | | | | | | | |

| | | | | | | | | | |
|--|-----|-----|-----|-----|-----|-----|-----|-----|-----|
| 24 刘子健 | | | | | | | | | |
| <table border="1"><tr><td>1/3</td><td></td><td>0/3</td></tr><tr><td>3/7</td><td>1/1</td><td>0/2</td></tr><tr><td>0/4</td><td>1/2</td><td>1/4</td></tr></table> | 1/3 | | 0/3 | 3/7 | 1/1 | 0/2 | 0/4 | 1/2 | 1/4 |
| 1/3 | | 0/3 | | | | | | | |
| 3/7 | 1/1 | 0/2 | | | | | | | |
| 0/4 | 1/2 | 1/4 | | | | | | | |

| | | | | | | | | | |
|--|--|-----|--|-----|--|-----|-----|--|-----|
| 28 何喜年 | | | | | | | | | |
| <table border="1"><tr><td></td><td></td><td></td></tr><tr><td>0/1</td><td></td><td>1/3</td></tr><tr><td>0/3</td><td></td><td>0/7</td></tr></table> | | | | 0/1 | | 1/3 | 0/3 | | 0/7 |
| | | | | | | | | | |
| 0/1 | | 1/3 | | | | | | | |
| 0/3 | | 0/7 | | | | | | | |

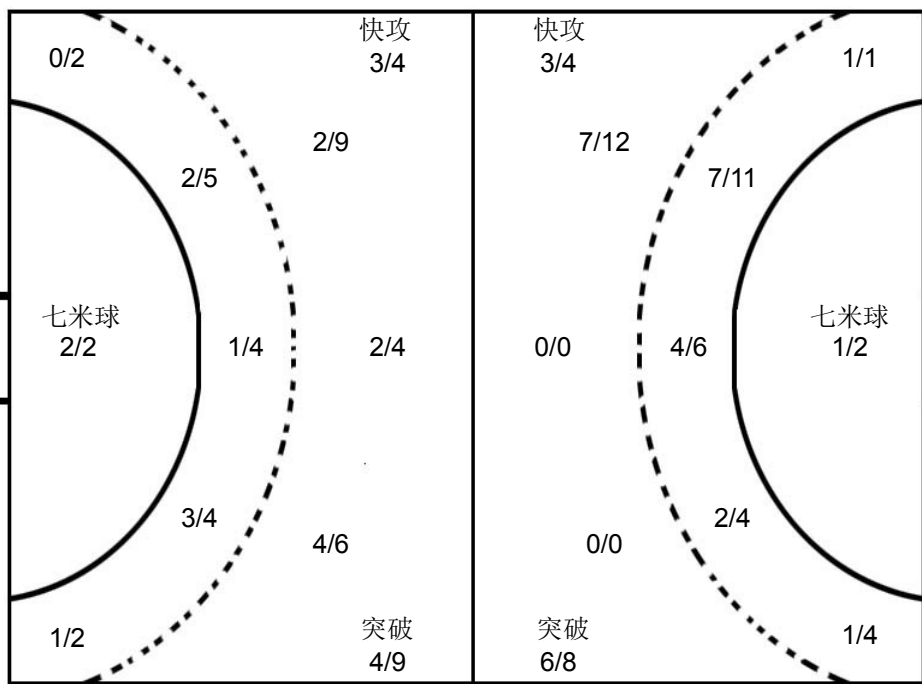

| | | | | | | | | | |
|--|--|--|--|--|--|--|--|--|--|
| 3 王哲一 | | | | | | | | | |
| <table border="1"><tr><td></td><td></td><td></td></tr><tr><td></td><td></td><td></td></tr><tr><td></td><td></td><td></td></tr></table> | | | | | | | | | |
| | | | | | | | | | |
| | | | | | | | | | |
| | | | | | | | | | |

| | | | | | | | | | |
|---|-----|------|-----|-----|-----|------|-----|--|-----|
| 16 马佳鹏 | | | | | | | | | |
| <table border="1"><tr><td>1/4</td><td>0/1</td><td>2/6</td></tr><tr><td>4/4</td><td>2/2</td><td>5/11</td></tr><tr><td>3/6</td><td></td><td>1/8</td></tr></table> | 1/4 | 0/1 | 2/6 | 4/4 | 2/2 | 5/11 | 3/6 | | 1/8 |
| 1/4 | 0/1 | 2/6 | | | | | | | |
| 4/4 | 2/2 | 5/11 | | | | | | | |
| 3/6 | | 1/8 | | | | | | | |

| | | | | | | | | | |
|--|--|--|--|--|--|--|--|--|--|
| | | | | | | | | | |
| <table border="1"><tr><td></td><td></td><td></td></tr><tr><td></td><td></td><td></td></tr><tr><td></td><td></td><td></td></tr></table> | | | | | | | | | |
| | | | | | | | | | |
| | | | | | | | | | |
| | | | | | | | | | |

北京队

| | | | | | | | | | | | | | | | | | | | | | | | | | | | | | | | | | | | | | | | | | | | | | | | | | | | | | | | | | | | | | | | | | | | | | | | | | | | | | | | |
|--|-----------------------------|-----------------------------|-----------------------------|-----------------------------|-----------------------------|-----------------------------|-----------------------------|--|--|--|--|--|---|---|--|---|--|--|---|--|--|--|--|--|--|---|--|--|---|--|---|--|---|---|--|---|---|--|---|---|--|--|--|--|--|--|---|--|--|---|--|--|--|--|--|--|---|--|--|--|--|--|--|--|--|--|--|--|--|---|--|--|---|--|--|--|--|--|--|
| 3 王哲一 | 4 朱广刚 | 6 赵一涵 | 7 卞友山 | 11 李旭 | 15 逯明松 | 16 马佳鹏 | 18 李明远 | | | | | | | | | | | | | | | | | | | | | | | | | | | | | | | | | | | | | | | | | | | | | | | | | | | | | | | | | | | | | | | | | | | | | | | | |
| <table border="1"><tr><td></td><td></td><td>1</td></tr><tr><td></td><td></td><td></td></tr><tr><td>1</td><td></td><td></td></tr></table> | | | 1 | | | | 1 | | | <table border="1"><tr><td></td><td></td><td>1</td></tr><tr><td>4</td><td></td><td>1</td></tr><tr><td></td><td></td><td>2</td></tr></table> | | | 1 | 4 | | 1 | | | 2 | <table border="1"><tr><td></td><td></td><td></td></tr><tr><td></td><td></td><td>1</td></tr><tr><td></td><td></td><td>3</td></tr></table> | | | | | | 1 | | | 3 | <table border="1"><tr><td>1</td><td></td><td></td></tr><tr><td></td><td></td><td>1</td></tr><tr><td>4</td><td></td><td>3</td></tr></table> | 1 | | | | | 1 | 4 | | 3 | <table border="1"><tr><td></td><td></td><td></td></tr><tr><td></td><td></td><td></td></tr><tr><td>1</td><td></td><td></td></tr></table> | | | | | | | 1 | | | <table border="1"><tr><td></td><td></td><td></td></tr><tr><td></td><td></td><td></td></tr><tr><td>2</td><td></td><td></td></tr></table> | | | | | | | 2 | | | <table border="1"><tr><td></td><td></td><td></td></tr><tr><td></td><td></td><td></td></tr><tr><td></td><td></td><td></td></tr></table> | | | | | | | | | | <table border="1"><tr><td></td><td></td><td>1</td></tr><tr><td></td><td></td><td></td></tr><tr><td></td><td></td><td></td></tr></table> | | | 1 | | | | | | |
| | | 1 | | | | | | | | | | | | | | | | | | | | | | | | | | | | | | | | | | | | | | | | | | | | | | | | | | | | | | | | | | | | | | | | | | | | | | | | | | | | | |
| | | | | | | | | | | | | | | | | | | | | | | | | | | | | | | | | | | | | | | | | | | | | | | | | | | | | | | | | | | | | | | | | | | | | | | | | | | | | | | | |
| 1 | | | | | | | | | | | | | | | | | | | | | | | | | | | | | | | | | | | | | | | | | | | | | | | | | | | | | | | | | | | | | | | | | | | | | | | | | | | | | | | |
| | | 1 | | | | | | | | | | | | | | | | | | | | | | | | | | | | | | | | | | | | | | | | | | | | | | | | | | | | | | | | | | | | | | | | | | | | | | | | | | | | | |
| 4 | | 1 | | | | | | | | | | | | | | | | | | | | | | | | | | | | | | | | | | | | | | | | | | | | | | | | | | | | | | | | | | | | | | | | | | | | | | | | | | | | | |
| | | 2 | | | | | | | | | | | | | | | | | | | | | | | | | | | | | | | | | | | | | | | | | | | | | | | | | | | | | | | | | | | | | | | | | | | | | | | | | | | | | |
| | | | | | | | | | | | | | | | | | | | | | | | | | | | | | | | | | | | | | | | | | | | | | | | | | | | | | | | | | | | | | | | | | | | | | | | | | | | | | | | |
| | | 1 | | | | | | | | | | | | | | | | | | | | | | | | | | | | | | | | | | | | | | | | | | | | | | | | | | | | | | | | | | | | | | | | | | | | | | | | | | | | | |
| | | 3 | | | | | | | | | | | | | | | | | | | | | | | | | | | | | | | | | | | | | | | | | | | | | | | | | | | | | | | | | | | | | | | | | | | | | | | | | | | | | |
| 1 | | | | | | | | | | | | | | | | | | | | | | | | | | | | | | | | | | | | | | | | | | | | | | | | | | | | | | | | | | | | | | | | | | | | | | | | | | | | | | | |
| | | 1 | | | | | | | | | | | | | | | | | | | | | | | | | | | | | | | | | | | | | | | | | | | | | | | | | | | | | | | | | | | | | | | | | | | | | | | | | | | | | |
| 4 | | 3 | | | | | | | | | | | | | | | | | | | | | | | | | | | | | | | | | | | | | | | | | | | | | | | | | | | | | | | | | | | | | | | | | | | | | | | | | | | | | |
| | | | | | | | | | | | | | | | | | | | | | | | | | | | | | | | | | | | | | | | | | | | | | | | | | | | | | | | | | | | | | | | | | | | | | | | | | | | | | | | |
| | | | | | | | | | | | | | | | | | | | | | | | | | | | | | | | | | | | | | | | | | | | | | | | | | | | | | | | | | | | | | | | | | | | | | | | | | | | | | | | |
| 1 | | | | | | | | | | | | | | | | | | | | | | | | | | | | | | | | | | | | | | | | | | | | | | | | | | | | | | | | | | | | | | | | | | | | | | | | | | | | | | | |
| | | | | | | | | | | | | | | | | | | | | | | | | | | | | | | | | | | | | | | | | | | | | | | | | | | | | | | | | | | | | | | | | | | | | | | | | | | | | | | | |
| | | | | | | | | | | | | | | | | | | | | | | | | | | | | | | | | | | | | | | | | | | | | | | | | | | | | | | | | | | | | | | | | | | | | | | | | | | | | | | | |
| 2 | | | | | | | | | | | | | | | | | | | | | | | | | | | | | | | | | | | | | | | | | | | | | | | | | | | | | | | | | | | | | | | | | | | | | | | | | | | | | | | |
| | | | | | | | | | | | | | | | | | | | | | | | | | | | | | | | | | | | | | | | | | | | | | | | | | | | | | | | | | | | | | | | | | | | | | | | | | | | | | | | |
| | | | | | | | | | | | | | | | | | | | | | | | | | | | | | | | | | | | | | | | | | | | | | | | | | | | | | | | | | | | | | | | | | | | | | | | | | | | | | | | |
| | | | | | | | | | | | | | | | | | | | | | | | | | | | | | | | | | | | | | | | | | | | | | | | | | | | | | | | | | | | | | | | | | | | | | | | | | | | | | | | |
| | | 1 | | | | | | | | | | | | | | | | | | | | | | | | | | | | | | | | | | | | | | | | | | | | | | | | | | | | | | | | | | | | | | | | | | | | | | | | | | | | | |
| | | | | | | | | | | | | | | | | | | | | | | | | | | | | | | | | | | | | | | | | | | | | | | | | | | | | | | | | | | | | | | | | | | | | | | | | | | | | | | | |
| | | | | | | | | | | | | | | | | | | | | | | | | | | | | | | | | | | | | | | | | | | | | | | | | | | | | | | | | | | | | | | | | | | | | | | | | | | | | | | | |
| Post - 0 Miss - 0 Block - 0 | Post - 1 Miss - 1 Block - 4 | Post - 1 Miss - 0 Block - 0 | Post - 0 Miss - 0 Block - 0 | Post - 0 Miss - 0 Block - 0 | Post - 2 Miss - 0 Block - 0 | Post - 0 Miss - 0 Block - 0 | Post - 0 Miss - 1 Block - 0 | | | | | | | | | | | | | | | | | | | | | | | | | | | | | | | | | | | | | | | | | | | | | | | | | | | | | | | | | | | | | | | | | | | | | | | | |
| 19 陈旭 | 23 刘帅 | 25 张斌 | 26 吴锐樊 | 35 高云健 | 36 王鹏皓 | | | | | | | | | | | | | | | | | | | | | | | | | | | | | | | | | | | | | | | | | | | | | | | | | | | | | | | | | | | | | | | | | | | | | | | | | | |
| <table border="1"><tr><td></td><td></td><td></td></tr><tr><td></td><td></td><td></td></tr><tr><td></td><td></td><td></td></tr></table> | | | | | | | | | | <table border="1"><tr><td></td><td></td><td></td></tr><tr><td></td><td></td><td></td></tr><tr><td></td><td></td><td>1</td></tr></table> | | | | | | | | | 1 | <table border="1"><tr><td></td><td></td><td></td></tr><tr><td></td><td></td><td></td></tr><tr><td></td><td></td><td></td></tr></table> | | | | | | | | | | <table border="1"><tr><td></td><td></td><td>1</td></tr><tr><td>1</td><td></td><td>1</td></tr><tr><td></td><td></td><td>1</td></tr></table> | | | 1 | 1 | | 1 | | | 1 | <table border="1"><tr><td></td><td></td><td></td></tr><tr><td></td><td></td><td></td></tr><tr><td></td><td></td><td></td></tr></table> | | | | | | | | | | <table border="1"><tr><td></td><td></td><td></td></tr><tr><td></td><td></td><td></td></tr><tr><td></td><td></td><td></td></tr></table> | | | | | | | | | | <table border="1"><tr><td></td><td></td><td></td></tr><tr><td></td><td></td><td></td></tr><tr><td></td><td></td><td></td></tr></table> | | | | | | | | | | <table border="1"><tr><td></td><td></td><td></td></tr><tr><td></td><td></td><td></td></tr><tr><td></td><td></td><td></td></tr></table> | | | | | | | | | |
| | | | | | | | | | | | | | | | | | | | | | | | | | | | | | | | | | | | | | | | | | | | | | | | | | | | | | | | | | | | | | | | | | | | | | | | | | | | | | | | |
| | | | | | | | | | | | | | | | | | | | | | | | | | | | | | | | | | | | | | | | | | | | | | | | | | | | | | | | | | | | | | | | | | | | | | | | | | | | | | | | |
| | | | | | | | | | | | | | | | | | | | | | | | | | | | | | | | | | | | | | | | | | | | | | | | | | | | | | | | | | | | | | | | | | | | | | | | | | | | | | | | |
| | | | | | | | | | | | | | | | | | | | | | | | | | | | | | | | | | | | | | | | | | | | | | | | | | | | | | | | | | | | | | | | | | | | | | | | | | | | | | | | |
| | | | | | | | | | | | | | | | | | | | | | | | | | | | | | | | | | | | | | | | | | | | | | | | | | | | | | | | | | | | | | | | | | | | | | | | | | | | | | | | |
| | | 1 | | | | | | | | | | | | | | | | | | | | | | | | | | | | | | | | | | | | | | | | | | | | | | | | | | | | | | | | | | | | | | | | | | | | | | | | | | | | | |
| | | | | | | | | | | | | | | | | | | | | | | | | | | | | | | | | | | | | | | | | | | | | | | | | | | | | | | | | | | | | | | | | | | | | | | | | | | | | | | | |
| | | | | | | | | | | | | | | | | | | | | | | | | | | | | | | | | | | | | | | | | | | | | | | | | | | | | | | | | | | | | | | | | | | | | | | | | | | | | | | | |
| | | | | | | | | | | | | | | | | | | | | | | | | | | | | | | | | | | | | | | | | | | | | | | | | | | | | | | | | | | | | | | | | | | | | | | | | | | | | | | | |
| | | 1 | | | | | | | | | | | | | | | | | | | | | | | | | | | | | | | | | | | | | | | | | | | | | | | | | | | | | | | | | | | | | | | | | | | | | | | | | | | | | |
| 1 | | 1 | | | | | | | | | | | | | | | | | | | | | | | | | | | | | | | | | | | | | | | | | | | | | | | | | | | | | | | | | | | | | | | | | | | | | | | | | | | | | |
| | | 1 | | | | | | | | | | | | | | | | | | | | | | | | | | | | | | | | | | | | | | | | | | | | | | | | | | | | | | | | | | | | | | | | | | | | | | | | | | | | | |
| | | | | | | | | | | | | | | | | | | | | | | | | | | | | | | | | | | | | | | | | | | | | | | | | | | | | | | | | | | | | | | | | | | | | | | | | | | | | | | | |
| | | | | | | | | | | | | | | | | | | | | | | | | | | | | | | | | | | | | | | | | | | | | | | | | | | | | | | | | | | | | | | | | | | | | | | | | | | | | | | | |
| | | | | | | | | | | | | | | | | | | | | | | | | | | | | | | | | | | | | | | | | | | | | | | | | | | | | | | | | | | | | | | | | | | | | | | | | | | | | | | | |
| | | | | | | | | | | | | | | | | | | | | | | | | | | | | | | | | | | | | | | | | | | | | | | | | | | | | | | | | | | | | | | | | | | | | | | | | | | | | | | | |
| | | | | | | | | | | | | | | | | | | | | | | | | | | | | | | | | | | | | | | | | | | | | | | | | | | | | | | | | | | | | | | | | | | | | | | | | | | | | | | | |
| | | | | | | | | | | | | | | | | | | | | | | | | | | | | | | | | | | | | | | | | | | | | | | | | | | | | | | | | | | | | | | | | | | | | | | | | | | | | | | | |
| | | | | | | | | | | | | | | | | | | | | | | | | | | | | | | | | | | | | | | | | | | | | | | | | | | | | | | | | | | | | | | | | | | | | | | | | | | | | | | | |
| | | | | | | | | | | | | | | | | | | | | | | | | | | | | | | | | | | | | | | | | | | | | | | | | | | | | | | | | | | | | | | | | | | | | | | | | | | | | | | | |
| | | | | | | | | | | | | | | | | | | | | | | | | | | | | | | | | | | | | | | | | | | | | | | | | | | | | | | | | | | | | | | | | | | | | | | | | | | | | | | | |
| | | | | | | | | | | | | | | | | | | | | | | | | | | | | | | | | | | | | | | | | | | | | | | | | | | | | | | | | | | | | | | | | | | | | | | | | | | | | | | | |
| | | | | | | | | | | | | | | | | | | | | | | | | | | | | | | | | | | | | | | | | | | | | | | | | | | | | | | | | | | | | | | | | | | | | | | | | | | | | | | | |
| | | | | | | | | | | | | | | | | | | | | | | | | | | | | | | | | | | | | | | | | | | | | | | | | | | | | | | | | | | | | | | | | | | | | | | | | | | | | | | | |
| Post - 0 Miss - 0 Block - 0 | Post - 0 Miss - 0 Block - 0 | Post - 0 Miss - 0 Block - 0 | Post - 0 Miss - 2 Block - 0 | Post - 0 Miss - 0 Block - 0 | Post - 0 Miss - 0 Block - 0 | | | | | | | | | | | | | | | | | | | | | | | | | | | | | | | | | | | | | | | | | | | | | | | | | | | | | | | | | | | | | | | | | | | | | | | | | | |

注释: Post=击柱 Miss=射失 Block=被封



预赛 Group B
青年男子 全国比赛

2016年“体彩杯”全国手球男子青年锦标赛

| | | | | | | | | | | | | | |
|------------------------|-----------------------------------|---|---------------------|---------------------------|----------------|--|--|--|-----------|---|----|----------|----|
| Team A A 安徽队 | | Team B B 四川队 | | Match Number 27 | | | | | | | | | |
| played in China | | in the hall 重庆万州 | | on 25/03/2016 | | | | | | | | | |
| | | | | at 13:00 hours | | | | | | | | | |
| Spectators | | | | | | | | | | | | | |
| Half-time (30') | A 14 | B 12 | End of playing time | A 32 | B 31 | | | | | | | | |
| 1st extra time | | | | 2nd extra time | | | | | | | | | |
| | | | | After penalty throws | | | | | | | | | |
| | | | | | | | | | | | | | |
| Number of 7 m | A 0/0 | Team time-out | | Team time-out | | | | | | | | | |
| | | Full name of players and officials | | Number of 7 m | | | | | | | | | |
| | | | | | | | | | | | | | |
| No. | Team A | | | | Team B | | | | G | W | 2' | D | DR |
| 1 | 郭世伟 | | | | 宋继强 | | | | | | | | |
| 2 | 金勇峰 | | | | 刘赵梁 | | | | 5 | | | | |
| 9 | 陈开勇 | | | | 王凯 | | | | 3 | | | | |
| 17 | 王巨柱 | | | | 仇瑞祥 | | | | | | | | |
| 18 | 李双 | | | | 罗尧尧 | | | | 11 | | | | |
| 19 | 何山 | | | | 许翔宇 | | | | 1 | | | | |
| 21 | 李明 | | | | 徐彦昊 | | | | 6 | 1 | | | |
| 24 | 徐安格 | | | | 张天豪 | | | | | | | | |
| 25 | 李文哲 | | | | 刘树豪 | | | | | | | | |
| 26 | 程浩然 | | | | 尹文珂 | | | | | | | | |
| 27 | 王长旭 | | | | 徐逸 | | | | | | | | |
| 28 | 丁浩然 | | | | 谢庆龙 | | | | 3 | | 1 | | |
| 32 | 许浩翔 | | | | 张睿梁 | | | | | | | | |
| 33 | 姚紫祥 | | | | 庞连康 | | | | 2 | 1 | 1 | | |
| 41 | 刘润民 | | | | 张文健 | | | | | | | | |
| 42 | 王成龙 | | | | 曹修庆 | | | | | | | | |
| A | 王来黔 (主教练) | | | | B | | | | 张文韬 (主教练) | | | | |
| B | 陆万红 | | | | | | | | | | | | |
| C | 吴翔 | | | | | | | | | | | | |
| A | | Signature of Responsible Official of the Teams (Off. A) | | | | | | | | | | B | |
| TP | Remarks of Referee / CHA Official | | | | | | | | | | | TP | |

Signatures

| | | | | |
|------------------|-----------|-----------|--|--|
| Referees | 倪震 (CHN) | 马晓晔 (CHN) | | |
| Techn. Delegates | 李英才 (CHN) | | | |
| CHA Official | 吴瑞亭 (CHN) | | | |

Note: Number of 7m Throws Awarded to Team A and B, Goals (G), Warnings (W), Suspensions (2'), Direct Disqualification (D), Disqualification with Report (DR) and Team Penalty (TP).

Table Officials:

Statisticians: 李双

刘永欢





2016年“体彩杯”全国手球男子青年锦标赛 竞赛技术统计(媒体表)

| | | | | | | |
|----------------|-----------|------------|----|-----------|------------------|-----------|
| 预赛 | 组别 | B | 轮次 | 5 | 场次 | 27 |
| 重庆万州 | | 25/03/2016 | | | 201602027-51-1/1 | |
| 安徽队 | 安徽 | 32 | vs | 31 | 四川 | 四川队 |
| 14 : 12 | | | | | | |

| 裁判员 | | 倪震 (CHN) | | | | | | | | | | | / | | | | | | | | | | | 马晓晔 (CHN) | | | | | | | | | | |
|---------------|-----|----------|-------|-----|------|-----|-----|-----|-------|------|----|----|----|----|--------|----------|-------|------|-------|-----|---|-----|--|-----------|--|--|--|--|--|--|--|--|--|--|
| 安徽 | | 远 | 近 | 边 | 快 | 突 | 任意 | 7m | 合计 | % | 助攻 | 失误 | 警告 | 2' | D & DR | 安徽 | | 比赛进程 | | 四川 | | | | | | | | | | | | | | |
| 主教练：王来黔 | | 射 | 射 | 射 | 攻 | 破 | 球 | 球 | | | | | | | | | | | | | | | | | | | | | | | | | | |
| 1 | 郭世伟 | 2/4 | 2/3 | | | 1/1 | | | 5/8 | 62.5 | | 5 | | 1 | | 1st Half | | 0 | 02:24 | 1 | 3 | 刘赵梁 | | | | | | | | | | | | |
| 2 | 金勇峰 | 2/3 | 2/3 | 1/2 | 2/2 | 1/1 | | | 8/11 | 72.7 | 1 | 2 | 1 | | | 0 | 03:10 | 2 | 8 | 罗尧尧 | | | | | | | | | | | | | | |
| 9 | 陈开勇 | 0/1 | 1/1 | | 5/6 | | | | 6/8 | 75.0 | | 1 | | | | 1 | 03:30 | 2 | | | | | | | | | | | | | | | | |
| 17 | 王巨柱 | 6/12 | 2/3 | | 0/2 | | 0/2 | | 8/19 | 42.1 | | 4 | | | | 1 | 04:10 | 3 | 8 | 罗尧尧 | | | | | | | | | | | | | | |
| 18 | 李双 | 1/6 | 4/4 | 0/1 | | | | | 5/11 | 45.5 | 5 | 3 | 1 | | | 1 | 05:08 | 4 | 5 | 王凯 | | | | | | | | | | | | | | |
| 19 | 何山 | | | 0/3 | | | | | 0/3 | 0.0 | | 2 | 1 | | | 1 | 05:18 | 4 | 4 | | | | | | | | | | | | | | | |
| 21 | 李明 | | | | | | | | | | | | | | | 3 | 06:16 | 4 | 5 | | | | | | | | | | | | | | | |
| 24 | 徐安格 | | | | | | | | | | | | | | | 3 | 10:38 | 5 | 19 | 庞连康 | | | | | | | | | | | | | | |
| 25 | 李文哲 | | | | | | | | | | | | | | | 3 | 11:53 | 6 | 8 | 罗尧尧 | | | | | | | | | | | | | | |
| 26 | 程浩然 | | | | | | | | | | | | | | | 4 | 12:06 | 6 | 6 | | | | | | | | | | | | | | | |
| 27 | 王长旭 | | | | | | | | | | | | | | | 4 | 12:39 | 7 | 9 | 许翔宇 | | | | | | | | | | | | | | |
| 28 | 丁浩然 | | | | | | | | | | | | | | | 5 | 13:11 | 7 | 7 | | | | | | | | | | | | | | | |
| 32 | 许浩翔 | | | | | | | | | | | | | | | 5 | 14:11 | 8 | 8 | 罗尧尧 | | | | | | | | | | | | | | |
| 33 | 姚紫祥 | | | | | | | | | | | | | | | 6 | 15:38 | 8 | 8 | | | | | | | | | | | | | | | |
| 41 | 刘润民 | | | | | | | | | | | | | | | 6 | 16:57 | 9 | 8 | 罗尧尧 | | | | | | | | | | | | | | |
| 42 | 王成龙 | | | | | | | | | | | | | | | 7 | 19:50 | 9 | 9 | | | | | | | | | | | | | | | |
| 运动员 合计 | | 11/26 | 11/14 | 1/6 | 7/10 | 2/2 | 0/2 | | 32/60 | 53.3 | 6 | 18 | 3 | 1 | | 7 | 20:51 | 9 | 9 | | | | | | | | | | | | | | | |
| 1 | 郭世伟 | | | | | | | | | | | | | | | 8 | 21:45 | 9 | 9 | | | | | | | | | | | | | | | |
| 2 | 金勇峰 | | | | | | | | | | | | | | | 9 | 22:19 | 10 | 19 | 庞连康 | | | | | | | | | | | | | | |
| 21 | 李明 | 7/13 | 6/14 | 3/9 | 3/5 | 2/4 | | 1/8 | 22/53 | 41.5 | | 1 | | | | 2 | 23:09 | 10 | 23 | 刘赵梁 | | | | | | | | | | | | | | |
| 守门员 合计 | | 7/13 | 6/14 | 3/9 | 3/5 | 2/4 | | 1/8 | 22/53 | 41.5 | | 1 | | 1 | | 10 | 23:20 | 11 | 3 | 刘赵梁 | | | | | | | | | | | | | | |
| | | | | | | | | | | | | | | | | 11 | 23:33 | 11 | | | | | | | | | | | | | | | | |
| | | | | | | | | | | | | | | | | 12 | 24:28 | 11 | | | | | | | | | | | | | | | | |
| | | | | | | | | | | | | | | | | 12 | 25:08 | 12 | 3 | 刘赵梁 | | | | | | | | | | | | | | |
| | | | | | | | | | | | | | | | | 13 | 26:54 | 12 | | | | | | | | | | | | | | | | |
| | | | | | | | | | | | | | | | | 14 | 29:53 | 12 | | | | | | | | | | | | | | | | |
| | | | | | | | | | | | | | | | | 2nd Half | | 15 | 00:23 | 12 | | | | | | | | | | | | | | |
| | | | | | | | | | | | | | | | | 16 | 01:27 | 12 | | | | | | | | | | | | | | | | |
| | | | | | | | | | | | | | | | | 16 | 02:29 | 13 | 8 | 罗尧尧 | | | | | | | | | | | | | | |
| | | | | | | | | | | | | | | | | 16 | 03:40 | 14 | 10 | 徐彦昊 | | | | | | | | | | | | | | |
| | | | | | | | | | | | | | | | | 17 | 04:57 | 14 | | | | | | | | | | | | | | | | |
| | | | | | | | | | | | | | | | | 17 | 05:28 | 15 | 8 | 罗尧尧 | | | | | | | | | | | | | | |
| | | | | | | | | | | | | | | | | 17 | 05:50 | 16 | 10 | 徐彦昊 | | | | | | | | | | | | | | |
| | | | | | | | | | | | | | | | | 17 | 07:06 | 17 | 3 | 刘赵梁 | | | | | | | | | | | | | | |
| | | | | | | | | | | | | | | | | 17 | 07:30 | 17 | | | | | | | | | | | | | | | | |
| | | | | | | | | | | | | | | | | 18 | 07:40 | 18 | 3 | 刘赵梁 | | | | | | | | | | | | | | |
| | | | | | | | | | | | | | | | | 18 | 08:23 | 19 | 8 | 罗尧尧 | | | | | | | | | | | | | | |
| | | | | | | | | | | | | | | | | 19 | 08:45 | 19 | | | | | | | | | | | | | | | | |
| | | | | | | | | | | | | | | | | 20 | 10:12 | 20 | 8 | 罗尧尧 | | | | | | | | | | | | | | |
| | | | | | | | | | | | | | | | | 20 | 12:44 | 20 | | | | | | | | | | | | | | | | |
| | | | | | | | | | | | | | | | | 21 | 13:41 | 21 | 17 | 谢庆龙 | | | | | | | | | | | | | | |
| | | | | | | | | | | | | | | | | 21 | 14:21 | 22 | 10 | 徐彦昊 | | | | | | | | | | | | | | |
| | | | | | | | | | | | | | | | | 22 | 14:46 | 22 | | | | | | | | | | | | | | | | |
| | | | | | | | | | | | | | | | | 23 | 15:25 | 22 | | | | | | | | | | | | | | | | |
| | | | | | | | | | | | | | | | | 23 | 15:57 | 23 | 5 | 王凯 | | | | | | | | | | | | | | |
| | | | | | | | | | | | | | | | | 24 | 17:07 | 23 | | | | | | | | | | | | | | | | |
| | | | | | | | | | | | | | | | | 24 | 17:47 | 24 | 17 | 谢庆龙 | | | | | | | | | | | | | | |
| | | | | | | | | | | | | | | | | 25 | 19:13 | 24 | | | | | | | | | | | | | | | | |
| | | | | | | | | | | | | | | | | 26 | 20:36 | 24 | | | | | | | | | | | | | | | | |
| | | | | | | | | | | | | | | | | 27 | 21:06 | 24 | | | | | | | | | | | | | | | | |
| | | | | | | | | | | | | | | | | 27 | 21:34 | 25 | 10 | 徐彦昊 | | | | | | | | | | | | | | |
| | | | | | | | | | | | | | | | | 28 | 21:49 | 25 | | | | | | | | | | | | | | | | |
| | | | | | | | | | | | | | | | | 29 | 22:48 | 25 | | | | | | | | | | | | | | | | |
| | | | | | | | | | | | | | | | | 30 | 23:30 | 25 | | | | | | | | | | | | | | | | |
| | | | | | | | | | | | | | | | | 30 | 24:01 | 26 | 8 | 罗尧尧 | | | | | | | | | | | | | | |
| | | | | | | | | | | | | | | | | 31 | 25:52 | 26 | | | | | | | | | | | | | | | | |
| | | | | | | | | | | | | | | | | 31 | 26:28 | 27 | 10 | 徐彦昊 | | | | | | | | | | | | | | |
| | | | | | | | | | | | | | | | | 31 | 27:35 | 28 | 17 | 谢庆龙 | | | | | | | | | | | | | | |
| | | | | | | | | | | | | | | | | 32 | 28:06 | 28 | | | | | | | | | | | | | | | | |
| | | | | | | | | | | | | | | | | 32 | 28:22 | 29 | 8 | 罗尧尧 | | | | | | | | | | | | | | |
| | | | | | | | | | | | | | | | | 32 | 28:58 | 30 | 10 | 徐彦昊 | | | | | | | | | | | | | | |
| | | | | | | | | | | | | | | | | 32 | 29:54 | 31 | 5 | 王凯 | | | | | | | | | | | | | | |

场上队员：得分 / 射门

守门员：救球 / 射门

| | | | | | | | | | | | | | |
|----|------------|--|----|--------------|--|-----|------------|--|-----|----------|--|----|---------|
| 快攻 | Fast Break | | 突破 | Breakthrough | | 任意球 | Free Throw | | 7M球 | 7M Throw | | 助攻 | Assist |
| 警告 | Warning | | 失误 | Error | | 2' | Suspension | | D | 取消资格 | | DR | 取消资格+报告 |





2016年“体彩杯”全国手球男子青年锦标赛 图式比赛技术统计表

轮次 5

场次 27

201602027-21-1/1

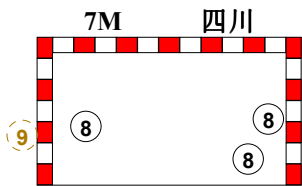
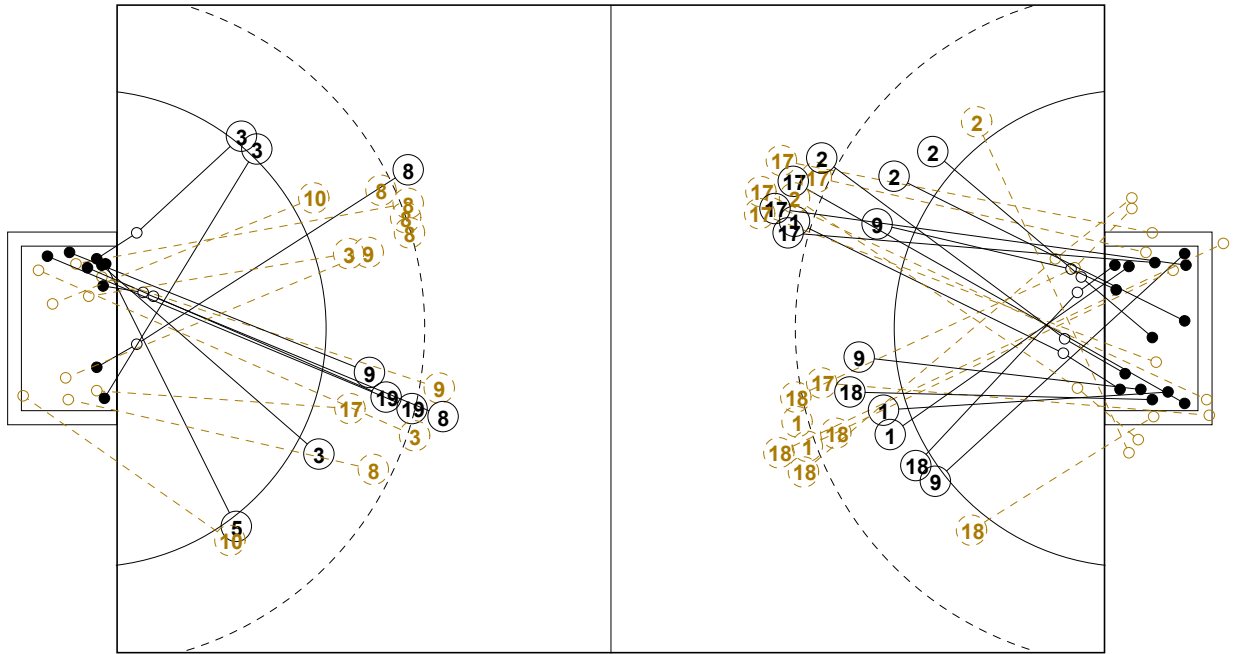

1st Half
12 : 14

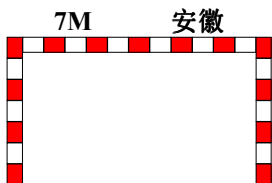
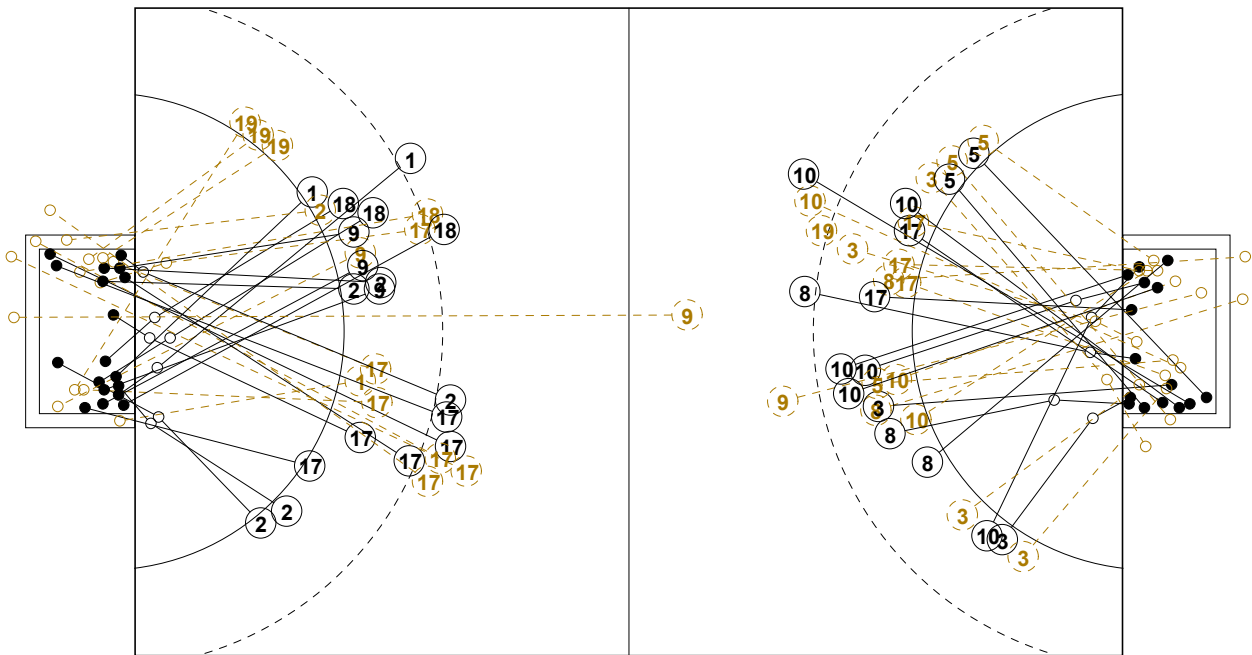
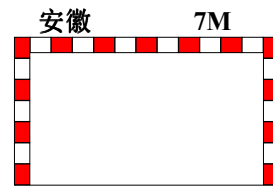

2nd Half
32 : 31

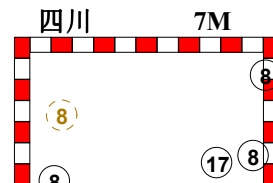



2016年“体彩杯”全国手球男子青年锦标赛

个人/全队技术统计表

正式表
手球
青年男子预赛
轮次 5组别 B
场次 27201602027-14-1/2
重庆万州
25/03/2016 13:00

| 号码 | 姓名 | 远射 | 近射 | 边射 | 快攻 | 突破 | 任意 | 7M | 合计 | % | 助攻 | 失误 | 警告 | 2' | 取消 | 时间 |
|----------------|-----|-------|-------|-----|------|-----|-----|-----|-------|-------|----|----|----|----|----|----------|
| 安徽队(安徽) | | | | | | | | | | | | | | | | |
| <i>(场上队员)</i> | | | | | | | | | | | | | | | | |
| 1 | 郭世伟 | 2/4 | 2/3 | | | 1/1 | | | 5/8 | 62.5% | | 5 | | 1 | | 02:00:00 |
| 2 | 金勇峰 | 2/3 | 2/3 | 1/2 | 2/2 | 1/1 | | | 8/11 | 72.7% | 1 | 2 | 1 | | | 01:00:00 |
| 9 | 陈开勇 | 0/1 | 1/1 | | 5/6 | | | | 6/8 | 75.0% | | 1 | | | | 01:00:00 |
| 17 | 王巨柱 | 6/12 | 2/3 | | 0/2 | | 0/2 | | 8/19 | 42.1% | | 4 | | | | 01:00:00 |
| 18 | 李双 | 1/6 | 4/4 | 0/1 | | | | | 5/11 | 45.5% | 5 | 3 | 1 | | | 01:00:00 |
| 19 | 何山 | | | 0/3 | | | | | 0/3 | 0.0% | | 2 | 1 | | | 01:00:00 |
| 21 | 李明 | | | | | | | | | 0.0% | | 1 | | | | 01:00:00 |
| 24 | 徐安格 | | | | | | | | | 0.0% | | | | | | 00:00:00 |
| 25 | 李文哲 | | | | | | | | | 0.0% | | | | | | 00:00:00 |
| 26 | 程浩然 | | | | | | | | | 0.0% | | | | | | 00:00:00 |
| 27 | 王长旭 | | | | | | | | | 0.0% | | | | | | 00:00:00 |
| 28 | 丁浩然 | | | | | | | | | 0.0% | | | | | | 00:00:00 |
| 32 | 许浩翔 | | | | | | | | | 0.0% | | | | | | 00:00:00 |
| 33 | 姚紫祥 | | | | | | | | | 0.0% | | | | | | 00:00:00 |
| 41 | 刘润民 | | | | | | | | | 0.0% | | | | | | 00:00:00 |
| 42 | 王成龙 | | | | | | | | | 0.0% | | | | | | 00:00:00 |
| 合计 | | 11/26 | 11/14 | 1/6 | 7/10 | 2/2 | 0/2 | | 32/60 | 53.3% | 6 | 18 | 3 | 1 | | |
| <i>(守门员)</i> | | | | | | | | | | | | | | | | |
| 1 | 郭世伟 | | | | | | | | | 0.0% | | | | 1 | | 02:00:00 |
| 2 | 金勇峰 | | | | | | | | | 0.0% | | | | | | 01:00:00 |
| 21 | 李明 | 7/13 | 6/14 | 3/9 | 3/5 | 2/4 | | 1/8 | 22/53 | 41.5% | | 1 | | | | 01:00:00 |
| 合计 | | 7/13 | 6/14 | 3/9 | 3/5 | 2/4 | | 1/8 | 22/53 | 41.5% | | 1 | | 1 | | |

场上队员：得分/射门

守门员：救球/射门

| 全队合计 | 得分 | 被救 | 射失 | 击柱 | 封球 | 合计 | % |
|------|----|----|----|----|----|----|--------|
| 远射 | 11 | 5 | 6 | 2 | 2 | 26 | 42.3% |
| 近射 | 11 | 1 | | 2 | | 14 | 78.6% |
| 边射 | 1 | 3 | 1 | 1 | | 6 | 16.7% |
| 快攻 | 7 | 2 | | 1 | | 10 | 70.0% |
| 突破 | 2 | | | | | 2 | 100.0% |
| 任意 | | | 1 | 1 | | 2 | 0.0% |
| 7M | | | | | | | 0.0% |





2016年“体彩杯”全国手球男子青年锦标赛

个人/全队技术统计表

正式表
手球
青年男子预赛
轮次 5组别 B
场次 27201602027-14-2/2
重庆万州
25/03/2016 13:00

| 号码 | 姓名 | 远射 | 近射 | 边射 | 快攻 | 突破 | 任意 | 7M | 合计 | % | 助攻 | 失误 | 警告 | 2' | 取消 | 时间 |
|----------------|-----|------|------|-----|-----|-----|----|-----|-------|-------|----|----|----|----|----|----------|
| 四川队(四川) | | | | | | | | | | | | | | | | |
| <i>(上场队员)</i> | | | | | | | | | | | | | | | | |
| 1 | 宋继强 | | | | | | | | | 0.0% | | | | | | 00:48:20 |
| 3 | 刘赵梁 | 0/2 | 1/3 | 3/4 | 1/2 | | | | 5/11 | 45.5% | | 2 | | | | 01:00:00 |
| 5 | 王凯 | | 1/2 | 2/3 | 0/1 | | | | 3/6 | 50.0% | 1 | | | | | 01:00:00 |
| 7 | 仇瑞祥 | | | | | | | | | 0.0% | | | | | | 00:00:00 |
| 8 | 罗尧尧 | 3/8 | 1/2 | | 0/1 | 1/1 | | 6/7 | 11/19 | 57.9% | 1 | 5 | | | | 00:59:33 |
| 9 | 许翔宇 | 0/2 | 1/2 | | | | | 0/1 | 1/5 | 20.0% | 1 | 4 | | | | 00:30:11 |
| 10 | 徐彦昊 | 2/3 | 1/1 | 1/2 | 1/2 | 1/3 | | | 6/11 | 54.5% | 3 | 2 | 1 | | | 00:36:31 |
| 11 | 张天豪 | | | | | | | | | 0.0% | | | | | | 00:00:00 |
| 12 | 刘树豪 | | | | | | | | | 0.0% | | | | | | 00:11:40 |
| 13 | 尹文珂 | | | | | | | | | 0.0% | | | | | | 00:00:00 |
| 15 | 徐逸 | | | | | | | | | 0.0% | | | | | | 00:00:00 |
| 17 | 谢庆龙 | | 2/6 | | | | | 1/1 | 3/7 | 42.9% | | 4 | | 1 | | 01:09:48 |
| 18 | 张睿梁 | | | | | | | | | 0.0% | | | | | | 00:00:00 |
| 19 | 庞连康 | 1/2 | 1/1 | | | | | | 2/3 | 66.7% | 1 | 4 | 1 | 1 | | 01:00:00 |
| 20 | 张文健 | | | | | | | | | 0.0% | | | | | | 00:00:00 |
| 21 | 曹修庆 | | | | | | | | | 0.0% | | | | | | 00:00:00 |
| 合计 | | 6/17 | 8/17 | 6/9 | 2/6 | 2/4 | | 7/9 | 31/62 | 50.0% | 7 | 21 | 2 | 2 | | |
| <i>(守门员)</i> | | | | | | | | | | | | | | | | |
| 1 | 宋继强 | 4/13 | 1/12 | 3/4 | 2/8 | 0/2 | | | 10/39 | 25.6% | | | | | | 00:48:20 |
| 11 | 张天豪 | | | | | | | | | 0.0% | | | | | | 00:00:00 |
| 12 | 刘树豪 | 1/3 | | | 0/1 | | | | 1/4 | 25.0% | | | | | | 00:11:40 |
| 合计 | | 5/16 | 1/12 | 3/4 | 2/9 | 0/2 | | | 11/43 | 25.6% | | | | | | |

场上队员：得分/射门

守门员：救球/射门

| 全队合计 | 得分 | 被救 | 射失 | 击柱 | 封球 | 合计 | % |
|------|----|----|----|----|----|----|-------|
| 远射 | 6 | 7 | | | 4 | 17 | 35.3% |
| 近射 | 8 | 6 | 2 | 1 | | 17 | 47.1% |
| 边射 | 6 | 3 | | | | 9 | 66.7% |
| 快攻 | 2 | 3 | 1 | | | 6 | 33.3% |
| 突破 | 2 | 2 | | | | 4 | 50.0% |
| 任意 | | | | | | | 0.0% |
| 7M | 7 | 1 | 1 | | | 9 | 77.8% |





2016年“体彩杯”全国手球男子青年锦标赛

图式射门区域统计

轮次 5 场次 27

201602027-41-1/1

安徽队

| | | | | | | | | | | | | | | | | | | | | | | | | | | | | | | | | | | | | | | | | | | | | | | | | | | | | | | | | | | | | | | | | | | | | | | | | | | | | | | | |
|---|-----------------------------|-----------------------------|-----------------------------|-----------------------------|-----------------------------|-----------------------------|-----------------------------|--|---|--|---|---|--|--|---|---|---|--|---|---|---|--|--|---|--|---|---|--|---|---|---|--|---|---|--|--|--|---|---|---|--|--|--|---|--|---|---|--|--|--|--|--|--|--|--|--|--|--|--|--|--|--|--|--|--|--|--|--|--|--|--|--|--|--|--|--|--|--|--|
| 1 郭世伟 | 2 金勇峰 | 9 陈开勇 | 17 王巨柱 | 18 李双 | 19 何山 | 21 李明 | 24 徐安格 | | | | | | | | | | | | | | | | | | | | | | | | | | | | | | | | | | | | | | | | | | | | | | | | | | | | | | | | | | | | | | | | | | | | | | | | |
| <table border="1"><tr><td></td><td></td><td>1</td></tr><tr><td></td><td></td><td></td></tr><tr><td>3</td><td></td><td>1</td></tr></table> | | | 1 | | | | 3 | | 1 | <table border="1"><tr><td>1</td><td>1</td><td></td></tr><tr><td></td><td>1</td><td>1</td></tr><tr><td>1</td><td></td><td>3</td></tr></table> | 1 | 1 | | | 1 | 1 | 1 | | 3 | <table border="1"><tr><td>1</td><td></td><td></td></tr><tr><td>1</td><td></td><td>1</td></tr><tr><td>2</td><td></td><td>1</td></tr></table> | 1 | | | 1 | | 1 | 2 | | 1 | <table border="1"><tr><td>1</td><td></td><td>3</td></tr><tr><td>2</td><td></td><td></td></tr><tr><td></td><td>1</td><td>1</td></tr></table> | 1 | | 3 | 2 | | | | 1 | 1 | <table border="1"><tr><td></td><td></td><td></td></tr><tr><td>1</td><td></td><td>1</td></tr><tr><td>3</td><td></td><td></td></tr></table> | | | | 1 | | 1 | 3 | | | <table border="1"><tr><td></td><td></td><td></td></tr><tr><td></td><td></td><td></td></tr><tr><td></td><td></td><td></td></tr></table> | | | | | | | | | | <table border="1"><tr><td></td><td></td><td></td></tr><tr><td></td><td></td><td></td></tr><tr><td></td><td></td><td></td></tr></table> | | | | | | | | | | <table border="1"><tr><td></td><td></td><td></td></tr><tr><td></td><td></td><td></td></tr><tr><td></td><td></td><td></td></tr></table> | | | | | | | | | |
| | | 1 | | | | | | | | | | | | | | | | | | | | | | | | | | | | | | | | | | | | | | | | | | | | | | | | | | | | | | | | | | | | | | | | | | | | | | | | | | | | | |
| | | | | | | | | | | | | | | | | | | | | | | | | | | | | | | | | | | | | | | | | | | | | | | | | | | | | | | | | | | | | | | | | | | | | | | | | | | | | | | | |
| 3 | | 1 | | | | | | | | | | | | | | | | | | | | | | | | | | | | | | | | | | | | | | | | | | | | | | | | | | | | | | | | | | | | | | | | | | | | | | | | | | | | | |
| 1 | 1 | | | | | | | | | | | | | | | | | | | | | | | | | | | | | | | | | | | | | | | | | | | | | | | | | | | | | | | | | | | | | | | | | | | | | | | | | | | | | | |
| | 1 | 1 | | | | | | | | | | | | | | | | | | | | | | | | | | | | | | | | | | | | | | | | | | | | | | | | | | | | | | | | | | | | | | | | | | | | | | | | | | | | | |
| 1 | | 3 | | | | | | | | | | | | | | | | | | | | | | | | | | | | | | | | | | | | | | | | | | | | | | | | | | | | | | | | | | | | | | | | | | | | | | | | | | | | | |
| 1 | | | | | | | | | | | | | | | | | | | | | | | | | | | | | | | | | | | | | | | | | | | | | | | | | | | | | | | | | | | | | | | | | | | | | | | | | | | | | | | |
| 1 | | 1 | | | | | | | | | | | | | | | | | | | | | | | | | | | | | | | | | | | | | | | | | | | | | | | | | | | | | | | | | | | | | | | | | | | | | | | | | | | | | |
| 2 | | 1 | | | | | | | | | | | | | | | | | | | | | | | | | | | | | | | | | | | | | | | | | | | | | | | | | | | | | | | | | | | | | | | | | | | | | | | | | | | | | |
| 1 | | 3 | | | | | | | | | | | | | | | | | | | | | | | | | | | | | | | | | | | | | | | | | | | | | | | | | | | | | | | | | | | | | | | | | | | | | | | | | | | | | |
| 2 | | | | | | | | | | | | | | | | | | | | | | | | | | | | | | | | | | | | | | | | | | | | | | | | | | | | | | | | | | | | | | | | | | | | | | | | | | | | | | | |
| | 1 | 1 | | | | | | | | | | | | | | | | | | | | | | | | | | | | | | | | | | | | | | | | | | | | | | | | | | | | | | | | | | | | | | | | | | | | | | | | | | | | | |
| | | | | | | | | | | | | | | | | | | | | | | | | | | | | | | | | | | | | | | | | | | | | | | | | | | | | | | | | | | | | | | | | | | | | | | | | | | | | | | | |
| 1 | | 1 | | | | | | | | | | | | | | | | | | | | | | | | | | | | | | | | | | | | | | | | | | | | | | | | | | | | | | | | | | | | | | | | | | | | | | | | | | | | | |
| 3 | | | | | | | | | | | | | | | | | | | | | | | | | | | | | | | | | | | | | | | | | | | | | | | | | | | | | | | | | | | | | | | | | | | | | | | | | | | | | | | |
| | | | | | | | | | | | | | | | | | | | | | | | | | | | | | | | | | | | | | | | | | | | | | | | | | | | | | | | | | | | | | | | | | | | | | | | | | | | | | | | |
| | | | | | | | | | | | | | | | | | | | | | | | | | | | | | | | | | | | | | | | | | | | | | | | | | | | | | | | | | | | | | | | | | | | | | | | | | | | | | | | |
| | | | | | | | | | | | | | | | | | | | | | | | | | | | | | | | | | | | | | | | | | | | | | | | | | | | | | | | | | | | | | | | | | | | | | | | | | | | | | | | |
| | | | | | | | | | | | | | | | | | | | | | | | | | | | | | | | | | | | | | | | | | | | | | | | | | | | | | | | | | | | | | | | | | | | | | | | | | | | | | | | |
| | | | | | | | | | | | | | | | | | | | | | | | | | | | | | | | | | | | | | | | | | | | | | | | | | | | | | | | | | | | | | | | | | | | | | | | | | | | | | | | |
| | | | | | | | | | | | | | | | | | | | | | | | | | | | | | | | | | | | | | | | | | | | | | | | | | | | | | | | | | | | | | | | | | | | | | | | | | | | | | | | |
| | | | | | | | | | | | | | | | | | | | | | | | | | | | | | | | | | | | | | | | | | | | | | | | | | | | | | | | | | | | | | | | | | | | | | | | | | | | | | | | |
| | | | | | | | | | | | | | | | | | | | | | | | | | | | | | | | | | | | | | | | | | | | | | | | | | | | | | | | | | | | | | | | | | | | | | | | | | | | | | | | |
| | | | | | | | | | | | | | | | | | | | | | | | | | | | | | | | | | | | | | | | | | | | | | | | | | | | | | | | | | | | | | | | | | | | | | | | | | | | | | | | |
| Post - 1 Miss - 0 Block - 1 | Post - 1 Miss - 2 Block - 0 | Post - 0 Miss - 1 Block - 0 | Post - 4 Miss - 2 Block - 0 | Post - 1 Miss - 3 Block - 1 | Post - 0 Miss - 0 Block - 0 | Post - 0 Miss - 0 Block - 0 | Post - 0 Miss - 0 Block - 0 | | | | | | | | | | | | | | | | | | | | | | | | | | | | | | | | | | | | | | | | | | | | | | | | | | | | | | | | | | | | | | | | | | | | | | | | |
| 25 李文哲 | 26 程浩然 | 27 王长旭 | 28 丁浩然 | 32 许浩翔 | 33 姚紫祥 | 41 刘润民 | 42 王成龙 | | | | | | | | | | | | | | | | | | | | | | | | | | | | | | | | | | | | | | | | | | | | | | | | | | | | | | | | | | | | | | | | | | | | | | | | |
| <table border="1"><tr><td></td><td></td><td></td></tr><tr><td></td><td></td><td></td></tr><tr><td></td><td></td><td></td></tr></table> | | | | | | | | | | <table border="1"><tr><td></td><td></td><td></td></tr><tr><td></td><td></td><td></td></tr><tr><td></td><td></td><td></td></tr></table> | | | | | | | | | | <table border="1"><tr><td></td><td></td><td></td></tr><tr><td></td><td></td><td></td></tr><tr><td></td><td></td><td></td></tr></table> | | | | | | | | | | <table border="1"><tr><td></td><td></td><td></td></tr><tr><td></td><td></td><td></td></tr><tr><td></td><td></td><td></td></tr></table> | | | | | | | | | | <table border="1"><tr><td></td><td></td><td></td></tr><tr><td></td><td></td><td></td></tr><tr><td></td><td></td><td></td></tr></table> | | | | | | | | | | <table border="1"><tr><td></td><td></td><td></td></tr><tr><td></td><td></td><td></td></tr><tr><td></td><td></td><td></td></tr></table> | | | | | | | | | | <table border="1"><tr><td></td><td></td><td></td></tr><tr><td></td><td></td><td></td></tr><tr><td></td><td></td><td></td></tr></table> | | | | | | | | | | <table border="1"><tr><td></td><td></td><td></td></tr><tr><td></td><td></td><td></td></tr><tr><td></td><td></td><td></td></tr></table> | | | | | | | | | |
| | | | | | | | | | | | | | | | | | | | | | | | | | | | | | | | | | | | | | | | | | | | | | | | | | | | | | | | | | | | | | | | | | | | | | | | | | | | | | | | |
| | | | | | | | | | | | | | | | | | | | | | | | | | | | | | | | | | | | | | | | | | | | | | | | | | | | | | | | | | | | | | | | | | | | | | | | | | | | | | | | |
| | | | | | | | | | | | | | | | | | | | | | | | | | | | | | | | | | | | | | | | | | | | | | | | | | | | | | | | | | | | | | | | | | | | | | | | | | | | | | | | |
| | | | | | | | | | | | | | | | | | | | | | | | | | | | | | | | | | | | | | | | | | | | | | | | | | | | | | | | | | | | | | | | | | | | | | | | | | | | | | | | |
| | | | | | | | | | | | | | | | | | | | | | | | | | | | | | | | | | | | | | | | | | | | | | | | | | | | | | | | | | | | | | | | | | | | | | | | | | | | | | | | |
| | | | | | | | | | | | | | | | | | | | | | | | | | | | | | | | | | | | | | | | | | | | | | | | | | | | | | | | | | | | | | | | | | | | | | | | | | | | | | | | |
| | | | | | | | | | | | | | | | | | | | | | | | | | | | | | | | | | | | | | | | | | | | | | | | | | | | | | | | | | | | | | | | | | | | | | | | | | | | | | | | |
| | | | | | | | | | | | | | | | | | | | | | | | | | | | | | | | | | | | | | | | | | | | | | | | | | | | | | | | | | | | | | | | | | | | | | | | | | | | | | | | |
| | | | | | | | | | | | | | | | | | | | | | | | | | | | | | | | | | | | | | | | | | | | | | | | | | | | | | | | | | | | | | | | | | | | | | | | | | | | | | | | |
| | | | | | | | | | | | | | | | | | | | | | | | | | | | | | | | | | | | | | | | | | | | | | | | | | | | | | | | | | | | | | | | | | | | | | | | | | | | | | | | |
| | | | | | | | | | | | | | | | | | | | | | | | | | | | | | | | | | | | | | | | | | | | | | | | | | | | | | | | | | | | | | | | | | | | | | | | | | | | | | | | |
| | | | | | | | | | | | | | | | | | | | | | | | | | | | | | | | | | | | | | | | | | | | | | | | | | | | | | | | | | | | | | | | | | | | | | | | | | | | | | | | |
| | | | | | | | | | | | | | | | | | | | | | | | | | | | | | | | | | | | | | | | | | | | | | | | | | | | | | | | | | | | | | | | | | | | | | | | | | | | | | | | |
| | | | | | | | | | | | | | | | | | | | | | | | | | | | | | | | | | | | | | | | | | | | | | | | | | | | | | | | | | | | | | | | | | | | | | | | | | | | | | | | |
| | | | | | | | | | | | | | | | | | | | | | | | | | | | | | | | | | | | | | | | | | | | | | | | | | | | | | | | | | | | | | | | | | | | | | | | | | | | | | | | |
| | | | | | | | | | | | | | | | | | | | | | | | | | | | | | | | | | | | | | | | | | | | | | | | | | | | | | | | | | | | | | | | | | | | | | | | | | | | | | | | |
| | | | | | | | | | | | | | | | | | | | | | | | | | | | | | | | | | | | | | | | | | | | | | | | | | | | | | | | | | | | | | | | | | | | | | | | | | | | | | | | |
| | | | | | | | | | | | | | | | | | | | | | | | | | | | | | | | | | | | | | | | | | | | | | | | | | | | | | | | | | | | | | | | | | | | | | | | | | | | | | | | |
| | | | | | | | | | | | | | | | | | | | | | | | | | | | | | | | | | | | | | | | | | | | | | | | | | | | | | | | | | | | | | | | | | | | | | | | | | | | | | | | |
| | | | | | | | | | | | | | | | | | | | | | | | | | | | | | | | | | | | | | | | | | | | | | | | | | | | | | | | | | | | | | | | | | | | | | | | | | | | | | | | |
| | | | | | | | | | | | | | | | | | | | | | | | | | | | | | | | | | | | | | | | | | | | | | | | | | | | | | | | | | | | | | | | | | | | | | | | | | | | | | | | |
| | | | | | | | | | | | | | | | | | | | | | | | | | | | | | | | | | | | | | | | | | | | | | | | | | | | | | | | | | | | | | | | | | | | | | | | | | | | | | | | |
| | | | | | | | | | | | | | | | | | | | | | | | | | | | | | | | | | | | | | | | | | | | | | | | | | | | | | | | | | | | | | | | | | | | | | | | | | | | | | | | |
| | | | | | | | | | | | | | | | | | | | | | | | | | | | | | | | | | | | | | | | | | | | | | | | | | | | | | | | | | | | | | | | | | | | | | | | | | | | | | | | |
| Post - 0 Miss - 0 Block - 0 | Post - 0 Miss - 0 Block - 0 | Post - 0 Miss - 0 Block - 0 | Post - 0 Miss - 0 Block - 0 | Post - 0 Miss - 0 Block - 0 | Post - 0 Miss - 0 Block - 0 | Post - 0 Miss - 0 Block - 0 | Post - 0 Miss - 0 Block - 0 | | | | | | | | | | | | | | | | | | | | | | | | | | | | | | | | | | | | | | | | | | | | | | | | | | | | | | | | | | | | | | | | | | | | | | | | |

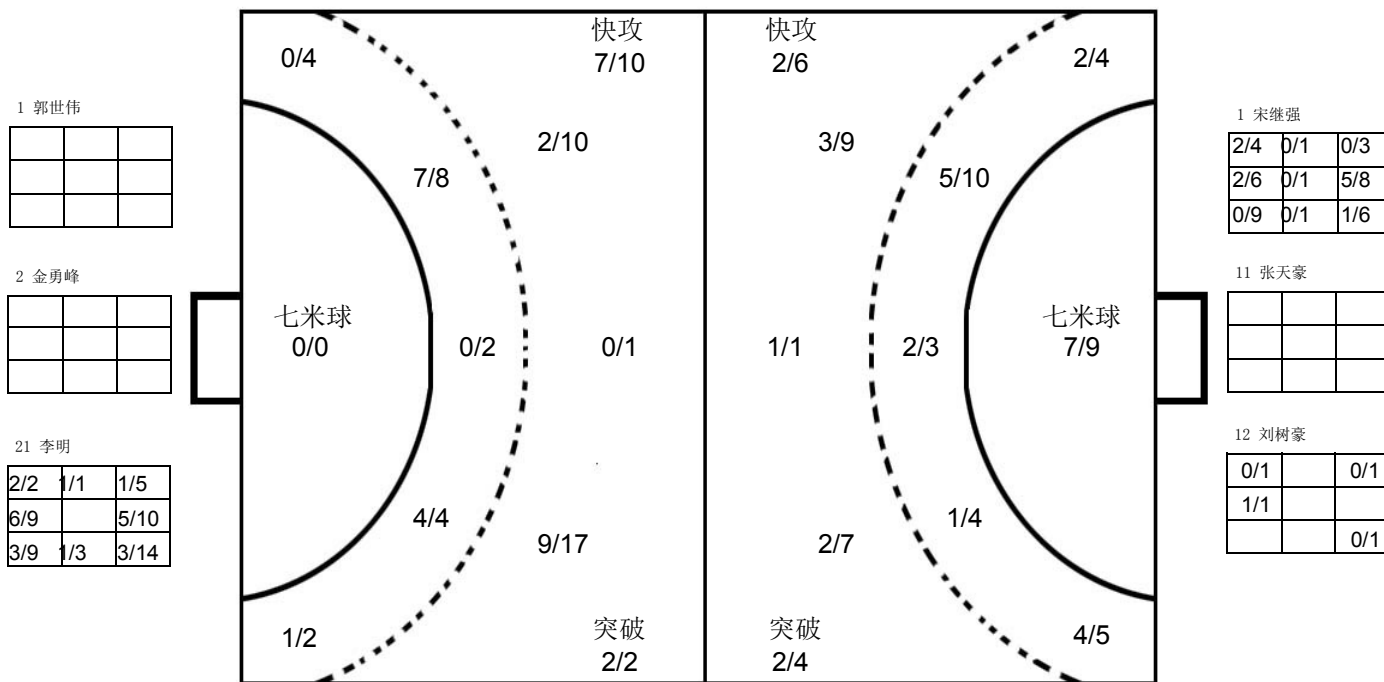

四川队

| | | | | | | | | | | | | | | | | | | | | | | | | | | | | | | | | | | | | | | | | | | | | | | | | | | | | | | | | | | | | | | | | | | | | | | | | | | | | | | | |
|--|-----------------------------|-----------------------------|-----------------------------|-----------------------------|-----------------------------|-----------------------------|-----------------------------|--|--|---|--|--|--|--|--|---|---|--|---|--|--|--|---|--|--|--|--|--|---|---|--|--|--|--|--|---|--|---|---|--|--|--|---|---|--|---|---|---|---|--|--|--|---|--|--|---|--|--|---|--|--|--|--|--|--|--|---|--|---|--|--|--|--|--|--|--|--|--|--|
| 1 宋继强 | 3 刘赵梁 | 5 王凯 | 7 仇瑞祥 | 8 罗尧尧 | 9 许翔宇 | 10 徐彦昊 | 11 张天豪 | | | | | | | | | | | | | | | | | | | | | | | | | | | | | | | | | | | | | | | | | | | | | | | | | | | | | | | | | | | | | | | | | | | | | | | | |
| <table border="1"><tr><td></td><td></td><td></td></tr><tr><td></td><td></td><td></td></tr><tr><td></td><td></td><td></td></tr></table> | | | | | | | | | | <table border="1"><tr><td></td><td></td><td></td></tr><tr><td></td><td></td><td>1</td></tr><tr><td>1</td><td></td><td>3</td></tr></table> | | | | | | 1 | 1 | | 3 | <table border="1"><tr><td></td><td></td><td>1</td></tr><tr><td></td><td></td><td></td></tr><tr><td></td><td></td><td>2</td></tr></table> | | | 1 | | | | | | 2 | <table border="1"><tr><td></td><td></td><td></td></tr><tr><td></td><td></td><td></td></tr><tr><td></td><td></td><td></td></tr></table> | | | | | | | | | | <table border="1"><tr><td></td><td></td><td>1</td></tr><tr><td>2</td><td></td><td>1</td></tr><tr><td>2</td><td>1</td><td>4</td></tr></table> | | | 1 | 2 | | 1 | 2 | 1 | 4 | <table border="1"><tr><td></td><td></td><td></td></tr><tr><td></td><td></td><td>1</td></tr><tr><td></td><td></td><td></td></tr></table> | | | | | | 1 | | | | <table border="1"><tr><td></td><td></td><td></td></tr><tr><td></td><td></td><td></td></tr><tr><td>1</td><td></td><td>1</td></tr></table> | | | | | | | 1 | | 1 | <table border="1"><tr><td></td><td></td><td></td></tr><tr><td></td><td></td><td></td></tr><tr><td></td><td></td><td></td></tr></table> | | | | | | | | | |
| | | | | | | | | | | | | | | | | | | | | | | | | | | | | | | | | | | | | | | | | | | | | | | | | | | | | | | | | | | | | | | | | | | | | | | | | | | | | | | | |
| | | | | | | | | | | | | | | | | | | | | | | | | | | | | | | | | | | | | | | | | | | | | | | | | | | | | | | | | | | | | | | | | | | | | | | | | | | | | | | | |
| | | | | | | | | | | | | | | | | | | | | | | | | | | | | | | | | | | | | | | | | | | | | | | | | | | | | | | | | | | | | | | | | | | | | | | | | | | | | | | | |
| | | | | | | | | | | | | | | | | | | | | | | | | | | | | | | | | | | | | | | | | | | | | | | | | | | | | | | | | | | | | | | | | | | | | | | | | | | | | | | | |
| | | 1 | | | | | | | | | | | | | | | | | | | | | | | | | | | | | | | | | | | | | | | | | | | | | | | | | | | | | | | | | | | | | | | | | | | | | | | | | | | | | |
| 1 | | 3 | | | | | | | | | | | | | | | | | | | | | | | | | | | | | | | | | | | | | | | | | | | | | | | | | | | | | | | | | | | | | | | | | | | | | | | | | | | | | |
| | | 1 | | | | | | | | | | | | | | | | | | | | | | | | | | | | | | | | | | | | | | | | | | | | | | | | | | | | | | | | | | | | | | | | | | | | | | | | | | | | | |
| | | | | | | | | | | | | | | | | | | | | | | | | | | | | | | | | | | | | | | | | | | | | | | | | | | | | | | | | | | | | | | | | | | | | | | | | | | | | | | | |
| | | 2 | | | | | | | | | | | | | | | | | | | | | | | | | | | | | | | | | | | | | | | | | | | | | | | | | | | | | | | | | | | | | | | | | | | | | | | | | | | | | |
| | | | | | | | | | | | | | | | | | | | | | | | | | | | | | | | | | | | | | | | | | | | | | | | | | | | | | | | | | | | | | | | | | | | | | | | | | | | | | | | |
| | | | | | | | | | | | | | | | | | | | | | | | | | | | | | | | | | | | | | | | | | | | | | | | | | | | | | | | | | | | | | | | | | | | | | | | | | | | | | | | |
| | | | | | | | | | | | | | | | | | | | | | | | | | | | | | | | | | | | | | | | | | | | | | | | | | | | | | | | | | | | | | | | | | | | | | | | | | | | | | | | |
| | | 1 | | | | | | | | | | | | | | | | | | | | | | | | | | | | | | | | | | | | | | | | | | | | | | | | | | | | | | | | | | | | | | | | | | | | | | | | | | | | | |
| 2 | | 1 | | | | | | | | | | | | | | | | | | | | | | | | | | | | | | | | | | | | | | | | | | | | | | | | | | | | | | | | | | | | | | | | | | | | | | | | | | | | | |
| 2 | 1 | 4 | | | | | | | | | | | | | | | | | | | | | | | | | | | | | | | | | | | | | | | | | | | | | | | | | | | | | | | | | | | | | | | | | | | | | | | | | | | | | |
| | | | | | | | | | | | | | | | | | | | | | | | | | | | | | | | | | | | | | | | | | | | | | | | | | | | | | | | | | | | | | | | | | | | | | | | | | | | | | | | |
| | | 1 | | | | | | | | | | | | | | | | | | | | | | | | | | | | | | | | | | | | | | | | | | | | | | | | | | | | | | | | | | | | | | | | | | | | | | | | | | | | | |
| | | | | | | | | | | | | | | | | | | | | | | | | | | | | | | | | | | | | | | | | | | | | | | | | | | | | | | | | | | | | | | | | | | | | | | | | | | | | | | | |
| | | | | | | | | | | | | | | | | | | | | | | | | | | | | | | | | | | | | | | | | | | | | | | | | | | | | | | | | | | | | | | | | | | | | | | | | | | | | | | | |
| | | | | | | | | | | | | | | | | | | | | | | | | | | | | | | | | | | | | | | | | | | | | | | | | | | | | | | | | | | | | | | | | | | | | | | | | | | | | | | | |
| 1 | | 1 | | | | | | | | | | | | | | | | | | | | | | | | | | | | | | | | | | | | | | | | | | | | | | | | | | | | | | | | | | | | | | | | | | | | | | | | | | | | | |
| | | | | | | | | | | | | | | | | | | | | | | | | | | | | | | | | | | | | | | | | | | | | | | | | | | | | | | | | | | | | | | | | | | | | | | | | | | | | | | | |
| | | | | | | | | | | | | | | | | | | | | | | | | | | | | | | | | | | | | | | | | | | | | | | | | | | | | | | | | | | | | | | | | | | | | | | | | | | | | | | | |
| | | | | | | | | | | | | | | | | | | | | | | | | | | | | | | | | | | | | | | | | | | | | | | | | | | | | | | | | | | | | | | | | | | | | | | | | | | | | | | | |
| Post - 0 Miss - 0 Block - 0 | Post - 0 Miss - 1 Block - 0 | Post - 1 Miss - 0 Block - 0 | Post - 0 Miss - 0 Block - 0 | Post - 0 Miss - 2 Block - 3 | Post - 0 Miss - 1 Block - 0 | Post - 0 Miss - 0 Block - 0 | Post - 0 Miss - 0 Block - 0 | | | | | | | | | | | | | | | | | | | | | | | | | | | | | | | | | | | | | | | | | | | | | | | | | | | | | | | | | | | | | | | | | | | | | | | | |
| 12 刘树豪 | 13 尹文珂 | 15 徐逸 | 17 谢庆龙 | 18 张睿梁 | 19 庞连康 | 20 张文健 | 21 曹修庆 | | | | | | | | | | | | | | | | | | | | | | | | | | | | | | | | | | | | | | | | | | | | | | | | | | | | | | | | | | | | | | | | | | | | | | | | |
| <table border="1"><tr><td></td><td></td><td></td></tr><tr><td></td><td></td><td></td></tr><tr><td></td><td></td><td></td></tr></table> | | | | | | | | | | <table border="1"><tr><td></td><td></td><td></td></tr><tr><td></td><td></td><td></td></tr><tr><td></td><td></td><td></td></tr></table> | | | | | | | | | | <table border="1"><tr><td></td><td></td><td></td></tr><tr><td></td><td></td><td></td></tr><tr><td></td><td></td><td></td></tr></table> | | | | | | | | | | <table border="1"><tr><td></td><td></td><td></td></tr><tr><td></td><td></td><td>1</td></tr><tr><td></td><td>1</td><td>1</td></tr></table> | | | | | | 1 | | 1 | 1 | <table border="1"><tr><td></td><td></td><td></td></tr><tr><td></td><td></td><td></td></tr><tr><td></td><td></td><td></td></tr></table> | | | | | | | | | | <table border="1"><tr><td></td><td></td><td>1</td></tr><tr><td></td><td></td><td></td></tr><tr><td></td><td></td><td>1</td></tr></table> | | | 1 | | | | | | 1 | <table border="1"><tr><td></td><td></td><td></td></tr><tr><td></td><td></td><td></td></tr><tr><td></td><td></td><td></td></tr></table> | | | | | | | | | | <table border="1"><tr><td></td><td></td><td></td></tr><tr><td></td><td></td><td></td></tr><tr><td></td><td></td><td></td></tr></table> | | | | | | | | | |
| | | | | | | | | | | | | | | | | | | | | | | | | | | | | | | | | | | | | | | | | | | | | | | | | | | | | | | | | | | | | | | | | | | | | | | | | | | | | | | | |
| | | | | | | | | | | | | | | | | | | | | | | | | | | | | | | | | | | | | | | | | | | | | | | | | | | | | | | | | | | | | | | | | | | | | | | | | | | | | | | | |
| | | | | | | | | | | | | | | | | | | | | | | | | | | | | | | | | | | | | | | | | | | | | | | | | | | | | | | | | | | | | | | | | | | | | | | | | | | | | | | | |
| | | | | | | | | | | | | | | | | | | | | | | | | | | | | | | | | | | | | | | | | | | | | | | | | | | | | | | | | | | | | | | | | | | | | | | | | | | | | | | | |
| | | | | | | | | | | | | | | | | | | | | | | | | | | | | | | | | | | | | | | | | | | | | | | | | | | | | | | | | | | | | | | | | | | | | | | | | | | | | | | | |
| | | | | | | | | | | | | | | | | | | | | | | | | | | | | | | | | | | | | | | | | | | | | | | | | | | | | | | | | | | | | | | | | | | | | | | | | | | | | | | | |
| | | | | | | | | | | | | | | | | | | | | | | | | | | | | | | | | | | | | | | | | | | | | | | | | | | | | | | | | | | | | | | | | | | | | | | | | | | | | | | | |
| | | | | | | | | | | | | | | | | | | | | | | | | | | | | | | | | | | | | | | | | | | | | | | | | | | | | | | | | | | | | | | | | | | | | | | | | | | | | | | | |
| | | | | | | | | | | | | | | | | | | | | | | | | | | | | | | | | | | | | | | | | | | | | | | | | | | | | | | | | | | | | | | | | | | | | | | | | | | | | | | | |
| | | | | | | | | | | | | | | | | | | | | | | | | | | | | | | | | | | | | | | | | | | | | | | | | | | | | | | | | | | | | | | | | | | | | | | | | | | | | | | | |
| | | 1 | | | | | | | | | | | | | | | | | | | | | | | | | | | | | | | | | | | | | | | | | | | | | | | | | | | | | | | | | | | | | | | | | | | | | | | | | | | | | |
| | 1 | 1 | | | | | | | | | | | | | | | | | | | | | | | | | | | | | | | | | | | | | | | | | | | | | | | | | | | | | | | | | | | | | | | | | | | | | | | | | | | | | |
| | | | | | | | | | | | | | | | | | | | | | | | | | | | | | | | | | | | | | | | | | | | | | | | | | | | | | | | | | | | | | | | | | | | | | | | | | | | | | | | |
| | | | | | | | | | | | | | | | | | | | | | | | | | | | | | | | | | | | | | | | | | | | | | | | | | | | | | | | | | | | | | | | | | | | | | | | | | | | | | | | |
| | | | | | | | | | | | | | | | | | | | | | | | | | | | | | | | | | | | | | | | | | | | | | | | | | | | | | | | | | | | | | | | | | | | | | | | | | | | | | | | |
| | | 1 | | | | | | | | | | | | | | | | | | | | | | | | | | | | | | | | | | | | | | | | | | | | | | | | | | | | | | | | | | | | | | | | | | | | | | | | | | | | | |
| | | | | | | | | | | | | | | | | | | | | | | | | | | | | | | | | | | | | | | | | | | | | | | | | | | | | | | | | | | | | | | | | | | | | | | | | | | | | | | | |
| | | 1 | | | | | | | | | | | | | | | | | | | | | | | | | | | | | | | | | | | | | | | | | | | | | | | | | | | | | | | | | | | | | | | | | | | | | | | | | | | | | |
| | | | | | | | | | | | | | | | | | | | | | | | | | | | | | | | | | | | | | | | | | | | | | | | | | | | | | | | | | | | | | | | | | | | | | | | | | | | | | | | |
| | | | | | | | | | | | | | | | | | | | | | | | | | | | | | | | | | | | | | | | | | | | | | | | | | | | | | | | | | | | | | | | | | | | | | | | | | | | | | | | |
| | | | | | | | | | | | | | | | | | | | | | | | | | | | | | | | | | | | | | | | | | | | | | | | | | | | | | | | | | | | | | | | | | | | | | | | | | | | | | | | |
| | | | | | | | | | | | | | | | | | | | | | | | | | | | | | | | | | | | | | | | | | | | | | | | | | | | | | | | | | | | | | | | | | | | | | | | | | | | | | | | |
| | | | | | | | | | | | | | | | | | | | | | | | | | | | | | | | | | | | | | | | | | | | | | | | | | | | | | | | | | | | | | | | | | | | | | | | | | | | | | | | |
| | | | | | | | | | | | | | | | | | | | | | | | | | | | | | | | | | | | | | | | | | | | | | | | | | | | | | | | | | | | | | | | | | | | | | | | | | | | | | | | |
| Post - 0 Miss - 0 Block - 0 | Post - 0 Miss - 0 Block - 0 | Post - 0 Miss - 0 Block - 0 | Post - 0 Miss - 0 Block - 0 | Post - 0 Miss - 0 Block - 0 | Post - 0 Miss - 0 Block - 1 | Post - 0 Miss - 0 Block - 0 | Post - 0 Miss - 0 Block - 0 | | | | | | | | | | | | | | | | | | | | | | | | | | | | | | | | | | | | | | | | | | | | | | | | | | | | | | | | | | | | | | | | | | | | | | | | |

注释: Post=击柱 Miss=射失 Block=被封





预赛 Group A
青年男子 全国比赛

2016年“体彩杯”全国手球男子青年锦标赛

| | | | | | | | | | | | | | | | | | | | | | |
|--------------------|---|---------------------------------|---------------------|------------------|------------------------------------|-------------------|---|---------------------------|---|----|-----|----------------------|---------------|---|--|--|---|---|----|----|----|
| Team A A 山东队 | | | | Team B B 浙江队 | | | | Match Number 28 | | | | | | | | | | | | | |
| played in China | | in the hall 重庆万州 | | on 25/03/2016 | | at 14:30 hours | | Spectators | | | | | | | | | | | | | |
| Half-time (30') | A 23 | B 9 | End of playing time | A 37 | B 22 | 1st extra time | A | B | 2nd extra time | A | B | After penalty throws | A | B | | | | | | | |
| Number of 7 m | A 1/3 | Team time-out 1 2 3 47:03 | | | Full name of players and officials | | | | Team time-out 1 2 3 10:58 19:21 55:16 | | | B 1/1 | Number of 7 m | | | | | | | | |
| No. | Team A | | | | | G | W | 2' | D | DR | No. | Team B | | | | | G | W | 2' | D | DR |
| 1 | 刘继超 | | | | | | | | | | 1 | 林先方 | | | | | 4 | 1 | 1 | | |
| 2 | 冯鑫宇 | | | | | 1 | | | | | 2 | 李恩铭 | | | | | 2 | | | | |
| 3 | 王铁林 | | | | | 1 | | | | | 3 | 郑尧俊 | | | | | 6 | | | | |
| 5 | 王晓峰 | | | | | 2 | | | | | 5 | 高家南 | | | | | | | | | |
| 6 | 王军鸣 | | | | | | | | | | 9 | 李家乐 | | | | | 1 | | | | |
| 7 | 徐勇林 | | | | | 7 | | | | | 10 | 徐正飞 | | | | | 2 | | | | |
| 10 | 孙芳伟 | | | | | 2 | | | | | 14 | 虞勇灿 | | | | | | | | | |
| 11 | 王洋 | | | | | 4 | | | | | 15 | 张佩力 | | | | | | | | | |
| 12 | 刘道林 | | | | | | | | | | 17 | 罗明杰 | | | | | | | | | |
| 13 | 于欣君 | | | | | | | | | | 18 | 倪陈辉 | | | | | 7 | 1 | | | |
| 17 | 薛盼龙 | | | | | 7 | 1 | | | | 19 | 王浩 | | | | | | | | | |
| 18 | 李玮 | | | | | 3 | | | | | | | | | | | | | | | |
| 21 | 王腾达 | | | | | 7 | 1 | | | | | | | | | | | | | | |
| 22 | 李子跃 | | | | | 3 | 1 | | | | | | | | | | | | | | |
| 23 | 李荣健 | | | | | | | | | | | | | | | | | | | | |
| B | 王莉莉 (主教练) | | | | | | | | | | C | 柳佳 | | | | | | | | | |
| | | | | | | | | | | | D | 项建生 | | | | | | | | | |
| | | | | | | | | | | | E | 刘晓辉 | | | | | | | | | |
| A | Signature of Responsible Official of the Teams (Off. A) | | | | | | | | | | | | | | | | | | | B | |
| TP | Remarks of Referee / CHA Official | | | | | | | | | | | | | | | | | | | TP | |

Signatures

| | | | | |
|------------------|-----------|-----------|--|--|
| Referees | 张智伟 (CHN) | 陈炳威 (CHN) | | |
| Techn. Delegates | 徐健 (CHN) | | | |
| CHA Official | 吴瑞亭 (CHN) | | | |

Note: Number of 7m Throws Awarded to Team A and B, Goals (G), Warnings (W), Suspensions (2'), Direct Disqualification (D), Disqualification with Report (DR) and Team Penalty (TP).

Table Officials:

Statisticians: 李双

刘永欢





2016年“体彩杯”全国手球男子青年锦标赛 竞赛技术统计(媒体表)

| | | | | | | |
|-----------|-----------|------------|---------------|-----------|------------------|-----------|
| 预赛 | 组别 | A | 轮次 | 5 | 场次 | 28 |
| 重庆万州 | | 25/03/2016 | | | 201602028-51-1/1 | |
| 山东队 | 山东 | 37 | vs | 22 | 浙江 | 浙江队 |
| | | | 23 : 9 | | | |

| | | | |
|-----|-----------|---|-----------|
| 裁判员 | 张智伟 (CHN) | / | 张炳威 (CHN) |
|-----|-----------|---|-----------|

| 山东 | | | | | | | | | | | | | | 比赛进程 | | 浙江 | |
|---------------|-------------|--------------|------------|--------------|------------|------------|------------|--------------|-------------|-----------|-----------|----------|----------|-----------------|---------------------|-----------|--|
| 主教练：王莉莉 | | | | | | | | | | | | | | | | | |
| 远射 | 近射 | 边射 | 快攻 | 突破 | 任意球 | 7m球 | 合计 | % | 助攻 | 失误 | 警告 | 2' | D & DR | 山东 | 浙江 | | |
| 1 刘继超 | | | | | | | | | | | | | | 17 薛盼龙 | 1st Half 00:51 0 | | |
| 2 冯鑫宇 | 0/1 | | | | 1/1 | 0/1 | 1/3 | 33.3 | | 1 | | | | 1 李恩铭 | 01:20 1 2 | | |
| 3 王铁林 | | | 1/1 | | | | 1/1 | 100 | | | | | | 1 03:59 2 3 郑尧俊 | 04:37 2 | | |
| 5 王晓峰 | 2/3 | | | | | | 2/3 | 66.7 | | | | | | 10 孙芳伟 | 04:37 2 | | |
| 6 王军鸣 | | | | | | | | | | | | | | 17 薛盼龙 | 05:12 2 | | |
| 7 徐勇林 | 2/3 | 3/4 | | 1/1 | 1/1 | | 7/9 | 77.8 | 5 | 1 | | | | 3 06:00 3 3 郑尧俊 | 06:23 3 | | |
| 10 孙芳伟 | 1/3 | 0/2 | | 1/1 | | | 2/6 | 33.3 | 2 | | | | | 11 王洋 | 07:03 3 | | |
| 11 王洋 | | 2/3 | 2/2 | | | | 4/5 | 80.0 | 1 | 1 | | | | 7 徐勇林 | 07:57 3 | | |
| 12 刘道林 | | | | | | | | | | | | | | 18 李玮 | 09:31 3 | | |
| 13 于欣君 | | | | | | | | | | | | | | 21 王腾达 | 10:54 3 | | |
| 17 薛盼龙 | 0/2 | 4/5 | 0/1 | 3/3 | | | 7/11 | 63.6 | | 2 | 1 | | | 17 薛盼龙 | 11:29 3 | | |
| 18 李玮 | 0/1 | 2/2 | 1/2 | | | | 3/5 | 60.0 | 5 | 5 | | | | 10 孙芳伟 | 12:04 3 | | |
| 21 王腾达 | | 2/2 | 1/1 | 4/4 | | | 7/7 | 100 | 1 | 1 | 1 | | | 17 薛盼龙 | 13:01 3 | | |
| 22 李子跃 | 1/7 | 0/1 | 1/3 | | | | 1/2 | 3/13 | 23.1 | | | 1 | | 21 王腾达 | 13:31 3 | | |
| 23 李荣健 | | | | | | | | | 1 | | | | | 17 薛盼龙 | 14:22 3 | | |
| 运动员 合计 | 6/20 | 13/19 | 5/9 | 10/10 | 2/2 | | 1/3 | 37/63 | 58.7 | 15 | 11 | 3 | | 21 王腾达 | 14:50 3 | | |
| 1 刘继超 | 3/3 | 1/1 | | 0/1 | | | 0/1 | 4/6 | 66.7 | | | | | 18 李玮 | 15:45 3 | | |
| 3 王铁林 | | | | | | | | | | | | | | 17 薛盼龙 | 16:34 3 | | |
| 12 刘道林 | 2/6 | 1/7 | 2/4 | 0/2 | 0/5 | 0/1 | 5/25 | 20.0 | | | | | | 7 徐勇林 | 16:57 4 1 林先方 | | |
| 守门员 合计 | 5/9 | 2/8 | 2/4 | 0/3 | 0/5 | 0/1 | 0/1 | 9/31 | 29.0 | | | | | 7 徐勇林 | 17:38 4 | | |
| | | | | | | | | | | | | | | 2nd Half | | | |
| | | | | | | | | | | | | | | 23 00:19 | 10 18 倪陈辉 | | |
| | | | | | | | | | | | | | | 23 01:07 | 11 18 倪陈辉 | | |
| | | | | | | | | | | | | | | 23 01:35 | 12 1 林先方 | | |
| | | | | | | | | | | | | | | 23 03:12 | 13 3 郑尧俊 | | |
| | | | | | | | | | | | | | | 22 李子跃 | 24 04:01 | 13 | |
| | | | | | | | | | | | | | | 24 04:59 | 14 2 李恩铭 | | |
| | | | | | | | | | | | | | | 24 05:49 | 15 18 倪陈辉 | | |
| | | | | | | | | | | | | | | 24 06:40 | 16 1 林先方 | | |
| | | | | | | | | | | | | | | 11 王洋 | 25 07:18 | 16 | |
| | | | | | | | | | | | | | | 21 王腾达 | 25 07:36 | 17 10 徐正飞 | |
| | | | | | | | | | | | | | | 7 徐勇林 | 26 09:00 | 17 | |
| | | | | | | | | | | | | | | 27 09:59 | 17 | | |
| | | | | | | | | | | | | | | 27 11:14 | 18 1 林先方 | | |
| | | | | | | | | | | | | | | 21 王腾达 | 28 12:24 | 18 | |
| | | | | | | | | | | | | | | 28 14:19 | 19 18 倪陈辉 | | |
| | | | | | | | | | | | | | | 11 王洋 | 29 14:43 | 19 | |
| | | | | | | | | | | | | | | 18 李玮 | 30 15:17 | 19 | |
| | | | | | | | | | | | | | | 21 王腾达 | 30 15:35 | 20 3 郑尧俊 | |
| | | | | | | | | | | | | | | 31 15:58 | 20 | | |
| | | | | | | | | | | | | | | 31 17:28 | 21 3 郑尧俊 | | |
| | | | | | | | | | | | | | | 31 18:42 | 22 18 倪陈辉 | | |
| | | | | | | | | | | | | | | 17 薛盼龙 | 32 19:58 | 22 | |
| | | | | | | | | | | | | | | 2 冯鑫宇 | 33 22:15 | 22 | |
| | | | | | | | | | | | | | | 17 薛盼龙 | 34 23:22 | 22 | |
| | | | | | | | | | | | | | | 5 王晓峰 | 35 24:23 | 22 | |
| | | | | | | | | | | | | | | 5 王晓峰 | 36 25:14 | 22 | |
| | | | | | | | | | | | | | | 3 王铁林 | 37 25:55 | 22 | |
| 运动员 合计 | 4/18 | 6/9 | 2/7 | 3/3 | 5/5 | 1/2 | 1/1 | 22/45 | 48.9 | 4 | 30 | 2 | 1 | | | | |
| 1 林先方 | | | | | | | | | | 2 | 3 | | | | | | |
| 14 虞勇灿 | 5/10 | 3/12 | 3/7 | 0/8 | 0/2 | | 0/1 | 11/40 | 27.5 | | | | | | | | |
| 15 张佩力 | 0/1 | 2/6 | 0/1 | 0/2 | | | 2/10 | 20.0 | | | | | | | | | |
| 守门员 合计 | 5/11 | 5/18 | 3/8 | 0/10 | 0/2 | | 0/1 | 13/50 | 26.0 | 2 | 3 | | | | | | |

场上队员：得分 / 射门

守门员：救球 / 射门

| | | | | | | | | | |
|----|------------|----|--------------|-----|------------|-----|----------|----|---------|
| 快攻 | Fast Break | 突破 | Breakthrough | 任意球 | Free Throw | 7M球 | 7M Throw | 助攻 | Assist |
| 警告 | Warning | 失误 | Error | 2' | Suspension | D | 取消资格 | DR | 取消资格+报告 |





2016年“体彩杯”全国手球男子青年锦标赛 图式比赛技术统计表

轮次 5

场次 28

201602028-21-1/1

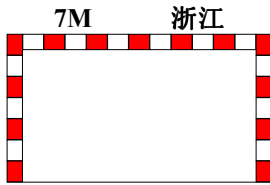
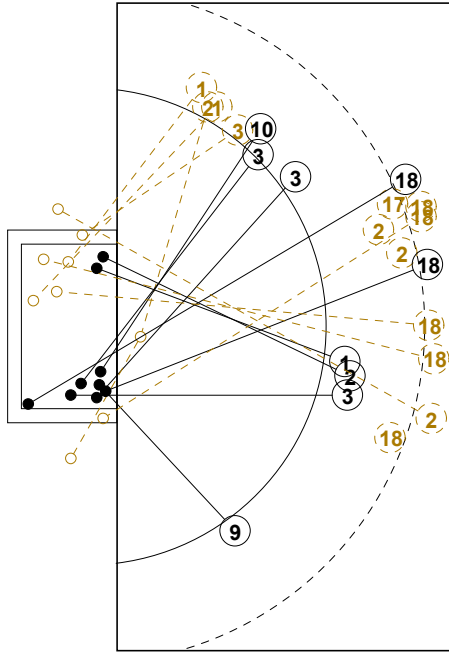

1st Half
9 : 23

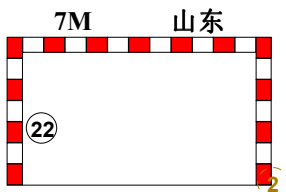
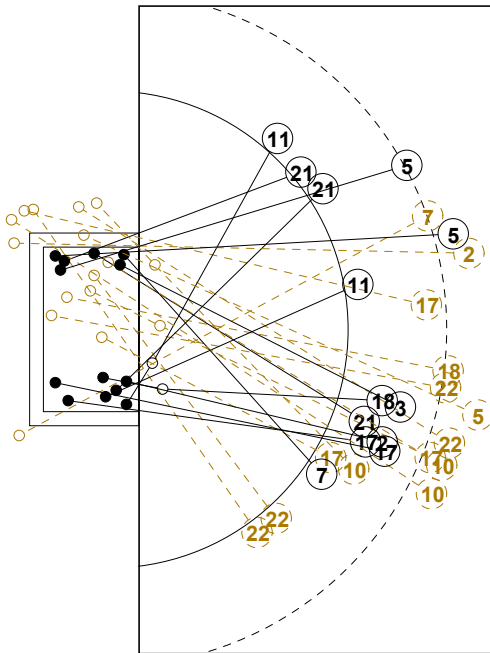
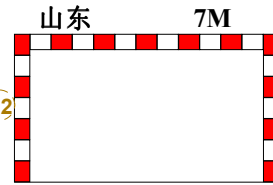
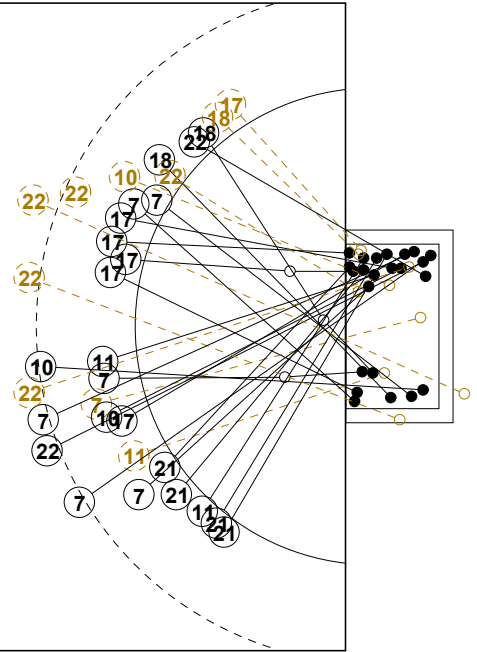

2nd Half
37 : 22

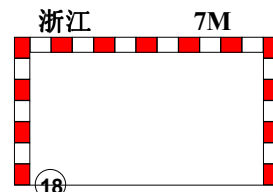
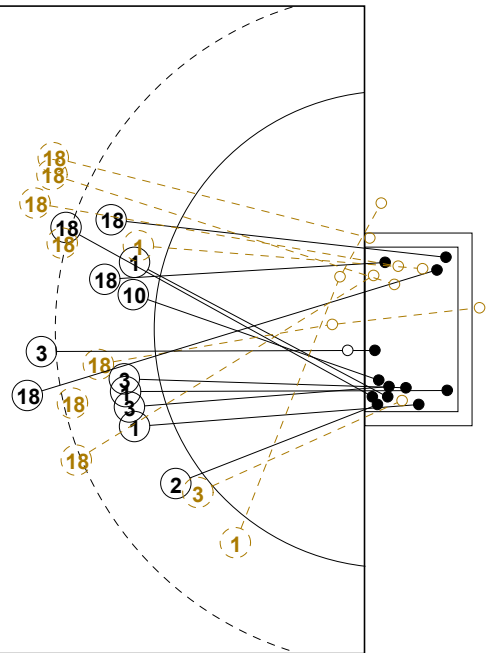



2016年“体彩杯”全国手球男子青年锦标赛

个人/全队技术统计表

正式表
手球
青年男子预赛
轮次 5组别 A
场次 28201602028-14-1/2
重庆万州
25/03/2016 14:30

| 号码 | 姓名 | 远射 | 近射 | 边射 | 快攻 | 突破 | 任意 | 7M | 合计 | % | 助攻 | 失误 | 警告 | 2' | 取消 | 时间 |
|----------------|-----|------|-------|-----|-------|-----|-----|-----|-------|-------|----|----|----|----|----|----------|
| 山东队(山东) | | | | | | | | | | | | | | | | |
| <i>(场上队员)</i> | | | | | | | | | | | | | | | | |
| 1 | 刘继超 | | | | | | | | | 0.0% | | | | | | 00:08:56 |
| 2 | 冯鑫宇 | 0/1 | | | | 1/1 | | 0/1 | 1/3 | 33.3% | | 1 | | | | 00:17:23 |
| 3 | 王铁林 | | | | 1/1 | | | | 1/1 | 100% | | | | | | 00:09:35 |
| 5 | 王晓峰 | 2/3 | | | | | | | 2/3 | 66.7% | | | | | | 00:08:55 |
| 6 | 王军鸣 | | | | | | | | | 0.0% | | | | | | 00:00:00 |
| 7 | 徐勇林 | 2/3 | 3/4 | | 1/1 | 1/1 | | | 7/9 | 77.8% | 5 | 1 | | | | 00:47:03 |
| 10 | 孙芳伟 | 1/3 | 0/2 | | 1/1 | | | | 2/6 | 33.3% | 2 | | | | | 00:22:30 |
| 11 | 王洋 | | 2/3 | 2/2 | | | | | 4/5 | 80.0% | 1 | 1 | | | | 00:47:03 |
| 12 | 刘道林 | | | | | | | | | 0.0% | | | | | | 00:47:03 |
| 13 | 于欣君 | | | | | | | | | 0.0% | | | | | | 00:00:00 |
| 17 | 薛盼龙 | 0/2 | 4/5 | 0/1 | 3/3 | | | | 7/11 | 63.6% | | 2 | 1 | | | 00:55:58 |
| 18 | 李玮 | 0/1 | 2/2 | 1/2 | | | | | 3/5 | 60.0% | 5 | 5 | | | | 00:46:23 |
| 21 | 王腾达 | | 2/2 | 1/1 | 4/4 | | | | 7/7 | 100% | 1 | 1 | 1 | | | 00:38:20 |
| 22 | 李子跃 | 1/7 | 0/1 | 1/3 | | | | 1/2 | 3/13 | 23.1% | | | 1 | | | 00:33:28 |
| 23 | 李荣健 | | | | | | | | | 0.0% | 1 | | | | | 00:08:56 |
| 合计 | | 6/20 | 13/19 | 5/9 | 10/10 | 2/2 | | 1/3 | 37/63 | 58.7% | 15 | 11 | 3 | | | |
| <i>(守门员)</i> | | | | | | | | | | | | | | | | |
| 1 | 刘继超 | 3/3 | 1/1 | | 0/1 | | | 0/1 | 4/6 | 66.7% | | | | | | 00:08:56 |
| 3 | 王铁林 | | | | | | | | | 0.0% | | | | | | 00:09:35 |
| 12 | 刘道林 | 2/6 | 1/7 | 2/4 | 0/2 | 0/5 | 0/1 | | 5/25 | 20.0% | | | | | | 00:47:03 |
| 合计 | | 5/9 | 2/8 | 2/4 | 0/3 | 0/5 | 0/1 | 0/1 | 9/31 | 29.0% | | | | | | |

场上队员：得分/射门

守门员：救球/射门

| 全队合计 | 得分 | 被救 | 射失 | 击柱 | 封球 | 合计 | % |
|------|----|----|----|----|----|----|--------|
| 远射 | 6 | 5 | 6 | 2 | 1 | 20 | 30.0% |
| 近射 | 13 | 5 | 1 | | | 19 | 68.4% |
| 边射 | 5 | 3 | 1 | | | 9 | 55.6% |
| 快攻 | 10 | | | | | 10 | 100.0% |
| 突破 | 2 | | | | | 2 | 100.0% |
| 任意 | | | | | | | 0.0% |
| 7M | 1 | | 1 | 1 | | 3 | 33.3% |





2016年“体彩杯”全国手球男子青年锦标赛

个人/全队技术统计表

正式表
手球
青年男子预赛
轮次 5组别 A
场次 28201602028-14-2/2
重庆万州
25/03/2016 14:30

| 号码 | 姓名 | 远射 | 近射 | 边射 | 快攻 | 突破 | 任意 | 7M | 合计 | % | 助攻 | 失误 | 警告 | 2' | 取消 | 时间 |
|----------------|-----|------|------|-----|-----|-----|-----|-----|-------|-------|----|----|----|----|----|----------|
| 浙江队(浙江) | | | | | | | | | | | | | | | | |
| <i>(上场队员)</i> | | | | | | | | | | | | | | | | |
| 1 | 林先方 | | 1/2 | 0/3 | | 3/3 | | | 4/8 | 50.0% | 3 | 13 | 1 | 1 | | 00:55:58 |
| 2 | 李恩铭 | 0/3 | 1/1 | 0/1 | 1/1 | | | | 2/6 | 33.3% | | 1 | | | | 00:55:58 |
| 3 | 郑尧俊 | 1/1 | 1/2 | 0/1 | 2/2 | 2/2 | | | 6/8 | 75.0% | | 7 | | | | 00:55:58 |
| 5 | 高家南 | | | | | | | | | 0.0% | | 1 | | | | 00:11:02 |
| 9 | 李家乐 | | | 1/1 | | | | | 1/1 | 100% | | | | | | 00:14:05 |
| 10 | 徐正飞 | | 1/1 | 1/1 | | | | | 2/2 | 100% | | | | | | 00:44:45 |
| 14 | 虞勇灿 | | | | | | | | | 0.0% | | | | | | 00:45:01 |
| 15 | 张佩力 | | | | | | | | | 0.0% | | | | | | 00:10:58 |
| 17 | 罗明杰 | 0/1 | | | | | | | 0/1 | 0.0% | | 1 | | | | 00:36:42 |
| 18 | 倪陈辉 | 3/13 | 2/3 | | | | 1/2 | 1/1 | 7/19 | 36.8% | 1 | 7 | 1 | | | 00:52:30 |
| 19 | 王浩 | | | | | | | | | 0.0% | | | | | | 00:09:10 |
| 合计 | | | | | | | | | | | | | | | | |
| <i>(守门员)</i> | | | | | | | | | | | | | | | | |
| 1 | 林先方 | | | | | | | | | 0.0% | 2 | 3 | | | | 00:55:58 |
| 14 | 虞勇灿 | 5/10 | 3/12 | 3/7 | 0/8 | 0/2 | | 0/1 | 11/40 | 27.5% | | | | | | 00:45:01 |
| 15 | 张佩力 | 0/1 | 2/6 | 0/1 | 0/2 | | | | 2/10 | 20.0% | | | | | | 00:10:58 |
| 合计 | | | | | | | | | | | | | | | | |

场上队员：得分/射门

守门员：救球/射门

| 全队合计 | 得分 | 被救 | 射失 | 击柱 | 封球 | 合计 | % |
|------|----|----|----|----|----|----|--------|
| 远射 | 4 | 5 | 1 | 1 | 7 | 18 | 22.2% |
| 近射 | 6 | 2 | 1 | | | 9 | 66.7% |
| 边射 | 2 | 2 | 2 | 1 | | 7 | 28.6% |
| 快攻 | 3 | | | | | 3 | 100.0% |
| 突破 | 5 | | | | | 5 | 100.0% |
| 任意 | 1 | | | 1 | | 2 | 50.0% |
| 7M | 1 | | | | | 1 | 100.0% |





2016年“体彩杯”全国手球男子青年锦标赛

图式射门区域统计

轮次 5 场次 28

201602028-41-1/1

山东队

| | | | | | | | | | | | | | | | | | | | | | | | | | | | | | | | | | | | | | | | | | | | | | | | | | | | | | | | | | | | | | | | | | | | | | | | | | | | | | | | |
|--|-----------------------------|-----------------------------|-----------------------------|-----------------------------|-----------------------------|-----------------------------|-----------------------------|--|--|---|--|--|--|--|--|--|---|--|--|--|---|--|--|---|--|--|---|--|---|---|--|--|---|---|--|---|--|--|---|--|--|--|---|---|--|---|---|--|--|--|---|--|---|---|--|--|---|--|---|---|--|--|--|--|--|--|---|--|--|---|--|--|--|--|--|--|---|--|--|
| 1 刘继超 | 2 冯鑫宇 | 3 王铁林 | 5 王晓峰 | 6 王军鸣 | 7 徐勇林 | 10 孙芳伟 | 11 王洋 | | | | | | | | | | | | | | | | | | | | | | | | | | | | | | | | | | | | | | | | | | | | | | | | | | | | | | | | | | | | | | | | | | | | | | | | |
| <table border="1"><tr><td></td><td></td><td></td></tr><tr><td></td><td></td><td></td></tr><tr><td></td><td></td><td></td></tr></table> | | | | | | | | | | <table border="1"><tr><td></td><td></td><td></td></tr><tr><td></td><td></td><td></td></tr><tr><td>1</td><td></td><td></td></tr></table> | | | | | | | 1 | | | <table border="1"><tr><td></td><td></td><td></td></tr><tr><td></td><td></td><td></td></tr><tr><td></td><td></td><td>1</td></tr></table> | | | | | | | | | 1 | <table border="1"><tr><td></td><td></td><td>2</td></tr><tr><td></td><td></td><td></td></tr><tr><td></td><td></td><td></td></tr></table> | | | 2 | | | | | | | <table border="1"><tr><td></td><td></td><td></td></tr><tr><td></td><td></td><td></td></tr><tr><td></td><td></td><td></td></tr></table> | | | | | | | | | | <table border="1"><tr><td>2</td><td></td><td>1</td></tr><tr><td></td><td></td><td></td></tr><tr><td>1</td><td></td><td>3</td></tr></table> | 2 | | 1 | | | | 1 | | 3 | <table border="1"><tr><td></td><td></td><td></td></tr><tr><td></td><td></td><td></td></tr><tr><td>1</td><td></td><td></td></tr></table> | | | | | | | 1 | | | <table border="1"><tr><td></td><td></td><td></td></tr><tr><td></td><td></td><td></td></tr><tr><td>1</td><td></td><td></td></tr></table> | | | | | | | 1 | | |
| | | | | | | | | | | | | | | | | | | | | | | | | | | | | | | | | | | | | | | | | | | | | | | | | | | | | | | | | | | | | | | | | | | | | | | | | | | | | | | | |
| | | | | | | | | | | | | | | | | | | | | | | | | | | | | | | | | | | | | | | | | | | | | | | | | | | | | | | | | | | | | | | | | | | | | | | | | | | | | | | | |
| | | | | | | | | | | | | | | | | | | | | | | | | | | | | | | | | | | | | | | | | | | | | | | | | | | | | | | | | | | | | | | | | | | | | | | | | | | | | | | | |
| | | | | | | | | | | | | | | | | | | | | | | | | | | | | | | | | | | | | | | | | | | | | | | | | | | | | | | | | | | | | | | | | | | | | | | | | | | | | | | | |
| | | | | | | | | | | | | | | | | | | | | | | | | | | | | | | | | | | | | | | | | | | | | | | | | | | | | | | | | | | | | | | | | | | | | | | | | | | | | | | | |
| 1 | | | | | | | | | | | | | | | | | | | | | | | | | | | | | | | | | | | | | | | | | | | | | | | | | | | | | | | | | | | | | | | | | | | | | | | | | | | | | | | |
| | | | | | | | | | | | | | | | | | | | | | | | | | | | | | | | | | | | | | | | | | | | | | | | | | | | | | | | | | | | | | | | | | | | | | | | | | | | | | | | |
| | | | | | | | | | | | | | | | | | | | | | | | | | | | | | | | | | | | | | | | | | | | | | | | | | | | | | | | | | | | | | | | | | | | | | | | | | | | | | | | |
| | | 1 | | | | | | | | | | | | | | | | | | | | | | | | | | | | | | | | | | | | | | | | | | | | | | | | | | | | | | | | | | | | | | | | | | | | | | | | | | | | | |
| | | 2 | | | | | | | | | | | | | | | | | | | | | | | | | | | | | | | | | | | | | | | | | | | | | | | | | | | | | | | | | | | | | | | | | | | | | | | | | | | | | |
| | | | | | | | | | | | | | | | | | | | | | | | | | | | | | | | | | | | | | | | | | | | | | | | | | | | | | | | | | | | | | | | | | | | | | | | | | | | | | | | |
| | | | | | | | | | | | | | | | | | | | | | | | | | | | | | | | | | | | | | | | | | | | | | | | | | | | | | | | | | | | | | | | | | | | | | | | | | | | | | | | |
| | | | | | | | | | | | | | | | | | | | | | | | | | | | | | | | | | | | | | | | | | | | | | | | | | | | | | | | | | | | | | | | | | | | | | | | | | | | | | | | |
| | | | | | | | | | | | | | | | | | | | | | | | | | | | | | | | | | | | | | | | | | | | | | | | | | | | | | | | | | | | | | | | | | | | | | | | | | | | | | | | |
| | | | | | | | | | | | | | | | | | | | | | | | | | | | | | | | | | | | | | | | | | | | | | | | | | | | | | | | | | | | | | | | | | | | | | | | | | | | | | | | |
| 2 | | 1 | | | | | | | | | | | | | | | | | | | | | | | | | | | | | | | | | | | | | | | | | | | | | | | | | | | | | | | | | | | | | | | | | | | | | | | | | | | | | |
| | | | | | | | | | | | | | | | | | | | | | | | | | | | | | | | | | | | | | | | | | | | | | | | | | | | | | | | | | | | | | | | | | | | | | | | | | | | | | | | |
| 1 | | 3 | | | | | | | | | | | | | | | | | | | | | | | | | | | | | | | | | | | | | | | | | | | | | | | | | | | | | | | | | | | | | | | | | | | | | | | | | | | | | |
| | | | | | | | | | | | | | | | | | | | | | | | | | | | | | | | | | | | | | | | | | | | | | | | | | | | | | | | | | | | | | | | | | | | | | | | | | | | | | | | |
| | | | | | | | | | | | | | | | | | | | | | | | | | | | | | | | | | | | | | | | | | | | | | | | | | | | | | | | | | | | | | | | | | | | | | | | | | | | | | | | |
| 1 | | | | | | | | | | | | | | | | | | | | | | | | | | | | | | | | | | | | | | | | | | | | | | | | | | | | | | | | | | | | | | | | | | | | | | | | | | | | | | | |
| | | | | | | | | | | | | | | | | | | | | | | | | | | | | | | | | | | | | | | | | | | | | | | | | | | | | | | | | | | | | | | | | | | | | | | | | | | | | | | | |
| | | | | | | | | | | | | | | | | | | | | | | | | | | | | | | | | | | | | | | | | | | | | | | | | | | | | | | | | | | | | | | | | | | | | | | | | | | | | | | | |
| 1 | | | | | | | | | | | | | | | | | | | | | | | | | | | | | | | | | | | | | | | | | | | | | | | | | | | | | | | | | | | | | | | | | | | | | | | | | | | | | | | |
| Post - 0 Miss - 0 Block - 0 | Post - 1 Miss - 1 Block - 0 | Post - 0 Miss - 0 Block - 0 | Post - 1 Miss - 0 Block - 0 | Post - 0 Miss - 0 Block - 0 | Post - 0 Miss - 1 Block - 0 | Post - 0 Miss - 2 Block - 0 | Post - 0 Miss - 0 Block - 0 | | | | | | | | | | | | | | | | | | | | | | | | | | | | | | | | | | | | | | | | | | | | | | | | | | | | | | | | | | | | | | | | | | | | | | | | |
| 12 刘道林 | 13 于欣君 | 17 薛盼龙 | 18 李玮 | 21 王腾达 | 22 李子跃 | 23 李荣健 | | | | | | | | | | | | | | | | | | | | | | | | | | | | | | | | | | | | | | | | | | | | | | | | | | | | | | | | | | | | | | | | | | | | | | | | | |
| <table border="1"><tr><td></td><td></td><td></td></tr><tr><td></td><td></td><td></td></tr><tr><td></td><td></td><td></td></tr></table> | | | | | | | | | | <table border="1"><tr><td></td><td></td><td></td></tr><tr><td></td><td></td><td></td></tr><tr><td></td><td></td><td></td></tr></table> | | | | | | | | | | <table border="1"><tr><td>2</td><td></td><td></td></tr><tr><td>2</td><td></td><td></td></tr><tr><td>2</td><td></td><td>1</td></tr></table> | 2 | | | 2 | | | 2 | | 1 | <table border="1"><tr><td></td><td></td><td></td></tr><tr><td>1</td><td></td><td>1</td></tr><tr><td></td><td></td><td>1</td></tr></table> | | | | 1 | | 1 | | | 1 | <table border="1"><tr><td></td><td></td><td>1</td></tr><tr><td>2</td><td></td><td>1</td></tr><tr><td>3</td><td></td><td></td></tr></table> | | | 1 | 2 | | 1 | 3 | | | <table border="1"><tr><td>2</td><td></td><td></td></tr><tr><td>1</td><td></td><td></td></tr><tr><td></td><td></td><td></td></tr></table> | 2 | | | 1 | | | | | | <table border="1"><tr><td></td><td></td><td></td></tr><tr><td></td><td></td><td></td></tr><tr><td></td><td></td><td></td></tr></table> | | | | | | | | | | <table border="1"><tr><td></td><td></td><td></td></tr><tr><td></td><td></td><td></td></tr><tr><td></td><td></td><td></td></tr></table> | | | | | | | | | |
| | | | | | | | | | | | | | | | | | | | | | | | | | | | | | | | | | | | | | | | | | | | | | | | | | | | | | | | | | | | | | | | | | | | | | | | | | | | | | | | |
| | | | | | | | | | | | | | | | | | | | | | | | | | | | | | | | | | | | | | | | | | | | | | | | | | | | | | | | | | | | | | | | | | | | | | | | | | | | | | | | |
| | | | | | | | | | | | | | | | | | | | | | | | | | | | | | | | | | | | | | | | | | | | | | | | | | | | | | | | | | | | | | | | | | | | | | | | | | | | | | | | |
| | | | | | | | | | | | | | | | | | | | | | | | | | | | | | | | | | | | | | | | | | | | | | | | | | | | | | | | | | | | | | | | | | | | | | | | | | | | | | | | |
| | | | | | | | | | | | | | | | | | | | | | | | | | | | | | | | | | | | | | | | | | | | | | | | | | | | | | | | | | | | | | | | | | | | | | | | | | | | | | | | |
| | | | | | | | | | | | | | | | | | | | | | | | | | | | | | | | | | | | | | | | | | | | | | | | | | | | | | | | | | | | | | | | | | | | | | | | | | | | | | | | |
| 2 | | | | | | | | | | | | | | | | | | | | | | | | | | | | | | | | | | | | | | | | | | | | | | | | | | | | | | | | | | | | | | | | | | | | | | | | | | | | | | | |
| 2 | | | | | | | | | | | | | | | | | | | | | | | | | | | | | | | | | | | | | | | | | | | | | | | | | | | | | | | | | | | | | | | | | | | | | | | | | | | | | | | |
| 2 | | 1 | | | | | | | | | | | | | | | | | | | | | | | | | | | | | | | | | | | | | | | | | | | | | | | | | | | | | | | | | | | | | | | | | | | | | | | | | | | | | |
| | | | | | | | | | | | | | | | | | | | | | | | | | | | | | | | | | | | | | | | | | | | | | | | | | | | | | | | | | | | | | | | | | | | | | | | | | | | | | | | |
| 1 | | 1 | | | | | | | | | | | | | | | | | | | | | | | | | | | | | | | | | | | | | | | | | | | | | | | | | | | | | | | | | | | | | | | | | | | | | | | | | | | | | |
| | | 1 | | | | | | | | | | | | | | | | | | | | | | | | | | | | | | | | | | | | | | | | | | | | | | | | | | | | | | | | | | | | | | | | | | | | | | | | | | | | | |
| | | 1 | | | | | | | | | | | | | | | | | | | | | | | | | | | | | | | | | | | | | | | | | | | | | | | | | | | | | | | | | | | | | | | | | | | | | | | | | | | | | |
| 2 | | 1 | | | | | | | | | | | | | | | | | | | | | | | | | | | | | | | | | | | | | | | | | | | | | | | | | | | | | | | | | | | | | | | | | | | | | | | | | | | | | |
| 3 | | | | | | | | | | | | | | | | | | | | | | | | | | | | | | | | | | | | | | | | | | | | | | | | | | | | | | | | | | | | | | | | | | | | | | | | | | | | | | | |
| 2 | | | | | | | | | | | | | | | | | | | | | | | | | | | | | | | | | | | | | | | | | | | | | | | | | | | | | | | | | | | | | | | | | | | | | | | | | | | | | | | |
| 1 | | | | | | | | | | | | | | | | | | | | | | | | | | | | | | | | | | | | | | | | | | | | | | | | | | | | | | | | | | | | | | | | | | | | | | | | | | | | | | | |
| | | | | | | | | | | | | | | | | | | | | | | | | | | | | | | | | | | | | | | | | | | | | | | | | | | | | | | | | | | | | | | | | | | | | | | | | | | | | | | | |
| | | | | | | | | | | | | | | | | | | | | | | | | | | | | | | | | | | | | | | | | | | | | | | | | | | | | | | | | | | | | | | | | | | | | | | | | | | | | | | | |
| | | | | | | | | | | | | | | | | | | | | | | | | | | | | | | | | | | | | | | | | | | | | | | | | | | | | | | | | | | | | | | | | | | | | | | | | | | | | | | | |
| | | | | | | | | | | | | | | | | | | | | | | | | | | | | | | | | | | | | | | | | | | | | | | | | | | | | | | | | | | | | | | | | | | | | | | | | | | | | | | | |
| | | | | | | | | | | | | | | | | | | | | | | | | | | | | | | | | | | | | | | | | | | | | | | | | | | | | | | | | | | | | | | | | | | | | | | | | | | | | | | | |
| | | | | | | | | | | | | | | | | | | | | | | | | | | | | | | | | | | | | | | | | | | | | | | | | | | | | | | | | | | | | | | | | | | | | | | | | | | | | | | | |
| | | | | | | | | | | | | | | | | | | | | | | | | | | | | | | | | | | | | | | | | | | | | | | | | | | | | | | | | | | | | | | | | | | | | | | | | | | | | | | | |
| Post - 0 Miss - 0 Block - 0 | Post - 0 Miss - 0 Block - 0 | Post - 0 Miss - 1 Block - 0 | Post - 0 Miss - 0 Block - 0 | Post - 0 Miss - 0 Block - 0 | Post - 1 Miss - 4 Block - 1 | Post - 0 Miss - 0 Block - 0 | | | | | | | | | | | | | | | | | | | | | | | | | | | | | | | | | | | | | | | | | | | | | | | | | | | | | | | | | | | | | | | | | | | | | | | | | |

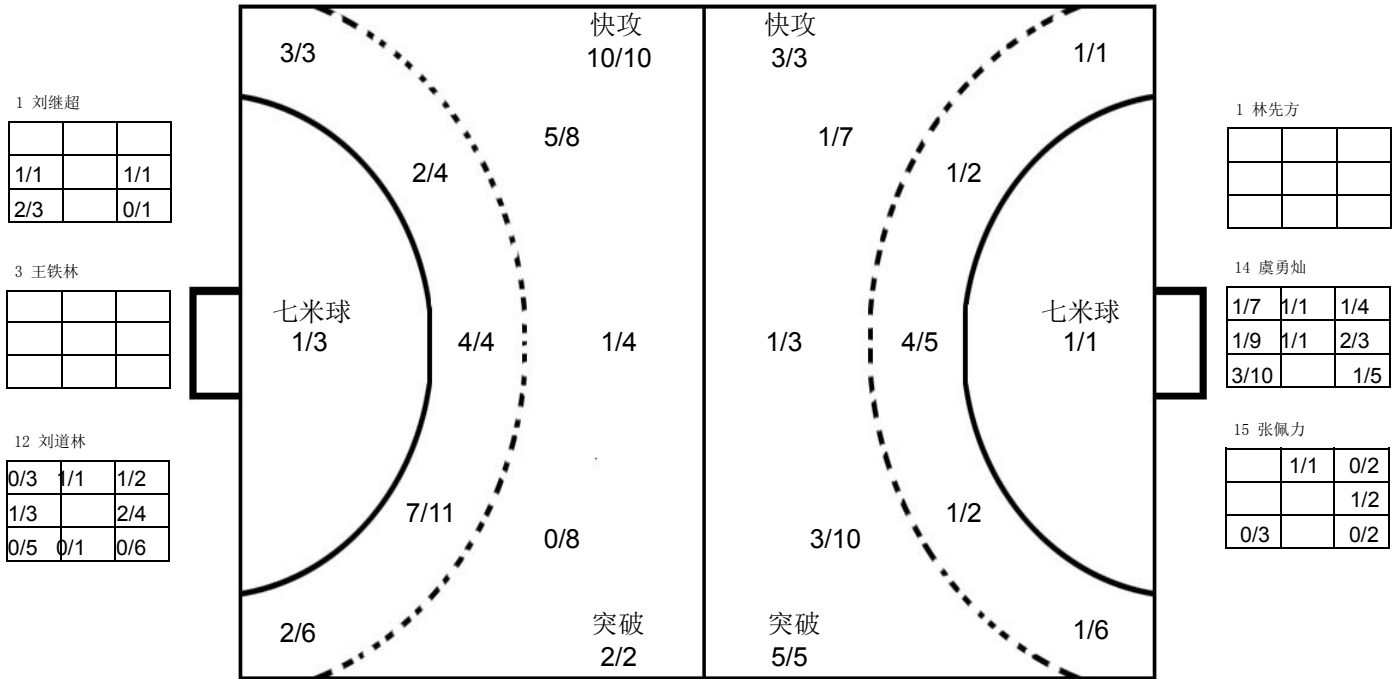

浙江队

| | | | | | | | | | | | | | | | | | | | | | | | | | | | | | | | | | | | | | | | | | | | | | | | | | | | | | | | | | | | | | | | | | | | | | | | | | | | | | | | |
|---|-----------------------------|-----------------------------|-----------------------------|-----------------------------|-----------------------------|-----------------------------|-----------------------------|--|---|---|--|--|--|---|--|--|---|--|---|---|--|--|--|---|--|---|---|---|---|--|--|--|--|--|--|--|--|--|--|---|--|--|--|---|--|--|--|--|--|--|--|--|--|--|--|--|---|--|---|--|--|--|--|--|--|--|--|--|--|--|--|--|--|--|--|--|--|--|--|
| 1 林先方 | 2 李恩铭 | 3 郑尧俊 | 5 高家南 | 9 李家乐 | 10 徐正飞 | 14 虞勇灿 | 15 张佩力 | | | | | | | | | | | | | | | | | | | | | | | | | | | | | | | | | | | | | | | | | | | | | | | | | | | | | | | | | | | | | | | | | | | | | | | | |
| <table border="1"><tr><td></td><td></td><td>1</td></tr><tr><td></td><td></td><td>1</td></tr><tr><td></td><td></td><td>2</td></tr></table> | | | 1 | | | 1 | | | 2 | <table border="1"><tr><td></td><td></td><td></td></tr><tr><td></td><td></td><td></td></tr><tr><td></td><td></td><td>2</td></tr></table> | | | | | | | | | 2 | <table border="1"><tr><td></td><td></td><td></td></tr><tr><td>2</td><td></td><td>1</td></tr><tr><td>1</td><td>1</td><td>1</td></tr></table> | | | | 2 | | 1 | 1 | 1 | 1 | <table border="1"><tr><td></td><td></td><td></td></tr><tr><td></td><td></td><td></td></tr><tr><td></td><td></td><td></td></tr></table> | | | | | | | | | | <table border="1"><tr><td></td><td></td><td></td></tr><tr><td>1</td><td></td><td></td></tr><tr><td></td><td></td><td></td></tr></table> | | | | 1 | | | | | | <table border="1"><tr><td></td><td></td><td></td></tr><tr><td></td><td></td><td></td></tr><tr><td>1</td><td></td><td>1</td></tr></table> | | | | | | | 1 | | 1 | <table border="1"><tr><td></td><td></td><td></td></tr><tr><td></td><td></td><td></td></tr><tr><td></td><td></td><td></td></tr></table> | | | | | | | | | | <table border="1"><tr><td></td><td></td><td></td></tr><tr><td></td><td></td><td></td></tr><tr><td></td><td></td><td></td></tr></table> | | | | | | | | | |
| | | 1 | | | | | | | | | | | | | | | | | | | | | | | | | | | | | | | | | | | | | | | | | | | | | | | | | | | | | | | | | | | | | | | | | | | | | | | | | | | | | |
| | | 1 | | | | | | | | | | | | | | | | | | | | | | | | | | | | | | | | | | | | | | | | | | | | | | | | | | | | | | | | | | | | | | | | | | | | | | | | | | | | | |
| | | 2 | | | | | | | | | | | | | | | | | | | | | | | | | | | | | | | | | | | | | | | | | | | | | | | | | | | | | | | | | | | | | | | | | | | | | | | | | | | | | |
| | | | | | | | | | | | | | | | | | | | | | | | | | | | | | | | | | | | | | | | | | | | | | | | | | | | | | | | | | | | | | | | | | | | | | | | | | | | | | | | |
| | | | | | | | | | | | | | | | | | | | | | | | | | | | | | | | | | | | | | | | | | | | | | | | | | | | | | | | | | | | | | | | | | | | | | | | | | | | | | | | |
| | | 2 | | | | | | | | | | | | | | | | | | | | | | | | | | | | | | | | | | | | | | | | | | | | | | | | | | | | | | | | | | | | | | | | | | | | | | | | | | | | | |
| | | | | | | | | | | | | | | | | | | | | | | | | | | | | | | | | | | | | | | | | | | | | | | | | | | | | | | | | | | | | | | | | | | | | | | | | | | | | | | | |
| 2 | | 1 | | | | | | | | | | | | | | | | | | | | | | | | | | | | | | | | | | | | | | | | | | | | | | | | | | | | | | | | | | | | | | | | | | | | | | | | | | | | | |
| 1 | 1 | 1 | | | | | | | | | | | | | | | | | | | | | | | | | | | | | | | | | | | | | | | | | | | | | | | | | | | | | | | | | | | | | | | | | | | | | | | | | | | | | |
| | | | | | | | | | | | | | | | | | | | | | | | | | | | | | | | | | | | | | | | | | | | | | | | | | | | | | | | | | | | | | | | | | | | | | | | | | | | | | | | |
| | | | | | | | | | | | | | | | | | | | | | | | | | | | | | | | | | | | | | | | | | | | | | | | | | | | | | | | | | | | | | | | | | | | | | | | | | | | | | | | |
| | | | | | | | | | | | | | | | | | | | | | | | | | | | | | | | | | | | | | | | | | | | | | | | | | | | | | | | | | | | | | | | | | | | | | | | | | | | | | | | |
| | | | | | | | | | | | | | | | | | | | | | | | | | | | | | | | | | | | | | | | | | | | | | | | | | | | | | | | | | | | | | | | | | | | | | | | | | | | | | | | |
| 1 | | | | | | | | | | | | | | | | | | | | | | | | | | | | | | | | | | | | | | | | | | | | | | | | | | | | | | | | | | | | | | | | | | | | | | | | | | | | | | | |
| | | | | | | | | | | | | | | | | | | | | | | | | | | | | | | | | | | | | | | | | | | | | | | | | | | | | | | | | | | | | | | | | | | | | | | | | | | | | | | | |
| | | | | | | | | | | | | | | | | | | | | | | | | | | | | | | | | | | | | | | | | | | | | | | | | | | | | | | | | | | | | | | | | | | | | | | | | | | | | | | | |
| | | | | | | | | | | | | | | | | | | | | | | | | | | | | | | | | | | | | | | | | | | | | | | | | | | | | | | | | | | | | | | | | | | | | | | | | | | | | | | | |
| 1 | | 1 | | | | | | | | | | | | | | | | | | | | | | | | | | | | | | | | | | | | | | | | | | | | | | | | | | | | | | | | | | | | | | | | | | | | | | | | | | | | | |
| | | | | | | | | | | | | | | | | | | | | | | | | | | | | | | | | | | | | | | | | | | | | | | | | | | | | | | | | | | | | | | | | | | | | | | | | | | | | | | | |
| | | | | | | | | | | | | | | | | | | | | | | | | | | | | | | | | | | | | | | | | | | | | | | | | | | | | | | | | | | | | | | | | | | | | | | | | | | | | | | | |
| | | | | | | | | | | | | | | | | | | | | | | | | | | | | | | | | | | | | | | | | | | | | | | | | | | | | | | | | | | | | | | | | | | | | | | | | | | | | | | | |
| | | | | | | | | | | | | | | | | | | | | | | | | | | | | | | | | | | | | | | | | | | | | | | | | | | | | | | | | | | | | | | | | | | | | | | | | | | | | | | | |
| | | | | | | | | | | | | | | | | | | | | | | | | | | | | | | | | | | | | | | | | | | | | | | | | | | | | | | | | | | | | | | | | | | | | | | | | | | | | | | | |
| | | | | | | | | | | | | | | | | | | | | | | | | | | | | | | | | | | | | | | | | | | | | | | | | | | | | | | | | | | | | | | | | | | | | | | | | | | | | | | | |
| Post - 0 Miss - 1 Block - 0 | Post - 0 Miss - 2 Block - 2 | Post - 1 Miss - 0 Block - 0 | Post - 0 Miss - 0 Block - 0 | Post - 0 Miss - 0 Block - 0 | Post - 0 Miss - 0 Block - 0 | Post - 0 Miss - 0 Block - 0 | Post - 0 Miss - 0 Block - 0 | | | | | | | | | | | | | | | | | | | | | | | | | | | | | | | | | | | | | | | | | | | | | | | | | | | | | | | | | | | | | | | | | | | | | | | | |
| 17 罗明杰 | 18 倪陈辉 | 19 王浩 | | | | | | | | | | | | | | | | | | | | | | | | | | | | | | | | | | | | | | | | | | | | | | | | | | | | | | | | | | | | | | | | | | | | | | | | | | | | | |
| <table border="1"><tr><td></td><td></td><td></td></tr><tr><td></td><td></td><td></td></tr><tr><td></td><td></td><td></td></tr></table> | | | | | | | | | | <table border="1"><tr><td></td><td></td><td></td></tr><tr><td>3</td><td></td><td></td></tr><tr><td>3</td><td></td><td>1</td></tr></table> | | | | 3 | | | 3 | | 1 | <table border="1"><tr><td></td><td></td><td></td></tr><tr><td></td><td></td><td></td></tr><tr><td></td><td></td><td></td></tr></table> | | | | | | | | | | <table border="1"><tr><td></td><td></td><td></td></tr><tr><td></td><td></td><td></td></tr><tr><td></td><td></td><td></td></tr></table> | | | | | | | | | | <table border="1"><tr><td></td><td></td><td></td></tr><tr><td></td><td></td><td></td></tr><tr><td></td><td></td><td></td></tr></table> | | | | | | | | | | <table border="1"><tr><td></td><td></td><td></td></tr><tr><td></td><td></td><td></td></tr><tr><td></td><td></td><td></td></tr></table> | | | | | | | | | | <table border="1"><tr><td></td><td></td><td></td></tr><tr><td></td><td></td><td></td></tr><tr><td></td><td></td><td></td></tr></table> | | | | | | | | | | <table border="1"><tr><td></td><td></td><td></td></tr><tr><td></td><td></td><td></td></tr><tr><td></td><td></td><td></td></tr></table> | | | | | | | | | |
| | | | | | | | | | | | | | | | | | | | | | | | | | | | | | | | | | | | | | | | | | | | | | | | | | | | | | | | | | | | | | | | | | | | | | | | | | | | | | | | |
| | | | | | | | | | | | | | | | | | | | | | | | | | | | | | | | | | | | | | | | | | | | | | | | | | | | | | | | | | | | | | | | | | | | | | | | | | | | | | | | |
| | | | | | | | | | | | | | | | | | | | | | | | | | | | | | | | | | | | | | | | | | | | | | | | | | | | | | | | | | | | | | | | | | | | | | | | | | | | | | | | |
| | | | | | | | | | | | | | | | | | | | | | | | | | | | | | | | | | | | | | | | | | | | | | | | | | | | | | | | | | | | | | | | | | | | | | | | | | | | | | | | |
| 3 | | | | | | | | | | | | | | | | | | | | | | | | | | | | | | | | | | | | | | | | | | | | | | | | | | | | | | | | | | | | | | | | | | | | | | | | | | | | | | | |
| 3 | | 1 | | | | | | | | | | | | | | | | | | | | | | | | | | | | | | | | | | | | | | | | | | | | | | | | | | | | | | | | | | | | | | | | | | | | | | | | | | | | | |
| | | | | | | | | | | | | | | | | | | | | | | | | | | | | | | | | | | | | | | | | | | | | | | | | | | | | | | | | | | | | | | | | | | | | | | | | | | | | | | | |
| | | | | | | | | | | | | | | | | | | | | | | | | | | | | | | | | | | | | | | | | | | | | | | | | | | | | | | | | | | | | | | | | | | | | | | | | | | | | | | | |
| | | | | | | | | | | | | | | | | | | | | | | | | | | | | | | | | | | | | | | | | | | | | | | | | | | | | | | | | | | | | | | | | | | | | | | | | | | | | | | | |
| | | | | | | | | | | | | | | | | | | | | | | | | | | | | | | | | | | | | | | | | | | | | | | | | | | | | | | | | | | | | | | | | | | | | | | | | | | | | | | | |
| | | | | | | | | | | | | | | | | | | | | | | | | | | | | | | | | | | | | | | | | | | | | | | | | | | | | | | | | | | | | | | | | | | | | | | | | | | | | | | | |
| | | | | | | | | | | | | | | | | | | | | | | | | | | | | | | | | | | | | | | | | | | | | | | | | | | | | | | | | | | | | | | | | | | | | | | | | | | | | | | | |
| | | | | | | | | | | | | | | | | | | | | | | | | | | | | | | | | | | | | | | | | | | | | | | | | | | | | | | | | | | | | | | | | | | | | | | | | | | | | | | | |
| | | | | | | | | | | | | | | | | | | | | | | | | | | | | | | | | | | | | | | | | | | | | | | | | | | | | | | | | | | | | | | | | | | | | | | | | | | | | | | | |
| | | | | | | | | | | | | | | | | | | | | | | | | | | | | | | | | | | | | | | | | | | | | | | | | | | | | | | | | | | | | | | | | | | | | | | | | | | | | | | | |
| | | | | | | | | | | | | | | | | | | | | | | | | | | | | | | | | | | | | | | | | | | | | | | | | | | | | | | | | | | | | | | | | | | | | | | | | | | | | | | | |
| | | | | | | | | | | | | | | | | | | | | | | | | | | | | | | | | | | | | | | | | | | | | | | | | | | | | | | | | | | | | | | | | | | | | | | | | | | | | | | | |
| | | | | | | | | | | | | | | | | | | | | | | | | | | | | | | | | | | | | | | | | | | | | | | | | | | | | | | | | | | | | | | | | | | | | | | | | | | | | | | | |
| | | | | | | | | | | | | | | | | | | | | | | | | | | | | | | | | | | | | | | | | | | | | | | | | | | | | | | | | | | | | | | | | | | | | | | | | | | | | | | | |
| | | | | | | | | | | | | | | | | | | | | | | | | | | | | | | | | | | | | | | | | | | | | | | | | | | | | | | | | | | | | | | | | | | | | | | | | | | | | | | | |
| | | | | | | | | | | | | | | | | | | | | | | | | | | | | | | | | | | | | | | | | | | | | | | | | | | | | | | | | | | | | | | | | | | | | | | | | | | | | | | | |
| | | | | | | | | | | | | | | | | | | | | | | | | | | | | | | | | | | | | | | | | | | | | | | | | | | | | | | | | | | | | | | | | | | | | | | | | | | | | | | | |
| | | | | | | | | | | | | | | | | | | | | | | | | | | | | | | | | | | | | | | | | | | | | | | | | | | | | | | | | | | | | | | | | | | | | | | | | | | | | | | | |
| | | | | | | | | | | | | | | | | | | | | | | | | | | | | | | | | | | | | | | | | | | | | | | | | | | | | | | | | | | | | | | | | | | | | | | | | | | | | | | | |
| Post - 0 Miss - 0 Block - 1 | Post - 2 Miss - 1 Block - 4 | Post - 0 Miss - 0 Block - 0 | | | | | | | | | | | | | | | | | | | | | | | | | | | | | | | | | | | | | | | | | | | | | | | | | | | | | | | | | | | | | | | | | | | | | | | | | | | | | |

注释: Post=击柱 Miss=射失 Block=被封





预赛 Group A
青年男子 全国比赛

2016年“体彩杯”全国手球男子青年锦标赛

| | | | | | | | | | | | | | | | | | | | | | |
|-------------------------|---|--------------------------------|---------------------|------------------------|------------------------------------|-------------------|----------|---------------------------|--|----------|----------|----------------------|---------------|----------|--|--|----|---|----|---|----|
| Team A A 解放军队 | | | | Team B B 江苏队 | | | | Match Number 29 | | | | | | | | | | | | | |
| played in China | | in the hall 重庆万州 | | on 25/03/2016 | | at 16:00 hours | | Spectators | | | | | | | | | | | | | |
| Half-time (30') | A 17 | B 19 | End of playing time | A 37 | B 30 | 1st extra time | A | B | 2nd extra time | A | B | After penalty throws | A | B | | | | | | | |
| Number of 7 m | A 3 / 4 | Team time-out 1 05:33 2 3 3 | | | Full name of players and officials | | | | Team time-out 1 20:41 2 39:42 3 55:26 | | | B 3 / 5 | Number of 7 m | | | | | | | | |
| No. | Team A | | | | | G | W | 2' | D | DR | No. | Team B | | | | | G | W | 2' | D | DR |
| 1 | 郭梦雨 | | | | | | | | | | 1 | 潘博琦 | | | | | | | | | |
| 3 | 张昌轲 | | | | | 7 | | | | | 3 | 赵韦光 | | | | | | | | | |
| 4 | 张洋 | | | | | | | | | | 4 | 张瑞恒 | | | | | | | | | |
| 5 | 尹一楠 | | | | | | | | | | 6 | 季雨 | | | | | | | | | |
| 6 | 吴昊 | | | | | 5 | 1 | | | | 7 | 任超凡 | | | | | 2 | | | | |
| 7 | 姜钦 | | | | | 5 | | | | | 8 | 姜童耀 | | | | | | 1 | | | |
| 8 | 邹峻楠 | | | | | | | | | | 9 | 王俊威 | | | | | | | | | |
| 9 | 李天枢 | | | | | | | | | | 11 | 周傲 | | | | | 7 | 1 | | | |
| 10 | 范保坤 | | | | | 2 | | 2 | | | 13 | 尹吉祥 | | | | | 11 | | | | |
| 11 | 王誌汉 | | | | | 4 | 1 | 2 | | | 14 | 罗中熠 | | | | | | | | | |
| 12 | 左子健 | | | | | | | | | | 15 | 阎冠中 | | | | | 2 | | | | |
| 13 | 徐崧清 | | | | | 3 | | | | | 17 | 马益奎 | | | | | 3 | 1 | 2 | | |
| 14 | 孙耀琦 | | | | | 11 | | 1 | | | 18 | 耿畅 | | | | | 5 | | 1 | | |
| 16 | 池猛 | | | | | | | | | | | | | | | | | | | | |
| 17 | 刘安宁 | | | | | | | | | | | | | | | | | | | | |
| A | 杜长义 (主教练) | | | | | | | | | | B | 贾淑君 (主教练) | | | | | | | | | |
| A | Signature of Responsible Official of the Teams (Off. A) | | | | | | | | | | B | | | | | | | | | | |
| TP | Remarks of Referee / CHA Official | | | | | | | | | | TP | | | | | | | | | | |

Signatures

| | | | | |
|------------------|-----------|----------|--|--|
| Referees | 尹静阳 (CHN) | 王洋 (CHN) | | |
| Techn. Delegates | 许宜扬 (CHN) | | | |
| CHA Official | 吴瑞亭 (CHN) | | | |

Note: Number of 7m Throws Awarded to Team A and B, Goals (G), Warnings (W), Suspensions (2'), Direct Disqualification (D), Disqualification with Report (DR) and Team Penalty (TP).

Table Officials:

Statisticians:





2016年“体彩杯”全国手球男子青年锦标赛
竞赛技术统计(媒体表)

预赛 组别 A 轮次 5 场次 29

重庆万州

25/03/2016

201602029-51-1/1

解放军队 解放军 37 vs 30 江苏 江苏队
17:19

裁判员 尹静阳 (CHN) / 王洋 (CHN)

Main statistics table for the match between 解放军 (Jiexian Army) and 江苏 (Jiangsu). Includes columns for player names, positions, and various performance metrics like goals, assists, and suspensions. Includes sub-tables for 1st Half and 2nd Half.

场上队员: 得分 / 射门

守门员: 救球 / 射门

Legend table for abbreviations used in the statistics, such as 快攻 (Fast Break), 突破 (Breakthrough), 任意球 (Free Throw), etc.





2016年“体彩杯”全国手球男子青年锦标赛 图式比赛技术统计表

轮次 5

场次 29

201602029-21-1/1

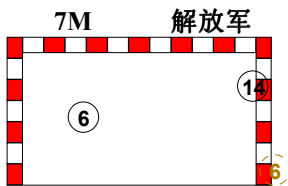
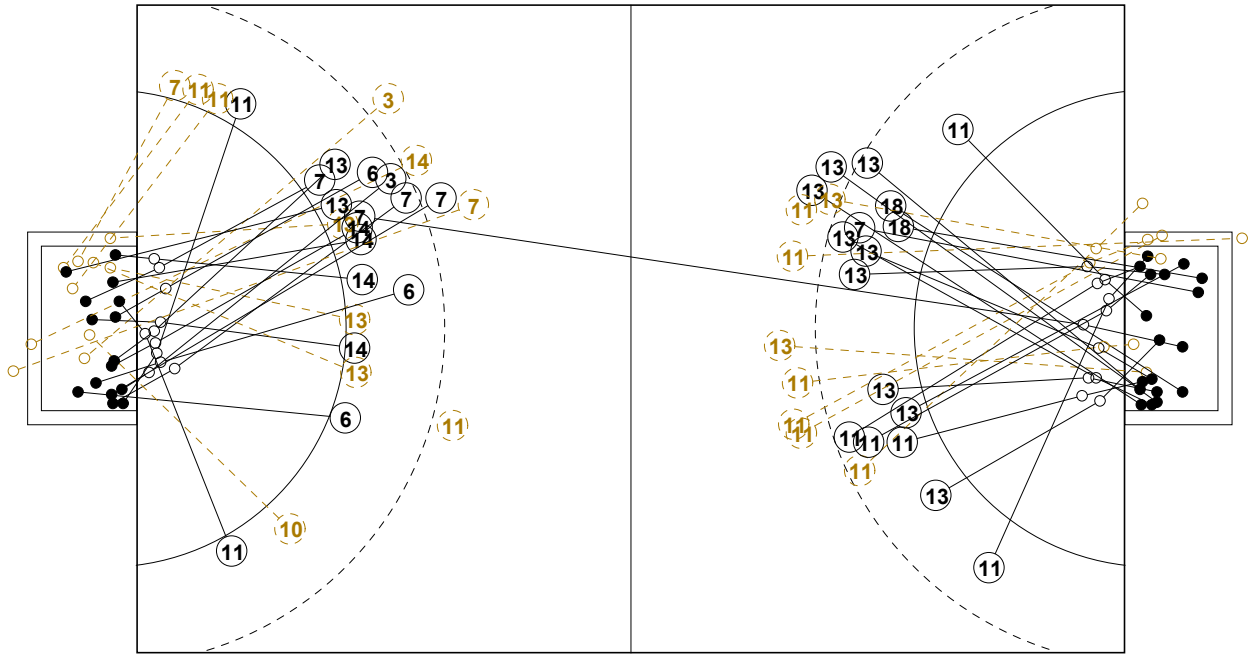

1st Half
17 : 19

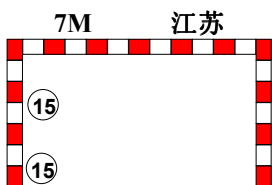
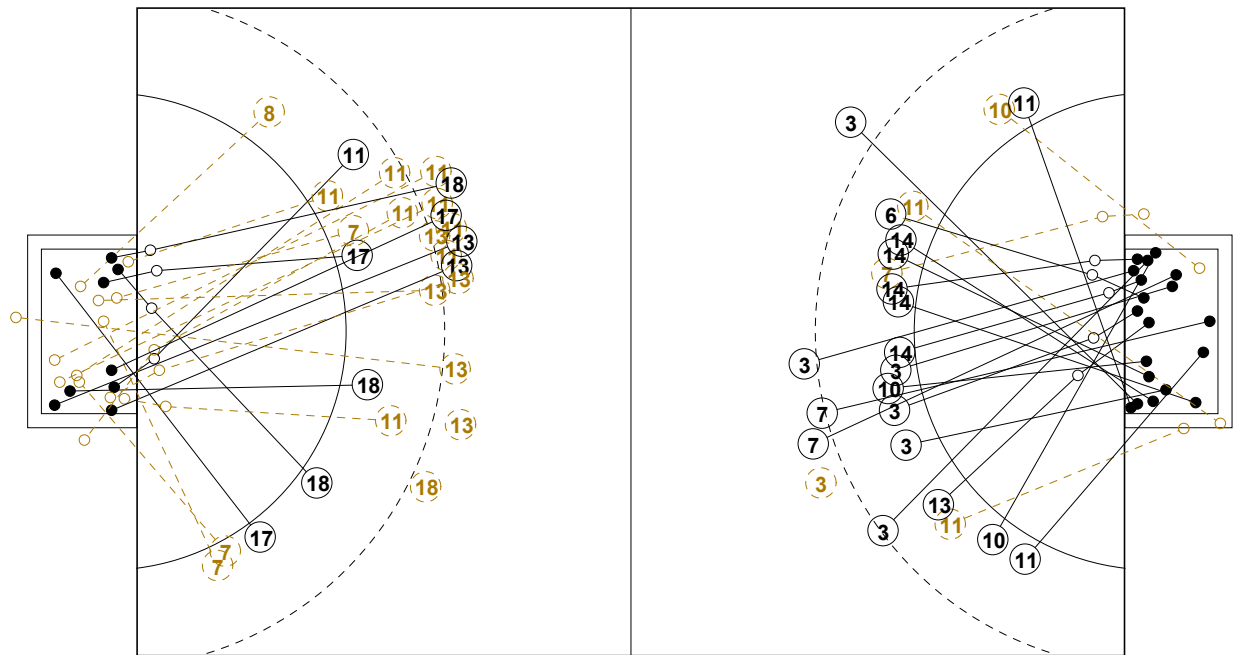
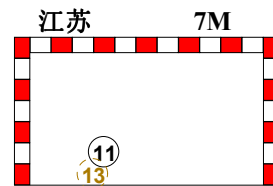

2nd Half
30 : 37

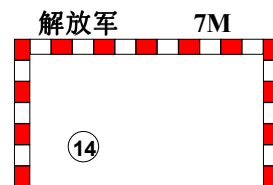



2016年“体彩杯”全国手球男子青年锦标赛

个人/全队技术统计表

正式表
手球
青年男子预赛
轮次 5组别 A
场次 29201602029-14-1/2
重庆万州
25/03/2016 16:00

| 号码 | 姓名 | 远射 | 近射 | 边射 | 快攻 | 突破 | 任意 | 7M | 合计 | % | 助攻 | 失误 | 警告 | 2' | 取消 | 时间 |
|------------------|-----|------|-------|------|-----|-----|-----|-----|-------|-------|----|----|----|----|----|----------|
| 解放军队(解放军) | | | | | | | | | | | | | | | | |
| <i>(场上队员)</i> | | | | | | | | | | | | | | | | |
| 1 | 郭梦雨 | | | | | | | | | 0.0% | | 1 | | | | 00:59:27 |
| 3 | 张昌轲 | 3/5 | 1/1 | | | 2/2 | 1/1 | | 7/9 | 77.8% | 5 | 7 | | | | 01:00:00 |
| 4 | 张洋 | | | | | | | | | 0.0% | | 1 | | | | 00:01:06 |
| 5 | 尹一楠 | | | | | | | | | 0.0% | | 1 | | | | 00:01:21 |
| 6 | 吴昊 | 1/1 | 1/1 | | | 2/2 | | 1/2 | 5/6 | 83.3% | 4 | 4 | 1 | | | 01:00:00 |
| 7 | 姜钦 | 2/2 | 1/2 | 0/1 | | | 2/3 | | 5/8 | 62.5% | 5 | | | | | 00:59:35 |
| 8 | 邹峻楠 | | | | | | | | | 0.0% | | | | | | 00:00:00 |
| 9 | 李天枢 | | | | | | | | | 0.0% | | | | | | 00:00:00 |
| 10 | 范保坤 | | | 1/3 | 1/1 | | | | 2/4 | 50.0% | 1 | | | 2 | | 00:52:33 |
| 11 | 王誌汉 | 0/1 | 0/1 | 4/6 | 0/1 | | | | 4/9 | 44.4% | | 1 | 1 | 2 | | 00:41:44 |
| 12 | 左子健 | | | | | | | | | 0.0% | | | | | | 00:00:33 |
| 13 | 徐峻清 | | 1/4 | | 2/2 | | | | 3/6 | 50.0% | | | | | | 00:24:20 |
| 14 | 孙耀琦 | 0/1 | 9/9 | | | | | 2/2 | 11/12 | 91.7% | 2 | | | 1 | | 00:57:05 |
| 16 | 池猛 | | | | | | | | | 0.0% | | | | | | 00:00:00 |
| 17 | 刘安宁 | | | | | | | | | 0.0% | | | | | | 00:00:00 |
| 合计 | | 6/10 | 13/18 | 5/10 | 3/4 | 4/4 | 3/4 | 3/4 | 37/54 | 68.5% | 17 | 15 | 2 | 5 | | |
| <i>(守门员)</i> | | | | | | | | | | | | | | | | |
| 1 | 郭梦雨 | 8/17 | 3/12 | 3/5 | 0/3 | 0/3 | 0/1 | 1/3 | 15/44 | 34.1% | | 1 | | | | 00:59:27 |
| 12 | 左子健 | | | | | | | 0/1 | 0/1 | 0.0% | | | | | | 00:00:33 |
| 合计 | | 8/17 | 3/12 | 3/5 | 0/3 | 0/3 | 0/1 | 1/4 | 15/45 | 33.3% | | 1 | | | | |

场上队员：得分/射门

守门员：救球/射门

| 全队合计 | 得分 | 被救 | 射失 | 击柱 | 封球 | 合计 | % |
|------|----|----|----|----|----|----|--------|
| 远射 | 6 | 1 | | 1 | 2 | 10 | 60.0% |
| 近射 | 13 | 2 | 1 | 2 | | 18 | 72.2% |
| 边射 | 5 | 5 | | | | 10 | 50.0% |
| 快攻 | 3 | | | 1 | | 4 | 75.0% |
| 突破 | 4 | | | | | 4 | 100.0% |
| 任意 | 3 | | 1 | | | 4 | 75.0% |
| 7M | 3 | | | 1 | | 4 | 75.0% |





2016年“体彩杯”全国手球男子青年锦标赛

个人/全队技术统计表

正式表
手球
青年男子预赛
轮次 5组别 A
场次 29201602029-14-2/2
重庆万州
25/03/2016 16:00

| 号码 | 姓名 | 远射 | 近射 | 边射 | 快攻 | 突破 | 任意 | 7M | 合计 | % | 助攻 | 失误 | 警告 | 2' | 取消 | 时间 |
|----------------|-----|------|------|------|-----|-----|-----|-----|-------|-------|----|----|----|----|----|----------|
| 江苏队(江苏) | | | | | | | | | | | | | | | | |
| <i>(上场队员)</i> | | | | | | | | | | | | | | | | |
| 1 | 潘博琦 | | | | | | | | | 0.0% | | | | | | 00:00:00 |
| 3 | 赵韦光 | | | | | | | | | 0.0% | | | | | | 00:01:34 |
| 4 | 张瑞恒 | | | | | | | | | 0.0% | | | | | | 00:00:00 |
| 6 | 季雨 | | | | | | | | | 0.0% | | | | | | 00:01:45 |
| 7 | 任超凡 | 2/2 | 0/1 | 0/2 | | | | | 2/5 | 40.0% | | 1 | | | | 01:00:00 |
| 8 | 姜童耀 | | | 0/1 | | | | | 0/1 | 0.0% | | 3 | 1 | | | 00:55:00 |
| 9 | 王俊威 | | | | | | | | | 0.0% | | | | | | 00:04:34 |
| 11 | 周傲 | 0/11 | 3/5 | 1/1 | 1/1 | 1/1 | 0/1 | 1/1 | 7/21 | 33.3% | | 3 | 1 | | | 01:00:00 |
| 13 | 尹吉祥 | 5/12 | 3/3 | | | 2/2 | 1/1 | 0/2 | 11/20 | 55.0% | 2 | 6 | | | | 00:58:24 |
| 14 | 罗中熠 | | | | | | | | | 0.0% | | | | | | 00:55:26 |
| 15 | 阎冠中 | | | | | | | 2/2 | 2/2 | 100% | | | | | | 00:03:12 |
| 17 | 马益奎 | 1/1 | 1/1 | 1/1 | | | | | 3/3 | 100% | | 2 | 1 | 2 | | 01:00:00 |
| 18 | 耿畅 | 1/2 | 2/2 | | 2/2 | | | | 5/6 | 83.3% | | 3 | | 1 | | 01:00:00 |
| 合计 | | | | | | | | | | | | | | | | |
| <i>(守门员)</i> | | 9/28 | 9/12 | 2/5 | 3/3 | 3/3 | 1/2 | 3/5 | 30/58 | 51.7% | 2 | 18 | 3 | 3 | | |
| 13 | 尹吉祥 | 0/1 | 0/1 | | | | | | 0/2 | 0.0% | | | | | | 00:58:24 |
| 14 | 罗中熠 | 1/6 | 2/14 | 5/10 | 0/3 | 0/4 | 0/3 | 0/3 | 8/43 | 18.6% | | | | | | 00:55:26 |
| 合计 | | | | | | | | | | | | | | | | |
| | | 1/7 | 2/15 | 5/10 | 0/3 | 0/4 | 0/3 | 0/3 | 8/45 | 17.8% | | | | | | |

场上队员：得分/射门

守门员：救球/射门

| 全队合计 | 得分 | 被救 | 射失 | 击柱 | 封球 | 合计 | % |
|------|----|----|----|----|----|----|--------|
| 远射 | 9 | 8 | 4 | 1 | 6 | 28 | 32.1% |
| 近射 | 9 | 3 | | | | 12 | 75.0% |
| 边射 | 2 | 3 | | | | 5 | 40.0% |
| 快攻 | 3 | | | | | 3 | 100.0% |
| 突破 | 3 | | | | | 3 | 100.0% |
| 任意 | 1 | | | 1 | | 2 | 50.0% |
| 7M | 3 | 1 | 1 | | | 5 | 60.0% |





2016年“体彩杯”全国手球男子青年锦标赛

图式射门区域统计

轮次 5 场次 29

201602029-41-1/1

解放军队

| | | | | | | | |
|--|--|--|--|---|---|--|---|
| 1 郭梦雨 [] [] [] [] [] [] [] [] [] Post - 0 Miss - 0 Block - 0 | 3 张昌柯 [] [] [] 1 [] [] 1 3 [] 1 [] 1 Post - 0 Miss - 0 Block - 1 | 4 张洋 [] [] [] [] [] [] [] [] [] Post - 0 Miss - 0 Block - 0 | 5 尹一楠 [] [] [] [] [] [] [] [] [] Post - 0 Miss - 0 Block - 0 | 6 吴昊 [] [] [] 3 [] [] [] 1 [] 1 [] Post - 1 Miss - 0 Block - 0 | 7 姜钦 [] [] [] [] [] 1 [] 1 [] 1 [] 2 [] [] [] Post - 0 Miss - 2 Block - 0 | 8 邹峻楠 [] [] [] [] [] [] [] [] [] Post - 0 Miss - 0 Block - 0 | 9 李天枢 [] [] [] [] [] [] [] [] [] Post - 0 Miss - 0 Block - 0 |
| 10 范保坤 [] [] [] 1 [] [] [] [] [] [] 1 Post - 0 Miss - 0 Block - 0 | 11 王誌汉 [] [] [] [] [] 1 [] 1 [] 1 [] 1 Post - 2 Miss - 0 Block - 1 | 12 左子健 [] [] [] [] [] [] [] [] [] Post - 0 Miss - 0 Block - 0 | 13 徐崧清 [] [] [] [] [] [] 1 1 [] 1 [] Post - 1 Miss - 0 Block - 0 | 14 孙耀琦 [] [] [] [] [] [] 2 1 [] 1 [] 3 [] [] 4 Post - 1 Miss - 0 Block - 0 | 16 池猛 [] [] [] [] [] [] [] [] [] Post - 0 Miss - 0 Block - 0 | 17 刘安宇 [] [] [] [] [] [] [] [] [] Post - 0 Miss - 0 Block - 0 | |

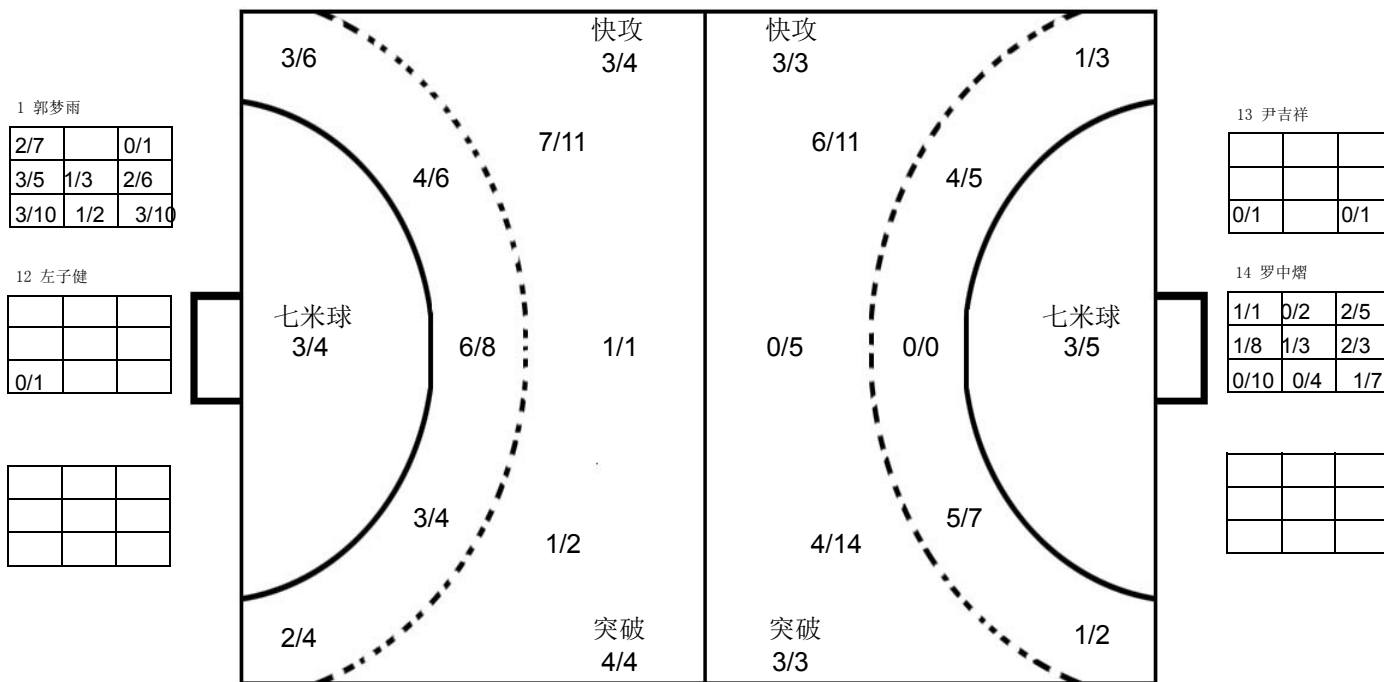

江苏队

| | | | | | | | |
|--|--|--|---|--|---|---|---|
| 1 潘博琦 [] [] [] [] [] [] [] [] [] Post - 0 Miss - 0 Block - 0 | 3 赵韦光 [] [] [] [] [] [] [] [] [] Post - 0 Miss - 0 Block - 0 | 4 张瑞恒 [] [] [] [] [] [] [] [] [] Post - 0 Miss - 0 Block - 0 | 6 季雨 [] [] [] [] [] [] [] [] [] Post - 0 Miss - 0 Block - 0 | 7 任超凡 [] [] [] 1 [] [] [] [] [] 1 [] Post - 0 Miss - 0 Block - 0 | 8 姜童耀 [] [] [] [] [] [] [] [] [] Post - 0 Miss - 0 Block - 0 | 9 王俊威 [] [] [] [] [] [] [] [] [] Post - 0 Miss - 0 Block - 0 | 11 周傲 [] [] [] [] [] [] 5 [] 1 [] 1 Post - 2 Miss - 3 Block - 3 |
| 13 尹吉祥 1 [] [] [] 2 [] 1 [] 2 1 [] [] 4 Post - 0 Miss - 2 Block - 2 | 14 罗中熠 [] [] [] [] [] [] [] [] [] Post - 0 Miss - 0 Block - 0 | 15 阎冠中 [] [] [] 1 [] [] [] 1 [] [] [] Post - 0 Miss - 0 Block - 0 | 17 马益奎 [] [] [] [] [] [] 1 [] [] [] 1 1 [] [] [] Post - 0 Miss - 0 Block - 0 | 18 耿畅 [] [] [] 2 [] [] [] [] [] [] 1 [] [] [] 2 Post - 0 Miss - 0 Block - 1 | | | |

注释: Post=击柱 Miss=射失 Block=被封





预赛 Group A
青年男子 全国比赛

2016年“体彩杯”全国手球男子青年锦标赛

| | | | | | | | | | | | | | | | | | | | | | |
|--------------------|---|---------------------------------|---------------------|------------------|------------------------------------|-------------------|---|---------------------------|---------------------------------|----|-----|----------------------|---------------|---|--|--|---|---|----|---|----|
| Team A A 上海队 | | | | Team B B 广东队 | | | | Match Number 30 | | | | | | | | | | | | | |
| played in China | | in the hall 重庆万州 | | on 25/03/2016 | | at 17:30 hours | | Spectators | | | | | | | | | | | | | |
| Half-time (30') | A 10 | B 19 | End of playing time | A 26 | B 37 | 1st extra time | A | B | 2nd extra time | A | B | After penalty throws | A | B | | | | | | | |
| Number of 7 m | A 3 / 3 | Team time-out 1 2 3 21:39 | | | Full name of players and officials | | | | Team time-out 1 2 3 25:45 | | | B 3 / 6 | Number of 7 m | | | | | | | | |
| No. | Team A | | | | | G | W | 2' | D | DR | No. | Team B | | | | | G | W | 2' | D | DR |
| 2 | 谢智超 | | | | | | | | | | 1 | 王帅 | | | | | | | | | |
| 3 | 高天伦 | | | | | 1 | | 1 | | | 2 | 姚雪岩 | | | | | 5 | | | | |
| 4 | 高震东 | | | | | | | | | | 4 | 高玉杰 | | | | | 3 | 1 | | | |
| 5 | 曹磊 | | | | | 6 | | | | | 5 | 黄培杰 | | | | | 8 | | | | |
| 6 | 季晨旭 | | | | | | | | | | 7 | 段飞宇 | | | | | | | | | |
| 7 | 蒋家敏 | | | | | 2 | 1 | 1 | | | 9 | 周凯峰 | | | | | | | | | |
| 8 | 庄旭杰 | | | | | 4 | | | | | 10 | 周仲坤 | | | | | 7 | 1 | 2 | | |
| 10 | 董凯 | | | | | 8 | 1 | | | | 11 | 胡国富 | | | | | 5 | | 1 | | |
| 12 | 张润民 | | | | | | | | | | 12 | 李壮 | | | | | | | | | |
| 14 | 吴佳兵 | | | | | 3 | 1 | | | | 13 | 蔡杰 | | | | | | | | | |
| 16 | 陈辰 | | | | | | | | | | 14 | 王泽润 | | | | | | | | | |
| 18 | 吴双 | | | | | 2 | | | | | 15 | 张建杰 | | | | | 5 | 1 | | | |
| | | | | | | | | | | | 16 | 王猛 | | | | | | | | | |
| | | | | | | | | | | | 18 | 李文金 | | | | | 4 | | | | |
| A | 马仲顺 | | | | | | | | | | B | 刘康伶 (主教练) | | | | | | | | | |
| | | | | | | | | | | | C | 刘文宁 | | | | | | | | | |
| | | | | | | | | | | | D | 王永存 | | | | | | | | | |
| A | Signature of Responsible Official of the Teams (Off. A) | | | | | | | | | | | | | | | | | | B | | |
| TP | Remarks of Referee / CHA Official | | | | | | | | | | | | | | | | | | TP | | |

Signatures

Referees: 许翔 (CHN) 王雨洋 (CHN)

Techn. Delegates: 徐健 (CHN)

CHA Official: 张春生 (CHN)

Note: Number of 7m Throws Awarded to Team A and B, Goals (G), Warnings (W), Suspensions (2'), Direct Disqualification (D), Disqualification with Report (DR) and Team Penalty (TP).

Table Officials:

Statisticians:





2016年“体彩杯”全国手球男子青年锦标赛 竞赛技术统计(媒体表)

| | | | | | | |
|------|----|------------|----|----|------------------|-----|
| 预赛 | 组别 | A | 轮次 | 5 | 场次 | 30 |
| 重庆万州 | | 25/03/2016 | | | 201602030-51-1/1 | |
| 上海队 | | 上海 | 26 | vs | 37 | 广东 |
| | | 10 : 19 | | | | 广东队 |

| | | | | | | | | | |
|-----|----------|--|--|--|---|-----------|--|--|--|
| 裁判员 | 许翔 (CHN) | | | | / | 王雨洋 (CHN) | | | |
|-----|----------|--|--|--|---|-----------|--|--|--|

| 上海 | | 远射 | 近射 | 边射 | 快攻 | 突破 | 任意球 | 7m球 | 合计 | % | 助攻 | 失误 | 警告 | 2' | D & DR | 比赛进程 | |
|---------------|-----|-------------|--------------|------------|--------------|------------|------------|------------|--------------|-------------|-----------|-----------|----------|----------|--------|------|-----------------|
| 主教练：马仲顺 | | | | | | | | | | | | | | | | | |
| 2 | 谢智超 | | | | | | | | | | | | | | | | 00:35 1 2 姚雪岩 |
| 3 | 高天伦 | | 1/4 | | | | | 1/4 | 25.0 | 7 | 4 | | | 1 | | | 00:56 2 2 姚雪岩 |
| 4 | 高震东 | | | | | | | | | | | | | | | | 02:36 3 15 张建杰 |
| 5 | 曹磊 | 1/2 | 2/3 | 0/1 | | 2/2 | | 1/1 | 6/9 | 66.7 | 1 | 1 | | | | | 03:15 3 |
| 6 | 季晨旭 | | | | | | | | | | | | | | | | 05:55 4 2 姚雪岩 |
| 7 | 蒋家敏 | 0/1 | 1/2 | 1/1 | | | | 2/4 | 50.0 | | | 1 | 1 | 1 | | | 07:03 5 15 张建杰 |
| 8 | 庄旭杰 | | | 3/6 | | 1/1 | | 4/7 | 57.1 | | | 1 | | | | | 08:44 5 |
| 10 | 董凯 | 0/2 | 7/9 | | | | | 1/1 | 8/12 | 66.7 | 1 | 1 | 1 | | | | 09:02 6 5 黄培杰 |
| 12 | 张润民 | | | | | | | | | | | | | 2 | | | 10:57 7 15 张建杰 |
| 14 | 吴佳兵 | 0/2 | 3/5 | | | | | 3/7 | 42.9 | | | 5 | 1 | | | | 13:07 8 |
| 16 | 陈辰 | | | | | | | | | | | | | | | | 17:49 8 |
| 18 | 吴双 | 1/10 | 0/1 | 0/1 | | | | 1/1 | 2/13 | 15.4 | | | | | | | 18:15 9 15 张建杰 |
| 运动员 合计 | | 2/17 | 14/24 | 4/9 | | 3/3 | | 3/3 | 26/56 | 46.4 | 9 | 25 | 3 | 2 | | | 18:35 9 |
| 12 | 张润民 | 1/2 | 5/17 | 3/7 | 2/14 | 2/5 | 2/4 | 2/5 | 17/54 | 31.5 | | | 2 | | | | 18:48 10 15 张建杰 |
| 16 | 陈辰 | | | | | | | | | | | | | | | | 19:21 10 |
| 守门员 合计 | | 1/2 | 5/17 | 3/7 | 2/14 | 2/5 | 2/4 | 2/5 | 17/54 | 31.5 | | 2 | | | | | 19:52 11 5 黄培杰 |
| 广东 | | 远射 | 近射 | 边射 | 快攻 | 突破 | 任意球 | 7m球 | 合计 | % | 助攻 | 失误 | 警告 | 2' | D & DR | 比赛进程 | |
| 教练：刘康伶 | | | | | | | | | | | | | | | | | |
| 1 | 王帅 | | | | | | | | | | 1 | | | | | | 00:48 20 5 黄培杰 |
| 2 | 姚雪岩 | 0/2 | 2/3 | | | | 0/1 | 3/3 | 5/9 | 55.6 | 3 | | | | | | 02:07 21 4 高玉杰 |
| 4 | 高玉杰 | | 1/1 | 0/2 | 2/3 | 0/1 | | 3/7 | 42.9 | 1 | 2 | 1 | | | | | 03:50 22 10 周仲坤 |
| 5 | 黄培杰 | | 2/3 | 2/3 | 3/4 | 1/1 | | 0/1 | 8/12 | 66.7 | 5 | 6 | | | | | 04:32 22 |
| 7 | 段飞宇 | | | | | | | | | | | | 1 | | | | 05:48 23 18 李文金 |
| 9 | 周凯峰 | | | | | | | | | | | | | | | | 07:30 24 2 姚雪岩 |
| 10 | 周仲坤 | 0/1 | 1/3 | 1/1 | 3/3 | 1/3 | 1/1 | 7/12 | 58.3 | | | 2 | 1 | 2 | | | 07:52 24 |
| 11 | 胡国富 | | 0/1 | 1/3 | 4/5 | | 0/1 | 5/10 | 50.0 | 4 | 2 | | | 1 | | | 08:24 25 4 高玉杰 |
| 12 | 李壮 | | 0/2 | | | | | 0/2 | 0/4 | 0.0 | | 2 | | | | | 08:33 25 |
| 13 | 蔡杰 | | | | | | | | | | | | | | | | 09:25 25 |
| 14 | 王泽润 | | | | | | | | | | | | | | | | 09:46 26 10 周仲坤 |
| 15 | 张建杰 | 1/2 | 2/2 | | | 1/1 | 1/3 | 5/8 | 62.5 | | | | 1 | | | | 10:18 26 |
| 16 | 王猛 | | | 4/4 | | | | 4/4 | 100 | | | 2 | | | | | 12:06 27 10 周仲坤 |
| 18 | 李文金 | | | | | | | | | | | | | | | | 12:18 27 |
| 运动员 合计 | | 1/5 | 12/19 | 4/9 | 12/15 | 3/6 | 2/6 | 3/6 | 37/66 | 56.1 | 16 | 15 | 3 | 3 | | | 13:32 27 |
| 1 | 王帅 | 6/7 | 1/9 | 2/3 | | | | 9/19 | 47.4 | | 1 | | | | | | 14:19 27 |
| 14 | 王泽润 | 1/6 | 1/6 | 0/1 | | 0/2 | | 0/3 | 1/12 | 8.3 | | | | | | | 14:26 28 10 周仲坤 |
| 16 | 王猛 | 2/3 | 1/2 | 1/3 | | 0/1 | | 4/9 | 44.4 | | 2 | | | | | | 14:52 28 |
| 守门员 合计 | | 8/10 | 3/17 | 3/7 | | 0/3 | | 0/3 | 14/40 | 35.0 | 3 | | | | | | 16:22 29 5 黄培杰 |
| 场上队员：得分 / 射门 | | 守门员：救球 / 射门 | | | | | | | | | | | | | | | |

| | | | | | | | | | |
|----|------------|----|--------------|-----|------------|-----|----------|----|---------|
| 快攻 | Fast Break | 突破 | Breakthrough | 任意球 | Free Throw | 7M球 | 7M Throw | 助攻 | Assist |
| 警告 | Warning | 失误 | Error | 2' | Suspension | D | 取消资格 | DR | 取消资格+报告 |





2016年“体彩杯”全国手球男子青年锦标赛 图式比赛技术统计表

轮次 5

场次 30

201602030-21-1/1

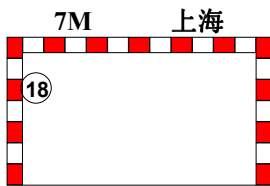
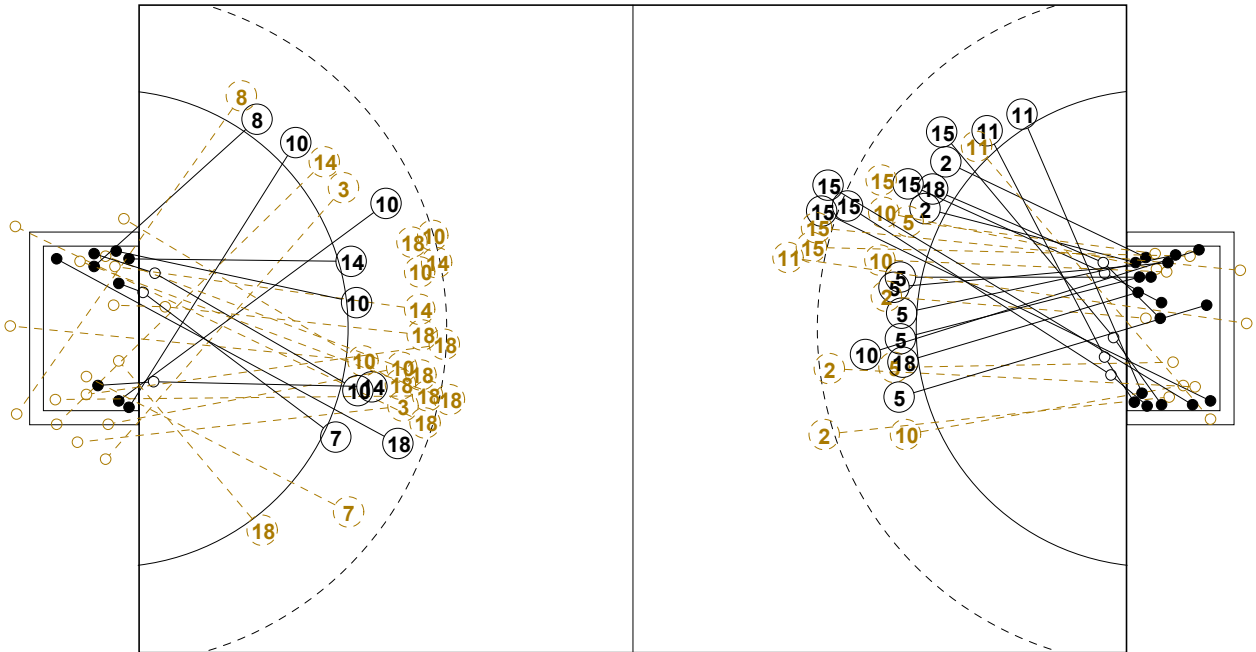

1st Half
10 : 19

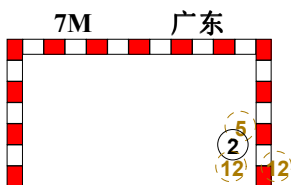
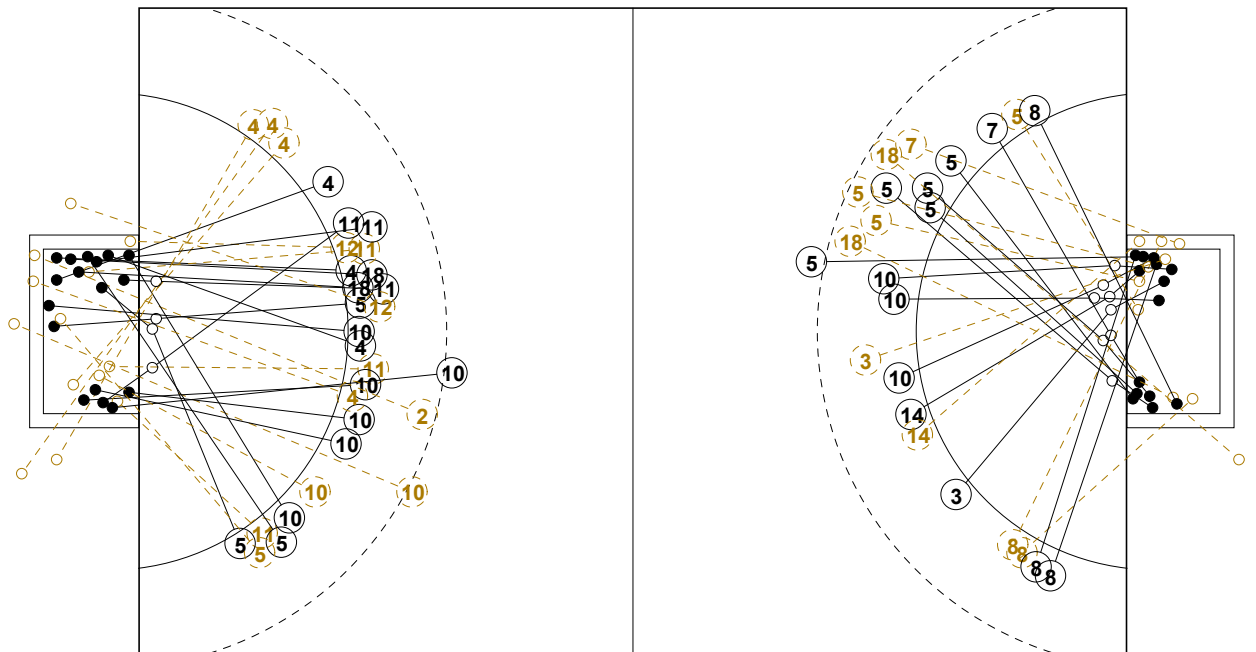
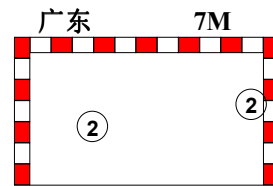

2nd Half
37 : 26

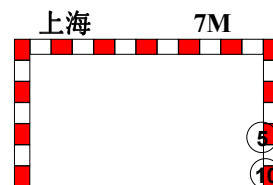



2016年“体彩杯”全国手球男子青年锦标赛

个人/全队技术统计表

正式表
手球
青年男子预赛
轮次 5组别 A
场次 30201602030-14-1/2
重庆万州
25/03/2016 17:30

| 号码 | 姓名 | 远射 | 近射 | 边射 | 快攻 | 突破 | 任意 | 7M | 合计 | % | 助攻 | 失误 | 警告 | 2' | 取消 | 时间 |
|----------------|-----|------|------|-----|------|-----|-----|-----|-------|-------|----|----|----|----|----|----------|
| 上海队(上海) | | | | | | | | | | | | | | | | |
| <i>(场上队员)</i> | | | | | | | | | | | | | | | | |
| 2 | 谢智超 | | | | | | | | | 0.0% | | | | | | 00:00:00 |
| 3 | 高天伦 | | 1/4 | | | | | | 1/4 | 25.0% | 7 | 4 | | 1 | | 00:56:38 |
| 4 | 高震东 | | | | | | | | | 0.0% | | | | | | 00:00:00 |
| 5 | 曹磊 | 1/2 | 2/3 | 0/1 | | 2/2 | | 1/1 | 6/9 | 66.7% | 1 | 1 | | | | 00:22:36 |
| 6 | 季晨旭 | | | | | | | | | 0.0% | | | | | | 00:00:00 |
| 7 | 蒋家敏 | 0/1 | 1/2 | 1/1 | | | | | 2/4 | 50.0% | | 1 | 1 | 1 | | 01:00:00 |
| 8 | 庄旭杰 | | | 3/6 | | 1/1 | | | 4/7 | 57.1% | | 1 | | | | 01:00:00 |
| 10 | 董凯 | 0/2 | 7/9 | | | | | 1/1 | 8/12 | 66.7% | 1 | 1 | 1 | | | 01:00:00 |
| 12 | 张润民 | | | | | | | | | 0.0% | | 2 | | | | 00:58:42 |
| 14 | 吴佳兵 | 0/2 | 3/5 | | | | | | 3/7 | 42.9% | | 5 | 1 | | | 00:57:00 |
| 16 | 陈辰 | | | | | | | | | 0.0% | | | | | | 00:01:18 |
| 18 | 吴双 | 1/10 | 0/1 | 0/1 | | | | 1/1 | 2/13 | 15.4% | | 10 | | | | 00:43:42 |
| 合计 | | | | | | | | | | | | | | | | |
| <i>(守门员)</i> | | | | | | | | | | | | | | | | |
| 12 | 张润民 | 1/2 | 5/17 | 3/7 | 2/14 | 2/5 | 2/4 | 2/5 | 17/54 | 31.5% | | 2 | | | | 00:58:42 |
| 16 | 陈辰 | | | | | | | | | 0.0% | | | | | | 00:01:18 |
| 合计 | | | | | | | | | | | | | | | | |
| | | 1/2 | 5/17 | 3/7 | 2/14 | 2/5 | 2/4 | 2/5 | 17/54 | 31.5% | | 2 | | | | |

场上队员：得分/射门

守门员：救球/射门

| 全队合计 | 得分 | 被救 | 射失 | 击柱 | 封球 | 合计 | % |
|------|----|----|----|----|----|----|--------|
| 远射 | 2 | 8 | 2 | 1 | 4 | 17 | 11.8% |
| 近射 | 14 | 3 | 4 | 3 | | 24 | 58.3% |
| 边射 | 4 | 3 | 1 | 1 | | 9 | 44.4% |
| 快攻 | | | | | | | 0.0% |
| 突破 | 3 | | | | | 3 | 100.0% |
| 任意 | | | | | | | 0.0% |
| 7M | 3 | | | | | 3 | 100.0% |





2016年“体彩杯”全国手球男子青年锦标赛

个人/全队技术统计表

正式表
手球
青年男子预赛
轮次 5组别 A
场次 30201602030-14-2/2
重庆万州
25/03/2016 17:30

| 号码 | 姓名 | 远射 | 近射 | 边射 | 快攻 | 突破 | 任意 | 7M | 合计 | % | 助攻 | 失误 | 警告 | 2' | 取消 | 时间 |
|----------------|-----|------|-------|-----|-------|-----|-----|-----|-------|-------|----|----|----|----|----|----------|
| 广东队(广东) | | | | | | | | | | | | | | | | |
| <i>(上场队员)</i> | | | | | | | | | | | | | | | | |
| 1 | 王帅 | | | | | | | | | 0.0% | 1 | | | | | 00:36:23 |
| 2 | 姚雪岩 | 0/2 | 2/3 | | | | 0/1 | 3/3 | 5/9 | 55.6% | 3 | | | | | 00:38:06 |
| 4 | 高玉杰 | | 1/1 | 0/2 | 2/3 | 0/1 | | | 3/7 | 42.9% | 1 | 2 | 1 | | | 00:29:57 |
| 5 | 黄培杰 | | 2/3 | 2/3 | 3/4 | 1/1 | | 0/1 | 8/12 | 66.7% | 5 | 6 | | | | 01:00:00 |
| 7 | 段飞宇 | | | | | | | | | 0.0% | | 1 | | | | 00:20:24 |
| 9 | 周凯峰 | | | | | | | | | 0.0% | | | | | | 00:00:00 |
| 10 | 周仲坤 | 0/1 | 1/3 | 1/1 | 3/3 | 1/3 | 1/1 | | 7/12 | 58.3% | | 2 | 1 | 2 | | 01:00:00 |
| 11 | 胡国富 | | 0/1 | 1/3 | 4/5 | | 0/1 | | 5/10 | 50.0% | 4 | 2 | | 1 | | 01:00:00 |
| 12 | 李壮 | | 0/2 | | | | | 0/2 | 0/4 | 0.0% | | 2 | | | | 00:21:52 |
| 13 | 蔡杰 | | | | | | | | | 0.0% | | | | | | 00:00:00 |
| 14 | 王泽润 | | | | | | | | | 0.0% | | | | | | 00:12:31 |
| 15 | 张建杰 | 1/2 | 2/2 | | | 1/1 | 1/3 | | 5/8 | 62.5% | | | 1 | | | 00:30:00 |
| 16 | 王猛 | | | | | | | | | 0.0% | 2 | | | | | 00:11:06 |
| 18 | 李文金 | | 4/4 | | | | | | 4/4 | 100% | | | | | | 00:39:35 |
| 合计 | | 1/5 | 12/19 | 4/9 | 12/15 | 3/6 | 2/6 | 3/6 | 37/66 | 56.1% | 16 | 15 | 3 | 3 | | |
| <i>(守门员)</i> | | | | | | | | | | | | | | | | |
| 1 | 王帅 | 6/7 | 1/9 | 2/3 | | | | | 9/19 | 47.4% | 1 | | | | | 00:36:23 |
| 14 | 王泽润 | | 1/6 | 0/1 | | 0/2 | | 0/3 | 1/12 | 8.3% | | | | | | 00:12:31 |
| 16 | 王猛 | 2/3 | 1/2 | 1/3 | | 0/1 | | | 4/9 | 44.4% | 2 | | | | | 00:11:06 |
| 合计 | | 8/10 | 3/17 | 3/7 | | 0/3 | | 0/3 | 14/40 | 35.0% | 3 | | | | | |

场上队员：得分/射门

守门员：救球/射门

| 全队合计 | 得分 | 被救 | 射失 | 击柱 | 封球 | 合计 | % |
|------|----|----|----|----|----|----|-------|
| 远射 | 1 | 1 | 1 | 1 | 1 | 5 | 20.0% |
| 近射 | 12 | 5 | 1 | 1 | | 19 | 63.2% |
| 边射 | 4 | 3 | 1 | 1 | | 9 | 44.4% |
| 快攻 | 12 | 2 | | 1 | | 15 | 80.0% |
| 突破 | 3 | 2 | 1 | | | 6 | 50.0% |
| 任意 | 2 | 2 | 2 | | | 6 | 33.3% |
| 7M | 3 | 2 | | 1 | | 6 | 50.0% |





2016年“体彩杯”全国手球男子青年锦标赛

图式射门区域统计

轮次 5 场次 30

201602030-41-1/1

上海队

| | | | | | | | | | | | | | | | | | | | | | | | | | | | | | | | | | | | | | | | | | | | | | | | | | | | | | | | | | | | | | | | | | | | | | | | | | | | | | | | |
|--|-----------------------------|-----------------------------|-----------------------------|-----------------------------|-----------------------------|-----------------------------|-----------------------------|--|--|---|--|---|--|---|--|--|---|--|---|--|--|--|--|--|--|--|--|--|--|---|---|--|---|--|--|--|---|--|---|--|--|--|--|--|--|--|--|--|--|---|--|--|--|--|--|--|--|--|---|--|--|--|---|--|--|--|---|--|--|--|--|--|--|---|--|---|---|--|---|
| 2 谢智超 | 3 高天伦 | 4 高震东 | 5 曹磊 | 6 季晨旭 | 7 蒋家敏 | 8 庄旭杰 | 10 董凯 | | | | | | | | | | | | | | | | | | | | | | | | | | | | | | | | | | | | | | | | | | | | | | | | | | | | | | | | | | | | | | | | | | | | | | | | |
| <table border="1"><tr><td></td><td></td><td></td></tr><tr><td></td><td></td><td></td></tr><tr><td></td><td></td><td></td></tr></table> | | | | | | | | | | <table border="1"><tr><td></td><td>1</td><td></td></tr><tr><td></td><td></td><td></td></tr><tr><td></td><td></td><td></td></tr></table> | | 1 | | | | | | | | <table border="1"><tr><td></td><td></td><td></td></tr><tr><td></td><td></td><td></td></tr><tr><td></td><td></td><td></td></tr></table> | | | | | | | | | | <table border="1"><tr><td></td><td></td><td>1</td></tr><tr><td></td><td></td><td></td></tr><tr><td>1</td><td></td><td>4</td></tr></table> | | | 1 | | | | 1 | | 4 | <table border="1"><tr><td></td><td></td><td></td></tr><tr><td></td><td></td><td></td></tr><tr><td></td><td></td><td></td></tr></table> | | | | | | | | | | <table border="1"><tr><td></td><td></td><td></td></tr><tr><td></td><td></td><td></td></tr><tr><td></td><td></td><td>2</td></tr></table> | | | | | | | | | 2 | <table border="1"><tr><td></td><td></td><td>2</td></tr><tr><td></td><td></td><td></td></tr><tr><td>2</td><td></td><td></td></tr></table> | | | 2 | | | | 2 | | | <table border="1"><tr><td></td><td></td><td></td></tr><tr><td>2</td><td></td><td>1</td></tr><tr><td>3</td><td></td><td>2</td></tr></table> | | | | 2 | | 1 | 3 | | 2 |
| | | | | | | | | | | | | | | | | | | | | | | | | | | | | | | | | | | | | | | | | | | | | | | | | | | | | | | | | | | | | | | | | | | | | | | | | | | | | | | | |
| | | | | | | | | | | | | | | | | | | | | | | | | | | | | | | | | | | | | | | | | | | | | | | | | | | | | | | | | | | | | | | | | | | | | | | | | | | | | | | | |
| | | | | | | | | | | | | | | | | | | | | | | | | | | | | | | | | | | | | | | | | | | | | | | | | | | | | | | | | | | | | | | | | | | | | | | | | | | | | | | | |
| | 1 | | | | | | | | | | | | | | | | | | | | | | | | | | | | | | | | | | | | | | | | | | | | | | | | | | | | | | | | | | | | | | | | | | | | | | | | | | | | | | |
| | | | | | | | | | | | | | | | | | | | | | | | | | | | | | | | | | | | | | | | | | | | | | | | | | | | | | | | | | | | | | | | | | | | | | | | | | | | | | | | |
| | | | | | | | | | | | | | | | | | | | | | | | | | | | | | | | | | | | | | | | | | | | | | | | | | | | | | | | | | | | | | | | | | | | | | | | | | | | | | | | |
| | | | | | | | | | | | | | | | | | | | | | | | | | | | | | | | | | | | | | | | | | | | | | | | | | | | | | | | | | | | | | | | | | | | | | | | | | | | | | | | |
| | | | | | | | | | | | | | | | | | | | | | | | | | | | | | | | | | | | | | | | | | | | | | | | | | | | | | | | | | | | | | | | | | | | | | | | | | | | | | | | |
| | | | | | | | | | | | | | | | | | | | | | | | | | | | | | | | | | | | | | | | | | | | | | | | | | | | | | | | | | | | | | | | | | | | | | | | | | | | | | | | |
| | | 1 | | | | | | | | | | | | | | | | | | | | | | | | | | | | | | | | | | | | | | | | | | | | | | | | | | | | | | | | | | | | | | | | | | | | | | | | | | | | | |
| | | | | | | | | | | | | | | | | | | | | | | | | | | | | | | | | | | | | | | | | | | | | | | | | | | | | | | | | | | | | | | | | | | | | | | | | | | | | | | | |
| 1 | | 4 | | | | | | | | | | | | | | | | | | | | | | | | | | | | | | | | | | | | | | | | | | | | | | | | | | | | | | | | | | | | | | | | | | | | | | | | | | | | | |
| | | | | | | | | | | | | | | | | | | | | | | | | | | | | | | | | | | | | | | | | | | | | | | | | | | | | | | | | | | | | | | | | | | | | | | | | | | | | | | | |
| | | | | | | | | | | | | | | | | | | | | | | | | | | | | | | | | | | | | | | | | | | | | | | | | | | | | | | | | | | | | | | | | | | | | | | | | | | | | | | | |
| | | | | | | | | | | | | | | | | | | | | | | | | | | | | | | | | | | | | | | | | | | | | | | | | | | | | | | | | | | | | | | | | | | | | | | | | | | | | | | | |
| | | | | | | | | | | | | | | | | | | | | | | | | | | | | | | | | | | | | | | | | | | | | | | | | | | | | | | | | | | | | | | | | | | | | | | | | | | | | | | | |
| | | | | | | | | | | | | | | | | | | | | | | | | | | | | | | | | | | | | | | | | | | | | | | | | | | | | | | | | | | | | | | | | | | | | | | | | | | | | | | | |
| | | 2 | | | | | | | | | | | | | | | | | | | | | | | | | | | | | | | | | | | | | | | | | | | | | | | | | | | | | | | | | | | | | | | | | | | | | | | | | | | | | |
| | | 2 | | | | | | | | | | | | | | | | | | | | | | | | | | | | | | | | | | | | | | | | | | | | | | | | | | | | | | | | | | | | | | | | | | | | | | | | | | | | | |
| | | | | | | | | | | | | | | | | | | | | | | | | | | | | | | | | | | | | | | | | | | | | | | | | | | | | | | | | | | | | | | | | | | | | | | | | | | | | | | | |
| 2 | | | | | | | | | | | | | | | | | | | | | | | | | | | | | | | | | | | | | | | | | | | | | | | | | | | | | | | | | | | | | | | | | | | | | | | | | | | | | | | |
| | | | | | | | | | | | | | | | | | | | | | | | | | | | | | | | | | | | | | | | | | | | | | | | | | | | | | | | | | | | | | | | | | | | | | | | | | | | | | | | |
| 2 | | 1 | | | | | | | | | | | | | | | | | | | | | | | | | | | | | | | | | | | | | | | | | | | | | | | | | | | | | | | | | | | | | | | | | | | | | | | | | | | | | |
| 3 | | 2 | | | | | | | | | | | | | | | | | | | | | | | | | | | | | | | | | | | | | | | | | | | | | | | | | | | | | | | | | | | | | | | | | | | | | | | | | | | | | |
| Post - 0 Miss - 0 Block - 0 | Post - 0 Miss - 2 Block - 0 | Post - 0 Miss - 0 Block - 0 | Post - 0 Miss - 0 Block - 0 | Post - 0 Miss - 0 Block - 0 | Post - 1 Miss - 0 Block - 0 | Post - 1 Miss - 1 Block - 0 | Post - 1 Miss - 1 Block - 2 | | | | | | | | | | | | | | | | | | | | | | | | | | | | | | | | | | | | | | | | | | | | | | | | | | | | | | | | | | | | | | | | | | | | | | | | |
| 12 张润民 | 14 吴佳兵 | 16 陈辰 | 18 吴双 | | | | | | | | | | | | | | | | | | | | | | | | | | | | | | | | | | | | | | | | | | | | | | | | | | | | | | | | | | | | | | | | | | | | | | | | | | | | |
| <table border="1"><tr><td></td><td></td><td></td></tr><tr><td></td><td></td><td></td></tr><tr><td></td><td></td><td></td></tr></table> | | | | | | | | | | <table border="1"><tr><td></td><td></td><td></td></tr><tr><td>1</td><td></td><td></td></tr><tr><td>1</td><td></td><td>1</td></tr></table> | | | | 1 | | | 1 | | 1 | <table border="1"><tr><td></td><td></td><td></td></tr><tr><td></td><td></td><td></td></tr><tr><td></td><td></td><td></td></tr></table> | | | | | | | | | | <table border="1"><tr><td>1</td><td></td><td>1</td></tr><tr><td></td><td></td><td></td></tr><tr><td></td><td></td><td></td></tr></table> | 1 | | 1 | | | | | | | <table border="1"><tr><td></td><td></td><td></td></tr><tr><td></td><td></td><td></td></tr><tr><td></td><td></td><td></td></tr></table> | | | | | | | | | | <table border="1"><tr><td></td><td></td><td></td></tr><tr><td></td><td></td><td></td></tr><tr><td></td><td></td><td></td></tr></table> | | | | | | | | | | <table border="1"><tr><td></td><td></td><td></td></tr><tr><td></td><td></td><td></td></tr><tr><td></td><td></td><td></td></tr></table> | | | | | | | | | | <table border="1"><tr><td></td><td></td><td></td></tr><tr><td></td><td></td><td></td></tr><tr><td></td><td></td><td></td></tr></table> | | | | | | | | | |
| | | | | | | | | | | | | | | | | | | | | | | | | | | | | | | | | | | | | | | | | | | | | | | | | | | | | | | | | | | | | | | | | | | | | | | | | | | | | | | | |
| | | | | | | | | | | | | | | | | | | | | | | | | | | | | | | | | | | | | | | | | | | | | | | | | | | | | | | | | | | | | | | | | | | | | | | | | | | | | | | | |
| | | | | | | | | | | | | | | | | | | | | | | | | | | | | | | | | | | | | | | | | | | | | | | | | | | | | | | | | | | | | | | | | | | | | | | | | | | | | | | | |
| | | | | | | | | | | | | | | | | | | | | | | | | | | | | | | | | | | | | | | | | | | | | | | | | | | | | | | | | | | | | | | | | | | | | | | | | | | | | | | | |
| 1 | | | | | | | | | | | | | | | | | | | | | | | | | | | | | | | | | | | | | | | | | | | | | | | | | | | | | | | | | | | | | | | | | | | | | | | | | | | | | | | |
| 1 | | 1 | | | | | | | | | | | | | | | | | | | | | | | | | | | | | | | | | | | | | | | | | | | | | | | | | | | | | | | | | | | | | | | | | | | | | | | | | | | | | |
| | | | | | | | | | | | | | | | | | | | | | | | | | | | | | | | | | | | | | | | | | | | | | | | | | | | | | | | | | | | | | | | | | | | | | | | | | | | | | | | |
| | | | | | | | | | | | | | | | | | | | | | | | | | | | | | | | | | | | | | | | | | | | | | | | | | | | | | | | | | | | | | | | | | | | | | | | | | | | | | | | |
| | | | | | | | | | | | | | | | | | | | | | | | | | | | | | | | | | | | | | | | | | | | | | | | | | | | | | | | | | | | | | | | | | | | | | | | | | | | | | | | |
| 1 | | 1 | | | | | | | | | | | | | | | | | | | | | | | | | | | | | | | | | | | | | | | | | | | | | | | | | | | | | | | | | | | | | | | | | | | | | | | | | | | | | |
| | | | | | | | | | | | | | | | | | | | | | | | | | | | | | | | | | | | | | | | | | | | | | | | | | | | | | | | | | | | | | | | | | | | | | | | | | | | | | | | |
| | | | | | | | | | | | | | | | | | | | | | | | | | | | | | | | | | | | | | | | | | | | | | | | | | | | | | | | | | | | | | | | | | | | | | | | | | | | | | | | |
| | | | | | | | | | | | | | | | | | | | | | | | | | | | | | | | | | | | | | | | | | | | | | | | | | | | | | | | | | | | | | | | | | | | | | | | | | | | | | | | |
| | | | | | | | | | | | | | | | | | | | | | | | | | | | | | | | | | | | | | | | | | | | | | | | | | | | | | | | | | | | | | | | | | | | | | | | | | | | | | | | |
| | | | | | | | | | | | | | | | | | | | | | | | | | | | | | | | | | | | | | | | | | | | | | | | | | | | | | | | | | | | | | | | | | | | | | | | | | | | | | | | |
| | | | | | | | | | | | | | | | | | | | | | | | | | | | | | | | | | | | | | | | | | | | | | | | | | | | | | | | | | | | | | | | | | | | | | | | | | | | | | | | |
| | | | | | | | | | | | | | | | | | | | | | | | | | | | | | | | | | | | | | | | | | | | | | | | | | | | | | | | | | | | | | | | | | | | | | | | | | | | | | | | |
| | | | | | | | | | | | | | | | | | | | | | | | | | | | | | | | | | | | | | | | | | | | | | | | | | | | | | | | | | | | | | | | | | | | | | | | | | | | | | | | |
| | | | | | | | | | | | | | | | | | | | | | | | | | | | | | | | | | | | | | | | | | | | | | | | | | | | | | | | | | | | | | | | | | | | | | | | | | | | | | | | |
| | | | | | | | | | | | | | | | | | | | | | | | | | | | | | | | | | | | | | | | | | | | | | | | | | | | | | | | | | | | | | | | | | | | | | | | | | | | | | | | |
| | | | | | | | | | | | | | | | | | | | | | | | | | | | | | | | | | | | | | | | | | | | | | | | | | | | | | | | | | | | | | | | | | | | | | | | | | | | | | | | |
| | | | | | | | | | | | | | | | | | | | | | | | | | | | | | | | | | | | | | | | | | | | | | | | | | | | | | | | | | | | | | | | | | | | | | | | | | | | | | | | |
| | | | | | | | | | | | | | | | | | | | | | | | | | | | | | | | | | | | | | | | | | | | | | | | | | | | | | | | | | | | | | | | | | | | | | | | | | | | | | | | |
| | | | | | | | | | | | | | | | | | | | | | | | | | | | | | | | | | | | | | | | | | | | | | | | | | | | | | | | | | | | | | | | | | | | | | | | | | | | | | | | |
| Post - 0 Miss - 0 Block - 0 | Post - 2 Miss - 0 Block - 1 | Post - 0 Miss - 0 Block - 0 | Post - 0 Miss - 3 Block - 1 | | | | | | | | | | | | | | | | | | | | | | | | | | | | | | | | | | | | | | | | | | | | | | | | | | | | | | | | | | | | | | | | | | | | | | | | | | | | |

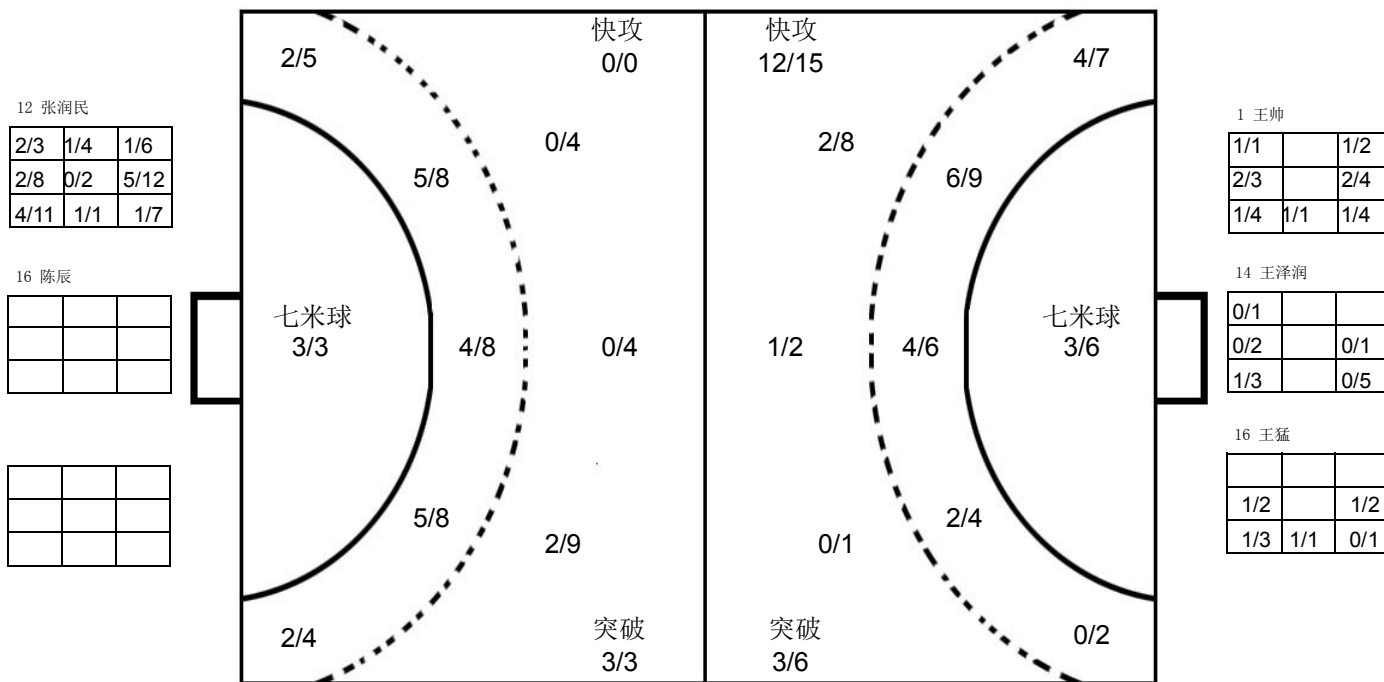

广东队

| | | | | | | | | | | | | | | | | | | | | | | | | | | | | | | | | | | | | | | | | | | | | | | | | | | | | | | | | | | | | | | | | | | | | | | | | | | | | | | | |
|--|-----------------------------|-----------------------------|-----------------------------|-----------------------------|-----------------------------|-----------------------------|-----------------------------|--|--|---|--|--|--|---|--|---|---|--|--|--|--|--|---|--|--|--|--|--|---|--|--|---|---|---|---|---|---|--|---|--|--|--|--|--|--|--|--|--|--|--|--|--|---|--|---|---|---|--|--|---|--|---|---|---|--|--|---|--|---|---|--|--|--|---|--|--|--|--|--|
| 1 王帅 | 2 姚雪岩 | 4 高玉杰 | 5 黄培杰 | 7 段飞宇 | 9 周凯峰 | 10 周仲坤 | 11 胡国富 | | | | | | | | | | | | | | | | | | | | | | | | | | | | | | | | | | | | | | | | | | | | | | | | | | | | | | | | | | | | | | | | | | | | | | | | |
| <table border="1"><tr><td></td><td></td><td></td></tr><tr><td></td><td></td><td></td></tr><tr><td></td><td></td><td></td></tr></table> | | | | | | | | | | <table border="1"><tr><td></td><td></td><td></td></tr><tr><td>1</td><td></td><td>2</td></tr><tr><td>2</td><td></td><td></td></tr></table> | | | | 1 | | 2 | 2 | | | <table border="1"><tr><td></td><td></td><td>2</td></tr><tr><td></td><td></td><td></td></tr><tr><td></td><td></td><td>1</td></tr></table> | | | 2 | | | | | | 1 | <table border="1"><tr><td></td><td>2</td><td></td></tr><tr><td>2</td><td></td><td>2</td></tr><tr><td>2</td><td></td><td></td></tr></table> | | 2 | | 2 | | 2 | 2 | | | <table border="1"><tr><td></td><td></td><td></td></tr><tr><td></td><td></td><td></td></tr><tr><td></td><td></td><td></td></tr></table> | | | | | | | | | | <table border="1"><tr><td></td><td></td><td></td></tr><tr><td></td><td></td><td></td></tr><tr><td></td><td></td><td></td></tr></table> | | | | | | | | | | <table border="1"><tr><td></td><td>1</td><td>1</td></tr><tr><td>2</td><td></td><td></td></tr><tr><td>2</td><td></td><td>1</td></tr></table> | | 1 | 1 | 2 | | | 2 | | 1 | <table border="1"><tr><td></td><td></td><td></td></tr><tr><td>1</td><td></td><td></td></tr><tr><td></td><td></td><td></td></tr></table> | | | | 1 | | | | | |
| | | | | | | | | | | | | | | | | | | | | | | | | | | | | | | | | | | | | | | | | | | | | | | | | | | | | | | | | | | | | | | | | | | | | | | | | | | | | | | | |
| | | | | | | | | | | | | | | | | | | | | | | | | | | | | | | | | | | | | | | | | | | | | | | | | | | | | | | | | | | | | | | | | | | | | | | | | | | | | | | | |
| | | | | | | | | | | | | | | | | | | | | | | | | | | | | | | | | | | | | | | | | | | | | | | | | | | | | | | | | | | | | | | | | | | | | | | | | | | | | | | | |
| | | | | | | | | | | | | | | | | | | | | | | | | | | | | | | | | | | | | | | | | | | | | | | | | | | | | | | | | | | | | | | | | | | | | | | | | | | | | | | | |
| 1 | | 2 | | | | | | | | | | | | | | | | | | | | | | | | | | | | | | | | | | | | | | | | | | | | | | | | | | | | | | | | | | | | | | | | | | | | | | | | | | | | | |
| 2 | | | | | | | | | | | | | | | | | | | | | | | | | | | | | | | | | | | | | | | | | | | | | | | | | | | | | | | | | | | | | | | | | | | | | | | | | | | | | | | |
| | | 2 | | | | | | | | | | | | | | | | | | | | | | | | | | | | | | | | | | | | | | | | | | | | | | | | | | | | | | | | | | | | | | | | | | | | | | | | | | | | | |
| | | | | | | | | | | | | | | | | | | | | | | | | | | | | | | | | | | | | | | | | | | | | | | | | | | | | | | | | | | | | | | | | | | | | | | | | | | | | | | | |
| | | 1 | | | | | | | | | | | | | | | | | | | | | | | | | | | | | | | | | | | | | | | | | | | | | | | | | | | | | | | | | | | | | | | | | | | | | | | | | | | | | |
| | 2 | | | | | | | | | | | | | | | | | | | | | | | | | | | | | | | | | | | | | | | | | | | | | | | | | | | | | | | | | | | | | | | | | | | | | | | | | | | | | | |
| 2 | | 2 | | | | | | | | | | | | | | | | | | | | | | | | | | | | | | | | | | | | | | | | | | | | | | | | | | | | | | | | | | | | | | | | | | | | | | | | | | | | | |
| 2 | | | | | | | | | | | | | | | | | | | | | | | | | | | | | | | | | | | | | | | | | | | | | | | | | | | | | | | | | | | | | | | | | | | | | | | | | | | | | | | |
| | | | | | | | | | | | | | | | | | | | | | | | | | | | | | | | | | | | | | | | | | | | | | | | | | | | | | | | | | | | | | | | | | | | | | | | | | | | | | | | |
| | | | | | | | | | | | | | | | | | | | | | | | | | | | | | | | | | | | | | | | | | | | | | | | | | | | | | | | | | | | | | | | | | | | | | | | | | | | | | | | |
| | | | | | | | | | | | | | | | | | | | | | | | | | | | | | | | | | | | | | | | | | | | | | | | | | | | | | | | | | | | | | | | | | | | | | | | | | | | | | | | |
| | | | | | | | | | | | | | | | | | | | | | | | | | | | | | | | | | | | | | | | | | | | | | | | | | | | | | | | | | | | | | | | | | | | | | | | | | | | | | | | |
| | | | | | | | | | | | | | | | | | | | | | | | | | | | | | | | | | | | | | | | | | | | | | | | | | | | | | | | | | | | | | | | | | | | | | | | | | | | | | | | |
| | | | | | | | | | | | | | | | | | | | | | | | | | | | | | | | | | | | | | | | | | | | | | | | | | | | | | | | | | | | | | | | | | | | | | | | | | | | | | | | |
| | 1 | 1 | | | | | | | | | | | | | | | | | | | | | | | | | | | | | | | | | | | | | | | | | | | | | | | | | | | | | | | | | | | | | | | | | | | | | | | | | | | | | |
| 2 | | | | | | | | | | | | | | | | | | | | | | | | | | | | | | | | | | | | | | | | | | | | | | | | | | | | | | | | | | | | | | | | | | | | | | | | | | | | | | | |
| 2 | | 1 | | | | | | | | | | | | | | | | | | | | | | | | | | | | | | | | | | | | | | | | | | | | | | | | | | | | | | | | | | | | | | | | | | | | | | | | | | | | | |
| | | | | | | | | | | | | | | | | | | | | | | | | | | | | | | | | | | | | | | | | | | | | | | | | | | | | | | | | | | | | | | | | | | | | | | | | | | | | | | | |
| 1 | | | | | | | | | | | | | | | | | | | | | | | | | | | | | | | | | | | | | | | | | | | | | | | | | | | | | | | | | | | | | | | | | | | | | | | | | | | | | | | |
| | | | | | | | | | | | | | | | | | | | | | | | | | | | | | | | | | | | | | | | | | | | | | | | | | | | | | | | | | | | | | | | | | | | | | | | | | | | | | | | |
| Post - 0 Miss - 0 Block - 0 | Post - 1 Miss - 0 Block - 0 | Post - 1 Miss - 2 Block - 0 | Post - 0 Miss - 0 Block - 0 | Post - 0 Miss - 0 Block - 0 | Post - 0 Miss - 0 Block - 0 | Post - 0 Miss - 1 Block - 0 | Post - 1 Miss - 1 Block - 0 | | | | | | | | | | | | | | | | | | | | | | | | | | | | | | | | | | | | | | | | | | | | | | | | | | | | | | | | | | | | | | | | | | | | | | | | |
| 12 李壮 | 13 蔡杰 | 14 王泽润 | 15 张建杰 | 16 王猛 | 18 李文金 | | | | | | | | | | | | | | | | | | | | | | | | | | | | | | | | | | | | | | | | | | | | | | | | | | | | | | | | | | | | | | | | | | | | | | | | | | |
| <table border="1"><tr><td></td><td></td><td></td></tr><tr><td></td><td></td><td></td></tr><tr><td></td><td></td><td></td></tr></table> | | | | | | | | | | <table border="1"><tr><td></td><td></td><td></td></tr><tr><td></td><td></td><td></td></tr><tr><td></td><td></td><td></td></tr></table> | | | | | | | | | | <table border="1"><tr><td></td><td></td><td></td></tr><tr><td></td><td></td><td></td></tr><tr><td></td><td></td><td></td></tr></table> | | | | | | | | | | <table border="1"><tr><td></td><td></td><td>2</td></tr><tr><td></td><td>1</td><td>1</td></tr><tr><td></td><td></td><td>1</td></tr></table> | | | 2 | | 1 | 1 | | | 1 | <table border="1"><tr><td></td><td></td><td></td></tr><tr><td></td><td></td><td></td></tr><tr><td></td><td></td><td></td></tr></table> | | | | | | | | | | <table border="1"><tr><td></td><td></td><td>1</td></tr><tr><td></td><td>1</td><td>1</td></tr><tr><td>1</td><td></td><td></td></tr></table> | | | 1 | | 1 | 1 | 1 | | | <table border="1"><tr><td></td><td></td><td></td></tr><tr><td></td><td></td><td></td></tr><tr><td></td><td></td><td></td></tr></table> | | | | | | | | | | <table border="1"><tr><td></td><td></td><td></td></tr><tr><td></td><td></td><td></td></tr><tr><td></td><td></td><td></td></tr></table> | | | | | | | | | |
| | | | | | | | | | | | | | | | | | | | | | | | | | | | | | | | | | | | | | | | | | | | | | | | | | | | | | | | | | | | | | | | | | | | | | | | | | | | | | | | |
| | | | | | | | | | | | | | | | | | | | | | | | | | | | | | | | | | | | | | | | | | | | | | | | | | | | | | | | | | | | | | | | | | | | | | | | | | | | | | | | |
| | | | | | | | | | | | | | | | | | | | | | | | | | | | | | | | | | | | | | | | | | | | | | | | | | | | | | | | | | | | | | | | | | | | | | | | | | | | | | | | |
| | | | | | | | | | | | | | | | | | | | | | | | | | | | | | | | | | | | | | | | | | | | | | | | | | | | | | | | | | | | | | | | | | | | | | | | | | | | | | | | |
| | | | | | | | | | | | | | | | | | | | | | | | | | | | | | | | | | | | | | | | | | | | | | | | | | | | | | | | | | | | | | | | | | | | | | | | | | | | | | | | |
| | | | | | | | | | | | | | | | | | | | | | | | | | | | | | | | | | | | | | | | | | | | | | | | | | | | | | | | | | | | | | | | | | | | | | | | | | | | | | | | |
| | | | | | | | | | | | | | | | | | | | | | | | | | | | | | | | | | | | | | | | | | | | | | | | | | | | | | | | | | | | | | | | | | | | | | | | | | | | | | | | |
| | | | | | | | | | | | | | | | | | | | | | | | | | | | | | | | | | | | | | | | | | | | | | | | | | | | | | | | | | | | | | | | | | | | | | | | | | | | | | | | |
| | | | | | | | | | | | | | | | | | | | | | | | | | | | | | | | | | | | | | | | | | | | | | | | | | | | | | | | | | | | | | | | | | | | | | | | | | | | | | | | |
| | | 2 | | | | | | | | | | | | | | | | | | | | | | | | | | | | | | | | | | | | | | | | | | | | | | | | | | | | | | | | | | | | | | | | | | | | | | | | | | | | | |
| | 1 | 1 | | | | | | | | | | | | | | | | | | | | | | | | | | | | | | | | | | | | | | | | | | | | | | | | | | | | | | | | | | | | | | | | | | | | | | | | | | | | | |
| | | 1 | | | | | | | | | | | | | | | | | | | | | | | | | | | | | | | | | | | | | | | | | | | | | | | | | | | | | | | | | | | | | | | | | | | | | | | | | | | | | |
| | | | | | | | | | | | | | | | | | | | | | | | | | | | | | | | | | | | | | | | | | | | | | | | | | | | | | | | | | | | | | | | | | | | | | | | | | | | | | | | |
| | | | | | | | | | | | | | | | | | | | | | | | | | | | | | | | | | | | | | | | | | | | | | | | | | | | | | | | | | | | | | | | | | | | | | | | | | | | | | | | |
| | | | | | | | | | | | | | | | | | | | | | | | | | | | | | | | | | | | | | | | | | | | | | | | | | | | | | | | | | | | | | | | | | | | | | | | | | | | | | | | |
| | | 1 | | | | | | | | | | | | | | | | | | | | | | | | | | | | | | | | | | | | | | | | | | | | | | | | | | | | | | | | | | | | | | | | | | | | | | | | | | | | | |
| | 1 | 1 | | | | | | | | | | | | | | | | | | | | | | | | | | | | | | | | | | | | | | | | | | | | | | | | | | | | | | | | | | | | | | | | | | | | | | | | | | | | | |
| 1 | | | | | | | | | | | | | | | | | | | | | | | | | | | | | | | | | | | | | | | | | | | | | | | | | | | | | | | | | | | | | | | | | | | | | | | | | | | | | | | |
| | | | | | | | | | | | | | | | | | | | | | | | | | | | | | | | | | | | | | | | | | | | | | | | | | | | | | | | | | | | | | | | | | | | | | | | | | | | | | | | |
| | | | | | | | | | | | | | | | | | | | | | | | | | | | | | | | | | | | | | | | | | | | | | | | | | | | | | | | | | | | | | | | | | | | | | | | | | | | | | | | |
| | | | | | | | | | | | | | | | | | | | | | | | | | | | | | | | | | | | | | | | | | | | | | | | | | | | | | | | | | | | | | | | | | | | | | | | | | | | | | | | |
| | | | | | | | | | | | | | | | | | | | | | | | | | | | | | | | | | | | | | | | | | | | | | | | | | | | | | | | | | | | | | | | | | | | | | | | | | | | | | | | |
| | | | | | | | | | | | | | | | | | | | | | | | | | | | | | | | | | | | | | | | | | | | | | | | | | | | | | | | | | | | | | | | | | | | | | | | | | | | | | | | |
| | | | | | | | | | | | | | | | | | | | | | | | | | | | | | | | | | | | | | | | | | | | | | | | | | | | | | | | | | | | | | | | | | | | | | | | | | | | | | | | |
| Post - 2 Miss - 1 Block - 0 | Post - 0 Miss - 0 Block - 0 | Post - 0 Miss - 0 Block - 0 | Post - 0 Miss - 1 Block - 1 | Post - 0 Miss - 0 Block - 0 | Post - 0 Miss - 0 Block - 0 | | | | | | | | | | | | | | | | | | | | | | | | | | | | | | | | | | | | | | | | | | | | | | | | | | | | | | | | | | | | | | | | | | | | | | | | | | |

注释: Post=击柱 Miss=射失 Block=被封



9-12名

青年男子 全国比赛

2016年“体彩杯”全国手球男子青年锦标赛

| | | | | | | | | | | | | | | | | | | | |
|-----------------|---|---------------|---------------------|------------|------------------------------------|----------------|----|--------------|----------------|-----|--------|----------------------|---------------|---|---|---|----|---|----|
| Team A | | | | Team B | | | | Match Number | | | | | | | | | | | |
| A 浙江队 | | | | B 天津队 | | | | 31 | | | | | | | | | | | |
| played in | | in the hall | | on | | at | | Spectators | | | | | | | | | | | |
| China | | 重庆万州 | | 26/03/2016 | | 08:30 | | hours | | | | | | | | | | | |
| Half-time (30') | A | B | End of playing time | A | B | 1st extra time | A | B | 2nd extra time | A | B | After penalty throws | A | B | | | | | |
| | 11 | 19 | | 12 | 27 | | | | | | | | | | | | | | |
| Number of 7 m | A | Team time-out | | | Full name of players and officials | | | | Team time-out | | | B | Number of 7 m | | | | | | |
| | 2/2 | 1 | 2 | 3 | | | | | 1 | 2 | 3 | 2/2 | | | | | | | |
| No. | Team A | | | | G | W | 2' | D | DR | No. | Team B | | | | G | W | 2' | D | DR |
| 1 | 林先方 | | | | 8 | 1 | | | | 9 | 吴明远 | | | | 6 | | | | |
| 2 | 李恩铭 | | | | 2 | | 1 | | | 21 | 潘玉帅 | | | | 8 | | | | |
| 3 | 郑尧俊 | | | | 2 | | 1 | | | 22 | 魏雨童 | | | | 9 | 1 | 1 | | |
| 5 | 高家南 | | | | | | | | | 24 | 刘子健 | | | | | | | | |
| 9 | 李家乐 | | | | | | | | | 25 | 王一雄 | | | | 1 | 1 | | | |
| 10 | 徐正飞 | | | | | | | | | 26 | 刘思远 | | | | 3 | | | | |
| 14 | 虞勇灿 | | | | | | | | | 27 | 左金龙 | | | | | | | | |
| 15 | 张佩力 | | | | | | | | | 28 | 何喜年 | | | | | | | | |
| 17 | 罗明杰 | | | | | | 1 | | | | | | | | | | | | |
| 18 | 倪陈辉 | | | | | | 1 | 1 | | | | | | | | | | | |
| 19 | 王浩 | | | | | | | | | | | | | | | | | | |
| D | 项建生 | | | | | | | | | A | 李志成 | | | | | | | | |
| E | 刘晓辉 | | | | | | | | | B | 潘玉强 | | | | | | | | |
| A | Signature of Responsible Official of the Teams (Off. A) | | | | | | | | | | | | | | | | B | | |
| TP | Remarks of Referee / CHA Official | | | | | | | | | | | | | | | | TP | | |

Signatures

| | | | | |
|------------------|-----------|----------|--|--|
| Referees | 严璐 (CHN) | 王羚 (CHN) | | |
| Techn. Delegates | 徐健 (CHN) | | | |
| CHA Official | 吴瑞亭 (CHN) | | | |

Note: Number of 7m Throws Awarded to Team A and B, Goals (G), Warnings (W), Suspensions (2'), Direct Disqualification (D), Disqualification with Report (DR) and Team Penalty (TP).

Table Officials:

Statisticians: 李双

刘永欢





2016年“体彩杯”全国手球男子青年锦标赛
竞赛技术统计(媒体表)

| | | | | | | |
|---------|----|----|------------|----|----|------------------|
| 9-12名 | 组别 | C | 轮次 | 6 | 场次 | 31 |
| 重庆万州 | | | 26/03/2016 | | | 201602031-51-1/1 |
| 浙江队 | 浙江 | 12 | vs | 27 | 天津 | 天津队 |
| 11 : 19 | | | | | | |

| 裁判员 | | 严璐 (CHN) | | | | | | | | | | | 王羚 (CHN) | | | | | | | | | | | | | | | | | | | | | | | |
|---------------|-----|----------|-----|-----|-----|-----|-----|-----|-------|------|----|----|----------|----|----------|-----------|-------|------|-------|----|----|-----|----|--|--|--|--|----|-----------|--|--|--|--|--|--|--|
| 浙江 | | 远射 | 近射 | 边射 | 快攻 | 突破 | 任意球 | 7m球 | 合计 | % | 助攻 | 失误 | 警告 | 2' | D & DR | 浙江 | | 比赛进程 | | | | | | | | | | | 天津 | | | | | | | |
| 主教练：项建生 | | | | | | | | | | | | | | | 1st Half | | | | | | | | | | | | | | | | | | | | | |
| 1 | 林先方 | | 4/4 | | | 2/2 | 0/1 | 2/2 | 8/9 | 88.9 | 1 | 2 | 1 | | | 1 | 林先方 | 1 | 02:20 | 1 | 9 | 吴明远 | 0 | | | | | | | | | | | | | |
| 2 | 李恩铭 | | 1/1 | 1/2 | | | | | 2/3 | 66.7 | 1 | 2 | | 1 | | 1 | 林先方 | 1 | 03:39 | 2 | 22 | 魏雨童 | 2 | | | | | | | | | | | | | |
| 3 | 郑尧俊 | 0/1 | 1/2 | | 1/1 | | | | 2/4 | 50.0 | | 4 | | 1 | | 2 | 林先方 | 2 | 04:47 | 2 | | | 3 | | | | | | | | | | | | | |
| 5 | 高家南 | | | | | | | | | | | 1 | | | | 2 | 林先方 | 2 | 04:56 | 3 | 21 | 潘玉帅 | 4 | | | | | | | | | | | | | |
| 9 | 李家乐 | | | | | | | | | | | | | | | 2 | 林先方 | 2 | 06:01 | 4 | 21 | 潘玉帅 | 5 | | | | | | | | | | | | | |
| 10 | 徐正飞 | | | | | | | | | | | | | | | 3 | 林先方 | 3 | 07:18 | 4 | | | 6 | | | | | | | | | | | | | |
| 14 | 虞勇灿 | | | | | | | | | | | | | | | 3 | 林先方 | 3 | 08:17 | 5 | 21 | 潘玉帅 | 7 | | | | | | | | | | | | | |
| 15 | 张佩力 | | | | | | | | | | | | | | | 3 | 林先方 | 3 | 08:55 | 6 | 22 | 魏雨童 | 8 | | | | | | | | | | | | | |
| 17 | 罗明杰 | | | | | | | | | | | 2 | 1 | | | 3 | 郑尧俊 | 4 | 12:03 | 7 | | | 9 | | | | | | | | | | | | | |
| 18 | 倪陈辉 | 0/5 | 0/1 | | | | 0/2 | | 0/8 | 0.0 | | 12 | 1 | 1 | | 4 | 林先方 | 4 | 12:17 | 8 | 9 | 吴明远 | 10 | | | | | | | | | | | | | |
| 19 | 王浩 | | | | | | | | | | | | | | | 5 | 林先方 | 5 | 13:00 | 8 | | | 11 | | | | | | | | | | | | | |
| 运动员 合计 | | 0/6 | 6/8 | 1/2 | 1/1 | 2/2 | 0/3 | 2/2 | 12/24 | 50.0 | 2 | 23 | 3 | 3 | | 5 | 林先方 | 5 | 13:43 | 9 | 22 | 魏雨童 | 12 | | | | | | | | | | | | | |
| 14 | 虞勇灿 | 0/1 | | 1/1 | 0/1 | 0/3 | | | 1/6 | 16.7 | | | | | | 5 | 林先方 | 5 | 14:15 | 10 | 22 | 魏雨童 | 13 | | | | | | | | | | | | | |
| 15 | 张佩力 | 2/5 | 1/8 | 3/3 | 0/5 | 0/4 | 0/1 | 0/2 | 6/28 | 21.4 | | | | | | 6 | 林先方 | 6 | 15:40 | 11 | 22 | 魏雨童 | 14 | | | | | | | | | | | | | |
| 守门员 合计 | | 2/6 | 1/8 | 4/4 | 0/6 | 0/7 | 0/1 | 0/2 | 7/34 | 20.6 | | | | | | 6 | 林先方 | 6 | 18:08 | 12 | 26 | 刘思远 | 15 | | | | | | | | | | | | | |
| 天津 | | 远射 | 近射 | 边射 | 快攻 | 突破 | 任意球 | 7m球 | 合计 | % | 助攻 | 失误 | 警告 | 2' | D & DR | 2nd Half | | | | | | | | | | | | | | | | | | | | |
| 教练：潘玉强 | | | | | | | | | | | | | | | 11 | | 00:33 | | | | | | | | | | | 20 | | | | | | | | |
| 9 | 吴明远 | 0/1 | 3/3 | | 0/1 | 2/2 | 1/1 | | 6/8 | 75.0 | | 2 | | | | 11 | 林先方 | 11 | 01:56 | 21 | 26 | 刘思远 | 21 | | | | | | | | | | | | | |
| 21 | 潘玉帅 | 2/4 | 1/1 | 0/1 | 3/3 | 1/2 | | 1/1 | 8/12 | 66.7 | 3 | 2 | | | | 12 | 林先方 | 12 | 02:40 | 21 | | | 22 | | | | | | | | | | | | | |
| 22 | 魏雨童 | 1/1 | 1/1 | | 2/2 | 4/4 | | 1/1 | 9/9 | 100 | 1 | 1 | 1 | 1 | | 12 | 林先方 | 12 | 03:12 | 22 | 9 | 吴明远 | 23 | | | | | | | | | | | | | |
| 24 | 刘子健 | | | | | | | | | | | | | | | 12 | 林先方 | 12 | 04:21 | 23 | 21 | 潘玉帅 | 24 | | | | | | | | | | | | | |
| 25 | 王一雄 | 1/1 | 0/1 | | | | | | 1/2 | 50.0 | | 1 | 1 | | | 12 | 林先方 | 12 | 05:18 | 24 | 22 | 魏雨童 | 25 | | | | | | | | | | | | | |
| 26 | 刘思远 | | 2/2 | 0/3 | 1/1 | | | | 3/6 | 50.0 | | 2 | | | | 12 | 林先方 | 12 | 06:09 | 25 | 9 | 吴明远 | 26 | | | | | | | | | | | | | |
| 27 | 左金龙 | | | | | | | | | | | | | | | 12 | 林先方 | 12 | 06:45 | 26 | 26 | 刘思远 | 27 | | | | | | | | | | | | | |
| 28 | 何喜年 | | | | | | | | | | | 1 | | | | 12 | 林先方 | 12 | 07:27 | 27 | 21 | 潘玉帅 | | | | | | | | | | | | | | |
| 运动员 合计 | | 4/7 | 7/8 | 0/4 | 6/7 | 7/8 | 1/1 | 2/2 | 27/37 | 73.0 | 4 | 9 | 2 | 1 | | | | | | | | | | | | | | | | | | | | | | |
| 24 | 刘子健 | 1/1 | 0/5 | | 0/1 | 0/1 | 1/1 | 0/1 | 2/9 | 22.2 | | | | | | | | | | | | | | | | | | | | | | | | | | |
| 28 | 何喜年 | | 1/2 | 0/1 | 0/1 | 0/1 | | 0/1 | 1/6 | 16.7 | | 1 | | | | | | | | | | | | | | | | | | | | | | | | |
| 守门员 合计 | | 1/1 | 1/7 | 0/1 | 0/1 | 0/2 | 1/1 | 0/2 | 3/15 | 20.0 | | 1 | | | | | | | | | | | | | | | | | | | | | | | | |

场上队员：得分 / 射门

守门员：救球 / 射门

| | | | | | | | | | | | | | |
|----|------------|--|----|--------------|--|-----|------------|--|-----|----------|--|----|---------|
| 快攻 | Fast Break | | 突破 | Breakthrough | | 任意球 | Free Throw | | 7M球 | 7M Throw | | 助攻 | Assist |
| 警告 | Warning | | 失误 | Error | | 2' | Suspension | | D | 取消资格 | | DR | 取消资格+报告 |



2016年“体彩杯”全国手球男子青年锦标赛 图式比赛技术统计表

轮次 6

场次 31

201602031-21-1/1

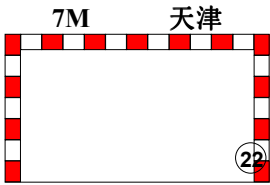
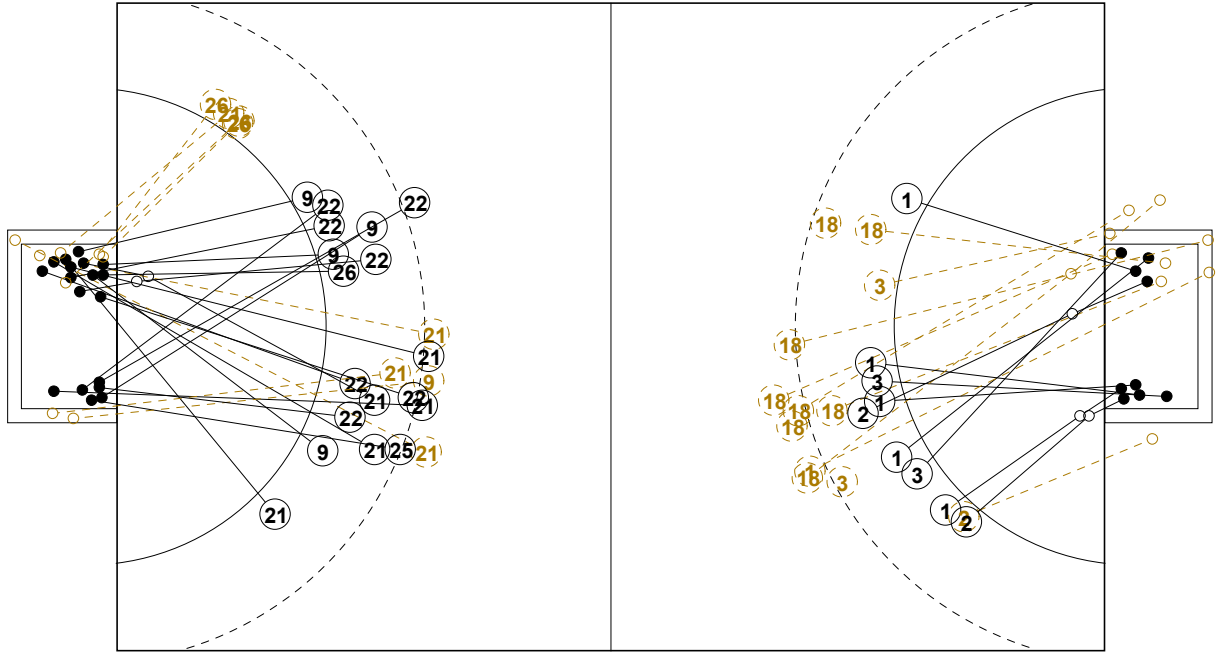

1st Half
19 : 11

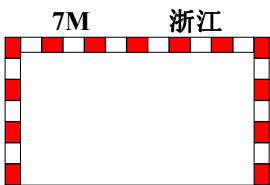
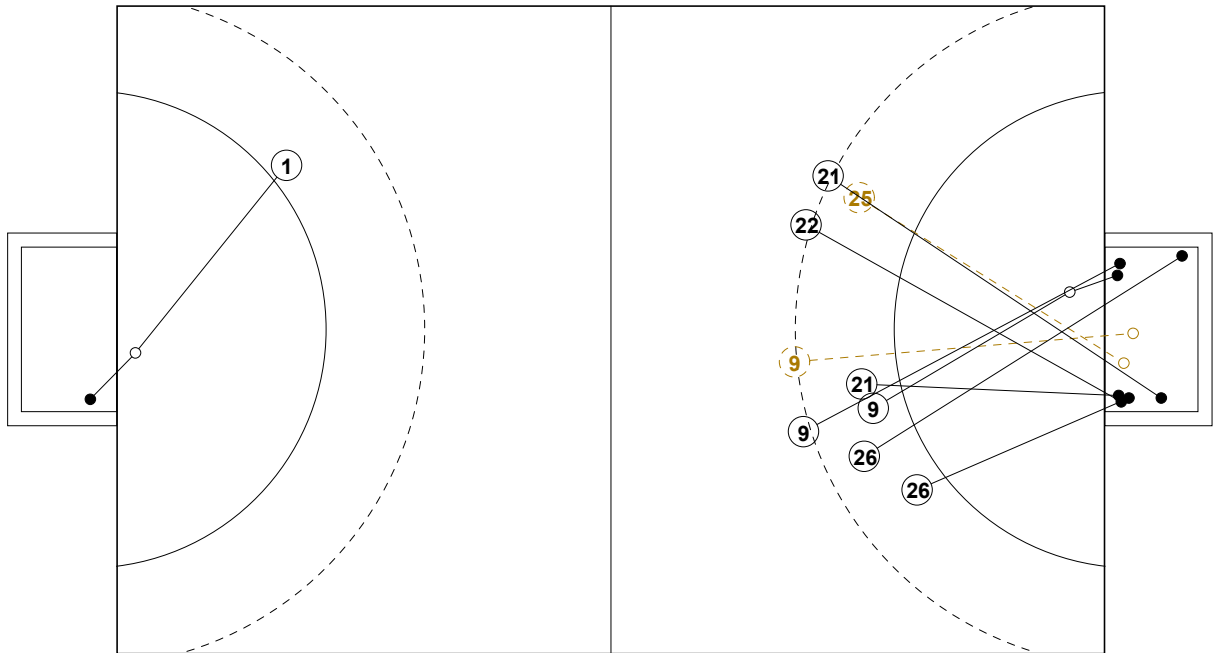
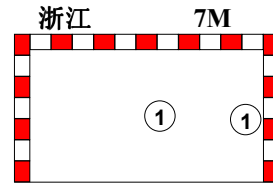

2nd Half
12 : 27

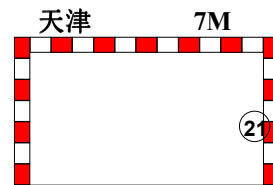



2016年“体彩杯”全国手球男子青年锦标赛

个人/全队技术统计表

正式表
手球
青年男子9-12名
轮次 6组别 C
场次 31201602031-14-1/2
重庆万州
26/03/2016 08:30

| 号码 | 姓名 | 远射 | 近射 | 边射 | 快攻 | 突破 | 任意 | 7M | 合计 | % | 助攻 | 失误 | 警告 | 2' | 取消 | 时间 |
|----------------|-----|-----|-----|-----|-----|-----|-----|-----|-------|-------|----|----|----|----|----|----------|
| 浙江队(浙江) | | | | | | | | | | | | | | | | |
| <i>(场上队员)</i> | | | | | | | | | | | | | | | | |
| 1 | 林先方 | | 4/4 | | | 2/2 | 0/1 | 2/2 | 8/9 | 88.9% | 1 | 2 | 1 | | | 01:04:36 |
| 2 | 李恩铭 | | 1/1 | 1/2 | | | | | 2/3 | 66.7% | 1 | 2 | | 1 | | 00:39:15 |
| 3 | 郑尧俊 | 0/1 | 1/2 | | 1/1 | | | | 2/4 | 50.0% | | 4 | | 1 | | 01:00:00 |
| 5 | 高家南 | | | | | | | | | 0.0% | | 1 | | | | 00:25:40 |
| 9 | 李家乐 | | | | | | | | | 0.0% | | | | | | 00:40:56 |
| 10 | 徐正飞 | | | | | | | | | 0.0% | | | | | | 00:36:25 |
| 14 | 虞勇灿 | | | | | | | | | 0.0% | | | | | | 00:06:32 |
| 15 | 张佩力 | | | | | | | | | 0.0% | | | | | | 00:53:28 |
| 17 | 罗明杰 | | | | | | | | | 0.0% | | 2 | 1 | | | 00:42:17 |
| 18 | 倪陈辉 | 0/5 | 0/1 | | | | 0/2 | | 0/8 | 0.0% | | 12 | 1 | 1 | | 01:00:00 |
| 19 | 王浩 | | | | | | | | | 0.0% | | | | | | 00:00:00 |
| 合计 | | | | | | | | | | | | | | | | |
| <i>(守门员)</i> | | | | | | | | | | | | | | | | |
| | | 0/6 | 6/8 | 1/2 | 1/1 | 2/2 | 0/3 | 2/2 | 12/24 | 50.0% | 2 | 23 | 3 | 3 | | |
| 14 | 虞勇灿 | 0/1 | | 1/1 | 0/1 | 0/3 | | | 1/6 | 16.7% | | | | | | 00:06:32 |
| 15 | 张佩力 | 2/5 | 1/8 | 3/3 | 0/5 | 0/4 | 0/1 | 0/2 | 6/28 | 21.4% | | | | | | 00:53:28 |
| 合计 | | | | | | | | | | | | | | | | |
| | | 2/6 | 1/8 | 4/4 | 0/6 | 0/7 | 0/1 | 0/2 | 7/34 | 20.6% | | | | | | |

场上队员：得分/射门

守门员：救球/射门

| 全队合计 | 得分 | 被救 | 射失 | 击柱 | 封球 | 合计 | % |
|------|----|----|----|----|----|----|--------|
| 远射 | | 1 | 1 | 1 | 3 | 6 | 0.0% |
| 近射 | 6 | 1 | | 1 | | 8 | 75.0% |
| 边射 | 1 | | 1 | | | 2 | 50.0% |
| 快攻 | 1 | | | | | 1 | 100.0% |
| 突破 | 2 | | | | | 2 | 100.0% |
| 任意 | | 1 | 1 | 1 | | 3 | 0.0% |
| 7M | 2 | | | | | 2 | 100.0% |





2016年“体彩杯”全国手球男子青年锦标赛

个人/全队技术统计表

正式表
手球
青年男子9-12名
轮次 6组别 C
场次 31201602031-14-2/2
重庆万州
26/03/2016 08:30

| 号码 | 姓名 | 远射 | 近射 | 边射 | 快攻 | 突破 | 任意 | 7M | 合计 | % | 助攻 | 失误 | 警告 | 2' | 取消 | 时间 |
|----------------|-----|-----|-----|-----|-----|-----|-----|-----|------|-------|----|----|----|----|----|----------|
| 天津队(天津) | | | | | | | | | | | | | | | | |
| <i>(上场队员)</i> | | | | | | | | | | | | | | | | |
| 9 | 吴明远 | 0/1 | 3/3 | | 0/1 | 2/2 | 1/1 | | 6/8 | 75.0% | | 2 | | | | 01:00:00 |
| 21 | 潘玉帅 | 2/4 | 1/1 | 0/1 | 3/3 | 1/2 | | 1/1 | 8/12 | 66.7% | 3 | 2 | | | | 01:00:00 |
| 22 | 魏雨童 | 1/1 | 1/1 | | 2/2 | 4/4 | | 1/1 | 9/9 | 100% | 1 | 1 | 1 | 1 | | 01:00:00 |
| 24 | 刘子健 | | | | | | | | | 0.0% | | | | | | 00:17:16 |
| 25 | 王一雄 | 1/1 | 0/1 | | | | | | 1/2 | 50.0% | | 1 | 1 | | | 01:03:59 |
| 26 | 刘思远 | | 2/2 | 0/3 | 1/1 | | | | 3/6 | 50.0% | | 2 | | | | 01:00:00 |
| 27 | 左金龙 | | | | | | | | | 0.0% | | | | | | 01:00:00 |
| 28 | 何喜年 | | | | | | | | | 0.0% | | 1 | | | | 00:42:44 |
| 合计 | | | | | | | | | | | | | | | | |
| <i>(守门员)</i> | | | | | | | | | | | | | | | | |
| 24 | | 1/1 | 0/5 | | | 0/1 | 1/1 | 0/1 | 2/9 | 22.2% | | | | | | 00:17:16 |
| 28 | | | 1/2 | 0/1 | 0/1 | 0/1 | | 0/1 | 1/6 | 16.7% | | 1 | | | | 00:42:44 |
| 合计 | | | | | | | | | | | | | | | | |

场上队员：得分/射门

守门员：救球/射门

| 全队合计 | 得分 | 被救 | 射失 | 击柱 | 封球 | 合计 | % |
|------|----|----|----|----|----|----|--------|
| 远射 | 4 | 2 | | 1 | | 7 | 57.1% |
| 近射 | 7 | 1 | | | | 8 | 87.5% |
| 边射 | | 4 | | | | 4 | 0.0% |
| 快攻 | 6 | | | 1 | | 7 | 85.7% |
| 突破 | 7 | | | 1 | | 8 | 87.5% |
| 任意 | 1 | | | | | 1 | 100.0% |
| 7M | 2 | | | | | 2 | 100.0% |





2016年“体彩杯”全国手球男子青年锦标赛

图式射门区域统计

轮次 6 场次 31

201602031-41-1/1

浙江队

| | | | | | | | | | | | | | | | | | | | | | | | | | | | | | | | | | | | | | | | | | | | | | | | | | | | | | | | | | | | | | | | | | | | | | | | | | | | | | | | |
|---|-----------------------------|-----------------------------|-----------------------------|-----------------------------|-----------------------------|-----------------------------|-----------------------------|--|---|--|--|--|--|---|--|--|--|--|---|--|--|--|---|--|--|--|---|--|--|--|--|--|--|--|--|--|--|--|--|--|--|--|--|--|--|--|--|--|--|--|--|--|--|--|--|--|--|--|--|--|--|--|--|--|--|--|--|--|--|--|--|--|--|--|--|--|--|--|--|
| 1 林先方 | 2 李恩铭 | 3 郑尧俊 | 5 高家南 | 9 李家乐 | 10 徐正飞 | 14 虞勇灿 | 15 张佩力 | | | | | | | | | | | | | | | | | | | | | | | | | | | | | | | | | | | | | | | | | | | | | | | | | | | | | | | | | | | | | | | | | | | | | | | | |
| <table border="1"><tr><td></td><td></td><td></td></tr><tr><td>2</td><td>1</td><td>3</td></tr><tr><td>1</td><td></td><td>1</td></tr></table> | | | | 2 | 1 | 3 | 1 | | 1 | <table border="1"><tr><td></td><td></td><td></td></tr><tr><td>1</td><td></td><td></td></tr><tr><td></td><td></td><td>1</td></tr></table> | | | | 1 | | | | | 1 | <table border="1"><tr><td></td><td></td><td>1</td></tr><tr><td></td><td></td><td></td></tr><tr><td>1</td><td></td><td></td></tr></table> | | | 1 | | | | 1 | | | <table border="1"><tr><td></td><td></td><td></td></tr><tr><td></td><td></td><td></td></tr><tr><td></td><td></td><td></td></tr></table> | | | | | | | | | | <table border="1"><tr><td></td><td></td><td></td></tr><tr><td></td><td></td><td></td></tr><tr><td></td><td></td><td></td></tr></table> | | | | | | | | | | <table border="1"><tr><td></td><td></td><td></td></tr><tr><td></td><td></td><td></td></tr><tr><td></td><td></td><td></td></tr></table> | | | | | | | | | | <table border="1"><tr><td></td><td></td><td></td></tr><tr><td></td><td></td><td></td></tr><tr><td></td><td></td><td></td></tr></table> | | | | | | | | | | <table border="1"><tr><td></td><td></td><td></td></tr><tr><td></td><td></td><td></td></tr><tr><td></td><td></td><td></td></tr></table> | | | | | | | | | |
| | | | | | | | | | | | | | | | | | | | | | | | | | | | | | | | | | | | | | | | | | | | | | | | | | | | | | | | | | | | | | | | | | | | | | | | | | | | | | | | |
| 2 | 1 | 3 | | | | | | | | | | | | | | | | | | | | | | | | | | | | | | | | | | | | | | | | | | | | | | | | | | | | | | | | | | | | | | | | | | | | | | | | | | | | | |
| 1 | | 1 | | | | | | | | | | | | | | | | | | | | | | | | | | | | | | | | | | | | | | | | | | | | | | | | | | | | | | | | | | | | | | | | | | | | | | | | | | | | | |
| | | | | | | | | | | | | | | | | | | | | | | | | | | | | | | | | | | | | | | | | | | | | | | | | | | | | | | | | | | | | | | | | | | | | | | | | | | | | | | | |
| 1 | | | | | | | | | | | | | | | | | | | | | | | | | | | | | | | | | | | | | | | | | | | | | | | | | | | | | | | | | | | | | | | | | | | | | | | | | | | | | | | |
| | | 1 | | | | | | | | | | | | | | | | | | | | | | | | | | | | | | | | | | | | | | | | | | | | | | | | | | | | | | | | | | | | | | | | | | | | | | | | | | | | | |
| | | 1 | | | | | | | | | | | | | | | | | | | | | | | | | | | | | | | | | | | | | | | | | | | | | | | | | | | | | | | | | | | | | | | | | | | | | | | | | | | | | |
| | | | | | | | | | | | | | | | | | | | | | | | | | | | | | | | | | | | | | | | | | | | | | | | | | | | | | | | | | | | | | | | | | | | | | | | | | | | | | | | |
| 1 | | | | | | | | | | | | | | | | | | | | | | | | | | | | | | | | | | | | | | | | | | | | | | | | | | | | | | | | | | | | | | | | | | | | | | | | | | | | | | | |
| | | | | | | | | | | | | | | | | | | | | | | | | | | | | | | | | | | | | | | | | | | | | | | | | | | | | | | | | | | | | | | | | | | | | | | | | | | | | | | | |
| | | | | | | | | | | | | | | | | | | | | | | | | | | | | | | | | | | | | | | | | | | | | | | | | | | | | | | | | | | | | | | | | | | | | | | | | | | | | | | | |
| | | | | | | | | | | | | | | | | | | | | | | | | | | | | | | | | | | | | | | | | | | | | | | | | | | | | | | | | | | | | | | | | | | | | | | | | | | | | | | | |
| | | | | | | | | | | | | | | | | | | | | | | | | | | | | | | | | | | | | | | | | | | | | | | | | | | | | | | | | | | | | | | | | | | | | | | | | | | | | | | | |
| | | | | | | | | | | | | | | | | | | | | | | | | | | | | | | | | | | | | | | | | | | | | | | | | | | | | | | | | | | | | | | | | | | | | | | | | | | | | | | | |
| | | | | | | | | | | | | | | | | | | | | | | | | | | | | | | | | | | | | | | | | | | | | | | | | | | | | | | | | | | | | | | | | | | | | | | | | | | | | | | | |
| | | | | | | | | | | | | | | | | | | | | | | | | | | | | | | | | | | | | | | | | | | | | | | | | | | | | | | | | | | | | | | | | | | | | | | | | | | | | | | | |
| | | | | | | | | | | | | | | | | | | | | | | | | | | | | | | | | | | | | | | | | | | | | | | | | | | | | | | | | | | | | | | | | | | | | | | | | | | | | | | | |
| | | | | | | | | | | | | | | | | | | | | | | | | | | | | | | | | | | | | | | | | | | | | | | | | | | | | | | | | | | | | | | | | | | | | | | | | | | | | | | | |
| | | | | | | | | | | | | | | | | | | | | | | | | | | | | | | | | | | | | | | | | | | | | | | | | | | | | | | | | | | | | | | | | | | | | | | | | | | | | | | | |
| | | | | | | | | | | | | | | | | | | | | | | | | | | | | | | | | | | | | | | | | | | | | | | | | | | | | | | | | | | | | | | | | | | | | | | | | | | | | | | | |
| | | | | | | | | | | | | | | | | | | | | | | | | | | | | | | | | | | | | | | | | | | | | | | | | | | | | | | | | | | | | | | | | | | | | | | | | | | | | | | | |
| | | | | | | | | | | | | | | | | | | | | | | | | | | | | | | | | | | | | | | | | | | | | | | | | | | | | | | | | | | | | | | | | | | | | | | | | | | | | | | | |
| | | | | | | | | | | | | | | | | | | | | | | | | | | | | | | | | | | | | | | | | | | | | | | | | | | | | | | | | | | | | | | | | | | | | | | | | | | | | | | | |
| | | | | | | | | | | | | | | | | | | | | | | | | | | | | | | | | | | | | | | | | | | | | | | | | | | | | | | | | | | | | | | | | | | | | | | | | | | | | | | | |
| Post - 1 Miss - 0 Block - 0 | Post - 0 Miss - 1 Block - 0 | Post - 1 Miss - 0 Block - 1 | Post - 0 Miss - 0 Block - 0 | Post - 0 Miss - 0 Block - 0 | Post - 0 Miss - 0 Block - 0 | Post - 0 Miss - 0 Block - 0 | Post - 0 Miss - 0 Block - 0 | | | | | | | | | | | | | | | | | | | | | | | | | | | | | | | | | | | | | | | | | | | | | | | | | | | | | | | | | | | | | | | | | | | | | | | | |
| 17 罗明杰 | 18 倪陈辉 | 19 王浩 | | | | | | | | | | | | | | | | | | | | | | | | | | | | | | | | | | | | | | | | | | | | | | | | | | | | | | | | | | | | | | | | | | | | | | | | | | | | | |
| <table border="1"><tr><td></td><td></td><td></td></tr><tr><td></td><td></td><td></td></tr><tr><td></td><td></td><td></td></tr></table> | | | | | | | | | | <table border="1"><tr><td></td><td></td><td></td></tr><tr><td></td><td></td><td></td></tr><tr><td></td><td></td><td></td></tr></table> | | | | | | | | | | <table border="1"><tr><td></td><td></td><td></td></tr><tr><td></td><td></td><td></td></tr><tr><td></td><td></td><td></td></tr></table> | | | | | | | | | | | | | | | | | | | | | | | | | | | | | | | | | | | | | | | | | | | | | | | | | | | | | | | | | | | |
| | | | | | | | | | | | | | | | | | | | | | | | | | | | | | | | | | | | | | | | | | | | | | | | | | | | | | | | | | | | | | | | | | | | | | | | | | | | | | | | |
| | | | | | | | | | | | | | | | | | | | | | | | | | | | | | | | | | | | | | | | | | | | | | | | | | | | | | | | | | | | | | | | | | | | | | | | | | | | | | | | |
| | | | | | | | | | | | | | | | | | | | | | | | | | | | | | | | | | | | | | | | | | | | | | | | | | | | | | | | | | | | | | | | | | | | | | | | | | | | | | | | |
| | | | | | | | | | | | | | | | | | | | | | | | | | | | | | | | | | | | | | | | | | | | | | | | | | | | | | | | | | | | | | | | | | | | | | | | | | | | | | | | |
| | | | | | | | | | | | | | | | | | | | | | | | | | | | | | | | | | | | | | | | | | | | | | | | | | | | | | | | | | | | | | | | | | | | | | | | | | | | | | | | |
| | | | | | | | | | | | | | | | | | | | | | | | | | | | | | | | | | | | | | | | | | | | | | | | | | | | | | | | | | | | | | | | | | | | | | | | | | | | | | | | |
| | | | | | | | | | | | | | | | | | | | | | | | | | | | | | | | | | | | | | | | | | | | | | | | | | | | | | | | | | | | | | | | | | | | | | | | | | | | | | | | |
| | | | | | | | | | | | | | | | | | | | | | | | | | | | | | | | | | | | | | | | | | | | | | | | | | | | | | | | | | | | | | | | | | | | | | | | | | | | | | | | |
| | | | | | | | | | | | | | | | | | | | | | | | | | | | | | | | | | | | | | | | | | | | | | | | | | | | | | | | | | | | | | | | | | | | | | | | | | | | | | | | |
| Post - 0 Miss - 0 Block - 0 | Post - 1 Miss - 2 Block - 2 | Post - 0 Miss - 0 Block - 0 | | | | | | | | | | | | | | | | | | | | | | | | | | | | | | | | | | | | | | | | | | | | | | | | | | | | | | | | | | | | | | | | | | | | | | | | | | | | | |

| | | | | | | | | | |
|--|-----|-----|--|--|--|-----|-----|--|-----|
| 14 虞勇灿 | | | | | | | | | |
| <table border="1"><tr><td>0/1</td><td></td><td></td></tr><tr><td></td><td></td><td>0/1</td></tr><tr><td>0/3</td><td></td><td>1/1</td></tr></table> | 0/1 | | | | | 0/1 | 0/3 | | 1/1 |
| 0/1 | | | | | | | | | |
| | | 0/1 | | | | | | | |
| 0/3 | | 1/1 | | | | | | | |

| | | | | | | | | | |
|--|-----|------|-----|-----|--|-----|-----|-----|------|
| 15 张佩力 | | | | | | | | | |
| <table border="1"><tr><td>0/1</td><td></td><td>1/3</td></tr><tr><td>0/1</td><td></td><td>2/9</td></tr><tr><td>0/3</td><td>1/1</td><td>2/10</td></tr></table> | 0/1 | | 1/3 | 0/1 | | 2/9 | 0/3 | 1/1 | 2/10 |
| 0/1 | | 1/3 | | | | | | | |
| 0/1 | | 2/9 | | | | | | | |
| 0/3 | 1/1 | 2/10 | | | | | | | |

| |
|--|
| |
| |
| |

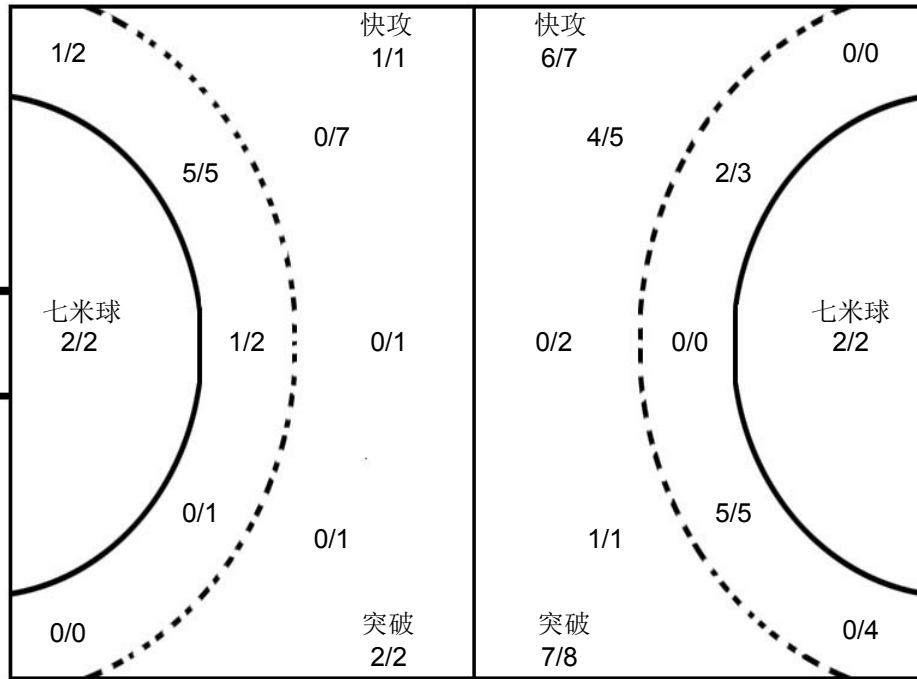

| | | | | | | | | | |
|--|--|-----|--|-----|--|-----|-----|--|-----|
| 24 刘子健 | | | | | | | | | |
| <table border="1"><tr><td></td><td></td><td></td></tr><tr><td>1/4</td><td></td><td>0/1</td></tr><tr><td>1/3</td><td></td><td>0/1</td></tr></table> | | | | 1/4 | | 0/1 | 1/3 | | 0/1 |
| | | | | | | | | | |
| 1/4 | | 0/1 | | | | | | | |
| 1/3 | | 0/1 | | | | | | | |

| | | | | | | | | | |
|---|-----|-----|-----|-----|-----|-----|--|--|-----|
| 28 何喜年 | | | | | | | | | |
| <table border="1"><tr><td></td><td></td><td>0/1</td></tr><tr><td>1/1</td><td>0/1</td><td>0/2</td></tr><tr><td></td><td></td><td>0/1</td></tr></table> | | | 0/1 | 1/1 | 0/1 | 0/2 | | | 0/1 |
| | | 0/1 | | | | | | | |
| 1/1 | 0/1 | 0/2 | | | | | | | |
| | | 0/1 | | | | | | | |

| |
|--|
| |
| |
| |

天津队

| | | | | | | | | | | | | | | | | | | | | | | | | | | | | | | | | | | | | | | | | | | | | | | | | | | | | | | | | | | | | | | | | | | | | | | | | | | | | | | | |
|---|-----------------------------|-----------------------------|-----------------------------|-----------------------------|-----------------------------|-----------------------------|-----------------------------|--|---|--|---|--|---|--|--|---|--|--|---|---|--|--|---|---|--|---|---|--|---|--|--|--|--|--|--|--|--|--|--|---|--|--|--|--|--|--|---|--|--|---|--|--|--|--|--|--|--|--|---|--|--|--|--|--|--|--|--|--|--|--|--|--|--|--|--|--|--|--|--|
| 9 吴明远 | 21 潘玉帅 | 22 魏雨童 | 24 刘子健 | 25 王一雄 | 26 刘思远 | 27 左金龙 | 28 何喜年 | | | | | | | | | | | | | | | | | | | | | | | | | | | | | | | | | | | | | | | | | | | | | | | | | | | | | | | | | | | | | | | | | | | | | | | | |
| <table border="1"><tr><td></td><td></td><td></td></tr><tr><td></td><td></td><td>1</td></tr><tr><td>3</td><td></td><td>2</td></tr></table> | | | | | | 1 | 3 | | 2 | <table border="1"><tr><td>1</td><td></td><td>1</td></tr><tr><td></td><td></td><td>5</td></tr><tr><td></td><td></td><td>1</td></tr></table> | 1 | | 1 | | | 5 | | | 1 | <table border="1"><tr><td></td><td></td><td>1</td></tr><tr><td>1</td><td></td><td>2</td></tr><tr><td>2</td><td></td><td>3</td></tr></table> | | | 1 | 1 | | 2 | 2 | | 3 | <table border="1"><tr><td></td><td></td><td></td></tr><tr><td></td><td></td><td></td></tr><tr><td></td><td></td><td></td></tr></table> | | | | | | | | | | <table border="1"><tr><td></td><td></td><td></td></tr><tr><td></td><td></td><td></td></tr><tr><td>1</td><td></td><td></td></tr></table> | | | | | | | 1 | | | <table border="1"><tr><td></td><td></td><td></td></tr><tr><td></td><td></td><td></td></tr><tr><td></td><td></td><td>2</td></tr></table> | | | | | | | | | 2 | <table border="1"><tr><td></td><td></td><td></td></tr><tr><td></td><td></td><td></td></tr><tr><td></td><td></td><td></td></tr></table> | | | | | | | | | | <table border="1"><tr><td></td><td></td><td></td></tr><tr><td></td><td></td><td></td></tr><tr><td></td><td></td><td></td></tr></table> | | | | | | | | | |
| | | | | | | | | | | | | | | | | | | | | | | | | | | | | | | | | | | | | | | | | | | | | | | | | | | | | | | | | | | | | | | | | | | | | | | | | | | | | | | | |
| | | 1 | | | | | | | | | | | | | | | | | | | | | | | | | | | | | | | | | | | | | | | | | | | | | | | | | | | | | | | | | | | | | | | | | | | | | | | | | | | | | |
| 3 | | 2 | | | | | | | | | | | | | | | | | | | | | | | | | | | | | | | | | | | | | | | | | | | | | | | | | | | | | | | | | | | | | | | | | | | | | | | | | | | | | |
| 1 | | 1 | | | | | | | | | | | | | | | | | | | | | | | | | | | | | | | | | | | | | | | | | | | | | | | | | | | | | | | | | | | | | | | | | | | | | | | | | | | | | |
| | | 5 | | | | | | | | | | | | | | | | | | | | | | | | | | | | | | | | | | | | | | | | | | | | | | | | | | | | | | | | | | | | | | | | | | | | | | | | | | | | | |
| | | 1 | | | | | | | | | | | | | | | | | | | | | | | | | | | | | | | | | | | | | | | | | | | | | | | | | | | | | | | | | | | | | | | | | | | | | | | | | | | | | |
| | | 1 | | | | | | | | | | | | | | | | | | | | | | | | | | | | | | | | | | | | | | | | | | | | | | | | | | | | | | | | | | | | | | | | | | | | | | | | | | | | | |
| 1 | | 2 | | | | | | | | | | | | | | | | | | | | | | | | | | | | | | | | | | | | | | | | | | | | | | | | | | | | | | | | | | | | | | | | | | | | | | | | | | | | | |
| 2 | | 3 | | | | | | | | | | | | | | | | | | | | | | | | | | | | | | | | | | | | | | | | | | | | | | | | | | | | | | | | | | | | | | | | | | | | | | | | | | | | | |
| | | | | | | | | | | | | | | | | | | | | | | | | | | | | | | | | | | | | | | | | | | | | | | | | | | | | | | | | | | | | | | | | | | | | | | | | | | | | | | | |
| | | | | | | | | | | | | | | | | | | | | | | | | | | | | | | | | | | | | | | | | | | | | | | | | | | | | | | | | | | | | | | | | | | | | | | | | | | | | | | | |
| | | | | | | | | | | | | | | | | | | | | | | | | | | | | | | | | | | | | | | | | | | | | | | | | | | | | | | | | | | | | | | | | | | | | | | | | | | | | | | | |
| | | | | | | | | | | | | | | | | | | | | | | | | | | | | | | | | | | | | | | | | | | | | | | | | | | | | | | | | | | | | | | | | | | | | | | | | | | | | | | | |
| | | | | | | | | | | | | | | | | | | | | | | | | | | | | | | | | | | | | | | | | | | | | | | | | | | | | | | | | | | | | | | | | | | | | | | | | | | | | | | | |
| 1 | | | | | | | | | | | | | | | | | | | | | | | | | | | | | | | | | | | | | | | | | | | | | | | | | | | | | | | | | | | | | | | | | | | | | | | | | | | | | | | |
| | | | | | | | | | | | | | | | | | | | | | | | | | | | | | | | | | | | | | | | | | | | | | | | | | | | | | | | | | | | | | | | | | | | | | | | | | | | | | | | |
| | | | | | | | | | | | | | | | | | | | | | | | | | | | | | | | | | | | | | | | | | | | | | | | | | | | | | | | | | | | | | | | | | | | | | | | | | | | | | | | |
| | | 2 | | | | | | | | | | | | | | | | | | | | | | | | | | | | | | | | | | | | | | | | | | | | | | | | | | | | | | | | | | | | | | | | | | | | | | | | | | | | | |
| | | | | | | | | | | | | | | | | | | | | | | | | | | | | | | | | | | | | | | | | | | | | | | | | | | | | | | | | | | | | | | | | | | | | | | | | | | | | | | | |
| | | | | | | | | | | | | | | | | | | | | | | | | | | | | | | | | | | | | | | | | | | | | | | | | | | | | | | | | | | | | | | | | | | | | | | | | | | | | | | | |
| | | | | | | | | | | | | | | | | | | | | | | | | | | | | | | | | | | | | | | | | | | | | | | | | | | | | | | | | | | | | | | | | | | | | | | | | | | | | | | | |
| | | | | | | | | | | | | | | | | | | | | | | | | | | | | | | | | | | | | | | | | | | | | | | | | | | | | | | | | | | | | | | | | | | | | | | | | | | | | | | | |
| | | | | | | | | | | | | | | | | | | | | | | | | | | | | | | | | | | | | | | | | | | | | | | | | | | | | | | | | | | | | | | | | | | | | | | | | | | | | | | | |
| | | | | | | | | | | | | | | | | | | | | | | | | | | | | | | | | | | | | | | | | | | | | | | | | | | | | | | | | | | | | | | | | | | | | | | | | | | | | | | | |
| Post - 1 Miss - 0 Block - 0 | Post - 2 Miss - 0 Block - 0 | Post - 0 Miss - 0 Block - 0 | Post - 0 Miss - 0 Block - 0 | Post - 0 Miss - 0 Block - 0 | Post - 0 Miss - 0 Block - 0 | Post - 0 Miss - 0 Block - 0 | Post - 0 Miss - 0 Block - 0 | | | | | | | | | | | | | | | | | | | | | | | | | | | | | | | | | | | | | | | | | | | | | | | | | | | | | | | | | | | | | | | | | | | | | | | | |
| | | | | | | | | | | | | | | | | | | | | | | | | | | | | | | | | | | | | | | | | | | | | | | | | | | | | | | | | | | | | | | | | | | | | | | | | | | | | | | | |
| | | | | | | | | | | | | | | | | | | | | | | | | | | | | | | | | | | | | | | | | | | | | | | | | | | | | | | | | | | | | | | | | | | | | | | | | | | | | | | | |

注释: Post=击柱 Miss=射失 Block=被封





9-12名
青年男子 全国比赛

2016年“体彩杯”全国手球男子青年锦标赛

| | | | | | | | | | | | | | | | | | | | | | |
|--------------------|---|------------------------------|---------------------|------------------|------------------------------------|-------------------|---|---------------------------|------------------------------|----|-----|----------------------|---------------|---|--|--|----|---|----|---|----|
| Team A A 上海队 | | | | Team B B 辽宁队 | | | | Match Number 32 | | | | | | | | | | | | | |
| played in China | | in the hall 重庆万州 | | on 26/03/2016 | | at 10:00 hours | | Spectators | | | | | | | | | | | | | |
| Half-time (30') | A 12 | B 25 | End of playing time | A 12 | B 27 | 1st extra time | A | B | 2nd extra time | A | B | After penalty throws | A | B | | | | | | | |
| Number of 7 m | A 0/0 | Team time-out 1 11:01 2 3 | | | Full name of players and officials | | | | Team time-out 1 21:41 2 3 | | | B 0/0 | Number of 7 m | | | | | | | | |
| No. | Team A | | | | | G | W | 2' | D | DR | No. | Team B | | | | | G | W | 2' | D | DR |
| 2 | 谢智超 | | | | | | | | | | 1 | 高尚君 | | | | | | | | | |
| 3 | 高天伦 | | | | | 2 | 1 | | | | 2 | 王司雨 | | | | | | | | | |
| 4 | 高震东 | | | | | | | | | | 3 | 李星浩 | | | | | 4 | 1 | | | |
| 5 | 曹磊 | | | | | | | | | | 5 | 余昊锦 | | | | | 1 | | | | |
| 6 | 季晨旭 | | | | | | | | | | 6 | 陈庆港 | | | | | 4 | | | | |
| 7 | 蒋家敏 | | | | | 1 | | | | | 7 | 孙义广 | | | | | 3 | 1 | 1 | | |
| 8 | 庄旭杰 | | | | | | | | | | 8 | 王鑫鹏 | | | | | | | | | |
| 10 | 董凯 | | | | | 6 | 1 | | | | 10 | 王柏淇 | | | | | 11 | | | | |
| 12 | 张润民 | | | | | | | | | | 11 | 庞东阳 | | | | | 3 | 1 | | | |
| 14 | 吴佳兵 | | | | | | | | | | 13 | 杨洁 | | | | | 1 | | | | |
| 16 | 陈辰 | | | | | | | | | | 14 | 吕昊臻 | | | | | | | | | |
| 18 | 吴双 | | | | | 3 | 1 | | | | 16 | 吴阳 | | | | | | | | | |
| | | | | | | | | | | | 17 | 李傲 | | | | | | | | | |
| | | | | | | | | | | | 18 | 梅凯博 | | | | | | | | | |
| | | | | | | | | | | | 19 | 赵鑫 | | | | | | | | | |
| | | | | | | | | | | | 20 | 赵佛赐 | | | | | | | | | |
| A | 马仲顺 | | | | | | | | | | B | 赵影 (主教练) | | | | | | | | | |
| | | | | | | | | | | | C | 刘启迪 | | | | | | | | | |
| | | | | | | | | | | | | | | | | | | | | | |
| | | | | | | | | | | | | | | | | | | | | | |
| | | | | | | | | | | | | | | | | | | | | | |
| A | Signature of Responsible Official of the Teams (Off. A) | | | | | | | | | | | | | | | | | | B | | |
| TP | Remarks of Referee / CHA Official | | | | | | | | | | | | | | | | | | TP | | |

Signatures

Referees: 程钰峰 (CHN) 周云磊 (CHN)

Techn. Delegates: 徐健 (CHN)

CHA Official: 吴瑞亭 (CHN)

Note: Number of 7m Throws Awarded to Team A and B, Goals (G), Warnings (W), Suspensions (2'), Direct Disqualification (D), Disqualification with Report (DR) and Team Penalty (TP).

Table Officials:

Statisticians: 刘永欢

李双





2016年“体彩杯”全国手球男子青年锦标赛

个人/全队技术统计表

正式表
手球
青年男子9-12名
轮次 6组别 C
场次 32201602032-14-1/2
重庆万州
26/03/2016 10:00

| 号码 | 姓名 | 远射 | 近射 | 边射 | 快攻 | 突破 | 任意 | 7M | 合计 | % | 助攻 | 失误 | 警告 | 2' | 取消 | 时间 |
|--------------------------------------|-----|-----|-----|-----|-----|-----|-----|----|------|-------|----|----|----|----|----|----------|
| 上海队(上海) | | | | | | | | | | | | | | | | |
| <i>(场上队员)</i> | | | | | | | | | | | | | | | | |
| 2 | 谢智超 | | | | | | | | | 0.0% | | | | | | 00:00:00 |
| 3 | 高天伦 | | 1/1 | 1/2 | | | | | 2/3 | 66.7% | 1 | 5 | 1 | | | 00:32:21 |
| 4 | 高震东 | | | | | | | | | 0.0% | | | | | | 00:00:00 |
| 5 | 曹磊 | | | 0/1 | | | | | 0/1 | 0.0% | | 1 | | | | 00:11:11 |
| 6 | 季晨旭 | | | | | | | | | 0.0% | | | | | | 00:00:00 |
| 7 | 蒋家敏 | | 0/2 | 1/2 | | | | | 1/4 | 25.0% | | 2 | | | | 00:32:21 |
| 8 | 庄旭杰 | | | 0/2 | | | | | 0/2 | 0.0% | | 4 | | | | 00:21:06 |
| 10 | 董凯 | 2/3 | 3/4 | 1/1 | | | | | 6/8 | 75.0% | | 2 | 1 | | | 00:32:21 |
| 12 | 张润民 | | | | | | | | | 0.0% | | 1 | | | | 00:26:50 |
| 14 | 吴佳兵 | | 0/1 | | | | | | 0/1 | 0.0% | | 1 | | | | 00:32:21 |
| 16 | 陈辰 | | | | | | | | | 0.0% | | | | | | 00:05:31 |
| 18 | 吴双 | 1/2 | 0/3 | 1/1 | 1/1 | | | | 3/7 | 42.9% | | 5 | 1 | | | 00:32:21 |
| 合计 | | | | | | | | | | | | | | | | |
| <i>(守门员)</i> | | | | | | | | | | | | | | | | |
| 12 | 张润民 | 1/3 | 2/8 | 0/4 | 1/7 | 1/5 | 1/1 | | 6/28 | 21.4% | | 1 | | | | 00:26:50 |
| 16 | 陈辰 | 0/1 | 0/1 | 0/2 | 0/1 | | | | 0/5 | 0.0% | | | | | | 00:05:31 |
| 合计 | | | | | | | | | | | | | | | | |
| 1/4 2/9 0/6 1/8 1/5 1/1 6/33 18.2% 1 | | | | | | | | | | | | | | | | |

场上队员：得分/射门

守门员：救球/射门

| 全队合计 | 得分 | 被救 | 射失 | 击柱 | 封球 | 合计 | % |
|------|----|----|----|----|----|----|--------|
| 远射 | 3 | | 1 | | 1 | 5 | 60.0% |
| 近射 | 4 | 5 | 2 | | | 11 | 36.4% |
| 边射 | 4 | 3 | 2 | | | 9 | 44.4% |
| 快攻 | 1 | | | | | 1 | 100.0% |
| 突破 | | | | | | | 0.0% |
| 任意 | | | | | | | 0.0% |
| 7M | | | | | | | 0.0% |





2016年“体彩杯”全国手球男子青年锦标赛

个人/全队技术统计表

正式表
手球
青年男子9-12名
轮次 6组别 C
场次 32201602032-14-2/2
重庆万州
26/03/2016 10:00

| 号码 | 姓名 | 远射 | 近射 | 边射 | 快攻 | 突破 | 任意 | 7M | 合计 | % | 助攻 | 失误 | 警告 | 2' | 取消 | 时间 |
|----------------|-----|-----|------|-----|-----|-----|-----|----|-------|-------|----|----|----|----|----|----------|
| 辽宁队(辽宁) | | | | | | | | | | | | | | | | |
| <i>(上场队员)</i> | | | | | | | | | | | | | | | | |
| 1 | 高尚君 | | | | | | | | | 0.0% | 1 | | | | | 00:32:21 |
| 2 | 王司雨 | | | | | | | | | 0.0% | | | | | | 00:01:21 |
| 3 | 李星浩 | | 4/5 | | | | | | 4/5 | 80.0% | 1 | | 1 | | | 00:31:55 |
| 5 | 余昊锦 | | | 1/1 | | | | | 1/1 | 100% | | | | | | 00:08:04 |
| 6 | 陈庆港 | | 0/1 | 3/3 | | 1/2 | | | 4/6 | 66.7% | | | | | | 00:32:21 |
| 7 | 孙义广 | | | 2/2 | 1/1 | | | | 3/3 | 100% | | 1 | 1 | 1 | | 00:32:21 |
| 8 | 王鑫鹏 | | | | | | | | | 0.0% | | | | | | 00:00:00 |
| 10 | 王柏淇 | 2/5 | 1/1 | | 5/7 | 3/3 | 0/2 | | 11/18 | 61.1% | 3 | 3 | | | | 00:30:58 |
| 11 | 庞东阳 | 0/2 | 2/2 | | 1/1 | 0/1 | | | 3/6 | 50.0% | 1 | 1 | 1 | | | 00:32:21 |
| 13 | 杨洁 | 1/2 | 0/1 | | | | | | 1/3 | 33.3% | | 1 | | | | 00:24:16 |
| 14 | 吕昊臻 | | | | | | | | | 0.0% | | | | | | 00:00:00 |
| 16 | 吴阳 | | | | | | | | | 0.0% | | | | | | 00:00:00 |
| 17 | 李傲 | | | | | | | | | 0.0% | | | | | | 00:00:00 |
| 18 | 梅凯博 | | | | | | | | | 0.0% | | | | | | 00:00:00 |
| 19 | 赵鑫 | | | | | | | | | 0.0% | | | | | | 00:00:00 |
| 20 | 赵佛赐 | | | | | | | | | 0.0% | | | | | | 00:00:00 |
| 合计 | | 3/9 | 7/10 | 6/6 | 7/9 | 4/6 | 0/2 | | 27/42 | 64.3% | 6 | 6 | 3 | 1 | | |
| <i>(守门员)</i> | | | | | | | | | | | | | | | | |
| 1 | 高尚君 | 0/3 | 5/9 | 3/7 | 0/1 | | | | 8/20 | 40.0% | 1 | | | | | 00:32:21 |
| 合计 | | 0/3 | 5/9 | 3/7 | 0/1 | | | | 8/20 | 40.0% | 1 | | | | | |

场上队员：得分/射门

守门员：救球/射门

| 全队合计 | 得分 | 被救 | 射失 | 击柱 | 封球 | 合计 | % |
|------|----|----|----|----|----|----|--------|
| 远射 | 3 | 1 | 3 | 1 | 1 | 9 | 33.3% |
| 近射 | 7 | 2 | 1 | | | 10 | 70.0% |
| 边射 | 6 | | | | | 6 | 100.0% |
| 快攻 | 7 | 1 | 1 | | | 9 | 77.8% |
| 突破 | 4 | 1 | 1 | | | 6 | 66.7% |
| 任意 | | 1 | | 1 | | 2 | 0.0% |
| 7M | | | | | | | 0.0% |





2016年“体彩杯”全国手球男子青年锦标赛

图式射门区域统计

轮次 6 场次 32

201602032-41-1/1

上海队

| | | | | | | | | | | | | | | | | | | | | | | | | | | | | | | | | | | | | | | | | | | | | | | | | | | | | | | | | | | | | | | | | | | | | | | | | | | | | | | | |
|--|-----------------------------|-----------------------------|-----------------------------|-----------------------------|-----------------------------|-----------------------------|-----------------------------|--|--|--|---|--|--|--|--|--|---|--|--|--|--|--|--|--|--|--|--|--|--|--|--|---|--|--|--|--|--|---|--|--|--|--|--|--|--|--|--|--|--|---|--|--|--|--|--|--|---|--|--|--|--|--|--|--|--|--|--|--|--|---|--|---|--|---|---|--|---|--|---|
| 2 谢智超 | 3 高天伦 | 4 高震东 | 5 曹磊 | 6 季晨旭 | 7 蒋家敏 | 8 庄旭杰 | 10 董凯 | | | | | | | | | | | | | | | | | | | | | | | | | | | | | | | | | | | | | | | | | | | | | | | | | | | | | | | | | | | | | | | | | | | | | | | | |
| <table border="1"><tr><td></td><td></td><td></td></tr><tr><td></td><td></td><td></td></tr><tr><td></td><td></td><td></td></tr></table> | | | | | | | | | | <table border="1"><tr><td>1</td><td></td><td></td></tr><tr><td></td><td></td><td></td></tr><tr><td>1</td><td></td><td></td></tr></table> | 1 | | | | | | 1 | | | <table border="1"><tr><td></td><td></td><td></td></tr><tr><td></td><td></td><td></td></tr><tr><td></td><td></td><td></td></tr></table> | | | | | | | | | | <table border="1"><tr><td></td><td></td><td></td></tr><tr><td></td><td></td><td></td></tr><tr><td></td><td></td><td></td></tr></table> | | | | | | | | | | <table border="1"><tr><td></td><td></td><td></td></tr><tr><td></td><td></td><td></td></tr><tr><td></td><td></td><td></td></tr></table> | | | | | | | | | | <table border="1"><tr><td></td><td></td><td></td></tr><tr><td></td><td></td><td></td></tr><tr><td>1</td><td></td><td></td></tr></table> | | | | | | | 1 | | | <table border="1"><tr><td></td><td></td><td></td></tr><tr><td></td><td></td><td></td></tr><tr><td></td><td></td><td></td></tr></table> | | | | | | | | | | <table border="1"><tr><td></td><td>1</td><td></td></tr><tr><td>1</td><td>1</td><td></td></tr><tr><td>2</td><td></td><td>1</td></tr></table> | | 1 | | 1 | 1 | | 2 | | 1 |
| | | | | | | | | | | | | | | | | | | | | | | | | | | | | | | | | | | | | | | | | | | | | | | | | | | | | | | | | | | | | | | | | | | | | | | | | | | | | | | | |
| | | | | | | | | | | | | | | | | | | | | | | | | | | | | | | | | | | | | | | | | | | | | | | | | | | | | | | | | | | | | | | | | | | | | | | | | | | | | | | | |
| | | | | | | | | | | | | | | | | | | | | | | | | | | | | | | | | | | | | | | | | | | | | | | | | | | | | | | | | | | | | | | | | | | | | | | | | | | | | | | | |
| 1 | | | | | | | | | | | | | | | | | | | | | | | | | | | | | | | | | | | | | | | | | | | | | | | | | | | | | | | | | | | | | | | | | | | | | | | | | | | | | | | |
| | | | | | | | | | | | | | | | | | | | | | | | | | | | | | | | | | | | | | | | | | | | | | | | | | | | | | | | | | | | | | | | | | | | | | | | | | | | | | | | |
| 1 | | | | | | | | | | | | | | | | | | | | | | | | | | | | | | | | | | | | | | | | | | | | | | | | | | | | | | | | | | | | | | | | | | | | | | | | | | | | | | | |
| | | | | | | | | | | | | | | | | | | | | | | | | | | | | | | | | | | | | | | | | | | | | | | | | | | | | | | | | | | | | | | | | | | | | | | | | | | | | | | | |
| | | | | | | | | | | | | | | | | | | | | | | | | | | | | | | | | | | | | | | | | | | | | | | | | | | | | | | | | | | | | | | | | | | | | | | | | | | | | | | | |
| | | | | | | | | | | | | | | | | | | | | | | | | | | | | | | | | | | | | | | | | | | | | | | | | | | | | | | | | | | | | | | | | | | | | | | | | | | | | | | | |
| | | | | | | | | | | | | | | | | | | | | | | | | | | | | | | | | | | | | | | | | | | | | | | | | | | | | | | | | | | | | | | | | | | | | | | | | | | | | | | | |
| | | | | | | | | | | | | | | | | | | | | | | | | | | | | | | | | | | | | | | | | | | | | | | | | | | | | | | | | | | | | | | | | | | | | | | | | | | | | | | | |
| | | | | | | | | | | | | | | | | | | | | | | | | | | | | | | | | | | | | | | | | | | | | | | | | | | | | | | | | | | | | | | | | | | | | | | | | | | | | | | | |
| | | | | | | | | | | | | | | | | | | | | | | | | | | | | | | | | | | | | | | | | | | | | | | | | | | | | | | | | | | | | | | | | | | | | | | | | | | | | | | | |
| | | | | | | | | | | | | | | | | | | | | | | | | | | | | | | | | | | | | | | | | | | | | | | | | | | | | | | | | | | | | | | | | | | | | | | | | | | | | | | | |
| | | | | | | | | | | | | | | | | | | | | | | | | | | | | | | | | | | | | | | | | | | | | | | | | | | | | | | | | | | | | | | | | | | | | | | | | | | | | | | | |
| | | | | | | | | | | | | | | | | | | | | | | | | | | | | | | | | | | | | | | | | | | | | | | | | | | | | | | | | | | | | | | | | | | | | | | | | | | | | | | | |
| | | | | | | | | | | | | | | | | | | | | | | | | | | | | | | | | | | | | | | | | | | | | | | | | | | | | | | | | | | | | | | | | | | | | | | | | | | | | | | | |
| 1 | | | | | | | | | | | | | | | | | | | | | | | | | | | | | | | | | | | | | | | | | | | | | | | | | | | | | | | | | | | | | | | | | | | | | | | | | | | | | | | |
| | | | | | | | | | | | | | | | | | | | | | | | | | | | | | | | | | | | | | | | | | | | | | | | | | | | | | | | | | | | | | | | | | | | | | | | | | | | | | | | |
| | | | | | | | | | | | | | | | | | | | | | | | | | | | | | | | | | | | | | | | | | | | | | | | | | | | | | | | | | | | | | | | | | | | | | | | | | | | | | | | |
| | | | | | | | | | | | | | | | | | | | | | | | | | | | | | | | | | | | | | | | | | | | | | | | | | | | | | | | | | | | | | | | | | | | | | | | | | | | | | | | |
| | 1 | | | | | | | | | | | | | | | | | | | | | | | | | | | | | | | | | | | | | | | | | | | | | | | | | | | | | | | | | | | | | | | | | | | | | | | | | | | | | | |
| 1 | 1 | | | | | | | | | | | | | | | | | | | | | | | | | | | | | | | | | | | | | | | | | | | | | | | | | | | | | | | | | | | | | | | | | | | | | | | | | | | | | | |
| 2 | | 1 | | | | | | | | | | | | | | | | | | | | | | | | | | | | | | | | | | | | | | | | | | | | | | | | | | | | | | | | | | | | | | | | | | | | | | | | | | | | | |
| Post - 0 Miss - 0 Block - 0 | Post - 0 Miss - 0 Block - 0 | Post - 0 Miss - 0 Block - 0 | Post - 0 Miss - 0 Block - 0 | Post - 0 Miss - 0 Block - 0 | Post - 0 Miss - 1 Block - 0 | Post - 0 Miss - 2 Block - 0 | Post - 0 Miss - 0 Block - 1 | | | | | | | | | | | | | | | | | | | | | | | | | | | | | | | | | | | | | | | | | | | | | | | | | | | | | | | | | | | | | | | | | | | | | | | | |
| 12 张润民 | 14 吴佳兵 | 16 陈辰 | 18 吴双 | | | | | | | | | | | | | | | | | | | | | | | | | | | | | | | | | | | | | | | | | | | | | | | | | | | | | | | | | | | | | | | | | | | | | | | | | | | | |
| <table border="1"><tr><td></td><td></td><td></td></tr><tr><td></td><td></td><td></td></tr><tr><td></td><td></td><td></td></tr></table> | | | | | | | | | | <table border="1"><tr><td></td><td></td><td></td></tr><tr><td></td><td></td><td></td></tr><tr><td></td><td></td><td></td></tr></table> | | | | | | | | | | <table border="1"><tr><td></td><td></td><td></td></tr><tr><td></td><td></td><td></td></tr><tr><td></td><td></td><td></td></tr></table> | | | | | | | | | | <table border="1"><tr><td></td><td>1</td><td></td></tr><tr><td></td><td></td><td></td></tr><tr><td></td><td>2</td><td></td></tr></table> | | 1 | | | | | | 2 | | <table border="1"><tr><td></td><td></td><td></td></tr><tr><td></td><td></td><td></td></tr><tr><td></td><td></td><td></td></tr></table> | | | | | | | | | | <table border="1"><tr><td></td><td></td><td></td></tr><tr><td></td><td></td><td></td></tr><tr><td></td><td></td><td></td></tr></table> | | | | | | | | | | <table border="1"><tr><td></td><td></td><td></td></tr><tr><td></td><td></td><td></td></tr><tr><td></td><td></td><td></td></tr></table> | | | | | | | | | | <table border="1"><tr><td></td><td></td><td></td></tr><tr><td></td><td></td><td></td></tr><tr><td></td><td></td><td></td></tr></table> | | | | | | | | | |
| | | | | | | | | | | | | | | | | | | | | | | | | | | | | | | | | | | | | | | | | | | | | | | | | | | | | | | | | | | | | | | | | | | | | | | | | | | | | | | | |
| | | | | | | | | | | | | | | | | | | | | | | | | | | | | | | | | | | | | | | | | | | | | | | | | | | | | | | | | | | | | | | | | | | | | | | | | | | | | | | | |
| | | | | | | | | | | | | | | | | | | | | | | | | | | | | | | | | | | | | | | | | | | | | | | | | | | | | | | | | | | | | | | | | | | | | | | | | | | | | | | | |
| | | | | | | | | | | | | | | | | | | | | | | | | | | | | | | | | | | | | | | | | | | | | | | | | | | | | | | | | | | | | | | | | | | | | | | | | | | | | | | | |
| | | | | | | | | | | | | | | | | | | | | | | | | | | | | | | | | | | | | | | | | | | | | | | | | | | | | | | | | | | | | | | | | | | | | | | | | | | | | | | | |
| | | | | | | | | | | | | | | | | | | | | | | | | | | | | | | | | | | | | | | | | | | | | | | | | | | | | | | | | | | | | | | | | | | | | | | | | | | | | | | | |
| | | | | | | | | | | | | | | | | | | | | | | | | | | | | | | | | | | | | | | | | | | | | | | | | | | | | | | | | | | | | | | | | | | | | | | | | | | | | | | | |
| | | | | | | | | | | | | | | | | | | | | | | | | | | | | | | | | | | | | | | | | | | | | | | | | | | | | | | | | | | | | | | | | | | | | | | | | | | | | | | | |
| | | | | | | | | | | | | | | | | | | | | | | | | | | | | | | | | | | | | | | | | | | | | | | | | | | | | | | | | | | | | | | | | | | | | | | | | | | | | | | | |
| | 1 | | | | | | | | | | | | | | | | | | | | | | | | | | | | | | | | | | | | | | | | | | | | | | | | | | | | | | | | | | | | | | | | | | | | | | | | | | | | | | |
| | | | | | | | | | | | | | | | | | | | | | | | | | | | | | | | | | | | | | | | | | | | | | | | | | | | | | | | | | | | | | | | | | | | | | | | | | | | | | | | |
| | 2 | | | | | | | | | | | | | | | | | | | | | | | | | | | | | | | | | | | | | | | | | | | | | | | | | | | | | | | | | | | | | | | | | | | | | | | | | | | | | | |
| | | | | | | | | | | | | | | | | | | | | | | | | | | | | | | | | | | | | | | | | | | | | | | | | | | | | | | | | | | | | | | | | | | | | | | | | | | | | | | | |
| | | | | | | | | | | | | | | | | | | | | | | | | | | | | | | | | | | | | | | | | | | | | | | | | | | | | | | | | | | | | | | | | | | | | | | | | | | | | | | | |
| | | | | | | | | | | | | | | | | | | | | | | | | | | | | | | | | | | | | | | | | | | | | | | | | | | | | | | | | | | | | | | | | | | | | | | | | | | | | | | | |
| | | | | | | | | | | | | | | | | | | | | | | | | | | | | | | | | | | | | | | | | | | | | | | | | | | | | | | | | | | | | | | | | | | | | | | | | | | | | | | | |
| | | | | | | | | | | | | | | | | | | | | | | | | | | | | | | | | | | | | | | | | | | | | | | | | | | | | | | | | | | | | | | | | | | | | | | | | | | | | | | | |
| | | | | | | | | | | | | | | | | | | | | | | | | | | | | | | | | | | | | | | | | | | | | | | | | | | | | | | | | | | | | | | | | | | | | | | | | | | | | | | | |
| | | | | | | | | | | | | | | | | | | | | | | | | | | | | | | | | | | | | | | | | | | | | | | | | | | | | | | | | | | | | | | | | | | | | | | | | | | | | | | | |
| | | | | | | | | | | | | | | | | | | | | | | | | | | | | | | | | | | | | | | | | | | | | | | | | | | | | | | | | | | | | | | | | | | | | | | | | | | | | | | | |
| | | | | | | | | | | | | | | | | | | | | | | | | | | | | | | | | | | | | | | | | | | | | | | | | | | | | | | | | | | | | | | | | | | | | | | | | | | | | | | | |
| | | | | | | | | | | | | | | | | | | | | | | | | | | | | | | | | | | | | | | | | | | | | | | | | | | | | | | | | | | | | | | | | | | | | | | | | | | | | | | | |
| | | | | | | | | | | | | | | | | | | | | | | | | | | | | | | | | | | | | | | | | | | | | | | | | | | | | | | | | | | | | | | | | | | | | | | | | | | | | | | | |
| | | | | | | | | | | | | | | | | | | | | | | | | | | | | | | | | | | | | | | | | | | | | | | | | | | | | | | | | | | | | | | | | | | | | | | | | | | | | | | | |
| Post - 0 Miss - 0 Block - 0 | Post - 0 Miss - 0 Block - 0 | Post - 0 Miss - 0 Block - 0 | Post - 0 Miss - 2 Block - 0 | | | | | | | | | | | | | | | | | | | | | | | | | | | | | | | | | | | | | | | | | | | | | | | | | | | | | | | | | | | | | | | | | | | | | | | | | | | | |

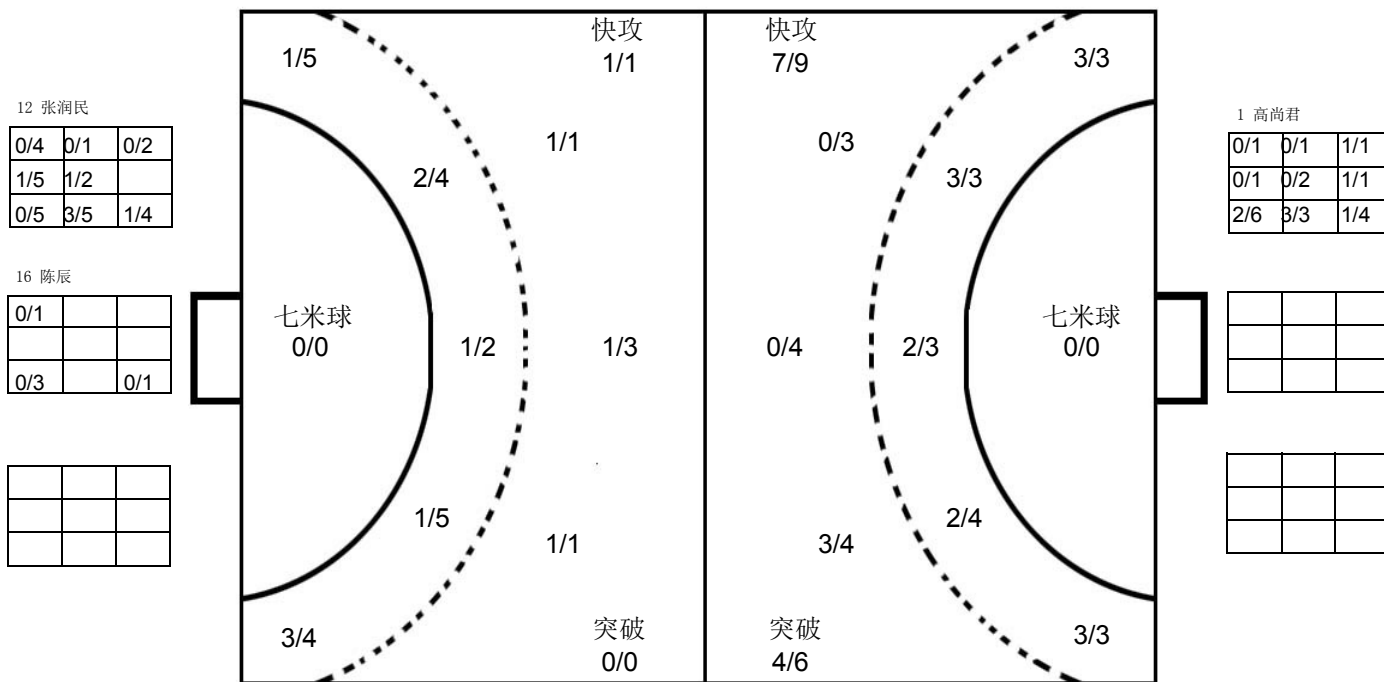

辽宁队

| | | | | | | | | | | | | | | | | | | | | | | | | | | | | | | | | | | | | | | | | | | | | | | | | | | | | | | | | | | | | | | | | | | | | | | | | | | | | | | | |
|---|-----------------------------|-----------------------------|-----------------------------|-----------------------------|-----------------------------|-----------------------------|-----------------------------|--|--|---|--|--|--|--|--|--|---|--|--|---|---|--|--|--|--|--|---|--|---|---|--|--|--|--|---|--|--|--|--|--|---|--|---|--|--|--|--|---|---|--|--|--|--|--|--|--|---|--|---|--|--|--|--|--|--|--|--|--|--|--|---|---|---|---|--|--|---|--|---|
| 1 高尚君 | 2 王司雨 | 3 李星浩 | 5 余昊锦 | 6 陈庆港 | 7 孙义广 | 8 王鑫鹏 | 10 王柏淇 | | | | | | | | | | | | | | | | | | | | | | | | | | | | | | | | | | | | | | | | | | | | | | | | | | | | | | | | | | | | | | | | | | | | | | | | |
| <table border="1"><tr><td></td><td></td><td></td></tr><tr><td></td><td></td><td></td></tr><tr><td></td><td></td><td></td></tr></table> | | | | | | | | | | <table border="1"><tr><td></td><td></td><td></td></tr><tr><td></td><td></td><td></td></tr><tr><td></td><td></td><td></td></tr></table> | | | | | | | | | | <table border="1"><tr><td>1</td><td></td><td></td></tr><tr><td></td><td></td><td></td></tr><tr><td>2</td><td></td><td>1</td></tr></table> | 1 | | | | | | 2 | | 1 | <table border="1"><tr><td></td><td></td><td></td></tr><tr><td></td><td>1</td><td></td></tr><tr><td></td><td></td><td></td></tr></table> | | | | | 1 | | | | | <table border="1"><tr><td>1</td><td></td><td>1</td></tr><tr><td></td><td></td><td></td></tr><tr><td></td><td>1</td><td>1</td></tr></table> | 1 | | 1 | | | | | 1 | 1 | <table border="1"><tr><td></td><td></td><td></td></tr><tr><td></td><td></td><td></td></tr><tr><td>2</td><td></td><td>1</td></tr></table> | | | | | | | 2 | | 1 | <table border="1"><tr><td></td><td></td><td></td></tr><tr><td></td><td></td><td></td></tr><tr><td></td><td></td><td></td></tr></table> | | | | | | | | | | <table border="1"><tr><td>3</td><td>1</td><td>1</td></tr><tr><td>3</td><td></td><td></td></tr><tr><td>2</td><td></td><td>1</td></tr></table> | 3 | 1 | 1 | 3 | | | 2 | | 1 |
| | | | | | | | | | | | | | | | | | | | | | | | | | | | | | | | | | | | | | | | | | | | | | | | | | | | | | | | | | | | | | | | | | | | | | | | | | | | | | | | |
| | | | | | | | | | | | | | | | | | | | | | | | | | | | | | | | | | | | | | | | | | | | | | | | | | | | | | | | | | | | | | | | | | | | | | | | | | | | | | | | |
| | | | | | | | | | | | | | | | | | | | | | | | | | | | | | | | | | | | | | | | | | | | | | | | | | | | | | | | | | | | | | | | | | | | | | | | | | | | | | | | |
| | | | | | | | | | | | | | | | | | | | | | | | | | | | | | | | | | | | | | | | | | | | | | | | | | | | | | | | | | | | | | | | | | | | | | | | | | | | | | | | |
| | | | | | | | | | | | | | | | | | | | | | | | | | | | | | | | | | | | | | | | | | | | | | | | | | | | | | | | | | | | | | | | | | | | | | | | | | | | | | | | |
| | | | | | | | | | | | | | | | | | | | | | | | | | | | | | | | | | | | | | | | | | | | | | | | | | | | | | | | | | | | | | | | | | | | | | | | | | | | | | | | |
| 1 | | | | | | | | | | | | | | | | | | | | | | | | | | | | | | | | | | | | | | | | | | | | | | | | | | | | | | | | | | | | | | | | | | | | | | | | | | | | | | | |
| | | | | | | | | | | | | | | | | | | | | | | | | | | | | | | | | | | | | | | | | | | | | | | | | | | | | | | | | | | | | | | | | | | | | | | | | | | | | | | | |
| 2 | | 1 | | | | | | | | | | | | | | | | | | | | | | | | | | | | | | | | | | | | | | | | | | | | | | | | | | | | | | | | | | | | | | | | | | | | | | | | | | | | | |
| | | | | | | | | | | | | | | | | | | | | | | | | | | | | | | | | | | | | | | | | | | | | | | | | | | | | | | | | | | | | | | | | | | | | | | | | | | | | | | | |
| | 1 | | | | | | | | | | | | | | | | | | | | | | | | | | | | | | | | | | | | | | | | | | | | | | | | | | | | | | | | | | | | | | | | | | | | | | | | | | | | | | |
| | | | | | | | | | | | | | | | | | | | | | | | | | | | | | | | | | | | | | | | | | | | | | | | | | | | | | | | | | | | | | | | | | | | | | | | | | | | | | | | |
| 1 | | 1 | | | | | | | | | | | | | | | | | | | | | | | | | | | | | | | | | | | | | | | | | | | | | | | | | | | | | | | | | | | | | | | | | | | | | | | | | | | | | |
| | | | | | | | | | | | | | | | | | | | | | | | | | | | | | | | | | | | | | | | | | | | | | | | | | | | | | | | | | | | | | | | | | | | | | | | | | | | | | | | |
| | 1 | 1 | | | | | | | | | | | | | | | | | | | | | | | | | | | | | | | | | | | | | | | | | | | | | | | | | | | | | | | | | | | | | | | | | | | | | | | | | | | | | |
| | | | | | | | | | | | | | | | | | | | | | | | | | | | | | | | | | | | | | | | | | | | | | | | | | | | | | | | | | | | | | | | | | | | | | | | | | | | | | | | |
| | | | | | | | | | | | | | | | | | | | | | | | | | | | | | | | | | | | | | | | | | | | | | | | | | | | | | | | | | | | | | | | | | | | | | | | | | | | | | | | |
| 2 | | 1 | | | | | | | | | | | | | | | | | | | | | | | | | | | | | | | | | | | | | | | | | | | | | | | | | | | | | | | | | | | | | | | | | | | | | | | | | | | | | |
| | | | | | | | | | | | | | | | | | | | | | | | | | | | | | | | | | | | | | | | | | | | | | | | | | | | | | | | | | | | | | | | | | | | | | | | | | | | | | | | |
| | | | | | | | | | | | | | | | | | | | | | | | | | | | | | | | | | | | | | | | | | | | | | | | | | | | | | | | | | | | | | | | | | | | | | | | | | | | | | | | |
| | | | | | | | | | | | | | | | | | | | | | | | | | | | | | | | | | | | | | | | | | | | | | | | | | | | | | | | | | | | | | | | | | | | | | | | | | | | | | | | |
| 3 | 1 | 1 | | | | | | | | | | | | | | | | | | | | | | | | | | | | | | | | | | | | | | | | | | | | | | | | | | | | | | | | | | | | | | | | | | | | | | | | | | | | | |
| 3 | | | | | | | | | | | | | | | | | | | | | | | | | | | | | | | | | | | | | | | | | | | | | | | | | | | | | | | | | | | | | | | | | | | | | | | | | | | | | | | |
| 2 | | 1 | | | | | | | | | | | | | | | | | | | | | | | | | | | | | | | | | | | | | | | | | | | | | | | | | | | | | | | | | | | | | | | | | | | | | | | | | | | | | |
| Post - 0 Miss - 0 Block - 0 | Post - 0 Miss - 0 Block - 0 | Post - 0 Miss - 0 Block - 0 | Post - 0 Miss - 0 Block - 0 | Post - 0 Miss - 0 Block - 0 | Post - 0 Miss - 0 Block - 0 | Post - 0 Miss - 0 Block - 0 | Post - 2 Miss - 3 Block - 0 | | | | | | | | | | | | | | | | | | | | | | | | | | | | | | | | | | | | | | | | | | | | | | | | | | | | | | | | | | | | | | | | | | | | | | | | |
| 11 庞东阳 | 13 杨洁 | 14 吕昊臻 | 16 吴阳 | 17 李傲 | 18 梅凯博 | 19 赵鑫 | 20 赵佛赐 | | | | | | | | | | | | | | | | | | | | | | | | | | | | | | | | | | | | | | | | | | | | | | | | | | | | | | | | | | | | | | | | | | | | | | | | |
| <table border="1"><tr><td>1</td><td></td><td></td></tr><tr><td>1</td><td>1</td><td></td></tr><tr><td></td><td></td><td></td></tr></table> | 1 | | | 1 | 1 | | | | | <table border="1"><tr><td></td><td></td><td></td></tr><tr><td></td><td></td><td></td></tr><tr><td>1</td><td></td><td></td></tr></table> | | | | | | | 1 | | | <table border="1"><tr><td></td><td></td><td></td></tr><tr><td></td><td></td><td></td></tr><tr><td></td><td></td><td></td></tr></table> | | | | | | | | | | <table border="1"><tr><td></td><td></td><td></td></tr><tr><td></td><td></td><td></td></tr><tr><td></td><td></td><td></td></tr></table> | | | | | | | | | | <table border="1"><tr><td></td><td></td><td></td></tr><tr><td></td><td></td><td></td></tr><tr><td></td><td></td><td></td></tr></table> | | | | | | | | | | <table border="1"><tr><td></td><td></td><td></td></tr><tr><td></td><td></td><td></td></tr><tr><td></td><td></td><td></td></tr></table> | | | | | | | | | | <table border="1"><tr><td></td><td></td><td></td></tr><tr><td></td><td></td><td></td></tr><tr><td></td><td></td><td></td></tr></table> | | | | | | | | | | <table border="1"><tr><td></td><td></td><td></td></tr><tr><td></td><td></td><td></td></tr><tr><td></td><td></td><td></td></tr></table> | | | | | | | | | |
| 1 | | | | | | | | | | | | | | | | | | | | | | | | | | | | | | | | | | | | | | | | | | | | | | | | | | | | | | | | | | | | | | | | | | | | | | | | | | | | | | | |
| 1 | 1 | | | | | | | | | | | | | | | | | | | | | | | | | | | | | | | | | | | | | | | | | | | | | | | | | | | | | | | | | | | | | | | | | | | | | | | | | | | | | | |
| | | | | | | | | | | | | | | | | | | | | | | | | | | | | | | | | | | | | | | | | | | | | | | | | | | | | | | | | | | | | | | | | | | | | | | | | | | | | | | | |
| | | | | | | | | | | | | | | | | | | | | | | | | | | | | | | | | | | | | | | | | | | | | | | | | | | | | | | | | | | | | | | | | | | | | | | | | | | | | | | | |
| | | | | | | | | | | | | | | | | | | | | | | | | | | | | | | | | | | | | | | | | | | | | | | | | | | | | | | | | | | | | | | | | | | | | | | | | | | | | | | | |
| 1 | | | | | | | | | | | | | | | | | | | | | | | | | | | | | | | | | | | | | | | | | | | | | | | | | | | | | | | | | | | | | | | | | | | | | | | | | | | | | | | |
| | | | | | | | | | | | | | | | | | | | | | | | | | | | | | | | | | | | | | | | | | | | | | | | | | | | | | | | | | | | | | | | | | | | | | | | | | | | | | | | |
| | | | | | | | | | | | | | | | | | | | | | | | | | | | | | | | | | | | | | | | | | | | | | | | | | | | | | | | | | | | | | | | | | | | | | | | | | | | | | | | |
| | | | | | | | | | | | | | | | | | | | | | | | | | | | | | | | | | | | | | | | | | | | | | | | | | | | | | | | | | | | | | | | | | | | | | | | | | | | | | | | |
| | | | | | | | | | | | | | | | | | | | | | | | | | | | | | | | | | | | | | | | | | | | | | | | | | | | | | | | | | | | | | | | | | | | | | | | | | | | | | | | |
| | | | | | | | | | | | | | | | | | | | | | | | | | | | | | | | | | | | | | | | | | | | | | | | | | | | | | | | | | | | | | | | | | | | | | | | | | | | | | | | |
| | | | | | | | | | | | | | | | | | | | | | | | | | | | | | | | | | | | | | | | | | | | | | | | | | | | | | | | | | | | | | | | | | | | | | | | | | | | | | | | |
| | | | | | | | | | | | | | | | | | | | | | | | | | | | | | | | | | | | | | | | | | | | | | | | | | | | | | | | | | | | | | | | | | | | | | | | | | | | | | | | |
| | | | | | | | | | | | | | | | | | | | | | | | | | | | | | | | | | | | | | | | | | | | | | | | | | | | | | | | | | | | | | | | | | | | | | | | | | | | | | | | |
| | | | | | | | | | | | | | | | | | | | | | | | | | | | | | | | | | | | | | | | | | | | | | | | | | | | | | | | | | | | | | | | | | | | | | | | | | | | | | | | |
| | | | | | | | | | | | | | | | | | | | | | | | | | | | | | | | | | | | | | | | | | | | | | | | | | | | | | | | | | | | | | | | | | | | | | | | | | | | | | | | |
| | | | | | | | | | | | | | | | | | | | | | | | | | | | | | | | | | | | | | | | | | | | | | | | | | | | | | | | | | | | | | | | | | | | | | | | | | | | | | | | |
| | | | | | | | | | | | | | | | | | | | | | | | | | | | | | | | | | | | | | | | | | | | | | | | | | | | | | | | | | | | | | | | | | | | | | | | | | | | | | | | |
| | | | | | | | | | | | | | | | | | | | | | | | | | | | | | | | | | | | | | | | | | | | | | | | | | | | | | | | | | | | | | | | | | | | | | | | | | | | | | | | |
| | | | | | | | | | | | | | | | | | | | | | | | | | | | | | | | | | | | | | | | | | | | | | | | | | | | | | | | | | | | | | | | | | | | | | | | | | | | | | | | |
| | | | | | | | | | | | | | | | | | | | | | | | | | | | | | | | | | | | | | | | | | | | | | | | | | | | | | | | | | | | | | | | | | | | | | | | | | | | | | | | |
| | | | | | | | | | | | | | | | | | | | | | | | | | | | | | | | | | | | | | | | | | | | | | | | | | | | | | | | | | | | | | | | | | | | | | | | | | | | | | | | |
| | | | | | | | | | | | | | | | | | | | | | | | | | | | | | | | | | | | | | | | | | | | | | | | | | | | | | | | | | | | | | | | | | | | | | | | | | | | | | | | |
| | | | | | | | | | | | | | | | | | | | | | | | | | | | | | | | | | | | | | | | | | | | | | | | | | | | | | | | | | | | | | | | | | | | | | | | | | | | | | | | |
| Post - 0 Miss - 1 Block - 1 | Post - 0 Miss - 2 Block - 0 | Post - 0 Miss - 0 Block - 0 | Post - 0 Miss - 0 Block - 0 | Post - 0 Miss - 0 Block - 0 | Post - 0 Miss - 0 Block - 0 | Post - 0 Miss - 0 Block - 0 | Post - 0 Miss - 0 Block - 0 | | | | | | | | | | | | | | | | | | | | | | | | | | | | | | | | | | | | | | | | | | | | | | | | | | | | | | | | | | | | | | | | | | | | | | | | |

注释: Post=击柱 Miss=射失 Block=被封



四分之一决赛
青年男子 全国比赛

2016年“体彩杯”全国手球男子青年锦标赛

| | | | | | | | | | | | | | | | | | | |
|--------------------|---|---------------------|---------------------|------------------|------------------------------------|-------------------|----------------|------------|-------|-------|----------------|------------|-------|----------|----------------------|--|-------|-------|
| Team A | | Team B | | | | Match Number | | 33 | | | | | | | | | | |
| A 山东队 | | B 北京队 | | | | | | | | | | | | | | | | |
| played in China | | in the hall 重庆万州 | | on 26/03/2016 | | at 13:00 hours | | Spectators | | | | | | | | | | |
| Half-time (30') | A 18 | B 18 | End of playing time | | A 41 | B 39 | 1st extra time | | A | B | 2nd extra time | | A | B | After penalty throws | | A | B |
| Number of 7 m | A 0/0 | Team time-out | | | Full name of players and officials | | | | | | Team time-out | | | B 0/1 | Number of 7 m | | | |
| | | 1 22:01 | 2 56:24 | 3 | | | | | | | 1 24:36 | 2 34:37 | 3 | | | | | |
| No. | Team A | | | | | Team B | | | | | G | W | 2' | D | DR | | | |
| 1 | 刘继超 | | | | | 3 王哲一 | | | | | 2 | | | | | | | |
| 2 | 冯鑫宇 | | | | | 4 朱广刚 | | | | | 8 | 1 | 1 | | | | | |
| 3 | 王铁林 | | | | | 6 赵一涵 | | | | | 12 | | | | | | | |
| 5 | 王晓峰 | | | | | 7 卞友山 | | | | | | | | | | | | |
| 6 | 王军鸣 | | | | | 11 李旭 | | | | | 1 | | | | | | | |
| 7 | 徐勇林 | | | | | 15 逯明松 | | | | | | | | | | | | |
| 10 | 孙芳伟 | | | | | 16 马佳鹏 | | | | | | | | | | | | |
| 11 | 王洋 | | | | | 18 李明远 | | | | | | | | | | | | |
| 12 | 刘道林 | | | | | 19 陈旭 | | | | | 5 | 1 | 1 | | | | | |
| 13 | 于欣君 | | | | | 23 刘帅 | | | | | | | | | | | | |
| 17 | 薛盼龙 | | | | | 25 张斌 | | | | | | | | | | | | |
| 18 | 李玮 | | | | | 26 吴锐樊 | | | | | 8 | | | | | | | |
| 21 | 王腾达 | | | | | 35 高云健 | | | | | | | | | | | | |
| 22 | 李子跃 | | | | | 36 王鹏皓 | | | | | 3 | | | | | | | |
| 23 | 李荣健 | | | | | | | | | | | | | | | | | |
| B | 王莉莉 (主教练) | | | | | B 吴健 (主教练) | | | | | | | | | | | | |
| | | | | | | C 宋刚 | | | | | | | | | | | | |
| | | | | | | D 陈璇 | | | | | | | | | | | | |
| A | Signature of Responsible Official of the Teams (Off. A) | | | | | | | | | | | | | | B | | | |
| TP | Remarks of Referee / CHA Official | | | | | | | | | | | | | | TP | | | |

Signatures

| | | | |
|------------------|-----------|----------|--|
| Referees | 倪震 (CHN) | 王洋 (CHN) | |
| Techn. Delegates | 许宜扬 (CHN) | | |
| CHA Official | 张春生 (CHN) | | |

Note: Number of 7m Throws Awarded to Team A and B, Goals (G), Warnings (W), Suspensions (2'), Direct Disqualification (D), Disqualification with Report (DR) and Team Penalty (TP).

Table Officials:

Statisticians: 李双

刘永欢





2016年“体彩杯”全国手球男子青年锦标赛 竞赛技术统计(媒体表)

| | | | | | | |
|--------|----|----------|----|----------|----|-----------|
| 四分之一决赛 | 组别 | X | 轮次 | 6 | 场次 | 33 |
|--------|----|----------|----|----------|----|-----------|

重庆万州

26/03/2016

201602033-51-1/1

| | | | | | | |
|----------------|-----------|-----------|----|-----------|-----------|-----|
| 山东队 | 山东 | 41 | vs | 39 | 北京 | 北京队 |
| 18 : 18 | | | | | | |

| | | | |
|-----|----------|---|----------|
| 裁判员 | 倪震 (CHN) | / | 王洋 (CHN) |
|-----|----------|---|----------|

| 山东 | | 远 | 近 | 边 | 快 | 突 | 任意 | 7m | 合计 | % | 助攻 | 失误 | 警告 | 2' | D & DR | 比赛进程 | | | |
|---------------|------------|-------|-------|--------------|-----|-------|------------|-----|-------|----------|----|----|---------|----|--------|----------|-----------|----------|-----------|
| 主教练：王莉莉 | | 射 | 射 | 射 | 攻 | 破 | 球 | 球 | | | | | | | | 1st Half | 北京 | | |
| 1 | 刘继超 | | | | | | | | | | | | | | | 6 | 王军鸣 | 0 02:10 | 1 6 赵一涵 |
| 2 | 冯鑫宇 | 2/2 | 2/4 | | | 0/1 | | | 4/7 | 57.1 | | 1 | | | | 6 | 王军鸣 | 1 02:31 | 1 |
| 3 | 王铁林 | | 2/5 | 4/7 | 2/2 | | | | 8/14 | 57.1 | | 1 | | 1 | | 17 | 薛盼龙 | 2 04:23 | 1 |
| 5 | 王晓峰 | 4/7 | | | 1/1 | | 3/3 | | 8/11 | 72.7 | 2 | 1 | 1 | | | 3 | 王铁林 | 3 06:07 | 2 |
| 6 | 王军鸣 | 3/9 | 2/4 | | | | | | 5/13 | 38.5 | 3 | 6 | 1 | | | 4 | 王铁林 | 4 07:27 | 3 |
| 7 | 徐勇林 | 0/1 | | | | | | | 0/1 | 0.0 | | 1 | | | | 10 | 孙芳伟 | 5 08:07 | 4 |
| 10 | 孙芳伟 | 3/12 | 2/2 | 2/2 | 1/1 | 2/2 | | | 10/19 | 52.6 | 1 | 5 | 1 | 1 | | 5 | 王晓峰 | 5 08:53 | 5 6 赵一涵 |
| 11 | 王洋 | | | | | | | | | | | | | | | 6 | 王铁林 | 6 09:46 | 5 |
| 12 | 刘道林 | | | | | | | | | | | | | | | 7 | 王铁林 | 7 10:08 | 5 |
| 13 | 于欣君 | 1/2 | 0/2 | | 0/1 | | 0/1 | | 1/6 | 16.7 | | | | | | 7 | 王铁林 | 7 10:21 | 6 26 吴锐樊 |
| 17 | 薛盼龙 | 0/1 | 1/1 | | | | | | 1/2 | 50.0 | | | | 1 | | 7 | 王铁林 | 7 10:53 | 7 6 赵一涵 |
| 18 | 李玮 | | | | | | | | | | | | | | | 8 | 王军鸣 | 8 11:35 | 7 |
| 21 | 王腾达 | | | | | | | | | | | | | | | 10 | 孙芳伟 | 8 11:56 | 8 19 陈旭 |
| 22 | 李子跃 | | | | | | | | | | | | | | | 9 | 王铁林 | 9 12:17 | 8 |
| 23 | 李荣健 | | 2/2 | 2/2 | | | | | 4/4 | 100 | 1 | 1 | | | | 10 | 孙芳伟 | 10 13:27 | 8 |
| 运动员 合计 | | 13/34 | 11/20 | 8/11 | 4/5 | 2/3 | 3/4 | | 41/77 | 53.2 | 7 | 16 | 3 | 3 | | 10 | 孙芳伟 | 10 13:37 | 9 6 赵一涵 |
| 1 | 刘继超 | 10/14 | 13/29 | 1/5 | 2/6 | 0/10 | 0/1 | 1/1 | 27/66 | 40.9 | | | | | | 10 | 孙芳伟 | 11 13:59 | 9 |
| 守门员 合计 | | 10/14 | 13/29 | 1/5 | 2/6 | 0/10 | 0/1 | 1/1 | 27/66 | 40.9 | | | | | | 5 | 王晓峰 | 12 14:16 | 9 |
| 北京 | | | | | | | | | | | | | | | | 12 | 王军鸣 | 12 14:31 | 10 26 吴锐樊 |
| 教练：吴健 | | | | | | | | | | | | | | | | 13 | 王军鸣 | 13 14:56 | 10 |
| 3 | 王哲一 | | 1/1 | | 1/1 | | | | 2/2 | 100 | | | | | | 13 | 王军鸣 | 13 17:09 | 11 4 朱广刚 |
| 4 | 朱广刚 | 2/5 | 3/3 | | | 2/2 | 1/1 | | 8/11 | 72.7 | 4 | 8 | 1 | 1 | | 13 | 王铁林 | 13 18:28 | 12 6 赵一涵 |
| 6 | 赵一涵 | 1/4 | 4/8 | | | 7/7 | | | 12/19 | 63.2 | 5 | 5 | | | | 14 | 王铁林 | 14 19:40 | 12 |
| 7 | 卞友山 | | 0/1 | | | | | | 0/1 | 0.0 | | 1 | | | | 14 | 王铁林 | 14 21:24 | 13 4 朱广刚 |
| 11 | 李旭 | | 1/3 | | | | | | 1/4 | 25.0 | 1 | 2 | | | | 15 | 冯鑫宇 | 15 22:54 | 13 |
| 15 | 透明松 | 0/1 | 0/2 | 0/1 | | | | | 0/4 | 0.0 | | | | | | 15 | 冯鑫宇 | 15 23:10 | 14 19 陈旭 |
| 16 | 马佳鹏 | | | | | | | | | | | | | | | 16 | 冯鑫宇 | 16 23:50 | 14 |
| 18 | 李明远 | | | | | | | | | | | | | | | 16 | 冯鑫宇 | 16 25:16 | 15 6 赵一涵 |
| 19 | 陈旭 | 1/10 | 2/4 | | 1/1 | 1/1 | | | 5/16 | 31.3 | | 4 | 1 | 1 | | 16 | 冯鑫宇 | 16 25:48 | 16 26 吴锐樊 |
| 23 | 刘帅 | | | | | | | | | | | | | | | 17 | 孙芳伟 | 17 27:30 | 16 |
| 25 | 张斌 | | | | | | | | | | | | | | | 17 | 孙芳伟 | 17 28:54 | 17 4 朱广刚 |
| 26 | 吴锐樊 | | 4/5 | 3/3 | 1/2 | | | | 8/10 | 80.0 | | 2 | | | | 18 | 孙芳伟 | 18 29:14 | 17 |
| 35 | 高云健 | | | | | | | | 3/15 | 20.0 | | | | | | 18 | 孙芳伟 | 18 29:34 | 18 6 赵一涵 |
| 36 | 王鹏皓 | | 1/4 | 1/1 | 1/2 | | | | 3/7 | 42.9 | | | | | | 18 | 孙芳伟 | 18 29:34 | 18 6 赵一涵 |
| 运动员 合计 | | 4/20 | 16/31 | 4/5 | 4/6 | 10/10 | 1/1 | 0/1 | 39/74 | 52.7 | 10 | 22 | 2 | 2 | | 18 | 孙芳伟 | 18 01:04 | 19 6 赵一涵 |
| 16 | 马佳鹏 | 8/19 | 6/13 | 3/8 | 0/2 | 0/1 | 1/4 | | 18/47 | 38.3 | | | | | | 18 | 孙芳伟 | 18 01:37 | 20 26 吴锐樊 |
| 35 | 高云健 | 0/2 | 1/5 | 0/3 | 1/3 | 1/2 | | | 3/15 | 20.0 | | | | | | 19 | 王晓峰 | 19 01:44 | 20 |
| 守门员 合计 | | 8/21 | 7/18 | 3/11 | 1/5 | 1/3 | 1/4 | | 21/62 | 33.9 | | | | | | 20 | 冯鑫宇 | 20 02:10 | 20 |
| 场上队员：得分 / 射门 | | | | | | | | | | | | | | | | 20 | 冯鑫宇 | 20 02:10 | 20 |
| 守门员：救球 / 射门 | | | | | | | | | | | | | | | | 21 | 冯鑫宇 | 21 04:11 | 20 |
| 快攻 | Fast Break | | 突破 | Breakthrough | | 任意球 | Free Throw | | 7M球 | 7M Throw | | 助攻 | Assist | 21 | 冯鑫宇 | 21 05:21 | 21 36 王鹏皓 | | |
| 警告 | Warning | | 失误 | Error | | 2' | Suspension | | D | 取消资格 | | DR | 取消资格+报告 | 22 | 冯鑫宇 | 22 06:54 | 21 | | |

场上队员：得分 / 射门

守门员：救球 / 射门

| | | | | | | | | | | | | | |
|----|------------|--|----|--------------|--|-----|------------|--|-----|----------|--|----|---------|
| 快攻 | Fast Break | | 突破 | Breakthrough | | 任意球 | Free Throw | | 7M球 | 7M Throw | | 助攻 | Assist |
| 警告 | Warning | | 失误 | Error | | 2' | Suspension | | D | 取消资格 | | DR | 取消资格+报告 |





2016年“体彩杯”全国手球男子青年锦标赛

个人/全队技术统计表

正式表
手球
青年男子四分之一决赛
轮次 6组别 X
场次 33201602033-14-1/2
重庆万州
26/03/2016 13:00

| 号码 | 姓名 | 远射 | 近射 | 边射 | 快攻 | 突破 | 任意 | 7M | 合计 | % | 助攻 | 失误 | 警告 | 2' | 取消 | 时间 |
|----------------|-----|-------|-------|------|-----|------|-----|-----|-------|-------|----|----|----|----|----|----------|
| 山东队(山东) | | | | | | | | | | | | | | | | |
| <i>(场上队员)</i> | | | | | | | | | | | | | | | | |
| 1 | 刘继超 | | | | | | | | | 0.0% | | | | | | 01:00:00 |
| 2 | 冯鑫宇 | 2/2 | 2/4 | | | 0/1 | | | 4/7 | 57.1% | | 1 | | | | 00:41:39 |
| 3 | 王铁林 | | 2/5 | 4/7 | 2/2 | | | | 8/14 | 57.1% | | 1 | | 1 | | 01:04:37 |
| 5 | 王晓峰 | 4/7 | | | 1/1 | | 3/3 | | 8/11 | 72.7% | 2 | 1 | 1 | | | 01:00:00 |
| 6 | 王军鸣 | 3/9 | 2/4 | | | | | | 5/13 | 38.5% | 3 | 6 | 1 | | | 01:10:35 |
| 7 | 徐勇林 | 0/1 | | | | | | | 0/1 | 0.0% | | 1 | | | | 00:15:21 |
| 10 | 孙芳伟 | 3/12 | 2/2 | 2/2 | 1/1 | 2/2 | | | 10/19 | 52.6% | 1 | 5 | 1 | 1 | | 01:00:00 |
| 11 | 王洋 | | | | | | | | | 0.0% | | | | | | 00:14:38 |
| 12 | 刘道林 | | | | | | | | | 0.0% | | | | | | 00:00:00 |
| 13 | 于欣君 | 1/2 | 0/2 | | | 0/1 | 0/1 | | 1/6 | 16.7% | | | | | | 00:20:43 |
| 17 | 薛盼龙 | 0/1 | 1/1 | | | | | | 1/2 | 50.0% | | | | 1 | | 00:12:05 |
| 18 | 李玮 | | | | | | | | | 0.0% | | | | | | 00:00:00 |
| 21 | 王腾达 | | | | | | | | | 0.0% | | | | | | 00:00:00 |
| 22 | 李子跃 | | | | | | | | | 0.0% | | | | | | 00:00:00 |
| 23 | 李荣健 | | 2/2 | 2/2 | | | | | 4/4 | 100% | 1 | 1 | | | | 00:30:00 |
| 合计 | | 13/34 | 11/20 | 8/11 | 4/5 | 2/3 | 3/4 | | 41/77 | 53.2% | 7 | 16 | 3 | 3 | | |
| <i>(守门员)</i> | | | | | | | | | | | | | | | | |
| 1 | 刘继超 | 10/14 | 13/29 | 1/5 | 2/6 | 0/10 | 0/1 | 1/1 | 27/66 | 40.9% | | | | | | 01:00:00 |
| 合计 | | 10/14 | 13/29 | 1/5 | 2/6 | 0/10 | 0/1 | 1/1 | 27/66 | 40.9% | | | | | | |

场上队员：得分/射门

守门员：救球/射门

| 全队合计 | 得分 | 被救 | 射失 | 击柱 | 封球 | 合计 | % |
|------|----|----|----|----|----|----|-------|
| 远射 | 13 | 8 | 6 | 5 | 2 | 34 | 38.2% |
| 近射 | 11 | 7 | 2 | | | 20 | 55.0% |
| 边射 | 8 | 3 | | | | 11 | 72.7% |
| 快攻 | 4 | 1 | | | | 5 | 80.0% |
| 突破 | 2 | 1 | | | | 3 | 66.7% |
| 任意 | 3 | 1 | | | | 4 | 75.0% |
| 7M | | | | | | | 0.0% |





2016年“体彩杯”全国手球男子青年锦标赛

个人/全队技术统计表

正式表
手球
青年男子四分之一决赛
轮次 6组别 X
场次 33201602033-14-2/2
重庆万州
26/03/2016 13:00

| 号码 | 姓名 | 远射 | 近射 | 边射 | 快攻 | 突破 | 任意 | 7M | 合计 | % | 助攻 | 失误 | 警告 | 2' | 取消 | 时间 |
|--|-----|------|------|-----|-----|-----|-----|-----|-------|-------|----|----|----|----|----|----------|
| 北京队(北京) | | | | | | | | | | | | | | | | |
| <i>(上场队员)</i> | | | | | | | | | | | | | | | | |
| 3 | 王哲一 | | 1/1 | | 1/1 | | | | 2/2 | 100% | | | | | | 00:08:06 |
| 4 | 朱广刚 | 2/5 | 3/3 | | | 2/2 | 1/1 | | 8/11 | 72.7% | 4 | 8 | 1 | 1 | | 01:00:00 |
| 6 | 赵一涵 | 1/4 | 4/8 | | | 7/7 | | | 12/19 | 63.2% | 5 | 5 | | | | 01:00:00 |
| 7 | 卞友山 | | 0/1 | | | | | | 0/1 | 0.0% | | 1 | | | | 00:29:24 |
| 11 | 李旭 | | 1/3 | | | | | 0/1 | 1/4 | 25.0% | 1 | 2 | | | | 00:30:34 |
| 15 | 逯明松 | 0/1 | 0/2 | 0/1 | | | | | 0/4 | 0.0% | | | | | | 00:24:37 |
| 16 | 马佳鹏 | | | | | | | | | 0.0% | | | | | | 00:49:08 |
| 18 | 李明远 | | | | | | | | | 0.0% | | | | | | 00:00:00 |
| 19 | 陈旭 | 1/10 | 2/4 | | 1/1 | 1/1 | | | 5/16 | 31.3% | | 4 | 1 | 1 | | 01:00:00 |
| 23 | 刘帅 | | | | | | | | | 0.0% | | | | | | 00:00:00 |
| 25 | 张斌 | | | | | | | | | 0.0% | | | | | | 00:00:00 |
| 26 | 吴锐樊 | | 4/5 | 3/3 | 1/2 | | | | 8/10 | 80.0% | | 2 | | | | 01:06:00 |
| 35 | 高云健 | | | | | | | | | 0.0% | | | | | | 00:10:52 |
| 36 | 王鹏皓 | | 1/4 | 1/1 | 1/2 | | | | 3/7 | 42.9% | | | | | | 00:35:22 |
| 合计 | | | | | | | | | | | | | | | | |
| <i>(守门员)</i> | | | | | | | | | | | | | | | | |
| 16 | 马佳鹏 | 8/19 | 6/13 | 3/8 | 0/2 | 0/1 | 1/4 | | 18/47 | 38.3% | | | | | | 00:49:08 |
| 35 | 高云健 | 0/2 | 1/5 | 0/3 | 1/3 | 1/2 | | | 3/15 | 20.0% | | | | | | 00:10:52 |
| 合计 | | | | | | | | | | | | | | | | |
| 8/21 7/18 3/11 1/5 1/3 1/4 21/62 33.9% | | | | | | | | | | | | | | | | |

场上队员：得分/射门

守门员：救球/射门

| 全队合计 | 得分 | 被救 | 射失 | 击柱 | 封球 | 合计 | % |
|------|----|----|----|----|----|----|--------|
| 远射 | 4 | 10 | 2 | 4 | | 20 | 20.0% |
| 近射 | 16 | 13 | | 2 | | 31 | 51.6% |
| 边射 | 4 | 1 | | | | 5 | 80.0% |
| 快攻 | 4 | 2 | | | | 6 | 66.7% |
| 突破 | 10 | | | | | 10 | 100.0% |
| 任意 | 1 | | | | | 1 | 100.0% |
| 7M | | 1 | | | | 1 | 0.0% |





2016年“体彩杯”全国手球男子青年锦标赛

图式射门区域统计

轮次 6 场次 33

201602033-41-1/1

山东队

Player statistics for Shandong team including names like 刘继超, 冯鑫宇, 王铁林, etc., and their respective goal counts in different positions.

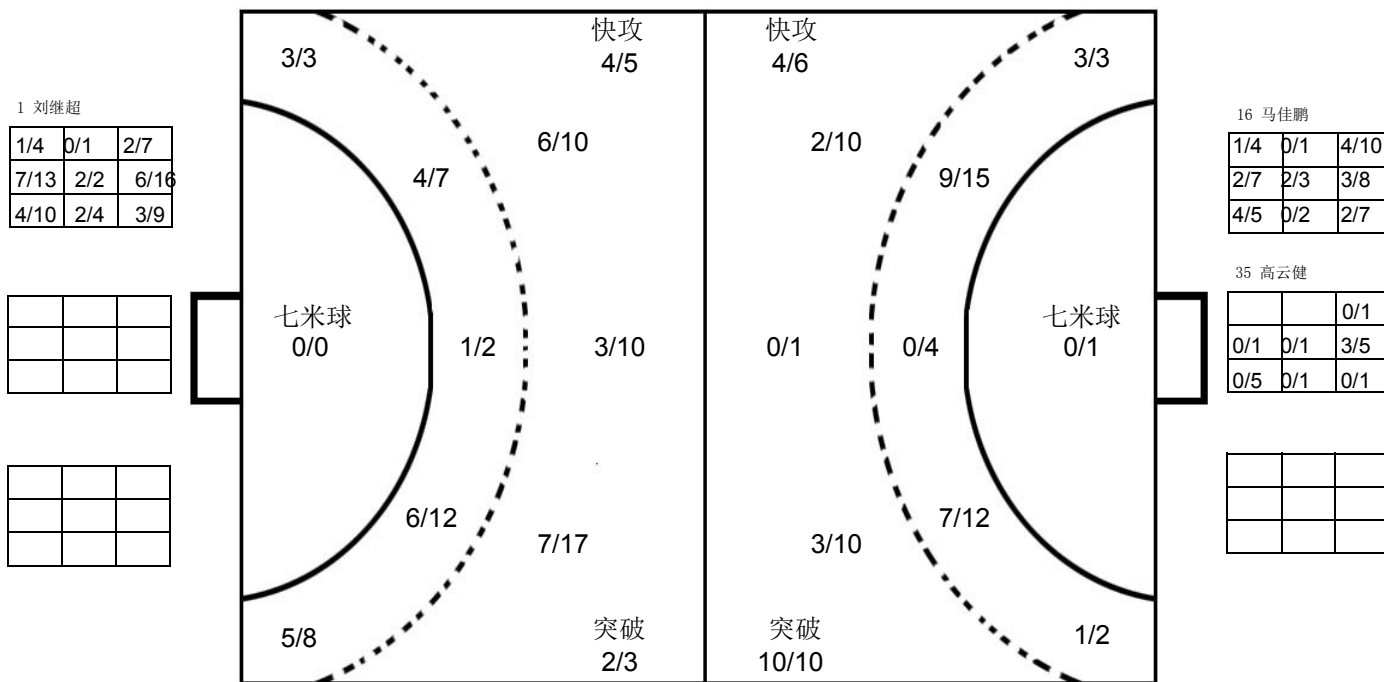

北京队

Player statistics for Beijing team including names like 王哲一, 朱广刚, 赵一涵, etc., and their respective goal counts in different positions.

注释: Post=击柱 Miss=射失 Block=被封





四分之一决赛
青年男子 全国比赛

2016年“体彩杯”全国手球男子青年锦标赛

| | | | | | | | | | | | |
|---|-----------------------------------|-------------------------|---------------------|---------------------------|----------------|-----|-----------|---|----|---|----------|
| Team A A 新疆队 | | Team B B 解放军队 | | Match Number 34 | | | | | | | |
| played in China | | in the hall 重庆万州 | | on 26/03/2016 | | | | | | | |
| | | | | at 14:30 hours | | | | | | | |
| Spectators | | | | | | | | | | | |
| Half-time (30') | A 23 | B 15 | End of playing time | A 40 | B 36 | | | | | | |
| 1st extra time | | | | 2nd extra time | | | | | | | |
| | | | | After penalty throws | | | | | | | |
| | | | | | | | | | | | |
| Number of 7 m | A 0/0 | Team time-out | | Team time-out | | | | | | | |
| | | 41:13 | | 07:14 | | | | | | | |
| Full name of players and officials | | | | | | | | | | | |
| No. | Team A | | | | Team B | | | | | | |
| | G | W | 2' | D | DR | No. | G | W | 2' | D | DR |
| 1 | | | | | | 1 | | | | | |
| 2 | 2 | | 1 | | | 3 | 3 | | | | |
| 4 | 2 | | | | | 4 | | | | | |
| 5 | 6 | | | | | 5 | | | | | |
| 6 | | | | | | 6 | 3 | 1 | | | |
| 7 | 8 | 1 | | | | 7 | 6 | | 1 | | |
| 10 | 6 | | | | | 8 | | | | | |
| 12 | | | | | | 9 | | | | | |
| 13 | 2 | | | | | 10 | 6 | 1 | | | |
| 15 | 4 | | | | | 11 | 4 | | | | |
| 16 | | | | | | 12 | | | | | |
| 17 | 3 | 1 | | | | 13 | 8 | | | | |
| 18 | | | | | | 14 | 6 | 1 | | | |
| 19 | 7 | 1 | | | | 16 | | | | | |
| 24 | | | 1 | | | 17 | | | | | |
| A | 孔德宾 (主教练) | | | | | A | 杜长义 (主教练) | | | | |
| B | 陈鹏波 | | | | | | | | | | |
| C | 李楠 | | | | | | | | | | |
| Signature of Responsible Official of the Teams (Off. A) | | | | | | | | | | | |
| | | | | | | | | | | | B |
| TP | Remarks of Referee / CHA Official | | | | | | | | | | TP |
| | | | | | | | | | | | |

Signatures

| | | | | |
|------------------|-----------|-----------|--|--|
| Referees | 许翔 (CHN) | 王雨洋 (CHN) | | |
| Techn. Delegates | 许宜扬 (CHN) | | | |
| CHA Official | 张春生 (CHN) | | | |

Note: Number of 7m Throws Awarded to Team A and B, Goals (G), Warnings (W), Suspensions (2'), Direct Disqualification (D), Disqualification with Report (DR) and Team Penalty (TP).

Table Officials:

Statisticians: 刘永欢

李双





2016年“体彩杯”全国手球男子青年锦标赛 竞赛技术统计(媒体表)

| | | | | | | | |
|--------|--|------------|-----------|----------------|------------------|------------|-----------|
| 四分之一决赛 | | 组别 | X | 轮次 | 5 | 场次 | 34 |
| 重庆万州 | | 26/03/2016 | | | 201602034-51-1/1 | | |
| 新疆队 | | 新疆 | 40 | vs | 36 | 解放军 | 解放军队 |
| | | | | 23 : 15 | | | |

| | | | | | | | |
|-----|----------|--|--|---|-----------|--|--|
| 裁判员 | 许翔 (CHN) | | | / | 王雨洋 (CHN) | | |
|-----|----------|--|--|---|-----------|--|--|

| 新疆 | | | | | | | | | | | | | | 解放军 | | | | | | | | | | | | | | |
|---------------|-------------|--------------|------------|--------------|------------|------------|--------------|-------------|-----------|-----------|----------|----------|--------|------------|----|-------|----|----|-----|-----|----|---|----|----|----|--------|--------|--|
| 主教练: 孔德宾 | | | | | | | | | | | | | | 教练: 杜长义 | | | | | | | | | | | | | | |
| 远射 | 近射 | 边射 | 快攻 | 突破 | 任意球 | 7m球 | 合计 | % | 助攻 | 失误 | 警告 | 2' | D & DR | 远射 | 近射 | 边射 | 快攻 | 突破 | 任意球 | 7m球 | 合计 | % | 助攻 | 失误 | 警告 | 2' | D & DR | |
| 1 宋晓晨 | | | | | | | | | 4 | | | | | 19 李龙吉 | 1 | 00:24 | 0 | | | | | | | | | | | |
| 2 王泽川 | | 1/2 | | 1/1 | | | 2/3 | 66.7 | | | | 1 | | 7 林豪文 | 2 | 00:52 | 0 | | | | | | | | | 11 王誌汉 | | |
| 4 谷通金 | 0/1 | 2/2 | | 0/1 | 0/1 | | 2/5 | 40.0 | | | | | | 7 林豪文 | 3 | 02:42 | 1 | | | | | | | | | | | |
| 5 徐伟 | | 1/1 | | 5/7 | 0/1 | | 6/9 | 66.7 | | 1 | | | | 19 李龙吉 | 4 | 03:28 | 1 | | | | | | | | | | 6 吴昊 | |
| 6 白光宇 | | | | | | | | | | | | | | 7 林豪文 | 4 | 05:25 | 2 | | | | | | | | | | | |
| 7 林豪文 | 4/6 | | 1/1 | 1/1 | 1/1 | 1/1 | 8/10 | 80.0 | 2 | 2 | 1 | | | 19 李龙吉 | 5 | 05:48 | 2 | | | | | | | | | | | |
| 10 王钟彬 | 2/2 | 2/3 | | 1/1 | 1/1 | | 6/7 | 85.7 | 1 | 3 | | | | 19 李龙吉 | 6 | 06:42 | 2 | | | | | | | | | | | |
| 12 王金鑫 | | | | | | | | | | | | | | 6 孙耀琦 | 7 | 07:30 | 3 | | | | | | | | | | | |
| 13 苏兴伟 | 0/2 | 2/2 | | | | | 2/4 | 50.0 | | | | | | 7 林豪文 | 7 | 07:57 | 3 | | | | | | | | | | | |
| 15 王维东 | 1/1 | 0/2 | 1/3 | 2/2 | | | 4/8 | 50.0 | 1 | 3 | | | | 10 王钟彬 | 8 | 09:07 | 4 | | | | | | | | | | | |
| 16 李佳懿 | | | | | | | | | | | | | | 19 李龙吉 | 9 | 09:34 | 4 | | | | | | | | | | | |
| 17 胡晋铭 | | 3/4 | 0/1 | | | | 3/5 | 60.0 | 1 | | 1 | | | 5 徐伟 | 10 | 10:04 | 4 | | | | | | | | | | | |
| 18 李万兴 | | | | | | | | | | | | | | 10 孙耀琦 | 10 | 10:58 | 5 | | | | | | | | | | | |
| 19 李龙吉 | 1/1 | 2/4 | 1/1 | 3/3 | | | 7/9 | 77.8 | 2 | 5 | 1 | | | 19 李龙吉 | 11 | 12:24 | 5 | | | | | | | | | | | |
| 24 陈伟华 | | | 0/2 | | | | 0/2 | 0.0 | | | | 1 | | 10 王钟彬 | 12 | 14:10 | 5 | | | | | | | | | | | |
| 运动员 合计 | 8/13 | 13/20 | 3/8 | 13/16 | 2/4 | 1/1 | 40/62 | 64.5 | 11 | 17 | 3 | 2 | | 5 徐伟 | 13 | 14:29 | 5 | | | | | | | | | | | |
| 1 宋晓晨 | 4/9 | 6/14 | 1/5 | 0/2 | | | 0/3 | 11/33 | 33.3 | 4 | | | | 19 李龙吉 | 14 | 15:13 | 5 | | | | | | | | | | | |
| 16 李佳懿 | 1/1 | 2/10 | 0/4 | 0/2 | | | 1/1 | 4/18 | 22.2 | | | | | 14 孙耀琦 | 14 | 16:22 | 6 | | | | | | | | | | | |
| 守门员 合计 | 5/10 | 8/24 | 1/9 | 0/4 | | 1/4 | 15/51 | 29.4 | 4 | | | | | 7 林豪文 | 15 | 17:06 | 7 | | | | | | | | | | | |
| 解放军 | | | | | | | | | | | | | | 新疆 | | | | | | | | | | | | | | |
| 远射 | 近射 | 边射 | 快攻 | 突破 | 任意球 | 7m球 | 合计 | % | 助攻 | 失误 | 警告 | 2' | D & DR | 远射 | 近射 | 边射 | 快攻 | 突破 | 任意球 | 7m球 | 合计 | % | 助攻 | 失误 | 警告 | 2' | D & DR | |
| 1 郭梦雨 | | | | | | | | | | | | | | 19 李龙吉 | 15 | 17:31 | 8 | | | | | | | | | | | |
| 3 张昌轲 | 1/2 | 1/3 | | | | 0/1 | 1/1 | 3/7 | 42.9 | 2 | 8 | | | 15 王誌汉 | 15 | 18:38 | 9 | | | | | | | | | | | |
| 4 张洋 | | | | | | | | | | | | | | 15 徐峻清 | 15 | 19:38 | 10 | | | | | | | | | | | |
| 5 尹一楠 | | | | | | | | | | | | | | 10 王钟彬 | 16 | 20:02 | 10 | | | | | | | | | | | |
| 6 吴昊 | 1/4 | 2/3 | | | | | 3/7 | 42.9 | 2 | 5 | 1 | | | 10 王钟彬 | 16 | 20:26 | 11 | | | | | | | | | | | |
| 7 姜钦 | 3/13 | 3/7 | | | | | 6/21 | 28.6 | 3 | 2 | | 1 | | 10 王钟彬 | 17 | 21:20 | 11 | | | | | | | | | | | |
| 8 邹峻楠 | | | | | | | | | | | | | | 10 王钟彬 | 18 | 21:47 | 11 | | | | | | | | | | | |
| 9 李天枢 | | | | | | | | | | | | | | 5 徐伟 | 19 | 22:59 | 11 | | | | | | | | | | | |
| 10 范保坤 | | 2/2 | 4/5 | 0/1 | | | 6/8 | 75.0 | | 1 | 1 | | | 19 李龙吉 | 19 | 24:32 | 12 | | | | | | | | | | | |
| 11 王誌汉 | | 2/2 | 1/1 | 1/1 | | | 4/4 | 100 | | 3 | | | | 17 胡晋铭 | 19 | 25:33 | 13 | | | | | | | | | | | |
| 12 左子健 | | | | | | | | | | | | | | 17 胡晋铭 | 20 | 25:58 | 13 | | | | | | | | | | | |
| 13 徐峻清 | | 3/6 | 3/3 | 2/2 | | | 8/11 | 72.7 | | | | | | 4 谷通金 | 20 | 26:37 | 14 | | | | | | | | | | | |
| 14 孙耀琦 | | 3/3 | | 1/1 | | | 2/3 | 6/7 | 85.7 | | | | | 5 徐伟 | 21 | 28:28 | 14 | | | | | | | | | | | |
| 16 池猛 | | | | | | | | | | | | | | 10 王钟彬 | 22 | 29:04 | 14 | | | | | | | | | | | |
| 17 刘安宁 | | | | | | | | | | | | | | 10 王钟彬 | 22 | 29:37 | 15 | | | | | | | | | | | |
| 运动员 合计 | 5/19 | 16/26 | 8/9 | 4/5 | 0/2 | 3/4 | 36/65 | 55.4 | 7 | 24 | 3 | 1 | | 10 王钟彬 | 23 | 29:45 | 15 | | | | | | | | | | | |
| 1 郭梦雨 | 2/8 | 2/9 | 1/2 | 0/9 | 1/3 | 0/1 | 6/32 | 18.8 | | | | | | 5 徐伟 | 23 | 00:26 | 16 | | | | | | | | | | | |
| 12 左子健 | 3/5 | 4/10 | 2/4 | 3/7 | 1/1 | | 13/27 | 48.1 | | 1 | | | | 5 徐伟 | 24 | 01:11 | 16 | | | | | | | | | | | |
| 守门员 合计 | 5/13 | 6/19 | 3/6 | 3/16 | 2/4 | 0/1 | 19/59 | 32.2 | | 1 | | | | 17 林豪文 | 25 | 02:39 | 16 | | | | | | | | | | | |

场上队员: 得分 / 射门

守门员: 救球 / 射门

| | | | | | | | | | |
|----|------------|----|--------------|-----|------------|-----|----------|----|---------|
| 快攻 | Fast Break | 突破 | Breakthrough | 任意球 | Free Throw | 7M球 | 7M Throw | 助攻 | Assist |
| 警告 | Warning | 失误 | Error | 2' | Suspension | D | 取消资格 | DR | 取消资格+报告 |





2016年“体彩杯”全国手球男子青年锦标赛 图式比赛技术统计表

轮次 5

场次 34

201602034-21-1/1

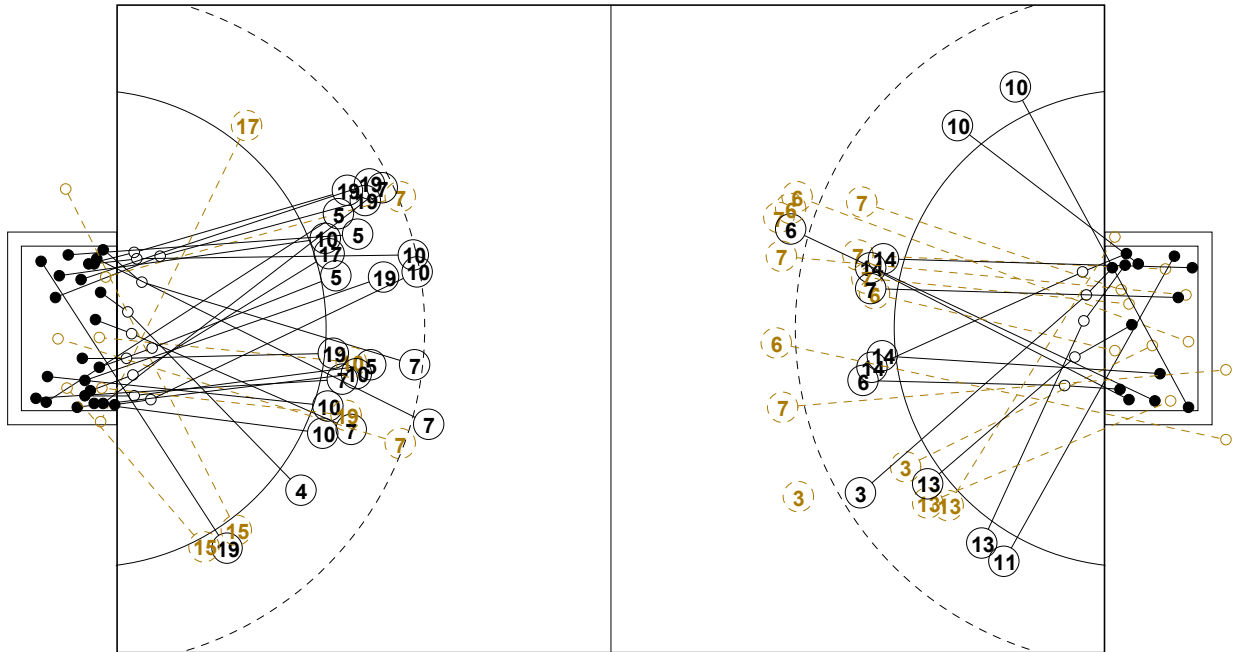

7M 新疆

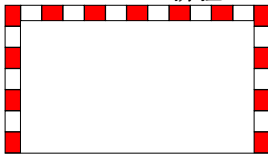

解放军 7M

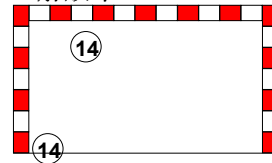

1st Half
23 : 15

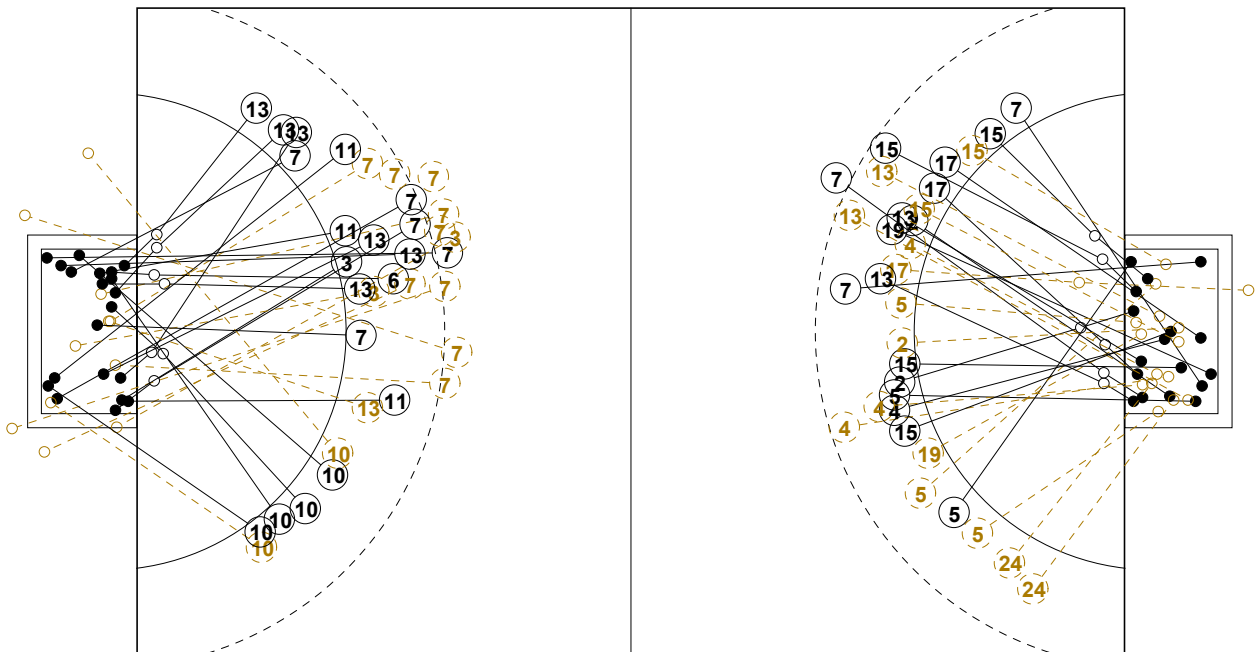

7M 解放军



新疆 7M

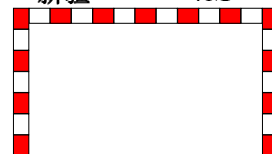

2nd Half
36 : 40



2016年“体彩杯”全国手球男子青年锦标赛

个人/全队技术统计表

正式表
手球
青年男子四分之一决赛
轮次 5组别 X
场次 34201602034-14-1/2
重庆万州
26/03/2016 14:30

| 号码 | 姓名 | 远射 | 近射 | 边射 | 快攻 | 突破 | 任意 | 7M | 合计 | % | 助攻 | 失误 | 警告 | 2' | 取消 | 时间 |
|----------------|-----|------|-------|-----|-------|-----|-----|-----|-------|-------|----|----|----|----|----|----------|
| 新疆队(新疆) | | | | | | | | | | | | | | | | |
| <i>(场上队员)</i> | | | | | | | | | | | | | | | | |
| 1 | 宋晓晨 | | | | | | | | | 0.0% | 4 | | | | | 00:41:13 |
| 2 | 王泽川 | | 1/2 | | 1/1 | | | | 2/3 | 66.7% | | | | 1 | | 00:18:47 |
| 4 | 谷通金 | 0/1 | 2/2 | | 0/1 | 0/1 | | | 2/5 | 40.0% | | | | | | 00:23:05 |
| 5 | 徐伟 | | 1/1 | | 5/7 | 0/1 | | | 6/9 | 66.7% | | 1 | | | | 00:41:13 |
| 6 | 白光宇 | | | | | | | | | 0.0% | | | | | | 00:00:00 |
| 7 | 林豪文 | 4/6 | | 1/1 | 1/1 | 1/1 | 1/1 | | 8/10 | 80.0% | 2 | 2 | 1 | | | 00:41:13 |
| 10 | 王钟彬 | 2/2 | 2/3 | | 1/1 | 1/1 | | | 6/7 | 85.7% | 1 | 3 | | | | 00:41:13 |
| 12 | 王金鑫 | | | | | | | | | 0.0% | | | | | | 00:00:00 |
| 13 | 苏兴伟 | 0/2 | 2/2 | | | | | | 2/4 | 50.0% | | | | | | 00:18:47 |
| 15 | 王维东 | 1/1 | 0/2 | 1/3 | 2/2 | | | | 4/8 | 50.0% | 1 | 3 | | | | 00:55:41 |
| 16 | 李佳懿 | | | | | | | | | 0.0% | | | | | | 00:18:47 |
| 17 | 胡晋铭 | | 3/4 | 0/1 | | | | | 3/5 | 60.0% | 1 | | 1 | | | 00:41:13 |
| 18 | 李万兴 | | | | | | | | | 0.0% | | 3 | | | | 00:18:47 |
| 19 | 李龙吉 | 1/1 | 2/4 | 1/1 | 3/3 | | | | 7/9 | 77.8% | 2 | 5 | 1 | | | 00:41:13 |
| 24 | 陈伟华 | | | 0/2 | | | | | 0/2 | 0.0% | | | | 1 | | 00:18:47 |
| 合计 | | 8/13 | 13/20 | 3/8 | 13/16 | 2/4 | 1/1 | | 40/62 | 64.5% | 11 | 17 | 3 | 2 | | |
| <i>(守门员)</i> | | | | | | | | | | | | | | | | |
| 1 | 宋晓晨 | 4/9 | 6/14 | 1/5 | 0/2 | | | 0/3 | 11/33 | 33.3% | 4 | | | | | 00:41:13 |
| 16 | 李佳懿 | 1/1 | 2/10 | 0/4 | 0/2 | | | 1/1 | 4/18 | 22.2% | | | | | | 00:18:47 |
| 合计 | | 5/10 | 8/24 | 1/9 | 0/4 | | | 1/4 | 15/51 | 29.4% | 4 | | | | | |

场上队员：得分/射门

守门员：救球/射门

| 全队合计 | 得分 | 被救 | 射失 | 击柱 | 封球 | 合计 | % |
|------|----|----|----|----|----|----|--------|
| 远射 | 8 | 5 | | | | 13 | 61.5% |
| 近射 | 13 | 6 | 1 | | | 20 | 65.0% |
| 边射 | 3 | 3 | 1 | 1 | | 8 | 37.5% |
| 快攻 | 13 | 3 | | | | 16 | 81.3% |
| 突破 | 2 | 2 | | | | 4 | 50.0% |
| 任意 | 1 | | | | | 1 | 100.0% |
| 7M | | | | | | | 0.0% |





2016年“体彩杯”全国手球男子青年锦标赛

个人/全队技术统计表

正式表
手球
青年男子四分之一决赛
轮次 5组别 X
场次 34201602034-14-2/2
重庆万州
26/03/2016 14:30

| 号码 | 姓名 | 远射 | 近射 | 边射 | 快攻 | 突破 | 任意 | 7M | 合计 | % | 助攻 | 失误 | 警告 | 2' | 取消 | 时间 |
|------------------|-----|------|-------|-----|------|-----|-----|-----|-------|-------|----|----|----|----|----|----------|
| 解放军队(解放军) | | | | | | | | | | | | | | | | |
| <i>(上场队员)</i> | | | | | | | | | | | | | | | | |
| 1 | 郭梦雨 | | | | | | | | | 0.0% | | | | | | 00:33:08 |
| 3 | 张昌轲 | 1/2 | 1/3 | | | | 0/1 | 1/1 | 3/7 | 42.9% | 2 | 8 | | | | 01:00:00 |
| 4 | 张洋 | | | | | | | | | 0.0% | | | | | | 00:00:00 |
| 5 | 尹一楠 | | | | | | | | | 0.0% | | | | | | 00:00:00 |
| 6 | 吴昊 | 1/4 | 2/3 | | | | | | 3/7 | 42.9% | 2 | 5 | 1 | | | 00:47:54 |
| 7 | 姜钦 | 3/13 | 3/7 | | | | 0/1 | | 6/21 | 28.6% | 3 | 2 | | 1 | | 01:00:00 |
| 8 | 邹峻楠 | | | | | | | | | 0.0% | | | | | | 00:00:00 |
| 9 | 李天枢 | | | | | | | | | 0.0% | | | | | | 00:00:00 |
| 10 | 范保坤 | | 2/2 | 4/5 | 0/1 | | | | 6/8 | 75.0% | | 1 | 1 | | | 01:00:00 |
| 11 | 王誌汉 | | 2/2 | 1/1 | 1/1 | | | | 4/4 | 100% | | 3 | | | | 00:21:45 |
| 12 | 左子健 | | | | | | | | | 0.0% | | 1 | | | | 00:26:52 |
| 13 | 徐崧清 | | 3/6 | 3/3 | 2/2 | | | | 8/11 | 72.7% | | 4 | | | | 00:50:18 |
| 14 | 孙耀琦 | | 3/3 | | 1/1 | | | 2/3 | 6/7 | 85.7% | | | 1 | | | 01:00:00 |
| 16 | 池猛 | | | | | | | | | 0.0% | | | | | | 00:00:00 |
| 17 | 刘安宁 | | | | | | | | | 0.0% | | | | | | 00:00:00 |
| 合计 | | 5/19 | 16/26 | 8/9 | 4/5 | | 0/2 | 3/4 | 36/65 | 55.4% | 7 | 24 | 3 | 1 | | |
| <i>(守门员)</i> | | | | | | | | | | | | | | | | |
| 1 | 郭梦雨 | 2/8 | 2/9 | 1/2 | 0/9 | 1/3 | 0/1 | | 6/32 | 18.8% | | | | | | 00:33:08 |
| 12 | 左子健 | 3/5 | 4/10 | 2/4 | 3/7 | 1/1 | | | 13/27 | 48.1% | | 1 | | | | 00:26:52 |
| 合计 | | 5/13 | 6/19 | 3/6 | 3/16 | 2/4 | 0/1 | | 19/59 | 32.2% | | 1 | | | | |

场上队员：得分/射门

守门员：救球/射门

| 全队合计 | 得分 | 被救 | 射失 | 击柱 | 封球 | 合计 | % |
|------|----|----|----|----|----|----|-------|
| 远射 | 5 | 5 | 3 | | 6 | 19 | 26.3% |
| 近射 | 16 | 8 | 1 | 1 | | 26 | 61.5% |
| 边射 | 8 | 1 | | | | 9 | 88.9% |
| 快攻 | 4 | | 1 | | | 5 | 80.0% |
| 突破 | | | | | | | 0.0% |
| 任意 | | | 1 | 1 | | 2 | 0.0% |
| 7M | 3 | 1 | | | | 4 | 75.0% |





2016年“体彩杯”全国手球男子青年锦标赛

图式射门区域统计

轮次 5 场次 34

201602034-41-1/1

新疆队

| | | | | | | | | | | | | | | | | | | | | | | | | | | | | | | | | | | | | | | | | | | | | | | | | | | | | | | | | | | | | | | | | | | | | | | | | | | | | | | | |
|---|-----------------------------|-----------------------------|-----------------------------|-----------------------------|-----------------------------|-----------------------------|-----------------------------|--|---|---|--|--|--|--|---|---|---|---|--|--|--|--|--|--|---|--|--|--|---|---|---|---|---|---|--|---|---|--|---|--|--|--|--|--|--|--|--|--|--|---|---|--|---|---|--|---|---|---|---|---|---|--|--|---|--|---|---|--|---|--|--|--|--|--|--|--|--|--|--|
| 1 宋晓晨 | 2 王泽川 | 4 谷通金 | 5 徐伟 | 6 白光宇 | 7 林豪文 | 10 王钟彬 | 12 王金鑫 | | | | | | | | | | | | | | | | | | | | | | | | | | | | | | | | | | | | | | | | | | | | | | | | | | | | | | | | | | | | | | | | | | | | | | | | |
| <table border="1"><tr><td></td><td></td><td></td></tr><tr><td></td><td></td><td></td></tr><tr><td></td><td></td><td></td></tr></table> | | | | | | | | | | <table border="1"><tr><td></td><td></td><td></td></tr><tr><td></td><td></td><td>1</td></tr><tr><td></td><td>1</td><td></td></tr></table> | | | | | | 1 | | 1 | | <table border="1"><tr><td></td><td></td><td></td></tr><tr><td></td><td>1</td><td></td></tr><tr><td></td><td></td><td>1</td></tr></table> | | | | | 1 | | | | 1 | <table border="1"><tr><td>1</td><td></td><td>1</td></tr><tr><td>1</td><td></td><td>1</td></tr><tr><td>2</td><td></td><td></td></tr></table> | 1 | | 1 | 1 | | 1 | 2 | | | <table border="1"><tr><td></td><td></td><td></td></tr><tr><td></td><td></td><td></td></tr><tr><td></td><td></td><td></td></tr></table> | | | | | | | | | | <table border="1"><tr><td>2</td><td></td><td>1</td></tr><tr><td></td><td></td><td></td></tr><tr><td>1</td><td>1</td><td>3</td></tr></table> | 2 | | 1 | | | | 1 | 1 | 3 | <table border="1"><tr><td>1</td><td></td><td></td></tr><tr><td>1</td><td></td><td>1</td></tr><tr><td>2</td><td></td><td>1</td></tr></table> | 1 | | | 1 | | 1 | 2 | | 1 | <table border="1"><tr><td></td><td></td><td></td></tr><tr><td></td><td></td><td></td></tr><tr><td></td><td></td><td></td></tr></table> | | | | | | | | | |
| | | | | | | | | | | | | | | | | | | | | | | | | | | | | | | | | | | | | | | | | | | | | | | | | | | | | | | | | | | | | | | | | | | | | | | | | | | | | | | | |
| | | | | | | | | | | | | | | | | | | | | | | | | | | | | | | | | | | | | | | | | | | | | | | | | | | | | | | | | | | | | | | | | | | | | | | | | | | | | | | | |
| | | | | | | | | | | | | | | | | | | | | | | | | | | | | | | | | | | | | | | | | | | | | | | | | | | | | | | | | | | | | | | | | | | | | | | | | | | | | | | | |
| | | | | | | | | | | | | | | | | | | | | | | | | | | | | | | | | | | | | | | | | | | | | | | | | | | | | | | | | | | | | | | | | | | | | | | | | | | | | | | | |
| | | 1 | | | | | | | | | | | | | | | | | | | | | | | | | | | | | | | | | | | | | | | | | | | | | | | | | | | | | | | | | | | | | | | | | | | | | | | | | | | | | |
| | 1 | | | | | | | | | | | | | | | | | | | | | | | | | | | | | | | | | | | | | | | | | | | | | | | | | | | | | | | | | | | | | | | | | | | | | | | | | | | | | | |
| | | | | | | | | | | | | | | | | | | | | | | | | | | | | | | | | | | | | | | | | | | | | | | | | | | | | | | | | | | | | | | | | | | | | | | | | | | | | | | | |
| | 1 | | | | | | | | | | | | | | | | | | | | | | | | | | | | | | | | | | | | | | | | | | | | | | | | | | | | | | | | | | | | | | | | | | | | | | | | | | | | | | |
| | | 1 | | | | | | | | | | | | | | | | | | | | | | | | | | | | | | | | | | | | | | | | | | | | | | | | | | | | | | | | | | | | | | | | | | | | | | | | | | | | | |
| 1 | | 1 | | | | | | | | | | | | | | | | | | | | | | | | | | | | | | | | | | | | | | | | | | | | | | | | | | | | | | | | | | | | | | | | | | | | | | | | | | | | | |
| 1 | | 1 | | | | | | | | | | | | | | | | | | | | | | | | | | | | | | | | | | | | | | | | | | | | | | | | | | | | | | | | | | | | | | | | | | | | | | | | | | | | | |
| 2 | | | | | | | | | | | | | | | | | | | | | | | | | | | | | | | | | | | | | | | | | | | | | | | | | | | | | | | | | | | | | | | | | | | | | | | | | | | | | | | |
| | | | | | | | | | | | | | | | | | | | | | | | | | | | | | | | | | | | | | | | | | | | | | | | | | | | | | | | | | | | | | | | | | | | | | | | | | | | | | | | |
| | | | | | | | | | | | | | | | | | | | | | | | | | | | | | | | | | | | | | | | | | | | | | | | | | | | | | | | | | | | | | | | | | | | | | | | | | | | | | | | |
| | | | | | | | | | | | | | | | | | | | | | | | | | | | | | | | | | | | | | | | | | | | | | | | | | | | | | | | | | | | | | | | | | | | | | | | | | | | | | | | |
| 2 | | 1 | | | | | | | | | | | | | | | | | | | | | | | | | | | | | | | | | | | | | | | | | | | | | | | | | | | | | | | | | | | | | | | | | | | | | | | | | | | | | |
| | | | | | | | | | | | | | | | | | | | | | | | | | | | | | | | | | | | | | | | | | | | | | | | | | | | | | | | | | | | | | | | | | | | | | | | | | | | | | | | |
| 1 | 1 | 3 | | | | | | | | | | | | | | | | | | | | | | | | | | | | | | | | | | | | | | | | | | | | | | | | | | | | | | | | | | | | | | | | | | | | | | | | | | | | | |
| 1 | | | | | | | | | | | | | | | | | | | | | | | | | | | | | | | | | | | | | | | | | | | | | | | | | | | | | | | | | | | | | | | | | | | | | | | | | | | | | | | |
| 1 | | 1 | | | | | | | | | | | | | | | | | | | | | | | | | | | | | | | | | | | | | | | | | | | | | | | | | | | | | | | | | | | | | | | | | | | | | | | | | | | | | |
| 2 | | 1 | | | | | | | | | | | | | | | | | | | | | | | | | | | | | | | | | | | | | | | | | | | | | | | | | | | | | | | | | | | | | | | | | | | | | | | | | | | | | |
| | | | | | | | | | | | | | | | | | | | | | | | | | | | | | | | | | | | | | | | | | | | | | | | | | | | | | | | | | | | | | | | | | | | | | | | | | | | | | | | |
| | | | | | | | | | | | | | | | | | | | | | | | | | | | | | | | | | | | | | | | | | | | | | | | | | | | | | | | | | | | | | | | | | | | | | | | | | | | | | | | |
| | | | | | | | | | | | | | | | | | | | | | | | | | | | | | | | | | | | | | | | | | | | | | | | | | | | | | | | | | | | | | | | | | | | | | | | | | | | | | | | |
| Post - 0 Miss - 0 Block - 0 | Post - 0 Miss - 0 Block - 0 | Post - 0 Miss - 0 Block - 0 | Post - 0 Miss - 0 Block - 0 | Post - 0 Miss - 0 Block - 0 | Post - 0 Miss - 0 Block - 0 | Post - 0 Miss - 0 Block - 0 | Post - 0 Miss - 0 Block - 0 | | | | | | | | | | | | | | | | | | | | | | | | | | | | | | | | | | | | | | | | | | | | | | | | | | | | | | | | | | | | | | | | | | | | | | | | |
| 13 苏兴伟 | 15 王维东 | 16 李佳懿 | 17 胡晋铭 | 18 李万兴 | 19 李龙吉 | 24 陈伟华 | | | | | | | | | | | | | | | | | | | | | | | | | | | | | | | | | | | | | | | | | | | | | | | | | | | | | | | | | | | | | | | | | | | | | | | | | |
| <table border="1"><tr><td></td><td></td><td></td></tr><tr><td></td><td></td><td></td></tr><tr><td></td><td></td><td>2</td></tr></table> | | | | | | | | | 2 | <table border="1"><tr><td></td><td></td><td></td></tr><tr><td></td><td>1</td><td>1</td></tr><tr><td>2</td><td></td><td></td></tr></table> | | | | | 1 | 1 | 2 | | | <table border="1"><tr><td></td><td></td><td></td></tr><tr><td></td><td></td><td></td></tr><tr><td></td><td></td><td></td></tr></table> | | | | | | | | | | <table border="1"><tr><td></td><td>1</td><td></td></tr><tr><td></td><td></td><td></td></tr><tr><td>1</td><td></td><td>1</td></tr></table> | | 1 | | | | | 1 | | 1 | <table border="1"><tr><td></td><td></td><td></td></tr><tr><td></td><td></td><td></td></tr><tr><td></td><td></td><td></td></tr></table> | | | | | | | | | | <table border="1"><tr><td></td><td></td><td>2</td></tr><tr><td>2</td><td></td><td>2</td></tr><tr><td></td><td></td><td>1</td></tr></table> | | | 2 | 2 | | 2 | | | 1 | <table border="1"><tr><td></td><td></td><td></td></tr><tr><td></td><td></td><td></td></tr><tr><td></td><td></td><td></td></tr></table> | | | | | | | | | | <table border="1"><tr><td></td><td></td><td></td></tr><tr><td></td><td></td><td></td></tr><tr><td></td><td></td><td></td></tr></table> | | | | | | | | | |
| | | | | | | | | | | | | | | | | | | | | | | | | | | | | | | | | | | | | | | | | | | | | | | | | | | | | | | | | | | | | | | | | | | | | | | | | | | | | | | | |
| | | | | | | | | | | | | | | | | | | | | | | | | | | | | | | | | | | | | | | | | | | | | | | | | | | | | | | | | | | | | | | | | | | | | | | | | | | | | | | | |
| | | 2 | | | | | | | | | | | | | | | | | | | | | | | | | | | | | | | | | | | | | | | | | | | | | | | | | | | | | | | | | | | | | | | | | | | | | | | | | | | | | |
| | | | | | | | | | | | | | | | | | | | | | | | | | | | | | | | | | | | | | | | | | | | | | | | | | | | | | | | | | | | | | | | | | | | | | | | | | | | | | | | |
| | 1 | 1 | | | | | | | | | | | | | | | | | | | | | | | | | | | | | | | | | | | | | | | | | | | | | | | | | | | | | | | | | | | | | | | | | | | | | | | | | | | | | |
| 2 | | | | | | | | | | | | | | | | | | | | | | | | | | | | | | | | | | | | | | | | | | | | | | | | | | | | | | | | | | | | | | | | | | | | | | | | | | | | | | | |
| | | | | | | | | | | | | | | | | | | | | | | | | | | | | | | | | | | | | | | | | | | | | | | | | | | | | | | | | | | | | | | | | | | | | | | | | | | | | | | | |
| | | | | | | | | | | | | | | | | | | | | | | | | | | | | | | | | | | | | | | | | | | | | | | | | | | | | | | | | | | | | | | | | | | | | | | | | | | | | | | | |
| | | | | | | | | | | | | | | | | | | | | | | | | | | | | | | | | | | | | | | | | | | | | | | | | | | | | | | | | | | | | | | | | | | | | | | | | | | | | | | | |
| | 1 | | | | | | | | | | | | | | | | | | | | | | | | | | | | | | | | | | | | | | | | | | | | | | | | | | | | | | | | | | | | | | | | | | | | | | | | | | | | | | |
| | | | | | | | | | | | | | | | | | | | | | | | | | | | | | | | | | | | | | | | | | | | | | | | | | | | | | | | | | | | | | | | | | | | | | | | | | | | | | | | |
| 1 | | 1 | | | | | | | | | | | | | | | | | | | | | | | | | | | | | | | | | | | | | | | | | | | | | | | | | | | | | | | | | | | | | | | | | | | | | | | | | | | | | |
| | | | | | | | | | | | | | | | | | | | | | | | | | | | | | | | | | | | | | | | | | | | | | | | | | | | | | | | | | | | | | | | | | | | | | | | | | | | | | | | |
| | | | | | | | | | | | | | | | | | | | | | | | | | | | | | | | | | | | | | | | | | | | | | | | | | | | | | | | | | | | | | | | | | | | | | | | | | | | | | | | |
| | | | | | | | | | | | | | | | | | | | | | | | | | | | | | | | | | | | | | | | | | | | | | | | | | | | | | | | | | | | | | | | | | | | | | | | | | | | | | | | |
| | | 2 | | | | | | | | | | | | | | | | | | | | | | | | | | | | | | | | | | | | | | | | | | | | | | | | | | | | | | | | | | | | | | | | | | | | | | | | | | | | | |
| 2 | | 2 | | | | | | | | | | | | | | | | | | | | | | | | | | | | | | | | | | | | | | | | | | | | | | | | | | | | | | | | | | | | | | | | | | | | | | | | | | | | | |
| | | 1 | | | | | | | | | | | | | | | | | | | | | | | | | | | | | | | | | | | | | | | | | | | | | | | | | | | | | | | | | | | | | | | | | | | | | | | | | | | | | |
| | | | | | | | | | | | | | | | | | | | | | | | | | | | | | | | | | | | | | | | | | | | | | | | | | | | | | | | | | | | | | | | | | | | | | | | | | | | | | | | |
| | | | | | | | | | | | | | | | | | | | | | | | | | | | | | | | | | | | | | | | | | | | | | | | | | | | | | | | | | | | | | | | | | | | | | | | | | | | | | | | |
| | | | | | | | | | | | | | | | | | | | | | | | | | | | | | | | | | | | | | | | | | | | | | | | | | | | | | | | | | | | | | | | | | | | | | | | | | | | | | | | |
| | | | | | | | | | | | | | | | | | | | | | | | | | | | | | | | | | | | | | | | | | | | | | | | | | | | | | | | | | | | | | | | | | | | | | | | | | | | | | | | |
| | | | | | | | | | | | | | | | | | | | | | | | | | | | | | | | | | | | | | | | | | | | | | | | | | | | | | | | | | | | | | | | | | | | | | | | | | | | | | | | |
| | | | | | | | | | | | | | | | | | | | | | | | | | | | | | | | | | | | | | | | | | | | | | | | | | | | | | | | | | | | | | | | | | | | | | | | | | | | | | | | |
| Post - 0 Miss - 0 Block - 0 | Post - 0 Miss - 1 Block - 0 | Post - 0 Miss - 0 Block - 0 | Post - 1 Miss - 1 Block - 0 | Post - 0 Miss - 0 Block - 0 | Post - 0 Miss - 0 Block - 0 | Post - 0 Miss - 0 Block - 0 | Post - 0 Miss - 0 Block - 0 | | | | | | | | | | | | | | | | | | | | | | | | | | | | | | | | | | | | | | | | | | | | | | | | | | | | | | | | | | | | | | | | | | | | | | | | |

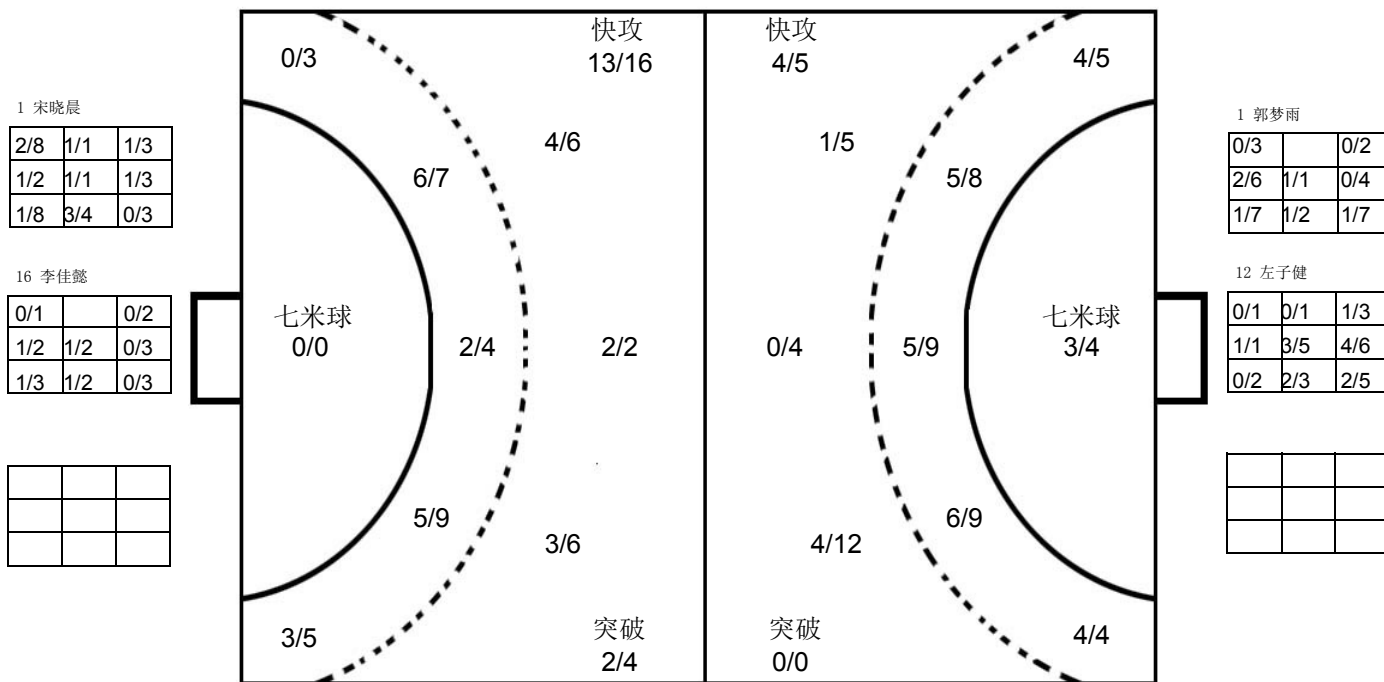

解放军队

| | | | | | | | | | | | | | | | | | | | | | | | | | | | | | | | | | | | | | | | | | | | | | | | | | | | | | | | | | | | | | | | | | | | | | | | | | | | | | | | |
|--|-----------------------------|-----------------------------|-----------------------------|-----------------------------|-----------------------------|-----------------------------|-----------------------------|---|---|---|---|--|--|--|--|---|---|--|--|--|--|--|--|--|--|--|--|--|--|--|--|--|---|---|--|---|---|---|---|--|---|--|--|--|--|---|---|--|---|--|---|--|---|--|---|--|---|--|--|--|--|--|--|--|--|--|--|--|--|--|--|--|--|--|--|--|--|--|--|
| 1 郭梦雨 | 3 张昌柯 | 4 张洋 | 5 尹一楠 | 6 吴昊 | 7 姜钦 | 8 邹峻楠 | 9 李天枢 | | | | | | | | | | | | | | | | | | | | | | | | | | | | | | | | | | | | | | | | | | | | | | | | | | | | | | | | | | | | | | | | | | | | | | | | |
| <table border="1"><tr><td></td><td></td><td></td></tr><tr><td></td><td></td><td></td></tr><tr><td></td><td></td><td></td></tr></table> | | | | | | | | | | <table border="1"><tr><td></td><td></td><td></td></tr><tr><td></td><td></td><td></td></tr><tr><td>3</td><td></td><td></td></tr></table> | | | | | | | 3 | | | <table border="1"><tr><td></td><td></td><td></td></tr><tr><td></td><td></td><td></td></tr><tr><td></td><td></td><td></td></tr></table> | | | | | | | | | | <table border="1"><tr><td></td><td></td><td></td></tr><tr><td></td><td></td><td></td></tr><tr><td></td><td></td><td></td></tr></table> | | | | | | | | | | <table border="1"><tr><td></td><td></td><td></td></tr><tr><td></td><td></td><td>1</td></tr><tr><td></td><td></td><td>2</td></tr></table> | | | | | | 1 | | | 2 | <table border="1"><tr><td>2</td><td></td><td>2</td></tr><tr><td></td><td>1</td><td></td></tr><tr><td>1</td><td></td><td></td></tr></table> | 2 | | 2 | | 1 | | 1 | | | <table border="1"><tr><td></td><td></td><td></td></tr><tr><td></td><td></td><td></td></tr><tr><td></td><td></td><td></td></tr></table> | | | | | | | | | | <table border="1"><tr><td></td><td></td><td></td></tr><tr><td></td><td></td><td></td></tr><tr><td></td><td></td><td></td></tr></table> | | | | | | | | | |
| | | | | | | | | | | | | | | | | | | | | | | | | | | | | | | | | | | | | | | | | | | | | | | | | | | | | | | | | | | | | | | | | | | | | | | | | | | | | | | | |
| | | | | | | | | | | | | | | | | | | | | | | | | | | | | | | | | | | | | | | | | | | | | | | | | | | | | | | | | | | | | | | | | | | | | | | | | | | | | | | | |
| | | | | | | | | | | | | | | | | | | | | | | | | | | | | | | | | | | | | | | | | | | | | | | | | | | | | | | | | | | | | | | | | | | | | | | | | | | | | | | | |
| | | | | | | | | | | | | | | | | | | | | | | | | | | | | | | | | | | | | | | | | | | | | | | | | | | | | | | | | | | | | | | | | | | | | | | | | | | | | | | | |
| | | | | | | | | | | | | | | | | | | | | | | | | | | | | | | | | | | | | | | | | | | | | | | | | | | | | | | | | | | | | | | | | | | | | | | | | | | | | | | | |
| 3 | | | | | | | | | | | | | | | | | | | | | | | | | | | | | | | | | | | | | | | | | | | | | | | | | | | | | | | | | | | | | | | | | | | | | | | | | | | | | | | |
| | | | | | | | | | | | | | | | | | | | | | | | | | | | | | | | | | | | | | | | | | | | | | | | | | | | | | | | | | | | | | | | | | | | | | | | | | | | | | | | |
| | | | | | | | | | | | | | | | | | | | | | | | | | | | | | | | | | | | | | | | | | | | | | | | | | | | | | | | | | | | | | | | | | | | | | | | | | | | | | | | |
| | | | | | | | | | | | | | | | | | | | | | | | | | | | | | | | | | | | | | | | | | | | | | | | | | | | | | | | | | | | | | | | | | | | | | | | | | | | | | | | |
| | | | | | | | | | | | | | | | | | | | | | | | | | | | | | | | | | | | | | | | | | | | | | | | | | | | | | | | | | | | | | | | | | | | | | | | | | | | | | | | |
| | | | | | | | | | | | | | | | | | | | | | | | | | | | | | | | | | | | | | | | | | | | | | | | | | | | | | | | | | | | | | | | | | | | | | | | | | | | | | | | |
| | | | | | | | | | | | | | | | | | | | | | | | | | | | | | | | | | | | | | | | | | | | | | | | | | | | | | | | | | | | | | | | | | | | | | | | | | | | | | | | |
| | | | | | | | | | | | | | | | | | | | | | | | | | | | | | | | | | | | | | | | | | | | | | | | | | | | | | | | | | | | | | | | | | | | | | | | | | | | | | | | |
| | | 1 | | | | | | | | | | | | | | | | | | | | | | | | | | | | | | | | | | | | | | | | | | | | | | | | | | | | | | | | | | | | | | | | | | | | | | | | | | | | | |
| | | 2 | | | | | | | | | | | | | | | | | | | | | | | | | | | | | | | | | | | | | | | | | | | | | | | | | | | | | | | | | | | | | | | | | | | | | | | | | | | | | |
| 2 | | 2 | | | | | | | | | | | | | | | | | | | | | | | | | | | | | | | | | | | | | | | | | | | | | | | | | | | | | | | | | | | | | | | | | | | | | | | | | | | | | |
| | 1 | | | | | | | | | | | | | | | | | | | | | | | | | | | | | | | | | | | | | | | | | | | | | | | | | | | | | | | | | | | | | | | | | | | | | | | | | | | | | | |
| 1 | | | | | | | | | | | | | | | | | | | | | | | | | | | | | | | | | | | | | | | | | | | | | | | | | | | | | | | | | | | | | | | | | | | | | | | | | | | | | | | |
| | | | | | | | | | | | | | | | | | | | | | | | | | | | | | | | | | | | | | | | | | | | | | | | | | | | | | | | | | | | | | | | | | | | | | | | | | | | | | | | |
| | | | | | | | | | | | | | | | | | | | | | | | | | | | | | | | | | | | | | | | | | | | | | | | | | | | | | | | | | | | | | | | | | | | | | | | | | | | | | | | |
| | | | | | | | | | | | | | | | | | | | | | | | | | | | | | | | | | | | | | | | | | | | | | | | | | | | | | | | | | | | | | | | | | | | | | | | | | | | | | | | |
| | | | | | | | | | | | | | | | | | | | | | | | | | | | | | | | | | | | | | | | | | | | | | | | | | | | | | | | | | | | | | | | | | | | | | | | | | | | | | | | |
| | | | | | | | | | | | | | | | | | | | | | | | | | | | | | | | | | | | | | | | | | | | | | | | | | | | | | | | | | | | | | | | | | | | | | | | | | | | | | | | |
| | | | | | | | | | | | | | | | | | | | | | | | | | | | | | | | | | | | | | | | | | | | | | | | | | | | | | | | | | | | | | | | | | | | | | | | | | | | | | | | |
| Post - 0 Miss - 0 Block - 0 | Post - 1 Miss - 0 Block - 1 | Post - 0 Miss - 0 Block - 0 | Post - 0 Miss - 0 Block - 0 | Post - 0 Miss - 1 Block - 1 | Post - 0 Miss - 4 Block - 4 | Post - 0 Miss - 0 Block - 0 | Post - 0 Miss - 0 Block - 0 | | | | | | | | | | | | | | | | | | | | | | | | | | | | | | | | | | | | | | | | | | | | | | | | | | | | | | | | | | | | | | | | | | | | | | | | |
| 10 范保坤 | 11 王誌汉 | 12 左子健 | 13 徐峻清 | 14 孙耀琦 | 16 池猛 | 17 刘安宁 | | | | | | | | | | | | | | | | | | | | | | | | | | | | | | | | | | | | | | | | | | | | | | | | | | | | | | | | | | | | | | | | | | | | | | | | | |
| <table border="1"><tr><td>1</td><td></td><td>1</td></tr><tr><td>1</td><td></td><td>1</td></tr><tr><td></td><td>1</td><td>1</td></tr></table> | 1 | | 1 | 1 | | 1 | | 1 | 1 | <table border="1"><tr><td>2</td><td></td><td></td></tr><tr><td></td><td></td><td>1</td></tr><tr><td>1</td><td></td><td></td></tr></table> | 2 | | | | | 1 | 1 | | | <table border="1"><tr><td></td><td></td><td></td></tr><tr><td></td><td></td><td></td></tr><tr><td></td><td></td><td></td></tr></table> | | | | | | | | | | <table border="1"><tr><td></td><td></td><td>1</td></tr><tr><td>1</td><td></td><td>1</td></tr><tr><td>2</td><td>1</td><td>2</td></tr></table> | | | 1 | 1 | | 1 | 2 | 1 | 2 | <table border="1"><tr><td>2</td><td></td><td></td></tr><tr><td></td><td></td><td>1</td></tr><tr><td>2</td><td></td><td>1</td></tr></table> | 2 | | | | | 1 | 2 | | 1 | <table border="1"><tr><td></td><td></td><td></td></tr><tr><td></td><td></td><td></td></tr><tr><td></td><td></td><td></td></tr></table> | | | | | | | | | | <table border="1"><tr><td></td><td></td><td></td></tr><tr><td></td><td></td><td></td></tr><tr><td></td><td></td><td></td></tr></table> | | | | | | | | | | <table border="1"><tr><td></td><td></td><td></td></tr><tr><td></td><td></td><td></td></tr><tr><td></td><td></td><td></td></tr></table> | | | | | | | | | |
| 1 | | 1 | | | | | | | | | | | | | | | | | | | | | | | | | | | | | | | | | | | | | | | | | | | | | | | | | | | | | | | | | | | | | | | | | | | | | | | | | | | | | |
| 1 | | 1 | | | | | | | | | | | | | | | | | | | | | | | | | | | | | | | | | | | | | | | | | | | | | | | | | | | | | | | | | | | | | | | | | | | | | | | | | | | | | |
| | 1 | 1 | | | | | | | | | | | | | | | | | | | | | | | | | | | | | | | | | | | | | | | | | | | | | | | | | | | | | | | | | | | | | | | | | | | | | | | | | | | | | |
| 2 | | | | | | | | | | | | | | | | | | | | | | | | | | | | | | | | | | | | | | | | | | | | | | | | | | | | | | | | | | | | | | | | | | | | | | | | | | | | | | | |
| | | 1 | | | | | | | | | | | | | | | | | | | | | | | | | | | | | | | | | | | | | | | | | | | | | | | | | | | | | | | | | | | | | | | | | | | | | | | | | | | | | |
| 1 | | | | | | | | | | | | | | | | | | | | | | | | | | | | | | | | | | | | | | | | | | | | | | | | | | | | | | | | | | | | | | | | | | | | | | | | | | | | | | | |
| | | | | | | | | | | | | | | | | | | | | | | | | | | | | | | | | | | | | | | | | | | | | | | | | | | | | | | | | | | | | | | | | | | | | | | | | | | | | | | | |
| | | | | | | | | | | | | | | | | | | | | | | | | | | | | | | | | | | | | | | | | | | | | | | | | | | | | | | | | | | | | | | | | | | | | | | | | | | | | | | | |
| | | | | | | | | | | | | | | | | | | | | | | | | | | | | | | | | | | | | | | | | | | | | | | | | | | | | | | | | | | | | | | | | | | | | | | | | | | | | | | | |
| | | 1 | | | | | | | | | | | | | | | | | | | | | | | | | | | | | | | | | | | | | | | | | | | | | | | | | | | | | | | | | | | | | | | | | | | | | | | | | | | | | |
| 1 | | 1 | | | | | | | | | | | | | | | | | | | | | | | | | | | | | | | | | | | | | | | | | | | | | | | | | | | | | | | | | | | | | | | | | | | | | | | | | | | | | |
| 2 | 1 | 2 | | | | | | | | | | | | | | | | | | | | | | | | | | | | | | | | | | | | | | | | | | | | | | | | | | | | | | | | | | | | | | | | | | | | | | | | | | | | | |
| 2 | | | | | | | | | | | | | | | | | | | | | | | | | | | | | | | | | | | | | | | | | | | | | | | | | | | | | | | | | | | | | | | | | | | | | | | | | | | | | | | |
| | | 1 | | | | | | | | | | | | | | | | | | | | | | | | | | | | | | | | | | | | | | | | | | | | | | | | | | | | | | | | | | | | | | | | | | | | | | | | | | | | | |
| 2 | | 1 | | | | | | | | | | | | | | | | | | | | | | | | | | | | | | | | | | | | | | | | | | | | | | | | | | | | | | | | | | | | | | | | | | | | | | | | | | | | | |
| | | | | | | | | | | | | | | | | | | | | | | | | | | | | | | | | | | | | | | | | | | | | | | | | | | | | | | | | | | | | | | | | | | | | | | | | | | | | | | | |
| | | | | | | | | | | | | | | | | | | | | | | | | | | | | | | | | | | | | | | | | | | | | | | | | | | | | | | | | | | | | | | | | | | | | | | | | | | | | | | | |
| | | | | | | | | | | | | | | | | | | | | | | | | | | | | | | | | | | | | | | | | | | | | | | | | | | | | | | | | | | | | | | | | | | | | | | | | | | | | | | | |
| | | | | | | | | | | | | | | | | | | | | | | | | | | | | | | | | | | | | | | | | | | | | | | | | | | | | | | | | | | | | | | | | | | | | | | | | | | | | | | | |
| | | | | | | | | | | | | | | | | | | | | | | | | | | | | | | | | | | | | | | | | | | | | | | | | | | | | | | | | | | | | | | | | | | | | | | | | | | | | | | | |
| | | | | | | | | | | | | | | | | | | | | | | | | | | | | | | | | | | | | | | | | | | | | | | | | | | | | | | | | | | | | | | | | | | | | | | | | | | | | | | | |
| | | | | | | | | | | | | | | | | | | | | | | | | | | | | | | | | | | | | | | | | | | | | | | | | | | | | | | | | | | | | | | | | | | | | | | | | | | | | | | | |
| | | | | | | | | | | | | | | | | | | | | | | | | | | | | | | | | | | | | | | | | | | | | | | | | | | | | | | | | | | | | | | | | | | | | | | | | | | | | | | | |
| | | | | | | | | | | | | | | | | | | | | | | | | | | | | | | | | | | | | | | | | | | | | | | | | | | | | | | | | | | | | | | | | | | | | | | | | | | | | | | | |
| Post - 0 Miss - 1 Block - 0 | Post - 0 Miss - 0 Block - 0 | Post - 0 Miss - 0 Block - 0 | Post - 1 Miss - 0 Block - 0 | Post - 0 Miss - 0 Block - 0 | Post - 0 Miss - 0 Block - 0 | Post - 0 Miss - 0 Block - 0 | Post - 0 Miss - 0 Block - 0 | | | | | | | | | | | | | | | | | | | | | | | | | | | | | | | | | | | | | | | | | | | | | | | | | | | | | | | | | | | | | | | | | | | | | | | | |

注释: Post=击柱 Miss=射失 Block=被封





四分之一决赛
青年男子 全国比赛

2016年“体彩杯”全国手球男子青年锦标赛

| | | | | | | | | | | | |
|---|-----------------------------------|-------------------------|---------------------|---------------------------|----------------|-----|-----------|---|----|---|----------|
| Team A A 新疆队 | | Team B B 解放军队 | | Match Number 34 | | | | | | | |
| played in China | | in the hall 重庆万州 | | on 26/03/2016 | | | | | | | |
| | | | | at 14:30 hours | | | | | | | |
| Spectators | | | | | | | | | | | |
| Half-time (30') | A 23 | B 15 | End of playing time | A 40 | B 36 | | | | | | |
| 1st extra time | | | | 2nd extra time | | | | | | | |
| | | | | After penalty throws | | | | | | | |
| | | | | | | | | | | | |
| Number of 7 m | A 0/0 | Team time-out | | Team time-out | | | | | | | |
| | | 41:13 | | 07:14 | | | | | | | |
| Full name of players and officials | | | | | | | | | | | |
| No. | Team A | | | | Team B | | | | | | |
| | G | W | 2' | D | DR | No. | G | W | 2' | D | DR |
| 1 | | | | | | 1 | | | | | |
| 2 | 2 | | 1 | | | 3 | 3 | | | | |
| 4 | 2 | | | | | 4 | | | | | |
| 5 | 6 | | | | | 5 | | | | | |
| 6 | | | | | | 6 | 3 | 1 | | | |
| 7 | 8 | 1 | | | | 7 | 6 | | 1 | | |
| 10 | 6 | | | | | 8 | | | | | |
| 12 | | | | | | 9 | | | | | |
| 13 | 2 | | | | | 10 | 6 | 1 | | | |
| 15 | 4 | | | | | 11 | 4 | | | | |
| 16 | | | | | | 12 | | | | | |
| 17 | 3 | 1 | | | | 13 | 8 | | | | |
| 18 | | | | | | 14 | 6 | 1 | | | |
| 19 | 7 | 1 | | | | 16 | | | | | |
| 24 | | | 1 | | | 17 | | | | | |
| A | 孔德宾 (主教练) | | | | | A | 杜长义 (主教练) | | | | |
| B | 陈鹏波 | | | | | | | | | | |
| C | 李楠 | | | | | | | | | | |
| Signature of Responsible Official of the Teams (Off. A) | | | | | | | | | | | |
| | | | | | | | | | | | B |
| TP | Remarks of Referee / CHA Official | | | | | | | | | | TP |
| | | | | | | | | | | | |

Signatures

| | | | | |
|------------------|-----------|-----------|--|--|
| Referees | 许翔 (CHN) | 王雨洋 (CHN) | | |
| Techn. Delegates | 许宜扬 (CHN) | | | |
| CHA Official | 张春生 (CHN) | | | |

Note: Number of 7m Throws Awarded to Team A and B, Goals (G), Warnings (W), Suspensions (2'), Direct Disqualification (D), Disqualification with Report (DR) and Team Penalty (TP).

Table Officials:

Statisticians: 刘永欢

李双





2016年“体彩杯”全国手球男子青年锦标赛 竞赛技术统计(媒体表)

| | | | | | | |
|--------|----|---|----|---|----|----|
| 四分之一决赛 | 组别 | X | 轮次 | 5 | 场次 | 34 |
|--------|----|---|----|---|----|----|

重庆万州

26/03/2016

201602034-51-1/1

| | | | | | | |
|-----|-----------|-----------|----|----------------|------------|------|
| 新疆队 | 新疆 | 40 | vs | 36 | 解放军 | 解放军队 |
| | | | | 23 : 15 | | |

| | | | | | | | | | |
|-----|----------|--|--|--|---|-----------|--|--|--|
| 裁判员 | 许翔 (CHN) | | | | / | 王雨洋 (CHN) | | | |
|-----|----------|--|--|--|---|-----------|--|--|--|

| 新疆 | | 远射 | 近射 | 边射 | 快攻 | 突破 | 任意球 | 7m球 | 合计 | % | 助攻 | 失误 | 警告 | 2' | D & DR | 新疆 | | 解放军 | | | |
|---------------|-----|-------------|--------------|------------|--------------|------------|------------|--------------|--------------|-------------|-----------|----------|----------|----------|--------|------|-----|-----|-------|----|--------|
| 主教练：孔德宾 | | | | | | | | | | | | | | | | 比赛进程 | | | | | |
| 1 | 宋晓晨 | | | | | | | | | | 4 | | | | | 19 | 李龙吉 | 1 | 00:24 | 0 | |
| 2 | 王泽川 | | 1/2 | | 1/1 | | | 2/3 | 66.7 | | | | | 1 | | 7 | 林豪文 | 2 | 00:52 | 0 | 11 王誌汉 |
| 4 | 谷通金 | 0/1 | 2/2 | | 0/1 | 0/1 | | 2/5 | 40.0 | | | | | | | 7 | 林豪文 | 3 | 02:42 | 1 | |
| 5 | 徐伟 | | 1/1 | | 5/7 | 0/1 | | 6/9 | 66.7 | | 1 | | | | | 19 | 李龙吉 | 4 | 03:28 | 1 | |
| 6 | 白光宇 | | | | | | | | | | | | | | | 7 | 林豪文 | 4 | 05:25 | 2 | 6 吴昊 |
| 7 | 林豪文 | 4/6 | | 1/1 | 1/1 | 1/1 | 1/1 | 8/10 | 80.0 | 2 | 2 | 1 | | | | 5 | 林豪文 | 5 | 05:48 | 2 | |
| 10 | 王钟彬 | 2/2 | 2/3 | | 1/1 | 1/1 | | 6/7 | 85.7 | 1 | 3 | | | | | 19 | 李龙吉 | 6 | 06:42 | 2 | |
| 12 | 王金鑫 | | | | | | | | | | | | | | | 6 | 李龙吉 | 7 | 07:30 | 3 | 14 孙耀琦 |
| 13 | 苏兴伟 | 0/2 | 2/2 | | | | | 2/4 | 50.0 | | | | | | | 7 | 林豪文 | 7 | 07:57 | 3 | |
| 15 | 王维东 | 1/1 | 0/2 | 1/3 | 2/2 | | | 4/8 | 50.0 | 1 | 3 | | | | | 7 | 王钟彬 | 8 | 08:20 | 4 | 14 孙耀琦 |
| 16 | 李佳懿 | | | | | | | | | | | | | | | 10 | 王钟彬 | 9 | 09:07 | 4 | |
| 17 | 胡晋铭 | | 3/4 | 0/1 | | | | 3/5 | 60.0 | 1 | | 1 | | | | 19 | 李龙吉 | 9 | 09:34 | 4 | |
| 18 | 李万兴 | | | | | | | | | | 3 | | | | | 5 | 徐伟 | 10 | 10:04 | 4 | |
| 19 | 李龙吉 | 1/1 | 2/4 | 1/1 | 3/3 | | | 7/9 | 77.8 | 2 | 5 | 1 | | | | 10 | 李龙吉 | 10 | 10:58 | 5 | 14 孙耀琦 |
| 24 | 陈伟华 | | | 0/2 | | | | 0/2 | 0.0 | | | | | 1 | | 19 | 李龙吉 | 11 | 12:24 | 5 | |
| 运动员 合计 | | 8/13 | 13/20 | 3/8 | 13/16 | 2/4 | 1/1 | 40/62 | 64.5 | 11 | 17 | 3 | 2 | 2 | | 10 | 王钟彬 | 12 | 14:10 | 5 | |
| 1 | 宋晓晨 | 4/9 | 6/14 | 1/5 | 0/2 | | | 0/3 | 11/33 | 33.3 | 4 | | | | | 5 | 徐伟 | 13 | 14:29 | 5 | |
| 16 | 李佳懿 | 1/1 | 2/10 | 0/4 | 0/2 | | | 1/1 | 4/18 | 22.2 | | | | | | 19 | 李龙吉 | 14 | 15:13 | 5 | |
| 守门员 合计 | | 5/10 | 8/24 | 1/9 | 0/4 | | | 1/4 | 15/51 | 29.4 | 4 | | | | | 14 | 徐伟 | 14 | 16:22 | 6 | 14 孙耀琦 |
| 解放军 | | | | | | | | | | | | | | | | 14 | 胡晋铭 | 14 | 16:59 | 7 | 14 孙耀琦 |
| 教练：杜长义 | | | | | | | | | | | | | | | | 7 | 林豪文 | 15 | 17:06 | 7 | |
| 1 | 郭梦雨 | | | | | | | | | | | | | | | 15 | 王钟彬 | 15 | 17:31 | 8 | 6 吴昊 |
| 3 | 张昌轲 | 1/2 | 1/3 | | | | 0/1 | 1/1 | 3/7 | 42.9 | 2 | 8 | | | | 15 | 王钟彬 | 15 | 18:38 | 9 | 13 徐峻清 |
| 4 | 张洋 | | | | | | | | | | | | | | | 15 | 王钟彬 | 15 | 19:38 | 10 | 3 张昌轲 |
| 5 | 尹一楠 | | | | | | | | | | | | | | | 10 | 王钟彬 | 16 | 20:02 | 10 | |
| 6 | 吴昊 | 1/4 | 2/3 | | | | | 3/7 | 42.9 | 2 | 5 | 1 | | | | 10 | 王钟彬 | 16 | 20:26 | 11 | 7 姜钦 |
| 7 | 姜钦 | 3/13 | 3/7 | | | | 0/1 | 6/21 | 28.6 | 3 | 2 | | 1 | | | 10 | 王钟彬 | 17 | 21:20 | 11 | |
| 8 | 邹峻楠 | | | | | | | | | | | | | | | 10 | 王钟彬 | 18 | 21:47 | 11 | |
| 9 | 李天枢 | | | | | | | | | | | | | | | 5 | 徐伟 | 19 | 22:59 | 11 | |
| 10 | 范保坤 | | 2/2 | 4/5 | 0/1 | | | 6/8 | 75.0 | | 1 | 1 | | | | 19 | 李龙吉 | 19 | 24:32 | 12 | 10 范保坤 |
| 11 | 王誌汉 | | 2/2 | 1/1 | 1/1 | | | 4/4 | 100 | | 3 | | | | | 19 | 李龙吉 | 19 | 25:33 | 13 | 14 孙耀琦 |
| 12 | 左子健 | | | | | | | | | | | | | | | 17 | 胡晋铭 | 20 | 25:58 | 13 | |
| 13 | 徐峻清 | | 3/6 | 3/3 | 2/2 | | | 8/11 | 72.7 | | | | | | | 20 | 谷通金 | 20 | 26:37 | 14 | 13 徐峻清 |
| 14 | 孙耀琦 | | 3/3 | | 1/1 | | | 2/3 | 6/7 | 85.7 | | | | | | 4 | 谷通金 | 21 | 28:28 | 14 | |
| 16 | 池猛 | | | | | | | | | | | | | | | 5 | 徐伟 | 22 | 29:04 | 14 | |
| 17 | 刘安宁 | | | | | | | | | | | | | | | 22 | 徐伟 | 22 | 29:37 | 15 | 10 范保坤 |
| 运动员 合计 | | 5/19 | 16/26 | 8/9 | 4/5 | 0/2 | 3/4 | 36/65 | 55.4 | 7 | 24 | 3 | 1 | 1 | | 10 | 王钟彬 | 23 | 29:45 | 15 | |
| 1 | 郭梦雨 | 2/8 | 2/9 | 1/2 | 0/9 | 1/3 | 0/1 | 6/32 | 18.8 | | | | | | | 23 | 徐伟 | 23 | 00:26 | 16 | 7 姜钦 |
| 12 | 左子健 | 3/5 | 4/10 | 2/4 | 3/7 | 1/1 | | 13/27 | 48.1 | | 1 | | | | | 5 | 徐伟 | 24 | 01:11 | 16 | |
| 守门员 合计 | | 5/13 | 6/19 | 3/6 | 3/16 | 2/4 | 0/1 | 19/59 | 32.2 | | 1 | | | | | 5 | 徐伟 | 25 | 02:39 | 16 | |

场上队员：得分 / 射门

守门员：救球 / 射门

| | | | | | | | | | |
|----|------------|----|--------------|-----|------------|-----|----------|----|---------|
| 快攻 | Fast Break | 突破 | Breakthrough | 任意球 | Free Throw | 7M球 | 7M Throw | 助攻 | Assist |
| 警告 | Warning | 失误 | Error | 2' | Suspension | D | 取消资格 | DR | 取消资格+报告 |





2016年“体彩杯”全国手球男子青年锦标赛 图式比赛技术统计表

轮次 5

场次 34

201602034-21-1/1

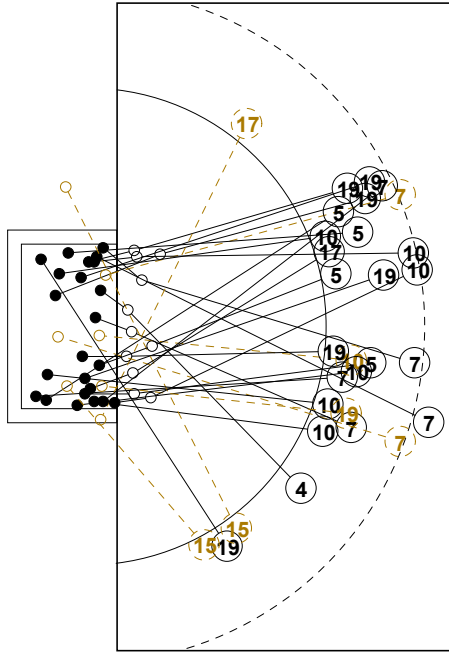

7M 新疆

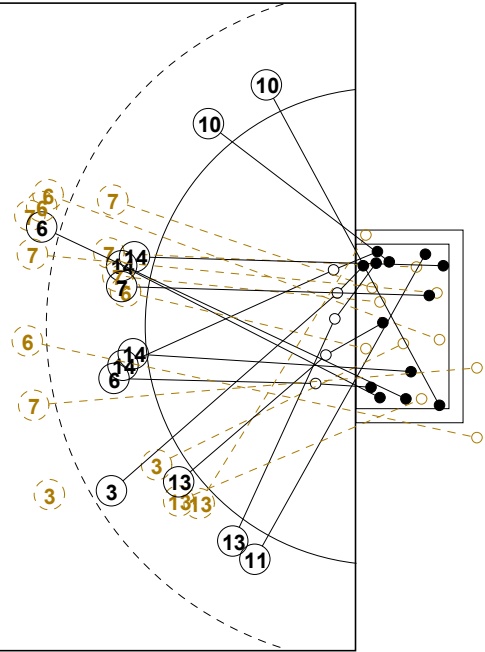
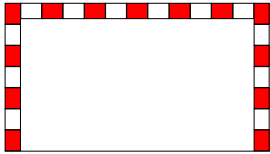

解放军 7M

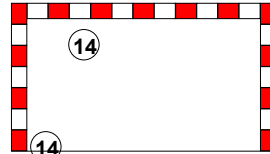

1st Half
23 : 15

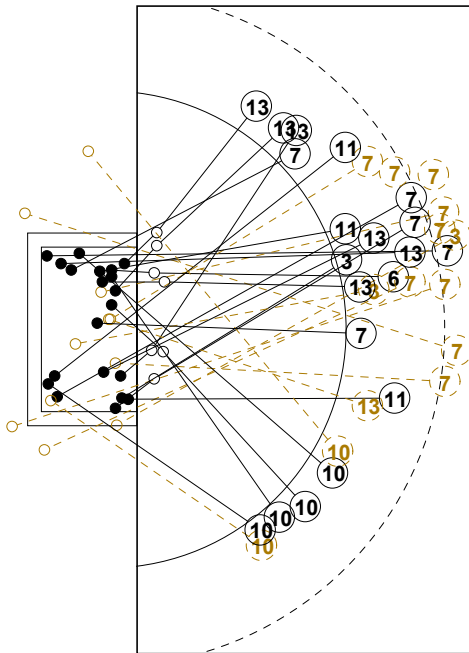

7M 解放军

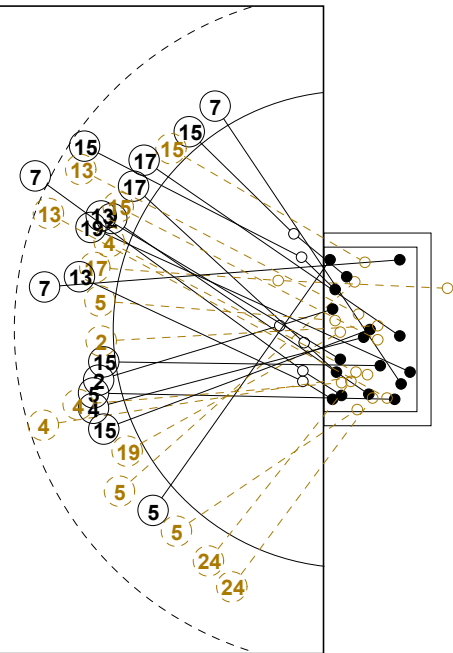
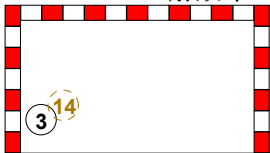

新疆 7M

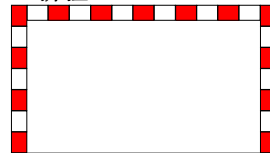

2nd Half
36 : 40



2016年“体彩杯”全国手球男子青年锦标赛

个人/全队技术统计表

正式表
手球
青年男子四分之一决赛
轮次 5组别 X
场次 34201602034-14-1/2
重庆万州
26/03/2016 14:30

| 号码 | 姓名 | 远射 | 近射 | 边射 | 快攻 | 突破 | 任意 | 7M | 合计 | % | 助攻 | 失误 | 警告 | 2' | 取消 | 时间 |
|----------------|-----|------|-------|-----|-------|-----|-----|-----|-------|-------|----|----|----|----|----|----------|
| 新疆队(新疆) | | | | | | | | | | | | | | | | |
| <i>(场上队员)</i> | | | | | | | | | | | | | | | | |
| 1 | 宋晓晨 | | | | | | | | | 0.0% | 4 | | | | | 00:41:13 |
| 2 | 王泽川 | | 1/2 | | 1/1 | | | | 2/3 | 66.7% | | | | 1 | | 00:18:47 |
| 4 | 谷通金 | 0/1 | 2/2 | | 0/1 | 0/1 | | | 2/5 | 40.0% | | | | | | 00:23:05 |
| 5 | 徐伟 | | 1/1 | | 5/7 | 0/1 | | | 6/9 | 66.7% | | 1 | | | | 00:41:13 |
| 6 | 白光宇 | | | | | | | | | 0.0% | | | | | | 00:00:00 |
| 7 | 林豪文 | 4/6 | | 1/1 | 1/1 | 1/1 | 1/1 | | 8/10 | 80.0% | 2 | 2 | 1 | | | 00:41:13 |
| 10 | 王钟彬 | 2/2 | 2/3 | | 1/1 | 1/1 | | | 6/7 | 85.7% | 1 | 3 | | | | 00:41:13 |
| 12 | 王金鑫 | | | | | | | | | 0.0% | | | | | | 00:00:00 |
| 13 | 苏兴伟 | 0/2 | 2/2 | | | | | | 2/4 | 50.0% | | | | | | 00:18:47 |
| 15 | 王维东 | 1/1 | 0/2 | 1/3 | 2/2 | | | | 4/8 | 50.0% | 1 | 3 | | | | 00:55:41 |
| 16 | 李佳懿 | | | | | | | | | 0.0% | | | | | | 00:18:47 |
| 17 | 胡晋铭 | | 3/4 | 0/1 | | | | | 3/5 | 60.0% | 1 | | 1 | | | 00:41:13 |
| 18 | 李万兴 | | | | | | | | | 0.0% | | 3 | | | | 00:18:47 |
| 19 | 李龙吉 | 1/1 | 2/4 | 1/1 | 3/3 | | | | 7/9 | 77.8% | 2 | 5 | 1 | | | 00:41:13 |
| 24 | 陈伟华 | | | 0/2 | | | | | 0/2 | 0.0% | | | | 1 | | 00:18:47 |
| 合计 | | 8/13 | 13/20 | 3/8 | 13/16 | 2/4 | 1/1 | | 40/62 | 64.5% | 11 | 17 | 3 | 2 | | |
| <i>(守门员)</i> | | | | | | | | | | | | | | | | |
| 1 | 宋晓晨 | 4/9 | 6/14 | 1/5 | 0/2 | | | 0/3 | 11/33 | 33.3% | 4 | | | | | 00:41:13 |
| 16 | 李佳懿 | 1/1 | 2/10 | 0/4 | 0/2 | | | 1/1 | 4/18 | 22.2% | | | | | | 00:18:47 |
| 合计 | | 5/10 | 8/24 | 1/9 | 0/4 | | | 1/4 | 15/51 | 29.4% | 4 | | | | | |

场上队员：得分/射门

守门员：救球/射门

| 全队合计 | 得分 | 被救 | 射失 | 击柱 | 封球 | 合计 | % |
|------|----|----|----|----|----|----|--------|
| 远射 | 8 | 5 | | | | 13 | 61.5% |
| 近射 | 13 | 6 | 1 | | | 20 | 65.0% |
| 边射 | 3 | 3 | 1 | 1 | | 8 | 37.5% |
| 快攻 | 13 | 3 | | | | 16 | 81.3% |
| 突破 | 2 | 2 | | | | 4 | 50.0% |
| 任意 | 1 | | | | | 1 | 100.0% |
| 7M | | | | | | | 0.0% |





2016年“体彩杯”全国手球男子青年锦标赛

个人/全队技术统计表

正式表
手球
青年男子四分之一决赛
轮次 5组别 X
场次 34201602034-14-2/2
重庆万州
26/03/2016 14:30

| 号码 | 姓名 | 远射 | 近射 | 边射 | 快攻 | 突破 | 任意 | 7M | 合计 | % | 助攻 | 失误 | 警告 | 2' | 取消 | 时间 |
|------------------|-----|------|-------|-----|------|-----|-----|-----|-------|-------|----|----|----|----|----|----------|
| 解放军队(解放军) | | | | | | | | | | | | | | | | |
| <i>(上场队员)</i> | | | | | | | | | | | | | | | | |
| 1 | 郭梦雨 | | | | | | | | | 0.0% | | | | | | 00:33:08 |
| 3 | 张昌轲 | 1/2 | 1/3 | | | | 0/1 | 1/1 | 3/7 | 42.9% | 2 | 8 | | | | 01:00:00 |
| 4 | 张洋 | | | | | | | | | 0.0% | | | | | | 00:00:00 |
| 5 | 尹一楠 | | | | | | | | | 0.0% | | | | | | 00:00:00 |
| 6 | 吴昊 | 1/4 | 2/3 | | | | | | 3/7 | 42.9% | 2 | 5 | 1 | | | 00:47:54 |
| 7 | 姜钦 | 3/13 | 3/7 | | | | 0/1 | | 6/21 | 28.6% | 3 | 2 | | 1 | | 01:00:00 |
| 8 | 邹峻楠 | | | | | | | | | 0.0% | | | | | | 00:00:00 |
| 9 | 李天枢 | | | | | | | | | 0.0% | | | | | | 00:00:00 |
| 10 | 范保坤 | | 2/2 | 4/5 | 0/1 | | | | 6/8 | 75.0% | | 1 | 1 | | | 01:00:00 |
| 11 | 王誌汉 | | 2/2 | 1/1 | 1/1 | | | | 4/4 | 100% | | 3 | | | | 00:21:45 |
| 12 | 左子健 | | | | | | | | | 0.0% | | 1 | | | | 00:26:52 |
| 13 | 徐崧清 | | 3/6 | 3/3 | 2/2 | | | | 8/11 | 72.7% | | 4 | | | | 00:50:18 |
| 14 | 孙耀琦 | | 3/3 | | 1/1 | | | 2/3 | 6/7 | 85.7% | | | 1 | | | 01:00:00 |
| 16 | 池猛 | | | | | | | | | 0.0% | | | | | | 00:00:00 |
| 17 | 刘安宁 | | | | | | | | | 0.0% | | | | | | 00:00:00 |
| 合计 | | 5/19 | 16/26 | 8/9 | 4/5 | | 0/2 | 3/4 | 36/65 | 55.4% | 7 | 24 | 3 | 1 | | |
| <i>(守门员)</i> | | | | | | | | | | | | | | | | |
| 1 | 郭梦雨 | 2/8 | 2/9 | 1/2 | 0/9 | 1/3 | 0/1 | | 6/32 | 18.8% | | | | | | 00:33:08 |
| 12 | 左子健 | 3/5 | 4/10 | 2/4 | 3/7 | 1/1 | | | 13/27 | 48.1% | | 1 | | | | 00:26:52 |
| 合计 | | 5/13 | 6/19 | 3/6 | 3/16 | 2/4 | 0/1 | | 19/59 | 32.2% | | 1 | | | | |

场上队员：得分/射门

守门员：救球/射门

| 全队合计 | 得分 | 被救 | 射失 | 击柱 | 封球 | 合计 | % |
|------|----|----|----|----|----|----|-------|
| 远射 | 5 | 5 | 3 | | 6 | 19 | 26.3% |
| 近射 | 16 | 8 | 1 | 1 | | 26 | 61.5% |
| 边射 | 8 | 1 | | | | 9 | 88.9% |
| 快攻 | 4 | | 1 | | | 5 | 80.0% |
| 突破 | | | | | | | 0.0% |
| 任意 | | | 1 | 1 | | 2 | 0.0% |
| 7M | 3 | 1 | | | | 4 | 75.0% |





2016年“体彩杯”全国手球男子青年锦标赛

图式射门区域统计

轮次 5 场次 34

201602034-41-1/1

新疆队

| | | | | | | | | | | | | | | | | | | | | | | | | | | | | | | | | | | | | | | | | | | | | | | | | | | | | | | | | | | | | | | | | | | | | | | | | | | | | | | | |
|---|-----------------------------|-----------------------------|-----------------------------|-----------------------------|-----------------------------|-----------------------------|-----------------------------|--|---|---|--|--|--|--|---|---|---|---|--|--|--|--|--|--|---|--|--|--|---|---|---|---|---|---|--|---|---|--|---|--|--|--|--|--|--|--|--|--|--|---|---|--|---|---|--|---|---|---|---|---|---|--|--|---|--|---|---|--|---|--|--|--|--|--|--|--|--|--|--|
| 1 宋晓晨 | 2 王泽川 | 4 谷通金 | 5 徐伟 | 6 白光宇 | 7 林豪文 | 10 王钟彬 | 12 王金鑫 | | | | | | | | | | | | | | | | | | | | | | | | | | | | | | | | | | | | | | | | | | | | | | | | | | | | | | | | | | | | | | | | | | | | | | | | |
| <table border="1"><tr><td></td><td></td><td></td></tr><tr><td></td><td></td><td></td></tr><tr><td></td><td></td><td></td></tr></table> | | | | | | | | | | <table border="1"><tr><td></td><td></td><td></td></tr><tr><td></td><td></td><td>1</td></tr><tr><td></td><td>1</td><td></td></tr></table> | | | | | | 1 | | 1 | | <table border="1"><tr><td></td><td></td><td></td></tr><tr><td></td><td>1</td><td></td></tr><tr><td></td><td></td><td>1</td></tr></table> | | | | | 1 | | | | 1 | <table border="1"><tr><td>1</td><td></td><td>1</td></tr><tr><td>1</td><td></td><td>1</td></tr><tr><td>2</td><td></td><td></td></tr></table> | 1 | | 1 | 1 | | 1 | 2 | | | <table border="1"><tr><td></td><td></td><td></td></tr><tr><td></td><td></td><td></td></tr><tr><td></td><td></td><td></td></tr></table> | | | | | | | | | | <table border="1"><tr><td>2</td><td></td><td>1</td></tr><tr><td></td><td></td><td></td></tr><tr><td>1</td><td>1</td><td>3</td></tr></table> | 2 | | 1 | | | | 1 | 1 | 3 | <table border="1"><tr><td>1</td><td></td><td></td></tr><tr><td>1</td><td></td><td>1</td></tr><tr><td>2</td><td></td><td>1</td></tr></table> | 1 | | | 1 | | 1 | 2 | | 1 | <table border="1"><tr><td></td><td></td><td></td></tr><tr><td></td><td></td><td></td></tr><tr><td></td><td></td><td></td></tr></table> | | | | | | | | | |
| | | | | | | | | | | | | | | | | | | | | | | | | | | | | | | | | | | | | | | | | | | | | | | | | | | | | | | | | | | | | | | | | | | | | | | | | | | | | | | | |
| | | | | | | | | | | | | | | | | | | | | | | | | | | | | | | | | | | | | | | | | | | | | | | | | | | | | | | | | | | | | | | | | | | | | | | | | | | | | | | | |
| | | | | | | | | | | | | | | | | | | | | | | | | | | | | | | | | | | | | | | | | | | | | | | | | | | | | | | | | | | | | | | | | | | | | | | | | | | | | | | | |
| | | | | | | | | | | | | | | | | | | | | | | | | | | | | | | | | | | | | | | | | | | | | | | | | | | | | | | | | | | | | | | | | | | | | | | | | | | | | | | | |
| | | 1 | | | | | | | | | | | | | | | | | | | | | | | | | | | | | | | | | | | | | | | | | | | | | | | | | | | | | | | | | | | | | | | | | | | | | | | | | | | | | |
| | 1 | | | | | | | | | | | | | | | | | | | | | | | | | | | | | | | | | | | | | | | | | | | | | | | | | | | | | | | | | | | | | | | | | | | | | | | | | | | | | | |
| | | | | | | | | | | | | | | | | | | | | | | | | | | | | | | | | | | | | | | | | | | | | | | | | | | | | | | | | | | | | | | | | | | | | | | | | | | | | | | | |
| | 1 | | | | | | | | | | | | | | | | | | | | | | | | | | | | | | | | | | | | | | | | | | | | | | | | | | | | | | | | | | | | | | | | | | | | | | | | | | | | | | |
| | | 1 | | | | | | | | | | | | | | | | | | | | | | | | | | | | | | | | | | | | | | | | | | | | | | | | | | | | | | | | | | | | | | | | | | | | | | | | | | | | | |
| 1 | | 1 | | | | | | | | | | | | | | | | | | | | | | | | | | | | | | | | | | | | | | | | | | | | | | | | | | | | | | | | | | | | | | | | | | | | | | | | | | | | | |
| 1 | | 1 | | | | | | | | | | | | | | | | | | | | | | | | | | | | | | | | | | | | | | | | | | | | | | | | | | | | | | | | | | | | | | | | | | | | | | | | | | | | | |
| 2 | | | | | | | | | | | | | | | | | | | | | | | | | | | | | | | | | | | | | | | | | | | | | | | | | | | | | | | | | | | | | | | | | | | | | | | | | | | | | | | |
| | | | | | | | | | | | | | | | | | | | | | | | | | | | | | | | | | | | | | | | | | | | | | | | | | | | | | | | | | | | | | | | | | | | | | | | | | | | | | | | |
| | | | | | | | | | | | | | | | | | | | | | | | | | | | | | | | | | | | | | | | | | | | | | | | | | | | | | | | | | | | | | | | | | | | | | | | | | | | | | | | |
| | | | | | | | | | | | | | | | | | | | | | | | | | | | | | | | | | | | | | | | | | | | | | | | | | | | | | | | | | | | | | | | | | | | | | | | | | | | | | | | |
| 2 | | 1 | | | | | | | | | | | | | | | | | | | | | | | | | | | | | | | | | | | | | | | | | | | | | | | | | | | | | | | | | | | | | | | | | | | | | | | | | | | | | |
| | | | | | | | | | | | | | | | | | | | | | | | | | | | | | | | | | | | | | | | | | | | | | | | | | | | | | | | | | | | | | | | | | | | | | | | | | | | | | | | |
| 1 | 1 | 3 | | | | | | | | | | | | | | | | | | | | | | | | | | | | | | | | | | | | | | | | | | | | | | | | | | | | | | | | | | | | | | | | | | | | | | | | | | | | | |
| 1 | | | | | | | | | | | | | | | | | | | | | | | | | | | | | | | | | | | | | | | | | | | | | | | | | | | | | | | | | | | | | | | | | | | | | | | | | | | | | | | |
| 1 | | 1 | | | | | | | | | | | | | | | | | | | | | | | | | | | | | | | | | | | | | | | | | | | | | | | | | | | | | | | | | | | | | | | | | | | | | | | | | | | | | |
| 2 | | 1 | | | | | | | | | | | | | | | | | | | | | | | | | | | | | | | | | | | | | | | | | | | | | | | | | | | | | | | | | | | | | | | | | | | | | | | | | | | | | |
| | | | | | | | | | | | | | | | | | | | | | | | | | | | | | | | | | | | | | | | | | | | | | | | | | | | | | | | | | | | | | | | | | | | | | | | | | | | | | | | |
| | | | | | | | | | | | | | | | | | | | | | | | | | | | | | | | | | | | | | | | | | | | | | | | | | | | | | | | | | | | | | | | | | | | | | | | | | | | | | | | |
| | | | | | | | | | | | | | | | | | | | | | | | | | | | | | | | | | | | | | | | | | | | | | | | | | | | | | | | | | | | | | | | | | | | | | | | | | | | | | | | |
| Post - 0 Miss - 0 Block - 0 | Post - 0 Miss - 0 Block - 0 | Post - 0 Miss - 0 Block - 0 | Post - 0 Miss - 0 Block - 0 | Post - 0 Miss - 0 Block - 0 | Post - 0 Miss - 0 Block - 0 | Post - 0 Miss - 0 Block - 0 | Post - 0 Miss - 0 Block - 0 | | | | | | | | | | | | | | | | | | | | | | | | | | | | | | | | | | | | | | | | | | | | | | | | | | | | | | | | | | | | | | | | | | | | | | | | |
| 13 苏兴伟 | 15 王维东 | 16 李佳懿 | 17 胡晋铭 | 18 李万兴 | 19 李龙吉 | 24 陈伟华 | | | | | | | | | | | | | | | | | | | | | | | | | | | | | | | | | | | | | | | | | | | | | | | | | | | | | | | | | | | | | | | | | | | | | | | | | |
| <table border="1"><tr><td></td><td></td><td></td></tr><tr><td></td><td></td><td></td></tr><tr><td></td><td></td><td>2</td></tr></table> | | | | | | | | | 2 | <table border="1"><tr><td></td><td></td><td></td></tr><tr><td></td><td>1</td><td>1</td></tr><tr><td>2</td><td></td><td></td></tr></table> | | | | | 1 | 1 | 2 | | | <table border="1"><tr><td></td><td></td><td></td></tr><tr><td></td><td></td><td></td></tr><tr><td></td><td></td><td></td></tr></table> | | | | | | | | | | <table border="1"><tr><td></td><td>1</td><td></td></tr><tr><td></td><td></td><td></td></tr><tr><td>1</td><td></td><td>1</td></tr></table> | | 1 | | | | | 1 | | 1 | <table border="1"><tr><td></td><td></td><td></td></tr><tr><td></td><td></td><td></td></tr><tr><td></td><td></td><td></td></tr></table> | | | | | | | | | | <table border="1"><tr><td></td><td></td><td>2</td></tr><tr><td>2</td><td></td><td>2</td></tr><tr><td></td><td></td><td>1</td></tr></table> | | | 2 | 2 | | 2 | | | 1 | <table border="1"><tr><td></td><td></td><td></td></tr><tr><td></td><td></td><td></td></tr><tr><td></td><td></td><td></td></tr></table> | | | | | | | | | | <table border="1"><tr><td></td><td></td><td></td></tr><tr><td></td><td></td><td></td></tr><tr><td></td><td></td><td></td></tr></table> | | | | | | | | | |
| | | | | | | | | | | | | | | | | | | | | | | | | | | | | | | | | | | | | | | | | | | | | | | | | | | | | | | | | | | | | | | | | | | | | | | | | | | | | | | | |
| | | | | | | | | | | | | | | | | | | | | | | | | | | | | | | | | | | | | | | | | | | | | | | | | | | | | | | | | | | | | | | | | | | | | | | | | | | | | | | | |
| | | 2 | | | | | | | | | | | | | | | | | | | | | | | | | | | | | | | | | | | | | | | | | | | | | | | | | | | | | | | | | | | | | | | | | | | | | | | | | | | | | |
| | | | | | | | | | | | | | | | | | | | | | | | | | | | | | | | | | | | | | | | | | | | | | | | | | | | | | | | | | | | | | | | | | | | | | | | | | | | | | | | |
| | 1 | 1 | | | | | | | | | | | | | | | | | | | | | | | | | | | | | | | | | | | | | | | | | | | | | | | | | | | | | | | | | | | | | | | | | | | | | | | | | | | | | |
| 2 | | | | | | | | | | | | | | | | | | | | | | | | | | | | | | | | | | | | | | | | | | | | | | | | | | | | | | | | | | | | | | | | | | | | | | | | | | | | | | | |
| | | | | | | | | | | | | | | | | | | | | | | | | | | | | | | | | | | | | | | | | | | | | | | | | | | | | | | | | | | | | | | | | | | | | | | | | | | | | | | | |
| | | | | | | | | | | | | | | | | | | | | | | | | | | | | | | | | | | | | | | | | | | | | | | | | | | | | | | | | | | | | | | | | | | | | | | | | | | | | | | | |
| | | | | | | | | | | | | | | | | | | | | | | | | | | | | | | | | | | | | | | | | | | | | | | | | | | | | | | | | | | | | | | | | | | | | | | | | | | | | | | | |
| | 1 | | | | | | | | | | | | | | | | | | | | | | | | | | | | | | | | | | | | | | | | | | | | | | | | | | | | | | | | | | | | | | | | | | | | | | | | | | | | | | |
| | | | | | | | | | | | | | | | | | | | | | | | | | | | | | | | | | | | | | | | | | | | | | | | | | | | | | | | | | | | | | | | | | | | | | | | | | | | | | | | |
| 1 | | 1 | | | | | | | | | | | | | | | | | | | | | | | | | | | | | | | | | | | | | | | | | | | | | | | | | | | | | | | | | | | | | | | | | | | | | | | | | | | | | |
| | | | | | | | | | | | | | | | | | | | | | | | | | | | | | | | | | | | | | | | | | | | | | | | | | | | | | | | | | | | | | | | | | | | | | | | | | | | | | | | |
| | | | | | | | | | | | | | | | | | | | | | | | | | | | | | | | | | | | | | | | | | | | | | | | | | | | | | | | | | | | | | | | | | | | | | | | | | | | | | | | |
| | | | | | | | | | | | | | | | | | | | | | | | | | | | | | | | | | | | | | | | | | | | | | | | | | | | | | | | | | | | | | | | | | | | | | | | | | | | | | | | |
| | | 2 | | | | | | | | | | | | | | | | | | | | | | | | | | | | | | | | | | | | | | | | | | | | | | | | | | | | | | | | | | | | | | | | | | | | | | | | | | | | | |
| 2 | | 2 | | | | | | | | | | | | | | | | | | | | | | | | | | | | | | | | | | | | | | | | | | | | | | | | | | | | | | | | | | | | | | | | | | | | | | | | | | | | | |
| | | 1 | | | | | | | | | | | | | | | | | | | | | | | | | | | | | | | | | | | | | | | | | | | | | | | | | | | | | | | | | | | | | | | | | | | | | | | | | | | | | |
| | | | | | | | | | | | | | | | | | | | | | | | | | | | | | | | | | | | | | | | | | | | | | | | | | | | | | | | | | | | | | | | | | | | | | | | | | | | | | | | |
| | | | | | | | | | | | | | | | | | | | | | | | | | | | | | | | | | | | | | | | | | | | | | | | | | | | | | | | | | | | | | | | | | | | | | | | | | | | | | | | |
| | | | | | | | | | | | | | | | | | | | | | | | | | | | | | | | | | | | | | | | | | | | | | | | | | | | | | | | | | | | | | | | | | | | | | | | | | | | | | | | |
| | | | | | | | | | | | | | | | | | | | | | | | | | | | | | | | | | | | | | | | | | | | | | | | | | | | | | | | | | | | | | | | | | | | | | | | | | | | | | | | |
| | | | | | | | | | | | | | | | | | | | | | | | | | | | | | | | | | | | | | | | | | | | | | | | | | | | | | | | | | | | | | | | | | | | | | | | | | | | | | | | |
| | | | | | | | | | | | | | | | | | | | | | | | | | | | | | | | | | | | | | | | | | | | | | | | | | | | | | | | | | | | | | | | | | | | | | | | | | | | | | | | |
| Post - 0 Miss - 0 Block - 0 | Post - 0 Miss - 1 Block - 0 | Post - 0 Miss - 0 Block - 0 | Post - 1 Miss - 1 Block - 0 | Post - 0 Miss - 0 Block - 0 | Post - 0 Miss - 0 Block - 0 | Post - 0 Miss - 0 Block - 0 | | | | | | | | | | | | | | | | | | | | | | | | | | | | | | | | | | | | | | | | | | | | | | | | | | | | | | | | | | | | | | | | | | | | | | | | | |

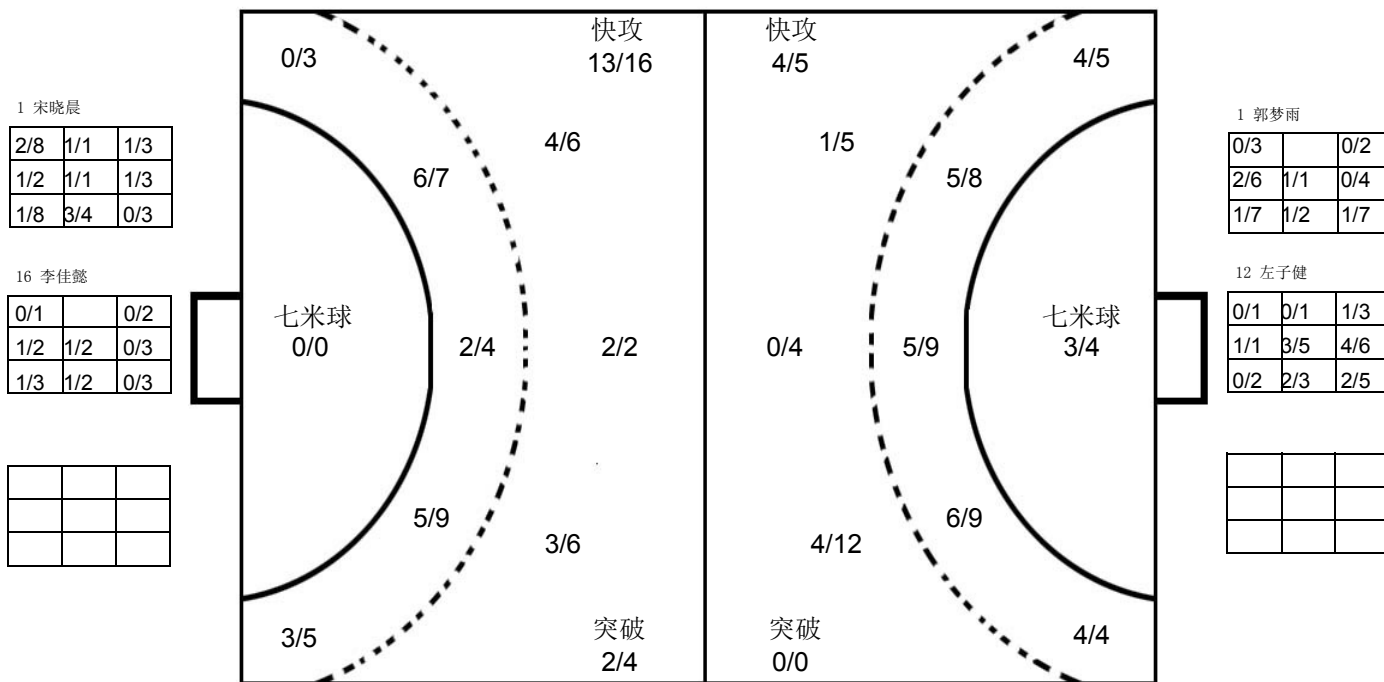

解放军队

| | | | | | | | | | | | | | | | | | | | | | | | | | | | | | | | | | | | | | | | | | | | | | | | | | | | | | | | | | | | | | | | | | | | | | | | | | | | | | | | |
|--|-----------------------------|-----------------------------|-----------------------------|-----------------------------|-----------------------------|-----------------------------|-----------------------------|---|---|---|---|--|--|--|--|---|---|--|--|--|--|--|--|--|--|--|--|--|--|--|--|--|---|---|--|---|---|---|---|--|---|--|--|--|--|---|---|--|---|--|---|--|---|--|---|--|---|--|--|--|--|--|--|--|--|--|--|--|--|--|--|--|--|--|--|--|--|--|--|
| 1 郭梦雨 | 3 张昌柯 | 4 张洋 | 5 尹一楠 | 6 吴昊 | 7 姜钦 | 8 邹峻楠 | 9 李天枢 | | | | | | | | | | | | | | | | | | | | | | | | | | | | | | | | | | | | | | | | | | | | | | | | | | | | | | | | | | | | | | | | | | | | | | | | |
| <table border="1"><tr><td></td><td></td><td></td></tr><tr><td></td><td></td><td></td></tr><tr><td></td><td></td><td></td></tr></table> | | | | | | | | | | <table border="1"><tr><td></td><td></td><td></td></tr><tr><td></td><td></td><td></td></tr><tr><td>3</td><td></td><td></td></tr></table> | | | | | | | 3 | | | <table border="1"><tr><td></td><td></td><td></td></tr><tr><td></td><td></td><td></td></tr><tr><td></td><td></td><td></td></tr></table> | | | | | | | | | | <table border="1"><tr><td></td><td></td><td></td></tr><tr><td></td><td></td><td></td></tr><tr><td></td><td></td><td></td></tr></table> | | | | | | | | | | <table border="1"><tr><td></td><td></td><td></td></tr><tr><td></td><td></td><td>1</td></tr><tr><td></td><td></td><td>2</td></tr></table> | | | | | | 1 | | | 2 | <table border="1"><tr><td>2</td><td></td><td>2</td></tr><tr><td></td><td>1</td><td></td></tr><tr><td>1</td><td></td><td></td></tr></table> | 2 | | 2 | | 1 | | 1 | | | <table border="1"><tr><td></td><td></td><td></td></tr><tr><td></td><td></td><td></td></tr><tr><td></td><td></td><td></td></tr></table> | | | | | | | | | | <table border="1"><tr><td></td><td></td><td></td></tr><tr><td></td><td></td><td></td></tr><tr><td></td><td></td><td></td></tr></table> | | | | | | | | | |
| | | | | | | | | | | | | | | | | | | | | | | | | | | | | | | | | | | | | | | | | | | | | | | | | | | | | | | | | | | | | | | | | | | | | | | | | | | | | | | | |
| | | | | | | | | | | | | | | | | | | | | | | | | | | | | | | | | | | | | | | | | | | | | | | | | | | | | | | | | | | | | | | | | | | | | | | | | | | | | | | | |
| | | | | | | | | | | | | | | | | | | | | | | | | | | | | | | | | | | | | | | | | | | | | | | | | | | | | | | | | | | | | | | | | | | | | | | | | | | | | | | | |
| | | | | | | | | | | | | | | | | | | | | | | | | | | | | | | | | | | | | | | | | | | | | | | | | | | | | | | | | | | | | | | | | | | | | | | | | | | | | | | | |
| | | | | | | | | | | | | | | | | | | | | | | | | | | | | | | | | | | | | | | | | | | | | | | | | | | | | | | | | | | | | | | | | | | | | | | | | | | | | | | | |
| 3 | | | | | | | | | | | | | | | | | | | | | | | | | | | | | | | | | | | | | | | | | | | | | | | | | | | | | | | | | | | | | | | | | | | | | | | | | | | | | | | |
| | | | | | | | | | | | | | | | | | | | | | | | | | | | | | | | | | | | | | | | | | | | | | | | | | | | | | | | | | | | | | | | | | | | | | | | | | | | | | | | |
| | | | | | | | | | | | | | | | | | | | | | | | | | | | | | | | | | | | | | | | | | | | | | | | | | | | | | | | | | | | | | | | | | | | | | | | | | | | | | | | |
| | | | | | | | | | | | | | | | | | | | | | | | | | | | | | | | | | | | | | | | | | | | | | | | | | | | | | | | | | | | | | | | | | | | | | | | | | | | | | | | |
| | | | | | | | | | | | | | | | | | | | | | | | | | | | | | | | | | | | | | | | | | | | | | | | | | | | | | | | | | | | | | | | | | | | | | | | | | | | | | | | |
| | | | | | | | | | | | | | | | | | | | | | | | | | | | | | | | | | | | | | | | | | | | | | | | | | | | | | | | | | | | | | | | | | | | | | | | | | | | | | | | |
| | | | | | | | | | | | | | | | | | | | | | | | | | | | | | | | | | | | | | | | | | | | | | | | | | | | | | | | | | | | | | | | | | | | | | | | | | | | | | | | |
| | | | | | | | | | | | | | | | | | | | | | | | | | | | | | | | | | | | | | | | | | | | | | | | | | | | | | | | | | | | | | | | | | | | | | | | | | | | | | | | |
| | | 1 | | | | | | | | | | | | | | | | | | | | | | | | | | | | | | | | | | | | | | | | | | | | | | | | | | | | | | | | | | | | | | | | | | | | | | | | | | | | | |
| | | 2 | | | | | | | | | | | | | | | | | | | | | | | | | | | | | | | | | | | | | | | | | | | | | | | | | | | | | | | | | | | | | | | | | | | | | | | | | | | | | |
| 2 | | 2 | | | | | | | | | | | | | | | | | | | | | | | | | | | | | | | | | | | | | | | | | | | | | | | | | | | | | | | | | | | | | | | | | | | | | | | | | | | | | |
| | 1 | | | | | | | | | | | | | | | | | | | | | | | | | | | | | | | | | | | | | | | | | | | | | | | | | | | | | | | | | | | | | | | | | | | | | | | | | | | | | | |
| 1 | | | | | | | | | | | | | | | | | | | | | | | | | | | | | | | | | | | | | | | | | | | | | | | | | | | | | | | | | | | | | | | | | | | | | | | | | | | | | | | |
| | | | | | | | | | | | | | | | | | | | | | | | | | | | | | | | | | | | | | | | | | | | | | | | | | | | | | | | | | | | | | | | | | | | | | | | | | | | | | | | |
| | | | | | | | | | | | | | | | | | | | | | | | | | | | | | | | | | | | | | | | | | | | | | | | | | | | | | | | | | | | | | | | | | | | | | | | | | | | | | | | |
| | | | | | | | | | | | | | | | | | | | | | | | | | | | | | | | | | | | | | | | | | | | | | | | | | | | | | | | | | | | | | | | | | | | | | | | | | | | | | | | |
| | | | | | | | | | | | | | | | | | | | | | | | | | | | | | | | | | | | | | | | | | | | | | | | | | | | | | | | | | | | | | | | | | | | | | | | | | | | | | | | |
| | | | | | | | | | | | | | | | | | | | | | | | | | | | | | | | | | | | | | | | | | | | | | | | | | | | | | | | | | | | | | | | | | | | | | | | | | | | | | | | |
| | | | | | | | | | | | | | | | | | | | | | | | | | | | | | | | | | | | | | | | | | | | | | | | | | | | | | | | | | | | | | | | | | | | | | | | | | | | | | | | |
| Post - 0 Miss - 0 Block - 0 | Post - 1 Miss - 0 Block - 1 | Post - 0 Miss - 0 Block - 0 | Post - 0 Miss - 0 Block - 0 | Post - 0 Miss - 1 Block - 1 | Post - 0 Miss - 4 Block - 4 | Post - 0 Miss - 0 Block - 0 | Post - 0 Miss - 0 Block - 0 | | | | | | | | | | | | | | | | | | | | | | | | | | | | | | | | | | | | | | | | | | | | | | | | | | | | | | | | | | | | | | | | | | | | | | | | |
| 10 范保坤 | 11 王誌汉 | 12 左子健 | 13 徐峻清 | 14 孙耀琦 | 16 池猛 | 17 刘安宁 | | | | | | | | | | | | | | | | | | | | | | | | | | | | | | | | | | | | | | | | | | | | | | | | | | | | | | | | | | | | | | | | | | | | | | | | | |
| <table border="1"><tr><td>1</td><td></td><td>1</td></tr><tr><td>1</td><td></td><td>1</td></tr><tr><td></td><td>1</td><td>1</td></tr></table> | 1 | | 1 | 1 | | 1 | | 1 | 1 | <table border="1"><tr><td>2</td><td></td><td></td></tr><tr><td></td><td></td><td>1</td></tr><tr><td>1</td><td></td><td></td></tr></table> | 2 | | | | | 1 | 1 | | | <table border="1"><tr><td></td><td></td><td></td></tr><tr><td></td><td></td><td></td></tr><tr><td></td><td></td><td></td></tr></table> | | | | | | | | | | <table border="1"><tr><td></td><td></td><td>1</td></tr><tr><td>1</td><td></td><td>1</td></tr><tr><td>2</td><td>1</td><td>2</td></tr></table> | | | 1 | 1 | | 1 | 2 | 1 | 2 | <table border="1"><tr><td>2</td><td></td><td></td></tr><tr><td></td><td></td><td>1</td></tr><tr><td>2</td><td></td><td>1</td></tr></table> | 2 | | | | | 1 | 2 | | 1 | <table border="1"><tr><td></td><td></td><td></td></tr><tr><td></td><td></td><td></td></tr><tr><td></td><td></td><td></td></tr></table> | | | | | | | | | | <table border="1"><tr><td></td><td></td><td></td></tr><tr><td></td><td></td><td></td></tr><tr><td></td><td></td><td></td></tr></table> | | | | | | | | | | <table border="1"><tr><td></td><td></td><td></td></tr><tr><td></td><td></td><td></td></tr><tr><td></td><td></td><td></td></tr></table> | | | | | | | | | |
| 1 | | 1 | | | | | | | | | | | | | | | | | | | | | | | | | | | | | | | | | | | | | | | | | | | | | | | | | | | | | | | | | | | | | | | | | | | | | | | | | | | | | |
| 1 | | 1 | | | | | | | | | | | | | | | | | | | | | | | | | | | | | | | | | | | | | | | | | | | | | | | | | | | | | | | | | | | | | | | | | | | | | | | | | | | | | |
| | 1 | 1 | | | | | | | | | | | | | | | | | | | | | | | | | | | | | | | | | | | | | | | | | | | | | | | | | | | | | | | | | | | | | | | | | | | | | | | | | | | | | |
| 2 | | | | | | | | | | | | | | | | | | | | | | | | | | | | | | | | | | | | | | | | | | | | | | | | | | | | | | | | | | | | | | | | | | | | | | | | | | | | | | | |
| | | 1 | | | | | | | | | | | | | | | | | | | | | | | | | | | | | | | | | | | | | | | | | | | | | | | | | | | | | | | | | | | | | | | | | | | | | | | | | | | | | |
| 1 | | | | | | | | | | | | | | | | | | | | | | | | | | | | | | | | | | | | | | | | | | | | | | | | | | | | | | | | | | | | | | | | | | | | | | | | | | | | | | | |
| | | | | | | | | | | | | | | | | | | | | | | | | | | | | | | | | | | | | | | | | | | | | | | | | | | | | | | | | | | | | | | | | | | | | | | | | | | | | | | | |
| | | | | | | | | | | | | | | | | | | | | | | | | | | | | | | | | | | | | | | | | | | | | | | | | | | | | | | | | | | | | | | | | | | | | | | | | | | | | | | | |
| | | | | | | | | | | | | | | | | | | | | | | | | | | | | | | | | | | | | | | | | | | | | | | | | | | | | | | | | | | | | | | | | | | | | | | | | | | | | | | | |
| | | 1 | | | | | | | | | | | | | | | | | | | | | | | | | | | | | | | | | | | | | | | | | | | | | | | | | | | | | | | | | | | | | | | | | | | | | | | | | | | | | |
| 1 | | 1 | | | | | | | | | | | | | | | | | | | | | | | | | | | | | | | | | | | | | | | | | | | | | | | | | | | | | | | | | | | | | | | | | | | | | | | | | | | | | |
| 2 | 1 | 2 | | | | | | | | | | | | | | | | | | | | | | | | | | | | | | | | | | | | | | | | | | | | | | | | | | | | | | | | | | | | | | | | | | | | | | | | | | | | | |
| 2 | | | | | | | | | | | | | | | | | | | | | | | | | | | | | | | | | | | | | | | | | | | | | | | | | | | | | | | | | | | | | | | | | | | | | | | | | | | | | | | |
| | | 1 | | | | | | | | | | | | | | | | | | | | | | | | | | | | | | | | | | | | | | | | | | | | | | | | | | | | | | | | | | | | | | | | | | | | | | | | | | | | | |
| 2 | | 1 | | | | | | | | | | | | | | | | | | | | | | | | | | | | | | | | | | | | | | | | | | | | | | | | | | | | | | | | | | | | | | | | | | | | | | | | | | | | | |
| | | | | | | | | | | | | | | | | | | | | | | | | | | | | | | | | | | | | | | | | | | | | | | | | | | | | | | | | | | | | | | | | | | | | | | | | | | | | | | | |
| | | | | | | | | | | | | | | | | | | | | | | | | | | | | | | | | | | | | | | | | | | | | | | | | | | | | | | | | | | | | | | | | | | | | | | | | | | | | | | | |
| | | | | | | | | | | | | | | | | | | | | | | | | | | | | | | | | | | | | | | | | | | | | | | | | | | | | | | | | | | | | | | | | | | | | | | | | | | | | | | | |
| | | | | | | | | | | | | | | | | | | | | | | | | | | | | | | | | | | | | | | | | | | | | | | | | | | | | | | | | | | | | | | | | | | | | | | | | | | | | | | | |
| | | | | | | | | | | | | | | | | | | | | | | | | | | | | | | | | | | | | | | | | | | | | | | | | | | | | | | | | | | | | | | | | | | | | | | | | | | | | | | | |
| | | | | | | | | | | | | | | | | | | | | | | | | | | | | | | | | | | | | | | | | | | | | | | | | | | | | | | | | | | | | | | | | | | | | | | | | | | | | | | | |
| | | | | | | | | | | | | | | | | | | | | | | | | | | | | | | | | | | | | | | | | | | | | | | | | | | | | | | | | | | | | | | | | | | | | | | | | | | | | | | | |
| | | | | | | | | | | | | | | | | | | | | | | | | | | | | | | | | | | | | | | | | | | | | | | | | | | | | | | | | | | | | | | | | | | | | | | | | | | | | | | | |
| | | | | | | | | | | | | | | | | | | | | | | | | | | | | | | | | | | | | | | | | | | | | | | | | | | | | | | | | | | | | | | | | | | | | | | | | | | | | | | | |
| Post - 0 Miss - 1 Block - 0 | Post - 0 Miss - 0 Block - 0 | Post - 0 Miss - 0 Block - 0 | Post - 1 Miss - 0 Block - 0 | Post - 0 Miss - 0 Block - 0 | Post - 0 Miss - 0 Block - 0 | Post - 0 Miss - 0 Block - 0 | | | | | | | | | | | | | | | | | | | | | | | | | | | | | | | | | | | | | | | | | | | | | | | | | | | | | | | | | | | | | | | | | | | | | | | | | |

注释: Post=击柱 Miss=射失 Block=被封



四分之一决赛
青年男子 全国比赛

2016年“体彩杯”全国手球男子青年锦标赛

| | | | | | | | | | | | |
|------------------------------------|---|---------------------|---------------------|---------------------------|---------|-----|-----------|---|----|---|----|
| Team A A 广东队 | | Team B B 四川队 | | Match Number 35 | | | | | | | |
| played in China | | in the hall 重庆万州 | | on 26/03/2016 | | | | | | | |
| | | | | at 16:00 hours | | | | | | | |
| Spectators | | | | | | | | | | | |
| Half-time (30') | A 13 | B 20 | End of playing time | A 30 | B 39 | | | | | | |
| 1st extra time | | A | | B | | | | | | | |
| 2nd extra time | | A | | B | | | | | | | |
| After penalty throws | | A | | B | | | | | | | |
| Number of 7 m | A 3/4 | Team time-out | | B 4/4 | | | | | | | |
| 1 12:06 | | 2 | | 3 | | | | | | | |
| Full name of players and officials | | 1 15:08 | | 2 39:23 | | | | | | | |
| 3 | | | | | | | | | | | |
| No. | Team A | | | | | No. | Team B | | | | |
| | G | W | 2' | D | DR | | G | W | 2' | D | DR |
| 1 | | | | | | 1 | | | | | |
| 2 | 4 | | | | | 3 | 3 | | | | |
| 4 | 1 | | | | | 5 | 4 | | | | |
| 5 | 1 | 1 | | | | 7 | 2 | | | | |
| 7 | | | | | | 8 | 9 | | | | |
| 9 | | | | | | 9 | 1 | | | | |
| 10 | 7 | | 1 | | | 10 | 5 | | | | |
| 11 | 7 | | 1 | | | 11 | 2 | | 1 | | |
| 12 | 1 | | | | | 12 | | | | | |
| 13 | | | | | | 13 | 6 | | 1 | | |
| 14 | | | | | | 15 | 1 | | | | |
| 15 | 8 | 1 | | | | 17 | 4 | 1 | | | |
| 16 | | | | | | 18 | | | | 1 | |
| 18 | 1 | | | | | 19 | 2 | 1 | | | |
| | | | | | | 20 | | | | | |
| | | | | | | 21 | | | | | |
| B | 刘康伶 (主教练) | | | | | B | 张文韬 (主教练) | | | | |
| C | 刘文宁 | | | | | | | | | | |
| D | 王永存 | | | | | | | | | | |
| | | | | | | | | | | | |
| | | | | | | | | | | | |
| A | Signature of Responsible Official of the Teams (Off. A) | | | | | | | | | | B |
| TP | Remarks of Referee / CHA Official | | | | | | | | | | TP |
| | | | | | | | | | | | |
| | | | | | | | | | | | |

Signatures

| | | | | |
|------------------|-----------|-----------|--|--|
| Referees | 尹静阳 (CHN) | 马晓晔 (CHN) | | |
| Techn. Delegates | 许宜扬 (CHN) | | | |
| CHA Official | 张春生 (CHN) | | | |

Note: Number of 7m Throws Awarded to Team A and B, Goals (G), Warnings (W), Suspensions (2'), Direct Disqualification (D), Disqualification with Report (DR) and Team Penalty (TP).

Table Officials:

Statisticians:





2016年“体彩杯”全国手球男子青年锦标赛
竞赛技术统计(媒体表)

四分之一决赛 组别 X 轮次 5 场次 35

重庆万州

26/03/2016

201602035-51-1/1

广东队 广东 30 vs 39 四川 四川队
13:20

裁判员 尹静阳 (CHN) / 马晓晔 (CHN)

Main statistics table with columns for player names, positions, and various performance metrics for both Guangdong and Sichuan teams.

场上队员: 得分 / 射门

守门员: 救球 / 射门

Legend table for abbreviations: 快攻 (Fast Break), 突破 (Breakthrough), 任意球 (Free Throw), 7M球 (7M Throw), 助攻 (Assist), 警告 (Warning), 失误 (Error), 2' (Suspension), D (取消资格 - Disqualification), DR (取消资格+报告 - Disqualification+Report)





2016年“体彩杯”全国手球男子青年锦标赛 图式比赛技术统计表

轮次 5

场次 35

201602035-21-1/1

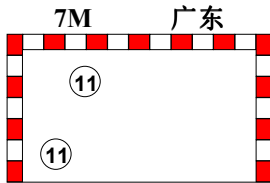
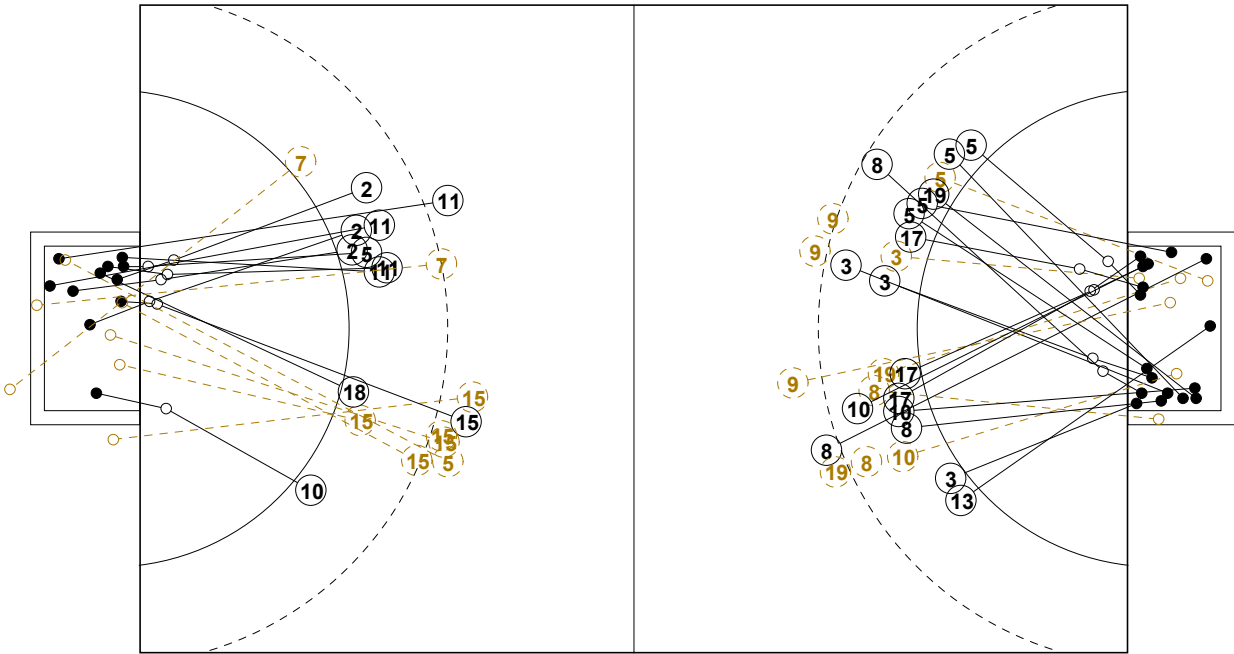

1st Half
13 : 20

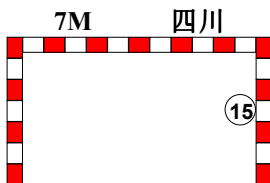
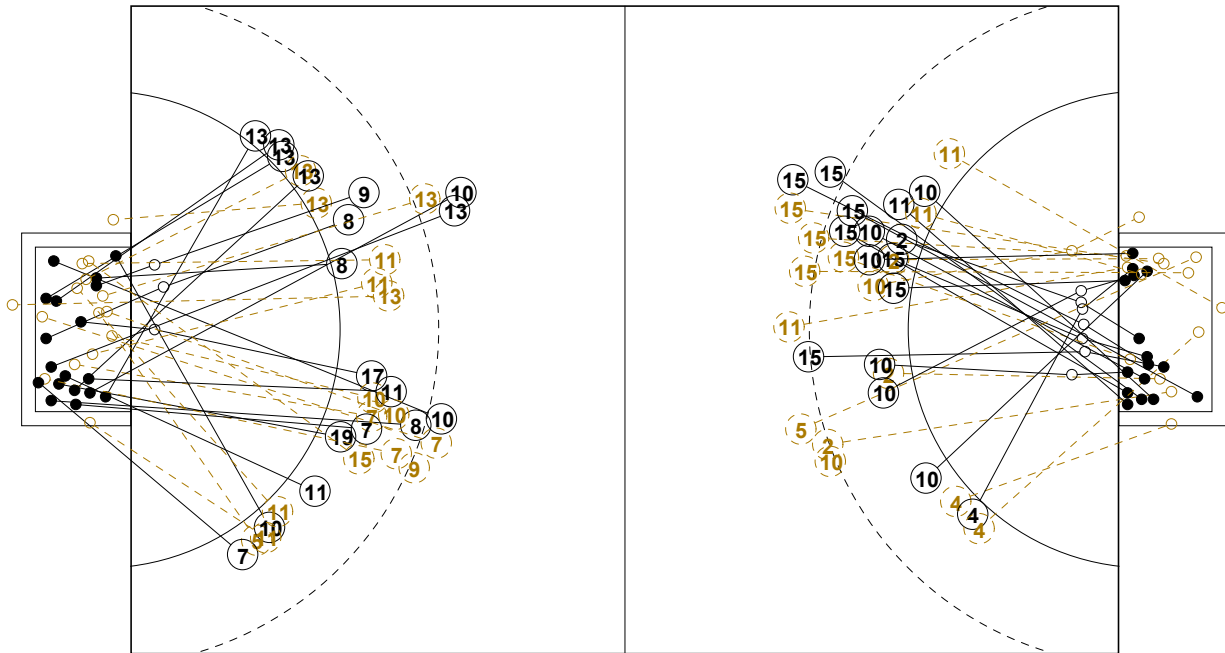
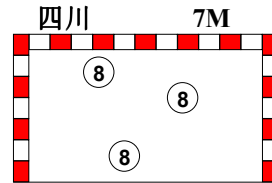

2nd Half
39 : 30

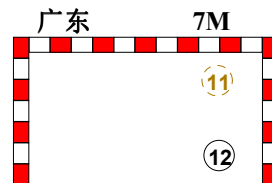



2016年“体彩杯”全国手球男子青年锦标赛

个人/全队技术统计表

正式表
手球
青年男子四分之一决赛
轮次 5组别 X
场次 35201602035-14-1/2
重庆万州
26/03/2016 16:00

| 号码 | 姓名 | 远射 | 近射 | 边射 | 快攻 | 突破 | 任意 | 7M | 合计 | % | 助攻 | 失误 | 警告 | 2' | 取消 | 时间 |
|----------------|-----|------|-------|-----|------|-----|-----|-----|-------|-------|----|----|----|----|----|----------|
| 广东队(广东) | | | | | | | | | | | | | | | | |
| <i>(场上队员)</i> | | | | | | | | | | | | | | | | |
| 1 | 王帅 | | | | | | | | | 0.0% | 2 | | | | | 00:59:32 |
| 2 | 姚雪岩 | | 2/4 | | | 2/2 | 0/1 | | 4/7 | 57.1% | 1 | 3 | | | | 01:07:23 |
| 4 | 高玉杰 | | 0/1 | 1/2 | | | | | 1/3 | 33.3% | | | | | | 00:30:00 |
| 5 | 黄培杰 | 0/2 | | | 1/1 | | | | 1/3 | 33.3% | 4 | 6 | 1 | | | 01:00:00 |
| 7 | 段飞宇 | | 0/1 | | 0/1 | | | | 0/2 | 0.0% | | 1 | | | | 00:04:38 |
| 9 | 周凯峰 | | | | | | | | | 0.0% | | | | | | 00:00:00 |
| 10 | 周仲坤 | 0/1 | 6/7 | | | 1/1 | | | 7/9 | 77.8% | | 3 | | 1 | | 01:04:00 |
| 11 | 胡国富 | 1/2 | 1/3 | | 3/3 | | | 2/3 | 7/11 | 63.6% | | 5 | | 1 | | 01:00:00 |
| 12 | 李壮 | | | | | | | 1/1 | 1/1 | 100% | | | | | | 00:00:20 |
| 13 | 蔡杰 | | | | | | | | | 0.0% | | | | | | 00:00:00 |
| 14 | 王泽润 | | | | | | | | | 0.0% | | | | | | 00:00:10 |
| 15 | 张建杰 | 5/12 | 1/1 | | | 2/3 | 0/1 | | 8/17 | 47.1% | 3 | 4 | 1 | | | 01:00:00 |
| 16 | 王猛 | | | | | | | | | 0.0% | | | | | | 00:00:18 |
| 18 | 李文金 | | 1/1 | | | | | | 1/1 | 100% | | 4 | | | | 00:25:22 |
| 合计 | | 6/17 | 11/18 | 1/2 | 4/5 | 5/6 | 0/2 | 3/4 | 30/54 | 55.6% | 10 | 26 | 2 | 2 | | |
| <i>(守门员)</i> | | | | | | | | | | | | | | | | |
| 1 | 王帅 | 4/10 | 7/24 | 2/6 | 3/10 | | 1/2 | 0/2 | 17/54 | 31.5% | 2 | | | | | 00:59:32 |
| 14 | 王泽润 | | | | | | | 0/1 | 0/1 | 0.0% | | | | | | 00:00:10 |
| 16 | 王猛 | | | | | | | 0/1 | 0/1 | 0.0% | | | | | | 00:00:18 |
| 合计 | | 4/10 | 7/24 | 2/6 | 3/10 | | 1/2 | 0/4 | 17/56 | 30.4% | 2 | | | | | |

场上队员：得分/射门

守门员：救球/射门

| 全队合计 | 得分 | 被救 | 射失 | 击柱 | 封球 | 合计 | % |
|------|----|----|----|----|----|----|-------|
| 远射 | 6 | 8 | 1 | | 2 | 17 | 35.3% |
| 近射 | 11 | 3 | 2 | 2 | | 18 | 61.1% |
| 边射 | 1 | 1 | | | | 2 | 50.0% |
| 快攻 | 4 | | | 1 | | 5 | 80.0% |
| 突破 | 5 | 1 | | | | 6 | 83.3% |
| 任意 | | 2 | | | | 2 | 0.0% |
| 7M | 3 | 1 | | | | 4 | 75.0% |





2016年“体彩杯”全国手球男子青年锦标赛

个人/全队技术统计表

正式表
手球
青年男子四分之一决赛
轮次 5组别 X
场次 35201602035-14-2/2
重庆万州
26/03/2016 16:00

| 号码 | 姓名 | 远射 | 近射 | 边射 | 快攻 | 突破 | 任意 | 7M | 合计 | % | 助攻 | 失误 | 警告 | 2' | 取消 | 时间 |
|----------------|-----|------|-------|-----|------|-----|-----|-----|-------|-------|----|----|----|----|----|----------|
| 四川队(四川) | | | | | | | | | | | | | | | | |
| <i>(上场队员)</i> | | | | | | | | | | | | | | | | |
| 1 | 宋继强 | | | | | | | | | 0.0% | | | | | | 00:00:00 |
| 3 | 刘赵梁 | | 1/2 | | 2/2 | | | | 3/4 | 75.0% | | | | | | 00:25:26 |
| 5 | 王凯 | | 2/3 | 0/1 | 2/2 | | | | 4/6 | 66.7% | 1 | 1 | | | | 00:39:33 |
| 7 | 仇瑞祥 | 0/2 | 1/1 | 1/1 | 0/1 | | | | 2/5 | 40.0% | 4 | 1 | | | | 00:20:26 |
| 8 | 罗尧尧 | 2/3 | 2/2 | | 1/1 | 0/1 | 1/1 | 3/3 | 9/11 | 81.8% | 6 | 2 | | | | 00:39:16 |
| 9 | 许翔宇 | 0/4 | 1/1 | | | | | | 1/5 | 20.0% | 6 | 1 | | | | 00:33:54 |
| 10 | 徐彦昊 | 3/3 | 0/1 | 1/1 | 1/2 | | 0/1 | | 5/8 | 62.5% | | 5 | | | | 00:42:21 |
| 11 | 张天豪 | | 1/3 | 0/2 | 1/1 | | | | 2/6 | 33.3% | | 1 | | 1 | | 00:16:57 |
| 12 | 刘树豪 | | | | | | | | | 0.0% | 2 | | | | | 01:00:00 |
| 13 | 尹文珂 | 1/2 | 3/5 | 2/2 | 0/1 | | | | 6/10 | 60.0% | | 2 | | 1 | | 00:34:34 |
| 15 | 徐逸 | | | | 0/1 | | | 1/1 | 1/2 | 50.0% | | | | | | 00:10:06 |
| 17 | 谢庆龙 | | 4/4 | | | | | | 4/4 | 100% | | | 1 | | | 00:54:57 |
| 18 | 张睿梁 | | | | | | | | | 0.0% | | | | 1 | | 00:19:54 |
| 19 | 庞连康 | 0/1 | 2/3 | | | | | | 2/4 | 50.0% | 1 | 1 | 1 | | | 00:37:22 |
| 20 | 张文健 | | | | | | | | | 0.0% | | | | | | 00:00:00 |
| 21 | 曹修庆 | | | | | | | | | 0.0% | | | | | | 00:00:00 |
| 合计 | | 6/15 | 17/25 | 4/7 | 7/11 | 0/1 | 1/2 | 4/4 | 39/65 | 60.0% | 20 | 14 | 2 | 3 | | |
| <i>(守门员)</i> | | | | | | | | | | | | | | | | |
| 12 | 刘树豪 | 8/14 | 3/14 | 1/2 | 0/4 | 1/6 | 2/2 | 1/4 | 16/46 | 34.8% | 2 | | | | | 01:00:00 |
| 合计 | | | | | | | | | | | | | | | | |
| 合计 | | 8/14 | 3/14 | 1/2 | 0/4 | 1/6 | 2/2 | 1/4 | 16/46 | 34.8% | 2 | | | | | |

场上队员：得分/射门

守门员：救球/射门

| 全队合计 | 得分 | 被救 | 射失 | 击柱 | 封球 | 合计 | % |
|------|----|----|----|----|----|----|--------|
| 远射 | 6 | 4 | | | 5 | 15 | 40.0% |
| 近射 | 17 | 7 | 1 | | | 25 | 68.0% |
| 边射 | 4 | 2 | | 1 | | 7 | 57.1% |
| 快攻 | 7 | 3 | 1 | | | 11 | 63.6% |
| 突破 | | | | 1 | | 1 | 0.0% |
| 任意 | 1 | 1 | | | | 2 | 50.0% |
| 7M | 4 | | | | | 4 | 100.0% |





2016年“体彩杯”全国手球男子青年锦标赛

图式射门区域统计

轮次 5 场次 35

201602035-41-1/1

广东队

| | | | | | | | | | | | | | | | | | | | | | | | | | | | | | | | | | | | | | | | | | | | | | | | | | | | | | | | | | | | | | | | | | | | | | | | | | | | | | | | | | | | | | |
|---|-----------------------------|-----------------------------|-----------------------------|-----------------------------|-----------------------------|-----------------------------|-----------------------------|--|---|--|--|--|---|--|---|--|--|---|---|---|--|--|--|--|--|--|---|--|--|---|--|--|---|--|--|---|---|---|---|--|--|--|--|--|--|--|--|--|--|---|--|--|--|--|--|---|--|--|--|--|--|--|--|---|--|---|---|--|---|---|--|--|---|--|---|--|--|--|--|---|--|--|---|--|---|
| 1 王帅 | 2 姚雪岩 | 4 高玉杰 | 5 黄培杰 | 7 段飞宇 | 9 周凯峰 | 10 周仲坤 | 11 胡国富 | | | | | | | | | | | | | | | | | | | | | | | | | | | | | | | | | | | | | | | | | | | | | | | | | | | | | | | | | | | | | | | | | | | | | | | | | | | | | | |
| <table border="1"><tr><td></td><td></td><td></td></tr><tr><td></td><td></td><td></td></tr><tr><td></td><td></td><td></td></tr></table> | | | | | | | | | | <table border="1"><tr><td></td><td></td><td>1</td></tr><tr><td></td><td>1</td><td></td></tr><tr><td></td><td>1</td><td>1</td></tr></table> | | | 1 | | 1 | | | 1 | 1 | <table border="1"><tr><td></td><td></td><td></td></tr><tr><td></td><td></td><td></td></tr><tr><td>1</td><td></td><td></td></tr></table> | | | | | | | 1 | | | <table border="1"><tr><td></td><td></td><td></td></tr><tr><td></td><td></td><td></td></tr><tr><td></td><td></td><td>1</td></tr></table> | | | | | | | | | 1 | <table border="1"><tr><td></td><td></td><td></td></tr><tr><td></td><td></td><td></td></tr><tr><td></td><td></td><td></td></tr></table> | | | | | | | | | | <table border="1"><tr><td></td><td></td><td></td></tr><tr><td></td><td></td><td></td></tr><tr><td></td><td></td><td></td></tr></table> | | | | | | | | | | <table border="1"><tr><td></td><td></td><td></td></tr><tr><td>1</td><td></td><td>1</td></tr><tr><td>3</td><td></td><td>2</td></tr></table> | | | | 1 | | 1 | 3 | | 2 | <table border="1"><tr><td></td><td></td><td>1</td><td></td><td>2</td></tr><tr><td></td><td></td><td></td><td></td><td>1</td></tr><tr><td></td><td></td><td>1</td><td></td><td>2</td></tr></table> | | | 1 | | 2 | | | | | 1 | | | 1 | | 2 |
| | | | | | | | | | | | | | | | | | | | | | | | | | | | | | | | | | | | | | | | | | | | | | | | | | | | | | | | | | | | | | | | | | | | | | | | | | | | | | | | | | | | | | |
| | | | | | | | | | | | | | | | | | | | | | | | | | | | | | | | | | | | | | | | | | | | | | | | | | | | | | | | | | | | | | | | | | | | | | | | | | | | | | | | | | | | | | |
| | | | | | | | | | | | | | | | | | | | | | | | | | | | | | | | | | | | | | | | | | | | | | | | | | | | | | | | | | | | | | | | | | | | | | | | | | | | | | | | | | | | | | |
| | | 1 | | | | | | | | | | | | | | | | | | | | | | | | | | | | | | | | | | | | | | | | | | | | | | | | | | | | | | | | | | | | | | | | | | | | | | | | | | | | | | | | | | | |
| | 1 | | | | | | | | | | | | | | | | | | | | | | | | | | | | | | | | | | | | | | | | | | | | | | | | | | | | | | | | | | | | | | | | | | | | | | | | | | | | | | | | | | | | |
| | 1 | 1 | | | | | | | | | | | | | | | | | | | | | | | | | | | | | | | | | | | | | | | | | | | | | | | | | | | | | | | | | | | | | | | | | | | | | | | | | | | | | | | | | | | |
| | | | | | | | | | | | | | | | | | | | | | | | | | | | | | | | | | | | | | | | | | | | | | | | | | | | | | | | | | | | | | | | | | | | | | | | | | | | | | | | | | | | | | |
| | | | | | | | | | | | | | | | | | | | | | | | | | | | | | | | | | | | | | | | | | | | | | | | | | | | | | | | | | | | | | | | | | | | | | | | | | | | | | | | | | | | | | |
| 1 | | | | | | | | | | | | | | | | | | | | | | | | | | | | | | | | | | | | | | | | | | | | | | | | | | | | | | | | | | | | | | | | | | | | | | | | | | | | | | | | | | | | | |
| | | | | | | | | | | | | | | | | | | | | | | | | | | | | | | | | | | | | | | | | | | | | | | | | | | | | | | | | | | | | | | | | | | | | | | | | | | | | | | | | | | | | | |
| | | | | | | | | | | | | | | | | | | | | | | | | | | | | | | | | | | | | | | | | | | | | | | | | | | | | | | | | | | | | | | | | | | | | | | | | | | | | | | | | | | | | | |
| | | 1 | | | | | | | | | | | | | | | | | | | | | | | | | | | | | | | | | | | | | | | | | | | | | | | | | | | | | | | | | | | | | | | | | | | | | | | | | | | | | | | | | | | |
| | | | | | | | | | | | | | | | | | | | | | | | | | | | | | | | | | | | | | | | | | | | | | | | | | | | | | | | | | | | | | | | | | | | | | | | | | | | | | | | | | | | | | |
| | | | | | | | | | | | | | | | | | | | | | | | | | | | | | | | | | | | | | | | | | | | | | | | | | | | | | | | | | | | | | | | | | | | | | | | | | | | | | | | | | | | | | |
| | | | | | | | | | | | | | | | | | | | | | | | | | | | | | | | | | | | | | | | | | | | | | | | | | | | | | | | | | | | | | | | | | | | | | | | | | | | | | | | | | | | | | |
| | | | | | | | | | | | | | | | | | | | | | | | | | | | | | | | | | | | | | | | | | | | | | | | | | | | | | | | | | | | | | | | | | | | | | | | | | | | | | | | | | | | | | |
| | | | | | | | | | | | | | | | | | | | | | | | | | | | | | | | | | | | | | | | | | | | | | | | | | | | | | | | | | | | | | | | | | | | | | | | | | | | | | | | | | | | | | |
| | | | | | | | | | | | | | | | | | | | | | | | | | | | | | | | | | | | | | | | | | | | | | | | | | | | | | | | | | | | | | | | | | | | | | | | | | | | | | | | | | | | | | |
| | | | | | | | | | | | | | | | | | | | | | | | | | | | | | | | | | | | | | | | | | | | | | | | | | | | | | | | | | | | | | | | | | | | | | | | | | | | | | | | | | | | | | |
| 1 | | 1 | | | | | | | | | | | | | | | | | | | | | | | | | | | | | | | | | | | | | | | | | | | | | | | | | | | | | | | | | | | | | | | | | | | | | | | | | | | | | | | | | | | |
| 3 | | 2 | | | | | | | | | | | | | | | | | | | | | | | | | | | | | | | | | | | | | | | | | | | | | | | | | | | | | | | | | | | | | | | | | | | | | | | | | | | | | | | | | | | |
| | | 1 | | 2 | | | | | | | | | | | | | | | | | | | | | | | | | | | | | | | | | | | | | | | | | | | | | | | | | | | | | | | | | | | | | | | | | | | | | | | | | | | | | | | | | |
| | | | | 1 | | | | | | | | | | | | | | | | | | | | | | | | | | | | | | | | | | | | | | | | | | | | | | | | | | | | | | | | | | | | | | | | | | | | | | | | | | | | | | | | | |
| | | 1 | | 2 | | | | | | | | | | | | | | | | | | | | | | | | | | | | | | | | | | | | | | | | | | | | | | | | | | | | | | | | | | | | | | | | | | | | | | | | | | | | | | | | | |
| Post - 0 Miss - 0 Block - 0 | Post - 0 Miss - 0 Block - 0 | Post - 1 Miss - 0 Block - 0 | Post - 0 Miss - 0 Block - 0 | Post - 1 Miss - 1 Block - 0 | Post - 0 Miss - 0 Block - 0 | Post - 0 Miss - 1 Block - 1 | Post - 1 Miss - 0 Block - 0 | | | | | | | | | | | | | | | | | | | | | | | | | | | | | | | | | | | | | | | | | | | | | | | | | | | | | | | | | | | | | | | | | | | | | | | | | | | | | | |
| 12 李壮 | 13 蔡杰 | 14 王泽润 | 15 张建杰 | 16 王猛 | 18 李文金 | | | | | | | | | | | | | | | | | | | | | | | | | | | | | | | | | | | | | | | | | | | | | | | | | | | | | | | | | | | | | | | | | | | | | | | | | | | | | | | | |
| <table border="1"><tr><td></td><td></td><td></td></tr><tr><td></td><td></td><td></td></tr><tr><td></td><td></td><td>1</td></tr></table> | | | | | | | | | 1 | <table border="1"><tr><td></td><td></td><td></td></tr><tr><td></td><td></td><td></td></tr><tr><td></td><td></td><td></td></tr></table> | | | | | | | | | | <table border="1"><tr><td></td><td></td><td></td></tr><tr><td></td><td></td><td></td></tr><tr><td></td><td></td><td></td></tr></table> | | | | | | | | | | <table border="1"><tr><td></td><td></td><td>1</td></tr><tr><td></td><td></td><td>1</td></tr><tr><td>1</td><td>2</td><td>3</td></tr></table> | | | 1 | | | 1 | 1 | 2 | 3 | <table border="1"><tr><td></td><td></td><td></td></tr><tr><td></td><td></td><td></td></tr><tr><td></td><td></td><td></td></tr></table> | | | | | | | | | | <table border="1"><tr><td></td><td></td><td></td></tr><tr><td></td><td></td><td>1</td></tr><tr><td></td><td></td><td></td></tr></table> | | | | | | 1 | | | | <table border="1"><tr><td></td><td></td><td></td></tr><tr><td></td><td></td><td></td></tr><tr><td></td><td></td><td></td></tr></table> | | | | | | | | | | <table border="1"><tr><td></td><td></td><td></td></tr><tr><td></td><td></td><td></td></tr><tr><td></td><td></td><td></td></tr></table> | | | | | | | | | | | | | | | |
| | | | | | | | | | | | | | | | | | | | | | | | | | | | | | | | | | | | | | | | | | | | | | | | | | | | | | | | | | | | | | | | | | | | | | | | | | | | | | | | | | | | | | |
| | | | | | | | | | | | | | | | | | | | | | | | | | | | | | | | | | | | | | | | | | | | | | | | | | | | | | | | | | | | | | | | | | | | | | | | | | | | | | | | | | | | | | |
| | | 1 | | | | | | | | | | | | | | | | | | | | | | | | | | | | | | | | | | | | | | | | | | | | | | | | | | | | | | | | | | | | | | | | | | | | | | | | | | | | | | | | | | | |
| | | | | | | | | | | | | | | | | | | | | | | | | | | | | | | | | | | | | | | | | | | | | | | | | | | | | | | | | | | | | | | | | | | | | | | | | | | | | | | | | | | | | | |
| | | | | | | | | | | | | | | | | | | | | | | | | | | | | | | | | | | | | | | | | | | | | | | | | | | | | | | | | | | | | | | | | | | | | | | | | | | | | | | | | | | | | | |
| | | | | | | | | | | | | | | | | | | | | | | | | | | | | | | | | | | | | | | | | | | | | | | | | | | | | | | | | | | | | | | | | | | | | | | | | | | | | | | | | | | | | | |
| | | | | | | | | | | | | | | | | | | | | | | | | | | | | | | | | | | | | | | | | | | | | | | | | | | | | | | | | | | | | | | | | | | | | | | | | | | | | | | | | | | | | | |
| | | | | | | | | | | | | | | | | | | | | | | | | | | | | | | | | | | | | | | | | | | | | | | | | | | | | | | | | | | | | | | | | | | | | | | | | | | | | | | | | | | | | | |
| | | | | | | | | | | | | | | | | | | | | | | | | | | | | | | | | | | | | | | | | | | | | | | | | | | | | | | | | | | | | | | | | | | | | | | | | | | | | | | | | | | | | | |
| | | 1 | | | | | | | | | | | | | | | | | | | | | | | | | | | | | | | | | | | | | | | | | | | | | | | | | | | | | | | | | | | | | | | | | | | | | | | | | | | | | | | | | | | |
| | | 1 | | | | | | | | | | | | | | | | | | | | | | | | | | | | | | | | | | | | | | | | | | | | | | | | | | | | | | | | | | | | | | | | | | | | | | | | | | | | | | | | | | | |
| 1 | 2 | 3 | | | | | | | | | | | | | | | | | | | | | | | | | | | | | | | | | | | | | | | | | | | | | | | | | | | | | | | | | | | | | | | | | | | | | | | | | | | | | | | | | | | |
| | | | | | | | | | | | | | | | | | | | | | | | | | | | | | | | | | | | | | | | | | | | | | | | | | | | | | | | | | | | | | | | | | | | | | | | | | | | | | | | | | | | | | |
| | | | | | | | | | | | | | | | | | | | | | | | | | | | | | | | | | | | | | | | | | | | | | | | | | | | | | | | | | | | | | | | | | | | | | | | | | | | | | | | | | | | | | |
| | | | | | | | | | | | | | | | | | | | | | | | | | | | | | | | | | | | | | | | | | | | | | | | | | | | | | | | | | | | | | | | | | | | | | | | | | | | | | | | | | | | | | |
| | | | | | | | | | | | | | | | | | | | | | | | | | | | | | | | | | | | | | | | | | | | | | | | | | | | | | | | | | | | | | | | | | | | | | | | | | | | | | | | | | | | | | |
| | | 1 | | | | | | | | | | | | | | | | | | | | | | | | | | | | | | | | | | | | | | | | | | | | | | | | | | | | | | | | | | | | | | | | | | | | | | | | | | | | | | | | | | | |
| | | | | | | | | | | | | | | | | | | | | | | | | | | | | | | | | | | | | | | | | | | | | | | | | | | | | | | | | | | | | | | | | | | | | | | | | | | | | | | | | | | | | | |
| | | | | | | | | | | | | | | | | | | | | | | | | | | | | | | | | | | | | | | | | | | | | | | | | | | | | | | | | | | | | | | | | | | | | | | | | | | | | | | | | | | | | | |
| | | | | | | | | | | | | | | | | | | | | | | | | | | | | | | | | | | | | | | | | | | | | | | | | | | | | | | | | | | | | | | | | | | | | | | | | | | | | | | | | | | | | | |
| | | | | | | | | | | | | | | | | | | | | | | | | | | | | | | | | | | | | | | | | | | | | | | | | | | | | | | | | | | | | | | | | | | | | | | | | | | | | | | | | | | | | | |
| | | | | | | | | | | | | | | | | | | | | | | | | | | | | | | | | | | | | | | | | | | | | | | | | | | | | | | | | | | | | | | | | | | | | | | | | | | | | | | | | | | | | | |
| | | | | | | | | | | | | | | | | | | | | | | | | | | | | | | | | | | | | | | | | | | | | | | | | | | | | | | | | | | | | | | | | | | | | | | | | | | | | | | | | | | | | | |
| | | | | | | | | | | | | | | | | | | | | | | | | | | | | | | | | | | | | | | | | | | | | | | | | | | | | | | | | | | | | | | | | | | | | | | | | | | | | | | | | | | | | | |
| Post - 0 Miss - 0 Block - 0 | Post - 0 Miss - 0 Block - 0 | Post - 0 Miss - 0 Block - 0 | Post - 0 Miss - 1 Block - 1 | Post - 0 Miss - 0 Block - 0 | Post - 0 Miss - 0 Block - 0 | | | | | | | | | | | | | | | | | | | | | | | | | | | | | | | | | | | | | | | | | | | | | | | | | | | | | | | | | | | | | | | | | | | | | | | | | | | | | | | | |

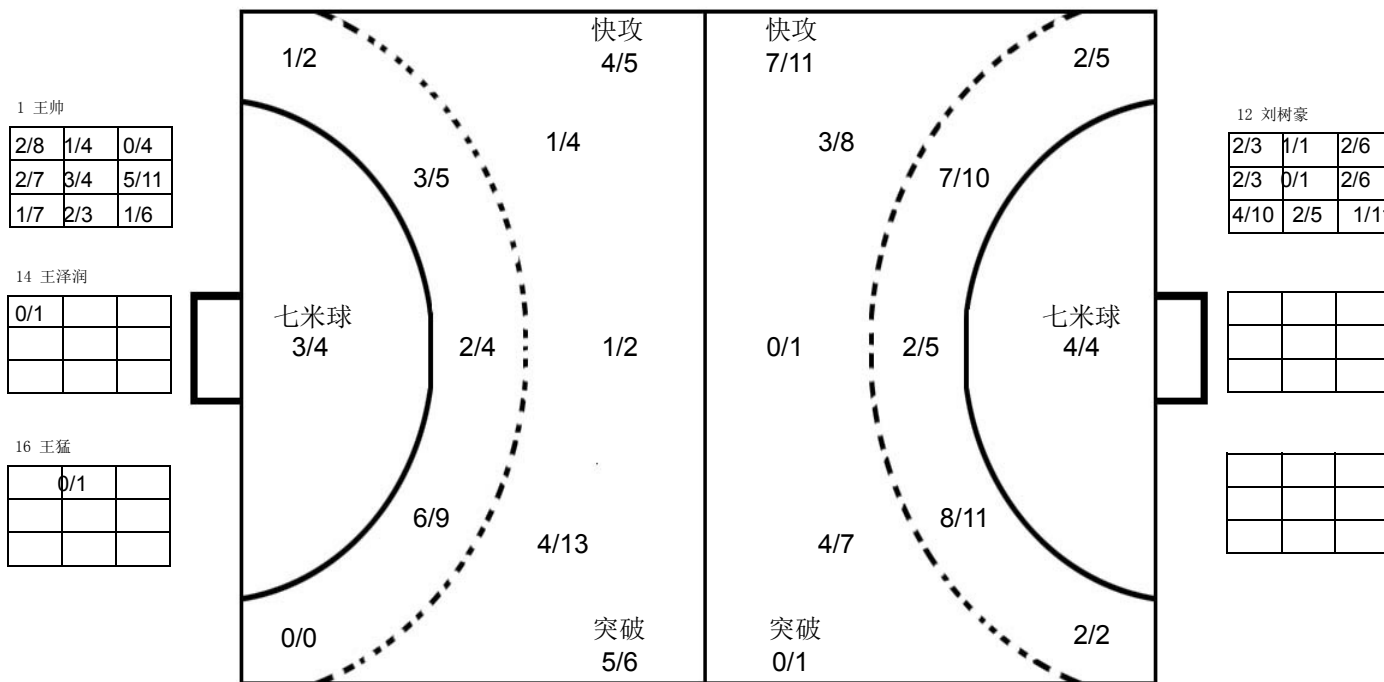

四川队

| | | | | | | | | | | | | | | | | | | | | | | | | | | | | | | | | | | | | | | | | | | | | | | | | | | | | | | | | | | | | | | | | | | | | | | | | | | | | | | | | | | | | | | | | | | | |
|--|-----------------------------|-----------------------------|-----------------------------|-----------------------------|-----------------------------|-----------------------------|-----------------------------|--|--|---|---|---|---|---|--|---|---|--|--|--|--|--|---|--|---|---|--|---|--|--|--|--|---|--|---|--|---|--|--|--|--|--|--|--|--|---|---|---|--|--|--|---|--|---|---|---|--|--|--|--|--|---|--|--|--|--|--|--|---|--|--|--|---|--|---|--|--|--|---|--|--|--|--|---|--|--|--|--|--|--|--|
| 1 宋继强 | 3 刘赵梁 | 5 王凯 | 7 仇瑞祥 | 8 罗尧尧 | 9 许翔宇 | 10 徐彦昊 | 11 张天豪 | | | | | | | | | | | | | | | | | | | | | | | | | | | | | | | | | | | | | | | | | | | | | | | | | | | | | | | | | | | | | | | | | | | | | | | | | | | | | | | | | | | | |
| <table border="1"><tr><td></td><td></td><td></td></tr><tr><td></td><td></td><td></td></tr><tr><td></td><td></td><td></td></tr></table> | | | | | | | | | | <table border="1"><tr><td></td><td></td><td>1</td></tr><tr><td></td><td></td><td>2</td></tr><tr><td></td><td></td><td></td></tr></table> | | | 1 | | | 2 | | | | <table border="1"><tr><td></td><td></td><td>1</td><td></td><td>1</td></tr><tr><td></td><td></td><td>1</td><td></td><td>1</td></tr><tr><td></td><td></td><td>1</td><td></td><td>1</td></tr></table> | | | 1 | | 1 | | | 1 | | 1 | | | 1 | | 1 | <table border="1"><tr><td>1</td><td></td><td></td></tr><tr><td>1</td><td></td><td></td></tr><tr><td></td><td></td><td></td></tr></table> | 1 | | | 1 | | | | | | <table border="1"><tr><td>3</td><td>2</td><td></td></tr><tr><td></td><td></td><td>2</td></tr><tr><td></td><td>1</td><td>1</td></tr></table> | 3 | 2 | | | | 2 | | 1 | 1 | <table border="1"><tr><td></td><td></td><td></td></tr><tr><td></td><td></td><td>1</td></tr><tr><td></td><td></td><td></td></tr></table> | | | | | | 1 | | | | <table border="1"><tr><td></td><td></td><td>2</td></tr><tr><td>1</td><td></td><td></td></tr><tr><td>1</td><td></td><td>1</td></tr></table> | | | 2 | 1 | | | 1 | | 1 | <table border="1"><tr><td></td><td></td><td>1</td><td></td><td></td></tr><tr><td></td><td></td><td>1</td><td></td><td></td></tr><tr><td></td><td></td><td></td><td></td><td></td></tr></table> | | | 1 | | | | | 1 | | | | | | | |
| | | | | | | | | | | | | | | | | | | | | | | | | | | | | | | | | | | | | | | | | | | | | | | | | | | | | | | | | | | | | | | | | | | | | | | | | | | | | | | | | | | | | | | | | | | | |
| | | | | | | | | | | | | | | | | | | | | | | | | | | | | | | | | | | | | | | | | | | | | | | | | | | | | | | | | | | | | | | | | | | | | | | | | | | | | | | | | | | | | | | | | | | | |
| | | | | | | | | | | | | | | | | | | | | | | | | | | | | | | | | | | | | | | | | | | | | | | | | | | | | | | | | | | | | | | | | | | | | | | | | | | | | | | | | | | | | | | | | | | | |
| | | 1 | | | | | | | | | | | | | | | | | | | | | | | | | | | | | | | | | | | | | | | | | | | | | | | | | | | | | | | | | | | | | | | | | | | | | | | | | | | | | | | | | | | | | | | | | |
| | | 2 | | | | | | | | | | | | | | | | | | | | | | | | | | | | | | | | | | | | | | | | | | | | | | | | | | | | | | | | | | | | | | | | | | | | | | | | | | | | | | | | | | | | | | | | | |
| | | | | | | | | | | | | | | | | | | | | | | | | | | | | | | | | | | | | | | | | | | | | | | | | | | | | | | | | | | | | | | | | | | | | | | | | | | | | | | | | | | | | | | | | | | | |
| | | 1 | | 1 | | | | | | | | | | | | | | | | | | | | | | | | | | | | | | | | | | | | | | | | | | | | | | | | | | | | | | | | | | | | | | | | | | | | | | | | | | | | | | | | | | | | | | | |
| | | 1 | | 1 | | | | | | | | | | | | | | | | | | | | | | | | | | | | | | | | | | | | | | | | | | | | | | | | | | | | | | | | | | | | | | | | | | | | | | | | | | | | | | | | | | | | | | | |
| | | 1 | | 1 | | | | | | | | | | | | | | | | | | | | | | | | | | | | | | | | | | | | | | | | | | | | | | | | | | | | | | | | | | | | | | | | | | | | | | | | | | | | | | | | | | | | | | | |
| 1 | | | | | | | | | | | | | | | | | | | | | | | | | | | | | | | | | | | | | | | | | | | | | | | | | | | | | | | | | | | | | | | | | | | | | | | | | | | | | | | | | | | | | | | | | | | |
| 1 | | | | | | | | | | | | | | | | | | | | | | | | | | | | | | | | | | | | | | | | | | | | | | | | | | | | | | | | | | | | | | | | | | | | | | | | | | | | | | | | | | | | | | | | | | | |
| | | | | | | | | | | | | | | | | | | | | | | | | | | | | | | | | | | | | | | | | | | | | | | | | | | | | | | | | | | | | | | | | | | | | | | | | | | | | | | | | | | | | | | | | | | | |
| 3 | 2 | | | | | | | | | | | | | | | | | | | | | | | | | | | | | | | | | | | | | | | | | | | | | | | | | | | | | | | | | | | | | | | | | | | | | | | | | | | | | | | | | | | | | | | | | | |
| | | 2 | | | | | | | | | | | | | | | | | | | | | | | | | | | | | | | | | | | | | | | | | | | | | | | | | | | | | | | | | | | | | | | | | | | | | | | | | | | | | | | | | | | | | | | | | |
| | 1 | 1 | | | | | | | | | | | | | | | | | | | | | | | | | | | | | | | | | | | | | | | | | | | | | | | | | | | | | | | | | | | | | | | | | | | | | | | | | | | | | | | | | | | | | | | | | |
| | | | | | | | | | | | | | | | | | | | | | | | | | | | | | | | | | | | | | | | | | | | | | | | | | | | | | | | | | | | | | | | | | | | | | | | | | | | | | | | | | | | | | | | | | | | |
| | | 1 | | | | | | | | | | | | | | | | | | | | | | | | | | | | | | | | | | | | | | | | | | | | | | | | | | | | | | | | | | | | | | | | | | | | | | | | | | | | | | | | | | | | | | | | | |
| | | | | | | | | | | | | | | | | | | | | | | | | | | | | | | | | | | | | | | | | | | | | | | | | | | | | | | | | | | | | | | | | | | | | | | | | | | | | | | | | | | | | | | | | | | | |
| | | 2 | | | | | | | | | | | | | | | | | | | | | | | | | | | | | | | | | | | | | | | | | | | | | | | | | | | | | | | | | | | | | | | | | | | | | | | | | | | | | | | | | | | | | | | | | |
| 1 | | | | | | | | | | | | | | | | | | | | | | | | | | | | | | | | | | | | | | | | | | | | | | | | | | | | | | | | | | | | | | | | | | | | | | | | | | | | | | | | | | | | | | | | | | | |
| 1 | | 1 | | | | | | | | | | | | | | | | | | | | | | | | | | | | | | | | | | | | | | | | | | | | | | | | | | | | | | | | | | | | | | | | | | | | | | | | | | | | | | | | | | | | | | | | | |
| | | 1 | | | | | | | | | | | | | | | | | | | | | | | | | | | | | | | | | | | | | | | | | | | | | | | | | | | | | | | | | | | | | | | | | | | | | | | | | | | | | | | | | | | | | | | | | |
| | | 1 | | | | | | | | | | | | | | | | | | | | | | | | | | | | | | | | | | | | | | | | | | | | | | | | | | | | | | | | | | | | | | | | | | | | | | | | | | | | | | | | | | | | | | | | | |
| | | | | | | | | | | | | | | | | | | | | | | | | | | | | | | | | | | | | | | | | | | | | | | | | | | | | | | | | | | | | | | | | | | | | | | | | | | | | | | | | | | | | | | | | | | | |
| Post - 0 Miss - 0 Block - 0 | Post - 0 Miss - 0 Block - 0 | Post - 0 Miss - 0 Block - 0 | Post - 0 Miss - 0 Block - 0 | Post - 1 Miss - 0 Block - 1 | Post - 0 Miss - 0 Block - 3 | Post - 0 Miss - 0 Block - 0 | Post - 1 Miss - 0 Block - 0 | | | | | | | | | | | | | | | | | | | | | | | | | | | | | | | | | | | | | | | | | | | | | | | | | | | | | | | | | | | | | | | | | | | | | | | | | | | | | | | | | | | | |
| 12 刘树豪 | 13 尹文珂 | 15 徐逸 | 17 谢庆龙 | 18 张睿梁 | 19 庞连康 | 20 张文健 | 21 曹修庆 | | | | | | | | | | | | | | | | | | | | | | | | | | | | | | | | | | | | | | | | | | | | | | | | | | | | | | | | | | | | | | | | | | | | | | | | | | | | | | | | | | | | |
| <table border="1"><tr><td></td><td></td><td></td></tr><tr><td></td><td></td><td></td></tr><tr><td></td><td></td><td></td></tr></table> | | | | | | | | | | <table border="1"><tr><td>1</td><td>2</td><td>1</td></tr><tr><td>1</td><td></td><td></td></tr><tr><td>1</td><td></td><td></td></tr></table> | 1 | 2 | 1 | 1 | | | 1 | | | <table border="1"><tr><td></td><td></td><td></td></tr><tr><td></td><td></td><td>1</td></tr><tr><td></td><td></td><td></td></tr></table> | | | | | | 1 | | | | <table border="1"><tr><td></td><td></td><td></td></tr><tr><td></td><td>1</td><td></td></tr><tr><td>3</td><td></td><td></td></tr></table> | | | | | 1 | | 3 | | | <table border="1"><tr><td></td><td></td><td></td></tr><tr><td></td><td></td><td></td></tr><tr><td></td><td></td><td></td></tr></table> | | | | | | | | | | <table border="1"><tr><td></td><td></td><td></td></tr><tr><td>1</td><td></td><td>1</td></tr><tr><td></td><td></td><td></td></tr></table> | | | | 1 | | 1 | | | | <table border="1"><tr><td></td><td></td><td></td></tr><tr><td></td><td></td><td></td></tr><tr><td></td><td></td><td></td></tr></table> | | | | | | | | | | <table border="1"><tr><td></td><td></td><td></td></tr><tr><td></td><td></td><td></td></tr><tr><td></td><td></td><td></td></tr></table> | | | | | | | | | | | | | | | | | | | | | |
| | | | | | | | | | | | | | | | | | | | | | | | | | | | | | | | | | | | | | | | | | | | | | | | | | | | | | | | | | | | | | | | | | | | | | | | | | | | | | | | | | | | | | | | | | | | |
| | | | | | | | | | | | | | | | | | | | | | | | | | | | | | | | | | | | | | | | | | | | | | | | | | | | | | | | | | | | | | | | | | | | | | | | | | | | | | | | | | | | | | | | | | | | |
| | | | | | | | | | | | | | | | | | | | | | | | | | | | | | | | | | | | | | | | | | | | | | | | | | | | | | | | | | | | | | | | | | | | | | | | | | | | | | | | | | | | | | | | | | | | |
| 1 | 2 | 1 | | | | | | | | | | | | | | | | | | | | | | | | | | | | | | | | | | | | | | | | | | | | | | | | | | | | | | | | | | | | | | | | | | | | | | | | | | | | | | | | | | | | | | | | | |
| 1 | | | | | | | | | | | | | | | | | | | | | | | | | | | | | | | | | | | | | | | | | | | | | | | | | | | | | | | | | | | | | | | | | | | | | | | | | | | | | | | | | | | | | | | | | | | |
| 1 | | | | | | | | | | | | | | | | | | | | | | | | | | | | | | | | | | | | | | | | | | | | | | | | | | | | | | | | | | | | | | | | | | | | | | | | | | | | | | | | | | | | | | | | | | | |
| | | | | | | | | | | | | | | | | | | | | | | | | | | | | | | | | | | | | | | | | | | | | | | | | | | | | | | | | | | | | | | | | | | | | | | | | | | | | | | | | | | | | | | | | | | | |
| | | 1 | | | | | | | | | | | | | | | | | | | | | | | | | | | | | | | | | | | | | | | | | | | | | | | | | | | | | | | | | | | | | | | | | | | | | | | | | | | | | | | | | | | | | | | | | |
| | | | | | | | | | | | | | | | | | | | | | | | | | | | | | | | | | | | | | | | | | | | | | | | | | | | | | | | | | | | | | | | | | | | | | | | | | | | | | | | | | | | | | | | | | | | |
| | | | | | | | | | | | | | | | | | | | | | | | | | | | | | | | | | | | | | | | | | | | | | | | | | | | | | | | | | | | | | | | | | | | | | | | | | | | | | | | | | | | | | | | | | | | |
| | 1 | | | | | | | | | | | | | | | | | | | | | | | | | | | | | | | | | | | | | | | | | | | | | | | | | | | | | | | | | | | | | | | | | | | | | | | | | | | | | | | | | | | | | | | | | | |
| 3 | | | | | | | | | | | | | | | | | | | | | | | | | | | | | | | | | | | | | | | | | | | | | | | | | | | | | | | | | | | | | | | | | | | | | | | | | | | | | | | | | | | | | | | | | | | |
| | | | | | | | | | | | | | | | | | | | | | | | | | | | | | | | | | | | | | | | | | | | | | | | | | | | | | | | | | | | | | | | | | | | | | | | | | | | | | | | | | | | | | | | | | | | |
| | | | | | | | | | | | | | | | | | | | | | | | | | | | | | | | | | | | | | | | | | | | | | | | | | | | | | | | | | | | | | | | | | | | | | | | | | | | | | | | | | | | | | | | | | | | |
| | | | | | | | | | | | | | | | | | | | | | | | | | | | | | | | | | | | | | | | | | | | | | | | | | | | | | | | | | | | | | | | | | | | | | | | | | | | | | | | | | | | | | | | | | | | |
| | | | | | | | | | | | | | | | | | | | | | | | | | | | | | | | | | | | | | | | | | | | | | | | | | | | | | | | | | | | | | | | | | | | | | | | | | | | | | | | | | | | | | | | | | | | |
| 1 | | 1 | | | | | | | | | | | | | | | | | | | | | | | | | | | | | | | | | | | | | | | | | | | | | | | | | | | | | | | | | | | | | | | | | | | | | | | | | | | | | | | | | | | | | | | | | |
| | | | | | | | | | | | | | | | | | | | | | | | | | | | | | | | | | | | | | | | | | | | | | | | | | | | | | | | | | | | | | | | | | | | | | | | | | | | | | | | | | | | | | | | | | | | |
| | | | | | | | | | | | | | | | | | | | | | | | | | | | | | | | | | | | | | | | | | | | | | | | | | | | | | | | | | | | | | | | | | | | | | | | | | | | | | | | | | | | | | | | | | | | |
| | | | | | | | | | | | | | | | | | | | | | | | | | | | | | | | | | | | | | | | | | | | | | | | | | | | | | | | | | | | | | | | | | | | | | | | | | | | | | | | | | | | | | | | | | | | |
| | | | | | | | | | | | | | | | | | | | | | | | | | | | | | | | | | | | | | | | | | | | | | | | | | | | | | | | | | | | | | | | | | | | | | | | | | | | | | | | | | | | | | | | | | | | |
| | | | | | | | | | | | | | | | | | | | | | | | | | | | | | | | | | | | | | | | | | | | | | | | | | | | | | | | | | | | | | | | | | | | | | | | | | | | | | | | | | | | | | | | | | | | |
| | | | | | | | | | | | | | | | | | | | | | | | | | | | | | | | | | | | | | | | | | | | | | | | | | | | | | | | | | | | | | | | | | | | | | | | | | | | | | | | | | | | | | | | | | | | |
| | | | | | | | | | | | | | | | | | | | | | | | | | | | | | | | | | | | | | | | | | | | | | | | | | | | | | | | | | | | | | | | | | | | | | | | | | | | | | | | | | | | | | | | | | | | |
| Post - 0 Miss - 0 Block - 0 | Post - 0 Miss - 2 Block - 0 | Post - 0 Miss - 0 Block - 0 | Post - 0 Miss - 0 Block - 0 | Post - 0 Miss - 0 Block - 0 | Post - 0 Miss - 0 Block - 1 | Post - 0 Miss - 0 Block - 0 | Post - 0 Miss - 0 Block - 0 | | | | | | | | | | | | | | | | | | | | | | | | | | | | | | | | | | | | | | | | | | | | | | | | | | | | | | | | | | | | | | | | | | | | | | | | | | | | | | | | | | | | |

注释: Post=击柱 Miss=射失 Block=被封





四分之一决赛
青年男子 全国比赛

2016年“体彩杯”全国手球男子青年锦标赛

| | | | | | | | | | | | | | | | | | | | | | |
|--------------------|---|---------------------|---------------------|------------------|------------------------------------|-------------------|---|---------------------------|----------------|----|-----|----------------------|---------------|---|--|--|---|---|----|---|----|
| Team A A 安徽队 | | | | Team B B 江苏队 | | | | Match Number 36 | | | | | | | | | | | | | |
| played in China | | in the hall 重庆万州 | | on 26/03/2016 | | at 17:30 hours | | Spectators | | | | | | | | | | | | | |
| Half-time (30') | A 22 | B 10 | End of playing time | A 41 | B 27 | 1st extra time | A | B | 2nd extra time | A | B | After penalty throws | A | B | | | | | | | |
| Number of 7 m | A 0/0 | Team time-out | | | Full name of players and officials | | | | Team time-out | | | B 1/2 | Number of 7 m | | | | | | | | |
| | 1 | 2 | 3 | | | | | 1 | 2 | 3 | | | | | | | | | | | |
| No. | Team A | | | | | G | W | 2' | D | DR | No. | Team B | | | | | G | W | 2' | D | DR |
| 1 | 郭世伟 | | | | | 9 | | | | | 1 | 潘博琦 | | | | | | | | | |
| 2 | 金勇峰 | | | | | 5 | | | | | 3 | 赵韦光 | | | | | | | | | |
| 9 | 陈开勇 | | | | | 5 | 1 | | | | 4 | 张瑞恒 | | | | | | | | | |
| 17 | 王巨柱 | | | | | 1 | | | | | 6 | 季雨 | | | | | 1 | | 1 | | |
| 18 | 李双 | | | | | 5 | 1 | 1 | | | 7 | 任超凡 | | | | | 5 | | | | |
| 19 | 何山 | | | | | 2 | | | | | 8 | 姜童耀 | | | | | 2 | | | | |
| 21 | 李明 | | | | | | | | | | 9 | 王俊威 | | | | | 1 | | | | |
| 24 | 徐安格 | | | | | 3 | | 2 | | | 11 | 周傲 | | | | | 8 | | | | |
| 25 | 李文哲 | | | | | | | | | | 13 | 尹吉祥 | | | | | 5 | | | | |
| 26 | 程浩然 | | | | | 4 | | 2 | | | 14 | 罗中熠 | | | | | | | | | 1 |
| 27 | 王长旭 | | | | | 5 | | 2 | | | 15 | 阎冠中 | | | | | | | | | |
| 28 | 丁浩然 | | | | | 2 | | | | | 17 | 马益奎 | | | | | 4 | 1 | 1 | | |
| 32 | 许浩翔 | | | | | | | | | | 18 | 耿畅 | | | | | 1 | 1 | 1 | | |
| 33 | 姚紫祥 | | | | | | | | | | | | | | | | | | | | |
| 41 | 刘润民 | | | | | | | | | | | | | | | | | | | | |
| 42 | 王成龙 | | | | | | | | | | | | | | | | | | | | |
| A | 王来黔 (主教练) | | | | | | | | | | B | 贾淑君 (主教练) | | | | | | | | | |
| B | 陆万红 | | | | | | | | | | | | | | | | | | | | |
| C | 吴翔 | | | | | | | | | | | | | | | | | | | | |
| A | Signature of Responsible Official of the Teams (Off. A) | | | | | | | | | | | | | | | | | | B | | |
| TP | Remarks of Referee / CHA Official | | | | | | | | | | | | | | | | | | TP | | |

Signatures

Referees: 汤怡 (CHN) 缪俊 (CHN)

Techn. Delegates: 李英才 (CHN)

CHA Official: 吴瑞亭 (CHN)

Note: Number of 7m Throws Awarded to Team A and B, Goals (G), Warnings (W), Suspensions (2'), Direct Disqualification (D), Disqualification with Report (DR) and Team Penalty (TP).

Table Officials:

Statisticians:





2016年“体彩杯”全国手球男子青年锦标赛 竞赛技术统计(媒体表)

| | | | | | | |
|----------------|-----------|------------|----|-----------|------------------|-----------|
| 四分之一决赛 | 组别 | X | 轮次 | 6 | 场次 | 36 |
| 重庆万州 | | 26/03/2016 | | | 201602036-51-1/1 | |
| 安徽队 | 安徽 | 41 | vs | 27 | 江苏 | 江苏队 |
| 22 : 10 | | | | | | |

| 裁判员 | | 汤怡 (CHN) | | | | | | | | | | | / | 缪俊 (CHN) | | | | | | | | | | | | | | | |
|---------------|-----|--------------|--------------|-------------|--------------|------------|------------|------------|--------------|-------------|-----------|-----------|----------|----------|----------|-----------|----|----------|-----------|----|-----|--|--|--|--|--|--|--|--|
| 安徽 | | 远射 | 近射 | 边射 | 快攻 | 突破 | 任意球 | 7m球 | 合计 | % | 助攻 | 失误 | 警告 | 2' | D & DR | 安徽 | | 比赛进程 | 江苏 | | | | | | | | | | |
| 主教练: 王来黔 | | | | | | | | | | | | | | | | | | 1st Half | | | | | | | | | | | |
| 1 | 郭世伟 | 6/8 | 2/4 | | 1/1 | 0/1 | | | 9/14 | 64.3 | 1 | 2 | | | | | 0 | 00:30 | 1 | 13 | 尹吉祥 | | | | | | | | |
| 2 | 金勇峰 | 1/3 | 2/2 | | | 2/2 | | | 5/7 | 71.4 | 2 | 5 | | | | | 0 | 01:18 | 2 | 18 | 耿畅 | | | | | | | | |
| 9 | 陈开勇 | | 1/1 | | 3/4 | | 1/1 | | 5/6 | 83.3 | | | 1 | | | 18 | 1 | 01:38 | 2 | 8 | 姜童耀 | | | | | | | | |
| 17 | 王巨柱 | 1/1 | 0/2 | | | | | | 1/3 | 33.3 | 2 | | | | | 1 | 2 | 02:37 | 3 | 3 | | | | | | | | | |
| 18 | 李双 | 1/2 | 2/3 | | 1/1 | | 1/1 | | 5/7 | 71.4 | 1 | | 1 | 1 | | 17 | 3 | 03:07 | 3 | 3 | | | | | | | | | |
| 19 | 何山 | | | | 2/2 | 0/1 | | | 2/3 | 66.7 | | 2 | | | | 18 | 4 | 05:13 | 3 | 3 | | | | | | | | | |
| 21 | 李明 | | | | | | | | | | 5 | 1 | | | | 9 | 5 | 06:06 | 3 | 3 | | | | | | | | | |
| 24 | 徐安格 | | 3/3 | | | | | | 3/3 | 100 | | 1 | | 2 | | 1 | 6 | 07:03 | 3 | 3 | | | | | | | | | |
| 25 | 李文哲 | | | | | | | | | | | | | | | 9 | 7 | 07:38 | 3 | 3 | | | | | | | | | |
| 26 | 程浩然 | 1/2 | 2/2 | | 0/1 | 1/1 | 0/1 | | 4/7 | 57.1 | | 4 | | 2 | | 9 | 8 | 08:52 | 4 | 13 | 尹吉祥 | | | | | | | | |
| 27 | 王长旭 | | 1/1 | 0/1 | 3/3 | 1/1 | | | 5/6 | 83.3 | 2 | 2 | | 2 | | 9 | 9 | 09:34 | 4 | 4 | | | | | | | | | |
| 28 | 丁浩然 | | | 1/3 | 1/1 | | | | 2/4 | 50.0 | | 2 | | | | 19 | 10 | 10:52 | 4 | 4 | | | | | | | | | |
| 32 | 许浩翔 | 0/1 | | | | | | | 0/1 | 0.0 | 1 | 1 | | | | 9 | 10 | 11:41 | 5 | 13 | 尹吉祥 | | | | | | | | |
| 33 | 姚紫祥 | | | | | | | | | | | | | | | 11 | 11 | 12:01 | 5 | 5 | | | | | | | | | |
| 41 | 刘润民 | | | | | | | | | | | | | | | 18 | 12 | 14:31 | 5 | 5 | | | | | | | | | |
| 42 | 王成龙 | | | | | | | | | | | | | | | 18 | 12 | 15:07 | 6 | 17 | 马益奎 | | | | | | | | |
| 运动员 合计 | | 10/17 | 13/18 | 1/4 | 11/13 | 4/6 | 2/3 | | 41/61 | 67.2 | 14 | 20 | 2 | 7 | | 12 | 12 | 15:44 | 7 | 11 | 周傲 | | | | | | | | |
| 21 | 李明 | 12/18 | 5/14 | 1/2 | 1/1 | 1/1 | 0/1 | 0/1 | 20/37 | 54.1 | 5 | 1 | | | | 19 | 13 | 16:32 | 7 | 7 | | | | | | | | | |
| 32 | 许浩翔 | 2/3 | 0/6 | 4/6 | 1/2 | | 1/1 | 1/1 | 9/19 | 47.4 | 1 | 1 | | | | 2 | 14 | 17:07 | 7 | 7 | | | | | | | | | |
| 守门员 合计 | | 14/21 | 5/20 | 5/8 | 1/2 | 1/1 | 2/2 | 1/2 | 29/56 | 51.8 | 6 | 2 | | | | 14 | 15 | 17:37 | 8 | 11 | 周傲 | | | | | | | | |
| 江苏 | | | | | | | | | | | | | | | | | | | | | | | | | | | | | |
| 江苏 | | 远射 | 近射 | 边射 | 快攻 | 突破 | 任意球 | 7m球 | 合计 | % | 助攻 | 失误 | 警告 | 2' | D & DR | 安徽 | | 比赛进程 | 江苏 | | | | | | | | | | |
| 教练: 贾淑君 | | | | | | | | | | | | | | | | | | 2nd Half | | | | | | | | | | | |
| 1 | 潘博琦 | | | | | | | | | | | | | | | 2 | 13 | 18:10 | 9 | 13 | 尹吉祥 | | | | | | | | |
| 3 | 赵韦光 | | | | | | | | | | | | | | | 18 | 14 | 18:10 | 9 | 13 | 尹吉祥 | | | | | | | | |
| 4 | 张瑞恒 | | | | | | | | | | | | | | | 18 | 15 | 18:34 | 9 | 9 | | | | | | | | | |
| 6 | 季雨 | | | 1/1 | | | | | 1/1 | 100 | | | | 1 | | 18 | 16 | 19:55 | 9 | 9 | | | | | | | | | |
| 7 | 任超凡 | 1/1 | 3/5 | 0/1 | 1/1 | | 0/1 | | 5/9 | 55.6 | 1 | 1 | | | | 1 | 17 | 20:51 | 9 | 9 | | | | | | | | | |
| 8 | 姜童耀 | | 1/1 | 1/1 | | | | | 2/2 | 100 | | 1 | | | | 1 | 18 | 22:54 | 9 | 9 | | | | | | | | | |
| 9 | 王俊威 | | 1/1 | 1/1 | | | | | 1/1 | 100 | | | | | | 1 | 19 | 23:30 | 9 | 9 | | | | | | | | | |
| 11 | 周傲 | 2/11 | 6/7 | | 0/1 | 0/1 | 0/1 | | 8/21 | 38.1 | 5 | 5 | | | | 19 | 20 | 24:11 | 10 | 13 | 尹吉祥 | | | | | | | | |
| 13 | 尹吉祥 | 3/17 | 1/2 | | | | | 1/1 | 5/20 | 25.0 | | 4 | | | | 2 | 20 | 24:48 | 10 | 10 | | | | | | | | | |
| 14 | 罗中熠 | | | | | | | | | | | | | | | 1 | 21 | 25:22 | 10 | 10 | | | | | | | | | |
| 15 | 阎冠中 | | | 0/3 | | | | 0/1 | 0/4 | 0.0 | | 3 | | | | 26 | 22 | 28:09 | 10 | 10 | | | | | | | | | |
| 17 | 马益奎 | 0/1 | 4/6 | 0/2 | 0/1 | | | | 4/10 | 40.0 | | 1 | 1 | 1 | | 2 | 23 | 00:52 | 10 | 10 | | | | | | | | | |
| 18 | 耿畅 | 1/1 | 0/1 | 0/1 | | | | | 1/3 | 33.3 | | 2 | 1 | 1 | | 27 | 24 | 02:15 | 10 | 10 | | | | | | | | | |
| 运动员 合计 | | 7/31 | 15/22 | 3/10 | 1/3 | 0/1 | 0/2 | 1/2 | 27/71 | 38.0 | 6 | 17 | 2 | 3 | 1 | 24 | 25 | 03:10 | 10 | 10 | | | | | | | | | |
| 4 | 张瑞恒 | 1/5 | 0/5 | | 2/6 | 1/4 | 0/2 | | 4/22 | 18.2 | | | | | | 24 | 26 | 04:11 | 10 | 10 | | | | | | | | | |
| 13 | 尹吉祥 | 2/6 | 2/7 | 2/3 | 0/2 | 0/1 | 1/1 | | 7/20 | 35.0 | | | | | | 1 | 26 | 04:52 | 11 | 11 | 周傲 | | | | | | | | |
| 14 | 罗中熠 | 0/2 | 2/5 | 2/3 | 0/5 | | | | 2/12 | 16.7 | | | | | | 27 | 27 | 05:09 | 11 | 11 | 周傲 | | | | | | | | |
| 守门员 合计 | | 3/13 | 4/17 | 2/3 | 2/13 | 1/5 | 1/3 | | 13/54 | 24.1 | | | | | | 26 | 28 | 07:01 | 13 | 14 | 任超凡 | | | | | | | | |

场上队员: 得分 / 射门

守门员: 救球 / 射门

| | | | | | | | | | |
|----|------------|----|--------------|-----|------------|-----|----------|----|---------|
| 快攻 | Fast Break | 突破 | Breakthrough | 任意球 | Free Throw | 7M球 | 7M Throw | 助攻 | Assist |
| 警告 | Warning | 失误 | Error | 2' | Suspension | D | 取消资格 | DR | 取消资格+报告 |





2016年“体彩杯”全国手球男子青年锦标赛 图式比赛技术统计表

轮次 6

场次 36

201602036-21-1/1

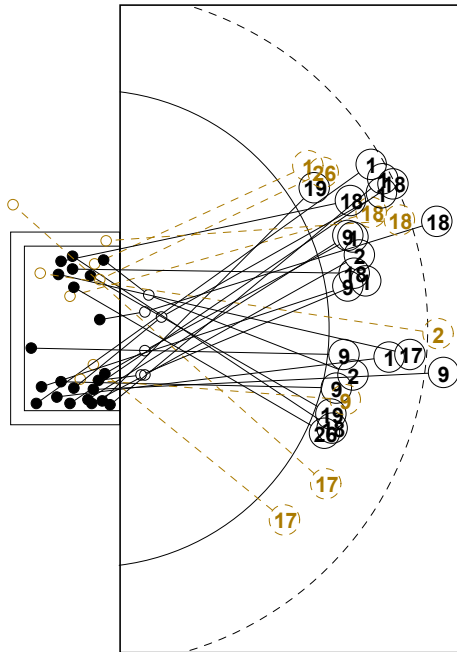

7M 安徽

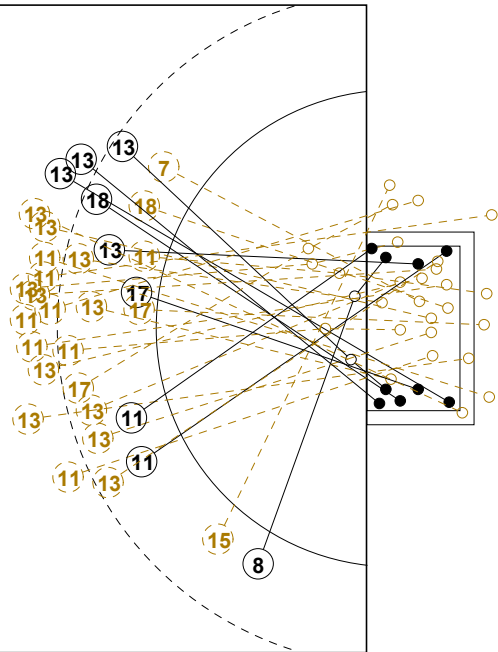
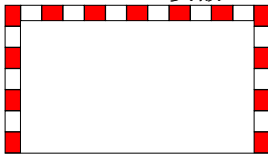

江苏 7M

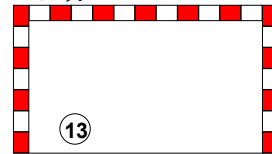

1st Half
22 : 10

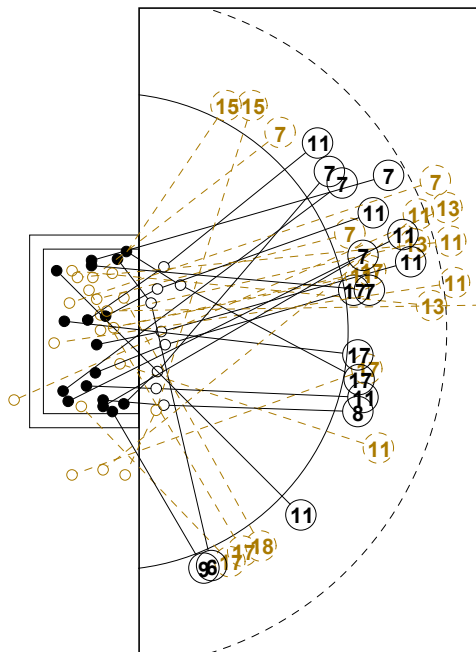

7M 江苏

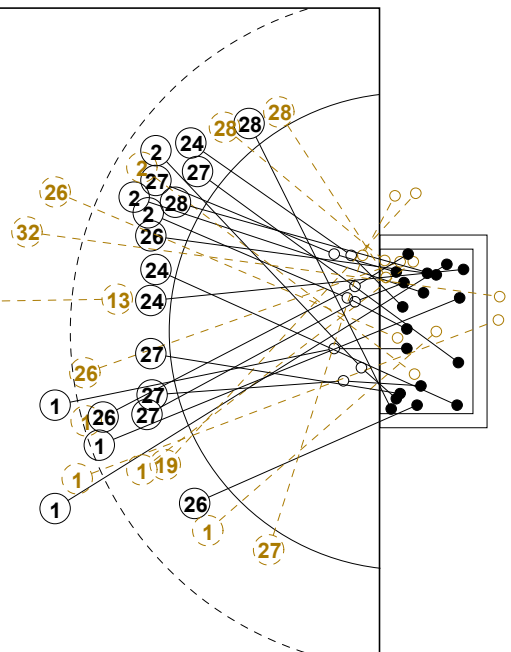
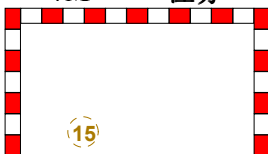

安徽 7M

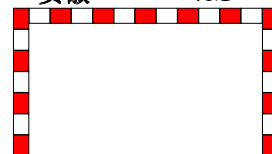

2nd Half
27 : 41



2016年“体彩杯”全国手球男子青年锦标赛

个人/全队技术统计表

正式表
手球
青年男子四分之一决赛
轮次 6组别 X
场次 36201602036-14-1/2
重庆万州
26/03/2016 17:30

| 号码 | 姓名 | 远射 | 近射 | 边射 | 快攻 | 突破 | 任意 | 7M | 合计 | % | 助攻 | 失误 | 警告 | 2' | 取消 | 时间 |
|----------------|-----|-------|-------|-----|-------|-----|-----|-----|-------|-------|----|----|----|----|----|----------|
| 安徽队(安徽) | | | | | | | | | | | | | | | | |
| <i>(场上队员)</i> | | | | | | | | | | | | | | | | |
| 1 | 郭世伟 | 6/8 | 2/4 | | 1/1 | 0/1 | | | 9/14 | 64.3% | 1 | 2 | | | | 00:49:46 |
| 2 | 金勇峰 | 1/3 | 2/2 | | | 2/2 | | | 5/7 | 71.4% | 2 | 5 | | | | 01:00:00 |
| 9 | 陈开勇 | | 1/1 | | 3/4 | | 1/1 | | 5/6 | 83.3% | | | 1 | | | 00:13:34 |
| 17 | 王巨柱 | 1/1 | 0/2 | | | | | | 1/3 | 33.3% | 2 | | | | | 00:18:24 |
| 18 | 李双 | 1/2 | 2/3 | | 1/1 | | 1/1 | | 5/7 | 71.4% | 1 | | 1 | 1 | | 00:22:31 |
| 19 | 何山 | | | | 2/2 | 0/1 | | | 2/3 | 66.7% | | 2 | | | | 00:36:03 |
| 21 | 李明 | | | | | | | | | 0.0% | 5 | 1 | | | | 00:43:13 |
| 24 | 徐安格 | | 3/3 | | | | | | 3/3 | 100% | | 1 | | 2 | | 00:46:20 |
| 25 | 李文哲 | | | | | | | | | 0.0% | | | | | | 00:06:56 |
| 26 | 程浩然 | 1/2 | 2/2 | | 0/1 | 1/1 | 0/1 | | 4/7 | 57.1% | | 4 | | 2 | | 00:37:23 |
| 27 | 王长旭 | | 1/1 | 0/1 | 3/3 | 1/1 | | | 5/6 | 83.3% | 2 | 2 | | 2 | | 00:37:28 |
| 28 | 丁浩然 | | | 1/3 | 1/1 | | | | 2/4 | 50.0% | | 2 | | | | 00:17:54 |
| 32 | 许浩翔 | 0/1 | | | | | | | 0/1 | 0.0% | 1 | 1 | | | | 00:16:47 |
| 33 | 姚紫祥 | | | | | | | | | 0.0% | | | | | | 00:00:00 |
| 41 | 刘润民 | | | | | | | | | 0.0% | | | | | | 00:13:20 |
| 42 | 王成龙 | | | | | | | | | 0.0% | | | | | | 00:00:00 |
| 合计 | | 10/17 | 13/18 | 1/4 | 11/13 | 4/6 | 2/3 | | 41/61 | 67.2% | 14 | 20 | 2 | 7 | | |
| <i>(守门员)</i> | | | | | | | | | | | | | | | | |
| 21 | 李明 | 12/18 | 5/14 | 1/2 | | 1/1 | 1/1 | 0/1 | 20/37 | 54.1% | 5 | 1 | | | | 00:43:13 |
| 32 | 许浩翔 | 2/3 | 0/6 | 4/6 | 1/2 | | 1/1 | 1/1 | 9/19 | 47.4% | 1 | 1 | | | | 00:16:47 |
| 合计 | | 14/21 | 5/20 | 5/8 | 1/2 | 1/1 | 2/2 | 1/2 | 29/56 | 51.8% | 6 | 2 | | | | |

场上队员：得分/射门

守门员：救球/射门

| 全队合计 | 得分 | 被救 | 射失 | 击柱 | 封球 | 合计 | % |
|------|----|----|----|----|----|----|-------|
| 远射 | 10 | 3 | 2 | 1 | 1 | 17 | 58.8% |
| 近射 | 13 | 4 | 1 | | | 18 | 72.2% |
| 边射 | 1 | 2 | 1 | | | 4 | 25.0% |
| 快攻 | 11 | 2 | | | | 13 | 84.6% |
| 突破 | 4 | 1 | 1 | | | 6 | 66.7% |
| 任意 | 2 | 1 | | | | 3 | 66.7% |
| 7M | | | | | | | 0.0% |



2016年“体彩杯”全国手球男子青年锦标赛

个人/全队技术统计表

正式表
手球
青年男子四分之一决赛
轮次 6组别 X
场次 36201602036-14-2/2
重庆万州
26/03/2016 17:30

| 号码 | 姓名 | 远射 | 近射 | 边射 | 快攻 | 突破 | 任意 | 7M | 合计 | % | 助攻 | 失误 | 警告 | 2' | 取消 | 时间 |
|----------------|-----|------|-----|-----|-----|-----|-----|-----|------|-------|----|----|----|----|----|----------|
| 江苏队(江苏) | | | | | | | | | | | | | | | | |
| <i>(上场队员)</i> | | | | | | | | | | | | | | | | |
| 1 | 潘博琦 | | | | | | | | | 0.0% | | | | | | 00:00:00 |
| 3 | 赵韦光 | | | | | | | | | 0.0% | | | | | | 00:00:00 |
| 4 | 张瑞恒 | | | | | | | | | 0.0% | | | | | | 00:26:23 |
| 6 | 季雨 | | | 1/1 | | | | 1/1 | 1/1 | 100% | | | | 1 | | 00:21:50 |
| 7 | 任超凡 | 1/1 | 3/5 | 0/1 | 1/1 | | 0/1 | | 5/9 | 55.6% | 1 | 1 | | | | 01:00:00 |
| 8 | 姜童耀 | | 1/1 | 1/1 | | | | | 2/2 | 100% | | 1 | | | | 00:29:31 |
| 9 | 王俊威 | | | 1/1 | | | | | 1/1 | 100% | | | | | | 00:22:42 |
| 11 | 周傲 | 2/11 | 6/7 | | 0/1 | 0/1 | 0/1 | | 8/21 | 38.1% | 5 | 5 | | | | 01:00:00 |
| 13 | 尹吉祥 | 3/17 | 1/2 | | | | | 1/1 | 5/20 | 25.0% | | 4 | | | | 00:56:22 |
| 14 | 罗中熠 | | | | | | | | | 0.0% | | | | 1 | | 00:11:02 |
| 15 | 阎冠中 | | | 0/3 | | | | 0/1 | 0/4 | 0.0% | | 3 | | | | 00:34:49 |
| 17 | 马益奎 | 0/1 | 4/6 | 0/2 | 0/1 | | | | 4/10 | 40.0% | | 1 | 1 | 1 | | 01:18:16 |
| 18 | 耿畅 | 1/1 | 0/1 | 0/1 | | | | | 1/3 | 33.3% | | 2 | 1 | 1 | | 00:59:37 |
| 合计 | | | | | | | | | | | | | | | | |
| <i>(守门员)</i> | | | | | | | | | | | | | | | | |
| 4 | 张瑞恒 | 1/5 | 0/5 | | 2/6 | 1/4 | 0/2 | | 4/22 | 18.2% | | | | | | 00:26:23 |
| 13 | 尹吉祥 | 2/6 | 2/7 | 2/3 | 0/2 | 0/1 | 1/1 | | 7/20 | 35.0% | | | | | | 00:56:22 |
| 14 | 罗中熠 | 0/2 | 2/5 | | 0/5 | | | | 2/12 | 16.7% | | | | 1 | | 00:11:02 |
| 合计 | | | | | | | | | | | | | | | | |

场上队员：得分/射门

守门员：救球/射门

| 全队合计 | 得分 | 被救 | 射失 | 击柱 | 封球 | 合计 | % |
|------|----|----|----|----|----|----|-------|
| 远射 | 7 | 14 | 6 | 3 | 1 | 31 | 22.6% |
| 近射 | 15 | 5 | 2 | | | 22 | 68.2% |
| 边射 | 3 | 5 | 2 | | | 10 | 30.0% |
| 快攻 | 1 | 1 | 1 | | | 3 | 33.3% |
| 突破 | | 1 | | | | 1 | 0.0% |
| 任意 | | 2 | | | | 2 | 0.0% |
| 7M | 1 | 1 | | | | 2 | 50.0% |





2016年“体彩杯”全国手球男子青年锦标赛

图式射门区域统计

轮次 6 场次 36

201602036-41-1/1

安徽队

| | | | | | | | |
|-----------------------------|-----------------------------|-----------------------------|-----------------------------|-----------------------------|-----------------------------|-----------------------------|-----------------------------|
| 1 郭世伟 | 2 金勇峰 | 9 陈开勇 | 17 王巨柱 | 18 李双 | 19 何山 | 21 李明 | 24 徐安格 |
| 4 1 3 | 1 1 1 | 1 1 2 1 | 1 | 1 1 | 1 1 | | 1 1 |
| Post - 0 Miss - 1 Block - 1 | Post - 0 Miss - 0 Block - 0 | Post - 0 Miss - 0 Block - 0 | Post - 0 Miss - 1 Block - 0 | Post - 1 Miss - 0 Block - 0 | Post - 0 Miss - 1 Block - 0 | Post - 0 Miss - 0 Block - 0 | Post - 0 Miss - 0 Block - 0 |
| 25 李文哲 | 26 程浩然 | 27 王长旭 | 28 丁浩然 | 32 许浩翔 | 33 姚紫祥 | 41 刘润民 | 42 王成龙 |
| | 1 1 | 1 1 2 | 1 1 | | | | |
| Post - 0 Miss - 0 Block - 0 | Post - 0 Miss - 0 Block - 0 | Post - 0 Miss - 1 Block - 0 | Post - 0 Miss - 0 Block - 0 | Post - 0 Miss - 1 Block - 0 | Post - 0 Miss - 0 Block - 0 | Post - 0 Miss - 0 Block - 0 | Post - 0 Miss - 0 Block - 0 |

| |
|-------------|
| 21 李明 |
| 3/4 5/5 1/2 |
| 2/6 4/6 1/4 |
| 1/5 1/1 2/4 |

| |
|-------------|
| 32 许浩翔 |
| 0/2 1/2 0/1 |
| 1/2 1/2 3/4 |
| 1/2 1/1 1/3 |

| |
|--|
| |
| |
| |

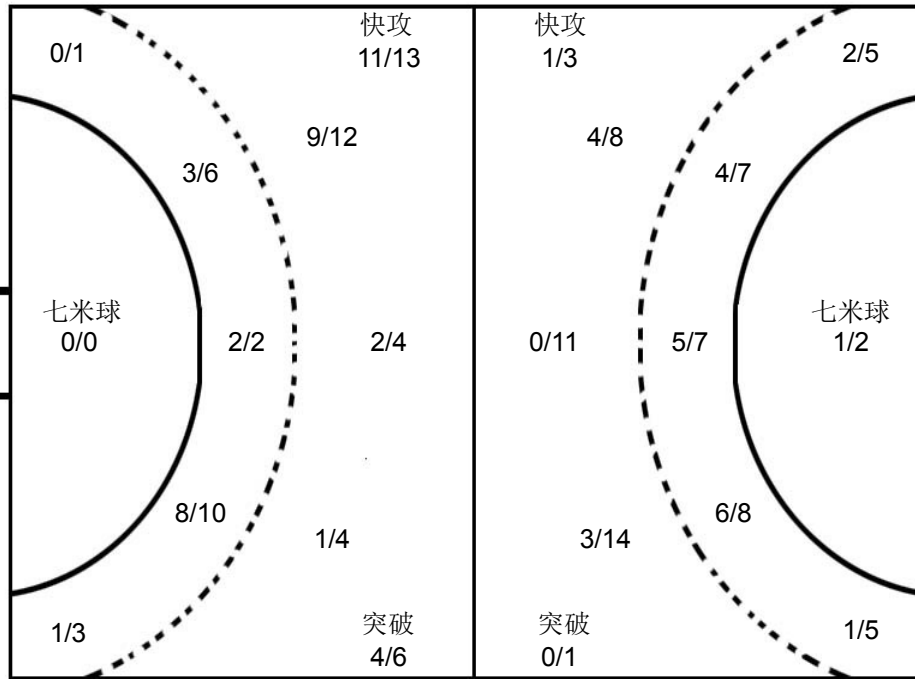

| |
|-------------|
| 4 张瑞恒 |
| 1/1 |
| 1/5 0/3 |
| 0/7 0/3 2/3 |

| |
|-------------|
| 13 尹吉祥 |
| 0/3 0/2 |
| 1/2 1/1 1/2 |
| 3/5 1/2 0/3 |

| |
|---------|
| 14 罗中熠 |
| 0/3 0/1 |
| 0/2 1/4 |
| 1/1 0/1 |

江苏队

| | | | | | | | |
|-----------------------------|-----------------------------|-----------------------------|-----------------------------|-----------------------------|-----------------------------|-----------------------------|-----------------------------|
| 1 潘博琦 | 3 赵韦光 | 4 张瑞恒 | 6 季雨 | 7 任超凡 | 8 姜童耀 | 9 王俊威 | 11 周傲 |
| | | | 1 | 1 2 | 1 | 1 | 2 1 |
| Post - 0 Miss - 0 Block - 0 | Post - 0 Miss - 0 Block - 0 | Post - 0 Miss - 0 Block - 0 | Post - 0 Miss - 0 Block - 0 | Post - 0 Miss - 0 Block - 0 | Post - 0 Miss - 0 Block - 0 | Post - 0 Miss - 0 Block - 0 | Post - 0 Miss - 5 Block - 1 |
| 13 尹吉祥 | 14 罗中熠 | 15 阎冠中 | 17 马益奎 | 18 耿畅 | | | |
| 1 2 | | | 1 1 1 | 1 | | | |
| Post - 3 Miss - 1 Block - 0 | Post - 0 Miss - 0 Block - 0 | Post - 0 Miss - 2 Block - 0 | Post - 0 Miss - 3 Block - 0 | Post - 0 Miss - 0 Block - 0 | | | |

注释: Post=击柱 Miss=射失 Block=被封





11-12名
青年男子 全国比赛

2016年“体彩杯”全国手球男子青年锦标赛

| | | | | | | | | | | | | | | | | | | | | | |
|--------------------|---|--|---------------------|------------------|------------------------------------|-------------------|---|---------------------------|------------------------------|----|-----|----------------------|---------------|---|--|--|----|---|----|---|----|
| Team A A 上海队 | | | | Team B B 天津队 | | | | Match Number 37 | | | | | | | | | | | | | |
| played in China | | in the hall 重庆万州 | | on 28/03/2016 | | at 08:30 hours | | Spectators | | | | | | | | | | | | | |
| Half-time (30') | A 12 | B 15 | End of playing time | A 25 | B 29 | 1st extra time | A | B | 2nd extra time | A | B | After penalty throws | A | B | | | | | | | |
| Number of 7 m | A 0 / 1 | Team time-out 1 18:14 2 47:55 3 55:45 | | | Full name of players and officials | | | | Team time-out 1 29:58 2 3 | | | B 2 / 2 | Number of 7 m | | | | | | | | |
| No. | Team A | | | | | G | W | 2' | D | DR | No. | Team B | | | | | G | W | 2' | D | DR |
| 2 | 谢智超 | | | | | | | | | | 9 | 吴明远 | | | | | 11 | | | | |
| 3 | 高天伦 | | | | | 8 | | | | | 18 | 王晓琪 | | | | | 5 | | | | |
| 4 | 高震东 | | | | | | | | | | 21 | 潘玉帅 | | | | | 1 | 1 | 1 | | |
| 5 | 曹磊 | | | | | 4 | 1 | 1 | | | 22 | 魏雨童 | | | | | 8 | | 1 | | |
| 6 | 季晨旭 | | | | | | | | | | 24 | 刘子健 | | | | | | | | | |
| 7 | 蒋家敏 | | | | | | | | | | 25 | 王一雄 | | | | | 2 | | | | |
| 8 | 庄旭杰 | | | | | 5 | | 1 | | | 26 | 刘思远 | | | | | 2 | | | | |
| 10 | 董凯 | | | | | 5 | 1 | | | | 27 | 左金龙 | | | | | | | | | |
| 12 | 张润民 | | | | | | | | | | 28 | 何喜年 | | | | | | | | | |
| 14 | 吴佳兵 | | | | | | | 1 | | | | | | | | | | | | | |
| 16 | 陈辰 | | | | | | | | | | | | | | | | | | | | |
| 18 | 吴双 | | | | | 3 | | | | | | | | | | | | | | | |
| A | 马仲顺 | | | | | | | | | | A | 李志成 | | | | | | | | | |
| | | | | | | | | | | | B | 潘玉强 | | | | | 1 | | | | |
| | | | | | | | | | | | | | | | | | | | | | |
| | | | | | | | | | | | | | | | | | | | | | |
| | | | | | | | | | | | | | | | | | | | | | |
| A | Signature of Responsible Official of the Teams (Off. A) | | | | | | | | | | B | | | | | | | | | | |
| TP | Remarks of Referee / CHA Official | | | | | | | | | | TP | | | | | | | | | | |
| | | | | | | | | | | | | | | | | | | | | | |
| | | | | | | | | | | | | | | | | | | | | | |
| | | | | | | | | | | | | | | | | | | | | | |

Signatures

| | | | | |
|------------------|-----------|-----------|--|--|
| Referees | 张智伟 (CHN) | 陈炳威 (CHN) | | |
| Techn. Delegates | 许宜扬 (CHN) | | | |
| CHA Official | 徐健 (CHN) | | | |

Note: Number of 7m Throws Awarded to Team A and B, Goals (G), Warnings (W), Suspensions (2'), Direct Disqualification (D), Disqualification with Report (DR) and Team Penalty (TP).

Table Officials:

Statisticians:





2016年“体彩杯”全国手球男子青年锦标赛 图式比赛技术统计表

轮次 7

场次 37

201602037-21-1/1

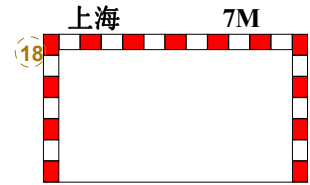
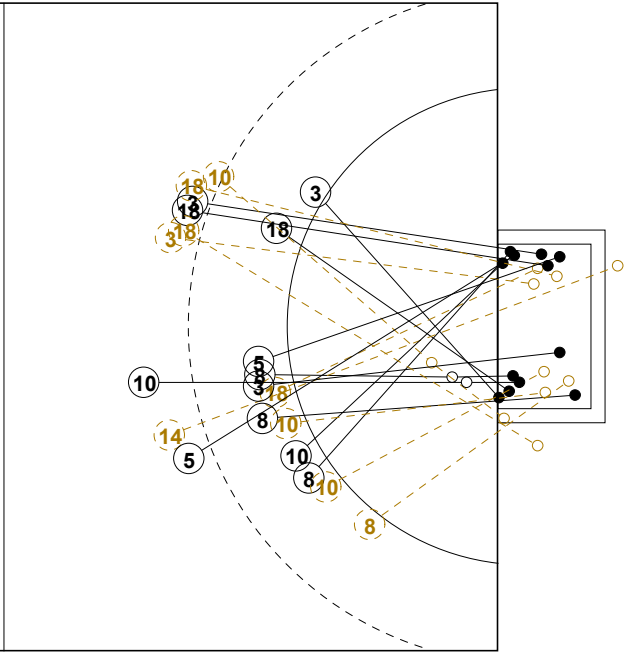
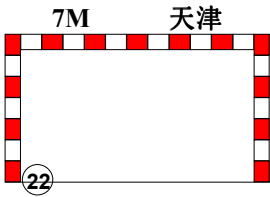
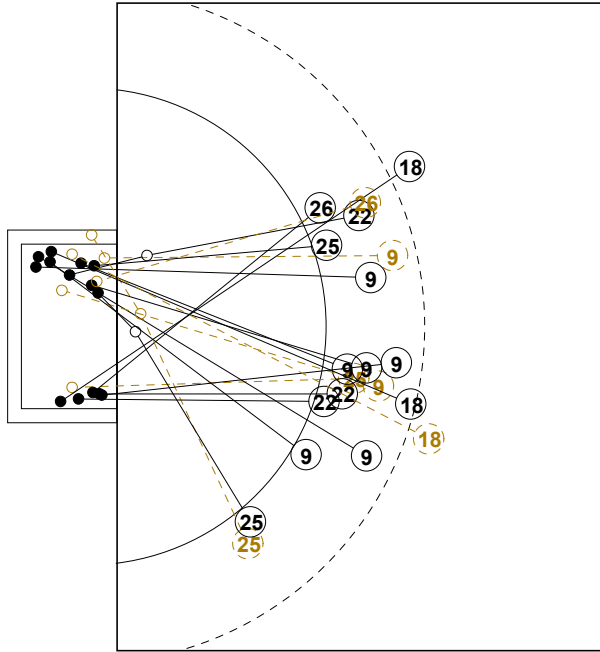

1st Half
15 : 12

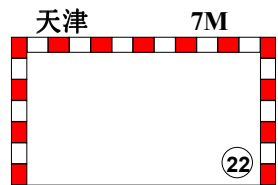
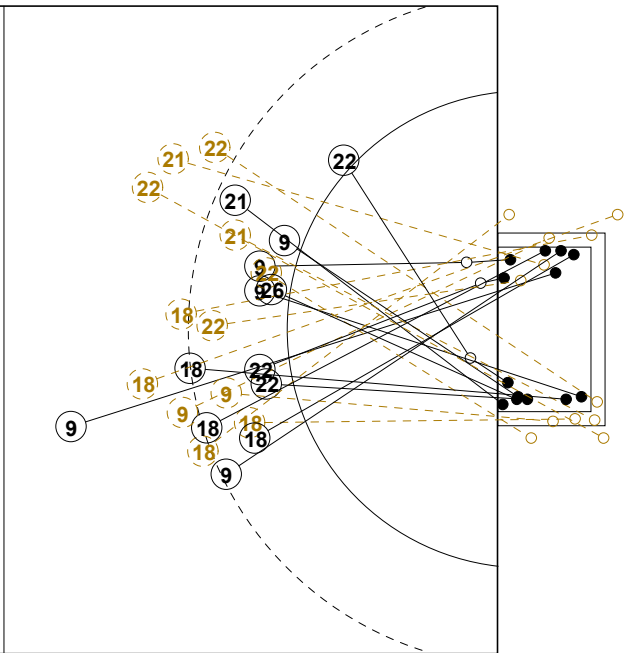
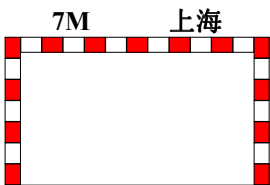
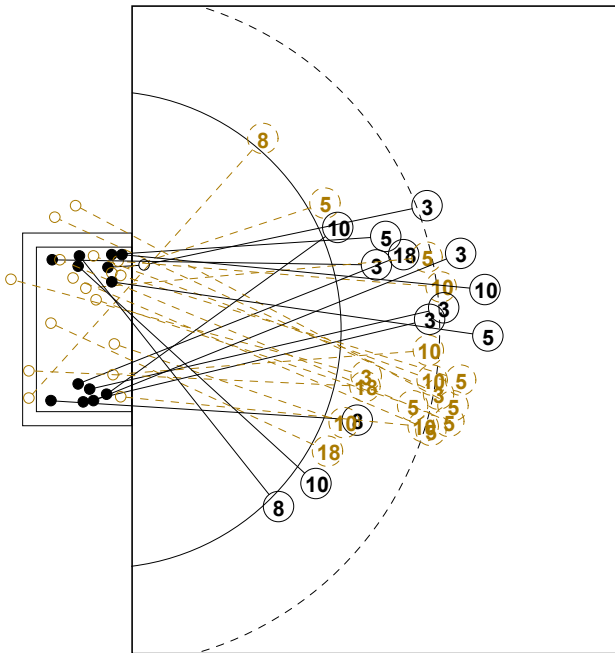

2nd Half
25 : 29



2016年“体彩杯”全国手球男子青年锦标赛

个人/全队技术统计表

正式表
手球
青年男子11-12名
轮次 7组别 C
场次 37201602037-14-1/2
重庆万州
28/03/2016 08:30

| 号码 | 姓名 | 远射 | 近射 | 边射 | 快攻 | 突破 | 任意 | 7M | 合计 | % | 助攻 | 失误 | 警告 | 2' | 取消 | 时间 |
|----------------|-----|------|------|-----|-----|-----|-----|-----|------|-------|----|----|----|----|----|----------|
| 上海队(上海) | | | | | | | | | | | | | | | | |
| <i>(场上队员)</i> | | | | | | | | | | | | | | | | |
| 2 | 谢智超 | | | | | | | | | 0.0% | | | | | | 00:00:00 |
| 3 | 高天伦 | 5/7 | 3/4 | | | | | | 8/11 | 72.7% | | 6 | | | | 01:00:00 |
| 4 | 高震东 | | | | | | | | | 0.0% | | | | | | 00:00:00 |
| 5 | 曹磊 | 2/8 | 0/1 | | 1/1 | 1/1 | | | 4/11 | 36.4% | 2 | | 1 | 1 | | 00:34:01 |
| 6 | 季晨旭 | | | | | | | | | 0.0% | | | | | | 00:00:00 |
| 7 | 蒋家敏 | | | | | | | | | 0.0% | | 1 | | | | 01:00:00 |
| 8 | 庄旭杰 | | | 0/2 | 4/4 | 1/1 | | | 5/7 | 71.4% | | 3 | | 1 | | 01:00:00 |
| 10 | 董凯 | 2/7 | 2/4 | | 1/1 | 0/1 | | | 5/13 | 38.5% | 2 | 4 | 1 | | | 00:58:06 |
| 12 | 张润民 | | | | | | | | | 0.0% | | | | | | 01:00:00 |
| 14 | 吴佳兵 | 0/1 | | | | | | | 0/1 | 0.0% | | 2 | 1 | | | 00:27:49 |
| 16 | 陈辰 | | | | | | | | | 0.0% | | | | | | 00:00:00 |
| 18 | 吴双 | 1/2 | 0/2 | | 1/1 | 1/2 | 0/1 | 0/1 | 3/9 | 33.3% | 3 | 3 | | | | 01:00:00 |
| 合计 | | | | | | | | | | | | | | | | |
| <i>(守门员)</i> | | | | | | | | | | | | | | | | |
| 12 | 张润民 | 4/12 | 3/12 | 0/1 | 0/4 | 0/5 | | 0/2 | 7/36 | 19.4% | | | | | | 01:00:00 |
| 合计 | | | | | | | | | | | | | | | | |

场上队员：得分/射门

守门员：救球/射门

| 全队合计 | 得分 | 被救 | 射失 | 击柱 | 封球 | 合计 | % |
|------|----|----|----|----|----|----|--------|
| 远射 | 10 | 10 | 4 | 1 | | 25 | 40.0% |
| 近射 | 5 | 4 | 1 | 1 | | 11 | 45.5% |
| 边射 | | 1 | | 1 | | 2 | 0.0% |
| 快攻 | 7 | | | | | 7 | 100.0% |
| 突破 | 3 | 2 | | | | 5 | 60.0% |
| 任意 | | 1 | | | | 1 | 0.0% |
| 7M | | | 1 | | | 1 | 0.0% |





2016年“体彩杯”全国手球男子青年锦标赛

个人/全队技术统计表

正式表
手球
青年男子11-12名
轮次 7组别 C
场次 37201602037-14-2/2
重庆万州
28/03/2016 08:30

| 号码 | 姓名 | 远射 | 近射 | 边射 | 快攻 | 突破 | 任意 | 7M | 合计 | % | 助攻 | 失误 | 警告 | 2' | 取消 | 时间 |
|----------------|-----|-----|-----|-----|-----|-----|----|-----|-------|-------|----|----|----|----|----|----------|
| 天津队(天津) | | | | | | | | | | | | | | | | |
| <i>(上场队员)</i> | | | | | | | | | | | | | | | | |
| 9 | 吴明远 | 3/5 | 4/6 | | 1/1 | 3/3 | | | 11/15 | 73.3% | 2 | 3 | | | | 00:59:48 |
| 18 | 王晓琪 | 4/8 | 0/1 | | | 1/1 | | | 5/10 | 50.0% | 4 | 1 | | | | 01:00:00 |
| 21 | 潘玉帅 | 1/2 | 0/1 | | | | | | 1/3 | 33.3% | 2 | 6 | 1 | 1 | | 01:00:00 |
| 22 | 魏雨童 | 0/3 | 3/4 | | 2/2 | 1/1 | | 2/2 | 8/12 | 66.7% | 1 | 2 | | 1 | | 01:00:00 |
| 24 | 刘子健 | | | | | | | | | 0.0% | | | | | | 00:32:41 |
| 25 | 王一雄 | | 1/2 | 1/2 | | | | | 2/4 | 50.0% | | 2 | | | | 01:00:00 |
| 26 | 刘思远 | | 1/2 | | 1/1 | | | | 2/3 | 66.7% | | 3 | | | | 01:00:00 |
| 27 | 左金龙 | | | | | | | | | 0.0% | | | | | | 00:00:11 |
| 28 | 何喜年 | | | | | | | | | 0.0% | | 1 | | | | 00:27:19 |

| | | | | | | | | | | | | | | | | |
|--------------|--|-------|------|-----|-----|-----|-----|-----|-------|-------|---|----|---|---|--|----------|
| 合计 | | 8/18 | 9/16 | 1/2 | 4/4 | 5/5 | | 2/2 | 29/47 | 61.7% | 9 | 18 | 1 | 2 | | |
| <i>(守门员)</i> | | | | | | | | | | | | | | | | |
| 24 | | 4/9 | 3/5 | 1/1 | 0/4 | 1/3 | | | 9/22 | 40.9% | | | | | | 00:32:41 |
| 28 | | 6/11 | 1/4 | | 0/3 | 1/2 | 1/1 | | 9/21 | 42.9% | | 1 | | | | 00:27:19 |
| 合计 | | 10/20 | 4/9 | 1/1 | 0/7 | 2/5 | 1/1 | | 18/43 | 41.9% | | 1 | | | | |

场上队员：得分/射门

守门员：救球/射门

| 全队合计 | 得分 | 被救 | 射失 | 击柱 | 封球 | 合计 | % |
|------|----|----|----|----|----|----|--------|
| 远射 | 8 | 4 | 3 | 3 | | 18 | 44.4% |
| 近射 | 9 | 3 | 1 | 3 | | 16 | 56.3% |
| 边射 | 1 | | | 1 | | 2 | 50.0% |
| 快攻 | 4 | | | | | 4 | 100.0% |
| 突破 | 5 | | | | | 5 | 100.0% |
| 任意 | | | | | | | 0.0% |
| 7M | 2 | | | | | 2 | 100.0% |





2016年“体彩杯”全国手球男子青年锦标赛

图式射门区域统计

轮次 7 场次 37

201602037-41-1/1

上海队

| | | | | | | | |
|--|--|---|---|---|---|---|---|
| 2 谢智超 0/0 0/0 0/0 Post - 0 Miss - 0 Block - 0 | 3 高天伦 1/1 4/0 0/2 Post - 0 Miss - 2 Block - 0 | 4 高震东 0/0 0/0 0/0 Post - 0 Miss - 0 Block - 0 | 5 曹磊 1/0 1/2 0/0 Post - 0 Miss - 1 Block - 0 | 6 季晨旭 0/0 0/0 0/0 Post - 0 Miss - 0 Block - 0 | 7 蒋家敏 0/0 0/0 0/0 Post - 0 Miss - 0 Block - 0 | 8 庄旭杰 1/1 0/1 1/1 Post - 1 Miss - 0 Block - 0 | 10 董凯 0/0 0/1 2/2 Post - 1 Miss - 0 Block - 0 |
| 12 张润民 0/0 0/0 0/0 Post - 0 Miss - 0 Block - 0 | 14 吴佳兵 0/0 0/0 0/0 Post - 0 Miss - 1 Block - 0 | 16 陈辰 0/0 0/0 0/0 Post - 0 Miss - 0 Block - 0 | 18 吴双 2/0 0/1 0/0 Post - 1 Miss - 2 Block - 0 | | | | |

| | |
|-----|------|
| 0/2 | 0/6 |
| 2/6 | 2/4 |
| 1/7 | 2/11 |

| | | |
|--|--|--|
| | | |
| | | |
| | | |

| | | |
|--|--|--|
| | | |
| | | |
| | | |

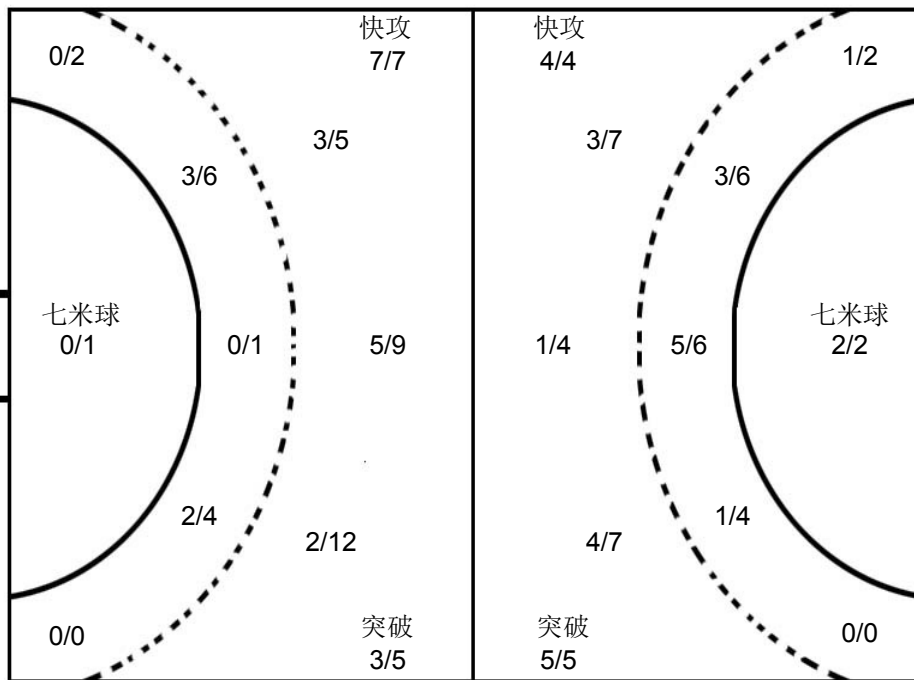

| | | |
|-----|-----|-----|
| 0/1 | 1/1 | 2/4 |
| 2/4 | | 2/2 |
| 0/1 | | 2/9 |

| | | |
|-----|-----|-----|
| 0/1 | 0/1 | |
| 1/5 | | 4/6 |
| 2/5 | 1/1 | 1/2 |

| | | |
|--|--|--|
| | | |
| | | |
| | | |

天津队

| | | | | | | | |
|--|--|--|--|--|--|--|--|
| 9 吴明远 1/4 1/1 2/2 Post - 2 Miss - 0 Block - 0 | 18 王晓琪 1/2 2/0 0/0 Post - 2 Miss - 2 Block - 0 | 21 潘玉帅 0/0 0/0 0/1 Post - 1 Miss - 0 Block - 0 | 22 魏雨童 1/1 3/3 0/0 Post - 1 Miss - 2 Block - 0 | 24 刘子健 0/0 0/0 0/0 Post - 0 Miss - 0 Block - 0 | 25 王一雄 0/0 0/0 2/0 Post - 1 Miss - 0 Block - 0 | 26 刘思远 1/1 0/0 0/0 Post - 0 Miss - 0 Block - 0 | 27 左金龙 0/0 0/0 0/0 Post - 0 Miss - 0 Block - 0 |
| 28 何喜年 0/0 0/0 0/0 Post - 0 Miss - 0 Block - 0 | | | | | | | |

注释: Post=击柱 Miss=射失 Block=被封





2016年“体彩杯”全国手球男子青年锦标赛 竞赛技术统计(媒体表)

| | | | | | | |
|-------|----|------------|----|----|------------------|-----|
| 9-10名 | 组别 | C | 轮次 | 7 | 场次 | 38 |
| 重庆万州 | | 28/03/2016 | | | 201602038-51-1/1 | |
| 浙江队 | | 浙江 | 14 | vs | 29 | 辽宁 |
| | | 12 : 19 | | | | 辽宁队 |

| 裁判员 | | 汤怡 (CHN) | | | | | | | | | | | / | | | | | | | | | | | 缪俊 (CHN) | | | | | | | | | | | | | |
|---------------|-----|----------|-------|-----|------|-----|-----|-----|-------|------|----|----|----|----|--------|--------------------------|--|--|--|--|--|--|--|----------|--|--|--|--|--|--|--|--|--|--|--|--|--|
| 浙江 | | 远射 | 近射 | 边射 | 快攻 | 突破 | 任意球 | 7m球 | 合计 | % | 助攻 | 失误 | 警告 | 2' | D & DR | 浙江 比赛进程 辽宁 | | | | | | | | | | | | | | | | | | | | | |
| 主教练：项建生 | | | | | | | | | | | | | | | | | | | | | | | | | | | | | | | | | | | | | |
| 1 | 林先方 | | 0/3 | 1/3 | | | | 1/1 | 2/7 | 28.6 | 2 | 5 | | | | 1st Half | | | | | | | | | | | | | | | | | | | | | |
| 2 | 李恩铭 | | | 0/3 | 1/2 | | | | 1/5 | 20.0 | | 1 | | | | 0 00:36 1 13 杨洁 | | | | | | | | | | | | | | | | | | | | | |
| 3 | 郑尧俊 | 0/1 | 3/5 | | | 6/7 | | | 9/13 | 69.2 | | 7 | | | | 0 03:22 2 13 杨洁 | | | | | | | | | | | | | | | | | | | | | |
| 5 | 高家南 | | | | | | | | | | | 1 | 1 | | | 1 06:34 3 13 杨洁 | | | | | | | | | | | | | | | | | | | | | |
| 9 | 李家乐 | | | 0/1 | | | | 0/1 | 0.0 | | | | | | | 1 08:27 4 3 李星浩 | | | | | | | | | | | | | | | | | | | | | |
| 10 | 徐正飞 | | | | | | | | | | | | | 1 | 1 | 1 09:48 5 13 杨洁 | | | | | | | | | | | | | | | | | | | | | |
| 14 | 虞勇灿 | | | | | | | | | | | | | | | 2 11:11 5 | | | | | | | | | | | | | | | | | | | | | |
| 15 | 张佩力 | | | | | | | | | | | | | | | 2 12:37 6 3 李星浩 | | | | | | | | | | | | | | | | | | | | | |
| 17 | 罗明杰 | | | | | | | | | | | | | | | 2 14:00 7 14 吕昊臻 | | | | | | | | | | | | | | | | | | | | | |
| 18 | 倪陈辉 | 0/5 | 2/2 | | | | 0/1 | 2/8 | 25.0 | | | 8 | | | | 2 15:10 8 14 吕昊臻 | | | | | | | | | | | | | | | | | | | | | |
| 19 | 王浩 | | | | | | | | | | | | | | | 2 16:07 9 3 李星浩 | | | | | | | | | | | | | | | | | | | | | |
| 运动员 合计 | | 0/6 | 5/10 | 1/7 | 1/2 | 6/7 | 0/1 | 1/1 | 14/34 | 41.2 | 2 | 24 | 2 | | | 3 郑尧俊 3 16:57 9 | | | | | | | | | | | | | | | | | | | | | |
| 14 | 虞勇灿 | 3/5 | 0/3 | | 1/3 | | | 0/1 | 4/12 | 33.3 | | | | | | 3 17:16 10 14 吕昊臻 | | | | | | | | | | | | | | | | | | | | | |
| 15 | 张佩力 | 4/7 | 3/13 | 0/1 | 0/6 | 0/1 | 1/1 | | 8/29 | 27.6 | | | | | | 3 17:47 11 7 孙义广 | | | | | | | | | | | | | | | | | | | | | |
| 守门员 合计 | | 7/12 | 3/16 | 0/1 | 1/9 | 0/1 | 1/1 | 0/1 | 12/41 | 29.3 | | | | | | 4 18:37 11 | | | | | | | | | | | | | | | | | | | | | |
| 辽宁 | | 远射 | 近射 | 边射 | 快攻 | 突破 | 任意球 | 7m球 | 合计 | % | 助攻 | 失误 | 警告 | 2' | D & DR | 4 19:19 12 5 余昊锦 | | | | | | | | | | | | | | | | | | | | | |
| 教练：赵影 | | | | | | | | | | | | | | | | | | | | | | | | | | | | | | | | | | | | | |
| 1 | 高尚君 | 1/1 | | | | | | | 1/1 | 100 | 4 | 2 | | | | 3 郑尧俊 4 20:34 12 | | | | | | | | | | | | | | | | | | | | | |
| 2 | 王司雨 | 1/1 | 1/1 | | | | | | 2/2 | 100 | | | | | | 3 郑尧俊 5 22:39 12 | | | | | | | | | | | | | | | | | | | | | |
| 3 | 李星浩 | | 3/3 | | | | | | 3/3 | 100 | | 1 | | | | 6 23:14 13 7 孙义广 | | | | | | | | | | | | | | | | | | | | | |
| 5 | 余昊锦 | 0/1 | 1/1 | | 1/1 | | | | 2/3 | 66.7 | 1 | | | | | 18 倪陈辉 7 24:02 14 14 吕昊臻 | | | | | | | | | | | | | | | | | | | | | |
| 6 | 陈庆港 | | 0/1 | | 1/1 | | | | 1/2 | 50.0 | 2 | 4 | | | | 3 郑尧俊 8 24:27 14 | | | | | | | | | | | | | | | | | | | | | |
| 7 | 孙义广 | | 1/1 | | 2/2 | | | | 3/3 | 100 | | | | | | 8 25:23 15 7 孙义广 | | | | | | | | | | | | | | | | | | | | | |
| 8 | 王鑫鹏 | | | | | | | | | | | | | | | 8 25:52 16 5 余昊锦 | | | | | | | | | | | | | | | | | | | | | |
| 10 | 王柏淇 | 0/4 | 0/2 | 1/1 | 1/1 | | | | 2/8 | 25.0 | 3 | 2 | | | | 9 26:20 16 | | | | | | | | | | | | | | | | | | | | | |
| 11 | 庞东阳 | | 2/2 | | 1/2 | | | | 3/4 | 75.0 | 2 | | | | | 9 27:00 17 14 吕昊臻 | | | | | | | | | | | | | | | | | | | | | |
| 13 | 杨洁 | | 2/3 | | 2/2 | | | | 4/5 | 80.0 | 1 | | | | | 9 28:03 18 14 吕昊臻 | | | | | | | | | | | | | | | | | | | | | |
| 14 | 吕昊臻 | 3/6 | 3/3 | | 0/1 | 1/1 | 0/1 | 1/1 | 8/13 | 61.5 | | 1 | | | | 10 28:24 18 | | | | | | | | | | | | | | | | | | | | | |
| 16 | 吴阳 | | | | | | | | | | | | | | | 11 28:47 18 | | | | | | | | | | | | | | | | | | | | | |
| 17 | 李傲 | | | | | | | | | | | | 1 | 1 | | 11 29:50 19 14 吕昊臻 | | | | | | | | | | | | | | | | | | | | | |
| 18 | 梅凯博 | | | | | | | | | | | | | | 1 | 12 30:00 19 | | | | | | | | | | | | | | | | | | | | | |
| 19 | 赵鑫 | | | | | | | | | | | | | | 1 | | | | | | | | | | | | | | | | | | | | | | |
| 20 | 赵佛赐 | | | | | | | | | | | | | | 1 | | | | | | | | | | | | | | | | | | | | | | |
| 运动员 合计 | | 5/13 | 13/17 | 1/1 | 8/10 | 1/1 | 0/1 | 1/1 | 29/44 | 65.9 | 13 | 13 | 1 | 2 | | | | | | | | | | | | | | | | | | | | | | | |
| 1 | 高尚君 | 4/4 | 4/9 | 4/5 | 0/1 | 1/7 | | 0/1 | 13/27 | 48.1 | 4 | 2 | | | | | | | | | | | | | | | | | | | | | | | | | |
| 守门员 合计 | | 4/4 | 4/9 | 4/5 | 0/1 | 1/7 | | 0/1 | 13/27 | 48.1 | 4 | 2 | | | | | | | | | | | | | | | | | | | | | | | | | |

场上队员：得分 / 射门

守门员：救球 / 射门

| | | | | | | | | | |
|----|------------|----|--------------|-----|------------|-----|----------|----|---------|
| 快攻 | Fast Break | 突破 | Breakthrough | 任意球 | Free Throw | 7M球 | 7M Throw | 助攻 | Assist |
| 警告 | Warning | 失误 | Error | 2' | Suspension | D | 取消资格 | DR | 取消资格+报告 |





2016年“体彩杯”全国手球男子青年锦标赛 图式比赛技术统计表

轮次 7

场次 38

201602038-21-1/1

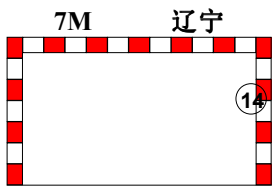
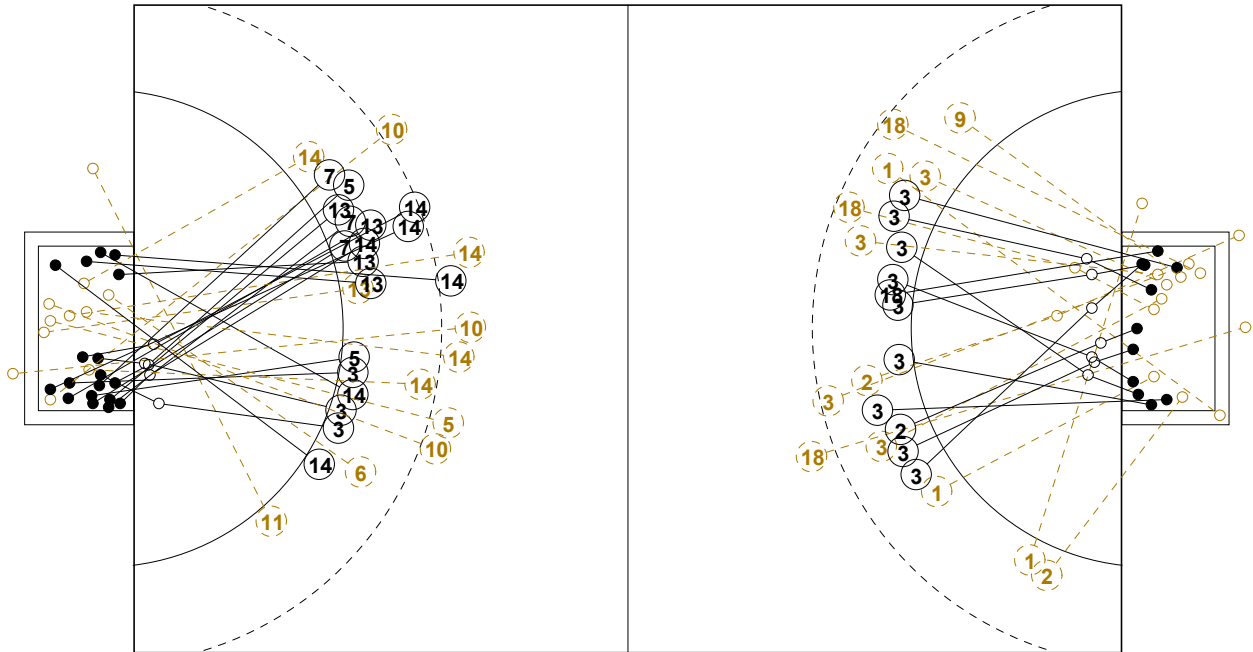

1st Half
19 : 12

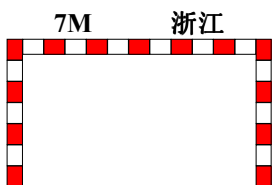
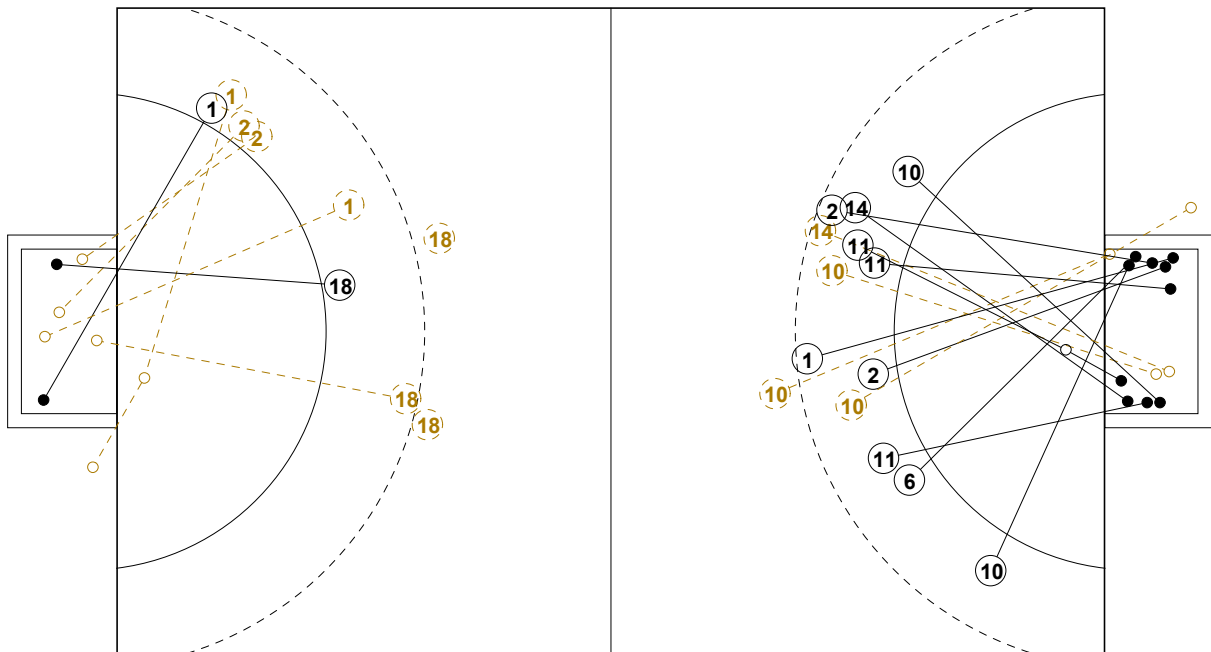
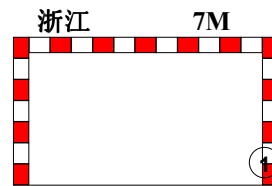

2nd Half
14 : 29

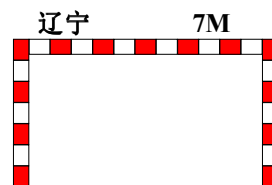



2016年“体彩杯”全国手球男子青年锦标赛

个人/全队技术统计表

正式表
手球
青年男子9-10名
轮次 7组别 C
场次 38201602038-14-1/2
重庆万州
28/03/2016 10:00

| 号码 | 姓名 | 远射 | 近射 | 边射 | 快攻 | 突破 | 任意 | 7M | 合计 | % | 助攻 | 失误 | 警告 | 2' | 取消 | 时间 |
|----------------|-----|------|------|-----|-----|-----|-----|-----|-------|-------|----|----|----|----|----|----------|
| 浙江队(浙江) | | | | | | | | | | | | | | | | |
| <i>(场上队员)</i> | | | | | | | | | | | | | | | | |
| 1 | 林先方 | | 0/3 | 1/3 | | | | 1/1 | 2/7 | 28.6% | 2 | 5 | | | | 00:40:14 |
| 2 | 李恩铭 | | | 0/3 | 1/2 | | | | 1/5 | 20.0% | | 1 | | | | 00:36:12 |
| 3 | 郑尧俊 | 0/1 | 3/5 | | | 6/7 | | | 9/13 | 69.2% | | 7 | | | | 00:40:14 |
| 5 | 高家南 | | | | | | | | | 0.0% | | 1 | 1 | | | 00:23:53 |
| 9 | 李家乐 | | | 0/1 | | | | | 0/1 | 0.0% | | | | | | 00:07:31 |
| 10 | 徐正飞 | | | | | | | | | 0.0% | | 1 | 1 | | | 00:14:53 |
| 14 | 虞勇灿 | | | | | | | | | 0.0% | | | | | | 00:10:38 |
| 15 | 张佩力 | | | | | | | | | 0.0% | | | | | | 00:29:36 |
| 17 | 罗明杰 | | | | | | | | | 0.0% | | 1 | | | | 00:33:53 |
| 18 | 倪陈辉 | 0/5 | 2/2 | | | | 0/1 | | 2/8 | 25.0% | | 8 | | | | 00:40:14 |
| 19 | 王浩 | | | | | | | | | 0.0% | | | | | | 00:03:54 |
| 合计 | | | | | | | | | | | | | | | | |
| <i>(守门员)</i> | | | | | | | | | | | | | | | | |
| 14 | 虞勇灿 | 3/5 | 0/3 | | 1/3 | | | 0/1 | 4/12 | 33.3% | | | | | | 00:10:38 |
| 15 | 张佩力 | 4/7 | 3/13 | 0/1 | 0/6 | 0/1 | 1/1 | | 8/29 | 27.6% | | | | | | 00:29:36 |
| 合计 | | | | | | | | | | | | | | | | |
| | | 7/12 | 3/16 | 0/1 | 1/9 | 0/1 | 1/1 | 0/1 | 12/41 | 29.3% | | | | | | |

场上队员：得分/射门

守门员：救球/射门

| 全队合计 | 得分 | 被救 | 射失 | 击柱 | 封球 | 合计 | % |
|------|----|----|----|----|----|----|--------|
| 远射 | | 4 | | | 2 | 6 | 0.0% |
| 近射 | 5 | 4 | | 1 | | 10 | 50.0% |
| 边射 | 1 | 4 | 2 | | | 7 | 14.3% |
| 快攻 | 1 | | 1 | | | 2 | 50.0% |
| 突破 | 6 | 1 | | | | 7 | 85.7% |
| 任意 | | | 1 | | | 1 | 0.0% |
| 7M | 1 | | | | | 1 | 100.0% |





2016年“体彩杯”全国手球男子青年锦标赛

个人/全队技术统计表

正式表
手球
青年男子9-10名
轮次 7组别 C
场次 38201602038-14-2/2
重庆万州
28/03/2016 10:00

| 号码 | 姓名 | 远射 | 近射 | 边射 | 快攻 | 突破 | 任意 | 7M | 合计 | % | 助攻 | 失误 | 警告 | 2' | 取消 | 时间 |
|----------------|-----|------|-------|-----|------|-----|-----|-----|-------|-------|----|----|----|----|----|----------|
| 辽宁队(辽宁) | | | | | | | | | | | | | | | | |
| <i>(上场队员)</i> | | | | | | | | | | | | | | | | |
| 1 | 高尚君 | 1/1 | | | | | | | 1/1 | 100% | 4 | 2 | | | | 00:40:14 |
| 2 | 王司雨 | 1/1 | 1/1 | | | | | | 2/2 | 100% | | | | | | 00:10:14 |
| 3 | 李星浩 | | 3/3 | | | | | | 3/3 | 100% | | 1 | | | | 00:16:10 |
| 5 | 余昊锦 | 0/1 | 1/1 | | 1/1 | | | | 2/3 | 66.7% | 1 | | | | | 00:13:50 |
| 6 | 陈庆港 | | 0/1 | | 1/1 | | | | 1/2 | 50.0% | 2 | 4 | | | | 00:20:20 |
| 7 | 孙义广 | | 1/1 | | 2/2 | | | | 3/3 | 100% | | | | | | 00:13:50 |
| 8 | 王鑫鹏 | | | | | | | | | 0.0% | | | | | | 00:10:14 |
| 10 | 王柏淇 | 0/4 | 0/2 | 1/1 | 1/1 | | | | 2/8 | 25.0% | 3 | 2 | | | | 00:19:52 |
| 11 | 庞东阳 | | 2/2 | | 1/2 | | | | 3/4 | 75.0% | 2 | | | | | 00:24:29 |
| 13 | 杨洁 | | 2/3 | | 2/2 | | | | 4/5 | 80.0% | 1 | | | | | 00:10:58 |
| 14 | 吕昊臻 | 3/6 | 3/3 | | 0/1 | 1/1 | 0/1 | 1/1 | 8/13 | 61.5% | | 1 | | | | 00:29:15 |
| 16 | 吴阳 | | | | | | | | | 0.0% | | | | | | 00:16:10 |
| 17 | 李傲 | | | | | | | | | 0.0% | | 1 | 1 | | | 00:16:10 |
| 18 | 梅凯博 | | | | | | | | | 0.0% | | | | 1 | | 00:10:14 |
| 19 | 赵鑫 | | | | | | | | | 0.0% | | 1 | | 1 | | 00:13:50 |
| 20 | 赵佛赐 | | | | | | | | | 0.0% | | 1 | | | | 00:13:50 |
| 合计 | | 5/13 | 13/17 | 1/1 | 8/10 | 1/1 | 0/1 | 1/1 | 29/44 | 65.9% | 13 | 13 | 1 | 2 | | |
| <i>(守门员)</i> | | | | | | | | | | | | | | | | |
| 1 | 高尚君 | 4/4 | 4/9 | 4/5 | 0/1 | 1/7 | | 0/1 | 13/27 | 48.1% | 4 | 2 | | | | 00:40:14 |
| 合计 | | 4/4 | 4/9 | 4/5 | 0/1 | 1/7 | | 0/1 | 13/27 | 48.1% | 4 | 2 | | | | |

场上队员：得分/射门

守门员：救球/射门

| 全队合计 | 得分 | 被救 | 射失 | 击柱 | 封球 | 合计 | % |
|------|----|----|----|----|----|----|--------|
| 远射 | 5 | 7 | 1 | | | 13 | 38.5% |
| 近射 | 13 | 3 | 1 | | | 17 | 76.5% |
| 边射 | 1 | | | | | 1 | 100.0% |
| 快攻 | 8 | 1 | 1 | | | 10 | 80.0% |
| 突破 | 1 | | | | | 1 | 100.0% |
| 任意 | | 1 | | | | 1 | 0.0% |
| 7M | 1 | | | | | 1 | 100.0% |





2016年“体彩杯”全国手球男子青年锦标赛

图式射门区域统计

轮次 7 场次 38

201602038-41-1/1

浙江队

| | | | | | | | |
|-----------------------------|-----------------------------|-----------------------------|-----------------------------|-----------------------------|-----------------------------|-----------------------------|-----------------------------|
| 1 林先方 1 1 | 2 李恩铭 1 | 3 郑尧俊 1 1 3 1 3 | 5 高家南 | 9 李家乐 | 10 徐正飞 | 14 虞勇灿 | 15 张佩力 |
| Post - 1 Miss - 2 Block - 0 | Post - 0 Miss - 1 Block - 0 | Post - 0 Miss - 0 Block - 0 | Post - 0 Miss - 0 Block - 0 | Post - 0 Miss - 0 Block - 0 | Post - 0 Miss - 0 Block - 0 | Post - 0 Miss - 0 Block - 0 | Post - 0 Miss - 0 Block - 0 |
| 17 罗明杰 | 18 倪陈辉 1 1 | 19 王浩 | | | | | |
| Post - 0 Miss - 0 Block - 0 | Post - 0 Miss - 1 Block - 2 | Post - 0 Miss - 0 Block - 0 | | | | | |

| |
|-------------|
| 14 虞勇灿 |
| 1/3 1/1 0/1 |
| 1/4 1/1 |
| 0/1 0/1 |

| |
|-------------|
| 15 张佩力 |
| 0/3 3/3 1/2 |
| 0/6 1/1 1/5 |
| 1/5 1/4 |

| |
|--|
| |
| |
| |

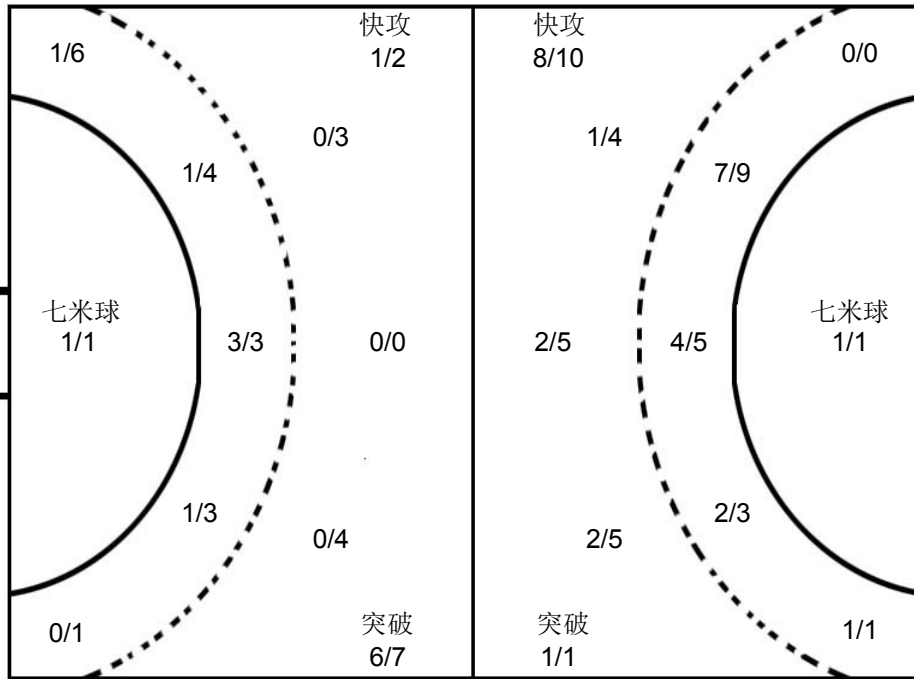

| |
|-------------|
| 1 高尚君 |
| 2/3 1/1 |
| 4/6 2/2 3/5 |
| 0/3 1/3 0/4 |

| |
|--|
| |
| |
| |

| |
|--|
| |
| |
| |

辽宁队

| | | | | | | | |
|-----------------------------|-----------------------------|-----------------------------|-----------------------------|-----------------------------|-----------------------------|-----------------------------|-----------------------------|
| 1 高尚君 1 | 2 王司雨 2 | 3 李星浩 1 2 | 5 余昊锦 1 1 | 6 陈庆港 1 | 7 孙义广 2 1 | 8 王鑫鹏 | 10 王柏淇 1 |
| Post - 0 Miss - 0 Block - 0 | Post - 0 Miss - 0 Block - 0 | Post - 0 Miss - 0 Block - 0 | Post - 0 Miss - 0 Block - 0 | Post - 0 Miss - 0 Block - 0 | Post - 0 Miss - 0 Block - 0 | Post - 0 Miss - 0 Block - 0 | Post - 0 Miss - 2 Block - 0 |
| 11 庞东阳 1 1 1 | 13 杨洁 1 1 1 | 14 吕昊臻 1 2 1 1 2 | 16 吴阳 | 17 李傲 | 18 梅凯博 | 19 赵鑫 | 20 赵佛赐 |
| Post - 0 Miss - 1 Block - 0 | Post - 0 Miss - 0 Block - 0 | Post - 0 Miss - 0 Block - 0 | Post - 0 Miss - 0 Block - 0 | Post - 0 Miss - 0 Block - 0 | Post - 0 Miss - 0 Block - 0 | Post - 0 Miss - 0 Block - 0 | Post - 0 Miss - 0 Block - 0 |

注释: Post=击柱 Miss=射失 Block=被封





5-8名
青年男子 全国比赛

2016年“体彩杯”全国手球男子青年锦标赛

| | | | | | | | | | | | | | | | | | | | | | |
|--------------------|---|---------------------|---------------------|------------------|------------------------------------|-------------------|---|---------------------------|----------------|------------|------------|----------------------|---------------|---|--|--|---|---|----|----|----|
| Team A A 北京队 | | | | Team B B 解放军队 | | | | Match Number 39 | | | | | | | | | | | | | |
| played in China | | in the hall 重庆万州 | | on 28/03/2016 | | at 13:00 hours | | Spectators | | | | | | | | | | | | | |
| Half-time (30') | A 18 | B 14 | End of playing time | A 32 | B 31 | 1st extra time | A | B | 2nd extra time | A | B | After penalty throws | A | B | | | | | | | |
| Number of 7 m | A 4/5 | Team time-out | | | Full name of players and officials | | | | Team time-out | | | B 2/2 | Number of 7 m | | | | | | | | |
| | | 1 12:08 | 2 41:01 | 3 59:16 | | | | | 1 | 2 52:42 | 3 59:36 | | | | | | | | | | |
| No. | Team A | | | | | G | W | 2' | D | DR | No. | Team B | | | | | G | W | 2' | D | DR |
| 3 | 王哲一 | | | | | 1 | | | | | 1 | 郭梦雨 | | | | | | | | | |
| 4 | 朱广刚 | | | | | 5 | | 2 | | | 3 | 张昌轲 | | | | | 5 | | 2 | | |
| 6 | 赵一涵 | | | | | 7 | 1 | 1 | | | 4 | 张洋 | | | | | | | | | |
| 7 | 卞友山 | | | | | | | | | | 5 | 尹一楠 | | | | | | | | | |
| 11 | 李旭 | | | | | 4 | | | | | 6 | 吴昊 | | | | | 4 | 1 | 3 | | |
| 15 | 逯明松 | | | | | 2 | | | | | 7 | 姜钦 | | | | | 6 | | | | |
| 16 | 马佳鹏 | | | | | | | | | | 8 | 邹峻楠 | | | | | | | | | |
| 18 | 李明远 | | | | | 5 | | | | | 9 | 李天枢 | | | | | | | | | |
| 19 | 陈旭 | | | | | | | | | | 10 | 范保坤 | | | | | | | | | |
| 23 | 刘帅 | | | | | | | | | | 11 | 王誌汉 | | | | | 8 | | | | |
| 25 | 张斌 | | | | | | | | | | 12 | 左子健 | | | | | | | | | |
| 26 | 吴锐樊 | | | | | 1 | | | | | 13 | 徐峻清 | | | | | 1 | 1 | | | |
| 35 | 高云健 | | | | | | | | | | 14 | 孙耀琦 | | | | | 7 | 1 | 1 | | |
| 36 | 王鹏皓 | | | | | 7 | | | | | 16 | 池猛 | | | | | | | | | |
| | | | | | | | | | | | 17 | 刘安宁 | | | | | | | | | |
| B | 吴健 (主教练) | | | | | | | | | | A | 杜长义 (主教练) | | | | | | | | | |
| C | 宋刚 | | | | | | | | | | | | | | | | | | | | |
| D | 陈璇 | | | | | | | | | | | | | | | | | | | | |
| A | Signature of Responsible Official of the Teams (Off. A) | | | | | | | | | | | | | | | | | | | B | |
| TP | Remarks of Referee / CHA Official | | | | | | | | | | | | | | | | | | | TP | |

Signatures

| | | | | |
|------------------|-----------|-----------|--|--|
| Referees | 程钰峰 (CHN) | 周云磊 (CHN) | | |
| Techn. Delegates | 徐健 (CHN) | | | |
| CHA Official | 张春生 (CHN) | | | |

Note: Number of 7m Throws Awarded to Team A and B, Goals (G), Warnings (W), Suspensions (2'), Direct Disqualification (D), Disqualification with Report (DR) and Team Penalty (TP).

Table Officials:

Statisticians: 李双

刘永欢





2016年“体彩杯”全国手球男子青年锦标赛 竞赛技术统计(媒体表)

| | | | | | | |
|------|----|----------|----|----------|----|-----------|
| 5-8名 | 组别 | X | 轮次 | 7 | 场次 | 39 |
|------|----|----------|----|----------|----|-----------|

重庆万州

28/03/2016

201602039-51-1/1

| | | | | | | |
|-----|-----------|----------------|----|-----------|------------|------|
| 北京队 | 北京 | 32 | vs | 31 | 解放军 | 解放军队 |
| | | 18 : 14 | | | | |

| | | | |
|-----|-----------|---|-----------|
| 裁判员 | 程钰峰 (CHN) | / | 周云磊 (CHN) |
|-----|-----------|---|-----------|

| 北京 | | 远 | 近 | 边 | 快 | 突 | 任意 | 7m | 合计 | % | 助攻 | 失误 | 警告 | 2' | D & DR | 北京 | | 比赛 进程 | 解放军 | | |
|---------------|-----|-------------|-------------|------------|------------|------------|------------|------------|--------------|-------------|----------|-----------|----------|----------|--------|----|----------|----------|-----|-------|-----|
| 主教练： 吴健 | | 射 | 射 | 射 | 攻 | 破 | 球 | 球 | | | | | | | | | | | | | |
| 3 | 王哲一 | 1/2 | 0/1 | 0/2 | | | | | 1/5 | 20.0 | | 1 | | | | | 36 | 王鹏皓 | 1 | 01:30 | 0 |
| 4 | 朱广刚 | 1/2 | 0/1 | | 1/1 | 1/2 | 2/2 | | 5/8 | 62.5 | 1 | 2 | | 2 | | | 18 | 李明远 | 2 | 02:19 | 0 |
| 6 | 赵一涵 | 3/6 | 3/3 | | | 1/1 | | | 7/10 | 70.0 | | 5 | 1 | 1 | | | 36 | 王鹏皓 | 3 | 03:49 | 0 |
| 7 | 卞友山 | | | | | | | 0/1 | 0/1 | 0.0 | | | | | | | 4 | 朱广刚 | 3 | 04:10 | 1 |
| 11 | 李旭 | 1/2 | 3/3 | | | | | | 4/5 | 80.0 | 2 | | | | | | 4 | 朱广刚 | 4 | 07:02 | 2 |
| 15 | 逯明松 | 0/1 | 1/3 | 1/2 | | | | | 2/6 | 33.3 | | | | | | | 18 | 李明远 | 5 | 10:18 | 4 |
| 16 | 马佳鹏 | | | | | | | | | | | | | | | | 11 | 李旭 | 6 | 11:39 | 4 |
| 18 | 李明远 | 1/1 | 1/2 | | 1/2 | 2/2 | 0/1 | | 5/8 | 62.5 | 1 | 7 | | | | | 4 | 朱广刚 | 7 | 12:26 | 4 |
| 19 | 陈旭 | | | | | | | | | | | | | | | | 4 | 朱广刚 | 8 | 13:45 | 4 |
| 23 | 刘帅 | | | | | | | | | | | | | | | | 6 | 赵一涵 | 9 | 17:19 | 7 |
| 25 | 张斌 | | | | | | | | | | | | | | | | 11 | 李旭 | 10 | 18:14 | 7 |
| 26 | 吴锐樊 | | 1/1 | | 0/1 | | | | 1/2 | 50.0 | | 1 | | | | | 4 | 朱广刚 | 10 | 18:34 | 8 |
| 35 | 高云健 | | | | | | | | | | | | | | | | 6 | 赵一涵 | 11 | 19:24 | 8 |
| 36 | 王鹏皓 | 1/1 | 0/1 | | 2/2 | | | 4/4 | 7/8 | 87.5 | 1 | | | | | | 6 | 赵一涵 | 12 | 20:37 | 8 |
| 运动员 合计 | | 8/15 | 9/15 | 1/4 | 4/6 | 4/5 | 2/3 | 4/5 | 32/53 | 60.4 | 5 | 16 | 1 | 3 | | | 15 | 逯明松 | 12 | 21:08 | 9 |
| 16 | 马佳鹏 | 6/9 | 7/20 | 4/6 | 2/7 | 1/5 | 1/3 | 0/2 | 21/52 | 40.4 | | | | | | | 26 | 吴锐樊 | 13 | 22:27 | 9 |
| 守门员 合计 | | 6/9 | 7/20 | 4/6 | 2/7 | 1/5 | 1/3 | 0/2 | 21/52 | 40.4 | | | | | | | 15 | 逯明松 | 13 | 22:51 | 10 |
| | | | | | | | | | | | | | | | | | 26 | 吴锐樊 | 14 | 23:09 | 10 |
| | | | | | | | | | | | | | | | | | 6 | 赵一涵 | 14 | 23:38 | 11 |
| | | | | | | | | | | | | | | | | | 6 | 赵一涵 | 15 | 24:09 | 11 |
| | | | | | | | | | | | | | | | | | 6 | 赵一涵 | 15 | 25:29 | 12 |
| | | | | | | | | | | | | | | | | | 6 | 赵一涵 | 16 | 25:52 | 12 |
| | | | | | | | | | | | | | | | | | 36 | 王鹏皓 | 16 | 26:52 | 13 |
| | | | | | | | | | | | | | | | | | 36 | 王鹏皓 | 17 | 27:39 | 13 |
| | | | | | | | | | | | | | | | | | 36 | 王鹏皓 | 17 | 28:12 | 14 |
| | | | | | | | | | | | | | | | | | 36 | 王鹏皓 | 18 | 30:00 | 14 |
| | | | | | | | | | | | | | | | | | 2nd Half | | | | |
| | | | | | | | | | | | | | | | | | 18 | 李明远 | 18 | 00:19 | 15 |
| | | | | | | | | | | | | | | | | | 18 | 李明远 | 19 | 00:33 | 15 |
| | | | | | | | | | | | | | | | | | 6 | 赵一涵 | 19 | 01:02 | 16 |
| | | | | | | | | | | | | | | | | | 18 | 李明远 | 20 | 01:38 | 16 |
| | | | | | | | | | | | | | | | | | 18 | 李明远 | 21 | 03:35 | 16 |
| | | | | | | | | | | | | | | | | | 3 | 王哲一 | 21 | 04:24 | 17 |
| | | | | | | | | | | | | | | | | | 22 | 05:53 | 17 | | |
| | | | | | | | | | | | | | | | | | 15 | 逯明松 | 22 | 09:03 | 18 |
| | | | | | | | | | | | | | | | | | 4 | 朱广刚 | 23 | 10:17 | 18 |
| | | | | | | | | | | | | | | | | | 15 | 逯明松 | 23 | 10:31 | 19 |
| | | | | | | | | | | | | | | | | | 4 | 朱广刚 | 23 | 10:31 | 19 |
| | | | | | | | | | | | | | | | | | 23 | 12:02 | 20 | 11 | 王誌汉 |
| | | | | | | | | | | | | | | | | | 4 | 朱广刚 | 24 | 13:11 | 20 |
| | | | | | | | | | | | | | | | | | 24 | 13:30 | 21 | 3 | 张昌轲 |
| | | | | | | | | | | | | | | | | | 24 | 14:13 | 22 | 11 | 王誌汉 |
| | | | | | | | | | | | | | | | | | 6 | 赵一涵 | 24 | 15:10 | 23 |
| | | | | | | | | | | | | | | | | | 36 | 王鹏皓 | 25 | 17:04 | 23 |
| | | | | | | | | | | | | | | | | | 26 | 17:33 | 23 | | |
| | | | | | | | | | | | | | | | | | 6 | 赵一涵 | 26 | 18:02 | 24 |
| | | | | | | | | | | | | | | | | | 6 | 赵一涵 | 26 | 19:01 | 25 |
| | | | | | | | | | | | | | | | | | 6 | 赵一涵 | 26 | 19:01 | 25 |
| | | | | | | | | | | | | | | | | | 11 | 李旭 | 27 | 19:22 | 25 |
| | | | | | | | | | | | | | | | | | 18 | 李明远 | 27 | 19:36 | 26 |
| | | | | | | | | | | | | | | | | | 11 | 李旭 | 27 | 20:37 | 27 |
| | | | | | | | | | | | | | | | | | 18 | 李明远 | 28 | 22:12 | 27 |
| | | | | | | | | | | | | | | | | | 11 | 李旭 | 29 | 22:30 | 28 |
| | | | | | | | | | | | | | | | | | 36 | 王鹏皓 | 29 | 25:09 | 28 |
| | | | | | | | | | | | | | | | | | 11 | 李旭 | 30 | 25:39 | 28 |
| | | | | | | | | | | | | | | | | | 36 | 王鹏皓 | 31 | 26:14 | 28 |
| | | | | | | | | | | | | | | | | | 31 | 27:01 | 29 | 14 | 孙耀琦 |
| | | | | | | | | | | | | | | | | | 31 | 27:44 | 30 | 11 | 王誌汉 |
| | | | | | | | | | | | | | | | | | 36 | 王鹏皓 | 31 | 29:10 | 31 |
| | | | | | | | | | | | | | | | | | 32 | 29:25 | 31 | | |
| | | | | | | | | | | | | | | | | | | | | | |

场上队员： 得分 / 射门

守门员： 救球 / 射门

| | | | | | | | | | | | | | |
|----|------------|--|----|--------------|--|-----|------------|--|-----|----------|--|----|---------|
| 快攻 | Fast Break | | 突破 | Breakthrough | | 任意球 | Free Throw | | 7M球 | 7M Throw | | 助攻 | Assist |
| 警告 | Warning | | 失误 | Error | | 2' | Suspension | | D | 取消资格 | | DR | 取消资格+报告 |



2016年“体彩杯”全国手球男子青年锦标赛 图式比赛技术统计表

轮次 7

场次 39

201602039-21-1/1

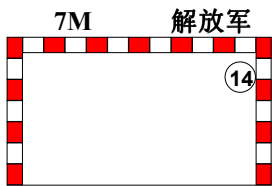
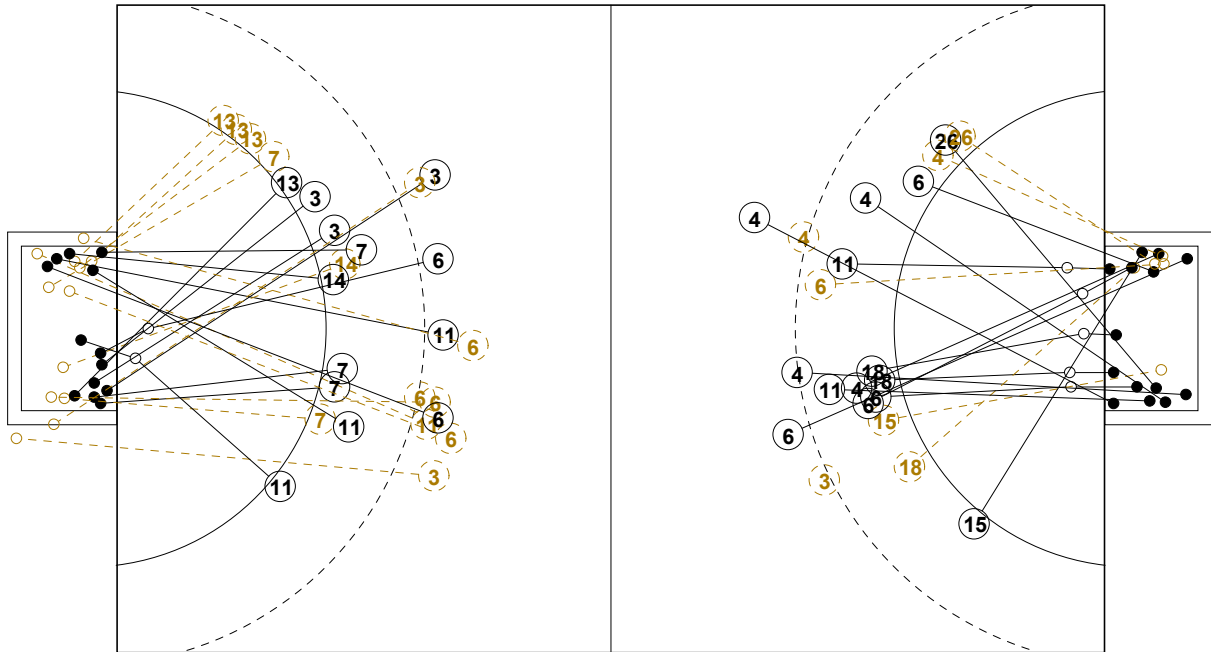

1st Half
14 : 18

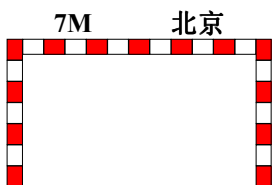
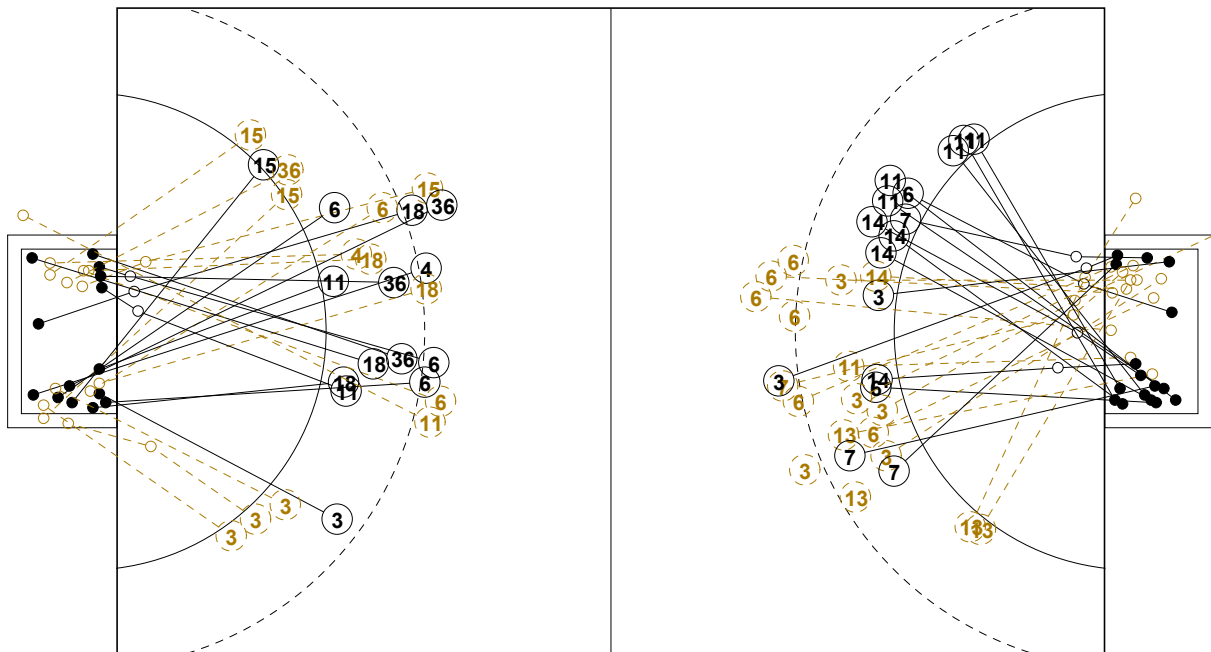
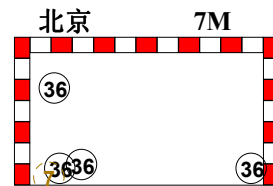

2nd Half
32 : 31

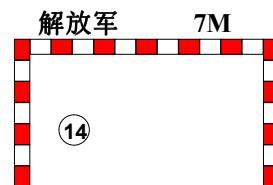



2016年“体彩杯”全国手球男子青年锦标赛

个人/全队技术统计表

正式表
手球
青年男子5-8名
轮次 7组别 X
场次 39201602039-14-1/2
重庆万州
28/03/2016 13:00

| 号码 | 姓名 | 远射 | 近射 | 边射 | 快攻 | 突破 | 任意 | 7M | 合计 | % | 助攻 | 失误 | 警告 | 2' | 取消 | 时间 |
|----------------|-----|-----|------|-----|-----|-----|-----|-----|-------|-------|----|----|----|----|----|----------|
| 北京队(北京) | | | | | | | | | | | | | | | | |
| <i>(场上队员)</i> | | | | | | | | | | | | | | | | |
| 3 | 王哲一 | 1/2 | 0/1 | 0/2 | | | | | 1/5 | 20.0% | | 1 | | | | 00:38:10 |
| 4 | 朱广刚 | 1/2 | 0/1 | | 1/1 | 1/2 | 2/2 | | 5/8 | 62.5% | 1 | 2 | | 2 | | 00:56:01 |
| 6 | 赵一涵 | 3/6 | 3/3 | | | 1/1 | | | 7/10 | 70.0% | | 5 | 1 | 1 | | 00:57:31 |
| 7 | 卞友山 | | | | | | | 0/1 | 0/1 | 0.0% | | | | | | 00:02:10 |
| 11 | 李旭 | 1/2 | 3/3 | | | | | | 4/5 | 80.0% | 2 | | | | | 00:55:25 |
| 15 | 逯明松 | 0/1 | 1/3 | 1/2 | | | | | 2/6 | 33.3% | | | | | | 00:45:06 |
| 16 | 马佳鹏 | | | | | | | | | 0.0% | | | | | | 01:00:00 |
| 18 | 李明远 | 1/1 | 1/2 | | 1/2 | 2/2 | 0/1 | | 5/8 | 62.5% | 1 | 7 | | | | 01:00:00 |
| 19 | 陈旭 | | | | | | | | | 0.0% | | | | | | 00:04:34 |
| 23 | 刘帅 | | | | | | | | | 0.0% | | | | | | 00:00:00 |
| 25 | 张斌 | | | | | | | | | 0.0% | | | | | | 00:00:00 |
| 26 | 吴锐樊 | | 1/1 | | 0/1 | | | | 1/2 | 50.0% | | 1 | | | | 00:20:37 |
| 35 | 高云健 | | | | | | | | | 0.0% | | | | | | 00:00:00 |
| 36 | 王鹏皓 | 1/1 | 0/1 | | 2/2 | | | 4/4 | 7/8 | 87.5% | 1 | | | | | 00:16:23 |
| 合计 | | | | | | | | | | | | | | | | |
| <i>(守门员)</i> | | | | | | | | | | | | | | | | |
| 16 | 马佳鹏 | 6/9 | 7/20 | 4/6 | 2/7 | 1/5 | 1/3 | 0/2 | 21/52 | 40.4% | | | | | | 01:00:00 |
| 合计 | | | | | | | | | | | | | | | | |

场上队员：得分/射门

守门员：救球/射门

| 全队合计 | 得分 | 被救 | 射失 | 击柱 | 封球 | 合计 | % |
|------|----|----|----|----|----|----|-------|
| 远射 | 8 | 4 | 1 | | 2 | 15 | 53.3% |
| 近射 | 9 | 5 | | 1 | | 15 | 60.0% |
| 边射 | 1 | 2 | | 1 | | 4 | 25.0% |
| 快攻 | 4 | 2 | | | | 6 | 66.7% |
| 突破 | 4 | 1 | | | | 5 | 80.0% |
| 任意 | 2 | 1 | | | | 3 | 66.7% |
| 7M | 4 | 1 | | | | 5 | 80.0% |





2016年“体彩杯”全国手球男子青年锦标赛

个人/全队技术统计表

正式表
手球
青年男子5-8名
轮次 7组别 X
场次 39201602039-14-2/2
重庆万州
28/03/2016 13:00

| 号码 | 姓名 | 远射 | 近射 | 边射 | 快攻 | 突破 | 任意 | 7M | 合计 | % | 助攻 | 失误 | 警告 | 2' | 取消 | 时间 |
|------------------|-----|------|-------|-----|-----|-----|-----|-----|-------|-------|----|----|----|----|----|----------|
| 解放军队(解放军) | | | | | | | | | | | | | | | | |
| <i>(上场队员)</i> | | | | | | | | | | | | | | | | |
| 1 | 郭梦雨 | | | | | | | | | 0.0% | 1 | | | | | 01:00:00 |
| 3 | 张昌轲 | 1/3 | 1/3 | | | 2/4 | 1/2 | | 5/12 | 41.7% | 6 | 1 | | 2 | | 00:58:02 |
| 4 | 张洋 | | | | | | | | | 0.0% | | | | | | 00:00:00 |
| 5 | 尹一楠 | | | | | | | | | 0.0% | | | | | | 00:00:00 |
| 6 | 吴昊 | 1/10 | 1/2 | | | 1/1 | 1/1 | | 4/14 | 28.6% | 4 | 3 | 1 | 3 | | 00:57:00 |
| 7 | 姜钦 | 1/1 | 4/6 | | | 1/1 | 0/1 | | 6/9 | 66.7% | | 1 | | | | 01:00:00 |
| 8 | 邹峻楠 | | | | | | | | | 0.0% | | | | | | 00:00:00 |
| 9 | 李天枢 | | | | | | | | | 0.0% | | | | | | 00:00:00 |
| 10 | 范保坤 | | | | | | | | | 0.0% | | | | | | 00:09:28 |
| 11 | 王誌汉 | 0/1 | 1/1 | 2/2 | 5/6 | | | | 8/10 | 80.0% | 2 | 2 | | | | 00:59:42 |
| 12 | 左子健 | | | | | | | | | 0.0% | | | | | | 00:00:00 |
| 13 | 徐崧清 | 0/1 | 1/1 | 0/5 | 0/1 | | | | 1/8 | 12.5% | | 2 | 1 | | | 00:54:01 |
| 14 | 孙耀琦 | | 5/7 | | | | | 2/2 | 7/9 | 77.8% | | 2 | 1 | 1 | | 01:00:00 |
| 16 | 池猛 | | | | | | | | | 0.0% | | | | | | 00:00:00 |
| 17 | 刘安宁 | | | | | | | | | 0.0% | | | | | | 00:00:00 |
| 合计 | | 3/16 | 13/20 | 2/7 | 5/7 | 4/6 | 2/4 | 2/2 | 31/62 | 50.0% | 13 | 11 | 3 | 6 | | |
| <i>(守门员)</i> | | | | | | | | | | | | | | | | |
| 1 | 郭梦雨 | 4/12 | 5/14 | 2/3 | 2/6 | 1/5 | 1/3 | 1/5 | 16/48 | 33.3% | 1 | | | | | 01:00:00 |
| 合计 | | 4/12 | 5/14 | 2/3 | 2/6 | 1/5 | 1/3 | 1/5 | 16/48 | 33.3% | 1 | | | | | |

场上队员：得分/射门

守门员：救球/射门

| 全队合计 | 得分 | 被救 | 射失 | 击柱 | 封球 | 合计 | % |
|------|----|----|----|----|----|----|--------|
| 远射 | 3 | 6 | | 2 | 5 | 16 | 18.8% |
| 近射 | 13 | 7 | | | | 20 | 65.0% |
| 边射 | 2 | 4 | 1 | | | 7 | 28.6% |
| 快攻 | 5 | 2 | | | | 7 | 71.4% |
| 突破 | 4 | 1 | 1 | | | 6 | 66.7% |
| 任意 | 2 | 1 | 1 | | | 4 | 50.0% |
| 7M | 2 | | | | | 2 | 100.0% |





2016年“体彩杯”全国手球男子青年锦标赛

图式射门区域统计

轮次 7 场次 39

201602039-41-1/1

北京队

| | | | | | | | | | | | | | | | | | | | | | | | | | | | | | | | | | | | | | | | | | | | | | | | | | | | | | | | | | | | | | | | | | | | | | | | | | | | | | | | |
|---|-----------------------------|-----------------------------|-----------------------------|-----------------------------|-----------------------------|-----------------------------|-----------------------------|--|--|---|---|--|---|---|--|---|--|--|---|---|---|--|--|---|--|---|---|--|---|---|--|--|---|--|--|--|--|--|--|---|--|--|--|--|--|---|---|--|---|--|---|--|--|---|--|--|---|---|--|--|--|--|--|--|--|--|--|--|--|---|--|---|---|--|--|--|---|---|---|
| 3 王哲一 | 4 朱广刚 | 6 赵一涵 | 7 卞友山 | 11 李旭 | 15 逯明松 | 16 马佳鹏 | 18 李明远 | | | | | | | | | | | | | | | | | | | | | | | | | | | | | | | | | | | | | | | | | | | | | | | | | | | | | | | | | | | | | | | | | | | | | | | | |
| <table border="1"><tr><td></td><td></td><td></td></tr><tr><td></td><td></td><td></td></tr><tr><td>1</td><td></td><td></td></tr></table> | | | | | | | 1 | | | <table border="1"><tr><td>1</td><td></td><td>1</td></tr><tr><td>1</td><td></td><td>1</td></tr><tr><td></td><td></td><td>1</td></tr></table> | 1 | | 1 | 1 | | 1 | | | 1 | <table border="1"><tr><td>1</td><td></td><td></td></tr><tr><td>2</td><td></td><td>1</td></tr><tr><td>2</td><td></td><td>1</td></tr></table> | 1 | | | 2 | | 1 | 2 | | 1 | <table border="1"><tr><td></td><td></td><td></td></tr><tr><td></td><td></td><td></td></tr><tr><td></td><td></td><td></td></tr></table> | | | | | | | | | | <table border="1"><tr><td></td><td></td><td></td></tr><tr><td></td><td></td><td>1</td></tr><tr><td>2</td><td></td><td>1</td></tr></table> | | | | | | 1 | 2 | | 1 | <table border="1"><tr><td></td><td></td><td></td></tr><tr><td>2</td><td></td><td></td></tr><tr><td></td><td></td><td></td></tr></table> | | | | 2 | | | | | | <table border="1"><tr><td></td><td></td><td></td></tr><tr><td></td><td></td><td></td></tr><tr><td></td><td></td><td></td></tr></table> | | | | | | | | | | <table border="1"><tr><td></td><td>1</td><td>1</td></tr><tr><td></td><td></td><td></td></tr><tr><td>1</td><td>1</td><td>1</td></tr></table> | | 1 | 1 | | | | 1 | 1 | 1 |
| | | | | | | | | | | | | | | | | | | | | | | | | | | | | | | | | | | | | | | | | | | | | | | | | | | | | | | | | | | | | | | | | | | | | | | | | | | | | | | | |
| | | | | | | | | | | | | | | | | | | | | | | | | | | | | | | | | | | | | | | | | | | | | | | | | | | | | | | | | | | | | | | | | | | | | | | | | | | | | | | | |
| 1 | | | | | | | | | | | | | | | | | | | | | | | | | | | | | | | | | | | | | | | | | | | | | | | | | | | | | | | | | | | | | | | | | | | | | | | | | | | | | | | |
| 1 | | 1 | | | | | | | | | | | | | | | | | | | | | | | | | | | | | | | | | | | | | | | | | | | | | | | | | | | | | | | | | | | | | | | | | | | | | | | | | | | | | |
| 1 | | 1 | | | | | | | | | | | | | | | | | | | | | | | | | | | | | | | | | | | | | | | | | | | | | | | | | | | | | | | | | | | | | | | | | | | | | | | | | | | | | |
| | | 1 | | | | | | | | | | | | | | | | | | | | | | | | | | | | | | | | | | | | | | | | | | | | | | | | | | | | | | | | | | | | | | | | | | | | | | | | | | | | | |
| 1 | | | | | | | | | | | | | | | | | | | | | | | | | | | | | | | | | | | | | | | | | | | | | | | | | | | | | | | | | | | | | | | | | | | | | | | | | | | | | | | |
| 2 | | 1 | | | | | | | | | | | | | | | | | | | | | | | | | | | | | | | | | | | | | | | | | | | | | | | | | | | | | | | | | | | | | | | | | | | | | | | | | | | | | |
| 2 | | 1 | | | | | | | | | | | | | | | | | | | | | | | | | | | | | | | | | | | | | | | | | | | | | | | | | | | | | | | | | | | | | | | | | | | | | | | | | | | | | |
| | | | | | | | | | | | | | | | | | | | | | | | | | | | | | | | | | | | | | | | | | | | | | | | | | | | | | | | | | | | | | | | | | | | | | | | | | | | | | | | |
| | | | | | | | | | | | | | | | | | | | | | | | | | | | | | | | | | | | | | | | | | | | | | | | | | | | | | | | | | | | | | | | | | | | | | | | | | | | | | | | |
| | | | | | | | | | | | | | | | | | | | | | | | | | | | | | | | | | | | | | | | | | | | | | | | | | | | | | | | | | | | | | | | | | | | | | | | | | | | | | | | |
| | | | | | | | | | | | | | | | | | | | | | | | | | | | | | | | | | | | | | | | | | | | | | | | | | | | | | | | | | | | | | | | | | | | | | | | | | | | | | | | |
| | | 1 | | | | | | | | | | | | | | | | | | | | | | | | | | | | | | | | | | | | | | | | | | | | | | | | | | | | | | | | | | | | | | | | | | | | | | | | | | | | | |
| 2 | | 1 | | | | | | | | | | | | | | | | | | | | | | | | | | | | | | | | | | | | | | | | | | | | | | | | | | | | | | | | | | | | | | | | | | | | | | | | | | | | | |
| | | | | | | | | | | | | | | | | | | | | | | | | | | | | | | | | | | | | | | | | | | | | | | | | | | | | | | | | | | | | | | | | | | | | | | | | | | | | | | | |
| 2 | | | | | | | | | | | | | | | | | | | | | | | | | | | | | | | | | | | | | | | | | | | | | | | | | | | | | | | | | | | | | | | | | | | | | | | | | | | | | | | |
| | | | | | | | | | | | | | | | | | | | | | | | | | | | | | | | | | | | | | | | | | | | | | | | | | | | | | | | | | | | | | | | | | | | | | | | | | | | | | | | |
| | | | | | | | | | | | | | | | | | | | | | | | | | | | | | | | | | | | | | | | | | | | | | | | | | | | | | | | | | | | | | | | | | | | | | | | | | | | | | | | |
| | | | | | | | | | | | | | | | | | | | | | | | | | | | | | | | | | | | | | | | | | | | | | | | | | | | | | | | | | | | | | | | | | | | | | | | | | | | | | | | |
| | | | | | | | | | | | | | | | | | | | | | | | | | | | | | | | | | | | | | | | | | | | | | | | | | | | | | | | | | | | | | | | | | | | | | | | | | | | | | | | |
| | 1 | 1 | | | | | | | | | | | | | | | | | | | | | | | | | | | | | | | | | | | | | | | | | | | | | | | | | | | | | | | | | | | | | | | | | | | | | | | | | | | | | |
| | | | | | | | | | | | | | | | | | | | | | | | | | | | | | | | | | | | | | | | | | | | | | | | | | | | | | | | | | | | | | | | | | | | | | | | | | | | | | | | |
| 1 | 1 | 1 | | | | | | | | | | | | | | | | | | | | | | | | | | | | | | | | | | | | | | | | | | | | | | | | | | | | | | | | | | | | | | | | | | | | | | | | | | | | | |
| Post - 1 Miss - 0 Block - 1 | Post - 0 Miss - 0 Block - 1 | Post - 0 Miss - 0 Block - 0 | Post - 0 Miss - 0 Block - 0 | Post - 0 Miss - 1 Block - 0 | Post - 1 Miss - 0 Block - 0 | Post - 0 Miss - 0 Block - 0 | Post - 0 Miss - 0 Block - 0 | | | | | | | | | | | | | | | | | | | | | | | | | | | | | | | | | | | | | | | | | | | | | | | | | | | | | | | | | | | | | | | | | | | | | | | | |
| 19 陈旭 | 23 刘帅 | 25 张斌 | 26 吴锐樊 | 35 高云健 | 36 王鹏皓 | | | | | | | | | | | | | | | | | | | | | | | | | | | | | | | | | | | | | | | | | | | | | | | | | | | | | | | | | | | | | | | | | | | | | | | | | | |
| <table border="1"><tr><td></td><td></td><td></td></tr><tr><td></td><td></td><td></td></tr><tr><td></td><td></td><td></td></tr></table> | | | | | | | | | | <table border="1"><tr><td></td><td></td><td></td></tr><tr><td></td><td></td><td></td></tr><tr><td></td><td></td><td></td></tr></table> | | | | | | | | | | <table border="1"><tr><td></td><td></td><td></td></tr><tr><td></td><td></td><td></td></tr><tr><td></td><td></td><td></td></tr></table> | | | | | | | | | | <table border="1"><tr><td></td><td></td><td>1</td></tr><tr><td></td><td></td><td></td></tr><tr><td></td><td></td><td></td></tr></table> | | | 1 | | | | | | | <table border="1"><tr><td></td><td></td><td></td></tr><tr><td></td><td></td><td></td></tr><tr><td></td><td></td><td></td></tr></table> | | | | | | | | | | <table border="1"><tr><td>1</td><td></td><td></td></tr><tr><td>1</td><td></td><td></td></tr><tr><td>2</td><td>3</td><td></td></tr></table> | 1 | | | 1 | | | 2 | 3 | | <table border="1"><tr><td></td><td></td><td></td></tr><tr><td></td><td></td><td></td></tr><tr><td></td><td></td><td></td></tr></table> | | | | | | | | | | <table border="1"><tr><td></td><td></td><td></td></tr><tr><td></td><td></td><td></td></tr><tr><td></td><td></td><td></td></tr></table> | | | | | | | | | |
| | | | | | | | | | | | | | | | | | | | | | | | | | | | | | | | | | | | | | | | | | | | | | | | | | | | | | | | | | | | | | | | | | | | | | | | | | | | | | | | |
| | | | | | | | | | | | | | | | | | | | | | | | | | | | | | | | | | | | | | | | | | | | | | | | | | | | | | | | | | | | | | | | | | | | | | | | | | | | | | | | |
| | | | | | | | | | | | | | | | | | | | | | | | | | | | | | | | | | | | | | | | | | | | | | | | | | | | | | | | | | | | | | | | | | | | | | | | | | | | | | | | |
| | | | | | | | | | | | | | | | | | | | | | | | | | | | | | | | | | | | | | | | | | | | | | | | | | | | | | | | | | | | | | | | | | | | | | | | | | | | | | | | |
| | | | | | | | | | | | | | | | | | | | | | | | | | | | | | | | | | | | | | | | | | | | | | | | | | | | | | | | | | | | | | | | | | | | | | | | | | | | | | | | |
| | | | | | | | | | | | | | | | | | | | | | | | | | | | | | | | | | | | | | | | | | | | | | | | | | | | | | | | | | | | | | | | | | | | | | | | | | | | | | | | |
| | | | | | | | | | | | | | | | | | | | | | | | | | | | | | | | | | | | | | | | | | | | | | | | | | | | | | | | | | | | | | | | | | | | | | | | | | | | | | | | |
| | | | | | | | | | | | | | | | | | | | | | | | | | | | | | | | | | | | | | | | | | | | | | | | | | | | | | | | | | | | | | | | | | | | | | | | | | | | | | | | |
| | | | | | | | | | | | | | | | | | | | | | | | | | | | | | | | | | | | | | | | | | | | | | | | | | | | | | | | | | | | | | | | | | | | | | | | | | | | | | | | |
| | | 1 | | | | | | | | | | | | | | | | | | | | | | | | | | | | | | | | | | | | | | | | | | | | | | | | | | | | | | | | | | | | | | | | | | | | | | | | | | | | | |
| | | | | | | | | | | | | | | | | | | | | | | | | | | | | | | | | | | | | | | | | | | | | | | | | | | | | | | | | | | | | | | | | | | | | | | | | | | | | | | | |
| | | | | | | | | | | | | | | | | | | | | | | | | | | | | | | | | | | | | | | | | | | | | | | | | | | | | | | | | | | | | | | | | | | | | | | | | | | | | | | | |
| | | | | | | | | | | | | | | | | | | | | | | | | | | | | | | | | | | | | | | | | | | | | | | | | | | | | | | | | | | | | | | | | | | | | | | | | | | | | | | | |
| | | | | | | | | | | | | | | | | | | | | | | | | | | | | | | | | | | | | | | | | | | | | | | | | | | | | | | | | | | | | | | | | | | | | | | | | | | | | | | | |
| | | | | | | | | | | | | | | | | | | | | | | | | | | | | | | | | | | | | | | | | | | | | | | | | | | | | | | | | | | | | | | | | | | | | | | | | | | | | | | | |
| 1 | | | | | | | | | | | | | | | | | | | | | | | | | | | | | | | | | | | | | | | | | | | | | | | | | | | | | | | | | | | | | | | | | | | | | | | | | | | | | | | |
| 1 | | | | | | | | | | | | | | | | | | | | | | | | | | | | | | | | | | | | | | | | | | | | | | | | | | | | | | | | | | | | | | | | | | | | | | | | | | | | | | | |
| 2 | 3 | | | | | | | | | | | | | | | | | | | | | | | | | | | | | | | | | | | | | | | | | | | | | | | | | | | | | | | | | | | | | | | | | | | | | | | | | | | | | | |
| | | | | | | | | | | | | | | | | | | | | | | | | | | | | | | | | | | | | | | | | | | | | | | | | | | | | | | | | | | | | | | | | | | | | | | | | | | | | | | | |
| | | | | | | | | | | | | | | | | | | | | | | | | | | | | | | | | | | | | | | | | | | | | | | | | | | | | | | | | | | | | | | | | | | | | | | | | | | | | | | | |
| | | | | | | | | | | | | | | | | | | | | | | | | | | | | | | | | | | | | | | | | | | | | | | | | | | | | | | | | | | | | | | | | | | | | | | | | | | | | | | | |
| | | | | | | | | | | | | | | | | | | | | | | | | | | | | | | | | | | | | | | | | | | | | | | | | | | | | | | | | | | | | | | | | | | | | | | | | | | | | | | | |
| | | | | | | | | | | | | | | | | | | | | | | | | | | | | | | | | | | | | | | | | | | | | | | | | | | | | | | | | | | | | | | | | | | | | | | | | | | | | | | | |
| | | | | | | | | | | | | | | | | | | | | | | | | | | | | | | | | | | | | | | | | | | | | | | | | | | | | | | | | | | | | | | | | | | | | | | | | | | | | | | | |
| Post - 0 Miss - 0 Block - 0 | Post - 0 Miss - 0 Block - 0 | Post - 0 Miss - 0 Block - 0 | Post - 0 Miss - 0 Block - 0 | Post - 0 Miss - 0 Block - 0 | Post - 0 Miss - 0 Block - 0 | | | | | | | | | | | | | | | | | | | | | | | | | | | | | | | | | | | | | | | | | | | | | | | | | | | | | | | | | | | | | | | | | | | | | | | | | | |

16 马佳鹏

| | | |
|------|-----|------|
| 1/2 | 0/1 | 2/5 |
| 5/8 | 0/1 | 4/13 |
| 6/13 | 2/3 | 1/6 |

| | | |
|--|--|--|
| | | |
| | | |
| | | |

| | | |
|--|--|--|
| | | |
| | | |
| | | |

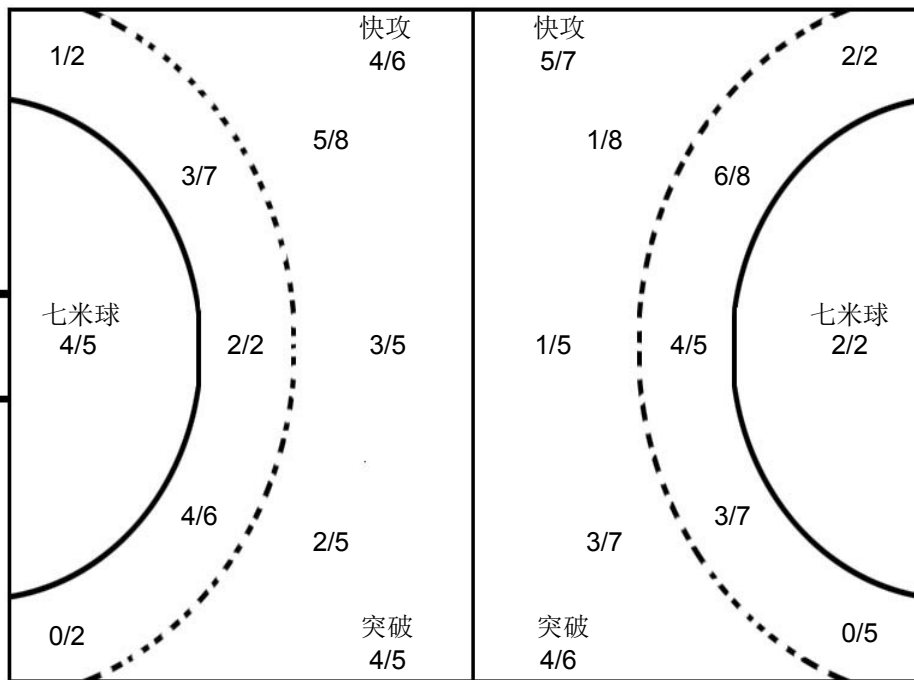

1 郭梦雨

| | | |
|------|-----|-----|
| 1/4 | 0/1 | 2/4 |
| 4/10 | | 4/8 |
| 4/12 | 0/1 | 1/8 |

| | | |
|--|--|--|
| | | |
| | | |
| | | |

| | | |
|--|--|--|
| | | |
| | | |
| | | |

解放军队

| | | | | | | | | | | | | | | | | | | | | | | | | | | | | | | | | | | | | | | | | | | | | | | | | | | | | | | | | | | | | | | | | | | | | | | | | | | | | | | | |
|--|-----------------------------|-----------------------------|-----------------------------|-----------------------------|-----------------------------|-----------------------------|-----------------------------|--|--|--|---|--|---|--|---|---|---|--|---|--|--|--|--|--|--|--|--|--|--|---|--|--|--|---|--|--|--|--|--|--|--|---|---|---|--|---|--|---|---|--|--|--|--|---|--|---|---|--|---|--|--|--|--|--|--|--|--|--|--|--|--|--|--|--|--|--|--|--|--|
| 1 郭梦雨 | 3 张昌柯 | 4 张洋 | 5 尹一楠 | 6 吴昊 | 7 姜钦 | 8 邹峻楠 | 9 李天枢 | | | | | | | | | | | | | | | | | | | | | | | | | | | | | | | | | | | | | | | | | | | | | | | | | | | | | | | | | | | | | | | | | | | | | | | | |
| <table border="1"><tr><td></td><td></td><td></td></tr><tr><td></td><td></td><td></td></tr><tr><td></td><td></td><td></td></tr></table> | | | | | | | | | | <table border="1"><tr><td>1</td><td></td><td></td></tr><tr><td></td><td></td><td></td></tr><tr><td>4</td><td></td><td></td></tr></table> | 1 | | | | | | 4 | | | <table border="1"><tr><td></td><td></td><td></td></tr><tr><td></td><td></td><td></td></tr><tr><td></td><td></td><td></td></tr></table> | | | | | | | | | | <table border="1"><tr><td></td><td></td><td></td></tr><tr><td></td><td></td><td></td></tr><tr><td></td><td></td><td></td></tr></table> | | | | | | | | | | <table border="1"><tr><td></td><td>1</td><td>1</td></tr><tr><td></td><td></td><td>1</td></tr><tr><td></td><td>1</td><td></td></tr></table> | | 1 | 1 | | | 1 | | 1 | | <table border="1"><tr><td></td><td></td><td></td></tr><tr><td>1</td><td></td><td>1</td></tr><tr><td>3</td><td></td><td>1</td></tr></table> | | | | 1 | | 1 | 3 | | 1 | <table border="1"><tr><td></td><td></td><td></td></tr><tr><td></td><td></td><td></td></tr><tr><td></td><td></td><td></td></tr></table> | | | | | | | | | | <table border="1"><tr><td></td><td></td><td></td></tr><tr><td></td><td></td><td></td></tr><tr><td></td><td></td><td></td></tr></table> | | | | | | | | | |
| | | | | | | | | | | | | | | | | | | | | | | | | | | | | | | | | | | | | | | | | | | | | | | | | | | | | | | | | | | | | | | | | | | | | | | | | | | | | | | | |
| | | | | | | | | | | | | | | | | | | | | | | | | | | | | | | | | | | | | | | | | | | | | | | | | | | | | | | | | | | | | | | | | | | | | | | | | | | | | | | | |
| | | | | | | | | | | | | | | | | | | | | | | | | | | | | | | | | | | | | | | | | | | | | | | | | | | | | | | | | | | | | | | | | | | | | | | | | | | | | | | | |
| 1 | | | | | | | | | | | | | | | | | | | | | | | | | | | | | | | | | | | | | | | | | | | | | | | | | | | | | | | | | | | | | | | | | | | | | | | | | | | | | | | |
| | | | | | | | | | | | | | | | | | | | | | | | | | | | | | | | | | | | | | | | | | | | | | | | | | | | | | | | | | | | | | | | | | | | | | | | | | | | | | | | |
| 4 | | | | | | | | | | | | | | | | | | | | | | | | | | | | | | | | | | | | | | | | | | | | | | | | | | | | | | | | | | | | | | | | | | | | | | | | | | | | | | | |
| | | | | | | | | | | | | | | | | | | | | | | | | | | | | | | | | | | | | | | | | | | | | | | | | | | | | | | | | | | | | | | | | | | | | | | | | | | | | | | | |
| | | | | | | | | | | | | | | | | | | | | | | | | | | | | | | | | | | | | | | | | | | | | | | | | | | | | | | | | | | | | | | | | | | | | | | | | | | | | | | | |
| | | | | | | | | | | | | | | | | | | | | | | | | | | | | | | | | | | | | | | | | | | | | | | | | | | | | | | | | | | | | | | | | | | | | | | | | | | | | | | | |
| | | | | | | | | | | | | | | | | | | | | | | | | | | | | | | | | | | | | | | | | | | | | | | | | | | | | | | | | | | | | | | | | | | | | | | | | | | | | | | | |
| | | | | | | | | | | | | | | | | | | | | | | | | | | | | | | | | | | | | | | | | | | | | | | | | | | | | | | | | | | | | | | | | | | | | | | | | | | | | | | | |
| | | | | | | | | | | | | | | | | | | | | | | | | | | | | | | | | | | | | | | | | | | | | | | | | | | | | | | | | | | | | | | | | | | | | | | | | | | | | | | | |
| | 1 | 1 | | | | | | | | | | | | | | | | | | | | | | | | | | | | | | | | | | | | | | | | | | | | | | | | | | | | | | | | | | | | | | | | | | | | | | | | | | | | | |
| | | 1 | | | | | | | | | | | | | | | | | | | | | | | | | | | | | | | | | | | | | | | | | | | | | | | | | | | | | | | | | | | | | | | | | | | | | | | | | | | | | |
| | 1 | | | | | | | | | | | | | | | | | | | | | | | | | | | | | | | | | | | | | | | | | | | | | | | | | | | | | | | | | | | | | | | | | | | | | | | | | | | | | | |
| | | | | | | | | | | | | | | | | | | | | | | | | | | | | | | | | | | | | | | | | | | | | | | | | | | | | | | | | | | | | | | | | | | | | | | | | | | | | | | | |
| 1 | | 1 | | | | | | | | | | | | | | | | | | | | | | | | | | | | | | | | | | | | | | | | | | | | | | | | | | | | | | | | | | | | | | | | | | | | | | | | | | | | | |
| 3 | | 1 | | | | | | | | | | | | | | | | | | | | | | | | | | | | | | | | | | | | | | | | | | | | | | | | | | | | | | | | | | | | | | | | | | | | | | | | | | | | | |
| | | | | | | | | | | | | | | | | | | | | | | | | | | | | | | | | | | | | | | | | | | | | | | | | | | | | | | | | | | | | | | | | | | | | | | | | | | | | | | | |
| | | | | | | | | | | | | | | | | | | | | | | | | | | | | | | | | | | | | | | | | | | | | | | | | | | | | | | | | | | | | | | | | | | | | | | | | | | | | | | | |
| | | | | | | | | | | | | | | | | | | | | | | | | | | | | | | | | | | | | | | | | | | | | | | | | | | | | | | | | | | | | | | | | | | | | | | | | | | | | | | | |
| | | | | | | | | | | | | | | | | | | | | | | | | | | | | | | | | | | | | | | | | | | | | | | | | | | | | | | | | | | | | | | | | | | | | | | | | | | | | | | | |
| | | | | | | | | | | | | | | | | | | | | | | | | | | | | | | | | | | | | | | | | | | | | | | | | | | | | | | | | | | | | | | | | | | | | | | | | | | | | | | | |
| | | | | | | | | | | | | | | | | | | | | | | | | | | | | | | | | | | | | | | | | | | | | | | | | | | | | | | | | | | | | | | | | | | | | | | | | | | | | | | | |
| Post - 0 Miss - 0 Block - 0 | Post - 1 Miss - 2 Block - 1 | Post - 0 Miss - 0 Block - 0 | Post - 0 Miss - 0 Block - 0 | Post - 1 Miss - 0 Block - 3 | Post - 0 Miss - 0 Block - 0 | Post - 0 Miss - 0 Block - 0 | Post - 0 Miss - 0 Block - 0 | | | | | | | | | | | | | | | | | | | | | | | | | | | | | | | | | | | | | | | | | | | | | | | | | | | | | | | | | | | | | | | | | | | | | | | | |
| 10 范保坤 | 11 王誌汉 | 12 左子健 | 13 徐峻清 | 14 孙耀琦 | 16 池猛 | 17 刘安宁 | | | | | | | | | | | | | | | | | | | | | | | | | | | | | | | | | | | | | | | | | | | | | | | | | | | | | | | | | | | | | | | | | | | | | | | | | |
| <table border="1"><tr><td></td><td></td><td></td></tr><tr><td></td><td></td><td></td></tr><tr><td></td><td></td><td></td></tr></table> | | | | | | | | | | <table border="1"><tr><td></td><td></td><td>1</td></tr><tr><td></td><td>1</td><td>3</td></tr><tr><td></td><td></td><td>3</td></tr></table> | | | 1 | | 1 | 3 | | | 3 | <table border="1"><tr><td></td><td></td><td></td></tr><tr><td></td><td></td><td></td></tr><tr><td></td><td></td><td></td></tr></table> | | | | | | | | | | <table border="1"><tr><td></td><td></td><td></td></tr><tr><td>1</td><td></td><td></td></tr><tr><td></td><td></td><td></td></tr></table> | | | | 1 | | | | | | <table border="1"><tr><td></td><td></td><td>1</td></tr><tr><td>1</td><td></td><td>4</td></tr><tr><td></td><td></td><td>1</td></tr></table> | | | 1 | 1 | | 4 | | | 1 | <table border="1"><tr><td></td><td></td><td></td></tr><tr><td></td><td></td><td></td></tr><tr><td></td><td></td><td></td></tr></table> | | | | | | | | | | <table border="1"><tr><td></td><td></td><td></td></tr><tr><td></td><td></td><td></td></tr><tr><td></td><td></td><td></td></tr></table> | | | | | | | | | | <table border="1"><tr><td></td><td></td><td></td></tr><tr><td></td><td></td><td></td></tr><tr><td></td><td></td><td></td></tr></table> | | | | | | | | | |
| | | | | | | | | | | | | | | | | | | | | | | | | | | | | | | | | | | | | | | | | | | | | | | | | | | | | | | | | | | | | | | | | | | | | | | | | | | | | | | | |
| | | | | | | | | | | | | | | | | | | | | | | | | | | | | | | | | | | | | | | | | | | | | | | | | | | | | | | | | | | | | | | | | | | | | | | | | | | | | | | | |
| | | | | | | | | | | | | | | | | | | | | | | | | | | | | | | | | | | | | | | | | | | | | | | | | | | | | | | | | | | | | | | | | | | | | | | | | | | | | | | | |
| | | 1 | | | | | | | | | | | | | | | | | | | | | | | | | | | | | | | | | | | | | | | | | | | | | | | | | | | | | | | | | | | | | | | | | | | | | | | | | | | | | |
| | 1 | 3 | | | | | | | | | | | | | | | | | | | | | | | | | | | | | | | | | | | | | | | | | | | | | | | | | | | | | | | | | | | | | | | | | | | | | | | | | | | | | |
| | | 3 | | | | | | | | | | | | | | | | | | | | | | | | | | | | | | | | | | | | | | | | | | | | | | | | | | | | | | | | | | | | | | | | | | | | | | | | | | | | | |
| | | | | | | | | | | | | | | | | | | | | | | | | | | | | | | | | | | | | | | | | | | | | | | | | | | | | | | | | | | | | | | | | | | | | | | | | | | | | | | | |
| | | | | | | | | | | | | | | | | | | | | | | | | | | | | | | | | | | | | | | | | | | | | | | | | | | | | | | | | | | | | | | | | | | | | | | | | | | | | | | | |
| | | | | | | | | | | | | | | | | | | | | | | | | | | | | | | | | | | | | | | | | | | | | | | | | | | | | | | | | | | | | | | | | | | | | | | | | | | | | | | | |
| | | | | | | | | | | | | | | | | | | | | | | | | | | | | | | | | | | | | | | | | | | | | | | | | | | | | | | | | | | | | | | | | | | | | | | | | | | | | | | | |
| 1 | | | | | | | | | | | | | | | | | | | | | | | | | | | | | | | | | | | | | | | | | | | | | | | | | | | | | | | | | | | | | | | | | | | | | | | | | | | | | | | |
| | | | | | | | | | | | | | | | | | | | | | | | | | | | | | | | | | | | | | | | | | | | | | | | | | | | | | | | | | | | | | | | | | | | | | | | | | | | | | | | |
| | | 1 | | | | | | | | | | | | | | | | | | | | | | | | | | | | | | | | | | | | | | | | | | | | | | | | | | | | | | | | | | | | | | | | | | | | | | | | | | | | | |
| 1 | | 4 | | | | | | | | | | | | | | | | | | | | | | | | | | | | | | | | | | | | | | | | | | | | | | | | | | | | | | | | | | | | | | | | | | | | | | | | | | | | | |
| | | 1 | | | | | | | | | | | | | | | | | | | | | | | | | | | | | | | | | | | | | | | | | | | | | | | | | | | | | | | | | | | | | | | | | | | | | | | | | | | | | |
| | | | | | | | | | | | | | | | | | | | | | | | | | | | | | | | | | | | | | | | | | | | | | | | | | | | | | | | | | | | | | | | | | | | | | | | | | | | | | | | |
| | | | | | | | | | | | | | | | | | | | | | | | | | | | | | | | | | | | | | | | | | | | | | | | | | | | | | | | | | | | | | | | | | | | | | | | | | | | | | | | |
| | | | | | | | | | | | | | | | | | | | | | | | | | | | | | | | | | | | | | | | | | | | | | | | | | | | | | | | | | | | | | | | | | | | | | | | | | | | | | | | |
| | | | | | | | | | | | | | | | | | | | | | | | | | | | | | | | | | | | | | | | | | | | | | | | | | | | | | | | | | | | | | | | | | | | | | | | | | | | | | | | |
| | | | | | | | | | | | | | | | | | | | | | | | | | | | | | | | | | | | | | | | | | | | | | | | | | | | | | | | | | | | | | | | | | | | | | | | | | | | | | | | |
| | | | | | | | | | | | | | | | | | | | | | | | | | | | | | | | | | | | | | | | | | | | | | | | | | | | | | | | | | | | | | | | | | | | | | | | | | | | | | | | |
| | | | | | | | | | | | | | | | | | | | | | | | | | | | | | | | | | | | | | | | | | | | | | | | | | | | | | | | | | | | | | | | | | | | | | | | | | | | | | | | |
| | | | | | | | | | | | | | | | | | | | | | | | | | | | | | | | | | | | | | | | | | | | | | | | | | | | | | | | | | | | | | | | | | | | | | | | | | | | | | | | |
| | | | | | | | | | | | | | | | | | | | | | | | | | | | | | | | | | | | | | | | | | | | | | | | | | | | | | | | | | | | | | | | | | | | | | | | | | | | | | | | |
| Post - 0 Miss - 0 Block - 0 | Post - 0 Miss - 0 Block - 0 | Post - 0 Miss - 0 Block - 0 | Post - 0 Miss - 1 Block - 1 | Post - 0 Miss - 0 Block - 0 | Post - 0 Miss - 0 Block - 0 | Post - 0 Miss - 0 Block - 0 | | | | | | | | | | | | | | | | | | | | | | | | | | | | | | | | | | | | | | | | | | | | | | | | | | | | | | | | | | | | | | | | | | | | | | | | | |

注释: Post=击柱 Miss=射失 Block=被封





5-8名
青年男子 全国比赛

2016年“体彩杯”全国手球男子青年锦标赛

| | | | | | | | | | | | | | | | | | | | | | |
|--------------------|---|--|---------------------|------------------|------------------------------------|-------------------|---|--------------------|------------------------------------|----|-----|----------------------|---------------|---|--|--|----|---|----|---|----|
| Team A A 广东队 | | | | Team B B 江苏队 | | | | Match Number 40 | | | | | | | | | | | | | |
| played in China | | in the hall 重庆万州 | | on 28/03/2016 | | at 14:30 hours | | Spectators | | | | | | | | | | | | | |
| Half-time (30') | A 26 | B 16 | End of playing time | A 45 | B 35 | 1st extra time | A | B | 2nd extra time | A | B | After penalty throws | A | B | | | | | | | |
| Number of 7 m | A 1/1 | Team time-out 1 26:02 2 40:45 3 51:10 | | | Full name of players and officials | | | | Team time-out 1 17:37 2 46:52 3 | | | B 1/3 | Number of 7 m | | | | | | | | |
| No. | Team A | | | | | G | W | 2' | D | DR | No. | Team B | | | | | G | W | 2' | D | DR |
| 1 | 王帅 | | | | | | | | | | 1 | 潘博琦 | | | | | | | | | |
| 2 | 姚雪岩 | | | | | 5 | | | | | 3 | 赵韦光 | | | | | | | | | |
| 4 | 高玉杰 | | | | | 6 | | | | | 4 | 张瑞恒 | | | | | | | | | |
| 5 | 黄培杰 | | | | | 6 | 1 | | | | 6 | 季雨 | | | | | | | | | |
| 7 | 段飞宇 | | | | | 2 | | | | | 7 | 任超凡 | | | | | 7 | | | | |
| 9 | 周凯峰 | | | | | 2 | | | | | 8 | 姜童耀 | | | | | | | | | |
| 10 | 周仲坤 | | | | | 5 | | | | | 9 | 王俊威 | | | | | | | | | |
| 11 | 胡国富 | | | | | 8 | | | | | 11 | 周傲 | | | | | 10 | | | | |
| 12 | 李壮 | | | | | 2 | | | | | 13 | 尹吉祥 | | | | | 3 | | 1 | | |
| 13 | 蔡杰 | | | | | | | | | | 15 | 阎冠中 | | | | | | | | | |
| 14 | 王泽润 | | | | | | | | | | 17 | 马益奎 | | | | | 10 | 1 | 2 | | |
| 15 | 张建杰 | | | | | 3 | 1 | | | | 18 | 耿畅 | | | | | 5 | | | | |
| 16 | 王猛 | | | | | | | | | | | | | | | | | | | | |
| 18 | 李文金 | | | | | 6 | | | | | | | | | | | | | | | |
| B | 刘康伶 (主教练) | | | | | | | | | | B | 贾淑君 (主教练) | | | | | | | | | |
| C | 刘文宁 | | | | | | | | | | | | | | | | | | | | |
| D | 王永存 | | | | | | | | | | | | | | | | | | | | |
| A | Signature of Responsible Official of the Teams (Off. A) | | | | | | | | | | B | | | | | | | | | | |
| TP | Remarks of Referee / CHA Official | | | | | | | | | | TP | | | | | | | | | | |

Signatures

| | | | | |
|------------------|-----------|----------|--|--|
| Referees | 尹静阳 (CHN) | 严璐 (CHN) | | |
| Techn. Delegates | 张春生 (CHN) | | | |
| CHA Official | 吴瑞亭 (CHN) | | | |

Note: Number of 7m Throws Awarded to Team A and B, Goals (G), Warnings (W), Suspensions (2'), Direct Disqualification (D), Disqualification with Report (DR) and Team Penalty (TP).

Table Officials:

Statisticians: 王玲

刘永欢





2016年“体彩杯”全国手球男子青年锦标赛 竞赛技术统计(媒体表)

| | | | | | | |
|------|----|----------|----|----------|----|-----------|
| 5-8名 | 组别 | X | 轮次 | 7 | 场次 | 40 |
|------|----|----------|----|----------|----|-----------|

重庆万州

28/03/2016

201602040-51-1/1

| | | | | | | |
|---------|-----------|-----------|----|-----------|----|-----|
| 广东队 | 广东 | 45 | vs | 35 | 江苏 | 江苏队 |
| 26 : 16 | | | | | | |

| | | | |
|-----|-----------|---|----------|
| 裁判员 | 尹静阳 (CHN) | / | 严璐 (CHN) |
|-----|-----------|---|----------|

| 广东 | | 远 | 近 | 边 | 快 | 突 | 任意 | 7m | 合计 | % | 助攻 | 失误 | 警告 | 2' | D & DR | 比赛进程 | | 江苏 | | | | |
|---------------|-----|------|-------|------|-----|------|-----|-----|-------|------|----|----|----|----|--------|----------|-------|----|-------|-----|--|--|
| 主教练：刘康伶 | | 射 | 射 | 射 | 攻 | 破 | 球 | 球 | | | | | | | | | | | | | | |
| 1 | 王帅 | | | | | | | | | | | | | | | 4 | 高玉杰 | 1 | 00:58 | 0 | | |
| 2 | 姚雪岩 | 2/2 | 1/2 | | 1/1 | | 1/2 | | 5/7 | 71.4 | 1 | 3 | | | | 1 | 01:19 | 1 | 11 | 周傲 | | |
| 4 | 高玉杰 | 1/3 | | 2/2 | 1/1 | 2/2 | | | 6/8 | 75.0 | | 3 | | | | 2 | 01:52 | 2 | 13 | 尹吉祥 | | |
| 5 | 黄培杰 | 0/1 | 2/2 | 1/3 | 1/1 | 2/3 | | | 6/10 | 60.0 | 5 | 4 | 1 | | | 2 | 02:14 | 2 | | | | |
| 7 | 段飞宇 | | | 1/3 | 1/1 | | | | 2/4 | 50.0 | 2 | 3 | | | | 2 | 03:01 | 3 | 7 | 任超凡 | | |
| 9 | 周凯峰 | | 1/2 | 1/2 | | | | | 2/4 | 50.0 | | 3 | | | | 2 | 03:15 | 4 | 11 | 周傲 | | |
| 10 | 周仲坤 | 2/2 | 2/2 | | | | 1/3 | | 5/7 | 71.4 | 2 | 2 | | | | 2 | 04:14 | 5 | 17 | 马益奎 | | |
| 11 | 胡国富 | 1/1 | 3/4 | 0/1 | 3/3 | 1/1 | | | 8/10 | 80.0 | | 3 | | | | 3 | 05:52 | 5 | | | | |
| 12 | 李壮 | | 1/2 | | | | 0/2 | 1/1 | 2/5 | 40.0 | | 2 | | | | 4 | 06:22 | 5 | | | | |
| 13 | 蔡杰 | | | 0/1 | | | | | 0/1 | 0.0 | | 1 | | | | 5 | 07:02 | 5 | | | | |
| 14 | 王泽润 | | | | | | | | | | | | | | | 5 | 07:22 | 6 | 17 | 马益奎 | | |
| 15 | 张建杰 | | | | 1/1 | 1/1 | 1/1 | | 3/4 | 75.0 | 2 | 1 | 1 | | | 6 | 08:14 | 7 | 18 | 耿畅 | | |
| 16 | 王猛 | | | | | | | | | | | | | | | 7 | 08:38 | 7 | | | | |
| 18 | 李文金 | 0/1 | 5/5 | | 1/1 | | | | 6/7 | 85.7 | | 1 | | | | 8 | 09:45 | 7 | | | | |
| 运动员 合计 | | 6/10 | 15/20 | 5/12 | 9/9 | 7/10 | 2/5 | 1/1 | 45/67 | 67.2 | 13 | 26 | 2 | | | 8 | 10:35 | 8 | 11 | 周傲 | | |
| 1 | 王帅 | | | | | | | | | | | | | | | 9 | 10:49 | 8 | | | | |
| 14 | 王泽润 | 4/9 | 3/11 | 1/2 | 1/2 | 2/3 | | | 11/27 | 40.7 | | | | | | 9 | 12:29 | 9 | 13 | 尹吉祥 | | |
| 16 | 王猛 | 1/2 | 5/10 | 2/5 | 2/7 | 2/5 | 0/1 | 1/2 | 13/32 | 40.6 | 1 | | | | | 10 | 13:19 | 9 | | | | |
| 守门员 合计 | | 5/11 | 8/21 | 3/7 | 3/9 | 4/8 | 0/1 | 1/2 | 24/59 | 40.7 | 1 | | | | | 11 | 14:19 | 9 | | | | |
| 江苏 | | 远 | 近 | 边 | 快 | 突 | 任意 | 7m | 合计 | % | 助攻 | 失误 | 警告 | 2' | D & DR | | | | | | | |
| 教练：贾淑君 | | 射 | 射 | 射 | 攻 | 破 | 球 | 球 | | | | | | | | | | | | | | |
| 1 | 潘博琦 | | | | | | | | | | | | | | | 11 | 15:09 | 10 | 18 | 耿畅 | | |
| 3 | 赵韦光 | | | | | | | | | | | | | | | 11 | 15:31 | 10 | | | | |
| 4 | 张瑞恒 | | | | | | | | | | | | | | | 11 | 18:11 | 11 | 17 | 马益奎 | | |
| 6 | 季雨 | | | | | | | | | | | | | | | 12 | 18:51 | 11 | | | | |
| 7 | 任超凡 | | | 3/5 | 2/4 | 2/2 | | | 7/11 | 63.6 | 1 | 5 | | | | 13 | 18:11 | 11 | | | | |
| 8 | 姜童耀 | | | | | | | | | | | | | | | 14 | 18:53 | 11 | | | | |
| 9 | 王俊威 | | | | | | | | | | | | | | | 15 | 19:16 | 11 | | | | |
| 11 | 周傲 | 4/5 | 2/10 | | 0/2 | 3/6 | 1/1 | 0/1 | 10/25 | 40.0 | 11 | 5 | | | | 16 | 19:39 | 11 | | | | |
| 13 | 尹吉祥 | 2/7 | 0/1 | | 1/1 | | | | 3/9 | 33.3 | 4 | 5 | | 1 | | 16 | 21:19 | 12 | 11 | 周傲 | | |
| 15 | 阎冠中 | | | | | | | | 0/1 | 0.0 | | 1 | | | | 17 | 21:42 | 12 | | | | |
| 17 | 马益奎 | | | 7/7 | 0/1 | 2/2 | | 1/1 | 10/11 | 90.9 | 1 | 2 | 1 | 2 | | 18 | 22:12 | 12 | | | | |
| 18 | 耿畅 | 0/2 | 1/2 | 2/2 | 1/2 | 1/2 | | | 5/10 | 50.0 | 2 | 5 | | | | 18 | 22:12 | 12 | | | | |
| 运动员 合计 | | 6/14 | 13/25 | 4/7 | 6/9 | 4/8 | 1/1 | 1/3 | 35/67 | 52.2 | 19 | 26 | 1 | 3 | | 19 | 23:04 | 12 | | | | |
| 1 | 潘博琦 | | | | | | | | | | | | | | | 19 | 23:46 | 13 | 11 | 周傲 | | |
| 4 | 张瑞恒 | 1/6 | 3/15 | 2/5 | 0/8 | 3/10 | 1/3 | 0/1 | 10/48 | 20.8 | | | | | | 19 | 24:15 | 14 | 7 | 任超凡 | | |
| 13 | 尹吉祥 | 1/2 | 0/3 | 2/4 | 0/1 | 1/1 | 1/1 | | 4/11 | 36.4 | 1 | | | | | 20 | 24:40 | 14 | | | | |
| 守门员 合计 | | 2/8 | 3/18 | 4/9 | 0/9 | 3/10 | 2/4 | 0/1 | 14/59 | 23.7 | 1 | | | | | 21 | 25:21 | 14 | | | | |
| | | | | | | | | | | | | | | | | 22 | 26:32 | 15 | 7 | 任超凡 | | |
| | | | | | | | | | | | | | | | | 23 | 27:31 | 15 | | | | |
| | | | | | | | | | | | | | | | | 23 | 28:08 | 16 | 13 | 尹吉祥 | | |
| | | | | | | | | | | | | | | | | 24 | 28:39 | 16 | | | | |
| | | | | | | | | | | | | | | | | 25 | 28:55 | 16 | | | | |
| | | | | | | | | | | | | | | | | 26 | 29:52 | 16 | | | | |
| | | | | | | | | | | | | | | | | 2nd Half | | | | | | |
| | | | | | | | | | | | | | | | | 27 | 00:30 | 16 | | | | |
| | | | | | | | | | | | | | | | | 27 | 00:48 | 17 | 11 | 周傲 | | |
| | | | | | | | | | | | | | | | | 27 | 01:09 | 18 | 18 | 耿畅 | | |
| | | | | | | | | | | | | | | | | 28 | 01:32 | 18 | | | | |
| | | | | | | | | | | | | | | | | 29 | 01:52 | 18 | | | | |
| | | | | | | | | | | | | | | | | 30 | 02:38 | 18 | | | | |
| | | | | | | | | | | | | | | | | 30 | 03:00 | 19 | 7 | 任超凡 | | |
| | | | | | | | | | | | | | | | | 30 | 03:47 | 20 | 11 | 周傲 | | |
| | | | | | | | | | | | | | | | | 30 | 05:34 | 21 | 18 | 耿畅 | | |
| | | | | | | | | | | | | | | | | 31 | 06:44 | 21 | | | | |
| | | | | | | | | | | | | | | | | 32 | 07:40 | 21 | | | | |
| | | | | | | | | | | | | | | | | 32 | 08:50 | 22 | 7 | 任超凡 | | |
| | | | | | | | | | | | | | | | | 33 | 09:13 | 22 | | | | |
| | | | | | | | | | | | | | | | | 34 | 10:24 | 22 | | | | |
| | | | | | | | | | | | | | | | | 34 | 11:19 | 23 | 7 | 任超凡 | | |
| | | | | | | | | | | | | | | | | 35 | 11:46 | 23 | | | | |
| | | | | | | | | | | | | | | | | 35 | 12:14 | 24 | 17 | 马益奎 | | |
| | | | | | | | | | | | | | | | | 36 | 12:33 | 24 | | | | |
| | | | | | | | | | | | | | | | | 36 | 14:10 | 25 | 11 | 周傲 | | |
| | | | | | | | | | | | | | | | | 36 | 15:06 | 26 | 11 | 周傲 | | |
| | | | | | | | | | | | | | | | | 37 | 15:34 | 26 | | | | |
| | | | | | | | | | | | | | | | | 38 | 16:48 | 26 | | | | |
| | | | | | | | | | | | | | | | | 38 | 17:10 | 27 | 17 | 马益奎 | | |
| | | | | | | | | | | | | | | | | 39 | 18:30 | 27 | | | | |
| | | | | | | | | | | | | | | | | 40 | 18:52 | 27 | | | | |
| | | | | | | | | | | | | | | | | 40 | 19:10 | 28 | 17 | 马益奎 | | |
| | | | | | | | | | | | | | | | | 41 | 20:33 | 28 | | | | |
| | | | | | | | | | | | | | | | | 42 | 21:04 | 28 | | | | |
| | | | | | | | | | | | | | | | | 42 | 21:57 | 29 | 17 | 马益奎 | | |
| | | | | | | | | | | | | | | | | 42 | 23:04 | 30 | 18 | 耿畅 | | |
| | | | | | | | | | | | | | | | | 43 | 23:35 | 30 | | | | |
| | | | | | | | | | | | | | | | | 43 | 24:06 | 31 | 11 | 周傲 | | |
| | | | | | | | | | | | | | | | | 44 | 24:26 | 31 | | | | |
| | | | | | | | | | | | | | | | | 44 | 25:55 | 32 | 17 | 马益奎 | | |
| | | | | | | | | | | | | | | | | 45 | 26:18 | 32 | | | | |
| | | | | | | | | | | | | | | | | 45 | 27:46 | 33 | 7 | 任超凡 | | |
| | | | | | | | | | | | | | | | | 45 | 28:54 | 34 | 17 | 马益奎 | | |
| | | | | | | | | | | | | | | | | 45 | 29:55 | 35 | 17 | 马益奎 | | |

场上队员：得分 / 射门

守门员：救球 / 射门

| | | | | | | | | | |
|----|------------|----|--------------|-----|------------|-----|----------|----|---------|
| 快攻 | Fast Break | 突破 | Breakthrough | 任意球 | Free Throw | 7M球 | 7M Throw | 助攻 | Assist |
| 警告 | Warning | 失误 | Error | 2' | Suspension | D | 取消资格 | DR | 取消资格+报告 |





2016年“体彩杯”全国手球男子青年锦标赛 图式比赛技术统计表

轮次 7

场次 40

201602040-21-1/1

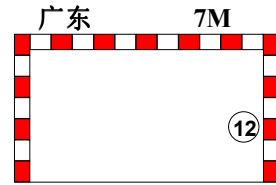
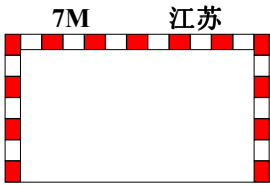
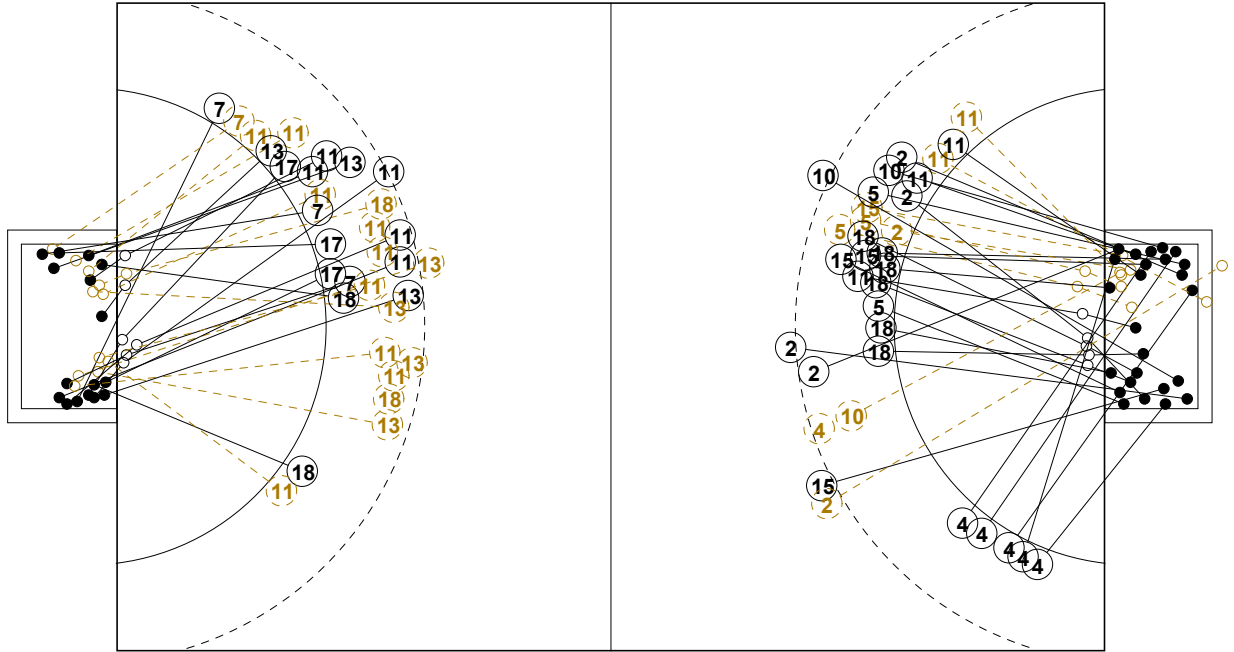

1st Half
16 : 26

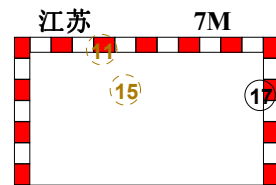
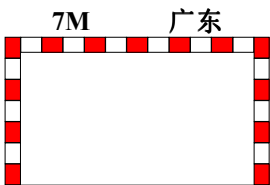
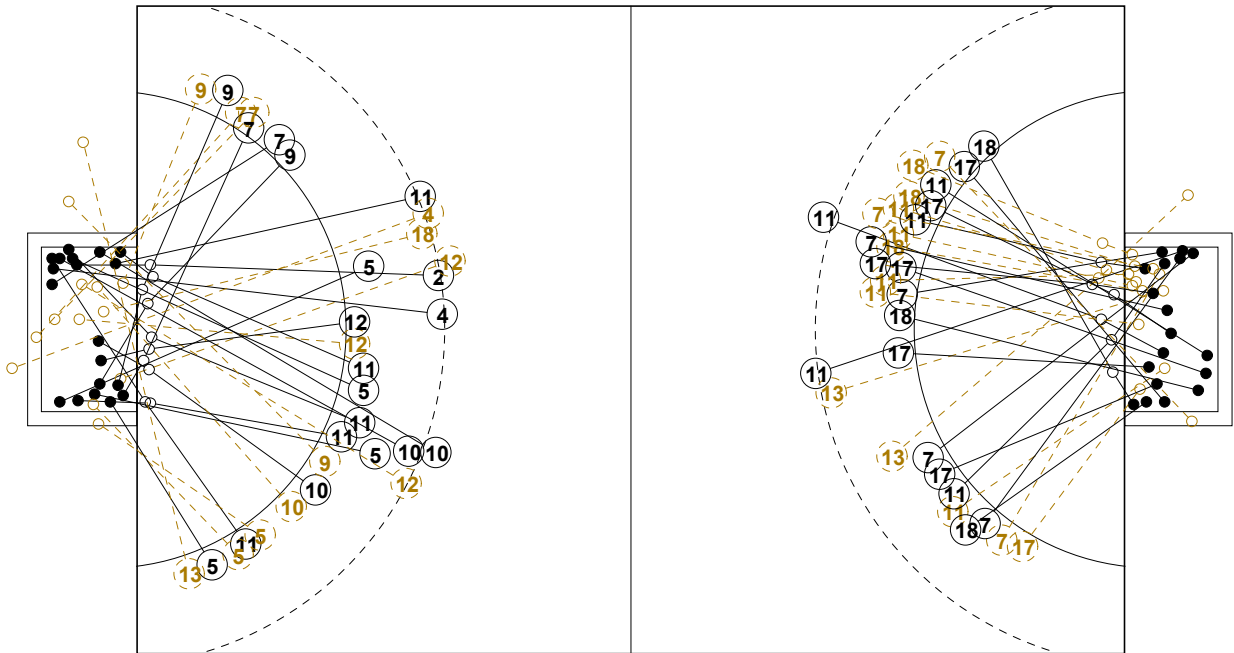

2nd Half
45 : 35



2016年“体彩杯”全国手球男子青年锦标赛

个人/全队技术统计表

正式表
手球
青年男子5-8名
轮次 7组别 X
场次 40201602040-14-1/2
重庆万州
28/03/2016 14:30

| 号码 | 姓名 | 远射 | 近射 | 边射 | 快攻 | 突破 | 任意 | 7M | 合计 | % | 助攻 | 失误 | 警告 | 2' | 取消 | 时间 |
|----------------|-----|-----|------|-----|-----|-----|-----|-----|-------|-------|----|----|----|----|----|----------|
| 广东队(广东) | | | | | | | | | | | | | | | | |
| <i>(场上队员)</i> | | | | | | | | | | | | | | | | |
| 1 | 王帅 | | | | | | | | | 0.0% | | | | | | 00:00:00 |
| 2 | 姚雪岩 | 2/2 | 1/2 | | 1/1 | | 1/2 | | 5/7 | 71.4% | 1 | 3 | | | | 00:42:19 |
| 4 | 高玉杰 | 1/3 | | 2/2 | 1/1 | 2/2 | | | 6/8 | 75.0% | | 3 | | | | 00:49:11 |
| 5 | 黄培杰 | 0/1 | 2/2 | 1/3 | 1/1 | 2/3 | | | 6/10 | 60.0% | 5 | 4 | 1 | | | 00:51:55 |
| 7 | 段飞宇 | | | 1/3 | 1/1 | | | | 2/4 | 50.0% | 2 | 3 | | | | 00:30:00 |
| 9 | 周凯峰 | | 1/2 | 1/2 | | | | | 2/4 | 50.0% | | 3 | | | | 00:07:41 |
| 10 | 周仲坤 | 2/2 | 2/2 | | | 1/3 | | | 5/7 | 71.4% | 2 | 2 | | | | 00:39:43 |
| 11 | 胡国富 | 1/1 | 3/4 | 0/1 | 3/3 | 1/1 | | | 8/10 | 80.0% | | 3 | | | | 00:40:47 |
| 12 | 李壮 | | 1/2 | | | | 0/2 | 1/1 | 2/5 | 40.0% | | 2 | | | | 00:30:19 |
| 13 | 蔡杰 | | | 0/1 | | | | | 0/1 | 0.0% | | 1 | | | | 00:06:45 |
| 14 | 王泽润 | | | | | | | | | 0.0% | | | | | | 00:30:00 |
| 15 | 张建杰 | | 0/1 | | 1/1 | 1/1 | 1/1 | | 3/4 | 75.0% | 2 | 1 | 1 | | | 00:20:17 |
| 16 | 王猛 | | | | | | | | | 0.0% | 1 | | | | | 00:30:00 |
| 18 | 李文金 | 0/1 | 5/5 | | 1/1 | | | | 6/7 | 85.7% | | 1 | | | | 00:40:18 |
| 合计 | | | | | | | | | | | | | | | | |
| <i>(守门员)</i> | | | | | | | | | | | | | | | | |
| 1 | 王帅 | | | | | | | | | 0.0% | | | | | | 00:00:00 |
| 14 | 王泽润 | 4/9 | 3/11 | 1/2 | 1/2 | 2/3 | | | 11/27 | 40.7% | | | | | | 00:30:00 |
| 16 | 王猛 | 1/2 | 5/10 | 2/5 | 2/7 | 2/5 | 0/1 | 1/2 | 13/32 | 40.6% | 1 | | | | | 00:30:00 |
| 合计 | | | | | | | | | | | | | | | | |

场上队员：得分/射门

守门员：救球/射门

| 全队合计 | 得分 | 被救 | 射失 | 击柱 | 封球 | 合计 | % |
|------|----|----|----|----|----|----|--------|
| 远射 | 6 | 2 | 1 | | 1 | 10 | 60.0% |
| 近射 | 15 | 3 | 1 | 1 | | 20 | 75.0% |
| 边射 | 5 | 4 | 1 | 2 | | 12 | 41.7% |
| 快攻 | 9 | | | | | 9 | 100.0% |
| 突破 | 7 | 3 | | | | 10 | 70.0% |
| 任意 | 2 | 2 | 1 | | | 5 | 40.0% |
| 7M | 1 | | | | | 1 | 100.0% |





2016年“体彩杯”全国手球男子青年锦标赛

个人/全队技术统计表

正式表
手球
青年男子5-8名
轮次 7组别 X
场次 40201602040-14-2/2
重庆万州
28/03/2016 14:30

| 号码 | 姓名 | 远射 | 近射 | 边射 | 快攻 | 突破 | 任意 | 7M | 合计 | % | 助攻 | 失误 | 警告 | 2' | 取消 | 时间 |
|----------------|-----|-----|------|-----|-----|------|-----|-----|-------|-------|----|----|----|----|----|----------|
| 江苏队(江苏) | | | | | | | | | | | | | | | | |
| <i>(上场队员)</i> | | | | | | | | | | | | | | | | |
| 1 | 潘博琦 | | | | | | | | | 0.0% | | | | | | 00:00:00 |
| 3 | 赵韦光 | | | | | | | | | 0.0% | | | | | | 00:00:00 |
| 4 | 张瑞恒 | | | | | | | | | 0.0% | | | | | | 00:47:40 |
| 6 | 季雨 | | | | | | | | | 0.0% | | 2 | | | | 00:19:15 |
| 7 | 任超凡 | | 3/5 | 2/4 | 2/2 | | | | 7/11 | 63.6% | 1 | 5 | | | | 01:00:00 |
| 8 | 姜童耀 | | | | | | | | | 0.0% | | | | | | 00:00:00 |
| 9 | 王俊威 | | | | | | | | | 0.0% | | 1 | | | | 00:42:42 |
| 11 | 周傲 | 4/5 | 2/10 | | 0/2 | 3/6 | 1/1 | 0/1 | 10/25 | 40.0% | 11 | 5 | | | | 01:00:00 |
| 13 | 尹吉祥 | 2/7 | 0/1 | | 1/1 | | | | 3/9 | 33.3% | 4 | 5 | | 1 | | 00:53:05 |
| 15 | 阎冠中 | | | | | | | 0/1 | 0/1 | 0.0% | | 1 | | | | 00:17:16 |
| 17 | 马益奎 | | 7/7 | 0/1 | 2/2 | | | 1/1 | 10/11 | 90.9% | 1 | 2 | 1 | 2 | | 01:00:00 |
| 18 | 耿畅 | 0/2 | 1/2 | 2/2 | 1/2 | 1/2 | | | 5/10 | 50.0% | 2 | 5 | | | | 01:00:00 |
| 合计 | | | | | | | | | | | | | | | | |
| <i>(守门员)</i> | | | | | | | | | | | | | | | | |
| 1 | 潘博琦 | | | | | | | | | 0.0% | | | | | | 00:00:00 |
| 4 | 张瑞恒 | 1/6 | 3/15 | 2/5 | 0/8 | 3/10 | 1/3 | 0/1 | 10/48 | 20.8% | | | | | | 00:47:40 |
| 13 | 尹吉祥 | 1/2 | 0/3 | 2/4 | 0/1 | | 1/1 | | 4/11 | 36.4% | 1 | | | | | 00:53:05 |
| 合计 | | | | | | | | | | | | | | | | |

场上队员：得分/射门

守门员：救球/射门

| 全队合计 | 得分 | 被救 | 射失 | 击柱 | 封球 | 合计 | % |
|------|----|----|----|----|----|----|--------|
| 远射 | 6 | 5 | | | 3 | 14 | 42.9% |
| 近射 | 13 | 8 | 1 | 1 | 2 | 25 | 52.0% |
| 边射 | 4 | 3 | | | | 7 | 57.1% |
| 快攻 | 6 | 3 | | | | 9 | 66.7% |
| 突破 | 4 | 4 | | | | 8 | 50.0% |
| 任意 | 1 | | | | | 1 | 100.0% |
| 7M | 1 | 1 | | 1 | | 3 | 33.3% |





2016年“体彩杯”全国手球男子青年锦标赛

图式射门区域统计

轮次 7 场次 40

201602040-41-1/1

广东队

| | | | | | | | | | | | | | | | | | | | | | | | | | | | | | | | | | | | | | | | | | | | | | | | | | | | | | | | | | | | | | | | | | | | | | | | | | | | | | | | |
|--|-----------------------------|-----------------------------|-----------------------------|-----------------------------|-----------------------------|-----------------------------|-----------------------------|--|--|--|---|--|---|--|--|---|---|--|--|---|---|--|---|---|--|---|---|--|--|---|---|--|---|---|--|---|---|--|---|--|--|--|---|--|--|--|---|--|--|---|---|---|---|---|--|---|---|--|--|--|--|--|---|---|---|---|--|--|--|--|--|--|---|---|---|--|--|--|---|
| 1 王帅 | 2 姚雪岩 | 4 高玉杰 | 5 黄培杰 | 7 段飞宇 | 9 周凯峰 | 10 周仲坤 | 11 胡国富 | | | | | | | | | | | | | | | | | | | | | | | | | | | | | | | | | | | | | | | | | | | | | | | | | | | | | | | | | | | | | | | | | | | | | | | | |
| <table border="1"><tr><td></td><td></td><td></td></tr><tr><td></td><td></td><td></td></tr><tr><td></td><td></td><td></td></tr></table> | | | | | | | | | | <table border="1"><tr><td>1</td><td></td><td>1</td></tr><tr><td></td><td></td><td>2</td></tr><tr><td>1</td><td></td><td></td></tr></table> | 1 | | 1 | | | 2 | 1 | | | <table border="1"><tr><td>2</td><td></td><td>1</td></tr><tr><td>1</td><td></td><td>1</td></tr><tr><td>1</td><td></td><td></td></tr></table> | 2 | | 1 | 1 | | 1 | 1 | | | <table border="1"><tr><td>2</td><td></td><td>1</td></tr><tr><td>1</td><td></td><td></td></tr><tr><td>1</td><td></td><td>1</td></tr></table> | 2 | | 1 | 1 | | | 1 | | 1 | <table border="1"><tr><td></td><td></td><td>1</td></tr><tr><td></td><td></td><td></td></tr><tr><td>1</td><td></td><td></td></tr></table> | | | 1 | | | | 1 | | | <table border="1"><tr><td></td><td></td><td></td></tr><tr><td>1</td><td></td><td></td></tr><tr><td>1</td><td></td><td></td></tr></table> | | | | 1 | | | 1 | | | <table border="1"><tr><td></td><td></td><td>2</td></tr><tr><td>1</td><td>1</td><td>1</td></tr><tr><td></td><td></td><td></td></tr></table> | | | 2 | 1 | 1 | 1 | | | | <table border="1"><tr><td></td><td></td><td>2</td></tr><tr><td>3</td><td>1</td><td></td></tr><tr><td></td><td></td><td>2</td></tr></table> | | | 2 | 3 | 1 | | | | 2 |
| | | | | | | | | | | | | | | | | | | | | | | | | | | | | | | | | | | | | | | | | | | | | | | | | | | | | | | | | | | | | | | | | | | | | | | | | | | | | | | | |
| | | | | | | | | | | | | | | | | | | | | | | | | | | | | | | | | | | | | | | | | | | | | | | | | | | | | | | | | | | | | | | | | | | | | | | | | | | | | | | | |
| | | | | | | | | | | | | | | | | | | | | | | | | | | | | | | | | | | | | | | | | | | | | | | | | | | | | | | | | | | | | | | | | | | | | | | | | | | | | | | | |
| 1 | | 1 | | | | | | | | | | | | | | | | | | | | | | | | | | | | | | | | | | | | | | | | | | | | | | | | | | | | | | | | | | | | | | | | | | | | | | | | | | | | | |
| | | 2 | | | | | | | | | | | | | | | | | | | | | | | | | | | | | | | | | | | | | | | | | | | | | | | | | | | | | | | | | | | | | | | | | | | | | | | | | | | | | |
| 1 | | | | | | | | | | | | | | | | | | | | | | | | | | | | | | | | | | | | | | | | | | | | | | | | | | | | | | | | | | | | | | | | | | | | | | | | | | | | | | | |
| 2 | | 1 | | | | | | | | | | | | | | | | | | | | | | | | | | | | | | | | | | | | | | | | | | | | | | | | | | | | | | | | | | | | | | | | | | | | | | | | | | | | | |
| 1 | | 1 | | | | | | | | | | | | | | | | | | | | | | | | | | | | | | | | | | | | | | | | | | | | | | | | | | | | | | | | | | | | | | | | | | | | | | | | | | | | | |
| 1 | | | | | | | | | | | | | | | | | | | | | | | | | | | | | | | | | | | | | | | | | | | | | | | | | | | | | | | | | | | | | | | | | | | | | | | | | | | | | | | |
| 2 | | 1 | | | | | | | | | | | | | | | | | | | | | | | | | | | | | | | | | | | | | | | | | | | | | | | | | | | | | | | | | | | | | | | | | | | | | | | | | | | | | |
| 1 | | | | | | | | | | | | | | | | | | | | | | | | | | | | | | | | | | | | | | | | | | | | | | | | | | | | | | | | | | | | | | | | | | | | | | | | | | | | | | | |
| 1 | | 1 | | | | | | | | | | | | | | | | | | | | | | | | | | | | | | | | | | | | | | | | | | | | | | | | | | | | | | | | | | | | | | | | | | | | | | | | | | | | | |
| | | 1 | | | | | | | | | | | | | | | | | | | | | | | | | | | | | | | | | | | | | | | | | | | | | | | | | | | | | | | | | | | | | | | | | | | | | | | | | | | | | |
| | | | | | | | | | | | | | | | | | | | | | | | | | | | | | | | | | | | | | | | | | | | | | | | | | | | | | | | | | | | | | | | | | | | | | | | | | | | | | | | |
| 1 | | | | | | | | | | | | | | | | | | | | | | | | | | | | | | | | | | | | | | | | | | | | | | | | | | | | | | | | | | | | | | | | | | | | | | | | | | | | | | | |
| | | | | | | | | | | | | | | | | | | | | | | | | | | | | | | | | | | | | | | | | | | | | | | | | | | | | | | | | | | | | | | | | | | | | | | | | | | | | | | | |
| 1 | | | | | | | | | | | | | | | | | | | | | | | | | | | | | | | | | | | | | | | | | | | | | | | | | | | | | | | | | | | | | | | | | | | | | | | | | | | | | | | |
| 1 | | | | | | | | | | | | | | | | | | | | | | | | | | | | | | | | | | | | | | | | | | | | | | | | | | | | | | | | | | | | | | | | | | | | | | | | | | | | | | | |
| | | 2 | | | | | | | | | | | | | | | | | | | | | | | | | | | | | | | | | | | | | | | | | | | | | | | | | | | | | | | | | | | | | | | | | | | | | | | | | | | | | |
| 1 | 1 | 1 | | | | | | | | | | | | | | | | | | | | | | | | | | | | | | | | | | | | | | | | | | | | | | | | | | | | | | | | | | | | | | | | | | | | | | | | | | | | | |
| | | | | | | | | | | | | | | | | | | | | | | | | | | | | | | | | | | | | | | | | | | | | | | | | | | | | | | | | | | | | | | | | | | | | | | | | | | | | | | | |
| | | 2 | | | | | | | | | | | | | | | | | | | | | | | | | | | | | | | | | | | | | | | | | | | | | | | | | | | | | | | | | | | | | | | | | | | | | | | | | | | | | |
| 3 | 1 | | | | | | | | | | | | | | | | | | | | | | | | | | | | | | | | | | | | | | | | | | | | | | | | | | | | | | | | | | | | | | | | | | | | | | | | | | | | | | |
| | | 2 | | | | | | | | | | | | | | | | | | | | | | | | | | | | | | | | | | | | | | | | | | | | | | | | | | | | | | | | | | | | | | | | | | | | | | | | | | | | | |
| Post - 0 Miss - 0 Block - 0 | Post - 0 Miss - 1 Block - 0 | Post - 0 Miss - 1 Block - 1 | Post - 1 Miss - 0 Block - 0 | Post - 1 Miss - 0 Block - 0 | Post - 0 Miss - 1 Block - 0 | Post - 0 Miss - 0 Block - 0 | Post - 1 Miss - 0 Block - 0 | | | | | | | | | | | | | | | | | | | | | | | | | | | | | | | | | | | | | | | | | | | | | | | | | | | | | | | | | | | | | | | | | | | | | | | | |
| 12 李壮 | 13 蔡杰 | 14 王泽润 | 15 张建杰 | 16 王猛 | 18 李文金 | | | | | | | | | | | | | | | | | | | | | | | | | | | | | | | | | | | | | | | | | | | | | | | | | | | | | | | | | | | | | | | | | | | | | | | | | | |
| <table border="1"><tr><td>1</td><td></td><td>1</td></tr><tr><td></td><td></td><td></td></tr><tr><td></td><td></td><td></td></tr></table> | 1 | | 1 | | | | | | | <table border="1"><tr><td></td><td></td><td></td></tr><tr><td></td><td></td><td></td></tr><tr><td></td><td></td><td></td></tr></table> | | | | | | | | | | <table border="1"><tr><td></td><td></td><td></td></tr><tr><td></td><td></td><td></td></tr><tr><td></td><td></td><td></td></tr></table> | | | | | | | | | | <table border="1"><tr><td>1</td><td></td><td>1</td></tr><tr><td></td><td></td><td>1</td></tr><tr><td></td><td></td><td></td></tr></table> | 1 | | 1 | | | 1 | | | | <table border="1"><tr><td></td><td></td><td></td></tr><tr><td></td><td></td><td></td></tr><tr><td></td><td></td><td></td></tr></table> | | | | | | | | | | <table border="1"><tr><td>1</td><td>1</td><td>1</td></tr><tr><td>1</td><td></td><td>2</td></tr><tr><td></td><td></td><td></td></tr></table> | 1 | 1 | 1 | 1 | | 2 | | | | <table border="1"><tr><td></td><td></td><td></td></tr><tr><td></td><td></td><td></td></tr><tr><td></td><td></td><td></td></tr></table> | | | | | | | | | | <table border="1"><tr><td></td><td></td><td></td></tr><tr><td></td><td></td><td></td></tr><tr><td></td><td></td><td></td></tr></table> | | | | | | | | | |
| 1 | | 1 | | | | | | | | | | | | | | | | | | | | | | | | | | | | | | | | | | | | | | | | | | | | | | | | | | | | | | | | | | | | | | | | | | | | | | | | | | | | | |
| | | | | | | | | | | | | | | | | | | | | | | | | | | | | | | | | | | | | | | | | | | | | | | | | | | | | | | | | | | | | | | | | | | | | | | | | | | | | | | | |
| | | | | | | | | | | | | | | | | | | | | | | | | | | | | | | | | | | | | | | | | | | | | | | | | | | | | | | | | | | | | | | | | | | | | | | | | | | | | | | | |
| | | | | | | | | | | | | | | | | | | | | | | | | | | | | | | | | | | | | | | | | | | | | | | | | | | | | | | | | | | | | | | | | | | | | | | | | | | | | | | | |
| | | | | | | | | | | | | | | | | | | | | | | | | | | | | | | | | | | | | | | | | | | | | | | | | | | | | | | | | | | | | | | | | | | | | | | | | | | | | | | | |
| | | | | | | | | | | | | | | | | | | | | | | | | | | | | | | | | | | | | | | | | | | | | | | | | | | | | | | | | | | | | | | | | | | | | | | | | | | | | | | | |
| | | | | | | | | | | | | | | | | | | | | | | | | | | | | | | | | | | | | | | | | | | | | | | | | | | | | | | | | | | | | | | | | | | | | | | | | | | | | | | | |
| | | | | | | | | | | | | | | | | | | | | | | | | | | | | | | | | | | | | | | | | | | | | | | | | | | | | | | | | | | | | | | | | | | | | | | | | | | | | | | | |
| | | | | | | | | | | | | | | | | | | | | | | | | | | | | | | | | | | | | | | | | | | | | | | | | | | | | | | | | | | | | | | | | | | | | | | | | | | | | | | | |
| 1 | | 1 | | | | | | | | | | | | | | | | | | | | | | | | | | | | | | | | | | | | | | | | | | | | | | | | | | | | | | | | | | | | | | | | | | | | | | | | | | | | | |
| | | 1 | | | | | | | | | | | | | | | | | | | | | | | | | | | | | | | | | | | | | | | | | | | | | | | | | | | | | | | | | | | | | | | | | | | | | | | | | | | | | |
| | | | | | | | | | | | | | | | | | | | | | | | | | | | | | | | | | | | | | | | | | | | | | | | | | | | | | | | | | | | | | | | | | | | | | | | | | | | | | | | |
| | | | | | | | | | | | | | | | | | | | | | | | | | | | | | | | | | | | | | | | | | | | | | | | | | | | | | | | | | | | | | | | | | | | | | | | | | | | | | | | |
| | | | | | | | | | | | | | | | | | | | | | | | | | | | | | | | | | | | | | | | | | | | | | | | | | | | | | | | | | | | | | | | | | | | | | | | | | | | | | | | |
| | | | | | | | | | | | | | | | | | | | | | | | | | | | | | | | | | | | | | | | | | | | | | | | | | | | | | | | | | | | | | | | | | | | | | | | | | | | | | | | |
| 1 | 1 | 1 | | | | | | | | | | | | | | | | | | | | | | | | | | | | | | | | | | | | | | | | | | | | | | | | | | | | | | | | | | | | | | | | | | | | | | | | | | | | | |
| 1 | | 2 | | | | | | | | | | | | | | | | | | | | | | | | | | | | | | | | | | | | | | | | | | | | | | | | | | | | | | | | | | | | | | | | | | | | | | | | | | | | | |
| | | | | | | | | | | | | | | | | | | | | | | | | | | | | | | | | | | | | | | | | | | | | | | | | | | | | | | | | | | | | | | | | | | | | | | | | | | | | | | | |
| | | | | | | | | | | | | | | | | | | | | | | | | | | | | | | | | | | | | | | | | | | | | | | | | | | | | | | | | | | | | | | | | | | | | | | | | | | | | | | | |
| | | | | | | | | | | | | | | | | | | | | | | | | | | | | | | | | | | | | | | | | | | | | | | | | | | | | | | | | | | | | | | | | | | | | | | | | | | | | | | | |
| | | | | | | | | | | | | | | | | | | | | | | | | | | | | | | | | | | | | | | | | | | | | | | | | | | | | | | | | | | | | | | | | | | | | | | | | | | | | | | | |
| | | | | | | | | | | | | | | | | | | | | | | | | | | | | | | | | | | | | | | | | | | | | | | | | | | | | | | | | | | | | | | | | | | | | | | | | | | | | | | | |
| | | | | | | | | | | | | | | | | | | | | | | | | | | | | | | | | | | | | | | | | | | | | | | | | | | | | | | | | | | | | | | | | | | | | | | | | | | | | | | | |
| | | | | | | | | | | | | | | | | | | | | | | | | | | | | | | | | | | | | | | | | | | | | | | | | | | | | | | | | | | | | | | | | | | | | | | | | | | | | | | | |
| Post - 0 Miss - 0 Block - 0 | Post - 0 Miss - 1 Block - 0 | Post - 0 Miss - 0 Block - 0 | Post - 0 Miss - 0 Block - 0 | Post - 0 Miss - 0 Block - 0 | Post - 0 Miss - 0 Block - 0 | | | | | | | | | | | | | | | | | | | | | | | | | | | | | | | | | | | | | | | | | | | | | | | | | | | | | | | | | | | | | | | | | | | | | | | | | | |

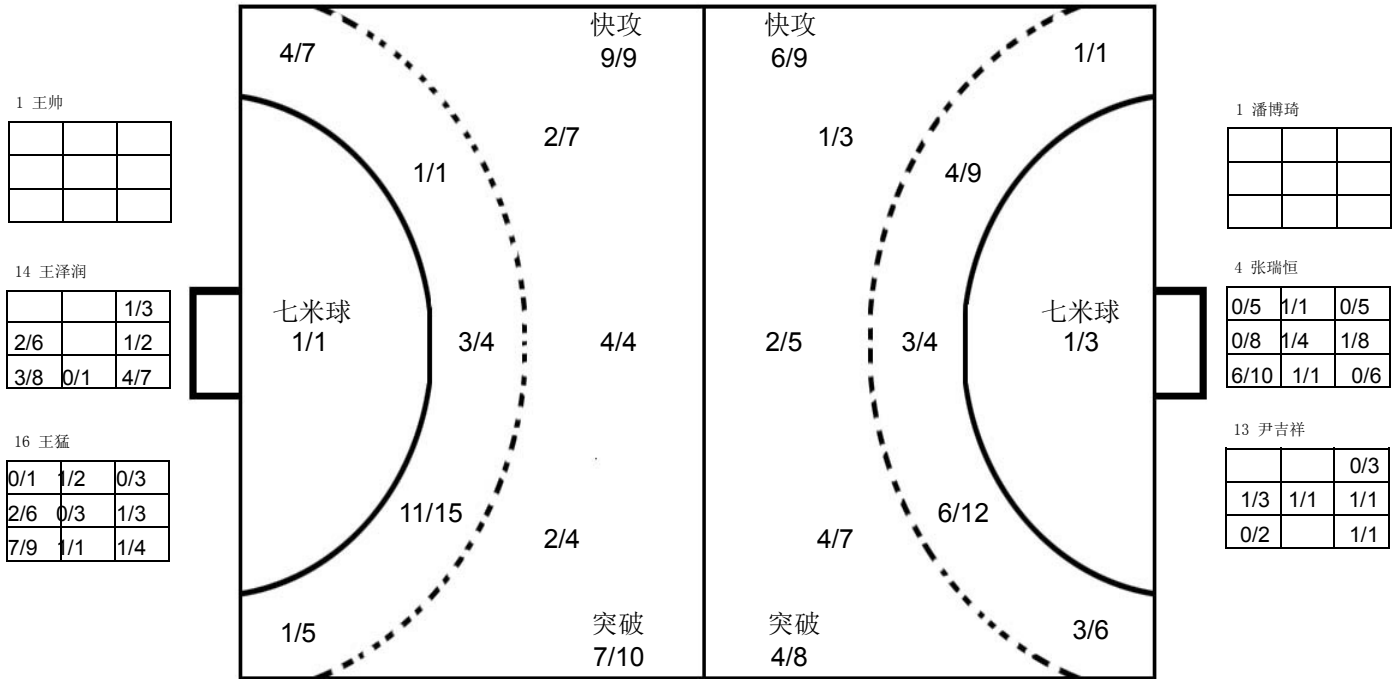

江苏队

| | | | | | | | | | | | | | | | | | | | | | | | | | | | | | | | | | | | | | | | | | | | | | | | | | | | | | | | | | | | | | | | | | | | | | | | | | | | | | | | |
|---|-----------------------------|-----------------------------|-----------------------------|-----------------------------|-----------------------------|-----------------------------|-----------------------------|---|--|--|--|--|--|--|--|--|--|--|--|---|--|--|---|--|---|---|---|--|---|---|--|--|---|--|--|--|---|--|---|--|---|--|---|---|---|--|--|--|--|--|--|--|--|--|--|--|--|--|--|--|--|--|--|--|--|--|--|--|--|---|--|---|--|---|---|--|---|--|---|
| 1 潘博琦 | 3 赵韦光 | 4 张瑞恒 | 6 季雨 | 7 任超凡 | 8 姜童耀 | 9 王俊威 | 11 周傲 | | | | | | | | | | | | | | | | | | | | | | | | | | | | | | | | | | | | | | | | | | | | | | | | | | | | | | | | | | | | | | | | | | | | | | | | |
| <table border="1"><tr><td></td><td></td><td></td></tr><tr><td></td><td></td><td></td></tr><tr><td></td><td></td><td></td></tr></table> | | | | | | | | | | <table border="1"><tr><td></td><td></td><td></td></tr><tr><td></td><td></td><td></td></tr><tr><td></td><td></td><td></td></tr></table> | | | | | | | | | | <table border="1"><tr><td></td><td></td><td></td></tr><tr><td></td><td></td><td></td></tr><tr><td></td><td></td><td></td></tr></table> | | | | | | | | | | <table border="1"><tr><td></td><td></td><td></td></tr><tr><td></td><td></td><td></td></tr><tr><td></td><td></td><td></td></tr></table> | | | | | | | | | | <table border="1"><tr><td>1</td><td></td><td>1</td></tr><tr><td>4</td><td>1</td><td></td></tr><tr><td></td><td></td><td></td></tr></table> | 1 | | 1 | 4 | 1 | | | | | <table border="1"><tr><td></td><td></td><td></td></tr><tr><td></td><td></td><td></td></tr><tr><td></td><td></td><td></td></tr></table> | | | | | | | | | | <table border="1"><tr><td></td><td></td><td></td></tr><tr><td></td><td></td><td></td></tr><tr><td></td><td></td><td></td></tr></table> | | | | | | | | | | <table border="1"><tr><td></td><td>1</td><td></td></tr><tr><td>4</td><td>1</td><td></td></tr><tr><td>2</td><td></td><td>2</td></tr></table> | | 1 | | 4 | 1 | | 2 | | 2 |
| | | | | | | | | | | | | | | | | | | | | | | | | | | | | | | | | | | | | | | | | | | | | | | | | | | | | | | | | | | | | | | | | | | | | | | | | | | | | | | | |
| | | | | | | | | | | | | | | | | | | | | | | | | | | | | | | | | | | | | | | | | | | | | | | | | | | | | | | | | | | | | | | | | | | | | | | | | | | | | | | | |
| | | | | | | | | | | | | | | | | | | | | | | | | | | | | | | | | | | | | | | | | | | | | | | | | | | | | | | | | | | | | | | | | | | | | | | | | | | | | | | | |
| | | | | | | | | | | | | | | | | | | | | | | | | | | | | | | | | | | | | | | | | | | | | | | | | | | | | | | | | | | | | | | | | | | | | | | | | | | | | | | | |
| | | | | | | | | | | | | | | | | | | | | | | | | | | | | | | | | | | | | | | | | | | | | | | | | | | | | | | | | | | | | | | | | | | | | | | | | | | | | | | | |
| | | | | | | | | | | | | | | | | | | | | | | | | | | | | | | | | | | | | | | | | | | | | | | | | | | | | | | | | | | | | | | | | | | | | | | | | | | | | | | | |
| | | | | | | | | | | | | | | | | | | | | | | | | | | | | | | | | | | | | | | | | | | | | | | | | | | | | | | | | | | | | | | | | | | | | | | | | | | | | | | | |
| | | | | | | | | | | | | | | | | | | | | | | | | | | | | | | | | | | | | | | | | | | | | | | | | | | | | | | | | | | | | | | | | | | | | | | | | | | | | | | | |
| | | | | | | | | | | | | | | | | | | | | | | | | | | | | | | | | | | | | | | | | | | | | | | | | | | | | | | | | | | | | | | | | | | | | | | | | | | | | | | | |
| | | | | | | | | | | | | | | | | | | | | | | | | | | | | | | | | | | | | | | | | | | | | | | | | | | | | | | | | | | | | | | | | | | | | | | | | | | | | | | | |
| | | | | | | | | | | | | | | | | | | | | | | | | | | | | | | | | | | | | | | | | | | | | | | | | | | | | | | | | | | | | | | | | | | | | | | | | | | | | | | | |
| | | | | | | | | | | | | | | | | | | | | | | | | | | | | | | | | | | | | | | | | | | | | | | | | | | | | | | | | | | | | | | | | | | | | | | | | | | | | | | | |
| 1 | | 1 | | | | | | | | | | | | | | | | | | | | | | | | | | | | | | | | | | | | | | | | | | | | | | | | | | | | | | | | | | | | | | | | | | | | | | | | | | | | | |
| 4 | 1 | | | | | | | | | | | | | | | | | | | | | | | | | | | | | | | | | | | | | | | | | | | | | | | | | | | | | | | | | | | | | | | | | | | | | | | | | | | | | | |
| | | | | | | | | | | | | | | | | | | | | | | | | | | | | | | | | | | | | | | | | | | | | | | | | | | | | | | | | | | | | | | | | | | | | | | | | | | | | | | | |
| | | | | | | | | | | | | | | | | | | | | | | | | | | | | | | | | | | | | | | | | | | | | | | | | | | | | | | | | | | | | | | | | | | | | | | | | | | | | | | | |
| | | | | | | | | | | | | | | | | | | | | | | | | | | | | | | | | | | | | | | | | | | | | | | | | | | | | | | | | | | | | | | | | | | | | | | | | | | | | | | | |
| | | | | | | | | | | | | | | | | | | | | | | | | | | | | | | | | | | | | | | | | | | | | | | | | | | | | | | | | | | | | | | | | | | | | | | | | | | | | | | | |
| | | | | | | | | | | | | | | | | | | | | | | | | | | | | | | | | | | | | | | | | | | | | | | | | | | | | | | | | | | | | | | | | | | | | | | | | | | | | | | | |
| | | | | | | | | | | | | | | | | | | | | | | | | | | | | | | | | | | | | | | | | | | | | | | | | | | | | | | | | | | | | | | | | | | | | | | | | | | | | | | | |
| | | | | | | | | | | | | | | | | | | | | | | | | | | | | | | | | | | | | | | | | | | | | | | | | | | | | | | | | | | | | | | | | | | | | | | | | | | | | | | | |
| | 1 | | | | | | | | | | | | | | | | | | | | | | | | | | | | | | | | | | | | | | | | | | | | | | | | | | | | | | | | | | | | | | | | | | | | | | | | | | | | | | |
| 4 | 1 | | | | | | | | | | | | | | | | | | | | | | | | | | | | | | | | | | | | | | | | | | | | | | | | | | | | | | | | | | | | | | | | | | | | | | | | | | | | | | |
| 2 | | 2 | | | | | | | | | | | | | | | | | | | | | | | | | | | | | | | | | | | | | | | | | | | | | | | | | | | | | | | | | | | | | | | | | | | | | | | | | | | | | |
| Post - 0 Miss - 0 Block - 0 | Post - 0 Miss - 0 Block - 0 | Post - 0 Miss - 0 Block - 0 | Post - 0 Miss - 0 Block - 0 | Post - 1 Miss - 0 Block - 0 | Post - 0 Miss - 0 Block - 0 | Post - 0 Miss - 0 Block - 0 | Post - 1 Miss - 0 Block - 3 | | | | | | | | | | | | | | | | | | | | | | | | | | | | | | | | | | | | | | | | | | | | | | | | | | | | | | | | | | | | | | | | | | | | | | | | |
| 13 尹吉祥 | 15 阎冠中 | 17 马益奎 | 18 耿畅 | | | | | | | | | | | | | | | | | | | | | | | | | | | | | | | | | | | | | | | | | | | | | | | | | | | | | | | | | | | | | | | | | | | | | | | | | | | | |
| <table border="1"><tr><td></td><td></td><td>1</td></tr><tr><td></td><td></td><td></td></tr><tr><td>1</td><td>1</td><td></td></tr></table> | | | 1 | | | | 1 | 1 | | <table border="1"><tr><td></td><td></td><td></td></tr><tr><td></td><td></td><td></td></tr><tr><td></td><td></td><td></td></tr></table> | | | | | | | | | | <table border="1"><tr><td></td><td></td><td>2</td></tr><tr><td></td><td>1</td><td>3</td></tr><tr><td>3</td><td></td><td>1</td></tr></table> | | | 2 | | 1 | 3 | 3 | | 1 | <table border="1"><tr><td></td><td></td><td>1</td></tr><tr><td></td><td></td><td></td></tr><tr><td>1</td><td></td><td>3</td></tr></table> | | | 1 | | | | 1 | | 3 | <table border="1"><tr><td></td><td></td><td></td></tr><tr><td></td><td></td><td></td></tr><tr><td></td><td></td><td></td></tr></table> | | | | | | | | | | <table border="1"><tr><td></td><td></td><td></td></tr><tr><td></td><td></td><td></td></tr><tr><td></td><td></td><td></td></tr></table> | | | | | | | | | | <table border="1"><tr><td></td><td></td><td></td></tr><tr><td></td><td></td><td></td></tr><tr><td></td><td></td><td></td></tr></table> | | | | | | | | | | <table border="1"><tr><td></td><td></td><td></td></tr><tr><td></td><td></td><td></td></tr><tr><td></td><td></td><td></td></tr></table> | | | | | | | | | |
| | | 1 | | | | | | | | | | | | | | | | | | | | | | | | | | | | | | | | | | | | | | | | | | | | | | | | | | | | | | | | | | | | | | | | | | | | | | | | | | | | | |
| | | | | | | | | | | | | | | | | | | | | | | | | | | | | | | | | | | | | | | | | | | | | | | | | | | | | | | | | | | | | | | | | | | | | | | | | | | | | | | | |
| 1 | 1 | | | | | | | | | | | | | | | | | | | | | | | | | | | | | | | | | | | | | | | | | | | | | | | | | | | | | | | | | | | | | | | | | | | | | | | | | | | | | | |
| | | | | | | | | | | | | | | | | | | | | | | | | | | | | | | | | | | | | | | | | | | | | | | | | | | | | | | | | | | | | | | | | | | | | | | | | | | | | | | | |
| | | | | | | | | | | | | | | | | | | | | | | | | | | | | | | | | | | | | | | | | | | | | | | | | | | | | | | | | | | | | | | | | | | | | | | | | | | | | | | | |
| | | | | | | | | | | | | | | | | | | | | | | | | | | | | | | | | | | | | | | | | | | | | | | | | | | | | | | | | | | | | | | | | | | | | | | | | | | | | | | | |
| | | 2 | | | | | | | | | | | | | | | | | | | | | | | | | | | | | | | | | | | | | | | | | | | | | | | | | | | | | | | | | | | | | | | | | | | | | | | | | | | | | |
| | 1 | 3 | | | | | | | | | | | | | | | | | | | | | | | | | | | | | | | | | | | | | | | | | | | | | | | | | | | | | | | | | | | | | | | | | | | | | | | | | | | | | |
| 3 | | 1 | | | | | | | | | | | | | | | | | | | | | | | | | | | | | | | | | | | | | | | | | | | | | | | | | | | | | | | | | | | | | | | | | | | | | | | | | | | | | |
| | | 1 | | | | | | | | | | | | | | | | | | | | | | | | | | | | | | | | | | | | | | | | | | | | | | | | | | | | | | | | | | | | | | | | | | | | | | | | | | | | | |
| | | | | | | | | | | | | | | | | | | | | | | | | | | | | | | | | | | | | | | | | | | | | | | | | | | | | | | | | | | | | | | | | | | | | | | | | | | | | | | | |
| 1 | | 3 | | | | | | | | | | | | | | | | | | | | | | | | | | | | | | | | | | | | | | | | | | | | | | | | | | | | | | | | | | | | | | | | | | | | | | | | | | | | | |
| | | | | | | | | | | | | | | | | | | | | | | | | | | | | | | | | | | | | | | | | | | | | | | | | | | | | | | | | | | | | | | | | | | | | | | | | | | | | | | | |
| | | | | | | | | | | | | | | | | | | | | | | | | | | | | | | | | | | | | | | | | | | | | | | | | | | | | | | | | | | | | | | | | | | | | | | | | | | | | | | | |
| | | | | | | | | | | | | | | | | | | | | | | | | | | | | | | | | | | | | | | | | | | | | | | | | | | | | | | | | | | | | | | | | | | | | | | | | | | | | | | | |
| | | | | | | | | | | | | | | | | | | | | | | | | | | | | | | | | | | | | | | | | | | | | | | | | | | | | | | | | | | | | | | | | | | | | | | | | | | | | | | | |
| | | | | | | | | | | | | | | | | | | | | | | | | | | | | | | | | | | | | | | | | | | | | | | | | | | | | | | | | | | | | | | | | | | | | | | | | | | | | | | | |
| | | | | | | | | | | | | | | | | | | | | | | | | | | | | | | | | | | | | | | | | | | | | | | | | | | | | | | | | | | | | | | | | | | | | | | | | | | | | | | | |
| | | | | | | | | | | | | | | | | | | | | | | | | | | | | | | | | | | | | | | | | | | | | | | | | | | | | | | | | | | | | | | | | | | | | | | | | | | | | | | | |
| | | | | | | | | | | | | | | | | | | | | | | | | | | | | | | | | | | | | | | | | | | | | | | | | | | | | | | | | | | | | | | | | | | | | | | | | | | | | | | | |
| | | | | | | | | | | | | | | | | | | | | | | | | | | | | | | | | | | | | | | | | | | | | | | | | | | | | | | | | | | | | | | | | | | | | | | | | | | | | | | | |
| | | | | | | | | | | | | | | | | | | | | | | | | | | | | | | | | | | | | | | | | | | | | | | | | | | | | | | | | | | | | | | | | | | | | | | | | | | | | | | | |
| | | | | | | | | | | | | | | | | | | | | | | | | | | | | | | | | | | | | | | | | | | | | | | | | | | | | | | | | | | | | | | | | | | | | | | | | | | | | | | | |
| | | | | | | | | | | | | | | | | | | | | | | | | | | | | | | | | | | | | | | | | | | | | | | | | | | | | | | | | | | | | | | | | | | | | | | | | | | | | | | | |
| Post - 0 Miss - 1 Block - 1 | Post - 0 Miss - 0 Block - 0 | Post - 0 Miss - 0 Block - 0 | Post - 0 Miss - 0 Block - 1 | | | | | | | | | | | | | | | | | | | | | | | | | | | | | | | | | | | | | | | | | | | | | | | | | | | | | | | | | | | | | | | | | | | | | | | | | | | | |

注释: Post=击柱 Miss=射失 Block=被封





5-8名
青年男子 全国比赛

2016年“体彩杯”全国手球男子青年锦标赛

| | | | | | | | | | | | | | | | | | | | | | |
|--------------------|---|---------------------|---------------------|------------------|------------------------------------|-------------------|---|--------------------|----------------|-------|-----|----------------------|---------------|---|--|--|----|---|----|----|----|
| Team A A 广东队 | | | | Team B B 江苏队 | | | | Match Number 40 | | | | | | | | | | | | | |
| played in China | | in the hall 重庆万州 | | on 28/03/2016 | | at 14:30 hours | | Spectators | | | | | | | | | | | | | |
| Half-time (30') | A 26 | B 16 | End of playing time | A 45 | B 35 | 1st extra time | A | B | 2nd extra time | A | B | After penalty throws | A | B | | | | | | | |
| Number of 7 m | A 1/1 | Team time-out | | | Full name of players and officials | | | | Team time-out | | | B 1/3 | Number of 7 m | | | | | | | | |
| | | 1 | 2 | 3 | | | | | 1 | 2 | 3 | | | | | | | | | | |
| | | 26:02 | 40:45 | 51:10 | | | | | 17:37 | 46:52 | | | | | | | | | | | |
| No. | Team A | | | | | G | W | 2' | D | DR | No. | Team B | | | | | G | W | 2' | D | DR |
| 1 | 王帅 | | | | | | | | | | 1 | 潘博琦 | | | | | | | | | |
| 2 | 姚雪岩 | | | | | 5 | | | | | 3 | 赵韦光 | | | | | | | | | |
| 4 | 高玉杰 | | | | | 6 | | | | | 4 | 张瑞恒 | | | | | | | | | |
| 5 | 黄培杰 | | | | | 6 | 1 | | | | 6 | 季雨 | | | | | | | | | |
| 7 | 段飞宇 | | | | | 2 | | | | | 7 | 任超凡 | | | | | 7 | | | | |
| 9 | 周凯峰 | | | | | 2 | | | | | 8 | 姜童耀 | | | | | | | | | |
| 10 | 周仲坤 | | | | | 5 | | | | | 9 | 王俊威 | | | | | | | | | |
| 11 | 胡国富 | | | | | 8 | | | | | 11 | 周傲 | | | | | 10 | | | | |
| 12 | 李壮 | | | | | 2 | | | | | 13 | 尹吉祥 | | | | | 3 | | 1 | | |
| 13 | 蔡杰 | | | | | | | | | | 15 | 阎冠中 | | | | | | | | | |
| 14 | 王泽润 | | | | | | | | | | 17 | 马益奎 | | | | | 10 | 1 | 2 | | |
| 15 | 张建杰 | | | | | 3 | 1 | | | | 18 | 耿畅 | | | | | 5 | | | | |
| 16 | 王猛 | | | | | | | | | | | | | | | | | | | | |
| 18 | 李文金 | | | | | 6 | | | | | | | | | | | | | | | |
| B | 刘康伶 (主教练) | | | | | | | | | | B | 贾淑君 (主教练) | | | | | | | | | |
| C | 刘文宁 | | | | | | | | | | | | | | | | | | | | |
| D | 王永存 | | | | | | | | | | | | | | | | | | | | |
| A | Signature of Responsible Official of the Teams (Off. A) | | | | | | | | | | | | | | | | | | | B | |
| TP | Remarks of Referee / CHA Official | | | | | | | | | | | | | | | | | | | TP | |

Signatures

| | | | | |
|------------------|-----------|----------|--|--|
| Referees | 尹静阳 (CHN) | 严璐 (CHN) | | |
| Techn. Delegates | 张春生 (CHN) | | | |
| CHA Official | 吴瑞亭 (CHN) | | | |

Note: Number of 7m Throws Awarded to Team A and B, Goals (G), Warnings (W), Suspensions (2'), Direct Disqualification (D), Disqualification with Report (DR) and Team Penalty (TP).

Table Officials:

Statisticians: 王玲

刘永欢





2016年“体彩杯”全国手球男子青年锦标赛
竞赛技术统计(媒体表)

5-8名 组别 X 轮次 7 场次 40

重庆万州

28/03/2016

201602040-51-1/1

广东队 广东 45 vs 35 江苏 江苏队
26 : 16

裁判员 尹静阳 (CHN) / 严璐 (CHN)

Main statistics table with columns for player names, positions, and various performance metrics (shots, goals, assists, etc.) for both Guangdong and Jiangsu teams.

场上队员: 得分 / 射门

守门员: 救球 / 射门

Summary table for key statistics: 快攻 (Fast Break), 警告 (Warning), 突破 (Breakthrough), 任意球 (Free Throw), 7M球 (7M Throw), 助攻 (Assist).





2016年“体彩杯”全国手球男子青年锦标赛 图式比赛技术统计表

轮次 7

场次 40

201602040-21-1/1

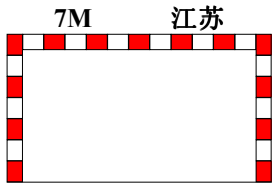
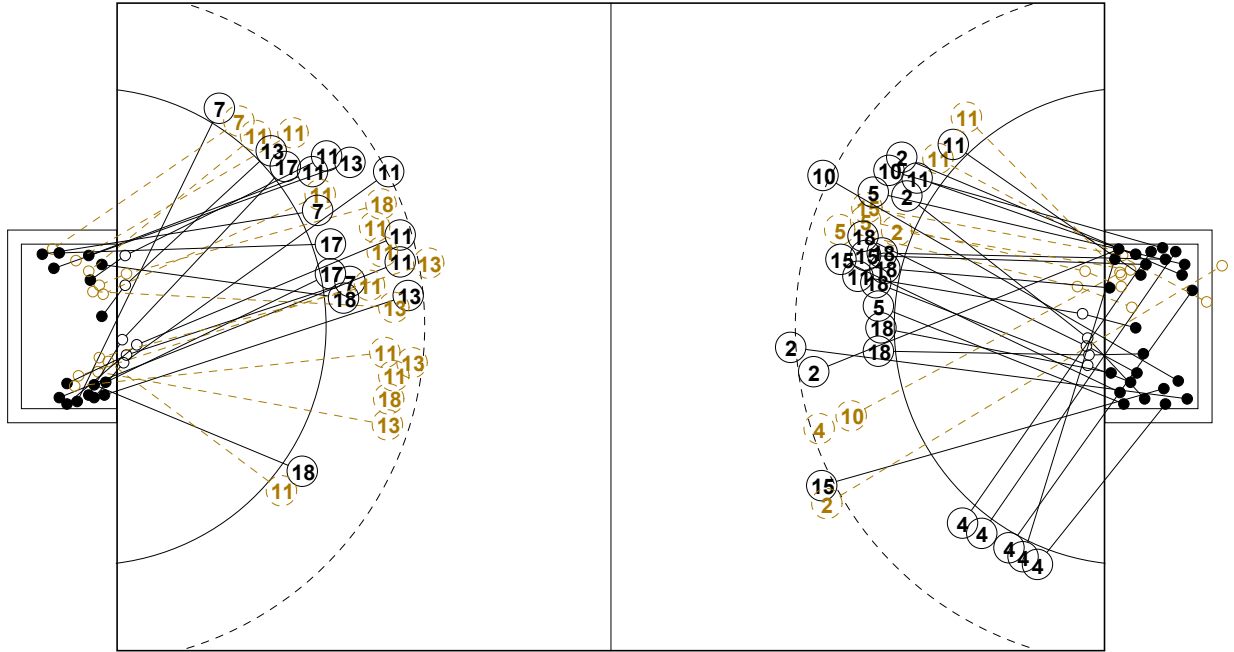

1st Half
16 : 26

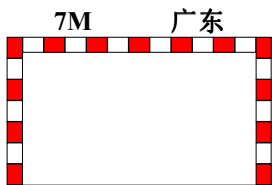
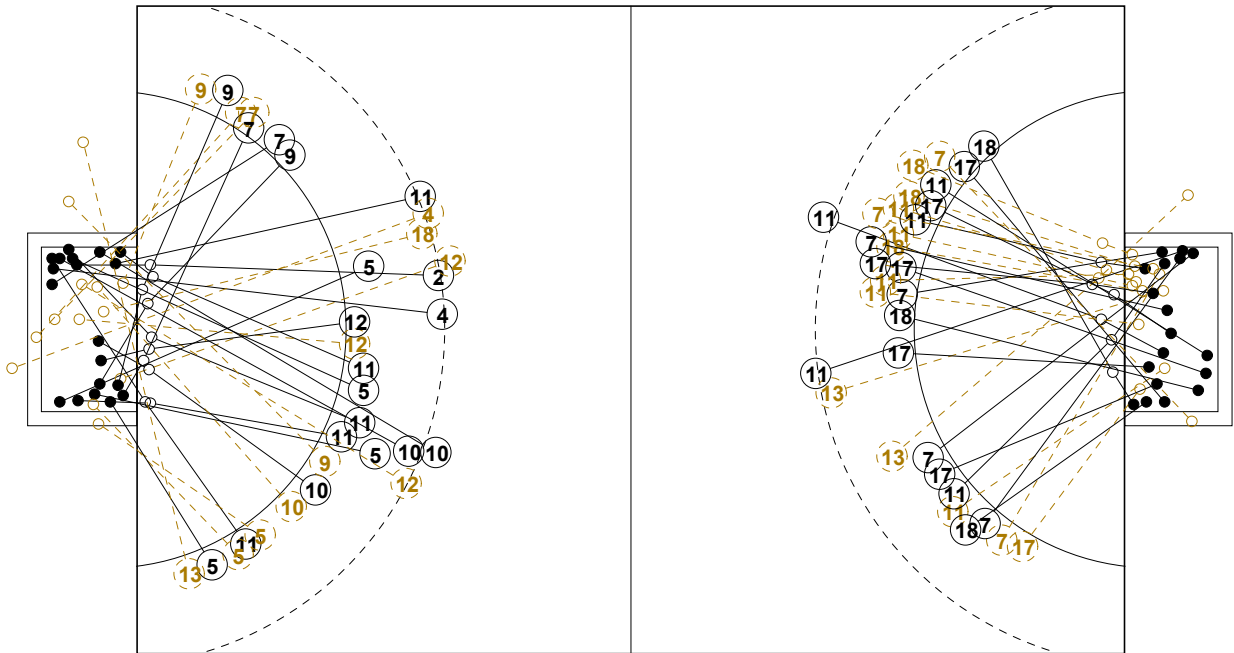
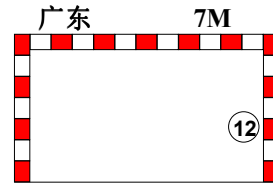

2nd Half
45 : 35

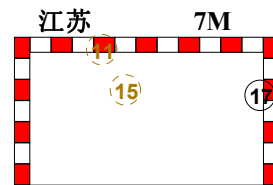



2016年“体彩杯”全国手球男子青年锦标赛

个人/全队技术统计表

正式表
手球
青年男子5-8名
轮次 7组别 X
场次 40201602040-14-1/2
重庆万州
28/03/2016 14:30

| 号码 | 姓名 | 远射 | 近射 | 边射 | 快攻 | 突破 | 任意 | 7M | 合计 | % | 助攻 | 失误 | 警告 | 2' | 取消 | 时间 |
|----------------|-----|-----|------|-----|-----|-----|-----|-----|-------|-------|----|----|----|----|----|----------|
| 广东队(广东) | | | | | | | | | | | | | | | | |
| <i>(场上队员)</i> | | | | | | | | | | | | | | | | |
| 1 | 王帅 | | | | | | | | | 0.0% | | | | | | 00:00:00 |
| 2 | 姚雪岩 | 2/2 | 1/2 | | 1/1 | | 1/2 | | 5/7 | 71.4% | 1 | 3 | | | | 00:42:19 |
| 4 | 高玉杰 | 1/3 | | 2/2 | 1/1 | 2/2 | | | 6/8 | 75.0% | | 3 | | | | 00:49:11 |
| 5 | 黄培杰 | 0/1 | 2/2 | 1/3 | 1/1 | 2/3 | | | 6/10 | 60.0% | 5 | 4 | 1 | | | 00:51:55 |
| 7 | 段飞宇 | | | 1/3 | 1/1 | | | | 2/4 | 50.0% | 2 | 3 | | | | 00:30:00 |
| 9 | 周凯峰 | | 1/2 | 1/2 | | | | | 2/4 | 50.0% | | 3 | | | | 00:07:41 |
| 10 | 周仲坤 | 2/2 | 2/2 | | | 1/3 | | | 5/7 | 71.4% | 2 | 2 | | | | 00:39:43 |
| 11 | 胡国富 | 1/1 | 3/4 | 0/1 | 3/3 | 1/1 | | | 8/10 | 80.0% | | 3 | | | | 00:40:47 |
| 12 | 李壮 | | 1/2 | | | | 0/2 | 1/1 | 2/5 | 40.0% | | 2 | | | | 00:30:19 |
| 13 | 蔡杰 | | | 0/1 | | | | | 0/1 | 0.0% | | 1 | | | | 00:06:45 |
| 14 | 王泽润 | | | | | | | | | 0.0% | | | | | | 00:30:00 |
| 15 | 张建杰 | | 0/1 | | 1/1 | 1/1 | 1/1 | | 3/4 | 75.0% | 2 | 1 | 1 | | | 00:20:17 |
| 16 | 王猛 | | | | | | | | | 0.0% | 1 | | | | | 00:30:00 |
| 18 | 李文金 | 0/1 | 5/5 | | 1/1 | | | | 6/7 | 85.7% | | 1 | | | | 00:40:18 |
| 合计 | | | | | | | | | | | | | | | | |
| <i>(守门员)</i> | | | | | | | | | | | | | | | | |
| 1 | 王帅 | | | | | | | | | 0.0% | | | | | | 00:00:00 |
| 14 | 王泽润 | 4/9 | 3/11 | 1/2 | 1/2 | 2/3 | | | 11/27 | 40.7% | | | | | | 00:30:00 |
| 16 | 王猛 | 1/2 | 5/10 | 2/5 | 2/7 | 2/5 | 0/1 | 1/2 | 13/32 | 40.6% | 1 | | | | | 00:30:00 |
| 合计 | | | | | | | | | | | | | | | | |

场上队员：得分/射门

守门员：救球/射门

| 全队合计 | 得分 | 被救 | 射失 | 击柱 | 封球 | 合计 | % |
|------|----|----|----|----|----|----|--------|
| 远射 | 6 | 2 | 1 | | 1 | 10 | 60.0% |
| 近射 | 15 | 3 | 1 | 1 | | 20 | 75.0% |
| 边射 | 5 | 4 | 1 | 2 | | 12 | 41.7% |
| 快攻 | 9 | | | | | 9 | 100.0% |
| 突破 | 7 | 3 | | | | 10 | 70.0% |
| 任意 | 2 | 2 | 1 | | | 5 | 40.0% |
| 7M | 1 | | | | | 1 | 100.0% |





2016年“体彩杯”全国手球男子青年锦标赛

个人/全队技术统计表

正式表
手球
青年男子5-8名
轮次 7组别 X
场次 40201602040-14-2/2
重庆万州
28/03/2016 14:30

| 号码 | 姓名 | 远射 | 近射 | 边射 | 快攻 | 突破 | 任意 | 7M | 合计 | % | 助攻 | 失误 | 警告 | 2' | 取消 | 时间 |
|----------------|-----|-----|------|-----|-----|------|-----|-----|-------|-------|----|----|----|----|----|----------|
| 江苏队(江苏) | | | | | | | | | | | | | | | | |
| <i>(上场队员)</i> | | | | | | | | | | | | | | | | |
| 1 | 潘博琦 | | | | | | | | | 0.0% | | | | | | 00:00:00 |
| 3 | 赵韦光 | | | | | | | | | 0.0% | | | | | | 00:00:00 |
| 4 | 张瑞恒 | | | | | | | | | 0.0% | | | | | | 00:47:40 |
| 6 | 季雨 | | | | | | | | | 0.0% | | 2 | | | | 00:19:15 |
| 7 | 任超凡 | | 3/5 | 2/4 | 2/2 | | | | 7/11 | 63.6% | 1 | 5 | | | | 01:00:00 |
| 8 | 姜童耀 | | | | | | | | | 0.0% | | | | | | 00:00:00 |
| 9 | 王俊威 | | | | | | | | | 0.0% | | 1 | | | | 00:42:42 |
| 11 | 周傲 | 4/5 | 2/10 | | 0/2 | 3/6 | 1/1 | 0/1 | 10/25 | 40.0% | 11 | 5 | | | | 01:00:00 |
| 13 | 尹吉祥 | 2/7 | 0/1 | | 1/1 | | | | 3/9 | 33.3% | 4 | 5 | | 1 | | 00:53:05 |
| 15 | 阎冠中 | | | | | | | 0/1 | 0/1 | 0.0% | | 1 | | | | 00:17:16 |
| 17 | 马益奎 | | 7/7 | 0/1 | 2/2 | | | 1/1 | 10/11 | 90.9% | 1 | 2 | 1 | 2 | | 01:00:00 |
| 18 | 耿畅 | 0/2 | 1/2 | 2/2 | 1/2 | 1/2 | | | 5/10 | 50.0% | 2 | 5 | | | | 01:00:00 |
| 合计 | | | | | | | | | | | | | | | | |
| <i>(守门员)</i> | | | | | | | | | | | | | | | | |
| 1 | 潘博琦 | | | | | | | | | 0.0% | | | | | | 00:00:00 |
| 4 | 张瑞恒 | 1/6 | 3/15 | 2/5 | 0/8 | 3/10 | 1/3 | 0/1 | 10/48 | 20.8% | | | | | | 00:47:40 |
| 13 | 尹吉祥 | 1/2 | 0/3 | 2/4 | 0/1 | | 1/1 | | 4/11 | 36.4% | 1 | | | | | 00:53:05 |
| 合计 | | | | | | | | | | | | | | | | |

场上队员：得分/射门

守门员：救球/射门

| 全队合计 | 得分 | 被救 | 射失 | 击柱 | 封球 | 合计 | % |
|------|----|----|----|----|----|----|--------|
| 远射 | 6 | 5 | | | 3 | 14 | 42.9% |
| 近射 | 13 | 8 | 1 | 1 | 2 | 25 | 52.0% |
| 边射 | 4 | 3 | | | | 7 | 57.1% |
| 快攻 | 6 | 3 | | | | 9 | 66.7% |
| 突破 | 4 | 4 | | | | 8 | 50.0% |
| 任意 | 1 | | | | | 1 | 100.0% |
| 7M | 1 | 1 | | 1 | | 3 | 33.3% |





2016年“体彩杯”全国手球男子青年锦标赛

图式射门区域统计

轮次 7 场次 40

201602040-41-1/1

广东队

| | | | | | | | | | | | | | | | | | | | | | | | | | | | | | | | | | | | | | | | | | | | | | | | | | | | | | | | | | | | | | | | | | | | | | | | | | | | | | | | |
|--|-----------------------------|-----------------------------|-----------------------------|-----------------------------|-----------------------------|-----------------------------|-----------------------------|--|--|--|---|--|---|--|--|---|---|--|--|---|---|--|---|---|--|---|---|--|--|---|---|--|---|---|--|---|---|--|---|--|--|--|---|--|--|--|---|--|--|---|---|---|---|---|--|---|---|--|--|--|--|--|---|---|---|---|--|--|--|--|--|--|---|---|---|--|--|--|---|
| 1 王帅 | 2 姚雪岩 | 4 高玉杰 | 5 黄培杰 | 7 段飞宇 | 9 周凯峰 | 10 周仲坤 | 11 胡国富 | | | | | | | | | | | | | | | | | | | | | | | | | | | | | | | | | | | | | | | | | | | | | | | | | | | | | | | | | | | | | | | | | | | | | | | | |
| <table border="1"><tr><td></td><td></td><td></td></tr><tr><td></td><td></td><td></td></tr><tr><td></td><td></td><td></td></tr></table> | | | | | | | | | | <table border="1"><tr><td>1</td><td></td><td>1</td></tr><tr><td></td><td></td><td>2</td></tr><tr><td>1</td><td></td><td></td></tr></table> | 1 | | 1 | | | 2 | 1 | | | <table border="1"><tr><td>2</td><td></td><td>1</td></tr><tr><td>1</td><td></td><td>1</td></tr><tr><td>1</td><td></td><td></td></tr></table> | 2 | | 1 | 1 | | 1 | 1 | | | <table border="1"><tr><td>2</td><td></td><td>1</td></tr><tr><td>1</td><td></td><td></td></tr><tr><td>1</td><td></td><td>1</td></tr></table> | 2 | | 1 | 1 | | | 1 | | 1 | <table border="1"><tr><td></td><td></td><td>1</td></tr><tr><td></td><td></td><td></td></tr><tr><td>1</td><td></td><td></td></tr></table> | | | 1 | | | | 1 | | | <table border="1"><tr><td></td><td></td><td></td></tr><tr><td>1</td><td></td><td></td></tr><tr><td>1</td><td></td><td></td></tr></table> | | | | 1 | | | 1 | | | <table border="1"><tr><td></td><td></td><td>2</td></tr><tr><td>1</td><td>1</td><td>1</td></tr><tr><td></td><td></td><td></td></tr></table> | | | 2 | 1 | 1 | 1 | | | | <table border="1"><tr><td></td><td></td><td>2</td></tr><tr><td>3</td><td>1</td><td></td></tr><tr><td></td><td></td><td>2</td></tr></table> | | | 2 | 3 | 1 | | | | 2 |
| | | | | | | | | | | | | | | | | | | | | | | | | | | | | | | | | | | | | | | | | | | | | | | | | | | | | | | | | | | | | | | | | | | | | | | | | | | | | | | | |
| | | | | | | | | | | | | | | | | | | | | | | | | | | | | | | | | | | | | | | | | | | | | | | | | | | | | | | | | | | | | | | | | | | | | | | | | | | | | | | | |
| | | | | | | | | | | | | | | | | | | | | | | | | | | | | | | | | | | | | | | | | | | | | | | | | | | | | | | | | | | | | | | | | | | | | | | | | | | | | | | | |
| 1 | | 1 | | | | | | | | | | | | | | | | | | | | | | | | | | | | | | | | | | | | | | | | | | | | | | | | | | | | | | | | | | | | | | | | | | | | | | | | | | | | | |
| | | 2 | | | | | | | | | | | | | | | | | | | | | | | | | | | | | | | | | | | | | | | | | | | | | | | | | | | | | | | | | | | | | | | | | | | | | | | | | | | | | |
| 1 | | | | | | | | | | | | | | | | | | | | | | | | | | | | | | | | | | | | | | | | | | | | | | | | | | | | | | | | | | | | | | | | | | | | | | | | | | | | | | | |
| 2 | | 1 | | | | | | | | | | | | | | | | | | | | | | | | | | | | | | | | | | | | | | | | | | | | | | | | | | | | | | | | | | | | | | | | | | | | | | | | | | | | | |
| 1 | | 1 | | | | | | | | | | | | | | | | | | | | | | | | | | | | | | | | | | | | | | | | | | | | | | | | | | | | | | | | | | | | | | | | | | | | | | | | | | | | | |
| 1 | | | | | | | | | | | | | | | | | | | | | | | | | | | | | | | | | | | | | | | | | | | | | | | | | | | | | | | | | | | | | | | | | | | | | | | | | | | | | | | |
| 2 | | 1 | | | | | | | | | | | | | | | | | | | | | | | | | | | | | | | | | | | | | | | | | | | | | | | | | | | | | | | | | | | | | | | | | | | | | | | | | | | | | |
| 1 | | | | | | | | | | | | | | | | | | | | | | | | | | | | | | | | | | | | | | | | | | | | | | | | | | | | | | | | | | | | | | | | | | | | | | | | | | | | | | | |
| 1 | | 1 | | | | | | | | | | | | | | | | | | | | | | | | | | | | | | | | | | | | | | | | | | | | | | | | | | | | | | | | | | | | | | | | | | | | | | | | | | | | | |
| | | 1 | | | | | | | | | | | | | | | | | | | | | | | | | | | | | | | | | | | | | | | | | | | | | | | | | | | | | | | | | | | | | | | | | | | | | | | | | | | | | |
| | | | | | | | | | | | | | | | | | | | | | | | | | | | | | | | | | | | | | | | | | | | | | | | | | | | | | | | | | | | | | | | | | | | | | | | | | | | | | | | |
| 1 | | | | | | | | | | | | | | | | | | | | | | | | | | | | | | | | | | | | | | | | | | | | | | | | | | | | | | | | | | | | | | | | | | | | | | | | | | | | | | | |
| | | | | | | | | | | | | | | | | | | | | | | | | | | | | | | | | | | | | | | | | | | | | | | | | | | | | | | | | | | | | | | | | | | | | | | | | | | | | | | | |
| 1 | | | | | | | | | | | | | | | | | | | | | | | | | | | | | | | | | | | | | | | | | | | | | | | | | | | | | | | | | | | | | | | | | | | | | | | | | | | | | | | |
| 1 | | | | | | | | | | | | | | | | | | | | | | | | | | | | | | | | | | | | | | | | | | | | | | | | | | | | | | | | | | | | | | | | | | | | | | | | | | | | | | | |
| | | 2 | | | | | | | | | | | | | | | | | | | | | | | | | | | | | | | | | | | | | | | | | | | | | | | | | | | | | | | | | | | | | | | | | | | | | | | | | | | | | |
| 1 | 1 | 1 | | | | | | | | | | | | | | | | | | | | | | | | | | | | | | | | | | | | | | | | | | | | | | | | | | | | | | | | | | | | | | | | | | | | | | | | | | | | | |
| | | | | | | | | | | | | | | | | | | | | | | | | | | | | | | | | | | | | | | | | | | | | | | | | | | | | | | | | | | | | | | | | | | | | | | | | | | | | | | | |
| | | 2 | | | | | | | | | | | | | | | | | | | | | | | | | | | | | | | | | | | | | | | | | | | | | | | | | | | | | | | | | | | | | | | | | | | | | | | | | | | | | |
| 3 | 1 | | | | | | | | | | | | | | | | | | | | | | | | | | | | | | | | | | | | | | | | | | | | | | | | | | | | | | | | | | | | | | | | | | | | | | | | | | | | | | |
| | | 2 | | | | | | | | | | | | | | | | | | | | | | | | | | | | | | | | | | | | | | | | | | | | | | | | | | | | | | | | | | | | | | | | | | | | | | | | | | | | | |
| Post - 0 Miss - 0 Block - 0 | Post - 0 Miss - 1 Block - 0 | Post - 0 Miss - 1 Block - 1 | Post - 1 Miss - 0 Block - 0 | Post - 1 Miss - 0 Block - 0 | Post - 0 Miss - 1 Block - 0 | Post - 0 Miss - 0 Block - 0 | Post - 1 Miss - 0 Block - 0 | | | | | | | | | | | | | | | | | | | | | | | | | | | | | | | | | | | | | | | | | | | | | | | | | | | | | | | | | | | | | | | | | | | | | | | | |
| 12 李壮 | 13 蔡杰 | 14 王泽润 | 15 张建杰 | 16 王猛 | 18 李文金 | | | | | | | | | | | | | | | | | | | | | | | | | | | | | | | | | | | | | | | | | | | | | | | | | | | | | | | | | | | | | | | | | | | | | | | | | | |
| <table border="1"><tr><td>1</td><td></td><td>1</td></tr><tr><td></td><td></td><td></td></tr><tr><td></td><td></td><td></td></tr></table> | 1 | | 1 | | | | | | | <table border="1"><tr><td></td><td></td><td></td></tr><tr><td></td><td></td><td></td></tr><tr><td></td><td></td><td></td></tr></table> | | | | | | | | | | <table border="1"><tr><td></td><td></td><td></td></tr><tr><td></td><td></td><td></td></tr><tr><td></td><td></td><td></td></tr></table> | | | | | | | | | | <table border="1"><tr><td>1</td><td></td><td>1</td></tr><tr><td></td><td></td><td>1</td></tr><tr><td></td><td></td><td></td></tr></table> | 1 | | 1 | | | 1 | | | | <table border="1"><tr><td></td><td></td><td></td></tr><tr><td></td><td></td><td></td></tr><tr><td></td><td></td><td></td></tr></table> | | | | | | | | | | <table border="1"><tr><td>1</td><td>1</td><td>1</td></tr><tr><td>1</td><td></td><td>2</td></tr><tr><td></td><td></td><td></td></tr></table> | 1 | 1 | 1 | 1 | | 2 | | | | <table border="1"><tr><td></td><td></td><td></td></tr><tr><td></td><td></td><td></td></tr><tr><td></td><td></td><td></td></tr></table> | | | | | | | | | | <table border="1"><tr><td></td><td></td><td></td></tr><tr><td></td><td></td><td></td></tr><tr><td></td><td></td><td></td></tr></table> | | | | | | | | | |
| 1 | | 1 | | | | | | | | | | | | | | | | | | | | | | | | | | | | | | | | | | | | | | | | | | | | | | | | | | | | | | | | | | | | | | | | | | | | | | | | | | | | | |
| | | | | | | | | | | | | | | | | | | | | | | | | | | | | | | | | | | | | | | | | | | | | | | | | | | | | | | | | | | | | | | | | | | | | | | | | | | | | | | | |
| | | | | | | | | | | | | | | | | | | | | | | | | | | | | | | | | | | | | | | | | | | | | | | | | | | | | | | | | | | | | | | | | | | | | | | | | | | | | | | | |
| | | | | | | | | | | | | | | | | | | | | | | | | | | | | | | | | | | | | | | | | | | | | | | | | | | | | | | | | | | | | | | | | | | | | | | | | | | | | | | | |
| | | | | | | | | | | | | | | | | | | | | | | | | | | | | | | | | | | | | | | | | | | | | | | | | | | | | | | | | | | | | | | | | | | | | | | | | | | | | | | | |
| | | | | | | | | | | | | | | | | | | | | | | | | | | | | | | | | | | | | | | | | | | | | | | | | | | | | | | | | | | | | | | | | | | | | | | | | | | | | | | | |
| | | | | | | | | | | | | | | | | | | | | | | | | | | | | | | | | | | | | | | | | | | | | | | | | | | | | | | | | | | | | | | | | | | | | | | | | | | | | | | | |
| | | | | | | | | | | | | | | | | | | | | | | | | | | | | | | | | | | | | | | | | | | | | | | | | | | | | | | | | | | | | | | | | | | | | | | | | | | | | | | | |
| | | | | | | | | | | | | | | | | | | | | | | | | | | | | | | | | | | | | | | | | | | | | | | | | | | | | | | | | | | | | | | | | | | | | | | | | | | | | | | | |
| 1 | | 1 | | | | | | | | | | | | | | | | | | | | | | | | | | | | | | | | | | | | | | | | | | | | | | | | | | | | | | | | | | | | | | | | | | | | | | | | | | | | | |
| | | 1 | | | | | | | | | | | | | | | | | | | | | | | | | | | | | | | | | | | | | | | | | | | | | | | | | | | | | | | | | | | | | | | | | | | | | | | | | | | | | |
| | | | | | | | | | | | | | | | | | | | | | | | | | | | | | | | | | | | | | | | | | | | | | | | | | | | | | | | | | | | | | | | | | | | | | | | | | | | | | | | |
| | | | | | | | | | | | | | | | | | | | | | | | | | | | | | | | | | | | | | | | | | | | | | | | | | | | | | | | | | | | | | | | | | | | | | | | | | | | | | | | |
| | | | | | | | | | | | | | | | | | | | | | | | | | | | | | | | | | | | | | | | | | | | | | | | | | | | | | | | | | | | | | | | | | | | | | | | | | | | | | | | |
| | | | | | | | | | | | | | | | | | | | | | | | | | | | | | | | | | | | | | | | | | | | | | | | | | | | | | | | | | | | | | | | | | | | | | | | | | | | | | | | |
| 1 | 1 | 1 | | | | | | | | | | | | | | | | | | | | | | | | | | | | | | | | | | | | | | | | | | | | | | | | | | | | | | | | | | | | | | | | | | | | | | | | | | | | | |
| 1 | | 2 | | | | | | | | | | | | | | | | | | | | | | | | | | | | | | | | | | | | | | | | | | | | | | | | | | | | | | | | | | | | | | | | | | | | | | | | | | | | | |
| | | | | | | | | | | | | | | | | | | | | | | | | | | | | | | | | | | | | | | | | | | | | | | | | | | | | | | | | | | | | | | | | | | | | | | | | | | | | | | | |
| | | | | | | | | | | | | | | | | | | | | | | | | | | | | | | | | | | | | | | | | | | | | | | | | | | | | | | | | | | | | | | | | | | | | | | | | | | | | | | | |
| | | | | | | | | | | | | | | | | | | | | | | | | | | | | | | | | | | | | | | | | | | | | | | | | | | | | | | | | | | | | | | | | | | | | | | | | | | | | | | | |
| | | | | | | | | | | | | | | | | | | | | | | | | | | | | | | | | | | | | | | | | | | | | | | | | | | | | | | | | | | | | | | | | | | | | | | | | | | | | | | | |
| | | | | | | | | | | | | | | | | | | | | | | | | | | | | | | | | | | | | | | | | | | | | | | | | | | | | | | | | | | | | | | | | | | | | | | | | | | | | | | | |
| | | | | | | | | | | | | | | | | | | | | | | | | | | | | | | | | | | | | | | | | | | | | | | | | | | | | | | | | | | | | | | | | | | | | | | | | | | | | | | | |
| | | | | | | | | | | | | | | | | | | | | | | | | | | | | | | | | | | | | | | | | | | | | | | | | | | | | | | | | | | | | | | | | | | | | | | | | | | | | | | | |
| Post - 0 Miss - 0 Block - 0 | Post - 0 Miss - 1 Block - 0 | Post - 0 Miss - 0 Block - 0 | Post - 0 Miss - 0 Block - 0 | Post - 0 Miss - 0 Block - 0 | Post - 0 Miss - 0 Block - 0 | | | | | | | | | | | | | | | | | | | | | | | | | | | | | | | | | | | | | | | | | | | | | | | | | | | | | | | | | | | | | | | | | | | | | | | | | | |

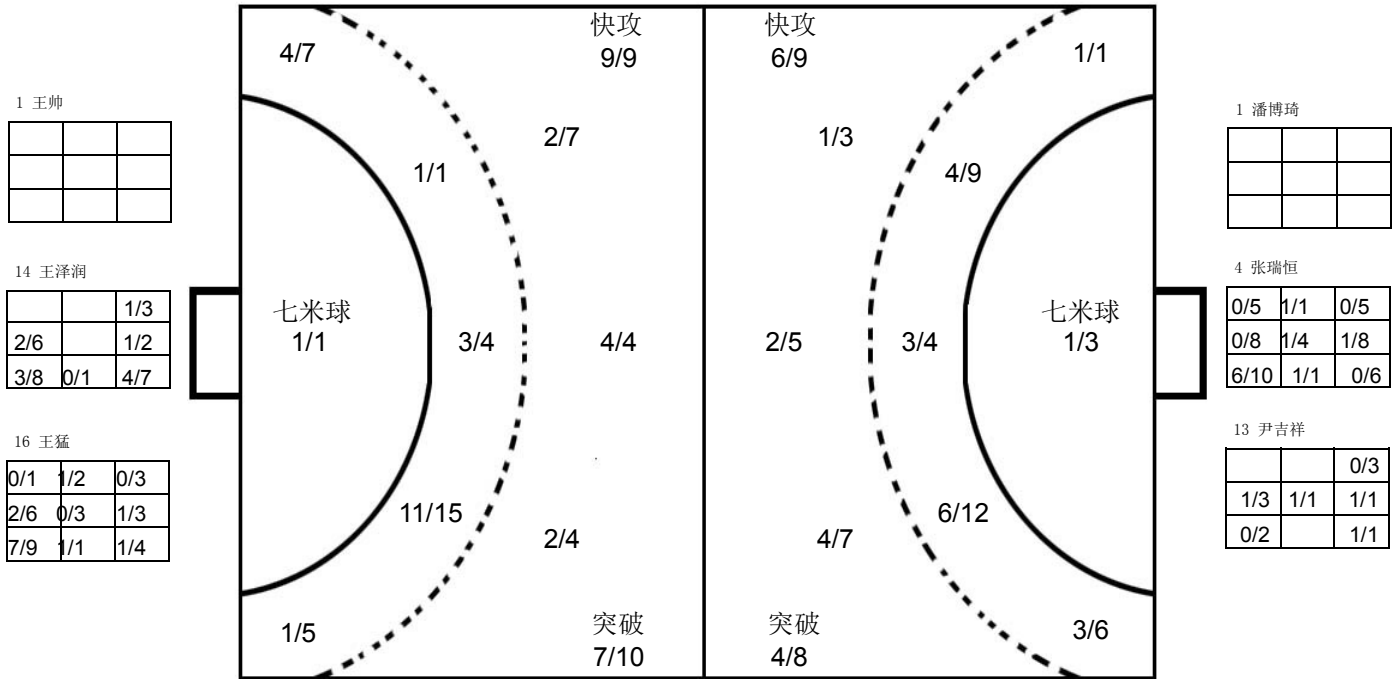

江苏队

| | | | | | | | | | | | | | | | | | | | | | | | | | | | | | | | | | | | | | | | | | | | | | | | | | | | | | | | | | | | | | | | | | | | | | | | | | | | | | | | |
|---|-----------------------------|-----------------------------|-----------------------------|-----------------------------|-----------------------------|-----------------------------|-----------------------------|---|--|--|--|--|--|--|--|--|--|--|--|---|--|--|---|--|---|---|---|--|---|---|--|--|---|--|--|--|---|--|---|--|---|--|---|---|---|--|--|--|--|--|--|--|--|--|--|--|--|--|--|--|--|--|--|--|--|--|--|--|--|---|--|---|--|---|---|--|---|--|---|
| 1 潘博琦 | 3 赵韦光 | 4 张瑞恒 | 6 季雨 | 7 任超凡 | 8 姜童耀 | 9 王俊威 | 11 周傲 | | | | | | | | | | | | | | | | | | | | | | | | | | | | | | | | | | | | | | | | | | | | | | | | | | | | | | | | | | | | | | | | | | | | | | | | |
| <table border="1"><tr><td></td><td></td><td></td></tr><tr><td></td><td></td><td></td></tr><tr><td></td><td></td><td></td></tr></table> | | | | | | | | | | <table border="1"><tr><td></td><td></td><td></td></tr><tr><td></td><td></td><td></td></tr><tr><td></td><td></td><td></td></tr></table> | | | | | | | | | | <table border="1"><tr><td></td><td></td><td></td></tr><tr><td></td><td></td><td></td></tr><tr><td></td><td></td><td></td></tr></table> | | | | | | | | | | <table border="1"><tr><td></td><td></td><td></td></tr><tr><td></td><td></td><td></td></tr><tr><td></td><td></td><td></td></tr></table> | | | | | | | | | | <table border="1"><tr><td>1</td><td></td><td>1</td></tr><tr><td>4</td><td>1</td><td></td></tr><tr><td></td><td></td><td></td></tr></table> | 1 | | 1 | 4 | 1 | | | | | <table border="1"><tr><td></td><td></td><td></td></tr><tr><td></td><td></td><td></td></tr><tr><td></td><td></td><td></td></tr></table> | | | | | | | | | | <table border="1"><tr><td></td><td></td><td></td></tr><tr><td></td><td></td><td></td></tr><tr><td></td><td></td><td></td></tr></table> | | | | | | | | | | <table border="1"><tr><td></td><td>1</td><td></td></tr><tr><td>4</td><td>1</td><td></td></tr><tr><td>2</td><td></td><td>2</td></tr></table> | | 1 | | 4 | 1 | | 2 | | 2 |
| | | | | | | | | | | | | | | | | | | | | | | | | | | | | | | | | | | | | | | | | | | | | | | | | | | | | | | | | | | | | | | | | | | | | | | | | | | | | | | | |
| | | | | | | | | | | | | | | | | | | | | | | | | | | | | | | | | | | | | | | | | | | | | | | | | | | | | | | | | | | | | | | | | | | | | | | | | | | | | | | | |
| | | | | | | | | | | | | | | | | | | | | | | | | | | | | | | | | | | | | | | | | | | | | | | | | | | | | | | | | | | | | | | | | | | | | | | | | | | | | | | | |
| | | | | | | | | | | | | | | | | | | | | | | | | | | | | | | | | | | | | | | | | | | | | | | | | | | | | | | | | | | | | | | | | | | | | | | | | | | | | | | | |
| | | | | | | | | | | | | | | | | | | | | | | | | | | | | | | | | | | | | | | | | | | | | | | | | | | | | | | | | | | | | | | | | | | | | | | | | | | | | | | | |
| | | | | | | | | | | | | | | | | | | | | | | | | | | | | | | | | | | | | | | | | | | | | | | | | | | | | | | | | | | | | | | | | | | | | | | | | | | | | | | | |
| | | | | | | | | | | | | | | | | | | | | | | | | | | | | | | | | | | | | | | | | | | | | | | | | | | | | | | | | | | | | | | | | | | | | | | | | | | | | | | | |
| | | | | | | | | | | | | | | | | | | | | | | | | | | | | | | | | | | | | | | | | | | | | | | | | | | | | | | | | | | | | | | | | | | | | | | | | | | | | | | | |
| | | | | | | | | | | | | | | | | | | | | | | | | | | | | | | | | | | | | | | | | | | | | | | | | | | | | | | | | | | | | | | | | | | | | | | | | | | | | | | | |
| | | | | | | | | | | | | | | | | | | | | | | | | | | | | | | | | | | | | | | | | | | | | | | | | | | | | | | | | | | | | | | | | | | | | | | | | | | | | | | | |
| | | | | | | | | | | | | | | | | | | | | | | | | | | | | | | | | | | | | | | | | | | | | | | | | | | | | | | | | | | | | | | | | | | | | | | | | | | | | | | | |
| | | | | | | | | | | | | | | | | | | | | | | | | | | | | | | | | | | | | | | | | | | | | | | | | | | | | | | | | | | | | | | | | | | | | | | | | | | | | | | | |
| 1 | | 1 | | | | | | | | | | | | | | | | | | | | | | | | | | | | | | | | | | | | | | | | | | | | | | | | | | | | | | | | | | | | | | | | | | | | | | | | | | | | | |
| 4 | 1 | | | | | | | | | | | | | | | | | | | | | | | | | | | | | | | | | | | | | | | | | | | | | | | | | | | | | | | | | | | | | | | | | | | | | | | | | | | | | | |
| | | | | | | | | | | | | | | | | | | | | | | | | | | | | | | | | | | | | | | | | | | | | | | | | | | | | | | | | | | | | | | | | | | | | | | | | | | | | | | | |
| | | | | | | | | | | | | | | | | | | | | | | | | | | | | | | | | | | | | | | | | | | | | | | | | | | | | | | | | | | | | | | | | | | | | | | | | | | | | | | | |
| | | | | | | | | | | | | | | | | | | | | | | | | | | | | | | | | | | | | | | | | | | | | | | | | | | | | | | | | | | | | | | | | | | | | | | | | | | | | | | | |
| | | | | | | | | | | | | | | | | | | | | | | | | | | | | | | | | | | | | | | | | | | | | | | | | | | | | | | | | | | | | | | | | | | | | | | | | | | | | | | | |
| | | | | | | | | | | | | | | | | | | | | | | | | | | | | | | | | | | | | | | | | | | | | | | | | | | | | | | | | | | | | | | | | | | | | | | | | | | | | | | | |
| | | | | | | | | | | | | | | | | | | | | | | | | | | | | | | | | | | | | | | | | | | | | | | | | | | | | | | | | | | | | | | | | | | | | | | | | | | | | | | | |
| | | | | | | | | | | | | | | | | | | | | | | | | | | | | | | | | | | | | | | | | | | | | | | | | | | | | | | | | | | | | | | | | | | | | | | | | | | | | | | | |
| | 1 | | | | | | | | | | | | | | | | | | | | | | | | | | | | | | | | | | | | | | | | | | | | | | | | | | | | | | | | | | | | | | | | | | | | | | | | | | | | | | |
| 4 | 1 | | | | | | | | | | | | | | | | | | | | | | | | | | | | | | | | | | | | | | | | | | | | | | | | | | | | | | | | | | | | | | | | | | | | | | | | | | | | | | |
| 2 | | 2 | | | | | | | | | | | | | | | | | | | | | | | | | | | | | | | | | | | | | | | | | | | | | | | | | | | | | | | | | | | | | | | | | | | | | | | | | | | | | |
| Post - 0 Miss - 0 Block - 0 | Post - 0 Miss - 0 Block - 0 | Post - 0 Miss - 0 Block - 0 | Post - 0 Miss - 0 Block - 0 | Post - 1 Miss - 0 Block - 0 | Post - 0 Miss - 0 Block - 0 | Post - 0 Miss - 0 Block - 0 | Post - 1 Miss - 0 Block - 3 | | | | | | | | | | | | | | | | | | | | | | | | | | | | | | | | | | | | | | | | | | | | | | | | | | | | | | | | | | | | | | | | | | | | | | | | |
| 13 尹吉祥 | 15 阎冠中 | 17 马益奎 | 18 耿畅 | | | | | | | | | | | | | | | | | | | | | | | | | | | | | | | | | | | | | | | | | | | | | | | | | | | | | | | | | | | | | | | | | | | | | | | | | | | | |
| <table border="1"><tr><td></td><td></td><td>1</td></tr><tr><td></td><td></td><td></td></tr><tr><td>1</td><td>1</td><td></td></tr></table> | | | 1 | | | | 1 | 1 | | <table border="1"><tr><td></td><td></td><td></td></tr><tr><td></td><td></td><td></td></tr><tr><td></td><td></td><td></td></tr></table> | | | | | | | | | | <table border="1"><tr><td></td><td></td><td>2</td></tr><tr><td></td><td>1</td><td>3</td></tr><tr><td>3</td><td></td><td>1</td></tr></table> | | | 2 | | 1 | 3 | 3 | | 1 | <table border="1"><tr><td></td><td></td><td>1</td></tr><tr><td></td><td></td><td></td></tr><tr><td>1</td><td></td><td>3</td></tr></table> | | | 1 | | | | 1 | | 3 | <table border="1"><tr><td></td><td></td><td></td></tr><tr><td></td><td></td><td></td></tr><tr><td></td><td></td><td></td></tr></table> | | | | | | | | | | <table border="1"><tr><td></td><td></td><td></td></tr><tr><td></td><td></td><td></td></tr><tr><td></td><td></td><td></td></tr></table> | | | | | | | | | | <table border="1"><tr><td></td><td></td><td></td></tr><tr><td></td><td></td><td></td></tr><tr><td></td><td></td><td></td></tr></table> | | | | | | | | | | <table border="1"><tr><td></td><td></td><td></td></tr><tr><td></td><td></td><td></td></tr><tr><td></td><td></td><td></td></tr></table> | | | | | | | | | |
| | | 1 | | | | | | | | | | | | | | | | | | | | | | | | | | | | | | | | | | | | | | | | | | | | | | | | | | | | | | | | | | | | | | | | | | | | | | | | | | | | | |
| | | | | | | | | | | | | | | | | | | | | | | | | | | | | | | | | | | | | | | | | | | | | | | | | | | | | | | | | | | | | | | | | | | | | | | | | | | | | | | | |
| 1 | 1 | | | | | | | | | | | | | | | | | | | | | | | | | | | | | | | | | | | | | | | | | | | | | | | | | | | | | | | | | | | | | | | | | | | | | | | | | | | | | | |
| | | | | | | | | | | | | | | | | | | | | | | | | | | | | | | | | | | | | | | | | | | | | | | | | | | | | | | | | | | | | | | | | | | | | | | | | | | | | | | | |
| | | | | | | | | | | | | | | | | | | | | | | | | | | | | | | | | | | | | | | | | | | | | | | | | | | | | | | | | | | | | | | | | | | | | | | | | | | | | | | | |
| | | | | | | | | | | | | | | | | | | | | | | | | | | | | | | | | | | | | | | | | | | | | | | | | | | | | | | | | | | | | | | | | | | | | | | | | | | | | | | | |
| | | 2 | | | | | | | | | | | | | | | | | | | | | | | | | | | | | | | | | | | | | | | | | | | | | | | | | | | | | | | | | | | | | | | | | | | | | | | | | | | | | |
| | 1 | 3 | | | | | | | | | | | | | | | | | | | | | | | | | | | | | | | | | | | | | | | | | | | | | | | | | | | | | | | | | | | | | | | | | | | | | | | | | | | | | |
| 3 | | 1 | | | | | | | | | | | | | | | | | | | | | | | | | | | | | | | | | | | | | | | | | | | | | | | | | | | | | | | | | | | | | | | | | | | | | | | | | | | | | |
| | | 1 | | | | | | | | | | | | | | | | | | | | | | | | | | | | | | | | | | | | | | | | | | | | | | | | | | | | | | | | | | | | | | | | | | | | | | | | | | | | | |
| | | | | | | | | | | | | | | | | | | | | | | | | | | | | | | | | | | | | | | | | | | | | | | | | | | | | | | | | | | | | | | | | | | | | | | | | | | | | | | | |
| 1 | | 3 | | | | | | | | | | | | | | | | | | | | | | | | | | | | | | | | | | | | | | | | | | | | | | | | | | | | | | | | | | | | | | | | | | | | | | | | | | | | | |
| | | | | | | | | | | | | | | | | | | | | | | | | | | | | | | | | | | | | | | | | | | | | | | | | | | | | | | | | | | | | | | | | | | | | | | | | | | | | | | | |
| | | | | | | | | | | | | | | | | | | | | | | | | | | | | | | | | | | | | | | | | | | | | | | | | | | | | | | | | | | | | | | | | | | | | | | | | | | | | | | | |
| | | | | | | | | | | | | | | | | | | | | | | | | | | | | | | | | | | | | | | | | | | | | | | | | | | | | | | | | | | | | | | | | | | | | | | | | | | | | | | | |
| | | | | | | | | | | | | | | | | | | | | | | | | | | | | | | | | | | | | | | | | | | | | | | | | | | | | | | | | | | | | | | | | | | | | | | | | | | | | | | | |
| | | | | | | | | | | | | | | | | | | | | | | | | | | | | | | | | | | | | | | | | | | | | | | | | | | | | | | | | | | | | | | | | | | | | | | | | | | | | | | | |
| | | | | | | | | | | | | | | | | | | | | | | | | | | | | | | | | | | | | | | | | | | | | | | | | | | | | | | | | | | | | | | | | | | | | | | | | | | | | | | | |
| | | | | | | | | | | | | | | | | | | | | | | | | | | | | | | | | | | | | | | | | | | | | | | | | | | | | | | | | | | | | | | | | | | | | | | | | | | | | | | | |
| | | | | | | | | | | | | | | | | | | | | | | | | | | | | | | | | | | | | | | | | | | | | | | | | | | | | | | | | | | | | | | | | | | | | | | | | | | | | | | | |
| | | | | | | | | | | | | | | | | | | | | | | | | | | | | | | | | | | | | | | | | | | | | | | | | | | | | | | | | | | | | | | | | | | | | | | | | | | | | | | | |
| | | | | | | | | | | | | | | | | | | | | | | | | | | | | | | | | | | | | | | | | | | | | | | | | | | | | | | | | | | | | | | | | | | | | | | | | | | | | | | | |
| | | | | | | | | | | | | | | | | | | | | | | | | | | | | | | | | | | | | | | | | | | | | | | | | | | | | | | | | | | | | | | | | | | | | | | | | | | | | | | | |
| | | | | | | | | | | | | | | | | | | | | | | | | | | | | | | | | | | | | | | | | | | | | | | | | | | | | | | | | | | | | | | | | | | | | | | | | | | | | | | | |
| Post - 0 Miss - 1 Block - 1 | Post - 0 Miss - 0 Block - 0 | Post - 0 Miss - 0 Block - 0 | Post - 0 Miss - 0 Block - 1 | | | | | | | | | | | | | | | | | | | | | | | | | | | | | | | | | | | | | | | | | | | | | | | | | | | | | | | | | | | | | | | | | | | | | | | | | | | | |

注释: Post=击柱 Miss=射失 Block=被封





半决赛
青年男子 全国比赛

2016年“体彩杯”全国手球男子青年锦标赛

| | | | | | | | | | | | | | | | | | | | | | |
|--------------------|---|---------------------|----------------------|------------------------------------|------------|----|---|----|---|----|-----|-----------|--|--|--|--|---|---|----|----|----|
| Team A A 山东队 | | Team B B 新疆队 | | Match Number 41 | | | | | | | | | | | | | | | | | |
| played in China | | in the hall 重庆万州 | | on 28/03/2016 | | | | | | | | | | | | | | | | | |
| | | | | at 16:00 hours | | | | | | | | | | | | | | | | | |
| Spectators | | | | | | | | | | | | | | | | | | | | | |
| Half-time (30') | A 11 | B 19 | End of playing time | A 30 | B 38 | | | | | | | | | | | | | | | | |
| | | | 1st extra time | A | B | | | | | | | | | | | | | | | | |
| | | | 2nd extra time | A | B | | | | | | | | | | | | | | | | |
| | | | After penalty throws | A | B | | | | | | | | | | | | | | | | |
| Number of 7 m | A 5 / 7 | Team time-out | | Full name of players and officials | | | | | | | | | | | | | | | | | |
| | 1 16:24 | 2 51:44 | 3 | 1 | 2 57:18 | | | | | | | | | | | | | | | | |
| | | | 3 | Team time-out | | | | | | | | | | | | | | | | | |
| | | | | B 1 / 1 | | | | | | | | | | | | | | | | | |
| | | | | Number of 7 m | | | | | | | | | | | | | | | | | |
| No. | Team A | | | | | G | W | 2' | D | DR | No. | Team B | | | | | G | W | 2' | D | DR |
| 1 | 刘继超 | | | | | | | | | | 1 | 宋晓晨 | | | | | | | | | |
| 2 | 冯鑫宇 | | | | | 9 | | | | | 2 | 王泽川 | | | | | 2 | | | | |
| 3 | 王铁林 | | | | | 3 | 1 | 1 | | | 4 | 谷通金 | | | | | | | | | |
| 5 | 王晓峰 | | | | | 2 | | | | | 5 | 徐伟 | | | | | 7 | | | | |
| 6 | 王军鸣 | | | | | 3 | | 3 | | | 6 | 白光宇 | | | | | | | | | |
| 7 | 徐勇林 | | | | | | | | | | 7 | 林豪文 | | | | | 4 | 1 | | | |
| 10 | 孙芳伟 | | | | | 11 | 1 | | | | 10 | 王钟彬 | | | | | 6 | | 1 | | |
| 11 | 王洋 | | | | | | | | | | 12 | 王金鑫 | | | | | | | | | |
| 12 | 刘道林 | | | | | | | | | | 13 | 苏兴伟 | | | | | 1 | | | | |
| 13 | 于欣君 | | | | | 2 | | | | | 15 | 王维东 | | | | | 4 | | | | |
| 17 | 薛盼龙 | | | | | | | | | | 16 | 李佳懿 | | | | | | | | | |
| 18 | 李玮 | | | | | | | | | | 17 | 胡晋铭 | | | | | 7 | 1 | | | |
| 21 | 王腾达 | | | | | | | | | | 18 | 李万兴 | | | | | | | | | |
| 22 | 李子跃 | | | | | | | | | | 19 | 李龙吉 | | | | | 6 | 1 | 1 | | |
| 23 | 李荣健 | | | | | | | | | | 24 | 陈伟华 | | | | | 1 | | | | |
| B | 王莉莉 (主教练) | | | | | | | | | | A | 孔德宾 (主教练) | | | | | | | | | |
| | | | | | | | | | | | B | 陈鹏波 | | | | | | | | | |
| | | | | | | | | | | | C | 李楠 | | | | | | | | | |
| | | | | | | | | | | | | | | | | | | | | | |
| A | Signature of Responsible Official of the Teams (Off. A) | | | | | | | | | | | | | | | | | | | B | |
| TP | Remarks of Referee / CHA Official | | | | | | | | | | | | | | | | | | | TP | |

Signatures

| | | | | |
|------------------|-----------|-----------|--|--|
| Referees | 许翔 (CHN) | 王雨洋 (CHN) | | |
| Techn. Delegates | 徐健 (CHN) | | | |
| CHA Official | 张春生 (CHN) | | | |

Note: Number of 7m Throws Awarded to Team A and B, Goals (G), Warnings (W), Suspensions (2'), Direct Disqualification (D), Disqualification with Report (DR) and Team Penalty (TP).

Table Officials:

Statisticians: 刘永欢

李双





2016年“体彩杯”全国手球男子青年锦标赛

个人/全队技术统计表

正式表
手球
青年男子半决赛
轮次 7组别 X
场次 41201602041-14-1/2
重庆万州
28/03/2016 16:00

| 号码 | 姓名 | 远射 | 近射 | 边射 | 快攻 | 突破 | 任意 | 7M | 合计 | % | 助攻 | 失误 | 警告 | 2' | 取消 | 时间 |
|----------------|-----|------|-------|-----|-----|-----|-----|-----|-------|-------|----|----|----|----|----|----------|
| 山东队(山东) | | | | | | | | | | | | | | | | |
| <i>(场上队员)</i> | | | | | | | | | | | | | | | | |
| 1 | 刘继超 | | | | | | | | | 0.0% | | 1 | | | | 01:00:00 |
| 2 | 冯鑫宇 | 0/1 | 4/9 | | 3/3 | 1/1 | | 1/3 | 9/17 | 52.9% | | 6 | | | | 01:24:02 |
| 3 | 王铁林 | 0/1 | 1/2 | 2/3 | 0/1 | | | | 3/7 | 42.9% | | 2 | 1 | 1 | | 01:00:00 |
| 5 | 王晓峰 | 0/6 | 1/3 | | | | 1/3 | | 2/12 | 16.7% | | 1 | | | | 00:50:26 |
| 6 | 王军鸣 | 0/2 | 2/3 | | 0/1 | | | 1/1 | 3/7 | 42.9% | | 2 | | 3 | | 00:32:05 |
| 7 | 徐勇林 | | | | | | | | | 0.0% | | | | | | 00:00:00 |
| 10 | 孙芳伟 | 3/11 | 3/7 | 0/1 | 2/2 | | | 3/3 | 11/24 | 45.8% | 2 | 3 | 1 | | | 01:00:00 |
| 11 | 王洋 | | | | | | | | | 0.0% | | | | | | 00:00:00 |
| 12 | 刘道林 | | | | | | | | | 0.0% | | | | | | 00:00:00 |
| 13 | 于欣君 | 0/1 | 1/3 | 0/1 | 0/1 | 1/1 | 0/1 | | 2/8 | 25.0% | 3 | 1 | | | | 00:46:31 |
| 17 | 薛盼龙 | | 0/1 | | | | | | 0/1 | 0.0% | | 1 | | | | 00:27:53 |
| 18 | 李玮 | | | | | | | | | 0.0% | | | | | | 00:00:00 |
| 21 | 王腾达 | | | | | | | | | 0.0% | | | | | | 00:00:00 |
| 22 | 李子跃 | | | | | | | | | 0.0% | | | | | | 00:00:00 |
| 23 | 李荣健 | | 0/1 | 0/2 | | | | | 0/3 | 0.0% | 2 | | | | | 00:25:54 |
| 合计 | | 3/22 | 12/29 | 2/7 | 5/8 | 2/2 | 1/4 | 5/7 | 30/79 | 38.0% | 7 | 17 | 2 | 4 | | |
| <i>(守门员)</i> | | | | | | | | | | | | | | | | |
| 1 | 刘继超 | 7/11 | 8/31 | 3/7 | 1/5 | 1/3 | | 0/1 | 20/58 | 34.5% | | 1 | | | | 01:00:00 |
| 合计 | | 7/11 | 8/31 | 3/7 | 1/5 | 1/3 | | 0/1 | 20/58 | 34.5% | | 1 | | | | |

场上队员：得分/射门

守门员：救球/射门

| 全队合计 | 得分 | 被救 | 射失 | 击柱 | 封球 | 合计 | % |
|------|----|----|----|----|----|----|--------|
| 远射 | 3 | 7 | 5 | 1 | 6 | 22 | 13.6% |
| 近射 | 12 | 13 | 1 | 3 | | 29 | 41.4% |
| 边射 | 2 | 4 | 1 | | | 7 | 28.6% |
| 快攻 | 5 | 3 | | | | 8 | 62.5% |
| 突破 | 2 | | | | | 2 | 100.0% |
| 任意 | 1 | 2 | | 1 | | 4 | 25.0% |
| 7M | 5 | 2 | | | | 7 | 71.4% |





2016年“体彩杯”全国手球男子青年锦标赛

个人/全队技术统计表

正式表
手球
青年男子半决赛
轮次 7组别 X
场次 41201602041-14-2/2
重庆万州
28/03/2016 16:00

| 号码 | 姓名 | 远射 | 近射 | 边射 | 快攻 | 突破 | 任意 | 7M | 合计 | % | 助攻 | 失误 | 警告 | 2' | 取消 | 时间 |
|----------------|-----|------|-------|-----|-----|-----|-----|-----|-------|-------|----|----|----|----|----|----------|
| 新疆队(新疆) | | | | | | | | | | | | | | | | |
| <i>(上场队员)</i> | | | | | | | | | | | | | | | | |
| 1 | 宋晓晨 | | | | | | | | | 0.0% | 1 | 1 | | | | 00:57:08 |
| 2 | 王泽川 | | 2/2 | | | | | | 2/2 | 100% | | | | | | 00:10:19 |
| 4 | 谷通金 | 0/1 | 0/1 | 0/1 | | | | | 0/3 | 0.0% | | | | | | 00:08:52 |
| 5 | 徐伟 | | 3/3 | 4/5 | 0/2 | | | | 7/10 | 70.0% | | | | | | 00:54:25 |
| 6 | 白光宇 | | | | | | | | | 0.0% | | | | | | 00:00:00 |
| 7 | 林豪文 | 1/4 | 3/3 | 0/1 | | | | | 4/8 | 50.0% | 7 | 2 | 1 | | | 00:57:18 |
| 10 | 王钟彬 | 1/6 | 4/6 | | | 1/1 | | | 6/13 | 46.2% | 1 | 9 | | 1 | | 00:55:30 |
| 12 | 王金鑫 | | | | | | | | | 0.0% | | | | | | 00:00:10 |
| 13 | 苏兴伟 | 1/1 | | | | | | | 1/1 | 100% | 1 | 1 | | | | 00:02:42 |
| 15 | 王维东 | 0/1 | 1/2 | 0/1 | 2/2 | 1/1 | | | 4/7 | 57.1% | | 2 | | | | 00:53:30 |
| 16 | 李佳懿 | | | | | | | | | 0.0% | | | | | | 00:02:42 |
| 17 | 胡晋铭 | 0/1 | 6/7 | | 1/1 | | | | 7/9 | 77.8% | | | 1 | | | 00:49:40 |
| 18 | 李万兴 | | | | | | | | | 0.0% | | | | | | 00:04:20 |
| 19 | 李龙吉 | 0/2 | 4/8 | | 1/1 | 0/1 | | 1/1 | 6/13 | 46.2% | 2 | 6 | 1 | 1 | | 00:55:03 |
| 24 | 陈伟华 | 1/1 | | 0/1 | | | | | 1/2 | 50.0% | | 1 | | | | 00:08:17 |
| 合计 | | 4/17 | 23/32 | 4/9 | 4/6 | 2/3 | | 1/1 | 38/68 | 55.9% | 12 | 22 | 3 | 2 | | |
| <i>(守门员)</i> | | | | | | | | | | | | | | | | |
| 1 | 宋晓晨 | 7/9 | 12/23 | 4/6 | 3/8 | 0/2 | 2/2 | 2/6 | 30/56 | 53.6% | 1 | 1 | | | | 00:57:08 |
| 12 | 王金鑫 | | | | | | | 0/1 | 0/1 | 0.0% | | | | | | 00:00:10 |
| 16 | 李佳懿 | 0/1 | 1/2 | | | | 0/1 | | 1/4 | 25.0% | | | | | | 00:02:42 |
| 合计 | | 7/10 | 13/25 | 4/6 | 3/8 | 0/2 | 2/3 | 2/7 | 31/61 | 50.8% | 1 | 1 | | | | |

场上队员：得分/射门

守门员：救球/射门

| 全队合计 | 得分 | 被救 | 射失 | 击柱 | 封球 | 合计 | % |
|------|----|----|----|----|----|----|--------|
| 远射 | 4 | 7 | 2 | 2 | 2 | 17 | 23.5% |
| 近射 | 23 | 8 | | 1 | | 32 | 71.9% |
| 边射 | 4 | 3 | 2 | | | 9 | 44.4% |
| 快攻 | 4 | 1 | 1 | | | 6 | 66.7% |
| 突破 | 2 | 1 | | | | 3 | 66.7% |
| 任意 | | | | | | | 0.0% |
| 7M | 1 | | | | | 1 | 100.0% |





2016年“体彩杯”全国手球男子青年锦标赛

图式射门区域统计

轮次 7 场次 41

201602041-41-1/1

山东队

| | | | | | | | | | | | | | | | | | | | | | | | | | | | | | | | | | | | | | | | | | | | | | | | | | | | | | | | | | | | | | | | | | | | | | | | | | | | | | | | |
|--|-----------------------------|-----------------------------|-----------------------------|-----------------------------|-----------------------------|-----------------------------|-----------------------------|--|--|---|--|--|--|---|--|--|---|--|---|---|---|--|--|--|--|---|---|--|--|--|--|--|--|--|--|--|---|--|---|---|---|--|---|--|--|--|---|--|--|--|--|--|--|--|--|--|--|--|--|--|---|--|---|---|--|---|---|--|---|--|--|--|--|--|--|--|--|--|--|
| 1 刘继超 | 2 冯鑫宇 | 3 王铁林 | 5 王晓峰 | 6 王军鸣 | 7 徐勇林 | 10 孙芳伟 | 11 王洋 | | | | | | | | | | | | | | | | | | | | | | | | | | | | | | | | | | | | | | | | | | | | | | | | | | | | | | | | | | | | | | | | | | | | | | | | |
| <table border="1"><tr><td></td><td></td><td></td></tr><tr><td></td><td></td><td></td></tr><tr><td></td><td></td><td></td></tr></table> | | | | | | | | | | <table border="1"><tr><td></td><td></td><td></td></tr><tr><td>3</td><td></td><td></td></tr><tr><td>2</td><td></td><td>4</td></tr></table> | | | | 3 | | | 2 | | 4 | <table border="1"><tr><td>1</td><td></td><td></td></tr><tr><td></td><td></td><td>1</td></tr><tr><td>1</td><td></td><td></td></tr></table> | 1 | | | | | 1 | 1 | | | <table border="1"><tr><td></td><td></td><td></td></tr><tr><td></td><td></td><td></td></tr><tr><td>1</td><td></td><td>1</td></tr></table> | | | | | | | 1 | | 1 | <table border="1"><tr><td>1</td><td></td><td>1</td></tr><tr><td></td><td></td><td></td></tr><tr><td>1</td><td></td><td></td></tr></table> | 1 | | 1 | | | | 1 | | | <table border="1"><tr><td></td><td></td><td></td></tr><tr><td></td><td></td><td></td></tr><tr><td></td><td></td><td></td></tr></table> | | | | | | | | | | <table border="1"><tr><td>2</td><td></td><td>1</td></tr><tr><td>3</td><td></td><td>2</td></tr><tr><td>2</td><td></td><td>1</td></tr></table> | 2 | | 1 | 3 | | 2 | 2 | | 1 | <table border="1"><tr><td></td><td></td><td></td></tr><tr><td></td><td></td><td></td></tr><tr><td></td><td></td><td></td></tr></table> | | | | | | | | | |
| | | | | | | | | | | | | | | | | | | | | | | | | | | | | | | | | | | | | | | | | | | | | | | | | | | | | | | | | | | | | | | | | | | | | | | | | | | | | | | | |
| | | | | | | | | | | | | | | | | | | | | | | | | | | | | | | | | | | | | | | | | | | | | | | | | | | | | | | | | | | | | | | | | | | | | | | | | | | | | | | | |
| | | | | | | | | | | | | | | | | | | | | | | | | | | | | | | | | | | | | | | | | | | | | | | | | | | | | | | | | | | | | | | | | | | | | | | | | | | | | | | | |
| | | | | | | | | | | | | | | | | | | | | | | | | | | | | | | | | | | | | | | | | | | | | | | | | | | | | | | | | | | | | | | | | | | | | | | | | | | | | | | | |
| 3 | | | | | | | | | | | | | | | | | | | | | | | | | | | | | | | | | | | | | | | | | | | | | | | | | | | | | | | | | | | | | | | | | | | | | | | | | | | | | | | |
| 2 | | 4 | | | | | | | | | | | | | | | | | | | | | | | | | | | | | | | | | | | | | | | | | | | | | | | | | | | | | | | | | | | | | | | | | | | | | | | | | | | | | |
| 1 | | | | | | | | | | | | | | | | | | | | | | | | | | | | | | | | | | | | | | | | | | | | | | | | | | | | | | | | | | | | | | | | | | | | | | | | | | | | | | | |
| | | 1 | | | | | | | | | | | | | | | | | | | | | | | | | | | | | | | | | | | | | | | | | | | | | | | | | | | | | | | | | | | | | | | | | | | | | | | | | | | | | |
| 1 | | | | | | | | | | | | | | | | | | | | | | | | | | | | | | | | | | | | | | | | | | | | | | | | | | | | | | | | | | | | | | | | | | | | | | | | | | | | | | | |
| | | | | | | | | | | | | | | | | | | | | | | | | | | | | | | | | | | | | | | | | | | | | | | | | | | | | | | | | | | | | | | | | | | | | | | | | | | | | | | | |
| | | | | | | | | | | | | | | | | | | | | | | | | | | | | | | | | | | | | | | | | | | | | | | | | | | | | | | | | | | | | | | | | | | | | | | | | | | | | | | | |
| 1 | | 1 | | | | | | | | | | | | | | | | | | | | | | | | | | | | | | | | | | | | | | | | | | | | | | | | | | | | | | | | | | | | | | | | | | | | | | | | | | | | | |
| 1 | | 1 | | | | | | | | | | | | | | | | | | | | | | | | | | | | | | | | | | | | | | | | | | | | | | | | | | | | | | | | | | | | | | | | | | | | | | | | | | | | | |
| | | | | | | | | | | | | | | | | | | | | | | | | | | | | | | | | | | | | | | | | | | | | | | | | | | | | | | | | | | | | | | | | | | | | | | | | | | | | | | | |
| 1 | | | | | | | | | | | | | | | | | | | | | | | | | | | | | | | | | | | | | | | | | | | | | | | | | | | | | | | | | | | | | | | | | | | | | | | | | | | | | | | |
| | | | | | | | | | | | | | | | | | | | | | | | | | | | | | | | | | | | | | | | | | | | | | | | | | | | | | | | | | | | | | | | | | | | | | | | | | | | | | | | |
| | | | | | | | | | | | | | | | | | | | | | | | | | | | | | | | | | | | | | | | | | | | | | | | | | | | | | | | | | | | | | | | | | | | | | | | | | | | | | | | |
| | | | | | | | | | | | | | | | | | | | | | | | | | | | | | | | | | | | | | | | | | | | | | | | | | | | | | | | | | | | | | | | | | | | | | | | | | | | | | | | |
| 2 | | 1 | | | | | | | | | | | | | | | | | | | | | | | | | | | | | | | | | | | | | | | | | | | | | | | | | | | | | | | | | | | | | | | | | | | | | | | | | | | | | |
| 3 | | 2 | | | | | | | | | | | | | | | | | | | | | | | | | | | | | | | | | | | | | | | | | | | | | | | | | | | | | | | | | | | | | | | | | | | | | | | | | | | | | |
| 2 | | 1 | | | | | | | | | | | | | | | | | | | | | | | | | | | | | | | | | | | | | | | | | | | | | | | | | | | | | | | | | | | | | | | | | | | | | | | | | | | | | |
| | | | | | | | | | | | | | | | | | | | | | | | | | | | | | | | | | | | | | | | | | | | | | | | | | | | | | | | | | | | | | | | | | | | | | | | | | | | | | | | |
| | | | | | | | | | | | | | | | | | | | | | | | | | | | | | | | | | | | | | | | | | | | | | | | | | | | | | | | | | | | | | | | | | | | | | | | | | | | | | | | |
| | | | | | | | | | | | | | | | | | | | | | | | | | | | | | | | | | | | | | | | | | | | | | | | | | | | | | | | | | | | | | | | | | | | | | | | | | | | | | | | |
| Post - 0 Miss - 0 Block - 0 | Post - 1 Miss - 1 Block - 0 | Post - 0 Miss - 0 Block - 0 | Post - 2 Miss - 2 Block - 3 | Post - 0 Miss - 0 Block - 2 | Post - 0 Miss - 0 Block - 0 | Post - 0 Miss - 2 Block - 1 | Post - 0 Miss - 0 Block - 0 | | | | | | | | | | | | | | | | | | | | | | | | | | | | | | | | | | | | | | | | | | | | | | | | | | | | | | | | | | | | | | | | | | | | | | | | |
| 12 刘道林 | 13 于欣君 | 17 薛盼龙 | 18 李玮 | 21 王腾达 | 22 李子跃 | 23 李荣健 | | | | | | | | | | | | | | | | | | | | | | | | | | | | | | | | | | | | | | | | | | | | | | | | | | | | | | | | | | | | | | | | | | | | | | | | | |
| <table border="1"><tr><td></td><td></td><td></td></tr><tr><td></td><td></td><td></td></tr><tr><td></td><td></td><td></td></tr></table> | | | | | | | | | | <table border="1"><tr><td></td><td></td><td></td></tr><tr><td>1</td><td></td><td></td></tr><tr><td></td><td></td><td>1</td></tr></table> | | | | 1 | | | | | 1 | <table border="1"><tr><td></td><td></td><td></td></tr><tr><td></td><td></td><td></td></tr><tr><td></td><td></td><td></td></tr></table> | | | | | | | | | | <table border="1"><tr><td></td><td></td><td></td></tr><tr><td></td><td></td><td></td></tr><tr><td></td><td></td><td></td></tr></table> | | | | | | | | | | <table border="1"><tr><td></td><td></td><td></td></tr><tr><td></td><td></td><td></td></tr><tr><td></td><td></td><td></td></tr></table> | | | | | | | | | | <table border="1"><tr><td></td><td></td><td></td></tr><tr><td></td><td></td><td></td></tr><tr><td></td><td></td><td></td></tr></table> | | | | | | | | | | <table border="1"><tr><td></td><td></td><td></td></tr><tr><td></td><td></td><td></td></tr><tr><td></td><td></td><td></td></tr></table> | | | | | | | | | | <table border="1"><tr><td></td><td></td><td></td></tr><tr><td></td><td></td><td></td></tr><tr><td></td><td></td><td></td></tr></table> | | | | | | | | | |
| | | | | | | | | | | | | | | | | | | | | | | | | | | | | | | | | | | | | | | | | | | | | | | | | | | | | | | | | | | | | | | | | | | | | | | | | | | | | | | | |
| | | | | | | | | | | | | | | | | | | | | | | | | | | | | | | | | | | | | | | | | | | | | | | | | | | | | | | | | | | | | | | | | | | | | | | | | | | | | | | | |
| | | | | | | | | | | | | | | | | | | | | | | | | | | | | | | | | | | | | | | | | | | | | | | | | | | | | | | | | | | | | | | | | | | | | | | | | | | | | | | | |
| | | | | | | | | | | | | | | | | | | | | | | | | | | | | | | | | | | | | | | | | | | | | | | | | | | | | | | | | | | | | | | | | | | | | | | | | | | | | | | | |
| 1 | | | | | | | | | | | | | | | | | | | | | | | | | | | | | | | | | | | | | | | | | | | | | | | | | | | | | | | | | | | | | | | | | | | | | | | | | | | | | | | |
| | | 1 | | | | | | | | | | | | | | | | | | | | | | | | | | | | | | | | | | | | | | | | | | | | | | | | | | | | | | | | | | | | | | | | | | | | | | | | | | | | | |
| | | | | | | | | | | | | | | | | | | | | | | | | | | | | | | | | | | | | | | | | | | | | | | | | | | | | | | | | | | | | | | | | | | | | | | | | | | | | | | | |
| | | | | | | | | | | | | | | | | | | | | | | | | | | | | | | | | | | | | | | | | | | | | | | | | | | | | | | | | | | | | | | | | | | | | | | | | | | | | | | | |
| | | | | | | | | | | | | | | | | | | | | | | | | | | | | | | | | | | | | | | | | | | | | | | | | | | | | | | | | | | | | | | | | | | | | | | | | | | | | | | | |
| | | | | | | | | | | | | | | | | | | | | | | | | | | | | | | | | | | | | | | | | | | | | | | | | | | | | | | | | | | | | | | | | | | | | | | | | | | | | | | | |
| | | | | | | | | | | | | | | | | | | | | | | | | | | | | | | | | | | | | | | | | | | | | | | | | | | | | | | | | | | | | | | | | | | | | | | | | | | | | | | | |
| | | | | | | | | | | | | | | | | | | | | | | | | | | | | | | | | | | | | | | | | | | | | | | | | | | | | | | | | | | | | | | | | | | | | | | | | | | | | | | | |
| | | | | | | | | | | | | | | | | | | | | | | | | | | | | | | | | | | | | | | | | | | | | | | | | | | | | | | | | | | | | | | | | | | | | | | | | | | | | | | | |
| | | | | | | | | | | | | | | | | | | | | | | | | | | | | | | | | | | | | | | | | | | | | | | | | | | | | | | | | | | | | | | | | | | | | | | | | | | | | | | | |
| | | | | | | | | | | | | | | | | | | | | | | | | | | | | | | | | | | | | | | | | | | | | | | | | | | | | | | | | | | | | | | | | | | | | | | | | | | | | | | | |
| | | | | | | | | | | | | | | | | | | | | | | | | | | | | | | | | | | | | | | | | | | | | | | | | | | | | | | | | | | | | | | | | | | | | | | | | | | | | | | | |
| | | | | | | | | | | | | | | | | | | | | | | | | | | | | | | | | | | | | | | | | | | | | | | | | | | | | | | | | | | | | | | | | | | | | | | | | | | | | | | | |
| | | | | | | | | | | | | | | | | | | | | | | | | | | | | | | | | | | | | | | | | | | | | | | | | | | | | | | | | | | | | | | | | | | | | | | | | | | | | | | | |
| | | | | | | | | | | | | | | | | | | | | | | | | | | | | | | | | | | | | | | | | | | | | | | | | | | | | | | | | | | | | | | | | | | | | | | | | | | | | | | | |
| | | | | | | | | | | | | | | | | | | | | | | | | | | | | | | | | | | | | | | | | | | | | | | | | | | | | | | | | | | | | | | | | | | | | | | | | | | | | | | | |
| | | | | | | | | | | | | | | | | | | | | | | | | | | | | | | | | | | | | | | | | | | | | | | | | | | | | | | | | | | | | | | | | | | | | | | | | | | | | | | | |
| | | | | | | | | | | | | | | | | | | | | | | | | | | | | | | | | | | | | | | | | | | | | | | | | | | | | | | | | | | | | | | | | | | | | | | | | | | | | | | | |
| | | | | | | | | | | | | | | | | | | | | | | | | | | | | | | | | | | | | | | | | | | | | | | | | | | | | | | | | | | | | | | | | | | | | | | | | | | | | | | | |
| | | | | | | | | | | | | | | | | | | | | | | | | | | | | | | | | | | | | | | | | | | | | | | | | | | | | | | | | | | | | | | | | | | | | | | | | | | | | | | | |
| Post - 0 Miss - 0 Block - 0 | Post - 2 Miss - 1 Block - 0 | Post - 0 Miss - 0 Block - 0 | Post - 0 Miss - 0 Block - 0 | Post - 0 Miss - 0 Block - 0 | Post - 0 Miss - 0 Block - 0 | Post - 0 Miss - 1 Block - 0 | | | | | | | | | | | | | | | | | | | | | | | | | | | | | | | | | | | | | | | | | | | | | | | | | | | | | | | | | | | | | | | | | | | | | | | | | |

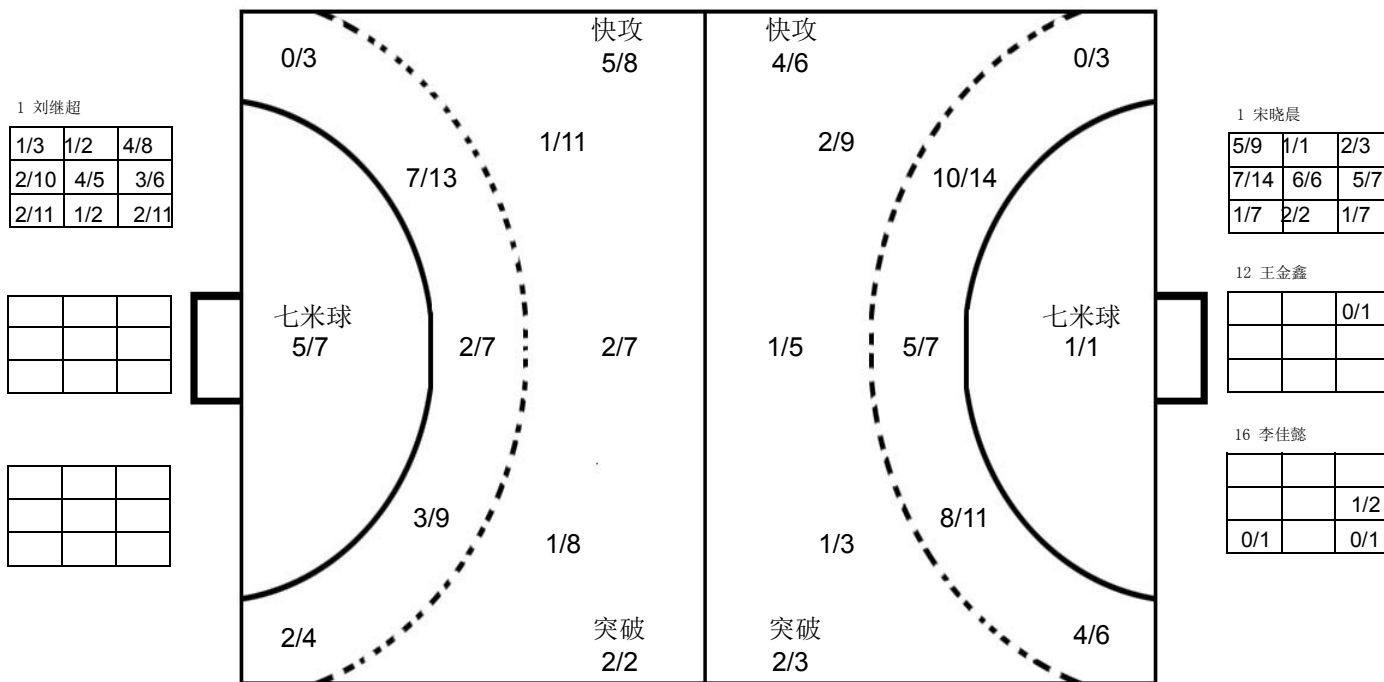

新疆队

| | | | | | | | | | | | | | | | | | | | | | | | | | | | | | | | | | | | | | | | | | | | | | | | | | | | | | | | | | | | | | | | | | | | | | | | | | | | | | | | |
|---|-----------------------------|-----------------------------|-----------------------------|-----------------------------|-----------------------------|-----------------------------|-----------------------------|--|--|--|--|---|---|---|--|--|--|--|---|--|--|--|--|--|--|--|--|--|--|---|---|--|--|---|--|---|---|---|---|--|--|--|--|--|--|--|--|--|--|---|--|--|--|---|---|---|---|--|---|--|--|--|---|---|--|---|--|--|---|--|--|--|--|--|--|--|--|--|--|
| 1 宋晓晨 | 2 王泽川 | 4 谷通金 | 5 徐伟 | 6 白光宇 | 7 林豪文 | 10 王钟彬 | 12 王金鑫 | | | | | | | | | | | | | | | | | | | | | | | | | | | | | | | | | | | | | | | | | | | | | | | | | | | | | | | | | | | | | | | | | | | | | | | | |
| <table border="1"><tr><td></td><td></td><td></td></tr><tr><td></td><td></td><td></td></tr><tr><td></td><td></td><td></td></tr></table> | | | | | | | | | | <table border="1"><tr><td></td><td></td><td></td></tr><tr><td>1</td><td></td><td></td></tr><tr><td></td><td></td><td>1</td></tr></table> | | | | 1 | | | | | 1 | <table border="1"><tr><td></td><td></td><td></td></tr><tr><td></td><td></td><td></td></tr><tr><td></td><td></td><td></td></tr></table> | | | | | | | | | | <table border="1"><tr><td>2</td><td></td><td></td></tr><tr><td>1</td><td></td><td>1</td></tr><tr><td>2</td><td>1</td><td></td></tr></table> | 2 | | | 1 | | 1 | 2 | 1 | | <table border="1"><tr><td></td><td></td><td></td></tr><tr><td></td><td></td><td></td></tr><tr><td></td><td></td><td></td></tr></table> | | | | | | | | | | <table border="1"><tr><td></td><td></td><td></td></tr><tr><td>1</td><td></td><td>1</td></tr><tr><td>2</td><td></td><td></td></tr></table> | | | | 1 | | 1 | 2 | | | <table border="1"><tr><td></td><td></td><td>2</td></tr><tr><td>1</td><td></td><td>1</td></tr><tr><td></td><td></td><td>2</td></tr></table> | | | 2 | 1 | | 1 | | | 2 | <table border="1"><tr><td></td><td></td><td></td></tr><tr><td></td><td></td><td></td></tr><tr><td></td><td></td><td></td></tr></table> | | | | | | | | | |
| | | | | | | | | | | | | | | | | | | | | | | | | | | | | | | | | | | | | | | | | | | | | | | | | | | | | | | | | | | | | | | | | | | | | | | | | | | | | | | | |
| | | | | | | | | | | | | | | | | | | | | | | | | | | | | | | | | | | | | | | | | | | | | | | | | | | | | | | | | | | | | | | | | | | | | | | | | | | | | | | | |
| | | | | | | | | | | | | | | | | | | | | | | | | | | | | | | | | | | | | | | | | | | | | | | | | | | | | | | | | | | | | | | | | | | | | | | | | | | | | | | | |
| | | | | | | | | | | | | | | | | | | | | | | | | | | | | | | | | | | | | | | | | | | | | | | | | | | | | | | | | | | | | | | | | | | | | | | | | | | | | | | | |
| 1 | | | | | | | | | | | | | | | | | | | | | | | | | | | | | | | | | | | | | | | | | | | | | | | | | | | | | | | | | | | | | | | | | | | | | | | | | | | | | | | |
| | | 1 | | | | | | | | | | | | | | | | | | | | | | | | | | | | | | | | | | | | | | | | | | | | | | | | | | | | | | | | | | | | | | | | | | | | | | | | | | | | | |
| | | | | | | | | | | | | | | | | | | | | | | | | | | | | | | | | | | | | | | | | | | | | | | | | | | | | | | | | | | | | | | | | | | | | | | | | | | | | | | | |
| | | | | | | | | | | | | | | | | | | | | | | | | | | | | | | | | | | | | | | | | | | | | | | | | | | | | | | | | | | | | | | | | | | | | | | | | | | | | | | | |
| | | | | | | | | | | | | | | | | | | | | | | | | | | | | | | | | | | | | | | | | | | | | | | | | | | | | | | | | | | | | | | | | | | | | | | | | | | | | | | | |
| 2 | | | | | | | | | | | | | | | | | | | | | | | | | | | | | | | | | | | | | | | | | | | | | | | | | | | | | | | | | | | | | | | | | | | | | | | | | | | | | | | |
| 1 | | 1 | | | | | | | | | | | | | | | | | | | | | | | | | | | | | | | | | | | | | | | | | | | | | | | | | | | | | | | | | | | | | | | | | | | | | | | | | | | | | |
| 2 | 1 | | | | | | | | | | | | | | | | | | | | | | | | | | | | | | | | | | | | | | | | | | | | | | | | | | | | | | | | | | | | | | | | | | | | | | | | | | | | | | |
| | | | | | | | | | | | | | | | | | | | | | | | | | | | | | | | | | | | | | | | | | | | | | | | | | | | | | | | | | | | | | | | | | | | | | | | | | | | | | | | |
| | | | | | | | | | | | | | | | | | | | | | | | | | | | | | | | | | | | | | | | | | | | | | | | | | | | | | | | | | | | | | | | | | | | | | | | | | | | | | | | |
| | | | | | | | | | | | | | | | | | | | | | | | | | | | | | | | | | | | | | | | | | | | | | | | | | | | | | | | | | | | | | | | | | | | | | | | | | | | | | | | |
| | | | | | | | | | | | | | | | | | | | | | | | | | | | | | | | | | | | | | | | | | | | | | | | | | | | | | | | | | | | | | | | | | | | | | | | | | | | | | | | |
| 1 | | 1 | | | | | | | | | | | | | | | | | | | | | | | | | | | | | | | | | | | | | | | | | | | | | | | | | | | | | | | | | | | | | | | | | | | | | | | | | | | | | |
| 2 | | | | | | | | | | | | | | | | | | | | | | | | | | | | | | | | | | | | | | | | | | | | | | | | | | | | | | | | | | | | | | | | | | | | | | | | | | | | | | | |
| | | 2 | | | | | | | | | | | | | | | | | | | | | | | | | | | | | | | | | | | | | | | | | | | | | | | | | | | | | | | | | | | | | | | | | | | | | | | | | | | | | |
| 1 | | 1 | | | | | | | | | | | | | | | | | | | | | | | | | | | | | | | | | | | | | | | | | | | | | | | | | | | | | | | | | | | | | | | | | | | | | | | | | | | | | |
| | | 2 | | | | | | | | | | | | | | | | | | | | | | | | | | | | | | | | | | | | | | | | | | | | | | | | | | | | | | | | | | | | | | | | | | | | | | | | | | | | | |
| | | | | | | | | | | | | | | | | | | | | | | | | | | | | | | | | | | | | | | | | | | | | | | | | | | | | | | | | | | | | | | | | | | | | | | | | | | | | | | | |
| | | | | | | | | | | | | | | | | | | | | | | | | | | | | | | | | | | | | | | | | | | | | | | | | | | | | | | | | | | | | | | | | | | | | | | | | | | | | | | | |
| | | | | | | | | | | | | | | | | | | | | | | | | | | | | | | | | | | | | | | | | | | | | | | | | | | | | | | | | | | | | | | | | | | | | | | | | | | | | | | | |
| Post - 0 Miss - 0 Block - 0 | Post - 0 Miss - 0 Block - 0 | Post - 0 Miss - 1 Block - 0 | Post - 0 Miss - 1 Block - 0 | Post - 0 Miss - 0 Block - 0 | Post - 2 Miss - 2 Block - 0 | Post - 1 Miss - 0 Block - 2 | Post - 0 Miss - 0 Block - 0 | | | | | | | | | | | | | | | | | | | | | | | | | | | | | | | | | | | | | | | | | | | | | | | | | | | | | | | | | | | | | | | | | | | | | | | | |
| 13 苏兴伟 | 15 王维东 | 16 李佳懿 | 17 胡晋铭 | 18 李万兴 | 19 李龙吉 | 24 陈伟华 | | | | | | | | | | | | | | | | | | | | | | | | | | | | | | | | | | | | | | | | | | | | | | | | | | | | | | | | | | | | | | | | | | | | | | | | | |
| <table border="1"><tr><td></td><td></td><td></td></tr><tr><td></td><td></td><td></td></tr><tr><td>1</td><td></td><td></td></tr></table> | | | | | | | 1 | | | <table border="1"><tr><td></td><td>1</td><td>1</td></tr><tr><td>1</td><td></td><td></td></tr><tr><td></td><td></td><td>1</td></tr></table> | | 1 | 1 | 1 | | | | | 1 | <table border="1"><tr><td></td><td></td><td></td></tr><tr><td></td><td></td><td></td></tr><tr><td></td><td></td><td></td></tr></table> | | | | | | | | | | <table border="1"><tr><td></td><td></td><td></td></tr><tr><td>2</td><td></td><td></td></tr><tr><td>4</td><td></td><td>1</td></tr></table> | | | | 2 | | | 4 | | 1 | <table border="1"><tr><td></td><td></td><td></td></tr><tr><td></td><td></td><td></td></tr><tr><td></td><td></td><td></td></tr></table> | | | | | | | | | | <table border="1"><tr><td></td><td></td><td></td></tr><tr><td>1</td><td>1</td><td></td></tr><tr><td></td><td></td><td>4</td></tr></table> | | | | 1 | 1 | | | | 4 | <table border="1"><tr><td></td><td></td><td>1</td></tr><tr><td></td><td></td><td></td></tr><tr><td></td><td></td><td></td></tr></table> | | | 1 | | | | | | | <table border="1"><tr><td></td><td></td><td></td></tr><tr><td></td><td></td><td></td></tr><tr><td></td><td></td><td></td></tr></table> | | | | | | | | | |
| | | | | | | | | | | | | | | | | | | | | | | | | | | | | | | | | | | | | | | | | | | | | | | | | | | | | | | | | | | | | | | | | | | | | | | | | | | | | | | | |
| | | | | | | | | | | | | | | | | | | | | | | | | | | | | | | | | | | | | | | | | | | | | | | | | | | | | | | | | | | | | | | | | | | | | | | | | | | | | | | | |
| 1 | | | | | | | | | | | | | | | | | | | | | | | | | | | | | | | | | | | | | | | | | | | | | | | | | | | | | | | | | | | | | | | | | | | | | | | | | | | | | | | |
| | 1 | 1 | | | | | | | | | | | | | | | | | | | | | | | | | | | | | | | | | | | | | | | | | | | | | | | | | | | | | | | | | | | | | | | | | | | | | | | | | | | | | |
| 1 | | | | | | | | | | | | | | | | | | | | | | | | | | | | | | | | | | | | | | | | | | | | | | | | | | | | | | | | | | | | | | | | | | | | | | | | | | | | | | | |
| | | 1 | | | | | | | | | | | | | | | | | | | | | | | | | | | | | | | | | | | | | | | | | | | | | | | | | | | | | | | | | | | | | | | | | | | | | | | | | | | | | |
| | | | | | | | | | | | | | | | | | | | | | | | | | | | | | | | | | | | | | | | | | | | | | | | | | | | | | | | | | | | | | | | | | | | | | | | | | | | | | | | |
| | | | | | | | | | | | | | | | | | | | | | | | | | | | | | | | | | | | | | | | | | | | | | | | | | | | | | | | | | | | | | | | | | | | | | | | | | | | | | | | |
| | | | | | | | | | | | | | | | | | | | | | | | | | | | | | | | | | | | | | | | | | | | | | | | | | | | | | | | | | | | | | | | | | | | | | | | | | | | | | | | |
| | | | | | | | | | | | | | | | | | | | | | | | | | | | | | | | | | | | | | | | | | | | | | | | | | | | | | | | | | | | | | | | | | | | | | | | | | | | | | | | |
| 2 | | | | | | | | | | | | | | | | | | | | | | | | | | | | | | | | | | | | | | | | | | | | | | | | | | | | | | | | | | | | | | | | | | | | | | | | | | | | | | | |
| 4 | | 1 | | | | | | | | | | | | | | | | | | | | | | | | | | | | | | | | | | | | | | | | | | | | | | | | | | | | | | | | | | | | | | | | | | | | | | | | | | | | | |
| | | | | | | | | | | | | | | | | | | | | | | | | | | | | | | | | | | | | | | | | | | | | | | | | | | | | | | | | | | | | | | | | | | | | | | | | | | | | | | | |
| | | | | | | | | | | | | | | | | | | | | | | | | | | | | | | | | | | | | | | | | | | | | | | | | | | | | | | | | | | | | | | | | | | | | | | | | | | | | | | | |
| | | | | | | | | | | | | | | | | | | | | | | | | | | | | | | | | | | | | | | | | | | | | | | | | | | | | | | | | | | | | | | | | | | | | | | | | | | | | | | | |
| | | | | | | | | | | | | | | | | | | | | | | | | | | | | | | | | | | | | | | | | | | | | | | | | | | | | | | | | | | | | | | | | | | | | | | | | | | | | | | | |
| 1 | 1 | | | | | | | | | | | | | | | | | | | | | | | | | | | | | | | | | | | | | | | | | | | | | | | | | | | | | | | | | | | | | | | | | | | | | | | | | | | | | | |
| | | 4 | | | | | | | | | | | | | | | | | | | | | | | | | | | | | | | | | | | | | | | | | | | | | | | | | | | | | | | | | | | | | | | | | | | | | | | | | | | | | |
| | | 1 | | | | | | | | | | | | | | | | | | | | | | | | | | | | | | | | | | | | | | | | | | | | | | | | | | | | | | | | | | | | | | | | | | | | | | | | | | | | | |
| | | | | | | | | | | | | | | | | | | | | | | | | | | | | | | | | | | | | | | | | | | | | | | | | | | | | | | | | | | | | | | | | | | | | | | | | | | | | | | | |
| | | | | | | | | | | | | | | | | | | | | | | | | | | | | | | | | | | | | | | | | | | | | | | | | | | | | | | | | | | | | | | | | | | | | | | | | | | | | | | | |
| | | | | | | | | | | | | | | | | | | | | | | | | | | | | | | | | | | | | | | | | | | | | | | | | | | | | | | | | | | | | | | | | | | | | | | | | | | | | | | | |
| | | | | | | | | | | | | | | | | | | | | | | | | | | | | | | | | | | | | | | | | | | | | | | | | | | | | | | | | | | | | | | | | | | | | | | | | | | | | | | | |
| | | | | | | | | | | | | | | | | | | | | | | | | | | | | | | | | | | | | | | | | | | | | | | | | | | | | | | | | | | | | | | | | | | | | | | | | | | | | | | | |
| Post - 0 Miss - 0 Block - 0 | Post - 0 Miss - 0 Block - 0 | Post - 0 Miss - 0 Block - 0 | Post - 0 Miss - 0 Block - 0 | Post - 0 Miss - 0 Block - 0 | Post - 0 Miss - 1 Block - 0 | Post - 0 Miss - 0 Block - 0 | | | | | | | | | | | | | | | | | | | | | | | | | | | | | | | | | | | | | | | | | | | | | | | | | | | | | | | | | | | | | | | | | | | | | | | | | |

注释: Post=击柱 Miss=射失 Block=被封



半决赛
青年男子 全国比赛

2016年“体彩杯”全国手球男子青年锦标赛

| | | | | | | | | | | | | | | | | | | | | | |
|-----------------------------|---|---------------------------------------|---------------------|---------------------------------------|---------|----|---|----|---|----|-----|-----------|--|--|--|--|----|---|----|---|----|
| Team A A 四川队 | | Team B B 安徽队 | | Match Number 42 | | | | | | | | | | | | | | | | | |
| played in China | | in the hall 重庆万州 | | on 28/03/2016 | | | | | | | | | | | | | | | | | |
| | | | | at 17:30 hours | | | | | | | | | | | | | | | | | |
| Spectators | | | | | | | | | | | | | | | | | | | | | |
| Half-time (30') | A 20 | B 15 | End of playing time | A 36 | B 35 | | | | | | | | | | | | | | | | |
| 1st extra time | | 2nd extra time | | After penalty throws | | | | | | | | | | | | | | | | | |
| Number of 7 m A 4 / 5 | | Team time-out 1 2 3 32:38 43:13 | | Full name of players and officials | | | | | | | | | | | | | | | | | |
| | | | | Team time-out 1 2 3 26:16 59:17 | | | | | | | | | | | | | | | | | |
| | | | | B 2 / 3 | | | | | | | | | | | | | | | | | |
| | | | | Number of 7 m | | | | | | | | | | | | | | | | | |
| No. | Team A | | | | | G | W | 2' | D | DR | No. | Team B | | | | | G | W | 2' | D | DR |
| 1 | 宋继强 | | | | | | | | | | 1 | 郭世伟 | | | | | 7 | | | | |
| 3 | 刘赵梁 | | | | | 8 | | | | | 2 | 金勇峰 | | | | | 1 | | 1 | | |
| 5 | 王凯 | | | | | 1 | | | | | 9 | 陈开勇 | | | | | 4 | 1 | | | |
| 7 | 仇瑞祥 | | | | | | | | | | 17 | 王巨柱 | | | | | 10 | | | | |
| 8 | 罗尧尧 | | | | | 11 | 1 | | | | 18 | 李双 | | | | | 7 | 1 | 2 | | |
| 9 | 许翔宇 | | | | | 4 | | 1 | | | 19 | 何山 | | | | | 6 | | 1 | | |
| 10 | 徐彦昊 | | | | | 4 | | | | | 21 | 李明 | | | | | | | 1 | | |
| 11 | 张天豪 | | | | | | | | | | 24 | 徐安格 | | | | | | | | | |
| 12 | 刘树豪 | | | | | | | | | | 25 | 李文哲 | | | | | | | | | |
| 13 | 尹文珂 | | | | | 1 | | | | | 26 | 程浩然 | | | | | | | | | |
| 15 | 徐逸 | | | | | | | | | | 27 | 王长旭 | | | | | | | | | |
| 17 | 谢庆龙 | | | | | 2 | | | | | 28 | 丁浩然 | | | | | | | | | |
| 18 | 张睿梁 | | | | | | | | | | 32 | 许浩翔 | | | | | | | | | |
| 19 | 庞连康 | | | | | 5 | 1 | 2 | | | 33 | 姚紫祥 | | | | | | | | | |
| 20 | 张文健 | | | | | | | | | | 41 | 刘润民 | | | | | | | | | |
| 21 | 曹修庆 | | | | | | | | | | 42 | 王成龙 | | | | | | | | | |
| B | 张文韬 (主教练) | | | | | | | | | | A | 王来黔 (主教练) | | | | | | | | | |
| | | | | | | | | | | | B | 陆万红 | | | | | | | | | |
| | | | | | | | | | | | C | 吴翔 | | | | | | | | | |
| | | | | | | | | | | | | | | | | | | | | | |
| A | Signature of Responsible Official of the Teams (Off. A) | | | | | | | | | | | | | | | | | | B | | |
| TP | Remarks of Referee / CHA Official | | | | | | | | | | | | | | | | | | TP | | |

Signatures

| | | | | |
|------------------|-----------|-----------|--|--|
| Referees | 倪震 (CHN) | 马晓晔 (CHN) | | |
| Techn. Delegates | 李英才 (CHN) | | | |
| CHA Official | 吴瑞亭 (CHN) | | | |

Note: Number of 7m Throws Awarded to Team A and B, Goals (G), Warnings (W), Suspensions (2'), Direct Disqualification (D), Disqualification with Report (DR) and Team Penalty (TP).

Table Officials:

Statisticians: 刘永欢

李双





2016年“体彩杯”全国手球男子青年锦标赛
竞赛技术统计(媒体表)

半决赛 组别 X 轮次 7 场次 42

重庆万州

28/03/2016

201602042-51-1/1

四川队 四川 36 vs 35 安徽 安徽队
20 : 15

裁判员 倪震 (CHN) / 马晓晔 (CHN)

Main statistics table for Sichuan and Anhui teams, including player names, positions, and performance metrics like goals, assists, and suspensions.

场上队员: 得分 / 射门

守门员: 救球 / 射门

Legend table for abbreviations: 快攻 (Fast Break), 突破 (Breakthrough), 任意球 (Free Throw), 7M球 (7M Throw), 助攻 (Assist), 警告 (Warning), 失误 (Error), 2' (Suspension), D (取消资格 - Disqualification), DR (取消资格+报告 - Disqualification+Report)





2016年“体彩杯”全国手球男子青年锦标赛 图式比赛技术统计表

轮次 7

场次 42

201602042-21-1/1

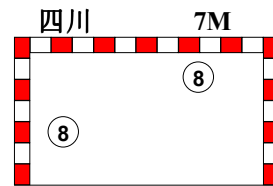
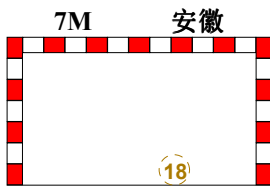
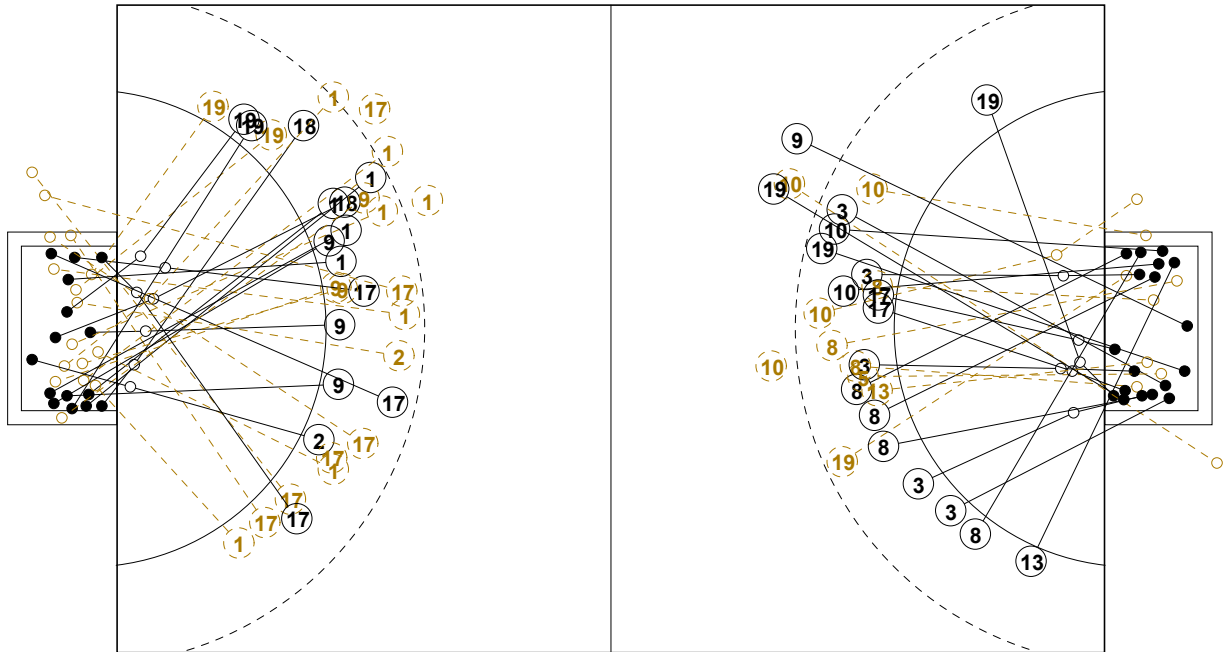

1st Half
15 : 20

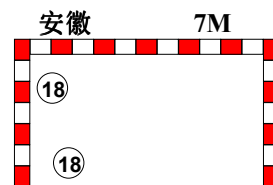
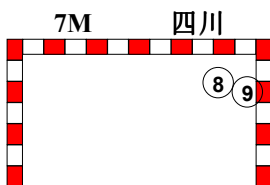
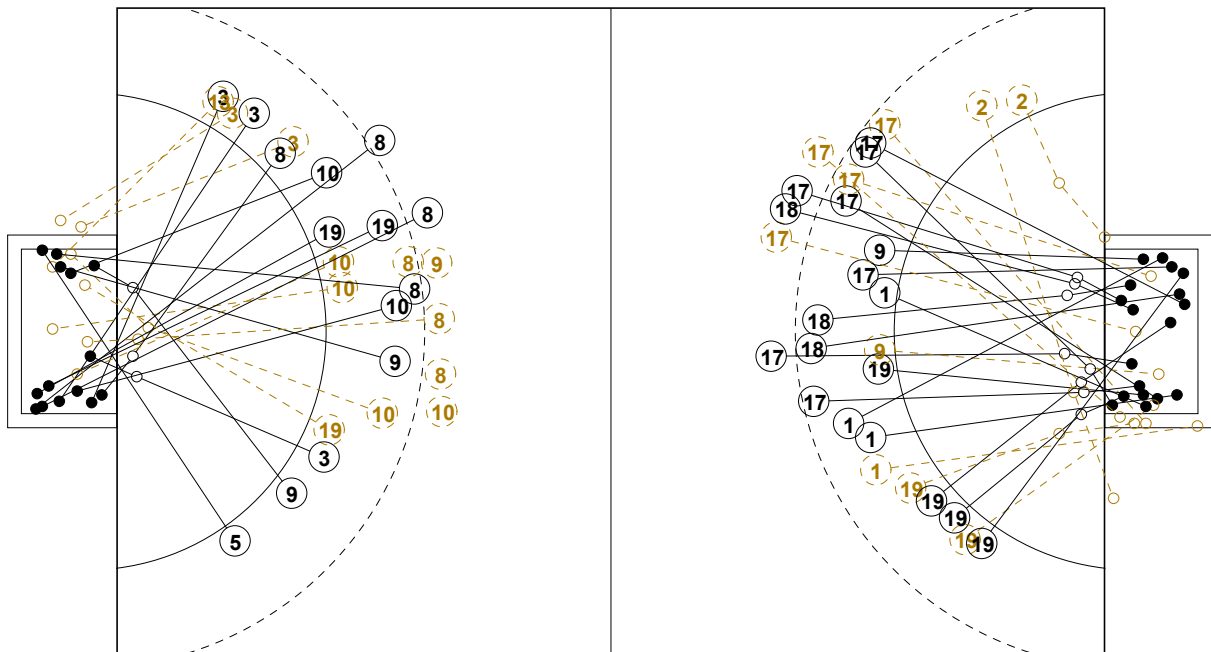

2nd Half
36 : 35



2016年“体彩杯”全国手球男子青年锦标赛

个人/全队技术统计表

正式表
手球
青年男子半决赛
轮次 7组别 X
场次 42201602042-14-1/2
重庆万州
28/03/2016 17:30

| 号码 | 姓名 | 远射 | 近射 | 边射 | 快攻 | 突破 | 任意 | 7M | 合计 | % | 助攻 | 失误 | 警告 | 2' | 取消 | 时间 |
|----------------|-----|------|------|-----|------|-----|-----|-----|-------|-------|----|----|----|----|----|----------|
| 四川队(四川) | | | | | | | | | | | | | | | | |
| <i>(场上队员)</i> | | | | | | | | | | | | | | | | |
| 1 | 宋继强 | | | | | | | | | 0.0% | | | | | | 00:00:00 |
| 3 | 刘赵梁 | | 3/4 | 2/3 | 3/3 | | | | 8/10 | 80.0% | 1 | 5 | | | | 00:56:08 |
| 5 | 王凯 | | | 1/1 | 0/1 | | | | 1/2 | 50.0% | | | | | | 01:00:00 |
| 7 | 仇瑞祥 | | | | | | | | | 0.0% | | | | | | 00:00:00 |
| 8 | 罗尧尧 | 2/5 | 2/5 | | 1/1 | 2/2 | 1/1 | 3/4 | 11/18 | 61.1% | | 5 | 1 | | | 00:46:05 |
| 9 | 许翔宇 | 2/3 | | | | 1/1 | | 1/1 | 4/5 | 80.0% | 2 | 3 | | 1 | | 00:27:51 |
| 10 | 徐彦昊 | 2/6 | 1/3 | | 1/3 | | | | 4/12 | 33.3% | 1 | 4 | | | | 00:55:01 |
| 11 | 张天豪 | | | | | | | | | 0.0% | | | | | | 00:00:00 |
| 12 | 刘树豪 | | | | | | | | | 0.0% | 1 | | | | | 01:00:00 |
| 13 | 尹文珂 | | | 1/2 | 0/1 | | | | 1/3 | 33.3% | | | | | | 00:03:48 |
| 15 | 徐逸 | | | | | | | | | 0.0% | | | | | | 00:00:00 |
| 17 | 谢庆龙 | | 2/2 | | | | | | 2/2 | 100% | | 1 | | | | 01:00:00 |
| 18 | 张睿梁 | | | | | | | | | 0.0% | | | | | | 00:00:00 |
| 19 | 庞连康 | 3/4 | 0/1 | 1/1 | 1/1 | | | | 5/7 | 71.4% | | 3 | 1 | 2 | | 01:16:39 |
| 20 | 张文健 | | | | | | | | | 0.0% | | | | | | 00:00:00 |
| 21 | 曹修庆 | | | | | | | | | 0.0% | | | | | | 00:00:00 |
| 合计 | | 9/18 | 8/15 | 5/7 | 6/10 | 3/3 | 1/1 | 4/5 | 36/59 | 61.0% | 5 | 21 | 2 | 3 | | |
| <i>(守门员)</i> | | | | | | | | | | | | | | | | |
| 12 | 刘树豪 | 7/17 | 3/16 | 4/8 | 1/4 | 0/2 | 0/1 | 1/3 | 16/51 | 31.4% | 1 | | | | | 01:00:00 |
| 合计 | | | | | | | | | | | | | | | | |
| 合计 | | 7/17 | 3/16 | 4/8 | 1/4 | 0/2 | 0/1 | 1/3 | 16/51 | 31.4% | 1 | | | | | |

场上队员：得分/射门

守门员：救球/射门

| 全队合计 | 得分 | 被救 | 射失 | 击柱 | 封球 | 合计 | % |
|------|----|----|----|----|----|----|--------|
| 远射 | 9 | 2 | 2 | | 5 | 18 | 50.0% |
| 近射 | 8 | 5 | 1 | 1 | | 15 | 53.3% |
| 边射 | 5 | 1 | 1 | | | 7 | 71.4% |
| 快攻 | 6 | 4 | | | | 10 | 60.0% |
| 突破 | 3 | | | | | 3 | 100.0% |
| 任意 | 1 | | | | | 1 | 100.0% |
| 7M | 4 | | 1 | | | 5 | 80.0% |





2016年“体彩杯”全国手球男子青年锦标赛

个人/全队技术统计表

正式表
手球
青年男子半决赛
轮次 7组别 X
场次 42201602042-14-2/2
重庆万州
28/03/2016 17:30

| 号码 | 姓名 | 远射 | 近射 | 边射 | 快攻 | 突破 | 任意 | 7M | 合计 | % | 助攻 | 失误 | 警告 | 2' | 取消 | 时间 |
|----------------|-----|-------|-------|------|------|-----|-----|-----|-------|-------|----|----|----|----|----|----------|
| 安徽队(安徽) | | | | | | | | | | | | | | | | |
| <i>(上场队员)</i> | | | | | | | | | | | | | | | | |
| 1 | 郭世伟 | 1/6 | 3/5 | 0/1 | 1/1 | 2/2 | | | 7/15 | 46.7% | | 1 | | | | 01:21:37 |
| 2 | 金勇峰 | 0/1 | 1/1 | 0/2 | | | | | 1/4 | 25.0% | 1 | 1 | | 1 | | 01:00:00 |
| 9 | 陈开勇 | | 4/7 | | 0/1 | | | | 4/8 | 50.0% | 1 | 6 | 1 | | | 01:25:04 |
| 17 | 王巨柱 | 6/12 | 1/4 | 0/1 | 2/2 | | 1/1 | | 10/20 | 50.0% | 4 | 3 | | | | 01:00:00 |
| 18 | 李双 | 3/3 | 2/2 | | | | | 2/3 | 7/8 | 87.5% | 3 | 5 | 1 | 2 | | 01:00:00 |
| 19 | 何山 | | 2/3 | 4/7 | | | | | 6/10 | 60.0% | | | | 1 | | 00:58:25 |
| 21 | 李明 | | | | | | | | | 0.0% | | 1 | | 1 | | 00:58:04 |
| 24 | 徐安格 | | | | | | | | | 0.0% | | | | | | 00:00:00 |
| 25 | 李文哲 | | | | | | | | | 0.0% | | | | | | 00:00:00 |
| 26 | 程浩然 | | | | | | | | | 0.0% | | | | | | 00:00:00 |
| 27 | 王长旭 | | | | | | | | | 0.0% | | | | | | 00:00:00 |
| 28 | 丁浩然 | | | | | | | | | 0.0% | | | | | | 00:00:00 |
| 32 | 许浩翔 | | | | | | | | | 0.0% | | | | | | 00:01:56 |
| 33 | 姚紫祥 | | | | | | | | | 0.0% | | | | | | 00:00:00 |
| 41 | 刘润民 | | | | | | | | | 0.0% | | | | | | 00:00:00 |
| 42 | 王成龙 | | | | | | | | | 0.0% | | | | | | 00:00:00 |
| 合计 | | 10/22 | 13/22 | 4/11 | 3/4 | 2/2 | 1/1 | 2/3 | 35/65 | 53.8% | 9 | 17 | 2 | 5 | | |
| <i>(守门员)</i> | | | | | | | | | | | | | | | | |
| 21 | 李明 | 2/10 | 5/12 | 1/6 | 3/8 | 0/3 | 0/1 | 0/4 | 11/44 | 25.0% | | 1 | | 1 | | 00:58:04 |
| 32 | 许浩翔 | 0/1 | 0/1 | | 1/2 | | | | 1/4 | 25.0% | | | | | | 00:01:56 |
| 合计 | | 2/11 | 5/13 | 1/6 | 4/10 | 0/3 | 0/1 | 0/4 | 12/48 | 25.0% | | 1 | | 1 | | |

场上队员：得分/射门

守门员：救球/射门

| 全队合计 | 得分 | 被救 | 射失 | 击柱 | 封球 | 合计 | % |
|------|----|----|----|----|----|----|--------|
| 远射 | 10 | 7 | 1 | 2 | 2 | 22 | 45.5% |
| 近射 | 13 | 3 | 1 | 4 | 1 | 22 | 59.1% |
| 边射 | 4 | 4 | 1 | 2 | | 11 | 36.4% |
| 快攻 | 3 | 1 | | | | 4 | 75.0% |
| 突破 | 2 | | | | | 2 | 100.0% |
| 任意 | 1 | | | | | 1 | 100.0% |
| 7M | 2 | 1 | | | | 3 | 66.7% |





2016年“体彩杯”全国手球男子青年锦标赛

图式射门区域统计

轮次 7 场次 42

201602042-41-1/1

四川队

| | | | | | | | | | | | | | | | | | | | | | | | | | | | | | | | | | | | | | | | | | | | | | | | | | | | | | | | | | | | | | | | | | | | | | | | | | | | | | | | |
|--|-----------------------------|-----------------------------|-----------------------------|-----------------------------|-----------------------------|-----------------------------|-----------------------------|--|--|--|---|--|---|---|--|---|---|---|---|---|--|--|---|--|--|--|--|--|--|--|--|--|--|--|--|--|--|---|---|---|---|--|---|---|--|---|---|--|--|--|--|---|---|--|--|---|--|--|---|--|--|--|--|---|--|---|--|--|--|--|--|--|--|--|--|--|--|--|--|
| 1 宋继强 | 3 刘赵梁 | 5 王凯 | 7 仇瑞祥 | 8 罗尧尧 | 9 许翔宇 | 10 徐彦昊 | 11 张天豪 | | | | | | | | | | | | | | | | | | | | | | | | | | | | | | | | | | | | | | | | | | | | | | | | | | | | | | | | | | | | | | | | | | | | | | | | |
| <table border="1"><tr><td></td><td></td><td></td></tr><tr><td></td><td></td><td></td></tr><tr><td></td><td></td><td></td></tr></table> | | | | | | | | | | <table border="1"><tr><td></td><td></td><td>1</td></tr><tr><td>2</td><td></td><td>2</td></tr><tr><td>1</td><td>1</td><td>1</td></tr></table> | | | 1 | 2 | | 2 | 1 | 1 | 1 | <table border="1"><tr><td></td><td></td><td>1</td></tr><tr><td></td><td></td><td></td></tr><tr><td></td><td></td><td></td></tr></table> | | | 1 | | | | | | | <table border="1"><tr><td></td><td></td><td></td></tr><tr><td></td><td></td><td></td></tr><tr><td></td><td></td><td></td></tr></table> | | | | | | | | | | <table border="1"><tr><td>2</td><td></td><td>2</td></tr><tr><td>3</td><td></td><td>2</td></tr><tr><td>2</td><td></td><td></td></tr></table> | 2 | | 2 | 3 | | 2 | 2 | | | <table border="1"><tr><td></td><td>1</td><td>1</td></tr><tr><td></td><td></td><td>1</td></tr><tr><td></td><td></td><td>1</td></tr></table> | | 1 | 1 | | | 1 | | | 1 | <table border="1"><tr><td></td><td></td><td></td></tr><tr><td>3</td><td></td><td>1</td></tr><tr><td></td><td></td><td></td></tr></table> | | | | 3 | | 1 | | | | <table border="1"><tr><td></td><td></td><td></td></tr><tr><td></td><td></td><td></td></tr><tr><td></td><td></td><td></td></tr></table> | | | | | | | | | |
| | | | | | | | | | | | | | | | | | | | | | | | | | | | | | | | | | | | | | | | | | | | | | | | | | | | | | | | | | | | | | | | | | | | | | | | | | | | | | | | |
| | | | | | | | | | | | | | | | | | | | | | | | | | | | | | | | | | | | | | | | | | | | | | | | | | | | | | | | | | | | | | | | | | | | | | | | | | | | | | | | |
| | | | | | | | | | | | | | | | | | | | | | | | | | | | | | | | | | | | | | | | | | | | | | | | | | | | | | | | | | | | | | | | | | | | | | | | | | | | | | | | |
| | | 1 | | | | | | | | | | | | | | | | | | | | | | | | | | | | | | | | | | | | | | | | | | | | | | | | | | | | | | | | | | | | | | | | | | | | | | | | | | | | | |
| 2 | | 2 | | | | | | | | | | | | | | | | | | | | | | | | | | | | | | | | | | | | | | | | | | | | | | | | | | | | | | | | | | | | | | | | | | | | | | | | | | | | | |
| 1 | 1 | 1 | | | | | | | | | | | | | | | | | | | | | | | | | | | | | | | | | | | | | | | | | | | | | | | | | | | | | | | | | | | | | | | | | | | | | | | | | | | | | |
| | | 1 | | | | | | | | | | | | | | | | | | | | | | | | | | | | | | | | | | | | | | | | | | | | | | | | | | | | | | | | | | | | | | | | | | | | | | | | | | | | | |
| | | | | | | | | | | | | | | | | | | | | | | | | | | | | | | | | | | | | | | | | | | | | | | | | | | | | | | | | | | | | | | | | | | | | | | | | | | | | | | | |
| | | | | | | | | | | | | | | | | | | | | | | | | | | | | | | | | | | | | | | | | | | | | | | | | | | | | | | | | | | | | | | | | | | | | | | | | | | | | | | | |
| | | | | | | | | | | | | | | | | | | | | | | | | | | | | | | | | | | | | | | | | | | | | | | | | | | | | | | | | | | | | | | | | | | | | | | | | | | | | | | | |
| | | | | | | | | | | | | | | | | | | | | | | | | | | | | | | | | | | | | | | | | | | | | | | | | | | | | | | | | | | | | | | | | | | | | | | | | | | | | | | | |
| | | | | | | | | | | | | | | | | | | | | | | | | | | | | | | | | | | | | | | | | | | | | | | | | | | | | | | | | | | | | | | | | | | | | | | | | | | | | | | | |
| 2 | | 2 | | | | | | | | | | | | | | | | | | | | | | | | | | | | | | | | | | | | | | | | | | | | | | | | | | | | | | | | | | | | | | | | | | | | | | | | | | | | | |
| 3 | | 2 | | | | | | | | | | | | | | | | | | | | | | | | | | | | | | | | | | | | | | | | | | | | | | | | | | | | | | | | | | | | | | | | | | | | | | | | | | | | | |
| 2 | | | | | | | | | | | | | | | | | | | | | | | | | | | | | | | | | | | | | | | | | | | | | | | | | | | | | | | | | | | | | | | | | | | | | | | | | | | | | | | |
| | 1 | 1 | | | | | | | | | | | | | | | | | | | | | | | | | | | | | | | | | | | | | | | | | | | | | | | | | | | | | | | | | | | | | | | | | | | | | | | | | | | | | |
| | | 1 | | | | | | | | | | | | | | | | | | | | | | | | | | | | | | | | | | | | | | | | | | | | | | | | | | | | | | | | | | | | | | | | | | | | | | | | | | | | | |
| | | 1 | | | | | | | | | | | | | | | | | | | | | | | | | | | | | | | | | | | | | | | | | | | | | | | | | | | | | | | | | | | | | | | | | | | | | | | | | | | | | |
| | | | | | | | | | | | | | | | | | | | | | | | | | | | | | | | | | | | | | | | | | | | | | | | | | | | | | | | | | | | | | | | | | | | | | | | | | | | | | | | |
| 3 | | 1 | | | | | | | | | | | | | | | | | | | | | | | | | | | | | | | | | | | | | | | | | | | | | | | | | | | | | | | | | | | | | | | | | | | | | | | | | | | | | |
| | | | | | | | | | | | | | | | | | | | | | | | | | | | | | | | | | | | | | | | | | | | | | | | | | | | | | | | | | | | | | | | | | | | | | | | | | | | | | | | |
| | | | | | | | | | | | | | | | | | | | | | | | | | | | | | | | | | | | | | | | | | | | | | | | | | | | | | | | | | | | | | | | | | | | | | | | | | | | | | | | |
| | | | | | | | | | | | | | | | | | | | | | | | | | | | | | | | | | | | | | | | | | | | | | | | | | | | | | | | | | | | | | | | | | | | | | | | | | | | | | | | |
| | | | | | | | | | | | | | | | | | | | | | | | | | | | | | | | | | | | | | | | | | | | | | | | | | | | | | | | | | | | | | | | | | | | | | | | | | | | | | | | |
| Post - 0 Miss - 0 Block - 0 | Post - 0 Miss - 2 Block - 0 | Post - 0 Miss - 0 Block - 0 | Post - 0 Miss - 0 Block - 0 | Post - 0 Miss - 1 Block - 2 | Post - 0 Miss - 0 Block - 1 | Post - 1 Miss - 2 Block - 2 | Post - 0 Miss - 0 Block - 0 | | | | | | | | | | | | | | | | | | | | | | | | | | | | | | | | | | | | | | | | | | | | | | | | | | | | | | | | | | | | | | | | | | | | | | | | |
| 12 刘树豪 | 13 尹文珂 | 15 徐逸 | 17 谢庆龙 | 18 张睿梁 | 19 庞连康 | 20 张文健 | 21 曹修庆 | | | | | | | | | | | | | | | | | | | | | | | | | | | | | | | | | | | | | | | | | | | | | | | | | | | | | | | | | | | | | | | | | | | | | | | | |
| <table border="1"><tr><td></td><td></td><td></td></tr><tr><td></td><td></td><td></td></tr><tr><td></td><td></td><td></td></tr></table> | | | | | | | | | | <table border="1"><tr><td>1</td><td></td><td></td></tr><tr><td></td><td></td><td></td></tr><tr><td></td><td></td><td></td></tr></table> | 1 | | | | | | | | | <table border="1"><tr><td></td><td></td><td></td></tr><tr><td></td><td></td><td></td></tr><tr><td></td><td></td><td></td></tr></table> | | | | | | | | | | <table border="1"><tr><td></td><td></td><td></td></tr><tr><td></td><td></td><td></td></tr><tr><td></td><td>1</td><td>1</td></tr></table> | | | | | | | | 1 | 1 | <table border="1"><tr><td></td><td></td><td></td></tr><tr><td></td><td></td><td></td></tr><tr><td></td><td></td><td></td></tr></table> | | | | | | | | | | <table border="1"><tr><td></td><td>2</td><td>1</td></tr><tr><td></td><td></td><td></td></tr><tr><td></td><td></td><td>2</td></tr></table> | | 2 | 1 | | | | | | 2 | <table border="1"><tr><td></td><td></td><td></td></tr><tr><td></td><td></td><td></td></tr><tr><td></td><td></td><td></td></tr></table> | | | | | | | | | | <table border="1"><tr><td></td><td></td><td></td></tr><tr><td></td><td></td><td></td></tr><tr><td></td><td></td><td></td></tr></table> | | | | | | | | | |
| | | | | | | | | | | | | | | | | | | | | | | | | | | | | | | | | | | | | | | | | | | | | | | | | | | | | | | | | | | | | | | | | | | | | | | | | | | | | | | | |
| | | | | | | | | | | | | | | | | | | | | | | | | | | | | | | | | | | | | | | | | | | | | | | | | | | | | | | | | | | | | | | | | | | | | | | | | | | | | | | | |
| | | | | | | | | | | | | | | | | | | | | | | | | | | | | | | | | | | | | | | | | | | | | | | | | | | | | | | | | | | | | | | | | | | | | | | | | | | | | | | | |
| 1 | | | | | | | | | | | | | | | | | | | | | | | | | | | | | | | | | | | | | | | | | | | | | | | | | | | | | | | | | | | | | | | | | | | | | | | | | | | | | | | |
| | | | | | | | | | | | | | | | | | | | | | | | | | | | | | | | | | | | | | | | | | | | | | | | | | | | | | | | | | | | | | | | | | | | | | | | | | | | | | | | |
| | | | | | | | | | | | | | | | | | | | | | | | | | | | | | | | | | | | | | | | | | | | | | | | | | | | | | | | | | | | | | | | | | | | | | | | | | | | | | | | |
| | | | | | | | | | | | | | | | | | | | | | | | | | | | | | | | | | | | | | | | | | | | | | | | | | | | | | | | | | | | | | | | | | | | | | | | | | | | | | | | |
| | | | | | | | | | | | | | | | | | | | | | | | | | | | | | | | | | | | | | | | | | | | | | | | | | | | | | | | | | | | | | | | | | | | | | | | | | | | | | | | |
| | | | | | | | | | | | | | | | | | | | | | | | | | | | | | | | | | | | | | | | | | | | | | | | | | | | | | | | | | | | | | | | | | | | | | | | | | | | | | | | |
| | | | | | | | | | | | | | | | | | | | | | | | | | | | | | | | | | | | | | | | | | | | | | | | | | | | | | | | | | | | | | | | | | | | | | | | | | | | | | | | |
| | | | | | | | | | | | | | | | | | | | | | | | | | | | | | | | | | | | | | | | | | | | | | | | | | | | | | | | | | | | | | | | | | | | | | | | | | | | | | | | |
| | 1 | 1 | | | | | | | | | | | | | | | | | | | | | | | | | | | | | | | | | | | | | | | | | | | | | | | | | | | | | | | | | | | | | | | | | | | | | | | | | | | | | |
| | | | | | | | | | | | | | | | | | | | | | | | | | | | | | | | | | | | | | | | | | | | | | | | | | | | | | | | | | | | | | | | | | | | | | | | | | | | | | | | |
| | | | | | | | | | | | | | | | | | | | | | | | | | | | | | | | | | | | | | | | | | | | | | | | | | | | | | | | | | | | | | | | | | | | | | | | | | | | | | | | |
| | | | | | | | | | | | | | | | | | | | | | | | | | | | | | | | | | | | | | | | | | | | | | | | | | | | | | | | | | | | | | | | | | | | | | | | | | | | | | | | |
| | 2 | 1 | | | | | | | | | | | | | | | | | | | | | | | | | | | | | | | | | | | | | | | | | | | | | | | | | | | | | | | | | | | | | | | | | | | | | | | | | | | | | |
| | | | | | | | | | | | | | | | | | | | | | | | | | | | | | | | | | | | | | | | | | | | | | | | | | | | | | | | | | | | | | | | | | | | | | | | | | | | | | | | |
| | | 2 | | | | | | | | | | | | | | | | | | | | | | | | | | | | | | | | | | | | | | | | | | | | | | | | | | | | | | | | | | | | | | | | | | | | | | | | | | | | | |
| | | | | | | | | | | | | | | | | | | | | | | | | | | | | | | | | | | | | | | | | | | | | | | | | | | | | | | | | | | | | | | | | | | | | | | | | | | | | | | | |
| | | | | | | | | | | | | | | | | | | | | | | | | | | | | | | | | | | | | | | | | | | | | | | | | | | | | | | | | | | | | | | | | | | | | | | | | | | | | | | | |
| | | | | | | | | | | | | | | | | | | | | | | | | | | | | | | | | | | | | | | | | | | | | | | | | | | | | | | | | | | | | | | | | | | | | | | | | | | | | | | | |
| | | | | | | | | | | | | | | | | | | | | | | | | | | | | | | | | | | | | | | | | | | | | | | | | | | | | | | | | | | | | | | | | | | | | | | | | | | | | | | | |
| | | | | | | | | | | | | | | | | | | | | | | | | | | | | | | | | | | | | | | | | | | | | | | | | | | | | | | | | | | | | | | | | | | | | | | | | | | | | | | | |
| | | | | | | | | | | | | | | | | | | | | | | | | | | | | | | | | | | | | | | | | | | | | | | | | | | | | | | | | | | | | | | | | | | | | | | | | | | | | | | | |
| Post - 0 Miss - 0 Block - 0 | Post - 0 Miss - 0 Block - 0 | Post - 0 Miss - 0 Block - 0 | Post - 0 Miss - 0 Block - 0 | Post - 0 Miss - 0 Block - 0 | Post - 0 Miss - 0 Block - 0 | Post - 0 Miss - 0 Block - 0 | Post - 0 Miss - 0 Block - 0 | | | | | | | | | | | | | | | | | | | | | | | | | | | | | | | | | | | | | | | | | | | | | | | | | | | | | | | | | | | | | | | | | | | | | | | | |

12 刘树豪

| | | |
|-----|-----|-----|
| 0/7 | 0/2 | 1/3 |
| 5/9 | 3/5 | 3/9 |
| 1/7 | 2/4 | 1/5 |

| | | |
|--|--|--|
| | | |
| | | |
| | | |

| | | |
|--|--|--|
| | | |
| | | |
| | | |

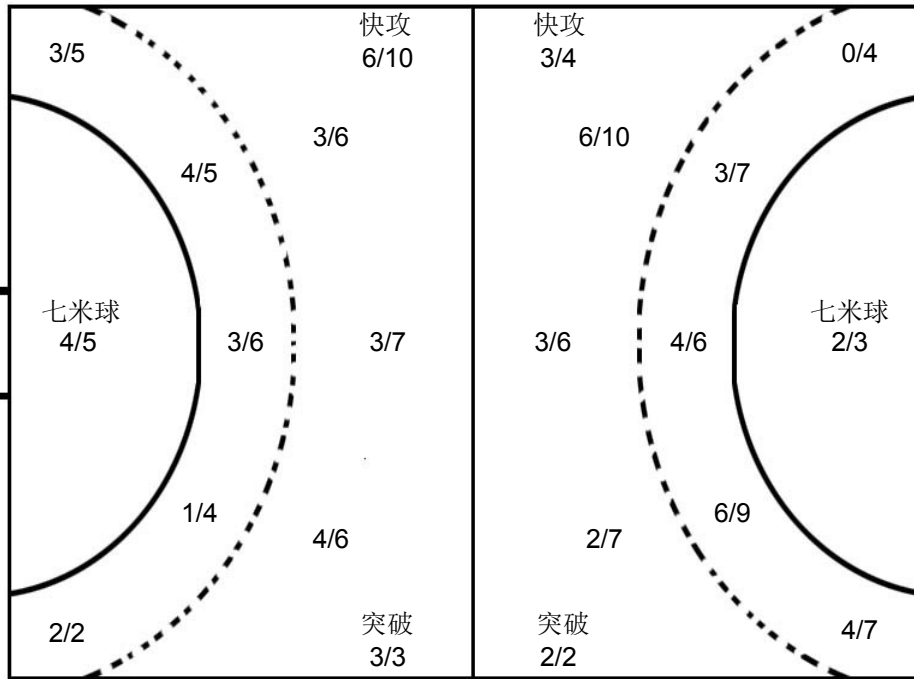

21 李明

| | | |
|-----|-----|-----|
| 1/6 | 1/2 | 1/7 |
| 1/9 | 1/1 | 4/9 |
| 1/4 | 1/3 | 0/3 |

32 许浩翔

| | | |
|--|--|-----|
| | | |
| | | 1/2 |
| | | 0/2 |

| | | |
|--|--|--|
| | | |
| | | |
| | | |

安徽队

| | | | | | | | | | | | | | | | | | | | | | | | | | | | | | | | | | | | | | | | | | | | | | | | | | | | | | | | | | | | | | | | | | | | | | | | | | | | | | | | |
|---|-----------------------------|-----------------------------|-----------------------------|-----------------------------|-----------------------------|-----------------------------|-----------------------------|--|--|---|---|--|--|--|--|--|--|--|--|---|---|--|--|---|--|--|--|---|--|--|---|---|---|--|--|---|---|--|---|--|---|--|--|--|---|--|---|---|--|--|---|---|--|---|---|---|--|--|---|--|--|--|--|--|--|--|--|--|--|--|--|--|--|--|--|--|--|--|--|
| 1 郭世伟 | 2 金勇峰 | 9 陈开勇 | 17 王巨柱 | 18 李双 | 19 何山 | 21 李明 | 24 徐安格 | | | | | | | | | | | | | | | | | | | | | | | | | | | | | | | | | | | | | | | | | | | | | | | | | | | | | | | | | | | | | | | | | | | | | | | | |
| <table border="1"><tr><td>1</td><td></td><td>1</td></tr><tr><td>1</td><td></td><td>2</td></tr><tr><td>2</td><td></td><td></td></tr></table> | 1 | | 1 | 1 | | 2 | 2 | | | <table border="1"><tr><td>1</td><td></td><td></td></tr><tr><td></td><td></td><td></td></tr><tr><td></td><td></td><td></td></tr></table> | 1 | | | | | | | | | <table border="1"><tr><td>1</td><td></td><td></td></tr><tr><td>2</td><td></td><td></td></tr><tr><td></td><td>1</td><td></td></tr></table> | 1 | | | 2 | | | | 1 | | <table border="1"><tr><td>1</td><td>1</td><td>1</td></tr><tr><td></td><td></td><td>3</td></tr><tr><td>1</td><td></td><td>3</td></tr></table> | 1 | 1 | 1 | | | 3 | 1 | | 3 | <table border="1"><tr><td>2</td><td></td><td></td></tr><tr><td></td><td>1</td><td></td></tr><tr><td>3</td><td>1</td><td></td></tr></table> | 2 | | | | 1 | | 3 | 1 | | <table border="1"><tr><td>1</td><td>1</td><td></td></tr><tr><td>1</td><td>1</td><td>1</td></tr><tr><td></td><td></td><td>1</td></tr></table> | 1 | 1 | | 1 | 1 | 1 | | | 1 | <table border="1"><tr><td></td><td></td><td></td></tr><tr><td></td><td></td><td></td></tr><tr><td></td><td></td><td></td></tr></table> | | | | | | | | | | <table border="1"><tr><td></td><td></td><td></td></tr><tr><td></td><td></td><td></td></tr><tr><td></td><td></td><td></td></tr></table> | | | | | | | | | |
| 1 | | 1 | | | | | | | | | | | | | | | | | | | | | | | | | | | | | | | | | | | | | | | | | | | | | | | | | | | | | | | | | | | | | | | | | | | | | | | | | | | | | |
| 1 | | 2 | | | | | | | | | | | | | | | | | | | | | | | | | | | | | | | | | | | | | | | | | | | | | | | | | | | | | | | | | | | | | | | | | | | | | | | | | | | | | |
| 2 | | | | | | | | | | | | | | | | | | | | | | | | | | | | | | | | | | | | | | | | | | | | | | | | | | | | | | | | | | | | | | | | | | | | | | | | | | | | | | | |
| 1 | | | | | | | | | | | | | | | | | | | | | | | | | | | | | | | | | | | | | | | | | | | | | | | | | | | | | | | | | | | | | | | | | | | | | | | | | | | | | | | |
| | | | | | | | | | | | | | | | | | | | | | | | | | | | | | | | | | | | | | | | | | | | | | | | | | | | | | | | | | | | | | | | | | | | | | | | | | | | | | | | |
| | | | | | | | | | | | | | | | | | | | | | | | | | | | | | | | | | | | | | | | | | | | | | | | | | | | | | | | | | | | | | | | | | | | | | | | | | | | | | | | |
| 1 | | | | | | | | | | | | | | | | | | | | | | | | | | | | | | | | | | | | | | | | | | | | | | | | | | | | | | | | | | | | | | | | | | | | | | | | | | | | | | | |
| 2 | | | | | | | | | | | | | | | | | | | | | | | | | | | | | | | | | | | | | | | | | | | | | | | | | | | | | | | | | | | | | | | | | | | | | | | | | | | | | | | |
| | 1 | | | | | | | | | | | | | | | | | | | | | | | | | | | | | | | | | | | | | | | | | | | | | | | | | | | | | | | | | | | | | | | | | | | | | | | | | | | | | | |
| 1 | 1 | 1 | | | | | | | | | | | | | | | | | | | | | | | | | | | | | | | | | | | | | | | | | | | | | | | | | | | | | | | | | | | | | | | | | | | | | | | | | | | | | |
| | | 3 | | | | | | | | | | | | | | | | | | | | | | | | | | | | | | | | | | | | | | | | | | | | | | | | | | | | | | | | | | | | | | | | | | | | | | | | | | | | | |
| 1 | | 3 | | | | | | | | | | | | | | | | | | | | | | | | | | | | | | | | | | | | | | | | | | | | | | | | | | | | | | | | | | | | | | | | | | | | | | | | | | | | | |
| 2 | | | | | | | | | | | | | | | | | | | | | | | | | | | | | | | | | | | | | | | | | | | | | | | | | | | | | | | | | | | | | | | | | | | | | | | | | | | | | | | |
| | 1 | | | | | | | | | | | | | | | | | | | | | | | | | | | | | | | | | | | | | | | | | | | | | | | | | | | | | | | | | | | | | | | | | | | | | | | | | | | | | | |
| 3 | 1 | | | | | | | | | | | | | | | | | | | | | | | | | | | | | | | | | | | | | | | | | | | | | | | | | | | | | | | | | | | | | | | | | | | | | | | | | | | | | | |
| 1 | 1 | | | | | | | | | | | | | | | | | | | | | | | | | | | | | | | | | | | | | | | | | | | | | | | | | | | | | | | | | | | | | | | | | | | | | | | | | | | | | | |
| 1 | 1 | 1 | | | | | | | | | | | | | | | | | | | | | | | | | | | | | | | | | | | | | | | | | | | | | | | | | | | | | | | | | | | | | | | | | | | | | | | | | | | | | |
| | | 1 | | | | | | | | | | | | | | | | | | | | | | | | | | | | | | | | | | | | | | | | | | | | | | | | | | | | | | | | | | | | | | | | | | | | | | | | | | | | | |
| | | | | | | | | | | | | | | | | | | | | | | | | | | | | | | | | | | | | | | | | | | | | | | | | | | | | | | | | | | | | | | | | | | | | | | | | | | | | | | | |
| | | | | | | | | | | | | | | | | | | | | | | | | | | | | | | | | | | | | | | | | | | | | | | | | | | | | | | | | | | | | | | | | | | | | | | | | | | | | | | | |
| | | | | | | | | | | | | | | | | | | | | | | | | | | | | | | | | | | | | | | | | | | | | | | | | | | | | | | | | | | | | | | | | | | | | | | | | | | | | | | | |
| | | | | | | | | | | | | | | | | | | | | | | | | | | | | | | | | | | | | | | | | | | | | | | | | | | | | | | | | | | | | | | | | | | | | | | | | | | | | | | | |
| | | | | | | | | | | | | | | | | | | | | | | | | | | | | | | | | | | | | | | | | | | | | | | | | | | | | | | | | | | | | | | | | | | | | | | | | | | | | | | | |
| | | | | | | | | | | | | | | | | | | | | | | | | | | | | | | | | | | | | | | | | | | | | | | | | | | | | | | | | | | | | | | | | | | | | | | | | | | | | | | | |
| Post - 1 Miss - 0 Block - 1 | Post - 1 Miss - 1 Block - 0 | Post - 1 Miss - 0 Block - 0 | Post - 4 Miss - 2 Block - 2 | Post - 0 Miss - 0 Block - 0 | Post - 1 Miss - 0 Block - 0 | Post - 0 Miss - 0 Block - 0 | Post - 0 Miss - 0 Block - 0 | | | | | | | | | | | | | | | | | | | | | | | | | | | | | | | | | | | | | | | | | | | | | | | | | | | | | | | | | | | | | | | | | | | | | | | | |
| 25 李文哲 | 26 程浩然 | 27 王长旭 | 28 丁浩然 | 32 许浩翔 | 33 姚紫祥 | 41 刘润民 | 42 王成龙 | | | | | | | | | | | | | | | | | | | | | | | | | | | | | | | | | | | | | | | | | | | | | | | | | | | | | | | | | | | | | | | | | | | | | | | | |
| <table border="1"><tr><td></td><td></td><td></td></tr><tr><td></td><td></td><td></td></tr><tr><td></td><td></td><td></td></tr></table> | | | | | | | | | | <table border="1"><tr><td></td><td></td><td></td></tr><tr><td></td><td></td><td></td></tr><tr><td></td><td></td><td></td></tr></table> | | | | | | | | | | <table border="1"><tr><td></td><td></td><td></td></tr><tr><td></td><td></td><td></td></tr><tr><td></td><td></td><td></td></tr></table> | | | | | | | | | | <table border="1"><tr><td></td><td></td><td></td></tr><tr><td></td><td></td><td></td></tr><tr><td></td><td></td><td></td></tr></table> | | | | | | | | | | <table border="1"><tr><td></td><td></td><td></td></tr><tr><td></td><td></td><td></td></tr><tr><td></td><td></td><td></td></tr></table> | | | | | | | | | | <table border="1"><tr><td></td><td></td><td></td></tr><tr><td></td><td></td><td></td></tr><tr><td></td><td></td><td></td></tr></table> | | | | | | | | | | <table border="1"><tr><td></td><td></td><td></td></tr><tr><td></td><td></td><td></td></tr><tr><td></td><td></td><td></td></tr></table> | | | | | | | | | | <table border="1"><tr><td></td><td></td><td></td></tr><tr><td></td><td></td><td></td></tr><tr><td></td><td></td><td></td></tr></table> | | | | | | | | | |
| | | | | | | | | | | | | | | | | | | | | | | | | | | | | | | | | | | | | | | | | | | | | | | | | | | | | | | | | | | | | | | | | | | | | | | | | | | | | | | | |
| | | | | | | | | | | | | | | | | | | | | | | | | | | | | | | | | | | | | | | | | | | | | | | | | | | | | | | | | | | | | | | | | | | | | | | | | | | | | | | | |
| | | | | | | | | | | | | | | | | | | | | | | | | | | | | | | | | | | | | | | | | | | | | | | | | | | | | | | | | | | | | | | | | | | | | | | | | | | | | | | | |
| | | | | | | | | | | | | | | | | | | | | | | | | | | | | | | | | | | | | | | | | | | | | | | | | | | | | | | | | | | | | | | | | | | | | | | | | | | | | | | | |
| | | | | | | | | | | | | | | | | | | | | | | | | | | | | | | | | | | | | | | | | | | | | | | | | | | | | | | | | | | | | | | | | | | | | | | | | | | | | | | | |
| | | | | | | | | | | | | | | | | | | | | | | | | | | | | | | | | | | | | | | | | | | | | | | | | | | | | | | | | | | | | | | | | | | | | | | | | | | | | | | | |
| | | | | | | | | | | | | | | | | | | | | | | | | | | | | | | | | | | | | | | | | | | | | | | | | | | | | | | | | | | | | | | | | | | | | | | | | | | | | | | | |
| | | | | | | | | | | | | | | | | | | | | | | | | | | | | | | | | | | | | | | | | | | | | | | | | | | | | | | | | | | | | | | | | | | | | | | | | | | | | | | | |
| | | | | | | | | | | | | | | | | | | | | | | | | | | | | | | | | | | | | | | | | | | | | | | | | | | | | | | | | | | | | | | | | | | | | | | | | | | | | | | | |
| | | | | | | | | | | | | | | | | | | | | | | | | | | | | | | | | | | | | | | | | | | | | | | | | | | | | | | | | | | | | | | | | | | | | | | | | | | | | | | | |
| | | | | | | | | | | | | | | | | | | | | | | | | | | | | | | | | | | | | | | | | | | | | | | | | | | | | | | | | | | | | | | | | | | | | | | | | | | | | | | | |
| | | | | | | | | | | | | | | | | | | | | | | | | | | | | | | | | | | | | | | | | | | | | | | | | | | | | | | | | | | | | | | | | | | | | | | | | | | | | | | | |
| | | | | | | | | | | | | | | | | | | | | | | | | | | | | | | | | | | | | | | | | | | | | | | | | | | | | | | | | | | | | | | | | | | | | | | | | | | | | | | | |
| | | | | | | | | | | | | | | | | | | | | | | | | | | | | | | | | | | | | | | | | | | | | | | | | | | | | | | | | | | | | | | | | | | | | | | | | | | | | | | | |
| | | | | | | | | | | | | | | | | | | | | | | | | | | | | | | | | | | | | | | | | | | | | | | | | | | | | | | | | | | | | | | | | | | | | | | | | | | | | | | | |
| | | | | | | | | | | | | | | | | | | | | | | | | | | | | | | | | | | | | | | | | | | | | | | | | | | | | | | | | | | | | | | | | | | | | | | | | | | | | | | | |
| | | | | | | | | | | | | | | | | | | | | | | | | | | | | | | | | | | | | | | | | | | | | | | | | | | | | | | | | | | | | | | | | | | | | | | | | | | | | | | | |
| | | | | | | | | | | | | | | | | | | | | | | | | | | | | | | | | | | | | | | | | | | | | | | | | | | | | | | | | | | | | | | | | | | | | | | | | | | | | | | | |
| | | | | | | | | | | | | | | | | | | | | | | | | | | | | | | | | | | | | | | | | | | | | | | | | | | | | | | | | | | | | | | | | | | | | | | | | | | | | | | | |
| | | | | | | | | | | | | | | | | | | | | | | | | | | | | | | | | | | | | | | | | | | | | | | | | | | | | | | | | | | | | | | | | | | | | | | | | | | | | | | | |
| | | | | | | | | | | | | | | | | | | | | | | | | | | | | | | | | | | | | | | | | | | | | | | | | | | | | | | | | | | | | | | | | | | | | | | | | | | | | | | | |
| | | | | | | | | | | | | | | | | | | | | | | | | | | | | | | | | | | | | | | | | | | | | | | | | | | | | | | | | | | | | | | | | | | | | | | | | | | | | | | | |
| | | | | | | | | | | | | | | | | | | | | | | | | | | | | | | | | | | | | | | | | | | | | | | | | | | | | | | | | | | | | | | | | | | | | | | | | | | | | | | | |
| | | | | | | | | | | | | | | | | | | | | | | | | | | | | | | | | | | | | | | | | | | | | | | | | | | | | | | | | | | | | | | | | | | | | | | | | | | | | | | | |
| Post - 0 Miss - 0 Block - 0 | Post - 0 Miss - 0 Block - 0 | Post - 0 Miss - 0 Block - 0 | Post - 0 Miss - 0 Block - 0 | Post - 0 Miss - 0 Block - 0 | Post - 0 Miss - 0 Block - 0 | Post - 0 Miss - 0 Block - 0 | Post - 0 Miss - 0 Block - 0 | | | | | | | | | | | | | | | | | | | | | | | | | | | | | | | | | | | | | | | | | | | | | | | | | | | | | | | | | | | | | | | | | | | | | | | | |

注释: Post=击柱 Miss=射失 Block=被封





7-8名

青年男子 全国比赛

2016年“体彩杯”全国手球男子青年锦标赛

| | | | | | | | | | | | | | | | | | | | | | |
|-------------------------|---|---------------------------------|---------------------|------------------------|------------------------------------|-------------------|----------|---------------------------|---------------------------------------|----------|----------|----------------------|---------------|----------|--|--|----|---|----|---|----|
| Team A A 解放军队 | | | | Team B B 江苏队 | | | | Match Number 43 | | | | | | | | | | | | | |
| played in China | | in the hall 重庆万州 | | on 29/03/2016 | | at 10:00 hours | | Spectators | | | | | | | | | | | | | |
| Half-time (30') | A 21 | B 15 | End of playing time | A 45 | B 33 | 1st extra time | A | B | 2nd extra time | A | B | After penalty throws | A | B | | | | | | | |
| Number of 7 m | A 2 / 2 | Team time-out 1 2 3 25:46 | | | Full name of players and officials | | | | Team time-out 1 2 3 17:54 47:44 | | | B 5 / 8 | Number of 7 m | | | | | | | | |
| No. | Team A | | | | | G | W | 2' | D | DR | No. | Team B | | | | | G | W | 2' | D | DR |
| 1 | 郭梦雨 | | | | | | | | | | 1 | 潘博琦 | | | | | | | | | |
| 3 | 张昌轲 | | | | | 8 | | 1 | | | 3 | 赵韦光 | | | | | | | | | |
| 4 | 张洋 | | | | | | | | | | 4 | 张瑞恒 | | | | | | | | | |
| 5 | 尹一楠 | | | | | | | | | | 6 | 季雨 | | | | | | | | | |
| 6 | 吴昊 | | | | | 6 | 1 | | | | 7 | 任超凡 | | | | | | | 1 | | |
| 7 | 姜钦 | | | | | 13 | | | | | 8 | 姜童耀 | | | | | | | | | |
| 8 | 邹峻楠 | | | | | | | | | | 9 | 王俊威 | | | | | 1 | | | | |
| 9 | 李天枢 | | | | | | | | | | 11 | 周傲 | | | | | 14 | | | | |
| 10 | 范保坤 | | | | | 1 | | | | | 13 | 尹吉祥 | | | | | 7 | | | | |
| 11 | 王誌汉 | | | | | 5 | | | | | 14 | 罗中熠 | | | | | | | | | |
| 12 | 左子健 | | | | | | | | | | 15 | 阎冠中 | | | | | 1 | | | | |
| 13 | 徐崧清 | | | | | 7 | 1 | | | | 17 | 马益奎 | | | | | 7 | 1 | | | |
| 14 | 孙耀琦 | | | | | 5 | 1 | | | | 18 | 耿畅 | | | | | 3 | 1 | 1 | | |
| 16 | 池猛 | | | | | | | | | | | | | | | | | | | | |
| 17 | 刘安宁 | | | | | | | | | | | | | | | | | | | | |
| A | 杜长义 (主教练) | | | | | | | | | | B | 贾淑君 (主教练) | | | | | | | | | |
| A | Signature of Responsible Official of the Teams (Off. A) | | | | | | | | | | B | | | | | | | | | | |
| TP | Remarks of Referee / CHA Official | | | | | | | | | | TP | | | | | | | | | | |

Signatures

| | | | | |
|------------------|-----------|-----------|--|--|
| Referees | 许翔 (CHN) | 王雨洋 (CHN) | | |
| Techn. Delegates | 杨凯 (CHN) | | | |
| CHA Official | 吴瑞亭 (CHN) | | | |

Note: Number of 7m Throws Awarded to Team A and B, Goals (G), Warnings (W), Suspensions (2'), Direct Disqualification (D), Disqualification with Report (DR) and Team Penalty (TP).

Table Officials:

Statisticians: 李双

刘永欢





2016年“体彩杯”全国手球男子青年锦标赛 竞赛技术统计(媒体表)

| | | | | | | |
|------|----|----------|----|----------|----|-----------|
| 7-8名 | 组别 | X | 轮次 | 8 | 场次 | 43 |
|------|----|----------|----|----------|----|-----------|

重庆万州

29/03/2016

201602043-51-1/1

| | | | | | | |
|----------------|------------|-----------|----|-----------|-----------|-----|
| 解放军队 | 解放军 | 45 | vs | 33 | 江苏 | 江苏队 |
| 21 : 15 | | | | | | |

| | | | |
|-----|----------|---|-----------|
| 裁判员 | 许翔 (CHN) | / | 王雨洋 (CHN) |
|-----|----------|---|-----------|

| 解放军 | | 远 | 近 | 边 | 快 | 突 | 任意 | 7m | 合计 | % | 助攻 | 失误 | 警告 | 2' | D & DR | 解放军 | | 比赛 | 江苏 | |
|--------------|-----|------|-------|-----|------|-----|-----|-----|-------|------|----|----|----|----|--------|-------------|-------|----|-------|-----|
| 主教练：杜长义 | | 射 | 射 | 射 | 攻 | 破 | 球 | 球 | | | | | | | | 进程 | | | | |
| 1 | 郭梦雨 | | | | | | | | | | | | | | | 7 | 姜钦 | 1 | 00:37 | 0 |
| 3 | 张昌轲 | 3/4 | 3/3 | | 1/1 | | | 1/1 | 8/9 | 88.9 | 6 | 6 | | 1 | | 3 | 张昌轲 | 2 | 01:29 | 0 |
| 4 | 张洋 | | | | | | | | | | | | | | | 6 | 吴昊 | 3 | 02:43 | 1 |
| 5 | 尹一楠 | | | | | | | | | | | | | | | 7 | 姜钦 | 4 | 03:46 | 1 |
| 6 | 吴昊 | | 6/7 | | | | | | 6/7 | 85.7 | | 2 | 1 | | | 6 | 吴昊 | 5 | 04:31 | 1 |
| 7 | 姜钦 | 4/5 | 4/5 | | | 3/3 | 1/2 | 1/1 | 13/16 | 81.3 | 8 | 9 | | | | 14 | 孙耀琦 | 6 | 05:08 | 1 |
| 8 | 邹峻楠 | | | | | | | | | | | | | | | 6 | 05:27 | 2 | 11 | 周傲 |
| 9 | 李天枢 | | | | | | | | | | | | | | | 6 | 07:30 | 3 | 11 | 周傲 |
| 10 | 范保坤 | | | 1/3 | | | | | 1/3 | 33.3 | | 1 | | | | 6 | 09:16 | 4 | 18 | 耿畅 |
| 11 | 王誌汉 | | 3/4 | 2/3 | 0/1 | | | | 5/8 | 62.5 | | 3 | | | | 7 | 09:34 | 4 | | |
| 12 | 左子健 | | | | | | | | | | | | | | | 7 | 10:19 | 5 | 11 | 周傲 |
| 13 | 徐峻清 | | 5/5 | 0/1 | 2/3 | | | | 7/9 | 77.8 | | 2 | 1 | | | 8 | 10:42 | 5 | | |
| 14 | 孙耀琦 | 1/1 | 3/7 | | 1/1 | | | | 5/9 | 55.6 | 2 | 3 | 1 | | | 10 | 范保坤 | 9 | 13:20 | 7 |
| 16 | 池猛 | | | | | | | | | | | | | | | 9 | 13:36 | 8 | 18 | 耿畅 |
| 17 | 刘安宁 | | | | | | | | | | | | | | | 6 | 15:55 | 8 | | |
| 运动员 合计 | | 8/10 | 24/31 | 3/7 | 4/6 | 3/3 | 1/2 | 2/2 | 45/61 | 73.8 | 16 | 26 | 3 | 1 | | 3 | 张昌轲 | 11 | 16:30 | 8 |
| 1 | 郭梦雨 | 5/9 | 12/30 | 3/4 | 3/7 | 2/3 | | 2/6 | 27/59 | 45.8 | | | | | | 3 | 张昌轲 | 12 | 17:04 | 8 |
| 12 | 左子健 | 1/1 | | | 2/2 | | | 0/1 | 3/4 | 75.0 | | | | | | 3 | 张昌轲 | 12 | 17:04 | 8 |
| 守门员 合计 | | 6/10 | 12/30 | 3/4 | 5/9 | 2/3 | | 2/7 | 30/63 | 47.6 | | | | | | 3 | 张昌轲 | 12 | 17:04 | 8 |
| 江苏 | | 远 | 近 | 边 | 快 | 突 | 任意 | 7m | 合计 | % | 助攻 | 失误 | 警告 | 2' | D & DR | 江苏 | | 比赛 | 江苏 | |
| 教练：贾淑君 | | 射 | 射 | 射 | 攻 | 破 | 球 | 球 | | | | | | | | 进程 | | | | |
| 1 | 潘博琦 | | | | | | | | | | | | | | | 3 | 张昌轲 | 22 | 00:31 | 15 |
| 3 | 赵韦光 | | | | | | | | | | | | | | | 22 | 00:48 | 16 | 17 | 马益奎 |
| 4 | 张瑞恒 | | | | | | | | | | | | | | | 22 | 01:17 | 17 | 17 | 马益奎 |
| 6 | 季雨 | | | | | | | | | | | | | | | 6 | 吴昊 | 23 | 01:35 | 17 |
| 7 | 任超凡 | | | 0/2 | | | | | 0/2 | 0.0 | | 3 | | 1 | | 14 | 孙耀琦 | 23 | 01:44 | 18 |
| 8 | 姜童耀 | | | | | | | | | | | | | | | 13 | 徐峻清 | 24 | 02:37 | 18 |
| 9 | 王俊威 | | 1/1 | 0/1 | | | | | 1/2 | 50.0 | 1 | | | | | 13 | 徐峻清 | 24 | 03:05 | 19 |
| 11 | 周傲 | 1/4 | 7/13 | 1/2 | 1/4 | | | 4/5 | 14/28 | 50.0 | 7 | 11 | | | | 6 | 吴昊 | 25 | 03:48 | 19 |
| 13 | 尹吉祥 | 3/7 | 3/8 | | 0/2 | 1/3 | | 0/2 | 7/22 | 31.8 | 1 | 4 | | | | 7 | 姜钦 | 25 | 04:37 | 20 |
| 14 | 罗中熠 | | | | | | | | | | | | | | | 11 | 王誌汉 | 26 | 04:57 | 20 |
| 15 | 阎冠中 | | 0/1 | | | | | 1/1 | 1/2 | 50.0 | | | | | | 11 | 王誌汉 | 26 | 05:23 | 21 |
| 17 | 马益奎 | 0/2 | 6/7 | | 1/1 | | | | 7/10 | 70.0 | 2 | 2 | 1 | | | 27 | 姜钦 | 27 | 06:14 | 22 |
| 18 | 耿畅 | 0/3 | 1/5 | 0/1 | 2/3 | | | | 3/12 | 25.0 | 1 | 2 | 1 | 1 | | 13 | 徐峻清 | 27 | 06:46 | 23 |
| 运动员 合计 | | 4/16 | 18/35 | 1/6 | 4/10 | 1/3 | | 5/8 | 33/78 | 42.3 | 13 | 22 | 2 | 2 | | 7 | 姜钦 | 28 | 07:09 | 23 |
| 4 | 张瑞恒 | 0/2 | 1/3 | 1/2 | 0/1 | | 0/1 | | 2/9 | 22.2 | | | | | | 13 | 徐峻清 | 29 | 07:28 | 23 |
| 14 | 罗中熠 | 1/7 | 5/27 | 2/4 | 1/4 | 0/3 | 1/1 | 0/2 | 10/48 | 20.8 | | | | | | 11 | 王誌汉 | 30 | 08:16 | 23 |
| 守门员 合计 | | 1/9 | 6/30 | 3/6 | 1/5 | 0/3 | 1/2 | 0/2 | 12/57 | 21.1 | | | | | | 13 | 徐峻清 | 31 | 09:13 | 23 |
| 场上队员：得分 / 射门 | | | | | | | | | | | | | | | | 守门员：救球 / 射门 | | | | |

| | | | | | | | | | | | | | |
|----|------------|--|----|--------------|--|-----|------------|--|-----|----------|--|----|---------|
| 快攻 | Fast Break | | 突破 | Breakthrough | | 任意球 | Free Throw | | 7M球 | 7M Throw | | 助攻 | Assist |
| 警告 | Warning | | 失误 | Error | | 2' | Suspension | | D | 取消资格 | | DR | 取消资格+报告 |





2016年“体彩杯”全国手球男子青年锦标赛 图式比赛技术统计表

轮次 8

场次 43

201602043-21-1/1

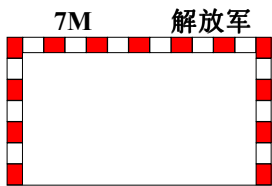
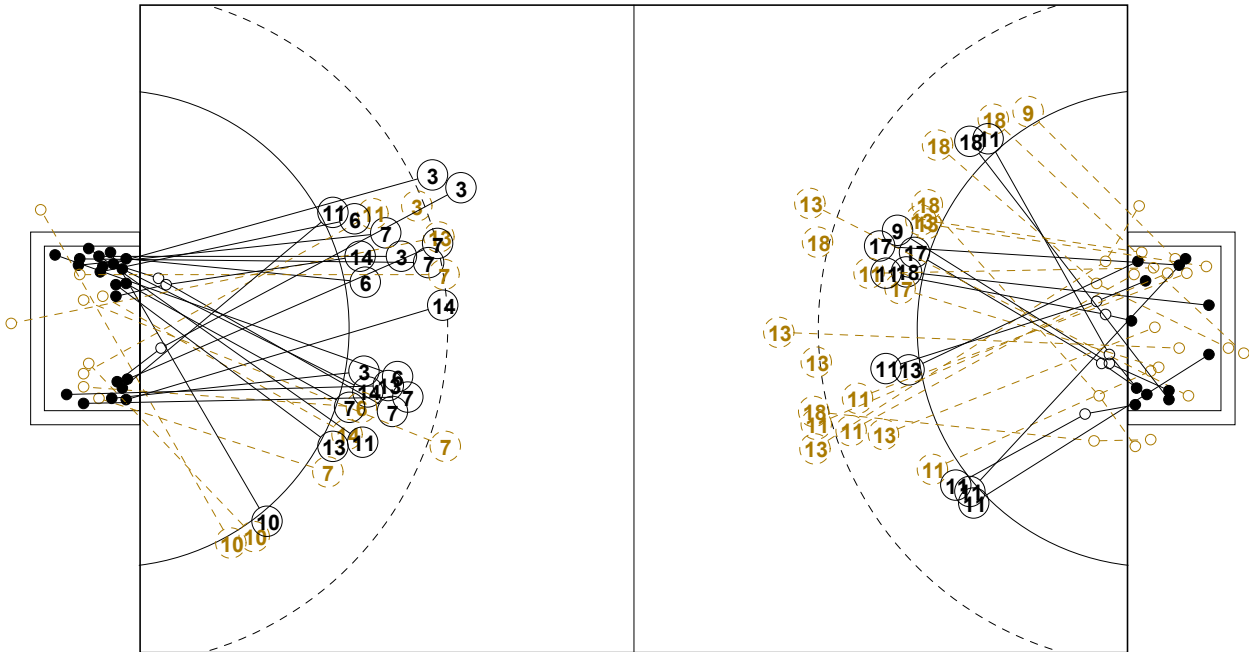

1st Half
21 : 15

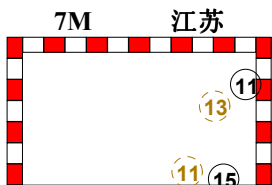
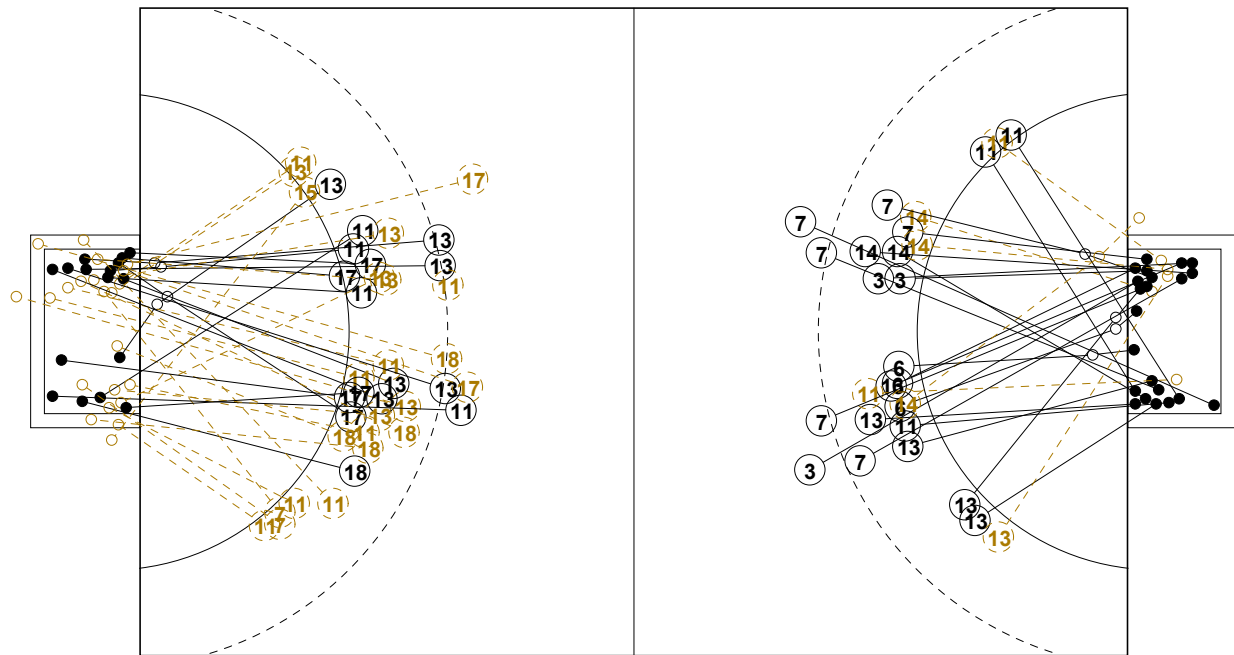
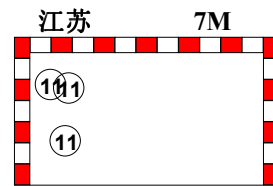

2nd Half
33 : 45

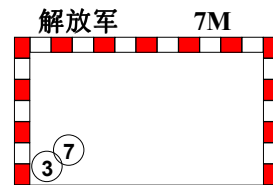



2016年“体彩杯”全国手球男子青年锦标赛

个人/全队技术统计表

正式表
手球
青年男子7-8名
轮次 8组别 X
场次 43201602043-14-1/2
重庆万州
29/03/2016 10:00

| 号码 | 姓名 | 远射 | 近射 | 边射 | 快攻 | 突破 | 任意 | 7M | 合计 | % | 助攻 | 失误 | 警告 | 2' | 取消 | 时间 |
|------------------|-----|------|-------|-----|-----|-----|-----|-----|-------|-------|----|----|----|----|----|----------|
| 解放军队(解放军) | | | | | | | | | | | | | | | | |
| <i>(场上队员)</i> | | | | | | | | | | | | | | | | |
| 1 | 郭梦雨 | | | | | | | | | 0.0% | | | | | | 00:57:30 |
| 3 | 张昌轲 | 3/4 | 3/3 | | 1/1 | | | 1/1 | 8/9 | 88.9% | 6 | 6 | | 1 | | 01:00:00 |
| 4 | 张洋 | | | | | | | | | 0.0% | | | | | | 00:00:00 |
| 5 | 尹一楠 | | | | | | | | | 0.0% | | | | | | 00:00:00 |
| 6 | 吴昊 | | 6/7 | | | | | | 6/7 | 85.7% | | 2 | | 1 | | 00:59:27 |
| 7 | 姜钦 | 4/5 | 4/5 | | | 3/3 | 1/2 | 1/1 | 13/16 | 81.3% | 8 | 9 | | | | 01:03:00 |
| 8 | 邹峻楠 | | | | | | | | | 0.0% | | | | | | 00:00:00 |
| 9 | 李天枢 | | | | | | | | | 0.0% | | | | | | 00:00:00 |
| 10 | 范保坤 | | | 1/3 | | | | | 1/3 | 33.3% | | 1 | | | | 00:11:26 |
| 11 | 王誌汉 | | 3/4 | 2/3 | 0/1 | | | | 5/8 | 62.5% | | 3 | | | | 00:54:01 |
| 12 | 左子健 | | | | | | | | | 0.0% | | | | | | 00:02:30 |
| 13 | 徐峻清 | | 5/5 | 0/1 | 2/3 | | | | 7/9 | 77.8% | | 2 | | 1 | | 01:00:00 |
| 14 | 孙耀琦 | 1/1 | 3/7 | | 1/1 | | | | 5/9 | 55.6% | 2 | 3 | | 1 | | 01:00:00 |
| 16 | 池猛 | | | | | | | | | 0.0% | | | | | | 00:00:00 |
| 17 | 刘安宁 | | | | | | | | | 0.0% | | | | | | 00:00:00 |
| 合计 | | 8/10 | 24/31 | 3/7 | 4/6 | 3/3 | 1/2 | 2/2 | 45/61 | 73.8% | 16 | 26 | 3 | 1 | | |
| <i>(守门员)</i> | | | | | | | | | | | | | | | | |
| 1 | 郭梦雨 | 5/9 | 12/30 | 3/4 | 3/7 | 2/3 | | 2/6 | 27/59 | 45.8% | | | | | | 00:57:30 |
| 12 | 左子健 | 1/1 | | | 2/2 | | | 0/1 | 3/4 | 75.0% | | | | | | 00:02:30 |
| 合计 | | 6/10 | 12/30 | 3/4 | 5/9 | 2/3 | | 2/7 | 30/63 | 47.6% | | | | | | |

场上队员：得分/射门

守门员：救球/射门

| 全队合计 | 得分 | 被救 | 射失 | 击柱 | 封球 | 合计 | % |
|------|----|----|----|----|----|----|--------|
| 远射 | 8 | 1 | | | 1 | 10 | 80.0% |
| 近射 | 24 | 6 | 1 | | | 31 | 77.4% |
| 边射 | 3 | 3 | 1 | | | 7 | 42.9% |
| 快攻 | 4 | 1 | 1 | | | 6 | 66.7% |
| 突破 | 3 | | | | | 3 | 100.0% |
| 任意 | 1 | 1 | | | | 2 | 50.0% |
| 7M | 2 | | | | | 2 | 100.0% |





2016年“体彩杯”全国手球男子青年锦标赛

个人/全队技术统计表

正式表
手球
青年男子7-8名
轮次 8组别 X
场次 43201602043-14-2/2
重庆万州
29/03/2016 10:00

| 号码 | 姓名 | 远射 | 近射 | 边射 | 快攻 | 突破 | 任意 | 7M | 合计 | % | 助攻 | 失误 | 警告 | 2' | 取消 | 时间 |
|--|-----|-----|------|-----|-----|-----|-----|-----|-------|-------|----|----|----|----|----|----------|
| 江苏队(江苏) | | | | | | | | | | | | | | | | |
| <i>(上场队员)</i> | | | | | | | | | | | | | | | | |
| 1 | 潘博琦 | | | | | | | | | 0.0% | | | | | | 00:00:00 |
| 3 | 赵韦光 | | | | | | | | | 0.0% | | | | | | 00:00:00 |
| 4 | 张瑞恒 | | | | | | | | | 0.0% | | | | | | 00:10:50 |
| 6 | 季雨 | | | | | | | | | 0.0% | 1 | | | | | 00:29:34 |
| 7 | 任超凡 | | | 0/2 | | | | | 0/2 | 0.0% | | 3 | | 1 | | 00:36:18 |
| 8 | 姜童耀 | | | | | | | | | 0.0% | | | | | | 00:00:00 |
| 9 | 王俊威 | | 1/1 | 0/1 | | | | | 1/2 | 50.0% | 1 | | | | | 00:34:03 |
| 11 | 周傲 | 1/4 | 7/13 | 1/2 | 1/4 | | | 4/5 | 14/28 | 50.0% | 7 | 11 | | | | 01:00:00 |
| 13 | 尹吉祥 | 3/7 | 3/8 | | 0/2 | 1/3 | | 0/2 | 7/22 | 31.8% | 1 | 4 | | | | 01:00:00 |
| 14 | 罗中熠 | | | | | | | | | 0.0% | | | | | | 00:49:10 |
| 15 | 阎冠中 | | 0/1 | | | | | 1/1 | 1/2 | 50.0% | | | | | | 00:20:05 |
| 17 | 马益奎 | 0/2 | 6/7 | | 1/1 | | | | 7/10 | 70.0% | 2 | 2 | 1 | | | 01:00:00 |
| 18 | 耿畅 | 0/3 | 1/5 | 0/1 | 2/3 | | | | 3/12 | 25.0% | 1 | 2 | 1 | 1 | | 01:00:00 |
| 合计 | | | | | | | | | | | | | | | | |
| <i>(守门员)</i> | | | | | | | | | | | | | | | | |
| 4 | 张瑞恒 | 0/2 | 1/3 | 1/2 | 0/1 | | 0/1 | | 2/9 | 22.2% | | | | | | 00:10:50 |
| 14 | 罗中熠 | 1/7 | 5/27 | 2/4 | 1/4 | 0/3 | 1/1 | 0/2 | 10/48 | 20.8% | | | | | | 00:49:10 |
| 合计 | | | | | | | | | | | | | | | | |
| 1/9 6/30 3/6 1/5 0/3 1/2 0/2 12/57 21.1% | | | | | | | | | | | | | | | | |

场上队员：得分/射门

守门员：救球/射门

| 全队合计 | 得分 | 被救 | 射失 | 击柱 | 封球 | 合计 | % |
|------|----|----|----|----|----|----|-------|
| 远射 | 4 | 6 | 2 | 1 | 3 | 16 | 25.0% |
| 近射 | 18 | 12 | 3 | 2 | | 35 | 51.4% |
| 边射 | 1 | 3 | 1 | 1 | | 6 | 16.7% |
| 快攻 | 4 | 5 | | 1 | | 10 | 40.0% |
| 突破 | 1 | 2 | | | | 3 | 33.3% |
| 任意 | | | | | | | 0.0% |
| 7M | 5 | 2 | 1 | | | 8 | 62.5% |





2016年“体彩杯”全国手球男子青年锦标赛

图式射门区域统计

轮次 8 场次 43

201602043-41-1/1

解放军队

| | | | | | | | | | | | | | | | | | | | | | | | | | | | | | | | | | | | | | | | | | | | | | | | | | | | | | | | | | | | | | | | | | | | | | | | | | | | | | | | |
|---|-----------------------------|-----------------------------|-----------------------------|-----------------------------|-----------------------------|-----------------------------|-----------------------------|--|---|---|---|--|--|--|--|---|---|--|---|--|--|--|--|--|--|--|--|--|--|--|---|--|--|---|--|--|---|--|---|---|---|--|---|--|--|---|---|---|---|--|--|--|---|--|--|---|---|--|---|--|--|--|--|--|--|--|--|--|--|--|--|--|--|--|--|--|--|--|--|
| 1 郭梦雨 | 3 张昌轲 | 4 张洋 | 5 尹一楠 | 6 吴昊 | 7 姜钦 | 8 邹峻楠 | 9 李天枢 | | | | | | | | | | | | | | | | | | | | | | | | | | | | | | | | | | | | | | | | | | | | | | | | | | | | | | | | | | | | | | | | | | | | | | | | |
| <table border="1"><tr><td></td><td></td><td></td></tr><tr><td></td><td></td><td></td></tr><tr><td></td><td></td><td></td></tr></table> | | | | | | | | | | <table border="1"><tr><td>1</td><td></td><td></td></tr><tr><td></td><td></td><td>2</td></tr><tr><td>5</td><td></td><td></td></tr></table> | 1 | | | | | 2 | 5 | | | <table border="1"><tr><td></td><td></td><td></td></tr><tr><td></td><td></td><td></td></tr><tr><td></td><td></td><td></td></tr></table> | | | | | | | | | | <table border="1"><tr><td></td><td></td><td></td></tr><tr><td></td><td></td><td></td></tr><tr><td></td><td></td><td></td></tr></table> | | | | | | | | | | <table border="1"><tr><td></td><td></td><td>1</td></tr><tr><td></td><td></td><td>1</td></tr><tr><td>1</td><td>2</td><td>1</td></tr></table> | | | 1 | | | 1 | 1 | 2 | 1 | <table border="1"><tr><td></td><td></td><td>1</td></tr><tr><td></td><td></td><td>3</td></tr><tr><td>5</td><td></td><td>2</td></tr></table> | | | 1 | | | 3 | 5 | | 2 | <table border="1"><tr><td></td><td></td><td></td></tr><tr><td></td><td></td><td></td></tr><tr><td></td><td></td><td></td></tr></table> | | | | | | | | | | <table border="1"><tr><td></td><td></td><td></td></tr><tr><td></td><td></td><td></td></tr><tr><td></td><td></td><td></td></tr></table> | | | | | | | | | |
| | | | | | | | | | | | | | | | | | | | | | | | | | | | | | | | | | | | | | | | | | | | | | | | | | | | | | | | | | | | | | | | | | | | | | | | | | | | | | | | |
| | | | | | | | | | | | | | | | | | | | | | | | | | | | | | | | | | | | | | | | | | | | | | | | | | | | | | | | | | | | | | | | | | | | | | | | | | | | | | | | |
| | | | | | | | | | | | | | | | | | | | | | | | | | | | | | | | | | | | | | | | | | | | | | | | | | | | | | | | | | | | | | | | | | | | | | | | | | | | | | | | |
| 1 | | | | | | | | | | | | | | | | | | | | | | | | | | | | | | | | | | | | | | | | | | | | | | | | | | | | | | | | | | | | | | | | | | | | | | | | | | | | | | | |
| | | 2 | | | | | | | | | | | | | | | | | | | | | | | | | | | | | | | | | | | | | | | | | | | | | | | | | | | | | | | | | | | | | | | | | | | | | | | | | | | | | |
| 5 | | | | | | | | | | | | | | | | | | | | | | | | | | | | | | | | | | | | | | | | | | | | | | | | | | | | | | | | | | | | | | | | | | | | | | | | | | | | | | | |
| | | | | | | | | | | | | | | | | | | | | | | | | | | | | | | | | | | | | | | | | | | | | | | | | | | | | | | | | | | | | | | | | | | | | | | | | | | | | | | | |
| | | | | | | | | | | | | | | | | | | | | | | | | | | | | | | | | | | | | | | | | | | | | | | | | | | | | | | | | | | | | | | | | | | | | | | | | | | | | | | | |
| | | | | | | | | | | | | | | | | | | | | | | | | | | | | | | | | | | | | | | | | | | | | | | | | | | | | | | | | | | | | | | | | | | | | | | | | | | | | | | | |
| | | | | | | | | | | | | | | | | | | | | | | | | | | | | | | | | | | | | | | | | | | | | | | | | | | | | | | | | | | | | | | | | | | | | | | | | | | | | | | | |
| | | | | | | | | | | | | | | | | | | | | | | | | | | | | | | | | | | | | | | | | | | | | | | | | | | | | | | | | | | | | | | | | | | | | | | | | | | | | | | | |
| | | | | | | | | | | | | | | | | | | | | | | | | | | | | | | | | | | | | | | | | | | | | | | | | | | | | | | | | | | | | | | | | | | | | | | | | | | | | | | | |
| | | 1 | | | | | | | | | | | | | | | | | | | | | | | | | | | | | | | | | | | | | | | | | | | | | | | | | | | | | | | | | | | | | | | | | | | | | | | | | | | | | |
| | | 1 | | | | | | | | | | | | | | | | | | | | | | | | | | | | | | | | | | | | | | | | | | | | | | | | | | | | | | | | | | | | | | | | | | | | | | | | | | | | | |
| 1 | 2 | 1 | | | | | | | | | | | | | | | | | | | | | | | | | | | | | | | | | | | | | | | | | | | | | | | | | | | | | | | | | | | | | | | | | | | | | | | | | | | | | |
| | | 1 | | | | | | | | | | | | | | | | | | | | | | | | | | | | | | | | | | | | | | | | | | | | | | | | | | | | | | | | | | | | | | | | | | | | | | | | | | | | | |
| | | 3 | | | | | | | | | | | | | | | | | | | | | | | | | | | | | | | | | | | | | | | | | | | | | | | | | | | | | | | | | | | | | | | | | | | | | | | | | | | | | |
| 5 | | 2 | | | | | | | | | | | | | | | | | | | | | | | | | | | | | | | | | | | | | | | | | | | | | | | | | | | | | | | | | | | | | | | | | | | | | | | | | | | | | |
| | | | | | | | | | | | | | | | | | | | | | | | | | | | | | | | | | | | | | | | | | | | | | | | | | | | | | | | | | | | | | | | | | | | | | | | | | | | | | | | |
| | | | | | | | | | | | | | | | | | | | | | | | | | | | | | | | | | | | | | | | | | | | | | | | | | | | | | | | | | | | | | | | | | | | | | | | | | | | | | | | |
| | | | | | | | | | | | | | | | | | | | | | | | | | | | | | | | | | | | | | | | | | | | | | | | | | | | | | | | | | | | | | | | | | | | | | | | | | | | | | | | |
| | | | | | | | | | | | | | | | | | | | | | | | | | | | | | | | | | | | | | | | | | | | | | | | | | | | | | | | | | | | | | | | | | | | | | | | | | | | | | | | |
| | | | | | | | | | | | | | | | | | | | | | | | | | | | | | | | | | | | | | | | | | | | | | | | | | | | | | | | | | | | | | | | | | | | | | | | | | | | | | | | |
| | | | | | | | | | | | | | | | | | | | | | | | | | | | | | | | | | | | | | | | | | | | | | | | | | | | | | | | | | | | | | | | | | | | | | | | | | | | | | | | |
| Post - 0 Miss - 0 Block - 0 | Post - 0 Miss - 0 Block - 1 | Post - 0 Miss - 0 Block - 0 | Post - 0 Miss - 0 Block - 0 | Post - 0 Miss - 0 Block - 0 | Post - 0 Miss - 0 Block - 0 | Post - 0 Miss - 0 Block - 0 | Post - 0 Miss - 0 Block - 0 | | | | | | | | | | | | | | | | | | | | | | | | | | | | | | | | | | | | | | | | | | | | | | | | | | | | | | | | | | | | | | | | | | | | | | | | |
| 10 范保坤 | 11 王誌汉 | 12 左子健 | 13 徐崧清 | 14 孙耀琦 | 16 池猛 | 17 刘安宁 | | | | | | | | | | | | | | | | | | | | | | | | | | | | | | | | | | | | | | | | | | | | | | | | | | | | | | | | | | | | | | | | | | | | | | | | | |
| <table border="1"><tr><td></td><td></td><td></td></tr><tr><td></td><td></td><td></td></tr><tr><td></td><td></td><td>1</td></tr></table> | | | | | | | | | 1 | <table border="1"><tr><td></td><td></td><td></td></tr><tr><td></td><td></td><td>3</td></tr><tr><td>1</td><td></td><td>1</td></tr></table> | | | | | | 3 | 1 | | 1 | <table border="1"><tr><td></td><td></td><td></td></tr><tr><td></td><td></td><td></td></tr><tr><td></td><td></td><td></td></tr></table> | | | | | | | | | | <table border="1"><tr><td>1</td><td></td><td></td></tr><tr><td>1</td><td></td><td></td></tr><tr><td>1</td><td></td><td>4</td></tr></table> | 1 | | | 1 | | | 1 | | 4 | <table border="1"><tr><td>1</td><td></td><td></td></tr><tr><td></td><td></td><td></td></tr><tr><td>1</td><td></td><td>3</td></tr></table> | 1 | | | | | | 1 | | 3 | <table border="1"><tr><td></td><td></td><td></td></tr><tr><td></td><td></td><td></td></tr><tr><td></td><td></td><td></td></tr></table> | | | | | | | | | | <table border="1"><tr><td></td><td></td><td></td></tr><tr><td></td><td></td><td></td></tr><tr><td></td><td></td><td></td></tr></table> | | | | | | | | | | <table border="1"><tr><td></td><td></td><td></td></tr><tr><td></td><td></td><td></td></tr><tr><td></td><td></td><td></td></tr></table> | | | | | | | | | |
| | | | | | | | | | | | | | | | | | | | | | | | | | | | | | | | | | | | | | | | | | | | | | | | | | | | | | | | | | | | | | | | | | | | | | | | | | | | | | | | |
| | | | | | | | | | | | | | | | | | | | | | | | | | | | | | | | | | | | | | | | | | | | | | | | | | | | | | | | | | | | | | | | | | | | | | | | | | | | | | | | |
| | | 1 | | | | | | | | | | | | | | | | | | | | | | | | | | | | | | | | | | | | | | | | | | | | | | | | | | | | | | | | | | | | | | | | | | | | | | | | | | | | | |
| | | | | | | | | | | | | | | | | | | | | | | | | | | | | | | | | | | | | | | | | | | | | | | | | | | | | | | | | | | | | | | | | | | | | | | | | | | | | | | | |
| | | 3 | | | | | | | | | | | | | | | | | | | | | | | | | | | | | | | | | | | | | | | | | | | | | | | | | | | | | | | | | | | | | | | | | | | | | | | | | | | | | |
| 1 | | 1 | | | | | | | | | | | | | | | | | | | | | | | | | | | | | | | | | | | | | | | | | | | | | | | | | | | | | | | | | | | | | | | | | | | | | | | | | | | | | |
| | | | | | | | | | | | | | | | | | | | | | | | | | | | | | | | | | | | | | | | | | | | | | | | | | | | | | | | | | | | | | | | | | | | | | | | | | | | | | | | |
| | | | | | | | | | | | | | | | | | | | | | | | | | | | | | | | | | | | | | | | | | | | | | | | | | | | | | | | | | | | | | | | | | | | | | | | | | | | | | | | |
| | | | | | | | | | | | | | | | | | | | | | | | | | | | | | | | | | | | | | | | | | | | | | | | | | | | | | | | | | | | | | | | | | | | | | | | | | | | | | | | |
| 1 | | | | | | | | | | | | | | | | | | | | | | | | | | | | | | | | | | | | | | | | | | | | | | | | | | | | | | | | | | | | | | | | | | | | | | | | | | | | | | | |
| 1 | | | | | | | | | | | | | | | | | | | | | | | | | | | | | | | | | | | | | | | | | | | | | | | | | | | | | | | | | | | | | | | | | | | | | | | | | | | | | | | |
| 1 | | 4 | | | | | | | | | | | | | | | | | | | | | | | | | | | | | | | | | | | | | | | | | | | | | | | | | | | | | | | | | | | | | | | | | | | | | | | | | | | | | |
| 1 | | | | | | | | | | | | | | | | | | | | | | | | | | | | | | | | | | | | | | | | | | | | | | | | | | | | | | | | | | | | | | | | | | | | | | | | | | | | | | | |
| | | | | | | | | | | | | | | | | | | | | | | | | | | | | | | | | | | | | | | | | | | | | | | | | | | | | | | | | | | | | | | | | | | | | | | | | | | | | | | | |
| 1 | | 3 | | | | | | | | | | | | | | | | | | | | | | | | | | | | | | | | | | | | | | | | | | | | | | | | | | | | | | | | | | | | | | | | | | | | | | | | | | | | | |
| | | | | | | | | | | | | | | | | | | | | | | | | | | | | | | | | | | | | | | | | | | | | | | | | | | | | | | | | | | | | | | | | | | | | | | | | | | | | | | | |
| | | | | | | | | | | | | | | | | | | | | | | | | | | | | | | | | | | | | | | | | | | | | | | | | | | | | | | | | | | | | | | | | | | | | | | | | | | | | | | | |
| | | | | | | | | | | | | | | | | | | | | | | | | | | | | | | | | | | | | | | | | | | | | | | | | | | | | | | | | | | | | | | | | | | | | | | | | | | | | | | | |
| | | | | | | | | | | | | | | | | | | | | | | | | | | | | | | | | | | | | | | | | | | | | | | | | | | | | | | | | | | | | | | | | | | | | | | | | | | | | | | | |
| | | | | | | | | | | | | | | | | | | | | | | | | | | | | | | | | | | | | | | | | | | | | | | | | | | | | | | | | | | | | | | | | | | | | | | | | | | | | | | | |
| | | | | | | | | | | | | | | | | | | | | | | | | | | | | | | | | | | | | | | | | | | | | | | | | | | | | | | | | | | | | | | | | | | | | | | | | | | | | | | | |
| | | | | | | | | | | | | | | | | | | | | | | | | | | | | | | | | | | | | | | | | | | | | | | | | | | | | | | | | | | | | | | | | | | | | | | | | | | | | | | | |
| | | | | | | | | | | | | | | | | | | | | | | | | | | | | | | | | | | | | | | | | | | | | | | | | | | | | | | | | | | | | | | | | | | | | | | | | | | | | | | | |
| | | | | | | | | | | | | | | | | | | | | | | | | | | | | | | | | | | | | | | | | | | | | | | | | | | | | | | | | | | | | | | | | | | | | | | | | | | | | | | | |
| Post - 0 Miss - 1 Block - 0 | Post - 0 Miss - 0 Block - 0 | Post - 0 Miss - 0 Block - 0 | Post - 0 Miss - 1 Block - 0 | Post - 0 Miss - 1 Block - 0 | Post - 0 Miss - 0 Block - 0 | Post - 0 Miss - 0 Block - 0 | | | | | | | | | | | | | | | | | | | | | | | | | | | | | | | | | | | | | | | | | | | | | | | | | | | | | | | | | | | | | | | | | | | | | | | | | |

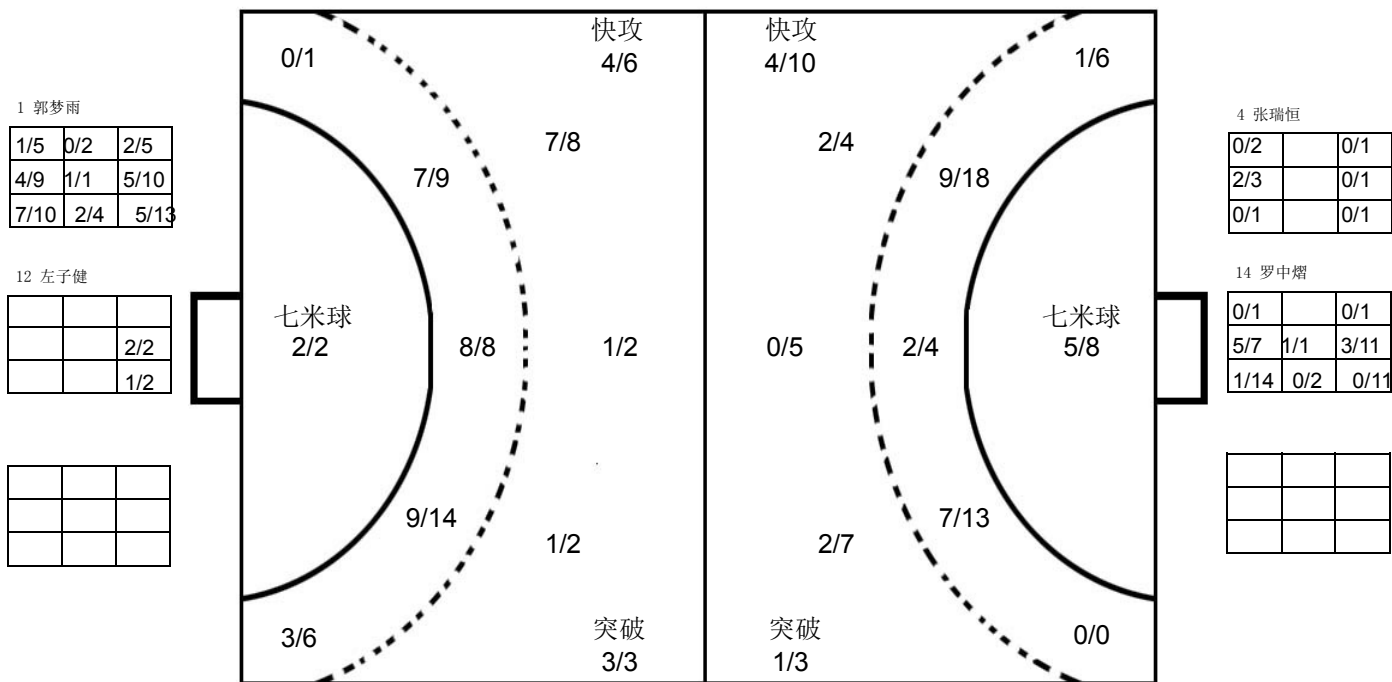

江苏队

| | | | | | | | | | | | | | | | | | | | | | | | | | | | | | | | | | | | | | | | | | | | | | | | | | | | | | | | | | | | | | | | | | | | | | | | | | | | | | | | |
|---|-----------------------------|-----------------------------|-----------------------------|-----------------------------|-----------------------------|-----------------------------|-----------------------------|---|---|--|--|--|--|--|--|--|--|--|--|---|--|--|--|--|--|--|--|--|---|--|---|--|--|---|--|--|---|--|---|---|--|---|--|---|--|---|--|--|--|--|--|--|--|--|--|--|--|--|--|---|--|--|--|--|--|---|--|--|--|--|---|---|---|---|--|---|---|---|---|
| 1 潘博琦 | 3 赵韦光 | 4 张瑞恒 | 6 季雨 | 7 任超凡 | 8 姜童耀 | 9 王俊威 | 11 周傲 | | | | | | | | | | | | | | | | | | | | | | | | | | | | | | | | | | | | | | | | | | | | | | | | | | | | | | | | | | | | | | | | | | | | | | | | |
| <table border="1"><tr><td></td><td></td><td></td></tr><tr><td></td><td></td><td></td></tr><tr><td></td><td></td><td></td></tr></table> | | | | | | | | | | <table border="1"><tr><td></td><td></td><td></td></tr><tr><td></td><td></td><td></td></tr><tr><td></td><td></td><td></td></tr></table> | | | | | | | | | | <table border="1"><tr><td></td><td></td><td></td></tr><tr><td></td><td></td><td></td></tr><tr><td></td><td></td><td></td></tr></table> | | | | | | | | | | <table border="1"><tr><td></td><td></td><td></td></tr><tr><td></td><td></td><td></td></tr><tr><td></td><td></td><td></td></tr></table> | | | | | | | | | | <table border="1"><tr><td></td><td></td><td></td></tr><tr><td></td><td></td><td></td></tr><tr><td></td><td></td><td></td></tr></table> | | | | | | | | | | <table border="1"><tr><td></td><td></td><td></td></tr><tr><td></td><td></td><td></td></tr><tr><td></td><td></td><td></td></tr></table> | | | | | | | | | | <table border="1"><tr><td></td><td></td><td></td></tr><tr><td></td><td></td><td>1</td></tr><tr><td></td><td></td><td></td></tr></table> | | | | | | 1 | | | | <table border="1"><tr><td>3</td><td>1</td><td>1</td></tr><tr><td>3</td><td></td><td>1</td></tr><tr><td>1</td><td>1</td><td>3</td></tr></table> | 3 | 1 | 1 | 3 | | 1 | 1 | 1 | 3 |
| | | | | | | | | | | | | | | | | | | | | | | | | | | | | | | | | | | | | | | | | | | | | | | | | | | | | | | | | | | | | | | | | | | | | | | | | | | | | | | | |
| | | | | | | | | | | | | | | | | | | | | | | | | | | | | | | | | | | | | | | | | | | | | | | | | | | | | | | | | | | | | | | | | | | | | | | | | | | | | | | | |
| | | | | | | | | | | | | | | | | | | | | | | | | | | | | | | | | | | | | | | | | | | | | | | | | | | | | | | | | | | | | | | | | | | | | | | | | | | | | | | | |
| | | | | | | | | | | | | | | | | | | | | | | | | | | | | | | | | | | | | | | | | | | | | | | | | | | | | | | | | | | | | | | | | | | | | | | | | | | | | | | | |
| | | | | | | | | | | | | | | | | | | | | | | | | | | | | | | | | | | | | | | | | | | | | | | | | | | | | | | | | | | | | | | | | | | | | | | | | | | | | | | | |
| | | | | | | | | | | | | | | | | | | | | | | | | | | | | | | | | | | | | | | | | | | | | | | | | | | | | | | | | | | | | | | | | | | | | | | | | | | | | | | | |
| | | | | | | | | | | | | | | | | | | | | | | | | | | | | | | | | | | | | | | | | | | | | | | | | | | | | | | | | | | | | | | | | | | | | | | | | | | | | | | | |
| | | | | | | | | | | | | | | | | | | | | | | | | | | | | | | | | | | | | | | | | | | | | | | | | | | | | | | | | | | | | | | | | | | | | | | | | | | | | | | | |
| | | | | | | | | | | | | | | | | | | | | | | | | | | | | | | | | | | | | | | | | | | | | | | | | | | | | | | | | | | | | | | | | | | | | | | | | | | | | | | | |
| | | | | | | | | | | | | | | | | | | | | | | | | | | | | | | | | | | | | | | | | | | | | | | | | | | | | | | | | | | | | | | | | | | | | | | | | | | | | | | | |
| | | | | | | | | | | | | | | | | | | | | | | | | | | | | | | | | | | | | | | | | | | | | | | | | | | | | | | | | | | | | | | | | | | | | | | | | | | | | | | | |
| | | | | | | | | | | | | | | | | | | | | | | | | | | | | | | | | | | | | | | | | | | | | | | | | | | | | | | | | | | | | | | | | | | | | | | | | | | | | | | | |
| | | | | | | | | | | | | | | | | | | | | | | | | | | | | | | | | | | | | | | | | | | | | | | | | | | | | | | | | | | | | | | | | | | | | | | | | | | | | | | | |
| | | | | | | | | | | | | | | | | | | | | | | | | | | | | | | | | | | | | | | | | | | | | | | | | | | | | | | | | | | | | | | | | | | | | | | | | | | | | | | | |
| | | | | | | | | | | | | | | | | | | | | | | | | | | | | | | | | | | | | | | | | | | | | | | | | | | | | | | | | | | | | | | | | | | | | | | | | | | | | | | | |
| | | | | | | | | | | | | | | | | | | | | | | | | | | | | | | | | | | | | | | | | | | | | | | | | | | | | | | | | | | | | | | | | | | | | | | | | | | | | | | | |
| | | | | | | | | | | | | | | | | | | | | | | | | | | | | | | | | | | | | | | | | | | | | | | | | | | | | | | | | | | | | | | | | | | | | | | | | | | | | | | | |
| | | | | | | | | | | | | | | | | | | | | | | | | | | | | | | | | | | | | | | | | | | | | | | | | | | | | | | | | | | | | | | | | | | | | | | | | | | | | | | | |
| | | | | | | | | | | | | | | | | | | | | | | | | | | | | | | | | | | | | | | | | | | | | | | | | | | | | | | | | | | | | | | | | | | | | | | | | | | | | | | | |
| | | 1 | | | | | | | | | | | | | | | | | | | | | | | | | | | | | | | | | | | | | | | | | | | | | | | | | | | | | | | | | | | | | | | | | | | | | | | | | | | | | |
| | | | | | | | | | | | | | | | | | | | | | | | | | | | | | | | | | | | | | | | | | | | | | | | | | | | | | | | | | | | | | | | | | | | | | | | | | | | | | | | |
| 3 | 1 | 1 | | | | | | | | | | | | | | | | | | | | | | | | | | | | | | | | | | | | | | | | | | | | | | | | | | | | | | | | | | | | | | | | | | | | | | | | | | | | | |
| 3 | | 1 | | | | | | | | | | | | | | | | | | | | | | | | | | | | | | | | | | | | | | | | | | | | | | | | | | | | | | | | | | | | | | | | | | | | | | | | | | | | | |
| 1 | 1 | 3 | | | | | | | | | | | | | | | | | | | | | | | | | | | | | | | | | | | | | | | | | | | | | | | | | | | | | | | | | | | | | | | | | | | | | | | | | | | | | |
| Post - 0 Miss - 0 Block - 0 | Post - 0 Miss - 0 Block - 0 | Post - 0 Miss - 0 Block - 0 | Post - 0 Miss - 0 Block - 0 | Post - 0 Miss - 0 Block - 0 | Post - 0 Miss - 0 Block - 0 | Post - 0 Miss - 0 Block - 0 | Post - 2 Miss - 0 Block - 1 | | | | | | | | | | | | | | | | | | | | | | | | | | | | | | | | | | | | | | | | | | | | | | | | | | | | | | | | | | | | | | | | | | | | | | | | |
| 13 尹吉祥 | 14 罗中熠 | 15 阎冠中 | 17 马益奎 | 18 耿畅 | | | | | | | | | | | | | | | | | | | | | | | | | | | | | | | | | | | | | | | | | | | | | | | | | | | | | | | | | | | | | | | | | | | | | | | | | | | |
| <table border="1"><tr><td></td><td></td><td>2</td></tr><tr><td></td><td></td><td>2</td></tr><tr><td>1</td><td>1</td><td>1</td></tr></table> | | | 2 | | | 2 | 1 | 1 | 1 | <table border="1"><tr><td></td><td></td><td></td></tr><tr><td></td><td></td><td></td></tr><tr><td></td><td></td><td></td></tr></table> | | | | | | | | | | <table border="1"><tr><td></td><td></td><td></td></tr><tr><td></td><td></td><td></td></tr><tr><td></td><td></td><td>1</td></tr></table> | | | | | | | | | 1 | <table border="1"><tr><td>1</td><td></td><td></td></tr><tr><td>1</td><td></td><td></td></tr><tr><td>1</td><td></td><td>4</td></tr></table> | 1 | | | 1 | | | 1 | | 4 | <table border="1"><tr><td></td><td>1</td><td></td></tr><tr><td>1</td><td></td><td>1</td></tr><tr><td></td><td></td><td></td></tr></table> | | 1 | | 1 | | 1 | | | | <table border="1"><tr><td></td><td></td><td></td></tr><tr><td></td><td></td><td></td></tr><tr><td></td><td></td><td></td></tr></table> | | | | | | | | | | <table border="1"><tr><td></td><td></td><td></td></tr><tr><td></td><td></td><td></td></tr><tr><td></td><td></td><td></td></tr></table> | | | | | | | | | | <table border="1"><tr><td></td><td></td><td></td></tr><tr><td></td><td></td><td></td></tr><tr><td></td><td></td><td></td></tr></table> | | | | | | | | | |
| | | 2 | | | | | | | | | | | | | | | | | | | | | | | | | | | | | | | | | | | | | | | | | | | | | | | | | | | | | | | | | | | | | | | | | | | | | | | | | | | | | |
| | | 2 | | | | | | | | | | | | | | | | | | | | | | | | | | | | | | | | | | | | | | | | | | | | | | | | | | | | | | | | | | | | | | | | | | | | | | | | | | | | | |
| 1 | 1 | 1 | | | | | | | | | | | | | | | | | | | | | | | | | | | | | | | | | | | | | | | | | | | | | | | | | | | | | | | | | | | | | | | | | | | | | | | | | | | | | |
| | | | | | | | | | | | | | | | | | | | | | | | | | | | | | | | | | | | | | | | | | | | | | | | | | | | | | | | | | | | | | | | | | | | | | | | | | | | | | | | |
| | | | | | | | | | | | | | | | | | | | | | | | | | | | | | | | | | | | | | | | | | | | | | | | | | | | | | | | | | | | | | | | | | | | | | | | | | | | | | | | |
| | | | | | | | | | | | | | | | | | | | | | | | | | | | | | | | | | | | | | | | | | | | | | | | | | | | | | | | | | | | | | | | | | | | | | | | | | | | | | | | |
| | | | | | | | | | | | | | | | | | | | | | | | | | | | | | | | | | | | | | | | | | | | | | | | | | | | | | | | | | | | | | | | | | | | | | | | | | | | | | | | |
| | | | | | | | | | | | | | | | | | | | | | | | | | | | | | | | | | | | | | | | | | | | | | | | | | | | | | | | | | | | | | | | | | | | | | | | | | | | | | | | |
| | | 1 | | | | | | | | | | | | | | | | | | | | | | | | | | | | | | | | | | | | | | | | | | | | | | | | | | | | | | | | | | | | | | | | | | | | | | | | | | | | | |
| 1 | | | | | | | | | | | | | | | | | | | | | | | | | | | | | | | | | | | | | | | | | | | | | | | | | | | | | | | | | | | | | | | | | | | | | | | | | | | | | | | |
| 1 | | | | | | | | | | | | | | | | | | | | | | | | | | | | | | | | | | | | | | | | | | | | | | | | | | | | | | | | | | | | | | | | | | | | | | | | | | | | | | | |
| 1 | | 4 | | | | | | | | | | | | | | | | | | | | | | | | | | | | | | | | | | | | | | | | | | | | | | | | | | | | | | | | | | | | | | | | | | | | | | | | | | | | | |
| | 1 | | | | | | | | | | | | | | | | | | | | | | | | | | | | | | | | | | | | | | | | | | | | | | | | | | | | | | | | | | | | | | | | | | | | | | | | | | | | | | |
| 1 | | 1 | | | | | | | | | | | | | | | | | | | | | | | | | | | | | | | | | | | | | | | | | | | | | | | | | | | | | | | | | | | | | | | | | | | | | | | | | | | | | |
| | | | | | | | | | | | | | | | | | | | | | | | | | | | | | | | | | | | | | | | | | | | | | | | | | | | | | | | | | | | | | | | | | | | | | | | | | | | | | | | |
| | | | | | | | | | | | | | | | | | | | | | | | | | | | | | | | | | | | | | | | | | | | | | | | | | | | | | | | | | | | | | | | | | | | | | | | | | | | | | | | |
| | | | | | | | | | | | | | | | | | | | | | | | | | | | | | | | | | | | | | | | | | | | | | | | | | | | | | | | | | | | | | | | | | | | | | | | | | | | | | | | |
| | | | | | | | | | | | | | | | | | | | | | | | | | | | | | | | | | | | | | | | | | | | | | | | | | | | | | | | | | | | | | | | | | | | | | | | | | | | | | | | |
| | | | | | | | | | | | | | | | | | | | | | | | | | | | | | | | | | | | | | | | | | | | | | | | | | | | | | | | | | | | | | | | | | | | | | | | | | | | | | | | |
| | | | | | | | | | | | | | | | | | | | | | | | | | | | | | | | | | | | | | | | | | | | | | | | | | | | | | | | | | | | | | | | | | | | | | | | | | | | | | | | |
| | | | | | | | | | | | | | | | | | | | | | | | | | | | | | | | | | | | | | | | | | | | | | | | | | | | | | | | | | | | | | | | | | | | | | | | | | | | | | | | |
| | | | | | | | | | | | | | | | | | | | | | | | | | | | | | | | | | | | | | | | | | | | | | | | | | | | | | | | | | | | | | | | | | | | | | | | | | | | | | | | |
| | | | | | | | | | | | | | | | | | | | | | | | | | | | | | | | | | | | | | | | | | | | | | | | | | | | | | | | | | | | | | | | | | | | | | | | | | | | | | | | |
| | | | | | | | | | | | | | | | | | | | | | | | | | | | | | | | | | | | | | | | | | | | | | | | | | | | | | | | | | | | | | | | | | | | | | | | | | | | | | | | |
| Post - 0 Miss - 3 Block - 1 | Post - 0 Miss - 0 Block - 0 | Post - 0 Miss - 1 Block - 0 | Post - 0 Miss - 0 Block - 0 | Post - 3 Miss - 3 Block - 1 | | | | | | | | | | | | | | | | | | | | | | | | | | | | | | | | | | | | | | | | | | | | | | | | | | | | | | | | | | | | | | | | | | | | | | | | | | | |

注释: Post=击柱 Miss=射失 Block=被封



5-6名
青年男子 全国比赛

2016年“体彩杯”全国手球男子青年锦标赛

| | | | | | | | | | | | | | | | | | | | | | |
|--------------------|---|---------------------|---------------------|------------------|------------------------------------|-------------------|---|---------------------------|----------------|----|-----|----------------------|---------------|---|--|--|---|---|----|---|----|
| Team A A 北京队 | | | | Team B B 广东队 | | | | Match Number 44 | | | | | | | | | | | | | |
| played in China | | in the hall 重庆万州 | | on 29/03/2016 | | at 13:00 hours | | Spectators | | | | | | | | | | | | | |
| Half-time (30') | A 11 | B 16 | End of playing time | A 27 | B 38 | 1st extra time | A | B | 2nd extra time | A | B | After penalty throws | A | B | | | | | | | |
| Number of 7 m | A 2/4 | Team time-out | | | Full name of players and officials | | | | Team time-out | | | B 1/2 | Number of 7 m | | | | | | | | |
| | | 1 | 2 | 3 | | | | | 1 | 2 | 3 | | | | | | | | | | |
| No. | Team A | | | | | G | W | 2' | D | DR | No. | Team B | | | | | G | W | 2' | D | DR |
| 3 | 王哲一 | | | | | 1 | | | | | 1 | 王帅 | | | | | | | | | |
| 4 | 朱广刚 | | | | | 6 | | | | | 2 | 姚雪岩 | | | | | 7 | 1 | | | |
| 6 | 赵一涵 | | | | | 5 | 1 | 1 | | | 4 | 高玉杰 | | | | | 2 | | 1 | | |
| 7 | 卞友山 | | | | | 3 | | | | | 5 | 黄培杰 | | | | | 6 | 1 | 1 | | |
| 11 | 李旭 | | | | | 1 | 1 | | | | 7 | 段飞宇 | | | | | 3 | | | | |
| 15 | 逯明松 | | | | | | | | | | 9 | 周凯峰 | | | | | | | | | |
| 16 | 马佳鹏 | | | | | | | | | | 10 | 周仲坤 | | | | | 4 | | | | |
| 18 | 李明远 | | | | | 3 | | | | | 11 | 胡国富 | | | | | 6 | | 1 | | |
| 19 | 陈旭 | | | | | | | | | | 12 | 李壮 | | | | | 1 | | | | |
| 23 | 刘帅 | | | | | | | | | | 13 | 蔡杰 | | | | | | | | | |
| 25 | 张斌 | | | | | 2 | | | | | 14 | 王泽润 | | | | | | | | | |
| 26 | 吴锐樊 | | | | | 2 | | | | | 15 | 张建杰 | | | | | 9 | 1 | | | |
| 35 | 高云健 | | | | | | | | | | 16 | 王猛 | | | | | | | | | |
| 36 | 王鹏皓 | | | | | 4 | | | | | 18 | 李文金 | | | | | | | | | |
| B | 吴健 (主教练) | | | | | | | | | | B | 刘康伶 (主教练) | | | | | 1 | | | | |
| C | 宋刚 | | | | | | | | | | C | 刘文宁 | | | | | | | | | |
| D | 陈璇 | | | | | | | | | | D | 王永存 | | | | | | | | | |
| A | Signature of Responsible Official of the Teams (Off. A) | | | | | | | | | | | | | | | | | | B | | |
| TP | Remarks of Referee / CHA Official | | | | | | | | | | | | | | | | | | TP | | |

Signatures

| | | | | |
|------------------|-----------|-----------|--|--|
| Referees | 程钰峰 (CHN) | 周云磊 (CHN) | | |
| Techn. Delegates | 徐健 (CHN) | | | |
| CHA Official | 张春生 (CHN) | | | |

Note: Number of 7m Throws Awarded to Team A and B, Goals (G), Warnings (W), Suspensions (2'), Direct Disqualification (D), Disqualification with Report (DR) and Team Penalty (TP).

Table Officials:

Statisticians: 李双

刘永欢





2016年“体彩杯”全国手球男子青年锦标赛 图式比赛技术统计表

轮次 8

场次 44

201602044-21-1/1

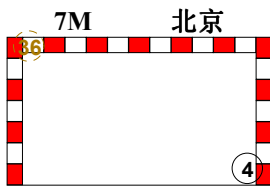
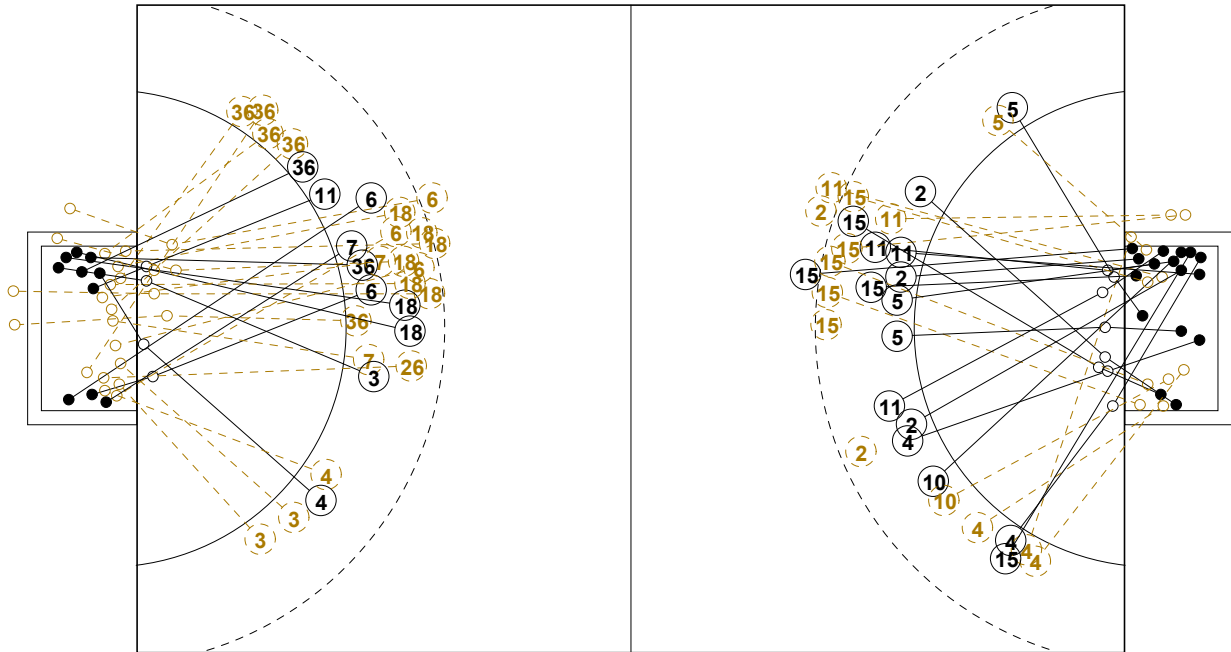

1st Half
11 : 16

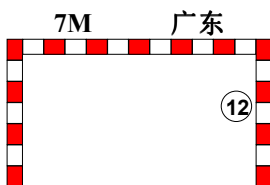
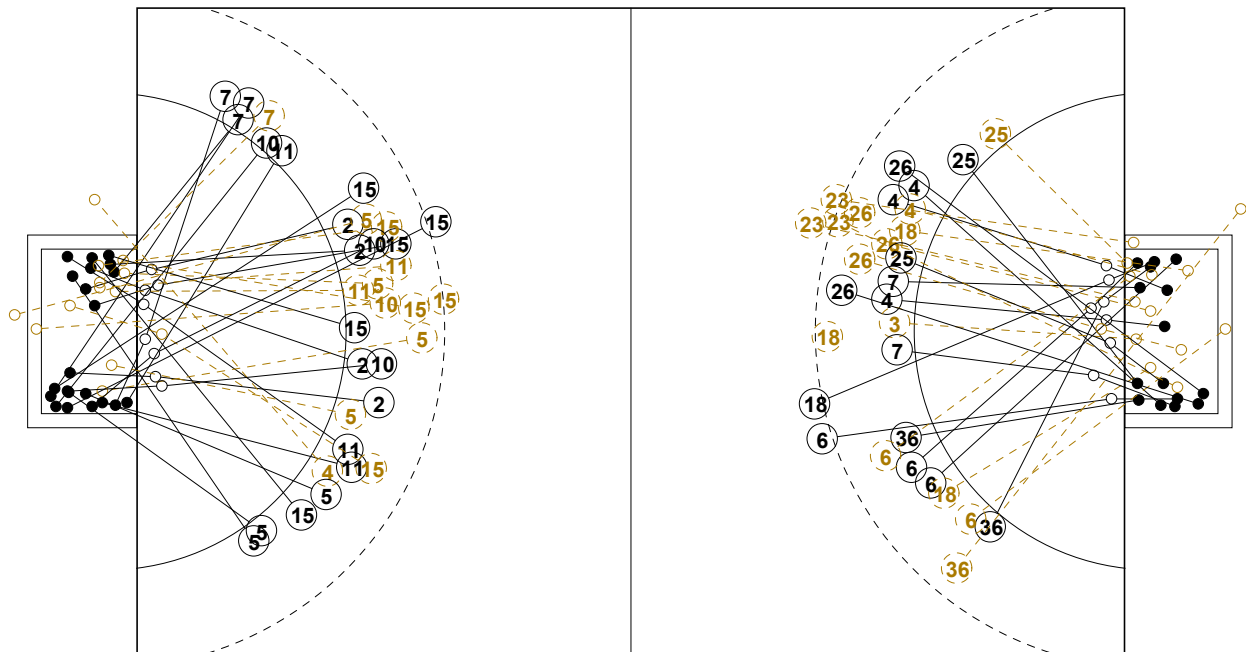
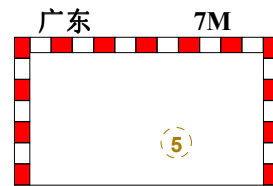

2nd Half
38 : 27

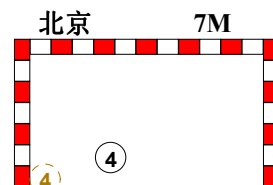



2016年“体彩杯”全国手球男子青年锦标赛

个人/全队技术统计表

正式表
手球
青年男子5-6名
轮次 8组别 X
场次 44201602044-14-1/2
重庆万州
29/03/2016 13:00

| 号码 | 姓名 | 远射 | 近射 | 边射 | 快攻 | 突破 | 任意 | 7M | 合计 | % | 助攻 | 失误 | 警告 | 2' | 取消 | 时间 |
|----------------|-----|------|-------|------|------|-----|-----|-----|-------|-------|----|----|----|----|----|----------|
| 北京队(北京) | | | | | | | | | | | | | | | | |
| <i>(场上队员)</i> | | | | | | | | | | | | | | | | |
| 3 | 王哲一 | | 0/1 | 0/1 | 1/2 | | | | 1/4 | 25.0% | 1 | 1 | | | | 00:23:06 |
| 4 | 朱广刚 | | 1/2 | | 1/1 | 2/3 | | 2/3 | 6/9 | 66.7% | 2 | 1 | | | | 00:58:27 |
| 6 | 赵一涵 | 1/3 | 2/3 | | | 2/4 | | | 5/10 | 50.0% | 2 | 4 | 1 | 1 | | 01:00:00 |
| 7 | 卞友山 | | 2/4 | | 1/1 | | | | 3/5 | 60.0% | | | | | | 00:20:45 |
| 11 | 李旭 | | 1/1 | | | | | | 1/1 | 100% | | 1 | 1 | | | 00:39:10 |
| 15 | 逯明松 | | | | | | | | | 0.0% | | | | | | 00:00:00 |
| 16 | 马佳鹏 | | | | | | | | | 0.0% | | | | | | 00:54:02 |
| 18 | 李明远 | 0/5 | 2/6 | | | | 1/1 | | 3/12 | 25.0% | 2 | 11 | | | | 00:53:47 |
| 19 | 陈旭 | | | | | | | | | 0.0% | | | | | | 00:00:00 |
| 23 | 刘帅 | 0/2 | | | | | 0/1 | | 0/3 | 0.0% | | 1 | | | | 00:01:31 |
| 25 | 张斌 | | 1/1 | 0/1 | 1/1 | | | | 2/3 | 66.7% | | 1 | | | | 00:17:55 |
| 26 | 吴锐樊 | 0/1 | 0/2 | | 0/1 | 2/2 | | | 2/6 | 33.3% | | 2 | | | | 00:25:08 |
| 35 | 高云健 | | | | | | | | | 0.0% | 1 | | | | | 00:05:58 |
| 36 | 王鹏皓 | | 1/3 | 1/5 | 2/2 | | | 0/1 | 4/11 | 36.4% | | 1 | | | | 01:00:00 |
| 合计 | | | | | | | | | | | | | | | | |
| <i>(守门员)</i> | | | | | | | | | | | | | | | | |
| | | 1/11 | 10/23 | 1/7 | 6/8 | 6/9 | 1/2 | 2/4 | 27/64 | 42.2% | 8 | 23 | 2 | 1 | | |
| 16 | 马佳鹏 | 6/7 | 3/16 | 4/10 | 4/9 | 0/5 | 0/1 | 1/2 | 18/50 | 36.0% | | | | | | 00:54:02 |
| 35 | 高云健 | | 0/2 | 0/3 | 0/1 | | | | 0/6 | 0.0% | 1 | | | | | 00:05:58 |
| 合计 | | | | | | | | | | | | | | | | |
| | | 6/7 | 3/18 | 4/13 | 4/10 | 0/5 | 0/1 | 1/2 | 18/56 | 32.1% | 1 | | | | | |

场上队员：得分/射门

守门员：救球/射门

| 全队合计 | 得分 | 被救 | 射失 | 击柱 | 封球 | 合计 | % |
|------|----|----|----|----|----|----|-------|
| 远射 | 1 | 5 | 2 | | 3 | 11 | 9.1% |
| 近射 | 10 | 11 | 1 | 1 | | 23 | 43.5% |
| 边射 | 1 | 5 | 1 | | | 7 | 14.3% |
| 快攻 | 6 | 2 | | | | 8 | 75.0% |
| 突破 | 6 | 2 | | 1 | | 9 | 66.7% |
| 任意 | 1 | | | 1 | | 2 | 50.0% |
| 7M | 2 | 1 | | 1 | | 4 | 50.0% |





2016年“体彩杯”全国手球男子青年锦标赛

个人/全队技术统计表

正式表
手球
青年男子5-6名
轮次 8组别 X
场次 44201602044-14-2/2
重庆万州
29/03/2016 13:00

| 号码 | 姓名 | 远射 | 近射 | 边射 | 快攻 | 突破 | 任意 | 7M | 合计 | % | 助攻 | 失误 | 警告 | 2' | 取消 | 时间 |
|---|-----|-----|-------|-----|-----|-----|-----|-----|-------|-------|----|----|----|----|----|----------|
| 广东队(广东) | | | | | | | | | | | | | | | | |
| <i>(上场队员)</i> | | | | | | | | | | | | | | | | |
| 1 | 王帅 | | | | | | | | | 0.0% | | | | | | 00:59:09 |
| 2 | 姚雪岩 | 0/2 | 5/5 | | 1/1 | 1/1 | | | 7/9 | 77.8% | 2 | 3 | 1 | | | 01:00:00 |
| 4 | 高玉杰 | | 0/1 | 1/4 | 1/1 | | | | 2/6 | 33.3% | | 2 | | 1 | | 00:41:42 |
| 5 | 黄培杰 | 0/1 | 1/1 | 2/3 | 2/5 | 1/1 | | 0/1 | 6/12 | 50.0% | 3 | 1 | 1 | 1 | | 00:59:10 |
| 7 | 段飞宇 | | | 3/4 | | | | | 3/4 | 75.0% | 1 | | | | | 00:30:47 |
| 9 | 周凯峰 | | | | | | | | | 0.0% | | | | | | 00:00:00 |
| 10 | 周仲坤 | | 2/4 | 1/1 | 1/1 | | | | 4/6 | 66.7% | 1 | 1 | | | | 01:00:00 |
| 11 | 胡国富 | 0/1 | 4/4 | 1/1 | 1/4 | | | | 6/10 | 60.0% | 2 | 7 | | 1 | | 01:00:00 |
| 12 | 李壮 | | | | | | | 1/1 | 1/1 | 100% | | | | | | 00:00:21 |
| 13 | 蔡杰 | | | | | | | | | 0.0% | | | | | | 00:00:00 |
| 14 | 王泽润 | | | | | | | | | 0.0% | | | | | | 00:00:51 |
| 15 | 张建杰 | 1/8 | 3/5 | 1/1 | | 3/3 | 1/1 | | 9/18 | 50.0% | 3 | 6 | 1 | | | 00:47:10 |
| 16 | 王猛 | | | | | | | | | 0.0% | | | | | | 00:00:00 |
| 18 | 李文金 | | | | | | | | | 0.0% | | | | | | 00:00:00 |
| 合计 | | | | | | | | | | | | | | | | |
| <i>(守门员)</i> | | | | | | | | | | | | | | | | |
| 1 | 王帅 | 5/6 | 11/21 | 5/6 | 2/8 | 2/8 | 0/1 | 0/2 | 25/52 | 48.1% | | | | | | 00:59:09 |
| 14 | 王泽润 | | | | | | | 1/1 | 1/1 | 100% | | | | | | 00:00:51 |
| 合计 | | | | | | | | | | | | | | | | |
| 5/6 11/21 5/6 2/8 2/8 0/1 1/3 26/53 49.1% | | | | | | | | | | | | | | | | |

场上队员：得分/射门

守门员：救球/射门

| 全队合计 | 得分 | 被救 | 射失 | 击柱 | 封球 | 合计 | % |
|------|----|----|----|----|----|----|--------|
| 远射 | 1 | 6 | 1 | | 4 | 12 | 8.3% |
| 近射 | 15 | 3 | 1 | 1 | | 20 | 75.0% |
| 边射 | 9 | 4 | | 1 | | 14 | 64.3% |
| 快攻 | 6 | 4 | 2 | | | 12 | 50.0% |
| 突破 | 5 | | | | | 5 | 100.0% |
| 任意 | 1 | | | | | 1 | 100.0% |
| 7M | 1 | 1 | | | | 2 | 50.0% |





2016年“体彩杯”全国手球男子青年锦标赛

图式射门区域统计

轮次 8 场次 44

201602044-41-1/1

北京队

| | | | | | | | |
|---|--|---|--|---|---|---------------------------------------|---|
| 3 王哲一 1 Post - 0 Miss - 0 Block - 0 | 4 朱广刚 1 1 2 1 1 Post - 0 Miss - 0 Block - 0 | 6 赵一涵 1 1 2 1 1 Post - 1 Miss - 1 Block - 0 | 7 卞友山 1 2 Post - 0 Miss - 0 Block - 0 | 11 李旭 1 Post - 0 Miss - 0 Block - 0 | 15 逯明松 Post - 0 Miss - 0 Block - 0 | 16 马佳鹏 Post - 0 Miss - 0 Block - 0 | 18 李明远 1 1 1 Post - 1 Miss - 1 Block - 2 |
| 19 陈旭 Post - 0 Miss - 0 Block - 0 | 23 刘帅 Post - 1 Miss - 0 Block - 0 | 25 张斌 1 1 Post - 0 Miss - 0 Block - 0 | 26 吴锐樊 2 Post - 0 Miss - 0 Block - 1 | 35 高云健 Post - 0 Miss - 0 Block - 0 | 36 王鹏皓 2 2 1 1 Post - 1 Miss - 2 Block - 0 | | |

16 马佳鹏

| | | |
|-----|-----|-----|
| 0/8 | 1/2 | 0/3 |
| 2/9 | 1/3 | 6/9 |
| 3/8 | 0/1 | 5/7 |

35 高云健

| | | |
|-----|--|-----|
| 0/2 | | |
| | | 0/2 |
| 0/1 | | 0/1 |

| | | |
|--|--|--|
| | | |
| | | |
| | | |

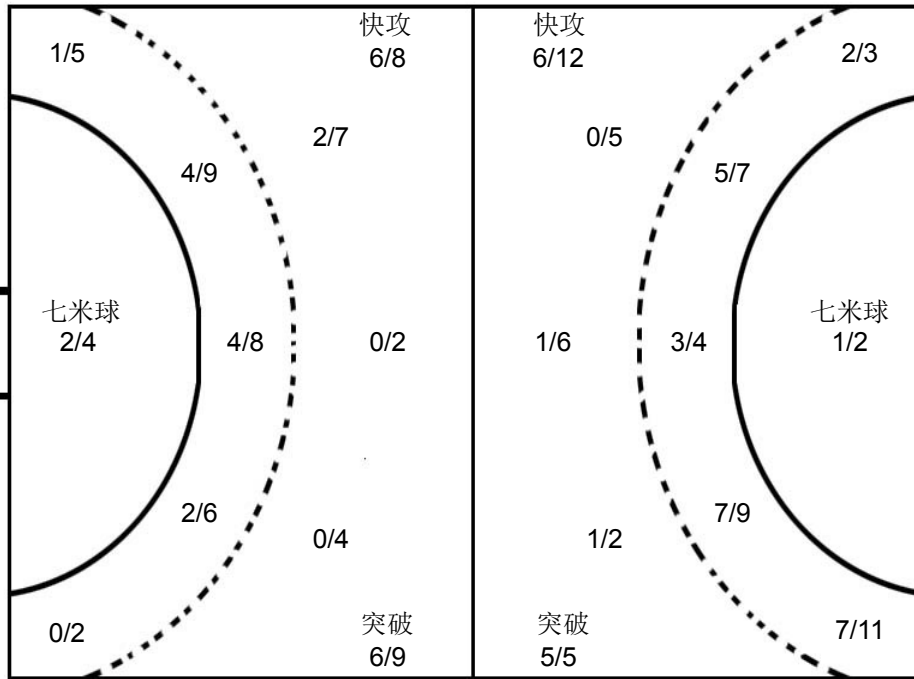

1 王帅

| | | |
|------|-----|------|
| 1/2 | | 0/4 |
| 3/6 | 1/2 | 3/12 |
| 7/13 | 5/5 | 5/8 |

14 王泽润

| | | |
|-----|--|--|
| | | |
| 1/1 | | |

| | | |
|--|--|--|
| | | |
| | | |
| | | |

广东队

| | | | | | | | |
|---|--|---|--|--|---------------------------------------|--|--|
| 1 王帅 Post - 0 Miss - 0 Block - 0 | 2 姚雪岩 1 3 1 1 Post - 0 Miss - 0 Block - 2 | 4 高玉杰 1 1 Post - 1 Miss - 1 Block - 0 | 5 黄培杰 1 1 2 1 1 Post - 0 Miss - 1 Block - 0 | 7 段飞宇 1 1 1 1 Post - 0 Miss - 0 Block - 0 | 9 周凯峰 Post - 0 Miss - 0 Block - 0 | 10 周仲坤 2 2 Post - 1 Miss - 0 Block - 0 | 11 胡国富 1 1 2 2 2 Post - 0 Miss - 1 Block - 0 |
| 12 李壮 1 Post - 0 Miss - 0 Block - 0 | 13 蔡杰 Post - 0 Miss - 0 Block - 0 | 14 王泽润 Post - 0 Miss - 0 Block - 0 | 15 张建杰 3 2 1 1 2 1 Post - 0 Miss - 1 Block - 2 | 16 王猛 Post - 0 Miss - 0 Block - 0 | 18 李文金 Post - 0 Miss - 0 Block - 0 | | |

注释: Post=击柱 Miss=射失 Block=被封





3-4名

青年男子 全国比赛

2016年“体彩杯”全国手球男子青年锦标赛

| | | | | | | | | | | | | | | | | | | | | | |
|--------------------|---|--|---------------------|------------------|------------------------------------|-------------------|---|--------------------|------------------------|----|-----|----------------------|---------------|---|--|--|----|---|----|----|----|
| Team A A 山东队 | | | | Team B B 安徽队 | | | | Match Number 45 | | | | | | | | | | | | | |
| played in China | | in the hall 重庆万州 | | on 29/03/2016 | | at 14:30 hours | | Spectators | | | | | | | | | | | | | |
| Half-time (30') | A 19 | B 26 | End of playing time | A 35 | B 42 | 1st extra time | A | B | 2nd extra time | A | B | After penalty throws | A | B | | | | | | | |
| Number of 7 m | A 3/3 | Team time-out 1 09:13 2 19:50 3 54:55 | | | Full name of players and officials | | | | Team time-out 1 2 3 | | | B 3/3 | Number of 7 m | | | | | | | | |
| No. | Team A | | | | | G | W | 2' | D | DR | No. | Team B | | | | | G | W | 2' | D | DR |
| 1 | 刘继超 | | | | | | | | | | 1 | 郭世伟 | | | | | 11 | | | | |
| 2 | 冯鑫宇 | | | | | 1 | | | | | 2 | 金勇峰 | | | | | 1 | 1 | | | |
| 3 | 王铁林 | | | | | 3 | 1 | 2 | | | 9 | 陈开勇 | | | | | 8 | | | | |
| 5 | 王晓峰 | | | | | 6 | | | | | 17 | 王巨柱 | | | | | 1 | | | | |
| 6 | 王军鸣 | | | | | 10 | 1 | | | | 18 | 李双 | | | | | 13 | | 1 | | |
| 7 | 徐勇林 | | | | | 1 | | | | | 19 | 何山 | | | | | 1 | | | | |
| 10 | 孙芳伟 | | | | | 8 | 1 | | | | 21 | 李明 | | | | | | | | | |
| 11 | 王洋 | | | | | 4 | | | | | 24 | 徐安格 | | | | | 1 | | | | |
| 12 | 刘道林 | | | | | | | | | | 25 | 李文哲 | | | | | | | | | |
| 13 | 于欣君 | | | | | 1 | | | | | 26 | 程浩然 | | | | | 2 | 1 | | | |
| 17 | 薛盼龙 | | | | | 1 | | | | | 27 | 王长旭 | | | | | 4 | | | | |
| 18 | 李玮 | | | | | | | | | | 28 | 丁浩然 | | | | | | | | | |
| 21 | 王腾达 | | | | | | | | | | 32 | 许浩翔 | | | | | | | | | |
| 22 | 李子跃 | | | | | | | | | | 33 | 姚紫祥 | | | | | | | | | |
| 23 | 李荣健 | | | | | | | | | | 41 | 刘润民 | | | | | | | | | |
| | | | | | | | | | | | 42 | 王成龙 | | | | | | | | | |
| B | 王莉莉 (主教练) | | | | | | | | | | A | 王来黔 (主教练) | | | | | | | | | |
| | | | | | | | | | | | B | 陆万红 | | | | | | | | | |
| | | | | | | | | | | | C | 吴翔 | | | | | | | | | |
| A | Signature of Responsible Official of the Teams (Off. A) | | | | | | | | | | | | | | | | | | | B | |
| TP | Remarks of Referee / CHA Official | | | | | | | | | | | | | | | | | | | TP | |

Signatures

| | | | | |
|------------------|-----------|----------|--|--|
| Referees | 倪震 (CHN) | 王洋 (CHN) | | |
| Techn. Delegates | 徐健 (CHN) | | | |
| CHA Official | 吴瑞亭 (CHN) | | | |

Note: Number of 7m Throws Awarded to Team A and B, Goals (G), Warnings (W), Suspensions (2'), Direct Disqualification (D), Disqualification with Report (DR) and Team Penalty (TP).

Table Officials:

Statisticians: 刘永欢

李双





2016年“体彩杯”全国手球男子青年锦标赛 竞赛技术统计(媒体表)

| | | | | | | |
|---------|----|----|------------|----|----|------------------|
| 3-4名 | 组别 | X | 轮次 | 8 | 场次 | 45 |
| 重庆万州 | | | 29/03/2016 | | | 201602045-51-1/1 |
| 山东队 | | 山东 | 35 | vs | 42 | 安徽队 |
| 19 : 26 | | | | | | |

| 裁判员 | | 倪震 (CHN) | | | | | | | | | | | 王洋 (CHN) | | | | | | | | | | | | | | | | | | | | |
|---------------|-----|----------|-------|------|------|-----|-----|------|-------|------|----|----|----------|----|----------|-----------|-----|-------|-------|----|-----|----|--|--|--|--|--|--|-----------|--|--|--|--|
| 山东 | | 远射 | 近射 | 边射 | 快攻 | 突破 | 任意球 | 7m球 | 合计 | % | 助攻 | 失误 | 警告 | 2' | D & DR | 山东 | | 比赛进程 | | | | | | | | | | | 安徽 | | | | |
| 主教练：王莉莉 | | | | | | | | | | | | | | | 1st Half | | | | | | | | | | | | | | | | | | |
| 1 | 刘继超 | | | | | | | | | | | | | | | 10 | 孙芳伟 | 0 | 00:38 | 1 | 18 | 李双 | | | | | | | | | | | |
| 2 | 冯鑫宇 | | 1/2 | | | | | 1/2 | 50.0 | | | | | | | 1 | | 1 | 01:37 | 2 | 18 | 李双 | | | | | | | | | | | |
| 3 | 王铁林 | 1/2 | | 1/1 | 1/1 | | | 3/4 | 75.0 | | 1 | 1 | 2 | | 1 | | 1 | 02:16 | 3 | 1 | 郭世伟 | | | | | | | | | | | | |
| 5 | 王晓峰 | 4/12 | 1/1 | 0/2 | 1/1 | | | 6/16 | 37.5 | | 7 | | | | 2 | | 2 | 03:59 | 3 | | | | | | | | | | | | | | |
| 6 | 王军鸣 | 0/2 | 4/9 | 1/1 | 1/1 | | 1/2 | 3/3 | 10/18 | 55.6 | 2 | 4 | 1 | | 3 | | 3 | 06:32 | 6 | 9 | 陈开勇 | | | | | | | | | | | | |
| 7 | 徐勇林 | 0/1 | | 1/3 | | | | 1/4 | 25.0 | | 1 | | | | 4 | | 4 | 07:40 | 7 | 18 | 李双 | | | | | | | | | | | | |
| 10 | 孙芳伟 | 6/16 | 2/4 | | 0/1 | 0/1 | | 8/22 | 36.4 | 2 | 2 | 1 | | | 5 | | 5 | 07:46 | 7 | | | | | | | | | | | | | | |
| 11 | 王洋 | 1/1 | 0/1 | 3/4 | | | | 4/6 | 66.7 | | 2 | | | | 5 | | 5 | 08:09 | 8 | 9 | 陈开勇 | | | | | | | | | | | | |
| 12 | 刘道林 | | | | | | | | | | | | | | 5 | | 5 | 08:57 | 9 | 9 | 陈开勇 | | | | | | | | | | | | |
| 13 | 于欣君 | | | | 1/1 | | | 1/1 | 100 | 1 | | | | | 5 | | 5 | 09:09 | 10 | 1 | 郭世伟 | | | | | | | | | | | | |
| 17 | 薛盼龙 | 0/1 | 1/1 | | | | | 1/2 | 50.0 | | 4 | | | | 6 | | 6 | 10:27 | 11 | 10 | 何山 | | | | | | | | | | | | |
| 18 | 李玮 | | | 0/1 | | | | 0/1 | 0.0 | | | | | | 6 | | 6 | 11:12 | 12 | 9 | 陈开勇 | | | | | | | | | | | | |
| 21 | 王腾达 | | | | | | | | | | | | | | 6 | | 6 | 11:46 | 13 | 1 | 郭世伟 | | | | | | | | | | | | |
| 22 | 李子跃 | | | | | | | | | | | | | | 7 | | 7 | 12:21 | 13 | | | | | | | | | | | | | | |
| 23 | 李荣健 | | | 0/1 | | | | 0/1 | 0.0 | | | | | | 7 | | 7 | 13:03 | 14 | 9 | 陈开勇 | | | | | | | | | | | | |
| 运动员 合计 | | 12/35 | 9/18 | 6/13 | 4/5 | 0/1 | 1/2 | 3/3 | 35/77 | 45.5 | 5 | 21 | 3 | 2 | 8 | | 8 | 14:01 | 14 | | | | | | | | | | | | | | |
| 1 | 刘继超 | 6/16 | 5/19 | 4/6 | 3/10 | 0/4 | | 0/3 | 18/58 | 31.0 | | | | | 9 | | 9 | 14:55 | 14 | | | | | | | | | | | | | | |
| 12 | 刘道林 | | 0/1 | | 0/1 | | | 0/2 | 0.0 | | | | | | 10 | | 10 | 15:56 | 14 | | | | | | | | | | | | | | |
| 守门员 合计 | | 6/16 | 5/20 | 4/6 | 3/11 | 0/4 | | 0/3 | 18/60 | 30.0 | | | | | 10 | | 10 | 16:16 | 15 | 9 | 陈开勇 | | | | | | | | | | | | |
| 安徽 | | 远射 | 近射 | 边射 | 快攻 | 突破 | 任意球 | 7m球 | 合计 | % | 助攻 | 失误 | 警告 | 2' | D & DR | | | | | | | | | | | | | | | | | | |
| 教练：王来黔 | | | | | | | | | | | | | | | 2nd Half | | | | | | | | | | | | | | | | | | |
| 1 | 郭世伟 | 2/4 | 4/4 | 0/1 | 3/4 | 2/2 | | | 11/15 | 73.3 | | 4 | | | 19 | | 19 | 01:25 | 27 | 24 | 徐安格 | | | | | | | | | | | | |
| 2 | 金勇峰 | 1/2 | 0/1 | 0/1 | | | | 1/4 | 25.0 | 3 | | 1 | | | 20 | | 20 | 02:48 | 27 | | | | | | | | | | | | | | |
| 9 | 陈开勇 | | 6/7 | | 2/2 | | | 8/9 | 88.9 | | 2 | | | | 20 | | 20 | 03:03 | 28 | 1 | 郭世伟 | | | | | | | | | | | | |
| 17 | 王巨柱 | 1/4 | | | | | | 1/4 | 25.0 | 9 | 4 | | | | 5 | | 5 | 03:24 | 28 | | | | | | | | | | | | | | |
| 18 | 李双 | 5/7 | 4/5 | | 2/2 | 1/1 | | 1/1 | 13/16 | 81.3 | 1 | 3 | | 1 | 3 | | 3 | 05:58 | 28 | | | | | | | | | | | | | | |
| 19 | 何山 | | | 1/2 | | | | 1/2 | 50.0 | | 1 | | | | 6 | | 6 | 06:28 | 28 | | | | | | | | | | | | | | |
| 21 | 李明 | | | | | | | | | | 2 | 3 | | | 23 | | 23 | 07:02 | 29 | 27 | 王长旭 | | | | | | | | | | | | |
| 24 | 徐安格 | 0/1 | 1/2 | | | | | 1/3 | 33.3 | | | | | | 23 | | 23 | 07:29 | 30 | 1 | 郭世伟 | | | | | | | | | | | | |
| 25 | 李文哲 | | | | | | | | | | | | | | 6 | | 6 | 07:55 | 30 | | | | | | | | | | | | | | |
| 26 | 程浩然 | | 0/2 | 0/1 | 1/2 | 1/1 | | 2/6 | 33.3 | | 1 | 1 | | | 11 | | 11 | 09:37 | 30 | | | | | | | | | | | | | | |
| 27 | 王长旭 | 1/1 | | 1/2 | 0/2 | | | 2/2 | 4/7 | 57.1 | | 3 | | | 25 | | 25 | 11:29 | 32 | 27 | 王长旭 | | | | | | | | | | | | |
| 28 | 丁浩然 | | | 0/1 | | | | 0/1 | 0.0 | | 1 | | | | 25 | | 25 | 12:20 | 33 | 18 | 李双 | | | | | | | | | | | | |
| 32 | 许浩翔 | | | | | | | | | | | | | | 25 | | 25 | 13:13 | 34 | 18 | 李双 | | | | | | | | | | | | |
| 33 | 姚紫祥 | | | | | | | | | | | | | | 25 | | 25 | 15:08 | 35 | 18 | 李双 | | | | | | | | | | | | |
| 41 | 刘润民 | | | | | | | | | | | | | | 26 | | 26 | 15:56 | 35 | | | | | | | | | | | | | | |
| 42 | 王成龙 | | | | | | | | | | | | | | 26 | | 26 | 16:46 | 36 | 1 | 郭世伟 | | | | | | | | | | | | |
| 运动员 合计 | | 10/19 | 15/21 | 2/8 | 8/12 | 4/4 | | 3/3 | 42/67 | 62.7 | 15 | 22 | 2 | 1 | 26 | | 26 | 17:17 | 37 | 18 | 李双 | | | | | | | | | | | | |
| 21 | 李明 | 13/25 | 9/17 | 6/12 | 0/4 | 1/1 | 1/2 | 0/3 | 30/64 | 46.9 | 2 | 3 | | | 17 | | 17 | 17:33 | 37 | | | | | | | | | | | | | | |
| 32 | 许浩翔 | 1/1 | 0/1 | | | | | 1/2 | 50.0 | | | | | | 6 | | 6 | 18:04 | 37 | | | | | | | | | | | | | | |
| 守门员 合计 | | 14/26 | 9/18 | 6/12 | 0/4 | 1/1 | 1/2 | 0/3 | 31/66 | 47.0 | 2 | 3 | | | 6 | | 6 | 18:53 | 37 | | | | | | | | | | | | | | |

场上队员：得分 / 射门

守门员：救球 / 射门

| | | | | | | | | | |
|----|------------|----|--------------|-----|------------|-----|----------|----|---------|
| 快攻 | Fast Break | 突破 | Breakthrough | 任意球 | Free Throw | 7M球 | 7M Throw | 助攻 | Assist |
| 警告 | Warning | 失误 | Error | 2' | Suspension | D | 取消资格 | DR | 取消资格+报告 |





2016年“体彩杯”全国手球男子青年锦标赛 图式比赛技术统计表

轮次 8

场次 45

201602045-21-1/1

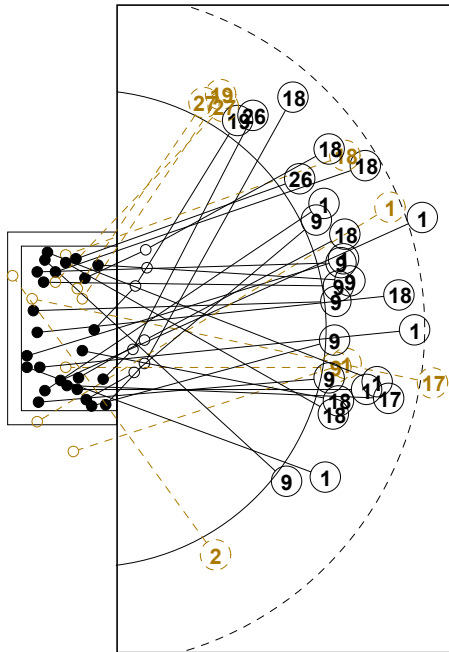

7M 安徽

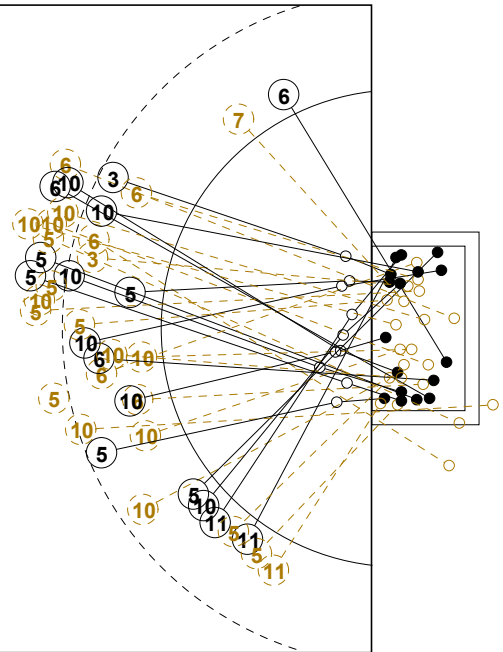
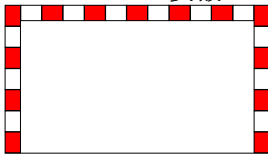

山东 7M

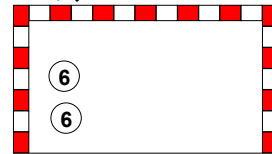

1st Half
26 : 19

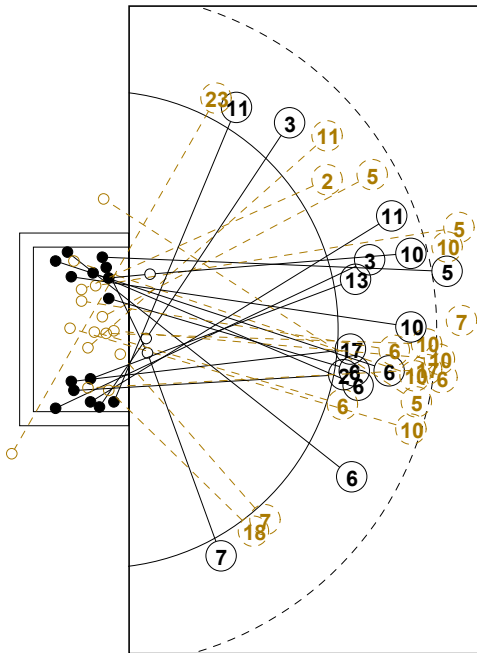

7M 山东

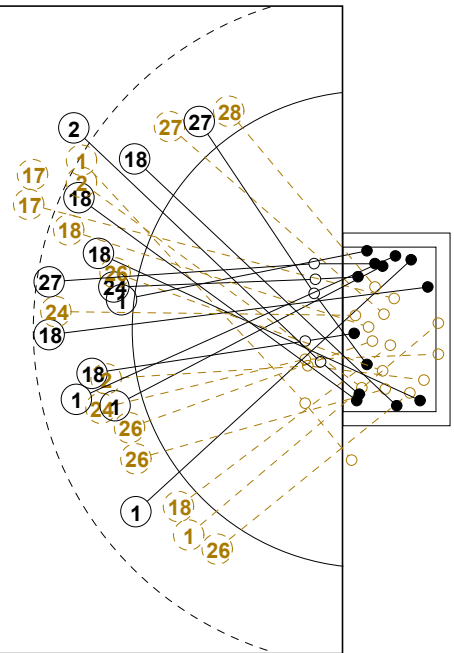
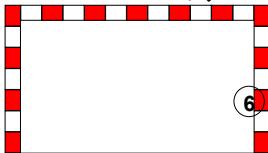

安徽 7M

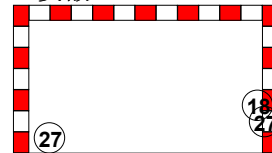

2nd Half
35 : 42



2016年“体彩杯”全国手球男子青年锦标赛

个人/全队技术统计表

正式表
手球
青年男子3-4名
轮次 8组别 X
场次 45201602045-14-1/2
重庆万州
29/03/2016 14:30

| 号码 | 姓名 | 远射 | 近射 | 边射 | 快攻 | 突破 | 任意 | 7M | 合计 | % | 助攻 | 失误 | 警告 | 2' | 取消 | 时间 |
|----------------|-----|-------|------|------|------|-----|-----|-----|-------|-------|----|----|----|----|----|----------|
| 山东队(山东) | | | | | | | | | | | | | | | | |
| <i>(场上队员)</i> | | | | | | | | | | | | | | | | |
| 1 | 刘继超 | | | | | | | | | 0.0% | | | | | | 00:56:32 |
| 2 | 冯鑫宇 | | 1/2 | | | | | | 1/2 | 50.0% | | | | | | 00:06:12 |
| 3 | 王铁林 | 1/2 | | 1/1 | 1/1 | | | | 3/4 | 75.0% | | 1 | 1 | 2 | | 00:55:57 |
| 5 | 王晓峰 | 4/12 | 1/1 | 0/2 | 1/1 | | | | 6/16 | 37.5% | | 7 | | | | 00:48:07 |
| 6 | 王军鸣 | 0/2 | 4/9 | 1/1 | 1/1 | | 1/2 | 3/3 | 10/18 | 55.6% | 2 | 4 | 1 | | | 00:53:39 |
| 7 | 徐勇林 | 0/1 | | 1/3 | | | | | 1/4 | 25.0% | | 1 | | | | 00:16:16 |
| 10 | 孙芳伟 | 6/16 | 2/4 | | 0/1 | 0/1 | | | 8/22 | 36.4% | 2 | 2 | 1 | | | 00:54:55 |
| 11 | 王洋 | 1/1 | 0/1 | 3/4 | | | | | 4/6 | 66.7% | | 2 | | | | 00:54:55 |
| 12 | 刘道林 | | | | | | | | | 0.0% | | | | | | 00:03:28 |
| 13 | 于欣君 | | | | 1/1 | | | | 1/1 | 100% | 1 | | | | | 00:05:05 |
| 17 | 薛盼龙 | 0/1 | 1/1 | | | | | | 1/2 | 50.0% | | 4 | | | | 00:53:56 |
| 18 | 李玮 | | | 0/1 | | | | | 0/1 | 0.0% | | | | | | 00:05:05 |
| 21 | 王腾达 | | | | | | | | | 0.0% | | | | | | 00:00:00 |
| 22 | 李子跃 | | | | | | | | | 0.0% | | | | | | 00:00:00 |
| 23 | 李荣健 | | | 0/1 | | | | | 0/1 | 0.0% | | | | | | 00:05:05 |
| 合计 | | 12/35 | 9/18 | 6/13 | 4/5 | 0/1 | 1/2 | 3/3 | 35/77 | 45.5% | 5 | 21 | 3 | 2 | | |
| <i>(守门员)</i> | | | | | | | | | | | | | | | | |
| 1 | 刘继超 | 6/16 | 5/19 | 4/6 | 3/10 | 0/4 | | 0/3 | 18/58 | 31.0% | | | | | | 00:56:32 |
| 12 | 刘道林 | | 0/1 | | 0/1 | | | | 0/2 | 0.0% | | | | | | 00:03:28 |
| 合计 | | 6/16 | 5/20 | 4/6 | 3/11 | 0/4 | | 0/3 | 18/60 | 30.0% | | | | | | |

场上队员：得分/射门

守门员：救球/射门

| 全队合计 | 得分 | 被救 | 射失 | 击柱 | 封球 | 合计 | % |
|------|----|----|----|----|----|----|--------|
| 远射 | 12 | 14 | 3 | 1 | 5 | 35 | 34.3% |
| 近射 | 9 | 9 | | | | 18 | 50.0% |
| 边射 | 6 | 6 | 1 | | | 13 | 46.2% |
| 快攻 | 4 | | | | 1 | 5 | 80.0% |
| 突破 | | 1 | | | | 1 | 0.0% |
| 任意 | 1 | 1 | | | | 2 | 50.0% |
| 7M | 3 | | | | | 3 | 100.0% |





2016年“体彩杯”全国手球男子青年锦标赛

个人/全队技术统计表

正式表
手球
青年男子3-4名
轮次 8组别 X
场次 45201602045-14-2/2
重庆万州
29/03/2016 14:30

| 号码 | 姓名 | 远射 | 近射 | 边射 | 快攻 | 突破 | 任意 | 7M | 合计 | % | 助攻 | 失误 | 警告 | 2' | 取消 | 时间 |
|----------------|-----|-------|-------|------|------|-----|-----|-----|-------|-------|----|----|----|----|----|----------|
| 安徽队(安徽) | | | | | | | | | | | | | | | | |
| <i>(上场队员)</i> | | | | | | | | | | | | | | | | |
| 1 | 郭世伟 | 2/4 | 4/4 | 0/1 | 3/4 | 2/2 | | | 11/15 | 73.3% | | 4 | | | | 01:00:00 |
| 2 | 金勇峰 | 1/2 | 0/1 | 0/1 | | | | | 1/4 | 25.0% | 3 | | 1 | | | 00:33:06 |
| 9 | 陈开勇 | | 6/7 | | 2/2 | | | | 8/9 | 88.9% | | 2 | | | | 00:27:40 |
| 17 | 王巨柱 | 1/4 | | | | | | | 1/4 | 25.0% | 9 | 4 | | | | 00:46:53 |
| 18 | 李双 | 5/7 | 4/5 | | 2/2 | 1/1 | | 1/1 | 13/16 | 81.3% | 1 | 3 | | 1 | | 01:00:00 |
| 19 | 何山 | | | 1/2 | | | | | 1/2 | 50.0% | | 1 | | | | 00:19:50 |
| 21 | 李明 | | | | | | | | | 0.0% | 2 | 3 | | | | 00:57:54 |
| 24 | 徐安格 | 0/1 | 1/2 | | | | | | 1/3 | 33.3% | | | | | | 00:32:18 |
| 25 | 李文哲 | | | | | | | | | 0.0% | | | | | | 00:00:00 |
| 26 | 程浩然 | | 0/2 | 0/1 | 1/2 | 1/1 | | | 2/6 | 33.3% | | 1 | 1 | | | 00:36:23 |
| 27 | 王长旭 | 1/1 | | 1/2 | 0/2 | | | 2/2 | 4/7 | 57.1% | | 3 | | | | 00:40:10 |
| 28 | 丁浩然 | | | 0/1 | | | | | 0/1 | 0.0% | | 1 | | | | 00:03:32 |
| 32 | 许浩翔 | | | | | | | | | 0.0% | | | | | | 00:02:06 |
| 33 | 姚紫祥 | | | | | | | | | 0.0% | | | | | | 00:00:00 |
| 41 | 刘润民 | | | | | | | | | 0.0% | | | | | | 00:00:00 |
| 42 | 王成龙 | | | | | | | | | 0.0% | | | | | | 00:00:00 |
| 合计 | | 10/19 | 15/21 | 2/8 | 8/12 | 4/4 | | 3/3 | 42/67 | 62.7% | 15 | 22 | 2 | 1 | | |
| <i>(守门员)</i> | | | | | | | | | | | | | | | | |
| 21 | 李明 | 13/25 | 9/17 | 6/12 | 0/4 | 1/1 | 1/2 | 0/3 | 30/64 | 46.9% | 2 | 3 | | | | 00:57:54 |
| 32 | 许浩翔 | 1/1 | 0/1 | | | | | | 1/2 | 50.0% | | | | | | 00:02:06 |
| 合计 | | 14/26 | 9/18 | 6/12 | 0/4 | 1/1 | 1/2 | 0/3 | 31/66 | 47.0% | 2 | 3 | | | | |

场上队员：得分/射门

守门员：救球/射门

| 全队合计 | 得分 | 被救 | 射失 | 击柱 | 封球 | 合计 | % |
|------|----|----|----|----|----|----|--------|
| 远射 | 10 | 6 | 1 | 1 | 1 | 19 | 52.6% |
| 近射 | 15 | 5 | | 1 | | 21 | 71.4% |
| 边射 | 2 | 4 | | 2 | | 8 | 25.0% |
| 快攻 | 8 | 3 | 1 | | | 12 | 66.7% |
| 突破 | 4 | | | | | 4 | 100.0% |
| 任意 | | | | | | | 0.0% |
| 7M | 3 | | | | | 3 | 100.0% |





2016年“体彩杯”全国手球男子青年锦标赛

图式射门区域统计

轮次 8 场次 45

201602045-41-1/1

山东队

| | | | | | | | | | | | | | | | | | | | | | | | | | | | | | | | | | | | | | | | | | | | | | | | | | | | | | | | | | | | | | | | | | | | | | | | | | | | | | | | |
|--|-----------------------------|-----------------------------|-----------------------------|-----------------------------|-----------------------------|-----------------------------|-----------------------------|--|--|---|--|--|--|---|--|--|--|--|--|--|---|--|--|---|--|--|---|--|--|--|---|--|--|--|--|---|---|--|---|---|--|--|---|---|--|---|---|--|---|---|--|--|--|--|--|--|--|--|---|--|---|--|--|---|--|---|---|---|---|--|--|--|--|---|--|--|---|--|--|
| 1 刘继超 | 2 冯鑫宇 | 3 王铁林 | 5 王晓峰 | 6 王军鸣 | 7 徐勇林 | 10 孙芳伟 | 11 王洋 | | | | | | | | | | | | | | | | | | | | | | | | | | | | | | | | | | | | | | | | | | | | | | | | | | | | | | | | | | | | | | | | | | | | | | | | |
| <table border="1"><tr><td></td><td></td><td></td></tr><tr><td></td><td></td><td></td></tr><tr><td></td><td></td><td></td></tr></table> | | | | | | | | | | <table border="1"><tr><td></td><td></td><td></td></tr><tr><td>1</td><td></td><td></td></tr><tr><td></td><td></td><td></td></tr></table> | | | | 1 | | | | | | <table border="1"><tr><td>1</td><td></td><td></td></tr><tr><td></td><td></td><td></td></tr><tr><td>2</td><td></td><td></td></tr></table> | 1 | | | | | | 2 | | | <table border="1"><tr><td>1</td><td></td><td></td></tr><tr><td></td><td></td><td>1</td></tr><tr><td>1</td><td></td><td>3</td></tr></table> | 1 | | | | | 1 | 1 | | 3 | <table border="1"><tr><td></td><td></td><td>3</td></tr><tr><td>1</td><td></td><td>4</td></tr><tr><td>1</td><td></td><td>1</td></tr></table> | | | 3 | 1 | | 4 | 1 | | 1 | <table border="1"><tr><td></td><td></td><td></td></tr><tr><td></td><td></td><td></td></tr><tr><td></td><td></td><td>1</td></tr></table> | | | | | | | | | 1 | <table border="1"><tr><td>1</td><td></td><td></td></tr><tr><td>1</td><td></td><td>1</td></tr><tr><td>1</td><td>1</td><td>3</td></tr></table> | 1 | | | 1 | | 1 | 1 | 1 | 3 | <table border="1"><tr><td></td><td></td><td></td></tr><tr><td>1</td><td></td><td></td></tr><tr><td>3</td><td></td><td></td></tr></table> | | | | 1 | | | 3 | | |
| | | | | | | | | | | | | | | | | | | | | | | | | | | | | | | | | | | | | | | | | | | | | | | | | | | | | | | | | | | | | | | | | | | | | | | | | | | | | | | | |
| | | | | | | | | | | | | | | | | | | | | | | | | | | | | | | | | | | | | | | | | | | | | | | | | | | | | | | | | | | | | | | | | | | | | | | | | | | | | | | | |
| | | | | | | | | | | | | | | | | | | | | | | | | | | | | | | | | | | | | | | | | | | | | | | | | | | | | | | | | | | | | | | | | | | | | | | | | | | | | | | | |
| | | | | | | | | | | | | | | | | | | | | | | | | | | | | | | | | | | | | | | | | | | | | | | | | | | | | | | | | | | | | | | | | | | | | | | | | | | | | | | | |
| 1 | | | | | | | | | | | | | | | | | | | | | | | | | | | | | | | | | | | | | | | | | | | | | | | | | | | | | | | | | | | | | | | | | | | | | | | | | | | | | | | |
| | | | | | | | | | | | | | | | | | | | | | | | | | | | | | | | | | | | | | | | | | | | | | | | | | | | | | | | | | | | | | | | | | | | | | | | | | | | | | | | |
| 1 | | | | | | | | | | | | | | | | | | | | | | | | | | | | | | | | | | | | | | | | | | | | | | | | | | | | | | | | | | | | | | | | | | | | | | | | | | | | | | | |
| | | | | | | | | | | | | | | | | | | | | | | | | | | | | | | | | | | | | | | | | | | | | | | | | | | | | | | | | | | | | | | | | | | | | | | | | | | | | | | | |
| 2 | | | | | | | | | | | | | | | | | | | | | | | | | | | | | | | | | | | | | | | | | | | | | | | | | | | | | | | | | | | | | | | | | | | | | | | | | | | | | | | |
| 1 | | | | | | | | | | | | | | | | | | | | | | | | | | | | | | | | | | | | | | | | | | | | | | | | | | | | | | | | | | | | | | | | | | | | | | | | | | | | | | | |
| | | 1 | | | | | | | | | | | | | | | | | | | | | | | | | | | | | | | | | | | | | | | | | | | | | | | | | | | | | | | | | | | | | | | | | | | | | | | | | | | | | |
| 1 | | 3 | | | | | | | | | | | | | | | | | | | | | | | | | | | | | | | | | | | | | | | | | | | | | | | | | | | | | | | | | | | | | | | | | | | | | | | | | | | | | |
| | | 3 | | | | | | | | | | | | | | | | | | | | | | | | | | | | | | | | | | | | | | | | | | | | | | | | | | | | | | | | | | | | | | | | | | | | | | | | | | | | | |
| 1 | | 4 | | | | | | | | | | | | | | | | | | | | | | | | | | | | | | | | | | | | | | | | | | | | | | | | | | | | | | | | | | | | | | | | | | | | | | | | | | | | | |
| 1 | | 1 | | | | | | | | | | | | | | | | | | | | | | | | | | | | | | | | | | | | | | | | | | | | | | | | | | | | | | | | | | | | | | | | | | | | | | | | | | | | | |
| | | | | | | | | | | | | | | | | | | | | | | | | | | | | | | | | | | | | | | | | | | | | | | | | | | | | | | | | | | | | | | | | | | | | | | | | | | | | | | | |
| | | | | | | | | | | | | | | | | | | | | | | | | | | | | | | | | | | | | | | | | | | | | | | | | | | | | | | | | | | | | | | | | | | | | | | | | | | | | | | | |
| | | 1 | | | | | | | | | | | | | | | | | | | | | | | | | | | | | | | | | | | | | | | | | | | | | | | | | | | | | | | | | | | | | | | | | | | | | | | | | | | | | |
| 1 | | | | | | | | | | | | | | | | | | | | | | | | | | | | | | | | | | | | | | | | | | | | | | | | | | | | | | | | | | | | | | | | | | | | | | | | | | | | | | | |
| 1 | | 1 | | | | | | | | | | | | | | | | | | | | | | | | | | | | | | | | | | | | | | | | | | | | | | | | | | | | | | | | | | | | | | | | | | | | | | | | | | | | | |
| 1 | 1 | 3 | | | | | | | | | | | | | | | | | | | | | | | | | | | | | | | | | | | | | | | | | | | | | | | | | | | | | | | | | | | | | | | | | | | | | | | | | | | | | |
| | | | | | | | | | | | | | | | | | | | | | | | | | | | | | | | | | | | | | | | | | | | | | | | | | | | | | | | | | | | | | | | | | | | | | | | | | | | | | | | |
| 1 | | | | | | | | | | | | | | | | | | | | | | | | | | | | | | | | | | | | | | | | | | | | | | | | | | | | | | | | | | | | | | | | | | | | | | | | | | | | | | | |
| 3 | | | | | | | | | | | | | | | | | | | | | | | | | | | | | | | | | | | | | | | | | | | | | | | | | | | | | | | | | | | | | | | | | | | | | | | | | | | | | | | |
| Post - 0 Miss - 0 Block - 0 | Post - 0 Miss - 0 Block - 0 | Post - 0 Miss - 0 Block - 0 | Post - 1 Miss - 1 Block - 2 | Post - 0 Miss - 1 Block - 1 | Post - 0 Miss - 0 Block - 1 | Post - 0 Miss - 1 Block - 2 | Post - 0 Miss - 0 Block - 0 | | | | | | | | | | | | | | | | | | | | | | | | | | | | | | | | | | | | | | | | | | | | | | | | | | | | | | | | | | | | | | | | | | | | | | | | |
| 12 刘道林 | 13 于欣君 | 17 薛盼龙 | 18 李玮 | 21 王腾达 | 22 李子跃 | 23 李荣健 | | | | | | | | | | | | | | | | | | | | | | | | | | | | | | | | | | | | | | | | | | | | | | | | | | | | | | | | | | | | | | | | | | | | | | | | | |
| <table border="1"><tr><td></td><td></td><td></td></tr><tr><td></td><td></td><td></td></tr><tr><td></td><td></td><td></td></tr></table> | | | | | | | | | | <table border="1"><tr><td></td><td></td><td></td></tr><tr><td>1</td><td></td><td></td></tr><tr><td></td><td></td><td></td></tr></table> | | | | 1 | | | | | | <table border="1"><tr><td></td><td></td><td></td></tr><tr><td>1</td><td></td><td></td></tr><tr><td></td><td></td><td></td></tr></table> | | | | 1 | | | | | | <table border="1"><tr><td></td><td></td><td></td></tr><tr><td></td><td></td><td></td></tr><tr><td></td><td></td><td></td></tr></table> | | | | | | | | | | <table border="1"><tr><td></td><td></td><td></td></tr><tr><td></td><td></td><td></td></tr><tr><td></td><td></td><td></td></tr></table> | | | | | | | | | | <table border="1"><tr><td></td><td></td><td></td></tr><tr><td></td><td></td><td></td></tr><tr><td></td><td></td><td></td></tr></table> | | | | | | | | | | <table border="1"><tr><td></td><td></td><td></td></tr><tr><td></td><td></td><td></td></tr><tr><td></td><td></td><td></td></tr></table> | | | | | | | | | | <table border="1"><tr><td></td><td></td><td></td></tr><tr><td></td><td></td><td></td></tr><tr><td></td><td></td><td></td></tr></table> | | | | | | | | | |
| | | | | | | | | | | | | | | | | | | | | | | | | | | | | | | | | | | | | | | | | | | | | | | | | | | | | | | | | | | | | | | | | | | | | | | | | | | | | | | | |
| | | | | | | | | | | | | | | | | | | | | | | | | | | | | | | | | | | | | | | | | | | | | | | | | | | | | | | | | | | | | | | | | | | | | | | | | | | | | | | | |
| | | | | | | | | | | | | | | | | | | | | | | | | | | | | | | | | | | | | | | | | | | | | | | | | | | | | | | | | | | | | | | | | | | | | | | | | | | | | | | | |
| | | | | | | | | | | | | | | | | | | | | | | | | | | | | | | | | | | | | | | | | | | | | | | | | | | | | | | | | | | | | | | | | | | | | | | | | | | | | | | | |
| 1 | | | | | | | | | | | | | | | | | | | | | | | | | | | | | | | | | | | | | | | | | | | | | | | | | | | | | | | | | | | | | | | | | | | | | | | | | | | | | | | |
| | | | | | | | | | | | | | | | | | | | | | | | | | | | | | | | | | | | | | | | | | | | | | | | | | | | | | | | | | | | | | | | | | | | | | | | | | | | | | | | |
| | | | | | | | | | | | | | | | | | | | | | | | | | | | | | | | | | | | | | | | | | | | | | | | | | | | | | | | | | | | | | | | | | | | | | | | | | | | | | | | |
| 1 | | | | | | | | | | | | | | | | | | | | | | | | | | | | | | | | | | | | | | | | | | | | | | | | | | | | | | | | | | | | | | | | | | | | | | | | | | | | | | | |
| | | | | | | | | | | | | | | | | | | | | | | | | | | | | | | | | | | | | | | | | | | | | | | | | | | | | | | | | | | | | | | | | | | | | | | | | | | | | | | | |
| | | | | | | | | | | | | | | | | | | | | | | | | | | | | | | | | | | | | | | | | | | | | | | | | | | | | | | | | | | | | | | | | | | | | | | | | | | | | | | | |
| | | | | | | | | | | | | | | | | | | | | | | | | | | | | | | | | | | | | | | | | | | | | | | | | | | | | | | | | | | | | | | | | | | | | | | | | | | | | | | | |
| | | | | | | | | | | | | | | | | | | | | | | | | | | | | | | | | | | | | | | | | | | | | | | | | | | | | | | | | | | | | | | | | | | | | | | | | | | | | | | | |
| | | | | | | | | | | | | | | | | | | | | | | | | | | | | | | | | | | | | | | | | | | | | | | | | | | | | | | | | | | | | | | | | | | | | | | | | | | | | | | | |
| | | | | | | | | | | | | | | | | | | | | | | | | | | | | | | | | | | | | | | | | | | | | | | | | | | | | | | | | | | | | | | | | | | | | | | | | | | | | | | | |
| | | | | | | | | | | | | | | | | | | | | | | | | | | | | | | | | | | | | | | | | | | | | | | | | | | | | | | | | | | | | | | | | | | | | | | | | | | | | | | | |
| | | | | | | | | | | | | | | | | | | | | | | | | | | | | | | | | | | | | | | | | | | | | | | | | | | | | | | | | | | | | | | | | | | | | | | | | | | | | | | | |
| | | | | | | | | | | | | | | | | | | | | | | | | | | | | | | | | | | | | | | | | | | | | | | | | | | | | | | | | | | | | | | | | | | | | | | | | | | | | | | | |
| | | | | | | | | | | | | | | | | | | | | | | | | | | | | | | | | | | | | | | | | | | | | | | | | | | | | | | | | | | | | | | | | | | | | | | | | | | | | | | | |
| | | | | | | | | | | | | | | | | | | | | | | | | | | | | | | | | | | | | | | | | | | | | | | | | | | | | | | | | | | | | | | | | | | | | | | | | | | | | | | | |
| | | | | | | | | | | | | | | | | | | | | | | | | | | | | | | | | | | | | | | | | | | | | | | | | | | | | | | | | | | | | | | | | | | | | | | | | | | | | | | | |
| | | | | | | | | | | | | | | | | | | | | | | | | | | | | | | | | | | | | | | | | | | | | | | | | | | | | | | | | | | | | | | | | | | | | | | | | | | | | | | | |
| | | | | | | | | | | | | | | | | | | | | | | | | | | | | | | | | | | | | | | | | | | | | | | | | | | | | | | | | | | | | | | | | | | | | | | | | | | | | | | | |
| | | | | | | | | | | | | | | | | | | | | | | | | | | | | | | | | | | | | | | | | | | | | | | | | | | | | | | | | | | | | | | | | | | | | | | | | | | | | | | | |
| | | | | | | | | | | | | | | | | | | | | | | | | | | | | | | | | | | | | | | | | | | | | | | | | | | | | | | | | | | | | | | | | | | | | | | | | | | | | | | | |
| Post - 0 Miss - 0 Block - 0 | Post - 0 Miss - 0 Block - 0 | Post - 0 Miss - 0 Block - 0 | Post - 0 Miss - 0 Block - 0 | Post - 0 Miss - 0 Block - 0 | Post - 0 Miss - 0 Block - 0 | Post - 0 Miss - 1 Block - 0 | | | | | | | | | | | | | | | | | | | | | | | | | | | | | | | | | | | | | | | | | | | | | | | | | | | | | | | | | | | | | | | | | | | | | | | | | |

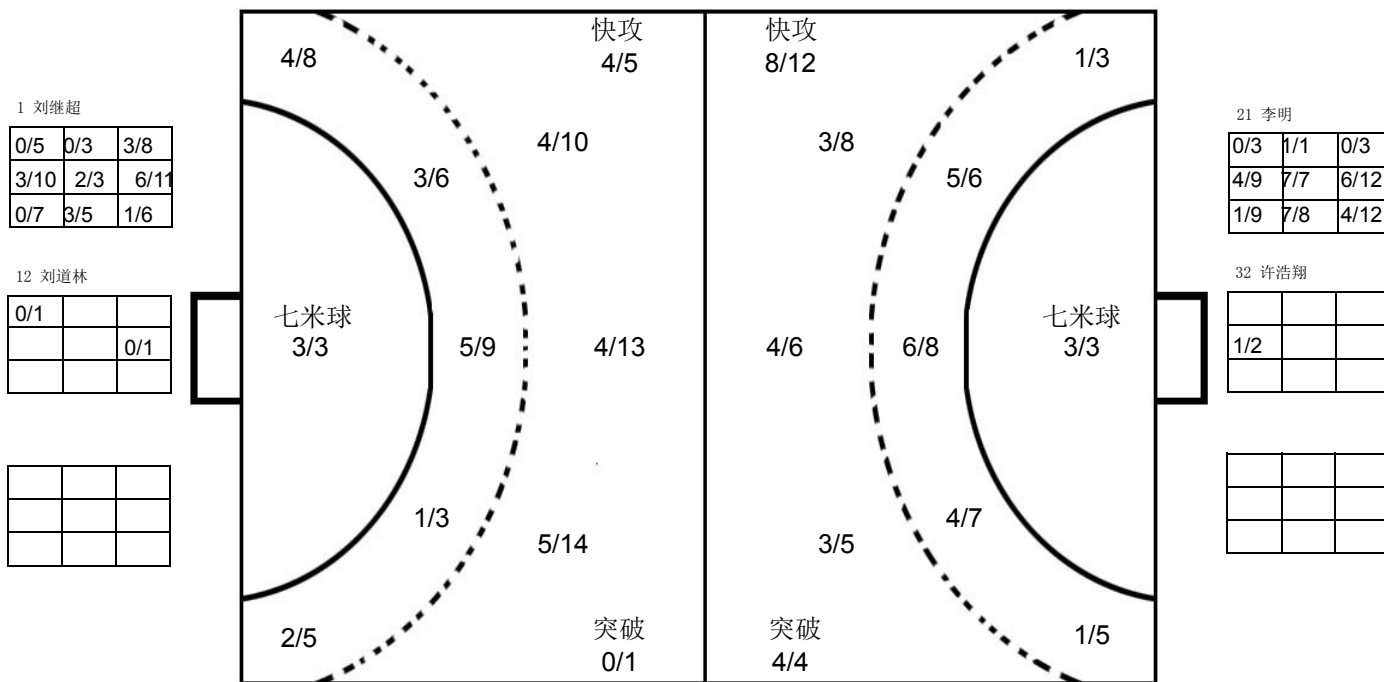

安徽队

| | | | | | | | | | | | | | | | | | | | | | | | | | | | | | | | | | | | | | | | | | | | | | | | | | | | | | | | | | | | | | | | | | | | | | | | | | | | | | | | |
|---|-----------------------------|-----------------------------|-----------------------------|-----------------------------|-----------------------------|-----------------------------|-----------------------------|--|--|--|--|--|--|--|--|---|---|--|---|---|---|---|---|---|--|--|---|--|---|---|--|--|--|---|--|--|--|--|--|---|---|---|---|---|---|---|---|---|---|---|--|--|--|--|--|--|--|---|--|--|--|--|--|--|--|--|--|--|--|---|--|--|--|--|--|--|---|--|--|
| 1 郭世伟 | 2 金勇峰 | 9 陈开勇 | 17 王巨柱 | 18 李双 | 19 何山 | 21 李明 | 24 徐安格 | | | | | | | | | | | | | | | | | | | | | | | | | | | | | | | | | | | | | | | | | | | | | | | | | | | | | | | | | | | | | | | | | | | | | | | | |
| <table border="1"><tr><td>4</td><td>1</td><td>1</td></tr><tr><td>4</td><td></td><td></td></tr><tr><td>1</td><td></td><td></td></tr></table> | 4 | 1 | 1 | 4 | | | 1 | | | <table border="1"><tr><td></td><td></td><td></td></tr><tr><td></td><td></td><td></td></tr><tr><td></td><td></td><td>1</td></tr></table> | | | | | | | | | 1 | <table border="1"><tr><td>1</td><td>1</td><td>3</td></tr><tr><td></td><td></td><td></td></tr><tr><td>2</td><td></td><td>1</td></tr></table> | 1 | 1 | 3 | | | | 2 | | 1 | <table border="1"><tr><td></td><td></td><td></td></tr><tr><td>1</td><td></td><td></td></tr><tr><td></td><td></td><td></td></tr></table> | | | | 1 | | | | | | <table border="1"><tr><td>1</td><td>1</td><td>1</td></tr><tr><td>1</td><td>1</td><td>5</td></tr><tr><td>1</td><td>1</td><td>1</td></tr></table> | 1 | 1 | 1 | 1 | 1 | 5 | 1 | 1 | 1 | <table border="1"><tr><td></td><td></td><td></td></tr><tr><td></td><td></td><td></td></tr><tr><td></td><td>1</td><td></td></tr></table> | | | | | | | | 1 | | <table border="1"><tr><td></td><td></td><td></td></tr><tr><td></td><td></td><td></td></tr><tr><td></td><td></td><td></td></tr></table> | | | | | | | | | | <table border="1"><tr><td></td><td></td><td></td></tr><tr><td></td><td></td><td></td></tr><tr><td>1</td><td></td><td></td></tr></table> | | | | | | | 1 | | |
| 4 | 1 | 1 | | | | | | | | | | | | | | | | | | | | | | | | | | | | | | | | | | | | | | | | | | | | | | | | | | | | | | | | | | | | | | | | | | | | | | | | | | | | | |
| 4 | | | | | | | | | | | | | | | | | | | | | | | | | | | | | | | | | | | | | | | | | | | | | | | | | | | | | | | | | | | | | | | | | | | | | | | | | | | | | | | |
| 1 | | | | | | | | | | | | | | | | | | | | | | | | | | | | | | | | | | | | | | | | | | | | | | | | | | | | | | | | | | | | | | | | | | | | | | | | | | | | | | | |
| | | | | | | | | | | | | | | | | | | | | | | | | | | | | | | | | | | | | | | | | | | | | | | | | | | | | | | | | | | | | | | | | | | | | | | | | | | | | | | | |
| | | | | | | | | | | | | | | | | | | | | | | | | | | | | | | | | | | | | | | | | | | | | | | | | | | | | | | | | | | | | | | | | | | | | | | | | | | | | | | | |
| | | 1 | | | | | | | | | | | | | | | | | | | | | | | | | | | | | | | | | | | | | | | | | | | | | | | | | | | | | | | | | | | | | | | | | | | | | | | | | | | | | |
| 1 | 1 | 3 | | | | | | | | | | | | | | | | | | | | | | | | | | | | | | | | | | | | | | | | | | | | | | | | | | | | | | | | | | | | | | | | | | | | | | | | | | | | | |
| | | | | | | | | | | | | | | | | | | | | | | | | | | | | | | | | | | | | | | | | | | | | | | | | | | | | | | | | | | | | | | | | | | | | | | | | | | | | | | | |
| 2 | | 1 | | | | | | | | | | | | | | | | | | | | | | | | | | | | | | | | | | | | | | | | | | | | | | | | | | | | | | | | | | | | | | | | | | | | | | | | | | | | | |
| | | | | | | | | | | | | | | | | | | | | | | | | | | | | | | | | | | | | | | | | | | | | | | | | | | | | | | | | | | | | | | | | | | | | | | | | | | | | | | | |
| 1 | | | | | | | | | | | | | | | | | | | | | | | | | | | | | | | | | | | | | | | | | | | | | | | | | | | | | | | | | | | | | | | | | | | | | | | | | | | | | | | |
| | | | | | | | | | | | | | | | | | | | | | | | | | | | | | | | | | | | | | | | | | | | | | | | | | | | | | | | | | | | | | | | | | | | | | | | | | | | | | | | |
| 1 | 1 | 1 | | | | | | | | | | | | | | | | | | | | | | | | | | | | | | | | | | | | | | | | | | | | | | | | | | | | | | | | | | | | | | | | | | | | | | | | | | | | | |
| 1 | 1 | 5 | | | | | | | | | | | | | | | | | | | | | | | | | | | | | | | | | | | | | | | | | | | | | | | | | | | | | | | | | | | | | | | | | | | | | | | | | | | | | |
| 1 | 1 | 1 | | | | | | | | | | | | | | | | | | | | | | | | | | | | | | | | | | | | | | | | | | | | | | | | | | | | | | | | | | | | | | | | | | | | | | | | | | | | | |
| | | | | | | | | | | | | | | | | | | | | | | | | | | | | | | | | | | | | | | | | | | | | | | | | | | | | | | | | | | | | | | | | | | | | | | | | | | | | | | | |
| | | | | | | | | | | | | | | | | | | | | | | | | | | | | | | | | | | | | | | | | | | | | | | | | | | | | | | | | | | | | | | | | | | | | | | | | | | | | | | | |
| | 1 | | | | | | | | | | | | | | | | | | | | | | | | | | | | | | | | | | | | | | | | | | | | | | | | | | | | | | | | | | | | | | | | | | | | | | | | | | | | | | |
| | | | | | | | | | | | | | | | | | | | | | | | | | | | | | | | | | | | | | | | | | | | | | | | | | | | | | | | | | | | | | | | | | | | | | | | | | | | | | | | |
| | | | | | | | | | | | | | | | | | | | | | | | | | | | | | | | | | | | | | | | | | | | | | | | | | | | | | | | | | | | | | | | | | | | | | | | | | | | | | | | |
| | | | | | | | | | | | | | | | | | | | | | | | | | | | | | | | | | | | | | | | | | | | | | | | | | | | | | | | | | | | | | | | | | | | | | | | | | | | | | | | |
| | | | | | | | | | | | | | | | | | | | | | | | | | | | | | | | | | | | | | | | | | | | | | | | | | | | | | | | | | | | | | | | | | | | | | | | | | | | | | | | |
| | | | | | | | | | | | | | | | | | | | | | | | | | | | | | | | | | | | | | | | | | | | | | | | | | | | | | | | | | | | | | | | | | | | | | | | | | | | | | | | |
| 1 | | | | | | | | | | | | | | | | | | | | | | | | | | | | | | | | | | | | | | | | | | | | | | | | | | | | | | | | | | | | | | | | | | | | | | | | | | | | | | | |
| Post - 2 Miss - 2 Block - 0 | Post - 1 Miss - 0 Block - 0 | Post - 0 Miss - 0 Block - 0 | Post - 0 Miss - 0 Block - 1 | Post - 0 Miss - 0 Block - 0 | Post - 0 Miss - 0 Block - 0 | Post - 0 Miss - 0 Block - 0 | Post - 1 Miss - 0 Block - 0 | | | | | | | | | | | | | | | | | | | | | | | | | | | | | | | | | | | | | | | | | | | | | | | | | | | | | | | | | | | | | | | | | | | | | | | | |
| 25 李文哲 | 26 程浩然 | 27 王长旭 | 28 丁浩然 | 32 许浩翔 | 33 姚紫祥 | 41 刘润民 | 42 王成龙 | | | | | | | | | | | | | | | | | | | | | | | | | | | | | | | | | | | | | | | | | | | | | | | | | | | | | | | | | | | | | | | | | | | | | | | | |
| <table border="1"><tr><td></td><td></td><td></td></tr><tr><td></td><td></td><td></td></tr><tr><td></td><td></td><td></td></tr></table> | | | | | | | | | | <table border="1"><tr><td></td><td></td><td></td></tr><tr><td></td><td></td><td>1</td></tr><tr><td>1</td><td></td><td></td></tr></table> | | | | | | 1 | 1 | | | <table border="1"><tr><td></td><td></td><td></td></tr><tr><td>1</td><td></td><td></td></tr><tr><td>1</td><td></td><td>2</td></tr></table> | | | | 1 | | | 1 | | 2 | <table border="1"><tr><td></td><td></td><td></td></tr><tr><td></td><td></td><td></td></tr><tr><td></td><td></td><td></td></tr></table> | | | | | | | | | | <table border="1"><tr><td></td><td></td><td></td></tr><tr><td></td><td></td><td></td></tr><tr><td></td><td></td><td></td></tr></table> | | | | | | | | | | <table border="1"><tr><td></td><td></td><td></td></tr><tr><td></td><td></td><td></td></tr><tr><td></td><td></td><td></td></tr></table> | | | | | | | | | | <table border="1"><tr><td></td><td></td><td></td></tr><tr><td></td><td></td><td></td></tr><tr><td></td><td></td><td></td></tr></table> | | | | | | | | | | <table border="1"><tr><td></td><td></td><td></td></tr><tr><td></td><td></td><td></td></tr><tr><td></td><td></td><td></td></tr></table> | | | | | | | | | |
| | | | | | | | | | | | | | | | | | | | | | | | | | | | | | | | | | | | | | | | | | | | | | | | | | | | | | | | | | | | | | | | | | | | | | | | | | | | | | | | |
| | | | | | | | | | | | | | | | | | | | | | | | | | | | | | | | | | | | | | | | | | | | | | | | | | | | | | | | | | | | | | | | | | | | | | | | | | | | | | | | |
| | | | | | | | | | | | | | | | | | | | | | | | | | | | | | | | | | | | | | | | | | | | | | | | | | | | | | | | | | | | | | | | | | | | | | | | | | | | | | | | |
| | | | | | | | | | | | | | | | | | | | | | | | | | | | | | | | | | | | | | | | | | | | | | | | | | | | | | | | | | | | | | | | | | | | | | | | | | | | | | | | |
| | | 1 | | | | | | | | | | | | | | | | | | | | | | | | | | | | | | | | | | | | | | | | | | | | | | | | | | | | | | | | | | | | | | | | | | | | | | | | | | | | | |
| 1 | | | | | | | | | | | | | | | | | | | | | | | | | | | | | | | | | | | | | | | | | | | | | | | | | | | | | | | | | | | | | | | | | | | | | | | | | | | | | | | |
| | | | | | | | | | | | | | | | | | | | | | | | | | | | | | | | | | | | | | | | | | | | | | | | | | | | | | | | | | | | | | | | | | | | | | | | | | | | | | | | |
| 1 | | | | | | | | | | | | | | | | | | | | | | | | | | | | | | | | | | | | | | | | | | | | | | | | | | | | | | | | | | | | | | | | | | | | | | | | | | | | | | | |
| 1 | | 2 | | | | | | | | | | | | | | | | | | | | | | | | | | | | | | | | | | | | | | | | | | | | | | | | | | | | | | | | | | | | | | | | | | | | | | | | | | | | | |
| | | | | | | | | | | | | | | | | | | | | | | | | | | | | | | | | | | | | | | | | | | | | | | | | | | | | | | | | | | | | | | | | | | | | | | | | | | | | | | | |
| | | | | | | | | | | | | | | | | | | | | | | | | | | | | | | | | | | | | | | | | | | | | | | | | | | | | | | | | | | | | | | | | | | | | | | | | | | | | | | | |
| | | | | | | | | | | | | | | | | | | | | | | | | | | | | | | | | | | | | | | | | | | | | | | | | | | | | | | | | | | | | | | | | | | | | | | | | | | | | | | | |
| | | | | | | | | | | | | | | | | | | | | | | | | | | | | | | | | | | | | | | | | | | | | | | | | | | | | | | | | | | | | | | | | | | | | | | | | | | | | | | | |
| | | | | | | | | | | | | | | | | | | | | | | | | | | | | | | | | | | | | | | | | | | | | | | | | | | | | | | | | | | | | | | | | | | | | | | | | | | | | | | | |
| | | | | | | | | | | | | | | | | | | | | | | | | | | | | | | | | | | | | | | | | | | | | | | | | | | | | | | | | | | | | | | | | | | | | | | | | | | | | | | | |
| | | | | | | | | | | | | | | | | | | | | | | | | | | | | | | | | | | | | | | | | | | | | | | | | | | | | | | | | | | | | | | | | | | | | | | | | | | | | | | | |
| | | | | | | | | | | | | | | | | | | | | | | | | | | | | | | | | | | | | | | | | | | | | | | | | | | | | | | | | | | | | | | | | | | | | | | | | | | | | | | | |
| | | | | | | | | | | | | | | | | | | | | | | | | | | | | | | | | | | | | | | | | | | | | | | | | | | | | | | | | | | | | | | | | | | | | | | | | | | | | | | | |
| | | | | | | | | | | | | | | | | | | | | | | | | | | | | | | | | | | | | | | | | | | | | | | | | | | | | | | | | | | | | | | | | | | | | | | | | | | | | | | | |
| | | | | | | | | | | | | | | | | | | | | | | | | | | | | | | | | | | | | | | | | | | | | | | | | | | | | | | | | | | | | | | | | | | | | | | | | | | | | | | | |
| | | | | | | | | | | | | | | | | | | | | | | | | | | | | | | | | | | | | | | | | | | | | | | | | | | | | | | | | | | | | | | | | | | | | | | | | | | | | | | | |
| | | | | | | | | | | | | | | | | | | | | | | | | | | | | | | | | | | | | | | | | | | | | | | | | | | | | | | | | | | | | | | | | | | | | | | | | | | | | | | | |
| | | | | | | | | | | | | | | | | | | | | | | | | | | | | | | | | | | | | | | | | | | | | | | | | | | | | | | | | | | | | | | | | | | | | | | | | | | | | | | | |
| | | | | | | | | | | | | | | | | | | | | | | | | | | | | | | | | | | | | | | | | | | | | | | | | | | | | | | | | | | | | | | | | | | | | | | | | | | | | | | | |
| Post - 0 Miss - 0 Block - 0 | Post - 0 Miss - 0 Block - 0 | Post - 0 Miss - 0 Block - 0 | Post - 0 Miss - 0 Block - 0 | Post - 0 Miss - 0 Block - 0 | Post - 0 Miss - 0 Block - 0 | Post - 0 Miss - 0 Block - 0 | Post - 0 Miss - 0 Block - 0 | | | | | | | | | | | | | | | | | | | | | | | | | | | | | | | | | | | | | | | | | | | | | | | | | | | | | | | | | | | | | | | | | | | | | | | | |

注释: Post=击柱 Miss=射失 Block=被封





决赛
青年男子 全国比赛

2016年“体彩杯”全国手球男子青年锦标赛

| | | | | | | | | | | | | | | | | | | | | | |
|--------------------|---|----------------|---------------------|------------|------------------------------------|------------------|----------------|-------------------|----------|----------------|------------|---------------|----------------------|---------------|----------|--|----|---|----|---|----|
| Team A | | | | | Team B | | | | | Match Number | | | | | | | | | | | |
| A 新疆队 | | | | | B 四川队 | | | | | 46 | | | | | | | | | | | |
| played in China | | | in the hall 重庆万州 | | | on 29/03/2016 | | at 16:00 hours | | Spectators | | | | | | | | | | | |
| Half-time (30') | A 18 | B 16 | End of playing time | | A 28 | B 27 | 1st extra time | A | B | 2nd extra time | A | B | After penalty throws | A | B | | | | | | |
| Number of 7 m | A 4 / 6 | Team time-out | | | Full name of players and officials | | | | | Team time-out | | | B 3 / 6 | Number of 7 m | | | | | | | |
| | | 1 20:25 | 2 50:19 | 3 59:21 | | | | | | 1 27:03 | 2 43:11 | 3 54:54 | | | | | | | | | |
| No. | Team A | | | | | G | W | 2' | D | DR | No. | Team B | | | | | G | W | 2' | D | DR |
| 1 | 宋晓晨 | | | | | | | | | | 1 | 宋继强 | | | | | | | | | |
| 2 | 王泽川 | | | | | | | | | | 3 | 刘赵梁 | | | | | 2 | | | | |
| 4 | 谷通金 | | | | | | | | | | 5 | 王凯 | | | | | 2 | | | | |
| 5 | 徐伟 | | | | | 3 | | 1 | | | 7 | 仇瑞祥 | | | | | 2 | | | | |
| 6 | 白光宇 | | | | | 2 | | | | | 8 | 罗尧尧 | | | | | 10 | | | | |
| 7 | 林豪文 | | | | | 5 | | 2 | | | 9 | 许翔宇 | | | | | 4 | 1 | 1 | | |
| 10 | 王钟彬 | | | | | 6 | | 2 | | | 10 | 徐彦昊 | | | | | 1 | | | | |
| 12 | 王金鑫 | | | | | | | | | | 11 | 张天豪 | | | | | | | | | |
| 13 | 苏兴伟 | | | | | | | | | | 12 | 刘树豪 | | | | | | | | | |
| 15 | 王维东 | | | | | 2 | | | | | 13 | 尹文珂 | | | | | 3 | | 1 | | |
| 16 | 李佳懿 | | | | | | | | | | 15 | 徐逸 | | | | | | | | | |
| 17 | 胡晋铭 | | | | | 4 | 1 | 1 | | | 17 | 谢庆龙 | | | | | 1 | 1 | 1 | | |
| 18 | 李万兴 | | | | | | | | | | 18 | 张睿梁 | | | | | | | | | |
| 19 | 李龙吉 | | | | | 6 | | | | | 19 | 庞连康 | | | | | 2 | | | | |
| 24 | 陈伟华 | | | | | | | | | | 20 | 张文健 | | | | | | | | | |
| | | | | | | | | | | | 21 | 曹修庆 | | | | | | | | | |
| A | 孔德宾 (主教练) | | | | | | | | | | B | 张文韬 (主教练) | | | | | | | | | |
| B | 陈鹏波 | | | | | | | | | | | | | | | | | | | | |
| C | 李楠 | | | | | | | | | | | | | | | | | | | | |
| | | | | | | | | | | | | | | | | | | | | | |
| | | | | | | | | | | | | | | | | | | | | | |
| | | | | | | | | | | | | | | | | | | | | | |
| A | Signature of Responsible Official of the Teams (Off. A) | | | | | | | | | | B | | | | | | | | | | |
| TP | Remarks of Referee / CHA Official | | | | | | | | | | | | | | | | | | TP | | |

Signatures

| | | | |
|------------------|-----------|-----------|--|
| Referees | 尹静阳 (CHN) | 马晓晔 (CHN) | |
| Techn. Delegates | 张春生 (CHN) | | |
| CHA Official | 吴瑞亭 (CHN) | | |

Note: Number of 7m Throws Awarded to Team A and B, Goals (G), Warnings (W), Suspensions (2'), Direct Disqualification (D), Disqualification with Report (DR) and Team Penalty (TP).

Table Officials:

Statisticians: 李双

刘永欢



2016年“体彩杯”全国手球男子青年锦标赛
竞赛技术统计(媒体表)

决赛 组别 X 轮次 8 场次 46

重庆万州

29/03/2016

201602046-51-1/1

新疆队 新疆 28 vs 27 四川 四川队
18 : 16

裁判员 尹静阳 (CHN) / 马晓晔 (CHN)

Main statistics table with columns for players, teams (新疆, 四川), and various performance metrics like shots, goals, assists, and suspensions.

场上队员: 得分 / 射门

守门员: 救球 / 射门

Legend table for abbreviations: 快攻 (Fast Break), 突破 (Breakthrough), 任意球 (Free Throw), 7M球 (7M Throw), 助攻 (Assist), 警告 (Warning), 失误 (Error), 2' (Suspension), D (取消资格), DR (取消资格+报告)





2016年“体彩杯”全国手球男子青年锦标赛 图式比赛技术统计表

轮次 8

场次 46

201602046-21-1/1

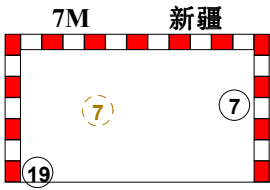
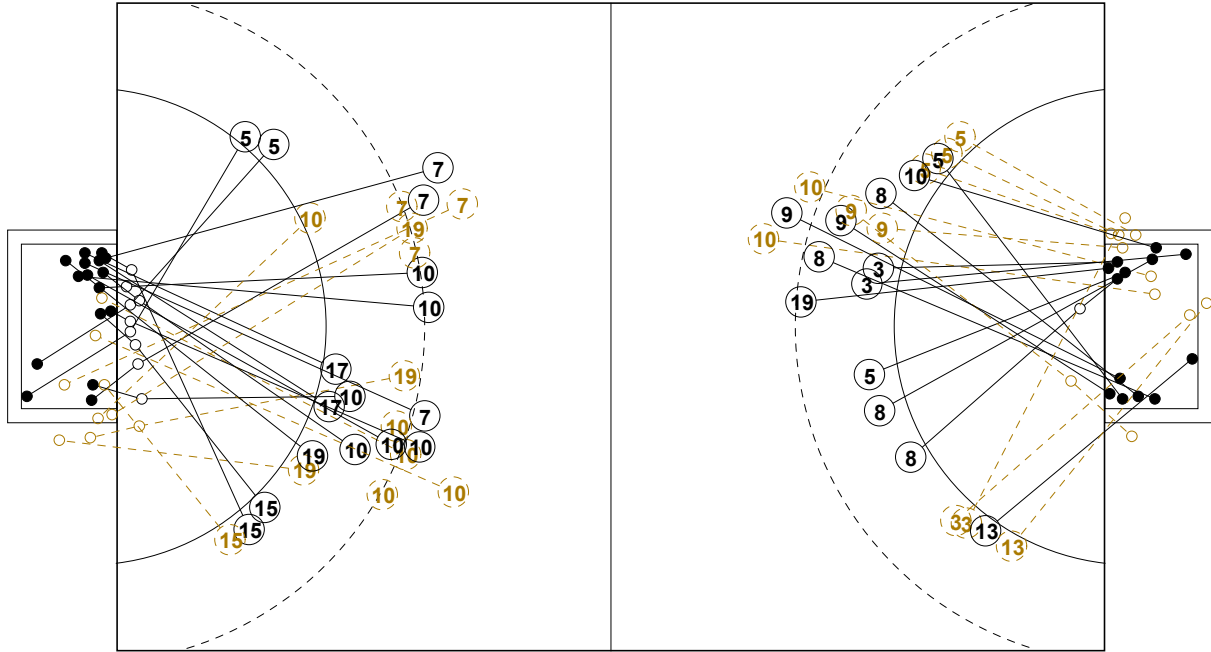

1st Half
18 : 16

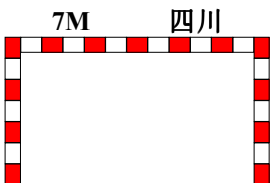
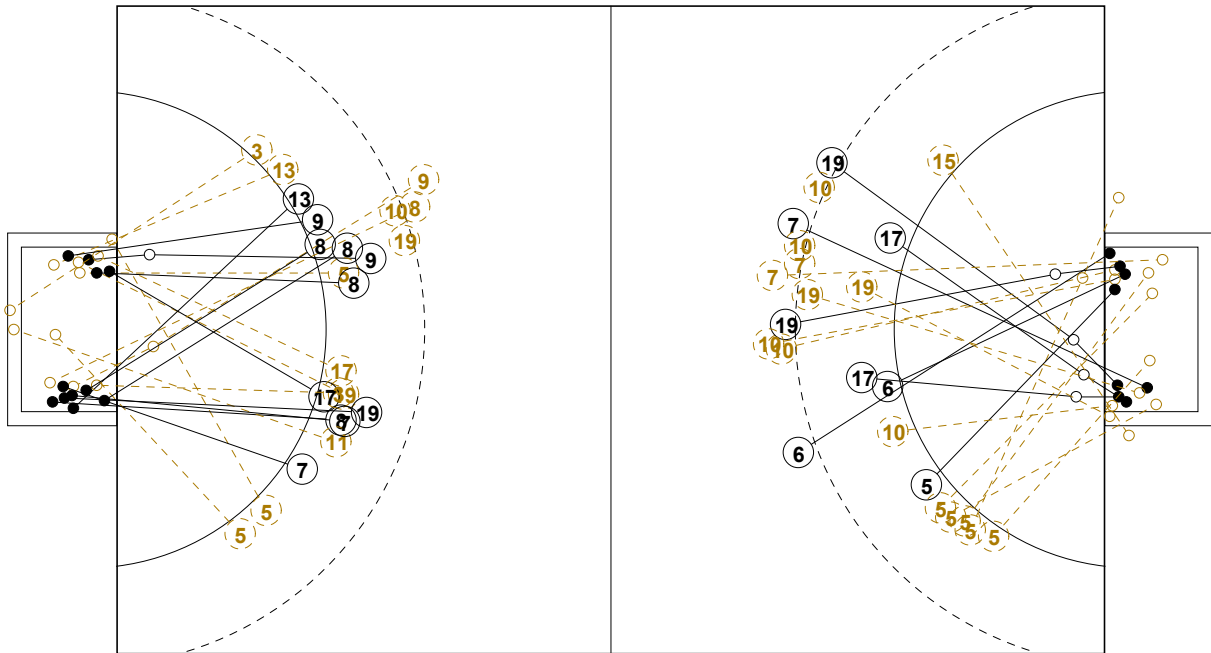
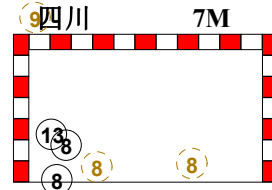

2nd Half
27 : 28

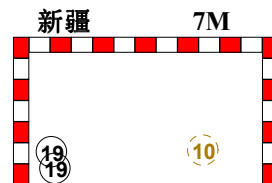



2016年“体彩杯”全国手球男子青年锦标赛

个人/全队技术统计表

正式表
手球
青年男子决赛
轮次 8组别 X
场次 46201602046-14-1/2
重庆万州
29/03/2016 16:00

| 号码 | 姓名 | 远射 | 近射 | 边射 | 快攻 | 突破 | 任意 | 7M | 合计 | % | 助攻 | 失误 | 警告 | 2' | 取消 | 时间 |
|----------------|-----|------|------|-----|-----|-----|-----|-----|-------|-------|----|----|----|----|----|----------|
| 新疆队(新疆) | | | | | | | | | | | | | | | | |
| <i>(场上队员)</i> | | | | | | | | | | | | | | | | |
| 1 | 宋晓晨 | | | | | | | | | 0.0% | | | | | | 01:00:00 |
| 2 | 王泽川 | | | | | | | | | 0.0% | | | | | | 00:00:00 |
| 4 | 谷通金 | | | | | | | | | 0.0% | | | | | | 00:00:00 |
| 5 | 徐伟 | | 2/4 | 1/4 | | | | | 3/8 | 37.5% | 1 | 3 | | 1 | | 01:00:00 |
| 6 | 白光宇 | 1/1 | 1/1 | | | | | | 2/2 | 100% | | 2 | | | | 00:14:36 |
| 7 | 林豪文 | 2/7 | | | | | 2/2 | 1/2 | 5/11 | 45.5% | | 1 | | 2 | | 01:00:00 |
| 10 | 王钟彬 | 3/11 | 1/3 | | 1/1 | | 1/1 | 0/1 | 6/17 | 35.3% | 2 | 3 | | 2 | | 01:00:00 |
| 12 | 王金鑫 | | | | | | | | | 0.0% | | | | | | 00:00:00 |
| 13 | 苏兴伟 | | | | | | | | | 0.0% | | | | | | 00:00:00 |
| 15 | 王维东 | | 0/1 | 2/3 | | | | | 2/4 | 50.0% | | 1 | | | | 00:45:23 |
| 16 | 李佳懿 | | | | | | | | | 0.0% | | | | | | 00:00:00 |
| 17 | 胡晋铭 | | 4/4 | | | | | | 4/4 | 100% | | 4 | 1 | 1 | | 01:00:00 |
| 18 | 李万兴 | | | | | | | | | 0.0% | | | | | | 00:00:00 |
| 19 | 李龙吉 | 2/4 | 0/1 | | 0/1 | 1/2 | | 3/3 | 6/11 | 54.5% | 3 | 9 | | | | 01:00:00 |
| 24 | 陈伟华 | | | | | | | | | 0.0% | | | | | | 00:00:00 |
| 合计 | | 8/23 | 8/14 | 3/7 | 1/2 | 1/2 | 3/3 | 4/6 | 28/57 | 49.1% | 6 | 23 | 1 | 6 | | |
| <i>(守门员)</i> | | | | | | | | | | | | | | | | |
| 1 | 宋晓晨 | 4/6 | 5/19 | 2/3 | 0/5 | 1/2 | 0/1 | 2/5 | 14/41 | 34.1% | | | | | | 01:00:00 |
| 合计 | | 4/6 | 5/19 | 2/3 | 0/5 | 1/2 | 0/1 | 2/5 | 14/41 | 34.1% | | | | | | |

场上队员：得分/射门

守门员：救球/射门

| 全队合计 | 得分 | 被救 | 射失 | 击柱 | 封球 | 合计 | % |
|------|----|----|----|----|----|----|--------|
| 远射 | 8 | 7 | | 1 | 7 | 23 | 34.8% |
| 近射 | 8 | 3 | 1 | 2 | | 14 | 57.1% |
| 边射 | 3 | 3 | 1 | | | 7 | 42.9% |
| 快攻 | 1 | | 1 | | | 2 | 50.0% |
| 突破 | 1 | | 1 | | | 2 | 50.0% |
| 任意 | 3 | | | | | 3 | 100.0% |
| 7M | 4 | 2 | | | | 6 | 66.7% |





2016年“体彩杯”全国手球男子青年锦标赛

个人/全队技术统计表

正式表
手球
青年男子决赛
轮次 8组别 X
场次 46201602046-14-2/2
重庆万州
29/03/2016 16:00

| 号码 | 姓名 | 远射 | 近射 | 边射 | 快攻 | 突破 | 任意 | 7M | 合计 | % | 助攻 | 失误 | 警告 | 2' | 取消 | 时间 |
|----------------|-----|------|-------|-----|-----|-----|-----|-----|-------|-------|----|----|----|----|----|----------|
| 四川队(四川) | | | | | | | | | | | | | | | | |
| <i>(上场队员)</i> | | | | | | | | | | | | | | | | |
| 1 | 宋继强 | | | | | | | | | 0.0% | | | | | | 00:31:57 |
| 3 | 刘赵梁 | | 2/2 | 0/3 | | 0/1 | | | 2/6 | 33.3% | 1 | 3 | | | | 00:40:57 |
| 5 | 王凯 | | 2/5 | 0/2 | 0/1 | | | | 2/8 | 25.0% | 1 | 1 | | | | 00:46:07 |
| 7 | 仇瑞祥 | | 1/1 | | | 1/1 | | | 2/2 | 100% | | 1 | | | | 00:04:25 |
| 8 | 罗尧尧 | 1/2 | 3/3 | | 4/4 | | | 2/4 | 10/13 | 76.9% | 5 | 4 | | | | 00:51:25 |
| 9 | 许翔宇 | 1/2 | 2/4 | | | | 1/1 | 0/1 | 4/8 | 50.0% | 3 | 3 | 1 | 1 | | 00:52:50 |
| 10 | 徐彦昊 | 0/3 | 1/1 | | | | | | 1/4 | 25.0% | 1 | 1 | | | | 00:20:05 |
| 11 | 张天豪 | | 0/1 | | | | | | 0/1 | 0.0% | | | | | | 00:08:55 |
| 12 | 刘树豪 | | | | | | | | | 0.0% | | | | | | 00:28:03 |
| 13 | 尹文珂 | | 1/2 | 1/2 | | | | 1/1 | 3/5 | 60.0% | | | | 1 | | 00:19:15 |
| 15 | 徐逸 | | | | | | | | | 0.0% | | | | | | 00:00:00 |
| 17 | 谢庆龙 | | 1/2 | | | | | | 1/2 | 50.0% | 1 | 2 | 1 | 1 | | 01:00:00 |
| 18 | 张睿梁 | | | | | | | | | 0.0% | | | | | | 00:00:00 |
| 19 | 庞连康 | 0/1 | 1/2 | | 1/1 | | | | 2/4 | 50.0% | | 5 | | | | 00:57:13 |
| 20 | 张文健 | | | | | | | | | 0.0% | | | | | | 00:00:00 |
| 21 | 曹修庆 | | | | | | | | | 0.0% | | | | | | 00:00:00 |
| 合计 | | 2/8 | 14/23 | 1/7 | 5/6 | 1/2 | 1/1 | 3/6 | 27/53 | 50.9% | 12 | 20 | 2 | 3 | | |
| <i>(守门员)</i> | | | | | | | | | | | | | | | | |
| 1 | 宋继强 | 3/9 | 2/6 | 2/3 | | 0/1 | 0/2 | 0/1 | 7/22 | 31.8% | | | | | | 00:31:57 |
| 12 | 刘树豪 | 4/6 | 1/5 | 1/3 | 0/1 | | 0/1 | 2/5 | 8/21 | 38.1% | | | | | | 00:28:03 |
| 合计 | | 7/15 | 3/11 | 3/6 | 0/1 | 0/1 | 0/3 | 2/6 | 15/43 | 34.9% | | | | | | |

场上队员：得分/射门

守门员：救球/射门

| 全队合计 | 得分 | 被救 | 射失 | 击柱 | 封球 | 合计 | % |
|------|----|----|----|----|----|----|--------|
| 远射 | 2 | 4 | | | 2 | 8 | 25.0% |
| 近射 | 14 | 5 | 1 | 3 | | 23 | 60.9% |
| 边射 | 1 | 2 | 1 | 3 | | 7 | 14.3% |
| 快攻 | 5 | | | 1 | | 6 | 83.3% |
| 突破 | 1 | 1 | | | | 2 | 50.0% |
| 任意 | 1 | | | | | 1 | 100.0% |
| 7M | 3 | 2 | 1 | | | 6 | 50.0% |





2016年“体彩杯”全国手球男子青年锦标赛

图式射门区域统计

轮次 8 场次 46

201602046-41-1/1

新疆队

| | | | | | | | | | | | | | | | | | | | | | | | | | | | | | | | | | | | | | | | | | | | | | | | | | | | | | | | | | | | | | | | | | | | | | | | | | | | | | | | | | | |
|--|-----------------------------|-----------------------------|-----------------------------|-----------------------------|-----------------------------|-----------------------------|-----------------------------|--|--|--|--|--|--|--|--|--|--|---|---|--|--|--|--|--|--|--|--|--|--|--|---|--|--|--|--|--|---|---|--|---|--|---|--|--|--|--|---|--|--|--|--|--|--|--|--|--|---|--|---|---|--|--|--|--|--|--|---|---|---|--|--|--|--|--|--|--|--|--|--|--|--|--|
| 1 宋晓晨 | 2 王泽川 | 4 谷通金 | 5 徐伟 | 6 白光宇 | 7 林豪文 | 10 王钟彬 | 12 王金鑫 | | | | | | | | | | | | | | | | | | | | | | | | | | | | | | | | | | | | | | | | | | | | | | | | | | | | | | | | | | | | | | | | | | | | | | | | | | | |
| <table border="1"><tr><td></td><td></td><td></td></tr><tr><td></td><td></td><td></td></tr><tr><td></td><td></td><td></td></tr></table> | | | | | | | | | | <table border="1"><tr><td></td><td></td><td></td></tr><tr><td></td><td></td><td></td></tr><tr><td></td><td></td><td></td></tr></table> | | | | | | | | | | <table border="1"><tr><td></td><td></td><td></td></tr><tr><td></td><td></td><td></td></tr><tr><td></td><td></td><td></td></tr></table> | | | | | | | | | | <table border="1"><tr><td>2</td><td></td><td></td></tr><tr><td></td><td></td><td></td></tr><tr><td>1</td><td></td><td></td></tr></table> | 2 | | | | | | 1 | | | <table border="1"><tr><td></td><td></td><td></td></tr><tr><td></td><td></td><td></td></tr><tr><td>2</td><td></td><td></td></tr></table> | | | | | | | 2 | | | <table border="1"><tr><td></td><td></td><td></td></tr><tr><td></td><td></td><td></td></tr><tr><td>1</td><td></td><td>1</td></tr></table> | | | | | | | 1 | | 1 | <table border="1"><tr><td></td><td></td><td></td></tr><tr><td></td><td></td><td></td></tr><tr><td>1</td><td>1</td><td>3</td></tr></table> | | | | | | | 1 | 1 | 3 | <table border="1"><tr><td></td><td></td><td></td></tr><tr><td></td><td></td><td></td></tr><tr><td></td><td></td><td></td></tr></table> | | | | | | | | | | | | |
| | | | | | | | | | | | | | | | | | | | | | | | | | | | | | | | | | | | | | | | | | | | | | | | | | | | | | | | | | | | | | | | | | | | | | | | | | | | | | | | | | | |
| | | | | | | | | | | | | | | | | | | | | | | | | | | | | | | | | | | | | | | | | | | | | | | | | | | | | | | | | | | | | | | | | | | | | | | | | | | | | | | | | | | |
| | | | | | | | | | | | | | | | | | | | | | | | | | | | | | | | | | | | | | | | | | | | | | | | | | | | | | | | | | | | | | | | | | | | | | | | | | | | | | | | | | | |
| | | | | | | | | | | | | | | | | | | | | | | | | | | | | | | | | | | | | | | | | | | | | | | | | | | | | | | | | | | | | | | | | | | | | | | | | | | | | | | | | | | |
| | | | | | | | | | | | | | | | | | | | | | | | | | | | | | | | | | | | | | | | | | | | | | | | | | | | | | | | | | | | | | | | | | | | | | | | | | | | | | | | | | | |
| | | | | | | | | | | | | | | | | | | | | | | | | | | | | | | | | | | | | | | | | | | | | | | | | | | | | | | | | | | | | | | | | | | | | | | | | | | | | | | | | | | |
| | | | | | | | | | | | | | | | | | | | | | | | | | | | | | | | | | | | | | | | | | | | | | | | | | | | | | | | | | | | | | | | | | | | | | | | | | | | | | | | | | | |
| | | | | | | | | | | | | | | | | | | | | | | | | | | | | | | | | | | | | | | | | | | | | | | | | | | | | | | | | | | | | | | | | | | | | | | | | | | | | | | | | | | |
| | | | | | | | | | | | | | | | | | | | | | | | | | | | | | | | | | | | | | | | | | | | | | | | | | | | | | | | | | | | | | | | | | | | | | | | | | | | | | | | | | | |
| 2 | | | | | | | | | | | | | | | | | | | | | | | | | | | | | | | | | | | | | | | | | | | | | | | | | | | | | | | | | | | | | | | | | | | | | | | | | | | | | | | | | | |
| | | | | | | | | | | | | | | | | | | | | | | | | | | | | | | | | | | | | | | | | | | | | | | | | | | | | | | | | | | | | | | | | | | | | | | | | | | | | | | | | | | |
| 1 | | | | | | | | | | | | | | | | | | | | | | | | | | | | | | | | | | | | | | | | | | | | | | | | | | | | | | | | | | | | | | | | | | | | | | | | | | | | | | | | | | |
| | | | | | | | | | | | | | | | | | | | | | | | | | | | | | | | | | | | | | | | | | | | | | | | | | | | | | | | | | | | | | | | | | | | | | | | | | | | | | | | | | | |
| | | | | | | | | | | | | | | | | | | | | | | | | | | | | | | | | | | | | | | | | | | | | | | | | | | | | | | | | | | | | | | | | | | | | | | | | | | | | | | | | | | |
| 2 | | | | | | | | | | | | | | | | | | | | | | | | | | | | | | | | | | | | | | | | | | | | | | | | | | | | | | | | | | | | | | | | | | | | | | | | | | | | | | | | | | |
| | | | | | | | | | | | | | | | | | | | | | | | | | | | | | | | | | | | | | | | | | | | | | | | | | | | | | | | | | | | | | | | | | | | | | | | | | | | | | | | | | | |
| | | | | | | | | | | | | | | | | | | | | | | | | | | | | | | | | | | | | | | | | | | | | | | | | | | | | | | | | | | | | | | | | | | | | | | | | | | | | | | | | | | |
| 1 | | 1 | | | | | | | | | | | | | | | | | | | | | | | | | | | | | | | | | | | | | | | | | | | | | | | | | | | | | | | | | | | | | | | | | | | | | | | | | | | | | | | | |
| | | | | | | | | | | | | | | | | | | | | | | | | | | | | | | | | | | | | | | | | | | | | | | | | | | | | | | | | | | | | | | | | | | | | | | | | | | | | | | | | | | |
| | | | | | | | | | | | | | | | | | | | | | | | | | | | | | | | | | | | | | | | | | | | | | | | | | | | | | | | | | | | | | | | | | | | | | | | | | | | | | | | | | | |
| 1 | 1 | 3 | | | | | | | | | | | | | | | | | | | | | | | | | | | | | | | | | | | | | | | | | | | | | | | | | | | | | | | | | | | | | | | | | | | | | | | | | | | | | | | | |
| | | | | | | | | | | | | | | | | | | | | | | | | | | | | | | | | | | | | | | | | | | | | | | | | | | | | | | | | | | | | | | | | | | | | | | | | | | | | | | | | | | |
| | | | | | | | | | | | | | | | | | | | | | | | | | | | | | | | | | | | | | | | | | | | | | | | | | | | | | | | | | | | | | | | | | | | | | | | | | | | | | | | | | | |
| | | | | | | | | | | | | | | | | | | | | | | | | | | | | | | | | | | | | | | | | | | | | | | | | | | | | | | | | | | | | | | | | | | | | | | | | | | | | | | | | | | |
| Post - 0 Miss - 0 Block - 0 | Post - 0 Miss - 0 Block - 0 | Post - 0 Miss - 0 Block - 0 | Post - 0 Miss - 1 Block - 0 | Post - 0 Miss - 0 Block - 0 | Post - 0 Miss - 0 Block - 3 | Post - 1 Miss - 0 Block - 4 | Post - 0 Miss - 0 Block - 0 | | | | | | | | | | | | | | | | | | | | | | | | | | | | | | | | | | | | | | | | | | | | | | | | | | | | | | | | | | | | | | | | | | | | | | | | | | | |
| 13 苏兴伟 | 15 王维东 | 16 李佳懿 | 17 胡晋铭 | 18 李万兴 | 19 李龙吉 | 24 陈伟华 | | | | | | | | | | | | | | | | | | | | | | | | | | | | | | | | | | | | | | | | | | | | | | | | | | | | | | | | | | | | | | | | | | | | | | | | | | | | |
| <table border="1"><tr><td></td><td></td><td></td></tr><tr><td></td><td></td><td></td></tr><tr><td></td><td></td><td></td></tr></table> | | | | | | | | | | <table border="1"><tr><td></td><td></td><td></td></tr><tr><td></td><td></td><td></td></tr><tr><td></td><td>1</td><td>1</td></tr></table> | | | | | | | | 1 | 1 | <table border="1"><tr><td></td><td></td><td></td></tr><tr><td></td><td></td><td></td></tr><tr><td></td><td></td><td></td></tr></table> | | | | | | | | | | <table border="1"><tr><td></td><td></td><td></td></tr><tr><td></td><td></td><td></td></tr><tr><td></td><td>1</td><td></td></tr><tr><td></td><td></td><td>3</td></tr></table> | | | | | | | | 1 | | | | 3 | <table border="1"><tr><td></td><td></td><td></td></tr><tr><td></td><td></td><td></td></tr><tr><td></td><td></td><td></td></tr></table> | | | | | | | | | | <table border="1"><tr><td></td><td></td><td></td></tr><tr><td></td><td></td><td></td></tr><tr><td></td><td></td><td></td></tr></table> | | | | | | | | | | <table border="1"><tr><td></td><td></td><td></td></tr><tr><td></td><td></td><td></td></tr><tr><td></td><td></td><td></td></tr></table> | | | | | | | | | | <table border="1"><tr><td></td><td></td><td></td></tr><tr><td></td><td></td><td></td></tr><tr><td></td><td></td><td></td></tr></table> | | | | | | | | | |
| | | | | | | | | | | | | | | | | | | | | | | | | | | | | | | | | | | | | | | | | | | | | | | | | | | | | | | | | | | | | | | | | | | | | | | | | | | | | | | | | | | |
| | | | | | | | | | | | | | | | | | | | | | | | | | | | | | | | | | | | | | | | | | | | | | | | | | | | | | | | | | | | | | | | | | | | | | | | | | | | | | | | | | | |
| | | | | | | | | | | | | | | | | | | | | | | | | | | | | | | | | | | | | | | | | | | | | | | | | | | | | | | | | | | | | | | | | | | | | | | | | | | | | | | | | | | |
| | | | | | | | | | | | | | | | | | | | | | | | | | | | | | | | | | | | | | | | | | | | | | | | | | | | | | | | | | | | | | | | | | | | | | | | | | | | | | | | | | | |
| | | | | | | | | | | | | | | | | | | | | | | | | | | | | | | | | | | | | | | | | | | | | | | | | | | | | | | | | | | | | | | | | | | | | | | | | | | | | | | | | | | |
| | 1 | 1 | | | | | | | | | | | | | | | | | | | | | | | | | | | | | | | | | | | | | | | | | | | | | | | | | | | | | | | | | | | | | | | | | | | | | | | | | | | | | | | | |
| | | | | | | | | | | | | | | | | | | | | | | | | | | | | | | | | | | | | | | | | | | | | | | | | | | | | | | | | | | | | | | | | | | | | | | | | | | | | | | | | | | |
| | | | | | | | | | | | | | | | | | | | | | | | | | | | | | | | | | | | | | | | | | | | | | | | | | | | | | | | | | | | | | | | | | | | | | | | | | | | | | | | | | | |
| | | | | | | | | | | | | | | | | | | | | | | | | | | | | | | | | | | | | | | | | | | | | | | | | | | | | | | | | | | | | | | | | | | | | | | | | | | | | | | | | | | |
| | | | | | | | | | | | | | | | | | | | | | | | | | | | | | | | | | | | | | | | | | | | | | | | | | | | | | | | | | | | | | | | | | | | | | | | | | | | | | | | | | | |
| | | | | | | | | | | | | | | | | | | | | | | | | | | | | | | | | | | | | | | | | | | | | | | | | | | | | | | | | | | | | | | | | | | | | | | | | | | | | | | | | | | |
| | 1 | | | | | | | | | | | | | | | | | | | | | | | | | | | | | | | | | | | | | | | | | | | | | | | | | | | | | | | | | | | | | | | | | | | | | | | | | | | | | | | | | |
| | | 3 | | | | | | | | | | | | | | | | | | | | | | | | | | | | | | | | | | | | | | | | | | | | | | | | | | | | | | | | | | | | | | | | | | | | | | | | | | | | | | | | |
| | | | | | | | | | | | | | | | | | | | | | | | | | | | | | | | | | | | | | | | | | | | | | | | | | | | | | | | | | | | | | | | | | | | | | | | | | | | | | | | | | | |
| | | | | | | | | | | | | | | | | | | | | | | | | | | | | | | | | | | | | | | | | | | | | | | | | | | | | | | | | | | | | | | | | | | | | | | | | | | | | | | | | | | |
| | | | | | | | | | | | | | | | | | | | | | | | | | | | | | | | | | | | | | | | | | | | | | | | | | | | | | | | | | | | | | | | | | | | | | | | | | | | | | | | | | | |
| | | | | | | | | | | | | | | | | | | | | | | | | | | | | | | | | | | | | | | | | | | | | | | | | | | | | | | | | | | | | | | | | | | | | | | | | | | | | | | | | | | |
| | | | | | | | | | | | | | | | | | | | | | | | | | | | | | | | | | | | | | | | | | | | | | | | | | | | | | | | | | | | | | | | | | | | | | | | | | | | | | | | | | | |
| | | | | | | | | | | | | | | | | | | | | | | | | | | | | | | | | | | | | | | | | | | | | | | | | | | | | | | | | | | | | | | | | | | | | | | | | | | | | | | | | | | |
| | | | | | | | | | | | | | | | | | | | | | | | | | | | | | | | | | | | | | | | | | | | | | | | | | | | | | | | | | | | | | | | | | | | | | | | | | | | | | | | | | | |
| | | | | | | | | | | | | | | | | | | | | | | | | | | | | | | | | | | | | | | | | | | | | | | | | | | | | | | | | | | | | | | | | | | | | | | | | | | | | | | | | | | |
| | | | | | | | | | | | | | | | | | | | | | | | | | | | | | | | | | | | | | | | | | | | | | | | | | | | | | | | | | | | | | | | | | | | | | | | | | | | | | | | | | | |
| | | | | | | | | | | | | | | | | | | | | | | | | | | | | | | | | | | | | | | | | | | | | | | | | | | | | | | | | | | | | | | | | | | | | | | | | | | | | | | | | | | |
| | | | | | | | | | | | | | | | | | | | | | | | | | | | | | | | | | | | | | | | | | | | | | | | | | | | | | | | | | | | | | | | | | | | | | | | | | | | | | | | | | | |
| | | | | | | | | | | | | | | | | | | | | | | | | | | | | | | | | | | | | | | | | | | | | | | | | | | | | | | | | | | | | | | | | | | | | | | | | | | | | | | | | | | |
| Post - 0 Miss - 0 Block - 0 | Post - 0 Miss - 1 Block - 0 | Post - 0 Miss - 0 Block - 0 | Post - 0 Miss - 0 Block - 0 | Post - 0 Miss - 0 Block - 0 | Post - 2 Miss - 2 Block - 0 | Post - 0 Miss - 0 Block - 0 | | | | | | | | | | | | | | | | | | | | | | | | | | | | | | | | | | | | | | | | | | | | | | | | | | | | | | | | | | | | | | | | | | | | | | | | | | | | |

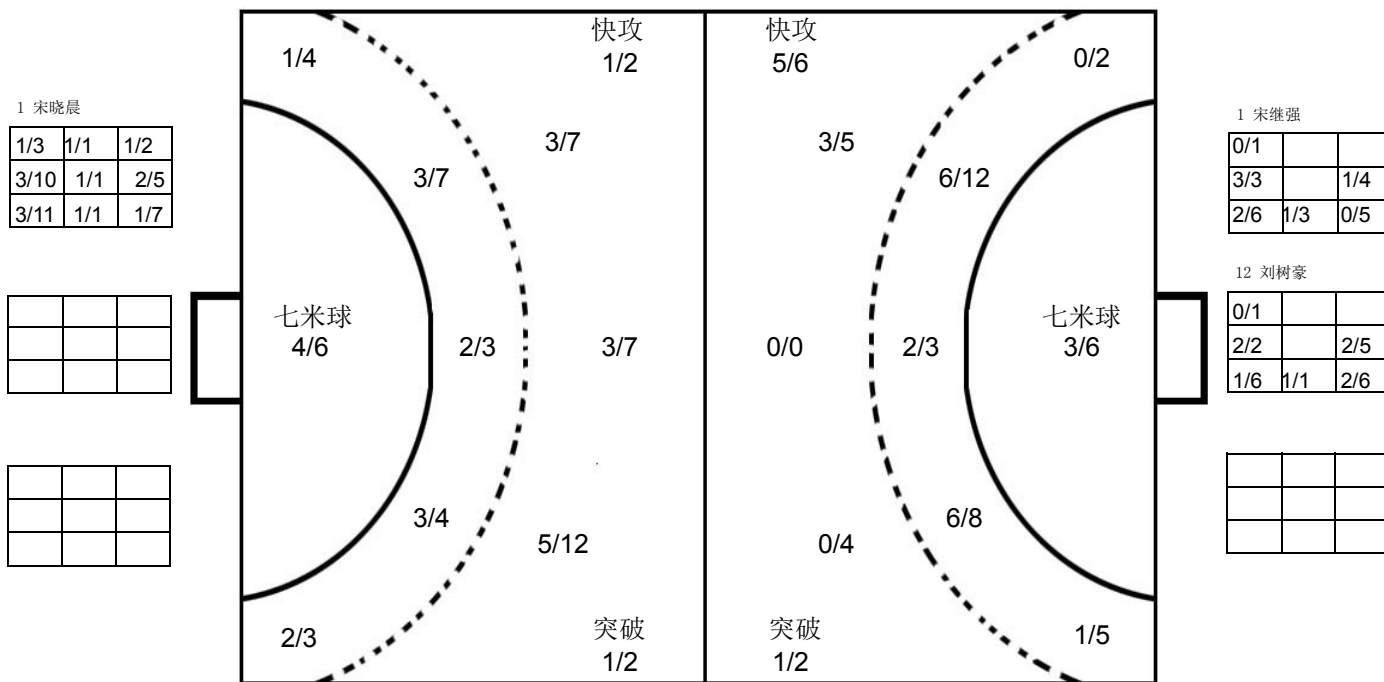

四川队

| | | | | | | | | | | | | | | | | | | | | | | | | | | | | | | | | | | | | | | | | | | | | | | | | | | | | | | | | | | | | | | | | | | | | | | | | | | | | | | | | | | |
|--|-----------------------------|-----------------------------|-----------------------------|-----------------------------|-----------------------------|-----------------------------|-----------------------------|--|--|--|---|--|---|--|--|--|---|--|--|--|--|--|--|--|--|--|---|--|---|---|--|--|--|---|--|--|--|--|---|---|---|--|--|---|--|---|---|--|---|--|--|--|--|--|--|--|---|--|---|---|--|---|---|--|--|--|--|--|--|---|--|--|--|--|--|--|--|--|--|--|--|--|
| 1 宋继强 | 3 刘赵梁 | 5 王凯 | 7 仇瑞祥 | 8 罗尧尧 | 9 许翔宇 | 10 徐彦昊 | 11 张天豪 | | | | | | | | | | | | | | | | | | | | | | | | | | | | | | | | | | | | | | | | | | | | | | | | | | | | | | | | | | | | | | | | | | | | | | | | | | | |
| <table border="1"><tr><td></td><td></td><td></td></tr><tr><td></td><td></td><td></td></tr><tr><td></td><td></td><td></td></tr></table> | | | | | | | | | | <table border="1"><tr><td>1</td><td></td><td></td></tr><tr><td></td><td></td><td></td></tr><tr><td>1</td><td></td><td></td></tr></table> | 1 | | | | | | 1 | | | <table border="1"><tr><td></td><td></td><td></td></tr><tr><td></td><td></td><td></td></tr><tr><td>1</td><td></td><td>1</td></tr></table> | | | | | | | 1 | | 1 | <table border="1"><tr><td></td><td></td><td></td></tr><tr><td>2</td><td></td><td></td></tr><tr><td></td><td></td><td></td></tr></table> | | | | 2 | | | | | | <table border="1"><tr><td>1</td><td></td><td></td></tr><tr><td>1</td><td></td><td>2</td></tr><tr><td>5</td><td></td><td>1</td></tr></table> | 1 | | | 1 | | 2 | 5 | | 1 | <table border="1"><tr><td></td><td></td><td></td></tr><tr><td></td><td></td><td></td></tr><tr><td></td><td></td><td>1</td></tr><tr><td></td><td></td><td>3</td></tr></table> | | | | | | | | | 1 | | | 3 | <table border="1"><tr><td></td><td></td><td></td></tr><tr><td></td><td></td><td></td></tr><tr><td>1</td><td></td><td></td></tr></table> | | | | | | | 1 | | | <table border="1"><tr><td></td><td></td><td></td></tr><tr><td></td><td></td><td></td></tr><tr><td></td><td></td><td></td></tr></table> | | | | | | | | | |
| | | | | | | | | | | | | | | | | | | | | | | | | | | | | | | | | | | | | | | | | | | | | | | | | | | | | | | | | | | | | | | | | | | | | | | | | | | | | | | | | | | |
| | | | | | | | | | | | | | | | | | | | | | | | | | | | | | | | | | | | | | | | | | | | | | | | | | | | | | | | | | | | | | | | | | | | | | | | | | | | | | | | | | | |
| | | | | | | | | | | | | | | | | | | | | | | | | | | | | | | | | | | | | | | | | | | | | | | | | | | | | | | | | | | | | | | | | | | | | | | | | | | | | | | | | | | |
| 1 | | | | | | | | | | | | | | | | | | | | | | | | | | | | | | | | | | | | | | | | | | | | | | | | | | | | | | | | | | | | | | | | | | | | | | | | | | | | | | | | | | |
| | | | | | | | | | | | | | | | | | | | | | | | | | | | | | | | | | | | | | | | | | | | | | | | | | | | | | | | | | | | | | | | | | | | | | | | | | | | | | | | | | | |
| 1 | | | | | | | | | | | | | | | | | | | | | | | | | | | | | | | | | | | | | | | | | | | | | | | | | | | | | | | | | | | | | | | | | | | | | | | | | | | | | | | | | | |
| | | | | | | | | | | | | | | | | | | | | | | | | | | | | | | | | | | | | | | | | | | | | | | | | | | | | | | | | | | | | | | | | | | | | | | | | | | | | | | | | | | |
| | | | | | | | | | | | | | | | | | | | | | | | | | | | | | | | | | | | | | | | | | | | | | | | | | | | | | | | | | | | | | | | | | | | | | | | | | | | | | | | | | | |
| 1 | | 1 | | | | | | | | | | | | | | | | | | | | | | | | | | | | | | | | | | | | | | | | | | | | | | | | | | | | | | | | | | | | | | | | | | | | | | | | | | | | | | | | |
| | | | | | | | | | | | | | | | | | | | | | | | | | | | | | | | | | | | | | | | | | | | | | | | | | | | | | | | | | | | | | | | | | | | | | | | | | | | | | | | | | | |
| 2 | | | | | | | | | | | | | | | | | | | | | | | | | | | | | | | | | | | | | | | | | | | | | | | | | | | | | | | | | | | | | | | | | | | | | | | | | | | | | | | | | | |
| | | | | | | | | | | | | | | | | | | | | | | | | | | | | | | | | | | | | | | | | | | | | | | | | | | | | | | | | | | | | | | | | | | | | | | | | | | | | | | | | | | |
| 1 | | | | | | | | | | | | | | | | | | | | | | | | | | | | | | | | | | | | | | | | | | | | | | | | | | | | | | | | | | | | | | | | | | | | | | | | | | | | | | | | | | |
| 1 | | 2 | | | | | | | | | | | | | | | | | | | | | | | | | | | | | | | | | | | | | | | | | | | | | | | | | | | | | | | | | | | | | | | | | | | | | | | | | | | | | | | | |
| 5 | | 1 | | | | | | | | | | | | | | | | | | | | | | | | | | | | | | | | | | | | | | | | | | | | | | | | | | | | | | | | | | | | | | | | | | | | | | | | | | | | | | | | |
| | | | | | | | | | | | | | | | | | | | | | | | | | | | | | | | | | | | | | | | | | | | | | | | | | | | | | | | | | | | | | | | | | | | | | | | | | | | | | | | | | | |
| | | | | | | | | | | | | | | | | | | | | | | | | | | | | | | | | | | | | | | | | | | | | | | | | | | | | | | | | | | | | | | | | | | | | | | | | | | | | | | | | | | |
| | | 1 | | | | | | | | | | | | | | | | | | | | | | | | | | | | | | | | | | | | | | | | | | | | | | | | | | | | | | | | | | | | | | | | | | | | | | | | | | | | | | | | |
| | | 3 | | | | | | | | | | | | | | | | | | | | | | | | | | | | | | | | | | | | | | | | | | | | | | | | | | | | | | | | | | | | | | | | | | | | | | | | | | | | | | | | |
| | | | | | | | | | | | | | | | | | | | | | | | | | | | | | | | | | | | | | | | | | | | | | | | | | | | | | | | | | | | | | | | | | | | | | | | | | | | | | | | | | | |
| | | | | | | | | | | | | | | | | | | | | | | | | | | | | | | | | | | | | | | | | | | | | | | | | | | | | | | | | | | | | | | | | | | | | | | | | | | | | | | | | | | |
| 1 | | | | | | | | | | | | | | | | | | | | | | | | | | | | | | | | | | | | | | | | | | | | | | | | | | | | | | | | | | | | | | | | | | | | | | | | | | | | | | | | | | |
| | | | | | | | | | | | | | | | | | | | | | | | | | | | | | | | | | | | | | | | | | | | | | | | | | | | | | | | | | | | | | | | | | | | | | | | | | | | | | | | | | | |
| | | | | | | | | | | | | | | | | | | | | | | | | | | | | | | | | | | | | | | | | | | | | | | | | | | | | | | | | | | | | | | | | | | | | | | | | | | | | | | | | | | |
| | | | | | | | | | | | | | | | | | | | | | | | | | | | | | | | | | | | | | | | | | | | | | | | | | | | | | | | | | | | | | | | | | | | | | | | | | | | | | | | | | | |
| Post - 0 Miss - 0 Block - 0 | Post - 1 Miss - 1 Block - 0 | Post - 4 Miss - 0 Block - 0 | Post - 0 Miss - 0 Block - 0 | Post - 0 Miss - 0 Block - 0 | Post - 0 Miss - 2 Block - 0 | Post - 0 Miss - 0 Block - 1 | Post - 1 Miss - 0 Block - 0 | | | | | | | | | | | | | | | | | | | | | | | | | | | | | | | | | | | | | | | | | | | | | | | | | | | | | | | | | | | | | | | | | | | | | | | | | | | |
| 12 刘树豪 | 13 尹文珂 | 15 徐逸 | 17 谢庆龙 | 18 张睿梁 | 19 庞连康 | 20 张文健 | 21 曹修庆 | | | | | | | | | | | | | | | | | | | | | | | | | | | | | | | | | | | | | | | | | | | | | | | | | | | | | | | | | | | | | | | | | | | | | | | | | | | |
| <table border="1"><tr><td></td><td></td><td></td></tr><tr><td></td><td></td><td></td></tr><tr><td></td><td></td><td></td></tr></table> | | | | | | | | | | <table border="1"><tr><td></td><td></td><td>1</td></tr><tr><td></td><td></td><td></td></tr><tr><td>2</td><td></td><td></td></tr></table> | | | 1 | | | | 2 | | | <table border="1"><tr><td></td><td></td><td></td></tr><tr><td></td><td></td><td></td></tr><tr><td></td><td></td><td></td></tr></table> | | | | | | | | | | <table border="1"><tr><td></td><td></td><td></td></tr><tr><td></td><td></td><td></td></tr><tr><td></td><td></td><td>1</td></tr></table> | | | | | | | | | 1 | <table border="1"><tr><td></td><td></td><td></td></tr><tr><td></td><td></td><td></td></tr><tr><td></td><td></td><td></td></tr></table> | | | | | | | | | | <table border="1"><tr><td></td><td></td><td></td></tr><tr><td></td><td></td><td></td></tr><tr><td>1</td><td></td><td></td></tr><tr><td>1</td><td></td><td></td></tr></table> | | | | | | | 1 | | | 1 | | | <table border="1"><tr><td></td><td></td><td></td></tr><tr><td></td><td></td><td></td></tr><tr><td></td><td></td><td></td></tr></table> | | | | | | | | | | <table border="1"><tr><td></td><td></td><td></td></tr><tr><td></td><td></td><td></td></tr><tr><td></td><td></td><td></td></tr></table> | | | | | | | | | |
| | | | | | | | | | | | | | | | | | | | | | | | | | | | | | | | | | | | | | | | | | | | | | | | | | | | | | | | | | | | | | | | | | | | | | | | | | | | | | | | | | | |
| | | | | | | | | | | | | | | | | | | | | | | | | | | | | | | | | | | | | | | | | | | | | | | | | | | | | | | | | | | | | | | | | | | | | | | | | | | | | | | | | | | |
| | | | | | | | | | | | | | | | | | | | | | | | | | | | | | | | | | | | | | | | | | | | | | | | | | | | | | | | | | | | | | | | | | | | | | | | | | | | | | | | | | | |
| | | 1 | | | | | | | | | | | | | | | | | | | | | | | | | | | | | | | | | | | | | | | | | | | | | | | | | | | | | | | | | | | | | | | | | | | | | | | | | | | | | | | | |
| | | | | | | | | | | | | | | | | | | | | | | | | | | | | | | | | | | | | | | | | | | | | | | | | | | | | | | | | | | | | | | | | | | | | | | | | | | | | | | | | | | |
| 2 | | | | | | | | | | | | | | | | | | | | | | | | | | | | | | | | | | | | | | | | | | | | | | | | | | | | | | | | | | | | | | | | | | | | | | | | | | | | | | | | | | |
| | | | | | | | | | | | | | | | | | | | | | | | | | | | | | | | | | | | | | | | | | | | | | | | | | | | | | | | | | | | | | | | | | | | | | | | | | | | | | | | | | | |
| | | | | | | | | | | | | | | | | | | | | | | | | | | | | | | | | | | | | | | | | | | | | | | | | | | | | | | | | | | | | | | | | | | | | | | | | | | | | | | | | | | |
| | | | | | | | | | | | | | | | | | | | | | | | | | | | | | | | | | | | | | | | | | | | | | | | | | | | | | | | | | | | | | | | | | | | | | | | | | | | | | | | | | | |
| | | | | | | | | | | | | | | | | | | | | | | | | | | | | | | | | | | | | | | | | | | | | | | | | | | | | | | | | | | | | | | | | | | | | | | | | | | | | | | | | | | |
| | | | | | | | | | | | | | | | | | | | | | | | | | | | | | | | | | | | | | | | | | | | | | | | | | | | | | | | | | | | | | | | | | | | | | | | | | | | | | | | | | | |
| | | 1 | | | | | | | | | | | | | | | | | | | | | | | | | | | | | | | | | | | | | | | | | | | | | | | | | | | | | | | | | | | | | | | | | | | | | | | | | | | | | | | | |
| | | | | | | | | | | | | | | | | | | | | | | | | | | | | | | | | | | | | | | | | | | | | | | | | | | | | | | | | | | | | | | | | | | | | | | | | | | | | | | | | | | |
| | | | | | | | | | | | | | | | | | | | | | | | | | | | | | | | | | | | | | | | | | | | | | | | | | | | | | | | | | | | | | | | | | | | | | | | | | | | | | | | | | | |
| | | | | | | | | | | | | | | | | | | | | | | | | | | | | | | | | | | | | | | | | | | | | | | | | | | | | | | | | | | | | | | | | | | | | | | | | | | | | | | | | | | |
| | | | | | | | | | | | | | | | | | | | | | | | | | | | | | | | | | | | | | | | | | | | | | | | | | | | | | | | | | | | | | | | | | | | | | | | | | | | | | | | | | | |
| | | | | | | | | | | | | | | | | | | | | | | | | | | | | | | | | | | | | | | | | | | | | | | | | | | | | | | | | | | | | | | | | | | | | | | | | | | | | | | | | | | |
| 1 | | | | | | | | | | | | | | | | | | | | | | | | | | | | | | | | | | | | | | | | | | | | | | | | | | | | | | | | | | | | | | | | | | | | | | | | | | | | | | | | | | |
| 1 | | | | | | | | | | | | | | | | | | | | | | | | | | | | | | | | | | | | | | | | | | | | | | | | | | | | | | | | | | | | | | | | | | | | | | | | | | | | | | | | | | |
| | | | | | | | | | | | | | | | | | | | | | | | | | | | | | | | | | | | | | | | | | | | | | | | | | | | | | | | | | | | | | | | | | | | | | | | | | | | | | | | | | | |
| | | | | | | | | | | | | | | | | | | | | | | | | | | | | | | | | | | | | | | | | | | | | | | | | | | | | | | | | | | | | | | | | | | | | | | | | | | | | | | | | | | |
| | | | | | | | | | | | | | | | | | | | | | | | | | | | | | | | | | | | | | | | | | | | | | | | | | | | | | | | | | | | | | | | | | | | | | | | | | | | | | | | | | | |
| | | | | | | | | | | | | | | | | | | | | | | | | | | | | | | | | | | | | | | | | | | | | | | | | | | | | | | | | | | | | | | | | | | | | | | | | | | | | | | | | | | |
| | | | | | | | | | | | | | | | | | | | | | | | | | | | | | | | | | | | | | | | | | | | | | | | | | | | | | | | | | | | | | | | | | | | | | | | | | | | | | | | | | | |
| | | | | | | | | | | | | | | | | | | | | | | | | | | | | | | | | | | | | | | | | | | | | | | | | | | | | | | | | | | | | | | | | | | | | | | | | | | | | | | | | | | |
| Post - 0 Miss - 0 Block - 0 | Post - 1 Miss - 0 Block - 0 | Post - 0 Miss - 0 Block - 0 | Post - 0 Miss - 0 Block - 0 | Post - 0 Miss - 0 Block - 0 | Post - 0 Miss - 0 Block - 1 | Post - 0 Miss - 0 Block - 0 | Post - 0 Miss - 0 Block - 0 | | | | | | | | | | | | | | | | | | | | | | | | | | | | | | | | | | | | | | | | | | | | | | | | | | | | | | | | | | | | | | | | | | | | | | | | | | | |

注释: Post=击柱 Miss=射失 Block=被封





2016年“体彩杯”全国手球男子青年锦标赛

比赛进程表

正式表
手球
青年男子决赛
轮次 8组别 X
场次 46201602046-13-1/6
重庆万州
29/03/2016 16:00

| 时间 | 队员 | 动作 | 比分 | 队员 | 动作 |
|------------|--------|---------|------------|--------|---------|
| 新疆队 | | | 上半时 | | |
| 四川队 | | | | | |
| 00:46 | 7 林豪文 | 右远射 得分 | 1 - 0 | 12 刘树豪 | 被射入 |
| 01:28 | 7 林豪文 | 使被罚7M球 | | 8 罗尧尧 | 造7M |
| 01:40 | 1 宋晓晨 | 被射入 | 1 - 1 | 8 罗尧尧 | 7M球 得分 |
| 02:07 | 19 李龙吉 | 接球失误 | | 10 徐彦昊 | 抢球 |
| 02:10 | 7 林豪文 | 使被罚7M球 | | 3 刘赵梁 | 快攻 造7M |
| 02:11 | | 裁判暂停 | | | |
| 02:11 | 7 林豪文 | 罚出场2分钟 | | | |
| 02:12 | 1 宋晓晨 | 被射入 | 1 - 2 | 8 罗尧尧 | 7M球 得分 |
| 02:41 | 15 王维东 | 左边射 得分 | 2 - 2 | 12 刘树豪 | 被射入 |
| 03:16 | 1 宋晓晨 | 挡住球 | | 10 徐彦昊 | 左远射 被救 |
| 03:21 | | | | 5 王凯 | 近射 击柱 |
| 03:55 | 17 胡晋铭 | 造7M | | 8 罗尧尧 | 使被罚7M球 |
| 04:06 | 19 李龙吉 | 7M球 得分 | 3 - 2 | 12 刘树豪 | 被射入 |
| 04:46 | 19 李龙吉 | 断球 | | 8 罗尧尧 | 传球失误 |
| 04:51 | 19 李龙吉 | 一传快攻 射失 | | | |
| 05:03 | 10 王钟彬 | 断球 | | 19 庞连康 | 传球失误 |
| 05:08 | 10 王钟彬 | 一传快攻 得分 | 4 - 2 | 12 刘树豪 | 被射入 |
| 05:33 | 1 宋晓晨 | 挡住球 | | 10 徐彦昊 | 左远射 被救 |
| 05:44 | 10 王钟彬 | 近射 得分 | 5 - 2 | 12 刘树豪 | 被射入 |
| 05:59 | 17 胡晋铭 | 使被罚7M球 | | 5 王凯 | 造7M |
| 06:02 | 17 胡晋铭 | 警告 | | | |
| 06:16 | 1 宋晓晨 | 挡住球 | | 8 罗尧尧 | 7M球 被救 |
| 06:42 | 10 王钟彬 | 中远射 得分 | 6 - 2 | 12 刘树豪 | 被射入 |
| 06:50 | 1 宋晓晨 | 被射入 | 6 - 3 | 9 许翔宇 | 左远射 得分 |
| 07:16 | 17 胡晋铭 | 近射 得分 | 7 - 3 | 12 刘树豪 | 被射入 |
| 07:18 | 5 徐伟 | 助攻 | | | |
| 07:19 | | | | 9 许翔宇 | 选位 失误 |
| 07:22 | | | | 9 许翔宇 | 警告 |
| 07:37 | 1 宋晓晨 | 被射入 | 7 - 4 | 8 罗尧尧 | 左远射 得分 |
| 08:05 | 17 胡晋铭 | 进攻犯规 | | 17 谢庆龙 | 造犯规 |
| 08:34 | 1 宋晓晨 | 被射入 | 7 - 5 | 3 刘赵梁 | 近射 得分 |
| 08:36 | | | | 8 罗尧尧 | 助攻 |
| 08:58 | 10 王钟彬 | 左远射 被救 | | 12 刘树豪 | 挡住球 |
| 08:59 | | 裁判暂停 | | | |
| 09:16 | 10 王钟彬 | 左远射 被封 | | 3 刘赵梁 | 封球 |
| 09:17 | | 裁判暂停 | | | |
| 09:23 | 10 王钟彬 | 传球失误 | | 5 王凯 | 断球 |
| 09:27 | 1 宋晓晨 | 被射入 | 7 - 6 | 8 罗尧尧 | 一传快攻 得分 |
| 09:33 | | | | 5 王凯 | 助攻 |



2016年“体彩杯”全国手球男子青年锦标赛

比赛进程表

正式表
手球
青年男子决赛
轮次 8组别 X
场次 46201602046-13-2/6
重庆万州
29/03/2016 16:00

| 时间 | 队员 | 动作 | 比分 | 队员 | 动作 |
|------------|--------|--------|------------|--------|---------|
| 新疆队 | | | 上半时 | | |
| 四川队 | | | | | |
| 09:56 | 15 王维东 | 造7M | | 13 尹文珂 | 使被罚7M球 |
| 09:57 | | 裁判暂停 | | | |
| 09:57 | | | | 13 尹文珂 | 罚出场2分钟 |
| 09:59 | 7 林豪文 | 7M球 得分 | 8 - 6 | 12 刘树豪 | 被射入 |
| 10:23 | 1 宋晓晨 | 被射入 | 8 - 7 | 5 王凯 | 近射 得分 |
| 10:25 | | | | 8 罗尧尧 | 助攻 |
| 10:34 | 19 李龙吉 | 突破 射失 | | 8 罗尧尧 | 顶贴 失误 |
| 10:36 | | | | 9 许翔宇 | 运球失误 |
| 11:03 | | | | 17 谢庆龙 | 使被罚7M球 |
| 11:20 | 19 李龙吉 | 造7M | | 12 刘树豪 | 挡住球 |
| 11:37 | 7 林豪文 | 7M球 被救 | | 19 庞连康 | 四步 |
| 11:56 | | | | 12 刘树豪 | 被射入 |
| 12:40 | 10 王钟彬 | 任意球 得分 | 9 - 7 | | |
| 12:49 | | 裁判暂停 | | | |
| 12:49 | 7 林豪文 | 使被罚7M球 | | 3 刘赵梁 | 造7M |
| 12:49 | 7 林豪文 | 罚出场2分钟 | | | |
| 12:51 | 1 宋晓晨 | 挡住球 | | 8 罗尧尧 | 7M球 被救 |
| 13:51 | 5 徐伟 | 右边射 得分 | 10 - 7 | 12 刘树豪 | 被射入 |
| 14:03 | 1 宋晓晨 | 被射入 | 10 - 8 | 5 王凯 | 近射 得分 |
| 14:23 | 19 李龙吉 | 传球失误 | | 17 谢庆龙 | 断球 |
| 14:25 | | | | 17 谢庆龙 | 快攻 四步 |
| 15:13 | 7 林豪文 | 任意球 得分 | 11 - 8 | 1 宋继强 | 被射入 |
| 15:41 | 1 宋晓晨 | 被射入 | 11 - 9 | 3 刘赵梁 | 近射 得分 |
| 15:44 | | | | 8 罗尧尧 | 助攻 |
| 16:05 | 17 胡晋铭 | 近射 得分 | 12 - 9 | 1 宋继强 | 被射入 |
| 16:39 | | | | 9 许翔宇 | 近射 射失 |
| 17:15 | 10 王钟彬 | 左远射 被封 | | 17 谢庆龙 | 封球 |
| 17:32 | 5 徐伟 | 近射 得分 | 13 - 9 | 1 宋继强 | 被射入 |
| 18:16 | 1 宋晓晨 | 被射入 | 13 - 10 | 9 许翔宇 | 任意球 得分 |
| 18:39 | 10 王钟彬 | 近射 击柱 | | | |
| 18:48 | | | | 5 王凯 | 一传快攻 击柱 |
| 18:50 | | | | 8 罗尧尧 | 助攻 |
| 19:18 | 19 李龙吉 | 右远射 击柱 | | | |
| 19:29 | 1 宋晓晨 | 挡住球 | | 3 刘赵梁 | 右边射 被救 |
| 19:48 | 10 王钟彬 | 传球失误 | | 17 谢庆龙 | 断球 |
| 19:54 | 1 宋晓晨 | 被射入 | 13 - 11 | 8 罗尧尧 | 短传快攻 得分 |
| 20:25 | | 球队暂停 | | | |
| 20:43 | 17 胡晋铭 | 接球失误 | | 19 庞连康 | 抢球 |
| 20:46 | 1 宋晓晨 | 被射入 | 13 - 12 | 19 庞连康 | 一传快攻 得分 |



2016年“体彩杯”全国手球男子青年锦标赛

比赛进程表

正式表
手球
青年男子决赛
轮次 8组别 X
场次 46201602046-13-3/6
重庆万州
29/03/2016 16:00

| 时间 | 队员 | 动作 | 比分 | 队员 | 动作 |
|------------|--------|--------|----------------|--------|--------|
| 新疆队 | | | 上半时 | | |
| 四川队 | | | | | |
| 21:17 | 7 林豪文 | 右远射 被封 | | 9 许翔宇 | 封球 |
| 21:28 | 7 林豪文 | 任意球 得分 | 14 - 12 | 1 宋继强 | 被射入 |
| 21:36 | 17 胡晋铭 | 使被罚7M球 | | 17 谢庆龙 | 造7M |
| 21:37 | | 裁判暂停 | | | |
| 21:37 | 17 胡晋铭 | 罚出场2分钟 | | | |
| 21:39 | | | | 9 许翔宇 | 7M球 射失 |
| 22:07 | 7 林豪文 | 右远射 被救 | | 1 宋继强 | 挡住球 |
| 22:12 | | | | 3 刘赵梁 | 快攻 侵区 |
| 23:05 | 7 林豪文 | 右远射 被封 | | 17 谢庆龙 | 封球 |
| 23:17 | 19 李龙吉 | 进攻犯规 | | 8 罗尧尧 | 造犯规 |
| 23:31 | 1 宋晓晨 | 挡住球 | | 9 许翔宇 | 近射 被救 |
| 23:47 | 1 宋晓晨 | 被射入 | 14 - 13 | 8 罗尧尧 | 近射 得分 |
| 24:29 | | | | 17 谢庆龙 | 警告 |
| 24:35 | | 裁判暂停 | | | |
| 24:47 | 10 王钟彬 | 左远射 被救 | | 1 宋继强 | 挡住球 |
| 24:55 | | | | 19 庞连康 | 侵区 |
| 25:05 | 10 王钟彬 | 左远射 得分 | 15 - 13 | 1 宋继强 | 被射入 |
| 25:14 | | | | 3 刘赵梁 | 右边射 射失 |
| 25:26 | 19 李龙吉 | 突破 得分 | 16 - 13 | 1 宋继强 | 被射入 |
| 25:28 | | | | 8 罗尧尧 | 顶贴 失误 |
| 25:35 | | | | 8 罗尧尧 | 侵区 |
| 26:12 | 5 徐伟 | 接球失误 | | | |
| 26:23 | | | | 8 罗尧尧 | 四步 |
| 26:59 | 10 王钟彬 | 左远射 得分 | 17 - 13 | 1 宋继强 | 被射入 |
| 27:03 | | | | | 球队暂停 |
| 27:32 | 1 宋晓晨 | 被射入 | 17 - 14 | 13 尹文珂 | 右边射 得分 |
| 28:03 | 19 李龙吉 | 进攻犯规 | | 13 尹文珂 | 造犯规 |
| 28:27 | 1 宋晓晨 | 被射入 | 17 - 15 | 10 徐彦昊 | 近射 得分 |
| 28:28 | | | | 9 许翔宇 | 助攻 |
| 28:59 | 15 王维东 | 左边射 被救 | | 1 宋继强 | 挡住球 |
| 29:26 | | | | 13 尹文珂 | 右边射 击柱 |
| 29:30 | 5 徐伟 | 使被罚7M球 | | 9 许翔宇 | 造7M |
| 29:31 | | 裁判暂停 | | | |
| 29:31 | 5 徐伟 | 罚出场2分钟 | | | |
| 29:32 | 1 宋晓晨 | 被射入 | 17 - 16 | 13 尹文珂 | 7M球 得分 |
| 29:52 | 15 王维东 | 左边射 得分 | 18 - 16 | 1 宋继强 | 被射入 |
| 30:00 | | | | 5 王凯 | 左边射 击柱 |



2016年“体彩杯”全国手球男子青年锦标赛

比赛进程表

正式表
手球
青年男子决赛
轮次 8组别 X
场次 46201602046-13-4/6
重庆万州
29/03/2016 16:00

| 时间 | 队员 | 动作 | 比分 | 队员 | 动作 |
|------------|--------|--------|------------|--------|---------|
| 新疆队 | | | 下半场 | | |
| 四川队 | | | | | |
| 00:25 | 15 王维东 | 封球 | | 10 徐彦昊 | 右远射 被封 |
| 00:42 | 17 胡晋铭 | 封球 | | 19 庞连康 | 右远射 被封 |
| 00:54 | 15 王维东 | 侵区 | | | |
| 01:29 | | | | 5 王凯 | 近射 击柱 |
| 01:37 | 5 徐伟 | 近射 被救 | | 1 宋继强 | 挡住球 |
| 02:19 | 19 李龙吉 | 左远射 得分 | 19 - 16 | 1 宋继强 | 被射入 |
| 02:57 | 1 宋晓晨 | 挡住球 | | 9 许翔宇 | 右远射 被救 |
| 03:33 | 19 李龙吉 | 造7M | | 19 庞连康 | 使被罚7M球 |
| 03:42 | 19 李龙吉 | 7M球 得分 | 20 - 16 | 1 宋继强 | 被射入 |
| 04:11 | 1 宋晓晨 | 挡住球 | | 19 庞连康 | 近射 被救 |
| 04:12 | | | | 9 许翔宇 | 助攻 |
| 04:17 | 19 李龙吉 | 进攻犯规 | | 9 许翔宇 | 造犯规 |
| 04:41 | 1 宋晓晨 | 被射入 | 20 - 17 | 9 许翔宇 | 近射 得分 |
| 05:13 | 5 徐伟 | 传球失误 | | | |
| 05:32 | | | | 9 许翔宇 | 传球失误 |
| 06:08 | 10 王钟彬 | 中远射 被救 | | 1 宋继强 | 挡住球 |
| 06:14 | | | | 8 罗尧尧 | 传球失误 |
| 06:46 | 19 李龙吉 | 传球失误 | | | |
| 07:11 | 1 宋晓晨 | 挡住球 | | 5 王凯 | 近射 被救 |
| 07:13 | | | | 8 罗尧尧 | 助攻 |
| 07:16 | 1 宋晓晨 | 被射入 | 20 - 18 | 13 尹文珂 | 近射 得分 |
| 07:43 | 17 胡晋铭 | 近射 得分 | 21 - 18 | 1 宋继强 | 被射入 |
| 07:45 | 19 李龙吉 | 助攻 | | | |
| 08:05 | 1 宋晓晨 | 挡住球 | | 13 尹文珂 | 近射 被救 |
| 08:52 | 10 王钟彬 | 接球失误 | | 8 罗尧尧 | 抢球 |
| 08:55 | 1 宋晓晨 | 被射入 | 21 - 19 | 8 罗尧尧 | 一传快攻 得分 |
| 09:38 | 7 林豪文 | 传球失误 | | 17 谢庆龙 | 断球 |
| 09:43 | 5 徐伟 | 造失误 | | 17 谢庆龙 | 快攻 运球失误 |
| 09:47 | 5 徐伟 | 传球失误 | | 17 谢庆龙 | 断球 |
| 09:49 | 1 宋晓晨 | 被射入 | 21 - 20 | 8 罗尧尧 | 一传快攻 得分 |
| 09:51 | | | | 17 谢庆龙 | 助攻 |
| 10:41 | 6 白光宇 | 右远射 得分 | 22 - 20 | 1 宋继强 | 被射入 |
| 11:10 | 1 宋晓晨 | 挡住球 | | 5 王凯 | 左边射 被救 |
| 11:20 | 5 徐伟 | 近射 被救 | | 1 宋继强 | 挡住球 |
| 11:22 | 10 王钟彬 | 助攻 | | | |
| 11:48 | 10 王钟彬 | 左远射 被封 | | 8 罗尧尧 | 封球 |
| 12:01 | 5 徐伟 | 右边射 被救 | | 1 宋继强 | 挡住球 |
| 12:02 | | 裁判暂停 | | | |
| 12:09 | 7 林豪文 | 左远射 得分 | 23 - 20 | 1 宋继强 | 被射入 |



2016年“体彩杯”全国手球男子青年锦标赛

比赛进程表

正式表
手球
青年男子决赛
轮次 8组别 X
场次 46201602046-13-5/6
重庆万州
29/03/2016 16:00

| 时间 | 队员 | 动作 | 比分 | 队员 | 动作 |
|------------|--------|--------|----------------|--------|--------|
| 新疆队 | | | 下半场 | | |
| 四川队 | | | | | |
| 12:34 | | | | 9 许翔宇 | 传球失误 |
| 13:06 | 6 白光宇 | 近射 得分 | 24 - 20 | 1 宋继强 | 被射入 |
| 13:07 | 19 李龙吉 | 助攻 | | | |
| 13:11 | | | | | 球队暂停 |
| 13:38 | 1 宋晓晨 | 挡住球 | | 17 谢庆龙 | 近射 被救 |
| 13:40 | | | | 9 许翔宇 | 助攻 |
| 13:41 | 17 胡晋铭 | 选位 失误 | | | |
| 13:51 | 5 徐伟 | 右边射 射失 | | | |
| 14:46 | | 裁判暂停 | | | |
| 14:46 | 10 王钟彬 | 罚出场2分钟 | | | |
| 15:00 | | | | 3 刘赵梁 | 右边射 击柱 |
| 15:43 | 19 李龙吉 | 中远射 得分 | 25 - 20 | 1 宋继强 | 被射入 |
| 15:59 | | | | 19 庞连康 | 传球失误 |
| 16:26 | | 裁判暂停 | | | |
| 16:44 | 7 林豪文 | 左远射 被封 | | 17 谢庆龙 | 封球 |
| 17:14 | | 裁判暂停 | | | |
| 17:25 | 1 宋晓晨 | 被射入 | 25 - 21 | 17 谢庆龙 | 近射 得分 |
| 17:27 | | | | 3 刘赵梁 | 助攻 |
| 17:45 | | 裁判暂停 | | | |
| 17:45 | 17 胡晋铭 | 进攻犯规 | | 8 罗尧尧 | 造犯规 |
| 18:03 | 1 宋晓晨 | 被射入 | 25 - 22 | 8 罗尧尧 | 近射 得分 |
| 18:32 | 17 胡晋铭 | 近射 得分 | 26 - 22 | 12 刘树豪 | 被射入 |
| 18:34 | 10 王钟彬 | 助攻 | | | |
| 18:44 | | | | 11 张天豪 | 近射 击柱 |
| 18:46 | | | | 10 徐彦昊 | 助攻 |
| 18:48 | 17 胡晋铭 | 选位 失误 | | | |
| 18:59 | 6 白光宇 | 进攻犯规 | | 17 谢庆龙 | 造犯规 |
| 19:37 | 1 宋晓晨 | 被射入 | 26 - 23 | 19 庞连康 | 近射 得分 |
| 20:19 | | 球队暂停 | | | |
| 20:30 | | 裁判暂停 | | | |
| 20:42 | 19 李龙吉 | 传球失误 | | 10 徐彦昊 | 断球 |
| 21:09 | 1 宋晓晨 | 挡住球 | | 3 刘赵梁 | 突破 被救 |
| 21:11 | 7 林豪文 | 顶贴 失误 | | | |
| 21:28 | 17 胡晋铭 | 进攻犯规 | | 17 谢庆龙 | 造犯规 |
| 21:50 | 1 宋晓晨 | 挡住球 | | 8 罗尧尧 | 右远射 被救 |
| 22:06 | 19 李龙吉 | 传球失误 | | | |
| 22:16 | 1 宋晓晨 | 被射入 | 26 - 24 | 8 罗尧尧 | 近射 得分 |
| 22:43 | 10 王钟彬 | 中远射 被救 | | 12 刘树豪 | 挡住球 |
| 23:01 | | | | 19 庞连康 | 传球失误 |



2016年“体彩杯”全国手球男子青年锦标赛

比赛进程表

正式表
手球
青年男子决赛
轮次 8组别 X
场次 46201602046-13-6/6
重庆万州
29/03/2016 16:00

| 时间 | 队员 | 动作 | 比分 | 队员 | 动作 |
|------------|--------|--------|----------------|--------|--------|
| 新疆队 | | | 下半场 | | |
| 四川队 | | | | | |
| 23:12 | 5 徐伟 | 近射 得分 | 27 - 24 | 12 刘树豪 | 被射入 |
| 23:23 | 19 李龙吉 | 抢球 | | 3 刘赵梁 | 接球失误 |
| 23:38 | 10 王钟彬 | 近射 被救 | | 12 刘树豪 | 挡住球 |
| 23:40 | 19 李龙吉 | 助攻 | | | |
| 23:52 | | | | 10 徐彦昊 | 其它失误 |
| 24:18 | 6 白光宇 | 进攻犯规 | | 8 罗尧尧 | 造犯规 |
| 24:54 | | | | | 球队暂停 |
| 25:11 | 1 宋晓晨 | 被射入 | 27 - 25 | 9 许翔宇 | 近射 得分 |
| 25:49 | | 裁判暂停 | | | |
| 25:55 | 7 林豪文 | 中远射 被救 | | 12 刘树豪 | 挡住球 |
| 25:58 | 15 王维东 | 近射 射失 | | | |
| 26:34 | 1 宋晓晨 | 被射入 | 27 - 26 | 7 仇瑞祥 | 近射 得分 |
| 26:58 | 19 李龙吉 | 近射 击柱 | | | |
| 27:00 | | 裁判暂停 | | | |
| 27:00 | 15 王维东 | 造7M | | 17 谢庆龙 | 使被罚7M球 |
| 27:00 | | | | 17 谢庆龙 | 罚出场2分钟 |
| 27:04 | 19 李龙吉 | 7M球 得分 | 28 - 26 | 12 刘树豪 | 被射入 |
| 27:23 | | | | 5 王凯 | 传球失误 |
| 27:45 | 10 王钟彬 | 左远射 被封 | | 19 庞连康 | 封球 |
| 27:59 | 7 林豪文 | 造7M | | 19 庞连康 | 使被罚7M球 |
| 28:13 | 10 王钟彬 | 7M球 被救 | | 12 刘树豪 | 挡住球 |
| 28:31 | 10 王钟彬 | 断球 | | 7 仇瑞祥 | 传球失误 |
| 28:45 | 5 徐伟 | 右边射 被救 | | 12 刘树豪 | 挡住球 |
| 28:59 | 1 宋晓晨 | 被射入 | 28 - 27 | 7 仇瑞祥 | 突破 得分 |
| 29:00 | | 裁判暂停 | | | |
| 29:00 | 10 王钟彬 | 罚出场2分钟 | | | |
| 29:18 | | 裁判暂停 | | | |
| 29:18 | | | | 9 许翔宇 | 罚出场2分钟 |
| 29:21 | | 球队暂停 | | | |
| 29:36 | 19 李龙吉 | 进攻犯规 | | 9 许翔宇 | 造犯规 |
| 29:42 | 19 李龙吉 | 造失误 | | 3 刘赵梁 | 运球失误 |
| 29:50 | 19 李龙吉 | 中远射 被救 | | 12 刘树豪 | 挡住球 |