

2016



2016年全国女子手球锦标赛

# 成绩与技术统计数据册

2016



2016

数据由PHMS收集生成



PHMS 国际手球联合会官方技术统计系统

# 成绩与技术统计数据册目录

## 1 比赛结果

- 1) 名次
- 2) 场次成绩
- 3) 分组成绩

## 2 运动员排名

- 1) 得分
- 2) 助攻
- 3) 封球
- 4) 防守
- 5) 失误
- 6) 受罚

## 3 守门员排名

- 1) 救球
- 2) 救 7M 球

## 4 球队累计表

## 5 球队受罚表

## 6 球队信息

- 1) 球队名单
- 2) 个人/全队技术累计表
- 3) 球队射门区域累计

## 7 比赛统计数据

- 1) 比赛记录表
- 2) 比赛统计(媒体表)
- 3) 每场个人/全队技术统计表
- 4) 图式统计表
- 5) 每场射门区域统计
- 6) 比赛进程表(决赛场次)

注：如需更多比赛统计数据，请通过以下电邮联络：[handball@126.com](mailto:handball@126.com)



## 2016年全国女子手球锦标赛 排名表

正式表  
手球  
女子

截止至第 54场

2016052016050541204  
China  
2016/9/13 18:30:00

奖牌	排名	编码	队名
Gold	1	安徽	安徽
Silver	2	江苏	江苏
Bronze	3	上海	上海
	4	广东	广东
	5	解放军	解放军
	6	新疆	新疆
	7	辽宁	辽宁
	8	天津	天津
	9	山东	山东
	10	北京	北京
	11	四川	四川
	12	广西	广西
	13	黑龙江	黑龙江



## 2016年全国女子手球锦标赛 场次成绩

正式表  
手球  
女子

截止至第54场

201605054-1203-1/1  
安徽滁州  
2016/9/13 18:30:00

日期	时间	场次	体育馆	组别	球队	成绩 (半时)	阶段
11/09/16	08:30	37	滁州体育馆	F	北京-广西	35-28 (18-13)	名次赛
	10:00	38	滁州体育馆	F	四川-黑龙江	28-25 (13-12)	名次赛
	14:00	39	滁州体育馆	X	江苏-解放军	44-20 (21-9)	四分之一决赛
	15:30	40	滁州体育馆	X	辽宁-广东	24-26 (13-18)	四分之一决赛
	17:00	41	滁州体育馆	X	安徽-天津	44-17 (20-10)	四分之一决赛
	18:30	42	滁州体育馆	X	上海-新疆	30-14 (13-10)	四分之一决赛
12/09/16	08:30	43	滁州体育馆	F	山东-四川	30-22 (13-13)	名次赛
	10:00	44	滁州体育馆	F	北京-黑龙江	37-22 (24-11)	名次赛
	14:00	45	滁州体育馆	X	解放军-辽宁	31-30 (15-16)	5-8名
	15:30	46	滁州体育馆	X	天津-新疆	17-26 (8-13)	5-8名
	17:00	47	滁州体育馆	X	江苏-广东	38-26 (22-9)	半决赛
	18:30	48	滁州体育馆	X	安徽-上海	35-25 (15-13)	半决赛
13/09/16	08:30	49	滁州体育馆	F	广西-四川	36-37 (20-16)	名次赛
	10:00	50	滁州体育馆	F	山东-北京	36-24 (22-13)	名次赛
	14:00	51	滁州体育馆	X	辽宁-天津	31-26 (13-11)	7-8名
	15:30	52	滁州体育馆	X	解放军-新疆	35-24 (18-10)	5-6名
	17:00	53	滁州体育馆	X	广东-上海	22-34 (9-19)	3-4名
	18:30	54	滁州体育馆	X	江苏-安徽	33-34 (15-19)	决赛







2016年全国女子手球锦标赛

正式表  
手球  
女子

分组成绩

01605-1202-1/1

安徽滁州

截止至第 54 场

2016/09/03

组别: F 名次赛

名次	球队	积	场	胜	平	负	得分	失分	净胜
1	山东	8	4	4	0	0	123	74	49
2	北京	6	4	3	0	1	130	115	15
3	四川	4	4	2	0	2	116	125	-9
4	广西	2	4	1	0	3	114	130	-16
5	黑龙江	0	4	0	0	4	74	113	-39

球队	山东	北京	四川	广西	黑龙江
山东		36-24	30-22	35-24	22-4
北京	24-36		34-29	35-28	37-22
四川	22-30	29-34		37-36	28-25
广西	24-35	28-35	36-37		26-23
黑龙江	4-22	22-37	25-28	23-26	

名次	球队	积	场	胜	平	负	得分	失分	净胜

球队					

名次	球队	积	场	胜	平	负	得分	失分	净胜

球队					

名次	球队	积	场	胜	平	负	得分	失分	净胜

球队					

Legend: 积 = 积分 场 = 已比赛场次 胜 = 胜场 平 = 平场 负 = 负场  
得分 = 得分累计 失分 = 失分累计 净胜 = 净胜分





### 2016年全国女子手球锦标赛

正式表  
手球  
女子

分组成绩

201605-1202-1/1

安徽滁州

截止至第 36 场

2016/09/03

组别: A 预赛

名次	球队	积	场	胜	平	负	得分	失分	净胜
1	江苏	12	6	6	0	0	177	105	72
2	安徽	10	6	5	0	1	182	111	71
3	广东	6	6	3	0	3	149	145	4
4	新疆	6	6	3	0	3	148	163	-15
5	山东	6	6	3	0	3	155	142	13
6	广西	2	6	1	0	5	105	167	-62
7	黑龙江	0	6	0	0	6	76	159	-83

球队	江苏	安徽	广东	新疆	山东	广西	黑龙江
江苏		36-35	27-12	35-20	33-23	24-9	22-6
安徽	35-36		36-21	28-13	30-24	28-8	25-9
广东	12-27	21-36		29-30	27-22	27-12	33-18
新疆	20-35	13-28	30-29		24-29	30-26	31-16
山东	23-33	24-30	22-27	29-24		35-24	22-4
广西	9-24	8-28	12-27	26-30	24-35		26-23
黑龙江	6-22	9-25	18-33	16-31	4-22	23-26	

组别: B 预赛

名次	球队	积	场	胜	平	负	得分	失分	净胜
1	上海	10	5	5	0	0	155	88	67
2	辽宁	6	5	3	0	2	145	127	18
3	天津	6	5	3	0	2	116	133	-17
4	解放军	6	5	3	0	2	146	146	0
5	北京	2	5	1	0	4	122	158	-36
6	四川	0	5	0	0	5	141	173	-32

球队	上海	辽宁	天津	解放军	北京	四川
上海		33-24	23-8	24-9	32-17	43-30
辽宁	24-33		30-20	31-35	31-16	29-23
天津	8-23	20-30		29-28	28-24	31-28
解放军	9-24	35-31	28-29		38-31	36-31
北京	17-32	16-31	24-28	31-38		34-29
四川	30-43	23-29	28-31	31-36	29-34	

名次	球队	积	场	胜	平	负	得分	失分	净胜

球队						

名次	球队	积	场	胜	平	负	得分	失分	净胜

球队						

Legend: 积 = 积分 场 = 已比赛场次 胜 = 胜场 平 = 平场 负 = 负场  
得分 = 得分累计 失分 = 失分累计 净胜 = 净胜分





## 2016年全国女子手球锦标赛

## 得分排名表(场上队员)

正式表  
手球  
女子截止至第 54场  
按总得分201605054-1601-1/5  
安徽滁州  
03/09/2016 13:00

排序	号码	姓名	球队	远射	近射	边射	快攻	突破	任意	7M	合计	%	助攻	场数
1	3	王丹	四川	10-37	13-20	10-17	5-7	11-12	1-4	18-22	68-119	57.1	16	8
2	69	石梓薇	北京	21-50	12-20	2-3	5-6	7-8	0-1	12-14	59-102	57.8	8	8
3	8	杨娇	辽宁	27-53	5-8	2-2	1-1	3-3	5-12	12-22	55-101	54.5	25	8
4	6	沈萍	安徽	23-34	12-17	0-2	2-3	4-4	1-4	11-12	53-76	69.7	10	9
5	2	林燕群	山东	9-24	16-20	4-11	4-6	7-8	0-0	8-10	48-79	60.8	0	8
6	23	王书慧	江苏	11-39	14-21	5-8	7-9	8-11	0-1	2-3	47-92	51.1	0	9
7	21	李瑶	安徽	3-21	8-12	3-8	18-20	10-11	1-1	0-1	43-74	58.1	12	9
8	18	戴小宇	四川	12-30	10-14	1-1	1-1	6-7	0-0	12-15	42-68	61.8	4	8
9	88	李晓晴	解放军	13-33	6-10	1-2	2-2	3-3	1-3	15-17	41-70	58.6	5	8
10	17	周婷	安徽	3-5	16-21	3-4	9-11	7-9	0-0	0-1	38-51	74.5	10	9
11	14	刘晓妹	安徽	17-29	2-6	1-1	3-3	8-12	6-7	1-2	38-60	63.3	14	9
12	3	季小桐	北京	11-27	8-17	2-6	6-8	8-10	1-1	2-2	38-71	53.5	3	8
13	66	梁海珍	辽宁	10-30	8-13	13-20	2-3	2-3	0-1	3-3	38-73	52.1	7	8
14	7	廖露	广西	20-53	8-9	2-3	2-2	3-5	1-1	2-2	38-75	50.7	8	8
15	18	崔娟	新疆	18-64	10-13	0-0	1-3	1-1	2-2	5-9	37-92	40.2	14	9
16	8	王彬	山东	8-17	6-10	4-7	2-3	4-5	0-0	12-12	36-54	66.7	7	8
17	8	吴茵	上海	12-26	9-13	2-2	5-5	4-4	0-1	4-5	36-56	64.3	18	8
18	93	张婷婷	新疆	15-42	6-11	2-3	3-5	4-7	0-0	6-9	36-77	46.8	15	9
19	3	张海侠	江苏	2-2	6-9	15-19	11-16	0-0	0-0	1-1	35-47	74.5	3	9
20	33	金梦青	江苏	10-24	2-3	2-4	16-20	0-0	0-0	5-7	35-58	60.3	6	9
21	6	黄妍	上海	16-28	8-14	0-0	2-2	1-1	0-2	7-11	34-58	58.6	7	8
22	10	周琴	广西	5-17	3-11	7-14	5-6	5-6	0-0	9-11	34-65	52.3	1	8
23	11	蔡雪洁	天津	11-46	9-18	3-5	1-3	6-6	1-1	3-3	34-82	41.5	4	8
24	41	杜机娟	安徽	0-1	1-1	9-14	11-16	0-0	0-0	12-15	33-47	70.2	0	9
25	11	魏梦庭	广东	9-40	9-16	1-2	1-1	6-6	0-0	6-7	32-72	44.4	4	9
26	24	韦娜娜	解放军	0-5	6-6	13-21	10-13	0-0	0-0	2-2	31-47	66.0	1	8
27	9	韦宝桂	广东	12-39	2-5	2-4	4-4	3-3	0-2	8-10	31-67	46.3	6	9
28	18	舒文琪	天津	13-50	6-9	3-5	1-1	5-6	2-2	1-1	31-74	41.9	7	8
29	6	阿孜古	新疆	0-0	26-34	1-1	3-5	0-0	0-0	0-1	30-41	73.2	1	9
30	4	赵佳芹	江苏	13-32	3-4	1-1	2-3	5-5	2-2	4-4	30-51	58.8	15	8
31	5	辛颜	辽宁	1-4	23-32	0-0	1-1	3-4	0-0	0-0	28-41	68.3	2	8
32	11	孙梦颖	上海	17-31	4-7	0-1	7-7	0-1	0-0	0-1	28-48	58.3	2	8
33	13	吴佳	黑龙江	12-39	2-6	5-10	2-2	6-7	1-2	0-4	28-70	40.0	2	8
34	8	乔如	江苏	1-1	17-18	0-1	5-5	0-0	1-1	3-3	27-29	93.1	4	9
35	13	张格格	解放军	0-0	21-29	1-1	5-6	0-0	0-0	0-0	27-36	75.0	2	8
36	19	吕秋雪	辽宁	5-15	11-15	1-6	7-9	3-4	0-0	0-0	27-49	55.1	2	8
37	3	王晓梅	天津	19-38	1-3	1-1	0-1	1-1	0-0	5-6	27-50	54.0	4	8
38	7	刘彤	广东	0-5	3-4	17-33	5-7	0-0	0-0	2-2	27-51	52.9	3	9
39	8	周亚茹	解放军	17-42	3-7	1-2	0-0	1-2	0-1	5-9	27-63	42.9	0	8
40	2	崔云莉	解放军	12-47	2-4	6-8	6-6	0-0	0-1	1-1	27-67	40.3	6	8
41	6	于婷婷	解放军	9-14	7-11	3-3	3-3	4-4	0-0	0-0	26-35	74.3	8	8
42	11	于源源	江苏	1-1	3-3	9-18	12-13	1-1	0-0	0-0	26-36	72.2	0	9
43	19	印尼	上海	4-12	11-14	2-2	0-0	6-8	0-1	3-3	26-40	65.0	3	8
44	23	周梦雪	天津	9-27	7-15	1-4	1-2	7-7	0-0	1-2	26-57	45.6	5	8
45	6	凤洋	四川	5-13	4-8	5-21	9-13	3-3	0-0	0-0	26-58	44.8	2	8
46	21	锁珊珊	新疆	9-41	5-10	1-4	2-4	2-3	0-1	7-9	26-72	36.1	6	9
47	10	孙来苗	安徽	1-1	14-16	2-2	6-6	0-0	0-0	2-2	25-27	92.6	1	9





## 2016年全国女子手球锦标赛

## 得分排名表(场上队员)

正式表  
手球  
女子截止至第 54场  
按助攻201605054-1610-1/5  
安徽滁州  
03/09/2016 13:00

排序	号码	姓名	球队	远射	近射	边射	快攻	突破	任意	7M	合计	%	助攻	场数
1	8	杨娇	辽宁	27-53	5-8	2-2	1-1	3-3	5-12	12-22	55-101	54.5	25	8
2	8	吴茵	上海	12-26	9-13	2-2	5-5	4-4	0-1	4-5	36-56	64.3	18	8
3	3	王丹	四川	10-37	13-20	10-17	5-7	11-12	1-4	18-22	68-119	57.1	16	8
4	93	张婷婷	新疆	15-42	6-11	2-3	3-5	4-7	0-0	6-9	36-77	46.8	15	9
5	4	赵佳芹	江苏	13-32	3-4	1-1	2-3	5-5	2-2	4-4	30-51	58.8	15	8
6	44	刘洋麦文	解放军	8-35	1-2	1-2	1-2	4-5	2-2	1-1	18-49	36.7	15	8
7	14	刘晓妹	安徽	17-29	2-6	1-1	3-3	8-12	6-7	1-2	38-60	63.3	14	9
8	18	崔娟	新疆	18-64	10-13	0-0	1-3	1-1	2-2	5-9	37-92	40.2	14	9
9	21	李瑶	安徽	3-21	8-12	3-8	18-20	10-11	1-1	0-1	43-74	58.1	12	9
10	6	沈萍	安徽	23-34	12-17	0-2	2-3	4-4	1-4	11-12	53-76	69.7	10	9
11	17	周婷	安徽	3-5	16-21	3-4	9-11	7-9	0-0	0-1	38-51	74.5	10	9
12	26	宋婷婷	新疆	7-18	3-5	0-0	2-2	1-3	0-0	6-9	19-37	51.4	9	8
13	69	石梓薇	北京	21-50	12-20	2-3	5-6	7-8	0-1	12-14	59-102	57.8	8	8
14	7	廖露	广西	20-53	8-9	2-3	2-2	3-5	1-1	2-2	38-75	50.7	8	8
15	6	于婷婷	解放军	9-14	7-11	3-3	3-3	4-4	0-0	0-0	26-35	74.3	8	8
16	1	陆婷	江苏	0-0	0-0	0-0	0-0	0-0	0-0	0-0	0-0	0.0	8	9
17	66	梁海珍	辽宁	10-30	8-13	13-20	2-3	2-3	0-1	3-3	38-73	52.1	7	8
18	8	王彬	山东	8-17	6-10	4-7	2-3	4-5	0-0	12-12	36-54	66.7	7	8
19	6	黄妍	上海	16-28	8-14	0-0	2-2	1-1	0-2	7-11	34-58	58.6	7	8
20	18	舒文琪	天津	13-50	6-9	3-5	1-1	5-6	2-2	1-1	31-74	41.9	7	8
21	17	修丽杰	江苏	9-28	8-15	1-1	4-4	1-1	0-0	1-3	24-52	46.2	7	9
22	11	朱海云	四川	5-25	7-11	1-4	1-2	5-5	0-1	0-1	19-49	38.8	7	8
23	16	朱莉珍	安徽	0-0	0-0	0-0	0-0	0-0	0-0	0-0	0-0	0.0	7	9
24	33	金梦青	江苏	10-24	2-3	2-4	16-20	0-0	0-0	5-7	35-58	60.3	6	9
25	9	韦宝桂	广东	12-39	2-5	2-4	4-4	3-3	0-2	8-10	31-67	46.3	6	9
26	2	崔云莉	解放军	12-47	2-4	6-8	6-6	0-0	0-1	1-1	27-67	40.3	6	8
27	21	锁珊珊	新疆	9-41	5-10	1-4	2-4	2-3	0-1	7-9	26-72	36.1	6	9
28	69	蓝小玲	江苏	7-10	2-4	1-1	6-6	0-1	0-2	4-4	20-28	71.4	6	9
29	15	吴作扬	山东	6-21	5-7	0-1	0-1	0-1	1-3	4-5	16-39	41.0	6	8
30	3	李兵	安徽	0-0	6-8	1-2	2-2	1-1	0-0	0-0	10-13	76.9	6	9
31	88	李晓晴	解放军	13-33	6-10	1-2	2-2	3-3	1-3	15-17	41-70	58.6	5	8
32	23	周梦雪	天津	9-27	7-15	1-4	1-2	7-7	0-0	1-2	26-57	45.6	5	8
33	19	邝雪花	广东	3-19	5-11	5-9	0-1	7-9	0-0	0-0	20-49	40.8	5	9
34	2	陆雪云	广西	5-24	4-6	5-8	2-2	3-3	0-2	0-0	19-45	42.2	5	8
35	11	曾蓝花	广西	7-33	2-5	1-4	1-2	1-1	0-0	0-3	12-48	25.0	5	8
36	3	赵莹雪	辽宁	2-6	5-8	0-2	0-1	4-4	0-0	0-0	11-21	52.4	5	8
37	16	王小华	江苏	0-0	0-0	0-0	0-0	0-0	0-0	0-0	0-0	0.0	5	9
38	12	宋琛茜	四川	0-0	0-0	0-0	0-0	0-0	0-0	0-0	0-0	0.0	5	8
39	18	戴小宇	四川	12-30	10-14	1-1	1-1	6-7	0-0	12-15	42-68	61.8	4	8
40	11	蔡雪洁	天津	11-46	9-18	3-5	1-3	6-6	1-1	3-3	34-82	41.5	4	8
41	11	魏梦庭	广东	9-40	9-16	1-2	1-1	6-6	0-0	6-7	32-72	44.4	4	9
42	8	乔如	江苏	1-1	17-18	0-1	5-5	0-0	1-1	3-3	27-29	93.1	4	9
43	3	王晓梅	天津	19-38	1-3	1-1	0-1	1-1	0-0	5-6	27-50	54.0	4	8
44	10	田秀秀	山东	4-15	9-14	1-2	3-6	6-6	2-2	0-1	25-46	54.3	4	8
45	3	安妮	广东	1-6	6-10	0-1	3-4	3-4	0-0	1-1	14-26	53.8	4	9
46	28	闫美珠	北京	8-30	1-3	1-3	0-0	0-0	2-2	0-0	12-38	31.6	4	8
47	9	周钰婷	山东	3-14	1-4	0-0	1-1	0-0	0-0	0-1	5-20	25.0	4	8





## 2016年全国女子手球锦标赛

### 得分排名表(场上队员)

正式表  
手球  
女子

截止至第 54场  
按封球

201605054-1611-1/5  
安徽滁州  
03/09/2016 13:00

名次	号码	姓名	球队	抢球	断球	造失误	造犯规	合计	封球	场数
1	23	王如	广东	0	5	0	2	7	21	9
2	6	沈萍	安徽	1	4	0	3	8	18	9
3	5	辛颜	辽宁	0	6	1	0	7	16	8
4	8	乔如	江苏	0	6	0	1	7	16	9
5	8	杨娇	辽宁	2	7	1	0	10	14	8
6	5	班晨晨	安徽	0	1	0	0	1	12	9
7	18	沙正文	上海	0	9	0	1	10	10	8
8	88	李晓晴	解放军	2	5	0	0	7	10	8
9	69	蓝小玲	江苏	1	12	3	1	17	8	9
10	3	李兵	安徽	1	7	1	4	13	8	9
11	5	孙姣	四川	0	6	0	0	6	6	8
12	22	李海鸥	北京	0	5	1	0	6	6	8
13	19	邝雪花	广东	2	4	1	2	9	6	9
14	6	阿孜古	新疆	0	2	1	2	5	6	9
15	18	崔娟	新疆	0	10	1	0	11	6	9
16	20	李军政	广东	0	1	0	0	1	6	9
17	5	周美微	黑龙江	0	4	1	0	5	5	8
18	10	王可可	江苏	0	0	1	1	2	5	9
19	17	周婷	安徽	0	10	0	2	12	5	9
20	17	居晔	上海	1	0	0	0	1	4	8
21	5	郭威	上海	0	1	0	0	1	4	8
22	23	徐悦	山东	0	1	0	1	2	4	8
23	15	吴作扬	山东	0	1	0	0	1	4	8
24	19	吕秋雪	辽宁	0	5	0	0	5	4	8
25	4	孙佳	北京	0	6	0	0	6	4	8
26	14	刘晓妹	安徽	0	7	0	4	11	4	9
27	5	李纯	广东	0	0	0	0	0	4	9
28	13	张格格	解放军	0	6	1	2	9	3	8
29	8	吴茵	上海	0	5	2	1	8	3	8
30	23	田媛	北京	0	2	0	0	2	3	8
31	9	郑宇	黑龙江	0	3	0	1	4	3	8
32	10	孙来苗	安徽	0	2	0	1	3	3	9
33	27	谢辰辰	新疆	1	2	0	1	4	3	9
34	23	都好	上海	0	0	1	0	1	2	8
35	2	周蕾	上海	0	2	1	2	5	2	8
36	28	崔金娜	山东	0	2	0	1	3	2	8
37	13	杜江花	辽宁	0	1	0	0	1	2	8
38	10	刘雪露	黑龙江	0	1	0	0	1	2	8
39	9	姚梦园	四川	0	5	1	0	6	2	8
40	23	张政	黑龙江	0	0	0	0	0	2	8
41	3	王晓梅	天津	0	1	0	1	2	2	8
42	10	刘莎	北京	0	2	1	3	6	2	8
43	9	莫蒙蒙	江苏	1	3	0	0	4	2	9
44	17	戴莹莹	新疆	1	0	0	0	1	2	9
45	23	王书慧	江苏	2	2	0	0	4	2	9
46	32	张馨予	解放军	0	0	0	0	0	1	8
47	6	黄妍	上海	1	1	0	1	3	1	8
48	18	舒文琪	天津	0	1	2	0	3	1	8





## 2016年全国女子手球锦标赛

### 得分排名表(场上队员)

正式表  
手球  
女子

截止至第 54场  
按防守

201605054-1612-1/5  
安徽滁州  
03/09/2016 13:00

名次	号码	姓名	球队	抢球	断球	造失误	造犯规	合计	封球	场数
1	2	林燕群	山东	5	15	0	1	21	1	8
2	69	蓝小玲	江苏	1	12	3	1	17	8	9
3	3	王丹	四川	1	13	1	2	17	0	8
4	4	赵佳芹	江苏	0	10	4	0	14	1	8
5	3	李兵	安徽	1	7	1	4	13	8	9
6	17	周婷	安徽	0	10	0	2	12	5	9
7	14	刘晓妹	安徽	0	7	0	4	11	4	9
8	18	崔娟	新疆	0	10	1	0	11	6	9
9	93	张婷婷	新疆	4	6	0	0	10	1	9
10	8	杨娇	辽宁	2	7	1	0	10	14	8
11	18	沙正文	上海	0	9	0	1	10	10	8
12	10	田秀秀	山东	6	3	1	0	10	0	8
13	21	锁珊珊	新疆	1	5	2	1	9	0	9
14	3	安妮	广东	0	7	0	2	9	0	9
15	19	邝雪花	广东	2	4	1	2	9	6	9
16	6	凤洋	四川	2	5	2	0	9	0	8
17	2	朱徐婷	辽宁	1	8	0	0	9	0	8
18	13	张格格	解放军	0	6	1	2	9	3	8
19	11	蔡雪洁	天津	2	5	1	1	9	0	8
20	6	沈萍	安徽	1	4	0	3	8	18	9
21	2	崔云莉	解放军	1	6	0	1	8	1	8
22	8	吴茵	上海	0	5	2	1	8	3	8
23	69	石梓薇	北京	1	7	0	0	8	0	8
24	21	李瑶	安徽	1	4	0	2	7	0	9
25	23	王如	广东	0	5	0	2	7	21	9
26	11	魏梦庭	广东	0	3	1	3	7	0	9
27	8	乔如	江苏	0	6	0	1	7	16	9
28	5	辛颜	辽宁	0	6	1	0	7	16	8
29	88	李晓晴	解放军	2	5	0	0	7	10	8
30	10	周琴	广西	1	4	0	2	7	0	8
31	2	陆雪云	广西	1	4	2	0	7	0	8
32	23	周梦雪	天津	0	6	0	1	7	0	8
33	24	韦娜娜	解放军	1	4	0	2	7	0	8
34	3	季小桐	北京	1	5	0	1	7	0	8
35	31	史小军	广东	0	4	0	2	6	1	9
36	15	兰姝娇	新疆	1	5	0	0	6	0	9
37	7	吴志娟	新疆	2	2	0	2	6	0	9
38	3	张海侠	江苏	1	4	0	1	6	0	9
39	9	武娜娜	上海	2	2	1	1	6	1	8
40	8	周亚茹	解放军	1	3	0	2	6	0	8
41	4	孙佳	北京	0	6	0	0	6	4	8
42	11	朱海云	四川	0	4	1	1	6	0	8
43	5	孙姣	四川	0	6	0	0	6	6	8
44	3	赵莹雪	辽宁	1	3	1	1	6	1	8
45	9	姚梦园	四川	0	5	1	0	6	2	8
46	8	韦如芳	广西	1	3	1	1	6	0	8
47	10	刘莎	北京	0	2	1	3	6	2	8
48	22	李海鸥	北京	0	5	1	0	6	6	8





## 2016年全国女子手球锦标赛

## 得分排名表(场上队员)

正式表  
手球  
女子截止至第 54场  
失误排名表201605054-1613-1/5  
安徽滁州  
03/09/2016 13:00

排序	号码	姓名	球队	传失	接失	两次	四步	侵区	撞人	其它	合计	场数
1	18	舒文琪	天津	12	3	6	11	1	2	3	38	8
2	3	王丹	四川	19	2	3	5	1	2	3	35	8
3	3	季小桐	北京	16	6	5	3	1	2	0	33	8
4	11	曾蓝花	广西	20	4	5	2	0	0	0	31	8
5	18	崔娟	新疆	14	5	2	6	1	1	1	30	9
6	93	张婷婷	新疆	15	2	5	2	1	2	2	29	9
7	2	陆雪云	广西	15	1	4	4	1	0	2	27	8
8	23	周梦雪	天津	17	3	2	1	2	0	1	26	8
9	2	林燕群	山东	7	5	3	5	2	2	2	26	8
10	10	田秀秀	山东	9	4	6	1	1	4	0	25	8
11	11	蔡雪洁	天津	9	6	1	6	0	2	0	24	8
12	10	刘雪露	黑龙江	8	2	3	4	0	1	4	22	8
13	21	锁珊珊	新疆	13	0	0	4	2	0	2	21	9
14	69	石梓薇	北京	13	1	1	5	1	0	0	21	8
15	8	杨娇	辽宁	14	2	0	2	0	2	1	21	8
16	23	王书慧	江苏	10	1	2	3	1	3	0	20	9
17	6	沈萍	安徽	9	2	0	6	3	0	0	20	9
18	13	吴佳	黑龙江	11	3	2	0	1	1	2	20	8
19	11	朱海云	四川	12	1	2	2	3	0	0	20	8
20	18	戴小宇	四川	5	5	1	6	0	1	1	19	8
21	19	邝雪花	广东	8	4	2	2	0	2	0	18	9
22	44	刘洋麦文	解放军	11	0	0	4	1	0	2	18	8
23	8	王彬	山东	7	2	4	2	3	0	0	18	8
24	21	李瑶	安徽	10	3	0	2	0	2	0	17	9
25	9	韦宝桂	广东	11	3	0	1	0	2	0	17	9
26	7	廖露	广西	11	1	2	0	0	1	2	17	8
27	6	于婷婷	解放军	6	0	2	4	1	2	2	17	8
28	8	吴茵	上海	11	1	1	1	1	2	0	17	8
29	15	吴作扬	山东	9	4	2	1	1	0	0	17	8
30	17	于利婷	解放军	11	2	1	1	1	0	0	16	8
31	17	杨政赢	北京	10	3	1	1	0	0	1	16	8
32	14	黄艳芳	广西	4	3	2	1	4	1	1	16	8
33	6	王梦艺	黑龙江	11	3	0	1	0	0	1	16	8
34	11	魏梦庭	广东	9	3	1	1	0	0	1	15	9
35	14	刘晓妹	安徽	9	1	2	1	1	1	0	15	9
36	3	王晓梅	天津	6	0	1	5	1	2	0	15	8
37	88	李晓晴	解放军	8	2	0	3	0	1	1	15	8
38	4	尤婉莹	四川	2	3	2	3	2	1	2	15	8
39	17	周婷	安徽	8	2	0	0	0	3	1	14	9
40	3	安妮	广东	10	1	1	2	0	0	0	14	9
41	66	梁海珍	辽宁	13	0	0	0	1	0	0	14	8
42	2	崔云莉	解放军	10	1	0	3	0	0	0	14	8
43	20	李军政	广东	4	3	0	2	3	1	0	13	9
44	10	张文慧	天津	3	5	1	1	3	0	0	13	8
45	6	黄妍	上海	7	1	0	3	0	0	2	13	8
46	5	孙姣	四川	2	6	0	1	3	0	1	13	8
47	22	马琳	黑龙江	6	1	1	4	0	1	0	13	8
48	11	孙梦颖	上海	3	1	3	0	3	3	0	13	8





## 2016年全国女子手球锦标赛

## 得分排名表(场上队员)

正式表  
手球  
女子截止至第 54场  
受罚排名表201605054-1614-1/5  
安徽滁州  
03/09/2016 13:00

排序	号码	姓名	球队	警告	罚2分钟	D+DR	场数
1	7	杨嘉露	山东	1	2	1	7
2	4	赵佳芹	江苏	2	1	1	8
3	9	莫蒙蒙	江苏	0	6	0	9
4	6	阿孜古	新疆	5	5	0	9
5	17	修丽杰	江苏	3	5	0	9
6	18	戴小宇	四川	1	5	0	8
7	23	徐悦	山东	0	5	0	8
8	18	沙正文	上海	6	4	0	8
9	19	吕秋雪	辽宁	5	4	0	8
10	69	蓝小玲	江苏	4	4	0	9
11	7	刘彤	广东	4	4	0	9
12	4	孙佳	北京	4	4	0	8
13	8	张慧	天津	3	4	0	8
14	10	孙来苗	安徽	2	4	0	9
15	3	季小桐	北京	1	4	0	8
16	10	张文慧	天津	7	3	0	8
17	5	孙姣	四川	4	3	0	8
18	18	舒文琪	天津	4	3	0	8
19	3	王丹	四川	3	3	0	8
20	8	周亚茹	解放军	2	3	0	8
21	9	郑宇	黑龙江	2	3	0	8
22	14	黄艳芳	广西	2	3	0	8
23	11	蔡雪洁	天津	2	3	0	8
24	28	崔金娜	山东	2	3	0	8
25	19	邝雪花	广东	1	3	0	9
26	14	刘晓妹	安徽	1	3	0	9
27	23	都好	上海	1	3	0	8
28	33	王彩琳	山东	0	3	0	8
29	20	张悦	山东	6	2	0	8
30	5	周美微	黑龙江	5	2	0	8
31	6	沈萍	安徽	4	2	0	9
32	9	武娜娜	上海	4	2	0	8
33	5	辛颜	辽宁	4	2	0	8
34	2	周蕾	上海	4	2	0	8
35	17	戴莹莹	新疆	3	2	0	9
36	23	王书慧	江苏	3	2	0	9
37	8	乔如	江苏	3	2	0	9
38	10	周琴	广西	3	2	0	8
39	2	陈艳楠	四川	3	2	0	8
40	2	陆雪云	广西	3	2	0	8
41	2	林燕群	山东	3	2	0	8
42	3	安妮	广东	2	2	0	9
43	15	兰姝娇	新疆	2	2	0	9
44	31	史小军	广东	2	2	0	9
45	8	吴茵	上海	2	2	0	8
46	18	庞娇	广西	2	2	0	8
47	17	周婷	安徽	1	2	0	9
48	7	廖露	广西	1	2	0	8







## 2016年全国女子手球锦标赛

排名表(守门员)

正式表  
手球  
女子截止至第 54场  
得分排名表201605054-1701-1/1  
安徽滁州  
03/09/2016 13:00

排序	号码	姓名	球队	远射	近射	边射	快攻	突破	任意	7M	合计	%	助攻	场数
1	12	宋琛茜	四川	40-79	26-116	14-62	6-41	5-39	3-5	7-23	101-365	27.7	5	8
2	16	王海叶	北京	38-71	20-65	25-42	8-36	4-29	0-1	3-13	98-257	38.1	2	8
3	16	商志运	广西	28-59	25-71	23-49	3-35	2-14	1-1	6-23	88-252	34.9	1	8
4	32	杨雨柔	新疆	41-68	16-64	15-42	4-40	2-13	1-3	9-23	88-253	34.8	1	9
5	1	许沫	上海	37-60	23-53	9-20	4-8	2-16	1-4	5-15	81-176	46.0	4	8
6	16	方文博	解放军	39-76	14-67	12-23	6-22	3-23	1-2	2-16	77-229	33.6	3	8
7	12	肖宁桐	黑龙江	30-62	12-49	20-39	5-41	4-24	0-2	4-15	75-232	32.3	1	8
8	12	张苑琳	山东	37-61	9-38	9-32	4-32	3-12	2-5	3-8	67-188	35.6	0	8
9	16	朱莉珍	安徽	39-73	7-24	8-17	5-13	2-5	0-1	1-19	62-152	40.8	7	9
10	16	王小华	江苏	22-39	15-40	14-24	2-11	3-12	3-10	0-7	59-143	41.3	5	9
11	16	王选	天津	16-41	15-66	19-41	1-23	0-13	2-5	4-22	57-211	27.0	1	8
12	93	赵琦	辽宁	30-67	9-25	10-27	4-21	1-12	1-1	0-2	55-155	35.5	2	8
13	1	司艳	安徽	30-50	7-31	6-25	1-6	3-9	4-5	2-14	53-140	37.9	3	9
14	22	刘晓玉	广东	37-62	2-16	4-11	5-17	0-2	2-2	1-5	51-115	44.3	3	9
15	12	王欣冉	天津	21-35	12-34	9-24	3-14	0-4	0-0	5-19	50-130	38.5	0	8
16	26	马晓卉	广东	18-53	9-28	9-22	4-30	2-13	1-2	5-22	48-170	28.2	1	9
17	12	郑冯	上海	15-27	16-39	7-15	2-10	0-6	1-1	1-8	42-106	39.6	2	8
18	1	陆婷	江苏	24-37	7-22	6-13	2-9	0-10	1-3	1-6	41-100	41.0	8	9
19	27	王丹	辽宁	21-52	12-34	3-15	2-13	0-6	0-2	2-17	40-139	28.8	0	8
20	1	路畅	山东	13-23	6-23	7-13	4-13	0-4	0-1	4-13	34-90	37.8	0	8
21	12	黄霞	江苏	13-19	4-14	3-7	2-5	2-6	0-1	2-16	26-68	38.2	2	9
22	10	李静	新疆	13-42	3-18	3-10	3-19	0-4	0-0	2-11	24-104	23.1	0	9
23	1	宋嘉蕾	北京	7-15	7-32	5-12	1-12	0-6	0-1	2-10	22-88	25.0	0	8
24	66	杨丽丽	解放军	7-14	4-19	2-9	2-15	4-9	0-1	2-6	21-73	28.8	3	8
25	12	江燕红	广西	5-18	6-29	2-11	4-22	0-3	0-0	2-11	19-94	20.2	0	8
26	16	李娟	广东	11-28	2-9	1-6	1-14	3-8	0-0	0-8	18-73	24.7	0	9
27	8	徐仕媛	安徽	9-13	2-2	1-4	1-1	0-2	0-0	1-1	14-23	60.9	0	9
28	1	徐佳蓉	黑龙江	4-12	3-16	1-7	1-11	0-3	0-1	1-3	10-53	18.9	0	8
29	16	杜宪	黑龙江	3-8	1-7	2-4	2-6	0-2	0-0	0-5	8-32	25.0	1	8
30	77	唐魏萍	解放军	3-8	3-14	1-6	0-9	0-3	0-0	1-8	8-48	16.7	1	8
31	22	朱赞	山东	2-4	0-0	2-3	0-0	0-0	0-0	2-10	6-17	35.3	0	8
32	1	于薇诗	辽宁	1-9	3-4	1-1	0-0	0-1	0-1	0-0	5-16	31.3	0	8
33	47	刘泽	北京	2-4	1-7	0-1	0-3	0-2	0-0	0-5	3-22	13.6	0	8



## 2016年全国女子手球锦标赛

排名表(守门员)

正式表  
手球  
女子截止至第 54场  
7M球得分排名表201605054-1703-1/1  
安徽滁州  
03/09/2016 13:00

排序	号码	姓名	球队	远射	近射	边射	快攻	突破	任意	7M	合计	%	助攻	场数
1	32	杨雨柔	新疆	41-68	16-64	15-42	4-40	2-13	1-3	9-23	88-253	39.1	1	9
2	12	宋琛茜	四川	40-79	26-116	14-62	6-41	5-39	3-5	7-23	101-365	30.4	5	8
3	16	商志运	广西	28-59	25-71	23-49	3-35	2-14	1-1	6-23	88-252	26.1	1	8
4	1	许沫	上海	37-60	23-53	9-20	4-8	2-16	1-4	5-15	81-176	33.3	4	8
5	12	王欣冉	天津	21-35	12-34	9-24	3-14	0-4	0-0	5-19	50-130	26.3	0	8
6	26	马晓卉	广东	18-53	9-28	9-22	4-30	2-13	1-2	5-22	48-170	22.7	1	9
7	1	路畅	山东	13-23	6-23	7-13	4-13	0-4	0-1	4-13	34-90	30.8	0	8
8	12	肖宁桐	黑龙江	30-62	12-49	20-39	5-41	4-24	0-2	4-15	75-232	26.7	1	8
9	16	王选	天津	16-41	15-66	19-41	1-23	0-13	2-5	4-22	57-211	18.2	1	8
10	12	张苑琳	山东	37-61	9-38	9-32	4-32	3-12	2-5	3-8	67-188	37.5	0	8
11	16	王海叶	北京	38-71	20-65	25-42	8-36	4-29	0-1	3-13	98-257	23.1	2	8
12	66	杨丽丽	解放军	7-14	4-19	2-9	2-15	4-9	0-1	2-6	21-73	33.3	3	8
13	1	宋嘉蕾	北京	7-15	7-32	5-12	1-12	0-6	0-1	2-10	22-88	20.0	0	8
14	22	朱赟	山东	2-4	0-0	2-3	0-0	0-0	0-0	2-10	6-17	20.0	0	8
15	10	李静	新疆	13-42	3-18	3-10	3-19	0-4	0-0	2-11	24-104	18.2	0	9
16	12	江燕红	广西	5-18	6-29	2-11	4-22	0-3	0-0	2-11	19-94	18.2	0	8
17	1	司艳	安徽	30-50	7-31	6-25	1-6	3-9	4-5	2-14	53-140	14.3	3	9
18	16	方文博	解放军	39-76	14-67	12-23	6-22	3-23	1-2	2-16	77-229	12.5	3	8
19	12	黄霞	江苏	13-19	4-14	3-7	2-5	2-6	0-1	2-16	26-68	12.5	2	9
20	27	王丹	辽宁	21-52	12-34	3-15	2-13	0-6	0-2	2-17	40-139	11.8	0	8
21	8	徐仕媛	安徽	9-13	2-2	1-4	1-1	0-2	0-0	1-1	14-23	100.0	0	9
22	1	徐佳蓉	黑龙江	4-12	3-16	1-7	1-11	0-3	0-1	1-3	10-53	33.3	0	8
23	22	刘晓玉	广东	37-62	2-16	4-11	5-17	0-2	2-2	1-5	51-115	20.0	3	9
24	1	陆婷	江苏	24-37	7-22	6-13	2-9	0-10	1-3	1-6	41-100	16.7	8	9
25	12	郑冯	上海	15-27	16-39	7-15	2-10	0-6	1-1	1-8	42-106	12.5	2	8
26	77	唐魏萍	解放军	3-8	3-14	1-6	0-9	0-3	0-0	1-8	8-48	12.5	1	8
27	16	朱莉珍	安徽	39-73	7-24	8-17	5-13	2-5	0-1	1-19	62-152	5.3	7	9
28	1	于薇诗	辽宁	1-9	3-4	1-1	0-0	0-1	0-1	0-0	5-16	0.0	0	8
29	93	赵琦	辽宁	30-67	9-25	10-27	4-21	1-12	1-1	0-2	55-155	0.0	2	8
30	16	杜宪	黑龙江	3-8	1-7	2-4	2-6	0-2	0-0	0-5	8-32	0.0	1	8
31	47	刘泽	北京	2-4	1-7	0-1	0-3	0-2	0-0	0-5	3-22	0.0	0	8
32	16	王小华	江苏	22-39	15-40	14-24	2-11	3-12	3-10	0-7	59-143	0.0	5	9
33	16	李娟	广东	11-28	2-9	1-6	1-14	3-8	0-0	0-8	18-73	0.0	0	9





## 2016年全国女子手球锦标赛

攻防成功率统计总表

20160554-3102-1/1

13/09/16

安徽滁州

序号	球队	比分	进攻成功率												助攻	防守成功率											
			阵地进攻			一传快攻			短传快攻			合计		多打少		少打多		封打抢断	守门员	对方射失	对方失误	合计	%				
			得分	进攻	%	得分	进攻	%	得分	进攻	%	得分	进攻	%		得分	进攻							%	得分	进攻	%
1	安徽	295 : 186	230	442	52.0	41	47	87.2	24	49	49.0	295	538	54.8	18	29	62.1	6	12	50.0	67	115	129	64	19	327	58.0
2	北京	218 : 244	184	490	37.6	17	21	81.0	17	27	63.0	218	538	40.5	21	44	47.7	8	20	40.0	28	60	123	42	56	281	51.9
3	广东	223 : 241	190	518	36.7	18	23	78.3	15	29	51.7	223	571	39.1	23	35	65.7	8	21	38.1	30	91	117	47	39	294	51.1
4	广西	169 : 239	151	468	32.3	8	12	66.7	10	19	52.6	169	499	33.9	13	22	59.1	12	19	63.2	20	35	107	39	47	228	48.6
5	黑龙江	123 : 224	111	400	27.8	7	11	63.6	5	22	22.7	123	433	28.4	15	23	65.2	7	13	53.8	11	41	93	39	44	217	47.7
6	江苏	292 : 185	212	452	46.9	53	65	81.5	27	45	60.0	292	562	52.0	18	24	75.0	22	35	62.9	62	105	126	43	61	335	60.4
7	解放军	232 : 244	198	506	39.1	21	26	80.8	13	26	50.0	232	558	41.6	10	16	62.5	4	9	44.4	46	65	106	49	72	292	52.8
8	辽宁	230 : 210	202	468	43.2	15	19	78.9	13	30	43.3	230	517	44.5	21	31	67.7	6	12	50.0	47	79	100	66	20	265	51.8
9	山东	221 : 188	188	439	42.8	21	28	75.0	12	27	44.4	221	495	44.6	19	30	63.3	9	15	60.0	26	65	107	52	60	284	58.6
10	上海	244 : 159	202	391	51.7	20	29	69.0	22	34	64.7	244	454	53.7	21	28	75.0	13	19	68.4	46	71	123	45	33	272	59.4
11	四川	228 : 264	187	498	37.6	21	27	77.8	20	41	48.8	228	566	40.3	33	56	58.9	6	19	31.6	40	61	101	49	75	286	51.2
12	天津	176 : 234	156	470	33.2	11	13	84.6	9	23	39.1	176	506	34.8	12	16	75.0	10	21	47.6	22	40	107	64	64	275	53.7
13	新疆	212 : 245	192	532	36.1	11	17	64.7	9	26	34.6	212	575	36.9	12	19	63.2	5	19	26.3	52	75	112	54	70	311	54.2

注释： 进攻 = 进攻次数（射门 + 进攻失误） 对方射失 = 对方射门失误（射失 + 击柱） 防守成功率% = 本方防守合计 / 对方进攻合计



## 2016年全国女子手球锦标赛

防守技术统计总表

20160554-3402-1/1

13/09/2016

安徽滁州

场次	球队	比分	防守成功						防守(成功:失误)							处罚				守门员				
			封球	抢球	断球	造失	造犯	合计	选位	顶贴	观察	移动	换防	其他	合计	警告 2'	取消	DR	合计	救球	射门	%		
1	安徽	295:186	51	4	41	1	18	115	0:0	0:0	0:0	0:0	0:0	0:0	0:0	0:0	21	12	0	0	33	129	315	40.95
2	北京	218:244	16	4	32	3	5	60	0:0	0:0	0:0	0:0	0:0	0:0	0:0	0:0	24	18	0	0	42	123	367	33.51
3	广东	223:241	40	2	32	2	15	91	0:0	0:0	0:0	0:0	0:0	0:0	0:0	0:0	26	16	0	0	42	117	358	32.68
4	广西	169:239	2	8	17	4	4	35	0:0	0:0	0:0	0:0	0:0	0:0	0:0	0:0	20	11	0	0	31	107	346	30.92
5	黑龙江	123:224	14	2	17	4	4	41	0:0	0:0	0:0	0:0	0:0	0:0	0:0	0:0	21	13	0	0	34	93	317	29.34
6	江苏	292:185	35	7	47	8	8	105	0:0	0:0	0:0	0:0	0:0	0:0	0:0	0:0	25	21	1	0	47	126	311	40.51
7	解放军	232:244	17	6	29	2	11	65	0:0	0:0	0:0	0:0	0:0	0:0	0:0	0:0	20	10	0	0	30	106	350	30.29
8	辽宁	230:210	37	5	33	3	1	79	0:0	0:0	0:0	0:0	0:0	0:0	0:0	0:0	23	11	0	0	34	100	310	32.26
9	山东	221:188	13	15	33	1	3	65	0:0	0:0	0:0	0:0	0:0	0:0	0:0	0:0	22	21	1	0	44	107	295	36.27
10	上海	244:159	27	5	26	6	7	71	0:0	0:0	0:0	0:0	0:0	0:0	0:0	0:0	21	16	0	0	37	123	282	43.62
11	四川	228:264	9	5	37	6	4	61	0:0	0:0	0:0	0:0	0:0	0:0	0:0	0:0	19	15	0	0	34	101	365	27.67
12	天津	176:234	3	5	25	3	4	40	0:0	0:0	0:0	0:0	0:0	0:0	0:0	0:0	23	19	0	0	42	107	341	31.38
13	新疆	212:245	18	10	35	6	6	75	0:0	0:0	0:0	0:0	0:0	0:0	0:0	0:0	20	15	0	0	35	112	357	31.37

注释: 造失 = 造对方失误    造犯 = 造对方犯规    DR = 取消资格+报告



## 2016年全国女子手球锦标赛

## 球队名单(媒体表)

安徽

201605000-53-1/1

号码	姓名	位置	生日	年龄	俱乐部	身高 (CM)	体重 (KG)	总场次	总进球
1	司艳	守门员	09/12/1989	26	安徽	183	70		
3	李兵	底线	21/01/1980	36	安徽	180	69		
5	班晨晨	右后卫	06/06/1991	25	安徽	185	85		
6	沈萍	中后卫	04/07/1983	33	安徽	182	77		
7	赵江川	右后卫	24/02/1985	31	安徽	177	73		
8	徐仕媛	守门员	23/05/1997	19	安徽	180	78		
10	孙来苗	底线	08/04/1981	35	安徽	182	70		
14	刘晓妹	中后卫	02/05/1985	31	安徽	178	76		
16	朱莉珍	守门员	18/02/1974	42	安徽	181	65		
17	周婷	左边锋	27/03/1987	29	安徽	182	70		
18	郑冬冬	底线	10/12/1988	27	安徽	180	74		
20	周雪婷	左边锋	04/01/1996	20	安徽	175	67		
21	李瑶	后卫	07/06/1992	24	安徽	172	60		
23	张天洁	右边锋	30/11/1991	24	安徽	186	75		
41	杜机娟	右边锋	12/08/1989	27	安徽	178	68		
46	陶传红								
平均				28.6		180.1	71.8		

## 替换队员

编码	姓名	职务
A	吴立军	领队
E	张舜	医生
D	刘晓妹	教练
C	沈萍	教练
B	孙来苗	主教练



## 2016年全国女子手球锦标赛

## 球队名单(媒体表)

北京

201605000-53-1/1

号码	姓名	位置	生日	年龄	俱乐部	身高 (CM)	体重 (KG)	总场次	总进球
1	宋嘉蕾	守门员	25/01/1995	21	北京女子手球队	190	75		
3	季小桐	中后卫	12/10/1994	21	北京女子手球队	178	60		
4	孙佳	底线	25/09/1995	20	北京女子手球队	176	68		
6	刘亚男	后卫	27/04/1986	30	北京女子手球队	176	64		
8	杨铭豫	底线	22/08/1993	23	北京女子手球队	178	65		
10	刘莎	边锋	05/06/1992	24	北京女子手球队	168	63		
11	纪婉	边锋	26/01/1995	21	北京女子手球队	165	58		
16	王海叶	守门员	03/07/1991	25	北京女子手球队	178	63		
17	杨政赢	后卫	20/11/1998	17	北京女子手球队	180	76		
22	李海鸥	底线	08/07/1990	26	北京女子手球队	178	67		
23	田媛	后卫	22/02/1997	19	北京女子手球队	178	72		
28	闫美珠	右后卫	28/01/1989	27	北京女子手球队	189	73		
33	栾征	后卫	02/05/1984	32	北京女子手球队	175	63		
47	刘泽	守门员	30/05/1994	22	北京女子手球队	177	63		
58	李华	右边锋	08/05/1994	22	北京女子手球队	167	63		
69	石梓薇	左后卫	25/09/1996	19	北京女子手球队	178	68		
平均				23.1		176.9	66.3		

## 替换队员

编码	姓名	职务
A	蔡建国	领队
B	石伟	主教练
C	李翼	教练
E	史良玉	医生
D	栾征	教练



## 2016年全国女子手球锦标赛

## 球队名单(媒体表)

广东

201605000-53-1/1

号码	姓名	位置	生日	年龄	俱乐部	身高 (CM)	体重 (KG)	总场次	总进球
3	安妮	左后卫	11/06/1987	29	广东省黄村体育训练中心	175	70		
5	李纯	底线	26/03/1997	19	广东省黄村体育训练中心	186	80		
7	刘彤	左边锋	03/06/1993	23	广东省黄村体育训练中心	170	61		
8	李诗棋	右后卫	17/01/1997	19	广东省黄村体育训练中心	168	60		
9	韦宝桂	右后卫	20/03/1990	26	广东省黄村体育训练中心	179	63		
11	魏梦庭	中后卫	01/09/1989	27	广东省黄村体育训练中心	175	68		
15	杨慧	中后卫	13/09/1998	17	广东省黄村体育训练中心	171	65		
16	李娟	守门员	10/05/1989	27	广东省黄村体育训练中心	178	66		
18	李玉玲	右后卫			广东省黄村体育训练中心				
19	邝雪花	右后卫	11/01/1992	24	广东省黄村体育训练中心	179	70		
20	李军政	左边锋	25/03/1992	24	广东省黄村体育训练中心	175	72		
22	刘晓玉	守门员	09/01/1993	23	广东省黄村体育训练中心	176	70		
23	王如	守门员	30/04/1988	28	广东省黄村体育训练中心	177	71		
26	马晓卉	守门员	04/08/1993	23	广东省黄村体育训练中心	182	80		
28	刘金兰	左边锋	14/11/1985	30	广东省黄村体育训练中心	175	72		
31	史小军	右边锋	21/05/1986	30	广东省黄村体育训练中心	175	73		
平均				24.6		176.1	69.4		

## 替换队员

编码	姓名	职务
A	李细利	领队
B	郭艳辉	主教练
D	祝捷	教练
E	赵善良	医生



## 2016年全国女子手球锦标赛

## 球队名单(媒体表)

广西

201605000-53-1/1

号码	姓名	位置	生日	年龄	俱乐部	身高 (CM)	体重 (KG)	总场次	总进球
1	胡霜梅	守门员	18/01/1995	21		184	65		
2	陆雪云	左后卫	13/08/1992	24		173	65		
5	黄海玉	右边锋	09/02/2000	16		170	60		
6	韦惠文	左后卫	29/07/1993	23		177	60		
7	廖露	中后卫	13/09/1994	21		177	60		
8	韦如芳	左边锋	28/03/1995	21		170	60		
9	蓝雪梅	右后卫	07/02/1998	18		170	65		
10	周琴	右边锋	06/12/1993	22		173	60		
11	曾蓝花	右后卫	23/02/1993	23		170	60		
12	江燕红	守门员	29/11/1998	17		180	65		
14	黄艳芳	底线	30/09/1995	20		175	65		
15	陈依依	左边锋	18/12/1998	17		171	55		
16	商志运	守门员	17/10/1987	28		180	65		
17	杨杨	左后卫	24/01/1998	18		180	65		
18	庞娇	右后卫	28/04/1990	26		178	65		
平均				21.0		175.2	62.3		

## 替换队员

编码	姓名	职务
C	王林	教练
D	刘雪波	医生





## 2016年全国女子手球锦标赛

## 球队名单(媒体表)

黑龙江

201605000-53-1/1

号码	姓名	位置	生日	年龄	俱乐部	身高 (CM)	体重 (KG)	总场次	总进球
1	徐佳蓉	守门员	19/07/1998	18		178	62		
3	刘诗彤	左边锋	09/02/2000	16		170	60		
5	周美微	底线	10/03/1989	27		180	75		
6	王梦艺	后卫	29/10/1989	26		172	62		
9	郑宇	右后卫	07/06/1995	21		176	71		
10	刘雪露	左后卫	10/09/1996	19		187	72		
11	刘天茹	左边锋	24/12/1993	22		172	60		
12	肖宁桐	右后卫	06/06/1996	20		182	65		
13	吴佳	右后卫	14/07/1993	23		175	75		
14	黄荣	后卫	04/03/1988	28		178	60		
16	杜宪	守门员	24/02/1995	21		179	60		
19	梁文煜	右边锋	21/02/1991	25		176	63		
21	王戈	左边锋	26/08/1996	20		170	63		
22	马琳	底线	20/11/1996	19		180	78		
23	张政	底线	05/06/1995	21		178	80		
平均				21.7		176.9	67.1		

## 替换队员

编码	姓名	职务
B	张立梅	主教练
C	黄冬杰	教练
D	于兹香	教练
E	马婧	医生
A	许岩	领队



## 2016年全国女子手球锦标赛

## 球队名单(媒体表)

江苏

201605000-53-1/1

号码	姓名	位置	生日	年龄	俱乐部	身高 (CM)	体重 (KG)	总场次	总进球
1	陆婷	守门员	08/01/1986	30	江苏女子手球队	183	69		
3	张海侠	右边锋	10/02/1995	21	江苏女子手球队	175	63		
4	赵佳芹	中后卫	22/01/1986	30	江苏女子手球队	174	67		
5	高媛媛	左后卫	16/01/1999	17	江苏女子手球队	176	65		
8	乔如	底线	05/01/1995	21	江苏女子手球队	182	85		
9	莫蒙蒙	底线	06/01/1995	21	江苏女子手球队	178	77		
10	王可可	左后卫	20/10/1999	16	江苏女子手球队	182	65		
11	于源源	左边锋	30/01/1995	21	江苏女子手球队	173	66		
12	黄霞	守门员	19/01/1995	21	江苏女子手球队	178	58		
13	黄慧影	左后卫	09/02/1998	18	江苏女子手球队	175	60		
16	王小华	守门员	15/04/1993	23	江苏女子手球队	186	74		
17	修丽杰	右后卫	18/04/1988	28	江苏女子手球队	178	73		
18	韦秋香	右边锋	15/02/1986	30	江苏女子手球队	176	65		
23	王书慧	左后卫	12/07/1993	23	江苏女子手球队	179	70		
33	金梦青	中后卫	29/05/1995	21	江苏女子手球队	172	65		
69	蓝小玲	左后卫	22/05/1993	23	江苏女子手球队	180	70		
平均				22.8		177.9	68.3		

## 替换队员

编码	姓名	职务
B	金甲洙	主教练
C	马彪	教练
D	李海鹰	教练
E	陈志伟	医生
A	姚治前	领队



## 2016年全国女子手球锦标赛

## 球队名单(媒体表)

解放军

201605000-53-1/1

号码	姓名	位置	生日	年龄	俱乐部	身高 (CM)	体重 (KG)	总场次	总进球
2	崔云莉	中后卫	24/04/1999	17		175	60		
5	徐鸣昭	左后卫	11/12/1995	20		174	66		
6	于婷婷	右后卫	15/02/1995	21		174	60		
8	周亚茹	左后卫	16/02/1996	20		178	70		
13	张格格	底线	17/07/1994	22		175	68		
16	方文博	守门员	27/06/1992	24		180	66		
17	于利婷	右边锋	07/06/1998	18		178	68		
23	顾天澍	底线	03/03/1999	17		172	68		
24	韦娜娜	后卫	02/10/1999	16		168	67		
32	张馨予	底线	05/09/1999	17		183	72		
36	李朴	左后卫	26/03/1997	19		189	72		
44	刘洋麦文	中后卫	14/02/1995	21		168	60		
66	杨丽丽	守门员	12/03/1996	20		181	76		
77	唐魏萍	守门员	09/01/1995	21		176	67		
81	戴丹妮	左边锋	01/08/1996	20		164	55		
88	李晓晴	左后卫	22/12/1995	20		178	72		
平均				19.6		175.8	66.7		

## 替换队员

编码	姓名	职务
A	刘德东	主教练
B	刘凤娟	领队
D	吴明群	医生
C	丛艳霞	教练
E	王凤鸣	医生



## 2016年全国女子手球锦标赛

## 球队名单(媒体表)

辽宁

201605000-53-1/1

号码	姓名	位置	生日	年龄	俱乐部	身高 (CM)	体重 (KG)	总场次	总进球
1	于薇诗	守门员	16/08/1996	20					
2	朱徐婷	边锋	31/03/1992	24					
3	赵莹雪	中后卫	06/12/1994	21					
5	辛颜	底线	30/09/1995	20					
8	杨娇	左后卫	07/09/1994	22					
9	刁卫丽	边锋	22/10/1992	23					
12	刘雪菲	守门员	27/08/1994	22					
13	杜江花	后卫	13/03/1994	22					
19	吕秋雪	右后卫	10/11/1995	20					
20	孙弘玲	后卫	22/01/1998	18					
24	陈思雨	边锋	11/03/1997	19					
27	王丹	守门员	15/10/1997	18	替补				
66	梁海珍	边锋	19/01/1994	22					
93	赵琦	守门员	24/03/1993	23					
98	张永婷	底线	16/12/1998	17					
99	郑锦宜	底线	06/01/1993	23					
平均				20.9					

## 替换队员

编码	姓名	职务
B	李丽荣	领队
C	金京男	主教练
E	程万里	医生
A	吕艳梦	教练
D	韩书香	工作人员





## 2016年全国女子手球锦标赛

## 球队名单(媒体表)

山东

201605000-53-1/1

号码	姓名	位置	生日	年龄	俱乐部	身高 (CM)	体重 (KG)	总场次	总进球
1	路畅		06/04/1998	18		180			
2	林燕群		16/05/1997	19		175			
7	杨嘉露		01/03/1997	19		178			
8	王彬		06/09/1993	23		177			
9	周钰婷		26/10/1995	20		180			
10	田秀秀		13/01/1996	20		170			
11	吕青纹		22/05/1998	18		164			
12	张苑琳		18/08/1996	20		180			
15	吴作扬		18/06/1994	22		184			
19	姜伟珊		22/01/1997	19		170			
20	张悦		09/02/1995	21		175			
22	朱赞		01/07/1989	27		180			
23	徐悦		22/02/1998	18		180			
28	崔金娜		23/07/1992	24		180			
33	王彩琳		20/04/1995	21		178			
77	穆庆丛		26/05/1997	19		178			
	平均			20.5		176.8			

## 替换队员

编码	姓名	职务
B	马海湧	主教练
C	徐强	教练
E	王日东	医生
A	杜晓青	领队
D	王莎莎	教练



## 2016年全国女子手球锦标赛

## 球队名单(媒体表)

上海

201605000-53-1/1

号码	姓名	位置	生日	年龄	俱乐部	身高 (CM)	体重 (KG)	总场次	总进球
1	许沫	守门员	02/03/1990	26		183	66		
2	周蕾	右边锋	25/10/1994	21		171	75		
5	郭威	中后卫	10/08/1984	32		181	73		
6	黄妍	左后卫	29/11/1993	22		184	65		
7	车婉茹	底线	23/11/1988	27		180	77		
8	吴茵	中后卫	13/04/1988	28		176	65		
9	武娜娜	左边锋	04/03/1990	26		176	65		
10	斯文	右后卫	14/12/1990	25		171	71		
11	孙梦颖	右后卫	11/04/1990	26		178	68		
12	郑冯	守门员	14/10/1993	22		183	73		
13	徐娟	右后卫	25/11/1993	22		177	66		
17	居晔	左边锋	27/07/1994	22		176	71		
18	沙正文	底线	18/06/1990	26		190	78		
19	印尼	左后卫	23/06/1992	24		182	76		
21	王嘉怡	中后卫	02/08/1999	17		167	64		
23	都好	底线	18/11/1994	21		179	75		
平均				24.2		178.4	70.5		

## 替换队员

编码	姓名	职务
B	陈进培	主教练
C	金锺顺	教练
D	贺业磊	教练
F	周瑜宸	医生
A	孙琦敏	领队
E	郑明星	工作人员



## 2016年全国女子手球锦标赛

## 球队名单(媒体表)

四川

201605000-53-1/1

号码	姓名	位置	生日	年龄	俱乐部	身高 (CM)	体重 (KG)	总场次	总进球
1	张雪纯	底线	07/09/1998	18	四川女子手球队	180	86		
2	陈艳楠	右后卫	20/03/1997	19	四川女子手球队	175	67		
3	王丹	中后卫	20/08/1997	19	四川女子手球队	165	63		
4	尤婉莹	边锋	12/06/1998	18	四川女子手球队	180	65		
5	孙姣	底线	07/11/1998	17	四川女子手球队	175	70		
6	凤洋	右边锋	18/08/1999	17	四川女子手球队	168	58		
7	练素琪	左边锋	23/02/2000	16	四川女子手球队	160	52		
9	姚梦园	左边锋	28/01/1999	17	四川女子手球队	167	60		
10	高静	右后卫	22/12/2000	15	四川女子手球队	178	68		
11	朱海云	中后卫	28/08/2000	16	四川女子手球队	169	59		
12	宋琛茜	守门员	26/01/2000	16	四川女子手球队	180	65		
17	史雨欣	底线	06/04/1999	17	四川女子手球队	174	60		
18	戴小宇	中后卫	21/08/1999	17	四川女子手球队	175	66		
27	吴美琪	左后卫	22/09/1999	16	四川女子手球队	175	65		
平均				17.0		172.9	64.6		

## 替换队员

编码	姓名	职务
A	金鸿	领队
B	郎正平	教练
C	陈志伟	医生



## 2016年全国女子手球锦标赛

## 球队名单(媒体表)

天津

201605000-53-1/1

号码	姓名	位置	生日	年龄	俱乐部	身高 (CM)	体重 (KG)	总场次	总进球
3	王晓梅		21/05/1995	21	天津,	181	87		
4	朱佳瑜		11/08/1995	21	天津	187	95		
5	丁丽洁		20/01/1998	18	天津	175	62		
7	张心茹		25/02/1997	19	天津	173	65		
8	张慧		10/12/1999	16	天津	174	62		
10	张文慧		21/04/1998	18	天津	177	67		
11	蔡雪洁		10/02/1997	19	天津	176	60		
12	王欣冉	守门员	04/07/1999	17	天津	182	82		
14	刘洁		14/03/1999	17	天津	175	62		
15	李窈窈		29/06/1999	17	天津	176	63		
16	王选	守门员	15/06/1999	17	天津	174	60		
17	聂晓雪		19/03/1999	17	天津	174	62		
18	舒文琪		06/05/1999	17	天津	175	62		
21	李默雅		11/05/1998	18	天津	171	60		
22	王聪		01/07/1999	17	天津	165	58		
23	周梦雪		20/02/2000	16	天津	180	72		
平均				17.8		175.9	67.4		

## 替换队员

编码	姓名	职务
A	付明双	领队
B	王明星	主教练
C	岳连娥	教练





## 2016年全国女子手球锦标赛

## 球队名单(媒体表)

新疆

201605000-53-1/1

号码	姓名	位置	生日	年龄	俱乐部	身高 (CM)	体重 (KG)	总场次	总进球
3	葛立双	中后卫	01/02/1998	18		172	61		
6	阿孜古	底线	10/03/1992	24		183	75		
7	吴志娟	右边锋	03/05/1989	27		174	62		
8	马乐	左边锋	17/01/1994	22		174	60		
10	李静	守门员	15/12/1991	24		176	62		
11	陈培培	边锋	03/04/1993	23		175	69		
12	艾敏加尔汉	底线	19/11/1997	18		177	68		
15	兰姝娇	边锋	13/10/1998	17		174	63		
17	戴莹莹	底线	10/07/1994	22		177	70		
18	崔娟	中后卫	01/01/1986	30		175	64		
21	锁珊珊	左后卫	27/01/1997	19		178	67		
23	张艺璇	边锋	11/08/1997	19		170	58		
26	宋婷婷	右后卫	26/02/1991	25		178	70		
27	谢辰辰	中后卫	06/01/1993	23		178	70		
32	杨雨柔	守门员	16/07/1996	20		187	75		
93	张婷婷	右后卫	03/09/1996	20		185	70		
平均				21.9		177.1	66.5		

## 替换队员

编码	姓名	职务
B	于涛	主教练
D	高璇	医生
A	邓雷	领队
C	崔娟	教练



## 2016年全国女子手球锦标赛

个人/全队技术累计表

正式表  
手球  
女子

截至第 54场

201605054-15-1/1  
安徽滁州  
13/09/2016 18:30

号码	姓名	远射	近射	边射	快攻	突破	任意	7M	合计	%	助攻	失误	警告	2'	取消	场次	时间
<b>安徽</b>																	
<i>(场上队员)</i>																	
1	司艳	0/1							0/1	0.0%	3	2				9	03:27:01
3	李兵		6/8	1/2	2/2	1/1			10/13	76.9%	6	12	2			9	04:48:05
5	班晨晨	4/6	8/10	2/4	1/2	2/3		2/2	19/27	70.4%	2	3	3			9	02:51:00
6	沈萍	23/34	12/17	0/2	2/3	4/4	1/4	11/12	53/76	69.7%	10	20	4	2		9	05:32:43
7	赵江川									0.0%						9	00:00:00
8	徐仕媛									0.0%		1				9	00:26:24
10	孙来苗	1/1	14/16	2/2	6/6			2/2	25/27	92.6%	1	6	2	4		9	04:18:16
14	刘晓妹	17/29	2/6	1/1	3/3	8/12	6/7	1/2	38/60	63.3%	14	15	1	3		9	05:44:33
16	朱莉珍									0.0%	7	3				9	03:48:08
17	周婷	3/5	16/21	3/4	9/11	7/9		0/1	38/51	74.5%	10	14	1	2		9	06:02:15
18	郑冬冬	1/1	11/12	2/2	2/3	1/1			17/19	89.5%	1	2	1			9	01:31:10
20	周雪婷			0/4	5/5				5/9	55.6%	1	4	2			9	01:43:15
21	李瑶	3/21	8/12	3/8	18/20	10/11	1/1	0/1	43/74	58.1%	12	17	3			9	05:51:15
23	张天洁	0/1	4/6	2/4	5/6				11/17	64.7%		2	1	1		9	03:16:53
41	杜机娟	0/1	1/1	9/14	11/16				12/15	33/47	70.2%		8	1		9	04:28:16
46	陶传红			2/4	1/1			0/1	3/6	50.0%		2				9	00:23:55

<b>合计</b>		52/100	82/109	27/51	65/78	33/41	8/12	28/36	295/427	69.1%	67	111	21	12		144	
<i>(守门员)</i>																	
1	司艳	30/50	7/31	6/25	1/6	3/9	4/5	2/14	53/140	37.9%	3	2				9	03:27:01
8	徐仕媛	9/13	2/2	1/4	1/1	0/2		1/1	14/23	60.9%		1				9	00:26:24
16	朱莉珍	39/73	7/24	8/17	5/13	2/5	0/1	1/19	62/152	40.8%	7	3				9	03:48:08

<b>合计</b>		78/136	16/57	15/46	7/20	5/16	4/6	4/34	129/315	41.0%	10	6				27
-----------	--	--------	-------	-------	------	------	-----	------	---------	-------	----	---	--	--	--	----

场上队员：得分/射门

守门员：救球/射门

全队合计	进球	被救	射失	击柱	封球	合计	%
远射	52	26	8	5	9	100	52.0%
近射	82	21	3	3		109	75.2%
边射	27	16	3	5		51	52.9%
快攻	65	11	1	1		78	83.3%
突破	33	5	2	1		41	80.5%
任意	8	3	1			12	66.7%
7M	28	5	1	2		36	77.8%

## 已打比赛

阶段	场次	对手	比分
预赛	3	江苏	35:36 (15:11)
预赛	14	广东	36:21 (19:12)
预赛	20	广西	28:8 (28:8)
预赛	25	山东	30:24 (15:12)
预赛	28	黑龙江	25:9 (25:9)
预赛	35	新疆	28:13 (18:10)
四分之一决赛	41	天津	44:17 (20:10)
半决赛	48	上海	35:25 (15:13)
决赛	54	江苏	34:33 (19:15)





2016年全国女子手球锦标赛

图式射门区域累计

截止至第54场

201605054-42-1/1

安徽

Table of player statistics for Anhui team, including names like 李兵, 班晨晨, 沈萍, etc., and their respective performance metrics in a grid format.

Statistics for player 1 司艳

Statistics for player 8 徐仕媛

Statistics for player 16 朱莉珍

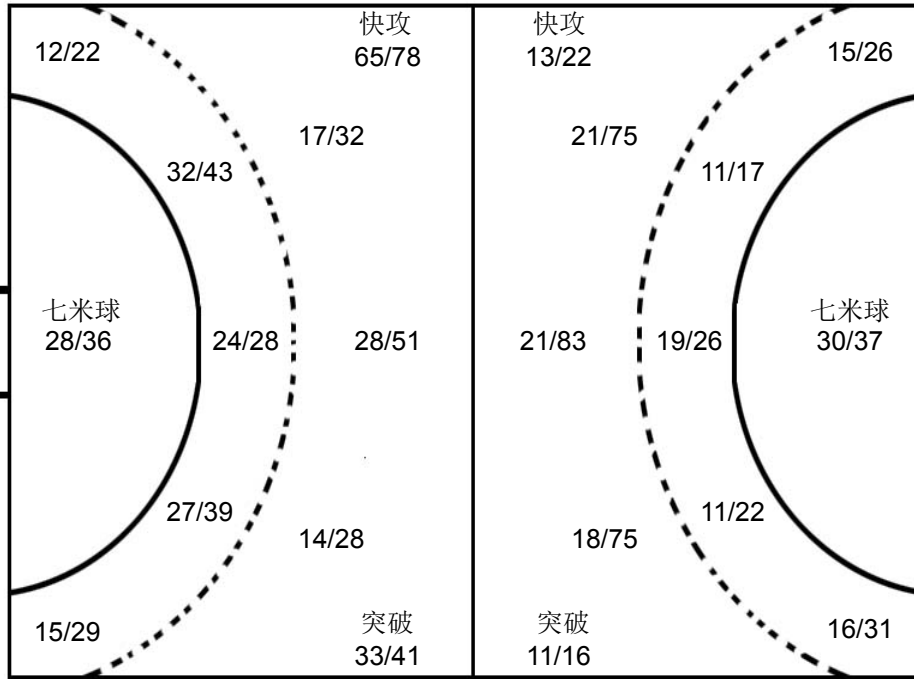

Statistics for player 16 王小华 (江苏)

Statistics for player 12 张苑琳 (山东)

Statistics for player 1 许沫 (上海)

对手

Table of player statistics for the opponent team, including names like 张海侠, 赵佳芹, 乔如, etc., and their performance metrics.

注释: Post=击柱 Miss=射失 Block=被封





## 2016年全国女子手球锦标赛

个人/全队技术累计表

正式表  
手球  
女子

截至第 54场

201605054-15-1/1  
安徽滁州  
13/09/2016 18:30

号码	姓名	远射	近射	边射	快攻	突破	任意	7M	合计	%	助攻	失误	警告	2'	取消	场次	时间
<b>江苏</b>																	
<i>(场上队员)</i>																	
1	陆婷									0.0%	8					9	02:25:37
3	张海侠	2/2	6/9	15/19	11/16			1/1	35/47	74.5%	3	6	3			9	05:33:32
4	赵佳芹	13/32	3/4	1/1	2/3	5/5	2/2	4/4	30/51	58.8%	15	6	2	1	1	8	04:33:32
5	高媛媛	1/5	2/3		1/1			2/2	6/11	54.5%		3				9	00:53:17
8	乔如	1/1	17/18	0/1	5/5		1/1	3/3	27/29	93.1%	4	9	3	2		9	04:50:02
9	莫蒙蒙		6/8	1/1	5/7			0/3	12/19	63.2%		1		6		9	03:35:05
10	王可可	6/10	1/6		1/1	3/3		1/1	12/21	57.1%	2	8				9	01:52:10
11	于源源	1/1	3/3	9/18	12/13	1/1			26/36	72.2%		2	4			9	04:31:39
12	黄霞									0.0%	2	2				9	01:20:57
13	黄慧影	0/1	0/1	2/2	4/4			1/2	7/10	70.0%	2	2				9	01:14:08
16	王小华									0.0%	5	4				9	03:50:58
17	修丽杰	9/28	8/15	1/1	4/4	1/1		1/3	24/52	46.2%	7	11	3	5		9	05:36:24
18	韦秋香	0/1		4/6	6/7			1/1	11/15	73.3%	2	3	1	1		9	01:51:34
23	王书慧	11/39	14/21	5/8	7/9	8/11	0/1	2/3	47/92	51.1%		20	3	2		9	03:26:12
33	金梦青	10/24	2/3	2/4	16/20			5/7	35/58	60.3%	6	8	2			9	03:57:50
69	蓝小玲	7/10	2/4	1/1	6/6	0/1	0/2	4/4	20/28	71.4%	6	8	4	4		9	03:54:42

<b>合计</b>		61/154	64/95	41/62	80/96	18/22	3/6	25/34	292/469	62.3%	62	93	25	21	1	143	
<i>(守门员)</i>																	
1	陆婷	24/37	7/22	6/13	2/9	0/10	1/3	1/6	41/100	41.0%	8					9	02:25:37
12	黄霞	13/19	4/14	3/7	2/5	2/6	0/1	2/16	26/68	38.2%	2	2				9	01:20:57
16	王小华	22/39	15/40	14/24	2/11	3/12	3/10	0/7	59/143	41.3%	5	4				9	03:50:58

<b>合计</b>		59/95	26/76	23/44	6/25	5/28	4/14	3/29	126/311	40.5%	15	6				27	
-----------	--	-------	-------	-------	------	------	------	------	---------	-------	----	---	--	--	--	----	--

场上队员：得分/射门

守门员：救球/射门

全队合计	进球	被救	射失	击柱	封球	合计	%
远射	61	50	9	14	20	154	39.6%
近射	64	23	5	3		95	67.4%
边射	41	14	2	5		62	66.1%
快攻	80	10		6		96	83.3%
突破	18	3	1			22	81.8%
任意	3	2		1		6	50.0%
7M	25	6	2	1		34	73.5%

## 已打比赛

阶段	场次	对手	比分
预赛	3	安徽	36:35 (11:15)
预赛	7	山东	33:23 (16:9)
预赛	19	新疆	35:20 (18:11)
预赛	27	黑龙江	22:6 (22:6)
预赛	29	广西	24:9 (22:9)
预赛	36	广东	27:12 (17:9)
四分之一决赛	39	解放军	44:20 (21:9)
半决赛	47	广东	38:26 (22:9)
决赛	54	安徽	33:34 (15:19)





2016年全国女子手球锦标赛

图式射门区域累计

截止至第54场

201605054-42-1/1

江苏

Table of player statistics for Jiangsu team, including names like 陆婷, 张海侠, 赵佳芹, etc., and their respective performance metrics in a grid format.

Player statistics for 陆婷 (Lu Ting) in a 3x3 grid.

Player statistics for 黄霞 (Huang Xia) in a 3x3 grid.

Player statistics for 王小华 (Wang Xiaohua) in a 3x3 grid.

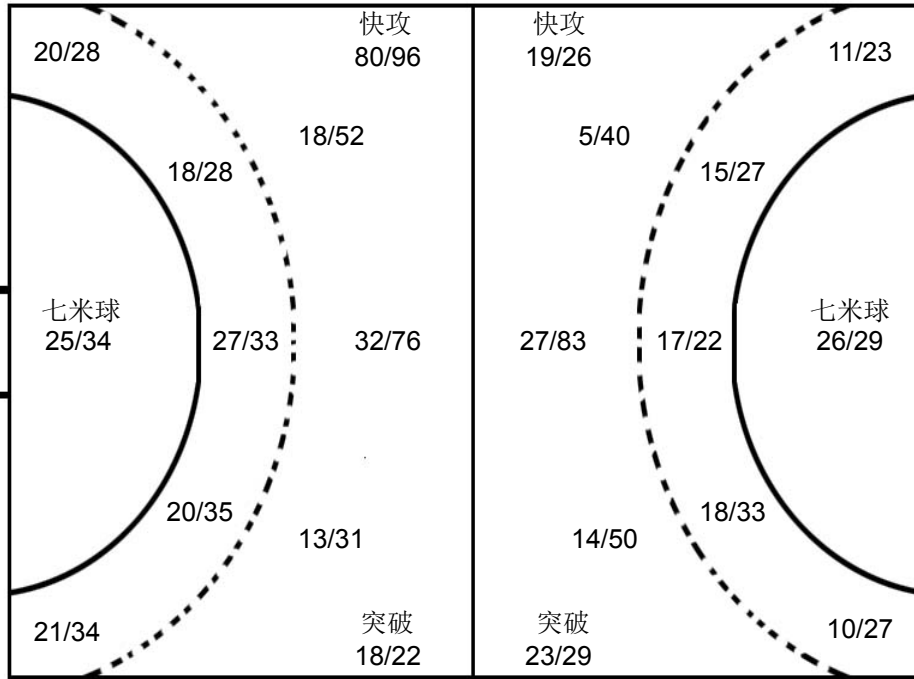

Player statistics for 安徽 (Anhui) team, including player 司艳 (Si Yan) in a 3x3 grid.

Player statistics for 新疆 (Xinjiang) team, including player 杨雨柔 (Yang Yurou) in a 3x3 grid.

Player statistics for 广东 (Guangdong) team, including player 李娟 (Li Juan) in a 3x3 grid.

对手

Table of player statistics for the opponent team, including players from 安徽, 山东, and 广东, in a grid format.

注释: Post=击柱 Miss=射失 Block=被封





## 2016年全国女子手球锦标赛

个人/全队技术累计表

正式表  
手球  
女子

截至第 54场

201605054-15-1/1  
安徽滁州  
13/09/2016 18:30

号码	姓名	远射	近射	边射	快攻	突破	任意	7M	合计	%	助攻	失误	警告	2'	取消	场次	时间
<b>上海</b>																	
<i>(场上队员)</i>																	
1	许沫									0.0%	4	2				8	04:27:55
2	周蕾		3/4	6/12	7/10	1/1			17/27	63.0%	3	4	4	2		8	04:17:59
5	郭威	2/8	6/7			1/1		8/8	17/24	70.8%	3	3		1		8	01:48:34
6	黄妍	16/28	8/14		2/2	1/1	0/2	7/11	34/58	58.6%	7	13				8	03:43:48
7	车婉茹		1/2					1/1	2/3	66.7%					1	8	00:57:12
8	吴茵	12/26	9/13	2/2	5/5	4/4	0/1	4/5	36/56	64.3%	18	17	2	2		8	04:13:07
9	武娜娜		2/3	6/9	12/18				20/30	66.7%	1	6	4	2		8	05:13:42
10	斯文	5/10	5/8	11/14	3/4	1/1			25/37	67.6%		4	2			8	03:46:07
11	孙梦颖	17/31	4/7	0/1	7/7	0/1		0/1	28/48	58.3%	2	13				8	05:22:46
12	郑冯									0.0%	2	1				8	02:51:52
13	徐娟	1/1						2/2	3/3	100%	1	1				8	01:16:19
17	居晔		0/1	5/6	2/2				7/9	77.8%		2	2	1		8	02:46:20
18	沙正文	0/1	19/22		2/3	1/2			22/28	78.6%	2	2	6	4		8	04:47:59
19	印尼	4/12	11/14	2/2		6/8	0/1	3/3	26/40	65.0%	3	7				8	02:49:55
21	王嘉怡	1/1	1/1	1/2	1/1				4/5	80.0%		3				8	01:00:49
23	都好		2/5	0/1	1/2				3/8	37.5%			1	3		8	02:00:07

<b>合计</b>		58/118	71/101	33/49	42/54	15/19	0/4	25/31	244/376	64.9%	46	78	21	16		128	
<i>(守门员)</i>																	
1	许沫	37/60	23/53	9/20	4/8	2/16	1/4	5/15	81/176	46.0%	4	2				8	04:27:55
12	郑冯	15/27	16/39	7/15	2/10	0/6	1/1	1/8	42/106	39.6%	2	1				8	02:51:52

<b>合计</b>		52/87	39/92	16/35	6/18	2/22	2/5	6/23	123/282	43.6%	6	3				16	
-----------	--	-------	-------	-------	------	------	-----	------	---------	-------	---	---	--	--	--	----	--

场上队员：得分/射门

守门员：救球/射门

全队合计	进球	被救	射失	击柱	封球	合计	%
远射	58	22	12	12	14	118	49.2%
近射	71	22	3	5		101	70.3%
边射	33	7	4	5		49	67.3%
快攻	42	9	2	1		54	77.8%
突破	15	4				19	78.9%
任意	2	1	1			4	0.0%
7M	25	5	1			31	80.6%

## 已打比赛

阶段	场次	对手	比分
预赛	4	北京	32:17 (19:10)
预赛	11	四川	43:30 (22:21)
预赛	16	天津	23:8 (21:8)
预赛	23	解放军	24:9 (21:9)
预赛	33	辽宁	33:24 (16:13)
四分之一决赛	42	新疆	30:14 (13:10)
半决赛	48	安徽	25:35 (13:15)
3-4名	53	广东	34:22 (19:9)





2016年全国女子手球锦标赛

图式射门区域累计

截止至第54场

201605054-42-1/1

上海

Table of player statistics for Shanghai team, including names like 许沫, 周蕾, 郭威, etc., and their respective performance metrics in a grid format.

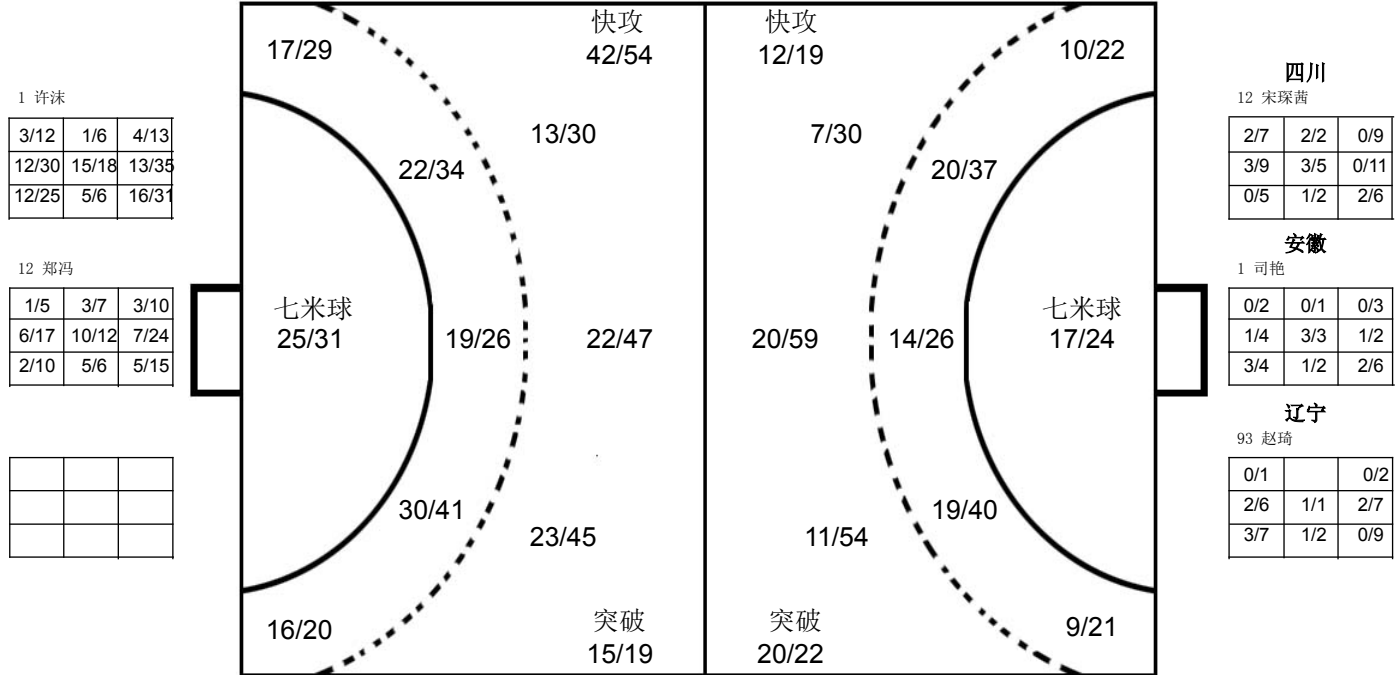

Table of player statistics for the opponent team (对手), including names like 杨娇, 沈萍, 王丹, etc., and their performance metrics.

注释: Post=击柱 Miss=射失 Block=被封



## 2016年全国女子手球锦标赛

个人/全队技术累计表

正式表  
手球  
女子

截至第 54场

201605054-15-1/1  
安徽滁州  
13/09/2016 18:30

号码	姓名	远射	近射	边射	快攻	突破	任意	7M	合计	%	助攻	失误	警告	2'	取消	场次	时间
<b>广东</b>																	
<i>(场上队员)</i>																	
3	安妮	1/6	6/10	0/1	3/4	3/4		1/1	14/26	53.8%	4	14	2	2		9	03:28:16
5	李纯									0.0%		1		1		9	01:14:32
7	刘彤	0/5	3/4	17/33	5/7			2/2	27/51	52.9%	3	11	4	4		9	05:37:17
8	李诗棋			4/6	3/4	0/1		0/1	7/12	58.3%		7	1			9	01:36:48
9	韦宝桂	12/39	2/5	2/4	4/4	3/3	0/2	8/10	31/67	46.3%	6	17	3	1		9	04:43:26
11	魏梦庭	9/40	9/16	1/2	1/1	6/6		6/7	32/72	44.4%	4	15	2			9	05:57:21
15	杨慧		1/1	0/1		1/2			2/4	50.0%		3	1			9	00:57:49
16	李娟									0.0%						9	01:28:00
18	李玉玲	1/13	4/4	1/2	1/1	1/1		14/17	22/38	57.9%	1	10	1			9	02:18:27
19	邝雪花	3/19	5/11	5/9	0/1	7/9			20/49	40.8%	5	18	1	3		9	05:05:19
20	李军政	0/1	8/11	7/21					15/33	45.5%	1	13	5	1		9	05:10:37
22	刘晓玉									0.0%	3	1				9	03:15:41
23	王如		13/17	0/1	7/7	1/1	0/1		21/27	77.8%	1	5	2	1		9	05:48:00
26	马晓卉									0.0%	1	2				9	04:04:41
28	刘金兰	1/3	2/4	8/18	5/8	1/1		5/8	22/42	52.4%	1	8	2	1		9	04:22:36
31	史小军	0/4	3/5	2/2	4/5	1/2			10/18	55.6%		7	2	2		9	03:28:01
<b>合计</b>																	
		27/130	56/88	47/10	33/42	24/30	0/3	36/46	223/439	50.8%	30	132	26	16		144	
<i>(守门员)</i>																	
				0													
16	李娟	11/28	2/9		1/14	3/8		0/8	18/73	24.7%						9	01:28:00
22	刘晓玉	37/62	2/16	1/6	5/17	0/2	2/2	1/5	51/115	44.3%	3	1				9	03:15:41
26	马晓卉	18/53	9/28	4/11	4/30	2/13	1/2	5/22	48/170	28.2%	1	2				9	04:04:41
<b>合计</b>																	
		66/143	13/53		10/61	5/23	3/4	6/35	117/358	32.7%	4	3				27	

场上队员：得分/射门

守门员：救球/射门

全队合计	进球	被救	射失	击柱	封球	合计	%
远射	27	55	14	11	23	130	20.8%
近射	56	24	2	6		88	63.6%
边射	47	35	6	12		100	47.0%
快攻	33	6	1	1	1	42	78.6%
突破	24	5		1		30	80.0%
任意			2	1		3	0.0%
7M	36	7	1	2		46	78.3%

## 已打比赛

阶段	场次	对手	比分
预赛	2	山东	27:22 (13:8)
预赛	8	黑龙江	33:18 (15:8)
预赛	14	安徽	21:36 (12:19)
预赛	26	广西	27:12 (18:10)
预赛	30	新疆	29:30 (9:14)
预赛	36	江苏	12:27 (9:17)
四分之一决赛	40	辽宁	26:24 (18:13)
半决赛	47	江苏	26:38 (9:22)
3-4名	53	上海	22:34 (9:19)







2016年全国女子手球锦标赛

图式射门区域累计

截止至第54场

201605054-42-1/1

广东

Table of player statistics for Guangdong team, including names like 安妮, 李纯, 刘彤, etc., and their respective performance metrics in a grid format.

Player statistics for 李娟 (Li Juan)

Player statistics for 刘晓玉 (Liu Xiaoyu)

Player statistics for 马晓卉 (Ma Xiaohui)

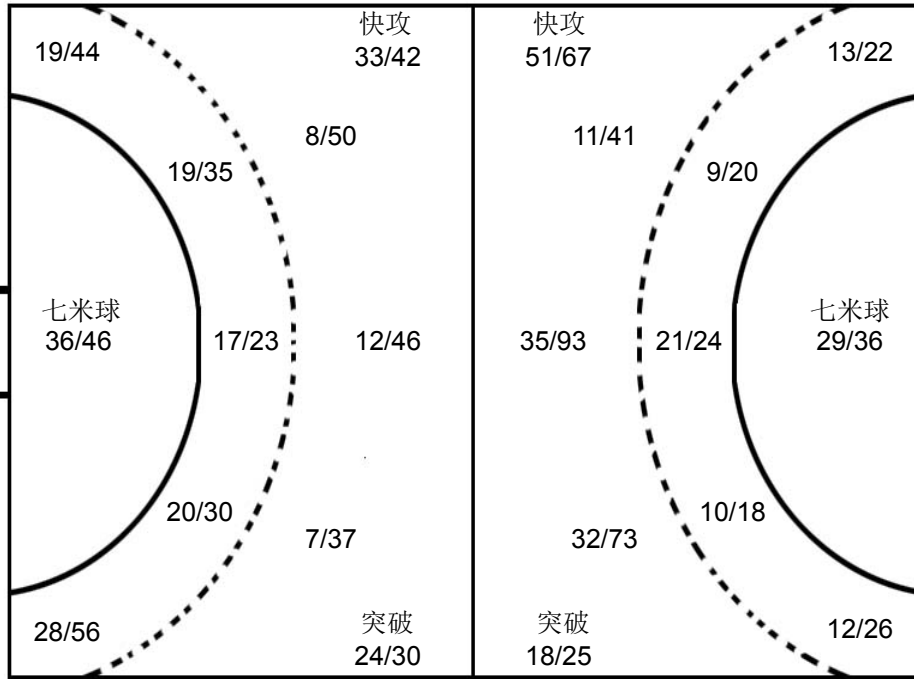

Player statistics for 江苏 team (Jiangsu)

Player statistics for 上海 team (Shanghai)

Player statistics for 新疆 team (Xinjiang)

对手

Table of player statistics for the opponent team, including names like 金梦青, 王书慧, 吴茵, etc., and their performance metrics.

注释: Post=击柱 Miss=射失 Block=被封





## 2016年全国女子手球锦标赛

个人/全队技术累计表

正式表  
手球  
女子

截至第 54场

201605054-15-1/1  
安徽滁州  
13/09/2016 18:30

号码	姓名	远射	近射	边射	快攻	突破	任意	7M	合计	%	助攻	失误	警告	2'	取消	场次	时间
<b>解放军</b>																	
<i>(场上队员)</i>																	
2	崔云莉	12/47	2/4	6/8	6/6		0/1	1/1	27/67	40.3%	6	14	4	1		8	05:26:01
5	徐鸣昭	4/10	5/8	0/1		2/3			11/22	50.0%		1				8	01:43:18
6	于婷婷	9/14	7/11	3/3	3/3	4/4			26/35	74.3%	8	17	1	1		8	04:52:30
8	周亚茹	17/42	3/7	1/2		1/2	0/1	5/9	27/63	42.9%		12	2	3		8	03:28:10
13	张格格		21/29	1/1	5/6				27/36	75.0%	2	7	5	1		8	05:54:22
16	方文博									0.0%	3	1				8	05:46:48
17	于利婷	5/17		1/3	2/3	1/1			9/24	37.5%		16	2			8	02:39:20
23	顾天澍		5/5	3/9	2/3				10/17	58.8%	2	9	1	1		8	04:40:07
24	韦娜娜	0/5	6/6	13/21	10/13			2/2	31/47	66.0%	1	6	2			8	07:06:15
32	张馨予	0/2	0/1				1/1		1/4	25.0%		3		2		8	00:43:37
36	李朴							0/1	0/1	0.0%						8	00:00:07
44	刘洋麦文	8/35	1/2	1/2	1/2	4/5	2/2	1/1	18/49	36.7%	15	18				8	03:52:24
66	杨丽丽									0.0%	3					8	01:29:48
77	唐魏萍									0.0%	1					8	01:04:57
81	戴丹妮				3/3	1/1			4/4	100%						7	00:27:44
88	李晓晴	13/33	6/10	1/2	2/2	3/3	1/3	15/17	41/70	58.6%	5	15	3	1		8	05:11:02

<b>合计</b>		68/205	56/83	30/52	34/41	16/19	4/8	24/31	232/439	52.8%	46	119	20	10		127	
-----------	--	--------	-------	-------	-------	-------	-----	-------	---------	-------	----	-----	----	----	--	-----	--

*(守门员)*

16	方文博	39/76	14/67	12/23	6/22	3/23	1/2	2/16	77/229	33.6%	3	1				8	05:46:48
66	杨丽丽	7/14	4/19	2/9	2/15	4/9	0/1	2/6	21/73	28.8%	3					8	01:29:48
77	唐魏萍	3/8	3/14	1/6	0/9	0/3		1/8	8/48	16.7%	1					8	01:04:57

<b>合计</b>		49/98	21/100	15/38	8/46	7/35	1/3	5/30	106/350	30.3%	7	1				24	
-----------	--	-------	--------	-------	------	------	-----	------	---------	-------	---	---	--	--	--	----	--

场上队员：得分/射门

守门员：救球/射门

全队合计	进球	被救	射失	击柱	封球	合计	%
远射	68	60	30	13	34	205	33.2%
近射	56	21	2	3	1	83	67.5%
边射	30	11	8	3		52	57.7%
快攻	34	5	1	1		41	82.9%
突破	16	3				19	84.2%
任意	4	1	2	1		8	50.0%
7M	24	6		1		31	77.4%

已打比赛

阶段	场次	对手	比分
预赛	6	四川	36:31 (20:14)
预赛	12	天津	28:29 (13:13)
预赛	17	辽宁	35:31 (15:11)
预赛	23	上海	9:24 (9:21)
预赛	32	北京	38:31 (19:11)
四分之一决赛	39	江苏	20:44 (9:21)
5-8名	45	辽宁	31:30 (15:16)
5-6名	52	新疆	35:24 (18:10)





2016年全国女子手球锦标赛

图式射门区域累计

截止至第54场

201605054-42-1/1

解放军

Table of player statistics for the '解放军' team, including names like 崔云莉, 徐鸣昭, 于婷婷, etc., and their respective performance metrics in a grid format.

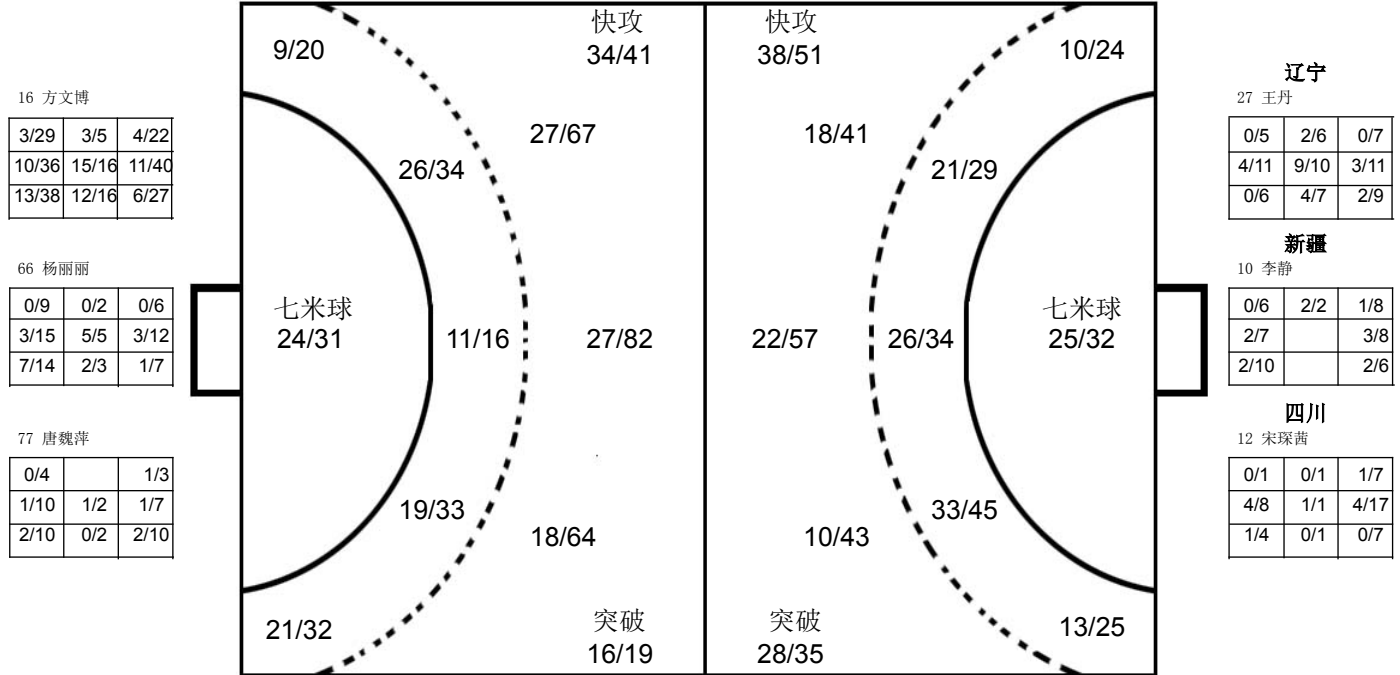

Table of player statistics for the '对手' (opponent) team, including names like 杨娇, 王咏梅, 石梓薇, etc., and their respective performance metrics in a grid format.

注释: Post=击柱 Miss=射失 Block=被封



## 2016年全国女子手球锦标赛

个人/全队技术累计表

正式表  
手球  
女子

截至第 54场

201605054-15-1/1  
安徽滁州  
13/09/2016 18:30

号码	姓名	远射	近射	边射	快攻	突破	任意	7M	合计	%	助攻	失误	警告	2'	取消	场次	时间
<b>新疆</b>																	
<i>(场上队员)</i>																	
3	葛立双	2/10	2/3	0/6		2/2		2/2	8/23	34.8%		4		1		9	01:31:12
6	阿孜古		26/34	1/1	3/5			0/1	30/41	73.2%	1	8	5	5		9	06:28:57
7	吴志娟		5/7	10/19	5/6				20/32	62.5%	2	9	1	1		9	07:14:34
10	李静									0.0%		2				9	02:12:09
11	陈培培									0.0%						9	00:09:28
12	艾敏加尔汉									0.0%		1				9	00:20:08
15	兰姝娇		3/3	5/10	1/2	5/6		3/3	17/24	70.8%		8	2	2		9	04:54:14
17	戴莹莹	1/1	10/14	1/2	2/2			0/1	14/20	70.0%	2	9	3	2		9	04:26:44
18	崔娟	18/64	10/13		1/3	1/1	2/2	5/9	37/92	40.2%	14	30	6	1		9	07:27:05
21	锁珊珊	9/41	5/10	1/4	2/4	2/3	0/1	7/9	26/72	36.1%	6	21	1			9	05:59:12
23	张艺璇			0/1					0/1	0.0%					1	9	01:01:18
26	宋婷婷	7/18	3/5		2/2	1/3		6/9	19/37	51.4%	9	13		1		8	02:00:45
27	谢辰辰	0/5	3/4		1/1	1/1			5/11	45.5%	2	7	1			9	02:49:02
32	杨雨柔									0.0%	1	4				9	06:30:41
93	张婷婷	15/42	6/11	2/3	3/5	4/7		6/9	36/77	46.8%	15	29	1	1		9	07:26:36

<b>合计</b>		52/181	73/104	20/46	20/30	16/23	2/3	29/43	212/430	49.3%	52	145	20	15		134	
<i>(守门员)</i>																	
10	李静	13/42	3/18	3/10	3/19	0/4		2/11	24/104	23.1%		2				9	02:12:09
32	杨雨柔	41/68	16/64	15/42	4/40	2/13	1/3	9/23	88/253	34.8%	1	4				9	06:30:41

<b>合计</b>		54/110	19/82	18/52	7/59	2/17	1/3	11/34	112/357	31.4%	1	6				18	
-----------	--	--------	-------	-------	------	------	-----	-------	---------	-------	---	---	--	--	--	----	--

场上队员：得分/射门

守门员：救球/射门

全队合计	进球	被救	射失	击柱	封球	合计	%
远射	52	74	18	10	27	181	28.7%
近射	73	21	5	5		104	70.2%
边射	20	14	6	6		46	43.5%
快攻	20	7	2	1		30	66.7%
突破	16	6		1		23	69.6%
任意	2	1				3	66.7%
7M	29	12	1	1		43	67.4%

## 已打比赛

阶段	场次	对手	比分
预赛	1	黑龙江	31:16 (14:11)
预赛	9	广西	30:26 (16:14)
预赛	15	山东	24:29 (11:17)
预赛	19	江苏	20:35 (11:18)
预赛	30	广东	30:29 (14:9)
预赛	35	安徽	13:28 (10:18)
四分之一决赛	42	上海	14:30 (10:13)
5-8名	46	天津	26:17 (13:8)
5-6名	52	解放军	24:35 (10:18)





2016年全国女子手球锦标赛

图式射门区域累计

截止至第54场

201605054-42-1/1

新疆

Player statistics for Xinjiang team including names like 葛立双, 阿孜古, 吴志娟, etc., with corresponding goalkeeping and shooting data.

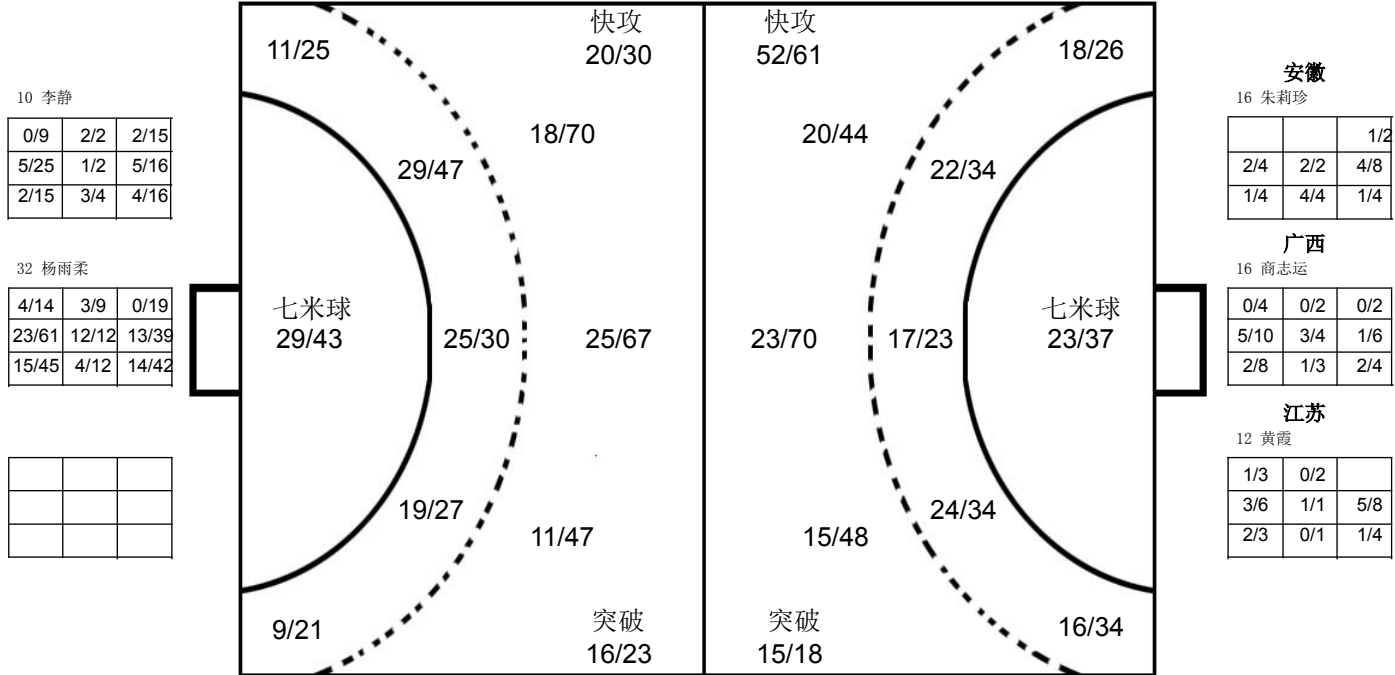

对手

Opponent statistics table listing players from various teams like 安徽, 山东, 江苏, etc., with their performance metrics.

注释: Post=击柱 Miss=射失 Block=被封



## 2016年全国女子手球锦标赛

个人/全队技术累计表

正式表  
手球  
女子

截至第 54场

201605054-15-1/1  
安徽滁州  
13/09/2016 18:30

号码	姓名	远射	近射	边射	快攻	突破	任意	7M	合计	%	助攻	失误	警告	2'	取消	场次	时间
<b>辽宁</b>																	
<i>(场上队员)</i>																	
1	于薇诗									0.0%						8	00:19:34
2	朱徐婷		4/5	9/21	11/13				24/39	61.5%	1	13				8	06:26:01
3	赵莹雪	2/6	5/8	0/2	0/1	4/4			11/21	52.4%	5	11	5	1		8	04:41:54
5	辛颜	1/4	23/32		1/1	3/4			28/41	68.3%	2	8	4	2		8	06:57:28
8	杨娇	27/53	5/8	2/2	1/1	3/3	5/12	12/22	55/101	54.5%	25	21	4	1		8	07:14:26
9	刁卫丽		2/2	2/4	5/7				9/13	69.2%		4	1	1		8	01:27:32
12	刘雪菲									0.0%						8	00:00:00
13	杜江花	3/12	8/10	1/1	1/2			10/13	23/38	60.5%	2	11	2	1		8	02:23:53
19	吕秋雪	5/15	11/15	1/6	7/9	3/4			27/49	55.1%	2	10	5	4		8	07:09:56
20	孙弘玲	0/8	5/9	4/5	0/1	4/7			13/30	43.3%	1	11	1			8	02:42:24
24	陈思雨									0.0%						8	00:00:00
27	王丹									0.0%						8	03:20:26
66	梁海珍	10/30	8/13	13/20	2/3	2/3	0/1	3/3	38/73	52.1%	7	14				8	06:20:41
93	赵琦									0.0%	2	2				8	04:35:37
98	张永婷		2/2		0/1				2/3	66.7%		2		1		8	00:36:48
99	郑锦宜			0/1					0/1	0.0%		1	1			8	00:22:44

<b>合计</b>	48/128	73/104	32/62	28/39	19/25	5/13	25/38	230/409	56.2%	47	108	23	11			128
-----------	--------	--------	-------	-------	-------	------	-------	---------	-------	----	-----	----	----	--	--	-----

*(守门员)*

1	于薇诗	1/9	3/4	1/1		0/1	0/1	5/16	31.3%							8	00:19:34
27	王丹	21/52	12/34	3/15	2/13	0/6	0/2	2/17	40/139	28.8%						8	03:20:26
93	赵琦	30/67	9/25	10/27	4/21	1/12	1/1	0/2	55/155	35.5%	2	2				8	04:35:37

<b>合计</b>	52/128	24/63	14/43	6/34	1/19	1/4	2/19	100/310	32.3%	2	2					24
-----------	--------	-------	-------	------	------	-----	------	---------	-------	---	---	--	--	--	--	----

场上队员：得分/射门

守门员：救球/射门

全队合计	进球	被救	射失	击柱	封球	合计	%
远射	48	40	10	14	16	128	37.5%
近射	73	21	3	7		104	70.2%
边射	32	20	5	5		62	51.6%
快攻	28	7	1	3		39	71.8%
突破	19	5		1		25	76.0%
任意	5	5	1	2		13	38.5%
7M	25	9		4		38	65.8%

已打比赛

阶段	场次	对手	比分
预赛	5	天津	30:20 (14:11)
预赛	10	北京	31:16 (18:11)
预赛	17	解放军	31:35 (11:15)
预赛	22	四川	29:23 (17:11)
预赛	33	上海	24:33 (13:16)
四分之一决赛	40	广东	24:26 (13:18)
5-8名	45	解放军	30:31 (16:15)
7-8名	51	天津	31:26 (13:11)





2016年全国女子手球锦标赛

图式射门区域累计

截止至第54场

201605054-42-1/1

辽宁

Table of player statistics for Liaoning team, including names like 于薇诗, 朱徐婷, 赵莹雪, etc., and their respective performance metrics in a grid format.

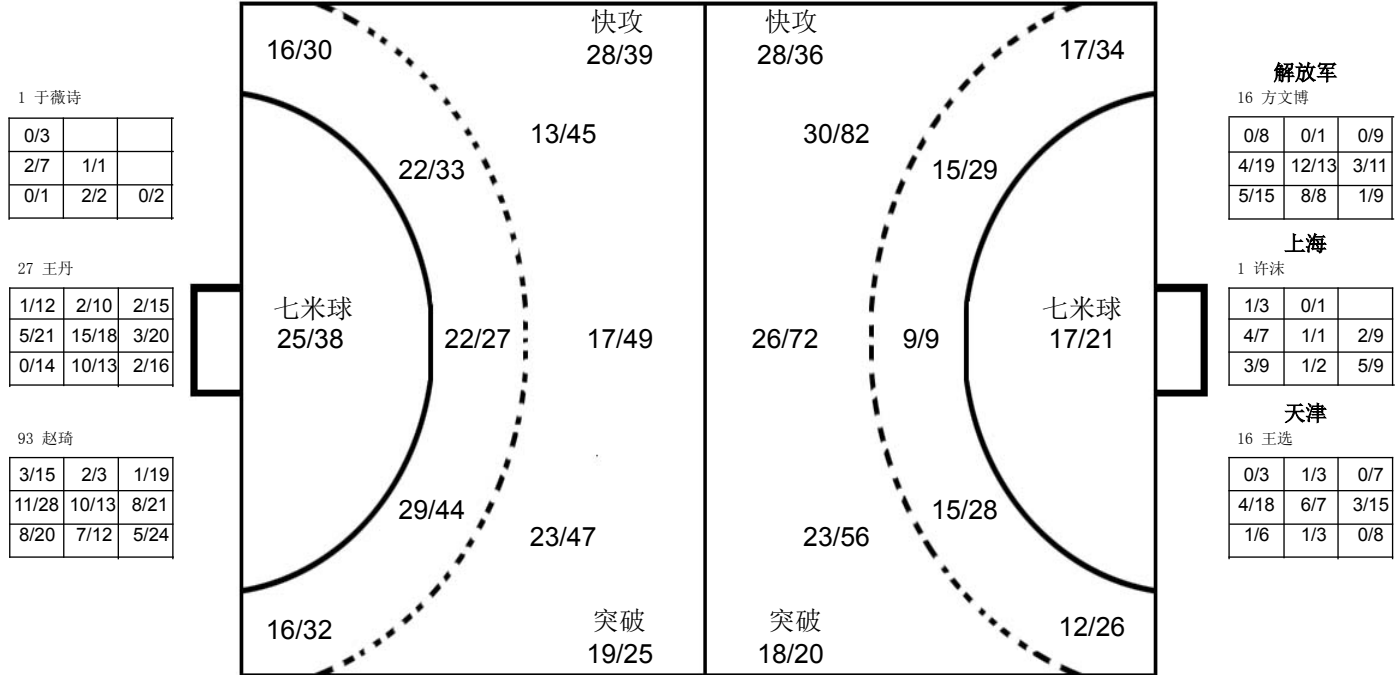

Table of player statistics for the opponent team (对手), including names like 蔡雪洁, 于婷婷, 韦娜娜, etc., and their performance metrics.

注释: Post=击柱 Miss=射失 Block=被封



## 2016年全国女子手球锦标赛

个人/全队技术累计表

正式表  
手球  
女子

截至第 54场

201605054-15-1/1  
安徽滁州  
13/09/2016 18:30

号码	姓名	远射	近射	边射	快攻	突破	任意	7M	合计	%	助攻	失误	警告	2'	取消	场次	时间
<b>天津</b>																	
<i>(场上队员)</i>																	
3	王晓梅	19/38	1/3	1/1	0/1	1/1		5/6	27/50	54.0%	4	15	1	2		8	01:51:18
4	朱佳瑜		1/2		1/1			6/7	8/10	80.0%		3				8	00:50:44
5	丁丽洁	0/1	1/2		1/1				2/4	50.0%		2	1	1		8	02:24:05
7	张心茹									0.0%						8	00:00:00
8	张慧	0/1	2/3	4/14	7/8				13/26	50.0%	1	7	3	4		8	06:38:48
10	张文慧		12/14	0/2	3/4				15/20	75.0%		13	7	3		8	06:57:36
11	蔡雪洁	11/46	9/18	3/5	1/3	6/6	1/1	3/3	34/82	41.5%	4	24	2	3		8	06:51:19
12	王欣冉									0.0%						8	03:09:17
14	刘洁	0/1							0/1	0.0%		1				8	00:46:15
15	李窈窈	0/1							0/1	0.0%		5	1	1		8	00:38:17
16	王选									0.0%	1	1				8	04:52:32
17	聂晓雪	2/6	3/3	0/1	0/1	2/2			7/13	53.8%		6		1		8	03:19:41
18	舒文琪	13/50	6/9	3/5	1/1	5/6	2/2	1/1	31/74	41.9%	7	38	4	3		8	06:07:12
21	李默雅	1/5	0/1	7/14	5/5				13/25	52.0%		2	1			8	03:44:16
22	王聪									0.0%						8	00:00:00
23	周梦雪	9/27	7/15	1/4	1/2	7/7		1/2	26/57	45.6%	5	26	3	1		8	05:28:32
<b>合计</b>																	
		55/176	42/70	19/46	20/27	21/22	3/3	16/19	176/363	48.5%	22	143	23	19		128	
<i>(守门员)</i>																	
12	王欣冉	21/35	12/34	9/24	3/14	0/4		5/19	50/130	38.5%						8	03:09:17
16	王选	16/41	15/66	19/41	1/23	0/13	2/5	4/22	57/211	27.0%	1	1				8	04:52:32
<b>合计</b>																	
		37/76	27/100	28/65	4/37	0/17	2/5	9/41	107/341	31.4%	1	1				16	

场上队员：得分/射门

守门员：救球/射门

全队合计	进球	被救	射失	击柱	封球	合计	%
远射	55	61	20	8	32	176	31.3%
近射	42	19	5	4		70	60.0%
边射	19	18	7	2		46	41.3%
快攻	20	5	1	1		27	74.1%
突破	21	1				22	95.5%
任意	3					3	100.0%
7M	16	2		1		19	84.2%

## 已打比赛

阶段	场次	对手	比分
预赛	5	辽宁	20:30 (11:14)
预赛	12	解放军	29:28 (13:13)
预赛	16	上海	8:23 (8:21)
预赛	24	北京	28:24 (16:13)
预赛	31	四川	31:28 (19:12)
四分之一决赛	41	安徽	17:44 (10:20)
5-8名	46	新疆	17:26 (8:13)
7-8名	51	辽宁	26:31 (11:13)







2016年全国女子手球锦标赛

图式射门区域累计

截止至第54场

201605054-42-1/1

天津

Player statistics for Tianjin team, including names like 王晓梅, 朱佳瑜, 丁丽洁, etc., and their respective goal counts in different areas.

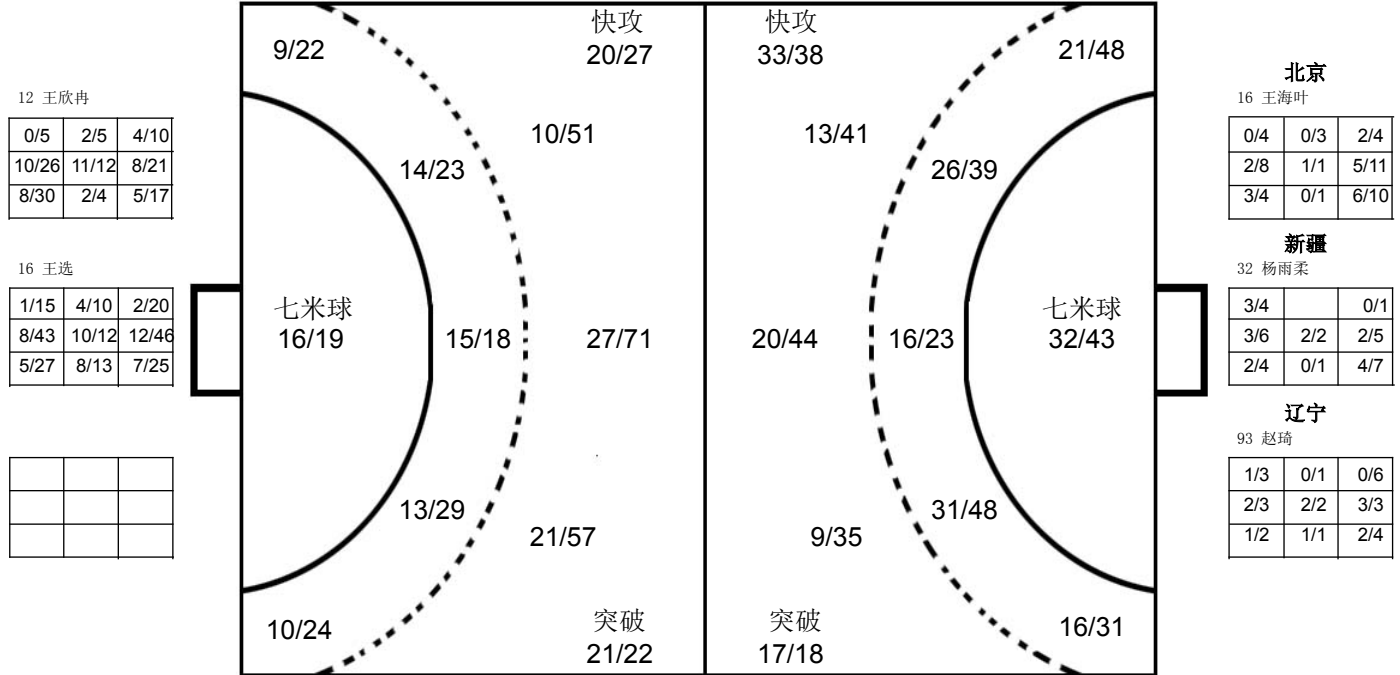

对手

Opponent statistics table listing players from teams like 辽宁, 解放军, 上海, 四川, 安徽, 北京, and their performance metrics.

注释: Post=击柱 Miss=射失 Block=被封



## 2016年全国女子手球锦标赛

个人/全队技术累计表

正式表  
手球  
女子

截至第 54场

201605054-15-1/1  
安徽滁州  
13/09/2016 18:30

号码	姓名	远射	近射	边射	快攻	突破	任意	7M	合计	%	助攻	失误	警告	2'	取消	场次	时间
<b>山东</b>																	
<i>(场上队员)</i>																	
1	刘畅									0.0%		1				8	02:17:42
2	林燕群	9/24	16/20	4/11	4/6	7/8		8/10	48/79	60.8%		26	3	2		8	06:12:45
7	杨嘉露	4/9	0/2	0/1				1/1	5/13	38.5%	1	2	1	2	1	7	01:31:38
8	王彬	8/17	6/10	4/7	2/3	4/5		12/12	36/54	66.7%	7	18		1		8	02:47:39
9	周钰婷	3/14	1/4		1/1			0/1	5/20	25.0%	4	5	2	1		8	01:47:15
10	田秀秀	4/15	9/14	1/2	3/6	6/6	2/2	0/1	25/46	54.3%	4	25	2			8	05:13:23
11	吕青纹	0/1	3/6	9/13	11/12	1/1			24/33	72.7%		5	3			8	06:21:24
12	张苑琳									0.0%		2				8	04:55:45
15	吴作扬	6/21	5/7	0/1	0/1	0/1	1/3	4/5	16/39	41.0%	6	17	2	1		8	03:35:30
19	姜伟珊		0/4	1/1	0/1				1/6	16.7%		1				8	00:54:16
20	张悦	1/1	7/8	4/5	8/9				20/23	87.0%	1	5	6	2		8	06:12:43
22	朱赞									0.0%						8	00:16:33
23	徐悦		4/4						4/4	100%	1			5		8	02:41:46
28	崔金娜		10/12		1/1	1/1			12/14	85.7%	2	2	2	3		8	04:34:51
33	王彩琳	4/9	8/9	0/1	1/1	7/7			20/27	74.1%		11		3		8	01:59:30
77	穆庆丛	0/1	2/5		2/4			1/3	5/13	38.5%		4	1	1		8	01:39:10

<b>合计</b>		39/112	71/105	23/42	33/45	26/29	3/5	26/33	221/371	59.6%	26	124	22	21	1	127	
<i>(守门员)</i>																	
1	刘畅	13/23	6/23	7/13	4/13	0/4	0/1	4/13	34/90	37.8%		1				8	02:17:42
12	张苑琳	37/61	9/38	9/32	4/32	3/12	2/5	3/8	67/188	35.6%		2				8	04:55:45
22	朱赞	2/4		2/3				2/10	6/17	35.3%						8	00:16:33

<b>合计</b>		52/88	15/61	18/48	8/45	3/16	2/6	9/31	107/295	36.3%		3				24	
-----------	--	-------	-------	-------	------	------	-----	------	---------	-------	--	---	--	--	--	----	--

场上队员：得分/射门

守门员：救球/射门

全队合计	进球	被救	射失	击柱	封球	合计	%
远射	39	35	11	6	21	112	34.8%
近射	71	23	2	7	2	105	67.6%
边射	23	15	2	2		42	54.8%
快攻	33	9	2		1	45	73.3%
突破	26	2		1		29	89.7%
任意	3		1	1		5	60.0%
7M	26	5		2		33	78.8%

## 已打比赛

阶段	场次	对手	比分
预赛	2	广东	22:27 (8:13)
预赛	7	江苏	23:33 (9:16)
预赛	15	新疆	29:24 (17:11)
预赛	21	黑龙江	22:4 (22:4)
预赛	25	安徽	24:30 (12:15)
预赛	34	广西	35:24 (17:11)
名次赛	43	四川	30:22 (13:13)
名次赛	50	北京	36:24 (22:13)





2016年全国女子手球锦标赛

图式射门区域累计

截止至第54场

201605054-42-1/1

山东

Table with 8 columns of player statistics for Shandong, including names like 1 刘畅, 2 林燕群, 7 杨嘉露, etc., and their respective performance metrics.

Player statistics for 1 刘畅: 1/6, 0/3, 0/2; 5/18, 12/12, 5/21; 4/14, 1/1, 6/13

Player statistics for 12 张苑琳: 4/18, 6/14, 1/17; 6/23, 13/15, 11/39; 10/26, 7/9, 9/27

Player statistics for 22 朱贇: 0/1, 0/2; 2/4, 2/2, 1/2; 0/4, 1/2

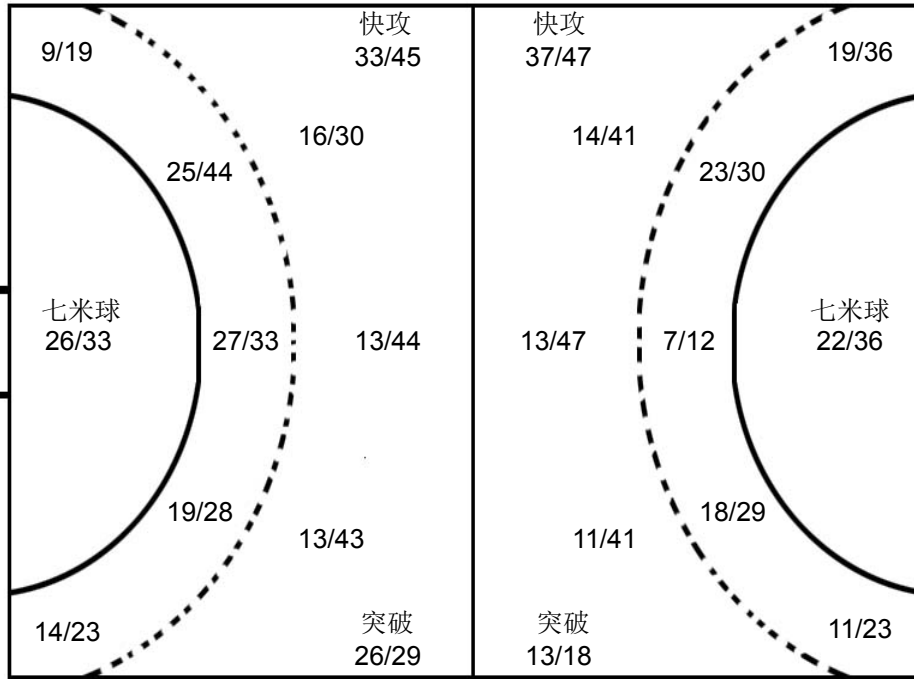

Player statistics for Jiangsu 1 陆婷: 0/2, 0/3; 4/9, 3/9; 5/7, 1/3

Player statistics for Sichuan 12 宋琛茜: 0/2, 1/5; 1/9, 1/1, 2/8; 4/7, 1/2, 1/7

Player statistics for Anhui 16 朱莉珍: 0/2, 1/2, 0/3; 3/9, 1/7; 4/6, 1/1, 1/5

对手

Table with 8 columns of player statistics for opponents: 7 廖露 (Guangxi), 21 李瑶 (Anhui), 23 王书慧 (Jiangsu), 6 沈萍 (Anhui), 41 杜机娟 (Anhui), 11 纪婉 (Beijing), 69 石梓薇 (Beijing), 9 韦宝桂 (Guangdong), 11 于源源 (Jiangsu), 3 王丹 (Sichuan), 6 阿孜古 (Xinjiang), 17 杨政赢 (Beijing), 7 刘彤 (Guangdong), 11 魏梦庭 (Guangdong), 33 金梦青 (Jiangsu), 17 周婷 (Anhui).

注释: Post=击柱 Miss=射失 Block=被封





## 2016年全国女子手球锦标赛

个人/全队技术累计表

正式表  
手球  
女子

截至第 54场

201605054-15-1/1  
安徽滁州  
13/09/2016 18:30

号码	姓名	远射	近射	边射	快攻	突破	任意	7M	合计	%	助攻	失误	警告	2'	取消	场次	时间
<b>北京</b>																	
<i>(场上队员)</i>																	
1	宋嘉蕾									0.0%		1				8	01:32:22
3	季小桐	11/27	8/17	2/6	6/8	8/10	1/1	2/2	38/71	53.5%	3	33	1	4		8	05:57:36
4	孙佳		6/11	2/5	2/2				10/18	55.6%	2	2	4	4		8	03:39:14
6	刘亚男									0.0%	1	1	1	1		8	01:16:03
8	杨铭豫		6/8	10/15	2/4	1/1			19/28	67.9%		7	3			8	04:06:23
10	刘莎	1/1	2/2	5/11	2/2	1/1		2/6	13/23	56.5%	1	2	2	1		8	03:16:23
11	纪婉		3/5	5/13	6/6	4/5		0/1	18/30	60.0%	1	9				8	04:02:39
16	王海叶									0.0%	2					8	05:32:54
17	杨政赢	10/27	4/8	0/1	1/1	3/4	0/2	0/1	18/44	40.9%	3	16	1	2		8	03:10:57
22	李海鸥		9/16		8/8				17/24	70.8%		8	3			8	05:10:45
23	田媛	4/18	2/6	2/3	2/2	2/2	0/1		12/32	37.5%	3	13	3	1		8	03:14:28
28	闫美珠	8/30	1/3	1/3			2/2		12/38	31.6%	4	4	1	2		8	02:32:31
33	栾征	0/1	0/2	1/1					1/4	25.0%				2		8	00:55:19
47	刘泽									0.0%						8	00:30:59
58	李华			1/4					1/4	25.0%		3	1	1		8	01:22:49
69	石梓薇	21/50	12/20	2/3	5/6	7/8	0/1	12/14	59/102	57.8%	8	21	4			8	06:42:33

<b>合计</b>		55/154	53/98	31/65	34/39	26/31	3/7	16/24	218/418	52.2%	28	120	24	18		128	
-----------	--	--------	-------	-------	-------	-------	-----	-------	---------	-------	----	-----	----	----	--	-----	--

*(守门员)*

1	宋嘉蕾	7/15	7/32	5/12	1/12	0/6	0/1	2/10	22/88	25.0%		1				8	01:32:22
16	王海叶	38/71	20/65	25/42	8/36	4/29	0/1	3/13	98/257	38.1%	2					8	05:32:54
47	刘泽	2/4	1/7	0/1	0/3	0/2		0/5	3/22	13.6%						8	00:30:59

<b>合计</b>		47/90	28/104	30/55	9/51	4/37	0/2	5/28	123/367	33.5%	2	1				24	
-----------	--	-------	--------	-------	------	------	-----	------	---------	-------	---	---	--	--	--	----	--

场上队员：得分/射门

守门员：救球/射门

全队合计	进球	被救	射失	击柱	封球	合计	%
远射	55	49	18	16	16	154	35.7%
近射	53	35	3	7		98	54.1%
边射	31	26	1	7		65	47.7%
快攻	34	4	1			39	87.2%
突破	26	4		1		31	83.9%
任意	3	3	1			7	42.9%
7M	16	7		1		24	66.7%

已打比赛

阶段	场次	对手	比分
预赛	4	上海	17:32 (10:19)
预赛	10	辽宁	16:31 (11:18)
预赛	18	四川	34:29 (17:12)
预赛	24	天津	24:28 (13:16)
预赛	32	解放军	31:38 (11:19)
名次赛	37	广西	35:28 (18:13)
名次赛	44	黑龙江	37:22 (24:11)
名次赛	50	山东	24:36 (13:22)





2016年全国女子手球锦标赛

图式射门区域累计

截止至第54场

201605054-42-1/1

北京

Player statistics for Beijing team, including names like 宋嘉蕾, 季小桐, 孙佳, etc., and their respective performance metrics in a grid format.

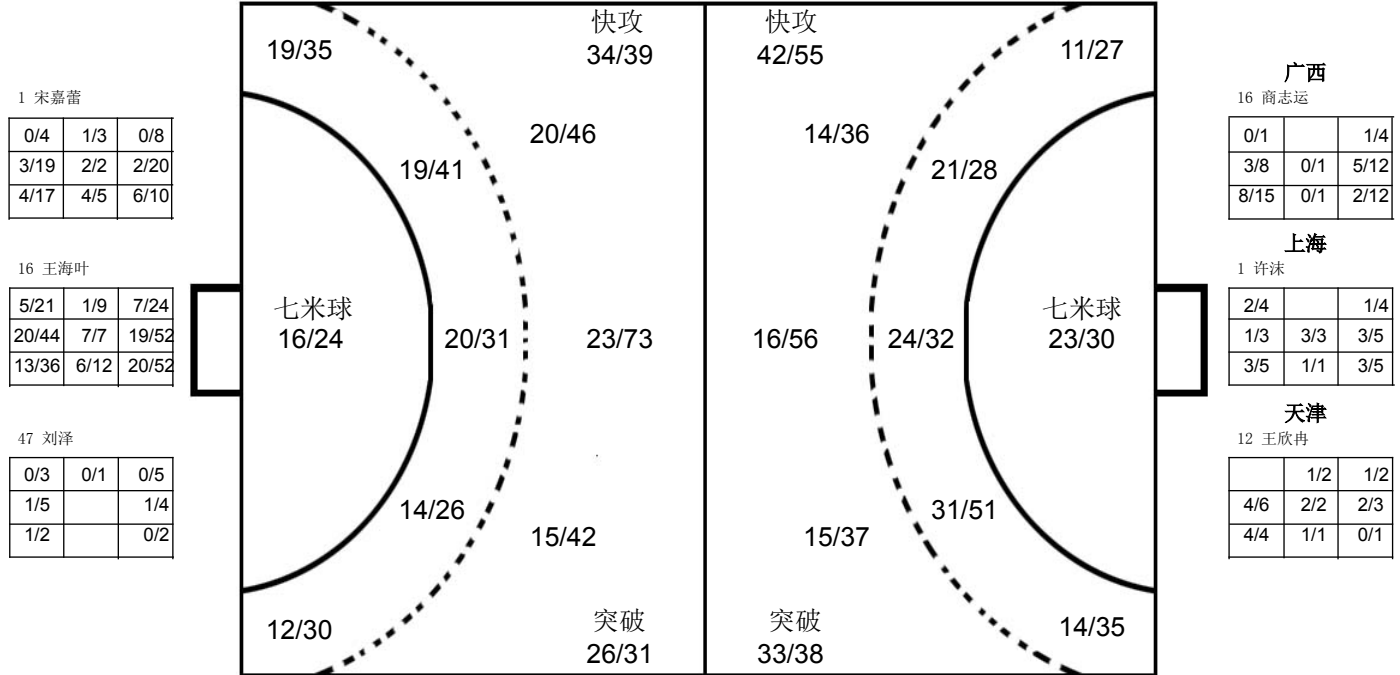

Opponent statistics for Beijing, listing players from teams like 辽宁, 解放军, 四川, 广西, 黑龙江, and 山东, with their performance metrics.

注释: Post=击柱 Miss=射失 Block=被封



## 2016年全国女子手球锦标赛

个人/全队技术累计表

正式表  
手球  
女子

截至第 54场

201605054-15-1/1  
安徽滁州  
13/09/2016 18:30

号码	姓名	远射	近射	边射	快攻	突破	任意	7M	合计	%	助攻	失误	警告	2'	取消	场次	时间
<b>四川</b>																	
<i>(场上队员)</i>																	
1	张雪纯									0.0%						8	00:00:00
2	陈艳楠	2/5	3/7		2/2				7/14	50.0%	1	6	3	2		8	02:29:43
3	王丹	10/37	13/20	10/17	5/7	11/12	1/4	18/22	68/119	57.1%	16	35	3	3		8	07:32:30
4	尤婉莹	1/8	6/14	5/10	4/5	4/5			20/42	47.6%	2	15	3	1		8	05:10:11
5	孙姣	0/3	14/20	0/1	7/8	1/1	1/1	1/1	24/35	68.6%	2	13	4	3		8	07:37:20
6	凤洋	5/13	4/8	5/21	9/13	3/3			26/58	44.8%	2	13				8	06:33:12
7	练素琪			0/4	1/1				1/5	20.0%		1				8	00:30:00
9	姚梦园	0/1	4/5	1/10	10/12				15/28	53.6%	1	2	3			8	06:07:17
10	高静		1/2						1/2	50.0%				1		8	00:23:36
11	朱海云	5/25	7/11	1/4	1/2	5/5	0/1	0/1	19/49	38.8%	7	20	2			8	05:14:25
12	宋琛茜									0.0%	5	2				8	08:28:16
17	史雨欣									0.0%		4				8	00:29:34
18	戴小宇	12/30	10/14	1/1	1/1	6/7		12/15	42/68	61.8%	4	19	1	5		8	05:10:33
27	吴美琪	2/4		0/2	1/1		1/1	1/3	5/11	45.5%		5				8	01:10:38
<b>合计</b>																	
		37/126	62/101	23/70	41/52	30/33	3/7	32/42	228/431	52.9%	40	135	19	15		112	
<i>(守门员)</i>																	
12	宋琛茜	40/79	26/116	14/62	6/41	5/39	3/5	7/23	101/365	27.7%	5	2				8	08:28:16
<b>合计</b>																	
		40/79	26/116	14/62	6/41	5/39	3/5	7/23	101/365	27.7%	5	2				8	

场上队员：得分/射门

守门员：救球/射门

全队合计	进球	被救	射失	击柱	封球	合计	%
远射	37	46	14	9	20	126	29.4%
近射	62	35	2	2		101	61.4%
边射	23	36	2	9		70	32.9%
快攻	41	8	1	2		52	78.8%
突破	30	2	1			33	90.9%
任意	3	4				7	42.9%
7M	32	7	1	2		42	76.2%

## 已打比赛

阶段	场次	对手	比分
预赛	6	解放军	31:36 (14:20)
预赛	11	上海	30:43 (21:22)
预赛	18	北京	29:34 (12:17)
预赛	22	辽宁	23:29 (11:17)
预赛	31	天津	28:31 (12:19)
名次赛	38	黑龙江	28:25 (13:12)
名次赛	43	山东	22:30 (13:13)
名次赛	49	广西	37:36 (16:20)





2016年全国女子手球锦标赛

图式射门区域累计

截止至第54场

201605054-42-1/1

四川

1 张雪纯 Post - 0 Miss - 0 Block - 0	2 陈艳楠 Post - 0 Miss - 1 Block - 0	3 王丹 Post - 8 Miss - 4 Block - 6	4 尤婉莹 Post - 2 Miss - 0 Block - 2	5 孙姣 Post - 1 Miss - 2 Block - 1	6 凤洋 Post - 5 Miss - 3 Block - 1	7 练素琪 Post - 0 Miss - 2 Block - 0	9 姚梦园 Post - 1 Miss - 0 Block - 1
10 高静 Post - 0 Miss - 0 Block - 0	11 朱海云 Post - 3 Miss - 5 Block - 4	12 宋琛茜 Post - 0 Miss - 0 Block - 0	17 史雨欣 Post - 0 Miss - 0 Block - 0	18 戴小宇 Post - 2 Miss - 3 Block - 5	27 吴美琪 Post - 2 Miss - 1 Block - 0		

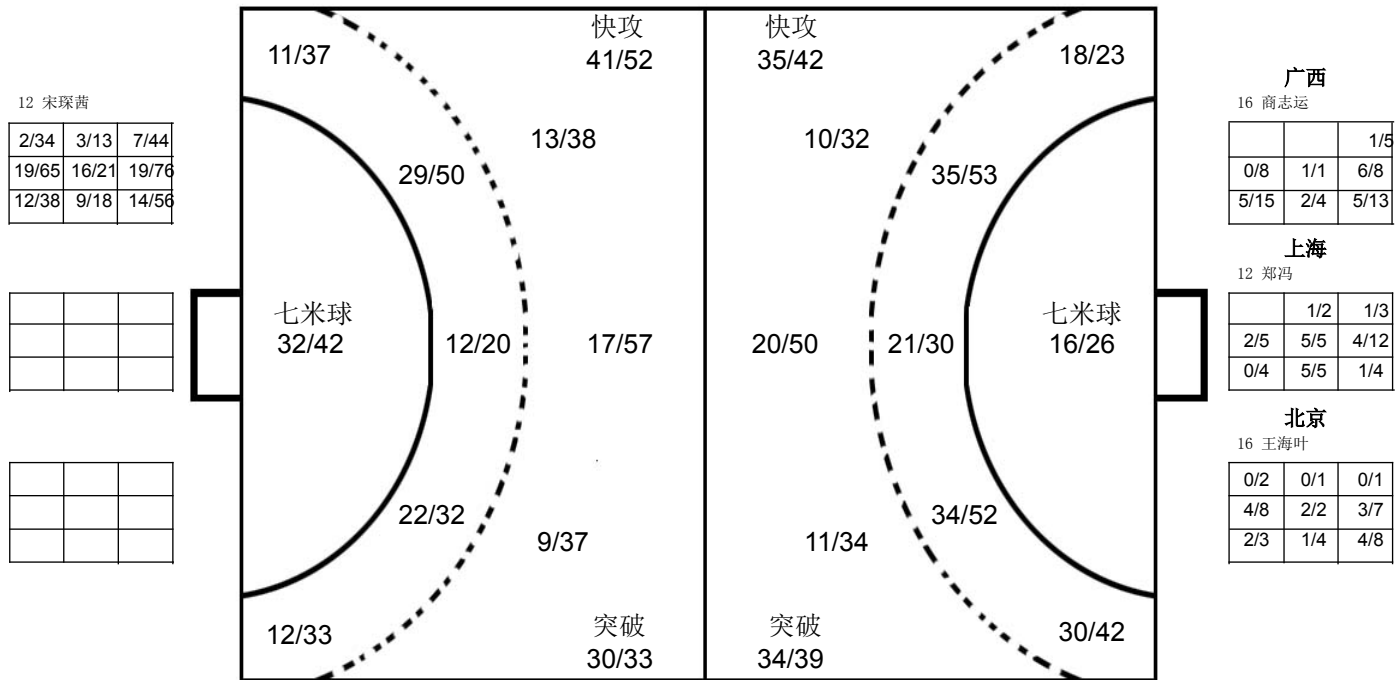

12 宋琛茜

2/34	3/13	7/44
19/65	16/21	19/76
12/38	9/18	14/56



广西

16 商志运

		1/5
0/8	1/1	6/8
5/15	2/4	5/13

上海

12 郑冯

	1/2	1/3
2/5	5/5	4/12
0/4	5/5	1/4

北京

16 王海叶

0/2	0/1	0/1
4/8	2/2	3/7
2/3	1/4	4/8

对手

北京 3 季小桐 Post - 2 Miss - 0 Block - 0	北京 69 石梓薇 Post - 0 Miss - 1 Block - 0	天津 18 舒文琪 Post - 0 Miss - 1 Block - 0	广西 7 廖露 Post - 0 Miss - 1 Block - 2	广西 10 周琴 Post - 1 Miss - 2 Block - 1	广西 14 黄艳芳 Post - 1 Miss - 0 Block - 0	解放军 88 李晓晴 Post - 1 Miss - 0 Block - 0	广西 2 陆雪云 Post - 0 Miss - 0 Block - 0
黑龙江 13 吴佳 Post - 0 Miss - 0 Block - 0	黑龙江 19 梁文煜 Post - 1 Miss - 0 Block - 0	解放军 6 于婷婷 Post - 0 Miss - 0 Block - 0	辽宁 5 辛颜 Post - 2 Miss - 0 Block - 0	上海 10 斯文 Post - 0 Miss - 0 Block - 0	上海 18 沙正文 Post - 0 Miss - 0 Block - 0	天津 11 蔡雪洁 Post - 1 Miss - 0 Block - 0	天津 23 周梦雪 Post - 2 Miss - 3 Block - 2

注释: Post=击柱 Miss=射失 Block=被封





## 2016年全国女子手球锦标赛

个人/全队技术累计表

正式表  
手球  
女子

截至第 54场

201605054-15-1/1  
安徽滁州  
13/09/2016 18:30

号码	姓名	远射	近射	边射	快攻	突破	任意	7M	合计	%	助攻	失误	警告	2'	取消	场次	时间
<b>广西</b>																	
<i>(场上队员)</i>																	
1	胡霜梅									0.0%						8	00:04:19
2	陆雪云	5/24	4/6	5/8	2/2	3/3	0/2		19/45	42.2%	5	27	3	2		8	05:07:15
5	黄海玉	0/3						0/1	0/4	0.0%		1				8	01:41:45
6	韦惠文	1/1							1/1	100%		1				8	00:48:55
7	廖露	20/53	8/9	2/3	2/2	3/5	1/1	2/2	38/75	50.7%	8	17	1	2		8	05:12:47
8	韦如芳	0/2	6/6	11/21	2/5	2/2		1/1	22/37	59.5%		12	2			8	06:26:54
9	蓝雪梅	2/7	0/3						2/10	20.0%		6	1			8	00:38:51
10	周琴	5/17	3/11	7/14	5/6	5/6		9/11	34/65	52.3%	1	10	3	2		8	04:52:03
11	曾蓝花	7/33	2/5	1/4	1/2	1/1		0/3	12/48	25.0%	5	31	3			8	05:16:24
12	江燕红									0.0%						8	01:34:46
14	黄艳芳	0/2	18/29	2/6	4/5		0/1		24/43	55.8%		16	2	3		8	06:16:03
15	陈依依									0.0%		1				7	00:04:49
16	商志运									0.0%	1	2				8	05:08:57
17	杨杨	1/8	1/1	1/1	2/3		0/1		5/14	35.7%		4	3			8	01:55:40
18	庞娇	4/16	6/7	2/4					12/27	44.4%		2	2	2		8	02:43:23

<b>合计</b>		45/166	48/77	31/61	18/25	14/17	1/5	12/18	169/369	45.8%	20	130	20	11		119	
<i>(守门员)</i>																	
12	江燕红	5/18	6/29	2/11	4/22	0/3		2/11	19/94	20.2%						8	01:34:46
16	商志运	28/59	25/71	23/49	3/35	2/14	1/1	6/23	88/252	34.9%	1	2				8	05:08:57

<b>合计</b>		33/77	31/100	25/60	7/57	2/17	1/1	8/34	107/346	30.9%	1	2				16	
-----------	--	-------	--------	-------	------	------	-----	------	---------	-------	---	---	--	--	--	----	--

场上队员：得分/射门

守门员：救球/射门

全队合计	进球	被救	射失	击柱	封球	合计	%
远射	45	70	16	8	27	166	27.1%
近射	48	19	6	4		77	62.3%
边射	31	21	3	6		61	50.8%
快攻	18	6		1		25	72.0%
突破	14	3				17	82.4%
任意	1	3	1			5	20.0%
7M	12	2		4		18	66.7%

## 已打比赛

阶段	场次	对手	比分
预赛	9	新疆	26:30 (14:16)
预赛	13	黑龙江	26:23 (11:10)
预赛	20	安徽	8:28 (8:28)
预赛	26	广东	12:27 (10:18)
预赛	29	江苏	9:24 (9:22)
预赛	34	山东	24:35 (11:17)
名次赛	37	北京	28:35 (13:18)
名次赛	49	四川	36:37 (20:16)







2016年全国女子手球锦标赛

图式射门区域累计

截止至第54场

201605054-42-1/1

广西

1 胡霜梅	2 陆雪云	5 黄海玉	6 韦惠文	7 廖露	8 韦如芳	9 蓝雪梅	10 周琴
	5 1 1			4 1 5			3
	2 1 2		1	7	6		10
	5 1 1			8	4	1	14
Post - 0 Miss - 0 Block - 0	Post - 2 Miss - 4 Block - 1	Post - 2 Miss - 0 Block - 2	Post - 0 Miss - 0 Block - 0	Post - 1 Miss - 7 Block - 6	Post - 4 Miss - 1 Block - 0	Post - 0 Miss - 0 Block - 1	Post - 3 Miss - 3 Block - 5
11 曾蓝花	12 江燕红	14 黄艳芳	15 陈依依	16 商志运	17 杨杨	18 庞娇	
		3 4				1 1	
2		3			2	1	
5		6 2 4			1	1	
Post - 6 Miss - 4 Block - 7	Post - 0 Miss - 0 Block - 0	Post - 2 Miss - 4 Block - 0	Post - 0 Miss - 0 Block - 0	Post - 0 Miss - 0 Block - 0	Post - 3 Miss - 2 Block - 1	Post - 0 Miss - 1 Block - 4	

12 江燕红

1/8	0/2	1/15
5/18	5/5	3/22
1/8	1/2	2/14

16 商志运

0/13	3/7	2/15
12/49	14/16	16/45
23/57	5/10	13/40

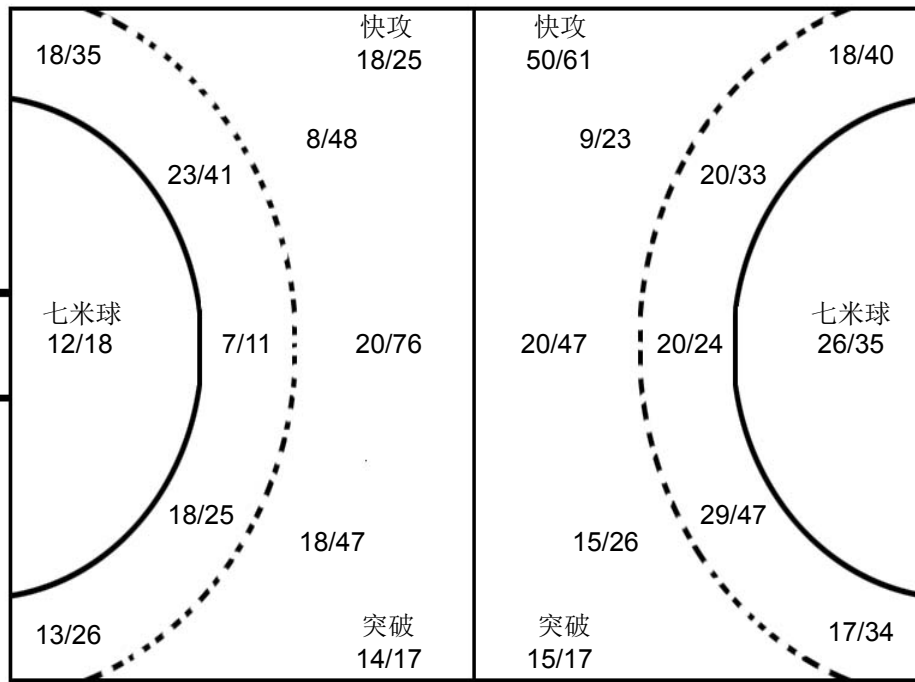
黑龙江

12 肖宁桐

1/2		
0/7	2/2	0/2
7/15	5/5	2/7

北京

16 王海叶

0/2	0/2	0/1
3/8		5/7
1/9	3/3	5/12

江苏

1 陆婷

0/1		2/4
2/3	4/4	2/3
1/2	4/4	1/1

对手

2 林燕群	18 戴小宇	69 石梓薇	3 王丹	7 刘彤	26 宋婷婷	3 季小桐	8 杨铭豫
2	5	3	2	3	1	1	
6		1	2	4		4	
3	2	2	5		1	1	4
Post - 0 Miss - 0 Block - 1	Post - 0 Miss - 0 Block - 0	Post - 1 Miss - 2 Block - 0	Post - 0 Miss - 0 Block - 0	Post - 0 Miss - 1 Block - 0	Post - 0 Miss - 0 Block - 0	Post - 0 Miss - 1 Block - 0	Post - 0 Miss - 0 Block - 0
11 魏梦庭	8 王彬	20 张悦	6 凤洋	5 班晨晨	22 李海鸥	10 刘雪露	11 吕青纹
1	2	1		3	1	3	
	2	2	1		1	1	1
4	1	2	2	1		1	1
Post - 0 Miss - 0 Block - 0	Post - 0 Miss - 1 Block - 0	Post - 1 Miss - 0 Block - 0	Post - 1 Miss - 1 Block - 0	Post - 0 Miss - 0 Block - 0	Post - 0 Miss - 0 Block - 0	Post - 2 Miss - 1 Block - 0	Post - 0 Miss - 1 Block - 0

注释: Post=击柱 Miss=射失 Block=被封





## 2016年全国女子手球锦标赛

个人/全队技术累计表

正式表  
手球  
女子

截至第 54场

201605054-15-1/1  
安徽滁州  
13/09/2016 18:30

号码	姓名	远射	近射	边射	快攻	突破	任意	7M	合计	%	助攻	失误	警告	2'	取消	场次	时间
<b>黑龙江</b>																	
<i>(场上队员)</i>																	
1	徐佳蓉									0.0%						8	01:03:44
3	刘诗彤		1/1	2/4	0/2				3/7	42.9%		4	3	1		8	02:27:03
5	周美微	0/2	4/10	1/1	1/1				6/14	42.9%		6	5	2		8	02:48:25
6	王梦艺	4/14	4/8	0/2	1/1	3/4	1/1		13/30	43.3%	1	16	2			8	03:59:57
9	郑宇	3/14	5/7	2/2	1/2	1/1		1/2	13/28	46.4%	1	12	2	3		8	03:46:34
10	刘雪露	8/32						2/2	10/34	29.4%	2	22		2		8	03:38:36
11	刘天茹	0/3		5/14	1/1				6/18	33.3%		6	1			8	02:38:30
12	肖宁桐									0.0%	1	3				8	04:39:15
13	吴佳	12/39	2/6	5/10	2/2	6/7	1/2	0/4	28/70	40.0%	2	20	1	2		8	04:41:05
14	黄荣	0/1	0/1					4/7	4/9	44.4%						8	00:06:26
16	杜宪									0.0%	1	1				8	00:33:13
19	梁文煜	7/22	2/5	6/14	1/1				16/42	38.1%	1	8	2	1		8	05:08:21
21	王戈	0/3		5/10	4/7	1/1			10/21	47.6%		6	1	1		8	03:35:14
22	马琳	2/16	3/6	1/1		1/1	0/1	3/3	10/28	35.7%	1	13	1	1		8	02:31:06
23	张政	0/1	3/5		1/1				4/7	57.1%	1	8	3			8	02:10:48

<b>合计</b>		36/147	24/49	27/58	12/18	12/14	2/4	10/18	123/308	39.9%	11	125	21	13		120	
<i>(守门员)</i>																	
1	徐佳蓉	4/12	3/16	1/7	1/11	0/3	0/1	1/3	10/53	18.9%						8	01:03:44
12	肖宁桐	30/62	12/49	20/39	5/41	4/24	0/2	4/15	75/232	32.3%	1	3				8	04:39:15
16	杜宪	3/8	1/7	2/4	2/6	0/2		0/5	8/32	25.0%	1	1				8	00:33:13

<b>合计</b>		37/82	16/72	23/50	8/58	4/29	0/3	5/23	93/317	29.3%	2	4				24	
-----------	--	-------	-------	-------	------	------	-----	------	--------	-------	---	---	--	--	--	----	--

场上队员：得分/射门

守门员：救球/射门

全队合计	进球	被救	射失	击柱	封球	合计	%
远射	36	68	15	10	18	147	24.5%
近射	24	17	7	1		49	49.0%
边射	27	20	5	6		58	46.6%
快攻	12	5		1		18	66.7%
突破	12	2				14	85.7%
任意	2		1	1		4	50.0%
7M	10	7	1			18	55.6%

## 已打比赛

阶段	场次	对手	比分
预赛	1	新疆	16:31 (11:14)
预赛	8	广东	18:33 (8:15)
预赛	13	广西	23:26 (10:11)
预赛	21	山东	4:22 (4:22)
预赛	27	江苏	6:22 (6:22)
预赛	28	安徽	9:25 (9:25)
名次赛	38	四川	25:28 (12:13)
名次赛	44	北京	22:37 (11:24)





2016年全国女子手球锦标赛

图式射门区域累计

截止至第54场

201605054-42-1/1

黑龙江

Table of player statistics for Heilongjiang team, including names like 徐佳蓉, 刘诗彤, 周美薇, etc., and their respective performance metrics in a grid format.

Statistical tables for players 1 徐佳蓉, 12 肖宁桐, and 16 杜宪, showing shot counts and ratios.

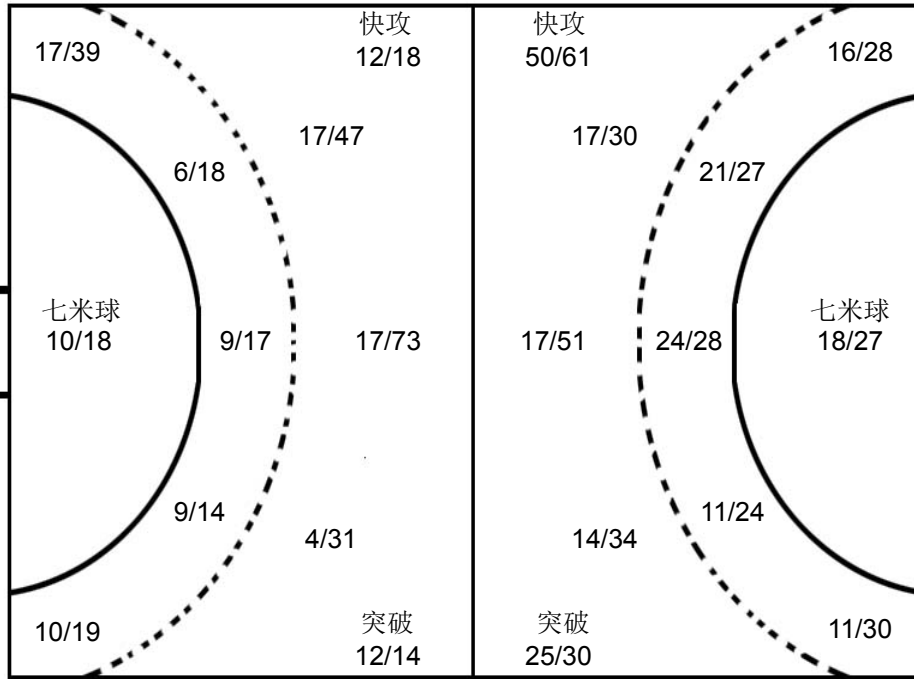

Statistical tables for players from the opposing team: 16 王海叶, 12 宋琛茜, and 32 杨雨柔.

对手

Table of player statistics for the opposing team, including names like 林燕群, 李玉玲, 王丹, etc., and their performance metrics.

注释: Post=击柱 Miss=射失 Block=被封





预赛 Group A

女子 全国比赛

2016年全国女子手球锦标赛

Team A										Team B										Match Number											
A 黑龙江										B 新疆										1											
played in China										in the hall 滁州体育馆										on 03/09/2016		at 13:00 hours		Spectators							
Half-time (30')		A 11		B 14		End of playing time		A 16		B 31		1st extra time		A		B		2nd extra time		A		B		After penalty		A		B			
Number of 7 m		A 1/2		Team time-out			Full name of players and officials										Team time-out			B 3/6		Number of 7 m									
			1	2	3	13:04	37:59	46:43																							
No.	Team A										G	W	2'	D	DR	No.	Team B										G	W	2'	D	DR
1	徐佳蓉															3	葛立双										2				
3	刘诗彤															6	阿孜古										2	1			
5	周美微										1	1				7	吴志娟										4				
6	王梦艺										3	1				10	李静														
9	郑宇										2		1			11	陈培培														
10	刘雪露										2					12	艾敏加尔汉														
11	刘天茹										1					15	兰姝娇										1				
12	肖宁桐															17	戴莹莹										4				
13	吴佳										4					18	崔娟										4				
14	黄荣															21	锁珊珊										5				
16	杜宛															23	张艺璇														
19	梁文煜										2					26	宋婷婷										3				
21	王戈															27	谢辰辰										1	1			
22	马琳															32	杨雨柔														
23	张政										1	1				93	张婷婷										5	1			
B	张立梅 (主教练)															A	邓雷														
C	黄冬杰															B	于涛 (主教练)														
D	于兹香															C	崔娟														
E	马婧															D	高璇														
A											Signature of Responsible Official of the Teams (Off. A)											B									
TP	Remarks of Referee / CHA Official																					TP									

Signatures

Referees: 张耿 (CHN)      王洋 (CHN)

Techn. Delegates: 许宜扬 (CHN)

CHA Official: 高斌 (CHN)

Note: Number of 7m Throws Awarded to Team A and B, Goals (G), Warnings (W), Suspensions (2), Direct Disqualification (D), Disqualification with Report (DR) and Team Penalty (TP).

Table Officials: 佟金正

贾俊秋

Statisticians: 闫冲

陈柱





## 2016年全国女子手球锦标赛 竞赛技术统计(媒体表)

<b>预赛</b>	组别	<b>A</b>	轮次	<b>1</b>	场次	<b>1</b>
滁州体育馆		03/09/2016			201605001-51-1/1	
黑龙江	<b>黑龙江</b>	<b>16</b>	vs	<b>31</b>	<b>新疆</b>	新疆
<b>11 : 14</b>						

裁判员	张耿 (CHN)	/	王洋 (CHN)
-----	----------	---	----------

黑龙江														比赛进程		新疆		
主教练：张立梅																		
	远射	近射	边射	快攻	突破	任意球	7m球	合计	%	助攻	失误	警告	2'	D & DR				
1 徐佳蓉																		
3 刘诗彤			0/1					0/1	0.0									
5 周美微		1/2						1/2	50.0			1						
6 王梦艺	1/4	1/1	0/1	1/1				3/7	42.9		5	1						
9 郑宇	0/1	1/3	1/1					2/5	40.0		3		1					
10 刘雪露	1/4						1/1	2/5	40.0	1	1							
11 刘天茹	0/2		1/2					1/4	25.0									
12 肖宁桐											1							
13 吴佳	1/6	1/2	2/2				0/1	4/11	36.4	1	3							
14 黄荣																		
16 杜宪																		
19 梁文煜	1/3		1/1					2/4	50.0		1							
21 王戈			0/1					0/1	0.0		1							
22 马琳	0/3							0/3	0.0		2							
23 张政		1/3						1/3	33.3		1	1						
<b>运动员 合计</b>	<b>4/23</b>	<b>5/11</b>	<b>5/9</b>	<b>1/1</b>			<b>1/2</b>	<b>16/46</b>	<b>34.8</b>	<b>2</b>	<b>18</b>	<b>3</b>	<b>1</b>					
1 徐佳蓉	2/4	1/4	0/2	0/2			0/1	3/13	23.1									
12 肖宁桐	5/10	2/7	0/1	1/5	0/3	0/1	2/4	10/31	32.3		1							
<b>守门员 合计</b>	<b>7/14</b>	<b>3/11</b>	<b>0/3</b>	<b>1/7</b>	<b>0/3</b>	<b>0/1</b>	<b>2/5</b>	<b>13/44</b>	<b>29.5</b>		<b>1</b>							
新疆																		
教练：于涛																		
	远射	近射	边射	快攻	突破	任意球	7m球	合计	%	助攻	失误	警告	2'	D & DR				
3 葛立双		1/1					1/1	2/2	100				1					
6 阿孜古		1/1		1/1				2/2	100			1						
7 吴志娟		2/2	0/2	2/2				4/6	66.7		3							
10 李静																		
11 陈培培																		
12 艾敏加尔汉																		
15 兰姝娇					1/1			1/1	100		1							
17 戴莹莹	1/1	2/3	1/1				0/1	4/6	66.7	1	1							
18 崔娟	1/3	1/1		0/1		1/1	1/1	4/7	57.1	1	1							
21 锁珊珊	2/4	0/1	1/1	1/1	1/1		0/1	5/9	55.6		2							
23 张艺璇																		
26 宋婷婷	1/3				1/1		1/1	3/5	60.0		2							
27 谢辰辰	0/1	1/2						1/3	33.3		1	1						
32 杨雨柔											2							
93 张婷婷	2/4		1/1	2/2			0/1	5/8	62.5	1	2	1						
<b>运动员 合计</b>	<b>7/16</b>	<b>8/11</b>	<b>3/5</b>	<b>6/7</b>	<b>3/3</b>	<b>1/1</b>	<b>3/6</b>	<b>31/49</b>	<b>63.3</b>	<b>3</b>	<b>15</b>	<b>3</b>	<b>1</b>					
10 李静	2/2	0/1					0/1	2/4	50.0									
32 杨雨柔	8/12	5/9	3/8	0/1				16/30	53.3		2							
<b>守门员 合计</b>	<b>10/14</b>	<b>5/10</b>	<b>3/8</b>	<b>0/1</b>			<b>0/1</b>	<b>18/34</b>	<b>52.9</b>		<b>2</b>							

场上队员：得分 / 射门

守门员：救球 / 射门

快攻	Fast Break		突破	Breakthrough		任意球	Free Throw		7M球	7M Throw		助攻	Assist
警告	Warning		失误	Error		2'	Suspension		D	取消资格		DR	取消资格+报告



### 2016年全国女子手球锦标赛 图式比赛技术统计表

轮次 1

场次 1

201605001-21-1/1

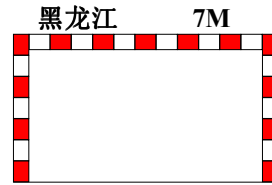
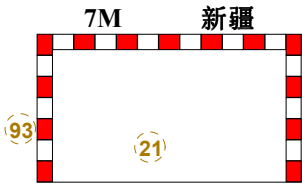
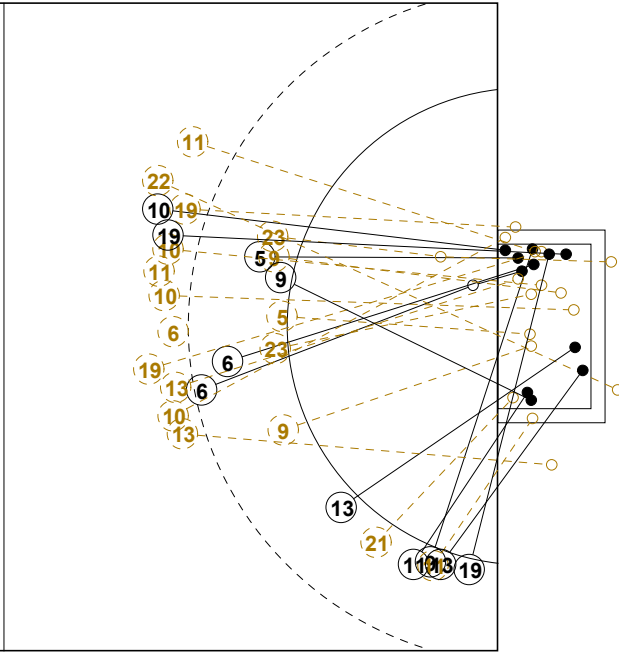
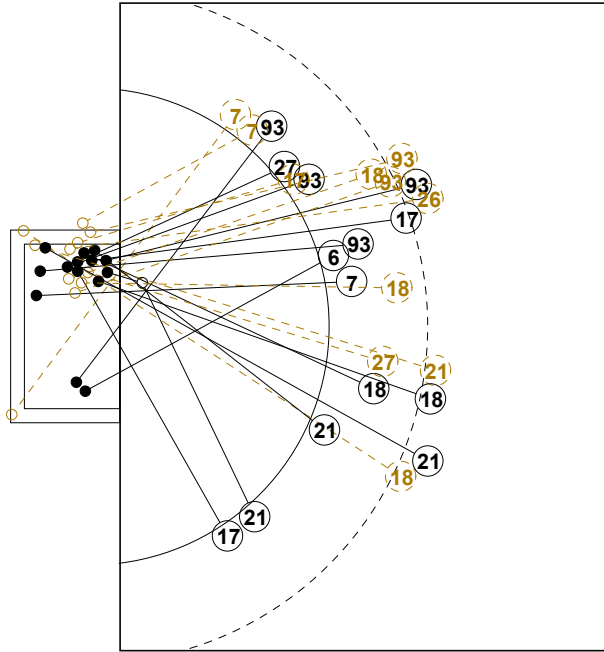

1st Half  
14 : 11

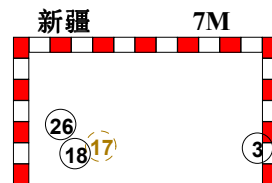
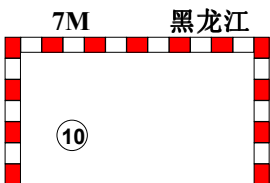
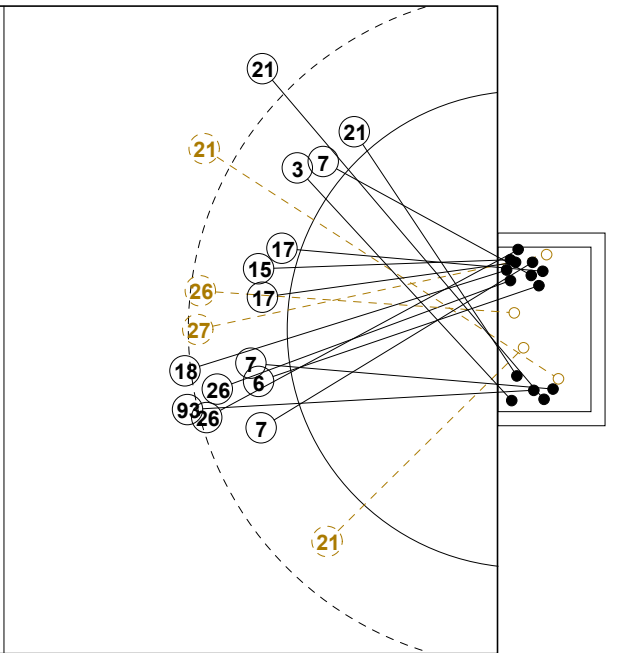
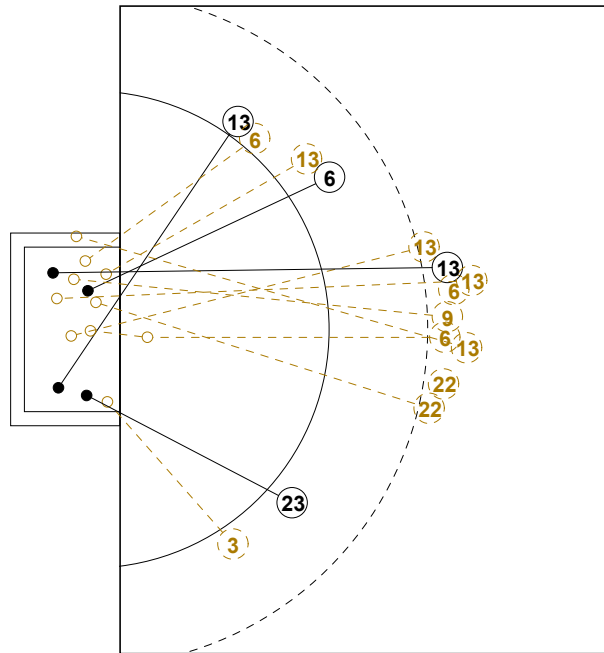

2nd Half  
16 : 31



## 2016年全国女子手球锦标赛

## 个人/全队技术统计表

正式表  
手球  
女子预赛  
轮次 1组别 A  
场次 1201605001-14-1/2  
滁州体育馆  
03/09/2016 13:00

号码	姓名	远射	近射	边射	快攻	突破	任意	7M	合计	%	助攻	失误	警告	2'	取消	时间
<b>黑龙江(黑龙江)</b>																
<i>(场上队员)</i>																
1	徐佳蓉									0.0%						00:19:15
3	刘诗彤			0/1					0/1	0.0%						00:20:05
5	周美微		1/2						1/2	50.0%			1			00:35:01
6	王梦艺	1/4	1/1	0/1	1/1				3/7	42.9%		5	1			00:32:19
9	郑宇	0/1	1/3	1/1					2/5	40.0%		3		1		00:41:58
10	刘雪露	1/4						1/1	2/5	40.0%	1	1				00:30:56
11	刘天茹	0/2		1/2					1/4	25.0%						00:19:46
12	肖宁桐									0.0%		1				00:35:24
13	吴佳	1/6	1/2	2/2				0/1	4/11	36.4%	1	3				00:39:13
14	黄荣									0.0%						00:00:00
16	杜宪									0.0%						00:00:00
19	梁文煜	1/3		1/1					2/4	50.0%		1				00:38:32
21	王戈			0/1					0/1	0.0%		1				00:28:15
22	马琳	0/3							0/3	0.0%		2				00:19:12
23	张政		1/3						1/3	33.3%		1	1			00:21:27
<b>合计</b>		4/23	5/11	5/9	1/1			1/2	16/46	34.8%	2	18	3	1		
<i>(守门员)</i>																
1	徐佳蓉	2/4	1/4	0/2	0/2			0/1	3/13	23.1%						00:19:15
12	肖宁桐	5/10	2/7	0/1	1/5	0/3	0/1	2/4	10/31	32.3%		1				00:35:24
<b>合计</b>		7/14	3/11	0/3	1/7	0/3	0/1	2/5	13/44	29.5%		1				

场上队员：得分/射门

守门员：救球/射门

全队合计	得分	被救	射失	击柱	封球	合计	%
远射	4	10	2	3	4	23	17.4%
近射	5	5	1			11	45.5%
边射	5	3		1		9	55.6%
快攻	1					1	100.0%
突破							0.0%
任意							0.0%
7M	1		1			2	50.0%





## 2016年全国女子手球锦标赛

## 个人/全队技术统计表

正式表  
手球  
女子预赛  
轮次 1组别 A  
场次 1201605001-14-2/2  
滁州体育馆  
03/09/2016 13:00

号码	姓名	远射	近射	边射	快攻	突破	任意	7M	合计	%	助攻	失误	警告	2'	取消	时间
<b>新疆(新疆)</b>																
<i>(上场队员)</i>																
3	葛立双		1/1					1/1	2/2	100%				1		00:04:55
6	阿孜古		1/1		1/1				2/2	100%			1			00:48:36
7	吴志娟		2/2	0/2	2/2				4/6	66.7%		3				00:43:58
10	李静									0.0%						00:08:56
11	陈培培									0.0%						00:03:32
12	艾敏加尔汉									0.0%						00:00:00
15	兰姝娇					1/1			1/1	100%		1				00:36:53
17	戴莹莹	1/1	2/3	1/1				0/1	4/6	66.7%	1	1				00:30:53
18	崔娟	1/3	1/1		0/1		1/1	1/1	4/7	57.1%	1	1				00:39:24
21	锁珊珊	2/4	0/1	1/1	1/1	1/1		0/1	5/9	55.6%		2				00:36:21
23	张艺璇									0.0%						00:04:47
26	宋婷婷	1/3				1/1		1/1	3/5	60.0%		2				00:14:09
27	谢辰辰	0/1	1/2						1/3	33.3%		1	1			00:24:02
32	杨雨柔									0.0%		2				00:45:43
93	张婷婷	2/4		1/1	2/2			0/1	5/8	62.5%	1	2	1			00:37:46
<b>合计</b>		7/16	8/11	3/5	6/7	3/3	1/1	3/6	31/49	63.3%	3	15	3	1		
<i>(守门员)</i>																
10	李静	2/2	0/1					0/1	2/4	50.0%						00:08:56
32	杨雨柔	8/12	5/9	3/8	0/1				16/30	53.3%		2				00:45:43
<b>合计</b>		10/14	5/10	3/8	0/1			0/1	18/34	52.9%		2				

场上队员：得分/射门

守门员：救球/射门

全队合计	得分	被救	射失	击柱	封球	合计	%
远射	7	7		2		16	43.8%
近射	8	3				11	72.7%
边射	3		1	1		5	60.0%
快攻	6	1				7	85.7%
突破	3					3	100.0%
任意	1					1	100.0%
7M	3	2	1			6	50.0%







### 2016年全国女子手球锦标赛

#### 图式射门区域统计

轮次 1 场次 1

201605001-41-1/1

## 黑龙江

1 徐佳蓉	3 刘诗彤	5 周美微	6 王梦艺	9 郑宇	10 刘雪露	11 刘天茹	12 肖宁桐																																																																								
<table border="1"><tr><td></td><td></td><td></td></tr><tr><td></td><td></td><td></td></tr><tr><td></td><td></td><td></td></tr></table>										<table border="1"><tr><td></td><td></td><td></td></tr><tr><td></td><td></td><td></td></tr><tr><td></td><td></td><td></td></tr></table>										<table border="1"><tr><td></td><td></td><td></td></tr><tr><td></td><td></td><td></td></tr><tr><td>1</td><td></td><td></td></tr></table>							1			<table border="1"><tr><td></td><td></td><td></td></tr><tr><td>1</td><td></td><td>1</td></tr><tr><td></td><td></td><td></td></tr></table>				1		1				<table border="1"><tr><td></td><td></td><td></td></tr><tr><td>1</td><td></td><td></td></tr><tr><td></td><td></td><td></td></tr></table>				1						<table border="1"><tr><td></td><td></td><td></td></tr><tr><td>1</td><td></td><td></td></tr><tr><td></td><td></td><td></td></tr></table>				1						<table border="1"><tr><td></td><td></td><td></td></tr><tr><td></td><td></td><td></td></tr><tr><td></td><td></td><td>1</td></tr></table>									1	<table border="1"><tr><td></td><td></td><td></td></tr><tr><td></td><td></td><td></td></tr><tr><td></td><td></td><td></td></tr></table>									
1																																																																															
1		1																																																																													
1																																																																															
1																																																																															
		1																																																																													
Post - 0 Miss - 0 Block - 0	Post - 0 Miss - 0 Block - 0	Post - 0 Miss - 0 Block - 0	Post - 0 Miss - 0 Block - 2	Post - 0 Miss - 0 Block - 0	Post - 1 Miss - 0 Block - 0	Post - 1 Miss - 0 Block - 1	Post - 0 Miss - 0 Block - 0																																																																								
13 吴佳	14 黄荣	16 杜宪	19 梁文煜	21 王戈	22 马琳	23 张政																																																																									
<table border="1"><tr><td></td><td>1</td><td>2</td></tr><tr><td>1</td><td></td><td></td></tr><tr><td></td><td></td><td></td></tr></table>		1	2	1						<table border="1"><tr><td></td><td></td><td></td></tr><tr><td></td><td></td><td></td></tr><tr><td></td><td></td><td></td></tr></table>										<table border="1"><tr><td></td><td></td><td></td></tr><tr><td></td><td></td><td></td></tr><tr><td></td><td></td><td></td></tr></table>										<table border="1"><tr><td></td><td></td><td></td></tr><tr><td>1</td><td></td><td></td></tr><tr><td>1</td><td></td><td></td></tr></table>				1			1			<table border="1"><tr><td></td><td></td><td></td></tr><tr><td></td><td></td><td></td></tr><tr><td></td><td></td><td></td></tr></table>										<table border="1"><tr><td></td><td></td><td></td></tr><tr><td></td><td></td><td></td></tr><tr><td></td><td></td><td></td></tr></table>										<table border="1"><tr><td></td><td></td><td></td></tr><tr><td></td><td></td><td></td></tr><tr><td>1</td><td></td><td></td></tr></table>							1			<table border="1"><tr><td></td><td></td><td></td></tr><tr><td></td><td></td><td></td></tr><tr><td></td><td></td><td></td></tr></table>									
	1	2																																																																													
1																																																																															
1																																																																															
1																																																																															
1																																																																															
Post - 1 Miss - 2 Block - 0	Post - 0 Miss - 0 Block - 0	Post - 0 Miss - 0 Block - 0	Post - 1 Miss - 0 Block - 0	Post - 0 Miss - 0 Block - 0	Post - 0 Miss - 1 Block - 1	Post - 0 Miss - 1 Block - 0																																																																									

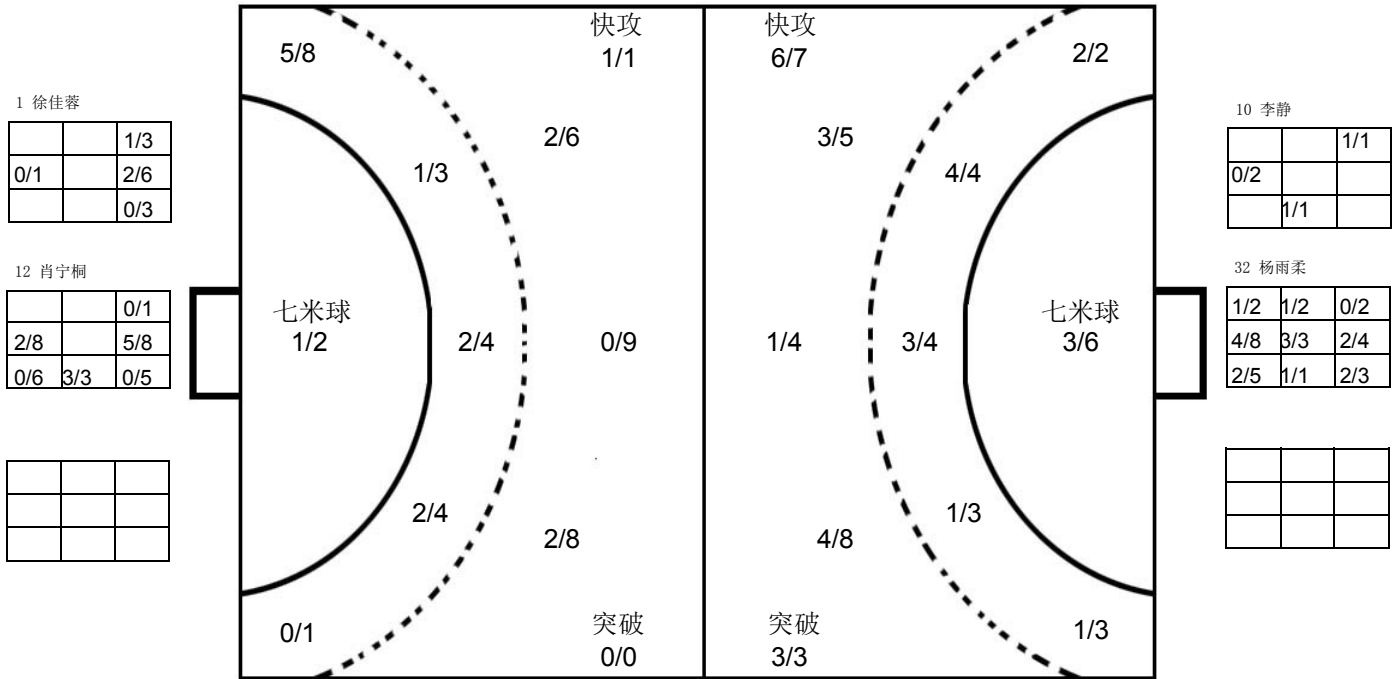

## 新疆

3 葛立双	6 阿孜古	7 吴志娟	10 李静	11 陈培培	12 艾敏加尔汉	15 兰姝娇	17 戴莹莹																																																																								
<table border="1"><tr><td></td><td></td><td></td></tr><tr><td></td><td></td><td></td></tr><tr><td></td><td></td><td>2</td></tr></table>									2	<table border="1"><tr><td></td><td></td><td></td></tr><tr><td>2</td><td></td><td></td></tr><tr><td></td><td></td><td></td></tr></table>				2						<table border="1"><tr><td></td><td></td><td>1</td></tr><tr><td>2</td><td></td><td>1</td></tr><tr><td></td><td></td><td></td></tr></table>			1	2		1				<table border="1"><tr><td></td><td></td><td></td></tr><tr><td></td><td></td><td></td></tr><tr><td></td><td></td><td></td></tr></table>										<table border="1"><tr><td></td><td></td><td></td></tr><tr><td></td><td></td><td></td></tr><tr><td></td><td></td><td></td></tr></table>										<table border="1"><tr><td></td><td></td><td></td></tr><tr><td></td><td></td><td></td></tr><tr><td></td><td></td><td></td></tr></table>										<table border="1"><tr><td></td><td></td><td></td></tr><tr><td>1</td><td></td><td></td></tr><tr><td></td><td></td><td></td></tr></table>				1						<table border="1"><tr><td></td><td></td><td></td></tr><tr><td>1</td><td></td><td>1</td></tr><tr><td>1</td><td></td><td>1</td></tr></table>				1		1	1		1
		2																																																																													
2																																																																															
		1																																																																													
2		1																																																																													
1																																																																															
1		1																																																																													
1		1																																																																													
Post - 0 Miss - 0 Block - 0	Post - 0 Miss - 0 Block - 0	Post - 1 Miss - 1 Block - 0	Post - 0 Miss - 0 Block - 0	Post - 0 Miss - 0 Block - 0	Post - 0 Miss - 0 Block - 0	Post - 0 Miss - 0 Block - 0	Post - 0 Miss - 0 Block - 0																																																																								
18 崔娟	21 锁珊珊	23 张艺璇	26 宋婷婷	27 谢辰辰	32 杨雨柔	93 张婷婷																																																																									
<table border="1"><tr><td></td><td></td><td></td></tr><tr><td></td><td></td><td>1</td></tr><tr><td>2</td><td></td><td>1</td></tr></table>						1	2		1	<table border="1"><tr><td></td><td></td><td>1</td></tr><tr><td></td><td></td><td>1</td></tr><tr><td></td><td></td><td>3</td></tr></table>			1			1			3	<table border="1"><tr><td></td><td></td><td></td></tr><tr><td></td><td></td><td></td></tr><tr><td></td><td></td><td></td></tr></table>										<table border="1"><tr><td></td><td></td><td></td></tr><tr><td>1</td><td></td><td></td></tr><tr><td>2</td><td></td><td></td></tr></table>				1			2			<table border="1"><tr><td></td><td></td><td></td></tr><tr><td></td><td></td><td>1</td></tr><tr><td></td><td></td><td></td></tr></table>						1				<table border="1"><tr><td></td><td></td><td></td></tr><tr><td></td><td></td><td></td></tr><tr><td></td><td></td><td></td></tr></table>										<table border="1"><tr><td></td><td></td><td>1</td></tr><tr><td>1</td><td></td><td>2</td></tr><tr><td></td><td></td><td>1</td></tr></table>			1	1		2			1	<table border="1"><tr><td></td><td></td><td></td></tr><tr><td></td><td></td><td></td></tr><tr><td></td><td></td><td></td></tr></table>									
		1																																																																													
2		1																																																																													
		1																																																																													
		1																																																																													
		3																																																																													
1																																																																															
2																																																																															
		1																																																																													
		1																																																																													
1		2																																																																													
		1																																																																													
Post - 1 Miss - 0 Block - 0	Post - 0 Miss - 0 Block - 0	Post - 0 Miss - 0 Block - 0	Post - 0 Miss - 0 Block - 0	Post - 0 Miss - 0 Block - 0	Post - 0 Miss - 0 Block - 0	Post - 1 Miss - 1 Block - 0																																																																									

注释: Post=击柱 Miss=射失 Block=被封





预赛 Group A

女子 全国比赛

2016年全国女子手球锦标赛

Team A										Team B										Match Number											
A 山东					B 广东					2																					
played in					in the hall					on					at		Spectators														
China					滁州体育馆					03/09/2016					14:30		hours														
Half-time (30')		A		B		End of playing time		A		B		1st extra time		A		B		2nd extra time		A		B		After penalty		A		B			
		8		13		22		27																							
Number of 7 m		A		Team time-out			Full name of players and officials										Team time-out			B		Number of 7 m									
5 / 6		14:46		45:36															19:44		50:09		2 / 2								
No.	Team A										G	W	2'	D	DR	No.	Team B										G	W	2'	D	DR
1	路畅															3	安妮														
2	林燕群										3	1				5	李纯														
7	杨嘉露															7	刘彤										5		2		
8	王彬										5					8	李诗棋														
9	周钰婷										3					9	韦宝桂										6	1			
10	田秀秀										4	1				11	魏梦庭										5	1			
11	吕青纹										2	1				15	杨慧														
12	张苑琳															16	李娟														
15	吴作扬										3		1			18	李玉玲										1				
19	姜伟珊															19	邝雪花												2		
20	张悦															20	李军政														
22	朱赟															22	刘晓玉														
23	徐悦															23	王如										3				
28	崔金娜										1					26	马晓卉														
33	王彩琳															28	刘金兰										4	1			
77	穆庆丛										1					31	史小军										3				
B	马海湧 (主教练)										1					A	李细利														
C	徐强															B	郭艳辉 (主教练)														
E	王日东															D	祝捷														
																E	赵善良														
A		Signature of Responsible Official of the Teams (Off. A)										B																			
TP	Remarks of Referee / CHA Official										TP																				

Signatures

Referees	陈晓波 (CHN)	林晓佟 (CHN)		
Techn. Delegates	许宜扬 (CHN)			
CHA Official	高斌 (CHN)			

Note: Number of 7m Throws Awarded to Team A and B, Goals (G), Warnings (W), Suspensions (2), Direct Disqualification (D), Disqualification with Report (DR) and Team Penalty (TP).

Table Officials: 伍豪

陈文丽

Statisticians: 黄岩

陈柱





## 2016年全国女子手球锦标赛 竞赛技术统计(媒体表)

<b>预赛</b>	组别	<b>A</b>	轮次	<b>1</b>	场次	<b>2</b>
滁州体育馆		03/09/2016			201605002-51-1/1	
山东	<b>山东</b>	<b>22</b>	vs	<b>27</b>	广东	广东
		<b>8 : 13</b>				

裁判员	陈晓波 (CHN)	/	林晓佟 (CHN)
-----	-----------	---	-----------

山东														比赛进程		广东		
主教练：马海湧																		
远射	近射	边射	快攻	突破	任意球	7m球	合计	%	助攻	失误	警告	2'	D & DR					
1 刘畅															28 崔金娜	1st Half	1 01:26	0
2 林燕群	1/6			0/1	1/2		1/2	3/11	27.3						10 田秀秀	2 03:35	0	
7 杨嘉露															2 04:12	1	7 刘彤	
8 王彬	1/4	0/1	1/2				3/3	5/10	50.0	2	2				2 07:06	2	9 韦宝桂	
9 周钰婷	1/2	1/1		1/1				3/4	75.0	2	1				2 08:38	3	28 刘金兰	
10 田秀秀	2/7	1/3			1/1			4/11	36.4	1	7	1			3 09:59	3		
11 吕青纹			0/1	2/2				2/3	66.7						3 13:13	4	7 刘彤	
12 张苑琳															3 14:16	5	31 史小军	
15 吴作扬	2/6			0/1		0/1	1/1	3/9	33.3		4		1		3 15:20	6	9 韦宝桂	
19 姜伟珊															4 16:19	6		
20 张悦															4 16:52	7	11 魏梦庭	
22 朱贇															4 17:05	8	23 王如	
23 徐悦															5 18:13	8		
28 崔金娜		1/1						1/1	100	1					5 21:22	9	9 韦宝桂	
33 王彩琳															6 21:57	9		
77 穆庆丛		1/2		0/1				1/3	33.3						6 22:33	10	28 刘金兰	
<b>运动员 合计</b>	<b>7/25</b>	<b>4/8</b>	<b>1/3</b>	<b>3/6</b>	<b>2/3</b>	<b>0/1</b>	<b>5/6</b>	<b>22/52</b>	<b>42.3</b>	<b>6</b>	<b>18</b>	<b>3</b>	<b>1</b>		6 23:49	11	7 刘彤	
1 刘畅	2/3	1/4	3/5	1/2	0/1		0/1	7/16	43.8						7 25:09	11		
12 张苑琳	4/5	2/5	2/8	0/4	1/4		0/1	9/27	33.3						7 26:07	12	28 刘金兰	
<b>守门员 合计</b>	<b>6/8</b>	<b>3/9</b>	<b>5/13</b>	<b>1/6</b>	<b>1/5</b>		<b>0/2</b>	<b>16/43</b>	<b>37.2</b>						8 28:38	12		
广东																		
教练：郭艳辉																		
远射	近射	边射	快攻	突破	任意球	7m球	合计	%	助攻	失误	警告	2'	D & DR					
3 安妮															8 王彬	9 00:24	13	
5 李纯															9 00:56	14	11 魏梦庭	
7 刘彤	0/2	1/1	4/8					5/11	45.5				2		10 02:01	14		
8 李诗棋															10 02:42	15	23 王如	
9 韦宝桂	1/2	1/1	1/1	2/2	1/1			6/7	85.7	3	1	1			10 04:23	16	9 韦宝桂	
11 魏梦庭	1/5	2/2			2/2			5/9	55.6	1	2	1			11 05:13	16		
15 杨慧															12 06:37	16		
16 李娟															12 07:10	17	11 魏梦庭	
18 李玉玲	0/1						1/1	1/2	50.0						12 07:47	18	7 刘彤	
19 卞雪花	0/1	0/1		0/1				0/3	0.0						13 08:43	18		
20 李军政															13 09:16	19	28 刘金兰	
22 刘晓玉															14 10:31	19		
23 王如		2/3		1/1		0/1		3/5	60.0						14 11:27	20	9 韦宝桂	
26 马晓卉															15 12:30	20		
28 刘金兰			2/5	1/1			1/1	4/7	57.1						15 14:02	21	9 韦宝桂	
31 史小军		0/1	1/1	1/1	1/2			3/5	60.0						15 17:24	22	18 李玉玲	
<b>运动员 合计</b>	<b>2/11</b>	<b>6/9</b>	<b>8/15</b>	<b>5/6</b>	<b>4/5</b>	<b>0/1</b>	<b>2/2</b>	<b>27/49</b>	<b>55.1</b>	<b>4</b>	<b>13</b>	<b>3</b>	<b>4</b>		15 19:07	23	31 史小军	
22 刘晓玉	5/8	1/3	1/1	2/4	0/1		0/1	9/18	50.0						16 20:02	23		
26 马晓卉	2/6	2/4	1/2	0/1	1/2		0/4	6/19	31.6						17 20:55	23		
<b>守门员 合计</b>	<b>7/14</b>	<b>3/7</b>	<b>2/3</b>	<b>2/5</b>	<b>1/3</b>		<b>0/5</b>	<b>15/37</b>	<b>40.5</b>						18 21:57	23		

场上队员：得分 / 射门

守门员：救球 / 射门

快攻	Fast Break		突破	Breakthrough		任意球	Free Throw		7M球	7M Throw		助攻	Assist
警告	Warning		失误	Error		2'	Suspension		D	取消资格		DR	取消资格+报告





### 2016年全国女子手球锦标赛 图式比赛技术统计表

轮次 1

场次 2

201605002-21-1/1

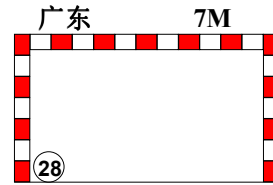
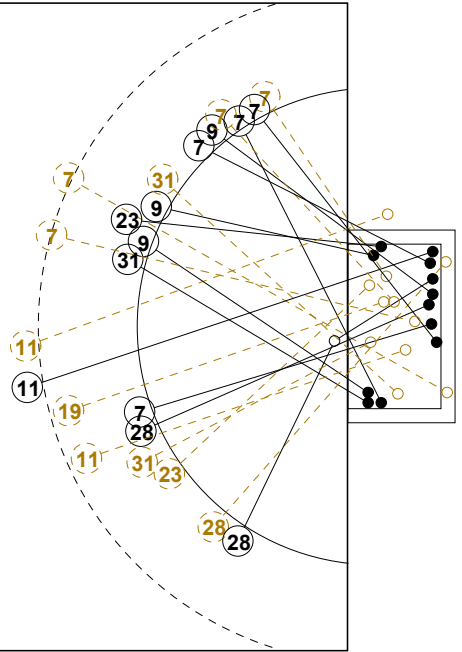
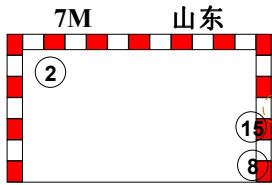
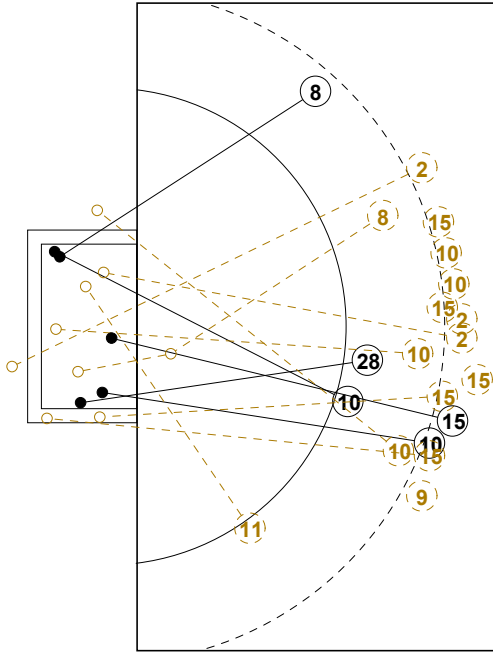

1st Half  
8 : 13

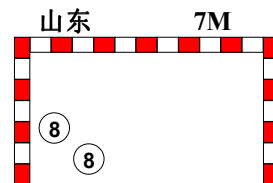
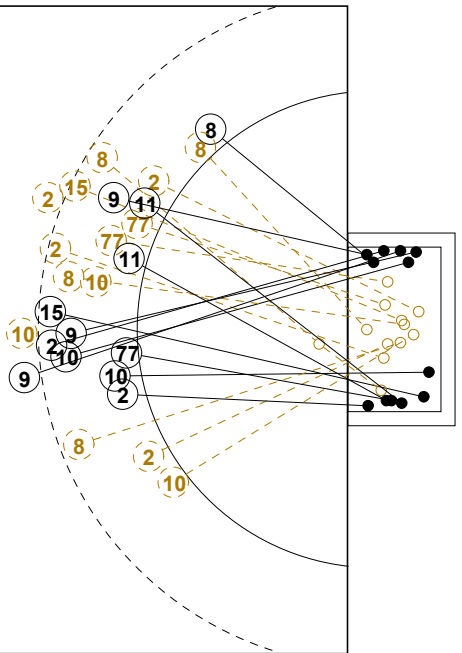
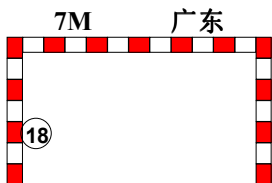
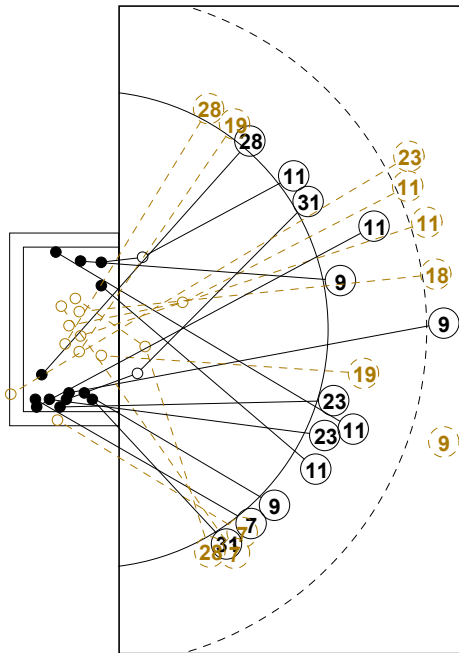

2nd Half  
27 : 22



## 2016年全国女子手球锦标赛

## 个人/全队技术统计表

正式表  
手球  
女子预赛  
轮次 1组别 A  
场次 2201605002-14-1/2  
滁州体育馆  
03/09/2016 14:30

号码	姓名	远射	近射	边射	快攻	突破	任意	7M	合计	%	助攻	失误	警告	2'	取消	时间
<b>山东(山东)</b>																
<i>(场上队员)</i>																
1	刘畅									0.0%						00:21:58
2	林燕群	1/6			0/1	1/2		1/2	3/11	27.3%		3	1			00:51:13
7	杨嘉露									0.0%						00:00:00
8	王彬	1/4	0/1	1/2				3/3	5/10	50.0%	2	2				00:33:09
9	周钰婷	1/2	1/1		1/1				3/4	75.0%	2	1				00:23:17
10	田秀秀	2/7	1/3			1/1			4/11	36.4%	1	7	1			00:48:27
11	吕青纹			0/1	2/2				2/3	66.7%			1			00:44:22
12	张苑琳									0.0%						00:38:02
15	吴作扬	2/6			0/1		0/1	1/1	3/9	33.3%		4		1		00:37:06
19	姜伟珊									0.0%						00:00:00
20	张悦									0.0%						00:59:55
22	朱赞									0.0%						00:00:00
23	徐悦									0.0%						00:02:19
28	崔金娜		1/1						1/1	100%	1					00:33:54
33	王彩琳									0.0%						00:00:00
77	穆庆丛		1/2		0/1				1/3	33.3%		1				00:26:00
<b>合计</b>		7/25	4/8	1/3	3/6	2/3	0/1	5/6	22/52	42.3%	6	18	3	1		
<i>(守门员)</i>																
1	刘畅	2/3	1/4	3/5	1/2	0/1		0/1	7/16	43.8%						00:21:58
12	张苑琳	4/5	2/5	2/8	0/4	1/4		0/1	9/27	33.3%						00:38:02
<b>合计</b>		6/8	3/9	5/13	1/6	1/5		0/2	16/43	37.2%						

场上队员：得分/射门

守门员：救球/射门

全队合计	得分	被救	射失	击柱	封球	合计	%
远射	7	7	2	1	8	25	28.0%
近射	4	3			1	8	50.0%
边射	1	2				3	33.3%
快攻	3	2			1	6	50.0%
突破	2	1				3	66.7%
任意				1		1	0.0%
7M	5			1		6	83.3%





## 2016年全国女子手球锦标赛

## 个人/全队技术统计表

正式表  
手球  
女子预赛  
轮次 1组别 A  
场次 2201605002-14-2/2  
滁州体育馆  
03/09/2016 14:30

号码	姓名	远射	近射	边射	快攻	突破	任意	7M	合计	%	助攻	失误	警告	2'	取消	时间
<b>广东(广东)</b>																
<i>(上场队员)</i>																
3	安妮									0.0%						00:10:25
5	李纯									0.0%						00:00:00
7	刘彤	0/2	1/1	4/8					5/11	45.5%		1		2		00:58:14
8	李诗棋									0.0%						00:00:00
9	韦宝桂	1/2	1/1	1/1	2/2	1/1			6/7	85.7%	3	1	1			00:49:34
11	魏梦庭	1/5	2/2			2/2			5/9	55.6%	1	2	1			00:54:12
15	杨慧									0.0%						00:00:00
16	李娟									0.0%						00:00:00
18	李玉玲	0/1						1/1	1/2	50.0%		2				00:05:35
19	邝雪花	0/1	0/1		0/1				0/3	0.0%		3		2		00:27:25
20	李军政									0.0%		1				00:11:15
22	刘晓玉									0.0%						00:20:24
23	王如		2/3		1/1		0/1		3/5	60.0%		1				00:43:37
26	马晓卉									0.0%						00:39:36
28	刘金兰			2/5	1/1			1/1	4/7	57.1%			1			00:48:53
31	史小军		0/1	1/1	1/1	1/2			3/5	60.0%		2				00:50:26
<b>合计</b>		2/11	6/9	8/15	5/6	4/5	0/1	2/2	27/49	55.1%	4	13	3	4		
<i>(守门员)</i>																
22	刘晓玉	5/8	1/3	1/1	2/4	0/1		0/1	9/18	50.0%						00:20:24
26	马晓卉	2/6	2/4	1/2	0/1	1/2		0/4	6/19	31.6%						00:39:36
<b>合计</b>		7/14	3/7	2/3	2/5	1/3		0/5	15/37	40.5%						

场上队员：得分/射门

守门员：救球/射门

全队合计	得分	被救	射失	击柱	封球	合计	%
远射	2	6	1	1	1	11	18.2%
近射	6	3				9	66.7%
边射	8	5		2		15	53.3%
快攻	5	1				6	83.3%
突破	4	1				5	80.0%
任意				1		1	0.0%
7M	2					2	100.0%





2016年全国女子手球锦标赛

图式射门区域统计

轮次 1 场次 2

201605002-41-1/1

山东

1 路畅	2 林燕群	7 杨嘉露	8 王彬	9 周钰婷	10 田秀秀	11 吕青纹	12 张苑琳																																																																								
<table border="1"><tr><td></td><td></td><td></td></tr><tr><td></td><td></td><td></td></tr><tr><td></td><td></td><td></td></tr></table>										<table border="1"><tr><td>1</td><td></td><td></td></tr><tr><td>1</td><td></td><td></td></tr><tr><td></td><td></td><td>1</td></tr></table>	1			1					1	<table border="1"><tr><td></td><td></td><td></td></tr><tr><td></td><td></td><td></td></tr><tr><td></td><td></td><td></td></tr></table>										<table border="1"><tr><td></td><td></td><td>1</td></tr><tr><td>1</td><td></td><td></td></tr><tr><td>2</td><td></td><td>1</td></tr></table>			1	1			2		1	<table border="1"><tr><td>1</td><td></td><td></td></tr><tr><td>1</td><td></td><td></td></tr><tr><td>1</td><td></td><td></td></tr></table>	1			1			1			<table border="1"><tr><td></td><td></td><td>2</td></tr><tr><td>2</td><td></td><td></td></tr><tr><td></td><td></td><td></td></tr></table>			2	2						<table border="1"><tr><td></td><td></td><td></td></tr><tr><td></td><td></td><td></td></tr><tr><td></td><td></td><td>2</td></tr></table>									2	<table border="1"><tr><td></td><td></td><td></td></tr><tr><td></td><td></td><td></td></tr><tr><td></td><td></td><td></td></tr></table>									
1																																																																															
1																																																																															
		1																																																																													
		1																																																																													
1																																																																															
2		1																																																																													
1																																																																															
1																																																																															
1																																																																															
		2																																																																													
2																																																																															
		2																																																																													
Post - 0 Miss - 0 Block - 0	Post - 1 Miss - 1 Block - 2	Post - 0 Miss - 0 Block - 0	Post - 0 Miss - 0 Block - 0	Post - 0 Miss - 0 Block - 1	Post - 0 Miss - 1 Block - 4	Post - 0 Miss - 0 Block - 0	Post - 0 Miss - 0 Block - 0																																																																								
15 吴作扬	19 姜伟珊	20 张悦	22 朱赟	23 徐悦	28 崔金娜	33 王彩琳	77 穆庆丛																																																																								
<table border="1"><tr><td></td><td></td><td>1</td></tr><tr><td></td><td></td><td>1</td></tr><tr><td></td><td>1</td><td></td></tr></table>			1			1		1		<table border="1"><tr><td></td><td></td><td></td></tr><tr><td></td><td></td><td></td></tr><tr><td></td><td></td><td></td></tr></table>										<table border="1"><tr><td></td><td></td><td></td></tr><tr><td></td><td></td><td></td></tr><tr><td></td><td></td><td></td></tr></table>										<table border="1"><tr><td></td><td></td><td></td></tr><tr><td></td><td></td><td></td></tr><tr><td></td><td></td><td></td></tr></table>										<table border="1"><tr><td></td><td></td><td></td></tr><tr><td></td><td></td><td></td></tr><tr><td></td><td></td><td></td></tr></table>										<table border="1"><tr><td></td><td></td><td></td></tr><tr><td>1</td><td></td><td></td></tr><tr><td></td><td></td><td></td></tr></table>				1						<table border="1"><tr><td></td><td></td><td></td></tr><tr><td></td><td></td><td></td></tr><tr><td></td><td></td><td></td></tr></table>										<table border="1"><tr><td></td><td></td><td></td></tr><tr><td></td><td></td><td>1</td></tr><tr><td></td><td></td><td></td></tr></table>						1			
		1																																																																													
		1																																																																													
	1																																																																														
1																																																																															
		1																																																																													
Post - 2 Miss - 0 Block - 3	Post - 0 Miss - 0 Block - 0	Post - 0 Miss - 0 Block - 0	Post - 0 Miss - 0 Block - 0	Post - 0 Miss - 0 Block - 0	Post - 0 Miss - 0 Block - 0	Post - 0 Miss - 0 Block - 0	Post - 0 Miss - 0 Block - 0																																																																								

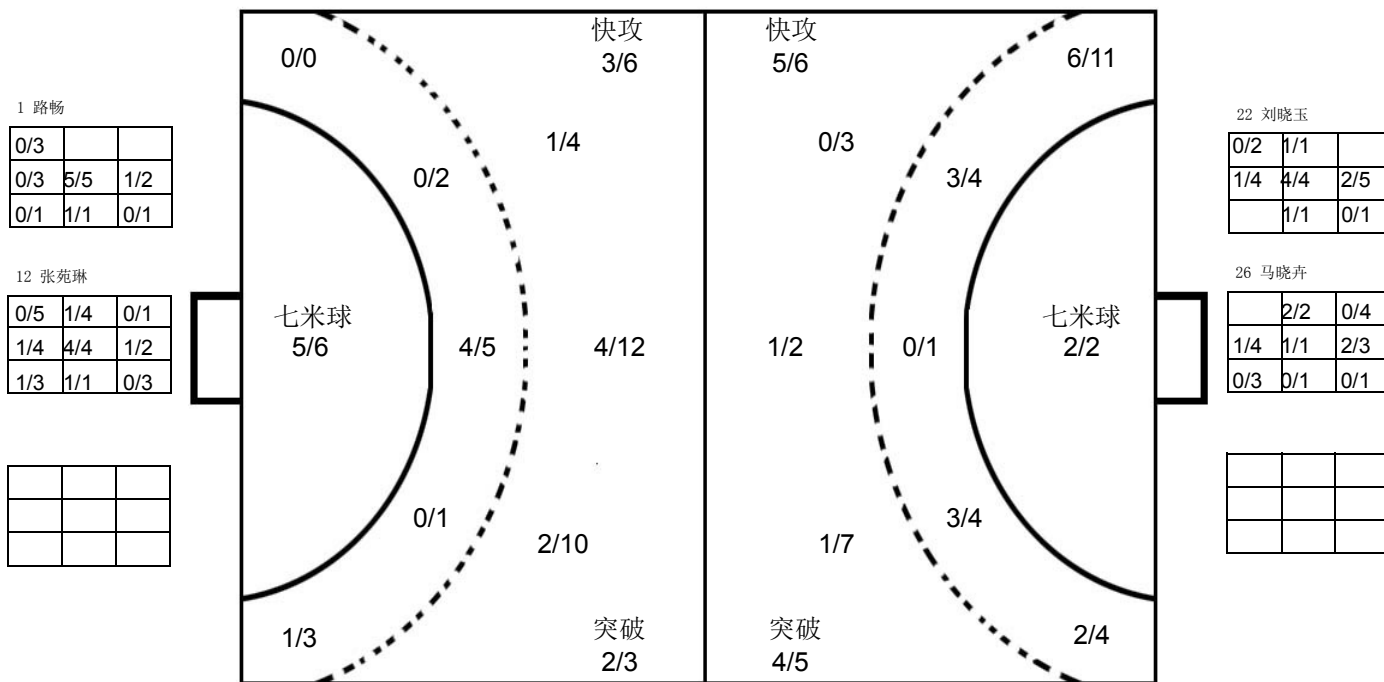

广东

3 安妮	5 李纯	7 刘彤	8 李诗棋	9 韦宝桂	11 魏梦庭	15 杨慧	16 李娟																																																																								
<table border="1"><tr><td></td><td></td><td></td></tr><tr><td></td><td></td><td></td></tr><tr><td></td><td></td><td></td></tr></table>										<table border="1"><tr><td></td><td></td><td></td></tr><tr><td></td><td></td><td></td></tr><tr><td></td><td></td><td></td></tr></table>										<table border="1"><tr><td>2</td><td>2</td><td></td></tr><tr><td></td><td></td><td>1</td></tr><tr><td></td><td></td><td></td></tr></table>	2	2				1				<table border="1"><tr><td></td><td></td><td></td></tr><tr><td></td><td></td><td></td></tr><tr><td></td><td></td><td></td></tr></table>										<table border="1"><tr><td>1</td><td></td><td></td></tr><tr><td>2</td><td></td><td>1</td></tr><tr><td>1</td><td></td><td>1</td></tr></table>	1			2		1	1		1	<table border="1"><tr><td>2</td><td></td><td>1</td></tr><tr><td></td><td></td><td></td></tr><tr><td></td><td></td><td>2</td></tr></table>	2		1						2	<table border="1"><tr><td></td><td></td><td></td></tr><tr><td></td><td></td><td></td></tr><tr><td></td><td></td><td></td></tr></table>										<table border="1"><tr><td></td><td></td><td></td></tr><tr><td></td><td></td><td></td></tr><tr><td></td><td></td><td></td></tr></table>									
2	2																																																																														
		1																																																																													
1																																																																															
2		1																																																																													
1		1																																																																													
2		1																																																																													
		2																																																																													
Post - 0 Miss - 0 Block - 0	Post - 0 Miss - 0 Block - 0	Post - 2 Miss - 0 Block - 0	Post - 0 Miss - 0 Block - 0	Post - 0 Miss - 0 Block - 1	Post - 0 Miss - 1 Block - 0	Post - 0 Miss - 0 Block - 0	Post - 0 Miss - 0 Block - 0																																																																								
18 李玉玲	19 邝雪花	20 李军政	22 刘晓玉	23 王如	26 马晓卉	28 刘金兰	31 史小军																																																																								
<table border="1"><tr><td>1</td><td></td><td></td></tr><tr><td></td><td></td><td></td></tr><tr><td></td><td></td><td></td></tr></table>	1									<table border="1"><tr><td></td><td></td><td></td></tr><tr><td></td><td></td><td></td></tr><tr><td></td><td></td><td></td></tr></table>										<table border="1"><tr><td></td><td></td><td></td></tr><tr><td></td><td></td><td></td></tr><tr><td></td><td></td><td></td></tr></table>										<table border="1"><tr><td></td><td></td><td></td></tr><tr><td></td><td></td><td></td></tr><tr><td></td><td></td><td></td></tr></table>										<table border="1"><tr><td>1</td><td></td><td></td></tr><tr><td>2</td><td></td><td></td></tr><tr><td></td><td></td><td></td></tr></table>	1			2						<table border="1"><tr><td></td><td></td><td></td></tr><tr><td></td><td></td><td></td></tr><tr><td></td><td></td><td></td></tr></table>										<table border="1"><tr><td>2</td><td>1</td><td></td></tr><tr><td></td><td></td><td></td></tr><tr><td>1</td><td></td><td></td></tr></table>	2	1					1			<table border="1"><tr><td></td><td></td><td></td></tr><tr><td>1</td><td></td><td></td></tr><tr><td></td><td></td><td>1</td></tr></table>				1					1
1																																																																															
1																																																																															
2																																																																															
2	1																																																																														
1																																																																															
1																																																																															
		1																																																																													
Post - 0 Miss - 0 Block - 0	Post - 0 Miss - 0 Block - 0	Post - 0 Miss - 0 Block - 0	Post - 0 Miss - 0 Block - 0	Post - 1 Miss - 0 Block - 0	Post - 0 Miss - 0 Block - 0	Post - 1 Miss - 0 Block - 0	Post - 0 Miss - 0 Block - 0																																																																								

注释: Post=击柱 Miss=射失 Block=被封





预赛 Group A

女子 全国比赛

2016年全国女子手球锦标赛

Team A A 安徽				Team B B 江苏				Match Number <b>3</b>													
played in China		in the hall 滁州体育馆		on 03/09/2016		at 16:00 hours		Spectators													
Half-time (30')	A 15	B 11	End of playing time	A 29	B 29	1st extra time	A	B	2nd extra time	A	B	After penalty throws	A 35	B 36							
Number of 7 m	A 9 / 11	Team time-out 1 21:38 2 32:51 3			Full name of players and officials				Team time-out 1 2 3 40:58 58:18			B 10 / 13	Number of 7 m								
No.	Team A					G	W	2'	D	DR	No.	Team B					G	W	2'	D	DR
1	司艳										1	陆婷									
3	李兵										3	张海侠					7	1			
5	班晨晨										4	赵佳芹					3			1	
6	沈萍					10					5	高媛媛									
7	赵江川										8	乔如					8		1		
8	徐仕媛										9	莫蒙蒙									
10	孙来苗					6		1			10	王可可									
14	刘晓妹					6					11	于源源					4				
16	朱莉珍										12	黄霞									
17	周婷					3		2			13	黄慧影									
18	郑冬冬										16	王小华									
20	周雪婷							1			17	修丽杰					1				
21	李瑶					5		1			18	韦秋香									
23	张天洁					1					23	王书慧					5	1			
41	杜机娟					4					33	金梦青					3				
46	陶传红										69	蓝小玲					5	1	1		
A	吴立军										B	金甲洙 (主教练)					1				
E	张舜										C	马彪									
											D	李海鹰									
											E	陈志伟									
A	Signature of Responsible Official of the Teams (Off. A)										B										
TP	Remarks of Referee / CHA Official										TP										

Signatures

Referees	张栋 (CHN)	马晓晔 (CHN)		
Techn. Delegates	于中迅 (CHN)			
CHA Official	刘书勇 (CHN)			

Note: Number of 7m Throws Awarded to Team A and B, Goals (G), Warnings (W), Suspensions (2'), Direct Disqualification (D), Disqualification with Report (DR) and Team Penalty (TP).

Table Officials: 佟金正

贾俊秋

Statisticians: 陈柱

闫冲

Printed by PHMS Copyright: IHF / CHA 03/09/2016 17:41:31

Longman Sportsoft



handball@126.com







## 2016年全国女子手球锦标赛 图式比赛技术统计表

轮次 1

场次 3

201605003-21-1/1

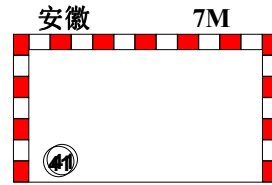
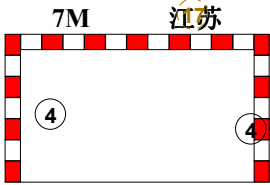
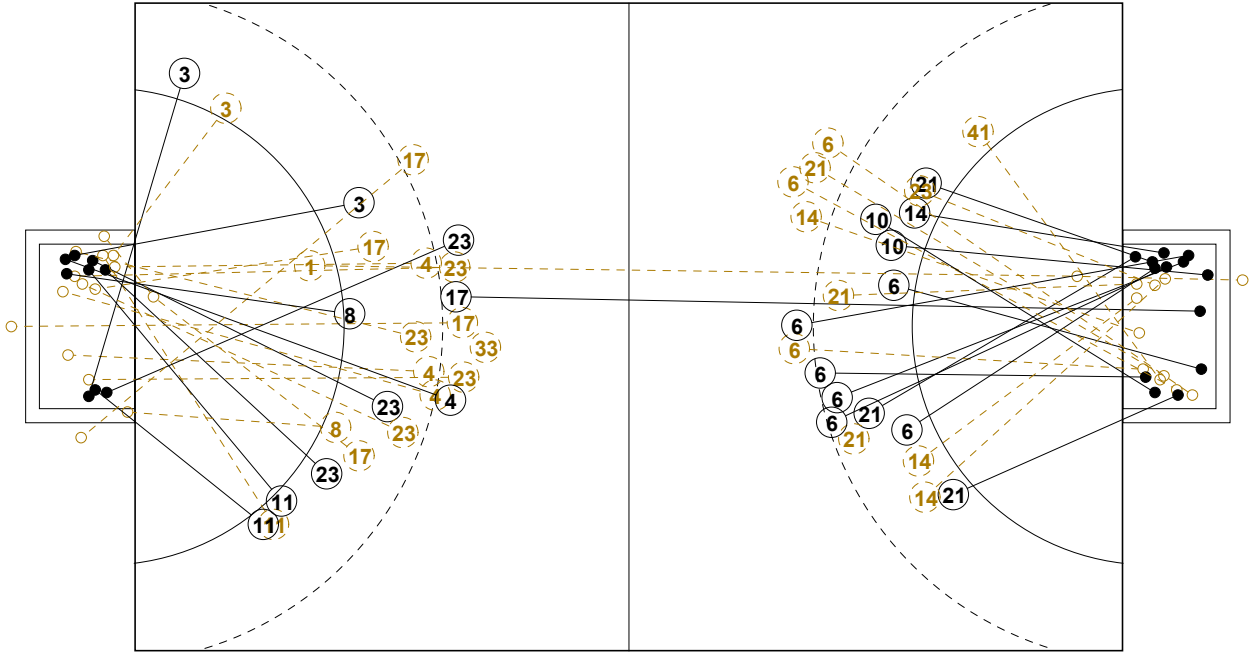

1st Half  
11 : 15

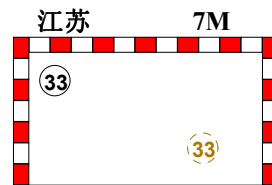
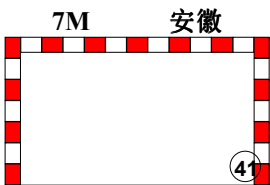
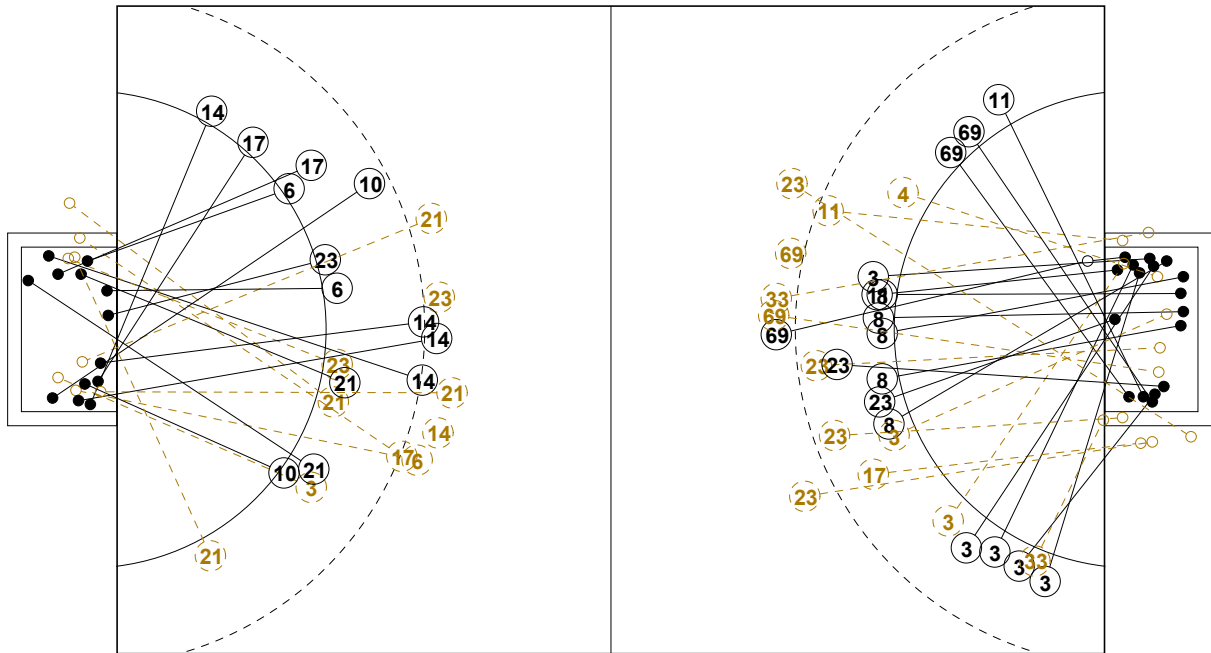

2nd Half  
29 : 29



### 2016年全国女子手球锦标赛 图式比赛技术统计表

轮次 1

场次 3

201605003-21-1/1

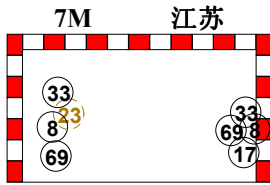
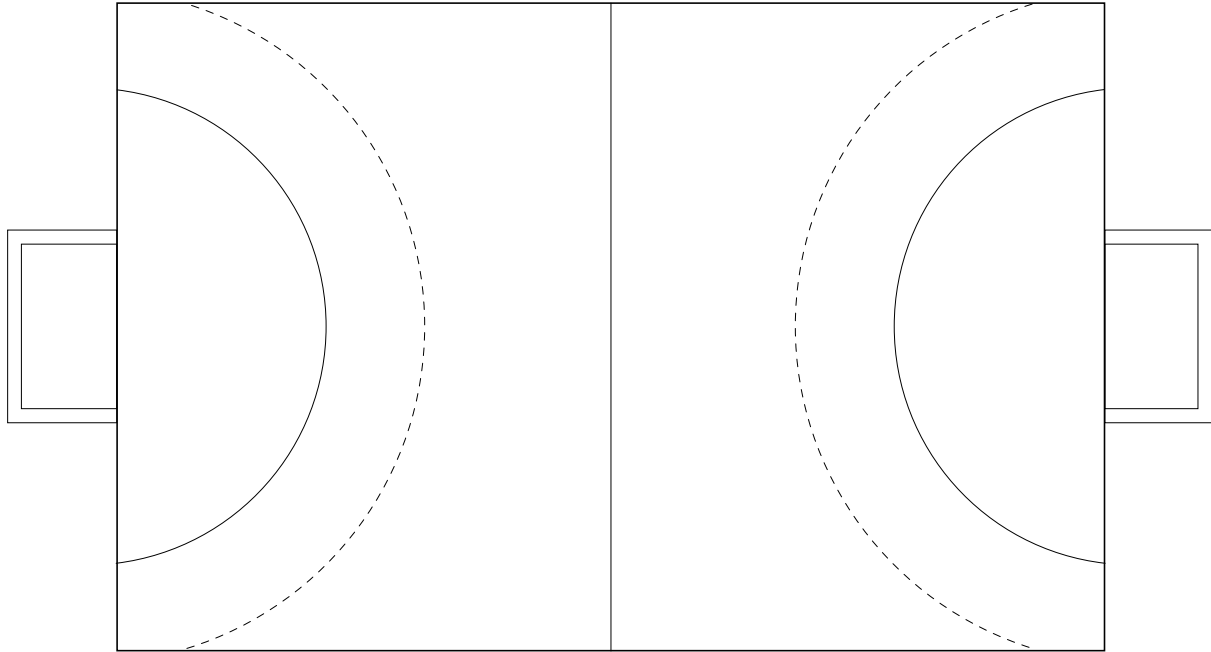

7M-Throw  
36 : 35

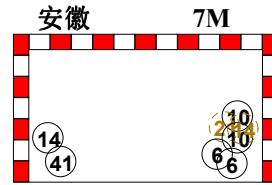



## 2016年全国女子手球锦标赛

个人/全队技术累计表

正式表  
手球  
女子

截至第 2场

201605002-15-1/1

安徽滁州

03/09/2016 14:30

号码	姓名	远射	近射	边射	快攻	突破	任意	7M	合计	%	助攻	失误	警告	2'	取消	场次	时间
<b>广东</b>																	
<i>(场上队员)</i>																	
3	安妮									0.0%						1	00:10:25
5	李纯									0.0%						1	00:00:00
7	刘彤	0/2	1/1	4/8					5/11	45.5%	1			2		1	00:58:14
8	李诗棋									0.0%						1	00:00:00
9	韦宝桂	1/2	1/1	1/1	2/2	1/1			6/7	85.7%	3	1	1			1	00:49:34
11	魏梦庭	1/5	2/2			2/2			5/9	55.6%	1	2	1			1	00:54:12
15	杨慧									0.0%						1	00:00:00
16	李娟									0.0%						1	00:00:00
18	李玉玲	0/1						1/1	1/2	50.0%		2				1	00:05:35
19	卞雪花	0/1	0/1		0/1				0/3	0.0%		3		2		1	00:27:25
20	李军政									0.0%		1				1	00:11:15
22	刘晓玉									0.0%						1	00:20:24
23	王如		2/3		1/1		0/1		3/5	60.0%		1				1	00:43:37
26	马晓卉									0.0%						1	00:39:36
28	刘金兰			2/5	1/1			1/1	4/7	57.1%			1			1	00:48:53
31	史小军		0/1	1/1	1/1	1/2			3/5	60.0%		2				1	00:50:26
<b>合计</b>																	
		2/11	6/9	8/15	5/6	4/5	0/1	2/2	27/49	55.1%	4	13	3	4		16	
<i>(守门员)</i>																	
22	刘晓玉	5/8	1/3	1/1	2/4	0/1		0/1	9/18	50.0%						1	00:20:24
26	马晓卉	2/6	2/4	1/2	0/1	1/2		0/4	6/19	31.6%						1	00:39:36
<b>合计</b>																	
		7/14	3/7	2/3	2/5	1/3		0/5	15/37	40.5%						2	

场上队员：得分/射门

守门员：救球/射门

已打比赛

全队合计	进球	被救	射失	击柱	封球	合计	%
远射	2	6	1	1	1	11	18.2%
近射	6	3				9	66.7%
边射	8	5		2		15	53.3%
快攻	5	1				6	83.3%
突破	4	1				5	80.0%
任意				1		1	0.0%
7M	2					2	100.0%

阶段	场次	对手	比分
预赛	2	山东	27:22 (13:8)





## 2016年全国女子手球锦标赛

## 个人/全队技术统计表

正式表  
手球  
女子预赛  
轮次 1组别 A  
场次 3201605003-14-1/2  
滁州体育馆  
03/09/2016 16:00

号码	姓名	远射	近射	边射	快攻	突破	任意	7M	合计	%	助攻	失误	警告	2'	取消	时间
<b>安徽(安徽)</b>																
<i>(场上队员)</i>																
1	司艳	0/1							0/1	0.0%						00:45:35
3	李兵		0/1						0/1	0.0%		3				00:40:02
5	班晨晨									0.0%						00:02:01
6	沈萍	4/7	4/4				0/1	2/2	10/14	71.4%		6				00:49:15
7	赵江川									0.0%						00:00:00
8	徐仕媛									0.0%						00:00:00
10	孙来苗	1/1	2/2		1/1			2/2	6/6	100%		1		1		00:38:46
14	刘晓妹	1/3	0/2	1/1	1/1		2/2	1/2	6/11	54.5%	1	3				00:45:44
16	朱莉珍									0.0%						00:14:25
17	周婷	1/2	1/1	1/1					3/4	75.0%		1		2		00:49:45
18	郑冬冬									0.0%						00:02:34
20	周雪婷									0.0%		1	1			00:13:51
21	李瑶	0/5	2/3	0/1	1/1	2/2		0/1	5/13	38.5%		3	1			00:52:59
23	张天洁	0/1	1/3						1/4	25.0%						00:36:14
41	杜机娟			0/1				4/4	4/5	80.0%						00:27:09
46	陶传红									0.0%						00:00:00
<b>合计</b>		7/20	10/16	2/4	3/3	2/2	2/3	9/11	35/59	59.3%	1	18	2	3		
<i>(守门员)</i>																
1	司艳	8/10	2/9	2/6	0/3	0/1	1/1	2/11	15/41	36.6%						00:45:35
16	朱莉珍	0/1	1/5	0/3	1/2			0/1	2/12	16.7%						00:14:25
<b>合计</b>		8/11	3/14	2/9	1/5	0/1	1/1	2/12	17/53	32.1%						

场上队员：得分/射门

守门员：救球/射门

全队合计	得分	被救	射失	击柱	封球	合计	%
远射	7	8	1	1	3	20	35.0%
近射	10	5	1			16	62.5%
边射	2	2				4	50.0%
快攻	3					3	100.0%
突破	2					2	100.0%
任意	2	1				3	66.7%
7M	9	2				11	81.8%





## 2016年全国女子手球锦标赛

## 个人/全队技术统计表

正式表  
手球  
女子预赛  
轮次 1组别 A  
场次 3201605003-14-2/2  
滁州体育馆  
03/09/2016 16:00

号码	姓名	远射	近射	边射	快攻	突破	任意	7M	合计	%	助攻	失误	警告	2'	取消	时间
<b>江苏(江苏)</b>																
<i>(上场队员)</i>																
1	陆婷									0.0%						00:05:19
3	张海侠		1/3	5/6	1/1				7/10	70.0%			1			00:59:51
4	赵佳芹	1/4			0/1			2/2	3/7	42.9%	1	1		1	00:41:34	
5	高媛媛									0.0%						00:00:00
8	乔如		6/7					2/2	8/9	88.9%		1		1		00:54:52
9	莫蒙蒙									0.0%						00:09:50
10	王可可									0.0%						00:00:00
11	于源源		1/1	1/2	2/3				4/6	66.7%		1				00:56:33
12	黄霞									0.0%						00:00:20
13	黄慧影									0.0%						00:00:00
16	王小华									0.0%		2				00:54:21
17	修丽杰	0/2	0/3					1/2	1/7	14.3%	1	2				00:43:30
18	韦秋香									0.0%						00:00:00
23	王书慧	1/9	3/3			1/1		0/1	5/14	35.7%		3	1			00:25:51
33	金梦青	0/2		0/1				3/4	3/7	42.9%	1	1				00:23:30
69	蓝小玲	1/2		1/1	1/1		0/1	2/2	5/7	71.4%		2	1	1		00:42:20
<b>合计</b>		3/19	11/17	7/10	4/6	1/1	0/1	10/13	36/67	53.7%	2	13	3	2	1	
<i>(守门员)</i>																
1	陆婷	0/1			0/1	0/1			0/3	0.0%						00:05:19
12	黄霞							2/9	2/9	22.2%						00:00:20
16	王小华	8/14	5/15	2/4	0/2	0/1	1/3	0/2	16/41	39.0%		2				00:54:21
<b>合计</b>		8/15	5/15	2/4	0/3	0/2	1/3	2/11	18/53	34.0%		2				

场上队员：得分/射门

守门员：救球/射门

全队合计	得分	被救	射失	击柱	封球	合计	%
远射	3	8	4	2	2	19	15.8%
近射	11	3	1	2		17	64.7%
边射	7	2		1		10	70.0%
快攻	4	1		1		6	66.7%
突破	1					1	100.0%
任意		1				1	0.0%
7M	10	2	1			13	76.9%





### 2016年全国女子手球锦标赛

#### 图式射门区域统计

轮次 1 场次 3

201605003-41-1/1

## 安徽

1 司艳	3 李兵	5 班晨晨	6 沈萍	7 赵江川	8 徐仕媛	10 孙来苗	14 刘晓妹																																																																								
<table border="1"><tr><td></td><td></td><td></td></tr><tr><td></td><td></td><td></td></tr><tr><td></td><td></td><td></td></tr></table>										<table border="1"><tr><td></td><td></td><td></td></tr><tr><td></td><td></td><td></td></tr><tr><td></td><td></td><td></td></tr></table>										<table border="1"><tr><td></td><td></td><td></td></tr><tr><td></td><td></td><td></td></tr><tr><td></td><td></td><td></td></tr></table>										<table border="1"><tr><td>1</td><td></td><td>1</td></tr><tr><td>3</td><td></td><td></td></tr><tr><td></td><td></td><td>5</td></tr></table>	1		1	3					5	<table border="1"><tr><td></td><td></td><td></td></tr><tr><td></td><td></td><td></td></tr><tr><td></td><td></td><td></td></tr></table>										<table border="1"><tr><td></td><td></td><td></td></tr><tr><td></td><td></td><td></td></tr><tr><td></td><td></td><td></td></tr></table>										<table border="1"><tr><td>2</td><td></td><td></td></tr><tr><td>1</td><td></td><td>3</td></tr><tr><td></td><td></td><td></td></tr></table>	2			1		3				<table border="1"><tr><td></td><td></td><td>1</td></tr><tr><td>3</td><td></td><td></td></tr><tr><td>2</td><td></td><td></td></tr></table>			1	3			2		
1		1																																																																													
3																																																																															
		5																																																																													
2																																																																															
1		3																																																																													
		1																																																																													
3																																																																															
2																																																																															
Post - 0 Miss - 1 Block - 0	Post - 0 Miss - 0 Block - 0	Post - 0 Miss - 0 Block - 0	Post - 0 Miss - 0 Block - 0	Post - 0 Miss - 0 Block - 0	Post - 0 Miss - 0 Block - 0	Post - 0 Miss - 0 Block - 0	Post - 0 Miss - 0 Block - 1																																																																								
16 朱莉珍	17 周婷	18 郑冬冬	20 周雪婷	21 李瑶	23 张天洁	41 杜机娟	46 陶传红																																																																								
<table border="1"><tr><td></td><td></td><td></td></tr><tr><td></td><td></td><td></td></tr><tr><td></td><td></td><td></td></tr></table>										<table border="1"><tr><td></td><td>1</td><td></td></tr><tr><td></td><td></td><td>1</td></tr><tr><td>1</td><td></td><td></td></tr></table>		1				1	1			<table border="1"><tr><td></td><td></td><td></td></tr><tr><td></td><td></td><td></td></tr><tr><td></td><td></td><td></td></tr></table>										<table border="1"><tr><td></td><td></td><td></td></tr><tr><td></td><td></td><td></td></tr><tr><td></td><td></td><td></td></tr></table>										<table border="1"><tr><td></td><td></td><td>1</td></tr><tr><td></td><td></td><td>2</td></tr><tr><td>2</td><td></td><td></td></tr></table>			1			2	2			<table border="1"><tr><td></td><td></td><td></td></tr><tr><td></td><td></td><td></td></tr><tr><td></td><td>1</td><td></td></tr></table>								1		<table border="1"><tr><td></td><td></td><td></td></tr><tr><td>3</td><td></td><td>1</td></tr><tr><td></td><td></td><td></td></tr></table>				3		1				<table border="1"><tr><td></td><td></td><td></td></tr><tr><td></td><td></td><td></td></tr><tr><td></td><td></td><td></td></tr></table>									
	1																																																																														
		1																																																																													
1																																																																															
		1																																																																													
		2																																																																													
2																																																																															
	1																																																																														
3		1																																																																													
Post - 0 Miss - 0 Block - 0	Post - 1 Miss - 0 Block - 0	Post - 0 Miss - 0 Block - 0	Post - 0 Miss - 0 Block - 0	Post - 0 Miss - 1 Block - 1	Post - 0 Miss - 0 Block - 1	Post - 0 Miss - 0 Block - 0	Post - 0 Miss - 0 Block - 0																																																																								

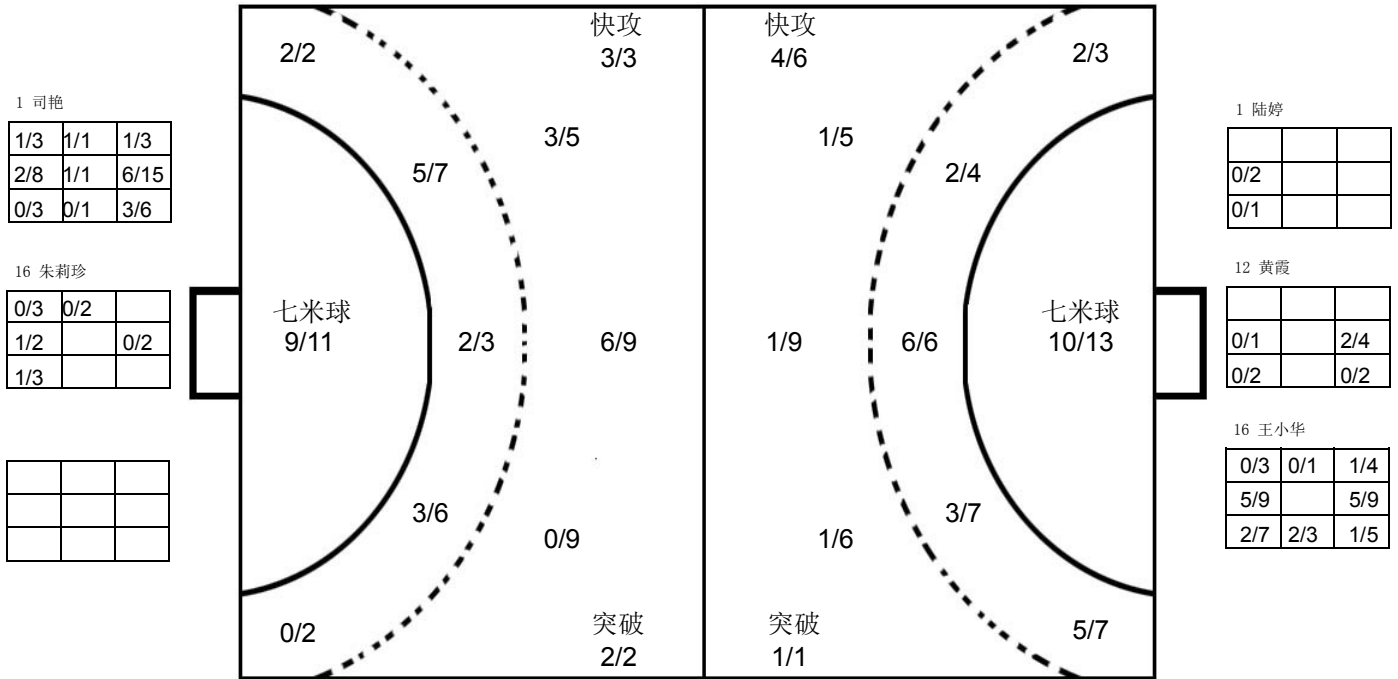

## 江苏

1 陆婷	3 张海侠	4 赵佳芹	5 高媛媛	8 乔如	9 莫蒙蒙	10 王可可	11 于源源																																																																								
<table border="1"><tr><td></td><td></td><td></td></tr><tr><td></td><td></td><td></td></tr><tr><td></td><td></td><td></td></tr></table>										<table border="1"><tr><td></td><td></td><td></td></tr><tr><td>4</td><td></td><td>2</td></tr><tr><td>1</td><td></td><td></td></tr></table>				4		2	1			<table border="1"><tr><td></td><td></td><td>1</td></tr><tr><td>1</td><td></td><td>1</td></tr><tr><td></td><td></td><td></td></tr></table>			1	1		1				<table border="1"><tr><td></td><td></td><td></td></tr><tr><td></td><td></td><td></td></tr><tr><td></td><td></td><td></td></tr></table>										<table border="1"><tr><td>3</td><td>2</td><td>1</td></tr><tr><td>1</td><td></td><td>1</td></tr><tr><td></td><td></td><td></td></tr></table>	3	2	1	1		1				<table border="1"><tr><td></td><td></td><td></td></tr><tr><td></td><td></td><td></td></tr><tr><td></td><td></td><td></td></tr></table>										<table border="1"><tr><td></td><td></td><td></td></tr><tr><td></td><td></td><td></td></tr><tr><td></td><td></td><td></td></tr></table>										<table border="1"><tr><td></td><td></td><td></td></tr><tr><td>1</td><td></td><td>2</td></tr><tr><td>1</td><td></td><td></td></tr></table>				1		2	1		
4		2																																																																													
1																																																																															
		1																																																																													
1		1																																																																													
3	2	1																																																																													
1		1																																																																													
1		2																																																																													
1																																																																															
Post - 0 Miss - 0 Block - 0	Post - 0 Miss - 0 Block - 0	Post - 0 Miss - 0 Block - 0	Post - 0 Miss - 0 Block - 0	Post - 1 Miss - 0 Block - 0	Post - 0 Miss - 0 Block - 0	Post - 0 Miss - 0 Block - 0	Post - 1 Miss - 0 Block - 0																																																																								
12 黄霞	13 黄慧影	16 王小华	17 修丽杰	18 韦秋香	23 王书慧	33 金梦青	69 蓝小玲																																																																								
<table border="1"><tr><td></td><td></td><td></td></tr><tr><td></td><td></td><td></td></tr><tr><td></td><td></td><td></td></tr></table>										<table border="1"><tr><td></td><td></td><td></td></tr><tr><td></td><td></td><td></td></tr><tr><td></td><td></td><td></td></tr></table>										<table border="1"><tr><td></td><td></td><td></td></tr><tr><td></td><td></td><td></td></tr><tr><td></td><td></td><td></td></tr></table>										<table border="1"><tr><td></td><td></td><td></td></tr><tr><td></td><td></td><td></td></tr><tr><td></td><td></td><td>1</td></tr></table>									1	<table border="1"><tr><td></td><td></td><td></td></tr><tr><td></td><td></td><td></td></tr><tr><td></td><td></td><td></td></tr></table>										<table border="1"><tr><td></td><td></td><td></td></tr><tr><td></td><td></td><td>2</td></tr><tr><td>1</td><td>1</td><td>1</td></tr></table>						2	1	1	1	<table border="1"><tr><td>2</td><td></td><td></td></tr><tr><td></td><td></td><td>1</td></tr><tr><td></td><td></td><td></td></tr></table>	2					1				<table border="1"><tr><td></td><td></td><td></td></tr><tr><td></td><td></td><td>2</td></tr><tr><td>2</td><td></td><td>1</td></tr></table>						2	2		1
		1																																																																													
		2																																																																													
1	1	1																																																																													
2																																																																															
		1																																																																													
		2																																																																													
2		1																																																																													
Post - 0 Miss - 0 Block - 0	Post - 0 Miss - 0 Block - 0	Post - 0 Miss - 0 Block - 0	Post - 1 Miss - 4 Block - 0	Post - 0 Miss - 0 Block - 0	Post - 1 Miss - 2 Block - 0	Post - 2 Miss - 0 Block - 1	Post - 0 Miss - 0 Block - 1																																																																								

注释: Post=击柱 Miss=射失 Block=被封





预赛 Group B

女子 全国比赛

2016年全国女子手球锦标赛

Team A A 上海				Team B B 北京				Match Number 4													
played in China		in the hall 滁州体育馆		on 03/09/2016		at 17:30 hours		Spectators													
Half-time (30')	A 19	B 10	End of playing time	A 32	B 17	1st extra time	A	B	2nd extra time	A	B	After penalty throws	A	B							
Number of 7 m	A 4 / 5	Team time-out			Full name of players and officials				Team time-out			B 2 / 4	Number of 7 m								
No.	Team A					G	W	2'	D	DR	No.	Team B					G	W	2'	D	DR
1	许沫										1	宋嘉蕾									
2	周蕾					3	1	1			3	季小桐					2	1	1		
5	郭威					1					4	孙佳								1	
6	黄妍					4					6	刘亚男						1			
7	车婉茹					1					8	杨铭豫					1				
8	吴茵					4	1				10	刘莎					1	1			
9	武娜娜					3					11	纪婉									
10	斯文					5					16	王海叶									
11	孙梦颖					5					17	杨政赢									
12	郑冯										22	李海鸥					2				
13	徐娟					1					23	田媛					1				
17	居晔										28	闫美珠					3				
18	沙正文					2	1				33	栾征									
19	印尼					3					47	刘泽									
21	王嘉怡										58	李华									
23	都好										69	石梓薇					7				
B	陈进培 (主教练)										A	蔡建国									
C	金锺顺										B	石伟 (主教练)									
D	贺业磊										C	李翼									
F	周瑜宸										E	史良玉									
A	Signature of Responsible Official of the Teams (Off. A)																		B		
TP	Remarks of Referee / CHA Official																		TP		

Signatures

Referees: 严璐 (CHN)      王雨洋 (CHN)

Techn. Delegates: 许宜扬 (CHN)

CHA Official: 刘书勇 (CHN)

Note: Number of 7m Throws Awarded to Team A and B, Goals (G), Warnings (W), Suspensions (2'), Direct Disqualification (D), Disqualification with Report (DR) and Team Penalty (TP).

Table Officials: 伍豪

陈文丽

Statisticians: 闫冲

黄岩

Printed by PHMS Copyright: IHF / CHA 03/09/2016 18:55:50

Longman Sportsoft



handball@126.com



2016年全国女子手球锦标赛  
竞赛技术统计(媒体表)

预赛	组别	B	轮次	1	场次	4
滁州体育馆		03/09/2016			201605004-51-1/1	
上海		上海	32	vs	17	北京
		19:10				北京

裁判员	严璐 (CHN)		/	王雨洋 (CHN)	
-----	----------	--	---	-----------	--

上海		远射	近射	边射	快攻	突破	任意球	7m球	合计	%	助攻	失误	警告	2'	D & DR	上海	比赛进程	北京
主教练: 陈进培																		
1	许沫										1					8	吴茵	1 00:27 0
2	周蕾		1/1	1/3	1/2				3/6	50.0	1		1	1		11	孙梦颖	2 01:55 0
5	郭威	0/2	1/1						1/3	33.3						6	黄妍	3 02:28 1
6	黄妍	1/3	2/4					1/1	4/8	50.0		1				8	吴茵	4 03:08 1
7	车婉茹		0/1					1/1	1/2	50.0						11	孙梦颖	5 04:47 1
8	吴茵		3/4					1/1	4/5	80.0	4		1			6	黄妍	5 05:36 2
9	武娜娜		1/1		2/3				3/4	75.0		1				2	周蕾	6 06:19 2
10	斯文	1/1	1/2	1/1	2/2				5/6	83.3						10	斯文	7 06:52 2
11	孙梦颖	2/4	1/1		2/2			0/1	5/8	62.5		1				7	吴茵	8 08:55 3
12	郑冯															8	斯文	8 10:10 3
13	徐娟							1/1	1/1	100						8	吴茵	8 10:59 4
17	居晔		0/1						0/1	0.0						8	斯文	8 12:30 5
18	沙正文		2/3						2/3	66.7			1			8	孙梦颖	8 12:34 6
19	印尼		1/1	1/1		1/1			3/3	100						9	孙梦颖	9 12:58 6
21	王嘉怡															2	周蕾	9 14:05 6
23	都好															18	沙正文	10 14:05 6
运动员 合计		4/10	13/20	3/5	7/9	1/1		4/5	32/50	64.0	6	3	3	1		2	周蕾	10 15:17 6
1	许沫	4/8	9/13	2/3		0/2	0/1	2/3	17/30	56.7	1					8	吴茵	11 16:44 6
12	郑冯		0/1	0/2				0/1	0/4	0.0						5	郭威	12 16:44 6
守门员 合计		4/8	9/14	2/5		0/2	0/1	2/4	17/34	50.0	1					11	孙梦颖	13 16:57 6
北京		远射	近射	边射	快攻	突破	任意球	7m球	合计	%	助攻	失误	警告	2'	D & DR	2nd Half		
教练: 石伟																19	01:28	11 69 石梓薇
1	宋嘉蕾															9	武娜娜	19 02:51 12 69 石梓薇
3	季小桐	0/2	0/1			1/1		1/1	2/5	40.0		3	1	1		9	武娜娜	20 04:35 12
4	孙佳		0/1						0/1	0.0						9	武娜娜	21 05:20 12
6	刘亚男										1	1	1			21	05:52	13 69 石梓薇
8	杨铭豫		1/1						1/1	100						8	吴茵	22 06:04 13
10	刘莎	1/1		0/1					1/2	50.0			1			9	武娜娜	23 06:49 13
11	纪婉		0/1					0/1	0/2	0.0		1				19	印尼	24 08:05 13
16	王海叶															18	沙正文	25 09:19 13
17	杨政赢	0/1	0/1						0/2	0.0		1				19	印尼	26 10:27 13
22	李海鸥		2/4						2/4	50.0						26	11:37	14 3 季小桐
23	田媛			1/1					1/1	100	1	1				10	斯文	27 12:33 14
28	闫美珠	2/10	0/1				1/1		3/12	25.0						27	12:46	15 69 石梓薇
33	栾征		0/1						0/1	0.0						10	斯文	28 13:08 15
47	刘泽															10	斯文	29 13:43 15
58	李华			0/1					0/1	0.0		1				19	印尼	29 13:58 16
69	石梓薇	1/3	2/4	2/2		1/1		1/2	7/12	58.3		1				30	14:26	16 8 杨铭豫
运动员 合计		4/17	5/15	3/5		2/2	1/1	2/4	17/44	38.6	2	9	3	2		30	15:54	17 23 田媛
1	宋嘉蕾	4/7	2/11	1/3	0/4			1/3	8/28	28.6						13	徐娟	31 16:37 17
16	王海叶	0/1	4/8	1/2	2/5	0/1		0/2	7/19	36.8						7	车婉茹	32 17:51 17
守门员 合计		4/8	6/19	2/5	2/9	0/1		1/5	15/47	31.9								

场上队员: 得分 / 射门

守门员: 救球 / 射门

快攻	Fast Break		突破	Breakthrough		任意球	Free Throw		7M球	7M Throw		助攻	Assist
警告	Warning		失误	Error		2'	Suspension		D	取消资格		DR	取消资格+报告







## 2016年全国女子手球锦标赛

## 个人/全队技术统计表

正式表  
手球  
女子预赛  
轮次 1组别 B  
场次 4201605004-14-1/2  
滁州体育馆  
03/09/2016 17:30

号码	姓名	远射	近射	边射	快攻	突破	任意	7M	合计	%	助攻	失误	警告	2'	取消	时间
<b>上海(上海)</b>																
<i>(场上队员)</i>																
1	许沫									0.0%	1					00:41:24
2	周蕾		1/1	1/3	1/2				3/6	50.0%	1		1	1		00:28:43
5	郭威	0/2	1/1						1/3	33.3%						00:16:46
6	黄妍	1/3	2/4					1/1	4/8	50.0%		1				00:39:10
7	车婉茹		0/1					1/1	1/2	50.0%						00:07:38
8	吴茵		3/4					1/1	4/5	80.0%	4		1			00:28:29
9	武娜娜		1/1		2/3				3/4	75.0%		1				00:39:17
10	斯文	1/1	1/2	1/1	2/2				5/6	83.3%			1			00:27:48
11	孙梦颖	2/4	1/1		2/2			0/1	5/8	62.5%		1				00:31:38
12	郑冯									0.0%						00:06:34
13	徐娟							1/1	1/1	100%						00:02:38
17	居晔		0/1						0/1	0.0%						00:08:22
18	沙正文		2/3						2/3	66.7%			1			00:36:32
19	印尼		1/1	1/1		1/1			3/3	100%						00:10:00
21	王嘉怡									0.0%						00:04:11
23	都好									0.0%						00:06:05
<b>合计</b>		4/10	13/20	3/5	7/9	1/1		4/5	32/50	64.0%	6	3	3	1		
<i>(守门员)</i>																
1	许沫	4/8	9/13	2/3		0/2	0/1	2/3	17/30	56.7%	1					00:41:24
12	郑冯		0/1	0/2				0/1	0/4	0.0%						00:06:34
<b>合计</b>		4/8	9/14	2/5		0/2	0/1	2/4	17/34	50.0%	1					

场上队员：得分/射门

守门员：救球/射门

全队合计	得分	被救	射失	击柱	封球	合计	%
远射	4	4	1		1	10	40.0%
近射	13	6		1		20	65.0%
边射	3	2				5	60.0%
快攻	7	2				9	77.8%
突破	1					1	100.0%
任意							0.0%
7M	4	1				5	80.0%





## 2016年全国女子手球锦标赛

## 个人/全队技术统计表

正式表  
手球  
女子预赛  
轮次 1组别 B  
场次 4201605004-14-2/2  
滁州体育馆  
03/09/2016 17:30

号码	姓名	远射	近射	边射	快攻	突破	任意	7M	合计	%	助攻	失误	警告	2'	取消	时间
<b>北京(北京)</b>																
<i>(上场队员)</i>																
1	宋嘉蕾									0.0%						00:30:12
3	季小桐	0/2	0/1			1/1		1/1	2/5	40.0%		3	1	1		00:41:19
4	孙佳		0/1						0/1	0.0%				1		00:10:36
6	刘亚男									0.0%	1	1	1			00:30:00
8	杨铭豫		1/1						1/1	100%						00:17:57
10	刘莎	1/1		0/1					1/2	50.0%			1			00:30:00
11	纪婉		0/1					0/1	0/2	0.0%		1				00:17:57
16	王海叶									0.0%						00:17:46
17	杨政赢	0/1	0/1						0/2	0.0%		1				00:14:10
22	李海鸥		2/4						2/4	50.0%						00:30:00
23	田媛			1/1					1/1	100%	1	1				00:11:05
28	闫美珠	2/10	0/1				1/1		3/12	25.0%						00:30:00
33	栾征		0/1						0/1	0.0%						00:11:10
47	刘泽									0.0%						00:00:00
58	李华			0/1					0/1	0.0%		1				00:02:57
69	石梓薇	1/3	2/4	2/2		1/1		1/2	7/12	58.3%		1				00:40:50
<b>合计</b>		4/17	5/15	3/5		2/2	1/1	2/4	17/44	38.6%	2	9	3	2		
<i>(守门员)</i>																
1	宋嘉蕾	4/7	2/11	1/3	0/4			1/3	8/28	28.6%						00:30:12
16	王海叶	0/1	4/8	1/2	2/5	0/1		0/2	7/19	36.8%						00:17:46
<b>合计</b>		4/8	6/19	2/5	2/9	0/1		1/5	15/47	31.9%						

场上队员：得分/射门

守门员：救球/射门

全队合计	得分	被救	射失	击柱	封球	合计	%
远射	4	4	3		6	17	23.5%
近射	5	9		1		15	33.3%
边射	3	2				5	60.0%
快攻							0.0%
突破	2					2	100.0%
任意	1					1	100.0%
7M	2	2				4	50.0%





### 2016年全国女子手球锦标赛

#### 图式射门区域统计

轮次 1 场次 4

201605004-41-1/1

## 上海

1 许沫	2 周蕾	5 郭威	6 黄妍	7 车婉茹	8 吴茵	9 武娜娜	10 斯文																																																																								
<table border="1"><tr><td></td><td></td><td></td></tr><tr><td></td><td></td><td></td></tr><tr><td></td><td></td><td></td></tr></table>										<table border="1"><tr><td></td><td></td><td></td></tr><tr><td>2</td><td></td><td></td></tr><tr><td>1</td><td></td><td></td></tr></table>				2			1			<table border="1"><tr><td>1</td><td></td><td></td></tr><tr><td></td><td></td><td></td></tr><tr><td></td><td></td><td></td></tr></table>	1									<table border="1"><tr><td></td><td></td><td>1</td></tr><tr><td>1</td><td></td><td>1</td></tr><tr><td>1</td><td></td><td></td></tr></table>			1	1		1	1			<table border="1"><tr><td></td><td></td><td>1</td></tr><tr><td></td><td></td><td></td></tr><tr><td></td><td></td><td></td></tr></table>			1							<table border="1"><tr><td></td><td></td><td></td></tr><tr><td>1</td><td></td><td></td></tr><tr><td>2</td><td></td><td>1</td></tr></table>				1			2		1	<table border="1"><tr><td></td><td></td><td></td></tr><tr><td>1</td><td></td><td></td></tr><tr><td></td><td></td><td>1</td></tr></table>				1					1	<table border="1"><tr><td></td><td></td><td></td></tr><tr><td>2</td><td></td><td>1</td></tr><tr><td>2</td><td></td><td></td></tr></table>				2		1	2		
2																																																																															
1																																																																															
1																																																																															
		1																																																																													
1		1																																																																													
1																																																																															
		1																																																																													
1																																																																															
2		1																																																																													
1																																																																															
		1																																																																													
2		1																																																																													
2																																																																															
Post - 0 Miss - 0 Block - 0	Post - 0 Miss - 0 Block - 0	Post - 0 Miss - 0 Block - 1	Post - 0 Miss - 0 Block - 0	Post - 0 Miss - 0 Block - 0	Post - 0 Miss - 0 Block - 0	Post - 0 Miss - 0 Block - 0	Post - 0 Miss - 0 Block - 0																																																																								
11 孙梦颖	12 郑冯	13 徐娟	17 居晔	18 沙正文	19 印尼	21 王嘉怡	23 都好																																																																								
<table border="1"><tr><td></td><td></td><td></td></tr><tr><td>3</td><td></td><td>1</td></tr><tr><td></td><td></td><td>1</td></tr></table>				3		1			1	<table border="1"><tr><td></td><td></td><td></td></tr><tr><td></td><td></td><td></td></tr><tr><td></td><td></td><td></td></tr></table>										<table border="1"><tr><td></td><td></td><td></td></tr><tr><td></td><td></td><td>1</td></tr><tr><td></td><td></td><td></td></tr></table>						1				<table border="1"><tr><td></td><td></td><td></td></tr><tr><td></td><td></td><td></td></tr><tr><td></td><td></td><td></td></tr></table>										<table border="1"><tr><td></td><td></td><td>1</td></tr><tr><td></td><td></td><td>1</td></tr><tr><td></td><td></td><td></td></tr></table>			1			1				<table border="1"><tr><td></td><td></td><td>1</td></tr><tr><td></td><td></td><td>1</td></tr><tr><td></td><td></td><td></td></tr></table>			1			1				<table border="1"><tr><td></td><td></td><td></td></tr><tr><td></td><td></td><td></td></tr><tr><td></td><td></td><td></td></tr></table>										<table border="1"><tr><td></td><td></td><td></td></tr><tr><td></td><td></td><td></td></tr><tr><td></td><td></td><td></td></tr></table>									
3		1																																																																													
		1																																																																													
		1																																																																													
		1																																																																													
		1																																																																													
		1																																																																													
		1																																																																													
Post - 0 Miss - 1 Block - 0	Post - 0 Miss - 0 Block - 0	Post - 0 Miss - 0 Block - 0	Post - 1 Miss - 0 Block - 0	Post - 0 Miss - 0 Block - 0	Post - 0 Miss - 0 Block - 0	Post - 0 Miss - 0 Block - 0	Post - 0 Miss - 0 Block - 0																																																																								

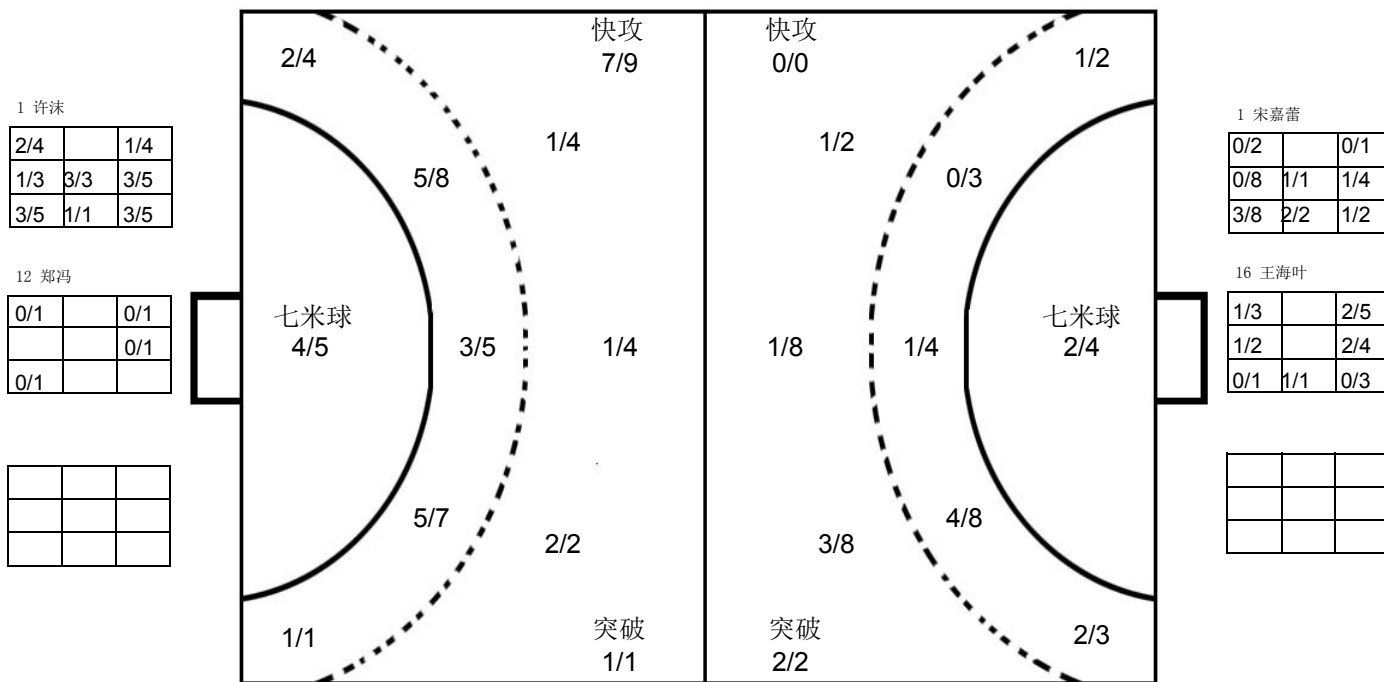

## 北京

1 宋嘉蕾	3 季小桐	4 孙佳	6 刘亚男	8 杨铭豫	10 刘莎	11 纪婉	16 王海叶																																																																								
<table border="1"><tr><td></td><td></td><td></td></tr><tr><td></td><td></td><td></td></tr><tr><td></td><td></td><td></td></tr></table>										<table border="1"><tr><td></td><td></td><td>1</td></tr><tr><td></td><td></td><td>1</td></tr><tr><td></td><td></td><td></td></tr></table>			1			1				<table border="1"><tr><td></td><td></td><td></td></tr><tr><td></td><td></td><td></td></tr><tr><td></td><td></td><td></td></tr></table>										<table border="1"><tr><td></td><td></td><td></td></tr><tr><td></td><td></td><td></td></tr><tr><td></td><td></td><td></td></tr></table>										<table border="1"><tr><td></td><td></td><td></td></tr><tr><td>1</td><td></td><td></td></tr><tr><td></td><td></td><td></td></tr></table>				1						<table border="1"><tr><td></td><td></td><td></td></tr><tr><td></td><td></td><td>1</td></tr><tr><td></td><td></td><td></td></tr></table>						1				<table border="1"><tr><td></td><td></td><td></td></tr><tr><td></td><td></td><td></td></tr><tr><td></td><td></td><td></td></tr></table>										<table border="1"><tr><td></td><td></td><td></td></tr><tr><td></td><td></td><td></td></tr><tr><td></td><td></td><td></td></tr></table>									
		1																																																																													
		1																																																																													
1																																																																															
		1																																																																													
Post - 0 Miss - 0 Block - 0	Post - 0 Miss - 0 Block - 1	Post - 0 Miss - 0 Block - 0	Post - 0 Miss - 0 Block - 0	Post - 0 Miss - 0 Block - 0	Post - 0 Miss - 0 Block - 0	Post - 0 Miss - 0 Block - 0	Post - 0 Miss - 0 Block - 0																																																																								
17 杨政赢	22 李海鸥	23 田媛	28 闫美珠	33 栾征	47 刘泽	58 李华	69 石梓薇																																																																								
<table border="1"><tr><td></td><td></td><td></td></tr><tr><td></td><td></td><td></td></tr><tr><td></td><td></td><td></td></tr></table>										<table border="1"><tr><td></td><td></td><td>1</td></tr><tr><td></td><td></td><td></td></tr><tr><td>1</td><td></td><td></td></tr></table>			1				1			<table border="1"><tr><td></td><td></td><td></td></tr><tr><td></td><td></td><td>1</td></tr><tr><td></td><td></td><td></td></tr></table>						1				<table border="1"><tr><td></td><td></td><td>2</td></tr><tr><td></td><td></td><td></td></tr><tr><td></td><td></td><td>1</td></tr></table>			2						1	<table border="1"><tr><td></td><td></td><td></td></tr><tr><td></td><td></td><td></td></tr><tr><td></td><td></td><td></td></tr></table>										<table border="1"><tr><td></td><td></td><td></td></tr><tr><td></td><td></td><td></td></tr><tr><td></td><td></td><td></td></tr></table>										<table border="1"><tr><td></td><td></td><td></td></tr><tr><td></td><td></td><td></td></tr><tr><td></td><td></td><td></td></tr></table>										<table border="1"><tr><td></td><td></td><td>1</td></tr><tr><td></td><td></td><td>2</td></tr><tr><td></td><td></td><td>1</td></tr></table>			1			2			1
		1																																																																													
1																																																																															
		1																																																																													
		2																																																																													
		1																																																																													
		1																																																																													
		2																																																																													
		1																																																																													
Post - 0 Miss - 0 Block - 1	Post - 0 Miss - 0 Block - 0	Post - 0 Miss - 0 Block - 0	Post - 0 Miss - 3 Block - 3	Post - 1 Miss - 0 Block - 0	Post - 0 Miss - 0 Block - 0	Post - 0 Miss - 0 Block - 0	Post - 0 Miss - 0 Block - 1																																																																								

注释: Post=击柱 Miss=射失 Block=被封





预赛 Group B

女子 全国比赛

2016年全国女子手球锦标赛

Team A <b>A 辽宁</b>				Team B <b>B 天津</b>				Match Number <b>5</b>													
played in China		in the hall 滁州体育馆		on 03/09/2016		at 19:00 hours		Spectators													
Half-time (30')	<b>A</b> 14	<b>B</b> 11	End of playing time	<b>A</b> 30	<b>B</b> 20	1st extra time	<b>A</b>	<b>B</b>	2nd extra time	<b>A</b>	<b>B</b>	After penalty throws	<b>A</b>	<b>B</b>							
Number of 7 m	<b>A</b> 7/8	Team time-out			Full name of players and officials				Team time-out			<b>B</b> 0/0	Number of 7 m								
		1	2	3					1	2	3										
		11:58	51:40						26:45	44:05											
No.	Team <b>A</b>					G	W	2'	D	DR	No.	Team <b>B</b>					G	W	2'	D	DR
1	于薇诗										3	王晓梅					9	1			
2	朱徐婷					3					4	朱佳瑜									
3	赵莹雪										5	丁丽洁									
5	辛颜					3	1				7	张心茹									
8	杨娇					8	1				8	张慧					1		1		
9	刁卫丽					2					10	张文慧						1	1		
12	刘雪菲										11	蔡雪洁					5				
13	杜江花					4					12	王欣冉									
19	吕秋雪					3	1	1			14	刘洁									
20	孙弘玲					2					15	李窈窈							1		
24	陈思雨										16	王选									
27	王丹										17	聂晓雪					1		1		
66	梁海珍					5					18	舒文琪					1	1			
93	赵琦										21	李默雅					2				
98	张永婷										22	王聪									
99	郑锦宜										23	周梦雪					1				
<b>B</b>	李丽荣										<b>A</b>	付明双									
<b>C</b>	金京男 (主教练)										<b>B</b>	王明星 (主教练)					1				
<b>D</b>	韩书香										<b>C</b>	岳连娥									
<b>E</b>	程万里																				
<b>A</b>	Signature of Responsible Official of the Teams (Off. A)																			<b>B</b>	
TP	Remarks of Referee / CHA Official																			TP	

Signatures

Referees	徐健 (CHN)	曹宏俊 (CHN)		
Techn. Delegates	于中迅 (CHN)			
CHA Official	高斌 (CHN)			

Note: Number of 7m Throws Awarded to Team A and B, Goals (G), Warnings (W), Suspensions (2'), Direct Disqualification (D), Disqualification with Report (DR) and Team Penalty (TP).

Table Officials: 伍豪

陈文丽

Statisticians: 黄岩

刘永欢

Printed by PHMS Copyright: IHF / CHA 03/09/2016 20:28:44

Longman Sportsoft



handball@126.com



## 2016年全国女子手球锦标赛 竞赛技术统计(媒体表)

<b>预赛</b>	组别	<b>B</b>	轮次	<b>1</b>	场次	<b>5</b>
滁州体育馆			03/09/2016		201605005-51-1/1	
辽宁		<b>辽宁</b>	<b>30</b>	vs	<b>20</b>	天津
		<b>14 : 11</b>				

裁判员	徐健 (CHN)		/	曹宏俊 (CHN)	
-----	----------	--	---	-----------	--

辽宁		远	近	边	快	突	任意	7m	合计	%	助攻	失误	警告	2'	D & DR	天津	
主教练：金京男		射	射	射	攻	破	球	球								比赛进程	
1	于薇诗															1st Half	
2	朱徐婷		1/1	2/5				3/6	50.0		3					19 吕秋雪 1 03:01 0	
3	赵莹雪	0/1						0/1	0.0		2					8 杨娇 2 07:32 0	
5	辛颜		3/3					3/3	100		1	1				8 杨娇 3 09:49 1	
8	杨娇	1/4	2/2	1/1			1/2	3/4	61.5	1	1	1				3 10:10 2 11 蔡雪洁	
9	刁卫丽		1/1	0/1	1/1			2/3	66.7		1					3 11:40 3 3 王晓梅	
12	刘雪菲															3 13:30 4 18 舒文琪	
13	杜江花	0/1						4/4	4/5	80.0	1					4 14:21 4	
19	吕秋雪		3/3					3/3	100				1	1		4 14:30 5 3 王晓梅	
20	孙弘玲			2/2				2/2	100		2					5 15:22 5	
24	陈思雨															5 17:28 6 21 李默雅	
27	王丹															5 18:12 7 11 蔡雪洁	
66	梁海珍	0/4	2/2	2/3		1/1		5/10	50.0		1					8 杨娇 6 19:06 7	
93	赵琦															19 吕秋雪 7 19:51 7	
98	张永婷															66 梁海珍 8 20:57 7	
99	郑锦宜															8 杨娇 8 21:56 8 17 聂晓雪	
<b>运动员 合计</b>		1/10	12/12	7/12	1/1	1/1	1/2	7/8	30/46	65.2	1	12	3	1		5 辛颜 9 22:34 8	
27	王丹	1/5	0/1	1/2		0/1		2/9	22.2							5 辛颜 10 23:23 8	
93	赵琦	6/14	2/4	3/5	1/2			12/25	48.0							66 梁海珍 10 23:49 9 21 李默雅	
<b>守门员 合计</b>		7/19	2/5	4/7	1/2	0/1		14/34	41.2							66 梁海珍 11 25:35 9	
天津		远	近	边	快	突	任意	7m	合计	%	助攻	失误	警告	2'	D & DR	天津	
教练：王明星		射	射	射	攻	破	球	球								比赛进程	
3	王晓梅	9/14	0/1					9/15	60.0		1	1				8 杨娇 15 00:54 11	
4	朱佳瑜															19 吕秋雪 15 02:46 12 3 王晓梅	
5	丁丽洁															16 03:21 12	
7	张心茹															16 04:01 13 3 王晓梅	
8	张慧			1/3				1/3	33.3					1		13 杜江花 17 05:10 13	
10	张文慧		0/1					0/1	0.0		2	1	1			2 朱徐婷 18 05:50 13	
11	蔡雪洁	2/6	2/3		1/1			5/10	50.0		3					18 10:24 14 11 蔡雪洁	
12	王欣冉															2 朱徐婷 19 11:07 14	
14	刘洁															8 杨娇 19 11:14 15 8 张慧	
15	李宛宛										1			1		8 杨娇 20 12:11 15	
16	王选															5 辛颜 21 13:31 15	
17	聂晓雪	1/1						1/1	100		1			1		9 刁卫丽 22 16:09 15	
18	舒文琪	0/3				1/1		1/4	25.0		1	1				20 孙弘玲 23 17:20 15	
21	李默雅			2/5				2/5	40.0							20 孙弘玲 24 18:01 15	
22	王聪															66 梁海珍 25 18:19 15	
23	周梦雪		1/2	0/1	0/1			1/4	25.0		2					25 18:51 16 3 王晓梅	
<b>运动员 合计</b>		12/24	3/7	3/9	1/2	1/1		20/43	46.5		13	3	4			8 杨娇 26 19:19 16	
12	王欣冉	1/1	0/2	1/2				0/2	2/7	28.6						9 刁卫丽 27 20:01 16	
16	王选	3/4	0/10	3/9	0/1	0/1	0/1	1/6	7/32	21.9						27 21:24 17 11 蔡雪洁	
<b>守门员 合计</b>		4/5	0/12	4/11	0/1	0/1	0/1	1/8	9/39	23.1						27 22:57 18 3 王晓梅	

场上队员：得分 / 射门

守门员：救球 / 射门

快攻	Fast Break		突破	Breakthrough		任意球	Free Throw		7M球	7M Throw		助攻	Assist
警告	Warning		失误	Error		2'	Suspension		D	取消资格		DR	取消资格+报告



## 2016年全国女子手球锦标赛 图式比赛技术统计表

轮次 1

场次 5

201605005-21-1/1

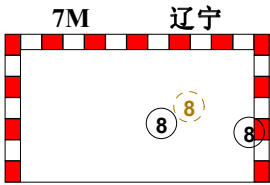
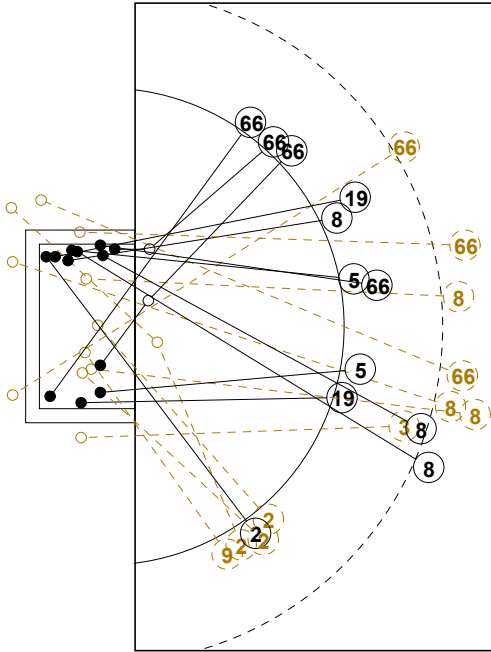

1st Half  
14 : 11

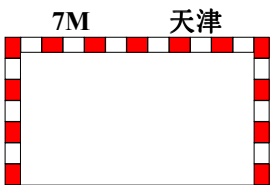
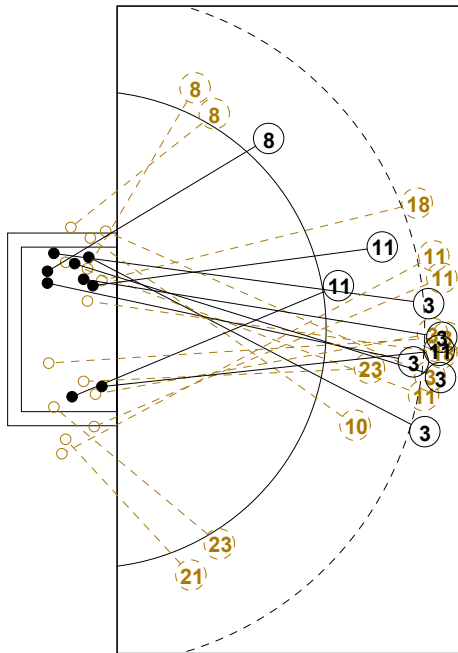
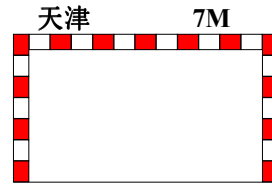
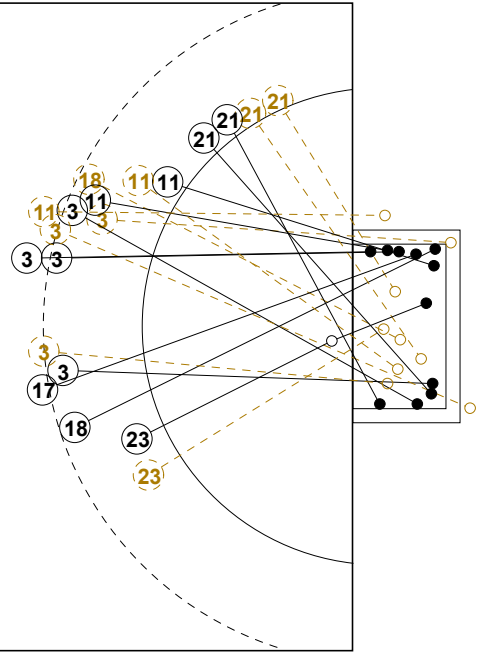

2nd Half  
20 : 30

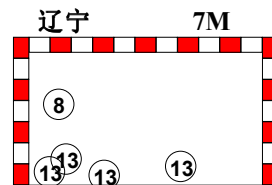
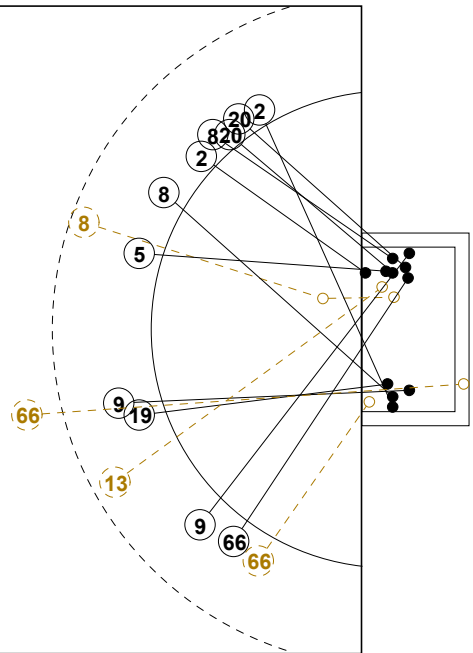





## 2016年全国女子手球锦标赛

## 个人/全队技术统计表

正式表  
手球  
女子预赛  
轮次 1组别 B  
场次 5201605005-14-1/2  
滁州体育馆  
03/09/2016 19:00

号码	姓名	远射	近射	边射	快攻	突破	任意	7M	合计	%	助攻	失误	警告	2'	取消	时间
<b>辽宁(辽宁)</b>																
<i>(场上队员)</i>																
1	于薇诗									0.0%						00:00:00
2	朱徐婷		1/1	2/5					3/6	50.0%		3				00:40:25
3	赵莹雪	0/1							0/1	0.0%		2				00:49:04
5	辛颜		3/3						3/3	100%		1	1			00:47:34
8	杨娇	1/4	2/2	1/1			1/2	3/4	8/13	61.5%	1		1			00:54:56
9	刁卫丽		1/1	0/1	1/1				2/3	66.7%		1				00:25:48
12	刘雪菲									0.0%						00:00:00
13	杜江花	0/1						4/4	4/5	80.0%		1				00:12:17
19	吕秋雪		3/3						3/3	100%			1	1		00:44:36
20	孙弘玲			2/2					2/2	100%		2				00:14:07
24	陈思雨									0.0%						00:00:00
27	王丹									0.0%						00:15:31
66	梁海珍	0/4	2/2	2/3		1/1			5/10	50.0%		1				00:54:15
93	赵琦									0.0%						00:44:29
98	张永婷									0.0%						00:10:54
99	郑锦宜									0.0%		1				00:05:44
<b>合计</b>		1/10	12/12	7/12	1/1	1/1	1/2	7/8	30/46	65.2%	1	12	3	1		
<i>(守门员)</i>																
27	王丹	1/5	0/1	1/2		0/1			2/9	22.2%						00:15:31
93	赵琦	6/14	2/4	3/5	1/2				12/25	48.0%						00:44:29
<b>合计</b>		7/19	2/5	4/7	1/2	0/1			14/34	41.2%						

场上队员：得分/射门

守门员：救球/射门

全队合计	得分	被救	射失	击柱	封球	合计	%
远射	1	4	3	2		10	10.0%
近射	12					12	100.0%
边射	7	4	1			12	58.3%
快攻	1					1	100.0%
突破	1					1	100.0%
任意	1		1			2	50.0%
7M	7	1				8	87.5%





## 2016年全国女子手球锦标赛

## 个人/全队技术统计表

正式表  
手球  
女子预赛  
轮次 1组别 B  
场次 5201605005-14-2/2  
滁州体育馆  
03/09/2016 19:00

号码	姓名	远射	近射	边射	快攻	突破	任意	7M	合计	%	助攻	失误	警告	2'	取消	时间
<b>天津(天津)</b>																
<i>(上场队员)</i>																
3	王晓梅	9/14	0/1						9/15	60.0%		1	1			00:28:18
4	朱佳瑜									0.0%		2				00:10:47
5	丁丽洁									0.0%						00:20:29
7	张心茹									0.0%						00:00:00
8	张慧			1/3					1/3	33.3%				1		01:00:00
10	张文慧		0/1						0/1	0.0%		2	1	1		00:55:13
11	蔡雪洁	2/6	2/3		1/1				5/10	50.0%		3				00:53:49
12	王欣冉									0.0%						00:10:04
14	刘洁									0.0%						00:00:00
15	李窈窕									0.0%		1		1		00:11:33
16	王选									0.0%						00:49:56
17	聂晓雪	1/1							1/1	100%		1		1		00:20:10
18	舒文琪	0/3				1/1			1/4	25.0%		1	1			00:31:10
21	李默雅			2/5					2/5	40.0%						00:37:11
22	王聪									0.0%						00:00:00
23	周梦雪		1/2	0/1	0/1				1/4	25.0%		2				00:29:31
<b>合计</b>		12/24	3/7	3/9	1/2	1/1			20/43	46.5%		13	3	4		
<i>(守门员)</i>																
12	王欣冉	1/1	0/2	1/2				0/2	2/7	28.6%						00:10:04
16	王选	3/4	0/10	3/9	0/1	0/1	0/1	1/6	7/32	21.9%						00:49:56
<b>合计</b>																
		4/5	0/12	4/11	0/1	0/1	0/1	1/8	9/39	23.1%						

场上队员：得分/射门

守门员：救球/射门

全队合计	得分	被救	射失	击柱	封球	合计	%
远射	12	7	3	2		24	50.0%
近射	3	2		2		7	42.9%
边射	3	4	2			9	33.3%
快攻	1	1				2	50.0%
突破	1					1	100.0%
任意							0.0%
7M							0.0%





### 2016年全国女子手球锦标赛

#### 图式射门区域统计

轮次 1 场次 5

201605005-41-1/1

## 辽宁

1 于薇诗	2 朱徐婷	3 赵莹雪	5 辛颜	8 杨娇	9 刁卫丽	12 刘雪菲	13 杜江花																																																																											
<table border="1"><tr><td></td><td></td><td></td></tr><tr><td></td><td></td><td></td></tr><tr><td></td><td></td><td></td></tr></table>										<table border="1"><tr><td></td><td></td><td>1</td></tr><tr><td></td><td></td><td>1</td></tr><tr><td>1</td><td></td><td></td></tr></table>			1			1	1			<table border="1"><tr><td></td><td></td><td></td></tr><tr><td></td><td></td><td></td></tr><tr><td></td><td></td><td></td></tr></table>										<table border="1"><tr><td></td><td></td><td>1</td></tr><tr><td>1</td><td></td><td></td></tr><tr><td>1</td><td></td><td></td></tr></table>			1	1			1			<table border="1"><tr><td></td><td></td><td>1</td></tr><tr><td>2</td><td>1</td><td>4</td></tr><tr><td></td><td></td><td></td></tr></table>			1	2	1	4				<table border="1"><tr><td></td><td></td><td></td></tr><tr><td>1</td><td></td><td>1</td></tr><tr><td></td><td></td><td></td></tr></table>				1		1				<table border="1"><tr><td></td><td></td><td></td></tr><tr><td></td><td></td><td></td></tr><tr><td></td><td></td><td></td></tr></table>										<table border="1"><tr><td></td><td></td><td></td></tr><tr><td></td><td></td><td></td></tr><tr><td>3</td><td>1</td><td></td></tr></table>							3	1				
		1																																																																																
		1																																																																																
1																																																																																		
		1																																																																																
1																																																																																		
1																																																																																		
		1																																																																																
2	1	4																																																																																
1		1																																																																																
3	1																																																																																	
Post - 0 Miss - 0 Block - 0	Post - 0 Miss - 1 Block - 0	Post - 0 Miss - 1 Block - 0	Post - 0 Miss - 0 Block - 0	Post - 0 Miss - 1 Block - 0	Post - 0 Miss - 0 Block - 0	Post - 0 Miss - 0 Block - 0	Post - 0 Miss - 0 Block - 0																																																																											
19 吕秋雪	20 孙弘玲	24 陈思雨	27 王丹	66 梁海珍	93 赵琦	98 张永婷	99 郑锦宜																																																																											
<table border="1"><tr><td></td><td></td><td>1</td></tr><tr><td>1</td><td></td><td></td></tr><tr><td></td><td></td><td>1</td></tr></table>			1	1					1	<table border="1"><tr><td></td><td></td><td></td></tr><tr><td>2</td><td></td><td></td></tr><tr><td></td><td></td><td></td></tr></table>				2						<table border="1"><tr><td></td><td></td><td></td></tr><tr><td></td><td></td><td></td></tr><tr><td></td><td></td><td></td></tr></table>										<table border="1"><tr><td></td><td></td><td></td></tr><tr><td></td><td></td><td></td></tr><tr><td></td><td></td><td></td></tr></table>										<table border="1"><tr><td></td><td></td><td></td></tr><tr><td>1</td><td></td><td></td></tr><tr><td>2</td><td></td><td>1</td></tr><tr><td></td><td></td><td>1</td></tr></table>				1			2		1			1	<table border="1"><tr><td></td><td></td><td></td></tr><tr><td></td><td></td><td></td></tr><tr><td></td><td></td><td></td></tr></table>										<table border="1"><tr><td></td><td></td><td></td></tr><tr><td></td><td></td><td></td></tr><tr><td></td><td></td><td></td></tr></table>										<table border="1"><tr><td></td><td></td><td></td></tr><tr><td></td><td></td><td></td></tr><tr><td></td><td></td><td></td></tr></table>									
		1																																																																																
1																																																																																		
		1																																																																																
2																																																																																		
1																																																																																		
2		1																																																																																
		1																																																																																
Post - 0 Miss - 0 Block - 0	Post - 0 Miss - 0 Block - 0	Post - 0 Miss - 0 Block - 0	Post - 0 Miss - 0 Block - 0	Post - 2 Miss - 2 Block - 0	Post - 0 Miss - 0 Block - 0	Post - 0 Miss - 0 Block - 0	Post - 0 Miss - 0 Block - 0																																																																											

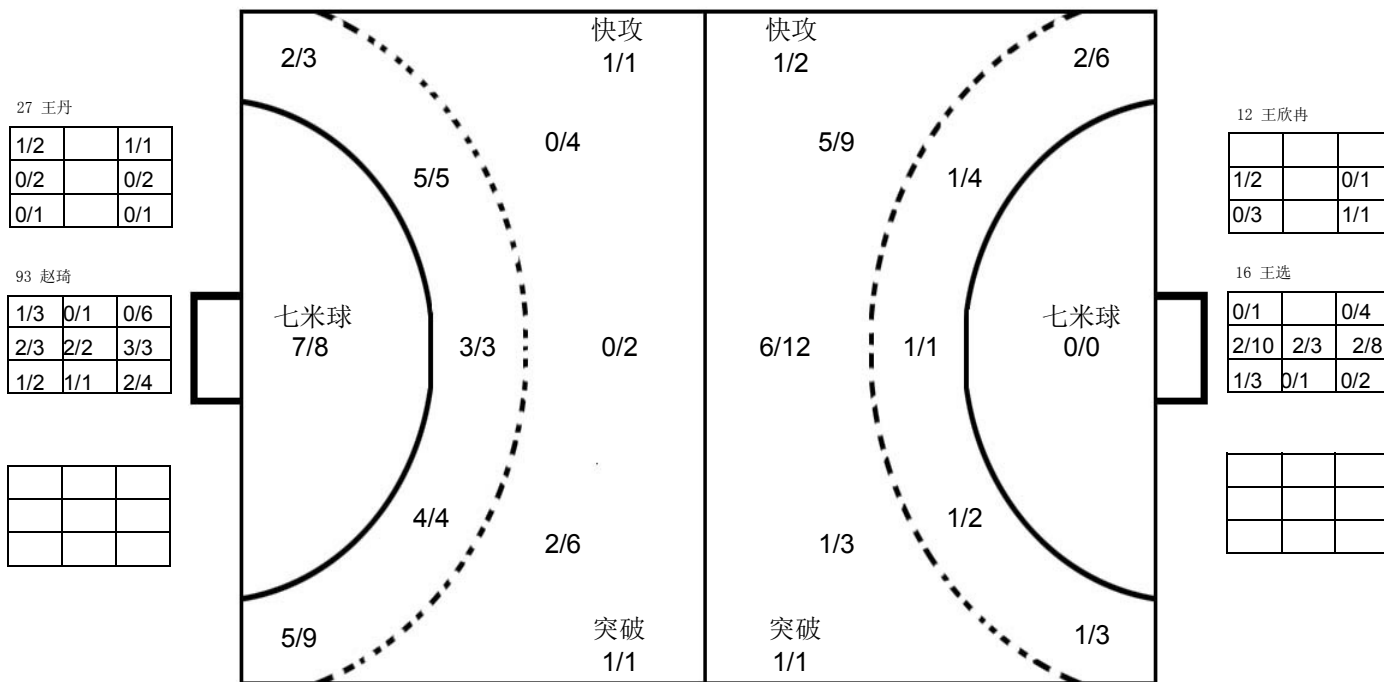

## 天津

3 王晓梅	4 朱佳瑜	5 丁丽洁	7 张心茹	8 张慧	10 张文慧	11 蔡雪洁	12 王欣冉																																																																								
<table border="1"><tr><td></td><td></td><td>4</td></tr><tr><td>1</td><td></td><td>2</td></tr><tr><td>1</td><td></td><td>1</td></tr></table>			4	1		2	1		1	<table border="1"><tr><td></td><td></td><td></td></tr><tr><td></td><td></td><td></td></tr><tr><td></td><td></td><td></td></tr></table>										<table border="1"><tr><td></td><td></td><td></td></tr><tr><td></td><td></td><td></td></tr><tr><td></td><td></td><td></td></tr></table>										<table border="1"><tr><td></td><td></td><td></td></tr><tr><td></td><td></td><td></td></tr><tr><td></td><td></td><td></td></tr></table>										<table border="1"><tr><td></td><td></td><td>1</td></tr><tr><td></td><td></td><td></td></tr><tr><td></td><td></td><td></td></tr></table>			1							<table border="1"><tr><td></td><td></td><td></td></tr><tr><td></td><td></td><td></td></tr><tr><td></td><td></td><td></td></tr></table>										<table border="1"><tr><td></td><td></td><td>1</td></tr><tr><td>2</td><td></td><td></td></tr><tr><td>1</td><td></td><td>1</td></tr></table>			1	2			1		1	<table border="1"><tr><td></td><td></td><td></td></tr><tr><td></td><td></td><td></td></tr><tr><td></td><td></td><td></td></tr></table>									
		4																																																																													
1		2																																																																													
1		1																																																																													
		1																																																																													
		1																																																																													
2																																																																															
1		1																																																																													
Post - 2 Miss - 1 Block - 0	Post - 0 Miss - 0 Block - 0	Post - 0 Miss - 0 Block - 0	Post - 0 Miss - 0 Block - 0	Post - 0 Miss - 1 Block - 0	Post - 1 Miss - 0 Block - 0	Post - 1 Miss - 2 Block - 0	Post - 0 Miss - 0 Block - 0																																																																								
14 刘洁	15 李窈窕	16 王选	17 聂晓雪	18 舒文琪	21 李默雅	22 王聪	23 周梦雪																																																																								
<table border="1"><tr><td></td><td></td><td></td></tr><tr><td></td><td></td><td></td></tr><tr><td></td><td></td><td></td></tr></table>										<table border="1"><tr><td></td><td></td><td></td></tr><tr><td></td><td></td><td></td></tr><tr><td></td><td></td><td></td></tr></table>										<table border="1"><tr><td></td><td></td><td></td></tr><tr><td></td><td></td><td></td></tr><tr><td></td><td></td><td></td></tr></table>										<table border="1"><tr><td></td><td></td><td>1</td></tr><tr><td></td><td></td><td></td></tr><tr><td></td><td></td><td></td></tr></table>			1							<table border="1"><tr><td></td><td></td><td>1</td></tr><tr><td></td><td></td><td></td></tr><tr><td></td><td></td><td></td></tr></table>			1							<table border="1"><tr><td></td><td></td><td>1</td></tr><tr><td></td><td></td><td></td></tr><tr><td></td><td></td><td>1</td></tr></table>			1						1	<table border="1"><tr><td></td><td></td><td></td></tr><tr><td></td><td></td><td></td></tr><tr><td></td><td></td><td></td></tr></table>										<table border="1"><tr><td></td><td></td><td>1</td></tr><tr><td></td><td></td><td></td></tr><tr><td></td><td></td><td></td></tr></table>			1						
		1																																																																													
		1																																																																													
		1																																																																													
		1																																																																													
		1																																																																													
Post - 0 Miss - 0 Block - 0	Post - 0 Miss - 0 Block - 0	Post - 0 Miss - 0 Block - 0	Post - 0 Miss - 0 Block - 0	Post - 0 Miss - 0 Block - 0	Post - 0 Miss - 1 Block - 0	Post - 0 Miss - 0 Block - 0	Post - 0 Miss - 0 Block - 0																																																																								

注释: Post=击柱 Miss=射失 Block=被封





预赛 Group B

女子 全国比赛

2016年全国女子手球锦标赛

Team A					Team B					Match Number											
A 解放军					B 四川					6											
played in			in the hall			on			at		Spectators										
China			滁州体育馆			03/09/2016			20:30 hours												
Half-time (30')	A	B	End of playing time		A	B	1st extra time		A	B	After penalty										
	20	14	36	31							A	B									
Number of 7 m	A	Team time-out			Full name of players and officials						Team time-out			B	Number of 7 m						
		1	2	3							1	2	3								
	5 / 5												5 / 7								
No.	Team A					G	W	2'	D	DR	No.	Team B					G	W	2'	D	DR
2	崔云莉					3					1	张雪纯									
5	徐鸣昭					1					2	陈艳楠					2	1			
6	于婷婷					6					3	王丹					7	1			
8	周亚茹					1		2			4	尤婉莹					1	1			
13	张格格					5	1				5	孙姣					5				
16	方文博										6	凤洋					3				
17	于利婷					2					7	练素琪									
23	顾天澍					1		1			9	姚梦园					4				
24	韦娜娜					2	1				10	高静					1		1		
32	张馨予							1			11	朱海云									
36	李朴										12	宋琛茜									
44	刘洋麦文					4					17	史雨欣									
66	杨丽丽										18	戴小宇					7		1		
77	唐魏萍										27	吴美琪					1				
81	戴丹妮					4															
88	李晓晴					7															
A	刘德东 (主教练)										A	金鸿									
B	刘凤娟										B	郎正平									
D	吴明群										C	陈志伟									
A					Signature of Responsible Official of the Teams (Off. A)										B						
TP	Remarks of Referee / CHA Official																			TP	

Signatures

Referees: 倪震 (CHN)      杜新 (CHN)

Techn. Delegates: 于中迅 (CHN)

CHA Official: 吴国忠 (CHN)

Note: Number of 7m Throws Awarded to Team A and B, Goals (G), Warnings (W), Suspensions (2), Direct Disqualification (D), Disqualification with Report (DR) and Team Penalty (TP).

Table Officials: 佟金正      赵涵      Statisticians: 陈柱      闫冲

Printed by PHMS Copyright: IHF / CHA 03/09/2016 21:57:09

Longman Sportsoft      handball@126.com



2016年全国女子手球锦标赛  
竞赛技术统计(媒体表)

预赛	组别	B	轮次	1	场次	6
----	----	---	----	---	----	---

滁州体育馆

03/09/2016

201605006-51-1/1

解放军	解放军	36	vs	31	四川	四川
20 : 14						

裁判员	倪震 (CHN)	/	杜新 (CHN)
-----	----------	---	----------

解放军		远	近	边	快	突	任意	7m	合计	%	助攻	失误	警告	2'	D & DR	解放军	比赛进程	四川		
主教练：刘德东		射	射	射	攻	破	球	球												
2	崔云莉	0/5	1/1	1/1	1/1				3/8	37.5	1					88 李晓晴	1st Half	0		
5	徐鸣昭	0/1	1/1						1/2	50.0						1	02:22	1 3 王丹		
6	于婷婷	2/3	2/3	1/1		1/1			6/8	75.0	1	2				6	02:37	1		
8	周亚茹	1/3	0/1						1/4	25.0		1		2		6	03:26	2 5 孙姣		
13	张格格		5/6						5/6	83.3		2	1			6	04:09	2		
16	方文博															88 李晓晴	3	04:27	3 18 戴小宇	
17	于利婷	1/2			1/1				2/3	66.7		2				2	05:19	4 27 吴美琪		
23	顾天澍		1/1						1/1	100		1		1		88 李晓晴	4	04:35	3	
24	韦娜娜		1/1					1/1	2/2	100	1	3	1			88 李晓晴	5	05:45	4	
32	张馨予	0/1	0/1						0/2	0.0		1		1		88 李晓晴	6	06:25	4	
36	李朴															88 李晓晴	7	07:26	4	
44	刘洋麦文	2/6	0/1	1/1	0/1	1/1			4/10	40.0	1	2				81 戴丹妮	8	08:09	4	
66	杨丽丽															81 戴丹妮	9	08:48	4	
77	唐魏萍										1					81 戴丹妮	9	09:17	5 5 孙姣	
81	戴丹妮				3/3	1/1			4/4	100						13 张格格	10	10:04	5	
88	李晓晴	1/2	2/2					4/4	7/8	87.5		2				10	10:53	6 3 王丹		
运动员 合计		7/23	13/18	3/3	5/6	3/3		5/5	36/58	62.1	5	16	2	4		88 李晓晴	10	11:04	6	
16	方文博	2/3	1/7		1/1	0/1		0/2	4/14	28.6						88 李晓晴	11	11:23	6	
66	杨丽丽	2/3	0/4	1/1		1/2	0/1	1/1	5/12	41.7						6	11:50	7 2 陈艳楠		
77	唐魏萍	1/1	1/5	1/2	0/5	0/1		1/4	4/18	22.2	1					11	12:10	8 3 王丹		
守门员 合计		5/7	2/16	2/3	1/6	1/4	0/1	2/7	13/44	29.5	1					2	12:31	9 2 陈艳楠		
四川		远	近	边	快	突	任意	7m	合计	%	助攻	失误	警告	2'	D & DR					
教练：郎正平		射	射	射	攻	破	球	球												
1	张雪纯															44 刘洋麦文	21	00:31	14	
2	陈艳楠		2/2						2/2	100		3	1			44 刘洋麦文	21	01:35	15 18 戴小宇	
3	王丹	1/4	2/2		1/2	1/1		2/3	7/12	58.3	2	5	1			88 李晓晴	22	02:04	15	
4	尤婉莹	0/1	0/1	0/1		1/1			1/4	25.0	1	2	1			88 李晓晴	23	03:30	15	
5	孙姣		4/4				1/1		5/5	100	1	2				81 戴丹妮	23	03:56	16 4 尤婉莹	
6	风洋		2/2		1/2				3/4	75.0						24 韦娜娜	24	04:50	16	
7	练素琪															24 韦娜娜	25	05:24	16	
9	姚梦园			1/2	3/3				4/5	80.0						25	05:53	17 6 风洋		
10	高静		1/2						1/2	50.0				1		25	07:19	18 5 孙姣		
11	朱海云	0/4							0/4	0.0		5				26	07:34	18		
12	宋琛茜															26	09:09	19 6 风洋		
17	史雨欣										2					27	10:52	19		
18	戴小宇	1/4	3/3			1/2		2/2	7/11	63.6	1	2		1		81 戴丹妮	27	12:05	20 9 姚梦园	
27	吴美琪							1/2	1/2	50.0						6	12:17	20		
运动员 合计		2/13	14/16	1/3	5/7	3/4	1/1	5/7	31/51	60.8	7	22	3	2		28	15:31	21 3 王丹		
12	宋琛茜	7/14	3/16	0/3	1/6	0/3		0/5	11/47	23.4	2					28	16:04	22 9 姚梦园		
守门员 合计		7/14	3/16	0/3	1/6	0/3		0/5	11/47	23.4	2					17	17:29	22 3 王丹		
																6	17:45	23 3 王丹		
																6	18:15	23		
																81 戴丹妮	31	18:58	23	
																24 韦娜娜	32	20:08	23	
																17	20:45	24 18 戴小宇		
																13 张格格	33	21:27	24	
																13 张格格	33	21:49	25 9 姚梦园	
																	34	22:01	25	
																	34	22:31	26 18 戴小宇	
																	34	24:02	27 9 姚梦园	
																	34	25:11	28 3 王丹	
																	34	26:27	29 18 戴小宇	
																	23 顾天澍	35	26:56	29
																	35	28:32	30 3 王丹	
																	13 张格格	35	29:10	31 10 高静
																	13 张格格	36	29:28	31

场上队员：得分 / 射门

守门员：救球 / 射门

快攻	Fast Break		突破	Breakthrough		任意球	Free Throw		7M球	7M Throw		助攻	Assist
警告	Warning		失误	Error		2'	Suspension		D	取消资格		DR	取消资格+报告





## 2016年全国女子手球锦标赛 图式比赛技术统计表

轮次 1

场次 6

201605006-21-1/1

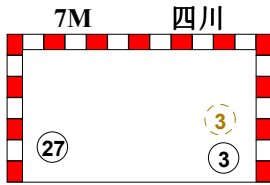
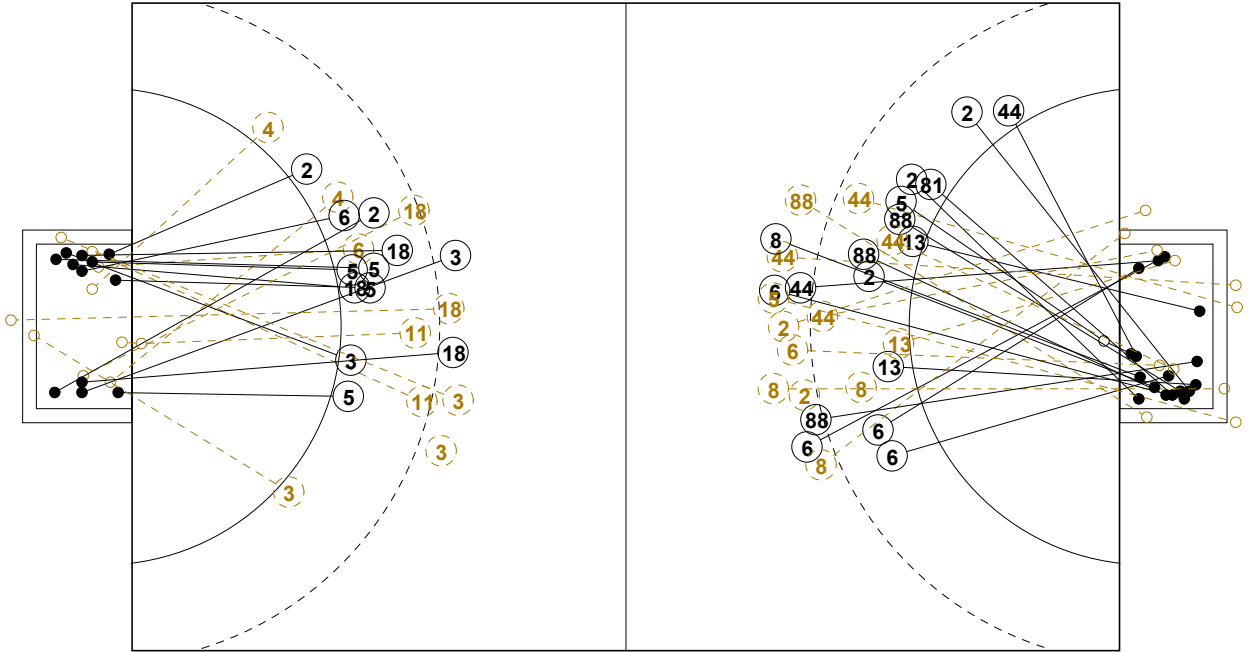

**1st Half  
14 : 20**

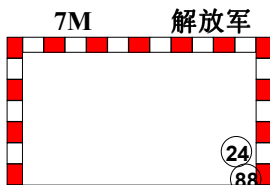
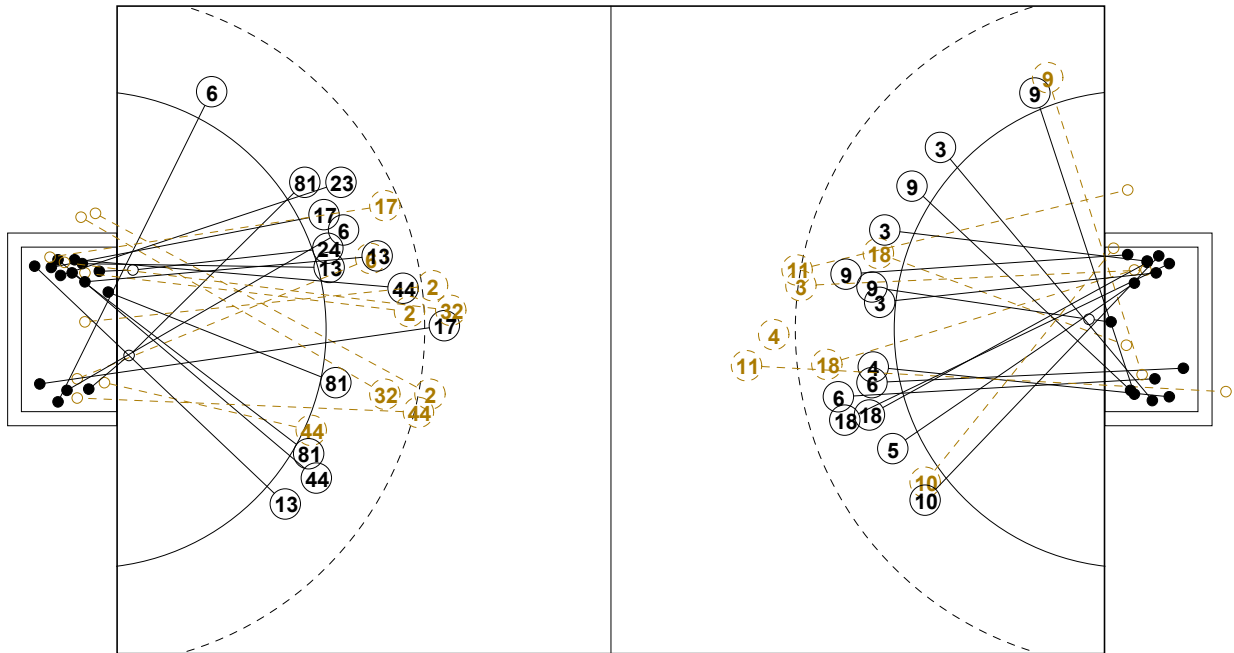
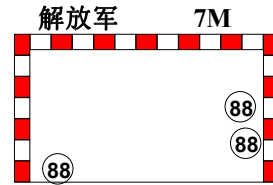

**2nd Half  
36 : 31**

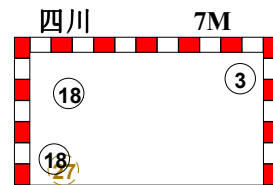



## 2016年全国女子手球锦标赛

## 个人/全队技术统计表

正式表  
手球  
女子预赛  
轮次 1组别 B  
场次 6201605006-14-1/2  
滁州体育馆  
03/09/2016 20:30

号码	姓名	远射	近射	边射	快攻	突破	任意	7M	合计	%	助攻	失误	警告	2'	取消	时间
<b>解放军(解放军)</b>																
<i>(场上队员)</i>																
2	崔云莉	0/5	1/1	1/1	1/1				3/8	37.5%	1					00:38:21
5	徐鸣昭	0/1	1/1						1/2	50.0%						00:13:25
6	于婷婷	2/3	2/3	1/1		1/1			6/8	75.0%	1	2				00:49:30
8	周亚茹	1/3	0/1						1/4	25.0%		1		2		00:15:04
13	张格格		5/6						5/6	83.3%		2	1			00:51:57
16	方文博									0.0%						00:13:51
17	于利婷	1/2			1/1				2/3	66.7%		2				00:16:16
23	顾天澍		1/1						1/1	100%		1		1		00:18:29
24	韦娜娜		1/1					1/1	2/2	100%	1	3	1			01:00:00
32	张馨予	0/1	0/1						0/2	0.0%		1		1		00:05:01
36	李朴									0.0%						00:00:00
44	刘洋麦文	2/6	0/1	1/1	0/1	1/1			4/10	40.0%	1	2				00:32:35
66	杨丽丽									0.0%						00:22:14
77	唐魏萍									0.0%	1					00:23:55
81	戴丹妮				3/3	1/1			4/4	100%						00:27:44
88	李晓晴	1/2	2/2					4/4	7/8	87.5%		2				00:31:18
<b>合计</b>		7/23	13/18	3/3	5/6	3/3		5/5	36/58	62.1%	5	16	2	4		
<i>(守门员)</i>																
16	方文博	2/3	1/7		1/1	0/1		0/2	4/14	28.6%						00:13:51
66	杨丽丽	2/3	0/4	1/1		1/2	0/1	1/1	5/12	41.7%						00:22:14
77	唐魏萍	1/1	1/5	1/2	0/5	0/1		1/4	4/18	22.2%	1					00:23:55
<b>合计</b>		5/7	2/16	2/3	1/6	1/4	0/1	2/7	13/44	29.5%	1					

场上队员：得分/射门

守门员：救球/射门

全队合计	得分	被救	射失	击柱	封球	合计	%
远射	7	7	5	3	1	23	30.4%
近射	13	3	1		1	18	72.2%
边射	3					3	100.0%
快攻	5	1				6	83.3%
突破	3					3	100.0%
任意							0.0%
7M	5					5	100.0%





## 2016年全国女子手球锦标赛

## 个人/全队技术统计表

正式表  
手球  
女子预赛  
轮次 1组别 B  
场次 6201605006-14-2/2  
滁州体育馆  
03/09/2016 20:30

号码	姓名	远射	近射	边射	快攻	突破	任意	7M	合计	%	助攻	失误	警告	2'	取消	时间
<b>四川(四川)</b>																
<i>(上场队员)</i>																
1	张雪纯									0.0%						00:00:00
2	陈艳楠		2/2						2/2	100%		3	1			00:17:33
3	王丹	1/4	2/2		1/2	1/1		2/3	7/12	58.3%	2	5	1			00:59:42
4	尤婉莹	0/1	0/1	0/1		1/1			1/4	25.0%	1	2	1			00:35:30
5	孙姣		4/4				1/1		5/5	100%	1	2				00:42:50
6	凤洋		2/2		1/2				3/4	75.0%						00:47:47
7	练素琪									0.0%						00:00:00
9	姚梦园			1/2	3/3				4/5	80.0%						00:31:33
10	高静		1/2						1/2	50.0%				1		00:12:09
11	朱海云	0/4							0/4	0.0%		5				00:51:11
12	宋琛茜									0.0%	2					01:00:00
17	史雨欣									0.0%		3				00:17:07
18	戴小宇	1/4	3/3			1/2		2/2	7/11	63.6%	1	2		1		00:43:58
27	吴美琪							1/2	1/2	50.0%						00:00:16
<b>合计</b>		2/13	14/16	1/3	5/7	3/4	1/1	5/7	31/51	60.8%	7	22	3	2		
<i>(守门员)</i>																
12	宋琛茜	7/14	3/16	0/3	1/6	0/3		0/5	11/47	23.4%	2					01:00:00
<b>合计</b>		7/14	3/16	0/3	1/6	0/3		0/5	11/47	23.4%	2					

场上队员：得分/射门

守门员：救球/射门

全队合计	得分	被救	射失	击柱	封球	合计	%
远射	2	5	3	1	2	13	15.4%
近射	14	2				16	87.5%
边射	1	2				3	33.3%
快攻	5	1		1		7	71.4%
突破	3	1				4	75.0%
任意	1					1	100.0%
7M	5	2				7	71.4%







### 2016年全国女子手球锦标赛

#### 图式射门区域统计

轮次 1 场次 6

201605006-41-1/1

## 解放军

2 崔云莉	5 徐鸣昭	6 于婷婷	8 周亚茹	13 张格格	16 方文博	17 于利婷	23 顾天澍																																																																								
<table border="1"><tr><td></td><td></td><td>1</td></tr><tr><td></td><td></td><td>1</td></tr><tr><td></td><td></td><td>1</td></tr></table>			1			1			1	<table border="1"><tr><td></td><td></td><td></td></tr><tr><td></td><td></td><td></td></tr><tr><td></td><td>1</td><td></td></tr></table>								1		<table border="1"><tr><td></td><td></td><td>1</td></tr><tr><td>3</td><td></td><td>1</td></tr><tr><td>1</td><td></td><td></td></tr></table>			1	3		1	1			<table border="1"><tr><td></td><td></td><td></td></tr><tr><td></td><td></td><td>1</td></tr><tr><td></td><td></td><td></td></tr></table>						1				<table border="1"><tr><td></td><td>1</td><td>2</td></tr><tr><td></td><td></td><td>2</td></tr><tr><td></td><td></td><td></td></tr></table>		1	2			2				<table border="1"><tr><td></td><td></td><td></td></tr><tr><td></td><td></td><td></td></tr><tr><td></td><td></td><td></td></tr></table>										<table border="1"><tr><td></td><td>1</td><td></td></tr><tr><td></td><td></td><td>1</td></tr><tr><td></td><td></td><td></td></tr></table>		1				1				<table border="1"><tr><td></td><td></td><td></td></tr><tr><td></td><td></td><td></td></tr><tr><td></td><td></td><td>1</td></tr></table>									1
		1																																																																													
		1																																																																													
		1																																																																													
	1																																																																														
		1																																																																													
3		1																																																																													
1																																																																															
		1																																																																													
	1	2																																																																													
		2																																																																													
	1																																																																														
		1																																																																													
		1																																																																													
Post - 0 Miss - 2 Block - 1	Post - 0 Miss - 1 Block - 0	Post - 0 Miss - 0 Block - 0	Post - 2 Miss - 0 Block - 1	Post - 0 Miss - 0 Block - 0	Post - 0 Miss - 0 Block - 0	Post - 0 Miss - 0 Block - 0	Post - 0 Miss - 0 Block - 0																																																																								
24 韦娜娜	32 张馨予	36 李朴	44 刘洋麦文	66 杨丽丽	77 唐魏萍	81 戴丹妮	88 李晓晴																																																																								
<table border="1"><tr><td></td><td></td><td></td></tr><tr><td></td><td></td><td></td></tr><tr><td></td><td></td><td>2</td></tr></table>									2	<table border="1"><tr><td></td><td></td><td></td></tr><tr><td></td><td></td><td></td></tr><tr><td></td><td></td><td></td></tr></table>										<table border="1"><tr><td></td><td></td><td></td></tr><tr><td></td><td></td><td></td></tr><tr><td></td><td></td><td></td></tr></table>										<table border="1"><tr><td></td><td></td><td></td></tr><tr><td>1</td><td></td><td>2</td></tr><tr><td></td><td></td><td>1</td></tr></table>				1		2			1	<table border="1"><tr><td></td><td></td><td></td></tr><tr><td></td><td></td><td></td></tr><tr><td></td><td></td><td></td></tr></table>										<table border="1"><tr><td></td><td></td><td></td></tr><tr><td></td><td></td><td></td></tr><tr><td></td><td></td><td></td></tr></table>										<table border="1"><tr><td></td><td></td><td></td></tr><tr><td></td><td></td><td>2</td></tr><tr><td></td><td></td><td></td></tr></table>						2				<table border="1"><tr><td></td><td></td><td></td></tr><tr><td></td><td></td><td></td></tr><tr><td>1</td><td></td><td>1</td></tr></table>							1		1
		2																																																																													
1		2																																																																													
		1																																																																													
		2																																																																													
1		1																																																																													
Post - 0 Miss - 0 Block - 0	Post - 0 Miss - 1 Block - 0	Post - 0 Miss - 0 Block - 0	Post - 0 Miss - 2 Block - 0	Post - 0 Miss - 0 Block - 0	Post - 0 Miss - 0 Block - 0	Post - 0 Miss - 0 Block - 0	Post - 1 Miss - 0 Block - 0																																																																								

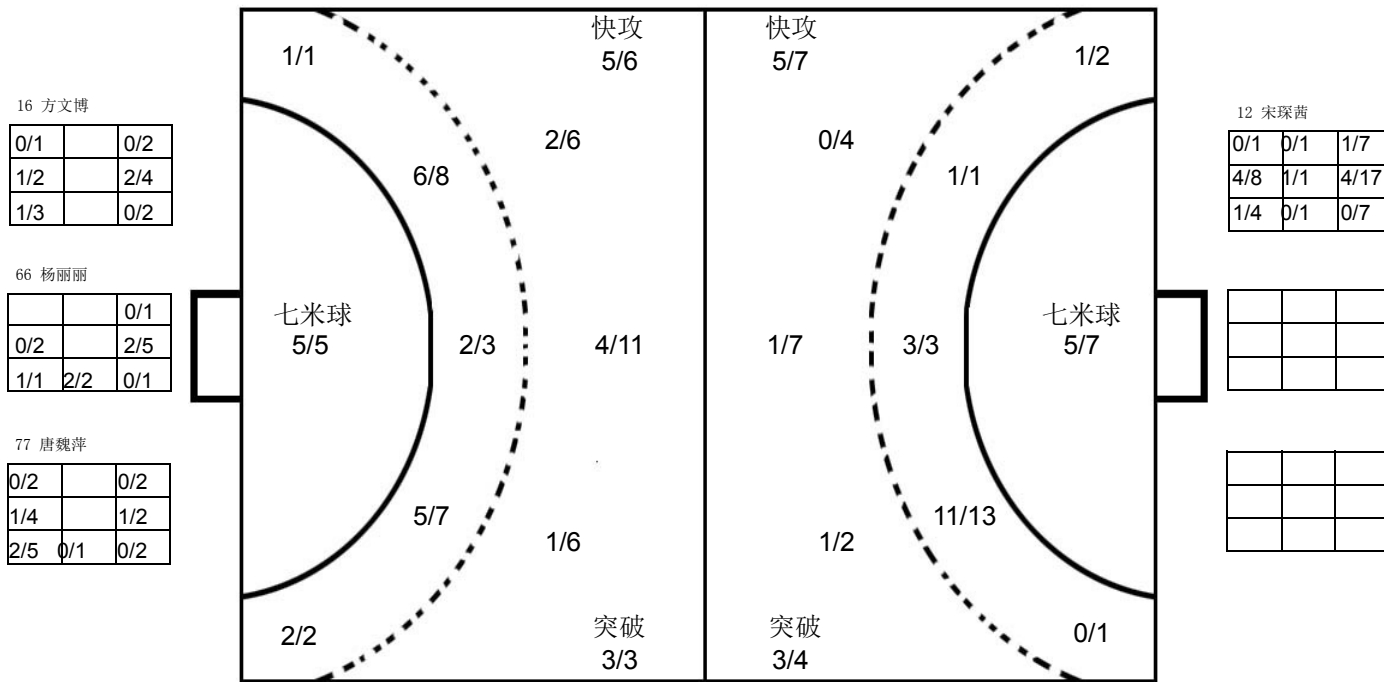

## 四川

1 张雪纯	2 陈艳楠	3 王丹	4 尤婉莹	5 孙姣	6 凤洋	7 练素琪	9 姚梦园																																																																								
<table border="1"><tr><td></td><td></td><td></td></tr><tr><td></td><td></td><td></td></tr><tr><td></td><td></td><td></td></tr></table>										<table border="1"><tr><td></td><td>1</td><td></td></tr><tr><td></td><td></td><td></td></tr><tr><td></td><td></td><td>1</td></tr></table>		1							1	<table border="1"><tr><td></td><td></td><td>2</td></tr><tr><td>3</td><td></td><td>1</td></tr><tr><td></td><td></td><td>1</td></tr></table>			2	3		1			1	<table border="1"><tr><td></td><td></td><td></td></tr><tr><td></td><td></td><td>1</td></tr><tr><td></td><td></td><td></td></tr></table>						1				<table border="1"><tr><td></td><td></td><td>1</td></tr><tr><td></td><td></td><td>1</td></tr><tr><td>2</td><td></td><td>1</td></tr></table>			1			1	2		1	<table border="1"><tr><td></td><td></td><td></td></tr><tr><td></td><td></td><td>1</td></tr><tr><td></td><td></td><td>2</td></tr></table>						1			2	<table border="1"><tr><td></td><td></td><td></td></tr><tr><td></td><td></td><td></td></tr><tr><td></td><td></td><td></td></tr></table>										<table border="1"><tr><td></td><td></td><td></td></tr><tr><td></td><td></td><td></td></tr><tr><td>1</td><td>1</td><td>2</td></tr></table>							1	1	2
	1																																																																														
		1																																																																													
		2																																																																													
3		1																																																																													
		1																																																																													
		1																																																																													
		1																																																																													
		1																																																																													
2		1																																																																													
		1																																																																													
		2																																																																													
1	1	2																																																																													
Post - 0 Miss - 0 Block - 0	Post - 0 Miss - 0 Block - 0	Post - 2 Miss - 0 Block - 1	Post - 0 Miss - 0 Block - 1	Post - 0 Miss - 0 Block - 0	Post - 0 Miss - 0 Block - 0	Post - 0 Miss - 0 Block - 0	Post - 0 Miss - 0 Block - 0																																																																								
10 高静	11 朱海云	12 宋琛茜	17 史雨欣	18 戴小宇	27 吴美琪																																																																										
<table border="1"><tr><td></td><td></td><td></td></tr><tr><td>1</td><td></td><td></td></tr><tr><td></td><td></td><td></td></tr></table>				1						<table border="1"><tr><td></td><td></td><td></td></tr><tr><td></td><td></td><td></td></tr><tr><td></td><td></td><td></td></tr></table>										<table border="1"><tr><td></td><td></td><td></td></tr><tr><td></td><td></td><td></td></tr><tr><td></td><td></td><td></td></tr></table>										<table border="1"><tr><td></td><td></td><td></td></tr><tr><td></td><td></td><td></td></tr><tr><td></td><td></td><td></td></tr></table>										<table border="1"><tr><td></td><td></td><td></td></tr><tr><td>2</td><td></td><td></td></tr><tr><td>2</td><td></td><td>2</td></tr></table>				2			2		2	<table border="1"><tr><td></td><td></td><td></td></tr><tr><td></td><td></td><td></td></tr><tr><td>1</td><td></td><td></td></tr></table>							1			<table border="1"><tr><td></td><td></td><td></td></tr><tr><td></td><td></td><td></td></tr><tr><td></td><td></td><td></td></tr></table>										<table border="1"><tr><td></td><td></td><td></td></tr><tr><td></td><td></td><td></td></tr><tr><td></td><td></td><td></td></tr></table>									
1																																																																															
2																																																																															
2		2																																																																													
1																																																																															
Post - 0 Miss - 0 Block - 0	Post - 0 Miss - 2 Block - 0	Post - 0 Miss - 0 Block - 0	Post - 0 Miss - 0 Block - 0	Post - 0 Miss - 1 Block - 0	Post - 0 Miss - 0 Block - 0																																																																										

注释: Post=击柱 Miss=射失 Block=被封





预赛 Group A

女子 全国比赛

2016年全国女子手球锦标赛

Team A				Team B				Match Number													
A 江苏				B 山东				7													
played in		in the hall		on		at		Spectators													
China		滁州体育馆		04/09/2016		13:00		hours													
Half-time (30')	A	B	End of playing time	A	B	1st extra time	A	B	2nd extra time	A	B	After penalty throws	A	B							
	16	9		33	23																
Number of 7 m	A	Team time-out			Full name of players and officials						Team time-out			B	Number of 7 m						
		1	2	3							1	2	3								
	2 / 4	29:06								05:50	25:18		4 / 5								
No.	Team A					G	W	2'	D	DR	No.	Team B					G	W	2'	D	DR
1	陆婷										1	路畅									
3	张海侠					4					2	林燕群					4		1		
5	高媛媛										7	杨嘉露						1		1	
8	乔如					3					8	王彬					3				
9	莫蒙蒙					1		3			9	周钰婷									
10	王可可					1					10	田秀秀									
11	于源源					6	1				11	吕青纹					1				
12	黄霞										12	张苑琳									
13	黄慧影										15	吴作扬					3				
16	王小华										19	姜伟珊									
17	修丽杰					2		1			20	张悦						1			
18	韦秋香					1					22	朱贇									
23	王书慧					8	1				23	徐悦									
33	金梦青					5					28	崔金娜					2				
69	蓝小玲					2	1	1			33	王彩琳					10		1		
											77	穆庆丛					1				
B	金甲洙 (主教练)					1					B	马海湧 (主教练)									
C	马彪										C	徐强									
D	李海鹰										E	王日东									
E	陈志伟																				
A	Signature of Responsible Official of the Teams (Off. A)																		B		
TP	Remarks of Referee / CHA Official																		TP		

Signatures

Referees	倪震 (CHN)	马晓晔 (CHN)		
Techn. Delegates	吴国忠 (CHN)			
CHA Official	许宜扬 (CHN)			

Note: Number of 7m Throws Awarded to Team A and B, Goals (G), Warnings (W), Suspensions (2'), Direct Disqualification (D), Disqualification with Report (DR) and Team Penalty (TP).

Table Officials: 赵涵

李诚

Statisticians: 陈柱

闫冲





## 2016年全国女子手球锦标赛 竞赛技术统计(媒体表)

预赛	组别	A	轮次	2	场次	7
滁州体育馆			04/09/2016		201605007-51-1/1	
江苏	江苏	33	vs	23	山东	山东
16 : 9						

裁判员	倪震 (CHN)				/	马晓晔 (CHN)			
-----	----------	--	--	--	---	-----------	--	--	--

江苏		远	近	边	快	突	任意	7m	合计	%	助攻	失误	警告	2'	D & DR	江苏		山东		
主教练：金甲洙		射	射	射	攻	破	球	球								比赛进程				
1	陆婷										3					3	张海侠	1	00:46	0
3	张海侠		2/2	1/2	1/2				4/6	66.7		2				8	乔如	2	02:41	0
5	高媛媛															17	修丽杰	3	04:00	0
8	乔如				2/2		1/1					1				3	张海侠	4	05:26	0
9	莫蒙萌		0/1	1/1					1/2	50.0					3	11	于源源	5	07:26	0
10	王可可							1/1	1/1	100						11	于源源	5	08:29	1
11	于源源		1/1	4/5	1/1				6/7	85.7			1			11	于源源	6	11:41	1
12	黄霞								0/1	0.0						8	乔如	7	11:50	1
13	黄慧影								0/1	0.0						7	于源源	7	12:34	2
16	王小华															8	乔如	8	13:58	2
17	修丽杰	1/2	1/3					0/1	2/6	33.3		3			1	8	乔如	8	17:04	3
18	韦秋香				1/2				1/2	50.0						8	乔如	8	18:09	4
23	王书慧	0/3	2/3	2/2	3/4	1/1			8/13	61.5		5	1			8	乔如	9	19:00	4
33	金梦青	3/7	0/1	1/1				1/1	5/10	50.0	1	1				23	王书慧	10	19:35	4
69	蓝小玲	1/1	1/2						2/3	66.7	1	1	1	1		23	王书慧	11	19:44	4
<b>运动员 合计</b>		5/13	7/13	8/10	9/12	1/1	1/1	2/4	33/54	61.1	5	13	3	5		11	于源源	11	22:10	5
1	陆婷	4/6	4/13	2/4	2/3	0/4		1/3	13/33	39.4	3					11	于源源	11	22:42	6
12	黄霞		0/1					0/2	0/3	0.0						11	于源源	12	23:05	6
<b>守门员 合计</b>		4/6	4/14	2/4	2/3	0/4		1/5	13/36	36.1	3					11	于源源	12	23:14	7
<b>山东</b>		远	近	边	快	突	任意	7m	合计	%	助攻	失误	警告	2'	D & DR	2nd Half				
教练：马海湧		射	射	射	攻	破	球	球								16	01:24	10	2	
1	刘畅															16	02:31	11	11	
2	林燕群	1/4	1/1			1/1		1/1	4/7	57.1		3		1		3	张海侠	17	03:00	11
7	杨嘉露	0/1	0/2						0/3	0.0			1		1	17	03:32	12	28	
8	王彬			1/1	0/1			2/2	3/4	75.0		2				17	04:45	13	2	
9	周钰婷	0/4	0/1						0/5	0.0	1	2				33	金梦青	18	04:53	13
10	田秀秀	0/1							0/1	0.0		4				11	于源源	18	05:37	13
11	吕青纹		0/1	1/3					1/4	25.0						69	蓝小玲	20	07:46	13
12	张苑琳															33	金梦青	21	08:06	13
15	吴作扬	0/3	2/2					1/1	3/6	50.0		3				11	于源源	22	08:43	13
19	姜伟珊		0/1						0/1	0.0		1				3	张海侠	22	09:49	14
20	张悦				0/1				0/1	0.0			1			23	01:16	14		
22	朱贇															23	10:44	15	33	
23	徐悦															17	修丽杰	24	12:49	15
28	崔金娜		2/2						2/2	100						24	13:27	16	33	
33	王彩琳	1/1	5/5		1/1	3/3		10/10	10/10	100		2		1		9	莫蒙萌	25	13:39	16
77	穆庆丛				0/1			0/1	0/2	0.0						25	14:44	17	33	
<b>运动员 合计</b>		2/14	10/15	2/4	1/4	4/4		4/5	23/46	50.0	1	17	3	2	1	26	15:09	17		
1	刘畅	3/6	2/5	0/2	1/2	0/1		1/1	7/17	41.2						26	15:33	18	33	
12	张苑琳	3/5	3/7	1/7	2/10		0/1	1/1	9/30	30.0						69	蓝小玲	27	16:49	18
22	朱贇							1/3	1/3	33.3						10	王可可	28	19:25	18
<b>守门员 合计</b>		6/11	5/12	1/9	3/12	0/1	0/1	2/4	17/50	34.0						23	王书慧	28	19:39	19
场上队员：得分 / 射门																守门员：救球 / 射门				

快攻	Fast Break		突破	Breakthrough		任意球	Free Throw		7M球	7M Throw		助攻	Assist
警告	Warning		失误	Error		2'	Suspension		D	取消资格		DR	取消资格+报告





### 2016年全国女子手球锦标赛 图式比赛技术统计表

轮次 2

场次 7

201605007-21-1/1

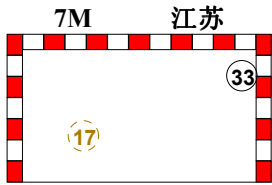
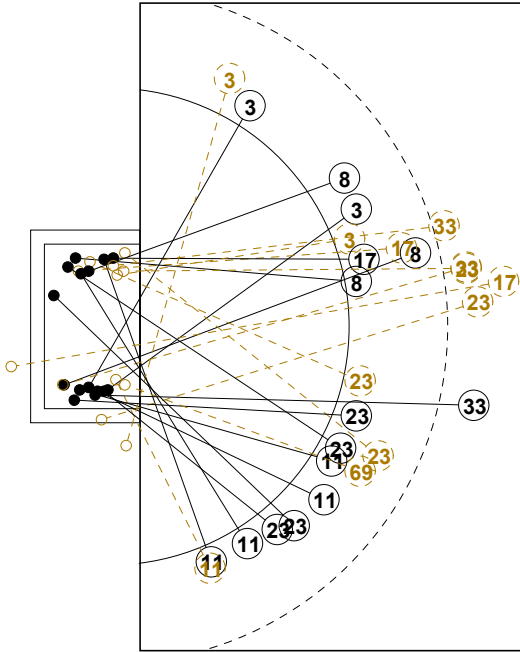

1st Half  
16 : 9

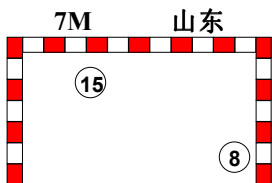
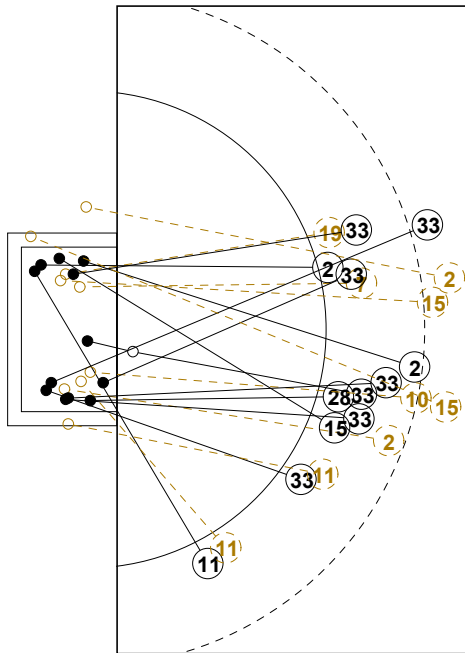
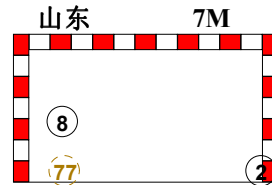
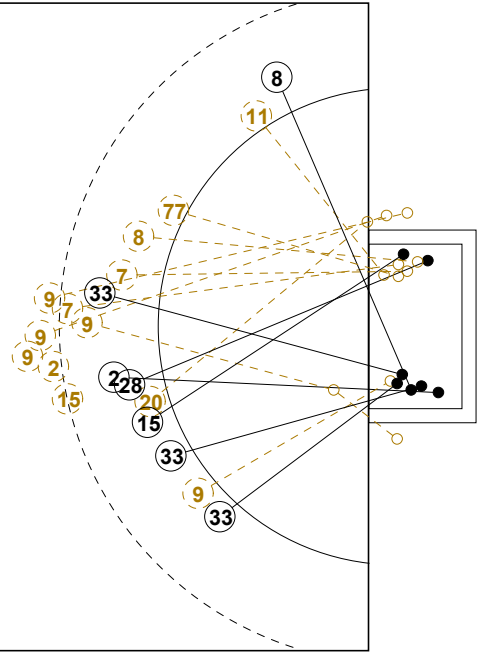

2nd Half  
23 : 33

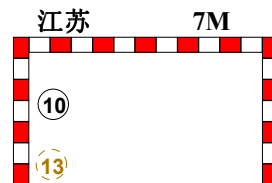
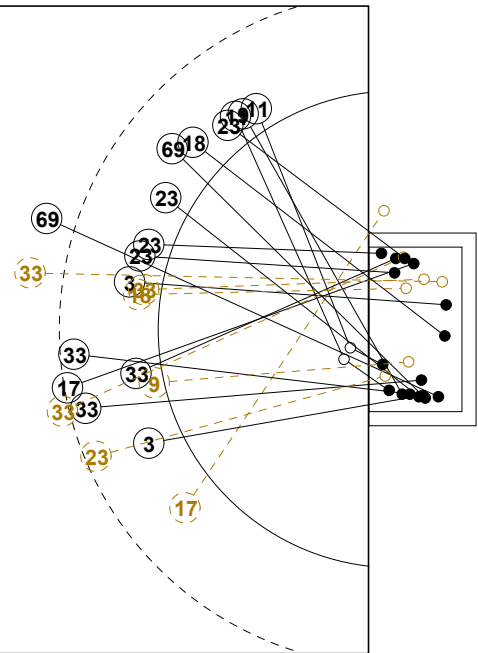



## 2016年全国女子手球锦标赛

## 个人/全队技术统计表

正式表  
手球  
女子预赛  
轮次 2组别 A  
场次 7201605007-14-1/2  
滁州体育馆  
04/09/2016 13:00

号码	姓名	远射	近射	边射	快攻	突破	任意	7M	合计	%	助攻	失误	警告	2'	取消	时间
<b>江苏(江苏)</b>																
<i>(场上队员)</i>																
1	陆婷									0.0%	3					00:54:06
3	张海侠		2/2	1/2	1/2				4/6	66.7%		2				00:50:01
5	高媛媛									0.0%						00:00:00
8	乔如				2/2		1/1		3/3	100%		1				00:35:46
9	莫蒙蒙		0/1	1/1					1/2	50.0%				3		00:30:46
10	王可可							1/1	1/1	100%						00:05:19
11	于源源		1/1	4/5	1/1				6/7	85.7%			1			00:40:51
12	黄霞									0.0%						00:05:54
13	黄慧影							0/1	0/1	0.0%						00:19:07
16	王小华									0.0%						00:00:00
17	修丽杰	1/2	1/3					0/1	2/6	33.3%		3		1		00:52:42
18	韦秋香				1/2				1/2	50.0%						00:11:02
23	王书慧	0/3	2/3	2/2	3/4	1/1			8/13	61.5%		5	1			00:40:43
33	金梦青	3/7	0/1		1/1			1/1	5/10	50.0%	1	1				00:27:06
69	蓝小玲	1/1	1/2						2/3	66.7%	1	1	1	1		00:43:26
<b>合计</b>		5/13	7/13	8/10	9/12	1/1	1/1	2/4	33/54	61.1%	5	13	3	5		
<i>(守门员)</i>																
1	陆婷	4/6	4/13	2/4	2/3	0/4		1/3	13/33	39.4%	3					00:54:06
12	黄霞		0/1					0/2	0/3	0.0%						00:05:54
<b>合计</b>		4/6	4/14	2/4	2/3	0/4		1/5	13/36	36.1%	3					

场上队员：得分/射门

守门员：救球/射门

全队合计	得分	被救	射失	击柱	封球	合计	%
远射	5	6	1	1		13	38.5%
近射	7	5	1			13	53.8%
边射	8	1	1			10	80.0%
快攻	9	3				12	75.0%
突破	1					1	100.0%
任意	1					1	100.0%
7M	2	2				4	50.0%





## 2016年全国女子手球锦标赛

## 个人/全队技术统计表

正式表  
手球  
女子预赛  
轮次 2组别 A  
场次 7201605007-14-2/2  
滁州体育馆  
04/09/2016 13:00

号码	姓名	远射	近射	边射	快攻	突破	任意	7M	合计	%	助攻	失误	警告	2'	取消	时间
<b>山东(山东)</b>																
<i>(上场队员)</i>																
1	刘畅									0.0%						00:21:01
2	林燕群	1/4	1/1			1/1		1/1	4/7	57.1%		3		1		00:33:55
7	杨嘉露	0/1	0/2						0/3	0.0%			1	1		00:19:09
8	王彬			1/1	0/1			2/2	3/4	75.0%		2				00:21:14
9	周钰婷	0/4	0/1						0/5	0.0%	1	2				00:24:42
10	田秀秀	0/1							0/1	0.0%		4				00:32:16
11	吕青纹		0/1	1/3					1/4	25.0%						00:49:03
12	张苑琳									0.0%						00:38:05
15	吴作扬	0/3	2/2					1/1	3/6	50.0%		3				00:33:26
19	姜伟珊		0/1						0/1	0.0%		1				00:30:00
20	张悦				0/1				0/1	0.0%			1			00:30:00
22	朱赞									0.0%						00:00:54
23	徐悦									0.0%						00:16:20
28	崔金娜		2/2						2/2	100%						00:19:32
33	王彩琳	1/1	5/5		1/1	3/3			10/10	100%		2		1		00:26:08
77	穆庆丛				0/1			0/1	0/2	0.0%			1			00:22:56
<b>合计</b>		2/14	10/15	2/4	1/4	4/4		4/5	23/46	50.0%	1	17	3	2	1	
<i>(守门员)</i>																
1	刘畅	3/6	2/5	0/2	1/2	0/1		1/1	7/17	41.2%						00:21:01
12	张苑琳	3/5	3/7	1/7	2/10		0/1		9/30	30.0%						00:38:05
22	朱赞							1/3	1/3	33.3%						00:00:54
<b>合计</b>		6/11	5/12	1/9	3/12	0/1	0/1	2/4	17/50	34.0%						

场上队员：得分/射门

守门员：救球/射门

全队合计	得分	被救	射失	击柱	封球	合计	%
远射	2	4	4	1	3	14	14.3%
近射	10	4		1		15	66.7%
边射	2	2				4	50.0%
快攻	1	2	1			4	25.0%
突破	4					4	100.0%
任意							0.0%
7M	4	1				5	80.0%





### 2016年全国女子手球锦标赛

#### 图式射门区域统计

轮次 2 场次 7

201605007-41-1/1

## 江苏

1 陆婷	3 张海侠	5 高媛媛	8 乔如	9 莫蒙蒙	10 王可可	11 于源源	12 黄霞																																																																								
<table border="1"><tr><td></td><td></td><td></td></tr><tr><td></td><td></td><td></td></tr><tr><td></td><td></td><td></td></tr></table>										<table border="1"><tr><td></td><td>1</td><td></td></tr><tr><td>2</td><td></td><td>1</td></tr><tr><td></td><td></td><td></td></tr></table>		1		2		1				<table border="1"><tr><td></td><td></td><td></td></tr><tr><td></td><td></td><td></td></tr><tr><td></td><td></td><td></td></tr></table>										<table border="1"><tr><td>1</td><td></td><td>1</td></tr><tr><td></td><td></td><td>1</td></tr><tr><td></td><td></td><td></td></tr></table>	1		1			1				<table border="1"><tr><td></td><td></td><td></td></tr><tr><td></td><td></td><td>1</td></tr><tr><td></td><td></td><td></td></tr></table>						1				<table border="1"><tr><td></td><td></td><td></td></tr><tr><td>1</td><td></td><td></td></tr><tr><td></td><td></td><td></td></tr></table>				1						<table border="1"><tr><td></td><td></td><td></td></tr><tr><td>2</td><td></td><td>2</td></tr><tr><td></td><td></td><td>2</td></tr></table>				2		2			2	<table border="1"><tr><td></td><td></td><td></td></tr><tr><td></td><td></td><td></td></tr><tr><td></td><td></td><td></td></tr></table>									
	1																																																																														
2		1																																																																													
1		1																																																																													
		1																																																																													
		1																																																																													
1																																																																															
2		2																																																																													
		2																																																																													
Post - 0 Miss - 0 Block - 0	Post - 0 Miss - 1 Block - 0	Post - 0 Miss - 0 Block - 0	Post - 0 Miss - 0 Block - 0	Post - 0 Miss - 0 Block - 0	Post - 0 Miss - 0 Block - 0	Post - 0 Miss - 0 Block - 0	Post - 0 Miss - 0 Block - 0																																																																								
13 黄慧影	16 王小华	17 修丽杰	18 韦秋香	23 王书慧	33 金梦青	69 蓝小玲																																																																									
<table border="1"><tr><td></td><td></td><td></td></tr><tr><td></td><td></td><td></td></tr><tr><td></td><td></td><td></td></tr></table>										<table border="1"><tr><td></td><td></td><td></td></tr><tr><td></td><td></td><td></td></tr><tr><td></td><td></td><td></td></tr></table>										<table border="1"><tr><td></td><td></td><td></td></tr><tr><td>1</td><td></td><td></td></tr><tr><td></td><td></td><td>1</td></tr></table>				1					1	<table border="1"><tr><td></td><td>1</td><td></td></tr><tr><td></td><td></td><td></td></tr><tr><td></td><td></td><td></td></tr></table>		1								<table border="1"><tr><td>1</td><td></td><td>2</td></tr><tr><td>2</td><td></td><td>1</td></tr><tr><td>2</td><td></td><td></td></tr></table>	1		2	2		1	2			<table border="1"><tr><td></td><td></td><td>1</td></tr><tr><td>1</td><td></td><td>2</td></tr><tr><td>1</td><td></td><td></td></tr></table>			1	1		2	1			<table border="1"><tr><td></td><td></td><td>1</td></tr><tr><td></td><td></td><td>1</td></tr><tr><td></td><td></td><td></td></tr></table>			1			1				<table border="1"><tr><td></td><td></td><td></td></tr><tr><td></td><td></td><td></td></tr><tr><td></td><td></td><td></td></tr></table>									
1																																																																															
		1																																																																													
	1																																																																														
1		2																																																																													
2		1																																																																													
2																																																																															
		1																																																																													
1		2																																																																													
1																																																																															
		1																																																																													
		1																																																																													
Post - 0 Miss - 0 Block - 0	Post - 0 Miss - 0 Block - 0	Post - 0 Miss - 2 Block - 0	Post - 0 Miss - 0 Block - 0	Post - 1 Miss - 0 Block - 0	Post - 0 Miss - 0 Block - 0	Post - 0 Miss - 0 Block - 0																																																																									

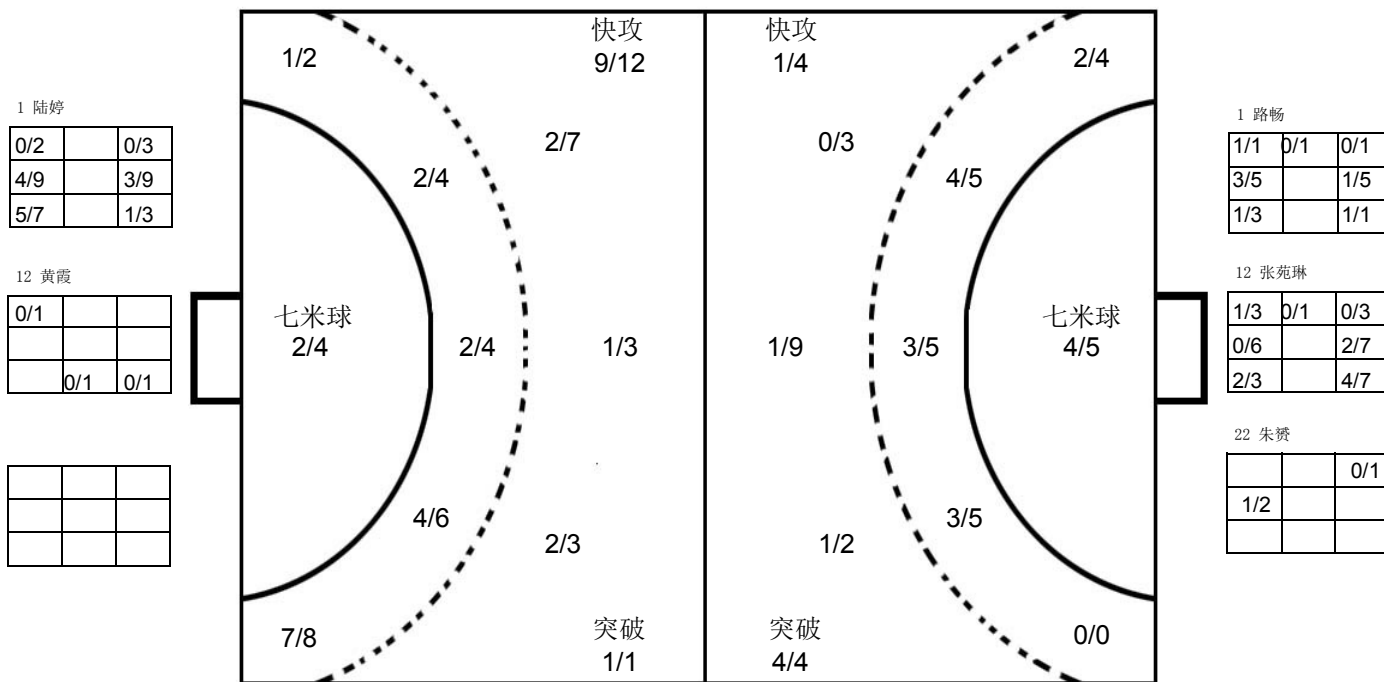

## 山东

1 刘畅	2 林燕群	7 杨嘉露	8 王彬	9 周钰婷	10 田秀秀	11 吕青纹	12 张苑琳																																																																								
<table border="1"><tr><td></td><td></td><td></td></tr><tr><td></td><td></td><td></td></tr><tr><td></td><td></td><td></td></tr></table>										<table border="1"><tr><td></td><td>2</td><td></td></tr><tr><td></td><td>1</td><td></td></tr><tr><td></td><td>1</td><td></td></tr></table>		2			1			1		<table border="1"><tr><td></td><td></td><td></td></tr><tr><td></td><td></td><td></td></tr><tr><td></td><td></td><td></td></tr></table>										<table border="1"><tr><td>1</td><td></td><td>1</td></tr><tr><td></td><td></td><td>1</td></tr><tr><td></td><td></td><td></td></tr></table>	1		1			1				<table border="1"><tr><td></td><td></td><td></td></tr><tr><td></td><td></td><td></td></tr><tr><td></td><td></td><td></td></tr></table>										<table border="1"><tr><td></td><td></td><td></td></tr><tr><td></td><td></td><td></td></tr><tr><td></td><td></td><td></td></tr></table>										<table border="1"><tr><td></td><td></td><td>1</td></tr><tr><td></td><td></td><td></td></tr><tr><td></td><td></td><td></td></tr></table>			1							<table border="1"><tr><td></td><td></td><td></td></tr><tr><td></td><td></td><td></td></tr><tr><td></td><td></td><td></td></tr></table>									
	2																																																																														
	1																																																																														
	1																																																																														
1		1																																																																													
		1																																																																													
		1																																																																													
Post - 0 Miss - 0 Block - 0	Post - 0 Miss - 1 Block - 1	Post - 0 Miss - 0 Block - 0	Post - 0 Miss - 0 Block - 0	Post - 0 Miss - 3 Block - 1	Post - 0 Miss - 0 Block - 0	Post - 1 Miss - 0 Block - 0	Post - 0 Miss - 0 Block - 0																																																																								
15 吴作扬	19 姜伟珊	20 张悦	22 朱贇	23 徐悦	28 崔金娜	33 王彩琳	77 穆庆丛																																																																								
<table border="1"><tr><td>1</td><td></td><td></td></tr><tr><td>1</td><td></td><td>1</td></tr><tr><td></td><td></td><td></td></tr></table>	1			1		1				<table border="1"><tr><td></td><td></td><td></td></tr><tr><td></td><td></td><td></td></tr><tr><td></td><td></td><td></td></tr></table>										<table border="1"><tr><td></td><td></td><td></td></tr><tr><td></td><td></td><td></td></tr><tr><td></td><td></td><td></td></tr></table>										<table border="1"><tr><td></td><td></td><td></td></tr><tr><td></td><td></td><td></td></tr><tr><td></td><td></td><td></td></tr></table>										<table border="1"><tr><td></td><td></td><td></td></tr><tr><td></td><td></td><td></td></tr><tr><td></td><td></td><td></td></tr></table>										<table border="1"><tr><td></td><td></td><td></td></tr><tr><td>1</td><td></td><td></td></tr><tr><td>1</td><td></td><td></td></tr></table>				1			1			<table border="1"><tr><td>2</td><td></td><td></td></tr><tr><td>2</td><td></td><td>3</td></tr><tr><td>1</td><td>1</td><td>1</td></tr></table>	2			2		3	1	1	1	<table border="1"><tr><td></td><td></td><td></td></tr><tr><td></td><td></td><td></td></tr><tr><td></td><td></td><td></td></tr></table>									
1																																																																															
1		1																																																																													
1																																																																															
1																																																																															
2																																																																															
2		3																																																																													
1	1	1																																																																													
Post - 1 Miss - 0 Block - 1	Post - 0 Miss - 0 Block - 0	Post - 0 Miss - 1 Block - 0	Post - 0 Miss - 0 Block - 0	Post - 0 Miss - 0 Block - 0	Post - 0 Miss - 0 Block - 0	Post - 0 Miss - 0 Block - 0	Post - 0 Miss - 0 Block - 0																																																																								

注释: Post=击柱 Miss=射失 Block=被封



预赛 Group A

女子 全国比赛

2016年全国女子手球锦标赛

Team A A 广东				Team B B 黑龙江				Match Number 8													
played in China		in the hall 滁州体育馆		on 04/09/2016		at 14:30 hours		Spectators													
Half-time (30')	A 15	B 8	End of playing time	A 33	B 18	1st extra time	A	B	2nd extra time	A	B	After penalty throws	A	B							
Number of 7 m	A 5/8	Team time-out			Full name of players and officials				Team time-out			B 3/3	Number of 7 m								
	1	2	3					1	2	3											
								23:47	42:04	49:16											
No.	Team A					G	W	2'	D	DR	No.	Team B					G	W	2'	D	DR
3	安妮					3		1			1	徐佳蓉									
5	李纯										3	刘诗彤					1		1		
7	刘彤					2					5	周美微					3	1			
8	李诗棋					2	1				6	王梦艺						1			
9	韦宝桂					1					9	郑宇					3		1		
11	魏梦庭					7					10	刘雪露							1		
15	杨慧										11	刘天茹					1	1			
16	李娟										12	肖宁桐									
18	李玉玲					8					13	吴佳					2		1		
19	邝雪花					3		1			14	黄莹					1				
20	李军政					1	1	1			16	杜宪									
22	刘晓玉										19	梁文煜					3				
23	王如					1	1				21	王戈									
26	马晓卉										22	马琳					4				
28	刘金兰					2					23	张政									
31	史小军					3															
A	李细利										B	张立梅 (主教练)									
B	郭艳辉 (主教练)										C	黄冬杰									
D	祝捷										D	于兹香									
E	赵善良										E	马婧									
A	Signature of Responsible Official of the Teams (Off. A)																			B	
TP	Remarks of Referee / CHA Official																			TP	

Signatures

Referees	王雨洋 (CHN)	刘晓辉 (CHN)		
Techn. Delegates	吴国忠 (CHN)			
CHA Official	许宜扬 (CHN)			

Note: Number of 7m Throws Awarded to Team A and B, Goals (G), Warnings (W), Suspensions (2'), Direct Disqualification (D), Disqualification with Report (DR) and Team Penalty (TP).

Table Officials: 佟金正

贾俊秋

Statisticians: 闫冲

陈柱

Printed by PHMS Copyright: IHF/CHA 04/09/2016 10:53:50

Longman Sportsoft



handball@126.com





### 2016年全国女子手球锦标赛 竞赛技术统计(媒体表)

预赛	组别	A	轮次	2	场次	8
滁州体育馆		04/09/2016			201605008-51-1/1	
广东	广东	33	vs	18	黑龙江	黑龙江
		15 : 8				

裁判员	王雨洋 (CHN)	/	刘晓辉 (CHN)
-----	-----------	---	-----------

广东														比赛进程		黑龙江		
主教练	远射	近射	边射	快攻	突破	任意球	7m球	合计	%	助攻	失误	警告	2'	D & DR	广东	黑龙江		
郭艳辉															1st Half			
3 安妮	0/1	2/4		1/1				3/6	50.0		1		1		7 刘彤	1 01:00	0	
5 李纯															1 1 01:48	1 13 吴佳		
7 刘彤			2/2	0/1				2/3	66.7		1				28 刘金兰	2 03:38	1	
8 李诗棋			1/1	1/1			0/1	2/3	66.7		1	1			18 李玉玲	3 05:20	1	
9 韦宝桂	1/1						0/1	1/2	50.0						31 史小军	4 06:03	1	
11 魏梦庭	3/7	1/1			2/2		1/1	7/11	63.6		1				4 06:36	2 5 周美微		
15 杨慧			0/1					0/1	0.0						18 李玉玲	5 07:09	2	
16 李娟															31 史小军	6 12:43	2	
18 李玉玲	1/4	3/3		1/1			3/4	8/12	66.7						18 李玉玲	7 14:35	2	
19 邝雪花	1/2		2/2		0/1			3/5	60.0		1		1		3 安妮	8 17:18	2	
20 李军政		1/1	0/2					1/3	33.3		1	1	1		8 18:31	3 19 梁文煜		
22 刘晓玉										2					9 18:42	3		
23 王如				1/1				1/1	100			1			19 邝雪花	10 19:43	4	
26 马晓卉										1					19 邝雪花	11 20:20	4	
28 刘金兰					1/3		1/1	2/4	50.0		3				11 魏梦庭	12 20:47	4	
31 史小军		1/1		2/2				3/3	100		1				3 安妮	12 21:35	5 14 黄荣	
<b>运动员 合计</b>	<b>6/15</b>	<b>8/10</b>	<b>5/8</b>	<b>7/10</b>	<b>2/3</b>		<b>5/8</b>	<b>33/54</b>	<b>61.1</b>	<b>3</b>	<b>10</b>	<b>3</b>	<b>3</b>		11 魏梦庭	13 22:09	5	
16 李娟	1/3	0/2	1/2	0/1	0/1		0/2	2/11	18.2						11 魏梦庭	14 25:08	6	
22 刘晓玉	7/10	0/1	1/1	1/1				9/13	69.2	2					20 李军政	15 29:02	6	
26 马晓卉	3/6		1/2				0/1	4/9	44.4	1					15 29:28	7 5 周美微		
<b>守门员 合计</b>	<b>11/19</b>	<b>0/3</b>	<b>3/5</b>	<b>1/2</b>	<b>0/1</b>		<b>0/3</b>	<b>15/33</b>	<b>45.5</b>	<b>3</b>					15 29:57	8 5 周美微		
黑龙江														2nd Half				
教练	远射	近射	边射	快攻	突破	任意球	7m球	合计	%	助攻	失误	警告	2'	D & DR	广东	黑龙江		
张立梅															9 韦宝桂	16 00:23	8	
1 徐佳蓉															11 魏梦庭	17 01:31	9	
3 刘诗彤		1/1		0/1				1/2	50.0		2		1		28 刘金兰	18 02:44	10	
5 周美微	0/2	1/1	1/1	1/1				3/5	60.0		1	1			7 刘彤	18 03:01	11 22 马琳	
6 王梦艺	0/2							0/2	0.0		1	1			11 魏梦庭	19 03:16	11	
9 郑宇	1/4				1/1		1/1	3/6	50.0				1		19 邝雪花	19 03:47	12 19 梁文煜	
10 刘雪露	0/2							0/2	0.0	1	4		1		11 魏梦庭	20 04:08	12	
11 刘天茹			1/2					1/2	50.0		2	1			11 魏梦庭	20 05:30	13 9 郑宇	
12 肖宁桐											1				19 邝雪花	21 08:00	13	
13 吴佳	2/6		0/1					2/7	28.6		4		1		11 魏梦庭	22 08:52	13	
14 黄荣							1/1	1/1	100						11 魏梦庭	22 10:16	14 3 刘诗彤	
16 杜宪															11 魏梦庭	23 10:45	14	
19 梁文煜	3/6		0/1					3/7	42.9						23 11:08	15 19 梁文煜		
21 王戈			0/1					0/1	0.0						24 14:22	16 13 吴佳		
22 马琳	2/5	1/1					1/1	4/7	57.1		3				18 李玉玲	25 14:36	16	
23 张政											2				3 安妮	25 15:07	17 11 刘天茹	
<b>运动员 合计</b>	<b>8/27</b>	<b>3/3</b>	<b>2/6</b>	<b>1/2</b>	<b>1/1</b>		<b>3/3</b>	<b>18/42</b>	<b>42.9</b>	<b>1</b>	<b>20</b>	<b>3</b>	<b>4</b>		31 史小军	26 15:39	17	
12 肖宁桐	5/11	1/7	3/7	2/9	1/3		1/3	13/40	32.5		1				8 李诗棋	27 16:28	17	
16 杜宪	1/1	0/2	0/1				0/3	1/7	14.3						18 李玉玲	28 17:22	17	
<b>守门员 合计</b>	<b>6/12</b>	<b>1/9</b>	<b>3/8</b>	<b>2/9</b>	<b>1/3</b>		<b>1/6</b>	<b>14/47</b>	<b>29.8</b>		<b>1</b>				18 李玉玲	29 18:51	17	

场上队员：得分 / 射门

守门员：救球 / 射门

快攻	Fast Break	突破	Breakthrough	任意球	Free Throw	7M球	7M Throw	助攻	Assist
警告	Warning	失误	Error	2'	Suspension	D	取消资格	DR	取消资格+报告





### 2016年全国女子手球锦标赛 图式比赛技术统计表

轮次 2

场次 8

201605008-21-1/1

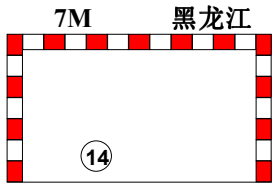
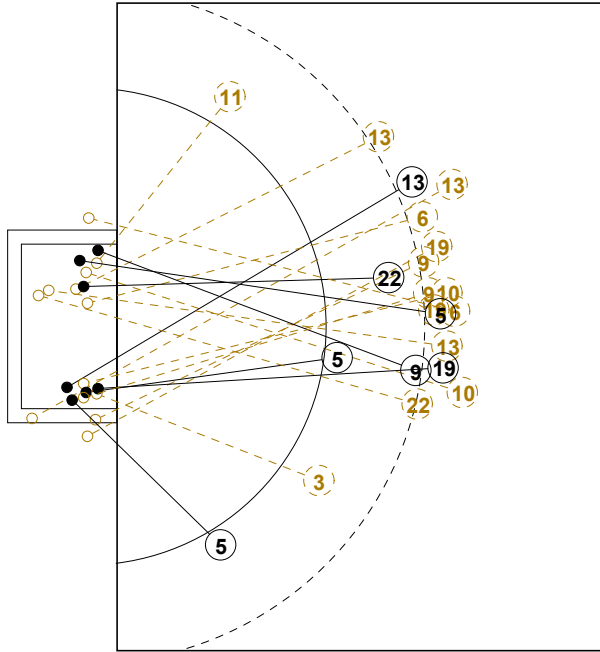

1st Half  
8 : 15

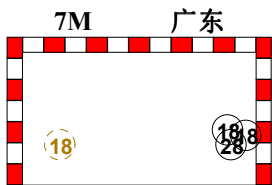
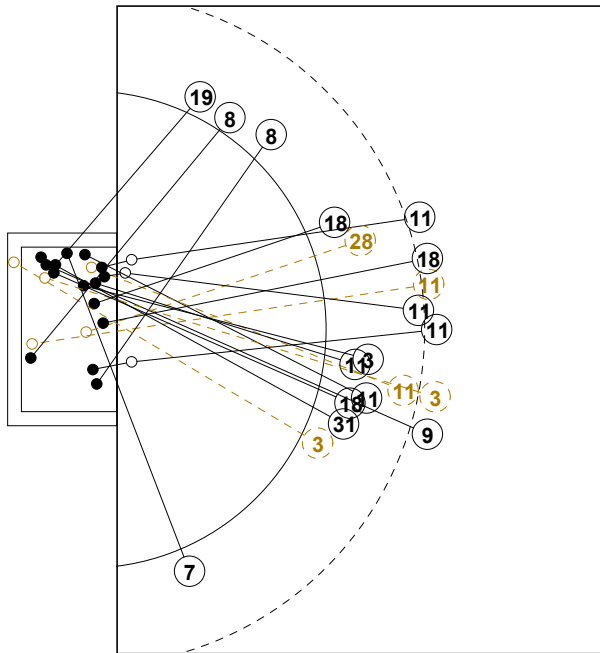
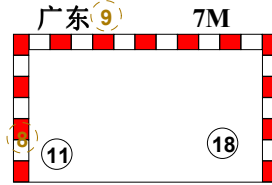
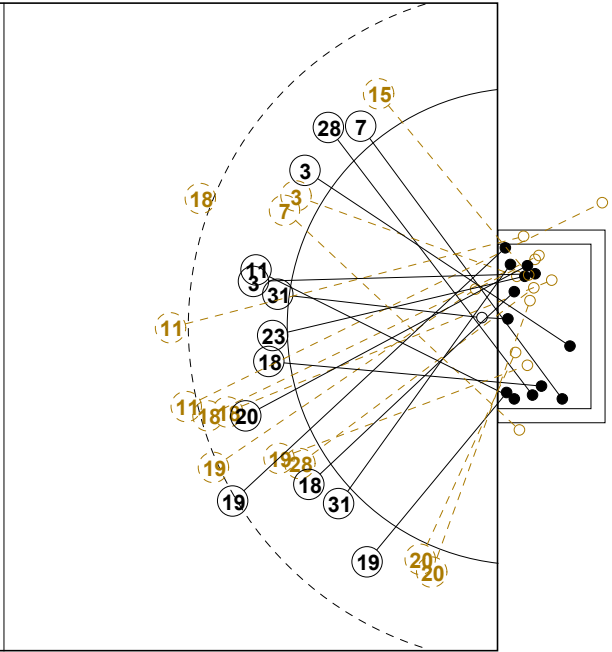

2nd Half  
33 : 18

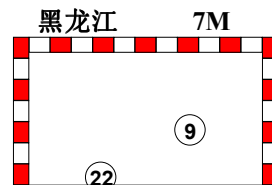
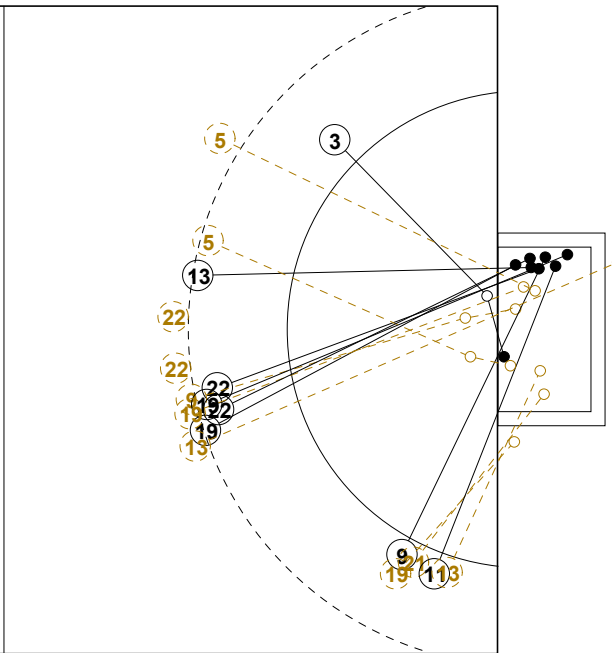



## 2016年全国女子手球锦标赛

## 个人/全队技术统计表

正式表  
手球  
女子预赛  
轮次 2组别 A  
场次 8201605008-14-1/2  
滁州体育馆  
04/09/2016 14:30

号码	姓名	远射	近射	边射	快攻	突破	任意	7M	合计	%	助攻	失误	警告	2'	取消	时间
<b>广东(广东)</b>																
<i>(场上队员)</i>																
3	安妮	0/1	2/4		1/1				3/6	50.0%		1		1		00:38:56
5	李纯									0.0%						00:22:16
7	刘彤			2/2	0/1				2/3	66.7%		1				00:29:56
8	李诗棋			1/1	1/1			0/1	2/3	66.7%		1	1			00:22:45
9	韦宝桂	1/1						0/1	1/2	50.0%						00:23:12
11	魏梦庭	3/7	1/1			2/2		1/1	7/11	63.6%		1				00:34:26
15	杨慧			0/1					0/1	0.0%						00:15:30
16	李娟									0.0%						00:18:49
18	李玉玲	1/4	3/3		1/1			3/4	8/12	66.7%						00:28:57
19	邝雪花	1/2		2/2		0/1			3/5	60.0%		1		1		00:27:56
20	李军政		1/1	0/2					1/3	33.3%		1	1	1		00:19:08
22	刘晓玉									0.0%	2					00:21:30
23	王如				1/1				1/1	100%				1		00:19:30
26	马晓卉									0.0%	1					00:16:16
28	刘金兰				1/3			1/1	2/4	50.0%		3				00:26:23
31	史小军		1/1		2/2				3/3	100%		1				00:29:13
<b>合计</b>		6/15	8/10	5/8	7/10	2/3		5/8	33/54	61.1%	3	10	3	3		
<i>(守门员)</i>																
16	李娟	1/3	0/2	1/2	0/1	0/1		0/2	2/11	18.2%						00:18:49
22	刘晓玉	7/10	0/1	1/1	1/1				9/13	69.2%	2					00:21:30
26	马晓卉	3/6		1/2				0/1	4/9	44.4%	1					00:16:16
<b>合计</b>		11/19	0/3	3/5	1/2	0/1		0/3	15/33	45.5%	3					

场上队员：得分/射门

守门员：救球/射门

全队合计	得分	被救	射失	击柱	封球	合计	%
远射	6	6	1	1	1	15	40.0%
近射	8	1		1		10	80.0%
边射	5	3				8	62.5%
快攻	7	2	1			10	70.0%
突破	2	1				3	66.7%
任意							0.0%
7M	5	1	1	1		8	62.5%





## 2016年全国女子手球锦标赛

## 个人/全队技术统计表

正式表  
手球  
女子预赛  
轮次 2组别 A  
场次 8201605008-14-2/2  
滁州体育馆  
04/09/2016 14:30

号码	姓名	远射	近射	边射	快攻	突破	任意	7M	合计	%	助攻	失误	警告	2'	取消	时间
<b>黑龙江(黑龙江)</b>																
<i>(上场队员)</i>																
1	徐佳蓉									0.0%						00:00:00
3	刘诗彤		1/1		0/1				1/2	50.0%		2		1		00:32:22
5	周美微	0/2	1/1	1/1	1/1				3/5	60.0%		1	1			00:24:28
6	王梦艺	0/2							0/2	0.0%		1	1			00:24:40
9	郑宇	1/4				1/1		1/1	3/6	50.0%				1		00:30:45
10	刘雪露	0/2							0/2	0.0%	1	4		1		00:25:30
11	刘天茹			1/2					1/2	50.0%		2	1			00:32:50
12	肖宁桐									0.0%		1				00:48:16
13	吴佳	2/6		0/1					2/7	28.6%		4		1		00:31:57
14	黄荣							1/1	1/1	100%						00:00:10
16	杜宪									0.0%						00:08:35
19	梁文煜	3/6		0/1					3/7	42.9%						00:38:38
21	王戈			0/1					0/1	0.0%						00:33:33
22	马琳	2/5	1/1					1/1	4/7	57.1%		3				00:29:32
23	张政									0.0%		2				00:31:14
<b>合计</b>		8/27	3/3	2/6	1/2	1/1		3/3	18/42	42.9%	1	20	3	4		
<i>(守门员)</i>																
12	肖宁桐	5/11	1/7	3/7	2/9	1/3		1/3	13/40	32.5%		1				00:48:16
16	杜宪	1/1	0/2	0/1				0/3	1/7	14.3%						00:08:35
<b>合计</b>		6/12	1/9	3/8	2/9	1/3		1/6	14/47	29.8%		1				

场上队员：得分/射门

守门员：救球/射门

全队合计	得分	被救	射失	击柱	封球	合计	%
远射	8	11	3	2	3	27	29.6%
近射	3					3	100.0%
边射	2	3	1			6	33.3%
快攻	1	1				2	50.0%
突破	1					1	100.0%
任意							0.0%
7M	3					3	100.0%





### 2016年全国女子手球锦标赛

#### 图式射门区域统计

轮次 2 场次 8

201605008-41-1/1

## 广东

3 安妮	5 李纯	7 刘彤	8 李诗棋	9 韦宝柱	11 魏梦庭	15 杨慧	16 李娟																																																																								
<table border="1"><tr><td></td><td>1</td><td></td></tr><tr><td>1</td><td></td><td>1</td></tr><tr><td></td><td></td><td></td></tr></table>		1		1		1				<table border="1"><tr><td></td><td></td><td></td></tr><tr><td></td><td></td><td></td></tr><tr><td></td><td></td><td></td></tr></table>										<table border="1"><tr><td></td><td></td><td>1</td></tr><tr><td></td><td></td><td>1</td></tr><tr><td></td><td></td><td></td></tr></table>			1			1				<table border="1"><tr><td>1</td><td></td><td></td></tr><tr><td></td><td></td><td></td></tr><tr><td>1</td><td></td><td></td></tr></table>	1						1			<table border="1"><tr><td></td><td></td><td>1</td></tr><tr><td></td><td></td><td></td></tr><tr><td></td><td></td><td></td></tr></table>			1							<table border="1"><tr><td></td><td></td><td></td></tr><tr><td></td><td></td><td>1</td></tr><tr><td>2</td><td></td><td>4</td></tr></table>						1	2		4	<table border="1"><tr><td></td><td></td><td></td></tr><tr><td></td><td></td><td></td></tr><tr><td></td><td></td><td></td></tr></table>										<table border="1"><tr><td></td><td></td><td></td></tr><tr><td></td><td></td><td></td></tr><tr><td></td><td></td><td></td></tr></table>									
	1																																																																														
1		1																																																																													
		1																																																																													
		1																																																																													
1																																																																															
1																																																																															
		1																																																																													
		1																																																																													
2		4																																																																													
Post - 1 Miss - 0 Block - 0	Post - 0 Miss - 0 Block - 0	Post - 0 Miss - 1 Block - 0	Post - 1 Miss - 0 Block - 0	Post - 0 Miss - 1 Block - 0	Post - 1 Miss - 1 Block - 0	Post - 0 Miss - 0 Block - 0	Post - 0 Miss - 0 Block - 0																																																																								
18 李玉玲	19 邝雪花	20 李军政	22 刘晓玉	23 王如	26 马晓卉	28 刘金兰	31 史小军																																																																								
<table border="1"><tr><td></td><td></td><td>1</td></tr><tr><td></td><td></td><td>4</td></tr><tr><td>1</td><td>2</td><td></td></tr></table>			1			4	1	2		<table border="1"><tr><td></td><td></td><td></td></tr><tr><td></td><td></td><td>1</td></tr><tr><td>1</td><td></td><td>1</td></tr></table>						1	1		1	<table border="1"><tr><td></td><td></td><td></td></tr><tr><td></td><td></td><td></td></tr><tr><td>1</td><td></td><td></td></tr></table>							1			<table border="1"><tr><td></td><td></td><td></td></tr><tr><td></td><td></td><td></td></tr><tr><td></td><td></td><td></td></tr></table>										<table border="1"><tr><td></td><td></td><td></td></tr><tr><td></td><td></td><td></td></tr><tr><td>1</td><td></td><td></td></tr></table>							1			<table border="1"><tr><td></td><td></td><td></td></tr><tr><td></td><td></td><td></td></tr><tr><td></td><td></td><td></td></tr></table>										<table border="1"><tr><td></td><td></td><td></td></tr><tr><td></td><td></td><td>2</td></tr><tr><td></td><td></td><td></td></tr></table>						2				<table border="1"><tr><td></td><td></td><td>1</td></tr><tr><td></td><td></td><td></td></tr><tr><td>1</td><td>1</td><td></td></tr></table>			1				1	1	
		1																																																																													
		4																																																																													
1	2																																																																														
		1																																																																													
1		1																																																																													
1																																																																															
1																																																																															
		2																																																																													
		1																																																																													
1	1																																																																														
Post - 0 Miss - 0 Block - 1	Post - 0 Miss - 0 Block - 0	Post - 0 Miss - 0 Block - 0	Post - 0 Miss - 0 Block - 0	Post - 0 Miss - 0 Block - 0	Post - 0 Miss - 0 Block - 0	Post - 0 Miss - 0 Block - 0	Post - 0 Miss - 0 Block - 0																																																																								

16 李娟									
<table border="1"><tr><td></td><td></td><td></td></tr><tr><td>0/3</td><td>0/1</td><td>1/3</td></tr><tr><td>0/2</td><td>1/2</td><td></td></tr></table>				0/3	0/1	1/3	0/2	1/2	
0/3	0/1	1/3							
0/2	1/2								

22 刘晓玉									
<table border="1"><tr><td></td><td></td><td>2/2</td></tr><tr><td>2/3</td><td></td><td>1/1</td></tr><tr><td>1/3</td><td>1/1</td><td>2/3</td></tr></table>			2/2	2/3		1/1	1/3	1/1	2/3
		2/2							
2/3		1/1							
1/3	1/1	2/3							

26 马晓卉									
<table border="1"><tr><td>0/1</td><td></td><td></td></tr><tr><td>1/4</td><td></td><td>1/1</td></tr><tr><td>1/2</td><td></td><td>1/1</td></tr></table>	0/1			1/4		1/1	1/2		1/1
0/1									
1/4		1/1							
1/2		1/1							

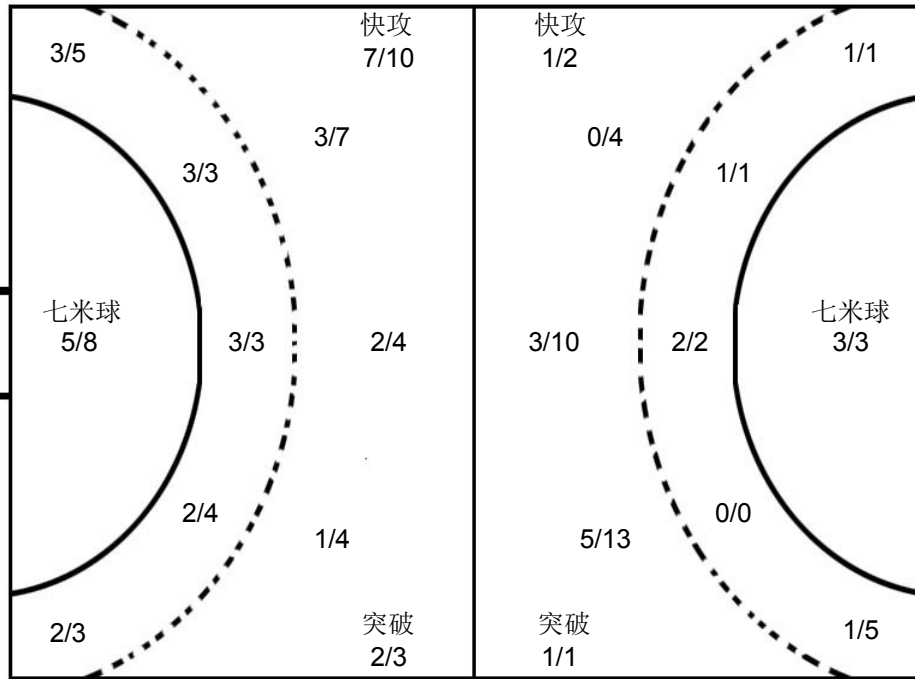

12 肖宁桐									
<table border="1"><tr><td></td><td>1/2</td><td>0/3</td></tr><tr><td>6/7</td><td>1/1</td><td>0/7</td></tr><tr><td>1/9</td><td>2/4</td><td>2/7</td></tr></table>		1/2	0/3	6/7	1/1	0/7	1/9	2/4	2/7
	1/2	0/3							
6/7	1/1	0/7							
1/9	2/4	2/7							

16 杜宪									
<table border="1"><tr><td>0/1</td><td></td><td>1/2</td></tr><tr><td></td><td></td><td>0/3</td></tr><tr><td></td><td>0/1</td><td></td></tr></table>	0/1		1/2			0/3		0/1	
0/1		1/2							
		0/3							
	0/1								

<table border="1"><tr><td></td><td></td><td></td></tr><tr><td></td><td></td><td></td></tr><tr><td></td><td></td><td></td></tr></table>									

## 黑龙江

1 徐佳蓉	3 刘诗彤	5 周美微	6 王梦艺	9 郑宇	10 刘雪露	11 刘天茹	12 肖宁桐																																																																								
<table border="1"><tr><td></td><td></td><td></td></tr><tr><td></td><td></td><td></td></tr><tr><td></td><td></td><td></td></tr></table>										<table border="1"><tr><td></td><td></td><td></td></tr><tr><td></td><td></td><td>1</td></tr><tr><td></td><td></td><td></td></tr></table>						1				<table border="1"><tr><td></td><td></td><td>1</td></tr><tr><td></td><td></td><td>1</td></tr><tr><td></td><td></td><td></td></tr></table>			1			1				<table border="1"><tr><td></td><td></td><td></td></tr><tr><td></td><td></td><td></td></tr><tr><td></td><td></td><td></td></tr></table>										<table border="1"><tr><td></td><td></td><td></td></tr><tr><td>1</td><td>1</td><td></td></tr><tr><td></td><td></td><td>1</td></tr></table>				1	1				1	<table border="1"><tr><td></td><td></td><td></td></tr><tr><td></td><td></td><td></td></tr><tr><td></td><td></td><td></td></tr></table>										<table border="1"><tr><td></td><td></td><td></td></tr><tr><td></td><td></td><td>1</td></tr><tr><td></td><td></td><td></td></tr></table>						1				<table border="1"><tr><td></td><td></td><td></td></tr><tr><td></td><td></td><td></td></tr><tr><td></td><td></td><td></td></tr></table>									
		1																																																																													
		1																																																																													
		1																																																																													
1	1																																																																														
		1																																																																													
		1																																																																													
Post - 0 Miss - 0 Block - 0	Post - 0 Miss - 0 Block - 0	Post - 0 Miss - 0 Block - 0	Post - 0 Miss - 1 Block - 0	Post - 1 Miss - 0 Block - 0	Post - 0 Miss - 0 Block - 0	Post - 0 Miss - 0 Block - 0	Post - 0 Miss - 0 Block - 0																																																																								
13 吴佳	14 黄荣	16 杜宪	19 梁文煜	21 王戈	22 马琳	23 张政																																																																									
<table border="1"><tr><td></td><td></td><td></td></tr><tr><td>2</td><td></td><td></td></tr><tr><td></td><td></td><td></td></tr></table>				2						<table border="1"><tr><td></td><td></td><td></td></tr><tr><td></td><td></td><td></td></tr><tr><td>1</td><td></td><td></td></tr></table>							1			<table border="1"><tr><td></td><td></td><td></td></tr><tr><td></td><td></td><td></td></tr><tr><td></td><td></td><td></td></tr></table>										<table border="1"><tr><td></td><td></td><td>1</td></tr><tr><td></td><td></td><td></td></tr><tr><td>2</td><td></td><td></td></tr></table>			1				2			<table border="1"><tr><td></td><td></td><td></td></tr><tr><td></td><td></td><td></td></tr><tr><td></td><td></td><td></td></tr></table>										<table border="1"><tr><td></td><td></td><td></td></tr><tr><td>2</td><td></td><td>1</td></tr><tr><td>1</td><td></td><td></td></tr></table>				2		1	1			<table border="1"><tr><td></td><td></td><td></td></tr><tr><td></td><td></td><td></td></tr><tr><td></td><td></td><td></td></tr></table>										<table border="1"><tr><td></td><td></td><td></td></tr><tr><td></td><td></td><td></td></tr><tr><td></td><td></td><td></td></tr></table>									
2																																																																															
1																																																																															
		1																																																																													
2																																																																															
2		1																																																																													
1																																																																															
Post - 1 Miss - 1 Block - 0	Post - 0 Miss - 0 Block - 0	Post - 0 Miss - 0 Block - 0	Post - 0 Miss - 2 Block - 1	Post - 0 Miss - 0 Block - 0	Post - 0 Miss - 0 Block - 2	Post - 0 Miss - 0 Block - 0																																																																									

注释: Post=击柱 Miss=射失 Block=被封





预赛 Group A

女子 全国比赛

2016年全国女子手球锦标赛

Team A <b>A 新疆</b>				Team B <b>B 广西</b>				Match Number <b>9</b>													
played in China		in the hall 滁州体育馆		on 04/09/2016		at 16:00 hours		Spectators													
Half-time (30')	<b>A</b> 16	<b>B</b> 14	End of playing time	<b>A</b> 30	<b>B</b> 26	1st extra time	<b>A</b>	<b>B</b>	2nd extra time	<b>A</b>	<b>B</b>	After penalty throws	<b>A</b>	<b>B</b>							
Number of 7 m	<b>A</b> 4 / 7	Team time-out			Full name of players and officials				Team time-out			<b>B</b> 2 / 4	Number of 7 m								
		1	2	3					1	2	3										
		23:50	43:37						11:12	29:41	39:32										
No.	Team <b>A</b>					G	W	2'	D	DR	No.	Team <b>B</b>					G	W	2'	D	DR
3	葛立双										1	胡霜梅									
6	阿孜古					4	1				2	陆雪云					4				
7	吴志娟					5					5	黄海玉									
10	李静										6	韦惠文									
11	陈培培										7	廖露					5				
12	艾敏加尔汉										8	韦如芳					3				
15	兰姝娇					2					9	蓝雪梅									
17	戴莹莹					1		1			10	周琴					7				
18	崔娟					5	1				11	曾蓝花					3	1			
21	锁珊珊					2	1				12	江燕红									
23	张艺璇										14	黄艳芳					3	1	2		
26	宋婷婷					7					16	商志运									
27	谢辰辰					1					17	杨杨									
32	杨雨柔										18	庞娇					1				
93	张婷婷					3		1													
A	邓雷										C	王林									
B	于涛 (主教练)										D	刘雪波									
D	高璇																				
<b>A</b>	Signature of Responsible Official of the Teams (Off. A)																		<b>B</b>		
TP	Remarks of Referee / CHA Official																		TP		

Signatures

Referees	陈晓波 (CHN)	张栋 (CHN)		
Techn. Delegates	许宜扬 (CHN)			
CHA Official	刘书勇 (CHN)			

Note: Number of 7m Throws Awarded to Team A and B, Goals (G), Warnings (W), Suspensions (2'), Direct Disqualification (D), Disqualification with Report (DR) and Team Penalty (TP).

Table Officials: 佟金正

贾俊秋

Statisticians: 陈柱

闫冲

Printed by PHMS Copyright: IHF / CHA 12/09/2016 21:44:27

Longman Sportsoft



handball@126.com



## 2016年全国女子手球锦标赛 竞赛技术统计(媒体表)

预赛	组别	A	轮次	2	场次	9
滁州体育馆		04/09/2016			201605009-51-1/1	
新疆	新疆	30	vs	26	广西	广西
<b>16 : 14</b>						

裁判员	陈晓波 (CHN)	/	张栋 (CHN)
-----	-----------	---	----------

新疆		远射	近射	边射	快攻	突破	任意球	7m球	合计	%	助攻	失误	警告	2'	D & DR	比赛进程	
主教练：于涛																新疆	广西
3	葛立双															0	00:48
6	阿孜古		4/4					4/4	100		1	1				1	14 黄艳芳
7	吴志娟		1/1	2/3	2/2			5/6	83.3		1					1	2 10 周琴
10	李静															2	04:11
11	陈培培															2	05:08
12	艾敏加尔汉															3	05:49
15	兰妹娇			0/2	1/2		1/1	2/5	40.0							3	07:18
17	戴莹莹		1/2					1/2	50.0					1		4	07:56
18	崔娟	3/5	1/1		1/1		0/1	5/8	62.5	1	3	1				5	08:48
21	锁珊珊	0/3	1/1	0/1			1/2	2/7	28.6	1	4	1				6	09:35
23	张艺璇															7	11:06
26	宋婷婷	2/3	3/4		1/1	0/1	1/2	7/11	63.6	1	3					8	12:27
27	谢辰辰				1/1			1/1	100							9	13:01
32	杨雨柔										1					10	14:07
93	张婷婷		1/1	0/1	1/1		1/1	3/4	75.0	1	3			1		11	15:36
<b>运动员 合计</b>		5/11	12/14	2/7	7/8	0/1	4/7	30/48	62.5	5	15	3	2			12	16:44
10	李静	0/4			0/1		0/1	0/6	0.0							13	17:56
32	杨雨柔	6/9	0/6	3/5	1/6	0/2	1/2	12/32	37.5	1						14	18:39
<b>守门员 合计</b>		6/13	0/6	3/5	1/7	0/2	1/2	1/3	12/38	31.6	1					15	20:07
广西		远射	近射	边射	快攻	突破	任意球	7m球	合计	%	助攻	失误	警告	2'	D & DR	1st Half	
教练：王林																新疆	广西
1	胡霜梅															0	00:48
2	陆雪云	1/4	1/1	0/1	2/2		0/1	4/9	44.4	1	3					1	00:52
5	黄海玉															2	03:16
6	韦惠文															2	04:11
7	廖露	2/5			1/1	1/1	1/1	5/8	62.5		4					3	05:08
8	韦如芳		1/1	1/2	1/2			3/5	60.0		2					3	05:49
9	蓝雪梅															4	07:18
10	周琴	1/2	2/2	1/4		1/1	2/3	7/12	58.3	1	1					4	07:56
11	曾蓝花	2/6		0/1	1/1		0/1	3/9	33.3		8	1				5	08:48
12	江燕红															6	09:35
14	黄艳芳	0/1	2/2		1/1			3/4	75.0		3	1	2			7	11:06
16	商志运															8	12:27
17	杨杨	0/1			0/1			0/2	0.0							9	13:01
18	庞娇	1/2						1/2	50.0							10	14:07
<b>运动员 合计</b>		7/21	6/6	2/8	6/8	2/2	2/4	26/51	51.0	2	21	2	2			11	15:36
12	江燕红						0/1	0/1	0.0							12	16:44
16	商志运	6/11	1/13	3/5	0/7	1/1	3/6	14/43	32.6							13	17:56
<b>守门员 合计</b>		6/11	1/13	3/5	0/7	1/1	3/7	14/44	31.8							14	18:39

场上队员：得分 / 射门

守门员：救球 / 射门

快攻	Fast Break	突破	Breakthrough	任意球	Free Throw	7M球	7M Throw	助攻	Assist
警告	Warning	失误	Error	2'	Suspension	D	取消资格	DR	取消资格+报告





### 2016年全国女子手球锦标赛 图式比赛技术统计表

轮次 2

场次 9

201605009-21-1/1

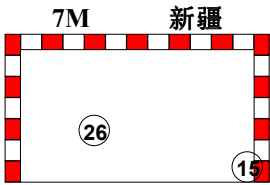
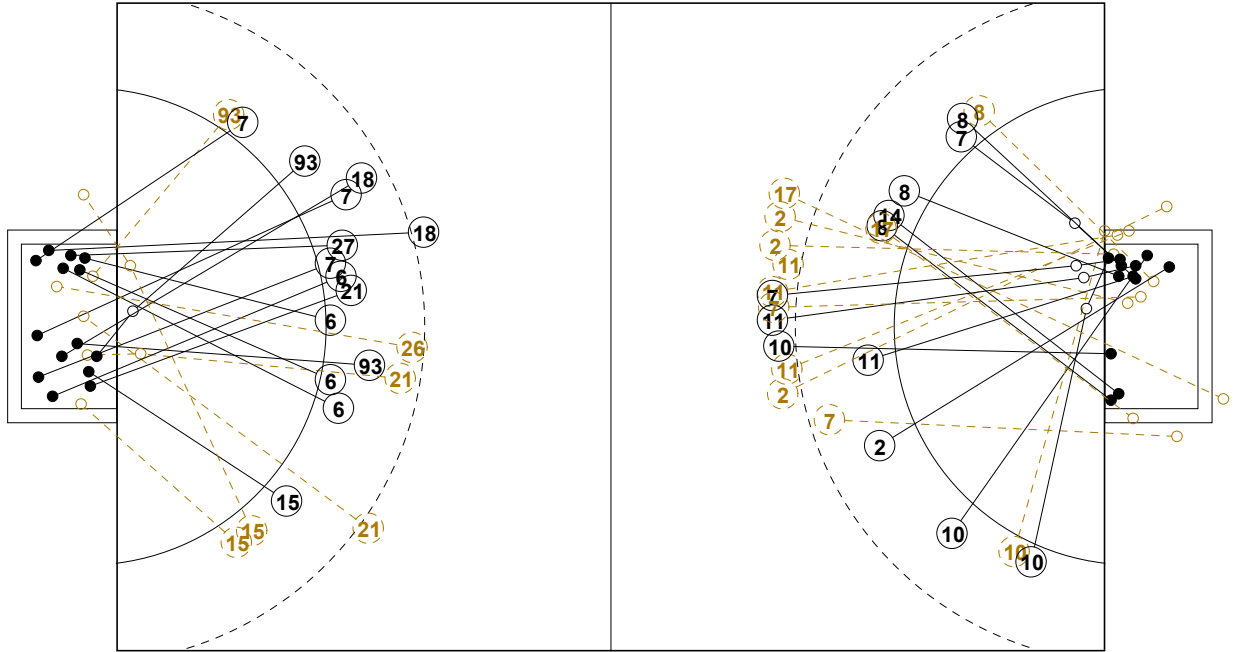

1st Half  
16 : 14

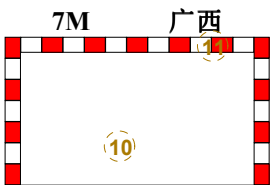
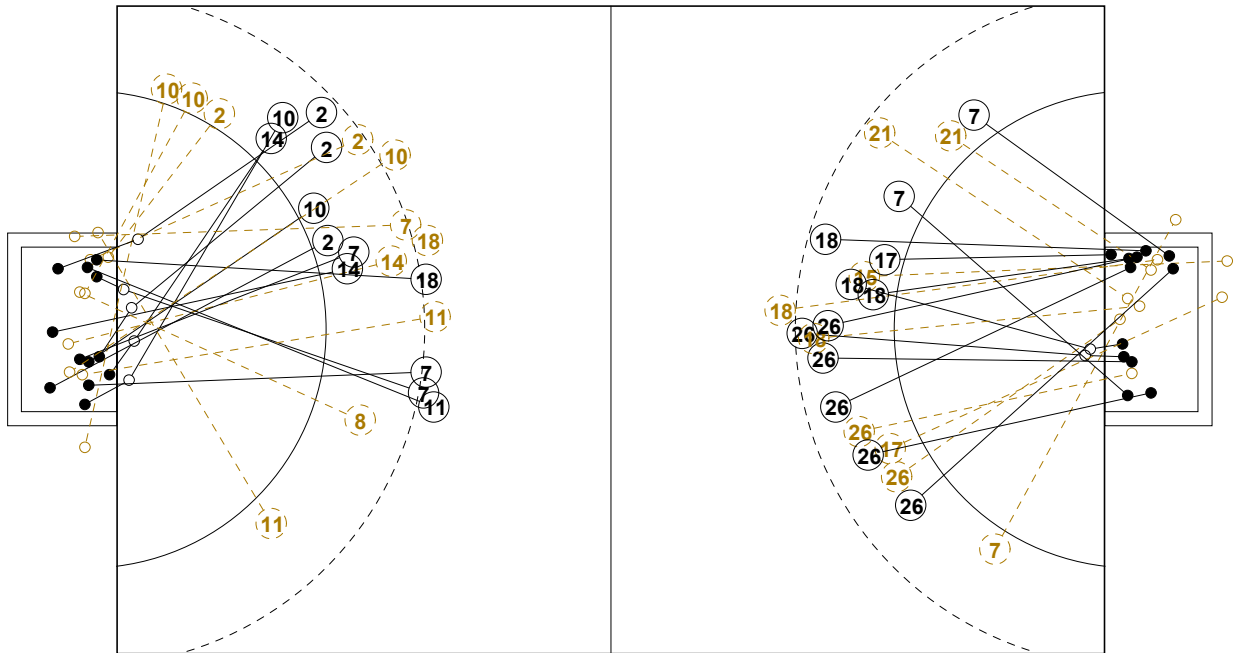
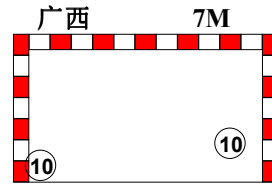

2nd Half  
26 : 30

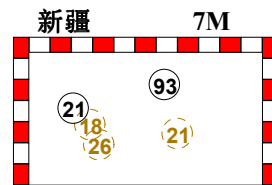





## 2016年全国女子手球锦标赛

## 个人/全队技术统计表

正式表  
手球  
女子预赛  
轮次 2组别 A  
场次 9201605009-14-1/2  
滁州体育馆  
04/09/2016 16:00

号码	姓名	远射	近射	边射	快攻	突破	任意	7M	合计	%	助攻	失误	警告	2'	取消	时间
<b>新疆(新疆)</b>																
<i>(场上队员)</i>																
3	葛立双									0.0%						00:00:00
6	阿孜古		4/4						4/4	100%		1	1			00:55:24
7	吴志娟		1/1	2/3	2/2				5/6	83.3%		1				00:51:30
10	李静									0.0%						00:08:51
11	陈培培									0.0%						00:00:00
12	艾敏加尔汉									0.0%						00:00:00
15	兰妹娇			0/2	1/2			1/1	2/5	40.0%						00:37:17
17	戴莹莹		1/2						1/2	50.0%				1		00:21:12
18	崔娟	3/5	1/1		1/1			0/1	5/8	62.5%	1	3	1			00:59:09
21	锁珊珊	0/3	1/1	0/1				1/2	2/7	28.6%	1	4	1			00:44:14
23	张艺璇									0.0%						00:00:00
26	宋婷婷	2/3	3/4		1/1	0/1		1/2	7/11	63.6%	1	3				00:37:19
27	谢辰辰				1/1				1/1	100%						00:17:48
32	杨雨柔									0.0%	1					00:31:45
93	张婷婷		1/1	0/1	1/1			1/1	3/4	75.0%	1	3		1		00:44:38
<b>合计</b>		5/11	12/14	2/7	7/8	0/1		4/7	30/48	62.5%	5	15	3	2		
<i>(守门员)</i>																
10	李静	0/4			0/1			0/1	0/6	0.0%						00:08:51
32	杨雨柔	6/9	0/6	3/5	1/6	0/2	1/2	1/2	12/32	37.5%	1					00:31:45
<b>合计</b>		6/13	0/6	3/5	1/7	0/2	1/2	1/3	12/38	31.6%	1					

场上队员：得分/射门

守门员：救球/射门

全队合计	得分	被救	射失	击柱	封球	合计	%
远射	5	6				11	45.5%
近射	12	1	1			14	85.7%
边射	2	3	2			7	28.6%
快攻	7		1			8	87.5%
突破		1				1	0.0%
任意							0.0%
7M	4	3				7	57.1%





## 2016年全国女子手球锦标赛

## 个人/全队技术统计表

正式表  
手球  
女子预赛  
轮次 2组别 A  
场次 9201605009-14-2/2  
滁州体育馆  
04/09/2016 16:00

号码	姓名	远射	近射	边射	快攻	突破	任意	7M	合计	%	助攻	失误	警告	2'	取消	时间
<b>广西(广西)</b>																
<i>(上场队员)</i>																
1	胡霜梅									0.0%						00:00:00
2	陆雪云	1/4	1/1	0/1	2/2		0/1		4/9	44.4%	1	3				00:47:12
5	黄海玉									0.0%						00:00:10
6	韦惠文									0.0%						00:02:12
7	廖露	2/5			1/1	1/1	1/1		5/8	62.5%		4				00:54:31
8	韦如芳		1/1	1/2	1/2				3/5	60.0%		2				00:57:45
9	蓝雪梅									0.0%						00:00:00
10	周琴	1/2	2/2	1/4		1/1		2/3	7/12	58.3%	1	1				01:00:00
11	曾蓝花	2/6		0/1	1/1			0/1	3/9	33.3%		8	1			01:00:00
12	江燕红									0.0%						00:00:09
14	黄艳芳	0/1	2/2		1/1				3/4	75.0%		3	1	2		01:00:00
16	商志运									0.0%						00:59:51
17	杨杨	0/1			0/1				0/2	0.0%						00:09:39
18	庞娇	1/2							1/2	50.0%						00:08:09
<b>合计</b>																
<i>(守门员)</i>																
12	江燕红							0/1	0/1	0.0%						00:00:09
16	商志运	6/11	1/13	3/5	0/7	1/1		3/6	14/43	32.6%						00:59:51
<b>合计</b>																
6/11 1/13 3/5 0/7 1/1 3/7 14/44 31.8%																

场上队员：得分/射门

守门员：救球/射门

全队合计	得分	被救	射失	击柱	封球	合计	%
远射	7	6	3	3	2	21	33.3%
近射	6					6	100.0%
边射	2	3	1	2		8	25.0%
快攻	6	1		1		8	75.0%
突破	2					2	100.0%
任意	1	1				2	50.0%
7M	2	1		1		4	50.0%





2016年全国女子手球锦标赛

图式射门区域统计

轮次 2 场次 9

201605009-41-1/1

新疆

3 葛立双 0/0 0/0 0/0 Post - 0 Miss - 0 Block - 0	6 阿孜古 1 0/0 3 Post - 0 Miss - 0 Block - 0	7 吴志娟 2 1 1 0/0 1 Post - 0 Miss - 1 Block - 0	10 李静 0/0 0/0 0/0 Post - 0 Miss - 0 Block - 0	11 陈培培 0/0 0/0 0/0 Post - 0 Miss - 0 Block - 0	12 艾敏加尔汉 0/0 0/0 0/0 Post - 0 Miss - 0 Block - 0	15 兰姝娇 0/0 1 1 Post - 0 Miss - 2 Block - 0	17 戴莹莹 0/0 1 0/0 Post - 0 Miss - 1 Block - 0
18 崔娟 0/0 2 1 1 Post - 0 Miss - 0 Block - 0	21 锁珊珊 0/0 1 1 Post - 0 Miss - 0 Block - 0	23 张艺璇 0/0 0/0 0/0 Post - 0 Miss - 0 Block - 0	26 宋婷婷 1 2 1 1 1 Post - 0 Miss - 0 Block - 0	27 谢辰辰 0/0 0/0 1 Post - 0 Miss - 0 Block - 0	32 杨雨柔 0/0 0/0 0/0 Post - 0 Miss - 0 Block - 0	93 张婷婷 0/0 1 1 1 Post - 0 Miss - 0 Block - 0	

10 李静
0/1
0/1
0/1 0/1 0/1

32 杨雨柔
0/1 0/1
4/8 2/2 2/3
1/9 1/2 2/6

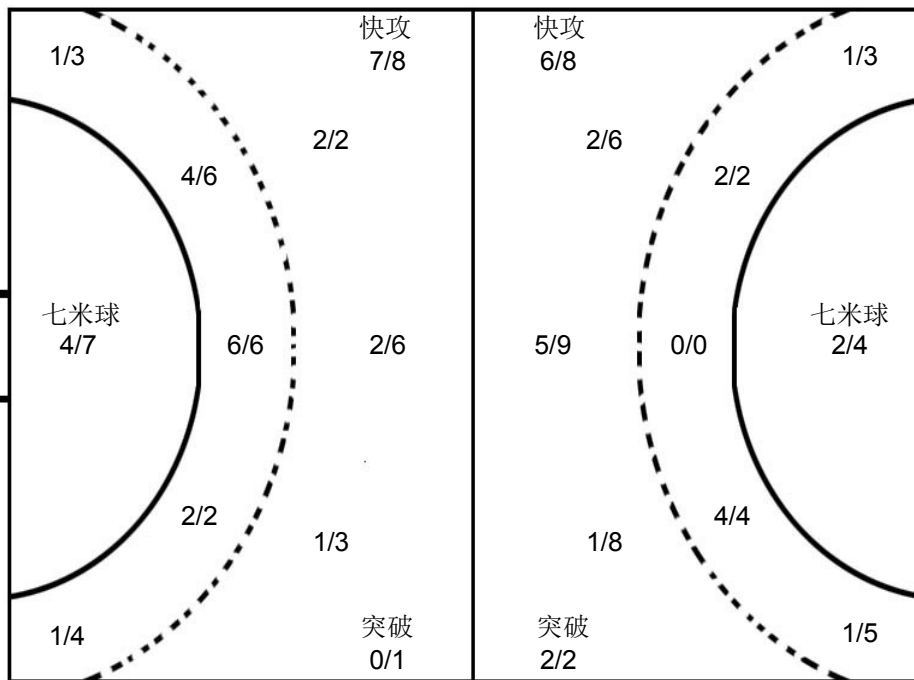
12 江燕红
0/1

16 商志运
0/4 0/2 0/2
5/10 3/4 1/6
2/8 1/3 2/4

广西

1 胡霜梅 0/0 0/0 0/0 Post - 0 Miss - 0 Block - 0	2 陆雪云 2 0/0 1 1 Post - 0 Miss - 1 Block - 0	5 黄海玉 0/0 0/0 0/0 Post - 0 Miss - 0 Block - 0	6 韦惠文 0/0 0/0 0/0 Post - 0 Miss - 0 Block - 0	7 廖露 1 3 1 Post - 1 Miss - 1 Block - 0	8 韦如芳 1 1 1 Post - 0 Miss - 0 Block - 0	9 蓝雪梅 0/0 0/0 0/0 Post - 0 Miss - 0 Block - 0	10 周琴 2 3 1 1 Post - 1 Miss - 1 Block - 0
11 曾蓝花 1 1 1 Post - 4 Miss - 0 Block - 1	12 江燕红 0/0 0/0 0/0 Post - 0 Miss - 0 Block - 0	14 黄艳芳 1 1 1 Post - 0 Miss - 0 Block - 0	16 商志运 0/0 0/0 0/0 Post - 0 Miss - 0 Block - 0	17 杨杨 0/0 0/0 0/0 Post - 1 Miss - 1 Block - 0	18 庞娇 0/0 0/0 1 Post - 0 Miss - 0 Block - 1		

注释: Post=击柱 Miss=射失 Block=被封





预赛 Group B

女子 全国比赛

2016年全国女子手球锦标赛

Team A <b>A 北京</b>				Team B <b>B 辽宁</b>				Match Number <b>10</b>													
played in China		in the hall 滁州体育馆		on 04/09/2016		at 17:30 hours		Spectators													
Half-time (30')	<b>A</b> 11	<b>B</b> 18	End of playing time	<b>A</b> 16	<b>B</b> 31	1st extra time	<b>A</b>	<b>B</b>	2nd extra time	<b>A</b>	<b>B</b>	After penalty throws	<b>A</b>	<b>B</b>							
Number of 7 m	<b>A</b> 1/2	Team time-out 1 12:47 2 41:40 3			Full name of players and officials				Team time-out 1 23:11 2 46:18 3			<b>B</b> 3/4	Number of 7 m								
No.	Team <b>A</b>					G	W	2'	D	DR	No.	Team <b>B</b>					G	W	2'	D	DR
1	宋嘉蕾										1	于薇诗									
3	季小桐					4		1			2	朱徐婷					3				
4	孙佳										3	赵莹雪					2	1			
6	刘亚男							1			5	辛颜					3				
8	杨铭豫										8	杨娇					4	1			
10	刘莎					5	1				9	刁卫丽									
11	纪婉										12	刘雪菲									
16	王海叶										13	杜江花					2		1		
17	杨政赢										19	吕秋雪					4	1			
22	李海鸥					1	1				20	孙弘玲					2				
23	田媛					2					24	陈思雨									
28	闫美珠					2		1			27	王丹									
33	栾征										66	梁海珍					11				
47	刘泽										93	赵琦									
58	李华										98	张永婷									
69	石梓薇										99	郑锦宜									
<b>A</b>	蔡建国										<b>A</b>	吕艳梦									
<b>B</b>	石伟 (主教练)										<b>B</b>	李丽荣									
<b>C</b>	李翼										<b>C</b>	金京男 (主教练)									
<b>E</b>	史良玉										<b>E</b>	程万里									
<b>A</b>	Signature of Responsible Official of the Teams (Off. A)																			<b>B</b>	
TP	Remarks of Referee / CHA Official																			TP	

Signatures

Referees	邓军 (CHN)	张耿 (CHN)		
Techn. Delegates	吴国忠 (CHN)			
CHA Official	刘书勇 (CHN)			

Note: Number of 7m Throws Awarded to Team A and B, Goals (G), Warnings (W), Suspensions (2'), Direct Disqualification (D), Disqualification with Report (DR) and Team Penalty (TP).

Table Officials: 赵涵

李诚

Statisticians: 刘永欢

黄岩





### 2016年全国女子手球锦标赛 竞赛技术统计(媒体表)

<b>预赛</b>		组别	<b>B</b>	轮次	<b>2</b>	场次	<b>10</b>
滁州体育馆					04/09/2016	201605010-51-1/1	
北京		<b>北京</b>	<b>16</b>	vs	<b>31</b>	<b>辽宁</b>	辽宁
				<b>11 : 18</b>			

裁判员	邓军 (CHN)			/	张耿 (CHN)		
-----	----------	--	--	---	----------	--	--

<b>北京</b>														北京		辽宁																
主教练：石伟														比赛进程																		
远射	近射	边射	快攻	突破	任意球	7m球	合计	%	助攻	失误	警告	2'	D & DR	北京	辽宁																	
1	宋嘉蕾														0	00:52	1	2	朱徐婷													
3	季小桐	0/1	3/4	1/1	0/1		4/7	57.1		5		1			10	02:23	1															
4	孙佳														1	03:29	2	5	辛颜													
6	刘亚男												1		1	04:18	3	8	杨娇													
8	杨铭豫														2	05:19	3															
10	刘莎			3/3	1/1		1/2	5/6	83.3		1	1			28	08:41	4	8	杨娇													
11	纪婉														3	08:50	4															
16	王海叶														3	09:48	5	8	杨娇													
17	杨政赢														3	12:15	6	8	杨娇													
22	李海鸥		0/1		1/1		1/2	50.0							3	12:34	7	19	吕秋雪													
23	田媛	2/6					2/6	33.3							10	13:14	7															
28	闫美珠	2/8	0/1	0/1			2/10	20.0	1	1					4	13:45	8	5	辛颜													
33	栾征														4	14:07	8															
47	刘洋														3	14:28	9	5	辛颜													
58	李华														5	15:19	9															
69	石梓薇	2/8	0/1				2/9	22.2		2	1				6	15:29	9															
<b>运动员 合计</b>														69	石梓薇	7	16:24	9														
1	宋嘉蕾	0/2					0/1	0/3	0.0						7	16:47	10	19	吕秋雪													
16	王海叶	2/11	3/10	4/7	1/6	0/2	1/3	11/39	28.2	1					7	17:36	11	66	梁海珍													
<b>守门员 合计</b>														22	李海鸥	7	18:15	12	2	朱徐婷												
														7	19:16	13	66	梁海珍														
														8	20:26	13																
														8	21:25	14	13	杜江花														
														8	23:45	15	66	梁海珍														
														69	石梓薇	9	24:15	15														
														3	季小桐	9	25:06	16	66	梁海珍												
														3	季小桐	10	25:29	16														
														3	季小桐	10	25:54	17	66	梁海珍												
														3	季小桐	11	26:43	17														
														3	季小桐	11	29:28	18	3	赵莹雪												
														<b>2nd Half</b>																		
														10	刘莎	12	02:02	18														
														12	03:01	19	19	吕秋雪														
														12	06:30	20	2	朱徐婷														
														10	刘莎	13	06:49	20														
														13	07:13	21	20	孙弘玲														
														13	07:32	22	19	吕秋雪														
														13	08:36	23	66	梁海珍														
														13	10:26	24	66	梁海珍														
														13	11:22	25	3	赵莹雪														
														28	闫美珠	14	12:08	25														
														14	14:21	26	66	梁海珍														
														23	田媛	15	15:55	26														
														15	16:47	27	66	梁海珍														
														15	17:32	28	20	孙弘玲														
														15	19:26	29	66	梁海珍														
														23	田媛	16	19:58	29														
														16	20:37	30	13	杜江花														
														16	23:30	31	66	梁海珍														

场上队员：得分 / 射门

守门员：救球 / 射门

快攻	Fast Break	突破	Breakthrough	任意球	Free Throw	7M球	7M Throw	助攻	Assist
警告	Warning	失误	Error	2'	Suspension	D	取消资格	DR	取消资格+报告





# 2016年全国女子手球锦标赛 图式比赛技术统计表

轮次 2

场次 10

201605010-21-1/1

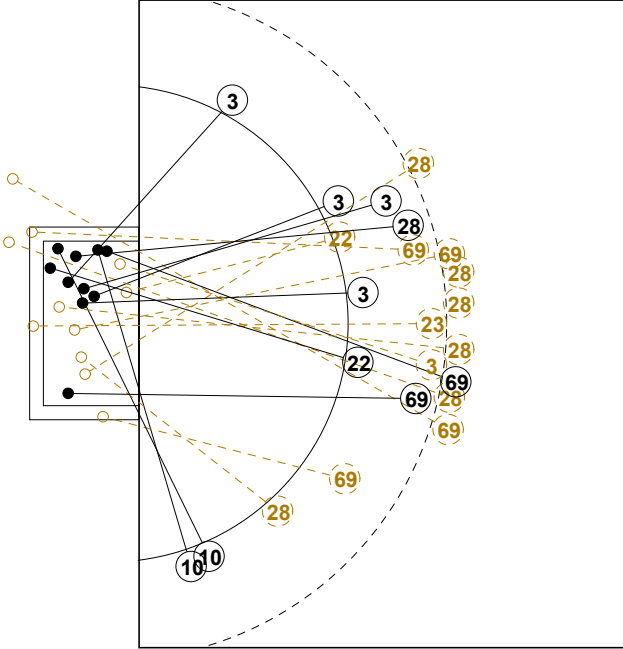

7M 北京

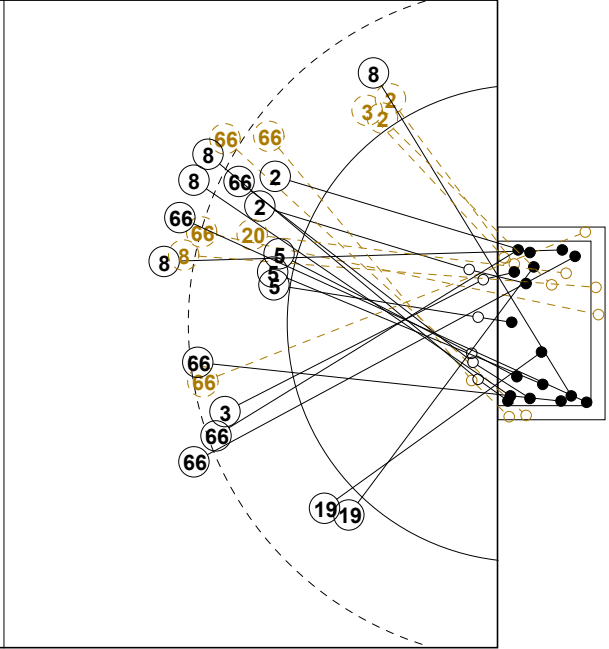
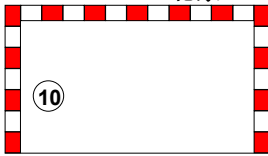

辽宁 7M

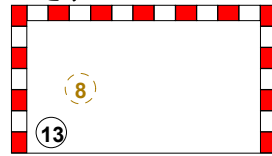

1st Half  
11 : 18

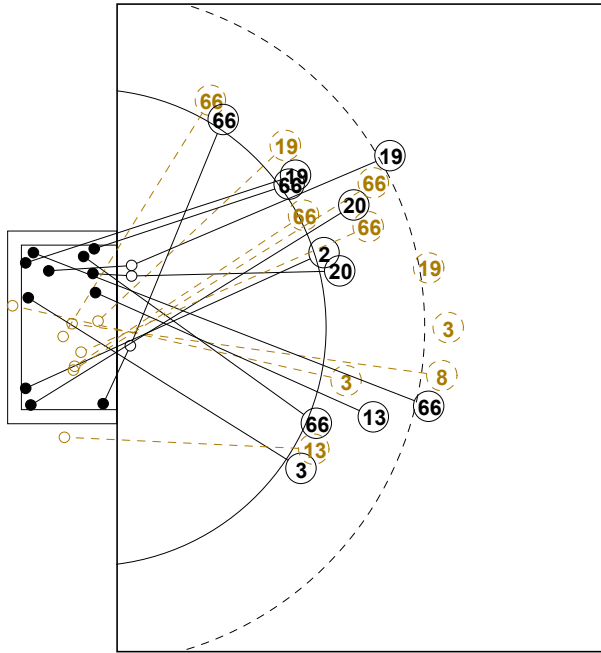

7M 辽宁

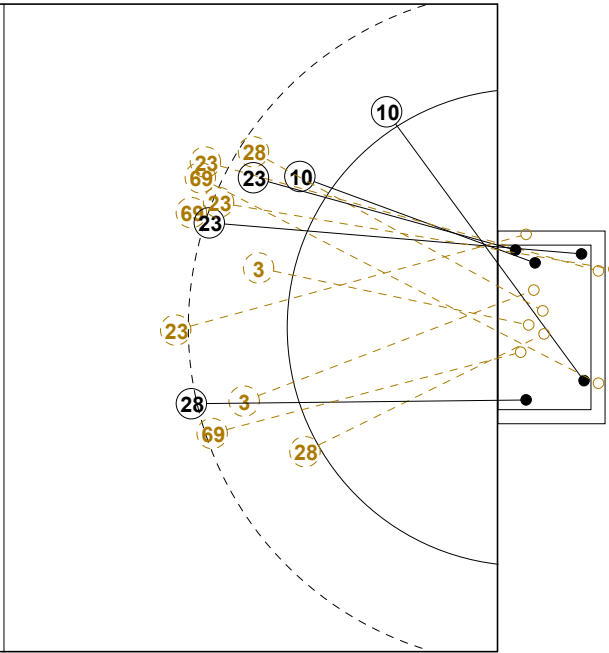
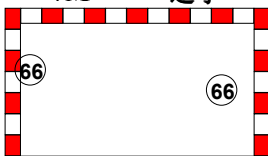

北京 7M



2nd Half  
31 : 16



## 2016年全国女子手球锦标赛

## 个人/全队技术统计表

正式表  
手球  
女子预赛  
轮次 2组别 B  
场次 10201605010-14-1/2  
滁州体育馆  
04/09/2016 17:30

号码	姓名	远射	近射	边射	快攻	突破	任意	7M	合计	%	助攻	失误	警告	2'	取消	时间
<b>北京(北京)</b>																
<i>(场上队员)</i>																
1	宋嘉蕾									0.0%						00:02:13
3	季小桐	0/1	3/4	1/1	0/1				4/7	57.1%		5		1		00:36:02
4	孙佳									0.0%						00:04:04
6	刘亚男									0.0%				1		00:46:03
8	杨铭豫									0.0%		1				00:01:39
10	刘莎			3/3	1/1			1/2	5/6	83.3%		1	1			00:49:12
11	纪婉									0.0%						00:04:23
16	王海叶									0.0%	1					00:51:22
17	杨政赢									0.0%						00:00:00
22	李海鸥		0/1		1/1			1/2	50.0%			3	1			00:47:25
23	田媛	2/6							2/6	33.3%		2				00:20:55
28	闫美珠	2/8	0/1	0/1					2/10	20.0%	1	1		1		00:49:30
33	栾征									0.0%						00:02:07
47	刘泽									0.0%						00:00:00
58	李华									0.0%						00:08:21
69	石梓薇	2/8	0/1						2/9	22.2%		2	1			00:51:14
<b>合计</b>		6/23	3/7	4/5	2/3			1/2	16/40	40.0%	2	15	3	3		
<i>(守门员)</i>																
1	宋嘉蕾	0/2						0/1	0/3	0.0%						00:02:13
16	王海叶	2/11	3/10	4/7	1/6	0/2		1/3	11/39	28.2%	1					00:51:22
<b>合计</b>		2/13	3/10	4/7	1/6	0/2		1/4	11/42	26.2%	1					

场上队员：得分/射门

守门员：救球/射门

全队合计	得分	被救	射失	击柱	封球	合计	%
远射	6	6	3	5	3	23	26.1%
近射	3	3		1		7	42.9%
边射	4	1				5	80.0%
快攻	2	1				3	66.7%
突破							0.0%
任意							0.0%
7M	1			1		2	50.0%





## 2016年全国女子手球锦标赛

## 个人/全队技术统计表

正式表  
手球  
女子预赛  
轮次 2组别 B  
场次 10201605010-14-2/2  
滁州体育馆  
04/09/2016 17:30

号码	姓名	远射	近射	边射	快攻	突破	任意	7M	合计	%	助攻	失误	警告	2'	取消	时间
<b>辽宁(辽宁)</b>																
<i>(上场队员)</i>																
1	于薇诗									0.0%						00:00:36
2	朱徐婷			0/2	3/3				3/5	60.0%						00:48:50
3	赵莹雪	1/2		0/1	0/1	1/1			2/5	40.0%	1	2	1		00:41:25	
5	辛颜		3/3						3/3	100%	1				00:53:35	
8	杨娇	3/5		1/1				0/1	4/7	57.1%			1		00:34:42	
9	刁卫丽									0.0%					00:04:44	
12	刘雪菲									0.0%					00:00:00	
13	杜江花		1/2					1/1	2/3	66.7%				1	00:13:13	
19	吕秋雪	1/2	0/1	1/1	2/2				4/6	66.7%			1		00:45:28	
20	孙弘玲		1/2			1/1			2/3	66.7%		2			00:27:50	
24	陈思雨									0.0%					00:00:00	
27	王丹									0.0%					00:14:31	
66	梁海珍	6/11	2/3	1/2	0/1			2/2	11/19	57.9%	1	2			00:51:21	
93	赵琦									0.0%	1				00:38:28	
98	张永婷									0.0%					00:00:00	
99	郑锦宜									0.0%					00:00:00	
<b>合计</b>		11/20	7/11	3/7	5/7	2/2		3/4	31/51	60.8%	4	6	3	1		
<i>(守门员)</i>																
1	于薇诗									0.0%						00:00:36
27	王丹	2/5	1/1					0/1	3/7	42.9%					00:14:31	
93	赵琦	4/7	2/5	1/5	1/3				8/20	40.0%	1				00:38:28	
<b>合计</b>		6/12	3/6	1/5	1/3			0/1	11/27	40.7%	1					

场上队员：得分/射门

守门员：救球/射门

全队合计	得分	被救	射失	击柱	封球	合计	%
远射	11	2		5	2	20	55.0%
近射	7	3	1			11	63.6%
边射	3	4				7	42.9%
快攻	5	1		1		7	71.4%
突破	2					2	100.0%
任意							0.0%
7M	3	1				4	75.0%







### 2016年全国女子手球锦标赛

#### 图式射门区域统计

轮次 2 场次 10

201605010-41-1/1

## 北京

1 宋嘉蕾	3 季小桐	4 孙佳	6 刘亚男	8 杨铭豫	10 刘莎	11 纪婉	16 王海叶																																																																								
<table border="1"><tr><td></td><td></td><td></td></tr><tr><td></td><td></td><td></td></tr><tr><td></td><td></td><td></td></tr></table>										<table border="1"><tr><td></td><td></td><td>1</td></tr><tr><td></td><td>2</td><td>1</td></tr><tr><td></td><td></td><td></td></tr></table>			1		2	1				<table border="1"><tr><td></td><td></td><td></td></tr><tr><td></td><td></td><td></td></tr><tr><td></td><td></td><td></td></tr></table>										<table border="1"><tr><td></td><td></td><td></td></tr><tr><td></td><td></td><td></td></tr><tr><td></td><td></td><td></td></tr></table>										<table border="1"><tr><td></td><td></td><td></td></tr><tr><td></td><td></td><td></td></tr><tr><td></td><td></td><td></td></tr></table>										<table border="1"><tr><td></td><td></td><td>2</td></tr><tr><td></td><td></td><td>1</td></tr><tr><td></td><td></td><td></td></tr></table>			2			1				<table border="1"><tr><td></td><td></td><td></td></tr><tr><td></td><td></td><td></td></tr><tr><td></td><td></td><td></td></tr></table>										<table border="1"><tr><td></td><td></td><td></td></tr><tr><td></td><td></td><td></td></tr><tr><td></td><td></td><td></td></tr></table>									
		1																																																																													
	2	1																																																																													
		2																																																																													
		1																																																																													
Post - 0 Miss - 0 Block - 0	Post - 0 Miss - 0 Block - 0	Post - 0 Miss - 0 Block - 0	Post - 0 Miss - 0 Block - 0	Post - 0 Miss - 0 Block - 0	Post - 1 Miss - 0 Block - 0	Post - 0 Miss - 0 Block - 0	Post - 0 Miss - 0 Block - 0																																																																								
17 杨政赢	22 李海鸥	23 田媛	28 闫美珠	33 栾征	47 刘泽	58 李华	69 石梓薇																																																																								
<table border="1"><tr><td></td><td></td><td></td></tr><tr><td></td><td></td><td></td></tr><tr><td></td><td></td><td></td></tr></table>										<table border="1"><tr><td></td><td></td><td>1</td></tr><tr><td></td><td></td><td></td></tr><tr><td></td><td></td><td></td></tr></table>			1							<table border="1"><tr><td>1</td><td></td><td></td></tr><tr><td></td><td></td><td></td></tr><tr><td>1</td><td></td><td></td></tr></table>	1						1			<table border="1"><tr><td></td><td></td><td>1</td></tr><tr><td></td><td></td><td></td></tr><tr><td></td><td></td><td>1</td></tr></table>			1						1	<table border="1"><tr><td></td><td></td><td></td></tr><tr><td></td><td></td><td></td></tr><tr><td></td><td></td><td></td></tr></table>										<table border="1"><tr><td></td><td></td><td></td></tr><tr><td></td><td></td><td></td></tr><tr><td></td><td></td><td></td></tr></table>										<table border="1"><tr><td></td><td></td><td></td></tr><tr><td></td><td></td><td></td></tr><tr><td></td><td></td><td></td></tr></table>										<table border="1"><tr><td></td><td></td><td>1</td></tr><tr><td></td><td></td><td></td></tr><tr><td></td><td></td><td>1</td></tr></table>			1						1
		1																																																																													
1																																																																															
1																																																																															
		1																																																																													
		1																																																																													
		1																																																																													
		1																																																																													
Post - 0 Miss - 0 Block - 0	Post - 0 Miss - 0 Block - 0	Post - 3 Miss - 1 Block - 0	Post - 0 Miss - 1 Block - 2	Post - 0 Miss - 0 Block - 0	Post - 0 Miss - 0 Block - 0	Post - 0 Miss - 0 Block - 0	Post - 3 Miss - 1 Block - 1																																																																								

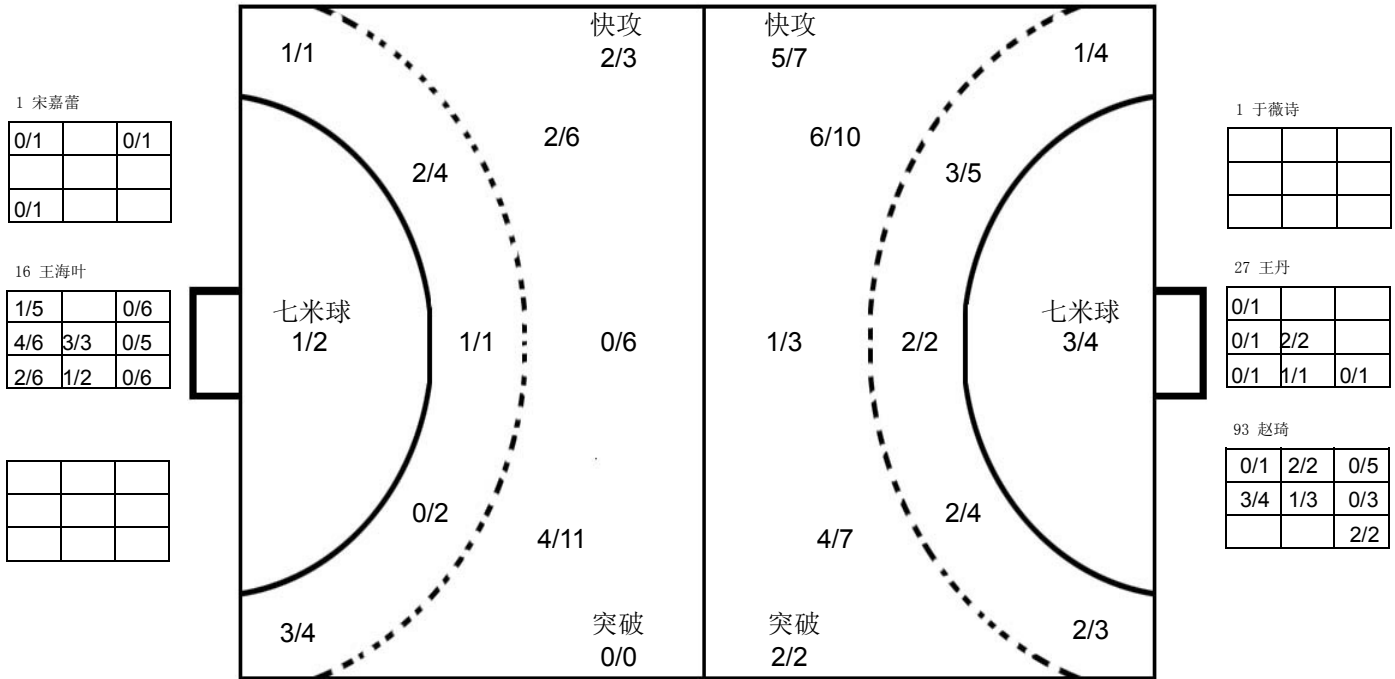

## 辽宁

1 于薇诗	2 朱徐婷	3 赵莹雪	5 辛颜	8 杨娇	9 刁卫丽	12 刘雪菲	13 杜江花																																																																								
<table border="1"><tr><td></td><td></td><td></td></tr><tr><td></td><td></td><td></td></tr><tr><td></td><td></td><td></td></tr></table>										<table border="1"><tr><td>1</td><td></td><td></td></tr><tr><td>1</td><td></td><td></td></tr><tr><td>1</td><td></td><td></td></tr></table>	1			1			1			<table border="1"><tr><td></td><td></td><td>1</td></tr><tr><td></td><td></td><td></td></tr><tr><td>1</td><td></td><td></td></tr></table>			1				1			<table border="1"><tr><td></td><td></td><td></td></tr><tr><td></td><td></td><td>1</td></tr><tr><td></td><td>1</td><td>1</td></tr></table>						1		1	1	<table border="1"><tr><td>1</td><td></td><td>1</td></tr><tr><td></td><td></td><td></td></tr><tr><td></td><td></td><td>2</td></tr></table>	1		1						2	<table border="1"><tr><td></td><td></td><td></td></tr><tr><td></td><td></td><td></td></tr><tr><td></td><td></td><td></td></tr></table>										<table border="1"><tr><td></td><td></td><td></td></tr><tr><td></td><td></td><td></td></tr><tr><td></td><td></td><td></td></tr></table>										<table border="1"><tr><td></td><td></td><td></td></tr><tr><td></td><td></td><td></td></tr><tr><td></td><td></td><td></td></tr></table>									
1																																																																															
1																																																																															
1																																																																															
		1																																																																													
1																																																																															
		1																																																																													
	1	1																																																																													
1		1																																																																													
		2																																																																													
Post - 0 Miss - 0 Block - 0	Post - 0 Miss - 0 Block - 0	Post - 1 Miss - 0 Block - 1	Post - 0 Miss - 0 Block - 0	Post - 1 Miss - 0 Block - 0	Post - 0 Miss - 0 Block - 0	Post - 0 Miss - 0 Block - 0	Post - 0 Miss - 1 Block - 0																																																																								
19 吕秋雪	20 孙弘玲	24 陈思雨	27 王丹	66 梁海珍	93 赵琦	98 张永婷	99 郑锦宜																																																																								
<table border="1"><tr><td></td><td></td><td>2</td></tr><tr><td>1</td><td></td><td>1</td></tr><tr><td></td><td></td><td></td></tr></table>			2	1		1				<table border="1"><tr><td>1</td><td></td><td></td></tr><tr><td></td><td></td><td></td></tr><tr><td></td><td></td><td>1</td></tr></table>	1								1	<table border="1"><tr><td></td><td></td><td></td></tr><tr><td></td><td></td><td></td></tr><tr><td></td><td></td><td></td></tr></table>										<table border="1"><tr><td></td><td></td><td></td></tr><tr><td></td><td></td><td></td></tr><tr><td></td><td></td><td></td></tr></table>										<table border="1"><tr><td>2</td><td></td><td>3</td></tr><tr><td></td><td></td><td>3</td></tr><tr><td>2</td><td></td><td>1</td></tr></table>	2		3			3	2		1	<table border="1"><tr><td></td><td></td><td></td></tr><tr><td></td><td></td><td></td></tr><tr><td></td><td></td><td></td></tr></table>										<table border="1"><tr><td></td><td></td><td></td></tr><tr><td></td><td></td><td></td></tr><tr><td></td><td></td><td></td></tr></table>										<table border="1"><tr><td></td><td></td><td></td></tr><tr><td></td><td></td><td></td></tr><tr><td></td><td></td><td></td></tr></table>									
		2																																																																													
1		1																																																																													
1																																																																															
		1																																																																													
2		3																																																																													
		3																																																																													
2		1																																																																													
Post - 0 Miss - 0 Block - 1	Post - 0 Miss - 0 Block - 0	Post - 0 Miss - 0 Block - 0	Post - 0 Miss - 0 Block - 0	Post - 4 Miss - 0 Block - 0	Post - 0 Miss - 0 Block - 0	Post - 0 Miss - 0 Block - 0	Post - 0 Miss - 0 Block - 0																																																																								

注释: Post=击柱 Miss=射失 Block=被封





预赛 Group B

女子 全国比赛

2016年全国女子手球锦标赛

Team A A 四川				Team B B 上海				Match Number <b>11</b>													
played in China		in the hall 滁州体育馆		on 04/09/2016		at 19:00 hours		Spectators													
Half-time (30')	A 21	B 22	End of playing time	A 30	B 43	1st extra time	A	B	2nd extra time	A	B	After penalty throws	A	B							
Number of 7 m	A 1/1	Team time-out 1 15:19 2 3			Full name of players and officials				Team time-out 1 07:29 2 3			B 3/4	Number of 7 m								
No.	Team A					G	W	2'	D	DR	No.	Team B					G	W	2'	D	DR
1	张雪纯										1	许沫									
2	陈艳楠										2	周蕾					4				
3	王丹					9					5	郭威					3				
4	尤婉莹					4	1				6	黄妍					2				
5	孙姣					3		1			7	车婉茹					1	1			
6	凤洋					3					8	吴茵					5				
7	练素琪										9	武娜娜					4	1			
9	姚梦园					2					10	斯文					6				
10	高静										11	孙梦颖					3				
11	朱海云					5					12	郑冯									
12	宋琛茜										13	徐娟									
17	史雨欣										17	居晔					3				
18	戴小宇					4		1			18	沙正文					6	1			
27	吴美琪										19	印尼					5				
											21	王嘉怡									
											23	都好					1	1			
A	金鸿					1					B	陈进培 (主教练)									
B	郎正平										C	金钟顺									
C	陈志伟										D	贺业磊									
											F	周瑜宸									
A	Signature of Responsible Official of the Teams (Off. A)																		B		
TP	Remarks of Referee / CHA Official																		TP		

Signatures

Referees	严璐 (CHN)	隆晓磊 (CHN)		
Techn. Delegates	高斌 (CHN)			
CHA Official	刘书勇 (CHN)			

Note: Number of 7m Throws Awarded to Team A and B, Goals (G), Warnings (W), Suspensions (2'), Direct Disqualification (D), Disqualification with Report (DR) and Team Penalty (TP).

Table Officials:

Statisticians: 黄岩

刘永欢





## 2016年全国女子手球锦标赛 竞赛技术统计(媒体表)

预赛	组别	B	轮次	2	场次	11
滁州体育馆			04/09/2016		201605011-51-1/1	
四川	四川	30	vs	43	上海	上海
<b>21 : 22</b>						

裁判员	严璐 (CHN)	/	隆晓磊 (CHN)
-----	----------	---	-----------

四川		远	近	边	快	突	任意	7m	合计	%	助攻	失误	警告	2'	D & DR	四川		比赛	上海			
主教练 : 郎正平		射	射	射	攻	破	球	球								进程						
1	张雪纯															11	朱海云	1st Half	1	01:25	0	
2	陈艳楠	0/1							0/1	0.0						1	01:58	1	18	沙正文		
3	王丹	1/4	3/4	1/2	2/3	1/1		1/1	9/15	60.0	4	3				6	凤洋	2	02:36	1		
4	尤婉莹	1/3	0/2	2/2	1/2				4/9	44.4	1		1			5	孙皎	3	03:45	2	8	吴茵
5	孙皎		3/5	0/1					3/6	50.0		2		1		9	姚梦园	4	04:55	2		
6	凤洋	1/4		2/4					3/8	37.5	1	1				18	戴小宇	4	05:05	3	6	黄妍
7	练素琪															18	戴小宇	5	05:36	3		
9	姚梦园	0/1	1/1	0/1	1/2				2/5	40.0	1					6	凤洋	6	06:22	3		
10	高静															3	王丹	7	06:49	3		
11	朱海云	1/3	2/6			2/2	0/1		5/12	41.7	4	4				18	戴小宇	7	07:00	4	10	斯文
12	宋琛茜															8	尤婉莹	8	07:25	4		
17	史雨欣															4	尤婉莹	9	08:25	5		
18	戴小宇	0/2	3/4			1/1			4/7	57.1	1	1		1		18	戴小宇	10	09:25	5		
27	吴美琪															10	戴小宇	10	09:40	6	18	沙正文
<b>运动员 合计</b>		4/18	12/22	5/10	4/7	4/4	0/1	1/1	30/63	47.6	12	11	1	2		10	戴小宇	10	10:09	7	2	周蕾
12	宋琛茜	1/3	4/26	3/12	3/9	1/2		1/4	13/56	23.2						18	戴小宇	11	10:28	7		
<b>守门员 合计</b>		1/3	4/26	3/12	3/9	1/2		1/4	13/56	23.2						11	朱海云	11	10:38	8	6	黄妍
<b>上海</b>		远	近	边	快	突	任意	7m	合计	%	助攻	失误	警告	2'	D & DR	四川		比赛	上海			
教练 : 陈进培		射	射	射	攻	破	球	球								进程						
1	许沫															5	孙皎	12	11:11	8		
2	周蕾		1/2	1/2	1/1	1/1			4/6	66.7	1					3	王丹	13	11:28	8		
5	郭威	0/2	1/1					2/2	3/5	60.0	1					5	孙皎	12	11:11	8		
6	黄妍	1/2	1/2					0/1	2/5	40.0		1				3	王丹	13	11:28	8		
7	车婉茹		1/1						1/1	100				1		5	孙皎	13	11:46	9	18	沙正文
8	吴茵	1/1	2/2		2/2				5/5	100	5	2				5	孙皎	14	12:05	9		
9	武娜娜		1/1	2/3	1/3				4/7	57.1	1	2		1		4	尤婉莹	15	13:27	9		
10	斯文		3/4	3/4					6/8	75.0						15	朱海云	15	13:54	10	23	都好
11	孙梦颖	0/1	2/2		1/1				3/4	75.0		4				15	朱海云	16	14:37	11	2	周蕾
12	郑冯															15	朱海云	16	15:15	12	9	武娜娜
13	徐娟															15	朱海云	16	16:01	13	11	孙梦颖
17	居晔			2/2	1/1				3/3	100						15	朱海云	17	17:03	14	19	印尼
18	沙正文		6/6		0/1				6/7	85.7						11	朱海云	17	24:24	17	10	斯文
19	印尼	0/1	3/6	1/1		0/1		1/1	5/10	50.0	2					17	朱海云	17	24:50	18	19	印尼
21	王嘉怡															3	王丹	18	26:33	19		
23	都好		1/2	0/1	0/1				1/4	25.0				1		11	朱海云	18	26:59	20	8	吴茵
<b>运动员 合计</b>		2/7	22/29	9/13	6/10	1/2		3/4	43/65	66.2	12	9		4		11	朱海云	19	27:19	20		
1	许沫		1/4	0/4	1/2	0/1			2/11	18.2						11	朱海云	19	28:09	21	19	印尼
12	郑冯	4/8	8/17	4/5	2/5	0/3	1/1	0/1	19/40	47.5	2					11	朱海云	20	29:09	21		
<b>守门员 合计</b>		4/8	9/21	4/9	3/7	0/4	1/1	0/1	21/51	41.2	2					4	尤婉莹	20	29:22	22	11	孙梦颖
<b>场上队员: 得分 / 射门</b>																<b>守门员: 救球 / 射门</b>						
快攻	Fast Break		突破	Breakthrough		任意球	Free Throw		7M球	7M Throw		助攻	Assist									
警告	Warning		失误	Error		2'	Suspension		D	取消资格		DR	取消资格+报告									

场上队员: 得分 / 射门

守门员: 救球 / 射门

快攻	Fast Break		突破	Breakthrough		任意球	Free Throw		7M球	7M Throw		助攻	Assist								
警告	Warning		失误	Error		2'	Suspension		D	取消资格		DR	取消资格+报告								





### 2016年全国女子手球锦标赛 图式比赛技术统计表

轮次 2

场次 11

201605011-21-1/1

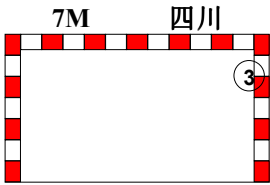
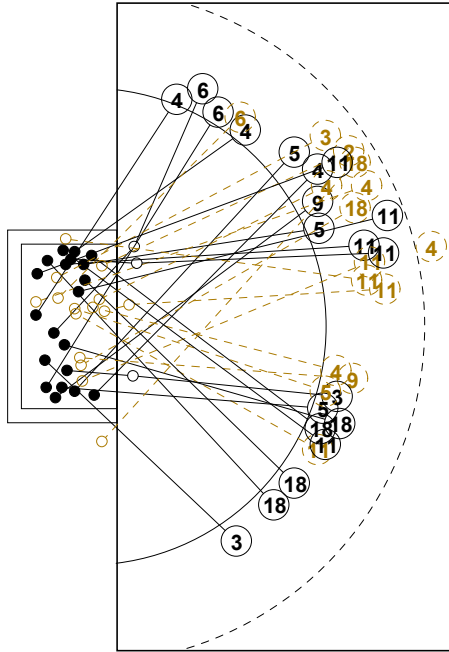

7M 四川

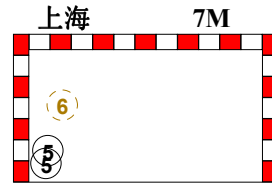
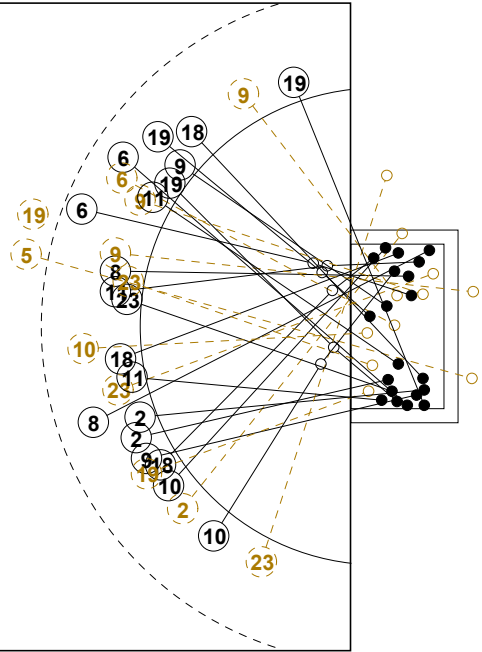

上海 7M

1st Half  
21 : 22

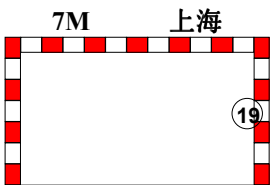
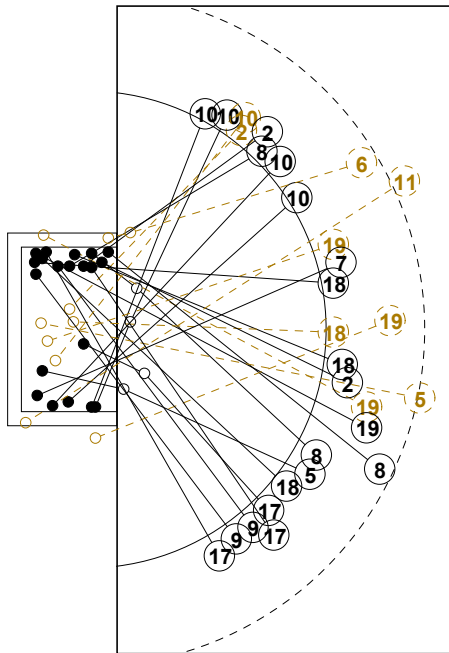

7M 上海

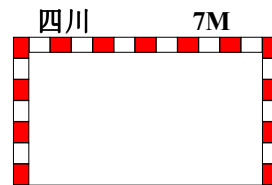
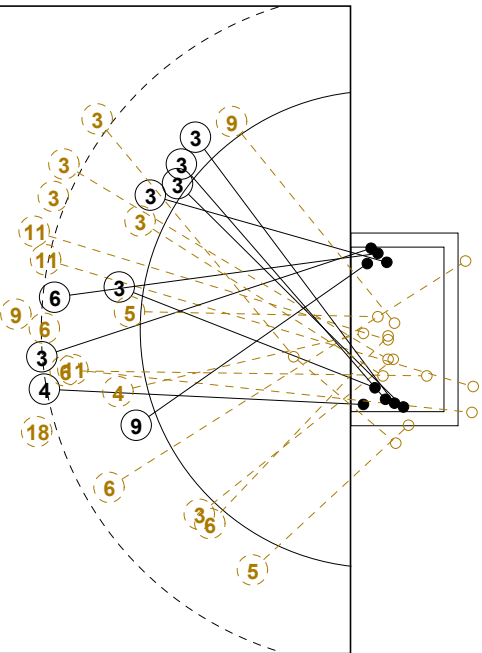

四川 7M

2nd Half  
43 : 30



## 2016年全国女子手球锦标赛

## 个人/全队技术统计表

正式表  
手球  
女子预赛  
轮次 2组别 B  
场次 11201605011-14-1/2  
滁州体育馆  
04/09/2016 19:00

号码	姓名	远射	近射	边射	快攻	突破	任意	7M	合计	%	助攻	失误	警告	2'	取消	时间
<b>四川(四川)</b>																
<i>(场上队员)</i>																
1	张雪纯									0.0%						00:00:00
2	陈艳楠	0/1							0/1	0.0%						00:02:50
3	王丹	1/4	3/4	1/2	2/3	1/1		1/1	9/15	60.0%	4	3				01:00:00
4	尤婉莹	1/3	0/2	2/2	1/2				4/9	44.4%	1		1			00:40:41
5	孙姣		3/5	0/1					3/6	50.0%		2		1		00:56:06
6	凤洋	1/4		2/4					3/8	37.5%	1	1				00:49:06
7	练素琪									0.0%						00:00:00
9	姚梦园	0/1	1/1	0/1	1/2				2/5	40.0%	1					00:54:11
10	高静									0.0%						00:00:00
11	朱海云	1/3	2/6			2/2	0/1		5/12	41.7%	4	4				01:04:00
12	宋琛茜									0.0%						01:00:00
17	史雨欣									0.0%						00:08:35
18	戴小宇	0/2	3/4			1/1			4/7	57.1%	1	1		1		00:41:27
27	吴美琪									0.0%						00:00:00
<b>合计</b>																
<i>(守门员)</i>																
12	宋琛茜	1/3	4/26	3/12	3/9	1/2		1/4	13/56	23.2%						01:00:00
<b>合计</b>																

场上队员：得分/射门

守门员：救球/射门

全队合计	得分	被救	射失	击柱	封球	合计	%
远射	4	4	5		5	18	22.2%
近射	12	9		1		22	54.5%
边射	5	4		1		10	50.0%
快攻	4	3				7	57.1%
突破	4					4	100.0%
任意		1				1	0.0%
7M	1					1	100.0%





## 2016年全国女子手球锦标赛

## 个人/全队技术统计表

正式表  
手球  
女子预赛  
轮次 2组别 B  
场次 11201605011-14-2/2  
滁州体育馆  
04/09/2016 19:00

号码	姓名	远射	近射	边射	快攻	突破	任意	7M	合计	%	助攻	失误	警告	2'	取消	时间
<b>上海(上海)</b>																
<i>(上场队员)</i>																
1	许沫									0.0%						00:09:16
2	周蕾		1/2	1/2	1/1	1/1			4/6	66.7%	1					00:38:24
5	郭威	0/2	1/1					2/2	3/5	60.0%	1					00:15:09
6	黄妍	1/2	1/2					0/1	2/5	40.0%		1				00:19:03
7	车婉茹		1/1						1/1	100%				1		00:11:03
8	吴茵	1/1	2/2		2/2				5/5	100%	5	2				00:33:49
9	武娜娜		1/1	2/3	1/3				4/7	57.1%	1	2		1		00:46:27
10	斯文		3/4	3/4					6/8	75.0%						00:38:56
11	孙梦颖	0/1	2/2		1/1				3/4	75.0%		4				00:42:32
12	郑冯									0.0%	2					00:50:44
13	徐娟									0.0%						00:06:19
17	居晔			2/2	1/1				3/3	100%						00:22:51
18	沙正文		6/6		0/1				6/7	85.7%				1		00:37:57
19	印尼	0/1	3/6	1/1		0/1		1/1	5/10	50.0%	2					00:35:53
21	王嘉怡									0.0%						00:00:00
23	都好		1/2	0/1	0/1				1/4	25.0%				1		00:19:27
<b>合计</b>		<b>2/7</b>	<b>22/29</b>	<b>9/13</b>	<b>6/10</b>	<b>1/2</b>		<b>3/4</b>	<b>43/65</b>	<b>66.2%</b>	<b>12</b>	<b>9</b>		<b>4</b>		
<i>(守门员)</i>																
1	许沫		1/4	0/4	1/2	0/1			2/11	18.2%						00:09:16
12	郑冯	4/8	8/17	4/5	2/5	0/3	1/1	0/1	19/40	47.5%	2					00:50:44
<b>合计</b>		<b>4/8</b>	<b>9/21</b>	<b>4/9</b>	<b>3/7</b>	<b>0/4</b>	<b>1/1</b>	<b>0/1</b>	<b>21/51</b>	<b>41.2%</b>	<b>2</b>					

场上队员：得分/射门

守门员：救球/射门

全队合计	得分	被救	射失	击柱	封球	合计	%
远射	2	1	1	2	1	7	28.6%
近射	22	4	1	2		29	75.9%
边射	9	3	1			13	69.2%
快攻	6	3	1			10	60.0%
突破	1	1				2	50.0%
任意							0.0%
7M	3	1				4	75.0%





### 2016年全国女子手球锦标赛

#### 图式射门区域统计

轮次 2 场次 11

201605011-41-1/1

## 四川

1 张雪纯	2 陈艳楠	3 王丹	4 尤婉莹	5 孙姣	6 凤洋	7 练素琪	9 姚梦园																																																																								
<table border="1"><tr><td></td><td></td><td></td></tr><tr><td></td><td></td><td></td></tr><tr><td></td><td></td><td></td></tr></table>										<table border="1"><tr><td></td><td></td><td></td></tr><tr><td></td><td></td><td></td></tr><tr><td></td><td></td><td></td></tr></table>										<table border="1"><tr><td>1</td><td></td><td>1</td></tr><tr><td>2</td><td></td><td>3</td></tr><tr><td>1</td><td></td><td>1</td></tr></table>	1		1	2		3	1		1	<table border="1"><tr><td></td><td>1</td><td></td></tr><tr><td></td><td></td><td>1</td></tr><tr><td>1</td><td></td><td>1</td></tr></table>		1				1	1		1	<table border="1"><tr><td></td><td></td><td></td></tr><tr><td>2</td><td></td><td>1</td></tr><tr><td></td><td></td><td></td></tr></table>				2		1				<table border="1"><tr><td>1</td><td></td><td>1</td></tr><tr><td></td><td></td><td></td></tr><tr><td>1</td><td></td><td></td></tr></table>	1		1				1			<table border="1"><tr><td></td><td></td><td></td></tr><tr><td></td><td></td><td></td></tr><tr><td></td><td></td><td></td></tr></table>										<table border="1"><tr><td></td><td></td><td></td></tr><tr><td>1</td><td></td><td></td></tr><tr><td>1</td><td></td><td></td></tr></table>				1			1		
1		1																																																																													
2		3																																																																													
1		1																																																																													
	1																																																																														
		1																																																																													
1		1																																																																													
2		1																																																																													
1		1																																																																													
1																																																																															
1																																																																															
1																																																																															
Post - 0 Miss - 0 Block - 0	Post - 0 Miss - 0 Block - 0	Post - 0 Miss - 1 Block - 1	Post - 0 Miss - 0 Block - 1	Post - 1 Miss - 0 Block - 0	Post - 0 Miss - 1 Block - 1	Post - 0 Miss - 0 Block - 0	Post - 0 Miss - 0 Block - 1																																																																								
10 高静	11 朱海云	12 宋琛茜	17 史雨欣	18 戴小宇	27 吴美琪																																																																										
<table border="1"><tr><td></td><td></td><td></td></tr><tr><td></td><td></td><td></td></tr><tr><td></td><td></td><td></td></tr></table>										<table border="1"><tr><td></td><td></td><td>1</td></tr><tr><td></td><td></td><td>4</td></tr><tr><td></td><td></td><td></td></tr></table>			1			4				<table border="1"><tr><td></td><td></td><td></td></tr><tr><td></td><td></td><td></td></tr><tr><td></td><td></td><td></td></tr></table>										<table border="1"><tr><td></td><td></td><td></td></tr><tr><td></td><td></td><td></td></tr><tr><td></td><td></td><td></td></tr></table>										<table border="1"><tr><td></td><td></td><td>1</td></tr><tr><td></td><td>1</td><td>1</td></tr><tr><td></td><td></td><td>1</td></tr></table>			1		1	1			1	<table border="1"><tr><td></td><td></td><td></td></tr><tr><td></td><td></td><td></td></tr><tr><td></td><td></td><td></td></tr></table>										<table border="1"><tr><td></td><td></td><td></td></tr><tr><td></td><td></td><td></td></tr><tr><td></td><td></td><td></td></tr></table>										<table border="1"><tr><td></td><td></td><td></td></tr><tr><td></td><td></td><td></td></tr><tr><td></td><td></td><td></td></tr></table>									
		1																																																																													
		4																																																																													
		1																																																																													
	1	1																																																																													
		1																																																																													
Post - 0 Miss - 0 Block - 0	Post - 1 Miss - 2 Block - 0	Post - 0 Miss - 0 Block - 0	Post - 0 Miss - 0 Block - 0	Post - 0 Miss - 1 Block - 1	Post - 0 Miss - 0 Block - 0																																																																										

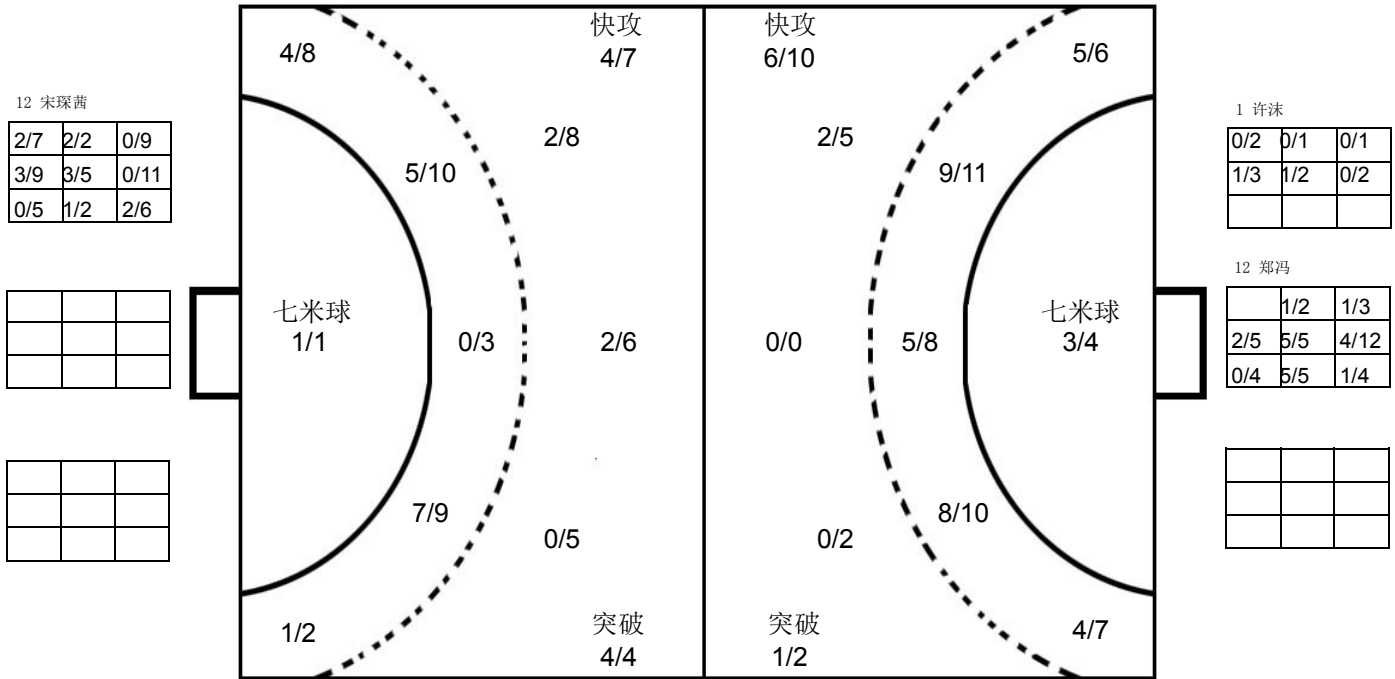

## 上海

1 许沫	2 周蕾	5 郭威	6 黄妍	7 车婉茹	8 吴茵	9 武娜娜	10 斯文																																																																								
<table border="1"><tr><td></td><td></td><td></td></tr><tr><td></td><td></td><td></td></tr><tr><td></td><td></td><td></td></tr></table>										<table border="1"><tr><td></td><td></td><td>1</td></tr><tr><td></td><td></td><td>2</td></tr><tr><td></td><td></td><td>1</td></tr></table>			1			2			1	<table border="1"><tr><td>1</td><td></td><td></td></tr><tr><td></td><td></td><td></td></tr><tr><td>2</td><td></td><td></td></tr></table>	1						2			<table border="1"><tr><td></td><td></td><td></td></tr><tr><td>1</td><td></td><td>1</td></tr><tr><td></td><td></td><td></td></tr></table>				1		1				<table border="1"><tr><td>1</td><td></td><td></td></tr><tr><td></td><td></td><td></td></tr><tr><td></td><td></td><td></td></tr></table>	1									<table border="1"><tr><td>1</td><td></td><td></td></tr><tr><td>1</td><td></td><td>1</td></tr><tr><td></td><td></td><td>2</td></tr></table>	1			1		1			2	<table border="1"><tr><td></td><td></td><td>2</td></tr><tr><td></td><td>1</td><td>1</td></tr><tr><td></td><td></td><td></td></tr></table>			2		1	1				<table border="1"><tr><td>1</td><td></td><td></td></tr><tr><td>3</td><td></td><td></td></tr><tr><td>2</td><td></td><td></td></tr></table>	1			3			2		
		1																																																																													
		2																																																																													
		1																																																																													
1																																																																															
2																																																																															
1		1																																																																													
1																																																																															
1																																																																															
1		1																																																																													
		2																																																																													
		2																																																																													
	1	1																																																																													
1																																																																															
3																																																																															
2																																																																															
Post - 0 Miss - 0 Block - 0	Post - 1 Miss - 0 Block - 0	Post - 0 Miss - 1 Block - 0	Post - 1 Miss - 0 Block - 0	Post - 0 Miss - 0 Block - 0	Post - 0 Miss - 0 Block - 0	Post - 0 Miss - 1 Block - 0	Post - 0 Miss - 0 Block - 0																																																																								
11 孙梦颖	12 郑冯	13 徐娟	17 居晔	18 沙正文	19 印尼	21 王嘉怡	23 都好																																																																								
<table border="1"><tr><td>1</td><td></td><td></td></tr><tr><td></td><td></td><td>2</td></tr><tr><td></td><td></td><td></td></tr></table>	1					2				<table border="1"><tr><td></td><td></td><td></td></tr><tr><td></td><td></td><td></td></tr><tr><td></td><td></td><td></td></tr></table>										<table border="1"><tr><td></td><td></td><td></td></tr><tr><td></td><td></td><td></td></tr><tr><td></td><td></td><td></td></tr></table>										<table border="1"><tr><td></td><td></td><td>1</td></tr><tr><td></td><td>1</td><td></td></tr><tr><td></td><td></td><td>1</td></tr></table>			1		1				1	<table border="1"><tr><td></td><td></td><td>3</td></tr><tr><td>1</td><td></td><td>1</td></tr><tr><td>1</td><td></td><td></td></tr></table>			3	1		1	1			<table border="1"><tr><td></td><td></td><td>2</td></tr><tr><td></td><td></td><td>2</td></tr><tr><td></td><td>1</td><td></td></tr></table>			2			2		1		<table border="1"><tr><td></td><td></td><td></td></tr><tr><td></td><td></td><td></td></tr><tr><td></td><td></td><td></td></tr></table>										<table border="1"><tr><td></td><td></td><td></td></tr><tr><td></td><td></td><td>1</td></tr><tr><td></td><td></td><td></td></tr></table>						1			
1																																																																															
		2																																																																													
		1																																																																													
	1																																																																														
		1																																																																													
		3																																																																													
1		1																																																																													
1																																																																															
		2																																																																													
		2																																																																													
	1																																																																														
		1																																																																													
Post - 1 Miss - 0 Block - 0	Post - 0 Miss - 0 Block - 0	Post - 0 Miss - 0 Block - 0	Post - 0 Miss - 0 Block - 0	Post - 0 Miss - 0 Block - 0	Post - 1 Miss - 1 Block - 1	Post - 0 Miss - 0 Block - 0	Post - 0 Miss - 1 Block - 0																																																																								

注释: Post=击柱 Miss=射失 Block=被封





预赛 Group B

女子 全国比赛

2016年全国女子手球锦标赛

Team A <b>A 天津</b>				Team B <b>B 解放军</b>				Match Number <b>12</b>													
played in China		in the hall 滁州体育馆		on 04/09/2016		at 20:30 hours		Spectators													
Half-time (30')	<b>A</b> 13	<b>B</b> 13	End of playing time	<b>A</b> 24	<b>B</b> 24	1st extra time	<b>A</b>	<b>B</b>	2nd extra time	<b>A</b>	<b>B</b>	After penalty throws	<b>A</b> 29	<b>B</b> 28							
Number of 7 m	<b>A</b> 6 / 6	Team time-out 1 28:16 2 43:14 3 59:39			Full name of players and officials				Team time-out 1 20:54 2 52:50 3			<b>B</b> 10 / 13	Number of 7 m								
No.	Team <b>A</b>					G	W	2'	D	DR	No.	Team <b>B</b>					G	W	2'	D	DR
3	王晓梅					10					2	崔云莉					1	1			
4	朱佳瑜					1					5	徐鸣昭									
5	丁丽洁					1					6	于婷婷					1	1			
7	张心茹										8	周亚茹					4				
8	张慧							1			13	张格格						1			
10	张文慧					2	1				16	方文博									
11	蔡雪洁					3	1				17	于利婷									
12	王欣冉										23	顾天澍									
14	刘洁										24	韦娜娜					6				
15	李窈窈										32	张馨予									
16	王选										36	李朴									
17	聂晓雪										44	刘洋麦文					4				
18	舒文琪					5	1				66	杨丽丽									
21	李默雅					2					77	唐魏萍									
22	王聪										81	戴丹妮									
23	周梦雪					5					88	李晓晴					12				
A	付明双										A	刘德东 (主教练)									
B	王明星 (主教练)										B	刘凤娟									
C	岳连娥										D	吴明群									
Signature of Responsible Official of the Teams (Off. A)											Signature of Responsible Official of the Teams (Off. B)										
TP	Remarks of Referee / CHA Official																			TP	

Signatures

Referees	徐健 (CHN)	曹宏俊 (CHN)		
Techn. Delegates	高斌 (CHN)			
CHA Official	于中迅 (CHN)			

Note: Number of 7m Throws Awarded to Team A and B, Goals (G), Warnings (W), Suspensions (2'), Direct Disqualification (D), Disqualification with Report (DR) and Team Penalty (TP).

Table Officials:

Statisticians: 刘永欢

黄岩







## 2016年全国女子手球锦标赛 竞赛技术统计(媒体表)

预赛	组别	B	轮次	2	场次	12
----	----	---	----	---	----	----

滁州体育馆

04/09/2016

201605012-51-1/1

天津	天津	29	vs	28	解放军	解放军
13 : 13						

裁判员	徐健 (CHN)	/	曹宏俊 (CHN)
-----	----------	---	-----------

天津													解放军												
主教练：王明星													比赛进程												
远射	近射	边射	快攻	突破	任意球	7m球	合计	%	助攻	失误	警告	2'	D & DR	天津	进程	解放军									
3 王晓梅	7/16				1/1	2/2	10/19	52.6	1	8				18 舒文琪	0 01:46	1 44 刘洋麦文									
4 朱佳瑜						1/1	1/1	100						1 舒文琪	1 03:20	1 1 李晓晴									
5 丁丽洁				1/1			1/1	100						3 王晓梅	2 04:21	2 2 李晓晴									
7 张心茹														3 王晓梅	3 06:03	2 3 李晓晴									
8 张慧			0/1				0/1	0.0				1		3 王晓梅	3 07:38	3 88 李晓晴									
10 张文慧		1/1		1/1			2/2	100		1	1			3 王晓梅	4 09:17	4 24 韦娜娜									
11 蔡雪洁	0/2	2/4				1/1	3/7	42.9		6	1			10 张文慧	5 11:37	5 44 刘洋麦文									
12 王欣冉														5 蔡雪洁	5 12:30	6 88 李晓晴									
14 刘洁														6 王欣冉	6 14:06	6 7 李晓晴									
15 李窈窕														18 舒文琪	7 14:58	7 8 韦娜娜									
16 王选														7 王选	7 15:59	9 6 于婷婷									
17 聂晓雪	0/1						0/1	0.0						3 王晓梅	8 17:33	9 24 韦娜娜									
18 舒文琪	1/4	3/3				1/1	5/8	62.5		9	1			8 王选	8 19:38	10 24 韦娜娜									
21 李默雅	1/1		1/1				2/2	100						8 王选	8 21:28	11 8 周亚茹									
22 王聪														23 周梦雪	9 23:33	11 10 李晓晴									
23 周梦雪	2/2		1/1	1/1		1/1	5/5	100						10 张文慧	10 23:55	11 23 周梦雪									
<b>运动员 合计</b>	<b>11/26</b>	<b>6/8</b>	<b>1/2</b>	<b>3/3</b>	<b>2/2</b>	<b>6/6</b>	<b>29/47</b>	<b>61.7</b>	<b>1</b>	<b>24</b>	<b>3</b>	<b>1</b>		11 周梦雪	11 25:09	12 8 周亚茹									
12 王欣冉	5/7	1/2	1/5			2/5	9/19	47.4						3 王晓梅	12 27:10	12 13 李默雅									
16 王选	4/7	3/7	1/1	0/1	0/2	0/1	1/8	9/27	33.3					13 李默雅	13 28:47	12 13 8 周亚茹									
<b>守门员 合计</b>	<b>9/14</b>	<b>4/9</b>	<b>2/6</b>	<b>0/1</b>	<b>0/2</b>	<b>0/1</b>	<b>3/13</b>	<b>18/46</b>	<b>39.1</b>																
解放军													2nd Half												
教练：刘德东													进程												
远射	近射	边射	快攻	突破	任意球	7m球	合计	%	助攻	失误	警告	2'	D & DR	天津	进程	解放军									
2 崔云莉		0/1				1/1	1/2	50.0				1		3 王晓梅	14 01:01	13 15 02:00									
5 徐鸣昭														3 王晓梅	15 01:45	13 15 03:24									
6 于婷婷	1/3	0/1					1/4	25.0		3	1			23 周梦雪	16 05:30	15 16 05:54									
8 周亚茹	1/4	0/1	1/2			2/4	4/11	36.4		1				16 周梦雪	16 06:54	17 88 李晓晴									
13 张格格		0/1					0/1	0.0	1	1	1			16 周梦雪	16 08:15	18 8 周亚茹									
16 方文博														16 周梦雪	16 09:19	19 88 李晓晴									
17 于利婷	0/1						0/1	0.0		3				17 李默雅	17 09:47	19 17 10:14									
23 顾天澍														23 周梦雪	18 13:37	20 18 15:40									
24 韦娜娜		2/2	2/6	1/1		1/1	6/10	60.0						5 丁丽洁	18 16:44	21 18 17:49									
32 张馨予														18 舒文琪	19 19:52	22 24 韦娜娜									
36 李朴														18 舒文琪	20 20:48	23 21 22:01									
44 刘洋麦文	2/9				1/1	1/1	4/11	36.4	1	4				11 蔡雪洁	22 22:38	23 23 26:29									
66 杨丽丽							0/2	0.0						23 王晓梅	23 26:29	23 23 26:52									
77 唐魏萍							0/1	0.0						11 蔡雪洁	24 28:07	24 24 28:07									
81 戴丹妮																									
88 李晓晴	1/4	3/5	1/1		2/2	5/6	12/18	66.7	1	2															
<b>运动员 合计</b>	<b>5/21</b>	<b>5/10</b>	<b>4/10</b>	<b>1/1</b>	<b>2/2</b>	<b>1/1</b>	<b>10/13</b>	<b>28/58</b>	<b>48.3</b>	<b>3</b>	<b>14</b>	<b>3</b>													
16 方文博	10/21	2/8	0/1	0/3	0/2	0/3	12/38	31.6																	
66 杨丽丽						0/2	0/2	0.0																	
77 唐魏萍						0/1	0/1	0.0																	
<b>守门员 合计</b>	<b>10/21</b>	<b>2/8</b>	<b>0/1</b>	<b>0/3</b>	<b>0/2</b>	<b>0/6</b>	<b>12/41</b>	<b>29.3</b>																	

场上队员：得分 / 射门

守门员：救球 / 射门

快攻	Fast Break	突破	Breakthrough	任意球	Free Throw	7M球	7M Throw	助攻	Assist
警告	Warning	失误	Error	2'	Suspension	D	取消资格	DR	取消资格+报告





### 2016年全国女子手球锦标赛 图式比赛技术统计表

轮次 2

场次 12

201605012-21-1/1

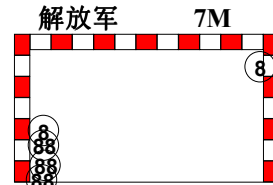
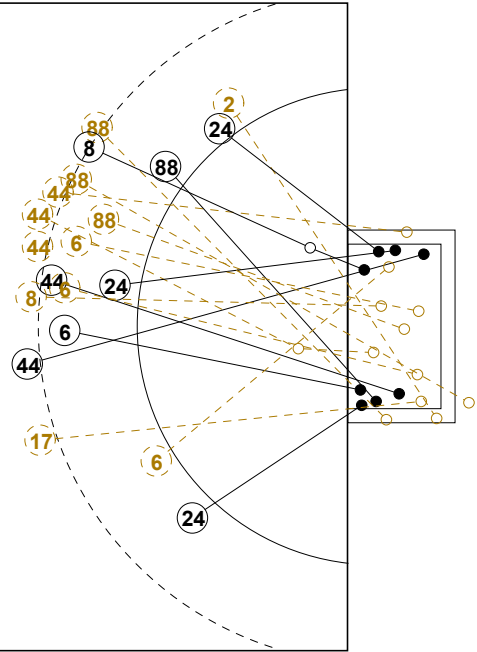
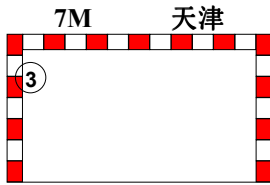
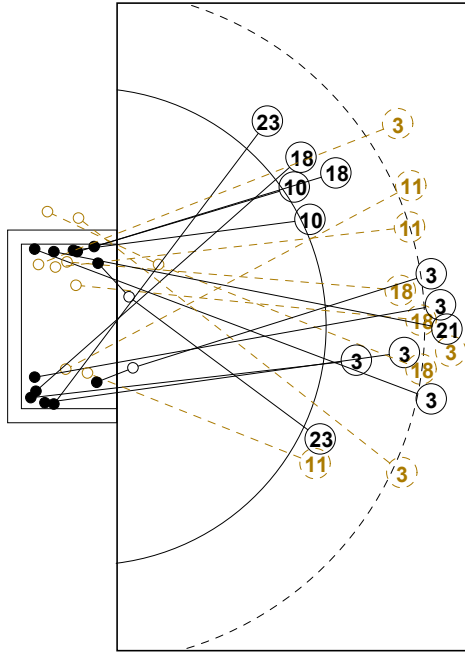

1st Half  
13 : 13

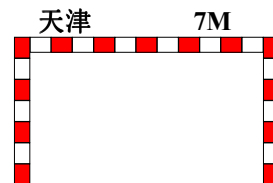
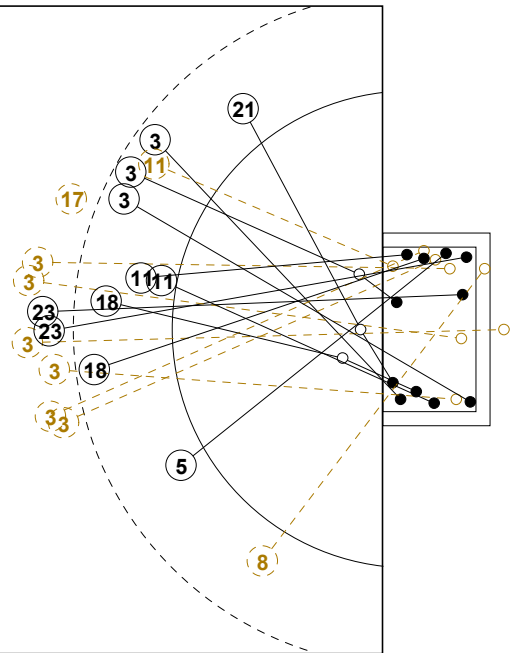
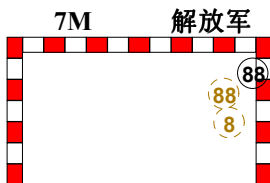
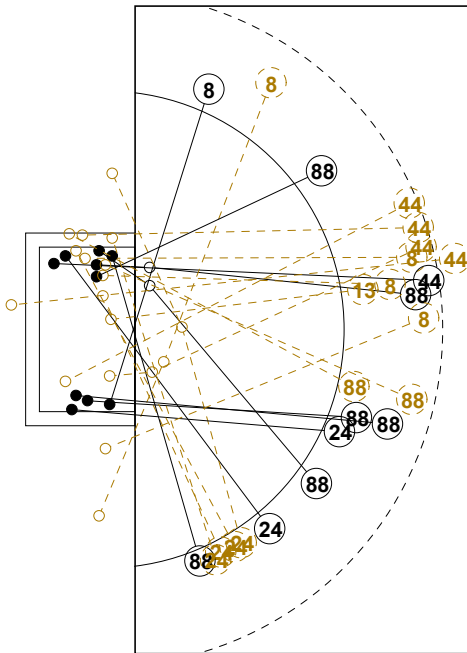

2nd Half  
24 : 24



### 2016年全国女子手球锦标赛 图式比赛技术统计表

轮次 2

场次 12

201605012-21-1/1

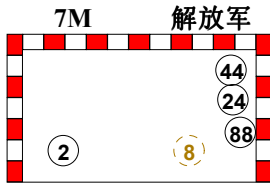
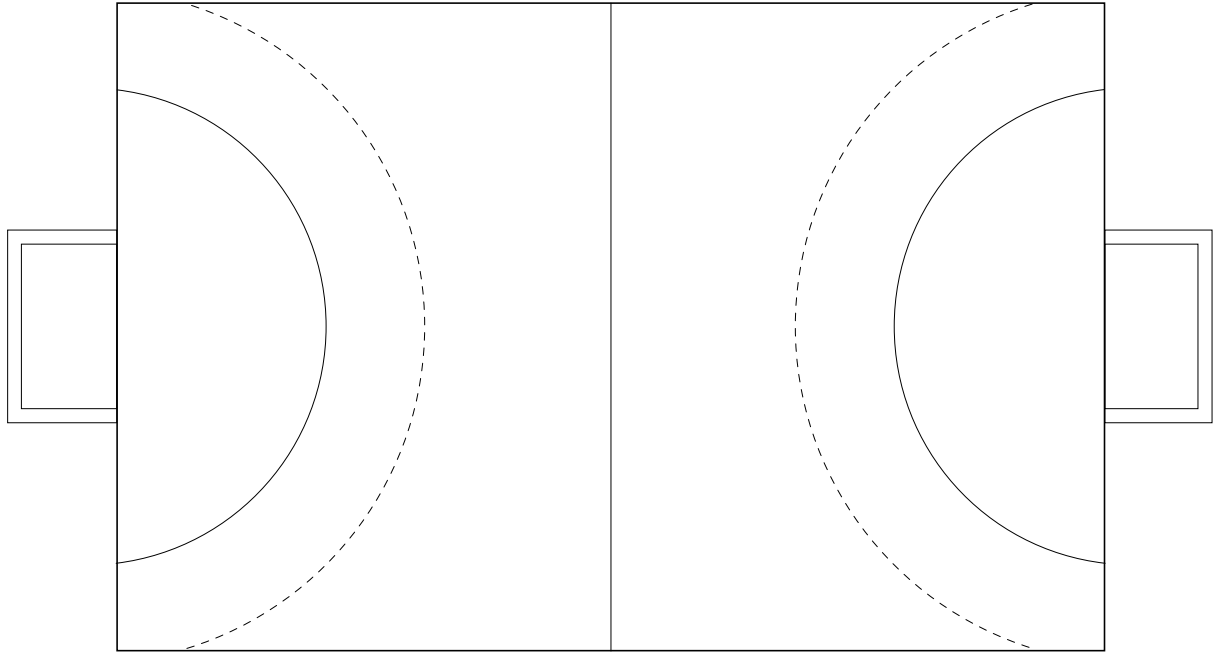

7M-Throw  
28 : 29

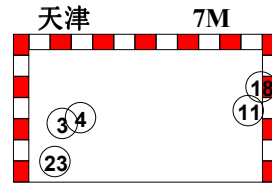



## 2016年全国女子手球锦标赛

## 个人/全队技术统计表

正式表  
手球  
女子预赛  
轮次 2组别 B  
场次 12201605012-14-1/2  
滁州体育馆  
04/09/2016 20:30

号码	姓名	远射	近射	边射	快攻	突破	任意	7M	合计	%	助攻	失误	警告	2'	取消	时间
<b>天津(天津)</b>																
<i>(场上队员)</i>																
3	王晓梅	7/16				1/1		2/2	10/19	52.6%	1	8				00:39:20
4	朱佳瑜							1/1	1/1	100%						00:00:25
5	丁丽洁				1/1				1/1	100%						00:14:25
7	张心茹									0.0%						00:00:00
8	张慧			0/1					0/1	0.0%				1		01:00:00
10	张文慧		1/1		1/1				2/2	100%		1	1			01:00:00
11	蔡雪洁	0/2	2/4					1/1	3/7	42.9%		6	1			00:48:40
12	王欣冉									0.0%						00:52:20
14	刘洁									0.0%						00:00:00
15	李窈窈									0.0%						00:03:53
16	王选									0.0%						00:37:40
17	聂晓雪	0/1							0/1	0.0%						00:14:41
18	舒文琪	1/4	3/3					1/1	5/8	62.5%		9	1			00:38:09
21	李默雅	1/1		1/1					2/2	100%						00:39:52
22	王聪									0.0%						00:00:00
23	周梦雪	2/2			1/1	1/1		1/1	5/5	100%						00:39:40
<b>合计</b>		11/26	6/8	1/2	3/3	2/2		6/6	29/47	61.7%	1	24	3	1		
<i>(守门员)</i>																
12	王欣冉	5/7	1/2	1/5				2/5	9/19	47.4%						00:52:20
16	王选	4/7	3/7	1/1	0/1	0/2	0/1	1/8	9/27	33.3%						00:37:40
<b>合计</b>		9/14	4/9	2/6	0/1	0/2	0/1	3/13	18/46	39.1%						

场上队员：得分/射门

守门员：救球/射门

全队合计	得分	被救	射失	击柱	封球	合计	%
远射	11	10	3		2	26	42.3%
近射	6	2				8	75.0%
边射	1			1		2	50.0%
快攻	3					3	100.0%
突破	2					2	100.0%
任意							0.0%
7M	6					6	100.0%





## 2016年全国女子手球锦标赛

## 个人/全队技术统计表

正式表  
手球  
女子预赛  
轮次 2组别 B  
场次 12201605012-14-2/2  
滁州体育馆  
04/09/2016 20:30

号码	姓名	远射	近射	边射	快攻	突破	任意	7M	合计	%	助攻	失误	警告	2'	取消	时间
<b>解放军(解放军)</b>																
<i>(上场队员)</i>																
2	崔云莉			0/1				1/1	1/2	50.0%			1			00:21:36
5	徐鸣昭									0.0%						00:00:00
6	于婷婷	1/3	0/1						1/4	25.0%		3	1			01:00:00
8	周亚茹	1/4	0/1	1/2				2/4	4/11	36.4%		1				00:39:06
13	张格格		0/1						0/1	0.0%	1	1	1			01:00:00
16	方文博									0.0%						01:30:00
17	于利婷	0/1							0/1	0.0%		3				00:12:47
23	顾天澍									0.0%						00:00:00
24	韦娜娜		2/2	2/6	1/1			1/1	6/10	60.0%						00:59:57
32	张馨予									0.0%						00:00:00
36	李朴									0.0%						00:00:00
44	刘洋麦文	2/9					1/1	1/1	4/11	36.4%	1	4				00:51:18
66	杨丽丽									0.0%						00:00:00
77	唐魏萍									0.0%						00:00:00
81	戴丹妮									0.0%						00:00:00
88	李晓晴	1/4	3/5	1/1		2/2		5/6	12/18	66.7%	1	2				00:55:09
<b>合计</b>		5/21	5/10	4/10	1/1	2/2	1/1	10/13	28/58	48.3%	3	14	3			
<i>(守门员)</i>																
16	方文博	10/21	2/8	0/1	0/3	0/2		0/3	12/38	31.6%						01:30:00
66	杨丽丽							0/2	0/2	0.0%						00:00:00
77	唐魏萍							0/1	0/1	0.0%						00:00:00
<b>合计</b>		10/21	2/8	0/1	0/3	0/2		0/6	12/41	29.3%						

场上队员：得分/射门

守门员：救球/射门

全队合计	得分	被救	射失	击柱	封球	合计	%
远射	5	9	3	3	1	21	23.8%
近射	5	4		1		10	50.0%
边射	4	2	2	2		10	40.0%
快攻	1					1	100.0%
突破	2					2	100.0%
任意	1					1	100.0%
7M	10	3				13	76.9%





2016年全国女子手球锦标赛

图式射门区域统计

轮次 2 场次 12

201605012-41-1/1

天津

3 王晓梅	4 朱佳瑜	5 丁丽洁	7 张心茹	8 张慧	10 张文慧	11 蔡雪洁	12 王欣冉
4 1 1 1 1	1	1			2	2	
Post - 0 Miss - 2 Block - 1	Post - 0 Miss - 0 Block - 0	Post - 0 Miss - 0 Block - 0	Post - 0 Miss - 0 Block - 0	Post - 1 Miss - 0 Block - 0	Post - 0 Miss - 0 Block - 0	Post - 0 Miss - 0 Block - 0	Post - 0 Miss - 0 Block - 0
14 刘洁	15 李窈窈	16 王选	17 聂晓雪	18 舒文琪	21 李默雅	22 王聪	23 周梦雪
				1 1 1 1 1	1		3 1 1
Post - 0 Miss - 0 Block - 0	Post - 0 Miss - 0 Block - 0	Post - 0 Miss - 0 Block - 0	Post - 0 Miss - 0 Block - 1	Post - 0 Miss - 1 Block - 0	Post - 0 Miss - 0 Block - 0	Post - 0 Miss - 0 Block - 0	Post - 0 Miss - 0 Block - 0

12 王欣冉
1/1 3/5
1/4 1/1 2/3
0/3 1/2

16 王选
1/3 0/4
0/2 1/1 3/7
1/4 2/2 1/4

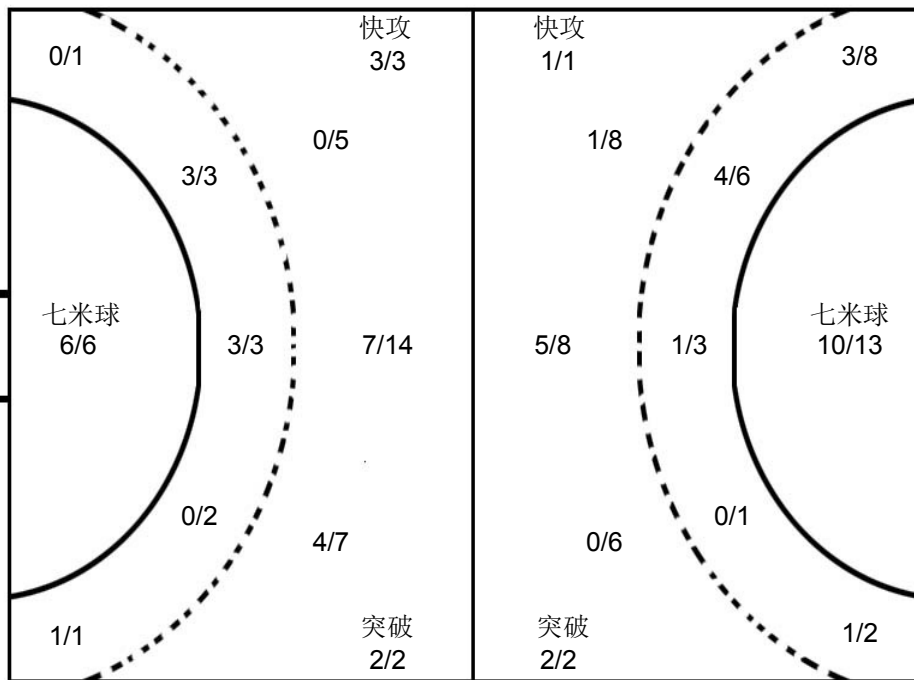
16 方文博
1/10 1/1 2/5
3/5 3/8
2/4 0/1 0/4

66 杨丽丽
0/1
0/1

77 唐魏萍
0/1

解放军

2 崔云莉	5 徐鸣昭	6 于婷婷	8 周亚茹	13 张格格	16 方文博	17 于利婷	23 顾天溯
1		1	1 2				
Post - 1 Miss - 0 Block - 0	Post - 0 Miss - 0 Block - 0	Post - 0 Miss - 0 Block - 0	Post - 0 Miss - 2 Block - 0	Post - 0 Miss - 0 Block - 0	Post - 0 Miss - 0 Block - 0	Post - 0 Miss - 0 Block - 0	Post - 0 Miss - 0 Block - 0
24 韦娜娜	32 张馨予	36 李朴	44 刘洋麦文	66 杨丽丽	77 唐魏萍	81 戴丹妮	88 李晓晴
1 2 1			1 2 1				1 2 4 3 2
Post - 1 Miss - 1 Block - 0	Post - 0 Miss - 0 Block - 0	Post - 0 Miss - 0 Block - 0	Post - 2 Miss - 1 Block - 1	Post - 0 Miss - 0 Block - 0	Post - 0 Miss - 0 Block - 0	Post - 0 Miss - 0 Block - 0	Post - 2 Miss - 1 Block - 0

注释: Post=击柱 Miss=射失 Block=被封





预赛 Group A

女子 全国比赛

2016年全国女子手球锦标赛

Team A <b>A 黑龙江</b>				Team B <b>B 广西</b>				Match Number <b>13</b>													
played in China		in the hall 滁州体育馆		on 05/09/2016		at 14:30 hours		Spectators													
Half-time (30')	<b>A</b> 10	<b>B</b> 11	End of playing time	<b>A</b> 23	<b>B</b> 26	1st extra time	<b>A</b>	<b>B</b>	2nd extra time	<b>A</b>	<b>B</b>	After penalty throws	<b>A</b>	<b>B</b>							
Number of 7 m	<b>A</b> 2 / 2	Team time-out 1 18:40 2 43:47 3 52:20			Full name of players and officials				Team time-out 1 17:06 2 37:53 3 59:27			<b>B</b> 0 / 0	Number of 7 m								
No.	Team <b>A</b>					G	W	2'	D	DR	No.	Team <b>B</b>					G	W	2'	D	DR
1	徐佳蓉										1	胡霜梅									
3	刘诗彤										2	陆雪云					3				
5	周美微					2	1	2			5	黄海玉									
6	王梦艺					2					6	韦惠文									
9	郑宇					2					7	廖露					7				
10	刘雪露					5					8	韦如芳					5	1			
11	刘天茹					1					9	蓝雪梅									
12	肖宁桐										10	周琴					4	1			
13	吴佳					3	1				11	曾蓝花					1				
14	黄荣										12	江燕红									
16	杜宪										14	黄艳芳					2				
19	梁文煜					3	1	1			15	陈依依									
21	王戈					4					16	商志运									
22	马琳					1					17	杨杨									
23	张政										18	庞娇					4		1		
B	张立梅 (主教练)										C	王林									
C	黄冬杰										D	刘雪波									
D	于兹香																				
E	马婧																				
<b>A</b>	Signature of Responsible Official of the Teams (Off. A)																		<b>B</b>		
TP	Remarks of Referee / CHA Official																		TP		

Signatures

Referees	张耿 (CHN)	王洋 (CHN)		
Techn. Delegates	于中迅 (CHN)			
CHA Official	许宜扬 (CHN)			

Note: Number of 7m Throws Awarded to Team A and B, Goals (G), Warnings (W), Suspensions (2'), Direct Disqualification (D), Disqualification with Report (DR) and Team Penalty (TP).

Table Officials: 伍豪

陈文丽

Statisticians: 闫冲

黄岩

Printed by PHMS Copyright: IHF / CHA 05/09/2016 10:59:01

Longman Sportsoft



handball@126.com



## 2016年全国女子手球锦标赛 竞赛技术统计(媒体表)

<b>预赛</b>	组别	<b>A</b>	轮次	<b>3</b>	场次	<b>13</b>
滁州体育馆			05/09/2016		201605013-51-1/1	
黑龙江	<b>黑龙江</b>	<b>23</b>	vs	<b>26</b>	广西	广西
			<b>10 : 11</b>			

裁判员	张耿 (CHN)	/	王洋 (CHN)
-----	----------	---	----------

<b>黑龙江</b>													比赛进程		<b>广西</b>				
主教练 : 张立梅	远射	近射	边射	快攻	突破	任意球	7m球	合计	%	助攻	失误	警告	2'	D & DR					
1 徐佳蓉															10 刘雪露	1 00:57	0		
3 刘诗彤															13 吴佳	2 01:31	0		
5 周美微		2/4						2/4	50.0		1	1	2		2 02:22	1	2	陆雪云	
6 王梦艺	0/1	2/2	0/1					2/4	50.0	1					2 03:29	2	7	廖露	
9 郑宇	0/1	1/1	1/1	0/1				2/4	50.0	1					3 03:56	2	2		
10 刘雪露	4/10						1/1	5/11	45.5		3				3 05:01	3	8	韦如芳	
11 刘天茹			1/5					1/5	20.0		1				4 05:34	3			
12 肖宁桐											1				4 08:27	4	2	陆雪云	
13 吴佳	1/4	0/2	1/2	1/1				3/9	33.3		2	1			5 09:56	4			
14 黄荣															6 12:57	4			
16 杜宪															7 14:14	4			
19 梁文煜	0/1	1/1	1/4	1/1				3/7	42.9	1	2	1	1		8 17:02	4			
21 王戈			2/2	1/1	1/1			4/4	100		1				8 17:28	5	8	韦如芳	
22 马琳							1/1	1/1	100						8 18:25	6	10	周琴	
23 张政										1	1				8 20:25	7	8	韦如芳	
<b>运动员 合计</b>	<b>5/17</b>	<b>6/10</b>	<b>6/15</b>	<b>3/4</b>	<b>1/1</b>		<b>2/2</b>	<b>23/49</b>	<b>46.9</b>	<b>4</b>	<b>12</b>	<b>3</b>	<b>3</b>		9 20:44	7			
1 徐佳蓉	0/1	2/3		1/2				3/6	50.0						9 21:21	8	7	廖露	
12 肖宁桐	11/20	2/6	3/9	0/1	1/4			17/40	42.5		1				9 22:58	9	7	廖露	
<b>守门员 合计</b>	<b>11/21</b>	<b>4/9</b>	<b>3/9</b>	<b>1/3</b>	<b>1/4</b>			<b>20/46</b>	<b>43.5</b>		<b>1</b>				10 23:27	9			
															10 24:32	10	2	陆雪云	
															10 28:57	11	14	黄艳芳	
<b>广西</b>													2nd Half		<b>广西</b>				
教练 : 王林	远射	近射	边射	快攻	突破	任意球	7m球	合计	%	助攻	失误	警告	2'	D & DR					
1 胡霜梅															11 01:24	11			
2 陆雪云	3/8							3/8	37.5		4				12 04:45	11			
5 黄海玉	0/1							0/1	0.0						13 07:25	11			
6 韦惠文															13 08:08	12	10	周琴	
7 廖露	3/8	2/2	2/2					7/12	58.3	1	4				13 09:50	13	8	韦如芳	
8 韦如芳	0/1		4/6		1/1			5/8	62.5		2	1			14 11:32	13			
9 蓝雪梅															14 12:41	14	18	庞娇	
10 周琴	2/4	0/3		1/1	1/2			4/10	40.0		2	1			14 13:32	15	7	廖露	
11 曾蓝花	0/3	0/1	0/1		1/1			1/6	16.7						15 14:07	15			
12 江燕红															15 14:56	16	18	庞娇	
14 黄艳芳		1/2	0/1	1/2				2/5	40.0						16 16:12	16			
15 陈依依															16 17:11	17	18	庞娇	
16 商志运											1				16 18:24	18	7	廖露	
17 杨杨															17 19:17	18			
18 庞娇	2/5	2/2						4/7	57.1		1		1		17 19:32	19	7	廖露	
<b>运动员 合计</b>	<b>10/30</b>	<b>5/10</b>	<b>6/10</b>	<b>2/3</b>	<b>3/4</b>			<b>26/57</b>	<b>45.6</b>	<b>1</b>	<b>16</b>	<b>2</b>	<b>1</b>		17 20:22	20	8	韦如芳	
12 江燕红	2/3	0/1		1/3	0/1		0/1	3/9	33.3						18 21:10	20			
16 商志运	4/8	4/9	4/10	0/1			0/1	12/29	41.4		1				18 22:04	22	11	曾蓝花	
<b>守门员 合计</b>	<b>6/11</b>	<b>4/10</b>	<b>4/10</b>	<b>1/4</b>	<b>0/1</b>		<b>0/2</b>	<b>15/38</b>	<b>39.5</b>		<b>1</b>				19 22:35	22			
															19 22:59	23	18	庞娇	
															20 25:48	23			
															20 26:34	24	10	周琴	
															21 26:48	24			
															22 27:55	24			
															22 28:29	25	10	周琴	
															23 29:18	25			
															23 29:42	26	14	黄艳芳	

场上队员: 得分 / 射门

守门员: 救球 / 射门

快攻	Fast Break		突破	Breakthrough		任意球	Free Throw		7M球	7M Throw		助攻	Assist
警告	Warning		失误	Error		2'	Suspension		D	取消资格		DR	取消资格+报告





# 2016年全国女子手球锦标赛 图式比赛技术统计表

轮次 3

场次 13

201605013-21-1/1

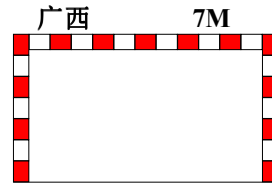
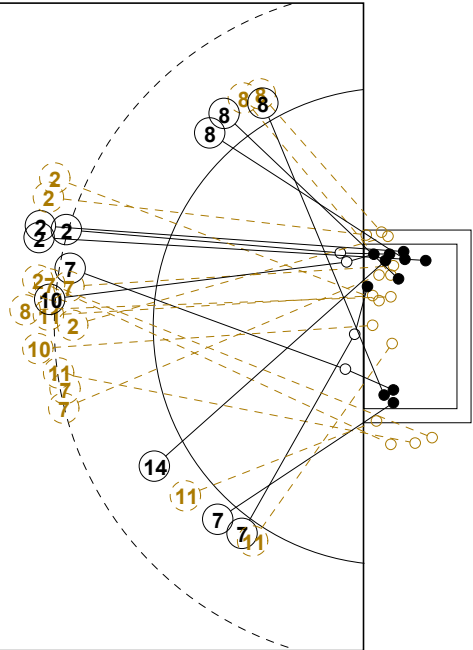
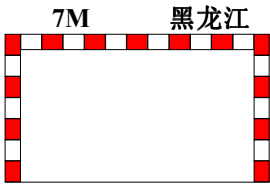
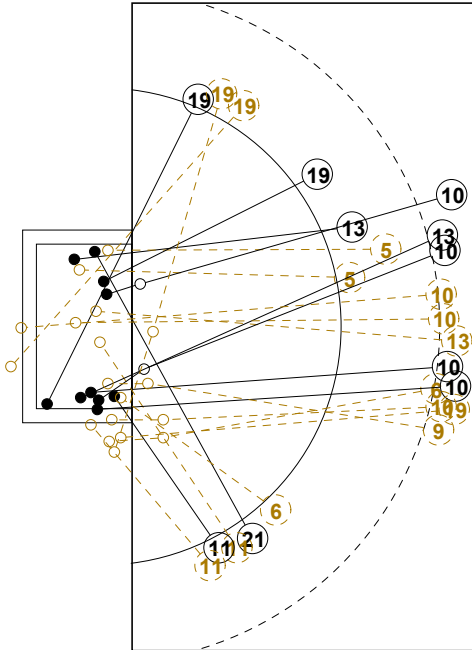

1st Half  
10 : 11

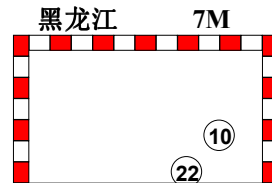
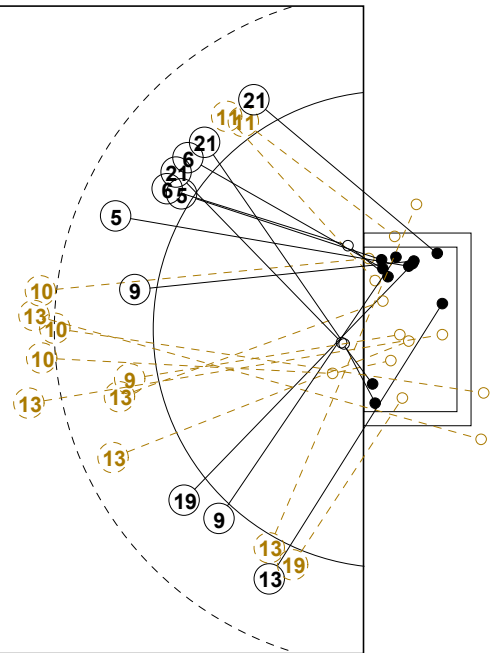
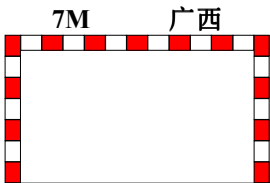
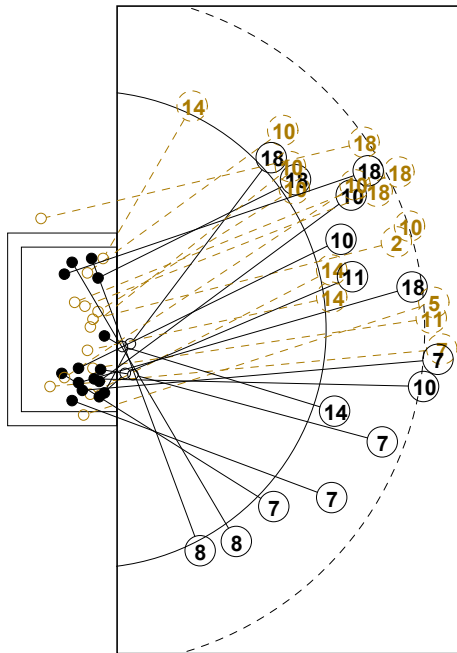

2nd Half  
26 : 23



## 2016年全国女子手球锦标赛

## 个人/全队技术统计表

正式表  
手球  
女子预赛  
轮次 3组别 A  
场次 13201605013-14-1/2  
滁州体育馆  
05/09/2016 14:30

号码	姓名	远射	近射	边射	快攻	突破	任意	7M	合计	%	助攻	失误	警告	2'	取消	时间
<b>黑龙江(黑龙江)</b>																
<i>(场上队员)</i>																
1	徐佳蓉									0.0%						00:06:53
3	刘诗彤									0.0%						00:10:23
5	周美微		2/4						2/4	50.0%		1	1	2		00:45:38
6	王梦艺	0/1	2/2	0/1					2/4	50.0%	1					00:55:26
9	郑宇	0/1	1/1	1/1	0/1				2/4	50.0%	1					00:23:16
10	刘雪露	4/10						1/1	5/11	45.5%		3				00:45:03
11	刘天茹			1/5					1/5	20.0%		1				00:29:04
12	肖宁桐									0.0%		1				00:53:07
13	吴佳	1/4	0/2	1/2	1/1				3/9	33.3%		2	1			00:51:09
14	黄荣									0.0%						00:00:00
16	杜宪									0.0%						00:00:00
19	梁文煜	0/1	1/1	1/4	1/1				3/7	42.9%	1	2	1	1		00:57:43
21	王戈			2/2	1/1	1/1			4/4	100%		1				00:30:51
22	马琳							1/1	1/1	100%						00:10:48
23	张政									0.0%	1	1				00:05:24
<b>合计</b>		5/17	6/10	6/15	3/4	1/1		2/2	23/49	46.9%	4	12	3	3		
<i>(守门员)</i>																
1	徐佳蓉	0/1	2/3		1/2				3/6	50.0%						00:06:53
12	肖宁桐	11/20	2/6	3/9	0/1	1/4			17/40	42.5%		1				00:53:07
<b>合计</b>		11/21	4/9	3/9	1/3	1/4			20/46	43.5%		1				

场上队员: 得分/射门

守门员: 救球/射门

全队合计	得分	被救	射失	击柱	封球	合计	%
远射	5	6	4	2		17	29.4%
近射	6	4				10	60.0%
边射	6	4	3	2		15	40.0%
快攻	3	1				4	75.0%
突破	1					1	100.0%
任意							0.0%
7M	2					2	100.0%





## 2016年全国女子手球锦标赛

## 个人/全队技术统计表

正式表  
手球  
女子预赛  
轮次 3组别 A  
场次 13201605013-14-2/2  
滁州体育馆  
05/09/2016 14:30

号码	姓名	远射	近射	边射	快攻	突破	任意	7M	合计	%	助攻	失误	警告	2'	取消	时间
<b>广西(广西)</b>																
<i>(上场队员)</i>																
1	胡霜梅									0.0%						00:04:19
2	陆雪云	3/8							3/8	37.5%		4				01:07:27
5	黄海玉	0/1							0/1	0.0%						00:24:50
6	韦惠文									0.0%						00:00:00
7	廖露	3/8	2/2	2/2					7/12	58.3%	1	4				00:42:19
8	韦如芳	0/1		4/6		1/1			5/8	62.5%		2	1			00:57:25
9	蓝雪梅									0.0%						00:00:00
10	周琴	2/4	0/3		1/1	1/2			4/10	40.0%		2	1			00:49:49
11	曾蓝花	0/3	0/1	0/1		1/1			1/6	16.7%		2				00:45:19
12	江燕红									0.0%						00:13:17
14	黄艳芳		1/2	0/1	1/2				2/5	40.0%						01:00:00
15	陈依依									0.0%						00:00:00
16	商志运									0.0%		1				00:46:43
17	杨杨									0.0%						00:00:00
18	庞娇	2/5	2/2						4/7	57.1%		1		1		00:26:08
<b>合计</b>		10/30	5/10	6/10	2/3	3/4			26/57	45.6%	1	16	2	1		
<i>(守门员)</i>																
12	江燕红	2/3	0/1		1/3	0/1		0/1	3/9	33.3%						00:13:17
16	商志运	4/8	4/9	4/10	0/1			0/1	12/29	41.4%		1				00:46:43
<b>合计</b>		6/11	4/10	4/10	1/4	0/1		0/2	15/38	39.5%		1				

场上队员：得分/射门

守门员：救球/射门

全队合计	得分	被救	射失	击柱	封球	合计	%
远射	10	11	4	3	2	30	33.3%
近射	5	4		1		10	50.0%
边射	6	3		1		10	60.0%
快攻	2	1				3	66.7%
突破	3	1				4	75.0%
任意							0.0%
7M							0.0%





### 2016年全国女子手球锦标赛

#### 图式射门区域统计

轮次 3 场次 13

201605013-41-1/1

## 黑龙江

1 徐佳蓉	3 刘诗彤	5 周美微	6 王梦艺	9 郑宇	10 刘雪露	11 刘天茹	12 肖宁桐																																																																								
<table border="1"><tr><td></td><td></td><td></td></tr><tr><td></td><td></td><td></td></tr><tr><td></td><td></td><td></td></tr></table>										<table border="1"><tr><td></td><td></td><td></td></tr><tr><td></td><td></td><td></td></tr><tr><td></td><td></td><td></td></tr></table>										<table border="1"><tr><td></td><td></td><td></td></tr><tr><td>1</td><td></td><td></td></tr><tr><td>1</td><td></td><td></td></tr></table>				1			1			<table border="1"><tr><td></td><td></td><td></td></tr><tr><td></td><td></td><td></td></tr><tr><td>2</td><td></td><td></td></tr></table>							2			<table border="1"><tr><td></td><td></td><td></td></tr><tr><td>2</td><td></td><td></td></tr><tr><td></td><td></td><td></td></tr></table>				2						<table border="1"><tr><td></td><td></td><td></td></tr><tr><td>3</td><td></td><td>1</td></tr><tr><td></td><td></td><td>1</td></tr></table>				3		1			1	<table border="1"><tr><td></td><td></td><td></td></tr><tr><td></td><td></td><td></td></tr><tr><td>1</td><td></td><td></td></tr></table>							1			<table border="1"><tr><td></td><td></td><td></td></tr><tr><td></td><td></td><td></td></tr><tr><td></td><td></td><td></td></tr></table>									
1																																																																															
1																																																																															
2																																																																															
2																																																																															
3		1																																																																													
		1																																																																													
1																																																																															
Post - 0 Miss - 0 Block - 0	Post - 0 Miss - 0 Block - 0	Post - 0 Miss - 0 Block - 0	Post - 0 Miss - 1 Block - 0	Post - 0 Miss - 0 Block - 0	Post - 2 Miss - 1 Block - 0	Post - 2 Miss - 0 Block - 0	Post - 0 Miss - 0 Block - 0																																																																								
13 吴佳	14 黄荣	16 杜宪	19 梁文煜	21 王戈	22 马琳	23 张政																																																																									
<table border="1"><tr><td></td><td>1</td><td></td></tr><tr><td>1</td><td></td><td>1</td></tr><tr><td></td><td></td><td></td></tr></table>		1		1		1				<table border="1"><tr><td></td><td></td><td></td></tr><tr><td></td><td></td><td></td></tr><tr><td></td><td></td><td></td></tr></table>										<table border="1"><tr><td></td><td></td><td></td></tr><tr><td></td><td></td><td></td></tr><tr><td></td><td></td><td></td></tr></table>										<table border="1"><tr><td></td><td></td><td></td></tr><tr><td>1</td><td></td><td></td></tr><tr><td>1</td><td></td><td></td></tr></table>				1			1			<table border="1"><tr><td></td><td></td><td></td></tr><tr><td>1</td><td></td><td></td></tr><tr><td></td><td></td><td>1</td></tr></table>				1					1	<table border="1"><tr><td></td><td></td><td></td></tr><tr><td></td><td></td><td></td></tr><tr><td></td><td></td><td></td></tr></table>										<table border="1"><tr><td></td><td></td><td></td></tr><tr><td></td><td></td><td></td></tr><tr><td></td><td></td><td></td></tr></table>										<table border="1"><tr><td></td><td></td><td></td></tr><tr><td></td><td></td><td></td></tr><tr><td></td><td></td><td></td></tr></table>									
	1																																																																														
1		1																																																																													
1																																																																															
1																																																																															
1																																																																															
		1																																																																													
Post - 0 Miss - 2 Block - 0	Post - 0 Miss - 0 Block - 0	Post - 0 Miss - 0 Block - 0	Post - 0 Miss - 3 Block - 0	Post - 0 Miss - 0 Block - 0	Post - 0 Miss - 0 Block - 0	Post - 0 Miss - 0 Block - 0																																																																									

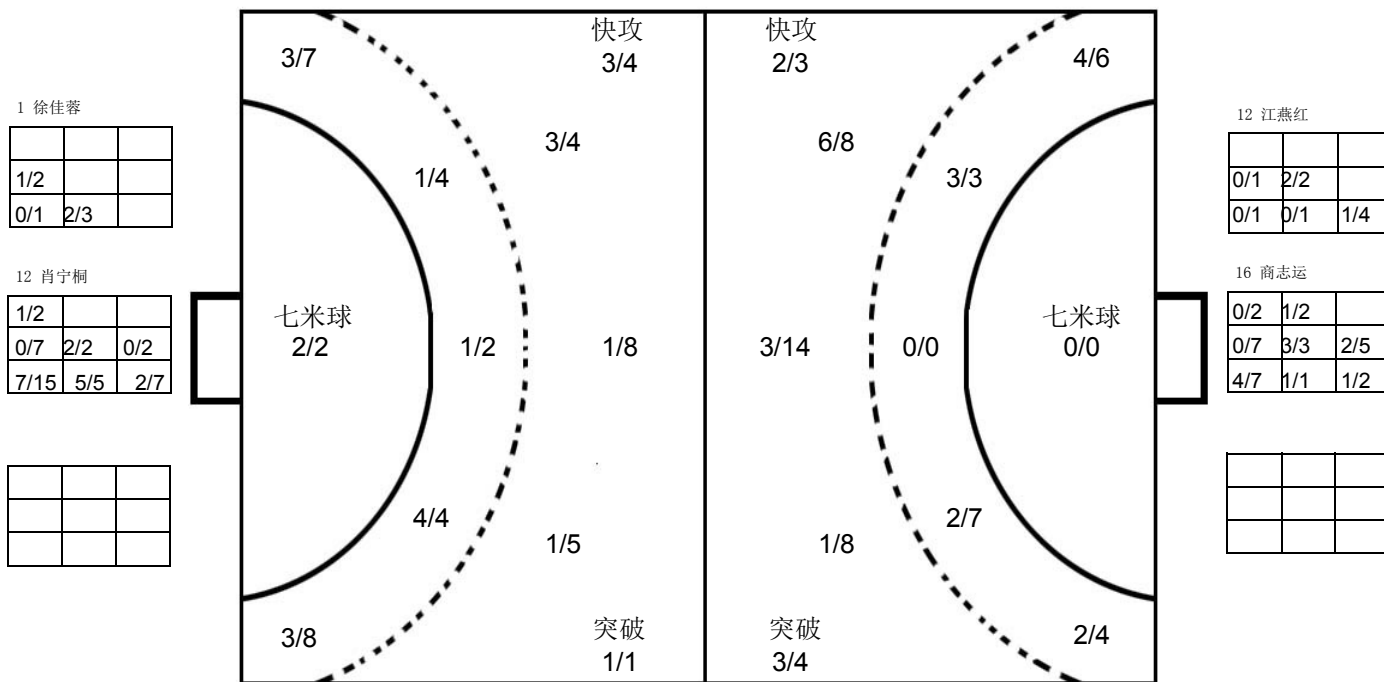

## 广西

1 胡霜梅	2 陆雪云	5 黄海玉	6 韦惠文	7 廖露	8 韦如芳	9 蓝雪梅	10 周琴																																																																								
<table border="1"><tr><td></td><td></td><td></td></tr><tr><td></td><td></td><td></td></tr><tr><td></td><td></td><td></td></tr></table>										<table border="1"><tr><td></td><td>1</td><td></td></tr><tr><td></td><td>1</td><td></td></tr><tr><td></td><td>1</td><td></td></tr></table>		1			1			1		<table border="1"><tr><td></td><td></td><td></td></tr><tr><td></td><td></td><td></td></tr><tr><td></td><td></td><td></td></tr></table>										<table border="1"><tr><td></td><td></td><td></td></tr><tr><td></td><td></td><td></td></tr><tr><td></td><td></td><td></td></tr></table>										<table border="1"><tr><td></td><td></td><td></td></tr><tr><td>3</td><td></td><td></td></tr><tr><td>2</td><td></td><td>2</td></tr></table>				3			2		2	<table border="1"><tr><td></td><td></td><td></td></tr><tr><td>2</td><td></td><td>1</td></tr><tr><td></td><td></td><td>2</td></tr></table>				2		1			2	<table border="1"><tr><td></td><td></td><td></td></tr><tr><td></td><td></td><td></td></tr><tr><td></td><td></td><td></td></tr></table>										<table border="1"><tr><td></td><td></td><td></td></tr><tr><td></td><td></td><td></td></tr><tr><td>1</td><td></td><td></td></tr></table>							1		
	1																																																																														
	1																																																																														
	1																																																																														
3																																																																															
2		2																																																																													
2		1																																																																													
		2																																																																													
1																																																																															
Post - 0 Miss - 0 Block - 0	Post - 2 Miss - 1 Block - 0	Post - 1 Miss - 0 Block - 0	Post - 0 Miss - 0 Block - 0	Post - 0 Miss - 1 Block - 1	Post - 1 Miss - 0 Block - 0	Post - 0 Miss - 0 Block - 0	Post - 0 Miss - 0 Block - 1																																																																								
11 曾蓝花	12 江燕红	14 黄艳芳	15 陈依依	16 商志运	17 杨杨	18 庞娇																																																																									
<table border="1"><tr><td></td><td></td><td></td></tr><tr><td>1</td><td></td><td></td></tr><tr><td></td><td></td><td></td></tr></table>				1						<table border="1"><tr><td></td><td></td><td></td></tr><tr><td></td><td></td><td></td></tr><tr><td></td><td></td><td></td></tr></table>										<table border="1"><tr><td></td><td></td><td></td></tr><tr><td>1</td><td>1</td><td></td></tr><tr><td></td><td></td><td></td></tr></table>				1	1					<table border="1"><tr><td></td><td></td><td></td></tr><tr><td></td><td></td><td></td></tr><tr><td></td><td></td><td></td></tr></table>										<table border="1"><tr><td></td><td></td><td></td></tr><tr><td></td><td></td><td></td></tr><tr><td></td><td></td><td></td></tr></table>										<table border="1"><tr><td></td><td></td><td></td></tr><tr><td></td><td></td><td></td></tr><tr><td></td><td></td><td></td></tr></table>										<table border="1"><tr><td></td><td></td><td></td></tr><tr><td>1</td><td></td><td>1</td></tr><tr><td>1</td><td></td><td>1</td></tr></table>				1		1	1		1	<table border="1"><tr><td></td><td></td><td></td></tr><tr><td></td><td></td><td></td></tr><tr><td></td><td></td><td></td></tr></table>									
1																																																																															
1	1																																																																														
1		1																																																																													
1		1																																																																													
Post - 1 Miss - 1 Block - 0	Post - 0 Miss - 0 Block - 0	Post - 0 Miss - 0 Block - 0	Post - 0 Miss - 0 Block - 0	Post - 0 Miss - 0 Block - 0	Post - 0 Miss - 0 Block - 0	Post - 0 Miss - 1 Block - 0																																																																									

注释: Post=击柱 Miss=射失 Block=被封





预赛 Group A

女子 全国比赛

2016年全国女子手球锦标赛

Team A A 安徽				Team B B 广东				Match Number <b>14</b>													
played in China		in the hall 滁州体育馆		on 05/09/2016		at 16:00 hours		Spectators													
Half-time (30')	A 19	B 12	End of playing time	A 36	B 21	1st extra time	A	B	2nd extra time	A	B	After penalty throws	A	B							
Number of 7 m	A 2/3	Team time-out 1 2 3			Full name of players and officials				Team time-out 1 2 3			B 4/5	Number of 7 m								
No.	Team A					G	W	2'	D	DR	No.	Team B					G	W	2'	D	DR
1	司艳										3	安妮					1				
3	李兵					1					5	李纯									
5	班晨晨					1	1				7	刘彤					4	1			
6	沈萍					6					8	李诗棋					1				
7	赵江川										9	韦宝桂					3	1			
8	徐仕媛										11	魏梦庭					3				
10	孙来苗					1					15	杨慧									
14	刘晓妹					8	1	1			16	李娟									
16	朱莉珍										18	李玉玲					1				
17	周婷					5					19	邝雪花					1				
18	郑冬冬										20	李军政					1	1			
20	周雪婷										22	刘晓玉									
21	李瑶					8					23	王如					2				
23	张天洁					1		1			26	马晓卉									
41	杜机娟					5	1				28	刘金兰					2				
46	陶传红										31	史小军					2				
A	吴立军					1					A	李细利									
E	张舜										B	郭艳辉 (主教练)									
											D	祝捷									
											E	赵善良									
A	Signature of Responsible Official of the Teams (Off. A)										B										
TP	Remarks of Referee / CHA Official										TP										

Signatures

Referees	张栋 (CHN)	倪震 (CHN)		
Techn. Delegates	高斌 (CHN)			
CHA Official	于中迅 (CHN)			

Note: Number of 7m Throws Awarded to Team A and B, Goals (G), Warnings (W), Suspensions (2'), Direct Disqualification (D), Disqualification with Report (DR) and Team Penalty (TP).

Table Officials: 佟金政 贾俊秋 Statisticians: 黄岩 刘永欢

Printed by PHMS Copyright: IHF/CHA 05/09/2016 12:47:02

Longman Sportsoft handball@126.com





### 2016年全国女子手球锦标赛 竞赛技术统计(媒体表)

<b>预赛</b>	组别	<b>A</b>	轮次	<b>3</b>	场次	<b>14</b>
滁州体育馆		05/09/2016			201605014-51-1/1	
安徽	<b>安徽</b>	<b>36</b>	vs	<b>21</b>	广东	广东
<b>19 : 12</b>						

裁判员		张栋 (CHN)											/	倪震 (CHN)																	
<b>安徽</b>		远射	近射	边射	快攻	突破	任意球	7m球	合计	%	助攻	失误	警告	2'	D & DR	<b>安徽</b>		比赛进程												<b>广东</b>	
主教练：孙来苗																		1st Half													
1	司艳									1						6	沈萍	0	00:37	1	20	李军政									
3	李兵		1/1					1/1	100		1					21	李瑶	2	01:52	1											
5	班晨晨				1/1			1/1	100		1	1				14	刘晓妹	2	02:38	2	31	史小军									
6	沈萍	5/7	0/1		0/1	1/1		0/1	6/11	54.5	2	1				14	刘晓妹	3	03:04	2											
7	赵江川															14	刘晓妹	3	04:41	3	9	韦宝桂									
8	徐仕媛															21	李瑶	4	05:04	3											
10	孙来苗			1/1				1/1	100			1				21	李瑶	5	05:32	3											
14	刘晓妹	5/6	1/1			1/2	1/1	8/10	80.0			3	1	1		5	班晨晨	6	07:20	3											
16	朱莉珍										1					21	李瑶	7	07:59	3											
17	周婷	0/1	1/1	1/1	1/2	2/3		5/8	62.5	1	2				17	周婷	8	09:30	3												
18	郑冬冬															6	沈萍	9	10:56	3											
20	周雪婷															41	杜机娟	10	11:46	3											
21	李瑶	0/3	1/2	1/2	4/4	2/2		8/13	61.5	1	2					10	13:57	4	18	李玉玲											
23	张天洁				1/1			1/1	100					1		10	14:50	5	31	史小军											
41	杜机娟			1/1	2/2			2/2	5/5	100			1			10	16:30	6	3	安妮											
46	陶传红															14	刘晓妹	11	18:10	6											
<b>运动员 合计</b>		10/17	4/6	4/5	9/11	6/8	1/1	2/3	36/51	70.6	6	11	3	2		14	刘晓妹	12	18:21	7	7	刘彤									
1	司艳	4/6	1/4	3/7	0/1			8/18	44.4	1					3	李兵	13	18:51	7												
16	朱莉珍	5/7	1/3	3/4	1/2	0/1		0/4	10/21	47.6	1				21	李瑶	13	19:09	8	11	魏梦庭										
<b>守门员 合计</b>		9/13	2/7	6/11	1/2	0/2	0/4	18/39	46.2	2					14	刘晓妹	14	19:35	8												
<b>广东</b>		远射	近射	边射	快攻	突破	任意球	7m球	合计	%	助攻	失误	警告	2'	D & DR	14	刘晓妹	15	20:13	8											
教练：郭艳辉																6	沈萍	15	20:57	9	7	刘彤									
3	安妮	1/1			0/1			1/2	50.0			4				14	刘晓妹	16	22:20	9											
5	李纯															23	张天洁	16	23:22	10	28	刘金兰									
7	刘彤	0/1		3/7	1/2			4/10	40.0			1	1		17	周婷	17	24:40	10												
8	李诗棋			1/1				1/1	100							17	周婷	18	25:16	11	11	魏梦庭									
9	韦宝桂	1/5						2/2	3/7	42.9			1	1		14	刘晓妹	19	26:22	12	7	刘彤									
11	魏梦庭	2/11				1/1		3/12	25.0	1	1				41	杜机娟	18	27:00	12												
15	杨慧															41	杜机娟	19	29:49	12											
16	李娟															17	周婷	20	00:23	12											
18	李玉玲	0/3						1/1	1/4	25.0		3				21	李瑶	20	00:51	13	9	韦宝桂									
19	卞雪花	0/1	0/1	0/1		1/1		1/4	25.0			2				17	周婷	21	01:16	13											
20	李军政		1/1	0/2				1/3	33.3							17	周婷	22	03:48	14	9	韦宝桂									
22	刘晓玉															14	刘晓妹	22	04:26	15	23	王如									
23	王如		2/2					2/2	100							21	李瑶	23	04:45	15											
26	马晓卉															6	沈萍	24	05:22	15											
28	刘金兰		0/1	1/2				1/2	2/5	40.0		2				17	周婷	24	08:41	16	23	王如									
31	史小军	0/1	2/2					2/3	66.7							17	周婷	25	09:06	16											
<b>运动员 合计</b>		4/23	5/7	5/13	1/3	2/2	4/5	21/53	39.6	1	15	3				17	周婷	26	09:40	16											
16	李娟	2/5	1/1	0/1	1/3	2/3	0/2	6/15	40.0							17	周婷	26	10:11	17	11	魏梦庭									
26	马晓卉	3/10	1/5	0/3	1/8	0/5	0/1	6/33	18.2							41	杜机娟	27	11:10	17											
<b>守门员 合计</b>		5/15	2/6	0/4	2/11	2/8	0/1	1/3	12/48	25.0						41	杜机娟	28	12:53	17											

场上队员：得分 / 射门

守门员：救球 / 射门

快攻	Fast Break	突破	Breakthrough	任意球	Free Throw	7M球	7M Throw	助攻	Assist
警告	Warning	失误	Error	2'	Suspension	D	取消资格	DR	取消资格+报告





### 2016年全国女子手球锦标赛 图式比赛技术统计表

轮次 3

场次 14

201605014-21-1/1

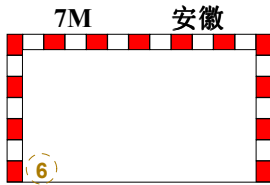
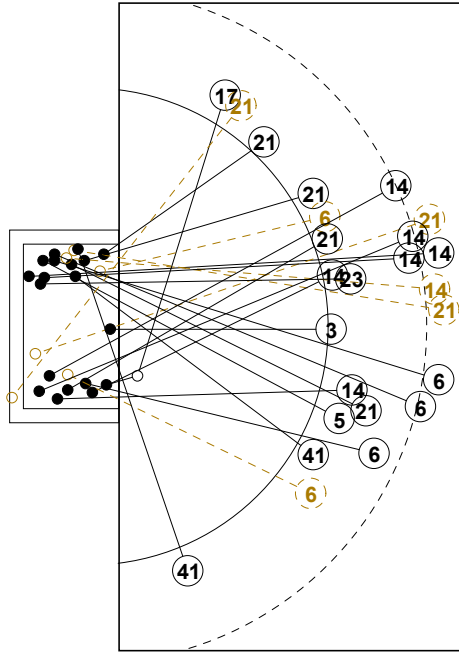

1st Half  
19 : 12

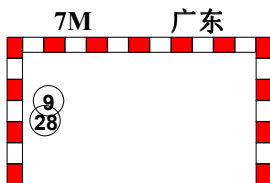
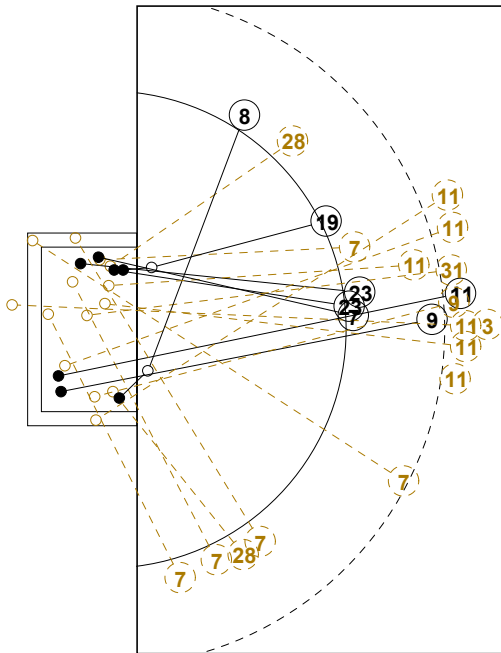
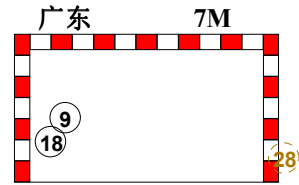
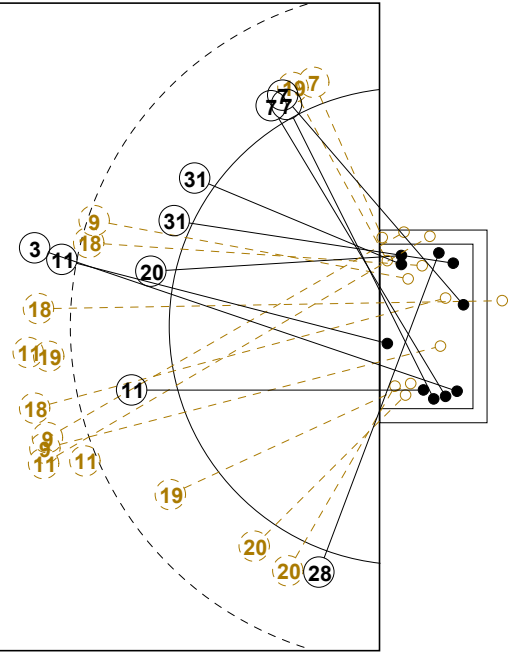

2nd Half  
21 : 36

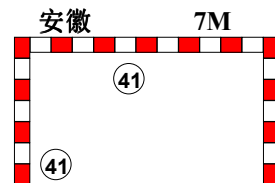
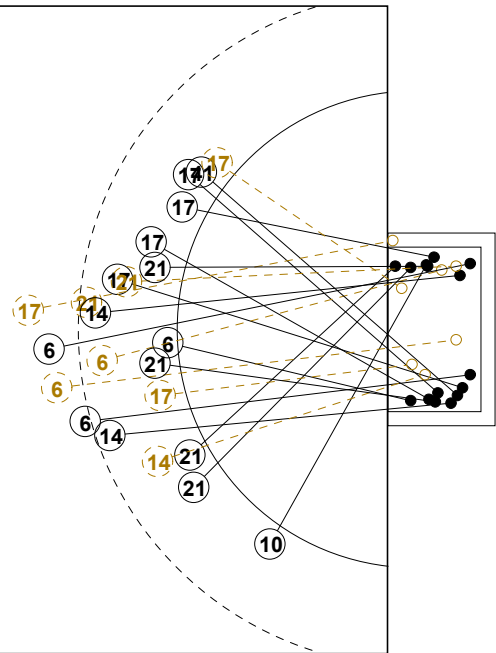



## 2016年全国女子手球锦标赛

## 个人/全队技术统计表

正式表  
手球  
女子预赛  
轮次 3组别 A  
场次 14201605014-14-1/2  
滁州体育馆  
05/09/2016 16:00

号码	姓名	远射	近射	边射	快攻	突破	任意	7M	合计	%	助攻	失误	警告	2'	取消	时间
<b>安徽(安徽)</b>																
<i>(场上队员)</i>																
1	司艳									0.0%	1					00:25:43
3	李兵		1/1						1/1	100%		1				00:21:43
5	班晨晨				1/1				1/1	100%		1	1			00:43:23
6	沈萍	5/7	0/1		0/1	1/1		0/1	6/11	54.5%	2	1				00:44:08
7	赵江川									0.0%						00:00:00
8	徐仕媛									0.0%						00:00:00
10	孙来苗			1/1					1/1	100%		1				00:25:08
14	刘晓妹	5/6	1/1			1/2	1/1		8/10	80.0%		3	1	1		00:51:50
16	朱莉珍									0.0%	1					00:32:01
17	周婷	0/1	1/1	1/1	1/2	2/3			5/8	62.5%	1	2				00:45:29
18	郑冬冬									0.0%						00:00:00
20	周雪婷									0.0%						00:00:00
21	李瑶	0/3	1/2	1/2	4/4	2/2			8/13	61.5%	1	2				00:43:09
23	张天洁				1/1				1/1	100%				1		00:13:11
41	杜机娟			1/1	2/2			2/2	5/5	100%			1			00:57:44
46	陶传红									0.0%						00:00:00
<b>合计</b>		10/17	4/6	4/5	9/11	6/8	1/1	2/3	36/51	70.6%	6	11	3	2		
<i>(守门员)</i>																
1	司艳	4/6	1/4	3/7		0/1			8/18	44.4%	1					00:25:43
16	朱莉珍	5/7	1/3	3/4	1/2	0/1		0/4	10/21	47.6%	1					00:32:01
<b>合计</b>		9/13	2/7	6/11	1/2	0/2		0/4	18/39	46.2%	2					

场上队员：得分/射门

守门员：救球/射门

全队合计	得分	被救	射失	击柱	封球	合计	%
远射	10	5		1	1	17	58.8%
近射	4	2				6	66.7%
边射	4			1		5	80.0%
快攻	9	2				11	81.8%
突破	6	2				8	75.0%
任意	1					1	100.0%
7M	2	1				3	66.7%







## 2016年全国女子手球锦标赛

## 个人/全队技术统计表

正式表  
手球  
女子预赛  
轮次 3组别 A  
场次 14201605014-14-2/2  
滁州体育馆  
05/09/2016 16:00

号码	姓名	远射	近射	边射	快攻	突破	任意	7M	合计	%	助攻	失误	警告	2'	取消	时间
<b>广东(广东)</b>																
<i>(上场队员)</i>																
3	安妮	1/1				0/1			1/2	50.0%		4				00:35:22
5	李纯									0.0%						00:00:00
7	刘彤	0/1		3/7	1/2				4/10	40.0%		1	1			00:48:12
8	李诗棋			1/1					1/1	100%		1				00:23:13
9	韦宝桂	1/5						2/2	3/7	42.9%		1	1			00:22:17
11	魏梦庭	2/11					1/1		3/12	25.0%	1	1				00:43:47
15	杨慧									0.0%						00:00:00
16	李娟									0.0%						00:16:14
18	李玉玲	0/3						1/1	1/4	25.0%		3				00:15:29
19	邝雪花	0/1	0/1	0/1		1/1			1/4	25.0%		2				00:41:17
20	李军政		1/1	0/2					1/3	33.3%			1			00:21:59
22	刘晓玉									0.0%						00:00:00
23	王如		2/2						2/2	100%						00:39:13
26	马晓卉									0.0%						00:41:30
28	刘金兰		0/1	1/2				1/2	2/5	40.0%		2				00:24:05
31	史小军	0/1	2/2						2/3	66.7%						00:30:46
<b>合计</b>		4/23	5/7	5/13	1/3	2/2		4/5	21/53	39.6%	1	15	3			
<i>(守门员)</i>																
16	李娟	2/5	1/1	0/1	1/3	2/3		0/2	6/15	40.0%						00:16:14
26	马晓卉	3/10	1/5	0/3	1/8	0/5	0/1	1/1	6/33	18.2%						00:41:30
<b>合计</b>		5/15	2/6	0/4	2/11	2/8	0/1	1/3	12/48	25.0%						

场上队员：得分/射门

守门员：救球/射门

全队合计	得分	被救	射失	击柱	封球	合计	%
远射	4	9	2	4	4	23	17.4%
近射	5	2				7	71.4%
边射	5	6		2		13	38.5%
快攻	1	1			1	3	33.3%
突破	2					2	100.0%
任意							0.0%
7M	4			1		5	80.0%





2016年全国女子手球锦标赛

图式射门区域统计

轮次 3 场次 14

201605014-41-1/1

安徽

1 司艳	3 李兵	5 班晨晨	6 沈萍	7 赵江川	8 徐仕媛	10 孙来苗	14 刘晓妹																																																																								
<table border="1"><tr><td></td><td></td><td></td></tr><tr><td></td><td></td><td></td></tr><tr><td></td><td></td><td></td></tr></table>										<table border="1"><tr><td></td><td></td><td></td></tr><tr><td></td><td></td><td></td></tr><tr><td></td><td>1</td><td></td></tr></table>								1		<table border="1"><tr><td></td><td></td><td>1</td></tr><tr><td></td><td></td><td></td></tr><tr><td></td><td></td><td></td></tr></table>			1							<table border="1"><tr><td>1</td><td></td><td>3</td></tr><tr><td>1</td><td></td><td></td></tr><tr><td></td><td></td><td>1</td></tr></table>	1		3	1					1	<table border="1"><tr><td></td><td></td><td></td></tr><tr><td></td><td></td><td></td></tr><tr><td></td><td></td><td></td></tr></table>										<table border="1"><tr><td></td><td></td><td></td></tr><tr><td></td><td></td><td></td></tr><tr><td></td><td></td><td></td></tr></table>										<table border="1"><tr><td></td><td></td><td></td></tr><tr><td>1</td><td></td><td></td></tr><tr><td></td><td></td><td></td></tr></table>				1						<table border="1"><tr><td>3</td><td></td><td>3</td></tr><tr><td>1</td><td></td><td></td></tr><tr><td>1</td><td></td><td></td></tr></table>	3		3	1			1		
	1																																																																														
		1																																																																													
1		3																																																																													
1																																																																															
		1																																																																													
1																																																																															
3		3																																																																													
1																																																																															
1																																																																															
Post - 0 Miss - 0 Block - 0	Post - 0 Miss - 0 Block - 0	Post - 0 Miss - 0 Block - 0	Post - 0 Miss - 0 Block - 0	Post - 0 Miss - 0 Block - 0	Post - 0 Miss - 0 Block - 0	Post - 0 Miss - 0 Block - 0	Post - 0 Miss - 0 Block - 0																																																																								
16 朱莉珍	17 周婷	18 郑冬冬	20 周雪婷	21 李瑶	23 张天洁	41 杜机娟	46 陶传红																																																																								
<table border="1"><tr><td></td><td></td><td></td></tr><tr><td></td><td></td><td></td></tr><tr><td></td><td></td><td></td></tr></table>										<table border="1"><tr><td></td><td></td><td>1</td></tr><tr><td>1</td><td></td><td>2</td></tr><tr><td>1</td><td></td><td></td></tr></table>			1	1		2	1			<table border="1"><tr><td></td><td></td><td></td></tr><tr><td></td><td></td><td></td></tr><tr><td></td><td></td><td></td></tr></table>										<table border="1"><tr><td></td><td></td><td></td></tr><tr><td></td><td></td><td></td></tr><tr><td></td><td></td><td></td></tr></table>										<table border="1"><tr><td></td><td></td><td></td></tr><tr><td>2</td><td></td><td>3</td></tr><tr><td>2</td><td></td><td>1</td></tr></table>				2		3	2		1	<table border="1"><tr><td></td><td></td><td></td></tr><tr><td></td><td></td><td>1</td></tr><tr><td></td><td></td><td></td></tr></table>						1				<table border="1"><tr><td></td><td>1</td><td>1</td></tr><tr><td></td><td></td><td>2</td></tr><tr><td>1</td><td></td><td></td></tr></table>		1	1			2	1			<table border="1"><tr><td></td><td></td><td></td></tr><tr><td></td><td></td><td></td></tr><tr><td></td><td></td><td></td></tr></table>									
		1																																																																													
1		2																																																																													
1																																																																															
2		3																																																																													
2		1																																																																													
		1																																																																													
	1	1																																																																													
		2																																																																													
1																																																																															
Post - 0 Miss - 0 Block - 0	Post - 1 Miss - 0 Block - 0	Post - 0 Miss - 0 Block - 0	Post - 0 Miss - 0 Block - 0	Post - 1 Miss - 0 Block - 1	Post - 0 Miss - 0 Block - 0	Post - 0 Miss - 0 Block - 0	Post - 0 Miss - 0 Block - 0																																																																								

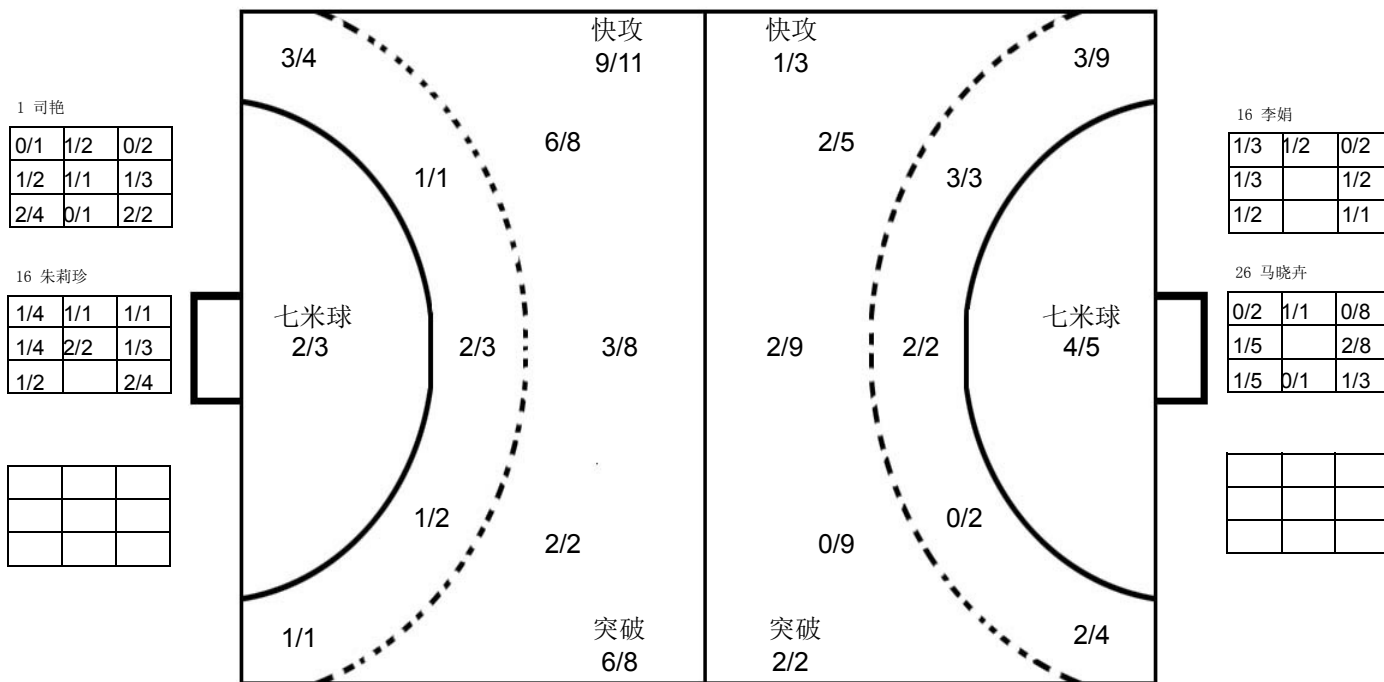

广东

3 安妮	5 李纯	7 刘彤	8 李诗棋	9 韦宝桂	11 魏梦庭	15 杨慧	16 李娟																																																																								
<table border="1"><tr><td></td><td></td><td>1</td></tr><tr><td></td><td></td><td></td></tr><tr><td></td><td></td><td></td></tr></table>			1							<table border="1"><tr><td></td><td></td><td></td></tr><tr><td></td><td></td><td></td></tr><tr><td></td><td></td><td></td></tr></table>										<table border="1"><tr><td></td><td>1</td><td>1</td></tr><tr><td></td><td></td><td>2</td></tr><tr><td></td><td></td><td></td></tr></table>		1	1			2				<table border="1"><tr><td></td><td></td><td></td></tr><tr><td></td><td></td><td></td></tr><tr><td></td><td></td><td></td></tr></table>										<table border="1"><tr><td>2</td><td></td><td></td></tr><tr><td>1</td><td></td><td></td></tr><tr><td></td><td></td><td></td></tr></table>	2			1						<table border="1"><tr><td>1</td><td></td><td></td></tr><tr><td></td><td></td><td>1</td></tr><tr><td></td><td>1</td><td></td></tr></table>	1					1		1		<table border="1"><tr><td></td><td></td><td></td></tr><tr><td></td><td></td><td></td></tr><tr><td></td><td></td><td></td></tr></table>										<table border="1"><tr><td></td><td></td><td></td></tr><tr><td></td><td></td><td></td></tr><tr><td></td><td></td><td></td></tr></table>									
		1																																																																													
	1	1																																																																													
		2																																																																													
2																																																																															
1																																																																															
1																																																																															
		1																																																																													
	1																																																																														
Post - 0 Miss - 0 Block - 1	Post - 0 Miss - 0 Block - 0	Post - 3 Miss - 0 Block - 0	Post - 0 Miss - 0 Block - 0	Post - 1 Miss - 0 Block - 0	Post - 2 Miss - 1 Block - 3	Post - 0 Miss - 0 Block - 0	Post - 0 Miss - 0 Block - 0																																																																								
18 李玉玲	19 邝雪花	20 李军政	22 刘晓玉	23 王如	26 马晓卉	28 刘金兰	31 史小军																																																																								
<table border="1"><tr><td>1</td><td></td><td></td></tr><tr><td></td><td></td><td></td></tr><tr><td></td><td></td><td></td></tr></table>	1									<table border="1"><tr><td></td><td></td><td></td></tr><tr><td></td><td></td><td></td></tr><tr><td></td><td></td><td>1</td></tr></table>									1	<table border="1"><tr><td></td><td></td><td></td></tr><tr><td></td><td></td><td></td></tr><tr><td>1</td><td></td><td></td></tr></table>							1			<table border="1"><tr><td></td><td></td><td></td></tr><tr><td></td><td></td><td></td></tr><tr><td></td><td></td><td></td></tr></table>										<table border="1"><tr><td></td><td></td><td></td></tr><tr><td></td><td></td><td>1</td></tr><tr><td></td><td></td><td>1</td></tr></table>						1			1	<table border="1"><tr><td></td><td></td><td></td></tr><tr><td></td><td></td><td></td></tr><tr><td></td><td></td><td></td></tr></table>										<table border="1"><tr><td></td><td></td><td></td></tr><tr><td>2</td><td></td><td></td></tr><tr><td></td><td></td><td></td></tr></table>				2						<table border="1"><tr><td></td><td></td><td></td></tr><tr><td></td><td></td><td></td></tr><tr><td></td><td></td><td></td></tr></table>									
1																																																																															
		1																																																																													
1																																																																															
		1																																																																													
		1																																																																													
2																																																																															
Post - 0 Miss - 1 Block - 0	Post - 0 Miss - 0 Block - 1	Post - 0 Miss - 0 Block - 0	Post - 0 Miss - 0 Block - 0	Post - 0 Miss - 0 Block - 0	Post - 0 Miss - 0 Block - 0	Post - 1 Miss - 0 Block - 0	Post - 0 Miss - 0 Block - 0																																																																								

注释: Post=击柱 Miss=射失 Block=被封





预赛 Group A

女子 全国比赛

2016年全国女子手球锦标赛

Team A <b>A 山东</b>				Team B <b>B 新疆</b>				Match Number <b>15</b>													
played in China		in the hall 滁州体育馆		on 05/09/2016		at 17:30 hours		Spectators													
Half-time (30')	<b>A</b> 17	<b>B</b> 11	End of playing time	<b>A</b> 29	<b>B</b> 24	1st extra time	<b>A</b>	<b>B</b>	2nd extra time	<b>A</b>	<b>B</b>	After penalty throws	<b>A</b>	<b>B</b>							
Number of 7 m	<b>A</b> 5 / 5	Team time-out 1 26:48 2 53:03 3			Full name of players and officials				Team time-out 1 05:44 2 12:50 3			<b>B</b> 3 / 6	Number of 7 m								
No.	Team <b>A</b>					G	W	2'	D	DR	No.	Team <b>B</b>					G	W	2'	D	DR
1	路畅										3	葛立双									
2	林燕群					4					6	阿孜古					6		2		
8	王彬					9					7	吴志娟					2				
9	周钰婷										10	李静									
10	田秀秀					6					11	陈培培									
11	吕青纹					1	1				12	艾敏加尔汉									
12	张苑琳										15	兰姝娇					2		1		
15	吴作扬					2	1				17	戴莹莹					1	1			
19	姜伟珊										18	崔娟					4	1			
20	张悦					2	1				21	锁珊珊									
22	朱赟										23	张艺璇									
23	徐悦							1			26	宋婷婷					4		1		
28	崔金娜					2					27	谢辰辰					1				
33	王彩琳					2		2			32	杨雨柔									
77	穆庆丛					1					93	张婷婷					4				
B	马海湧 (主教练)										A	邓雷									
C	徐强										B	于涛 (主教练)									
E	王日东										D	高璇									
<b>A</b>	Signature of Responsible Official of the Teams (Off. A)										<b>B</b>										
TP	Remarks of Referee / CHA Official										TP										

Signatures

Referees	陈晓波 (CHN)	马晓晔 (CHN)		
Techn. Delegates	刘书勇 (CHN)			
CHA Official	高斌 (CHN)			

Note: Number of 7m Throws Awarded to Team A and B, Goals (G), Warnings (W), Suspensions (2'), Direct Disqualification (D), Disqualification with Report (DR) and Team Penalty (TP).

Table Officials: 李诚 赵涵 Statisticians: 刘永欢 陈柱

Printed by PHMS Copyright: IHF / CHA 05/09/2016 13:54:01

Longman Sportsoft  handball@126.com



## 2016年全国女子手球锦标赛 竞赛技术统计(媒体表)

预赛	组别	A	轮次	3	场次	15
----	----	---	----	---	----	----

滁州体育馆		05/09/2016			201605015-51-1/1		
山东	山东	29	vs	24	新疆	新疆	
				17 : 11			

裁判员	陈晓波 (CHN)	/	马晓晔 (CHN)
-----	-----------	---	-----------

山东		远射	近射	边射	快攻	突破	任意球	7m球	合计	%	助攻	失误	警告	2'	D & DR	比赛进程			
主教练：马海湧																1st Half			
1	刘畅											1				2	林燕群 01:03 0		
2	林燕群	0/2	3/3	0/2				1/1	4/8	50.0		5				15	吴作扬 02:37 0		
8	王彬	1/2		2/3	2/2			4/4	9/11	81.8	1	5				28	崔金娜 03:56 0		
9	周钰婷															20	张悦 05:38 0		
10	田秀秀	1/3	2/3	1/1	1/1		1/1		6/9	66.7	1	3				10	田秀秀 06:25 0		
11	吕青纹			1/1				1/1		100		1	1			5	07:20 1 26 宋婷婷		
12	张苑琳															20	张悦 07:30 1		
15	吴作扬	1/1	1/1						2/2	100	2	3	1			6	08:19 2 6 阿孜古		
19	姜伟珊															6	09:01 3 6 阿孜古		
20	张悦		1/1		1/1				2/2	100			1			7	09:14 3		
22	朱赞															2	林燕群 10:49 3		
23	徐悦														1	10	田秀秀 12:24 3		
28	崔金娜		1/1			1/1		2/2	100	1						9	13:37 4 17 戴莹莹		
33	王彩琳	1/2	1/1					2/3	66.7			5		2		10	田秀秀 13:47 4		
77	穆庆丛		1/1					1/1	100							15	吴作扬 14:48 4		
<b>运动员 合计</b>		4/10	10/11	4/7	4/4	1/1	1/1	5/5	29/39	74.4	5	23	3	3			11	16:32 5 93 张婷婷	
1	刘畅	4/6	1/8	0/1	1/5			1/3	7/23	30.4		1					11	18:04 6 93 张婷婷	
12	张苑琳	0/3	0/2	1/3		1/1		1/1	3/10	30.0							11	18:30 7 93 张婷婷	
22	朱赞							1/2	1/2	50.0							2	林燕群 19:29 7	
<b>守门员 合计</b>		4/9	1/10	1/4	1/5	1/1		3/6	11/35	31.4		1					10	田秀秀 20:26 7	
<b>新疆</b>		远射	近射	边射	快攻	突破	任意球	7m球	合计	%	助攻	失误	警告	2'	D & DR	2nd Half			
教练：于涛																			
3	葛立双																17	00:37 12 18 崔娟	
6	阿孜古		3/5	1/1	2/2			6/8	75.0			1		2			17	01:22 13 26 宋婷婷	
7	吴志娟			1/2	1/1			2/3	66.7			2					17	03:26 14 15 兰姝娇	
10	李静																2	林燕群 04:07 14	
11	陈培培																11	吕青纹 05:57 14	
12	艾敏加尔汉																8	王彬 07:40 14	
15	兰姝娇		1/1					1/1	2/2	100		1		1			33	王彩琳 10:03 14	
17	戴莹莹		1/1	0/1				1/2	50.0				1				10	田秀秀 11:35 14	
18	崔娟	2/7	2/2					0/1	4/10	40.0	2	6	1				8	王彬 13:16 14	
21	锁珊珊	0/7			0/1			0/8	0.0			1					77	穆庆丛 14:01 15 26 宋婷婷	
23	张艺璇																24	19:00 15	
26	宋婷婷	1/3			1/1	0/1		2/3	4/8	50.0	6	2		1			24	19:34 16 93 张婷婷	
27	谢辰辰		1/1					1/1	100			1					33	王彩琳 20:00 16	
32	杨雨柔																	25	20:35 17 6 阿孜古
93	张婷婷	2/2	1/1	1/1	0/1	0/1		0/1	4/7	57.1	2	2					25	21:16 18 6 阿孜古	
<b>运动员 合计</b>		5/19	9/11	3/5	4/6	0/2		3/6	24/49	49.0	10	16	2	4			25	22:10 19 6 阿孜古	
10	李静							0/1	0/1	0.0							25	22:56 20 6 阿孜古	
32	杨雨柔	3/7	1/11	3/7	0/4	0/1	0/1	0/4	7/35	20.0							8	王彬 23:44 20	
<b>守门员 合计</b>		3/7	1/11	3/7	0/4	0/1	0/1	0/5	7/36	19.4								26	24:14 21 18 崔娟

场上队员：得分 / 射门

守门员：救球 / 射门

快攻	Fast Break	突破	Breakthrough	任意球	Free Throw	7M球	7M Throw	助攻	Assist
警告	Warning	失误	Error	2'	Suspension	D	取消资格	DR	取消资格+报告





## 2016年全国女子手球锦标赛 图式比赛技术统计表

轮次 3

场次 15

201605015-21-1/1

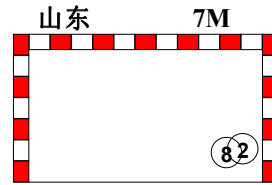
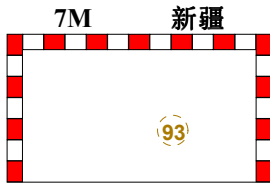
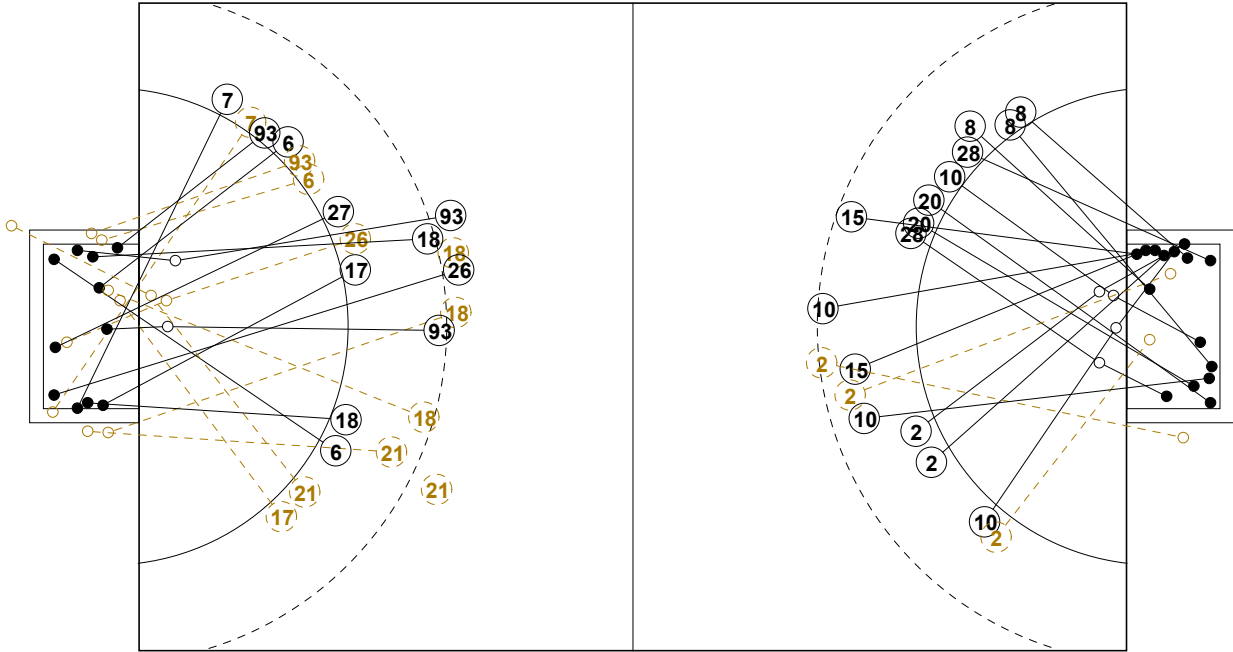

1st Half  
11 : 17

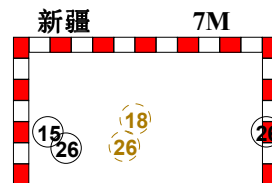
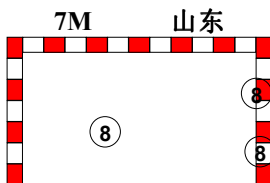
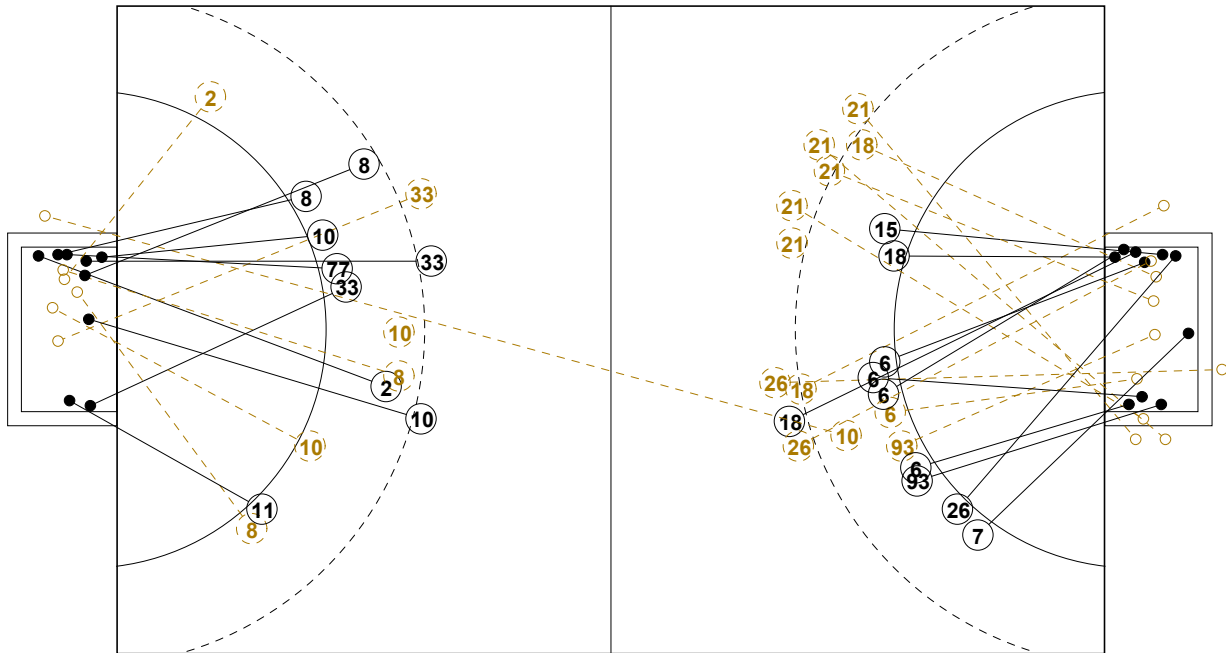

2nd Half  
29 : 24



## 2016年全国女子手球锦标赛

## 个人/全队技术统计表

正式表  
手球  
女子预赛  
轮次 3组别 A  
场次 15201605015-14-1/2  
滁州体育馆  
05/09/2016 17:30

号码	姓名	远射	近射	边射	快攻	突破	任意	7M	合计	%	助攻	失误	警告	2'	取消	时间
<b>山东(山东)</b>																
<i>(场上队员)</i>																
1	刘畅									0.0%		1				00:40:57
2	林燕群	0/2	3/3	0/2				1/1	4/8	50.0%		5				00:52:35
8	王彬	1/2		2/3	2/2			4/4	9/11	81.8%	1	5				00:45:41
9	周钰婷									0.0%						00:00:00
10	田秀秀	1/3	2/3	1/1	1/1		1/1		6/9	66.7%	1	3				00:40:30
11	吕青纹			1/1					1/1	100%		1	1			00:38:58
12	张苑琳									0.0%						00:18:48
15	吴作扬	1/1	1/1						2/2	100%	2	3	1			00:27:38
19	姜伟珊									0.0%						00:04:03
20	张悦		1/1		1/1				2/2	100%			1			00:51:35
22	朱贇									0.0%						00:00:15
23	徐悦									0.0%				1		00:32:01
28	崔金娜		1/1			1/1			2/2	100%	1					00:56:30
33	王彩琳	1/2	1/1						2/3	66.7%		5		2		00:24:49
77	穆庆丛		1/1						1/1	100%						00:02:21
<b>合计</b>		4/10	10/11	4/7	4/4	1/1	1/1	5/5	29/39	74.4%	5	23	3	3		
<i>(守门员)</i>																
1	刘畅	4/6	1/8	0/1	1/5			1/3	7/23	30.4%		1				00:40:57
12	张苑琳	0/3	0/2	1/3		1/1		1/1	3/10	30.0%						00:18:48
22	朱贇							1/2	1/2	50.0%						00:00:15
<b>合计</b>		4/9	1/10	1/4	1/5	1/1		3/6	11/35	31.4%		1				

场上队员：得分/射门

守门员：救球/射门

全队合计	得分	被救	射失	击柱	封球	合计	%
远射	4	3	2		1	10	40.0%
近射	10	1				11	90.9%
边射	4	3				7	57.1%
快攻	4					4	100.0%
突破	1					1	100.0%
任意	1					1	100.0%
7M	5					5	100.0%



## 2016年全国女子手球锦标赛

## 个人/全队技术统计表

正式表  
手球  
女子预赛  
轮次 3组别 A  
场次 15201605015-14-2/2  
滁州体育馆  
05/09/2016 17:30

号码	姓名	远射	近射	边射	快攻	突破	任意	7M	合计	%	助攻	失误	警告	2'	取消	时间
<b>新疆(新疆)</b>																
<i>(上场队员)</i>																
3	葛立双									0.0%						00:00:00
6	阿孜古		3/5	1/1	2/2				6/8	75.0%		1		2		00:49:02
7	吴志娟			1/2	1/1				2/3	66.7%		2				00:58:13
10	李静									0.0%						00:00:17
11	陈培培									0.0%						00:00:00
12	艾敏加尔汉									0.0%						00:00:00
15	兰姝娇		1/1					1/1	2/2	100%		1		1		00:20:27
17	戴莹莹		1/1	0/1					1/2	50.0%			1			00:20:10
18	崔娟	2/7	2/2					0/1	4/10	40.0%	2	6	1			00:52:02
21	锁珊珊	0/7			0/1				0/8	0.0%		1				00:50:19
23	张艺璇									0.0%						00:00:00
26	宋婷婷	1/3			1/1	0/1		2/3	4/8	50.0%	6	2		1		00:34:57
27	谢辰辰		1/1						1/1	100%		1				00:17:57
32	杨雨柔									0.0%						00:59:43
93	张婷婷	2/2	1/1	1/1	0/1	0/1		0/1	4/7	57.1%	2	2				00:55:03
<b>合计</b>		5/19	9/11	3/5	4/6	0/2		3/6	24/49	49.0%	10	16	2	4		
<i>(守门员)</i>																
10	李静							0/1	0/1	0.0%						00:00:17
32	杨雨柔	3/7	1/11	3/7	0/4	0/1	0/1	0/4	7/35	20.0%						00:59:43
<b>合计</b>		3/7	1/11	3/7	0/4	0/1	0/1	0/5	7/36	19.4%						

场上队员：得分/射门

守门员：救球/射门

全队合计	得分	被救	射失	击柱	封球	合计	%
远射	5	4	6	1	3	19	26.3%
近射	9	1		1		11	81.8%
边射	3	1		1		5	60.0%
快攻	4	1	1			6	66.7%
突破		1		1		2	0.0%
任意							0.0%
7M	3	3				6	50.0%





### 2016年全国女子手球锦标赛

#### 图式射门区域统计

轮次 3 场次 15

201605015-41-1/1

## 山东

1 路畅	2 林燕群	8 王彬	9 周钰婷	10 田秀秀	11 吕青纹	12 张苑琳	15 吴作扬																																																																								
<table border="1"><tr><td></td><td></td><td></td></tr><tr><td></td><td></td><td></td></tr><tr><td></td><td></td><td></td></tr></table>										<table border="1"><tr><td></td><td></td><td>1</td></tr><tr><td>2</td><td></td><td></td></tr><tr><td></td><td></td><td>1</td></tr></table>			1	2					1	<table border="1"><tr><td></td><td></td><td>2</td></tr><tr><td>2</td><td></td><td>2</td></tr><tr><td>1</td><td></td><td>2</td></tr></table>			2	2		2	1		2	<table border="1"><tr><td></td><td></td><td></td></tr><tr><td></td><td></td><td></td></tr><tr><td></td><td></td><td></td></tr></table>										<table border="1"><tr><td></td><td>1</td><td>1</td></tr><tr><td>1</td><td></td><td></td></tr><tr><td>1</td><td>1</td><td>1</td></tr></table>		1	1	1			1	1	1	<table border="1"><tr><td></td><td></td><td></td></tr><tr><td></td><td></td><td></td></tr><tr><td></td><td></td><td></td></tr></table>										<table border="1"><tr><td></td><td></td><td></td></tr><tr><td></td><td></td><td></td></tr><tr><td></td><td></td><td></td></tr></table>										<table border="1"><tr><td></td><td></td><td></td></tr><tr><td></td><td></td><td></td></tr><tr><td>2</td><td></td><td></td></tr></table>							2		
		1																																																																													
2																																																																															
		1																																																																													
		2																																																																													
2		2																																																																													
1		2																																																																													
	1	1																																																																													
1																																																																															
1	1	1																																																																													
2																																																																															
Post - 0 Miss - 0 Block - 0	Post - 0 Miss - 1 Block - 0	Post - 0 Miss - 0 Block - 0	Post - 0 Miss - 0 Block - 0	Post - 0 Miss - 1 Block - 1	Post - 0 Miss - 0 Block - 0	Post - 0 Miss - 0 Block - 0	Post - 0 Miss - 0 Block - 0																																																																								
19 姜伟珊	20 张悦	22 朱贇	23 徐悦	28 崔金娜	33 王彩琳	77 穆庆丛																																																																									
<table border="1"><tr><td></td><td></td><td></td></tr><tr><td></td><td></td><td></td></tr><tr><td></td><td></td><td></td></tr></table>										<table border="1"><tr><td></td><td></td><td>2</td></tr><tr><td></td><td></td><td></td></tr><tr><td></td><td></td><td></td></tr></table>			2							<table border="1"><tr><td></td><td></td><td></td></tr><tr><td></td><td></td><td></td></tr><tr><td></td><td></td><td></td></tr></table>										<table border="1"><tr><td></td><td></td><td></td></tr><tr><td></td><td></td><td></td></tr><tr><td></td><td></td><td></td></tr></table>										<table border="1"><tr><td></td><td></td><td>1</td></tr><tr><td></td><td></td><td></td></tr><tr><td></td><td></td><td></td></tr></table>			1							<table border="1"><tr><td></td><td></td><td></td></tr><tr><td></td><td></td><td></td></tr><tr><td>1</td><td></td><td>1</td></tr></table>							1		1	<table border="1"><tr><td></td><td></td><td></td></tr><tr><td></td><td></td><td></td></tr><tr><td></td><td></td><td>1</td></tr></table>									1	<table border="1"><tr><td></td><td></td><td></td></tr><tr><td></td><td></td><td></td></tr><tr><td></td><td></td><td></td></tr></table>									
		2																																																																													
		1																																																																													
1		1																																																																													
		1																																																																													
Post - 0 Miss - 0 Block - 0	Post - 0 Miss - 0 Block - 0	Post - 0 Miss - 0 Block - 0	Post - 0 Miss - 0 Block - 0	Post - 0 Miss - 0 Block - 0	Post - 0 Miss - 0 Block - 0	Post - 0 Miss - 0 Block - 0																																																																									

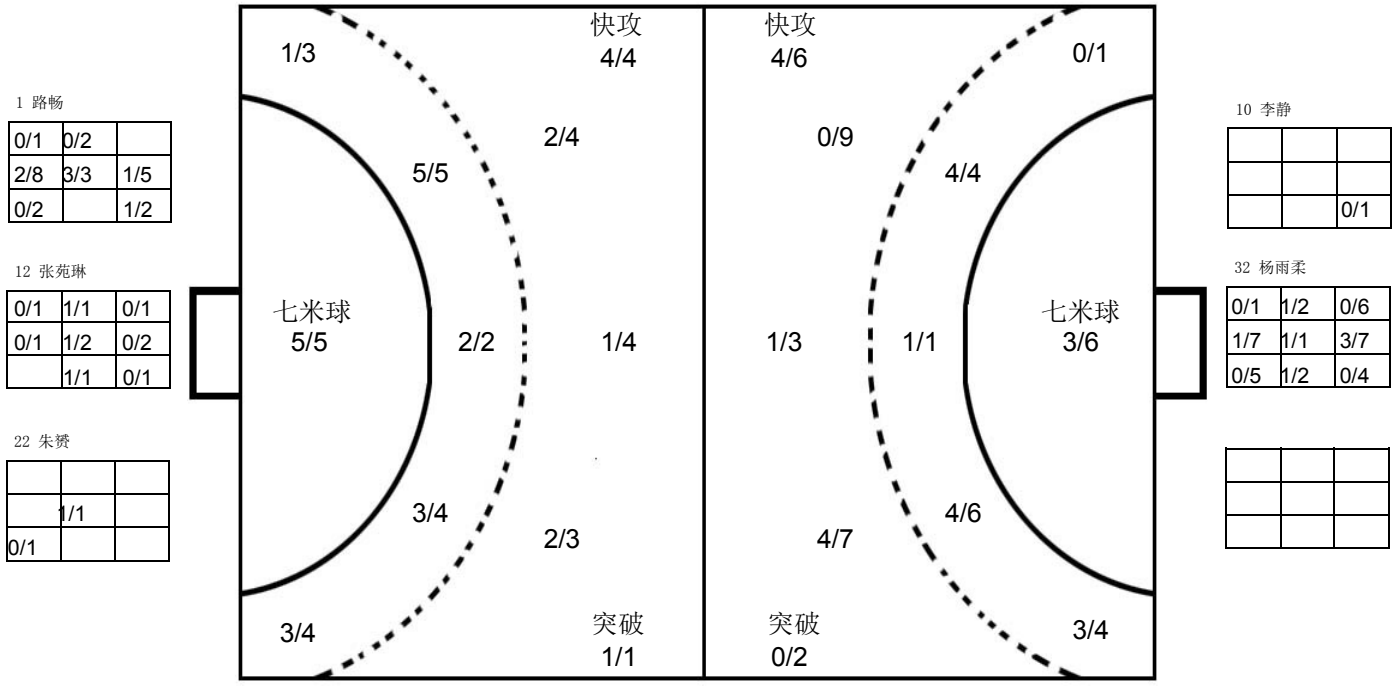

## 新疆

3 葛立双	6 阿孜古	7 吴志娟	10 李静	11 陈培培	12 艾敏加尔汉	15 兰姝娇	17 戴莹莹																																																																								
<table border="1"><tr><td></td><td></td><td></td></tr><tr><td></td><td></td><td></td></tr><tr><td></td><td></td><td></td></tr></table>										<table border="1"><tr><td></td><td></td><td>1</td></tr><tr><td>1</td><td></td><td>2</td></tr><tr><td>1</td><td></td><td>1</td></tr></table>			1	1		2	1		1	<table border="1"><tr><td></td><td>1</td><td></td></tr><tr><td>1</td><td></td><td></td></tr><tr><td></td><td></td><td></td></tr></table>		1		1						<table border="1"><tr><td></td><td></td><td></td></tr><tr><td></td><td></td><td></td></tr><tr><td></td><td></td><td></td></tr></table>										<table border="1"><tr><td></td><td></td><td></td></tr><tr><td></td><td></td><td></td></tr><tr><td></td><td></td><td></td></tr></table>										<table border="1"><tr><td></td><td></td><td></td></tr><tr><td></td><td></td><td></td></tr><tr><td></td><td></td><td></td></tr></table>										<table border="1"><tr><td></td><td></td><td></td></tr><tr><td>2</td><td></td><td></td></tr><tr><td></td><td></td><td></td></tr></table>				2						<table border="1"><tr><td></td><td></td><td></td></tr><tr><td>1</td><td></td><td></td></tr><tr><td></td><td></td><td></td></tr></table>				1					
		1																																																																													
1		2																																																																													
1		1																																																																													
	1																																																																														
1																																																																															
2																																																																															
1																																																																															
Post - 0 Miss - 0 Block - 0	Post - 1 Miss - 0 Block - 0	Post - 1 Miss - 0 Block - 0	Post - 0 Miss - 0 Block - 0	Post - 0 Miss - 0 Block - 0	Post - 0 Miss - 0 Block - 0	Post - 0 Miss - 0 Block - 0	Post - 0 Miss - 0 Block - 0																																																																								
18 崔娟	21 锁珊珊	23 张艺璇	26 宋婷婷	27 谢辰辰	32 杨雨柔	93 张婷婷																																																																									
<table border="1"><tr><td></td><td></td><td></td></tr><tr><td>2</td><td></td><td>1</td></tr><tr><td>1</td><td></td><td></td></tr></table>				2		1	1			<table border="1"><tr><td></td><td></td><td></td></tr><tr><td></td><td></td><td></td></tr><tr><td></td><td></td><td></td></tr></table>										<table border="1"><tr><td></td><td></td><td></td></tr><tr><td></td><td></td><td></td></tr><tr><td></td><td></td><td></td></tr></table>										<table border="1"><tr><td></td><td>2</td><td></td></tr><tr><td></td><td></td><td>1</td></tr><tr><td>1</td><td></td><td></td></tr></table>		2				1	1			<table border="1"><tr><td></td><td></td><td>1</td></tr><tr><td></td><td></td><td></td></tr><tr><td></td><td></td><td></td></tr></table>			1							<table border="1"><tr><td></td><td></td><td></td></tr><tr><td></td><td></td><td></td></tr><tr><td></td><td></td><td></td></tr></table>										<table border="1"><tr><td></td><td></td><td></td></tr><tr><td></td><td>1</td><td>2</td></tr><tr><td></td><td></td><td>1</td></tr></table>					1	2			1	<table border="1"><tr><td></td><td></td><td></td></tr><tr><td></td><td></td><td></td></tr><tr><td></td><td></td><td></td></tr></table>									
2		1																																																																													
1																																																																															
	2																																																																														
		1																																																																													
1																																																																															
		1																																																																													
	1	2																																																																													
		1																																																																													
Post - 0 Miss - 2 Block - 1	Post - 1 Miss - 4 Block - 2	Post - 0 Miss - 0 Block - 0	Post - 0 Miss - 1 Block - 0	Post - 0 Miss - 0 Block - 0	Post - 0 Miss - 0 Block - 0	Post - 1 Miss - 0 Block - 0																																																																									

注释: Post=击柱 Miss=射失 Block=被封







预赛 Group B

女子 全国比赛

2016年全国女子手球锦标赛

Team A A 上海				Team B B 天津				Match Number <b>16</b>													
played in China		in the hall 滁州体育馆		on 06/09/2016		at 13:00 hours		Spectators													
Half-time (30')	A 21	B 8	End of playing time	A 23	B 8	1st extra time	A	B	2nd extra time	A	B	After penalty throws	A	B							
Number of 7 m	A 2 / 2	Team time-out 1 20:07 2 3			Full name of players and officials				Team time-out 1 08:42 2 3			B 1 / 1	Number of 7 m								
No.	Team A					G	W	2'	D	DR	No.	Team B					G	W	2'	D	DR
1	许沫										3	王晓梅					2				
2	周蕾					3	1				4	朱佳瑜									
5	郭威					3					5	丁丽洁									
6	黄妍					7					7	张心茹									
7	车婉茹										8	张慧					1				
8	吴茵					1					10	张文慧						1	1		
9	武娜娜					1		1			11	蔡雪洁					2				
10	斯文					2					12	王欣冉									
11	孙梦颖					2					14	刘洁									
12	郑冯										15	李窈窈						1			
13	徐娟										16	王选									
17	居晔					1					17	聂晓雪									
18	沙正文					1	1				18	舒文琪					1				
19	印尼					2					21	李默雅									
21	王嘉怡										22	王聪									
23	都好						1				23	周梦雪					2				
B	陈进培 (主教练)										A	付明双									
C	金锺顺										B	王明星 (主教练)									
D	贺业磊										C	岳连娥									
F	周瑜宸																				
A	Signature of Responsible Official of the Teams (Off. A)																		B		
TP	Remarks of Referee / CHA Official																		TP		

Signatures

Referees	徐健 (CHN)	曹宏俊 (CHN)		
Techn. Delegates	高斌 (CHN)			
CHA Official	刘书勇 (CHN)			

Note: Number of 7m Throws Awarded to Team A and B, Goals (G), Warnings (W), Suspensions (2'), Direct Disqualification (D), Disqualification with Report (DR) and Team Penalty (TP).

Table Officials: 伍豪

陈文丽

Statisticians: 黄岩

刘永欢

Printed by PHMS Copyright: IHF / CHA 06/09/2016 08:45:49

Longman Sportsoft



handball@126.com



## 2016年全国女子手球锦标赛 竞赛技术统计(媒体表)

<b>预赛</b>	组别	<b>B</b>	轮次	<b>4</b>	场次	<b>16</b>
滁州体育馆			06/09/2016		201605016-51-1/1	
上海	上海	<b>23</b>	vs	<b>8</b>	天津	天津
			<b>21 : 8</b>			

裁判员	徐健 (CHN)	/	曹宏俊 (CHN)
-----	----------	---	-----------

上海		远	近	边	快	突	任意	7m	合计	%	助攻	失误	警告	2'	D & DR	上海		天津			
主教练：陈进培		射	射	射	攻	破	球	球								比赛进程					
1	许沫										1					1st Half					
2	周蕾		1/1	1/2	1/1				3/4	75.0		1	1			6 黄妍	1	01:32	0		
5	郭威		2/2					1/1	3/3	100						10 斯文	2	05:03	0		
6	黄妍	3/3	3/3				0/1	1/1	7/8	87.5	1	1				2 周蕾	3	06:42	0		
7	车婉茹															9 武娜娜	4	08:35	0		
8	吴茵	0/1				1/1			1/2	50.0	1					8 吴茵	5	10:34	0		
9	武娜娜			1/1	0/1				1/2	50.0					1	6 黄妍	6	11:08	0		
10	斯文		1/2		1/1				2/3	66.7						6 黄妍	7	12:11	0		
11	孙梦颖	1/3	0/1		1/1				2/5	40.0	1	2				7 车婉茹	8	13:20	1	11 蔡雪洁	
12	郑冯															6 黄妍	8	14:17	2	23 周梦雪	
13	徐娟															8 吴茵	9	14:41	2		
17	居晔			1/1					1/1	100						6 黄妍	10	15:39	2		
18	沙正文		1/1						1/1	100			1			11 孙梦颖	11	17:27	3		
19	印尼	0/1	2/2						2/3	66.7						18 沙正文	12	18:28	3	3 王晓梅	
21	王嘉怡															5 郭威	12	18:28	3		
23	都好															12 郑冯	12	18:52	4	23 周梦雪	
<b>运动员 合计</b>		4/8	10/12	3/4	3/4	1/1	0/1	2/2	23/32	71.9	4	4	3	1		5 郭威	13	19:18	4		
1	许沫	7/10	0/2	0/1		0/1		0/1	7/15	46.7	1					11 孙梦颖	14	21:16	4		
12	郑冯															6 黄妍	15	21:57	5		
<b>守门员 合计</b>		7/10	0/2	0/1		0/1		0/1	7/15	46.7	1					2 周蕾	16	23:19	5		
																5 郭威	17	23:43	5		
																17 居晔	17	24:07	6	8 张慧	
																2 周蕾	18	24:33	6		
																18 沙正文	18	25:30	7	18 舒文琪	
																19 印尼	19	26:06	7		
																19 印尼	20	27:17	7		
																20 郑冯	20	28:27	8	11 蔡雪洁	
																23 都好	21	28:55	8		
																2nd Half					
																6 黄妍	22	00:42	8		
																6 黄妍	23	01:46	8		

场上队员：得分 / 射门										守门员：救球 / 射门					
--------------	--	--	--	--	--	--	--	--	--	-------------	--	--	--	--	--

快攻	Fast Break		突破	Breakthrough	攻	任意球	Free Throw		7M球	7M Throw		助攻	Assist
警告	Warning		失误	Error	2'	Suspension		D	取消资格		DR	取消资格+报告	



### 2016年全国女子手球锦标赛 图式比赛技术统计表

轮次 4

场次 16

201605016-21-1/1

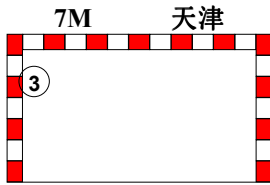
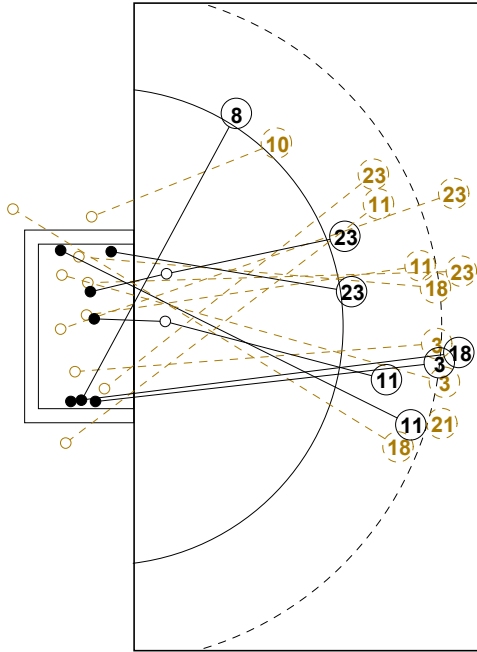

1st Half  
8 : 21

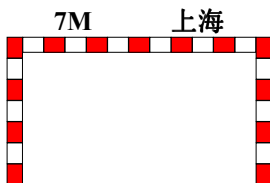
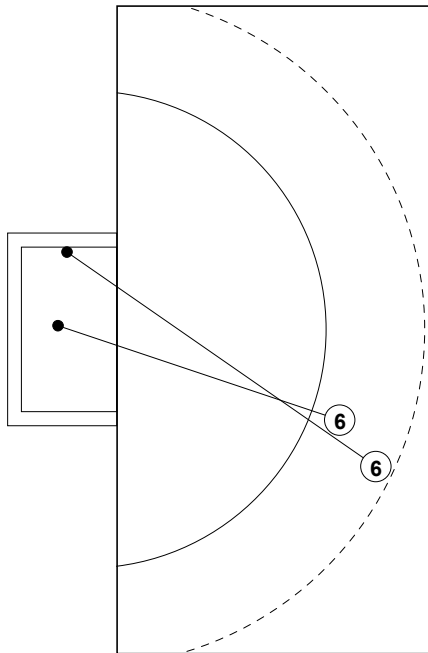
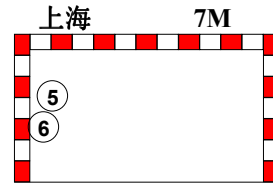
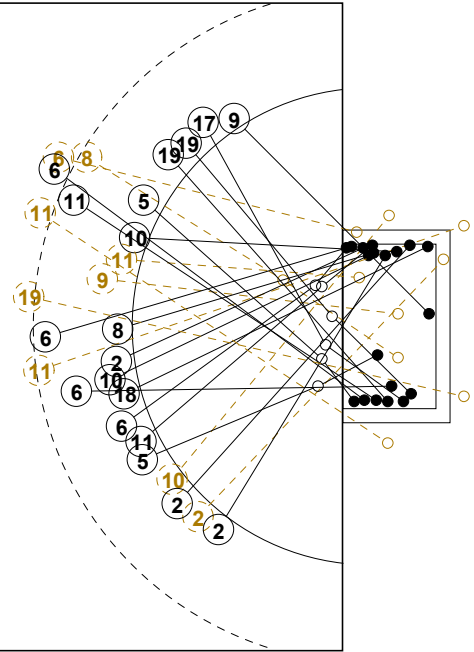

2nd Half  
23 : 8

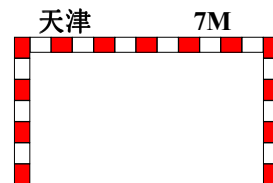
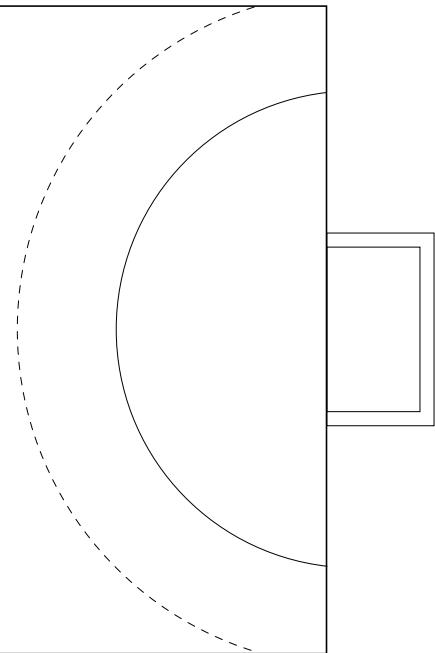



## 2016年全国女子手球锦标赛

## 个人/全队技术统计表

正式表  
手球  
女子预赛  
轮次 4组别 B  
场次 16201605016-14-1/2  
滁州体育馆  
06/09/2016 13:00

号码	姓名	远射	近射	边射	快攻	突破	任意	7M	合计	%	助攻	失误	警告	2'	取消	时间
<b>上海(上海)</b>																
<i>(场上队员)</i>																
1	许沫									0.0%	1					00:28:38
2	周蕾		1/1	1/2	1/1				3/4	75.0%		1	1			00:21:54
5	郭威		2/2					1/1	3/3	100%						00:09:06
6	黄妍	3/3	3/3				0/1	1/1	7/8	87.5%	1	1				00:27:28
7	车婉茹									0.0%						00:00:00
8	吴茵	0/1				1/1			1/2	50.0%	1					00:18:10
9	武娜娜			1/1	0/1				1/2	50.0%				1		00:24:17
10	斯文		1/2		1/1				2/3	66.7%						00:19:32
11	孙梦颖	1/3	0/1		1/1				2/5	40.0%	1	2				00:16:01
12	郑冯									0.0%						00:03:11
13	徐娟									0.0%						00:07:56
17	居晔			1/1					1/1	100%						00:07:31
18	沙正文		1/1						1/1	100%				1		00:24:10
19	印尼	0/1	2/2						2/3	66.7%						00:04:20
21	王嘉怡									0.0%						00:01:49
23	都好									0.0%				1		00:07:38
<b>合计</b>		4/8	10/12	3/4	3/4	1/1	0/1	2/2	23/32	71.9%	4	4	3	1		
<i>(守门员)</i>																
1	许沫	7/10	0/2	0/1		0/1		0/1	7/15	46.7%	1					00:28:38
12	郑冯									0.0%						00:03:11
<b>合计</b>		7/10	0/2	0/1		0/1		0/1	7/15	46.7%	1					

场上队员：得分/射门

守门员：救球/射门

全队合计	得分	被救	射失	击柱	封球	合计	%
远射	4	1	3			8	50.0%
近射	10	1	1			12	83.3%
边射	3			1		4	75.0%
快攻	3	1				4	75.0%
突破	1					1	100.0%
任意				1		1	0.0%
7M	2					2	100.0%





## 2016年全国女子手球锦标赛

## 个人/全队技术统计表

正式表  
手球  
女子预赛  
轮次 4组别 B  
场次 16201605016-14-2/2  
滁州体育馆  
06/09/2016 13:00

号码	姓名	远射	近射	边射	快攻	突破	任意	7M	合计	%	助攻	失误	警告	2'	取消	时间
<b>天津(天津)</b>																
<i>(上场队员)</i>																
3	王晓梅	1/3						1/1	2/4	50.0%	1	3				00:09:33
4	朱佳瑜									0.0%						00:00:00
5	丁丽洁									0.0%		1				00:07:08
7	张心茹									0.0%						00:00:00
8	张慧			1/1					1/1	100%		1				00:31:49
10	张文慧			0/1					0/1	0.0%		1	1	1		00:47:54
11	蔡雪洁	1/2	1/2						2/4	50.0%		1				00:33:23
12	王欣冉									0.0%						00:16:50
14	刘洁									0.0%						00:00:00
15	李窈窈									0.0%		1	1			00:03:30
16	王选									0.0%						00:14:59
17	聂晓雪									0.0%						00:16:00
18	舒文琪	1/3							1/3	33.3%		5				00:25:34
21	李默雅	0/1							0/1	0.0%						00:14:52
22	王聪									0.0%						00:00:00
23	周梦雪	0/3	1/1			1/1			2/5	40.0%		3				00:27:50
<b>合计</b>		3/12	2/3	1/2		1/1		1/1	8/19	42.1%	1	16	2	1		
<i>(守门员)</i>																
12	王欣冉	1/2	0/3	0/2	1/3	0/1		0/1	2/12	16.7%						00:16:50
16	王选	0/3	1/8	0/1	0/1			0/1	1/14	7.1%						00:14:59
<b>合计</b>																
		1/5	1/11	0/3	1/4	0/1		0/2	3/26	11.5%						

场上队员：得分/射门

守门员：救球/射门

全队合计	得分	被救	射失	击柱	封球	合计	%
远射	3	7	1		1	12	25.0%
近射	2		1			3	66.7%
边射	1		1			2	50.0%
快攻							0.0%
突破	1					1	100.0%
任意							0.0%
7M	1					1	100.0%





### 2016年全国女子手球锦标赛

#### 图式射门区域统计

轮次 4 场次 16

201605016-41-1/1

## 上海

1 许沫	2 周蕾	5 郭威	6 黄妍	7 车婉茹	8 吴茵	9 武娜娜	10 斯文																																																																								
<table border="1"><tr><td></td><td></td><td></td></tr><tr><td></td><td></td><td></td></tr><tr><td></td><td></td><td></td></tr></table>										<table border="1"><tr><td>1</td><td></td><td></td></tr><tr><td>1</td><td></td><td></td></tr><tr><td>1</td><td></td><td></td></tr></table>	1			1			1			<table border="1"><tr><td>1</td><td></td><td></td></tr><tr><td></td><td></td><td>1</td></tr><tr><td></td><td></td><td>1</td></tr></table>	1					1			1	<table border="1"><tr><td></td><td></td><td></td></tr><tr><td>1</td><td>1</td><td>2</td></tr><tr><td>2</td><td></td><td>1</td></tr></table>				1	1	2	2		1	<table border="1"><tr><td></td><td></td><td></td></tr><tr><td></td><td></td><td></td></tr><tr><td></td><td></td><td></td></tr></table>										<table border="1"><tr><td></td><td></td><td></td></tr><tr><td>1</td><td></td><td></td></tr><tr><td></td><td></td><td></td></tr></table>				1						<table border="1"><tr><td></td><td>1</td><td></td></tr><tr><td></td><td></td><td></td></tr><tr><td></td><td></td><td></td></tr></table>		1								<table border="1"><tr><td></td><td></td><td></td></tr><tr><td></td><td></td><td></td></tr><tr><td>1</td><td></td><td></td></tr></table>							1		
1																																																																															
1																																																																															
1																																																																															
1																																																																															
		1																																																																													
		1																																																																													
1	1	2																																																																													
2		1																																																																													
1																																																																															
	1																																																																														
1																																																																															
Post - 0 Miss - 0 Block - 0	Post - 1 Miss - 0 Block - 0	Post - 0 Miss - 0 Block - 0	Post - 1 Miss - 0 Block - 0	Post - 0 Miss - 0 Block - 0	Post - 0 Miss - 0 Block - 0	Post - 0 Miss - 0 Block - 0	Post - 0 Miss - 1 Block - 0																																																																								
11 孙梦颖	12 郑冯	13 徐娟	17 居晔	18 沙正文	19 印尼	21 王嘉怡	23 都好																																																																								
<table border="1"><tr><td></td><td></td><td></td></tr><tr><td></td><td></td><td>1</td></tr><tr><td>1</td><td></td><td></td></tr></table>						1	1			<table border="1"><tr><td></td><td></td><td></td></tr><tr><td></td><td></td><td></td></tr><tr><td></td><td></td><td></td></tr></table>										<table border="1"><tr><td></td><td></td><td></td></tr><tr><td></td><td></td><td></td></tr><tr><td></td><td></td><td></td></tr></table>										<table border="1"><tr><td></td><td></td><td></td></tr><tr><td></td><td></td><td>1</td></tr><tr><td></td><td></td><td></td></tr></table>						1				<table border="1"><tr><td>1</td><td></td><td></td></tr><tr><td></td><td></td><td></td></tr><tr><td></td><td></td><td></td></tr></table>	1									<table border="1"><tr><td></td><td></td><td>1</td></tr><tr><td></td><td></td><td>1</td></tr><tr><td></td><td></td><td></td></tr></table>			1			1				<table border="1"><tr><td></td><td></td><td></td></tr><tr><td></td><td></td><td></td></tr><tr><td></td><td></td><td></td></tr></table>										<table border="1"><tr><td></td><td></td><td></td></tr><tr><td></td><td></td><td></td></tr><tr><td></td><td></td><td></td></tr></table>									
		1																																																																													
1																																																																															
		1																																																																													
1																																																																															
		1																																																																													
		1																																																																													
Post - 0 Miss - 2 Block - 0	Post - 0 Miss - 0 Block - 0	Post - 0 Miss - 0 Block - 0	Post - 0 Miss - 0 Block - 0	Post - 0 Miss - 0 Block - 0	Post - 0 Miss - 1 Block - 0	Post - 0 Miss - 0 Block - 0	Post - 0 Miss - 0 Block - 0																																																																								

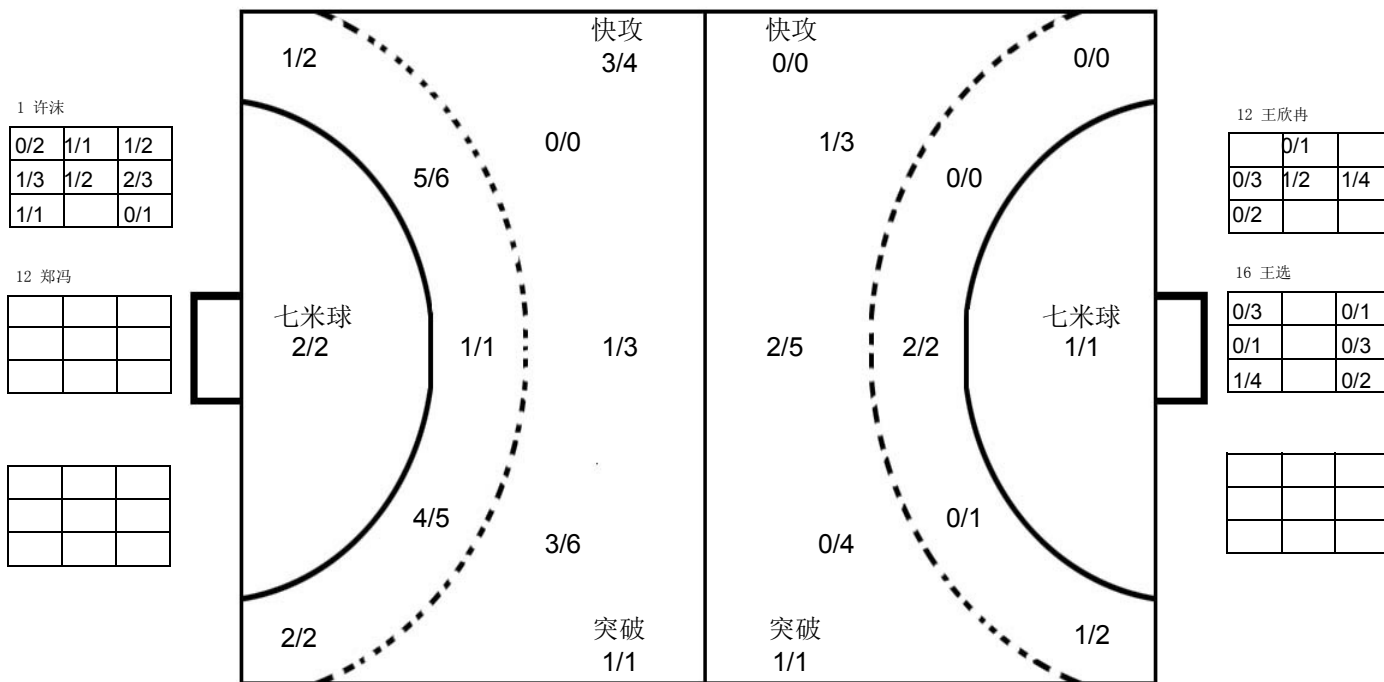

## 天津

3 王晓梅	4 朱佳瑜	5 丁丽洁	7 张心茹	8 张慧	10 张文慧	11 蔡雪洁	12 王欣冉																																																																								
<table border="1"><tr><td>1</td><td></td><td></td></tr><tr><td>1</td><td></td><td></td></tr><tr><td></td><td></td><td></td></tr></table>	1			1						<table border="1"><tr><td></td><td></td><td></td></tr><tr><td></td><td></td><td></td></tr><tr><td></td><td></td><td></td></tr></table>										<table border="1"><tr><td></td><td></td><td></td></tr><tr><td></td><td></td><td></td></tr><tr><td></td><td></td><td></td></tr></table>										<table border="1"><tr><td></td><td></td><td></td></tr><tr><td></td><td></td><td></td></tr><tr><td></td><td></td><td></td></tr></table>										<table border="1"><tr><td></td><td></td><td></td></tr><tr><td>1</td><td></td><td></td></tr><tr><td></td><td></td><td></td></tr></table>				1						<table border="1"><tr><td></td><td></td><td></td></tr><tr><td></td><td></td><td></td></tr><tr><td></td><td></td><td></td></tr></table>										<table border="1"><tr><td></td><td></td><td>1</td></tr><tr><td></td><td>1</td><td></td></tr><tr><td></td><td></td><td></td></tr></table>			1		1					<table border="1"><tr><td></td><td></td><td></td></tr><tr><td></td><td></td><td></td></tr><tr><td></td><td></td><td></td></tr></table>									
1																																																																															
1																																																																															
1																																																																															
		1																																																																													
	1																																																																														
Post - 0 Miss - 0 Block - 0	Post - 0 Miss - 0 Block - 0	Post - 0 Miss - 0 Block - 0	Post - 0 Miss - 0 Block - 0	Post - 0 Miss - 0 Block - 0	Post - 0 Miss - 1 Block - 0	Post - 0 Miss - 1 Block - 0	Post - 0 Miss - 0 Block - 0																																																																								
14 刘洁	15 李窈窈	16 王选	17 聂晓雪	18 舒文琪	21 李默雅	22 王聪	23 周梦雪																																																																								
<table border="1"><tr><td></td><td></td><td></td></tr><tr><td></td><td></td><td></td></tr><tr><td></td><td></td><td></td></tr></table>										<table border="1"><tr><td></td><td></td><td></td></tr><tr><td></td><td></td><td></td></tr><tr><td></td><td></td><td></td></tr></table>										<table border="1"><tr><td></td><td></td><td></td></tr><tr><td></td><td></td><td></td></tr><tr><td></td><td></td><td></td></tr></table>										<table border="1"><tr><td></td><td></td><td></td></tr><tr><td></td><td></td><td></td></tr><tr><td></td><td></td><td></td></tr></table>										<table border="1"><tr><td></td><td></td><td></td></tr><tr><td>1</td><td></td><td></td></tr><tr><td></td><td></td><td></td></tr></table>				1						<table border="1"><tr><td></td><td></td><td></td></tr><tr><td></td><td></td><td></td></tr><tr><td></td><td></td><td></td></tr></table>										<table border="1"><tr><td></td><td></td><td></td></tr><tr><td></td><td></td><td></td></tr><tr><td></td><td></td><td></td></tr></table>										<table border="1"><tr><td></td><td></td><td></td></tr><tr><td></td><td></td><td>1</td></tr><tr><td></td><td></td><td>1</td></tr></table>						1			1
1																																																																															
		1																																																																													
		1																																																																													
Post - 0 Miss - 0 Block - 0	Post - 0 Miss - 0 Block - 0	Post - 0 Miss - 0 Block - 0	Post - 0 Miss - 0 Block - 0	Post - 0 Miss - 1 Block - 0	Post - 0 Miss - 0 Block - 1	Post - 0 Miss - 0 Block - 0	Post - 0 Miss - 0 Block - 0																																																																								

注释: Post=击柱 Miss=射失 Block=被封



预赛 Group B

女子 全国比赛

2016年全国女子手球锦标赛

Team A <b>A 辽宁</b>				Team B <b>B 解放军</b>				Match Number <b>17</b>													
played in China		in the hall 滁州体育馆		on 06/09/2016		at 14:30 hours		Spectators													
Half-time (30')	<b>A</b> 11	<b>B</b> 15	End of playing time	<b>A</b> 31	<b>B</b> 35	1st extra time	<b>A</b>	<b>B</b>	2nd extra time	<b>A</b>	<b>B</b>	After penalty throws	<b>A</b>	<b>B</b>							
Number of 7 m	<b>A</b> 5 / 7	Team time-out 1 08:24 2 37:06 3			Full name of players and officials				Team time-out 1 2 3 58:10			<b>B</b> 0 / 1	Number of 7 m								
No.	Team <b>A</b>					G	W	2'	D	DR	No.	Team <b>B</b>					G	W	2'	D	DR
1	于薇诗										2	崔云莉					2	1			
2	朱徐婷					1					5	徐鸣昭					1				
3	赵莹雪					4	1				6	于婷婷					7				
5	辛颜					2	1				8	周亚茹					4				
8	杨娇					11					13	张格格					6	1			
9	刁卫丽										16	方文博									
12	刘雪菲										17	于利婷					1				
13	杜江花					2					23	顾天澍					2				
19	吕秋雪					1					24	韦娜娜					6				
20	孙弘玲					2	1				32	张馨予									
24	陈思雨										36	李朴									
27	王丹										44	刘洋麦文					2				
66	梁海珍					8					66	杨丽丽									
93	赵琦										77	唐魏萍									
98	张永婷										81	戴丹妮									
99	郑锦宜										88	李晓晴					4	1	1		
<b>A</b>	吕艳梦										<b>A</b>	刘德东 (主教练)									
<b>B</b>	李丽荣										<b>B</b>	刘凤娟									
<b>C</b>	金京男 (主教练)										<b>C</b>	丛艳霞									
<b>E</b>	程万里										<b>D</b>	吴明群									
<b>A</b>	Signature of Responsible Official of the Teams (Off. A)																			<b>B</b>	
TP	Remarks of Referee / CHA Official																			TP	

Signatures

Referees: 倪震 (CHN) 张栋 (CHN)

Techn. Delegates: 高斌 (CHN)

CHA Official: 刘书勇 (CHN)

Note: Number of 7m Throws Awarded to Team A and B, Goals (G), Warnings (W), Suspensions (2'), Direct Disqualification (D), Disqualification with Report (DR) and Team Penalty (TP).

Table Officials: 伍豪

陈文丽

Statisticians: 刘永欢

黄岩

Printed by PHMS Copyright: IHF / CHA 06/09/2016 15:32:04

Longman Sportsoft



handball@126.com



## 2016年全国女子手球锦标赛 竞赛技术统计(媒体表)

预赛	组别	<b>B</b>	轮次	<b>4</b>	场次	<b>17</b>
滁州体育馆		06/09/2016			201605017-51-1/1	
辽宁		辽宁		<b>31</b>	vs	<b>35</b> 解放军
				<b>11 : 15</b>		
裁判员		倪震 (CHN)			张栋 (CHN)	

辽宁		远射	近射	边射	快攻	突破	任意球	7m球	合计	%	助攻	失误	警告	2'	D & DR	辽宁	比赛进程	解放军
主教练：金京男																	1st Half	
1	于薇诗															2	朱徐婷 01:41	0
2	朱徐婷		1/1	0/4	0/1			1/6	16.7							3	赵莹雪 03:43	0
3	赵莹雪	0/1	3/4	0/1		1/1		4/7	57.1	1	1	1				2 04:08	1 2 崔云莉	
5	辛颜		2/2					2/2	100				1			2 05:12	2 13 张格格	
8	杨娇	4/10	2/3		1/1	1/1	1/2	2/4	52.4	3	3					2 06:06	3 17 于婷婷	
9	刁卫丽			0/1				0/1	0.0						66	梁海珍 3 06:58	3	
12	刘雪菲															3 07:13	4 24 韦娜娜	
13	杜江花							2/2	2/2	100						3 08:18	5 6 于婷婷	
19	吕秋雪	0/2	1/3	0/2				1/7	14.3	1					8	杨娇 4 09:04	5	
20	孙弘玲	0/1	1/1	1/1				2/3	66.7			1	1		4	4 12:03	6 13 张格格	
24	陈思雨														66	梁海珍 5 12:36	6	
27	王丹														5	5 15:01	7 6 于婷婷	
66	梁海珍	2/5	2/4	2/2		1/1	1/1	8/13	61.5	3	2				5	5 17:17	8 24 韦娜娜	
93	赵琦														8	6 18:23	8	
98	张永婷														8	6 18:23	8	
99	郑锦宜														8	7 19:37	8	
<b>运动员 合计</b>		<b>6/19</b>	<b>12/18</b>	<b>3/11</b>	<b>1/2</b>	<b>3/3</b>	<b>1/2</b>	<b>5/7</b>	<b>31/62</b>	<b>50.0</b>	<b>8</b>	<b>7</b>	<b>3</b>					
1	于薇诗	1/5						1/5	20.0						8	7 19:37	8	
27	王丹	7/12	2/5	0/4	0/4		0/1	9/26	34.6						8	7 20:20	9 6 于婷婷	
93	赵琦	1/7	0/3	1/5	0/1			2/16	12.5						13	8 21:24	9	
<b>守门员 合计</b>		<b>9/24</b>	<b>2/8</b>	<b>1/9</b>	<b>0/5</b>	<b>0/1</b>		<b>12/47</b>	<b>25.5</b>									
解放军		远射	近射	边射	快攻	突破	任意球	7m球	合计	%	助攻	失误	警告	2'	D & DR	<th> <th> </th></th>	<th> </th>	
教练：刘德东																	2nd Half	
2	崔云莉	2/7						2/7	28.6			2	1		11	01:48	16 13 张格格	
5	徐鸣昭	1/1						1/1	100						12	03:33	16	
6	于婷婷	4/5		2/2	1/1			7/8	87.5	2	3				12	03:47	17 88 李晓晴	
8	周亚茹	4/7	0/1					4/8	50.0		1				66	梁海珍 13 04:15	17	
13	张格格		5/5		1/1			6/6	100				1		13	04:50	18 88 李晓晴	
16	方文博														13	05:59	19 2 崔云莉	
17	于利婷			1/1											13	06:53	20 24 韦娜娜	
23	顾天澍			2/3				2/3	66.7						66	梁海珍 14 07:21	20	
24	韦娜娜			3/5	3/3			6/8	75.0						8	09:19	21 6 于婷婷	
32	张馨予														8	10:06	21	
36	李朴														66	梁海珍 15 10:27	22 88 李晓晴	
44	刘洋麦文	1/4					1/1	2/5	40.0	1					16	10:31	22	
66	杨丽丽														16	10:58	23 8 周亚茹	
77	唐魏萍														16	11:35	24 88 李晓晴	
81	戴丹妮														3	12:01	24	
88	李晓晴	3/8	1/2					4/11	36.4	3		1	1		17	12:14	25 8 周亚茹	
<b>运动员 合计</b>		<b>15/32</b>	<b>6/8</b>	<b>8/11</b>	<b>5/5</b>	<b>1/1</b>	<b>0/1</b>	<b>35/58</b>	<b>60.3</b>	<b>6</b>	<b>6</b>	<b>3</b>	<b>1</b>					
16	方文博	7/13	5/17	3/6	0/1	0/3	1/2	2/6	18/48	37.5					18	12:57	25	
66	杨丽丽							0/1	0/1	0.0					18	13:23	26 5 徐鸣昭	
<b>守门员 合计</b>		<b>7/13</b>	<b>5/17</b>	<b>3/6</b>	<b>0/1</b>	<b>0/3</b>	<b>1/2</b>	<b>2/7</b>	<b>18/49</b>	<b>36.7</b>								

场上队员：得分 / 射门

守门员：救球 / 射门

快攻	Fast Break	突破	Breakthrough	任意球	Free Throw	7M球	7M Throw	助攻	Assist
警告	Warning	失误	Error	2'	Suspension	D	取消资格	DR	取消资格+报告







## 2016年全国女子手球锦标赛 图式比赛技术统计表

轮次 4

场次 17

201605017-21-1/1

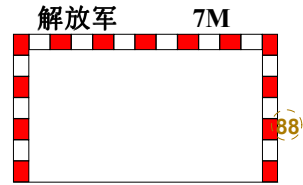
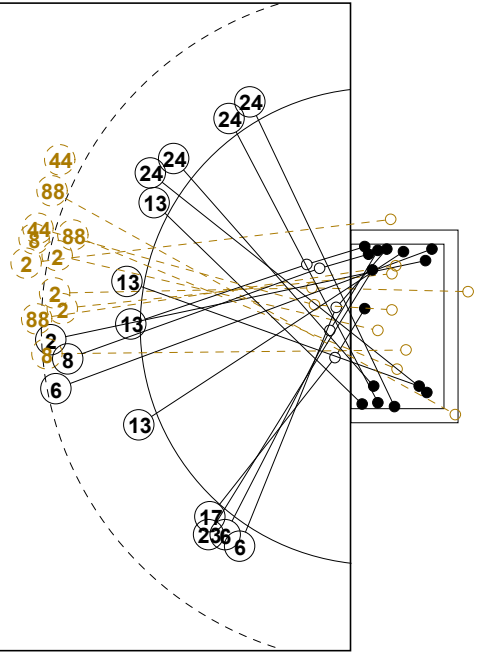
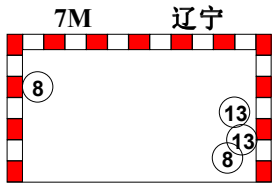
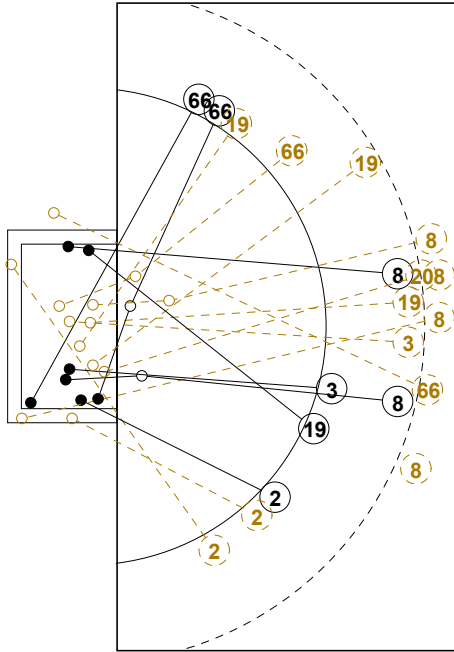

1st Half  
11 : 15

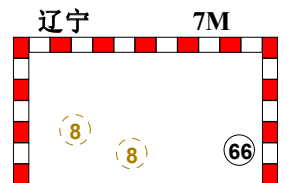
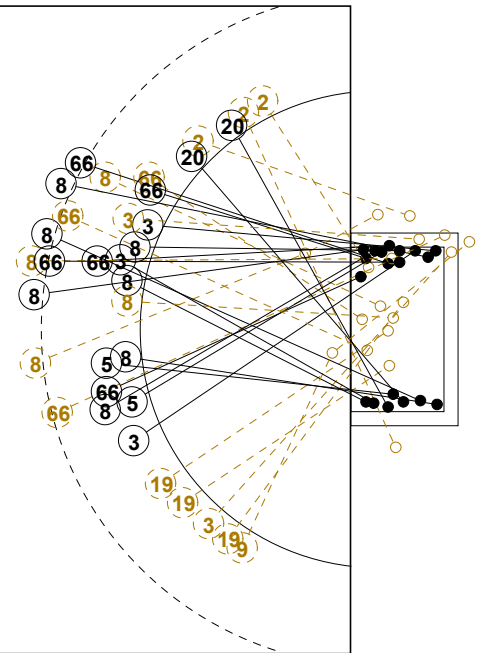
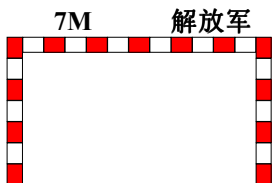
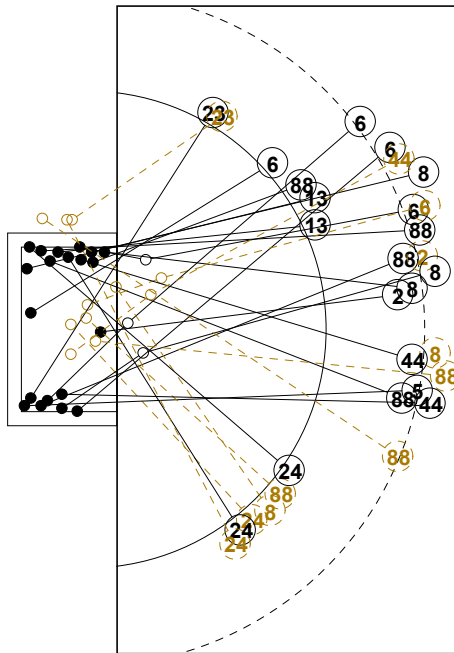

2nd Half  
35 : 31



## 2016年全国女子手球锦标赛

## 个人/全队技术统计表

正式表  
手球  
女子预赛  
轮次 4组别 B  
场次 17201605017-14-1/2  
滁州体育馆  
06/09/2016 14:30

号码	姓名	远射	近射	边射	快攻	突破	任意	7M	合计	%	助攻	失误	警告	2'	取消	时间
<b>辽宁(辽宁)</b>																
<i>(场上队员)</i>																
1	于薇诗									0.0%						00:04:52
2	朱徐婷		1/1	0/4	0/1				1/6	16.7%						00:13:59
3	赵莹雪	0/1	3/4	0/1		1/1			4/7	57.1%	1	1	1			00:51:04
5	辛颜		2/2						2/2	100%			1			00:28:07
8	杨娇	4/10	2/3		1/1	1/1	1/2	2/4	11/21	52.4%	3	3				00:46:41
9	刁卫丽			0/1					0/1	0.0%						00:07:41
12	刘雪菲									0.0%						00:00:00
13	杜江花							2/2	2/2	100%						00:00:00
19	吕秋雪	0/2	1/3	0/2					1/7	14.3%	1					00:25:14
20	孙弘玲	0/1	1/1	1/1					2/3	66.7%		1	1			00:17:30
24	陈思雨									0.0%						00:00:00
27	王丹									0.0%						00:34:57
66	梁海珍	2/5	2/4	2/2		1/1		1/1	8/13	61.5%	3	2				00:52:19
93	赵琦									0.0%						00:14:17
98	张永婷									0.0%						00:01:52
99	郑锦宜									0.0%						00:00:00
<b>合计</b>		6/19	12/18	3/11	1/2	3/3	1/2	5/7	31/62	50.0%	8	7	3			
<i>(守门员)</i>																
1	于薇诗	1/5							1/5	20.0%						00:04:52
27	王丹	7/12	2/5	0/4	0/4		0/1		9/26	34.6%						00:34:57
93	赵琦	1/7	0/3	1/5	0/1				2/16	12.5%						00:14:17
<b>合计</b>		9/24	2/8	1/9	0/5		0/1		12/47	25.5%						

场上队员：得分/射门

守门员：救球/射门

全队合计	得分	被救	射失	击柱	封球	合计	%
远射	6	7	2	2	2	19	31.6%
近射	12	5		1		18	66.7%
边射	3	3	2	3		11	27.3%
快攻	1		1			2	50.0%
突破	3					3	100.0%
任意	1	1				2	50.0%
7M	5	2				7	71.4%





## 2016年全国女子手球锦标赛

## 个人/全队技术统计表

正式表  
手球  
女子预赛  
轮次 4组别 B  
场次 17201605017-14-2/2  
滁州体育馆  
06/09/2016 14:30

号码	姓名	远射	近射	边射	快攻	突破	任意	7M	合计	%	助攻	失误	警告	2'	取消	时间
<b>解放军(解放军)</b>																
<i>(上场队员)</i>																
2	崔云莉	2/7							2/7	28.6%		2	1			00:32:11
5	徐鸣昭	1/1							1/1	100%						00:06:13
6	于婷婷	4/5		2/2	1/1				7/8	87.5%	2	3				00:30:00
8	周亚茹	4/7	0/1						4/8	50.0%		1				00:12:23
13	张格格		5/5		1/1				6/6	100%			1			00:30:00
16	方文博									0.0%						00:51:10
17	于利婷			1/1					1/1	100%						00:22:56
23	顾天澍			2/3					2/3	66.7%						00:30:00
24	韦娜娜			3/5	3/3				6/8	75.0%						00:30:00
32	张馨予									0.0%						00:00:00
36	李朴									0.0%						00:00:00
44	刘洋麦文	1/4					1/1		2/5	40.0%	1					00:07:45
66	杨丽丽									0.0%						00:00:23
77	唐魏萍									0.0%						00:00:00
81	戴丹妮									0.0%						00:00:00
88	李晓晴	3/8	1/2					0/1	4/11	36.4%	3		1	1		00:45:01
<b>合计</b>		15/32	6/8	8/11	5/5		1/1	0/1	35/58	60.3%	6	6	3	1		
<i>(守门员)</i>																
16	方文博	7/13	5/17	3/6	0/1	0/3	1/2	2/6	18/48	37.5%						00:51:10
66	杨丽丽							0/1	0/1	0.0%						00:00:23
<b>合计</b>		7/13	5/17	3/6	0/1	0/3	1/2	2/7	18/49	36.7%						

场上队员：得分/射门

守门员：救球/射门

全队合计	得分	被救	射失	击柱	封球	合计	%
远射	15	9	3	1	4	32	46.9%
近射	6	2				8	75.0%
边射	8	1	2			11	72.7%
快攻	5					5	100.0%
突破							0.0%
任意	1					1	100.0%
7M				1		1	0.0%





2016年全国女子手球锦标赛

图式射门区域统计

轮次 4 场次 17

201605017-41-1/1

辽宁

1 于薇诗	2 朱徐婷	3 赵莹雪	5 辛颜	8 杨娇	9 刁卫丽	12 刘雪菲	13 杜江花																																																																								
<table border="1"><tr><td></td><td></td><td></td></tr><tr><td></td><td></td><td></td></tr><tr><td></td><td></td><td></td></tr></table>										<table border="1"><tr><td></td><td></td><td></td></tr><tr><td>1</td><td></td><td></td></tr><tr><td></td><td></td><td></td></tr></table>				1						<table border="1"><tr><td>2</td><td></td><td></td></tr><tr><td>1</td><td></td><td></td></tr><tr><td></td><td></td><td>1</td></tr></table>	2			1					1	<table border="1"><tr><td></td><td></td><td></td></tr><tr><td>1</td><td></td><td>1</td></tr><tr><td></td><td></td><td></td></tr></table>				1		1				<table border="1"><tr><td>2</td><td></td><td>2</td></tr><tr><td>2</td><td></td><td>1</td></tr><tr><td>2</td><td></td><td>2</td></tr></table>	2		2	2		1	2		2	<table border="1"><tr><td></td><td></td><td></td></tr><tr><td></td><td></td><td></td></tr><tr><td></td><td></td><td></td></tr></table>										<table border="1"><tr><td></td><td></td><td></td></tr><tr><td></td><td></td><td></td></tr><tr><td></td><td></td><td></td></tr></table>										<table border="1"><tr><td></td><td></td><td></td></tr><tr><td></td><td></td><td></td></tr><tr><td></td><td></td><td>2</td></tr></table>									2
1																																																																															
2																																																																															
1																																																																															
		1																																																																													
1		1																																																																													
2		2																																																																													
2		1																																																																													
2		2																																																																													
		2																																																																													
Post - 0 Miss - 0 Block - 0	Post - 2 Miss - 2 Block - 0	Post - 2 Miss - 0 Block - 0	Post - 0 Miss - 0 Block - 0	Post - 1 Miss - 1 Block - 2	Post - 0 Miss - 1 Block - 0	Post - 0 Miss - 0 Block - 0	Post - 0 Miss - 0 Block - 0																																																																								
19 吕秋雪	20 孙弘玲	24 陈思雨	27 王丹	66 梁海珍	93 赵琦	98 张永婷	99 郑锦宜																																																																								
<table border="1"><tr><td></td><td></td><td></td></tr><tr><td></td><td></td><td></td></tr><tr><td></td><td></td><td>1</td></tr></table>									1	<table border="1"><tr><td></td><td></td><td></td></tr><tr><td></td><td></td><td>2</td></tr><tr><td></td><td></td><td></td></tr></table>						2				<table border="1"><tr><td></td><td></td><td></td></tr><tr><td></td><td></td><td></td></tr><tr><td></td><td></td><td></td></tr></table>										<table border="1"><tr><td></td><td></td><td></td></tr><tr><td></td><td></td><td></td></tr><tr><td></td><td></td><td></td></tr></table>										<table border="1"><tr><td>1</td><td></td><td></td></tr><tr><td>3</td><td></td><td></td></tr><tr><td>3</td><td></td><td>1</td></tr></table>	1			3			3		1	<table border="1"><tr><td></td><td></td><td></td></tr><tr><td></td><td></td><td></td></tr><tr><td></td><td></td><td></td></tr></table>										<table border="1"><tr><td></td><td></td><td></td></tr><tr><td></td><td></td><td></td></tr><tr><td></td><td></td><td></td></tr></table>										<table border="1"><tr><td></td><td></td><td></td></tr><tr><td></td><td></td><td></td></tr><tr><td></td><td></td><td></td></tr></table>									
		1																																																																													
		2																																																																													
1																																																																															
3																																																																															
3		1																																																																													
Post - 0 Miss - 0 Block - 0	Post - 0 Miss - 0 Block - 0	Post - 0 Miss - 0 Block - 0	Post - 0 Miss - 0 Block - 0	Post - 1 Miss - 1 Block - 0	Post - 0 Miss - 0 Block - 0	Post - 0 Miss - 0 Block - 0	Post - 0 Miss - 0 Block - 0																																																																								

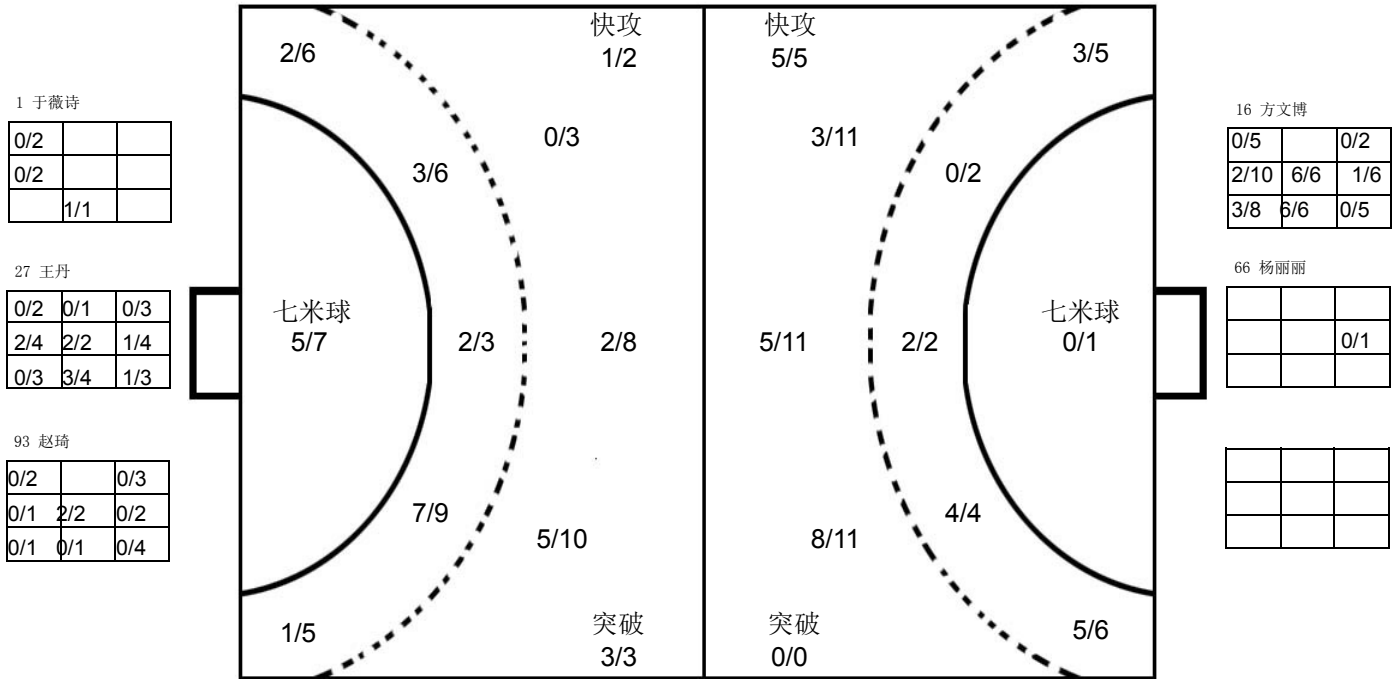

解放军

2 崔云莉	5 徐鸣昭	6 于婷婷	8 周亚茹	13 张格格	16 方文博	17 于利婷	23 顾天澍																																																																								
<table border="1"><tr><td>1</td><td></td><td></td></tr><tr><td></td><td></td><td></td></tr><tr><td></td><td></td><td></td></tr></table>	1									<table border="1"><tr><td>1</td><td></td><td></td></tr><tr><td></td><td></td><td></td></tr><tr><td></td><td></td><td></td></tr></table>	1									<table border="1"><tr><td>2</td><td>1</td><td></td></tr><tr><td>2</td><td></td><td>1</td></tr><tr><td>1</td><td></td><td></td></tr></table>	2	1		2		1	1			<table border="1"><tr><td></td><td></td><td></td></tr><tr><td>1</td><td></td><td></td></tr><tr><td>1</td><td></td><td>2</td></tr></table>				1			1		2	<table border="1"><tr><td></td><td></td><td>2</td></tr><tr><td>1</td><td></td><td>1</td></tr><tr><td>1</td><td></td><td>1</td></tr></table>			2	1		1	1		1	<table border="1"><tr><td></td><td></td><td></td></tr><tr><td></td><td></td><td></td></tr><tr><td></td><td></td><td></td></tr></table>										<table border="1"><tr><td></td><td></td><td></td></tr><tr><td></td><td></td><td></td></tr><tr><td></td><td>1</td><td></td></tr></table>								1		<table border="1"><tr><td></td><td></td><td></td></tr><tr><td></td><td></td><td></td></tr><tr><td></td><td></td><td></td></tr></table>									
1																																																																															
1																																																																															
2	1																																																																														
2		1																																																																													
1																																																																															
1																																																																															
1		2																																																																													
		2																																																																													
1		1																																																																													
1		1																																																																													
	1																																																																														
Post - 0 Miss - 2 Block - 1	Post - 0 Miss - 0 Block - 0	Post - 0 Miss - 0 Block - 0	Post - 0 Miss - 0 Block - 2	Post - 0 Miss - 0 Block - 0	Post - 0 Miss - 0 Block - 0	Post - 0 Miss - 0 Block - 0	Post - 0 Miss - 1 Block - 0																																																																								
24 韦娜娜	32 张馨予	36 李朴	44 刘洋麦文	66 杨丽丽	77 唐魏萍	81 戴丹妮	88 李晓晴																																																																								
<table border="1"><tr><td></td><td></td><td>2</td></tr><tr><td></td><td></td><td>2</td></tr><tr><td></td><td></td><td>2</td></tr></table>			2			2			2	<table border="1"><tr><td></td><td></td><td></td></tr><tr><td></td><td></td><td></td></tr><tr><td></td><td></td><td></td></tr></table>										<table border="1"><tr><td></td><td></td><td></td></tr><tr><td></td><td></td><td></td></tr><tr><td></td><td></td><td></td></tr></table>										<table border="1"><tr><td></td><td></td><td></td></tr><tr><td>1</td><td></td><td>1</td></tr><tr><td></td><td></td><td></td></tr></table>				1		1				<table border="1"><tr><td></td><td></td><td></td></tr><tr><td></td><td></td><td></td></tr><tr><td></td><td></td><td></td></tr></table>										<table border="1"><tr><td></td><td></td><td></td></tr><tr><td></td><td></td><td></td></tr><tr><td></td><td></td><td></td></tr></table>										<table border="1"><tr><td></td><td></td><td></td></tr><tr><td></td><td></td><td></td></tr><tr><td></td><td></td><td></td></tr></table>										<table border="1"><tr><td></td><td></td><td></td></tr><tr><td></td><td></td><td></td></tr><tr><td></td><td></td><td></td></tr></table>									
		2																																																																													
		2																																																																													
		2																																																																													
1		1																																																																													
Post - 0 Miss - 1 Block - 0	Post - 0 Miss - 0 Block - 0	Post - 0 Miss - 0 Block - 0	Post - 0 Miss - 0 Block - 1	Post - 0 Miss - 0 Block - 0	Post - 0 Miss - 0 Block - 0	Post - 0 Miss - 0 Block - 0	Post - 2 Miss - 1 Block - 0																																																																								

注释: Post=击柱 Miss=射失 Block=被封





预赛 Group B

女子 全国比赛

2016年全国女子手球锦标赛

Team A <b>A 北京</b>				Team B <b>B 四川</b>				Match Number <b>18</b>													
played in China		in the hall 滁州体育馆		on 06/09/2016		at 16:00 hours		Spectators													
Half-time (30')	<b>A</b> 17	<b>B</b> 12	End of playing time	<b>A</b> 34	<b>B</b> 29	1st extra time	<b>A</b>	<b>B</b>	2nd extra time	<b>A</b>	<b>B</b>	After penalty throws	<b>A</b>	<b>B</b>							
Number of 7 m	<b>A</b> 2 / 2	Team time-out			Full name of players and officials				Team time-out			<b>B</b> 3 / 4	Number of 7 m								
		1	2	3					1	2	3										
		27:25	37:56	57:34					21:35	49:56											
No.	Team <b>A</b>					G	W	2'	D	DR	No.	Team <b>B</b>					G	W	2'	D	DR
1	宋嘉蕾										1	张雪纯									
3	季小桐					10					2	陈艳楠					1				
4	孙佳					2					3	王丹					10		1		
6	刘亚男										4	尤婉莹					4	1			
8	杨铭豫					4	1				5	孙姣					3				
10	刘莎					1					6	凤洋					1				
11	纪婉					3					7	练素琪									
16	王海叶										9	姚梦园						1			
17	杨政赢							1			10	高静									
22	李海鸥										11	朱海云					4	1			
23	田媛						1	1			12	宋琛茜									
28	闫美珠					4	1	1			17	史雨欣									
33	栾征							2			18	戴小宇					6				
47	刘泽										27	吴美琪									
58	李华																				
69	石梓薇					10															
A	蔡建国										A	金鸿									
B	石伟 (主教练)										B	郎正平									
C	李翼										C	陈志伟									
E	史良玉																				
<b>A</b>	Signature of Responsible Official of the Teams (Off. A)																			<b>B</b>	
TP	Remarks of Referee / CHA Official																			TP	

Signatures

Referees	张耿 (CHN)	王雨洋 (CHN)		
Techn. Delegates	于中迅 (CHN)			
CHA Official	许宜扬 (CHN)			

Note: Number of 7m Throws Awarded to Team A and B, Goals (G), Warnings (W), Suspensions (2'), Direct Disqualification (D), Disqualification with Report (DR) and Team Penalty (TP).

Table Officials: 赵涵

李诚

Statisticians: 黄岩

刘永欢

Printed by PHMS Copyright: IHF / CHA 06/09/2016 17:12:35

Longman Sportsoft



handball@126.com

2016年全国女子手球锦标赛  
竞赛技术统计(媒体表)

预赛	组别	B	轮次	4	场次	18
滁州体育馆		06/09/2016		201605018-51-1/1		
北京		北京	34	vs	29	四川
		17:12				

裁判员	张耿 (CHN)	/	王雨洋 (CHN)
-----	----------	---	-----------

北京		远射	近射	边射	快攻	突破	任意球	7m球	合计	%	助攻	失误	警告	2'	D & DR	北京 比赛进程		四川	
主教练: 石伟																			
1	宋嘉蕾															3	季小桐	1st Half	0
3	季小桐	2/5	2/2	1/1	4/4	1/1			10/13	76.9	1	7				1	01:40	1	4 尤婉莹
4	孙佳		2/2						2/2	100						1	03:22	2	5 孙姣
6	刘亚男															2	04:23	2	
8	杨铭豫		1/1	3/4					4/5	80.0		1	1			2	04:50	3	3 王丹
10	刘莎					1/1			1/1	100						2	05:24	4	4 尤婉莹
11	纪婉		2/2			1/1			3/3	100		1				2	06:18	5	11 朱海云
16	王海叶															3	07:50	5	
17	杨政赢													1		4	08:38	5	
22	李海鸥		0/2						0/2	0.0		1				5	09:44	5	
23	田媛	0/1					0/1		0/2	0.0		2	1	1		6	11:39	5	
28	闫美珠	2/6	1/1	1/2					4/9	44.4	2	3	1	1		6	11:59	6	3 王丹
33	栾征															7	12:47	6	
47	刘洋															7	14:47	7	5 孙姣
58	李华															8	15:34	7	
69	石梓薇	2/4	4/6			2/2		2/2	10/14	71.4	2	3				8	16:00	8	4 尤婉莹
运动员 合计		6/16	12/16	5/7	4/4	5/5	0/1	2/2	34/51	66.7	5	18	3	5		8	16:11	8	
1	宋嘉蕾		0/3	1/2	0/1			0/1	1/7	14.3						9	16:55	8	
16	王海叶	7/11	3/4	5/7	1/6	0/6	0/1	0/1	16/36	44.4						10	17:48	8	
47	刘洋	0/1			0/1			0/1	0/3	0.0						11	19:09	9	18 戴小宇
守门员 合计		7/12	3/7	6/9	1/8	0/6	0/1	0/3	17/46	37.0						12	19:33	9	
四川		远射	近射	边射	快攻	突破	任意球	7m球	合计	%	助攻	失误	警告	2'	D & DR				
教练: 郎正平																			
1	张雪纯															11	20:06	16	
2	陈艳楠		0/1		1/1				1/2	50.0		1				11	20:15	17	18 戴小宇
3	王丹	1/3	0/1	2/2	1/1	2/2	1/1	3/3	10/13	76.9		7		1		12	20:48	18	5 孙姣
4	尤婉莹	0/1	2/2		1/1	1/1			4/5	80.0			1			13	21:11	9	
5	孙姣				3/3				3/3	100		3				14	22:48	9	
6	凤洋	0/1		0/5	0/1	1/1			1/8	12.5		2				15	23:11	10	3 王丹
7	练素琪															16	23:32	10	4 尤婉莹
9	姚梦园												1			17	24:07	11	3 王丹
10	高静															18	24:25	11	
11	朱海云	2/4	1/1	1/2					4/7	57.1		1	1			19	25:13	12	3 王丹
12	宋琛茜															20	26:22	12	
17	史雨欣															21	28:03	12	
18	戴小宇	2/4	1/2		1/1	2/2		0/1	6/10	60.0	1	4				22	28:24	13	3 王丹
27	吴美琪															23	29:06	14	2 陈艳楠
运动员 合计		5/13	4/7	3/9	7/8	6/6	1/1	3/4	29/48	60.4	1	18	3	1		24	29:28	14	
12	宋琛茜	5/11	3/15	2/7	0/4	0/5	1/1	0/2	11/45	24.4						25	29:41	15	11 朱海云
守门员 合计		5/11	3/15	2/7	0/4	0/5	1/1	0/2	11/45	24.4									

场上队员: 得分 / 射门

守门员: 救球 / 射门

快攻	Fast Break		突破	Breakthrough		任意球	Free Throw		7M球	7M Throw		助攻	Assist
警告	Warning		失误	Error		2'	Suspension		D	取消资格		DR	取消资格+报告





### 2016年全国女子手球锦标赛 图式比赛技术统计表

轮次 4

场次 18

201605018-21-1/1

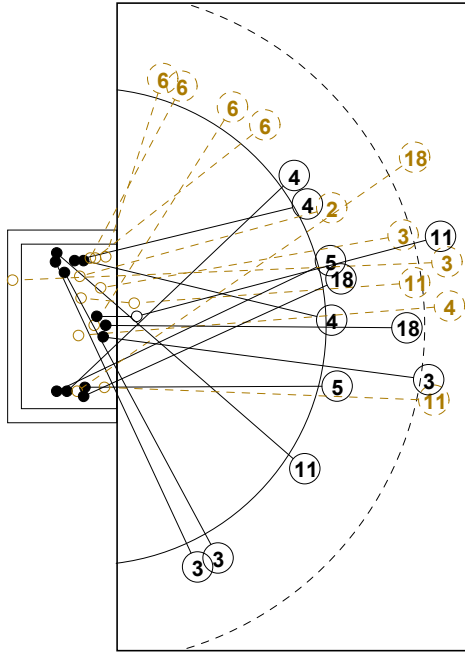

7M 四川

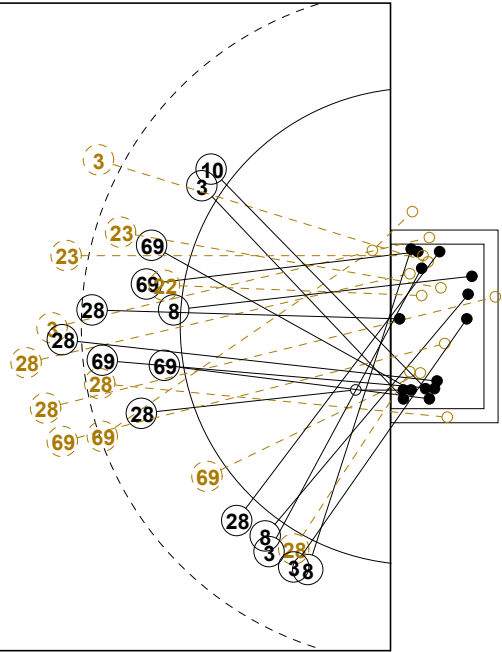
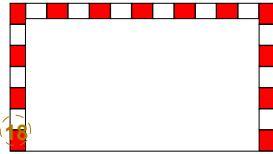

北京 7M

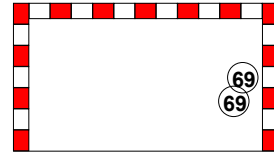

1st Half  
12 : 17

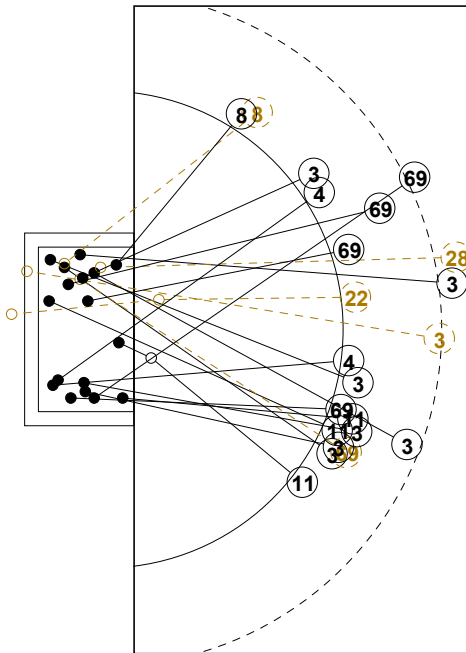

7M 北京

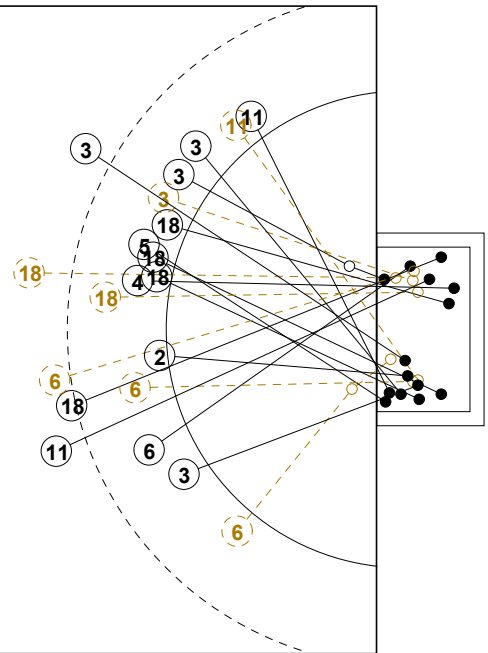
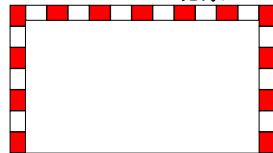

四川 7M

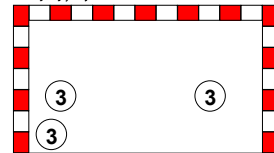

2nd Half  
34 : 29



## 2016年全国女子手球锦标赛

## 个人/全队技术统计表

正式表  
手球  
女子预赛  
轮次 4组别 B  
场次 18201605018-14-1/2  
滁州体育馆  
06/09/2016 16:00

号码	姓名	远射	近射	边射	快攻	突破	任意	7M	合计	%	助攻	失误	警告	2'	取消	时间
<b>北京(北京)</b>																
<i>(场上队员)</i>																
1	宋嘉蕾									0.0%						00:06:44
3	季小桐	2/5	2/2	1/1	4/4	1/1			10/13	76.9%	1	7				00:54:57
4	孙佳		2/2						2/2	100%						00:07:35
6	刘亚男									0.0%						00:00:00
8	杨铭豫		1/1	3/4					4/5	80.0%		1	1			00:53:59
10	刘莎					1/1			1/1	100%						00:11:36
11	纪婉		2/2			1/1			3/3	100%		1				00:35:42
16	王海叶									0.0%						00:51:37
17	杨政赢									0.0%				1		00:02:09
22	李海鸥		0/2						0/2	0.0%		1				00:53:13
23	田媛	0/1					0/1		0/2	0.0%		2	1	1		00:21:04
28	闫美珠	2/6	1/1	1/2					4/9	44.4%	2	3	1	1		00:53:58
33	栾征									0.0%				2		00:12:37
47	刘泽									0.0%						00:01:39
58	李华									0.0%						00:00:00
69	石梓薇	2/4	4/6			2/2		2/2	10/14	71.4%	2	3				00:52:15
<b>合计</b>		6/16	12/16	5/7	4/4	5/5	0/1	2/2	34/51	66.7%	5	18	3	5		
<i>(守门员)</i>																
1	宋嘉蕾		0/3	1/2	0/1			0/1	1/7	14.3%						00:06:44
16	王海叶	7/11	3/4	5/7	1/6	0/6	0/1	0/1	16/36	44.4%						00:51:37
47	刘泽	0/1			0/1			0/1	0/3	0.0%						00:01:39
<b>合计</b>		7/12	3/7	6/9	1/8	0/6	0/1	0/3	17/46	37.0%						

场上队员：得分/射门

守门员：救球/射门

全队合计	得分	被救	射失	击柱	封球	合计	%
远射	6	5	1	4		16	37.5%
近射	12	3	1			16	75.0%
边射	5	2				7	71.4%
快攻	4					4	100.0%
突破	5					5	100.0%
任意		1				1	0.0%
7M	2					2	100.0%







## 2016年全国女子手球锦标赛

## 个人/全队技术统计表

正式表  
手球  
女子预赛  
轮次 4组别 B  
场次 18201605018-14-2/2  
滁州体育馆  
06/09/2016 16:00

号码	姓名	远射	近射	边射	快攻	突破	任意	7M	合计	%	助攻	失误	警告	2'	取消	时间
<b>四川(四川)</b>																
<i>(上场队员)</i>																
1	张雪纯									0.0%						00:00:00
2	陈艳楠		0/1		1/1				1/2	50.0%		1				00:12:03
3	王丹	1/3	0/1	2/2	1/1	2/2	1/1	3/3	10/13	76.9%		7		1		00:57:20
4	尤婉莹	0/1	2/2		1/1	1/1			4/5	80.0%			1			00:47:46
5	孙姣				3/3				3/3	100%		3				01:00:00
6	凤洋	0/1		0/5	0/1	1/1			1/8	12.5%		2				00:48:14
7	练素琪									0.0%						00:00:00
9	姚梦园									0.0%			1			00:25:14
10	高静									0.0%						00:11:27
11	朱海云	2/4	1/1	1/2					4/7	57.1%		1	1			00:54:21
12	宋琛茜									0.0%						01:00:00
17	史雨欣									0.0%						00:00:00
18	戴小宇	2/4	1/2		1/1	2/2		0/1	6/10	60.0%	1	4				00:42:22
27	吴美琪									0.0%						00:00:00
<b>合计</b>																
<i>(守门员)</i>																
12	宋琛茜	5/11	3/15	2/7	0/4	0/5	1/1	0/2	11/45	24.4%						01:00:00
<b>合计</b>																
5/11 3/15 2/7 0/4 0/5 1/1 0/2 11/45 24.4%																

场上队员：得分/射门

守门员：救球/射门

全队合计	得分	被救	射失	击柱	封球	合计	%
远射	5	7		1		13	38.5%
近射	4	3				7	57.1%
边射	3	6				9	33.3%
快攻	7	1				8	87.5%
突破	6					6	100.0%
任意	1					1	100.0%
7M	3			1		4	75.0%





### 2016年全国女子手球锦标赛

#### 图式射门区域统计

轮次 4 场次 18

201605018-41-1/1

## 北京

1 宋嘉蕾	3 季小桐	4 孙佳	6 刘亚男	8 杨铭豫	10 刘莎	11 纪婉	16 王海叶																																																																											
<table border="1"><tr><td></td><td></td><td></td></tr><tr><td></td><td></td><td></td></tr><tr><td></td><td></td><td></td></tr></table>										<table border="1"><tr><td></td><td>1</td><td>2</td></tr><tr><td>3</td><td></td><td>3</td></tr><tr><td></td><td></td><td>1</td></tr></table>		1	2	3		3			1	<table border="1"><tr><td>2</td><td></td><td></td></tr><tr><td></td><td></td><td></td></tr><tr><td></td><td></td><td></td></tr></table>	2									<table border="1"><tr><td></td><td></td><td></td></tr><tr><td></td><td></td><td></td></tr><tr><td></td><td></td><td></td></tr></table>										<table border="1"><tr><td>2</td><td></td><td></td></tr><tr><td></td><td></td><td></td></tr><tr><td>1</td><td></td><td>1</td></tr></table>	2						1		1	<table border="1"><tr><td></td><td></td><td></td></tr><tr><td></td><td></td><td>1</td></tr><tr><td></td><td></td><td></td></tr></table>						1				<table border="1"><tr><td></td><td>1</td><td></td></tr><tr><td></td><td></td><td></td></tr><tr><td>1</td><td>1</td><td></td></tr></table>		1					1	1		<table border="1"><tr><td></td><td></td><td></td></tr><tr><td></td><td></td><td></td></tr><tr><td></td><td></td><td></td></tr></table>												
	1	2																																																																																
3		3																																																																																
		1																																																																																
2																																																																																		
2																																																																																		
1		1																																																																																
		1																																																																																
	1																																																																																	
1	1																																																																																	
Post - 0 Miss - 0 Block - 0	Post - 2 Miss - 0 Block - 0	Post - 0 Miss - 0 Block - 0	Post - 0 Miss - 0 Block - 0	Post - 0 Miss - 0 Block - 0	Post - 0 Miss - 0 Block - 0	Post - 0 Miss - 0 Block - 0	Post - 0 Miss - 0 Block - 0																																																																											
17 杨政赢	22 李海鸥	23 田媛	28 闫美珠	33 栾征	47 刘泽	58 李华	69 石梓薇																																																																											
<table border="1"><tr><td></td><td></td><td></td></tr><tr><td></td><td></td><td></td></tr><tr><td></td><td></td><td></td></tr></table>										<table border="1"><tr><td></td><td></td><td></td></tr><tr><td></td><td></td><td></td></tr><tr><td></td><td></td><td></td></tr></table>										<table border="1"><tr><td></td><td></td><td></td></tr><tr><td></td><td></td><td></td></tr><tr><td></td><td></td><td></td></tr></table>										<table border="1"><tr><td>1</td><td></td><td>1</td></tr><tr><td></td><td></td><td></td></tr><tr><td></td><td>1</td><td>1</td></tr></table>	1		1					1	1	<table border="1"><tr><td></td><td></td><td></td></tr><tr><td></td><td></td><td></td></tr><tr><td></td><td></td><td></td></tr></table>										<table border="1"><tr><td></td><td></td><td></td></tr><tr><td></td><td></td><td></td></tr><tr><td></td><td></td><td></td></tr></table>										<table border="1"><tr><td></td><td></td><td></td></tr><tr><td></td><td></td><td></td></tr><tr><td></td><td></td><td></td></tr></table>										<table border="1"><tr><td></td><td>1</td><td>1</td></tr><tr><td></td><td>1</td><td>1</td></tr><tr><td></td><td>1</td><td>4</td></tr><tr><td></td><td>1</td><td>1</td></tr></table>		1	1		1	1		1	4		1	1
1		1																																																																																
	1	1																																																																																
	1	1																																																																																
	1	1																																																																																
	1	4																																																																																
	1	1																																																																																
Post - 0 Miss - 0 Block - 0	Post - 0 Miss - 1 Block - 0	Post - 0 Miss - 0 Block - 0	Post - 2 Miss - 0 Block - 0	Post - 0 Miss - 0 Block - 0	Post - 0 Miss - 0 Block - 0	Post - 0 Miss - 0 Block - 0	Post - 0 Miss - 1 Block - 0																																																																											

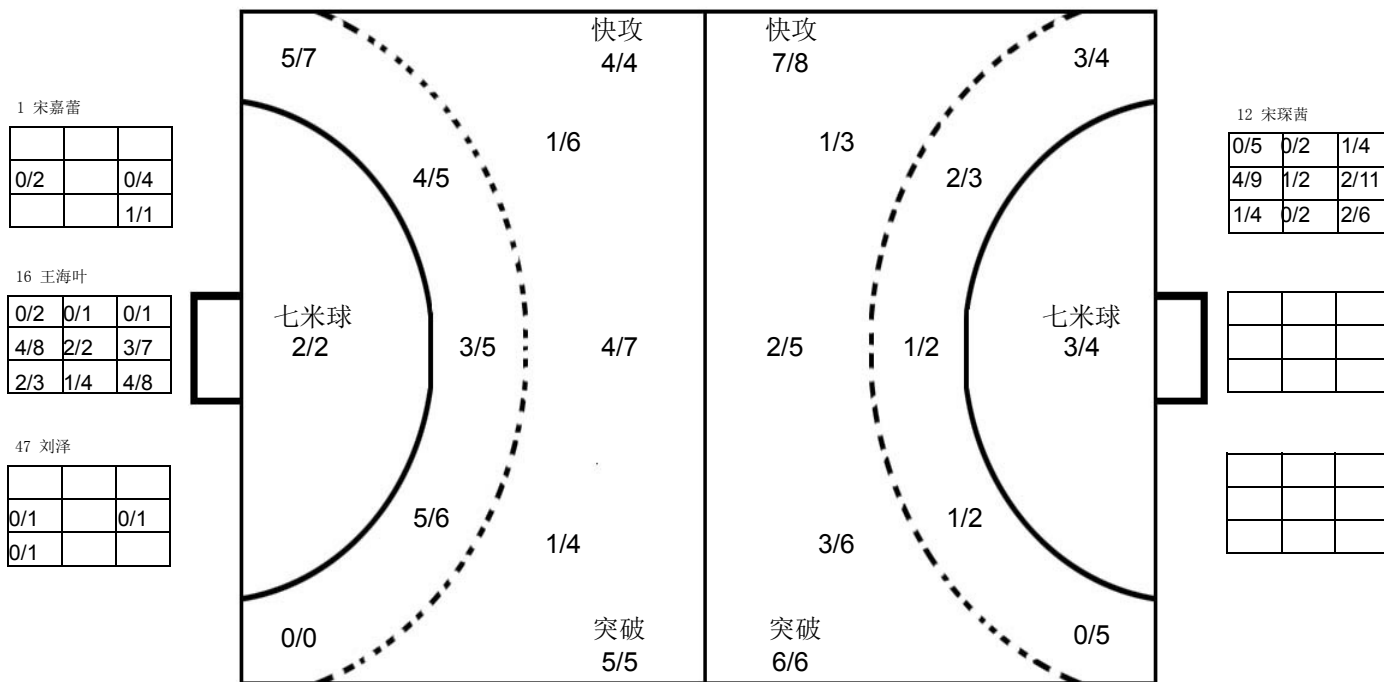

## 四川

1 张雪纯	2 陈艳楠	3 王丹	4 尤婉莹	5 孙姣	6 凤洋	7 练素琪	9 姚梦园																																																																								
<table border="1"><tr><td></td><td></td><td></td></tr><tr><td></td><td></td><td></td></tr><tr><td></td><td></td><td></td></tr></table>										<table border="1"><tr><td></td><td></td><td>1</td></tr><tr><td></td><td></td><td></td></tr><tr><td></td><td></td><td></td></tr></table>			1							<table border="1"><tr><td>1</td><td></td><td>4</td></tr><tr><td>2</td><td>1</td><td>2</td></tr><tr><td></td><td></td><td></td></tr></table>	1		4	2	1	2				<table border="1"><tr><td>1</td><td></td><td>2</td></tr><tr><td></td><td></td><td></td></tr><tr><td></td><td></td><td></td></tr></table>	1		2							<table border="1"><tr><td>2</td><td></td><td></td></tr><tr><td></td><td></td><td>1</td></tr><tr><td></td><td></td><td></td></tr></table>	2					1				<table border="1"><tr><td></td><td></td><td></td></tr><tr><td>1</td><td></td><td></td></tr><tr><td></td><td></td><td></td></tr></table>				1						<table border="1"><tr><td></td><td></td><td></td></tr><tr><td></td><td></td><td></td></tr><tr><td></td><td></td><td></td></tr></table>										<table border="1"><tr><td></td><td></td><td></td></tr><tr><td></td><td></td><td></td></tr><tr><td></td><td></td><td></td></tr></table>									
		1																																																																													
1		4																																																																													
2	1	2																																																																													
1		2																																																																													
2																																																																															
		1																																																																													
1																																																																															
Post - 0 Miss - 0 Block - 0	Post - 0 Miss - 0 Block - 0	Post - 1 Miss - 0 Block - 0	Post - 0 Miss - 0 Block - 0	Post - 0 Miss - 0 Block - 0	Post - 0 Miss - 0 Block - 0	Post - 0 Miss - 0 Block - 0	Post - 0 Miss - 0 Block - 0																																																																								
10 高静	11 朱海云	12 宋琛茜	17 史雨欣	18 戴小宇	27 吴美琪																																																																										
<table border="1"><tr><td></td><td></td><td></td></tr><tr><td></td><td></td><td></td></tr><tr><td></td><td></td><td></td></tr></table>										<table border="1"><tr><td></td><td>1</td><td>1</td></tr><tr><td></td><td></td><td></td></tr><tr><td></td><td>1</td><td>1</td></tr></table>		1	1					1	1	<table border="1"><tr><td></td><td></td><td></td></tr><tr><td></td><td></td><td></td></tr><tr><td></td><td></td><td></td></tr></table>										<table border="1"><tr><td></td><td></td><td></td></tr><tr><td></td><td></td><td></td></tr><tr><td></td><td></td><td></td></tr></table>										<table border="1"><tr><td>1</td><td>1</td><td>1</td></tr><tr><td>1</td><td></td><td>1</td></tr><tr><td></td><td>1</td><td></td></tr></table>	1	1	1	1		1		1		<table border="1"><tr><td></td><td></td><td></td></tr><tr><td></td><td></td><td></td></tr><tr><td></td><td></td><td></td></tr></table>										<table border="1"><tr><td></td><td></td><td></td></tr><tr><td></td><td></td><td></td></tr><tr><td></td><td></td><td></td></tr></table>										<table border="1"><tr><td></td><td></td><td></td></tr><tr><td></td><td></td><td></td></tr><tr><td></td><td></td><td></td></tr></table>									
	1	1																																																																													
	1	1																																																																													
1	1	1																																																																													
1		1																																																																													
	1																																																																														
Post - 0 Miss - 0 Block - 0	Post - 0 Miss - 0 Block - 0	Post - 0 Miss - 0 Block - 0	Post - 0 Miss - 0 Block - 0	Post - 1 Miss - 0 Block - 0	Post - 0 Miss - 0 Block - 0																																																																										

注释: Post=击柱 Miss=射失 Block=被封



预赛 Group A

女子 全国比赛

2016年全国女子手球锦标赛

Team A <b>A 新疆</b>		Team B <b>B 江苏</b>		Match Number <b>19</b>																	
played in China		in the hall 滁州体育馆		on 06/09/2016																	
				at 17:30 hours																	
Spectators																					
Half-time (30')	<b>A</b> 11	<b>B</b> 18	End of playing time	<b>A</b> 20	<b>B</b> 35																
			1st extra time	<b>A</b>	<b>B</b>																
			2nd extra time	<b>A</b>	<b>B</b>																
			After penalty throws	<b>A</b>	<b>B</b>																
Number of 7 m	<b>A</b> 1 / 1	Team time-out		Full name of players and officials																	
	1 06:54	2 37:22	3	1	2																
			Team time-out		<b>B</b> 0 / 3																
					Number of 7 m																
No.	Team <b>A</b>					G	W	2'	D	DR	No.	Team <b>B</b>					G	W	2'	D	DR
3	葛立双					2					1	陆婷									
6	阿孜古					3	1				3	张海侠					1	1			
7	吴志娟					3					4	赵佳芹					2				
10	李静										5	高媛媛					1				
11	陈培培										8	乔如					3				
12	艾敏加尔汉										9	莫蒙蒙					2				
15	兰姝娇					4					10	王可可					2				
17	戴莹莹					1	1	1			11	于源源						1			
18	崔娟					3		1			12	黄霞									
21	锁珊珊										13	黄慧影					4				
23	张艺璇										16	王小华									
26	宋婷婷					2					17	修丽杰					4				
27	谢辰辰										18	韦秋香					1	1			
32	杨雨柔										23	王书慧					8		1		
93	张婷婷					2					33	金梦青					7				
											69	蓝小玲									
A	邓雷										B	金甲洙 (主教练)									
B	于涛 (主教练)										C	马彪									
D	高璇										D	李海鹰									
											E	陈志伟									
<b>A</b>	Signature of Responsible Official of the Teams (Off. A)																			<b>B</b>	
TP	Remarks of Referee / CHA Official																			TP	

Signatures

Referees	王洋 (CHN)	林晓佟 (CHN)		
Techn. Delegates	于中迅 (CHN)			
CHA Official	许宜扬 (CHN)			

Note: Number of 7m Throws Awarded to Team A and B, Goals (G), Warnings (W), Suspensions (2'), Direct Disqualification (D), Disqualification with Report (DR) and Team Penalty (TP).

Table Officials: 李诚 赵涵 Statisticians: 闫冲 陈柱

Printed by PHMS Copyright: IHF / CHA 06/09/2016 18:37:33

Longman Sportsoft  handball@126.com



2016年全国女子手球锦标赛  
竞赛技术统计(媒体表)

Table with match details: 预赛, 组别 A, 轮次 4, 场次 19, 滁州体育馆, 06/09/2016, 201605019-51-1/1, 新疆 vs 江苏, 11:18

裁判员: 王洋 (CHN) / 林晓佟 (CHN)

Main statistics table for Xinjiang and Jiangsu teams, including player names, goals, assists, and game progress.

场上队员: 得分 / 射门

守门员: 救球 / 射门

Legend table for abbreviations: 快攻, 突破, 任意球, 警告, 助攻, etc.





### 2016年全国女子手球锦标赛 图式比赛技术统计表

轮次 4

场次 19

201605019-21-1/1

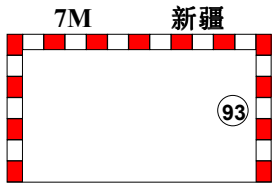
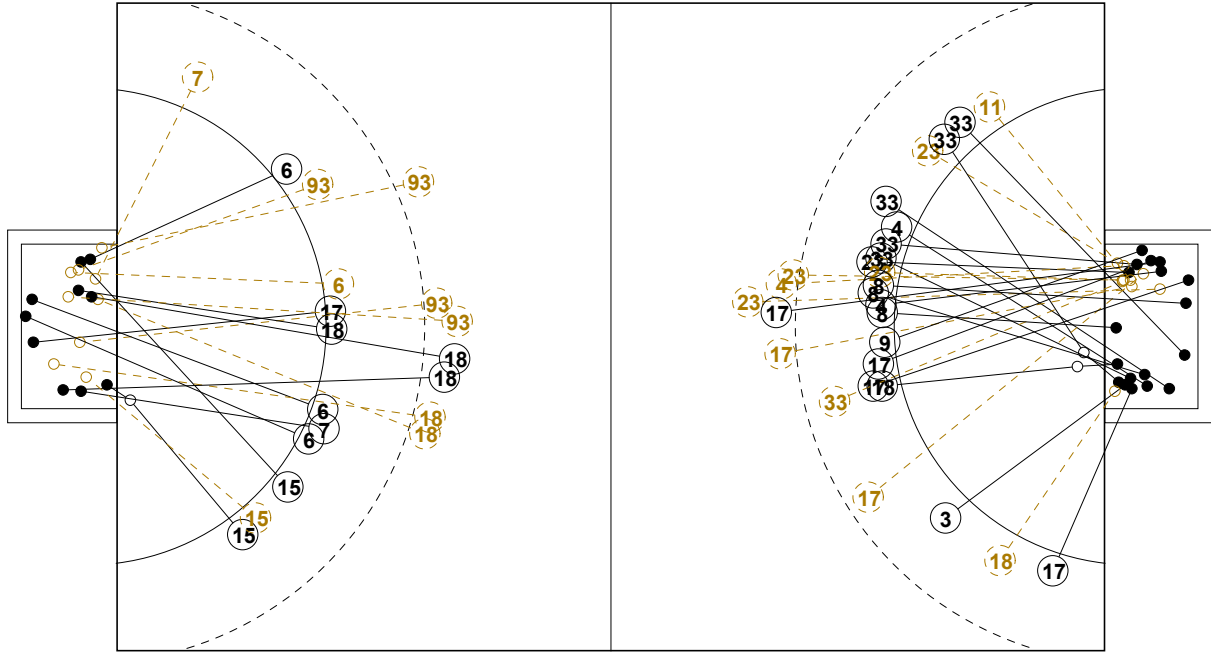

1st Half  
11 : 18

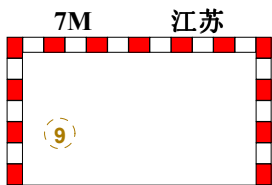
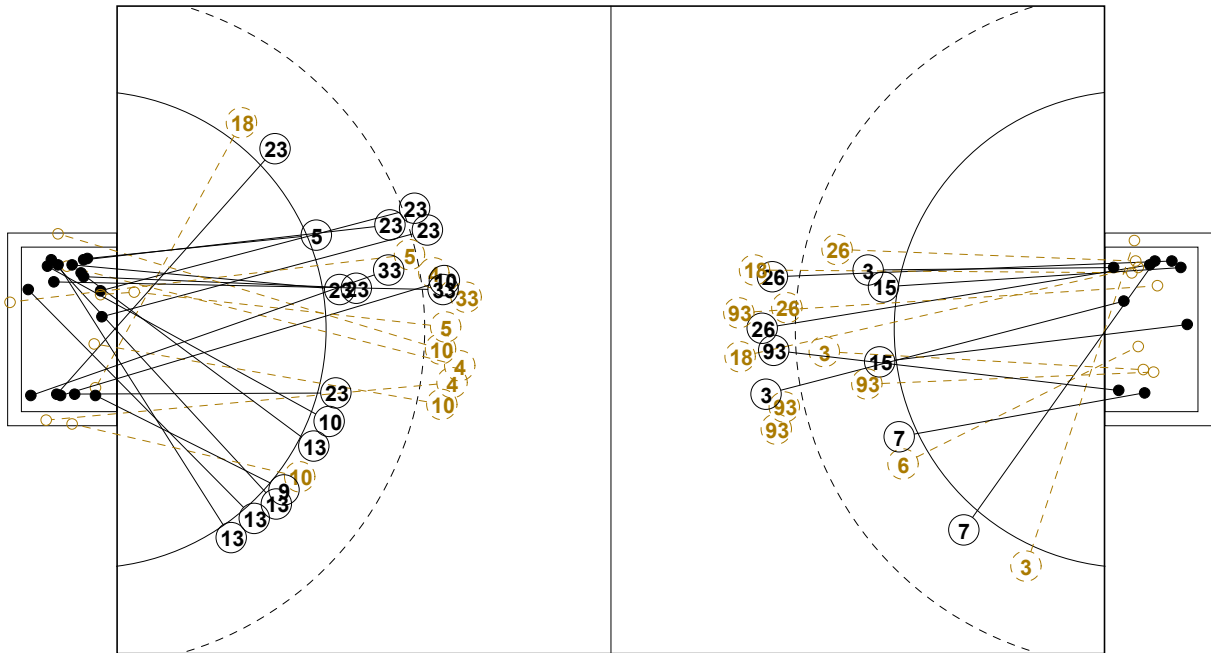
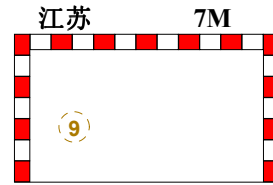

2nd Half  
35 : 20

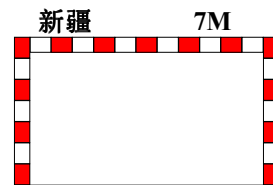



## 2016年全国女子手球锦标赛

## 个人/全队技术统计表

正式表  
手球  
女子预赛  
轮次 4组别 A  
场次 19201605019-14-1/2  
滁州体育馆  
06/09/2016 17:30

号码	姓名	远射	近射	边射	快攻	突破	任意	7M	合计	%	助攻	失误	警告	2'	取消	时间
<b>新疆(新疆)</b>																
<i>(场上队员)</i>																
3	葛立双	1/2		0/1		1/1			2/4	50.0%		3				00:19:45
6	阿孜古		3/4		0/1				3/5	60.0%	1	1	1			00:41:50
7	吴志娟		2/2	1/2					3/4	75.0%	1					00:48:25
10	李静									0.0%						00:13:49
11	陈培培									0.0%						00:00:00
12	艾敏加尔汉									0.0%						00:00:00
15	兰妹娇		2/2			2/3			4/5	80.0%						00:52:32
17	戴莹莹		1/1						1/1	100%			1	1		00:27:21
18	崔娟	1/5	1/1				1/1		3/7	42.9%	1	6		1		00:53:46
21	锁珊珊									0.0%						00:00:00
23	张艺璇									0.0%						00:06:29
26	宋婷婷	2/3	0/1						2/4	50.0%		5				00:19:16
27	谢辰辰									0.0%		1				00:02:04
32	杨雨柔									0.0%		1				00:39:57
93	张婷婷	1/7	0/1			0/1		1/1	2/10	20.0%	1	4				00:50:37
<b>合计</b>		5/17	9/12	1/3	0/1	3/5	1/1	1/1	20/40	50.0%	4	21	2	2		
<i>(守门员)</i>																
10	李静	2/5	0/1	0/1	0/4	0/1			2/12	16.7%						00:13:49
32	杨雨柔	7/11	1/6	3/4	1/13	0/3		2/2	14/39	35.9%		1				00:39:57
<b>合计</b>		9/16	1/7	3/5	1/17	0/4		2/2	16/51	31.4%		1				

场上队员：得分/射门

守门员：救球/射门

全队合计	得分	被救	射失	击柱	封球	合计	%
远射	5	9			3	17	29.4%
近射	9	3				12	75.0%
边射	1	1		1		3	33.3%
快攻		1				1	0.0%
突破	3	2				5	60.0%
任意	1					1	100.0%
7M	1					1	100.0%





## 2016年全国女子手球锦标赛

## 个人/全队技术统计表

正式表  
手球  
女子预赛  
轮次 4组别 A  
场次 19201605019-14-2/2  
滁州体育馆  
06/09/2016 17:30

号码	姓名	远射	近射	边射	快攻	突破	任意	7M	合计	%	助攻	失误	警告	2'	取消	时间
<b>江苏(江苏)</b>																
<i>(上场队员)</i>																
1	陆婷									0.0%						00:00:00
3	张海侠				1/1				1/1	100%		1	1			00:27:36
4	赵佳芹	0/4			1/1	1/1			2/6	33.3%	2	2				00:40:50
5	高媛媛	0/2			1/1				1/3	33.3%						00:09:01
8	乔如		2/2		1/1				3/3	100%						00:15:19
9	莫蒙蒙		1/1		1/1			0/3	2/5	40.0%		1				00:46:00
10	王可可	1/3	0/1			1/1			2/5	40.0%	1					00:23:55
11	于源源			0/1					0/1	0.0%			1			00:16:01
12	黄霞									0.0%	1	1				00:40:43
13	黄慧影			1/1	3/3				4/4	100%						00:19:42
16	王小华									0.0%						00:13:03
17	修丽杰	1/3		1/1	1/1	1/1			4/6	66.7%	1					00:29:51
18	韦秋香			0/2	1/1				1/3	33.3%	1		1			00:29:18
23	王书慧	3/5	2/3		2/3	1/1			8/12	66.7%		1		1		00:21:01
33	金梦青	2/4	1/1		4/4				7/9	77.8%		3				00:30:04
69	蓝小玲									0.0%	1					00:12:20
<b>合计</b>		7/21	6/8	2/5	16/17	4/4		0/3	35/58	60.3%	7	9	3	1		
<i>(守门员)</i>																
12	黄霞	7/12	3/9	0/1	1/1	2/3	0/1	0/1	13/28	46.4%	1	1				00:40:43
16	王小华	2/2	0/3	1/1		0/2			3/8	37.5%						00:13:03
<b>合计</b>		9/14	3/12	1/2	1/1	2/5	0/1	0/1	16/36	44.4%	1	1				

场上队员：得分/射门

守门员：救球/射门

全队合计	得分	被救	射失	击柱	封球	合计	%
远射	7	9		3	2	21	33.3%
近射	6	1		1		8	75.0%
边射	2	3				5	40.0%
快攻	16	1				17	94.1%
突破	4					4	100.0%
任意							0.0%
7M		2	1			3	0.0%





2016年全国女子手球锦标赛

图式射门区域统计

轮次 4 场次 19

201605019-41-1/1

新疆

3 葛立双	6 阿孜古	7 吴志娟	10 李静	11 陈培培	12 艾敏加尔汉	15 兰姝娇	17 戴莹莹																																																																								
<table border="1"><tr><td></td><td></td><td></td></tr><tr><td></td><td></td><td></td></tr><tr><td>1</td><td>1</td><td></td></tr></table>							1	1		<table border="1"><tr><td></td><td>2</td><td></td></tr><tr><td></td><td></td><td></td></tr><tr><td></td><td></td><td>1</td></tr></table>		2							1	<table border="1"><tr><td></td><td></td><td></td></tr><tr><td>2</td><td></td><td>1</td></tr><tr><td></td><td></td><td></td></tr></table>				2		1				<table border="1"><tr><td></td><td></td><td></td></tr><tr><td></td><td></td><td></td></tr><tr><td></td><td></td><td></td></tr></table>										<table border="1"><tr><td></td><td></td><td></td></tr><tr><td></td><td></td><td></td></tr><tr><td></td><td></td><td></td></tr></table>										<table border="1"><tr><td></td><td></td><td></td></tr><tr><td></td><td></td><td></td></tr><tr><td></td><td></td><td></td></tr></table>										<table border="1"><tr><td>1</td><td>1</td><td></td></tr><tr><td></td><td></td><td>1</td></tr><tr><td>1</td><td></td><td></td></tr></table>	1	1				1	1			<table border="1"><tr><td></td><td></td><td></td></tr><tr><td></td><td></td><td></td></tr><tr><td></td><td></td><td></td></tr></table>									
1	1																																																																														
	2																																																																														
		1																																																																													
2		1																																																																													
1	1																																																																														
		1																																																																													
1																																																																															
Post - 1 Miss - 0 Block - 0	Post - 0 Miss - 0 Block - 0	Post - 0 Miss - 0 Block - 0	Post - 0 Miss - 0 Block - 0	Post - 0 Miss - 0 Block - 0	Post - 0 Miss - 0 Block - 0	Post - 0 Miss - 0 Block - 0	Post - 0 Miss - 0 Block - 0																																																																								
18 崔娟	21 锁珊珊	23 张艺璇	26 宋婷婷	27 谢辰辰	32 杨雨柔	93 张婷婷																																																																									
<table border="1"><tr><td></td><td></td><td></td></tr><tr><td>1</td><td></td><td>1</td></tr><tr><td></td><td></td><td>1</td></tr></table>				1		1			1	<table border="1"><tr><td></td><td></td><td></td></tr><tr><td></td><td></td><td></td></tr><tr><td></td><td></td><td></td></tr></table>										<table border="1"><tr><td></td><td></td><td></td></tr><tr><td></td><td></td><td></td></tr><tr><td></td><td></td><td></td></tr></table>										<table border="1"><tr><td>1</td><td></td><td></td></tr><tr><td>1</td><td></td><td></td></tr><tr><td></td><td></td><td></td></tr></table>	1			1						<table border="1"><tr><td></td><td></td><td></td></tr><tr><td></td><td></td><td></td></tr><tr><td></td><td></td><td></td></tr></table>										<table border="1"><tr><td></td><td></td><td></td></tr><tr><td></td><td></td><td></td></tr><tr><td></td><td></td><td></td></tr></table>										<table border="1"><tr><td></td><td></td><td></td></tr><tr><td></td><td></td><td>1</td></tr><tr><td></td><td></td><td>1</td></tr></table>						1			1	<table border="1"><tr><td></td><td></td><td></td></tr><tr><td></td><td></td><td></td></tr><tr><td></td><td></td><td></td></tr></table>									
1		1																																																																													
		1																																																																													
1																																																																															
1																																																																															
		1																																																																													
		1																																																																													
Post - 0 Miss - 0 Block - 0	Post - 0 Miss - 0 Block - 0	Post - 0 Miss - 0 Block - 0	Post - 0 Miss - 0 Block - 1	Post - 0 Miss - 0 Block - 0	Post - 0 Miss - 0 Block - 0	Post - 0 Miss - 0 Block - 2																																																																									

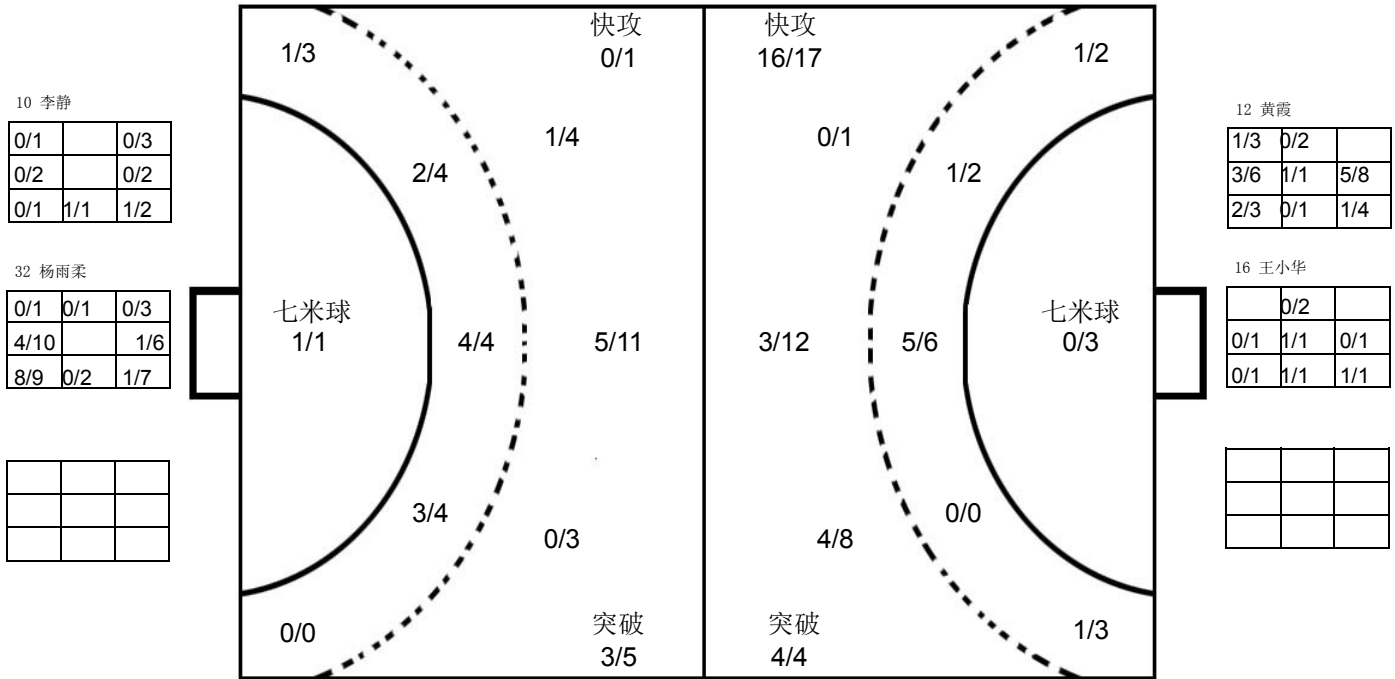

江苏

1 陆婷	3 张海侠	4 赵佳芹	5 高媛媛	8 乔如	9 莫蒙蒙	10 王可可	11 于源源																																																																								
<table border="1"><tr><td></td><td></td><td></td></tr><tr><td></td><td></td><td></td></tr><tr><td></td><td></td><td></td></tr></table>										<table border="1"><tr><td></td><td></td><td></td></tr><tr><td></td><td></td><td></td></tr><tr><td></td><td></td><td>1</td></tr></table>									1	<table border="1"><tr><td></td><td></td><td></td></tr><tr><td>1</td><td></td><td>1</td></tr><tr><td></td><td></td><td></td></tr></table>				1		1				<table border="1"><tr><td></td><td></td><td></td></tr><tr><td></td><td></td><td></td></tr><tr><td></td><td></td><td>1</td></tr></table>									1	<table border="1"><tr><td></td><td>1</td><td></td></tr><tr><td></td><td></td><td>1</td></tr><tr><td></td><td>1</td><td></td></tr></table>		1				1		1		<table border="1"><tr><td></td><td></td><td></td></tr><tr><td>1</td><td></td><td></td></tr><tr><td>1</td><td></td><td></td></tr></table>				1			1			<table border="1"><tr><td></td><td></td><td></td></tr><tr><td>1</td><td></td><td>1</td></tr><tr><td></td><td></td><td></td></tr></table>				1		1				<table border="1"><tr><td></td><td></td><td></td></tr><tr><td></td><td></td><td></td></tr><tr><td></td><td></td><td></td></tr></table>									
		1																																																																													
1		1																																																																													
		1																																																																													
	1																																																																														
		1																																																																													
	1																																																																														
1																																																																															
1																																																																															
1		1																																																																													
Post - 0 Miss - 0 Block - 0	Post - 0 Miss - 0 Block - 0	Post - 1 Miss - 0 Block - 1	Post - 1 Miss - 0 Block - 0	Post - 0 Miss - 0 Block - 0	Post - 0 Miss - 1 Block - 0	Post - 2 Miss - 0 Block - 0	Post - 0 Miss - 0 Block - 0																																																																								
12 黄霞	13 黄慧影	16 王小华	17 修丽杰	18 韦秋香	23 王书慧	33 金梦青	69 蓝小玲																																																																								
<table border="1"><tr><td></td><td></td><td></td></tr><tr><td></td><td></td><td></td></tr><tr><td></td><td></td><td></td></tr></table>										<table border="1"><tr><td></td><td></td><td>2</td></tr><tr><td></td><td></td><td>2</td></tr><tr><td></td><td></td><td></td></tr></table>			2			2				<table border="1"><tr><td></td><td></td><td></td></tr><tr><td></td><td></td><td></td></tr><tr><td></td><td></td><td></td></tr></table>										<table border="1"><tr><td>1</td><td></td><td></td></tr><tr><td>2</td><td></td><td></td></tr><tr><td></td><td></td><td>1</td></tr></table>	1			2					1	<table border="1"><tr><td></td><td></td><td></td></tr><tr><td></td><td></td><td></td></tr><tr><td></td><td></td><td>1</td></tr></table>									1	<table border="1"><tr><td></td><td></td><td></td></tr><tr><td>2</td><td></td><td>3</td></tr><tr><td>1</td><td>1</td><td>1</td></tr></table>				2		3	1	1	1	<table border="1"><tr><td>1</td><td></td><td>3</td></tr><tr><td>1</td><td></td><td></td></tr><tr><td></td><td></td><td>2</td></tr></table>	1		3	1					2	<table border="1"><tr><td></td><td></td><td></td></tr><tr><td></td><td></td><td></td></tr><tr><td></td><td></td><td></td></tr></table>									
		2																																																																													
		2																																																																													
1																																																																															
2																																																																															
		1																																																																													
		1																																																																													
2		3																																																																													
1	1	1																																																																													
1		3																																																																													
1																																																																															
		2																																																																													
Post - 0 Miss - 0 Block - 0	Post - 0 Miss - 0 Block - 0	Post - 0 Miss - 0 Block - 0	Post - 0 Miss - 0 Block - 0	Post - 0 Miss - 0 Block - 0	Post - 0 Miss - 0 Block - 0	Post - 0 Miss - 0 Block - 1	Post - 0 Miss - 0 Block - 0																																																																								

注释: Post=击柱 Miss=射失 Block=被封







预赛 Group A

女子 全国比赛

2016年全国女子手球锦标赛

Team A A 广西				Team B B 安徽				Match Number 20														
played in China		in the hall 滁州体育馆		on 06/09/2016		at 19:00 hours		Spectators														
Half-time (30')	A 8	B 28	End of playing time	A 8	B 28	1st extra time	A	B	2nd extra time	A	B	After penalty throws	A	B								
Number of 7 m	A 0/0	Team time-out			Full name of players and officials				Team time-out			B 2/3	Number of 7 m									
No.	Team A					G	W	2'	D	DR	No.	Team B					G	W	2'	D	DR	
1	胡霜梅										1	司艳										
2	陆雪云										3	李兵					2					
5	黄海玉										5	班晨晨					5					
6	韦惠文										6	沈萍					3	1				
7	廖露										7	赵江川										
8	韦如芳										8	徐仕媛										
9	蓝雪梅					2	1				10	孙来苗					1					
10	周琴										14	刘晓妹					3					
11	曾蓝花					5					16	朱莉珍										
12	江燕红										17	周婷					2					
14	黄艳芳										18	郑冬冬					3					
15	陈依依										20	周雪婷										
16	商志运										21	李瑶					3					
17	杨杨						1				23	张天洁					2					
18	庞娇					1	1				41	杜机娟					4					
											46	陶传红										
C	王林										A	吴立军										
D	刘雪波										E	张舜										
A																			Signature of Responsible Official of the Teams (Off. A)		B	
TP	Remarks of Referee / CHA Official																		TP			

Signatures

Referees: 马晓晔 (CHN) 刘正松 (CHN)

Techn. Delegates: 吴国忠 (CHN)

CHA Official: 于中迅 (CHN)

Note: Number of 7m Throws Awarded to Team A and B, Goals (G), Warnings (W), Suspensions (2'), Direct Disqualification (D), Disqualification with Report (DR) and Team Penalty (TP).

Table Officials: 佟金政 贾俊秋 Statisticians: 陈柱 闫冲

Printed by PHMS Copyright: IHF/CHA 06/09/2016 19:22:56

Longman Sportsoft handball@126.com





## 2016年全国女子手球锦标赛 竞赛技术统计(媒体表)

<b>预赛</b>	组别	<b>A</b>	轮次	<b>4</b>	场次	<b>20</b>
滁州体育馆			06/09/2016		201605020-51-1/1	
广西	<b>广西</b>	<b>8</b>	vs	<b>28</b>	<b>安徽</b>	安徽
			<b>8 : 28</b>			

裁判员	马晓晔 (CHN)	/	刘正松 (CHN)
-----	-----------	---	-----------

广西		远	近	边	快	突	任意	7m	合计	%	助攻	失误	警告	2'	D & DR	比赛进程		
主教练： 王林		射	射	射	攻	破	球	球								广西	安徽	
1	胡霜梅															0	00:32	1 6 沈萍
2	陆雪云															1	01:15	1 李兵
5	黄海玉	0/2							0/2	0.0		1				1	01:36	2 5 班晨晨
6	韦惠文															1	04:07	3 6 沈萍
7	廖露															1	04:43	4 21 李瑶
8	韦如芳															2	05:04	4 孙来苗
9	蓝雪梅	2/4	0/1						2/5	40.0		3	1			2	05:14	5 10 孙来苗
10	周琴	0/1							0/1	0.0		1				2	06:17	6 6 沈萍
11	曾蓝花	5/11							5/11	45.5	1	3				3	07:11	6 李瑶
12	江燕红															3	08:08	7 21 李瑶
14	黄艳芳		0/1						0/1	0.0						3	08:44	8 3 李兵
15	陈依依															3	10:23	9 17 周婷
16	商志运															4	11:12	9 杜机娟
17	杨杨	0/3					0/1	0/4	0.0	0.0		1	1			4	11:23	10 41 杜机娟
18	庞娇	1/6						1/6	16.7	16.7						4	12:21	11 41 杜机娟
<b>运动员 合计</b>		<b>8/27</b>	<b>0/2</b>				<b>0/1</b>	<b>8/30</b>	<b>26.7</b>	<b>26.7</b>	<b>1</b>	<b>11</b>	<b>3</b>			4	13:57	12 3 李兵
12	江燕红	0/4	0/12	1/5	2/7	0/1		0/2	3/31	9.7						4	14:36	13 41 杜机娟
<b>守门员 合计</b>		<b>0/4</b>	<b>0/12</b>	<b>1/5</b>	<b>2/7</b>	<b>0/1</b>		<b>0/2</b>	<b>3/31</b>	<b>9.7</b>						4	15:18	14 17 周婷
<b>安徽</b>		远	近	边	快	突	任意	7m	合计	%	助攻	失误	警告	2'	D & DR			
<b>教练： 孙来苗</b>		射	射	射	攻	破	球	球										
1	司艳																	
3	李兵		2/2						2/2	100								
5	班晨晨		5/5						5/5	100								
6	沈萍	2/2			1/1				3/3	100			1					
7	赵江川																	
8	徐仕媛																	
10	孙来苗		1/1					1/1	100	100								
14	刘晓妹	2/2			1/1			3/3	100	100	2							
16	朱莉珍										2							
17	周婷		2/2					0/1	2/3	66.7	3	1						
18	郑冬冬		1/1	1/1		1/1		3/3	100	100								
20	周雪婷											1						
21	李瑶		1/1	0/1	2/2			3/4	75.0	75.0	2	2						
23	张天洁			1/1	1/1			2/2	100	100								
41	杜机娟			2/2	0/2			2/2	4/6	66.7								
46	陶传红																	
<b>运动员 合计</b>		<b>4/4</b>	<b>12/12</b>	<b>4/5</b>	<b>5/7</b>	<b>1/1</b>		<b>2/3</b>	<b>28/32</b>	<b>87.5</b>	<b>9</b>	<b>4</b>	<b>1</b>					
16	朱莉珍	8/16	2/2					10/18	55.6	55.6	2							
<b>守门员 合计</b>		<b>8/16</b>	<b>2/2</b>					<b>10/18</b>	<b>55.6</b>	<b>55.6</b>	<b>2</b>							

场上队员： 得分 / 射门

守门员： 救球 / 射门

快攻	Fast Break		突破	Breakthrough		任意球	Free Throw		7M球	7M Throw		助攻	Assist
警告	Warning		失误	Error		2'	Suspension		D	取消资格		DR	取消资格+报告



### 2016年全国女子手球锦标赛 图式比赛技术统计表

轮次 4

场次 20

201605020-21-1/1

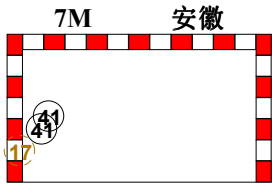
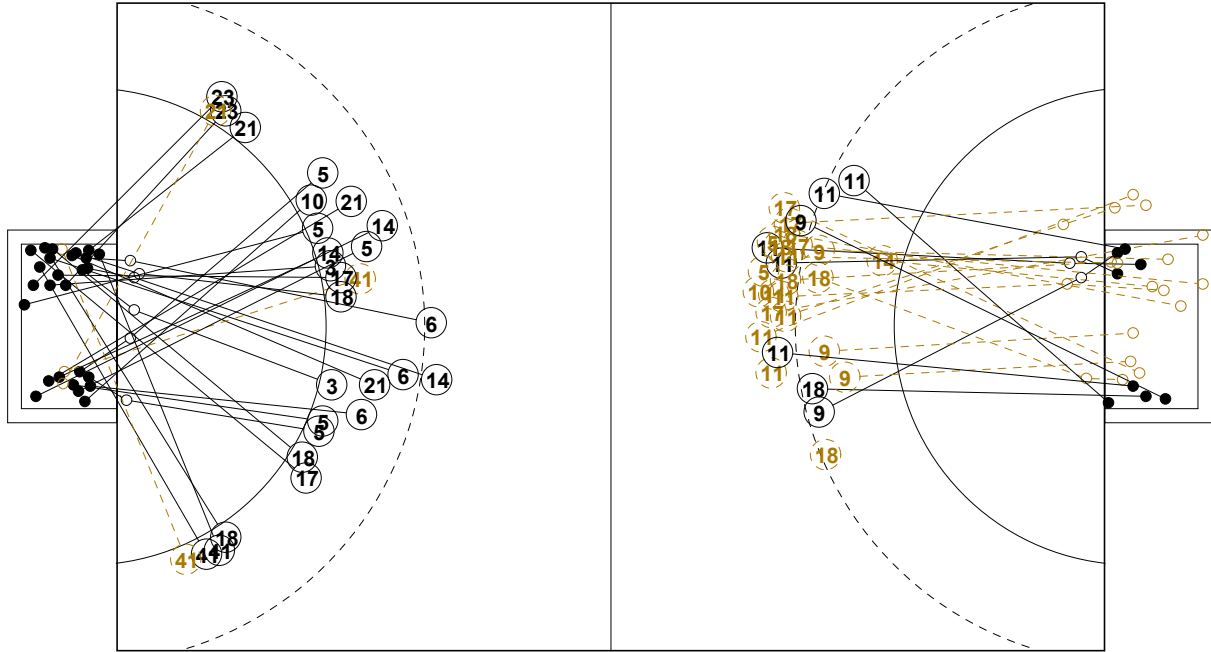

1st Half  
28 : 8

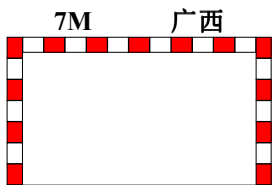
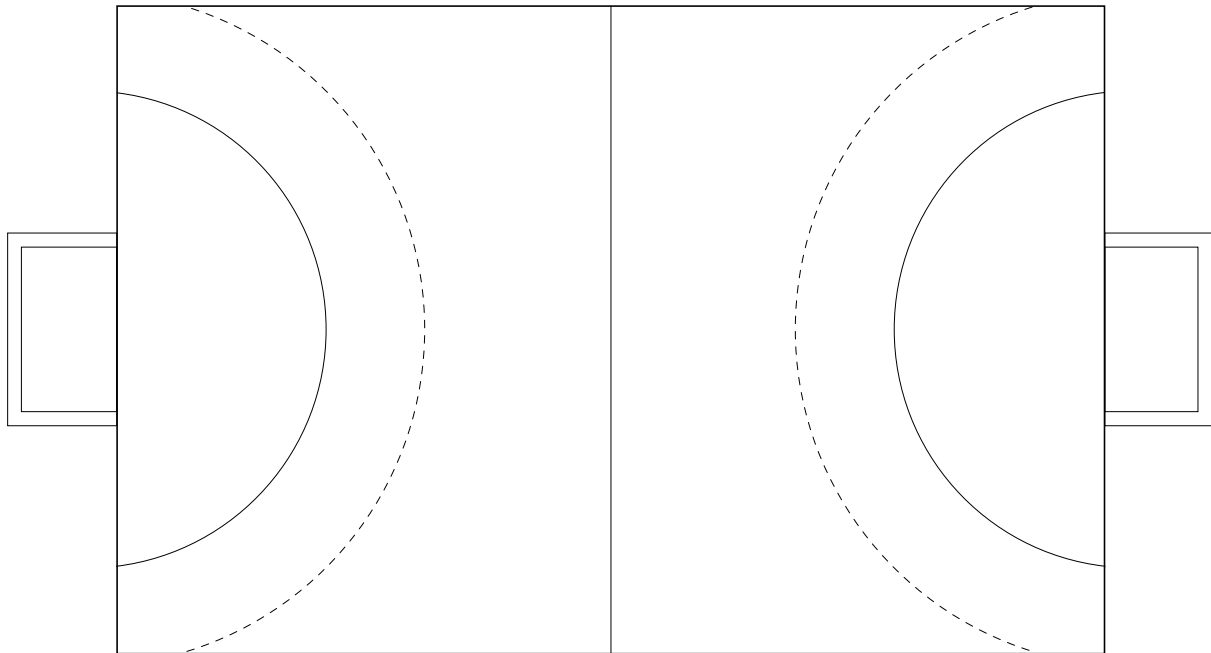
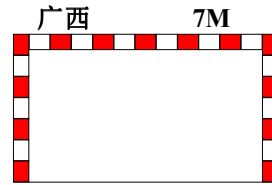

2nd Half  
8 : 28

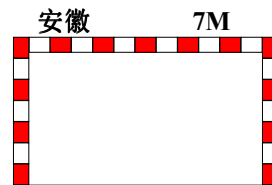



## 2016年全国女子手球锦标赛

## 个人/全队技术统计表

正式表  
手球  
女子预赛  
轮次 4组别 A  
场次 20201605020-14-1/2  
滁州体育馆  
06/09/2016 19:00

号码	姓名	远射	近射	边射	快攻	突破	任意	7M	合计	%	助攻	失误	警告	2'	取消	时间
<b>广西(广西)</b>																
<i>(场上队员)</i>																
1	胡霜梅									0.0%						00:00:00
2	陆雪云									0.0%						00:00:00
5	黄海玉	0/2							0/2	0.0%		1				00:21:58
6	韦惠文									0.0%						00:21:09
7	廖露									0.0%						00:00:00
8	韦如芳									0.0%						00:08:50
9	蓝雪梅	2/4	0/1						2/5	40.0%		3	1			00:19:27
10	周琴	0/1							0/1	0.0%		1				00:08:01
11	曾蓝花	5/11							5/11	45.5%	1	3				00:23:30
12	江燕红									0.0%						00:30:00
14	黄艳芳		0/1						0/1	0.0%		2				00:25:33
15	陈依依									0.0%						00:03:51
16	商志运									0.0%						00:00:00
17	杨杨	0/3					0/1		0/4	0.0%		1	1			00:30:00
18	庞娇	1/6							1/6	16.7%			1			00:17:25
<b>合计</b>		8/27	0/2				0/1		8/30	26.7%	1	11	3			
<i>(守门员)</i>																
12	江燕红	0/4	0/12	1/5	2/7	0/1		0/2	3/31	9.7%						00:30:00
<b>合计</b>		0/4	0/12	1/5	2/7	0/1		0/2	3/31	9.7%						

场上队员：得分/射门

守门员：救球/射门

全队合计	得分	被救	射失	击柱	封球	合计	%
远射	8	8	2	2	7	27	29.6%
近射		2				2	0.0%
边射							0.0%
快攻							0.0%
突破							0.0%
任意			1			1	0.0%
7M							0.0%





## 2016年全国女子手球锦标赛

## 个人/全队技术统计表

正式表  
手球  
女子预赛  
轮次 4组别 A  
场次 20201605020-14-2/2  
滁州体育馆  
06/09/2016 19:00

号码	姓名	远射	近射	边射	快攻	突破	任意	7M	合计	%	助攻	失误	警告	2'	取消	时间
<b>安徽(安徽)</b>																
<i>(上场队员)</i>																
1	司艳									0.0%						00:00:00
3	李兵		2/2						2/2	100%						00:19:15
5	班晨晨		5/5						5/5	100%						00:18:04
6	沈萍	2/2			1/1				3/3	100%			1			00:13:49
7	赵江川									0.0%						00:00:00
8	徐仕媛									0.0%						00:00:00
10	孙来苗		1/1						1/1	100%						00:16:40
14	刘晓妹	2/2			1/1				3/3	100%	2					00:16:10
16	朱莉珍									0.0%	2					00:30:00
17	周婷		2/2					0/1	2/3	66.7%	3	1				00:21:18
18	郑冬冬		1/1	1/1		1/1			3/3	100%						00:08:41
20	周雪婷									0.0%		1				00:09:32
21	李瑶		1/1	0/1	2/2				3/4	75.0%	2	2				00:25:13
23	张天洁			1/1	1/1				2/2	100%						00:13:20
41	杜机娟			2/2	0/2			2/2	4/6	66.7%						00:17:49
46	陶传红									0.0%						00:00:00
<b>合计</b>		4/4	12/12	4/5	5/7	1/1		2/3	28/32	87.5%	9	4	1			
<i>(守门员)</i>																
16	朱莉珍	8/16	2/2						10/18	55.6%	2					00:30:00
<b>合计</b>																
		8/16	2/2						10/18	55.6%	2					

场上队员：得分/射门

守门员：救球/射门

全队合计	得分	被救	射失	击柱	封球	合计	%
远射	4					4	100.0%
近射	12					12	100.0%
边射	4	1				5	80.0%
快攻	5	2				7	71.4%
突破	1					1	100.0%
任意							0.0%
7M	2			1		3	66.7%





2016年全国女子手球锦标赛

图式射门区域统计

轮次 4 场次 20

201605020-41-1/1

广西

1 胡霜梅	2 陆雪云	5 黄海玉	6 韦惠文	7 廖露	8 韦如芳	9 蓝雪梅	10 周琴																																																																								
<table border="1"><tr><td></td><td></td><td></td></tr><tr><td></td><td></td><td></td></tr><tr><td></td><td></td><td></td></tr></table>										<table border="1"><tr><td></td><td></td><td></td></tr><tr><td></td><td></td><td></td></tr><tr><td></td><td></td><td></td></tr></table>										<table border="1"><tr><td></td><td></td><td></td></tr><tr><td></td><td></td><td></td></tr><tr><td></td><td></td><td></td></tr></table>										<table border="1"><tr><td></td><td></td><td></td></tr><tr><td></td><td></td><td></td></tr><tr><td></td><td></td><td></td></tr></table>										<table border="1"><tr><td></td><td></td><td></td></tr><tr><td></td><td></td><td></td></tr><tr><td></td><td></td><td></td></tr></table>										<table border="1"><tr><td></td><td></td><td></td></tr><tr><td></td><td></td><td></td></tr><tr><td></td><td></td><td></td></tr></table>										<table border="1"><tr><td></td><td></td><td>1</td></tr><tr><td></td><td></td><td></td></tr><tr><td>1</td><td></td><td></td></tr></table>			1				1			<table border="1"><tr><td></td><td></td><td></td></tr><tr><td></td><td></td><td></td></tr><tr><td></td><td></td><td></td></tr></table>									
		1																																																																													
1																																																																															
Post - 0 Miss - 0 Block - 0	Post - 0 Miss - 0 Block - 0	Post - 0 Miss - 0 Block - 2	Post - 0 Miss - 0 Block - 0	Post - 0 Miss - 0 Block - 0	Post - 0 Miss - 0 Block - 0	Post - 0 Miss - 0 Block - 0	Post - 0 Miss - 0 Block - 1																																																																								
11 曾蓝花	12 江燕红	14 黄艳芳	15 陈依依	16 商志运	17 杨杨	18 庞娇																																																																									
<table border="1"><tr><td>1</td><td></td><td></td></tr><tr><td></td><td></td><td></td></tr><tr><td>2</td><td></td><td>2</td></tr></table>	1						2		2	<table border="1"><tr><td></td><td></td><td></td></tr><tr><td></td><td></td><td></td></tr><tr><td></td><td></td><td></td></tr></table>										<table border="1"><tr><td></td><td></td><td></td></tr><tr><td></td><td></td><td></td></tr><tr><td></td><td></td><td></td></tr></table>										<table border="1"><tr><td></td><td></td><td></td></tr><tr><td></td><td></td><td></td></tr><tr><td></td><td></td><td></td></tr></table>										<table border="1"><tr><td></td><td></td><td></td></tr><tr><td></td><td></td><td></td></tr><tr><td></td><td></td><td></td></tr></table>										<table border="1"><tr><td></td><td></td><td></td></tr><tr><td></td><td></td><td></td></tr><tr><td></td><td></td><td></td></tr></table>										<table border="1"><tr><td></td><td></td><td>1</td></tr><tr><td></td><td></td><td></td></tr><tr><td></td><td></td><td></td></tr></table>			1							<table border="1"><tr><td></td><td></td><td></td></tr><tr><td></td><td></td><td></td></tr><tr><td></td><td></td><td></td></tr></table>									
1																																																																															
2		2																																																																													
		1																																																																													
Post - 0 Miss - 2 Block - 2	Post - 0 Miss - 0 Block - 0	Post - 0 Miss - 0 Block - 0	Post - 0 Miss - 0 Block - 0	Post - 0 Miss - 0 Block - 0	Post - 2 Miss - 1 Block - 0	Post - 0 Miss - 0 Block - 2																																																																									

12 江燕红

0/2	0/1	0/7
2/9		1/6
0/2		0/4



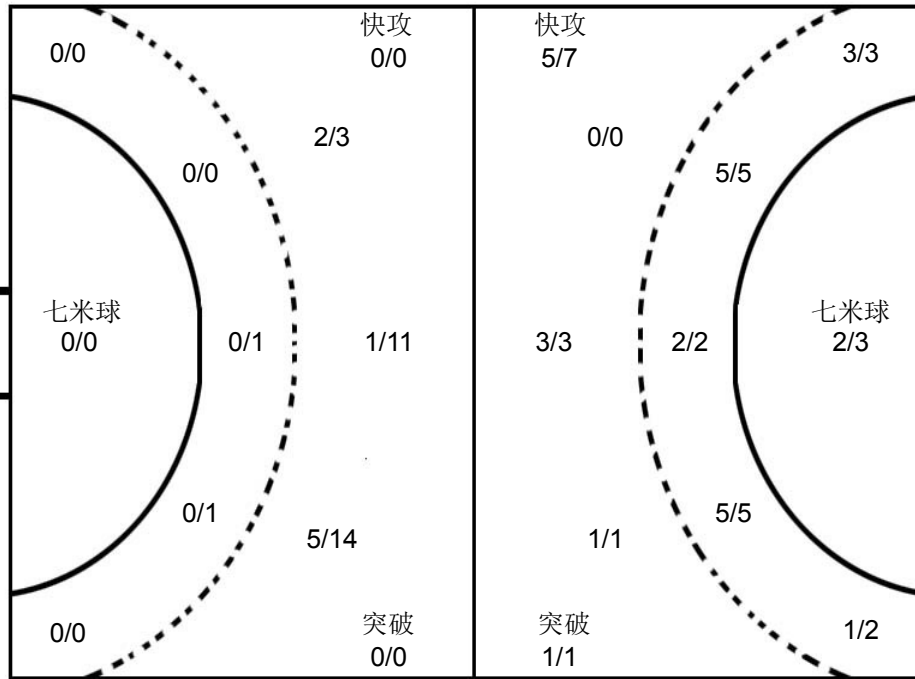

16 朱莉珍

1/1	1/1	
2/3		1/3
2/5	1/1	2/4



安徽

1 司艳	3 李兵	5 班晨晨	6 沈萍	7 赵江川	8 徐仕媛	10 孙来苗	14 刘晓妹																																																																								
<table border="1"><tr><td></td><td></td><td></td></tr><tr><td></td><td></td><td></td></tr><tr><td></td><td></td><td></td></tr></table>										<table border="1"><tr><td></td><td></td><td>1</td></tr><tr><td></td><td></td><td>1</td></tr><tr><td></td><td></td><td></td></tr></table>			1			1				<table border="1"><tr><td></td><td>1</td><td></td></tr><tr><td>3</td><td></td><td></td></tr><tr><td>1</td><td></td><td></td></tr></table>		1		3			1			<table border="1"><tr><td></td><td></td><td>1</td></tr><tr><td>1</td><td></td><td>1</td></tr><tr><td></td><td></td><td></td></tr></table>			1	1		1				<table border="1"><tr><td></td><td></td><td></td></tr><tr><td></td><td></td><td></td></tr><tr><td></td><td></td><td></td></tr></table>										<table border="1"><tr><td></td><td></td><td></td></tr><tr><td></td><td></td><td></td></tr><tr><td></td><td></td><td></td></tr></table>										<table border="1"><tr><td></td><td></td><td></td></tr><tr><td>1</td><td></td><td></td></tr><tr><td></td><td></td><td></td></tr></table>				1						<table border="1"><tr><td></td><td></td><td>1</td></tr><tr><td>1</td><td></td><td></td></tr><tr><td></td><td></td><td>1</td></tr></table>			1	1					1
		1																																																																													
		1																																																																													
	1																																																																														
3																																																																															
1																																																																															
		1																																																																													
1		1																																																																													
1																																																																															
		1																																																																													
1																																																																															
		1																																																																													
Post - 0 Miss - 0 Block - 0	Post - 0 Miss - 0 Block - 0	Post - 0 Miss - 0 Block - 0	Post - 0 Miss - 0 Block - 0	Post - 0 Miss - 0 Block - 0	Post - 0 Miss - 0 Block - 0	Post - 0 Miss - 0 Block - 0	Post - 0 Miss - 0 Block - 0																																																																								
16 朱莉珍	17 周婷	18 郑冬冬	20 周雪婷	21 李瑶	23 张天洁	41 杜机娟	46 陶传红																																																																								
<table border="1"><tr><td></td><td></td><td></td></tr><tr><td></td><td></td><td></td></tr><tr><td></td><td></td><td></td></tr></table>										<table border="1"><tr><td></td><td></td><td>1</td></tr><tr><td></td><td></td><td>1</td></tr><tr><td></td><td></td><td></td></tr></table>			1			1				<table border="1"><tr><td></td><td></td><td>2</td></tr><tr><td></td><td></td><td>1</td></tr><tr><td></td><td></td><td></td></tr></table>			2			1				<table border="1"><tr><td></td><td></td><td></td></tr><tr><td></td><td></td><td></td></tr><tr><td></td><td></td><td></td></tr></table>										<table border="1"><tr><td>1</td><td></td><td></td></tr><tr><td></td><td></td><td>1</td></tr><tr><td></td><td></td><td>1</td></tr></table>	1					1			1	<table border="1"><tr><td></td><td></td><td>1</td></tr><tr><td></td><td></td><td>1</td></tr><tr><td></td><td></td><td></td></tr></table>			1			1				<table border="1"><tr><td></td><td></td><td>1</td></tr><tr><td>2</td><td></td><td></td></tr><tr><td></td><td></td><td>1</td></tr></table>			1	2					1	<table border="1"><tr><td></td><td></td><td></td></tr><tr><td></td><td></td><td></td></tr><tr><td></td><td></td><td></td></tr></table>									
		1																																																																													
		1																																																																													
		2																																																																													
		1																																																																													
1																																																																															
		1																																																																													
		1																																																																													
		1																																																																													
		1																																																																													
		1																																																																													
2																																																																															
		1																																																																													
Post - 0 Miss - 0 Block - 0	Post - 1 Miss - 0 Block - 0	Post - 0 Miss - 0 Block - 0	Post - 0 Miss - 0 Block - 0	Post - 0 Miss - 0 Block - 0	Post - 0 Miss - 0 Block - 0	Post - 0 Miss - 0 Block - 0	Post - 0 Miss - 0 Block - 0																																																																								

注释: Post=击柱 Miss=射失 Block=被封





预赛 Group A

女子 全国比赛

2016年全国女子手球锦标赛

Team A <b>A 黑龙江</b>				Team B <b>B 山东</b>				Match Number <b>21</b>													
played in China		in the hall 滁州体育馆		on 06/09/2016		at 20:30 hours		Spectators													
Half-time (30')	<b>A</b> 4	<b>B</b> 22	End of playing time	<b>A</b> 4	<b>B</b> 22	1st extra time	<b>A</b>	<b>B</b>	2nd extra time	<b>A</b>	<b>B</b>	After penalty throws	<b>A</b>	<b>B</b>							
Number of 7 m	<b>A</b> 0/0	Team time-out 1 08:51 2 17:31 3			Full name of players and officials				Team time-out 1 2 3			<b>B</b> 1/2	Number of 7 m								
No.	Team <b>A</b>					G	W	2'	D	DR	No.	Team <b>B</b>					G	W	2'	D	DR
1	徐佳蓉										1	路畅									
3	刘诗彤						1				2	林燕群					9	1			
5	周美微										7	杨嘉露									
6	王梦艺										8	王彬									
9	郑宇					1	1				9	周钰婷									
10	刘雪露										10	田秀秀					3				
11	刘天茹										11	吕青纹					3				
12	肖宁桐										12	张苑琳									
13	吴佳					3		1			15	吴作扬					2				
14	黄荣										19	姜伟珊									
16	杜宪										20	张悦					2				
19	梁文煜										22	朱赟									
21	王戈						1				23	徐悦					1				
22	马琳										28	崔金娜					2				
23	张政										33	王彩琳									
											77	穆庆丛									
B	张立梅 (主教练)										B	马海湧 (主教练)									
C	黄冬杰										C	徐强									
D	于兹香										E	王日东									
E	马婧																				
<b>A</b>	Signature of Responsible Official of the Teams (Off. A)																		<b>B</b>		
TP	Remarks of Referee / CHA Official																		TP		

Signatures

Referees: 邓军 (CHN) 杜新 (CHN)

Techn. Delegates: 高斌 (CHN)

CHA Official: 吴国忠 (CHN)

Note: Number of 7m Throws Awarded to Team A and B, Goals (G), Warnings (W), Suspensions (2'), Direct Disqualification (D), Disqualification with Report (DR) and Team Penalty (TP).

Table Officials: 佟金政 贾俊秋 Statisticians: 陈柱 闫冲

Printed by PHMS Copyright: IHF/CHA 06/09/2016 20:44:47

Longman Sportsoft handball@126.com



2016年全国女子手球锦标赛  
竞赛技术统计(媒体表)

预赛	组别	A	轮次	4	场次	21
滁州体育馆		06/09/2016			201605021-51-1/1	
黑龙江	黑龙江	4	vs	22	山东	山东
				4 : 22		

裁判员	邓军 (CHN)	/	杜新 (CHN)
-----	----------	---	----------

黑龙江		远射	近射	边射	快攻	突破	任意球	7m球	合计	%	助攻	失误	警告	2'	D & DR	黑龙江	比赛进程	山东
主教练：张立梅																		
1	徐佳蓉																01:09	1 28 崔金娜
3	刘诗彤												1				03:10	1 林燕群
5	周美微																03:37	2 2 林燕群
6	王梦艺	0/1	0/1					0/2	0.0			1					06:24	3 10 田秀秀
9	郑宇	1/3						1/3	33.3			3	1				08:01	4 2 林燕群
10	刘雪露	0/2						0/2	0.0								08:42	5 15 吴作扬
11	刘天茹												1				10:04	6 2 林燕群
12	肖宁桐																10:48	6 林燕群
13	吴佳	2/5		0/1			1/1	3/7	42.9			3		1			12:04	7 11 吕青纹
14	黄荣																13:38	8 10 田秀秀
16	杜宪																14:58	9 20 张悦
19	梁文煜	0/2	0/1					0/3	0.0			3					16:35	10 20 张悦
21	王戈	0/1		0/1				0/2	0.0			1	1				17:19	11 28 崔金娜
22	马琳	0/1						0/1	0.0			1					18:18	11 林燕群
23	张政																18:28	12 2 林燕群
运动员 合计		3/15	0/2	0/2			1/1	4/20	20.0			13	3	1			19:12	13 2 林燕群
1	徐佳蓉	1/2	0/6	0/1	0/2		1/1	2/12	16.7								20:24	14 2 林燕群
12	肖宁桐	1/3	1/5	0/1	0/3	0/1	0/1	2/14	14.3								21:01	15 10 田秀秀
守门员 合计		2/5	1/11	0/2	0/5	0/1	1/2	4/26	15.4								21:40	15 林燕群

山东		远射	近射	边射	快攻	突破	任意球	7m球	合计	%	助攻	失误	警告	2'	D & DR
教练：马海湧															
1	路畅														
2	林燕群	1/1	3/4	1/1	2/2	1/1		1/2	9/11	81.8		2	1		
7	杨嘉露										1				
8	王彬														
9	周钰婷														
10	田秀秀	0/2	2/3		1/1			3/6	50.0		1				
11	吕青纹		0/1	1/1	2/2			3/4	75.0						
12	张苑琳														
15	吴作扬	1/2	1/1					2/3	66.7		2				
19	姜伟珊														
20	张悦	1/1	1/2					2/3	66.7						
22	朱贺														
23	徐悦		1/1					1/1	100						
28	崔金娜		2/2					2/2	100			1			
33	王彩琳														
77	穆庆丛														
运动员 合计		3/6	10/14	2/2	5/5	1/1	1/2	22/30	73.3		3	4	1		
12	张苑琳	7/10		1/1			0/1	8/12	66.7						
守门员 合计		7/10		1/1			0/1	8/12	66.7						

场上队员：得分 / 射门

守门员：救球 / 射门

快攻	Fast Break		突破	Breakthrough		任意球	Free Throw		7M球	7M Throw		助攻	Assist
警告	Warning		失误	Error		2'	Suspension		D	取消资格		DR	取消资格+报告







### 2016年全国女子手球锦标赛 图式比赛技术统计表

轮次 4

场次 21

201605021-21-1/1

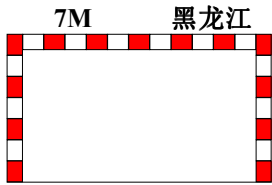
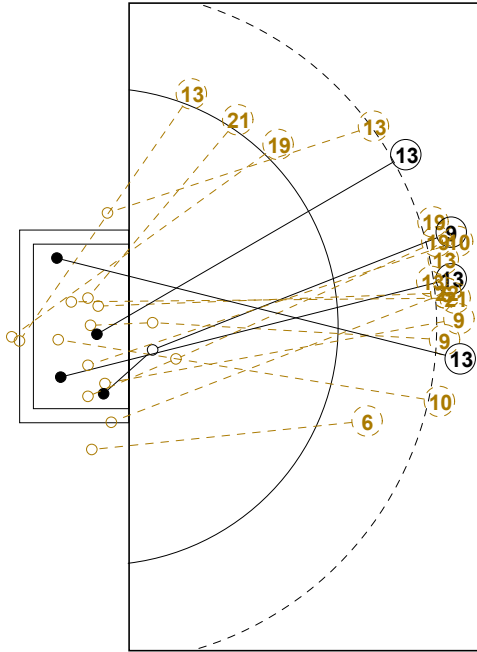

1st Half  
4 : 22

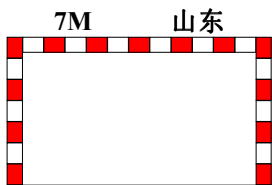
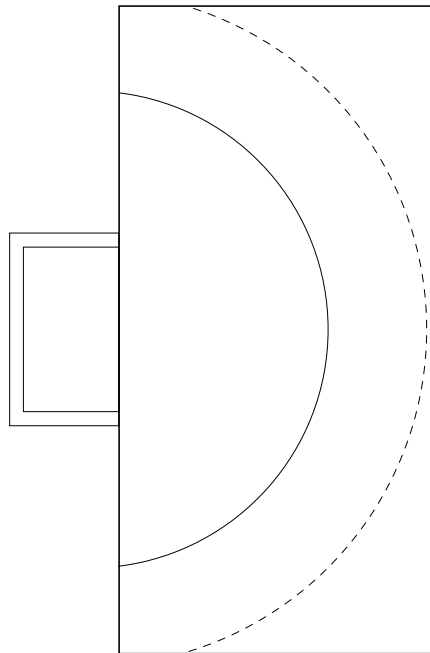
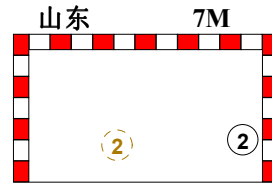
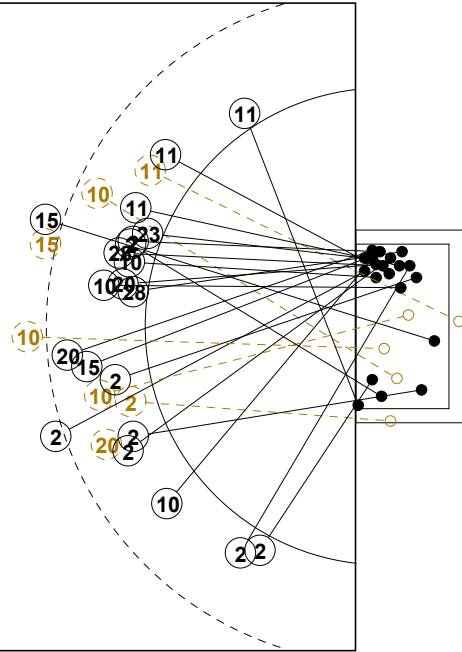

2nd Half  
22 : 4

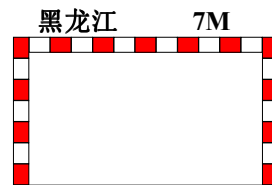
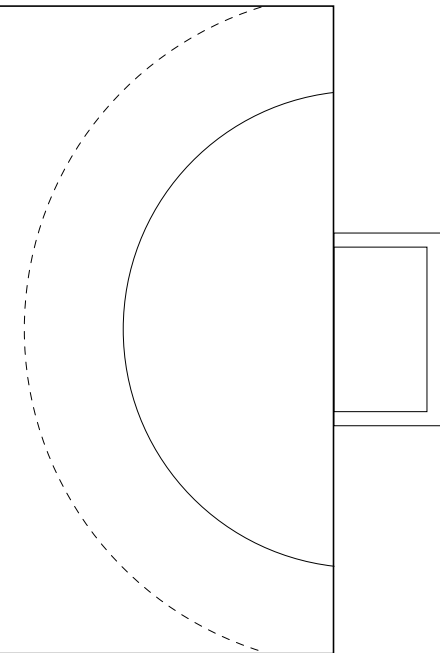



## 2016年全国女子手球锦标赛

## 个人/全队技术统计表

正式表  
手球  
女子预赛  
轮次 4组别 A  
场次 21201605021-14-1/2  
滁州体育馆  
06/09/2016 20:30

号码	姓名	远射	近射	边射	快攻	突破	任意	7M	合计	%	助攻	失误	警告	2'	取消	时间
<b>黑龙江(黑龙江)</b>																
<i>(场上队员)</i>																
1	徐佳蓉									0.0%						00:15:43
3	刘诗彤									0.0%			1			00:16:39
5	周美微									0.0%						00:00:00
6	王梦艺	0/1	0/1						0/2	0.0%		1				00:10:30
9	郑宇	1/3							1/3	33.3%		3	1			00:30:00
10	刘雪露	0/2							0/2	0.0%						00:15:15
11	刘天茹									0.0%		1				00:20:24
12	肖宁桐									0.0%						00:14:17
13	吴佳	2/5		0/1			1/1		3/7	42.9%		3		1		00:21:06
14	黄荣									0.0%						00:00:00
16	杜宪									0.0%						00:00:00
19	梁文煜	0/2	0/1						0/3	0.0%		3				00:22:40
21	王戈	0/1		0/1					0/2	0.0%		1	1			00:09:46
22	马琳	0/1							0/1	0.0%		1				00:15:38
23	张政									0.0%						00:17:36
<b>合计</b>		3/15	0/2	0/2			1/1		4/20	20.0%		13	3	1		
<i>(守门员)</i>																
1	徐佳蓉	1/2	0/6	0/1	0/2			1/1	2/12	16.7%						00:15:43
12	肖宁桐	1/3	1/5	0/1	0/3	0/1		0/1	2/14	14.3%						00:14:17
<b>合计</b>		2/5	1/11	0/2	0/5	0/1		1/2	4/26	15.4%						

场上队员：得分/射门

守门员：救球/射门

全队合计	得分	被救	射失	击柱	封球	合计	%
远射	3	7	1	1	3	15	20.0%
近射			2			2	0.0%
边射		1		1		2	0.0%
快攻							0.0%
突破							0.0%
任意	1					1	100.0%
7M							0.0%





## 2016年全国女子手球锦标赛

## 个人/全队技术统计表

正式表  
手球  
女子预赛  
轮次 4组别 A  
场次 21201605021-14-2/2  
滁州体育馆  
06/09/2016 20:30

号码	姓名	远射	近射	边射	快攻	突破	任意	7M	合计	%	助攻	失误	警告	2'	取消	时间
<b>山东(山东)</b>																
<i>(上场队员)</i>																
1	刘畅									0.0%						00:00:00
2	林燕群	1/1	3/4	1/1	2/2	1/1		1/2	9/11	81.8%		2	1			00:29:21
7	杨嘉露									0.0%	1					00:00:38
8	王彬									0.0%						00:00:00
9	周钰婷									0.0%						00:00:00
10	田秀秀	0/2	2/3		1/1				3/6	50.0%		1				00:30:00
11	吕青纹		0/1	1/1	2/2				3/4	75.0%						00:30:00
12	张苑琳									0.0%						00:30:00
15	吴作扬	1/2	1/1						2/3	66.7%	2					00:30:00
19	姜伟珊									0.0%						00:00:00
20	张悦	1/1	1/2						2/3	66.7%						00:30:00
22	朱赞									0.0%						00:00:00
23	徐悦		1/1						1/1	100%						00:05:39
28	崔金娜		2/2						2/2	100%		1				00:24:19
33	王彩琳									0.0%						00:00:00
77	穆庆丛									0.0%						00:00:00
<b>合计</b>		3/6	10/14	2/2	5/5	1/1		1/2	22/30	73.3%	3	4	1			
<i>(守门员)</i>																
12	张苑琳	7/10		1/1			0/1		8/12	66.7%						00:30:00
<b>合计</b>		7/10		1/1			0/1		8/12	66.7%						

场上队员：得分/射门

守门员：救球/射门

全队合计	得分	被救	射失	击柱	封球	合计	%
远射	3	2			1	6	50.0%
近射	10	1		2	1	14	71.4%
边射	2					2	100.0%
快攻	5					5	100.0%
突破	1					1	100.0%
任意							0.0%
7M	1	1				2	50.0%





### 2016年全国女子手球锦标赛

#### 图式射门区域统计

轮次 4 场次 21

201605021-41-1/1

## 黑龙江

1 徐佳蓉	3 刘诗彤	5 周美微	6 王梦艺	9 郑宇	10 刘雪露	11 刘天茹	12 肖宁桐																																																																								
<table border="1"><tr><td></td><td></td><td></td></tr><tr><td></td><td></td><td></td></tr><tr><td></td><td></td><td></td></tr></table>										<table border="1"><tr><td></td><td></td><td></td></tr><tr><td></td><td></td><td></td></tr><tr><td></td><td></td><td></td></tr></table>										<table border="1"><tr><td></td><td></td><td></td></tr><tr><td></td><td></td><td></td></tr><tr><td></td><td></td><td></td></tr></table>										<table border="1"><tr><td></td><td></td><td></td></tr><tr><td></td><td></td><td></td></tr><tr><td></td><td></td><td></td></tr></table>										<table border="1"><tr><td></td><td></td><td></td></tr><tr><td></td><td></td><td></td></tr><tr><td>1</td><td></td><td></td></tr></table>							1			<table border="1"><tr><td></td><td></td><td></td></tr><tr><td></td><td></td><td></td></tr><tr><td></td><td></td><td></td></tr></table>										<table border="1"><tr><td></td><td></td><td></td></tr><tr><td></td><td></td><td></td></tr><tr><td></td><td></td><td></td></tr></table>										<table border="1"><tr><td></td><td></td><td></td></tr><tr><td></td><td></td><td></td></tr><tr><td></td><td></td><td></td></tr></table>									
1																																																																															
Post - 0 Miss - 0 Block - 0	Post - 0 Miss - 0 Block - 0	Post - 0 Miss - 0 Block - 0	Post - 0 Miss - 1 Block - 0	Post - 0 Miss - 0 Block - 0	Post - 0 Miss - 0 Block - 0	Post - 0 Miss - 0 Block - 0	Post - 0 Miss - 0 Block - 0																																																																								
13 吴佳	14 黄荣	16 杜宪	19 梁文煜	21 王戈	22 马琳	23 张政																																																																									
<table border="1"><tr><td>1</td><td></td><td>1</td></tr><tr><td></td><td>1</td><td></td></tr><tr><td></td><td></td><td></td></tr></table>	1		1		1					<table border="1"><tr><td></td><td></td><td></td></tr><tr><td></td><td></td><td></td></tr><tr><td></td><td></td><td></td></tr></table>										<table border="1"><tr><td></td><td></td><td></td></tr><tr><td></td><td></td><td></td></tr><tr><td></td><td></td><td></td></tr></table>										<table border="1"><tr><td></td><td></td><td></td></tr><tr><td></td><td></td><td></td></tr><tr><td></td><td></td><td></td></tr></table>										<table border="1"><tr><td></td><td></td><td></td></tr><tr><td></td><td></td><td></td></tr><tr><td></td><td></td><td></td></tr></table>										<table border="1"><tr><td></td><td></td><td></td></tr><tr><td></td><td></td><td></td></tr><tr><td></td><td></td><td></td></tr></table>										<table border="1"><tr><td></td><td></td><td></td></tr><tr><td></td><td></td><td></td></tr><tr><td></td><td></td><td></td></tr></table>										<table border="1"><tr><td></td><td></td><td></td></tr><tr><td></td><td></td><td></td></tr><tr><td></td><td></td><td></td></tr></table>									
1		1																																																																													
	1																																																																														
Post - 1 Miss - 1 Block - 2	Post - 0 Miss - 0 Block - 0	Post - 0 Miss - 0 Block - 0	Post - 0 Miss - 1 Block - 1	Post - 0 Miss - 0 Block - 0	Post - 1 Miss - 0 Block - 0	Post - 0 Miss - 0 Block - 0																																																																									

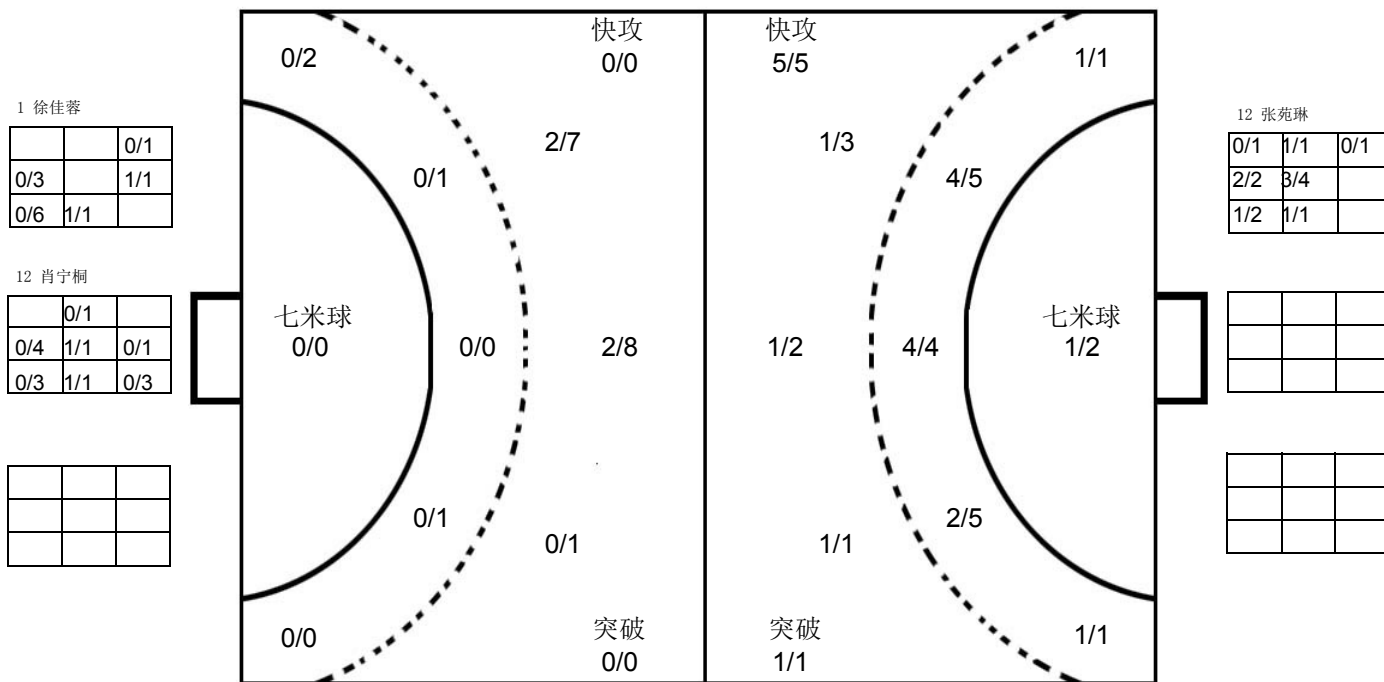

## 山东

1 路畅	2 林燕群	7 杨嘉露	8 王彬	9 周钰婷	10 田秀秀	11 吕青纹	12 张苑琳																																																																								
<table border="1"><tr><td></td><td></td><td></td></tr><tr><td></td><td></td><td></td></tr><tr><td></td><td></td><td></td></tr></table>										<table border="1"><tr><td></td><td>1</td><td></td></tr><tr><td>3</td><td></td><td>1</td></tr><tr><td>2</td><td></td><td>2</td></tr></table>		1		3		1	2		2	<table border="1"><tr><td></td><td></td><td></td></tr><tr><td></td><td></td><td></td></tr><tr><td></td><td></td><td></td></tr></table>										<table border="1"><tr><td></td><td></td><td></td></tr><tr><td></td><td></td><td></td></tr><tr><td></td><td></td><td></td></tr></table>										<table border="1"><tr><td></td><td></td><td></td></tr><tr><td></td><td></td><td></td></tr><tr><td></td><td></td><td></td></tr></table>										<table border="1"><tr><td></td><td></td><td></td></tr><tr><td>1</td><td></td><td></td></tr><tr><td>2</td><td></td><td></td></tr></table>				1			2			<table border="1"><tr><td></td><td></td><td></td></tr><tr><td>2</td><td></td><td></td></tr><tr><td></td><td></td><td>1</td></tr></table>				2					1	<table border="1"><tr><td></td><td></td><td></td></tr><tr><td></td><td></td><td></td></tr><tr><td></td><td></td><td></td></tr></table>									
	1																																																																														
3		1																																																																													
2		2																																																																													
1																																																																															
2																																																																															
2																																																																															
		1																																																																													
Post - 0 Miss - 0 Block - 0	Post - 1 Miss - 0 Block - 0	Post - 0 Miss - 0 Block - 0	Post - 0 Miss - 0 Block - 0	Post - 0 Miss - 0 Block - 0	Post - 0 Miss - 0 Block - 0	Post - 1 Miss - 0 Block - 0	Post - 0 Miss - 0 Block - 0																																																																								
15 吴作扬	19 姜伟珊	20 张悦	22 朱赞	23 徐悦	28 崔金娜	33 王彩琳	77 穆庆丛																																																																								
<table border="1"><tr><td></td><td>1</td><td></td></tr><tr><td></td><td></td><td></td></tr><tr><td>1</td><td></td><td></td></tr></table>		1					1			<table border="1"><tr><td></td><td></td><td></td></tr><tr><td></td><td></td><td></td></tr><tr><td></td><td></td><td></td></tr></table>										<table border="1"><tr><td></td><td></td><td></td></tr><tr><td></td><td></td><td></td></tr><tr><td>2</td><td></td><td></td></tr></table>							2			<table border="1"><tr><td></td><td></td><td></td></tr><tr><td></td><td></td><td></td></tr><tr><td></td><td></td><td></td></tr></table>										<table border="1"><tr><td></td><td></td><td></td></tr><tr><td></td><td></td><td></td></tr><tr><td>1</td><td></td><td></td></tr></table>							1			<table border="1"><tr><td></td><td></td><td></td></tr><tr><td>1</td><td></td><td></td></tr><tr><td></td><td></td><td></td></tr></table>				1						<table border="1"><tr><td></td><td></td><td></td></tr><tr><td></td><td></td><td></td></tr><tr><td></td><td></td><td></td></tr></table>										<table border="1"><tr><td></td><td></td><td></td></tr><tr><td></td><td></td><td></td></tr><tr><td></td><td></td><td></td></tr></table>									
	1																																																																														
1																																																																															
2																																																																															
1																																																																															
1																																																																															
Post - 0 Miss - 0 Block - 1	Post - 0 Miss - 0 Block - 0	Post - 0 Miss - 0 Block - 1	Post - 0 Miss - 0 Block - 0	Post - 0 Miss - 0 Block - 0	Post - 0 Miss - 0 Block - 0	Post - 0 Miss - 0 Block - 0	Post - 0 Miss - 0 Block - 0																																																																								

注释: Post=击柱 Miss=射失 Block=被封





预赛 Group B

女子 全国比赛

2016年全国女子手球锦标赛

Team A <b>A 辽宁</b>				Team B <b>B 四川</b>				Match Number <b>22</b>													
played in China		in the hall 滁州体育馆		on 07/09/2016		at 13:00 hours		Spectators													
Half-time (30')	<b>A</b> 17	<b>B</b> 11	End of playing time	<b>A</b> 29	<b>B</b> 23	1st extra time	<b>A</b>	<b>B</b>	2nd extra time	<b>A</b>	<b>B</b>	After penalty throws	<b>A</b>	<b>B</b>							
Number of 7 m	<b>A</b> 1/2	Team time-out 1 15:25 2 3			Full name of players and officials				Team time-out 1 2 3			<b>B</b> 3/4	Number of 7 m								
No.	Team <b>A</b>					G	W	2'	D	DR	No.	Team <b>B</b>					G	W	2'	D	DR
1	于薇诗										1	张雪纯									
2	朱徐婷					3					2	陈艳楠					2	1			
3	赵莹雪					3	1				3	王丹					9	1	1		
5	辛颜					6					4	尤婉莹					1				
8	杨娇					3	1	1			5	孙姣					1	1			
9	刁卫丽					1					6	凤洋					2				
12	刘雪菲										7	练素琪					1				
13	杜江花					4					9	姚梦园					1				
19	吕秋雪					4	1	1			10	高静									
20	孙弘玲										11	朱海云					3				
24	陈思雨										12	宋琛茜									
27	王丹										17	史雨欣									
66	梁海珍					5					18	戴小宇					3				
93	赵琦										27	吴美琪									
98	张永婷							1													
99	郑锦宜																				
A	吕艳梦										A	金鸿									
B	李丽荣										B	郎正平									
C	金京男 (主教练)										C	陈志伟									
E	程万里																				
<b>A</b>	Signature of Responsible Official of the Teams (Off. A)																		<b>B</b>		
TP	Remarks of Referee / CHA Official																		TP		

Signatures

Referees: 张耿 (CHN) 王雨洋 (CHN)

Techn. Delegates: 高斌 (CHN)

CHA Official: 许宜扬 (CHN)

Note: Number of 7m Throws Awarded to Team A and B, Goals (G), Warnings (W), Suspensions (2'), Direct Disqualification (D), Disqualification with Report (DR) and Team Penalty (TP).

Table Officials: 佟金政

贾俊秋

Statisticians: 黄岩

刘永欢

Printed by PHMS Copyright: IHF / CHA 07/09/2016 14:11:28

Longman Sportsoft



handball@126.com

2016年全国女子手球锦标赛  
竞赛技术统计(媒体表)

预赛	组别	B	轮次	5	场次	22
----	----	---	----	---	----	----

滁州体育馆

07/09/2016

201605022-51-1/1

辽宁	辽宁	29	vs	23	四川	四川
17 : 11						

裁判员	张耿 (CHN)	/	王雨洋 (CHN)
-----	----------	---	-----------

辽宁		远射	近射	边射	快攻	突破	任意球	7m球	合计	%	助攻	失误	警告	2'	D & DR	辽宁	比赛进程	四川
主教练：金京男																		
1	于薇诗																	
2	朱徐婷		1/2	2/2					3/4	75.0		3						
3	赵莹雪		1/2			2/2			3/4	75.0	2	3	1					
5	辛颜	1/1	4/6		1/1	0/1			6/9	66.7		1						
8	杨娇	1/1				1/1	1/3	0/1	3/6	50.0	5	2	1	1				
9	刁卫丽				1/1				1/1	100		1						
12	刘雪菲																	
13	杜江花	1/4	1/2	1/1				1/1	4/8	50.0	1	2						
19	吕秋雪	0/1	3/3		1/1				4/5	80.0	1	3	1	1				
20	孙弘玲					0/1			0/1	0.0		1						
24	陈思雨																	
27	王丹																	
66	梁海珍	1/3	2/3	2/2					5/8	62.5	1	3						
93	赵琦																	
98	张永婷														1			
99	郑锦宜																	
运动员 合计		4/10	12/18	5/5	3/3	3/5	1/3	1/2	29/46	63.0	10	19	3	3				
1	于薇诗		1/1	1/1					2/2	100								
27	王丹		1/3					1/4	2/7	28.6								
93	赵琦	8/13	1/3	4/7	0/4	0/4	1/1		14/32	43.8								
守门员 合计		8/13	3/7	5/8	0/4	0/4	1/1	1/4	18/41	43.9								
四川		远射	近射	边射	快攻	突破	任意球	7m球	合计	%	助攻	失误	警告	2'	D & DR			
教练：郎正平																		
1	张雪纯																	
2	陈艳楠	1/1	0/1		1/1				2/3	66.7		2	1					
3	王丹	1/4	2/3	1/1		3/4	0/1	2/2	9/15	60.0	1	4	1	1				
4	尤婉莹		0/1	1/1					1/2	50.0		2						
5	孙姣	0/1	1/1						1/2	50.0		1	1					
6	凤洋			1/3	1/1				2/4	50.0		1						
7	练素琪			0/4	1/1				1/5	20.0		1						
9	姚梦园				1/1				1/1	100								
10	高静																	
11	朱海云	2/8	1/1						3/9	33.3	2	3						
12	宋琛茜											1						
17	史雨欣																	
18	戴小宇	1/7				1/1		1/2	3/10	30.0		2						
27	吴美琪			0/2					0/2	0.0								
运动员 合计		5/21	4/7	3/11	4/4	4/5	0/1	3/4	23/53	43.4	3	17	3	1				
12	宋琛茜	6/10	4/16	0/5	0/3	2/5	2/3	0/1	14/43	32.6		1						
守门员 合计		6/10	4/16	0/5	0/3	2/5	2/3	0/1	14/43	32.6		1						

辽宁	比赛进程	四川
5 辛颜	1 00:51 0	
5 辛颜	2 01:35 0	
66 梁海珍	3 02:48 0	
3 赵莹雪	3 03:05 1 3 王丹	
5 辛颜	4 04:37 1	
5 辛颜	5 05:50 1	
5 辛颜	6 07:06 1	
66 梁海珍	7 07:59 1	
7 08:22 2 2 陈艳楠		
19 吕秋雪	8 10:17 2	
8 11:51 3 6 凤洋		
5 辛颜	9 12:12 3	
9 14:03 4 9 姚梦园		
9 14:20 5 2 陈艳楠		
66 梁海珍	10 15:59 5	
10 16:22 6 11 朱海云		
19 吕秋雪	11 16:50 6	
66 梁海珍	12 17:43 6	
12 19:35 7 6 凤洋		
8 杨娇	13 20:56 7	
13 24:03 8 3 王丹		
3 赵莹雪	14 25:32 8	
2 朱徐婷	15 26:44 8	
19 吕秋雪	16 27:16 8	
16 27:48 9 18 戴小宇		
16 28:17 10 11 朱海云		
3 赵莹雪	17 29:05 10	
17 29:27 11 3 王丹		
2nd Half		
17 02:38 12 3 王丹		
19 吕秋雪	18 03:20 12	
2 朱徐婷	19 04:28 12	
19 05:04 13 3 王丹		
2 朱徐婷	20 05:46 13	
20 07:21 14 7 练素琪		
13 杜江花	21 10:11 14	
21 10:30 15 18 戴小宇		
21 13:00 16 11 朱海云		
13 杜江花	22 13:10 16	
22 14:41 17 18 戴小宇		
13 杜江花	23 16:10 17	
23 16:27 18 4 尤婉莹		
66 梁海珍	24 17:00 18	
8 杨娇	25 19:00 18	
25 20:23 19 3 王丹		
5 辛颜	26 21:25 19	
8 杨娇	27 23:18 19	
27 24:01 20 3 王丹		
27 24:57 21 5 孙姣		
27 26:28 22 3 王丹		
13 杜江花	28 27:14 22	
9 刁卫丽	29 28:03 22	
29 28:10 23 3 王丹		

场上队员：得分 / 射门

守门员：救球 / 射门

快攻	Fast Break		突破	Breakthrough		任意球	Free Throw		7M球	7M Throw		助攻	Assist
警告	Warning		失误	Error		2'	Suspension		D	取消资格		DR	取消资格+报告





### 2016年全国女子手球锦标赛 图式比赛技术统计表

轮次 5

场次 22

201605022-21-1/1

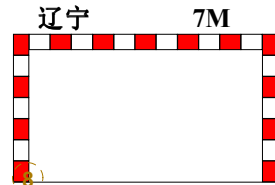
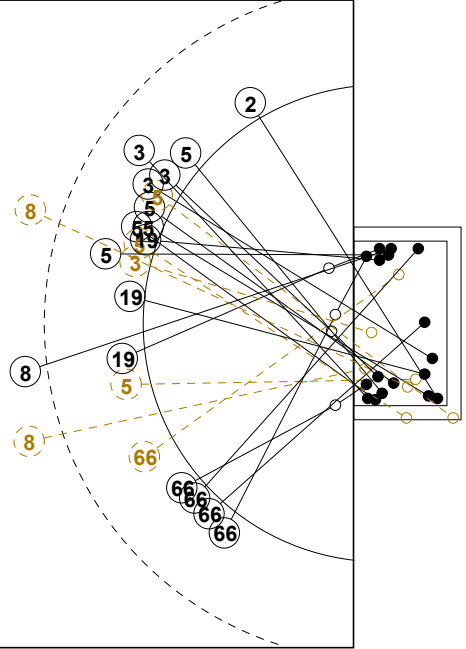
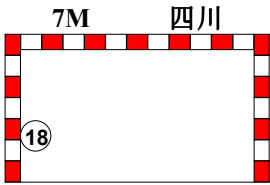
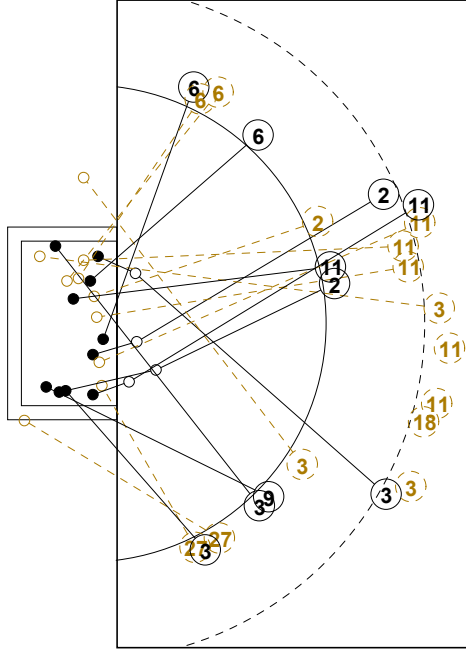

1st Half  
11 : 17

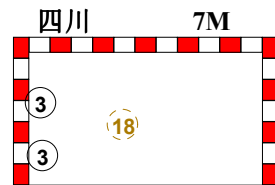
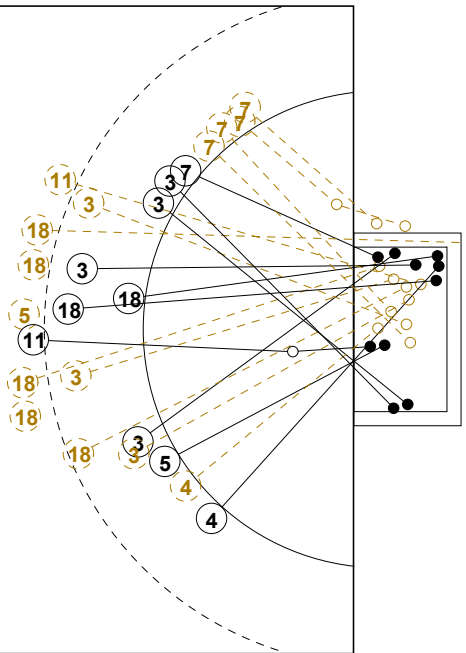
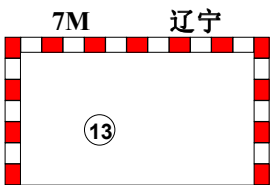
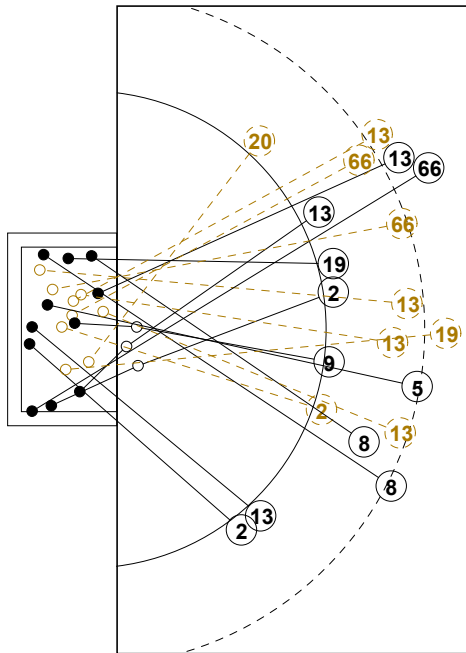

2nd Half  
29 : 23



## 2016年全国女子手球锦标赛

## 个人/全队技术统计表

正式表  
手球  
女子预赛  
轮次 5组别 B  
场次 22201605022-14-1/2  
滁州体育馆  
07/09/2016 13:00

号码	姓名	远射	近射	边射	快攻	突破	任意	7M	合计	%	助攻	失误	警告	2'	取消	时间
<b>辽宁(辽宁)</b>																
<i>(场上队员)</i>																
1	于薇诗									0.0%						00:01:39
2	朱徐婷		1/2	2/2					3/4	75.0%		3				00:58:30
3	赵莹雪		1/2			2/2			3/4	75.0%	2	3	1			00:49:01
5	辛颜	1/1	4/6		1/1	0/1			6/9	66.7%		1				00:56:34
8	杨娇	1/1				1/1	1/3	0/1	3/6	50.0%	5	2	1	1		00:58:07
9	刁卫丽				1/1				1/1	100%		1				00:01:52
12	刘雪菲									0.0%						00:00:00
13	杜江花	1/4	1/2	1/1				1/1	4/8	50.0%	1	2				00:20:48
19	吕秋雪	0/1	3/3		1/1				4/5	80.0%	1	3	1	1		00:51:39
20	孙弘玲					0/1			0/1	0.0%		1				00:07:36
24	陈思雨									0.0%						00:00:00
27	王丹									0.0%						00:04:59
66	梁海珍	1/3	2/3	2/2					5/8	62.5%	1	3				00:52:23
93	赵琦									0.0%						01:21:18
98	张永婷									0.0%				1		00:03:25
99	郑锦宜									0.0%						00:00:00
<b>合计</b>		4/10	12/18	5/5	3/3	3/5	1/3	1/2	29/46	63.0%	10	19	3	3		
<i>(守门员)</i>																
1	于薇诗		1/1	1/1					2/2	100%						00:01:39
27	王丹		1/3					1/4	2/7	28.6%						00:04:59
93	赵琦	8/13	1/3	4/7	0/4	0/4	1/1		14/32	43.8%						01:21:18
<b>合计</b>		8/13	3/7	5/8	0/4	0/4	1/1	1/4	18/41	43.9%						

场上队员：得分/射门

守门员：救球/射门

全队合计	得分	被救	射失	击柱	封球	合计	%
远射	4	6				10	40.0%
近射	12	4		2		18	66.7%
边射	5					5	100.0%
快攻	3					3	100.0%
突破	3	2				5	60.0%
任意	1	2				3	33.3%
7M	1			1		2	50.0%







## 2016年全国女子手球锦标赛

## 个人/全队技术统计表

正式表  
手球  
女子预赛  
轮次 5组别 B  
场次 22201605022-14-2/2  
滁州体育馆  
07/09/2016 13:00

号码	姓名	远射	近射	边射	快攻	突破	任意	7M	合计	%	助攻	失误	警告	2'	取消	时间
<b>四川(四川)</b>																
<i>(上场队员)</i>																
1	张雪纯									0.0%						00:00:00
2	陈艳楠	1/1	0/1		1/1				2/3	66.7%	2	1				00:30:00
3	王丹	1/4	2/3	1/1		3/4	0/1	2/2	9/15	60.0%	1	4	1	1		00:56:31
4	尤婉莹		0/1	1/1					1/2	50.0%		2				00:26:30
5	孙姣	0/1	1/1						1/2	50.0%		1	1			00:59:00
6	凤洋			1/3	1/1				2/4	50.0%		1				00:30:00
7	练素琪			0/4	1/1				1/5	20.0%		1				00:30:00
9	姚梦园				1/1				1/1	100%						00:33:16
10	高静									0.0%						00:00:00
11	朱海云	2/8	1/1						3/9	33.3%	2	3				00:58:56
12	宋琛茜									0.0%		1				01:28:16
17	史雨欣									0.0%						00:00:59
18	戴小宇	1/7				1/1		1/2	3/10	30.0%		2				00:33:26
27	吴美琪			0/2					0/2	0.0%						00:13:55
<b>合计</b>		5/21	4/7	3/11	4/4	4/5	0/1	3/4	23/53	43.4%	3	17	3	1		
<i>(守门员)</i>																
12	宋琛茜	6/10	4/16	0/5	0/3	2/5	2/3	0/1	14/43	32.6%		1				01:28:16
<b>合计</b>		6/10	4/16	0/5	0/3	2/5	2/3	0/1	14/43	32.6%		1				

场上队员：得分/射门

守门员：救球/射门

全队合计	得分	被救	射失	击柱	封球	合计	%
远射	5	8	1		7	21	23.8%
近射	4	3				7	57.1%
边射	3	5	2	1		11	27.3%
快攻	4					4	100.0%
突破	4		1			5	80.0%
任意		1				1	0.0%
7M	3	1				4	75.0%





### 2016年全国女子手球锦标赛

#### 图式射门区域统计

轮次 5 场次 22

201605022-41-1/1

## 辽宁

1 于薇诗	2 朱徐婷	3 赵莹雪	5 辛颜	8 杨娇	9 刁卫丽	12 刘雪菲	13 杜江花																																																																								
<table border="1"><tr><td></td><td></td><td></td></tr><tr><td></td><td></td><td></td></tr><tr><td></td><td></td><td></td></tr></table>										<table border="1"><tr><td>1</td><td>1</td><td>1</td></tr><tr><td></td><td></td><td></td></tr><tr><td></td><td></td><td></td></tr></table>	1	1	1							<table border="1"><tr><td></td><td></td><td>1</td></tr><tr><td></td><td></td><td></td></tr><tr><td></td><td></td><td>2</td></tr></table>			1						2	<table border="1"><tr><td></td><td>1</td><td>1</td></tr><tr><td>1</td><td></td><td>1</td></tr><tr><td></td><td></td><td>2</td></tr></table>		1	1	1		1			2	<table border="1"><tr><td></td><td></td><td>1</td></tr><tr><td>1</td><td></td><td></td></tr><tr><td></td><td></td><td>1</td></tr></table>			1	1					1	<table border="1"><tr><td></td><td></td><td></td></tr><tr><td></td><td>1</td><td></td></tr><tr><td></td><td></td><td></td></tr></table>					1					<table border="1"><tr><td></td><td></td><td></td></tr><tr><td></td><td></td><td></td></tr><tr><td></td><td></td><td></td></tr></table>										<table border="1"><tr><td></td><td>1</td><td></td></tr><tr><td>2</td><td></td><td></td></tr><tr><td></td><td></td><td>1</td></tr></table>		1		2					1
1	1	1																																																																													
		1																																																																													
		2																																																																													
	1	1																																																																													
1		1																																																																													
		2																																																																													
		1																																																																													
1																																																																															
		1																																																																													
	1																																																																														
	1																																																																														
2																																																																															
		1																																																																													
Post - 0 Miss - 0 Block - 0	Post - 0 Miss - 0 Block - 0	Post - 0 Miss - 0 Block - 0	Post - 2 Miss - 0 Block - 0	Post - 1 Miss - 0 Block - 0	Post - 0 Miss - 0 Block - 0	Post - 0 Miss - 0 Block - 0	Post - 0 Miss - 0 Block - 0																																																																								
19 吕秋雪	20 孙弘玲	24 陈思雨	27 王丹	66 梁海珍	93 赵琦	98 张永婷	99 郑锦宜																																																																								
<table border="1"><tr><td></td><td></td><td>1</td></tr><tr><td></td><td></td><td>1</td></tr><tr><td>2</td><td></td><td></td></tr></table>			1			1	2			<table border="1"><tr><td></td><td></td><td></td></tr><tr><td></td><td></td><td></td></tr><tr><td></td><td></td><td></td></tr></table>										<table border="1"><tr><td></td><td></td><td></td></tr><tr><td></td><td></td><td></td></tr><tr><td></td><td></td><td></td></tr></table>										<table border="1"><tr><td></td><td></td><td></td></tr><tr><td></td><td></td><td></td></tr><tr><td></td><td></td><td></td></tr></table>										<table border="1"><tr><td>2</td><td>1</td><td></td></tr><tr><td></td><td></td><td></td></tr><tr><td>1</td><td></td><td>1</td></tr></table>	2	1					1		1	<table border="1"><tr><td></td><td></td><td></td></tr><tr><td></td><td></td><td></td></tr><tr><td></td><td></td><td></td></tr></table>										<table border="1"><tr><td></td><td></td><td></td></tr><tr><td></td><td></td><td></td></tr><tr><td></td><td></td><td></td></tr></table>										<table border="1"><tr><td></td><td></td><td></td></tr><tr><td></td><td></td><td></td></tr><tr><td></td><td></td><td></td></tr></table>									
		1																																																																													
		1																																																																													
2																																																																															
2	1																																																																														
1		1																																																																													
Post - 0 Miss - 0 Block - 0	Post - 0 Miss - 0 Block - 0	Post - 0 Miss - 0 Block - 0	Post - 0 Miss - 0 Block - 0	Post - 0 Miss - 0 Block - 0	Post - 0 Miss - 0 Block - 0	Post - 0 Miss - 0 Block - 0	Post - 0 Miss - 0 Block - 0																																																																								

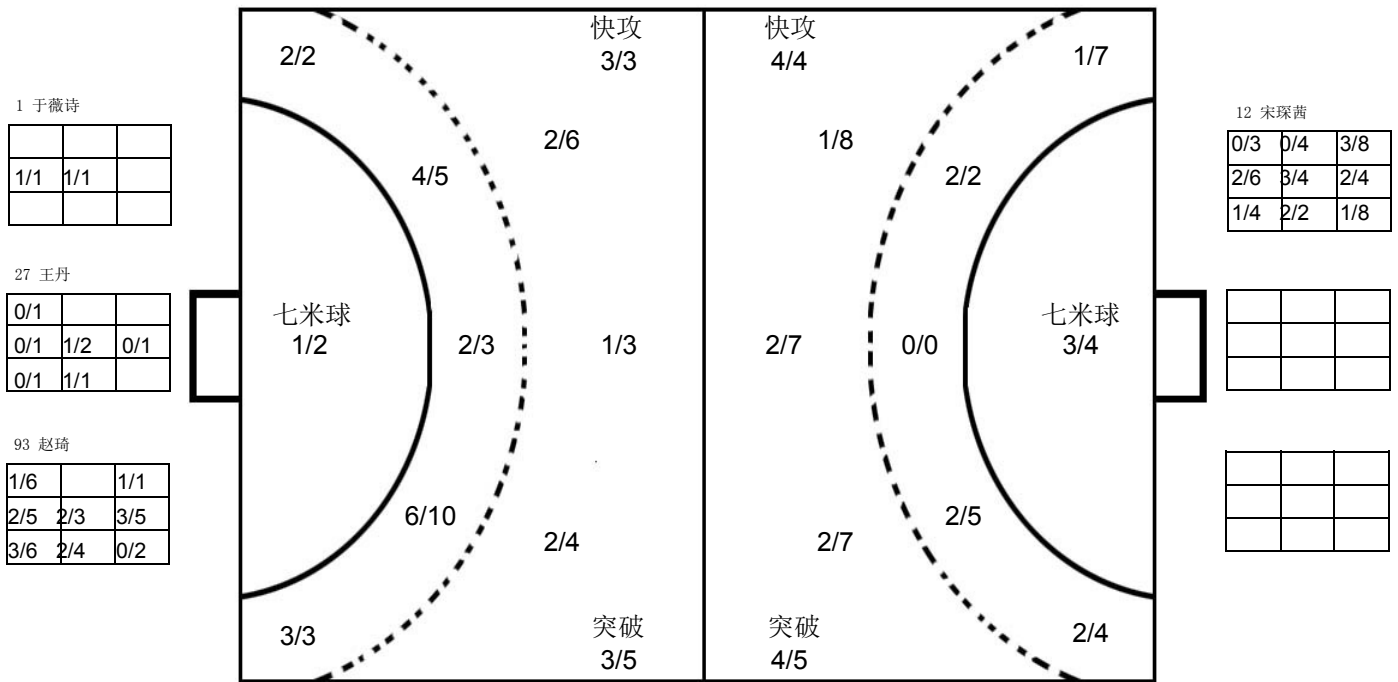

## 四川

1 张雪纯	2 陈艳楠	3 王丹	4 尤婉莹	5 孙姣	6 凤洋	7 练素琪	9 姚梦园																																																																								
<table border="1"><tr><td></td><td></td><td></td></tr><tr><td></td><td></td><td></td></tr><tr><td></td><td></td><td></td></tr></table>										<table border="1"><tr><td></td><td></td><td></td></tr><tr><td>1</td><td></td><td></td></tr><tr><td>1</td><td></td><td></td></tr></table>				1			1			<table border="1"><tr><td>2</td><td></td><td></td></tr><tr><td>2</td><td></td><td>3</td></tr><tr><td>1</td><td></td><td>1</td></tr></table>	2			2		3	1		1	<table border="1"><tr><td>1</td><td></td><td></td></tr><tr><td></td><td></td><td></td></tr><tr><td></td><td></td><td></td></tr></table>	1									<table border="1"><tr><td></td><td></td><td></td></tr><tr><td></td><td>1</td><td></td></tr><tr><td></td><td></td><td></td></tr></table>					1					<table border="1"><tr><td></td><td></td><td></td></tr><tr><td></td><td></td><td></td></tr><tr><td></td><td>1</td><td>1</td></tr></table>								1	1	<table border="1"><tr><td></td><td></td><td></td></tr><tr><td></td><td></td><td></td></tr><tr><td></td><td></td><td></td></tr></table>										<table border="1"><tr><td></td><td></td><td></td></tr><tr><td></td><td></td><td></td></tr><tr><td></td><td></td><td></td></tr></table>									
1																																																																															
1																																																																															
2																																																																															
2		3																																																																													
1		1																																																																													
1																																																																															
	1																																																																														
	1	1																																																																													
Post - 0 Miss - 0 Block - 0	Post - 0 Miss - 0 Block - 0	Post - 0 Miss - 1 Block - 1	Post - 0 Miss - 0 Block - 0	Post - 0 Miss - 0 Block - 1	Post - 0 Miss - 0 Block - 0	Post - 0 Miss - 2 Block - 0	Post - 0 Miss - 0 Block - 0																																																																								
10 高静	11 朱海云	12 宋琛茜	17 史雨欣	18 戴小宇	27 吴美琪																																																																										
<table border="1"><tr><td></td><td></td><td></td></tr><tr><td></td><td></td><td></td></tr><tr><td></td><td></td><td></td></tr></table>										<table border="1"><tr><td></td><td></td><td></td></tr><tr><td></td><td>1</td><td></td></tr><tr><td>1</td><td>1</td><td></td></tr></table>					1		1	1		<table border="1"><tr><td></td><td></td><td></td></tr><tr><td></td><td></td><td></td></tr><tr><td></td><td></td><td></td></tr></table>										<table border="1"><tr><td></td><td></td><td></td></tr><tr><td></td><td></td><td></td></tr><tr><td></td><td></td><td></td></tr></table>										<table border="1"><tr><td>2</td><td></td><td></td></tr><tr><td>1</td><td></td><td></td></tr><tr><td></td><td></td><td></td></tr></table>	2			1						<table border="1"><tr><td></td><td></td><td></td></tr><tr><td></td><td></td><td></td></tr><tr><td></td><td></td><td></td></tr></table>										<table border="1"><tr><td></td><td></td><td></td></tr><tr><td></td><td></td><td></td></tr><tr><td></td><td></td><td></td></tr></table>										<table border="1"><tr><td></td><td></td><td></td></tr><tr><td></td><td></td><td></td></tr><tr><td></td><td></td><td></td></tr></table>									
	1																																																																														
1	1																																																																														
2																																																																															
1																																																																															
Post - 0 Miss - 0 Block - 0	Post - 0 Miss - 0 Block - 2	Post - 0 Miss - 0 Block - 0	Post - 0 Miss - 0 Block - 0	Post - 0 Miss - 1 Block - 3	Post - 1 Miss - 0 Block - 0																																																																										

注释: Post=击柱 Miss=射失 Block=被封





预赛 Group B

女子 全国比赛

2016年全国女子手球锦标赛

Team A A 解放军				Team B B 上海				Match Number 23													
played in China		in the hall 滁州体育馆		on 07/09/2016		at 14:30 hours		Spectators													
Half-time (30')	A 9	B 21	End of playing time	A 9	B 24	1st extra time	A	B	2nd extra time	A	B	After penalty throws	A	B							
Number of 7 m	A 1 / 1	Team time-out 1 2 3			Full name of players and officials				Team time-out 1 2 3			B 2 / 2	Number of 7 m								
No.	Team A					G	W	2'	D	DR	No.	Team B					G	W	2'	D	DR
2	崔云莉										1	许沫									
5	徐鸣昭					2					2	周蕾					1				
6	于婷婷					1		1			5	郭威					1				
8	周亚茹					2					6	黄妍					2				
13	张格格					1					7	车婉茹									
16	方文博										8	吴茵									
17	于利婷										9	武娜娜					3	1			
23	顾天澍							1			10	斯文					1	1			
24	韦娜娜					2					11	孙梦颖					3				
32	张馨予										12	郑冯									
36	李朴										13	徐娟					1				
44	刘洋麦文										17	居晔					2				
66	杨丽丽										18	沙正文					3	1			
77	唐魏萍										19	印尼					2				
81	戴丹妮										21	王嘉怡					3				
88	李晓晴					1					23	都好					2				
A	刘德东 (主教练)										B	陈进培 (主教练)									
B	刘凤娟										C	金锺顺									
C	丛艳霞										D	贺业磊									
D	吴明群										F	周瑜宸									
A	Signature of Responsible Official of the Teams (Off. A)																		B		
TP	Remarks of Referee / CHA Official																		TP		

Signatures

Referees	徐健 (CHN)	曹宏俊 (CHN)		
Techn. Delegates	高斌 (CHN)			
CHA Official	许宜扬 (CHN)			

Note: Number of 7m Throws Awarded to Team A and B, Goals (G), Warnings (W), Suspensions (2'), Direct Disqualification (D), Disqualification with Report (DR) and Team Penalty (TP).

Table Officials: 佟金政 贾俊秋 Statisticians: 刘永欢 黄岩

Printed by PHMS Copyright: IHF / CHA 07/09/2016 15:10:09

Longman Sportsoft handball@126.com



2016年全国女子手球锦标赛  
竞赛技术统计(媒体表)

预赛	组别	B	轮次	5	场次	23
滁州体育馆		07/09/2016			201605023-51-1/1	
解放军	解放军	9	vs	24	上海	上海
		9 : 21				

裁判员	徐健 (CHN)	/	曹宏俊 (CHN)
-----	----------	---	-----------

解放军													比赛进程		上海									
主教练	远射	近射	边射	快攻	突破	任意球	7m球	合计	%	助攻	失误	警告	2'	D & DR	1st Half		2nd Half							
刘德东															0	01:57	1	18	沙正文	9	02:23	22	13	徐娟
2 崔云莉	0/4	0/1						0/5	0.0		2				0	02:55	2	18	沙正文	9	03:08	23	11	孙梦颖
5 徐鸣昭	1/1	1/1	0/1		0/1			2/4	50.0		1				1	03:12	2			9	04:08	24	19	印尼
6 于婷婷		1/1						1/1	100	2			1		1	03:40	3	6	黄妍					
8 周亚茹	1/6				1/1			2/7	28.6		2				1	04:54	4	6	黄妍					
13 张格格		1/4						1/4	25.0						1	05:20	5	18	沙正文					
16 方文博															1	06:48	6	9	武娜娜					
17 于利婷	0/4							0/4	0.0		1				2	07:38	6							
23 顾天澍															2	08:25	7	2	周蕾					
24 韦娜娜		1/1	1/1					2/2	100						2	09:45	8	9	武娜娜					
32 张馨予															2	12:11	9	10	斯文					
36 李朴															2	12:27	10	9	武娜娜					
44 刘洋麦文															3	13:14	10							
66 杨丽丽															3	13:51	11	23	都好					
77 唐魏萍															3	14:48	12	5	郭威					
81 戴丹妮															3	17:06	13	23	都好					
88 李晓晴	0/2	0/1	0/1				1/1	1/5	20.0		1				4	17:22	13							
运动员 合计	2/17	4/9	1/3		1/2		1/1	9/32	28.1	2	9	1	1		4	18:06	14	19	印尼					
16 方文博	0/1	0/1					0/1	0/3	0.0						5	18:53	15	17	居晔					
66 杨丽丽	0/1	0/4	0/1	1/8	1/1		0/1	2/16	12.5						5	20:15	15							
77 唐魏萍	0/3	0/1	0/2	0/1				0/7	0.0						5	20:37	16	21	王嘉怡					
守门员 合计	0/5	0/6	0/3	1/9	1/1		0/2	2/26	7.7						6	21:19	16							
													2nd Half											
													9	02:23	22	13	徐娟							
													9	03:08	23	11	孙梦颖							
													9	04:08	24	19	印尼							
上海																								
教练	远射	近射	边射	快攻	突破	任意球	7m球	合计	%	助攻	失误	警告	2'	D & DR										
陈进培																								
1 许沫										2	1													
2 周蕾				1/2				1/2	50.0															
5 郭威		1/1						1/1	100															
6 黄妍	1/1						1/1	2/2	100	3	3													
7 车婉茹																								
8 吴茵										3	1													
9 武娜娜				3/3				3/3	100			1												
10 斯文			1/1					1/1	100			1												
11 孙梦颖	3/3							3/3	100		2													
12 郑冯																								
13 徐娟							1/1	1/1	100															
17 居晔			2/3					2/3	66.7		1													
18 沙正文	0/1	1/2		2/2				3/5	60.0	1		1												
19 印尼		2/2			0/1			2/3	66.7		1													
21 王嘉怡	1/1	1/1	0/1	1/1				3/4	75.0															
23 都好		1/1		1/1				2/2	100															
运动员 合计	5/6	6/7	3/5	8/9	0/1		2/2	24/30	80.0	9	9	3												
1 许沫	4/6	0/2	2/2		1/1			7/11	63.6	2	1													
12 郑冯	2/2	3/5	0/1		0/1		0/1	5/10	50.0															
守门员 合计	6/8	3/7	2/3		1/2		0/1	12/21	57.1	2	1													

场上队员: 得分 / 射门

守门员: 救球 / 射门

快攻	Fast Break		突破	Breakthrough		任意球	Free Throw		7M球	7M Throw		助攻	Assist
警告	Warning		失误	Error		2'	Suspension		D	取消资格		DR	取消资格+报告





### 2016年全国女子手球锦标赛 图式比赛技术统计表

轮次 5

场次 23

201605023-21-1/1

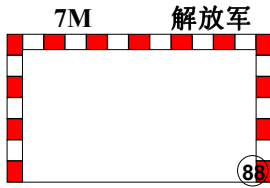
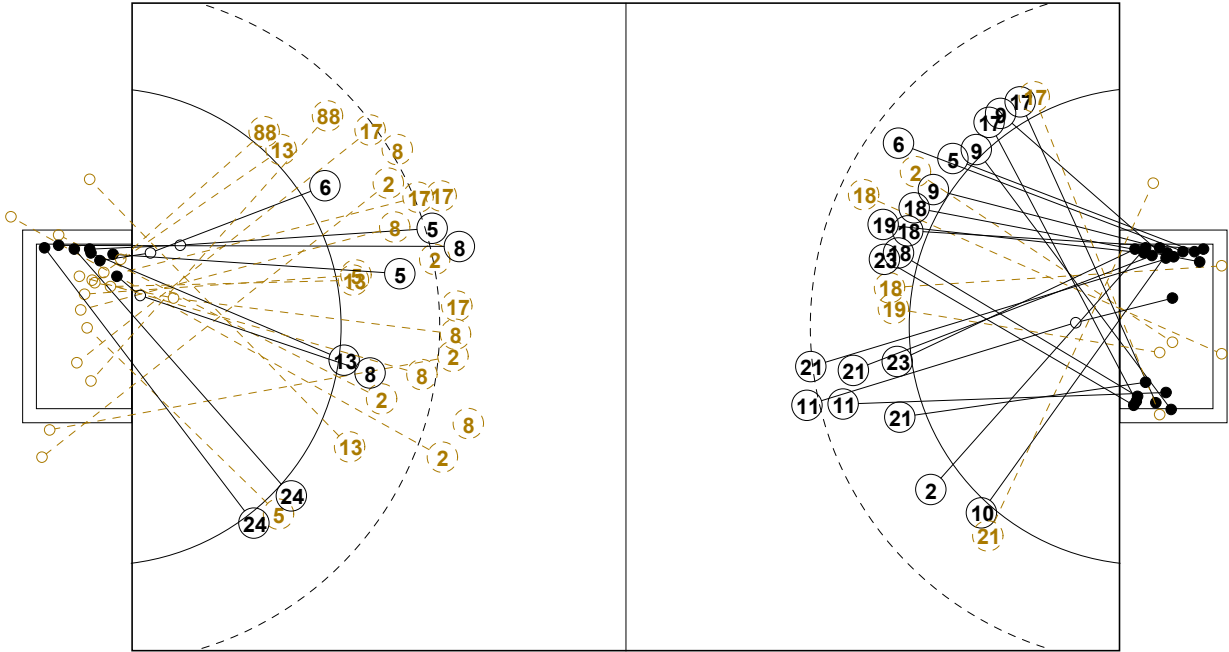

1st Half  
9 : 21

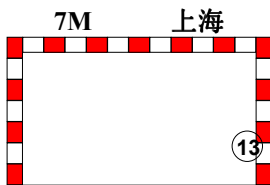
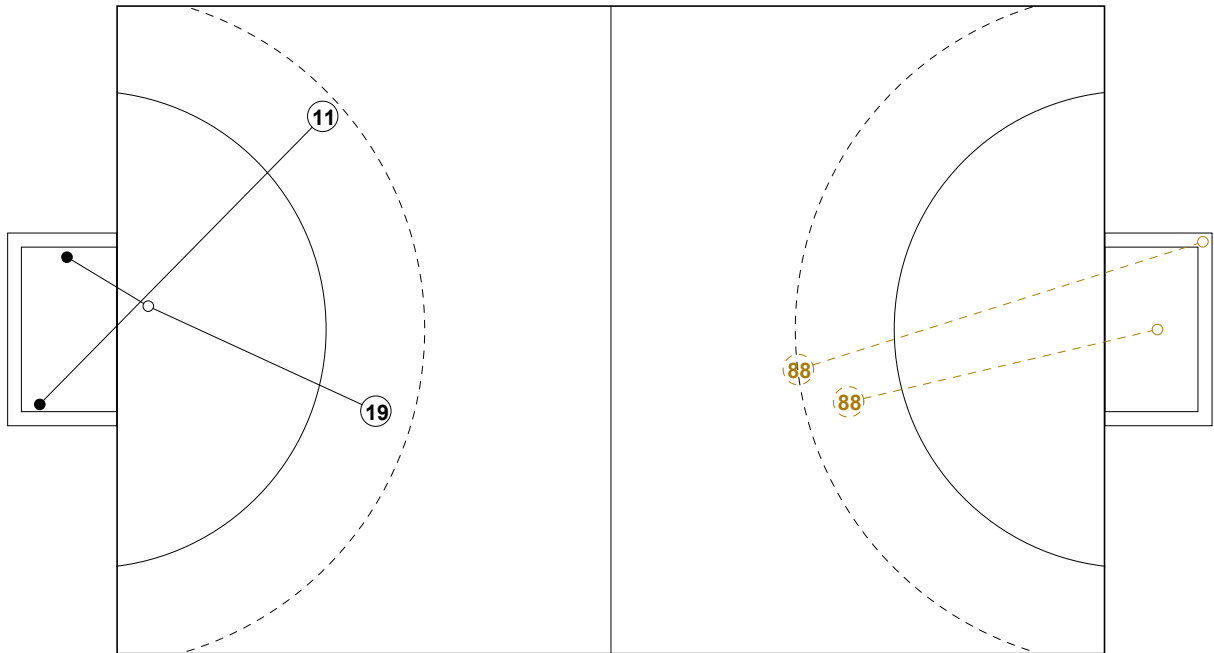
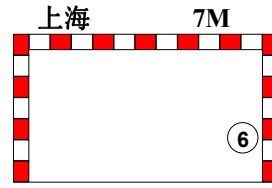

2nd Half  
24 : 9

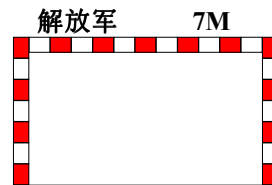



## 2016年全国女子手球锦标赛

## 个人/全队技术统计表

正式表  
手球  
女子预赛  
轮次 5组别 B  
场次 23201605023-14-1/2  
滁州体育馆  
07/09/2016 14:30

号码	姓名	远射	近射	边射	快攻	突破	任意	7M	合计	%	助攻	失误	警告	2'	取消	时间
<b>解放军(解放军)</b>																
<i>(场上队员)</i>																
2	崔云莉	0/4	0/1						0/5	0.0%		2				00:48:10
5	徐鸣昭	1/1	1/1	0/1		0/1			2/4	50.0%		1				00:12:54
6	于婷婷		1/1						1/1	100%	2			1		00:43:53
8	周亚茹	1/6				1/1			2/7	28.6%		2				00:17:03
13	张格格		1/4						1/4	25.0%						00:30:00
16	方文博									0.0%						00:30:00
17	于利婷	0/4							0/4	0.0%		1				00:16:06
23	顾天澍									0.0%		2	1			01:00:00
24	韦娜娜		1/1	1/1					2/2	100%						01:00:00
32	张馨予									0.0%						00:00:00
36	李朴									0.0%						00:00:00
44	刘洋麦文									0.0%						00:30:00
66	杨丽丽									0.0%						00:18:15
77	唐魏萍									0.0%						00:11:45
81	戴丹妮									0.0%						00:00:00
88	李晓晴	0/2	0/1	0/1				1/1	1/5	20.0%		1				00:41:49
<b>合计</b>		2/17	4/9	1/3		1/2		1/1	9/32	28.1%	2	9	1	1		
<i>(守门员)</i>																
16	方文博	0/1	0/1					0/1	0/3	0.0%						00:30:00
66	杨丽丽	0/1	0/4	0/1	1/8	1/1		0/1	2/16	12.5%						00:18:15
77	唐魏萍	0/3	0/1	0/2	0/1				0/7	0.0%						00:11:45
<b>合计</b>		0/5	0/6	0/3	1/9	1/1		0/2	2/26	7.7%						

场上队员：得分/射门

守门员：救球/射门

全队合计	得分	被救	射失	击柱	封球	合计	%
远射	2	6	3	1	5	17	11.8%
近射	4	3	1	1		9	44.4%
边射	1	2				3	33.3%
快攻							0.0%
突破	1	1				2	50.0%
任意							0.0%
7M	1					1	100.0%





## 2016年全国女子手球锦标赛

## 个人/全队技术统计表

正式表  
手球  
女子预赛  
轮次 5组别 B  
场次 23201605023-14-2/2  
滁州体育馆  
07/09/2016 14:30

号码	姓名	远射	近射	边射	快攻	突破	任意	7M	合计	%	助攻	失误	警告	2'	取消	时间
<b>上海(上海)</b>																
<i>(上场队员)</i>																
1	许沫									0.0%	2	1				00:18:57
2	周蕾				1/2				1/2	50.0%						00:09:56
5	郭威		1/1						1/1	100%						00:08:55
6	黄妍	1/1						1/1	2/2	100%	3	3				00:14:25
7	车婉茹									0.0%						00:38:31
8	吴茵									0.0%	3	1				00:10:40
9	武娜娜				3/3				3/3	100%			1			00:14:23
10	斯文			1/1					1/1	100%			1			00:17:43
11	孙梦颖	3/3							3/3	100%		2				00:56:44
12	郑冯									0.0%						00:41:03
13	徐娟							1/1	1/1	100%						00:32:18
17	居晔			2/3					2/3	66.7%		1				00:45:36
18	沙正文	0/1	1/2		2/2				3/5	60.0%	1		1			00:12:34
19	印尼		2/2			0/1			2/3	66.7%		1				00:45:34
21	王嘉怡	1/1	1/1	0/1	1/1				3/4	75.0%						00:43:38
23	都好		1/1		1/1				2/2	100%						00:08:53
<b>合计</b>		5/6	6/7	3/5	8/9	0/1		2/2	24/30	80.0%	9	9	3			
<i>(守门员)</i>																
1	许沫	4/6	0/2	2/2		1/1			7/11	63.6%	2	1				00:18:57
12	郑冯	2/2	3/5	0/1		0/1		0/1	5/10	50.0%						00:41:03
<b>合计</b>		6/8	3/7	2/3		1/2		0/1	12/21	57.1%	2	1				

场上队员：得分/射门

守门员：救球/射门

全队合计	得分	被救	射失	击柱	封球	合计	%
远射	5			1		6	83.3%
近射	6			1		7	85.7%
边射	3		1	1		5	60.0%
快攻	8	1				9	88.9%
突破		1				1	0.0%
任意							0.0%
7M	2					2	100.0%





### 2016年全国女子手球锦标赛

#### 图式射门区域统计

轮次 5 场次 23

201605023-41-1/1

## 解放军

2 崔云莉	5 徐鸣昭	6 于婷婷	8 周亚茹	13 张格格	16 方文博	17 于利婷	23 顾天澍																																																																								
<table border="1"><tr><td></td><td></td><td></td></tr><tr><td></td><td></td><td>1</td></tr><tr><td></td><td></td><td>1</td></tr></table>						1			1	<table border="1"><tr><td></td><td></td><td></td></tr><tr><td></td><td></td><td>1</td></tr><tr><td></td><td></td><td>1</td></tr></table>						1			1	<table border="1"><tr><td></td><td></td><td></td></tr><tr><td></td><td></td><td>1</td></tr><tr><td></td><td></td><td></td></tr></table>						1				<table border="1"><tr><td></td><td></td><td>1</td></tr><tr><td></td><td></td><td></td></tr><tr><td></td><td></td><td>1</td></tr></table>			1						1	<table border="1"><tr><td></td><td></td><td></td></tr><tr><td></td><td></td><td>1</td></tr><tr><td></td><td></td><td></td></tr></table>						1				<table border="1"><tr><td></td><td></td><td></td></tr><tr><td></td><td></td><td></td></tr><tr><td></td><td></td><td></td></tr></table>										<table border="1"><tr><td></td><td></td><td></td></tr><tr><td></td><td></td><td></td></tr><tr><td></td><td></td><td></td></tr></table>										<table border="1"><tr><td></td><td></td><td></td></tr><tr><td></td><td></td><td></td></tr><tr><td></td><td></td><td></td></tr></table>									
		1																																																																													
		1																																																																													
		1																																																																													
		1																																																																													
		1																																																																													
		1																																																																													
		1																																																																													
		1																																																																													
Post - 1 Miss - 3 Block - 1	Post - 0 Miss - 0 Block - 0	Post - 0 Miss - 0 Block - 0	Post - 0 Miss - 0 Block - 2	Post - 0 Miss - 1 Block - 0	Post - 0 Miss - 0 Block - 0	Post - 0 Miss - 0 Block - 2	Post - 0 Miss - 0 Block - 0																																																																								
24 韦娜娜	32 张馨予	36 李朴	44 刘洋麦文	66 杨丽丽	77 唐魏萍	81 戴丹妮	88 李晓晴																																																																								
<table border="1"><tr><td></td><td></td><td>1</td></tr><tr><td></td><td></td><td>1</td></tr><tr><td></td><td></td><td></td></tr></table>			1			1				<table border="1"><tr><td></td><td></td><td></td></tr><tr><td></td><td></td><td></td></tr><tr><td></td><td></td><td></td></tr></table>										<table border="1"><tr><td></td><td></td><td></td></tr><tr><td></td><td></td><td></td></tr><tr><td></td><td></td><td></td></tr></table>										<table border="1"><tr><td></td><td></td><td></td></tr><tr><td></td><td></td><td></td></tr><tr><td></td><td></td><td></td></tr></table>										<table border="1"><tr><td></td><td></td><td></td></tr><tr><td></td><td></td><td></td></tr><tr><td></td><td></td><td></td></tr></table>										<table border="1"><tr><td></td><td></td><td></td></tr><tr><td></td><td></td><td></td></tr><tr><td></td><td></td><td></td></tr></table>										<table border="1"><tr><td></td><td></td><td></td></tr><tr><td></td><td></td><td></td></tr><tr><td></td><td></td><td></td></tr></table>										<table border="1"><tr><td></td><td></td><td></td></tr><tr><td></td><td></td><td></td></tr><tr><td></td><td></td><td>1</td></tr></table>									1
		1																																																																													
		1																																																																													
		1																																																																													
Post - 0 Miss - 0 Block - 0	Post - 0 Miss - 0 Block - 0	Post - 0 Miss - 0 Block - 0	Post - 0 Miss - 0 Block - 0	Post - 0 Miss - 0 Block - 0	Post - 0 Miss - 0 Block - 0	Post - 0 Miss - 0 Block - 0	Post - 1 Miss - 0 Block - 0																																																																								

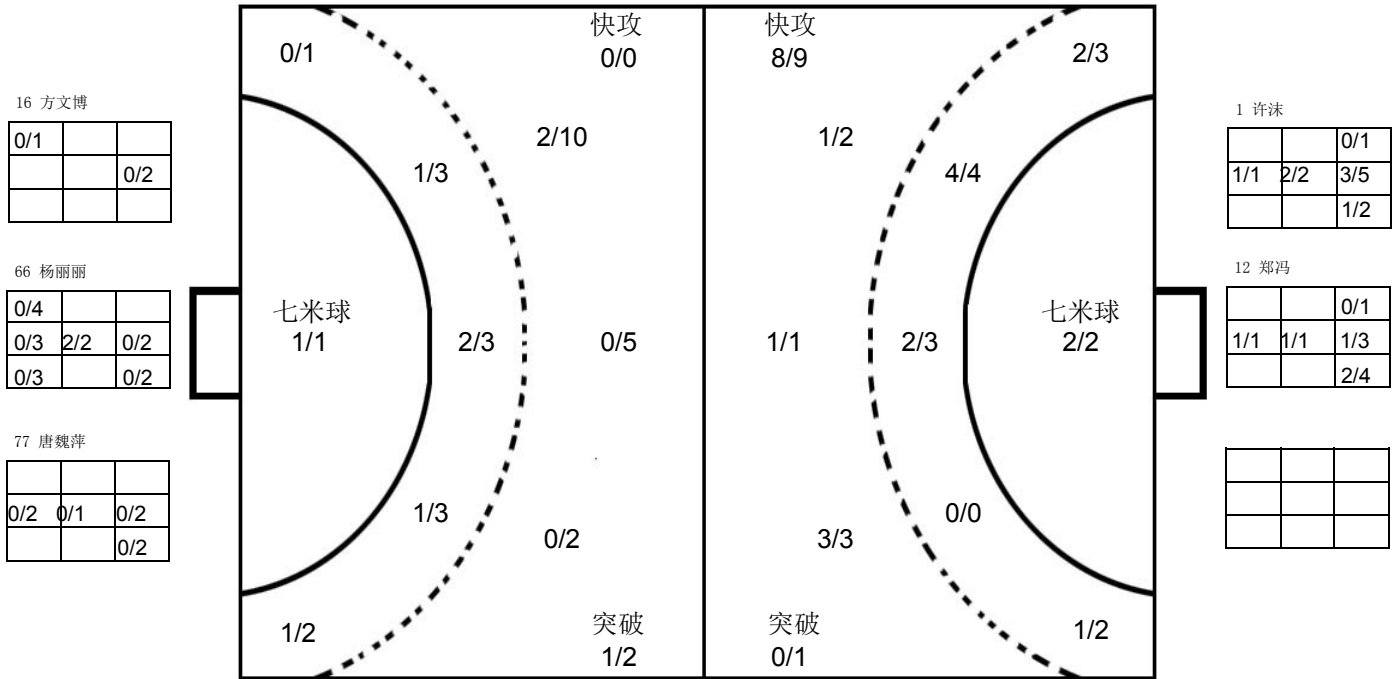

## 上海

1 许沫	2 周蕾	5 郭威	6 黄妍	7 车婉茹	8 吴茵	9 武娜娜	10 斯文																																																																								
<table border="1"><tr><td></td><td></td><td></td></tr><tr><td></td><td></td><td></td></tr><tr><td></td><td></td><td></td></tr></table>										<table border="1"><tr><td></td><td></td><td></td></tr><tr><td></td><td></td><td></td></tr><tr><td></td><td></td><td></td></tr></table>										<table border="1"><tr><td>1</td><td></td><td></td></tr><tr><td></td><td></td><td></td></tr><tr><td></td><td></td><td></td></tr></table>	1									<table border="1"><tr><td>1</td><td></td><td></td></tr><tr><td></td><td></td><td>1</td></tr><tr><td></td><td></td><td></td></tr></table>	1					1				<table border="1"><tr><td></td><td></td><td></td></tr><tr><td></td><td></td><td></td></tr><tr><td></td><td></td><td></td></tr></table>										<table border="1"><tr><td></td><td></td><td></td></tr><tr><td></td><td></td><td></td></tr><tr><td></td><td></td><td></td></tr></table>										<table border="1"><tr><td></td><td></td><td></td></tr><tr><td>2</td><td></td><td>1</td></tr><tr><td></td><td></td><td></td></tr></table>				2		1				<table border="1"><tr><td></td><td></td><td></td></tr><tr><td>1</td><td></td><td></td></tr><tr><td></td><td></td><td></td></tr></table>				1					
1																																																																															
1																																																																															
		1																																																																													
2		1																																																																													
1																																																																															
Post - 0 Miss - 0 Block - 0	Post - 0 Miss - 0 Block - 0	Post - 0 Miss - 0 Block - 0	Post - 0 Miss - 0 Block - 0	Post - 0 Miss - 0 Block - 0	Post - 0 Miss - 0 Block - 0	Post - 0 Miss - 0 Block - 0	Post - 0 Miss - 0 Block - 0																																																																								
11 孙梦颖	12 郑冯	13 徐娟	17 居晔	18 沙正文	19 印尼	21 王嘉怡	23 都好																																																																								
<table border="1"><tr><td>1</td><td></td><td></td></tr><tr><td></td><td>1</td><td>1</td></tr><tr><td></td><td></td><td></td></tr></table>	1				1	1				<table border="1"><tr><td></td><td></td><td></td></tr><tr><td></td><td></td><td></td></tr><tr><td></td><td></td><td></td></tr></table>										<table border="1"><tr><td></td><td></td><td></td></tr><tr><td></td><td></td><td>1</td></tr><tr><td></td><td></td><td></td></tr></table>						1				<table border="1"><tr><td></td><td></td><td></td></tr><tr><td></td><td></td><td>1</td></tr><tr><td></td><td></td><td>1</td></tr></table>						1			1	<table border="1"><tr><td>2</td><td></td><td></td></tr><tr><td></td><td></td><td></td></tr><tr><td></td><td></td><td>1</td></tr></table>	2								1	<table border="1"><tr><td></td><td></td><td></td></tr><tr><td></td><td></td><td></td></tr><tr><td></td><td></td><td>1</td></tr></table>									1	<table border="1"><tr><td></td><td></td><td></td></tr><tr><td>2</td><td></td><td></td></tr><tr><td></td><td></td><td>1</td></tr></table>				2					1	<table border="1"><tr><td></td><td></td><td></td></tr><tr><td></td><td></td><td></td></tr><tr><td>1</td><td></td><td>1</td></tr></table>							1		1
1																																																																															
	1	1																																																																													
		1																																																																													
		1																																																																													
		1																																																																													
2																																																																															
		1																																																																													
		1																																																																													
2																																																																															
		1																																																																													
1		1																																																																													
Post - 0 Miss - 0 Block - 0	Post - 0 Miss - 0 Block - 0	Post - 0 Miss - 0 Block - 0	Post - 1 Miss - 0 Block - 0	Post - 2 Miss - 0 Block - 0	Post - 0 Miss - 0 Block - 0	Post - 0 Miss - 1 Block - 0	Post - 0 Miss - 0 Block - 0																																																																								

注释: Post=击柱 Miss=射失 Block=被封







预赛 Group B

女子 全国比赛

2016年全国女子手球锦标赛

Team A				Team B				Match Number													
A 天津				B 北京				24													
played in		in the hall		on		at		Spectators													
China		滁州体育馆		07/09/2016		16:00 hours															
Half-time (30')	A	B	End of playing time	A	B	1st extra time	A	B	2nd extra time	A	B	After penalty throws	A	B							
	16	13		28	24																
Number of 7 m	A	Team time-out			Full name of players and officials						Team time-out			B	Number of 7 m						
		1	2	3							1	2	3			2/3					
No.	Team A					G	W	2'	D	DR	No.	Team B					G	W	2'	D	DR
3	王晓梅					6		2			1	宋嘉蕾									
4	朱佳瑜										3	季小桐					5				
5	丁丽洁					1					4	孙佳					1	1			
7	张心茹										6	刘亚男									
8	张慧					2	1				8	杨铭豫					1	1			
10	张文慧					2	1	1			10	刘莎									
11	蔡雪洁					5		1			11	纪婉					4				
12	王欣冉										16	王海叶									
14	刘洁										17	杨政赢									
15	李窈窈										22	李海鸥					1				
16	王选										23	田媛									
17	聂晓雪										28	闫美珠					3				
18	舒文琪					5	1	1			33	栾征					1				
21	李默雅					3					47	刘泽									
22	王聪										58	李华									
23	周梦雪										69	石梓薇					8	1			
A	付明双					1					A	蔡建国					1				
B	王明星 (主教练)										B	石伟 (主教练)									
C	岳连娥										C	李翼						1			
											E	史良玉									
A	Signature of Responsible Official of the Teams (Off. A)																		B		
TP	Remarks of Referee / CHA Official																		TP		

Signatures

Referees	刘书勇 (CHN)	倪震 (CHN)		
Techn. Delegates	吴国忠 (CHN)			
CHA Official	于中迅 (CHN)			

Note: Number of 7m Throws Awarded to Team A and B, Goals (G), Warnings (W), Suspensions (2'), Direct Disqualification (D), Disqualification with Report (DR) and Team Penalty (TP).

Table Officials: 伍豪

陈文丽

Statisticians: 黄岩

刘永欢



2016年全国女子手球锦标赛  
竞赛技术统计(媒体表)

预赛	组别	B	轮次	5	场次	24
滁州体育馆		07/09/2016			201605024-51-1/1	
天津	天津	28	vs	24	北京	北京
16 : 13						

裁判员	刘书勇 (CHN)			/	倪震 (CHN)		
-----	-----------	--	--	---	----------	--	--

天津		远射	近射	边射	快攻	突破	任意球	7m球	合计	%	助攻	失误	警告	2'	D & DR	天津	比赛进程	北京
主教练: 王明星																		
3	王晓梅	2/5	1/2	1/1	0/1			2/3	6/12	50.0	2	3		2		3	季小桐	
4	朱佳瑜															1	季小桐	
5	丁丽洁		1/1					1/1	1/1	100						2	季小桐	
7	张心茹															3	纪婉	
8	张慧	0/1	1/1	0/2	1/1			2/5	40.0		1		1			4	石梓薇	
10	张文慧		1/2		1/2			2/4	50.0				1	1		5	纪婉	
11	蔡雪洁	0/2	1/2	0/1		4/4		5/9	55.6		1	4		1		6	石梓薇	
12	王欣冉															7	石梓薇	
14	刘洁															8	纪婉	
15	李窈窕															9	石梓薇	
16	王选															10	石梓薇	
17	聂晓雪															11	石梓薇	
18	舒文琪	1/6	2/2	1/3		1/2		5/13	38.5		1	3	1	1		12	季小桐	
21	李默雅	0/1		1/2	2/2			3/5	60.0							13	孙佳	
22	王聪															14	李海鸥	
23	周梦雪	3/5	0/1	0/1		1/1		4/8	50.0			5		1		15	石梓薇	
运动员 合计		6/20	7/11	3/10	4/6	6/7	2/3	28/57	49.1		5	15	3	6		16	石梓薇	
12	王欣冉	6/8	3/4	4/5	1/1	0/1	1/2	15/21	71.4							17	石梓薇	
16	王选	3/11	2/5	2/5		0/2	1/2	8/26	30.8							18	石梓薇	
守门员 合计		9/19	5/9	6/10	1/1	0/3	1/2	23/47	48.9							19	石梓薇	
北京		远射	近射	边射	快攻	突破	任意球	7m球	合计	%	助攻	失误	警告	2'	D & DR			
教练: 石伟																		
1	宋嘉蕾															17	闫美珠	
3	季小桐	3/7	1/5	0/1		1/1		5/14	35.7			4				18	闫美珠	
4	孙佳		0/1	1/2				1/3	33.3			1	1			19	闫美珠	
6	刘亚男															20	石梓薇	
8	杨铭豫		0/1	1/2	0/1			1/4	25.0			1	1			21	石梓薇	
10	刘莎			0/2				0/2	0.0							22	石梓薇	
11	纪婉		1/2	1/4		2/2		4/8	50.0			3				23	石梓薇	
16	王海叶															24	石梓薇	
17	杨政赢															25	石梓薇	
22	李海鸥		1/1					1/1	100			1				26	石梓薇	
23	田媛															27	石梓薇	
28	闫美珠	2/6					1/1	3/7	42.9		1					28	石梓薇	
33	栾征	0/1	0/1	1/1				1/3	33.3							29	石梓薇	
47	刘泽															30	石梓薇	
58	李华															31	石梓薇	
69	石梓薇	5/12	1/1				0/1	2/3	8/17	47.1		3	1			32	石梓薇	
运动员 合计		10/26	4/12	4/12	0/1	3/3	1/2	24/59	40.7		1	13	3			33	石梓薇	
1	宋嘉蕾							0/1	0/1	0.0						34	石梓薇	
16	王海叶	6/12	3/10	7/10	2/6	1/7		0/1	19/46	41.3						35	石梓薇	
守门员 合计		6/12	3/10	7/10	2/6	1/7		0/2	19/47	40.4						36	石梓薇	

场上队员: 得分 / 射门

守门员: 救球 / 射门

快攻	Fast Break		突破	Breakthrough		任意球	Free Throw		7M球	7M Throw		助攻	Assist
警告	Warning		失误	Error		2'	Suspension		D	取消资格		DR	取消资格+报告





### 2016年全国女子手球锦标赛 图式比赛技术统计表

轮次 5

场次 24

201605024-21-1/1

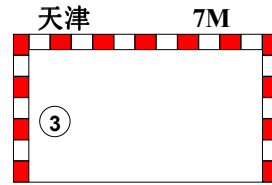
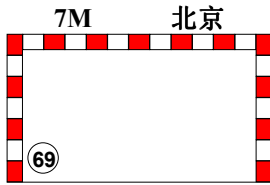
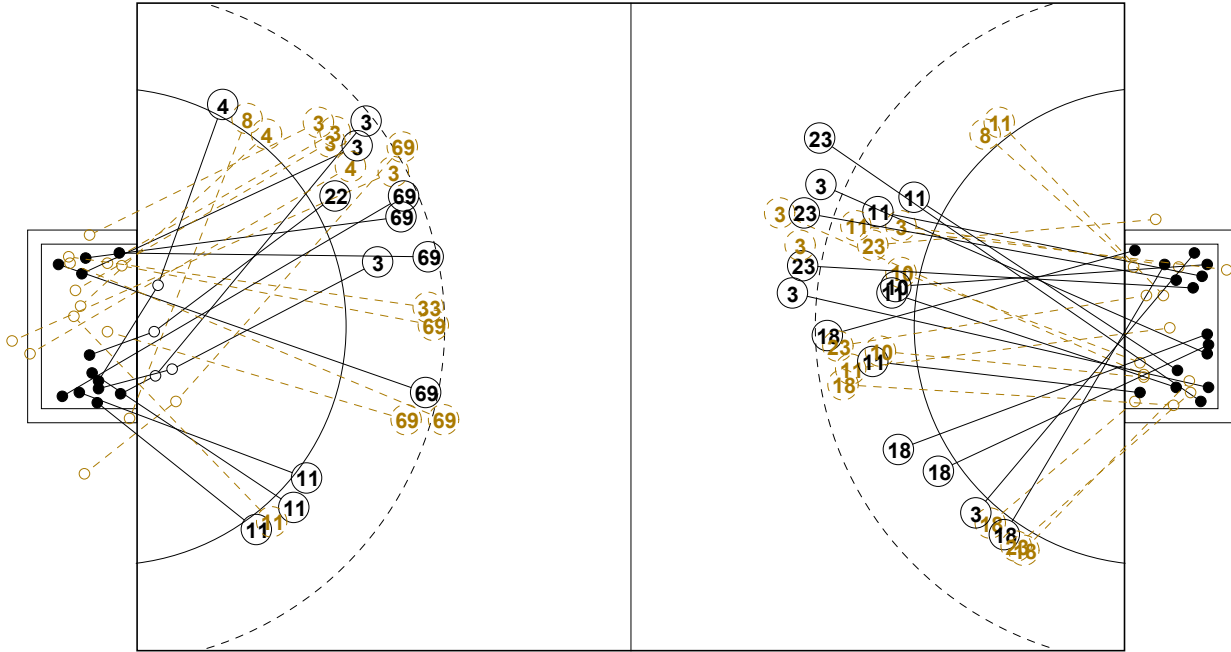

1st Half  
13 : 16

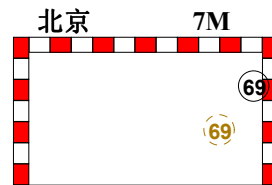
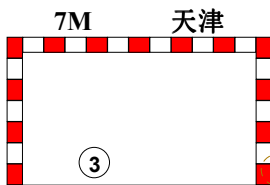
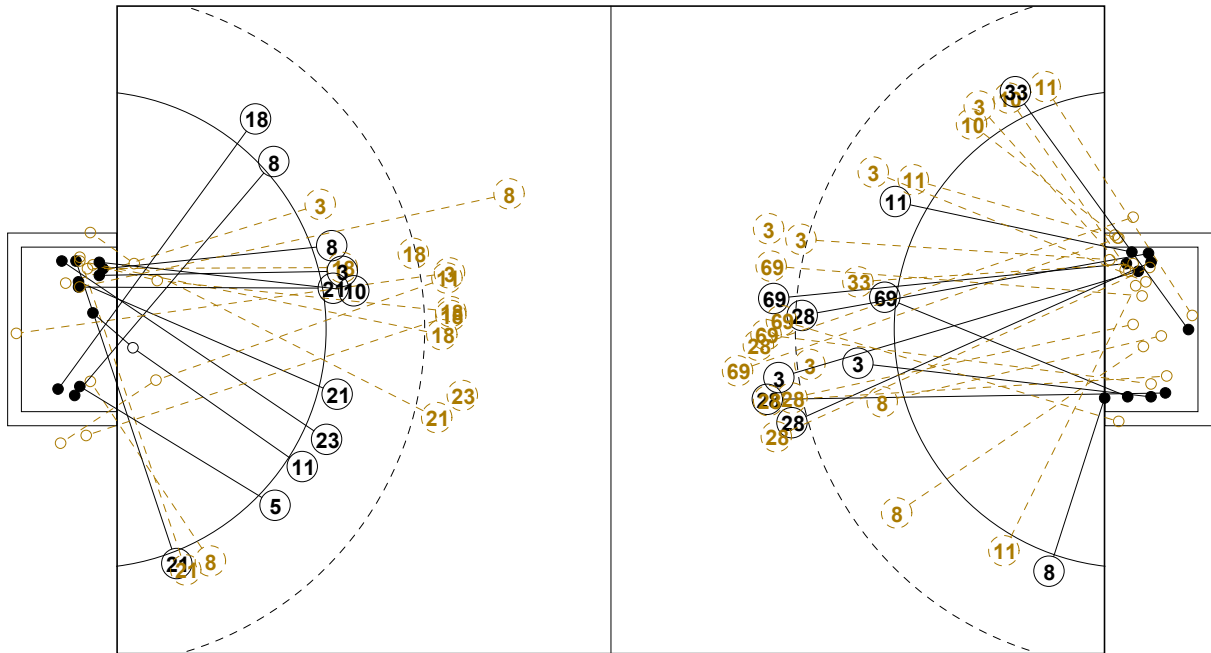

2nd Half  
28 : 24



## 2016年全国女子手球锦标赛

## 个人/全队技术统计表

正式表  
手球  
女子预赛  
轮次 5组别 B  
场次 24201605024-14-1/2  
滁州体育馆  
07/09/2016 16:00

号码	姓名	远射	近射	边射	快攻	突破	任意	7M	合计	%	助攻	失误	警告	2'	取消	时间
<b>天津(天津)</b>																
<i>(场上队员)</i>																
3	王晓梅	2/5	1/2	1/1	0/1			2/3	6/12	50.0%	2	3		2		00:34:07
4	朱佳瑜									0.0%						00:00:00
5	丁丽洁		1/1						1/1	100%						00:17:20
7	张心茹									0.0%						00:00:00
8	张慧	0/1	1/1	0/2	1/1				2/5	40.0%	1		1			01:00:00
10	张文慧		1/2		1/2				2/4	50.0%			1	1		00:53:17
11	蔡雪洁	0/2	1/2	0/1		4/4			5/9	55.6%	1	4		1		01:00:00
12	王欣冉									0.0%						00:21:23
14	刘洁									0.0%						00:00:00
15	李窈窕									0.0%						00:00:00
16	王选									0.0%						00:38:37
17	聂晓雪									0.0%						00:03:42
18	舒文琪	1/6	2/2	1/3		1/2			5/13	38.5%	1	3	1	1		00:54:09
21	李默雅	0/1		1/2	2/2				3/5	60.0%						00:23:30
22	王聪									0.0%						00:00:00
23	周梦雪	3/5	0/1	0/1		1/1			4/8	50.0%		5		1		00:52:57
<b>合计</b>		6/20	7/11	3/10	4/6	6/7		2/3	28/57	49.1%	5	15	3	6		
<i>(守门员)</i>																
12	王欣冉	6/8	3/4	4/5	1/1	0/1		1/2	15/21	71.4%						00:21:23
16	王选	3/11	2/5	2/5		0/2	1/2	0/1	8/26	30.8%						00:38:37
<b>合计</b>		9/19	5/9	6/10	1/1	0/3	1/2	1/3	23/47	48.9%						

场上队员：得分/射门

守门员：救球/射门

全队合计	得分	被救	射失	击柱	封球	合计	%
远射	6	6	2	3	3	20	30.0%
近射	7	3	1			11	63.6%
边射	3	7				10	30.0%
快攻	4	2				6	66.7%
突破	6	1				7	85.7%
任意							0.0%
7M	2			1		3	66.7%





## 2016年全国女子手球锦标赛

## 个人/全队技术统计表

正式表  
手球  
女子预赛  
轮次 5组别 B  
场次 24201605024-14-2/2  
滁州体育馆  
07/09/2016 16:00

号码	姓名	远射	近射	边射	快攻	突破	任意	7M	合计	%	助攻	失误	警告	2'	取消	时间
<b>北京(北京)</b>																
<i>(上场队员)</i>																
1	宋嘉蕾									0.0%						00:00:23
3	季小桐	3/7	1/5	0/1		1/1			5/14	35.7%		4				01:00:00
4	孙佳		0/1	1/2					1/3	33.3%		1	1			00:33:19
6	刘亚男									0.0%						00:00:00
8	杨铭豫		0/1	1/2	0/1				1/4	25.0%		1	1			00:32:04
10	刘莎			0/2					0/2	0.0%						00:05:34
11	纪婉		1/2	1/4		2/2			4/8	50.0%		3				00:54:23
16	王海叶									0.0%						00:59:37
17	杨政赢									0.0%						00:00:00
22	李海鸥		1/1						1/1	100%		1				00:56:53
23	田媛									0.0%						00:07:23
28	闫美珠	2/6					1/1		3/7	42.9%	1					00:19:03
33	栾征	0/1	0/1	1/1					1/3	33.3%						00:29:25
47	刘泽									0.0%						00:00:00
58	李华									0.0%						00:00:00
69	石梓薇	5/12	1/1				0/1	2/3	8/17	47.1%		3	1			01:00:00
<b>合计</b>		10/26	4/12	4/12	0/1	3/3	1/2	2/3	24/59	40.7%	1	13	3			
<i>(守门员)</i>																
1	宋嘉蕾							0/1	0/1	0.0%						00:00:23
16	王海叶	6/12	3/10	7/10	2/6	1/7		0/1	19/46	41.3%						00:59:37
<b>合计</b>		6/12	3/10	7/10	2/6	1/7		0/2	19/47	40.4%						

场上队员：得分/射门

守门员：救球/射门

全队合计	得分	被救	射失	击柱	封球	合计	%
远射	10	9	3	2	2	26	38.5%
近射	4	5		3		12	33.3%
边射	4	6		2		12	33.3%
快攻		1				1	0.0%
突破	3					3	100.0%
任意	1	1				2	50.0%
7M	2	1				3	66.7%





### 2016年全国女子手球锦标赛

#### 图式射门区域统计

轮次 5 场次 24

201605024-41-1/1

## 天津

3 王晓梅	4 朱佳瑜	5 丁丽洁	7 张心茹	8 张慧	10 张文慧	11 蔡雪洁	12 王欣冉																																																																								
<table border="1"><tr><td>1</td><td>1</td><td>1</td></tr><tr><td>1</td><td></td><td></td></tr><tr><td>1</td><td></td><td>1</td></tr></table>	1	1	1	1			1		1	<table border="1"><tr><td></td><td></td><td></td></tr><tr><td></td><td></td><td></td></tr><tr><td></td><td></td><td></td></tr></table>										<table border="1"><tr><td></td><td></td><td></td></tr><tr><td>1</td><td></td><td></td></tr><tr><td></td><td></td><td></td></tr></table>				1						<table border="1"><tr><td></td><td></td><td></td></tr><tr><td></td><td></td><td></td></tr><tr><td></td><td></td><td></td></tr></table>										<table border="1"><tr><td></td><td></td><td></td></tr><tr><td>1</td><td></td><td></td></tr><tr><td></td><td></td><td>1</td></tr></table>				1					1	<table border="1"><tr><td>1</td><td></td><td></td></tr><tr><td></td><td></td><td></td></tr><tr><td></td><td></td><td>1</td></tr></table>	1								1	<table border="1"><tr><td>1</td><td></td><td></td></tr><tr><td></td><td></td><td>2</td></tr><tr><td></td><td>1</td><td>1</td></tr></table>	1					2		1	1	<table border="1"><tr><td></td><td></td><td></td></tr><tr><td></td><td></td><td></td></tr><tr><td></td><td></td><td></td></tr></table>									
1	1	1																																																																													
1																																																																															
1		1																																																																													
1																																																																															
1																																																																															
		1																																																																													
1																																																																															
		1																																																																													
1																																																																															
		2																																																																													
	1	1																																																																													
Post - 2 Miss - 0 Block - 1	Post - 0 Miss - 0 Block - 0	Post - 0 Miss - 0 Block - 0	Post - 0 Miss - 0 Block - 0	Post - 0 Miss - 0 Block - 0	Post - 0 Miss - 0 Block - 0	Post - 1 Miss - 1 Block - 0	Post - 0 Miss - 0 Block - 0																																																																								
14 刘洁	15 李窈窈	16 王选	17 聂晓雪	18 舒文琪	21 李默雅	22 王聪	23 周梦雪																																																																								
<table border="1"><tr><td></td><td></td><td></td></tr><tr><td></td><td></td><td></td></tr><tr><td></td><td></td><td></td></tr></table>										<table border="1"><tr><td></td><td></td><td></td></tr><tr><td></td><td></td><td></td></tr><tr><td></td><td></td><td></td></tr></table>										<table border="1"><tr><td></td><td></td><td></td></tr><tr><td></td><td></td><td></td></tr><tr><td></td><td></td><td></td></tr></table>										<table border="1"><tr><td></td><td></td><td></td></tr><tr><td></td><td></td><td></td></tr><tr><td></td><td></td><td></td></tr></table>										<table border="1"><tr><td></td><td>2</td><td></td></tr><tr><td>2</td><td></td><td></td></tr><tr><td>1</td><td></td><td></td></tr></table>		2		2			1			<table border="1"><tr><td></td><td></td><td></td></tr><tr><td></td><td></td><td>3</td></tr><tr><td></td><td></td><td></td></tr></table>						3				<table border="1"><tr><td></td><td></td><td></td></tr><tr><td></td><td></td><td></td></tr><tr><td></td><td></td><td></td></tr></table>										<table border="1"><tr><td>1</td><td></td><td>1</td></tr><tr><td>1</td><td></td><td>1</td></tr><tr><td></td><td></td><td></td></tr></table>	1		1	1		1			
	2																																																																														
2																																																																															
1																																																																															
		3																																																																													
1		1																																																																													
1		1																																																																													
Post - 0 Miss - 0 Block - 0	Post - 0 Miss - 0 Block - 0	Post - 0 Miss - 0 Block - 0	Post - 0 Miss - 0 Block - 0	Post - 0 Miss - 1 Block - 1	Post - 1 Miss - 0 Block - 0	Post - 0 Miss - 0 Block - 0	Post - 0 Miss - 1 Block - 1																																																																								

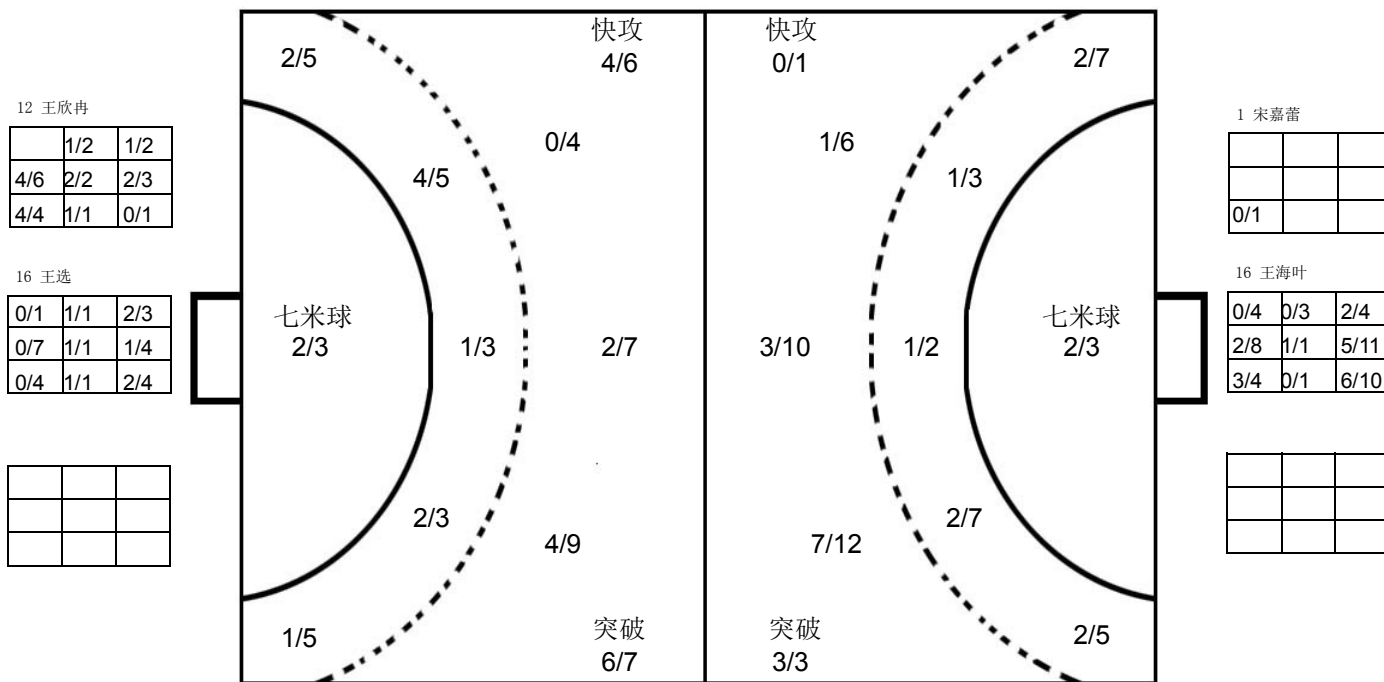

## 北京

1 宋嘉蕾	3 季小桐	4 孙佳	6 刘亚男	8 杨铭豫	10 刘莎	11 纪婉	16 王海叶																																																																								
<table border="1"><tr><td></td><td></td><td></td></tr><tr><td></td><td></td><td></td></tr><tr><td></td><td></td><td></td></tr></table>										<table border="1"><tr><td></td><td></td><td></td></tr><tr><td>2</td><td></td><td>2</td></tr><tr><td>1</td><td></td><td></td></tr></table>				2		2	1			<table border="1"><tr><td></td><td></td><td></td></tr><tr><td>1</td><td></td><td></td></tr><tr><td></td><td></td><td></td></tr></table>				1						<table border="1"><tr><td></td><td></td><td></td></tr><tr><td></td><td></td><td></td></tr><tr><td></td><td></td><td></td></tr></table>										<table border="1"><tr><td></td><td></td><td></td></tr><tr><td></td><td></td><td>1</td></tr><tr><td></td><td></td><td></td></tr></table>						1				<table border="1"><tr><td></td><td></td><td></td></tr><tr><td></td><td></td><td></td></tr><tr><td></td><td></td><td></td></tr></table>										<table border="1"><tr><td></td><td></td><td></td></tr><tr><td>3</td><td></td><td></td></tr><tr><td>1</td><td></td><td></td></tr></table>				3			1			<table border="1"><tr><td></td><td></td><td></td></tr><tr><td></td><td></td><td></td></tr><tr><td></td><td></td><td></td></tr></table>									
2		2																																																																													
1																																																																															
1																																																																															
		1																																																																													
3																																																																															
1																																																																															
Post - 0 Miss - 0 Block - 0	Post - 1 Miss - 1 Block - 2	Post - 1 Miss - 0 Block - 0	Post - 0 Miss - 0 Block - 0	Post - 1 Miss - 0 Block - 0	Post - 1 Miss - 0 Block - 0	Post - 1 Miss - 0 Block - 0	Post - 0 Miss - 0 Block - 0																																																																								
17 杨政赢	22 李海鸥	23 田媛	28 闫美珠	33 栾征	47 刘泽	58 李华	69 石梓薇																																																																								
<table border="1"><tr><td></td><td></td><td></td></tr><tr><td></td><td></td><td></td></tr><tr><td></td><td></td><td></td></tr></table>										<table border="1"><tr><td></td><td></td><td></td></tr><tr><td>1</td><td></td><td></td></tr><tr><td></td><td></td><td></td></tr></table>				1						<table border="1"><tr><td></td><td></td><td></td></tr><tr><td></td><td></td><td></td></tr><tr><td></td><td></td><td></td></tr></table>										<table border="1"><tr><td></td><td></td><td></td></tr><tr><td>2</td><td></td><td>1</td></tr><tr><td></td><td></td><td></td></tr></table>				2		1				<table border="1"><tr><td></td><td>1</td><td></td></tr><tr><td></td><td></td><td></td></tr><tr><td></td><td></td><td></td></tr></table>		1								<table border="1"><tr><td></td><td></td><td></td></tr><tr><td></td><td></td><td></td></tr><tr><td></td><td></td><td></td></tr></table>										<table border="1"><tr><td></td><td></td><td></td></tr><tr><td></td><td></td><td></td></tr><tr><td></td><td></td><td></td></tr></table>										<table border="1"><tr><td></td><td>1</td><td>2</td></tr><tr><td></td><td></td><td>1</td></tr><tr><td>2</td><td></td><td>2</td></tr></table>		1	2			1	2		2
1																																																																															
2		1																																																																													
	1																																																																														
	1	2																																																																													
		1																																																																													
2		2																																																																													
Post - 0 Miss - 0 Block - 0	Post - 0 Miss - 0 Block - 0	Post - 0 Miss - 0 Block - 0	Post - 0 Miss - 1 Block - 0	Post - 0 Miss - 0 Block - 0	Post - 0 Miss - 0 Block - 0	Post - 0 Miss - 0 Block - 0	Post - 2 Miss - 1 Block - 0																																																																								

注释: Post=击柱 Miss=射失 Block=被封





预赛 Group A

女子 全国比赛

2016年全国女子手球锦标赛

Team A <b>A 山东</b>				Team B <b>B 安徽</b>				Match Number <b>25</b>													
played in China		in the hall 滁州体育馆		on 07/09/2016		at 17:30 hours		Spectators													
Half-time (30')	<b>A</b> 12	<b>B</b> 15	End of playing time	<b>A</b> 24	<b>B</b> 30	1st extra time	<b>A</b>	<b>B</b>	2nd extra time	<b>A</b>	<b>B</b>	After penalty throws	<b>A</b>	<b>B</b>							
Number of 7 m	<b>A</b> 4 / 4	Team time-out 1 09:18 2 42:47 3			Full name of players and officials				Team time-out 1 2 3			<b>B</b> 5 / 6	Number of 7 m								
No.	Team <b>A</b>					G	W	2'	D	DR	No.	Team <b>B</b>					G	W	2'	D	DR
1	路畅										1	司艳									
2	林燕群					7					3	李兵					1	1			
7	杨嘉露					1					5	班晨晨									
8	王彬					3					6	沈萍					7				
9	周钰婷						1				7	赵江川									
10	田秀秀					1					8	徐仕媛									
11	吕青纹					4					10	孙来苗					2				
12	张苑琳										14	刘晓妹					1				
15	吴作扬					4					16	朱莉珍									
19	姜伟珊										17	周婷					4	1			
20	张悦					4	1	1			18	郑冬冬									
22	朱赟										20	周雪婷									
23	徐悦							1			21	李瑶					8	1			
28	崔金娜						1	1			23	张天洁					1				
33	王彩琳										41	杜机娟					6				
77	穆庆丛										46	陶传红									
<b>A</b>	杜晓青										<b>A</b>	吴立军									
<b>B</b>	马海湧 (主教练)										<b>E</b>	张舜									
<b>C</b>	徐强																				
<b>E</b>	王日东																				
<b>A</b>	Signature of Responsible Official of the Teams (Off. A)																			<b>B</b>	
TP	Remarks of Referee / CHA Official																			TP	

Signatures

Referees	陈晓波 (CHN)	林晓佟 (CHN)		
Techn. Delegates	吴国忠 (CHN)			
CHA Official	于中迅 (CHN)			

Note: Number of 7m Throws Awarded to Team A and B, Goals (G), Warnings (W), Suspensions (2'), Direct Disqualification (D), Disqualification with Report (DR) and Team Penalty (TP).

Table Officials: 伍豪

陈文丽

Statisticians: 闫冲

陈柱

Printed by PHMS Copyright: IHF / CHA 07/09/2016 18:51:11

Longman Sportsoft



handball@126.com

2016年全国女子手球锦标赛  
竞赛技术统计(媒体表)

预赛	组别	A	轮次	5	场次	25
滁州体育馆		07/09/2016			201605025-51-1/1	
山东	山东	24	vs	30	安徽	安徽
12 : 15						

裁判员		陈晓波 (CHN)											林晓佟 (CHN)										
山东		远射	近射	边射	快攻	突破	任意球	7m球	合计	%	助攻	失误	警告	2'	D & DR	山东	比赛进程	安徽					
主教练: 马海湧																							
1	刘畅															11	吕青纹	1 01:55 0					
2	林燕群	2/5	1/2	1/2	1/2	1/1		1/1	7/13	53.8		5				20	张悦	2 04:10 0					
7	杨嘉露	1/3							1/3	33.3						15	吴作扬	3 07:03 1					
8	王彬	1/2						2/2	3/4	75.0	1	1						3 07:23 2 17 周婷					
9	周钰婷	0/1							0/1	0.0			1					3 08:29 3 23 张天洁					
10	田秀秀	1/2		0/1					1/3	33.3	1	4						3 08:56 4 21 李瑶					
11	吕青纹			3/3	1/1				4/4	100		1						3 09:57 5 17 周婷					
12	张苑琳																	4 10:06 5					
15	吴作扬	2/8				0/1	1/1	1/1	4/11	36.4		4						5 11:14 5					
19	姜伟珊																	6 13:38 6 21 李瑶					
20	张悦		3/3	1/1					4/4	100				1	1			6 14:44 7 6 沈萍					
22	朱贇																	7 15:21 7					
23	徐悦																	7 18:23 8 17 周婷					
28	崔金娜		0/1						0/1	0.0								7 19:29 9 21 李瑶					
33	王彩琳																	8 19:55 9					
77	穆庆丛																	9 21:16 9					
运动员 合计		7/21	4/6	5/7	2/3	1/2	1/1	4/4	24/44	54.5	2	17	3	3				10 22:35 9					
1	刘畅							0/1	0/1	0.0								11 23:35 9					
12	张苑琳	6/9	2/9	3/4	1/10	1/5	0/1	0/2	13/40	32.5								11 25:29 10 21 李瑶					
22	朱贇							0/2	0/2	0.0								11 26:36 11 6 沈萍					
守门员 合计		6/9	2/9	3/4	1/10	1/5	0/1	0/5	13/43	30.2								11 27:18 12 41 杜机娟					
安徽		远射	近射	边射	快攻	突破	任意球	7m球	合计	%	助攻	失误	警告	2'	D & DR								
教练: 孙来苗																							
1	司艳																						
3	李兵			0/1	1/1				1/2	50.0	3		1										
5	班晨晨																						
6	沈萍	1/2	1/1			1/1		4/4	7/8	87.5	1	2											
7	赵江川																						
8	徐仕媛																						
10	孙来苗		1/1		1/1			2/2	2/2	100													
14	刘晓妹	0/3				1/2			1/5	20.0													
16	朱莉珍																						
17	周婷		2/5	0/1	1/1	1/2			4/9	44.4		1	1										
18	郑冬冬																						
20	周雪婷																						
21	李瑶	2/7	2/2	0/1	2/2	1/1	1/1		8/14	57.1		3	1										
23	张天洁		1/1						1/1	100													
41	杜机娟			1/2	4/5			1/2	6/9	66.7													
46	陶传红																						
运动员 合计		3/12	7/10	1/5	9/10	4/6	1/1	5/6	30/50	60.0	5	13	3										
16	朱莉珍	7/14	0/4	2/7	1/3	1/2	0/1	0/4	11/35	31.4	1	1											
守门员 合计		7/14	0/4	2/7	1/3	1/2	0/1	0/4	11/35	31.4	1	1											

场上队员: 得分 / 射门

守门员: 救球 / 射门

快攻	Fast Break		突破	Breakthrough		任意球	Free Throw		7M球	7M Throw		助攻	Assist
警告	Warning		失误	Error		2'	Suspension		D	取消资格		DR	取消资格+报告







## 2016年全国女子手球锦标赛 图式比赛技术统计表

轮次 5

场次 25

201605025-21-1/1

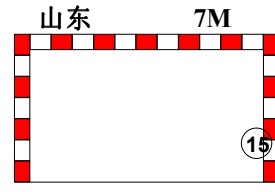
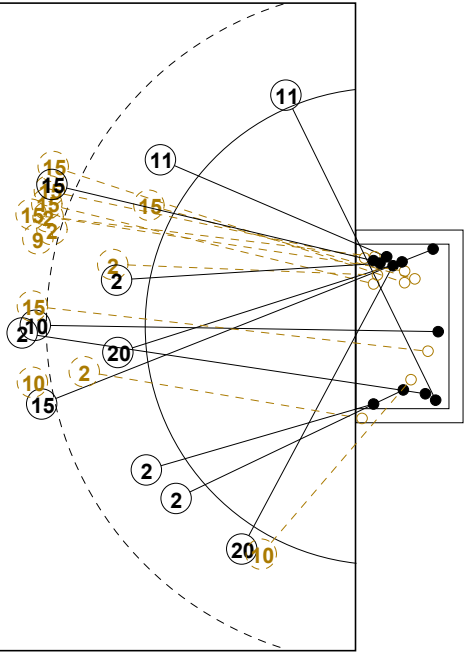
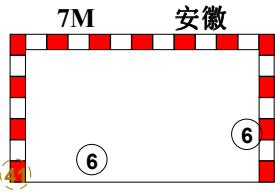
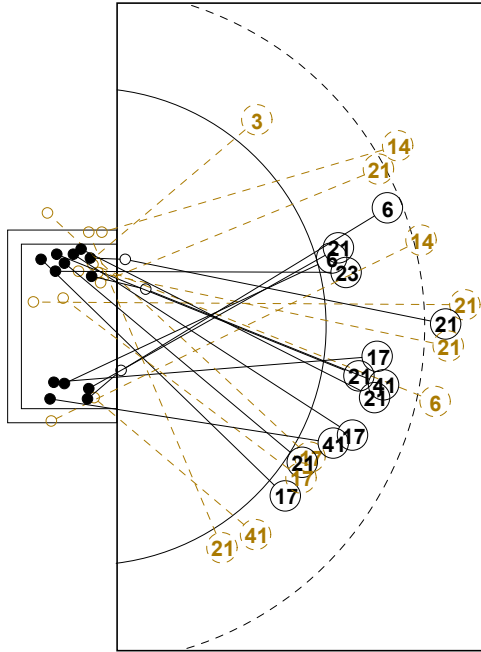

1st Half  
15 : 12

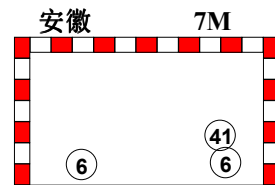
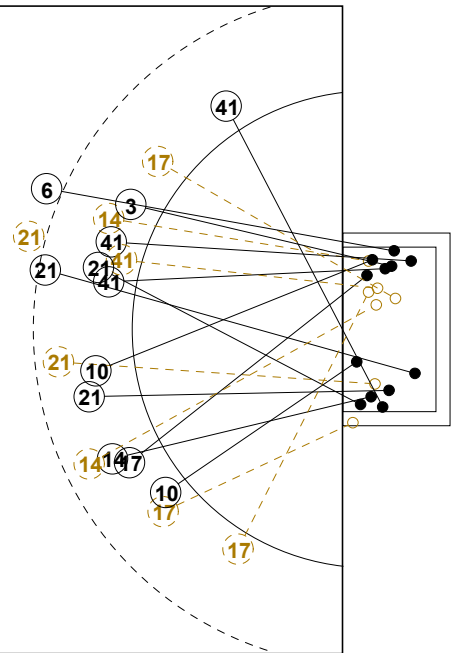
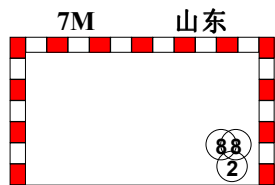
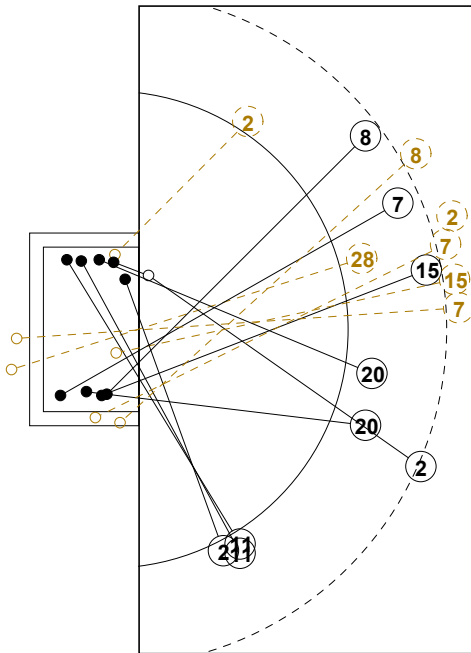

2nd Half  
24 : 30



## 2016年全国女子手球锦标赛

## 个人/全队技术统计表

正式表  
手球  
女子预赛  
轮次 5组别 A  
场次 25201605025-14-1/2  
滁州体育馆  
07/09/2016 17:30

号码	姓名	远射	近射	边射	快攻	突破	任意	7M	合计	%	助攻	失误	警告	2'	取消	时间
<b>山东(山东)</b>																
<i>(场上队员)</i>																
1	路畅									0.0%						00:00:17
2	林燕群	2/5	1/2	1/2	1/2	1/1		1/1	7/13	53.8%		5				00:50:19
7	杨嘉露	1/3							1/3	33.3%						00:14:03
8	王彬	1/2						2/2	3/4	75.0%	1	1				00:09:26
9	周钰婷	0/1							0/1	0.0%			1			00:03:48
10	田秀秀	1/2		0/1					1/3	33.3%	1	4				00:46:46
11	吕青纹			3/3	1/1				4/4	100%		1				01:00:00
12	张苑琳									0.0%						00:59:02
15	吴作扬	2/8				0/1	1/1	1/1	4/11	36.4%		4				00:38:39
19	姜伟珊									0.0%						00:00:00
20	张悦		3/3	1/1					4/4	100%			1	1		00:49:35
22	朱贇									0.0%						00:00:41
23	徐悦									0.0%				1		00:22:57
28	崔金娜		0/1						0/1	0.0%			1	1		00:48:11
33	王彩琳									0.0%		2				00:20:02
77	穆庆丛									0.0%						00:01:15
<b>合计</b>		7/21	4/6	5/7	2/3	1/2	1/1	4/4	24/44	54.5%	2	17	3	3		
<i>(守门员)</i>																
1	路畅							0/1	0/1	0.0%						00:00:17
12	张苑琳	6/9	2/9	3/4	1/10	1/5	0/1	0/2	13/40	32.5%						00:59:02
22	朱贇							0/2	0/2	0.0%						00:00:41
<b>合计</b>		6/9	2/9	3/4	1/10	1/5	0/1	0/5	13/43	30.2%						

场上队员：得分/射门

守门员：救球/射门

全队合计	得分	被救	射失	击柱	封球	合计	%
远射	7	7	1	2	4	21	33.3%
近射	4		1	1		6	66.7%
边射	5	2				7	71.4%
快攻	2	1				3	66.7%
突破	1	1				2	50.0%
任意	1					1	100.0%
7M	4					4	100.0%



## 2016年全国女子手球锦标赛

## 个人/全队技术统计表

正式表  
手球  
女子预赛  
轮次 5组别 A  
场次 25201605025-14-2/2  
滁州体育馆  
07/09/2016 17:30

号码	姓名	远射	近射	边射	快攻	突破	任意	7M	合计	%	助攻	失误	警告	2'	取消	时间
<b>安徽(安徽)</b>																
<i>(上场队员)</i>																
1	司艳									0.0%						00:00:00
3	李兵			0/1	1/1				1/2	50.0%	3			1		00:47:03
5	班晨晨									0.0%						00:04:28
6	沈萍	1/2	1/1			1/1		4/4	7/8	87.5%	1	2				00:44:32
7	赵江川									0.0%						00:00:00
8	徐仕媛									0.0%						00:00:00
10	孙来苗		1/1		1/1				2/2	100%						00:15:45
14	刘晓妹	0/3				1/2			1/5	20.0%						00:53:42
16	朱莉珍									0.0%	1	1				01:00:00
17	周婷		2/5	0/1	1/1	1/2			4/9	44.4%		3		1		00:41:21
18	郑冬冬									0.0%						00:02:18
20	周雪婷									0.0%						00:00:00
21	李瑶	2/7	2/2	0/1	2/2	1/1	1/1		8/14	57.1%		3		1		00:59:58
23	张天洁		1/1						1/1	100%		1				00:41:57
41	杜机娟			1/2	4/5			1/2	6/9	66.7%		3				00:48:32
46	陶传红									0.0%						00:00:00
<b>合计</b>		3/12	7/10	1/5	9/10	4/6	1/1	5/6	30/50	60.0%	5	13		3		
<i>(守门员)</i>																
16	朱莉珍	7/14	0/4	2/7	1/3	1/2	0/1	0/4	11/35	31.4%	1	1				01:00:00
<b>合计</b>																
		7/14	0/4	2/7	1/3	1/2	0/1	0/4	11/35	31.4%	1	1				

场上队员：得分/射门

守门员：救球/射门

全队合计	得分	被救	射失	击柱	封球	合计	%
远射	3	6		2	1	12	25.0%
近射	7	2		1		10	70.0%
边射	1	3		1		5	20.0%
快攻	9	1				10	90.0%
突破	4	1	1			6	66.7%
任意	1					1	100.0%
7M	5			1		6	83.3%





### 2016年全国女子手球锦标赛

#### 图式射门区域统计

轮次 5 场次 25

201605025-41-1/1

## 山东

1 路畅	2 林燕群	7 杨嘉露	8 王彬	9 周钰婷	10 田秀秀	11 吕青纹	12 张苑琳																																																																								
<table border="1"><tr><td></td><td></td><td></td></tr><tr><td></td><td></td><td></td></tr><tr><td></td><td></td><td></td></tr></table>										<table border="1"><tr><td></td><td></td><td>1</td></tr><tr><td></td><td></td><td>1</td></tr><tr><td>1</td><td></td><td>4</td></tr></table>			1			1	1		4	<table border="1"><tr><td>1</td><td></td><td></td></tr><tr><td></td><td></td><td></td></tr><tr><td></td><td></td><td></td></tr></table>	1									<table border="1"><tr><td></td><td></td><td></td></tr><tr><td>1</td><td></td><td>2</td></tr><tr><td></td><td></td><td></td></tr></table>				1		2				<table border="1"><tr><td></td><td></td><td></td></tr><tr><td></td><td></td><td></td></tr><tr><td></td><td></td><td></td></tr></table>										<table border="1"><tr><td></td><td></td><td>1</td></tr><tr><td></td><td></td><td></td></tr><tr><td></td><td></td><td></td></tr></table>			1							<table border="1"><tr><td></td><td></td><td>2</td></tr><tr><td></td><td></td><td></td></tr><tr><td>1</td><td></td><td>1</td></tr></table>			2				1		1	<table border="1"><tr><td></td><td></td><td></td></tr><tr><td></td><td></td><td></td></tr><tr><td></td><td></td><td></td></tr></table>									
		1																																																																													
		1																																																																													
1		4																																																																													
1																																																																															
1		2																																																																													
		1																																																																													
		2																																																																													
1		1																																																																													
Post - 0 Miss - 0 Block - 0	Post - 1 Miss - 0 Block - 2	Post - 1 Miss - 1 Block - 0	Post - 1 Miss - 0 Block - 0	Post - 0 Miss - 0 Block - 1	Post - 0 Miss - 0 Block - 1	Post - 0 Miss - 0 Block - 0	Post - 0 Miss - 0 Block - 0																																																																								
15 吴作扬	19 姜伟珊	20 张悦	22 朱贇	23 徐悦	28 崔金娜	33 王彩琳	77 穆庆丛																																																																								
<table border="1"><tr><td>1</td><td></td><td></td></tr><tr><td>1</td><td></td><td>1</td></tr><tr><td>1</td><td></td><td></td></tr></table>	1			1		1	1			<table border="1"><tr><td></td><td></td><td></td></tr><tr><td></td><td></td><td></td></tr><tr><td></td><td></td><td></td></tr></table>										<table border="1"><tr><td></td><td></td><td></td></tr><tr><td>3</td><td></td><td>1</td></tr><tr><td></td><td></td><td></td></tr></table>				3		1				<table border="1"><tr><td></td><td></td><td></td></tr><tr><td></td><td></td><td></td></tr><tr><td></td><td></td><td></td></tr></table>										<table border="1"><tr><td></td><td></td><td></td></tr><tr><td></td><td></td><td></td></tr><tr><td></td><td></td><td></td></tr></table>										<table border="1"><tr><td></td><td></td><td></td></tr><tr><td></td><td></td><td></td></tr><tr><td></td><td></td><td></td></tr></table>										<table border="1"><tr><td></td><td></td><td></td></tr><tr><td></td><td></td><td></td></tr><tr><td></td><td></td><td></td></tr></table>										<table border="1"><tr><td></td><td></td><td></td></tr><tr><td></td><td></td><td></td></tr><tr><td></td><td></td><td></td></tr></table>									
1																																																																															
1		1																																																																													
1																																																																															
3		1																																																																													
Post - 0 Miss - 0 Block - 0	Post - 0 Miss - 0 Block - 0	Post - 0 Miss - 0 Block - 0	Post - 0 Miss - 0 Block - 0	Post - 0 Miss - 0 Block - 0	Post - 0 Miss - 1 Block - 0	Post - 0 Miss - 0 Block - 0	Post - 0 Miss - 0 Block - 0																																																																								

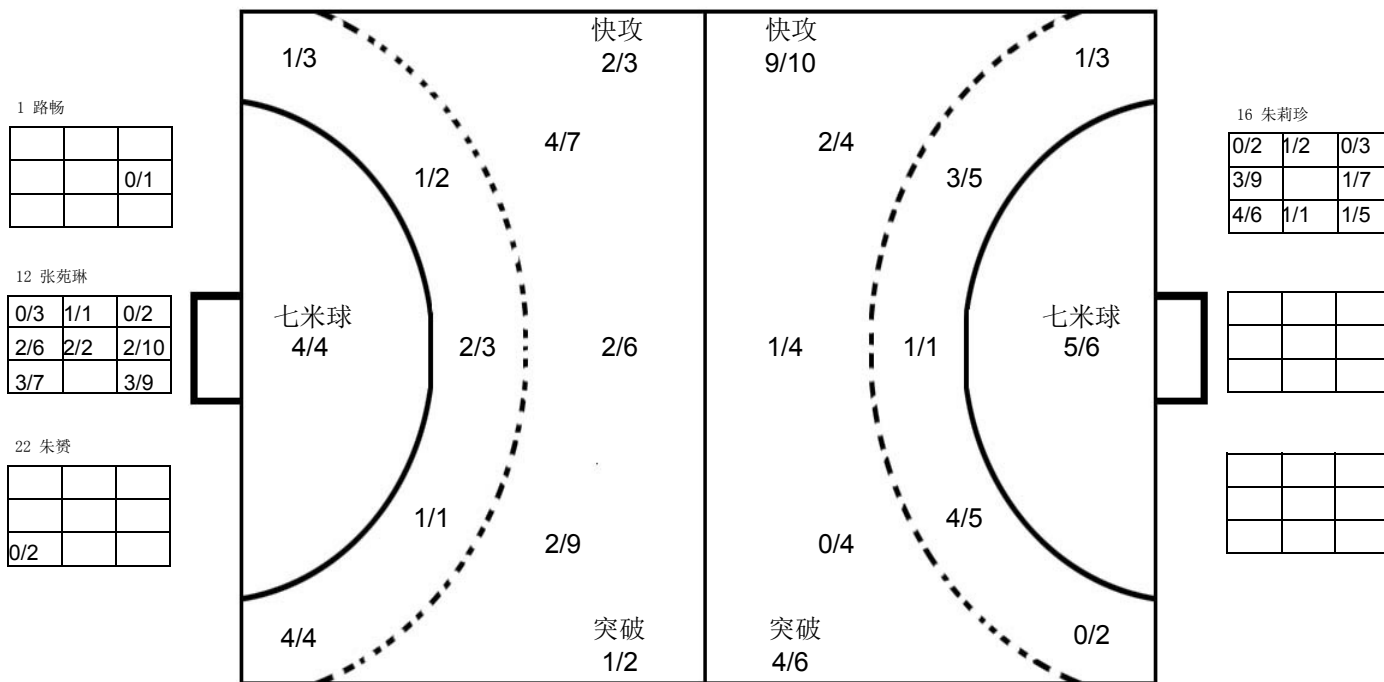

## 安徽

1 司艳	3 李兵	5 班晨晨	6 沈萍	7 赵江川	8 徐仕媛	10 孙来苗	14 刘晓妹																																																																								
<table border="1"><tr><td></td><td></td><td></td></tr><tr><td></td><td></td><td></td></tr><tr><td></td><td></td><td></td></tr></table>										<table border="1"><tr><td></td><td></td><td>1</td></tr><tr><td></td><td></td><td></td></tr><tr><td></td><td></td><td></td></tr></table>			1							<table border="1"><tr><td></td><td></td><td></td></tr><tr><td></td><td></td><td></td></tr><tr><td></td><td></td><td></td></tr></table>										<table border="1"><tr><td></td><td></td><td></td></tr><tr><td>2</td><td></td><td>1</td></tr><tr><td>3</td><td></td><td>1</td></tr></table>				2		1	3		1	<table border="1"><tr><td></td><td></td><td></td></tr><tr><td></td><td></td><td></td></tr><tr><td></td><td></td><td></td></tr></table>										<table border="1"><tr><td></td><td></td><td></td></tr><tr><td></td><td></td><td></td></tr><tr><td></td><td></td><td></td></tr></table>										<table border="1"><tr><td></td><td></td><td></td></tr><tr><td></td><td></td><td></td></tr><tr><td>1</td><td></td><td>1</td></tr></table>							1		1	<table border="1"><tr><td></td><td></td><td></td></tr><tr><td></td><td></td><td></td></tr><tr><td></td><td></td><td>1</td></tr></table>									1
		1																																																																													
2		1																																																																													
3		1																																																																													
1		1																																																																													
		1																																																																													
Post - 0 Miss - 0 Block - 0	Post - 0 Miss - 0 Block - 0	Post - 0 Miss - 0 Block - 0	Post - 0 Miss - 0 Block - 0	Post - 0 Miss - 0 Block - 0	Post - 0 Miss - 0 Block - 0	Post - 0 Miss - 0 Block - 0	Post - 2 Miss - 0 Block - 0																																																																								
16 朱莉珍	17 周婷	18 郑冬冬	20 周雪婷	21 李瑶	23 张天洁	41 杜机娟	46 陶传红																																																																								
<table border="1"><tr><td></td><td></td><td></td></tr><tr><td></td><td></td><td></td></tr><tr><td></td><td></td><td></td></tr></table>										<table border="1"><tr><td></td><td></td><td>1</td></tr><tr><td></td><td></td><td>1</td></tr><tr><td>1</td><td></td><td></td></tr></table>			1			1	1			<table border="1"><tr><td></td><td></td><td></td></tr><tr><td></td><td></td><td></td></tr><tr><td></td><td></td><td></td></tr></table>										<table border="1"><tr><td></td><td></td><td></td></tr><tr><td></td><td></td><td></td></tr><tr><td></td><td></td><td></td></tr></table>										<table border="1"><tr><td></td><td></td><td>1</td></tr><tr><td></td><td></td><td>4</td></tr><tr><td>1</td><td></td><td>2</td></tr></table>			1			4	1		2	<table border="1"><tr><td></td><td></td><td></td></tr><tr><td></td><td></td><td></td></tr><tr><td></td><td></td><td>1</td></tr></table>									1	<table border="1"><tr><td></td><td></td><td>2</td></tr><tr><td></td><td></td><td>2</td></tr><tr><td>1</td><td></td><td>1</td></tr></table>			2			2	1		1	<table border="1"><tr><td></td><td></td><td></td></tr><tr><td></td><td></td><td></td></tr><tr><td></td><td></td><td></td></tr></table>									
		1																																																																													
		1																																																																													
1																																																																															
		1																																																																													
		4																																																																													
1		2																																																																													
		1																																																																													
		2																																																																													
		2																																																																													
1		1																																																																													
Post - 0 Miss - 0 Block - 0	Post - 1 Miss - 1 Block - 0	Post - 0 Miss - 0 Block - 0	Post - 0 Miss - 0 Block - 0	Post - 1 Miss - 0 Block - 1	Post - 0 Miss - 0 Block - 0	Post - 1 Miss - 0 Block - 0	Post - 0 Miss - 0 Block - 0																																																																								

注释: Post=击柱 Miss=射失 Block=被封





预赛 Group A

女子 全国比赛

2016年全国女子手球锦标赛

Team A		Team B										Match Number									
A 广西		B 广东										26									
played in		in the hall				on		at		Spectators											
China		滁州体育馆				07/09/2016		19:00		hours											
Half-time (30')	A	B	End of playing time		A	B	1st extra time		A	B	2nd extra time		A	B	After penalty throws		A	B			
	10	18			12	27															
Number of 7 m	A	Team time-out			Full name of players and officials										Team time-out			B	Number of 7 m		
		1	2	3											1	2	3			2/3	
No.	Team A					G	W	2'	D	DR	No.	Team B					G	W	2'	D	DR
1	胡霜梅										3	安妮					1	1			
2	陆雪云							1			5	李纯							1		
5	黄海玉										7	刘彤					8	1			
6	韦惠文										8	李诗棋									
7	廖露					4	1				9	韦宝桂					1				
8	韦如芳										11	魏梦庭					6				
9	蓝雪梅										15	杨慧									
10	周琴					7					16	李娟									
11	曾蓝花										18	李玉玲					1				
12	江燕红										19	邝雪花					2				
14	黄艳芳										20	李军政					2				
15	陈依依										22	刘晓玉									
16	商志运										23	王如					1				
17	杨杨					1	1				26	马晓卉									
18	庞娇							1			28	刘金兰					4				
											31	史小军					1	1	1		
C	王林										A	李细利									
D	刘雪波										B	郭艳辉 (主教练)									
											D	祝捷									
											E	赵善良									
A	Signature of Responsible Official of the Teams (Off. A)										B										
TP	Remarks of Referee / CHA Official										TP										

Signatures

Referees	严璐 (CHN)	隆晓磊 (CHN)		
Techn. Delegates	吴国忠 (CHN)			
CHA Official	于中迅 (CHN)			

Note: Number of 7m Throws Awarded to Team A and B, Goals (G), Warnings (W), Suspensions (2'), Direct Disqualification (D), Disqualification with Report (DR) and Team Penalty (TP).

Table Officials: 李诚 赵涵 Statisticians: 陈柱 闫冲

Printed by PHMS Copyright: IHF / CHA 07/09/2016 20:03:47

Longman Sportsoft handball@126.com





## 2016年全国女子手球锦标赛 竞赛技术统计(媒体表)

<b>预赛</b>	组别	<b>A</b>	轮次	<b>5</b>	场次	<b>26</b>
滁州体育馆			07/09/2016		201605026-51-1/1	
广西	<b>广西</b>	<b>12</b>	vs	<b>27</b>	广东	广东
			<b>10 : 18</b>			

裁判员	严璐 (CHN)	/	隆晓磊 (CHN)
-----	----------	---	-----------

广西		远射	近射	边射	快攻	突破	任意球	7m球	合计	%	助攻	失误	警告	2'	D & DR	比赛进程	
主教练：王林																广西	广东
1	胡霜梅															10	周琴
2	陆雪云	0/2					0/1	0/3	0.0			2		1		1	00:35
5	黄海玉															7	廖露
6	韦惠文											1				2	01:03
7	廖露	2/8	2/2					4/10	40.0				1			2	02:12
8	韦如芳				0/1			0/1	0.0			1				2	02:38
9	蓝雪梅	0/1						0/1	0.0			1				2	03:44
10	周琴	1/6	1/1	0/1	1/1	1/1	3/3	7/13	53.8			3				2	05:33
11	曾蓝花	0/3						0/3	0.0			2				2	06:52
12	江燕红															7	廖露
14	黄艳芳		0/3					0/3	0.0			1				3	07:19
15	陈依依															3	08:59
16	商志运															4	11:11
17	杨杨	0/1		1/1				1/2	50.0			3	1			4	11:57
18	庞娇													1		5	12:23
<b>运动员 合计</b>		<b>3/21</b>	<b>3/6</b>	<b>1/2</b>	<b>1/2</b>	<b>1/1</b>	<b>0/1</b>	<b>3/3</b>	<b>12/36</b>	<b>33.3</b>		<b>14</b>	<b>3</b>	<b>1</b>		6	12:58
12	江燕红		0/2	1/3	0/1			1/6	16.7							6	14:02
16	商志运	3/5	2/10	3/7	1/6	0/1	1/3	10/32	31.3							7	15:04
<b>守门员 合计</b>		<b>3/5</b>	<b>2/12</b>	<b>4/10</b>	<b>1/7</b>	<b>0/1</b>	<b>1/3</b>	<b>11/38</b>	<b>28.9</b>							7	15:29
<b>广东</b>		远射	近射	边射	快攻	突破	任意球	7m球	合计	%	助攻	失误	警告	2'	D & DR	比赛进程	
教练：郭艳辉																广西	广东
3	安妮			0/1	1/1			1/2	50.0		1	1	1			10	周琴
5	李纯													1		11	02:17
7	刘彤		2/2	4/5	2/2			8/9	88.9		2		1			11	03:12
8	李诗棋				0/1			0/1	0.0							10	周琴
9	韦宝桂	1/1	0/1					0/1	1/3	33.3	1	2				11	03:54
11	魏梦庭	1/3	3/3		1/1	1/1		6/8	75.0			1				12	04:05
15	杨慧															12	04:41
16	李娟															12	05:24
18	李玉玲							1/1	1/1	100						12	05:41
19	庞雪花	0/1	1/1	1/3				2/5	40.0			2				12	06:10
20	李军政		1/1	1/1				2/2	100			2				12	06:16
22	刘晓玉											1				12	09:03
23	王如		1/1					1/1	100							12	10:26
26	马晓卉															12	12:05
28	刘金兰		2/3	0/1	1/1		1/1	4/6	66.7							12	12:05
31	史小军				1/2			1/2	50.0			1	1	1		12	12:05
<b>运动员 合计</b>		<b>2/5</b>	<b>10/12</b>	<b>6/11</b>	<b>6/8</b>	<b>1/1</b>	<b>2/3</b>	<b>27/40</b>	<b>67.5</b>		<b>4</b>	<b>10</b>	<b>3</b>	<b>2</b>			
16	李娟						0/1	0/1	0.0								
22	刘晓玉	12/15	1/4	1/2	1/2	0/1	1/1	16/25	64.0			1					
26	马晓卉						0/2	0/2	0.0								
<b>守门员 合计</b>		<b>12/15</b>	<b>1/4</b>	<b>1/2</b>	<b>1/2</b>	<b>0/1</b>	<b>1/1</b>	<b>0/3</b>	<b>16/28</b>	<b>57.1</b>		<b>1</b>					

场上队员：得分 / 射门

守门员：救球 / 射门

快攻	Fast Break	突破	Breakthrough	任意球	Free Throw	7M球	7M Throw	助攻	Assist
警告	Warning	失误	Error	2'	Suspension	D	取消资格	DR	取消资格+报告





### 2016年全国女子手球锦标赛 图式比赛技术统计表

轮次 5

场次 26

201605026-21-1/1

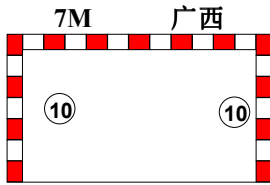
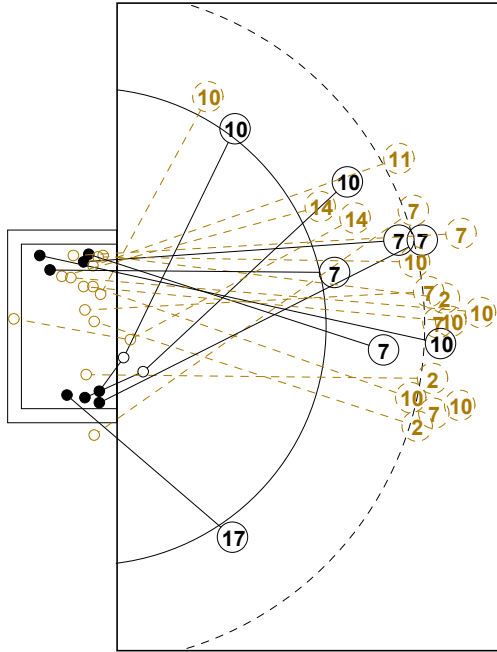

1st Half  
10 : 18

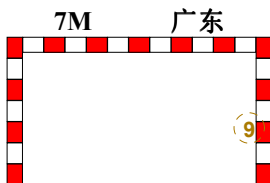
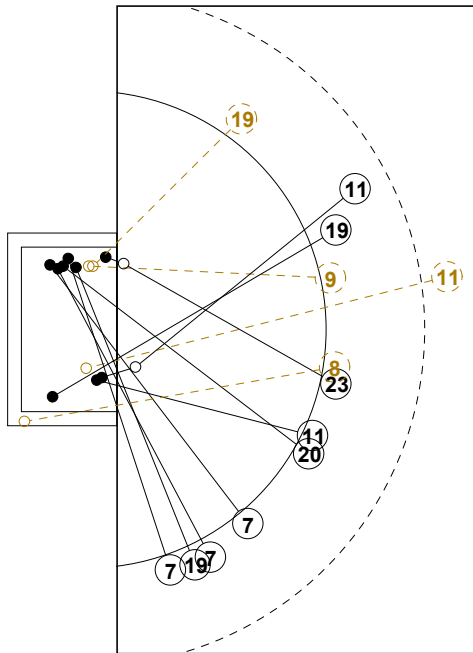
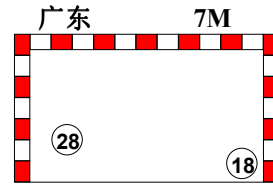
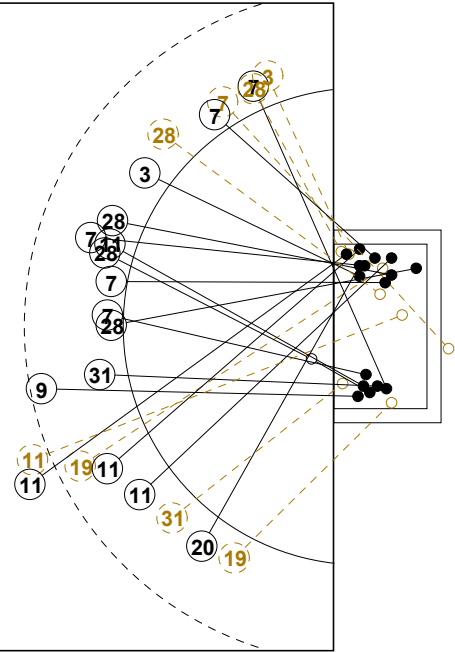

2nd Half  
27 : 12

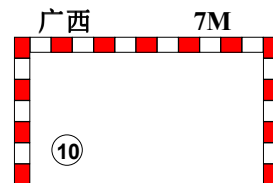
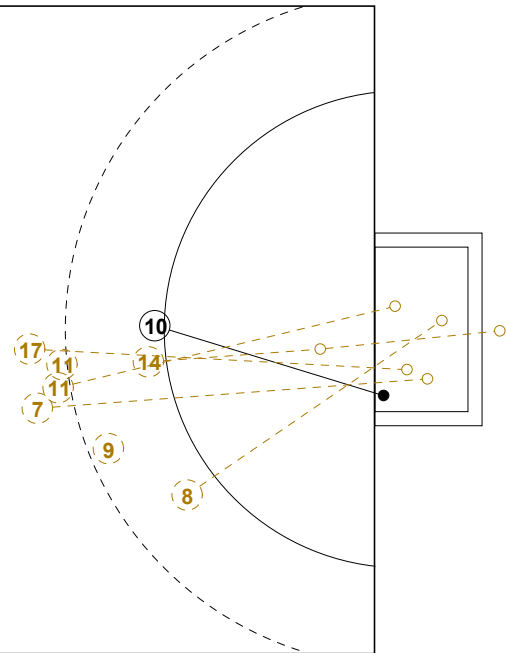



## 2016年全国女子手球锦标赛

## 个人/全队技术统计表

正式表  
手球  
女子预赛  
轮次 5组别 A  
场次 26201605026-14-1/2  
滁州体育馆  
07/09/2016 19:00

号码	姓名	远射	近射	边射	快攻	突破	任意	7M	合计	%	助攻	失误	警告	2'	取消	时间
<b>广西(广西)</b>																
<i>(场上队员)</i>																
1	胡霜梅									0.0%						00:00:00
2	陆雪云	0/2					0/1		0/3	0.0%		2		1		00:17:35
5	黄海玉									0.0%						00:09:31
6	韦惠文									0.0%		1				00:06:38
7	廖露	2/8	2/2						4/10	40.0%				1		00:28:30
8	韦如芳					0/1			0/1	0.0%		1				00:35:32
9	蓝雪梅	0/1							0/1	0.0%		1				00:06:36
10	周琴	1/6	1/1	0/1	1/1	1/1		3/3	7/13	53.8%		3				00:37:16
11	曾蓝花	0/3							0/3	0.0%		2				00:34:53
12	江燕红									0.0%						00:06:25
14	黄艳芳		0/3						0/3	0.0%		1				00:37:43
15	陈依依									0.0%						00:00:00
16	商志运									0.0%						00:35:47
17	杨杨	0/1		1/1					1/2	50.0%		3		1		00:25:12
18	庞娇									0.0%				1		00:13:16
<b>合计</b>		3/21	3/6	1/2	1/2	1/1	0/1	3/3	12/36	33.3%		14		3	1	
<i>(守门员)</i>																
12	江燕红		0/2	1/3	0/1				1/6	16.7%						00:06:25
16	商志运	3/5	2/10	3/7	1/6	0/1		1/3	10/32	31.3%						00:35:47
<b>合计</b>		3/5	2/12	4/10	1/7	0/1		1/3	11/38	28.9%						

场上队员：得分/射门

守门员：救球/射门

全队合计	得分	被救	射失	击柱	封球	合计	%
远射	3	12	1		5	21	14.3%
近射	3	1	1	1		6	50.0%
边射	1	1				2	50.0%
快攻	1	1				2	50.0%
突破	1					1	100.0%
任意		1				1	0.0%
7M	3					3	100.0%







## 2016年全国女子手球锦标赛

## 个人/全队技术统计表

正式表  
手球  
女子预赛  
轮次 5组别 A  
场次 26201605026-14-2/2  
滁州体育馆  
07/09/2016 19:00

号码	姓名	远射	近射	边射	快攻	突破	任意	7M	合计	%	助攻	失误	警告	2'	取消	时间
<b>广东(广东)</b>																
<i>(上场队员)</i>																
3	安妮			0/1	1/1				1/2	50.0%	1	1	1			00:23:45
5	李纯									0.0%				1		00:01:52
7	刘彤		2/2	4/5	2/2				8/9	88.9%	2		1			00:26:13
8	李诗棋					0/1			0/1	0.0%						00:03:51
9	韦宝桂	1/1	0/1					0/1	1/3	33.3%	1	2				00:18:23
11	魏梦庭	1/3	3/3		1/1	1/1			6/8	75.0%		1				00:39:18
15	杨慧									0.0%						00:00:00
16	李娟									0.0%						00:00:12
18	李玉玲							1/1	1/1	100%						00:03:34
19	邝雪花	0/1	1/1	1/3					2/5	40.0%		2				00:32:37
20	李军政		1/1	1/1					2/2	100%		2				00:22:55
22	刘晓玉									0.0%		1				00:41:19
23	王如		1/1						1/1	100%						00:26:27
26	马晓卉									0.0%						00:00:41
28	刘金兰		2/3	0/1	1/1			1/1	4/6	66.7%						00:35:10
31	史小军					1/2			1/2	50.0%		1	1	1		00:18:39
<b>合计</b>		2/5	10/12	6/11	6/8	1/1		2/3	27/40	67.5%	4	10	3	2		
<i>(守门员)</i>																
16	李娟							0/1	0/1	0.0%						00:00:12
22	刘晓玉	12/15	1/4	1/2	1/2	0/1	1/1		16/25	64.0%		1				00:41:19
26	马晓卉							0/2	0/2	0.0%						00:00:41
<b>合计</b>		12/15	1/4	1/2	1/2	0/1	1/1	0/3	16/28	57.1%		1				

场上队员：得分/射门

守门员：救球/射门

全队合计	得分	被救	射失	击柱	封球	合计	%
远射	2	3				5	40.0%
近射	10	2				12	83.3%
边射	6	4	1			11	54.5%
快攻	6	1		1		8	75.0%
突破	1					1	100.0%
任意							0.0%
7M	2	1				3	66.7%





### 2016年全国女子手球锦标赛

#### 图式射门区域统计

轮次 5 场次 26

201605026-41-1/1

## 广西

1 胡霜梅	2 陆雪云	5 黄海玉	6 韦惠文	7 廖露	8 韦如芳	9 蓝雪梅	10 周琴																																																																											
<table border="1"><tr><td></td><td></td><td></td></tr><tr><td></td><td></td><td></td></tr><tr><td></td><td></td><td></td></tr></table>										<table border="1"><tr><td></td><td></td><td></td></tr><tr><td></td><td></td><td></td></tr><tr><td></td><td></td><td></td></tr></table>										<table border="1"><tr><td></td><td></td><td></td></tr><tr><td></td><td></td><td></td></tr><tr><td></td><td></td><td></td></tr></table>										<table border="1"><tr><td></td><td></td><td></td></tr><tr><td></td><td></td><td></td></tr><tr><td></td><td></td><td></td></tr></table>										<table border="1"><tr><td></td><td></td><td>1</td></tr><tr><td></td><td></td><td>1</td></tr><tr><td>1</td><td></td><td>1</td></tr></table>			1			1	1		1	<table border="1"><tr><td></td><td></td><td></td></tr><tr><td></td><td></td><td></td></tr><tr><td></td><td></td><td></td></tr></table>										<table border="1"><tr><td></td><td></td><td></td></tr><tr><td></td><td></td><td></td></tr><tr><td></td><td></td><td></td></tr></table>										<table border="1"><tr><td></td><td></td><td>1</td></tr><tr><td></td><td></td><td>1</td></tr><tr><td>2</td><td></td><td>1</td></tr><tr><td>2</td><td></td><td>1</td></tr></table>			1			1	2		1	2		1
		1																																																																																
		1																																																																																
1		1																																																																																
		1																																																																																
		1																																																																																
2		1																																																																																
2		1																																																																																
Post - 0 Miss - 0 Block - 0	Post - 0 Miss - 0 Block - 0	Post - 0 Miss - 0 Block - 0	Post - 0 Miss - 0 Block - 0	Post - 0 Miss - 1 Block - 2	Post - 0 Miss - 0 Block - 0	Post - 0 Miss - 0 Block - 1	Post - 0 Miss - 0 Block - 1																																																																											
11 曾蓝花	12 江燕红	14 黄艳芳	15 陈依依	16 商志运	17 杨杨	18 庞娇																																																																												
<table border="1"><tr><td></td><td></td><td></td></tr><tr><td></td><td></td><td></td></tr><tr><td></td><td></td><td></td></tr></table>										<table border="1"><tr><td></td><td></td><td></td></tr><tr><td></td><td></td><td></td></tr><tr><td></td><td></td><td></td></tr></table>										<table border="1"><tr><td></td><td></td><td></td></tr><tr><td></td><td></td><td></td></tr><tr><td></td><td></td><td></td></tr></table>										<table border="1"><tr><td></td><td></td><td></td></tr><tr><td></td><td></td><td></td></tr><tr><td></td><td></td><td></td></tr></table>										<table border="1"><tr><td></td><td></td><td></td></tr><tr><td></td><td></td><td></td></tr><tr><td></td><td></td><td></td></tr></table>										<table border="1"><tr><td></td><td></td><td></td></tr><tr><td></td><td></td><td></td></tr><tr><td>1</td><td></td><td></td></tr></table>							1			<table border="1"><tr><td></td><td></td><td></td></tr><tr><td></td><td></td><td></td></tr><tr><td></td><td></td><td></td></tr></table>										<table border="1"><tr><td></td><td></td><td></td></tr><tr><td></td><td></td><td></td></tr><tr><td></td><td></td><td></td></tr></table>												
1																																																																																		
Post - 0 Miss - 0 Block - 1	Post - 0 Miss - 0 Block - 0	Post - 1 Miss - 1 Block - 0	Post - 0 Miss - 0 Block - 0	Post - 0 Miss - 0 Block - 0	Post - 0 Miss - 0 Block - 0	Post - 0 Miss - 0 Block - 0																																																																												

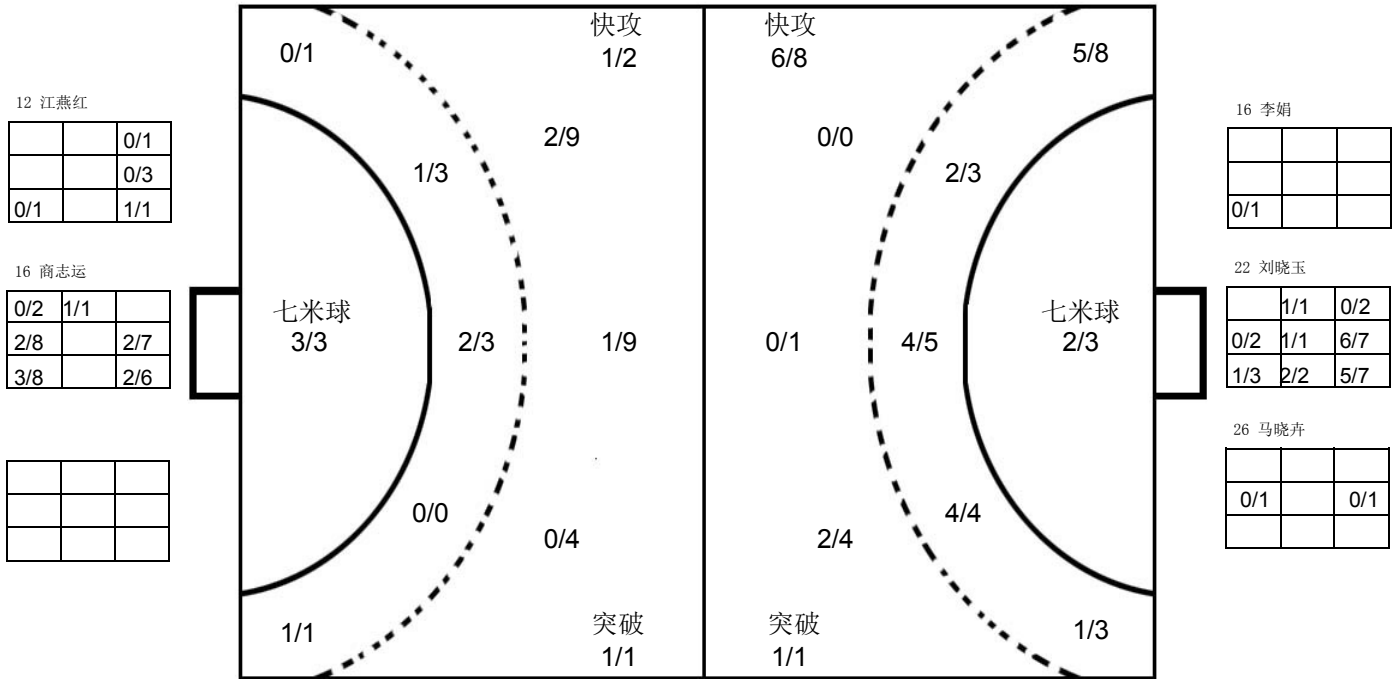

## 广东

3 安妮	5 李纯	7 刘彤	8 李诗棋	9 韦宝桂	11 魏梦庭	15 杨慧	16 李娟																																																																											
<table border="1"><tr><td></td><td></td><td></td></tr><tr><td></td><td></td><td></td></tr><tr><td>1</td><td></td><td></td></tr></table>							1			<table border="1"><tr><td></td><td></td><td></td></tr><tr><td></td><td></td><td></td></tr><tr><td></td><td></td><td></td></tr></table>										<table border="1"><tr><td></td><td></td><td>1</td></tr><tr><td>3</td><td></td><td>4</td></tr><tr><td></td><td></td><td></td></tr></table>			1	3		4				<table border="1"><tr><td></td><td></td><td></td></tr><tr><td></td><td></td><td></td></tr><tr><td></td><td></td><td></td></tr></table>										<table border="1"><tr><td></td><td></td><td></td></tr><tr><td></td><td></td><td>1</td></tr><tr><td></td><td></td><td></td></tr></table>						1				<table border="1"><tr><td></td><td></td><td></td></tr><tr><td></td><td></td><td></td></tr><tr><td>1</td><td></td><td></td></tr><tr><td>4</td><td></td><td>1</td></tr></table>							1			4		1	<table border="1"><tr><td></td><td></td><td></td></tr><tr><td></td><td></td><td></td></tr><tr><td></td><td></td><td></td></tr></table>										<table border="1"><tr><td></td><td></td><td></td></tr><tr><td></td><td></td><td></td></tr><tr><td></td><td></td><td></td></tr></table>									
1																																																																																		
		1																																																																																
3		4																																																																																
		1																																																																																
1																																																																																		
4		1																																																																																
Post - 0 Miss - 0 Block - 0	Post - 0 Miss - 0 Block - 0	Post - 0 Miss - 1 Block - 0	Post - 1 Miss - 0 Block - 0	Post - 0 Miss - 0 Block - 0	Post - 0 Miss - 0 Block - 0	Post - 0 Miss - 0 Block - 0	Post - 0 Miss - 0 Block - 0																																																																											
18 李玉玲	19 邝雪花	20 李军政	22 刘晓玉	23 王如	26 马晓卉	28 刘金兰	31 史小军																																																																											
<table border="1"><tr><td></td><td></td><td></td></tr><tr><td></td><td></td><td></td></tr><tr><td></td><td></td><td>1</td></tr></table>									1	<table border="1"><tr><td></td><td>1</td><td></td></tr><tr><td></td><td></td><td>1</td></tr><tr><td></td><td></td><td></td></tr></table>		1				1				<table border="1"><tr><td></td><td></td><td></td></tr><tr><td></td><td></td><td>1</td></tr><tr><td></td><td></td><td></td></tr></table>						1				<table border="1"><tr><td></td><td></td><td></td></tr><tr><td></td><td></td><td></td></tr><tr><td></td><td></td><td></td></tr></table>										<table border="1"><tr><td></td><td></td><td></td></tr><tr><td></td><td></td><td></td></tr><tr><td></td><td></td><td>1</td></tr></table>									1	<table border="1"><tr><td></td><td></td><td></td></tr><tr><td></td><td></td><td></td></tr><tr><td></td><td></td><td></td></tr></table>										<table border="1"><tr><td></td><td>1</td><td></td></tr><tr><td></td><td>2</td><td>1</td></tr><tr><td></td><td></td><td></td></tr></table>		1			2	1				<table border="1"><tr><td></td><td></td><td></td></tr><tr><td></td><td></td><td></td></tr><tr><td></td><td></td><td>1</td></tr></table>									1			
		1																																																																																
	1																																																																																	
		1																																																																																
		1																																																																																
		1																																																																																
	1																																																																																	
	2	1																																																																																
		1																																																																																
Post - 0 Miss - 0 Block - 0	Post - 0 Miss - 0 Block - 0	Post - 0 Miss - 0 Block - 0	Post - 0 Miss - 0 Block - 0	Post - 0 Miss - 0 Block - 0	Post - 0 Miss - 0 Block - 0	Post - 0 Miss - 0 Block - 0	Post - 0 Miss - 0 Block - 0																																																																											

注释: Post=击柱 Miss=射失 Block=被封





预赛 Group A

女子 全国比赛

2016年全国女子手球锦标赛

Team A				Team B				Match Number													
A 江苏				B 黑龙江				27													
played in		in the hall		on		at		Spectators													
China		滁州体育馆		07/09/2016		20:30 hours															
Half-time (30')	A	B	End of playing time	A	B	1st extra time	A	B	2nd extra time	A	B	After penalty throws	A	B							
	22	6		22	6																
Number of 7 m	A	Team time-out			Full name of players and officials				Team time-out			B	Number of 7 m								
	2/2	1	2	3					1	2	3	0/0									
	11:48																				
No.	Team A					G	W	2'	D	DR	No.	Team B					G	W	2'	D	DR
1	陆婷										1	徐佳蓉									
3	张海侠					3					3	刘诗彤					1				
4	赵佳芹					2					5	周美微						1			
5	高媛媛					1					6	王梦艺					1				
8	乔如					1					9	郑宇					1				
9	莫蒙蒙					3					10	刘雪露					1				
10	王可可					4					11	刘天茹									
11	于源源					1					12	肖宁桐									
12	黄霞										13	吴佳					1				
13	黄慧影										14	黄莹									
16	王小华										16	杜宪									
17	修丽杰					2	1	1			19	梁文煜									
18	韦秋香					1					21	王戈					1				
23	王书慧					1	1				22	马琳						1	1		
33	金梦青					2	1				23	张政						1			
69	蓝小玲																				
B	金甲洙 (主教练)										B	张立梅 (主教练)									
C	马彪										C	黄冬杰									
D	李海鹰										D	于兹香									
E	陈志伟										E	马婧									
A	Signature of Responsible Official of the Teams (Off. A)																			B	
TP	Remarks of Referee / CHA Official																			TP	

Signatures

Referees: 刘晓辉 (CHN) 刘正松 (CHN)

Techn. Delegates: 高斌 (CHN)

CHA Official: 许宜扬 (CHN)

Note: Number of 7m Throws Awarded to Team A and B, Goals (G), Warnings (W), Suspensions (2'), Direct Disqualification (D), Disqualification with Report (DR) and Team Penalty (TP).

Table Officials: 李诚

赵涵

Statisticians: 陈柱

闫冲

Printed by PHMS Copyright: IHF / CHA 07/09/2016 20:59:00

Longman Sportsoft



handball@126.com



### 2016年全国女子手球锦标赛 竞赛技术统计(媒体表)

<b>预赛</b>	组别	<b>A</b>	轮次	<b>5</b>	场次	<b>27</b>
滁州体育馆		07/09/2016			201605027-51-1/1	
江苏	<b>江苏</b>	<b>22</b>	vs	<b>6</b>	<b>黑龙江</b>	黑龙江
<b>22 : 6</b>						

裁判员	刘晓辉 (CHN)	/	刘正松 (CHN)
-----	-----------	---	-----------

<b>江苏</b>														比赛进程		<b>黑龙江</b>																
主教练：金甲洙																																
远射	近射	边射	快攻	突破	任意球	7m球	合计	%	助攻	失误	警告	2'	D & DR																			
1	陆婷								1						3	张海侠	1	01:27	0													
3	张海侠		1/1	2/3			3/4	75.0							9	莫蒙蒙	2	03:05	0													
4	赵佳芹	0/1	0/1		1/1	1/1	2/4	50.0							4	赵佳芹	3	05:12	0													
5	高媛媛					1/1	1/1	100		1					17	修丽杰	4	06:06	0													
8	乔如		1/1				1/1	100	1						4	赵佳芹	5	07:59	1													
9	莫蒙蒙		3/3				3/3	100							9	莫蒙蒙	6	09:07	2													
10	王可可	3/3	0/1	1/1			4/5	80.0	1	2					3	张海侠	7	11:33	2													
11	于源源			0/3	1/1		1/4	25.0							8	乔如	8	12:25	2													
12	黄霞														3	张海侠	9	13:06	2													
13	黄慧影	0/1					0/1	0.0	1	1					11	于源源	10	13:54	2													
16	王小华														17	修丽杰	11	14:34	2													
17	修丽杰	0/1	1/1	1/1			2/3	66.7			1	1			9	莫蒙蒙	11	15:07	3													
18	韦秋香					1/1	1/1	100	1						33	金梦青	12	15:34	3													
23	王书慧				1/1		1/1	100			1				5	高媛媛	13	16:32	3													
33	金梦青	0/1	0/1	2/2			2/4	50.0	3	1	1				69	蓝小玲	14	17:50	4													
69	蓝小玲			1/1			1/1	100							23	王书慧	15	18:45	4													
<b>运动员 合计</b>																																
<b>守门员 合计</b>																																
<b>黑龙江</b>																																
教练：张立梅																																
远射	近射	边射	快攻	突破	任意球	7m球	合计	%	助攻	失误	警告	2'	D & DR																			
1	徐佳蓉																															
3	刘诗彤		1/2				1/2	50.0																								
5	周美微									1	1																					
6	王梦艺				1/1		1/1	100																								
9	郑宇			1/1			1/1	100		2																						
10	刘雪露	1/5					1/5	20.0		7																						
11	刘天茹		0/1				0/1	0.0		1																						
12	肖宁桐																															
13	吴佳	1/3				0/1	1/4	25.0	1	2																						
14	黄荣																															
16	杜宪																															
19	梁文煜		0/1				0/1	0.0																								
21	王戈		1/1	0/1			1/2	50.0																								
22	马琳	0/2				0/1	0/3	0.0		2	1	1																				
23	张政									1	1																					
<b>运动员 合计</b>																																
<b>守门员 合计</b>																																

场上队员：得分 / 射门

守门员：救球 / 射门

快攻	Fast Break	突破	Breakthrough	任意球	Free Throw	7M球	7M Throw	助攻	Assist
警告	Warning	失误	Error	2'	Suspension	D	取消资格	DR	取消资格+报告



### 2016年全国女子手球锦标赛 图式比赛技术统计表

轮次 5

场次 27

201605027-21-1/1

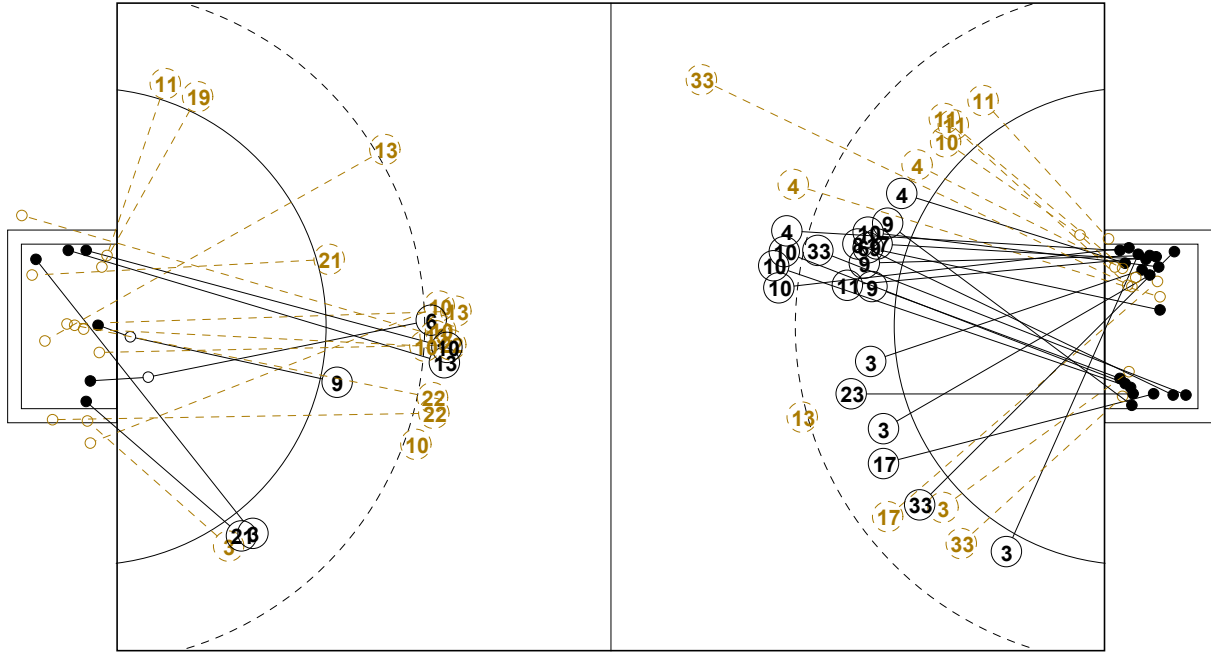

7M 黑龙江

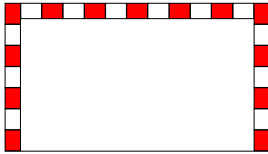

江苏 7M

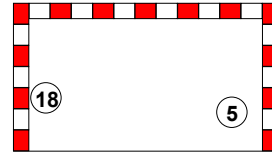

1st Half  
6 : 22

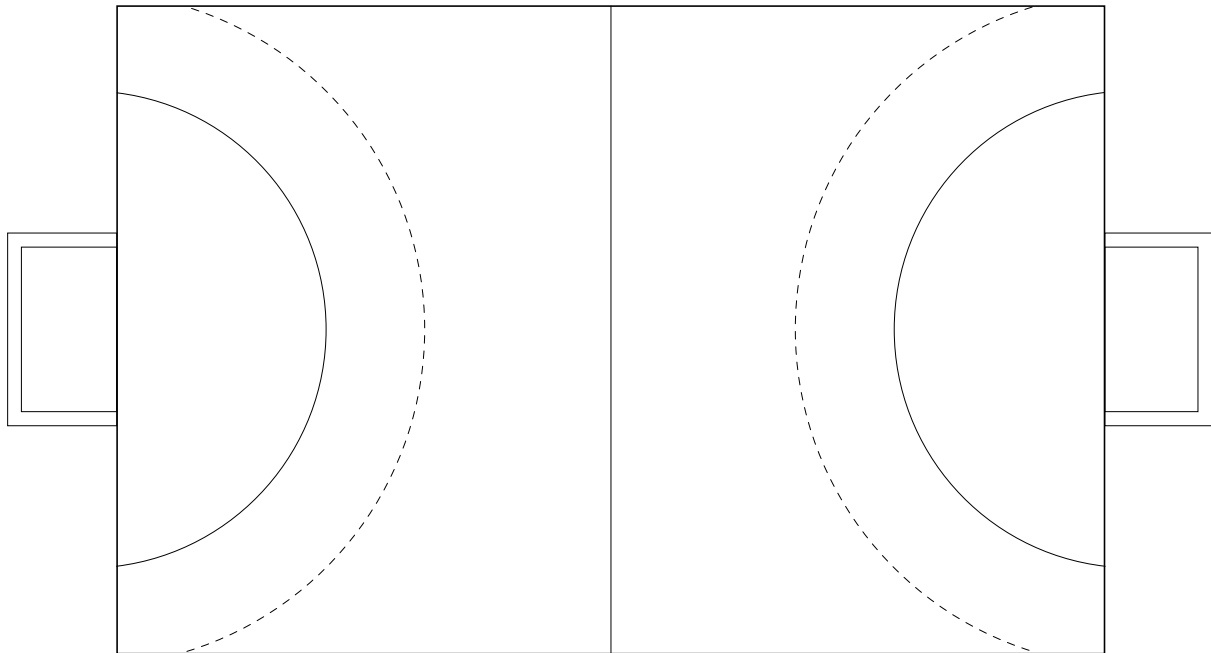

7M 江苏

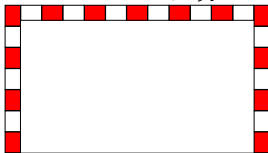

黑龙江 7M



2nd Half  
22 : 6



## 2016年全国女子手球锦标赛

## 个人/全队技术统计表

正式表  
手球  
女子预赛  
轮次 5组别 A  
场次 27201605027-14-1/2  
滁州体育馆  
07/09/2016 20:30

号码	姓名	远射	近射	边射	快攻	突破	任意	7M	合计	%	助攻	失误	警告	2'	取消	时间
<b>江苏(江苏)</b>																
<i>(场上队员)</i>																
1	陆婷									0.0%	1					00:10:29
3	张海侠			1/1	2/3				3/4	75.0%						00:18:34
4	赵佳芹	0/1	0/1			1/1	1/1		2/4	50.0%						00:14:00
5	高媛媛							1/1	1/1	100%		1				00:11:21
8	乔如		1/1						1/1	100%	1					00:11:51
9	莫蒙蒙		3/3						3/3	100%						00:30:00
10	王可可	3/3	0/1		1/1				4/5	80.0%	1	2				00:09:57
11	于源源			0/3	1/1				1/4	25.0%						00:30:00
12	黄霞									0.0%						00:08:55
13	黄慧影	0/1							0/1	0.0%	1	1				00:07:18
16	王小华									0.0%						00:10:36
17	修丽杰	0/1	1/1		1/1				2/3	66.7%			1	1		00:14:36
18	韦秋香							1/1	1/1	100%	1					00:06:03
23	王书慧					1/1			1/1	100%			1			00:08:40
33	金梦青	0/1		0/1	2/2				2/4	50.0%	3	1	1			00:13:45
69	蓝小玲				1/1				1/1	100%						00:03:21
<b>合计</b>		3/7	5/7	1/5	8/9	2/2	1/1	2/2	22/33	66.7%	8	5	3	1		
<i>(守门员)</i>																
1	陆婷	3/4			0/1				3/5	60.0%	1					00:10:29
12	黄霞	2/3		1/2	1/1				4/6	66.7%						00:08:55
16	王小华			1/2			0/1		1/3	33.3%						00:10:36
<b>合计</b>		5/7		2/4	1/2		0/1		8/14	57.1%	1					

场上队员：得分/射门

守门员：救球/射门

全队合计	得分	被救	射失	击柱	封球	合计	%
远射	3	3			1	7	42.9%
近射	5	2				7	71.4%
边射	1	3		1		5	20.0%
快攻	8	1				9	88.9%
突破	2					2	100.0%
任意	1					1	100.0%
7M	2					2	100.0%





## 2016年全国女子手球锦标赛

## 个人/全队技术统计表

正式表  
手球  
女子预赛  
轮次 5组别 A  
场次 27201605027-14-2/2  
滁州体育馆  
07/09/2016 20:30

号码	姓名	远射	近射	边射	快攻	突破	任意	7M	合计	%	助攻	失误	警告	2'	取消	时间
<b>黑龙江(黑龙江)</b>																
<i>(上场队员)</i>																
1	徐佳蓉									0.0%						00:04:29
3	刘诗彤			1/2					1/2	50.0%						00:15:58
5	周美微									0.0%		1	1			00:11:19
6	王梦艺						1/1		1/1	100%						00:11:48
9	郑宇				1/1				1/1	100%		2				00:15:16
10	刘雪露	1/5							1/5	20.0%		7				00:22:14
11	刘天茹			0/1					0/1	0.0%		1				00:14:05
12	肖宁桐									0.0%						00:25:31
13	吴佳	1/3					0/1		1/4	25.0%	1	2				00:22:44
14	黄荣									0.0%						00:00:00
16	杜宪									0.0%						00:00:00
19	梁文煜			0/1					0/1	0.0%						00:23:08
21	王戈			1/1	0/1				1/2	50.0%						00:14:00
22	马琳	0/2					0/1		0/3	0.0%		2	1	1		00:15:55
23	张政									0.0%		1	1			00:13:21
<b>合计</b>		2/10		2/5	1/2		1/3		6/20	30.0%	1	16	3	1		
<i>(守门员)</i>																
1	徐佳蓉	1/3		1/1	0/1				2/5	40.0%						00:04:29
12	肖宁桐	2/3	2/7	2/3	1/8	0/2	0/1	0/2	7/26	26.9%						00:25:31
<b>合计</b>		3/6	2/7	3/4	1/9	0/2	0/1	0/2	9/31	29.0%						

场上队员：得分/射门

守门员：救球/射门

全队合计	得分	被救	射失	击柱	封球	合计	%
远射	2	5	1		2	10	20.0%
近射							0.0%
边射	2	2		1		5	40.0%
快攻	1	1				2	50.0%
突破							0.0%
任意	1		1	1		3	33.3%
7M							0.0%





### 2016年全国女子手球锦标赛

#### 图式射门区域统计

轮次 5 场次 27

201605027-41-1/1

## 江苏

1 陆婷	3 张海侠	4 赵佳芹	5 高媛媛	8 乔如	9 莫蒙蒙	10 王可可	11 于源源																																																																								
<table border="1"><tr><td></td><td></td><td></td></tr><tr><td></td><td></td><td></td></tr><tr><td></td><td></td><td></td></tr></table>										<table border="1"><tr><td></td><td></td><td></td></tr><tr><td>3</td><td></td><td></td></tr><tr><td></td><td></td><td></td></tr></table>				3						<table border="1"><tr><td></td><td></td><td></td></tr><tr><td></td><td></td><td></td></tr><tr><td>2</td><td></td><td></td></tr></table>							2			<table border="1"><tr><td></td><td></td><td></td></tr><tr><td></td><td></td><td>1</td></tr><tr><td></td><td></td><td></td></tr></table>						1				<table border="1"><tr><td></td><td></td><td>1</td></tr><tr><td></td><td></td><td></td></tr><tr><td></td><td></td><td></td></tr></table>			1							<table border="1"><tr><td></td><td></td><td></td></tr><tr><td>1</td><td></td><td></td></tr><tr><td></td><td></td><td>2</td></tr></table>				1					2	<table border="1"><tr><td></td><td></td><td></td></tr><tr><td>1</td><td></td><td></td></tr><tr><td>1</td><td></td><td>2</td></tr></table>				1			1		2	<table border="1"><tr><td></td><td></td><td></td></tr><tr><td></td><td></td><td></td></tr><tr><td>1</td><td></td><td></td></tr></table>							1		
3																																																																															
2																																																																															
		1																																																																													
		1																																																																													
1																																																																															
		2																																																																													
1																																																																															
1		2																																																																													
1																																																																															
Post - 0 Miss - 0 Block - 0	Post - 0 Miss - 0 Block - 0	Post - 0 Miss - 0 Block - 0	Post - 0 Miss - 0 Block - 0	Post - 0 Miss - 0 Block - 0	Post - 0 Miss - 0 Block - 0	Post - 0 Miss - 0 Block - 0	Post - 1 Miss - 0 Block - 0																																																																								
12 黄霞	13 黄慧影	16 王小华	17 修丽杰	18 韦秋香	23 王书慧	33 金梦青	69 蓝小玲																																																																								
<table border="1"><tr><td></td><td></td><td></td></tr><tr><td></td><td></td><td></td></tr><tr><td></td><td></td><td></td></tr></table>										<table border="1"><tr><td></td><td></td><td></td></tr><tr><td></td><td></td><td></td></tr><tr><td></td><td></td><td></td></tr></table>										<table border="1"><tr><td></td><td></td><td></td></tr><tr><td></td><td></td><td></td></tr><tr><td></td><td></td><td></td></tr></table>										<table border="1"><tr><td></td><td></td><td></td></tr><tr><td>1</td><td></td><td>1</td></tr><tr><td></td><td></td><td></td></tr></table>				1		1				<table border="1"><tr><td></td><td></td><td></td></tr><tr><td>1</td><td></td><td></td></tr><tr><td></td><td></td><td></td></tr></table>				1						<table border="1"><tr><td></td><td></td><td></td></tr><tr><td></td><td></td><td></td></tr><tr><td></td><td></td><td>1</td></tr></table>									1	<table border="1"><tr><td></td><td></td><td></td></tr><tr><td>1</td><td></td><td>1</td></tr><tr><td></td><td></td><td></td></tr></table>				1		1				<table border="1"><tr><td></td><td></td><td></td></tr><tr><td></td><td></td><td></td></tr><tr><td></td><td></td><td>1</td></tr></table>									1
1		1																																																																													
1																																																																															
		1																																																																													
1		1																																																																													
		1																																																																													
Post - 0 Miss - 0 Block - 0	Post - 0 Miss - 0 Block - 1	Post - 0 Miss - 0 Block - 0	Post - 0 Miss - 0 Block - 0	Post - 0 Miss - 0 Block - 0	Post - 0 Miss - 0 Block - 0	Post - 0 Miss - 0 Block - 0	Post - 0 Miss - 0 Block - 0																																																																								

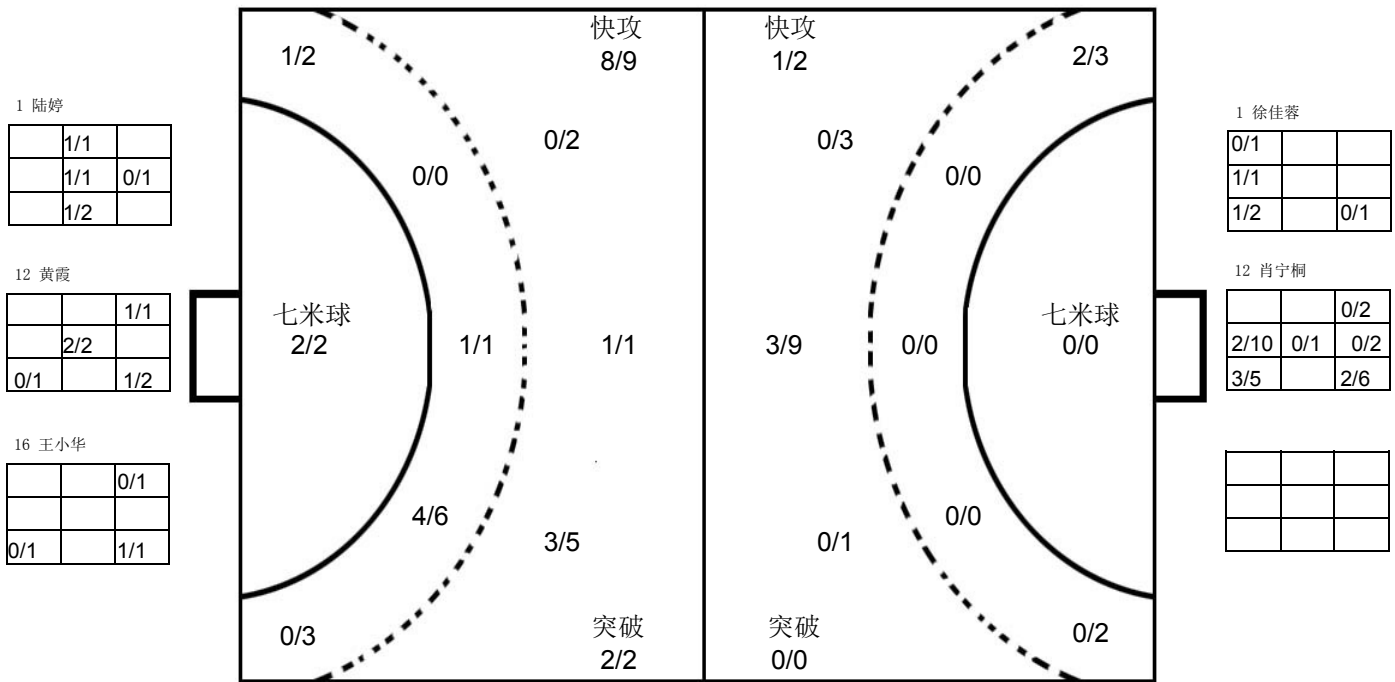

## 黑龙江

1 徐佳蓉	3 刘诗彤	5 周美微	6 王梦艺	9 郑宇	10 刘雪露	11 刘天茹	12 肖宁桐																																																																								
<table border="1"><tr><td></td><td></td><td></td></tr><tr><td></td><td></td><td></td></tr><tr><td></td><td></td><td></td></tr></table>										<table border="1"><tr><td></td><td></td><td>1</td></tr><tr><td></td><td></td><td></td></tr><tr><td></td><td></td><td></td></tr></table>			1							<table border="1"><tr><td></td><td></td><td></td></tr><tr><td></td><td></td><td></td></tr><tr><td></td><td></td><td></td></tr></table>										<table border="1"><tr><td></td><td></td><td></td></tr><tr><td>1</td><td></td><td></td></tr><tr><td></td><td></td><td></td></tr></table>				1						<table border="1"><tr><td></td><td></td><td></td></tr><tr><td></td><td></td><td></td></tr><tr><td></td><td></td><td>1</td></tr></table>									1	<table border="1"><tr><td></td><td></td><td></td></tr><tr><td></td><td></td><td></td></tr><tr><td></td><td></td><td>1</td></tr></table>									1	<table border="1"><tr><td></td><td></td><td></td></tr><tr><td></td><td></td><td></td></tr><tr><td></td><td></td><td></td></tr></table>										<table border="1"><tr><td></td><td></td><td></td></tr><tr><td></td><td></td><td></td></tr><tr><td></td><td></td><td></td></tr></table>									
		1																																																																													
1																																																																															
		1																																																																													
		1																																																																													
Post - 0 Miss - 0 Block - 0	Post - 1 Miss - 0 Block - 0	Post - 0 Miss - 0 Block - 0	Post - 0 Miss - 0 Block - 0	Post - 0 Miss - 0 Block - 0	Post - 0 Miss - 1 Block - 2	Post - 0 Miss - 0 Block - 0	Post - 0 Miss - 0 Block - 0																																																																								
13 吴佳	14 黄荣	16 杜亮	19 梁文煜	21 王戈	22 马琳	23 张政																																																																									
<table border="1"><tr><td></td><td></td><td></td></tr><tr><td></td><td></td><td>1</td></tr><tr><td></td><td></td><td></td></tr></table>						1				<table border="1"><tr><td></td><td></td><td></td></tr><tr><td></td><td></td><td></td></tr><tr><td></td><td></td><td></td></tr></table>										<table border="1"><tr><td></td><td></td><td></td></tr><tr><td></td><td></td><td></td></tr><tr><td></td><td></td><td></td></tr></table>										<table border="1"><tr><td></td><td></td><td></td></tr><tr><td></td><td></td><td></td></tr><tr><td></td><td></td><td></td></tr></table>										<table border="1"><tr><td></td><td></td><td></td></tr><tr><td></td><td></td><td></td></tr><tr><td>1</td><td></td><td></td></tr></table>							1			<table border="1"><tr><td></td><td></td><td></td></tr><tr><td></td><td></td><td></td></tr><tr><td></td><td></td><td></td></tr></table>										<table border="1"><tr><td></td><td></td><td></td></tr><tr><td></td><td></td><td></td></tr><tr><td></td><td></td><td></td></tr></table>										<table border="1"><tr><td></td><td></td><td></td></tr><tr><td></td><td></td><td></td></tr><tr><td></td><td></td><td></td></tr></table>									
		1																																																																													
1																																																																															
Post - 0 Miss - 1 Block - 0	Post - 0 Miss - 0 Block - 0	Post - 0 Miss - 0 Block - 0	Post - 0 Miss - 0 Block - 0	Post - 0 Miss - 0 Block - 0	Post - 1 Miss - 0 Block - 0	Post - 0 Miss - 0 Block - 0																																																																									

注释: Post=击柱 Miss=射失 Block=被封







预赛 Group A

女子 全国比赛

2016年全国女子手球锦标赛

Team A <b>A 安徽</b>		Team B <b>B 黑龙江</b>		Match Number <b>28</b>							
played in China		in the hall 滁州体育馆		on 08/09/2016							
				at 14:30 hours							
Spectators											
Half-time (30')	<b>A</b> 25	<b>B</b> 9	End of playing time	<b>A</b> 25	<b>B</b> 9						
			1st extra time	<b>A</b>	<b>B</b>						
			2nd extra time	<b>A</b>	<b>B</b>						
			After penalty throws	<b>A</b>	<b>B</b>						
Number of 7 m	<b>A</b> 1/2	Team time-out			<b>B</b> 0/1						
	1	2	3	Full name of players and officials							
				1	2						
				14:46	3						
No.	Team <b>A</b>					No.	Team <b>B</b>				
	G	W	2'	D	DR		G	W	2'	D	DR
1						1					
3	1					3	1				
5	6	1				5					
6	2	1				6	2				
7						9					
8						10	1				
10						11	1				
14						12					
16						13	2				
17	1					14					
18	4					16					
20	2					19	2	1			
21	3					21					
23	2					22					
41	1					23					
46	3										
A	吴立军					B	张立梅 (主教练)				
E	张舜					C	黄冬杰				
						D	于兹香				
						E	马婧				
<b>A</b>	Signature of Responsible Official of the Teams (Off. A)										<b>B</b>
TP	Remarks of Referee / CHA Official										TP

Signatures

Referees: 刘晓辉 (CHN)      林晓佟 (CHN)

Techn. Delegates: 高斌 (CHN)

CHA Official: 于中迅 (CHN)

Note: Number of 7m Throws Awarded to Team A and B, Goals (G), Warnings (W), Suspensions (2'), Direct Disqualification (D), Disqualification with Report (DR) and Team Penalty (TP).

Table Officials: 佟金政      贾俊秋      Statisticians: 陈柱      黄岩

Printed by PHMS      Copyright: IHF / CHA      08/09/2016 15:14:09

Longman Sportsoft      handball@126.com





### 2016年全国女子手球锦标赛 竞赛技术统计(媒体表)

<b>预赛</b>	组别	<b>A</b>	轮次	<b>6</b>	场次	<b>28</b>
滁州体育馆		08/09/2016			201605028-51-1/1	
安徽		<b>安徽</b>	<b>25</b>	vs	<b>9</b>	黑龙江
			<b>25 : 9</b>			

裁判员	刘晓辉 (CHN)		/	林晓佟 (CHN)	
-----	-----------	--	---	-----------	--

安徽													比赛进程		黑龙江														
主教练：孙来苗													进程																
	远射	近射	边射	快攻	突破	任意球	7m球	合计	%	助攻	失误	警告	2'	D & DR															
1 司艳															1st Half														
3 李兵		1/1						1/1	100						20 周雪婷 1 00:32 0														
5 班晨晨	2/2	1/1	2/3		1/1			6/7	85.7			1			41 杜机娟 2 01:26 0														
6 沈萍	1/1				1/1			2/2	100	1		1			5 班晨晨 3 03:02 0														
7 赵江川															23 张天洁 4 03:33 0														
8 徐仕媛											1				6 沈萍 5 04:26 0														
10 孙来苗															23 张天洁 6 05:17 0														
14 刘晓妹	0/1							0/1	0.0						5 班晨晨 7 06:31 1														
16 朱莉珍															6 05:44 1 13 吴佳														
17 周婷				1/1				1/1	100	4	1				7 06:58 2 10 刘雪露														
18 郑冬冬		4/4						4/4	100						8 09:25 2														
20 周雪婷			0/3	2/2				2/5	40.0			1			8 09:52 3 13 吴佳														
21 李瑶	0/1			3/3				3/4	75.0	3					8 10:34 4 6 王梦艺														
23 张天洁			1/1	1/1				2/2	100						6 沈萍 9 10:55 4														
41 杜机娟	0/1						1/1	1/2	50.0						5 班晨晨 10 11:42 4														
46 陶传红			2/4	1/1			0/1	3/6	50.0		2				46 陶传红 11 12:23 4														
<b>运动员 合计</b>	<b>3/6</b>	<b>6/6</b>	<b>5/11</b>	<b>8/8</b>	<b>2/2</b>		<b>1/2</b>	<b>25/35</b>	<b>71.4</b>	<b>8</b>	<b>5</b>	<b>2</b>			11 13:01 5 6 王梦艺														
8 徐仕媛	9/13	1/1	1/4	1/1	0/2		1/1	13/22	59.1		1				20 周雪婷 11 15:10 6														
16 朱莉珍	1/1		2/2					3/3	100						3 李兵 12 17:10 6														
<b>守门员 合计</b>	<b>10/14</b>	<b>1/1</b>	<b>3/6</b>	<b>1/1</b>	<b>0/2</b>		<b>1/1</b>	<b>16/25</b>	<b>64.0</b>		<b>1</b>				21 李瑶 13 20:11 6														
															17 周婷 21 28:00 7														
															5 班晨晨 21 28:13 8 3 刘诗彤														
															18 郑冬冬 22 28:33 8														
															18 郑冬冬 22 28:52 9 19 梁文煜														
															18 郑冬冬 23 29:05 9														
															21 李瑶 24 29:28 9														
															5 班晨晨 25 29:51 9														

场上队员：得分 / 射门													守门员：救球 / 射门						
快攻	Fast Break	突破	Breakthrough	任意球	Free Throw	7M球	7M Throw	助攻	Assist	警告	Warning	失误	Error	2'	Suspension	D	取消资格	DR	取消资格+报告
1 徐佳蓉																			
12 肖宁桐								1											
<b>守门员 合计</b>	<b>0/3</b>	<b>0/6</b>	<b>4/9</b>	<b>0/8</b>	<b>0/2</b>		<b>0/1</b>	<b>4/29</b>	<b>13.8</b>	<b>1</b>									





### 2016年全国女子手球锦标赛 图式比赛技术统计表

轮次 6

场次 28

201605028-21-1/1

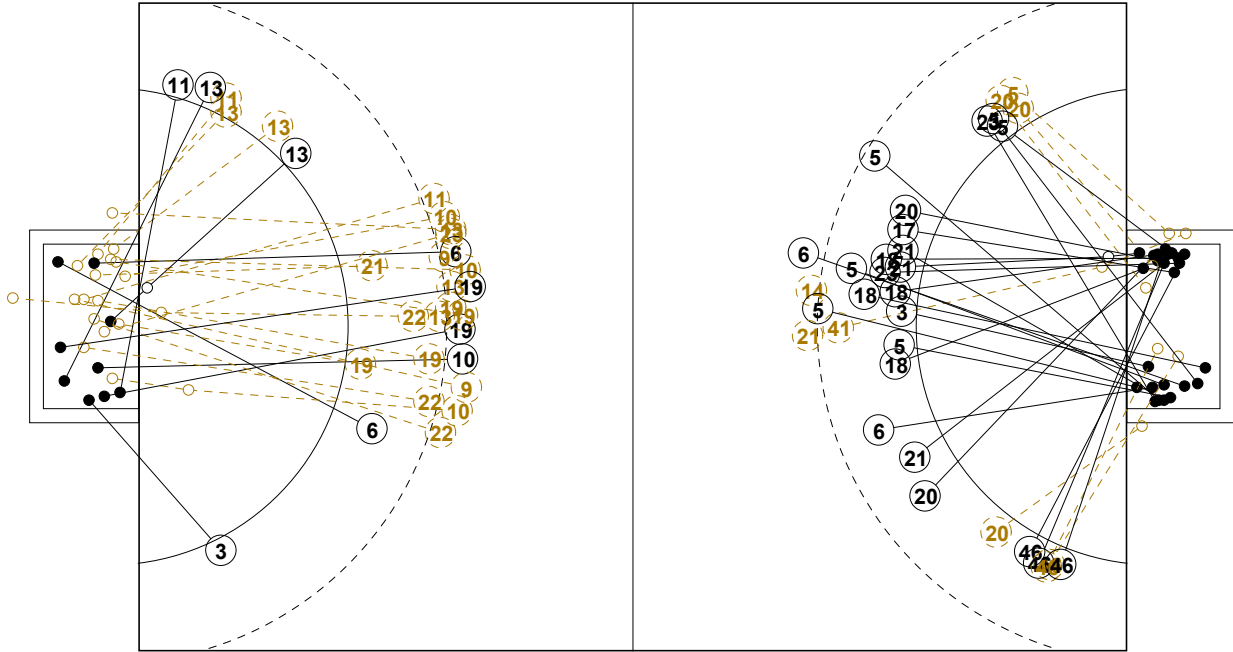

7M 黑龙江

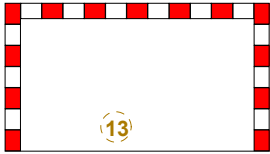

安徽 7M

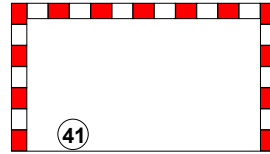

1st Half  
9 : 25

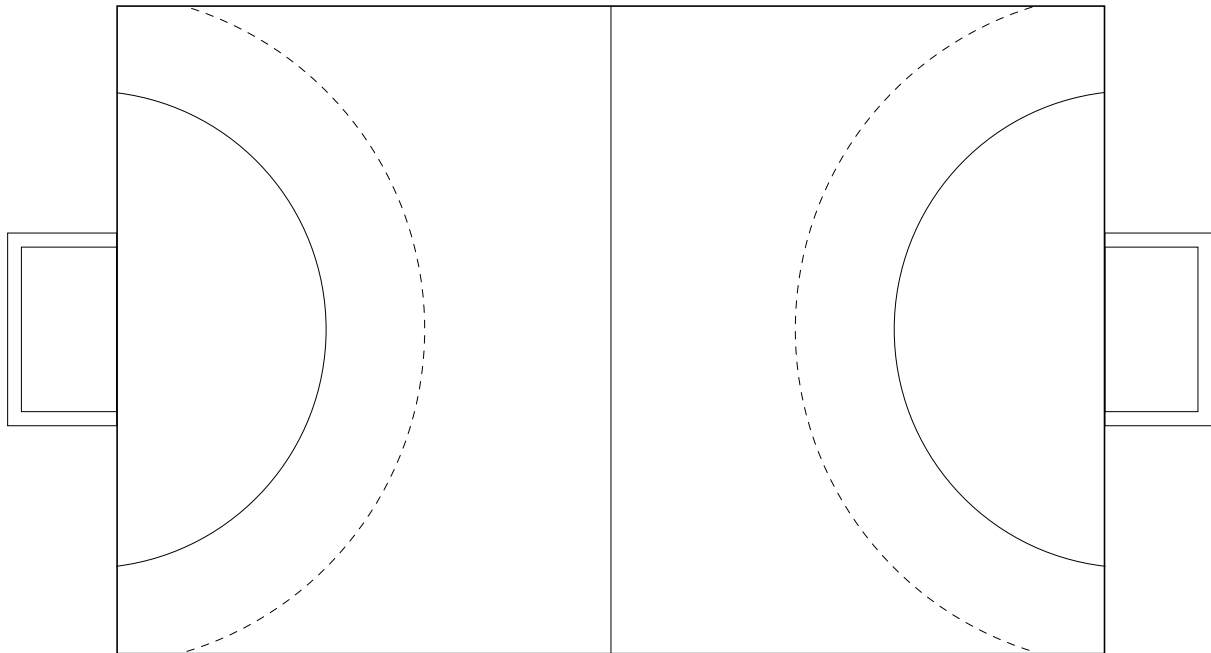

7M 安徽

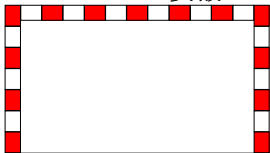

黑龙江 7M

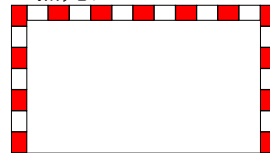

2nd Half  
25 : 9



## 2016年全国女子手球锦标赛

## 个人/全队技术统计表

正式表  
手球  
女子预赛  
轮次 6组别 A  
场次 28201605028-14-1/2  
滁州体育馆  
08/09/2016 14:30

号码	姓名	远射	近射	边射	快攻	突破	任意	7M	合计	%	助攻	失误	警告	2'	取消	时间
<b>安徽(安徽)</b>																
<i>(场上队员)</i>																
1	司艳									0.0%						00:00:00
3	李兵		1/1						1/1	100%						00:14:57
5	班晨晨	2/2	1/1	2/3		1/1			6/7	85.7%			1			00:18:17
6	沈萍	1/1				1/1			2/2	100%	1		1			00:14:53
7	赵江川									0.0%						00:00:00
8	徐仕媛									0.0%		1				00:24:56
10	孙来苗									0.0%						00:00:00
14	刘晓妹	0/1							0/1	0.0%						00:14:59
16	朱莉珍									0.0%						00:05:04
17	周婷				1/1				1/1	100%	4	1				00:14:25
18	郑冬冬		4/4						4/4	100%						00:15:05
20	周雪婷			0/3	2/2				2/5	40.0%		1				00:28:29
21	李瑶	0/1			3/3				3/4	75.0%	3					00:13:59
23	张天洁			1/1	1/1				2/2	100%						00:14:46
41	杜机娟	0/1						1/1	1/2	50.0%						00:06:14
46	陶传红			2/4	1/1			0/1	3/6	50.0%		2				00:23:46
<b>合计</b>		3/6	6/6	5/11	8/8	2/2		1/2	25/35	71.4%	8	5	2			
<i>(守门员)</i>																
8	徐仕媛	9/13	1/1	1/4	1/1	0/2		1/1	13/22	59.1%		1				00:24:56
16	朱莉珍	1/1		2/2					3/3	100%						00:05:04
<b>合计</b>		10/14	1/1	3/6	1/1	0/2		1/1	16/25	64.0%		1				

场上队员：得分/射门

守门员：救球/射门

全队合计	得分	被救	射失	击柱	封球	合计	%
远射	3			1	2	6	50.0%
近射	6					6	100.0%
边射	5	4		2		11	45.5%
快攻	8					8	100.0%
突破	2					2	100.0%
任意							0.0%
7M	1		1			2	50.0%





## 2016年全国女子手球锦标赛

## 个人/全队技术统计表

正式表  
手球  
女子预赛  
轮次 6组别 A  
场次 28201605028-14-2/2  
滁州体育馆  
08/09/2016 14:30

号码	姓名	远射	近射	边射	快攻	突破	任意	7M	合计	%	助攻	失误	警告	2'	取消	时间
<b>黑龙江(黑龙江)</b>																
<i>(上场队员)</i>																
1	徐佳蓉									0.0%						00:06:58
3	刘诗彤			1/1					1/1	100%		2				00:20:17
5	周美微									0.0%						00:15:13
6	王梦艺	1/1				1/1			2/2	100%		1				00:15:14
9	郑宇	0/2							0/2	0.0%		1				00:09:36
10	刘雪露	1/4							1/4	25.0%		1				00:15:15
11	刘天茹	0/1		1/2					1/3	33.3%		1				00:16:30
12	肖宁桐									0.0%	1					00:23:02
13	吴佳	0/3		1/3		1/1		0/1	2/8	25.0%						00:22:12
14	黄荣									0.0%						00:00:00
16	杜宪									0.0%						00:00:00
19	梁文煜	2/5	0/1						2/6	33.3%			1			00:21:46
21	王戈				0/1				0/1	0.0%		1				00:14:36
22	马琳	0/2	0/1						0/3	0.0%		2				00:14:42
23	张政	0/1							0/1	0.0%		2	1			00:14:39
<b>合计</b>		4/19	0/2	3/6	0/1	2/2		0/1	9/31	29.0%	1	11	2			
<i>(守门员)</i>																
1	徐佳蓉		0/2	0/2	0/4			0/1	0/9	0.0%						00:06:58
12	肖宁桐	0/3	0/4	4/7	0/4	0/2			4/20	20.0%	1					00:23:02
<b>合计</b>		0/3	0/6	4/9	0/8	0/2		0/1	4/29	13.8%	1					

场上队员：得分/射门

守门员：救球/射门

全队合计	得分	被救	射失	击柱	封球	合计	%
远射	4	10	1		4	19	21.1%
近射		1	1			2	0.0%
边射	3	3				6	50.0%
快攻		1				1	0.0%
突破	2					2	100.0%
任意							0.0%
7M		1				1	0.0%





### 2016年全国女子手球锦标赛

#### 图式射门区域统计

轮次 6 场次 28

201605028-41-1/1

## 安徽

1 司艳	3 李兵	5 班晨晨	6 沈萍	7 赵江川	8 徐仕媛	10 孙来苗	14 刘晓妹																																																																								
<table border="1"><tr><td></td><td></td><td></td></tr><tr><td></td><td></td><td></td></tr><tr><td></td><td></td><td></td></tr></table>										<table border="1"><tr><td></td><td></td><td></td></tr><tr><td></td><td></td><td></td></tr><tr><td></td><td></td><td>1</td></tr></table>									1	<table border="1"><tr><td></td><td></td><td>1</td></tr><tr><td>1</td><td></td><td>3</td></tr><tr><td></td><td></td><td>1</td></tr></table>			1	1		3			1	<table border="1"><tr><td></td><td></td><td></td></tr><tr><td></td><td></td><td>1</td></tr><tr><td></td><td></td><td>1</td></tr></table>						1			1	<table border="1"><tr><td></td><td></td><td></td></tr><tr><td></td><td></td><td></td></tr><tr><td></td><td></td><td></td></tr></table>										<table border="1"><tr><td></td><td></td><td></td></tr><tr><td></td><td></td><td></td></tr><tr><td></td><td></td><td></td></tr></table>										<table border="1"><tr><td></td><td></td><td></td></tr><tr><td></td><td></td><td></td></tr><tr><td></td><td></td><td></td></tr></table>										<table border="1"><tr><td></td><td></td><td></td></tr><tr><td></td><td></td><td></td></tr><tr><td></td><td></td><td></td></tr></table>									
		1																																																																													
		1																																																																													
1		3																																																																													
		1																																																																													
		1																																																																													
		1																																																																													
Post - 0 Miss - 0 Block - 0	Post - 0 Miss - 0 Block - 0	Post - 1 Miss - 0 Block - 0	Post - 0 Miss - 0 Block - 0	Post - 0 Miss - 0 Block - 0	Post - 0 Miss - 0 Block - 0	Post - 0 Miss - 0 Block - 0	Post - 0 Miss - 0 Block - 1																																																																								
16 朱莉珍	17 周婷	18 郑冬冬	20 周雪婷	21 李瑶	23 张天洁	41 杜机娟	46 陶传红																																																																								
<table border="1"><tr><td></td><td></td><td></td></tr><tr><td></td><td></td><td></td></tr><tr><td></td><td></td><td></td></tr></table>										<table border="1"><tr><td></td><td></td><td></td></tr><tr><td>1</td><td></td><td></td></tr><tr><td></td><td></td><td></td></tr></table>				1						<table border="1"><tr><td></td><td></td><td>1</td></tr><tr><td>2</td><td></td><td></td></tr><tr><td>1</td><td></td><td></td></tr></table>			1	2			1			<table border="1"><tr><td></td><td></td><td></td></tr><tr><td>1</td><td></td><td></td></tr><tr><td>1</td><td></td><td></td></tr></table>				1			1			<table border="1"><tr><td></td><td></td><td></td></tr><tr><td>1</td><td></td><td>1</td></tr><tr><td>1</td><td></td><td></td></tr></table>				1		1	1			<table border="1"><tr><td></td><td></td><td></td></tr><tr><td>1</td><td></td><td></td></tr><tr><td></td><td></td><td>1</td></tr></table>				1					1	<table border="1"><tr><td></td><td></td><td></td></tr><tr><td></td><td></td><td></td></tr><tr><td>1</td><td></td><td></td></tr></table>							1			<table border="1"><tr><td></td><td></td><td></td></tr><tr><td></td><td></td><td></td></tr><tr><td>3</td><td></td><td></td></tr></table>							3		
1																																																																															
		1																																																																													
2																																																																															
1																																																																															
1																																																																															
1																																																																															
1		1																																																																													
1																																																																															
1																																																																															
		1																																																																													
1																																																																															
3																																																																															
Post - 0 Miss - 0 Block - 0	Post - 0 Miss - 0 Block - 0	Post - 0 Miss - 0 Block - 0	Post - 1 Miss - 0 Block - 0	Post - 0 Miss - 0 Block - 1	Post - 0 Miss - 0 Block - 0	Post - 1 Miss - 0 Block - 0	Post - 0 Miss - 1 Block - 0																																																																								

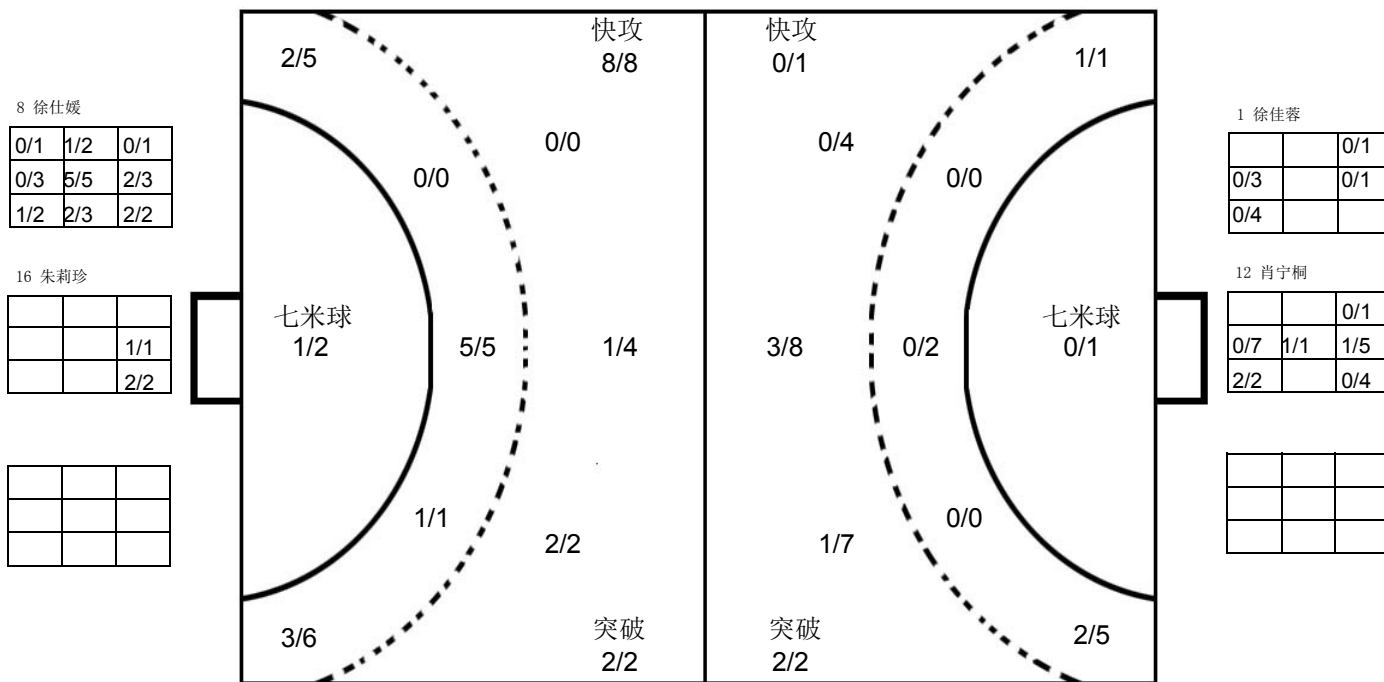

## 黑龙江

1 徐佳蓉	3 刘诗彤	5 周美微	6 王梦艺	9 郑宇	10 刘雪露	11 刘天茹	12 肖宁桐																																																																								
<table border="1"><tr><td></td><td></td><td></td></tr><tr><td></td><td></td><td></td></tr><tr><td></td><td></td><td></td></tr></table>										<table border="1"><tr><td></td><td></td><td></td></tr><tr><td>1</td><td></td><td></td></tr><tr><td></td><td></td><td></td></tr></table>				1						<table border="1"><tr><td></td><td></td><td></td></tr><tr><td></td><td></td><td></td></tr><tr><td></td><td></td><td></td></tr></table>										<table border="1"><tr><td></td><td></td><td>1</td></tr><tr><td></td><td></td><td>1</td></tr><tr><td></td><td></td><td></td></tr></table>			1			1				<table border="1"><tr><td></td><td></td><td></td></tr><tr><td></td><td></td><td></td></tr><tr><td></td><td></td><td></td></tr></table>										<table border="1"><tr><td></td><td></td><td></td></tr><tr><td></td><td></td><td></td></tr><tr><td>1</td><td></td><td></td></tr></table>							1			<table border="1"><tr><td></td><td></td><td></td></tr><tr><td></td><td></td><td></td></tr><tr><td>1</td><td></td><td></td></tr></table>							1			<table border="1"><tr><td></td><td></td><td></td></tr><tr><td></td><td></td><td></td></tr><tr><td></td><td></td><td></td></tr></table>									
1																																																																															
		1																																																																													
		1																																																																													
1																																																																															
1																																																																															
Post - 0 Miss - 0 Block - 0	Post - 0 Miss - 0 Block - 0	Post - 0 Miss - 0 Block - 0	Post - 0 Miss - 0 Block - 0	Post - 0 Miss - 0 Block - 1	Post - 0 Miss - 0 Block - 0	Post - 0 Miss - 0 Block - 0	Post - 0 Miss - 0 Block - 0																																																																								
13 吴佳	14 黄荣	16 杜亮	19 梁文煜	21 王戈	22 马琳	23 张政																																																																									
<table border="1"><tr><td>1</td><td></td><td></td></tr><tr><td></td><td></td><td></td></tr><tr><td></td><td></td><td></td></tr></table>	1									<table border="1"><tr><td></td><td></td><td></td></tr><tr><td></td><td></td><td></td></tr><tr><td></td><td></td><td></td></tr></table>										<table border="1"><tr><td></td><td></td><td></td></tr><tr><td></td><td></td><td></td></tr><tr><td></td><td></td><td></td></tr></table>										<table border="1"><tr><td></td><td></td><td>1</td></tr><tr><td>1</td><td></td><td></td></tr><tr><td></td><td></td><td></td></tr></table>			1	1						<table border="1"><tr><td></td><td></td><td></td></tr><tr><td></td><td></td><td></td></tr><tr><td></td><td></td><td></td></tr></table>										<table border="1"><tr><td></td><td></td><td></td></tr><tr><td></td><td></td><td></td></tr><tr><td></td><td></td><td></td></tr></table>										<table border="1"><tr><td></td><td></td><td></td></tr><tr><td></td><td></td><td></td></tr><tr><td></td><td></td><td></td></tr></table>										<table border="1"><tr><td></td><td></td><td></td></tr><tr><td></td><td></td><td></td></tr><tr><td></td><td></td><td></td></tr></table>									
1																																																																															
		1																																																																													
1																																																																															
Post - 0 Miss - 1 Block - 2	Post - 0 Miss - 0 Block - 0	Post - 0 Miss - 0 Block - 0	Post - 0 Miss - 0 Block - 1	Post - 0 Miss - 0 Block - 0	Post - 0 Miss - 1 Block - 0	Post - 0 Miss - 0 Block - 0																																																																									

注释: Post=击柱 Miss=射失 Block=被封





预赛 Group A

女子 全国比赛

2016年全国女子手球锦标赛

Team A <b>A 江苏</b>				Team B <b>B 广西</b>				Match Number <b>29</b>													
played in China		in the hall 滁州体育馆		on 08/09/2016		at 16:00 hours		Spectators													
Half-time (30')	<b>A</b> 22	<b>B</b> 9	End of playing time	<b>A</b> 24	<b>B</b> 9	1st extra time	<b>A</b>	<b>B</b>	2nd extra time	<b>A</b>	<b>B</b>	After penalty throws	<b>A</b>	<b>B</b>							
Number of 7 m	<b>A</b> 1 / 1	Team time-out			Full name of players and officials				Team time-out			<b>B</b> 0 / 0	Number of 7 m								
No.	Team <b>A</b>					G	W	2'	D	DR	No.	Team <b>B</b>					G	W	2'	D	DR
1	陆婷										1	胡霜梅									
3	张海侠					2					2	陆雪云									
4	赵佳芹					2					5	黄海玉									
5	高媛媛					1					6	韦惠文					1				
8	乔如					1					7	廖露					2				
9	莫蒙蒙					3					8	韦如芳					1	1			
10	王可可					1					9	蓝雪梅									
11	于源源					3	1				10	周琴					2				
12	黄霞										11	曾蓝花					1				
13	黄慧影										12	江燕红									
16	王小华										14	黄艳芳					1				
17	修丽杰					3		1			15	陈依依									
18	韦秋香					1					16	商志运									
23	王书慧					4					17	杨杨									
33	金梦青										18	庞娇					1				
69	蓝小玲					3															
B	金甲洙 (主教练)										C	王林									
C	马彪										D	刘雪波									
D	李海鹰																				
E	陈志伟																				
<b>A</b>	Signature of Responsible Official of the Teams (Off. A)										<b>B</b>										
TP	Remarks of Referee / CHA Official										TP										

Signatures

Referees: 王洋 (CHN) 隆晓磊 (CHN)

Techn. Delegates: 吴国忠 (CHN)

CHA Official: 刘书勇 (CHN)

Note: Number of 7m Throws Awarded to Team A and B, Goals (G), Warnings (W), Suspensions (2'), Direct Disqualification (D), Disqualification with Report (DR) and Team Penalty (TP).

Table Officials: 李诚 赵涵 Statisticians: 刘永欢 陈柱

Printed by PHMS Copyright: IHF / CHA 08/09/2016 16:35:50

Longman Sportsoft  handball@126.com



### 2016年全国女子手球锦标赛 竞赛技术统计(媒体表)

<b>预赛</b>	组别	<b>A</b>	轮次	<b>6</b>	场次	<b>29</b>
滁州体育馆		08/09/2016			201605029-51-1/1	
江苏	<b>江苏</b>	<b>24</b>	vs	<b>9</b>	广西	广西
<b>22 : 9</b>						

裁判员	王洋 (CHN)	/	隆晓磊 (CHN)
-----	----------	---	-----------

江苏		远射	近射	边射	快攻	突破	任意球	7m球	合计	%	助攻	失误	警告	2'	D & DR	江苏		广西			
主教练：金甲洙																比赛进程					
1	陆婷										3					9	莫蒙蒙	1	00:55	0	
3	张海侠			1/1	1/2				2/3	66.7	1					11	于源源	2	01:48	0	
4	赵佳芹	1/3	1/1						2/4	50.0	1					4	赵佳芹	3	02:27	1	11 曾蓝花
5	高媛媛	1/2							1/2	50.0						23	王书慧	4	02:53	1	
8	乔如		1/1						1/1	100		1				9	莫蒙蒙	5	04:20	2	7 廖露
9	莫蒙蒙		0/1		3/3				3/4	75.0						23	王书慧	6	06:08	2	
10	王可可	1/1	0/2						1/3	33.3		1				11	于源源	7	07:05	2	
11	于源源			1/1	2/2				3/3	100			1			69	蓝小玲	8	07:57	2	
12	黄霞										1					4	赵佳芹	9	08:39	2	
13	黄慧影		0/1						0/1	0.0						69	蓝小玲	10	09:09	2	
16	王小华															3	张海侠	11	10:15	2	
17	修丽杰	1/2	2/2						3/4	75.0	1	2		1		9	莫蒙蒙	12	10:50	2	
18	韦秋香				1/1				1/1	100						12	隆晓磊	12	11:35	3	14 黄艳芳
23	王书慧	1/2	1/2		1/1	1/1			4/6	66.7						23	王书慧	13	13:13	3	
33	金梦青															23	王书慧	14	14:38	3	
69	蓝小玲	1/1			1/1			1/1	3/3	100	1					69	蓝小玲	15	15:18	3	
<b>运动员 合计</b>		<b>6/11</b>	<b>5/10</b>	<b>2/2</b>	<b>9/10</b>	<b>1/1</b>		<b>1/1</b>	<b>24/35</b>	<b>68.6</b>	<b>8</b>	<b>4</b>	<b>1</b>	<b>1</b>		5	高媛媛	16	17:23	3	
1	陆婷	12/14	3/6	1/2					16/22	72.7	3					11	于源源	17	17:58	3	
12	黄霞	3/3	0/1	0/1	0/1				3/6	50.0	1					17	修丽杰	17	18:39	4	18 庞娇
<b>守门员 合计</b>		<b>15/17</b>	<b>3/7</b>	<b>1/3</b>	<b>0/1</b>				<b>19/28</b>	<b>67.9</b>	<b>4</b>					17	修丽杰	18	19:25	5	6 韦惠文
广西		远射	近射	边射	快攻	突破	任意球	7m球	合计	%	助攻	失误	警告	2'	D & DR						
教练：王林																					
1	胡霜梅															10	王可可	18	20:26	6	7 廖露
2	陆雪云	0/4	0/1						0/5	0.0		4				17	修丽杰	19	21:00	6	
5	黄海玉															17	修丽杰	20	22:47	6	
6	韦惠文	1/1							1/1	100						3	张海侠	21	24:36	7	8 韦如芳
7	廖露	1/5	1/1						2/6	33.3	1	1		1		21	莫蒙蒙	21	25:07	8	10 周琴
8	韦如芳	0/1	1/1						1/2	50.0						8	乔如	22	29:02	9	
9	蓝雪梅	0/2	0/2						0/4	0.0		1				2nd Half					
10	周琴	0/1		1/2	1/1				2/4	50.0						17	修丽杰	23	00:17	9	
11	曾蓝花	0/5		1/1					1/6	16.7	1	4				18	韦秋香	24	01:28	9	
12	江燕红																				
14	黄艳芳		1/2						1/2	50.0											
15	陈依依																				
16	商志运										1										
17	杨杨	0/2							0/2	0.0											
18	庞娇	0/2	1/2						1/4	25.0											
<b>运动员 合计</b>		<b>2/23</b>	<b>4/9</b>	<b>2/3</b>	<b>1/1</b>				<b>9/36</b>	<b>25.0</b>	<b>3</b>	<b>10</b>	<b>1</b>								
12	江燕红	3/7	3/5	0/1	0/8	0/1		0/1	6/23	26.1											
16	商志运	1/3	2/5	0/1	0/1				3/10	30.0	1										
<b>守门员 合计</b>		<b>4/10</b>	<b>5/10</b>	<b>0/2</b>	<b>0/9</b>	<b>0/1</b>		<b>0/1</b>	<b>9/33</b>	<b>27.3</b>	<b>1</b>										

场上队员：得分 / 射门

守门员：救球 / 射门

快攻	Fast Break	突破	Breakthrough	任意球	Free Throw	7M球	7M Throw	助攻	Assist
警告	Warning	失误	Error	2'	Suspension	D	取消资格	DR	取消资格+报告







### 2016年全国女子手球锦标赛 图式比赛技术统计表

轮次 6

场次 29

201605029-21-1/1

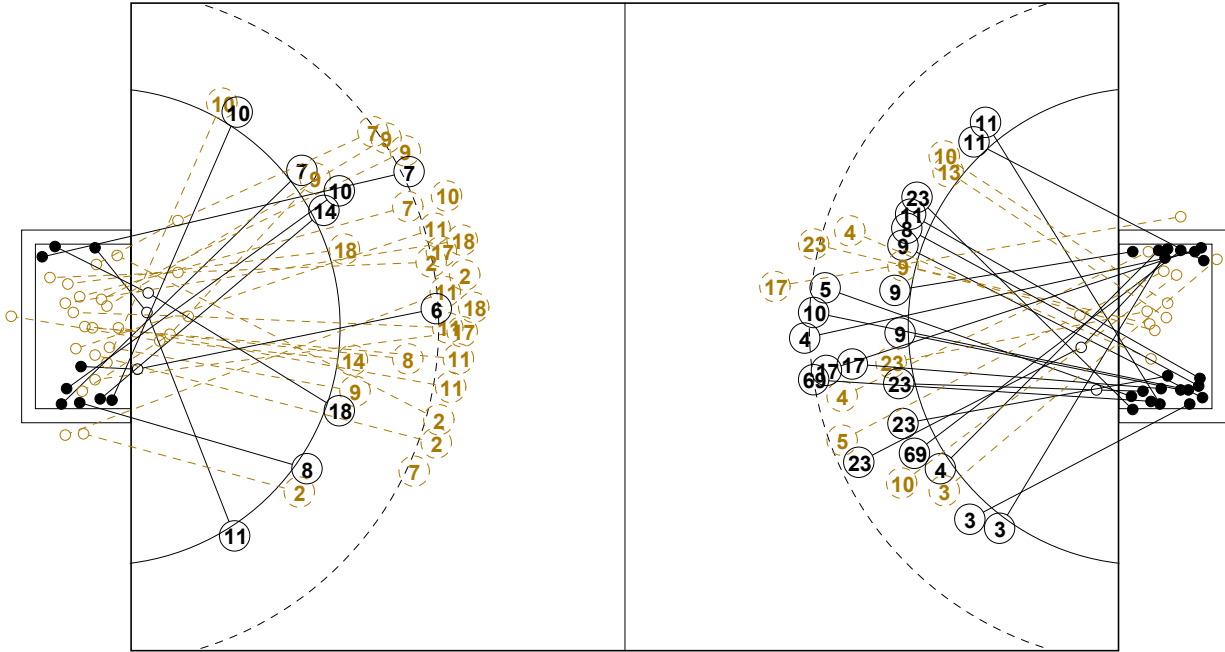

7M 广西

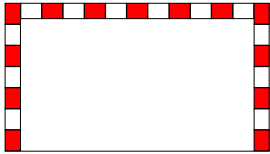

江苏 7M

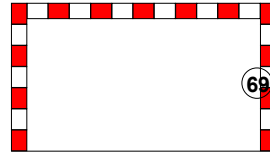

1st Half  
9 : 22

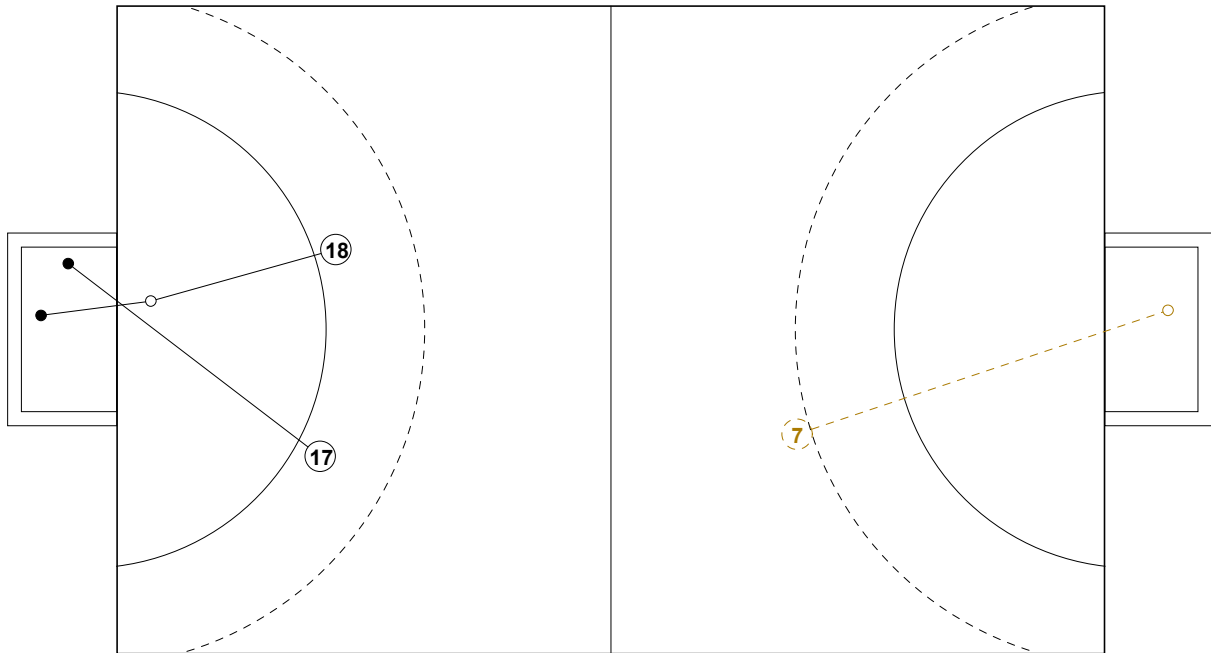

7M 江苏

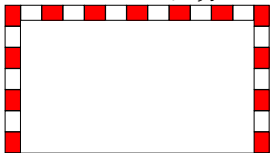

广西 7M



2nd Half  
24 : 9



## 2016年全国女子手球锦标赛

## 个人/全队技术统计表

正式表  
手球  
女子预赛  
轮次 6组别 A  
场次 29201605029-14-1/2  
滁州体育馆  
08/09/2016 16:00

号码	姓名	远射	近射	边射	快攻	突破	任意	7M	合计	%	助攻	失误	警告	2'	取消	时间
<b>江苏(江苏)</b>																
<i>(场上队员)</i>																
1	陆婷									0.0%	3					00:22:50
3	张海侠			1/1	1/2				2/3	66.7%	1					00:26:41
4	赵佳芹	1/3	1/1						2/4	50.0%	1					00:09:16
5	高媛媛	1/2							1/2	50.0%						00:09:50
8	乔如		1/1						1/1	100%		1				00:16:05
9	莫蒙蒙		0/1		3/3				3/4	75.0%						00:21:33
10	王可可	1/1	0/2						1/3	33.3%		1				00:22:14
11	于源源			1/1	2/2				3/3	100%			1			00:26:50
12	黄霞									0.0%	1					00:08:27
13	黄慧影		0/1						0/1	0.0%						00:04:40
16	王小华									0.0%						00:00:00
17	修丽杰	1/2	2/2						3/4	75.0%	1	2		1		00:22:29
18	韦秋香				1/1				1/1	100%						00:04:49
23	王书慧	1/2	1/2		1/1	1/1			4/6	66.7%						00:15:23
33	金梦青									0.0%						00:00:00
69	蓝小玲	1/1			1/1			1/1	3/3	100%	1					00:15:25
<b>合计</b>		6/11	5/10	2/2	9/10	1/1		1/1	24/35	68.6%	8	4	1	1		
<i>(守门员)</i>																
1	陆婷	12/14	3/6	1/2					16/22	72.7%	3					00:22:50
12	黄霞	3/3	0/1	0/1	0/1				3/6	50.0%	1					00:08:27
<b>合计</b>		15/17	3/7	1/3	0/1				19/28	67.9%	4					

场上队员：得分/射门

守门员：救球/射门

全队合计	得分	被救	射失	击柱	封球	合计	%
远射	6	4	1			11	54.5%
近射	5	5				10	50.0%
边射	2					2	100.0%
快攻	9			1		10	90.0%
突破	1					1	100.0%
任意							0.0%
7M	1					1	100.0%





## 2016年全国女子手球锦标赛

## 个人/全队技术统计表

正式表  
手球  
女子预赛  
轮次 6组别 A  
场次 29201605029-14-2/2  
滁州体育馆  
08/09/2016 16:00

号码	姓名	远射	近射	边射	快攻	突破	任意	7M	合计	%	助攻	失误	警告	2'	取消	时间
<b>广西(广西)</b>																
<i>(上场队员)</i>																
1	胡霜梅									0.0%						00:00:00
2	陆雪云	0/4	0/1						0/5	0.0%		4				00:18:06
5	黄海玉									0.0%						00:10:42
6	韦惠文	1/1							1/1	100%						00:13:29
7	廖露	1/5	1/1						2/6	33.3%	1	1				00:25:29
8	韦如芳	0/1	1/1						1/2	50.0%			1			00:18:00
9	蓝雪梅	0/2	0/2						0/4	0.0%		1				00:12:27
10	周琴	0/1		1/2	1/1				2/4	50.0%						00:20:47
11	曾蓝花	0/5		1/1					1/6	16.7%	1	4				00:24:42
12	江燕红									0.0%						00:18:21
14	黄艳芳		1/2						1/2	50.0%						00:25:07
15	陈依依									0.0%						00:00:00
16	商志运									0.0%	1					00:13:10
17	杨杨	0/2							0/2	0.0%						00:06:04
18	庞娇	0/2	1/2						1/4	25.0%						00:13:59
<b>合计</b>		2/23	4/9	2/3	1/1				9/36	25.0%	3	10	1			
<i>(守门员)</i>																
12	江燕红	3/7	3/5	0/1	0/8	0/1		0/1	6/23	26.1%						00:18:21
16	商志运	1/3	2/5	0/1	0/1				3/10	30.0%	1					00:13:10
<b>合计</b>		4/10	5/10	0/2	0/9	0/1		0/1	9/33	27.3%	1					

场上队员：得分/射门

守门员：救球/射门

全队合计	得分	被救	射失	击柱	封球	合计	%
远射	2	15	1		5	23	8.7%
近射	4	3	2			9	44.4%
边射	2	1				3	66.7%
快攻	1					1	100.0%
突破							0.0%
任意							0.0%
7M							0.0%





### 2016年全国女子手球锦标赛

#### 图式射门区域统计

轮次 6 场次 29

201605029-41-1/1

## 江苏

1 陆婷	3 张海侠	4 赵佳芹	5 高媛媛	8 乔如	9 莫蒙蒙	10 王可可	11 于源源																																																																								
<table border="1"><tr><td></td><td></td><td></td></tr><tr><td></td><td></td><td></td></tr><tr><td></td><td></td><td></td></tr></table>										<table border="1"><tr><td></td><td></td><td>1</td></tr><tr><td>1</td><td></td><td></td></tr><tr><td></td><td></td><td></td></tr></table>			1	1						<table border="1"><tr><td>1</td><td></td><td></td></tr><tr><td>1</td><td></td><td></td></tr><tr><td></td><td></td><td></td></tr></table>	1			1						<table border="1"><tr><td></td><td></td><td></td></tr><tr><td></td><td></td><td></td></tr><tr><td></td><td></td><td>1</td></tr></table>									1	<table border="1"><tr><td></td><td></td><td>1</td></tr><tr><td></td><td></td><td></td></tr><tr><td></td><td></td><td></td></tr></table>			1							<table border="1"><tr><td></td><td></td><td>2</td></tr><tr><td></td><td></td><td></td></tr><tr><td>1</td><td></td><td></td></tr></table>			2				1			<table border="1"><tr><td></td><td></td><td>1</td></tr><tr><td></td><td></td><td></td></tr><tr><td></td><td></td><td></td></tr></table>			1							<table border="1"><tr><td>1</td><td></td><td>1</td></tr><tr><td></td><td></td><td>1</td></tr><tr><td></td><td></td><td></td></tr></table>	1		1			1			
		1																																																																													
1																																																																															
1																																																																															
1																																																																															
		1																																																																													
		1																																																																													
		2																																																																													
1																																																																															
		1																																																																													
1		1																																																																													
		1																																																																													
Post - 0 Miss - 0 Block - 0	Post - 1 Miss - 0 Block - 0	Post - 0 Miss - 0 Block - 0	Post - 0 Miss - 0 Block - 0	Post - 0 Miss - 0 Block - 0	Post - 0 Miss - 0 Block - 0	Post - 0 Miss - 0 Block - 0	Post - 0 Miss - 0 Block - 0																																																																								
12 黄霞	13 黄慧影	16 王小华	17 修丽杰	18 韦秋香	23 王书慧	33 金梦青	69 蓝小玲																																																																								
<table border="1"><tr><td></td><td></td><td></td></tr><tr><td></td><td></td><td></td></tr><tr><td></td><td></td><td></td></tr></table>										<table border="1"><tr><td></td><td></td><td></td></tr><tr><td></td><td></td><td></td></tr><tr><td></td><td></td><td></td></tr></table>										<table border="1"><tr><td></td><td></td><td></td></tr><tr><td></td><td></td><td></td></tr><tr><td></td><td></td><td></td></tr></table>										<table border="1"><tr><td>1</td><td></td><td></td></tr><tr><td></td><td></td><td>2</td></tr><tr><td></td><td></td><td></td></tr></table>	1					2				<table border="1"><tr><td></td><td>1</td><td></td></tr><tr><td></td><td></td><td></td></tr><tr><td></td><td></td><td></td></tr></table>		1								<table border="1"><tr><td></td><td></td><td></td></tr><tr><td>1</td><td></td><td>1</td></tr><tr><td></td><td></td><td>2</td></tr></table>				1		1			2	<table border="1"><tr><td></td><td></td><td></td></tr><tr><td></td><td></td><td></td></tr><tr><td></td><td></td><td></td></tr></table>										<table border="1"><tr><td>1</td><td></td><td></td></tr><tr><td></td><td></td><td>2</td></tr><tr><td></td><td></td><td></td></tr></table>	1					2			
1																																																																															
		2																																																																													
	1																																																																														
1		1																																																																													
		2																																																																													
1																																																																															
		2																																																																													
Post - 0 Miss - 0 Block - 0	Post - 0 Miss - 0 Block - 0	Post - 0 Miss - 0 Block - 0	Post - 0 Miss - 1 Block - 0	Post - 0 Miss - 0 Block - 0	Post - 0 Miss - 0 Block - 0	Post - 0 Miss - 0 Block - 0	Post - 0 Miss - 0 Block - 0																																																																								

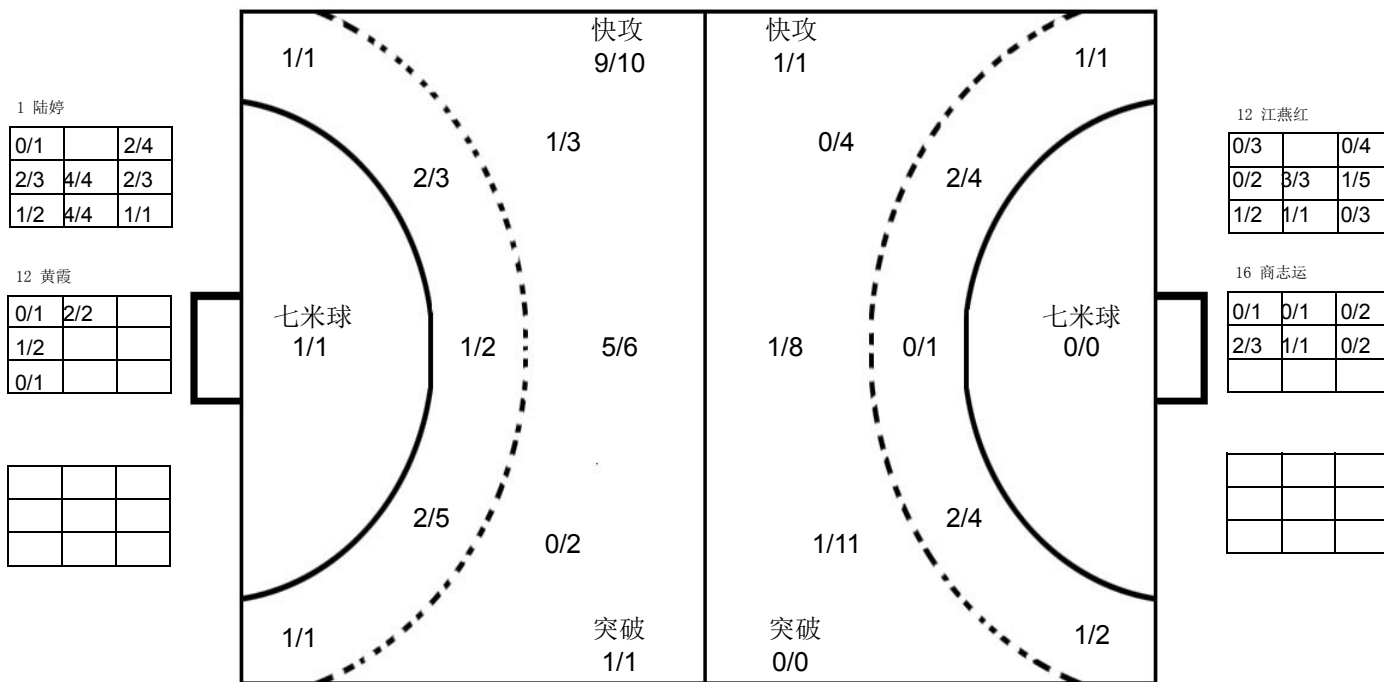

## 广西

1 胡霜梅	2 陆雪云	5 黄海玉	6 韦惠文	7 廖露	8 韦如芳	9 蓝雪梅	10 周琴																																																																								
<table border="1"><tr><td></td><td></td><td></td></tr><tr><td></td><td></td><td></td></tr><tr><td></td><td></td><td></td></tr></table>										<table border="1"><tr><td></td><td></td><td></td></tr><tr><td></td><td></td><td></td></tr><tr><td></td><td></td><td></td></tr></table>										<table border="1"><tr><td></td><td></td><td></td></tr><tr><td></td><td></td><td></td></tr><tr><td></td><td></td><td></td></tr></table>										<table border="1"><tr><td>1</td><td></td><td></td></tr><tr><td>1</td><td></td><td></td></tr><tr><td></td><td></td><td></td></tr></table>	1			1						<table border="1"><tr><td>1</td><td></td><td>1</td></tr><tr><td></td><td></td><td></td></tr><tr><td></td><td></td><td></td></tr></table>	1		1							<table border="1"><tr><td></td><td></td><td></td></tr><tr><td></td><td></td><td></td></tr><tr><td></td><td></td><td></td></tr></table>										<table border="1"><tr><td></td><td></td><td></td></tr><tr><td></td><td></td><td></td></tr><tr><td></td><td></td><td></td></tr></table>										<table border="1"><tr><td>1</td><td></td><td></td></tr><tr><td></td><td></td><td></td></tr><tr><td>1</td><td></td><td></td></tr></table>	1						1		
1																																																																															
1																																																																															
1		1																																																																													
1																																																																															
1																																																																															
Post - 0 Miss - 0 Block - 0	Post - 0 Miss - 1 Block - 1	Post - 0 Miss - 0 Block - 0	Post - 0 Miss - 0 Block - 0	Post - 0 Miss - 0 Block - 1	Post - 0 Miss - 0 Block - 0	Post - 0 Miss - 0 Block - 0	Post - 0 Miss - 0 Block - 1																																																																								
11 曾蓝花	12 江燕红	14 黄艳芳	15 陈依依	16 商志运	17 杨杨	18 庞娇																																																																									
<table border="1"><tr><td></td><td></td><td>1</td></tr><tr><td></td><td></td><td></td></tr><tr><td></td><td></td><td></td></tr></table>			1							<table border="1"><tr><td></td><td></td><td></td></tr><tr><td></td><td></td><td></td></tr><tr><td></td><td></td><td></td></tr></table>										<table border="1"><tr><td></td><td></td><td></td></tr><tr><td>1</td><td></td><td></td></tr><tr><td></td><td></td><td></td></tr></table>				1						<table border="1"><tr><td></td><td></td><td></td></tr><tr><td></td><td></td><td></td></tr><tr><td></td><td></td><td></td></tr></table>										<table border="1"><tr><td></td><td></td><td></td></tr><tr><td></td><td></td><td></td></tr><tr><td></td><td></td><td></td></tr></table>										<table border="1"><tr><td></td><td></td><td></td></tr><tr><td></td><td></td><td></td></tr><tr><td></td><td></td><td></td></tr></table>										<table border="1"><tr><td></td><td></td><td>1</td></tr><tr><td></td><td></td><td></td></tr><tr><td></td><td></td><td></td></tr></table>			1							<table border="1"><tr><td></td><td></td><td></td></tr><tr><td></td><td></td><td></td></tr><tr><td></td><td></td><td></td></tr></table>									
		1																																																																													
1																																																																															
		1																																																																													
Post - 0 Miss - 1 Block - 0	Post - 0 Miss - 0 Block - 0	Post - 0 Miss - 1 Block - 0	Post - 0 Miss - 0 Block - 0	Post - 0 Miss - 0 Block - 0	Post - 0 Miss - 0 Block - 1	Post - 0 Miss - 0 Block - 1																																																																									

注释: Post=击柱 Miss=射失 Block=被封



预赛 Group A

女子 全国比赛

2016年全国女子手球锦标赛

Team A <b>A 广东</b>				Team B <b>B 新疆</b>				Match Number <b>30</b>													
played in China		in the hall 滁州体育馆		on 08/09/2016		at 17:30 hours		Spectators													
Half-time (30')	<b>A</b> 9	<b>B</b> 14	End of playing time	<b>A</b> 24	<b>B</b> 24	1st extra time	<b>A</b>	<b>B</b>	2nd extra time	<b>A</b>	<b>B</b>	After penalty throws	<b>A</b> 29	<b>B</b> 30							
Number of 7 m	<b>A</b> 10 / 14	Team time-out			Full name of players and officials				Team time-out			<b>B</b> 9 / 12	Number of 7 m								
	1 08:03	2 58:01	3						1 17:11	2 53:12	3 59:26										
No.	Team <b>A</b>					G	W	2'	D	DR	No.	Team <b>B</b>					G	W	2'	D	DR
3	安妮					2					3	葛立双									
5	李纯										6	阿孜古					7	1	2		
7	刘彤					1					7	吴志娟					1				
8	李诗棋										10	李静									
9	韦宝桂					4					11	陈培培									
11	魏梦庭					2					12	艾敏加尔汉									
15	杨慧										15	兰姝娇					1				
16	李娟										17	戴莹莹						1			
18	李玉玲					7					18	崔娟					6				
19	邝雪花					4	1				21	锁珊珊					4				
20	李军政					3	1				23	张艺璇									
22	刘晓玉										26	宋婷婷					3				
23	王如					3					27	谢辰辰									
26	马晓卉										32	杨雨柔									
28	刘金兰					3	1				93	张婷婷					8				
31	史小军							1													
A	李细利										B	于涛 (主教练)									
B	郭艳辉 (主教练)										D	高璇									
D	祝捷																				
E	赵善良																				
<b>A</b>	Signature of Responsible Official of the Teams (Off. A)										<b>B</b>										
TP	Remarks of Referee / CHA Official										TP										

Signatures

Referees	张栋 (CHN)	马晓晔 (CHN)		
Techn. Delegates	刘书勇 (CHN)			
CHA Official	许宜扬 (CHN)			

Note: Number of 7m Throws Awarded to Team A and B, Goals (G), Warnings (W), Suspensions (2'), Direct Disqualification (D), Disqualification with Report (DR) and Team Penalty (TP).

Table Officials: 陈文丽

伍豪

Statisticians: 黄岩

刘永欢

Printed by PHMS Copyright: IHF / CHA 08/09/2016 18:48:56

Longman Sportsoft



handball@126.com



2016年全国女子手球锦标赛  
竞赛技术统计(媒体表)

预赛 组别 A 轮次 6 场次 30

滁州体育馆 08/09/2016 201605030-51-1/1  
广东 广东 29 vs 30 新疆 新疆  
9 : 14

裁判员 张栋 (CHN) / 马晓晔 (CHN)

Main statistics table for Guangdong and Xinjiang teams, including player names, positions, and various performance metrics like shots, goals, and assists.

场上队员: 得分 / 射门

守门员: 救球 / 射门

Summary table for key statistics: 快攻 (Fast Break), 突破 (Breakthrough), 任意球 (Free Throw), 7M球 (7M Throw), 助攻 (Assist), 警告 (Warning), 失误 (Error).





### 2016年全国女子手球锦标赛 图式比赛技术统计表

轮次 6

场次 30

201605030-21-1/1

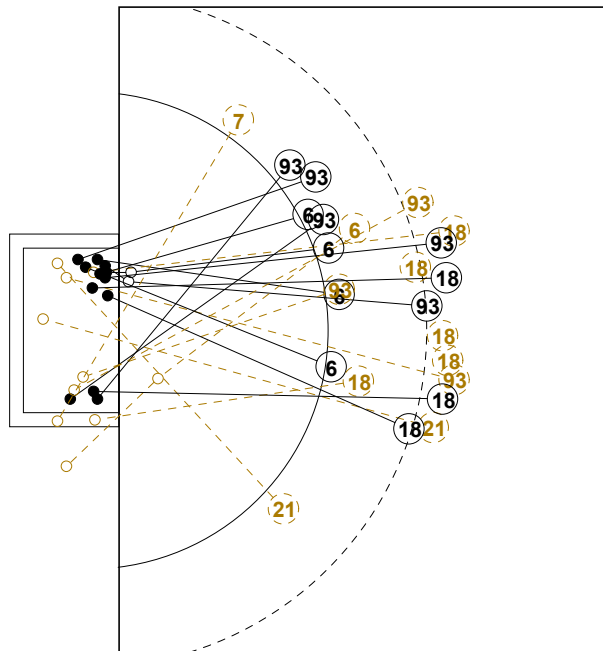

7M 新疆

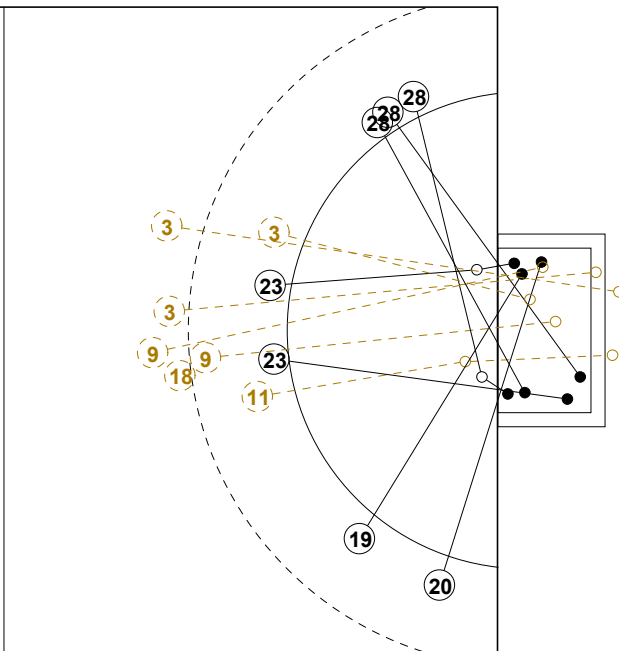
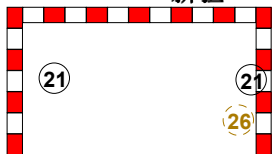

广东 7M

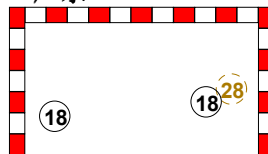

1st Half  
14 : 9

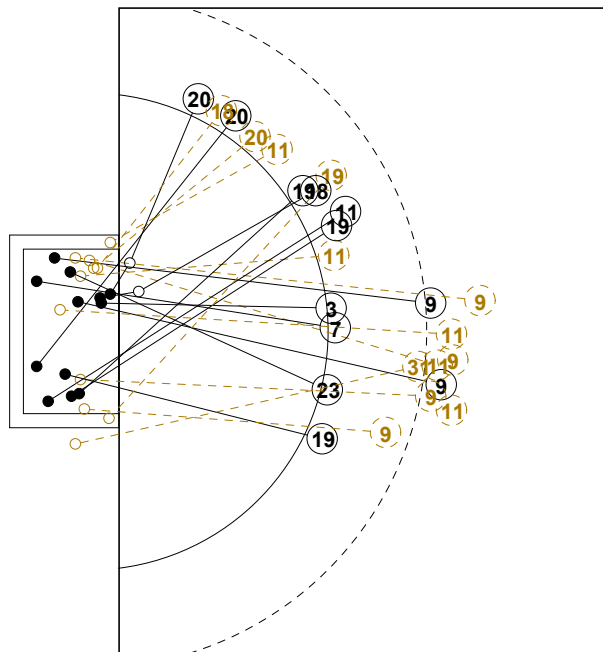

7M 广东

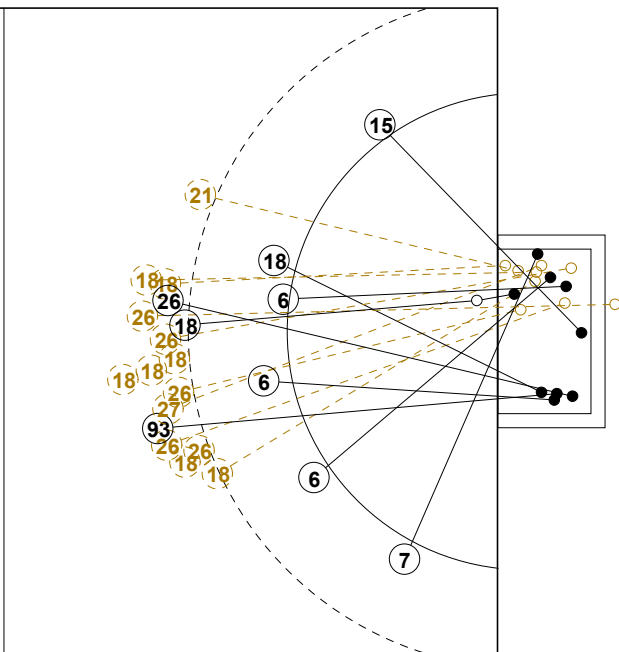
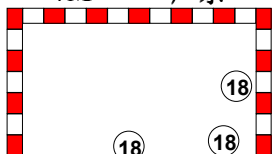

新疆 7M

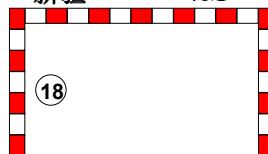

2nd Half  
24 : 24



### 2016年全国女子手球锦标赛 图式比赛技术统计表

轮次 6

场次 30

201605030-21-1/1

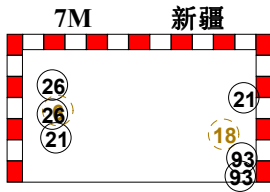
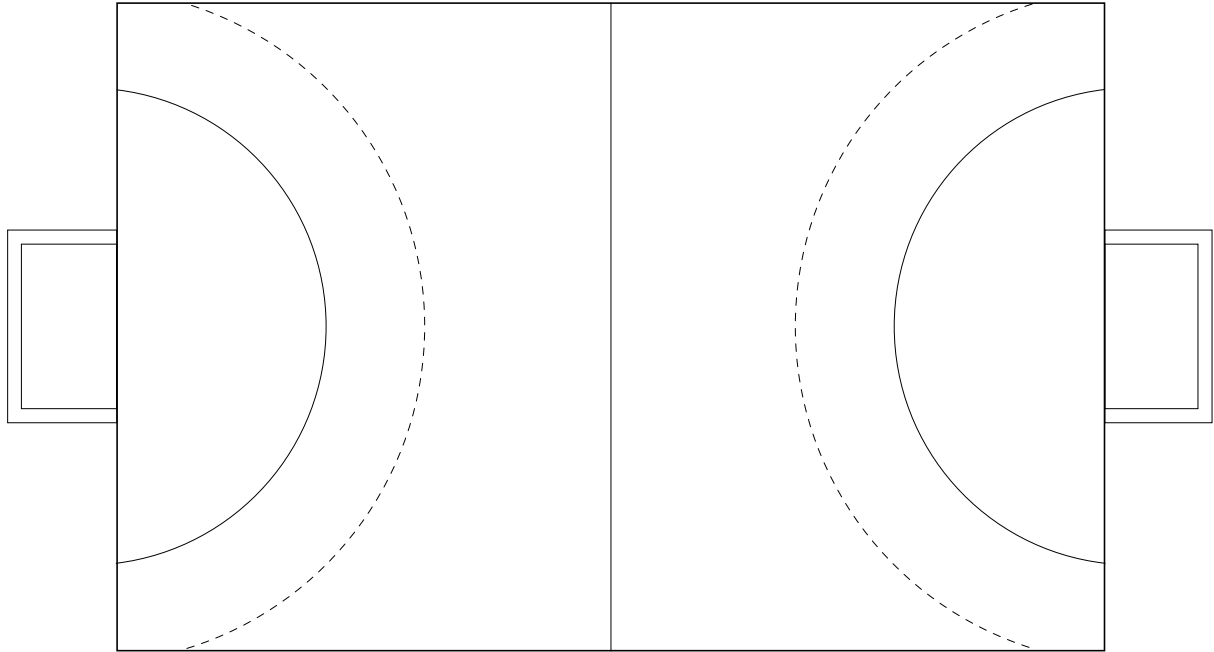

7M-Throw  
30 : 29

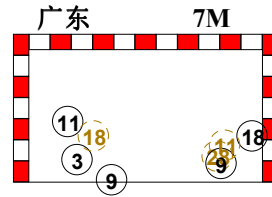





## 2016年全国女子手球锦标赛

## 个人/全队技术统计表

正式表  
手球  
女子预赛  
轮次 6组别 A  
场次 30201605030-14-1/2  
滁州体育馆  
08/09/2016 17:30

号码	姓名	远射	近射	边射	快攻	突破	任意	7M	合计	%	助攻	失误	警告	2'	取消	时间
<b>广东(广东)</b>																
<i>(场上队员)</i>																
3	安妮	0/2	1/1			0/1		1/1	2/5	40.0%	1					00:14:00
5	李纯									0.0%						00:00:00
7	刘彤				1/1				1/1	100%						00:10:03
8	李诗棋									0.0%						00:00:00
9	韦宝桂	2/8						2/2	4/10	40.0%	2	3				00:28:44
11	魏梦庭	0/3	1/4					1/2	2/9	22.2%		1				00:44:39
15	杨慧									0.0%						00:00:00
16	李娟									0.0%						00:00:26
18	李玉玲	0/1		0/1		1/1		6/7	7/10	70.0%		1				00:20:06
19	邝雪花		2/3	1/1		1/1			4/5	80.0%	1	4	1			00:46:54
20	李军政			3/4					3/4	75.0%		1	1			00:51:57
22	刘晓玉									0.0%						00:52:54
23	王如		2/2		1/1				3/3	100%						01:00:00
26	马晓卉									0.0%		1				00:36:40
28	刘金兰			3/3				0/2	3/5	60.0%			1			00:49:56
31	史小军	0/1							0/1	0.0%		2		1		00:32:28
<b>合计</b>		2/15	6/10	7/9	2/2	2/3		10/14	29/53	54.7%	4	13	3	1		
<i>(守门员)</i>																
16	李娟							0/1	0/1	0.0%						00:00:26
22	刘晓玉	7/11	0/3					1/3	8/17	47.1%						00:52:54
26	马晓卉	4/8	1/7	0/2	1/1	0/2	1/1	2/8	9/29	31.0%		1				00:36:40
<b>合计</b>		11/19	1/10	0/2	1/1	0/2	1/1	3/12	17/47	36.2%		1				

场上队员：得分/射门

守门员：救球/射门

全队合计	得分	被救	射失	击柱	封球	合计	%
远射	2	7	2	1	3	15	13.3%
近射	6	1	1	2		10	60.0%
边射	7	2				9	77.8%
快攻	2					2	100.0%
突破	2	1				3	66.7%
任意							0.0%
7M	10	4				14	71.4%





## 2016年全国女子手球锦标赛

## 个人/全队技术统计表

正式表  
手球  
女子预赛  
轮次 6组别 A  
场次 30201605030-14-2/2  
滁州体育馆  
08/09/2016 17:30

号码	姓名	远射	近射	边射	快攻	突破	任意	7M	合计	%	助攻	失误	警告	2'	取消	时间
<b>新疆(新疆)</b>																
<i>(上场队员)</i>																
3	葛立双									0.0%						00:00:00
6	阿孜古		7/8					0/1	7/9	77.8%		1	1	2		00:58:19
7	吴志娟			1/2					1/2	50.0%						00:55:08
10	李静									0.0%						00:00:13
11	陈培培									0.0%						00:00:00
12	艾敏加尔汉									0.0%						00:00:00
15	兰姝娇			1/1					1/1	100%						00:26:17
17	戴莹莹									0.0%			1			00:28:56
18	崔娟	4/15	1/1		0/1			1/2	6/19	31.6%	1	3				00:59:58
21	锁珊珊	0/1	0/1				0/1	4/4	4/7	57.1%	1	2				00:39:05
23	张艺璇									0.0%						00:00:00
26	宋婷婷	1/6						2/3	3/9	33.3%	2	1				00:13:06
27	谢辰辰	0/1							0/1	0.0%	1	1				00:17:45
32	杨雨柔									0.0%						01:29:47
93	张婷婷	3/5	1/1		0/1	2/2		2/2	8/11	72.7%	1	3				01:00:00
<b>合计</b>		8/28	9/11	2/3	0/2	2/2	0/1	9/12	30/59	50.8%	6	11	2	2		
<i>(守门员)</i>																
10	李静							2/4	2/4	50.0%						00:00:13
32	杨雨柔	7/9	1/7	2/9	0/2	1/3		2/10	13/40	32.5%						01:29:47
<b>合计</b>		7/9	1/7	2/9	0/2	1/3		4/14	15/44	34.1%						

场上队员：得分/射门

守门员：救球/射门

全队合计	得分	被救	射失	击柱	封球	合计	%
远射	8	11	1		8	28	28.6%
近射	9	1	1			11	81.8%
边射	2			1		3	66.7%
快攻		1		1		2	0.0%
突破	2					2	100.0%
任意		1				1	0.0%
7M	9	3				12	75.0%





### 2016年全国女子手球锦标赛

#### 图式射门区域统计

轮次 6 场次 30

201605030-41-1/1

## 广东

3 安妮	5 李纯	7 刘彤	8 李诗棋	9 韦宝柱	11 魏梦庭	15 杨慧	16 李娟																																																																								
<table border="1"><tr><td></td><td></td><td></td></tr><tr><td></td><td></td><td></td></tr><tr><td>1</td><td>1</td><td></td></tr></table>							1	1		<table border="1"><tr><td></td><td></td><td></td></tr><tr><td></td><td></td><td></td></tr><tr><td></td><td></td><td></td></tr></table>										<table border="1"><tr><td></td><td></td><td>1</td></tr><tr><td></td><td></td><td></td></tr><tr><td></td><td></td><td></td></tr></table>			1							<table border="1"><tr><td></td><td></td><td></td></tr><tr><td></td><td></td><td></td></tr><tr><td></td><td></td><td></td></tr></table>										<table border="1"><tr><td></td><td></td><td>1</td></tr><tr><td></td><td></td><td></td></tr><tr><td>1</td><td></td><td>1</td></tr></table>			1				1		1	<table border="1"><tr><td>1</td><td></td><td></td></tr><tr><td>1</td><td></td><td></td></tr><tr><td></td><td></td><td></td></tr></table>	1			1						<table border="1"><tr><td></td><td></td><td></td></tr><tr><td></td><td></td><td></td></tr><tr><td></td><td></td><td></td></tr></table>										<table border="1"><tr><td></td><td></td><td></td></tr><tr><td></td><td></td><td></td></tr><tr><td></td><td></td><td></td></tr></table>									
1	1																																																																														
		1																																																																													
		1																																																																													
1		1																																																																													
1																																																																															
1																																																																															
Post - 1 Miss - 1 Block - 0	Post - 0 Miss - 0 Block - 0	Post - 0 Miss - 0 Block - 0	Post - 0 Miss - 0 Block - 0	Post - 0 Miss - 0 Block - 1	Post - 1 Miss - 1 Block - 1	Post - 0 Miss - 0 Block - 0	Post - 0 Miss - 0 Block - 0																																																																								
18 李玉玲	19 邝雪花	20 李军政	22 刘晓玉	23 王如	26 马晓卉	28 刘金兰	31 史小军																																																																								
<table border="1"><tr><td></td><td></td><td></td></tr><tr><td>1</td><td></td><td>3</td></tr><tr><td></td><td>1</td><td>2</td></tr></table>				1		3		1	2	<table border="1"><tr><td></td><td></td><td></td></tr><tr><td>3</td><td></td><td></td></tr><tr><td>1</td><td></td><td></td></tr></table>				3			1			<table border="1"><tr><td>1</td><td></td><td></td></tr><tr><td>1</td><td></td><td></td></tr><tr><td></td><td></td><td>1</td></tr></table>	1			1					1	<table border="1"><tr><td></td><td></td><td></td></tr><tr><td></td><td></td><td></td></tr><tr><td></td><td></td><td></td></tr></table>										<table border="1"><tr><td></td><td></td><td>1</td></tr><tr><td></td><td></td><td></td></tr><tr><td>1</td><td></td><td></td></tr></table>			1				1			<table border="1"><tr><td></td><td></td><td></td></tr><tr><td></td><td></td><td></td></tr><tr><td></td><td></td><td></td></tr></table>										<table border="1"><tr><td></td><td></td><td>1</td></tr><tr><td></td><td></td><td></td></tr><tr><td></td><td></td><td>2</td></tr></table>			1						2	<table border="1"><tr><td></td><td></td><td></td></tr><tr><td></td><td></td><td></td></tr><tr><td></td><td></td><td></td></tr></table>									
1		3																																																																													
	1	2																																																																													
3																																																																															
1																																																																															
1																																																																															
1																																																																															
		1																																																																													
		1																																																																													
1																																																																															
		1																																																																													
		2																																																																													
Post - 0 Miss - 0 Block - 1	Post - 1 Miss - 0 Block - 0	Post - 0 Miss - 0 Block - 0	Post - 0 Miss - 0 Block - 0	Post - 0 Miss - 0 Block - 0	Post - 0 Miss - 0 Block - 0	Post - 0 Miss - 0 Block - 0	Post - 0 Miss - 1 Block - 0																																																																								

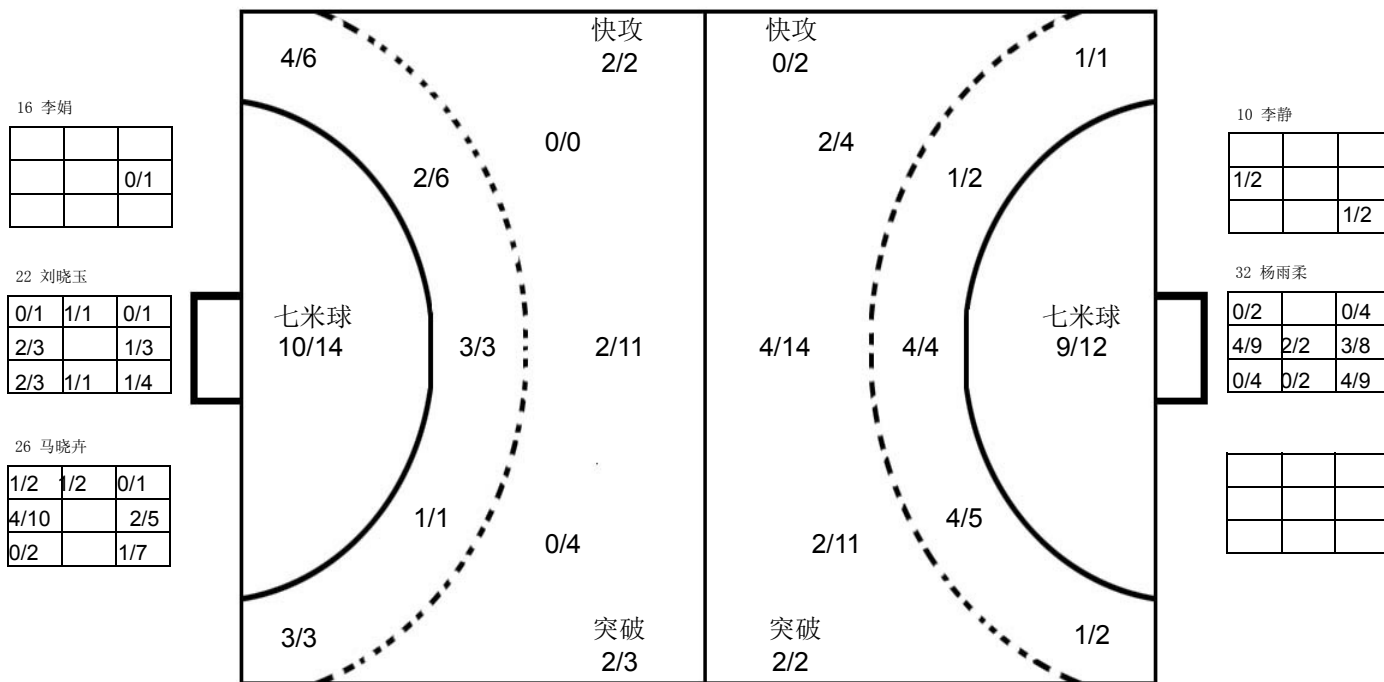

## 新疆

3 葛立双	6 阿孜古	7 吴志娟	10 李静	11 陈培培	12 艾敏加尔汉	15 兰姝娇	17 戴莹莹																																																																								
<table border="1"><tr><td></td><td></td><td></td></tr><tr><td></td><td></td><td></td></tr><tr><td></td><td></td><td></td></tr></table>										<table border="1"><tr><td>1</td><td></td><td></td></tr><tr><td>1</td><td></td><td>2</td></tr><tr><td></td><td></td><td>3</td></tr></table>	1			1		2			3	<table border="1"><tr><td></td><td></td><td></td></tr><tr><td>1</td><td></td><td></td></tr><tr><td></td><td></td><td></td></tr></table>				1						<table border="1"><tr><td></td><td></td><td></td></tr><tr><td></td><td></td><td></td></tr><tr><td></td><td></td><td></td></tr></table>										<table border="1"><tr><td></td><td></td><td></td></tr><tr><td></td><td></td><td></td></tr><tr><td></td><td></td><td></td></tr></table>										<table border="1"><tr><td></td><td></td><td></td></tr><tr><td></td><td></td><td></td></tr><tr><td></td><td></td><td></td></tr></table>										<table border="1"><tr><td></td><td></td><td>1</td></tr><tr><td></td><td></td><td></td></tr><tr><td></td><td></td><td></td></tr></table>			1							<table border="1"><tr><td></td><td></td><td></td></tr><tr><td></td><td></td><td></td></tr><tr><td></td><td></td><td></td></tr></table>									
1																																																																															
1		2																																																																													
		3																																																																													
1																																																																															
		1																																																																													
Post - 0 Miss - 0 Block - 0	Post - 0 Miss - 1 Block - 0	Post - 1 Miss - 0 Block - 0	Post - 0 Miss - 0 Block - 0	Post - 0 Miss - 0 Block - 0	Post - 0 Miss - 0 Block - 0	Post - 0 Miss - 0 Block - 0	Post - 0 Miss - 0 Block - 0																																																																								
18 崔娟	21 锁珊珊	23 张艺璇	26 宋婷婷	27 谢辰辰	32 杨雨柔	93 张婷婷																																																																									
<table border="1"><tr><td></td><td></td><td></td></tr><tr><td>1</td><td></td><td>1</td></tr><tr><td>2</td><td></td><td>2</td></tr></table>				1		1	2		2	<table border="1"><tr><td></td><td></td><td>1</td></tr><tr><td>2</td><td></td><td>1</td></tr><tr><td></td><td></td><td></td></tr></table>			1	2		1				<table border="1"><tr><td></td><td></td><td></td></tr><tr><td></td><td></td><td></td></tr><tr><td></td><td></td><td></td></tr></table>										<table border="1"><tr><td>1</td><td></td><td>1</td></tr><tr><td>1</td><td></td><td></td></tr><tr><td></td><td></td><td></td></tr></table>	1		1	1						<table border="1"><tr><td></td><td></td><td></td></tr><tr><td></td><td></td><td></td></tr><tr><td></td><td></td><td></td></tr></table>										<table border="1"><tr><td></td><td></td><td></td></tr><tr><td></td><td></td><td></td></tr><tr><td></td><td></td><td></td></tr></table>										<table border="1"><tr><td></td><td></td><td></td></tr><tr><td>1</td><td></td><td>2</td></tr><tr><td>1</td><td></td><td>4</td></tr></table>				1		2	1		4	<table border="1"><tr><td></td><td></td><td></td></tr><tr><td></td><td></td><td></td></tr><tr><td></td><td></td><td></td></tr></table>									
1		1																																																																													
2		2																																																																													
		1																																																																													
2		1																																																																													
1		1																																																																													
1																																																																															
1		2																																																																													
1		4																																																																													
Post - 1 Miss - 0 Block - 7	Post - 0 Miss - 0 Block - 0	Post - 0 Miss - 0 Block - 0	Post - 0 Miss - 1 Block - 1	Post - 0 Miss - 0 Block - 0	Post - 0 Miss - 0 Block - 0	Post - 0 Miss - 0 Block - 0																																																																									

注释: Post=击柱 Miss=射失 Block=被封





预赛 Group B

女子 全国比赛

2016年全国女子手球锦标赛

Team A A 四川				Team B B 天津				Match Number <b>31</b>								
played in China		in the hall 滁州体育馆		on 09/09/2016		at 13:00 hours		Spectators								
Half-time (30')	A 12	B 19	End of playing time	A 28	B 31	1st extra time	A	B	2nd extra time	A	B	After penalty throws	A	B		
Number of 7 m	A 3/5	Team time-out			Full name of players and officials				Team time-out			B 1/1	Number of 7 m			
		1	2	3					1	2	3					
		29:52							29:15	41:18	55:52					
No.	Team A					G	W	2'	D	DR	No.	Team B				
1	张雪纯										3	王晓梅				
2	陈艳楠										4	朱佳瑜				
3	王丹					9					5	丁丽洁				
4	尤婉莹					4		1			7	张心茹				
5	孙姣					4	1				8	张慧				
6	凤洋					7					10	张文慧				
7	练素琪										11	蔡雪洁				
9	姚梦园					1					12	王欣冉				
10	高静										14	刘洁				
11	朱海云										15	李窈窈				
12	宋琛茜										16	王选				
17	史雨欣										17	聂晓雪				
18	戴小宇					3	1	2			18	舒文琪				
27	吴美琪										21	李默雅				
											22	王聪				
											23	周梦雪				
A	金鸿										A	付明双				
B	郎正平										B	王明星 (主教练)				
C	陈志伟										C	岳连娥				
A	Signature of Responsible Official of the Teams (Off. A)														B	
TP	Remarks of Referee / CHA Official														TP	

Signatures

Referees	陈晓波 (CHN)	林晓佟 (CHN)		
Techn. Delegates	吴国忠 (CHN)			
CHA Official	刘书勇 (CHN)			

Note: Number of 7m Throws Awarded to Team A and B, Goals (G), Warnings (W), Suspensions (2'), Direct Disqualification (D), Disqualification with Report (DR) and Team Penalty (TP).

Table Officials: 佟金政

贾俊秋

Statisticians: 闫冲

陈柱

Printed by PHMS Copyright: IHF / CHA 09/09/2016 14:25:10

Longman Sportsoft



handball@126.com



## 2016年全国女子手球锦标赛 竞赛技术统计(媒体表)

预赛	组别	B	轮次	7	场次	31
滁州体育馆		09/09/2016			201605031-51-1/1	
四川	四川	28	vs	31	天津	天津
<b>12 : 19</b>						

裁判员	陈晓波 (CHN)	/	林晓佟 (CHN)
-----	-----------	---	-----------

四川		远	近	边	快	突	任意	7m	合计	%	助攻	失误	警告	2'	D & DR	比赛进程	
主教练：郎正平		射	射	射	攻	破	球	球								四川	天津
1	张雪纯																1st Half
2	陈艳楠	0/1	0/1						0/2	0.0							6 凤洋 1 00:27 0
3	王丹	2/5	2/3	2/5		1/1	0/1	2/4	9/19	47.4	6	4					3 王丹 2 01:31 0
4	尤婉莹		3/5	0/1	1/1				4/7	57.1		2					4 尤婉莹 2 04:34 2 8 张慧
5	孙蛟		3/6		1/1				4/7	57.1		1	1	1			4 尤婉莹 3 05:03 2
6	凤洋	0/2	1/2	1/5	5/5				7/14	50.0		2					18 戴小宇 3 08:29 3 23 周梦雪
7	练素琪																4 尤婉莹 4 09:39 4
9	姚梦园			0/1	1/1				1/2	50.0		1					4 尤婉莹 5 12:00 6 10 张文慧
10	高静																5 孙蛟 5 12:32 6
11	朱海云	0/1							0/1	0.0							5 孙蛟 5 12:54 7 23 周梦雪
12	宋琛茜																5 孙蛟 5 13:27 8 11 蔡雪洁
17	史雨欣																5 孙蛟 5 14:04 9 17 蔡晓雪
18	戴小宇	1/3	0/1	1/1													5 孙蛟 5 14:47 10 4 朱佳瑜
27	吴美琪																5 孙蛟 5 15:41 11 18 舒文琪
<b>运动员 合计</b>		<b>3/12</b>	<b>9/18</b>	<b>4/13</b>	<b>8/8</b>	<b>1/1</b>	<b>0/1</b>	<b>3/5</b>	<b>28/58</b>	<b>48.3</b>	<b>9</b>	<b>16</b>	<b>2</b>	<b>3</b>			6 凤洋 6 16:35 11
12	宋琛茜	4/7	2/12	3/10	0/3	0/6	0/1	0/1	9/40	22.5	3						6 凤洋 6 17:10 12 11 蔡雪洁
<b>守门员 合计</b>		<b>4/7</b>	<b>2/12</b>	<b>3/10</b>	<b>0/3</b>	<b>0/6</b>	<b>0/1</b>	<b>0/1</b>	<b>9/40</b>	<b>22.5</b>	<b>3</b>						6 凤洋 6 17:43 13 8 张慧
天津		远	近	边	快	突	任意	7m	合计	%	助攻	失误	警告	2'	D & DR		
教练：王明星		射	射	射	攻	破	球	球									
3	王晓梅																12 01:06 20 10 张文慧
4	朱佳瑜							1/1	1/1	100							12 02:31 21 18 舒文琪
5	丁丽洁																3 王丹 13 03:41 21
7	张心茹																5 孙蛟 14 04:30 21
8	张慧		1/1	2/3	1/1				4/5	80.0		2		1			4 尤婉莹 14 05:23 22 18 舒文琪
10	张文慧		3/3	0/1					3/4	75.0		1					4 尤婉莹 14 06:29 23 21 李默雅
11	蔡雪洁	0/4	1/2	3/4		2/2			6/12	50.0	2	3		1			4 尤婉莹 15 07:04 23
12	王欣冉																9 姚梦园 16 07:52 23
14	刘洁																5 孙蛟 17 08:35 23
15	李窈窕																9 姚梦园 17 09:49 24 11 蔡雪洁
16	王选																6 凤洋 17 12:36 25 17 蔡晓雪
17	聂晓雪		1/1			1/1			2/2	100		1					4 尤婉莹 18 13:45 25
18	舒文琪	1/2	1/2	2/2	1/1	2/2	1/1		8/10	80.0	1	5	1	1			6 凤洋 19 15:35 25
21	李默雅			0/1	1/1				1/2	50.0		1	1				18 戴小宇 19 17:03 26 23 周梦雪
22	王聪																6 凤洋 20 17:36 26
23	周梦雪	2/6	3/7			1/1			6/14	42.9		5	1				6 凤洋 21 18:33 26
<b>运动员 合计</b>		<b>3/12</b>	<b>10/16</b>	<b>7/11</b>	<b>3/3</b>	<b>6/6</b>	<b>1/1</b>	<b>1/1</b>	<b>31/50</b>	<b>62.0</b>	<b>3</b>	<b>18</b>	<b>3</b>	<b>3</b>			4 尤婉莹 22 21:14 27 18 舒文琪
12	王欣冉	4/7	4/10	2/5	0/3	0/1		2/4	12/30	40.0							4 尤婉莹 22 21:42 28 18 舒文琪
16	王选	2/2	5/8	4/5	0/5		1/1		12/22	54.5							3 王丹 23 22:47 28
<b>守门员 合计</b>		<b>6/9</b>	<b>9/18</b>	<b>6/10</b>	<b>0/8</b>	<b>0/1</b>	<b>1/1</b>	<b>2/5</b>	<b>24/52</b>	<b>46.2</b>							3 王丹 23 23:49 29 18 舒文琪

场上队员：得分 / 射门

守门员：救球 / 射门

快攻	Fast Break	突破	Breakthrough	任意球	Free Throw	7M球	7M Throw	助攻	Assist
警告	Warning	失误	Error	2'	Suspension	D	取消资格	DR	取消资格+报告





### 2016年全国女子手球锦标赛 图式比赛技术统计表

轮次 7

场次 31

201605031-21-1/1

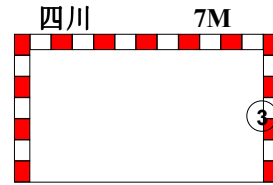
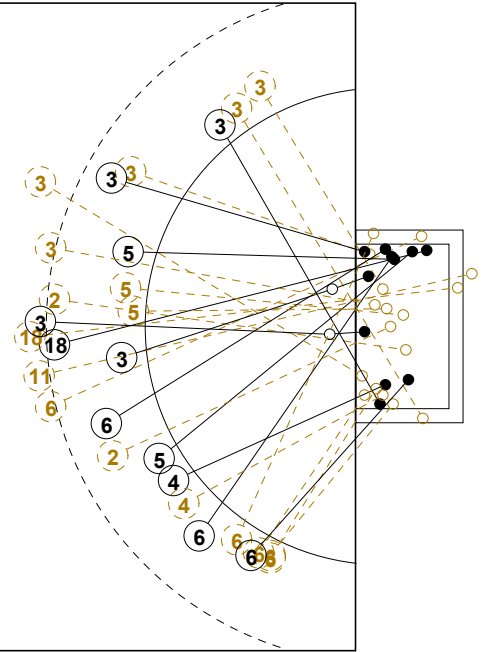
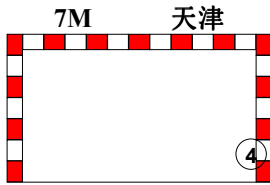
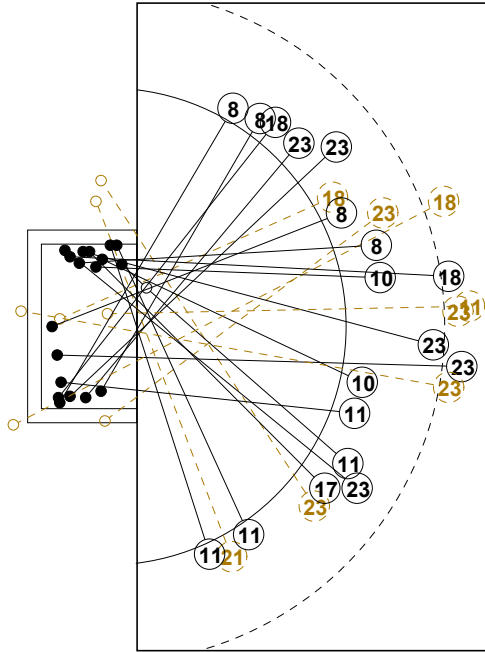

1st Half  
19 : 12

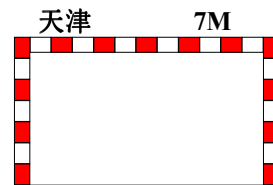
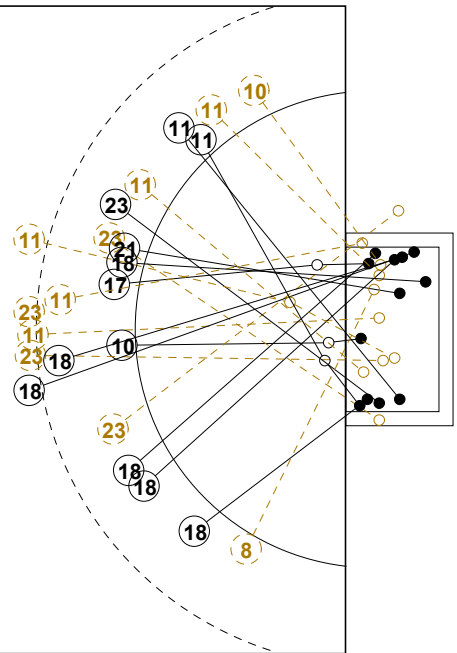
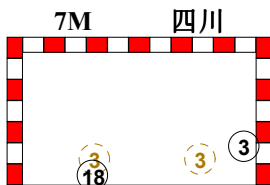
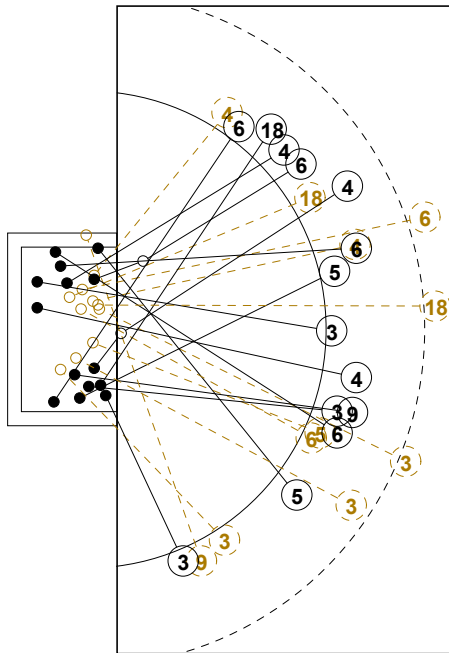

2nd Half  
28 : 31



## 2016年全国女子手球锦标赛

## 个人/全队技术统计表

正式表  
手球  
女子预赛  
轮次 7组别 B  
场次 31201605031-14-1/2  
滁州体育馆  
09/09/2016 13:00

号码	姓名	远射	近射	边射	快攻	突破	任意	7M	合计	%	助攻	失误	警告	2'	取消	时间
<b>四川(四川)</b>																
<i>(场上队员)</i>																
1	张雪纯									0.0%						00:00:00
2	陈艳楠	0/1	0/1						0/2	0.0%						00:07:50
3	王丹	2/5	2/3	2/5		1/1	0/1	2/4	9/19	47.4%	6	4				01:00:00
4	尤婉莹		3/5	0/1	1/1				4/7	57.1%		2		1		00:53:47
5	孙姣		3/6		1/1				4/7	57.1%		1	1			01:00:00
6	凤洋	0/2	1/2	1/5	5/5				7/14	50.0%		2				01:00:00
7	练素琪									0.0%						00:00:00
9	姚梦园			0/1	1/1				1/2	50.0%		1				00:51:45
10	高静									0.0%						00:00:00
11	朱海云	0/1							0/1	0.0%		2				00:21:48
12	宋琛茜									0.0%	3					01:00:00
17	史雨欣									0.0%						00:00:00
18	戴小宇	1/3	0/1	1/1				1/1	3/6	50.0%		4	1	2		00:45:57
27	吴美琪									0.0%						00:00:00
<b>合计</b>																
<i>(守门员)</i>																
12	宋琛茜	4/7	2/12	3/10	0/3	0/6	0/1	0/1	9/40	22.5%	3					01:00:00
<b>合计</b>																

场上队员：得分/射门

守门员：救球/射门

全队合计	得分	被救	射失	击柱	封球	合计	%
远射	3	6	1	2		12	25.0%
近射	9	9				18	50.0%
边射	4	6		3		13	30.8%
快攻	8					8	100.0%
突破	1					1	100.0%
任意		1				1	0.0%
7M	3	2				5	60.0%





## 2016年全国女子手球锦标赛

## 个人/全队技术统计表

正式表  
手球  
女子预赛  
轮次 7组别 B  
场次 31201605031-14-2/2  
滁州体育馆  
09/09/2016 13:00

号码	姓名	远射	近射	边射	快攻	突破	任意	7M	合计	%	助攻	失误	警告	2'	取消	时间
<b>天津(天津)</b>																
<i>(上场队员)</i>																
3	王晓梅									0.0%						00:00:00
4	朱佳瑜							1/1	1/1	100%						00:07:23
5	丁丽洁									0.0%						00:11:44
7	张心茹									0.0%						00:00:00
8	张慧		1/1	2/3	1/1				4/5	80.0%		2		1		01:00:00
10	张文慧		3/3	0/1					3/4	75.0%		1				00:57:40
11	蔡雪洁	0/4	1/2	3/4		2/2			6/12	50.0%	2	3		1		00:54:12
12	王欣冉									0.0%						00:34:37
14	刘洁									0.0%						00:00:00
15	李窈窕									0.0%						00:00:00
16	王选									0.0%						00:25:23
17	聂晓雪		1/1			1/1			2/2	100%		1				00:31:49
18	舒文琪	1/2	1/2	2/2	1/1	2/2	1/1		8/10	80.0%	1	5	1	1		01:00:00
21	李默雅			0/1	1/1				1/2	50.0%		1	1			00:28:11
22	王聪									0.0%						00:00:00
23	周梦雪	2/6	3/7			1/1			6/14	42.9%		5	1			00:48:58
<b>合计</b>		3/12	10/16	7/11	3/3	6/6	1/1	1/1	31/50	62.0%	3	18	3	3		
<i>(守门员)</i>																
12	王欣冉	4/7	4/10	2/5	0/3	0/1		2/4	12/30	40.0%						00:34:37
16	王选	2/2	5/8	4/5	0/5		1/1	0/1	12/22	54.5%						00:25:23
<b>合计</b>		6/9	9/18	6/10	0/8	0/1	1/1	2/5	24/52	46.2%						

场上队员：得分/射门

守门员：救球/射门

全队合计	得分	被救	射失	击柱	封球	合计	%
远射	3	4	2	1	2	12	25.0%
近射	10	2	2	2		16	62.5%
边射	7	3	1			11	63.6%
快攻	3					3	100.0%
突破	6					6	100.0%
任意	1					1	100.0%
7M	1					1	100.0%







### 2016年全国女子手球锦标赛

#### 图式射门区域统计

轮次 7 场次 31

201605031-41-1/1

## 四川

1 张雪纯	2 陈艳楠	3 王丹	4 尤婉莹	5 孙姣	6 凤洋	7 练素琪	9 姚梦园																																																																								
<table border="1"><tr><td></td><td></td><td></td></tr><tr><td></td><td></td><td></td></tr><tr><td></td><td></td><td></td></tr></table>										<table border="1"><tr><td></td><td></td><td></td></tr><tr><td></td><td></td><td></td></tr><tr><td></td><td></td><td></td></tr></table>										<table border="1"><tr><td></td><td></td><td>1</td></tr><tr><td></td><td></td><td>2</td></tr><tr><td>4</td><td>1</td><td>1</td></tr></table>			1			2	4	1	1	<table border="1"><tr><td></td><td>1</td><td></td></tr><tr><td></td><td></td><td>1</td></tr><tr><td>1</td><td></td><td>1</td></tr></table>		1				1	1		1	<table border="1"><tr><td></td><td></td><td></td></tr><tr><td></td><td></td><td></td></tr><tr><td>3</td><td></td><td></td></tr></table>							3			<table border="1"><tr><td></td><td>1</td><td></td></tr><tr><td></td><td></td><td>3</td></tr><tr><td>1</td><td></td><td>1</td></tr></table>		1				3	1		1	<table border="1"><tr><td></td><td></td><td></td></tr><tr><td></td><td></td><td></td></tr><tr><td></td><td></td><td></td></tr></table>										<table border="1"><tr><td></td><td></td><td></td></tr><tr><td></td><td></td><td></td></tr><tr><td>1</td><td></td><td></td></tr></table>							1		
		1																																																																													
		2																																																																													
4	1	1																																																																													
	1																																																																														
		1																																																																													
1		1																																																																													
3																																																																															
	1																																																																														
		3																																																																													
1		1																																																																													
1																																																																															
Post - 0 Miss - 0 Block - 0	Post - 0 Miss - 0 Block - 0	Post - 1 Miss - 0 Block - 0	Post - 0 Miss - 0 Block - 0	Post - 0 Miss - 0 Block - 0	Post - 2 Miss - 0 Block - 0	Post - 0 Miss - 0 Block - 0	Post - 1 Miss - 0 Block - 0																																																																								
10 高静	11 朱海云	12 宋琛茜	17 史雨欣	18 戴小宇	27 吴美琪																																																																										
<table border="1"><tr><td></td><td></td><td></td></tr><tr><td></td><td></td><td></td></tr><tr><td></td><td></td><td></td></tr></table>										<table border="1"><tr><td></td><td></td><td></td></tr><tr><td></td><td></td><td></td></tr><tr><td></td><td></td><td></td></tr></table>										<table border="1"><tr><td></td><td></td><td></td></tr><tr><td></td><td></td><td></td></tr><tr><td></td><td></td><td></td></tr></table>										<table border="1"><tr><td></td><td></td><td></td></tr><tr><td></td><td></td><td></td></tr><tr><td></td><td></td><td></td></tr></table>										<table border="1"><tr><td>1</td><td></td><td></td></tr><tr><td></td><td></td><td></td></tr><tr><td>2</td><td></td><td></td></tr></table>	1						2			<table border="1"><tr><td></td><td></td><td></td></tr><tr><td></td><td></td><td></td></tr><tr><td></td><td></td><td></td></tr></table>										<table border="1"><tr><td></td><td></td><td></td></tr><tr><td></td><td></td><td></td></tr><tr><td></td><td></td><td></td></tr></table>										<table border="1"><tr><td></td><td></td><td></td></tr><tr><td></td><td></td><td></td></tr><tr><td></td><td></td><td></td></tr></table>									
1																																																																															
2																																																																															
Post - 0 Miss - 0 Block - 0	Post - 0 Miss - 1 Block - 0	Post - 0 Miss - 0 Block - 0	Post - 0 Miss - 0 Block - 0	Post - 1 Miss - 0 Block - 0	Post - 0 Miss - 0 Block - 0																																																																										

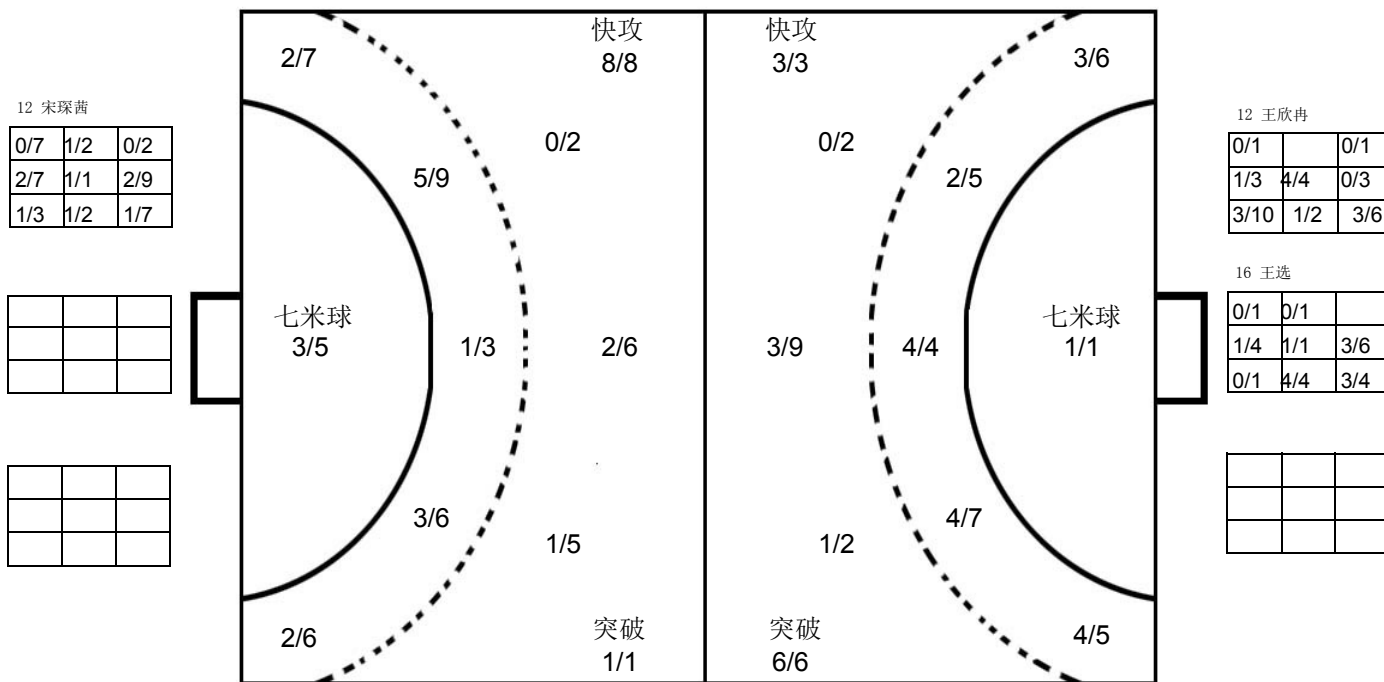

## 天津

3 王晓梅	4 朱佳瑜	5 丁丽洁	7 张心茹	8 张慧	10 张文慧	11 蔡雪洁	12 王欣冉																																																																								
<table border="1"><tr><td></td><td></td><td></td></tr><tr><td></td><td></td><td></td></tr><tr><td></td><td></td><td></td></tr></table>										<table border="1"><tr><td></td><td></td><td></td></tr><tr><td></td><td></td><td>1</td></tr><tr><td></td><td></td><td></td></tr></table>						1				<table border="1"><tr><td></td><td></td><td></td></tr><tr><td></td><td></td><td></td></tr><tr><td></td><td></td><td></td></tr></table>										<table border="1"><tr><td></td><td></td><td></td></tr><tr><td></td><td></td><td></td></tr><tr><td></td><td></td><td></td></tr></table>										<table border="1"><tr><td>1</td><td>1</td><td></td></tr><tr><td>1</td><td></td><td>1</td></tr><tr><td></td><td></td><td></td></tr></table>	1	1		1		1				<table border="1"><tr><td></td><td></td><td></td></tr><tr><td></td><td></td><td>2</td></tr><tr><td></td><td>1</td><td></td></tr></table>						2		1		<table border="1"><tr><td></td><td>1</td><td></td></tr><tr><td></td><td></td><td>1</td></tr><tr><td></td><td></td><td>4</td></tr></table>		1				1			4	<table border="1"><tr><td></td><td></td><td></td></tr><tr><td></td><td></td><td></td></tr><tr><td></td><td></td><td></td></tr></table>									
		1																																																																													
1	1																																																																														
1		1																																																																													
		2																																																																													
	1																																																																														
	1																																																																														
		1																																																																													
		4																																																																													
Post - 0 Miss - 0 Block - 0	Post - 0 Miss - 0 Block - 0	Post - 0 Miss - 0 Block - 0	Post - 0 Miss - 0 Block - 0	Post - 0 Miss - 0 Block - 0	Post - 0 Miss - 0 Block - 0	Post - 1 Miss - 0 Block - 0	Post - 0 Miss - 0 Block - 0																																																																								
14 刘洁	15 李窈窕	16 王选	17 聂晓雪	18 舒文琪	21 李默雅	22 王聪	23 周梦雪																																																																								
<table border="1"><tr><td></td><td></td><td></td></tr><tr><td></td><td></td><td></td></tr><tr><td></td><td></td><td></td></tr></table>										<table border="1"><tr><td></td><td></td><td></td></tr><tr><td></td><td></td><td></td></tr><tr><td></td><td></td><td></td></tr></table>										<table border="1"><tr><td></td><td></td><td></td></tr><tr><td></td><td></td><td></td></tr><tr><td></td><td></td><td></td></tr></table>										<table border="1"><tr><td></td><td></td><td>1</td></tr><tr><td></td><td></td><td></td></tr><tr><td>1</td><td></td><td></td></tr></table>			1				1			<table border="1"><tr><td>3</td><td></td><td>1</td></tr><tr><td>2</td><td></td><td></td></tr><tr><td>1</td><td></td><td>1</td></tr></table>	3		1	2			1		1	<table border="1"><tr><td></td><td></td><td></td></tr><tr><td></td><td></td><td></td></tr><tr><td>1</td><td></td><td></td></tr></table>							1			<table border="1"><tr><td></td><td></td><td></td></tr><tr><td></td><td></td><td></td></tr><tr><td></td><td></td><td></td></tr></table>										<table border="1"><tr><td></td><td>2</td><td>1</td></tr><tr><td></td><td>1</td><td>2</td></tr><tr><td></td><td></td><td></td></tr></table>		2	1		1	2			
		1																																																																													
1																																																																															
3		1																																																																													
2																																																																															
1		1																																																																													
1																																																																															
	2	1																																																																													
	1	2																																																																													
Post - 0 Miss - 0 Block - 0	Post - 0 Miss - 0 Block - 0	Post - 0 Miss - 0 Block - 0	Post - 0 Miss - 0 Block - 0	Post - 0 Miss - 1 Block - 0	Post - 0 Miss - 1 Block - 0	Post - 0 Miss - 0 Block - 0	Post - 2 Miss - 3 Block - 2																																																																								

注释: Post=击柱 Miss=射失 Block=被封



预赛 Group B

女子 全国比赛

2016年全国女子手球锦标赛

Team A A 解放军				Team B B 北京				Match Number 32													
played in China		in the hall 滁州体育馆		on 09/09/2016		at 14:30 hours		Spectators													
Half-time (30')	A 19	B 11	End of playing time	A 38	B 31	1st extra time	A	B	2nd extra time	A	B	After penalty throws	A	B							
Number of 7 m	A 3/5	Team time-out			Full name of players and officials				Team time-out			B 1/1	Number of 7 m								
No.	Team A					G	W	2'	D	DR	No.	Team B					G	W	2'	D	DR
2	崔云莉					10		1			1	宋嘉蕾									
5	徐鸣昭					1					3	季小桐					1				
6	于婷婷					7					4	孙佳					2		1		
8	周亚茹					4		1			6	刘亚男									
13	张格格					5	1				8	杨铭豫					2	1			
16	方文博										10	刘莎					2				
17	于利婷										11	纪婉					1				
23	顾天澍										16	王海叶									
24	韦娜娜					1					17	杨政赢					6	1			
32	张馨予										22	李海鸥					6	1			
36	李朴										23	田媛					3				
44	刘洋麦文					5					28	闫美珠									
66	杨丽丽										33	栾征									
77	唐魏萍										47	刘泽									
81	戴丹妮										58	李华								1	
88	李晓晴					5	1				69	石梓薇					8				
A	刘德东 (主教练)										A	蔡建国									
B	刘凤娟										B	石伟 (主教练)									
C	丛艳霞										C	李翼									
D	吴明群										E	史良玉									
A	Signature of Responsible Official of the Teams (Off. A)																		B		
TP	Remarks of Referee / CHA Official																		TP		

Signatures

Referees	倪震 (CHN)	张耿 (CHN)		
Techn. Delegates	刘书勇 (CHN)			
CHA Official	许宜扬 (CHN)			

Note: Number of 7m Throws Awarded to Team A and B, Goals (G), Warnings (W), Suspensions (2'), Direct Disqualification (D), Disqualification with Report (DR) and Team Penalty (TP).

Table Officials: 伍豪

陈文丽

Statisticians: 陈柱

闫冲

Printed by PHMS Copyright: IHF / CHA 09/09/2016 15:55:25

Longman Sportsoft



handball@126.com

2016年全国女子手球锦标赛  
竞赛技术统计(媒体表)

预赛	组别	B	轮次	7	场次	32
滁州体育馆		09/09/2016			201605032-51-1/1	
解放军	解放军	38	vs	31	北京	北京
19:11						

裁判员		倪震 (CHN)											张耿 (CHN)										
解放军		远射	近射	边射	快攻	突破	任意球	7m球	合计	%	助攻	失误	警告	2'	D & DR	解放军	比赛进程	北京					
主教练: 刘德东																1st Half							
2 崔云莉	3/6		3/4	4/4				10/14	71.4	2	1		1		44 刘洋麦文	0 00:28	1 17 杨政赢						
5 徐鸣昭	0/1	1/1						1/2	50.0						1 01:41	1							
6 于婷婷	0/1	4/4		1/1	2/2			7/8	87.5	1	4				2 于婷婷	2 03:49	2 69 石梓薇						
8 周亚茹	1/2	2/2					1/2	4/6	66.7		1		1		2 崔云莉	3 04:28	2						
13 张格格		4/4		1/2				5/6	83.3			3	1		6 于婷婷	4 05:56	2						
16 方文博															4 07:06	3 11 纪婉							
17 于利婷															88 李晓晴	5 07:51	3						
23 顾天澍			0/1					0/1	0.0		1				13 张格格	6 09:05	3						
24 韦娜娜	0/1		1/1	0/1				1/3	33.3		1				6 10:19	4 69 石梓薇							
32 张馨予															88 李晓晴	7 10:28	4						
36 李朴							0/1	0/1	0.0						7 11:49	5 8 杨铭豫							
44 刘洋麦文	1/6	1/1		1/1	2/3			5/11	45.5	5	5				88 李晓晴	8 12:26	5						
66 杨丽丽															44 刘洋麦文	9 12:59	5						
77 唐魏萍															6 于婷婷	10 15:18	5						
81 戴丹妮															10 15:47	6 69 石梓薇							
88 李晓晴	2/4				1/1		2/2	5/7	71.4	1	2	1			13 张格格	11 15:59	6						
运动员 合计	7/21	12/12	4/6	7/9	5/6		3/5	38/59	64.4	9	18	2	2		6 于婷婷	12 19:23	6						
16 方文博	7/13	2/12	5/6	0/3	1/5		0/1	15/40	37.5						8 周亚茹	13 19:49	6						
66 杨丽丽	0/2	1/3	0/1		1/2			2/8	25.0						44 刘洋麦文	14 20:33	6						
守门员 合计	7/15	3/15	5/7	0/3	2/7		0/1	17/48	35.4						14 20:57	7 23 田媛							
北京		远射	近射	边射	快攻	突破	任意球	7m球	合计	%	助攻	失误	警告	2'	D & DR	14 21:28	8 8 杨铭豫						
教练: 石伟																14 23:23	9 4 孙佳						
1 宋嘉蕾																14 24:19	10 17 杨政赢						
3 季小桐	0/1		0/1		1/1			1/3	33.3	1	4				13 张格格	15 24:32	10						
4 孙佳		1/2	1/2					2/4	50.0	1	1			1	8 周亚茹	15 25:08	11 3 季小桐						
6 刘亚男															88 李晓晴	16 25:32	11						
8 杨铭豫		2/2						2/2	100		1	1			2 崔云莉	17 27:02	11						
10 刘莎			1/2				1/1	2/3	66.7	1					2 崔云莉	18 28:52	11						
11 纪婉			0/2	1/1				1/3	33.3	1	1				2 崔云莉	19 29:37	11						
16 王海叶															20 00:21	11							
17 杨政赢	3/7	1/2			2/3			6/12	50.0	1	2	1			44 刘洋麦文	20 00:48	12 23 田媛						
22 李海鸥		5/6		1/1				6/7	85.7		1	1			20 02:27	12							
23 田媛	1/3	1/2			1/1			3/6	50.0	1	2				22 02:54	12							
28 闫美珠															22 03:08	13 22 李海鸥							
33 栾征															22 03:39	14 22 李海鸥							
47 刘泽															22 04:34	15 4 孙佳							
58 李华															2 崔云莉	23 05:06	15						
69 石梓薇	4/9	2/2	0/1	1/1	1/2			8/15	53.3		6				23 05:31	16 22 李海鸥							
运动员 合计	8/20	12/16	2/8	3/3	5/7		1/1	31/55	56.4	6	18	3	2		23 06:01	17 69 石梓薇							
1 宋嘉蕾	2/2	0/4	1/5	0/2	0/2		1/2	4/17	23.5						6 于婷婷	24 07:04	17						
16 王海叶	5/12	0/8		0/5	1/4		1/3	7/32	21.9						2 崔云莉	25 08:57	17						
守门员 合计	7/14	0/12	1/5	0/7	1/6		2/5	11/49	22.4						2 崔云莉	26 10:11	17						

场上队员: 得分 / 射门

守门员: 救球 / 射门

快攻	Fast Break		突破	Breakthrough		任意球	Free Throw		7M球	7M Throw		助攻	Assist
警告	Warning		失误	Error		2'	Suspension		D	取消资格		DR	取消资格+报告





### 2016年全国女子手球锦标赛 图式比赛技术统计表

轮次 7

场次 32

201605032-21-1/1

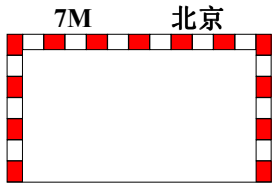
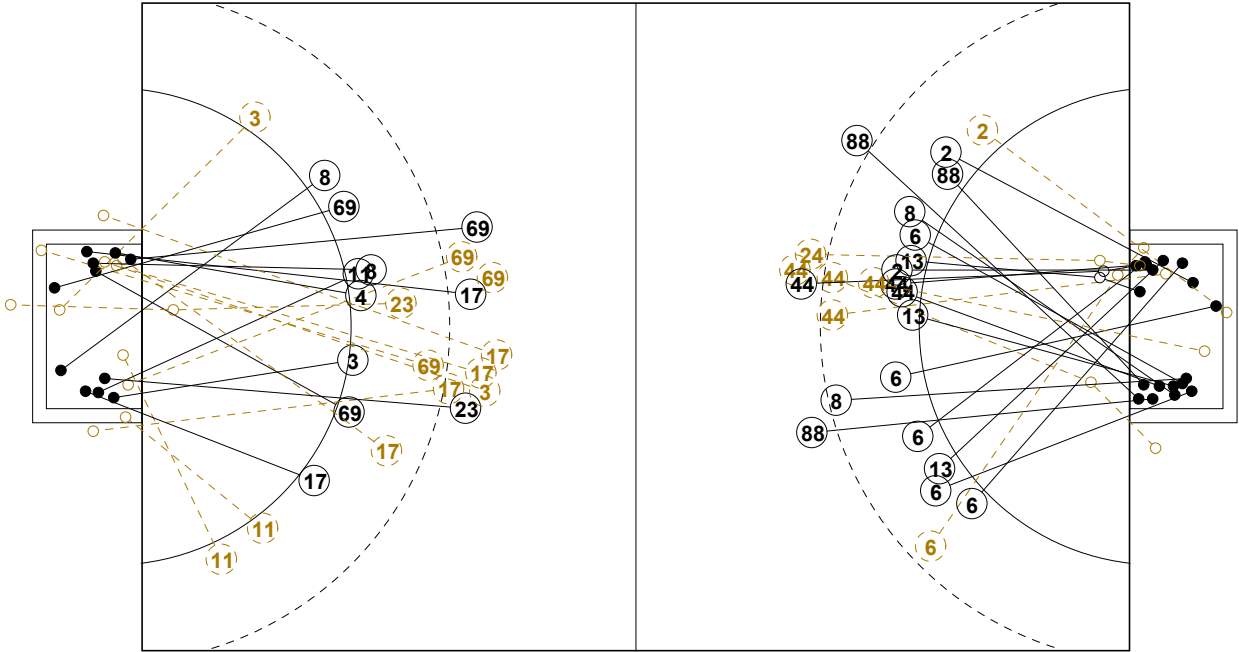

1st Half  
11 : 19

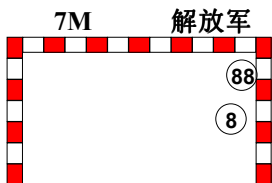
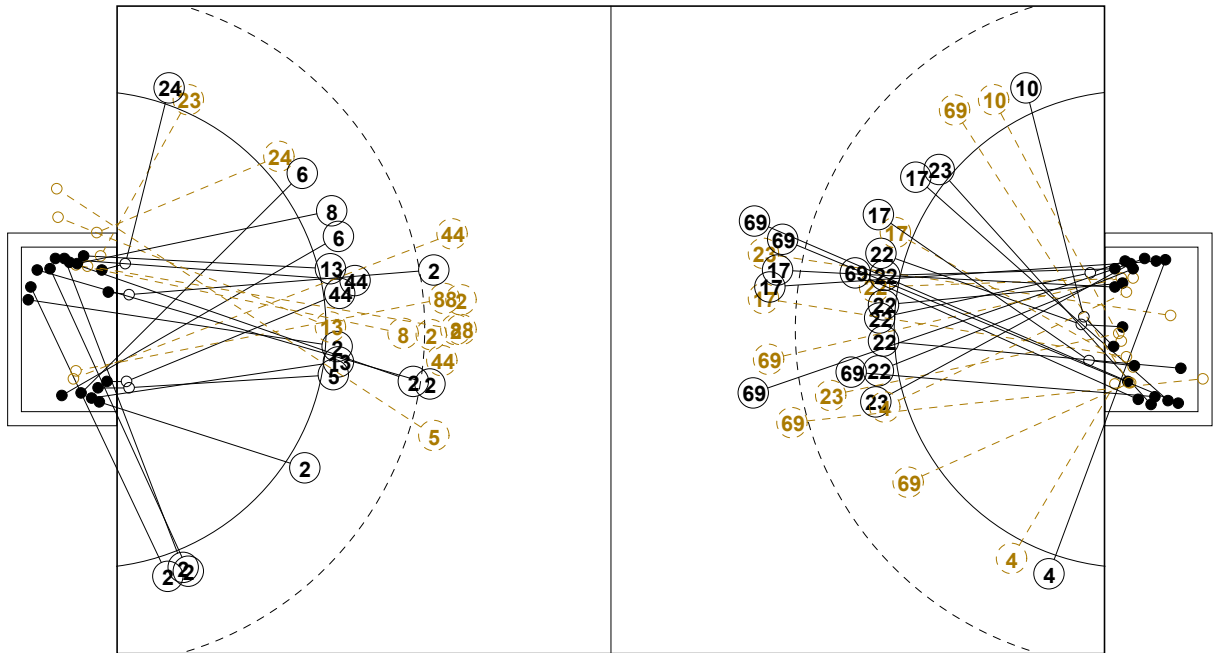
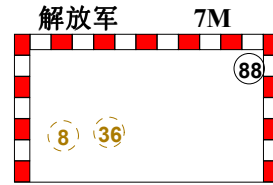

2nd Half  
38 : 31

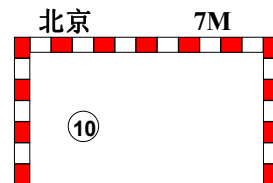



## 2016年全国女子手球锦标赛

## 个人/全队技术统计表

正式表  
手球  
女子预赛  
轮次 7组别 B  
场次 32201605032-14-1/2  
滁州体育馆  
09/09/2016 14:30

号码	姓名	远射	近射	边射	快攻	突破	任意	7M	合计	%	助攻	失误	警告	2'	取消	时间
<b>解放军(解放军)</b>																
<i>(场上队员)</i>																
2	崔云莉	3/6		3/4	4/4				10/14	71.4%	2	1		1		01:00:00
5	徐鸣昭	0/1	1/1						1/2	50.0%						00:08:52
6	于婷婷	0/1	4/4		1/1	2/2			7/8	87.5%	1	4				00:49:03
8	周亚茹	1/2	2/2					1/2	4/6	66.7%		1		1		00:17:52
13	张格格		4/4		1/2				5/6	83.3%		3	1			01:00:00
16	方文博									0.0%						00:52:31
17	于利婷									0.0%						00:08:33
23	顾天澍			0/1					0/1	0.0%		1				00:23:35
24	韦娜娜	0/1		1/1	0/1				1/3	33.3%		1				00:36:18
32	张馨予									0.0%						00:00:00
36	李朴							0/1	0/1	0.0%						00:00:07
44	刘洋麦文	1/6	1/1		1/1	2/3			5/11	45.5%	5	5				00:51:35
66	杨丽丽									0.0%						00:07:29
77	唐魏萍									0.0%						00:00:00
81	戴丹妮									0.0%						00:00:00
88	李晓晴	2/4				1/1		2/2	5/7	71.4%	1	2	1			00:43:41
<b>合计</b>		7/21	12/12	4/6	7/9	5/6		3/5	38/59	64.4%	9	18	2	2		
<i>(守门员)</i>																
16	方文博	7/13	2/12	5/6	0/3	1/5		0/1	15/40	37.5%						00:52:31
66	杨丽丽	0/2	1/3	0/1		1/2			2/8	25.0%						00:07:29
<b>合计</b>		7/15	3/15	5/7	0/3	2/7		0/1	17/48	35.4%						

场上队员：得分/射门

守门员：救球/射门

全队合计	得分	被救	射失	击柱	封球	合计	%
远射	7	7	2		5	21	33.3%
近射	12					12	100.0%
边射	4	1		1		6	66.7%
快攻	7		1	1		9	77.8%
突破	5	1				6	83.3%
任意							0.0%
7M	3	2				5	60.0%





## 2016年全国女子手球锦标赛

## 个人/全队技术统计表

正式表  
手球  
女子预赛  
轮次 7组别 B  
场次 32201605032-14-2/2  
滁州体育馆  
09/09/2016 14:30

号码	姓名	远射	近射	边射	快攻	突破	任意	7M	合计	%	助攻	失误	警告	2'	取消	时间
<b>北京(北京)</b>																
<i>(上场队员)</i>																
1	宋嘉蕾									0.0%						00:19:03
3	季小桐	0/1		0/1		1/1			1/3	33.3%	1	4				00:43:32
4	孙佳		1/2	1/2					2/4	50.0%	1	1		1		00:43:43
6	刘亚男									0.0%						00:00:00
8	杨铭豫		2/2						2/2	100%		1	1			00:27:19
10	刘莎			1/2				1/1	2/3	66.7%	1					00:30:00
11	纪婉			0/2	1/1				1/3	33.3%	1	1				00:30:00
16	王海叶									0.0%						00:40:57
17	杨政赢	3/7	1/2			2/3			6/12	50.0%	1	2	1			00:47:39
22	李海鸥		5/6		1/1				6/7	85.7%		1	1			00:43:32
23	田媛	1/3	1/2			1/1			3/6	50.0%	1	2				00:34:15
28	闫美珠									0.0%						00:00:00
33	栾征									0.0%						00:00:00
47	刘泽									0.0%						00:00:00
58	李华									0.0%				1		00:11:16
69	石梓薇	4/9	2/2	0/1	1/1	1/2			8/15	53.3%		6				00:48:16
<b>合计</b>		8/20	12/16	2/8	3/3	5/7		1/1	31/55	56.4%	6	18	3	2		
<i>(守门员)</i>																
1	宋嘉蕾	2/2	0/4	1/5	0/2	0/2		1/2	4/17	23.5%						00:19:03
16	王海叶	5/12	0/8		0/5	1/4		1/3	7/32	21.9%						00:40:57
<b>合计</b>		7/14	0/12	1/5	0/7	1/6		2/5	11/49	22.4%						

场上队员：得分/射门

守门员：救球/射门

全队合计	得分	被救	射失	击柱	封球	合计	%
远射	8	7	2	2	1	20	40.0%
近射	12	3	1			16	75.0%
边射	2	5		1		8	25.0%
快攻	3					3	100.0%
突破	5	2				7	71.4%
任意							0.0%
7M	1					1	100.0%





2016年全国女子手球锦标赛

图式射门区域统计

轮次 7 场次 32

201605032-41-1/1

解放军

2 崔云莉	5 徐鸣昭	6 于婷婷	8 周亚茹	13 张格格	16 方文博	17 于利婷	23 顾天澍
1 4 2 2 1	1	1 1 3 1 1	4	1 2 2			
Post - 1 Miss - 0 Block - 2	Post - 0 Miss - 1 Block - 0	Post - 0 Miss - 0 Block - 0	Post - 0 Miss - 0 Block - 0	Post - 0 Miss - 1 Block - 0	Post - 0 Miss - 0 Block - 0	Post - 0 Miss - 0 Block - 0	Post - 0 Miss - 0 Block - 0
24 韦娜娜	32 张馨予	36 李朴	44 刘洋麦文	66 杨丽丽	77 唐魏萍	81 戴丹妮	88 李晓晴
1			1 3 1				2 3
Post - 1 Miss - 0 Block - 0	Post - 0 Miss - 0 Block - 0	Post - 0 Miss - 0 Block - 0	Post - 0 Miss - 1 Block - 2	Post - 0 Miss - 0 Block - 0	Post - 0 Miss - 0 Block - 0	Post - 0 Miss - 0 Block - 0	Post - 0 Miss - 0 Block - 1

16 方文博
0/1 2/2 0/2
0/6 1/7
4/10 3/4 5/8

66 杨丽丽
0/2
0/1
1/2 0/1 1/2

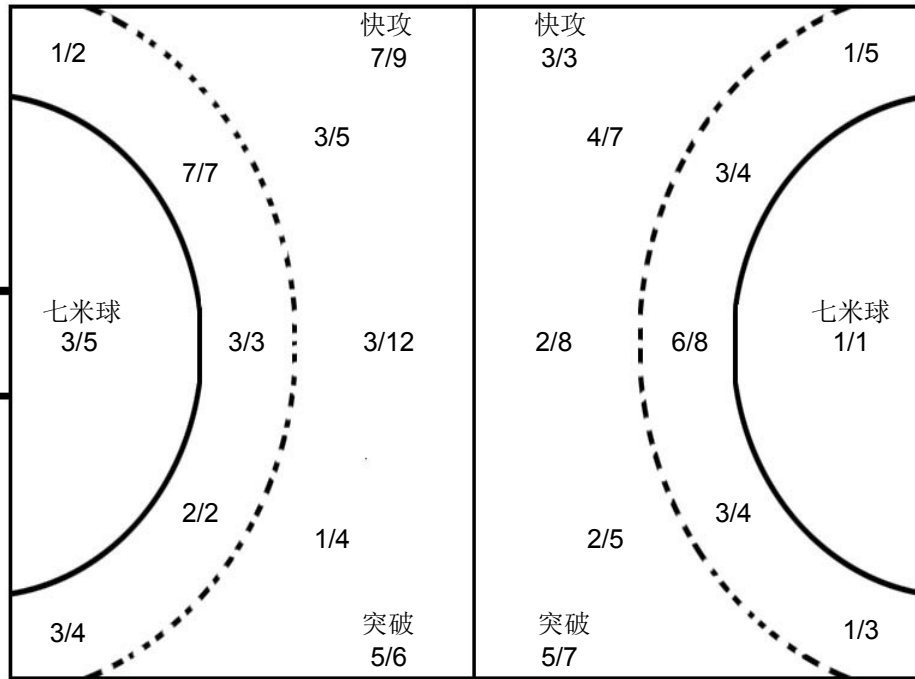
1 宋嘉蕾
0/4
3/5 0/3
0/3 1/2

16 王海叶
0/1 1/2 0/3
2/4 1/8
2/8 1/6

北京

1 宋嘉蕾	3 季小桐	4 孙佳	6 刘亚男	8 杨铭豫	10 刘莎	11 纪婉	16 王海叶
	1	1 1		1 1	1 1	1	
Post - 0 Miss - 0 Block - 0	Post - 0 Miss - 0 Block - 0	Post - 0 Miss - 0 Block - 0	Post - 0 Miss - 0 Block - 0	Post - 0 Miss - 0 Block - 0	Post - 0 Miss - 0 Block - 0	Post - 1 Miss - 0 Block - 0	Post - 0 Miss - 0 Block - 0
17 杨政赢	22 李海鸥	23 田媛	28 闫美珠	33 栾征	47 刘泽	58 李华	69 石梓薇
1 1	1	1 1					2 1 3 2
Post - 0 Miss - 2 Block - 0	Post - 0 Miss - 0 Block - 0	Post - 0 Miss - 1 Block - 0	Post - 0 Miss - 0 Block - 0	Post - 0 Miss - 0 Block - 0	Post - 0 Miss - 0 Block - 0	Post - 0 Miss - 0 Block - 0	Post - 2 Miss - 0 Block - 1

注释: Post=击柱 Miss=射失 Block=被封





预赛 Group B

女子 全国比赛

2016年全国女子手球锦标赛

Team A A 上海				Team B B 辽宁				Match Number <b>33</b>													
played in China		in the hall 滁州体育馆		on 09/09/2016		at 16:00 hours		Spectators													
Half-time (30')	A 16	B 13	End of playing time	A 33	B 24	1st extra time	A	B	2nd extra time	A	B	After penalty throws	A	B							
Number of 7 m	A 4 / 4	Team time-out			Full name of players and officials				Team time-out			B 2 / 4	Number of 7 m								
		1	2	3					1	2	3										
		19:31							07:30	41:34	47:38										
No.	Team A					G	W	2'	D	DR	No.	Team B					G	W	2'	D	DR
1	许沫										1	于薇诗									
2	周蕾						1				2	朱徐婷					2				
5	郭威					1					3	赵莹雪						1			
6	黄妍					7					5	辛颜					4	1			
7	车婉茹										8	杨娇					12				
8	吴茵					5					9	刁卫丽									
9	武娜娜					4	1				12	刘雪菲									
10	斯文					4					13	杜江花					2				
11	孙梦颖					2					19	吕秋雪					3				
12	郑冯										20	孙弘玲									
13	徐娟										24	陈思雨									
17	居晔										27	王丹									
18	沙正文					4	1	1			66	梁海珍					1				
19	印尼					6					93	赵琦									
21	王嘉怡										98	张永婷									
23	都好										99	郑锦宜									
B	陈进培 (主教练)										A	吕艳梦					1				
C	金锺顺										B	李丽荣									
D	贺业磊										C	金京男 (主教练)									
F	周瑜宸										E	程万里									
A	Signature of Responsible Official of the Teams (Off. A)																			B	
TP	Remarks of Referee / CHA Official																			TP	

Signatures

Referees	徐健 (CHN)	曹宏俊 (CHN)		
Techn. Delegates	刘书勇 (CHN)			
CHA Official	许宜扬 (CHN)			

Note: Number of 7m Throws Awarded to Team A and B, Goals (G), Warnings (W), Suspensions (2'), Direct Disqualification (D), Disqualification with Report (DR) and Team Penalty (TP).

Table Officials: 伍豪

陈文丽

Statisticians: 闫冲

陈柱

Printed by PHMS Copyright: IHF / CHA 09/09/2016 17:21:34

Longman Sportsoft



handball@126.com





## 2016年全国女子手球锦标赛 竞赛技术统计(媒体表)

<b>预赛</b>	组别	<b>B</b>	轮次	<b>7</b>	场次	<b>33</b>
滁州体育馆			09/09/2016		201605033-51-1/1	
上海		<b>33</b>	vs	<b>24</b>	辽宁	
<b>16 : 13</b>						

裁判员	徐健 (CHN)			/	曹宏俊 (CHN)		
-----	----------	--	--	---	-----------	--	--

上海		远	近	边	快	突	任意	7m	合计	%	助攻	失误	警告	2'	D & DR	比赛进程	
主教练：陈进培		射	射	射	攻	破	球	球								上海	辽宁
1	许沫															18	沙正文
2	周蕾				0/1				0/1	0.0			1			1	01:18
5	郭威	1/2							1/2	50.0	1					2	02:42
6	黄妍	2/6	1/1		1/1	1/1		2/2	7/11	63.6	1	1				3	03:06
7	车婉茹															4	03:39
8	吴茵	2/8					2/2	1/1	5/11	45.5	1	2				5	04:34
9	武娜娜		0/1	1/1	3/3				4/5	80.0			1			6	06:10
10	斯文	3/5		0/1		1/1			4/7	57.1		1				7	07:02
11	孙梦颖	2/5	0/2						2/7	28.6	1					8	07:42
12	郑冯															9	08:26
13	徐娟											1				10	09:26
17	居晔															11	10:37
18	沙正文		4/4						4/4	100			1	1		12	11:07
19	印尼	1/3	1/1			3/3		1/1	6/8	75.0						13	12:18
21	王嘉怡															14	13:00
23	都好															15	14:21
<b>运动员 合计</b>		<b>11/29</b>	<b>6/9</b>	<b>1/2</b>	<b>4/5</b>	<b>7/7</b>		<b>4/4</b>	<b>33/56</b>	<b>58.9</b>	<b>5</b>	<b>5</b>	<b>3</b>	<b>1</b>		16	15:21
1	许沫	7/15	3/11	1/3	2/2	1/3	1/3	2/4	17/41	41.5						17	16:06
<b>守门员 合计</b>		<b>7/15</b>	<b>3/11</b>	<b>1/3</b>	<b>2/2</b>	<b>1/3</b>	<b>1/3</b>	<b>2/4</b>	<b>17/41</b>	<b>41.5</b>						18	18:46
辽宁		远	近	边	快	突	任意	7m	合计	%	助攻	失误	警告	2'	D & DR	比赛进程	
教练：金京男		射	射	射	攻	破	球	球								上海	辽宁
1	于薇诗															19	印尼
2	朱徐婷		1/1	1/1				2/2	2/2	100						20	00:51
3	赵莹雪	0/1						0/1	0/1	0.0	1	2	1			21	05:13
5	辛颜	0/1	4/6					4/7	57.1			1	1			22	05:54
8	杨娇	7/13				1/1	2/3	2/2	12/19	63.2	2	4				23	06:54
9	刁卫丽															24	07:48
12	刘雪菲															25	09:15
13	杜江花	0/1	2/2					0/2	2/5	40.0		1				26	09:47
19	吕秋雪	1/2	1/1		0/1	1/1		3/5	60.0			3				27	10:17
20	孙弘玲		0/1		0/1			0/2	0.0			1				28	11:30
24	陈思雨															29	12:24
27	王丹															30	12:38
66	梁海珍	0/2		1/2		0/1	0/1	1/6	16.7			2				31	14:22
93	赵琦												1			32	15:06
98	张永婷															33	15:31
99	郑锦宜															34	16:33
<b>运动员 合计</b>		<b>8/20</b>	<b>8/11</b>	<b>2/3</b>	<b>0/2</b>	<b>2/3</b>	<b>2/4</b>	<b>2/4</b>	<b>24/47</b>	<b>51.1</b>	<b>3</b>	<b>15</b>	<b>2</b>			35	17:33
27	王丹	1/3	0/3					0/2	1/8	12.5						36	18:31
93	赵琦	5/14	3/6	0/1	1/5	0/7		0/2	9/35	25.7		1				37	18:56
<b>守门员 合计</b>		<b>6/17</b>	<b>3/9</b>	<b>0/1</b>	<b>1/5</b>	<b>0/7</b>		<b>0/4</b>	<b>10/43</b>	<b>23.3</b>		<b>1</b>				38	19:13

场上队员：得分 / 射门

守门员：救球 / 射门

快攻	Fast Break	突破	Breakthrough	任意球	Free Throw	7M球	7M Throw	助攻	Assist
警告	Warning	失误	Error	2'	Suspension	D	取消资格	DR	取消资格+报告





### 2016年全国女子手球锦标赛 图式比赛技术统计表

轮次 7

场次 33

201605033-21-1/1

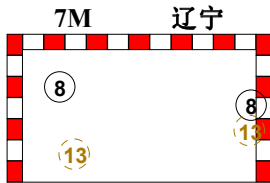
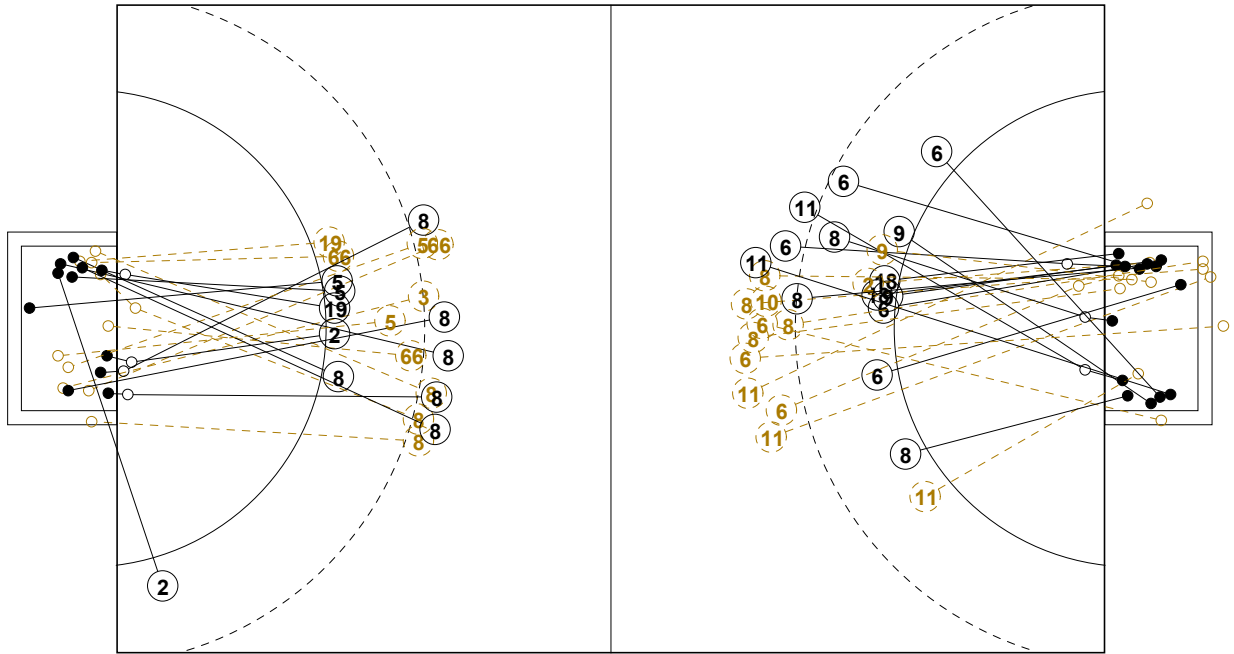

1st Half  
13 : 16

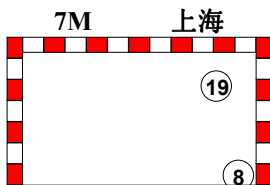
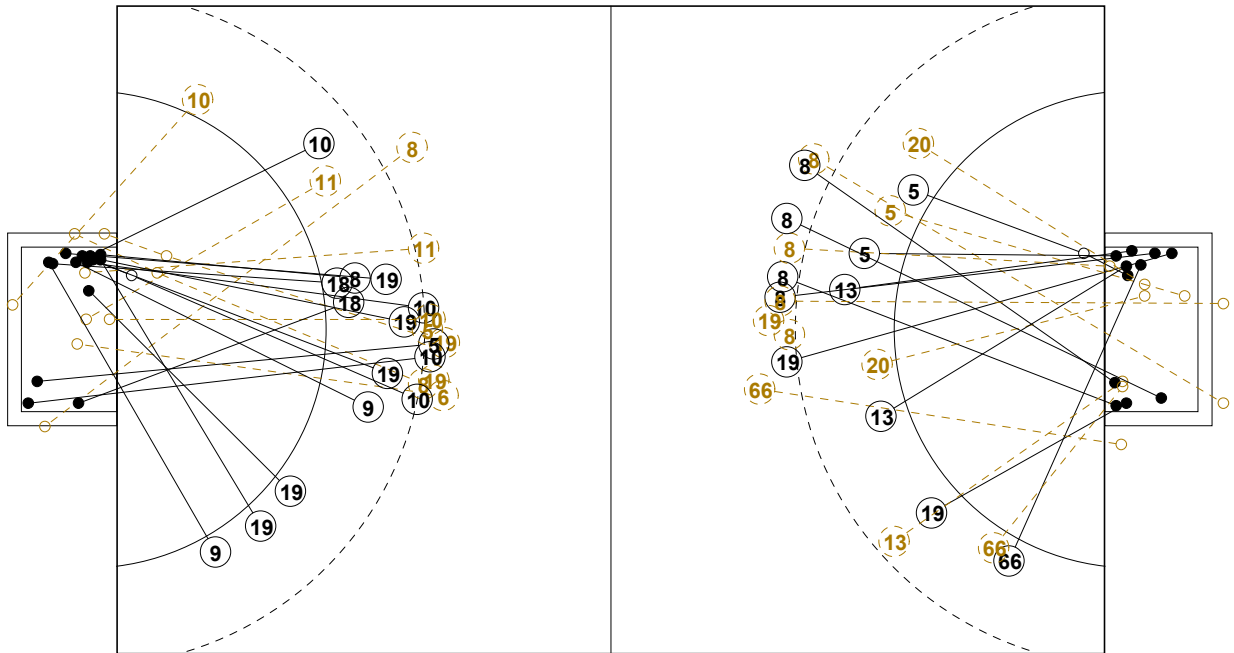
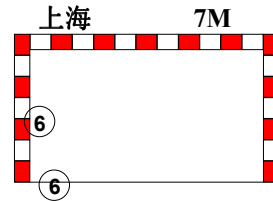

2nd Half  
33 : 24

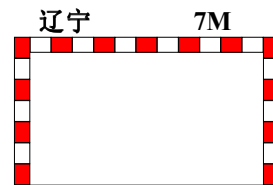



## 2016年全国女子手球锦标赛

## 个人/全队技术统计表

正式表  
手球  
女子预赛  
轮次 7组别 B  
场次 33201605033-14-1/2  
滁州体育馆  
09/09/2016 16:00

号码	姓名	远射	近射	边射	快攻	突破	任意	7M	合计	%	助攻	失误	警告	2'	取消	时间
<b>上海(上海)</b>																
<i>(场上队员)</i>																
1	许沫									0.0%						01:00:00
2	周蕾				0/1				0/1	0.0%			1			00:51:44
5	郭威	1/2							1/2	50.0%	1					00:04:08
6	黄妍	2/6	1/1		1/1	1/1		2/2	7/11	63.6%	1	1				00:31:51
7	车婉茹									0.0%						00:00:00
8	吴茵	2/8				2/2		1/1	5/11	45.5%	1	2				00:37:10
9	武娜娜		0/1	1/1	3/3				4/5	80.0%			1			00:53:51
10	斯文	3/5		0/1		1/1			4/7	57.1%		1				00:35:05
11	孙梦颖	2/5	0/2						2/7	28.6%	1					00:36:29
12	郑冯									0.0%						00:00:00
13	徐娟									0.0%	1	1				00:11:13
17	居晔									0.0%						00:17:41
18	沙正文		4/4						4/4	100%			1	1		00:39:18
19	印尼	1/3	1/1			3/3		1/1	6/8	75.0%						00:16:52
21	王嘉怡									0.0%						00:00:00
23	都好									0.0%						00:20:32
<b>合计</b>		11/29	6/9	1/2	4/5	7/7		4/4	33/56	58.9%	5	5	3	1		
<i>(守门员)</i>																
1	许沫	7/15	3/11	1/3	2/2	1/3	1/3	2/4	17/41	41.5%						01:00:00
<b>合计</b>																
<b>合计</b>		7/15	3/11	1/3	2/2	1/3	1/3	2/4	17/41	41.5%						

场上队员：得分/射门

守门员：救球/射门

全队合计	得分	被救	射失	击柱	封球	合计	%
远射	11	6	2	7	3	29	37.9%
近射	6	3				9	66.7%
边射	1			1		2	50.0%
快攻	4	1				5	80.0%
突破	7					7	100.0%
任意							0.0%
7M	4					4	100.0%





## 2016年全国女子手球锦标赛

## 个人/全队技术统计表

正式表  
手球  
女子预赛  
轮次 7组别 B  
场次 33201605033-14-2/2  
滁州体育馆  
09/09/2016 16:00

号码	姓名	远射	近射	边射	快攻	突破	任意	7M	合计	%	助攻	失误	警告	2'	取消	时间
<b>辽宁(辽宁)</b>																
<i>(上场队员)</i>																
1	于薇诗									0.0%						00:00:00
2	朱徐婷		1/1	1/1					2/2	100%						00:44:17
3	赵莹雪	0/1							0/1	0.0%	1	2	1			00:35:03
5	辛颜	0/1	4/6						4/7	57.1%		1	1			01:00:00
8	杨娇	7/13				1/1	2/3	2/2	12/19	63.2%	2	4				01:00:00
9	刁卫丽									0.0%						00:00:00
12	刘雪菲									0.0%						00:00:00
13	杜江花	0/1	2/2					0/2	2/5	40.0%		1				00:22:52
19	吕秋雪	1/2	1/1		0/1	1/1			3/5	60.0%		3				01:00:00
20	孙弘玲		0/1		0/1				0/2	0.0%		1				00:19:59
24	陈思雨									0.0%						00:00:00
27	王丹									0.0%						00:10:57
66	梁海珍	0/2		1/2		0/1	0/1		1/6	16.7%		2				00:57:39
93	赵琦									0.0%		1				00:49:03
98	张永婷									0.0%						00:00:00
99	郑锦宜									0.0%						00:00:00
<b>合计</b>		8/20	8/11	2/3	0/2	2/3	2/4	2/4	24/47	51.1%	3	15	2			
<i>(守门员)</i>																
27	王丹	1/3	0/3					0/2	1/8	12.5%						00:10:57
93	赵琦	5/14	3/6	0/1	1/5	0/7		0/2	9/35	25.7%		1				00:49:03
<b>合计</b>		6/17	3/9	0/1	1/5	0/7		0/4	10/43	23.3%		1				

场上队员：得分/射门

守门员：救球/射门

全队合计	得分	被救	射失	击柱	封球	合计	%
远射	8	7	3		2	20	40.0%
近射	8	3				11	72.7%
边射	2	1				3	66.7%
快攻		2				2	0.0%
突破	2	1				3	66.7%
任意	2	1		1		4	50.0%
7M	2	2				4	50.0%





### 2016年全国女子手球锦标赛

#### 图式射门区域统计

轮次 7 场次 33

201605033-41-1/1

## 上海

1 许沫 [ ] [ ] [ ] [ ] [ ] [ ] [ ] [ ] [ ] Post - 0 Miss - 0 Block - 0	2 周蕾 [ ] [ ] [ ] [ ] [ ] [ ] [ ] [ ] [ ] Post - 0 Miss - 0 Block - 0	5 郭威 1 [ ] [ ] [ ] [ ] [ ] [ ] [ ] [ ] Post - 0 Miss - 0 Block - 1	6 黄妍 1 [ ] [ ] 3 [ ] [ ] 1 2 [ ] [ ] [ ] Post - 1 Miss - 1 Block - 0	7 车婉茹 [ ] [ ] [ ] [ ] [ ] [ ] [ ] [ ] [ ] Post - 0 Miss - 0 Block - 0	8 吴茵 [ ] [ ] [ ] 1 [ ] [ ] [ ] [ ] [ ] [ ] Post - 4 Miss - 0 Block - 0	9 武娜娜 [ ] [ ] [ ] 1 [ ] [ ] [ ] 2 [ ] [ ] [ ] Post - 0 Miss - 0 Block - 0	10 斯文 [ ] [ ] [ ] 1 [ ] [ ] [ ] [ ] [ ] [ ] 3 Post - 1 Miss - 0 Block - 1
11 孙梦颖 [ ] [ ] [ ] 1 [ ] [ ] [ ] [ ] [ ] [ ] 1 Post - 1 Miss - 1 Block - 0	12 郑冯 [ ] [ ] [ ] [ ] [ ] [ ] [ ] [ ] [ ] Post - 0 Miss - 0 Block - 0	13 徐娟 [ ] [ ] [ ] [ ] [ ] [ ] [ ] [ ] [ ] Post - 0 Miss - 0 Block - 0	17 居晔 [ ] [ ] [ ] [ ] [ ] [ ] [ ] [ ] [ ] Post - 0 Miss - 0 Block - 0	18 沙正文 [ ] [ ] [ ] 1 2 [ ] [ ] [ ] 1 [ ] [ ] [ ] Post - 0 Miss - 0 Block - 0	19 印尼 [ ] [ ] [ ] 1 [ ] [ ] [ ] 2 [ ] [ ] [ ] 3 Post - 1 Miss - 0 Block - 1	21 王嘉怡 [ ] [ ] [ ] [ ] [ ] [ ] [ ] [ ] [ ] Post - 0 Miss - 0 Block - 0	23 都好 [ ] [ ] [ ] [ ] [ ] [ ] [ ] [ ] [ ] Post - 0 Miss - 0 Block - 0

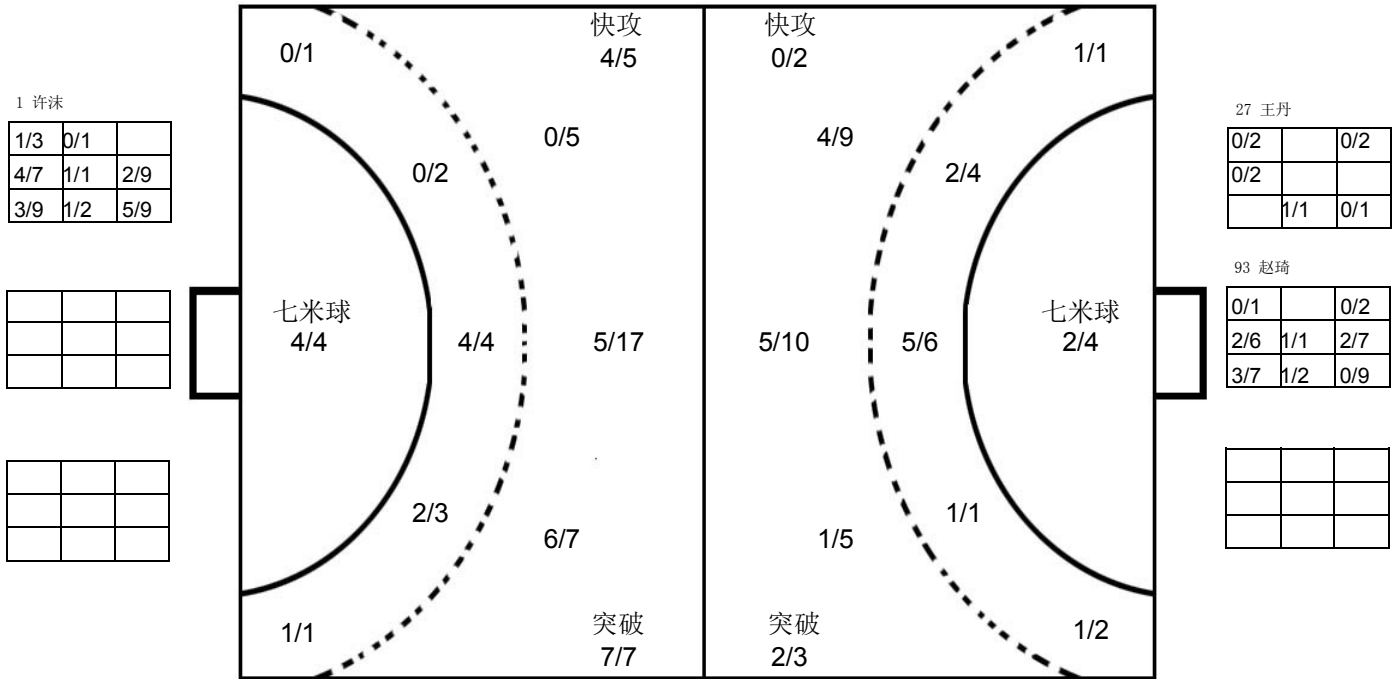

## 辽宁

1 于薇诗 [ ] [ ] [ ] [ ] [ ] [ ] [ ] [ ] [ ] Post - 0 Miss - 0 Block - 0	2 朱徐婷 [ ] [ ] [ ] [ ] [ ] [ ] 1 [ ] [ ] [ ] Post - 0 Miss - 0 Block - 0	3 赵莹雪 [ ] [ ] [ ] [ ] [ ] [ ] [ ] [ ] [ ] Post - 0 Miss - 0 Block - 0	5 辛颜 [ ] [ ] 1 [ ] [ ] [ ] 1 2 [ ] [ ] [ ] Post - 0 Miss - 0 Block - 0	8 杨娇 1 [ ] [ ] 2 [ ] [ ] 5 2 [ ] [ ] [ ] 2 Post - 1 Miss - 2 Block - 1	9 刁卫丽 [ ] [ ] [ ] [ ] [ ] [ ] [ ] [ ] [ ] Post - 0 Miss - 0 Block - 0	12 刘雪菲 [ ] [ ] [ ] [ ] [ ] [ ] [ ] [ ] [ ] Post - 0 Miss - 0 Block - 0	13 杜江花 [ ] [ ] [ ] [ ] [ ] [ ] [ ] [ ] [ ] 2 Post - 0 Miss - 0 Block - 0
19 吕秋雪 1 [ ] [ ] [ ] [ ] [ ] [ ] [ ] [ ] [ ] 2 Post - 0 Miss - 0 Block - 1	20 孙弘玲 [ ] [ ] [ ] [ ] [ ] [ ] [ ] [ ] [ ] Post - 0 Miss - 0 Block - 0	24 陈思雨 [ ] [ ] [ ] [ ] [ ] [ ] [ ] [ ] [ ] Post - 0 Miss - 0 Block - 0	27 王丹 [ ] [ ] [ ] [ ] [ ] [ ] [ ] [ ] [ ] Post - 0 Miss - 0 Block - 0	66 梁海珍 [ ] [ ] [ ] 1 [ ] [ ] [ ] [ ] [ ] [ ] Post - 0 Miss - 1 Block - 0	93 赵琦 [ ] [ ] [ ] [ ] [ ] [ ] [ ] [ ] [ ] Post - 0 Miss - 0 Block - 0	98 张永婷 [ ] [ ] [ ] [ ] [ ] [ ] [ ] [ ] [ ] Post - 0 Miss - 0 Block - 0	99 郑锦宜 [ ] [ ] [ ] [ ] [ ] [ ] [ ] [ ] [ ] Post - 0 Miss - 0 Block - 0

注释: Post=击柱 Miss=射失 Block=被封





预赛 Group A

女子 全国比赛

2016年全国女子手球锦标赛

Team A A 山东				Team B B 广西				Match Number 34													
played in China		in the hall 滁州体育馆		on 09/09/2016		at 17:30 hours		Spectators													
Half-time (30')	A 17	B 11	End of playing time	A 35	B 24	1st extra time	A	B	2nd extra time	A	B	After penalty throws	A	B							
Number of 7 m	A 4 / 6	Team time-out 1 2 3 42:20		Full name of players and officials				Team time-out 1 2 3 52:13 58:34		B 2 / 5	Number of 7 m										
No.	Team A					G	W	2'	D	DR	No.	Team B					G	W	2'	D	DR
1	路畅										1	胡霜梅									
2	林燕群					13	1	1			2	陆雪云					4	1			
7	杨嘉露					1					5	黄海玉									
8	王彬					6					6	韦惠文									
9	周钰婷							1			7	廖露					10				
10	田秀秀					3					8	韦如芳					3				
11	吕青纹					5					9	蓝雪梅									
12	张苑琳										10	周琴									
15	吴作扬					1	1				11	曾蓝花					2				
19	姜伟珊										12	江燕红									
20	张悦					6	1				14	黄艳芳					4	1			
22	朱赟										15	陈依依									
23	徐悦										16	商志运									
28	崔金娜										17	杨杨						1			
33	王彩琳										18	庞娇					1				
77	穆庆丛																				
A	杜晓青										C	王林									
B	马海湧 (主教练)										D	刘雪波									
C	徐强																				
E	王日东																				
A	Signature of Responsible Official of the Teams (Off. A)										B										
TP	Remarks of Referee / CHA Official										TP										

Signatures

Referees	邓军 (CHN)	严璐 (CHN)		
Techn. Delegates	吴国忠 (CHN)			
CHA Official	于中迅 (CHN)			

Note: Number of 7m Throws Awarded to Team A and B, Goals (G), Warnings (W), Suspensions (2'), Direct Disqualification (D), Disqualification with Report (DR) and Team Penalty (TP).

Table Officials: 李诚

赵涵

Statisticians: 黄岩

刘永欢

Printed by PHMS Copyright: IHF / CHA 09/09/2016 18:47:46

Longman Sportsoft



handball@126.com



## 2016年全国女子手球锦标赛 竞赛技术统计(媒体表)

预赛	组别	A	轮次	7	场次	34
----	----	---	----	---	----	----

滁州体育馆			09/09/2016			201605034-51-1/1		
山东	<b>山东</b>	<b>35</b>	vs	<b>24</b>	广西	广西		
<b>17 : 11</b>								

裁判员	邓军 (CHN)					/	严璐 (CHN)				
-----	----------	--	--	--	--	---	----------	--	--	--	--

山东													比赛进程		广西		
远射	近射	边射	快攻	突破	任意球	7m球	合计	%	助攻	失误	警告	2'	D & DR				
主教练: 马海湧																	
1 路畅															0 00:58	1 8 韦如芳	
2 林燕群	3/5	5/6	1/2	1/1	1/1	2/2	13/17	76.5		2	1	1		1 01:42	1 1 廖露		
7 杨嘉露	1/2						1/2	50.0						2 03:30	2 7 廖露		
8 王彬	3/4	2/5	0/1			1/1	6/11	54.5		1				2 04:09	3 8 韦如芳		
9 周钰婷	0/2						0/2	0.0				1		3 04:24	3 2 林燕群		
10 田秀秀				0/3	3/3	0/1	3/7	42.9	1	2				4 08:14	3 5 10:10	3 20 张悦	
11 吕青纹		1/2	3/3	1/2			5/7	71.4		1				5 10:42	3 10 田秀秀		
12 张苑琳														6 10:42	3 7 12:01	3 20 张悦	
15 吴作扬	0/1	0/1	0/1			1/1	1/4	25.0	1	2	1			7 12:25	4 8 韦如芳		
19 姜伟珊														8 12:36	4 10 田秀秀		
20 张悦		2/2	1/2	3/3			6/7	85.7	1	1	1			8 13:18	5 14 黄艳芳		
22 朱贇														9 13:29	5 20 张悦		
23 徐悦														9 14:51	6 7 廖露		
28 崔金娜														10 18:47	6 20 张悦		
33 王彩琳														10 19:16	7 7 廖露		
77 穆庆丛						0/1	0/1	0.0		1				11 19:46	7 20 张悦		
<b>运动员 合计</b>	<b>7/14</b>	<b>10/16</b>	<b>5/9</b>	<b>5/9</b>	<b>4/4</b>	<b>4/6</b>	<b>35/58</b>	<b>60.3</b>	<b>3</b>	<b>10</b>	<b>3</b>	<b>2</b>		12 20:41	8 14 黄艳芳		
1 路畅	1/3	1/3	3/4			1/2	6/12	50.0						13 22:06	8 11 吕青纹		
12 张苑琳	4/7	1/8	0/3	0/1	1/1		6/20	30.0						13 22:16	8 20 张悦		
22 朱贇	2/4		2/3			0/1	4/8	50.0						14 24:58	8 2 林燕群		
<b>守门员 合计</b>	<b>7/14</b>	<b>2/11</b>	<b>5/10</b>	<b>0/1</b>	<b>1/1</b>	<b>1/3</b>	<b>16/40</b>	<b>40.0</b>						14 26:04	9 11 曾蓝花		
广西																	
远射	近射	边射	快攻	突破	任意球	7m球	合计	%	助攻	失误	警告	2'	D & DR				
教练: 王林																	
1 胡霜梅															17 00:46	12 14 黄艳芳	
2 陆雪云	1/3		3/4				4/7	57.1	3	3	1			17 01:04	13 11 曾蓝花		
5 黄海玉						0/1	0/1	0.0						18 01:33	13 2 林燕群		
6 韦惠文														19 03:10	13 2 林燕群		
7 廖露	6/10	2/3				2/2	10/15	66.7	2	3				20 03:55	13 2 林燕群		
8 韦如芳			2/5	1/1			3/6	50.0		1				21 06:00	13 2 林燕群		
9 蓝雪梅														22 06:30	13 2 林燕群		
10 周琴														22 07:12	14 18 庞娇		
11 曾蓝花	0/4	2/3				0/2	2/9	22.2	1	5				22 07:49	15 2 陆雪云		
12 江燕红														23 08:50	15 2 林燕群		
14 黄艳芳		4/5	0/1		0/1		4/7	57.1		2	1			23 09:38	16 7 廖露		
15 陈依依														23 09:54	16 8 王彬		
16 商志运														24 10:36	17 2 陆雪云		
17 杨杨														24 11:34	18 7 廖露		
18 庞娇		1/1	0/2			1/3	33.3							24 12:07	19 7 廖露		
<b>运动员 合计</b>	<b>7/17</b>	<b>9/12</b>	<b>5/12</b>	<b>1/1</b>	<b>0/1</b>	<b>2/5</b>	<b>24/48</b>	<b>50.0</b>	<b>6</b>	<b>16</b>	<b>3</b>			25 12:36	19 11 吕青纹		
12 江燕红	0/4	3/9	0/2	1/2		2/4	6/21	28.6						26 13:22	19 8 王彬		
16 商志运	4/7	2/6	2/5	2/6	0/4	0/2	10/30	33.3						27 14:08	19 8 王彬		
<b>守门员 合计</b>	<b>4/11</b>	<b>5/15</b>	<b>2/7</b>	<b>3/8</b>	<b>0/4</b>	<b>2/6</b>	<b>16/51</b>	<b>31.4</b>						27 15:09	20 7 廖露		
场上队员: 得分 / 射门																	
守门员: 救球 / 射门																	

快攻	Fast Break	突破	Breakthrough	任意球	Free Throw	7M球	7M Throw	助攻	Assist
警告	Warning	失误	Error	2'	Suspension	D	取消资格	DR	取消资格+报告





## 2016年全国女子手球锦标赛 图式比赛技术统计表

轮次 7

场次 34

201605034-21-1/1

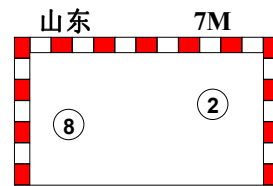
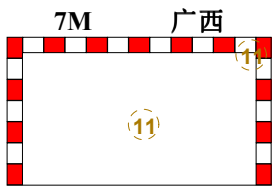
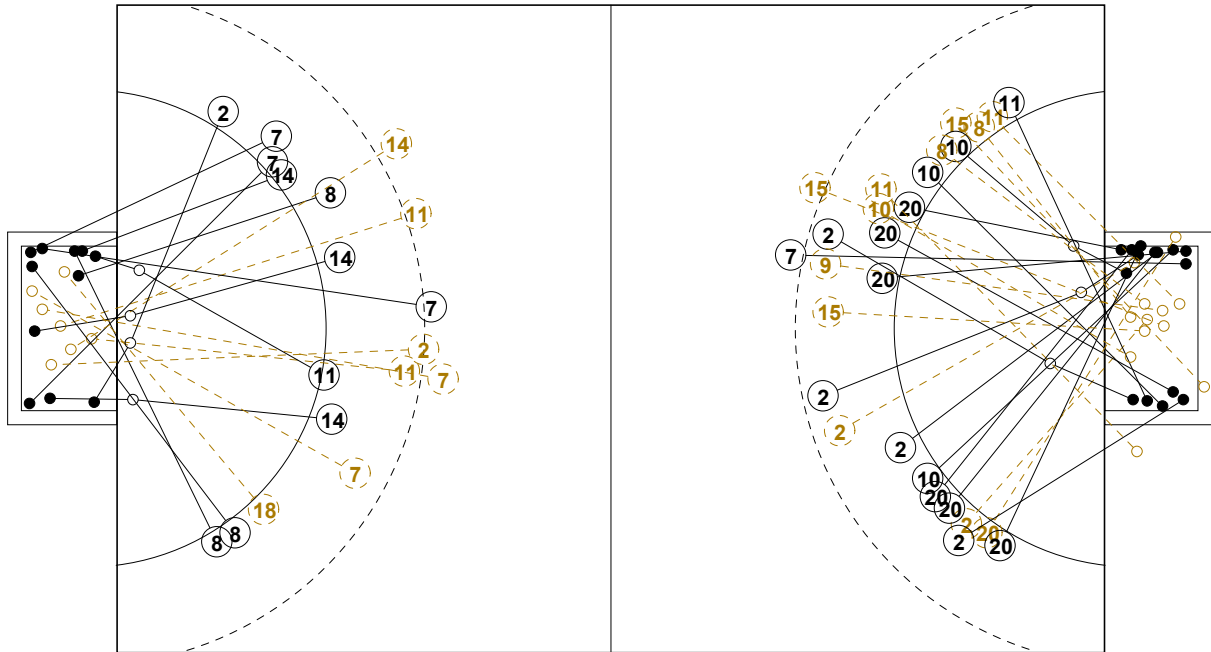

**1st Half**  
11 : 17

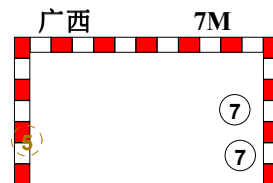
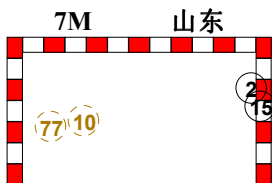
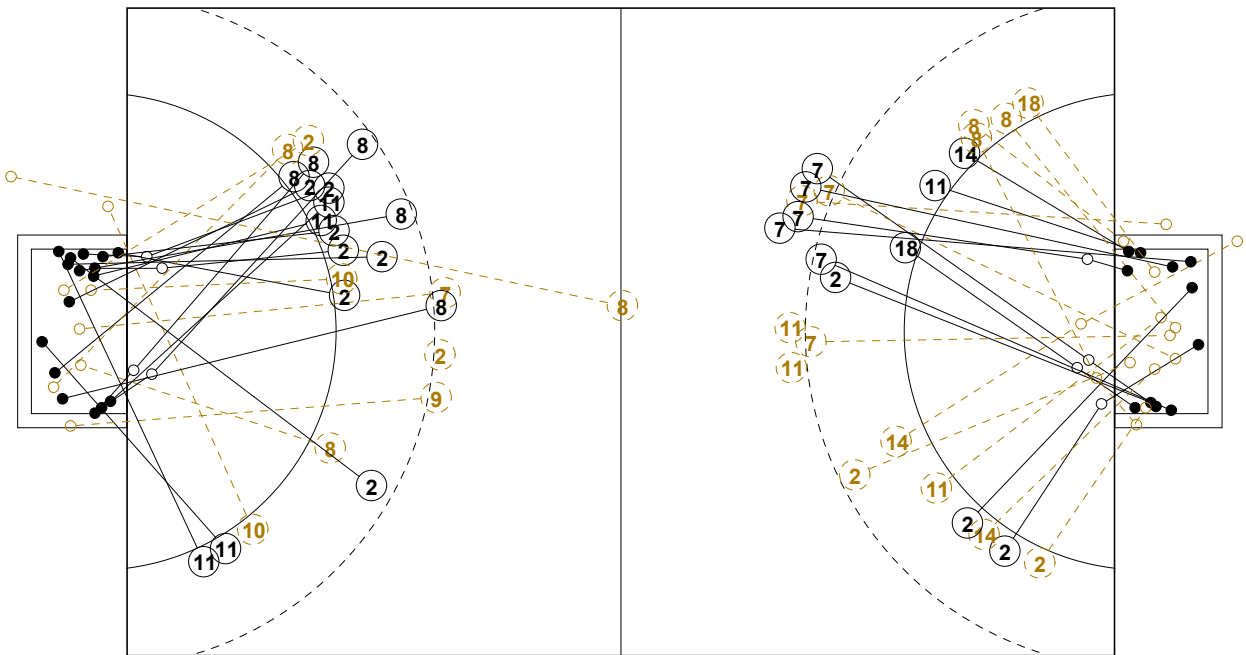

**2nd Half**  
35 : 24





## 2016年全国女子手球锦标赛

## 个人/全队技术统计表

正式表  
手球  
女子预赛  
轮次 7组别 A  
场次 34201605034-14-1/2  
滁州体育馆  
09/09/2016 17:30

号码	姓名	远射	近射	边射	快攻	突破	任意	7M	合计	%	助攻	失误	警告	2'	取消	时间
<b>山东(山东)</b>																
<i>(场上队员)</i>																
1	路畅									0.0%						00:09:44
2	林燕群	3/5	5/6	1/2	1/1	1/1		2/2	13/17	76.5%		2	1	1		01:10:05
7	杨嘉露	1/2							1/2	50.0%						00:16:22
8	王彬	3/4	2/5	0/1				1/1	6/11	54.5%		1				00:23:35
9	周钰婷	0/2							0/2	0.0%				1		00:22:10
10	田秀秀				0/3	3/3		0/1	3/7	42.9%	1	2				00:35:38
11	吕青纹		1/2	3/3	1/2				5/7	71.4%		1				00:48:26
12	张苑琳									0.0%						00:36:00
15	吴作扬	0/1	0/1	0/1				1/1	1/4	25.0%	1	2	1			00:20:24
19	姜伟珊									0.0%						00:04:59
20	张悦		2/2	1/2	3/3				6/7	85.7%	1	1	1			00:58:58
22	朱贇									0.0%						00:14:16
23	徐悦									0.0%						00:33:16
28	崔金娜									0.0%						00:30:55
33	王彩琳									0.0%						00:00:02
77	穆庆丛							0/1	0/1	0.0%		1				00:09:36
<b>合计</b>		7/14	10/16	5/9	5/9	4/4		4/6	35/58	60.3%	3	10	3	2		
<i>(守门员)</i>																
1	路畅	1/3	1/3	3/4				1/2	6/12	50.0%						00:09:44
12	张苑琳	4/7	1/8	0/3	0/1		1/1		6/20	30.0%						00:36:00
22	朱贇	2/4		2/3				0/1	4/8	50.0%						00:14:16
<b>合计</b>		7/14	2/11	5/10	0/1		1/1	1/3	16/40	40.0%						

场上队员：得分/射门

守门员：救球/射门

全队合计	得分	被救	射失	击柱	封球	合计	%
远射	7	4	1	1	1	14	50.0%
近射	10	5	1			16	62.5%
边射	5	2		2		9	55.6%
快攻	5	3	1			9	55.6%
突破	4					4	100.0%
任意							0.0%
7M	4	2				6	66.7%





## 2016年全国女子手球锦标赛

## 个人/全队技术统计表

正式表  
手球  
女子预赛  
轮次 7组别 A  
场次 34201605034-14-2/2  
滁州体育馆  
09/09/2016 17:30

号码	姓名	远射	近射	边射	快攻	突破	任意	7M	合计	%	助攻	失误	警告	2'	取消	时间
<b>广西(广西)</b>																
<i>(上场队员)</i>																
1	胡霜梅									0.0%						00:00:00
2	陆雪云	1/3		3/4					4/7	57.1%	3	3	1			00:54:58
5	黄海玉							0/1	0/1	0.0%						00:34:34
6	韦惠文									0.0%						00:05:27
7	廖露	6/10	2/3					2/2	10/15	66.7%	2	3				00:59:54
8	韦如芳			2/5	1/1				3/6	50.0%		1				01:00:00
9	蓝雪梅									0.0%		1				00:00:21
10	周琴									0.0%						00:00:00
11	曾蓝花	0/4	2/3					0/2	2/9	22.2%	1	5				00:58:52
12	江燕红									0.0%						00:24:02
14	黄艳芳		4/5	0/1			0/1		4/7	57.1%		2	1			00:53:29
15	陈依依									0.0%		1				00:00:58
16	商志运									0.0%						00:35:58
17	杨杨									0.0%			1			00:00:45
18	庞娇		1/1	0/2					1/3	33.3%						00:30:26
<b>合计</b>		7/17	9/12	5/12	1/1		0/1	2/5	24/48	50.0%	6	16	3			
<i>(守门员)</i>																
12	江燕红	0/4	3/9	0/2	1/2			2/4	6/21	28.6%						00:24:02
16	商志运	4/7	2/6	2/5	2/6	0/4		0/2	10/30	33.3%						00:35:58
<b>合计</b>		4/11	5/15	2/7	3/8	0/4		2/6	16/51	31.4%						

场上队员：得分/射门

守门员：救球/射门

全队合计	得分	被救	射失	击柱	封球	合计	%
远射	7	7	1		2	17	41.2%
近射	9	2	1			12	75.0%
边射	5	5		2		12	41.7%
快攻	1					1	100.0%
突破							0.0%
任意		1				1	0.0%
7M	2	1		2		5	40.0%





2016年全国女子手球锦标赛

图式射门区域统计

轮次 7 场次 34

201605034-41-1/1

山东

1 路畅	2 林燕群	7 杨嘉露	8 王彬	9 周钰婷	10 田秀秀	11 吕青纹	12 张苑琳																																																																								
<table border="1"><tr><td></td><td></td><td></td></tr><tr><td></td><td></td><td></td></tr><tr><td></td><td></td><td></td></tr></table>										<table border="1"><tr><td></td><td></td><td>2</td></tr><tr><td>2</td><td></td><td>6</td></tr><tr><td></td><td></td><td>3</td></tr></table>			2	2		6			3	<table border="1"><tr><td>1</td><td></td><td></td></tr><tr><td></td><td></td><td></td></tr><tr><td></td><td></td><td></td></tr></table>	1									<table border="1"><tr><td>2</td><td></td><td></td></tr><tr><td>2</td><td></td><td>1</td></tr><tr><td>1</td><td></td><td></td></tr></table>	2			2		1	1			<table border="1"><tr><td></td><td></td><td></td></tr><tr><td></td><td></td><td></td></tr><tr><td></td><td></td><td></td></tr></table>										<table border="1"><tr><td>1</td><td></td><td></td></tr><tr><td></td><td></td><td>1</td></tr><tr><td>1</td><td></td><td></td></tr></table>	1					1	1			<table border="1"><tr><td></td><td>1</td><td>1</td></tr><tr><td></td><td></td><td>2</td></tr><tr><td>1</td><td></td><td></td></tr></table>		1	1			2	1			<table border="1"><tr><td></td><td></td><td></td></tr><tr><td></td><td></td><td></td></tr><tr><td></td><td></td><td></td></tr></table>									
		2																																																																													
2		6																																																																													
		3																																																																													
1																																																																															
2																																																																															
2		1																																																																													
1																																																																															
1																																																																															
		1																																																																													
1																																																																															
	1	1																																																																													
		2																																																																													
1																																																																															
Post - 0 Miss - 0 Block - 0	Post - 0 Miss - 0 Block - 1	Post - 0 Miss - 0 Block - 0	Post - 0 Miss - 1 Block - 0	Post - 1 Miss - 0 Block - 0	Post - 0 Miss - 1 Block - 0	Post - 0 Miss - 1 Block - 0	Post - 0 Miss - 0 Block - 0																																																																								
15 吴作扬	19 姜伟珊	20 张悦	22 朱贇	23 徐悦	28 崔金娜	33 王彩琳	77 穆庆丛																																																																								
<table border="1"><tr><td></td><td></td><td></td></tr><tr><td></td><td></td><td>1</td></tr><tr><td></td><td></td><td></td></tr></table>						1				<table border="1"><tr><td></td><td></td><td></td></tr><tr><td></td><td></td><td></td></tr><tr><td></td><td></td><td></td></tr></table>										<table border="1"><tr><td>1</td><td></td><td>1</td></tr><tr><td>2</td><td></td><td></td></tr><tr><td>2</td><td></td><td></td></tr></table>	1		1	2			2			<table border="1"><tr><td></td><td></td><td></td></tr><tr><td></td><td></td><td></td></tr><tr><td></td><td></td><td></td></tr></table>										<table border="1"><tr><td></td><td></td><td></td></tr><tr><td></td><td></td><td></td></tr><tr><td></td><td></td><td></td></tr></table>										<table border="1"><tr><td></td><td></td><td></td></tr><tr><td></td><td></td><td></td></tr><tr><td></td><td></td><td></td></tr></table>										<table border="1"><tr><td></td><td></td><td></td></tr><tr><td></td><td></td><td></td></tr><tr><td></td><td></td><td></td></tr></table>										<table border="1"><tr><td></td><td></td><td></td></tr><tr><td></td><td></td><td></td></tr><tr><td></td><td></td><td></td></tr></table>									
		1																																																																													
1		1																																																																													
2																																																																															
2																																																																															
Post - 1 Miss - 0 Block - 0	Post - 0 Miss - 0 Block - 0	Post - 1 Miss - 0 Block - 0	Post - 0 Miss - 0 Block - 0	Post - 0 Miss - 0 Block - 0	Post - 0 Miss - 0 Block - 0	Post - 0 Miss - 0 Block - 0	Post - 0 Miss - 0 Block - 0																																																																								

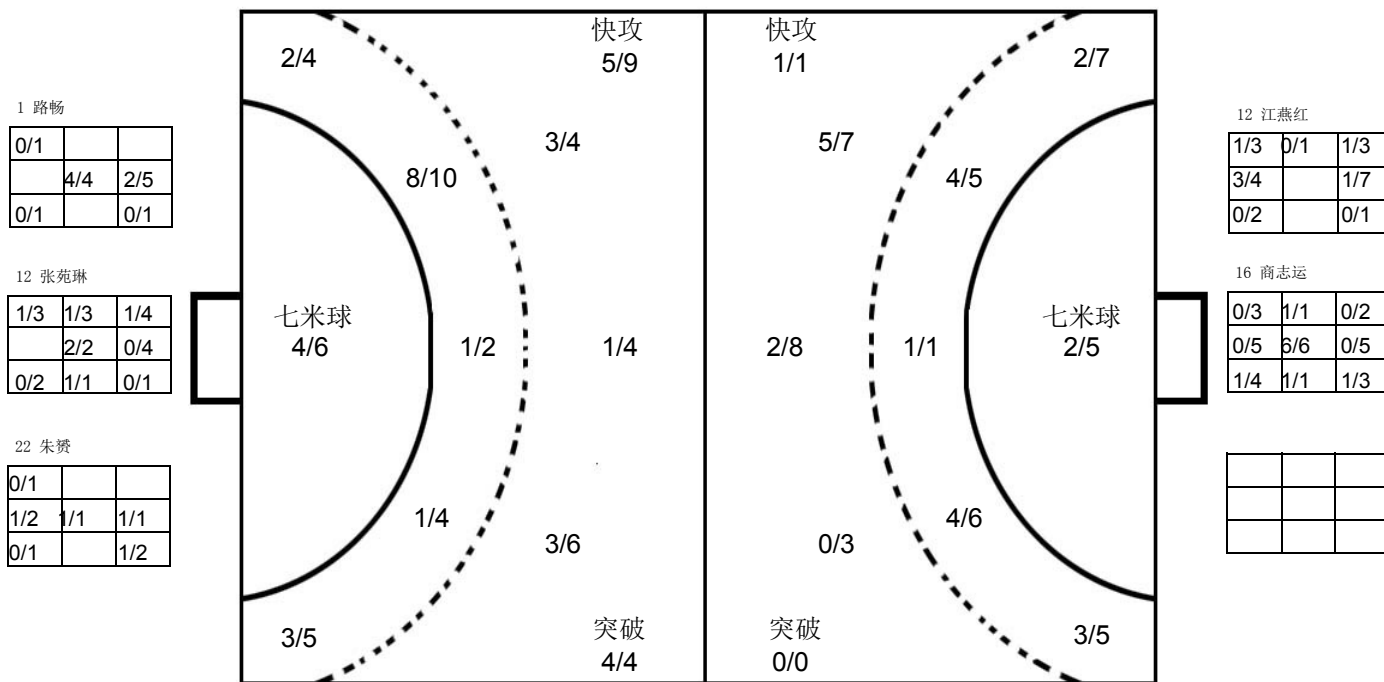

广西

1 胡霜梅	2 陆雪云	5 黄海玉	6 韦惠文	7 廖露	8 韦如芳	9 蓝雪梅	10 周琴																																																																								
<table border="1"><tr><td></td><td></td><td></td></tr><tr><td></td><td></td><td></td></tr><tr><td></td><td></td><td></td></tr></table>										<table border="1"><tr><td>1</td><td>1</td><td></td></tr><tr><td></td><td></td><td>1</td></tr><tr><td>1</td><td></td><td></td></tr></table>	1	1				1	1			<table border="1"><tr><td></td><td></td><td></td></tr><tr><td></td><td></td><td></td></tr><tr><td></td><td></td><td></td></tr></table>										<table border="1"><tr><td></td><td></td><td></td></tr><tr><td></td><td></td><td></td></tr><tr><td></td><td></td><td></td></tr></table>										<table border="1"><tr><td>2</td><td></td><td>2</td></tr><tr><td>1</td><td></td><td>3</td></tr><tr><td>1</td><td></td><td>1</td></tr></table>	2		2	1		3	1		1	<table border="1"><tr><td></td><td></td><td>1</td></tr><tr><td></td><td></td><td>2</td></tr><tr><td></td><td></td><td></td></tr></table>			1			2				<table border="1"><tr><td></td><td></td><td></td></tr><tr><td></td><td></td><td></td></tr><tr><td></td><td></td><td></td></tr></table>										<table border="1"><tr><td></td><td></td><td></td></tr><tr><td></td><td></td><td></td></tr><tr><td></td><td></td><td></td></tr></table>									
1	1																																																																														
		1																																																																													
1																																																																															
2		2																																																																													
1		3																																																																													
1		1																																																																													
		1																																																																													
		2																																																																													
Post - 0 Miss - 0 Block - 0	Post - 0 Miss - 0 Block - 0	Post - 1 Miss - 0 Block - 0	Post - 0 Miss - 0 Block - 0	Post - 0 Miss - 1 Block - 0	Post - 2 Miss - 0 Block - 0	Post - 0 Miss - 0 Block - 0	Post - 0 Miss - 0 Block - 0																																																																								
11 曾蓝花	12 江燕红	14 黄艳芳	15 陈依依	16 商志运	17 杨杨	18 庞娇																																																																									
<table border="1"><tr><td></td><td></td><td></td></tr><tr><td></td><td></td><td></td></tr><tr><td>1</td><td></td><td>1</td></tr></table>							1		1	<table border="1"><tr><td></td><td></td><td></td></tr><tr><td></td><td></td><td></td></tr><tr><td></td><td></td><td></td></tr></table>										<table border="1"><tr><td>1</td><td>1</td><td></td></tr><tr><td></td><td></td><td>1</td></tr><tr><td>1</td><td></td><td></td></tr></table>	1	1				1	1			<table border="1"><tr><td></td><td></td><td></td></tr><tr><td></td><td></td><td></td></tr><tr><td></td><td></td><td></td></tr></table>										<table border="1"><tr><td></td><td></td><td></td></tr><tr><td></td><td></td><td></td></tr><tr><td></td><td></td><td></td></tr></table>										<table border="1"><tr><td></td><td></td><td></td></tr><tr><td></td><td></td><td></td></tr><tr><td></td><td></td><td></td></tr></table>										<table border="1"><tr><td></td><td></td><td></td></tr><tr><td></td><td></td><td></td></tr><tr><td></td><td></td><td>1</td></tr></table>									1	<table border="1"><tr><td></td><td></td><td></td></tr><tr><td></td><td></td><td></td></tr><tr><td></td><td></td><td></td></tr></table>									
1		1																																																																													
1	1																																																																														
		1																																																																													
1																																																																															
		1																																																																													
Post - 1 Miss - 0 Block - 2	Post - 0 Miss - 0 Block - 0	Post - 0 Miss - 1 Block - 0	Post - 0 Miss - 0 Block - 0	Post - 0 Miss - 0 Block - 0	Post - 0 Miss - 0 Block - 0	Post - 0 Miss - 0 Block - 0																																																																									

注释: Post=击柱 Miss=射失 Block=被封





预赛 Group A

女子 全国比赛

2016年全国女子手球锦标赛

Team A <b>A 安徽</b>				Team B <b>B 新疆</b>				Match Number <b>35</b>													
played in China		in the hall 滁州体育馆		on 09/09/2016		at 19:00 hours		Spectators													
Half-time (30')	<b>A</b> 18	<b>B</b> 10	End of playing time	<b>A</b> 28	<b>B</b> 13	1st extra time	<b>A</b>	<b>B</b>	2nd extra time	<b>A</b>	<b>B</b>	After penalty throws	<b>A</b>	<b>B</b>							
Number of 7 m	<b>A</b> 1/2	Team time-out			Full name of players and officials				Team time-out			<b>B</b> 1/1	Number of 7 m								
		1	2	3					1	2	3										
No.	Team <b>A</b>					G	W	2'	D	DR	No.	Team <b>B</b>					G	W	2'	D	DR
1	司艳										3	葛立双					1				
3	李兵					1					6	阿孜古					1				
5	班晨晨					3					7	吴志娟						1			
6	沈萍					4	1				10	李静									
7	赵江川										11	陈培培									
8	徐仕媛										12	艾敏加尔汉									
10	孙来苗					1					15	兰姝娇						1			
14	刘晓妹										17	戴莹莹					1				
16	朱莉珍										18	崔娟					4	1			
17	周婷					9					21	锁珊珊					2				
18	郑冬冬					2					23	张艺璇									
20	周雪婷										26	宋婷婷									
21	李瑶					3					27	谢辰辰									
23	张天洁						1				32	杨雨柔									
41	杜机娟					5					93	张婷婷					4				
46	陶传红																				
<b>A</b>	吴立军										<b>B</b>	于涛 (主教练)									
<b>E</b>	张舜										<b>D</b>	高璇									
<b>A</b>	Signature of Responsible Official of the Teams (Off. A)																			<b>B</b>	
TP	Remarks of Referee / CHA Official																			TP	

Signatures

Referees	张栋 (CHN)	王洋 (CHN)		
Techn. Delegates	高斌 (CHN)			
CHA Official	于中迅 (CHN)			

Note: Number of 7m Throws Awarded to Team A and B, Goals (G), Warnings (W), Suspensions (2'), Direct Disqualification (D), Disqualification with Report (DR) and Team Penalty (TP).

Table Officials: 佟金政 贾俊秋 Statisticians: 刘永欢 黄岩

Printed by PHMS Copyright: IHF / CHA 09/09/2016 19:57:52

Longman Sportsoft  handball@126.com



## 2016年全国女子手球锦标赛 竞赛技术统计(媒体表)

<b>预赛</b>	组别	<b>A</b>	轮次	<b>7</b>	场次	<b>35</b>
滁州体育馆			09/09/2016		201605035-51-1/1	
安徽	<b>安徽</b>	<b>28</b>	vs	<b>13</b>	<b>新疆</b>	新疆
<b>18 : 10</b>						

裁判员	张栋 (CHN)	/	王洋 (CHN)
-----	----------	---	----------

安徽													比赛进程		新疆		
主教练： 孙来苗																	
远射	近射	边射	快攻	突破	任意球	7m球	合计	%	助攻	失误	警告	2'	D & DR				
1 司艳															6 沈萍	1 00:20	0
3 李兵		1/1					1/1	100		2					1 02:20	1 21 锁珊珊	
5 班晨晨	1/1	1/2	0/1	0/1	0/1	1/1	3/7	42.9		1					2 02:42	1	
6 沈萍	4/4	0/1					4/5	80.0	1	1	1				2 03:26	2 18 崔娟	
7 赵江川															3 03:54	2	
8 徐仕媛															4 04:52	2	
10 孙来苗		1/1					1/1	100							5 05:43	2	
14 刘晓妹															6 07:42	2	
16 朱莉珍									2	2					7 08:17	2	
17 周婷	1/1	6/6		1/1	1/1		9/9	100							8 08:51	2	
18 郑冬冬		1/1		1/1			2/2	100							9 11:17	2	
20 周雪婷															9 13:31	3 18 崔娟	
21 李瑶	1/3	0/1		1/2	1/2		3/8	37.5	3	1					9 14:15	4 18 崔娟	
23 张天洁															10 14:25	4	
41 杜机娟		1/1	1/1	3/4		0/1	5/7	71.4							11 16:48	4	
46 陶传红															12 18:35	4	
<b>运动员 合计</b>	<b>7/9</b>	<b>11/14</b>	<b>1/2</b>	<b>6/9</b>	<b>2/4</b>	<b>1/2</b>	<b>28/40</b>	<b>70.0</b>	<b>6</b>	<b>10</b>	<b>2</b>				12 19:07	5 6 阿孜古	
16 朱莉珍	10/17	3/8		1/1	1/1	0/1	15/28	53.6	2	2					12 20:45	6 17 戴莹莹	
<b>守门员 合计</b>	<b>10/17</b>	<b>3/8</b>		<b>1/1</b>	<b>1/1</b>	<b>0/1</b>	<b>15/28</b>	<b>53.6</b>	<b>2</b>	<b>2</b>					13 21:03	6	
新疆																	
教练： 于涛																	
远射	近射	边射	快攻	突破	任意球	7m球	合计	%	助攻	失误	警告	2'	D & DR				
3 葛立双	1/3	0/1	0/1				1/5	20.0							17 周婷	18 00:47	11 3 葛立双
6 阿孜古		1/1		0/1			1/2	50.0		2					19 01:28	11	
7 吴志娟		0/1	0/1				0/2	0.0							20 04:20	11	
10 李静															21 李瑶	21 04:57	11
11 陈培培															22 05:54	11	
12 艾敏加尔汉															23 06:37	11	
15 兰姝娇			0/1				0/1	0.0							24 07:34	11	
17 戴莹莹		1/1					1/1	100	1	3					25 08:12	11	
18 崔娟	1/7	2/3				1/1	4/11	36.4			1				25 08:46	12 18 崔娟	
21 锁珊珊	1/8	1/2					2/10	20.0	1	3					26 09:05	12	
23 张艺璇															26 10:08	13 21 锁珊珊	
26 宋婷婷															27 10:32	13	
27 谢辰辰	0/2						0/2	0.0		1					28 13:41	13	
32 杨雨柔																	
93 张婷婷	4/9				0/1		4/10	40.0	1	2							
<b>运动员 合计</b>	<b>7/29</b>	<b>5/9</b>	<b>0/3</b>	<b>0/1</b>	<b>0/1</b>	<b>1/1</b>	<b>13/44</b>	<b>29.5</b>	<b>3</b>	<b>11</b>	<b>3</b>						
10 李静	0/5	0/3	1/1	1/3	0/1	0/1	2/14	14.3									
32 杨雨柔	0/2	2/10	0/1	1/5	1/2	1/1	5/21	23.8									
<b>守门员 合计</b>	<b>0/7</b>	<b>2/13</b>	<b>1/2</b>	<b>2/8</b>	<b>1/3</b>	<b>1/2</b>	<b>7/35</b>	<b>20.0</b>									

场上队员： 得分 / 射门

守门员： 救球 / 射门

快攻	Fast Break	突破	Breakthrough	任意球	Free Throw	7M球	7M Throw	助攻	Assist
警告	Warning	失误	Error	2'	Suspension	D	取消资格	DR	取消资格+报告





### 2016年全国女子手球锦标赛 图式比赛技术统计表

轮次 7

场次 35

201605035-21-1/1

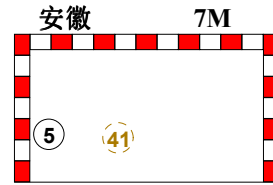
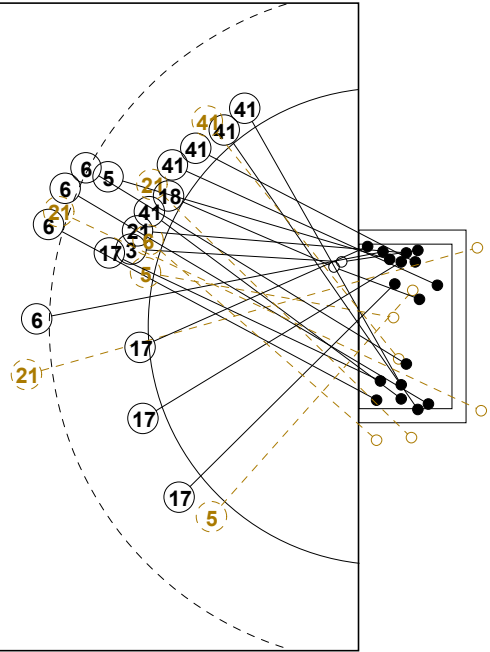
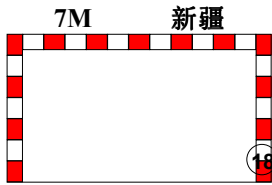
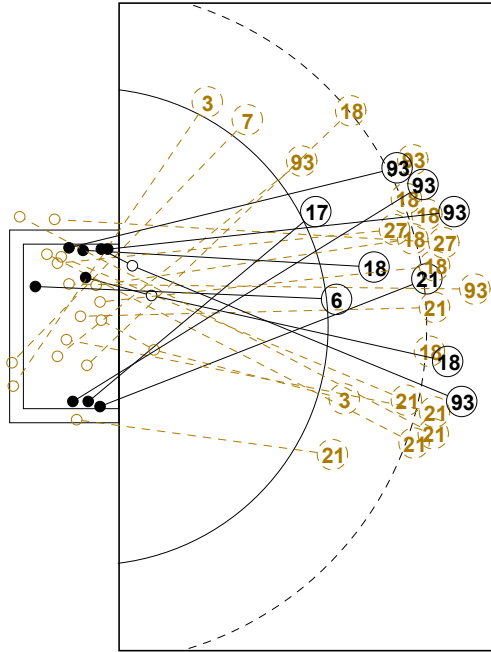

1st Half  
10 : 18

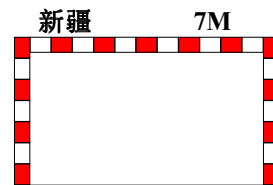
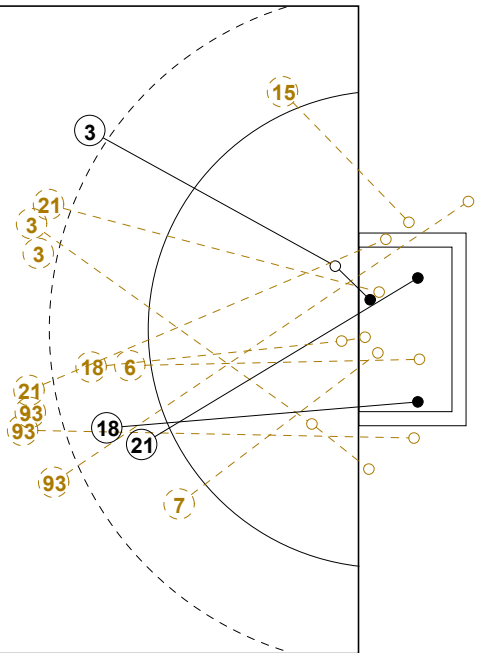
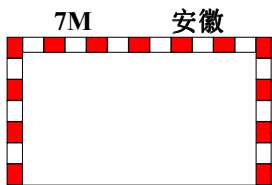
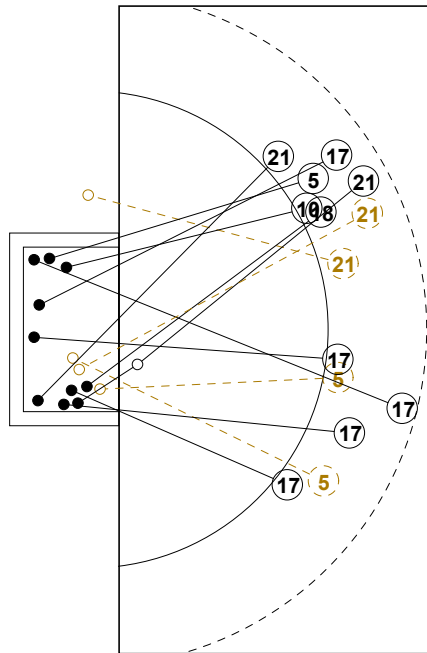

2nd Half  
28 : 13



## 2016年全国女子手球锦标赛

## 个人/全队技术统计表

正式表  
手球  
女子预赛  
轮次 7组别 A  
场次 35201605035-14-1/2  
滁州体育馆  
09/09/2016 19:00

号码	姓名	远射	近射	边射	快攻	突破	任意	7M	合计	%	助攻	失误	警告	2'	取消	时间
<b>安徽(安徽)</b>																
<i>(场上队员)</i>																
1	司艳									0.0%						00:00:00
3	李兵		1/1						1/1	100%		2				00:35:53
5	班晨晨	1/1	1/2	0/1	0/1	0/1		1/1	3/7	42.9%		1				00:43:49
6	沈萍	4/4	0/1						4/5	80.0%	1	1	1			00:30:00
7	赵江川									0.0%						00:00:00
8	徐仕媛									0.0%						00:00:00
10	孙来苗		1/1						1/1	100%						00:13:49
14	刘晓妹									0.0%						00:00:00
16	朱莉珍									0.0%	2	2				00:43:49
17	周婷	1/1	6/6		1/1	1/1			9/9	100%						00:52:45
18	郑冬冬		1/1		1/1				2/2	100%						00:22:59
20	周雪婷									0.0%		1				00:03:57
21	李瑶	1/3	0/1		1/2	1/2			3/8	37.5%	3	1				00:43:49
23	张天洁									0.0%			1			00:02:10
41	杜机娟		1/1	1/1	3/4			0/1	5/7	71.4%		2				00:39:51
46	陶传红									0.0%						00:00:00
<b>合计</b>		7/9	11/14	1/2	6/9	2/4		1/2	28/40	70.0%	6	10	2			
<i>(守门员)</i>																
16	朱莉珍	10/17	3/8		1/1	1/1		0/1	15/28	53.6%	2	2				00:43:49
<b>合计</b>																
<b>合计</b>		10/17	3/8		1/1	1/1		0/1	15/28	53.6%	2	2				

场上队员：得分/射门

守门员：救球/射门

全队合计	得分	被救	射失	击柱	封球	合计	%
远射	7		2			9	77.8%
近射	11	2	1			14	78.6%
边射	1	1				2	50.0%
快攻	6	2	1			9	66.7%
突破	2	1	1			4	50.0%
任意							0.0%
7M	1	1				2	50.0%





## 2016年全国女子手球锦标赛

## 个人/全队技术统计表

正式表  
手球  
女子预赛  
轮次 7组别 A  
场次 35201605035-14-2/2  
滁州体育馆  
09/09/2016 19:00

号码	姓名	远射	近射	边射	快攻	突破	任意	7M	合计	%	助攻	失误	警告	2'	取消	时间
<b>新疆(新疆)</b>																
<i>(上场队员)</i>																
3	葛立双	1/3	0/1	0/1					1/5	20.0%						00:16:03
6	阿孜古		1/1		0/1				1/2	50.0%		2				00:15:02
7	吴志娟		0/1	0/1					0/2	0.0%			1			00:30:17
10	李静									0.0%						00:16:22
11	陈培培									0.0%						00:00:00
12	艾敏加尔汉									0.0%						00:01:33
15	兰姝娇			0/1					0/1	0.0%			1			00:32:48
17	戴莹莹		1/1						1/1	100%	1	3				00:25:49
18	崔娟	1/7	2/3					1/1	4/11	36.4%			1			00:25:22
21	锁珊珊	1/8	1/2						2/10	20.0%	1	3				00:31:57
23	张艺璇									0.0%						00:18:28
26	宋婷婷									0.0%						00:01:58
27	谢辰辰	0/2							0/2	0.0%		1				00:26:56
32	杨雨柔									0.0%						00:27:27
93	张婷婷	4/9				0/1			4/10	40.0%	1	2				00:38:24
<b>合计</b>		7/29	5/9	0/3	0/1	0/1		1/1	13/44	29.5%	3	11	3			
<i>(守门员)</i>																
10	李静	0/5	0/3	1/1	1/3	0/1		0/1	2/14	14.3%						00:16:22
32	杨雨柔	0/2	2/10	0/1	1/5	1/2		1/1	5/21	23.8%						00:27:27
<b>合计</b>		0/7	2/13	1/2	2/8	1/3		1/2	7/35	20.0%						

场上队员：得分/射门

守门员：救球/射门

全队合计	得分	被救	射失	击柱	封球	合计	%
远射	7	10	5	1	6	29	24.1%
近射	5	3		1		9	55.6%
边射			1	2		3	0.0%
快攻		1				1	0.0%
突破		1				1	0.0%
任意							0.0%
7M	1					1	100.0%







### 2016年全国女子手球锦标赛

#### 图式射门区域统计

轮次 7 场次 35

201605035-41-1/1

## 安徽

1 司艳	3 李兵	5 班晨晨	6 沈萍	7 赵江川	8 徐仕媛	10 孙来苗	14 刘晓妹																																																																								
<table border="1"><tr><td></td><td></td><td></td></tr><tr><td></td><td></td><td></td></tr><tr><td></td><td></td><td></td></tr></table>										<table border="1"><tr><td></td><td></td><td></td></tr><tr><td>1</td><td></td><td></td></tr><tr><td></td><td></td><td></td></tr></table>				1						<table border="1"><tr><td></td><td></td><td>1</td></tr><tr><td>2</td><td></td><td></td></tr><tr><td></td><td></td><td></td></tr></table>			1	2						<table border="1"><tr><td></td><td></td><td>1</td></tr><tr><td></td><td></td><td>1</td></tr><tr><td>1</td><td></td><td>1</td></tr></table>			1			1	1		1	<table border="1"><tr><td></td><td></td><td></td></tr><tr><td></td><td></td><td></td></tr><tr><td></td><td></td><td></td></tr></table>										<table border="1"><tr><td></td><td></td><td></td></tr><tr><td></td><td></td><td></td></tr><tr><td></td><td></td><td></td></tr></table>										<table border="1"><tr><td></td><td></td><td></td></tr><tr><td></td><td></td><td>1</td></tr><tr><td></td><td></td><td></td></tr></table>						1				<table border="1"><tr><td></td><td></td><td></td></tr><tr><td></td><td></td><td></td></tr><tr><td></td><td></td><td></td></tr></table>									
1																																																																															
		1																																																																													
2																																																																															
		1																																																																													
		1																																																																													
1		1																																																																													
		1																																																																													
Post - 0 Miss - 0 Block - 0	Post - 0 Miss - 0 Block - 0	Post - 0 Miss - 0 Block - 0	Post - 0 Miss - 1 Block - 0	Post - 0 Miss - 0 Block - 0	Post - 0 Miss - 0 Block - 0	Post - 0 Miss - 0 Block - 0	Post - 0 Miss - 0 Block - 0																																																																								
16 朱莉珍	17 周婷	18 郑冬冬	20 周雪婷	21 李瑶	23 张天洁	41 杜机娟	46 陶传红																																																																								
<table border="1"><tr><td></td><td></td><td></td></tr><tr><td></td><td></td><td></td></tr><tr><td></td><td></td><td></td></tr></table>										<table border="1"><tr><td></td><td>2</td><td>1</td></tr><tr><td>4</td><td></td><td></td></tr><tr><td>1</td><td></td><td>1</td></tr></table>		2	1	4			1		1	<table border="1"><tr><td></td><td></td><td></td></tr><tr><td>1</td><td>1</td><td></td></tr><tr><td></td><td></td><td></td></tr></table>				1	1					<table border="1"><tr><td></td><td></td><td></td></tr><tr><td></td><td></td><td></td></tr><tr><td></td><td></td><td></td></tr></table>										<table border="1"><tr><td>1</td><td></td><td></td></tr><tr><td>2</td><td></td><td></td></tr><tr><td></td><td></td><td></td></tr></table>	1			2						<table border="1"><tr><td></td><td></td><td></td></tr><tr><td></td><td></td><td></td></tr><tr><td></td><td></td><td></td></tr></table>										<table border="1"><tr><td></td><td>1</td><td></td></tr><tr><td>1</td><td></td><td>3</td></tr><tr><td></td><td></td><td></td></tr></table>		1		1		3				<table border="1"><tr><td></td><td></td><td></td></tr><tr><td></td><td></td><td></td></tr><tr><td></td><td></td><td></td></tr></table>									
	2	1																																																																													
4																																																																															
1		1																																																																													
1	1																																																																														
1																																																																															
2																																																																															
	1																																																																														
1		3																																																																													
Post - 0 Miss - 0 Block - 0	Post - 0 Miss - 0 Block - 0	Post - 0 Miss - 0 Block - 0	Post - 0 Miss - 0 Block - 0	Post - 0 Miss - 4 Block - 0	Post - 0 Miss - 0 Block - 0	Post - 0 Miss - 0 Block - 0	Post - 0 Miss - 0 Block - 0																																																																								

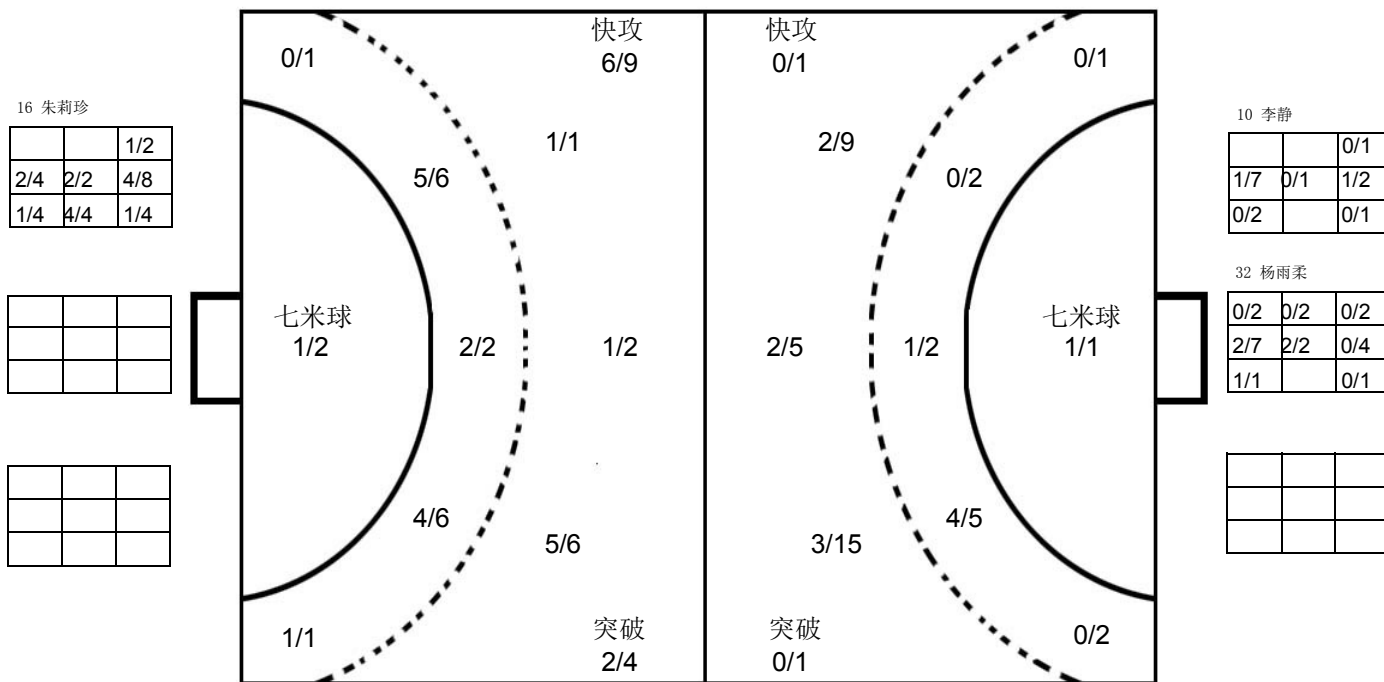

## 新疆

3 葛立双	6 阿孜古	7 吴志娟	10 李静	11 陈培培	12 艾敏加尔汉	15 兰姝娇	17 戴莹莹																																																																								
<table border="1"><tr><td></td><td></td><td></td></tr><tr><td>1</td><td></td><td></td></tr><tr><td></td><td></td><td></td></tr></table>				1						<table border="1"><tr><td></td><td></td><td>1</td></tr><tr><td></td><td></td><td></td></tr><tr><td></td><td></td><td></td></tr></table>			1							<table border="1"><tr><td></td><td></td><td></td></tr><tr><td></td><td></td><td></td></tr><tr><td></td><td></td><td></td></tr></table>										<table border="1"><tr><td></td><td></td><td></td></tr><tr><td></td><td></td><td></td></tr><tr><td></td><td></td><td></td></tr></table>										<table border="1"><tr><td></td><td></td><td></td></tr><tr><td></td><td></td><td></td></tr><tr><td></td><td></td><td></td></tr></table>										<table border="1"><tr><td></td><td></td><td></td></tr><tr><td></td><td></td><td></td></tr><tr><td></td><td></td><td></td></tr></table>										<table border="1"><tr><td></td><td></td><td></td></tr><tr><td></td><td></td><td></td></tr><tr><td></td><td></td><td></td></tr></table>										<table border="1"><tr><td></td><td></td><td></td></tr><tr><td></td><td></td><td></td></tr><tr><td></td><td></td><td></td></tr></table>									
1																																																																															
		1																																																																													
Post - 1 Miss - 1 Block - 1	Post - 0 Miss - 0 Block - 0	Post - 1 Miss - 0 Block - 0	Post - 0 Miss - 0 Block - 0	Post - 0 Miss - 0 Block - 0	Post - 0 Miss - 0 Block - 0	Post - 0 Miss - 1 Block - 0	Post - 0 Miss - 0 Block - 0																																																																								
18 崔娟	21 锁珊珊	23 张艺璇	26 宋婷婷	27 谢辰辰	32 杨雨柔	93 张婷婷																																																																									
<table border="1"><tr><td></td><td></td><td></td></tr><tr><td></td><td></td><td>3</td></tr><tr><td></td><td></td><td>1</td></tr></table>						3			1	<table border="1"><tr><td></td><td></td><td></td></tr><tr><td>1</td><td></td><td></td></tr><tr><td>1</td><td></td><td></td></tr></table>				1			1			<table border="1"><tr><td></td><td></td><td></td></tr><tr><td></td><td></td><td></td></tr><tr><td></td><td></td><td></td></tr></table>										<table border="1"><tr><td></td><td></td><td></td></tr><tr><td></td><td></td><td></td></tr><tr><td></td><td></td><td></td></tr></table>										<table border="1"><tr><td></td><td></td><td></td></tr><tr><td></td><td></td><td></td></tr><tr><td></td><td></td><td></td></tr></table>										<table border="1"><tr><td></td><td></td><td></td></tr><tr><td></td><td></td><td></td></tr><tr><td></td><td></td><td></td></tr></table>										<table border="1"><tr><td></td><td>1</td><td>1</td></tr><tr><td></td><td></td><td>2</td></tr><tr><td></td><td></td><td></td></tr></table>		1	1			2				<table border="1"><tr><td></td><td></td><td></td></tr><tr><td></td><td></td><td></td></tr><tr><td></td><td></td><td></td></tr></table>									
		3																																																																													
		1																																																																													
1																																																																															
1																																																																															
	1	1																																																																													
		2																																																																													
Post - 0 Miss - 0 Block - 3	Post - 2 Miss - 1 Block - 0	Post - 0 Miss - 0 Block - 0	Post - 0 Miss - 0 Block - 0	Post - 0 Miss - 1 Block - 0	Post - 0 Miss - 0 Block - 0	Post - 0 Miss - 2 Block - 2																																																																									

注释: Post=击柱 Miss=射失 Block=被封



预赛 Group A

女子 全国比赛

2016年全国女子手球锦标赛

Team A <b>A 江苏</b>				Team B <b>B 广东</b>				Match Number <b>36</b>													
played in China		in the hall 滁州体育馆		on 09/09/2016		at 20:30 hours		Spectators													
Half-time (30')	<b>A</b> 17	<b>B</b> 9	End of playing time	<b>A</b> 27	<b>B</b> 12	1st extra time	<b>A</b>	<b>B</b>	2nd extra time	<b>A</b>	<b>B</b>	After penalty throws	<b>A</b>	<b>B</b>							
Number of 7 m	<b>A</b> 1 / 1	Team time-out 1 2 3			Full name of players and officials				Team time-out 1 2 3			<b>B</b> 3 / 3	Number of 7 m								
No.	Team <b>A</b>					G	W	2'	D	DR	No.	Team <b>B</b>					G	W	2'	D	DR
1	陆婷										3	安妮									
3	张海侠					4					5	李纯									
4	赵佳芹					2					7	刘彤									
5	高媛媛										8	李诗棋									
8	乔如					1					9	韦宝桂					2				
9	莫蒙蒙					1					11	魏梦庭					3				
10	王可可										15	杨慧									
11	于源源					6	1				16	李娟									
12	黄霞										18	李玉玲					1				
13	黄慧影										19	邝雪花									
16	王小华										20	李军政					2	1			
17	修丽杰					4		1			22	刘晓玉									
18	韦秋香										23	王如					1				
23	王书慧					6					26	马晓卉									
33	金梦青					2	1				28	刘金兰					2				
69	蓝小玲					1	1				31	史小军					1	1			
B	金甲洙 (主教练)										A	李细利									
C	马彪										B	郭艳辉 (主教练)									
D	李海鹰										D	祝捷									
E	陈志伟										E	赵善良									
<b>A</b>	Signature of Responsible Official of the Teams (Off. A)										<b>B</b>										
TP	Remarks of Referee / CHA Official										TP										

Signatures

Referees: 马晓晔 (CHN)      王雨洋 (CHN)

Techn. Delegates: 高斌 (CHN)

CHA Official: 于中迅 (CHN)

Note: Number of 7m Throws Awarded to Team A and B, Goals (G), Warnings (W), Suspensions (2'), Direct Disqualification (D), Disqualification with Report (DR) and Team Penalty (TP).

Table Officials: 李诚      赵涵      Statisticians: 黄岩      刘永欢

Printed by PHMS Copyright: IHF / CHA 09/09/2016 21:09:57

Longman Sportsoft  handball@126.com



## 2016年全国女子手球锦标赛 竞赛技术统计(媒体表)

<b>预赛</b>	组别	<b>A</b>	轮次	<b>7</b>	场次	<b>36</b>
滁州体育馆			09/09/2016		201605036-51-1/1	
江苏	<b>江苏</b>	<b>27</b>	vs	<b>12</b>	广东	广东
<b>17 : 9</b>						

裁判员	马晓晔 (CHN)	/	王雨洋 (CHN)
-----	-----------	---	-----------

江苏		远	近	边	快	突	任意	7m	合计	%	助攻	失误	警告	2'	D & DR	江苏		比赛进程	广东		
主教练：金甲洙		射	射	射	攻	破	球	球													
1	陆婷																4	赵佳芹	1	00:27	0
3	张海侠			1/2	3/4				4/6	66.7							23	王书慧	2	03:54	0
4	赵佳芹	1/3			1/1				2/4	50.0	6						11	于源源	3	06:14	1
5	高媛媛																69	蓝小玲	4	06:54	1
8	乔如	1/1							1/1	100		2					17	修丽杰	5	07:50	1
9	莫蒙蒙				1/2				1/2	50.0							17	修丽杰	5	08:38	2
10	王可可																6	修丽杰	6	08:54	2
11	于源源			3/5	3/3				6/8	75.0							6	王如	6	10:12	3
12	黄霞																6	魏梦庭	6	11:22	4
13	黄慧影																6	韦宝桂	5	12:53	5
16	王小华																7	于源源	7	13:10	5
17	修丽杰	3/5	0/2		1/1				4/8	50.0							3	张海侠	8	13:40	5
18	韦秋香										3	1					17	修丽杰	9	14:18	5
23	王书慧	1/3	3/3	0/3	1/1	0/1		1/1	6/12	50.0		2					4	赵佳芹	10	15:26	5
33	金梦青				2/2				2/2	100							3	张海侠	10	15:56	6
69	蓝小玲				1/1				1/1	100	1	3	1				11	于源源	10	21:04	6
<b>运动员 合计</b>		6/12	3/5	4/10	13/15	0/1		1/1	27/44	61.4	10	8	3	1			11	于源源	12	22:10	6
12	黄霞							0/1	0/1	0.0							3	张海侠	11	22:46	6
16	王小华	5/6	4/8	7/10		0/1		0/2	16/27	59.3	3	1					3	张海侠	13	22:46	6
<b>守门员 合计</b>		5/6	4/8	7/10		0/1		0/3	16/28	57.1	3	1					3	张海侠	14	23:31	6
<b>广东</b>																					
教练：郭艳辉		远	近	边	快	突	任意	7m	合计	%	助攻	失误	警告	2'	D & DR						
3	安妮																				
5	李纯																				
7	刘彤	0/1		0/2					0/3	0.0	1	3									
8	李诗棋																				
9	韦宝桂	1/2					0/1	1/1	2/4	50.0		1									
11	魏梦庭	0/2	1/1	1/1				1/1	3/5	60.0		2									
15	杨慧																				
16	李娟																				
18	李玉玲	0/1	1/1						1/2	50.0		3									
19	卞雪花	0/4	0/2	0/1					0/7	0.0	1	3									
20	李军政		1/2	1/4					2/6	33.3		3	1								
22	刘晓玉																				
23	王如		1/3						1/3	33.3		1									
26	马晓卉																				
28	刘金兰	0/2		0/2		1/1		1/1	2/6	33.3		2									
31	史小军			1/1					1/1	100											
<b>运动员 合计</b>		1/12	4/9	3/11		1/1	0/1	3/3	12/37	32.4	2	19	2								
16	李娟	0/2	1/2	0/1	0/2			0/1	1/8	12.5											
22	刘晓玉	1/5	0/2	0/1	0/2				1/10	10.0											
26	马晓卉	1/1	1/1	4/6	1/10				7/18	38.9											
<b>守门员 合计</b>		2/8	2/5	4/8	1/14			0/1	9/36	25.0											

场上队员：得分 / 射门

守门员：救球 / 射门

快攻	Fast Break		突破	Breakthrough		任意球	Free Throw		7M球	7M Throw		助攻	Assist
警告	Warning		失误	Error		2'	Suspension		D	取消资格		DR	取消资格+报告





### 2016年全国女子手球锦标赛 图式比赛技术统计表

轮次 7

场次 36

201605036-21-1/1

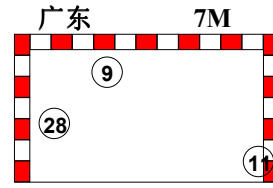
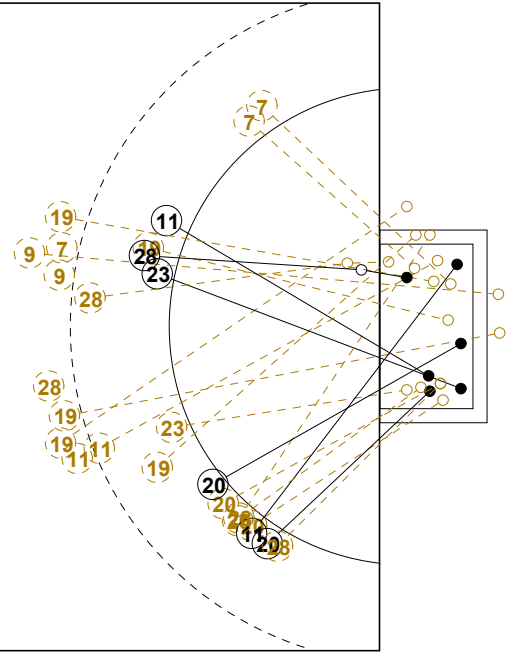
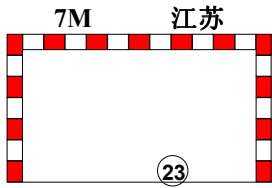
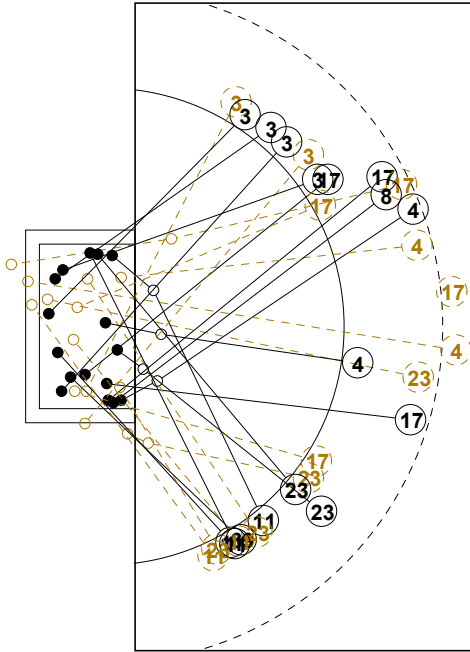

1st Half  
17 : 9

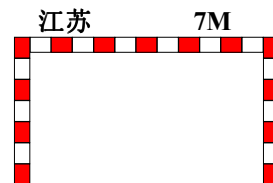
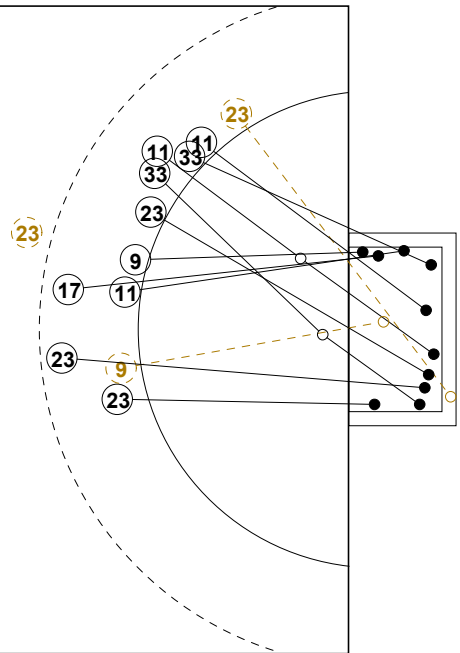
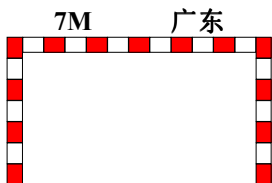
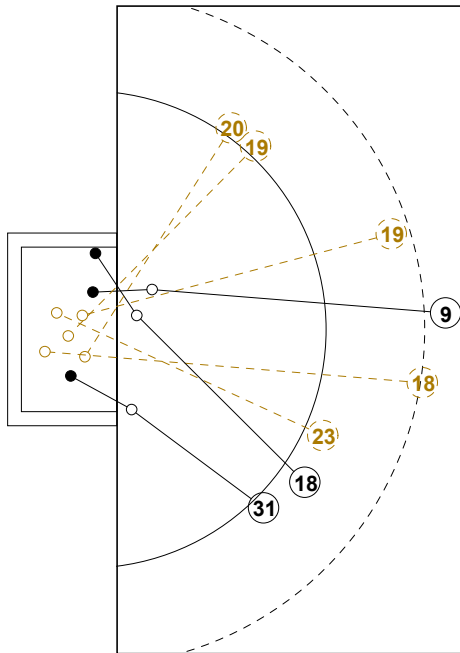

2nd Half  
12 : 27



## 2016年全国女子手球锦标赛

## 个人/全队技术统计表

正式表  
手球  
女子预赛  
轮次 7组别 A  
场次 36201605036-14-1/2  
滁州体育馆  
09/09/2016 20:30

号码	姓名	远射	近射	边射	快攻	突破	任意	7M	合计	%	助攻	失误	警告	2'	取消	时间
<b>江苏(江苏)</b>																
<i>(场上队员)</i>																
1	陆婷									0.0%						00:00:00
3	张海侠			1/2	3/4				4/6	66.7%						00:30:46
4	赵佳芹	1/3			1/1				2/4	50.0%	6					00:41:07
5	高媛媛									0.0%						00:00:00
8	乔如	1/1							1/1	100%		2				00:30:00
9	莫蒙蒙				1/2				1/2	50.0%						00:12:29
10	王可可									0.0%						00:00:44
11	于源源			3/5	3/3				6/8	75.0%			1			00:39:53
12	黄霞									0.0%						00:00:12
13	黄慧影									0.0%						00:00:00
16	王小华									0.0%	3	1				00:42:17
17	修丽杰	3/5	0/2		1/1				4/8	50.0%				1		00:42:29
18	韦秋香									0.0%						00:00:00
23	王书慧	1/3	3/3	0/3	1/1	0/1		1/1	6/12	50.0%		2				00:11:44
33	金梦青				2/2				2/2	100%				1		00:14:17
69	蓝小玲				1/1				1/1	100%	1	3	1			00:30:22
<b>合计</b>		6/12	3/5	4/10	13/15	0/1		1/1	27/44	61.4%	10	8	3	1		
<i>(守门员)</i>																
12	黄霞							0/1	0/1	0.0%						00:00:12
16	王小华	5/6	4/8	7/10		0/1		0/2	16/27	59.3%	3	1				00:42:17
<b>合计</b>		5/6	4/8	7/10		0/1		0/3	16/28	57.1%	3	1				

场上队员：得分/射门

守门员：救球/射门

全队合计	得分	被救	射失	击柱	封球	合计	%
远射	6	2	1	1	2	12	50.0%
近射	3	2				5	60.0%
边射	4	4		2		10	40.0%
快攻	13	1		1		15	86.7%
突破			1			1	0.0%
任意							0.0%
7M	1					1	100.0%





## 2016年全国女子手球锦标赛

## 个人/全队技术统计表

正式表  
手球  
女子预赛  
轮次 7组别 A  
场次 36201605036-14-2/2  
滁州体育馆  
09/09/2016 20:30

号码	姓名	远射	近射	边射	快攻	突破	任意	7M	合计	%	助攻	失误	警告	2'	取消	时间
<b>广东(广东)</b>																
<i>(上场队员)</i>																
3	安妮									0.0%		1				00:13:22
5	李纯									0.0%						00:00:00
7	刘彤	0/1		0/2					0/3	0.0%	1	3				00:42:29
8	李诗棋									0.0%						00:00:00
9	韦宝桂	1/2					0/1	1/1	2/4	50.0%		1				00:29:01
11	魏梦庭	0/2	1/1	1/1				1/1	3/5	60.0%		2				00:31:06
15	杨慧									0.0%						00:00:00
16	李娟									0.0%						00:08:50
18	李玉玲	0/1	1/1						1/2	50.0%		3				00:24:23
19	邝雪花	0/4	0/2	0/1					0/7	0.0%	1	3				00:30:25
20	李军政		1/2	1/4					2/6	33.3%		3	1			00:32:42
22	刘晓玉									0.0%						00:15:50
23	王如		1/3						1/3	33.3%		1				00:29:39
26	马晓卉									0.0%						00:17:49
28	刘金兰	0/2		0/2		1/1		1/1	2/6	33.3%		2				00:08:40
31	史小军			1/1					1/1	100%			1			00:12:47
<b>合计</b>		1/12	4/9	3/11		1/1	0/1	3/3	12/37	32.4%	2	19	2			
<i>(守门员)</i>																
16	李娟	0/2	1/2	0/1	0/2			0/1	1/8	12.5%						00:08:50
22	刘晓玉	1/5	0/2	0/1	0/2				1/10	10.0%						00:15:50
26	马晓卉	1/1	1/1	4/6	1/10				7/18	38.9%						00:17:49
<b>合计</b>		2/8	2/5	4/8	1/14			0/1	9/36	25.0%						

场上队员：得分/射门

守门员：救球/射门

全队合计	得分	被救	射失	击柱	封球	合计	%
远射	1	5	2		4	12	8.3%
近射	4	4		1		9	44.4%
边射	3	7		1		11	27.3%
快攻							0.0%
突破	1					1	100.0%
任意			1			1	0.0%
7M	3					3	100.0%





2016年全国女子手球锦标赛

图式射门区域统计

轮次 7 场次 36

201605036-41-1/1

江苏

1 陆婷	3 张海侠	4 赵佳芹	5 高媛媛	8 乔如	9 莫蒙蒙	10 王可可	11 于源源																																																																								
<table border="1"><tr><td></td><td></td><td></td></tr><tr><td></td><td></td><td></td></tr><tr><td></td><td></td><td></td></tr></table>										<table border="1"><tr><td>1</td><td>1</td><td>2</td></tr><tr><td></td><td></td><td></td></tr><tr><td></td><td></td><td></td></tr></table>	1	1	2							<table border="1"><tr><td></td><td></td><td></td></tr><tr><td></td><td></td><td></td></tr><tr><td>1</td><td>1</td><td></td></tr></table>							1	1		<table border="1"><tr><td></td><td></td><td></td></tr><tr><td></td><td></td><td></td></tr><tr><td></td><td></td><td></td></tr></table>										<table border="1"><tr><td></td><td></td><td></td></tr><tr><td></td><td></td><td></td></tr><tr><td>1</td><td></td><td></td></tr></table>							1			<table border="1"><tr><td></td><td></td><td></td></tr><tr><td></td><td></td><td></td></tr><tr><td>1</td><td></td><td></td></tr></table>							1			<table border="1"><tr><td></td><td></td><td></td></tr><tr><td></td><td></td><td></td></tr><tr><td></td><td></td><td></td></tr></table>										<table border="1"><tr><td></td><td>3</td><td></td></tr><tr><td>1</td><td></td><td>1</td></tr><tr><td></td><td></td><td>1</td></tr></table>		3		1		1			1
1	1	2																																																																													
1	1																																																																														
1																																																																															
1																																																																															
	3																																																																														
1		1																																																																													
		1																																																																													
Post - 0 Miss - 0 Block - 0	Post - 1 Miss - 0 Block - 0	Post - 1 Miss - 0 Block - 0	Post - 0 Miss - 0 Block - 0	Post - 0 Miss - 0 Block - 0	Post - 0 Miss - 0 Block - 0	Post - 0 Miss - 0 Block - 0	Post - 1 Miss - 0 Block - 0																																																																								
12 黄霞	13 黄慧影	16 王小华	17 修丽杰	18 韦秋香	23 王书慧	33 金梦青	69 蓝小玲																																																																								
<table border="1"><tr><td></td><td></td><td></td></tr><tr><td></td><td></td><td></td></tr><tr><td></td><td></td><td></td></tr></table>										<table border="1"><tr><td></td><td></td><td></td></tr><tr><td></td><td></td><td></td></tr><tr><td></td><td></td><td></td></tr></table>										<table border="1"><tr><td></td><td></td><td></td></tr><tr><td></td><td></td><td></td></tr><tr><td></td><td></td><td></td></tr></table>										<table border="1"><tr><td></td><td>1</td><td></td></tr><tr><td></td><td></td><td></td></tr><tr><td>3</td><td></td><td></td></tr></table>		1					3			<table border="1"><tr><td></td><td></td><td></td></tr><tr><td></td><td></td><td></td></tr><tr><td></td><td></td><td></td></tr></table>										<table border="1"><tr><td></td><td></td><td>2</td></tr><tr><td></td><td></td><td>1</td></tr><tr><td></td><td>2</td><td>1</td></tr></table>			2			1		2	1	<table border="1"><tr><td>1</td><td></td><td>1</td></tr><tr><td></td><td></td><td></td></tr><tr><td></td><td></td><td></td></tr></table>	1		1							<table border="1"><tr><td>1</td><td></td><td></td></tr><tr><td></td><td></td><td></td></tr><tr><td></td><td></td><td></td></tr></table>	1								
	1																																																																														
3																																																																															
		2																																																																													
		1																																																																													
	2	1																																																																													
1		1																																																																													
1																																																																															
Post - 0 Miss - 0 Block - 0	Post - 0 Miss - 0 Block - 0	Post - 0 Miss - 0 Block - 0	Post - 0 Miss - 1 Block - 1	Post - 0 Miss - 0 Block - 0	Post - 1 Miss - 1 Block - 1	Post - 0 Miss - 0 Block - 0	Post - 0 Miss - 0 Block - 0																																																																								

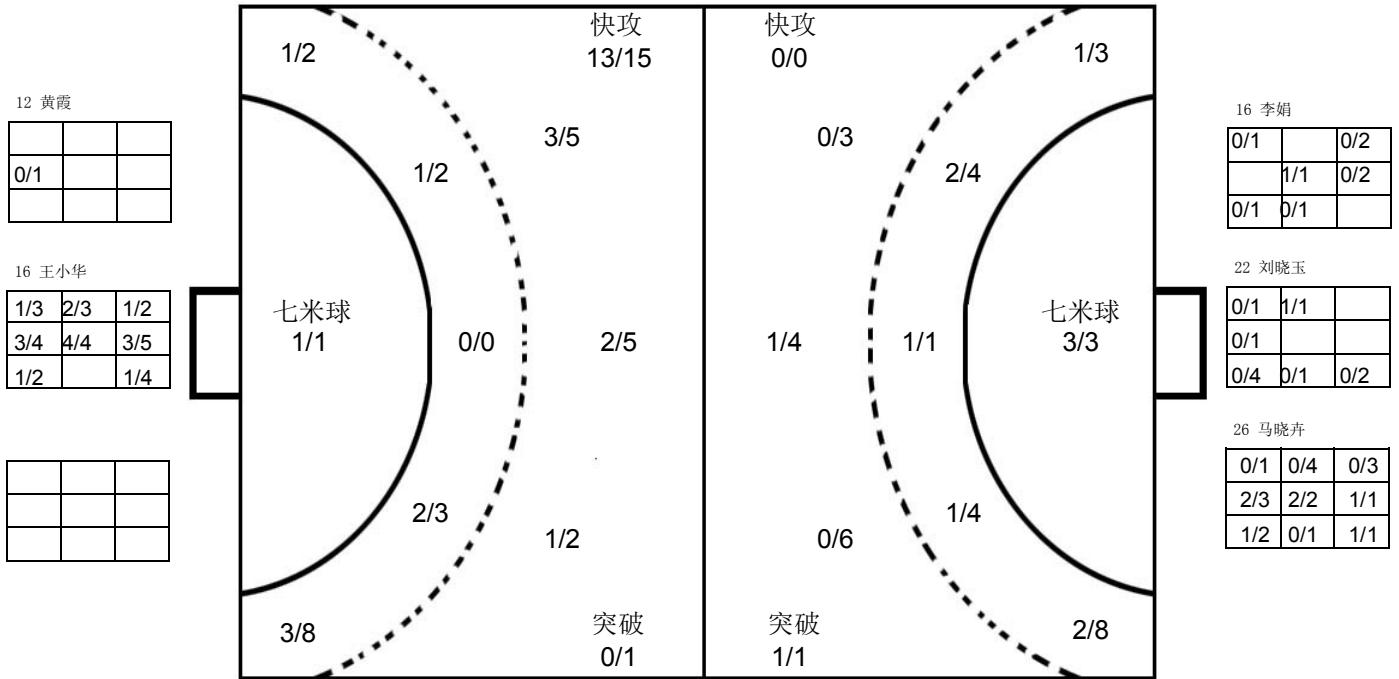

广东

3 安妮	5 李纯	7 刘彤	8 李诗棋	9 韦宝桂	11 魏梦庭	15 杨慧	16 李娟																																																																								
<table border="1"><tr><td></td><td></td><td></td></tr><tr><td></td><td></td><td></td></tr><tr><td></td><td></td><td></td></tr></table>										<table border="1"><tr><td></td><td></td><td></td></tr><tr><td></td><td></td><td></td></tr><tr><td></td><td></td><td></td></tr></table>										<table border="1"><tr><td></td><td></td><td></td></tr><tr><td></td><td></td><td></td></tr><tr><td></td><td></td><td></td></tr></table>										<table border="1"><tr><td></td><td></td><td></td></tr><tr><td></td><td></td><td></td></tr><tr><td></td><td></td><td></td></tr></table>										<table border="1"><tr><td>1</td><td></td><td></td></tr><tr><td></td><td></td><td></td></tr><tr><td></td><td></td><td>1</td></tr></table>	1								1	<table border="1"><tr><td>1</td><td></td><td></td></tr><tr><td></td><td></td><td>1</td></tr><tr><td></td><td></td><td>1</td></tr></table>	1					1			1	<table border="1"><tr><td></td><td></td><td></td></tr><tr><td></td><td></td><td></td></tr><tr><td></td><td></td><td></td></tr></table>										<table border="1"><tr><td></td><td></td><td></td></tr><tr><td></td><td></td><td></td></tr><tr><td></td><td></td><td></td></tr></table>									
1																																																																															
		1																																																																													
1																																																																															
		1																																																																													
		1																																																																													
Post - 0 Miss - 0 Block - 0	Post - 0 Miss - 0 Block - 0	Post - 0 Miss - 0 Block - 1	Post - 0 Miss - 0 Block - 0	Post - 0 Miss - 1 Block - 1	Post - 0 Miss - 0 Block - 1	Post - 0 Miss - 0 Block - 0	Post - 0 Miss - 0 Block - 0																																																																								
18 李玉玲	19 邝雪花	20 李军政	22 刘晓玉	23 王如	26 马晓卉	28 刘金兰	31 史小军																																																																								
<table border="1"><tr><td></td><td></td><td></td></tr><tr><td></td><td></td><td>1</td></tr><tr><td></td><td></td><td></td></tr></table>						1				<table border="1"><tr><td></td><td></td><td></td></tr><tr><td></td><td></td><td></td></tr><tr><td></td><td></td><td></td></tr></table>										<table border="1"><tr><td></td><td>1</td><td></td></tr><tr><td></td><td></td><td>1</td></tr><tr><td></td><td></td><td></td></tr></table>		1				1				<table border="1"><tr><td></td><td></td><td></td></tr><tr><td></td><td></td><td></td></tr><tr><td></td><td></td><td></td></tr></table>										<table border="1"><tr><td></td><td></td><td>1</td></tr><tr><td></td><td></td><td></td></tr><tr><td></td><td></td><td></td></tr></table>			1							<table border="1"><tr><td></td><td></td><td></td></tr><tr><td></td><td></td><td></td></tr><tr><td></td><td></td><td></td></tr></table>										<table border="1"><tr><td>1</td><td></td><td></td></tr><tr><td></td><td></td><td></td></tr><tr><td>1</td><td></td><td></td></tr></table>	1						1			<table border="1"><tr><td>1</td><td></td><td></td></tr><tr><td></td><td></td><td></td></tr><tr><td></td><td></td><td></td></tr></table>	1								
		1																																																																													
	1																																																																														
		1																																																																													
		1																																																																													
1																																																																															
1																																																																															
1																																																																															
Post - 0 Miss - 0 Block - 0	Post - 1 Miss - 2 Block - 0	Post - 1 Miss - 0 Block - 0	Post - 0 Miss - 0 Block - 0	Post - 0 Miss - 0 Block - 0	Post - 0 Miss - 0 Block - 0	Post - 0 Miss - 0 Block - 1	Post - 0 Miss - 0 Block - 0																																																																								

注释: Post=击柱 Miss=射失 Block=被封





名次赛 Group F

女子 全国比赛

2016年全国女子手球锦标赛

Team A <b>A 北京</b>				Team B <b>B 广西</b>				Match Number <b>37</b>													
played in China		in the hall 滁州体育馆		on 11/09/2016		at 08:30 hours		Spectators													
Half-time (30')	<b>A</b> 18	<b>B</b> 13	End of playing time	<b>A</b> 35	<b>B</b> 28	1st extra time	<b>A</b>	<b>B</b>	2nd extra time	<b>A</b>	<b>B</b>	After penalty throws	<b>A</b>	<b>B</b>							
Number of 7 m	<b>A</b> 4 / 6	Team time-out			Full name of players and officials				Team time-out			<b>B</b> 3 / 3	Number of 7 m								
	1 25:19	2 46:04	3 57:58					1	2 52:48	3											
No.	Team <b>A</b>					G	W	2'	D	DR	No.	Team <b>B</b>					G	W	2'	D	DR
1	宋嘉蕾										1	胡霜梅									
3	季小桐					6					2	陆雪云					2	1	1		
4	孙佳						1				5	黄海玉									
6	刘亚男										6	韦惠文									
8	杨铭豫					6					7	廖露					3		1		
10	刘莎					3		1			8	韦如芳					5				
11	纪婉										9	蓝雪梅									
16	王海叶										10	周琴					7	1	1		
17	杨政赢					3					11	曾蓝花						1			
22	李海鸥					5					12	江燕红									
23	田媛					1	1				14	黄艳芳					7		1		
28	闫美珠										15	陈依依									
33	栾征										16	商志运									
47	刘泽										17	杨杨									
58	李华										18	庞娇					4				
69	石梓薇					11	1														
A	蔡建国										C	王林									
B	石伟 (主教练)										D	刘雪波									
C	李翼																				
E	史良玉																				
<b>A</b>	Signature of Responsible Official of the Teams (Off. A)																		<b>B</b>		
TP	Remarks of Referee / CHA Official																		TP		

Signatures

Referees	陈晓波 (CHN)	林晓佟 (CHN)		
Techn. Delegates	吴国忠 (CHN)			
CHA Official	于中迅 (CHN)			

Note: Number of 7m Throws Awarded to Team A and B, Goals (G), Warnings (W), Suspensions (2'), Direct Disqualification (D), Disqualification with Report (DR) and Team Penalty (TP).

Table Officials: 伍豪

李诚

Statisticians: 陈柱

闫冲

Printed by PHMS Copyright: IHF / CHA 11/09/2016 04:46:51

Longman Sportsoft



handball@126.com





2016年全国女子手球锦标赛  
竞赛技术统计(媒体表)

Table with match details: 名次赛 (Ranking Match), 组别 (Group) F, 轮次 (Round) 8, 场次 (Match) 37. Venue: 滁州体育馆. Date: 11/09/2016. Referee: 陈晓波 (CHN). Score: 北京 35 vs 广西 28. Final score: 18:13.

Table with referee information: 裁判员 (Referee) 陈晓波 (CHN) / 林晓佟 (CHN).

Main statistics table for Beijing and Guangxi teams. Columns include player name, position, and various technical stats like shots, goals, assists, and suspensions. Includes sub-tables for Beijing and Guangxi players and goalkeepers.

场上队员: 得分 / 射门

守门员: 救球 / 射门

Legend table for abbreviations: 快攻 (Fast Break), 警告 (Warning), 突破 (Breakthrough), 任意球 (Free Throw), 7m球 (7M Throw), 助攻 (Assist).





### 2016年全国女子手球锦标赛 图式比赛技术统计表

轮次 8

场次 37

201605037-21-1/1

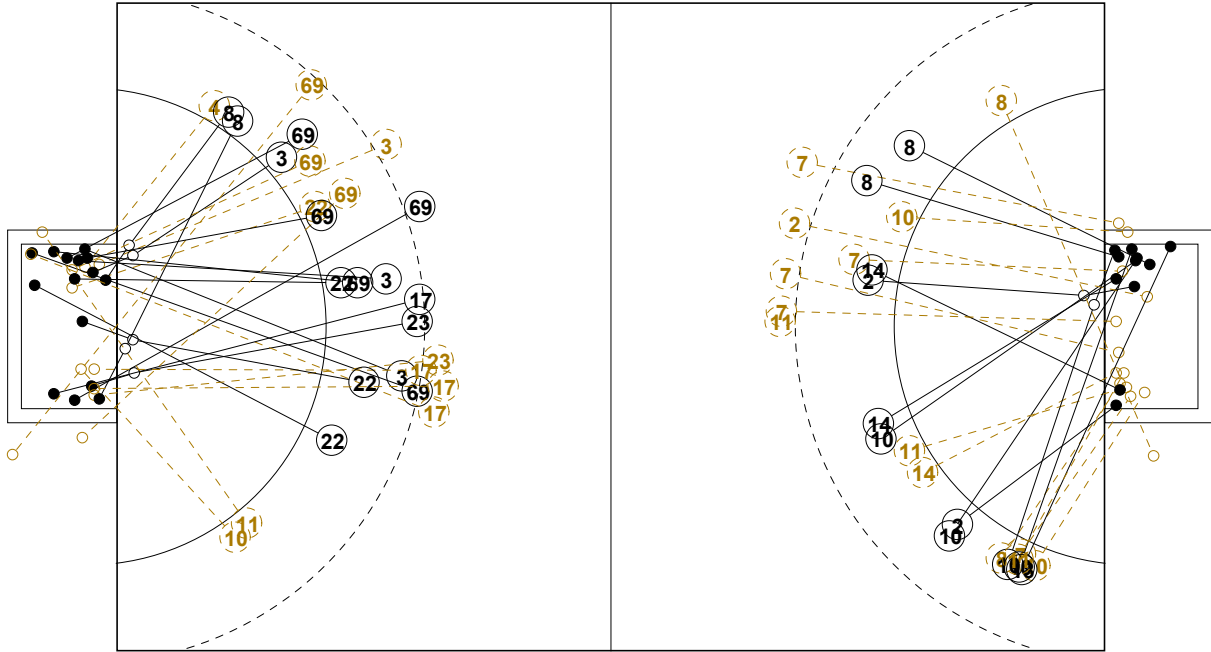

7M 北京

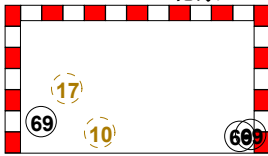

广西 7M

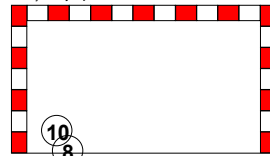

1st Half  
18 : 13

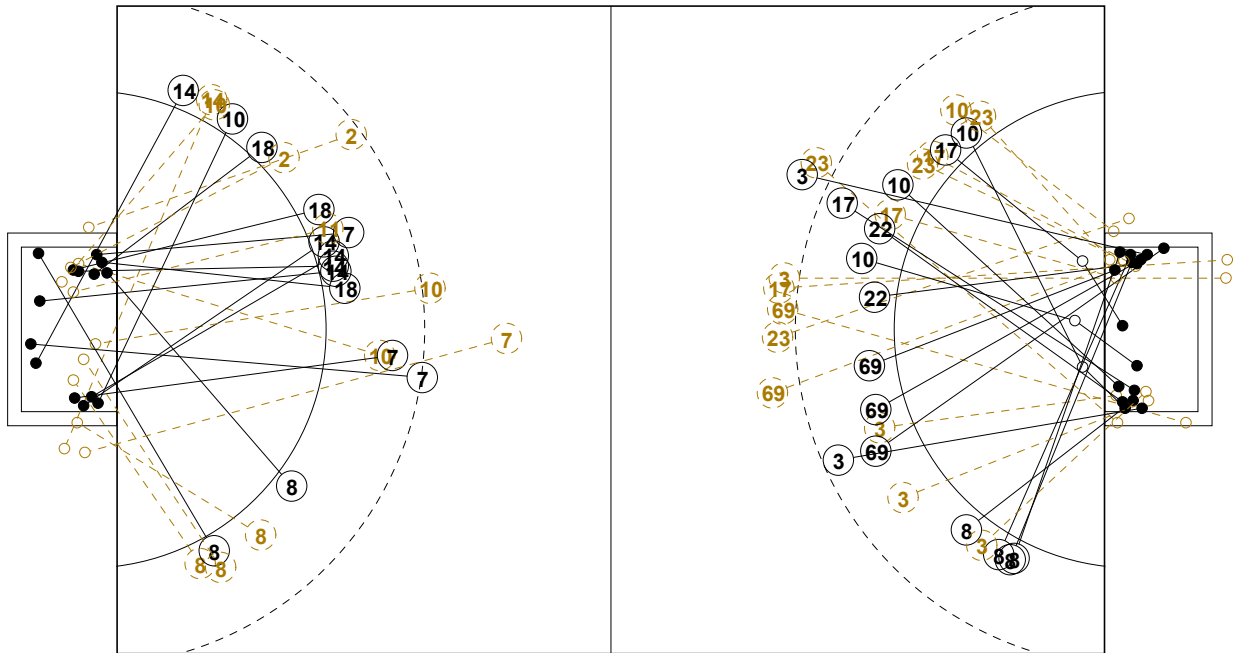

7M 广西

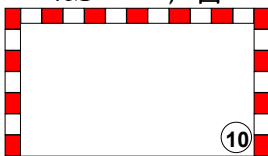

北京 7M



2nd Half  
28 : 35



## 2016年全国女子手球锦标赛

## 个人/全队技术统计表

正式表  
手球  
女子名次赛  
轮次 8组别 F  
场次 37201605037-14-1/2  
滁州体育馆  
11/09/2016 08:30

号码	姓名	远射	近射	边射	快攻	突破	任意	7M	合计	%	助攻	失误	警告	2'	取消	时间
<b>北京(北京)</b>																
<i>(场上队员)</i>																
1	宋嘉蕾									0.0%						00:00:34
3	季小桐	2/4	1/3	0/1	1/1	1/1		1/1	6/11	54.5%		2				00:52:20
4	孙佳			0/1					0/1	0.0%			1			00:37:59
6	刘亚男									0.0%						00:00:00
8	杨铭豫			6/6					6/6	100%		2				00:43:42
10	刘莎		1/1	1/3	1/1			0/1	3/6	50.0%		1		1		00:51:55
11	纪婉			0/1					0/1	0.0%						00:08:02
16	王海叶									0.0%						00:59:26
17	杨政赢	1/4	1/3		1/1		0/1	0/1	3/10	30.0%		1				00:34:15
22	李海鸥		1/2		4/4				5/6	83.3%		2				00:51:53
23	田媛	1/4	0/1	0/1					1/6	16.7%	1	2	1			00:27:46
28	闫美珠									0.0%						00:00:00
33	栾征									0.0%						00:00:00
47	刘泽									0.0%						00:00:00
58	李华									0.0%						00:00:00
69	石梓薇	2/5	3/5		2/2	1/1		3/3	11/16	68.8%	1	1	1			00:50:52
<b>合计</b>		6/17	7/15	7/13	9/9	2/2	0/1	4/6	35/63	55.6%	2	11	3	1		
<i>(守门员)</i>																
1	宋嘉蕾							0/1	0/1	0.0%						00:00:34
16	王海叶	4/5	4/17	6/13	2/4	1/3		0/2	17/44	38.6%						00:59:26
<b>合计</b>		4/5	4/17	6/13	2/4	1/3		0/3	17/45	37.8%						

场上队员：得分/射门

守门员：救球/射门

全队合计	得分	被救	射失	击柱	封球	合计	%
远射	6	6	3	2		17	35.3%
近射	7	7	1			15	46.7%
边射	7	4		2		13	53.8%
快攻	9					9	100.0%
突破	2					2	100.0%
任意			1			1	0.0%
7M	4	2				6	66.7%





## 2016年全国女子手球锦标赛

## 个人/全队技术统计表

正式表  
手球  
女子名次赛  
轮次 8组别 F  
场次 37201605037-14-2/2  
滁州体育馆  
11/09/2016 08:30

号码	姓名	远射	近射	边射	快攻	突破	任意	7M	合计	%	助攻	失误	警告	2'	取消	时间
<b>广西(广西)</b>																
<i>(上场队员)</i>																
1	胡霜梅									0.0%						00:00:00
2	陆雪云	0/2	1/2	1/1					2/5	40.0%		4	1	1		00:45:07
5	黄海玉									0.0%						00:00:00
6	韦惠文									0.0%						00:00:00
7	廖露	1/5	1/1	0/1	1/1	0/1			3/9	33.3%	2	3		1		00:57:14
8	韦如芳		3/3	1/5	0/1			1/1	5/10	50.0%		5				01:29:22
9	蓝雪梅									0.0%						00:00:00
10	周琴	0/1	0/2	2/4	1/1	2/2		2/2	7/12	58.3%		2	1	1		00:56:10
11	曾蓝花	0/1	0/1	0/1	0/1				0/4	0.0%	2	5	1			01:00:00
12	江燕红									0.0%						00:00:00
14	黄艳芳		6/7	1/2					7/9	77.8%		3		1		00:57:43
15	陈依依									0.0%						00:00:00
16	商志运									0.0%						01:00:00
17	杨杨									0.0%						00:00:00
18	庞娇		2/2	2/2					4/4	100%						00:25:12
<b>合计</b>		1/9	13/18	7/16	2/4	2/3		3/3	28/53	52.8%	4	22	3	4		
<i>(守门员)</i>																
16	商志运	6/12	7/14	4/11	0/9	0/2		2/6	19/54	35.2%						01:00:00
<b>合计</b>		6/12	7/14	4/11	0/9	0/2		2/6	19/54	35.2%						

场上队员：得分/射门

守门员：救球/射门

全队合计	得分	被救	射失	击柱	封球	合计	%
远射	1	4	3		1	9	11.1%
近射	13	4		1		18	72.2%
边射	7	6	2	1		16	43.8%
快攻	2	2				4	50.0%
突破	2	1				3	66.7%
任意							0.0%
7M	3					3	100.0%





### 2016年全国女子手球锦标赛

#### 图式射门区域统计

轮次 8 场次 37

201605037-41-1/1

## 北京

1 宋嘉蕾	3 季小桐	4 孙佳	6 刘亚男	8 杨铭豫	10 刘莎	11 纪婉	16 王海叶																																																																								
<table border="1"><tr><td></td><td></td><td></td></tr><tr><td></td><td></td><td></td></tr><tr><td></td><td></td><td></td></tr></table>										<table border="1"><tr><td></td><td></td><td></td></tr><tr><td>1</td><td></td><td>4</td></tr><tr><td></td><td></td><td>1</td></tr></table>				1		4			1	<table border="1"><tr><td></td><td></td><td></td></tr><tr><td></td><td></td><td></td></tr><tr><td></td><td></td><td></td></tr></table>										<table border="1"><tr><td></td><td></td><td></td></tr><tr><td></td><td></td><td></td></tr><tr><td></td><td></td><td></td></tr></table>										<table border="1"><tr><td></td><td></td><td></td></tr><tr><td></td><td></td><td></td></tr><tr><td>4</td><td></td><td>2</td></tr></table>							4		2	<table border="1"><tr><td></td><td></td><td></td></tr><tr><td></td><td></td><td></td></tr><tr><td></td><td></td><td>1</td></tr></table>									1	<table border="1"><tr><td></td><td></td><td></td></tr><tr><td></td><td></td><td></td></tr><tr><td></td><td></td><td></td></tr></table>										<table border="1"><tr><td></td><td></td><td></td></tr><tr><td></td><td></td><td></td></tr><tr><td></td><td></td><td></td></tr></table>									
1		4																																																																													
		1																																																																													
4		2																																																																													
		1																																																																													
Post - 0 Miss - 0 Block - 0	Post - 0 Miss - 1 Block - 0	Post - 0 Miss - 0 Block - 0	Post - 0 Miss - 0 Block - 0	Post - 0 Miss - 0 Block - 0	Post - 1 Miss - 0 Block - 0	Post - 1 Miss - 0 Block - 0	Post - 0 Miss - 0 Block - 0																																																																								
17 杨政赢	22 李海鹏	23 田媛	28 闫美珠	33 栾征	47 刘泽	58 李华	69 石梓薇																																																																								
<table border="1"><tr><td>1</td><td></td><td></td></tr><tr><td></td><td></td><td></td></tr><tr><td></td><td></td><td></td></tr></table>	1									<table border="1"><tr><td></td><td></td><td>1</td></tr><tr><td>1</td><td>1</td><td>1</td></tr><tr><td></td><td></td><td>1</td></tr></table>			1	1	1	1			1	<table border="1"><tr><td></td><td></td><td></td></tr><tr><td></td><td></td><td></td></tr><tr><td>1</td><td></td><td></td></tr></table>							1			<table border="1"><tr><td></td><td></td><td></td></tr><tr><td></td><td></td><td></td></tr><tr><td></td><td></td><td></td></tr></table>										<table border="1"><tr><td></td><td></td><td></td></tr><tr><td></td><td></td><td></td></tr><tr><td></td><td></td><td></td></tr></table>										<table border="1"><tr><td></td><td></td><td></td></tr><tr><td></td><td></td><td></td></tr><tr><td></td><td></td><td></td></tr></table>										<table border="1"><tr><td></td><td></td><td></td></tr><tr><td></td><td></td><td></td></tr><tr><td></td><td></td><td></td></tr></table>										<table border="1"><tr><td></td><td></td><td>2</td></tr><tr><td></td><td>3</td><td>1</td></tr><tr><td>2</td><td></td><td>3</td></tr></table>			2		3	1	2		3
1																																																																															
		1																																																																													
1	1	1																																																																													
		1																																																																													
1																																																																															
		2																																																																													
	3	1																																																																													
2		3																																																																													
Post - 0 Miss - 1 Block - 0	Post - 0 Miss - 0 Block - 0	Post - 1 Miss - 1 Block - 0	Post - 0 Miss - 0 Block - 0	Post - 0 Miss - 0 Block - 0	Post - 0 Miss - 0 Block - 0	Post - 0 Miss - 0 Block - 0	Post - 1 Miss - 2 Block - 0																																																																								

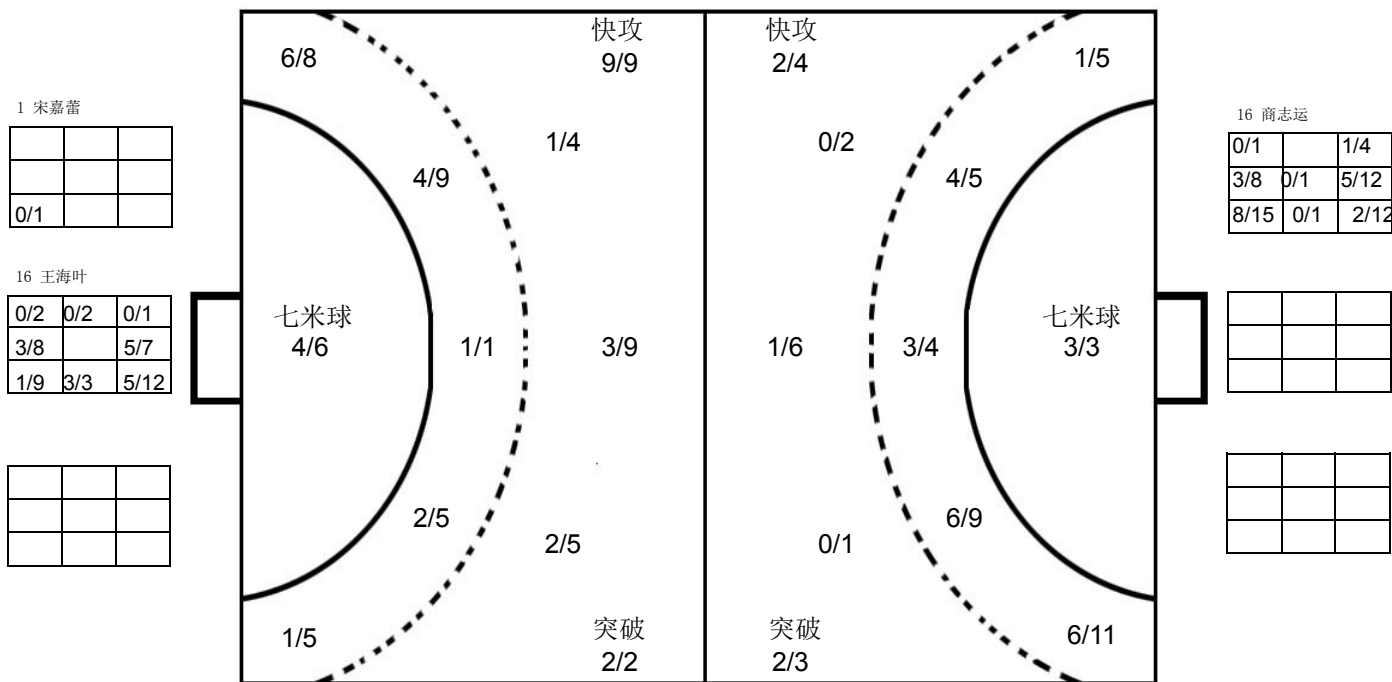

## 广西

1 胡霜梅	2 陆雪云	5 黄海玉	6 韦惠文	7 廖露	8 韦如芳	9 蓝雪梅	10 周琴																																																																								
<table border="1"><tr><td></td><td></td><td></td></tr><tr><td></td><td></td><td></td></tr><tr><td></td><td></td><td></td></tr></table>										<table border="1"><tr><td></td><td></td><td></td></tr><tr><td>1</td><td></td><td>1</td></tr><tr><td></td><td></td><td></td></tr></table>				1		1				<table border="1"><tr><td></td><td></td><td></td></tr><tr><td></td><td></td><td></td></tr><tr><td></td><td></td><td></td></tr></table>										<table border="1"><tr><td></td><td></td><td></td></tr><tr><td></td><td></td><td></td></tr><tr><td></td><td></td><td></td></tr></table>										<table border="1"><tr><td></td><td>1</td><td></td></tr><tr><td>1</td><td></td><td></td></tr><tr><td></td><td></td><td>1</td></tr></table>		1		1					1	<table border="1"><tr><td></td><td></td><td>1</td></tr><tr><td>1</td><td></td><td></td></tr><tr><td>2</td><td></td><td>1</td></tr></table>			1	1			2		1	<table border="1"><tr><td></td><td></td><td></td></tr><tr><td></td><td></td><td></td></tr><tr><td></td><td></td><td></td></tr></table>										<table border="1"><tr><td></td><td></td><td></td></tr><tr><td>2</td><td></td><td></td></tr><tr><td>4</td><td></td><td>1</td></tr></table>				2			4		1
1		1																																																																													
	1																																																																														
1																																																																															
		1																																																																													
		1																																																																													
1																																																																															
2		1																																																																													
2																																																																															
4		1																																																																													
Post - 0 Miss - 0 Block - 0	Post - 0 Miss - 1 Block - 0	Post - 0 Miss - 0 Block - 0	Post - 0 Miss - 0 Block - 0	Post - 0 Miss - 2 Block - 0	Post - 1 Miss - 1 Block - 0	Post - 0 Miss - 0 Block - 0	Post - 1 Miss - 0 Block - 0																																																																								
11 曾蓝花	12 江燕红	14 黄艳芳	15 陈依依	16 商志运	17 杨杨	18 庞娇																																																																									
<table border="1"><tr><td></td><td></td><td></td></tr><tr><td></td><td></td><td></td></tr><tr><td></td><td></td><td></td></tr></table>										<table border="1"><tr><td></td><td></td><td></td></tr><tr><td></td><td></td><td></td></tr><tr><td></td><td></td><td></td></tr></table>										<table border="1"><tr><td>1</td><td>1</td><td></td></tr><tr><td>1</td><td></td><td>1</td></tr><tr><td>2</td><td></td><td>1</td></tr></table>	1	1		1		1	2		1	<table border="1"><tr><td></td><td></td><td></td></tr><tr><td></td><td></td><td></td></tr><tr><td></td><td></td><td></td></tr></table>										<table border="1"><tr><td></td><td></td><td></td></tr><tr><td></td><td></td><td></td></tr><tr><td></td><td></td><td></td></tr></table>										<table border="1"><tr><td></td><td></td><td></td></tr><tr><td></td><td></td><td></td></tr><tr><td></td><td></td><td></td></tr></table>										<table border="1"><tr><td>1</td><td></td><td></td></tr><tr><td></td><td></td><td>1</td></tr><tr><td></td><td></td><td>2</td></tr></table>	1					1			2	<table border="1"><tr><td></td><td></td><td></td></tr><tr><td></td><td></td><td></td></tr><tr><td></td><td></td><td></td></tr></table>									
1	1																																																																														
1		1																																																																													
2		1																																																																													
1																																																																															
		1																																																																													
		2																																																																													
Post - 0 Miss - 0 Block - 1	Post - 0 Miss - 0 Block - 0	Post - 0 Miss - 1 Block - 0	Post - 0 Miss - 0 Block - 0	Post - 0 Miss - 0 Block - 0	Post - 0 Miss - 0 Block - 0	Post - 0 Miss - 0 Block - 0																																																																									

注释: Post=击柱 Miss=射失 Block=被封



名次赛 Group F

女子 全国比赛

2016年全国女子手球锦标赛

Team A <b>A 四川</b>		Team B <b>B 黑龙江</b>		Match Number <b>38</b>									
played in China		in the hall 滁州体育馆		on 11/09/2016									
				at 10:00 hours									
Spectators													
Half-time (30')	<b>A</b> 13	<b>B</b> 12	End of playing time	<b>A</b> 28	<b>B</b> 25								
1st extra time		<b>A</b>		<b>B</b>									
2nd extra time		<b>A</b>		<b>B</b>									
After penalty throws		<b>A</b>		<b>B</b>									
Number of 7 m	<b>A</b> 4/5	Team time-out		Team time-out									
		1 26:38 2 49:43 3		1 15:25 2 47:00 3 56:43									
Full name of players and officials													
No.	Team <b>A</b>				Team <b>B</b>				No.	Team <b>B</b>			
	G	W	2'	D	DR		G	W	2'	D	DR		
1						1							
2	2	1	1			3		1					
3	8	1	1			5		1					
4						6	2						
5	4	1	1			9	1	1					
6						10	1						
7						11	2						
9	4					12							
10						13	6						
11	7					14	2						
12						16							
17						19	6						
18	3					21	3		1				
27						22							
						23	2						
A	金鸿					B	张立梅 (主教练)						
B	郎正平					C	黄冬杰						
C	陈志伟					D	于兹香				1		
						E	马婧						
<b>A</b>	Signature of Responsible Official of the Teams (Off. A)										<b>B</b>		
TP	Remarks of Referee / CHA Official										TP		

Signatures

Referees	严璐 (CHN)	王雨洋 (CHN)		
Techn. Delegates	吴国忠 (CHN)			
CHA Official	于中迅 (CHN)			

Note: Number of 7m Throws Awarded to Team A and B, Goals (G), Warnings (W), Suspensions (2'), Direct Disqualification (D), Disqualification with Report (DR) and Team Penalty (TP).

Table Officials: 伍豪

李诚

Statisticians: 闫冲

陈柱



2016年全国女子手球锦标赛  
竞赛技术统计(媒体表)

名次赛	组别	F	轮次	8	场次	38
滁州体育馆			11/09/2016		201605038-51-1/1	
四川		四川	28	vs	25	黑龙江
		13 : 12				

裁判员	严璐 (CHN)		/	王雨洋 (CHN)		
-----	----------	--	---	-----------	--	--

四川		远射	近射	边射	快攻	突破	任意球	7m球	合计	%	助攻	失误	警告	2'	D & DR	四川	比赛进程	黑龙江	
主教练：郎正平																			
1	张雪纯																11 朱海云	0 00:31	1 13 吴佳
2	陈艳楠	1/1	1/2					2/3	66.7	1			1	1		11 朱海云	1 01:52	1	
3	王丹	3/10	1/3	2/4		1/1		1/1	8/19	42.1	2	3	1	1		3 王丹	2 03:07	1	
4	尤婉莹			0/1				0/1	0.0							9 姚梦园	3 04:25	2 21 王戈	
5	孙姣		2/2			1/1		1/1	4/4	100	1	1	1	1		11 朱海云	3 05:17	2	
6	凤洋			0/1	0/1			0/2	0.0	1	3					3 王丹	4 07:20	3 21 王戈	
7	练素琪															9 姚梦园	5 08:02	3	
9	姚梦园		1/1	0/1	3/4			4/6	66.7							11 朱海云	6 08:51	3	
10	高静															6	10:21	4 9 郑宇	
11	朱海云	0/2	3/3	0/2	1/2	3/3		7/12	58.3	1	3				3 王丹	7 10:56	4		
12	宋琛茜															7 姚梦园	8 14:09	5 6 王梦艺	
17	史雨欣												1			3 王丹	8 14:20	5	
18	戴小宇	1/3	0/1					2/2	3/6	50.0		3			9 姚梦园	9 15:20	5		
27	吴美琪							0/1	0/1	0.0					9	16:32	6 21 王戈		
<b>运动员 合计</b>		5/16	8/12	2/9	4/7	5/5		4/5	28/54	51.9	6	14	3	3		9	17:50	7 13 吴佳	
12	宋琛茜	5/10	4/9	2/10	1/3	1/4		5/7	18/43	41.9						18 戴小宇	10 18:41	7	
<b>守门员 合计</b>		5/10	4/9	2/10	1/3	1/4		5/7	18/43	41.9						5 孙姣	11 22:04	8 10 刘雪露	
黑龙江		远射	近射	边射	快攻	突破	任意球	7m球	合计	%	助攻	失误	警告	2'	D & DR				
教练：张立梅																			
1	徐佳蓉															11 朱海云	12 23:59	9 19 梁文煜	
3	刘诗彤				0/1			0/1	0.0				1			12 25:49	10 14	14 黄莹	
5	周美微		0/2					0/2	0.0			2	1		12 27:08	11 19	19 梁文煜		
6	王梦艺	1/2	0/2			1/1		2/5	40.0			5			3 王丹	13 28:37	11	23 张政	
9	郑宇		1/1					0/1	1/2	50.0			1		5 孙姣	14 29:06	12	20 11 刘天茹	
10	刘雪露	1/2						1/2	50.0			4			9 姚梦园	15 00:09	13 13	13 吴佳	
11	刘天茹			1/1	1/1			2/2	100						15	03:02	14 19	14 梁文煜	
12	肖宁桐														15	04:29	15 6	15 王梦艺	
13	吴佳	2/3	1/1	1/1		2/3		0/2	6/10	60.0		3			15	05:15	16 13	16 13 吴佳	
14	黄莹	0/1	0/1					2/4	2/6	33.3					16	06:37	16 19	16 梁文煜	
16	杜宪														16	07:24	17 19	17 梁文煜	
19	梁文煜	1/3	1/2	4/6				6/11	54.5			1			17	07:48	17		
21	王戈	0/1		2/2	1/1			3/4	75.0			1		1	18 戴小宇	18 10:42	17		
22	马琳	0/2						0/2	0.0	1	1				3 王丹	19 14:06	17		
23	张政		2/2					2/2	100						9 姚梦园	20 15:01	17		
<b>运动员 合计</b>		5/14	5/11	8/10	2/3	3/4		2/7	25/49	51.0	1	17	3	1		21 16:14	17	19 梁文煜	
1	徐佳蓉	0/1	0/1			0/1		0/3	0.0						21	16:36	18	19 梁文煜	
12	肖宁桐	3/5	1/5	4/6	0/2	0/2		1/3	9/23	39.1					22	16:51	18		
16	杜宪	1/3	1/4	1/1	2/4	0/2		0/2	5/16	31.3					22	18:51	19	23 张政	
<b>守门员 合计</b>		4/9	2/10	5/7	2/6	0/5		1/5	14/42	33.3					22	19:32	20	11 刘天茹	

场上队员：得分 / 射门

守门员：救球 / 射门

快攻	Fast Break	突破	Breakthrough	任意球	Free Throw	7M球	7M Throw	助攻	Assist
警告	Warning	失误	Error	2'	Suspension	D	取消资格	DR	取消资格+报告





### 2016年全国女子手球锦标赛 图式比赛技术统计表

轮次 8

场次 38

201605038-21-1/1

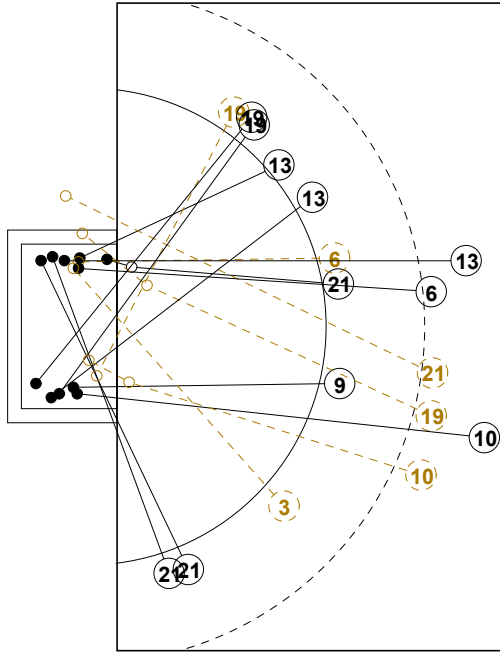

7M 黑龙江

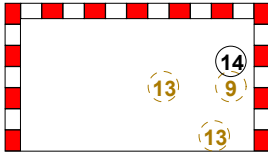

1st Half  
12 : 13

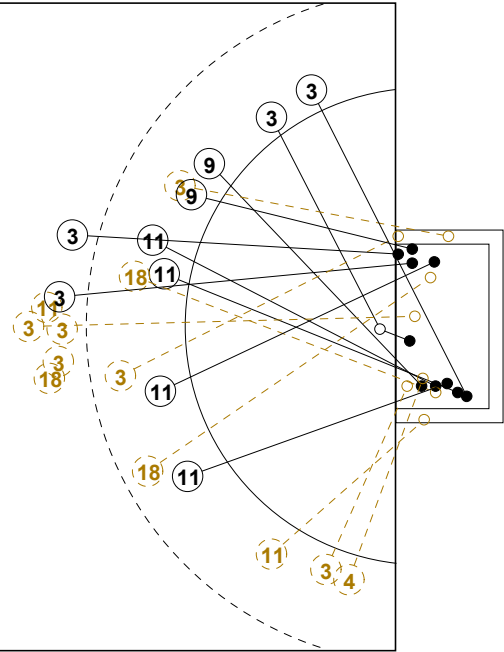

四川 7M

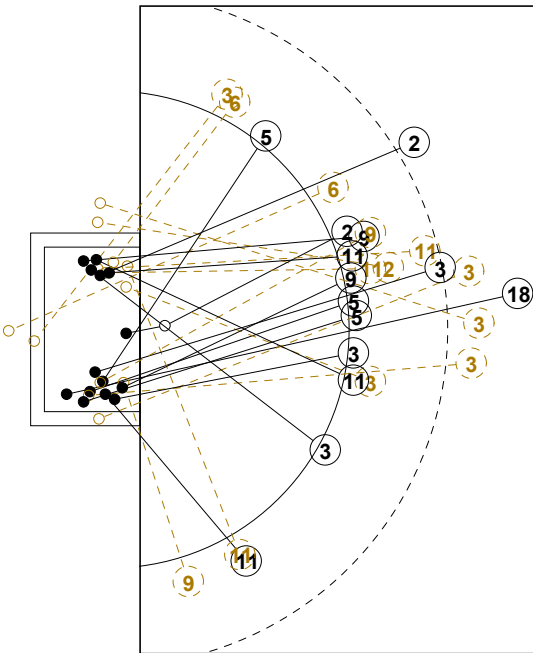
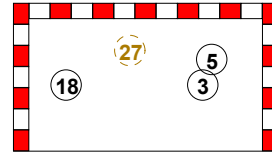

7M 四川

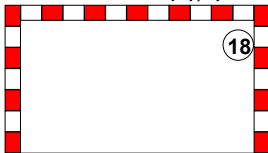

2nd Half  
28 : 25

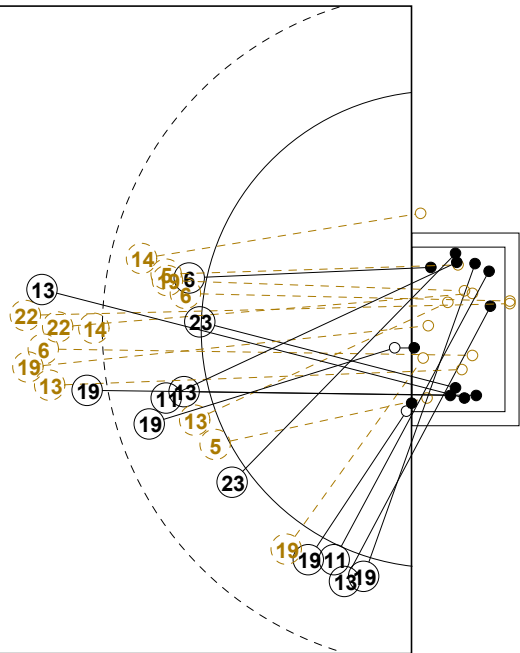

黑龙江 7M

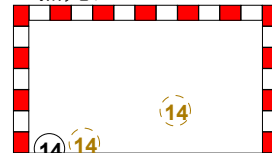





## 2016年全国女子手球锦标赛

## 个人/全队技术统计表

正式表  
手球  
女子名次赛  
轮次 8组别 F  
场次 38201605038-14-1/2  
滁州体育馆  
11/09/2016 10:00

号码	姓名	远射	近射	边射	快攻	突破	任意	7M	合计	%	助攻	失误	警告	2'	取消	时间
<b>四川(四川)</b>																
<i>(场上队员)</i>																
1	张雪纯									0.0%						00:00:00
2	陈艳楠	1/1	1/2						2/3	66.7%	1		1	1		00:44:39
3	王丹	3/10	1/3	2/4		1/1		1/1	8/19	42.1%	2	3	1	1		00:57:20
4	尤婉莹			0/1					0/1	0.0%						00:21:40
5	孙蛟		2/2			1/1		1/1	4/4	100%	1	1	1	1		01:00:00
6	凤洋			0/1	0/1				0/2	0.0%	1	3				00:38:05
7	练素琪									0.0%						00:00:00
9	姚梦园		1/1	0/1	3/4				4/6	66.7%						00:51:29
10	高静									0.0%						00:00:00
11	朱海云	0/2	3/3	0/2	1/2	3/3			7/12	58.3%	1	3				00:42:27
12	宋琛茜									0.0%						01:00:00
17	史雨欣									0.0%		1				00:02:53
18	戴小宇	1/3	0/1					2/2	3/6	50.0%		3				00:39:25
27	吴美琪							0/1	0/1	0.0%						00:00:17
<b>合计</b>																
<i>(守门员)</i>																
12	宋琛茜	5/10	4/9	2/10	1/3	1/4		5/7	18/43	41.9%						01:00:00
<b>合计</b>																

场上队员：得分/射门

守门员：救球/射门

全队合计	得分	被救	射失	击柱	封球	合计	%
远射	5	4	1	2	4	16	31.3%
近射	8	2	1	1		12	66.7%
边射	2	5		2		9	22.2%
快攻	4	2	1			7	57.1%
突破	5					5	100.0%
任意							0.0%
7M	4	1				5	80.0%





## 2016年全国女子手球锦标赛

## 个人/全队技术统计表

正式表  
手球  
女子名次赛  
轮次 8组别 F  
场次 38201605038-14-2/2  
滁州体育馆  
11/09/2016 10:00

号码	姓名	远射	近射	边射	快攻	突破	任意	7M	合计	%	助攻	失误	警告	2'	取消	时间
<b>黑龙江(黑龙江)</b>																
<i>(上场队员)</i>																
1	徐佳蓉									0.0%						00:02:55
3	刘诗彤				0/1				0/1	0.0%			1			00:14:04
5	周美微		0/2						0/2	0.0%		2	1			00:22:48
6	王梦艺	1/2	0/2			1/1			2/5	40.0%		5				00:47:48
9	郑宇		1/1					0/1	1/2	50.0%			1			00:40:37
10	刘雪露	1/2							1/2	50.0%		4				00:37:37
11	刘天茹			1/1	1/1				2/2	100%						00:13:45
12	肖宁桐									0.0%						00:42:08
13	吴佳	2/3	1/1	1/1		2/3		0/2	6/10	60.0%		3				00:49:45
14	黄荣	0/1	0/1						2/4	2/6	33.3%					00:05:43
16	杜宪									0.0%						00:14:57
19	梁文煜	1/3	1/2	4/6					6/11	54.5%		1				00:52:21
21	王戈	0/1		2/2	1/1				3/4	75.0%		1		1		00:51:59
22	马琳	0/2							0/2	0.0%	1	1				00:10:49
23	张政		2/2						2/2	100%						00:11:22
<b>合计</b>		5/14	5/11	8/10	2/3	3/4		2/7	25/49	51.0%	1	17	3	1		
<i>(守门员)</i>																
1	徐佳蓉	0/1	0/1			0/1			0/3	0.0%						00:02:55
12	肖宁桐	3/5	1/5	4/6	0/2	0/2		1/3	9/23	39.1%						00:42:08
16	杜宪	1/3	1/4	1/1	2/4	0/2		0/2	5/16	31.3%						00:14:57
<b>合计</b>		4/9	2/10	5/7	2/6	0/5		1/5	14/42	33.3%						

场上队员：得分/射门

守门员：救球/射门

全队合计	得分	被救	射失	击柱	封球	合计	%
远射	5	5	1	2	1	14	35.7%
近射	5	4	1	1		11	45.5%
边射	8	2				10	80.0%
快攻	2	1				3	66.7%
突破	3	1				4	75.0%
任意							0.0%
7M	2	5				7	28.6%





### 2016年全国女子手球锦标赛

#### 图式射门区域统计

轮次 8 场次 38

201605038-41-1/1

## 四川

1 张雪纯	2 陈艳楠	3 王丹	4 尤婉莹	5 孙姣	6 凤洋	7 练素琪	9 姚梦园																																																																								
<table border="1"><tr><td></td><td></td><td></td></tr><tr><td></td><td></td><td></td></tr><tr><td></td><td></td><td></td></tr></table>										<table border="1"><tr><td></td><td></td><td></td></tr><tr><td></td><td></td><td>1</td></tr><tr><td></td><td>1</td><td></td></tr></table>						1		1		<table border="1"><tr><td></td><td></td><td>1</td></tr><tr><td>1</td><td></td><td>2</td></tr><tr><td>3</td><td>1</td><td></td></tr></table>			1	1		2	3	1		<table border="1"><tr><td></td><td></td><td></td></tr><tr><td></td><td></td><td></td></tr><tr><td></td><td></td><td></td></tr></table>										<table border="1"><tr><td></td><td></td><td>1</td></tr><tr><td>3</td><td></td><td></td></tr><tr><td></td><td></td><td></td></tr></table>			1	3						<table border="1"><tr><td></td><td></td><td></td></tr><tr><td></td><td></td><td></td></tr><tr><td></td><td></td><td></td></tr></table>										<table border="1"><tr><td></td><td></td><td></td></tr><tr><td></td><td></td><td></td></tr><tr><td></td><td></td><td></td></tr></table>										<table border="1"><tr><td></td><td></td><td>1</td></tr><tr><td></td><td></td><td></td></tr><tr><td>2</td><td></td><td>1</td></tr></table>			1				2		1
		1																																																																													
	1																																																																														
		1																																																																													
1		2																																																																													
3	1																																																																														
		1																																																																													
3																																																																															
		1																																																																													
2		1																																																																													
Post - 0 Miss - 0 Block - 0	Post - 0 Miss - 1 Block - 0	Post - 4 Miss - 1 Block - 2	Post - 0 Miss - 0 Block - 0	Post - 0 Miss - 0 Block - 0	Post - 0 Miss - 1 Block - 0	Post - 0 Miss - 0 Block - 0	Post - 0 Miss - 0 Block - 0																																																																								
10 高静	11 朱海云	12 宋琛茜	17 史雨欣	18 戴小宇	27 吴美琪																																																																										
<table border="1"><tr><td></td><td></td><td></td></tr><tr><td></td><td></td><td></td></tr><tr><td></td><td></td><td></td></tr></table>										<table border="1"><tr><td></td><td></td><td>1</td></tr><tr><td>2</td><td></td><td>3</td></tr><tr><td></td><td></td><td>1</td></tr></table>			1	2		3			1	<table border="1"><tr><td></td><td></td><td></td></tr><tr><td></td><td></td><td></td></tr><tr><td></td><td></td><td></td></tr></table>										<table border="1"><tr><td></td><td></td><td></td></tr><tr><td></td><td></td><td></td></tr><tr><td></td><td></td><td></td></tr></table>										<table border="1"><tr><td></td><td></td><td>1</td></tr><tr><td>1</td><td></td><td>1</td></tr><tr><td>1</td><td></td><td></td></tr></table>			1	1		1	1			<table border="1"><tr><td></td><td></td><td></td></tr><tr><td></td><td></td><td></td></tr><tr><td></td><td></td><td></td></tr></table>										<table border="1"><tr><td></td><td></td><td></td></tr><tr><td></td><td></td><td></td></tr><tr><td></td><td></td><td></td></tr></table>										<table border="1"><tr><td></td><td></td><td></td></tr><tr><td></td><td></td><td></td></tr><tr><td></td><td></td><td></td></tr></table>									
		1																																																																													
2		3																																																																													
		1																																																																													
		1																																																																													
1		1																																																																													
1																																																																															
Post - 0 Miss - 0 Block - 0	Post - 1 Miss - 0 Block - 1	Post - 0 Miss - 0 Block - 0	Post - 0 Miss - 0 Block - 0	Post - 0 Miss - 0 Block - 1	Post - 0 Miss - 0 Block - 0																																																																										

12 宋琛茜

0/4	0/1	0/4
3/8	4/4	4/10
3/5	1/2	3/5



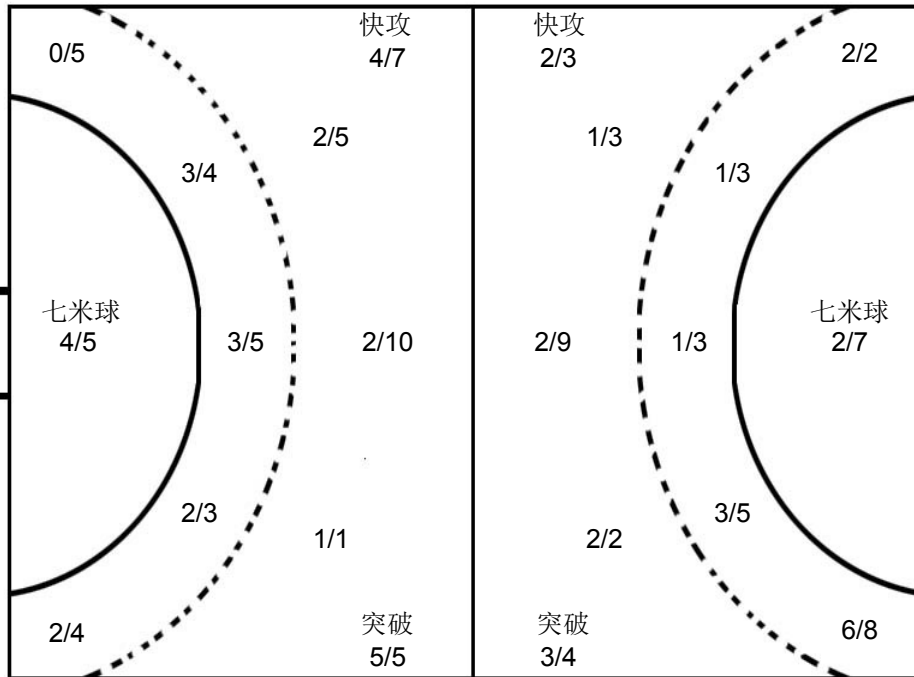

1 徐佳蓉

0/1		0/1
0/1		

12 肖宁桐

0/1	1/1	0/3
2/5		1/3
0/2	1/3	4/5

16 杜宪

		0/1
1/4		2/6
1/3		1/2

## 黑龙江

1 徐佳蓉	3 刘诗彤	5 周美微	6 王梦艺	9 郑宇	10 刘雪露	11 刘天茹	12 肖宁桐																																																																								
<table border="1"><tr><td></td><td></td><td></td></tr><tr><td></td><td></td><td></td></tr><tr><td></td><td></td><td></td></tr></table>										<table border="1"><tr><td></td><td></td><td></td></tr><tr><td></td><td></td><td></td></tr><tr><td></td><td></td><td></td></tr></table>										<table border="1"><tr><td></td><td></td><td></td></tr><tr><td></td><td></td><td></td></tr><tr><td></td><td></td><td></td></tr></table>										<table border="1"><tr><td></td><td></td><td>1</td></tr><tr><td>1</td><td></td><td></td></tr><tr><td></td><td></td><td></td></tr></table>			1	1						<table border="1"><tr><td></td><td></td><td></td></tr><tr><td>1</td><td></td><td></td></tr><tr><td></td><td></td><td></td></tr></table>				1						<table border="1"><tr><td></td><td></td><td></td></tr><tr><td>1</td><td></td><td></td></tr><tr><td></td><td></td><td></td></tr></table>				1						<table border="1"><tr><td>1</td><td></td><td></td></tr><tr><td>1</td><td></td><td></td></tr><tr><td></td><td></td><td></td></tr></table>	1			1						<table border="1"><tr><td></td><td></td><td></td></tr><tr><td></td><td></td><td></td></tr><tr><td></td><td></td><td></td></tr></table>									
		1																																																																													
1																																																																															
1																																																																															
1																																																																															
1																																																																															
1																																																																															
Post - 0 Miss - 0 Block - 0	Post - 0 Miss - 0 Block - 0	Post - 0 Miss - 0 Block - 0	Post - 1 Miss - 0 Block - 0	Post - 0 Miss - 0 Block - 0	Post - 0 Miss - 0 Block - 0	Post - 0 Miss - 0 Block - 0	Post - 0 Miss - 0 Block - 0																																																																								
13 吴佳	14 黄莹	16 杜宪	19 梁文煜	21 王戈	22 马琳	23 张政																																																																									
<table border="1"><tr><td>1</td><td>1</td><td></td></tr><tr><td></td><td></td><td>4</td></tr><tr><td></td><td></td><td></td></tr></table>	1	1				4				<table border="1"><tr><td></td><td></td><td>1</td></tr><tr><td></td><td></td><td></td></tr><tr><td>1</td><td></td><td></td></tr></table>			1				1			<table border="1"><tr><td></td><td></td><td></td></tr><tr><td></td><td></td><td></td></tr><tr><td></td><td></td><td></td></tr></table>										<table border="1"><tr><td>2</td><td></td><td>1</td></tr><tr><td>1</td><td></td><td></td></tr><tr><td></td><td>1</td><td>1</td></tr></table>	2		1	1				1	1	<table border="1"><tr><td></td><td></td><td>2</td></tr><tr><td></td><td></td><td></td></tr><tr><td></td><td></td><td>1</td></tr></table>			2						1	<table border="1"><tr><td></td><td></td><td></td></tr><tr><td></td><td></td><td></td></tr><tr><td></td><td></td><td></td></tr></table>										<table border="1"><tr><td></td><td></td><td></td></tr><tr><td>1</td><td></td><td>1</td></tr><tr><td></td><td></td><td></td></tr></table>				1		1				<table border="1"><tr><td></td><td></td><td></td></tr><tr><td></td><td></td><td></td></tr><tr><td></td><td></td><td></td></tr></table>									
1	1																																																																														
		4																																																																													
		1																																																																													
1																																																																															
2		1																																																																													
1																																																																															
	1	1																																																																													
		2																																																																													
		1																																																																													
1		1																																																																													
Post - 0 Miss - 0 Block - 0	Post - 0 Miss - 1 Block - 1	Post - 0 Miss - 0 Block - 0	Post - 1 Miss - 0 Block - 0	Post - 0 Miss - 1 Block - 0	Post - 1 Miss - 0 Block - 0	Post - 0 Miss - 0 Block - 0																																																																									

注释: Post=击柱 Miss=射失 Block=被封





四分之一决赛

女子 全国比赛

2016年全国女子手球锦标赛

Team A		Team B		Match Number																	
A 江苏		B 解放军		39																	
played in		in the hall		on																	
China		滁州体育馆		11/09/2016																	
				at 14:00 hours																	
Spectators																					
Half-time (30')	A	B	End of playing time	A	B																
	21	9	44 20	1st extra time	2nd extra time																
				A	B																
				After penalty	throws																
				A	B																
Number of 7 m	A	Team time-out			Full name of players and officials			Team time-out			B	Number of 7 m									
	3 / 4	1	2	3				1	2	3	1 / 1										
	12:51																				
No.	Team A					G	W	2'	D	DR	No.	Team B					G	W	2'	D	DR
1	陆婷										2	崔云莉					4	1			
3	张海侠					5					5	徐鸣昭									
4	赵佳芹					5	1				6	于婷婷									
5	高媛媛					3					8	周亚茹					5	1			
8	乔如					4	1				13	张格格					2				
9	莫蒙蒙					1		1			16	方文博									
10	王可可					3					17	于利婷					1	1			
11	于源源					4					23	顾天澍					2				
12	黄霞										24	韦娜娜					1				
13	黄慧影					2					32	张馨予					1		1		
16	王小华										36	李朴									
17	修丽杰					4	1				44	刘洋麦文									
18	韦秋香					2		1			66	杨丽丽									
23	王书慧					4					77	唐魏萍									
33	金梦青					6					81	戴丹妮									
69	蓝小玲					1					88	李晓晴					4				
B	金甲洙 (主教练)										A	刘德东 (主教练)									
C	马彪										B	刘凤娟									
D	李海鹰										C	丛艳霞									
E	陈志伟										D	吴明群									
A	Signature of Responsible Official of the Teams (Off. A)																		B		
TP	Remarks of Referee / CHA Official																		TP		

Signatures

Referees	张耿 (CHN)	刘晓辉 (CHN)		
Techn. Delegates	于中迅 (CHN)			
CHA Official	许宜扬 (CHN)			

Note: Number of 7m Throws Awarded to Team A and B, Goals (G), Warnings (W), Suspensions (2'), Direct Disqualification (D), Disqualification with Report (DR) and Team Penalty (TP).

Table Officials: 佟金政

贾俊秋

Statisticians: 黄岩

刘永欢



2016年全国女子手球锦标赛  
竞赛技术统计(媒体表)

四分之一决赛	组别	X	轮次	8	场次	39
滁州体育馆		11/09/2016			201605039-51-1/1	
江苏	江苏	44	vs	20	解放军	解放军
21:9						

裁判员		张耿 (CHN)											/	刘晓辉 (CHN)										
江苏		远射	近射	边射	快攻	突破	任意球	7m球	合计	%	助攻	失误	警告	2'	D & DR	江苏	比赛进程	解放军						
主教练: 金甲洙																1st Half								
1	陆婷															23	王书慧	0 01:01	1 88 李晓晴					
3	张海侠			3/4	2/3			5/7	71.4	2						8	乔如	1 01:20	1					
4	赵佳芹	4/4				1/1		5/5	100	2		1				2	张海侠	2 01:59	1					
5	高媛媛	0/1	2/3				1/1	3/5	60.0		2					3	赵佳芹	2 04:40	2 8 周亚茹					
8	乔如		2/2		2/2			4/4	100	1		1				4	王书慧	3 04:59	2					
9	莫蒙蒙		1/1		0/1			1/2	50.0					1		23	赵佳芹	4 06:35	3					
10	王可可	1/1	1/2			1/1		3/4	75.0		3					8	王书慧	5 08:20	3					
11	于源源	1/1	1/1		1/1	1/1		4/4	100		1					8	乔如	6 09:07	3					
12	黄霞															4	赵佳芹	7 09:42	3					
13	黄慧影				1/1		1/1	2/2	100	1	1					33	金梦青	8 10:34	3					
16	王小华															8	王可可	8 10:57	4 8 周亚茹					
17	修丽杰	1/3	3/3					4/6	66.7	2	2	1				8	乔如	8 11:50	5 2 崔云莉					
18	韦秋香	0/1		1/1	1/1			2/3	66.7		2			1		9	王书慧	9 13:24	5					
23	王书慧	1/2	1/1	1/1		1/1		4/5	80.0		1					23	王书慧	10 14:11	5					
33	金梦青	1/3	1/1		3/6		1/2	6/12	50.0	1						10	赵佳芹	10 15:50	6 88 李晓晴					
69	蓝小玲				1/1			1/1	100							11	修丽杰	11 16:05	6					
运动员 合计		9/16	12/14	5/6	11/16	4/4	3/4	44/60	73.3	11	12	3	2			17	修丽杰	12 17:18	6					
1	陆婷	3/7	0/2	1/3	0/1		0/1	4/14	28.6							17	修丽杰	12 18:07	7 88 李晓晴					
12	黄霞	1/1	1/1	1/1	0/1			3/5	60.0							4	赵佳芹	13 18:32	7					
16	王小华	5/11	2/2	0/1		1/1	1/2	9/17	52.9	2						17	修丽杰	13 20:32	8 8 周亚茹					
守门员 合计		9/19	3/5	2/5	0/2	1/1	1/3	16/36	44.4	2						17	修丽杰	14 20:50	8					
解放军		远射	近射	边射	快攻	突破	任意球	7m球	合计	%	助攻	失误	警告	2'	D & DR	11	于源源	15 22:13	8					
教练: 刘德东																11	于源源	16 23:08	8					
2	崔云莉	3/15			1/1		0/1	4/17	23.5		6	1				16	王书慧	16 24:22	9 8 周亚茹					
5	徐鸣昭	0/2	0/2					0/4	0.0							9	莫蒙蒙	17 25:51	9					
6	于婷婷															33	金梦青	17 26:44	9					
8	周亚茹	5/10				0/1	0/1	5/12	41.7		3	1				3	张海侠	18 27:49	10					
13	张格格		1/2	1/1				2/3	66.7							11	于源源	18 28:07	10					
16	方文博							1/4	25.0							3	张海侠	19 29:07	10					
17	于利婷	1/4									3	1				3	张海侠	20 06:47	10					
23	顾天澍		1/1	1/3				2/4	50.0	1	2					33	金梦青	20 08:33	10					
24	韦娜娜	0/2		1/2				1/4	25.0		1					18	韦秋香	20 10:11	10					
32	张馨予	0/1					1/1	1/2	50.0		2			1		11	于源源	21 10:55	10					
36	李朴															33	蓝小玲	21 12:28	11 2 崔云莉					
44	刘洋麦文															33	蓝小玲	21 13:11	12 24 韦娜娜					
66	杨丽丽															5	高媛媛	22 13:32	12					
77	唐魏萍															34	徐鸣昭	23 14:44	10 88 李晓晴					
81	戴丹妮															23	王书慧	24 02:00	10					
88	李晓晴	1/5			1/1		1/2	1/1	44.4		5					9	莫蒙蒙	25 03:10	10					
运动员 合计		10/39	2/5	3/6	2/2	0/1	2/5	1/1	20/59	33.9	1	22	3	1		33	金梦青	26 03:43	10					
16	方文博	2/10	0/6	1/3	2/5	0/1	0/1	5/26	19.2							3	张海侠	27 03:59	10					
66	杨丽丽	0/2	0/2	1/7	0/2			1/13	7.7							11	于源源	28 04:56	10					
77	唐魏萍	0/1	2/6	0/1	0/2	0/1	0/2	2/13	15.4							3	张海侠	29 06:06	10					
守门员 合计		2/11	2/14	1/6	3/14	0/4	0/3	8/52	15.4							3	张海侠	30 06:47	10					

场上队员: 得分 / 射门

守门员: 救球 / 射门

快攻	Fast Break	突破	Breakthrough	任意球	Free Throw	7M球	7M Throw	助攻	Assist
警告	Warning	失误	Error	2'	Suspension	D	取消资格	DR	取消资格+报告





# 2016年全国女子手球锦标赛 图式比赛技术统计表

轮次 8

场次 39

201605039-21-1/1

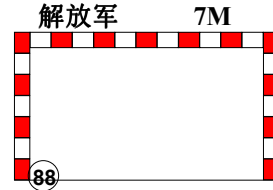
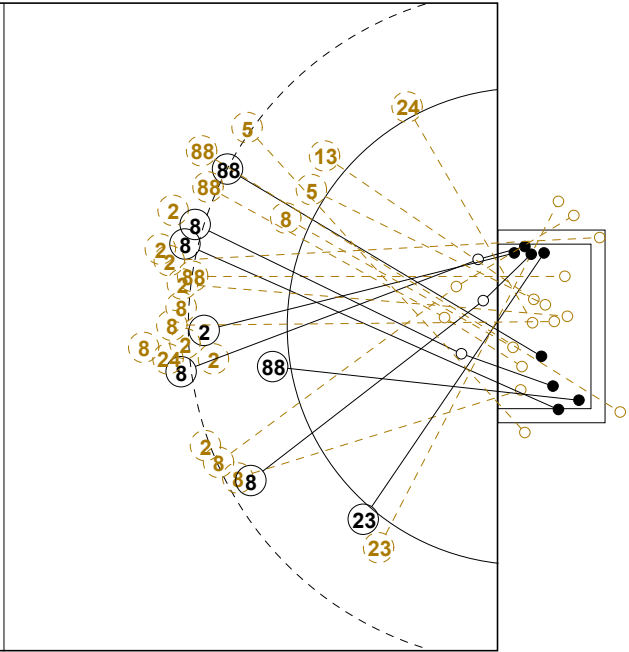
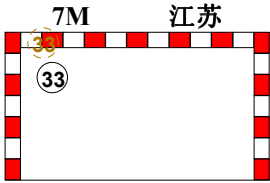
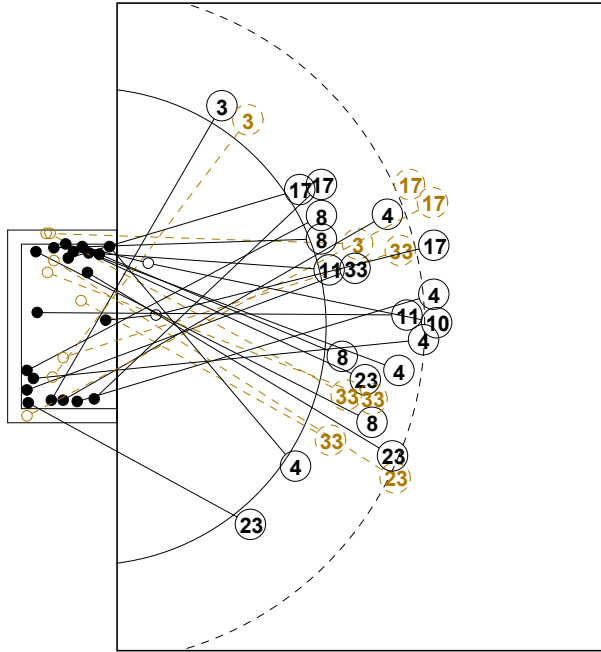

1st Half  
21 : 9

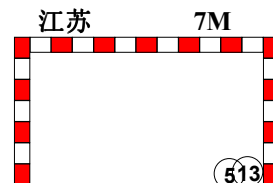
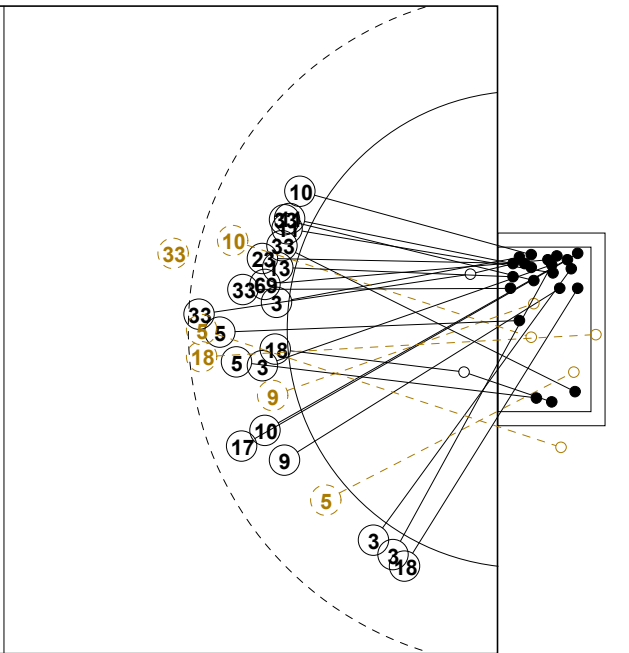
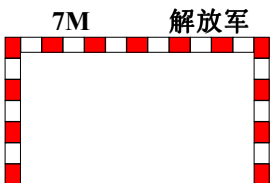
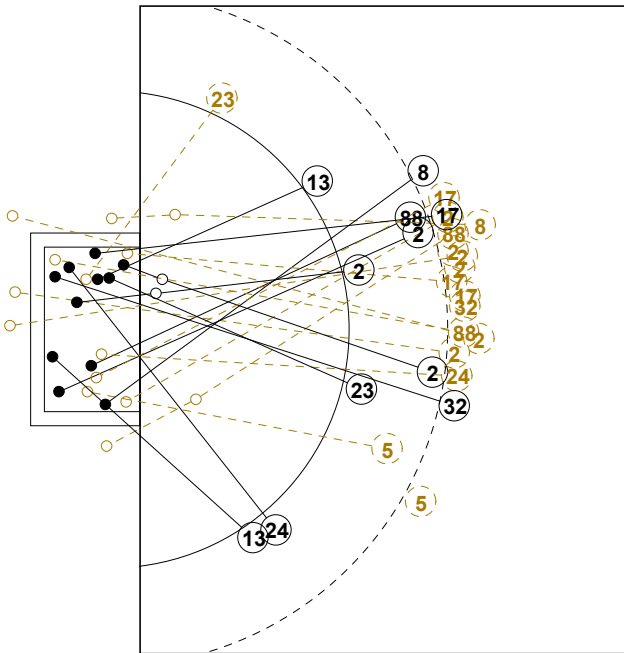

2nd Half  
20 : 44



## 2016年全国女子手球锦标赛

## 个人/全队技术统计表

正式表  
手球  
女子四分之一决赛  
轮次 8组别 X  
场次 39201605039-14-1/2  
滁州体育馆  
11/09/2016 14:00

号码	姓名	远射	近射	边射	快攻	突破	任意	7M	合计	%	助攻	失误	警告	2'	取消	时间
<b>江苏(江苏)</b>																
<i>(场上队员)</i>																
1	陆婷									0.0%						00:18:35
3	张海侠			3/4	2/3				5/7	71.4%	2					00:41:28
4	赵佳芹	4/4				1/1			5/5	100%	2		1			00:30:00
5	高媛媛	0/1	2/3					1/1	3/5	60.0%		2				00:20:49
8	乔如		2/2		2/2				4/4	100%	1		1			00:30:00
9	莫蒙蒙		1/1		0/1				1/2	50.0%				1		00:34:44
10	王可可	1/1	1/2			1/1			3/4	75.0%		3				00:28:23
11	于源源	1/1	1/1		1/1	1/1			4/4	100%		1				00:27:59
12	黄霞									0.0%						00:06:14
13	黄慧影				1/1			1/1	2/2	100%	1	1				00:19:00
16	王小华									0.0%	2					00:35:11
17	修丽杰	1/3	3/3						4/6	66.7%	2	2	1			00:35:38
18	韦秋香	0/1		1/1	1/1				2/3	66.7%		2		1		00:23:06
23	王书慧	1/2	1/1	1/1		1/1			4/5	80.0%		1				00:15:21
33	金梦青	1/3	1/1		3/6			1/2	6/12	50.0%	1					00:39:16
69	蓝小玲				1/1				1/1	100%						00:13:13
<b>合计</b>		9/16	12/14	5/6	11/16	4/4		3/4	44/60	73.3%	11	12	3	2		
<i>(守门员)</i>																
1	陆婷	3/7	0/2	1/3	0/1		0/1		4/14	28.6%						00:18:35
12	黄霞	1/1	1/1	1/1	0/1			0/1	3/5	60.0%						00:06:14
16	王小华	5/11	2/2	0/1		1/1	1/2		9/17	52.9%	2					00:35:11
<b>合计</b>		9/19	3/5	2/5	0/2	1/1	1/3	0/1	16/36	44.4%	2					

场上队员：得分/射门

守门员：救球/射门

全队合计	得分	被救	射失	击柱	封球	合计	%
远射	9	2	1	2	2	16	56.3%
近射	12	2				14	85.7%
边射	5	1				6	83.3%
快攻	11	3		2		16	68.8%
突破	4					4	100.0%
任意							0.0%
7M	3			1		4	75.0%





## 2016年全国女子手球锦标赛

## 个人/全队技术统计表

正式表  
手球  
女子四分之一决赛  
轮次 8组别 X  
场次 39201605039-14-2/2  
滁州体育馆  
11/09/2016 14:00

号码	姓名	远射	近射	边射	快攻	突破	任意	7M	合计	%	助攻	失误	警告	2'	取消	时间
<b>解放军(解放军)</b>																
<i>(上场队员)</i>																
2	崔云莉	3/15			1/1		0/1		4/17	23.5%		6	1			00:50:24
5	徐鸣昭	0/2	0/2						0/4	0.0%						00:16:12
6	于婷婷									0.0%						00:00:00
8	周亚茹	5/10				0/1	0/1		5/12	41.7%		3	1			00:40:58
13	张格格		1/2	1/1					2/3	66.7%						00:47:22
16	方文博									0.0%						00:30:00
17	于利婷	1/4							1/4	25.0%		3	1			00:33:07
23	顾天澍		1/1	1/3					2/4	50.0%	1	2				01:00:00
24	韦娜娜	0/2		1/2					1/4	25.0%		1				01:00:00
32	张馨予	0/1					1/1		1/2	50.0%		2		1		00:16:20
36	李朴									0.0%						00:00:00
44	刘洋麦文									0.0%						00:00:00
66	杨丽丽									0.0%						00:11:12
77	唐魏萍									0.0%						00:18:48
81	戴丹妮									0.0%						00:00:00
88	李晓晴	1/5			1/1		1/2	1/1	4/9	44.4%		5				00:35:29
<b>合计</b>		10/39	2/5	3/6	2/2	0/1	2/5	1/1	20/59	33.9%	1	22	3	1		
<i>(守门员)</i>																
16	方文博	2/10	0/6	1/3	2/5	0/1		0/1	5/26	19.2%						00:30:00
66	杨丽丽		0/2	0/2	1/7	0/2			1/13	7.7%						00:11:12
77	唐魏萍	0/1	2/6	0/1	0/2	0/1		0/2	2/13	15.4%						00:18:48
<b>合计</b>		2/11	2/14	1/6	3/14	0/4		0/3	8/52	15.4%						

场上队员：得分/射门

守门员：救球/射门

全队合计	得分	被救	射失	击柱	封球	合计	%
远射	10	9	7		13	39	25.6%
近射	2	3				5	40.0%
边射	3	2	1			6	50.0%
快攻	2					2	100.0%
突破		1				1	0.0%
任意	2	1	1	1		5	40.0%
7M	1					1	100.0%







2016年全国女子手球锦标赛

图式射门区域统计

轮次 8 场次 39

201605039-41-1/1

江苏

Player statistics for Jiangsu team including names like 陆婷, 张海侠, 赵佳芹, etc., with corresponding goalkeeping and shooting data.

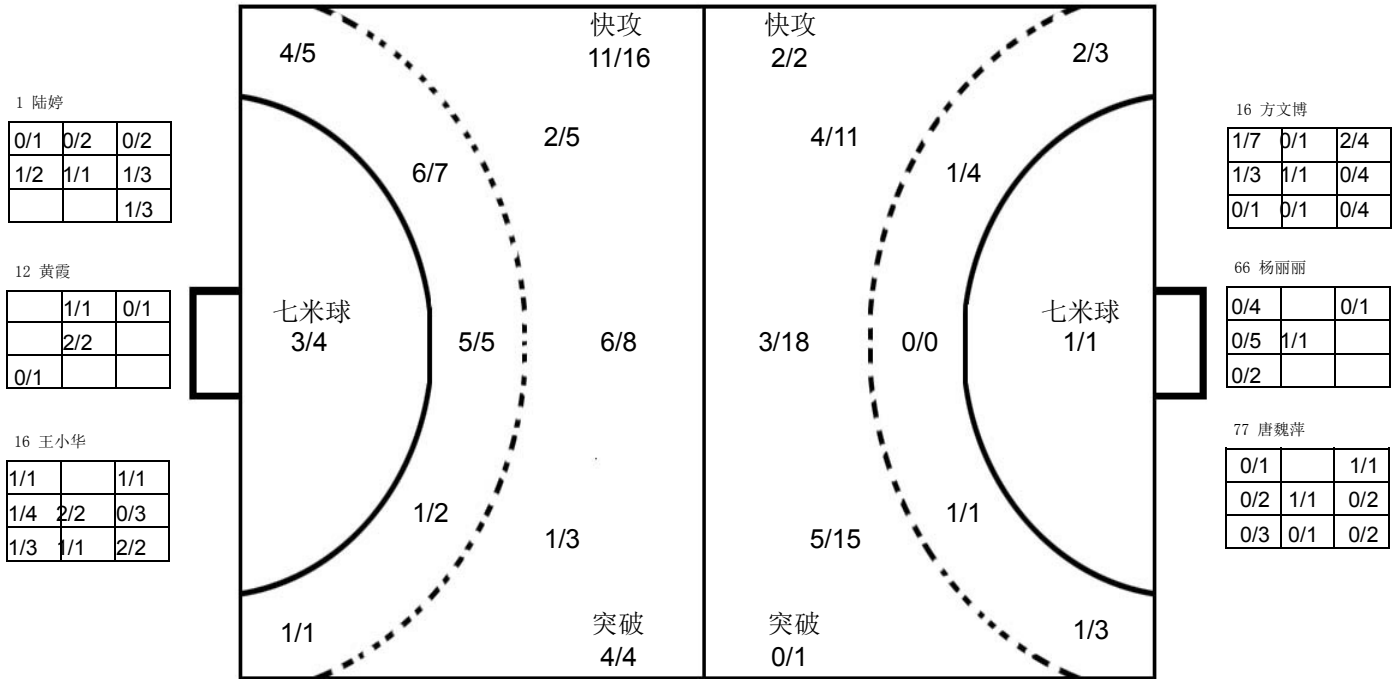

解放军

Player statistics for the Chinese People's Liberation Army team including names like 崔云莉, 徐鸣昭, 于婷婷, etc., with corresponding goalkeeping and shooting data.

注释: Post=击柱 Miss=射失 Block=被封





四分之一决赛

女子 全国比赛

2016年全国女子手球锦标赛

Team A <b>A 辽宁</b>				Team B <b>B 广东</b>				Match Number <b>40</b>													
played in China		in the hall 滁州体育馆		on 11/09/2016		at 15:30 hours		Spectators													
Half-time (30')	<b>A</b> 13	<b>B</b> 18	End of playing time	<b>A</b> 24	<b>B</b> 26	1st extra time	<b>A</b>	<b>B</b>	2nd extra time	<b>A</b>	<b>B</b>	After penalty throws	<b>A</b>	<b>B</b>							
Number of 7 m	<b>A</b> 2/3	Team time-out			Full name of players and officials				Team time-out			<b>B</b> 2/2	Number of 7 m								
		1	2	3					1	2	3										
		20:31	31:15	58:30					11:16	38:55	47:55										
No.	Team <b>A</b>					G	W	2'	D	DR	No.	Team <b>B</b>					G	W	2'	D	DR
1	于薇诗										3	安妮									
2	朱徐婷					5					5	李纯									
3	赵莹雪					2	1	1			7	刘彤					1	1	1		
5	辛颜					1	1	1			8	李诗棋									
8	杨娇					7					9	韦宝桂					9				
9	刁卫丽										11	魏梦庭						1			
12	刘雪菲										15	杨慧									
13	杜江花					1	1				16	李娟									
19	吕秋雪					5		1			18	李玉玲					3				
20	孙弘玲					1					19	邝雪花					3				
24	陈思雨										20	李军政					2				
27	王丹										22	刘晓玉									
66	梁海珍					2					23	王如					5	1			
93	赵琦										26	马晓卉									
98	张永婷										28	刘金兰					3				
99	郑锦宜										31	史小军									
A	吕艳梦										A	李细利									
B	李丽荣										B	郭艳辉 (主教练)									
C	金京男 (主教练)										D	祝捷									
E	程万里										E	赵善良									
<b>A</b>	Signature of Responsible Official of the Teams (Off. A)																			<b>B</b>	
TP	Remarks of Referee / CHA Official																			TP	

Signatures

Referees: 张栋 (CHN)      倪震 (CHN)

Techn. Delegates: 刘书勇 (CHN)

CHA Official: 许宜扬 (CHN)

Note: Number of 7m Throws Awarded to Team A and B, Goals (G), Warnings (W), Suspensions (2'), Direct Disqualification (D), Disqualification with Report (DR) and Team Penalty (TP).

Table Officials: 陈文丽      赵涵      Statisticians: 刘永欢      黄岩

Printed by PHMS Copyright: IHF / CHA 11/09/2016 11:48:33

Longman Sportsoft  handball@126.com



## 2016年全国女子手球锦标赛 竞赛技术统计(媒体表)

四分之一决赛		组别	X	轮次	8	场次	40
滁州体育馆					11/09/2016	201605040-51-1/1	
辽宁		辽宁	24	vs	26	广东	广东
				<b>13 : 18</b>			

裁判员		张栋 (CHN)											/	倪震 (CHN)																						
<b>辽宁</b>		远射	近射	边射	快攻	突破	任意球	7m球	合计	%	助攻	失误	警告	2'	D & DR	<b>辽宁</b>		比赛进程											<b>广东</b>							
主教练：金京男																																				
1	于薇诗															3	赵莹雪	0	00:32	1	23	王如														
2	朱徐婷			2/2	3/4			5/6	83.3		1					2	朱徐婷	2	02:01	1																
3	赵莹雪	1/1	1/2					2/3	66.7		1	1	1			2		2	02:26	2	9	韦宝桂														
5	辛颜		1/3					1/3	33.3		1	1	1			2		2	03:12	3	9	韦宝桂														
8	杨娇	4/7	1/1				0/1	2/3	58.3	5	6					4	19	吕秋雪	3	05:33	4	19	邝雪花													
9	刁卫丽															3	8	杨娇	3	06:36	4															
12	刘雪菲															4	66	梁海珍	4	07:09	5	9	韦宝桂													
13	杜江花	1/5			0/1			1/6	16.7		3	1				5	8	杨娇	4	08:23	5															
19	吕秋雪	2/3		0/1	2/2	1/1		5/7	71.4		1		1			5	66	梁海珍	5	09:05	6	9	韦宝桂													
20	孙弘玲	0/3	1/1			0/1		1/5	20.0							6	8	杨娇	5	10:01	7	23	王如													
24	陈思雨															7	66	梁海珍	6	10:26	7															
27	王丹															7	66	梁海珍	7	11:09	7															
66	梁海珍	1/5		0/3	1/1			2/9	22.2	2	2					8	19	吕秋雪	8	12:23	8	20	李军政													
93	赵琦										1	1				8	2	朱徐婷	8	14:02	8															
98	张永婷															9	8	杨娇	9	14:49	8															
99	郑锦宜															10	8	杨娇	10	15:59	8															
<b>运动员 合计</b>		9/24	4/7	2/6	6/8	1/2	0/1	2/3	24/51	47.1	8	16	3	3		10	19	吕秋雪	10	16:20	9	9	韦宝桂													
27	王丹	0/1	0/2	0/3	0/1			0/2	0/9	0.0						10	2	朱徐婷	10	18:05	10	28	刘金兰													
93	赵琦	6/12	1/4	1/4	1/6	1/1		10/27	37.0	1	1					10	8	杨娇	10	18:53	11	19	邝雪花													
<b>守门员 合计</b>		6/13	1/6	1/7	1/7	1/1		0/2	10/36	27.8	1	1				11	13	杜江花	11	20:47	11															
																11	8	杨娇	11	21:19	12	9	韦宝桂													
																11	13	杜江花	11	23:44	13	18	李玉玲													
																12	8	杨娇	12	24:52	13															
																12	8	杨娇	12	26:11	14	18	李玉玲													
																13	8	杨娇	13	26:47	14															
																13	13	赵琦	13	27:32	15	20	李军政													
																13	13	赵琦	13	27:45	16	28	刘金兰													
																13	13	赵琦	13	29:06	17	9	韦宝桂													
																13	13	赵琦	13	29:53	18	23	王如													
																<b>2nd Half</b>																				
																13	2	朱徐婷	13	00:53	19	9	韦宝桂													
																13	19	吕秋雪	13	01:13	20	7	刘彤													
																13	5	辛颜	13	02:18	21	9	韦宝桂													
																13	8	杨娇	13	04:18	22	23	王如													
																14	19	吕秋雪	14	06:48	22															
																15	5	辛颜	15	07:50	22															
																16	8	杨娇	16	08:52	22															
																17	8	杨娇	17	09:49	22															
																18	8	杨娇	18	12:09	22															
																19	8	杨娇	19	13:44	22															
																20	2	朱徐婷	20	15:38	22															
																21	19	吕秋雪	21	17:36	22															
																21	3	安妮	21	18:15	23	19	邝雪花													
																22	19	吕秋雪	22	19:19	23															
																22	19	吕秋雪	22	19:50	24	18	李玉玲													
																22	20	孙弘玲	22	21:21	25	28	刘金兰													
																22	2	朱徐婷	22	24:54	26	23	王如													
																23	2	朱徐婷	23	25:39	26															
																24	2	朱徐婷	24	26:12	26															

场上队员：得分 / 射门

守门员：救球 / 射门

快攻	Fast Break	突破	Breakthrough	任意球	Free Throw	7M球	7M Throw	助攻	Assist
警告	Warning	失误	Error	2'	Suspension	D	取消资格	DR	取消资格+报告





### 2016年全国女子手球锦标赛 图式比赛技术统计表

轮次 8

场次 40

201605040-21-1/1

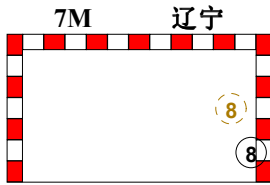
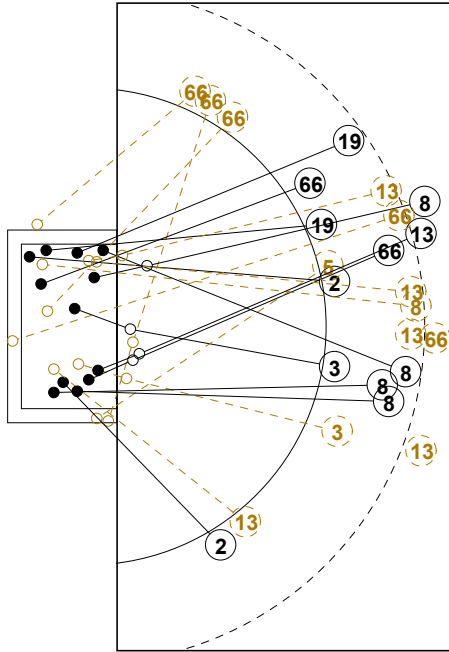

1st Half  
13 : 18

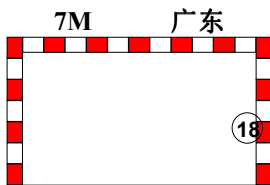
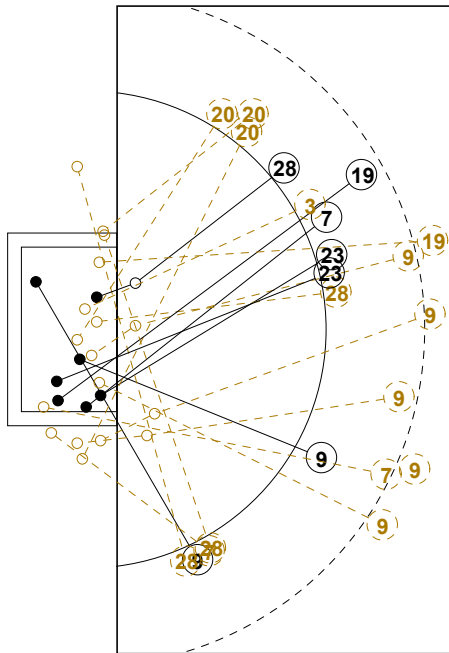
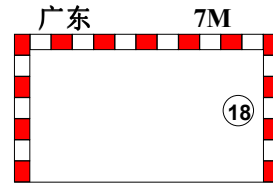
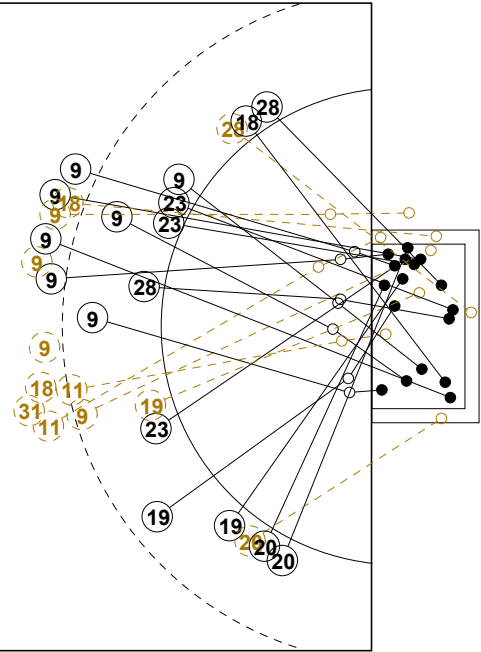

2nd Half  
26 : 24

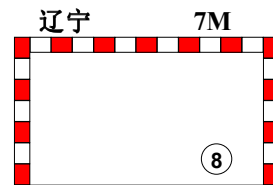
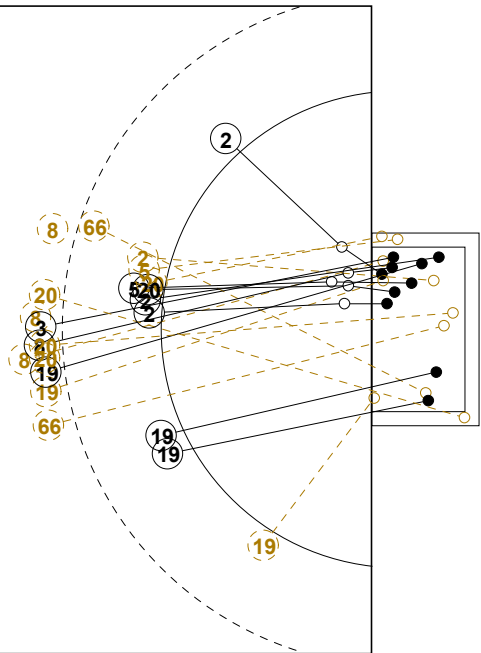



## 2016年全国女子手球锦标赛

## 个人/全队技术统计表

正式表  
手球  
女子四分之一决赛  
轮次 8组别 X  
场次 40201605040-14-1/2  
滁州体育馆  
11/09/2016 15:30

号码	姓名	远射	近射	边射	快攻	突破	任意	7M	合计	%	助攻	失误	警告	2'	取消	时间
<b>辽宁(辽宁)</b>																
<i>(场上队员)</i>																
1	于薇诗									0.0%						00:00:00
2	朱徐婷			2/2	3/4				5/6	83.3%		1				01:00:00
3	赵莹雪	1/1	1/2						2/3	66.7%		1	1	1		00:56:17
5	辛颜		1/3						1/3	33.3%		1	1	1		01:00:00
8	杨娇	4/7	1/1				0/1	2/3	7/12	58.3%	5	6				01:00:00
9	刁卫丽									0.0%						00:00:00
12	刘雪菲									0.0%						00:00:00
13	杜江花	1/5				0/1			1/6	16.7%		3	1			00:11:43
19	吕秋雪	2/3		0/1	2/2	1/1			5/7	71.4%		1		1		01:19:51
20	孙弘玲	0/3	1/1			0/1			1/5	20.0%						00:15:22
24	陈思雨									0.0%						00:00:00
27	王丹									0.0%						00:11:58
66	梁海珍	1/5		0/3	1/1				2/9	22.2%	2	2				00:52:44
93	赵琦									0.0%	1	1				00:48:02
98	张永婷									0.0%						00:00:00
99	郑锦宜									0.0%						00:00:00
<b>合计</b>		9/24	4/7	2/6	6/8	1/2	0/1	2/3	24/51	47.1%	8	16	3	3		
<i>(守门员)</i>																
27	王丹	0/1	0/2	0/3	0/1			0/2	0/9	0.0%						00:11:58
93	赵琦	6/12	1/4	1/4	1/6	1/1			10/27	37.0%	1	1				00:48:02
<b>合计</b>		6/13	1/6	1/7	1/7	1/1		0/2	10/36	27.8%	1	1				

场上队员：得分/射门

守门员：救球/射门

全队合计	得分	被救	射失	击柱	封球	合计	%
远射	9	7		2	6	24	37.5%
近射	4	1		2		7	57.1%
边射	2	2	1	1		6	33.3%
快攻	6	2				8	75.0%
突破	1			1		2	50.0%
任意		1				1	0.0%
7M	2	1				3	66.7%





## 2016年全国女子手球锦标赛

## 个人/全队技术统计表

正式表  
手球  
女子四分之一决赛  
轮次 8组别 X  
场次 40201605040-14-2/2  
滁州体育馆  
11/09/2016 15:30

号码	姓名	远射	近射	边射	快攻	突破	任意	7M	合计	%	助攻	失误	警告	2'	取消	时间
<b>广东(广东)</b>																
<i>(上场队员)</i>																
3	安妮		0/1						0/1	0.0%		2				00:08:29
5	李纯									0.0%						00:00:00
7	刘彤	0/1		0/1	1/1				1/3	33.3%			1	1		00:17:45
8	李诗棋									0.0%						00:00:00
9	韦宝桂	5/13	1/1	1/1	2/2		0/1		9/18	50.0%		6				00:53:15
11	魏梦庭	0/2							0/2	0.0%	2	2	1			00:25:47
15	杨慧									0.0%						00:00:00
16	李娟									0.0%						00:00:00
18	李玉玲	0/2		1/1				2/2	3/5	60.0%	1					00:25:12
19	邝雪花	2/3		1/1		0/1			3/5	60.0%	2					00:40:01
20	李军政			2/6					2/6	33.3%		1				01:00:00
22	刘晓玉									0.0%	1					00:18:21
23	王如		4/4		1/1				5/5	100%		2	1			01:00:00
26	马晓卉									0.0%		1				00:41:01
28	刘金兰			1/4	2/3				3/7	42.9%						00:47:18
31	史小军	0/1							0/1	0.0%						00:21:50
<b>合计</b>		7/22	5/6	6/14	6/7	0/1	0/1	2/2	26/53	49.1%	6	14	3	1		
<i>(守门员)</i>																
22	刘晓玉	3/5	0/1	1/3	1/3		1/1		6/13	46.2%	1					00:18:21
26	马晓卉	4/11	1/4	1/1	1/5	0/1		1/3	8/25	32.0%		1				00:41:01
<b>合计</b>		7/16	1/5	2/4	2/8	0/1	1/1	1/3	14/38	36.8%	1	1				

场上队员：得分/射门

守门员：救球/射门

全队合计	得分	被救	射失	击柱	封球	合计	%
远射	7	6	2	2	5	22	31.8%
近射	5	1				6	83.3%
边射	6	1	3	4		14	42.9%
快攻	6	1				7	85.7%
突破		1				1	0.0%
任意			1			1	0.0%
7M	2					2	100.0%





2016年全国女子手球锦标赛

图式射门区域统计

轮次 8 场次 40

201605040-41-1/1

辽宁

1 于薇诗	2 朱徐婷	3 赵莹雪	5 辛颜	8 杨娇	9 刁卫丽	12 刘雪菲	13 杜江花																																																																								
<table border="1"><tr><td></td><td></td><td></td></tr><tr><td></td><td></td><td></td></tr><tr><td></td><td></td><td></td></tr></table>										<table border="1"><tr><td>1</td><td></td><td>1</td></tr><tr><td>1</td><td></td><td></td></tr><tr><td>1</td><td>1</td><td></td></tr></table>	1		1	1			1	1		<table border="1"><tr><td></td><td></td><td></td></tr><tr><td></td><td>1</td><td></td></tr><tr><td>1</td><td></td><td></td></tr></table>					1		1			<table border="1"><tr><td></td><td></td><td></td></tr><tr><td>1</td><td></td><td></td></tr><tr><td></td><td></td><td></td></tr></table>				1						<table border="1"><tr><td>1</td><td></td><td></td></tr><tr><td>1</td><td></td><td></td></tr><tr><td>1</td><td></td><td>4</td></tr></table>	1			1			1		4	<table border="1"><tr><td></td><td></td><td></td></tr><tr><td></td><td></td><td></td></tr><tr><td></td><td></td><td></td></tr></table>										<table border="1"><tr><td></td><td></td><td></td></tr><tr><td></td><td></td><td></td></tr><tr><td></td><td></td><td></td></tr></table>										<table border="1"><tr><td></td><td></td><td></td></tr><tr><td></td><td></td><td></td></tr><tr><td>1</td><td></td><td></td></tr></table>							1		
1		1																																																																													
1																																																																															
1	1																																																																														
	1																																																																														
1																																																																															
1																																																																															
1																																																																															
1																																																																															
1		4																																																																													
1																																																																															
Post - 0 Miss - 0 Block - 0	Post - 0 Miss - 0 Block - 0	Post - 0 Miss - 0 Block - 0	Post - 2 Miss - 0 Block - 0	Post - 0 Miss - 0 Block - 2	Post - 0 Miss - 0 Block - 0	Post - 0 Miss - 0 Block - 0	Post - 0 Miss - 0 Block - 2																																																																								
19 吕秋雪	20 孙弘玲	24 陈思雨	27 王丹	66 梁海珍	93 赵琦	98 张永婷	99 郑锦宜																																																																								
<table border="1"><tr><td></td><td></td><td>2</td></tr><tr><td>1</td><td></td><td>2</td></tr><tr><td></td><td></td><td></td></tr></table>			2	1		2				<table border="1"><tr><td></td><td></td><td></td></tr><tr><td></td><td></td><td></td></tr><tr><td>1</td><td></td><td></td></tr></table>							1			<table border="1"><tr><td></td><td></td><td></td></tr><tr><td></td><td></td><td></td></tr><tr><td></td><td></td><td></td></tr></table>										<table border="1"><tr><td></td><td></td><td></td></tr><tr><td></td><td></td><td></td></tr><tr><td></td><td></td><td></td></tr></table>										<table border="1"><tr><td></td><td></td><td>1</td></tr><tr><td></td><td></td><td></td></tr><tr><td>1</td><td></td><td></td></tr></table>			1				1			<table border="1"><tr><td></td><td></td><td></td></tr><tr><td></td><td></td><td></td></tr><tr><td></td><td></td><td></td></tr></table>										<table border="1"><tr><td></td><td></td><td></td></tr><tr><td></td><td></td><td></td></tr><tr><td></td><td></td><td></td></tr></table>										<table border="1"><tr><td></td><td></td><td></td></tr><tr><td></td><td></td><td></td></tr><tr><td></td><td></td><td></td></tr></table>									
		2																																																																													
1		2																																																																													
1																																																																															
		1																																																																													
1																																																																															
Post - 0 Miss - 0 Block - 0	Post - 2 Miss - 0 Block - 1	Post - 0 Miss - 0 Block - 0	Post - 0 Miss - 0 Block - 0	Post - 2 Miss - 1 Block - 1	Post - 0 Miss - 0 Block - 0	Post - 0 Miss - 0 Block - 0	Post - 0 Miss - 0 Block - 0																																																																								

27 王丹

	0/2	0/1
0/1		0/3
0/2		

93 赵琦

1/2		0/2
2/9	2/2	0/1
1/4	3/4	1/3

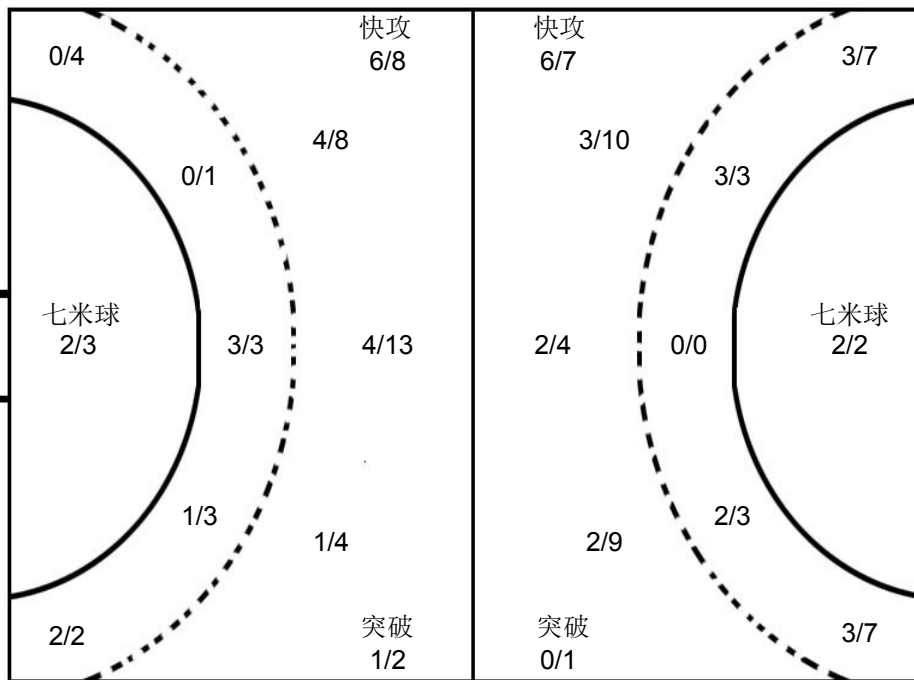
22 刘晓玉

1/1	1/1	0/1
0/2		1/2
1/3		2/3

26 马晓卉

1/3	2/2	1/4
1/3	0/1	1/2
1/5	0/1	1/4

广东

3 安妮	5 李纯	7 刘彤	8 李诗棋	9 韦宝桂	11 魏梦庭	15 杨慧	16 李娟																																																																								
<table border="1"><tr><td></td><td></td><td></td></tr><tr><td></td><td></td><td></td></tr><tr><td></td><td></td><td></td></tr></table>										<table border="1"><tr><td></td><td></td><td></td></tr><tr><td></td><td></td><td></td></tr><tr><td></td><td></td><td></td></tr></table>										<table border="1"><tr><td></td><td></td><td></td></tr><tr><td></td><td></td><td></td></tr><tr><td>1</td><td></td><td></td></tr></table>							1			<table border="1"><tr><td></td><td></td><td></td></tr><tr><td></td><td></td><td></td></tr><tr><td></td><td></td><td></td></tr></table>										<table border="1"><tr><td></td><td></td><td>2</td></tr><tr><td>2</td><td></td><td>2</td></tr><tr><td>2</td><td></td><td>1</td></tr></table>			2	2		2	2		1	<table border="1"><tr><td></td><td></td><td></td></tr><tr><td></td><td></td><td></td></tr><tr><td></td><td></td><td></td></tr></table>										<table border="1"><tr><td></td><td></td><td></td></tr><tr><td></td><td></td><td></td></tr><tr><td></td><td></td><td></td></tr></table>										<table border="1"><tr><td></td><td></td><td></td></tr><tr><td></td><td></td><td></td></tr><tr><td></td><td></td><td></td></tr></table>									
1																																																																															
		2																																																																													
2		2																																																																													
2		1																																																																													
Post - 0 Miss - 0 Block - 0	Post - 0 Miss - 0 Block - 0	Post - 0 Miss - 1 Block - 0	Post - 0 Miss - 0 Block - 0	Post - 0 Miss - 3 Block - 3	Post - 1 Miss - 0 Block - 0	Post - 0 Miss - 0 Block - 0	Post - 0 Miss - 0 Block - 0																																																																								
18 李玉玲	19 邝雪花	20 李军政	22 刘晓玉	23 王如	26 马晓卉	28 刘金兰	31 史小军																																																																								
<table border="1"><tr><td></td><td></td><td>1</td></tr><tr><td></td><td></td><td>2</td></tr><tr><td></td><td></td><td></td></tr></table>			1			2				<table border="1"><tr><td></td><td></td><td></td></tr><tr><td>2</td><td></td><td></td></tr><tr><td></td><td>1</td><td></td></tr></table>				2				1		<table border="1"><tr><td></td><td></td><td></td></tr><tr><td>1</td><td></td><td></td></tr><tr><td>1</td><td></td><td></td></tr></table>				1			1			<table border="1"><tr><td></td><td></td><td></td></tr><tr><td></td><td></td><td></td></tr><tr><td></td><td></td><td></td></tr></table>										<table border="1"><tr><td></td><td>1</td><td></td></tr><tr><td>3</td><td></td><td></td></tr><tr><td>1</td><td></td><td></td></tr></table>		1		3			1			<table border="1"><tr><td></td><td></td><td></td></tr><tr><td></td><td></td><td></td></tr><tr><td></td><td></td><td></td></tr></table>										<table border="1"><tr><td></td><td>1</td><td>1</td></tr><tr><td></td><td></td><td></td></tr><tr><td></td><td></td><td>1</td></tr></table>		1	1						1	<table border="1"><tr><td></td><td></td><td></td></tr><tr><td></td><td></td><td></td></tr><tr><td></td><td></td><td></td></tr></table>									
		1																																																																													
		2																																																																													
2																																																																															
	1																																																																														
1																																																																															
1																																																																															
	1																																																																														
3																																																																															
1																																																																															
	1	1																																																																													
		1																																																																													
Post - 1 Miss - 0 Block - 1	Post - 0 Miss - 0 Block - 0	Post - 2 Miss - 1 Block - 0	Post - 0 Miss - 0 Block - 0	Post - 0 Miss - 0 Block - 0	Post - 0 Miss - 0 Block - 0	Post - 2 Miss - 1 Block - 0	Post - 0 Miss - 0 Block - 1																																																																								

注释: Post=击柱 Miss=射失 Block=被封





四分之一决赛

女子 全国比赛

2016年全国女子手球锦标赛

Team A <b>A 安徽</b>				Team B <b>B 天津</b>				Match Number <b>41</b>													
played in China		in the hall 滁州体育馆		on 11/09/2016		at 17:00 hours		Spectators													
Half-time (30')	<b>A</b> 20	<b>B</b> 10	End of playing time	<b>A</b> 44	<b>B</b> 17	1st extra time	<b>A</b>	<b>B</b>	2nd extra time	<b>A</b>	<b>B</b>	After penalty throws	<b>A</b>	<b>B</b>							
Number of 7 m	<b>A</b> 1 / 1	Team time-out			Full name of players and officials				Team time-out			<b>B</b> 0 / 0	Number of 7 m								
No.	Team <b>A</b>					G	W	2'	D	DR	No.	Team <b>B</b>					G	W	2'	D	DR
1	司艳										3	王晓梅									
3	李兵										4	朱佳瑜									
5	班晨晨					4	1				5	丁丽洁									
6	沈萍					4					7	张心茹									
7	赵江川										8	张慧					2	1			
8	徐仕媛										10	张文慧					3	1			
10	孙来苗					6					11	蔡雪洁					1				
14	刘晓妹					6					12	王欣冉									
16	朱莉珍										14	刘洁									
17	周婷					5					15	李窈窈									
18	郑冬冬					8					16	王选									
20	周雪婷					3	1				17	聂晓雪					2				
21	李瑶										18	舒文琪					6				
23	张天洁					4					21	李默雅					1				
41	杜机娟					4					22	王聪									
46	陶传红										23	周梦雪					2	1			
<b>A</b>	吴立军										<b>A</b>	付明双									
<b>E</b>	张舜										<b>B</b>	王明星 (主教练)									
											<b>C</b>	岳连娥									
<b>A</b>	Signature of Responsible Official of the Teams (Off. A)										<b>B</b>										
TP	Remarks of Referee / CHA Official										TP										

Signatures

Referees: 杜新 (CHN) 刘正松 (CHN)

Techn. Delegates: 高斌 (CHN)

CHA Official: 刘书勇 (CHN)

Note: Number of 7m Throws Awarded to Team A and B, Goals (G), Warnings (W), Suspensions (2'), Direct Disqualification (D), Disqualification with Report (DR) and Team Penalty (TP).

Table Officials: 佟金政 贾俊秋 Statisticians: 陈柱 刘永欢

Printed by PHMS Copyright: IHF / CHA 11/09/2016 13:16:35

Longman Sportsoft handball@126.com





2016年全国女子手球锦标赛  
竞赛技术统计(媒体表)

四分之一决赛		组别	X	轮次	8	场次	41
滁州体育馆		11/09/2016			201605041-51-1/1		
安徽	安徽	44	vs	17	天津	天津	
				20 : 10			

裁判员		杜新 (CHN)											/											刘正松 (CHN)										
安徽		远射	近射	边射	快攻	突破	任意球	7m球	合计	%	助攻	失误	警告	2'	D & DR	安徽		比赛进程		天津														
主教练：孙来苗																		1st Half																
1	司艳									2	2				41	杜机娟	1	02:32	0															
3	李兵									2	2				18	郑冬冬	2	04:29	0															
5	班晨晨	1/3	1/1			1/1	1/1	4/6	66.7	2	1	1			6	沈萍	3	05:35	1	18	舒文琪	1												
6	沈萍	0/1	4/5					4/6	66.7	2	2				6	沈萍	4	06:12	1															
7	赵江川														6	沈萍	4	06:52	2	18	舒文琪	2												
8	徐仕媛														18	郑冬冬	5	08:09	2															
10	孙来苗		2/2	1/1	3/3			6/6	100	1	2				14	刘晓妹	6	09:25	2															
14	刘晓妹	3/5				3/4		6/9	66.7	9	2				6	刘晓妹	6	09:55	3	11	蔡雪洁	3												
16	朱莉珍									1					7	刘晓妹	7	11:07	3															
17	周婷		2/4		1/1	2/2		5/7	71.4	2	3				20	周雪婷	8	12:27	3															
18	郑冬冬	1/1	5/6	1/1	1/2			8/10	80.0	1	2				8	周婷	8	12:58	4	18	舒文琪	4												
20	周雪婷			0/1	3/3			3/4	75.0	1		1			17	周婷	9	14:36	4															
21	李瑶														23	张天洁	10	15:32	4															
23	张天洁		2/2	0/1	2/2			4/5	80.0		1				14	刘晓妹	11	17:13	4															
41	杜机娟			2/3	2/2			4/5	80.0		1				6	沈萍	12	18:09	4															
46	陶传红														12	周婷	12	18:57	5	10	张文慧	5												
运动员 合计		5/10	16/20	4/7	12/13	6/7	1/1	44/58	75.9	23	18	2			17	周婷	13	19:32	5															
1	司艳	6/8	0/2	1/2	0/1	0/1		7/14	50.0	2	2				17	周婷	13	20:09	6	18	舒文琪	6												
8	徐仕媛		1/1					1/1	100						17	周婷	14	20:30	6															
16	朱莉珍	8/14	0/1	1/1	1/4			10/20	50.0	1					14	刘晓妹	14	21:31	7	8	张慧	7												
守门员 合计		14/22	1/4	2/3	1/5	0/1		18/35	51.4	3	2				15	刘晓妹	15	21:54	7															
天津		远射	近射	边射	快攻	突破	任意球	7m球	合计	%	助攻	失误	警告	2'	D & DR			2nd Half																
教练：王明星																		6 沈萍		21 02:03 10														
3	王晓梅															5	班晨晨	22	03:33	10														
4	朱佳瑜															17	周婷	23	04:10	10														
5	丁丽洁	0/1						0/1	0.0							5	班晨晨	24	05:59	10														
7	张心茹															20	周雪婷	25	06:49	10														
8	张慧			0/1	2/2			2/3	66.7		2	1				25	周婷	25	07:07	11	17	聂晓雪	11											
10	张文慧		2/2		1/1			3/3	100		1	1				18	郑冬冬	26	07:35	11														
11	蔡雪洁	1/12			0/1			1/13	7.7		1					10	孙来苗	27	08:44	11														
12	王欣冉															18	郑冬冬	28	09:23	11														
14	刘洁	0/1						0/1	0.0		1					18	郑冬冬	29	10:04	11														
15	李宛宛	0/1						0/1	0.0		3					10	孙来苗	30	11:15	11														
16	王选															5	班晨晨	31	12:20	12														
17	聂晓雪	1/2	1/1					2/3	66.7		3					18	郑冬冬	32	13:58	12														
18	舒文琪	6/18						6/18	33.3	1	10					18	郑冬冬	33	14:39	12														
21	李默雅	0/1		0/2	1/1			1/4	25.0		1					10	孙来苗	34	15:22	12														
22	王聪															34	班晨晨	34	15:59	13	23	周梦雪	13											
23	周梦雪	0/3	0/1	1/2		1/1		2/7	28.6	2	3	1				10	孙来苗	35	16:29	13														
运动员 合计		8/39	3/4	1/5	4/5	1/1		17/54	31.5	3	25	3				23	张天洁	36	17:04	13														
12	王欣冉	2/4	3/10	0/2	0/6		0/1	5/23	21.7							10	孙来苗	37	17:50	13														
16	王选	1/4	1/10	2/4	1/7	0/6		5/31	16.1							37	周婷	37	19:11	14	18	舒文琪	14											
守门员 合计		3/8	4/20	2/6	1/13	0/6	0/1	10/54	18.5							37	周婷	37	20:58	15	23	周梦雪	15											
																38	刘晓妹	38	21:23	15														
																14	刘晓妹	39	23:40	16														
																14	刘晓妹	40	24:43	16														
																17	周婷	41	25:58	16														
																23	张天洁	42	26:42	16														
																20	周雪婷	43	27:51	16														
																18	郑冬冬	43	28:29	17	10	张文慧	17											
																		44	28:52	17														

场上队员：得分 / 射门

守门员：救球 / 射门

快攻	Fast Break		突破	Breakthrough		任意球	Free Throw		7M球	7M Throw		助攻	Assist
警告	Warning		失误	Error		2'	Suspension		D	取消资格		DR	取消资格+报告





### 2016年全国女子手球锦标赛 图式比赛技术统计表

轮次 8

场次 41

201605041-21-1/1

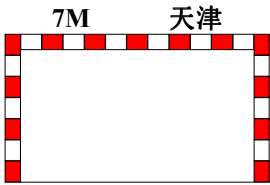
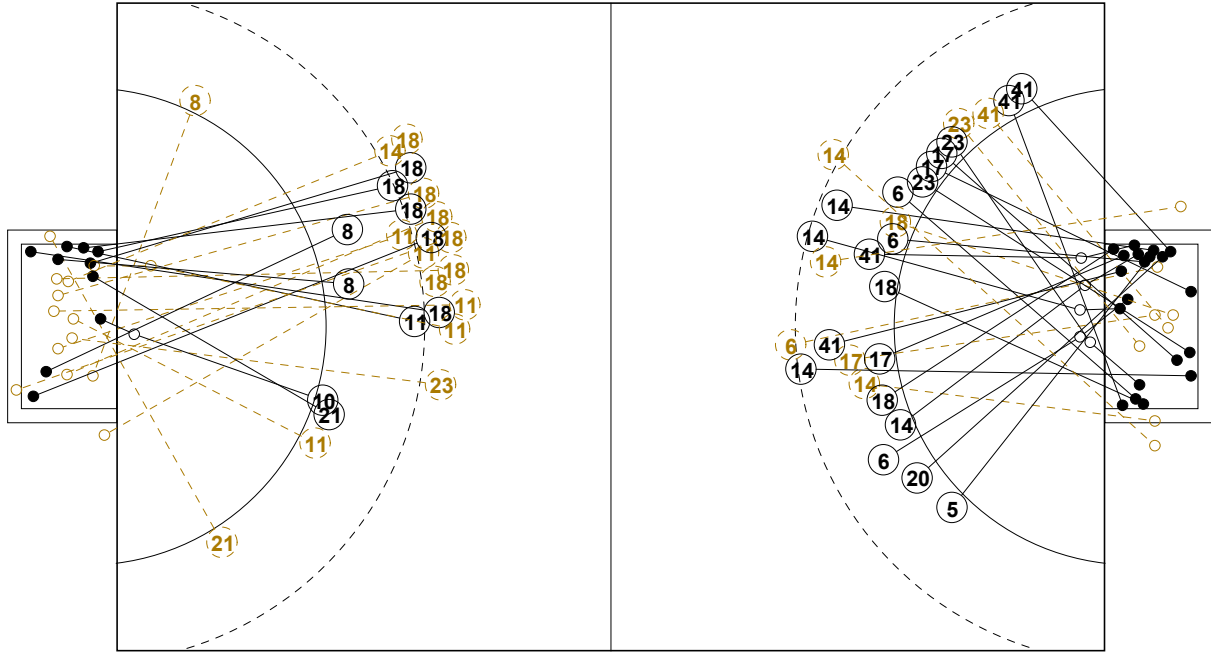

1st Half  
10 : 20

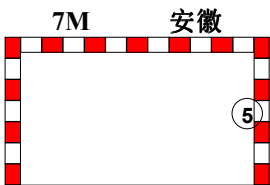
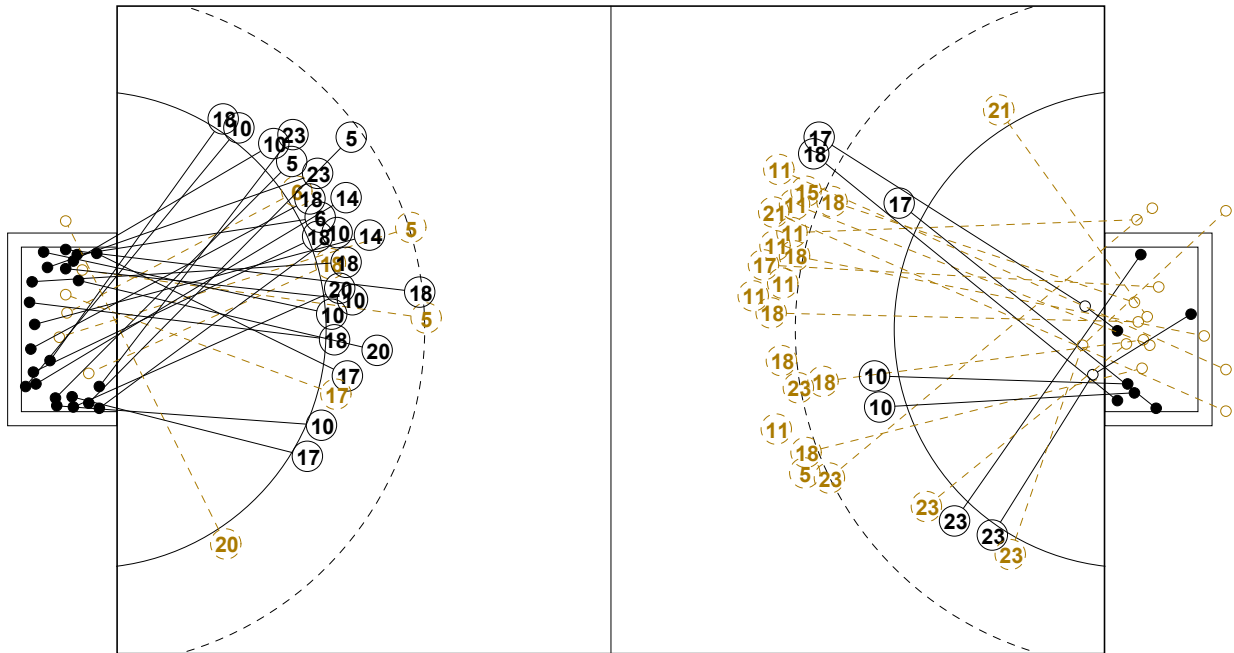
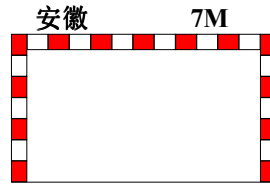

2nd Half  
44 : 17

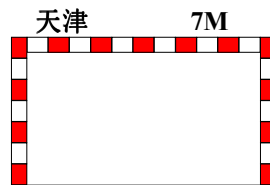



## 2016年全国女子手球锦标赛

## 个人/全队技术统计表

正式表  
手球  
女子四分之一决赛  
轮次 8组别 X  
场次 41201605041-14-1/2  
滁州体育馆  
11/09/2016 17:00

号码	姓名	远射	近射	边射	快攻	突破	任意	7M	合计	%	助攻	失误	警告	2'	取消	时间
<b>安徽(安徽)</b>																
<i>(场上队员)</i>																
1	司艳									0.0%	2	2				00:28:32
3	李兵									0.0%	2	2				00:17:39
5	班晨晨	1/3	1/1			1/1		1/1	4/6	66.7%	2	1	1			00:38:59
6	沈萍	0/1	4/5						4/6	66.7%	2	2				00:29:46
7	赵江川									0.0%						00:00:00
8	徐仕媛									0.0%						00:01:28
10	孙来苗		2/2	1/1	3/3				6/6	100%	1	2				00:30:00
14	刘晓妹	3/5				3/4			6/9	66.7%	9	2				00:44:43
16	朱莉珍									0.0%	1					00:30:00
17	周婷		2/4		1/1	2/2			5/7	71.4%	2	3				00:45:40
18	郑冬冬	1/1	5/6	1/1	1/2				8/10	80.0%	1	2				00:31:35
20	周雪婷			0/1	3/3				3/4	75.0%	1		1			00:47:26
21	李瑶									0.0%						00:00:00
23	张天洁		2/2	0/1	2/2				4/5	80.0%		1				00:43:51
41	杜机娟			2/3	2/2				4/5	80.0%		1				00:30:00
46	陶传红									0.0%						00:00:09
<b>合计</b>		5/10	16/20	4/7	12/13	6/7		1/1	44/58	75.9%	23	18	2			
<i>(守门员)</i>																
1	司艳	6/8	0/2	1/2	0/1	0/1			7/14	50.0%	2	2				00:28:32
8	徐仕媛		1/1						1/1	100%						00:01:28
16	朱莉珍	8/14	0/1	1/1	1/4				10/20	50.0%	1					00:30:00
<b>合计</b>		14/22	1/4	2/3	1/5	0/1			18/35	51.4%	3	2				

场上队员：得分/射门

守门员：救球/射门

全队合计	得分	被救	射失	击柱	封球	合计	%
远射	5	3	2			10	50.0%
近射	16	4				20	80.0%
边射	4	2	1			7	57.1%
快攻	12	1				13	92.3%
突破	6			1		7	85.7%
任意							0.0%
7M	1					1	100.0%





## 2016年全国女子手球锦标赛

## 个人/全队技术统计表

正式表  
手球  
女子四分之一决赛  
轮次 8组别 X  
场次 41201605041-14-2/2  
滁州体育馆  
11/09/2016 17:00

号码	姓名	远射	近射	边射	快攻	突破	任意	7M	合计	%	助攻	失误	警告	2'	取消	时间
<b>天津(天津)</b>																
<i>(上场队员)</i>																
3	王晓梅									0.0%						00:00:00
4	朱佳瑜									0.0%						00:09:59
5	丁丽洁	0/1							0/1	0.0%						00:09:21
7	张心茹									0.0%						00:00:00
8	张慧			0/1	2/2				2/3	66.7%		2	1			00:42:52
10	张文慧		2/2		1/1				3/3	100%		1	1			00:49:01
11	蔡雪洁	1/12			0/1				1/13	7.7%		1				00:49:33
12	王欣冉									0.0%						00:23:16
14	刘洁	0/1							0/1	0.0%		1				00:39:41
15	李窈窈	0/1							0/1	0.0%		3				00:12:31
16	王选									0.0%						00:36:44
17	聂晓雪	1/2	1/1						2/3	66.7%		3				00:33:22
18	舒文琪	6/18							6/18	33.3%	1	10				00:55:44
21	李默雅	0/1		0/2	1/1				1/4	25.0%		1				00:36:03
22	王聪									0.0%						00:00:00
23	周梦雪	0/3	0/1	1/2		1/1			2/7	28.6%	2	3	1			00:28:38
<b>合计</b>		8/39	3/4	1/5	4/5	1/1			17/54	31.5%	3	25	3			
<i>(守门员)</i>																
12	王欣冉	2/4	3/10	0/2	0/6			0/1	5/23	21.7%						00:23:16
16	王选	1/4	1/10	2/4	1/7	0/6			5/31	16.1%						00:36:44
<b>合计</b>																
		3/8	4/20	2/6	1/13	0/6		0/1	10/54	18.5%						

场上队员：得分/射门

守门员：救球/射门

全队合计	得分	被救	射失	击柱	封球	合计	%
远射	8	14	5	2	10	39	20.5%
近射	3	1				4	75.0%
边射	1	2	1	1		5	20.0%
快攻	4	1				5	80.0%
突破	1					1	100.0%
任意							0.0%
7M							0.0%





### 2016年全国女子手球锦标赛

#### 图式射门区域统计

轮次 8 场次 41

201605041-41-1/1

## 安徽

1 司艳	3 李兵	5 班晨晨	6 沈萍	7 赵江川	8 徐仕媛	10 孙来苗	14 刘晓妹																																																																								
<table border="1"><tr><td></td><td></td><td></td></tr><tr><td></td><td></td><td></td></tr><tr><td></td><td></td><td></td></tr></table>										<table border="1"><tr><td></td><td></td><td></td></tr><tr><td></td><td></td><td></td></tr><tr><td></td><td></td><td></td></tr></table>										<table border="1"><tr><td></td><td></td><td></td></tr><tr><td>2</td><td></td><td>1</td></tr><tr><td>1</td><td></td><td></td></tr></table>				2		1	1			<table border="1"><tr><td></td><td></td><td></td></tr><tr><td>1</td><td></td><td>2</td></tr><tr><td></td><td>1</td><td></td></tr></table>				1		2		1		<table border="1"><tr><td></td><td></td><td></td></tr><tr><td></td><td></td><td></td></tr><tr><td></td><td></td><td></td></tr></table>										<table border="1"><tr><td></td><td></td><td></td></tr><tr><td></td><td></td><td></td></tr><tr><td></td><td></td><td></td></tr></table>										<table border="1"><tr><td>1</td><td></td><td>1</td></tr><tr><td>1</td><td></td><td>2</td></tr><tr><td>1</td><td></td><td></td></tr></table>	1		1	1		2	1			<table border="1"><tr><td>1</td><td>1</td><td>1</td></tr><tr><td>2</td><td></td><td></td></tr><tr><td></td><td>1</td><td></td></tr></table>	1	1	1	2				1	
2		1																																																																													
1																																																																															
1		2																																																																													
	1																																																																														
1		1																																																																													
1		2																																																																													
1																																																																															
1	1	1																																																																													
2																																																																															
	1																																																																														
Post - 0 Miss - 0 Block - 0	Post - 0 Miss - 0 Block - 0	Post - 0 Miss - 0 Block - 0	Post - 0 Miss - 0 Block - 0	Post - 0 Miss - 0 Block - 0	Post - 0 Miss - 0 Block - 0	Post - 0 Miss - 0 Block - 0	Post - 1 Miss - 2 Block - 0																																																																								
16 朱莉珍	17 周婷	18 郑冬冬	20 周雪婷	21 李瑶	23 张天洁	41 杜机娟	46 陶传红																																																																								
<table border="1"><tr><td></td><td></td><td></td></tr><tr><td></td><td></td><td></td></tr><tr><td></td><td></td><td></td></tr></table>										<table border="1"><tr><td>1</td><td></td><td>1</td></tr><tr><td>1</td><td></td><td></td></tr><tr><td>1</td><td></td><td>1</td></tr></table>	1		1	1			1		1	<table border="1"><tr><td>2</td><td>2</td><td>1</td></tr><tr><td></td><td></td><td>2</td></tr><tr><td>1</td><td></td><td></td></tr></table>	2	2	1			2	1			<table border="1"><tr><td></td><td></td><td></td></tr><tr><td>2</td><td></td><td>1</td></tr><tr><td></td><td></td><td></td></tr></table>				2		1				<table border="1"><tr><td></td><td></td><td></td></tr><tr><td></td><td></td><td></td></tr><tr><td></td><td></td><td></td></tr></table>										<table border="1"><tr><td></td><td>1</td><td>1</td></tr><tr><td></td><td></td><td>1</td></tr><tr><td>1</td><td></td><td></td></tr></table>		1	1			1	1			<table border="1"><tr><td>1</td><td></td><td></td></tr><tr><td></td><td></td><td></td></tr><tr><td>2</td><td></td><td>1</td></tr></table>	1						2		1	<table border="1"><tr><td></td><td></td><td></td></tr><tr><td></td><td></td><td></td></tr><tr><td></td><td></td><td></td></tr></table>									
1		1																																																																													
1																																																																															
1		1																																																																													
2	2	1																																																																													
		2																																																																													
1																																																																															
2		1																																																																													
	1	1																																																																													
		1																																																																													
1																																																																															
1																																																																															
2		1																																																																													
Post - 0 Miss - 0 Block - 0	Post - 0 Miss - 0 Block - 0	Post - 0 Miss - 0 Block - 0	Post - 0 Miss - 1 Block - 0	Post - 0 Miss - 0 Block - 0	Post - 0 Miss - 0 Block - 0	Post - 0 Miss - 0 Block - 0	Post - 0 Miss - 0 Block - 0																																																																								

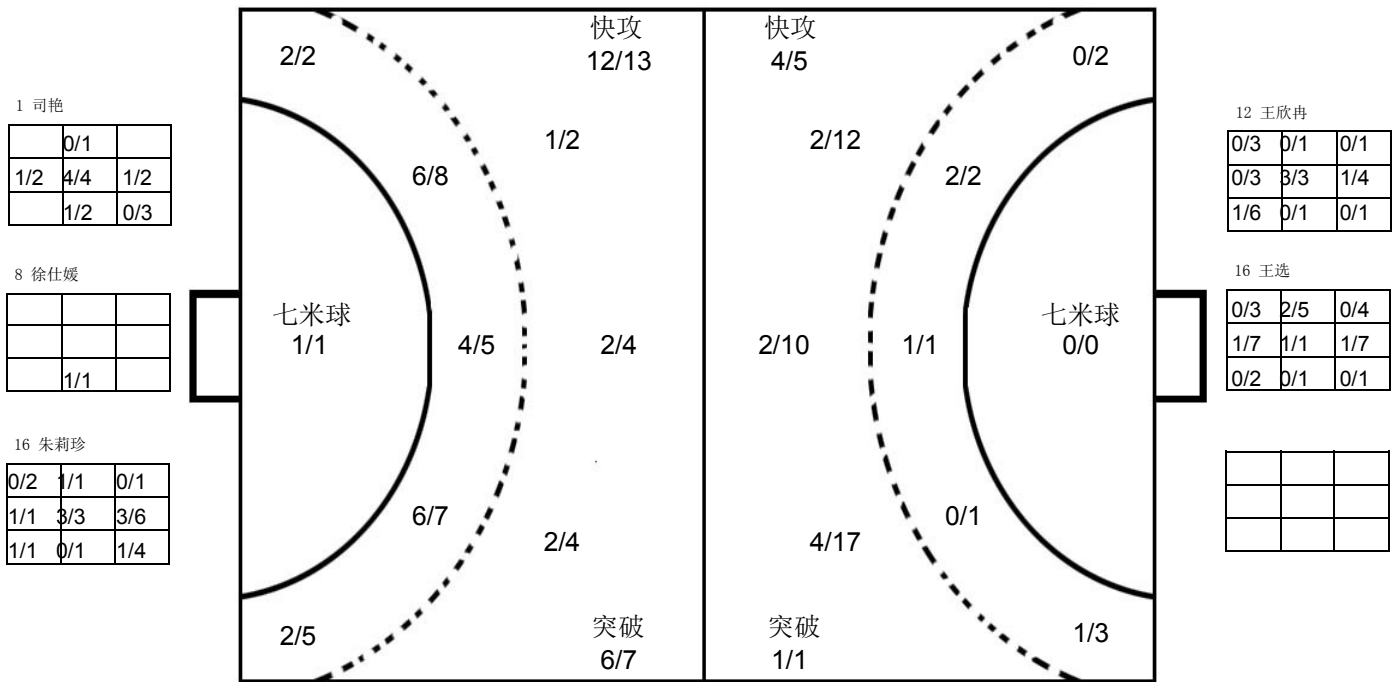

## 天津

3 王晓梅	4 朱佳瑜	5 丁丽洁	7 张心茹	8 张慧	10 张文慧	11 蔡雪洁	12 王欣冉																																																																								
<table border="1"><tr><td></td><td></td><td></td></tr><tr><td></td><td></td><td></td></tr><tr><td></td><td></td><td></td></tr></table>										<table border="1"><tr><td></td><td></td><td></td></tr><tr><td></td><td></td><td></td></tr><tr><td></td><td></td><td></td></tr></table>										<table border="1"><tr><td></td><td></td><td></td></tr><tr><td></td><td></td><td></td></tr><tr><td></td><td></td><td></td></tr></table>										<table border="1"><tr><td></td><td></td><td></td></tr><tr><td></td><td></td><td></td></tr><tr><td></td><td></td><td></td></tr></table>										<table border="1"><tr><td>1</td><td></td><td></td></tr><tr><td></td><td></td><td>1</td></tr><tr><td></td><td></td><td></td></tr></table>	1					1				<table border="1"><tr><td></td><td></td><td></td></tr><tr><td></td><td></td><td></td></tr><tr><td></td><td>1</td><td>2</td></tr></table>								1	2	<table border="1"><tr><td></td><td></td><td></td></tr><tr><td></td><td></td><td></td></tr><tr><td></td><td></td><td>1</td></tr></table>									1	<table border="1"><tr><td></td><td></td><td></td></tr><tr><td></td><td></td><td></td></tr><tr><td></td><td></td><td></td></tr></table>									
1																																																																															
		1																																																																													
	1	2																																																																													
		1																																																																													
Post - 0 Miss - 0 Block - 0	Post - 0 Miss - 0 Block - 0	Post - 0 Miss - 0 Block - 1	Post - 0 Miss - 0 Block - 0	Post - 0 Miss - 0 Block - 0	Post - 0 Miss - 0 Block - 0	Post - 0 Miss - 3 Block - 4	Post - 0 Miss - 0 Block - 0																																																																								
14 刘洁	15 李窈窈	16 王选	17 聂晓雪	18 舒文琪	21 李默雅	22 王聪	23 周梦雪																																																																								
<table border="1"><tr><td></td><td></td><td></td></tr><tr><td></td><td></td><td></td></tr><tr><td></td><td></td><td></td></tr></table>										<table border="1"><tr><td></td><td></td><td></td></tr><tr><td></td><td></td><td></td></tr><tr><td></td><td></td><td></td></tr></table>										<table border="1"><tr><td></td><td></td><td></td></tr><tr><td></td><td></td><td></td></tr><tr><td></td><td></td><td></td></tr></table>										<table border="1"><tr><td></td><td></td><td></td></tr><tr><td></td><td></td><td>1</td></tr><tr><td></td><td>1</td><td></td></tr></table>						1		1		<table border="1"><tr><td>1</td><td></td><td>1</td></tr><tr><td></td><td></td><td>1</td></tr><tr><td></td><td></td><td>3</td></tr></table>	1		1			1			3	<table border="1"><tr><td></td><td></td><td></td></tr><tr><td></td><td></td><td></td></tr><tr><td></td><td></td><td>1</td></tr></table>									1	<table border="1"><tr><td></td><td></td><td></td></tr><tr><td></td><td></td><td></td></tr><tr><td></td><td></td><td></td></tr></table>										<table border="1"><tr><td></td><td></td><td>1</td></tr><tr><td>1</td><td></td><td></td></tr><tr><td></td><td></td><td></td></tr></table>			1	1					
		1																																																																													
	1																																																																														
1		1																																																																													
		1																																																																													
		3																																																																													
		1																																																																													
		1																																																																													
1																																																																															
Post - 0 Miss - 0 Block - 0	Post - 0 Miss - 0 Block - 1	Post - 0 Miss - 0 Block - 0	Post - 0 Miss - 0 Block - 0	Post - 2 Miss - 0 Block - 3	Post - 1 Miss - 1 Block - 0	Post - 0 Miss - 0 Block - 0	Post - 0 Miss - 2 Block - 1																																																																								

注释: Post=击柱 Miss=射失 Block=被封





四分之一决赛

女子 全国比赛

2016年全国女子手球锦标赛

Team A A 上海				Team B B 新疆				Match Number 42													
played in China		in the hall 滁州体育馆		on 11/09/2016		at 18:30 hours		Spectators													
Half-time (30')	A 13	B 10	End of playing time	A 30	B 14	1st extra time	A	B	2nd extra time	A	B	After penalty throws	A	B							
Number of 7 m	A 1/2	Team time-out			Full name of players and officials				Team time-out			B 3/4	Number of 7 m								
		1 17:14	2 53:51	3					1 12:59	2 43:03	3 56:35										
No.	Team A					G	W	2'	D	DR	No.	Team B					G	W	2'	D	DR
1	许沫										3	葛立双									
2	周蕾					1		1			6	阿孜古					2				
5	郭威					2					7	吴志娟							1		
6	黄妍					4					10	李静									
7	车婉茹										11	陈培培									
8	吴茵					6		1			12	艾敏加尔汉									
9	武娜娜					3	1				15	兰姝娇									
10	斯文					3					17	戴莹莹					1				
11	孙梦颖					5					18	崔娟					3	1			
12	郑冯										21	锁珊珊					5				
13	徐娟										23	张艺璇							1		
17	居晔							1			26	宋婷婷									
18	沙正文							1	1		27	谢辰辰									
19	印尼					5					32	杨雨柔									
21	王嘉怡					1					93	张婷婷					3				
23	都好							1													
B	陈进培 (主教练)										B	于涛 (主教练)									
C	金锺顺										D	高璇									
D	贺业磊																				
F	周瑜宸																				
A	Signature of Responsible Official of the Teams (Off. A)																			B	
TP	Remarks of Referee / CHA Official																			TP	

Signatures

Referees	马晓晔 (CHN)	隆晓磊 (CHN)		
Techn. Delegates	高斌 (CHN)			
CHA Official	刘书勇 (CHN)			

Note: Number of 7m Throws Awarded to Team A and B, Goals (G), Warnings (W), Suspensions (2'), Direct Disqualification (D), Disqualification with Report (DR) and Team Penalty (TP).

Table Officials: 陈文丽 赵涵 Statisticians: 黄岩 闫冲





### 2016年全国女子手球锦标赛 竞赛技术统计(媒体表)

四分之一决赛	组别	X	轮次	8	场次	42
--------	----	---	----	---	----	----

滁州体育馆

11/09/2016

201605042-51-1/1

上海	上海	30	vs	14	新疆	新疆
13 : 10						

裁判员	马晓晔 (CHN)	/	隆晓磊 (CHN)
-----	-----------	---	-----------

上海																新疆	
主教练：陈进培																比赛进程	
	远射	近射	边射	快攻	突破	任意球	7m球	合计	%	助攻	失误	警告	2'	D & DR			
1 许沫											1				6 黄妍	1 01:41	0
2 周蕾			1/1					1/1	100		1		1		9 武娜娜	2 02:45	0
5 郭威	0/1	1/2					1/1	2/4	50.0		2				10 斯文	3 06:14	1 6 阿孜古
6 黄妍	4/5	0/1					0/1	4/7	57.1		1				10 斯文	4 07:28	2
7 车婉茹															4 09:11	3 21 锁珊珊	
8 吴茵	1/2	3/4	2/2					6/8	75.0		3		1		4 09:58	4 93 张婷婷	
9 武娜娜			0/1	3/3				3/4	75.0			1			5 10:22	4	
10 斯文	0/1		3/3					3/4	75.0		1				6 11:02	4	
11 孙梦颖	4/5			1/1				5/6	83.3		1				6 14:01	5 21 锁珊珊	
12 郑冯															6 16:54	6 18 崔娟	
13 徐娟															7 18:18	6	
17 居晔												1			8 19:06	6	
18 沙正文											1	1	1		11 孙梦颖	9 20:06	6
19 印尼	2/4	2/2			1/1			5/7	71.4		3				10 20:50	6	
21 王嘉怡			1/1					1/1	100						10 23:30	7 6 阿孜古	
23 都好		0/2						0/2	0.0				1		11 孙梦颖	10 08:30	10
<b>运动员 合计</b>	<b>11/18</b>	<b>6/11</b>	<b>7/8</b>	<b>4/4</b>	<b>1/1</b>		<b>1/2</b>	<b>30/44</b>	<b>68.2</b>		<b>14</b>	<b>3</b>	<b>4</b>		17 09:06	11 21 锁珊珊	
1 许沫	7/10	1/5	1/1		0/1		0/2	9/19	47.4		1				8 吴茵	18 10:31	11
12 郑冯	4/6	2/3	2/2				0/1	8/12	66.7						9 武娜娜	19 11:04	11
<b>守门员 合计</b>	<b>11/16</b>	<b>3/8</b>	<b>3/3</b>		<b>0/1</b>		<b>0/3</b>	<b>17/31</b>	<b>54.8</b>		<b>1</b>				8 吴茵	20 13:01	11
														2nd Half			
														10 斯文	14 01:16	10	
														11 孙梦颖	15 02:17	10	
														19 印尼	16 07:07	10	
														11 孙梦颖	17 08:30	10	
														17 09:06	11 21 锁珊珊		
														8 吴茵	18 10:31	11	
														9 武娜娜	19 11:04	11	
														8 吴茵	20 13:01	11	
														9 武娜娜	21 13:44	11	
														8 吴茵	22 16:02	11	
														22 17:20	12 17 戴莹莹		
														22 18:34	13 21 锁珊珊		
														5 郭威	23 19:37	13	
														6 黄妍	24 20:41	13	
														24 21:42	14 93 张婷婷		
														8 吴茵	25 22:05	14	
														5 郭威	26 22:44	14	
														21 王嘉怡	27 24:32	14	
														6 黄妍	28 25:46	14	
														2 周蕾	29 26:23	14	
														11 孙梦颖	30 28:07	14	

场上队员：得分 / 射门

守门员：救球 / 射门

快攻	Fast Break	突破	Breakthrough	任意球	Free Throw	7M球	7M Throw	助攻	Assist
警告	Warning	失误	Error	2'	Suspension	D	取消资格	DR	取消资格+报告





### 2016年全国女子手球锦标赛 图式比赛技术统计表

轮次 8

场次 42

201605042-21-1/1

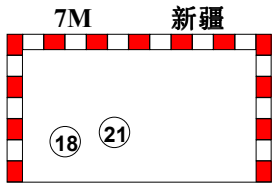
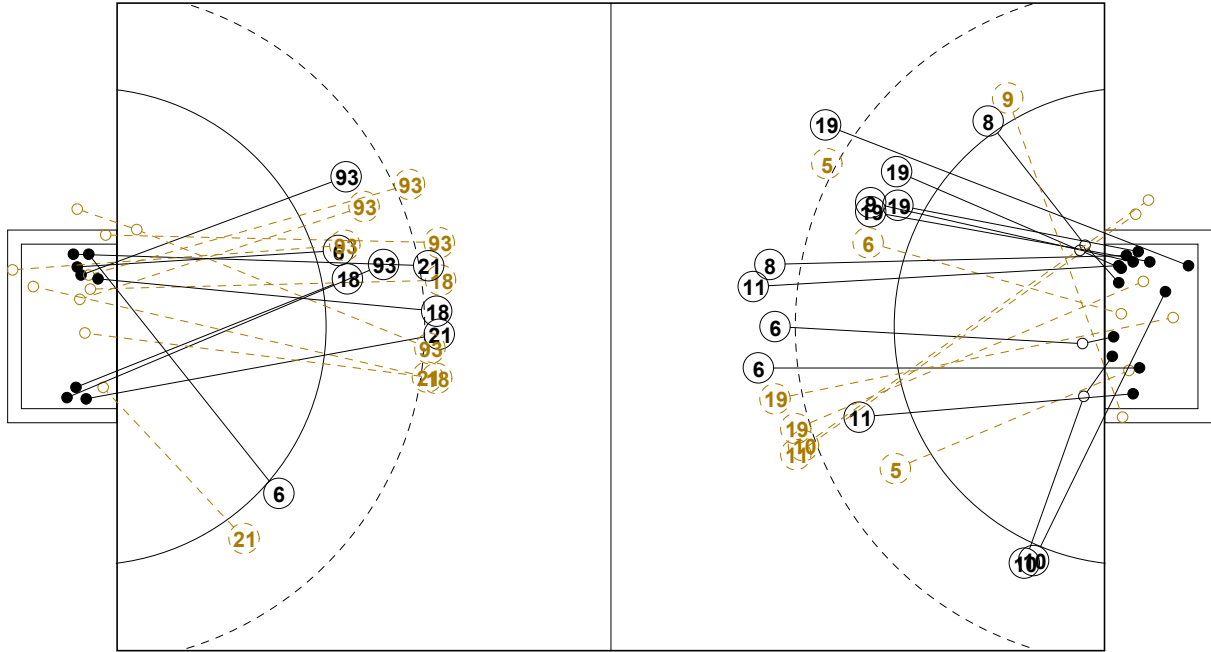

1st Half  
10 : 13

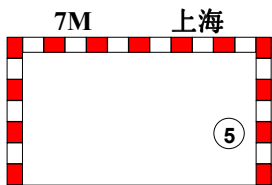
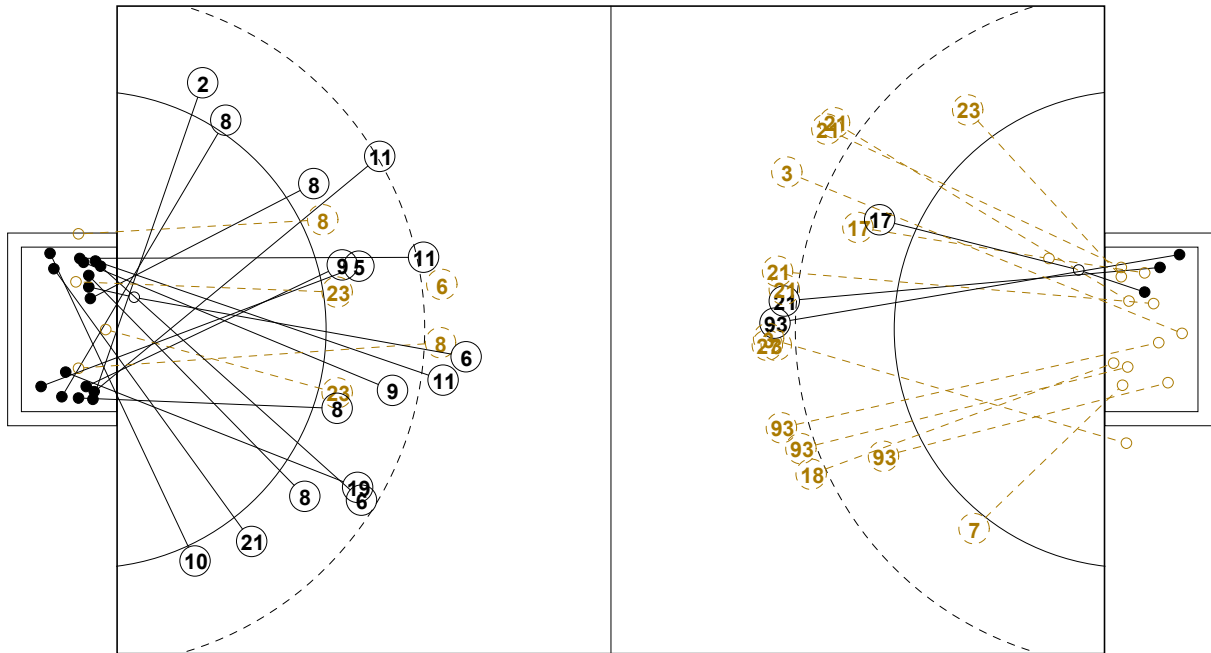
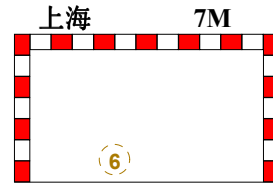

2nd Half  
30 : 14

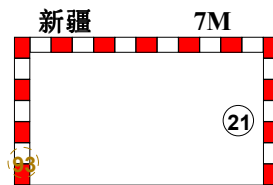





## 2016年全国女子手球锦标赛

## 个人/全队技术统计表

正式表  
手球  
女子四分之一决赛  
轮次 8组别 X  
场次 42201605042-14-1/2  
滁州体育馆  
11/09/2016 18:30

号码	姓名	远射	近射	边射	快攻	突破	任意	7M	合计	%	助攻	失误	警告	2'	取消	时间
<b>上海(上海)</b>																
<i>(场上队员)</i>																
1	许沫									0.0%		1				00:42:24
2	周蕾			1/1					1/1	100%		1		1		00:27:07
5	郭威	0/1	1/2					1/1	2/4	50.0%		2				00:16:19
6	黄妍	4/5	0/1					0/1	4/7	57.1%		1				00:26:46
7	车婉茹									0.0%						00:00:00
8	吴茵	1/2	3/4	2/2					6/8	75.0%		3		1		00:31:48
9	武娜娜			0/1	3/3				3/4	75.0%			1			00:34:50
10	斯文	0/1		3/3					3/4	75.0%		1				00:38:08
11	孙梦颖	4/5			1/1				5/6	83.3%		1				00:46:27
12	郑冯									0.0%						00:17:36
13	徐娟									0.0%						00:01:03
17	居晔									0.0%			1			00:29:03
18	沙正文									0.0%		1	1	1		00:43:59
19	印尼	2/4	2/2			1/1			5/7	71.4%		3				00:33:12
21	王嘉怡			1/1					1/1	100%						00:05:16
23	都好		0/2						0/2	0.0%				1		00:27:04
<b>合计</b>		11/18	6/11	7/8	4/4	1/1		1/2	30/44	68.2%		14	3	4		
<i>(守门员)</i>																
1	许沫	7/10	1/5	1/1		0/1		0/2	9/19	47.4%		1				00:42:24
12	郑冯	4/6	2/3	2/2				0/1	8/12	66.7%						00:17:36
<b>合计</b>		11/16	3/8	3/3		0/1		0/3	17/31	54.8%		1				

场上队员：得分/射门

守门员：救球/射门

全队合计	得分	被救	射失	击柱	封球	合计	%
远射	11	3	2		2	18	61.1%
近射	6	4		1		11	54.5%
边射	7			1		8	87.5%
快攻	4					4	100.0%
突破	1					1	100.0%
任意							0.0%
7M	1	1				2	50.0%





## 2016年全国女子手球锦标赛

## 个人/全队技术统计表

正式表  
手球  
女子四分之一决赛  
轮次 8组别 X  
场次 42201605042-14-2/2  
滁州体育馆  
11/09/2016 18:30

号码	姓名	远射	近射	边射	快攻	突破	任意	7M	合计	%	助攻	失误	警告	2'	取消	时间
<b>新疆(新疆)</b>																
<i>(上场队员)</i>																
3	葛立双	0/3							0/3	0.0%		1				00:15:38
6	阿孜古		2/2						2/2	100%		1				00:44:21
7	吴志娟			0/1					0/1	0.0%		1		1		00:56:08
10	李静									0.0%						00:16:07
11	陈培培									0.0%						00:00:00
12	艾敏加尔汉									0.0%						00:00:28
15	兰姝娇									0.0%		2				00:04:18
17	戴莹莹		1/2						1/2	50.0%		1				00:53:29
18	崔娟	1/4	1/1					1/1	3/6	50.0%		2	1			00:52:54
21	锁珊珊	3/8		0/1				2/2	5/11	45.5%		3				00:51:42
23	张艺璇			0/1					0/1	0.0%				1		00:21:15
26	宋婷婷									0.0%						00:00:00
27	谢辰辰	0/1							0/1	0.0%						00:16:51
32	杨雨柔									0.0%						00:43:53
93	张婷婷	1/6	1/4			1/1		0/1	3/12	25.0%	1	6				00:57:25
<b>合计</b>		5/22	5/9	0/3		1/1		3/4	14/39	35.9%	1	17	1	2		
<i>(守门员)</i>																
10	李静	1/4	2/5	0/2				0/1	3/12	25.0%						00:16:07
32	杨雨柔	2/10	2/5	0/5	0/4	0/1		1/1	5/26	19.2%						00:43:53
<b>合计</b>		3/14	4/10	0/7	0/4	0/1		1/2	8/38	21.1%						

场上队员：得分/射门

守门员：救球/射门

全队合计	得分	被救	射失	击柱	封球	合计	%
远射	5	11	2	1	3	22	22.7%
近射	5	3		1		9	55.6%
边射		3				3	0.0%
快攻							0.0%
突破	1					1	100.0%
任意							0.0%
7M	3			1		4	75.0%





2016年全国女子手球锦标赛

图式射门区域统计

轮次 8 场次 42

201605042-41-1/1

上海

1 许沫	2 周蕾	5 郭威	6 黄妍	7 车婉茹	8 吴茵	9 武娜娜	10 斯文																																																																								
<table border="1"><tr><td></td><td></td><td></td></tr><tr><td></td><td></td><td></td></tr><tr><td></td><td></td><td></td></tr></table>										<table border="1"><tr><td></td><td></td><td></td></tr><tr><td></td><td></td><td></td></tr><tr><td>1</td><td></td><td></td></tr></table>							1			<table border="1"><tr><td>1</td><td></td><td></td></tr><tr><td></td><td></td><td></td></tr><tr><td></td><td></td><td>1</td></tr></table>	1								1	<table border="1"><tr><td></td><td></td><td></td></tr><tr><td></td><td></td><td></td></tr><tr><td></td><td>1</td><td>2</td></tr></table>								1	2	<table border="1"><tr><td></td><td></td><td></td></tr><tr><td></td><td></td><td></td></tr><tr><td></td><td></td><td></td></tr></table>										<table border="1"><tr><td></td><td></td><td></td></tr><tr><td></td><td></td><td></td></tr><tr><td>2</td><td></td><td>2</td></tr></table>							2		2	<table border="1"><tr><td></td><td></td><td></td></tr><tr><td></td><td></td><td></td></tr><tr><td>2</td><td></td><td></td></tr></table>							2			<table border="1"><tr><td></td><td></td><td>1</td></tr><tr><td></td><td></td><td></td></tr><tr><td>1</td><td></td><td></td></tr></table>			1				1		
1																																																																															
1																																																																															
		1																																																																													
	1	2																																																																													
2		2																																																																													
2																																																																															
		1																																																																													
1																																																																															
Post - 0 Miss - 0 Block - 0	Post - 0 Miss - 0 Block - 0	Post - 0 Miss - 0 Block - 1	Post - 0 Miss - 0 Block - 1	Post - 0 Miss - 0 Block - 0	Post - 1 Miss - 0 Block - 0	Post - 1 Miss - 0 Block - 0	Post - 0 Miss - 1 Block - 0																																																																								
11 孙梦颖	12 郑冯	13 徐娟	17 居晔	18 沙正文	19 印尼	21 王嘉怡	23 都好																																																																								
<table border="1"><tr><td></td><td></td><td></td></tr><tr><td></td><td></td><td>1</td></tr><tr><td>2</td><td></td><td>2</td></tr></table>						1	2		2	<table border="1"><tr><td></td><td></td><td></td></tr><tr><td></td><td></td><td></td></tr><tr><td></td><td></td><td></td></tr></table>										<table border="1"><tr><td></td><td></td><td></td></tr><tr><td></td><td></td><td></td></tr><tr><td></td><td></td><td></td></tr></table>										<table border="1"><tr><td></td><td></td><td></td></tr><tr><td></td><td></td><td></td></tr><tr><td></td><td></td><td></td></tr></table>										<table border="1"><tr><td></td><td></td><td></td></tr><tr><td></td><td></td><td></td></tr><tr><td></td><td></td><td></td></tr></table>										<table border="1"><tr><td></td><td></td><td></td></tr><tr><td>1</td><td></td><td></td></tr><tr><td>3</td><td></td><td></td></tr></table>				1			3			<table border="1"><tr><td></td><td></td><td></td></tr><tr><td></td><td></td><td></td></tr><tr><td></td><td></td><td>1</td></tr></table>									1	<table border="1"><tr><td></td><td></td><td></td></tr><tr><td></td><td></td><td></td></tr><tr><td></td><td></td><td></td></tr></table>									
		1																																																																													
2		2																																																																													
1																																																																															
3																																																																															
		1																																																																													
Post - 0 Miss - 1 Block - 0	Post - 0 Miss - 0 Block - 0	Post - 0 Miss - 0 Block - 0	Post - 0 Miss - 0 Block - 0	Post - 0 Miss - 0 Block - 0	Post - 0 Miss - 0 Block - 0	Post - 0 Miss - 0 Block - 0	Post - 0 Miss - 0 Block - 0																																																																								

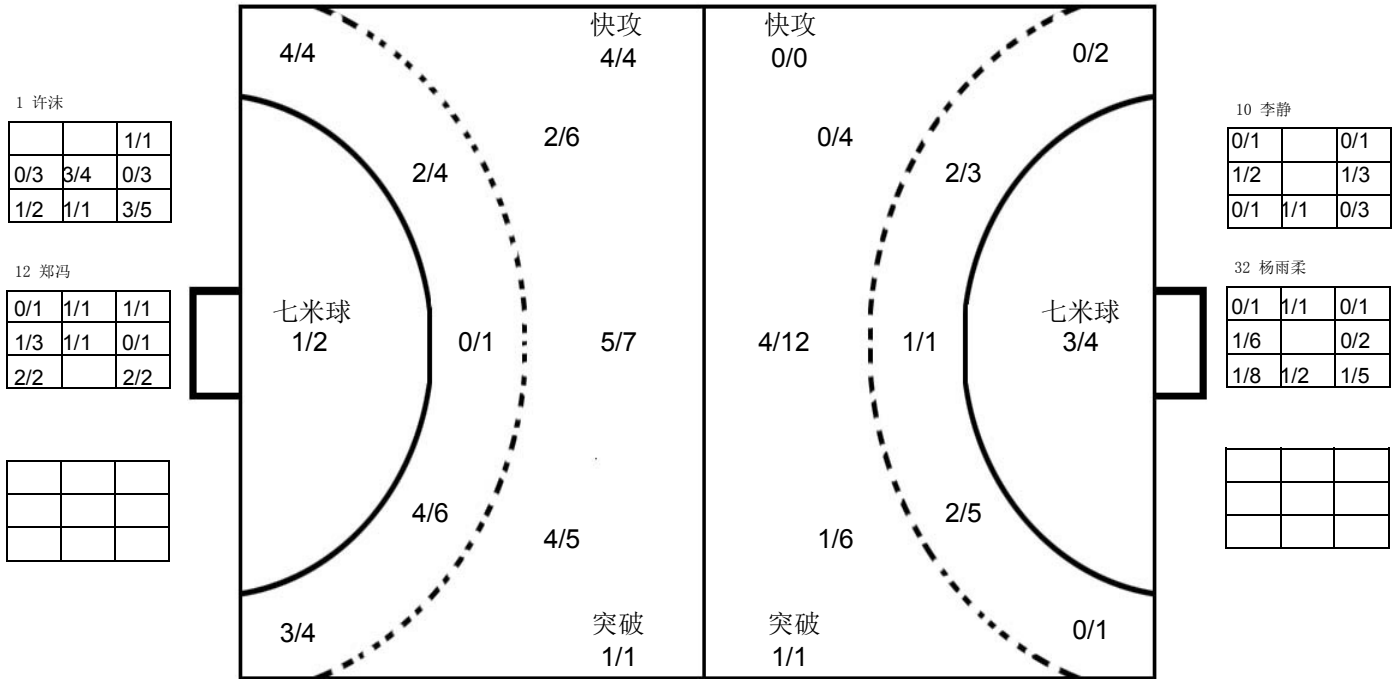

新疆

3 葛立双	6 阿孜古	7 吴志娟	10 李静	11 陈培培	12 艾敏加尔汉	15 兰姝娇	17 戴莹莹																																																																								
<table border="1"><tr><td></td><td></td><td></td></tr><tr><td></td><td></td><td></td></tr><tr><td></td><td></td><td></td></tr></table>										<table border="1"><tr><td></td><td></td><td></td></tr><tr><td></td><td></td><td>1</td></tr><tr><td></td><td></td><td>1</td></tr></table>						1			1	<table border="1"><tr><td></td><td></td><td></td></tr><tr><td></td><td></td><td></td></tr><tr><td></td><td></td><td></td></tr></table>										<table border="1"><tr><td></td><td></td><td></td></tr><tr><td></td><td></td><td></td></tr><tr><td></td><td></td><td></td></tr></table>										<table border="1"><tr><td></td><td></td><td></td></tr><tr><td></td><td></td><td></td></tr><tr><td></td><td></td><td></td></tr></table>										<table border="1"><tr><td></td><td></td><td></td></tr><tr><td></td><td></td><td></td></tr><tr><td></td><td></td><td></td></tr></table>										<table border="1"><tr><td></td><td></td><td></td></tr><tr><td></td><td></td><td></td></tr><tr><td></td><td></td><td></td></tr></table>										<table border="1"><tr><td></td><td></td><td></td></tr><tr><td></td><td></td><td></td></tr><tr><td></td><td></td><td></td></tr></table>									
		1																																																																													
		1																																																																													
Post - 0 Miss - 1 Block - 1	Post - 0 Miss - 0 Block - 0	Post - 0 Miss - 0 Block - 0	Post - 0 Miss - 0 Block - 0	Post - 0 Miss - 0 Block - 0	Post - 0 Miss - 0 Block - 0	Post - 0 Miss - 0 Block - 0	Post - 0 Miss - 0 Block - 0																																																																								
18 崔娟	21 锁珊珊	23 张艺璇	26 宋婷婷	27 谢辰辰	32 杨雨柔	93 张婷婷																																																																									
<table border="1"><tr><td></td><td></td><td></td></tr><tr><td>2</td><td></td><td></td></tr><tr><td></td><td></td><td>1</td></tr></table>				2					1	<table border="1"><tr><td></td><td></td><td></td></tr><tr><td>1</td><td>1</td><td>2</td></tr><tr><td>1</td><td></td><td></td></tr></table>				1	1	2	1			<table border="1"><tr><td></td><td></td><td></td></tr><tr><td></td><td></td><td></td></tr><tr><td></td><td></td><td></td></tr></table>										<table border="1"><tr><td></td><td></td><td></td></tr><tr><td></td><td></td><td></td></tr><tr><td></td><td></td><td></td></tr></table>										<table border="1"><tr><td></td><td></td><td></td></tr><tr><td></td><td></td><td></td></tr><tr><td></td><td></td><td></td></tr></table>										<table border="1"><tr><td></td><td></td><td></td></tr><tr><td></td><td></td><td></td></tr><tr><td></td><td></td><td></td></tr></table>										<table border="1"><tr><td></td><td></td><td></td></tr><tr><td>1</td><td></td><td></td></tr><tr><td>1</td><td></td><td>1</td></tr></table>				1			1		1	<table border="1"><tr><td></td><td></td><td></td></tr><tr><td></td><td></td><td></td></tr><tr><td></td><td></td><td></td></tr></table>									
2																																																																															
		1																																																																													
1	1	2																																																																													
1																																																																															
1																																																																															
1		1																																																																													
Post - 0 Miss - 0 Block - 0	Post - 0 Miss - 0 Block - 1	Post - 0 Miss - 0 Block - 0	Post - 0 Miss - 0 Block - 0	Post - 0 Miss - 0 Block - 1	Post - 0 Miss - 0 Block - 0	Post - 3 Miss - 1 Block - 0																																																																									

注释: Post=击柱 Miss=射失 Block=被封





名次赛 Group F

女子 全国比赛

2016年全国女子手球锦标赛

Team A <b>A 山东</b>				Team B <b>B 四川</b>				Match Number <b>43</b>								
played in China		in the hall 滁州体育馆		on 12/09/2016		at 08:30 hours		Spectators								
Half-time (30')	<b>A</b> 13	<b>B</b> 13	End of playing time	<b>A</b> 30	<b>B</b> 22	1st extra time	<b>A</b>	<b>B</b>	2nd extra time	<b>A</b>	<b>B</b>	After penalty throws	<b>A</b>	<b>B</b>		
Number of 7 m	<b>A</b> 0 / 2	Team time-out			Full name of players and officials				Team time-out			<b>B</b> 6 / 9	Number of 7 m			
No.	Team <b>A</b>					G	W	2'	D	DR	No.	Team <b>B</b>				
1	路畅										1	张雪纯				
2	林燕群					3					2	陈艳楠				
7	杨嘉露							1			3	王丹				
8	王彬					4		1			4	尤婉莹				
9	周钰婷					2					5	孙姣				
10	田秀秀					2					6	凤洋				
11	吕青纹					5	1				7	练素琪				
12	张苑琳										9	姚梦园				
15	吴作扬					1					10	高静				
19	姜伟珊					1					11	朱海云				
20	张悦					5	1				12	宋琛茜				
22	朱赟										17	史雨欣				
23	徐悦							1			18	戴小宇				
28	崔金娜					3	1	1			27	吴美琪				
33	王彩琳					3										
77	穆庆丛					1		1								
<b>A</b>	杜晓青					1					<b>A</b>	金鸿				
<b>B</b>	马海湧 (主教练)										<b>B</b>	郎正平				
<b>C</b>	徐强										<b>C</b>	陈志伟				
<b>E</b>	王日东															
<b>A</b>	Signature of Responsible Official of the Teams (Off. A)										<b>B</b>					
TP	Remarks of Referee / CHA Official										TP					

Signatures

Referees: 严璐 (CHN)      王雨洋 (CHN)

Techn. Delegates: 吴国忠 (CHN)

CHA Official: 于中迅 (CHN)

Note: Number of 7m Throws Awarded to Team A and B, Goals (G), Warnings (W), Suspensions (2'), Direct Disqualification (D), Disqualification with Report (DR) and Team Penalty (TP).

Table Officials: 李诚

赵涵

Statisticians: 陈柱

闫冲

Printed by PHMS Copyright: IHF / CHA 12/09/2016 04:44:11

Longman Sportsoft



handball@126.com

2016年全国女子手球锦标赛  
竞赛技术统计(媒体表)

名次赛	组别	F	轮次	9	场次	43
滁州体育馆		12/09/2016			201605043-51-1/1	
山东	山东	30	vs	22	四川	四川
		13 : 13				

裁判员	严璐 (CHN)	/	王雨洋 (CHN)
-----	----------	---	-----------

山东													比赛进程		
远射	近射	边射	快攻	突破	任意球	7m球	合计	%	助攻	失误	警告	2'	D & DR	山东	四川
主教练: 马海湧													1st Half		
1 刘畅														2 林燕群	1 02:00 0
2 林燕群	1/1		0/2		2/2		3/5	60.0		2				20 张悦	2 05:52 0
7 杨嘉露	0/1						0/1	0.0		2		1		28 崔金娜	3 08:02 1
8 王彬	1/1	2/2			1/1		4/4	100	1	3		1			3 09:08 2 6 风洋
9 周钰婷	2/4	0/1				0/1	2/6	33.3		1					3 09:42 3 27 吴美琪
10 田秀秀		1/1			1/1		2/2	100		2					3 10:42 4 4 尤婉莹
11 吕青纹		1/1	0/1	3/3	1/1		5/6	83.3		2	1				3 13:20 5 6 风洋
12 张苑琳										2				33 王彩琳	4 14:00 6 27 吴美琪
15 吴作扬		1/2				0/1	0/1	1/4	25.0	1	1			20 张悦	5 14:35 6
19 姜伟珊			1/1				1/1	100						10 田秀秀	6 15:49 7
20 张悦			2/2	3/3			5/5	100		2	1			11 吕青纹	7 17:26 7
22 朱贇														11 吕青纹	8 18:40 8
23 徐悦												1		33 王彩琳	8 19:29 9 3 王丹
28 崔金娜		3/4					3/4	75.0			1	1		20 张悦	9 20:11 9
33 王彩琳	1/3	0/1			2/2		3/6	50.0		1				11 吕青纹	10 20:42 9
77 穆庆丛		0/1		1/1			1/2	50.0		1		1		11 吕青纹	11 22:06 9
运动员 合计	5/10	8/13	3/6	7/7	7/7	0/1	0/2	30/46	65.2	2	19	3	5	9 周钰婷	12 23:52 10
1 刘畅	2/4	0/1	1/1	1/2	0/1	0/1	0/3	4/13	30.8					12 24:27 11 4 尤婉莹	
12 张苑琳	6/8	0/3	0/2	0/2	0/1		1/2	7/18	38.9		2			9 周钰婷	13 26:52 11
22 朱贇							0/2	0/2	0.0					13 27:14 12 18 戴小宇	
守门员 合计	8/12	0/4	1/3	1/4	0/2	0/1	1/7	11/33	33.3		2			13 29:12 13 18 戴小宇	
													2nd Half		
四川													15 吴作扬		13 00:35 14 27 吴美琪
教练: 郎正平													14 01:37 14		
1 张雪纯														14 02:56 15 5 孙皎	
2 陈艳楠														2 林燕群	15 03:24 15
3 王丹	0/4	1/1	1/1		1/1	3/4	6/11	54.5		5				28 崔金娜	16 04:57 15
4 尤婉莹	0/1	1/1	1/1				2/3	66.7		5				8 王彬	16 05:38 16 3 王丹
5 孙皎	0/2	1/1		1/2			2/5	40.0		1		1		2 林燕群	17 06:21 16
6 风洋	2/4			1/2	1/1		4/7	57.1		2				11 吕青纹	18 07:27 16
7 练素琪														11 吕青纹	19 07:57 16
9 姚梦园			0/1				0/1	0.0		1	1			11 吕青纹	20 08:51 16
10 高静														20 张悦	21 10:56 16
11 朱海云	0/2						0/1	0/3	0.0		2	1		11 吕青纹	22 12:24 16
12 宋琛茜											1			10 田秀秀	22 12:46 17 6 风洋
17 史雨欣														23 13:12 17	
18 戴小宇	0/1	1/1				3/4	4/6	66.7	1					23 13:50 18 6 风洋	
27 吴美琪	2/4			1/1	1/1	4/6	66.7			4				28 崔金娜	24 14:37 18
运动员 合计	4/18	4/4	2/3	3/5	2/2	1/1	6/9	22/42	52.4	1	21	2	2	24 15:18 19 18 戴小宇	
12 宋琛茜	5/10	3/11	2/5	0/7	0/7	1/1	11/41	26.8		1				24 16:03 20 18 戴小宇	
守门员 合计	5/10	3/11	2/5	0/7	0/7	1/1	11/41	26.8		1				25 17:19 20	

场上队员: 得分 / 射门

守门员: 救球 / 射门

快攻	Fast Break	突破	Breakthrough	任意球	Free Throw	7M球	7M Throw	助攻	Assist
警告	Warning	失误	Error	2'	Suspension	D	取消资格	DR	取消资格+报告





### 2016年全国女子手球锦标赛 图式比赛技术统计表

轮次 9

场次 43

201605043-21-1/1

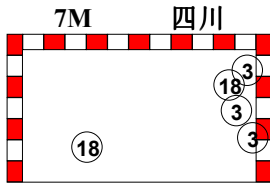
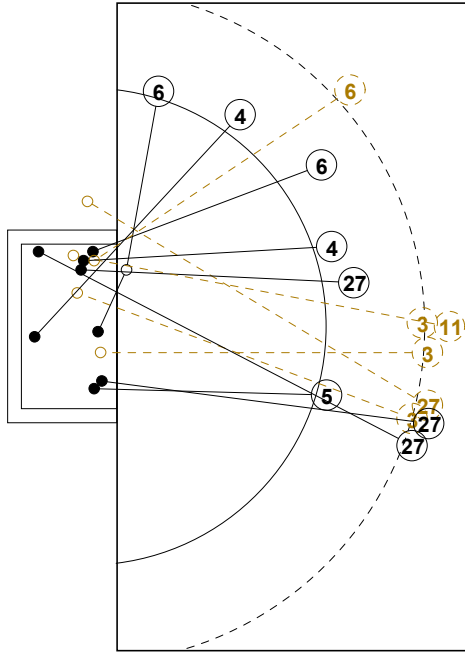

1st Half  
13 : 13

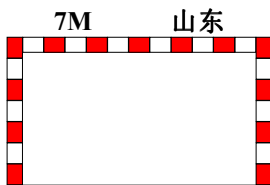
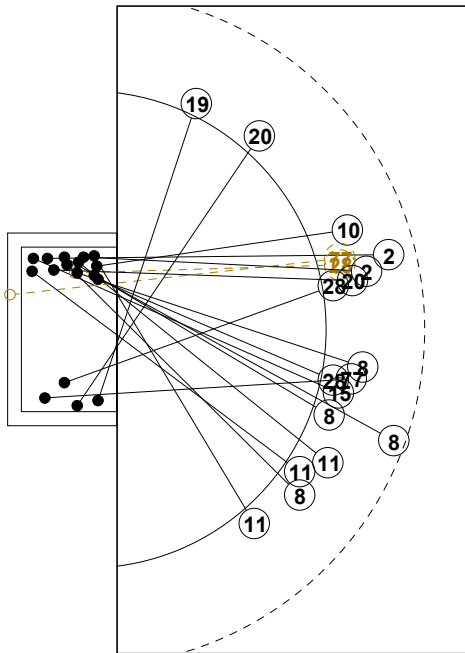
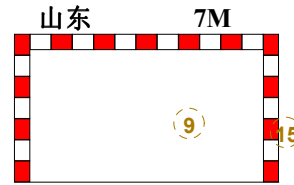
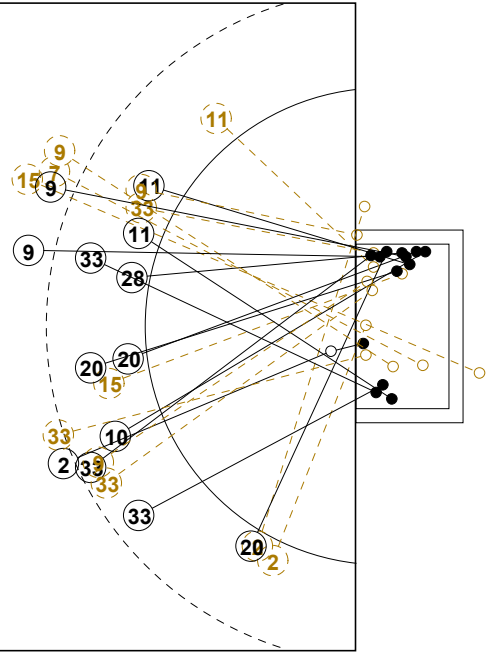

2nd Half  
30 : 22

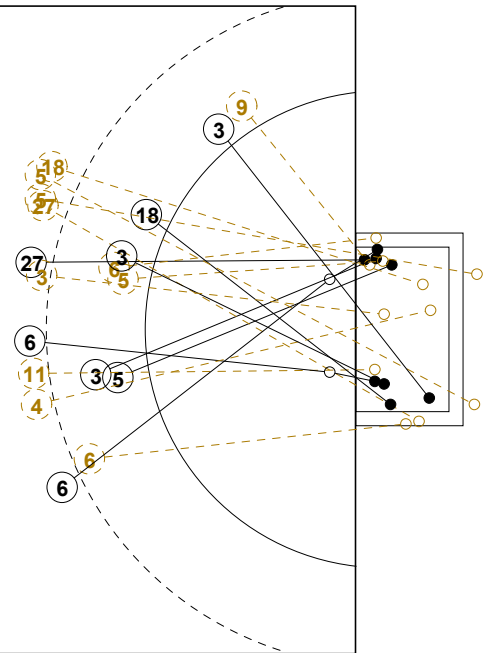



## 2016年全国女子手球锦标赛

## 个人/全队技术统计表

正式表  
手球  
女子名次赛  
轮次 9组别 F  
场次 43201605043-14-1/2  
滁州体育馆  
12/09/2016 08:30

号码	姓名	远射	近射	边射	快攻	突破	任意	7M	合计	%	助攻	失误	警告	2'	取消	时间
<b>山东(山东)</b>																
<i>(场上队员)</i>																
1	路畅									0.0%						00:25:39
2	林燕群	1/1		0/2		2/2			3/5	60.0%		2				00:40:23
7	杨嘉露	0/1							0/1	0.0%		2		1		00:12:20
8	王彬	1/1	2/2			1/1			4/4	100%	1	3		1		00:15:05
9	周钰婷	2/4	0/1					0/1	2/6	33.3%		1				00:10:09
10	田秀秀		1/1			1/1			2/2	100%		2				00:45:12
11	吕青纹		1/1	0/1	3/3	1/1			5/6	83.3%		2		1		01:00:00
12	张苑琳									0.0%		2				00:33:54
15	吴作扬		1/2				0/1	0/1	1/4	25.0%	1	1				00:28:17
19	姜伟珊			1/1					1/1	100%						00:05:05
20	张悦			2/2	3/3				5/5	100%		2		1		00:54:52
22	朱贇									0.0%						00:00:27
23	徐悦									0.0%				1		00:12:53
28	崔金娜		3/4						3/4	75.0%				1	1	00:40:40
33	王彩琳	1/3	0/1			2/2			3/6	50.0%		1				00:19:37
77	穆庆丛		0/1		1/1				1/2	50.0%		1		1		00:14:15
<b>合计</b>		5/10	8/13	3/6	7/7	7/7	0/1	0/2	30/46	65.2%	2	19	3	5		
<i>(守门员)</i>																
1	路畅	2/4	0/1	1/1	1/2	0/1	0/1	0/3	4/13	30.8%						00:25:39
12	张苑琳	6/8	0/3	0/2	0/2	0/1		1/2	7/18	38.9%		2				00:33:54
22	朱贇							0/2	0/2	0.0%						00:00:27
<b>合计</b>		8/12	0/4	1/3	1/4	0/2	0/1	1/7	11/33	33.3%		2				

场上队员：得分/射门

守门员：救球/射门

全队合计	得分	被救	射失	击柱	封球	合计	%
远射	5	5				10	50.0%
近射	8	3		2		13	61.5%
边射	3	2	1			6	50.0%
快攻	7					7	100.0%
突破	7					7	100.0%
任意			1			1	0.0%
7M		1		1		2	0.0%





## 2016年全国女子手球锦标赛

## 个人/全队技术统计表

正式表  
手球  
女子名次赛  
轮次 9组别 F  
场次 43201605043-14-2/2  
滁州体育馆  
12/09/2016 08:30

号码	姓名	远射	近射	边射	快攻	突破	任意	7M	合计	%	助攻	失误	警告	2'	取消	时间
<b>四川(四川)</b>																
<i>(上场队员)</i>																
1	张雪纯									0.0%						00:00:00
2	陈艳楠									0.0%				1		00:10:54
3	王丹	0/4	1/1	1/1		1/1		3/4	6/11	54.5%		5				00:46:33
4	尤婉莹	0/1	1/1	1/1					2/3	66.7%		5				00:48:46
5	孙姣	0/2	1/1		1/2				2/5	40.0%		1		1		00:59:24
6	凤洋	2/4			1/2	1/1			4/7	57.1%		2				01:00:00
7	练素琪									0.0%						00:00:00
9	姚梦园			0/1					0/1	0.0%		1	1			00:59:49
10	高静									0.0%						00:00:00
11	朱海云	0/2						0/1	0/3	0.0%		2	1			00:15:22
12	宋琛茜									0.0%		1				01:00:00
17	史雨欣									0.0%						00:00:00
18	戴小宇	0/1	1/1					3/4	4/6	66.7%	1					00:15:56
27	吴美琪	2/4			1/1		1/1		4/6	66.7%		4				00:42:30
<b>合计</b>		4/18	4/4	2/3	3/5	2/2	1/1	6/9	22/42	52.4%	1	21	2	2		
<i>(守门员)</i>																
12	宋琛茜	5/10	3/11	2/5	0/7	0/7		1/1	11/41	26.8%		1				01:00:00
<b>合计</b>		5/10	3/11	2/5	0/7	0/7		1/1	11/41	26.8%		1				

场上队员：得分/射门

守门员：救球/射门

全队合计	得分	被救	射失	击柱	封球	合计	%
远射	4	8	3	2	1	18	22.2%
近射	4					4	100.0%
边射	2	1				3	66.7%
快攻	3	1		1		5	60.0%
突破	2					2	100.0%
任意	1					1	100.0%
7M	6	1	1	1		9	66.7%







### 2016年全国女子手球锦标赛

#### 图式射门区域统计

轮次 9 场次 43

201605043-41-1/1

## 山东

1 路畅	2 林燕群	7 杨嘉露	8 王彬	9 周钰婷	10 田秀秀	11 吕青纹	12 张苑琳																																																																								
<table border="1"><tr><td></td><td></td><td></td></tr><tr><td></td><td></td><td></td></tr><tr><td></td><td></td><td></td></tr></table>										<table border="1"><tr><td></td><td></td><td>1</td></tr><tr><td></td><td></td><td>1</td></tr><tr><td></td><td>1</td><td></td></tr></table>			1			1		1		<table border="1"><tr><td></td><td></td><td></td></tr><tr><td></td><td></td><td></td></tr><tr><td></td><td></td><td></td></tr></table>										<table border="1"><tr><td></td><td></td><td></td></tr><tr><td></td><td></td><td>3</td></tr><tr><td></td><td></td><td>1</td></tr></table>						3			1	<table border="1"><tr><td></td><td></td><td></td></tr><tr><td>1</td><td></td><td></td></tr><tr><td>1</td><td></td><td></td></tr></table>				1			1			<table border="1"><tr><td></td><td></td><td></td></tr><tr><td>1</td><td></td><td></td></tr><tr><td></td><td></td><td>1</td></tr></table>				1					1	<table border="1"><tr><td></td><td></td><td>1</td></tr><tr><td></td><td></td><td>2</td></tr><tr><td></td><td></td><td>1</td></tr></table>			1			2			1	<table border="1"><tr><td></td><td></td><td></td></tr><tr><td></td><td></td><td></td></tr><tr><td></td><td></td><td></td></tr></table>									
		1																																																																													
		1																																																																													
	1																																																																														
		3																																																																													
		1																																																																													
1																																																																															
1																																																																															
1																																																																															
		1																																																																													
		1																																																																													
		2																																																																													
		1																																																																													
Post - 0 Miss - 0 Block - 0	Post - 0 Miss - 1 Block - 0	Post - 0 Miss - 0 Block - 0	Post - 0 Miss - 0 Block - 0	Post - 1 Miss - 0 Block - 0	Post - 0 Miss - 0 Block - 0	Post - 0 Miss - 0 Block - 0	Post - 0 Miss - 0 Block - 0																																																																								
15 吴作扬	19 姜伟珊	20 张悦	22 朱贇	23 徐悦	28 崔金娜	33 王彩琳	77 穆庆丛																																																																								
<table border="1"><tr><td></td><td></td><td>1</td></tr><tr><td></td><td></td><td></td></tr><tr><td></td><td></td><td></td></tr></table>			1							<table border="1"><tr><td></td><td></td><td></td></tr><tr><td></td><td></td><td></td></tr><tr><td>1</td><td></td><td></td></tr></table>							1			<table border="1"><tr><td></td><td></td><td>1</td></tr><tr><td>4</td><td></td><td></td></tr><tr><td></td><td></td><td></td></tr></table>			1	4						<table border="1"><tr><td></td><td></td><td></td></tr><tr><td></td><td></td><td></td></tr><tr><td></td><td></td><td></td></tr></table>										<table border="1"><tr><td></td><td></td><td></td></tr><tr><td></td><td></td><td></td></tr><tr><td></td><td></td><td></td></tr></table>										<table border="1"><tr><td></td><td></td><td></td></tr><tr><td>2</td><td></td><td></td></tr><tr><td></td><td></td><td>1</td></tr></table>				2					1	<table border="1"><tr><td></td><td></td><td></td></tr><tr><td></td><td></td><td></td></tr><tr><td>1</td><td></td><td>2</td></tr></table>							1		2	<table border="1"><tr><td></td><td></td><td>1</td></tr><tr><td></td><td></td><td></td></tr><tr><td></td><td></td><td></td></tr></table>			1						
		1																																																																													
1																																																																															
		1																																																																													
4																																																																															
2																																																																															
		1																																																																													
1		2																																																																													
		1																																																																													
Post - 1 Miss - 1 Block - 0	Post - 0 Miss - 0 Block - 0	Post - 0 Miss - 0 Block - 0	Post - 0 Miss - 0 Block - 0	Post - 0 Miss - 0 Block - 0	Post - 0 Miss - 0 Block - 0	Post - 0 Miss - 0 Block - 0	Post - 1 Miss - 0 Block - 0																																																																								

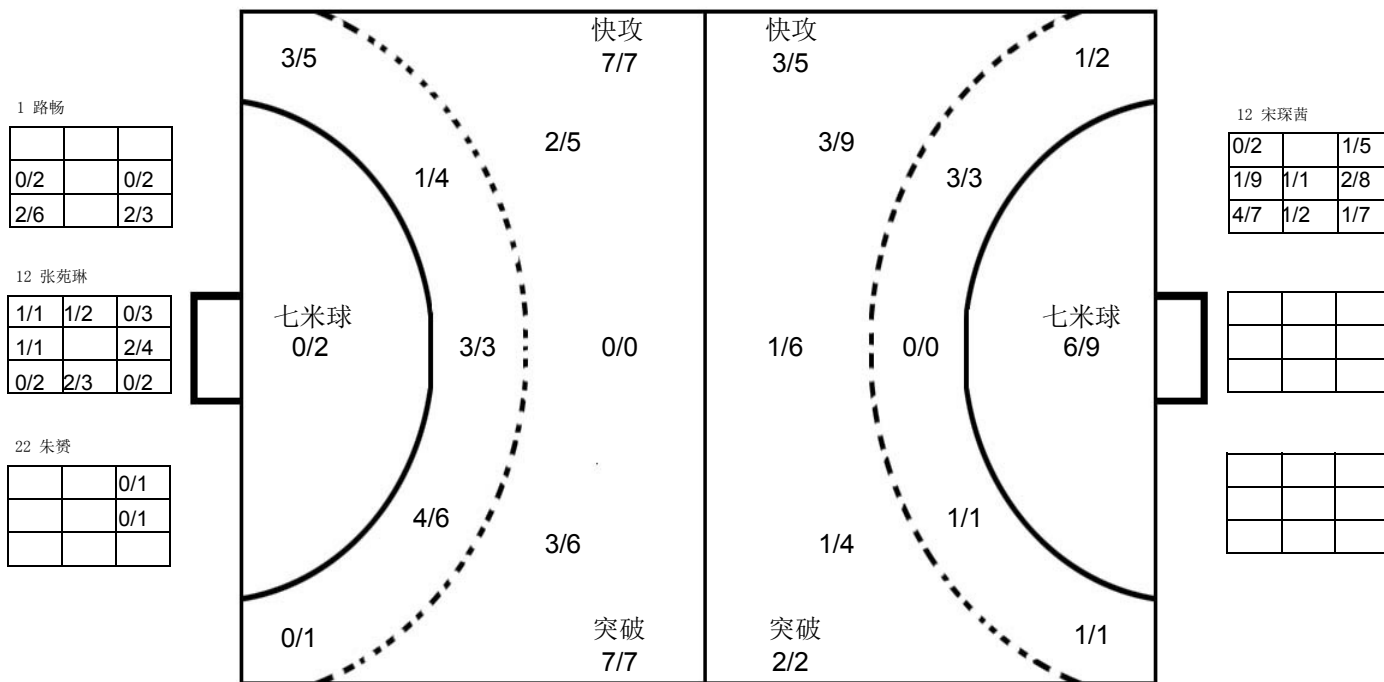

## 四川

1 张雪纯	2 陈艳楠	3 王丹	4 尤婉莹	5 孙姣	6 凤洋	7 练素琪	9 姚梦园																																																																								
<table border="1"><tr><td></td><td></td><td></td></tr><tr><td></td><td></td><td></td></tr><tr><td></td><td></td><td></td></tr></table>										<table border="1"><tr><td></td><td></td><td></td></tr><tr><td></td><td></td><td></td></tr><tr><td></td><td></td><td></td></tr></table>										<table border="1"><tr><td></td><td></td><td>2</td></tr><tr><td></td><td></td><td>2</td></tr><tr><td>1</td><td></td><td>1</td></tr></table>			2			2	1		1	<table border="1"><tr><td></td><td>1</td><td></td></tr><tr><td></td><td></td><td>1</td></tr><tr><td></td><td></td><td></td></tr></table>		1				1				<table border="1"><tr><td></td><td></td><td></td></tr><tr><td>1</td><td></td><td></td></tr><tr><td>1</td><td></td><td></td></tr></table>				1			1			<table border="1"><tr><td></td><td></td><td></td></tr><tr><td></td><td></td><td></td></tr><tr><td>1</td><td>1</td><td>2</td></tr></table>							1	1	2	<table border="1"><tr><td></td><td></td><td></td></tr><tr><td></td><td></td><td></td></tr><tr><td></td><td></td><td></td></tr></table>										<table border="1"><tr><td></td><td></td><td></td></tr><tr><td></td><td></td><td></td></tr><tr><td></td><td></td><td></td></tr></table>									
		2																																																																													
		2																																																																													
1		1																																																																													
	1																																																																														
		1																																																																													
1																																																																															
1																																																																															
1	1	2																																																																													
Post - 0 Miss - 0 Block - 0	Post - 0 Miss - 0 Block - 0	Post - 0 Miss - 1 Block - 1	Post - 0 Miss - 0 Block - 0	Post - 0 Miss - 2 Block - 0	Post - 2 Miss - 0 Block - 0	Post - 0 Miss - 0 Block - 0	Post - 0 Miss - 0 Block - 0																																																																								
10 高静	11 朱海云	12 宋琛茜	17 史雨欣	18 戴小宇	27 吴美琪																																																																										
<table border="1"><tr><td></td><td></td><td></td></tr><tr><td></td><td></td><td></td></tr><tr><td></td><td></td><td></td></tr></table>										<table border="1"><tr><td></td><td></td><td></td></tr><tr><td></td><td></td><td></td></tr><tr><td></td><td></td><td></td></tr></table>										<table border="1"><tr><td></td><td></td><td></td></tr><tr><td></td><td></td><td></td></tr><tr><td></td><td></td><td></td></tr></table>										<table border="1"><tr><td></td><td></td><td></td></tr><tr><td></td><td></td><td></td></tr><tr><td></td><td></td><td></td></tr></table>										<table border="1"><tr><td></td><td></td><td>1</td></tr><tr><td>1</td><td></td><td>1</td></tr><tr><td>1</td><td></td><td></td></tr></table>			1	1		1	1			<table border="1"><tr><td></td><td></td><td>1</td></tr><tr><td></td><td></td><td>1</td></tr><tr><td>2</td><td></td><td></td></tr></table>			1			1	2			<table border="1"><tr><td></td><td></td><td></td></tr><tr><td></td><td></td><td></td></tr><tr><td></td><td></td><td></td></tr></table>										<table border="1"><tr><td></td><td></td><td></td></tr><tr><td></td><td></td><td></td></tr><tr><td></td><td></td><td></td></tr></table>									
		1																																																																													
1		1																																																																													
1																																																																															
		1																																																																													
		1																																																																													
2																																																																															
Post - 0 Miss - 0 Block - 0	Post - 1 Miss - 0 Block - 0	Post - 0 Miss - 0 Block - 0	Post - 0 Miss - 0 Block - 0	Post - 0 Miss - 0 Block - 0	Post - 1 Miss - 1 Block - 0																																																																										

注释: Post=击柱 Miss=射失 Block=被封





名次赛 Group F

女子 全国比赛

2016年全国女子手球锦标赛

Team A <b>A 北京</b>				Team B <b>B 黑龙江</b>				Match Number <b>44</b>													
played in China		in the hall 滁州体育馆		on 12/09/2016		at 10:00 hours		Spectators													
Half-time (30')	<b>A</b> 24	<b>B</b> 11	End of playing time	<b>A</b> 37	<b>B</b> 22	1st extra time	<b>A</b>	<b>B</b>	2nd extra time	<b>A</b>	<b>B</b>	After penalty throws	<b>A</b>	<b>B</b>							
Number of 7 m	<b>A</b> 2 / 2	Team time-out 1 2 3 40:28			Full name of players and officials				Team time-out 1 2 3 13:09 22:08 51:33			<b>B</b> 2 / 3	Number of 7 m								
No.	Team <b>A</b>					G	W	2'	D	DR	No.	Team <b>B</b>					G	W	2'	D	DR
1	宋嘉蕾										1	徐佳蓉									
3	季小桐					7		1			3	刘诗彤						1			
4	孙佳					5	1	1			5	周美微									
6	刘亚男										6	王梦艺					3				
8	杨铭豫					4					9	郑宇					3		1		
10	刘莎					1					10	刘雪露							1		
11	纪婉					4					11	刘天茹									
16	王海叶										12	肖宁桐									
17	杨政赢					4		1			13	吴佳					7				
22	李海鸥					2	1				14	黄荣					1				
23	田媛					3					16	杜宪									
28	闫美珠										19	梁文煜									
33	栾征										21	王戈					2				
47	刘泽										22	马琳					5				
58	李华										23	张政					1				
69	石梓薇					7	1														
A	蔡建国										B	张立梅 (主教练)									
B	石伟 (主教练)										C	黄冬杰									
C	李翼										D	于兹香									
E	史良玉										E	马婧									
<b>A</b>	Signature of Responsible Official of the Teams (Off. A)																		<b>B</b>		
TP	Remarks of Referee / CHA Official																		TP		

Signatures

Referees	陈晓波 (CHN)	林晓佟 (CHN)		
Techn. Delegates	吴国忠 (CHN)			
CHA Official	于中迅 (CHN)			

Note: Number of 7m Throws Awarded to Team A and B, Goals (G), Warnings (W), Suspensions (2'), Direct Disqualification (D), Disqualification with Report (DR) and Team Penalty (TP).

Table Officials: 李诚

赵涵

Statisticians: 闫冲

陈柱

Printed by PHMS Copyright: IHF / CHA 12/09/2016 06:11:33

Longman Sportsoft



handball@126.com



2016年全国女子手球锦标赛  
竞赛技术统计(媒体表)

名次赛	组别	F	轮次	9	场次	44
滁州体育馆		12/09/2016			201605044-51-1/1	
北京	北京	37	vs	22	黑龙江	黑龙江
		24 : 11				

裁判员	陈晓波 (CHN)		/	林晓佟 (CHN)	
-----	-----------	--	---	-----------	--

北京													北京		黑龙江		
主教练：石伟													比赛进程				
	远射	近射	边射	快攻	突破	任意球	7m球	合计	%	助攻	失误	警告	2'	D & DR			
1 宋嘉蕾															11 纪婉	1 00:42	0
3 季小桐	3/5	0/1		1/2	2/4	1/1		7/13	53.8	1	4		1		8 杨铭豫	2 01:07	0
4 孙佳		3/4		2/2				5/6	83.3			1	1		23 田媛	3 02:47	0
6 刘亚男															3 季小桐	3 03:11	1 6 王梦艺
8 杨铭豫		2/3	0/3	1/2	1/1			4/9	44.4						8 杨铭豫	4 03:40	1
10 刘莎		1/1						1/1	100						4 孙佳	4 04:43	2 13 吴佳
11 纪婉			2/3	2/2	0/1			4/6	66.7		1				69 石梓薇	5 05:13	2
16 王海叶															11 纪婉	6 05:51	2
17 杨政赢	3/5				1/1			4/6	66.7	2	4		1		4 孙佳	7 07:27	2
22 李海鸥				2/2				2/2	100			1			7 王海叶	7 08:19	3 13 吴佳
23 田媛	0/2		1/1	1/1	1/1			3/5	60.0		3				8 杨铭豫	8 08:43	3
28 闫美珠															3 季小桐	9 09:28	3
33 栾征															9 王海叶	9 10:05	4 13 吴佳
47 刘洋															10 王海叶	10 10:34	4
58 李华			0/1				0/1	0/1	0.0		1				11 纪婉	11 13:50	5 23 张政
69 石梓薇	2/4			1/1	2/2		2/2	7/9	77.8	2	3	1			11 纪婉	12 14:33	6 22 马琳
运动员 合计	8/16	6/9	3/8	10/12	7/10	1/1	2/2	37/58	63.8	6	16	3	3		17 杨政赢	12 15:04	6
1 宋嘉蕾															22 李海鸥	13 17:25	6
16 王海叶	14/19	3/8	2/3	0/4	1/6		1/1	21/41	51.2	1					69 石梓薇	14 18:13	6
47 刘洋								0/2	0.0						69 石梓薇	15 18:34	6
守门员 合计	14/19	3/8	2/3	0/4	1/6		1/3	21/43	48.8	1					69 石梓薇	16 19:22	6

黑龙江													北京		黑龙江		
教练：张立梅													比赛进程				
	远射	近射	边射	快攻	突破	任意球	7m球	合计	%	助攻	失误	警告	2'	D & DR			
1 徐佳蓉															10 刘莎	18 21:06	7 22 马琳
3 刘诗彤												1			19 王海叶	19 21:46	7
5 周美微		0/1						0/1	0.0		1				3 季小桐	20 23:07	7
6 王梦艺	1/3	1/2			1/2			3/7	42.9		3				4 孙佳	20 23:40	8 22 马琳
9 郑宇	1/3	2/2						3/5	60.0		3		1		3 季小桐	21 24:59	8
10 刘雪露	0/3							0/3	0.0		2		1		22 李海鸥	22 26:27	8
11 刘天茹			0/1					0/1	0.0						22 李海鸥	22 26:45	9 13 吴佳
12 肖宁桐															22 李海鸥	22 27:18	10 13 吴佳
13 吴佳	3/9	0/1		1/1	3/3			7/14	50.0		3				69 石梓薇	23 27:46	10
14 黄莹							1/2	1/2	50.0						4 孙佳	23 28:27	11 22 马琳
16 杜宪															4 孙佳	24 29:52	11
19 梁文煜	0/2		0/1					0/3	0.0	1	1				25 纪婉	25 00:22	11
21 王戈	0/1		0/2	2/3				2/6	33.3		1				25 纪婉	25 00:50	12 9 郑宇
22 马琳	0/1	2/4	1/1		1/1		1/1	5/8	62.5		2				26 田媛	26 01:32	12
23 张政				1/1				1/1	100		1				26 田媛	26 02:18	13 14 黄莹
运动员 合计	5/22	5/10	1/5	4/5	5/6		2/3	22/51	43.1	1	18	1	2		26 田媛	26 05:40	14 22 马琳
1 徐佳蓉	0/1		0/1		0/2	0/1		0/5	0.0						69 石梓薇	27 07:32	14
12 肖宁桐	3/7	3/8	4/5	1/9	2/7		0/2	13/38	34.2						11 纪婉	27 07:51	15 9 郑宇
16 杜宪	1/4	0/1	1/2	0/2				2/9	22.2	1	1				11 纪婉	27 08:37	16 21 王戈
守门员 合计	4/12	3/9	5/8	1/11	2/9	0/1	0/2	15/52	28.8	1	1				11 纪婉	28 09:13	16

场上队员：得分 / 射门

守门员：救球 / 射门

快攻	Fast Break	突破	Breakthrough	任意球	Free Throw	7M球	7M Throw	助攻	Assist
警告	Warning	失误	Error	2'	Suspension	D	取消资格	DR	取消资格+报告





### 2016年全国女子手球锦标赛 图式比赛技术统计表

轮次 9

场次 44

201605044-21-1/1

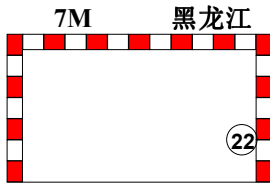
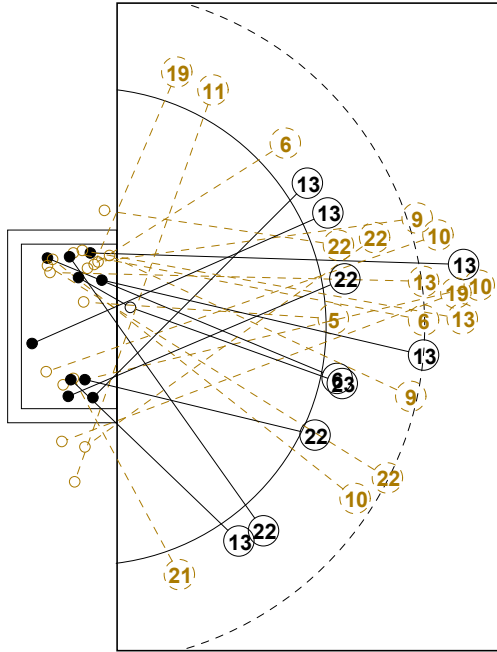

1st Half  
11 : 24

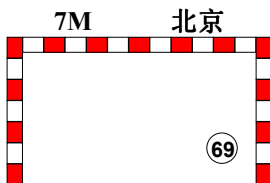
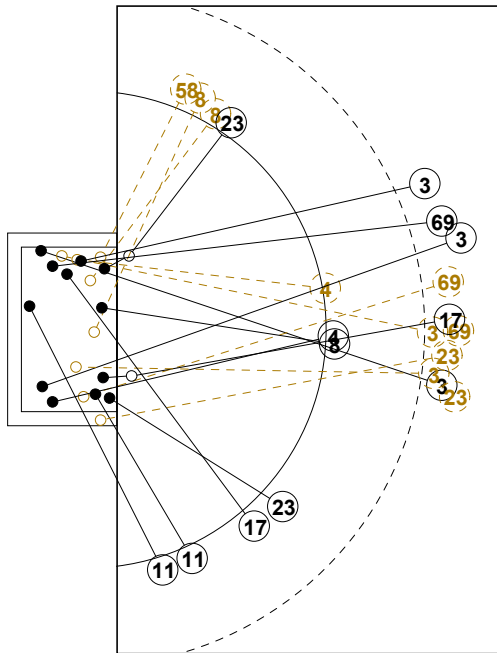
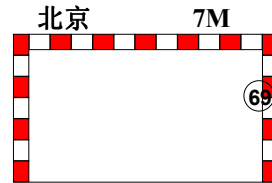
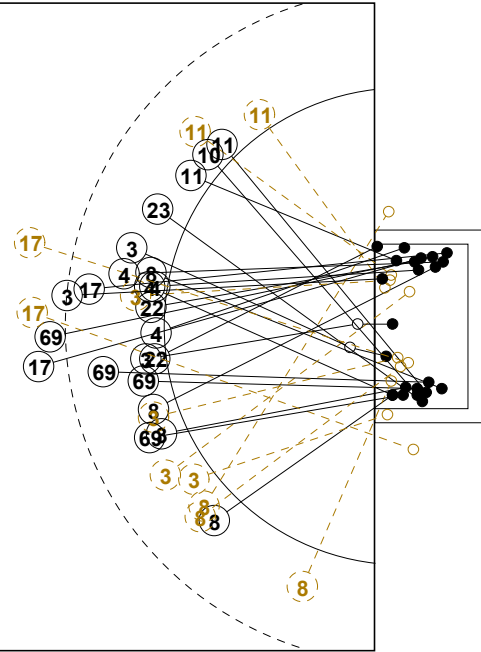

2nd Half  
37 : 22

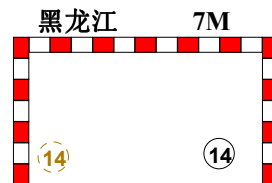
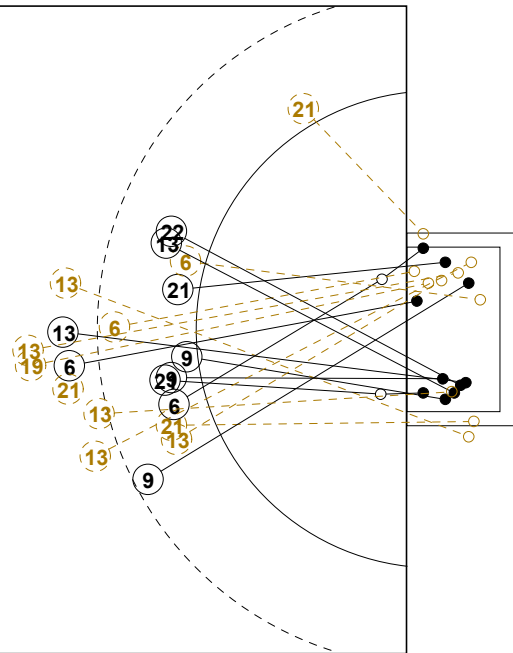



## 2016年全国女子手球锦标赛

## 个人/全队技术统计表

正式表  
手球  
女子名次赛  
轮次 9组别 F  
场次 44201605044-14-1/2  
滁州体育馆  
12/09/2016 10:00

号码	姓名	远射	近射	边射	快攻	突破	任意	7M	合计	%	助攻	失误	警告	2'	取消	时间
<b>北京(北京)</b>																
<i>(场上队员)</i>																
1	宋嘉蕾									0.0%						00:00:36
3	季小桐	3/5	0/1		1/2	2/4	1/1		7/13	53.8%	1	4		1		00:43:11
4	孙佳		3/4		2/2				5/6	83.3%			1	1		00:40:43
6	刘亚男									0.0%						00:00:00
8	杨铭豫		2/3	0/3	1/2	1/1			4/9	44.4%						00:50:43
10	刘莎		1/1						1/1	100%						00:17:52
11	纪婉			2/3	2/2	0/1			4/6	66.7%		1				00:36:21
16	王海叶									0.0%	1					00:52:09
17	杨政赢	3/5				1/1			4/6	66.7%	2	4		1		00:36:38
22	李海鸥				2/2				2/2	100%			1			00:27:49
23	田媛	0/2		1/1	1/1	1/1			3/5	60.0%		3				00:21:58
28	闫美珠									0.0%						00:00:00
33	栾征									0.0%						00:00:00
47	刘泽									0.0%						00:01:57
58	李华			0/1					0/1	0.0%		1				00:03:58
69	石梓薇	2/4			1/1	2/2		2/2	7/9	77.8%	2	3	1			00:47:04
<b>合计</b>		8/16	6/9	3/8	10/12	7/10	1/1	2/2	37/58	63.8%	6	16	3	3		
<i>(守门员)</i>																
1	宋嘉蕾									0.0%						00:00:36
16	王海叶	14/19	3/8	2/3	0/4	1/6		1/1	21/41	51.2%	1					00:52:09
47	刘泽							0/2	0/2	0.0%						00:01:57
<b>合计</b>		14/19	3/8	2/3	0/4	1/6		1/3	21/43	48.8%	1					

场上队员：得分/射门

守门员：救球/射门

全队合计	得分	被救	射失	击柱	封球	合计	%
远射	8	4	1	1	2	16	50.0%
近射	6	3				9	66.7%
边射	3	5				8	37.5%
快攻	10	1	1			12	83.3%
突破	7	2		1		10	70.0%
任意	1					1	100.0%
7M	2					2	100.0%





## 2016年全国女子手球锦标赛

## 个人/全队技术统计表

正式表  
手球  
女子名次赛  
轮次 9组别 F  
场次 44201605044-14-2/2  
滁州体育馆  
12/09/2016 10:00

号码	姓名	远射	近射	边射	快攻	突破	任意	7M	合计	%	助攻	失误	警告	2'	取消	时间
<b>黑龙江(黑龙江)</b>																
<i>(上场队员)</i>																
1	徐佳蓉									0.0%						00:07:31
3	刘诗彤									0.0%			1			00:17:15
5	周美微		0/1						0/1	0.0%		1				00:13:58
6	王梦艺	1/3	1/2			1/2			3/7	42.9%		3				00:42:12
9	郑宇	1/3	2/2						3/5	60.0%		3		1		00:35:06
10	刘雪露	0/3							0/3	0.0%		2		1		00:26:46
11	刘天茹			0/1					0/1	0.0%						00:12:06
12	肖宁桐									0.0%						00:37:30
13	吴佳	3/9	0/1		1/1	3/3			7/14	50.0%		3				00:42:59
14	黄荣							1/2	1/2	50.0%						00:00:33
16	杜宪									0.0%	1	1				00:09:41
19	梁文煜	0/2		0/1					0/3	0.0%		1				00:53:33
21	王戈	0/1		0/2	2/3				2/6	33.3%		1				00:32:14
22	马琳	0/1	2/4	1/1		1/1		1/1	5/8	62.5%		2				00:34:30
23	张政				1/1				1/1	100%		1				00:15:45
<b>合计</b>		5/22	5/10	1/5	4/5	5/6		2/3	22/51	43.1%	1	18	1	2		
<i>(守门员)</i>																
1	徐佳蓉	0/1		0/1		0/2	0/1		0/5	0.0%						00:07:31
12	肖宁桐	3/7	3/8	4/5	1/9	2/7		0/2	13/38	34.2%						00:37:30
16	杜宪	1/4	0/1	1/2	0/2				2/9	22.2%	1	1				00:09:41
<b>合计</b>		4/12	3/9	5/8	1/11	2/9	0/1	0/2	15/52	28.8%	1	1				

场上队员：得分/射门

守门员：救球/射门

全队合计	得分	被救	射失	击柱	封球	合计	%
远射	5	14	2		1	22	22.7%
近射	5	3	2			10	50.0%
边射	1	2	1	1		5	20.0%
快攻	4			1		5	80.0%
突破	5	1				6	83.3%
任意							0.0%
7M	2	1				3	66.7%





### 2016年全国女子手球锦标赛

#### 图式射门区域统计

轮次 9 场次 44

201605044-41-1/1

## 北京

1 宋嘉蕾	3 季小桐	4 孙佳	6 刘亚男	8 杨铭豫	10 刘莎	11 纪婉	16 王海叶																																																																								
<table border="1"><tr><td></td><td></td><td></td></tr><tr><td></td><td></td><td></td></tr><tr><td></td><td></td><td></td></tr></table>										<table border="1"><tr><td>1</td><td></td><td>1</td></tr><tr><td></td><td></td><td>2</td></tr><tr><td>1</td><td>1</td><td>1</td></tr></table>	1		1			2	1	1	1	<table border="1"><tr><td>2</td><td></td><td></td></tr><tr><td>1</td><td></td><td></td></tr><tr><td>1</td><td></td><td>1</td></tr></table>	2			1			1		1	<table border="1"><tr><td></td><td></td><td></td></tr><tr><td></td><td></td><td></td></tr><tr><td></td><td></td><td></td></tr></table>										<table border="1"><tr><td></td><td></td><td>1</td></tr><tr><td>1</td><td></td><td></td></tr><tr><td></td><td>1</td><td>1</td></tr></table>			1	1				1	1	<table border="1"><tr><td></td><td></td><td></td></tr><tr><td></td><td></td><td>1</td></tr><tr><td></td><td></td><td></td></tr></table>						1				<table border="1"><tr><td></td><td>1</td><td></td></tr><tr><td></td><td></td><td>1</td></tr><tr><td>2</td><td></td><td></td></tr></table>		1				1	2			<table border="1"><tr><td></td><td></td><td></td></tr><tr><td></td><td></td><td></td></tr><tr><td></td><td></td><td></td></tr></table>									
1		1																																																																													
		2																																																																													
1	1	1																																																																													
2																																																																															
1																																																																															
1		1																																																																													
		1																																																																													
1																																																																															
	1	1																																																																													
		1																																																																													
	1																																																																														
		1																																																																													
2																																																																															
Post - 0 Miss - 0 Block - 0	Post - 1 Miss - 0 Block - 0	Post - 0 Miss - 0 Block - 0	Post - 0 Miss - 0 Block - 0	Post - 0 Miss - 1 Block - 0	Post - 0 Miss - 0 Block - 0	Post - 0 Miss - 0 Block - 0	Post - 0 Miss - 0 Block - 0																																																																								
17 杨政赢	22 李海鸥	23 田媛	28 闫美珠	33 栾征	47 刘泽	58 李华	69 石梓薇																																																																								
<table border="1"><tr><td>1</td><td></td><td></td></tr><tr><td>1</td><td></td><td>1</td></tr><tr><td>1</td><td></td><td></td></tr></table>	1			1		1	1			<table border="1"><tr><td></td><td></td><td></td></tr><tr><td>1</td><td></td><td></td></tr><tr><td>1</td><td></td><td></td></tr></table>				1			1			<table border="1"><tr><td></td><td></td><td></td></tr><tr><td></td><td></td><td>1</td></tr><tr><td>1</td><td></td><td>1</td></tr></table>						1	1		1	<table border="1"><tr><td></td><td></td><td></td></tr><tr><td></td><td></td><td></td></tr><tr><td></td><td></td><td></td></tr></table>										<table border="1"><tr><td></td><td></td><td></td></tr><tr><td></td><td></td><td></td></tr><tr><td></td><td></td><td></td></tr></table>										<table border="1"><tr><td></td><td></td><td></td></tr><tr><td></td><td></td><td></td></tr><tr><td></td><td></td><td></td></tr></table>										<table border="1"><tr><td></td><td></td><td></td></tr><tr><td></td><td></td><td></td></tr><tr><td></td><td></td><td></td></tr></table>										<table border="1"><tr><td></td><td></td><td>2</td></tr><tr><td></td><td>1</td><td>3</td></tr><tr><td></td><td></td><td>1</td></tr></table>			2		1	3			1
1																																																																															
1		1																																																																													
1																																																																															
1																																																																															
1																																																																															
		1																																																																													
1		1																																																																													
		2																																																																													
	1	3																																																																													
		1																																																																													
Post - 0 Miss - 1 Block - 0	Post - 0 Miss - 0 Block - 0	Post - 1 Miss - 0 Block - 1	Post - 0 Miss - 0 Block - 0	Post - 0 Miss - 0 Block - 0	Post - 0 Miss - 0 Block - 0	Post - 0 Miss - 0 Block - 0	Post - 0 Miss - 0 Block - 1																																																																								

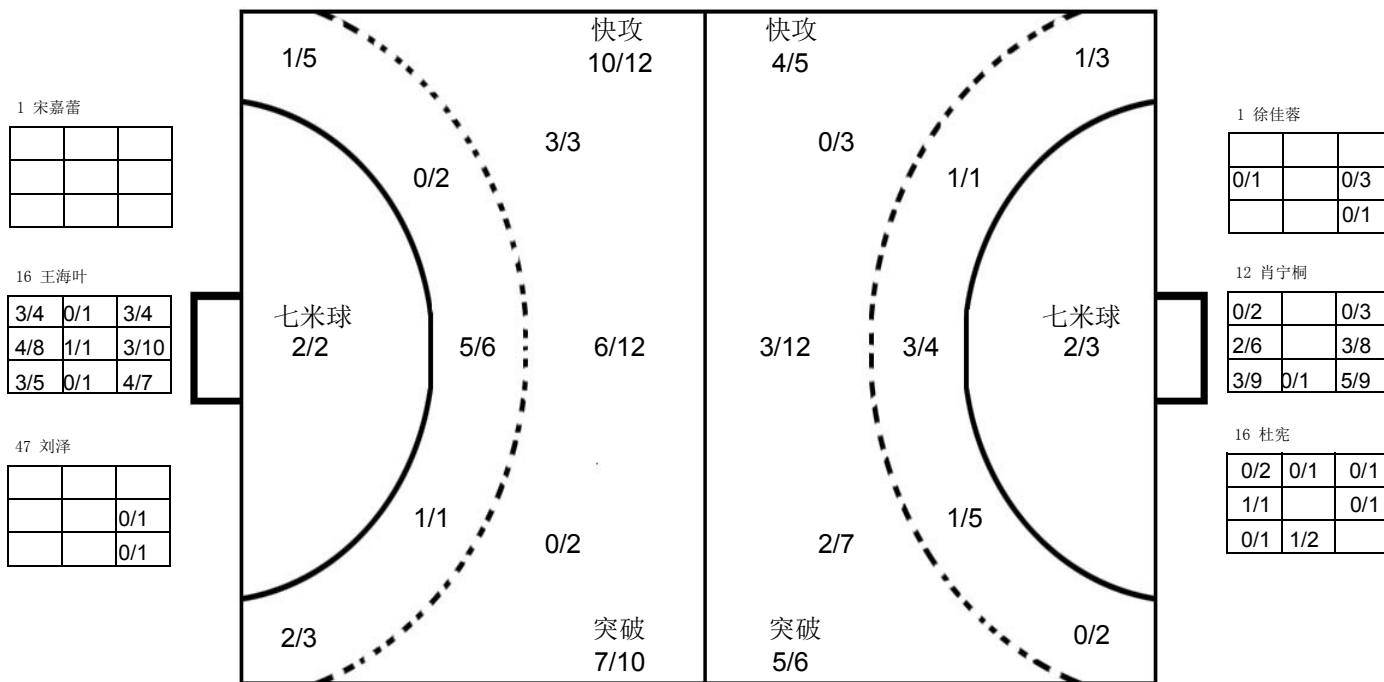

## 黑龙江

1 徐佳蓉	3 刘诗彤	5 周美微	6 王梦艺	9 郑宇	10 刘雪露	11 刘天茹	12 肖宁桐																																																																								
<table border="1"><tr><td></td><td></td><td></td></tr><tr><td></td><td></td><td></td></tr><tr><td></td><td></td><td></td></tr></table>										<table border="1"><tr><td></td><td></td><td></td></tr><tr><td></td><td></td><td></td></tr><tr><td></td><td></td><td></td></tr></table>										<table border="1"><tr><td></td><td></td><td></td></tr><tr><td></td><td></td><td></td></tr><tr><td></td><td></td><td></td></tr></table>										<table border="1"><tr><td></td><td></td><td>1</td></tr><tr><td>1</td><td>1</td><td></td></tr><tr><td></td><td></td><td></td></tr></table>			1	1	1					<table border="1"><tr><td>1</td><td></td><td></td></tr><tr><td></td><td></td><td>2</td></tr><tr><td></td><td></td><td></td></tr></table>	1					2				<table border="1"><tr><td></td><td></td><td></td></tr><tr><td></td><td></td><td></td></tr><tr><td></td><td></td><td></td></tr></table>										<table border="1"><tr><td></td><td></td><td></td></tr><tr><td></td><td></td><td></td></tr><tr><td></td><td></td><td></td></tr></table>										<table border="1"><tr><td></td><td></td><td></td></tr><tr><td></td><td></td><td></td></tr><tr><td></td><td></td><td></td></tr></table>									
		1																																																																													
1	1																																																																														
1																																																																															
		2																																																																													
Post - 0 Miss - 0 Block - 0	Post - 0 Miss - 0 Block - 0	Post - 0 Miss - 0 Block - 0	Post - 0 Miss - 0 Block - 0	Post - 0 Miss - 0 Block - 0	Post - 0 Miss - 0 Block - 0	Post - 0 Miss - 1 Block - 0	Post - 0 Miss - 0 Block - 0																																																																								
13 吴佳	14 黄莹	16 杜宪	19 梁文煜	21 王戈	22 马琳	23 张政																																																																									
<table border="1"><tr><td></td><td>1</td><td></td></tr><tr><td>1</td><td></td><td>2</td></tr><tr><td>1</td><td></td><td>2</td></tr></table>		1		1		2	1		2	<table border="1"><tr><td></td><td></td><td></td></tr><tr><td></td><td></td><td></td></tr><tr><td></td><td></td><td>1</td></tr></table>									1	<table border="1"><tr><td></td><td></td><td></td></tr><tr><td></td><td></td><td></td></tr><tr><td></td><td></td><td></td></tr></table>										<table border="1"><tr><td></td><td></td><td></td></tr><tr><td></td><td></td><td></td></tr><tr><td></td><td></td><td></td></tr></table>										<table border="1"><tr><td></td><td></td><td></td></tr><tr><td>1</td><td></td><td></td></tr><tr><td></td><td></td><td>1</td></tr></table>				1					1	<table border="1"><tr><td></td><td></td><td></td></tr><tr><td>2</td><td></td><td>3</td></tr><tr><td></td><td></td><td></td></tr></table>				2		3				<table border="1"><tr><td></td><td></td><td></td></tr><tr><td></td><td></td><td>1</td></tr><tr><td></td><td></td><td></td></tr></table>						1				<table border="1"><tr><td></td><td></td><td></td></tr><tr><td></td><td></td><td></td></tr><tr><td></td><td></td><td></td></tr></table>									
	1																																																																														
1		2																																																																													
1		2																																																																													
		1																																																																													
1																																																																															
		1																																																																													
2		3																																																																													
		1																																																																													
Post - 0 Miss - 1 Block - 0	Post - 0 Miss - 0 Block - 0	Post - 0 Miss - 0 Block - 0	Post - 0 Miss - 1 Block - 0	Post - 2 Miss - 0 Block - 1	Post - 0 Miss - 2 Block - 0	Post - 0 Miss - 0 Block - 0																																																																									

注释: Post=击柱 Miss=射失 Block=被封





5-8名

女子 全国比赛

2016年全国女子手球锦标赛

Team A		Team B		Match Number																	
A 解放军		B 辽宁		45																	
played in		in the hall		on																	
China		滁州体育馆		12/09/2016																	
				at 14:00 hours																	
Spectators																					
Half-time (30')	A	B	End of playing time	A	B																
	15	16	31	30																	
1st extra time		A		B																	
2nd extra time		A		B																	
After penalty throws		A		B																	
Number of 7 m	A	Team time-out			Full name of players and officials			Team time-out			B	Number of 7 m									
	4 / 5	1	2	3				1	2	3	2 / 3										
		59:56						11:32	46:43												
No.	Team A					G	W	2'	D	DR	No.	Team B					G	W	2'	D	DR
2	崔云莉					2					1	于薇诗									
5	徐鸣昭					3					2	朱徐婷					3				
6	于婷婷					4					3	赵莹雪									
8	周亚茹					5	1				5	辛颜					4		1		
13	张格格					2		1			8	杨娇					4				
16	方文博										9	刁卫丽					6	1	1		
17	于利婷										12	刘雪菲									
23	顾天澍					1					13	杜江花					3	1			
24	韦娜娜					5	1				19	吕秋雪					2	1	1		
32	张馨予										20	孙弘玲					6				
36	李朴										24	陈思雨									
44	刘洋麦文					3					27	王丹									
66	杨丽丽										66	梁海珍									
77	唐魏萍										93	赵琦									
81	戴丹妮										98	张永婷					2				
88	李晓晴					6	1				99	郑锦宜									
B	刘凤娟										A	吕艳梦									
C	丛艳霞										B	李丽荣									
D	吴明群										C	金京男 (主教练)									
											E	程万里									
A	Signature of Responsible Official of the Teams (Off. A)																			B	
TP	Remarks of Referee / CHA Official																			TP	

Signatures

Referees	邓军 (CHN)	张耿 (CHN)		
Techn. Delegates	于中迅 (CHN)			
CHA Official	许宜扬 (CHN)			

Note: Number of 7m Throws Awarded to Team A and B, Goals (G), Warnings (W), Suspensions (2'), Direct Disqualification (D), Disqualification with Report (DR) and Team Penalty (TP).

Table Officials: 伍豪

陈文丽

Statisticians: 黄岩

刘永欢







## 2016年全国女子手球锦标赛 竞赛技术统计(媒体表)

5-8名	组别	<b>X</b>	轮次	<b>9</b>	场次	<b>45</b>
滁州体育馆		12/09/2016			201605045-51-1/1	
解放军		<b>解放军</b>		<b>31</b>	vs	<b>30</b> <b>辽宁</b>
				<b>15 : 16</b>		<b>辽宁</b>

裁判员	邓军 (CHN)	/	张耿 (CHN)
-----	----------	---	----------

解放军		远	近	边	快	突	任意	7m	合计	%	助攻	失误	警告	2'	D & DR	比赛进程	
主教练：刘德东		射	射	射	攻	破	球	球								解放军	辽宁
2	崔云莉	0/1	0/1	2/2					2/4	50.0		1				6	于婷婷
5	徐鸣昭	0/1	2/3			1/1			3/5	60.0						1	01:09
6	于婷婷	2/2	0/2		1/1	1/1			4/6	66.7	2	4				1	02:45
8	周亚茹	2/5	1/2					2/3	5/10	50.0		2	1			2	04:33
13	张格格		2/2						2/2	100	1					2	06:55
16	方文博										1				1	2	07:59
17	于利婷			0/1	0/1				0/2	0.0						3	08:26
23	顾天澍				1/1				1/1	100		2				3	08:55
24	韦娜娜		2/2	1/1	2/3				5/6	83.3			1			4	09:25
32	张馨予															4	10:39
36	李朴															5	11:11
44	刘洋麦文	2/9		0/1		1/1			3/11	27.3	4	6				5	11:58
66	杨丽丽															6	13:18
77	唐魏萍															7	14:22
81	戴丹妮															7	14:47
88	李晓晴	3/6			1/1		0/1	2/2	6/10	60.0		2	1			8	15:26
<b>运动员 合计</b>		<b>9/24</b>	<b>7/12</b>	<b>3/5</b>	<b>5/7</b>	<b>3/3</b>	<b>0/1</b>	<b>4/5</b>	<b>31/57</b>	<b>54.4</b>	<b>8</b>	<b>17</b>	<b>3</b>	<b>1</b>		8	16:21
16	方文博	5/9	3/11	3/7	2/8	2/8		0/2	15/45	33.3	1					8	16:39
<b>守门员 合计</b>		<b>5/9</b>	<b>3/11</b>	<b>3/7</b>	<b>2/8</b>	<b>2/8</b>	<b>0/2</b>	<b>15/45</b>	<b>33.3</b>		<b>1</b>					9	17:37
<b>2nd Half</b>																	
13	张格格															16	00:40
13	张格格															16	01:42
6	于婷婷															17	02:06
88	李晓晴															17	03:43
88	李晓晴															17	04:53
8	周亚茹															18	05:39
5	徐鸣昭															18	06:22
5	徐鸣昭															19	06:22
2	崔云莉															19	08:06
8	周亚茹															20	08:29
88	李晓晴															20	09:32
6	于婷婷															20	10:21
24	韦娜娜															20	10:21
8	周亚茹															21	11:12
5	徐鸣昭															21	11:52
5	徐鸣昭															21	11:52
2	崔云莉															22	12:18
8	周亚茹															22	12:42
88	李晓晴															22	12:42
6	于婷婷															22	12:42
24	韦娜娜															23	13:29
88	李晓晴															23	13:29
6	于婷婷															24	14:34
24	韦娜娜															24	14:34
8	周亚茹															25	15:20
88	李晓晴															25	15:20
6	于婷婷															26	16:29
24	韦娜娜															26	16:29
88	李晓晴															26	17:11
6	于婷婷															26	17:11
24	韦娜娜															26	19:36
88	李晓晴															26	19:36
6	于婷婷															27	20:05
24	韦娜娜															27	20:05
88	李晓晴															28	20:39
5	徐鸣昭															28	20:39
88	李晓晴															29	21:19
6	于婷婷															29	21:19
24	韦娜娜															29	22:11
88	李晓晴															29	22:11
5	徐鸣昭															30	23:25
5	徐鸣昭															30	23:25
27	王丹															30	24:37
5	徐鸣昭															30	25:22
5	徐鸣昭															31	29:11
5	徐鸣昭															31	29:11
5	徐鸣昭															31	29:20
5	徐鸣昭															31	29:20

场上队员：得分 / 射门

守门员：救球 / 射门

快攻	Fast Break	突破	Breakthrough	任意球	Free Throw	7M球	7M Throw	助攻	Assist
警告	Warning	失误	Error	2'	Suspension	D	取消资格	DR	取消资格+报告





### 2016年全国女子手球锦标赛 图式比赛技术统计表

轮次 9

场次 45

201605045-21-1/1

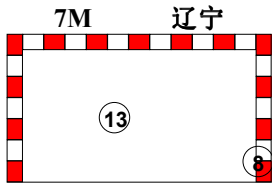
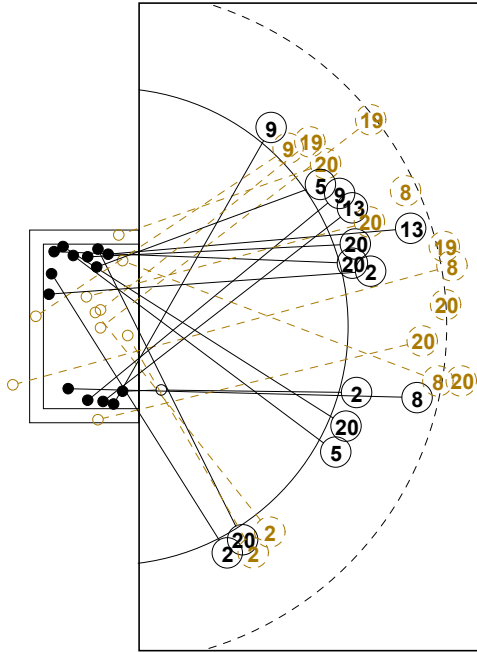

1st Half  
16 : 15

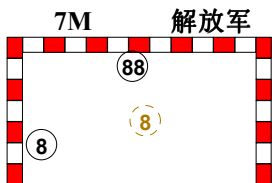
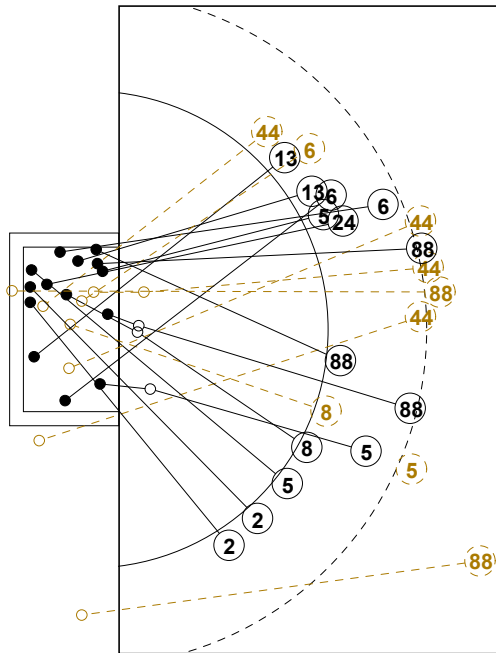
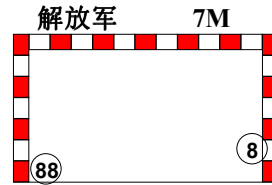
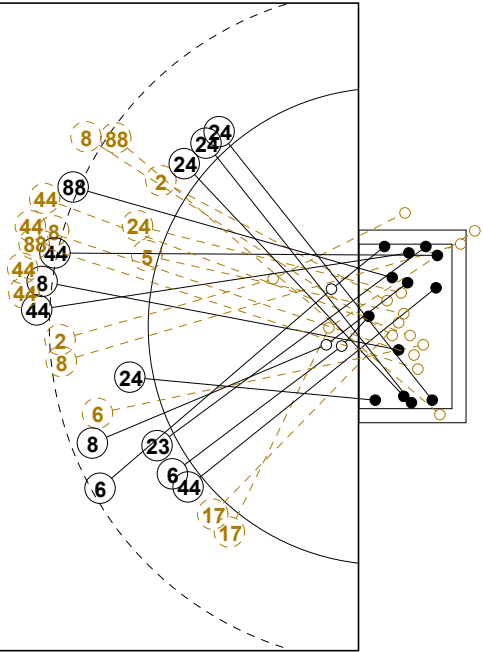

2nd Half  
31 : 30

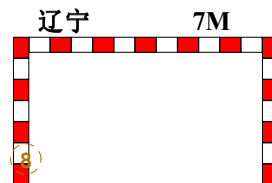
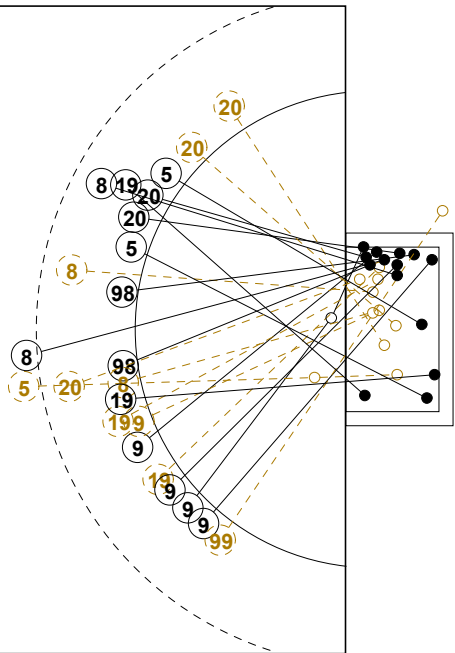



## 2016年全国女子手球锦标赛

## 个人/全队技术统计表

正式表  
手球  
女子5-8名  
轮次 9组别 X  
场次 45201605045-14-1/2  
滁州体育馆  
12/09/2016 14:00

号码	姓名	远射	近射	边射	快攻	突破	任意	7M	合计	%	助攻	失误	警告	2'	取消	时间
<b>解放军(解放军)</b>																
<i>(场上队员)</i>																
2	崔云莉	0/1	0/1	2/2					2/4	50.0%		1				00:25:04
5	徐鸣昭	0/1	2/3			1/1			3/5	60.0%						00:25:47
6	于婷婷	2/2	0/2		1/1	1/1			4/6	66.7%	2	4				00:54:02
8	周亚茹	2/5	1/2					2/3	5/10	50.0%		2	1			00:28:48
13	张格格		2/2						2/2	100%	1			1		00:48:06
16	方文博									0.0%	1					01:00:00
17	于利婷			0/1	0/1				0/2	0.0%						00:03:47
23	顾天澍				1/1				1/1	100%		2				00:29:06
24	韦娜娜		2/2	1/1	2/3				5/6	83.3%			1			01:00:00
32	张馨予									0.0%						00:00:00
36	李朴									0.0%						00:00:00
44	刘洋麦文	2/9		0/1		1/1			3/11	27.3%	4	6				00:49:27
66	杨丽丽									0.0%						00:00:00
77	唐魏萍									0.0%						00:00:00
81	戴丹妮									0.0%						00:00:00
88	李晓晴	3/6			1/1		0/1	2/2	6/10	60.0%		2	1			00:35:35
<b>合计</b>		9/24	7/12	3/5	5/7	3/3	0/1	4/5	31/57	54.4%	8	17	3	1		
<i>(守门员)</i>																
16	方文博	5/9	3/11	3/7	2/8	2/8		0/2	15/45	33.3%	1					01:00:00
<b>合计</b>																
<b>合计</b>		5/9	3/11	3/7	2/8	2/8		0/2	15/45	33.3%	1					

场上队员：得分/射门

守门员：救球/射门

全队合计	得分	被救	射失	击柱	封球	合计	%
远射	9	6	2	3	4	24	37.5%
近射	7	5				12	58.3%
边射	3	1	1			5	60.0%
快攻	5	2				7	71.4%
突破	3					3	100.0%
任意			1			1	0.0%
7M	4	1				5	80.0%





## 2016年全国女子手球锦标赛

## 个人/全队技术统计表

正式表  
手球  
女子5-8名  
轮次 9组别 X  
场次 45201605045-14-2/2  
滁州体育馆  
12/09/2016 14:00

号码	姓名	远射	近射	边射	快攻	突破	任意	7M	合计	%	助攻	失误	警告	2'	取消	时间	
<b>辽宁(辽宁)</b>																	
<i>(上场队员)</i>																	
1	于薇诗									0.0%						00:00:00	
2	朱徐婷			1/3	2/2				3/5	60.0%	1	3				01:00:00	
3	赵莹雪									0.0%						00:00:00	
5	辛颜	0/1	2/2			2/2			4/5	80.0%		2		1		00:51:38	
8	杨娇	3/7	0/1					1/2	4/10	40.0%	3	5				01:00:00	
9	刁卫丽		1/1	2/2	3/5				6/8	75.0%		2	1	1		00:47:27	
12	刘雪菲									0.0%						00:00:00	
13	杜江花	1/1	1/1					1/1	3/3	100%	1	2	1			00:23:26	
19	吕秋雪	0/2	0/1		1/2	1/2			2/7	28.6%		3	1	1		00:40:05	
20	孙弘玲	0/4	2/4	1/2		3/4			6/14	42.9%	1	4				01:00:00	
24	陈思雨									0.0%						00:00:00	
27	王丹									0.0%						01:00:00	
66	梁海珍									0.0%						00:00:00	
93	赵琦									0.0%						00:00:00	
98	张永婷		2/2						2/2	100%		2				00:13:41	
99	郑锦宜			0/1					0/1	0.0%						00:03:32	
<b>合计</b>		4/15	8/12	4/8	6/9	6/8		2/3	30/55	54.5%	6	23	3	3			
<i>(守门员)</i>																	
27	王丹	6/15	5/12	1/4	2/7	0/3		1/5	15/46	32.6%						01:00:00	
<b>合计</b>																	
		6/15	5/12	1/4	2/7	0/3		1/5	15/46	32.6%							

场上队员：得分/射门

守门员：救球/射门

全队合计	得分	被救	射失	击柱	封球	合计	%
远射	4	5	1	1	4	15	26.7%
近射	8	3		1		12	66.7%
边射	4	3	1			8	50.0%
快攻	6	2		1		9	66.7%
突破	6	2				8	75.0%
任意							0.0%
7M	2			1		3	66.7%





2016年全国女子手球锦标赛

图式射门区域统计

轮次 9 场次 45

201605045-41-1/1

解放军

2 崔云莉	5 徐鸣昭	6 于婷婷	8 周亚茹	13 张格格	16 方文博	17 于利婷	23 顾天澍																																																																								
<table border="1"><tr><td></td><td>1</td><td>1</td></tr><tr><td></td><td></td><td></td></tr><tr><td></td><td></td><td></td></tr></table>		1	1							<table border="1"><tr><td></td><td></td><td>1</td></tr><tr><td></td><td></td><td></td></tr><tr><td>1</td><td></td><td>1</td></tr></table>			1				1		1	<table border="1"><tr><td></td><td></td><td></td></tr><tr><td>1</td><td></td><td>1</td></tr><tr><td>1</td><td>1</td><td></td></tr></table>				1		1	1	1		<table border="1"><tr><td></td><td></td><td></td></tr><tr><td>2</td><td>1</td><td>1</td></tr><tr><td></td><td></td><td>1</td></tr></table>				2	1	1			1	<table border="1"><tr><td></td><td>1</td><td></td></tr><tr><td></td><td></td><td></td></tr><tr><td></td><td></td><td>1</td></tr></table>		1							1	<table border="1"><tr><td></td><td></td><td></td></tr><tr><td></td><td></td><td></td></tr><tr><td></td><td></td><td></td></tr></table>										<table border="1"><tr><td></td><td></td><td></td></tr><tr><td></td><td></td><td></td></tr><tr><td></td><td></td><td></td></tr></table>										<table border="1"><tr><td></td><td>1</td><td></td></tr><tr><td></td><td></td><td></td></tr><tr><td></td><td></td><td></td></tr></table>		1							
	1	1																																																																													
		1																																																																													
1		1																																																																													
1		1																																																																													
1	1																																																																														
2	1	1																																																																													
		1																																																																													
	1																																																																														
		1																																																																													
	1																																																																														
Post - 0 Miss - 1 Block - 0	Post - 0 Miss - 0 Block - 1	Post - 0 Miss - 0 Block - 0	Post - 1 Miss - 0 Block - 1	Post - 0 Miss - 0 Block - 0	Post - 0 Miss - 0 Block - 0	Post - 0 Miss - 1 Block - 0	Post - 0 Miss - 0 Block - 0																																																																								
24 韦娜娜	32 张馨予	36 李朴	44 刘洋麦文	66 杨丽丽	77 唐魏萍	81 戴丹妮	88 李晓晴																																																																								
<table border="1"><tr><td></td><td></td><td>2</td></tr><tr><td></td><td></td><td>2</td></tr><tr><td></td><td></td><td>1</td></tr></table>			2			2			1	<table border="1"><tr><td></td><td></td><td></td></tr><tr><td></td><td></td><td></td></tr><tr><td></td><td></td><td></td></tr></table>										<table border="1"><tr><td></td><td></td><td></td></tr><tr><td></td><td></td><td></td></tr><tr><td></td><td></td><td></td></tr></table>										<table border="1"><tr><td>2</td><td></td><td></td></tr><tr><td>1</td><td></td><td></td></tr><tr><td></td><td></td><td></td></tr></table>	2			1						<table border="1"><tr><td></td><td></td><td></td></tr><tr><td></td><td></td><td></td></tr><tr><td></td><td></td><td></td></tr></table>										<table border="1"><tr><td></td><td></td><td></td></tr><tr><td></td><td></td><td></td></tr><tr><td></td><td></td><td></td></tr></table>										<table border="1"><tr><td></td><td></td><td></td></tr><tr><td></td><td></td><td></td></tr><tr><td></td><td></td><td></td></tr></table>										<table border="1"><tr><td></td><td>1</td><td></td></tr><tr><td>1</td><td></td><td></td></tr><tr><td>1</td><td>1</td><td>2</td></tr></table>		1		1			1	1	2
		2																																																																													
		2																																																																													
		1																																																																													
2																																																																															
1																																																																															
	1																																																																														
1																																																																															
1	1	2																																																																													
Post - 0 Miss - 0 Block - 0	Post - 0 Miss - 0 Block - 0	Post - 0 Miss - 0 Block - 0	Post - 0 Miss - 1 Block - 2	Post - 0 Miss - 0 Block - 0	Post - 0 Miss - 0 Block - 0	Post - 0 Miss - 0 Block - 0	Post - 2 Miss - 1 Block - 0																																																																								

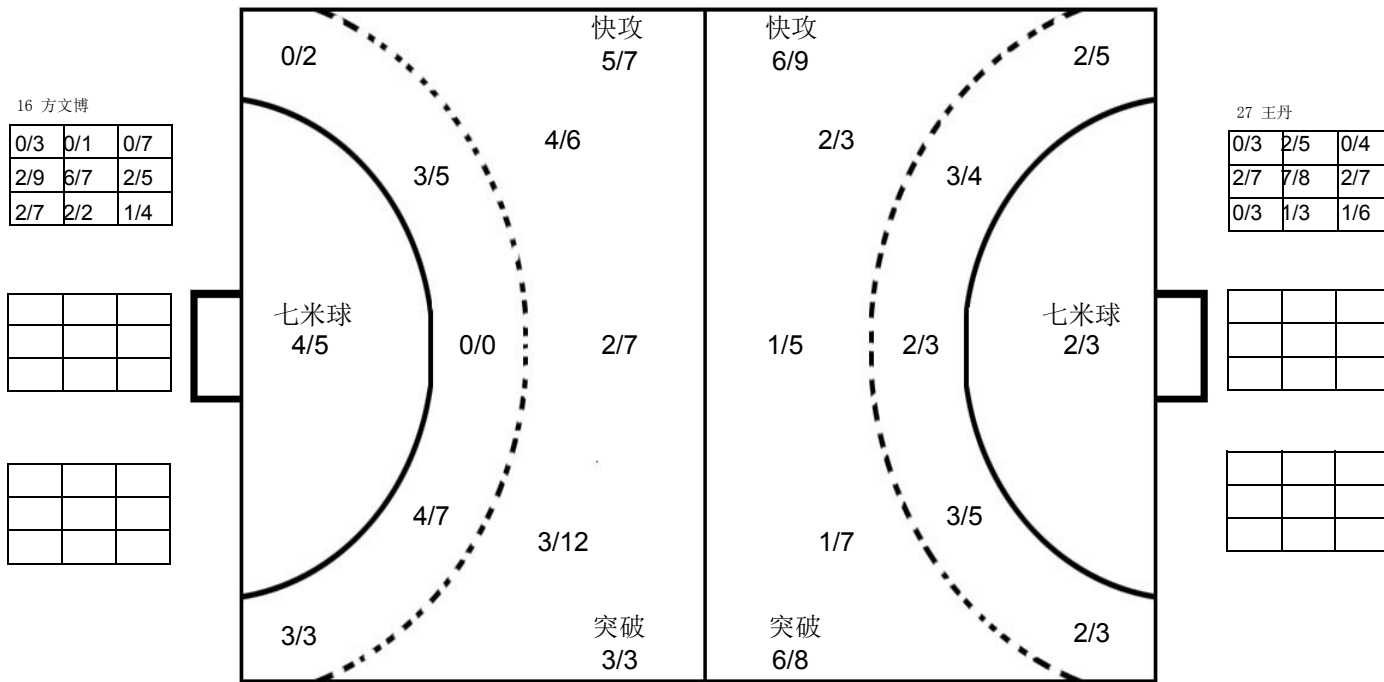

辽宁

1 于薇诗	2 朱徐婷	3 赵莹雪	5 辛颜	8 杨娇	9 刁卫丽	12 刘雪菲	13 杜江花																																																																								
<table border="1"><tr><td></td><td></td><td></td></tr><tr><td></td><td></td><td></td></tr><tr><td></td><td></td><td></td></tr></table>										<table border="1"><tr><td></td><td></td><td>2</td></tr><tr><td></td><td></td><td></td></tr><tr><td>1</td><td></td><td></td></tr></table>			2				1			<table border="1"><tr><td></td><td></td><td></td></tr><tr><td></td><td></td><td></td></tr><tr><td></td><td></td><td></td></tr></table>										<table border="1"><tr><td></td><td>1</td><td>2</td></tr><tr><td></td><td></td><td>1</td></tr><tr><td></td><td></td><td></td></tr></table>		1	2			1				<table border="1"><tr><td>1</td><td></td><td></td></tr><tr><td>2</td><td></td><td></td></tr><tr><td></td><td></td><td>1</td></tr></table>	1			2					1	<table border="1"><tr><td>1</td><td></td><td></td></tr><tr><td>3</td><td></td><td></td></tr><tr><td>2</td><td></td><td></td></tr></table>	1			3			2			<table border="1"><tr><td></td><td></td><td></td></tr><tr><td></td><td></td><td></td></tr><tr><td></td><td></td><td></td></tr></table>										<table border="1"><tr><td></td><td>1</td><td></td></tr><tr><td></td><td>1</td><td></td></tr><tr><td></td><td></td><td>1</td></tr></table>		1			1				1
		2																																																																													
1																																																																															
	1	2																																																																													
		1																																																																													
1																																																																															
2																																																																															
		1																																																																													
1																																																																															
3																																																																															
2																																																																															
	1																																																																														
	1																																																																														
		1																																																																													
Post - 0 Miss - 0 Block - 0	Post - 0 Miss - 0 Block - 0	Post - 0 Miss - 0 Block - 0	Post - 0 Miss - 0 Block - 0	Post - 1 Miss - 1 Block - 1	Post - 1 Miss - 0 Block - 0	Post - 0 Miss - 0 Block - 0	Post - 0 Miss - 0 Block - 0																																																																								
19 吕秋雪	20 孙弘玲	24 陈思雨	27 王丹	66 梁海珍	93 赵琦	98 张永婷	99 郑锦宜																																																																								
<table border="1"><tr><td></td><td></td><td>1</td></tr><tr><td></td><td></td><td></td></tr><tr><td></td><td></td><td>1</td></tr></table>			1						1	<table border="1"><tr><td></td><td></td><td>2</td></tr><tr><td>1</td><td></td><td>2</td></tr><tr><td>1</td><td></td><td></td></tr></table>			2	1		2	1			<table border="1"><tr><td></td><td></td><td></td></tr><tr><td></td><td></td><td></td></tr><tr><td></td><td></td><td></td></tr></table>										<table border="1"><tr><td></td><td></td><td></td></tr><tr><td></td><td></td><td></td></tr><tr><td></td><td></td><td></td></tr></table>										<table border="1"><tr><td></td><td></td><td></td></tr><tr><td></td><td></td><td></td></tr><tr><td></td><td></td><td></td></tr></table>										<table border="1"><tr><td></td><td></td><td></td></tr><tr><td></td><td></td><td></td></tr><tr><td></td><td></td><td></td></tr></table>										<table border="1"><tr><td></td><td>1</td><td></td></tr><tr><td></td><td></td><td></td></tr><tr><td>1</td><td></td><td></td></tr></table>		1					1			<table border="1"><tr><td></td><td></td><td></td></tr><tr><td></td><td></td><td></td></tr><tr><td></td><td></td><td></td></tr></table>									
		1																																																																													
		1																																																																													
		2																																																																													
1		2																																																																													
1																																																																															
	1																																																																														
1																																																																															
Post - 0 Miss - 0 Block - 1	Post - 2 Miss - 0 Block - 2	Post - 0 Miss - 0 Block - 0	Post - 0 Miss - 0 Block - 0	Post - 0 Miss - 0 Block - 0	Post - 0 Miss - 0 Block - 0	Post - 0 Miss - 0 Block - 0	Post - 0 Miss - 1 Block - 0																																																																								

注释: Post=击柱 Miss=射失 Block=被封





5-8名

女子 全国比赛

2016年全国女子手球锦标赛

Team A <b>A 天津</b>				Team B <b>B 新疆</b>				Match Number <b>46</b>								
played in China		in the hall 滁州体育馆		on 12/09/2016		at 15:30 hours		Spectators								
Half-time (30')	<b>A</b> 8	<b>B</b> 13	End of playing time	<b>A</b> 17	<b>B</b> 26	1st extra time	<b>A</b>	<b>B</b>	2nd extra time	<b>A</b>	<b>B</b>	After penalty throws	<b>A</b>	<b>B</b>		
Number of 7 m	<b>A</b> 3 / 5	Team time-out			Full name of players and officials				Team time-out			<b>B</b> 4 / 4	Number of 7 m			
No.	Team <b>A</b>					G	W	2'	D	DR	No.	Team <b>B</b>				
3	王晓梅										3	葛立双				
4	朱佳瑜					3					6	阿孜古				
5	丁丽洁						1				7	吴志娟				
7	张心茹										10	李静				
8	张慧					2					11	陈培培				
10	张文慧					3	1				12	艾敏加尔汉				
11	蔡雪洁					5	1				15	兰姝娇				
12	王欣冉										17	戴莹莹				
14	刘洁										18	崔娟				
15	李窈窈										21	锁珊珊				
16	王选										23	张艺璇				
17	聂晓雪										26	宋婷婷				
18	舒文琪										27	谢辰辰				
21	李默雅					3					32	杨雨柔				
22	王聪										93	张婷婷				
23	周梦雪					1										
<b>A</b>	付明双										<b>B</b>	于涛 (主教练)				
<b>B</b>	王明星 (主教练)										<b>D</b>	高璇				
<b>C</b>	岳连娥															
<b>A</b>	Signature of Responsible Official of the Teams (Off. A)										<b>B</b>					
TP	Remarks of Referee / CHA Official											TP				

Signatures

Referees	徐健 (CHN)	曹宏俊 (CHN)		
Techn. Delegates	高斌 (CHN)			
CHA Official	刘书勇 (CHN)			

Note: Number of 7m Throws Awarded to Team A and B, Goals (G), Warnings (W), Suspensions (2'), Direct Disqualification (D), Disqualification with Report (DR) and Team Penalty (TP).

Table Officials: 陈文丽 伍豪 Statisticians: 刘永欢 黄岩

Printed by PHMS Copyright: IHF / CHA 12/09/2016 16:51:05

Longman Sportsoft  handball@126.com



2016年全国女子手球锦标赛  
竞赛技术统计(媒体表)

5-8名 组别 X 轮次 9 场次 46

滁州体育馆 12/09/2016 201605046-51-1/1  
天津 17 vs 26 新疆 新疆  
8 : 13

裁判员 徐健 (CHN) / 曹宏俊 (CHN)

天津 主教练: 王明星  
远射 近射 边射 快攻 突破 任意球 7m球 合计 % 助攻 失误 警告 2' D & DR  
3 王晓梅  
4 朱佳瑜  
5 丁丽洁  
7 张心茹  
8 张慧  
10 张文慧  
11 蔡雪洁  
12 王欣冉  
14 刘洁  
15 李窈窈  
16 王选  
17 聂晓雪  
18 舒文琪  
21 李默雅  
22 王聪  
23 周梦雪  
运动员 合计  
12 王欣冉  
16 王选  
守门员 合计

新疆 教练: 于涛  
远射 近射 边射 快攻 突破 任意球 7m球 合计 % 助攻 失误 警告 2' D & DR  
3 葛立双  
6 阿孜古  
7 吴志娟  
10 李静  
11 陈培培  
12 艾敏加尔汉  
15 兰姝娇  
17 戴莹莹  
18 崔娟  
21 锁珊珊  
23 张艺璇  
26 宋婷婷  
27 谢辰辰  
32 杨雨柔  
93 张婷婷  
运动员 合计  
10 李静  
32 杨雨柔  
守门员 合计

场上队员: 得分 / 射门 守门员: 救球 / 射门  
快攻 Fast Break 突破 Breakthrough 任意球 Free Throw 7M球 7M Throw 助攻 Assist  
警告 Warning 失误 Error 2' Suspension D 取消资格 取消资格+报告



### 2016年全国女子手球锦标赛 图式比赛技术统计表

轮次 9

场次 46

201605046-21-1/1

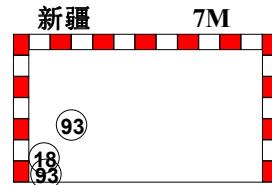
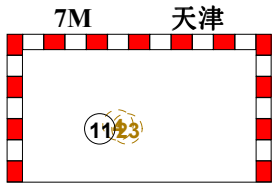
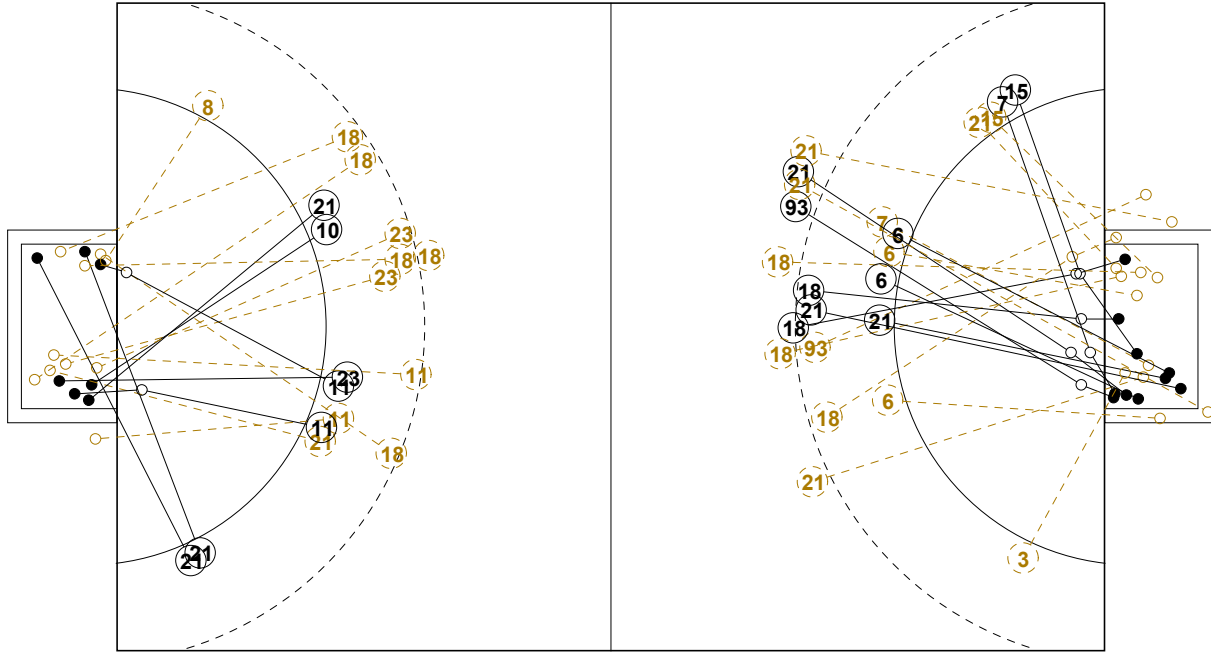

1st Half  
8 : 13

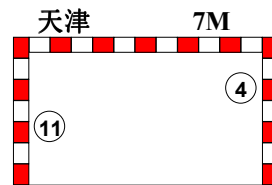
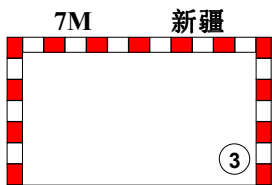
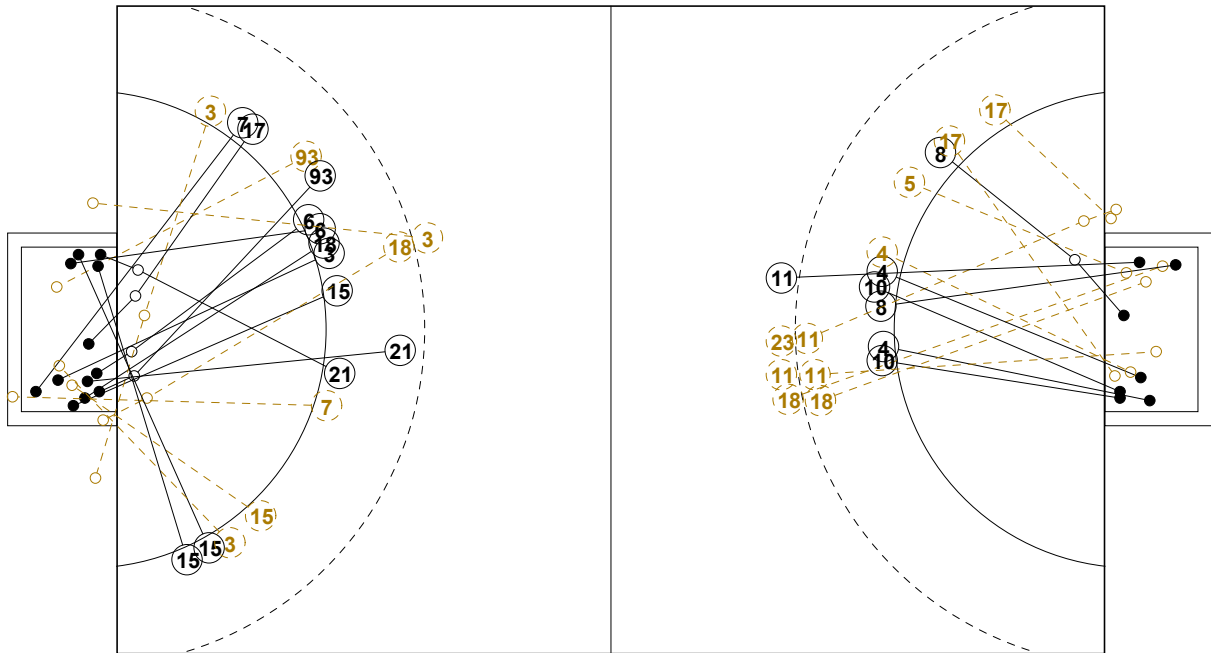

2nd Half  
26 : 17





## 2016年全国女子手球锦标赛

## 个人/全队技术统计表

正式表  
手球  
女子5-8名  
轮次 9组别 X  
场次 46201605046-14-1/2  
滁州体育馆  
12/09/2016 15:30

号码	姓名	远射	近射	边射	快攻	突破	任意	7M	合计	%	助攻	失误	警告	2'	取消	时间
<b>天津(天津)</b>																
<i>(场上队员)</i>																
3	王晓梅									0.0%						00:00:00
4	朱佳瑜		1/2		1/1			1/2	3/5	60.0%	1	1				00:11:27
5	丁丽洁		0/1						0/1	0.0%	1	1				00:39:33
7	张心茹									0.0%						00:00:00
8	张慧			0/1	2/2				2/3	66.7%	1					00:24:57
10	张文慧		3/3						3/3	100%	3	1				00:48:42
11	蔡雪洁	1/5	2/3					2/2	5/10	50.0%	1	5	1			00:54:35
12	王欣冉									0.0%						00:26:04
14	刘洁									0.0%						00:06:34
15	李窈窕									0.0%						00:06:50
16	王选									0.0%						00:33:56
17	聂晓雪			0/1	0/1				0/2	0.0%						00:33:46
18	舒文琪	0/7							0/7	0.0%	2	3				00:50:55
21	李默雅		0/1	2/2	1/1				3/4	75.0%						00:30:51
22	王聪									0.0%						00:00:00
23	周梦雪	0/2	0/1			1/1		0/1	1/5	20.0%	2	6				00:50:07
<b>合计</b>		1/14	6/11	2/4	4/5	1/1		3/5	17/40	42.5%	5	20	3			
<i>(守门员)</i>																
12	王欣冉	2/6	1/2	1/3	1/1	0/1		0/3	5/16	31.3%						00:26:04
16	王选	1/3	1/7	4/7	0/2	0/1		0/1	6/21	28.6%						00:33:56
<b>合计</b>		3/9	2/9	5/10	1/3	0/2		0/4	11/37	29.7%						

场上队员：得分/射门

守门员：救球/射门

全队合计	得分	被救	射失	击柱	封球	合计	%
远射	1	9	1		3	14	7.1%
近射	6	4	1			11	54.5%
边射	2	1	1			4	50.0%
快攻	4	1				5	80.0%
突破	1					1	100.0%
任意							0.0%
7M	3	2				5	60.0%





## 2016年全国女子手球锦标赛

## 个人/全队技术统计表

正式表  
手球  
女子5-8名  
轮次 9组别 X  
场次 46201605046-14-2/2  
滁州体育馆  
12/09/2016 15:30

号码	姓名	远射	近射	边射	快攻	突破	任意	7M	合计	%	助攻	失误	警告	2'	取消	时间
<b>新疆(新疆)</b>																
<i>(上场队员)</i>																
3	葛立双	0/1		0/3		1/1		1/1	2/6	33.3%						00:19:43
6	阿孜古		4/6						4/6	66.7%			1	1		00:49:36
7	吴志娟		0/1	2/2	0/1				2/4	50.0%	0/1	1				00:42:28
10	李静									0.0%						00:07:34
11	陈培培									0.0%						00:00:00
12	艾敏加尔汉									0.0%						00:06:38
15	兰姝娇			3/5		1/1			4/6	66.7%		2		1		00:40:26
17	戴莹莹				1/1				1/1	100%		2				00:25:41
18	崔娟	2/6	1/1					1/1	4/8	50.0%	4	4	1			00:49:38
21	锁珊珊	3/6	1/1	0/1	1/1				5/9	55.6%	1	3				00:51:56
23	张艺璇									0.0%						00:10:19
26	宋婷婷									0.0%						00:00:00
27	谢辰辰									0.0%	1					00:26:52
32	杨雨柔									0.0%		1				00:52:26
93	张婷婷	1/2	1/2					2/2	4/6	66.7%	5	4				00:55:15
<b>合计</b>		6/15	7/11	5/11	2/3	2/2		4/4	26/46	56.5%	11	17	2	2		
<i>(守门员)</i>																
10	李静	1/2						0/2	1/4	25.0%						00:07:34
32	杨雨柔	8/8	4/10	1/3	1/5	0/1		2/3	16/30	53.3%		1				00:52:26
<b>合计</b>		9/10	4/10	1/3	1/5	0/1		2/5	17/34	50.0%		1				

场上队员：得分/射门

守门员：救球/射门

全队合计	得分	被救	射失	击柱	封球	合计	%
远射	6	3	3	3		15	40.0%
近射	7	2		2		11	63.6%
边射	5	5	1			11	45.5%
快攻	2	1				3	66.7%
突破	2					2	100.0%
任意							0.0%
7M	4					4	100.0%





### 2016年全国女子手球锦标赛

#### 图式射门区域统计

轮次 9 场次 46

201605046-41-1/1

## 天津

3 王晓梅	4 朱佳瑜	5 丁丽洁	7 张心茹	8 张慧	10 张文慧	11 蔡雪洁	12 王欣冉																																																																								
<table border="1"><tr><td></td><td></td><td></td></tr><tr><td></td><td></td><td></td></tr><tr><td></td><td></td><td></td></tr></table>										<table border="1"><tr><td></td><td></td><td>1</td></tr><tr><td></td><td></td><td>2</td></tr><tr><td></td><td></td><td></td></tr></table>			1			2				<table border="1"><tr><td></td><td></td><td></td></tr><tr><td></td><td></td><td></td></tr><tr><td></td><td></td><td></td></tr></table>										<table border="1"><tr><td></td><td></td><td></td></tr><tr><td></td><td></td><td></td></tr><tr><td></td><td></td><td></td></tr></table>										<table border="1"><tr><td>1</td><td></td><td></td></tr><tr><td></td><td></td><td></td></tr><tr><td></td><td>1</td><td></td></tr></table>	1							1		<table border="1"><tr><td></td><td></td><td></td></tr><tr><td></td><td></td><td></td></tr><tr><td></td><td></td><td></td></tr></table>										<table border="1"><tr><td></td><td></td><td></td></tr><tr><td></td><td></td><td></td></tr><tr><td>4</td><td></td><td></td></tr></table>							4			<table border="1"><tr><td></td><td></td><td></td></tr><tr><td></td><td></td><td></td></tr><tr><td></td><td></td><td></td></tr></table>									
		1																																																																													
		2																																																																													
1																																																																															
	1																																																																														
4																																																																															
Post - 0 Miss - 0 Block - 0	Post - 0 Miss - 0 Block - 0	Post - 0 Miss - 0 Block - 0	Post - 0 Miss - 0 Block - 0	Post - 0 Miss - 0 Block - 0	Post - 0 Miss - 0 Block - 0	Post - 0 Miss - 2 Block - 1	Post - 0 Miss - 0 Block - 0																																																																								
14 刘洁	15 李窈窈	16 王选	17 聂晓雪	18 舒文琪	21 李默雅	22 王聪	23 周梦雪																																																																								
<table border="1"><tr><td></td><td></td><td></td></tr><tr><td></td><td></td><td></td></tr><tr><td></td><td></td><td></td></tr></table>										<table border="1"><tr><td></td><td></td><td></td></tr><tr><td></td><td></td><td></td></tr><tr><td></td><td></td><td></td></tr></table>										<table border="1"><tr><td></td><td></td><td></td></tr><tr><td></td><td></td><td></td></tr><tr><td></td><td></td><td></td></tr></table>										<table border="1"><tr><td></td><td></td><td></td></tr><tr><td></td><td></td><td></td></tr><tr><td></td><td></td><td></td></tr></table>										<table border="1"><tr><td></td><td></td><td></td></tr><tr><td></td><td></td><td></td></tr><tr><td></td><td></td><td></td></tr></table>										<table border="1"><tr><td></td><td></td><td>1</td></tr><tr><td></td><td></td><td>1</td></tr><tr><td>1</td><td></td><td></td></tr></table>			1			1	1			<table border="1"><tr><td></td><td></td><td></td></tr><tr><td></td><td></td><td></td></tr><tr><td></td><td></td><td></td></tr></table>										<table border="1"><tr><td></td><td></td><td></td></tr><tr><td></td><td></td><td></td></tr><tr><td>1</td><td></td><td></td></tr></table>							1		
		1																																																																													
		1																																																																													
1																																																																															
1																																																																															
Post - 0 Miss - 0 Block - 0	Post - 0 Miss - 0 Block - 0	Post - 0 Miss - 0 Block - 0	Post - 0 Miss - 1 Block - 0	Post - 0 Miss - 0 Block - 1	Post - 0 Miss - 0 Block - 0	Post - 0 Miss - 0 Block - 0	Post - 0 Miss - 0 Block - 1																																																																								

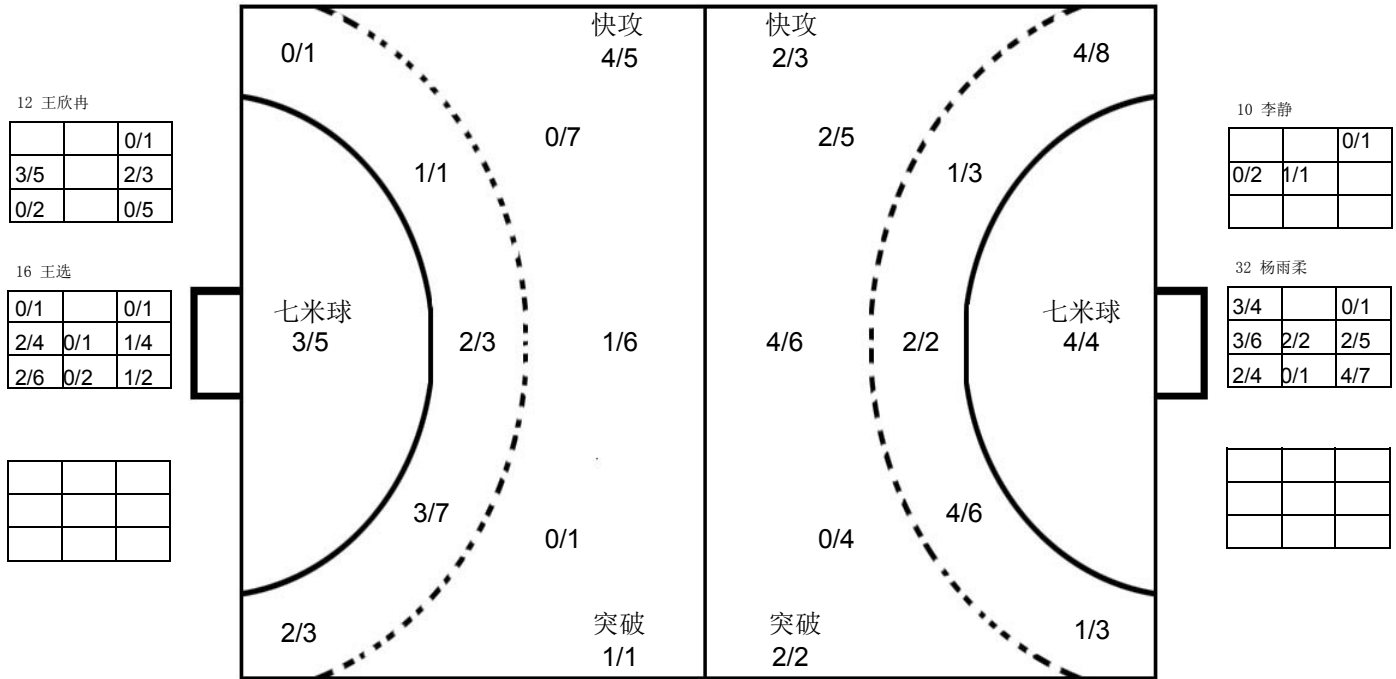

## 新疆

3 葛立双	6 阿孜古	7 吴志娟	10 李静	11 陈培培	12 艾敏加尔汉	15 兰姝娇	17 戴莹莹																																																																								
<table border="1"><tr><td></td><td></td><td></td></tr><tr><td>1</td><td></td><td></td></tr><tr><td></td><td></td><td>1</td></tr></table>				1					1	<table border="1"><tr><td></td><td></td><td>1</td></tr><tr><td></td><td></td><td>2</td></tr><tr><td>1</td><td></td><td></td></tr></table>			1			2	1			<table border="1"><tr><td>1</td><td></td><td></td></tr><tr><td></td><td></td><td></td></tr><tr><td></td><td></td><td>1</td></tr></table>	1								1	<table border="1"><tr><td></td><td></td><td></td></tr><tr><td></td><td></td><td></td></tr><tr><td></td><td></td><td></td></tr></table>										<table border="1"><tr><td></td><td></td><td></td></tr><tr><td></td><td></td><td></td></tr><tr><td></td><td></td><td></td></tr></table>										<table border="1"><tr><td></td><td></td><td></td></tr><tr><td></td><td></td><td></td></tr><tr><td></td><td></td><td></td></tr></table>										<table border="1"><tr><td></td><td></td><td></td></tr><tr><td>1</td><td>1</td><td>1</td></tr><tr><td></td><td></td><td>1</td></tr></table>				1	1	1			1	<table border="1"><tr><td></td><td></td><td></td></tr><tr><td></td><td></td><td></td></tr><tr><td></td><td></td><td>1</td></tr></table>									1
1																																																																															
		1																																																																													
		1																																																																													
		2																																																																													
1																																																																															
1																																																																															
		1																																																																													
1	1	1																																																																													
		1																																																																													
		1																																																																													
Post - 0 Miss - 2 Block - 0	Post - 1 Miss - 0 Block - 0	Post - 1 Miss - 0 Block - 0	Post - 0 Miss - 0 Block - 0	Post - 0 Miss - 0 Block - 0	Post - 0 Miss - 0 Block - 0	Post - 0 Miss - 0 Block - 0	Post - 0 Miss - 0 Block - 0																																																																								
18 崔娟	21 锁珊珊	23 张艺璇	26 宋婷婷	27 谢辰辰	32 杨雨柔	93 张婷婷																																																																									
<table border="1"><tr><td></td><td></td><td></td></tr><tr><td>1</td><td></td><td></td></tr><tr><td>2</td><td>1</td><td></td></tr></table>				1			2	1		<table border="1"><tr><td></td><td></td><td>1</td></tr><tr><td></td><td></td><td>1</td></tr><tr><td>1</td><td></td><td>2</td></tr></table>			1			1	1		2	<table border="1"><tr><td></td><td></td><td></td></tr><tr><td></td><td></td><td></td></tr><tr><td></td><td></td><td></td></tr></table>										<table border="1"><tr><td></td><td></td><td></td></tr><tr><td></td><td></td><td></td></tr><tr><td></td><td></td><td></td></tr></table>										<table border="1"><tr><td></td><td></td><td></td></tr><tr><td></td><td></td><td></td></tr><tr><td></td><td></td><td></td></tr></table>										<table border="1"><tr><td></td><td></td><td></td></tr><tr><td></td><td></td><td></td></tr><tr><td></td><td></td><td></td></tr></table>										<table border="1"><tr><td></td><td></td><td></td></tr><tr><td>1</td><td></td><td></td></tr><tr><td>2</td><td></td><td>1</td></tr></table>				1			2		1	<table border="1"><tr><td></td><td></td><td></td></tr><tr><td></td><td></td><td></td></tr><tr><td></td><td></td><td></td></tr></table>									
1																																																																															
2	1																																																																														
		1																																																																													
		1																																																																													
1		2																																																																													
1																																																																															
2		1																																																																													
Post - 2 Miss - 0 Block - 0	Post - 1 Miss - 1 Block - 0	Post - 0 Miss - 0 Block - 0	Post - 0 Miss - 0 Block - 0	Post - 0 Miss - 0 Block - 0	Post - 0 Miss - 0 Block - 0	Post - 0 Miss - 1 Block - 0																																																																									

注释: Post=击柱 Miss=射失 Block=被封





半决赛  
女子 全国比赛

2016年全国女子手球锦标赛

Team A <b>A 江苏</b>				Team B <b>B 广东</b>				Match Number <b>47</b>													
played in China		in the hall 滁州体育馆		on 12/09/2016		at 17:00 hours		Spectators													
Half-time (30')	<b>A</b> 22	<b>B</b> 9	End of playing time	<b>A</b> 38	<b>B</b> 26	1st extra time	<b>A</b>	<b>B</b>	2nd extra time	<b>A</b>	<b>B</b>	After penalty throws	<b>A</b>	<b>B</b>							
Number of 7 m	<b>A</b> 2 / 2	Team time-out			Full name of players and officials				Team time-out			<b>B</b> 4 / 4	Number of 7 m								
No.	Team <b>A</b>					G	W	2'	D	DR	No.	Team <b>B</b>					G	W	2'	D	DR
1	陆婷										3	安妮					4	1			
3	张海侠					3					5	李纯									
4	赵佳芹					5	1				7	刘彤					3		1		
5	高媛媛										8	李诗棋					4				
8	乔如					2	1				9	韦宝桂					3				
9	莫蒙蒙					1		2			11	魏梦庭					3				
10	王可可					1					15	杨慧					2	1			
11	于源源					2					16	李娟									
12	黄霞										18	李玉玲									
13	黄慧影					1					19	邝雪花					4				
16	王小华										20	李军政					2	1			
17	修丽杰					4					22	刘晓玉									
18	韦秋香					4					23	王如					1				
23	王书慧					4		1			26	马晓卉									
33	金梦青					9					28	刘金兰									
69	蓝小玲					2	1	1			31	史小军									
B	金甲洙 (主教练)										A	李细利									
C	马彪										B	郭艳辉 (主教练)									
D	李海鹰										D	祝捷									
E	陈志伟										E	赵善良									
<b>A</b>	Signature of Responsible Official of the Teams (Off. A)										<b>B</b>										
TP	Remarks of Referee / CHA Official										TP										

Signatures

Referees: 马晓晔 (CHN)      王洋 (CHN)

Techn. Delegates: 刘书勇 (CHN)

CHA Official: 许宜扬 (CHN)

Note: Number of 7m Throws Awarded to Team A and B, Goals (G), Warnings (W), Suspensions (2'), Direct Disqualification (D), Disqualification with Report (DR) and Team Penalty (TP).

Table Officials: 佟金政      贾俊秋      Statisticians: 陈柱      黄岩



## 2016年全国女子手球锦标赛 竞赛技术统计(媒体表)

半决赛		组别	X	轮次	9	场次	47
滁州体育馆		12/09/2016			201605047-51-1/1		
江苏	江苏	38	vs	26	广东	广东	
				22 : 9			

裁判员	马晓晔 (CHN)			/	王洋 (CHN)		
-----	-----------	--	--	---	----------	--	--

江苏		远	近	边	快	突	任意	7m	合计	%	助攻	失误	警告	2'	D & DR	江苏		比赛进程	广东			
主教练：金甲洙		射	射	射	攻	破	球	球														
1	陆婷										1					4	赵佳芹	1st Half	1	02:02	0	
3	张海侠	1/1	1/1					1/1	3/3	100		1				17	修丽杰	2	03:21	0		
4	赵佳芹	3/6	1/1			1/1			5/8	62.5	2	2	1			4	赵佳芹	3	04:15	1	3 安妮	
5	高媛媛															69	蓝小玲	4	04:40	1		
8	乔如		1/1	0/1				1/1	2/3	66.7	2	2	1			8	乔如	5	07:34	1		
9	莫蒙蒙		1/1						1/1	100				2		18	韦秋香	6	08:31	1		
10	王可可	0/2				1/1			1/3	33.3		2				4	赵佳芹	7	09:54	1		
11	于源源			0/1	2/2				2/3	66.7						33	金梦青	8	10:45	1		
12	黄霞											1				8	11:38	2	3 安妮			
13	黄慧影			1/1					1/1	100						17	修丽杰	9	11:43	2		
16	王小华															9	13:06	3	11 魏梦庭			
17	修丽杰	2/5	1/1		1/1				4/7	57.1	1	1				17	修丽杰	10	13:39	3		
18	韦秋香			2/2	2/2				4/4	100						10	14:06	4	20 李军政			
23	王书慧	2/6	1/3			1/2			4/11	36.4		3		1		18	韦秋香	11	15:09	4		
33	金梦青	4/5		1/1	4/5				9/11	81.8		1				33	金梦青	12	16:50	4		
69	蓝小玲	1/3			1/1				2/4	50.0		1	1	1		23	王书慧	13	17:24	4		
<b>运动员 合计</b>		<b>13/28</b>	<b>6/8</b>	<b>4/6</b>	<b>10/11</b>	<b>3/4</b>		<b>2/2</b>	<b>38/59</b>	<b>64.4</b>	<b>6</b>	<b>14</b>	<b>3</b>	<b>4</b>		13	18:06	5	8 李诗棋			
1	陆婷	2/4		2/4	0/2	0/5		0/2	4/17	23.5	1					13	18:19	6	9 韦宝桂			
12	黄霞		0/2	1/2	0/1	0/3		0/1	1/9	11.1		1				4	赵佳芹	14	18:37	6		
16	王小华		2/4	1/2		1/2		0/1	4/9	44.4						33	金梦青	15	19:10	6		
<b>守门员 合计</b>		<b>2/4</b>	<b>2/6</b>	<b>4/8</b>	<b>0/3</b>	<b>1/10</b>		<b>0/4</b>	<b>9/35</b>	<b>25.7</b>	<b>1</b>	<b>1</b>				33	金梦青	16	20:18	6		
/																						
广东		远	近	边	快	突	任意	7m	合计	%	助攻	失误	警告	2'	D & DR							
教练：郭艳辉		射	射	射	攻	破	球	球														
3	安妮	0/1	1/1			3/3			4/5	80.0	1	2	1			23	王书慧	23	03:19	9		
5	李纯											1				9	莫蒙蒙	24	04:19	9		
7	刘彤			2/5				1/1	3/6	50.0		5		1		24	05:02	10	3 安妮			
8	李诗棋			2/4	2/2	0/1			4/7	57.1		5				4	赵佳芹	25	05:41	10		
9	韦宝桂	0/4				1/1		2/2	3/7	42.9						3	张海侠	26	06:46	10		
11	魏梦庭	2/3	0/1					1/1	3/5	60.0		4				26	07:54	11	7 刘彤			
15	杨慧		1/1			1/2			2/3	66.7		3	1			26	09:19	12	15 杨慧			
16	李娟															26	09:55	13	23 王如			
18	李玉玲															10	王可可	27	10:24	13		
19	卞雪花	0/1				4/4			4/5	80.0		2				27	11:02	14	11 魏梦庭			
20	李军政	0/1	2/4						2/5	40.0		2	1			27	12:01	15	3 安妮			
22	刘晓玉															27	12:18	16	8 李诗棋			
23	王如				1/1			1/1	1/1	100						23	王书慧	28	12:43	16		
26	马晓卉															11	于源源	29	13:16	16		
28	刘金兰															29	14:36	17	11 魏梦庭			
31	史小军															29	15:48	18	19 卞雪花			
<b>运动员 合计</b>		<b>2/10</b>	<b>4/7</b>	<b>4/9</b>	<b>3/3</b>	<b>9/11</b>		<b>4/4</b>	<b>26/44</b>	<b>59.1</b>	<b>1</b>	<b>24</b>	<b>3</b>	<b>1</b>		33	金梦青	30	16:00	18		
16	李娟	8/18	0/4	0/2	0/8	1/4		0/1	9/37	24.3						3	张海侠	31	16:45	18		
22	刘晓玉	2/5	0/2	0/2	0/2			0/1	2/12	16.7						33	金梦青	32	19:42	19		
<b>守门员 合计</b>		<b>10/23</b>	<b>0/6</b>	<b>0/4</b>	<b>0/10</b>	<b>1/4</b>		<b>0/2</b>	<b>11/49</b>	<b>22.4</b>						33	金梦青	33	21:35	19		
/																						
场上队员：得分 / 射门																守门员：救球 / 射门						

快攻	Fast Break	突破	Breakthrough	任意球	Free Throw	7M球	7M Throw	助攻	Assist
警告	Warning	失误	Error	2'	Suspension	D	取消资格	DR	取消资格+报告





### 2016年全国女子手球锦标赛 图式比赛技术统计表

轮次 9

场次 47

201605047-21-1/1

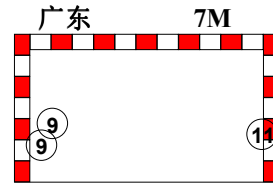
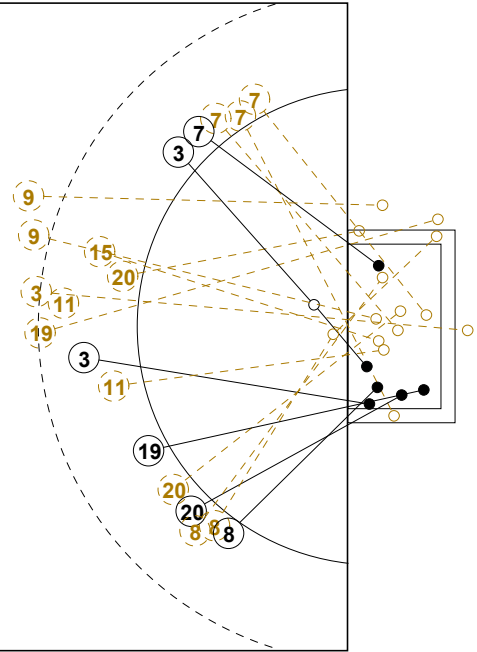
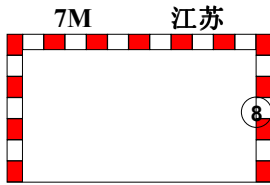
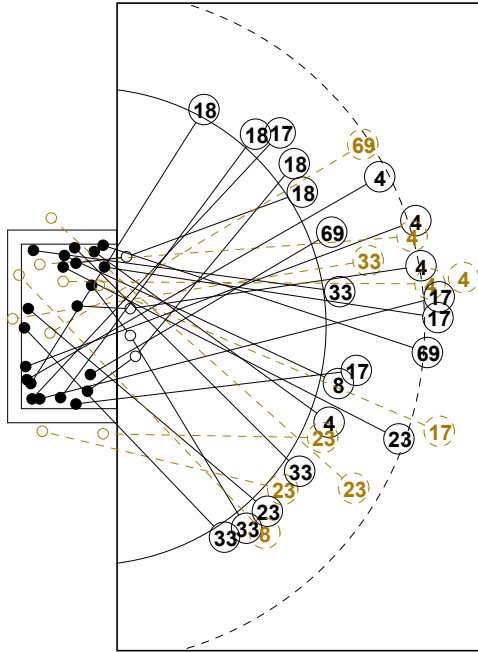

1st Half  
22 : 9

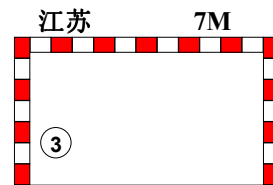
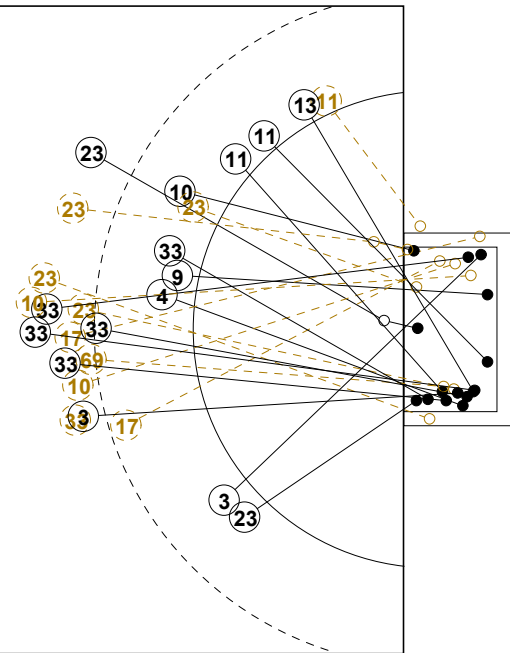
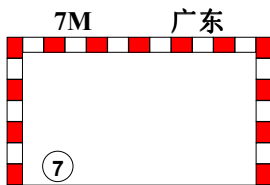
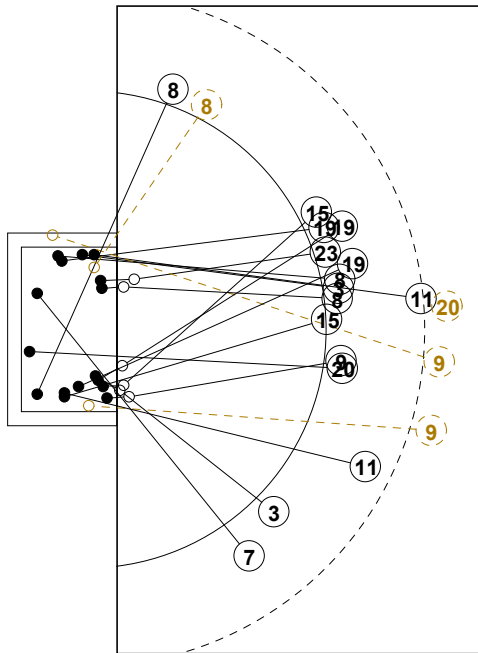

2nd Half  
26 : 38



## 2016年全国女子手球锦标赛

## 个人/全队技术统计表

正式表  
手球  
女子半决赛  
轮次 9组别 X  
场次 47201605047-14-1/2  
滁州体育馆  
12/09/2016 17:00

号码	姓名	远射	近射	边射	快攻	突破	任意	7M	合计	%	助攻	失误	警告	2'	取消	时间
<b>江苏(江苏)</b>																
<i>(场上队员)</i>																
1	陆婷									0.0%	1					00:29:05
3	张海侠	1/1	1/1					1/1	3/3	100%		1				00:30:00
4	赵佳芹	3/6	1/1			1/1			5/8	62.5%	2	2	1			00:36:51
5	高媛媛									0.0%						00:02:16
8	乔如		1/1	0/1				1/1	2/3	66.7%	2	2	1			00:36:09
9	莫蒙蒙		1/1						1/1	100%				2		00:27:52
10	王可可	0/2				1/1			1/3	33.3%		2				00:21:38
11	于源源			0/1	2/2				2/3	66.7%						00:25:37
12	黄霞									0.0%		1				00:10:03
13	黄慧影			1/1					1/1	100%						00:04:21
16	王小华									0.0%						00:20:52
17	修丽杰	2/5	1/1		1/1				4/7	57.1%	1	1				00:41:10
18	韦秋香			2/2	2/2				4/4	100%						00:30:00
23	王书慧	2/6	1/3			1/2			4/11	36.4%		3		1		00:31:18
33	金梦青	4/5		1/1	4/5				9/11	81.8%		1				00:47:39
69	蓝小玲	1/3			1/1				2/4	50.0%		1	1	1		00:33:40
<b>合计</b>		13/28	6/8	4/6	10/11	3/4		2/2	38/59	64.4%	6	14	3	4		
<i>(守门员)</i>																
1	陆婷	2/4		2/4	0/2	0/5		0/2	4/17	23.5%	1					00:29:05
12	黄霞		0/2	1/2	0/1	0/3		0/1	1/9	11.1%		1				00:10:03
16	王小华		2/4	1/2		1/2		0/1	4/9	44.4%						00:20:52
<b>合计</b>		2/4	2/6	4/8	0/3	1/10		0/4	9/35	25.7%	1	1				

场上队员：得分/射门

守门员：救球/射门

全队合计	得分	被救	射失	击柱	封球	合计	%
远射	13	10	1	2	2	28	46.4%
近射	6		2			8	75.0%
边射	4		1	1		6	66.7%
快攻	10			1		11	90.9%
突破	3	1				4	75.0%
任意							0.0%
7M	2					2	100.0%





## 2016年全国女子手球锦标赛

## 个人/全队技术统计表

正式表  
手球  
女子半决赛  
轮次 9组别 X  
场次 47201605047-14-2/2  
滁州体育馆  
12/09/2016 17:00

号码	姓名	远射	近射	边射	快攻	突破	任意	7M	合计	%	助攻	失误	警告	2'	取消	时间
<b>广东(广东)</b>																
<i>(上场队员)</i>																
3	安妮	0/1	1/1			3/3			4/5	80.0%	1	2	1			00:35:59
5	李纯									0.0%		1				00:44:21
7	刘彤			2/5				1/1	3/6	50.0%		5		1		00:58:56
8	李诗棋			2/4	2/2	0/1			4/7	57.1%		5				00:46:59
9	韦宝桂	0/4				1/1		2/2	3/7	42.9%						00:21:51
11	魏梦庭	2/3	0/1					1/1	3/5	60.0%		4				00:35:40
15	杨慧		1/1			1/2			2/3	66.7%		3	1			00:42:19
16	李娟									0.0%						00:43:29
18	李玉玲									0.0%						00:00:00
19	邝雪花	0/1				4/4			4/5	80.0%		2				00:27:18
20	李军政	0/1	2/4						2/5	40.0%		2	1			00:30:41
22	刘晓玉									0.0%						00:16:31
23	王如				1/1				1/1	100%						00:15:38
26	马晓卉									0.0%						00:00:00
28	刘金兰									0.0%						00:00:00
31	史小军									0.0%						00:00:00
<b>合计</b>		2/10	4/7	4/9	3/3	9/11		4/4	26/44	59.1%	1	24	3	1		
<i>(守门员)</i>																
16	李娟	8/18	0/4	0/2	0/8	1/4		0/1	9/37	24.3%						00:43:29
22	刘晓玉	2/5	0/2	0/2	0/2			0/1	2/12	16.7%						00:16:31
<b>合计</b>		10/23	0/6	0/4	0/10	1/4		0/2	11/49	22.4%						

场上队员：得分/射门

守门员：救球/射门

全队合计	得分	被救	射失	击柱	封球	合计	%
远射	2	2	3	1	2	10	20.0%
近射	4	2		1		7	57.1%
边射	4	4		1		9	44.4%
快攻	3					3	100.0%
突破	9	1		1		11	81.8%
任意							0.0%
7M	4					4	100.0%







### 2016年全国女子手球锦标赛

#### 图式射门区域统计

轮次 9 场次 47

201605047-41-1/1

## 江苏

1 陆婷	3 张海侠	4 赵佳芹	5 高媛媛	8 乔如	9 莫蒙蒙	10 王可可	11 于源源																																																																								
<table border="1"><tr><td></td><td></td><td></td></tr><tr><td></td><td></td><td></td></tr><tr><td></td><td></td><td></td></tr></table>										<table border="1"><tr><td>1</td><td></td><td></td></tr><tr><td>1</td><td></td><td>1</td></tr><tr><td></td><td></td><td></td></tr></table>	1			1		1				<table border="1"><tr><td>2</td><td></td><td></td></tr><tr><td></td><td>1</td><td>1</td></tr><tr><td></td><td></td><td>1</td></tr></table>	2				1	1			1	<table border="1"><tr><td></td><td></td><td></td></tr><tr><td></td><td></td><td></td></tr><tr><td></td><td></td><td></td></tr></table>										<table border="1"><tr><td></td><td></td><td></td></tr><tr><td></td><td></td><td>2</td></tr><tr><td></td><td></td><td></td></tr></table>						2				<table border="1"><tr><td>1</td><td></td><td></td></tr><tr><td></td><td></td><td></td></tr><tr><td></td><td></td><td></td></tr></table>	1									<table border="1"><tr><td></td><td></td><td></td></tr><tr><td></td><td></td><td></td></tr><tr><td>1</td><td></td><td></td></tr></table>							1			<table border="1"><tr><td></td><td></td><td>1</td></tr><tr><td></td><td></td><td>1</td></tr><tr><td></td><td></td><td></td></tr></table>			1			1			
1																																																																															
1		1																																																																													
2																																																																															
	1	1																																																																													
		1																																																																													
		2																																																																													
1																																																																															
1																																																																															
		1																																																																													
		1																																																																													
Post - 0 Miss - 0 Block - 0	Post - 0 Miss - 0 Block - 0	Post - 0 Miss - 0 Block - 1	Post - 0 Miss - 0 Block - 0	Post - 1 Miss - 0 Block - 0	Post - 0 Miss - 0 Block - 0	Post - 0 Miss - 0 Block - 0	Post - 0 Miss - 1 Block - 0																																																																								
12 黄霞	13 黄慧影	16 王小华	17 修丽杰	18 韦秋香	23 王书慧	33 金梦青	69 蓝小玲																																																																								
<table border="1"><tr><td></td><td></td><td></td></tr><tr><td></td><td></td><td></td></tr><tr><td></td><td></td><td></td></tr></table>										<table border="1"><tr><td></td><td></td><td>1</td></tr><tr><td></td><td></td><td></td></tr><tr><td></td><td></td><td></td></tr></table>			1							<table border="1"><tr><td></td><td></td><td></td></tr><tr><td></td><td></td><td></td></tr><tr><td></td><td></td><td></td></tr></table>										<table border="1"><tr><td>2</td><td></td><td></td></tr><tr><td>1</td><td></td><td></td></tr><tr><td></td><td></td><td>1</td></tr></table>	2			1					1	<table border="1"><tr><td>1</td><td></td><td></td></tr><tr><td>1</td><td></td><td>1</td></tr><tr><td>1</td><td></td><td></td></tr></table>	1			1		1	1			<table border="1"><tr><td></td><td>1</td><td></td></tr><tr><td></td><td></td><td>1</td></tr><tr><td></td><td>1</td><td>1</td></tr></table>		1				1		1	1	<table border="1"><tr><td>1</td><td>1</td><td>3</td></tr><tr><td></td><td></td><td>2</td></tr><tr><td></td><td></td><td>2</td></tr></table>	1	1	3			2			2	<table border="1"><tr><td></td><td></td><td></td></tr><tr><td></td><td></td><td></td></tr><tr><td>1</td><td></td><td>1</td></tr></table>							1		1
		1																																																																													
2																																																																															
1																																																																															
		1																																																																													
1																																																																															
1		1																																																																													
1																																																																															
	1																																																																														
		1																																																																													
	1	1																																																																													
1	1	3																																																																													
		2																																																																													
		2																																																																													
1		1																																																																													
Post - 0 Miss - 0 Block - 0	Post - 0 Miss - 0 Block - 0	Post - 0 Miss - 0 Block - 0	Post - 1 Miss - 0 Block - 0	Post - 0 Miss - 0 Block - 0	Post - 1 Miss - 3 Block - 0	Post - 1 Miss - 0 Block - 1	Post - 0 Miss - 0 Block - 0																																																																								

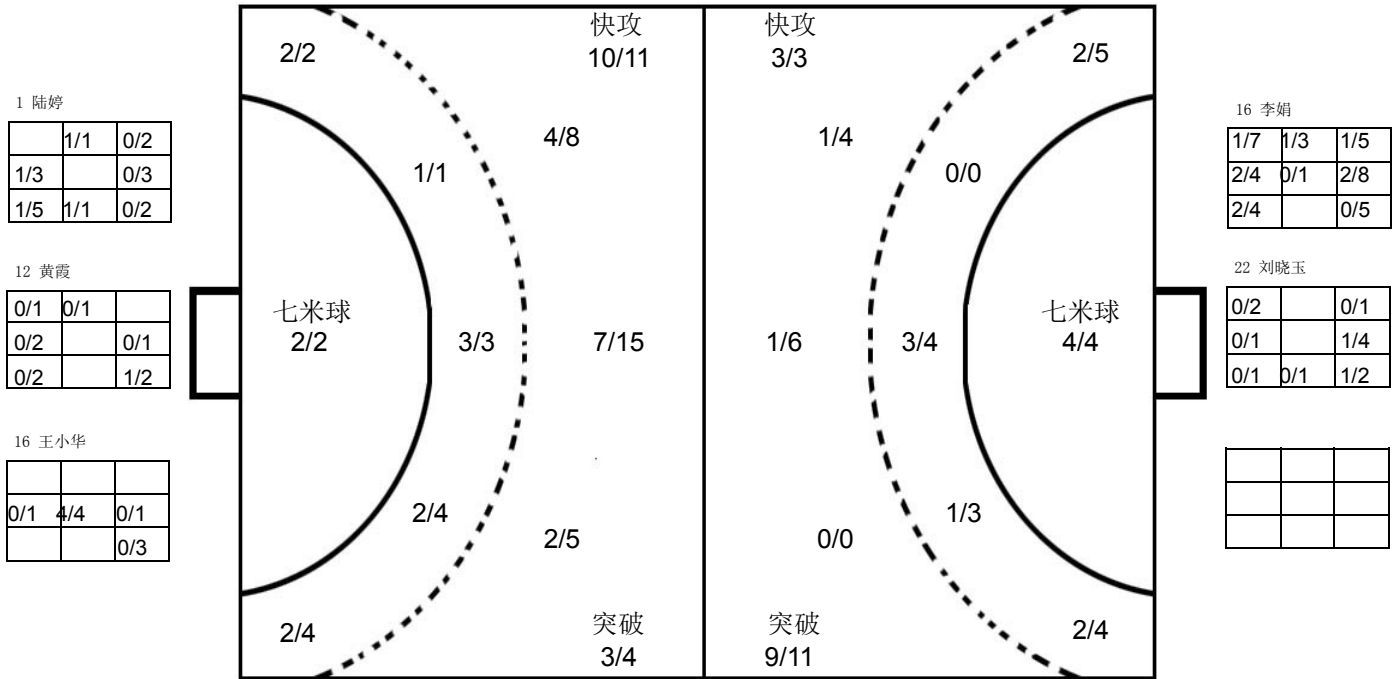

## 广东

3 安妮	5 李纯	7 刘彤	8 李诗棋	9 韦宝桂	11 魏梦庭	15 杨慧	16 李娟																																																																								
<table border="1"><tr><td></td><td></td><td></td></tr><tr><td></td><td></td><td>1</td></tr><tr><td>1</td><td></td><td>2</td></tr></table>						1	1		2	<table border="1"><tr><td></td><td></td><td></td></tr><tr><td></td><td></td><td></td></tr><tr><td></td><td></td><td></td></tr></table>										<table border="1"><tr><td></td><td></td><td>1</td></tr><tr><td>1</td><td></td><td></td></tr><tr><td>1</td><td></td><td></td></tr></table>			1	1			1			<table border="1"><tr><td>1</td><td></td><td></td></tr><tr><td></td><td></td><td>1</td></tr><tr><td></td><td></td><td>2</td></tr></table>	1					1			2	<table border="1"><tr><td></td><td></td><td></td></tr><tr><td>1</td><td></td><td></td></tr><tr><td>2</td><td></td><td></td></tr></table>				1			2			<table border="1"><tr><td></td><td></td><td></td></tr><tr><td>1</td><td></td><td>1</td></tr><tr><td></td><td></td><td>1</td></tr></table>				1		1			1	<table border="1"><tr><td></td><td></td><td></td></tr><tr><td>1</td><td></td><td></td></tr><tr><td></td><td></td><td></td></tr></table>				1						<table border="1"><tr><td></td><td></td><td></td></tr><tr><td></td><td></td><td></td></tr><tr><td></td><td></td><td></td></tr></table>									
		1																																																																													
1		2																																																																													
		1																																																																													
1																																																																															
1																																																																															
1																																																																															
		1																																																																													
		2																																																																													
1																																																																															
2																																																																															
1		1																																																																													
		1																																																																													
1																																																																															
Post - 0 Miss - 1 Block - 0	Post - 0 Miss - 0 Block - 0	Post - 1 Miss - 0 Block - 0	Post - 1 Miss - 0 Block - 0	Post - 1 Miss - 1 Block - 0	Post - 0 Miss - 0 Block - 1	Post - 0 Miss - 0 Block - 0	Post - 0 Miss - 0 Block - 0																																																																								
18 李玉玲	19 邝雪花	20 李军政	22 刘晓玉	23 王如	26 马晓卉	28 刘金兰	31 史小军																																																																								
<table border="1"><tr><td></td><td></td><td></td></tr><tr><td></td><td></td><td></td></tr><tr><td></td><td></td><td></td></tr></table>										<table border="1"><tr><td></td><td></td><td>1</td></tr><tr><td>1</td><td></td><td>1</td></tr><tr><td>1</td><td></td><td></td></tr></table>			1	1		1	1			<table border="1"><tr><td></td><td></td><td>1</td></tr><tr><td></td><td></td><td></td></tr><tr><td></td><td></td><td>1</td></tr></table>			1						1	<table border="1"><tr><td></td><td></td><td></td></tr><tr><td></td><td></td><td></td></tr><tr><td></td><td></td><td></td></tr></table>										<table border="1"><tr><td></td><td></td><td></td></tr><tr><td></td><td></td><td></td></tr><tr><td></td><td></td><td>1</td></tr></table>									1	<table border="1"><tr><td></td><td></td><td></td></tr><tr><td></td><td></td><td></td></tr><tr><td></td><td></td><td></td></tr></table>										<table border="1"><tr><td></td><td></td><td></td></tr><tr><td></td><td></td><td></td></tr><tr><td></td><td></td><td></td></tr></table>										<table border="1"><tr><td></td><td></td><td></td></tr><tr><td></td><td></td><td></td></tr><tr><td></td><td></td><td></td></tr></table>									
		1																																																																													
1		1																																																																													
1																																																																															
		1																																																																													
		1																																																																													
		1																																																																													
Post - 0 Miss - 0 Block - 0	Post - 0 Miss - 1 Block - 0	Post - 1 Miss - 0 Block - 1	Post - 0 Miss - 0 Block - 0	Post - 0 Miss - 0 Block - 0	Post - 0 Miss - 0 Block - 0	Post - 0 Miss - 0 Block - 0	Post - 0 Miss - 0 Block - 0																																																																								

注释: Post=击柱 Miss=射失 Block=被封





## 2016年全国女子手球锦标赛

## 比赛进程表

正式表  
手球  
女子半决赛  
轮次 9组别 X  
场次 47201605047-13-1/6  
滁州体育馆  
12/09/2016 17:00

时间	队员	动作	比分	队员	动作			
<b>江苏</b>			<b>上半时</b>			<b>广东</b>		
00:30	23 王书慧	近射 射失						
00:57				7 刘彤	传球失误			
01:02	4 赵佳芹	传球失误		3 安妮	断球			
01:42				3 安妮	助攻			
01:45				20 李军政	近射 击柱			
02:02	4 赵佳芹	右远射 得分	1 - 0	16 李娟	被射入			
02:53				19 邝雪花	中远射 射失			
03:21	17 修丽杰	近射 得分	2 - 0	16 李娟	被射入			
03:48	16 王小华	被射入	2 - 1	3 安妮	近射 得分			
03:56				3 安妮	警告			
04:15	4 赵佳芹	突破 得分	3 - 1	16 李娟	被射入			
04:31				20 李军政	接球失误			
04:40	69 蓝小玲	中远射 得分	4 - 1	16 李娟	被射入			
05:20	8 乔如	助攻						
05:23	33 金梦青	一传快攻 击柱						
05:45	69 蓝小玲	警告						
06:10				7 刘彤	左边射 击柱			
06:54	23 王书慧	左远射 射失						
07:11	16 王小华	挡住球		11 魏梦庭	近射 被救			
07:14	4 赵佳芹	警告						
07:31	4 赵佳芹	助攻						
07:34	8 乔如	近射 得分	5 - 1	16 李娟	被射入			
08:20	69 蓝小玲	断球		8 李诗棋	传球失误			
08:31	18 韦秋香	短传快攻 得分	6 - 1	16 李娟	被射入			
09:31	16 王小华	挡住球		20 李军政	近射 被救			
09:50	4 赵佳芹	右远射 被救		16 李娟	挡住球			
09:54	4 赵佳芹	右远射 得分	7 - 1	16 李娟	被射入			
10:23	16 王小华	挡住球		7 刘彤	左边射 被救			
10:45	33 金梦青	短传快攻 得分	8 - 1	16 李娟	被射入			
11:03				3 安妮	中远射 射失			
11:21	4 赵佳芹	中远射 被救		16 李娟	挡住球			
11:38	16 王小华	被射入	8 - 2	3 安妮	突破 得分			
11:43	17 修丽杰	短传快攻 得分	9 - 2	16 李娟	被射入			
12:13				19 邝雪花	传球失误			
12:18	4 赵佳芹	快攻 四步						
12:48	8 乔如	使被罚7M球		19 邝雪花	造7M			
12:49	8 乔如	警告						
13:01		裁判暂停						
13:06	12 黄霞	被射入	9 - 3	11 魏梦庭	7M球 得分			
13:39	17 修丽杰	中远射 得分	10 - 3	16 李娟	被射入			





## 2016年全国女子手球锦标赛

## 比赛进程表

正式表  
手球  
女子半决赛  
轮次 9组别 X  
场次 47201605047-13-2/6  
滁州体育馆  
12/09/2016 17:00

时间	队员	动作	比分	队员	动作			
<b>江苏</b>			<b>上半时</b>			<b>广东</b>		
14:06	16 王小华	被射入	10 - 4	20 李军政	近射 得分			
14:43	17 修丽杰	接球失误		19 邝雪花	抢球			
14:55				20 李军政	四步			
15:04	8 乔如	助攻						
15:09	18 韦秋香	一传快攻 得分	11 - 4	16 李娟	被射入			
15:18				20 李军政	警告			
15:37				7 刘彤	接球失误			
15:48	69 蓝小玲	右远射 被救		16 李娟	挡住球			
16:46				8 李诗棋	接球失误			
16:50	33 金梦青	左边射 得分	12 - 4	16 李娟	被射入			
17:17				8 李诗棋	突破 击柱			
17:24	23 王书慧	近射 得分	13 - 4	16 李娟	被射入			
18:03	8 乔如	使被罚7M球		5 李纯	造7M			
18:06	16 王小华	被射入	13 - 5	8 李诗棋	右边射 得分			
18:19	16 王小华	被射入	13 - 6	9 韦宝桂	7M球 得分			
18:37	4 赵佳芹	右远射 得分	14 - 6	16 李娟	被射入			
19:10	33 金梦青	一传快攻 得分	15 - 6	16 李娟	被射入			
20:13	16 王小华	挡住球		15 杨慧	突破 被救			
20:18	33 金梦青	一传快攻 得分	16 - 6	22 刘晓玉	被射入			
21:07	69 蓝小玲	封球		11 魏梦庭	中远射 被封			
21:18	17 修丽杰	中远射 得分	17 - 6	22 刘晓玉	被射入			
21:47	1 陆婷	被射入	17 - 7	7 刘彤	左边射 得分			
22:03	4 赵佳芹	中远射 被封		20 李军政	封球			
22:50	4 赵佳芹	使被罚7M球		15 杨慧	造7M			
23:09	1 陆婷	被射入	17 - 8	9 韦宝桂	7M球 得分			
23:37	17 修丽杰	助攻						
23:39	23 王书慧	近射 射失						
24:06	1 陆婷	挡住球		7 刘彤	左边射 被救			
24:18	18 韦秋香	右边射 得分	18 - 8	22 刘晓玉	被射入			
25:07	1 陆婷	挡住球		9 韦宝桂	左远射 被救			
25:09	8 乔如	侵区						
25:15				9 韦宝桂	左远射 射失			
25:42	23 王书慧	左远射 得分	19 - 8	22 刘晓玉	被射入			
26:16	1 陆婷	被射入	19 - 9	19 邝雪花	突破 得分			
26:25	18 韦秋香	右边射 得分	20 - 9	22 刘晓玉	被射入			
27:06	1 陆婷	挡住球		8 李诗棋	右边射 被救			
27:22	17 修丽杰	左远射 被救		22 刘晓玉	挡住球			
27:57	69 蓝小玲	断球		11 魏梦庭	传球失误			
28:00	69 蓝小玲	一传快攻 得分	21 - 9	22 刘晓玉	被射入			
28:53	33 金梦青	抢球		11 魏梦庭	接球失误			





## 2016年全国女子手球锦标赛

## 比赛进程表

正式表  
手球  
女子半决赛  
轮次 9组别 X  
场次 47201605047-13-3/6  
滁州体育馆  
12/09/2016 17:00

时间	队员	动作	比分	队员	动作
<b>江苏</b>			<b>上半时</b>		
<b>广东</b>					
29:02	33 金梦青	快攻 造7M		7 刘彤	使被罚7M球
29:04				7 刘彤	罚出场2分钟
29:05		裁判暂停			
29:07	8 乔如	7M球 得分	<b>22 - 9</b>	22 刘晓玉	被射入
29:22	4 赵佳芹	造失误		15 杨慧	运球失误
29:31	8 乔如	左边射 击柱			
29:58				5 李纯	接球失误



## 2016年全国女子手球锦标赛

## 比赛进程表

正式表  
手球  
女子半决赛  
轮次 9组别 X  
场次 47201605047-13-4/6  
滁州体育馆  
12/09/2016 17:00

时间	队员	动作	比分	队员	动作
<b>江苏</b>			<b>下半时</b>		
<b>广东</b>					
00:56				11 魏梦庭	传球失误
01:20	8 乔如	侵区			
01:56				8 李诗棋	侵区
02:15	11 于源源	左边射 射失			
02:47				3 安妮	传球失误
03:19	23 王书慧	左远射 得分	<b>23 - 9</b>	22 刘晓玉	被射入
04:06	1 陆婷	挡住球		9 韦宝桂	左远射 被救
04:19	9 莫蒙蒙	近射 得分	<b>24 - 9</b>	22 刘晓玉	被射入
04:21	4 赵佳芹	助攻			
05:02	1 陆婷	被射入	<b>24 - 10</b>	3 安妮	突破 得分
05:10	23 王书慧	中远射 被救		22 刘晓玉	挡住球
05:32	4 赵佳芹	断球		7 刘彤	传球失误
05:41	4 赵佳芹	近射 得分	<b>25 - 10</b>	22 刘晓玉	被射入
06:19	11 于源源	抢球		11 魏梦庭	接球失误
06:36	11 于源源	造7M		15 杨慧	使被罚7M球
06:38				15 杨慧	警告
06:46	3 张海侠	7M球 得分	<b>26 - 10</b>	16 李娟	被射入
07:19	17 修丽杰	中远射 击柱			
07:54	1 陆婷	被射入	<b>26 - 11</b>	7 刘彤	左边射 得分
08:42	17 修丽杰	右远射 被救		16 李娟	挡住球
08:46		裁判暂停			
08:46	23 王书慧	罚出场2分钟			
09:19	1 陆婷	被射入	<b>26 - 12</b>	15 杨慧	突破 得分
09:45	10 王可可	中远射 被救		16 李娟	挡住球
09:55	1 陆婷	被射入	<b>26 - 13</b>	23 王如	短传快攻 得分
10:24	10 王可可	突破 得分	<b>27 - 13</b>	16 李娟	被射入
11:02	1 陆婷	被射入	<b>27 - 14</b>	11 魏梦庭	中远射 得分
11:31	3 张海侠	传球失误			
12:01	1 陆婷	被射入	<b>27 - 15</b>	3 安妮	突破 得分
12:14	10 王可可	传球失误		8 李诗棋	断球
12:18	1 陆婷	被射入	<b>27 - 16</b>	8 李诗棋	一传快攻 得分
12:43	23 王书慧	突破 得分	<b>28 - 16</b>	16 李娟	被射入
13:07				15 杨慧	四步
13:16	11 于源源	一传快攻 得分	<b>29 - 16</b>	16 李娟	被射入
13:21	1 陆婷	助攻			
13:51		裁判暂停			
13:51	9 莫蒙蒙	罚出场2分钟			
14:02	10 王可可	造失误		8 李诗棋	运球失误
14:08	69 蓝小玲	快攻 侵区			
14:36	1 陆婷	被射入	<b>29 - 17</b>	11 魏梦庭	左远射 得分



## 2016年全国女子手球锦标赛

## 比赛进程表

正式表  
手球  
女子半决赛  
轮次 9组别 X  
场次 47201605047-13-5/6  
滁州体育馆  
12/09/2016 17:00

时间	队员	动作	比分	队员	动作
<b>江苏</b>			<b>下半时</b>		
<b>广东</b>					
15:10	23 王书慧	左远射 被救		16 李娟	挡住球
15:48	1 陆婷	被射入	<b>29 - 18</b>	19 邝雪花	突破 得分
16:00	33 金梦青	中远射 得分	<b>30 - 18</b>	16 李娟	被射入
16:37				3 安妮	运球失误
16:45	3 张海侠	近射 得分	<b>31 - 18</b>	16 李娟	被射入
16:54		裁判暂停			
17:20				9 韦宝桂	中远射 击柱
17:36	23 王书慧	中远射 击柱			
17:42	23 王书慧	四步			
17:57	11 于源源	使被罚7M球		8 李诗棋	造7M
18:11	1 陆婷	被射入	<b>31 - 19</b>	7 刘彤	7M球 得分
18:28	33 金梦青	四步			
19:19				8 李诗棋	运球失误
19:42	33 金梦青	中远射 得分	<b>32 - 19</b>	16 李娟	被射入
20:03				19 邝雪花	传球失误
20:28	69 蓝小玲	中远射 被救		16 李娟	挡住球
20:52				7 刘彤	侵区
21:01	23 王书慧	传球失误			
21:09	33 金梦青	断球		7 刘彤	快攻 传球失误
21:16	23 王书慧	突破 被救		16 李娟	挡住球
21:25				15 杨慧	接球失误
21:35	33 金梦青	一传快攻 得分	<b>33 - 19</b>	16 李娟	被射入
22:24	12 黄霞	被射入	<b>33 - 20</b>	19 邝雪花	突破 得分
22:35	10 王可可	进攻犯规		19 邝雪花	造犯规
22:59	12 黄霞	被射入	<b>33 - 21</b>	19 邝雪花	突破 得分
22:59		裁判暂停			
22:59	9 莫蒙蒙	罚出场2分钟			
23:24	33 金梦青	中远射 得分	<b>34 - 21</b>	16 李娟	被射入
23:47	10 王可可	封球		20 李军政	中远射 被封
24:03	12 黄霞	被射入	<b>34 - 22</b>	9 韦宝桂	突破 得分
24:30	33 金梦青	右远射 被封		5 李纯	封球
24:36	23 王书慧	运球失误			
24:44	12 黄霞	被射入	<b>34 - 23</b>	8 李诗棋	一传快攻 得分
24:50	11 于源源	一传快攻 得分	<b>35 - 23</b>	16 李娟	被射入
25:22	12 黄霞	被射入	<b>35 - 24</b>	15 杨慧	近射 得分
25:52	3 张海侠	右远射 得分	<b>36 - 24</b>	16 李娟	被射入
26:52	12 黄霞	运球失误			
27:22	12 黄霞	被射入	<b>36 - 25</b>	20 李军政	近射 得分
27:22		裁判暂停			
27:22	69 蓝小玲	罚出场2分钟			





## 2016年全国女子手球锦标赛

## 比赛进程表

正式表  
手球  
女子半决赛  
轮次 9组别 X  
场次 47201605047-13-6/6  
滁州体育馆  
12/09/2016 17:00

时间	队员	动作	比分	队员	动作
<b>江苏</b>			<b>下半场</b>		
			<b>广东</b>		
27:49	33 金梦青	中远射 得分	<b>37 - 25</b>	16 李娟	被射入
28:17	12 黄霞	被射入	<b>37 - 26</b>	8 李诗棋	右边射 得分
28:35	13 黄慧影	左边射 得分	<b>38 - 26</b>	16 李娟	被射入
29:00	12 黄霞	挡住球		8 李诗棋	右边射 被救
29:27	10 王可可	中远射 被救		16 李娟	挡住球



半决赛  
女子 全国比赛

2016年全国女子手球锦标赛

Team A A 安徽				Team B B 上海				Match Number <b>48</b>													
played in China		in the hall 滁州体育馆		on 12/09/2016		at 18:30 hours		Spectators													
Half-time (30')	A 15	B 13	End of playing time	A 35	B 25	1st extra time	A	B	2nd extra time	A	B	After penalty throws	A	B							
Number of 7 m	A 3/4	Team time-out			Full name of players and officials				Team time-out			B 7/9	Number of 7 m								
		1	2	3					1	2	3										
		08:59	20:39	47:35																	
No.	Team A					G	W	2'	D	DR	No.	Team B					G	W	2'	D	DR
1	司艳										1	许沫									
3	李兵					1					2	周蕾						1			
5	班晨晨										5	郭威					4				
6	沈萍					10	1	1			6	黄妍					4				
7	赵江川										7	车婉茹									
8	徐仕媛										8	吴茵					6		1		
10	孙来苗					3	1	1			9	武娜娜					1	1			
14	刘晓妹					7		1			10	斯文					2				
16	朱莉珍										11	孙梦颖					3				
17	周婷					6					12	郑冯									
18	郑冬冬						1				13	徐娟									
20	周雪婷										17	居晔									
21	李瑶					4					18	沙正文					2	1	1		
23	张天洁										19	印尼					3				
41	杜机娟					4					21	王嘉怡									
46	陶传红										23	都好							1		
A	吴立军										B	陈进培 (主教练)									
E	张舜										C	金锺顺									
											D	贺业磊									
											F	周瑜宸									
A	Signature of Responsible Official of the Teams (Off. A)																		B		
TP	Remarks of Referee / CHA Official																		TP		

Signatures

Referees: 张栋 (CHN) 倪震 (CHN)

Techn. Delegates: 高斌 (CHN)

CHA Official: 刘书勇 (CHN)

Note: Number of 7m Throws Awarded to Team A and B, Goals (G), Warnings (W), Suspensions (2'), Direct Disqualification (D), Disqualification with Report (DR) and Team Penalty (TP).

Table Officials: 佟金政 贾俊秋 Statisticians: 刘永欢 闫冲





## 2016年全国女子手球锦标赛 竞赛技术统计(媒体表)

半决赛		组别	X	轮次	9	场次	48
滁州体育馆					12/09/2016	201605048-51-1/1	
安徽		安徽	35	vs	25	上海	上海
				15 : 13			

裁判员		张栋 (CHN)											/	倪震 (CHN)										
安徽		远射	近射	边射	快攻	突破	任意球	7m球	合计	%	助攻	失误	警告	2'	D & DR	安徽	比赛进程	上海						
主教练: 孙来苗															1st Half									
1	司艳														21	李瑶	1 01:06	0						
3	李兵			1/1				1/1	100		1				1	02:37	1 18	沙正文						
5	班晨晨		0/1					0/1	0.0						21	李瑶	2 02:47	1						
6	沈萍	4/7	3/4	0/1	1/1	1/1	1/1	10/15	66.7		3	1	1		14	刘晓妹	3 04:32	1						
7	赵江川														14	刘晓妹	4 05:21	1						
8	徐仕媛														4	06:08	2 8	吴茵						
10	孙来苗		3/5					3/5	60.0				1	1	41	杜机娟	5 06:57	2						
14	刘晓妹	4/5	1/3			2/2		7/10	70.0		5			1	6	07:39	2							
16	朱莉珍														6	10:18	3	19	印尼					
17	周婷		1/1	1/1	3/3	1/1		6/6	100		1				7	12:04	3							
18	郑冬冬														41	杜机娟	7 12:41	4	6	黄妍				
20	周雪婷														6	13:12	4							
21	李瑶	0/2	1/2		1/1	2/2		4/7	57.1	2	2				17	周婷	9 13:55	4						
23	张天洁				0/1			0/1	0.0						41	杜机娟	10 17:03	4						
41	杜机娟			2/4	0/1		2/3	4/8	50.0		1				10	孙来苗	10 17:35	5	5	郭威				
46	陶传红														11	17:59	5							
<b>运动员 合计</b>		8/14	9/16	4/7	5/7	6/6	3/4	35/54	64.8	2	13	3	3		14	刘晓妹	11 17:59	5						
1	司艳	6/12	1/5	0/2	1/2	1/2	2/2	0/2	11/27	40.7					6	沈萍	12 18:58	5						
16	朱莉珍	0/2			0/1	0/1	1/6	1/10	10.0						12	19:07	6	8	吴茵					
<b>守门员 合计</b>		6/14	1/5	0/2	1/3	1/3	2/2	1/8	12/37	32.4					14	刘晓妹	13 20:01	6						
																13	21:41	7	11	孙梦颖				
																14	刘晓妹	14 22:07	7					
																14	孙来苗	14 22:34	8	19	印尼			
																15	23:00	8						
																15	25:13	9	8	吴茵				
																15	26:24	10	6	黄妍				
																15	27:08	11	6	黄妍				
																15	28:49	12	5	郭威				
																15	29:39	13	11	孙梦颖				
																2nd Half								
																17	周婷	16 00:30	13					
																16	03:40	14	9	武娜娜				
																16	04:20	15	6	黄妍				
																14	刘晓妹	17 04:57	15					
																21	李瑶	18 06:07	15					
																18	07:01	16	5	郭威				
																41	杜机娟	19 07:22	16					
																19	08:26	17	8	吴茵				
																6	沈萍	20 09:26	17					
																17	周婷	21 10:06	17					
																17	周婷	22 11:28	17					
																22	11:42	18	8	吴茵				
																6	沈萍	23 12:14	18					
																17	周婷	24 12:53	18					
																24	13:03	19	11	孙梦颖				
																24	14:03	20	10	斯文				
																21	李瑶	25 14:32	20					
																6	沈萍	26 15:23	20					
																10	孙来苗	27 17:21	20					
																6	沈萍	28 18:42	20					
																3	李兵	29 19:50	20					
																29	20:21	21	10	斯文				
																14	刘晓妹	30 20:54	21					
																30	21:24	22	5	郭威				
																6	沈萍	31 21:43	22					
																31	22:31	23	19	印尼				
																6	沈萍	32 22:46	23					
																17	周婷	33 23:46	23					
																33	24:16	24	18	沙正文				
																6	沈萍	34 24:47	24					
																34	25:16	25	8	吴茵				
																6	沈萍	35 27:08	25					

场上队员: 得分 / 射门

守门员: 救球 / 射门

快攻	Fast Break	突破	Breakthrough	任意球	Free Throw	7M球	7M Throw	助攻	Assist
警告	Warning	失误	Error	2'	Suspension	D	取消资格	DR	取消资格+报告





### 2016年全国女子手球锦标赛 图式比赛技术统计表

轮次 9

场次 48

201605048-21-1/1

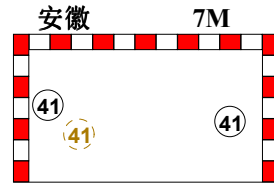
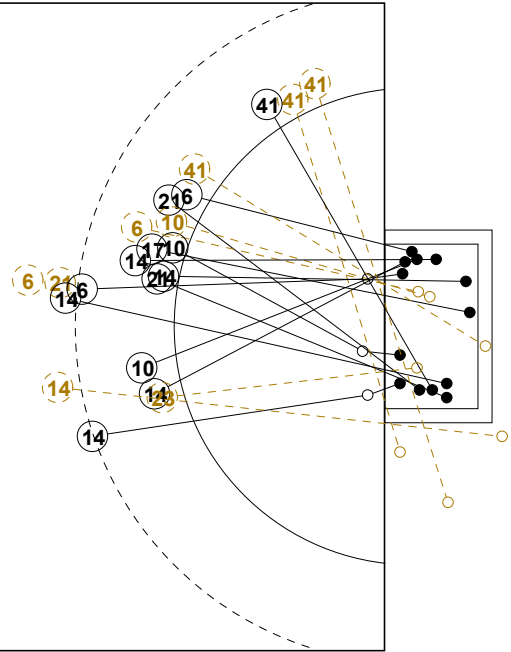
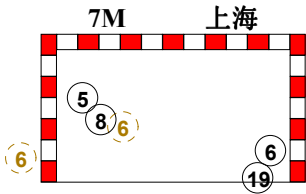
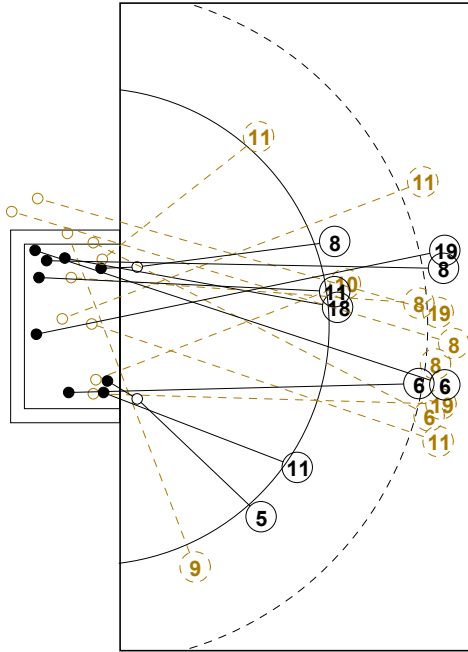

1st Half  
13 : 15

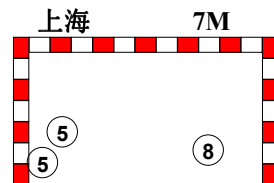
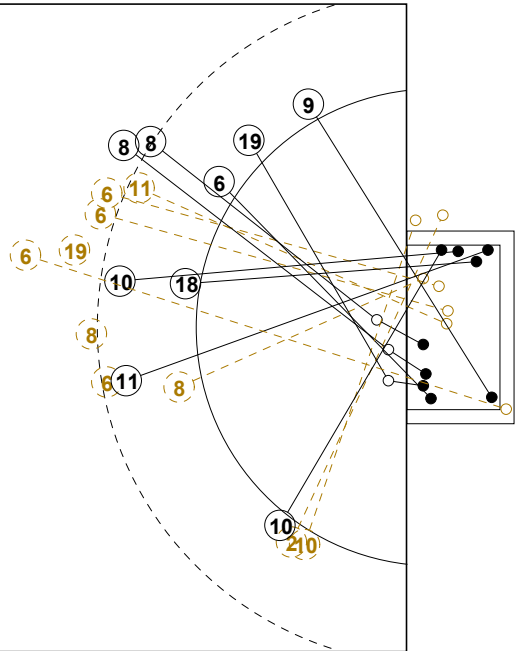
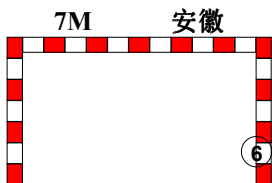
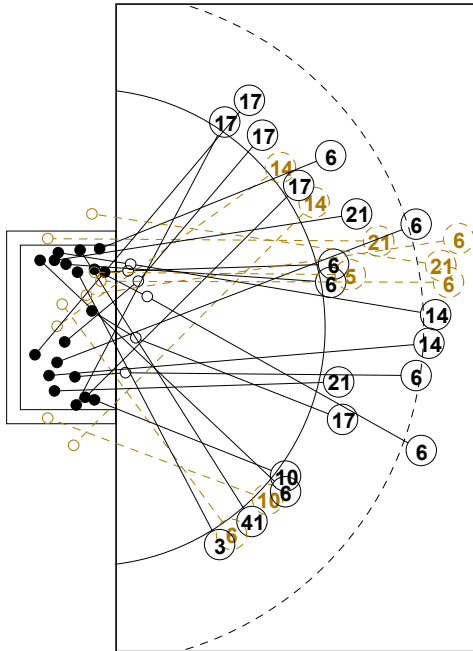

2nd Half  
35 : 25



## 2016年全国女子手球锦标赛

## 个人/全队技术统计表

正式表  
手球  
女子半决赛  
轮次 9组别 X  
场次 48201605048-14-1/2  
滁州体育馆  
12/09/2016 18:30

号码	姓名	远射	近射	边射	快攻	突破	任意	7M	合计	%	助攻	失误	警告	2'	取消	时间
<b>安徽(安徽)</b>																
<i>(场上队员)</i>																
1	司艳									0.0%						00:51:23
3	李兵			1/1					1/1	100%		1				00:39:55
5	班晨晨		0/1						0/1	0.0%						00:01:59
6	沈萍	4/7	3/4	0/1	1/1	1/1		1/1	10/15	66.7%		3	1	1		00:46:20
7	赵江川									0.0%						00:00:00
8	徐仕媛									0.0%						00:00:00
10	孙来苗		3/5						3/5	60.0%			1	1		01:00:00
14	刘晓妹	4/5	1/3			2/2			7/10	70.0%		5		1		01:00:00
16	朱莉珍									0.0%						00:08:37
17	周婷		1/1	1/1	3/3	1/1			6/6	100%		1				00:38:27
18	郑冬冬									0.0%			1			00:02:08
20	周雪婷									0.0%						00:00:00
21	李瑶	0/2	1/2		1/1	2/2			4/7	57.1%	2	2				00:52:13
23	张天洁				0/1				0/1	0.0%						00:24:29
41	杜机娟			2/4	0/1			2/3	4/8	50.0%		1				00:34:06
46	陶传红									0.0%						00:00:00
<b>合计</b>		8/14	9/16	4/7	5/7	6/6		3/4	35/54	64.8%	2	13	3	3		
<i>(守门员)</i>																
1	司艳	6/12	1/5	0/2	1/2	1/2	2/2	0/2	11/27	40.7%						00:51:23
16	朱莉珍	0/2			0/1	0/1		1/6	1/10	10.0%						00:08:37
<b>合计</b>		6/14	1/5	0/2	1/3	1/3	2/2	1/8	12/37	32.4%						

场上队员：得分/射门

守门员：救球/射门

全队合计	得分	被救	射失	击柱	封球	合计	%
远射	8	2	2		2	14	57.1%
近射	9	4	1	2		16	56.3%
边射	4	1	2			7	57.1%
快攻	5	1		1		7	71.4%
突破	6					6	100.0%
任意							0.0%
7M	3	1				4	75.0%





## 2016年全国女子手球锦标赛

## 个人/全队技术统计表

正式表  
手球  
女子半决赛  
轮次 9组别 X  
场次 48201605048-14-2/2  
滁州体育馆  
12/09/2016 18:30

号码	姓名	远射	近射	边射	快攻	突破	任意	7M	合计	%	助攻	失误	警告	2'	取消	时间
<b>上海(上海)</b>																
<i>(上场队员)</i>																
1	许沫									0.0%						00:28:16
2	周蕾			0/1					0/1	0.0%		1	1			00:36:12
5	郭威					1/1		3/3	4/4	100%		1				00:14:06
6	黄妍	2/6	1/1				0/1	1/3	4/11	36.4%		1				00:35:58
7	车婉茹									0.0%						00:00:00
8	吴茵	3/6	0/1		1/1		0/1	2/2	6/11	54.5%	2	3		1		00:47:30
9	武娜娜			1/2					1/2	50.0%		1	1			01:00:00
10	斯文	1/1		1/2	0/1				2/4	50.0%		1				00:21:07
11	孙梦颖	1/4	1/1		1/1	0/1			3/7	42.9%		2				00:41:21
12	郑冯									0.0%		1				00:31:44
13	徐娟									0.0%						00:02:27
17	居晔									0.0%						00:09:48
18	沙正文		2/2						2/2	100%		1	1	1		00:46:35
19	印尼	1/3				1/1	0/1	1/1	3/6	50.0%	1	3				00:24:04
21	王嘉怡									0.0%		1				00:00:02
23	都好									0.0%				1		00:17:24
<b>合计</b>		8/20	4/5	2/5	2/3	2/3	0/3	7/9	25/48	52.1%	3	16	3	3		
<i>(守门员)</i>																
1	许沫	2/5	3/6	0/2	1/3	0/5		0/2	6/23	26.1%						00:28:16
12	郑冯	0/5	1/7	1/3	0/3	0/1		1/2	3/21	14.3%		1				00:31:44
<b>合计</b>		2/10	4/13	1/5	1/6	0/6		1/4	9/44	20.5%		1				

场上队员：得分/射门

守门员：救球/射门

全队合计	得分	被救	射失	击柱	封球	合计	%
远射	8	6	1	1	4	20	40.0%
近射	4	1				5	80.0%
边射	2		2	1		5	40.0%
快攻	2	1				3	66.7%
突破	2	1				3	66.7%
任意		2	1			3	0.0%
7M	7	1	1			9	77.8%





### 2016年全国女子手球锦标赛

#### 图式射门区域统计

轮次 9 场次 48

201605048-41-1/1

## 安徽

1 司艳	3 李兵	5 班晨晨	6 沈萍	7 赵江川	8 徐仕媛	10 孙来苗	14 刘晓妹																																																																								
<table border="1"><tr><td></td><td></td><td></td></tr><tr><td></td><td></td><td></td></tr><tr><td></td><td></td><td></td></tr></table>										<table border="1"><tr><td></td><td></td><td></td></tr><tr><td></td><td></td><td>1</td></tr><tr><td></td><td></td><td></td></tr></table>						1				<table border="1"><tr><td></td><td></td><td></td></tr><tr><td></td><td></td><td></td></tr><tr><td></td><td></td><td></td></tr></table>										<table border="1"><tr><td></td><td></td><td>1</td></tr><tr><td></td><td></td><td>1</td></tr><tr><td></td><td></td><td>4</td></tr></table>			1			1			4	<table border="1"><tr><td></td><td></td><td></td></tr><tr><td></td><td></td><td></td></tr><tr><td></td><td></td><td></td></tr></table>										<table border="1"><tr><td></td><td></td><td></td></tr><tr><td></td><td></td><td></td></tr><tr><td></td><td></td><td></td></tr></table>										<table border="1"><tr><td></td><td></td><td></td></tr><tr><td></td><td></td><td>1</td></tr><tr><td></td><td></td><td>1</td></tr></table>						1			1	<table border="1"><tr><td></td><td></td><td></td></tr><tr><td></td><td></td><td>2</td></tr><tr><td></td><td></td><td>1</td></tr></table>						2			1
		1																																																																													
		1																																																																													
		1																																																																													
		4																																																																													
		1																																																																													
		1																																																																													
		2																																																																													
		1																																																																													
Post - 0 Miss - 0 Block - 0	Post - 0 Miss - 0 Block - 0	Post - 0 Miss - 0 Block - 0	Post - 0 Miss - 0 Block - 1	Post - 0 Miss - 0 Block - 0	Post - 0 Miss - 0 Block - 0	Post - 1 Miss - 0 Block - 0	Post - 0 Miss - 2 Block - 0																																																																								
16 朱莉珍	17 周婷	18 郑冬冬	20 周雪婷	21 李瑶	23 张天洁	41 杜机娟	46 陶传红																																																																								
<table border="1"><tr><td></td><td></td><td></td></tr><tr><td></td><td></td><td></td></tr><tr><td></td><td></td><td></td></tr></table>										<table border="1"><tr><td></td><td></td><td>2</td></tr><tr><td></td><td>1</td><td>1</td></tr><tr><td></td><td>1</td><td>1</td></tr></table>			2		1	1		1	1	<table border="1"><tr><td></td><td></td><td></td></tr><tr><td></td><td></td><td></td></tr><tr><td></td><td></td><td></td></tr></table>										<table border="1"><tr><td></td><td></td><td></td></tr><tr><td></td><td></td><td></td></tr><tr><td></td><td></td><td></td></tr></table>										<table border="1"><tr><td></td><td></td><td>1</td></tr><tr><td></td><td></td><td>2</td></tr><tr><td></td><td></td><td></td></tr></table>			1			2				<table border="1"><tr><td></td><td></td><td></td></tr><tr><td></td><td></td><td></td></tr><tr><td></td><td></td><td></td></tr></table>										<table border="1"><tr><td></td><td></td><td></td></tr><tr><td></td><td></td><td>1</td></tr><tr><td></td><td></td><td>3</td></tr></table>						1			3	<table border="1"><tr><td></td><td></td><td></td></tr><tr><td></td><td></td><td></td></tr><tr><td></td><td></td><td></td></tr></table>									
		2																																																																													
	1	1																																																																													
	1	1																																																																													
		1																																																																													
		2																																																																													
		1																																																																													
		3																																																																													
Post - 0 Miss - 0 Block - 0	Post - 0 Miss - 0 Block - 0	Post - 0 Miss - 0 Block - 0	Post - 0 Miss - 0 Block - 0	Post - 1 Miss - 1 Block - 1	Post - 0 Miss - 0 Block - 0	Post - 1 Miss - 2 Block - 0	Post - 0 Miss - 0 Block - 0																																																																								

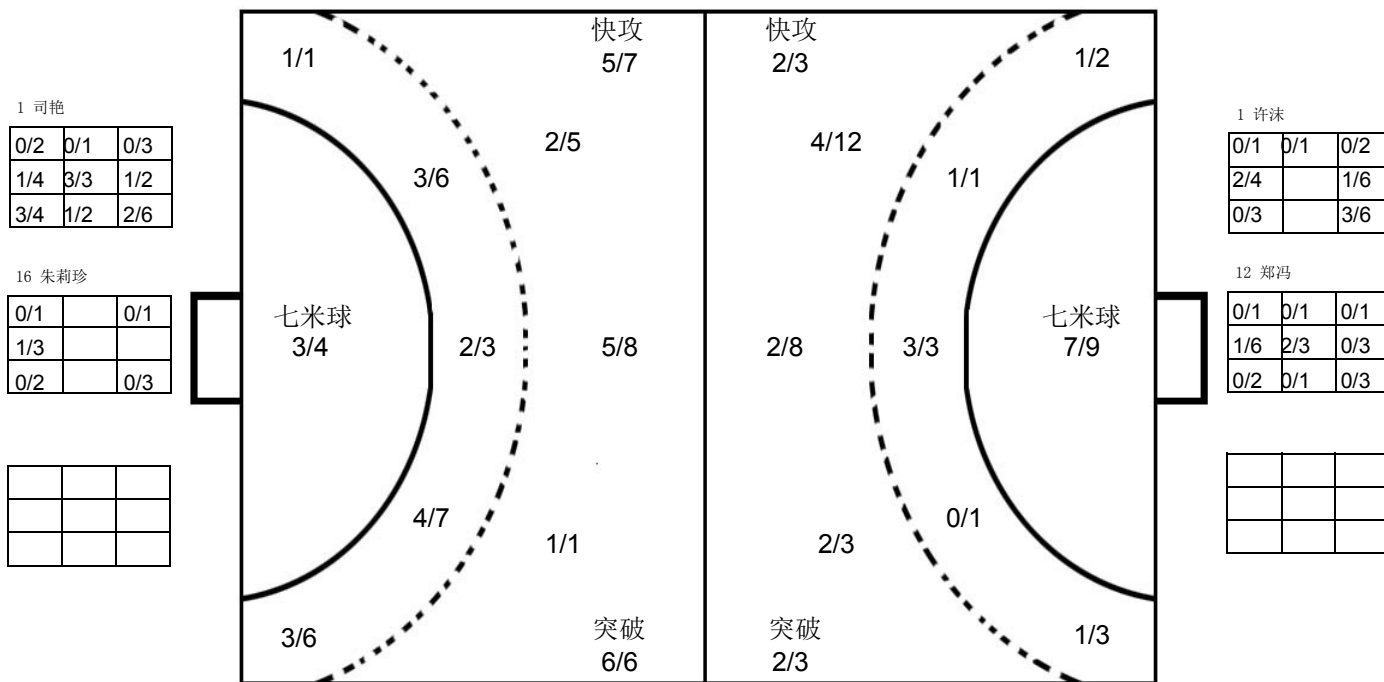

## 上海

1 许沫	2 周蕾	5 郭威	6 黄妍	7 车婉茹	8 吴茵	9 武娜娜	10 斯文																																																																								
<table border="1"><tr><td></td><td></td><td></td></tr><tr><td></td><td></td><td></td></tr><tr><td></td><td></td><td></td></tr></table>										<table border="1"><tr><td></td><td></td><td></td></tr><tr><td></td><td></td><td></td></tr><tr><td></td><td></td><td></td></tr></table>										<table border="1"><tr><td></td><td></td><td>1</td></tr><tr><td></td><td></td><td>1</td></tr><tr><td></td><td></td><td>2</td></tr></table>			1			1			2	<table border="1"><tr><td></td><td></td><td>1</td></tr><tr><td></td><td></td><td>2</td></tr><tr><td></td><td></td><td></td></tr></table>			1			2				<table border="1"><tr><td></td><td></td><td></td></tr><tr><td></td><td></td><td></td></tr><tr><td></td><td></td><td></td></tr></table>										<table border="1"><tr><td></td><td></td><td>1</td></tr><tr><td></td><td></td><td>1</td></tr><tr><td></td><td></td><td>3</td></tr></table>			1			1			3	<table border="1"><tr><td></td><td></td><td>1</td></tr><tr><td></td><td></td><td></td></tr><tr><td></td><td></td><td></td></tr></table>			1							<table border="1"><tr><td></td><td></td><td></td></tr><tr><td></td><td></td><td>2</td></tr><tr><td></td><td></td><td></td></tr></table>						2			
		1																																																																													
		1																																																																													
		2																																																																													
		1																																																																													
		2																																																																													
		1																																																																													
		1																																																																													
		3																																																																													
		1																																																																													
		2																																																																													
Post - 0 Miss - 0 Block - 0	Post - 0 Miss - 1 Block - 0	Post - 0 Miss - 0 Block - 0	Post - 1 Miss - 1 Block - 1	Post - 0 Miss - 0 Block - 0	Post - 0 Miss - 1 Block - 2	Post - 1 Miss - 0 Block - 0	Post - 0 Miss - 1 Block - 0																																																																								
11 孙梦颖	12 郑冯	13 徐娟	17 居晔	18 沙正文	19 印尼	21 王嘉怡	23 都好																																																																								
<table border="1"><tr><td></td><td></td><td>1</td></tr><tr><td></td><td></td><td>1</td></tr><tr><td></td><td></td><td></td></tr></table>			1			1				<table border="1"><tr><td></td><td></td><td></td></tr><tr><td></td><td></td><td></td></tr><tr><td></td><td></td><td></td></tr></table>										<table border="1"><tr><td></td><td></td><td></td></tr><tr><td></td><td></td><td></td></tr><tr><td></td><td></td><td></td></tr></table>										<table border="1"><tr><td></td><td></td><td></td></tr><tr><td></td><td></td><td></td></tr><tr><td></td><td></td><td></td></tr></table>										<table border="1"><tr><td></td><td></td><td>1</td></tr><tr><td></td><td></td><td>1</td></tr><tr><td></td><td></td><td></td></tr></table>			1			1				<table border="1"><tr><td></td><td></td><td>1</td></tr><tr><td></td><td></td><td></td></tr><tr><td></td><td></td><td>2</td></tr></table>			1						2	<table border="1"><tr><td></td><td></td><td></td></tr><tr><td></td><td></td><td></td></tr><tr><td></td><td></td><td></td></tr></table>										<table border="1"><tr><td></td><td></td><td></td></tr><tr><td></td><td></td><td></td></tr><tr><td></td><td></td><td></td></tr></table>									
		1																																																																													
		1																																																																													
		1																																																																													
		1																																																																													
		1																																																																													
		2																																																																													
Post - 0 Miss - 0 Block - 0	Post - 0 Miss - 0 Block - 0	Post - 0 Miss - 0 Block - 0	Post - 0 Miss - 0 Block - 0	Post - 0 Miss - 0 Block - 0	Post - 0 Miss - 1 Block - 1	Post - 0 Miss - 0 Block - 0	Post - 0 Miss - 0 Block - 0																																																																								

注释: Post=击柱 Miss=射失 Block=被封





## 2016年全国女子手球锦标赛

## 比赛进程表

正式表  
手球  
女子半决赛  
轮次 9组别 X  
场次 48201605048-13-1/6  
滁州体育馆  
12/09/2016 18:30

时间	队员	动作	比分	队员	动作
<b>安徽</b>			<b>上半时</b>		
<b>上海</b>					
01:06	21 李瑶	突破 得分	1 - 0	1 许沫	被射入
01:34				8 吴茵	传球失误
01:43	21 李瑶	中远射 被封		18 沙正文	封球
02:37	1 司艳	被射入	1 - 1	18 沙正文	近射 得分
02:42				8 吴茵	助攻
02:47	21 李瑶	突破 得分	2 - 1	1 许沫	被射入
02:53				2 周蕾	警告
03:13				9 武娜娜	左边射 击柱
03:14		裁判暂停			
03:47	6 沈萍	近射 被救		1 许沫	挡住球
04:20	1 司艳	挡住球		6 黄妍	任意球 被救
04:32	14 刘晓妹	右远射 得分	3 - 1	1 许沫	被射入
04:51				6 黄妍	传球失误
05:21	14 刘晓妹	突破 得分	4 - 1	1 许沫	被射入
05:52	1 司艳	挡住球		11 孙梦颖	右远射 被救
06:04	14 刘晓妹	传球失误		8 吴茵	断球
06:08	1 司艳	被射入	4 - 2	8 吴茵	一传快攻 得分
06:10	10 孙来苗	警告			
06:44	21 李瑶	造7M		18 沙正文	使被罚7M球
06:45				18 沙正文	警告
06:57	41 杜机娟	7M球 得分	5 - 2	1 许沫	被射入
07:24				8 吴茵	传球失误
07:39	10 孙来苗	近射 得分	6 - 2	1 许沫	被射入
07:42	21 李瑶	助攻			
08:06	1 司艳	挡住球		11 孙梦颖	突破 被救
08:43	1 司艳	挡住球		11 孙梦颖	左远射 被救
08:55	10 孙来苗	近射 被救		1 许沫	挡住球
08:57	21 李瑶	助攻			
08:59					球队暂停
09:22	6 沈萍	警告			
09:50	6 沈萍	使被罚7M球		18 沙正文	造7M
10:18	1 司艳	被射入	6 - 3	19 印尼	7M球 得分
10:40	41 杜机娟	左边射 射失			
11:26				8 吴茵	任意球 射失
11:43				18 沙正文	罚出场2分钟
12:04	41 杜机娟	左边射 得分	7 - 3	1 许沫	被射入
12:12		裁判暂停			
12:27	21 李瑶	使被罚7M球		10 斯文	造7M
12:37		裁判暂停			
12:41	16 朱莉珍	被射入	7 - 4	6 黄妍	7M球 得分





## 2016年全国女子手球锦标赛

## 比赛进程表

正式表  
手球  
女子半决赛  
轮次 9组别 X  
场次 48201605048-13-2/6  
滁州体育馆  
12/09/2016 18:30

时间	队员	动作	比分	队员	动作
<b>安徽</b>			<b>上半时</b>		
<b>上海</b>					
13:12	6 沈萍	突破 得分	8 - 4	1 许沫	被射入
13:42	1 司艳	挡住球		8 吴茵	中远射 被救
13:55	17 周婷	突破 得分	9 - 4	1 许沫	被射入
14:39	1 司艳	挡住球		19 印尼	任意球 被救
15:12	6 沈萍	传球失误			
15:25	10 孙来苗	封球		8 吴茵	中远射 被封
15:35	23 张天洁	一传快攻 被救		1 许沫	挡住球
15:37		裁判暂停			
16:00	14 刘晓妹	使被罚7M球		8 吴茵	造7M
16:25				6 黄妍	7M球 射失
16:49	17 周婷	造7M		17 居晔	使被罚7M球
17:03	41 杜机娟	7M球 得分	10 - 4	1 许沫	被射入
17:35	1 司艳	被射入	10 - 5	5 郭威	突破 得分
17:59	14 刘晓妹	突破 得分	11 - 5	12 郑冯	被射入
18:25				19 印尼	中远射 射失
18:58	6 沈萍	中远射 得分	12 - 5	12 郑冯	被射入
19:07	1 司艳	被射入	12 - 6	8 吴茵	右远射 得分
19:45	14 刘晓妹	传球失误		10 斯文	断球
19:54	1 司艳	挡住球		10 斯文	一传快攻 被救
20:01	14 刘晓妹	中远射 得分	13 - 6	12 郑冯	被射入
20:39					球队暂停
21:03	23 张天洁	断球		19 印尼	传球失误
21:12	41 杜机娟	一传快攻 击柱			
21:41	1 司艳	被射入	13 - 7	11 孙梦颖	近射 得分
21:44				19 印尼	助攻
21:52				9 武娜娜	警告
22:07	14 刘晓妹	近射 得分	14 - 7	12 郑冯	被射入
22:34	1 司艳	被射入	14 - 8	19 印尼	右远射 得分
23:00	10 孙来苗	近射 得分	15 - 8	12 郑冯	被射入
23:44				2 周蕾	传球失误
23:48	41 杜机娟	左边射 射失			
24:16		裁判暂停			
24:16	10 孙来苗	使被罚7M球		6 黄妍	造7M
24:16	10 孙来苗	罚出场2分钟			
24:27	16 朱莉珍	挡住球		6 黄妍	7M球 被救
24:39	6 沈萍	四步			
24:56	18 郑冬冬	使被罚7M球		2 周蕾	造7M
24:58	18 郑冬冬	警告			
25:06		裁判暂停			
25:13	16 朱莉珍	被射入	15 - 9	8 吴茵	7M球 得分





## 2016年全国女子手球锦标赛

## 比赛进程表

正式表  
手球  
女子半决赛  
轮次 9组别 X  
场次 48201605048-13-3/6  
滁州体育馆  
12/09/2016 18:30

时间	队员	动作	比分	队员	动作			
<b>安徽</b>			<b>上半时</b>			<b>上海</b>		
25:57	14 刘晓妹	传球失误						
26:24	16 朱莉珍	被射入	15 - 10	6 黄妍	左远射 得分			
26:37		球队暂停						
26:57	14 刘晓妹	右远射 射失						
27:08	16 朱莉珍	被射入	15 - 11	6 黄妍	左远射 得分			
27:39	21 李瑶	进攻犯规		6 黄妍	造犯规			
28:28	3 李兵	使被罚7M球		18 沙正文	造7M			
28:49	16 朱莉珍	被射入	15 - 12	5 郭威	7M球 得分			
29:20	6 沈萍	传球失误						
29:25	14 刘晓妹	断球		12 郑冯	快攻 传球失误			
29:32	6 沈萍	中远射 被封		18 沙正文	封球			
29:39	16 朱莉珍	被射入	15 - 13	11 孙梦颖	一传快攻 得分			
30:00	3 李兵	造7M		11 孙梦颖	使被罚7M球			
30:00	41 杜机娟	7M球 被救		12 郑冯	挡住球			





## 2016年全国女子手球锦标赛

## 比赛进程表

正式表  
手球  
女子半决赛  
轮次 9组别 X  
场次 48201605048-13-4/6  
滁州体育馆  
12/09/2016 18:30

时间	队员	动作	比分	队员	动作
<b>安徽</b>			<b>下半时</b>		
<b>上海</b>					
00:23	1 司艳	挡住球		11 孙梦颖	左远射 被救
00:30	17 周婷	右边射 得分	<b>16 - 13</b>	12 郑冯	被射入
00:59	1 司艳	挡住球		6 黄妍	左远射 被救
01:20		裁判暂停			
01:24		裁判暂停			
01:24				8 吴茵	罚出场2分钟
01:34	14 刘晓妹	近射 被救		12 郑冯	挡住球
02:00				11 孙梦颖	运球失误
02:06	41 杜机娟	侵区			
02:38	3 李兵	造犯规		9 武娜娜	进攻犯规
02:52	21 李瑶	进攻犯规		2 周蕾	造犯规
03:40	1 司艳	被射入	<b>16 - 14</b>	9 武娜娜	左边射 得分
04:07	14 刘晓妹	近射 射失			
04:20	1 司艳	被射入	<b>16 - 15</b>	6 黄妍	近射 得分
04:57	14 刘晓妹	中远射 得分	<b>17 - 15</b>	12 郑冯	被射入
06:07	21 李瑶	一传快攻 得分	<b>18 - 15</b>	12 郑冯	被射入
06:10	1 司艳	挡住球		8 吴茵	近射 被救
06:13		裁判暂停			
06:38	10 孙来苗	使被罚7M球		18 沙正文	造7M
07:01	1 司艳	被射入	<b>18 - 16</b>	5 郭威	7M球 得分
07:22	41 杜机娟	左边射 得分	<b>19 - 16</b>	12 郑冯	被射入
07:49	21 李瑶	造犯规		10 斯文	进攻犯规
07:54	21 李瑶	近射 击柱			
08:26	1 司艳	被射入	<b>19 - 17</b>	8 吴茵	左远射 得分
09:01	14 刘晓妹	造7M		17 居晔	使被罚7M球
09:26	6 沈萍	7M球 得分	<b>20 - 17</b>	12 郑冯	被射入
10:00	3 李兵	封球		6 黄妍	中远射 被封
10:06	17 周婷	短传快攻 得分	<b>21 - 17</b>	12 郑冯	被射入
10:14		裁判暂停			
10:41				2 周蕾	右边射 射失
11:11	6 沈萍	左边射 被救		12 郑冯	挡住球
11:28	17 周婷	近射 得分	<b>22 - 17</b>	12 郑冯	被射入
11:42	1 司艳	被射入	<b>22 - 18</b>	8 吴茵	左远射 得分
12:14	6 沈萍	左远射 得分	<b>23 - 18</b>	12 郑冯	被射入
12:47	6 沈萍	封球		8 吴茵	中远射 被封
12:53	17 周婷	一传快攻 得分	<b>24 - 18</b>	12 郑冯	被射入
13:03	1 司艳	被射入	<b>24 - 19</b>	11 孙梦颖	中远射 得分
13:26	14 刘晓妹	四步			
14:03	1 司艳	被射入	<b>24 - 20</b>	10 斯文	中远射 得分
14:32	21 李瑶	近射 得分	<b>25 - 20</b>	12 郑冯	被射入





## 2016年全国女子手球锦标赛

## 比赛进程表

正式表  
手球  
女子半决赛  
轮次 9组别 X  
场次 48201605048-13-5/6  
滁州体育馆  
12/09/2016 18:30

时间	队员	动作	比分	队员	动作
<b>安徽</b>			<b>下半时</b>		
<b>上海</b>					
15:06	3 李兵	造犯规		8 吴茵	进攻犯规
15:23	6 沈萍	近射 得分	<b>26 - 20</b>	12 郑冯	被射入
16:04				18 沙正文	传球失误
16:14	10 孙来苗	近射 击柱			
16:53	1 司艳	挡住球		6 黄妍	左远射 被救
17:21	10 孙来苗	近射 得分	<b>27 - 20</b>	12 郑冯	被射入
17:35					球队暂停
18:15	10 孙来苗	造犯规		19 印尼	进攻犯规
18:42	6 沈萍	右远射 得分	<b>28 - 20</b>	12 郑冯	被射入
18:52		裁判暂停			
18:52	6 沈萍	罚出场2分钟			
19:09				10 斯文	右边射 射失
19:50	3 李兵	左边射 得分	<b>29 - 20</b>	1 许沫	被射入
20:21	1 司艳	被射入	<b>29 - 21</b>	10 斯文	右边射 得分
20:42		裁判暂停			
20:42				23 都好	罚出场2分钟
20:48		裁判暂停			
20:54	14 刘晓妹	中远射 得分	<b>30 - 21</b>	1 许沫	被射入
21:18	3 李兵	使被罚7M球		8 吴茵	造7M
21:21		裁判暂停			
21:24	16 朱莉珍	被射入	<b>30 - 22</b>	5 郭威	7M球 得分
21:43	6 沈萍	中远射 得分	<b>31 - 22</b>	1 许沫	被射入
22:31	16 朱莉珍	被射入	<b>31 - 23</b>	19 印尼	突破 得分
22:46	6 沈萍	近射 得分	<b>32 - 23</b>	1 许沫	被射入
23:02				19 印尼	其它失误
23:40	10 孙来苗	封球		19 印尼	左远射 被封
23:46	17 周婷	一传快攻 得分	<b>33 - 23</b>	1 许沫	被射入
24:16	1 司艳	被射入	<b>33 - 24</b>	18 沙正文	近射 得分
24:18				8 吴茵	助攻
24:44	6 沈萍	中远射 被救		1 许沫	挡住球
24:47	6 沈萍	近射 得分	<b>34 - 24</b>	1 许沫	被射入
25:08	6 沈萍	使被罚7M球		18 沙正文	造7M
25:12		裁判暂停			
25:12	14 刘晓妹	罚出场2分钟			
25:16	16 朱莉珍	被射入	<b>34 - 25</b>	8 吴茵	7M球 得分
25:39	21 李瑶	右远射 射失			
25:58	3 李兵	造犯规		5 郭威	进攻犯规
26:33		裁判暂停			
26:50	6 沈萍	右远射 被救		1 许沫	挡住球
27:01	17 周婷	快攻 传球失误			



## 2016年全国女子手球锦标赛

## 比赛进程表

正式表  
手球  
女子半决赛  
轮次 9组别 X  
场次 48201605048-13-6/6  
滁州体育馆  
12/09/2016 18:30

时间	队员	动作	比分	队员	动作
<b>安徽</b>			<b>下半场</b>		
<b>安徽</b>			<b>上海</b>		
27:08	6 沈萍	短传快攻 得分	<b>35 - 25</b>	1 许沫	被射入
27:52	21 李瑶	造犯规		11 孙梦颖	进攻犯规
28:20	3 李兵	侵区			
28:56				6 黄妍	左远射 击柱
29:33	14 刘晓妹	传球失误			
29:45				21 王嘉怡	快攻 传球失误
29:50	5 班晨晨	近射 被救		1 许沫	挡住球



名次赛 Group F

女子 全国比赛

2016年全国女子手球锦标赛

Team A A 广西				Team B B 四川				Match Number 49													
played in China		in the hall 滁州体育馆		on 13/09/2016		at 08:30 hours		Spectators													
Half-time (30')	A 20	B 16	End of playing time	A 36	B 37	1st extra time	A	B	2nd extra time	A	B	After penalty throws	A	B							
Number of 7 m	A 2/3	Team time-out			Full name of players and officials				Team time-out			B 7/7	Number of 7 m								
		1 29:42	2 33:54	3					1	2 49:05	3 59:13										
No.	Team A					G	W	2'	D	DR	No.	Team B					G	W	2'	D	DR
1	胡霜梅										1	张雪纯									
2	陆雪云					6	1				2	陈艳楠									
5	黄海玉										3	王丹					10				
6	韦惠文										4	尤婉莹					4				
7	廖露					7		1			5	孙姣					2	1			
8	韦如芳					5					6	凤洋					6				
9	蓝雪梅										7	练素琪									
10	周琴					7	1	1			9	姚梦园					3	1			
11	曾蓝花						1				10	高静									
12	江燕红										11	朱海云									
14	黄艳芳					7					12	宋琛茜									
15	陈依依										17	史雨欣									
16	商志运										18	戴小宇					12		1		
17	杨杨					4					27	吴美琪									
18	庞娇							1													
C	王林										A	金鸿									
D	刘雪波										B	郎正平									
											C	陈志伟									
A	Signature of Responsible Official of the Teams (Off. A)																		B		
TP	Remarks of Referee / CHA Official																		TP		

Signatures

Referees	张栋 (CHN)	严璐 (CHN)		
Techn. Delegates	刘书勇 (CHN)			
CHA Official	于中迅 (CHN)			

Note: Number of 7m Throws Awarded to Team A and B, Goals (G), Warnings (W), Suspensions (2'), Direct Disqualification (D), Disqualification with Report (DR) and Team Penalty (TP).

Table Officials: 李诚

陈文丽

Statisticians: 陈柱

闫冲

Printed by PHMS Copyright: IHF / CHA 13/09/2016 09:45:49

Longman Sportsoft



handball@126.com

2016年全国女子手球锦标赛  
竞赛技术统计(媒体表)

名次赛	组别	F	轮次	10	场次	49
滁州体育馆		13/09/2016			201605049-51-1/1	
广西	广西	36	vs	37	四川	四川
		20 : 16				

裁判员		张栋 (CHN)											严璐 (CHN)										
广西		远射	近射	边射	快攻	突破	任意球	7m球	合计	%	助攻	失误	警告	2'	D & DR	广西	比赛进程	四川					
主教练: 王林																1st Half							
1	胡霜梅															14	黄艳芳	1	01:50	0			
2	陆雪云	0/1	2/2	1/2		3/3		6/8	75.0	1	7	1			1	02:18	1	5	孙皎				
5	黄海玉														1	03:53	2	3	王丹				
6	韦惠文														2	04:28	2						
7	廖露	5/12				2/3		7/15	46.7	2	2		1		2	05:52	3	3	王丹				
8	韦如芳		1/1	3/3		1/1		5/5	100		1				3	07:08	3						
9	蓝雪梅														4	07:51	3						
10	周琴	1/2	0/3	3/3	1/2		2/3	7/13	53.8		1	1	1		4	08:32	4	18	戴小宇				
11	曾蓝花														5	09:08	4						
12	江燕红														6	09:40	4						
14	黄艳芳	0/1	4/7	1/2	2/2			7/12	58.3		5				6	10:09	5	4	尤婉莹				
15	陈依依														6	11:05	6	3	王丹				
16	商志运														7	11:44	6						
17	杨杨	1/1	1/1		2/2			4/4	100						8	12:21	6						
18	庞娇	0/1						0/1	0.0		1		1		8	12:36	7	18	戴小宇				
运动员 合计		7/18	8/14	8/10	5/6	6/7	2/3	36/58	62.1	3	20	3	3		9	13:11	7						
12	江燕红				0/1		0/2	0/3	0.0						9	14:06	8	6	凤洋				
16	商志运	4/13	7/14	7/10	0/5	1/6	1/1	20/54	37.0		1				10	14:31	8						
守门员 合计		4/13	7/14	7/10	0/6	1/6	1/1	20/57	35.1		1				10	14:45	9	18	戴小宇				
四川															11	15:12	9						
教练: 郎正平															11	15:29	10	3	王丹				
1	张雪纯														12	15:55	10						
2	陈艳楠	0/1													12	16:13	11	9	姚梦园				
3	王丹	1/3	2/3	1/2	1/1	1/1	0/1	4/4	10/15	66.7	1	4			13	16:40	11						
4	尤婉莹	0/2	0/2	1/3	1/1	2/3		4/11	36.4		4				14	18:05	11						
5	孙皎		0/1		2/2			2/3	66.7		2	1			14	18:27	12	4	尤婉莹				
6	凤洋	2/2	1/4	1/3	1/1	1/1		6/11	54.5		2				14	18:59	13	6	凤洋				
7	练素琪														15	19:36	13						
9	姚梦园		2/3	0/4	1/1			3/8	37.5			1			16	20:11	13						
10	高静														16	21:07	14	18	戴小宇				
11	朱海云	0/1						0/1	0.0						17	22:28	14						
12	宋琛茜														17	22:50	15	6	凤洋				
17	史雨欣														18	23:14	15						
18	戴小宇	6/6	2/2			1/1	3/3	12/12	100		3		1		18	24:51	16	9	姚梦园				
27	吴美琪										1				19	25:38	16						
运动员 合计		9/15	7/15	3/12	6/6	5/6	0/1	7/7	37/62	59.7	1	16	2	1	20	27:11	16						
12	宋琛茜	7/14	3/11	2/10	1/6	1/7	0/2	14/50	28.0						2nd Half								
守门员 合计		7/14	3/11	2/10	1/6	1/7	0/2	14/50	28.0						20	03:15	17	6	凤洋				
场上队员: 得分 / 射门		守门员: 救球 / 射门											20	03:49	18	3	王丹						
快攻	Fast Break														20	04:58	19	18	戴小宇				
警告	Warning														21	05:42	19						
															21	06:26	20	3	王丹				
															22	06:51	20						
															22	07:28	21	18	戴小宇				
															23	08:15	21						
															8	08:59	21						
															25	10:16	21						
															25	10:36	22	18	戴小宇				
															26	12:10	22	3	王丹				
															26	12:54	23	5	孙皎				
															26	13:24	24	5	孙皎				
															26	14:27	25	3	王丹				
															26	15:39	26	4	尤婉莹				
															26	16:08	27	18	戴小宇				
															10	17:00	27						
															17	17:32	27						
															28	17:44	28	3	王丹				
															29	19:01	28						
															29	19:54	29	18	戴小宇				
															30	20:24	29						
															30	20:55	30	4	尤婉莹				
															31	21:25	30						
															32	21:42	30						
															32	22:04	31	18	戴小宇				
															32	22:52	32	6	凤洋				
															32	23:24	33	9	姚梦园				
															33	23:58	33						
															33	24:54	34	18	戴小宇				
															8	25:34	34						
															8	27:00	35	18	戴小宇				
															14	27:16	35						
															36	28:13	35						
															36	28:37	36	6	凤洋				
															36	30:00	37	3	王丹				

快攻	Fast Break		突破	Breakthrough	任意球	Free Throw	7M球	7M Throw		助攻	Assist
警告	Warning		失误	Error	2'	Suspension	D	取消资格		DR	取消资格+报告





### 2016年全国女子手球锦标赛 图式比赛技术统计表

轮次 10

场次 49

201605049-21-1/1

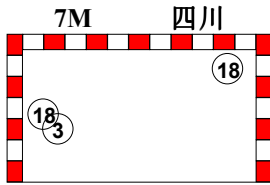
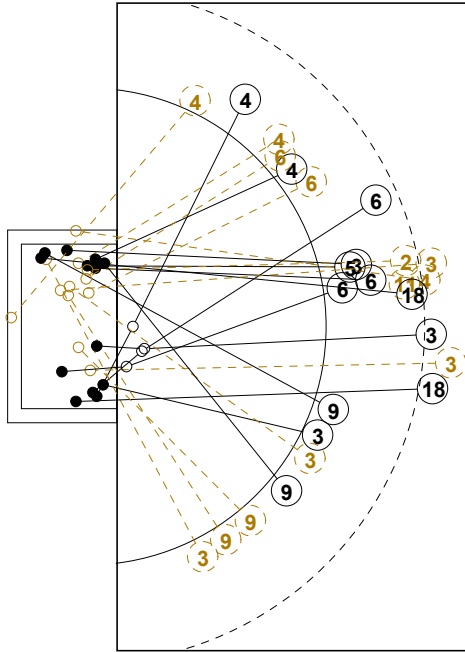

1st Half  
16 : 20

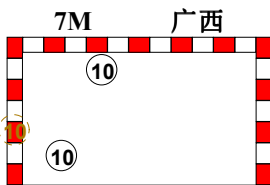
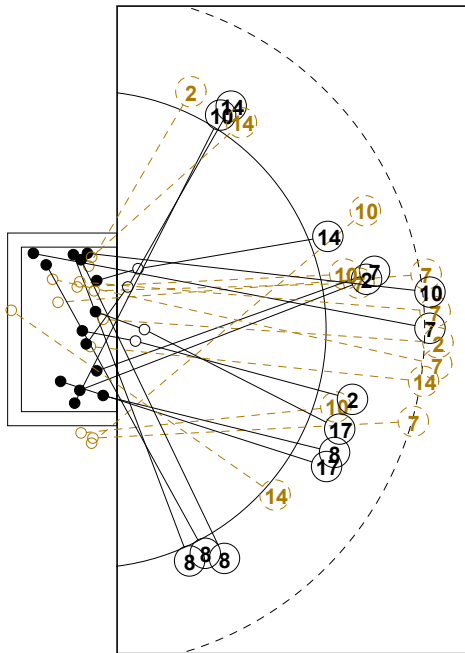
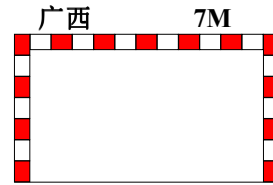
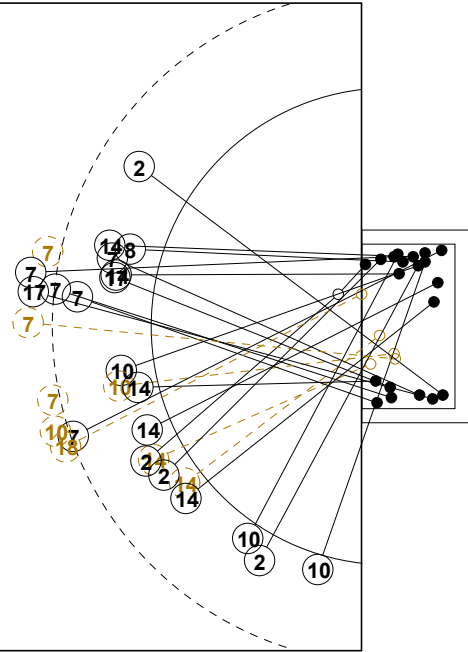

2nd Half  
36 : 37

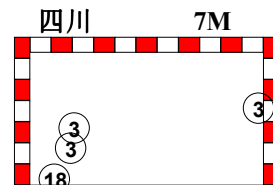
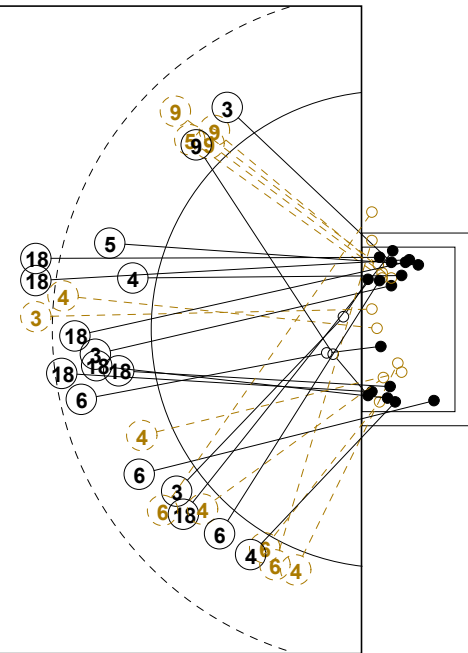



## 2016年全国女子手球锦标赛

## 个人/全队技术统计表

正式表  
手球  
女子名次赛  
轮次 10组别 F  
场次 49201605049-14-1/2  
滁州体育馆  
13/09/2016 08:30

号码	姓名	远射	近射	边射	快攻	突破	任意	7M	合计	%	助攻	失误	警告	2'	取消	时间
<b>广西(广西)</b>																
<i>(场上队员)</i>																
1	胡霜梅									0.0%						00:00:00
2	陆雪云	0/1	2/2	1/2		3/3			6/8	75.0%	1	7	1			00:56:50
5	黄海玉									0.0%						00:00:00
6	韦惠文									0.0%						00:00:00
7	廖露	5/12				2/3			7/15	46.7%	2	2		1		00:44:50
8	韦如芳		1/1	3/3		1/1			5/5	100%		1				01:00:00
9	蓝雪梅									0.0%						00:00:00
10	周琴	1/2	0/3	3/3	1/2			2/3	7/13	53.8%		1	1	1		01:00:00
11	曾蓝花									0.0%		2	1			00:09:08
12	江燕红									0.0%						00:02:32
14	黄艳芳	0/1	4/7	1/2	2/2				7/12	58.3%		5				00:56:28
15	陈依依									0.0%						00:00:00
16	商志运									0.0%		1				00:57:28
17	杨杨	1/1	1/1		2/2				4/4	100%						00:44:00
18	庞娇	0/1							0/1	0.0%		1		1		00:28:48
<b>合计</b>		7/18	8/14	8/10	5/6	6/7		2/3	36/58	62.1%	3	20	3	3		
<i>(守门员)</i>																
12	江燕红					0/1		0/2	0/3	0.0%						00:02:32
16	商志运	4/13	7/14	7/10	0/5	1/6	1/1	0/5	20/54	37.0%		1				00:57:28
<b>合计</b>		4/13	7/14	7/10	0/6	1/6	1/1	0/7	20/57	35.1%		1				

场上队员：得分/射门

守门员：救球/射门

全队合计	得分	被救	射失	击柱	封球	合计	%
远射	7	7	1		3	18	38.9%
近射	8	3	2	1		14	57.1%
边射	8	2				10	80.0%
快攻	5	1				6	83.3%
突破	6	1				7	85.7%
任意							0.0%
7M	2			1		3	66.7%





## 2016年全国女子手球锦标赛

## 个人/全队技术统计表

正式表  
手球  
女子名次赛  
轮次 10组别 F  
场次 49201605049-14-2/2  
滁州体育馆  
13/09/2016 08:30

号码	姓名	远射	近射	边射	快攻	突破	任意	7M	合计	%	助攻	失误	警告	2'	取消	时间
<b>四川(四川)</b>																
<i>(上场队员)</i>																
1	张雪纯									0.0%						00:00:00
2	陈艳楠	0/1							0/1	0.0%						00:23:54
3	王丹	1/3	2/3	1/2	1/1	1/1	0/1	4/4	10/15	66.7%	1	4				00:55:04
4	尤婉莹	0/2	0/2	1/3	1/1	2/3			4/11	36.4%		4				00:35:31
5	孙姣		0/1		2/2				2/3	66.7%		2	1			01:00:00
6	凤洋	2/2	1/4	1/3	1/1	1/1			6/11	54.5%		2				01:00:00
7	练素琪									0.0%						00:00:00
9	姚梦园		2/3	0/4	1/1				3/8	37.5%			1			01:00:00
10	高静									0.0%						00:00:00
11	朱海云	0/1							0/1	0.0%						00:06:20
12	宋琛茜									0.0%						01:00:00
17	史雨欣									0.0%						00:00:00
18	戴小宇	6/6	2/2			1/1		3/3	12/12	100%		3		1		00:48:02
27	吴美琪									0.0%		1				00:13:40
<b>合计</b>		9/15	7/15	3/12	6/6	5/6	0/1	7/7	37/62	59.7%	1	16	2	1		
<i>(守门员)</i>																
12	宋琛茜	7/14	3/11	2/10	1/6	1/7		0/2	14/50	28.0%						01:00:00
<b>合计</b>		7/14	3/11	2/10	1/6	1/7		0/2	14/50	28.0%						

场上队员：得分/射门

守门员：救球/射门

全队合计	得分	被救	射失	击柱	封球	合计	%
远射	9	4		1	1	15	60.0%
近射	7	7	1			15	46.7%
边射	3	7		2		12	25.0%
快攻	6					6	100.0%
突破	5	1				6	83.3%
任意		1				1	0.0%
7M	7					7	100.0%







### 2016年全国女子手球锦标赛

#### 图式射门区域统计

轮次 10 场次 49

201605049-41-1/1

## 广西

1 胡霜梅	2 陆雪云	5 黄海玉	6 韦惠文	7 廖露	8 韦如芳	9 蓝雪梅	10 周琴																																																																								
<table border="1"><tr><td></td><td></td><td></td></tr><tr><td></td><td></td><td></td></tr><tr><td></td><td></td><td></td></tr></table>										<table border="1"><tr><td>1</td><td></td><td>1</td></tr><tr><td>1</td><td>1</td><td></td></tr><tr><td>2</td><td></td><td></td></tr></table>	1		1	1	1		2			<table border="1"><tr><td></td><td></td><td></td></tr><tr><td></td><td></td><td></td></tr><tr><td></td><td></td><td></td></tr></table>										<table border="1"><tr><td></td><td></td><td></td></tr><tr><td></td><td></td><td></td></tr><tr><td></td><td></td><td></td></tr></table>										<table border="1"><tr><td>1</td><td></td><td>1</td></tr><tr><td>1</td><td></td><td>1</td></tr><tr><td>1</td><td></td><td>2</td></tr></table>	1		1	1		1	1		2	<table border="1"><tr><td></td><td></td><td>1</td></tr><tr><td>1</td><td></td><td>2</td></tr><tr><td>1</td><td></td><td></td></tr></table>			1	1		2	1			<table border="1"><tr><td></td><td></td><td></td></tr><tr><td></td><td></td><td></td></tr><tr><td></td><td></td><td></td></tr></table>										<table border="1"><tr><td>2</td><td></td><td></td></tr><tr><td>3</td><td></td><td></td></tr><tr><td>1</td><td></td><td>1</td></tr></table>	2			3			1		1
1		1																																																																													
1	1																																																																														
2																																																																															
1		1																																																																													
1		1																																																																													
1		2																																																																													
		1																																																																													
1		2																																																																													
1																																																																															
2																																																																															
3																																																																															
1		1																																																																													
Post - 0 Miss - 0 Block - 0	Post - 0 Miss - 0 Block - 0	Post - 0 Miss - 0 Block - 0	Post - 0 Miss - 0 Block - 0	Post - 0 Miss - 1 Block - 2	Post - 0 Miss - 0 Block - 0	Post - 0 Miss - 0 Block - 0	Post - 1 Miss - 2 Block - 1																																																																								
11 曾蓝花	12 江燕红	14 黄艳芳	15 陈依依	16 商志运	17 杨杨	18 庞娇																																																																									
<table border="1"><tr><td></td><td></td><td></td></tr><tr><td></td><td></td><td></td></tr><tr><td></td><td></td><td></td></tr></table>										<table border="1"><tr><td></td><td></td><td></td></tr><tr><td></td><td></td><td></td></tr><tr><td></td><td></td><td></td></tr></table>										<table border="1"><tr><td>1</td><td>1</td><td></td></tr><tr><td>2</td><td></td><td></td></tr><tr><td></td><td>1</td><td>2</td></tr></table>	1	1		2				1	2	<table border="1"><tr><td></td><td></td><td></td></tr><tr><td></td><td></td><td></td></tr><tr><td></td><td></td><td></td></tr></table>										<table border="1"><tr><td></td><td></td><td></td></tr><tr><td></td><td></td><td></td></tr><tr><td></td><td></td><td></td></tr></table>										<table border="1"><tr><td></td><td></td><td>1</td></tr><tr><td>1</td><td></td><td></td></tr><tr><td></td><td>1</td><td>1</td></tr></table>			1	1				1	1	<table border="1"><tr><td></td><td></td><td></td></tr><tr><td></td><td></td><td></td></tr><tr><td></td><td></td><td></td></tr></table>										<table border="1"><tr><td></td><td></td><td></td></tr><tr><td></td><td></td><td></td></tr><tr><td></td><td></td><td></td></tr></table>									
1	1																																																																														
2																																																																															
	1	2																																																																													
		1																																																																													
1																																																																															
	1	1																																																																													
Post - 0 Miss - 0 Block - 0	Post - 0 Miss - 0 Block - 0	Post - 1 Miss - 0 Block - 0	Post - 0 Miss - 0 Block - 0	Post - 0 Miss - 0 Block - 0	Post - 0 Miss - 0 Block - 0	Post - 0 Miss - 0 Block - 0																																																																									

12 江燕红

0/2		0/1

16 商志运

		1/5
0/8	1/1	6/8
5/15	2/4	5/13

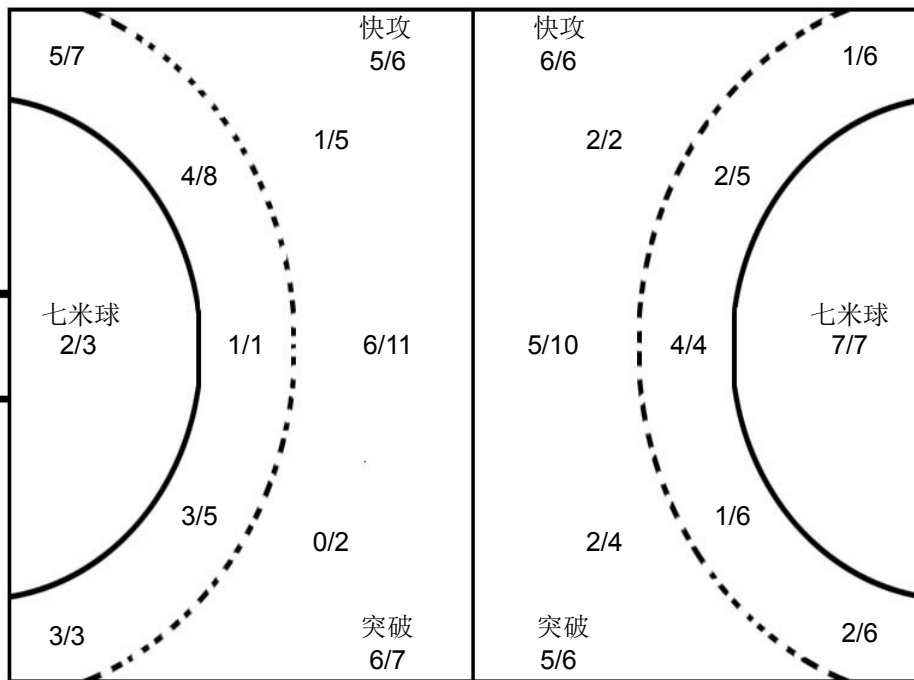
12 宋琛茜

0/5	0/1	1/5
0/9	2/3	3/6
1/6	3/5	4/10



## 四川

1 张雪纯	2 陈艳楠	3 王丹	4 尤婉莹	5 孙姣	6 凤洋	7 练素琪	9 姚梦园																																																																								
<table border="1"><tr><td></td><td></td><td></td></tr><tr><td></td><td></td><td></td></tr><tr><td></td><td></td><td></td></tr></table>										<table border="1"><tr><td></td><td></td><td></td></tr><tr><td></td><td></td><td></td></tr><tr><td></td><td></td><td></td></tr></table>										<table border="1"><tr><td>2</td><td></td><td>2</td></tr><tr><td>5</td><td>1</td><td></td></tr></table>	2		2	5	1		<table border="1"><tr><td>1</td><td></td><td>1</td></tr><tr><td>1</td><td></td><td>1</td></tr></table>	1		1	1		1	<table border="1"><tr><td>1</td><td></td><td></td></tr><tr><td></td><td></td><td>1</td></tr></table>	1					1	<table border="1"><tr><td></td><td></td><td>1</td></tr><tr><td>1</td><td></td><td>1</td></tr><tr><td>2</td><td>1</td><td>1</td></tr></table>			1	1		1	2	1	1	<table border="1"><tr><td></td><td></td><td></td></tr><tr><td></td><td></td><td></td></tr><tr><td></td><td></td><td></td></tr></table>										<table border="1"><tr><td></td><td></td><td>1</td></tr><tr><td></td><td></td><td></td></tr><tr><td></td><td></td><td>2</td></tr></table>			1						2									
2		2																																																																													
5	1																																																																														
1		1																																																																													
1		1																																																																													
1																																																																															
		1																																																																													
		1																																																																													
1		1																																																																													
2	1	1																																																																													
		1																																																																													
		2																																																																													
Post - 0 Miss - 0 Block - 0	Post - 0 Miss - 0 Block - 0	Post - 0 Miss - 0 Block - 0	Post - 2 Miss - 0 Block - 0	Post - 0 Miss - 0 Block - 0	Post - 1 Miss - 1 Block - 0	Post - 0 Miss - 0 Block - 0	Post - 0 Miss - 0 Block - 0																																																																								
10 高静	11 朱海云	12 宋琛茜	17 史雨欣	18 戴小宇	27 吴美琪																																																																										
<table border="1"><tr><td></td><td></td><td></td></tr><tr><td></td><td></td><td></td></tr><tr><td></td><td></td><td></td></tr></table>										<table border="1"><tr><td></td><td></td><td></td></tr><tr><td></td><td></td><td></td></tr><tr><td></td><td></td><td></td></tr></table>										<table border="1"><tr><td></td><td></td><td></td></tr><tr><td></td><td></td><td></td></tr><tr><td></td><td></td><td></td></tr></table>										<table border="1"><tr><td></td><td></td><td></td></tr><tr><td></td><td></td><td></td></tr><tr><td></td><td></td><td></td></tr></table>										<table border="1"><tr><td></td><td></td><td>2</td></tr><tr><td>5</td><td></td><td></td></tr><tr><td>2</td><td></td><td>3</td></tr></table>			2	5			2		3	<table border="1"><tr><td></td><td></td><td></td></tr><tr><td></td><td></td><td></td></tr><tr><td></td><td></td><td></td></tr></table>										<table border="1"><tr><td></td><td></td><td></td></tr><tr><td></td><td></td><td></td></tr><tr><td></td><td></td><td></td></tr></table>										<table border="1"><tr><td></td><td></td><td></td></tr><tr><td></td><td></td><td></td></tr><tr><td></td><td></td><td></td></tr></table>									
		2																																																																													
5																																																																															
2		3																																																																													
Post - 0 Miss - 0 Block - 0	Post - 0 Miss - 0 Block - 1	Post - 0 Miss - 0 Block - 0	Post - 0 Miss - 0 Block - 0	Post - 0 Miss - 0 Block - 0	Post - 0 Miss - 0 Block - 0																																																																										

注释: Post=击柱 Miss=射失 Block=被封





名次赛 Group F

女子 全国比赛

2016年全国女子手球锦标赛

Team A <b>A 山东</b>				Team B <b>B 北京</b>				Match Number <b>50</b>													
played in China		in the hall 滁州体育馆		on 13/09/2016		at 10:00 hours		Spectators													
Half-time (30')	<b>A</b> 22	<b>B</b> 13	End of playing time	<b>A</b> 36	<b>B</b> 24	1st extra time	<b>A</b>	<b>B</b>	2nd extra time	<b>A</b>	<b>B</b>	After penalty throws	<b>A</b>	<b>B</b>							
Number of 7 m	<b>A</b> 3 / 3	Team time-out 1 14:53 2 3			Full name of players and officials				Team time-out 1 11:08 2 47:58 3			<b>B</b> 2 / 4	Number of 7 m								
No.	Team <b>A</b>					G	W	2'	D	DR	No.	Team <b>B</b>					G	W	2'	D	DR
1	路畅										1	宋嘉蕾									
2	林燕群					5					3	季小桐					3		1		
7	杨嘉露					3		1			4	孙佳						1	1		
8	王彬					6					6	刘亚男									
9	周钰婷							1			8	杨铭豫					1				
10	田秀秀					6	1				10	刘莎									
11	吕青纹					3					11	纪婉					6				
12	张苑琳										16	王海叶									
15	吴作扬										17	杨政赢					5				
19	姜伟珊										22	李海鸥									
20	张悦					1	1	1			23	田媛					2	1			
22	朱赟										28	闫美珠									
23	徐悦					3		2			33	栾征									
28	崔金娜					2		1			47	刘泽									
33	王彩琳					5					58	李华					1	1			
77	穆庆丛					2					69	石梓薇					6				
A	杜晓青										A	蔡建国									
B	马海湧 (主教练)										B	石伟 (主教练)									
C	徐强										C	李翼									
E	王日东										E	史良玉									
<b>A</b>	Signature of Responsible Official of the Teams (Off. A)																		<b>B</b>		
TP	Remarks of Referee / CHA Official																		TP		

Signatures

Referees	张耿 (CHN)	林晓佟 (CHN)		
Techn. Delegates	刘书勇 (CHN)			
CHA Official	于中迅 (CHN)			

Note: Number of 7m Throws Awarded to Team A and B, Goals (G), Warnings (W), Suspensions (2'), Direct Disqualification (D), Disqualification with Report (DR) and Team Penalty (TP).



2016年全国女子手球锦标赛  
竞赛技术统计(媒体表)

名次赛	组别	F	轮次	10	场次	50
滁州体育馆		13/09/2016			201605050-51-1/1	
山东	山东	36	vs	24	北京	北京
<b>22 : 13</b>						

裁判员		张耿 (CHN)											林晓佟 (CHN)										
山东		远射	近射	边射	快攻	突破	任意球	7m球	合计	%	助攻	失误	警告	2'	D & DR	比赛进程		北京					
主教练: 马海湧																1st Half							
1	刘畅															10	田秀秀	1	00:33	0			
2	林燕群		3/4	1/2				1/1	5/7	71.4						1	02:24	1	8	杨铭豫			
7	杨嘉露	2/2		0/1				1/1	3/4	75.0				1		2	04:51	2	17	杨政赢			
8	王彬	1/4	2/2			3/4			6/10	60.0	2	4				2	05:33	3	69	石梓薇			
9	周钰婷	0/1	0/1						0/2	0.0	1	1	1			3	07:12	3					
10	田秀秀		3/4		1/1	1/1	1/1		6/7	85.7		2	1			4	08:33	4	3	1	纪婉		
11	吕青纹	0/1	1/1		2/2				3/4	75.0						5	08:51	4					
12	张苑琳															6	10:00	4					
15	吴作扬															7	10:38	4					
19	姜伟珊		0/3		0/1				0/4	0.0						7	11:46	5	3	季小桐			
20	张悦				1/1				1/1	100		2	1	1		8	11:55	5					
22	朱贇															9	13:11	5					
23	徐悦		3/3						3/3	100	1			2		9	14:03	6	69	石梓薇			
28	崔金娜		1/1		1/1				2/2	100		1		1		9	14:43	7	17	杨政赢			
33	王彩琳	1/3	2/2	0/1		2/2			5/8	62.5		1				10	16:35	7					
77	穆庆丛	0/1	0/1		1/1			1/1	2/4	50.0		1				10	17:54	7					
<b>运动员 合计</b>		<b>4/12</b>	<b>15/22</b>	<b>1/4</b>	<b>6/7</b>	<b>6/7</b>	<b>1/1</b>	<b>3/3</b>	<b>36/56</b>	<b>64.3</b>	<b>4</b>	<b>16</b>	<b>3</b>	<b>5</b>		10	18:42	7					
1	刘畅	1/1	1/2		0/2	0/1		1/2	3/8	37.5						12	18:50	8	17	杨政赢			
12	张苑琳	7/14	1/4	1/4	1/5	0/1	1/1	1/2	12/31	38.7						13	19:43	8					
<b>守门员 合计</b>		<b>8/15</b>	<b>2/6</b>	<b>1/4</b>	<b>1/7</b>	<b>0/2</b>	<b>1/1</b>	<b>2/4</b>	<b>15/39</b>	<b>38.5</b>						14	20:08	8					
<b>北京</b>		远射	近射	边射	快攻	突破	任意球	7m球	合计	%	助攻	失误	警告	2'	D & DR	2nd Half							
教练: 石伟																7	杨嘉露	23	00:05	13			
1	宋嘉蕾											1				33	王彩琳	24	02:24	13			
3	季小桐	1/2	1/1	0/1		1/1			3/5	60.0		4		1		24	03:55	14	3	季小桐			
4	孙佳		0/1						0/1	0.0	1		1	1		24	04:45	15	11	纪婉			
6	刘亚男															25	05:11	15					
8	杨铭豫				1/1				1/1	100		1				25	05:26	16	17	杨政赢			
10	刘莎							0/2	0/2	0.0						25	06:11	17	11	纪婉			
11	纪婉			2/3	3/3	1/1			6/7	85.7		2				26	06:56	17					
16	王海叶															27	08:08	17					
17	杨政赢	3/10	2/2	0/1			0/1		5/14	35.7		8				27	09:38	18	69	石梓薇			
22	李海鸥															28	09:45	18					
23	田媛	0/2	1/3		1/1				2/6	33.3		1	1			28	10:07	19	69	石梓薇			
28	闫美珠															29	11:16	19					
33	栾征															30	12:14	19					
47	刘泽			1/2					1/2	50.0		1	1			30	16:31	20	11	纪婉			
58	李华															31	16:51	20					
69	石梓薇	3/5	0/1		1/2			2/2	6/10	60.0	3	2				33	王彩琳	32	19:10	20			
<b>运动员 合计</b>		<b>7/19</b>	<b>4/8</b>	<b>3/7</b>	<b>6/7</b>	<b>2/2</b>	<b>0/1</b>	<b>2/4</b>	<b>24/48</b>	<b>50.0</b>	<b>4</b>	<b>20</b>	<b>3</b>	<b>2</b>		11	吕青纹	33	20:13	20			
1	宋嘉蕾	1/4	5/14	2/2	1/5	0/4	0/1	0/1	9/31	29.0		1				77	穆庆丛	34	20:56	20			
47	刘泽	2/3	1/7	0/1	0/2	0/2		0/2	3/17	17.6						34	22:25	21	69	石梓薇			
<b>守门员 合计</b>		<b>3/7</b>	<b>6/21</b>	<b>2/3</b>	<b>1/7</b>	<b>0/6</b>	<b>0/1</b>	<b>0/3</b>	<b>12/48</b>	<b>25.0</b>		<b>1</b>				35	23:13	21					

场上队员: 得分 / 射门

守门员: 救球 / 射门

快攻	Fast Break	突破	Breakthrough	任意球	Free Throw	7M球	7M Throw	助攻	Assist
警告	Warning	失误	Error	2'	Suspension	D	取消资格	DR	取消资格+报告





### 2016年全国女子手球锦标赛 图式比赛技术统计表

轮次 10

场次 50

201605050-21-1/1

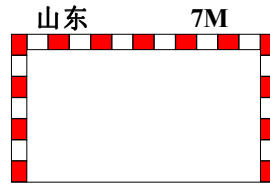
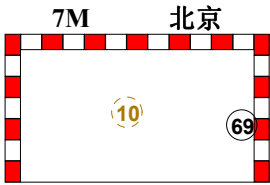
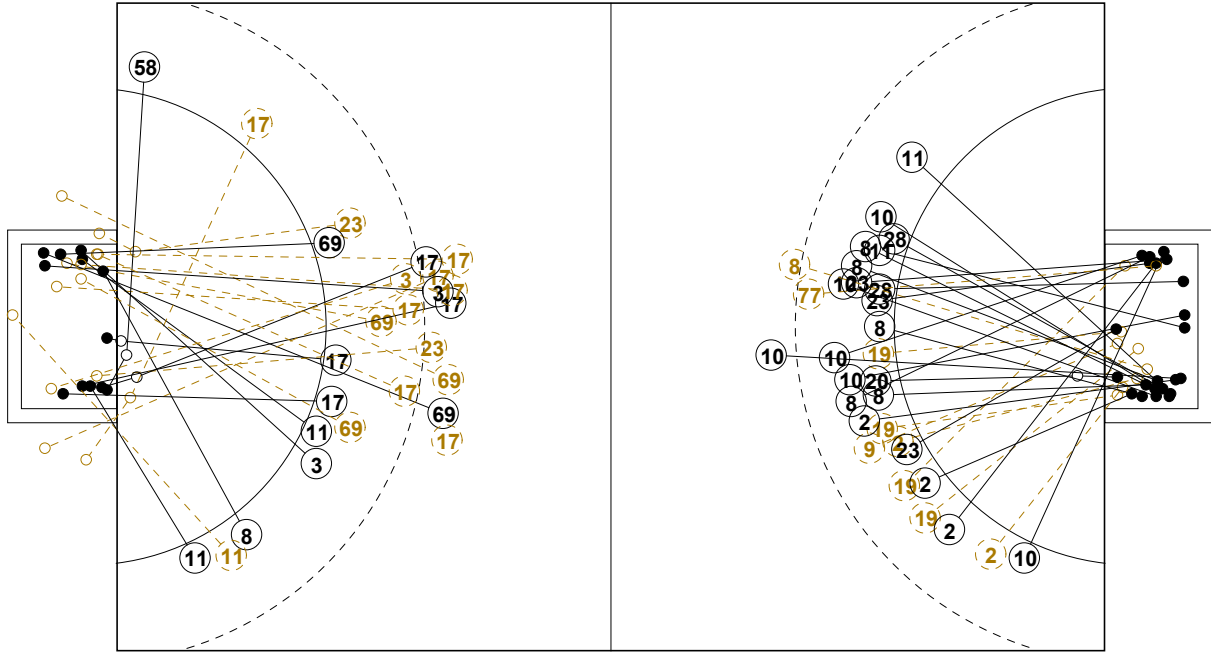

1st Half  
13 : 22

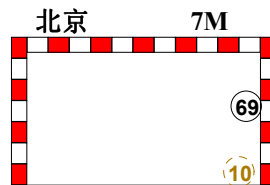
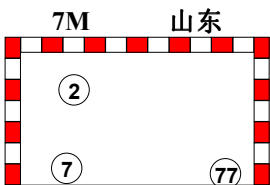
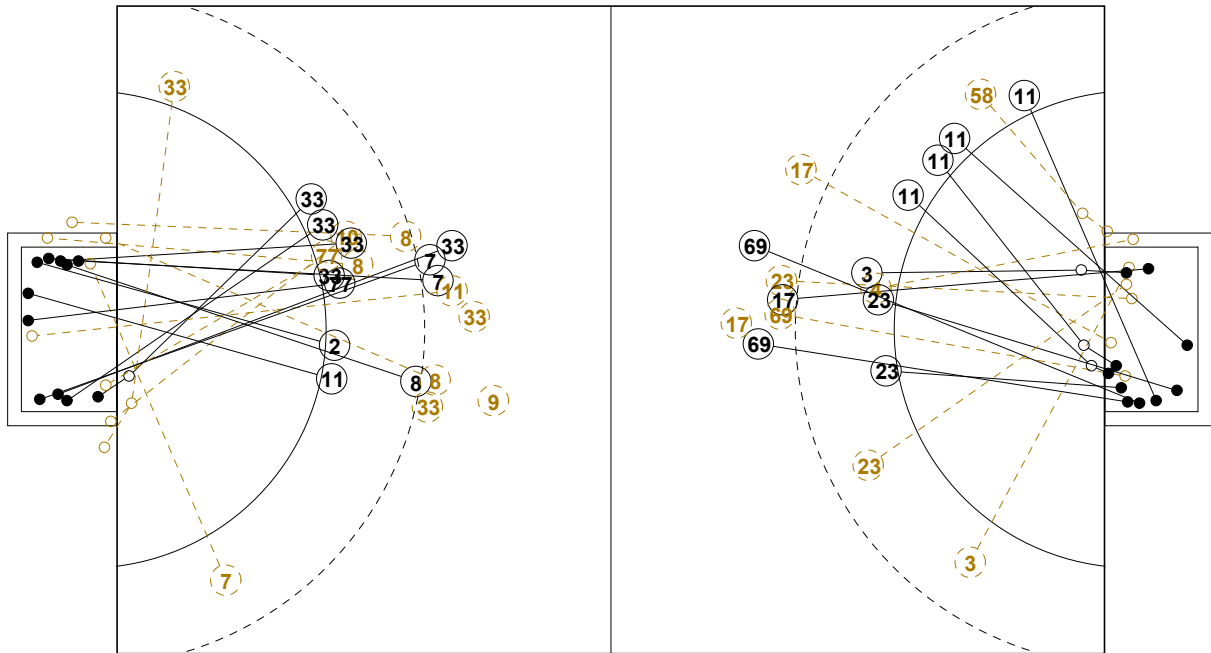

2nd Half  
36 : 24



## 2016年全国女子手球锦标赛

## 个人/全队技术统计表

正式表  
手球  
女子名次赛  
轮次 10组别 F  
场次 50201605050-14-1/2  
滁州体育馆  
13/09/2016 10:00

号码	姓名	远射	近射	边射	快攻	突破	任意	7M	合计	%	助攻	失误	警告	2'	取消	时间
<b>山东(山东)</b>																
<i>(场上队员)</i>																
1	路畅									0.0%						00:18:06
2	林燕群		3/4	1/2				1/1	5/7	71.4%		4				00:44:54
7	杨嘉露	2/2		0/1				1/1	3/4	75.0%				1		00:29:06
8	王彬	1/4	2/2			3/4			6/10	60.0%	2	4				00:19:29
9	周钰婷	0/1	0/1						0/2	0.0%	1	1	1			00:23:09
10	田秀秀		3/4		1/1	1/1	1/1		6/7	85.7%		2	1			00:34:34
11	吕青纹	0/1	1/1		2/2				3/4	75.0%						00:50:35
12	张苑琳									0.0%						00:41:54
15	吴作扬									0.0%						00:00:00
19	姜伟珊		0/3		0/1				0/4	0.0%						00:10:09
20	张悦				1/1				1/1	100%		2	1	1		00:37:48
22	朱赞									0.0%						00:00:00
23	徐悦		3/3						3/3	100%	1			2		00:36:21
28	崔金娜		1/1		1/1				2/2	100%		1		1		00:20:50
33	王彩琳	1/3	2/2	0/1		2/2			5/8	62.5%		1				00:28:52
77	穆庆丛	0/1	0/1		1/1			1/1	2/4	50.0%		1				00:22:47
<b>合计</b>		4/12	15/22	1/4	6/7	6/7	1/1	3/3	36/56	64.3%	4	16	3	5		
<i>(守门员)</i>																
1	路畅	1/1	1/2		0/2	0/1		1/2	3/8	37.5%						00:18:06
12	张苑琳	7/14	1/4	1/4	1/5	0/1	1/1	1/2	12/31	38.7%						00:41:54
<b>合计</b>		8/15	2/6	1/4	1/7	0/2	1/1	2/4	15/39	38.5%						

场上队员：得分/射门

守门员：救球/射门

全队合计	得分	被救	射失	击柱	封球	合计	%
远射	4	3	1	1	3	12	33.3%
近射	15	6		1		22	68.2%
边射	1	2	1			4	25.0%
快攻	6	1				7	85.7%
突破	6			1		7	85.7%
任意	1					1	100.0%
7M	3					3	100.0%





## 2016年全国女子手球锦标赛

## 个人/全队技术统计表

正式表  
手球  
女子名次赛  
轮次 10组别 F  
场次 50201605050-14-2/2  
滁州体育馆  
13/09/2016 10:00

号码	姓名	远射	近射	边射	快攻	突破	任意	7M	合计	%	助攻	失误	警告	2'	取消	时间
<b>北京(北京)</b>																
<i>(上场队员)</i>																
1	宋嘉蕾									0.0%		1				00:32:37
3	季小桐	1/2	1/1	0/1		1/1			3/5	60.0%		4		1		00:26:15
4	孙佳		0/1						0/1	0.0%	1		1	1		00:41:15
6	刘亚男									0.0%						00:00:00
8	杨铭豫				1/1				1/1	100%		1				00:19:00
10	刘莎							0/2	0/2	0.0%						00:00:14
11	纪婉			2/3	3/3	1/1			6/7	85.7%		2				00:55:51
16	王海叶									0.0%						00:00:00
17	杨政赢	3/10	2/2	0/1			0/1		5/14	35.7%		8				00:56:06
22	李海鸥									0.0%						00:00:00
23	田媛	0/2	1/3		1/1				2/6	33.3%		1	1			00:50:02
28	闫美珠									0.0%						00:00:00
33	栾征									0.0%						00:00:00
47	刘泽									0.0%						00:27:23
58	李华			1/2					1/2	50.0%		1	1			00:56:17
69	石梓薇	3/5	0/1		1/2			2/2	6/10	60.0%	3	2				00:52:02
<b>合计</b>		7/19	4/8	3/7	6/7	2/2	0/1	2/4	24/48	50.0%	4	20	3	2		
<i>(守门员)</i>																
1	宋嘉蕾	1/4	5/14	2/2	1/5	0/4	0/1	0/1	9/31	29.0%		1				00:32:37
47	刘泽	2/3	1/7	0/1	0/2	0/2		0/2	3/17	17.6%						00:27:23
<b>合计</b>		3/7	6/21	2/3	1/7	0/6	0/1	0/3	12/48	25.0%		1				

场上队员：得分/射门

守门员：救球/射门

全队合计	得分	被救	射失	击柱	封球	合计	%
远射	7	8	2		2	19	36.8%
近射	4	2		2		8	50.0%
边射	3	1	1	2		7	42.9%
快攻	6	1				7	85.7%
突破	2					2	100.0%
任意		1				1	0.0%
7M	2	2				4	50.0%





### 2016年全国女子手球锦标赛

#### 图式射门区域统计

轮次 10 场次 50

201605050-41-1/1

## 山东

1 路畅	2 林燕群	7 杨嘉露	8 王彬	9 周钰婷	10 田秀秀	11 吕青纹	12 张苑琳																																																																								
<table border="1"><tr><td></td><td></td><td></td></tr><tr><td></td><td></td><td></td></tr><tr><td></td><td></td><td></td></tr></table>										<table border="1"><tr><td>1</td><td></td><td>2</td></tr><tr><td>1</td><td></td><td></td></tr><tr><td></td><td></td><td>1</td></tr></table>	1		2	1					1	<table border="1"><tr><td>1</td><td></td><td></td></tr><tr><td></td><td></td><td>1</td></tr><tr><td>1</td><td></td><td></td></tr></table>	1					1	1			<table border="1"><tr><td></td><td></td><td>1</td></tr><tr><td>1</td><td></td><td>4</td></tr><tr><td></td><td></td><td></td></tr></table>			1	1		4				<table border="1"><tr><td></td><td></td><td></td></tr><tr><td></td><td></td><td></td></tr><tr><td></td><td></td><td></td></tr></table>										<table border="1"><tr><td></td><td>1</td><td>1</td></tr><tr><td>2</td><td></td><td>2</td></tr><tr><td></td><td></td><td></td></tr></table>		1	1	2		2				<table border="1"><tr><td></td><td>1</td><td>2</td></tr><tr><td></td><td></td><td></td></tr><tr><td></td><td></td><td></td></tr></table>		1	2							<table border="1"><tr><td></td><td></td><td></td></tr><tr><td></td><td></td><td></td></tr><tr><td></td><td></td><td></td></tr></table>									
1		2																																																																													
1																																																																															
		1																																																																													
1																																																																															
		1																																																																													
1																																																																															
		1																																																																													
1		4																																																																													
	1	1																																																																													
2		2																																																																													
	1	2																																																																													
Post - 0 Miss - 0 Block - 0	Post - 0 Miss - 0 Block - 0	Post - 0 Miss - 0 Block - 0	Post - 2 Miss - 1 Block - 0	Post - 0 Miss - 0 Block - 1	Post - 1 Miss - 0 Block - 0	Post - 0 Miss - 0 Block - 0	Post - 0 Miss - 0 Block - 0																																																																								
15 吴作扬	19 姜伟珊	20 张悦	22 朱贇	23 徐悦	28 崔金娜	33 王彩琳	77 穆庆丛																																																																								
<table border="1"><tr><td></td><td></td><td></td></tr><tr><td></td><td></td><td></td></tr><tr><td></td><td></td><td></td></tr></table>										<table border="1"><tr><td></td><td></td><td></td></tr><tr><td></td><td></td><td></td></tr><tr><td></td><td></td><td></td></tr></table>										<table border="1"><tr><td></td><td></td><td></td></tr><tr><td></td><td></td><td></td></tr><tr><td></td><td></td><td>1</td></tr></table>									1	<table border="1"><tr><td></td><td></td><td></td></tr><tr><td></td><td></td><td></td></tr><tr><td></td><td></td><td></td></tr></table>										<table border="1"><tr><td>1</td><td></td><td></td></tr><tr><td>1</td><td></td><td></td></tr><tr><td></td><td>1</td><td></td></tr></table>	1			1				1		<table border="1"><tr><td>1</td><td></td><td></td></tr><tr><td></td><td></td><td>1</td></tr><tr><td></td><td></td><td></td></tr></table>	1					1				<table border="1"><tr><td></td><td></td><td>1</td></tr><tr><td>2</td><td></td><td>1</td></tr><tr><td>1</td><td></td><td></td></tr></table>			1	2		1	1			<table border="1"><tr><td></td><td>1</td><td></td></tr><tr><td></td><td></td><td></td></tr><tr><td></td><td></td><td>1</td></tr></table>		1							1
		1																																																																													
1																																																																															
1																																																																															
	1																																																																														
1																																																																															
		1																																																																													
		1																																																																													
2		1																																																																													
1																																																																															
	1																																																																														
		1																																																																													
Post - 0 Miss - 0 Block - 0	Post - 0 Miss - 0 Block - 0	Post - 0 Miss - 0 Block - 0	Post - 0 Miss - 0 Block - 0	Post - 0 Miss - 0 Block - 0	Post - 0 Miss - 0 Block - 0	Post - 0 Miss - 1 Block - 2	Post - 0 Miss - 0 Block - 0																																																																								

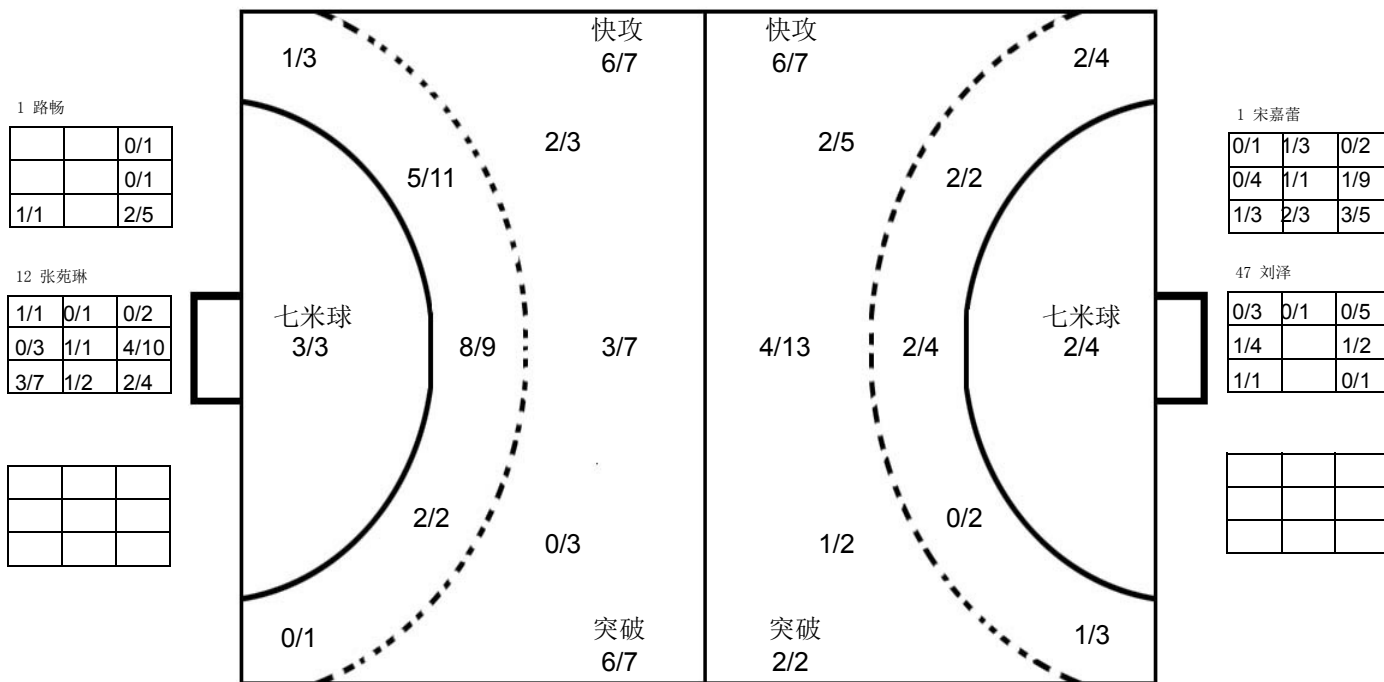

## 北京

1 宋嘉蕾	3 季小桐	4 孙佳	6 刘亚男	8 杨铭豫	10 刘莎	11 纪婉	16 王海叶																																																																								
<table border="1"><tr><td></td><td></td><td></td></tr><tr><td></td><td></td><td></td></tr><tr><td></td><td></td><td></td></tr></table>										<table border="1"><tr><td></td><td></td><td>1</td></tr><tr><td></td><td></td><td>1</td></tr><tr><td>1</td><td></td><td></td></tr></table>			1			1	1			<table border="1"><tr><td></td><td></td><td></td></tr><tr><td></td><td></td><td></td></tr><tr><td></td><td></td><td></td></tr></table>										<table border="1"><tr><td></td><td></td><td></td></tr><tr><td></td><td></td><td></td></tr><tr><td></td><td></td><td></td></tr></table>										<table border="1"><tr><td></td><td></td><td></td></tr><tr><td></td><td></td><td></td></tr><tr><td></td><td></td><td>1</td></tr></table>									1	<table border="1"><tr><td></td><td></td><td></td></tr><tr><td></td><td></td><td></td></tr><tr><td></td><td></td><td></td></tr></table>										<table border="1"><tr><td></td><td>1</td><td></td></tr><tr><td></td><td></td><td>2</td></tr><tr><td>1</td><td></td><td>2</td></tr></table>		1				2	1		2	<table border="1"><tr><td></td><td></td><td></td></tr><tr><td></td><td></td><td></td></tr><tr><td></td><td></td><td></td></tr></table>									
		1																																																																													
		1																																																																													
1																																																																															
		1																																																																													
	1																																																																														
		2																																																																													
1		2																																																																													
Post - 0 Miss - 0 Block - 0	Post - 0 Miss - 0 Block - 0	Post - 1 Miss - 0 Block - 0	Post - 0 Miss - 0 Block - 0	Post - 0 Miss - 0 Block - 0	Post - 0 Miss - 0 Block - 0	Post - 1 Miss - 0 Block - 0	Post - 0 Miss - 0 Block - 0																																																																								
17 杨政赢	22 李海鸥	23 田媛	28 闫美珠	33 栾征	47 刘泽	58 李华	69 石梓薇																																																																								
<table border="1"><tr><td></td><td></td><td></td></tr><tr><td>3</td><td></td><td></td></tr><tr><td>1</td><td>1</td><td></td></tr></table>				3			1	1		<table border="1"><tr><td></td><td></td><td></td></tr><tr><td></td><td></td><td></td></tr><tr><td></td><td></td><td></td></tr></table>										<table border="1"><tr><td></td><td></td><td>1</td></tr><tr><td></td><td></td><td></td></tr><tr><td></td><td></td><td>1</td></tr></table>			1						1	<table border="1"><tr><td></td><td></td><td></td></tr><tr><td></td><td></td><td></td></tr><tr><td></td><td></td><td></td></tr></table>										<table border="1"><tr><td></td><td></td><td></td></tr><tr><td></td><td></td><td></td></tr><tr><td></td><td></td><td></td></tr></table>										<table border="1"><tr><td></td><td></td><td></td></tr><tr><td></td><td></td><td></td></tr><tr><td></td><td></td><td></td></tr></table>										<table border="1"><tr><td></td><td></td><td></td></tr><tr><td></td><td></td><td></td></tr><tr><td>1</td><td></td><td></td></tr></table>							1			<table border="1"><tr><td></td><td></td><td>1</td></tr><tr><td></td><td></td><td>4</td></tr><tr><td></td><td></td><td>1</td></tr></table>			1			4			1
3																																																																															
1	1																																																																														
		1																																																																													
		1																																																																													
1																																																																															
		1																																																																													
		4																																																																													
		1																																																																													
Post - 0 Miss - 2 Block - 2	Post - 0 Miss - 0 Block - 0	Post - 1 Miss - 0 Block - 0	Post - 0 Miss - 0 Block - 0	Post - 0 Miss - 0 Block - 0	Post - 0 Miss - 0 Block - 0	Post - 1 Miss - 0 Block - 0	Post - 0 Miss - 1 Block - 0																																																																								

注释: Post=击柱 Miss=射失 Block=被封



7-8名

女子 全国比赛

2016年全国女子手球锦标赛

Team A		Team B		Match Number																	
A 辽宁		B 天津		51																	
played in		in the hall		on																	
China		滁州体育馆		13/09/2016																	
				at 14:00 hours																	
Spectators																					
Half-time (30')	A 13	B 11	End of playing time	A 31	B 26																
1st extra time		A		B																	
2nd extra time		A		B																	
After penalty throws		A		B																	
Number of 7 m	A 3/7	Team time-out			B 3/3																
Full name of players and officials		Team time-out		Number of 7 m																	
		1 07:53		2 49:18																	
		3																			
No.	Team A					G	W	2'	D	DR	No.	Team B					G	W	2'	D	DR
1	于薇诗										3	王晓梅									
2	朱徐婷					4					4	朱佳瑜					3				
3	赵莹雪										5	丁丽洁							1		
5	辛颜					5					7	张心茹									
8	杨娇					6	1				8	张慧					1	1	1		
9	刁卫丽										10	张文慧					2	1			
12	刘雪菲										11	蔡雪洁					7		1		
13	杜江花					5					12	王欣冉									
19	吕秋雪					5	1				14	刘洁									
20	孙弘玲										15	李窈窈									
24	陈思雨										16	王选									
27	王丹										17	聂晓雪					2				
66	梁海珍					6					18	舒文琪					5		1		
93	赵琦										21	李默雅					1				
98	张永婷										22	王聪									
99	郑锦宜										23	周梦雪					5	1			
A	吕艳梦										A	付明双									
B	李丽荣										B	王明星 (主教练)									
C	金京男 (主教练)										C	岳连娥									
E	程万里																				
Signature of Responsible Official of the Teams (Off. A)																				B	
TP	Remarks of Referee / CHA Official																		TP		

Signatures

Referees	徐健 (CHN)	曹宏俊 (CHN)		
Techn. Delegates	吴国忠 (CHN)			
CHA Official	高斌 (CHN)			

Note: Number of 7m Throws Awarded to Team A and B, Goals (G), Warnings (W), Suspensions (2'), Direct Disqualification (D), Disqualification with Report (DR) and Team Penalty (TP).

Table Officials: 伍豪

刘晓辉

Statisticians: 黄岩

刘永欢





2016年全国女子手球锦标赛  
竞赛技术统计(媒体表)

7-8名	组别	X	轮次	10	场次	51
滁州体育馆		13/09/2016			201605051-51-1/1	
辽宁		辽宁	31	vs	26	天津
		13 : 11				

裁判员		徐健 (CHN)											曹宏俊 (CHN)										
辽宁		远射	近射	边射	快攻	突破	任意球	7m球	合计	%	助攻	失误	警告	2'	D & DR	辽宁		比赛进程		天津			
主教练：金京男																		1st Half					
1	于薇诗															13	杜江花	0	01:12	1	23	周梦雪	
2	朱徐婷			1/2	3/3			4/5	80.0		3					66	梁海珍	1	01:56	1			
3	赵莹雪																	2	02:33	1			
5	辛颜	0/1	4/7			1/1		5/9	55.6	1	2					5	辛颜	2	04:21	2	17	聂晓雪	
8	杨娇	4/6	0/1				0/1	2/5	46.2	6	1	1				8	杨娇	3	05:22	2			
9	刁卫丽															4	杨娇	4	07:30	2			
12	刘雪菲															4	杨娇	4	08:21	3	11	蔡雪洁	
13	杜江花		3/3		1/1			1/2	5/6	83.3		2				13	杜江花	5	08:41	3			
19	吕秋雪	1/3	3/3	0/2	1/1			5/9	55.6			1				19	吕秋雪	6	10:45	3			
20	孙弘玲															6	吕秋雪	6	11:57	4	4	朱佳瑜	
24	陈思雨															6	吕秋雪	7	15:14	5			
27	王丹															5	辛颜	7	15:47	6	23	周梦雪	
66	梁海珍		0/1	5/6	1/1			6/8	75.0		2					7	辛颜	7	16:50	7	18	舒文琪	
93	赵琦															8	朱徐婷	8	17:12	7			
98	张永婷				0/1			0/1	0.0							8	朱徐婷	8	17:45	8	18	舒文琪	
99	郑锦宜															8	朱徐婷	9	18:29	9	11	蔡雪洁	
运动员 合计		5/10	10/15	6/10	6/7	1/1	0/1	3/7	31/51	60.8	7	10	3			8	杨娇	10	20:06	9			
1	于薇诗	0/4	2/3			0/1	0/1	2/9	22.2							2	朱徐婷	10	20:59	9			
27	王丹	4/11	3/7	1/2	0/1	0/2	0/1	0/3	8/27	29.6						8	杨娇	10	21:19	10	11	蔡雪洁	
守门员 合计		4/15	5/10	1/2	0/1	0/3	0/2	0/3	10/36	27.8						8	杨娇	11	21:56	10			
天津		远射	近射	边射	快攻	突破	任意球	7m球	合计	%	助攻	失误	警告	2'	D & DR			2nd Half					
教练：王明星																5	辛颜	13	00:56	12	11	蔡雪洁	
3	王晓梅															14	辛颜	14	01:26	12			
4	朱佳瑜							3/3	3/3	100						14	辛颜	14	01:57	13	10	张文慧	
5	丁丽洁													1		5	辛颜	15	02:19	13			
7	张心茹															15	辛颜	15	03:18	14	18	舒文琪	
8	张慧		0/1	0/2	1/2			1/5	20.0		1	1	1			15	辛颜	15	04:17	15	21	李默雅	
10	张文慧		2/2					2/2	100		4	1				15	辛颜	15	05:41	16	4	朱佳瑜	
11	蔡雪洁	6/13	0/2		0/1		1/1	7/17	41.2		1		1			8	杨娇	16	06:05	16			
12	王欣冉															16	梁海珍	16	06:59	17	23	周梦雪	
14	刘洁															66	梁海珍	17	07:33	17			
15	李宛宛															66	梁海珍	17	08:20	18	4	朱佳瑜	
16	王选										1	1				18	梁海珍	18	08:54	18			
17	聂晓雪	0/2	1/1			1/1		2/4	50.0			1				18	梁海珍	18	09:29	19	18	舒文琪	
18	舒文琪	3/7	0/2			1/1	1/1	5/11	45.5	2	2		1			18	梁海珍	18	10:41	20	11	蔡雪洁	
21	李默雅	0/1		1/1				1/2	50.0							19	吕秋雪	19	11:33	20			
22	王聪															8	杨娇	20	13:43	20			
23	周梦雪	2/6	2/2			1/1		5/9	55.6	1	2	1				20	吕秋雪	20	14:15	21	10	张文慧	
运动员 合计		11/29	5/10	1/3	1/3	3/3	2/2	3/3	26/53	49.1	4	12	3	4		13	杜江花	21	14:23	21	10	张文慧	
12	王欣冉		0/1					0/1	0/2	0.0						19	吕秋雪	21	15:32	22	11	蔡雪洁	
16	王选	2/7	2/11	3/9	0/6	0/1		2/4	9/38	23.7	1	1				22	梁海珍	22	15:52	22			
守门员 合计		2/7	2/12	3/9	0/6	0/1		2/5	9/40	22.5	1	1				66	梁海珍	23	16:36	22			

场上队员：得分 / 射门

守门员：救球 / 射门

快攻	Fast Break		突破	Breakthrough		任意球	Free Throw		7M球	7M Throw		助攻	Assist
警告	Warning		失误	Error		2'	Suspension		D	取消资格		DR	取消资格+报告





### 2016年全国女子手球锦标赛 图式比赛技术统计表

轮次 10

场次 51

201605051-21-1/1

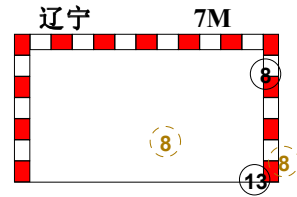
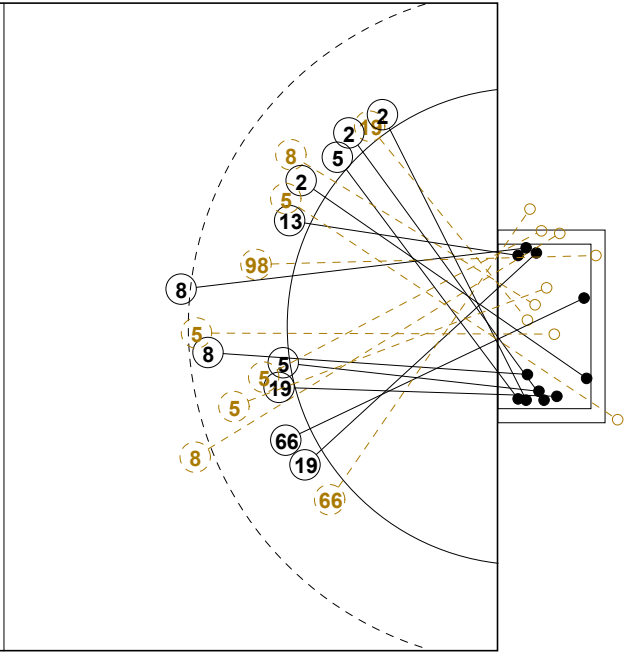
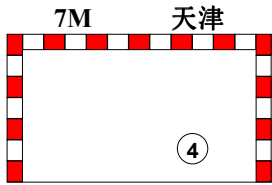
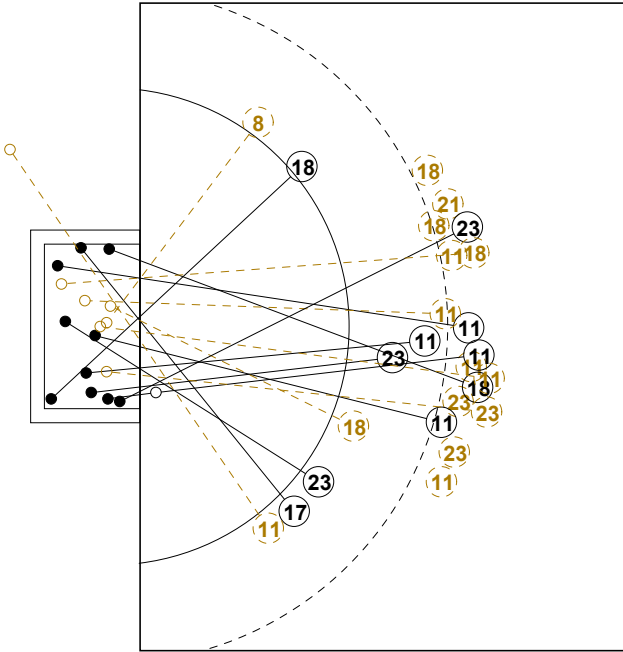

1st Half  
11 : 13

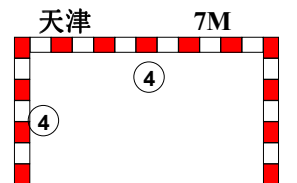
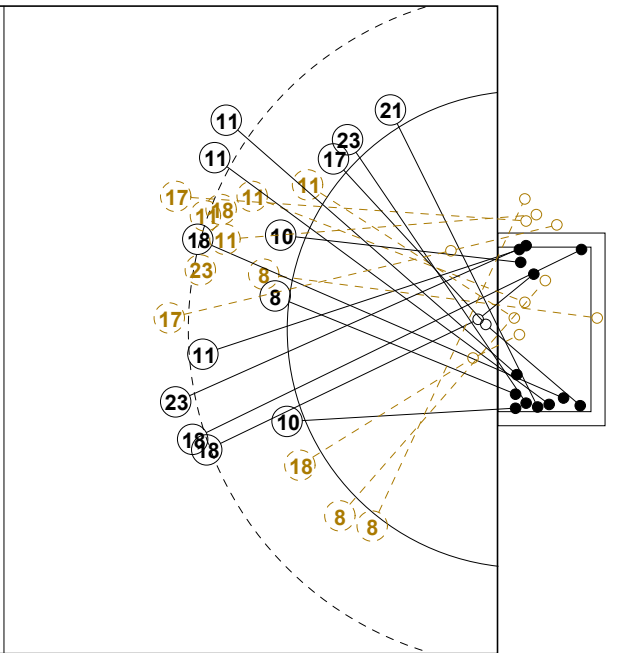
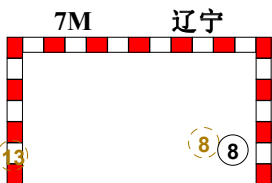
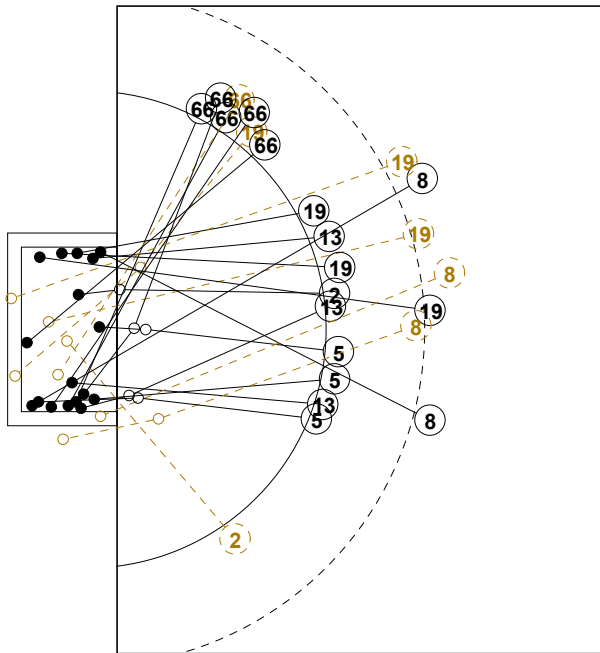

2nd Half  
31 : 26



## 2016年全国女子手球锦标赛

## 个人/全队技术统计表

正式表  
手球  
女子7-8名  
轮次 10组别 X  
场次 51201605051-14-1/2  
滁州体育馆  
13/09/2016 14:00

号码	姓名	远射	近射	边射	快攻	突破	任意	7M	合计	%	助攻	失误	警告	2'	取消	时间
<b>辽宁(辽宁)</b>																
<i>(场上队员)</i>																
1	于薇诗									0.0%						00:12:27
2	朱徐婷			1/2	3/3				4/5	80.0%		3				01:00:00
3	赵莹雪									0.0%						00:00:00
5	辛颜	0/1	4/7			1/1			5/9	55.6%	1	2				01:00:00
8	杨娇	4/6	0/1				0/1	2/5	6/13	46.2%	6	1	1			01:00:00
9	刁卫丽									0.0%						00:00:00
12	刘雪菲									0.0%						00:00:00
13	杜江花		3/3		1/1			1/2	5/6	83.3%		2				00:39:34
19	吕秋雪	1/3	3/3	0/2	1/1				5/9	55.6%			1			01:23:03
20	孙弘玲									0.0%						00:00:00
24	陈思雨									0.0%						00:00:00
27	王丹									0.0%						00:47:33
66	梁海珍		0/1	5/6	1/1				6/8	75.0%		2				01:00:00
93	赵琦									0.0%						00:00:00
98	张永婷				0/1				0/1	0.0%						00:06:56
99	郑锦宜									0.0%			1			00:13:28
<b>合计</b>		5/10	10/15	6/10	6/7	1/1	0/1	3/7	31/51	60.8%	7	10	3			
<i>(守门员)</i>																
1	于薇诗	0/4	2/3			0/1	0/1		2/9	22.2%						00:12:27
27	王丹	4/11	3/7	1/2	0/1	0/2	0/1	0/3	8/27	29.6%						00:47:33
<b>合计</b>		4/15	5/10	1/2	0/1	0/3	0/2	0/3	10/36	27.8%						

场上队员：得分/射门

守门员：救球/射门

全队合计	得分	被救	射失	击柱	封球	合计	%
远射	5	2	1	2		10	50.0%
近射	10	2	2	1		15	66.7%
边射	6	3		1		10	60.0%
快攻	6			1		7	85.7%
突破	1					1	100.0%
任意				1		1	0.0%
7M	3	2		2		7	42.9%





## 2016年全国女子手球锦标赛

## 个人/全队技术统计表

正式表  
手球  
女子7-8名  
轮次 10组别 X  
场次 51201605051-14-2/2  
滁州体育馆  
13/09/2016 14:00

号码	姓名	远射	近射	边射	快攻	突破	任意	7M	合计	%	助攻	失误	警告	2'	取消	时间
<b>天津(天津)</b>																
<i>(上场队员)</i>																
3	王晓梅									0.0%						00:00:00
4	朱佳瑜							3/3	3/3	100%						00:10:43
5	丁丽洁									0.0%				1		00:24:05
7	张心茹									0.0%						00:00:00
8	张慧		0/1	0/2	1/2				1/5	20.0%		1	1	1		00:59:10
10	张文慧		2/2						2/2	100%		4	1			00:45:49
11	蔡雪洁	6/13	0/2		0/1		1/1		7/17	41.2%		1		1		00:57:07
12	王欣冉									0.0%						00:04:43
14	刘洁									0.0%						00:00:00
15	李窈窕									0.0%						00:00:00
16	王选									0.0%	1	1				00:55:17
17	聂晓雪	0/2	1/1			1/1			2/4	50.0%		1				00:46:11
18	舒文琪	3/7	0/2			1/1	1/1		5/11	45.5%	2	2		1		00:51:31
21	李默雅	0/1		1/1					1/2	50.0%						00:13:46
22	王聪									0.0%						00:00:00
23	周梦雪	2/6	2/2			1/1			5/9	55.6%	1	2	1			00:50:51
<b>合计</b>		11/29	5/10	1/3	1/3	3/3	2/2	3/3	26/53	49.1%	4	12	3	4		
<i>(守门员)</i>																
12	王欣冉		0/1					0/1	0/2	0.0%						00:04:43
16	王选	2/7	2/11	3/9	0/6	0/1		2/4	9/38	23.7%	1	1				00:55:17
<b>合计</b>		2/7	2/12	3/9	0/6	0/1		2/5	9/40	22.5%	1	1				

场上队员：得分/射门

守门员：救球/射门

全队合计	得分	被救	射失	击柱	封球	合计	%
远射	11	4	3		11	29	37.9%
近射	5	5				10	50.0%
边射	1	1	1			3	33.3%
快攻	1		1	1		3	33.3%
突破	3					3	100.0%
任意	2					2	100.0%
7M	3					3	100.0%





### 2016年全国女子手球锦标赛

#### 图式射门区域统计

轮次 10 场次 51

201605051-41-1/1

## 辽宁

1 于薇诗	2 朱徐婷	3 赵莹雪	5 辛颜	8 杨娇	9 刁卫丽	12 刘雪菲	13 杜江花																																																																								
<table border="1"><tr><td></td><td></td><td></td></tr><tr><td></td><td></td><td></td></tr><tr><td></td><td></td><td></td></tr></table>										<table border="1"><tr><td></td><td></td><td>1</td></tr><tr><td></td><td></td><td>2</td></tr><tr><td></td><td></td><td>1</td></tr></table>			1			2			1	<table border="1"><tr><td></td><td></td><td></td></tr><tr><td></td><td></td><td></td></tr><tr><td></td><td></td><td></td></tr></table>										<table border="1"><tr><td>1</td><td></td><td></td></tr><tr><td></td><td></td><td>1</td></tr><tr><td>1</td><td>1</td><td>1</td></tr></table>	1					1	1	1	1	<table border="1"><tr><td>1</td><td></td><td>1</td></tr><tr><td></td><td></td><td></td></tr><tr><td>1</td><td></td><td>3</td></tr></table>	1		1				1		3	<table border="1"><tr><td></td><td></td><td></td></tr><tr><td></td><td></td><td></td></tr><tr><td></td><td></td><td></td></tr></table>										<table border="1"><tr><td></td><td></td><td></td></tr><tr><td></td><td></td><td></td></tr><tr><td></td><td></td><td></td></tr></table>										<table border="1"><tr><td></td><td></td><td></td></tr><tr><td>2</td><td></td><td></td></tr><tr><td>1</td><td></td><td>2</td></tr></table>				2			1		2
		1																																																																													
		2																																																																													
		1																																																																													
1																																																																															
		1																																																																													
1	1	1																																																																													
1		1																																																																													
1		3																																																																													
2																																																																															
1		2																																																																													
Post - 0 Miss - 0 Block - 0	Post - 0 Miss - 0 Block - 0	Post - 0 Miss - 0 Block - 0	Post - 1 Miss - 1 Block - 0	Post - 3 Miss - 1 Block - 0	Post - 0 Miss - 0 Block - 0	Post - 0 Miss - 0 Block - 0	Post - 1 Miss - 0 Block - 0																																																																								
19 吕秋雪	20 孙弘玲	24 陈思雨	27 王丹	66 梁海珍	93 赵琦	98 张永婷	99 郑锦宜																																																																								
<table border="1"><tr><td></td><td></td><td>1</td></tr><tr><td>1</td><td></td><td>3</td></tr><tr><td></td><td></td><td></td></tr></table>			1	1		3				<table border="1"><tr><td></td><td></td><td></td></tr><tr><td></td><td></td><td></td></tr><tr><td></td><td></td><td></td></tr></table>										<table border="1"><tr><td></td><td></td><td></td></tr><tr><td></td><td></td><td></td></tr><tr><td></td><td></td><td></td></tr></table>										<table border="1"><tr><td></td><td></td><td></td></tr><tr><td></td><td></td><td></td></tr><tr><td></td><td></td><td></td></tr></table>										<table border="1"><tr><td>1</td><td>2</td><td></td></tr><tr><td>3</td><td></td><td></td></tr><tr><td></td><td></td><td></td></tr></table>	1	2		3						<table border="1"><tr><td></td><td></td><td></td></tr><tr><td></td><td></td><td></td></tr><tr><td></td><td></td><td></td></tr></table>										<table border="1"><tr><td></td><td></td><td></td></tr><tr><td></td><td></td><td></td></tr><tr><td></td><td></td><td></td></tr></table>										<table border="1"><tr><td></td><td></td><td></td></tr><tr><td></td><td></td><td></td></tr><tr><td></td><td></td><td></td></tr></table>									
		1																																																																													
1		3																																																																													
1	2																																																																														
3																																																																															
Post - 2 Miss - 0 Block - 0	Post - 0 Miss - 0 Block - 0	Post - 0 Miss - 0 Block - 0	Post - 0 Miss - 0 Block - 0	Post - 0 Miss - 1 Block - 0	Post - 0 Miss - 0 Block - 0	Post - 1 Miss - 0 Block - 0	Post - 0 Miss - 0 Block - 0																																																																								

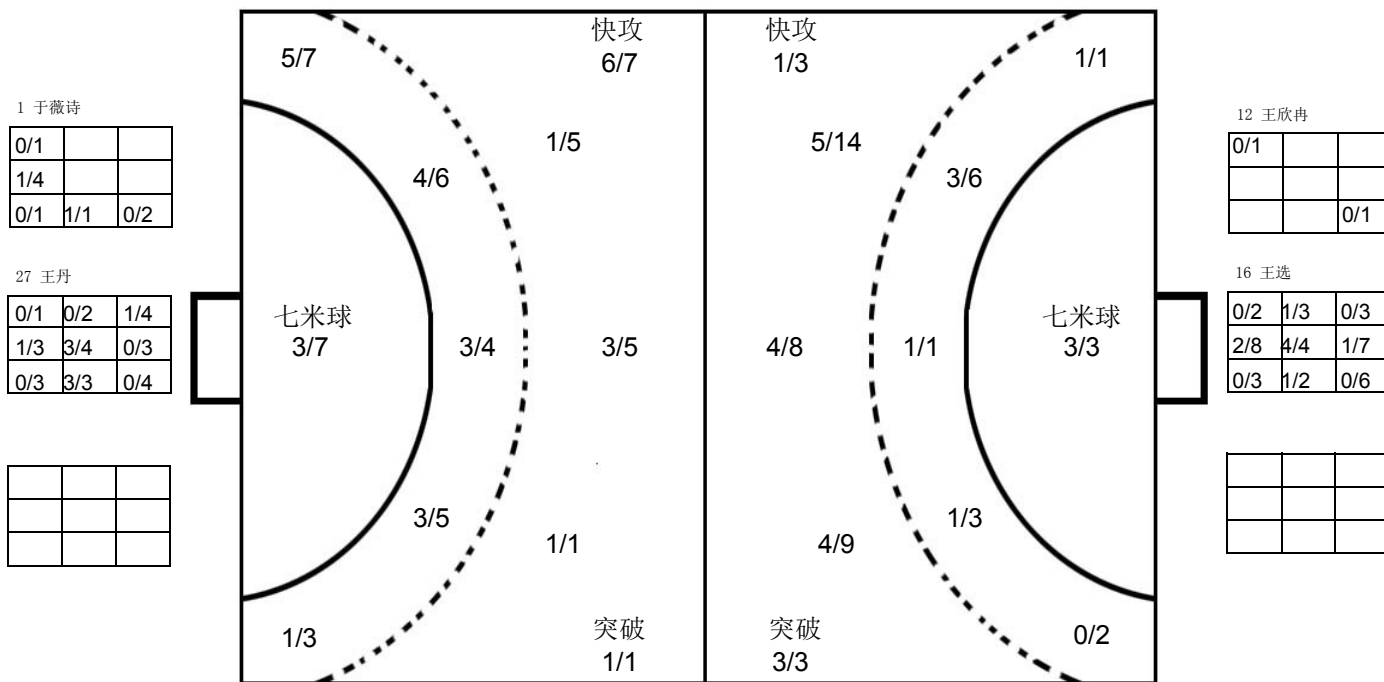

## 天津

3 王晓梅	4 朱佳瑜	5 丁丽洁	7 张心茹	8 张慧	10 张文慧	11 蔡雪洁	12 王欣冉																																																																								
<table border="1"><tr><td></td><td></td><td></td></tr><tr><td></td><td></td><td></td></tr><tr><td></td><td></td><td></td></tr></table>										<table border="1"><tr><td></td><td>1</td><td></td></tr><tr><td>1</td><td></td><td></td></tr><tr><td></td><td></td><td>1</td></tr></table>		1		1					1	<table border="1"><tr><td></td><td></td><td></td></tr><tr><td></td><td></td><td></td></tr><tr><td></td><td></td><td></td></tr></table>										<table border="1"><tr><td></td><td></td><td></td></tr><tr><td></td><td></td><td></td></tr><tr><td></td><td></td><td></td></tr></table>										<table border="1"><tr><td></td><td></td><td></td></tr><tr><td></td><td></td><td>1</td></tr><tr><td></td><td></td><td></td></tr></table>						1				<table border="1"><tr><td></td><td></td><td></td></tr><tr><td></td><td></td><td></td></tr><tr><td>1</td><td></td><td>1</td></tr></table>							1		1	<table border="1"><tr><td></td><td></td><td>1</td></tr><tr><td>2</td><td>1</td><td>1</td></tr><tr><td>1</td><td></td><td>1</td></tr></table>			1	2	1	1	1		1	<table border="1"><tr><td></td><td></td><td></td></tr><tr><td></td><td></td><td></td></tr><tr><td></td><td></td><td></td></tr></table>									
	1																																																																														
1																																																																															
		1																																																																													
		1																																																																													
1		1																																																																													
		1																																																																													
2	1	1																																																																													
1		1																																																																													
Post - 0 Miss - 0 Block - 0	Post - 0 Miss - 0 Block - 0	Post - 0 Miss - 0 Block - 0	Post - 0 Miss - 0 Block - 0	Post - 1 Miss - 1 Block - 0	Post - 0 Miss - 0 Block - 0	Post - 0 Miss - 2 Block - 4	Post - 0 Miss - 0 Block - 0																																																																								
14 刘洁	15 李窈窕	16 王选	17 聂晓雪	18 舒文琪	21 李默雅	22 王聪	23 周梦雪																																																																								
<table border="1"><tr><td></td><td></td><td></td></tr><tr><td></td><td></td><td></td></tr><tr><td></td><td></td><td></td></tr></table>										<table border="1"><tr><td></td><td></td><td></td></tr><tr><td></td><td></td><td></td></tr><tr><td></td><td></td><td></td></tr></table>										<table border="1"><tr><td></td><td></td><td></td></tr><tr><td></td><td></td><td></td></tr><tr><td></td><td></td><td></td></tr></table>										<table border="1"><tr><td></td><td></td><td>1</td></tr><tr><td></td><td></td><td>1</td></tr><tr><td></td><td></td><td></td></tr></table>			1			1				<table border="1"><tr><td>2</td><td></td><td>1</td></tr><tr><td>1</td><td></td><td></td></tr><tr><td></td><td></td><td>1</td></tr></table>	2		1	1					1	<table border="1"><tr><td></td><td></td><td></td></tr><tr><td></td><td></td><td>1</td></tr><tr><td></td><td></td><td></td></tr></table>						1				<table border="1"><tr><td></td><td></td><td></td></tr><tr><td></td><td></td><td></td></tr><tr><td></td><td></td><td></td></tr></table>										<table border="1"><tr><td></td><td></td><td>1</td></tr><tr><td>1</td><td></td><td></td></tr><tr><td>2</td><td></td><td>1</td></tr></table>			1	1			2		1
		1																																																																													
		1																																																																													
2		1																																																																													
1																																																																															
		1																																																																													
		1																																																																													
		1																																																																													
1																																																																															
2		1																																																																													
Post - 0 Miss - 0 Block - 0	Post - 0 Miss - 0 Block - 0	Post - 0 Miss - 0 Block - 0	Post - 0 Miss - 2 Block - 0	Post - 0 Miss - 0 Block - 3	Post - 0 Miss - 0 Block - 1	Post - 0 Miss - 0 Block - 0	Post - 0 Miss - 0 Block - 3																																																																								

注释: Post=击柱 Miss=射失 Block=被封





5-6名  
女子 全国比赛

2016年全国女子手球锦标赛

Team A <b>A 解放军</b>		Team B <b>B 新疆</b>		Match Number <b>52</b>								
played in China		in the hall 滁州体育馆		on 13/09/2016								
				at 15:30 hours								
Spectators												
Half-time (30')	<b>A</b> 18	<b>B</b> 10	End of playing time	<b>A</b> 35	<b>B</b> 24							
1st extra time				2nd extra time								
				After penalty throws								
Number of 7 m	<b>A</b> 0 / 0	Team time-out		Team time-out								
		53:02 56:53		07:23								
Full name of players and officials												
No.	Team <b>A</b>				Team <b>B</b>							
	G	W	2'	D	DR	No.	G	W	2'	D	DR	
2	崔云莉	5	1			3	葛立双	1				
5	徐鸣昭	3				6	阿孜古	1				
6	于婷婷					7	吴志娟	3				
8	周亚茹	2				10	李静					
13	张格格	6	1			11	陈培培					
16	方文博					12	艾敏加尔汉					
17	于利婷	5	1			15	兰姝娇	3	1			
23	顾天澍	4				17	戴莹莹	4				
24	韦娜娜	8				18	崔娟	4	1			
32	张馨予					21	锁珊珊	3				
36	李朴					23	张艺璇					
44	刘洋麦文					27	谢辰辰	2				
66	杨丽丽					32	杨雨柔					
77	唐魏萍					93	张婷婷	3				
88	李晓晴	2										
B	刘凤娟						B	于涛 (主教练)				
C	丛艳霞						D	高璇				
Signature of Responsible Official of the Teams (Off. A)												
											B	
TP	Remarks of Referee / CHA Official										TP	
Signatures												
Referees	陈晓波 (CHN)		倪震 (CHN)									
Techn. Delegates	高斌 (CHN)											
CHA Official	许宜扬 (CHN)											

Note: Number of 7m Throws Awarded to Team A and B, Goals (G), Warnings (W), Suspensions (2'), Direct Disqualification (D), Disqualification with Report (DR) and Team Penalty (TP).





## 2016年全国女子手球锦标赛 竞赛技术统计(媒体表)

5-6名	组别	X	轮次	10	场次	52
滁州体育馆		13/09/2016			201605052-51-1/1	
解放军	解放军	35	vs	24	新疆	新疆
<b>18 : 10</b>						

裁判员	陈晓波 (CHN)	/	倪震 (CHN)
-----	-----------	---	----------

解放军														比赛进程		新疆	
主教练：刘德东																	
远射	近射	边射	快攻	突破	任意球	7m球	合计	%	助攻	失误	警告	2'	D & DR				
2 崔云莉	4/9	1/1					5/10	50.0	3	2	1				13 张格格	0 00:29	1 93 张婷婷
5 徐鸣昭	2/3				1/1		3/4	75.0							13 张格格	1 00:44	1
6 于婷婷										1					24 韦娜娜	2 03:04	1
8 周亚茹	2/5						2/5	40.0		1					13 张格格	3 05:28	1
13 张格格		3/5		3/3			6/8	75.0		1	1				13 张格格	4 07:18	1
16 方文博									2	1					4 07:59	2 21 锁珊珊	
17 于利婷	3/6		0/1	1/1	1/1		5/9	55.6		7	1				88 李晓晴	5 08:58	2
23 顾天澍		3/3	0/2	1/2			4/7	57.1	1	1					88 李晓晴	6 10:08	2
24 韦娜娜	0/2		4/5	4/5			8/12	66.7		1					6 10:54	3 17 戴莹莹	
32 张馨予															7 11:17	3	
36 李朴															24 韦娜娜	8 12:18	3
44 刘洋麦文	0/1						0/1	0.0	3	1					13 张格格	9 13:05	3
66 杨丽丽															9 13:35	4 21 锁珊珊	
77 唐魏萍										3					10 14:35	4	
88 李晓晴	2/2						2/2	100		1					10 15:01	5 18 崔娟	
<b>运动员 合计</b>	<b>13/28</b>	<b>7/9</b>	<b>4/8</b>	<b>9/11</b>	<b>2/2</b>		<b>35/58</b>	<b>60.3</b>	<b>12</b>	<b>17</b>	<b>3</b>				17 于利婷	11 15:22	5
16 方文博	6/6	1/5		1/1	0/3		8/15	53.3	2	1					17 于利婷	11 15:22	5
66 杨丽丽	5/8	3/6	1/4		1/2	1/1	11/21	52.4	3						11 15:57	6 93 张婷婷	
77 唐魏萍	2/3	0/2	0/1	0/1	0/1	0/1	2/9	22.2							13 张格格	12 17:57	6
<b>守门员 合计</b>	<b>13/17</b>	<b>4/13</b>	<b>1/5</b>	<b>1/2</b>	<b>1/6</b>		<b>21/45</b>	<b>46.7</b>	<b>5</b>	<b>1</b>					12 19:06	7 27 谢辰辰	
新疆																	
教练：于涛																	
远射	近射	边射	快攻	突破	任意球	7m球	合计	%	助攻	失误	警告	2'	D & DR				
3 葛立双	0/1	1/1	0/1				1/3	33.3							23 顾天澍	13 21:47	8
6 阿孜古		1/3					1/3	33.3							24 韦娜娜	14 22:27	8
7 吴志娟			3/4				3/4	75.0	1	1					2 崔云莉	15 23:21	8
10 李静															15 23:21	8	
11 陈培培															17 于利婷	15 23:56	9 18 崔娟
12 艾敏加尔汉															16 26:31	9	
15 兰姝娇			1/1		1/1	1/1	3/3	100		2	1				2 崔云莉	16 26:31	9
17 戴莹莹		3/4		1/1			4/5	80.0		2					16 26:31	9	
18 崔娟	3/12	0/2			1/1		4/16	25.0	4	5	1				17 于利婷	16 26:31	9
21 锁珊珊	0/4	2/4		0/1	1/2		3/11	27.3	2	3					2 崔云莉	17 28:00	10 3 葛立双
23 张艺璇															24 韦娜娜	18 29:27	10
27 谢辰辰		1/1			1/1		2/2	100							18 29:27	10	
32 杨雨柔															19 01:25	10	
93 张婷婷	1/7	1/1			1/1		3/9	33.3	2	3					20 02:14	10	
<b>运动员 合计</b>	<b>4/24</b>	<b>9/16</b>	<b>4/6</b>	<b>1/2</b>	<b>5/6</b>		<b>24/56</b>	<b>42.9</b>	<b>9</b>	<b>22</b>	<b>2</b>				21 03:05	10	
10 李静	7/20	1/8	2/6	2/11	0/2		12/47	25.5		2					22 03:31	10	
<b>守门员 合计</b>	<b>7/20</b>	<b>1/8</b>	<b>2/6</b>	<b>2/11</b>	<b>0/2</b>		<b>12/47</b>	<b>25.5</b>		<b>2</b>					23 04:14	10	

场上队员：得分 / 射门

守门员：救球 / 射门

快攻	Fast Break	突破	Breakthrough	任意球	Free Throw	7M球	7M Throw	助攻	Assist
警告	Warning	失误	Error	2'	Suspension	D	取消资格	DR	取消资格+报告





### 2016年全国女子手球锦标赛 图式比赛技术统计表

轮次 10

场次 52

201605052-21-1/1

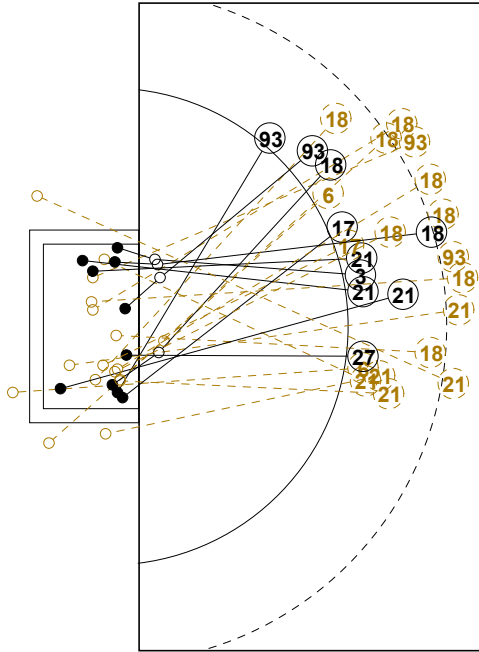

7M 新疆

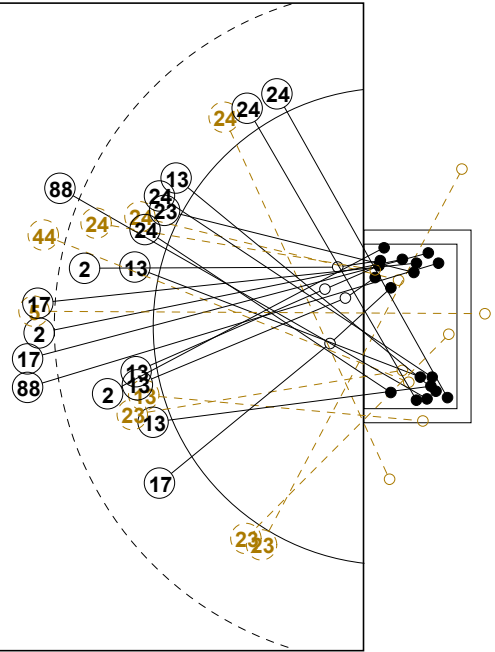
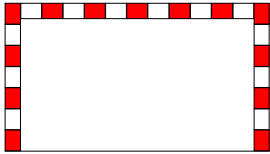

解放军 7M

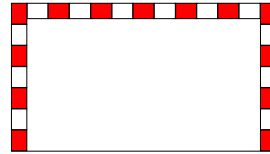

1st Half  
10 : 18

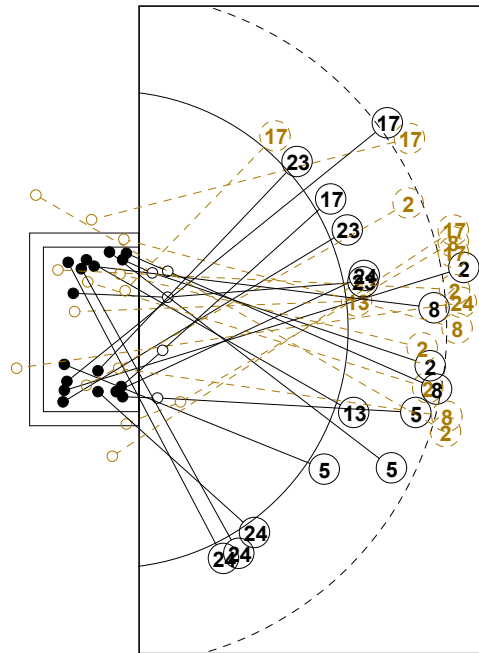

7M 解放军

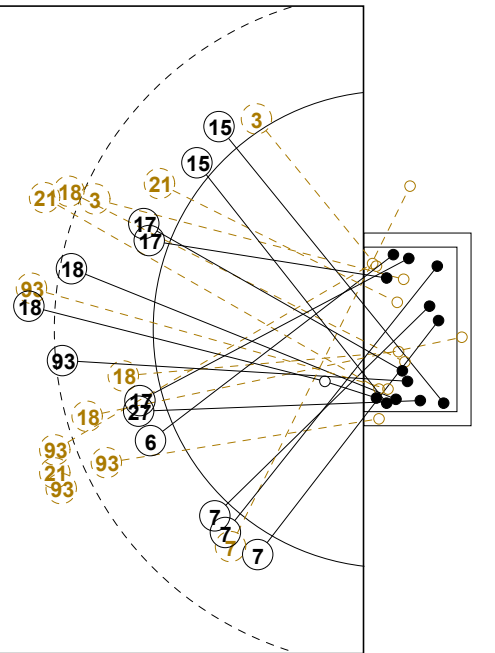
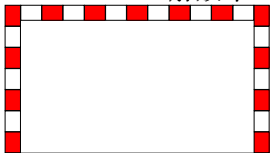

新疆 7M

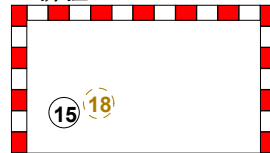

2nd Half  
35 : 24





## 2016年全国女子手球锦标赛

## 个人/全队技术统计表

正式表  
手球  
女子5-6名  
轮次 10组别 X  
场次 52201605052-14-1/2  
滁州体育馆  
13/09/2016 15:30

号码	姓名	远射	近射	边射	快攻	突破	任意	7M	合计	%	助攻	失误	警告	2'	取消	时间
<b>解放军(解放军)</b>																
<i>(场上队员)</i>																
2	崔云莉	4/9	1/1						5/10	50.0%	3	2	1			00:50:15
5	徐鸣昭	2/3				1/1			3/4	75.0%						00:19:55
6	于婷婷									0.0%	1					00:06:02
8	周亚茹	2/5							2/5	40.0%	1					00:36:56
13	张格格		3/5		3/3				6/8	75.0%	1	1				00:26:57
16	方文博									0.0%	2	1				00:19:16
17	于利婷	3/6		0/1	1/1	1/1			5/9	55.6%	7	1				00:45:48
23	顾天澍		3/3	0/2	1/2				4/7	57.1%	1	1				00:58:57
24	韦娜娜	0/2		4/5	4/5				8/12	66.7%	1					01:00:00
32	张馨予									0.0%						00:22:16
36	李朴									0.0%						00:00:00
44	刘洋麦文	0/1							0/1	0.0%	3	1				00:09:44
66	杨丽丽									0.0%	3					00:30:15
77	唐魏萍									0.0%						00:10:29
88	李晓晴	2/2							2/2	100%	1					00:23:00
<b>合计</b>		13/28	7/9	4/8	9/11	2/2			35/58	60.3%	12	17	3			
<i>(守门员)</i>																
16	方文博	6/6	1/5		1/1	0/3			8/15	53.3%	2	1				00:19:16
66	杨丽丽	5/8	3/6	1/4		1/2		1/1	11/21	52.4%	3					00:30:15
77	唐魏萍	2/3	0/2	0/1	0/1	0/1		0/1	2/9	22.2%						00:10:29
<b>合计</b>		13/17	4/13	1/5	1/2	1/6		1/2	21/45	46.7%	5	1				

场上队员：得分/射门

守门员：救球/射门

全队合计	得分	被救	射失	击柱	封球	合计	%
远射	13	7	5	2	1	28	46.4%
近射	7	1		1		9	77.8%
边射	4	2	2			8	50.0%
快攻	9	2				11	81.8%
突破	2					2	100.0%
任意							0.0%
7M							0.0%





## 2016年全国女子手球锦标赛

## 个人/全队技术统计表

正式表  
手球  
女子5-6名  
轮次 10组别 X  
场次 52201605052-14-2/2  
滁州体育馆  
13/09/2016 15:30

号码	姓名	远射	近射	边射	快攻	突破	任意	7M	合计	%	助攻	失误	警告	2'	取消	时间
<b>新疆(新疆)</b>																
<i>(上场队员)</i>																
3	葛立双	0/1	1/1	0/1					1/3	33.3%						00:15:08
6	阿孜古		1/3						1/3	33.3%		1				00:26:47
7	吴志娟			3/4					3/4	75.0%	1	1				00:48:27
10	李静									0.0%		2				01:00:00
11	陈培培									0.0%						00:05:56
12	艾敏加尔汉									0.0%		1				00:11:29
15	兰姝娇			1/1		1/1		1/1	3/3	100%		2	1			00:43:16
17	戴莹莹		3/4		1/1				4/5	80.0%		2				00:33:13
18	崔娟	3/12	0/2			1/1		0/1	4/16	25.0%	4	5	1			00:54:52
21	锁珊珊	0/4	2/4		0/1	1/2			3/11	27.3%	2	3				00:53:38
23	张艺璇									0.0%						00:00:00
27	谢辰辰		1/1			1/1			2/2	100%		2				00:18:47
32	杨雨柔									0.0%						00:00:00
93	张婷婷	1/7	1/1			1/1			3/9	33.3%	2	3				00:47:28
<b>合计</b>																
<i>(守门员)</i>																
10	李静	7/20	1/8	2/6	2/11	0/2			12/47	25.5%		2				01:00:00
<b>合计</b>																

场上队员：得分/射门

守门员：救球/射门

全队合计	得分	被救	射失	击柱	封球	合计	%
远射	4	13	1	2	4	24	16.7%
近射	9	4	3			16	56.3%
边射	4	1	1			6	66.7%
快攻	1	1				2	50.0%
突破	5	1				6	83.3%
任意							0.0%
7M	1	1				2	50.0%





### 2016年全国女子手球锦标赛

#### 图式射门区域统计

轮次 10 场次 52

201605052-41-1/1

## 解放军

2 崔云莉	5 徐鸣昭	6 于婷婷	8 周亚茹	13 张格格	16 方文博	17 于利婷	23 顾天澍																																																																								
<table border="1"><tr><td>1</td><td></td><td></td></tr><tr><td>1</td><td></td><td></td></tr><tr><td>2</td><td></td><td>1</td></tr></table>	1			1			2		1	<table border="1"><tr><td>1</td><td></td><td></td></tr><tr><td></td><td></td><td></td></tr><tr><td>1</td><td></td><td>1</td></tr></table>	1						1		1	<table border="1"><tr><td></td><td></td><td></td></tr><tr><td></td><td></td><td></td></tr><tr><td></td><td></td><td></td></tr></table>										<table border="1"><tr><td></td><td></td><td></td></tr><tr><td></td><td></td><td>1</td></tr><tr><td></td><td></td><td>1</td></tr></table>						1			1	<table border="1"><tr><td></td><td></td><td>2</td></tr><tr><td></td><td></td><td>2</td></tr><tr><td>2</td><td></td><td></td></tr></table>			2			2	2			<table border="1"><tr><td></td><td></td><td></td></tr><tr><td></td><td></td><td></td></tr><tr><td></td><td></td><td></td></tr></table>										<table border="1"><tr><td>2</td><td></td><td></td></tr><tr><td>1</td><td></td><td></td></tr><tr><td>2</td><td></td><td></td></tr></table>	2			1			2			<table border="1"><tr><td>1</td><td></td><td>1</td></tr><tr><td>2</td><td></td><td></td></tr><tr><td></td><td></td><td></td></tr></table>	1		1	2					
1																																																																															
1																																																																															
2		1																																																																													
1																																																																															
1		1																																																																													
		1																																																																													
		1																																																																													
		2																																																																													
		2																																																																													
2																																																																															
2																																																																															
1																																																																															
2																																																																															
1		1																																																																													
2																																																																															
Post - 0 Miss - 1 Block - 0	Post - 0 Miss - 1 Block - 0	Post - 0 Miss - 0 Block - 0	Post - 2 Miss - 0 Block - 0	Post - 1 Miss - 0 Block - 0	Post - 0 Miss - 0 Block - 0	Post - 0 Miss - 2 Block - 1	Post - 0 Miss - 1 Block - 0																																																																								
24 韦娜娜	32 张馨予	36 李朴	44 刘洋麦文	66 杨丽丽	77 唐魏萍	88 李晓晴																																																																									
<table border="1"><tr><td></td><td></td><td>3</td></tr><tr><td>1</td><td></td><td>2</td></tr><tr><td>1</td><td></td><td>1</td></tr></table>			3	1		2	1		1	<table border="1"><tr><td></td><td></td><td></td></tr><tr><td></td><td></td><td></td></tr><tr><td></td><td></td><td></td></tr></table>										<table border="1"><tr><td></td><td></td><td></td></tr><tr><td></td><td></td><td></td></tr><tr><td></td><td></td><td></td></tr></table>										<table border="1"><tr><td></td><td></td><td></td></tr><tr><td></td><td></td><td></td></tr><tr><td></td><td></td><td></td></tr></table>										<table border="1"><tr><td></td><td></td><td></td></tr><tr><td></td><td></td><td></td></tr><tr><td></td><td></td><td></td></tr></table>										<table border="1"><tr><td></td><td></td><td></td></tr><tr><td></td><td></td><td></td></tr><tr><td></td><td></td><td></td></tr></table>										<table border="1"><tr><td>1</td><td></td><td>1</td></tr><tr><td></td><td></td><td></td></tr><tr><td></td><td></td><td></td></tr></table>	1		1							<table border="1"><tr><td></td><td></td><td></td></tr><tr><td></td><td></td><td></td></tr><tr><td></td><td></td><td></td></tr></table>									
		3																																																																													
1		2																																																																													
1		1																																																																													
1		1																																																																													
Post - 0 Miss - 2 Block - 0	Post - 0 Miss - 0 Block - 0	Post - 0 Miss - 0 Block - 0	Post - 0 Miss - 0 Block - 0	Post - 0 Miss - 0 Block - 0	Post - 0 Miss - 0 Block - 0	Post - 0 Miss - 0 Block - 0																																																																									

16 方文博

1/1		
1/1	2/2	2/4
1/5	1/2	

66 杨丽丽

0/1	0/2	0/1
3/3	2/2	1/4
5/6		0/2

77 唐魏萍

0/1		
0/2		0/1
0/1		2/4

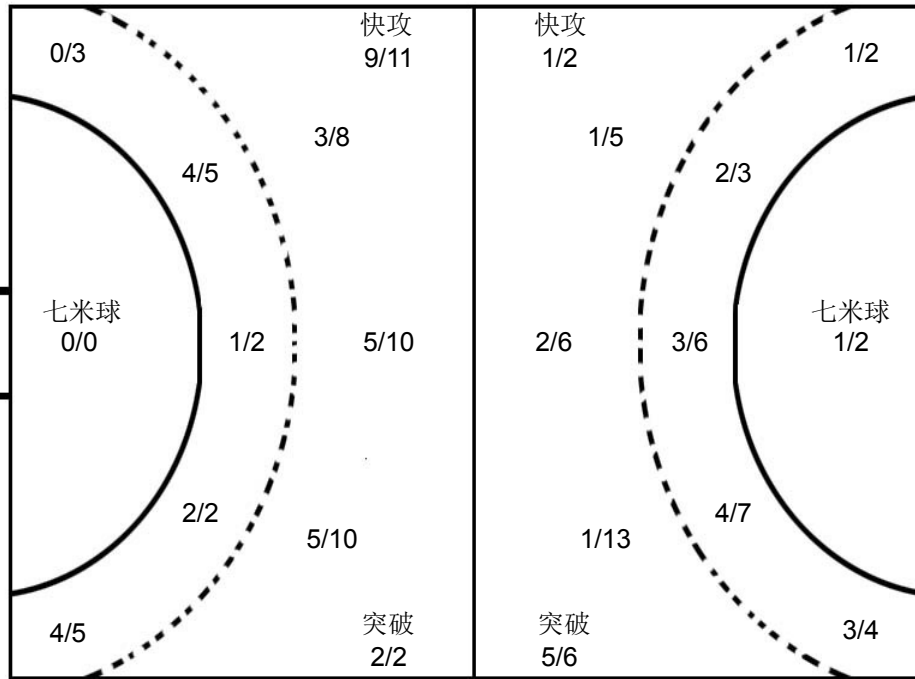

10 李静

0/6	2/2	1/8
2/7		3/8
2/10		2/6



## 新疆

3 葛立双	6 阿孜古	7 吴志娟	10 李静	11 陈培培	12 艾敏加尔汉	15 兰姝娇	17 戴莹莹																																																																								
<table border="1"><tr><td></td><td></td><td></td></tr><tr><td></td><td></td><td></td></tr><tr><td></td><td></td><td>1</td></tr></table>									1	<table border="1"><tr><td></td><td></td><td></td></tr><tr><td></td><td></td><td></td></tr><tr><td>1</td><td></td><td></td></tr></table>							1			<table border="1"><tr><td>1</td><td>2</td><td></td></tr><tr><td></td><td></td><td></td></tr><tr><td></td><td></td><td></td></tr></table>	1	2								<table border="1"><tr><td></td><td></td><td></td></tr><tr><td></td><td></td><td></td></tr><tr><td></td><td></td><td></td></tr></table>										<table border="1"><tr><td></td><td></td><td></td></tr><tr><td></td><td></td><td></td></tr><tr><td></td><td></td><td></td></tr></table>										<table border="1"><tr><td></td><td></td><td></td></tr><tr><td></td><td></td><td></td></tr><tr><td></td><td></td><td></td></tr></table>										<table border="1"><tr><td></td><td></td><td>1</td></tr><tr><td>1</td><td></td><td></td></tr><tr><td></td><td></td><td>1</td></tr></table>			1	1					1	<table border="1"><tr><td></td><td></td><td></td></tr><tr><td></td><td></td><td></td></tr><tr><td>1</td><td></td><td>1</td></tr></table>							1		1
		1																																																																													
1																																																																															
1	2																																																																														
		1																																																																													
1																																																																															
		1																																																																													
1		1																																																																													
Post - 0 Miss - 0 Block - 0	Post - 0 Miss - 2 Block - 0	Post - 0 Miss - 1 Block - 0	Post - 0 Miss - 0 Block - 0	Post - 0 Miss - 0 Block - 0	Post - 0 Miss - 0 Block - 0	Post - 0 Miss - 0 Block - 0	Post - 0 Miss - 0 Block - 0																																																																								
18 崔娟	21 锁珊珊	23 张艺璇	27 谢辰辰	32 杨雨柔	93 张婷婷																																																																										
<table border="1"><tr><td></td><td></td><td></td></tr><tr><td></td><td></td><td>1</td></tr><tr><td>1</td><td></td><td>2</td></tr></table>						1	1		2	<table border="1"><tr><td>1</td><td></td><td></td></tr><tr><td></td><td></td><td>2</td></tr><tr><td></td><td></td><td></td></tr></table>	1					2				<table border="1"><tr><td></td><td></td><td></td></tr><tr><td></td><td></td><td></td></tr><tr><td></td><td></td><td></td></tr></table>										<table border="1"><tr><td></td><td></td><td></td></tr><tr><td></td><td></td><td>1</td></tr><tr><td>1</td><td></td><td></td></tr></table>						1	1			<table border="1"><tr><td></td><td></td><td></td></tr><tr><td></td><td></td><td></td></tr><tr><td></td><td></td><td></td></tr></table>										<table border="1"><tr><td></td><td></td><td></td></tr><tr><td></td><td></td><td>1</td></tr><tr><td>1</td><td>1</td><td></td></tr></table>						1	1	1		<table border="1"><tr><td></td><td></td><td></td></tr><tr><td></td><td></td><td></td></tr><tr><td></td><td></td><td></td></tr></table>										<table border="1"><tr><td></td><td></td><td></td></tr><tr><td></td><td></td><td></td></tr><tr><td></td><td></td><td></td></tr></table>									
		1																																																																													
1		2																																																																													
1																																																																															
		2																																																																													
		1																																																																													
1																																																																															
		1																																																																													
1	1																																																																														
Post - 1 Miss - 0 Block - 1	Post - 0 Miss - 2 Block - 1	Post - 0 Miss - 0 Block - 0	Post - 0 Miss - 0 Block - 0	Post - 0 Miss - 0 Block - 0	Post - 1 Miss - 0 Block - 2																																																																										

注释: Post=击柱 Miss=射失 Block=被封





3-4名

女子 全国比赛

2016年全国女子手球锦标赛

Team A A 广东		Team B B 上海		Match Number <b>53</b>							
played in China		in the hall 滁州体育馆		on 13/09/2016							
				at 17:00 hours							
Spectators											
Half-time (30')	A 9	B 19	End of playing time	A 22	B 34						
1st extra time		A		B							
2nd extra time		A		B							
After penalty throws		A		B							
Number of 7 m	A 4/5	Team time-out		Team time-out							
		1 2 3		1 2 3							
		Full name of players and officials									
No.	Team A					No.	Team B				
	G	W	2'	D	DR		G	W	2'	D	DR
3	安妮	3		1		1	许沫				
5	李纯					2	周蕾	5			
7	刘彤	3	1			5	郭威	2		1	
8	李诗棋					6	黄妍	4			
9	韦宝桂	2	1	1		7	车婉茹				
11	魏梦庭	3				8	吴茵	9	1		
15	杨慧					9	武娜娜	1			
16	李娟					10	斯文	2	1		
18	李玉玲		1			11	孙梦颖	5			
19	邝雪花	3				12	郑冯				
20	李军政	2				13	徐娟	1			
22	刘晓玉					17	居晔	1	1	1	
23	王如	4		1		18	沙正文	4			
26	马晓卉					19	印尼				
28	刘金兰	2		1		21	王嘉怡				
31	史小军					23	都好				
A	李细利					B	陈进培 (主教练)				
B	郭艳辉 (主教练)					C	金锺顺				
D	祝捷					D	贺业磊				
E	赵善良					F	周瑜宸				
A	Signature of Responsible Official of the Teams (Off. A)										B
TP	Remarks of Referee / CHA Official										TP

Signatures

Referees	邓军 (CHN)	王雨洋 (CHN)		
Techn. Delegates	高斌 (CHN)			
CHA Official	许宜扬 (CHN)			

Note: Number of 7m Throws Awarded to Team A and B, Goals (G), Warnings (W), Suspensions (2'), Direct Disqualification (D), Disqualification with Report (DR) and Team Penalty (TP).

Table Officials: 伍豪

刘晓辉

Statisticians: 刘永欢

黄岩





## 2016年全国女子手球锦标赛 竞赛技术统计(媒体表)

3-4名	组别	X	轮次	10	场次	53
滁州体育馆		13/09/2016			201605053-51-1/1	
广东	广东	22	vs	34	上海	上海
9 : 19						

裁判员	邓军 (CHN)	/	王雨洋 (CHN)
-----	----------	---	-----------

广东														比赛进程		上海	
远射	近射	边射	快攻	突破	任意球	7m球	合计	%	助攻	失误	警告	2'	D & DR	广东	上海		
主教练：郭艳辉																	
3 安妮	0/1	2/3		1/1			3/5	60.0	1	3		1					
5 李纯																	
7 刘彤		0/1	2/3			1/1	3/5	60.0			1						
8 李诗棋																	
9 韦宝桂	0/3	0/2	0/2		1/1	1/1	2/9	22.2		3	1	1					
11 魏梦庭	0/4	1/4	0/1			2/2	3/11	27.3		1							
15 杨慧																	
16 李娟																	
18 李玉玲	0/1					0/1	0/2	0.0		1	1						
19 邝雪花	0/6	2/3			1/1		3/10	30.0	1	1							
20 李军政		2/2	0/2				2/4	50.0	1	2							
22 刘晓玉																	
23 王如		1/2	0/1	2/2	1/1		4/6	66.7	1	1		1					
26 马晓卉																	
28 刘金兰	1/1		1/1				2/2	100	1	1		1					
31 史小军	0/1	0/1					0/2	0.0		1							
<b>运动员 合计</b>	<b>1/17</b>	<b>8/18</b>	<b>3/10</b>	<b>3/3</b>	<b>3/3</b>	<b>4/5</b>	<b>22/56</b>	<b>39.3</b>	<b>5</b>	<b>14</b>	<b>3</b>	<b>4</b>					
22 刘晓玉	0/3		0/1	0/3			0/7	0.0									
26 马晓卉	1/11	3/7	2/6	0/5	1/3	1/3	8/35	22.9									
<b>守门员 合计</b>	<b>1/14</b>	<b>3/7</b>	<b>2/7</b>	<b>0/8</b>	<b>1/3</b>	<b>1/3</b>	<b>8/42</b>	<b>19.0</b>									
上海																	
远射	近射	边射	快攻	突破	任意球	7m球	合计	%	助攻	失误	警告	2'	D & DR	广东	上海		
教练：陈进培																	
1 许沫																	
2 周蕾			2/3	3/3			5/6	83.3	1	1							
5 郭威	1/1					1/1	2/2	100	1			1					
6 黄妍	2/2	0/2		1/1		1/1	4/6	66.7	2	4							
7 车婉茹																	
8 吴茵	5/8	1/2		2/2	1/1	0/1	9/14	64.3	2	6	1						
9 武娜娜			1/1	0/2			1/3	33.3		2							
10 斯文	0/2		2/2				2/4	50.0		1	1						
11 孙梦颖	4/6		0/1	1/1			5/8	62.5		1							
12 郑冯																	
13 徐娟	1/1						1/1	100									
17 居晔				1/1			1/1	100		1	1	1					
18 沙正文		3/4			1/2		4/6	66.7	1								
19 印尼											2						
21 王嘉怡																	
23 都好																	
<b>运动员 合计</b>	<b>13/20</b>	<b>4/8</b>	<b>5/7</b>	<b>8/10</b>	<b>2/3</b>	<b>2/3</b>	<b>34/51</b>	<b>66.7</b>	<b>7</b>	<b>18</b>	<b>3</b>	<b>2</b>					
1 许沫	6/6	6/10	3/4	0/1	0/2	1/3	16/26	61.5									
12 郑冯	5/6	2/6	0/2	0/2	0/1	0/2	7/19	36.8									
<b>守门员 合计</b>	<b>11/12</b>	<b>8/16</b>	<b>3/6</b>	<b>0/3</b>	<b>0/3</b>	<b>1/5</b>	<b>23/45</b>	<b>51.1</b>									

场上队员：得分 / 射门

守门员：救球 / 射门

快攻	Fast Break	突破	Breakthrough	任意球	Free Throw	7M球	7M Throw	助攻	Assist
警告	Warning	失误	Error	2'	Suspension	D	取消资格	DR	取消资格+报告





### 2016年全国女子手球锦标赛 图式比赛技术统计表

轮次 10

场次 53

201605053-21-1/1

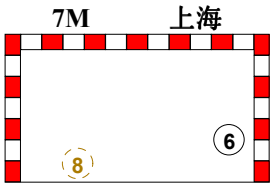
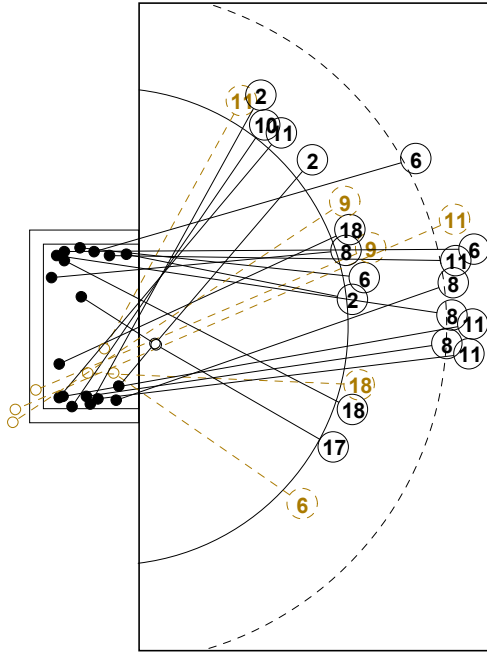

1st Half  
19 : 9

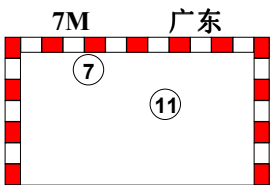
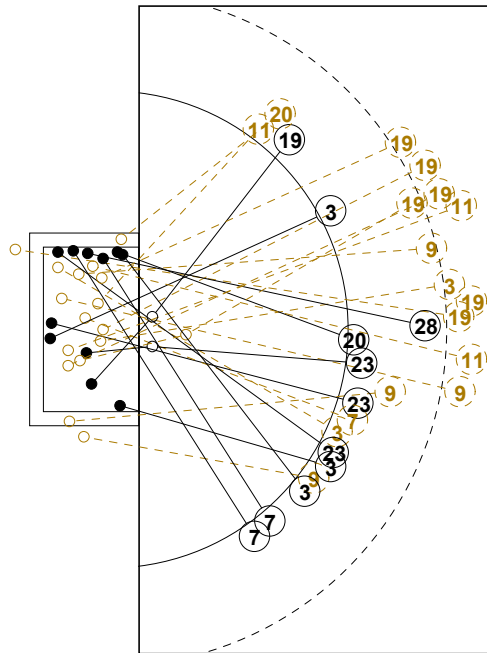
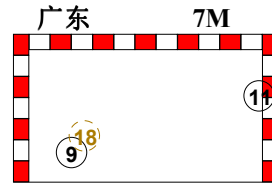
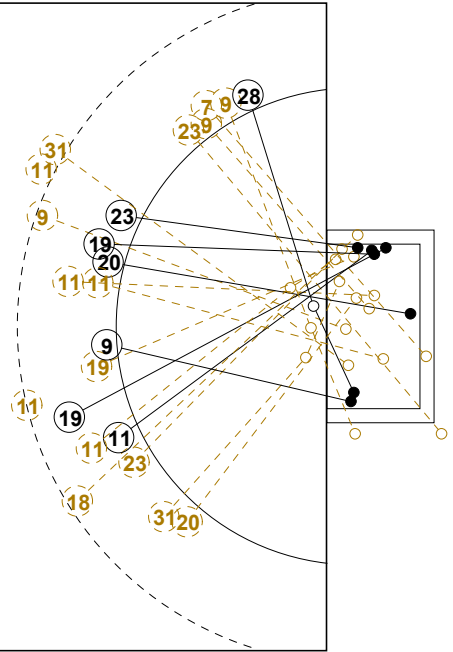

2nd Half  
22 : 34

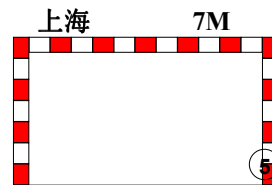
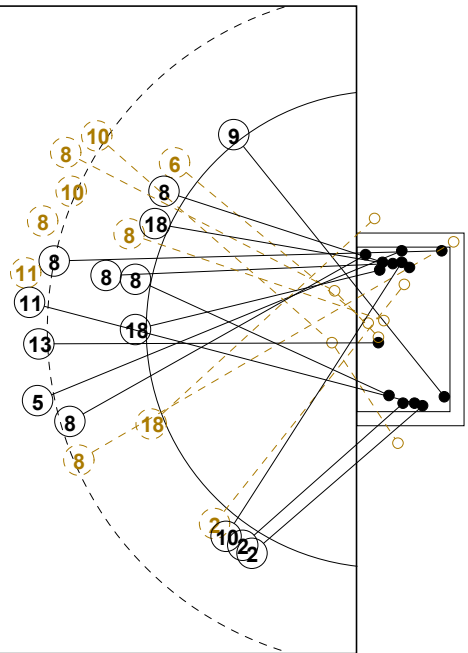



## 2016年全国女子手球锦标赛

## 个人/全队技术统计表

正式表  
手球  
女子3-4名  
轮次 10组别 X  
场次 53201605053-14-1/2  
滁州体育馆  
13/09/2016 17:00

号码	姓名	远射	近射	边射	快攻	突破	任意	7M	合计	%	助攻	失误	警告	2'	取消	时间
<b>广东(广东)</b>																
<i>(场上队员)</i>																
3	安妮	0/1	2/3		1/1				3/5	60.0%	1	3		1		00:27:58
5	李纯									0.0%						00:06:03
7	刘彤		0/1	2/3				1/1	3/5	60.0%			1			00:45:29
8	李诗棋									0.0%						00:00:00
9	韦宝桂	0/3	0/2	0/2		1/1		1/1	2/9	22.2%		3	1	1		00:37:09
11	魏梦庭	0/4	1/4	0/1				2/2	3/11	27.3%		1				00:48:26
15	杨慧									0.0%						00:00:00
16	李娟									0.0%						00:00:00
18	李玉玲	0/1						0/1	0/2	0.0%		1	1			00:15:11
19	邝雪花	0/6	2/3			1/1			3/10	30.0%	1	1				00:31:26
20	李军政		2/2	0/2					2/4	50.0%	1	2				01:00:00
22	刘晓玉									0.0%						00:08:52
23	王如		1/2	0/1	2/2	1/1			4/6	66.7%	1	1		1		00:53:56
26	马晓卉									0.0%						00:51:08
28	刘金兰	1/1		1/1					2/2	100%	1	1		1		00:22:11
31	史小军	0/1	0/1						0/2	0.0%		1				00:11:52
<b>合计</b>		1/17	8/18	3/10	3/3	3/3		4/5	22/56	39.3%	5	14	3	4		
<i>(守门员)</i>																
22	刘晓玉	0/3		0/1	0/3				0/7	0.0%						00:08:52
26	马晓卉	1/11	3/7	2/6	0/5	1/3		1/3	8/35	22.9%						00:51:08
<b>合计</b>		1/14	3/7	2/7	0/8	1/3		1/3	8/42	19.0%						

场上队员：得分/射门

守门员：救球/射门

全队合计	得分	被救	射失	击柱	封球	合计	%
远射	1	11	1	1	3	17	5.9%
近射	8	8	1	1		18	44.4%
边射	3	3	2	2		10	30.0%
快攻	3					3	100.0%
突破	3					3	100.0%
任意							0.0%
7M	4	1				5	80.0%





## 2016年全国女子手球锦标赛

## 个人/全队技术统计表

正式表  
手球  
女子3-4名  
轮次 10组别 X  
场次 53201605053-14-2/2  
滁州体育馆  
13/09/2016 17:00

号码	姓名	远射	近射	边射	快攻	突破	任意	7M	合计	%	助攻	失误	警告	2'	取消	时间
<b>上海(上海)</b>																
<i>(上场队员)</i>																
1	许沫									0.0%						00:39:00
2	周蕾			2/3	3/3				5/6	83.3%	1	1				00:43:59
5	郭威	1/1						1/1	2/2	100%	1			1		00:24:05
6	黄妍	2/2	0/2		1/1			1/1	4/6	66.7%	2	4				00:29:07
7	车婉茹									0.0%						00:00:00
8	吴茵	5/8	1/2		2/2	1/1		0/1	9/14	64.3%	2	6	1			00:45:31
9	武娜娜			1/1	0/2				1/3	33.3%		2				00:40:37
10	斯文	0/2		2/2					2/4	50.0%		1	1			00:27:48
11	孙梦颖	4/6		0/1	1/1				5/8	62.5%		1				00:51:34
12	郑冯									0.0%						00:21:00
13	徐娟	1/1							1/1	100%						00:12:25
17	居晔				1/1				1/1	100%		1	1	1		00:25:28
18	沙正文		3/4			1/2			4/6	66.7%	1					00:46:54
19	印尼									0.0%						00:00:00
21	王嘉怡									0.0%		2				00:05:53
23	都好									0.0%						00:13:04
<b>合计</b>		13/20	4/8	5/7	8/10	2/3		2/3	34/51	66.7%	7	18	3	2		
<i>(守门员)</i>																
1	许沫	6/6	6/10	3/4	0/1	0/2		1/3	16/26	61.5%						00:39:00
12	郑冯	5/6	2/6	0/2	0/2	0/1		0/2	7/19	36.8%						00:21:00
<b>合计</b>		11/12	8/16	3/6	0/3	0/3		1/5	23/45	51.1%						

场上队员：得分/射门

守门员：救球/射门

全队合计	得分	被救	射失	击柱	封球	合计	%
远射	13	1	2	1	3	20	65.0%
近射	4	3	1			8	50.0%
边射	5	2				7	71.4%
快攻	8		1	1		10	80.0%
突破	2	1				3	66.7%
任意							0.0%
7M	2	1				3	66.7%







### 2016年全国女子手球锦标赛

#### 图式射门区域统计

轮次 10 场次 53

201605053-41-1/1

## 广东

3 安妮	5 李纯	7 刘彤	8 李诗棋	9 韦宝柱	11 魏梦庭	15 杨慧	16 李娟																																																																								
<table border="1"><tr><td></td><td>1</td><td></td></tr><tr><td></td><td></td><td></td></tr><tr><td>1</td><td></td><td>1</td></tr></table>		1					1		1	<table border="1"><tr><td></td><td></td><td></td></tr><tr><td></td><td></td><td></td></tr><tr><td></td><td></td><td></td></tr></table>										<table border="1"><tr><td>1</td><td></td><td>1</td></tr><tr><td></td><td></td><td>1</td></tr><tr><td></td><td></td><td></td></tr></table>	1		1			1				<table border="1"><tr><td></td><td></td><td></td></tr><tr><td></td><td></td><td></td></tr><tr><td></td><td></td><td></td></tr></table>										<table border="1"><tr><td></td><td></td><td></td></tr><tr><td></td><td></td><td></td></tr><tr><td>1</td><td></td><td>1</td></tr></table>							1		1	<table border="1"><tr><td></td><td>1</td><td>1</td></tr><tr><td>1</td><td></td><td></td></tr><tr><td></td><td></td><td></td></tr></table>		1	1	1						<table border="1"><tr><td></td><td></td><td></td></tr><tr><td></td><td></td><td></td></tr><tr><td></td><td></td><td></td></tr></table>										<table border="1"><tr><td></td><td></td><td></td></tr><tr><td></td><td></td><td></td></tr><tr><td></td><td></td><td></td></tr></table>									
	1																																																																														
1		1																																																																													
1		1																																																																													
		1																																																																													
1		1																																																																													
	1	1																																																																													
1																																																																															
Post - 0 Miss - 0 Block - 0	Post - 0 Miss - 0 Block - 0	Post - 1 Miss - 0 Block - 0	Post - 0 Miss - 0 Block - 0	Post - 1 Miss - 2 Block - 0	Post - 0 Miss - 0 Block - 2	Post - 0 Miss - 0 Block - 0	Post - 0 Miss - 0 Block - 0																																																																								
18 李玉玲	19 邝雪花	20 李军政	22 刘晓玉	23 王如	26 马晓卉	28 刘金兰	31 史小军																																																																								
<table border="1"><tr><td></td><td></td><td></td></tr><tr><td></td><td></td><td></td></tr><tr><td></td><td></td><td></td></tr></table>										<table border="1"><tr><td>3</td><td></td><td></td></tr><tr><td></td><td></td><td></td></tr><tr><td></td><td></td><td></td></tr></table>	3									<table border="1"><tr><td></td><td>1</td><td></td></tr><tr><td></td><td></td><td></td></tr><tr><td></td><td></td><td>1</td></tr></table>		1							1	<table border="1"><tr><td></td><td></td><td></td></tr><tr><td></td><td></td><td></td></tr><tr><td></td><td></td><td></td></tr></table>										<table border="1"><tr><td></td><td>1</td><td>1</td></tr><tr><td>1</td><td>1</td><td></td></tr><tr><td></td><td></td><td></td></tr></table>		1	1	1	1					<table border="1"><tr><td></td><td></td><td></td></tr><tr><td></td><td></td><td></td></tr><tr><td></td><td></td><td></td></tr></table>										<table border="1"><tr><td></td><td></td><td>1</td></tr><tr><td></td><td></td><td></td></tr><tr><td></td><td></td><td>1</td></tr></table>			1						1	<table border="1"><tr><td></td><td></td><td></td></tr><tr><td></td><td></td><td></td></tr><tr><td></td><td></td><td></td></tr></table>									
3																																																																															
	1																																																																														
		1																																																																													
	1	1																																																																													
1	1																																																																														
		1																																																																													
		1																																																																													
Post - 1 Miss - 0 Block - 0	Post - 0 Miss - 1 Block - 1	Post - 1 Miss - 0 Block - 0	Post - 0 Miss - 0 Block - 0	Post - 0 Miss - 1 Block - 0	Post - 0 Miss - 0 Block - 0	Post - 0 Miss - 0 Block - 0	Post - 0 Miss - 0 Block - 0																																																																								

22 刘晓玉

0/2		0/2
0/1		0/1
0/1		

26 马晓卉

0/3		0/4
2/8	1/1	0/6
2/6	3/4	0/3

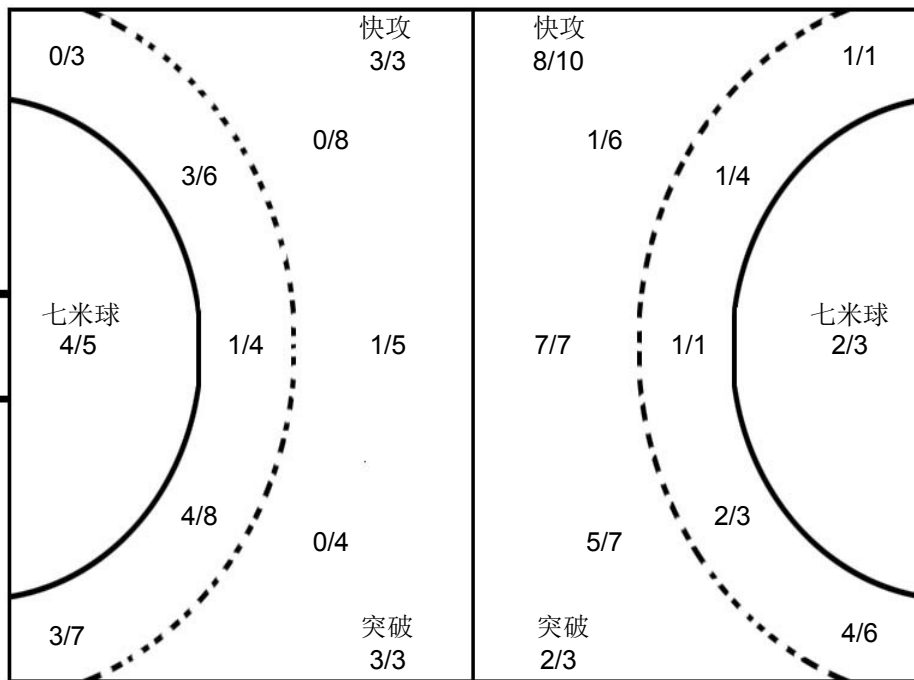
1 许沫

0/2		1/2
2/6	4/4	2/2
4/5	2/2	1/3

12 郑冯

1/2	1/3	1/3
1/2	1/2	2/4
0/1		0/2

## 上海

1 许沫	2 周蕾	5 郭威	6 黄妍	7 车婉茹	8 吴茵	9 武娜娜	10 斯文																																																																								
<table border="1"><tr><td></td><td></td><td></td></tr><tr><td></td><td></td><td></td></tr><tr><td></td><td></td><td></td></tr></table>										<table border="1"><tr><td></td><td></td><td>1</td></tr><tr><td>1</td><td></td><td>1</td></tr><tr><td>1</td><td></td><td>1</td></tr></table>			1	1		1	1		1	<table border="1"><tr><td>1</td><td></td><td></td></tr><tr><td></td><td></td><td></td></tr><tr><td></td><td></td><td>1</td></tr></table>	1								1	<table border="1"><tr><td></td><td></td><td>1</td></tr><tr><td></td><td></td><td>3</td></tr><tr><td></td><td></td><td></td></tr></table>			1			3				<table border="1"><tr><td></td><td></td><td></td></tr><tr><td></td><td></td><td></td></tr><tr><td></td><td></td><td></td></tr></table>										<table border="1"><tr><td>1</td><td></td><td>2</td></tr><tr><td>2</td><td></td><td>1</td></tr><tr><td>3</td><td></td><td></td></tr></table>	1		2	2		1	3			<table border="1"><tr><td></td><td></td><td>1</td></tr><tr><td></td><td></td><td></td></tr><tr><td></td><td></td><td></td></tr></table>			1							<table border="1"><tr><td>1</td><td></td><td></td></tr><tr><td>1</td><td></td><td></td></tr><tr><td>1</td><td></td><td></td></tr></table>	1			1			1		
		1																																																																													
1		1																																																																													
1		1																																																																													
1																																																																															
		1																																																																													
		1																																																																													
		3																																																																													
1		2																																																																													
2		1																																																																													
3																																																																															
		1																																																																													
1																																																																															
1																																																																															
1																																																																															
Post - 0 Miss - 0 Block - 0	Post - 0 Miss - 0 Block - 0	Post - 0 Miss - 0 Block - 0	Post - 0 Miss - 0 Block - 0	Post - 0 Miss - 0 Block - 0	Post - 1 Miss - 0 Block - 1	Post - 1 Miss - 1 Block - 0	Post - 0 Miss - 1 Block - 1																																																																								
11 孙梦颖	12 郑冯	13 徐娟	17 居晔	18 沙正文	19 印尼	21 王嘉怡	23 都好																																																																								
<table border="1"><tr><td>2</td><td></td><td></td></tr><tr><td>1</td><td></td><td>1</td></tr><tr><td></td><td></td><td>1</td></tr></table>	2			1		1			1	<table border="1"><tr><td></td><td></td><td></td></tr><tr><td></td><td></td><td></td></tr><tr><td></td><td></td><td></td></tr></table>										<table border="1"><tr><td></td><td></td><td></td></tr><tr><td></td><td></td><td></td></tr><tr><td></td><td></td><td>1</td></tr></table>									1	<table border="1"><tr><td></td><td></td><td></td></tr><tr><td></td><td></td><td>1</td></tr><tr><td></td><td></td><td></td></tr></table>						1				<table border="1"><tr><td>1</td><td></td><td>1</td></tr><tr><td>1</td><td></td><td></td></tr><tr><td>1</td><td></td><td></td></tr></table>	1		1	1			1			<table border="1"><tr><td></td><td></td><td></td></tr><tr><td></td><td></td><td></td></tr><tr><td></td><td></td><td></td></tr></table>										<table border="1"><tr><td></td><td></td><td></td></tr><tr><td></td><td></td><td></td></tr><tr><td></td><td></td><td></td></tr></table>										<table border="1"><tr><td></td><td></td><td></td></tr><tr><td></td><td></td><td></td></tr><tr><td></td><td></td><td></td></tr></table>									
2																																																																															
1		1																																																																													
		1																																																																													
		1																																																																													
		1																																																																													
1		1																																																																													
1																																																																															
1																																																																															
Post - 0 Miss - 1 Block - 1	Post - 0 Miss - 0 Block - 0	Post - 0 Miss - 0 Block - 0	Post - 0 Miss - 0 Block - 0	Post - 0 Miss - 1 Block - 0	Post - 0 Miss - 0 Block - 0	Post - 0 Miss - 0 Block - 0	Post - 0 Miss - 0 Block - 0																																																																								

注释: Post=击柱 Miss=射失 Block=被封



## 2016年全国女子手球锦标赛

## 比赛进程表

正式表  
手球  
女子3-4名  
轮次 10组别 X  
场次 53201605053-13-1/6  
滁州体育馆  
13/09/2016 17:00

时间	队员	动作	比分	队员	动作
<b>广东</b>			<b>上半时</b>		
<b>上海</b>					
00:35	9 韦宝桂	左远射 被救		1 许沫	挡住球
01:11	26 马晓卉	挡住球		18 沙正文	突破 被救
01:44	11 魏梦庭	近射 被救		1 许沫	挡住球
01:55	9 韦宝桂	使被罚7M球		10 斯文	快攻 造7M
01:58	9 韦宝桂	警告			
02:05	26 马晓卉	被射入	0 - 1	6 黄妍	7M球 得分
02:39	9 韦宝桂	接球失误		9 武娜娜	抢球
02:44	26 马晓卉	被射入	0 - 2	6 黄妍	一传快攻 得分
03:09	19 邝雪花	近射 被救		1 许沫	挡住球
03:10	20 李军政	助攻			
03:29	20 李军政	四步			
03:43	26 马晓卉	被射入	0 - 3	8 吴茵	中远射 得分
04:06	23 王如	左边射 射失			
04:46				11 孙梦颖	右远射 射失
05:26	11 魏梦庭	右远射 被封		18 沙正文	封球
05:41	7 刘彤	左边射 击柱			
05:45				6 黄妍	助攻
05:48				9 武娜娜	一传快攻 击柱
06:34	23 王如	助攻			
06:37	20 李军政	近射 得分	1 - 3	1 许沫	被射入
06:38				8 吴茵	警告
07:08				8 吴茵	运球失误
07:21	19 邝雪花	助攻			
07:24	23 王如	近射 被救		1 许沫	挡住球
07:30	7 刘彤	警告			
07:56	26 马晓卉	挡住球		6 黄妍	近射 被救
08:03	19 邝雪花	近射 得分	2 - 3	1 许沫	被射入
08:14	26 马晓卉	被射入	2 - 4	10 斯文	右边射 得分
08:17				8 吴茵	助攻
08:48	23 王如	突破 得分	3 - 4	1 许沫	被射入
08:56				8 吴茵	助攻
09:00	26 马晓卉	被射入	3 - 5	18 沙正文	近射 得分
09:05	18 李玉玲	警告			
10:00	9 韦宝桂	造7M		10 斯文	使被罚7M球
10:02				10 斯文	警告
10:14		裁判暂停			
10:15	9 韦宝桂	7M球 得分	4 - 5	1 许沫	被射入
10:28	26 马晓卉	挡住球		11 孙梦颖	右边射 被救
10:50	11 魏梦庭	近射 得分	5 - 5	1 许沫	被射入
10:59				6 黄妍	四步





## 2016年全国女子手球锦标赛

## 比赛进程表

正式表  
手球  
女子3-4名  
轮次 10组别 X  
场次 53201605053-13-2/6  
滁州体育馆  
13/09/2016 17:00

时间	队员	动作	比分	队员	动作			
<b>广东</b>			<b>上半时</b>			<b>上海</b>		
11:24	11 魏梦庭	近射 被救		1 许沫	挡住球			
12:03	9 韦宝桂	左边射 射失						
12:07					球队暂停			
12:51	26 马晓卉	被射入	<b>5 - 6</b>	8 吴茵	中远射 得分			
13:30	11 魏梦庭	传球失误						
13:38	26 马晓卉	被射入	<b>5 - 7</b>	2 周蕾	一传快攻 得分			
13:40				6 黄妍	助攻			
14:18	18 李玉玲	传球失误		2 周蕾	断球			
14:33	3 安妮	断球		6 黄妍	传球失误			
14:36	3 安妮	传球失误		6 黄妍	断球			
14:50	26 马晓卉	被射入	<b>5 - 8</b>	11 孙梦颖	右远射 得分			
15:17	3 安妮	四步						
15:24	26 马晓卉	被射入	<b>5 - 9</b>	11 孙梦颖	一传快攻 得分			
15:27				18 沙正文	助攻			
15:31		球队暂停						
16:02	28 刘金兰	左边射 得分	<b>6 - 9</b>	1 许沫	被射入			
16:34	26 马晓卉	被射入	<b>6 - 10</b>	6 黄妍	右远射 得分			
17:06				17 居晔	警告			
17:39	23 王如	造7M		17 居晔	使被罚7M球			
17:51	18 李玉玲	7M球 被救		1 许沫	挡住球			
18:26		裁判暂停						
18:26	28 刘金兰	罚出场2分钟						
18:44	26 马晓卉	被射入	<b>6 - 11</b>	18 沙正文	突破 得分			
19:31	31 史小军	左远射 被救		1 许沫	挡住球			
19:34				9 武娜娜	侵区			
19:57	18 李玉玲	右远射 击柱						
20:04				9 武娜娜	短传快攻 射失			
20:37	9 韦宝桂	传球失误		9 武娜娜	断球			
21:06		裁判暂停						
21:06	23 王如	罚出场2分钟						
21:19	26 马晓卉	被射入	<b>6 - 12</b>	8 吴茵	中远射 得分			
21:49	9 韦宝桂	左边射 被救		1 许沫	挡住球			
21:50		裁判暂停						
22:17	26 马晓卉	被射入	<b>6 - 13</b>	11 孙梦颖	中远射 得分			
22:46	31 史小军	近射 被救		1 许沫	挡住球			
22:50	22 刘晓玉	被射入	<b>6 - 14</b>	17 居晔	短传快攻 得分			
23:30	9 韦宝桂	突破 得分	<b>7 - 14</b>	1 许沫	被射入			
24:12	28 刘金兰	使被罚7M球		18 沙正文	造7M			
24:40	26 马晓卉	挡住球		8 吴茵	7M球 被救			
24:45	26 马晓卉	被射入	<b>7 - 15</b>	8 吴茵	近射 得分			





## 2016年全国女子手球锦标赛

## 比赛进程表

正式表  
手球  
女子3-4名  
轮次 10组别 X  
场次 53201605053-13-3/6  
滁州体育馆  
13/09/2016 17:00

时间	队员	动作	比分	队员	动作
<b>广东</b>			<b>上半时</b>		
<b>上海</b>					
25:21	11 魏梦庭	左远射 被封		2 周蕾	封球
25:39	9 韦宝桂	传球失误		18 沙正文	断球
25:45	22 刘晓玉	被射入	<b>7 - 16</b>	2 周蕾	短传快攻 得分
26:21	19 邝雪花	近射 得分	<b>8 - 16</b>	1 许沫	被射入
26:44	22 刘晓玉	被射入	<b>8 - 17</b>	6 黄妍	右远射 得分
27:08	11 魏梦庭	近射 被救		1 许沫	挡住球
27:19				8 吴茵	接球失误
27:46	28 刘金兰	传球失误		2 周蕾	断球
27:50	22 刘晓玉	被射入	<b>8 - 18</b>	2 周蕾	一传快攻 得分
28:17	20 李军政	右边射 被救		1 许沫	挡住球
28:59				17 居晔	侵区
29:26	19 邝雪花	造7M		18 沙正文	使被罚7M球
29:26		裁判暂停			
29:32	11 魏梦庭	7M球 得分	<b>9 - 18</b>	1 许沫	被射入
29:55	22 刘晓玉	被射入	<b>9 - 19</b>	11 孙梦颖	中远射 得分



## 2016年全国女子手球锦标赛

## 比赛进程表

正式表  
手球  
女子3-4名  
轮次 10组别 X  
场次 53201605053-13-4/6  
滁州体育馆  
13/09/2016 17:00

时间	队员	动作	比分	队员	动作
<b>广东</b>			<b>下半时</b>		
<b>上海</b>					
00:40	22 刘晓玉	被射入	9 - 20	9 武娜娜	左边射 得分
01:07	11 魏梦庭	右边射 被救		1 许沫	挡住球
01:45	22 刘晓玉	被射入	9 - 21	8 吴茵	左远射 得分
02:31	9 韦宝桂	近射 击柱			
02:58				6 黄妍	传球失误
03:08	9 韦宝桂	右远射 被救		1 许沫	挡住球
03:54	11 魏梦庭	断球		6 黄妍	传球失误
03:58	23 王如	一传快攻 得分	10 - 21	1 许沫	被射入
04:01		裁判暂停			
04:01	9 韦宝桂	使被罚7M球		2 周蕾	造7M
04:01	9 韦宝桂	罚出场2分钟			
04:01	1 李细利	警告			
04:01	1 李细利	罚出场2分钟			
04:02	26 马晓卉	被射入	10 - 22	5 郭威	7M球 得分
04:41	19 邝雪花	四步			
04:51	26 马晓卉	挡住球		2 周蕾	右边射 被救
04:56	26 马晓卉	挡住球		6 黄妍	近射 被救
05:33	19 邝雪花	中远射 射失			
06:13				8 吴茵	右远射 击柱
06:47	19 邝雪花	右远射 被救		1 许沫	挡住球
06:54	26 马晓卉	被射入	10 - 23	8 吴茵	短传快攻 得分
07:37	9 韦宝桂	左远射 被救		1 许沫	挡住球
07:43				10 斯文	快攻 接球失误
07:53	3 安妮	中远射 被救		1 许沫	挡住球
07:59	26 马晓卉	被射入	10 - 24	8 吴茵	短传快攻 得分
08:39	9 韦宝桂	近射 射失			
08:52	26 马晓卉	被射入	10 - 25	10 斯文	右边射 得分
09:31	7 刘彤	近射 被救		12 郑冯	挡住球
09:38				8 吴茵	侵区
10:26	28 刘金兰	中远射 得分	11 - 25	12 郑冯	被射入
11:03	26 马晓卉	被射入	11 - 26	5 郭威	右远射 得分
11:50	28 刘金兰	助攻			
11:53	3 安妮	近射 得分	12 - 26	12 郑冯	被射入
12:23	20 李军政	封球		10 斯文	左远射 被封
13:00	3 安妮	近射 被救		12 郑冯	挡住球
13:03	7 刘彤	左边射 得分	13 - 26	12 郑冯	被射入
13:29				10 斯文	左远射 射失
14:09	3 安妮	接球失误			
14:18	3 安妮	断球		21 王嘉怡	传球失误
14:23		裁判暂停			





## 2016年全国女子手球锦标赛

## 比赛进程表

正式表  
手球  
女子3-4名  
轮次 10组别 X  
场次 53201605053-13-5/6  
滁州体育馆  
13/09/2016 17:00

时间	队员	动作	比分	队员	动作
广东			上海		
			下半场		
14:23				5 郭威	罚出场2分钟
14:36	3 安妮	助攻			
14:40	23 王如	近射 得分	14 - 26	12 郑冯	被射入
15:30	26 马晓卉	被射入	14 - 27	13 徐娟	中远射 得分
15:52	11 魏梦庭	右远射 被救		12 郑冯	挡住球
16:28	19 邝雪花	断球		21 王嘉怡	传球失误
16:44	3 安妮	造7M		23 都好	使被罚7M球
17:01	11 魏梦庭	7M球 得分	15 - 27	12 郑冯	被射入
17:30	26 马晓卉	挡住球		8 吴茵	左远射 被救
17:41	19 邝雪花	突破 得分	16 - 27	12 郑冯	被射入
18:24	26 马晓卉	被射入	16 - 28	2 周蕾	右边射 得分
18:44	23 王如	其它失误			
18:53	11 魏梦庭	造犯规		9 武娜娜	进攻犯规
18:58	23 王如	短传快攻 得分	17 - 28	12 郑冯	被射入
19:49	19 邝雪花	封球		8 吴茵	左远射 被封
20:05	3 安妮	近射 得分	18 - 28	12 郑冯	被射入
20:13	26 马晓卉	挡住球		8 吴茵	近射 被救
20:16		裁判暂停			
20:46				2 周蕾	助攻
20:49				18 沙正文	近射 射失
21:21	20 李军政	近射 得分	19 - 28	12 郑冯	被射入
21:27					球队暂停
21:57	26 马晓卉	被射入	19 - 29	8 吴茵	突破 得分
22:37	11 魏梦庭	中远射 被救		12 郑冯	挡住球
23:01				11 孙梦颖	侵区
23:25	19 邝雪花	右远射 被救		12 郑冯	挡住球
23:48	26 马晓卉	被射入	19 - 30	8 吴茵	右远射 得分
24:39	19 邝雪花	中远射 被封		18 沙正文	封球
24:41	19 邝雪花	右远射 被救		12 郑冯	挡住球
24:52	26 马晓卉	被射入	19 - 31	11 孙梦颖	中远射 得分
25:35	19 邝雪花	右远射 被救		12 郑冯	挡住球
25:46	5 李纯	封球		11 孙梦颖	左远射 被封
26:02	26 马晓卉	被射入	19 - 32	18 沙正文	近射 得分
26:51	7 刘彤	左边射 得分	20 - 32	12 郑冯	被射入
27:02	26 马晓卉	被射入	20 - 33	2 周蕾	右边射 得分
27:03		裁判暂停			
27:03	3 安妮	罚出场2分钟			
27:23	20 李军政	传球失误			
27:59				5 郭威	助攻
28:02	26 马晓卉	被射入	20 - 34	18 沙正文	近射 得分





## 2016年全国女子手球锦标赛

## 比赛进程表

正式表  
手球  
女子3-4名  
轮次 10组别 X  
场次 53201605053-13-6/6  
滁州体育馆  
13/09/2016 17:00

时间	队员	动作	比分	队员	动作			
<b>广东</b>			<b>下 半 时</b>			<b>上 海</b>		
28:25	20 李军政	右边射 击柱						
28:33				2 周蕾	其它失误			
28:46	31 史小军	传球失误		18 沙正文	断球			
29:09				8 吴茵	四步			
29:14	3 安妮	短传快攻 得分	<b>21 - 34</b>	12 郑冯	被射入			
29:31	31 史小军	造犯规		8 吴茵	进攻犯规			
29:41		裁判暂停						
29:41	3 安妮	造7M		17 居晔	使被罚7M球			
29:41				17 居晔	罚出场2分钟			
29:44	7 刘彤	7M球 得分	<b>22 - 34</b>	12 郑冯	被射入			
30:00				8 吴茵	传球失误			



决赛  
女子 全国比赛

2016年全国女子手球锦标赛

Team A		Team B		Match Number	
A 江苏		B 安徽		54	
played in China		in the hall 滁州体育馆		on 13/09/2016	
				at 18:30 hours	
Spectators					
Half-time (30')	A 15	B 19	End of playing time	A 33	B 34
1st extra time		A		B	
2nd extra time		A		B	
After penalty throws		A		B	
Number of 7 m	A 4 / 4	Team time-out		B 4 / 4	
		Full name of players and officials		Number of 7 m	
Team A		Team B			
No.	G	W	2'	D	DR
1 陆婷					
3 张海侠	6	1			
4 赵佳芹	9		1		
5 高媛媛					
6 乔如	4	1	1		
7 莫蒙蒙					
8 王可可					
9 于源源					
10 黄霞					
11 黄慧影					
12 王小华					
13 修丽杰			1	1	
14 韦秋香	1				
15 王书慧	7				
16 金梦青	1				
17 蓝小玲					
18 司艳					
19 李兵	3	1			
20 班晨晨					
21 沈萍	7		1		
22 赵江川					
23 徐仕媛					
24 孙来苗	5	1	2		
25 刘晓妹	7		1		
26 朱莉珍					
27 周婷	3				
28 郑冬冬					
29 周雪婷					
30 李瑶	9	1			
31 张天洁					
32 杜机娟					
33 陶传红					
A 姚治前					
B 金甲洙 (主教练)					
C 马彪					
E 陈志伟					
A 吴立军					
E 张舜					
Signature of Responsible Official of the Teams (Off. A)		Signature of Responsible Official of the Teams (Off. B)			
TP	Remarks of Referee / CHA Official				TP

Signatures

Referees	刘书勇 (CHN)	马晓晔 (CHN)		
Techn. Delegates	高斌 (CHN)			
CHA Official	于中迅 (CHN)			

Note: Number of 7m Throws Awarded to Team A and B, Goals (G), Warnings (W), Suspensions (2'), Direct Disqualification (D), Disqualification with Report (DR) and Team Penalty (TP).

Table Officials: 佟金政

贾俊秋

Statisticians: 陈柱

刘永欢







## 2016年全国女子手球锦标赛 竞赛技术统计(媒体表)

<b>决赛</b>	组别	<b>X</b>	轮次	<b>10</b>	场次	<b>54</b>
滁州体育馆			13/09/2016		201605054-51-1/1	
江苏	<b>江苏</b>	<b>33</b>	vs	<b>34</b>	安徽	安徽
			<b>15 : 19</b>			

裁判员	刘书勇 (CHN)	/	马晓晔 (CHN)
-----	-----------	---	-----------

江苏		远	近	边	快	突	任意	7m	合计	%	助攻	失误	警告	2'	D & DR	江苏		比赛 进程	安徽	
主教练：金甲洙		射	射	射	攻	破	球	球												
1	陆婷																			
3	张海侠	1/1	2/3	3/3					6/7	85.7		2	1					14	刘晓妹	
4	赵佳芹	3/7	1/1	1/1		1/1	1/1	2/2	9/13	69.2	2	1		1				21	李瑶	
5	高媛媛																			
8	乔如		4/4					4/4	100			2	1	1						
9	莫蒙蒙																			
10	王可可																			
11	于源源																			
12	黄霞																			
13	黄慧影																			
16	王小华																			
17	修丽杰	0/5						0/5	0.0		1	1	1	1						
18	韦秋香			1/1				1/1	100			1								
23	王书慧	2/9	1/3	2/2		1/2	0/1	1/1	7/18	38.9		5								
33	金梦青	0/2		1/1				1/3	33.3			1								
69	蓝小玲	3/3	1/2			0/1	0/1	1/1	5/8	62.5	2	1		1						
<b>运动员 合计</b>		<b>9/27</b>	<b>9/13</b>	<b>8/8</b>		<b>2/4</b>	<b>1/3</b>	<b>4/4</b>	<b>33/59</b>	<b>55.9</b>	<b>5</b>	<b>15</b>	<b>3</b>	<b>4</b>						
1	陆婷	0/1	0/1		0/1		1/2	0/1	1/6	16.7										
12	黄霞							0/1	0/1	0.0										
16	王小华	2/6	2/8	2/4	2/9	1/5	1/4	0/2	10/38	26.3		1								
<b>守门员 合计</b>		<b>2/7</b>	<b>2/9</b>	<b>2/4</b>	<b>2/10</b>	<b>1/5</b>	<b>2/6</b>	<b>0/4</b>	<b>11/45</b>	<b>24.4</b>		<b>1</b>								
安徽		远	近	边	快	突	任意	7m	合计	%	助攻	失误	警告	2'	D & DR	江苏		比赛 进程	安徽	
教练：孙来苗		射	射	射	攻	破	球	球												
1	司艳																			
3	李兵		1/2		1/1	1/1			3/4	75.0	1	3	1							
5	班晨晨																			
6	沈萍	2/3	0/1	0/1			1/3	4/4	7/12	58.3	3	5		1						
7	赵江川																			
8	徐仕媛																			
10	孙来苗		4/4		1/1			5/5	100			2	1	2						
14	刘晓妹	2/4			1/1	1/2	3/4	7/11	63.6		2	2		1						
16	朱莉珍																			
17	周婷	1/1	1/1		1/2			3/4	75.0			2								
18	郑冬冬																			
20	周雪婷																			
21	李瑶		1/1	2/3	4/5	2/2		9/11	81.8		1	4	1							
23	张天洁			0/1				0/1	0.0											
41	杜机娟												1							
46	陶传红																			
<b>运动员 合计</b>		<b>5/8</b>	<b>7/9</b>	<b>2/5</b>	<b>8/10</b>	<b>4/5</b>	<b>4/7</b>	<b>4/4</b>	<b>34/48</b>	<b>70.8</b>	<b>7</b>	<b>19</b>	<b>3</b>	<b>4</b>						
1	司艳	6/14	3/11	0/8		2/4	1/2	0/1	12/40	30.0										
16	朱莉珍	0/1	0/1					0/3	0/5	0.0										
<b>守门员 合计</b>		<b>6/15</b>	<b>3/12</b>	<b>0/8</b>		<b>2/4</b>	<b>1/2</b>	<b>0/4</b>	<b>12/45</b>	<b>26.7</b>										
场上队员：得分 / 射门		守门员：救球 / 射门																		

快攻	Fast Break		突破	Breakthrough		任意球	Free Throw		7M球	7M Throw		助攻	Assist
警告	Warning		失误	Error		2'	Suspension		D	取消资格		DR	取消资格+报告





### 2016年全国女子手球锦标赛 图式比赛技术统计表

轮次 10

场次 54

201605054-21-1/1

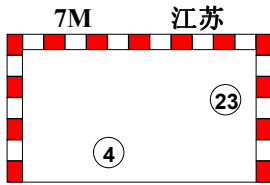
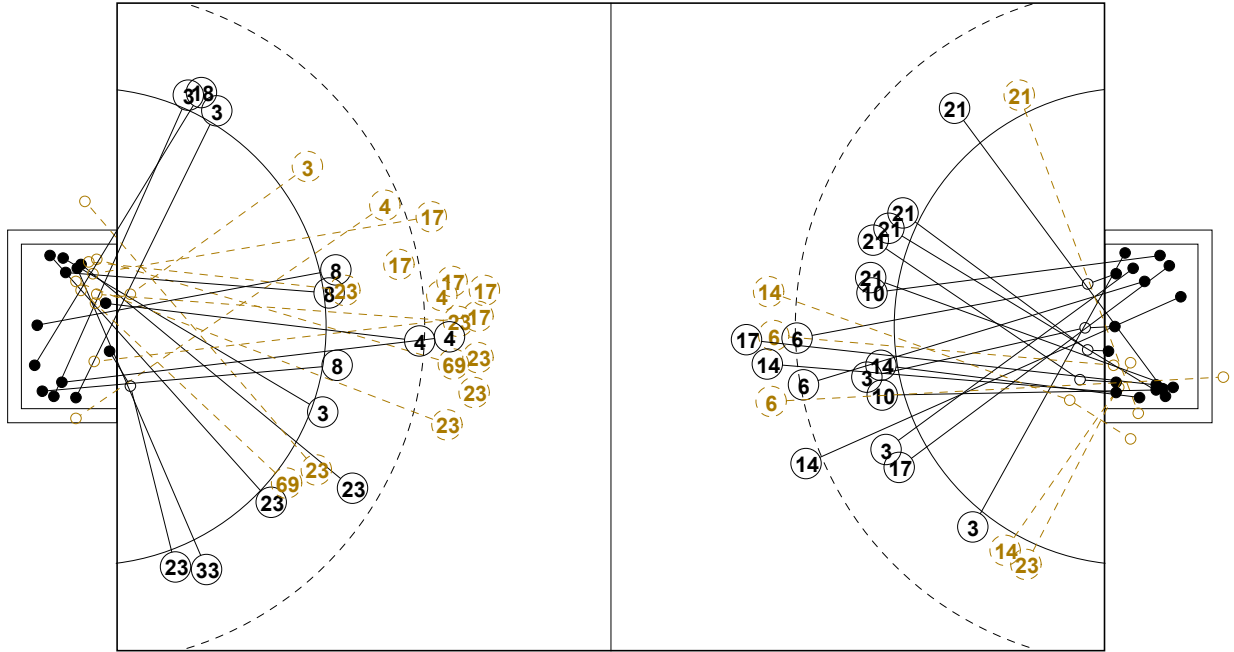

1st Half  
15 : 19

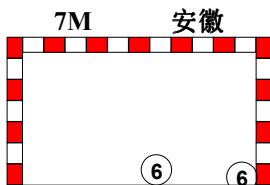
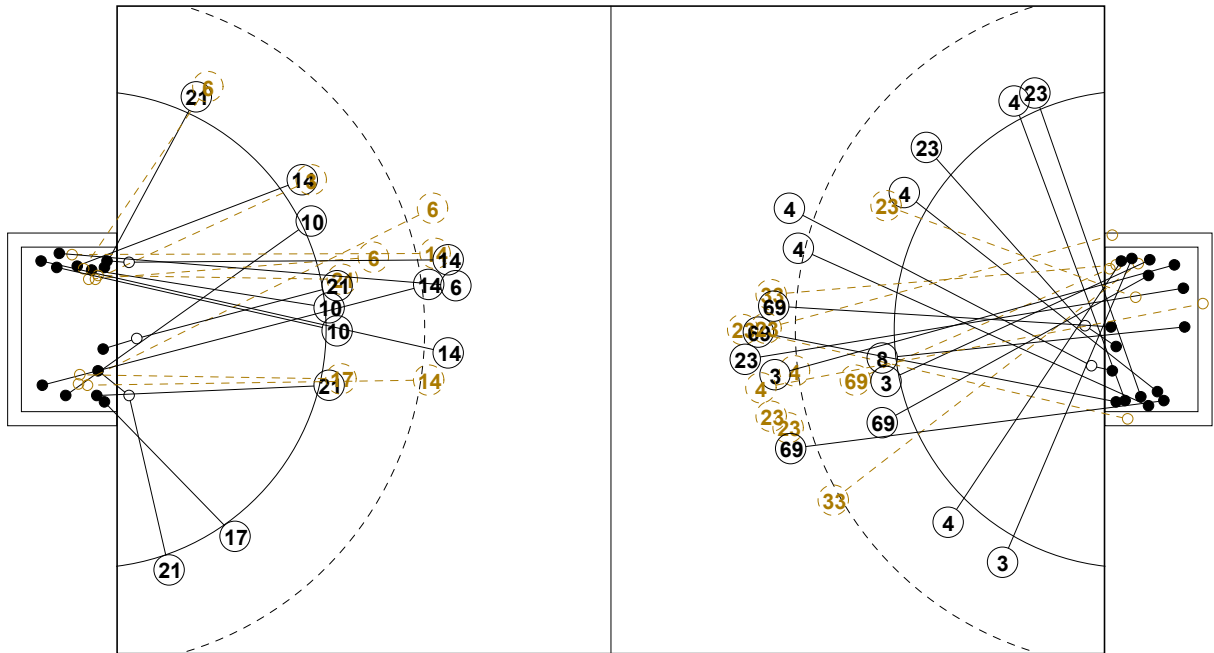
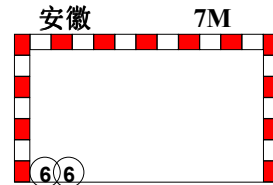

2nd Half  
34 : 33

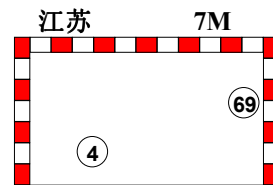



## 2016年全国女子手球锦标赛

## 个人/全队技术统计表

正式表  
手球  
女子决赛  
轮次 10组别 X  
场次 54201605054-14-1/2  
滁州体育馆  
13/09/2016 18:30

号码	姓名	远射	近射	边射	快攻	突破	任意	7M	合计	%	助攻	失误	警告	2'	取消	时间
<b>江苏(江苏)</b>																
<i>(场上队员)</i>																
1	陆婷									0.0%						00:05:13
3	张海侠	1/1	2/3	3/3					6/7	85.7%		2	1			00:48:35
4	赵佳芹	3/7	1/1	1/1		1/1	1/1	2/2	9/13	69.2%	2	1		1		00:59:54
5	高媛媛									0.0%						00:00:00
8	乔如		4/4						4/4	100%		2	1	1		01:00:00
9	莫蒙蒙									0.0%						00:01:51
10	王可可									0.0%						00:00:00
11	于源源									0.0%						00:07:55
12	黄霞									0.0%						00:00:09
13	黄慧影									0.0%						00:00:00
16	王小华									0.0%		1				00:54:38
17	修丽杰	0/5							0/5	0.0%	1	1	1	1		00:53:59
18	韦秋香			1/1					1/1	100%		1				00:07:16
23	王书慧	2/9	1/3	2/2		1/2	0/1	1/1	7/18	38.9%		5				00:36:11
33	金梦青	0/2		1/1					1/3	33.3%		1				00:42:13
69	蓝小玲	3/3	1/2			0/1	0/1	1/1	5/8	62.5%	2	1		1		00:40:35
<b>合计</b>		9/27	9/13	8/8		2/4	1/3	4/4	33/59	55.9%	5	15	3	4		
<i>(守门员)</i>																
1	陆婷	0/1	0/1		0/1		1/2	0/1	1/6	16.7%						00:05:13
12	黄霞							0/1	0/1	0.0%						00:00:09
16	王小华	2/6	2/8	2/4	2/9	1/5	1/4	0/2	10/38	26.3%		1				00:54:38
<b>合计</b>		2/7	2/9	2/4	2/10	1/5	2/6	0/4	11/45	24.4%		1				

场上队员：得分/射门

守门员：救球/射门

全队合计	得分	被救	射失	击柱	封球	合计	%
远射	9	6		3	9	27	33.3%
近射	9	3	1			13	69.2%
边射	8					8	100.0%
快攻							0.0%
突破	2	2				4	50.0%
任意	1	1		1		3	33.3%
7M	4					4	100.0%





## 2016年全国女子手球锦标赛

## 个人/全队技术统计表

正式表  
手球  
女子决赛  
轮次 10组别 X  
场次 54201605054-14-2/2  
滁州体育馆  
13/09/2016 18:30

号码	姓名	远射	近射	边射	快攻	突破	任意	7M	合计	%	助攻	失误	警告	2'	取消	时间
<b>安徽(安徽)</b>																
<i>(上场队员)</i>																
1	司艳									0.0%						00:55:48
3	李兵		1/2		1/1	1/1			3/4	75.0%	1	3	1			00:51:38
5	班晨晨									0.0%						00:00:00
6	沈萍	2/3	0/1	0/1			1/3	4/4	7/12	58.3%	3	5		1		01:00:00
7	赵江川									0.0%						00:00:00
8	徐仕媛									0.0%						00:00:00
10	孙来苗		4/4		1/1				5/5	100%		2	1	2		00:58:08
14	刘晓妹	2/4			1/1	1/2	3/4		7/11	63.6%	2	2		1		00:57:25
16	朱莉珍									0.0%						00:04:12
17	周婷	1/1	1/1		1/2				3/4	75.0%		2				00:53:05
18	郑冬冬									0.0%						00:05:50
20	周雪婷									0.0%						00:00:00
21	李瑶		1/1	2/3	4/5	2/2			9/11	81.8%	1	4	1			00:59:55
23	张天洁			0/1					0/1	0.0%						00:06:55
41	杜机娟									0.0%		1				00:06:51
46	陶传红									0.0%						00:00:00
<b>合计</b>		5/8	7/9	2/5	8/10	4/5	4/7	4/4	34/48	70.8%	7	19	3	4		
<i>(守门员)</i>																
1	司艳	6/14	3/11	0/8		2/4	1/2	0/1	12/40	30.0%						00:55:48
16	朱莉珍	0/1	0/1					0/3	0/5	0.0%						00:04:12
<b>合计</b>		6/15	3/12	0/8		2/4	1/2	0/4	12/45	26.7%						

场上队员：得分/射门

守门员：救球/射门

全队合计	得分	被救	射失	击柱	封球	合计	%
远射	5	2	1			8	62.5%
近射	7	2				9	77.8%
边射	2	2		1		5	40.0%
快攻	8	2				10	80.0%
突破	4	1				5	80.0%
任意	4	2	1			7	57.1%
7M	4					4	100.0%





2016年全国女子手球锦标赛

图式射门区域统计

轮次 10 场次 54

201605054-41-1/1

江苏

1 陆婷	3 张海侠	4 赵佳芹	5 高媛媛	8 乔如	9 莫蒙蒙	10 王可可	11 于源源																																																																								
<table border="1"><tr><td></td><td></td><td></td></tr><tr><td></td><td></td><td></td></tr><tr><td></td><td></td><td></td></tr></table>										<table border="1"><tr><td>2</td><td></td><td></td></tr><tr><td>2</td><td></td><td>1</td></tr><tr><td>1</td><td></td><td></td></tr></table>	2			2		1	1			<table border="1"><tr><td></td><td></td><td></td></tr><tr><td>1</td><td></td><td>2</td></tr><tr><td>2</td><td>2</td><td>2</td></tr></table>				1		2	2	2	2	<table border="1"><tr><td></td><td></td><td></td></tr><tr><td></td><td></td><td></td></tr><tr><td></td><td></td><td></td></tr></table>										<table border="1"><tr><td>1</td><td>2</td><td></td></tr><tr><td></td><td></td><td>1</td></tr><tr><td></td><td></td><td></td></tr></table>	1	2				1				<table border="1"><tr><td></td><td></td><td></td></tr><tr><td></td><td></td><td></td></tr><tr><td></td><td></td><td></td></tr></table>										<table border="1"><tr><td></td><td></td><td></td></tr><tr><td></td><td></td><td></td></tr><tr><td></td><td></td><td></td></tr></table>										<table border="1"><tr><td></td><td></td><td></td></tr><tr><td></td><td></td><td></td></tr><tr><td></td><td></td><td></td></tr></table>									
2																																																																															
2		1																																																																													
1																																																																															
1		2																																																																													
2	2	2																																																																													
1	2																																																																														
		1																																																																													
Post - 0 Miss - 0 Block - 0	Post - 0 Miss - 0 Block - 0	Post - 2 Miss - 0 Block - 2	Post - 0 Miss - 0 Block - 0	Post - 0 Miss - 0 Block - 0	Post - 0 Miss - 0 Block - 0	Post - 0 Miss - 0 Block - 0	Post - 0 Miss - 0 Block - 0																																																																								
12 黄霞	13 黄慧影	16 王小华	17 修丽杰	18 韦秋香	23 王书慧	33 金梦青	69 蓝小玲																																																																								
<table border="1"><tr><td></td><td></td><td></td></tr><tr><td></td><td></td><td></td></tr><tr><td></td><td></td><td></td></tr></table>										<table border="1"><tr><td></td><td></td><td></td></tr><tr><td></td><td></td><td></td></tr><tr><td></td><td></td><td></td></tr></table>										<table border="1"><tr><td></td><td></td><td></td></tr><tr><td></td><td></td><td></td></tr><tr><td></td><td></td><td></td></tr></table>										<table border="1"><tr><td></td><td></td><td></td></tr><tr><td></td><td></td><td></td></tr><tr><td></td><td></td><td></td></tr></table>										<table border="1"><tr><td>1</td><td></td><td></td></tr><tr><td></td><td></td><td></td></tr><tr><td></td><td></td><td></td></tr></table>	1									<table border="1"><tr><td>1</td><td></td><td>2</td></tr><tr><td></td><td></td><td>2</td></tr><tr><td></td><td>2</td><td></td></tr></table>	1		2			2		2		<table border="1"><tr><td></td><td></td><td></td></tr><tr><td></td><td></td><td>1</td></tr><tr><td></td><td></td><td></td></tr></table>						1				<table border="1"><tr><td></td><td></td><td>1</td></tr><tr><td>1</td><td></td><td>1</td></tr><tr><td></td><td>1</td><td>1</td></tr></table>			1	1		1		1	1
1																																																																															
1		2																																																																													
		2																																																																													
	2																																																																														
		1																																																																													
		1																																																																													
1		1																																																																													
	1	1																																																																													
Post - 0 Miss - 0 Block - 0	Post - 0 Miss - 0 Block - 0	Post - 0 Miss - 0 Block - 0	Post - 0 Miss - 0 Block - 3	Post - 0 Miss - 0 Block - 0	Post - 2 Miss - 1 Block - 4	Post - 0 Miss - 0 Block - 0	Post - 0 Miss - 0 Block - 0																																																																								

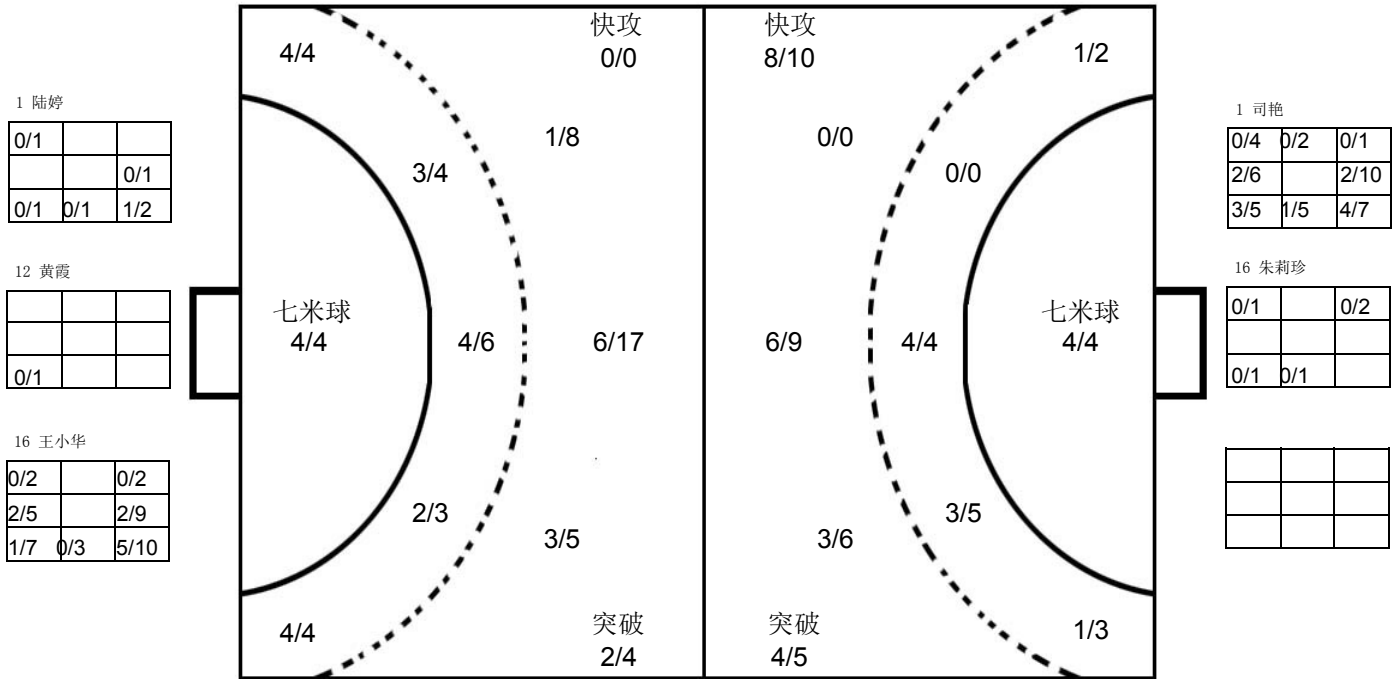

安徽

1 司艳	3 李兵	5 班晨晨	6 沈萍	7 赵江川	8 徐仕媛	10 孙来苗	14 刘晓妹																																																																								
<table border="1"><tr><td></td><td></td><td></td></tr><tr><td></td><td></td><td></td></tr><tr><td></td><td></td><td></td></tr></table>										<table border="1"><tr><td></td><td></td><td></td></tr><tr><td>2</td><td>1</td><td></td></tr><tr><td></td><td></td><td></td></tr></table>				2	1					<table border="1"><tr><td></td><td></td><td></td></tr><tr><td></td><td></td><td></td></tr><tr><td></td><td></td><td></td></tr></table>										<table border="1"><tr><td>1</td><td></td><td>1</td></tr><tr><td>3</td><td>1</td><td>1</td></tr><tr><td></td><td></td><td></td></tr></table>	1		1	3	1	1				<table border="1"><tr><td></td><td></td><td></td></tr><tr><td></td><td></td><td></td></tr><tr><td></td><td></td><td></td></tr></table>										<table border="1"><tr><td></td><td></td><td></td></tr><tr><td></td><td></td><td></td></tr><tr><td></td><td></td><td></td></tr></table>										<table border="1"><tr><td></td><td></td><td></td></tr><tr><td>2</td><td></td><td>2</td></tr><tr><td></td><td></td><td>1</td></tr></table>				2		2			1	<table border="1"><tr><td>2</td><td></td><td>1</td></tr><tr><td></td><td></td><td>2</td></tr><tr><td></td><td></td><td>2</td></tr></table>	2		1			2			2
2	1																																																																														
1		1																																																																													
3	1	1																																																																													
2		2																																																																													
		1																																																																													
2		1																																																																													
		2																																																																													
		2																																																																													
Post - 0 Miss - 0 Block - 0	Post - 0 Miss - 0 Block - 0	Post - 0 Miss - 0 Block - 0	Post - 0 Miss - 1 Block - 0	Post - 0 Miss - 0 Block - 0	Post - 0 Miss - 0 Block - 0	Post - 0 Miss - 0 Block - 0	Post - 0 Miss - 1 Block - 0																																																																								
16 朱莉珍	17 周婷	18 郑冬冬	20 周雪婷	21 李瑶	23 张天洁	41 杜机娟	46 陶传红																																																																								
<table border="1"><tr><td></td><td></td><td></td></tr><tr><td></td><td></td><td></td></tr><tr><td></td><td></td><td></td></tr></table>										<table border="1"><tr><td>1</td><td></td><td></td></tr><tr><td></td><td></td><td>1</td></tr><tr><td>1</td><td></td><td></td></tr></table>	1					1	1			<table border="1"><tr><td></td><td></td><td></td></tr><tr><td></td><td></td><td></td></tr><tr><td></td><td></td><td></td></tr></table>										<table border="1"><tr><td></td><td></td><td></td></tr><tr><td></td><td></td><td></td></tr><tr><td></td><td></td><td></td></tr></table>										<table border="1"><tr><td></td><td></td><td>1</td></tr><tr><td></td><td></td><td>2</td></tr><tr><td>2</td><td>2</td><td>2</td></tr></table>			1			2	2	2	2	<table border="1"><tr><td></td><td></td><td></td></tr><tr><td></td><td></td><td></td></tr><tr><td></td><td></td><td></td></tr></table>										<table border="1"><tr><td></td><td></td><td></td></tr><tr><td></td><td></td><td></td></tr><tr><td></td><td></td><td></td></tr></table>										<table border="1"><tr><td></td><td></td><td></td></tr><tr><td></td><td></td><td></td></tr><tr><td></td><td></td><td></td></tr></table>									
1																																																																															
		1																																																																													
1																																																																															
		1																																																																													
		2																																																																													
2	2	2																																																																													
Post - 0 Miss - 0 Block - 0	Post - 0 Miss - 0 Block - 0	Post - 0 Miss - 0 Block - 0	Post - 0 Miss - 0 Block - 0	Post - 1 Miss - 0 Block - 0	Post - 0 Miss - 0 Block - 0	Post - 0 Miss - 0 Block - 0	Post - 0 Miss - 0 Block - 0																																																																								

注释: Post=击柱 Miss=射失 Block=被封





## 2016年全国女子手球锦标赛

## 比赛进程表

正式表  
手球  
女子决赛  
轮次 10组别 X  
场次 54201605054-13-1/6  
滁州体育馆  
13/09/2016 18:30

时间	队员	动作	比分	队员	动作			
<b>江苏</b>			<b>上半时</b>			<b>安徽</b>		
00:33	3 张海侠	右边射 得分	1 - 0	1 司艳	被射入			
01:01	16 王小华	挡住球		14 刘晓妹	突破 被救			
01:12	17 修丽杰	右远射 被封		6 沈萍	封球			
01:24	16 王小华	被射入	1 - 1	14 刘晓妹	突破 得分			
01:37	23 王书慧	左远射 得分	2 - 1	1 司艳	被射入			
02:06	8 乔如	警告						
02:13		裁判暂停						
02:20				41 杜机娟	其它失误			
03:00	4 赵佳芹	右远射 击柱						
03:19		裁判暂停						
03:19	8 乔如	罚出场2分钟						
03:31	16 王小华	被射入	2 - 2	21 李瑶	突破 得分			
04:04	3 张海侠	近射 得分	3 - 2	1 司艳	被射入			
04:07	4 赵佳芹	助攻						
04:10				10 孙来苗	警告			
04:35	3 张海侠	断球		6 沈萍	传球失误			
05:08	69 蓝小玲	任意球 被救		1 司艳	挡住球			
05:19	16 王小华	挡住球		23 张天洁	右边射 被救			
05:41				21 李瑶	警告			
05:46	8 乔如	近射 得分	4 - 2	1 司艳	被射入			
06:08	16 王小华	被射入	4 - 3	10 孙来苗	近射 得分			
06:10		裁判暂停						
06:10				10 孙来苗	罚出场2分钟			
06:30	23 王书慧	突破 得分	5 - 3	1 司艳	被射入			
06:55					球队暂停			
07:05	3 张海侠	警告						
07:27				14 刘晓妹	运球失误			
07:36	17 修丽杰	右远射 被救		1 司艳	挡住球			
07:59				6 沈萍	侵区			
08:11	3 张海侠	右边射 得分	6 - 3	1 司艳	被射入			
08:39	16 王小华	被射入	6 - 4	21 李瑶	突破 得分			
08:55	8 乔如	造7M		3 李兵	使被罚7M球			
08:56				3 李兵	警告			
09:01		裁判暂停						
09:03	23 王书慧	7M球 得分	7 - 4	16 朱莉珍	被射入			
09:43	17 修丽杰	使被罚7M球		3 李兵	造7M			
09:45	17 修丽杰	警告						
09:54		裁判暂停						
09:58	12 黄霞	被射入	7 - 5	6 沈萍	7M球 得分			
10:34	23 王书慧	中远射 被救		1 司艳	挡住球			





## 2016年全国女子手球锦标赛

## 比赛进程表

正式表  
手球  
女子决赛  
轮次 10组别 X  
场次 54201605054-13-2/6  
滁州体育馆  
13/09/2016 18:30

时间	队员	动作	比分	队员	动作			
<b>江苏</b>			<b>上半时</b>			<b>安徽</b>		
10:56	23 王书慧	近射 射失						
11:08	16 王小华	被射入	7 - 6	3 李兵	突破 得分			
11:24	23 王书慧	左边射 得分	8 - 6	1 司艳	被射入			
11:45	16 王小华	被射入	8 - 7	14 刘晓妹	右远射 得分			
12:03	23 王书慧	中远射 被封		3 李兵	封球			
12:19	4 赵佳芹	中远射 得分	9 - 7	1 司艳	被射入			
12:49	16 王小华	被射入	9 - 8	3 李兵	近射 得分			
12:53				14 刘晓妹	助攻			
13:11	33 金梦青	左边射 得分	10 - 8	1 司艳	被射入			
13:46	17 修丽杰	造犯规		10 孙来苗	进攻犯规			
13:55	16 王小华	快攻 传球失误		3 李兵	断球			
14:00	16 王小华	被射入	10 - 9	3 李兵	一传快攻 得分			
14:30	23 王书慧	左远射 被救		1 司艳	挡住球			
14:49		裁判暂停						
15:04	16 王小华	被射入	10 - 10	6 沈萍	右远射 得分			
15:25	17 修丽杰	中远射 被救		1 司艳	挡住球			
15:43		裁判暂停						
15:49	1 陆婷	挡住球		6 沈萍	任意球 被救			
16:16	17 修丽杰	接球失误						
16:27	1 陆婷	被射入	10 - 11	21 李瑶	一传快攻 得分			
16:29				6 沈萍	助攻			
16:54	3 张海侠	近射 被救		1 司艳	挡住球			
17:02	1 陆婷	被射入	10 - 12	17 周婷	近射 得分			
17:22	69 蓝小玲	突破 被救		1 司艳	挡住球			
17:47	1 陆婷	被射入	10 - 13	14 刘晓妹	任意球 得分			
18:23	69 蓝小玲	造7M		6 沈萍	使被罚7M球			
18:25		裁判暂停						
18:25	4 赵佳芹	7M球 得分	11 - 13	16 朱莉珍	被射入			
19:04	1 陆婷	被射入	11 - 14	17 周婷	中远射 得分			
19:33	3 张海侠	侵区						
20:02		裁判暂停						
20:02	69 蓝小玲	使被罚7M球		3 李兵	造7M			
20:02	69 蓝小玲	罚出场2分钟						
20:07	1 陆婷	被射入	11 - 15	6 沈萍	7M球 得分			
20:24		球队暂停						
20:46	17 修丽杰	中远射 被封		6 沈萍	封球			
21:17	23 王书慧	左远射 被封		6 沈萍	封球			
21:21	16 王小华	被射入	11 - 16	21 李瑶	短传快攻 得分			
21:48		裁判暂停						
21:59	17 修丽杰	中远射 被封		6 沈萍	封球			





## 2016年全国女子手球锦标赛

## 比赛进程表

正式表  
手球  
女子决赛  
轮次 10组别 X  
场次 54201605054-13-3/6  
滁州体育馆  
13/09/2016 18:30

时间	队员	动作	比分	队员	动作
<b>江苏</b>			<b>上半时</b>		
<b>安徽</b>					
22:03		裁判暂停			
22:05		裁判暂停			
22:12	8 乔如	近射 得分	12 - 16	1 司艳	被射入
22:14	17 修丽杰	助攻			
22:42				3 李兵	侵区
23:07		裁判暂停			
23:26	4 赵佳芹	中远射 得分	13 - 16	1 司艳	被射入
24:03				21 李瑶	左边射 击柱
24:17	16 王小华	被射入	13 - 17	21 李瑶	近射 得分
24:21				3 李兵	助攻
24:51	18 韦秋香	传球失误		21 李瑶	断球
24:56	16 王小华	被射入	13 - 18	10 孙来苗	短传快攻 得分
25:04	23 王书慧	近射 被救		1 司艳	挡住球
25:41		裁判暂停			
25:51		裁判暂停			
25:51				10 孙来苗	罚出场2分钟
26:06	8 乔如	近射 得分	14 - 18	1 司艳	被射入
26:08	4 赵佳芹	助攻			
27:02	16 王小华	被射入	14 - 19	6 沈萍	中远射 得分
27:22	18 韦秋香	右边射 得分	15 - 19	1 司艳	被射入
27:54				14 刘晓妹	中远射 射失
28:27	4 赵佳芹	传球失误		17 周婷	断球
28:55				21 李瑶	传球失误
28:58		裁判暂停			
28:58				14 刘晓妹	罚出场2分钟
29:20	4 赵佳芹	中远射 被封		17 周婷	封球
29:33	23 王书慧	进攻犯规		6 沈萍	造犯规
30:00				6 沈萍	任意球 射失





## 2016年全国女子手球锦标赛

## 比赛进程表

正式表  
手球  
女子决赛  
轮次 10组别 X  
场次 54201605054-13-4/6  
滁州体育馆  
13/09/2016 18:30

时间	队员	动作	比分	队员	动作			
<b>江苏</b>			<b>下半时</b>			<b>安徽</b>		
00:12				17 周婷	接球失误			
00:24		裁判暂停						
00:49	4 赵佳芹	左边射 得分	16 - 19	1 司艳	被射入			
01:16				21 李瑶	四步			
01:32	4 赵佳芹	中远射 被封		6 沈萍	封球			
01:38				21 李瑶	快攻 接球失误			
01:48	69 蓝小玲	近射 被救		1 司艳	挡住球			
02:01	33 金梦青	右远射 被救		1 司艳	挡住球			
02:59	17 修丽杰	使被罚7M球		14 刘晓妹	造7M			
03:16	16 王小华	被射入	16 - 20	6 沈萍	7M球 得分			
03:34	4 赵佳芹	任意球 得分	17 - 20	1 司艳	被射入			
04:08	16 王小华	被射入	17 - 21	10 孙来苗	近射 得分			
04:11				14 刘晓妹	助攻			
04:16	23 王书慧	近射 得分	18 - 21	1 司艳	被射入			
04:34					球队暂停			
04:53	69 蓝小玲	造犯规		17 周婷	进攻犯规			
05:02	33 金梦青	中远射 被救		1 司艳	挡住球			
05:20	4 赵佳芹	突破 得分	19 - 21	1 司艳	被射入			
06:02	16 王小华	被射入	19 - 22	21 李瑶	右边射 得分			
06:16	17 修丽杰	造7M		3 李兵	使被罚7M球			
06:17		裁判暂停						
06:24	69 蓝小玲	7M球 得分	20 - 22	16 朱莉珍	被射入			
07:06	16 王小华	被射入	20 - 23	10 孙来苗	近射 得分			
07:09				21 李瑶	助攻			
07:23		裁判暂停						
07:47	69 蓝小玲	侵区						
08:28	69 蓝小玲	断球		21 李瑶	传球失误			
08:40	3 张海侠	近射 得分	21 - 23	1 司艳	被射入			
08:42	69 蓝小玲	助攻						
09:36	16 王小华	被射入	21 - 24	21 李瑶	左边射 得分			
09:45	4 赵佳芹	左远射 得分	22 - 24	1 司艳	被射入			
10:14				6 沈萍	四步			
11:05		裁判暂停						
11:13		球队暂停						
11:24	23 王书慧	任意球 击柱						
11:27	23 王书慧	右远射 被封		3 李兵	封球			
11:32	16 王小华	被射入	22 - 25	14 刘晓妹	短传快攻 得分			
11:41	23 王书慧	进攻犯规		14 刘晓妹	造犯规			
11:47	16 王小华	被射入	22 - 26	21 李瑶	一传快攻 得分			
11:50				6 沈萍	助攻			





## 2016年全国女子手球锦标赛

## 比赛进程表

正式表  
手球  
女子决赛  
轮次 10组别 X  
场次 54201605054-13-5/6  
滁州体育馆  
13/09/2016 18:30

时间	队员	动作	比分	队员	动作
<b>江苏</b>			<b>下半时</b>		
<b>安徽</b>					
12:21	69 蓝小玲	中远射 得分	23 - 26	1 司艳	被射入
12:33				6 沈萍	接球失误
12:48	69 蓝小玲	中远射 得分	24 - 26	1 司艳	被射入
13:07		裁判暂停			
13:07	4 赵佳芹	罚出场2分钟			
13:16	16 王小华	挡住球		6 沈萍	右远射 被救
13:48	8 乔如	近射 得分	25 - 26	1 司艳	被射入
13:50	69 蓝小玲	助攻			
14:12	16 王小华	挡住球		6 沈萍	右边射 被救
14:41	23 王书慧	右远射 被封		17 周婷	封球
14:42		裁判暂停			
14:49	23 王书慧	四步			
14:56	16 王小华	挡住球		21 李瑶	短传快攻 被救
15:34	23 王书慧	中远射 得分	26 - 26	1 司艳	被射入
16:21		裁判暂停			
16:27	16 王小华	挡住球		14 刘晓妹	任意球 被救
16:53	8 乔如	其它失误			
16:57				10 孙来苗	快攻 传球失误
17:27	3 张海侠	快攻 侵区			
17:38					球队暂停
18:05	33 金梦青	使被罚7M球		14 刘晓妹	造7M
18:25	16 王小华	被射入	26 - 27	6 沈萍	7M球 得分
18:48	4 赵佳芹	近射 得分	27 - 27	16 朱莉珍	被射入
19:09	17 修丽杰	造犯规		3 李兵	进攻犯规
19:17	3 张海侠	中远射 得分	28 - 27	16 朱莉珍	被射入
20:02	16 王小华	挡住球		6 沈萍	近射 被救
20:17	69 蓝小玲	近射 得分	29 - 27	1 司艳	被射入
20:55		裁判暂停			
21:33	16 王小华	被射入	29 - 28	14 刘晓妹	任意球 得分
21:50	23 王书慧	传球失误		6 沈萍	断球
21:57	16 王小华	被射入	29 - 29	21 李瑶	一传快攻 得分
21:59				6 沈萍	助攻
22:30	69 蓝小玲	右远射 得分	30 - 29	1 司艳	被射入
22:31		裁判暂停			
22:31				6 沈萍	罚出场2分钟
23:00				14 刘晓妹	传球失误
23:16	17 修丽杰	造7M		3 李兵	使被罚7M球
23:16		裁判暂停			
23:16	4 赵佳芹	7M球 得分	31 - 29	1 司艳	被射入
24:02	8 乔如	使被罚7M球		21 李瑶	造7M





## 2016年全国女子手球锦标赛

## 比赛进程表

正式表  
手球  
女子决赛  
轮次 10组别 X  
场次 54201605054-13-6/6  
滁州体育馆  
13/09/2016 18:30

时间	队员	动作	比分	队员	动作
<b>江苏</b>			<b>下半时</b>		
			<b>安徽</b>		
24:18	16 王小华	被射入	<b>31 - 30</b>	10 孙来苗	近射 得分
24:35	23 王书慧	突破 被救		1 司艳	挡住球
24:46	16 王小华	被射入	<b>31 - 31</b>	14 刘晓妹	中远射 得分
24:47		裁判暂停			
24:47	17 修丽杰	罚出场2分钟			
25:04		球队暂停			
25:21	8 乔如	传球失误			
25:27				6 沈萍	快攻 传球失误
25:37	23 王书慧	左边射 得分	<b>32 - 31</b>	1 司艳	被射入
26:09	16 王小华	挡住球		14 刘晓妹	右远射 被救
26:11	16 王小华	挡住球		3 李兵	近射 被救
26:18	33 金梦青	快攻 进攻犯规		6 沈萍	造犯规
26:26	16 王小华	被射入	<b>32 - 32</b>	17 周婷	短传快攻 得分
26:58	23 王书慧	传球失误			
27:06	16 王小华	挡住球		17 周婷	短传快攻 被救
27:17	23 王书慧	中远射 击柱			
28:13	16 王小华	被射入	<b>32 - 33</b>	14 刘晓妹	任意球 得分
28:34	4 赵佳芹	右远射 击柱			
28:37		裁判暂停			
28:57		裁判暂停			
29:24	8 乔如	造犯规		3 李兵	进攻犯规
29:32	3 张海侠	右边射 得分	<b>33 - 33</b>	1 司艳	被射入
30:00	16 王小华	被射入	<b>33 - 34</b>	6 沈萍	任意球 得分