

# 2016

## 2016年全国男子手球锦标赛

# 成绩与技术统计数据册

# 2016



# 2016

数据由PHMS收集生成



PHMS 国际手球联合会官方技术统计系统

# 成绩册目录

## 联赛总名次

### 第一阶段

#### 1 比赛结果

- 1) 名次
- 2) 场次成绩
- 3) 分组成绩

#### 2 运动员排名

- 1) 得分
- 2) 助攻
- 3) 封球
- 4) 防守
- 5) 失误
- 6) 受罚

#### 3 守门员排名

- 1) 救球
- 2) 救 7M 球

#### 4 球队累计表

#### 5 球队受罚表

#### 6 球队信息

- 1) 球队名单
- 2) 个人/全队技术累计表
- 3) 球队射门区域累计

#### 7 比赛统计数据

- 1) 比赛记录表
- 2) 比赛统计(媒体表)
- 3) 每场个人/全队技术统计表
- 4) 图式统计表
- 5) 每场射门区域统计



2016年全国男子手球锦标赛

OFFICAL  
HANDBALL  
成年 男子

Final Standings

201313020-1204-1/1

广东徐闻

UP TO MATCH 38

2016/10/29 18:59

Medal	Rank	Code	Team
Gold	1	江苏	江苏队
Silver	2	山东	山东队
Bronze	3	天津	天津队
	4	北京	北京队
	5	广东	广东队
	6	上海	上海队
	7	安徽	安徽队
	8	解放军	解放军队
	9	四川	四川队
	10	新疆	新疆队
	11	浙江	浙江队



## 2016年全国男子手球锦标赛 场次成绩

正式表  
手球  
男子

截止至第38场

201606038-1203-1/1  
广东徐闻  
2016/10/29 16:20:00

日期	时间	场次	体育馆	组别	球队	成绩 (半时)	阶段
27/10/16	14:00	26	徐闻县体育中心体育馆 X	X	江苏-上海	29-20 (13-5)	四分之一决赛
	15:40	27	徐闻县体育中心体育馆 X	X	天津-解放军	28-19 (14-13)	四分之一决赛
	19:00	28	徐闻县体育中心体育馆 X	X	北京-广东	22-21 (10-7)	四分之一决赛
	20:40	29	徐闻县体育中心体育馆 X	X	山东-安徽	40-23 (24-12)	四分之一决赛
28/10/16	13:30	30	徐闻县体育中心体育馆 C	C	新疆-四川	25-26 (10-8)	9-10名
	15:10	31	徐闻县体育中心体育馆 X	X	上海-解放军	22-17 (14-9)	5-8名
	16:50	32	徐闻县体育中心体育馆 X	X	广东-安徽	30-23 (15-14)	5-8名
	19:00	33	徐闻县体育中心体育馆 X	X	江苏-天津	30-19 (16-5)	半决赛
	20:40	34	徐闻县体育中心体育馆 X	X	北京-山东	18-27 (8-10)	半决赛
29/10/16	10:00	35	徐闻县体育中心体育馆 X	X	解放军-安徽	24-27 (13-13)	7-8名
	13:00	36	徐闻县体育中心体育馆 X	X	上海-广东	22-30 (11-16)	5-6名
	14:40	37	徐闻县体育中心体育馆 X	X	天津-北京	24-22 (11-11)	3-4名
	16:20	38	徐闻县体育中心体育馆 X	X	江苏-山东	25-22 (10-12)	决赛





2016年全国男子手球锦标赛

正式表  
手球  
男子

分组成绩

201606-1202-1/1

广东徐闻

截止至第 38 场

2016/10/20

组别：A 预赛

名次	球队	积	场	胜	平	负	得分	失分	净胜
1	江苏	8	4	4	0	0	119	83	36
2	北京	6	4	3	0	1	95	65	30
3	解放军	4	4	2	0	2	80	85	-5
4	安徽	2	4	1	0	3	92	102	-10
5	新疆	0	4	0	0	4	77	128	-51

球队	江苏	北京	解放军	安徽	新疆
江苏		27-18	23-17	29-23	40-25
北京	18-27		22-7	26-17	29-14
解放军	17-23	7-22		25-24	31-16
安徽	23-29	17-26	24-25		28-22
新疆	25-40	14-29	16-31	22-28	

组别：B 预赛

名次	球队	积	场	胜	平	负	得分	失分	净胜
1	山东	10	5	5	0	0	140	73	67
2	天津	8	5	4	0	1	132	97	35
3	广东	6	5	3	0	2	117	107	10
4	上海	4	5	2	0	3	106	94	12
5	四川	2	5	1	0	4	104	133	-29
6	浙江	0	5	0	0	5	21	116	-95

球队	山东	天津	广东	上海	四川	浙江
山东		30-23	29-14	26-15	31-16	24-5
天津	23-30		25-24	23-22	32-17	29-4
广东	14-29	24-25		21-19	35-30	23-4
上海	15-26	22-23	19-21		30-21	20-3
四川	16-31	17-32	30-35	21-30		20-5
浙江	5-24	4-29	4-23	3-20	5-20	

组别：C 9-10名

名次	球队	积	场	胜	平	负	得分	失分	净胜
1	四川	2	1	1	0	0	26	25	1
2	新疆	0	1	0	0	1	25	26	-1

球队	四川	新疆
四川		26-25
新疆	25-26	

名次	球队	积	场	胜	平	负	得分	失分	净胜

球队					

注：根据赛制，如参赛队分别为9、11个队时，则获小组第5、6名的队伍为本次比赛最后一名。浙江队为第十一名

Legend: 积 = 积分 场 = 已比赛场次 胜 = 胜场 平 = 平场 负 = 负场  
得分 = 得分累计 失分 = 失分累计 净胜 = 净胜分





## 2016年全国男子手球锦标赛

## 得分排名表(场上队员)

正式表  
手球  
男子截止至第 38场  
按总得分201606038-1601-1/4  
广东徐闻  
20/10/2016 13:30

排序	号码	姓名	球队	远射	近射	边射	快攻	突破	任意	7M	合计	%	助攻	场数
1	17	李中洲	广东	21-39	17-26	1-1	6-7	0-2	0-3	7-8	52-86	60.5	7	8
2	8	钱为玮	上海	3-7	12-13	16-27	16-19	0-0	0-2	0-0	47-68	69.1	1	8
3	8	曹悦	天津	15-38	13-22	1-1	4-4	6-7	0-1	5-8	44-81	54.3	7	8
4	19	李语庆	山东	2-8	4-10	8-10	16-20	2-3	0-0	8-9	40-60	66.7	3	8
5	17	王巨柱	安徽	21-50	7-14	0-0	2-2	3-3	1-2	4-5	38-76	50.0	10	7
6	7	张青	天津	15-39	10-14	0-0	4-4	2-4	0-1	5-6	36-68	52.9	6	8
7	15	李安	江苏	1-5	6-7	3-4	17-20	0-1	0-0	6-8	33-45	73.3	9	7
8	2	孙江山	广东	0-3	12-17	13-16	3-3	0-1	0-0	4-8	32-48	66.7	5	8
9	3	曲汝洋	广东	2-6	10-15	0-2	8-9	8-8	0-0	0-0	28-40	70.0	9	8
10	13	许松	天津	1-4	9-13	8-14	6-8	3-4	0-0	1-1	28-44	63.6	1	8
11	9	毕晓晨	解放军	6-12	14-18	4-10	2-3	0-0	0-0	2-3	28-46	60.9	5	7
12	8	周小坚	江苏	4-8	21-24	0-0	1-4	0-1	0-0	1-2	27-39	69.2	1	7
13	9	赵鑫	山东	6-15	8-12	1-1	6-6	6-8	0-0	0-0	27-42	64.3	10	8
14	4	徐俊吉	上海	0-2	11-17	2-3	1-2	0-0	0-0	10-13	24-37	64.9	0	8
15	78	张骥	北京	7-16	6-9	0-1	0-0	2-3	1-2	7-8	23-39	59.0	4	7
16	18	马麟晓	上海	15-48	4-4	0-1	0-0	2-3	1-3	1-1	23-60	38.3	18	8
17	9	陈开勇	安徽	1-2	14-25	0-0	6-8	0-0	0-0	1-2	22-37	59.5	1	7
18	27	于亚男	山东	6-17	9-13	1-1	4-5	2-5	0-0	0-0	22-41	53.7	3	8
19	18	王晓龙	解放军	5-20	6-15	2-3	1-2	3-3	0-0	5-6	22-49	44.9	2	7
20	17	王伟强	江苏	0-1	7-8	4-5	8-11	1-1	0-0	1-1	21-27	77.8	1	7
21	5	侯生升	广东	1-2	5-9	8-11	7-7	0-0	0-0	0-0	21-29	72.4	1	8
22	8	王烁	解放军	4-10	4-4	1-4	3-3	0-1	0-0	9-11	21-33	63.6	1	7
23	14	田剑侠	天津	4-13	8-12	2-2	1-1	3-4	0-0	3-5	21-37	56.8	4	7
24	6	赵晨	江苏	9-22	2-3	0-0	3-3	2-2	5-9	0-0	21-39	53.8	9	7
25	7	林豪文	新疆	14-39	2-7	1-1	1-1	1-1	1-2	1-1	21-52	40.4	4	5
26	10	王钟彬	新疆	9-29	4-15	0-0	3-5	1-1	0-0	4-6	21-56	37.5	4	5
27	5	潘翔	山东	1-1	12-21	0-1	4-5	3-3	0-0	0-0	20-31	64.5	0	8
28	13	刘晓	山东	6-14	8-12	1-1	1-1	3-4	0-0	1-2	20-34	58.8	3	8
29	18	赵楠	江苏	3-10	8-13	2-4	3-4	1-2	0-1	3-4	20-38	52.6	11	7
30	18	李双	安徽	7-26	10-13	0-1	1-2	2-3	0-1	0-0	20-46	43.5	9	7
31	3	王超	北京	0-0	6-9	5-11	7-8	1-1	0-0	0-0	19-29	65.5	2	7
32	15	朱世杰	上海	6-26	7-11	2-2	1-1	3-5	0-0	0-0	19-45	42.2	5	8
33	8	董智景	安徽	5-11	4-12	4-15	5-8	1-2	0-0	0-1	19-49	38.8	4	7
34	4	曹作亮	解放军	10-37	4-12	0-0	1-1	3-3	1-2	0-0	19-55	34.5	2	7
35	11	宋朋强	山东	9-24	5-8	0-0	1-2	2-2	1-2	0-0	18-38	47.4	14	8
36	23	于敏清	安徽	1-1	4-5	6-10	6-7	0-0	0-0	0-0	17-23	73.9	5	7
37	21	翟乾坤	山东	2-3	2-2	6-13	6-6	1-1	0-0	0-0	17-25	68.0	2	7
38	8	谢庆龙	四川	1-1	11-17	0-0	5-7	0-0	0-0	0-0	17-25	68.0	1	6
39	13	尹文珂	四川	1-2	3-7	3-5	5-5	0-0	0-0	5-7	17-26	65.4	1	6
40	6	解建飞	北京	4-7	5-5	1-6	4-5	0-0	1-2	2-3	17-28	60.7	2	7
41	10	郝可鑫	江苏	10-22	3-3	0-0	0-0	1-1	3-3	0-0	17-29	58.6	4	7
42	21	刘江	江苏	1-2	10-13	0-0	5-5	0-0	0-0	0-1	16-21	76.2	6	7
43	7	徐奕飞	江苏	0-0	2-4	7-8	6-8	1-1	0-0	0-0	16-21	76.2	2	7
44	21	胡瀛	北京	5-14	6-7	1-1	2-2	2-3	0-0	0-0	16-27	59.3	1	7
45	2	李岳朋	天津	8-12	6-11	2-2	0-2	0-1	0-0	0-0	16-28	57.1	5	8
46	3	刘赵梁	四川	0-0	6-15	2-3	5-7	3-3	0-0	0-0	16-28	57.1	2	6
47	10	成亚	北京	5-9	6-12	0-1	1-2	4-6	0-0	0-1	16-31	51.6	4	7





## 2016年全国男子手球锦标赛

## 得分排名表(场上队员)

正式表  
手球  
男子截止至第 38场  
按总得分201606038-1601-2/4  
广东徐闻  
20/10/2016 13:30

排序	号码	姓名	球队	远射	近射	边射	快攻	突破	任意	7M	合计	%	助攻	场数
48	9	许翔宇	四川	8-17	6-12	1-2	0-0	1-1	0-0	0-0	16-32	50.0	2	6
49	15	张继伟	山东	1-1	9-12	0-0	5-5	0-0	0-0	0-0	15-18	83.3	0	8
50	14	孙耀琦	解放军	0-0	14-20	0-0	1-1	0-0	0-0	0-0	15-21	71.4	0	7
51	6	李朝鹏	山东	2-5	8-11	1-1	2-2	1-2	0-0	1-1	15-22	68.2	11	8
52	6	王子欣	天津	0-0	5-9	1-4	7-7	1-1	0-0	1-1	15-22	68.2	1	8
53	4	张家纬	江苏	3-13	6-10	1-1	1-6	4-4	0-0	0-0	15-34	44.1	13	7
54	9	刘振	北京	2-14	4-5	0-0	0-0	5-5	0-0	3-3	14-27	51.9	5	7
55	84	王伟	广东	0-3	11-14	1-1	1-1	0-0	0-0	0-0	13-19	68.4	2	8
56	7	付云博	广东	0-2	6-9	0-2	3-4	2-3	0-0	2-3	13-23	56.5	2	8
57	17	王旭东	山东	5-14	3-5	1-1	4-4	0-2	0-0	0-0	13-26	50.0	7	8
58	19	李龙吉	新疆	1-9	5-17	0-0	1-1	2-3	0-1	4-5	13-36	36.1	1	5
59	5	徐伟	新疆	0-0	0-2	3-4	9-12	0-0	0-0	0-0	12-18	66.7	1	5
60	11	蒋维一	北京	0-1	10-15	0-0	2-4	0-0	0-0	0-0	12-20	60.0	0	7
61	11	张天豪	四川	0-0	4-8	3-5	3-5	0-0	0-0	2-4	12-22	54.5	1	6
62	25	马明辉	北京	0-1	4-9	4-12	4-4	0-0	0-0	0-0	12-26	46.2	0	7
63	21	马光	四川	9-22	2-3	0-0	0-0	1-2	0-0	0-0	12-27	44.4	2	6
64	5	史小帆	安徽	1-6	3-9	0-0	0-0	5-8	1-1	2-4	12-28	42.9	1	7
65	19	庞连康	四川	4-7	5-6	1-1	0-0	0-1	0-0	1-1	11-16	68.8	2	6
66	11	蒋承骅	上海	4-6	3-5	1-3	1-1	2-3	0-0	0-0	11-18	61.1	6	8
67	77	朱昕晨	北京	1-7	2-6	0-1	0-0	5-5	0-0	3-3	11-22	50.0	4	7
68	7	姚雄敏	安徽	3-6	4-10	0-0	1-1	2-6	0-0	1-2	11-25	44.0	2	7
69	4	李卓洋	广东	4-17	5-15	0-1	1-1	1-1	0-0	0-0	11-35	31.4	2	8
70	9	吴明远	天津	1-2	1-3	1-3	4-5	2-2	0-0	1-1	10-16	62.5	0	8
71	14	沈吉磊	上海	2-12	4-4	1-1	0-0	2-2	0-0	1-1	10-20	50.0	2	8
72	7	仇瑞祥	四川	1-2	2-5	0-2	1-2	1-1	0-0	5-9	10-21	47.6	2	6
73	6	吴昊	解放军	3-14	7-12	0-0	0-2	0-1	0-0	0-0	10-29	34.5	0	7
74	33	吴璟	上海	0-0	5-7	1-1	1-1	0-0	0-0	2-3	9-12	75.0	0	8
75	13	王立隆	广东	2-2	1-3	1-3	5-6	0-0	0-0	0-0	9-14	64.3	0	8
76	4	田瑞	山东	2-2	1-3	3-7	3-3	0-0	0-0	0-0	9-15	60.0	2	8
77	29	杜龙飞	北京	0-0	3-6	5-7	0-1	0-0	1-1	0-0	9-15	60.0	1	7
78	3	赵时俊	上海	0-4	2-5	3-4	1-1	1-3	0-0	2-3	9-20	45.0	5	8
79	1	罗尧尧	四川	5-16	3-4	0-0	0-1	1-1	0-0	0-0	9-22	40.9	2	6
80	11	王毅	天津	1-7	4-7	1-1	1-2	0-0	0-0	2-6	9-23	39.1	2	8
81	7	姜钦	解放军	3-15	3-6	0-0	1-1	2-2	0-0	0-0	9-24	37.5	7	7
82	1	郭世伟	安徽	0-2	4-8	1-5	3-6	1-3	0-0	0-0	9-24	37.5	1	7
83	20	赵元	新疆	4-10	1-7	0-1	2-2	2-2	0-1	0-1	9-24	37.5	2	5
84	17	贺政	上海	0-1	1-2	6-16	2-5	0-1	0-0	0-0	9-25	36.0	3	8
85	11	黎涛	安徽	3-16	4-6	0-1	1-1	0-0	0-0	1-1	9-25	36.0	2	7
86	17	周群	天津	1-1	7-10	0-0	0-0	0-0	0-0	0-0	8-11	72.7	0	8
87	22	魏雨童	天津	0-0	5-5	0-0	0-0	2-2	0-0	0-0	7-7	100.0	0	8
88	3	尹杰	山东	1-1	4-4	1-2	1-1	0-0	0-0	0-0	7-8	87.5	1	8
89	17	胡晋铭	新疆	0-0	6-7	0-0	0-0	1-1	0-0	0-0	7-8	87.5	1	5
90	3	陈强龙	安徽	0-0	5-7	0-0	2-2	0-0	0-0	0-0	7-9	77.8	1	7
91	5	闫亮	江苏	0-1	5-8	0-0	2-3	0-0	0-0	0-0	7-12	58.3	1	7
92	9	姜春晖	新疆	2-6	1-4	1-4	2-4	0-0	0-0	1-1	7-19	36.8	1	5
93	23	王军程	北京	4-15	0-2	0-0	0-0	1-1	1-2	1-2	7-22	31.8	1	6
94	10	赵建强	山东	0-0	4-5	1-1	0-0	1-1	0-0	0-0	6-7	85.7	5	8





## 2016年全国男子手球锦标赛

## 得分排名表(场上队员)

正式表  
手球  
男子截止至第 38场  
按总得分201606038-1601-3/4  
广东徐闻  
20/10/2016 13:30

排序	号码	姓名	球队	远射	近射	边射	快攻	突破	任意	7M	合计	%	助攻	场数
95	15	杨帆	解放军	1-4	3-4	0-0	0-0	2-2	0-0	0-0	6-10	60.0	5	7
96	15	张建杰	广东	2-5	0-2	0-0	3-3	1-1	0-0	0-0	6-11	54.5	1	8
97	15	刘劲松	四川	0-6	6-8	0-0	0-0	0-0	0-0	0-0	6-14	42.9	0	6
98	18	姜帅	新疆	4-10	2-4	0-0	0-0	0-0	0-0	0-0	6-14	42.9	0	5
99	20	顾艳超	江苏	3-11	2-5	1-1	0-0	0-2	0-0	0-0	6-19	31.6	9	7
100	12	林子健	广东	0-0	4-4	0-1	1-1	0-0	0-0	0-0	5-6	83.3	2	2
101	18	王晓琪	天津	3-6	1-1	0-0	1-2	0-0	0-0	0-0	5-9	55.6	2	8
102	11	肖东洋	解放军	1-4	3-4	0-0	1-1	0-0	0-0	0-0	5-9	55.6	2	7
103	3	李恩铭	浙江	0-1	3-7	2-6	0-0	0-0	0-0	0-0	5-14	35.7	0	5
104	20	黄培杰	广东	2-3	0-1	0-0	1-1	1-1	0-0	0-0	4-6	66.7	1	8
105	8	刘文宇	新疆	0-1	4-8	0-0	0-0	0-0	0-0	0-0	4-9	44.4	0	5
106	9	周傲	江苏	0-3	0-2	0-0	2-5	1-1	0-0	1-2	4-13	30.8	0	7
107	10	罗明杰	浙江	3-16	1-6	0-0	0-0	0-0	0-0	0-0	4-22	18.2	2	5
108	11	房友屯	广东	1-1	2-2	0-0	0-0	0-0	0-0	0-0	3-3	100.0	2	8
109	21	潘玉帅	天津	1-1	0-0	1-1	0-0	1-1	0-0	0-0	3-3	100.0	0	6
110	2	张文斌	上海	0-0	1-1	0-0	1-1	1-2	0-0	0-0	3-4	75.0	2	8
111	10	董凯	上海	1-1	1-4	1-1	0-0	0-0	0-0	0-0	3-6	50.0	0	8
112	7	吴双	上海	0-0	0-0	0-2	3-3	0-0	0-1	0-0	3-6	50.0	0	4
113	5	张昌轲	解放军	1-3	1-3	0-1	0-1	1-1	0-0	0-0	3-9	33.3	0	7
114	18	倪陈辉	浙江	0-6	2-4	0-4	0-0	0-0	1-2	0-0	3-16	18.8	0	5
115	1	李欢欢	浙江	0-0	2-3	0-0	0-0	0-0	0-0	0-0	2-3	66.7	0	5
116	18	任启双	四川	0-1	2-3	0-0	0-0	0-0	0-0	0-0	2-4	50.0	2	6
117	15	王维东	新疆	0-0	1-3	0-1	1-1	0-0	0-0	0-0	2-5	40.0	0	5
118	5	林先方	浙江	0-3	1-3	0-0	0-0	0-0	0-0	1-1	2-7	28.6	0	5
119	19	徐正飞	浙江	0-4	1-3	0-0	0-0	0-0	0-0	1-1	2-8	25.0	0	5
120	2	范保坤	解放军	0-0	0-0	1-1	0-0	0-0	0-0	0-0	1-1	100.0	0	7
121	33	冯宁	北京	0-0	1-1	0-0	0-0	0-0	0-0	0-0	1-1	100.0	1	7
122	9	李家乐	浙江	0-0	1-1	0-0	0-0	0-0	0-0	0-0	1-1	100.0	0	5
123	10	周仲坤	广东	1-1	0-0	0-0	0-1	0-0	0-0	0-0	1-2	50.0	0	8
124	21	李明	安徽	1-2	0-0	0-0	0-0	0-0	0-0	0-0	1-2	50.0	3	7
125	20	徐逸	四川	0-0	0-0	1-1	0-1	0-0	0-0	0-0	1-2	50.0	0	6
126	14	虞勇灿	浙江	0-0	1-1	0-1	0-0	0-0	0-0	0-0	1-2	50.0	0	5
127	7	金杰	浙江	1-2	0-0	0-1	0-0	0-0	0-0	0-0	1-3	33.3	1	5
128	4	李松浩	天津	0-0	1-3	0-0	0-1	0-0	0-0	0-0	1-4	25.0	0	8
129	20	刘智洋	解放军	0-2	0-0	0-0	1-2	0-0	0-0	0-0	1-4	25.0	0	7
130	10	徐彦昊	四川	0-1	0-1	1-3	0-0	0-0	0-0	0-0	1-5	20.0	2	6
131	12	崔剑	山东	0-0	0-0	0-0	0-0	0-0	0-0	0-0	0-0	0.0	2	8
132	1	王泽润	广东	0-0	0-0	0-0	0-0	0-0	0-0	0-0	0-0	0.0	1	8
133	12	周哲韬	上海	0-0	0-0	0-0	0-0	0-0	0-0	0-0	0-0	0.0	0	8
134	16	于性哲	山东	0-0	0-0	0-0	0-0	0-0	0-0	0-0	0-0	0.0	6	8
135	1	刘宗其	天津	0-0	0-0	0-0	0-0	0-0	0-0	0-0	0-0	0.0	7	8
136	12	杨峻	天津	0-0	0-0	0-0	0-0	0-0	0-0	0-0	0-0	0.0	0	8
137	8	于彦江	广东	0-0	0-0	0-0	0-0	0-0	0-0	0-0	0-0	0.0	0	8
138	16	刘海亮	天津	0-0	0-0	0-0	0-0	0-0	0-0	0-0	0-0	0.0	0	8
139	1	张峥	上海	0-0	0-0	0-0	0-0	0-0	0-0	0-0	0-0	0.0	2	8
140	12	孟辉	北京	0-0	0-0	0-0	0-0	0-0	0-0	0-0	0-0	0.0	5	7
141	22	王金宇	安徽	0-0	0-0	0-0	0-0	0-0	0-0	0-0	0-0	0.0	0	7







## 2016年全国男子手球锦标赛

## 得分排名表(场上队员)

正式表  
手球  
男子截止至第 38场  
按总得分201606038-1601-4/4  
广东徐闻  
20/10/2016 13:30

排序	号码	姓名	球队	远射	近射	边射	快攻	突破	任意	7M	合计	%	助攻	场数
142	16	刘迈科	北京	0-0	0-0	0-0	0-0	0-0	0-0	0-0	0-0	0.0	5	7
143	83	潘天	北京	0-0	0-0	0-0	0-0	0-0	0-0	0-0	0-0	0.0	0	7
144	19	何山	安徽	0-0	0-0	0-0	0-0	0-0	0-0	0-0	0-0	0.0	0	7
145	1	李梓宁	解放军	0-0	0-0	0-0	0-0	0-0	0-0	0-0	0-0	0.0	0	7
146	12	曾献辰	安徽	0-0	0-0	0-0	0-0	0-0	0-0	0-0	0-0	0.0	2	7
147	16	丛霖	解放军	0-0	0-0	0-0	0-0	0-0	0-0	0-0	0-0	0.0	0	7
148	12	姜明	解放军	0-0	0-0	0-0	0-0	0-0	0-0	0-0	0-0	0.0	0	7
149	10	严龙	安徽	0-0	0-0	0-0	0-0	0-0	0-0	0-0	0-0	0.0	1	7
150	16	张帅	江苏	0-0	0-0	0-0	0-0	0-0	0-0	0-0	0-0	0.0	1	7
151	16	宋继强	四川	0-0	0-0	0-0	0-0	0-0	0-0	0-0	0-0	0.0	0	6
152	16	朱春雷	上海	0-0	0-0	0-0	0-0	0-0	0-0	0-0	0-0	0.0	0	6
153	15	张佩力	浙江	0-0	0-0	0-0	0-0	0-0	0-0	0-0	0-0	0.0	0	5
154	13	苏兴伟	新疆	0-0	0-0	0-0	0-0	0-0	0-0	0-0	0-0	0.0	0	5
155	12	丁大伟	四川	0-0	0-0	0-0	0-0	0-0	0-0	0-0	0-0	0.0	3	5
156	24	毛军伟	浙江	0-0	0-0	0-0	0-0	0-0	0-0	0-0	0-0	0.0	0	5
157	1	宋晓晨	新疆	0-0	0-0	0-0	0-0	0-0	0-0	0-0	0-0	0.0	6	5
158	22	张瑞恒	江苏	0-0	0-0	0-0	0-0	0-0	0-0	0-0	0-0	0.0	0	5
159	11	陈渝天	浙江	0-0	0-0	0-0	0-0	0-0	0-0	0-0	0-0	0.0	0	5
160	24	王泽川	新疆	0-0	0-0	0-0	0-0	0-0	0-0	0-0	0-0	0.0	0	5
161	8	王浩	浙江	0-0	0-0	0-0	0-0	0-0	0-0	0-0	0-0	0.0	0	5
162	12	王金鑫	新疆	0-0	0-0	0-0	0-0	0-0	0-0	0-0	0-0	0.0	0	2
163	1	李濠壮	山东	0-0	0-0	0-0	0-0	0-0	0-0	0-0	0-0	0.0	0	2
164	16	马跃	广东	0-1	0-0	0-0	0-0	0-0	0-0	0-0	0-1	0.0	1	8
165	1	徐畅	江苏	0-1	0-0	0-0	0-0	0-0	0-0	0-0	0-1	0.0	1	7
166	8	王鹏	北京	0-0	0-1	0-0	0-0	0-0	0-0	0-0	0-1	0.0	0	7
167	12	王权	江苏	0-1	0-0	0-0	0-0	0-0	0-0	0-0	0-1	0.0	4	7
168	22	张睿梁	四川	0-1	0-0	0-0	0-0	0-0	0-0	0-0	0-1	0.0	2	6
169	2	金永峰	安徽	0-0	0-0	0-2	0-1	0-0	0-0	0-0	0-3	0.0	0	7
170	2	郑尧俊	浙江	0-4	0-1	0-0	0-0	0-0	0-0	0-0	0-5	0.0	0	5





## 2016年全国男子手球锦标赛

## 得分排名表(场上队员)

正式表  
手球  
男子截止至第 38场  
按助攻201606038-1610-1/4  
广东徐闻  
20/10/2016 13:30

排序	号码	姓名	球队	远射	近射	边射	快攻	突破	任意	7M	合计	%	助攻	场数
1	18	马麟晓	上海	15-48	4-4	0-1	0-0	2-3	1-3	1-1	23-60	38.3	18	8
2	11	宋朋强	山东	9-24	5-8	0-0	1-2	2-2	1-2	0-0	18-38	47.4	14	8
3	4	张家纬	江苏	3-13	6-10	1-1	1-6	4-4	0-0	0-0	15-34	44.1	13	7
4	18	赵楠	江苏	3-10	8-13	2-4	3-4	1-2	0-1	3-4	20-38	52.6	11	7
5	6	李朝鹏	山东	2-5	8-11	1-1	2-2	1-2	0-0	1-1	15-22	68.2	11	8
6	17	王巨柱	安徽	21-50	7-14	0-0	2-2	3-3	1-2	4-5	38-76	50.0	10	7
7	9	赵鑫	山东	6-15	8-12	1-1	6-6	6-8	0-0	0-0	27-42	64.3	10	8
8	15	李安	江苏	1-5	6-7	3-4	17-20	0-1	0-0	6-8	33-45	73.3	9	7
9	3	曲汝洋	广东	2-6	10-15	0-2	8-9	8-8	0-0	0-0	28-40	70.0	9	8
10	6	赵晨	江苏	9-22	2-3	0-0	3-3	2-2	5-9	0-0	21-39	53.8	9	7
11	18	李双	安徽	7-26	10-13	0-1	1-2	2-3	0-1	0-0	20-46	43.5	9	7
12	20	顾艳超	江苏	3-11	2-5	1-1	0-0	0-2	0-0	0-0	6-19	31.6	9	7
13	17	李中洲	广东	21-39	17-26	1-1	6-7	0-2	0-3	7-8	52-86	60.5	7	8
14	8	曹悦	天津	15-38	13-22	1-1	4-4	6-7	0-1	5-8	44-81	54.3	7	8
15	17	王旭东	山东	5-14	3-5	1-1	4-4	0-2	0-0	0-0	13-26	50.0	7	8
16	7	姜钦	解放军	3-15	3-6	0-0	1-1	2-2	0-0	0-0	9-24	37.5	7	7
17	1	刘宗其	天津	0-0	0-0	0-0	0-0	0-0	0-0	0-0	0-0	0.0	7	8
18	7	张青	天津	15-39	10-14	0-0	4-4	2-4	0-1	5-6	36-68	52.9	6	8
19	21	刘江	江苏	1-2	10-13	0-0	5-5	0-0	0-0	0-1	16-21	76.2	6	7
20	11	蒋承骅	上海	4-6	3-5	1-3	1-1	2-3	0-0	0-0	11-18	61.1	6	8
21	16	于性哲	山东	0-0	0-0	0-0	0-0	0-0	0-0	0-0	0-0	0.0	6	8
22	1	宋晓晨	新疆	0-0	0-0	0-0	0-0	0-0	0-0	0-0	0-0	0.0	6	5
23	2	孙江山	广东	0-3	12-17	13-16	3-3	0-1	0-0	4-8	32-48	66.7	5	8
24	9	毕晓晨	解放军	6-12	14-18	4-10	2-3	0-0	0-0	2-3	28-46	60.9	5	7
25	15	朱世杰	上海	6-26	7-11	2-2	1-1	3-5	0-0	0-0	19-45	42.2	5	8
26	23	于敏清	安徽	1-1	4-5	6-10	6-7	0-0	0-0	0-0	17-23	73.9	5	7
27	2	李岳朋	天津	8-12	6-11	2-2	0-2	0-1	0-0	0-0	16-28	57.1	5	8
28	9	刘振	北京	2-14	4-5	0-0	0-0	5-5	0-0	3-3	14-27	51.9	5	7
29	3	赵时俊	上海	0-4	2-5	3-4	1-1	1-3	0-0	2-3	9-20	45.0	5	8
30	10	赵建强	山东	0-0	4-5	1-1	0-0	1-1	0-0	0-0	6-7	85.7	5	8
31	15	杨帆	解放军	1-4	3-4	0-0	0-0	2-2	0-0	0-0	6-10	60.0	5	7
32	16	刘迈科	北京	0-0	0-0	0-0	0-0	0-0	0-0	0-0	0-0	0.0	5	7
33	12	孟辉	北京	0-0	0-0	0-0	0-0	0-0	0-0	0-0	0-0	0.0	5	7
34	78	张骥	北京	7-16	6-9	0-1	0-0	2-3	1-2	7-8	23-39	59.0	4	7
35	14	田剑侠	天津	4-13	8-12	2-2	1-1	3-4	0-0	3-5	21-37	56.8	4	7
36	7	林豪文	新疆	14-39	2-7	1-1	1-1	1-1	1-2	1-1	21-52	40.4	4	5
37	10	王钟彬	新疆	9-29	4-15	0-0	3-5	1-1	0-0	4-6	21-56	37.5	4	5
38	8	董智景	安徽	5-11	4-12	4-15	5-8	1-2	0-0	0-1	19-49	38.8	4	7
39	10	郝可鑫	江苏	10-22	3-3	0-0	0-0	1-1	3-3	0-0	17-29	58.6	4	7
40	10	成亚	北京	5-9	6-12	0-1	1-2	4-6	0-0	0-1	16-31	51.6	4	7
41	77	朱昕晨	北京	1-7	2-6	0-1	0-0	5-5	0-0	3-3	11-22	50.0	4	7
42	12	王权	江苏	0-1	0-0	0-0	0-0	0-0	0-0	0-0	0-1	0.0	4	7
43	19	李语庆	山东	2-8	4-10	8-10	16-20	2-3	0-0	8-9	40-60	66.7	3	8
44	27	于亚男	山东	6-17	9-13	1-1	4-5	2-5	0-0	0-0	22-41	53.7	3	8
45	13	刘晓	山东	6-14	8-12	1-1	1-1	3-4	0-0	1-2	20-34	58.8	3	8
46	17	贺政	上海	0-1	1-2	6-16	2-5	0-1	0-0	0-0	9-25	36.0	3	8
47	21	李明	安徽	1-2	0-0	0-0	0-0	0-0	0-0	0-0	1-2	50.0	3	7





## 2016年全国男子手球锦标赛

## 得分排名表(场上队员)

正式表  
手球  
男子截止至第 38场  
按助攻201606038-1610-2/4  
广东徐闻  
20/10/2016 13:30

排序	号码	姓名	球队	远射	近射	边射	快攻	突破	任意	7M	合计	%	助攻	场数
48	12	丁大伟	四川	0-0	0-0	0-0	0-0	0-0	0-0	0-0	0-0	0.0	3	5
49	18	王晓龙	解放军	5-20	6-15	2-3	1-2	3-3	0-0	5-6	22-49	44.9	2	7
50	3	王超	北京	0-0	6-9	5-11	7-8	1-1	0-0	0-0	19-29	65.5	2	7
51	4	曹作亮	解放军	10-37	4-12	0-0	1-1	3-3	1-2	0-0	19-55	34.5	2	7
52	21	翟乾坤	山东	2-3	2-2	6-13	6-6	1-1	0-0	0-0	17-25	68.0	2	7
53	6	解建飞	北京	4-7	5-5	1-6	4-5	0-0	1-2	2-3	17-28	60.7	2	7
54	7	徐奕飞	江苏	0-0	2-4	7-8	6-8	1-1	0-0	0-0	16-21	76.2	2	7
55	3	刘赵梁	四川	0-0	6-15	2-3	5-7	3-3	0-0	0-0	16-28	57.1	2	6
56	9	许翔宇	四川	8-17	6-12	1-2	0-0	1-1	0-0	0-0	16-32	50.0	2	6
57	84	王伟	广东	0-3	11-14	1-1	1-1	0-0	0-0	0-0	13-19	68.4	2	8
58	7	付云博	广东	0-2	6-9	0-2	3-4	2-3	0-0	2-3	13-23	56.5	2	8
59	21	马光	四川	9-22	2-3	0-0	0-0	1-2	0-0	0-0	12-27	44.4	2	6
60	19	庞连康	四川	4-7	5-6	1-1	0-0	0-1	0-0	1-1	11-16	68.8	2	6
61	7	姚雄敏	安徽	3-6	4-10	0-0	1-1	2-6	0-0	1-2	11-25	44.0	2	7
62	4	李卓洋	广东	4-17	5-15	0-1	1-1	1-1	0-0	0-0	11-35	31.4	2	8
63	14	沈吉磊	上海	2-12	4-4	1-1	0-0	2-2	0-0	1-1	10-20	50.0	2	8
64	7	仇瑞祥	四川	1-2	2-5	0-2	1-2	1-1	0-0	5-9	10-21	47.6	2	6
65	4	田瑞	山东	2-2	1-3	3-7	3-3	0-0	0-0	0-0	9-15	60.0	2	8
66	1	罗尧尧	四川	5-16	3-4	0-0	0-1	1-1	0-0	0-0	9-22	40.9	2	6
67	11	王毅	天津	1-7	4-7	1-1	1-2	0-0	0-0	2-6	9-23	39.1	2	8
68	20	赵元	新疆	4-10	1-7	0-1	2-2	2-2	0-1	0-1	9-24	37.5	2	5
69	11	黎涛	安徽	3-16	4-6	0-1	1-1	0-0	0-0	1-1	9-25	36.0	2	7
70	12	林子健	广东	0-0	4-4	0-1	1-1	0-0	0-0	0-0	5-6	83.3	2	2
71	18	王晓琪	天津	3-6	1-1	0-0	1-2	0-0	0-0	0-0	5-9	55.6	2	8
72	11	肖东洋	解放军	1-4	3-4	0-0	1-1	0-0	0-0	0-0	5-9	55.6	2	7
73	10	罗明杰	浙江	3-16	1-6	0-0	0-0	0-0	0-0	0-0	4-22	18.2	2	5
74	11	房友屯	广东	1-1	2-2	0-0	0-0	0-0	0-0	0-0	3-3	100.0	2	8
75	2	张文斌	上海	0-0	1-1	0-0	1-1	1-2	0-0	0-0	3-4	75.0	2	8
76	18	任启双	四川	0-1	2-3	0-0	0-0	0-0	0-0	0-0	2-4	50.0	2	6
77	10	徐彦昊	四川	0-1	0-1	1-3	0-0	0-0	0-0	0-0	1-5	20.0	2	6
78	1	张峥	上海	0-0	0-0	0-0	0-0	0-0	0-0	0-0	0-0	0.0	2	8
79	12	崔剑	山东	0-0	0-0	0-0	0-0	0-0	0-0	0-0	0-0	0.0	2	8
80	12	曾献辰	安徽	0-0	0-0	0-0	0-0	0-0	0-0	0-0	0-0	0.0	2	7
81	22	张睿梁	四川	0-1	0-0	0-0	0-0	0-0	0-0	0-0	0-1	0.0	2	6
82	8	钱为玮	上海	3-7	12-13	16-27	16-19	0-0	0-2	0-0	47-68	69.1	1	8
83	13	许松	天津	1-4	9-13	8-14	6-8	3-4	0-0	1-1	28-44	63.6	1	8
84	8	周小坚	江苏	4-8	21-24	0-0	1-4	0-1	0-0	1-2	27-39	69.2	1	7
85	9	陈开勇	安徽	1-2	14-25	0-0	6-8	0-0	0-0	1-2	22-37	59.5	1	7
86	17	王伟强	江苏	0-1	7-8	4-5	8-11	1-1	0-0	1-1	21-27	77.8	1	7
87	5	侯生升	广东	1-2	5-9	8-11	7-7	0-0	0-0	0-0	21-29	72.4	1	8
88	8	王烁	解放军	4-10	4-4	1-4	3-3	0-1	0-0	9-11	21-33	63.6	1	7
89	8	谢庆龙	四川	1-1	11-17	0-0	5-7	0-0	0-0	0-0	17-25	68.0	1	6
90	13	尹文珂	四川	1-2	3-7	3-5	5-5	0-0	0-0	5-7	17-26	65.4	1	6
91	21	胡瀛	北京	5-14	6-7	1-1	2-2	2-3	0-0	0-0	16-27	59.3	1	7
92	6	王子欣	天津	0-0	5-9	1-4	7-7	1-1	0-0	1-1	15-22	68.2	1	8
93	19	李龙吉	新疆	1-9	5-17	0-0	1-1	2-3	0-1	4-5	13-36	36.1	1	5
94	5	徐伟	新疆	0-0	0-2	3-4	9-12	0-0	0-0	0-0	12-18	66.7	1	5





## 2016年全国男子手球锦标赛

## 得分排名表(场上队员)

正式表  
手球  
男子截止至第 38场  
按助攻201606038-1610-3/4  
广东徐闻  
20/10/2016 13:30

排序	号码	姓名	球队	远射	近射	边射	快攻	突破	任意	7M	合计	%	助攻	场数
95	11	张天豪	四川	0-0	4-8	3-5	3-5	0-0	0-0	2-4	12-22	54.5	1	6
96	5	史小帆	安徽	1-6	3-9	0-0	0-0	5-8	1-1	2-4	12-28	42.9	1	7
97	29	杜龙飞	北京	0-0	3-6	5-7	0-1	0-0	1-1	0-0	9-15	60.0	1	7
98	1	郭世伟	安徽	0-2	4-8	1-5	3-6	1-3	0-0	0-0	9-24	37.5	1	7
99	3	尹杰	山东	1-1	4-4	1-2	1-1	0-0	0-0	0-0	7-8	87.5	1	8
100	17	胡晋铭	新疆	0-0	6-7	0-0	0-0	1-1	0-0	0-0	7-8	87.5	1	5
101	3	陈强龙	安徽	0-0	5-7	0-0	2-2	0-0	0-0	0-0	7-9	77.8	1	7
102	5	闫亮	江苏	0-1	5-8	0-0	2-3	0-0	0-0	0-0	7-12	58.3	1	7
103	9	姜春晖	新疆	2-6	1-4	1-4	2-4	0-0	0-0	1-1	7-19	36.8	1	5
104	23	王军程	北京	4-15	0-2	0-0	0-0	1-1	1-2	1-2	7-22	31.8	1	6
105	15	张建杰	广东	2-5	0-2	0-0	3-3	1-1	0-0	0-0	6-11	54.5	1	8
106	20	黄培杰	广东	2-3	0-1	0-0	1-1	1-1	0-0	0-0	4-6	66.7	1	8
107	33	冯宁	北京	0-0	1-1	0-0	0-0	0-0	0-0	0-0	1-1	100.0	1	7
108	7	金杰	浙江	1-2	0-0	0-1	0-0	0-0	0-0	0-0	1-3	33.3	1	5
109	1	王泽润	广东	0-0	0-0	0-0	0-0	0-0	0-0	0-0	0-0	0.0	1	8
110	16	张帅	江苏	0-0	0-0	0-0	0-0	0-0	0-0	0-0	0-0	0.0	1	7
111	10	严龙	安徽	0-0	0-0	0-0	0-0	0-0	0-0	0-0	0-0	0.0	1	7
112	16	马跃	广东	0-1	0-0	0-0	0-0	0-0	0-0	0-0	0-1	0.0	1	8
113	1	徐畅	江苏	0-1	0-0	0-0	0-0	0-0	0-0	0-0	0-1	0.0	1	7
114	4	徐俊吉	上海	0-2	11-17	2-3	1-2	0-0	0-0	10-13	24-37	64.9	0	8
115	5	潘翔	山东	1-1	12-21	0-1	4-5	3-3	0-0	0-0	20-31	64.5	0	8
116	15	张继伟	山东	1-1	9-12	0-0	5-5	0-0	0-0	0-0	15-18	83.3	0	8
117	14	孙耀琦	解放军	0-0	14-20	0-0	1-1	0-0	0-0	0-0	15-21	71.4	0	7
118	11	蒋维一	北京	0-1	10-15	0-0	2-4	0-0	0-0	0-0	12-20	60.0	0	7
119	25	马明辉	北京	0-1	4-9	4-12	4-4	0-0	0-0	0-0	12-26	46.2	0	7
120	9	吴明远	天津	1-2	1-3	1-3	4-5	2-2	0-0	1-1	10-16	62.5	0	8
121	6	吴昊	解放军	3-14	7-12	0-0	0-2	0-1	0-0	0-0	10-29	34.5	0	7
122	33	吴璟	上海	0-0	5-7	1-1	1-1	0-0	0-0	2-3	9-12	75.0	0	8
123	13	王立隆	广东	2-2	1-3	1-3	5-6	0-0	0-0	0-0	9-14	64.3	0	8
124	17	周群	天津	1-1	7-10	0-0	0-0	0-0	0-0	0-0	8-11	72.7	0	8
125	22	魏雨童	天津	0-0	5-5	0-0	0-0	2-2	0-0	0-0	7-7	100.0	0	8
126	15	刘劲松	四川	0-6	6-8	0-0	0-0	0-0	0-0	0-0	6-14	42.9	0	6
127	18	姜帅	新疆	4-10	2-4	0-0	0-0	0-0	0-0	0-0	6-14	42.9	0	5
128	3	李恩铭	浙江	0-1	3-7	2-6	0-0	0-0	0-0	0-0	5-14	35.7	0	5
129	8	刘文字	新疆	0-1	4-8	0-0	0-0	0-0	0-0	0-0	4-9	44.4	0	5
130	9	周傲	江苏	0-3	0-2	0-0	2-5	1-1	0-0	1-2	4-13	30.8	0	7
131	21	潘玉帅	天津	1-1	0-0	1-1	0-0	1-1	0-0	0-0	3-3	100.0	0	6
132	10	董凯	上海	1-1	1-4	1-1	0-0	0-0	0-0	0-0	3-6	50.0	0	8
133	7	吴双	上海	0-0	0-0	0-2	3-3	0-0	0-1	0-0	3-6	50.0	0	4
134	5	张昌轲	解放军	1-3	1-3	0-1	0-1	1-1	0-0	0-0	3-9	33.3	0	7
135	18	倪陈辉	浙江	0-6	2-4	0-4	0-0	0-0	1-2	0-0	3-16	18.8	0	5
136	1	李欢欢	浙江	0-0	2-3	0-0	0-0	0-0	0-0	0-0	2-3	66.7	0	5
137	15	王维东	新疆	0-0	1-3	0-1	1-1	0-0	0-0	0-0	2-5	40.0	0	5
138	5	林先方	浙江	0-3	1-3	0-0	0-0	0-0	0-0	1-1	2-7	28.6	0	5
139	19	徐正飞	浙江	0-4	1-3	0-0	0-0	0-0	0-0	1-1	2-8	25.0	0	5
140	2	范保坤	解放军	0-0	0-0	1-1	0-0	0-0	0-0	0-0	1-1	100.0	0	7
141	9	李家乐	浙江	0-0	1-1	0-0	0-0	0-0	0-0	0-0	1-1	100.0	0	5





## 2016年全国男子手球锦标赛

## 得分排名表(场上队员)

正式表  
手球  
男子截止至第 38场  
按助攻201606038-1610-4/4  
广东徐闻  
20/10/2016 13:30

排序	号码	姓名	球队	远射	近射	边射	快攻	突破	任意	7M	合计	%	助攻	场数
142	10	周仲坤	广东	1-1	0-0	0-0	0-1	0-0	0-0	0-0	1-2	50.0	0	8
143	20	徐逸	四川	0-0	0-0	1-1	0-1	0-0	0-0	0-0	1-2	50.0	0	6
144	14	虞勇灿	浙江	0-0	1-1	0-1	0-0	0-0	0-0	0-0	1-2	50.0	0	5
145	4	李松浩	天津	0-0	1-3	0-0	0-1	0-0	0-0	0-0	1-4	25.0	0	8
146	20	刘智洋	解放军	0-2	0-0	0-0	1-2	0-0	0-0	0-0	1-4	25.0	0	7
147	12	周哲韬	上海	0-0	0-0	0-0	0-0	0-0	0-0	0-0	0-0	0.0	0	8
148	12	杨峻	天津	0-0	0-0	0-0	0-0	0-0	0-0	0-0	0-0	0.0	0	8
149	8	于彦江	广东	0-0	0-0	0-0	0-0	0-0	0-0	0-0	0-0	0.0	0	8
150	16	刘海亮	天津	0-0	0-0	0-0	0-0	0-0	0-0	0-0	0-0	0.0	0	8
151	16	丛霖	解放军	0-0	0-0	0-0	0-0	0-0	0-0	0-0	0-0	0.0	0	7
152	1	李梓宁	解放军	0-0	0-0	0-0	0-0	0-0	0-0	0-0	0-0	0.0	0	7
153	19	何山	安徽	0-0	0-0	0-0	0-0	0-0	0-0	0-0	0-0	0.0	0	7
154	22	王金宇	安徽	0-0	0-0	0-0	0-0	0-0	0-0	0-0	0-0	0.0	0	7
155	83	潘天	北京	0-0	0-0	0-0	0-0	0-0	0-0	0-0	0-0	0.0	0	7
156	12	姜明	解放军	0-0	0-0	0-0	0-0	0-0	0-0	0-0	0-0	0.0	0	7
157	16	宋继强	四川	0-0	0-0	0-0	0-0	0-0	0-0	0-0	0-0	0.0	0	6
158	16	朱春雷	上海	0-0	0-0	0-0	0-0	0-0	0-0	0-0	0-0	0.0	0	6
159	15	张佩力	浙江	0-0	0-0	0-0	0-0	0-0	0-0	0-0	0-0	0.0	0	5
160	8	王浩	浙江	0-0	0-0	0-0	0-0	0-0	0-0	0-0	0-0	0.0	0	5
161	24	王泽川	新疆	0-0	0-0	0-0	0-0	0-0	0-0	0-0	0-0	0.0	0	5
162	22	张瑞恒	江苏	0-0	0-0	0-0	0-0	0-0	0-0	0-0	0-0	0.0	0	5
163	24	毛军伟	浙江	0-0	0-0	0-0	0-0	0-0	0-0	0-0	0-0	0.0	0	5
164	13	苏兴伟	新疆	0-0	0-0	0-0	0-0	0-0	0-0	0-0	0-0	0.0	0	5
165	11	陈渝天	浙江	0-0	0-0	0-0	0-0	0-0	0-0	0-0	0-0	0.0	0	5
166	12	王金鑫	新疆	0-0	0-0	0-0	0-0	0-0	0-0	0-0	0-0	0.0	0	2
167	1	李濠壮	山东	0-0	0-0	0-0	0-0	0-0	0-0	0-0	0-0	0.0	0	2
168	8	王鹏	北京	0-0	0-1	0-0	0-0	0-0	0-0	0-0	0-1	0.0	0	7
169	2	金永峰	安徽	0-0	0-0	0-2	0-1	0-0	0-0	0-0	0-3	0.0	0	7
170	2	郑尧俊	浙江	0-4	0-1	0-0	0-0	0-0	0-0	0-0	0-5	0.0	0	5





## 2016年全国男子手球锦标赛

### 得分排名表(场上队员)

正式表  
手球  
男子

截止至第 38场  
按封球

201606038-1611-1/4  
广东徐闻  
20/10/2016 13:30

名次	号码	姓名	球队	抢球	断球	造失误	造犯规	合计	封球	场数
1	6	赵晨	江苏	1	4	0	0	5	15	7
2	17	李中洲	广东	1	8	1	4	14	11	8
3	6	解建飞	北京	1	2	0	2	5	10	7
4	9	陈开勇	安徽	1	2	0	1	4	9	7
5	5	潘翔	山东	0	1	1	2	4	8	8
6	11	蒋维一	北京	0	1	0	1	2	6	7
7	14	孙耀琦	解放军	1	1	0	2	4	6	7
8	8	周小坚	江苏	0	6	0	0	6	6	7
9	84	王伟	广东	1	2	0	1	4	6	8
10	4	曹作亮	解放军	1	4	0	0	5	5	7
11	10	郝可鑫	江苏	0	1	0	0	1	4	7
12	6	吴昊	解放军	0	1	0	0	1	4	7
13	4	张家纬	江苏	1	4	1	0	6	4	7
14	5	闫亮	江苏	1	1	1	1	4	4	7
15	18	李双	安徽	1	1	1	0	3	4	7
16	11	蒋承骅	上海	3	5	0	0	8	4	8
17	83	潘天	北京	0	0	0	3	3	3	7
18	15	张继伟	山东	0	2	0	0	2	3	8
19	11	宋朋强	山东	0	7	1	1	9	3	8
20	7	林豪文	新疆	0	0	0	3	3	2	5
21	18	姜帅	新疆	0	0	0	0	0	2	5
22	8	王鹏	北京	1	1	0	0	2	2	7
23	29	杜龙飞	北京	0	1	0	1	2	2	7
24	8	钱为玮	上海	2	11	0	0	13	2	8
25	14	沈吉磊	上海	1	0	0	0	1	2	8
26	33	吴璟	上海	1	4	0	0	5	2	8
27	17	王旭东	山东	2	5	1	1	9	2	8
28	17	胡晋铭	新疆	0	0	0	0	0	1	5
29	8	刘文宇	新疆	0	1	0	0	1	1	5
30	15	刘劲松	四川	1	2	0	0	3	1	6
31	11	张天豪	四川	1	6	1	0	8	1	6
32	18	任启双	四川	0	1	0	0	1	1	6
33	19	庞连康	四川	0	2	0	1	3	1	6
34	21	马光	四川	0	1	0	0	1	1	6
35	21	翟乾坤	山东	1	2	1	2	6	1	7
36	9	刘振	北京	0	0	0	0	0	1	7
37	23	于敏清	安徽	0	3	1	0	4	1	7
38	21	刘江	江苏	1	7	0	1	9	1	7
39	20	顾艳超	江苏	0	4	1	0	5	1	7
40	9	周傲	江苏	0	0	0	0	0	1	7
41	77	朱昕晨	北京	0	2	0	1	3	1	7
42	5	史小帆	安徽	1	2	0	0	3	1	7
43	8	董智景	安徽	0	3	1	1	5	1	7
44	13	刘晓	山东	0	1	0	0	1	1	8
45	10	周仲坤	广东	0	3	0	0	3	1	8
46	18	马麟晓	上海	0	6	2	4	12	1	8
47	27	于亚男	山东	1	4	0	0	5	1	8
48	3	曲汝洋	广东	0	4	0	1	5	1	8





## 2016年全国男子手球锦标赛

### 得分排名表(场上队员)

正式表  
手球  
男子

截止至第 38场  
按封球

201606038-1611-2/4  
广东徐闻  
20/10/2016 13:30

名次	号码	姓名	球队	抢球	断球	造失误	造犯规	合计	封球	场数
49	4	徐俊吉	上海	0	0	0	1	1	1	8
50	7	张青	天津	2	5	0	1	8	1	8
51	2	李岳朋	天津	2	4	0	1	7	1	8
52	22	魏雨童	天津	0	0	0	0	0	1	8
53	12	王金鑫	新疆	0	0	0	0	0	0	2
54	1	李濛壮	山东	0	0	0	0	0	0	2
55	12	林子健	广东	0	3	0	1	4	0	2
56	7	吴双	上海	0	3	0	0	3	0	4
57	1	宋晓晨	新疆	0	0	0	0	0	0	5
58	19	李龙吉	新疆	0	1	0	0	1	0	5
59	24	王泽川	新疆	0	1	0	0	1	0	5
60	19	徐正飞	浙江	2	0	0	0	2	0	5
61	24	毛军伟	浙江	0	0	0	0	0	0	5
62	2	郑尧俊	浙江	0	0	0	0	0	0	5
63	8	王浩	浙江	0	0	0	0	0	0	5
64	5	林先方	浙江	0	0	0	0	0	0	5
65	11	陈渝天	浙江	0	0	0	0	0	0	5
66	7	金杰	浙江	0	0	0	0	0	0	5
67	22	张瑞恒	江苏	0	0	0	0	0	0	5
68	18	倪陈辉	浙江	0	2	0	0	2	0	5
69	1	李欢欢	浙江	0	0	0	0	0	0	5
70	15	张佩力	浙江	0	0	0	0	0	0	5
71	14	虞勇灿	浙江	0	0	0	0	0	0	5
72	9	李家乐	浙江	0	1	0	0	1	0	5
73	10	罗明杰	浙江	0	1	0	0	1	0	5
74	3	李恩铭	浙江	0	1	0	0	1	0	5
75	13	苏兴伟	新疆	0	0	0	0	0	0	5
76	5	徐伟	新疆	0	2	0	0	2	0	5
77	15	王维东	新疆	0	0	1	0	1	0	5
78	10	王钟彬	新疆	0	5	2	0	7	0	5
79	20	赵元	新疆	2	1	0	0	3	0	5
80	12	丁大伟	四川	0	0	0	0	0	0	5
81	9	姜春晖	新疆	1	0	1	0	2	0	5
82	20	徐逸	四川	1	0	0	1	2	0	6
83	8	谢庆龙	四川	1	4	0	0	5	0	6
84	10	徐彦昊	四川	0	1	1	0	2	0	6
85	7	仇瑞祥	四川	0	2	0	0	2	0	6
86	16	宋继强	四川	0	0	0	0	0	0	6
87	9	许翔宇	四川	0	1	0	0	1	0	6
88	22	张睿梁	四川	0	0	0	0	0	0	6
89	23	王军程	北京	0	0	0	0	0	0	6
90	21	潘玉帅	天津	0	0	0	0	0	0	6
91	13	尹文珂	四川	0	2	0	0	2	0	6
92	3	刘赵梁	四川	0	1	0	0	1	0	6
93	1	罗尧尧	四川	0	1	0	0	1	0	6
94	16	朱春雷	上海	0	0	0	0	0	0	6
95	22	王金宇	安徽	0	0	0	0	0	0	7
96	2	范保坤	解放军	0	0	0	0	0	0	7





## 2016年全国男子手球锦标赛

### 得分排名表(场上队员)

正式表  
手球  
男子

截止至第 38场  
按封球

201606038-1611-3/4  
广东徐闻  
20/10/2016 13:30

名次	号码	姓名	球队	抢球	断球	造失误	造犯规	合计	封球	场数
97	21	李明	安徽	0	0	0	0	0	0	7
98	10	成亚	北京	0	1	0	0	1	0	7
99	7	徐奕飞	江苏	0	3	0	0	3	0	7
100	17	王巨柱	安徽	1	2	0	0	3	0	7
101	12	曾献辰	安徽	0	0	0	0	0	0	7
102	11	黎涛	安徽	1	3	0	2	6	0	7
103	15	李安	江苏	2	5	0	0	7	0	7
104	10	严龙	安徽	0	0	0	0	0	0	7
105	25	马明辉	北京	0	2	0	0	2	0	7
106	7	姚雄敏	安徽	0	3	0	1	4	0	7
107	33	冯宁	北京	0	0	0	0	0	0	7
108	14	田剑侠	天津	0	3	0	0	3	0	7
109	3	陈强龙	安徽	0	1	0	0	1	0	7
110	2	金永峰	安徽	0	1	0	0	1	0	7
111	78	张骥	北京	0	0	1	1	2	0	7
112	3	王超	北京	0	1	0	0	1	0	7
113	1	徐畅	江苏	0	0	0	0	0	0	7
114	7	姜钦	解放军	0	1	0	1	2	0	7
115	20	刘智洋	解放军	0	0	0	0	0	0	7
116	18	王晓龙	解放军	0	4	0	1	5	0	7
117	16	丛霖	解放军	0	0	0	0	0	0	7
118	15	杨帆	解放军	1	0	1	0	2	0	7
119	12	姜明	解放军	0	0	0	0	0	0	7
120	11	肖东洋	解放军	0	0	0	1	1	0	7
121	9	毕晓晨	解放军	0	1	0	1	2	0	7
122	12	王权	江苏	0	0	0	0	0	0	7
123	8	王烁	解放军	0	2	0	0	2	0	7
124	1	李梓宁	解放军	0	0	0	0	0	0	7
125	21	胡瀛	北京	0	1	0	1	2	0	7
126	5	张昌轲	解放军	0	0	1	0	1	0	7
127	16	刘迈科	北京	0	0	0	0	0	0	7
128	1	郭世伟	安徽	2	1	0	0	3	0	7
129	12	孟辉	北京	0	0	0	0	0	0	7
130	19	何山	安徽	0	0	0	0	0	0	7
131	18	赵楠	江苏	0	3	0	2	5	0	7
132	17	王伟强	江苏	1	2	0	0	3	0	7
133	16	张帅	江苏	0	0	0	0	0	0	7
134	1	王泽润	广东	0	0	0	0	0	0	8
135	2	孙江山	广东	0	3	0	0	3	0	8
136	10	赵建强	山东	1	5	1	0	7	0	8
137	9	吴明远	天津	0	0	0	1	1	0	8
138	6	李朝鹏	山东	1	1	0	0	2	0	8
139	12	周哲韬	上海	0	0	0	0	0	0	8
140	15	朱世杰	上海	2	3	0	0	5	0	8
141	17	贺政	上海	0	1	0	2	3	0	8
142	1	刘宗其	天津	0	0	0	0	0	0	8
143	4	李松浩	天津	0	0	0	0	0	0	8
144	3	赵时俊	上海	0	1	0	0	1	0	8







## 2016年全国男子手球锦标赛

### 得分排名表(场上队员)

正式表  
手球  
男子

截止至第 38场  
按封球

201606038-1611-4/4  
广东徐闻  
20/10/2016 13:30

名次	号码	姓名	球队	抢球	断球	造失误	造犯规	合计	封球	场数
145	8	曹悦	天津	0	7	0	2	9	0	8
146	2	张文斌	上海	0	1	0	0	1	0	8
147	11	王毅	天津	0	0	0	0	0	0	8
148	12	杨峻	天津	0	0	0	0	0	0	8
149	13	许松	天津	1	5	1	0	7	0	8
150	16	刘海亮	天津	0	0	0	0	0	0	8
151	17	周群	天津	1	2	0	4	7	0	8
152	18	王晓琪	天津	1	1	1	0	3	0	8
153	6	王子欣	天津	1	3	0	0	4	0	8
154	3	尹杰	山东	1	1	0	0	2	0	8
155	5	侯生升	广东	1	1	0	1	3	0	8
156	7	付云博	广东	0	3	1	1	5	0	8
157	8	于彦江	广东	0	0	0	0	0	0	8
158	11	房友屯	广东	0	0	1	0	1	0	8
159	13	王立隆	广东	1	3	0	0	4	0	8
160	15	张建杰	广东	0	0	0	0	0	0	8
161	10	董凯	上海	0	1	0	0	1	0	8
162	20	黄培杰	广东	0	1	0	0	1	0	8
163	4	李卓洋	广东	0	3	0	1	4	0	8
164	4	田瑞	山东	0	0	0	0	0	0	8
165	9	赵鑫	山东	0	7	0	0	7	0	8
166	12	崔剑	山东	0	0	0	0	0	0	8
167	16	于性哲	山东	0	0	0	0	0	0	8
168	19	李语庆	山东	1	3	3	0	7	0	8
169	1	张崢	上海	0	0	0	0	0	0	8
170	16	马跃	广东	0	0	0	0	0	0	8





## 2016年全国男子手球锦标赛

### 得分排名表(场上队员)

正式表  
手球  
男子

截止至第 38场  
按防守

201606038-1612-1/4  
广东徐闻  
20/10/2016 13:30

名次	号码	姓名	球队	抢球	断球	造失误	造犯规	合计	封球	场数
1	17	李中洲	广东	1	8	1	4	14	11	8
2	8	钱为玮	上海	2	11	0	0	13	2	8
3	18	马麟晓	上海	0	6	2	4	12	1	8
4	11	宋朋强	山东	0	7	1	1	9	3	8
5	17	王旭东	山东	2	5	1	1	9	2	8
6	8	曹悦	天津	0	7	0	2	9	0	8
7	21	刘江	江苏	1	7	0	1	9	1	7
8	7	张青	天津	2	5	0	1	8	1	8
9	11	蒋承骅	上海	3	5	0	0	8	4	8
10	11	张天豪	四川	1	6	1	0	8	1	6
11	9	赵鑫	山东	0	7	0	0	7	0	8
12	19	李语庆	山东	1	3	3	0	7	0	8
13	10	赵建强	山东	1	5	1	0	7	0	8
14	17	周群	天津	1	2	0	4	7	0	8
15	2	李岳朋	天津	2	4	0	1	7	1	8
16	13	许松	天津	1	5	1	0	7	0	8
17	15	李安	江苏	2	5	0	0	7	0	7
18	10	王钟彬	新疆	0	5	2	0	7	0	5
19	4	张家纬	江苏	1	4	1	0	6	4	7
20	8	周小坚	江苏	0	6	0	0	6	6	7
21	21	翟乾坤	山东	1	2	1	2	6	1	7
22	11	黎涛	安徽	1	3	0	2	6	0	7
23	3	曲汝洋	广东	0	4	0	1	5	1	8
24	33	吴璟	上海	1	4	0	0	5	2	8
25	7	付云博	广东	0	3	1	1	5	0	8
26	15	朱世杰	上海	2	3	0	0	5	0	8
27	27	于亚男	山东	1	4	0	0	5	1	8
28	18	王晓龙	解放军	0	4	0	1	5	0	7
29	6	解建飞	北京	1	2	0	2	5	10	7
30	4	曹作亮	解放军	1	4	0	0	5	5	7
31	18	赵楠	江苏	0	3	0	2	5	0	7
32	8	董智景	安徽	0	3	1	1	5	1	7
33	6	赵晨	江苏	1	4	0	0	5	15	7
34	20	顾艳超	江苏	0	4	1	0	5	1	7
35	8	谢庆龙	四川	1	4	0	0	5	0	6
36	5	潘翔	山东	0	1	1	2	4	8	8
37	84	王伟	广东	1	2	0	1	4	6	8
38	13	王立隆	广东	1	3	0	0	4	0	8
39	4	李卓洋	广东	0	3	0	1	4	0	8
40	6	王子欣	天津	1	3	0	0	4	0	8
41	14	孙耀琦	解放军	1	1	0	2	4	6	7
42	23	于敏清	安徽	0	3	1	0	4	1	7
43	5	闫亮	江苏	1	1	1	1	4	4	7
44	9	陈开勇	安徽	1	2	0	1	4	9	7
45	7	姚雄敏	安徽	0	3	0	1	4	0	7
46	12	林子健	广东	0	3	0	1	4	0	2
47	5	侯生升	广东	1	1	0	1	3	0	8
48	2	孙江山	广东	0	3	0	0	3	0	8





## 2016年全国男子手球锦标赛

### 得分排名表(场上队员)

正式表  
手球  
男子

截止至第 38场  
按防守

201606038-1612-2/4  
广东徐闻  
20/10/2016 13:30

名次	号码	姓名	球队	抢球	断球	造失误	造犯规	合计	封球	场数
49	17	贺政	上海	0	1	0	2	3	0	8
50	18	王晓琪	天津	1	1	1	0	3	0	8
51	10	周仲坤	广东	0	3	0	0	3	1	8
52	5	史小帆	安徽	1	2	0	0	3	1	7
53	7	徐奕飞	江苏	0	3	0	0	3	0	7
54	77	朱昕晨	北京	0	2	0	1	3	1	7
55	18	李双	安徽	1	1	1	0	3	4	7
56	83	潘天	北京	0	0	0	3	3	3	7
57	17	王巨柱	安徽	1	2	0	0	3	0	7
58	1	郭世伟	安徽	2	1	0	0	3	0	7
59	17	王伟强	江苏	1	2	0	0	3	0	7
60	14	田剑侠	天津	0	3	0	0	3	0	7
61	15	刘劲松	四川	1	2	0	0	3	1	6
62	19	庞连康	四川	0	2	0	1	3	1	6
63	20	赵元	新疆	2	1	0	0	3	0	5
64	7	林豪文	新疆	0	0	0	3	3	2	5
65	7	吴双	上海	0	3	0	0	3	0	4
66	15	张继伟	山东	0	2	0	0	2	3	8
67	3	尹杰	山东	1	1	0	0	2	0	8
68	6	李朝鹏	山东	1	1	0	0	2	0	8
69	8	王烁	解放军	0	2	0	0	2	0	7
70	21	胡瀛	北京	0	1	0	1	2	0	7
71	11	蒋维一	北京	0	1	0	1	2	6	7
72	25	马明辉	北京	0	2	0	0	2	0	7
73	15	杨帆	解放军	1	0	1	0	2	0	7
74	8	王鹏	北京	1	1	0	0	2	2	7
75	7	姜钦	解放军	0	1	0	1	2	0	7
76	78	张骥	北京	0	0	1	1	2	0	7
77	29	杜龙飞	北京	0	1	0	1	2	2	7
78	9	毕晓晨	解放军	0	1	0	1	2	0	7
79	7	仇瑞祥	四川	0	2	0	0	2	0	6
80	20	徐逸	四川	1	0	0	1	2	0	6
81	10	徐彦昊	四川	0	1	1	0	2	0	6
82	13	尹文珂	四川	0	2	0	0	2	0	6
83	5	徐伟	新疆	0	2	0	0	2	0	5
84	19	徐正飞	浙江	2	0	0	0	2	0	5
85	9	姜春晖	新疆	1	0	1	0	2	0	5
86	18	倪陈辉	浙江	0	2	0	0	2	0	5
87	13	刘晓	山东	0	1	0	0	1	1	8
88	9	吴明远	天津	0	0	0	1	1	0	8
89	2	张文斌	上海	0	1	0	0	1	0	8
90	4	徐俊吉	上海	0	0	0	1	1	1	8
91	10	董凯	上海	0	1	0	0	1	0	8
92	14	沈吉磊	上海	1	0	0	0	1	2	8
93	20	黄培杰	广东	0	1	0	0	1	0	8
94	11	房友屯	广东	0	0	1	0	1	0	8
95	3	赵时俊	上海	0	1	0	0	1	0	8
96	10	郝可鑫	江苏	0	1	0	0	1	4	7





## 2016年全国男子手球锦标赛

### 得分排名表(场上队员)

正式表  
手球  
男子

截止至第 38场  
按防守

201606038-1612-3/4  
广东徐闻  
20/10/2016 13:30

名次	号码	姓名	球队	抢球	断球	造失误	造犯规	合计	封球	场数
97	5	张昌轲	解放军	0	0	1	0	1	0	7
98	6	吴昊	解放军	0	1	0	0	1	4	7
99	3	陈强龙	安徽	0	1	0	0	1	0	7
100	2	金永峰	安徽	0	1	0	0	1	0	7
101	3	王超	北京	0	1	0	0	1	0	7
102	10	成亚	北京	0	1	0	0	1	0	7
103	11	肖东洋	解放军	0	0	0	1	1	0	7
104	21	马光	四川	0	1	0	0	1	1	6
105	18	任启双	四川	0	1	0	0	1	1	6
106	9	许翔宇	四川	0	1	0	0	1	0	6
107	3	刘赵梁	四川	0	1	0	0	1	0	6
108	1	罗尧尧	四川	0	1	0	0	1	0	6
109	9	李家乐	浙江	0	1	0	0	1	0	5
110	15	王维东	新疆	0	0	1	0	1	0	5
111	3	李恩铭	浙江	0	1	0	0	1	0	5
112	19	李龙吉	新疆	0	1	0	0	1	0	5
113	8	刘文宇	新疆	0	1	0	0	1	1	5
114	10	罗明杰	浙江	0	1	0	0	1	0	5
115	24	王泽川	新疆	0	1	0	0	1	0	5
116	16	马跃	广东	0	0	0	0	0	0	8
117	1	王泽润	广东	0	0	0	0	0	0	8
118	16	刘海亮	天津	0	0	0	0	0	0	8
119	8	于彦江	广东	0	0	0	0	0	0	8
120	1	刘宗其	天津	0	0	0	0	0	0	8
121	4	李松浩	天津	0	0	0	0	0	0	8
122	4	田瑞	山东	0	0	0	0	0	0	8
123	12	周哲韬	上海	0	0	0	0	0	0	8
124	15	张建杰	广东	0	0	0	0	0	0	8
125	12	杨峻	天津	0	0	0	0	0	0	8
126	12	崔剑	山东	0	0	0	0	0	0	8
127	16	于性哲	山东	0	0	0	0	0	0	8
128	22	魏雨童	天津	0	0	0	0	0	1	8
129	1	张峥	上海	0	0	0	0	0	0	8
130	11	王毅	天津	0	0	0	0	0	0	8
131	21	李明	安徽	0	0	0	0	0	0	7
132	22	王金宇	安徽	0	0	0	0	0	0	7
133	10	严龙	安徽	0	0	0	0	0	0	7
134	33	冯宁	北京	0	0	0	0	0	0	7
135	12	孟辉	北京	0	0	0	0	0	0	7
136	19	何山	安徽	0	0	0	0	0	0	7
137	16	刘迈科	北京	0	0	0	0	0	0	7
138	12	曾献辰	安徽	0	0	0	0	0	0	7
139	9	刘振	北京	0	0	0	0	0	1	7
140	1	李梓宁	解放军	0	0	0	0	0	0	7
141	9	周傲	江苏	0	0	0	0	0	1	7
142	12	王权	江苏	0	0	0	0	0	0	7
143	16	张帅	江苏	0	0	0	0	0	0	7
144	2	范保坤	解放军	0	0	0	0	0	0	7





## 2016年全国男子手球锦标赛 得分排名表(场上队员)

正式表  
手球  
男子

截止至第 38场  
按防守

201606038-1612-4/4  
广东徐闻  
20/10/2016 13:30

名次	号码	姓名	球队	抢球	断球	造失误	造犯规	合计	封球	场数
145	12	姜明	解放军	0	0	0	0	0	0	7
146	20	刘智洋	解放军	0	0	0	0	0	0	7
147	16	丛霖	解放军	0	0	0	0	0	0	7
148	1	徐畅	江苏	0	0	0	0	0	0	7
149	22	张睿梁	四川	0	0	0	0	0	0	6
150	23	王军程	北京	0	0	0	0	0	0	6
151	16	朱春雷	上海	0	0	0	0	0	0	6
152	16	宋继强	四川	0	0	0	0	0	0	6
153	21	潘玉帅	天津	0	0	0	0	0	0	6
154	5	林先方	浙江	0	0	0	0	0	0	5
155	2	郑尧俊	浙江	0	0	0	0	0	0	5
156	1	宋晓晨	新疆	0	0	0	0	0	0	5
157	17	胡晋铭	新疆	0	0	0	0	0	1	5
158	18	姜帅	新疆	0	0	0	0	0	2	5
159	13	苏兴伟	新疆	0	0	0	0	0	0	5
160	12	丁大伟	四川	0	0	0	0	0	0	5
161	7	金杰	浙江	0	0	0	0	0	0	5
162	8	王浩	浙江	0	0	0	0	0	0	5
163	14	虞勇灿	浙江	0	0	0	0	0	0	5
164	15	张佩力	浙江	0	0	0	0	0	0	5
165	24	毛军伟	浙江	0	0	0	0	0	0	5
166	1	李欢欢	浙江	0	0	0	0	0	0	5
167	22	张瑞恒	江苏	0	0	0	0	0	0	5
168	11	陈渝天	浙江	0	0	0	0	0	0	5
169	12	王金鑫	新疆	0	0	0	0	0	0	2
170	1	李濛壮	山东	0	0	0	0	0	0	2





## 2016年全国男子手球锦标赛

## 得分排名表(场上队员)

正式表  
手球  
男子截止至第 38场  
失误排名表201606038-1613-1/4  
广东徐闻  
20/10/2016 13:30

排序	号码	姓名	球队	传失	接失	两次	四步	侵区	撞人	其它	合计	场数
1	18	马麟晓	上海	16	1	1	1	1	1	0	21	8
2	17	王巨柱	安徽	15	3	1	0	1	1	0	21	7
3	18	李双	安徽	14	0	2	1	2	2	0	21	7
4	10	罗明杰	浙江	13	3	3	1	0	0	1	21	5
5	8	周小坚	江苏	8	5	1	0	3	2	0	19	7
6	17	李中洲	广东	8	5	1	1	0	2	1	18	8
7	15	朱世杰	上海	9	2	4	3	0	0	0	18	8
8	78	张骥	北京	14	0	0	1	0	0	1	16	7
9	4	曹作亮	解放军	10	2	4	0	0	0	0	16	7
10	19	李龙吉	新疆	10	1	1	2	1	1	0	16	5
11	19	徐正飞	浙江	9	4	2	1	0	0	0	16	5
12	8	曹悦	天津	6	0	3	0	0	4	1	14	8
13	3	曲汝洋	广东	6	0	1	2	1	4	0	14	8
14	18	赵楠	江苏	6	1	2	2	1	2	0	14	7
15	13	许松	天津	3	2	3	3	0	1	1	13	8
16	20	顾艳超	江苏	8	2	2	0	1	0	0	13	7
17	9	许翔宇	四川	6	3	2	0	0	2	0	13	6
18	7	张青	天津	4	2	1	4	0	1	0	12	8
19	9	赵鑫	山东	6	1	4	0	1	0	0	12	8
20	7	付云博	广东	8	2	0	0	0	2	0	12	8
21	10	郝可鑫	江苏	7	2	1	1	1	0	0	12	7
22	8	王烁	解放军	2	3	1	2	4	0	0	12	7
23	8	董智景	安徽	6	3	0	1	2	0	0	12	7
24	11	黎涛	安徽	6	3	1	0	1	0	1	12	7
25	3	刘赵梁	四川	8	2	0	1	0	1	0	12	6
26	18	倪陈辉	浙江	4	2	2	2	1	1	0	12	5
27	27	于亚男	山东	5	0	2	1	0	3	0	11	8
28	2	李岳朋	天津	4	3	1	3	0	0	0	11	8
29	4	徐俊吉	上海	0	4	1	1	3	0	2	11	8
30	4	张家纬	江苏	6	2	0	0	1	2	0	11	7
31	8	钱为玮	上海	4	1	1	1	2	0	1	10	8
32	3	赵时俊	上海	5	3	1	1	0	0	0	10	8
33	7	姚雄敏	安徽	5	0	0	3	1	0	1	10	7
34	6	赵晨	江苏	5	2	1	1	0	1	0	10	7
35	10	成亚	北京	3	2	1	3	0	1	0	10	7
36	9	毕晓晨	解放军	3	2	0	2	3	0	0	10	7
37	3	李恩铭	浙江	3	6	0	0	0	0	1	10	5
38	2	郑尧俊	浙江	8	0	2	0	0	0	0	10	5
39	17	王旭东	山东	4	0	0	2	1	2	0	9	8
40	18	王晓龙	解放军	3	1	1	0	2	2	0	9	7
41	21	胡瀛	北京	1	4	1	1	0	1	1	9	7
42	20	赵元	新疆	3	1	0	1	2	1	1	9	5
43	11	宋朋强	山东	5	0	1	2	0	0	0	8	8
44	6	李朝鹏	山东	4	1	1	0	1	0	1	8	8
45	15	张建杰	广东	4	3	1	0	0	0	0	8	8
46	7	姜钦	解放军	4	0	1	2	0	1	0	8	7
47	6	吴昊	解放军	3	1	0	1	0	3	0	8	7
48	15	李安	江苏	4	1	1	0	0	1	1	8	7





## 2016年全国男子手球锦标赛

## 得分排名表(场上队员)

正式表  
手球  
男子截止至第 38场  
失误排名表201606038-1613-2/4  
广东徐闻  
20/10/2016 13:30

排序	号码	姓名	球队	传失	接失	两次	四步	侵区	撞人	其它	合计	场数
49	14	田剑侠	天津	1	4	0	1	0	1	1	8	7
50	7	仇瑞祥	四川	2	1	0	0	3	1	1	8	6
51	5	林先方	浙江	4	2	1	0	1	0	0	8	5
52	84	王伟	广东	2	1	1	0	0	3	0	7	8
53	17	贺政	上海	1	3	0	0	1	2	0	7	8
54	2	孙江山	广东	1	4	0	0	2	0	0	7	8
55	4	李卓洋	广东	6	0	1	0	0	0	0	7	8
56	17	王伟强	江苏	2	0	2	1	2	0	0	7	7
57	11	蒋维一	北京	1	1	1	1	1	2	0	7	7
58	77	朱昕晨	北京	5	0	0	2	0	0	0	7	7
59	21	刘江	江苏	4	2	0	0	1	0	0	7	7
60	11	张天豪	四川	5	1	0	0	0	0	1	7	6
61	10	王钟彬	新疆	5	1	1	0	0	0	0	7	5
62	11	蒋承骅	上海	1	1	1	0	0	3	0	6	8
63	19	李语庆	山东	1	1	0	0	0	2	2	6	8
64	17	周群	天津	2	0	2	0	2	0	0	6	8
65	5	潘翔	山东	3	2	1	0	0	0	0	6	8
66	9	陈开勇	安徽	0	5	0	0	1	0	0	6	7
67	21	马光	四川	1	1	3	0	1	0	0	6	6
68	1	宋晓晨	新疆	6	0	0	0	0	0	0	6	5
69	7	金杰	浙江	1	1	1	1	0	0	2	6	5
70	23	于敏清	安徽	0	4	1	0	0	0	0	5	7
71	7	徐奕飞	江苏	2	1	1	0	1	0	0	5	7
72	14	孙耀琦	解放军	0	3	0	1	0	1	0	5	7
73	23	王军程	北京	4	0	0	0	0	0	1	5	6
74	10	徐彦昊	四川	5	0	0	0	0	0	0	5	6
75	19	庞连康	四川	2	0	1	0	1	0	1	5	6
76	7	林豪文	新疆	5	0	0	0	0	0	0	5	5
77	5	侯生升	广东	0	2	1	0	1	0	0	4	8
78	10	董凯	上海	0	2	0	1	1	0	0	4	8
79	11	房友屯	广东	2	1	1	0	0	0	0	4	8
80	20	刘智洋	解放军	1	0	0	0	2	0	1	4	7
81	1	郭世伟	安徽	2	1	0	0	1	0	0	4	7
82	9	刘振	北京	3	0	0	1	0	0	0	4	7
83	3	王超	北京	2	0	0	0	1	1	0	4	7
84	15	刘劲松	四川	3	1	0	0	0	0	0	4	6
85	1	罗尧尧	四川	2	0	0	0	0	1	1	4	6
86	9	李家乐	浙江	1	3	0	0	0	0	0	4	5
87	9	姜春晖	新疆	1	2	1	0	0	0	0	4	5
88	4	李松浩	天津	1	2	0	0	0	0	0	3	8
89	9	吴明远	天津	1	0	1	0	1	0	0	3	8
90	10	周仲坤	广东	3	0	0	0	0	0	0	3	8
91	14	沈吉磊	上海	3	0	0	0	0	0	0	3	8
92	10	赵建强	山东	0	1	0	0	1	0	1	3	8
93	16	马跃	广东	2	0	0	0	0	0	1	3	8
94	15	张继伟	山东	1	1	0	0	1	0	0	3	8
95	13	刘晓	山东	2	1	0	0	0	0	0	3	8
96	21	李明	安徽	3	0	0	0	0	0	0	3	7



## 2016年全国男子手球锦标赛

## 得分排名表(场上队员)

正式表  
手球  
男子截止至第 38场  
失误排名表201606038-1613-3/4  
广东徐闻  
20/10/2016 13:30

排序	号码	姓名	球队	传失	接失	两次	四步	侵区	撞人	其它	合计	场数
97	29	杜龙飞	北京	1	0	0	0	2	0	0	3	7
98	16	刘迈科	北京	1	0	0	0	0	0	2	3	7
99	11	肖东洋	解放军	1	0	1	1	0	0	0	3	7
100	5	闫亮	江苏	1	1	0	0	1	0	0	3	7
101	12	孟辉	北京	3	0	0	0	0	0	0	3	7
102	3	陈强龙	安徽	0	3	0	0	0	0	0	3	7
103	9	周傲	江苏	1	1	1	0	0	0	0	3	7
104	13	尹文珂	四川	0	0	1	0	2	0	0	3	6
105	18	任启双	四川	0	2	0	0	1	0	0	3	6
106	8	刘文宇	新疆	0	2	0	0	1	0	0	3	5
107	17	胡晋铭	新疆	0	2	0	0	0	1	0	3	5
108	20	黄培杰	广东	1	0	1	0	0	0	0	2	8
109	13	王立隆	广东	1	0	0	0	1	0	0	2	8
110	22	魏雨童	天津	0	1	1	0	0	0	0	2	8
111	2	张文斌	上海	1	0	1	0	0	0	0	2	8
112	33	冯宁	北京	1	0	0	0	0	1	0	2	7
113	2	金永峰	安徽	1	1	0	0	0	0	0	2	7
114	2	范保坤	解放军	1	0	0	0	0	0	1	2	7
115	10	严龙	安徽	2	0	0	0	0	0	0	2	7
116	15	杨帆	解放军	1	0	0	1	0	0	0	2	7
117	5	史小帆	安徽	0	1	0	0	0	1	0	2	7
118	21	翟乾坤	山东	0	1	0	0	0	0	1	2	7
119	8	谢庆龙	四川	0	1	0	0	1	0	0	2	6
120	20	徐逸	四川	2	0	0	0	0	0	0	2	6
121	5	徐伟	新疆	0	1	0	0	1	0	0	2	5
122	24	毛军伟	浙江	1	0	1	0	0	0	0	2	5
123	1	李欢欢	浙江	1	0	0	0	1	0	0	2	5
124	7	吴双	上海	1	1	0	0	0	0	0	2	4
125	12	周哲韬	上海	1	0	0	0	0	0	0	1	8
126	6	王子欣	天津	0	1	0	0	0	0	0	1	8
127	3	尹杰	山东	1	0	0	0	0	0	0	1	8
128	12	崔剑	山东	1	0	0	0	0	0	0	1	8
129	4	田瑞	山东	0	0	0	0	0	0	1	1	8
130	18	王晓琪	天津	1	0	0	0	0	0	0	1	8
131	16	于性哲	山东	1	0	0	0	0	0	0	1	8
132	12	杨峻	天津	1	0	0	0	0	0	0	1	8
133	5	张昌轲	解放军	0	0	0	1	0	0	0	1	7
134	6	解建飞	北京	0	0	0	0	0	0	1	1	7
135	25	马明辉	北京	0	1	0	0	0	0	0	1	7
136	12	王权	江苏	1	0	0	0	0	0	0	1	7
137	1	李梓宁	解放军	1	0	0	0	0	0	0	1	7
138	1	徐畅	江苏	1	0	0	0	0	0	0	1	7
139	16	宋继强	四川	1	0	0	0	0	0	0	1	6
140	15	王维东	新疆	1	0	0	0	0	0	0	1	5
141	24	王泽川	新疆	0	1	0	0	0	0	0	1	5
142	18	姜帅	新疆	0	0	1	0	0	0	0	1	5
143	12	丁大伟	四川	1	0	0	0	0	0	0	1	5
144	15	张佩力	浙江	1	0	0	0	0	0	0	1	5







## 2016年全国男子手球锦标赛

## 得分排名表(场上队员)

正式表  
手球  
男子截止至第 38场  
失误排名表201606038-1613-4/4  
广东徐闻  
20/10/2016 13:30

排序	号码	姓名	球队	传失	接失	两次	四步	侵区	撞人	其它	合计	场数
145	12	林子健	广东	1	0	0	0	0	0	0	1	2
146	16	刘海亮	天津	0	0	0	0	0	0	0	0	8
147	1	王泽润	广东	0	0	0	0	0	0	0	0	8
148	1	刘宗其	天津	0	0	0	0	0	0	0	0	8
149	11	王毅	天津	0	0	0	0	0	0	0	0	8
150	33	吴璟	上海	0	0	0	0	0	0	0	0	8
151	1	张崢	上海	0	0	0	0	0	0	0	0	8
152	8	于彦江	广东	0	0	0	0	0	0	0	0	8
153	19	何山	安徽	0	0	0	0	0	0	0	0	7
154	12	曾献辰	安徽	0	0	0	0	0	0	0	0	7
155	22	王金宇	安徽	0	0	0	0	0	0	0	0	7
156	8	王鹏	北京	0	0	0	0	0	0	0	0	7
157	83	潘天	北京	0	0	0	0	0	0	0	0	7
158	16	丛霖	解放军	0	0	0	0	0	0	0	0	7
159	12	姜明	解放军	0	0	0	0	0	0	0	0	7
160	16	张帅	江苏	0	0	0	0	0	0	0	0	7
161	21	潘玉帅	天津	0	0	0	0	0	0	0	0	6
162	16	朱春雷	上海	0	0	0	0	0	0	0	0	6
163	22	张睿梁	四川	0	0	0	0	0	0	0	0	6
164	8	王浩	浙江	0	0	0	0	0	0	0	0	5
165	11	陈渝天	浙江	0	0	0	0	0	0	0	0	5
166	14	虞勇灿	浙江	0	0	0	0	0	0	0	0	5
167	22	张瑞恒	江苏	0	0	0	0	0	0	0	0	5
168	13	苏兴伟	新疆	0	0	0	0	0	0	0	0	5
169	1	李濠壮	山东	0	0	0	0	0	0	0	0	2
170	12	王金鑫	新疆	0	0	0	0	0	0	0	0	2





## 2016年全国男子手球锦标赛

## 得分排名表(场上队员)

正式表  
手球  
男子截止至第 38场  
受罚排名表201606038-1614-1/4  
广东徐闻  
20/10/2016 13:30

排序	号码	姓名	球队	警告	罚2分钟	D+DR	场数
1	14	田剑侠	天津	1	3	1	7
2	23	王军程	北京	0	3	1	6
3	21	翟乾坤	山东	1	0	1	7
4	17	王旭东	山东	3	6	0	8
5	15	朱世杰	上海	5	4	0	8
6	84	王伟	广东	3	4	0	8
7	4	曹作亮	解放军	2	4	0	7
8	19	李语庆	山东	1	4	0	8
9	20	赵元	新疆	1	4	0	5
10	77	朱昕晨	北京	0	4	0	7
11	14	孙耀琦	解放军	3	3	0	7
12	17	胡晋铭	新疆	2	3	0	5
13	8	钱为玮	上海	1	3	0	8
14	18	赵楠	江苏	1	3	0	7
15	9	毕晓晨	解放军	1	3	0	7
16	6	李朝鹏	山东	0	3	0	8
17	15	张继伟	山东	0	3	0	8
18	7	林豪文	新疆	0	3	0	5
19	6	解建飞	北京	5	2	0	7
20	2	李岳朋	天津	4	2	0	8
21	17	周群	天津	4	2	0	8
22	8	曹悦	天津	4	2	0	8
23	5	潘翔	山东	3	2	0	8
24	7	张青	天津	2	2	0	8
25	21	刘江	江苏	2	2	0	7
26	21	胡瀛	北京	2	2	0	7
27	11	蒋维一	北京	2	2	0	7
28	18	李双	安徽	2	2	0	7
29	5	侯生升	广东	1	2	0	8
30	4	田瑞	山东	1	2	0	8
31	17	贺政	上海	1	2	0	8
32	7	徐奕飞	江苏	1	2	0	7
33	8	王鹏	北京	1	2	0	7
34	6	王子欣	天津	0	2	0	8
35	17	王巨柱	安徽	0	2	0	7
36	8	周小坚	江苏	0	2	0	7
37	19	庞连康	四川	0	2	0	6
38	9	姜春晖	新疆	0	2	0	5
39	17	李中洲	广东	5	1	0	8
40	9	陈开勇	安徽	5	1	0	7
41	4	徐俊吉	上海	4	1	0	8
42	6	吴昊	解放军	4	1	0	7
43	3	赵时俊	上海	3	1	0	8
44	23	于敏清	安徽	3	1	0	7
45	25	马明辉	北京	3	1	0	7
46	7	姜钦	解放军	3	1	0	7
47	11	张天豪	四川	3	1	0	6
48	18	姜帅	新疆	3	1	0	5





## 2016年全国男子手球锦标赛

## 得分排名表(场上队员)

正式表  
手球  
男子截止至第 38场  
受罚排名表201606038-1614-2/4  
广东徐闻  
20/10/2016 13:30

排序	号码	姓名	球队	警告	罚2分钟	D+DR	场数
49	6	赵晨	江苏	2	1	0	7
50	21	马光	四川	2	1	0	6
51	8	刘文宇	新疆	2	1	0	5
52	10	王钟彬	新疆	2	1	0	5
53	11	蒋承骅	上海	1	1	0	8
54	4	李卓洋	广东	1	1	0	8
55	15	张建杰	广东	1	1	0	8
56	8	王烁	解放军	1	1	0	7
57	15	刘劲松	四川	1	1	0	6
58	15	王维东	新疆	1	1	0	5
59	10	周仲坤	广东	0	1	0	8
60	9	吴明远	天津	0	1	0	8
61	3	王超	北京	0	1	0	7
62	5	张昌轲	解放军	0	1	0	7
63	5	史小帆	安徽	0	1	0	7
64	3	陈强龙	安徽	0	1	0	7
65	15	杨帆	解放军	0	1	0	7
66	12	王权	江苏	0	1	0	7
67	8	谢庆龙	四川	0	1	0	6
68	24	王泽川	新疆	0	1	0	5
69	4	张家纬	江苏	4	0	0	7
70	27	于亚男	山东	3	0	0	8
71	18	马麟晓	上海	2	0	0	8
72	5	闫亮	江苏	2	0	0	7
73	8	董智景	安徽	2	0	0	7
74	18	王晓龙	解放军	2	0	0	7
75	1	郭世伟	安徽	2	0	0	7
76	18	任启双	四川	2	0	0	6
77	1	李欢欢	浙江	2	0	0	5
78	10	罗明杰	浙江	2	0	0	5
79	7	付云博	广东	1	0	0	8
80	11	房友屯	广东	1	0	0	8
81	9	赵鑫	山东	1	0	0	8
82	20	黄培杰	广东	1	0	0	8
83	3	曲汝洋	广东	1	0	0	8
84	2	张文斌	上海	1	0	0	8
85	14	沈吉磊	上海	1	0	0	8
86	11	宋朋强	山东	1	0	0	8
87	11	肖东洋	解放军	1	0	0	7
88	20	刘智洋	解放军	1	0	0	7
89	15	李安	江苏	1	0	0	7
90	83	潘天	北京	1	0	0	7
91	10	成亚	北京	1	0	0	7
92	9	许翔宇	四川	1	0	0	6
93	1	罗尧尧	四川	1	0	0	6
94	19	李龙吉	新疆	1	0	0	5
95	2	郑尧俊	浙江	1	0	0	5
96	3	李恩铭	浙江	1	0	0	5





## 2016年全国男子手球锦标赛

## 得分排名表(场上队员)

正式表  
手球  
男子截止至第 38场  
受罚排名表201606038-1614-3/4  
广东徐闻  
20/10/2016 13:30

排序	号码	姓名	球队	警告	罚2分钟	D+DR	场数
97	18	倪陈辉	浙江	1	0	0	5
98	18	王晓琪	天津	0	0	0	8
99	12	杨峻	天津	0	0	0	8
100	4	李松浩	天津	0	0	0	8
101	11	王毅	天津	0	0	0	8
102	1	刘宗其	天津	0	0	0	8
103	10	赵建强	山东	0	0	0	8
104	13	许松	天津	0	0	0	8
105	8	于彦江	广东	0	0	0	8
106	16	马跃	广东	0	0	0	8
107	22	魏雨童	天津	0	0	0	8
108	2	孙江山	广东	0	0	0	8
109	1	王泽润	广东	0	0	0	8
110	16	刘海亮	天津	0	0	0	8
111	13	刘晓	山东	0	0	0	8
112	3	尹杰	山东	0	0	0	8
113	10	董凯	上海	0	0	0	8
114	12	周哲韬	上海	0	0	0	8
115	13	王立隆	广东	0	0	0	8
116	33	吴璟	上海	0	0	0	8
117	1	张崢	上海	0	0	0	8
118	16	于性哲	山东	0	0	0	8
119	12	崔剑	山东	0	0	0	8
120	12	曾献辰	安徽	0	0	0	7
121	2	金永峰	安徽	0	0	0	7
122	17	王伟强	江苏	0	0	0	7
123	7	姚雄敏	安徽	0	0	0	7
124	33	冯宁	北京	0	0	0	7
125	10	严龙	安徽	0	0	0	7
126	12	孟辉	北京	0	0	0	7
127	29	杜龙飞	北京	0	0	0	7
128	22	王金宇	安徽	0	0	0	7
129	19	何山	安徽	0	0	0	7
130	16	刘迈科	北京	0	0	0	7
131	1	李梓宁	解放军	0	0	0	7
132	21	李明	安徽	0	0	0	7
133	78	张骥	北京	0	0	0	7
134	9	刘振	北京	0	0	0	7
135	11	黎涛	安徽	0	0	0	7
136	2	范保坤	解放军	0	0	0	7
137	16	丛霖	解放军	0	0	0	7
138	16	张帅	江苏	0	0	0	7
139	12	姜明	解放军	0	0	0	7
140	9	周傲	江苏	0	0	0	7
141	10	郝可鑫	江苏	0	0	0	7
142	20	顾艳超	江苏	0	0	0	7
143	1	徐畅	江苏	0	0	0	7
144	13	尹文珂	四川	0	0	0	6





## 2016年全国男子手球锦标赛

## 得分排名表(场上队员)

正式表  
手球  
男子截止至第 38场  
受罚排名表201606038-1614-4/4  
广东徐闻  
20/10/2016 13:30

排序	号码	姓名	球队	警告	罚2分钟	D+DR	场数
145	16	宋继强	四川	0	0	0	6
146	10	徐彦昊	四川	0	0	0	6
147	22	张睿梁	四川	0	0	0	6
148	7	仇瑞祥	四川	0	0	0	6
149	3	刘赵梁	四川	0	0	0	6
150	20	徐逸	四川	0	0	0	6
151	16	朱春雷	上海	0	0	0	6
152	21	潘玉帅	天津	0	0	0	6
153	9	李家乐	浙江	0	0	0	5
154	15	张佩力	浙江	0	0	0	5
155	24	毛军伟	浙江	0	0	0	5
156	11	陈渝天	浙江	0	0	0	5
157	19	徐正飞	浙江	0	0	0	5
158	14	虞勇灿	浙江	0	0	0	5
159	12	丁大伟	四川	0	0	0	5
160	8	王浩	浙江	0	0	0	5
161	5	徐伟	新疆	0	0	0	5
162	5	林先方	浙江	0	0	0	5
163	1	宋晓晨	新疆	0	0	0	5
164	22	张瑞恒	江苏	0	0	0	5
165	13	苏兴伟	新疆	0	0	0	5
166	7	金杰	浙江	0	0	0	5
167	7	吴双	上海	0	0	0	4
168	12	王金鑫	新疆	0	0	0	2
169	12	林子健	广东	0	0	0	2
170	1	李濠壮	山东	0	0	0	2





## 2016年全国男子手球锦标赛

排名表(守门员)

正式表  
手球  
男子截止至第 38场  
得分排名表201606038-1701-1/1  
广东徐闻  
20/10/2016 13:30

排序	号码	姓名	球队	远射	近射	边射	快攻	突破	任意	7M	合计	%	助攻	场数
1	16	刘迈科	北京	35-57	18-52	6-15	7-32	7-18	0-2	3-11	76-187	40.6	5	7
2	21	李明	安徽	24-59	31-101	4-14	5-29	2-20	3-5	3-15	72-243	29.6	3	7
3	1	刘宗其	天津	33-65	18-57	5-23	3-14	4-10	0-2	1-9	64-180	35.6	7	8
4	16	马跃	广东	22-62	21-82	3-18	3-20	3-16	3-5	3-11	58-214	27.1	1	8
5	16	于性哲	山东	18-41	18-43	9-16	5-15	3-9	2-4	1-14	56-142	39.4	6	8
6	16	丛霖	解放军	17-35	18-47	7-18	4-21	4-12	1-1	3-13	54-147	36.7	0	7
7	12	崔剑	山东	16-27	19-34	11-18	4-10	2-10	0-1	1-6	53-106	50.0	2	8
8	12	王权	江苏	24-39	10-21	10-23	2-13	2-5	0-0	1-5	49-106	46.2	4	7
9	12	周哲韬	上海	10-24	19-59	9-26	2-19	0-12	1-2	1-6	42-148	28.4	0	8
10	12	丁大伟	四川	13-33	11-45	2-16	3-20	3-7	0-0	4-10	36-131	27.5	3	5
11	1	张崢	上海	12-28	9-24	2-7	4-15	2-9	0-0	4-14	33-97	34.0	2	8
12	1	徐畅	江苏	14-40	10-33	3-9	1-12	0-2	1-2	4-7	33-105	31.4	1	7
13	1	宋晓晨	新疆	9-29	15-70	2-8	1-28	0-9	0-1	4-20	31-165	18.8	6	5
14	1	李梓宁	解放军	8-15	8-27	4-9	2-10	3-7	3-3	2-7	30-78	38.5	0	7
15	12	孟辉	北京	9-11	8-17	1-1	3-12	0-2	0-1	0-3	21-47	44.7	5	7
16	22	张睿梁	四川	10-16	6-22	2-3	1-7	1-4	0-0	0-1	20-53	37.7	2	6
17	12	杨峻	天津	6-16	10-31	1-4	2-10	1-2	0-2	0-4	20-69	29.0	0	8
18	15	张佩力	浙江	3-16	5-30	5-13	2-23	0-9	0-0	0-2	15-93	16.1	0	5
19	16	宋继强	四川	2-13	6-18	0-3	0-3	2-2	1-1	0-1	11-41	26.8	0	6
20	16	张帅	江苏	5-9	2-8	1-3	2-2	0-1	0-1	0-1	10-25	40.0	1	7
21	12	姜明	解放军	3-6	3-8	1-3	1-7	1-2	0-0	0-4	9-30	30.0	0	7
22	12	曾献辰	安徽	2-6	2-10	1-3	0-9	0-1	0-0	0-1	5-30	16.7	2	7
23	1	王泽润	广东	0-3	3-10	1-3	0-3	0-0	0-1	0-2	4-22	18.2	1	8
24	12	王金鑫	新疆	1-4	2-13	0-2	0-3	0-1	0-0	1-1	4-24	16.7	0	2
25	8	王浩	浙江	1-9	2-14	1-3	0-11	0-5	0-0	0-0	4-42	9.5	0	5
26	16	刘海亮	天津	0-0	0-0	0-0	0-0	0-0	0-0	1-4	1-4	25.0	0	8
27	11	黎涛	安徽	0-0	0-0	0-0	0-0	0-0	0-0	0-0	0-0	0.0	0	7
28	16	朱春雷	上海	0-0	0-0	0-0	0-0	0-0	0-0	0-0	0-0	0.0	0	6
29	1	李欢欢	浙江	0-0	0-0	0-0	0-0	0-0	0-0	0-0	0-0	0.0	0	5
30	15	王维东	新疆	0-0	0-0	0-0	0-0	0-0	0-0	0-0	0-0	0.0	0	5



## 2016年全国男子手球锦标赛

排名表(守门员)

正式表  
手球  
男子截止至第 38场  
7M球得分排名表201606038-1703-1/1  
广东徐闻  
20/10/2016 13:30

排序	号码	姓名	球队	远射	近射	边射	快攻	突破	任意	7M	合计	%	助攻	场数
1	1	徐畅	江苏	14-40	10-33	3-9	1-12	0-2	1-2	4-7	33-105	57.1	1	7
2	12	丁大伟	四川	13-33	11-45	2-16	3-20	3-7	0-0	4-10	36-131	40.0	3	5
3	1	张峥	上海	12-28	9-24	2-7	4-15	2-9	0-0	4-14	33-97	28.6	2	8
4	1	宋晓晨	新疆	9-29	15-70	2-8	1-28	0-9	0-1	4-20	31-165	20.0	6	5
5	16	刘迈科	北京	35-57	18-52	6-15	7-32	7-18	0-2	3-11	76-187	27.3	5	7
6	16	马跃	广东	22-62	21-82	3-18	3-20	3-16	3-5	3-11	58-214	27.3	1	8
7	16	丛霖	解放军	17-35	18-47	7-18	4-21	4-12	1-1	3-13	54-147	23.1	0	7
8	21	李明	安徽	24-59	31-101	4-14	5-29	2-20	3-5	3-15	72-243	20.0	3	7
9	1	李梓宁	解放军	8-15	8-27	4-9	2-10	3-7	3-3	2-7	30-78	28.6	0	7
10	12	王金鑫	新疆	1-4	2-13	0-2	0-3	0-1	0-0	1-1	4-24	100.0	0	2
11	16	刘海亮	天津	0-0	0-0	0-0	0-0	0-0	0-0	1-4	1-4	25.0	0	8
12	12	王权	江苏	24-39	10-21	10-23	2-13	2-5	0-0	1-5	49-106	20.0	4	7
13	12	崔剑	山东	16-27	19-34	11-18	4-10	2-10	0-1	1-6	53-106	16.7	2	8
14	12	周哲韬	上海	10-24	19-59	9-26	2-19	0-12	1-2	1-6	42-148	16.7	0	8
15	1	刘宗其	天津	33-65	18-57	5-23	3-14	4-10	0-2	1-9	64-180	11.1	7	8
16	16	于性哲	山东	18-41	18-43	9-16	5-15	3-9	2-4	1-14	56-142	7.1	6	8
17	8	王浩	浙江	1-9	2-14	1-3	0-11	0-5	0-0	0-0	4-42	0.0	0	5
18	11	黎涛	安徽	0-0	0-0	0-0	0-0	0-0	0-0	0-0	0-0	0.0	0	7
19	16	朱春雷	上海	0-0	0-0	0-0	0-0	0-0	0-0	0-0	0-0	0.0	0	6
20	1	李欢欢	浙江	0-0	0-0	0-0	0-0	0-0	0-0	0-0	0-0	0.0	0	5
21	15	王维东	新疆	0-0	0-0	0-0	0-0	0-0	0-0	0-0	0-0	0.0	0	5
22	22	张睿梁	四川	10-16	6-22	2-3	1-7	1-4	0-0	0-1	20-53	0.0	2	6
23	16	宋继强	四川	2-13	6-18	0-3	0-3	2-2	1-1	0-1	11-41	0.0	0	6
24	16	张帅	江苏	5-9	2-8	1-3	2-2	0-1	0-1	0-1	10-25	0.0	1	7
25	12	曾献辰	安徽	2-6	2-10	1-3	0-9	0-1	0-0	0-1	5-30	0.0	2	7
26	15	张佩力	浙江	3-16	5-30	5-13	2-23	0-9	0-0	0-2	15-93	0.0	0	5
27	1	王泽润	广东	0-3	3-10	1-3	0-3	0-0	0-1	0-2	4-22	0.0	1	8
28	12	孟辉	北京	9-11	8-17	1-1	3-12	0-2	0-1	0-3	21-47	0.0	5	7
29	12	杨峻	天津	6-16	10-31	1-4	2-10	1-2	0-2	0-4	20-69	0.0	0	8
30	12	姜明	解放军	3-6	3-8	1-3	1-7	1-2	0-0	0-4	9-30	0.0	0	7



## 2016年全国男子手球锦标赛

攻防成功率统计总表

20160638-3102-1/1

29/10/16

广东徐闻

序号	球队	比分	进攻成功率												助攻	防守成功率											
			阵地进攻			一传快攻			短传快攻			合计		多打少		少打多		封打抢断	守门员	对方射失	对方失误	合计	%				
			得分	进攻	%	得分	进攻	%	得分	进攻	%	得分	进攻	%		得分	进攻							%			
1	安徽	165 : 196	138	402	34.3	15	20	75.0	12	28	42.9	165	450	36.7	11	20	55.0	1	4	25.0	42	53	77	47	54	231	52.1
2	北京	157 : 137	137	330	41.5	13	16	81.3	7	17	41.2	157	363	43.3	27	44	61.4	7	17	41.2	35	50	97	55	10	212	56.7
3	广东	198 : 174	159	360	44.2	19	21	90.5	20	34	58.8	198	415	47.7	15	21	71.4	3	9	33.3	36	70	62	43	35	210	52.1
4	江苏	203 : 144	155	366	42.3	26	35	74.3	22	52	42.3	203	453	44.8	19	32	59.4	7	14	50.0	72	90	92	71	19	272	60.2
5	解放军	140 : 162	129	348	37.1	4	6	66.7	7	17	41.2	140	371	37.7	16	27	59.3	9	20	45.0	24	40	93	45	28	206	53.6
6	山东	229 : 139	176	367	48.0	23	26	88.5	30	49	61.2	229	442	51.8	12	15	80.0	18	36	50.0	69	80	109	45	38	272	63.3
7	上海	170 : 170	143	367	39.0	14	17	82.4	13	32	40.6	170	416	40.9	5	9	55.6	6	13	46.2	44	66	75	52	42	235	56.4
8	四川	130 : 158	111	279	39.8	11	15	73.3	8	27	29.6	130	321	40.5	15	23	65.2	2	7	28.6	24	37	67	38	24	166	50.3
9	天津	203 : 168	175	379	46.2	14	20	70.0	14	29	48.3	203	428	47.4	21	29	72.4	5	11	45.5	35	52	85	54	58	249	59.3
10	新疆	102 : 154	83	263	31.6	13	20	65.0	6	16	37.5	102	299	34.1	3	8	37.5	7	20	35.0	20	27	35	45	29	136	45.9
11	浙江	21 : 116	21	171	12.3	0	0	0	0	2	0	21	173	12.1	2	4	50.0	0	0	0	3	7	19	13	27	66	36.3

注释：进攻 = 进攻次数（射门 + 进攻失误） 对方射失 = 对方射门失误（射失 + 击柱） 防守成功率% = 本方防守合计 / 对方进攻合计





## 2016年全国男子手球锦标赛

防守技术统计总表

20160638-3402-1/1

29/10/2016

广东徐闻

场次	球队	比分	防守成功						防守(成功:失误)						处罚				守门员				
			封球	抢球	断球	造失	造犯	合计	选位	顶贴	观察	移动	换防	其他	合计	警告 2'	取消	DR	合计	救球	射门	%	
1	安徽	165:196	16	7	22	3	5	53	1:1	3:8	0:2	1:1	1:0	0:0	6:12	14	8	0	0	22	77	273	28.21
2	北京	157:137	25	2	12	1	10	50	0:0	0:1	0:0	0:0	0:0	0:0	0:3	15	17	1	0	33	97	234	41.45
3	广东	198:174	19	4	34	3	10	70	0:0	0:4	0:1	2:3	0:0	0:0	2:9	15	10	0	0	25	62	236	26.27
4	江苏	203:144	36	7	40	3	4	90	3:3	2:2	0:0	3:1	0:0	0:0	8:8	13	11	0	0	24	92	236	38.98
5	解放军	140:162	15	3	14	2	6	40	3:3	3:5	2:1	2:4	1:0	0:0	11:12	18	15	0	0	33	93	255	36.47
6	山东	229:139	19	8	39	8	6	80	0:0	1:3	0:0	0:4	0:0	0:0	1:7	14	20	0	1	35	109	248	43.95
7	上海	170:170	12	9	36	2	7	66	3:3	6:9	0:1	0:2	0:1	0:0	9:17	19	12	0	0	31	75	245	30.61
8	四川	130:158	5	4	24	2	2	37	0:0	0:1	0:0	0:1	0:0	0:0	0:2	10	6	0	0	16	67	225	29.78
9	天津	203:168	3	8	30	2	9	52	3:3	0:10	0:0	1:14	0:0	0:0	4:31	15	14	1	0	30	85	253	33.60
10	新疆	102:154	6	3	11	4	3	27	0:0	0:0	0:2	0:6	0:0	0:0	0:10	12	17	0	0	29	35	189	18.52
11	浙江	21:116	0	2	5	0	0	7	0:0	0:4	0:0	0:1	0:0	0:0	0:5	7	0	0	0	7	19	135	14.07

注释: 造失 = 造对方失误    造犯 = 造对方犯规    DR = 取消资格+报告



## 2016年全国男子手球锦标赛

## 球队名单(媒体表)

江苏队

201606000-53-1/1

号码	姓名	位置	生日	年龄	俱乐部	身高 (CM)	体重 (KG)	总场次	总进球
1	徐畅	守门员	22/03/1994	22		198	99		
4	张家纬	右后卫	25/09/1992	24		193	90		
5	闫亮	右后卫	23/01/1985	31		202	93		
6	赵晨	左后卫	24/06/1989	27		202	108		
7	徐奕飞	右边锋	13/03/1993	23		182	85		
8	周小坚	底线	13/01/1985	31		198	115		
9	周傲	中后卫	08/09/1999	17		180	68		
10	郝可鑫	中后卫	15/01/1986	30		197	105		
12	王权	守门员	21/11/1992	23		204	107		
15	李安	左边锋	20/03/1987	29		183	85		
16	张帅	守门员	11/05/1994	22		187	88		
17	王伟强	左边锋	07/01/1993	23		175	75		
18	赵楠	右边锋	07/05/1993	23		188	90		
20	顾艳超	中后卫	16/01/1993	23		188	84		
21	刘江	底线	23/03/1993	23		196	91		
22	张瑞恒	左后卫	05/04/1994	22		190	90		
平均				24.6		191.4	92.1		

## 替换队员

编码	姓名	职务

B	闫威名	主教练
C	贾淑君	教练
D	叶强	教练
E	王建国	医生
A	钱红	领队





## 2016年全国男子手球锦标赛

个人/全队技术累计表

正式表  
手球  
男子

截至第 38场

201606038-15-1/1  
广东徐闻  
29/10/2016 16:20

号码	姓名	远射	近射	边射	快攻	突破	任意	7M	合计	%	助攻	失误	警告	2'	取消	场次	时间
<b>江苏队</b>																	
<i>(场上队员)</i>																	
1	徐畅	0/1							0/1	0.0%	1	1				7	02:37:49
4	张家纬	3/13	6/10	1/1	1/6	4/4			15/34	44.1%	13	11	4			7	04:53:40
5	闫亮	0/1	5/8		2/3				7/12	58.3%	1	3	2			7	03:03:23
6	赵晨	9/22	2/3		3/3	2/2	5/9		21/39	53.8%	9	10	2	1		7	04:15:21
7	徐奕飞		2/4	7/8	6/8	1/1			16/21	76.2%	2	5	1	2		7	02:37:10
8	周小坚	4/8	21/24		1/4	0/1		1/2	27/39	69.2%	1	19		2		7	04:20:41
9	周傲	0/3	0/2		2/5	1/1		1/2	4/13	30.8%		3				7	01:13:06
10	郝可鑫	10/22	3/3			1/1	3/3		17/29	58.6%	4	12				7	02:51:43
12	王权	0/1							0/1	0.0%	4	1		1		7	03:32:06
15	李安	1/5	6/7	3/4	17/20	0/1		6/8	33/45	73.3%	9	8	1			7	04:09:27
16	张帅									0.0%	1					7	00:49:34
17	王伟强	0/1	7/8	4/5	8/11	1/1		1/1	21/27	77.8%	1	7				7	03:05:47
18	赵楠	3/10	8/13	2/4	3/4	1/2	0/1	3/4	20/38	52.6%	11	14	1	3		7	05:48:52
20	顾艳超	3/11	2/5	1/1		0/2			6/19	31.6%	9	13				7	02:45:00
21	刘江	1/2	10/13		5/5			0/1	16/21	76.2%	6	7	2	2		7	03:51:52
22	张瑞恒									0.0%						5	00:00:00

<b>合计</b>		34/100	72/100	18/23	48/69	11/16	8/13	12/18	203/339	59.9%	72	114	13	11		110	
-----------	--	--------	--------	-------	-------	-------	------	-------	---------	-------	----	-----	----	----	--	-----	--

*(守门员)*

1	徐畅	14/40	10/33	3/9	1/12	0/2	1/2	4/7	33/105	31.4%	1	1				7	02:37:49
12	王权	24/39	10/21	10/23	2/13	2/5		1/5	49/106	46.2%	4	1		1		7	03:32:06
16	张帅	5/9	2/8	1/3	2/2	0/1	0/1	0/1	10/25	40.0%	1					7	00:49:34

<b>合计</b>		43/88	22/62	14/35	5/27	2/8	1/3	5/13	92/236	39.0%	6	2		1		21	
-----------	--	-------	-------	-------	------	-----	-----	------	--------	-------	---	---	--	---	--	----	--

场上队员：得分/射门

守门员：救球/射门

全队合计	进球	被救	射失	击柱	封球	合计	%
远射	34	26	19	6	15	100	34.0%
近射	72	18	6	4		100	72.0%
边射	18	3	1	1		23	78.3%
快攻	48	15	3	3		69	69.6%
突破	11	3	1	1		16	68.8%
任意	8	2	2	1		13	61.5%
7M	12	3	2	1		18	66.7%

已打比赛

阶段	场次	对手	比分
预赛	1	安徽	29:23 (16:11)
预赛	10	新疆	40:25 (21:14)
预赛	17	解放军	23:17 (13:4)
预赛	25	北京	27:18 (14:11)
四分之一决赛	26	上海	29:20 (13:5)
半决赛	33	天津	30:19 (16:5)
决赛	38	山东	25:22 (10:12)





2016年全国男子手球锦标赛

图式射门区域累计

截止至第38场

201606038-42-1/1

江苏队

Table of player statistics for Jiangsu team, including names like 徐畅, 张家纬, 闫亮, etc., and their respective performance metrics in a grid format.

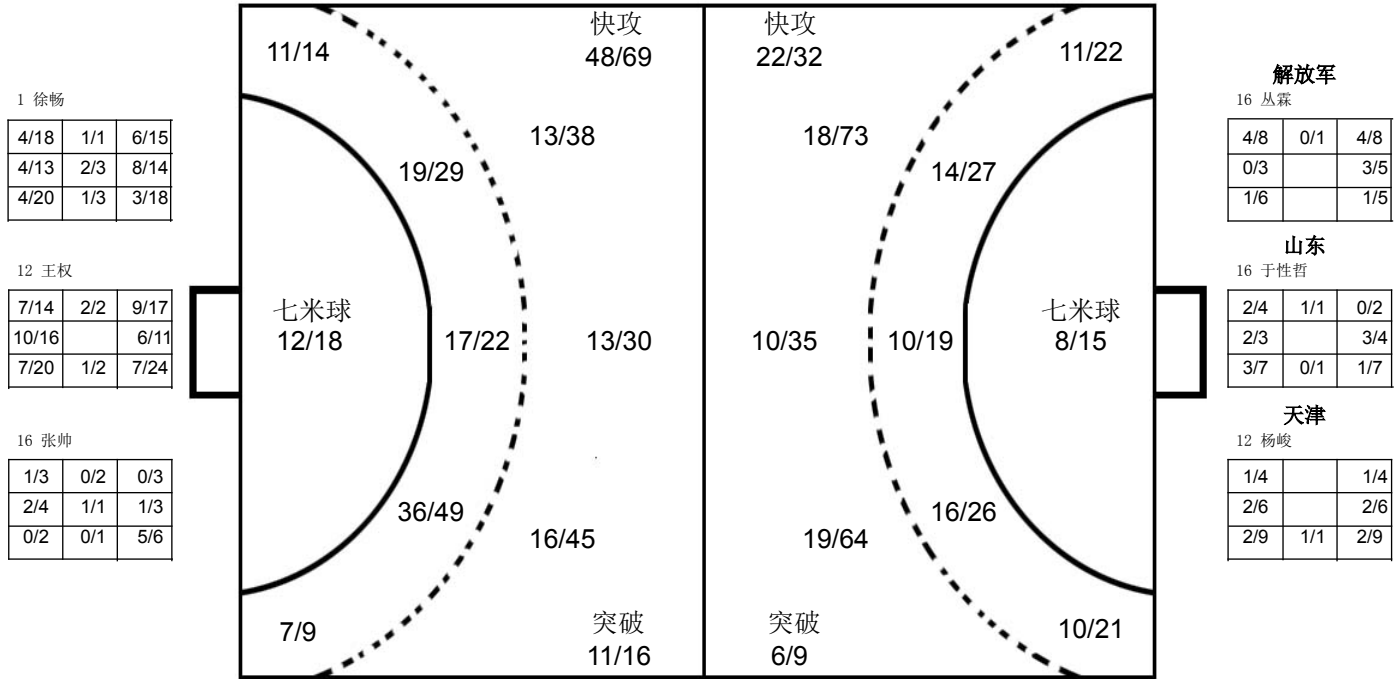

对手

Table of player statistics for the opponent team, including names like 董智景, 钱为玮, 林豪文, etc., and their respective performance metrics.

注释: Post=击柱 Miss=射失 Block=被封





## 2016年全国男子手球锦标赛

## 球队名单(媒体表)

山东队

201606000-53-1/1

号码	姓名	位置	生日	年龄	俱乐部	身高 (CM)	体重 (KG)	总场次	总进球
1	李濠壮	守门员	02/05/1995	21		190	102		
3	尹杰	左边锋	06/03/1993	23		182	90		
4	田瑞	左边锋	21/03/1993	23		195	85		
5	潘翔	底线	04/10/1986	30		192	98		
6	李朝鹏	中后卫	05/12/1992	23		186	90		
9	赵鑫	左后卫	10/04/1987	29		183	88		
10	赵建强	右边锋	30/03/1992	24		194	80		
11	宋朋强	后卫	12/02/1987	29		194	92		
12	崔剑	守门员	18/11/1991	24		197	100		
13	刘晓	右后卫	30/03/1992	24		192	100		
15	张继伟	底线	02/02/1993	23		203	105		
16	于性哲	守门员	25/06/1993	23		186	90		
17	王旭东	右边锋	06/12/1989	26		189	90		
19	李语庆	左边锋	07/03/1990	26		180	82		
21	翟乾坤	右边锋	29/08/1986	30		187	96		
27	于亚男	右后卫	25/11/1990	25		188	97		
	平均			25.2		189.9	92.8		

## 替换队员

编码	姓名	职务

A	markovic尼克	领队
B	王鸿斌	主教练
C	刘桂妮	教练
D	邢建刚	医生



## 2016年全国男子手球锦标赛

个人/全队技术累计表

正式表  
手球  
男子

截至第 38场

201606038-15-1/1  
广东徐闻  
29/10/2016 16:20

号码	姓名	远射	近射	边射	快攻	突破	任意	7M	合计	%	助攻	失误	警告	2'	取消	场次	时间
<b>山东队</b>																	
<i>(场上队员)</i>																	
1	李濠壮									0.0%						2	00:00:00
3	尹杰	1/1	4/4	1/2	1/1				7/8	87.5%	1	1				8	01:12:14
4	田瑞	2/2	1/3	3/7	3/3				9/15	60.0%	2	1	1	2		8	01:34:01
5	潘翔	1/1	12/21	0/1	4/5	3/3			20/31	64.5%		6	3	2		8	04:22:04
6	李朝鹏	2/5	8/11	1/1	2/2	1/2		1/1	15/22	68.2%	11	8		3		8	03:45:36
9	赵鑫	6/15	8/12	1/1	6/6	6/8			27/42	64.3%	10	12	1			8	03:48:48
10	赵建强		4/5	1/1		1/1			6/7	85.7%	5	3				8	00:47:35
11	宋朋强	9/24	5/8		1/2	2/2	1/2		18/38	47.4%	14	8	1			8	04:22:43
12	崔剑									0.0%	2	1				8	03:45:27
13	刘晓	6/14	8/12	1/1	1/1	3/4		1/2	20/34	58.8%	3	3				8	02:46:01
15	张继伟	1/1	9/12		5/5				15/18	83.3%		3		3		8	02:30:28
16	于性哲									0.0%	6	1				8	03:45:28
17	王旭东	5/14	3/5	1/1	4/4	0/2			13/26	50.0%	7	9	3	6		8	03:42:28
19	李语庆	2/8	4/10	8/10	16/20	2/3		8/9	40/60	66.7%	3	6	1	4		8	05:32:43
21	翟乾坤	2/3	2/2	6/13	6/6	1/1			17/25	68.0%	2	2	1		1	7	03:15:51
27	于亚男	6/17	9/13	1/1	4/5	2/5			22/41	53.7%	3	11	3			8	04:15:17

<b>合计</b>		43/105	77/118	24/39	53/60	21/31	1/2	10/12	229/367	62.4%	69	75	14	20	1	121	
<i>(守门员)</i>																	
12	崔剑	16/27	19/34	11/18	4/10	2/10	0/1	1/6	53/106	50.0%	2	1				8	03:45:27
16	于性哲	18/41	18/43	9/16	5/15	3/9	2/4	1/14	56/142	39.4%	6	1				8	03:45:28

<b>合计</b>	34/68	37/77	20/34	9/25	5/19	2/5	2/20	109/248	44.0%	8	2					16
-----------	-------	-------	-------	------	------	-----	------	---------	-------	---	---	--	--	--	--	----

场上队员：得分/射门

守门员：救球/射门

全队合计	进球	被救	射失	击柱	封球	合计	%
远射	43	26	12	12	12	105	41.0%
近射	77	31	2	8		118	65.3%
边射	24	7	5	3		39	61.5%
快攻	53	7				60	88.3%
突破	21	8		2		31	67.7%
任意	1		1			2	50.0%
7M	10	1		1		12	83.3%

## 已打比赛

阶段	场次	对手	比分
预赛	3	四川	31:16 (20:10)
预赛	6	上海	26:15 (17:9)
预赛	13	浙江	24:5 (24:5)
预赛	19	天津	30:23 (13:13)
预赛	23	广东	29:14 (18:11)
四分之一决赛	29	安徽	40:23 (24:12)
半决赛	34	北京	27:18 (10:8)
决赛	38	江苏	22:25 (12:10)







2016年全国男子手球锦标赛

图式射门区域累计

截止至第38场

201606038-42-1/1

山东队

Player statistics for Shandong team including names like 李濠壮, 尹杰, 田瑞, etc., with corresponding goalkeeping and shooting data.

Statistics for player 12 崔剑

Statistics for player 16 于性哲

Empty statistics table

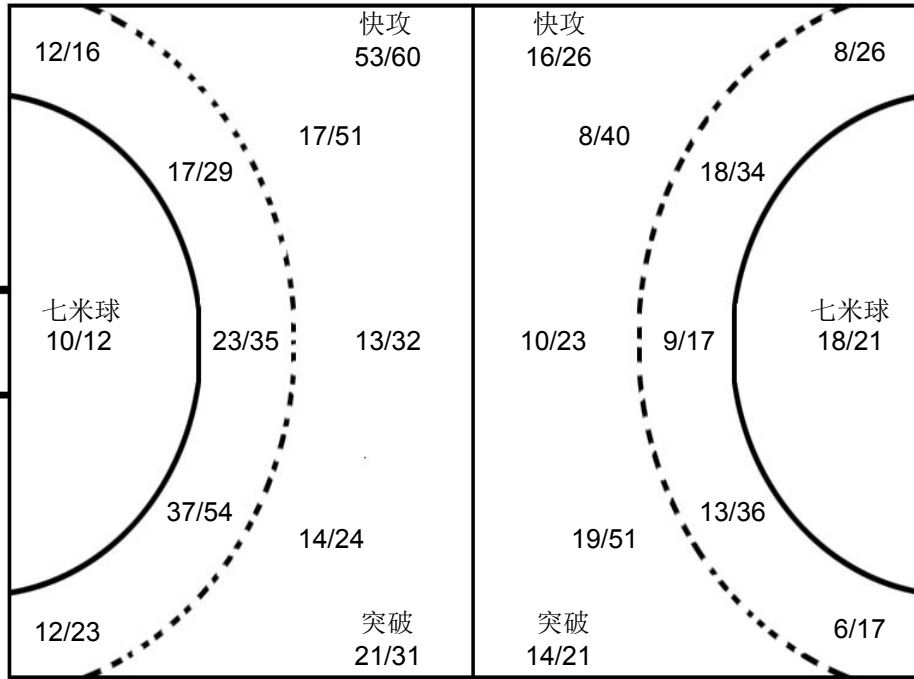

Statistics for player 16 刘迈科 (北京队)

Statistics for player 1 刘宗其 (天津)

Statistics for player 12 王权 (江苏队)

对手

Opponent statistics grid for various teams including 天津, 安徽, 江苏, 北京, 四川, 广东, 上海.

注释: Post=击柱 Miss=射失 Block=被封





## 2016年全国男子手球锦标赛

## 球队名单(媒体表)

天津队

201606000-53-1/1

号码	姓名	位置	生日	年龄	俱乐部	身高 (CM)	体重 (KG)	总场次	总进球
1	刘宗其	守门员	31/03/1991	25		191	88		
2	李岳朋	后卫	04/12/1986	29		194	95		
4	李松浩	后卫	25/01/1993	23		194	90		
6	王子欣	边锋	17/11/1995	20		190	88		
7	张青	后卫	16/04/1989	27		190	100		
8	曹悦	后卫	23/05/1993	23		200	100		
9	吴明远	边锋	21/03/1996	20		188	85		
11	王毅	边锋	28/02/1995	21		194	95		
12	杨峻	守门员	24/09/1995	21		198	89		
13	许松	边锋	02/04/1992	24		185	82		
14	田剑侠	中后卫	03/09/1986	30		190	90		
16	刘海亮	守门员	07/08/1990	26		193	88		
17	周群	底线	04/04/1994	22		195	100		
18	王晓琪	边锋	20/03/1997	19		193	90		
21	潘玉帅	左后卫	20/11/1997	18		196	90		
22	魏雨童	底线	05/10/1996	20		197	95		
	平均			23.0		193.0	91.6		

## 替换队员

编码	姓名	职务

A	贾守信	领队
B	杜瑞军	主教练
C	孟凡钢	教练
E	贾宁	医生
D	潘玉强	教练





## 2016年全国男子手球锦标赛

个人/全队技术累计表

正式表  
手球  
男子

截至第 37场

201606037-15-1/1  
广东徐闻  
29/10/2016 14:40

号码	姓名	远射	近射	边射	快攻	突破	任意	7M	合计	%	助攻	失误	警告	2'	取消	场次	时间
<b>天津队</b>																	
<i>(场上队员)</i>																	
1	刘宗其									0.0%	7					8	05:17:40
2	李岳朋	8/12	6/11	2/2	0/2	0/1			16/28	57.1%	5	11	4	2		8	05:51:59
4	李松浩		1/3		0/1				1/4	25.0%	3					8	00:26:05
6	王子欣		5/9	1/4	7/7	1/1		1/1	15/22	68.2%	1	1		2		8	05:46:26
7	张青	15/39	10/14		4/4	2/4	0/1	5/6	36/68	52.9%	6	12	2	2		8	05:59:05
8	曹悦	15/38	13/22	1/1	4/4	6/7	0/1	5/8	44/81	54.3%	7	14	4	2		8	06:23:47
9	吴明远	1/2	1/3	1/3	4/5	2/2		1/1	10/16	62.5%	3			1		8	01:40:18
11	王毅	1/7	4/7	1/1	1/2			2/6	9/23	39.1%	2					8	01:04:22
12	杨峻									0.0%	1					8	02:04:25
13	许松	1/4	9/13	8/14	6/8	3/4		1/1	28/44	63.6%	1	13				8	05:44:23
14	田剑侠	4/13	8/12	2/2	1/1	3/4		3/5	21/37	56.8%	4	8	1	3	1	7	03:17:55
16	刘海亮									0.0%						8	00:01:02
17	周群	1/1	7/10						8/11	72.7%	6	4		2		8	05:37:44
18	王晓琪	3/6	1/1		1/2				5/9	55.6%	2	1				8	00:32:18
21	潘玉帅	1/1		1/1		1/1			3/3	100%						6	00:07:23
22	魏雨童		5/5			2/2			7/7	100%	2					8	01:29:07
<b>合计</b>																	
		50/123	70/110	17/28	28/36	20/26	0/2	18/28	203/353	57.5%	35	75	15	14	1	125	
<i>(守门员)</i>																	
1	刘宗其	33/65	18/57	5/23	3/14	4/10	0/2	1/9	64/180	35.6%	7					8	05:17:40
12	杨峻	6/16	10/31	1/4	2/10	1/2	0/2	0/4	20/69	29.0%	1					8	02:00:37
16	刘海亮							1/4	1/4	25.0%						8	00:01:02
<b>合计</b>																	
		39/81	28/88	6/27	5/24	5/12	0/4	2/17	85/253	33.6%	7	1				24	

场上队员：得分/射门

守门员：救球/射门

全队合计	进球	被救	射失	击柱	封球	合计	%
远射	50	31	16	14	12	123	40.7%
近射	70	27	8	4	1	110	63.6%
边射	17	8	3			28	60.7%
快攻	28	2	1	5		36	77.8%
突破	20	5	1			26	76.9%
任意		2				2	0.0%
7M	18	8	1	1		28	64.3%

## 已打比赛

阶段	场次	对手	比分
预赛	4	浙江	29:4 (29:4)
预赛	8	四川	32:17 (17:11)
预赛	14	广东	25:24 (16:11)
预赛	19	山东	23:30 (13:13)
预赛	22	上海	23:22 (7:9)
四分之一决赛	27	解放军	28:19 (14:13)
半决赛	33	江苏	19:30 (5:16)
3-4名	37	北京	24:22 (11:11)





2016年全国男子手球锦标赛

图式射门区域累计

截止至第37场

201606038-42-1/1

天津队

Table with 11 columns representing players (1-11) and 3 rows of statistics (Goals, Misses, Blocks) for each player.

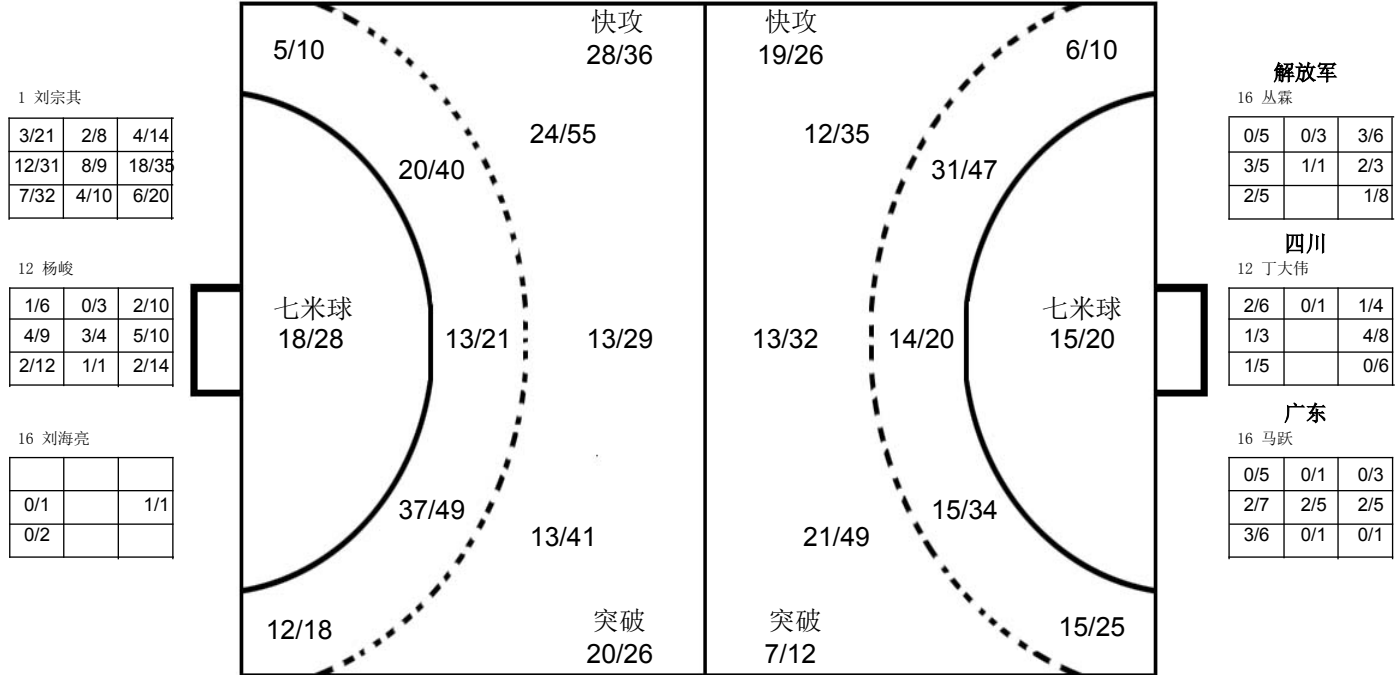

Table with 8 columns representing opponents (广东, 山东, 江苏, 北京, 解放军, 上海) and 3 rows of statistics for each.

注释: Post=击柱 Miss=射失 Block=被封



## 2016年全国男子手球锦标赛

## 球队名单(媒体表)

北京队

201606000-53-1/1

号码	姓名	位置	生日	年龄	俱乐部	身高 (CM)	体重 (KG)	总场次	总进球
3	王超	左边锋	12/11/1991	24		180	85		
6	解建飞	右后卫	10/09/1989	27		196	105		
8	王鹏	底线	05/11/1989	26		195	100		
9	刘振	左后卫	14/02/1988	28		189	89		
10	成亚	中后卫	14/06/1990	26		185	75		
11	蒋维一	底线	27/06/1987	29		193	90		
12	孟辉	右边锋	10/10/1981	35					
16	刘迈科	守门员	28/07/1994	22		183	95		
21	胡瀛	右后卫	21/07/1987	29		188	80		
23	王军程	左后卫	11/10/1995	21		197	78		
25	马明辉	右边锋	16/07/1994	22		196	82		
29	杜龙飞	右边锋	29/03/1990	26		185	90		
33	冯宁	右后卫	28/02/1984	32		185	78		
77	朱昕晨	左后卫	26/08/1982	34		197	97		
78	张骥	后卫	05/11/1978	37		189	90		
83	潘天	底线	28/09/1983	33		190	100		
平均				28.2		189.9	88.9		

## 替换队员

编码	姓名	职务

A	安福田	领队
B	郑永利	主教练
C	陈璇	医生



## 2016年全国男子手球锦标赛

个人/全队技术累计表

正式表  
手球  
男子

截至第 37场

201606037-15-1/1  
广东徐闻  
29/10/2016 14:40

号码	姓名	远射	近射	边射	快攻	突破	任意	7M	合计	%	助攻	失误	警告	2'	取消	场次	时间
<b>北京队</b>																	
<i>(场上队员)</i>																	
3	王超		6/9	5/11	7/8	1/1			19/29	65.5%	2	4		1		7	03:59:12
6	解建飞	4/7	5/5	1/6	4/5		1/2	2/3	17/28	60.7%	2	1	5	2		7	04:34:01
8	王鹏		0/1						0/1	0.0%			1	2		7	01:59:28
9	刘振	2/14	4/5			5/5		3/3	14/27	51.9%	5	4				7	03:43:44
10	成亚	5/9	6/12	0/1	1/2	4/6		0/1	16/31	51.6%	4	10	1			7	03:19:09
11	蒋维一	0/1	10/15		2/4				12/20	60.0%		7	2	2		7	04:09:39
12	孟辉									0.0%	5	3				7	01:24:34
16	刘迈科									0.0%	5	3				7	05:07:47
21	胡瀛	5/14	6/7	1/1	2/2	2/3			16/27	59.3%	1	9	2	2		7	03:29:47
23	王军程	4/15	0/2			1/1	1/2	1/2	7/22	31.8%	1	5		3	1	6	01:48:48
25	马明辉	0/1	4/9	4/12	4/4				12/26	46.2%		1	3	1		7	03:27:31
29	杜龙飞		3/6	5/7	0/1		1/1		9/15	60.0%	1	3				7	01:54:37
33	冯宁		1/1						1/1	100%	1	2				7	00:25:53
77	朱昕晨	1/7	2/6	0/1		5/5		3/3	11/22	50.0%	4	7		4		7	01:56:24
78	张骥	7/16	6/9	0/1		2/3	1/2	7/8	23/39	59.0%	4	16				7	02:43:52
83	潘天									0.0%			1			7	01:11:28

<b>合计</b>		28/84	53/87	16/40	20/26	20/24	4/7	16/20	157/288	54.5%	35	75	15	17	1	111	
<i>(守门员)</i>																	
12	孟辉	9/11	8/17	1/1	3/12	0/2	0/1	0/3	21/47	44.7%	5	3				7	01:24:34
16	刘迈科	35/57	18/52	6/15	7/32	7/18	0/2	3/11	76/187	40.6%	5	3				7	05:07:47

<b>合计</b>		44/68	26/69	7/16	10/44	7/20	0/3	3/14	97/234	41.5%	10	6				14	
场上队员：得分/射门									守门员：救球/射门								

全队合计	进球	被救	射失	击柱	封球	合计	%
远射	28	25	16	7	8	84	33.3%
近射	53	21	3	10		87	60.9%
边射	16	13	5	6		40	40.0%
快攻	20	4	1	1		26	76.9%
突破	20	4				24	83.3%
任意	4	1	2			7	57.1%
7M	16	2	1	1		20	80.0%

已打比赛			
阶段	场次	对手	比分
预赛	9	安徽	26:17 (9:10)
预赛	11	解放军	22:7 (20:7)
预赛	16	新疆	29:14 (16:9)
预赛	25	江苏	18:27 (11:14)
四分之一决赛	28	广东	22:21 (10:7)
半决赛	34	山东	18:27 (8:10)
3-4名	37	天津	22:24 (11:11)







2016年全国男子手球锦标赛

图式射门区域累计

截止至第37场

201606038-42-1/1

北京队

Player statistics for Beijing team including names like 王超, 解建飞, 王鹏, etc., and their respective performance metrics in a grid format.

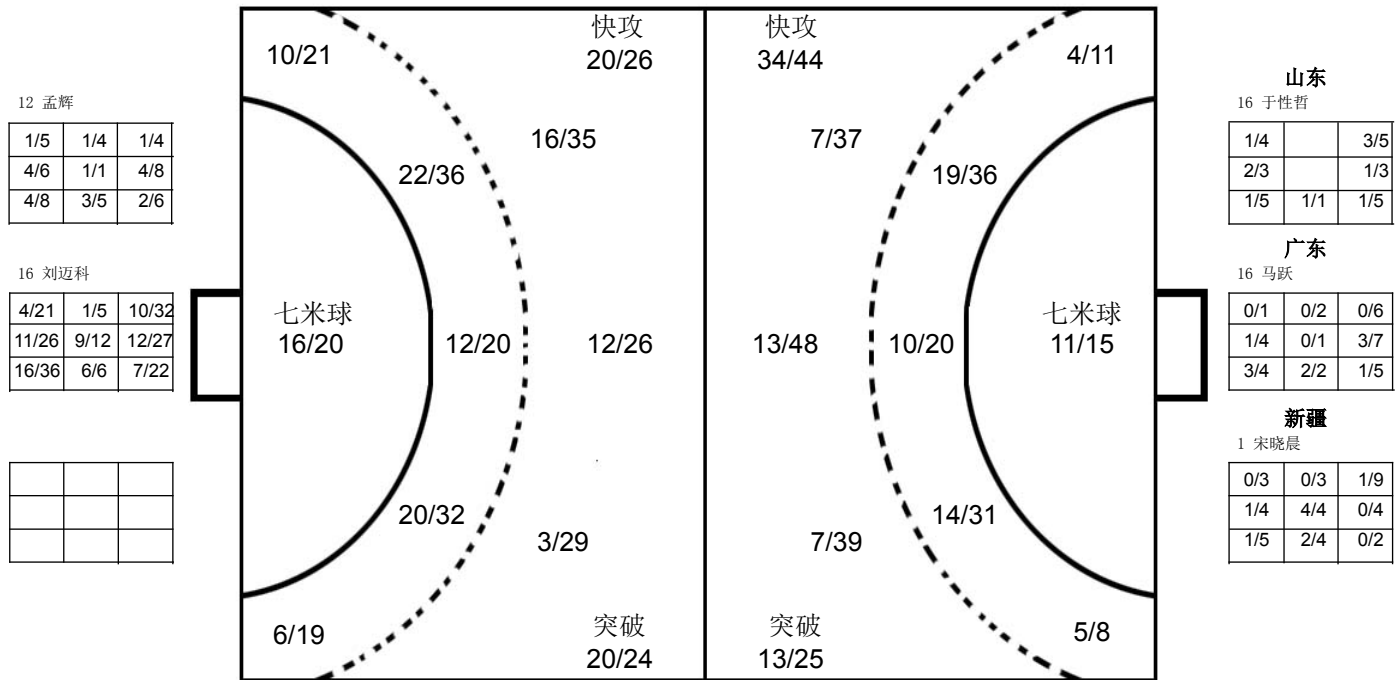

对手

Opponent statistics for various teams including Tianjin, Guangdong, Jiangsu, Shandong, and Xinjiang, with player names and performance metrics.

注释: Post=击柱 Miss=射失 Block=被封





## 2016年全国男子手球锦标赛

## 球队名单(媒体表)

广东队

201606000-53-1/1

号码	姓名	位置	生日	年龄	俱乐部	身高 (CM)	体重 (KG)	总场次	总进球
1	王泽润	右边锋	19/02/1998	18		197			
2	孙江山	右边锋	23/01/1991	25		199			
3	曲汝洋	左边锋	07/01/1989	27		185			
4	李卓洋	左后卫	04/02/1990	26		193			
5	侯生升	左边锋	25/10/1989	26		185			
7	付云博	中后卫	14/12/1990	25		192			
8	于彦江	右后卫	09/06/1990	26		197			
10	周仲坤	中后卫	02/01/1997	19		194			
11	房友屯	左边锋	03/01/1995	21		185			
12	林子健	右后卫	28/10/1991	24		191			
13	王立隆	后卫	04/01/1995	21		192			
15	张建杰	底线	29/10/1997	18		192			
16	马跃	守门员	04/12/1993	22		196			
17	李中洲	左后卫	10/03/1989	27		198			
20	黄培杰	右边锋	15/01/1998	18		180			
84	王伟	底线	18/11/1985	30		199			
	平均			23.3		192.2			

## 替换队员

编码	姓名	职务

B	王锋	主教练
C	刘康伶	教练
D	张广建	教练
E	王永存	医生
A	李晓忠	领队





## 2016年全国男子手球锦标赛

个人/全队技术累计表

正式表  
手球  
男子

截至第 36场

201606036-15-1/1  
广东徐闻  
29/10/2016 13:00

号码	姓名	远射	近射	边射	快攻	突破	任意	7M	合计	%	助攻	失误	警告	2'	取消	场次	时间
<b>广东队</b>																	
<i>(场上队员)</i>																	
1	王泽润									0.0%	1					8	00:50:23
2	孙江山	0/3	12/17	13/16	3/3	0/1		4/8	32/48	66.7%	5	7				8	05:54:58
3	曲汝洋	2/6	10/15	0/2	8/9	8/8			28/40	70.0%	9	14	1			8	04:45:03
4	李卓洋	4/17	5/15	0/1	1/1	1/1			11/35	31.4%	2	7	1	1		8	04:32:47
5	侯生升	1/2	5/9	8/11	7/7				21/29	72.4%	1	4	1	2		8	05:59:07
7	付云博	0/2	6/9	0/2	3/4	2/3		2/3	13/23	56.5%	2	12	1			8	04:29:17
8	于彦江									0.0%						8	00:00:00
10	周仲坤	1/1			0/1				1/2	50.0%		3		1		8	01:09:55
11	房友屯	1/1	2/2						3/3	100%	2	4	1			8	00:56:28
12	林子健		4/4	0/1	1/1				5/6	83.3%	2	1				2	00:30:00
13	王立隆	2/2	1/3	1/3	5/6				9/14	64.3%		2				8	00:50:42
15	张建杰	2/5	0/2		3/3	1/1			6/11	54.5%	1	8	1	1		8	01:03:44
16	马跃	0/1							0/1	0.0%	1	3				8	06:22:46
17	李中洲	21/39	17/26	1/1	6/7	0/2	0/3	7/8	52/86	60.5%	7	18	5	1		8	06:16:14
20	黄培杰	2/3	0/1		1/1	1/1			4/6	66.7%	1	2	1			8	00:41:07
84	王伟	0/3	11/14	1/1	1/1				13/19	68.4%	2	7	3	4		8	06:03:19

<b>合计</b>		36/85	73/117	24/38	39/44	13/17	0/3	13/19	198/323	61.3%	36	92	15	10		122	
<i>(守门员)</i>																	
1	王泽润	0/3	3/10	1/3	0/3		0/1	0/2	4/22	18.2%	1					8	00:50:23
16	马跃	22/62	21/82	3/18	3/20	3/16	3/5	3/11	58/214	27.1%	1	3				8	06:22:46

<b>合计</b>	22/65	24/92	4/21	3/23	3/16	3/6	3/13	62/236	26.3%	2	3					16	
-----------	-------	-------	------	------	------	-----	------	--------	-------	---	---	--	--	--	--	----	--

场上队员：得分/射门

守门员：救球/射门

全队合计	进球	被救	射失	击柱	封球	合计	%
远射	36	16	15	8	10	85	42.4%
近射	73	36	1	7		117	62.4%
边射	24	10	2	2		38	63.2%
快攻	39	2	2	1		44	88.6%
突破	13	2	2			17	76.5%
任意	2	1				3	0.0%
7M	13	3	3			19	68.4%

## 已打比赛

阶段	场次	对手	比分
预赛	5	上海	21:19 (8:8)
预赛	7	浙江	23:4 (23:4)
预赛	14	天津	24:25 (11:16)
预赛	18	四川	35:30 (13:11)
预赛	23	山东	14:29 (11:18)
四分之一决赛	28	北京	21:22 (7:10)
5-8名	32	安徽	30:23 (15:14)
5-6名	36	上海	30:22 (16:11)





2016年全国男子手球锦标赛

图式射门区域累计

截止至第36场

201606038-42-1/1

广东队

Table listing player statistics for Guangdong team, including names like 王泽润, 孙江山, 曲汝洋, etc., and their respective performance metrics in a grid format.

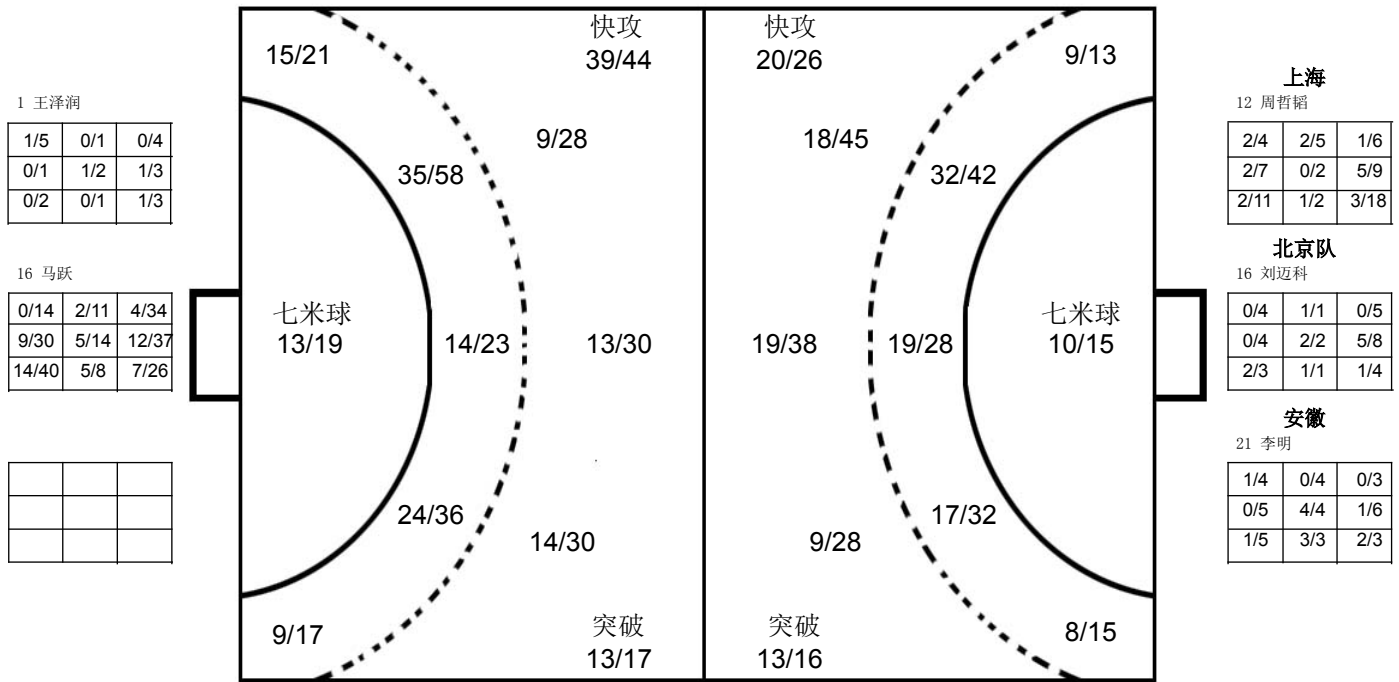

Table listing player statistics for the opponent team (对手), including names like 钱为玮, 马麟晓, 王巨柱, etc., and their performance metrics.

注释: Post=击柱 Miss=射失 Block=被封





## 2016年全国男子手球锦标赛

## 球队名单(媒体表)

上海队

201606000-53-1/1

号码	姓名	位置	生日	年龄	俱乐部	身高 (CM)	体重 (KG)	总场次	总进球
1	张崢	守门员	01/04/1988	28		190	90		
2	张文斌	中后卫	14/01/1995	21		185	80		
3	赵时俊	右后卫	07/10/1991	25		184	88		
4	徐俊吉	底线	23/05/1989	27		198	108		
7	吴双	左后卫	12/02/1998	18		193	95		
8	钱为玮	左边锋	17/11/1988	27		192	80		
10	董凯	底线	23/10/1995	20		195	90		
11	蒋承骅	底线	20/01/1991	25		197	110		
12	周哲韬	守门员	13/03/1995	21		190	83		
14	沈吉磊	左后卫	25/04/1995	21		191	86		
15	朱世杰	中后卫	20/05/1995	21		187	88		
16	朱春雷	守门员	19/04/1984	32		196	87		
17	贺政	右边锋	20/08/1996	20		186	83		
18	马麟晓	中后卫	03/09/1989	27		192	88		
19	祝君	左后卫	09/03/1987	29		188	87		
33	吴璟	底线	11/10/1983	33		191	105		
平均				24.7		190.9	90.5		

## 替换队员

编码	姓名	职务

A	吴龙基	主教练
B	张勇军	领队
C	金迪琦	教练
E	杨时	医生
D	金东健	工作人员





## 2016年全国男子手球锦标赛

个人/全队技术累计表

正式表  
手球  
男子

截至第 36场

201606036-15-1/1  
广东徐闻  
29/10/2016 13:00

号码	姓名	远射	近射	边射	快攻	突破	任意	7M	合计	%	助攻	失误	警告	2'	取消	场次	时间
<b>上海队</b>																	
<i>(场上队员)</i>																	
1	张崢									0.0%	2					8	02:39:38
2	张文斌		1/1		1/1	1/2			3/4	75.0%	2	2	1			8	00:36:27
3	赵时俊	0/4	2/5	3/4	1/1	1/3		2/3	9/20	45.0%	5	10	3	1		8	02:27:16
4	徐俊吉	0/2	11/17	2/3	1/2			10/13	24/37	64.9%		11	4	1		8	05:50:01
7	吴双			0/2	3/3		0/1		3/6	50.0%		2				4	00:38:54
8	钱为玮	3/7	12/13	16/27	16/19		0/2		47/68	69.1%	1	10	1	3		8	07:27:23
10	董凯	1/1	1/4	1/1					3/6	50.0%		4				8	00:42:39
11	蒋承骅	4/6	3/5	1/3	1/1	2/3			11/18	61.1%	6	6	1	1		8	06:00:41
12	周哲韬									0.0%		1				8	04:49:32
14	沈吉磊	2/12	4/4	1/1		2/2		1/1	10/20	50.0%	2	3	1			8	01:24:02
15	朱世杰	6/26	7/11	2/2	1/1	3/5			19/45	42.2%	5	18	5	4		8	06:03:19
16	朱春雷									0.0%						6	00:30:00
17	贺政	0/1	1/2	6/16	2/5	0/1			9/25	36.0%	3	7	1	2		8	05:36:15
18	马麟晓	15/48	4/4	0/1		2/3	1/3	1/1	23/60	38.3%	18	21	2			8	06:43:54
33	吴璟		5/7	1/1	1/1			2/3	9/12	75.0%						8	01:22:49

<b>合计</b>		31/107	51/73	33/61	27/34	11/19	1/6	16/21	170/321	53.0%	44	95	19	12		114	
<i>(守门员)</i>																	
1	张崢	12/28	9/24	2/7	4/15	2/9		4/14	33/97	34.0%	2					8	02:39:38
12	周哲韬	10/24	19/59	9/26	2/19	0/12	1/2	1/6	42/148	28.4%		1				8	04:49:32
16	朱春雷									0.0%						6	00:30:00

<b>合计</b>		22/52	28/83	11/33	6/34	2/21	1/2	5/20	75/245	30.6%	2	1				22	
-----------	--	-------	-------	-------	------	------	-----	------	--------	-------	---	---	--	--	--	----	--

场上队员：得分/射门

守门员：救球/射门

全队合计	进球	被救	射失	击柱	封球	合计	%
远射	31	31	19	9	17	107	29.0%
近射	51	17	4	1		73	69.9%
边射	33	15	6	7		61	54.1%
快攻	27	5	2			34	79.4%
突破	11	7		1		19	57.9%
任意	1	4	1			6	16.7%
7M	16	4		1		21	76.2%

## 已打比赛

阶段	场次	对手	比分
预赛	5	广东	19:21 (8:8)
预赛	6	山东	15:26 (9:17)
预赛	15	四川	30:21 (15:13)
预赛	20	浙江	20:3 (20:3)
预赛	22	天津	22:23 (9:7)
四分之一决赛	26	江苏	20:29 (5:13)
5-8名	31	解放军	22:17 (14:9)
5-6名	36	广东	22:30 (11:16)







2016年全国男子手球锦标赛

图式射门区域累计

截止至第36场

201606038-42-1/1

上海队

Table with 18 columns representing players (1-18) and 3 rows of statistics for each player, including Post, Miss, and Block counts.

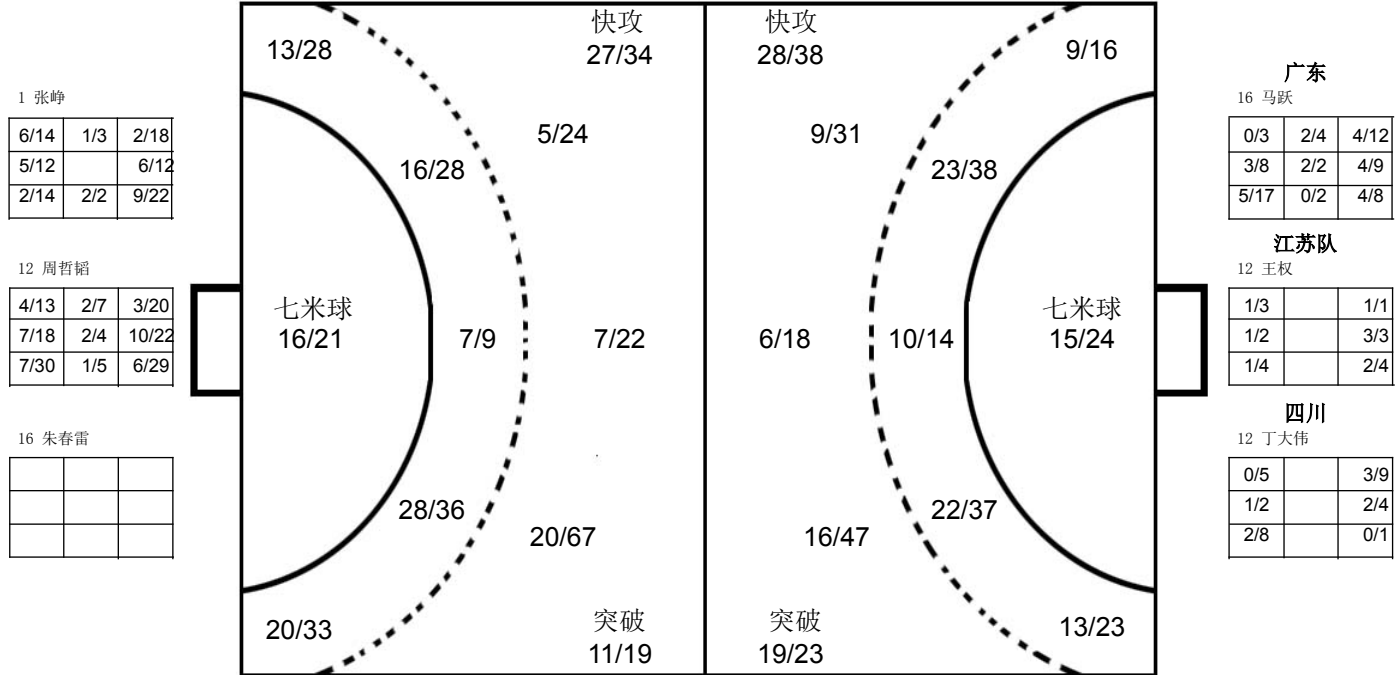

对手

Table with 18 columns representing opponents (1-18) and 3 rows of statistics for each opponent, including Post, Miss, and Block counts.

注释: Post=击柱 Miss=射失 Block=被封



## 2016年全国男子手球锦标赛

## 球队名单(媒体表)

安徽队

201606000-53-1/1

号码	姓名	位置	生日	年龄	俱乐部	身高 (CM)	体重 (KG)	总场次	总进球
1	郭世伟	右边锋	18/02/1997	19		180	70		
2	金永峰	底线	06/06/1999	17		189	90		
3	陈强龙	底线	11/11/1995	20		195	90		
5	史小帆	左后卫	15/03/1995	21		195	75		
7	姚雄敏	后卫	17/02/1993	23		184	80		
8	董智景	左边锋	15/10/1993	23		190	83		
9	陈开勇	底线	18/02/1996	20		192	102		
10	严龙	左边锋	22/05/1994	22		190	75		
11	黎涛	右后卫	28/10/1994	21		187	86		
12	曾献辰	守门员	29/06/1990	26		191	92		
17	王巨柱	左后卫	17/08/1997	19		194	80		
18	李双	右后卫	07/02/1997	19		192	75		
19	何山	右边锋	04/04/1999	17		185	85		
21	李明	守门员	04/05/1997	19		195	85		
22	王金宇	守门员	10/04/1996	20		190	85		
23	于敏清	右边锋	18/05/1991	25		189	80		
	平均			20.7		189.9	83.3		

## 替换队员

编码	姓名	职务

A	韦中平	领队
B	沈强	主教练
C	吴翔	教练
D	陈玉翔	医生





## 2016年全国男子手球锦标赛

个人/全队技术累计表

正式表  
手球  
男子

截至第 36场

201606036-15-1/1  
广东徐闻  
29/10/2016 13:00

号码	姓名	远射	近射	边射	快攻	突破	任意	7M	合计	%	助攻	失误	警告	2'	取消	场次	时间
<b>安徽队</b>																	
<i>(场上队员)</i>																	
1	郭世伟	0/2	4/8	1/5	3/6	1/3			9/24	37.5%	1	4	2			7	03:03:27
2	金永峰			0/2	0/1				0/3	0.0%		2				7	00:34:18
3	陈强龙		5/7		2/2				7/9	77.8%	1	3		1		7	02:15:14
5	史小帆	1/6	3/9			5/8	1/1	2/4	12/28	42.9%	1	2		1		7	03:06:22
7	姚雄敏	3/6	4/10		1/1	2/6		1/2	11/25	44.0%	2	10				7	02:46:09
8	董智景	5/11	4/12	4/15	5/8	1/2		0/1	19/49	38.8%	4	12	2			7	05:46:40
9	陈开勇	1/2	14/25		6/8			1/2	22/37	59.5%	1	6	5	1		7	05:35:52
10	严龙									0.0%	1	2				7	00:08:53
11	黎涛	3/16	4/6	0/1	1/1			1/1	9/25	36.0%	2	12				7	04:21:06
12	曾献辰									0.0%	2					7	00:43:30
17	王巨柱	21/50	7/14		2/2	3/3	1/2	4/5	38/76	50.0%	10	21		2		7	04:26:56
18	李双	7/26	10/13	0/1	1/2	2/3	0/1		20/46	43.5%	9	21	2	2		7	05:41:20
19	何山									0.0%						7	00:00:00
21	李明	1/2							1/2	50.0%	3	3				7	06:40:40
22	王金宇									0.0%						7	00:00:00
23	于敏清	1/1	4/5	6/10	6/7				17/23	73.9%	5	5	3	1		7	04:03:58

<b>合计</b>		43/122	59/109	11/34	27/38	14/25	2/4	9/15	165/347	47.6%	42	103	14	8		112	
-----------	--	--------	--------	-------	-------	-------	-----	------	---------	-------	----	-----	----	---	--	-----	--

*(守门员)*

11	黎涛									0.0%						7	00:23:27
12	曾献辰	2/6	2/10	1/3	0/9	0/1		0/1	5/30	16.7%	2					7	00:43:30
21	李明	24/59	31/101	4/14	5/29	2/20	3/5	3/15	72/243	29.6%	3	3				7	06:40:40

<b>合计</b>		26/65	33/111	5/17	5/38	2/21	3/5	3/16	77/273	28.2%	5	3				21	
-----------	--	-------	--------	------	------	------	-----	------	--------	-------	---	---	--	--	--	----	--

场上队员：得分/射门

守门员：救球/射门

全队合计	进球	被救	射失	击柱	封球	合计	%
远射	43	32	19	3	25	122	35.2%
近射	59	35	7	7	1	109	54.1%
边射	11	13	4	6		34	32.4%
快攻	27	8	2	1		38	71.1%
突破	14	7		4		25	56.0%
任意	2	1		1		4	50.0%
7M	9	4		2		15	60.0%

已打比赛

阶段	场次	对手	比分
预赛	1	江苏	23:29 (11:16)
预赛	9	北京	17:26 (10:9)
预赛	12	新疆	28:22 (13:10)
预赛	24	解放军	24:25 (12:11)
四分之一决赛	29	山东	23:40 (12:24)
5-8名	32	广东	23:30 (14:15)
7-8名	35	解放军	27:24 (13:13)





2016年全国男子手球锦标赛

图式射门区域累计

截止至第36场

201606038-42-1/1

安徽队

Player statistics for Anhui team including names like 郭世伟, 金永峰, 陈强龙, etc., with their respective goal counts in different positions.

Player statistics for 黎涛 (Li Tao).

Player statistics for 曾献辰 (Zeng Xianchen).

Player statistics for 李明 (Li Ming).

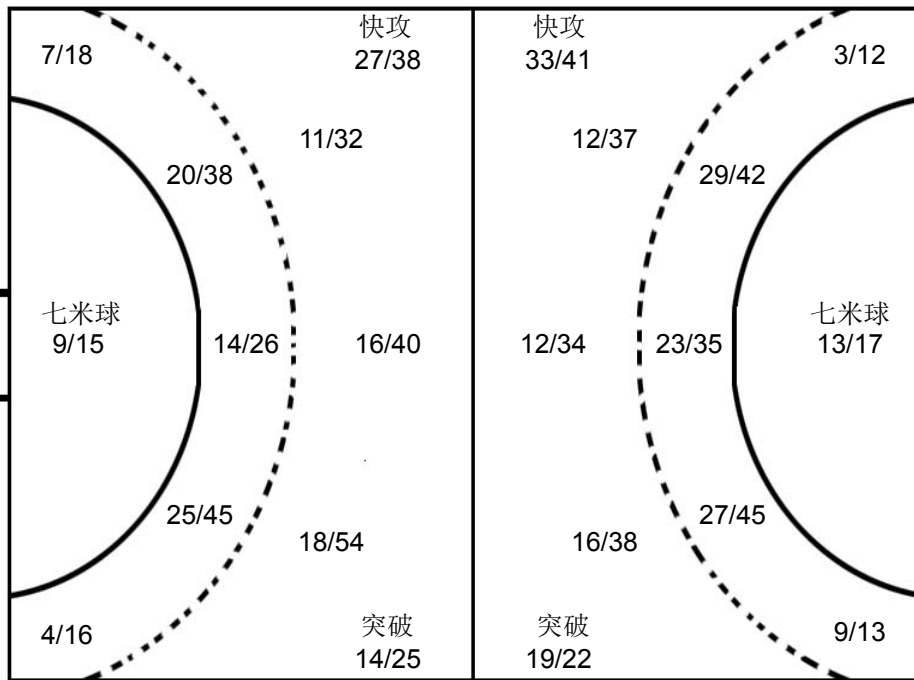

Player statistics for Beijing team (北京队) including 刘迈科 (Liu Maikang).

Player statistics for 解放军 (PLA) team including 丛霖 (Cong Lin).

Player statistics for 解放军 (PLA) team including 李梓宁 (Li Zining).

对手

Opponent statistics for various teams including 广东 (Guangdong), 解放军 (PLA), 江苏 (Jiangsu), 山东 (Shandong), and 新疆 (Xinjiang).

注释: Post=击柱 Miss=射失 Block=被封





## 2016年全国男子手球锦标赛

## 球队名单(媒体表)

解放军队

201606000-53-1/1

号码	姓名	位置	生日	年龄	俱乐部	身高 (CM)	体重 (KG)	总场次	总进球
1	李梓宁								
2	范保坤	右边锋	01/01/1999	17					
4	曹作亮	左后卫	28/08/1986	30					
5	张昌轲	中后卫	13/03/1999	17					
6	吴昊	底线	26/03/1998	18					
7	姜钦	左后卫	20/07/1998	18					
8	王烁	左边锋	29/07/1988	28					
9	毕晓晨	右边锋	23/03/1995	21					
11	肖东洋	中后卫	01/06/1994	22					
12	姜明	守门员	05/04/1993	23					
14	孙耀琦	底线	24/01/1996	20					
15	杨帆	中后卫	24/08/1984	32					
16	丛霖	守门员	03/07/1989	27					
18	王晓龙	右后卫	17/08/1989	27					
20	刘智洋	右后卫	29/02/1992	24					
平均				23.1					

## 替换队员

编码	姓名	职务

B	张敬敏	主教练
C	王学力	教练
D	刘捷	教练
E	刘军	医生





## 2016年全国男子手球锦标赛

个人/全队技术累计表

正式表  
手球  
男子

截至第 36场

201606036-15-1/1  
广东徐闻  
29/10/2016 13:00

号码	姓名	远射	近射	边射	快攻	突破	任意	7M	合计	%	助攻	失误	警告	2'	取消	场次	时间
<b>解放军队</b>																	
<i>(场上队员)</i>																	
1	李梓宁									0.0%		1				7	02:08:58
2	范保坤			1/1					1/1	100%		2				7	00:19:57
4	曹作亮	10/37	4/12		1/1	3/3	1/2		19/55	34.5%	2	16	2	4		7	04:43:53
5	张昌轲	1/3	1/3	0/1	0/1	1/1			3/9	33.3%		1		1		7	00:50:04
6	吴昊	3/14	7/12		0/2	0/1			10/29	34.5%		8	4	1		7	04:25:43
7	姜钦	3/15	3/6		1/1	2/2			9/24	37.5%	7	8	3	1		7	04:20:31
8	王烁	4/10	4/4	1/4	3/3	0/1		9/11	21/33	63.6%	1	12	1	1		7	05:22:19
9	毕晓晨	6/12	14/18	4/10	2/3			2/3	28/46	60.9%	5	10	1	3		7	06:13:31
11	肖东洋	1/4	3/4		1/1				5/9	55.6%	2	3	1			7	01:30:32
12	姜明									0.0%						7	00:34:24
14	孙耀琦		14/20		1/1				15/21	71.4%		5	3	3		7	05:57:31
15	杨帆	1/4	3/4			2/2			6/10	60.0%	5	2		1		7	01:48:39
16	丛霖									0.0%						7	04:12:35
18	王晓龙	5/20	6/15	2/3	1/2	3/3		5/6	22/49	44.9%	2	9	2			7	02:27:55
20	刘智洋	0/2			1/2				1/4	25.0%		4	1			7	01:05:34

合计		34/121	59/98	8/19	11/17	11/13	1/2	16/20	140/290	48.3%	24	81	18	15	105	
<i>(守门员)</i>																
1	李梓宁	8/15	8/27	4/9	2/10	3/7	3/3	2/7	30/78	38.5%		1			7	02:08:58
12	姜明	3/6	3/8	1/3	1/7	1/2		0/4	9/30	30.0%					7	00:34:24
16	丛霖	17/35	18/47	7/18	4/21	4/12	1/1	3/13	54/147	36.7%					7	04:12:35

合计	28/56	29/82	12/30	7/38	8/21	4/4	5/24	93/255	36.5%	1	21
----	-------	-------	-------	------	------	-----	------	--------	-------	---	----

场上队员：得分/射门

守门员：救球/射门

全队合计	进球	被救	射失	击柱	封球	合计	%
远射	34	38	25	5	19	121	28.1%
近射	59	23	10	4	2	98	60.2%
边射	8	5	5	1		19	42.1%
快攻	11	4	1	1		17	64.7%
突破	11	1	1			13	84.6%
任意	1		1			2	50.0%
7M	16	2	2			20	80.0%

## 已打比赛

阶段	场次	对手	比分
预赛	2	新疆	31:16 (17:10)
预赛	11	北京	7:22 (7:20)
预赛	17	江苏	17:23 (4:13)
预赛	24	安徽	25:24 (11:12)
四分之一决赛	27	天津	19:28 (13:14)
5-8名	31	上海	17:22 (9:14)
7-8名	35	安徽	24:27 (13:13)







2016年全国男子手球锦标赛

图式射门区域累计

截止至第36场

201606038-42-1/1

新疆队

Table with 8 columns of player statistics for Xinjiang team, including names like 宋晓晨, 徐伟, 林豪文, etc., and their respective goal counts in different positions.

Player statistics for Song Xiaochen (宋晓晨) and Wang Jinxun (王金鑫) for Xinjiang team.

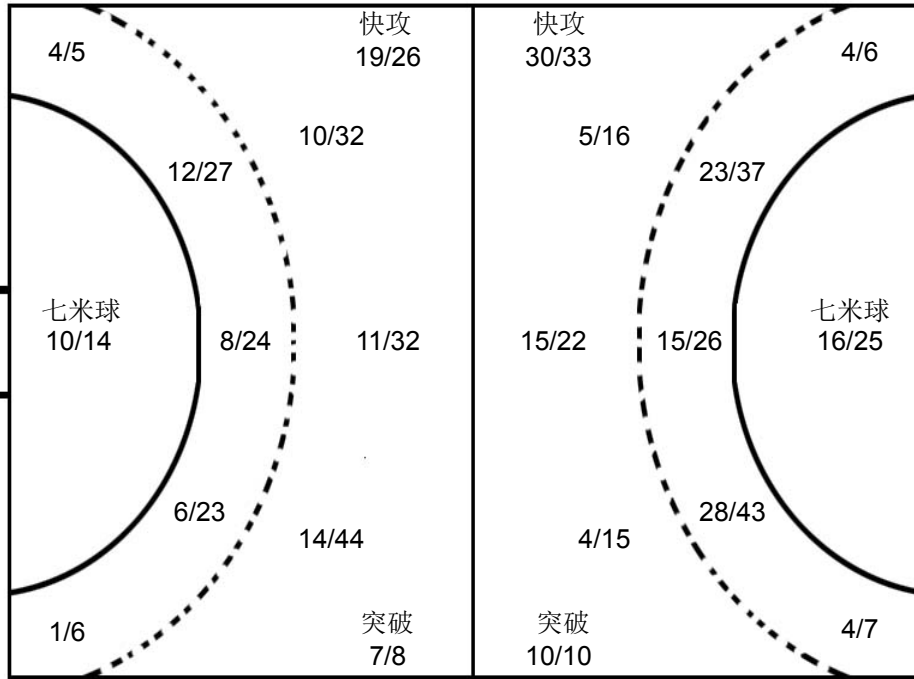

Player statistics for Xu Chang (徐畅), Li Ming (李明), and Meng Hui (孟辉) for the opponent team.

对手

Table with 8 columns of player statistics for the opponent team, including names like 毕晓晨, 王巨柱, 赵楠, etc., and their respective goal counts.

注释: Post=击柱 Miss=射失 Block=被封





## 2016年全国男子手球锦标赛

## 球队名单(媒体表)

四川队

201606000-53-1/1

号码	姓名	位置	生日	年龄	俱乐部	身高 (CM)	体重 (KG)	总场次	总进球
1	罗尧尧	中后卫	28/07/1996	20		190	90		
3	刘赵梁	右边锋	04/07/1997	19		188	75		
7	仇瑞祥	右边锋	23/07/1999	17		177	71		
8	谢庆龙	底线	24/10/2000	15		192	100		
9	许翔宇	左后卫	20/01/1997	19		190	85		
10	徐彦昊	后卫	24/01/1996	20		180	85		
11	张天豪	左边锋	02/06/1998	18		182	80		
12	丁大伟	守门员	06/02/1984	32		189	99		
13	尹文珂	左边锋	02/04/1999	17		187	89		
15	刘劲松	底线	05/12/1993	22		182	80		
16	宋继强	守门员	22/03/1997	19		192	81		
18	任启双	底线	19/03/1993	23		180	90		
19	庞连康	左后卫	02/07/1996	20		191	88		
20	徐逸	左边锋	24/05/1999	17		182	80		
21	马光	左后卫	04/12/1993	22		192	90		
22	张睿梁	底线	09/06/1998	18		192	120		
平均				19.9		186.6	87.7		

## 替换队员

编码	姓名	职务

B	张文韬	主教练
D	胡俊杰	医生



## 2016年全国男子手球锦标赛

个人/全队技术累计表

正式表  
手球  
男子

截至第 30场

201606030-15-1/1  
广东徐闻  
28/10/2016 13:30

号码	姓名	远射	近射	边射	快攻	突破	任意	7M	合计	%	助攻	失误	警告	2'	取消	场次	时间
<b>四川队</b>																	
<i>(场上队员)</i>																	
1	罗尧尧	5/16	3/4		0/1	1/1			9/22	40.9%	2	4	1			6	02:04:30
3	刘赵梁		6/15	2/3	5/7	3/3			16/28	57.1%	2	12				6	03:00:28
7	仇瑞祥	1/2	2/5	0/2	1/2	1/1		5/9	10/21	47.6%	2	8				6	02:20:03
8	谢庆龙	1/1	11/17		5/7				17/25	68.0%	1	2		1		6	02:40:52
9	许翔宇	8/17	6/12	1/2		1/1			16/32	50.0%	2	13	1			6	03:02:56
10	徐彦昊	0/1	0/1	1/3					1/5	20.0%	2	5				6	01:30:59
11	张天豪		4/8	3/5	3/5			2/4	12/22	54.5%	1	7	3	1		6	03:24:25
12	丁大伟									0.0%	3	1				5	02:55:40
13	尹文珂	1/2	3/7	3/5	5/5			5/7	17/26	65.4%	1	3				6	03:02:37
15	刘劲松	0/6	6/8						6/14	42.9%		4	1	1		6	01:48:41
16	宋继强									0.0%		1				6	01:06:44
18	任启双	0/1	2/3						2/4	50.0%	2	3	2			6	02:51:42
19	庞连康	4/7	5/6	1/1		0/1		1/1	11/16	68.8%	2	5		2		6	02:38:26
20	徐逸			1/1	0/1				1/2	50.0%		2				6	00:34:39
21	马光	9/22	2/3			1/2			12/27	44.4%	2	6	2	1		6	02:13:30
22	张睿梁	0/1							0/1	0.0%	2					6	01:05:33

<b>合计</b>		29/76	50/89	12/22	19/28	7/9		13/21	130/245	53.1%	24	76	10	6		95	
-----------	--	-------	-------	-------	-------	-----	--	-------	---------	-------	----	----	----	---	--	----	--

*(守门员)*

12	丁大伟	13/33	11/45	2/16	3/20	3/7		4/10	36/131	27.5%	3	1				5	02:55:40
16	宋继强	2/13	6/18	0/3	0/3	2/2	1/1	0/1	11/41	26.8%		1				6	01:06:44
22	张睿梁	10/16	6/22	2/3	1/7	1/4		0/1	20/53	37.7%	2					6	01:05:33

<b>合计</b>		25/62	23/85	4/22	4/30	6/13	1/1	4/12	67/225	29.8%	5	2				17	
-----------	--	-------	-------	------	------	------	-----	------	--------	-------	---	---	--	--	--	----	--

场上队员：得分/射门

守门员：救球/射门

全队合计	进球	被救	射失	击柱	封球	合计	%
远射	29	23	10	7	7	76	38.2%
近射	50	25	7	7		89	56.2%
边射	12	7	3			22	54.5%
快攻	19	4	2	3		28	67.9%
突破	7	2				9	77.8%
任意							0.0%
7M	13	6		2		21	61.9%

已打比赛

阶段	场次	对手	比分
预赛	3	山东	16:31 (10:20)
预赛	8	天津	17:32 (11:17)
预赛	15	上海	21:30 (13:15)
预赛	18	广东	30:35 (11:13)
预赛	21	浙江	20:5 (20:5)
9-10名	30	新疆	26:25 (8:10)





### 2016年全国男子手球锦标赛

#### 图式射门区域累计

截止至第30场

201606034-42-1/1

## 四川队

1 罗尧尧	3 刘赵梁	7 仇瑞祥	8 谢庆龙	9 许翔宇	10 徐彦昊	11 张天豪	12 丁大伟
1 3 3	3 1 3	1 3 2	3 2	1 5		1 1 1	
3 2		1 1		1 2 3		1	
3	5 3	2	3 1 4	2 2		4 2 2	
Post - 1 Miss - 5 Block - 2	Post - 4 Miss - 1 Block - 0	Post - 3 Miss - 2 Block - 0	Post - 1 Miss - 1 Block - 0	Post - 3 Miss - 2 Block - 3	Post - 0 Miss - 1 Block - 0	Post - 0 Miss - 3 Block - 0	Post - 0 Miss - 0 Block - 0
13 尹文珂	15 刘劲松	16 宋继强	18 任启双	19 庞连康	20 徐逸	21 马光	22 张睿梁
2 1 1				4 3		1 1 1	
6 3	1 1		1	1 2		4	
2 2	1 2					2 1 2	
Post - 2 Miss - 1 Block - 0	Post - 1 Miss - 1 Block - 0	Post - 0 Miss - 0 Block - 0	Post - 0 Miss - 0 Block - 0	Post - 1 Miss - 1 Block - 0	Post - 0 Miss - 1 Block - 0	Post - 3 Miss - 3 Block - 2	Post - 0 Miss - 0 Block - 0

12 丁大伟
2/20 1/2 6/24
6/16 1/2 11/24
6/26 3/4 0/13
16 宋继强
0/2 0/3 0/7
3/7 2/2 4/5
2/7 0/1 0/7
22 张睿梁
1/8 0/2 3/6
6/14 4/5 3/4
1/8 2/3 0/3

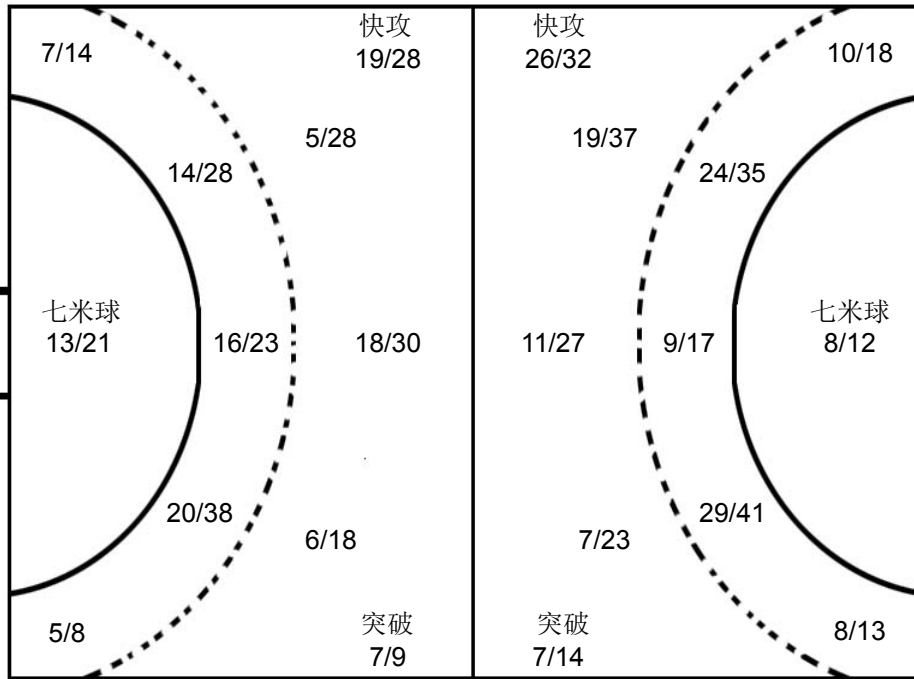

上海
1 张崢
3/6 0/1 2/6
1/3 3/6
0/5 2/2 4/7
天津
1 刘宗其
0/1 0/1 2/3
1/3 1/1 4/6
3/6 2/2 0/4
山东
16 于性哲
0/2 1/2 1/2
2/5 2/2 3/4
1/2 1/1 2/3

## 对手

天津	广东	广东	上海	新疆	上海	天津	新疆
8 曹悦	5 侯生升	17 李中洲	8 钱为玮	7 林豪文	15 朱世杰	14 田剑侠	10 王钟彬
2 1		1	1 5	2 1 3	1 1		
		2 1	1			3 1	1 1
4 2	4 2	2 2			4 1	1 2	2
Post - 0 Miss - 1 Block - 0	Post - 0 Miss - 0 Block - 0	Post - 1 Miss - 0 Block - 1	Post - 0 Miss - 1 Block - 0	Post - 0 Miss - 1 Block - 1	Post - 0 Miss - 0 Block - 0	Post - 0 Miss - 0 Block - 0	Post - 0 Miss - 1 Block - 0
新疆	广东	山东	山东	山东	上海	天津	广东
19 李龙吉	7 付云博	11 宋朋强	19 李语庆	27 于亚男	18 马麟晓	13 许松	2 孙江山
2 1 1			1 1	3 1	1		1 1 1
2			2				1
1	2 1 1	3	1		2 1		
Post - 1 Miss - 1 Block - 1	Post - 0 Miss - 0 Block - 0	Post - 0 Miss - 0 Block - 0	Post - 0 Miss - 0 Block - 0	Post - 1 Miss - 1 Block - 0	Post - 1 Miss - 1 Block - 0	Post - 0 Miss - 1 Block - 0	Post - 1 Miss - 1 Block - 1

注释: Post=击柱 Miss=射失 Block=被封





2016年全国男子手球锦标赛  
球队名单(媒体表)

新疆队

201606000-53-1/1

号码	姓名	位置	生日	年龄	俱乐部	身高 (CM)	体重 (KG)	总场次	总进球
1	宋晓晨	守门员	03/12/1996	19		192	85		
5	徐伟	左边锋	13/03/1996	20		185	77		
7	林豪文	左后卫	21/12/1997	18		187	92		
8	刘文字	底线	19/06/1995	21		191	110		
9	姜春晖	右边锋	27/03/1995	21		193	85		
10	王钟彬	右后卫	29/11/1996	19		188	90		
12	王金鑫	守门员	19/03/1999	17		185	95		
13	苏兴伟	底线	01/06/1999	17		190	80		
15	王维东	左后卫	08/10/1998	18		183	88		
17	胡晋铭	底线	02/09/1997	19		197	113		
18	姜帅	左后卫	09/12/1993	22		199	87		
19	李龙吉	后卫	04/08/1997	19		190	75		
20	赵元	右后卫	13/02/1997	19		198	82		
24	王泽川	左边锋	30/01/1999	17		180	72		
平均				19.0		189.9	87.9		

替换队员

编码	姓名	职务

A	孔德宾	主教练
B	陈鹏波	教练
C	孙均鹏	医生
D	时雨	工作人员





## 2016年全国男子手球锦标赛

个人/全队技术累计表

正式表  
手球  
男子

截至第 30场

201606030-15-1/1  
广东徐闻  
28/10/2016 13:30

号码	姓名	远射	近射	边射	快攻	突破	任意	7M	合计	%	助攻	失误	警告	2'	取消	场次	时间
<b>新疆队</b>																	
<i>(场上队员)</i>																	
1	宋晓晨									0.0%	6	6				5	04:21:03
5	徐伟		0/2	3/4	9/12				12/18	66.7%	1	2				5	04:01:47
7	林豪文	14/39	2/7	1/1	1/1	1/1	1/2	1/1	21/52	40.4%	4	5		3		5	03:25:59
8	刘文宇	0/1	4/8						4/9	44.4%		3	2	1		5	01:19:59
9	姜春晖	2/6	1/4	1/4	2/4			1/1	7/19	36.8%	1	4		2		5	02:44:57
10	王钟彬	9/29	4/15		3/5	1/1		4/6	21/56	37.5%	4	7	2	1		5	04:04:45
12	王金鑫									0.0%						2	00:38:57
13	苏兴伟									0.0%						5	00:19:28
15	王维东		1/3	0/1	1/1				2/5	40.0%		1	1	1		5	01:08:19
17	胡晋铭		6/7			1/1			7/8	87.5%	1	3	2	3		5	03:23:37
18	姜帅	4/10	2/4						6/14	42.9%		1	3	1		5	02:23:44
19	李龙吉	1/9	5/17		1/1	2/3	0/1	4/5	13/36	36.1%	1	16	1			5	03:27:20
20	赵元	4/10	1/7	0/1	2/2	2/2	0/1	0/1	9/24	37.5%	2	9	1	4		5	03:34:36
24	王泽川									0.0%		1		1		5	01:00:34

<b>合计</b>		34/104	26/74	5/11	19/26	7/8	1/4	10/14	102/241	42.3%	20	58	12	17		67	
-----------	--	--------	-------	------	-------	-----	-----	-------	---------	-------	----	----	----	----	--	----	--

*(守门员)*

1	宋晓晨	9/29	15/70	2/8	1/28	0/9	0/1	4/20	31/165	18.8%	6	6				5	04:21:03
12	王金鑫	1/4	2/13	0/2	0/3	0/1		1/1	4/24	16.7%						2	00:38:57
15	王维东									0.0%						5	00:00:00

<b>合计</b>		10/33	17/83	2/10	1/31	0/10	0/1	5/21	35/189	18.5%	6	6				12	
-----------	--	-------	-------	------	------	------	-----	------	--------	-------	---	---	--	--	--	----	--

场上队员：得分/射门

守门员：救球/射门

全队合计	进球	被救	射失	击柱	封球	合计	%
远射	34	29	13	6	22	104	32.7%
近射	26	29	11	5	3	74	35.1%
边射	5	3	1	2		11	45.5%
快攻	19	6	1			26	73.1%
突破	7	1				8	87.5%
任意	1	3				4	25.0%
7M	10	4				14	71.4%

已打比赛

阶段	场次	对手	比分
预赛	2	解放军	16:31 (10:17)
预赛	10	江苏	25:40 (14:21)
预赛	12	安徽	22:28 (10:13)
预赛	16	北京	14:29 (9:16)
9-10名	30	四川	25:26 (10:8)







### 2016年全国男子手球锦标赛

#### 图式射门区域累计

截止至第30场

201606034-42-1/1

## 新疆队

1 宋晓晨	5 徐伟	7 林豪文	8 刘文字	9 姜春晖	10 王钟彬	12 王金鑫	13 苏兴伟
	1 5 3	4 1 4 2 1 2 1 2 4	1 1 1	2 1 1 1 1 1 2	2 1 5 5 2 4 2		
Post - 0 Miss - 0 Block - 0	Post - 1 Miss - 0 Block - 0	Post - 3 Miss - 7 Block - 7	Post - 0 Miss - 3 Block - 0	Post - 3 Miss - 2 Block - 1	Post - 1 Miss - 2 Block - 9	Post - 0 Miss - 0 Block - 0	Post - 0 Miss - 0 Block - 0
15 王维东	17 胡晋铭	18 姜帅	19 李龙吉	20 赵元	24 王泽川		
	1 1 2 2	1 1 2 1 1	2 2 1 2 2 4	3 1 1 1 2 2			
Post - 0 Miss - 1 Block - 0	Post - 1 Miss - 0 Block - 0	Post - 2 Miss - 2 Block - 2	Post - 2 Miss - 5 Block - 4	Post - 0 Miss - 4 Block - 2	Post - 0 Miss - 0 Block - 0		

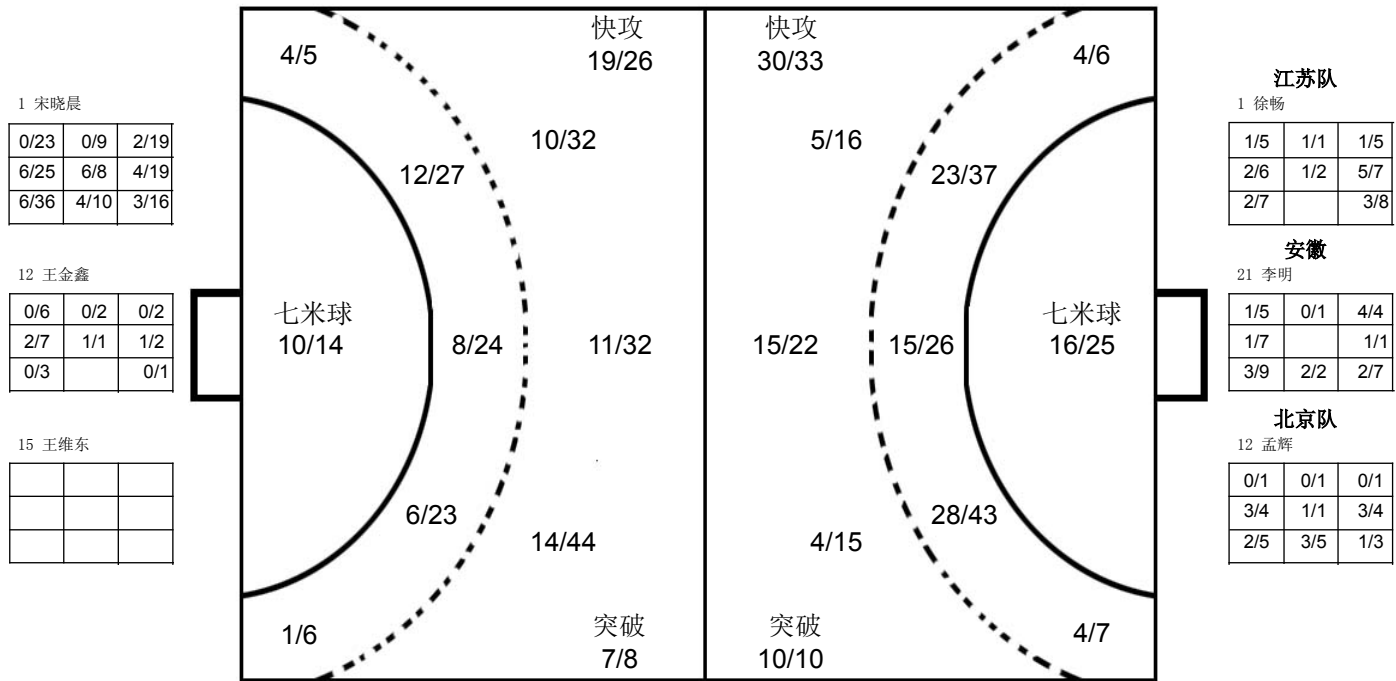

## 对手

9 毕晓晨	17 王巨柱	18 赵楠	8 周小坚	17 王伟强	9 陈开勇	18 李双	3 王超
5 1 3 1		2 1 2 2 1 1	1 2	1 1 1 1 2	1 1 2	1 2 1 1	1 1 1
Post - 0 Miss - 1 Block - 1	Post - 1 Miss - 0 Block - 1	Post - 1 Miss - 0 Block - 0	Post - 0 Miss - 2 Block - 0	Post - 0 Miss - 0 Block - 0	Post - 1 Miss - 0 Block - 0	Post - 0 Miss - 2 Block - 1	Post - 1 Miss - 0 Block - 0
23 王军程	15 李安	4 曹作亮	8 王烁	7 仇瑞祥	23 于敏清	10 成业	21 胡瀛
		2 1 2	2 2 1	1 2 1 1	1 1 1	1 2 1	1 1
Post - 1 Miss - 1 Block - 0	Post - 1 Miss - 0 Block - 0	Post - 0 Miss - 1 Block - 0	Post - 0 Miss - 0 Block - 0	Post - 2 Miss - 1 Block - 0	Post - 0 Miss - 0 Block - 0	Post - 1 Miss - 0 Block - 0	Post - 1 Miss - 1 Block - 0

注释: Post=击柱 Miss=射失 Block=被封





## 2016年全国男子手球锦标赛

## 球队名单(媒体表)

浙江队

201606000-53-1/1

号码	姓名	位置	生日	年龄	俱乐部	身高 (CM)	体重 (KG)	总场次	总进球
1	李欢欢	右边锋	22/09/1988	28		182	70		
2	郑尧俊	后卫	15/03/1999	17		172	70		
3	李恩铭	左边锋	14/01/1999	17		180	60		
5	林先方	右后卫	09/10/1998	18		180	72		
7	金杰	右边锋	25/07/1989	27		180	65		
8	王浩	底线	01/02/1999	17		193	78		
9	李家乐	右边锋	30/12/1998	17		180	68		
10	罗明杰	右边锋	18/02/1999	17		178	70		
11	陈渝天	后卫	28/10/1999	16		170	70		
14	虞勇灿	底线	14/12/1998	17		196	86		
15	张佩力	守门员	25/12/1999	16		197	101		
18	倪陈辉	左后卫	19/10/1996	20		180	70		
19	徐正飞	左后卫	07/03/1999	17		186	69		
24	毛军伟	右后卫	16/10/1998	18		190	67		
	平均			18.7		183.1	72.6		

## 替换队员

编码	姓名	职务

B	柳佳	主教练
C	项建生	教练
D	蒋云敏	医生





## 2016年全国男子手球锦标赛

个人/全队技术累计表

正式表  
手球  
男子

截至第 29场

201606029-15-1/1  
广东徐闻  
27/10/2016 20:40

号码	姓名	远射	近射	边射	快攻	突破	任意	7M	合计	%	助攻	失误	警告	2'	取消	场次	时间
<b>浙江队</b>																	
<i>(场上队员)</i>																	
1	李欢欢		2/3						2/3	66.7%		2	2			5	01:36:37
2	郑尧俊	0/4	0/1						0/5	0.0%		10	1			5	02:06:53
3	李恩铭	0/1	3/7	2/6					5/14	35.7%		10	1			5	01:44:08
5	林先方	0/3	1/3					1/1	2/7	28.6%		8				5	00:44:20
7	金杰	1/2		0/1					1/3	33.3%	1	6				5	00:28:28
8	王浩									0.0%						5	00:44:13
9	李家乐		1/1						1/1	100%		4				5	00:37:14
10	罗明杰	3/16	1/6						4/22	18.2%	2	21	2			5	02:09:01
11	陈渝天									0.0%						5	00:20:43
14	虞勇灿		1/1	0/1					1/2	50.0%						5	00:46:26
15	张佩力									0.0%		1				5	01:48:41
18	倪陈辉	0/6	2/4	0/4			1/2		3/16	18.8%		12	1			5	02:16:45
19	徐正飞	0/4	1/3					1/1	2/8	25.0%		16				5	01:56:08
24	毛军伟									0.0%		2				5	00:02:05

<b>合计</b>		4/36	12/29	2/12			1/2	2/2	21/81	25.9%	3	92	7			70	
-----------	--	------	-------	------	--	--	-----	-----	-------	-------	---	----	---	--	--	----	--

*(守门员)*

1	李欢欢									0.0%						5	00:19:12
8	王浩	1/9	2/14	1/3	0/11	0/5			4/42	9.5%						5	00:44:13
15	张佩力	3/16	5/30	5/13	2/23	0/9		0/2	15/93	16.1%		1				5	01:48:41

<b>合计</b>		4/25	7/44	6/16	2/34	0/14		0/2	19/135	14.1%		1				15	
-----------	--	------	------	------	------	------	--	-----	--------	-------	--	---	--	--	--	----	--

场上队员：得分/射门

守门员：救球/射门

全队合计	进球	被救	射失	击柱	封球	合计	%
远射	4	20	7	1	4	36	11.1%
近射	12	12	2	3		29	41.4%
边射	2	7	3			12	16.7%
快攻							0.0%
突破							0.0%
任意	1			1		2	50.0%
7M	2					2	100.0%

已打比赛

阶段	场次	对手	比分
预赛	4	天津	4:29 (4:29)
预赛	7	广东	4:23 (4:23)
预赛	13	山东	5:24 (5:24)
预赛	20	上海	3:20 (3:20)
预赛	21	四川	5:20 (5:20)





2016年全国男子手球锦标赛

图式射门区域累计

截止至第29场

201606034-42-1/1

浙江队

1 李欢欢	2 郑尧俊	3 李恩铭	5 林先方	7 金杰	8 王浩	9 李家乐	10 罗明杰																																																																								
<table border="1"><tr><td></td><td></td><td></td></tr><tr><td></td><td></td><td>2</td></tr><tr><td></td><td></td><td></td></tr></table>						2				<table border="1"><tr><td></td><td></td><td></td></tr><tr><td></td><td></td><td></td></tr><tr><td></td><td></td><td></td></tr></table>										<table border="1"><tr><td></td><td></td><td>2</td></tr><tr><td></td><td>1</td><td>1</td></tr><tr><td>1</td><td></td><td></td></tr></table>			2		1	1	1			<table border="1"><tr><td></td><td></td><td></td></tr><tr><td></td><td></td><td></td></tr><tr><td>2</td><td></td><td></td></tr></table>							2			<table border="1"><tr><td></td><td></td><td></td></tr><tr><td>1</td><td></td><td></td></tr><tr><td></td><td></td><td></td></tr></table>				1						<table border="1"><tr><td></td><td></td><td></td></tr><tr><td></td><td></td><td></td></tr><tr><td></td><td></td><td></td></tr></table>										<table border="1"><tr><td></td><td></td><td>1</td></tr><tr><td></td><td></td><td></td></tr><tr><td></td><td></td><td></td></tr></table>			1							<table border="1"><tr><td></td><td>1</td><td></td></tr><tr><td></td><td></td><td></td></tr><tr><td></td><td></td><td></td></tr></table>		1							
		2																																																																													
		2																																																																													
	1	1																																																																													
1																																																																															
2																																																																															
1																																																																															
		1																																																																													
	1																																																																														
Post - 0 Miss - 0 Block - 0	Post - 1 Miss - 2 Block - 0	Post - 0 Miss - 2 Block - 0	Post - 2 Miss - 1 Block - 0	Post - 0 Miss - 1 Block - 0	Post - 0 Miss - 0 Block - 0	Post - 0 Miss - 0 Block - 0	Post - 0 Miss - 3 Block - 0																																																																								
11 陈渝天	14 虞勇灿	15 张佩力	18 倪陈辉	19 徐正飞	24 毛军伟																																																																										
<table border="1"><tr><td></td><td></td><td></td></tr><tr><td></td><td></td><td></td></tr><tr><td></td><td></td><td></td></tr></table>										<table border="1"><tr><td></td><td></td><td></td></tr><tr><td>1</td><td></td><td></td></tr><tr><td></td><td></td><td></td></tr></table>				1						<table border="1"><tr><td></td><td></td><td></td></tr><tr><td></td><td></td><td></td></tr><tr><td></td><td></td><td></td></tr></table>										<table border="1"><tr><td></td><td>1</td><td>1</td></tr><tr><td></td><td>1</td><td></td></tr><tr><td></td><td></td><td></td></tr></table>		1	1		1					<table border="1"><tr><td></td><td></td><td></td></tr><tr><td>1</td><td></td><td></td></tr><tr><td></td><td></td><td></td></tr></table>				1						<table border="1"><tr><td></td><td></td><td></td></tr><tr><td></td><td></td><td></td></tr><tr><td></td><td></td><td></td></tr></table>																													
1																																																																															
	1	1																																																																													
	1																																																																														
1																																																																															
Post - 0 Miss - 0 Block - 0	Post - 0 Miss - 0 Block - 0	Post - 0 Miss - 0 Block - 0	Post - 1 Miss - 3 Block - 3	Post - 1 Miss - 0 Block - 1	Post - 0 Miss - 0 Block - 0																																																																										

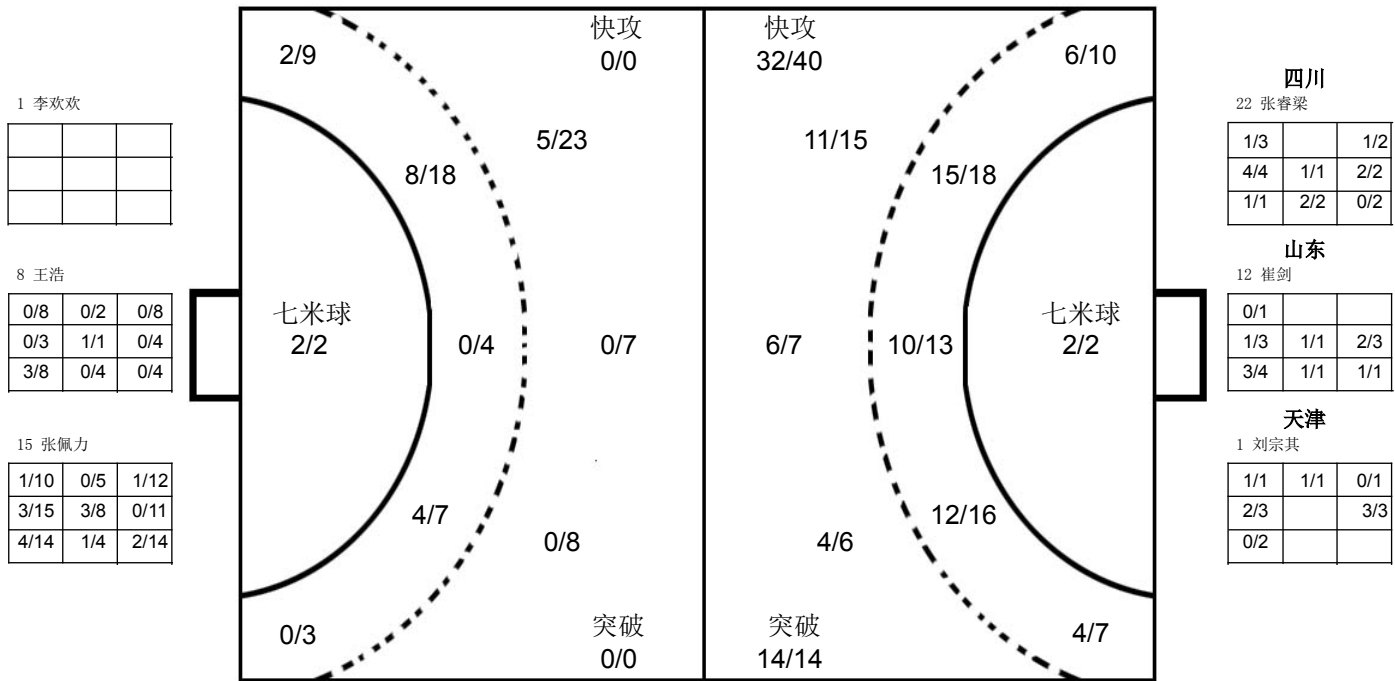

对手

8 钱为玮 (上海)	13 王立隆 (广东)	15 张继伟 (山东)	12 林子健 (广东)	6 李朝鹏 (山东)	11 张天豪 (四川)	15 张建杰 (广东)	20 黄培杰 (广东)																																																																								
<table border="1"><tr><td></td><td>1</td><td>2</td></tr><tr><td>2</td><td></td><td>3</td></tr><tr><td>1</td><td></td><td></td></tr></table>		1	2	2		3	1			<table border="1"><tr><td>2</td><td></td><td></td></tr><tr><td>2</td><td></td><td>1</td></tr><tr><td>2</td><td></td><td>1</td></tr></table>	2			2		1	2		1	<table border="1"><tr><td>1</td><td>1</td><td>1</td></tr><tr><td>1</td><td></td><td>1</td></tr><tr><td></td><td>1</td><td></td></tr></table>	1	1	1	1		1		1		<table border="1"><tr><td>1</td><td>1</td><td>1</td></tr><tr><td></td><td>1</td><td></td></tr><tr><td></td><td>1</td><td></td></tr></table>	1	1	1		1			1		<table border="1"><tr><td>3</td><td></td><td>2</td></tr><tr><td></td><td></td><td></td></tr><tr><td></td><td></td><td></td></tr></table>	3		2							<table border="1"><tr><td></td><td></td><td>1</td></tr><tr><td></td><td></td><td></td></tr><tr><td>2</td><td>1</td><td>1</td></tr></table>			1				2	1	1	<table border="1"><tr><td>1</td><td></td><td>1</td></tr><tr><td></td><td>1</td><td></td></tr><tr><td></td><td>1</td><td></td></tr></table>	1		1		1			1		<table border="1"><tr><td></td><td>1</td><td>2</td></tr><tr><td></td><td></td><td></td></tr><tr><td>1</td><td></td><td></td></tr></table>		1	2				1		
	1	2																																																																													
2		3																																																																													
1																																																																															
2																																																																															
2		1																																																																													
2		1																																																																													
1	1	1																																																																													
1		1																																																																													
	1																																																																														
1	1	1																																																																													
	1																																																																														
	1																																																																														
3		2																																																																													
		1																																																																													
2	1	1																																																																													
1		1																																																																													
	1																																																																														
	1																																																																														
	1	2																																																																													
1																																																																															
Post - 0 Miss - 0 Block - 0	Post - 0 Miss - 1 Block - 0	Post - 1 Miss - 0 Block - 0	Post - 0 Miss - 0 Block - 0	Post - 0 Miss - 0 Block - 0	Post - 0 Miss - 0 Block - 0	Post - 0 Miss - 0 Block - 0	Post - 1 Miss - 0 Block - 0																																																																								
3 尹杰 (山东)	9 赵鑫 (山东)	10 赵建强 (山东)	8 谢庆龙 (四川)	8 曹悦 (天津)	9 吴明远 (天津)	13 许松 (天津)	18 王晓琪 (天津)																																																																								
<table border="1"><tr><td></td><td>1</td><td></td></tr><tr><td></td><td>1</td><td></td></tr><tr><td></td><td></td><td>2</td></tr></table>		1			1				2	<table border="1"><tr><td></td><td></td><td></td></tr><tr><td>1</td><td></td><td>2</td></tr><tr><td>1</td><td></td><td></td></tr></table>				1		2	1			<table border="1"><tr><td>1</td><td>1</td><td>1</td></tr><tr><td></td><td>1</td><td></td></tr><tr><td></td><td></td><td></td></tr></table>	1	1	1		1					<table border="1"><tr><td>1</td><td></td><td>1</td></tr><tr><td></td><td></td><td></td></tr><tr><td>1</td><td></td><td>1</td></tr></table>	1		1				1		1	<table border="1"><tr><td></td><td></td><td></td></tr><tr><td>1</td><td></td><td>1</td></tr><tr><td></td><td></td><td>2</td></tr></table>				1		1			2	<table border="1"><tr><td></td><td></td><td>1</td></tr><tr><td></td><td></td><td></td></tr><tr><td>1</td><td></td><td>2</td></tr></table>			1				1		2	<table border="1"><tr><td>1</td><td></td><td>1</td></tr><tr><td>1</td><td></td><td></td></tr><tr><td></td><td></td><td>1</td></tr></table>	1		1	1					1	<table border="1"><tr><td>1</td><td></td><td></td></tr><tr><td></td><td>2</td><td></td></tr><tr><td>1</td><td></td><td></td></tr></table>	1				2		1		
	1																																																																														
	1																																																																														
		2																																																																													
1		2																																																																													
1																																																																															
1	1	1																																																																													
	1																																																																														
1		1																																																																													
1		1																																																																													
1		1																																																																													
		2																																																																													
		1																																																																													
1		2																																																																													
1		1																																																																													
1																																																																															
		1																																																																													
1																																																																															
	2																																																																														
1																																																																															
Post - 0 Miss - 0 Block - 0	Post - 0 Miss - 0 Block - 0	Post - 0 Miss - 1 Block - 0	Post - 0 Miss - 1 Block - 0	Post - 0 Miss - 0 Block - 0	Post - 0 Miss - 0 Block - 0	Post - 1 Miss - 0 Block - 0	Post - 0 Miss - 0 Block - 0																																																																								

注释: Post=击柱 Miss=射失 Block=被封





预赛 Group A

男子 全国比赛

2016年全国男子手球锦标赛

Team A				Team B				Match Number													
A 江苏队				B 安徽队				1													
played in		in the hall		on		at		Spectators													
China		徐闻县体育中心体育		20/10/2016		13:30		hours													
Half-time (30')	A	B	End of playing time	A	B	1st extra time	A	B	2nd extra time	A	B	After penalty throws	A	B							
	16	11		29	23																
Number of 7 m	A	Team time-out			Full name of players and officials	Team time-out			B	Number of 7 m											
		1	2	3		1	2	3													
	1/1	13:58	52:00							1/3											
No.	Team A					G	W	2'	D	DR	No.	Team B					G	W	2'	D	DR
1	徐畅										1	郭世伟					1				
4	张家纬					2					2	金永峰									
5	闫亮					3					3	陈强龙					1				
6	赵晨					1					5	史小帆					4				
7	徐奕飞							1			7	姚雄敏					1				
8	周小坚					7					8	董智景					6				
9	周傲										9	陈开勇					2	1			
10	郝可鑫					5					10	严龙									
12	王权										11	黎涛					1				
15	李安					2	1				12	曾献辰									
16	张帅										17	王巨柱					3				
17	王伟强					3					18	李双					1				
18	赵楠					3	1				19	何山									
20	顾艳超										21	李明									
21	刘江					3					22	王金宇									
22	张瑞恒										23	于敏清					3				
B	闫威名 (主教练)										A	韦中平									
C	贾淑君										B	沈强 (主教练)									
D	叶强										C	吴翔									
E	王建国										D	陈玉翔									
A	Signature of Responsible Official of the Teams (Off. A)										B										
TP	Remarks of Referee / CHA Official										TP										

Signatures

Referees: 程钰锋 (CHN)      王洋 (CHN)

Techn. Delegates: 刘凤娟 (CHN)

CHA Official: 李兆蒙 (CHN)

Note: Number of 7m Throws Awarded to Team A and B, Goals (G), Warnings (W), Suspensions (2), Direct Disqualification (D), Disqualification with Report (DR) and Team Penalty (TP).

Table Officials: 梁小熹      刘晓辉      Statisticians: 张程秀子      李双



## 2016年全国男子手球锦标赛 竞赛技术统计(媒体表)

预赛		组别	A	轮次	1	场次	1
徐闻县体育中心体育馆				20/10/2016		201606001-51-1/1	
江苏队		江苏	29	vs	23	安徽	安徽队
				16 : 11			

裁判员	程钰锋 (CHN)	/	王洋 (CHN)
-----	-----------	---	----------

江苏		远	近	边	快	突	任意	7m	合计	%	助攻	失误	警告	2'	D & DR	江苏		比赛	安徽		
主教练： 闫威名		射	射	射	攻	破	球	球								进程					
1	徐畅															1st Half					
4	张家纬	0/2	1/1		0/1	1/1			2/5	40.0	1	2				10	郝可鑫	1	00:36	0	
5	闫亮		2/2		1/1				3/3	100		1				8	周小坚	2	02:11	0	
6	赵晨	0/4	1/1				0/1		1/6	16.7	2					15	李安	3	03:59	0	
7	徐奕飞				0/1				0/1	0.0	2			1		8	周小坚	3	04:36	1	8 董智景
8	周小坚	1/1	6/6		0/1				7/8	87.5		3				18	赵楠	4	05:43	1	
9	周傲															4	周小坚	4	06:26	2	23 于敏清
10	郝可鑫	4/6					1/1		5/7	71.4		3				8	周小坚	5	06:39	2	
12	王权															4	张家纬	6	07:19	3	8 董智景
15	李安		1/1	1/1					2/2	100	2	4	1			8	周小坚	7	09:24	3	
16	张帅															10	郝可鑫	8	11:47	4	
17	王伟强		1/1		2/2				3/3	100		2				10	郝可鑫	8	14:44	5	3 陈强龙
18	赵楠	1/1		1/2				1/1	3/4	75.0	2		1			9	郝可鑫	9	15:20	5	
20	顾艳超	0/4	0/1						0/5	0.0	1	5				8	周小坚	9	16:09	6	8 董智景
21	刘江		3/3						3/3	100	1	1				8	周小坚	10	16:36	6	
22	张瑞恒															11	周小坚	11	19:12	6	
<b>运动员 合计</b>		<b>6/18</b>	<b>15/16</b>	<b>2/3</b>	<b>3/6</b>	<b>1/1</b>	<b>1/2</b>	<b>1/1</b>	<b>29/47</b>	<b>61.7</b>	<b>11</b>	<b>21</b>	<b>2</b>	<b>1</b>		18	赵楠	12	20:55	6	
1	徐畅	1/6	1/3	0/1	0/1		1/2	1/1	4/14	28.6						10	郝可鑫	13	22:12	7	7 姚雄敏
12	王权	3/4	2/2	2/5	0/2				7/13	53.8						10	郝可鑫	13	22:37	7	
16	张帅	0/2	2/4	0/1	1/1		0/1	0/1	3/10	30.0						13	刘江	13	22:57	8	23 于敏清
<b>守门员 合计</b>		<b>4/12</b>	<b>5/9</b>	<b>2/7</b>	<b>1/4</b>		<b>1/3</b>	<b>1/2</b>	<b>14/37</b>	<b>37.8</b>						13	郝可鑫	14	23:50	9	8 董智景
																14	郝可鑫	14	23:50	9	
																8	周小坚	15	26:11	10	17 王巨柱
																15	李安	16	29:00	11	5 史小帆
																2nd Half					
																4	张家纬	17	01:16	11	
																21	刘江	18	02:52	11	
																21	刘江	18	03:22	12	5 史小帆
																5	闫亮	19	03:30	12	
																5	闫亮	20	04:33	13	1 郭世伟
																5	闫亮	20	05:35	14	18 李双
																5	闫亮	20	05:55	15	5 史小帆
																17	王伟强	21	08:48	15	
																17	王伟强	22	11:06	15	
																6	赵晨	22	11:29	16	11 黎涛
																5	闫亮	23	13:10	16	
																5	闫亮	24	14:26	16	
																17	王伟强	24	15:03	17	9 陈开勇
																18	赵楠	25	16:42	17	
																18	赵楠	26	18:26	17	
																26	18:37	18	17	王巨柱	
																26	20:30	19	9	陈开勇	
																26	21:51	20	8	董智景	
																8	周小坚	27	22:30	20	
																21	刘江	27	23:13	21	17 王巨柱
																28	25:27	21			
																17	王伟强	28	26:51	22	5 史小帆
																29	28:24	22			
																29	29:56	23	8	董智景	

场上队员： 得分 / 射门

守门员： 救球 / 射门

快攻	Fast Break		突破	Breakthrough	任意球	Free Throw	7M球	7M Throw		助攻	Assist
警告	Warning		失误	Error	2'	Suspension	D	取消资格		DR	取消资格+报告



### 2016年全国男子手球锦标赛 图式比赛技术统计表

轮次 1

场次 1

201606001-21-1/1

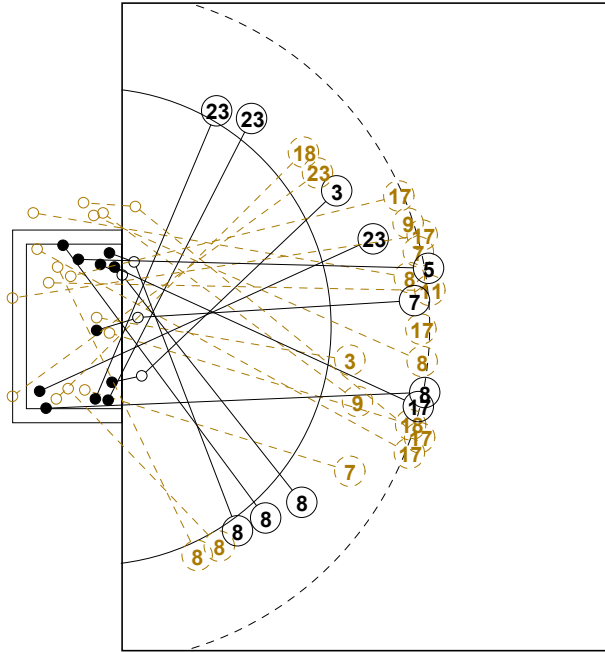

7M 安徽

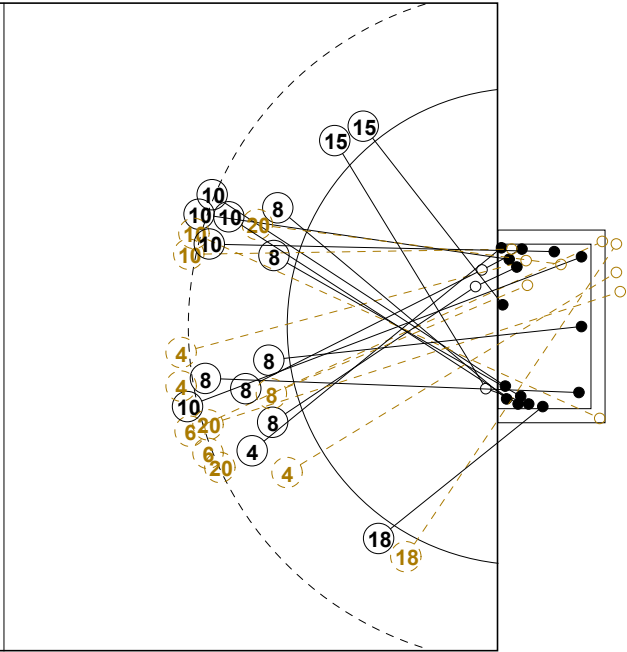
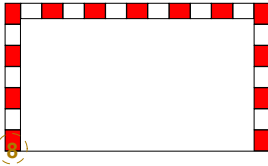

江苏 7M

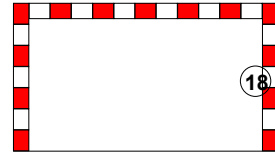

1st Half  
11 : 16

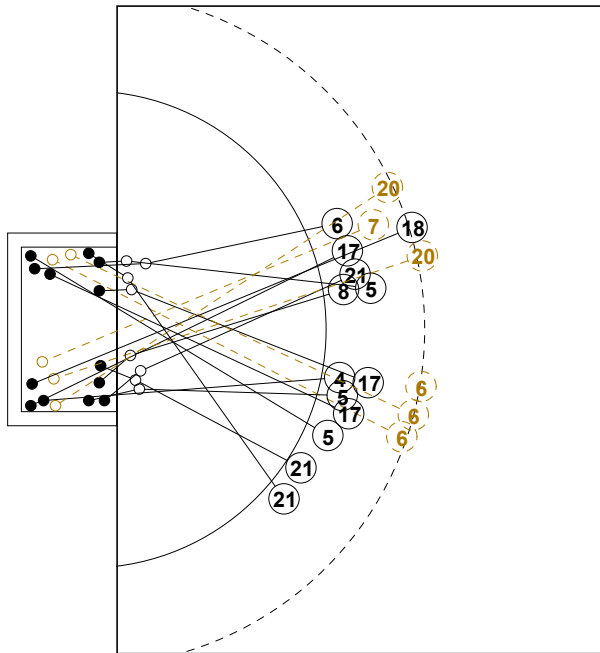

7M 江苏

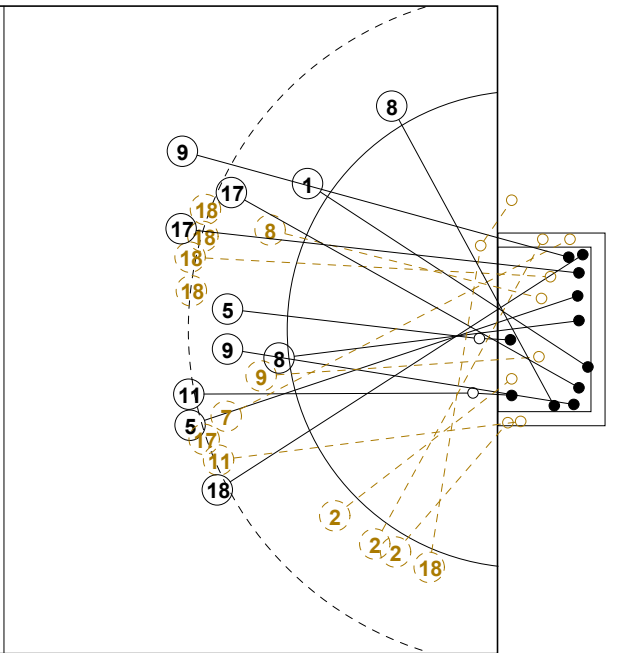
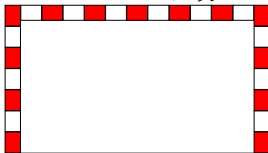

安徽 7M

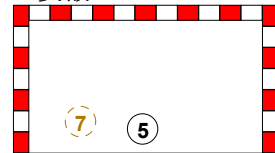

2nd Half  
29 : 23





## 2016年全国男子手球锦标赛

## 个人/全队技术统计表

正式表  
手球  
男子预赛  
轮次 1组别 A  
场次 1201606001-14-1/2  
徐闻县体育中心体育馆  
20/10/2016 13:30

号码	姓名	远射	近射	边射	快攻	突破	任意	7M	合计	%	助攻	失误	警告	2'	取消	时间
<b>江苏队(江苏)</b>																
<i>(场上队员)</i>																
1	徐畅									0.0%						00:21:38
4	张家纬	0/2	1/1		0/1	1/1			2/5	40.0%	1	2				00:41:35
5	闫亮		2/2		1/1				3/3	100%		1				00:28:59
6	赵晨	0/4	1/1				0/1		1/6	16.7%	2					00:35:13
7	徐奕飞				0/1				0/1	0.0%	2			1		00:29:44
8	周小坚	1/1	6/6		0/1				7/8	87.5%		3				00:37:46
9	周傲									0.0%						00:00:00
10	郝可鑫	4/6					1/1		5/7	71.4%		3				00:30:00
12	王权									0.0%						00:20:00
15	李安		1/1	1/1					2/2	100%	2	4	1			00:41:17
16	张帅									0.0%						00:18:22
17	王伟强		1/1		2/2				3/3	100%		2				00:18:42
18	赵楠	1/1		1/2				1/1	3/4	75.0%	2		1			00:40:32
20	顾艳超	0/4	0/1						0/5	0.0%	1	5				00:31:53
21	刘江		3/3						3/3	100%	1	1				00:23:45
22	张瑞恒									0.0%						00:00:00
<b>合计</b>		6/18	15/16	2/3	3/6	1/1	1/2	1/1	29/47	61.7%	11	21	2	1		
<i>(守门员)</i>																
1	徐畅	1/6	1/3	0/1	0/1		1/2	1/1	4/14	28.6%						00:21:38
12	王权	3/4	2/2	2/5	0/2				7/13	53.8%						00:20:00
16	张帅	0/2	2/4	0/1	1/1		0/1	0/1	3/10	30.0%						00:18:22
<b>合计</b>		4/12	5/9	2/7	1/4		1/3	1/2	14/37	37.8%						

场上队员：得分/射门

守门员：救球/射门

全队合计	得分	被救	射失	击柱	封球	合计	%
远射	6	5	1	2	4	18	33.3%
近射	15	1				16	93.8%
边射	2		1			3	66.7%
快攻	3	2	1			6	50.0%
突破	1					1	100.0%
任意	1	1				2	50.0%
7M	1					1	100.0%





## 2016年全国男子手球锦标赛

## 个人/全队技术统计表

正式表  
手球  
男子预赛  
轮次 1组别 A  
场次 1201606001-14-2/2  
徐闻县体育中心体育馆  
20/10/2016 13:30

号码	姓名	远射	近射	边射	快攻	突破	任意	7M	合计	%	助攻	失误	警告	2'	取消	时间
<b>安徽队(安徽)</b>																
<i>(上场队员)</i>																
1	郭世伟		1/1						1/1	100%		1				00:34:40
2	金永峰			0/2	0/1				0/3	0.0%						00:05:50
3	陈强龙		0/1		1/1				1/2	50.0%		1				00:27:49
5	史小帆	1/1	1/1				1/1	1/1	4/4	100%						00:16:06
7	姚雄敏	1/3	0/1					0/1	1/5	20.0%		2				00:32:05
8	董智景	1/2	1/2	3/5	1/2			0/1	6/12	50.0%		1				00:40:30
9	陈开勇	1/2	1/2		0/1				2/5	40.0%			1			00:40:52
10	严龙									0.0%						00:00:00
11	黎涛	1/3							1/3	33.3%	1	2				00:36:00
12	曾献辰									0.0%						00:00:00
17	王巨柱	2/7					1/2		3/9	33.3%	3	4				00:41:42
18	李双	1/5	0/1	0/1			0/1		1/8	12.5%		3				00:40:19
19	何山									0.0%						00:00:00
21	李明									0.0%	1	1				01:00:00
22	王金宇									0.0%						00:00:00
23	于敏清			2/2	1/2				3/4	75.0%		1				00:42:40
<b>合计</b>		8/23	4/9	5/10	3/7		2/4	1/3	23/56	41.1%	5	16	1			
<i>(守门员)</i>																
21	李明	5/11	1/16	0/2	2/5	0/1	1/2	0/1	9/38	23.7%	1	1				01:00:00
<b>合计</b>																
<b>合计</b>		5/11	1/16	0/2	2/5	0/1	1/2	0/1	9/38	23.7%	1	1				

场上队员：得分/射门

守门员：救球/射门

全队合计	得分	被救	射失	击柱	封球	合计	%
远射	8	4	2	2	7	23	34.8%
近射	4	5				9	44.4%
边射	5	2	1	2		10	50.0%
快攻	3	1	2	1		7	42.9%
突破							0.0%
任意	2	1		1		4	50.0%
7M	1	1		1		3	33.3%





2016年全国男子手球锦标赛

图式射门区域统计

轮次 1 场次 1

201606001-41-1/1

江苏队

1 徐畅	4 张家纬	5 闫亮	6 赵晨	7 徐奕飞	8 周小坚	9 周傲	10 郝可鑫																																																																								
<table border="1"><tr><td></td><td></td><td></td></tr><tr><td></td><td></td><td></td></tr><tr><td></td><td></td><td></td></tr></table>										<table border="1"><tr><td>1</td><td></td><td></td></tr><tr><td></td><td></td><td></td></tr><tr><td>1</td><td></td><td></td></tr></table>	1						1			<table border="1"><tr><td></td><td></td><td>1</td></tr><tr><td></td><td></td><td></td></tr><tr><td>1</td><td></td><td>1</td></tr></table>			1				1		1	<table border="1"><tr><td></td><td></td><td>1</td></tr><tr><td></td><td></td><td></td></tr><tr><td></td><td></td><td></td></tr></table>			1							<table border="1"><tr><td></td><td></td><td></td></tr><tr><td></td><td></td><td></td></tr><tr><td></td><td></td><td></td></tr></table>										<table border="1"><tr><td></td><td>1</td><td>1</td></tr><tr><td></td><td></td><td></td></tr><tr><td>3</td><td></td><td>2</td></tr></table>		1	1				3		2	<table border="1"><tr><td></td><td></td><td></td></tr><tr><td></td><td></td><td></td></tr><tr><td></td><td></td><td></td></tr></table>										<table border="1"><tr><td>1</td><td></td><td></td></tr><tr><td>1</td><td></td><td></td></tr><tr><td>1</td><td></td><td>2</td></tr></table>	1			1			1		2
1																																																																															
1																																																																															
		1																																																																													
1		1																																																																													
		1																																																																													
	1	1																																																																													
3		2																																																																													
1																																																																															
1																																																																															
1		2																																																																													
Post - 0 Miss - 0 Block - 0	Post - 0 Miss - 1 Block - 1	Post - 0 Miss - 0 Block - 0	Post - 1 Miss - 0 Block - 2	Post - 0 Miss - 0 Block - 0	Post - 0 Miss - 0 Block - 0	Post - 0 Miss - 0 Block - 0	Post - 1 Miss - 0 Block - 0																																																																								
12 王权	15 李安	16 张帅	17 王伟强	18 赵楠	20 顾艳超	21 刘江	22 张瑞恒																																																																								
<table border="1"><tr><td></td><td></td><td></td></tr><tr><td></td><td></td><td></td></tr><tr><td></td><td></td><td></td></tr></table>										<table border="1"><tr><td></td><td></td><td>1</td></tr><tr><td></td><td></td><td></td></tr><tr><td></td><td>1</td><td></td></tr></table>			1					1		<table border="1"><tr><td></td><td></td><td></td></tr><tr><td></td><td></td><td></td></tr><tr><td></td><td></td><td></td></tr></table>										<table border="1"><tr><td>1</td><td></td><td>1</td></tr><tr><td></td><td></td><td></td></tr><tr><td></td><td></td><td>1</td></tr></table>	1		1						1	<table border="1"><tr><td>1</td><td></td><td></td></tr><tr><td></td><td></td><td>2</td></tr><tr><td></td><td></td><td></td></tr></table>	1					2				<table border="1"><tr><td></td><td></td><td></td></tr><tr><td></td><td></td><td></td></tr><tr><td></td><td></td><td></td></tr></table>										<table border="1"><tr><td></td><td></td><td></td></tr><tr><td></td><td></td><td></td></tr><tr><td>2</td><td></td><td>1</td></tr></table>							2		1	<table border="1"><tr><td></td><td></td><td></td></tr><tr><td></td><td></td><td></td></tr><tr><td></td><td></td><td></td></tr></table>									
		1																																																																													
	1																																																																														
1		1																																																																													
		1																																																																													
1																																																																															
		2																																																																													
2		1																																																																													
Post - 0 Miss - 0 Block - 0	Post - 0 Miss - 0 Block - 0	Post - 0 Miss - 0 Block - 0	Post - 0 Miss - 0 Block - 0	Post - 0 Miss - 1 Block - 0	Post - 0 Miss - 1 Block - 1	Post - 0 Miss - 0 Block - 0	Post - 0 Miss - 0 Block - 0																																																																								

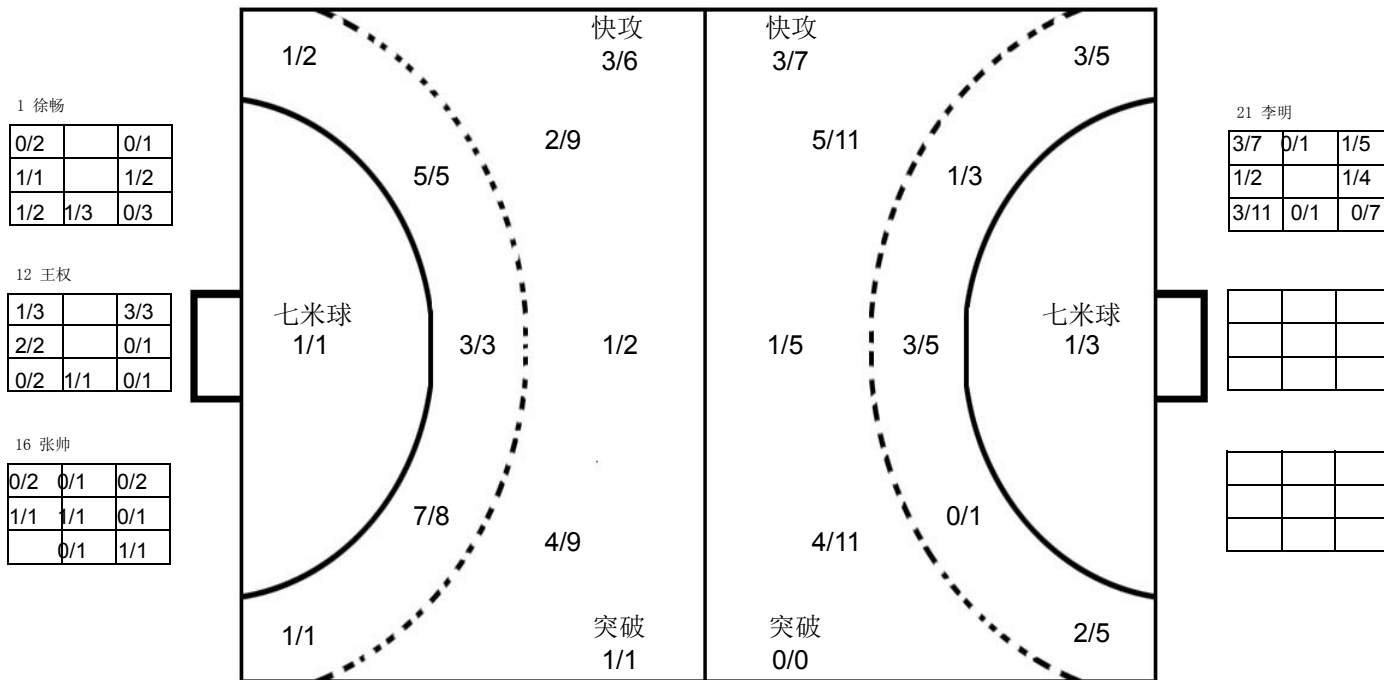

安徽队

1 郭世伟	2 金永峰	3 陈强龙	5 史小帆	7 姚雄敏	8 董智景	9 陈开勇	10 严龙																																																																								
<table border="1"><tr><td></td><td></td><td>1</td></tr><tr><td></td><td></td><td></td></tr><tr><td></td><td></td><td></td></tr></table>			1							<table border="1"><tr><td></td><td></td><td></td></tr><tr><td></td><td></td><td></td></tr><tr><td></td><td></td><td></td></tr></table>										<table border="1"><tr><td></td><td></td><td></td></tr><tr><td></td><td></td><td></td></tr><tr><td>1</td><td></td><td></td></tr></table>							1			<table border="1"><tr><td>1</td><td></td><td></td></tr><tr><td></td><td></td><td>1</td></tr><tr><td></td><td>2</td><td></td></tr></table>	1					1		2		<table border="1"><tr><td></td><td></td><td></td></tr><tr><td></td><td></td><td></td></tr><tr><td>1</td><td></td><td></td></tr></table>							1			<table border="1"><tr><td>1</td><td>1</td><td></td></tr><tr><td></td><td></td><td>2</td></tr><tr><td></td><td></td><td>2</td></tr></table>	1	1				2			2	<table border="1"><tr><td>1</td><td></td><td>1</td></tr><tr><td></td><td></td><td></td></tr><tr><td></td><td></td><td></td></tr></table>	1		1							<table border="1"><tr><td></td><td></td><td></td></tr><tr><td></td><td></td><td></td></tr><tr><td></td><td></td><td></td></tr></table>									
		1																																																																													
1																																																																															
1																																																																															
		1																																																																													
	2																																																																														
1																																																																															
1	1																																																																														
		2																																																																													
		2																																																																													
1		1																																																																													
Post - 0 Miss - 0 Block - 0	Post - 2 Miss - 0 Block - 0	Post - 0 Miss - 0 Block - 0	Post - 0 Miss - 0 Block - 0	Post - 1 Miss - 0 Block - 1	Post - 1 Miss - 2 Block - 0	Post - 0 Miss - 1 Block - 1	Post - 0 Miss - 0 Block - 0																																																																								
11 黎涛	12 曾献辰	17 王巨柱	18 李双	19 何山	21 李明	22 王金宇	23 于敏清																																																																								
<table border="1"><tr><td></td><td></td><td></td></tr><tr><td></td><td></td><td>1</td></tr><tr><td></td><td></td><td></td></tr></table>						1				<table border="1"><tr><td></td><td></td><td></td></tr><tr><td></td><td></td><td></td></tr><tr><td></td><td></td><td></td></tr></table>										<table border="1"><tr><td>1</td><td></td><td>1</td></tr><tr><td></td><td></td><td></td></tr><tr><td></td><td></td><td>1</td></tr></table>	1		1						1	<table border="1"><tr><td>1</td><td></td><td></td></tr><tr><td></td><td></td><td></td></tr><tr><td></td><td></td><td></td></tr></table>	1									<table border="1"><tr><td></td><td></td><td></td></tr><tr><td></td><td></td><td></td></tr><tr><td></td><td></td><td></td></tr></table>										<table border="1"><tr><td></td><td></td><td></td></tr><tr><td></td><td></td><td></td></tr><tr><td></td><td></td><td></td></tr></table>										<table border="1"><tr><td></td><td></td><td></td></tr><tr><td></td><td></td><td></td></tr><tr><td></td><td></td><td></td></tr></table>										<table border="1"><tr><td>1</td><td></td><td></td></tr><tr><td></td><td></td><td></td></tr><tr><td>2</td><td></td><td></td></tr></table>	1						2		
		1																																																																													
1		1																																																																													
		1																																																																													
1																																																																															
1																																																																															
2																																																																															
Post - 1 Miss - 0 Block - 0	Post - 0 Miss - 0 Block - 0	Post - 1 Miss - 1 Block - 2	Post - 0 Miss - 1 Block - 3	Post - 0 Miss - 0 Block - 0	Post - 0 Miss - 0 Block - 0	Post - 0 Miss - 0 Block - 0	Post - 1 Miss - 0 Block - 0																																																																								

注释: Post=击柱 Miss=射失 Block=被封





预赛 Group A

男子 全国比赛

2016年全国男子手球锦标赛

Team A				Team B				Match Number													
A 解放军队				B 新疆队				2													
played in		in the hall		on		at		Spectators													
China		徐闻县体育中心体育		20/10/2016		15:10 hours															
Half-time (30')	A	B	End of playing time	A	B	1st extra time	A	B	2nd extra time	A	B	After penalty throws	A	B							
	17	10		31	16																
Number of 7 m	A	Team time-out			Full name of players and officials	Team time-out			B	Number of 7 m											
		1	2	3		1	2	3													
	3/3	11:09	48:35			21:39			1/2												
No.	Team A					G	W	2'	D	DR	No.	Team B					G	W	2'	D	DR
1	李梓宁										1	宋晓晨									
2	范保坤										5	徐伟					4				
4	曹作亮					5	1	1			7	林豪文					2		1		
5	张昌轲										8	刘文宇							1		
6	吴昊					2	1				9	姜春晖					3				
7	姜钦										10	王钟彬					5				
8	王烁					5					12	王金鑫									
9	毕晓晨					11					13	苏兴伟									
11	肖东洋										15	王维东									
12	姜明										17	胡晋铭							1	1	
14	孙耀琦					3					18	姜帅					1	1			
15	杨帆					4					19	李龙吉					1	1			
16	丛霖										20	赵元							2		
18	王晓龙					1					24	王泽川									
20	刘智洋																				
B	张敬敏 (主教练)										A	孔德宾 (主教练)									
C	王学力										B	陈鹏波									
D	刘捷										C	孙均鹏									
E	刘军																				
A	Signature of Responsible Official of the Teams (Off. A)																			B	
TP	Remarks of Referee / CHA Official																			TP	

Signatures

Referees: 王科 (CHN) 倪震 (CHN)

Techn. Delegates: 许宜扬 (CHN)

CHA Official: 李兆蒙 (CHN)

Note: Number of 7m Throws Awarded to Team A and B, Goals (G), Warnings (W), Suspensions (2), Direct Disqualification (D), Disqualification with Report (DR) and Team Penalty (TP).

Table Officials: 刘晓辉 伍豪 Statisticians: 周亚桥 李双

Printed by PHMS Copyright: IHF / CHA 21/10/2016 16:21:36

Longman Sportsoft handball@126.com





## 2016年全国男子手球锦标赛 竞赛技术统计(媒体表)

预赛	组别	A	轮次	2	场次	2
----	----	---	----	---	----	---

徐闻县体育中心体育馆

20/10/2016

201606002-51-1/1

解放军队	<b>解放军</b>	<b>31</b>	vs	<b>16</b>	<b>新疆</b>	新疆队
<b>17 : 10</b>						

裁判员	王科 (CHN)	/	倪震 (CHN)
-----	----------	---	----------

解放军		远	近	边	快	突	任意	7m	合计	%	助攻	失误	警告	2'	D & DR	新疆	
主教练: 张敬敏		射	射	射	攻	破	球	球								比赛进程	
1	李祥宁											1				1st Half	
2	范保坤															4 曹作亮 1 00:30 0	
4	曹作亮	3/5	1/4			1/1			5/10	50.0		4	1	1	4 曹作亮 2 01:50 0		
5	张昌珂														8 王烁 3 04:26 1		
6	吴昊	1/1	1/2						2/3	66.7			1		8 王烁 4 05:43 2		
7	姜钦										2	1			9 毕晓晨 5 07:29 2		
8	王烁		1/1		1/1			3/3	5/5	100					15 杨帆 6 09:42 2		
9	毕晓晨		8/10	1/1	2/2			11/13	84.6			2			15 杨帆 7 10:15 3		
11	肖东洋														15 杨帆 8 12:07 3		
12	姜明														9 毕晓晨 8 13:26 4 7 林豪文		
14	孙耀琦		3/3					3/3	100			1			15 杨帆 9 14:40 4		
15	杨帆	1/1	2/3			1/1		4/5	80.0		3	1			9 毕晓晨 9 15:27 5 10 王钟彬		
16	丛霖														15 杨帆 10 16:19 5		
18	王晓龙		1/4					1/4	25.0		1				8 王烁 11 17:20 5		
20	刘智洋														9 毕晓晨 12 18:15 5		
<b>运动员 合计</b>		5/7	17/27	1/1	3/3	2/2		3/3	31/43	72.1	6	10	2	1	6 吴昊 17 00:33 11 7 林豪文		
1	李祥宁	1/4	1/3	0/2	0/2		3/3	0/1	5/15	33.3		1			4 曹作亮 19 03:36 11		
16	丛霖	0/1	5/8		0/2			1/1	6/12	50.0					14 孙耀琦 20 04:12 11		
<b>守门员 合计</b>		1/5	6/11	0/2	0/4		3/3	1/2	11/27	40.7		1			14 孙耀琦 20 05:55 12 10 王钟彬		
<b>新疆</b>		远	近	边	快	突	任意	7m	合计	%	助攻	失误	警告	2'	D & DR	9 毕晓晨 21 08:33 14	
教练: 孔德宾		射	射	射	攻	破	球	球								9 毕晓晨 21 09:28 15 10 王钟彬	
1	宋晓晨											1				18 王晓龙 22 09:49 15	
5	徐伟			1/1	3/3				4/4	100						18 王晓龙 23 12:47 15	
7	林豪文	1/1	1/3				0/1		2/5	40.0						14 孙耀琦 23 13:14 16 10 王钟彬	
8	刘文宇															4 曹作亮 25 15:51 16	
9	姜春晖	1/2	1/3	1/1	0/1				3/7	42.9		1				4 曹作亮 26 17:27 16	
10	王钟彬	2/4	2/8					1/1	5/13	38.5	1	3				9 毕晓晨 27 18:03 16	
12	王金鑫															14 孙耀琦 28 18:58 16	
13	苏兴伟															8 王烁 29 19:11 16	
15	王维东															9 毕晓晨 30 21:49 16	
17	胡晋铭											3	1	1		9 毕晓晨 31 22:40 16	
18	姜帅	0/1	1/3						1/4	25.0			1				
19	李龙吉		0/3		1/1		0/1		1/5	20.0		2	1				
20	赵元		0/1				0/1	0/1	0/3	0.0		3		2			
24	王泽川																
<b>运动员 合计</b>		4/8	5/21	2/2	4/5		0/3	1/2	16/41	39.0	1	13	3	5			
1	宋晓晨	2/5	1/9		0/2	0/1		0/3	3/20	15.0		1					
12	王金鑫	0/2	2/11	0/1	0/1	0/1			2/16	12.5							
<b>守门员 合计</b>		2/7	3/20	0/1	0/3	0/2		0/3	5/36	13.9		1					

场上队员: 得分 / 射门

守门员: 救球 / 射门

快攻	Fast Break	突破	Breakthrough	任意球	Free Throw	7M球	7M Throw	助攻	Assist
警告	Warning	失误	Error	2'	Suspension	D	取消资格	DR	取消资格+报告





### 2016年全国男子手球锦标赛 图式比赛技术统计表

轮次 2

场次 2

201606002-21-1/1

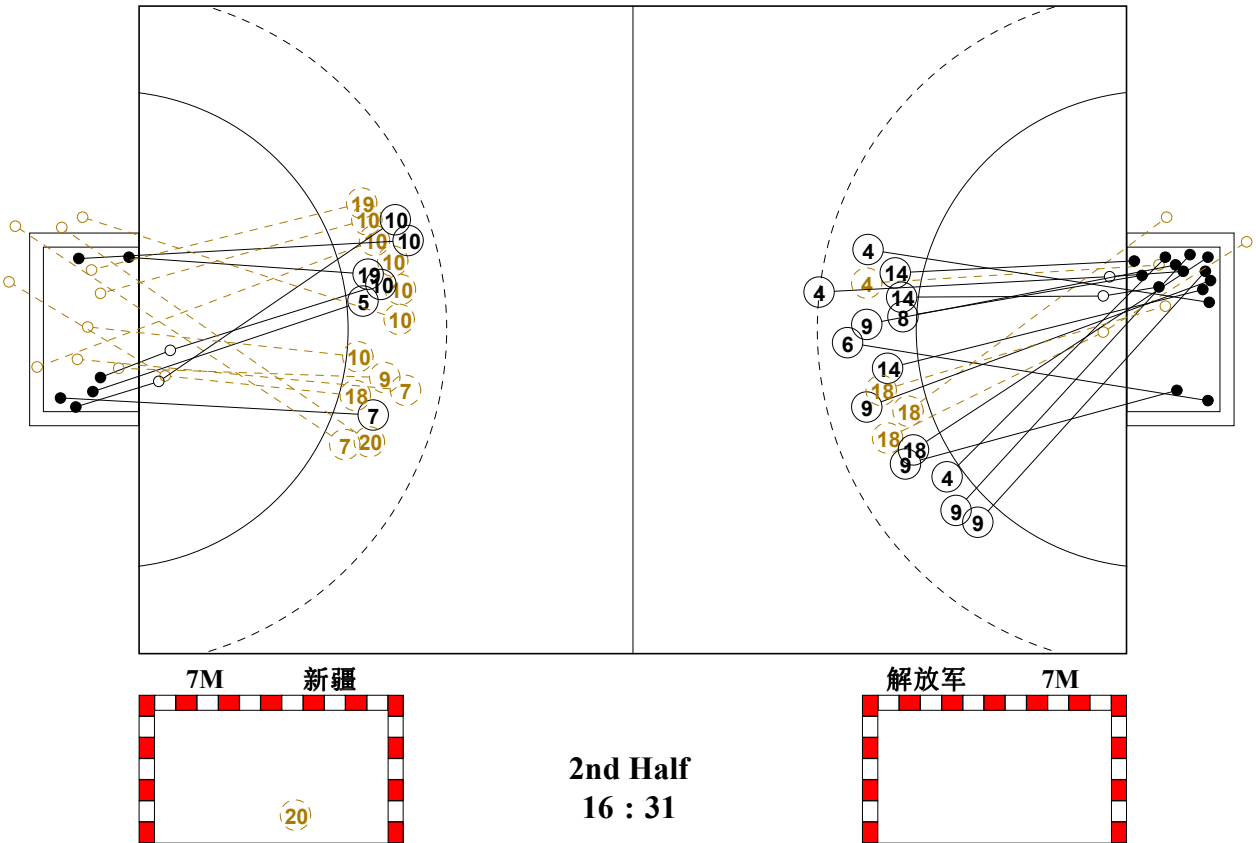
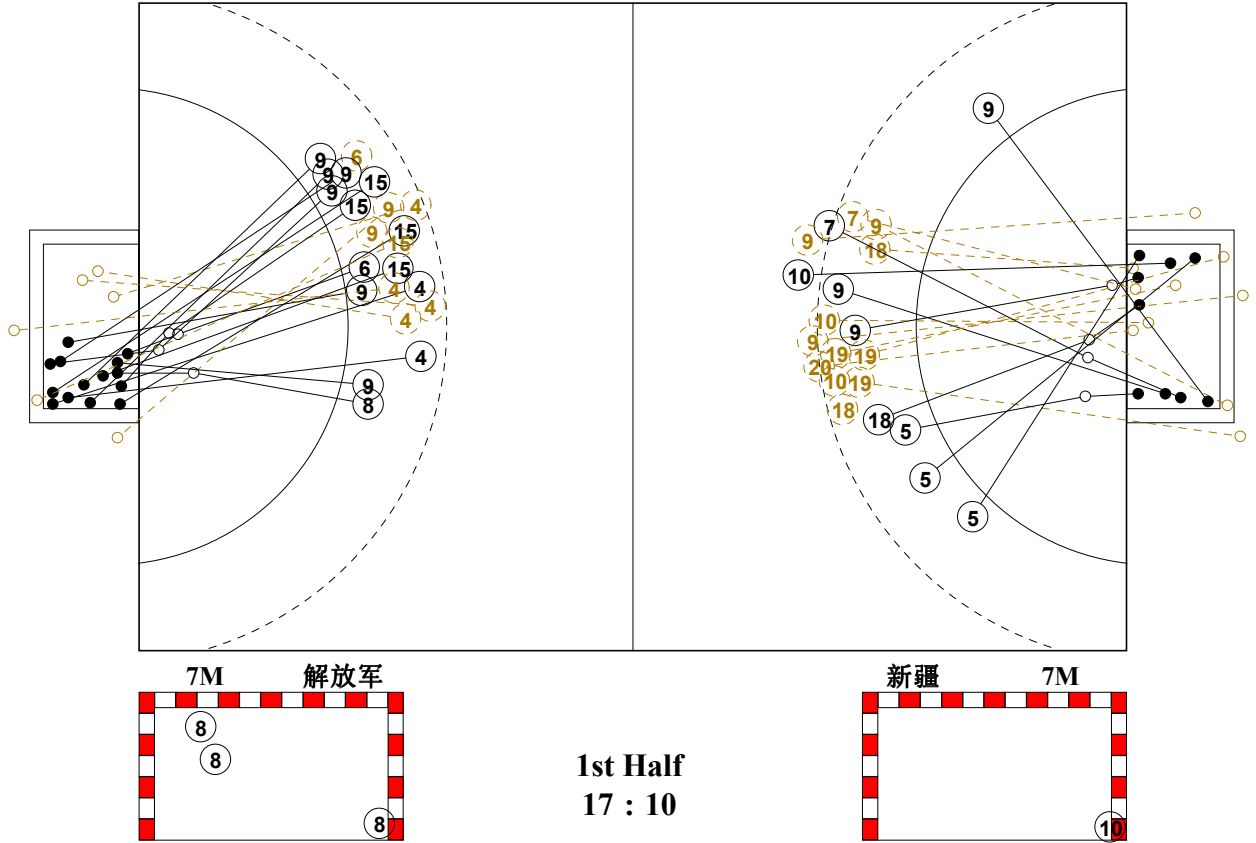



## 2016年全国男子手球锦标赛

## 个人/全队技术统计表

正式表  
手球  
男子预赛  
轮次 2组别 A  
场次 2201606002-14-1/2  
徐闻县体育中心体育馆  
20/10/2016 15:10

号码	姓名	远射	近射	边射	快攻	突破	任意	7M	合计	%	助攻	失误	警告	2'	取消	时间
<b>解放军队(解放军)</b>																
<i>(场上队员)</i>																
1	李梓宁									0.0%		1				00:30:00
2	范保坤									0.0%						00:00:00
4	曹作亮	3/5	1/4			1/1			5/10	50.0%		4	1	1		00:49:22
5	张昌轲									0.0%						00:09:23
6	吴昊	1/1	1/2						2/3	66.7%			1			00:41:52
7	姜钦									0.0%	2	1				00:23:49
8	王烁		1/1		1/1			3/3	5/5	100%						01:00:00
9	毕晓晨		8/10	1/1	2/2				11/13	84.6%		2				01:00:00
11	肖东洋									0.0%						00:11:19
12	姜明									0.0%						00:00:00
14	孙耀琦		3/3						3/3	100%		1				00:45:55
15	杨帆	1/1	2/3			1/1			4/5	80.0%	3	1				00:48:39
16	丛霖									0.0%						00:30:00
18	王晓龙		1/4						1/4	25.0%	1					00:09:27
20	刘智洋									0.0%						00:00:00
<b>合计</b>		5/7	17/27	1/1	3/3	2/2		3/3	31/43	72.1%	6	10	2	1		
<i>(守门员)</i>																
1	李梓宁	1/4	1/3	0/2	0/2		3/3	0/1	5/15	33.3%		1				00:30:00
16	丛霖	0/1	5/8		0/2			1/1	6/12	50.0%						00:30:00
<b>合计</b>		1/5	6/11	0/2	0/4		3/3	1/2	11/27	40.7%		1				

场上队员：得分/射门

守门员：救球/射门

全队合计	得分	被救	射失	击柱	封球	合计	%
远射	5	2				7	71.4%
近射	17	3	4	1	2	27	63.0%
边射	1					1	100.0%
快攻	3					3	100.0%
突破	2					2	100.0%
任意							0.0%
7M	3					3	100.0%





## 2016年全国男子手球锦标赛

## 个人/全队技术统计表

正式表  
手球  
男子预赛  
轮次 2组别 A  
场次 2201606002-14-2/2  
徐闻县体育中心体育馆  
20/10/2016 15:10

号码	姓名	远射	近射	边射	快攻	突破	任意	7M	合计	%	助攻	失误	警告	2'	取消	时间
<b>新疆队(新疆)</b>																
<i>(上场队员)</i>																
1	宋晓晨									0.0%		1				00:30:00
5	徐伟			1/1	3/3				4/4	100%						00:42:29
7	林豪文	1/1	1/3				0/1		2/5	40.0%				1		00:19:56
8	刘文宇									0.0%				1		00:16:55
9	姜春晖	1/2	1/3	1/1	0/1				3/7	42.9%		1				00:35:31
10	王钟彬	2/4	2/8					1/1	5/13	38.5%	1	3				00:50:48
12	王金鑫									0.0%						00:30:00
13	苏兴伟									0.0%						00:19:28
15	王维东									0.0%						00:09:47
17	胡晋铭									0.0%		3	1	1		00:30:12
18	姜帅	0/1	1/3						1/4	25.0%			1			00:35:03
19	李龙吉		0/3		1/1		0/1		1/5	20.0%		2	1			00:34:01
20	赵元		0/1				0/1	0/1	0/3	0.0%		3		2		00:49:06
24	王泽川									0.0%						00:16:02
<b>合计</b>		4/8	5/21	2/2	4/5		0/3	1/2	16/41	39.0%	1	13	3	5		
<i>(守门员)</i>																
1	宋晓晨	2/5	1/9		0/2	0/1		0/3	3/20	15.0%		1				00:30:00
12	王金鑫	0/2	2/11	0/1	0/1	0/1			2/16	12.5%						00:30:00
<b>合计</b>		2/7	3/20	0/1	0/3	0/2		0/3	5/36	13.9%		1				

场上队员：得分/射门

守门员：救球/射门

全队合计	得分	被救	射失	击柱	封球	合计	%
远射	4	1	1		2	8	50.0%
近射	5	6	5	3	2	21	23.8%
边射	2					2	100.0%
快攻	4		1			5	80.0%
突破							0.0%
任意		3				3	0.0%
7M	1	1				2	50.0%







### 2016年全国男子手球锦标赛

#### 图式射门区域统计

轮次 2 场次 2

201606002-41-1/1

## 解放军队

1 李梓宁	2 范保坤	4 曹作亮	5 张昌轲	6 吴昊	7 姜钦	8 王烁	9 毕晓晨																																																																								
<table border="1"><tr><td></td><td></td><td></td></tr><tr><td></td><td></td><td></td></tr><tr><td></td><td></td><td></td></tr></table>										<table border="1"><tr><td></td><td></td><td></td></tr><tr><td></td><td></td><td></td></tr><tr><td></td><td></td><td></td></tr></table>										<table border="1"><tr><td>2</td><td>1</td><td></td></tr><tr><td>2</td><td></td><td></td></tr><tr><td></td><td></td><td></td></tr></table>	2	1		2						<table border="1"><tr><td></td><td></td><td></td></tr><tr><td></td><td></td><td></td></tr><tr><td></td><td></td><td></td></tr></table>										<table border="1"><tr><td></td><td></td><td>1</td></tr><tr><td></td><td></td><td></td></tr><tr><td></td><td></td><td></td></tr></table>			1							<table border="1"><tr><td></td><td></td><td></td></tr><tr><td></td><td></td><td></td></tr><tr><td></td><td></td><td></td></tr></table>										<table border="1"><tr><td>2</td><td></td><td></td></tr><tr><td></td><td></td><td></td></tr><tr><td>2</td><td></td><td>1</td></tr></table>	2						2		1	<table border="1"><tr><td>5</td><td>1</td><td></td></tr><tr><td>3</td><td></td><td>1</td></tr><tr><td>1</td><td></td><td></td></tr></table>	5	1		3		1	1		
2	1																																																																														
2																																																																															
		1																																																																													
2																																																																															
2		1																																																																													
5	1																																																																														
3		1																																																																													
1																																																																															
Post - 0 Miss - 0 Block - 0	Post - 0 Miss - 0 Block - 0	Post - 0 Miss - 1 Block - 0	Post - 0 Miss - 0 Block - 0	Post - 0 Miss - 0 Block - 1	Post - 0 Miss - 0 Block - 0	Post - 0 Miss - 0 Block - 0	Post - 0 Miss - 1 Block - 1																																																																								
11 肖东洋	12 姜明	14 孙耀琦	15 杨帆	16 丛霖	18 王晓龙	20 刘智洋																																																																									
<table border="1"><tr><td></td><td></td><td></td></tr><tr><td></td><td></td><td></td></tr><tr><td></td><td></td><td></td></tr></table>										<table border="1"><tr><td></td><td></td><td></td></tr><tr><td></td><td></td><td></td></tr><tr><td></td><td></td><td></td></tr></table>										<table border="1"><tr><td>1</td><td></td><td></td></tr><tr><td>1</td><td></td><td></td></tr><tr><td>1</td><td></td><td></td></tr></table>	1			1			1			<table border="1"><tr><td>1</td><td></td><td></td></tr><tr><td>1</td><td></td><td></td></tr><tr><td>2</td><td></td><td></td></tr></table>	1			1			2			<table border="1"><tr><td></td><td></td><td></td></tr><tr><td></td><td></td><td></td></tr><tr><td></td><td></td><td></td></tr></table>										<table border="1"><tr><td>1</td><td></td><td></td></tr><tr><td></td><td></td><td></td></tr><tr><td></td><td></td><td></td></tr></table>	1									<table border="1"><tr><td></td><td></td><td></td></tr><tr><td></td><td></td><td></td></tr><tr><td></td><td></td><td></td></tr></table>										<table border="1"><tr><td></td><td></td><td></td></tr><tr><td></td><td></td><td></td></tr><tr><td></td><td></td><td></td></tr></table>									
1																																																																															
1																																																																															
1																																																																															
1																																																																															
1																																																																															
2																																																																															
1																																																																															
Post - 0 Miss - 0 Block - 0	Post - 0 Miss - 0 Block - 0	Post - 0 Miss - 0 Block - 0	Post - 1 Miss - 0 Block - 0	Post - 0 Miss - 0 Block - 0	Post - 0 Miss - 2 Block - 0	Post - 0 Miss - 0 Block - 0																																																																									

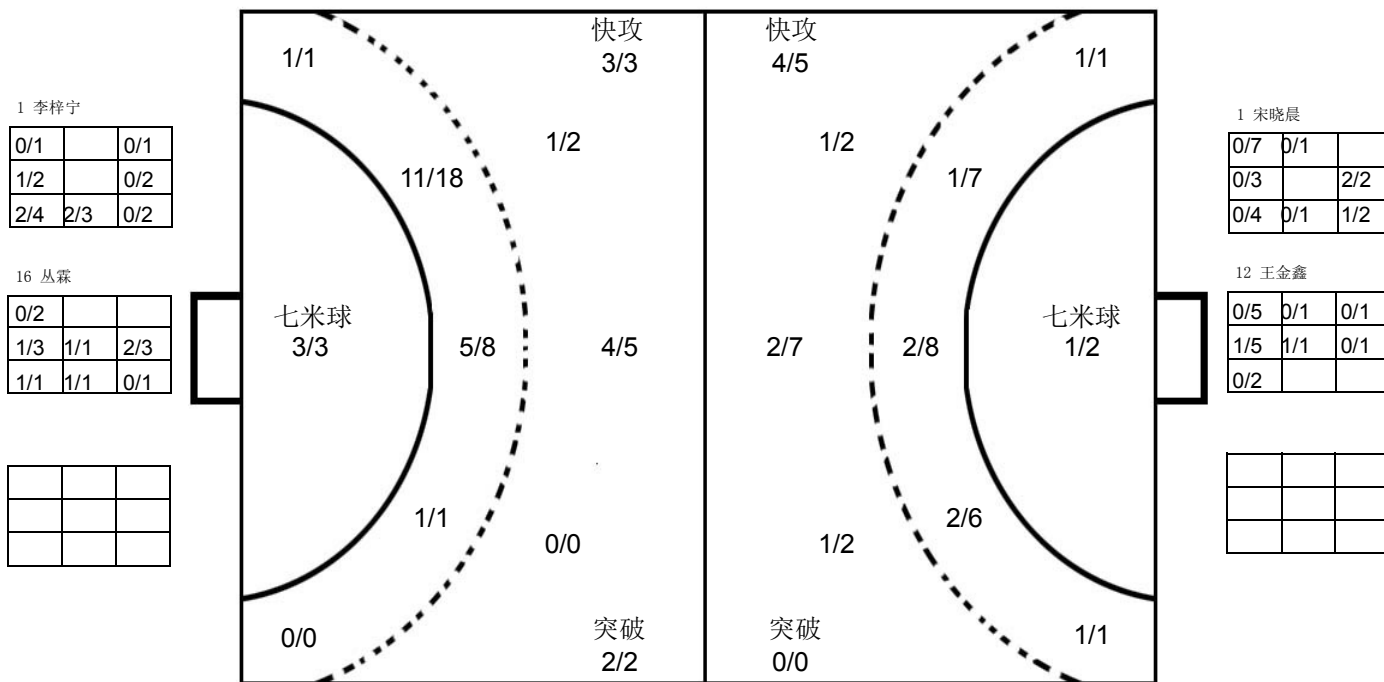

## 新疆队

1 宋晓晨	5 徐伟	7 林豪文	8 刘文宇	9 姜春晖	10 王钟彬	12 王金鑫	13 苏兴伟																																																																								
<table border="1"><tr><td></td><td></td><td></td></tr><tr><td></td><td></td><td></td></tr><tr><td></td><td></td><td></td></tr></table>										<table border="1"><tr><td>1</td><td></td><td></td></tr><tr><td>1</td><td></td><td></td></tr><tr><td>1</td><td></td><td>1</td></tr></table>	1			1			1		1	<table border="1"><tr><td>1</td><td></td><td></td></tr><tr><td></td><td></td><td>1</td></tr><tr><td></td><td></td><td></td></tr></table>	1					1				<table border="1"><tr><td></td><td></td><td></td></tr><tr><td></td><td></td><td></td></tr><tr><td></td><td></td><td></td></tr></table>										<table border="1"><tr><td></td><td></td><td>1</td></tr><tr><td></td><td></td><td>1</td></tr><tr><td>1</td><td></td><td></td></tr></table>			1			1	1			<table border="1"><tr><td>1</td><td></td><td></td></tr><tr><td>2</td><td></td><td>1</td></tr><tr><td></td><td></td><td>1</td></tr></table>	1			2		1			1	<table border="1"><tr><td></td><td></td><td></td></tr><tr><td></td><td></td><td></td></tr><tr><td></td><td></td><td></td></tr></table>										<table border="1"><tr><td></td><td></td><td></td></tr><tr><td></td><td></td><td></td></tr><tr><td></td><td></td><td></td></tr></table>									
1																																																																															
1																																																																															
1		1																																																																													
1																																																																															
		1																																																																													
		1																																																																													
		1																																																																													
1																																																																															
1																																																																															
2		1																																																																													
		1																																																																													
Post - 0 Miss - 0 Block - 0	Post - 0 Miss - 0 Block - 0	Post - 0 Miss - 1 Block - 0	Post - 0 Miss - 0 Block - 0	Post - 1 Miss - 2 Block - 0	Post - 1 Miss - 1 Block - 3	Post - 0 Miss - 0 Block - 0	Post - 0 Miss - 0 Block - 0																																																																								
15 王维东	17 胡晋铭	18 姜帅	19 李龙吉	20 赵元	24 王泽川																																																																										
<table border="1"><tr><td></td><td></td><td></td></tr><tr><td></td><td></td><td></td></tr><tr><td></td><td></td><td></td></tr></table>										<table border="1"><tr><td></td><td></td><td></td></tr><tr><td></td><td></td><td></td></tr><tr><td></td><td></td><td></td></tr></table>										<table border="1"><tr><td></td><td></td><td></td></tr><tr><td></td><td></td><td>1</td></tr><tr><td></td><td></td><td></td></tr></table>						1				<table border="1"><tr><td></td><td></td><td></td></tr><tr><td></td><td></td><td>1</td></tr><tr><td></td><td></td><td></td></tr></table>						1				<table border="1"><tr><td></td><td></td><td></td></tr><tr><td></td><td></td><td></td></tr><tr><td></td><td></td><td></td></tr></table>										<table border="1"><tr><td></td><td></td><td></td></tr><tr><td></td><td></td><td></td></tr><tr><td></td><td></td><td></td></tr></table>										<table border="1"><tr><td></td><td></td><td></td></tr><tr><td></td><td></td><td></td></tr><tr><td></td><td></td><td></td></tr></table>										<table border="1"><tr><td></td><td></td><td></td></tr><tr><td></td><td></td><td></td></tr><tr><td></td><td></td><td></td></tr></table>									
		1																																																																													
		1																																																																													
Post - 0 Miss - 0 Block - 0	Post - 0 Miss - 0 Block - 0	Post - 0 Miss - 1 Block - 1	Post - 1 Miss - 1 Block - 0	Post - 0 Miss - 1 Block - 0	Post - 0 Miss - 0 Block - 0																																																																										

注释: Post=击柱 Miss=射失 Block=被封





预赛 Group B

男子 全国比赛

2016年全国男子手球锦标赛

Team A A 四川队		Team B B 山东队		Match Number <b>3</b>	
played in China		in the hall 徐闻县体育中心体育		on 20/10/2016	
				at 16:50 hours	
Spectators					
Half-time (30')	A 10	B 20	End of playing time	A 16	B 31
1st extra time		A		B	
2nd extra time		A		B	
After penalty throws		A		B	
Number of 7 m	A 1/1	Team time-out		B 1/1	
1		2		3	
Full name of players and officials					
Team A		Team B		Team C	
No.		G	W	2'	D
1	罗尧尧	2			
3	刘赵梁	4			
7	仇瑞祥				
8	谢庆龙	2	1		
9	许翔宇				
10	徐彦昊				
11	张天豪	1	1		
12	丁大伟				
13	尹文珂	2			
15	刘劲松				
16	宋继强				
18	任启双				
19	庞连康	2			
20	徐逸				
21	马光	3			
22	张睿梁				
No.		G	W	2'	D
1	李濠壮				
3	尹杰	1			
4	田瑞	3			
5	潘翔	2	1		
6	李朝鹏	2	1		
9	赵鑫	2			
10	赵建强				
11	宋朋强	5			
12	崔剑				
13	刘晓	4			
15	张继伟		1		
16	于性哲				
17	王旭东	2	1	1	
19	李语庆	5			
21	翟乾坤				
27	于亚男	5			
B	张文韬 (主教练)				
D	胡俊杰				
A	markovic尼克				
B	王鸿斌 (主教练)				
C	刘桂妮				
D	邢建刚				
A	Signature of Responsible Official of the Teams (Off. A)				
B					
TP	Remarks of Referee / CHA Official				
TP					

Signatures

Referees	尹静阳 (CHN)	马晓晔 (CHN)		
Techn. Delegates	许宜扬 (CHN)			
CHA Official	李兆蒙 (CHN)			

Note: Number of 7m Throws Awarded to Team A and B, Goals (G), Warnings (W), Suspensions (2), Direct Disqualification (D), Disqualification with Report (DR) and Team Penalty (TP).

Table Officials: 梁小熹 鲍瑀

Statisticians: 李双

张程秀子





## 2016年全国男子手球锦标赛 竞赛技术统计(媒体表)

<b>预赛</b>	组别	<b>B</b>	轮次	<b>3</b>	场次	<b>3</b>
徐闻县体育中心体育馆			20/10/2016		201606003-51-1/1	
四川队	<i>四川</i>	<b>16</b>	vs	<b>31</b>	山东	山东队
<b>10 : 20</b>						

裁判员	尹静阳 (CHN)	/	马晓晔 (CHN)
-----	-----------	---	-----------

<i>四川</i>		远	近	边	快	突	任意	7m	合计	%	助攻	失误	警告	2'	D & DR	比赛进程	
主教练： 张文韬		射	射	射	攻	破	球	球								<i>四川</i>	<i>山东</i>
1	罗尧尧	1/3	1/2						2/5	40.0	1	1				13 尹文珂	0 00:37 1 5 潘翔
3	刘赵梁		2/6	2/2	0/1				4/9	44.4		3				1 01:49 1	1 02:16 2 27 于亚男
7	仇瑞祥	0/1		0/1					0/2	0.0		2				1 02:32 3 11 宋朋强	1 02:32 3 11 宋朋强
8	谢庆龙		2/4						2/4	50.0				1		1 03:21 4 19 李语庆	1 04:22 5 19 李语庆
9	许翔宇															1 05:35 6 5 潘翔	2 06:25 6
10	徐彦昊		0/1	0/1					0/2	0.0		2				2 07:21 7 19 李语庆	2 08:58 8 11 宋朋强
11	张天豪		0/1	1/2	0/1				1/4	25.0		2	1			2 09:46 9 6 李朝鹏	3 10:58 9
12	丁大伟															3 11:33 10 27 于亚男	3 12:06 11 19 李语庆
13	尹文珂		0/2		1/1			1/1	2/4	50.0						3 13:12 12 27 于亚男	4 13:55 12
15	刘劲松	0/1							0/1	0.0						4 14:10 13 19 李语庆	5 14:38 13
16	宋继强															6 15:36 13	6 15:36 13
18	任启双					0/1										6 18:38 14 13 刘晓	6 20:37 15 9 赵鑫
19	庞连康	1/2	1/1						2/3	66.7	1					7 21:18 15	7 22:37 16 6 李朝鹏
20	徐逸															8 23:11 16	8 24:43 17 9 赵鑫
21	马光	2/5	1/1						3/7	42.9		1				8 26:06 18 3 尹杰	8 27:25 19 13 刘晓
22	张春梁															9 27:57 19	9 28:37 20 4 田瑞
<b>运动员 合计</b>		<b>4/12</b>	<b>7/18</b>	<b>3/6</b>	<b>1/3</b>	<b>0/1</b>		<b>1/1</b>	<b>16/41</b>	<b>39.0</b>	<b>2</b>	<b>11</b>	<b>1</b>	<b>1</b>		10 29:26 20	
12	丁大伟	0/3	0/4	1/3	0/1	2/4			3/15	20.0						11 02:02 20	
22	张春梁	1/3	4/12		1/6	0/3		0/1	6/25	24.0						11 03:40 22 27 于亚男	
<b>守门员 合计</b>		<b>1/6</b>	<b>4/16</b>	<b>1/3</b>	<b>1/7</b>	<b>2/7</b>		<b>0/1</b>	<b>9/40</b>	<b>22.5</b>						12 04:17 22	
<b>2nd Half</b>																	
<i>山东</i>		远	近	边	快	突	任意	7m	合计	%	助攻	失误	警告	2'	D & DR		
教练： 王鸿斌		射	射	射	攻	破	球	球									
1	李漳壮															3 刘赵梁	15 15:39 28
3	尹杰		1/1						1/1	100						15 16:14 29 11 宋朋强	16 18:02 29
4	田瑞	2/2		1/3					3/5	60.0						16 18:20 30 13 刘晓	16 18:32 31 13 刘晓
5	潘翔		1/2		1/1				2/3	66.7			1				
6	李朝鹏	1/1	0/2		1/1	0/1			2/5	40.0		1		1			
9	赵鑫	0/2				2/2			2/4	50.0							
10	赵建强																
11	宋朋强	1/1	4/4						5/5	100	3	1					
12	崔剑																
13	刘晓	0/1	1/1		1/1	2/2			4/5	80.0	1						
15	张继伟													1			
16	于性哲																
17	王旭东	0/1		1/1	1/1				2/3	66.7	2		1	1			
19	李语庆		2/3		2/3			1/1	5/7	71.4							
21	翟乾坤											1					
27	于亚男	1/3	3/5			1/2			5/10	50.0		1					
<b>运动员 合计</b>		<b>5/11</b>	<b>12/18</b>	<b>2/4</b>	<b>6/7</b>	<b>5/7</b>		<b>1/1</b>	<b>31/48</b>	<b>64.6</b>	<b>6</b>	<b>4</b>	<b>2</b>	<b>3</b>			
12	崔剑	3/4	1/3	0/3					4/10	40.0							
16	于性哲	1/4	7/12	2/2	2/3	1/1		0/1	13/23	56.5							
<b>守门员 合计</b>		<b>4/8</b>	<b>8/15</b>	<b>2/5</b>	<b>2/3</b>	<b>1/1</b>		<b>0/1</b>	<b>17/33</b>	<b>51.5</b>							

场上队员： 得分 / 射门

守门员： 救球 / 射门

快攻	Fast Break		突破	Breakthrough		任意球	Free Throw		7M球	7M Throw		助攻	Assist
警告	Warning		失误	Error		2'	Suspension		D	取消资格		DR	取消资格+报告



### 2016年全国男子手球锦标赛 图式比赛技术统计表

轮次 3

场次 3

201606003-21-1/1

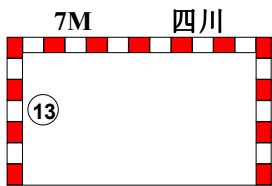
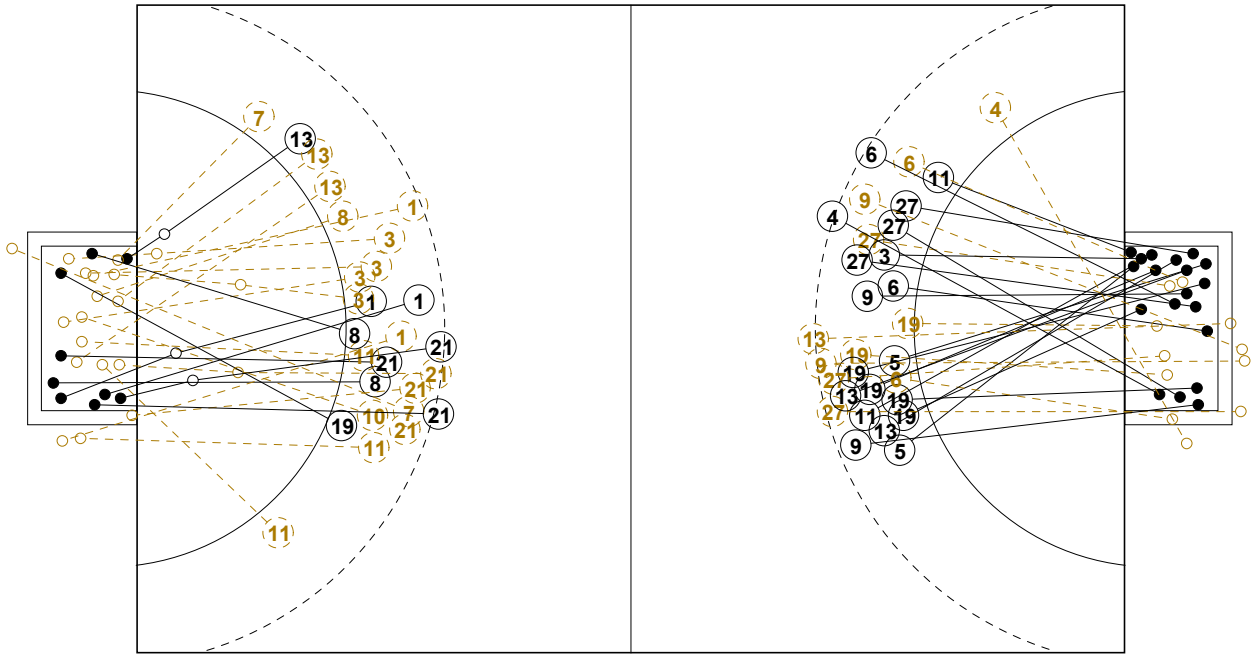

1st Half  
10 : 20

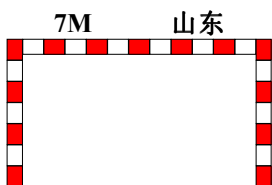
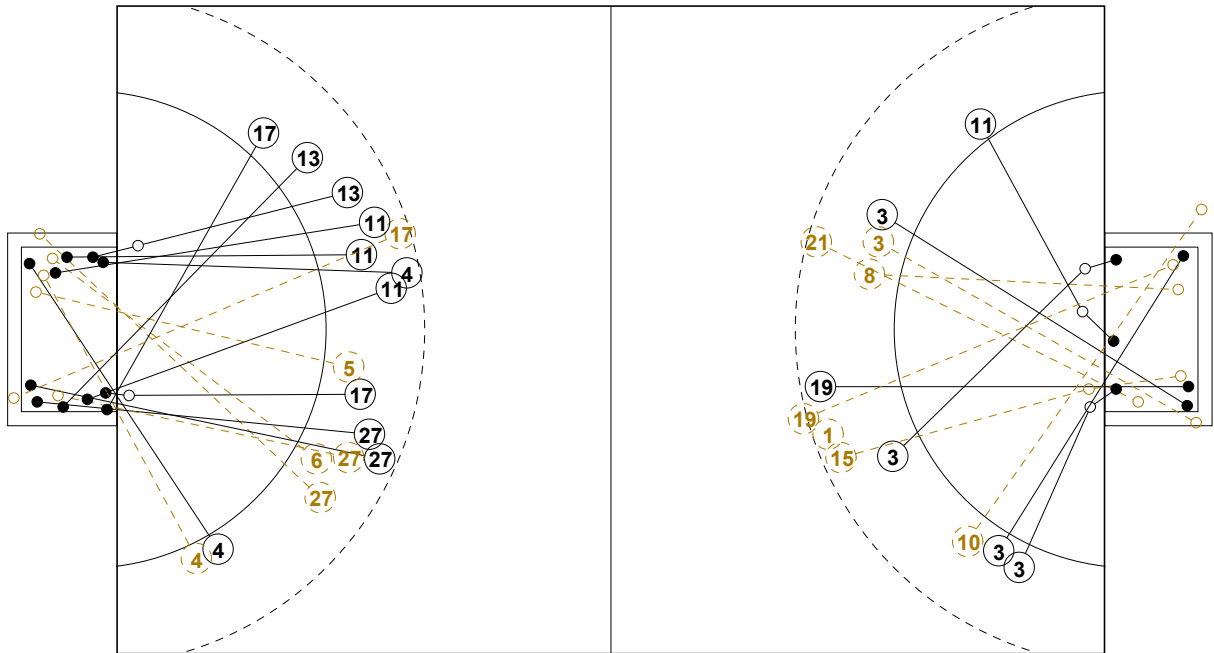
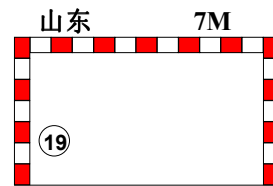

2nd Half  
31 : 16

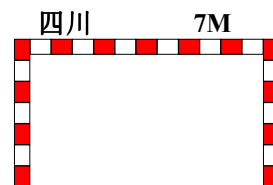



## 2016年全国男子手球锦标赛

## 个人/全队技术统计表

正式表  
手球  
男子预赛  
轮次 3组别 B  
场次 3201606003-14-1/2  
徐闻县体育中心体育馆  
20/10/2016 16:50

号码	姓名	远射	近射	边射	快攻	突破	任意	7M	合计	%	助攻	失误	警告	2'	取消	时间
<b>四川队(四川)</b>																
<i>(场上队员)</i>																
1	罗尧尧	1/3	1/2						2/5	40.0%	1	1				00:26:03
3	刘赵梁		2/6	2/2	0/1				4/9	44.4%		3				00:36:06
7	仇瑞祥	0/1		0/1					0/2	0.0%		2				00:17:08
8	谢庆龙		2/4						2/4	50.0%				1		00:29:30
9	许翔宇									0.0%						00:00:00
10	徐彦昊		0/1	0/1					0/2	0.0%		2				00:21:48
11	张天豪		0/1	1/2	0/1				1/4	25.0%		2	1			00:34:37
12	丁大伟									0.0%						00:21:51
13	尹文珂		0/2		1/1			1/1	2/4	50.0%						00:22:50
15	刘劲松	0/1							0/1	0.0%						00:21:12
16	宋继强									0.0%						00:00:00
18	任启双									0.0%						00:19:53
19	庞连康	1/2	1/1						2/3	66.7%	1					00:35:11
20	徐逸									0.0%						00:00:00
21	马光	2/5	1/1			0/1			3/7	42.9%		1				00:27:07
22	张春梁									0.0%						00:26:47
<b>合计</b>		4/12	7/18	3/6	1/3	0/1		1/1	16/41	39.0%	2	11	1	1		
<i>(守门员)</i>																
12	丁大伟	0/3	0/4	1/3	0/1	2/4			3/15	20.0%						00:21:51
22	张春梁	1/3	4/12		1/6	0/3		0/1	6/25	24.0%						00:26:47
<b>合计</b>																
		1/6	4/16	1/3	1/7	2/7		0/1	9/40	22.5%						

场上队员：得分/射门

守门员：救球/射门

全队合计	得分	被救	射失	击柱	封球	合计	%
远射	4	4	1	1	2	12	33.3%
近射	7	8	2	1		18	38.9%
边射	3	2	1			6	50.0%
快攻	1	2				3	33.3%
突破		1				1	0.0%
任意							0.0%
7M	1					1	100.0%





## 2016年全国男子手球锦标赛

## 个人/全队技术统计表

正式表  
手球  
男子预赛  
轮次 3组别 B  
场次 3201606003-14-2/2  
徐闻县体育中心体育馆  
20/10/2016 16:50

号码	姓名	远射	近射	边射	快攻	突破	任意	7M	合计	%	助攻	失误	警告	2'	取消	时间
<b>山东队(山东)</b>																
<i>(上场队员)</i>																
1	李濠壮									0.0%						00:00:00
3	尹杰		1/1						1/1	100%						00:07:17
4	田瑞	2/2		1/3					3/5	60.0%						00:14:03
5	潘翔		1/2		1/1				2/3	66.7%			1			00:33:05
6	李朝鹏	1/1	0/2		1/1	0/1			2/5	40.0%		1		1		00:30:01
9	赵鑫	0/2				2/2			2/4	50.0%						00:11:18
10	赵建强									0.0%						00:00:00
11	宋朋强	1/1	4/4						5/5	100%	3	1				00:42:30
12	崔剑									0.0%						00:18:38
13	刘晓	0/1	1/1		1/1	2/2			4/5	80.0%	1					00:19:09
15	张继伟									0.0%				1		00:15:31
16	于性哲									0.0%						00:30:00
17	王旭东	0/1		1/1	1/1				2/3	66.7%	2		1	1		00:29:26
19	李语庆		2/3		2/3			1/1	5/7	71.4%						00:41:18
21	翟乾坤									0.0%		1				00:04:32
27	于亚男	1/3	3/5			1/2			5/10	50.0%		1				00:43:26
<b>合计</b>		5/11	12/18	2/4	6/7	5/7		1/1	31/48	64.6%	6	4	2	3		
<i>(守门员)</i>																
12	崔剑	3/4	1/3	0/3					4/10	40.0%						00:18:38
16	于性哲	1/4	7/12	2/2	2/3	1/1		0/1	13/23	56.5%						00:30:00
<b>合计</b>		4/8	8/15	2/5	2/3	1/1		0/1	17/33	51.5%						

场上队员：得分/射门

守门员：救球/射门

全队合计	得分	被救	射失	击柱	封球	合计	%
远射	5	1	3	2		11	45.5%
近射	12	4		2		18	66.7%
边射	2	1	1			4	50.0%
快攻	6	1				7	85.7%
突破	5	2				7	71.4%
任意							0.0%
7M	1					1	100.0%





### 2016年全国男子手球锦标赛

#### 图式射门区域统计

轮次 3 场次 3

201606003-41-1/1

## 四川队

1 罗尧尧	3 刘赵梁	7 仇瑞祥	8 谢庆龙	9 许翔宇	10 徐彦昊	11 张天豪	12 丁大伟
1	1		1				
1							
	1					1	
Post - 0 Miss - 1 Block - 1	Post - 1 Miss - 0 Block - 0	Post - 0 Miss - 1 Block - 0	Post - 0 Miss - 0 Block - 0	Post - 0 Miss - 0 Block - 0	Post - 0 Miss - 1 Block - 0	Post - 0 Miss - 1 Block - 0	Post - 0 Miss - 0 Block - 0
13 尹文珂	15 刘劲松	16 宋继强	18 任启双	19 庞连康	20 徐逸	21 马光	22 张睿梁
					2		
1						1	
						1	
Post - 0 Miss - 0 Block - 0	Post - 0 Miss - 0 Block - 0	Post - 0 Miss - 0 Block - 0	Post - 0 Miss - 0 Block - 0	Post - 0 Miss - 0 Block - 0	Post - 0 Miss - 0 Block - 0	Post - 1 Miss - 0 Block - 1	Post - 0 Miss - 0 Block - 0

12 丁大伟	
0/3	2/4
1/1	0/3
0/3	0/1

22 张睿梁		
0/4	0/2	1/2
2/6	2/3	1/2
0/4	0/1	0/1

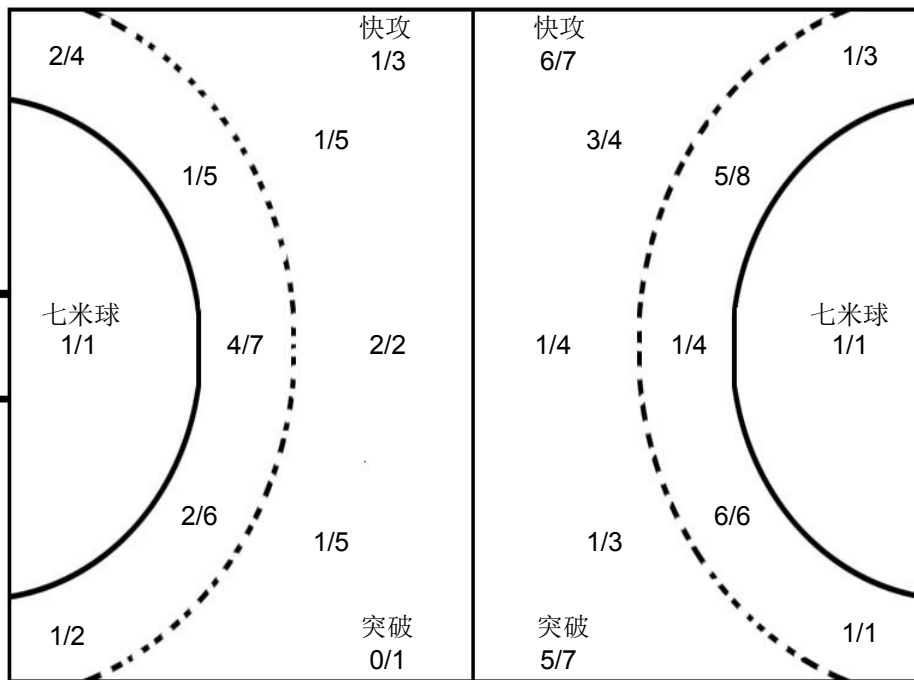
12 崔剑	
2/3	1/3
	1/1
0/1	0/1

16 于性哲		
0/2	1/2	1/2
2/5	2/2	3/4
1/2	1/1	2/3

## 山东队

1 李濠社	3 尹杰	4 田瑞	5 潘翔	6 李朝鹏	9 赵鑫	10 赵建强	11 宋朋强
		1	1	1	1		
		1		1			2
	1		1				3
Post - 0 Miss - 0 Block - 0	Post - 0 Miss - 0 Block - 0	Post - 0 Miss - 1 Block - 0	Post - 0 Miss - 0 Block - 0	Post - 1 Miss - 0 Block - 0	Post - 0 Miss - 2 Block - 0	Post - 0 Miss - 0 Block - 0	Post - 0 Miss - 0 Block - 0
12 崔剑	13 刘晓	15 张继伟	16 于性哲	17 王旭东	19 李语庆	21 翟乾坤	27 于亚男
	1				1	1	3
	2				2		1
				2	1		
Post - 0 Miss - 0 Block - 0	Post - 1 Miss - 0 Block - 0	Post - 0 Miss - 0 Block - 0	Post - 0 Miss - 0 Block - 0	Post - 1 Miss - 0 Block - 0	Post - 0 Miss - 0 Block - 0	Post - 0 Miss - 0 Block - 0	Post - 1 Miss - 1 Block - 0

注释: Post=击柱 Miss=射失 Block=被封





预赛 Group B

男子 全国比赛

2016年全国男子手球锦标赛

Team A A 浙江队				Team B B 天津队				Match Number 4													
played in China		in the hall 徐闻县体育中心体育		on 20/10/2016		at 18:30 hours		Spectators													
Half-time (30')	A 4	B 29	End of playing time	A 4	B 29	1st extra time	A	B	2nd extra time	A	B	After penalty throws	A	B							
Number of 7 m	A 1/1	Team time-out 1 06:46 2 13:12 3			Full name of players and officials				Team time-out 1 2 3			B 0/0	Number of 7 m								
No.	Team A					G	W	2'	D	DR	No.	Team B					G	W	2'	D	DR
1	李欢欢										1	刘宗其									
2	郑尧俊										2	李岳朋					2				
3	李恩铭					1	1				4	李松浩					1				
5	林先方					2					6	王子欣					1				
7	金杰										7	张青					1				
8	王浩										8	曹悦					4				
9	李家乐										9	吴明远					4				
10	罗明杰										11	王毅					2				
11	陈渝天										12	杨峻									
14	虞勇灿										13	许松					4				
15	张佩力										14	田剑侠					2				
18	倪陈辉					1					16	刘海亮									
19	徐正飞										17	周群									
24	毛军伟										18	王晓琪					4				
											21	潘玉帅					3				
											22	魏雨童					1				
B	柳佳 (主教练)										A	贾守信									
C	项建生										B	杜瑞军 (主教练)									
D	蒋云敏										C	孟凡钢									
											D	潘玉强									
											E	贾宁									
A	Signature of Responsible Official of the Teams (Off. A)																			B	
TP	Remarks of Referee / CHA Official																			TP	

Signatures

Referees: 丛艳霞 (CHN) 严璐 (CHN)

Techn. Delegates: 王科 (CHN)

CHA Official: 刘凤娟 (CHN)

Note: Number of 7m Throws Awarded to Team A and B, Goals (G), Warnings (W), Suspensions (2), Direct Disqualification (D), Disqualification with Report (DR) and Team Penalty (TP).

Table Officials: 鲍瑀

刘宇阳

Statisticians: 张程秀子

李双

Printed by PHMS Copyright: IHF / CHA 21/10/2016 16:27:37

Longman Sportsoft



handball@126.com



2016年全国男子手球锦标赛  
竞赛技术统计(媒体表)

预赛	组别	B	轮次	4	场次	4
徐闻县体育中心体育馆			20/10/2016		201606004-51-1/1	
浙江队		浙江	4	vs	29	天津队
				4 : 29		

裁判员	丛艳霞 (CHN)				/	严璐 (CHN)			
-----	-----------	--	--	--	---	----------	--	--	--

浙江		远射	近射	边射	快攻	突破	任意球	7m球	合计	%	助攻	失误	警告	2'	D & DR	浙江	比赛进程	天津
主教练：柳佳																		
1	李欢欢											1					01:53	1 8 曹悦
2	郑尧俊											2					02:32	2 8 曹悦
3	李恩铭		1/1	0/2				1/3	33.3			3	1				03:37	3 13 许松
5	林先方	0/3	1/2					1/1	2/6	33.3		4					04:21	4 2 李岳朋
7	金杰																06:05	5 13 许松
8	王浩																06:46	6 8 曹悦
9	李家乐																08:09	7 2 李岳朋
10	罗明杰	0/2	0/1					0/3	0.0		1	3					11:15	9 7 张青
11	陈渝天																11:51	10 13 许松
14	虞勇灿																12:40	11 13 许松
15	张佩力																13:11	12 6 王子欣
18	倪陈辉		1/1					1/1	100			1					13:39	13 9 吴明远
19	徐正飞	0/2						0/2	0.0			4					15:30	14 9 吴明远
24	毛军伟																16:37	15 9 吴明远
运动员 合计		0/7	3/5	0/2				1/1	4/15	26.7	1	18	1				17:27	16 9 吴明远
1	李欢欢																18:50	17 18 王晓琪
8	王浩	1/2	0/3	0/1	0/2	0/4		1/12	8.3								19:38	18 22 魏雨童
15	张佩力	0/4	0/4	0/3	0/3	0/4		0/18	0.0								20:26	19 14 田剑侠
守门员 合计		1/6	0/7	0/4	0/5	0/8		1/30	3.3								21:01	20 11 王毅

天津		远射	近射	边射	快攻	突破	任意球	7m球	合计	%	助攻	失误	警告	2'	D & DR
教练：杜瑞军															
1	刘宗其										2				
2	李岳朋	1/2	1/1					2/3	66.7		1				
4	李松浩		1/1		0/1			1/2	50.0						
6	王子欣				1/1			1/1	100						
7	张青	0/1	1/1					1/2	50.0						
8	曹悦	1/1			1/1	2/2		4/4	100	1	2				
9	吴明远			1/1	1/1	2/2		4/4	100						
11	王毅		1/1	1/1				2/2	100	1					
12	杨峻														
13	许松			1/1	0/1	3/3		4/5	80.0						
14	田剑侠		1/1		1/1			2/2	100	1	2				
16	刘海亮														
17	周群														
18	王晓琪	2/2	1/1		1/1			4/4	100						
21	潘玉帅	1/1		1/1		1/1		3/3	100						
22	魏雨童		1/1					1/1	100						
运动员 合计		5/7	7/7	4/4	5/7	8/8		29/33	87.9	6	4				
1	刘宗其	4/4	1/4	2/2				0/1	7/11	63.6	2				
守门员 合计		4/4	1/4	2/2				0/1	7/11	63.6	2				

场上队员：得分 / 射门

守门员：救球 / 射门

快攻	Fast Break		突破	Breakthrough		任意球	Free Throw		7M球	7M Throw		助攻	Assist
警告	Warning		失误	Error		2'	Suspension		D	取消资格		DR	取消资格+报告





### 2016年全国男子手球锦标赛 图式比赛技术统计表

轮次 4

场次 4

201606004-21-1/1

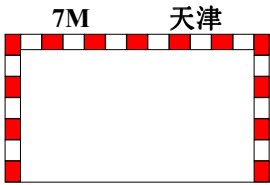
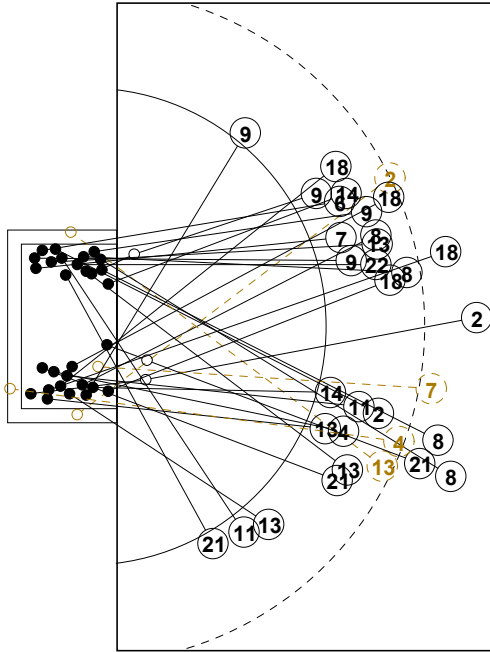

1st Half  
29 : 4

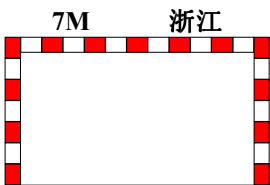
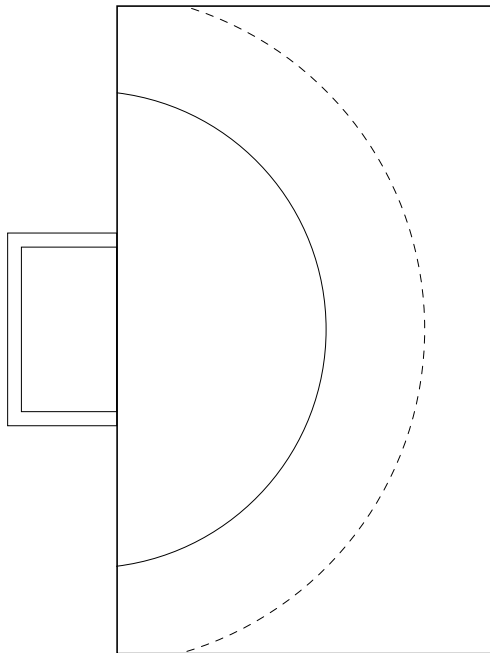
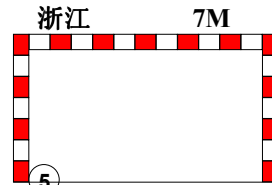
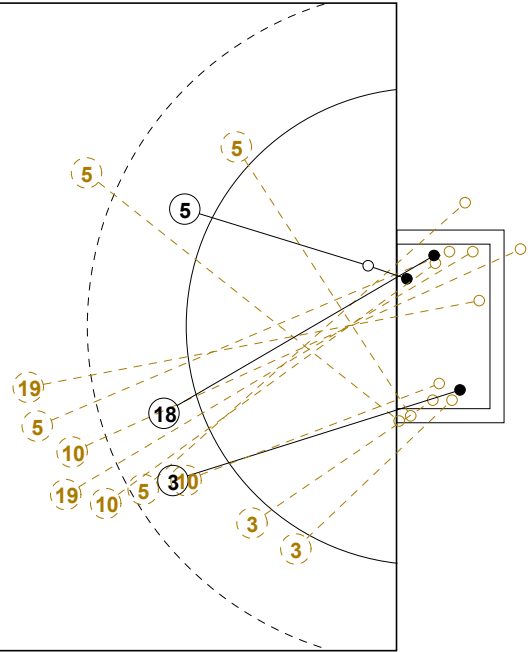

2nd Half  
4 : 29

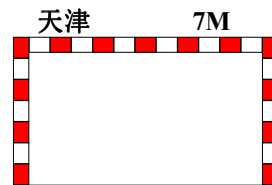
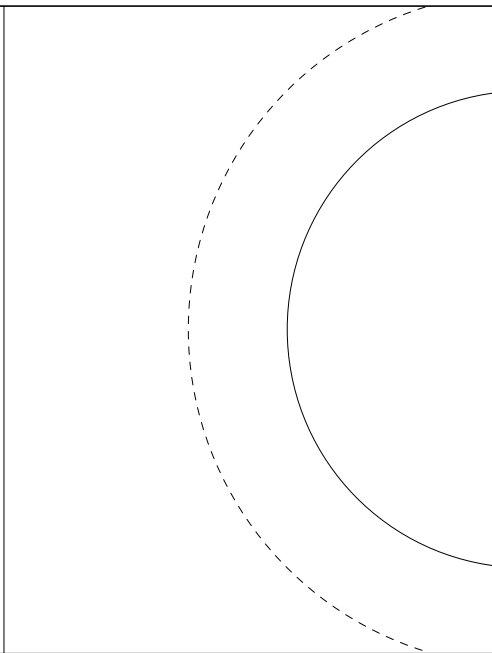



## 2016年全国男子手球锦标赛

## 个人/全队技术统计表

正式表  
手球  
男子预赛  
轮次 4组别 B  
场次 4201606004-14-1/2  
徐闻县体育中心体育馆  
20/10/2016 18:30

号码	姓名	远射	近射	边射	快攻	突破	任意	7M	合计	%	助攻	失误	警告	2'	取消	时间
<b>浙江队(浙江)</b>																
<i>(场上队员)</i>																
1	李欢欢									0.0%		1				00:19:12
2	郑尧俊									0.0%		2				00:28:41
3	李恩铭		1/1	0/2					1/3	33.3%		3	1			00:30:00
5	林先方	0/3	1/2					1/1	2/6	33.3%		4				00:28:19
7	金杰									0.0%						00:00:00
8	王浩									0.0%						00:13:21
9	李家乐									0.0%						00:00:00
10	罗明杰	0/2	0/1						0/3	0.0%	1	3				00:22:41
11	陈渝天									0.0%						00:00:00
14	虞勇灿									0.0%						00:12:28
15	张佩力									0.0%						00:19:33
18	倪陈辉		1/1						1/1	100%		1				00:24:36
19	徐正飞	0/2							0/2	0.0%		4				00:13:59
24	毛军伟									0.0%						00:00:00
<b>合计</b>																
<i>(守门员)</i>																
1	李欢欢									0.0%						00:19:12
8	王浩	1/2	0/3	0/1	0/2	0/4			1/12	8.3%						00:13:21
15	张佩力	0/4	0/4	0/3	0/3	0/4			0/18	0.0%						00:19:33
<b>合计</b>																

场上队员：得分/射门

守门员：救球/射门

全队合计	得分	被救	射失	击柱	封球	合计	%
远射		4	2	1		7	0.0%
近射	3	1		1		5	60.0%
边射		2				2	0.0%
快攻							0.0%
突破							0.0%
任意							0.0%
7M	1					1	100.0%





## 2016年全国男子手球锦标赛

## 个人/全队技术统计表

正式表  
手球  
男子预赛  
轮次 4组别 B  
场次 4201606004-14-2/2  
徐闻县体育中心体育馆  
20/10/2016 18:30

号码	姓名	远射	近射	边射	快攻	突破	任意	7M	合计	%	助攻	失误	警告	2'	取消	时间
<b>天津队(天津)</b>																
<i>(上场队员)</i>																
1	刘宗其									0.0%	2					00:30:00
2	李岳朋	1/2	1/1						2/3	66.7%	1					00:20:32
4	李松浩		1/1		0/1				1/2	50.0%						00:09:27
6	王子欣				1/1				1/1	100%						00:19:08
7	张青	0/1	1/1						1/2	50.0%						00:13:22
8	曹悦	1/1			1/1	2/2			4/4	100%	1	2				00:13:26
9	吴明远			1/1	1/1	2/2			4/4	100%						00:16:34
11	王毅		1/1	1/1					2/2	100%	1					00:11:38
12	杨峻									0.0%						00:03:48
13	许松			1/1	0/1	3/3			4/5	80.0%						00:00:30
14	田剑侠		1/1		1/1				2/2	100%	1	2				00:09:13
16	刘海亮									0.0%						00:00:00
17	周群									0.0%						00:13:24
18	王晓琪	2/2	1/1		1/1				4/4	100%						00:00:30
21	潘玉帅	1/1		1/1		1/1			3/3	100%						00:07:23
22	魏雨童		1/1						1/1	100%						00:16:36
<b>合计</b>		5/7	7/7	4/4	5/7	8/8			29/33	87.9%	6	4				
<i>(守门员)</i>																
1	刘宗其	4/4	1/4	2/2				0/1	7/11	63.6%	2					00:30:00
<b>合计</b>																
		4/4	1/4	2/2				0/1	7/11	63.6%	2					

场上队员：得分/射门

守门员：救球/射门

全队合计	得分	被救	射失	击柱	封球	合计	%
远射	5	1		1		7	71.4%
近射	7					7	100.0%
边射	4					4	100.0%
快攻	5			2		7	71.4%
突破	8					8	100.0%
任意							0.0%
7M							0.0%





2016年全国男子手球锦标赛

图式射门区域统计

轮次 4 场次 4

201606004-41-1/1

浙江队

1 李欢欢	2 郑尧俊	3 李恩铭	5 林先方	7 金杰	8 王浩	9 李家乐	10 罗明杰																																																																								
<table border="1"><tr><td></td><td></td><td></td></tr><tr><td></td><td></td><td></td></tr><tr><td></td><td></td><td></td></tr></table>										<table border="1"><tr><td></td><td></td><td></td></tr><tr><td></td><td></td><td></td></tr><tr><td></td><td></td><td></td></tr></table>										<table border="1"><tr><td></td><td></td><td>1</td></tr><tr><td></td><td></td><td></td></tr><tr><td></td><td></td><td></td></tr></table>			1							<table border="1"><tr><td></td><td></td><td></td></tr><tr><td></td><td></td><td></td></tr><tr><td></td><td></td><td>2</td></tr></table>									2	<table border="1"><tr><td></td><td></td><td></td></tr><tr><td></td><td></td><td></td></tr><tr><td></td><td></td><td></td></tr></table>										<table border="1"><tr><td></td><td></td><td></td></tr><tr><td></td><td></td><td></td></tr><tr><td></td><td></td><td></td></tr></table>										<table border="1"><tr><td></td><td></td><td></td></tr><tr><td></td><td></td><td></td></tr><tr><td></td><td></td><td></td></tr></table>										<table border="1"><tr><td></td><td></td><td></td></tr><tr><td></td><td></td><td></td></tr><tr><td></td><td></td><td></td></tr></table>									
		1																																																																													
		2																																																																													
Post - 0 Miss - 0 Block - 0	Post - 0 Miss - 0 Block - 0	Post - 0 Miss - 0 Block - 0	Post - 2 Miss - 1 Block - 0	Post - 0 Miss - 0 Block - 0	Post - 0 Miss - 0 Block - 0	Post - 0 Miss - 0 Block - 0	Post - 0 Miss - 1 Block - 0																																																																								
11 陈渝天	14 虞勇灿	15 张佩力	18 倪陈辉	19 徐正飞	24 毛军伟																																																																										
<table border="1"><tr><td></td><td></td><td></td></tr><tr><td></td><td></td><td></td></tr><tr><td></td><td></td><td></td></tr></table>										<table border="1"><tr><td></td><td></td><td></td></tr><tr><td></td><td></td><td></td></tr><tr><td></td><td></td><td></td></tr></table>										<table border="1"><tr><td></td><td></td><td></td></tr><tr><td></td><td></td><td></td></tr><tr><td></td><td></td><td></td></tr></table>										<table border="1"><tr><td></td><td></td><td>1</td></tr><tr><td></td><td></td><td></td></tr><tr><td></td><td></td><td></td></tr></table>			1							<table border="1"><tr><td></td><td></td><td></td></tr><tr><td></td><td></td><td></td></tr><tr><td></td><td></td><td></td></tr></table>										<table border="1"><tr><td></td><td></td><td></td></tr><tr><td></td><td></td><td></td></tr><tr><td></td><td></td><td></td></tr></table>																													
		1																																																																													
Post - 0 Miss - 0 Block - 0	Post - 0 Miss - 0 Block - 0	Post - 0 Miss - 0 Block - 0	Post - 0 Miss - 0 Block - 0	Post - 0 Miss - 0 Block - 0	Post - 0 Miss - 0 Block - 0																																																																										

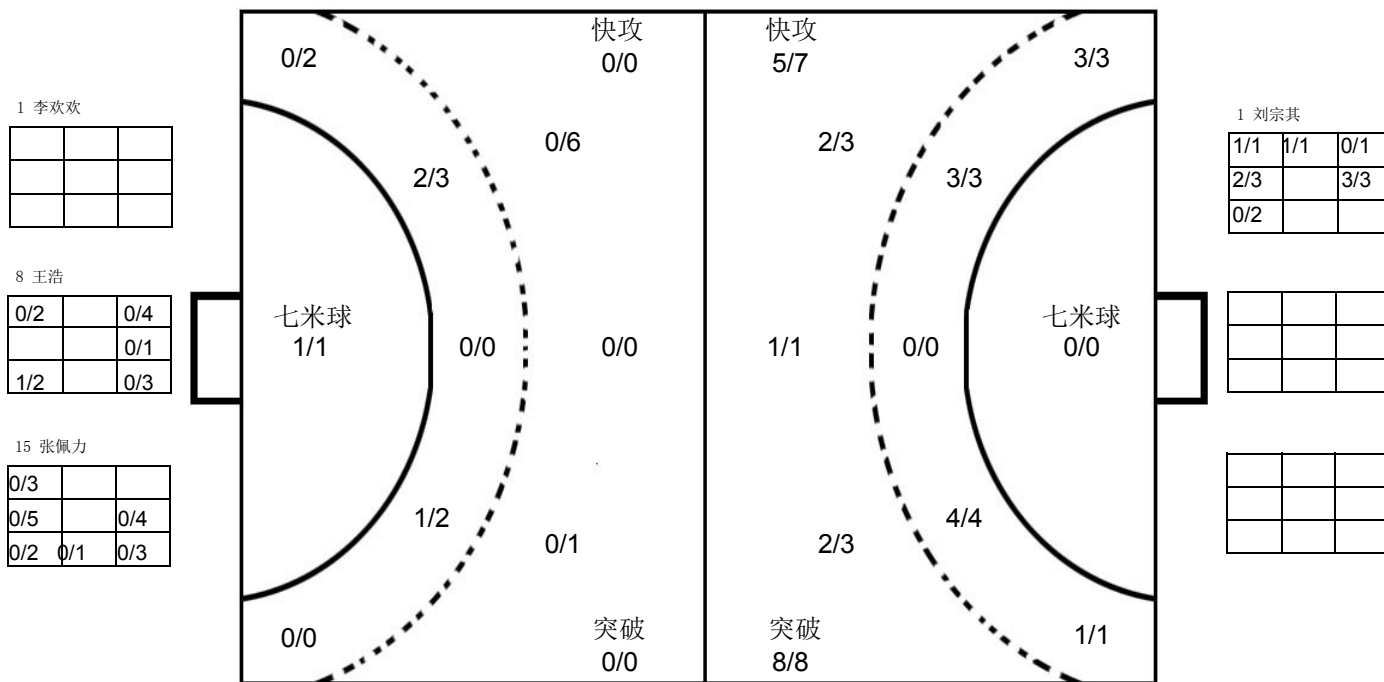

天津队

1 刘宗其	2 李岳朋	4 李松浩	6 王子欣	7 张青	8 曹悦	9 吴明远	11 王毅																																																																								
<table border="1"><tr><td></td><td></td><td></td></tr><tr><td></td><td></td><td></td></tr><tr><td></td><td></td><td></td></tr></table>										<table border="1"><tr><td>1</td><td></td><td></td></tr><tr><td></td><td></td><td>1</td></tr><tr><td></td><td></td><td></td></tr></table>	1					1				<table border="1"><tr><td>1</td><td></td><td></td></tr><tr><td></td><td></td><td></td></tr><tr><td></td><td></td><td></td></tr></table>	1									<table border="1"><tr><td></td><td></td><td>1</td></tr><tr><td></td><td></td><td></td></tr><tr><td></td><td></td><td></td></tr></table>			1							<table border="1"><tr><td></td><td></td><td>1</td></tr><tr><td></td><td></td><td></td></tr><tr><td></td><td></td><td></td></tr></table>			1							<table border="1"><tr><td></td><td></td><td></td></tr><tr><td>1</td><td></td><td>1</td></tr><tr><td></td><td></td><td>2</td></tr></table>				1		1			2	<table border="1"><tr><td></td><td></td><td>1</td></tr><tr><td></td><td></td><td></td></tr><tr><td>1</td><td></td><td>2</td></tr></table>			1				1		2	<table border="1"><tr><td></td><td></td><td></td></tr><tr><td>1</td><td></td><td>1</td></tr><tr><td></td><td></td><td></td></tr></table>				1		1			
1																																																																															
		1																																																																													
1																																																																															
		1																																																																													
		1																																																																													
1		1																																																																													
		2																																																																													
		1																																																																													
1		2																																																																													
1		1																																																																													
Post - 0 Miss - 0 Block - 0	Post - 1 Miss - 0 Block - 0	Post - 1 Miss - 0 Block - 0	Post - 0 Miss - 0 Block - 0	Post - 0 Miss - 0 Block - 0	Post - 0 Miss - 0 Block - 0	Post - 0 Miss - 0 Block - 0	Post - 0 Miss - 0 Block - 0																																																																								
12 杨峻	13 许松	14 田剑侠	16 刘海亮	17 周群	18 王晓琪	21 潘玉帅	22 魏雨童																																																																								
<table border="1"><tr><td></td><td></td><td></td></tr><tr><td></td><td></td><td></td></tr><tr><td></td><td></td><td></td></tr></table>										<table border="1"><tr><td>1</td><td></td><td>1</td></tr><tr><td>1</td><td></td><td></td></tr><tr><td></td><td></td><td>1</td></tr></table>	1		1	1					1	<table border="1"><tr><td></td><td></td><td></td></tr><tr><td></td><td></td><td></td></tr><tr><td>1</td><td></td><td>1</td></tr></table>							1		1	<table border="1"><tr><td></td><td></td><td></td></tr><tr><td></td><td></td><td></td></tr><tr><td></td><td></td><td></td></tr></table>										<table border="1"><tr><td></td><td></td><td></td></tr><tr><td></td><td></td><td></td></tr><tr><td></td><td></td><td></td></tr></table>										<table border="1"><tr><td></td><td></td><td></td></tr><tr><td>1</td><td></td><td></td></tr><tr><td>2</td><td></td><td></td></tr></table>				1			2			<table border="1"><tr><td></td><td></td><td></td></tr><tr><td>1</td><td></td><td></td></tr><tr><td></td><td></td><td>1</td></tr></table>				1					1	<table border="1"><tr><td></td><td></td><td></td></tr><tr><td></td><td></td><td></td></tr><tr><td></td><td></td><td>1</td></tr></table>									1
1		1																																																																													
1																																																																															
		1																																																																													
1		1																																																																													
1																																																																															
2																																																																															
1																																																																															
		1																																																																													
		1																																																																													
Post - 0 Miss - 0 Block - 0	Post - 1 Miss - 0 Block - 0	Post - 0 Miss - 0 Block - 0	Post - 0 Miss - 0 Block - 0	Post - 0 Miss - 0 Block - 0	Post - 0 Miss - 0 Block - 0	Post - 0 Miss - 0 Block - 0	Post - 0 Miss - 0 Block - 0																																																																								

注释: Post=击柱 Miss=射失 Block=被封





预赛 Group B

男子 全国比赛

2016年全国男子手球锦标赛

Team A				Team B				Match Number													
A 上海队				B 广东队				5													
played in		in the hall		on		at		Spectators													
China		徐闻县体育中心体育		20/10/2016		20:30		hours													
Half-time (30')	A	B	End of playing time		A	B	1st extra time	A	B	2nd extra time	A	B	After penalty throws	A	B						
	8	8			19	21															
Number of 7 m	A	Team time-out			Full name of players and officials						Team time-out			B	Number of 7 m						
		1	2	3							1	2	3								
	1/3	14:20	44:32	57:37							15:41	38:36	59:07	2/3							
No.	Team A					G	W	2'	D	DR	No.	Team B					G	W	2'	D	DR
1	张崢										1	王泽润									
2	张文斌										2	孙江山					7				
3	赵时俊										3	曲汝洋					2				
4	徐俊吉					1	1				4	李卓洋					2	1			
7	吴双										5	侯生升					4		1		
8	钱为玮					4		2			7	付云博					1				
10	董凯										8	于彦江									
11	蒋承骅					2					10	周仲坤									
12	周哲韬										11	房友屯									
14	沈吉磊					1					12	林子健									
15	朱世杰					2	1				13	王立隆									
16	朱春雷										15	张建杰									
17	贺政					1					16	马跃									
18	马麟晓					7					17	李中洲					5	1			
33	吴璟					1					20	黄培杰									
											84	王伟									
A	吴龙基 (主教练)										B	王锋 (主教练)									
B	张勇军										C	刘康伶									
C	金迪琦										D	张广建									
E	杨时										E	王永存									
A	Signature of Responsible Official of the Teams (Off. A)																		B		
TP	Remarks of Referee / CHA Official																		TP		

Signatures

Referees	李兆蒙 (CHN)	周云磊 (CHN)		
Techn. Delegates	王科 (CHN)			
CHA Official	刘凤娟 (CHN)			

Note: Number of 7m Throws Awarded to Team A and B, Goals (G), Warnings (W), Suspensions (2), Direct Disqualification (D), Disqualification with Report (DR) and Team Penalty (TP).

Table Officials: 伍豪

刘正松

Statisticians: 李双

张程秀子





## 2016年全国男子手球锦标赛 竞赛技术统计(媒体表)

预赛	组别	B	轮次	5	场次	5
徐闻县体育中心体育馆			20/10/2016		201606005-51-1/1	
上海队	上海	19	vs	21	广东	广东队
8 : 8						

裁判员	李兆蒙 (CHN)	/	周云磊 (CHN)
-----	-----------	---	-----------

上海		远	近	边	快	突	任意	7m	合计	%	助攻	失误	警告	2'	D & DR	上海		比赛	广东	
主教练： 吴龙基		射	射	射	攻	破	球	球								进程				
1	张崢																1st Half	1	5	侯生升
2	张文斌																04:58	2	2	孙江山
3	赵时俊																07:19	3	2	孙江山
4	徐俊吉	0/1	1/1					0/1	1/3	33.3			1				09:07	3	2	孙江山
7	吴双																09:39	3	3	
8	钱为玮	0/2	2/2	2/2	0/1				4/7	57.1		3		2			11:12	4	2	孙江山
10	董凯																11:38	4	4	
11	蒋承骅	0/1	0/1	1/1	1/1				2/4	50.0		2					13:06	5	5	侯生升
12	周哲韬																15:47	5	5	侯生升
14	沈吉磊		1/1						1/1	100							16:24	6	6	侯生升
15	朱世杰	0/5	2/3						2/8	25.0		2	1				16:59	6	6	
16	朱春雷																17:49	6	6	
17	贺政	0/1		0/1	1/3				1/5	20.0							20:09	6	6	
18	马麟晓	5/11					1/2	1/1	7/14	50.0	2	4					20:47	7	5	侯生升
33	吴璟		1/1					0/1	1/2	50.0							21:33	7	7	
<b>运动员 合计</b>		5/21	7/9	3/4	2/5		1/2	1/3	19/44	43.2	2	11	2	2			22:08	7	7	
1	张崢	0/1			0/1			0/1	0/3	0.0							27:20	8	4	李卓洋
12	周哲韬	3/4	6/13	2/8	0/3			0/1	11/29	37.9										
<b>守门员 合计</b>		3/5	6/13	2/8	0/4			0/2	11/32	34.4										
广东		远	近	边	快	突	任意	7m	合计	%	助攻	失误	警告	2'	D & DR	2nd Half				
教练： 王锋		射	射	射	攻	破	球	球								进程				
1	王泽润																00:42	9	2	孙江山
2	孙江山		3/4	3/4	1/1				7/9	77.8		3					01:12	9	3	曲汝洋
3	曲汝洋	0/1	1/2	0/1	1/1				2/5	40.0	3	5					02:06	10	17	李中洲
4	李卓洋	1/4	1/2						2/6	33.3	1	2	1				03:21	10	10	
5	侯生升	0/1	1/3	2/2	1/1				4/7	57.1				1			04:29	10	10	
7	付云博	0/1	1/1						1/2	50.0							05:36	10	10	
8	于彦江																07:13	10	10	
10	周仲坤																08:26	10	10	
11	房友屯																09:03	11	7	付云博
12	林子健																10:38	11	11	
13	王立隆																11:22	12	2	孙江山
15	张建杰																13:33	13	3	曲汝洋
16	马跃																15:41	14	4	李卓洋
17	李中洲	1/2	0/2	1/1	1/1			2/3	5/9	55.6	1	4	1				18:42	15	17	李中洲
20	黄培杰								0/2	0.0							19:59	16	17	李中洲
84	王伟		0/2														23:01	17	2	孙江山
<b>运动员 合计</b>		2/9	7/16	6/8	4/4			2/3	21/40	52.5	5	15	2	1			24:22	18	17	李中洲
16	马跃	9/14	2/9	0/3	2/4		0/1	1/2	14/33	42.4							24:54	18	18	
<b>守门员 合计</b>		9/14	2/9	0/3	2/4		0/1	1/2	14/33	42.4							25:26	19	3	曲汝洋
<b>场上队员： 得分 / 射门</b>																<b>守门员： 救球 / 射门</b>				

快攻	Fast Break		突破	Breakthrough		任意球	Free Throw		7M球	7M Throw		助攻	Assist
警告	Warning		失误	Error		2'	Suspension		D	取消资格		DR	取消资格+报告



### 2016年全国男子手球锦标赛 图式比赛技术统计表

轮次 5

场次 5

201606005-21-1/1

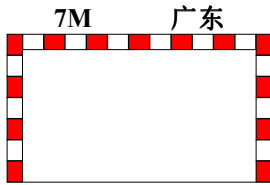
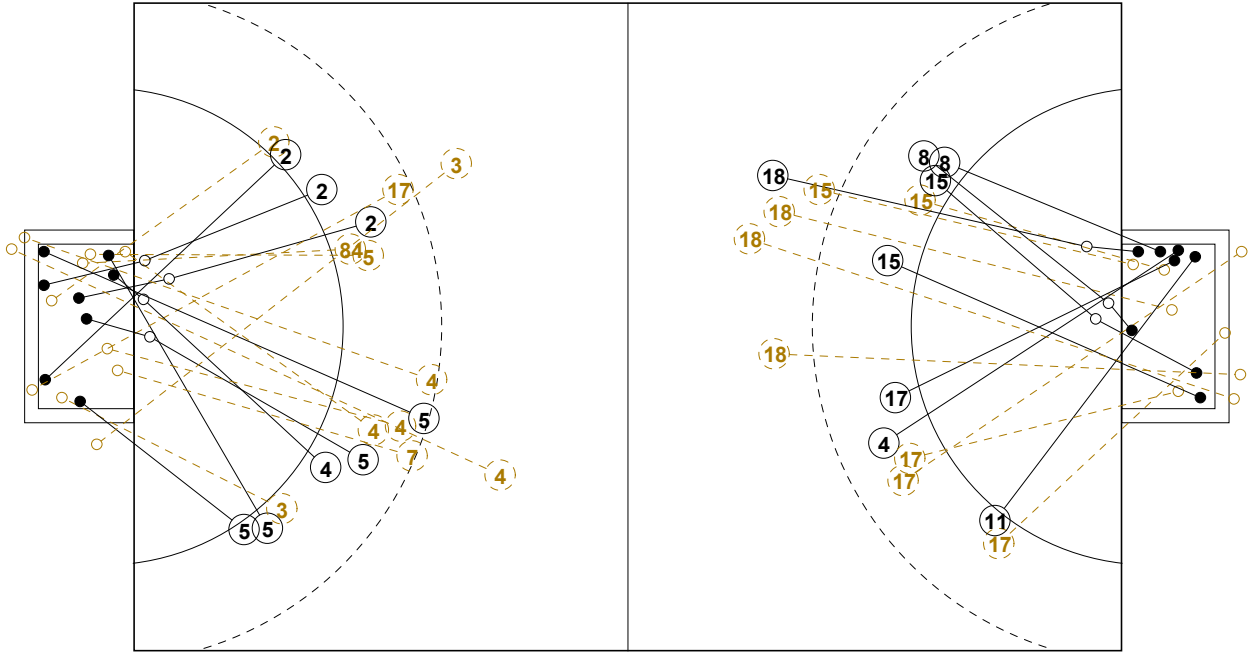

1st Half  
8 : 8

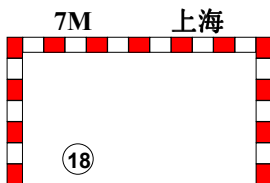
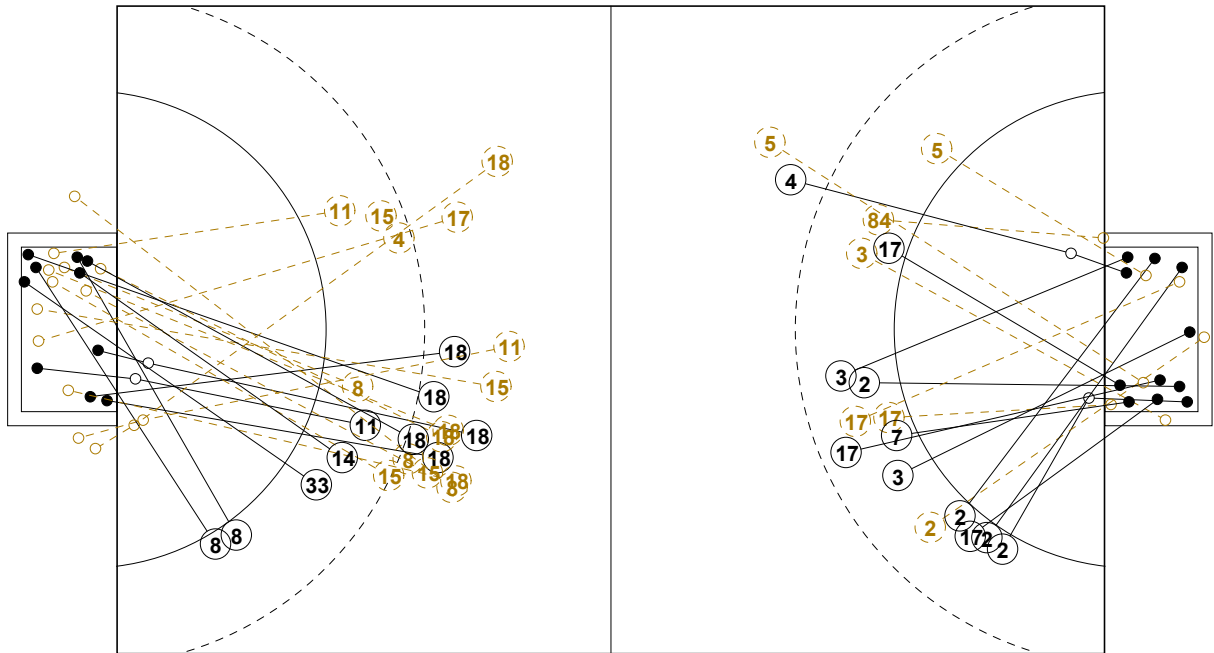
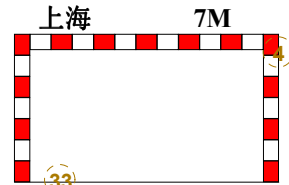

2nd Half  
19 : 21

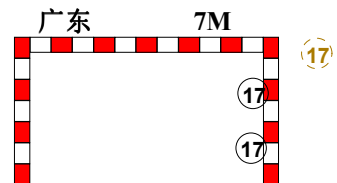





## 2016年全国男子手球锦标赛

## 个人/全队技术统计表

正式表  
手球  
男子预赛  
轮次 5组别 B  
场次 5201606005-14-1/2  
徐闻县体育中心体育馆  
20/10/2016 20:30

号码	姓名	远射	近射	边射	快攻	突破	任意	7M	合计	%	助攻	失误	警告	2'	取消	时间
<b>上海队(上海)</b>																
<i>(场上队员)</i>																
1	张崢									0.0%						00:02:09
2	张文斌									0.0%						00:00:00
3	赵时俊									0.0%						00:00:30
4	徐俊吉	0/1	1/1					0/1	1/3	33.3%			1			01:11:15
7	吴双									0.0%						00:06:47
8	钱为玮	0/2	2/2	2/2	0/1				4/7	57.1%		3		2		01:00:00
10	董凯									0.0%						00:00:00
11	蒋承骅	0/1	0/1	1/1	1/1				2/4	50.0%		2				00:53:12
12	周哲韬									0.0%						00:57:51
14	沈吉磊		1/1						1/1	100%						00:04:32
15	朱世杰	0/5	2/3						2/8	25.0%		2	1			00:55:28
16	朱春雷									0.0%						00:00:00
17	贺政	0/1		0/1	1/3				1/5	20.0%						00:59:36
18	马麟晓	5/11					1/2	1/1	7/14	50.0%	2	4				01:00:00
33	吴璟		1/1					0/1	1/2	50.0%						00:14:15
<b>合计</b>		5/21	7/9	3/4	2/5		1/2	1/3	19/44	43.2%	2	11	2	2		
<i>(守门员)</i>																
1	张崢	0/1			0/1			0/1	0/3	0.0%						00:02:09
12	周哲韬	3/4	6/13	2/8	0/3			0/1	11/29	37.9%						00:57:51
<b>合计</b>		3/5	6/13	2/8	0/4			0/2	11/32	34.4%						

场上队员：得分/射门

守门员：救球/射门

全队合计	得分	被救	射失	击柱	封球	合计	%
远射	5	9	4		3	21	23.8%
近射	7	2				9	77.8%
边射	3			1		4	75.0%
快攻	2	2	1			5	40.0%
突破							0.0%
任意	1		1			2	50.0%
7M	1	1		1		3	33.3%





## 2016年全国男子手球锦标赛

## 个人/全队技术统计表

正式表  
手球  
男子预赛  
轮次 5组别 B  
场次 5201606005-14-2/2  
徐闻县体育中心体育馆  
20/10/2016 20:30

号码	姓名	远射	近射	边射	快攻	突破	任意	7M	合计	%	助攻	失误	警告	2'	取消	时间
<b>广东队(广东)</b>																
<i>(上场队员)</i>																
1	王泽润									0.0%						00:00:00
2	孙江山		3/4	3/4	1/1				7/9	77.8%		3				01:00:00
3	曲汝洋	0/1	1/2	0/1	1/1				2/5	40.0%	3	5				00:52:34
4	李卓洋	1/4	1/2						2/6	33.3%	1	2	1			00:57:57
5	侯生升	0/1	1/3	2/2	1/1				4/7	57.1%				1		01:00:00
7	付云博	0/1	1/1						1/2	50.0%						00:15:26
8	于彦江									0.0%						00:00:00
10	周仲坤									0.0%						00:00:00
11	房友屯									0.0%						00:00:00
12	林子健									0.0%						00:00:00
13	王立隆									0.0%						00:00:00
15	张建杰									0.0%						00:00:00
16	马跃									0.0%						01:00:00
17	李中洲	1/2	0/2	1/1	1/1			2/3	5/9	55.6%	1	4	1			00:53:54
20	黄培杰									0.0%						00:00:00
84	王伟		0/2						0/2	0.0%		1				01:00:00
<b>合计</b>		2/9	7/16	6/8	4/4			2/3	21/40	52.5%	5	15	2	1		
<i>(守门员)</i>																
16	马跃	9/14	2/9	0/3	2/4		0/1	1/2	14/33	42.4%						01:00:00
<b>合计</b>																
		9/14	2/9	0/3	2/4		0/1	1/2	14/33	42.4%						

场上队员：得分/射门

守门员：救球/射门

全队合计	得分	被救	射失	击柱	封球	合计	%
远射	2	3	2	2		9	22.2%
近射	7	6		3		16	43.8%
边射	6	2				8	75.0%
快攻	4					4	100.0%
突破							0.0%
任意							0.0%
7M	2		1			3	66.7%





### 2016年全国男子手球锦标赛

#### 图式射门区域统计

轮次 5 场次 5

201606005-41-1/1

## 上海队

1 张峥	2 张文斌	3 赵时俊	4 徐俊吉	7 吴双	8 钱为玮	10 董凯	11 蒋承骅																																																																								
<table border="1"><tr><td></td><td></td><td></td></tr><tr><td></td><td></td><td></td></tr><tr><td></td><td></td><td></td></tr></table>										<table border="1"><tr><td></td><td></td><td></td></tr><tr><td></td><td></td><td></td></tr><tr><td></td><td></td><td></td></tr></table>										<table border="1"><tr><td></td><td></td><td></td></tr><tr><td></td><td></td><td></td></tr><tr><td></td><td></td><td></td></tr></table>										<table border="1"><tr><td></td><td></td><td></td></tr><tr><td>1</td><td></td><td></td></tr><tr><td></td><td></td><td></td></tr></table>				1						<table border="1"><tr><td></td><td></td><td></td></tr><tr><td></td><td></td><td></td></tr><tr><td></td><td></td><td></td></tr></table>										<table border="1"><tr><td></td><td></td><td>1</td></tr><tr><td>1</td><td></td><td>1</td></tr><tr><td></td><td>1</td><td></td></tr></table>			1	1		1		1		<table border="1"><tr><td></td><td></td><td></td></tr><tr><td></td><td></td><td></td></tr><tr><td></td><td></td><td></td></tr></table>										<table border="1"><tr><td></td><td></td><td>2</td></tr><tr><td></td><td></td><td></td></tr><tr><td></td><td></td><td></td></tr></table>			2						
1																																																																															
		1																																																																													
1		1																																																																													
	1																																																																														
		2																																																																													
Post - 0 Miss - 0 Block - 0	Post - 0 Miss - 0 Block - 0	Post - 0 Miss - 0 Block - 0	Post - 1 Miss - 0 Block - 1	Post - 0 Miss - 0 Block - 0	Post - 0 Miss - 1 Block - 1	Post - 0 Miss - 0 Block - 0	Post - 0 Miss - 1 Block - 0																																																																								
12 周哲韬	14 沈吉磊	15 朱世杰	16 朱春雷	17 贺政	18 马麟晓	33 吴璟																																																																									
<table border="1"><tr><td></td><td></td><td></td></tr><tr><td></td><td></td><td></td></tr><tr><td></td><td></td><td></td></tr></table>										<table border="1"><tr><td></td><td></td><td></td></tr><tr><td></td><td></td><td>1</td></tr><tr><td></td><td></td><td></td></tr></table>						1				<table border="1"><tr><td></td><td></td><td>2</td></tr><tr><td></td><td></td><td></td></tr><tr><td></td><td></td><td></td></tr></table>			2							<table border="1"><tr><td></td><td></td><td></td></tr><tr><td></td><td></td><td></td></tr><tr><td></td><td></td><td></td></tr></table>										<table border="1"><tr><td></td><td></td><td></td></tr><tr><td>1</td><td></td><td></td></tr><tr><td></td><td></td><td></td></tr></table>				1						<table border="1"><tr><td></td><td></td><td>1</td></tr><tr><td></td><td></td><td></td></tr><tr><td>4</td><td>1</td><td>1</td></tr></table>			1				4	1	1	<table border="1"><tr><td></td><td></td><td>1</td></tr><tr><td></td><td></td><td></td></tr><tr><td></td><td></td><td></td></tr></table>			1																
		1																																																																													
		2																																																																													
1																																																																															
		1																																																																													
4	1	1																																																																													
		1																																																																													
Post - 0 Miss - 0 Block - 0	Post - 0 Miss - 0 Block - 0	Post - 0 Miss - 0 Block - 1	Post - 0 Miss - 0 Block - 0	Post - 1 Miss - 1 Block - 0	Post - 0 Miss - 3 Block - 0	Post - 0 Miss - 0 Block - 0																																																																									

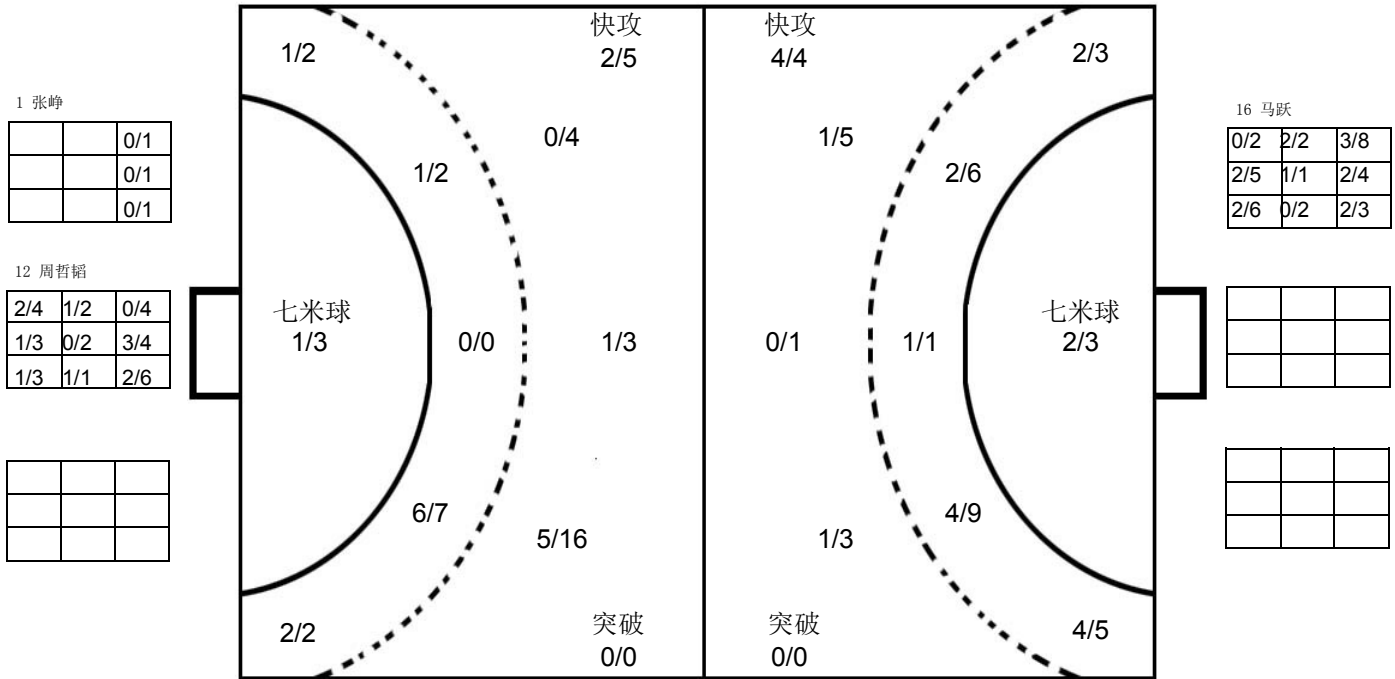

## 广东队

1 王泽润	2 孙江山	3 曲汝洋	4 李卓洋	5 侯生升	7 付云博	8 于彦江	10 周仲坤																																																																								
<table border="1"><tr><td></td><td></td><td></td></tr><tr><td></td><td></td><td></td></tr><tr><td></td><td></td><td></td></tr></table>										<table border="1"><tr><td>2</td><td></td><td>3</td></tr><tr><td>1</td><td>1</td><td></td></tr><tr><td></td><td></td><td></td></tr></table>	2		3	1	1					<table border="1"><tr><td></td><td>1</td><td></td></tr><tr><td></td><td></td><td></td></tr><tr><td>1</td><td></td><td></td></tr></table>		1					1			<table border="1"><tr><td></td><td></td><td></td></tr><tr><td></td><td></td><td></td></tr><tr><td>1</td><td></td><td>1</td></tr></table>							1		1	<table border="1"><tr><td></td><td></td><td>1</td></tr><tr><td>1</td><td>1</td><td></td></tr><tr><td></td><td></td><td>1</td></tr></table>			1	1	1				1	<table border="1"><tr><td></td><td></td><td></td></tr><tr><td></td><td></td><td></td></tr><tr><td></td><td></td><td>1</td></tr></table>									1	<table border="1"><tr><td></td><td></td><td></td></tr><tr><td></td><td></td><td></td></tr><tr><td></td><td></td><td></td></tr></table>										<table border="1"><tr><td></td><td></td><td></td></tr><tr><td></td><td></td><td></td></tr><tr><td></td><td></td><td></td></tr></table>									
2		3																																																																													
1	1																																																																														
	1																																																																														
1																																																																															
1		1																																																																													
		1																																																																													
1	1																																																																														
		1																																																																													
		1																																																																													
Post - 0 Miss - 0 Block - 0	Post - 1 Miss - 0 Block - 0	Post - 1 Miss - 1 Block - 0	Post - 1 Miss - 1 Block - 0	Post - 0 Miss - 0 Block - 0	Post - 0 Miss - 0 Block - 0	Post - 0 Miss - 0 Block - 0	Post - 0 Miss - 0 Block - 0																																																																								
11 房友屯	12 林子健	13 王立隆	15 张建杰	16 马跃	17 李中洲	20 黄培杰	84 王伟																																																																								
<table border="1"><tr><td></td><td></td><td></td></tr><tr><td></td><td></td><td></td></tr><tr><td></td><td></td><td></td></tr></table>										<table border="1"><tr><td></td><td></td><td></td></tr><tr><td></td><td></td><td></td></tr><tr><td></td><td></td><td></td></tr></table>										<table border="1"><tr><td></td><td></td><td></td></tr><tr><td></td><td></td><td></td></tr><tr><td></td><td></td><td></td></tr></table>										<table border="1"><tr><td></td><td></td><td></td></tr><tr><td></td><td></td><td></td></tr><tr><td></td><td></td><td></td></tr></table>										<table border="1"><tr><td></td><td></td><td></td></tr><tr><td></td><td></td><td></td></tr><tr><td></td><td></td><td></td></tr></table>										<table border="1"><tr><td></td><td></td><td>1</td></tr><tr><td></td><td></td><td>2</td></tr><tr><td></td><td></td><td>2</td></tr></table>			1			2			2	<table border="1"><tr><td></td><td></td><td></td></tr><tr><td></td><td></td><td></td></tr><tr><td></td><td></td><td></td></tr></table>										<table border="1"><tr><td></td><td></td><td></td></tr><tr><td></td><td></td><td></td></tr><tr><td></td><td></td><td></td></tr></table>									
		1																																																																													
		2																																																																													
		2																																																																													
Post - 0 Miss - 0 Block - 0	Post - 0 Miss - 0 Block - 0	Post - 0 Miss - 0 Block - 0	Post - 0 Miss - 0 Block - 0	Post - 0 Miss - 0 Block - 0	Post - 1 Miss - 1 Block - 0	Post - 0 Miss - 0 Block - 0	Post - 1 Miss - 0 Block - 0																																																																								

注释: Post=击柱 Miss=射失 Block=被封





预赛 Group B

男子 全国比赛

2016年全国男子手球锦标赛

Team A A 山东队				Team B B 上海队				Match Number <b>6</b>													
played in China		in the hall 徐闻县体育中心体育		on 21/10/2016		at 13:30 hours		Spectators													
Half-time (30')	A 17	B 9	End of playing time	A 26	B 15	1st extra time	A	B	2nd extra time	A	B	After penalty throws	A	B							
Number of 7 m	A 2 / 4	Team time-out 1 2 3 45:30		Full name of players and officials				Team time-out 1 2 3 10:34 50:45		B 3 / 3	Number of 7 m										
No.	Team A					G	W	2'	D	DR	No.	Team B					G	W	2'	D	DR
1	李濠壮										1	张峥									
3	尹杰										2	张文斌									
4	田瑞					1					3	赵时俊									
5	潘翔					3	1				4	徐俊吉					5				
6	李朝鹏							1			7	吴双									
9	赵鑫					1					8	钱为玮					3				
10	赵建强										10	董凯									
11	宋朋强					2	1				11	蒋承骅					4				
12	崔剑										12	周哲韬									
13	刘晓					1					14	沈吉磊									
15	张继伟										15	朱世杰						1			
16	于性哲										16	朱春雷									
17	王旭东					1					17	贺政					2		1		
19	李语庆					6		1			18	马麟晓						1			
21	翟乾坤					4	1				33	吴璟					1				
27	于亚男					7															
A	markovic尼克										A	吴龙基 (主教练)									
B	王鸿斌 (主教练)										B	张勇军									
C	刘桂妮										C	金迪琦									
D	邢建刚										E	杨时									
A	Signature of Responsible Official of the Teams (Off. A)										B										
TP	Remarks of Referee / CHA Official										TP										

Signatures

Referees	徐健 (CHN)	曹宏俊 (CHN)		
Techn. Delegates	许宜扬 (CHN)			
CHA Official	刘凤娟 (CHN)			

Note: Number of 7m Throws Awarded to Team A and B, Goals (G), Warnings (W), Suspensions (2'), Direct Disqualification (D), Disqualification with Report (DR) and Team Penalty (TP).

Table Officials: 鲍瑀

刘宇阳

Statisticians: 李双

张程秀子





## 2016年全国男子手球锦标赛 竞赛技术统计(媒体表)

<b>预赛</b>	组别	<b>B</b>	轮次	<b>2</b>	场次	<b>6</b>
徐闻县体育中心体育馆			21/10/2016		201606006-51-1/1	
山东队	<b>山东</b>	<b>26</b>	vs	<b>15</b>	上海	上海队
<b>17:9</b>						

裁判员		徐健 (CHN)											/	曹宏俊 (CHN)																	
<b>山东</b>		远射	近射	边射	快攻	突破	任意球	7m球	合计	%	助攻	失误	警告	2'	D & DR	<b>山东</b>		比赛进程		<b>上海</b>											
主教练: 王鸿斌																1st Half															
1	李濛壮															21	翟乾坤	1	02:05	0											
3	尹杰															19	李语庆	2	02:28	0											
4	田瑞		0/1		1/1			1/2	50.0		1					5	潘翔	3	05:15	1	4	徐俊吉									
5	潘翔		0/1	0/1	1/2	2/2		3/6	50.0		2	1				3	潘翔	3	05:48	2	11	蒋承骅									
6	李朝鹏													1		3	李语庆	3	07:21	3	11	蒋承骅									
9	赵鑫	0/1	1/1					1/2	50.0		1					19	李语庆	4	07:42	3											
10	赵建强															27	于亚男	5	08:51	3											
11	宋朋强	0/1	1/2		0/1	1/1		2/5	40.0	4		1				27	于亚男	6	10:17	3											
12	崔剑															6	翟乾坤	6	11:53	4	4	徐俊吉									
13	刘晓		1/1					0/1	1/2	50.0						5	潘翔	7	15:17	4											
15	张继伟															27	于亚男	8	18:03	4											
16	于性哲										2					17	王旭东	9	18:37	4											
17	王旭东	0/1			1/1	0/1		1/3	33.3	2	3					21	翟乾坤	10	19:18	4											
19	李语庆	1/1	0/1	2/2	1/1			2/3	6/8	75.0		2		1		19	李语庆	10	20:00	5	4	徐俊吉									
21	翟乾坤	1/1		1/3	2/2			4/6	66.7	1		1				11	李语庆	11	20:37	5											
27	于亚男	1/1	4/4	1/1	1/1	0/1		7/8	87.5		3					21	翟乾坤	12	22:06	6	11	蒋承骅									
<b>运动员 合计</b>		3/6	7/11	4/7	7/9	3/5	2/4	26/42	61.9	9	12	3	2			12	翟乾坤	12	22:41	7	4	徐俊吉									
12	崔剑	1/3	2/3	1/2	0/1		0/2	4/11	36.4							27	于亚男	13	23:15	7											
16	于性哲	1/2	1/2	1/4		1/3	1/1	5/13	38.5	2						14	李语庆	14	24:26	7											
<b>守门员 合计</b>		2/5	3/5	2/6	0/1	1/3	1/1	0/3	9/24	37.5	2					14	李语庆	14	24:26	7											
<b>上海</b>		远射	近射	边射	快攻	突破	任意球	7m球	合计	%	助攻	失误	警告	2'	D & DR	2nd Half															
教练: 吴龙基																17	翟乾坤	17	02:06	10	11	蒋承骅									
1	张崢															17	翟乾坤	17	05:49	11	4	徐俊吉									
2	张文斌															9	赵鑫	18	06:24	11											
3	赵时俊	0/1						0/1	0.0	2						18	翟乾坤	18	07:27	12	17	贺政									
4	徐俊吉	0/1	1/1	1/2				3/3	5/7	71.4		1				19	李语庆	19	10:03	12											
7	吴双															21	翟乾坤	20	11:48	12											
8	钱为玮	1/1		2/4	0/1		0/1	3/7	42.9		1					20	翟乾坤	20	12:39	13	33	吴璟									
10	董凯															11	宋朋强	21	13:29	13											
11	蒋承骅	2/2				2/2		4/4	100							21	宋朋强	21	16:59	14	8	钱为玮									
12	周哲韬															22	宋朋强	22	20:30	14											
14	沈吉磊	0/3						0/3	0.0	1	2					13	刘晓	23	23:11	14											
15	朱世杰	0/1						0/1	0.0	3	3	1				5	潘翔	24	24:18	14											
16	朱春雷															24	潘翔	24	24:18	14											
17	贺政		0/1	1/2	1/1			2/4	50.0		3			1		24	潘翔	24	25:08	15	8	钱为玮									
18	马麟晓	0/1				0/1		0/2	0.0	1	3	1				27	于亚男	25	25:58	15											
33	吴璟		1/3					1/3	33.3							4	田瑞	26	29:57	15											
<b>运动员 合计</b>		3/10	2/5	4/8	1/2	2/3	0/1	3/3	15/32	46.9	7	13	2	1																	
1	张崢	0/3	1/1		1/3	1/1		3/8	37.5																						
12	周哲韬	1/1	2/9	3/7	1/6	0/3		1/3	8/29	27.6																					
16	朱春雷																														
<b>守门员 合计</b>		1/4	3/10	3/7	2/9	1/4		1/3	11/37	29.7																					

场上队员: 得分 / 射门

守门员: 救球 / 射门

快攻	Fast Break		突破	Breakthrough		任意球	Free Throw		7M球	7M Throw		助攻	Assist
警告	Warning		失误	Error		2'	Suspension		D	取消资格		DR	取消资格+报告



### 2016年全国男子手球锦标赛 图式比赛技术统计表

轮次 2

场次 6

201606006-21-1/1

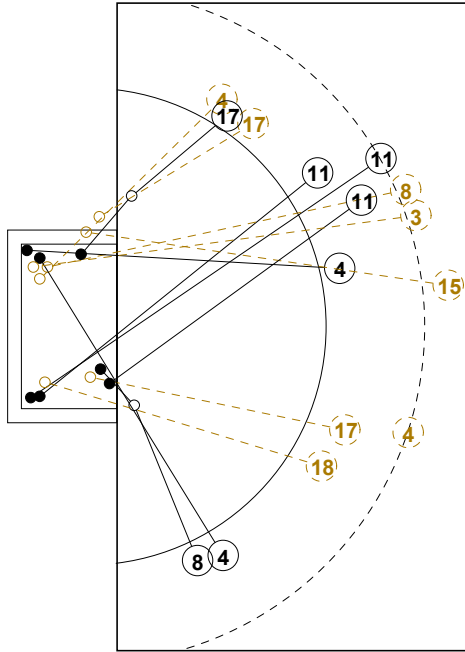

7M 上海

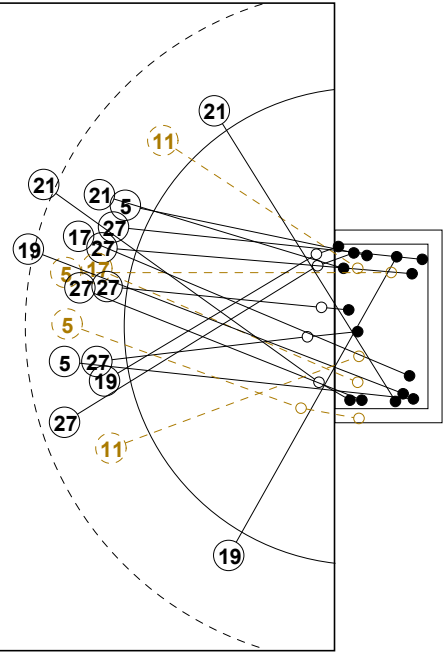
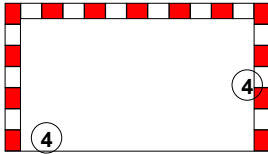

山东 7M

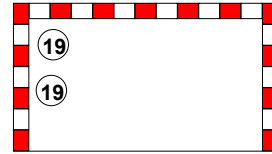

1st Half  
9 : 17

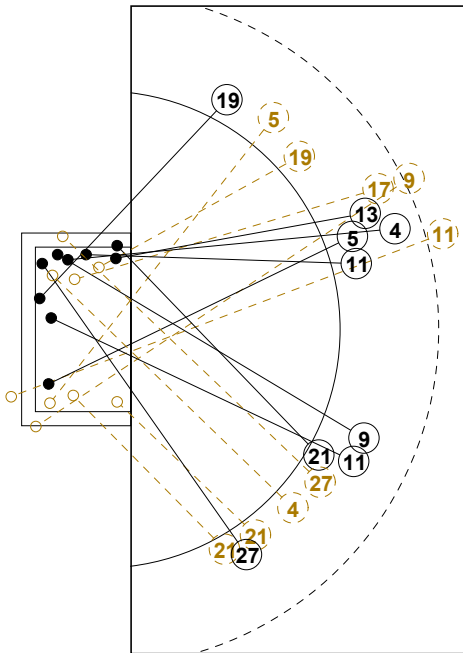

7M 山东

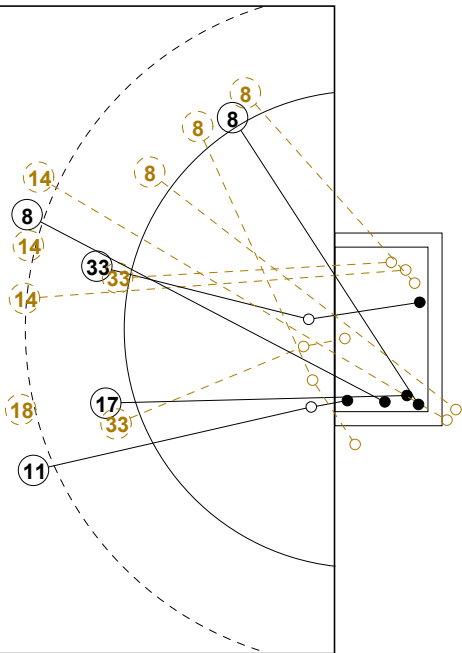
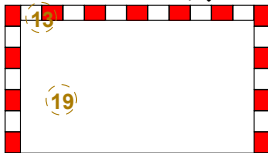

上海 7M

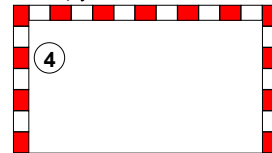

2nd Half  
26 : 15



## 2016年全国男子手球锦标赛

## 个人/全队技术统计表

正式表  
手球  
男子预赛  
轮次 2组别 B  
场次 6201606006-14-1/2  
徐闻县体育中心体育馆  
21/10/2016 13:30

号码	姓名	远射	近射	边射	快攻	突破	任意	7M	合计	%	助攻	失误	警告	2'	取消	时间
<b>山东队(山东)</b>																
<i>(场上队员)</i>																
1	李濠壮									0.0%						00:00:00
3	尹杰									0.0%						00:00:00
4	田瑞		0/1		1/1				1/2	50.0%	1					00:03:25
5	潘翔		0/1	0/1	1/2	2/2			3/6	50.0%	2	1				00:53:56
6	李朝鹏									0.0%				1		00:04:15
9	赵鑫	0/1	1/1						1/2	50.0%	1					00:35:19
10	赵建强									0.0%						00:03:25
11	宋朋强	0/1	1/2		0/1	1/1			2/5	40.0%	4		1			00:40:11
12	崔剑									0.0%						01:00:10
13	刘晓		1/1					0/1	1/2	50.0%						00:14:30
15	张继伟									0.0%						00:04:15
16	于性哲									0.0%	2					00:28:58
17	王旭东	0/1			1/1	0/1			1/3	33.3%	2	3				00:43:39
19	李语庆	1/1	0/1	2/2	1/1			2/3	6/8	75.0%	2			1		00:54:44
21	翟乾坤	1/1		1/3	2/2				4/6	66.7%	1		1			00:53:45
27	于亚男	1/1	4/4	1/1	1/1	0/1			7/8	87.5%	3					00:37:23
<b>合计</b>		3/6	7/11	4/7	7/9	3/5		2/4	26/42	61.9%	9	12	3	2		
<i>(守门员)</i>																
12	崔剑	1/3	2/3	1/2	0/1			0/2	4/11	36.4%						01:00:10
16	于性哲	1/2	1/2	1/4		1/3	1/1	0/1	5/13	38.5%	2					00:28:58
<b>合计</b>		2/5	3/5	2/6	0/1	1/3	1/1	0/3	9/24	37.5%	2					

场上队员：得分/射门

守门员：救球/射门

全队合计	得分	被救	射失	击柱	封球	合计	%
远射	3	1	1	1		6	50.0%
近射	7	3		1		11	63.6%
边射	4	3				7	57.1%
快攻	7	2				9	77.8%
突破	3	1		1		5	60.0%
任意							0.0%
7M	2	1		1		4	50.0%





## 2016年全国男子手球锦标赛

## 个人/全队技术统计表

正式表  
手球  
男子预赛  
轮次 2组别 B  
场次 6201606006-14-2/2  
徐闻县体育中心体育馆  
21/10/2016 13:30

号码	姓名	远射	近射	边射	快攻	突破	任意	7M	合计	%	助攻	失误	警告	2'	取消	时间
<b>上海队(上海)</b>																
<i>(上场队员)</i>																
1	张崢									0.0%						00:10:13
2	张文斌									0.0%						00:00:00
3	赵时俊	0/1							0/1	0.0%	2					00:11:52
4	徐俊吉	0/1	1/1	1/2				3/3	5/7	71.4%		1				00:45:38
7	吴双									0.0%						00:00:00
8	钱为玮	1/1		2/4	0/1		0/1		3/7	42.9%		1				00:57:56
10	董凯									0.0%						00:00:00
11	蒋承骅	2/2				2/2			4/4	100%						00:32:11
12	周哲韬									0.0%						00:48:57
14	沈吉磊	0/3							0/3	0.0%	1	2				00:19:43
15	朱世杰	0/1							0/1	0.0%	3	3	1			00:58:16
16	朱春雷									0.0%						00:30:00
17	贺政		0/1	1/2	1/1				2/4	50.0%		3		1		00:53:20
18	马麟晓	0/1				0/1			0/2	0.0%	1	3	1			00:57:34
33	吴璟		1/3						1/3	33.3%						00:12:40
<b>合计</b>		3/10	2/5	4/8	1/2	2/3	0/1	3/3	15/32	46.9%	7	13	2	1		
<i>(守门员)</i>																
1	张崢	0/3	1/1		1/3	1/1			3/8	37.5%						00:10:13
12	周哲韬	1/1	2/9	3/7	1/6	0/3		1/3	8/29	27.6%						00:48:57
16	朱春雷									0.0%						00:30:00
<b>合计</b>		1/4	3/10	3/7	2/9	1/4		1/3	11/37	29.7%						

场上队员：得分/射门

守门员：救球/射门

全队合计	得分	被救	射失	击柱	封球	合计	%
远射	3	2	1	1	3	10	30.0%
近射	2	3				5	40.0%
边射	4	2	2			8	50.0%
快攻	1		1			2	50.0%
突破	2	1				3	66.7%
任意		1				1	0.0%
7M	3					3	100.0%







### 2016年全国男子手球锦标赛

#### 图式射门区域统计

轮次 2 场次 6

201606006-41-1/1

## 山东队

1 李漳社	3 尹杰	4 田瑞	5 潘翔	6 李朝鹏	9 赵鑫	10 赵建强	11 宋朋强																																																																								
<table border="1"><tr><td></td><td></td><td></td></tr><tr><td></td><td></td><td></td></tr><tr><td></td><td></td><td></td></tr></table>										<table border="1"><tr><td></td><td></td><td></td></tr><tr><td></td><td></td><td></td></tr><tr><td></td><td></td><td></td></tr></table>										<table border="1"><tr><td></td><td></td><td>1</td></tr><tr><td></td><td></td><td></td></tr><tr><td></td><td></td><td></td></tr></table>			1							<table border="1"><tr><td>1</td><td></td><td>1</td></tr><tr><td>1</td><td></td><td></td></tr><tr><td></td><td></td><td></td></tr></table>	1		1	1						<table border="1"><tr><td></td><td></td><td></td></tr><tr><td></td><td></td><td></td></tr><tr><td></td><td></td><td></td></tr></table>										<table border="1"><tr><td></td><td></td><td>1</td></tr><tr><td></td><td></td><td></td></tr><tr><td></td><td></td><td></td></tr></table>			1							<table border="1"><tr><td></td><td></td><td></td></tr><tr><td></td><td></td><td></td></tr><tr><td></td><td></td><td></td></tr></table>										<table border="1"><tr><td></td><td>1</td><td></td></tr><tr><td></td><td></td><td></td></tr><tr><td></td><td></td><td>1</td></tr></table>		1							1
		1																																																																													
1		1																																																																													
1																																																																															
		1																																																																													
	1																																																																														
		1																																																																													
Post - 0 Miss - 0 Block - 0	Post - 0 Miss - 0 Block - 0	Post - 0 Miss - 0 Block - 0	Post - 1 Miss - 0 Block - 0	Post - 0 Miss - 0 Block - 0	Post - 1 Miss - 0 Block - 0	Post - 0 Miss - 0 Block - 0	Post - 0 Miss - 1 Block - 0																																																																								
12 崔剑	13 刘晓	15 张继伟	16 于性哲	17 王旭东	19 李语庆	21 翟乾坤	27 于亚男																																																																								
<table border="1"><tr><td></td><td></td><td></td></tr><tr><td></td><td></td><td></td></tr><tr><td></td><td></td><td></td></tr></table>										<table border="1"><tr><td></td><td></td><td>1</td></tr><tr><td></td><td></td><td></td></tr><tr><td></td><td></td><td></td></tr></table>			1							<table border="1"><tr><td></td><td></td><td></td></tr><tr><td></td><td></td><td></td></tr><tr><td></td><td></td><td></td></tr></table>										<table border="1"><tr><td></td><td></td><td></td></tr><tr><td></td><td></td><td></td></tr><tr><td></td><td></td><td></td></tr></table>										<table border="1"><tr><td></td><td></td><td>1</td></tr><tr><td></td><td></td><td></td></tr><tr><td></td><td></td><td></td></tr></table>			1							<table border="1"><tr><td>2</td><td></td><td>2</td></tr><tr><td>1</td><td></td><td></td></tr><tr><td>1</td><td></td><td></td></tr></table>	2		2	1			1			<table border="1"><tr><td></td><td></td><td>1</td></tr><tr><td></td><td></td><td></td></tr><tr><td>1</td><td></td><td>2</td></tr></table>			1				1		2	<table border="1"><tr><td>2</td><td></td><td>1</td></tr><tr><td></td><td></td><td></td></tr><tr><td>1</td><td>2</td><td>1</td></tr></table>	2		1				1	2	1
		1																																																																													
		1																																																																													
2		2																																																																													
1																																																																															
1																																																																															
		1																																																																													
1		2																																																																													
2		1																																																																													
1	2	1																																																																													
Post - 0 Miss - 0 Block - 0	Post - 1 Miss - 0 Block - 0	Post - 0 Miss - 0 Block - 0	Post - 0 Miss - 0 Block - 0	Post - 0 Miss - 0 Block - 0	Post - 0 Miss - 0 Block - 0	Post - 0 Miss - 0 Block - 0	Post - 1 Miss - 0 Block - 0																																																																								

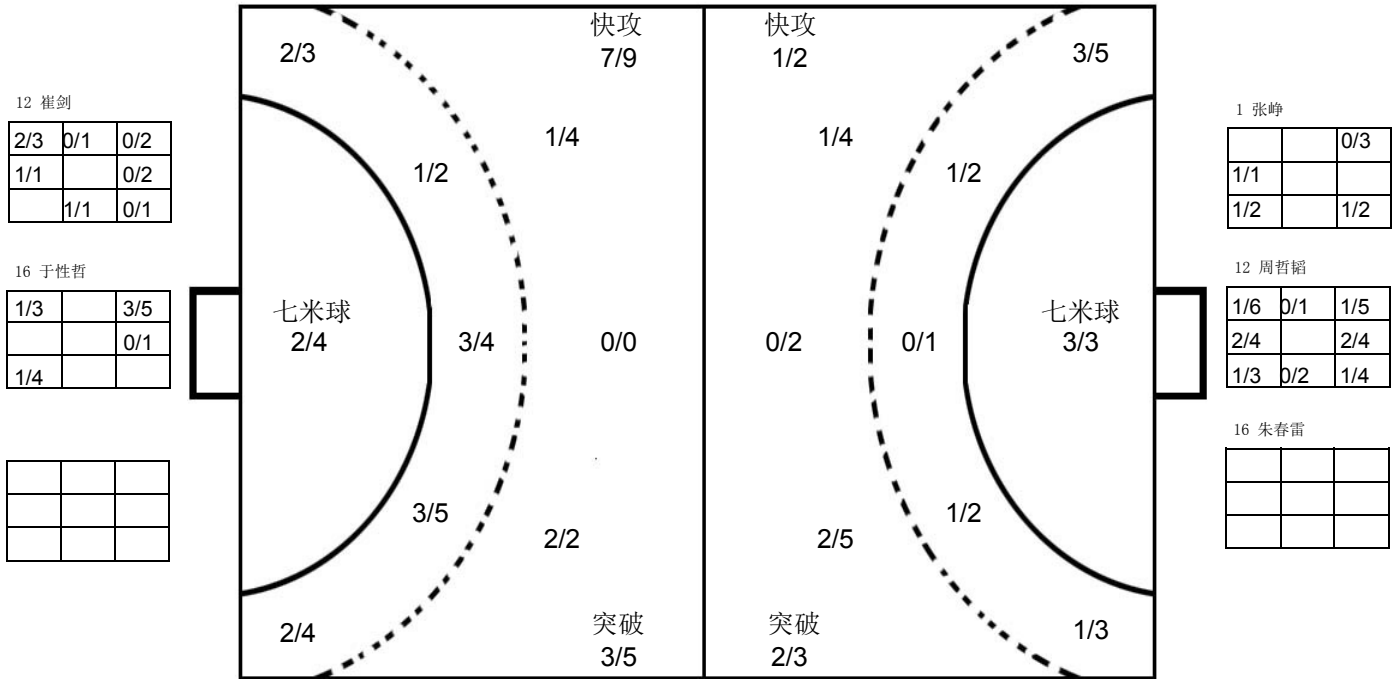

## 上海队

1 张峥	2 张文斌	3 赵时俊	4 徐俊吉	7 吴双	8 钱为玮	10 董凯	11 蒋承骅																																																																								
<table border="1"><tr><td></td><td></td><td></td></tr><tr><td></td><td></td><td></td></tr><tr><td></td><td></td><td></td></tr></table>										<table border="1"><tr><td></td><td></td><td></td></tr><tr><td></td><td></td><td></td></tr><tr><td></td><td></td><td></td></tr></table>										<table border="1"><tr><td></td><td></td><td></td></tr><tr><td></td><td></td><td></td></tr><tr><td></td><td></td><td></td></tr></table>										<table border="1"><tr><td>1</td><td></td><td>2</td></tr><tr><td></td><td></td><td>1</td></tr><tr><td>1</td><td></td><td></td></tr></table>	1		2			1	1			<table border="1"><tr><td></td><td></td><td></td></tr><tr><td></td><td></td><td></td></tr><tr><td></td><td></td><td></td></tr></table>										<table border="1"><tr><td></td><td></td><td>1</td></tr><tr><td></td><td></td><td>1</td></tr><tr><td>1</td><td></td><td></td></tr></table>			1			1	1			<table border="1"><tr><td></td><td></td><td></td></tr><tr><td></td><td></td><td></td></tr><tr><td></td><td></td><td></td></tr></table>										<table border="1"><tr><td>2</td><td></td><td></td></tr><tr><td></td><td></td><td></td></tr><tr><td>1</td><td></td><td>1</td></tr></table>	2						1		1
1		2																																																																													
		1																																																																													
1																																																																															
		1																																																																													
		1																																																																													
1																																																																															
2																																																																															
1		1																																																																													
Post - 0 Miss - 0 Block - 0	Post - 0 Miss - 0 Block - 0	Post - 0 Miss - 0 Block - 0	Post - 0 Miss - 0 Block - 1	Post - 0 Miss - 0 Block - 0	Post - 0 Miss - 2 Block - 0	Post - 0 Miss - 0 Block - 0	Post - 0 Miss - 0 Block - 0																																																																								
12 周哲韬	14 沈吉磊	15 朱世杰	16 朱春雷	17 贺政	18 马麟晓	33 吴璟																																																																									
<table border="1"><tr><td></td><td></td><td></td></tr><tr><td></td><td></td><td></td></tr><tr><td></td><td></td><td></td></tr></table>										<table border="1"><tr><td></td><td></td><td></td></tr><tr><td></td><td></td><td></td></tr><tr><td></td><td></td><td></td></tr></table>										<table border="1"><tr><td></td><td></td><td></td></tr><tr><td></td><td></td><td></td></tr><tr><td></td><td></td><td></td></tr></table>										<table border="1"><tr><td></td><td></td><td></td></tr><tr><td></td><td></td><td></td></tr><tr><td></td><td></td><td></td></tr></table>										<table border="1"><tr><td></td><td></td><td>1</td></tr><tr><td></td><td></td><td>1</td></tr><tr><td></td><td></td><td></td></tr></table>			1			1				<table border="1"><tr><td></td><td></td><td></td></tr><tr><td></td><td></td><td></td></tr><tr><td></td><td></td><td></td></tr></table>										<table border="1"><tr><td></td><td>1</td><td></td></tr><tr><td></td><td></td><td></td></tr><tr><td></td><td></td><td></td></tr></table>		1								<table border="1"><tr><td></td><td></td><td></td></tr><tr><td></td><td></td><td></td></tr><tr><td></td><td></td><td></td></tr></table>									
		1																																																																													
		1																																																																													
	1																																																																														
Post - 0 Miss - 0 Block - 0	Post - 0 Miss - 1 Block - 1	Post - 1 Miss - 0 Block - 0	Post - 0 Miss - 0 Block - 0	Post - 0 Miss - 1 Block - 0	Post - 0 Miss - 0 Block - 1	Post - 0 Miss - 0 Block - 0																																																																									

注释: Post=击柱 Miss=射失 Block=被封





预赛 Group B

男子 全国比赛

2016年全国男子手球锦标赛

Team A				Team B				Match Number													
A 广东队				B 浙江队				7													
played in		in the hall		on		at		Spectators													
China		徐闻县体育中心体育		21/10/2016		15:10 hours															
Half-time (30')	A	B	End of playing time	A	B	1st extra time	A	B	2nd extra time	A	B	After penalty throws	A	B							
	23	4		23	4																
Number of 7 m	A	Team time-out			Full name of players and officials				Team time-out			B	Number of 7 m								
		1	2	3					1	2	3										
	0/0																				
No.	Team A					G	W	2'	D	DR	No.	Team B					G	W	2'	D	DR
1	王泽润										1	李欢欢									
2	孙江山										2	郑尧俊									
3	曲汝洋										3	李恩铭					2				
4	李卓洋										5	林先方									
5	侯生升										7	金杰									
7	付云博										8	王浩									
8	于彦江										9	李家乐									
10	周仲坤					1					10	罗明杰									
11	房友屯					1					11	陈渝天									
12	林子健					5					14	虞勇灿									
13	王立隆					8					15	张佩力									
15	张建杰					4	1	1			18	倪陈辉					2				
16	马跃										19	徐正飞									
17	李中洲										24	毛军伟									
20	黄培杰					4	1														
84	王伟																				
B	王锋 (主教练)										B	柳佳 (主教练)									
C	刘康伶										C	项建生									
D	张广建																				
E	王永存																				
A	Signature of Responsible Official of the Teams (Off. A)										B										
TP	Remarks of Referee / CHA Official										TP										

Signatures

Referees: 马晓晔 (CHN)      王洋 (CHN)

Techn. Delegates: 许宜扬 (CHN)

CHA Official: 李兆蒙 (CHN)

Note: Number of 7m Throws Awarded to Team A and B, Goals (G), Warnings (W), Suspensions (2), Direct Disqualification (D), Disqualification with Report (DR) and Team Penalty (TP).

Table Officials: 鲍瑀

刘宇阳

Statisticians: 张程秀子

周亚桥



2016年全国男子手球锦标赛  
竞赛技术统计(媒体表)

预赛	组别	B	轮次	2	场次	7
徐闻县体育中心体育馆			21/10/2016		201606007-51-1/1	
广东队	广东	23	vs	4	浙江	浙江队
			23 : 4			

裁判员	马晓晔 (CHN)	/	王洋 (CHN)
-----	-----------	---	----------

广东		远射	近射	边射	快攻	突破	任意球	7m球	合计	%	助攻	失误	警告	2'	D & DR	广东	比赛进程	浙江
主教练：王锋																		
1	王泽润										1						13 王立隆 1 01:43 0	
2	孙江山																15 张建杰 2 02:17 0	
3	曲汝洋																12 林子健 3 03:13 0	
4	李卓洋																13 王立隆 4 05:47 0	
5	侯生升																20 黄培杰 5 06:33 0	
7	付云博																6 08:08 0	
8	于彦江																6 09:56 1 3 李恩铭	
10	周仲坤	1/1			0/1			1/2	50.0		1						7 11:33 1	
11	房友屯	1/1						1/1	100	2	2						7 12:24 2 18 倪陈辉	
12	林子健		4/4	0/1	1/1			5/6	83.3	2	1						8 12:29 2	
13	王立隆	2/2	1/1	1/1	4/5			8/9	88.9		2						20 黄培杰 9 13:33 2	
15	张建杰	1/1	0/1		3/3			4/5	80.0	1	4	1	1				10 13:57 2	
16	马跃																15 张建安 12 15:28 2	
17	李中洲																10 周仲坤 11 14:57 2	
20	黄培杰	2/3	0/1		1/1	1/1		4/6	66.7	1	1	1					12 15:28 2	
84	王伟																13 王立隆 13 16:03 2	
运动员 合计		7/8	5/7	1/2	9/11	1/1		23/29	79.3	7	11	2	1				12 15:28 2	
1	王泽润		3/5	1/2			0/1	4/8	50.0	1							13 王立隆 14 17:01 2	
守门员 合计			3/5	1/2			0/1	4/8	50.0	1							13 王立隆 15 18:23 2	
浙江		远射	近射	边射	快攻	突破	任意球	7m球	合计	%	助攻	失误	警告	2'	D & DR			
教练：柳佳																		
1	李欢欢											1						
2	郑尧俊																	
3	李恩铭		1/2	1/2				2/4	50.0			4						
5	林先方											1						
7	金杰											3						
8	王浩																	
9	李家乐											2						
10	罗明杰		0/3					0/3	0.0			4						
11	陈渝天																	
14	虞勇灿																	
15	张佩力											1						
18	倪陈辉	0/1	1/1	0/1			1/2	2/5	40.0			4						
19	徐正飞		0/1					0/1	0.0			4						
24	毛军伟																	
运动员 合计		0/1	2/7	1/3			1/2	4/13	30.8			24						
8	王浩	0/6	1/5	1/2	0/7	0/1		2/21	9.5									
15	张佩力	0/1	1/2		1/3			2/6	33.3			1						
守门员 合计		0/7	2/7	1/2	1/10	0/1		4/27	14.8			1						

场上队员：得分 / 射门

守门员：救球 / 射门

快攻	Fast Break		突破	Breakthrough		任意球	Free Throw		7M球	7M Throw		助攻	Assist
警告	Warning		失误	Error		2'	Suspension		D	取消资格		DR	取消资格+报告





### 2016年全国男子手球锦标赛 图式比赛技术统计表

轮次 2

场次 7

201606007-21-1/1

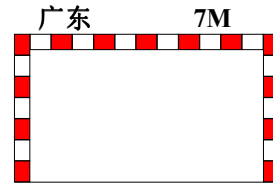
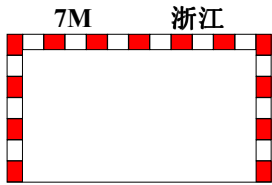
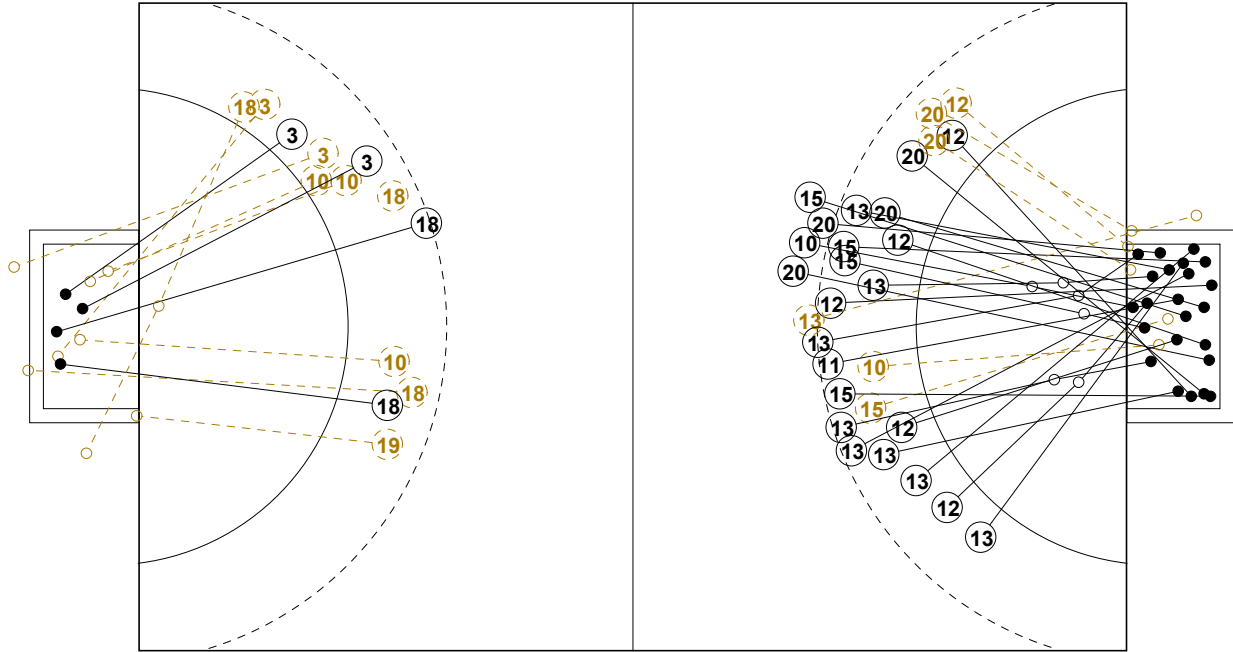

1st Half  
4 : 23

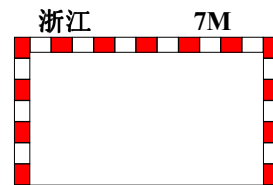
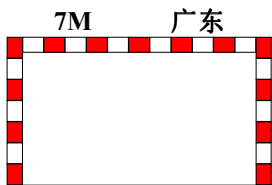
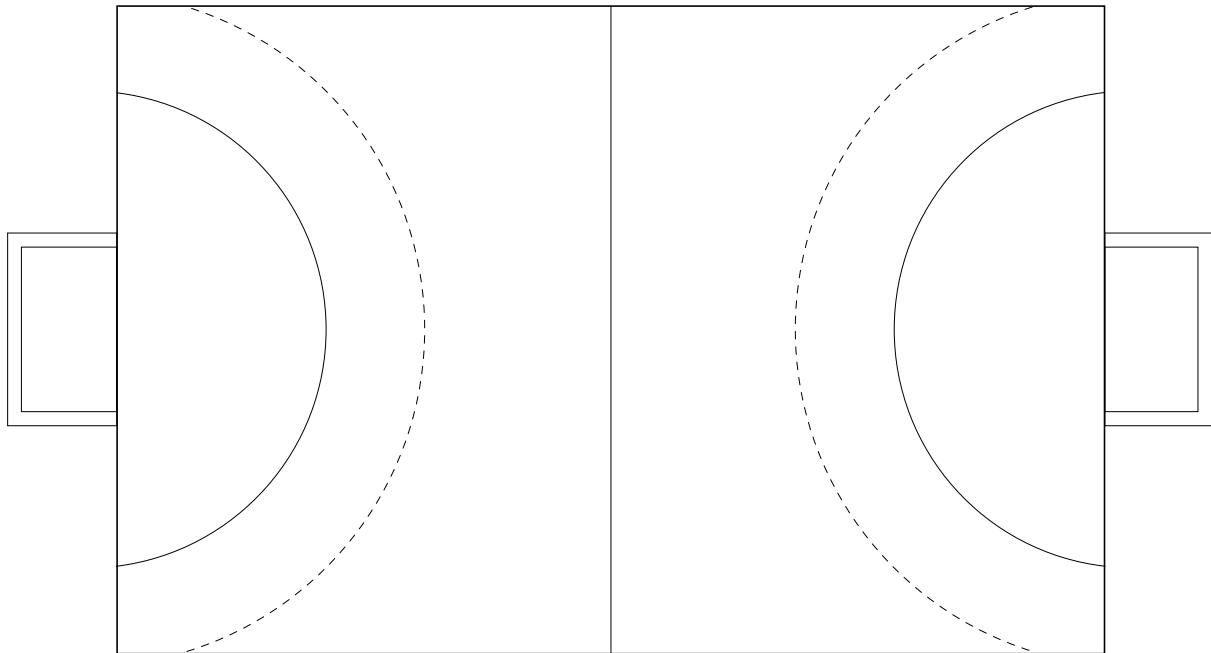

2nd Half  
23 : 4



## 2016年全国男子手球锦标赛

## 个人/全队技术统计表

正式表  
手球  
男子预赛  
轮次 2组别 B  
场次 7201606007-14-1/2  
徐闻县体育中心体育馆  
21/10/2016 15:10

号码	姓名	远射	近射	边射	快攻	突破	任意	7M	合计	%	助攻	失误	警告	2'	取消	时间
<b>广东队(广东)</b>																
<i>(场上队员)</i>																
1	王泽润									0.0%	1					00:30:00
2	孙江山									0.0%						00:00:00
3	曲汝洋									0.0%						00:00:00
4	李卓洋									0.0%						00:00:00
5	侯生升									0.0%						00:00:00
7	付云博									0.0%						00:00:00
8	于彦江									0.0%						00:00:00
10	周仲坤	1/1			0/1				1/2	50.0%		1				00:30:00
11	房友屯	1/1							1/1	100%	2	2				00:30:00
12	林子健		4/4	0/1	1/1				5/6	83.3%	2	1				00:30:00
13	王立隆	2/2	1/1	1/1	4/5				8/9	88.9%		2				00:30:00
15	张建杰	1/1	0/1		3/3				4/5	80.0%	1	4	1	1		00:30:00
16	马跃									0.0%						00:00:00
17	李中洲									0.0%						00:00:00
20	黄培杰	2/3	0/1		1/1	1/1			4/6	66.7%	1	1	1			00:30:00
84	王伟									0.0%						00:00:00
<b>合计</b>		7/8	5/7	1/2	9/11	1/1			23/29	79.3%	7	11	2	1		
<i>(守门员)</i>																
1	王泽润		3/5	1/2			0/1		4/8	50.0%	1					00:30:00
<b>合计</b>			3/5	1/2			0/1		4/8	50.0%	1					

场上队员：得分/射门

守门员：救球/射门

全队合计	得分	被救	射失	击柱	封球	合计	%
远射	7			1		8	87.5%
近射	5	2				7	71.4%
边射	1	1				2	50.0%
快攻	9	1	1			11	81.8%
突破	1					1	100.0%
任意							0.0%
7M							0.0%





## 2016年全国男子手球锦标赛

## 个人/全队技术统计表

正式表  
手球  
男子预赛  
轮次 2组别 B  
场次 7201606007-14-2/2  
徐闻县体育中心体育馆  
21/10/2016 15:10

号码	姓名	远射	近射	边射	快攻	突破	任意	7M	合计	%	助攻	失误	警告	2'	取消	时间
<b>浙江队(浙江)</b>																
<i>(上场队员)</i>																
1	李欢欢									0.0%		1				00:22:07
2	郑尧俊									0.0%						00:23:44
3	李恩铭		1/2	1/2					2/4	50.0%		4				00:25:08
5	林先方									0.0%		1				00:01:47
7	金杰									0.0%		3				00:06:18
8	王浩									0.0%						00:23:52
9	李家乐									0.0%		2				00:17:03
10	罗明杰		0/3						0/3	0.0%		4				00:23:42
11	陈渝天									0.0%						00:04:32
14	虞勇灿									0.0%						00:11:24
15	张佩力									0.0%		1				00:06:08
18	倪陈辉	0/1	1/1	0/1			1/2		2/5	40.0%		4				00:26:34
19	徐正飞		0/1						0/1	0.0%		4				00:17:15
24	毛军伟									0.0%						00:00:00
<b>合计</b>		0/1	2/7	1/3			1/2		4/13	30.8%		24				
<i>(守门员)</i>																
8	王浩	0/6	1/5	1/2	0/7	0/1			2/21	9.5%						00:23:52
15	张佩力	0/1	1/2		1/3				2/6	33.3%		1				00:06:08
<b>合计</b>		0/7	2/7	1/2	1/10	0/1			4/27	14.8%		1				

场上队员：得分/射门

守门员：救球/射门

全队合计	得分	被救	射失	击柱	封球	合计	%
远射					1	1	0.0%
近射	2	3	1	1		7	28.6%
边射	1	1	1			3	33.3%
快攻							0.0%
突破							0.0%
任意	1			1		2	50.0%
7M							0.0%





2016年全国男子手球锦标赛

图式射门区域统计

轮次 2 场次 7

201606007-41-1/1

广东队

1 王泽润	2 孙江山	3 曲汝洋	4 李卓洋	5 侯生升	7 付文博	8 于彦江	10 周仲坤
							1
Post - 0 Miss - 0 Block - 0	Post - 0 Miss - 0 Block - 0	Post - 0 Miss - 0 Block - 0	Post - 0 Miss - 0 Block - 0	Post - 0 Miss - 0 Block - 0	Post - 0 Miss - 0 Block - 0	Post - 0 Miss - 0 Block - 0	Post - 0 Miss - 0 Block - 0
11 房友屯	12 林子健	13 王立隆	15 张建杰	16 马跃	17 李中洲	20 黄培杰	84 王伟
	1 1 1	2	1 1			1 1 2	
	1	2 1	1			1	
	1	2 1	1				
Post - 0 Miss - 0 Block - 0	Post - 0 Miss - 0 Block - 0	Post - 0 Miss - 1 Block - 0	Post - 0 Miss - 0 Block - 0	Post - 0 Miss - 0 Block - 0	Post - 0 Miss - 0 Block - 0	Post - 1 Miss - 0 Block - 0	Post - 0 Miss - 0 Block - 0

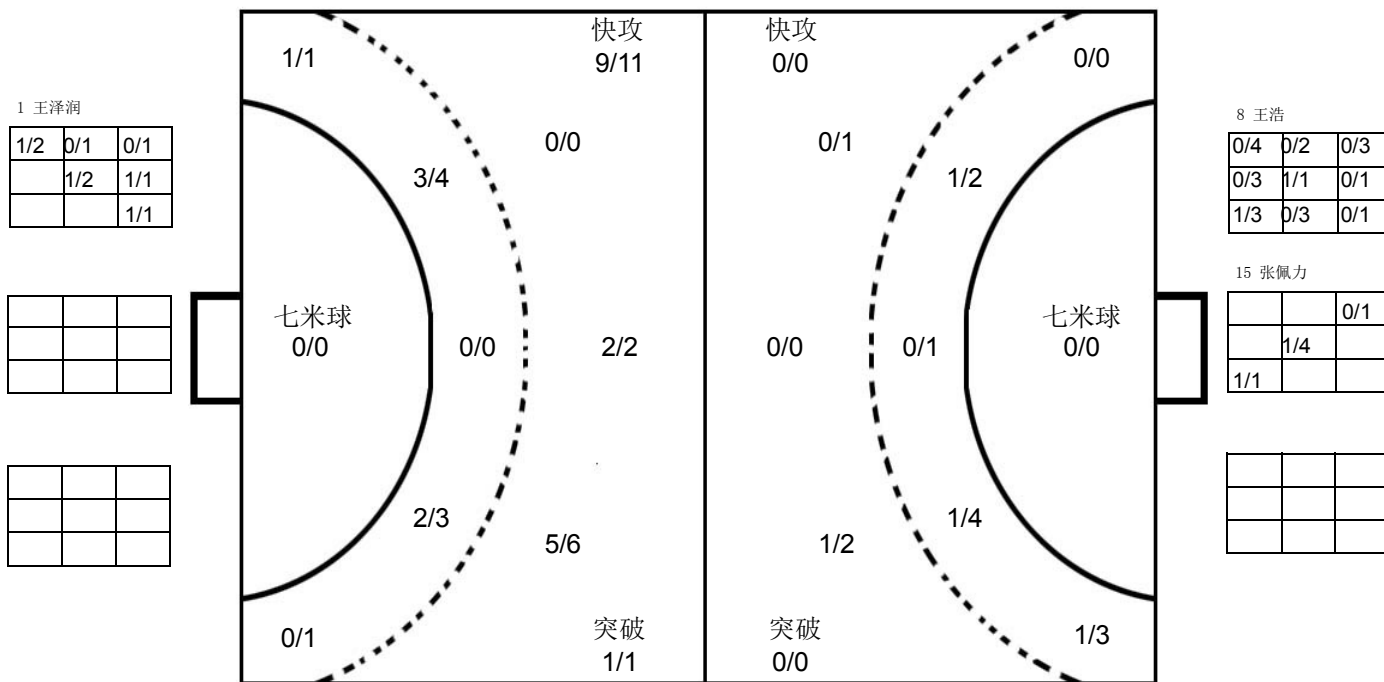

浙江队

1 李欢欢	2 郑尧俊	3 李恩铭	5 林先方	7 金杰	8 王浩	9 李家乐	10 罗明杰
		1					
Post - 0 Miss - 0 Block - 0	Post - 0 Miss - 0 Block - 0	Post - 0 Miss - 1 Block - 0	Post - 0 Miss - 0 Block - 0	Post - 0 Miss - 0 Block - 0	Post - 0 Miss - 0 Block - 0	Post - 0 Miss - 0 Block - 0	Post - 0 Miss - 0 Block - 0
11 陈渝天	14 虞勇灿	15 张佩力	18 倪陈辉	19 徐正飞	24 毛军伟		
			1 1				
Post - 0 Miss - 0 Block - 0	Post - 0 Miss - 0 Block - 0	Post - 0 Miss - 0 Block - 0	Post - 1 Miss - 1 Block - 1	Post - 1 Miss - 0 Block - 0	Post - 0 Miss - 0 Block - 0		

注释: Post=击柱 Miss=射失 Block=被封





预赛 Group B

男子 全国比赛

2016年全国男子手球锦标赛

Team A				Team B				Match Number		<b>8</b>											
A 天津队				B 四川队																	
played in		in the hall		on		at		Spectators													
China		徐闻县体育中心体育		21/10/2016		16:50 hours															
Half-time (30')	A	B	End of playing time	A	B	1st extra time	A	B	2nd extra time	A	B										
	17	11		32	17																
Number of 7 m	A	Team time-out			Full name of players and officials			Team time-out			B										
	1/3	1	2	3				1	2	3	2/3										
		28:25						11:27	20:06	45:04											
No.	Team A					G	W	2'	D	DR	No.	Team B					G	W	2'	D	DR
1	刘宗其										1	罗尧尧									
2	李岳朋					3	1				3	刘赵梁									
4	李松浩										7	仇瑞祥					2				
6	王子欣										8	谢庆龙					3				
7	张青										9	许翔宇					4	1			
8	曹悦					10	1				10	徐彦昊					1				
9	吴明远					4					11	张天豪					1	1			
11	王毅					2					12	丁大伟									
12	杨峻										13	尹文珂					4				
13	许松					5					15	刘劲松					1		1		
14	田剑侠					7		2			16	宋继强									
16	刘海亮										18	任启双									
17	周群						1	1			19	庞连康					1				
18	王晓琪										20	徐逸									
21	潘玉帅										21	马光									
22	魏雨童					1					22	张睿梁									
A	贾守信										B	张文韬 (主教练)									
B	杜瑞军 (主教练)										D	胡俊杰									
C	孟凡钢																				
E	贾宁																				
A	Signature of Responsible Official of the Teams (Off. A)																			B	
TP	Remarks of Referee / CHA Official																			TP	

Signatures

Referees	倪震 (CHN)	刘晓辉 (CHN)		
Techn. Delegates	许宜扬 (CHN)			
CHA Official	王科 (CHN)			

Note: Number of 7m Throws Awarded to Team A and B, Goals (G), Warnings (W), Suspensions (2), Direct Disqualification (D), Disqualification with Report (DR) and Team Penalty (TP).

Table Officials: 刘正松 齐红梅 Statisticians: 周亚桥 李双

Printed by PHMS Copyright: IHF / CHA 21/10/2016 17:33:23

Longman Sportsoft  handball@126.com







### 2016年全国男子手球锦标赛 图式比赛技术统计表

轮次 2

场次 8

201606008-21-1/1

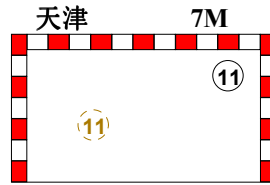
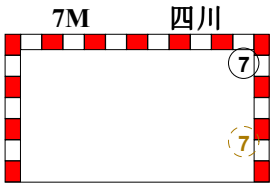
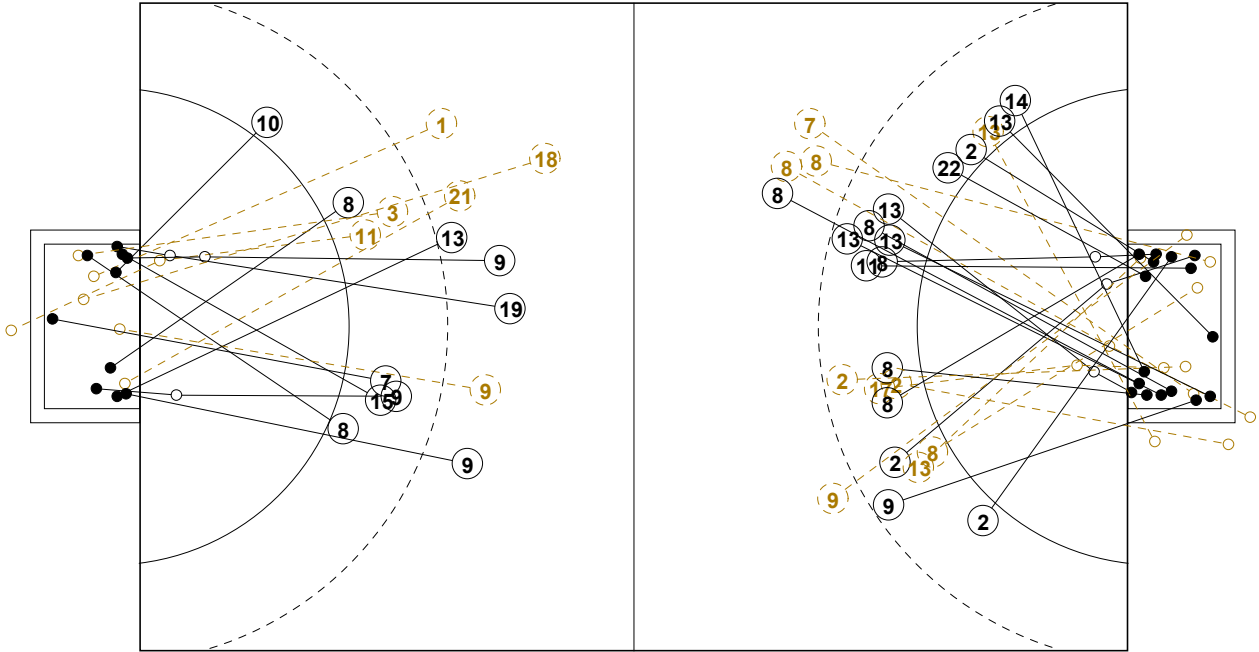

1st Half  
11 : 17

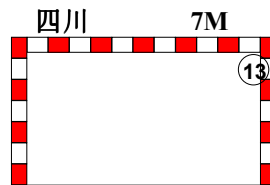
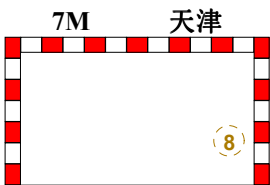
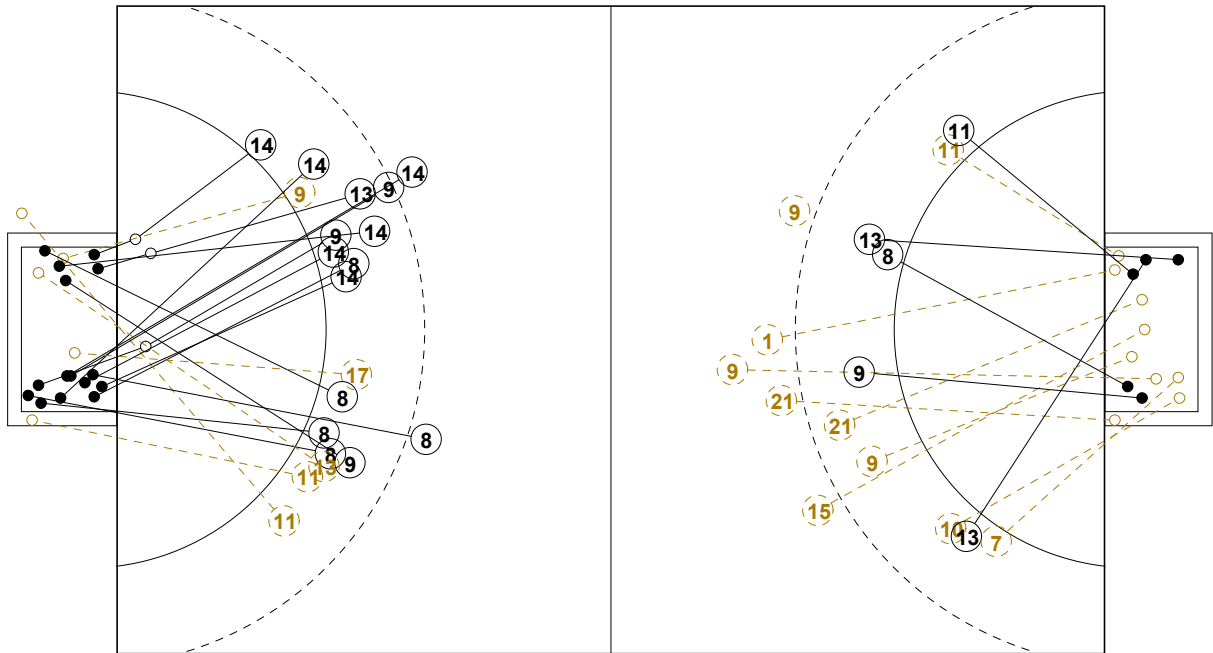

2nd Half  
32 : 17



## 2016年全国男子手球锦标赛

## 个人/全队技术统计表

正式表  
手球  
男子预赛  
轮次 2组别 B  
场次 8201606008-14-1/2  
徐闻县体育中心体育馆  
21/10/2016 16:50

号码	姓名	远射	近射	边射	快攻	突破	任意	7M	合计	%	助攻	失误	警告	2'	取消	时间
<b>天津队(天津)</b>																
<i>(场上队员)</i>																
1	刘宗其									0.0%	2					00:38:31
2	李岳朋		2/3	1/1	0/1				3/5	60.0%	1	2	1			00:40:20
4	李松浩									0.0%						00:00:00
6	王子欣									0.0%						00:23:37
7	张青	0/1							0/1	0.0%						00:33:39
8	曹悦	2/4	7/8		1/1			0/1	10/14	71.4%	3		1			00:42:57
9	吴明远	1/2	1/2		2/2				4/6	66.7%		1				00:25:24
11	王毅		1/2		0/1			1/2	2/5	40.0%						00:07:20
12	杨峻									0.0%						00:10:48
13	许松		2/3	1/2	2/2	0/1			5/8	62.5%	1	3				00:42:33
14	田剑侠	1/1	3/3	2/2		1/1			7/7	100%	3			2		00:40:11
16	刘海亮									0.0%						00:00:00
17	周群		0/2						0/2	0.0%			1	1		00:40:43
18	王晓琪									0.0%						00:00:30
21	潘玉帅									0.0%						00:00:00
22	魏雨童		1/1						1/1	100%		1				00:09:28
<b>合计</b>		4/8	17/24	4/5	5/7	1/2		1/3	32/49	65.3%	10	7	3	3		
<i>(守门员)</i>																
1	刘宗其	7/11	3/9	2/5				1/2	13/27	48.1%	2					00:38:31
12	杨峻	1/1	0/1		0/1			0/1	1/4	25.0%						00:10:48
<b>合计</b>		8/12	3/10	2/5	0/1			1/3	14/31	45.2%	2					

场上队员：得分/射门

守门员：救球/射门

全队合计	得分	被救	射失	击柱	封球	合计	%
远射	4	2	1	1		8	50.0%
近射	17	5	2			24	70.8%
边射	4		1			5	80.0%
快攻	5	1		1		7	71.4%
突破	1	1				2	50.0%
任意							0.0%
7M	1	2				3	33.3%





## 2016年全国男子手球锦标赛

## 个人/全队技术统计表

正式表  
手球  
男子预赛  
轮次 2组别 B  
场次 8201606008-14-2/2  
徐闻县体育中心体育馆  
21/10/2016 16:50

号码	姓名	远射	近射	边射	快攻	突破	任意	7M	合计	%	助攻	失误	警告	2'	取消	时间
<b>四川队(四川)</b>																
<i>(上场队员)</i>																
1	罗尧尧	0/2							0/2	0.0%		1				00:21:44
3	刘赵梁		0/1						0/1	0.0%		1				00:18:53
7	仇瑞祥		1/1	0/1				1/2	2/4	50.0%	1	3				00:16:16
8	谢庆龙		2/2		1/1				3/3	100%		1				00:19:41
9	许翔宇	2/5	2/3						4/8	50.0%		4	1			00:35:55
10	徐彦昊			1/2					1/2	50.0%	2	2				00:29:13
11	张天豪		0/2	1/1					1/3	33.3%		1	1			00:39:25
12	丁大伟									0.0%		1				00:41:32
13	尹文珂	1/1	1/1	1/1				1/1	4/4	100%						00:33:02
15	刘劲松	0/1	1/1						1/2	50.0%		3		1		00:14:41
16	宋继强									0.0%						00:00:00
18	任启双	0/1							0/1	0.0%	1	1				00:58:05
19	庞连康	1/1							1/1	100%						00:14:02
20	徐逸									0.0%		1				00:09:54
21	马光	0/3							0/3	0.0%		1				00:13:22
22	张春梁									0.0%						00:07:47
<b>合计</b>		4/14	7/11	3/5	1/1			2/3	17/34	50.0%	4	20	2	1		
<i>(守门员)</i>																
12	丁大伟	2/4	4/16	0/4	1/5	0/1		2/3	9/33	27.3%		1				00:41:32
22	张春梁	0/2	1/6		0/1	1/1			2/10	20.0%						00:07:47
<b>合计</b>		2/6	5/22	0/4	1/6	1/2		2/3	11/43	25.6%		1				

场上队员：得分/射门

守门员：救球/射门

全队合计	得分	被救	射失	击柱	封球	合计	%
远射	4	8		1	1	14	28.6%
近射	7	3	1			11	63.6%
边射	3	2				5	60.0%
快攻	1					1	100.0%
突破							0.0%
任意							0.0%
7M	2	1				3	66.7%





2016年全国男子手球锦标赛

图式射门区域统计

轮次 2 场次 8

201606008-41-1/1

天津队

1 刘宗其	2 李岳朋	4 李松浩	6 王子欣	7 张青	8 曹悦	9 吴明远	11 王毅
	1				2	1	1
	1					1	1
	1				4	2	
Post - 0 Miss - 0 Block - 0	Post - 0 Miss - 1 Block - 0	Post - 0 Miss - 0 Block - 0	Post - 0 Miss - 0 Block - 0	Post - 0 Miss - 0 Block - 0	Post - 0 Miss - 1 Block - 0	Post - 1 Miss - 0 Block - 0	Post - 1 Miss - 1 Block - 0
12 杨峻	13 许松	14 田剑侠	16 刘海亮	17 周群	18 王晓琪	21 潘玉帅	22 魏雨童
	1						
		3	1				
		1	2				1
Post - 0 Miss - 0 Block - 0	Post - 0 Miss - 1 Block - 0	Post - 0 Miss - 0 Block - 0	Post - 0 Miss - 0 Block - 0	Post - 0 Miss - 0 Block - 0	Post - 0 Miss - 0 Block - 0	Post - 0 Miss - 0 Block - 0	Post - 0 Miss - 0 Block - 0

1 刘宗其
0/1 0/1 2/3
1/3 1/1 4/6
3/6 2/2 0/4

12 杨峻
0/1
1/1
0/1 0/1

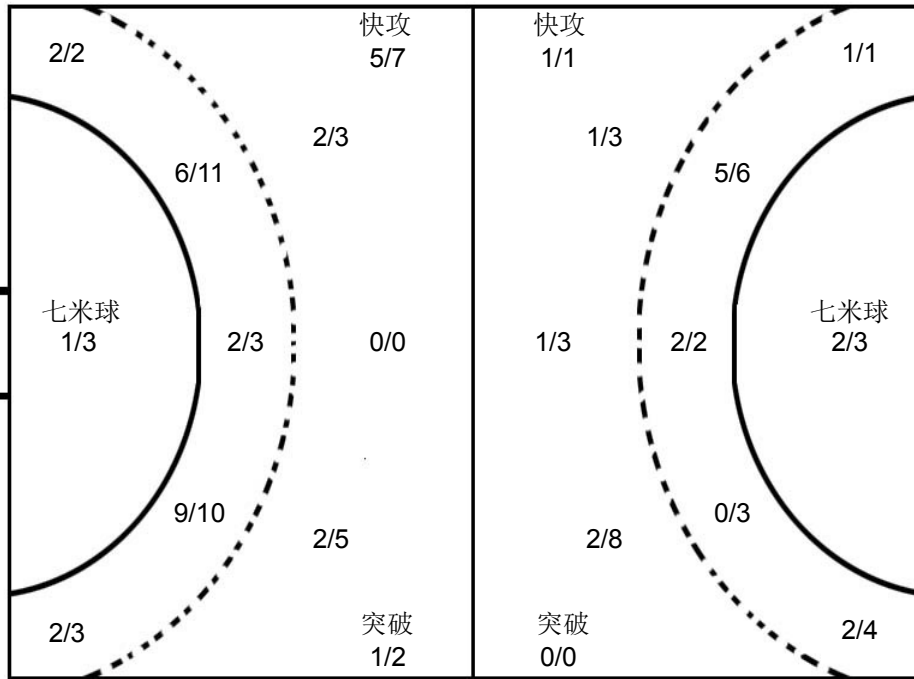
12 丁大伟
2/6 0/1 1/4
1/3 4/8
1/5 0/6

22 张睿梁
0/1 1/2
0/3 1/1
0/3

四川队

1 罗尧尧	3 刘赵梁	7 仇瑞祥	8 谢庆龙	9 许翔宇	10 徐彦昊	11 张天豪	12 丁大伟
		1					
		1		1			
			1	1		1	
Post - 0 Miss - 0 Block - 0	Post - 0 Miss - 0 Block - 0	Post - 0 Miss - 0 Block - 0	Post - 0 Miss - 0 Block - 0	Post - 0 Miss - 0 Block - 1	Post - 0 Miss - 0 Block - 0	Post - 0 Miss - 1 Block - 0	Post - 0 Miss - 0 Block - 0
13 尹文珂	15 刘劲松	16 宋继强	18 任启双	19 庞连康	20 徐逸	21 马光	22 张睿梁
1							
1							
1							
Post - 0 Miss - 0 Block - 0	Post - 0 Miss - 0 Block - 0	Post - 0 Miss - 0 Block - 0	Post - 0 Miss - 0 Block - 0	Post - 0 Miss - 0 Block - 0	Post - 0 Miss - 0 Block - 0	Post - 1 Miss - 0 Block - 0	Post - 0 Miss - 0 Block - 0

注释: Post=击柱 Miss=射失 Block=被封





预赛 Group A

男子 全国比赛

2016年全国男子手球锦标赛

Team A A 安徽队				Team B B 北京队				Match Number <b>9</b>													
played in China		in the hall 徐闻县体育中心体育		on 21/10/2016		at 19:00 hours		Spectators													
Half-time (30')	A 10	B 9	End of playing time	A 17	B 26	1st extra time	A	B	2nd extra time	A	B	After penalty throws	A	B							
Number of 7 m	A 2/3	Team time-out 1 16:02 2 43:30 3 51:20			Full name of players and officials				Team time-out 1 11:25 2 3 3			B 2/2	Number of 7 m								
No.	Team A					G	W	2'	D	DR	No.	Team B					G	W	2'	D	DR
1	郭世伟										3	王超					4				
2	金永峰										6	解建飞					4	1			
3	陈强龙					2					8	王鹏									
5	史小帆					2		1			9	刘振					2				
7	姚雄敏										10	成亚					2				
8	董智景					2					11	蒋维一					4	1			
9	陈开勇					4	1				12	孟辉									
10	严龙										16	刘迈科									
11	黎涛										21	胡瀛					1	1	1		
12	曾献辰										23	王军程							1	1	
17	王巨柱					3		1			25	马明辉					2				
18	李双					2	1	1			29	杜龙飞									
19	何山										33	冯宁					1				
21	李明										77	朱昕晨					1		1		
22	王金宇										78	张骥					5				
23	于敏清					2					83	潘天									
A	韦中平										A	安福田									
B	沈强 (主教练)										B	郑永利 (主教练)									
C	吴翔										C	陈璇									
D	陈玉翔																				
A	Signature of Responsible Official of the Teams (Off. A)																			B	
TP	Remarks of Referee / CHA Official																			TP	

Signatures

Referees	周云磊 (CHN)	程钰锋 (CHN)		
Techn. Delegates	刘凤娟 (CHN)			
CHA Official	王科 (CHN)			

Note: Number of 7m Throws Awarded to Team A and B, Goals (G), Warnings (W), Suspensions (2), Direct Disqualification (D), Disqualification with Report (DR) and Team Penalty (TP).

Table Officials: 刘正松

伍豪

Statisticians: 李双

张程秀子





## 2016年全国男子手球锦标赛 竞赛技术统计(媒体表)

预赛	组别	A	轮次	2	场次	9
----	----	---	----	---	----	---

徐闻县体育中心体育馆

21/10/2016

201606009-51-1/1

安徽队	<b>安徽</b>	17	vs	26	北京	北京队
10 : 9						

裁判员	周云磊 (CHN)	/	程钰锋 (CHN)
-----	-----------	---	-----------

安徽		远射	近射	边射	快攻	突破	任意球	7m球	合计	%	助攻	失误	警告	2'	D & DR	比赛进程	
主教练：沈强																安徽	北京
1	郭世伟		0/1	0/1					0/2	0.0		1	1			8 董智景	1st Half 1 00:31 0
2	金永峰															1 03:44 1	21 胡瀛
3	陈强龙		1/1		1/1				2/2	100	1					9 陈开勇	2 06:55 1
5	史小帆	0/2	0/1			1/3		1/2	2/8	25.0				1		17 王巨柱	3 08:27 1
7	姚雄敏		0/2			0/3			0/5	0.0	1	2					3 09:00 2
8	董智景		1/2	0/2	1/3				2/7	28.6	1	1					11 蒋维一
9	陈开勇		2/3		1/1			1/1	4/5	80.0			1				3 10:41 3
10	严龙																10 成亚
11	黎涛	0/4							0/4	0.0		1					5 6 解建飞
12	曾献辰																17 王巨柱
17	王巨柱	3/11	0/3						3/14	21.4	1	4		1			8 27:04 8
18	李双	0/1	1/1			1/1			2/3	66.7	1		1	1			8 27:37 9
19	何山																11 蒋维一
21	李明																9 28:26 9
22	王金宇																23 于敏清
23	于敏清				2/2				2/2	100		1					10 29:13 9
运动员 合计		3/18	5/14	0/3	5/7	2/7		2/3	17/52	32.7	6	10	3	3			2nd Half
21	李明	3/7	3/12	1/3	0/4	1/5	0/1	0/2	8/34	23.5	1						5 史小帆
守门员 合计		3/7	3/12	1/3	0/4	1/5	0/1	0/2	8/34	23.5	1						11 01:26 9
北京		远射	近射	边射	快攻	突破	任意球	7m球	合计	%	助攻	失误	警告	2'	D & DR		
教练：郑永利																	
3	王超		2/2	1/2	1/1				4/5	80.0	1	2					11 02:18 10
6	解建飞	2/2	1/1	0/1	1/2				4/6	66.7			1				78 张骥
8	王鹏																12 03:47 10
9	刘振	0/2	1/1			1/1			2/4	50.0	2	2					12 04:46 11
10	成亚	1/1				1/1			2/2	100	2	2					77 朱昕晨
11	蒋维一		4/5						4/5	80.0		1	1				3 陈强龙
12	孟辉																13 06:43 12
16	刘迈科																33 冯宁
21	胡瀛				1/1	0/1			1/2	50.0			1	1			13 07:36 13
23	王军程	0/2							0/2	0.0							25 马明辉
25	马明辉		0/1	1/1	1/1				2/3	66.7							13 11:33 14
29	杜龙飞		0/1	0/1					0/2	0.0		2					78 张骥
33	冯宁		1/1						1/1	100		2					13 13:33 14
77	朱昕晨	0/1	0/1			1/1			1/3	33.3				1			13 15:78 张骥
78	张骥	1/3	0/1			1/1	1/1	2/2	5/8	62.5	1						13 12:21 15
83	潘天																14 13:50 15
运动员 合计		4/11	9/14	2/5	4/5	4/5	1/1	2/2	26/43	60.5	6	11	3	3	1		14 13:50 15
12	孟辉		0/1						0/1	0.0							9 陈开勇
16	刘迈科	6/9	5/9	2/2	2/7	3/5		1/3	19/35	54.3							15 15:31 16
守门员 合计		6/9	5/10	2/2	2/7	3/5		1/3	19/36	52.8							10 成亚

场上队员：得分 / 射门

守门员：救球 / 射门

快攻	Fast Break	突破	Breakthrough	任意球	Free Throw	7M球	7M Throw	助攻	Assist
警告	Warning	失误	Error	2'	Suspension	D	取消资格	DR	取消资格+报告



### 2016年全国男子手球锦标赛 图式比赛技术统计表

轮次 2

场次 9

201606009-21-1/1

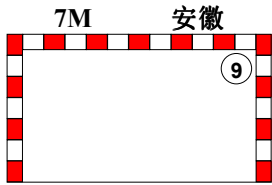
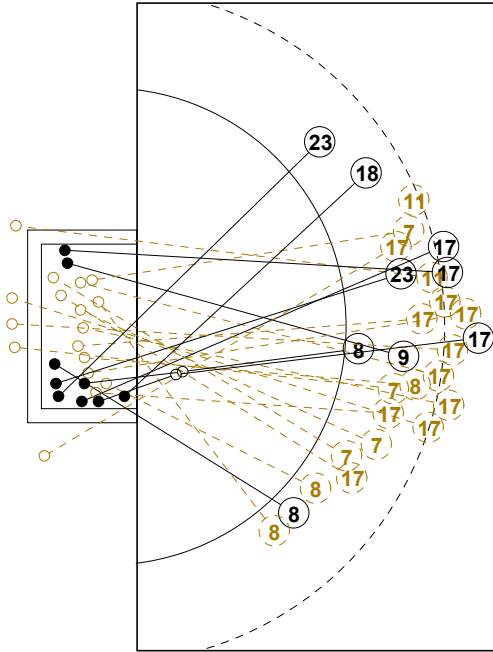

1st Half  
10 : 9

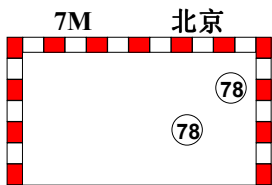
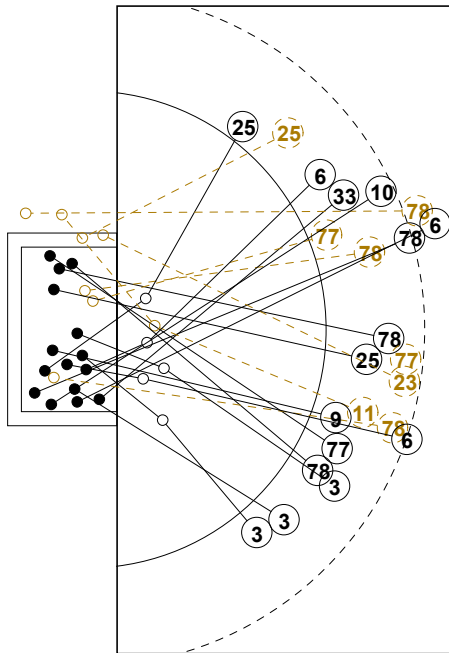
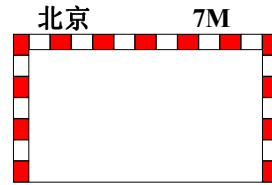
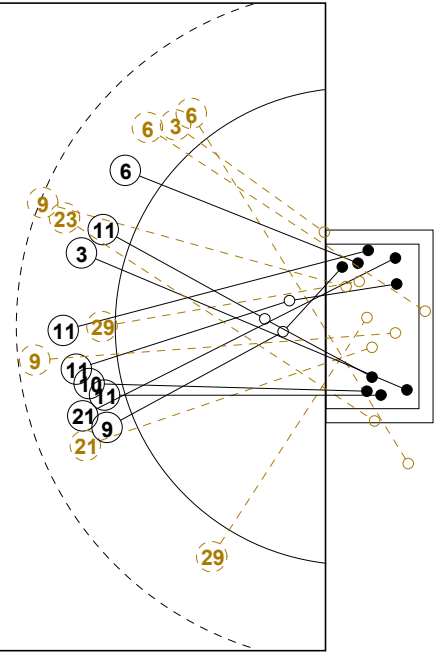

2nd Half  
26 : 17

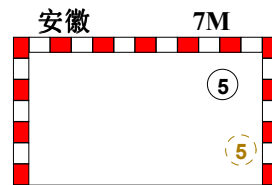
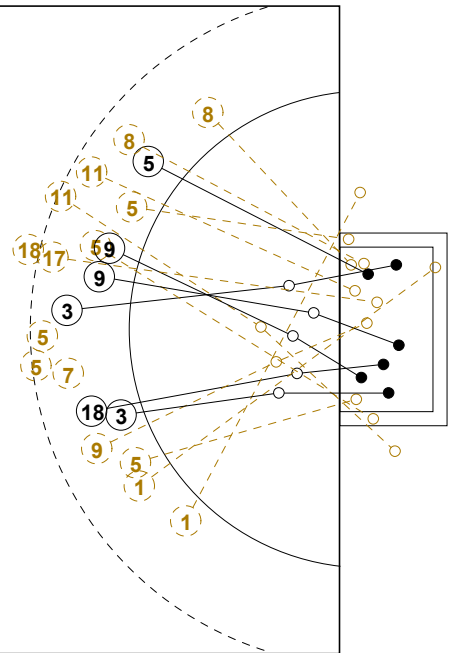





## 2016年全国男子手球锦标赛

## 个人/全队技术统计表

正式表  
手球  
男子预赛  
轮次 2组别 A  
场次 9201606009-14-1/2  
徐闻县体育中心体育馆  
21/10/2016 19:00

号码	姓名	远射	近射	边射	快攻	突破	任意	7M	合计	%	助攻	失误	警告	2'	取消	时间
<b>安徽队(安徽)</b>																
<i>(场上队员)</i>																
1	郭世伟		0/1	0/1					0/2	0.0%		1	1			00:22:25
2	金永峰									0.0%						00:04:06
3	陈强龙		1/1		1/1				2/2	100%	1					00:33:06
5	史小帆	0/2	0/1			1/3		1/2	2/8	25.0%				1		00:31:40
7	姚雄敏		0/2			0/3			0/5	0.0%	1	2				00:30:13
8	董智景		1/2	0/2	1/3				2/7	28.6%	1	1				00:55:52
9	陈开勇		2/3		1/1			1/1	4/5	80.0%			1			00:36:06
10	严龙									0.0%						00:00:00
11	黎涛	0/4							0/4	0.0%		1				00:38:59
12	曾献辰									0.0%						00:00:00
17	王巨柱	3/11	0/3						3/14	21.4%	1	4		1		00:35:04
18	李双	0/1	1/1			1/1			2/3	66.7%	1		1	1		00:34:03
19	何山									0.0%						00:00:00
21	李明									0.0%	1					01:00:00
22	王金宇									0.0%						00:00:00
23	于敏清				2/2				2/2	100%		1				00:37:33
<b>合计</b>		3/18	5/14	0/3	5/7	2/7		2/3	17/52	32.7%	6	10	3	3		
<i>(守门员)</i>																
21	李明	3/7	3/12	1/3	0/4	1/5	0/1	0/2	8/34	23.5%	1					01:00:00
<b>合计</b>																
<b>合计</b>		3/7	3/12	1/3	0/4	1/5	0/1	0/2	8/34	23.5%	1					

场上队员：得分/射门

守门员：救球/射门

全队合计	得分	被救	射失	击柱	封球	合计	%
远射	3	6	4		5	18	16.7%
近射	5	5	2	1	1	14	35.7%
边射		2	1			3	0.0%
快攻	5	2				7	71.4%
突破	2	3		2		7	28.6%
任意							0.0%
7M	2	1				3	66.7%





## 2016年全国男子手球锦标赛

## 个人/全队技术统计表

正式表  
手球  
男子预赛  
轮次 2组别 A  
场次 9201606009-14-2/2  
徐闻县体育中心体育馆  
21/10/2016 19:00

号码	姓名	远射	近射	边射	快攻	突破	任意	7M	合计	%	助攻	失误	警告	2'	取消	时间
<b>北京队(北京)</b>																
<i>(上场队员)</i>																
3	王超		2/2	1/2	1/1				4/5	80.0%	1	2				00:36:43
6	解建飞	2/2	1/1	0/1	1/2				4/6	66.7%			1			00:34:10
8	王鹏									0.0%						00:20:14
9	刘振	0/2	1/1			1/1			2/4	50.0%	2	2				00:37:02
10	成亚	1/1				1/1			2/2	100%	2	2				00:27:17
11	蒋维一		4/5						4/5	80.0%		1	1			00:44:16
12	孟辉									0.0%						00:04:05
16	刘迈科									0.0%						00:55:55
21	胡瀛				1/1	0/1			1/2	50.0%			1	1		00:31:08
23	王军程	0/2							0/2	0.0%				1	1	00:15:02
25	马明辉		0/1	1/1	1/1				2/3	66.7%						00:25:01
29	杜龙飞		0/1	0/1					0/2	0.0%		2				00:24:35
33	冯宁		1/1						1/1	100%		2				00:14:13
77	朱昕晨	0/1	0/1			1/1			1/3	33.3%				1		00:21:29
78	张骥	1/3	0/1			1/1	1/1	2/2	5/8	62.5%	1					00:14:57
83	潘天									0.0%						00:12:26
<b>合计</b>		4/11	9/14	2/5	4/5	4/5	1/1	2/2	26/43	60.5%	6	11	3	3	1	
<i>(守门员)</i>																
12	孟辉		0/1						0/1	0.0%						00:04:05
16	刘迈科	6/9	5/9	2/2	2/7	3/5		1/3	19/35	54.3%						00:55:55
<b>合计</b>		6/9	5/10	2/2	2/7	3/5		1/3	19/36	52.8%						

场上队员：得分/射门

守门员：救球/射门

全队合计	得分	被救	射失	击柱	封球	合计	%
远射	4	3	1	2	1	11	36.4%
近射	9	3	1	1		14	64.3%
边射	2	1	1	1		5	40.0%
快攻	4			1		5	80.0%
突破	4	1				5	80.0%
任意	1					1	100.0%
7M	2					2	100.0%





### 2016年全国男子手球锦标赛

#### 图式射门区域统计

轮次 2 场次 9

201606009-41-1/1

## 安徽队

1 郭世伟	2 金永峰	3 陈强龙	5 史小帆	7 姚雄敏	8 董智景	9 陈开勇	10 严龙																																																																								
<table border="1"><tr><td></td><td></td><td></td></tr><tr><td></td><td></td><td></td></tr><tr><td></td><td></td><td></td></tr></table>										<table border="1"><tr><td></td><td></td><td></td></tr><tr><td></td><td></td><td></td></tr><tr><td></td><td></td><td></td></tr></table>										<table border="1"><tr><td></td><td></td><td></td></tr><tr><td>1</td><td></td><td>1</td></tr><tr><td></td><td></td><td></td></tr></table>				1		1				<table border="1"><tr><td></td><td></td><td>1</td></tr><tr><td></td><td></td><td></td></tr><tr><td>1</td><td></td><td></td></tr></table>			1				1			<table border="1"><tr><td></td><td></td><td></td></tr><tr><td></td><td></td><td></td></tr><tr><td></td><td></td><td></td></tr></table>										<table border="1"><tr><td>1</td><td></td><td></td></tr><tr><td>1</td><td></td><td></td></tr><tr><td></td><td></td><td></td></tr></table>	1			1						<table border="1"><tr><td></td><td></td><td>2</td></tr><tr><td></td><td>1</td><td></td></tr><tr><td></td><td></td><td>1</td></tr></table>			2		1				1	<table border="1"><tr><td></td><td></td><td></td></tr><tr><td></td><td></td><td></td></tr><tr><td></td><td></td><td></td></tr></table>									
1		1																																																																													
		1																																																																													
1																																																																															
1																																																																															
1																																																																															
		2																																																																													
	1																																																																														
		1																																																																													
Post - 1 Miss - 1 Block - 0	Post - 0 Miss - 0 Block - 0	Post - 0 Miss - 0 Block - 0	Post - 2 Miss - 0 Block - 2	Post - 0 Miss - 1 Block - 1	Post - 0 Miss - 0 Block - 0	Post - 0 Miss - 0 Block - 0	Post - 0 Miss - 0 Block - 0																																																																								
11 黎涛	12 曾献辰	17 王巨柱	18 李双	19 何山	21 李明	22 王金宇	23 于敏清																																																																								
<table border="1"><tr><td></td><td></td><td></td></tr><tr><td></td><td></td><td></td></tr><tr><td></td><td></td><td></td></tr></table>										<table border="1"><tr><td></td><td></td><td></td></tr><tr><td></td><td></td><td></td></tr><tr><td></td><td></td><td></td></tr></table>										<table border="1"><tr><td></td><td></td><td>1</td></tr><tr><td>2</td><td></td><td></td></tr><tr><td></td><td></td><td></td></tr></table>			1	2						<table border="1"><tr><td></td><td></td><td></td></tr><tr><td></td><td></td><td>1</td></tr><tr><td>1</td><td></td><td></td></tr></table>						1	1			<table border="1"><tr><td></td><td></td><td></td></tr><tr><td></td><td></td><td></td></tr><tr><td></td><td></td><td></td></tr></table>										<table border="1"><tr><td></td><td></td><td></td></tr><tr><td></td><td></td><td></td></tr><tr><td></td><td></td><td></td></tr></table>										<table border="1"><tr><td></td><td></td><td></td></tr><tr><td></td><td></td><td></td></tr><tr><td></td><td></td><td></td></tr></table>										<table border="1"><tr><td></td><td></td><td>2</td></tr><tr><td></td><td></td><td></td></tr><tr><td></td><td></td><td></td></tr></table>			2						
		1																																																																													
2																																																																															
		1																																																																													
1																																																																															
		2																																																																													
Post - 0 Miss - 2 Block - 1	Post - 0 Miss - 0 Block - 0	Post - 0 Miss - 3 Block - 1	Post - 0 Miss - 0 Block - 1	Post - 0 Miss - 0 Block - 0	Post - 0 Miss - 0 Block - 0	Post - 0 Miss - 0 Block - 0	Post - 0 Miss - 0 Block - 0																																																																								

21 李明

1/6	1/2	0/4
1/6	2/4	1/7
1/4	1/1	



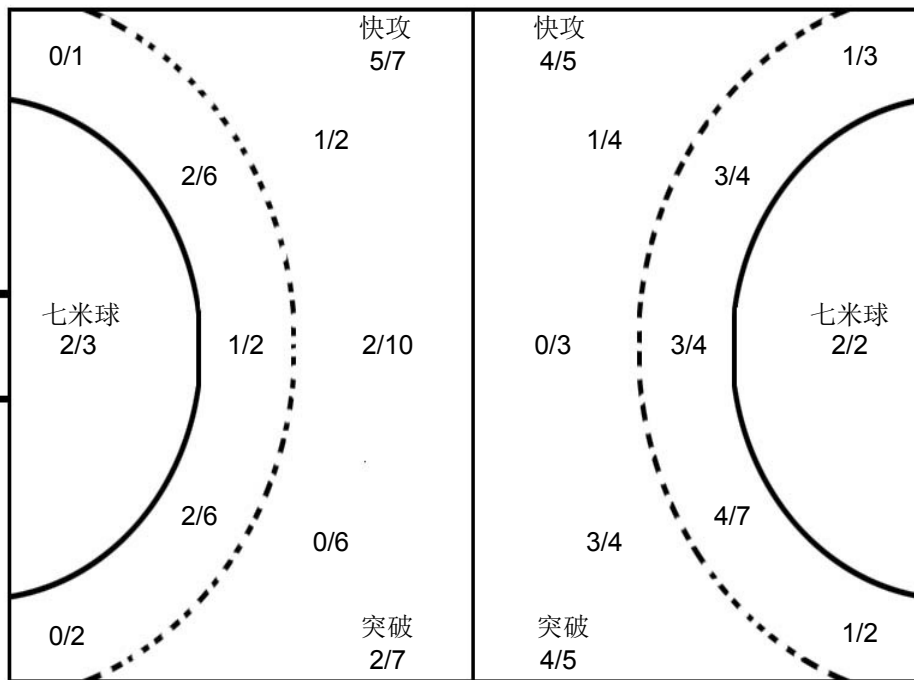

12 孟辉

		0/1

16 刘迈科

0/3		2/6
3/7	5/6	2/3
4/6	1/1	2/3

## 北京队

3 王超	6 解建飞	8 王鹏	9 刘振	10 成亚	11 蒋维一	12 孟辉	16 刘迈科																																																																								
<table border="1"><tr><td></td><td></td><td>1</td></tr><tr><td>1</td><td>2</td><td></td></tr><tr><td></td><td></td><td></td></tr></table>			1	1	2					<table border="1"><tr><td></td><td></td><td></td></tr><tr><td>3</td><td></td><td></td></tr><tr><td>1</td><td></td><td></td></tr></table>				3			1			<table border="1"><tr><td></td><td></td><td></td></tr><tr><td></td><td></td><td></td></tr><tr><td></td><td></td><td></td></tr></table>										<table border="1"><tr><td></td><td>1</td><td></td></tr><tr><td></td><td></td><td></td></tr><tr><td>1</td><td></td><td></td></tr></table>		1					1			<table border="1"><tr><td>1</td><td></td><td></td></tr><tr><td></td><td></td><td>1</td></tr><tr><td></td><td></td><td></td></tr></table>	1					1				<table border="1"><tr><td>1</td><td></td><td></td></tr><tr><td>1</td><td></td><td>2</td></tr><tr><td></td><td></td><td></td></tr></table>	1			1		2				<table border="1"><tr><td></td><td></td><td></td></tr><tr><td></td><td></td><td></td></tr><tr><td></td><td></td><td></td></tr></table>										<table border="1"><tr><td></td><td></td><td></td></tr><tr><td></td><td></td><td></td></tr><tr><td></td><td></td><td></td></tr></table>									
		1																																																																													
1	2																																																																														
3																																																																															
1																																																																															
	1																																																																														
1																																																																															
1																																																																															
		1																																																																													
1																																																																															
1		2																																																																													
Post - 1 Miss - 0 Block - 0	Post - 1 Miss - 1 Block - 0	Post - 0 Miss - 0 Block - 0	Post - 0 Miss - 0 Block - 0	Post - 0 Miss - 0 Block - 0	Post - 0 Miss - 1 Block - 0	Post - 0 Miss - 0 Block - 0	Post - 0 Miss - 0 Block - 0																																																																								
21 胡瀛	23 王军程	25 马明辉	29 杜龙飞	33 冯宁	77 朱昕晨	78 张骥	83 潘天																																																																								
<table border="1"><tr><td>1</td><td></td><td></td></tr><tr><td></td><td></td><td></td></tr><tr><td></td><td></td><td></td></tr></table>	1									<table border="1"><tr><td></td><td></td><td></td></tr><tr><td></td><td></td><td></td></tr><tr><td></td><td></td><td></td></tr></table>										<table border="1"><tr><td></td><td>1</td><td>1</td></tr><tr><td></td><td></td><td></td></tr><tr><td></td><td></td><td></td></tr></table>		1	1							<table border="1"><tr><td></td><td></td><td></td></tr><tr><td></td><td></td><td></td></tr><tr><td></td><td></td><td></td></tr></table>										<table border="1"><tr><td></td><td></td><td></td></tr><tr><td></td><td></td><td></td></tr><tr><td>1</td><td></td><td></td></tr></table>							1			<table border="1"><tr><td></td><td></td><td>1</td></tr><tr><td></td><td></td><td></td></tr><tr><td></td><td></td><td></td></tr></table>			1							<table border="1"><tr><td>1</td><td></td><td>1</td></tr><tr><td></td><td></td><td>3</td></tr><tr><td></td><td></td><td></td></tr></table>	1		1			3				<table border="1"><tr><td></td><td></td><td></td></tr><tr><td></td><td></td><td></td></tr><tr><td></td><td></td><td></td></tr></table>									
1																																																																															
	1	1																																																																													
1																																																																															
		1																																																																													
1		1																																																																													
		3																																																																													
Post - 0 Miss - 0 Block - 0	Post - 2 Miss - 0 Block - 0	Post - 1 Miss - 0 Block - 0	Post - 0 Miss - 0 Block - 0	Post - 0 Miss - 0 Block - 0	Post - 0 Miss - 0 Block - 1	Post - 0 Miss - 1 Block - 0	Post - 0 Miss - 0 Block - 0																																																																								

注释: Post=击柱 Miss=射失 Block=被封





预赛 Group A

男子 全国比赛

2016年全国男子手球锦标赛

Team A				Team B				Match Number													
A 新疆队				B 江苏队				10													
played in		in the hall		on		at		Spectators													
China		徐闻县体育中心体育		21/10/2016		20:40 hours															
Half-time (30')	A	B	End of playing time	A	B	1st extra time	A	B	2nd extra time	A	B	After penalty throws	A	B							
	14	21		25	40																
Number of 7 m	A	Team time-out			Full name of players and officials				Team time-out			B	Number of 7 m								
	0/0	1	2	3					1	2	3	3/6									
	11:54								15:55	46:51											
No.	Team A					G	W	2'	D	DR	No.	Team B					G	W	2'	D	DR
1	宋晓晨										1	徐畅									
5	徐伟					3					4	张家纬					2				
7	林豪文					6					5	闫亮									
8	刘文字					1	1				6	赵晨					1	1			
9	姜春晖					3		1			7	徐奕飞					1	1			
10	王钟彬					2	1				8	周小坚					7				
12	王金鑫										9	周傲									
13	苏兴伟										10	郝可鑫					4				
15	王维东					1		1			12	王权									
17	胡晋铭					3					15	李安					5				
18	姜帅					4	1	1			16	张帅									
19	李龙吉					2					17	王伟强					7				
20	赵元										18	赵楠					9				
24	王泽川										20	顾艳超									
											21	刘江					4				
A	孔德宾 (主教练)										B	闫威名 (主教练)									
B	陈鹏波										C	贾淑君									
C	孙均鹏										D	叶强									
											E	王建国									
A	Signature of Responsible Official of the Teams (Off. A)																		B		
TP	Remarks of Referee / CHA Official																		TP		

Signatures

Referees	刘禹 (CHN)	许翔 (CHN)		
Techn. Delegates	刘凤娟 (CHN)			
CHA Official	王科 (CHN)			

Note: Number of 7m Throws Awarded to Team A and B, Goals (G), Warnings (W), Suspensions (2), Direct Disqualification (D), Disqualification with Report (DR) and Team Penalty (TP).





## 2016年全国男子手球锦标赛 竞赛技术统计(媒体表)

预赛	组别	A	轮次	2	场次	10
徐闻县体育中心体育馆			21/10/2016		201606010-51-1/1	
新疆队	新疆	25	vs	40	江苏	江苏队
14 : 21						

裁判员	刘禹 (CHN)	/	许翔 (CHN)
-----	----------	---	----------

新疆		远	近	边	快	突	任意	7m	合计	%	助攻	失误	警告	2'	D & DR	新疆		江苏				
主教练：孔德宾		射	射	射	攻	破	球	球	球							比赛进程		江苏				
1	宋晓晨										2	2				1st Half		0	01:00	1	18	赵楠
5	徐伟			1/1	2/2				3/3	100						1	01:14	1				
7	林豪文	5/12		1/1					6/13	46.2		1				2	02:04	1				
8	刘文宇	0/1	1/4						1/5	20.0		1	1			3	02:14	2	10	郝可鑫		
9	姜春晖	1/4	0/1		2/2				3/7	42.9	1	2		1		3	02:25	2				
10	王钟彬	2/6	0/2		0/1				2/9	22.2	1	2	1			3	06:05	3	18	赵楠		
12	王金鑫															3	06:22	4	15	李安		
13	苏兴伟															3	08:57	5	10	郝可鑫		
15	王维东		1/1													3	09:28	6	15	李安		
17	胡晋铭		3/4													3	10:07	7	18	赵楠		
18	姜帅	3/7	1/1						4/8	50.0			1	1		3	10:53	8	8	周小坚		
19	李龙吉	1/2	1/4						2/6	33.3		4				3	11:53	9	4	张家纬		
20	赵元															3	12:33	10	8	周小坚		
24	王泽川															4	12:40	10				
运动员 合计		12/32	7/17	2/2	4/5				25/56	44.6	4	13	3	3		4	13:09	10				
1	宋晓晨	1/5	0/13	0/3	0/11			1/4	2/36	5.6	2	2				5	14:19	11	10	郝可鑫		
12	王金鑫	1/2	0/2	0/1	0/2			1/1	2/8	25.0						5	14:19	11	10	郝可鑫		
守门员 合计		2/7	0/15	0/4	0/13			2/5	4/44	9.1	2	2				6	15:42	11				
江苏		远	近	边	快	突	任意	7m	合计	%	助攻	失误	警告	2'	D & DR	2nd Half		江苏				
教练：闫威名		射	射	射	攻	破	球	球	球							14	00:38	22	15	李安		
1	徐畅	0/1							0/1	0.0	1					14	01:19	23	18	赵楠		
4	张家纬		1/2		1/1				2/3	66.7	2	1				14	02:15	24	8	周小坚		
5	闫亮															15	03:26	24				
6	赵晨	0/2	1/1						1/3	33.3	1	2	1			15	03:44	24				
7	徐奕飞				1/1				1/1	100		2	1			16	03:44	24				
8	周小坚	1/2	5/6													17	04:11	24				
9	周傲															17	05:29	25	15	李安		
10	郝可鑫	2/4	2/2								3	2				17	05:34	26	8	周小坚		
12	王权															17	05:37	27	6	赵晨		
15	李安	1/1			4/4				0/1	5/6	83.3	1	1			17	05:45	28	4	张家纬		
16	张帅															18	06:19	28				
17	王伟强		3/3	3/3	1/1				7/7	100		1				18	06:43	29	8	周小坚		
18	赵楠	1/3	2/3	1/1	3/3			2/3	9/13	69.2	1	3				19	07:13	29				
20	顾艳超															20	08:54	29				
21	刘江		1/1		3/3				4/4	100						21	10:03	29				
运动员 合计		5/13	15/18	4/4	13/13			3/6	40/54	74.1	12	16	2			22	10:35	29				
1	徐畅	8/20	7/14	0/2	1/5				16/41	39.0	1					22	10:50	30	8	周小坚		
守门员 合计		8/20	7/14	0/2	1/5			16/41	39.0	1	1					22	11:35	31	10	郝可鑫		
场上队员：得分 / 射门																守门员：救球 / 射门						

快攻	Fast Break	突破	Breakthrough	任意球	Free Throw	7M球	7M Throw	助攻	Assist
警告	Warning	失误	Error	2'	Suspension	D	取消资格	DR	取消资格+报告





## 2016年全国男子手球锦标赛 图式比赛技术统计表

轮次 2

场次 10

201606010-21-1/1

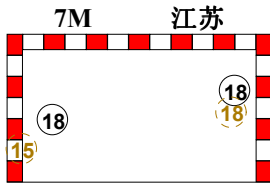
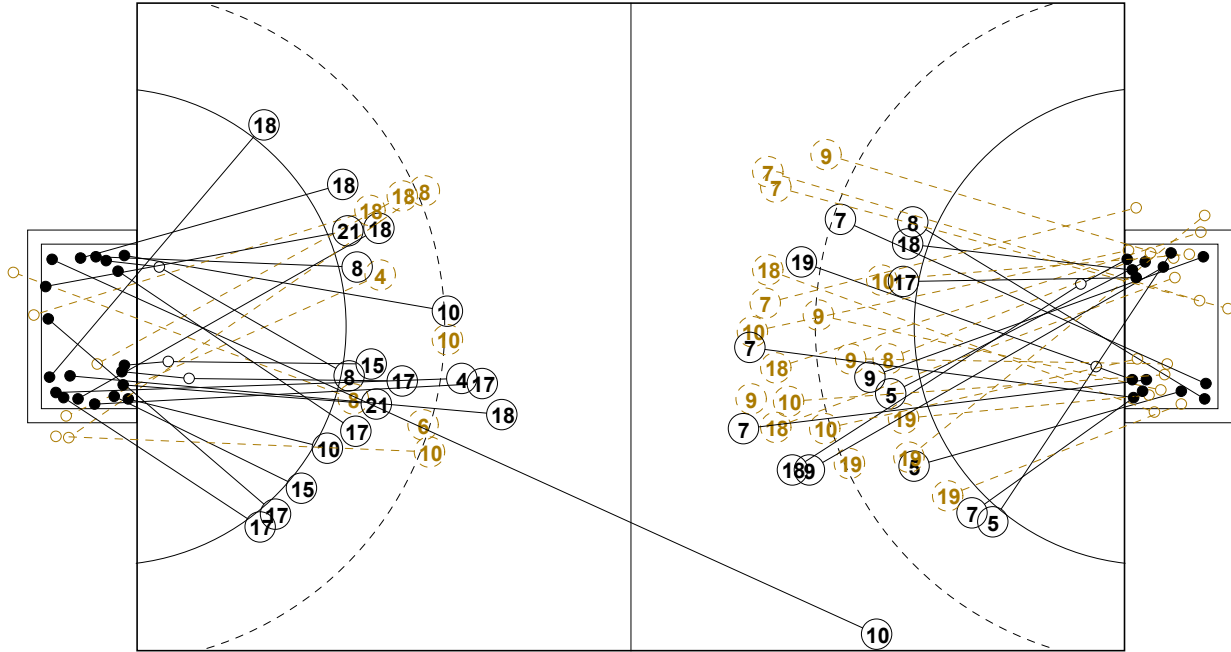

1st Half  
21 : 14

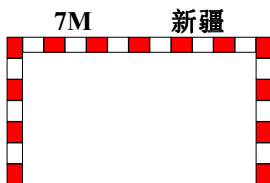
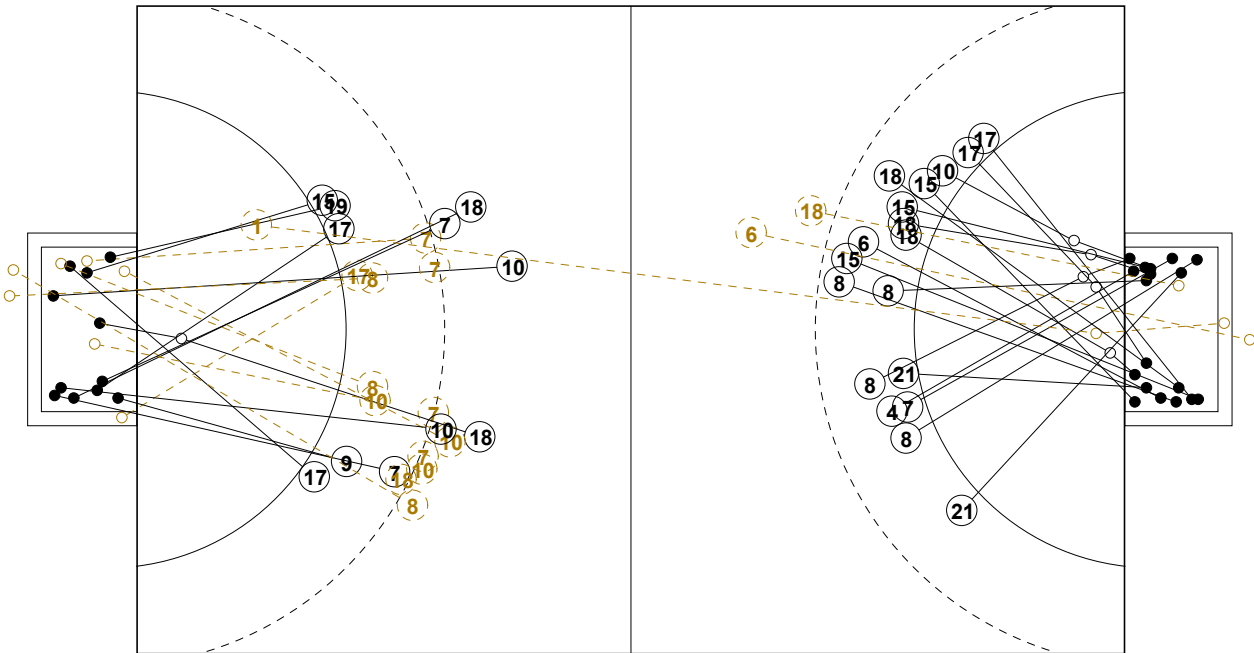
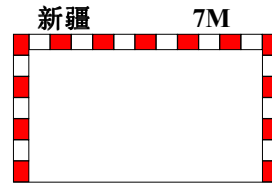

2nd Half  
25 : 40

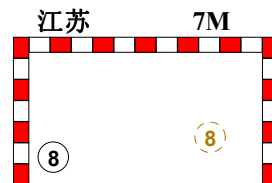



## 2016年全国男子手球锦标赛

## 个人/全队技术统计表

正式表  
手球  
男子预赛  
轮次 2组别 A  
场次 10201606010-14-1/2  
徐闻县体育中心体育馆  
21/10/2016 20:40

号码	姓名	远射	近射	边射	快攻	突破	任意	7M	合计	%	助攻	失误	警告	2'	取消	时间
<b>新疆队(新疆)</b>																
<i>(场上队员)</i>																
1	宋晓晨									0.0%	2	2				00:51:03
5	徐伟			1/1	2/2				3/3	100%						00:30:00
7	林豪文	5/12		1/1					6/13	46.2%		1				00:56:49
8	刘文字	0/1	1/4						1/5	20.0%		1	1			00:31:42
9	姜春晖	1/4	0/1		2/2				3/7	42.9%	1	2		1		00:49:58
10	王钟彬	2/6	0/2		0/1				2/9	22.2%	1	2	1			00:50:22
12	王金鑫									0.0%						00:08:57
13	苏兴伟									0.0%						00:00:00
15	王维东		1/1						1/1	100%		1		1		00:27:35
17	胡晋铭		3/4						3/4	75.0%						00:20:38
18	姜帅	3/7	1/1						4/8	50.0%			1	1		01:18:07
19	李龙吉	1/2	1/4						2/6	33.3%		4				00:53:44
20	赵元									0.0%						00:00:00
24	王泽川									0.0%						00:18:52
<b>合计</b>																
<i>(守门员)</i>																
1	宋晓晨	1/5	0/13	0/3	0/11			1/4	2/36	5.6%	2	2				00:51:03
12	王金鑫	1/2	0/2	0/1	0/2			1/1	2/8	25.0%						00:08:57
<b>合计</b>																

场上队员：得分/射门

守门员：救球/射门

全队合计	得分	被救	射失	击柱	封球	合计	%
远射	12	8	2	3	7	32	37.5%
近射	7	7	2	1		17	41.2%
边射	2					2	100.0%
快攻	4	1				5	80.0%
突破							0.0%
任意							0.0%
7M							0.0%





## 2016年全国男子手球锦标赛

## 个人/全队技术统计表

正式表  
手球  
男子预赛  
轮次 2组别 A  
场次 10201606010-14-2/2  
徐闻县体育中心体育馆  
21/10/2016 20:40

号码	姓名	远射	近射	边射	快攻	突破	任意	7M	合计	%	助攻	失误	警告	2'	取消	时间
<b>江苏队(江苏)</b>																
<i>(上场队员)</i>																
1	徐畅	0/1							0/1	0.0%	1					01:00:00
4	张家纬		1/2		1/1				2/3	66.7%	2	1				00:49:36
5	闫亮									0.0%	1					00:14:00
6	赵晨	0/2	1/1						1/3	33.3%	1	2	1			00:36:06
7	徐奕飞				1/1				1/1	100%		2	1			00:00:30
8	周小坚	1/2	5/6					1/2	7/10	70.0%		4				00:35:42
9	周傲									0.0%						00:10:02
10	郝可鑫	2/4	2/2						4/6	66.7%	3	2				00:48:49
12	王权									0.0%						00:00:00
15	李安	1/1			4/4			0/1	5/6	83.3%	1	1				00:35:21
16	张帅									0.0%						00:00:00
17	王伟强		3/3	3/3	1/1				7/7	100%		1				00:24:37
18	赵楠	1/3	2/3	1/1	3/3			2/3	9/13	69.2%	1	3				01:13:09
20	顾艳超									0.0%	2					00:23:37
21	刘江		1/1		3/3				4/4	100%						00:23:01
<b>合计</b>		5/13	15/18	4/4	13/13			3/6	40/54	74.1%	12	16	2			
<i>(守门员)</i>																
1	徐畅	8/20	7/14	0/2	1/5				16/41	39.0%	1					01:00:00
<b>合计</b>		8/20	7/14	0/2	1/5				16/41	39.0%	1					

场上队员：得分/射门

守门员：救球/射门

全队合计	得分	被救	射失	击柱	封球	合计	%
远射	5	2	3	1	2	13	38.5%
近射	15		1	2		18	83.3%
边射	4					4	100.0%
快攻	13					13	100.0%
突破							0.0%
任意							0.0%
7M	3	2		1		6	50.0%







2016年全国男子手球锦标赛

图式射门区域统计

轮次 2 场次 10

201606010-41-1/1

新疆队

1 宋晓晨	5 徐伟	7 林豪文	8 刘文宇	9 姜春晖	10 王钟彬	12 王金鑫	13 苏兴伟																																																																								
<table border="1"><tr><td></td><td></td><td></td></tr><tr><td></td><td></td><td></td></tr><tr><td></td><td></td><td></td></tr></table>										<table border="1"><tr><td></td><td></td><td></td></tr><tr><td>1</td><td></td><td>1</td></tr><tr><td>1</td><td></td><td></td></tr></table>				1		1	1			<table border="1"><tr><td>1</td><td></td><td>1</td></tr><tr><td>1</td><td></td><td></td></tr><tr><td></td><td></td><td>3</td></tr></table>	1		1	1					3	<table border="1"><tr><td></td><td></td><td>1</td></tr><tr><td></td><td></td><td></td></tr><tr><td></td><td></td><td></td></tr></table>			1							<table border="1"><tr><td>1</td><td></td><td></td></tr><tr><td>1</td><td></td><td></td></tr><tr><td>1</td><td></td><td></td></tr></table>	1			1			1			<table border="1"><tr><td>1</td><td></td><td>1</td></tr><tr><td></td><td></td><td></td></tr><tr><td></td><td></td><td></td></tr></table>	1		1							<table border="1"><tr><td></td><td></td><td></td></tr><tr><td></td><td></td><td></td></tr><tr><td></td><td></td><td></td></tr></table>										<table border="1"><tr><td></td><td></td><td></td></tr><tr><td></td><td></td><td></td></tr><tr><td></td><td></td><td></td></tr></table>									
1		1																																																																													
1																																																																															
1		1																																																																													
1																																																																															
		3																																																																													
		1																																																																													
1																																																																															
1																																																																															
1																																																																															
1		1																																																																													
Post - 0 Miss - 0 Block - 0	Post - 0 Miss - 0 Block - 0	Post - 1 Miss - 1 Block - 3	Post - 0 Miss - 2 Block - 0	Post - 0 Miss - 0 Block - 1	Post - 0 Miss - 0 Block - 1	Post - 0 Miss - 0 Block - 0	Post - 0 Miss - 0 Block - 0																																																																								
15 王维东	17 胡晋铭	18 姜帅	19 李龙吉	20 赵元	24 王泽川																																																																										
<table border="1"><tr><td></td><td></td><td></td></tr><tr><td></td><td></td><td>1</td></tr><tr><td></td><td></td><td></td></tr></table>						1				<table border="1"><tr><td></td><td></td><td>1</td></tr><tr><td>1</td><td></td><td></td></tr><tr><td>1</td><td></td><td></td></tr></table>			1	1			1			<table border="1"><tr><td>1</td><td></td><td></td></tr><tr><td></td><td>1</td><td></td></tr><tr><td>2</td><td></td><td></td></tr></table>	1				1		2			<table border="1"><tr><td></td><td></td><td></td></tr><tr><td></td><td></td><td></td></tr><tr><td></td><td></td><td>2</td></tr></table>									2	<table border="1"><tr><td></td><td></td><td></td></tr><tr><td></td><td></td><td></td></tr><tr><td></td><td></td><td></td></tr></table>										<table border="1"><tr><td></td><td></td><td></td></tr><tr><td></td><td></td><td></td></tr><tr><td></td><td></td><td></td></tr></table>																													
		1																																																																													
		1																																																																													
1																																																																															
1																																																																															
1																																																																															
	1																																																																														
2																																																																															
		2																																																																													
Post - 0 Miss - 0 Block - 0	Post - 1 Miss - 0 Block - 0	Post - 2 Miss - 0 Block - 1	Post - 0 Miss - 1 Block - 1	Post - 0 Miss - 0 Block - 0	Post - 0 Miss - 0 Block - 0																																																																										

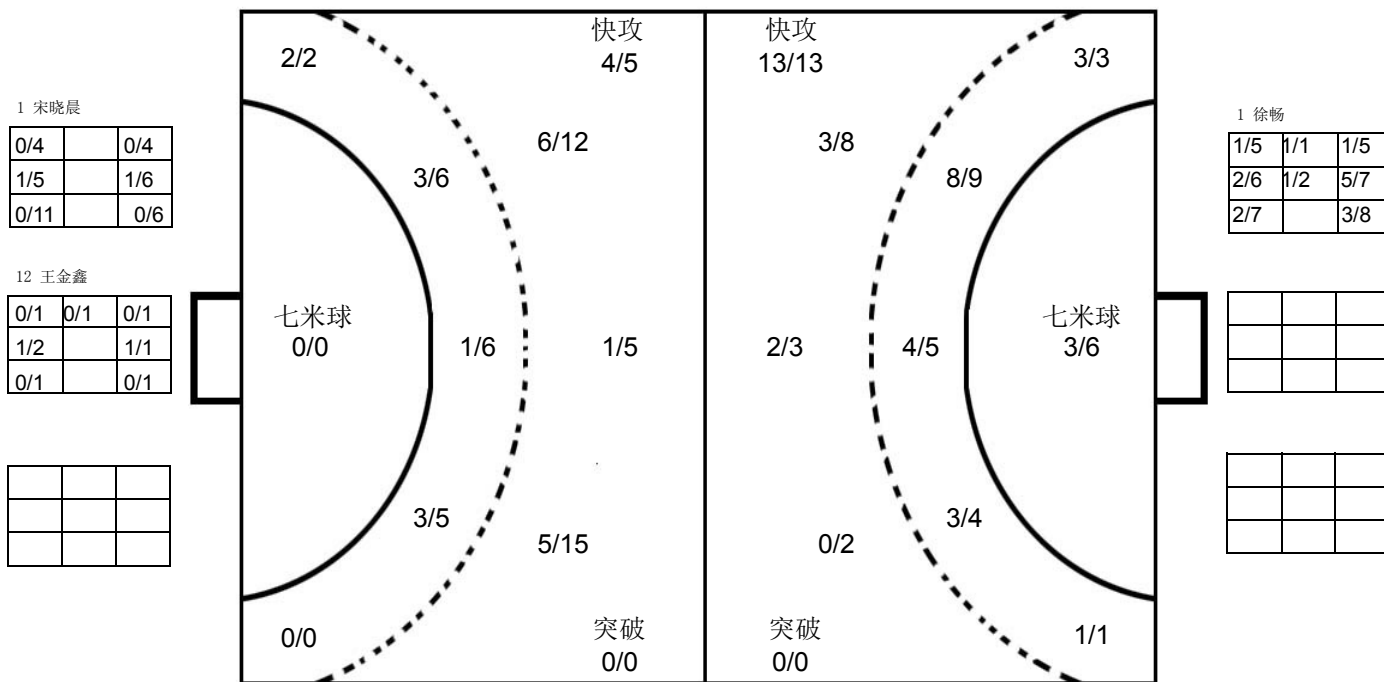

江苏队

1 徐畅	4 张家伟	5 闫亮	6 赵晨	7 徐奕飞	8 周小坚	9 周傲	10 郝可鑫																																																																								
<table border="1"><tr><td></td><td></td><td></td></tr><tr><td></td><td></td><td></td></tr><tr><td></td><td></td><td></td></tr></table>										<table border="1"><tr><td>1</td><td></td><td></td></tr><tr><td></td><td></td><td></td></tr><tr><td>1</td><td></td><td></td></tr></table>	1						1			<table border="1"><tr><td></td><td></td><td></td></tr><tr><td></td><td></td><td></td></tr><tr><td></td><td></td><td></td></tr></table>										<table border="1"><tr><td></td><td></td><td>1</td></tr><tr><td></td><td></td><td></td></tr><tr><td></td><td></td><td></td></tr></table>			1							<table border="1"><tr><td>1</td><td></td><td></td></tr><tr><td></td><td></td><td></td></tr><tr><td></td><td></td><td></td></tr></table>	1									<table border="1"><tr><td>1</td><td></td><td></td></tr><tr><td></td><td></td><td>2</td></tr><tr><td>3</td><td></td><td>1</td></tr></table>	1					2	3		1	<table border="1"><tr><td></td><td></td><td></td></tr><tr><td></td><td></td><td></td></tr><tr><td></td><td></td><td></td></tr></table>										<table border="1"><tr><td></td><td></td><td>1</td></tr><tr><td></td><td></td><td></td></tr><tr><td>2</td><td></td><td>1</td></tr></table>			1				2		1
1																																																																															
1																																																																															
		1																																																																													
1																																																																															
1																																																																															
		2																																																																													
3		1																																																																													
		1																																																																													
2		1																																																																													
Post - 1 Miss - 0 Block - 0	Post - 1 Miss - 0 Block - 0	Post - 0 Miss - 0 Block - 0	Post - 0 Miss - 1 Block - 1	Post - 0 Miss - 0 Block - 0	Post - 0 Miss - 2 Block - 0	Post - 0 Miss - 0 Block - 0	Post - 0 Miss - 1 Block - 1																																																																								
12 王权	15 李安	16 张帅	17 王伟强	18 赵楠	20 顾艳超	21 刘江																																																																									
<table border="1"><tr><td></td><td></td><td></td></tr><tr><td></td><td></td><td></td></tr><tr><td></td><td></td><td></td></tr></table>										<table border="1"><tr><td></td><td></td><td>1</td></tr><tr><td></td><td></td><td></td></tr><tr><td>3</td><td></td><td>1</td></tr></table>			1				3		1	<table border="1"><tr><td></td><td></td><td></td></tr><tr><td></td><td></td><td></td></tr><tr><td></td><td></td><td></td></tr></table>										<table border="1"><tr><td>1</td><td>1</td><td>1</td></tr><tr><td>1</td><td></td><td></td></tr><tr><td>1</td><td></td><td>2</td></tr></table>	1	1	1	1			1		2	<table border="1"><tr><td>2</td><td></td><td>1</td></tr><tr><td>2</td><td></td><td>2</td></tr><tr><td>1</td><td></td><td>1</td></tr></table>	2		1	2		2	1		1	<table border="1"><tr><td></td><td></td><td></td></tr><tr><td></td><td></td><td></td></tr><tr><td></td><td></td><td></td></tr></table>										<table border="1"><tr><td></td><td></td><td>1</td></tr><tr><td>1</td><td></td><td></td></tr><tr><td>1</td><td></td><td>1</td></tr></table>			1	1			1		1	<table border="1"><tr><td></td><td></td><td></td></tr><tr><td></td><td></td><td></td></tr><tr><td></td><td></td><td></td></tr></table>									
		1																																																																													
3		1																																																																													
1	1	1																																																																													
1																																																																															
1		2																																																																													
2		1																																																																													
2		2																																																																													
1		1																																																																													
		1																																																																													
1																																																																															
1		1																																																																													
Post - 0 Miss - 0 Block - 0	Post - 1 Miss - 0 Block - 0	Post - 0 Miss - 0 Block - 0	Post - 0 Miss - 0 Block - 0	Post - 1 Miss - 0 Block - 0	Post - 0 Miss - 0 Block - 0	Post - 0 Miss - 0 Block - 0																																																																									

注释: Post=击柱 Miss=射失 Block=被封





预赛 Group A

男子 全国比赛

2016年全国男子手球锦标赛

Team A A 北京队				Team B B 解放军队				Match Number <b>11</b>													
played in China		in the hall 徐闻县体育中心体育		on 22/10/2016		at 13:30 hours		Spectators													
Half-time (30')	A 20	B 7	End of playing time	A 22	B 7	1st extra time	A	B	2nd extra time	A	B	After penalty throws	A	B							
Number of 7 m	A 2/2	Team time-out 1 06:59 2 3			Full name of players and officials				Team time-out 1 10:23 2 21:13 3			B 0/0	Number of 7 m								
No.	Team A					G	W	2'	D	DR	No.	Team B					G	W	2'	D	DR
3	王超					5					1	李梓宁									
6	解建飞					2					2	范保坤									
8	王鹏										4	曹作亮									
9	刘振					2					5	张昌轲								1	
10	成亚					1					6	吴昊					2	1			
11	蒋维一					1					7	姜钦					1	1			
12	孟辉										8	王烁									
16	刘迈科										9	毕晓晨					2		2		
21	胡瀛							1			11	肖东洋						1			
25	马明辉					1	1				12	姜明									
29	杜龙飞					2					14	孙耀琦					2				
33	冯宁										15	杨帆									
77	朱昕晨					2					16	丛霖									
78	张骥					6					18	王晓龙									
83	潘天										20	刘智洋									
A	安福田										B	张敬敏 (主教练)									
B	郑永利 (主教练)										C	王学力									
C	陈璇										D	刘捷									
											E	刘军									
A	Signature of Responsible Official of the Teams (Off. A)										B										
TP	Remarks of Referee / CHA Official										TP										

Signatures

Referees: 王科 (CHN) 倪震 (CHN)

Techn. Delegates: 程钰峰 (CHN)

CHA Official: 刘禹 (CHN)

Note: Number of 7m Throws Awarded to Team A and B, Goals (G), Warnings (W), Suspensions (2), Direct Disqualification (D), Disqualification with Report (DR) and Team Penalty (TP).

Table Officials: 梁小熹 王亚光 Statisticians: 周亚桥 李双

Printed by PHMS Copyright: IHF / CHA 22/10/2016 14:24:53

Longman Sportsoft  handball@126.com



## 2016年全国男子手球锦标赛 竞赛技术统计(媒体表)

<b>预赛</b>	组别	<b>A</b>	轮次	<b>3</b>	场次	<b>11</b>
徐闻县体育中心体育馆			22/10/2016		201606011-51-1/1	
北京队	<b>北京</b>	<b>22</b>	vs	<b>7</b>	<b>解放军</b>	解放军队
<b>20 : 7</b>						

裁判员		王科 (CHN)											/	倪震 (CHN)					
<b>北京</b>		远射	近射	边射	快攻	突破	任意球	7m球	合计	%	助攻	失误	警告	2'	D & DR	<b>北京</b> 比赛进程 <b>解放军</b>			
主教练：郑永利																			
3	王超		1/2	1/2	3/3			5/7	71.4	1						1st Half			
6	解建飞			0/1	2/2			2/3	66.7							0 01:48 1 9 毕晓晨			
8	王鹏															0 02:26 2 14 孙耀琦			
9	刘振	0/1				2/2		2/3	66.7	1						78 张骥 1 02:42 2			
10	成亚	1/1		0/1	0/1	0/1		1/4	25.0							10 成亚 2 03:51 2			
11	蒋维一	0/1	1/1		0/1			1/3	33.3		2					9 刘振 3 07:11 2			
12	孟辉															25 马明辉 4 07:51 2			
16	刘迈科															78 张骥 5 08:23 2			
21	胡瀛													1		9 刘振 6 10:11 2			
25	马明辉			1/3				1/3	33.3				1			6 10:59 3 9 毕晓晨			
29	杜龙飞			2/2	0/1			2/3	66.7	1						7 12:32 3			
33	冯宁															78 张骥 7 13:09 4 7 姜钦			
77	朱昕晨	0/1	1/1				1/1	2/3	66.7							8 14:08 4			
78	张骥	2/4	2/2			1/2	1/1	6/9	66.7	1						6 解建飞 9 15:43 4			
83	潘天															78 张骥 10 17:53 4			
<b>运动员 合计</b>		3/8	5/6	4/9	5/8	3/5	2/2	22/38	57.9	9	2	1	1			10 18:38 5 14 孙耀琦			
12	孟辉	1/1						1/1	100	1						78 张骥 11 19:20 5			
16	刘迈科	5/6	0/3	0/2	1/2			6/13	46.2	3						3 王超 12 20:44 5			
<b>守门员 合计</b>		6/7	0/3	0/2	1/2			7/14	50.0	4						3 王超 13 21:08 5			
<b>解放军</b>		远射	近射	边射	快攻	突破	任意球	7m球	合计	%	助攻	失误	警告	2'	D & DR				
教练：张敬敏																			
1	李梓宁																		
2	范保坤																		
4	曹作亮																		
5	张昌轲			0/1				0/1	0.0		1			1					
6	吴昊	0/6	2/2		0/1	0/1		2/10	20.0		2	1							
7	姜钦	1/8						1/8	12.5	1	3	1							
8	王烁										1								
9	毕晓晨	0/3		2/2				2/5	40.0	2	1			2					
11	肖东洋	0/1						0/1	0.0		2	1							
12	姜明																		
14	孙耀琦		1/1		1/1			2/2	100										
15	杨帆																		
16	丛霖																		
18	王晓龙																		
20	刘智洋																		
<b>运动员 合计</b>		1/18	3/3	2/3	1/2	0/1		7/27	25.9	3	10	3	3						
1	李梓宁	1/4	1/4	3/6	2/6	2/5		0/1	9/26	34.6									
12	姜明		0/2	0/1	1/2			0/1	1/6	16.7									
<b>守门员 合计</b>		1/4	1/6	3/7	3/8	2/5		0/2	10/32	31.3									

场上队员：得分 / 射门

守门员：救球 / 射门

快攻	Fast Break		突破	Breakthrough		任意球	Free Throw		7M球	7M Throw		助攻	Assist
警告	Warning		失误	Error		2'	Suspension		D	取消资格		DR	取消资格+报告



### 2016年全国男子手球锦标赛 图式比赛技术统计表

轮次 3

场次 11

201606011-21-1/1

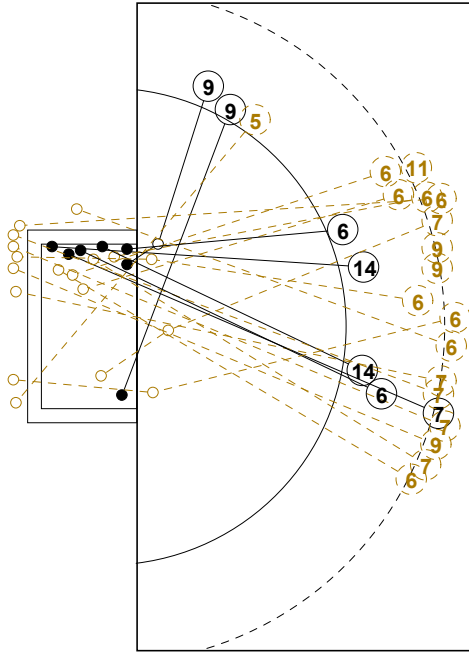

7M 解放军

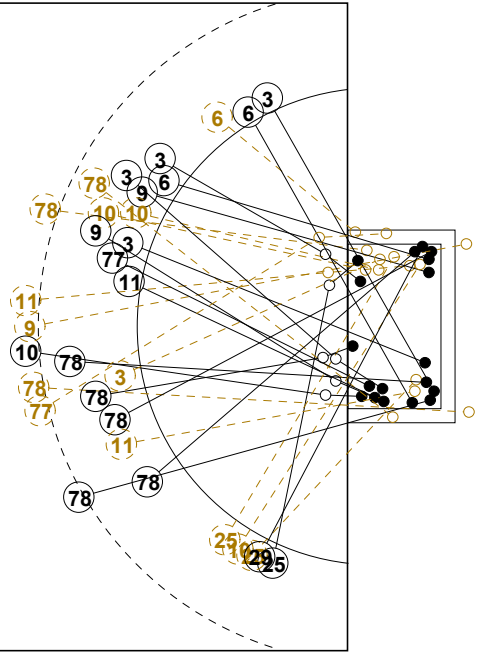
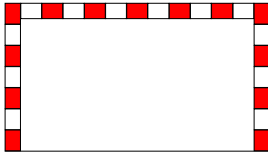

北京 7M

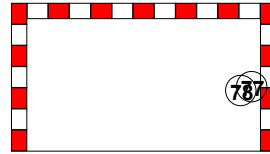

1st Half  
7 : 20

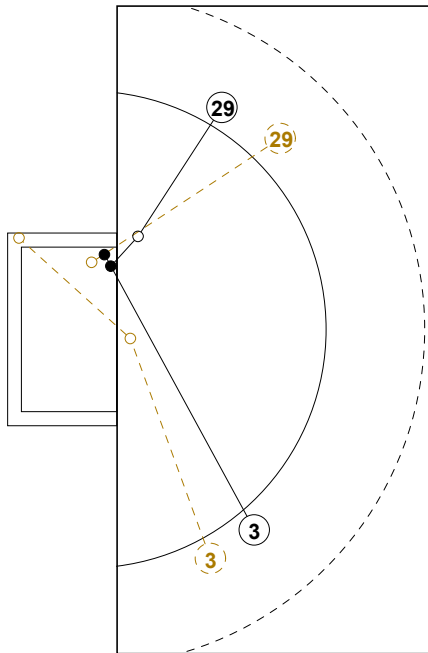

7M 北京

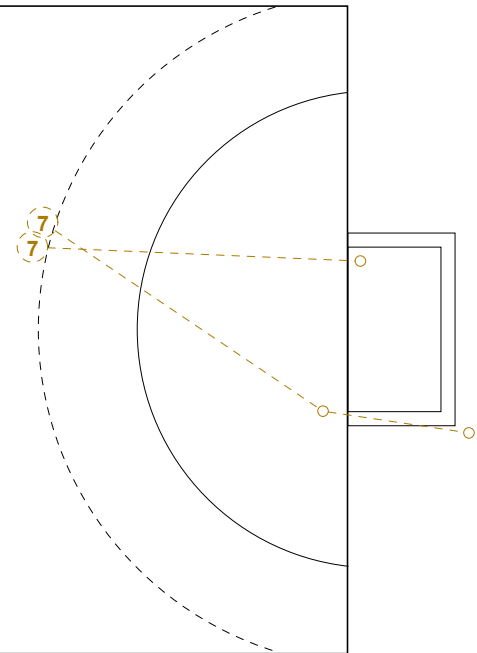
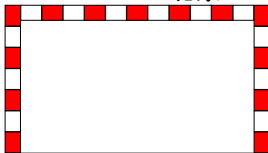

解放军 7M

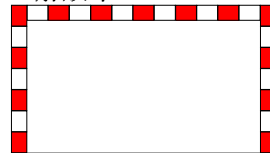

2nd Half  
22 : 7



## 2016年全国男子手球锦标赛

## 个人/全队技术统计表

正式表  
手球  
男子预赛  
轮次 3组别 A  
场次 11201606011-14-1/2  
徐闻县体育中心体育馆  
22/10/2016 13:30

号码	姓名	远射	近射	边射	快攻	突破	任意	7M	合计	%	助攻	失误	警告	2'	取消	时间
<b>北京队(北京)</b>																
<i>(场上队员)</i>																
3	王超		1/2	1/2	3/3				5/7	71.4%	1					00:12:14
6	解建飞			0/1	2/2				2/3	66.7%						00:28:30
8	王鹏									0.0%						00:03:30
9	刘振	0/1				2/2			2/3	66.7%	1					00:21:13
10	成亚	1/1		0/1	0/1	0/1			1/4	25.0%						00:23:18
11	蒋维一	0/1	1/1		0/1				1/3	33.3%		2				00:23:54
12	孟辉									0.0%	1					00:03:43
16	刘迈科									0.0%	3					00:28:38
21	胡瀛									0.0%				1		00:09:42
25	马明辉			1/3					1/3	33.3%			1			00:15:57
29	杜龙飞			2/2	0/1				2/3	66.7%	1					00:08:55
33	冯宁									0.0%	1					00:06:35
77	朱昕晨	0/1	1/1					1/1	2/3	66.7%						00:11:31
78	张骥	2/4	2/2			1/2		1/1	6/9	66.7%	1					00:16:12
83	潘天									0.0%						00:11:38
<b>合计</b>		3/8	5/6	4/9	5/8	3/5		2/2	22/38	57.9%	9	2	1	1		
<i>(守门员)</i>																
12	孟辉	1/1							1/1	100%	1					00:03:43
16	刘迈科	5/6	0/3	0/2	1/2				6/13	46.2%	3					00:28:38
<b>合计</b>		6/7	0/3	0/2	1/2				7/14	50.0%	4					

场上队员：得分/射门

守门员：救球/射门

全队合计	得分	被救	射失	击柱	封球	合计	%
远射	3	1	2	2		8	37.5%
近射	5	1				6	83.3%
边射	4	3		2		9	44.4%
快攻	5	3				8	62.5%
突破	3	2				5	60.0%
任意							0.0%
7M	2					2	100.0%





## 2016年全国男子手球锦标赛

## 个人/全队技术统计表

正式表  
手球  
男子预赛  
轮次 3组别 A  
场次 11201606011-14-2/2  
徐闻县体育中心体育馆  
22/10/2016 13:30

号码	姓名	远射	近射	边射	快攻	突破	任意	7M	合计	%	助攻	失误	警告	2'	取消	时间
<b>解放军队(解放军)</b>																
<i>(上场队员)</i>																
1	李梓宁									0.0%						00:28:01
2	范保坤									0.0%						00:00:00
4	曹作亮									0.0%						00:00:00
5	张昌轲			0/1					0/1	0.0%		1		1		00:16:20
6	吴昊	0/6	2/2		0/1	0/1			2/10	20.0%		2		1		00:32:21
7	姜钦	1/8							1/8	12.5%	1	3		1		00:32:21
8	王烁									0.0%		1				00:23:58
9	毕晓晨	0/3		2/2					2/5	40.0%	2	1		2		00:32:21
11	肖东洋	0/1							0/1	0.0%		2		1		00:18:07
12	姜明									0.0%						00:04:20
14	孙耀琦		1/1		1/1				2/2	100%						00:32:21
15	杨帆									0.0%						00:00:00
16	丛霖									0.0%						00:00:00
18	王晓龙									0.0%						00:00:00
20	刘智洋									0.0%						00:06:11
<b>合计</b>		1/18	3/3	2/3	1/2	0/1			7/27	25.9%	3	10	3	3		
<i>(守门员)</i>																
1	李梓宁	1/4	1/4	3/6	2/6	2/5		0/1	9/26	34.6%						00:28:01
12	姜明		0/2	0/1	1/2			0/1	1/6	16.7%						00:04:20
<b>合计</b>		1/4	1/6	3/7	3/8	2/5		0/2	10/32	31.3%						

场上队员：得分/射门

守门员：救球/射门

全队合计	得分	被救	射失	击柱	封球	合计	%
远射	1	6	8		3	18	5.6%
近射	3					3	100.0%
边射	2		1			3	66.7%
快攻	1	1				2	50.0%
突破			1			1	0.0%
任意							0.0%
7M							0.0%





### 2016年全国男子手球锦标赛

#### 图式射门区域统计

轮次 3 场次 11

201606011-41-1/1

## 北京队

3 王超	6 解建飞	8 王鹏	9 刘振	10 成亚	11 蒋维一	12 孟辉	16 刘迈科																																																																								
<table border="1"><tr><td></td><td></td><td>2</td></tr><tr><td></td><td></td><td>1</td></tr><tr><td>1</td><td></td><td>1</td></tr></table>			2			1	1		1	<table border="1"><tr><td>1</td><td></td><td>1</td></tr><tr><td></td><td></td><td></td></tr><tr><td></td><td></td><td></td></tr></table>	1		1							<table border="1"><tr><td></td><td></td><td></td></tr><tr><td></td><td></td><td></td></tr><tr><td></td><td></td><td></td></tr></table>										<table border="1"><tr><td>1</td><td></td><td></td></tr><tr><td></td><td></td><td></td></tr><tr><td></td><td></td><td>1</td></tr></table>	1								1	<table border="1"><tr><td></td><td></td><td></td></tr><tr><td></td><td></td><td></td></tr><tr><td></td><td></td><td>1</td></tr></table>									1	<table border="1"><tr><td></td><td></td><td></td></tr><tr><td></td><td></td><td></td></tr><tr><td></td><td></td><td>1</td></tr></table>									1	<table border="1"><tr><td></td><td></td><td></td></tr><tr><td></td><td></td><td></td></tr><tr><td></td><td></td><td></td></tr></table>										<table border="1"><tr><td></td><td></td><td></td></tr><tr><td></td><td></td><td></td></tr><tr><td></td><td></td><td></td></tr></table>									
		2																																																																													
		1																																																																													
1		1																																																																													
1		1																																																																													
1																																																																															
		1																																																																													
		1																																																																													
		1																																																																													
Post - 1 Miss - 0 Block - 0	Post - 1 Miss - 0 Block - 0	Post - 0 Miss - 0 Block - 0	Post - 0 Miss - 1 Block - 0	Post - 0 Miss - 0 Block - 0	Post - 0 Miss - 0 Block - 0	Post - 0 Miss - 0 Block - 0	Post - 0 Miss - 0 Block - 0																																																																								
21 胡瀛	25 马明辉	29 杜龙飞	33 冯宁	77 朱昕晨	78 张骥	83 潘天																																																																									
<table border="1"><tr><td></td><td></td><td></td></tr><tr><td></td><td></td><td></td></tr><tr><td></td><td></td><td></td></tr></table>										<table border="1"><tr><td></td><td></td><td></td></tr><tr><td></td><td></td><td></td></tr><tr><td>1</td><td></td><td></td></tr></table>							1			<table border="1"><tr><td>1</td><td></td><td></td></tr><tr><td></td><td></td><td></td></tr><tr><td></td><td></td><td>1</td></tr></table>	1								1	<table border="1"><tr><td></td><td></td><td></td></tr><tr><td></td><td></td><td></td></tr><tr><td></td><td></td><td></td></tr></table>										<table border="1"><tr><td></td><td></td><td></td></tr><tr><td></td><td></td><td></td></tr><tr><td></td><td></td><td>1</td></tr></table>									1	<table border="1"><tr><td>2</td><td></td><td>2</td></tr><tr><td></td><td></td><td>1</td></tr><tr><td></td><td></td><td></td></tr></table>	2		2			1				<table border="1"><tr><td></td><td></td><td></td></tr><tr><td></td><td></td><td></td></tr><tr><td></td><td></td><td></td></tr></table>										<table border="1"><tr><td></td><td></td><td></td></tr><tr><td></td><td></td><td></td></tr><tr><td></td><td></td><td></td></tr></table>									
1																																																																															
1																																																																															
		1																																																																													
		1																																																																													
2		2																																																																													
		1																																																																													
Post - 0 Miss - 0 Block - 0	Post - 0 Miss - 0 Block - 0	Post - 0 Miss - 0 Block - 0	Post - 0 Miss - 0 Block - 0	Post - 1 Miss - 0 Block - 0	Post - 1 Miss - 1 Block - 0	Post - 0 Miss - 0 Block - 0																																																																									

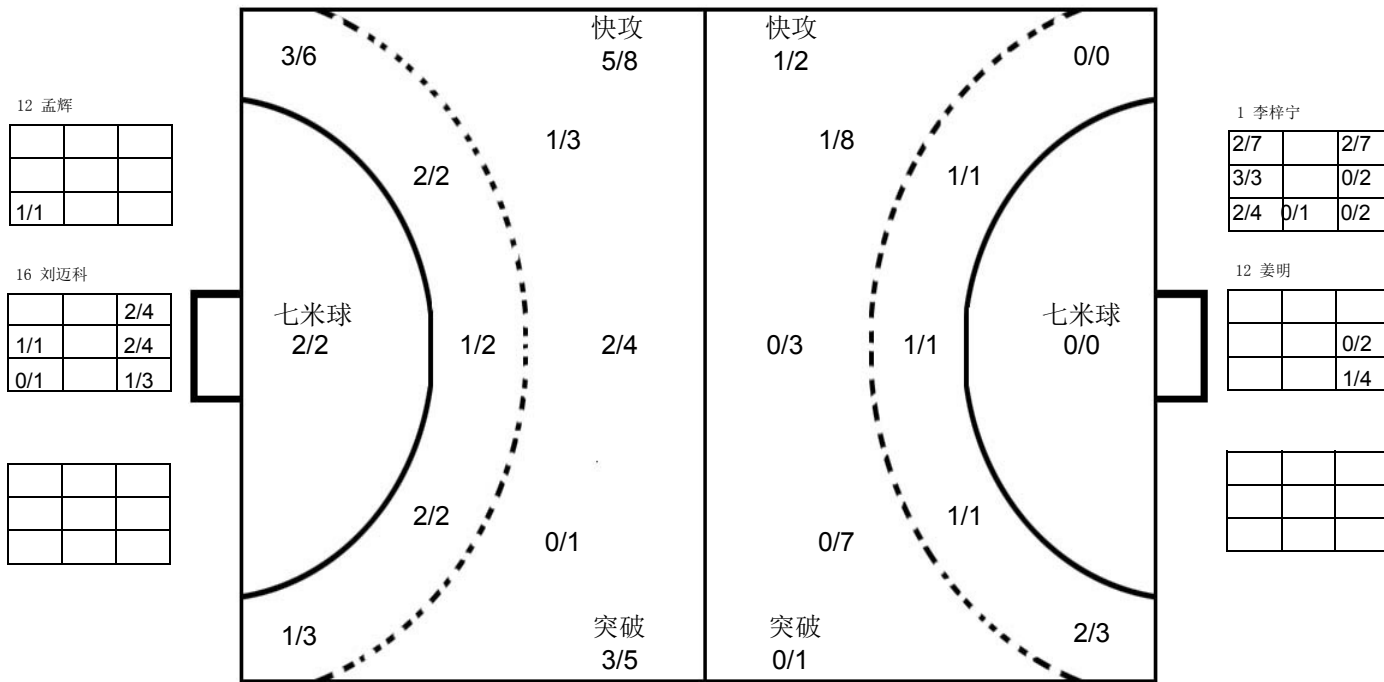

## 解放军队

1 李梓宁	2 范保坤	4 曹作亮	5 张昌柯	6 吴昊	7 姜钦	8 王烁	9 毕晓晨																																																																								
<table border="1"><tr><td></td><td></td><td></td></tr><tr><td></td><td></td><td></td></tr><tr><td></td><td></td><td></td></tr></table>										<table border="1"><tr><td></td><td></td><td></td></tr><tr><td></td><td></td><td></td></tr><tr><td></td><td></td><td></td></tr></table>										<table border="1"><tr><td></td><td></td><td></td></tr><tr><td></td><td></td><td></td></tr><tr><td></td><td></td><td></td></tr></table>										<table border="1"><tr><td></td><td></td><td></td></tr><tr><td></td><td></td><td></td></tr><tr><td></td><td></td><td></td></tr></table>										<table border="1"><tr><td></td><td></td><td></td></tr><tr><td></td><td></td><td>1</td></tr><tr><td></td><td></td><td>1</td></tr></table>						1			1	<table border="1"><tr><td></td><td></td><td>1</td></tr><tr><td></td><td></td><td></td></tr><tr><td></td><td></td><td></td></tr></table>			1							<table border="1"><tr><td></td><td></td><td></td></tr><tr><td></td><td></td><td></td></tr><tr><td></td><td></td><td></td></tr></table>										<table border="1"><tr><td></td><td></td><td></td></tr><tr><td></td><td></td><td></td></tr><tr><td>1</td><td></td><td>1</td></tr></table>							1		1
		1																																																																													
		1																																																																													
		1																																																																													
1		1																																																																													
Post - 0 Miss - 0 Block - 0	Post - 0 Miss - 0 Block - 0	Post - 0 Miss - 0 Block - 0	Post - 0 Miss - 1 Block - 0	Post - 0 Miss - 4 Block - 0	Post - 0 Miss - 4 Block - 0	Post - 0 Miss - 0 Block - 0	Post - 0 Miss - 1 Block - 2																																																																								
11 肖东洋	12 姜明	14 孙耀琦	15 杨帆	16 丛霖	18 王晓龙	20 刘智洋																																																																									
<table border="1"><tr><td></td><td></td><td></td></tr><tr><td></td><td></td><td></td></tr><tr><td></td><td></td><td></td></tr></table>										<table border="1"><tr><td></td><td></td><td></td></tr><tr><td></td><td></td><td></td></tr><tr><td></td><td></td><td></td></tr></table>										<table border="1"><tr><td></td><td></td><td>1</td></tr><tr><td></td><td></td><td>1</td></tr><tr><td></td><td></td><td></td></tr></table>			1			1				<table border="1"><tr><td></td><td></td><td></td></tr><tr><td></td><td></td><td></td></tr><tr><td></td><td></td><td></td></tr></table>										<table border="1"><tr><td></td><td></td><td></td></tr><tr><td></td><td></td><td></td></tr><tr><td></td><td></td><td></td></tr></table>										<table border="1"><tr><td></td><td></td><td></td></tr><tr><td></td><td></td><td></td></tr><tr><td></td><td></td><td></td></tr></table>										<table border="1"><tr><td></td><td></td><td></td></tr><tr><td></td><td></td><td></td></tr><tr><td></td><td></td><td></td></tr></table>										<table border="1"><tr><td></td><td></td><td></td></tr><tr><td></td><td></td><td></td></tr><tr><td></td><td></td><td></td></tr></table>									
		1																																																																													
		1																																																																													
Post - 0 Miss - 0 Block - 1	Post - 0 Miss - 0 Block - 0	Post - 0 Miss - 0 Block - 0	Post - 0 Miss - 0 Block - 0	Post - 0 Miss - 0 Block - 0	Post - 0 Miss - 0 Block - 0	Post - 0 Miss - 0 Block - 0																																																																									

注释: Post=击柱 Miss=射失 Block=被封





## 2016年全国男子手球锦标赛 竞赛技术统计(媒体表)

预赛	组别	A	轮次	3	场次	12
----	----	---	----	---	----	----

徐闻县体育中心体育馆

22/10/2016

201606012-51-1/1

安徽队	<b>安徽</b>	<b>28</b>	vs	<b>22</b>	<b>新疆</b>	新疆队
<b>13 : 10</b>						

裁判员	徐健 (CHN)	/	曹宏俊 (CHN)
-----	----------	---	-----------

安徽		远	近	边	快	突	任意	7m	合计	%	助攻	失误	警告	2'	D & DR	比赛进程	
主教练：沈强		射	射	射	攻	破	球	球								安徽	新疆
1	郭世伟		1/1	0/1					1/2	50.0	1					9	陈开勇
2	金永峰															1	03:34 0
3	陈强龙											1		1		17	王巨柱
5	史小帆		0/1					0/1	0.0							2	04:07 1
7	姚雄敏		1/1					1/1	100			1				3	04:36 1
8	董智景		0/1	1/3	1/1			2/5	40.0	1	2	1				4	04:59 1
9	陈开勇		4/4		1/2			0/1	5/7	71.4	1	2				9	陈开勇
10	严龙															4	05:48 1
11	黎涛															4	06:22 2
12	曾献辰															5	06:52 2
17	王巨柱	4/7	4/6					2/2	10/15	66.7	3	3				6	06:22 2
18	李双	1/5	2/2		1/1	1/1		5/9	55.6			1				7	07:20 3
19	何山															10	07:20 3
21	李明	0/1						0/1	0.0							6	10:23 3
22	王金宇															6	12:28 4
23	于敏清		2/3	2/2				4/5	80.0	3	1	1				6	12:28 4
<b>运动员 合计</b>		5/13	14/19	3/6	3/4	1/1		2/3	28/46	60.9	9	11	2	1		17	王巨柱
11	黎涛															5	06:52 2
21	李明	4/11	5/12	2/2	2/5	0/3		1/3	14/36	38.9						5	07:20 3
<b>守门员 合计</b>		4/11	5/12	2/2	2/5	0/3		1/3	14/36	38.9						9	陈开勇
<b>新疆</b>		远	近	边	快	突	任意	7m	合计	%	助攻	失误	警告	2'	D & DR	1st Half	
教练：孔德宾		射	射	射	攻	破	球	球								1	03:34 0
1	宋晓晨															1	04:07 1
5	徐伟			0/1	3/4				3/5	60.0	1	1				2	04:36 1
7	林豪文	2/8	1/2						3/10	30.0	4	2		1		3	04:59 1
8	刘文宇		2/2						2/2	100		1				4	05:48 1
9	姜春晖			0/3				1/1	1/4	25.0		1		1		4	06:22 2
10	王钟彬	2/7	2/3		0/1	1/1		1/2	6/14	42.9	2					5	06:52 2
13	苏兴伟															6	07:20 3
15	王维东															7	07:20 3
17	胡晋铭		2/2			1/1		3/3	100				1			8	10:23 3
18	姜帅	1/2						1/2	50.0			1	1			9	10:23 3
19	李龙吉	0/1						0/1	0.0	1	5					10	12:28 4
20	赵元	2/4	0/3			1/1		3/8	37.5	2	3			1		10	12:28 4
24	王泽川															11	12:28 4
<b>运动员 合计</b>		7/22	7/12	0/4	3/5	3/3		2/3	22/49	44.9	10	15	2	3		17	王巨柱
1	宋晓晨	2/7	3/17	0/3	1/4	0/1		0/2	6/34	17.6		1				18	李双
15	王维东															18	02:13 10
<b>守门员 合计</b>		2/7	3/17	0/3	1/4	0/1		0/2	6/34	17.6		1				14	02:45 11

场上队员：得分 / 射门

守门员：救球 / 射门

快攻	Fast Break	突破	Breakthrough	任意球	Free Throw	7M球	7M Throw	助攻	Assist
警告	Warning	失误	Error	2'	Suspension	D	取消资格	DR	取消资格+报告







预赛 Group A

男子 全国比赛

2016年全国男子手球锦标赛

Team A <b>A 安徽队</b>				Team B <b>B 新疆队</b>				Match Number <b>12</b>													
played in China		in the hall 徐闻县体育中心体育		on 22/10/2016		at 15:10 hours		Spectators													
Half-time (30')	<b>A</b> 13	<b>B</b> 10	End of playing time	<b>A</b> 28	<b>B</b> 22	1st extra time	<b>A</b>	<b>B</b>	2nd extra time	<b>A</b>	<b>B</b>	After penalty throws	<b>A</b>	<b>B</b>							
Number of 7 m	<b>A</b> 2/3	Team time-out 1 14:00 2 57:48 3			Full name of players and officials				Team time-out 1 06:02 2 47:47 3 56:44			<b>B</b> 2/3	Number of 7 m								
No.	Team <b>A</b>					G	W	2'	D	DR	No.	Team <b>B</b>					G	W	2'	D	DR
1	郭世伟					1					1	宋晓晨									
2	金永峰										5	徐伟					3				
3	陈强龙							1			7	林豪文					3		1		
5	史小帆										8	刘文宇					2				
7	姚雄敏					1					9	姜春晖					1		1		
8	董智景					2	1				10	王钟彬					6				
9	陈开勇					5					13	苏兴伟									
10	严龙										15	王维东									
11	黎涛										17	胡晋铭					3	1			
12	曾献辰										18	姜帅					1	1			
17	王巨柱					10					19	李龙吉									
18	李双					5					20	赵元					3		1		
19	何山										24	王泽川									
21	李明																				
22	王金宇																				
23	于敏清					4	1														
A	韦中平					1					B	陈鹏波									
B	沈强 (主教练)																				
C	吴翔																				
D	陈玉翔																				
<b>A</b>	Signature of Responsible Official of the Teams (Off. A)										<b>B</b>										
TP	Remarks of Referee / CHA Official										TP										

Signatures

Referees	徐健 (CHN)	曹宏俊 (CHN)		
Techn. Delegates	李兆蒙 (CHN)			
CHA Official	刘凤娟 (CHN)			

Note: Number of 7m Throws Awarded to Team A and B, Goals (G), Warnings (W), Suspensions (2'), Direct Disqualification (D), Disqualification with Report (DR) and Team Penalty (TP).

Table Officials: 梁小熹

伍豪

Statisticians: 李双

周亚桥

Printed by PHMS Copyright: IHF / CHA 22/10/2016 17:27:04

Longman Sportsoft



handball@126.com



### 2016年全国男子手球锦标赛 图式比赛技术统计表

轮次 3

场次 12

201606012-21-1/1

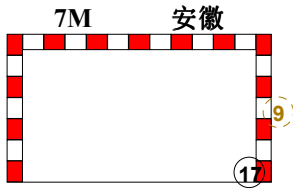
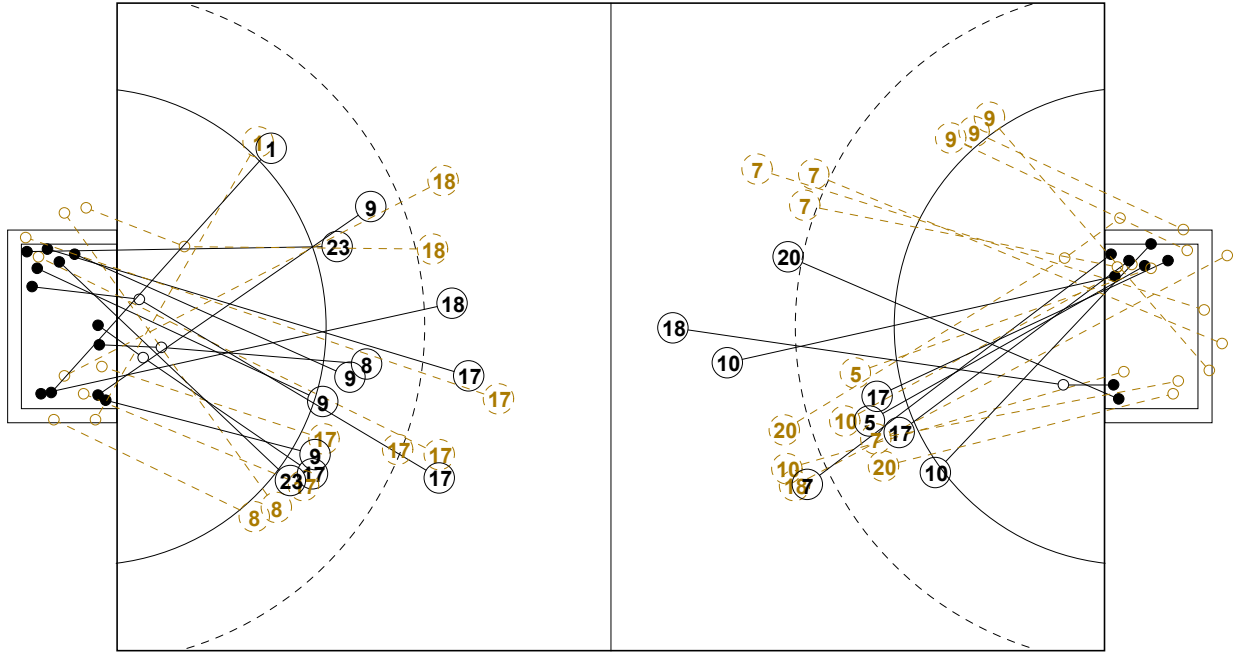

1st Half  
13 : 10

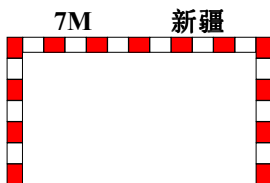
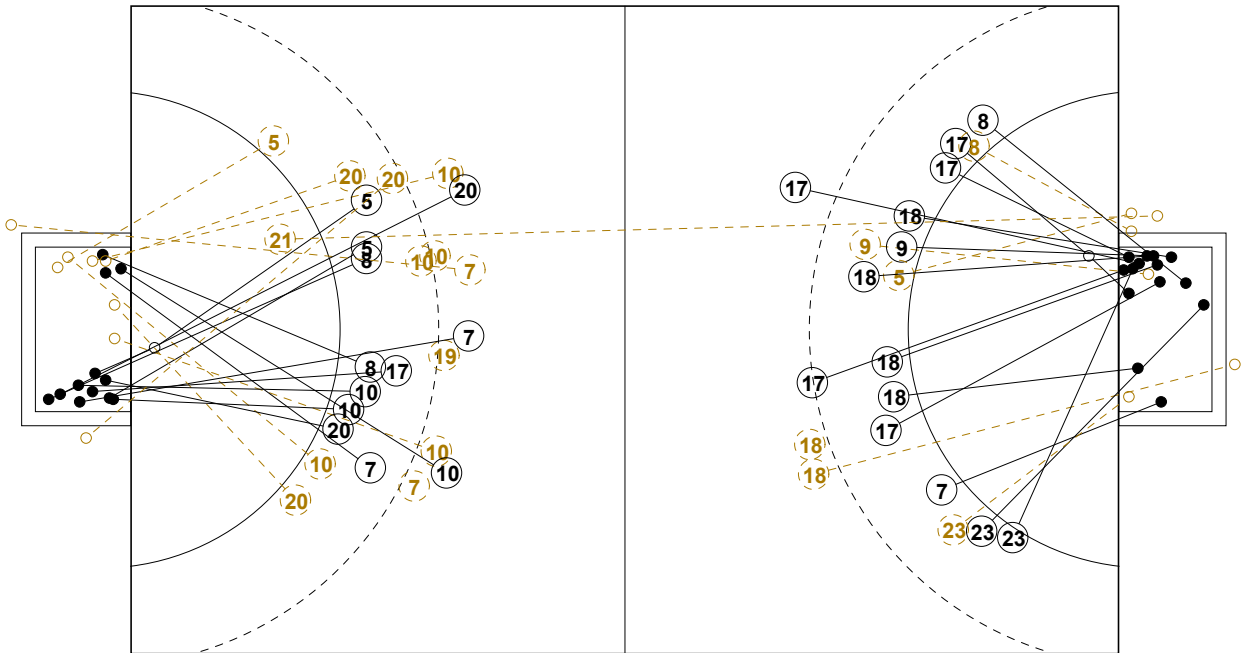
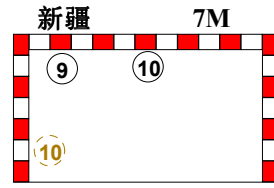

2nd Half  
22 : 28

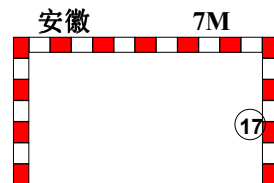



## 2016年全国男子手球锦标赛

## 个人/全队技术统计表

正式表  
手球  
男子预赛  
轮次 3组别 A  
场次 12201606012-14-1/2  
徐闻县体育中心体育馆  
22/10/2016 15:10

号码	姓名	远射	近射	边射	快攻	突破	任意	7M	合计	%	助攻	失误	警告	2'	取消	时间
<b>安徽队(安徽)</b>																
<i>(场上队员)</i>																
1	郭世伟		1/1	0/1					1/2	50.0%	1					00:28:52
2	金永峰									0.0%						00:00:00
3	陈强龙									0.0%		1		1		00:07:48
5	史小帆		0/1						0/1	0.0%						00:05:06
7	姚雄敏		1/1						1/1	100%		1				00:16:52
8	董智景		0/1	1/3	1/1				2/5	40.0%	1	2	1			01:00:00
9	陈开勇		4/4		1/2			0/1	5/7	71.4%	1	2				00:55:35
10	严龙									0.0%						00:00:00
11	黎涛									0.0%						00:23:27
12	曾献辰									0.0%						00:00:00
17	王巨柱	4/7	4/6					2/2	10/15	66.7%	3	3				01:00:00
18	李双	1/5	2/2		1/1	1/1			5/9	55.6%		1				00:58:35
19	何山									0.0%						00:00:00
21	李明	0/1							0/1	0.0%						01:00:00
22	王金宇									0.0%						00:00:00
23	于敏清		2/3	2/2					4/5	80.0%	3	1	1			00:43:39
<b>合计</b>		5/13	14/19	3/6	3/4	1/1		2/3	28/46	60.9%	9	11	2	1		
<i>(守门员)</i>																
11	黎涛									0.0%						00:23:27
21	李明	4/11	5/12	2/2	2/5	0/3		1/3	14/36	38.9%						01:00:00
<b>合计</b>		4/11	5/12	2/2	2/5	0/3		1/3	14/36	38.9%						

场上队员：得分/射门

守门员：救球/射门

全队合计	得分	被救	射失	击柱	封球	合计	%
远射	5	2	3	1	2	13	38.5%
近射	14	3	2			19	73.7%
边射	3			3		6	50.0%
快攻	3	1				4	75.0%
突破	1					1	100.0%
任意							0.0%
7M	2			1		3	66.7%





## 2016年全国男子手球锦标赛

## 个人/全队技术统计表

正式表  
手球  
男子预赛  
轮次 3组别 A  
场次 12201606012-14-2/2  
徐闻县体育中心体育馆  
22/10/2016 15:10

号码	姓名	远射	近射	边射	快攻	突破	任意	7M	合计	%	助攻	失误	警告	2'	取消	时间
<b>新疆队(新疆)</b>																
<i>(上场队员)</i>																
1	宋晓晨									0.0%		1				01:00:00
5	徐伟			0/1	3/4				3/5	60.0%	1	1				01:00:00
7	林豪文	2/8	1/2						3/10	30.0%	4	2		1		00:30:20
8	刘文字		2/2						2/2	100%		1				00:09:23
9	姜春晖			0/3				1/1	1/4	25.0%		1		1		00:42:56
10	王钟彬	2/7	2/3		0/1	1/1		1/2	6/14	42.9%	2					00:56:02
13	苏兴伟									0.0%						00:00:00
15	王维东									0.0%						00:00:00
17	胡晋铭		2/2			1/1			3/3	100%			1			00:50:36
18	姜帅	1/2							1/2	50.0%		1	1			00:27:27
19	李龙吉	0/1							0/1	0.0%	1	5				00:28:11
20	赵元	2/4	0/3			1/1			3/8	37.5%	2	3		1		00:54:36
24	王泽川									0.0%						00:00:00
<b>合计</b>																
<i>(守门员)</i>																
1	宋晓晨	2/7	3/17	0/3	1/4	0/1		0/2	6/34	17.6%		1				01:00:00
15	王维东									0.0%						00:00:00
<b>合计</b>																
2/7 3/17 0/3 1/4 0/1 0/2 6/34 17.6% 1																

场上队员：得分/射门

守门员：救球/射门

全队合计	得分	被救	射失	击柱	封球	合计	%
远射	7	4	6	1	4	22	31.8%
近射	7	5				12	58.3%
边射		2		2		4	0.0%
快攻	3	2				5	60.0%
突破	3					3	100.0%
任意							0.0%
7M	2	1				3	66.7%





2016年全国男子手球锦标赛

图式射门区域统计

轮次 3 场次 12

201606012-41-1/1

安徽队

1 郭世伟 1	2 金永峰	3 陈强龙	5 史小帆	7 姚雄敏 1	8 董智景 1	9 陈开勇 1 1 2	10 严龙
Post - 1 Miss - 0 Block - 0	Post - 0 Miss - 0 Block - 0	Post - 0 Miss - 0 Block - 0	Post - 0 Miss - 1 Block - 0	Post - 0 Miss - 0 Block - 0	Post - 2 Miss - 1 Block - 0	Post - 1 Miss - 0 Block - 0	Post - 0 Miss - 0 Block - 0
11 黎涛	12 曾献辰	17 王巨柱 2 1 1 4 1 1	18 李双 1 2 1 1	19 何山	21 李明	22 王金玉	23 于敏清 1 1 1
Post - 0 Miss - 0 Block - 0	Post - 0 Miss - 0 Block - 0	Post - 1 Miss - 0 Block - 1	Post - 0 Miss - 2 Block - 1	Post - 0 Miss - 0 Block - 0	Post - 0 Miss - 1 Block - 0	Post - 0 Miss - 0 Block - 0	Post - 0 Miss - 0 Block - 0

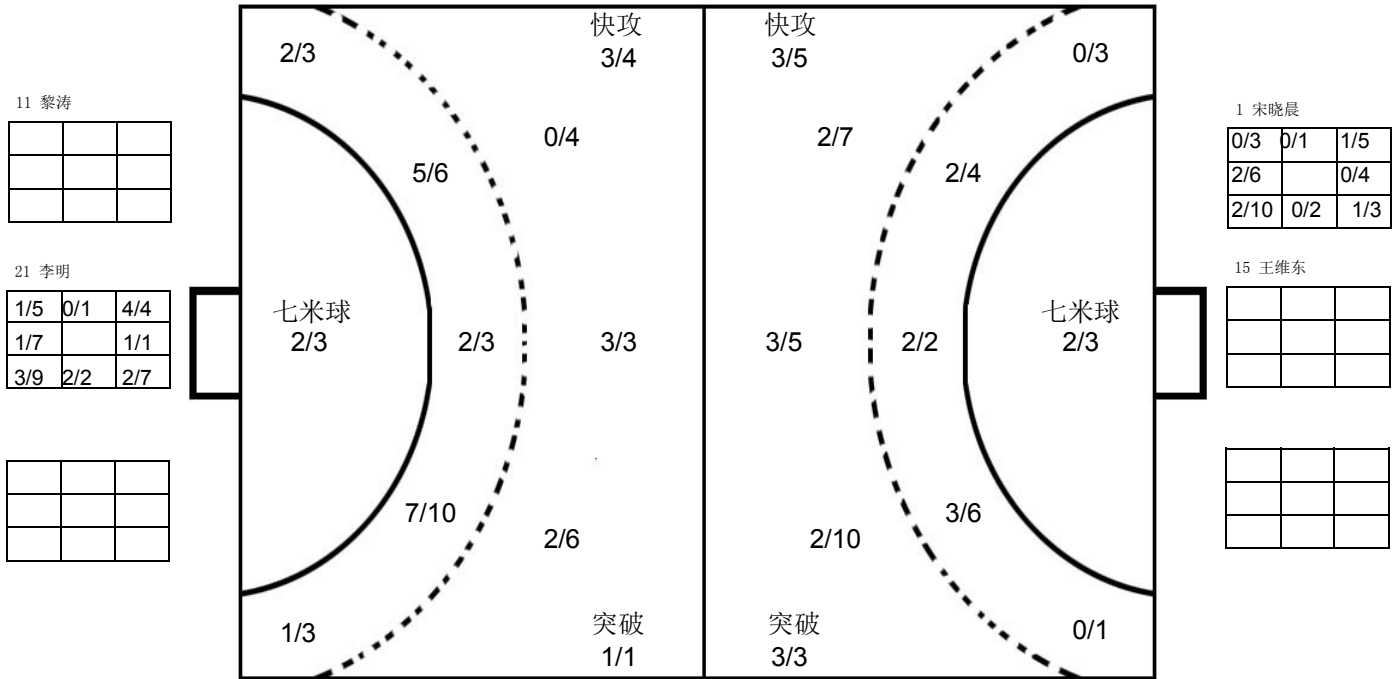

新疆队

1 宋晓晨	5 徐伟 2 1	7 林豪文 1 1 1	8 刘文宇 1 1	9 姜春晖 1	10 王钟彬 1 2 2 1	13 苏兴伟	15 王维东
Post - 0 Miss - 0 Block - 0	Post - 0 Miss - 0 Block - 0	Post - 1 Miss - 3 Block - 1	Post - 0 Miss - 0 Block - 0	Post - 2 Miss - 0 Block - 0	Post - 0 Miss - 0 Block - 2	Post - 0 Miss - 0 Block - 0	Post - 0 Miss - 0 Block - 0
17 胡晋铭 1 1 1	18 姜帅 1	19 李龙吉	20 赵元 1 1 1	24 王泽川			
Post - 0 Miss - 0 Block - 0	Post - 0 Miss - 1 Block - 0	Post - 0 Miss - 0 Block - 1	Post - 0 Miss - 2 Block - 0	Post - 0 Miss - 0 Block - 0			

注释: Post=击柱 Miss=射失 Block=被封





预赛 Group B

男子 全国比赛

2016年全国男子手球锦标赛

Team A A 山东队				Team B B 浙江队				Match Number <b>13</b>													
played in China		in the hall 徐闻县体育中心体育		on 22/10/2016		at 16:50 hours		Spectators													
Half-time (30')	A 24	B 5	End of playing time	A 24	B 5	1st extra time	A	B	2nd extra time	A	B	After penalty throws	A	B							
Number of 7 m	A 1 / 1	Team time-out 1 2 3			Full name of players and officials				Team time-out 1 2 3 12:33 18:42			B 1 / 1	Number of 7 m								
No.	Team A					G	W	2'	D	DR	No.	Team B					G	W	2'	D	DR
3	尹杰					4					1	李欢欢									
4	田瑞					1	1	1			2	郑尧俊									
5	潘翔										3	李恩铭					1				
6	李朝鹏					5					5	林先方									
9	赵鑫					4					7	金杰									
10	赵建强					4					8	王浩									
11	宋朋强										9	李家乐									
12	崔剑										10	罗明杰					2	1			
13	刘晓										11	陈渝天									
15	张继伟					6					14	虞勇灿									
16	于性哲										15	张佩力									
17	王旭东										18	倪陈辉									
19	李语庆										19	徐正飞					2				
21	翟乾坤										24	毛军伟									
27	于亚男																				
A	markovic尼克										B	柳佳 (主教练)									
B	王鸿斌 (主教练)										C	项建生									
C	刘桂妮																				
D	邢建刚																				
A	Signature of Responsible Official of the Teams (Off. A)																			B	
TP	Remarks of Referee / CHA Official																			TP	

Signatures

Referees	刘禹 (CHN)	许翔 (CHN)		
Techn. Delegates	王洋 (CHN)			
CHA Official	倪震 (CHN)			

Note: Number of 7m Throws Awarded to Team A and B, Goals (G), Warnings (W), Suspensions (2'), Direct Disqualification (D), Disqualification with Report (DR) and Team Penalty (TP).

Table Officials: 刘宇阳

鲍瑛

Statisticians: 周亚桥

张程秀子





## 2016年全国男子手球锦标赛 竞赛技术统计(媒体表)

预赛	组别	<b>B</b>	轮次	<b>3</b>	场次	<b>13</b>
----	----	----------	----	----------	----	-----------

徐闻县体育中心体育馆

22/10/2016

201606013-51-1/1

山东队	<b>山东</b>	<b>24</b>	vs	<b>5</b>	<b>浙江</b>	浙江队
<b>24 : 5</b>						

裁判员	刘禹 (CHN)	/	许翔 (CHN)
-----	----------	---	----------

山东		远	近	边	快	突	任意	7m	合计	%	助攻	失误	警告	2'	D & DR	比赛进程	
主教练：王鸿斌		射	射	射	攻	破	球	球								山东	浙江
3	尹杰	1/1	3/3	0/1					4/5	80.0	1					00:43	1 10 罗明杰
4	田瑞		1/1	0/1					1/2	50.0	2		1	1		01:13	1
5	潘翔															02:41	1
6	李朝鹏	1/1	3/4					1/1	5/6	83.3	2	3				03:28	1
9	赵鑫		3/4			1/1			4/5	80.0	2					05:21	1
10	赵建强		3/4			1/1			4/5	80.0	3	1				06:28	1
11	宋朋强															07:07	2 3 李恩铭
12	崔剑										1					08:33	2
13	刘晓															10:12	2
15	张继伟	1/1	3/5		2/2				6/8	75.0						11:04	2
16	于性哲															11:50	2
17	王旭东															12:26	2
19	李语庆															13:53	2
21	翟乾坤															14:29	2
27	于亚男															15:13	2
<b>运动员 合计</b>		3/3	16/21	0/2	2/2	2/2		1/1	24/31	77.4	11	4	1	1		15:49	2
12	崔剑	2/3	5/7	2/3				0/1	9/14	64.3	1					16:22	2
<b>守门员 合计</b>		2/3	5/7	2/3				0/1	9/14	64.3	1					17:20	2
浙江		远	近	边	快	突	任意	7m	合计	%	助攻	失误	警告	2'	D & DR		
教练：柳佳		射	射	射	攻	破	球	球									
1	李欢欢												1				
2	郑尧俊											2					
3	李恩铭	0/1	0/2	1/1					1/4	25.0		2					
5	林先方											1					
7	金杰												1				
8	王浩																
9	李家乐																
10	罗明杰	1/2	1/2						2/4	50.0		2	1				
11	陈渝天																
14	虞勇灿			0/1					0/1	0.0							
15	张佩力																
18	倪陈辉	0/2	0/2	0/1					0/5	0.0		2					
19	徐正飞	0/1	1/2					1/1	2/4	50.0		4					
24	毛军伟											2					
<b>运动员 合计</b>		1/6	2/8	1/3				1/1	5/18	27.8		15	2				
8	王浩	0/1	0/3		0/1				0/5	0.0							
15	张佩力	0/2	3/16	2/2	0/1	0/2		0/1	5/24	20.8							
<b>守门员 合计</b>		0/3	3/19	2/2	0/2	0/2		0/1	5/29	17.2							

场上队员：得分 / 射门

守门员：救球 / 射门

快攻	Fast Break		突破	Breakthrough		任意球	Free Throw		7M球	7M Throw		助攻	Assist
警告	Warning		失误	Error		2'	Suspension		D	取消资格		DR	取消资格+报告



### 2016年全国男子手球锦标赛 图式比赛技术统计表

轮次 3

场次 13

201606013-21-1/1

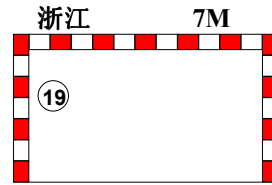
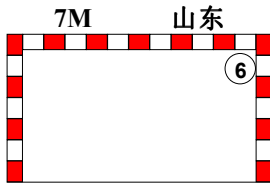
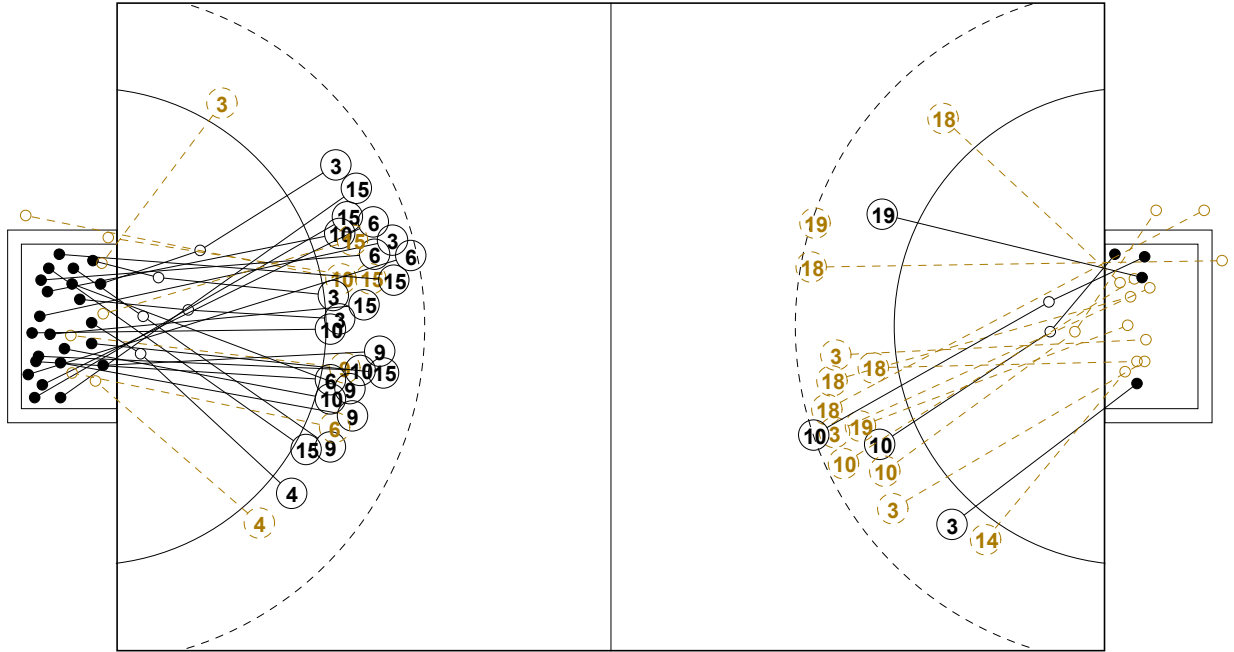

1st Half  
24 : 5

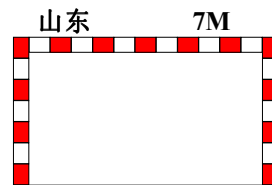
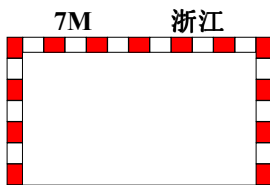
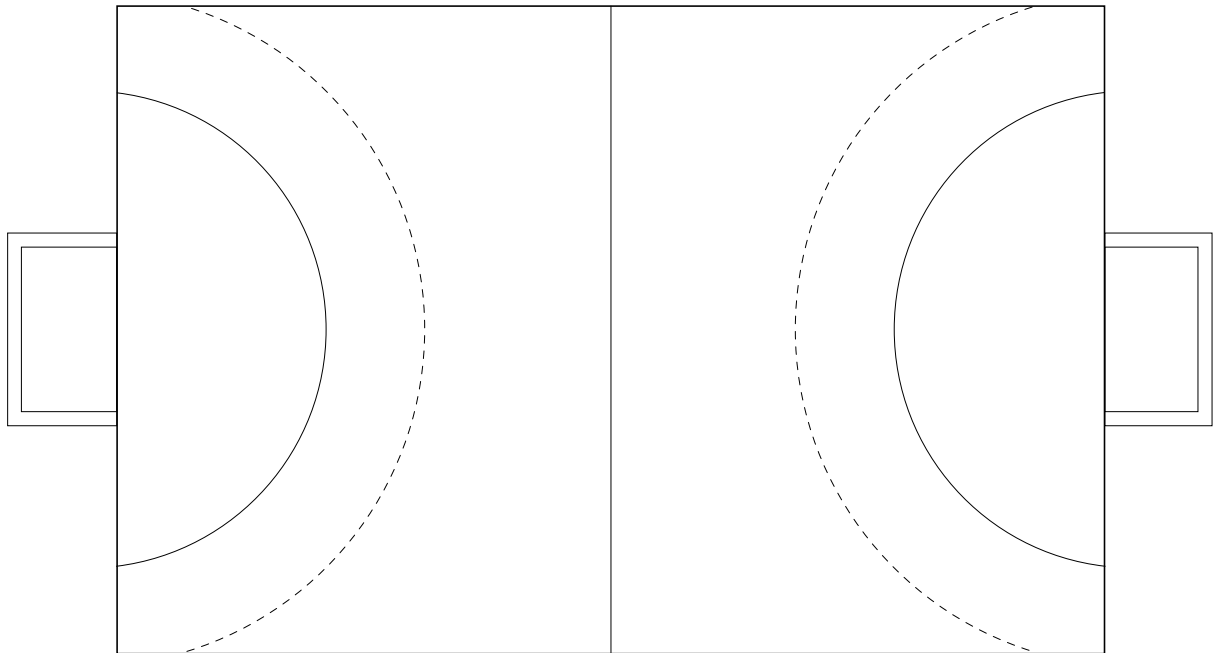

2nd Half  
5 : 24





## 2016年全国男子手球锦标赛

## 个人/全队技术统计表

正式表  
手球  
男子预赛  
轮次 3组别 B  
场次 13201606013-14-1/2  
徐闻县体育中心体育馆  
22/10/2016 16:50

号码	姓名	远射	近射	边射	快攻	突破	任意	7M	合计	%	助攻	失误	警告	2'	取消	时间
<b>山东队(山东)</b>																
<i>(场上队员)</i>																
3	尹杰	1/1	3/3	0/1					4/5	80.0%	1					00:30:00
4	田瑞		1/1	0/1					1/2	50.0%	2		1	1		00:30:00
5	潘翔									0.0%						00:00:00
6	李朝鹏	1/1	3/4					1/1	5/6	83.3%	2	3				00:30:00
9	赵鑫		3/4			1/1			4/5	80.0%	2					00:30:00
10	赵建强		3/4			1/1			4/5	80.0%	3	1				00:30:00
11	宋朋强									0.0%						00:00:00
12	崔剑									0.0%	1					00:30:00
13	刘晓									0.0%						00:00:00
15	张继伟	1/1	3/5		2/2				6/8	75.0%						00:30:00
16	于性哲									0.0%						00:00:00
17	王旭东									0.0%						00:00:00
19	李语庆									0.0%						00:00:00
21	翟乾坤									0.0%						00:00:00
27	于亚男									0.0%						00:00:00
<b>合计</b>		3/3	16/21	0/2	2/2	2/2		1/1	24/31	77.4%	11	4	1	1		
<i>(守门员)</i>																
12	崔剑	2/3	5/7	2/3				0/1	9/14	64.3%	1					00:30:00
<b>合计</b>		2/3	5/7	2/3				0/1	9/14	64.3%	1					

场上队员：得分/射门

守门员：救球/射门

全队合计	得分	被救	射失	击柱	封球	合计	%
远射	3					3	100.0%
近射	16	3	1	1		21	76.2%
边射		2				2	0.0%
快攻	2					2	100.0%
突破	2					2	100.0%
任意							0.0%
7M	1					1	100.0%





## 2016年全国男子手球锦标赛

## 个人/全队技术统计表

正式表  
手球  
男子预赛  
轮次 3组别 B  
场次 13201606013-14-2/2  
徐闻县体育中心体育馆  
22/10/2016 16:50

号码	姓名	远射	近射	边射	快攻	突破	任意	7M	合计	%	助攻	失误	警告	2'	取消	时间
<b>浙江队(浙江)</b>																
<i>(上场队员)</i>																
1	李欢欢									0.0%			1			00:17:36
2	郑尧俊									0.0%		2				00:29:15
3	李恩铭	0/1	0/2	1/1					1/4	25.0%		2				00:26:40
5	林先方									0.0%						00:00:00
7	金杰									0.0%		1				00:05:14
8	王浩									0.0%						00:04:25
9	李家乐									0.0%						00:00:37
10	罗明杰	1/2	1/2						2/4	50.0%		2	1			00:23:31
11	陈渝天									0.0%						00:06:37
14	虞勇灿			0/1					0/1	0.0%						00:12:26
15	张佩力									0.0%						00:25:35
18	倪陈辉	0/2	0/2	0/1					0/5	0.0%		2				00:25:35
19	徐正飞	0/1	1/2					1/1	2/4	50.0%		4				00:30:00
24	毛军伟									0.0%		2				00:02:05
<b>合计</b>		1/6	2/8	1/3				1/1	5/18	27.8%		15	2			
<i>(守门员)</i>																
8	王浩	0/1	0/3		0/1				0/5	0.0%						00:04:25
15	张佩力	0/2	3/16	2/2	0/1	0/2		0/1	5/24	20.8%						00:25:35
<b>合计</b>		0/3	3/19	2/2	0/2	0/2		0/1	5/29	17.2%						

场上队员：得分/射门

守门员：救球/射门

全队合计	得分	被救	射失	击柱	封球	合计	%
远射	1	2	2		1	6	16.7%
近射	2	5	1			8	25.0%
边射	1	2				3	33.3%
快攻							0.0%
突破							0.0%
任意							0.0%
7M	1					1	100.0%





2016年全国男子手球锦标赛

图式射门区域统计

轮次 3 场次 13

201606013-41-1/1

山东队

3 尹杰 1 1 2 Post - 0 Miss - 0 Block - 0	4 田瑞 1 Post - 0 Miss - 0 Block - 0	5 潘翔 Post - 0 Miss - 0 Block - 0	6 李朝鹏 3 2 Post - 0 Miss - 0 Block - 0	9 赵鑫 1 2 1 Post - 0 Miss - 0 Block - 0	10 赵建强 1 1 1 1 Post - 0 Miss - 1 Block - 0	11 宋朋强 Post - 0 Miss - 0 Block - 0	12 崔剑 Post - 0 Miss - 0 Block - 0
13 刘晓 Post - 0 Miss - 0 Block - 0	15 张继伟 1 1 1 1 1 1 Post - 1 Miss - 0 Block - 0	16 于性哲 Post - 0 Miss - 0 Block - 0	17 王旭东 Post - 0 Miss - 0 Block - 0	19 李语庆 Post - 0 Miss - 0 Block - 0	21 翟乾坤 Post - 0 Miss - 0 Block - 0	27 于亚男 Post - 0 Miss - 0 Block - 0	

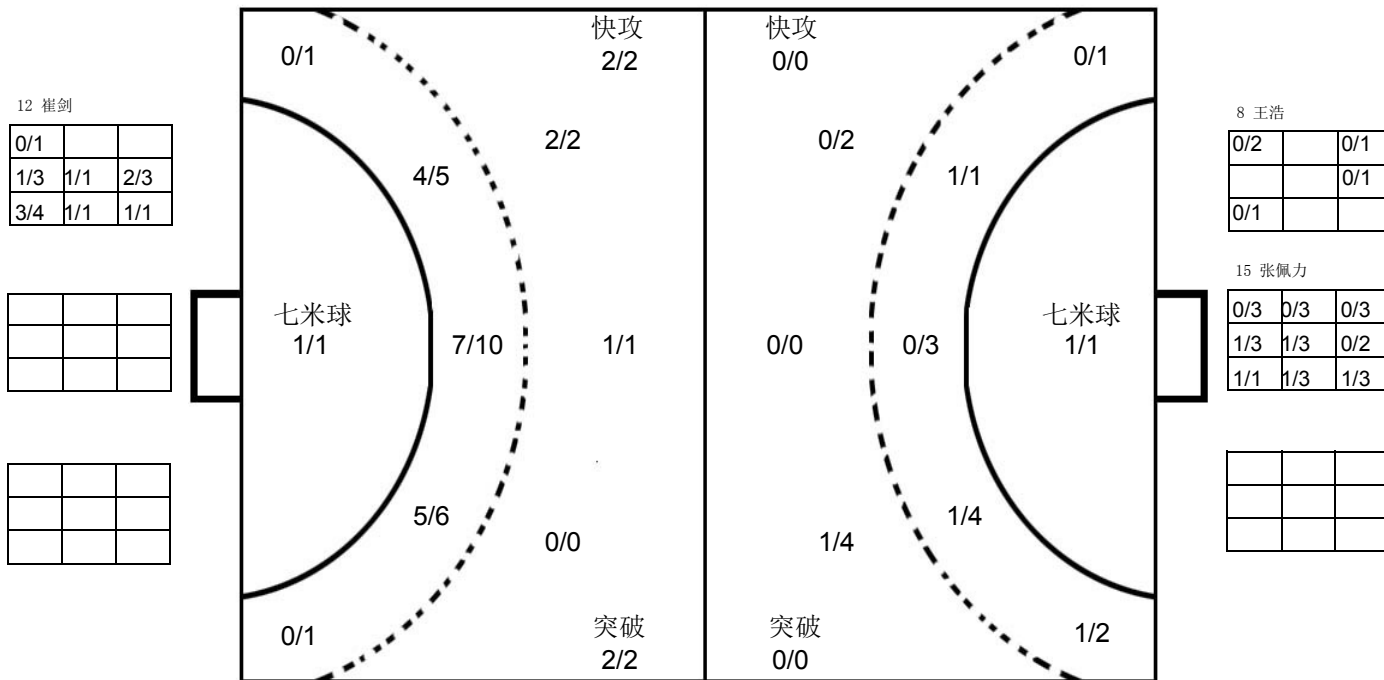

浙江队

1 李欢欢 Post - 0 Miss - 0 Block - 0	2 郑尧俊 Post - 0 Miss - 0 Block - 0	3 李恩铭 1 Post - 0 Miss - 0 Block - 0	5 林先方 Post - 0 Miss - 0 Block - 0	7 金杰 Post - 0 Miss - 0 Block - 0	8 王浩 Post - 0 Miss - 0 Block - 0	9 李家乐 Post - 0 Miss - 0 Block - 0	10 罗明杰 1 1 Post - 0 Miss - 1 Block - 0
11 陈渝天 Post - 0 Miss - 0 Block - 0	14 虞勇灿 Post - 0 Miss - 0 Block - 0	15 张佩力 Post - 0 Miss - 0 Block - 0	18 倪陈辉 Post - 0 Miss - 2 Block - 0	19 徐正飞 1 1 Post - 0 Miss - 0 Block - 1	24 毛军伟 Post - 0 Miss - 0 Block - 0		

注释: Post=击柱 Miss=射失 Block=被封





预赛 Group B

男子 全国比赛

2016年全国男子手球锦标赛

Team A <b>A 广东队</b>				Team B <b>B 天津队</b>				Match Number <b>14</b>																						
played in China				in the hall 徐闻县体育中心体育				on 22/10/2016				at 19:00 hours				Spectators														
Half-time (30')		<b>A</b> 11		<b>B</b> 16		End of playing time		<b>A</b> 24		<b>B</b> 25		1st extra time		<b>A</b>		<b>B</b>		2nd extra time		<b>A</b>		<b>B</b>		After penalty throws		<b>A</b>		<b>B</b>		
Number of 7 m		<b>A</b> 3 / 3		Team time-out			Full name of players and officials															Team time-out			<b>B</b> 1 / 2		Number of 7 m			
			1	2	3																									
No.	Team <b>A</b>										No.	Team <b>B</b>										G	W	2'	D	DR				
1	王泽润										1	刘宗其																		
2	孙江山										2	李岳朋											1							
3	曲汝洋										4	李松浩																		
4	李卓洋										6	王子欣										4		2						
5	侯生升										7	张青										3								
7	付云博										8	曹悦										4	1	1						
8	于彦江										9	吴明远																		
10	周仲坤										11	王毅																		
11	房友屯										12	杨峻																		
13	王立隆										13	许松										6								
15	张建杰										14	田剑侠										6								
16	马跃										16	刘海亮																		
17	李中洲										17	周群										2	1							
20	黄培杰										18	王晓琪																		
84	王伟										22	魏雨童																		
B	王锋 (主教练)										A	贾守信										1								
C	刘康伶										B	杜瑞军 (主教练)																		
D	张广建										D	潘玉强																		
E	王永存										E	贾宁																		
<b>A</b>	Signature of Responsible Official of the Teams (Off. A)										<b>B</b>											<b>B</b>								
TP	Remarks of Referee / CHA Official										TP											TP								

Signatures

Referees	李兆蒙 (CHN)	马晓晔 (CHN)		
Techn. Delegates	许宜扬 (CHN)			
CHA Official	刘凤娟 (CHN)			

Note: Number of 7m Throws Awarded to Team A and B, Goals (G), Warnings (W), Suspensions (2'), Direct Disqualification (D), Disqualification with Report (DR) and Team Penalty (TP).

Table Officials: 伍豪

刘正松

Statisticians: 李双

张程秀子





## 2016年全国男子手球锦标赛 竞赛技术统计(媒体表)

预赛	组别	B	轮次	3	场次	14
徐闻县体育中心体育馆			22/10/2016		201606014-51-1/1	
广东队	广东	24	vs	25	天津	天津队
<b>11 : 16</b>						

裁判员	李兆蒙 (CHN)	/	马晓晔 (CHN)
-----	-----------	---	-----------

广东														比赛进程		天津	
主教练：王锋																	
	远射	近射	边射	快攻	突破	任意球	7m球	合计	%	助攻	失误	警告	2'	D & DR	广东	天津	
1 王泽润																	
2 孙江山		2/3	4/6	1/1			1/1	8/11	72.7	2	2				17 李中洲	0 05:08 1 7 张青	
3 曲汝洋	0/1			1/1	1/1			2/3	66.7	2					1 06:23 1 13 许松		
4 李卓洋	0/2	1/2						1/4	25.0		2				2 08:01 2 13 许松		
5 侯生升												1	1		2 08:59 3 13 许松		
7 付云博	0/1	2/4						2/5	40.0		4				2 10:06 4 8 曹悦		
8 于彦江															3 10:58 4 8 曹悦		
10 周仲坤															3 11:47 5 17 周群		
11 房友屯															3 12:22 6 6 王子欣		
13 王立隆															3 12:58 7 13 许松		
15 张建杰															4 14:40 7 7 曹悦		
16 马跃															4 15:32 8 8 曹悦		
17 李中洲	5/8	2/2				0/1	2/2	9/13	69.2	1	3	1	1		5 16:29 8 8 曹悦		
20 黄培杰															5 17:30 9 14 田剑侠		
84 王伟	0/1	2/3						2/4	50.0	1	2	1	1		5 18:52 10 14 田剑侠		
<b>运动员 合计</b>	<b>5/13</b>	<b>9/14</b>	<b>4/6</b>	<b>2/2</b>	<b>1/1</b>	<b>0/1</b>	<b>3/3</b>	<b>24/40</b>	<b>60.0</b>	<b>6</b>	<b>14</b>	<b>3</b>	<b>3</b>		6 20:53 10 14 田剑侠		
16 马跃	4/11	3/12		0/4	1/5		1/2	9/34	26.5		1				6 22:01 10 7 张青		
<b>守门员 合计</b>	<b>4/11</b>	<b>3/12</b>		<b>0/4</b>	<b>1/5</b>		<b>1/2</b>	<b>9/34</b>	<b>26.5</b>		<b>1</b>				7 22:51 11 7 张青		
天津																	
教练：杜瑞军																	
	远射	近射	边射	快攻	突破	任意球	7m球	合计	%	助攻	失误	警告	2'	D & DR	广东	天津	
1 刘宗其																	
2 李岳朋		0/1						0/1	0.0	1	2	1				8 曹悦	
4 李松浩																13 01:23 17 8 曹悦	
6 王子欣		1/1		2/2	1/1			4/4	100				2			13 01:50 18 14 田剑侠	
7 张青	2/5	1/1		1/1	2/2			3/6	50.0		2					14 05:21 18 14 田剑侠	
8 曹悦	1/5	0/1		1/1	2/2			4/9	44.4	1	1	1	1			15 06:33 18 14 田剑侠	
9 吴明远																16 08:21 18 14 田剑侠	
11 王毅		0/1					0/1	0/2	0.0							16 08:21 18 14 田剑侠	
12 杨峻																17 10:00 18 14 田剑侠	
13 许松	1/2	4/5		1/2				6/9	66.7		4					17 10:46 19 6 王子欣	
14 田剑侠	3/4	1/1			1/2		1/1	6/8	75.0		1					17 11:12 19 6 王子欣	
16 刘海亮																18 14:10 19 6 王子欣	
17 周群		2/2						2/2	100			1				19 14:10 19 6 王子欣	
18 王晓琪																19 15:12 20 14 田剑侠	
22 魏雨童																20 17:48 20 14 田剑侠	
<b>运动员 合计</b>	<b>7/16</b>	<b>9/13</b>		<b>4/5</b>	<b>4/5</b>		<b>1/2</b>	<b>25/41</b>	<b>61.0</b>	<b>2</b>	<b>10</b>	<b>3</b>	<b>3</b>			20 20:38 21 13 许松	
1 刘宗其	2/5	3/9	0/4	0/2	0/1		0/1	5/22	22.7							20 21:23 22 13 许松	
12 杨峻	1/3	1/4					0/1	2/8	25.0							20 22:44 23 7 张青	
16 刘海亮							0/1	0/1	0.0							21 25:10 23 7 张青	
<b>守门员 合计</b>	<b>3/8</b>	<b>4/13</b>	<b>0/4</b>	<b>0/2</b>	<b>0/1</b>		<b>0/3</b>	<b>7/31</b>	<b>22.6</b>							22 26:08 23 7 张青	

场上队员：得分 / 射门

守门员：救球 / 射门

快攻	Fast Break	突破	Breakthrough	任意球	Free Throw	7M球	7M Throw	助攻	Assist
警告	Warning	失误	Error	2'	Suspension	D	取消资格	DR	取消资格+报告





## 2016年全国男子手球锦标赛 图式比赛技术统计表

轮次 3

场次 14

201606014-21-1/1

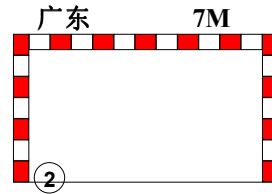
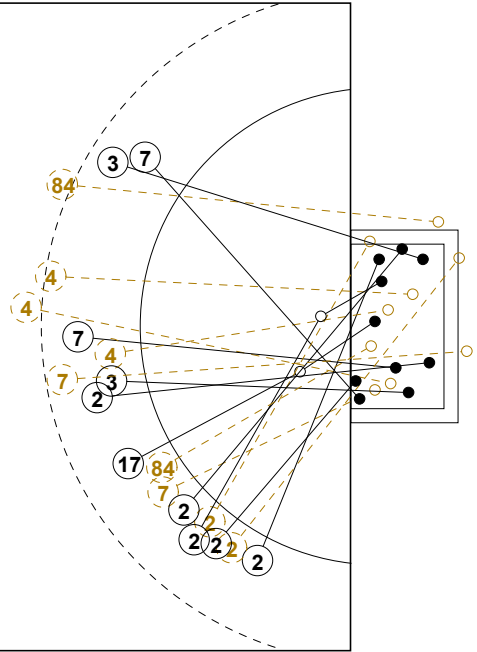
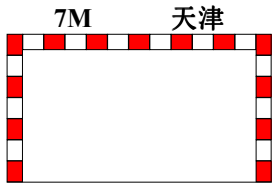
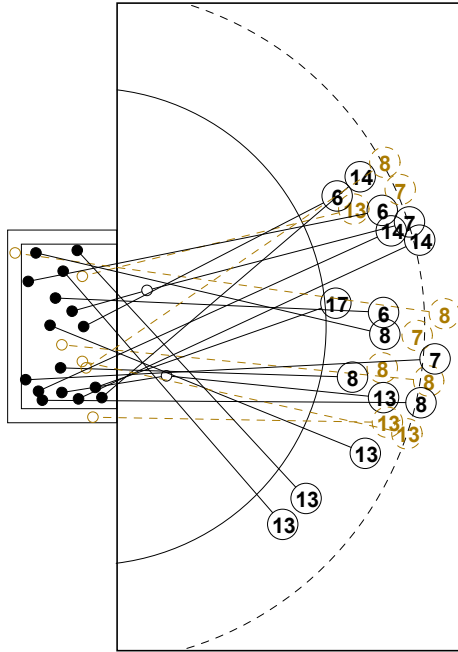

1st Half  
16 : 11

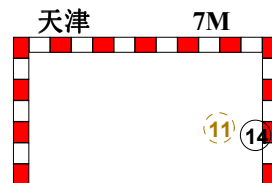
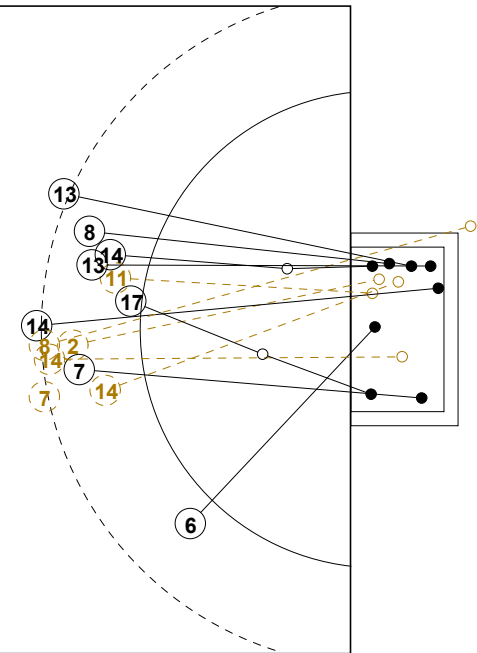
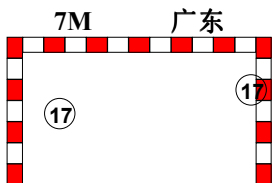
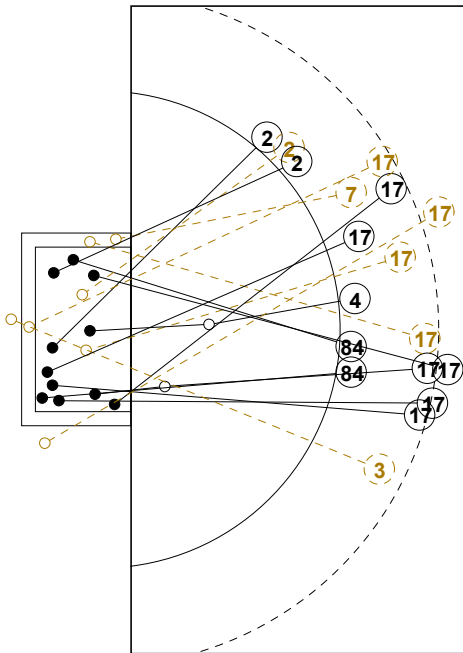

2nd Half  
24 : 25



## 2016年全国男子手球锦标赛

## 个人/全队技术统计表

正式表  
手球  
男子预赛  
轮次 3组别 B  
场次 14201606014-14-1/2  
徐闻县体育中心体育馆  
22/10/2016 19:00

号码	姓名	远射	近射	边射	快攻	突破	任意	7M	合计	%	助攻	失误	警告	2'	取消	时间
<b>广东队(广东)</b>																
<i>(场上队员)</i>																
1	王泽润									0.0%						00:00:00
2	孙江山		2/3	4/6	1/1			1/1	8/11	72.7%	2	2				00:49:59
3	曲汝洋	0/1			1/1	1/1			2/3	66.7%	2					00:42:54
4	李卓洋	0/2	1/2						1/4	25.0%		2				00:38:00
5	侯生升									0.0%			1	1		00:57:34
7	付云博	0/1	2/4						2/5	40.0%		4				00:53:09
8	于彦江									0.0%						00:00:00
10	周仲坤									0.0%						00:00:00
11	房友屯									0.0%						00:00:00
13	王立隆									0.0%						00:00:00
15	张建杰									0.0%						00:00:00
16	马跃									0.0%		1				01:00:00
17	李中洲	5/8	2/2				0/1	2/2	9/13	69.2%	1	3	1	1		00:59:29
20	黄培杰									0.0%						00:00:00
84	王伟	0/1	2/3						2/4	50.0%	1	2	1	1		00:57:57
<b>合计</b>		5/13	9/14	4/6	2/2	1/1	0/1	3/3	24/40	60.0%	6	14	3	3		
<i>(守门员)</i>																
16	马跃	4/11	3/12		0/4	1/5		1/2	9/34	26.5%		1				01:00:00
<b>合计</b>		4/11	3/12		0/4	1/5		1/2	9/34	26.5%		1				

场上队员：得分/射门

守门员：救球/射门

全队合计	得分	被救	射失	击柱	封球	合计	%
远射	5	3	3	2		13	38.5%
近射	9	4		1		14	64.3%
边射	4			2		6	66.7%
快攻	2					2	100.0%
突破	1					1	100.0%
任意			1			1	0.0%
7M	3					3	100.0%





## 2016年全国男子手球锦标赛

## 个人/全队技术统计表

正式表  
手球  
男子预赛  
轮次 3组别 B  
场次 14201606014-14-2/2  
徐闻县体育中心体育馆  
22/10/2016 19:00

号码	姓名	远射	近射	边射	快攻	突破	任意	7M	合计	%	助攻	失误	警告	2'	取消	时间
<b>天津队(天津)</b>																
<i>(上场队员)</i>																
1	刘宗其									0.0%						00:41:15
2	李岳朋		0/1						0/1	0.0%	1	2	1			00:46:40
4	李松浩									0.0%						00:00:00
6	王子欣		1/1		2/2	1/1			4/4	100%				2		00:51:14
7	张青	2/5	1/1						3/6	50.0%		2				01:00:00
8	曹悦	1/5	0/1		1/1	2/2			4/9	44.4%	1	1	1	1		00:57:37
9	吴明远									0.0%						00:00:00
11	王毅		0/1					0/1	0/2	0.0%						00:01:06
12	杨峻									0.0%						00:18:34
13	许松	1/2	4/5		1/2				6/9	66.7%		4				00:59:19
14	田剑侠	3/4	1/1			1/2		1/1	6/8	75.0%		1				00:29:55
16	刘海亮									0.0%						00:00:11
17	周群		2/2						2/2	100%			1			00:53:18
18	王晓琪									0.0%						00:00:00
22	魏雨童									0.0%						00:00:00
<b>合计</b>		7/16	9/13		4/5	4/5		1/2	25/41	61.0%	2	10	3	3		
<i>(守门员)</i>																
1	刘宗其	2/5	3/9	0/4	0/2	0/1		0/1	5/22	22.7%						00:41:15
12	杨峻	1/3	1/4					0/1	2/8	25.0%						00:18:34
16	刘海亮							0/1	0/1	0.0%						00:00:11
<b>合计</b>		3/8	4/13	0/4	0/2	0/1		0/3	7/31	22.6%						

场上队员：得分/射门

守门员：救球/射门

全队合计	得分	被救	射失	击柱	封球	合计	%
远射	7	4	1	1	3	16	43.8%
近射	9	3			1	13	69.2%
边射							0.0%
快攻	4			1		5	80.0%
突破	4	1				5	80.0%
任意							0.0%
7M	1	1				2	50.0%







### 2016年全国男子手球锦标赛

#### 图式射门区域统计

轮次 3 场次 14

201606014-41-1/1

## 广东队

1 王泽润	2 孙江山	3 曲汝洋	4 李卓洋	5 侯生升	7 付文博	8 于彦江	10 周仲坤																																																																								
<table border="1"><tr><td></td><td></td><td></td></tr><tr><td></td><td></td><td></td></tr><tr><td></td><td></td><td></td></tr></table>										<table border="1"><tr><td></td><td>1</td><td>2</td></tr><tr><td>2</td><td></td><td></td></tr><tr><td>2</td><td></td><td>1</td></tr></table>		1	2	2			2		1	<table border="1"><tr><td>1</td><td></td><td></td></tr><tr><td></td><td></td><td>1</td></tr><tr><td></td><td></td><td></td></tr></table>	1					1				<table border="1"><tr><td></td><td></td><td></td></tr><tr><td></td><td>1</td><td></td></tr><tr><td></td><td></td><td></td></tr></table>					1					<table border="1"><tr><td></td><td></td><td></td></tr><tr><td></td><td></td><td></td></tr><tr><td></td><td></td><td></td></tr></table>										<table border="1"><tr><td></td><td></td><td></td></tr><tr><td></td><td></td><td>1</td></tr><tr><td></td><td></td><td>1</td></tr></table>						1			1	<table border="1"><tr><td></td><td></td><td></td></tr><tr><td></td><td></td><td></td></tr><tr><td></td><td></td><td></td></tr></table>										<table border="1"><tr><td></td><td></td><td></td></tr><tr><td></td><td></td><td></td></tr><tr><td></td><td></td><td></td></tr></table>									
	1	2																																																																													
2																																																																															
2		1																																																																													
1																																																																															
		1																																																																													
	1																																																																														
		1																																																																													
		1																																																																													
Post - 0 Miss - 0 Block - 0	Post - 2 Miss - 0 Block - 0	Post - 0 Miss - 1 Block - 0	Post - 0 Miss - 0 Block - 0	Post - 0 Miss - 0 Block - 0	Post - 1 Miss - 1 Block - 0	Post - 0 Miss - 0 Block - 0	Post - 0 Miss - 0 Block - 0																																																																								
11 房友屯	13 王立隆	15 张建杰	16 马跃	17 李中洲	20 黄培杰	84 王伟																																																																									
<table border="1"><tr><td></td><td></td><td></td></tr><tr><td></td><td></td><td></td></tr><tr><td></td><td></td><td></td></tr></table>										<table border="1"><tr><td></td><td></td><td></td></tr><tr><td></td><td></td><td></td></tr><tr><td></td><td></td><td></td></tr></table>										<table border="1"><tr><td></td><td></td><td></td></tr><tr><td></td><td></td><td></td></tr><tr><td></td><td></td><td></td></tr></table>										<table border="1"><tr><td></td><td></td><td></td></tr><tr><td></td><td></td><td></td></tr><tr><td></td><td></td><td></td></tr></table>										<table border="1"><tr><td>3</td><td></td><td>1</td></tr><tr><td>2</td><td></td><td>1</td></tr><tr><td>1</td><td>1</td><td></td></tr></table>	3		1	2		1	1	1		<table border="1"><tr><td></td><td></td><td></td></tr><tr><td></td><td></td><td></td></tr><tr><td></td><td></td><td></td></tr></table>										<table border="1"><tr><td>1</td><td></td><td></td></tr><tr><td></td><td></td><td>1</td></tr><tr><td></td><td></td><td></td></tr></table>	1					1				<table border="1"><tr><td></td><td></td><td></td></tr><tr><td></td><td></td><td></td></tr><tr><td></td><td></td><td></td></tr></table>									
3		1																																																																													
2		1																																																																													
1	1																																																																														
1																																																																															
		1																																																																													
Post - 0 Miss - 0 Block - 0	Post - 0 Miss - 0 Block - 0	Post - 0 Miss - 0 Block - 0	Post - 0 Miss - 0 Block - 0	Post - 2 Miss - 1 Block - 0	Post - 0 Miss - 0 Block - 0	Post - 0 Miss - 1 Block - 0																																																																									

16 马跃

0/5	0/1	0/3
2/7	2/5	2/5
3/6	0/1	0/1



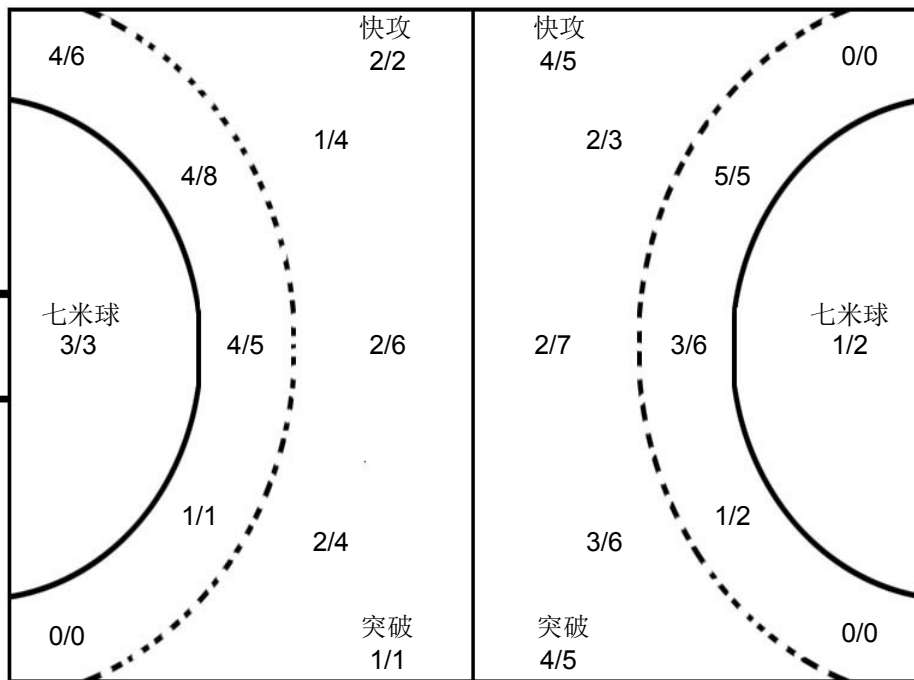

1 刘宗其

1/5	0/1	0/1
0/4	1/1	1/4
0/1	1/2	1/3

12 杨峻

0/1		0/2
	1/2	1/2
0/1		

16 刘海亮

0/1		

## 天津队

1 刘宗其	2 李岳朋	4 李松浩	6 王子欣	7 张青	8 曹悦	9 吴明远	11 王毅																																																																								
<table border="1"><tr><td></td><td></td><td></td></tr><tr><td></td><td></td><td></td></tr><tr><td></td><td></td><td></td></tr></table>										<table border="1"><tr><td></td><td></td><td></td></tr><tr><td></td><td></td><td></td></tr><tr><td></td><td></td><td></td></tr></table>										<table border="1"><tr><td></td><td></td><td></td></tr><tr><td></td><td></td><td></td></tr><tr><td></td><td></td><td></td></tr></table>										<table border="1"><tr><td></td><td></td><td>1</td></tr><tr><td></td><td>2</td><td></td></tr><tr><td></td><td>1</td><td></td></tr></table>			1		2			1		<table border="1"><tr><td>1</td><td></td><td>1</td></tr><tr><td></td><td>1</td><td></td></tr><tr><td></td><td></td><td></td></tr></table>	1		1		1					<table border="1"><tr><td>1</td><td></td><td>1</td></tr><tr><td>2</td><td></td><td></td></tr><tr><td></td><td></td><td></td></tr></table>	1		1	2						<table border="1"><tr><td></td><td></td><td></td></tr><tr><td></td><td></td><td></td></tr><tr><td></td><td></td><td></td></tr></table>										<table border="1"><tr><td></td><td></td><td></td></tr><tr><td></td><td></td><td></td></tr><tr><td></td><td></td><td></td></tr></table>									
		1																																																																													
	2																																																																														
	1																																																																														
1		1																																																																													
	1																																																																														
1		1																																																																													
2																																																																															
Post - 0 Miss - 0 Block - 0	Post - 0 Miss - 0 Block - 0	Post - 0 Miss - 0 Block - 0	Post - 0 Miss - 0 Block - 0	Post - 0 Miss - 0 Block - 3	Post - 1 Miss - 1 Block - 1	Post - 0 Miss - 0 Block - 0	Post - 0 Miss - 0 Block - 0																																																																								
12 杨峻	13 许松	14 田剑侠	16 刘海亮	17 周群	18 王晓琪	22 魏雨童																																																																									
<table border="1"><tr><td></td><td></td><td></td></tr><tr><td></td><td></td><td></td></tr><tr><td></td><td></td><td></td></tr></table>										<table border="1"><tr><td>1</td><td>1</td><td></td></tr><tr><td>2</td><td></td><td>2</td></tr><tr><td></td><td></td><td></td></tr></table>	1	1		2		2				<table border="1"><tr><td>2</td><td></td><td></td></tr><tr><td>1</td><td></td><td>1</td></tr><tr><td>2</td><td></td><td></td></tr></table>	2			1		1	2			<table border="1"><tr><td></td><td></td><td></td></tr><tr><td></td><td></td><td></td></tr><tr><td></td><td></td><td></td></tr></table>										<table border="1"><tr><td></td><td></td><td></td></tr><tr><td></td><td></td><td></td></tr><tr><td>1</td><td></td><td>1</td></tr></table>							1		1	<table border="1"><tr><td></td><td></td><td></td></tr><tr><td></td><td></td><td></td></tr><tr><td></td><td></td><td></td></tr></table>										<table border="1"><tr><td></td><td></td><td></td></tr><tr><td></td><td></td><td></td></tr><tr><td></td><td></td><td></td></tr></table>										<table border="1"><tr><td></td><td></td><td></td></tr><tr><td></td><td></td><td></td></tr><tr><td></td><td></td><td></td></tr></table>									
1	1																																																																														
2		2																																																																													
2																																																																															
1		1																																																																													
2																																																																															
1		1																																																																													
Post - 0 Miss - 0 Block - 0	Post - 1 Miss - 0 Block - 0	Post - 0 Miss - 0 Block - 0	Post - 0 Miss - 0 Block - 0	Post - 0 Miss - 0 Block - 0	Post - 0 Miss - 0 Block - 0	Post - 0 Miss - 0 Block - 0																																																																									

注释: Post=击柱 Miss=射失 Block=被封





预赛 Group B

男子 全国比赛

2016年全国男子手球锦标赛

Team A A 上海队				Team B B 四川队				Match Number <b>15</b>													
played in China		in the hall 徐闻县体育中心体育		on 22/10/2016		at 20:40 hours		Spectators													
Half-time (30')	A 15	B 13	End of playing time	A 30	B 21	1st extra time	A	B	2nd extra time	A	B	After penalty throws	A	B							
Number of 7 m	A 0/0	Team time-out			Full name of players and officials				Team time-out			B 3/5	Number of 7 m								
		1 17:05	2 46:37	3					1 14:36	2 42:28	3 57:53										
No.	Team A					G	W	2'	D	DR	No.	Team B					G	W	2'	D	DR
1	张崢										1	罗尧尧					2				
2	张文斌										3	刘赵梁					4				
3	赵时俊					1	1				7	仇瑞祥									
4	徐俊吉					4	1				8	谢庆龙					1				
7	吴双										9	许翔宇					2				
8	钱为玮					8					10	徐彦昊									
10	董凯					2					11	张天豪					2	1			
11	蒋承骅										12	丁大伟									
12	周哲韬										13	尹文珂					4				
14	沈吉磊					2					15	刘劲松									
15	朱世杰					7	1	1			16	宋继强									
17	贺政					1					18	任启双					1	1			
18	马麟晓					5					19	庞连康					2				
33	吴璟										20	徐逸									
											21	马光					3				
											22	张睿梁									
A	吴龙基 (主教练)										B	张文韬 (主教练)									
B	张勇军										D	胡俊杰									
C	金迪琦																				
E	杨时																				
A	Signature of Responsible Official of the Teams (Off. A)																		B		
TP	Remarks of Referee / CHA Official																		TP		

Signatures

Referees	丛艳霞 (CHN)	齐红梅 (CHN)		
Techn. Delegates	许宜扬 (CHN)			
CHA Official	王科 (CHN)			

Note: Number of 7m Throws Awarded to Team A and B, Goals (G), Warnings (W), Suspensions (2'), Direct Disqualification (D), Disqualification with Report (DR) and Team Penalty (TP).

Table Officials: 刘宇阳

鲍瑀

Statisticians: 张程秀子

周亚桥





### 2016年全国男子手球锦标赛 竞赛技术统计(媒体表)

预赛	组别	B	轮次	3	场次	15
徐闻县体育中心体育馆		22/10/2016			201606015-51-1/1	
上海队	上海	30	vs	21	四川	四川队
15 : 13						

裁判员		丛艳霞 (CHN)											/	齐红梅 (CHN)																																																																																																																																																																																																																																																																																																																																																																																																																																																																																																																																																																																																																																																																																																																																																																																																																																																																																																																																																																																																																																																																																																																																																																																																																																																																																																																																																																																																																																
主教练： 吴龙基		远射	近射	边射	快攻	突破	任意球	7m球	合计	%	助攻	失误	警告	2'	D & DR	<table border="1"> <thead> <tr> <th colspan="2">上海</th> <th colspan="22">比赛进程</th> <th colspan="2">四川</th> </tr> </thead> <tbody> <tr> <td colspan="2"></td> <td colspan="22">1st Half</td> <td colspan="2"></td> </tr> <tr> <td>4 徐俊吉</td><td>1</td><td>00:28</td><td colspan="19"></td><td>0</td><td colspan="2"></td> </tr> <tr> <td>15 朱世杰</td><td>1</td><td>00:56</td><td colspan="19"></td><td>1</td><td>21</td><td>马光</td> </tr> <tr> <td></td><td>2</td><td>01:55</td><td colspan="19"></td><td>1</td><td colspan="2"></td> </tr> <tr> <td></td><td>2</td><td>02:27</td><td colspan="19"></td><td>2</td><td>1</td><td>罗尧尧</td> </tr> <tr> <td></td><td>2</td><td>03:07</td><td colspan="19"></td><td>3</td><td>11</td><td>张天豪</td> </tr> <tr> <td>18 马麟晓</td><td>3</td><td>03:46</td><td colspan="19"></td><td>3</td><td colspan="2"></td> </tr> <tr> <td></td><td>3</td><td>05:31</td><td colspan="19"></td><td>4</td><td>21</td><td>马光</td> </tr> <tr> <td>18 马麟晓</td><td>4</td><td>06:01</td><td colspan="19"></td><td>4</td><td colspan="2"></td> </tr> <tr> <td></td><td>4</td><td>06:31</td><td colspan="19"></td><td>5</td><td>18</td><td>任启双</td> </tr> <tr> <td></td><td>4</td><td>07:24</td><td colspan="19"></td><td>6</td><td>1</td><td>罗尧尧</td> </tr> <tr> <td>15 朱世杰</td><td>5</td><td>07:57</td><td colspan="19"></td><td>6</td><td colspan="2"></td> </tr> <tr> <td></td><td>5</td><td>08:49</td><td colspan="19"></td><td>7</td><td>19</td><td>庞连康</td> </tr> <tr> <td>18 马麟晓</td><td>6</td><td>11:36</td><td colspan="19"></td><td>7</td><td colspan="2"></td> </tr> <tr> <td>8 钱为玮</td><td>7</td><td>12:49</td><td colspan="19"></td><td>7</td><td colspan="2"></td> </tr> <tr> <td>17 贺政</td><td>8</td><td>13:32</td><td colspan="19"></td><td>7</td><td colspan="2"></td> </tr> <tr> <td></td><td>8</td><td>15:33</td><td colspan="19"></td><td>8</td><td>3</td><td>刘赵梁</td> </tr> <tr> <td></td><td>8</td><td>17:04</td><td colspan="19"></td><td>9</td><td>8</td><td>谢庆龙</td> </tr> <tr> <td>15 朱世杰</td><td>9</td><td>17:32</td><td colspan="19"></td><td>9</td><td colspan="2"></td> </tr> <tr> <td>15 朱世杰</td><td>10</td><td>17:51</td><td colspan="19"></td><td>9</td><td colspan="2"></td> </tr> <tr> <td>3 赵时俊</td><td>11</td><td>19:45</td><td colspan="19"></td><td>9</td><td colspan="2"></td> </tr> <tr> <td>4 徐俊吉</td><td>12</td><td>21:28</td><td colspan="19"></td><td>9</td><td colspan="2"></td> </tr> <tr> <td></td><td>12</td><td>25:16</td><td colspan="19"></td><td>10</td><td>13</td><td>尹文珂</td> </tr> <tr> <td></td><td>12</td><td>26:11</td><td colspan="19"></td><td>11</td><td>3</td><td>刘赵梁</td> </tr> <tr> <td></td><td>12</td><td>27:29</td><td colspan="19"></td><td>12</td><td>13</td><td>尹文珂</td> </tr> <tr> <td>8 钱为玮</td><td>13</td><td>28:23</td><td colspan="19"></td><td>12</td><td colspan="2"></td> </tr> <tr> <td>8 钱为玮</td><td>14</td><td>29:06</td><td colspan="19"></td><td>12</td><td colspan="2"></td> </tr> <tr> <td></td><td>14</td><td>29:39</td><td colspan="19"></td><td>13</td><td>9</td><td>许翔宇</td> </tr> <tr> <td>4 徐俊吉</td><td>15</td><td>30:00</td><td colspan="19"></td><td>13</td><td colspan="2"></td> </tr> <tr> <td colspan="2"></td> <td colspan="22">2nd Half</td> <td colspan="2"></td> </tr> <tr> <td>8 钱为玮</td><td>16</td><td>01:06</td><td colspan="19"></td><td>13</td><td colspan="2"></td> </tr> <tr> <td></td><td>16</td><td>01:59</td><td colspan="19"></td><td>14</td><td>19</td><td>庞连康</td> </tr> <tr> <td></td><td>16</td><td>05:35</td><td colspan="19"></td><td>15</td><td>11</td><td>张天豪</td> </tr> <tr> <td>18 马麟晓</td><td>17</td><td>06:03</td><td colspan="19"></td><td>15</td><td colspan="2"></td> </tr> <tr> <td>8 钱为玮</td><td>18</td><td>09:37</td><td colspan="19"></td><td>15</td><td colspan="2"></td> </tr> <tr> <td>8 钱为玮</td><td>19</td><td>10:42</td><td colspan="19"></td><td>15</td><td colspan="2"></td> </tr> <tr> <td>15 朱世杰</td><td>20</td><td>13:07</td><td colspan="19"></td><td>15</td><td colspan="2"></td> </tr> <tr> <td>4 徐俊吉</td><td>21</td><td>13:23</td><td colspan="19"></td><td>15</td><td colspan="2"></td> </tr> <tr> <td>18 马麟晓</td><td>22</td><td>14:47</td><td colspan="19"></td><td>15</td><td colspan="2"></td> </tr> <tr> <td></td><td>22</td><td>15:05</td><td colspan="19"></td><td>16</td><td>9</td><td>许翔宇</td> </tr> <tr> <td>8 钱为玮</td><td>23</td><td>15:36</td><td colspan="19"></td><td>16</td><td colspan="2"></td> </tr> <tr> <td></td><td>23</td><td>16:16</td><td colspan="19"></td><td>17</td><td>13</td><td>尹文珂</td> </tr> <tr> <td>15 朱世杰</td><td>24</td><td>17:57</td><td colspan="19"></td><td>17</td><td colspan="2"></td> </tr> <tr> <td>10 董凯</td><td>25</td><td>19:00</td><td colspan="19"></td><td>17</td><td colspan="2"></td> </tr> <tr> <td></td><td>25</td><td>21:33</td><td colspan="19"></td><td>18</td><td>3</td><td>刘赵梁</td> </tr> <tr> <td></td><td>25</td><td>22:07</td><td colspan="19"></td><td>19</td><td>13</td><td>尹文珂</td> </tr> <tr> <td></td><td>25</td><td>22:47</td><td colspan="19"></td><td>20</td><td>3</td><td>刘赵梁</td> </tr> <tr> <td>14 沈吉磊</td><td>26</td><td>23:11</td><td colspan="19"></td><td>20</td><td colspan="2"></td> </tr> <tr> <td>14 沈吉磊</td><td>27</td><td>24:05</td><td colspan="19"></td><td>20</td><td colspan="2"></td> </tr> <tr> <td>15 朱世杰</td><td>28</td><td>26:19</td><td colspan="19"></td><td>20</td><td colspan="2"></td> </tr> <tr> <td>8 钱为玮</td><td>29</td><td>27:12</td><td colspan="19"></td><td>20</td><td colspan="2"></td> </tr> <tr> <td>10 董凯</td><td>30</td><td>28:35</td><td colspan="19"></td><td>20</td><td colspan="2"></td> </tr> <tr> <td></td><td>30</td><td>29:08</td><td colspan="19"></td><td>21</td><td>21</td><td>马光</td> </tr> </tbody> </table>																						上海		比赛进程																						四川				1st Half																								4 徐俊吉	1	00:28																				0			15 朱世杰	1	00:56																				1	21	马光		2	01:55																				1				2	02:27																				2	1	罗尧尧		2	03:07																				3	11	张天豪	18 马麟晓	3	03:46																				3				3	05:31																				4	21	马光	18 马麟晓	4	06:01																				4				4	06:31																				5	18	任启双		4	07:24																				6	1	罗尧尧	15 朱世杰	5	07:57																				6				5	08:49																				7	19	庞连康	18 马麟晓	6	11:36																				7			8 钱为玮	7	12:49																				7			17 贺政	8	13:32																				7				8	15:33																				8	3	刘赵梁		8	17:04																				9	8	谢庆龙	15 朱世杰	9	17:32																				9			15 朱世杰	10	17:51																				9			3 赵时俊	11	19:45																				9			4 徐俊吉	12	21:28																				9				12	25:16																				10	13	尹文珂		12	26:11																				11	3	刘赵梁		12	27:29																				12	13	尹文珂	8 钱为玮	13	28:23																				12			8 钱为玮	14	29:06																				12				14	29:39																				13	9	许翔宇	4 徐俊吉	15	30:00																				13					2nd Half																								8 钱为玮	16	01:06																				13				16	01:59																				14	19	庞连康		16	05:35																				15	11	张天豪	18 马麟晓	17	06:03																				15			8 钱为玮	18	09:37																				15			8 钱为玮	19	10:42																				15			15 朱世杰	20	13:07																				15			4 徐俊吉	21	13:23																				15			18 马麟晓	22	14:47																				15				22	15:05																				16	9	许翔宇	8 钱为玮	23	15:36																				16				23	16:16																				17	13	尹文珂	15 朱世杰	24	17:57																				17			10 董凯	25	19:00																				17				25	21:33																				18	3	刘赵梁		25	22:07																				19	13	尹文珂		25	22:47																				20	3	刘赵梁	14 沈吉磊	26	23:11																				20			14 沈吉磊	27	24:05																				20			15 朱世杰	28	26:19																				20			8 钱为玮	29	27:12																				20			10 董凯	30	28:35																				20				30	29:08																				21	21	马光
上海		比赛进程																						四川																																																																																																																																																																																																																																																																																																																																																																																																																																																																																																																																																																																																																																																																																																																																																																																																																																																																																																																																																																																																																																																																																																																																																																																																																																																																																																																																																																																																																						
		1st Half																																																																																																																																																																																																																																																																																																																																																																																																																																																																																																																																																																																																																																																																																																																																																																																																																																																																																																																																																																																																																																																																																																																																																																																																																																																																																																																																																																																																																																												
4 徐俊吉	1	00:28																				0																																																																																																																																																																																																																																																																																																																																																																																																																																																																																																																																																																																																																																																																																																																																																																																																																																																																																																																																																																																																																																																																																																																																																																																																																																																																																																																																																																																																																								
15 朱世杰	1	00:56																				1	21	马光																																																																																																																																																																																																																																																																																																																																																																																																																																																																																																																																																																																																																																																																																																																																																																																																																																																																																																																																																																																																																																																																																																																																																																																																																																																																																																																																																																																																																						
	2	01:55																				1																																																																																																																																																																																																																																																																																																																																																																																																																																																																																																																																																																																																																																																																																																																																																																																																																																																																																																																																																																																																																																																																																																																																																																																																																																																																																																																																																																																																																								
	2	02:27																				2	1	罗尧尧																																																																																																																																																																																																																																																																																																																																																																																																																																																																																																																																																																																																																																																																																																																																																																																																																																																																																																																																																																																																																																																																																																																																																																																																																																																																																																																																																																																																																						
	2	03:07																				3	11	张天豪																																																																																																																																																																																																																																																																																																																																																																																																																																																																																																																																																																																																																																																																																																																																																																																																																																																																																																																																																																																																																																																																																																																																																																																																																																																																																																																																																																																																																						
18 马麟晓	3	03:46																				3																																																																																																																																																																																																																																																																																																																																																																																																																																																																																																																																																																																																																																																																																																																																																																																																																																																																																																																																																																																																																																																																																																																																																																																																																																																																																																																																																																																																																								
	3	05:31																				4	21	马光																																																																																																																																																																																																																																																																																																																																																																																																																																																																																																																																																																																																																																																																																																																																																																																																																																																																																																																																																																																																																																																																																																																																																																																																																																																																																																																																																																																																																						
18 马麟晓	4	06:01																				4																																																																																																																																																																																																																																																																																																																																																																																																																																																																																																																																																																																																																																																																																																																																																																																																																																																																																																																																																																																																																																																																																																																																																																																																																																																																																																																																																																																																																								
	4	06:31																				5	18	任启双																																																																																																																																																																																																																																																																																																																																																																																																																																																																																																																																																																																																																																																																																																																																																																																																																																																																																																																																																																																																																																																																																																																																																																																																																																																																																																																																																																																																																						
	4	07:24																				6	1	罗尧尧																																																																																																																																																																																																																																																																																																																																																																																																																																																																																																																																																																																																																																																																																																																																																																																																																																																																																																																																																																																																																																																																																																																																																																																																																																																																																																																																																																																																																						
15 朱世杰	5	07:57																				6																																																																																																																																																																																																																																																																																																																																																																																																																																																																																																																																																																																																																																																																																																																																																																																																																																																																																																																																																																																																																																																																																																																																																																																																																																																																																																																																																																																																																								
	5	08:49																				7	19	庞连康																																																																																																																																																																																																																																																																																																																																																																																																																																																																																																																																																																																																																																																																																																																																																																																																																																																																																																																																																																																																																																																																																																																																																																																																																																																																																																																																																																																																																						
18 马麟晓	6	11:36																				7																																																																																																																																																																																																																																																																																																																																																																																																																																																																																																																																																																																																																																																																																																																																																																																																																																																																																																																																																																																																																																																																																																																																																																																																																																																																																																																																																																																																																								
8 钱为玮	7	12:49																				7																																																																																																																																																																																																																																																																																																																																																																																																																																																																																																																																																																																																																																																																																																																																																																																																																																																																																																																																																																																																																																																																																																																																																																																																																																																																																																																																																																																																																								
17 贺政	8	13:32																				7																																																																																																																																																																																																																																																																																																																																																																																																																																																																																																																																																																																																																																																																																																																																																																																																																																																																																																																																																																																																																																																																																																																																																																																																																																																																																																																																																																																																																								
	8	15:33																				8	3	刘赵梁																																																																																																																																																																																																																																																																																																																																																																																																																																																																																																																																																																																																																																																																																																																																																																																																																																																																																																																																																																																																																																																																																																																																																																																																																																																																																																																																																																																																																						
	8	17:04																				9	8	谢庆龙																																																																																																																																																																																																																																																																																																																																																																																																																																																																																																																																																																																																																																																																																																																																																																																																																																																																																																																																																																																																																																																																																																																																																																																																																																																																																																																																																																																																																						
15 朱世杰	9	17:32																				9																																																																																																																																																																																																																																																																																																																																																																																																																																																																																																																																																																																																																																																																																																																																																																																																																																																																																																																																																																																																																																																																																																																																																																																																																																																																																																																																																																																																																								
15 朱世杰	10	17:51																				9																																																																																																																																																																																																																																																																																																																																																																																																																																																																																																																																																																																																																																																																																																																																																																																																																																																																																																																																																																																																																																																																																																																																																																																																																																																																																																																																																																																																																								
3 赵时俊	11	19:45																				9																																																																																																																																																																																																																																																																																																																																																																																																																																																																																																																																																																																																																																																																																																																																																																																																																																																																																																																																																																																																																																																																																																																																																																																																																																																																																																																																																																																																																								
4 徐俊吉	12	21:28																				9																																																																																																																																																																																																																																																																																																																																																																																																																																																																																																																																																																																																																																																																																																																																																																																																																																																																																																																																																																																																																																																																																																																																																																																																																																																																																																																																																																																																																								
	12	25:16																				10	13	尹文珂																																																																																																																																																																																																																																																																																																																																																																																																																																																																																																																																																																																																																																																																																																																																																																																																																																																																																																																																																																																																																																																																																																																																																																																																																																																																																																																																																																																																																						
	12	26:11																				11	3	刘赵梁																																																																																																																																																																																																																																																																																																																																																																																																																																																																																																																																																																																																																																																																																																																																																																																																																																																																																																																																																																																																																																																																																																																																																																																																																																																																																																																																																																																																																						
	12	27:29																				12	13	尹文珂																																																																																																																																																																																																																																																																																																																																																																																																																																																																																																																																																																																																																																																																																																																																																																																																																																																																																																																																																																																																																																																																																																																																																																																																																																																																																																																																																																																																																						
8 钱为玮	13	28:23																				12																																																																																																																																																																																																																																																																																																																																																																																																																																																																																																																																																																																																																																																																																																																																																																																																																																																																																																																																																																																																																																																																																																																																																																																																																																																																																																																																																																																																																								
8 钱为玮	14	29:06																				12																																																																																																																																																																																																																																																																																																																																																																																																																																																																																																																																																																																																																																																																																																																																																																																																																																																																																																																																																																																																																																																																																																																																																																																																																																																																																																																																																																																																																								
	14	29:39																				13	9	许翔宇																																																																																																																																																																																																																																																																																																																																																																																																																																																																																																																																																																																																																																																																																																																																																																																																																																																																																																																																																																																																																																																																																																																																																																																																																																																																																																																																																																																																																						
4 徐俊吉	15	30:00																				13																																																																																																																																																																																																																																																																																																																																																																																																																																																																																																																																																																																																																																																																																																																																																																																																																																																																																																																																																																																																																																																																																																																																																																																																																																																																																																																																																																																																																								
		2nd Half																																																																																																																																																																																																																																																																																																																																																																																																																																																																																																																																																																																																																																																																																																																																																																																																																																																																																																																																																																																																																																																																																																																																																																																																																																																																																																																																																																																																																																												
8 钱为玮	16	01:06																				13																																																																																																																																																																																																																																																																																																																																																																																																																																																																																																																																																																																																																																																																																																																																																																																																																																																																																																																																																																																																																																																																																																																																																																																																																																																																																																																																																																																																																								
	16	01:59																				14	19	庞连康																																																																																																																																																																																																																																																																																																																																																																																																																																																																																																																																																																																																																																																																																																																																																																																																																																																																																																																																																																																																																																																																																																																																																																																																																																																																																																																																																																																																																						
	16	05:35																				15	11	张天豪																																																																																																																																																																																																																																																																																																																																																																																																																																																																																																																																																																																																																																																																																																																																																																																																																																																																																																																																																																																																																																																																																																																																																																																																																																																																																																																																																																																																																						
18 马麟晓	17	06:03																				15																																																																																																																																																																																																																																																																																																																																																																																																																																																																																																																																																																																																																																																																																																																																																																																																																																																																																																																																																																																																																																																																																																																																																																																																																																																																																																																																																																																																																								
8 钱为玮	18	09:37																				15																																																																																																																																																																																																																																																																																																																																																																																																																																																																																																																																																																																																																																																																																																																																																																																																																																																																																																																																																																																																																																																																																																																																																																																																																																																																																																																																																																																																																								
8 钱为玮	19	10:42																				15																																																																																																																																																																																																																																																																																																																																																																																																																																																																																																																																																																																																																																																																																																																																																																																																																																																																																																																																																																																																																																																																																																																																																																																																																																																																																																																																																																																																																								
15 朱世杰	20	13:07																				15																																																																																																																																																																																																																																																																																																																																																																																																																																																																																																																																																																																																																																																																																																																																																																																																																																																																																																																																																																																																																																																																																																																																																																																																																																																																																																																																																																																																																								
4 徐俊吉	21	13:23																				15																																																																																																																																																																																																																																																																																																																																																																																																																																																																																																																																																																																																																																																																																																																																																																																																																																																																																																																																																																																																																																																																																																																																																																																																																																																																																																																																																																																																																								
18 马麟晓	22	14:47																				15																																																																																																																																																																																																																																																																																																																																																																																																																																																																																																																																																																																																																																																																																																																																																																																																																																																																																																																																																																																																																																																																																																																																																																																																																																																																																																																																																																																																																								
	22	15:05																				16	9	许翔宇																																																																																																																																																																																																																																																																																																																																																																																																																																																																																																																																																																																																																																																																																																																																																																																																																																																																																																																																																																																																																																																																																																																																																																																																																																																																																																																																																																																																																						
8 钱为玮	23	15:36																				16																																																																																																																																																																																																																																																																																																																																																																																																																																																																																																																																																																																																																																																																																																																																																																																																																																																																																																																																																																																																																																																																																																																																																																																																																																																																																																																																																																																																																								
	23	16:16																				17	13	尹文珂																																																																																																																																																																																																																																																																																																																																																																																																																																																																																																																																																																																																																																																																																																																																																																																																																																																																																																																																																																																																																																																																																																																																																																																																																																																																																																																																																																																																																						
15 朱世杰	24	17:57																				17																																																																																																																																																																																																																																																																																																																																																																																																																																																																																																																																																																																																																																																																																																																																																																																																																																																																																																																																																																																																																																																																																																																																																																																																																																																																																																																																																																																																																								
10 董凯	25	19:00																				17																																																																																																																																																																																																																																																																																																																																																																																																																																																																																																																																																																																																																																																																																																																																																																																																																																																																																																																																																																																																																																																																																																																																																																																																																																																																																																																																																																																																																								
	25	21:33																				18	3	刘赵梁																																																																																																																																																																																																																																																																																																																																																																																																																																																																																																																																																																																																																																																																																																																																																																																																																																																																																																																																																																																																																																																																																																																																																																																																																																																																																																																																																																																																																						
	25	22:07																				19	13	尹文珂																																																																																																																																																																																																																																																																																																																																																																																																																																																																																																																																																																																																																																																																																																																																																																																																																																																																																																																																																																																																																																																																																																																																																																																																																																																																																																																																																																																																																						
	25	22:47																				20	3	刘赵梁																																																																																																																																																																																																																																																																																																																																																																																																																																																																																																																																																																																																																																																																																																																																																																																																																																																																																																																																																																																																																																																																																																																																																																																																																																																																																																																																																																																																																						
14 沈吉磊	26	23:11																				20																																																																																																																																																																																																																																																																																																																																																																																																																																																																																																																																																																																																																																																																																																																																																																																																																																																																																																																																																																																																																																																																																																																																																																																																																																																																																																																																																																																																																								
14 沈吉磊	27	24:05																				20																																																																																																																																																																																																																																																																																																																																																																																																																																																																																																																																																																																																																																																																																																																																																																																																																																																																																																																																																																																																																																																																																																																																																																																																																																																																																																																																																																																																																								
15 朱世杰	28	26:19																				20																																																																																																																																																																																																																																																																																																																																																																																																																																																																																																																																																																																																																																																																																																																																																																																																																																																																																																																																																																																																																																																																																																																																																																																																																																																																																																																																																																																																																								
8 钱为玮	29	27:12																				20																																																																																																																																																																																																																																																																																																																																																																																																																																																																																																																																																																																																																																																																																																																																																																																																																																																																																																																																																																																																																																																																																																																																																																																																																																																																																																																																																																																																																								
10 董凯	30	28:35																				20																																																																																																																																																																																																																																																																																																																																																																																																																																																																																																																																																																																																																																																																																																																																																																																																																																																																																																																																																																																																																																																																																																																																																																																																																																																																																																																																																																																																																								
	30	29:08																				21	21	马光																																																																																																																																																																																																																																																																																																																																																																																																																																																																																																																																																																																																																																																																																																																																																																																																																																																																																																																																																																																																																																																																																																																																																																																																																																																																																																																																																																																																																						
运动员 合计	8/17	10/14	7/11	5/6	0/2	0/1		30/51	58.8	8	10	3	1																																																																																																																																																																																																																																																																																																																																																																																																																																																																																																																																																																																																																																																																																																																																																																																																																																																																																																																																																																																																																																																																																																																																																																																																																																																																																																																																																																																																																																	
守门员 合计	6/10	5/9	2/4	0/5	0/3		2/5	15/36	41.7	1																																																																																																																																																																																																																																																																																																																																																																																																																																																																																																																																																																																																																																																																																																																																																																																																																																																																																																																																																																																																																																																																																																																																																																																																																																																																																																																																																																																																																																				
四川																																																																																																																																																																																																																																																																																																																																																																																																																																																																																																																																																																																																																																																																																																																																																																																																																																																																																																																																																																																																																																																																																																																																																																																																																																																																																																																																																																																																																																														
教练：张文韬		远射	近射	边射	快攻	突破	任意球	7m球	合计	%	助攻	失误	警告	2'	D & DR																																																																																																																																																																																																																																																																																																																																																																																																																																																																																																																																																																																																																																																																																																																																																																																																																																																																																																																																																																																																																																																																																																																																																																																																																																																																																																																																																																																																																															
1 罗尧尧	0/4	1/1			1/1				2/6	33.3		1																																																																																																																																																																																																																																																																																																																																																																																																																																																																																																																																																																																																																																																																																																																																																																																																																																																																																																																																																																																																																																																																																																																																																																																																																																																																																																																																																																																																																																		
3 刘赵梁		1/2	0/1	2/2	1/1				4/6	66.7		2																																																																																																																																																																																																																																																																																																																																																																																																																																																																																																																																																																																																																																																																																																																																																																																																																																																																																																																																																																																																																																																																																																																																																																																																																																																																																																																																																																																																																																		
7 仇瑞祥							0/2	0/2	0.0		1	2																																																																																																																																																																																																																																																																																																																																																																																																																																																																																																																																																																																																																																																																																																																																																																																																																																																																																																																																																																																																																																																																																																																																																																																																																																																																																																																																																																																																																																		
8 谢庆龙		0/2		1/1				1/3	33.3																																																																																																																																																																																																																																																																																																																																																																																																																																																																																																																																																																																																																																																																																																																																																																																																																																																																																																																																																																																																																																																																																																																																																																																																																																																																																																																																																																																																																																					
9 许翔宇	0/3	1/3	1/2					2/8	25.0	1	4																																																																																																																																																																																																																																																																																																																																																																																																																																																																																																																																																																																																																																																																																																																																																																																																																																																																																																																																																																																																																																																																																																																																																																																																																																																																																																																																																																																																																																			
10 徐彦昊	0/1							0/1	0.0				1																																																																																																																																																																																																																																																																																																																																																																																																																																																																																																																																																																																																																																																																																																																																																																																																																																																																																																																																																																																																																																																																																																																																																																																																																																																																																																																																																																																																																																	
11 张天豪			0/1	2/2				2/3	66.7																																																																																																																																																																																																																																																																																																																																																																																																																																																																																																																																																																																																																																																																																																																																																																																																																																																																																																																																																																																																																																																																																																																																																																																																																																																																																																																																																																																																																																					
12 丁大伟											2																																																																																																																																																																																																																																																																																																																																																																																																																																																																																																																																																																																																																																																																																																																																																																																																																																																																																																																																																																																																																																																																																																																																																																																																																																																																																																																																																																																																																																			
13 尹文珂			1/2				3/3	4/5	80.0		1																																																																																																																																																																																																																																																																																																																																																																																																																																																																																																																																																																																																																																																																																																																																																																																																																																																																																																																																																																																																																																																																																																																																																																																																																																																																																																																																																																																																																																			
15 刘劲松	0/2							0/2	0.0																																																																																																																																																																																																																																																																																																																																																																																																																																																																																																																																																																																																																																																																																																																																																																																																																																																																																																																																																																																																																																																																																																																																																																																																																																																																																																																																																																																																																																					
16 宋继强																																																																																																																																																																																																																																																																																																																																																																																																																																																																																																																																																																																																																																																																																																																																																																																																																																																																																																																																																																																																																																																																																																																																																																																																																																																																																																																																																																																																																																														
18 任启双		1/1						1/1	100	1	1	1																																																																																																																																																																																																																																																																																																																																																																																																																																																																																																																																																																																																																																																																																																																																																																																																																																																																																																																																																																																																																																																																																																																																																																																																																																																																																																																																																																																																																																		
19 庞连康	2/2	0/1						2/3	66.7	1	1																																																																																																																																																																																																																																																																																																																																																																																																																																																																																																																																																																																																																																																																																																																																																																																																																																																																																																																																																																																																																																																																																																																																																																																																																																																																																																																																																																																																																																			
20 徐逸																																																																																																																																																																																																																																																																																																																																																																																																																																																																																																																																																																																																																																																																																																																																																																																																																																																																																																																																																																																																																																																																																																																																																																																																																																																																																																																																																																																																																																														
21 马光	2/5				1/1			3/6	50.0	1	1																																																																																																																																																																																																																																																																																																																																																																																																																																																																																																																																																																																																																																																																																																																																																																																																																																																																																																																																																																																																																																																																																																																																																																																																																																																																																																																																																																																																																																			
22 张春梁																																																																																																																																																																																																																																																																																																																																																																																																																																																																																																																																																																																																																																																																																																																																																																																																																																																																																																																																																																																																																																																																																																																																																																																																																																																																																																																																																																																																																																														
运动员 合计	4/17	4/10	2/6	5/5	3/3		3/5	21/46	45.7	7	13	2																																																																																																																																																																																																																																																																																																																																																																																																																																																																																																																																																																																																																																																																																																																																																																																																																																																																																																																																																																																																																																																																																																																																																																																																																																																																																																																																																																																																																																		
守门员 合计	5/13	3/13	1/8	1/6	2/2	1/1		13/43	30.2	2																																																																																																																																																																																																																																																																																																																																																																																																																																																																																																																																																																																																																																																																																																																																																																																																																																																																																																																																																																																																																																																																																																																																																																																																																																																																																																																																																																																																																																				

场上队员：得分 / 射门

守门员：救球 / 射门

快攻	Fast Break		突破	Breakthrough		任意球	Free Throw		7M球	7M Throw		助攻	Assist
警告	Warning		失误	Error		2'	Suspension		D	取消资格		DR	取消资格+报告





### 2016年全国男子手球锦标赛 图式比赛技术统计表

轮次 3

场次 15

201606015-21-1/1

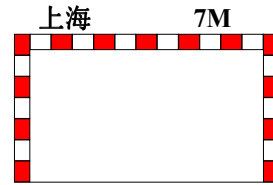
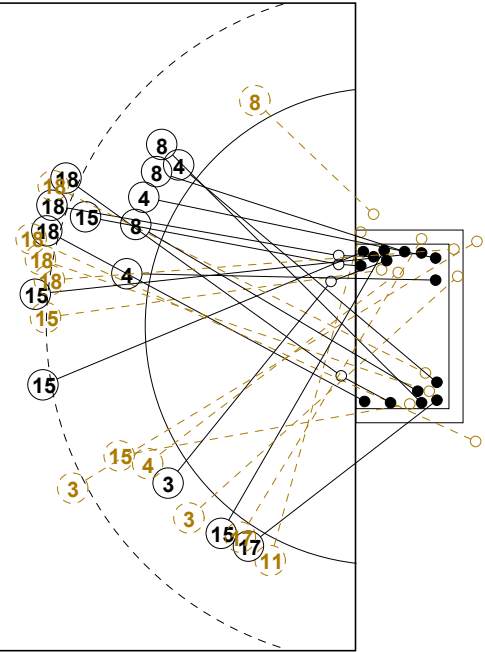
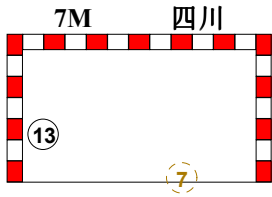
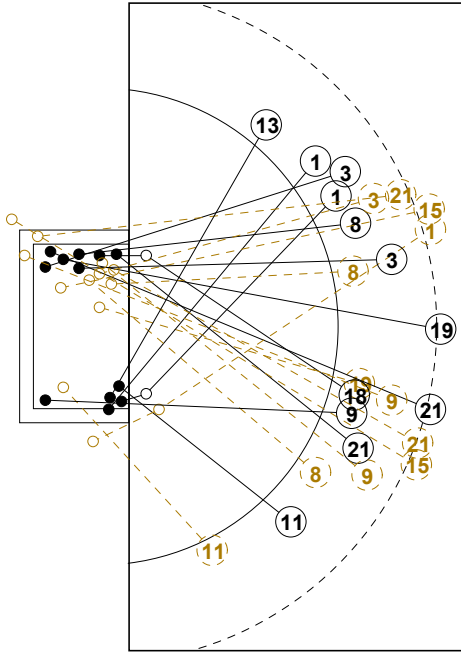

1st Half  
13 : 15

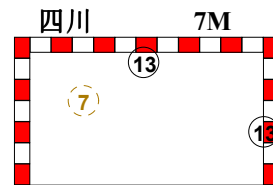
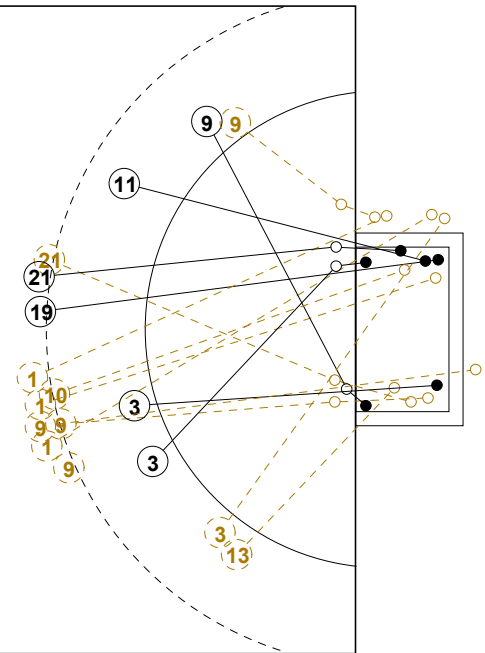
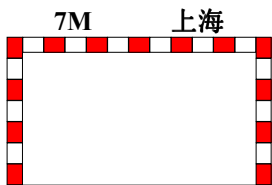
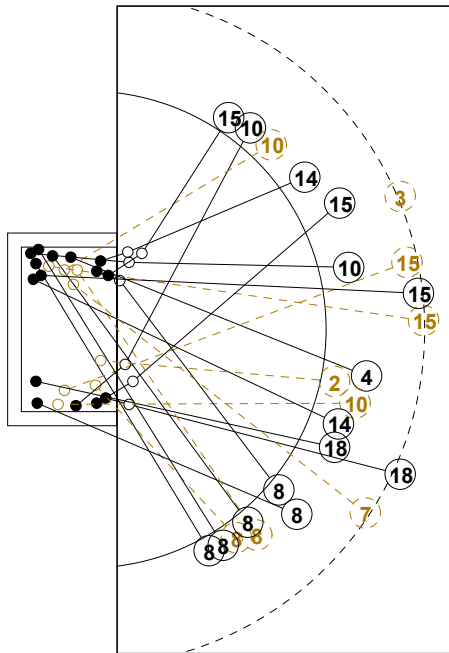

2nd Half  
30 : 21



## 2016年全国男子手球锦标赛

## 个人/全队技术统计表

正式表  
手球  
男子预赛  
轮次 3组别 B  
场次 15201606015-14-1/2  
徐闻县体育中心体育馆  
22/10/2016 20:40

号码	姓名	远射	近射	边射	快攻	突破	任意	7M	合计	%	助攻	失误	警告	2'	取消	时间
<b>上海队(上海)</b>																
<i>(场上队员)</i>																
1	张崢									0.0%	1					01:00:00
2	张文斌					0/1			0/1	0.0%	1					00:08:17
3	赵时俊	0/2	1/2						1/4	25.0%	1		1			00:32:26
4	徐俊吉		3/4		1/1				4/5	80.0%			1			00:48:04
7	吴双						0/1		0/1	0.0%						00:02:07
8	钱为玮		2/2	3/5	3/4				8/11	72.7%	1	4				01:00:00
10	董凯		1/3	1/1					2/4	50.0%		2				00:12:39
11	蒋承骅			0/1					0/1	0.0%						00:50:53
12	周哲韬									0.0%						00:00:00
14	沈吉磊		2/2						2/2	100%						00:06:27
15	朱世杰	4/7		2/2	1/1	0/1			7/11	63.6%		1	1	1		00:56:52
17	贺政			1/2					1/2	50.0%		1				00:30:00
18	马麟晓	4/8	1/1						5/9	55.6%	4	2				00:51:42
33	吴璟									0.0%						00:00:00
<b>合计</b>																
<i>(守门员)</i>																
1	张崢	6/10	5/9	2/4	0/5	0/3		2/5	15/36	41.7%	1					01:00:00
<b>合计</b>																

场上队员：得分/射门

守门员：救球/射门

全队合计	得分	被救	射失	击柱	封球	合计	%
远射	8	5	2	1	1	17	47.1%
近射	10	3		1		14	71.4%
边射	7	1	1	2		11	63.6%
快攻	5	1				6	83.3%
突破		2				2	0.0%
任意		1				1	0.0%
7M							0.0%





## 2016年全国男子手球锦标赛

## 个人/全队技术统计表

正式表  
手球  
男子预赛  
轮次 3组别 B  
场次 15201606015-14-2/2  
徐闻县体育中心体育馆  
22/10/2016 20:40

号码	姓名	远射	近射	边射	快攻	突破	任意	7M	合计	%	助攻	失误	警告	2'	取消	时间
<b>四川队(四川)</b>																
<i>(上场队员)</i>																
1	罗尧尧	0/4	1/1			1/1			2/6	33.3%		1				00:23:00
3	刘赵梁		1/2	0/1	2/2	1/1			4/6	66.7%		2				00:29:19
7	仇瑞祥							0/2	0/2	0.0%	1	2				00:31:37
8	谢庆龙		0/2		1/1				1/3	33.3%						00:34:30
9	许翔宇	0/3	1/3	1/2					2/8	25.0%	1	4				00:39:14
10	徐彦昊	0/1							0/1	0.0%						00:25:01
11	张天豪			0/1	2/2				2/3	66.7%			1			00:28:19
12	丁大伟									0.0%	2					00:39:55
13	尹文珂			1/2				3/3	4/5	80.0%		1				00:42:15
15	刘劲松	0/2							0/2	0.0%						00:13:11
16	宋继强									0.0%						00:19:06
18	任启双		1/1						1/1	100%	1	1	1			00:33:16
19	庞连康	2/2	0/1						2/3	66.7%	1	1				00:23:18
20	徐逸									0.0%						00:10:03
21	马光	2/5				1/1			3/6	50.0%	1	1				00:26:42
22	张春梁									0.0%						00:00:59
<b>合计</b>		4/17	4/10	2/6	5/5	3/3		3/5	21/46	45.7%	7	13	2			
<i>(守门员)</i>																
12	丁大伟	5/13	0/4	1/6	1/5	1/1			8/29	27.6%	2					00:39:55
16	宋继强		3/9	0/1	0/1	1/1	1/1		5/13	38.5%						00:19:06
22	张春梁			0/1					0/1	0.0%						00:00:59
<b>合计</b>		5/13	3/13	1/8	1/6	2/2	1/1		13/43	30.2%	2					

场上队员：得分/射门

守门员：救球/射门

全队合计	得分	被救	射失	击柱	封球	合计	%
远射	4	6	5	1	1	17	23.5%
近射	4	5		1		10	40.0%
边射	2	2	2			6	33.3%
快攻	5					5	100.0%
突破	3					3	100.0%
任意							0.0%
7M	3	2				5	60.0%





### 2016年全国男子手球锦标赛

#### 图式射门区域统计

轮次 3 场次 15

201606015-41-1/1

## 上海队

1 张峥	2 张文斌	3 赵时俊	4 徐俊吉	7 吴双	8 钱为玮	10 董凯	11 蒋承骅																																																																								
<table border="1"><tr><td></td><td></td><td></td></tr><tr><td></td><td></td><td></td></tr><tr><td></td><td></td><td></td></tr></table>										<table border="1"><tr><td></td><td></td><td></td></tr><tr><td></td><td></td><td></td></tr><tr><td></td><td></td><td></td></tr></table>										<table border="1"><tr><td></td><td></td><td></td></tr><tr><td>1</td><td></td><td></td></tr><tr><td></td><td></td><td></td></tr></table>				1						<table border="1"><tr><td>2</td><td></td><td>1</td></tr><tr><td></td><td></td><td>1</td></tr><tr><td></td><td></td><td></td></tr></table>	2		1			1				<table border="1"><tr><td></td><td></td><td></td></tr><tr><td></td><td></td><td></td></tr><tr><td></td><td></td><td></td></tr></table>										<table border="1"><tr><td>1</td><td></td><td>5</td></tr><tr><td>1</td><td></td><td></td></tr><tr><td></td><td></td><td>1</td></tr></table>	1		5	1					1	<table border="1"><tr><td></td><td></td><td>1</td></tr><tr><td></td><td></td><td></td></tr><tr><td></td><td></td><td></td></tr></table>			1							<table border="1"><tr><td></td><td></td><td></td></tr><tr><td></td><td></td><td></td></tr><tr><td></td><td></td><td></td></tr></table>									
1																																																																															
2		1																																																																													
		1																																																																													
1		5																																																																													
1																																																																															
		1																																																																													
		1																																																																													
Post - 0 Miss - 0 Block - 0	Post - 0 Miss - 0 Block - 0	Post - 1 Miss - 1 Block - 1	Post - 0 Miss - 0 Block - 0	Post - 0 Miss - 0 Block - 0	Post - 0 Miss - 1 Block - 0	Post - 0 Miss - 0 Block - 0	Post - 1 Miss - 0 Block - 0																																																																								
12 周哲韬	14 沈吉磊	15 朱世杰	17 贺政	18 马麟晓	33 吴璟																																																																										
<table border="1"><tr><td></td><td></td><td></td></tr><tr><td></td><td></td><td></td></tr><tr><td></td><td></td><td></td></tr></table>										<table border="1"><tr><td></td><td></td><td>1</td></tr><tr><td></td><td></td><td>1</td></tr><tr><td></td><td></td><td></td></tr></table>			1			1				<table border="1"><tr><td>1</td><td></td><td>1</td></tr><tr><td></td><td></td><td></td></tr><tr><td>4</td><td></td><td>1</td></tr></table>	1		1				4		1	<table border="1"><tr><td></td><td></td><td>1</td></tr><tr><td></td><td></td><td></td></tr><tr><td></td><td></td><td></td></tr></table>			1							<table border="1"><tr><td>1</td><td></td><td></td></tr><tr><td></td><td></td><td>1</td></tr><tr><td>2</td><td></td><td>1</td></tr></table>	1					1	2		1	<table border="1"><tr><td></td><td></td><td></td></tr><tr><td></td><td></td><td></td></tr><tr><td></td><td></td><td></td></tr></table>										<table border="1"><tr><td></td><td></td><td></td></tr><tr><td></td><td></td><td></td></tr><tr><td></td><td></td><td></td></tr></table>										<table border="1"><tr><td></td><td></td><td></td></tr><tr><td></td><td></td><td></td></tr><tr><td></td><td></td><td></td></tr></table>									
		1																																																																													
		1																																																																													
1		1																																																																													
4		1																																																																													
		1																																																																													
1																																																																															
		1																																																																													
2		1																																																																													
Post - 0 Miss - 0 Block - 0	Post - 0 Miss - 0 Block - 0	Post - 0 Miss - 0 Block - 0	Post - 1 Miss - 0 Block - 0	Post - 1 Miss - 1 Block - 0	Post - 0 Miss - 0 Block - 0																																																																										

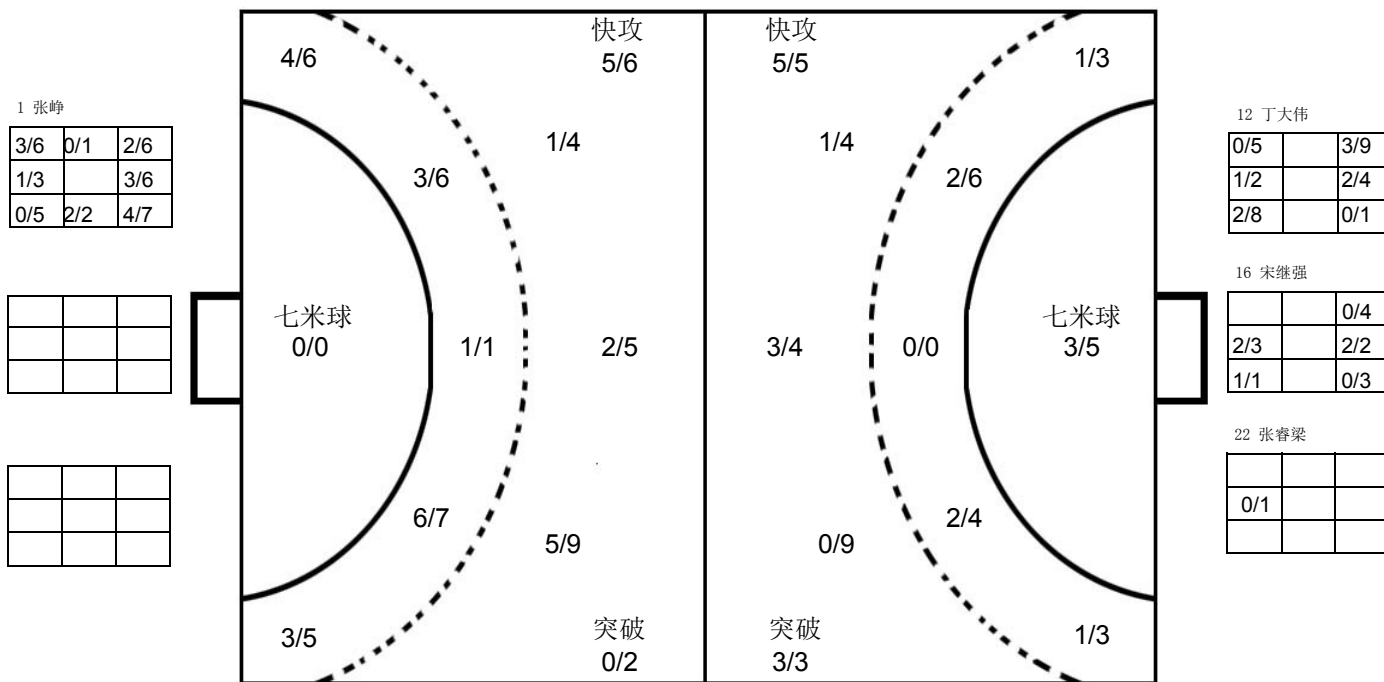

## 四川队

1 罗尧尧	3 刘赵梁	7 仇瑞祥	8 谢庆龙	9 许翔宇	10 徐彦昊	11 张天豪	12 丁大伟																																																																								
<table border="1"><tr><td></td><td></td><td></td></tr><tr><td></td><td></td><td></td></tr><tr><td>2</td><td></td><td></td></tr></table>							2			<table border="1"><tr><td></td><td></td><td>2</td></tr><tr><td></td><td></td><td>1</td></tr><tr><td></td><td></td><td></td></tr></table>			2			1				<table border="1"><tr><td></td><td></td><td></td></tr><tr><td></td><td></td><td></td></tr><tr><td></td><td></td><td></td></tr></table>										<table border="1"><tr><td></td><td></td><td></td></tr><tr><td></td><td></td><td>1</td></tr><tr><td></td><td></td><td></td></tr></table>						1				<table border="1"><tr><td>1</td><td></td><td></td></tr><tr><td></td><td></td><td></td></tr><tr><td></td><td></td><td>1</td></tr></table>	1								1	<table border="1"><tr><td></td><td></td><td></td></tr><tr><td></td><td></td><td></td></tr><tr><td></td><td></td><td></td></tr></table>										<table border="1"><tr><td></td><td></td><td>1</td></tr><tr><td></td><td></td><td></td></tr><tr><td></td><td></td><td></td></tr></table>			1							<table border="1"><tr><td></td><td></td><td></td></tr><tr><td></td><td></td><td></td></tr><tr><td></td><td></td><td></td></tr></table>									
2																																																																															
		2																																																																													
		1																																																																													
		1																																																																													
1																																																																															
		1																																																																													
		1																																																																													
Post - 0 Miss - 3 Block - 0	Post - 0 Miss - 1 Block - 0	Post - 0 Miss - 0 Block - 0	Post - 0 Miss - 0 Block - 0	Post - 1 Miss - 2 Block - 1	Post - 0 Miss - 0 Block - 0	Post - 0 Miss - 0 Block - 0	Post - 0 Miss - 0 Block - 0																																																																								
13 尹文珂	15 刘劲松	16 宋继强	18 任启双	19 庞连康	20 徐逸	21 马光	22 张睿梁																																																																								
<table border="1"><tr><td></td><td>1</td><td></td></tr><tr><td>1</td><td></td><td>1</td></tr><tr><td>1</td><td></td><td></td></tr></table>		1		1		1	1			<table border="1"><tr><td></td><td></td><td></td></tr><tr><td></td><td></td><td></td></tr><tr><td></td><td></td><td></td></tr></table>										<table border="1"><tr><td></td><td></td><td></td></tr><tr><td></td><td></td><td></td></tr><tr><td></td><td></td><td></td></tr></table>										<table border="1"><tr><td></td><td></td><td></td></tr><tr><td></td><td></td><td></td></tr><tr><td></td><td></td><td>1</td></tr></table>									1	<table border="1"><tr><td>1</td><td></td><td>1</td></tr><tr><td></td><td></td><td></td></tr><tr><td></td><td></td><td></td></tr></table>	1		1							<table border="1"><tr><td></td><td></td><td></td></tr><tr><td></td><td></td><td></td></tr><tr><td></td><td></td><td></td></tr></table>										<table border="1"><tr><td></td><td></td><td>1</td></tr><tr><td>1</td><td></td><td></td></tr><tr><td></td><td></td><td>1</td></tr></table>			1	1					1	<table border="1"><tr><td></td><td></td><td></td></tr><tr><td></td><td></td><td></td></tr><tr><td></td><td></td><td></td></tr></table>									
	1																																																																														
1		1																																																																													
1																																																																															
		1																																																																													
1		1																																																																													
		1																																																																													
1																																																																															
		1																																																																													
Post - 0 Miss - 0 Block - 0	Post - 0 Miss - 1 Block - 0	Post - 0 Miss - 0 Block - 0	Post - 0 Miss - 0 Block - 0	Post - 0 Miss - 0 Block - 0	Post - 0 Miss - 0 Block - 0	Post - 1 Miss - 0 Block - 0	Post - 0 Miss - 0 Block - 0																																																																								

注释: Post=击柱 Miss=射失 Block=被封





预赛 Group A

男子 全国比赛

2016年全国男子手球锦标赛

Team A <b>A 北京队</b>				Team B <b>B 新疆队</b>				Match Number <b>16</b>													
played in China		in the hall 徐闻县体育中心体育		on 24/10/2016		at 13:30 hours		Spectators													
Half-time (30')	<b>A</b> 16	<b>B</b> 9	End of playing time	<b>A</b> 29	<b>B</b> 14	1st extra time	<b>A</b>	<b>B</b>	2nd extra time	<b>A</b>	<b>B</b>	After penalty throws	<b>A</b>	<b>B</b>							
Number of 7 m	<b>A</b> 2/3	Team time-out			Full name of players and officials				Team time-out			<b>B</b> 2/2	Number of 7 m								
	1	2	3							1	2	3									
No.	Team <b>A</b>					G	W	2'	D	DR	No.	Team <b>B</b>					G	W	2'	D	DR
3	王超					5					1	宋晓晨									
6	解建飞					1					5	徐伟					1				
8	王鹏										7	林豪文					2		1		
9	刘振					2					8	刘文字					1	1			
10	成亚					4					9	姜春晖									
11	蒋维一					3	1				10	王钟彬					1				
12	孟辉										13	苏兴伟									
16	刘迈科										15	王维东					1				
21	胡瀛					4	1				17	胡晋铭									
23	王军程					5					18	姜帅									
25	马明辉					1	1				19	李龙吉					3				
29	杜龙飞					1					20	赵元					5		1		
33	冯宁										24	王泽川									
77	朱昕晨					2															
78	张骥					1															
83	潘天																				
A	安福田										B	陈鹏波									
B	郑永利 (主教练)										C	孙均鹏									
C	陈璇																				
<b>A</b>	Signature of Responsible Official of the Teams (Off. A)																		<b>B</b>		
TP	Remarks of Referee / CHA Official																		TP		

Signatures

Referees     尹静阳 (CHN)     严璐 (CHN)     \_\_\_\_\_     \_\_\_\_\_

Techn. Delegates     曹宏俊 (CHN)     \_\_\_\_\_     \_\_\_\_\_

CHA Official     徐健 (CHN)     \_\_\_\_\_     \_\_\_\_\_

Note: Number of 7m Throws Awarded to Team A and B, Goals (G), Warnings (W), Suspensions (2), Direct Disqualification (D), Disqualification with Report (DR) and Team Penalty (TP).

Table Officials: 梁小熹     伍豪

Statisticians: 张程秀子

周亚桥







## 2016年全国男子手球锦标赛 竞赛技术统计(媒体表)

预赛	组别	A	轮次	4	场次	16
----	----	---	----	---	----	----

徐闻县体育中心体育馆

24/10/2016

201606016-51-1/1

北京队	北京	29	vs	14	新疆	新疆队
16 : 9						

裁判员	尹静阳 (CHN)	/	严璐 (CHN)
-----	-----------	---	----------

北京														北京		新疆	
主教练： 郑永利														比赛进程		新疆	
远射	近射	边射	快攻	突破	任意球	7m球	合计	%	助攻	失误	警告	2'	D & DR				
3 王超		2/3		2/2	1/1		5/6	83.3							21 胡瀚	0 02:30	1 10 王钟彬
6 解建飞		1/1					1/1	100		1					11 蒋维一	1 02:53	1
8 王鹏															11 蒋维一	2 03:16	1
9 刘振	0/1	2/2					2/3	66.7							23 王军程	3 06:09	1
10 成亚		3/6		1/1			4/7	57.1		1					11 蒋维一	4 07:04	1
11 蒋维一		1/3		2/3			3/6	50.0			1	1			10 成亚	5 07:54	1
12 孟辉															25 马明辉	6 08:34	1
16 刘迈科										3	2				6 成亚	6 09:07	2 赵元
21 胡瀚	0/2	1/1		1/1	2/2		4/6	66.7	1		1				21 胡瀚	7 11:55	2
23 王军程	2/4	0/2			1/1	1/1	1/2	5/10	50.0			1			8 成亚	8 13:04	2
25 马明辉		0/1	0/1	1/1			1/3	33.3							10 成亚	9 14:46	2
29 杜龙飞		1/2					1/2	50.0		1					9 成亚	9 15:29	3 20 赵元
33 冯宁															23 王军程	10 16:04	3
77 朱昕晨	0/1	0/1			1/1		1/1	2/4	50.0						10 成亚	10 16:37	4 20 赵元
78 张骥		1/1													21 胡瀚	11 17:42	4
83 潘天															11 胡瀚	11 19:05	5 20 赵元
<b>运动员 合计</b>	<b>2/8</b>	<b>12/23</b>	<b>0/1</b>	<b>7/8</b>	<b>5/5</b>	<b>1/1</b>	<b>2/3</b>	<b>29/49</b>	<b>59.2</b>	<b>5</b>	<b>9</b>	<b>3</b>			23 王军程	12 19:42	5
12 孟辉	5/6	4/6	1/1	3/7	0/2	0/1	0/2	13/25	52.0	3	2				12 成亚	12 20:15	6 15 王卫东
16 刘迈科	5/5			0/1	0/1			5/7	71.4	1					12 成亚	12 20:55	7 20 赵元
<b>守门员 合计</b>	<b>10/11</b>	<b>4/6</b>	<b>1/1</b>	<b>3/8</b>	<b>0/3</b>	<b>0/1</b>	<b>0/2</b>	<b>18/32</b>	<b>56.3</b>	<b>4</b>	<b>2</b>				3 王超	13 21:49	7
新疆														2nd Half		新疆	
教练： 孔德宾														3 王超		3 王超	
远射	近射	边射	快攻	突破	任意球	7m球	合计	%	助攻	失误	警告	2'	D & DR				
1 宋晓晨										4					3 王超	17 01:08	9
5 徐伟		0/2		1/3			1/5	20.0		1					3 王超	18 02:36	9
7 林豪文	0/6				1/1	1/1	2/8	25.0		1		1			10 成亚	18 03:05	10 7 林豪文
8 刘文宇		1/1					1/1	100				1			19 成亚	19 03:46	10
9 姜春晖				0/1			0/1	0.0							3 王超	19 04:23	11 19 李龙吉
10 王钟彬	0/6	0/1		1/1			1/8	12.5		1					20 成亚	20 05:17	11
13 苏兴伟															78 张骥	21 05:51	11
15 王卫东		0/2	0/1	1/1			1/4	25.0							77 朱昕晨	22 06:33	11
17 胡晋铭										1					6 解建飞	23 07:23	11
18 姜帅															10 成亚	24 08:33	11
19 李龙吉	0/4	0/3			1/1		2/2	3/10	30.0		3				24 成亚	24 08:46	12 8 刘文宇
20 赵元	1/4	1/1		2/2	1/1		5/8	62.5		3			1		24 成亚	24 10:46	13 5 徐伟
24 王泽川															25 王军程	25 11:21	13
<b>运动员 合计</b>	<b>1/20</b>	<b>2/10</b>	<b>0/1</b>	<b>5/8</b>	<b>3/3</b>	<b>1/1</b>	<b>2/2</b>	<b>14/45</b>	<b>31.1</b>	<b>5</b>	<b>9</b>	<b>1</b>	<b>2</b>		9 刘振	26 12:02	13
1 宋晓晨	2/4	6/18	1/1	0/7	0/5	0/1	0/2	9/38	23.7	4					26 王军程	26 12:34	14 19 李龙吉
<b>守门员 合计</b>	<b>2/4</b>	<b>6/18</b>	<b>1/1</b>	<b>0/7</b>	<b>0/5</b>	<b>0/1</b>	<b>0/2</b>	<b>9/38</b>	<b>23.7</b>	<b>4</b>					9 刘振	27 13:23	14

场上队员： 得分 / 射门

守门员： 救球 / 射门

快攻	Fast Break	突破	Breakthrough	任意球	Free Throw	7M球	7M Throw	助攻	Assist
警告	Warning	失误	Error	2'	Suspension	D	取消资格	DR	取消资格+报告





### 2016年全国男子手球锦标赛 图式比赛技术统计表

轮次 4

场次 16

201606016-21-1/1

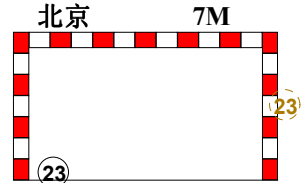
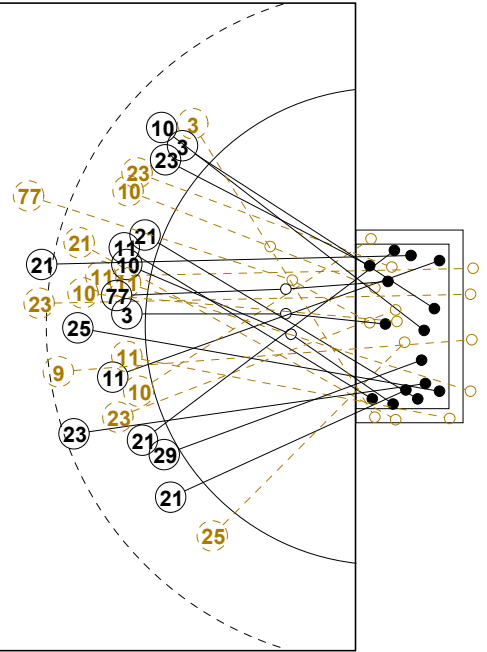
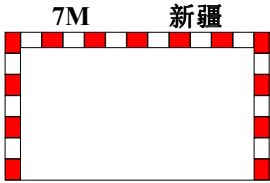
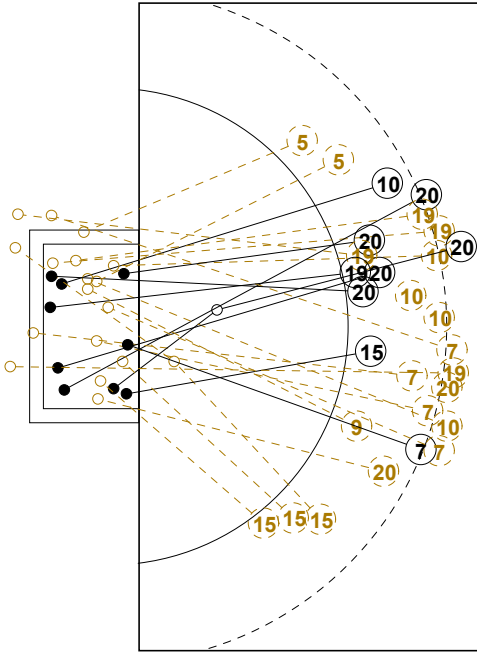

1st Half  
9 : 16

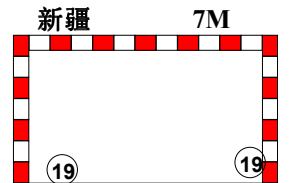
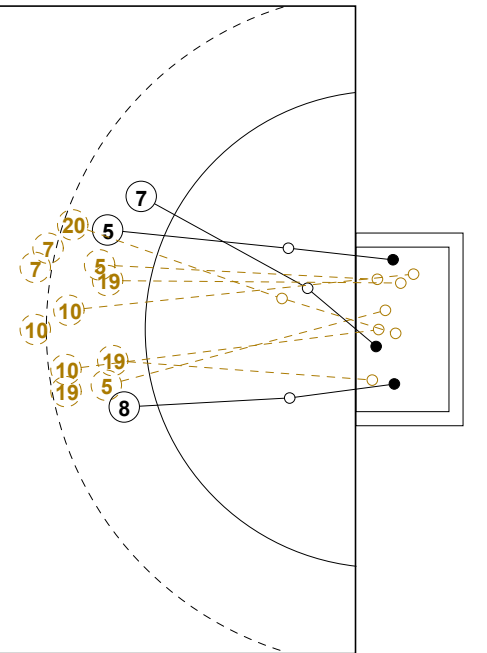
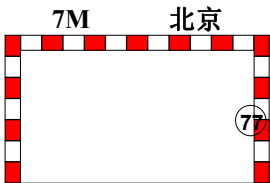
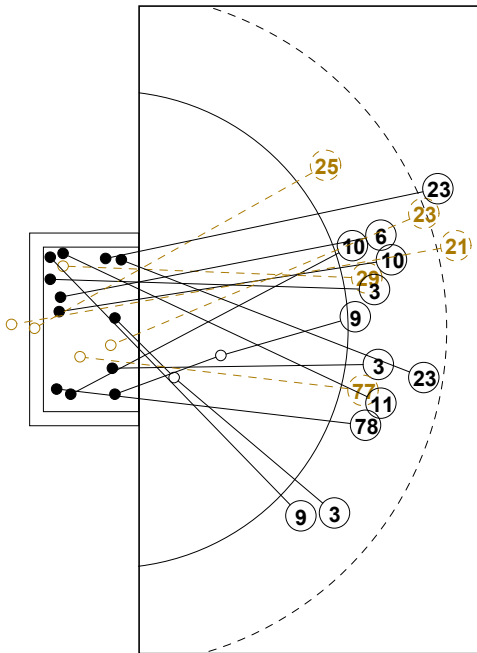

2nd Half  
29 : 14



## 2016年全国男子手球锦标赛

## 个人/全队技术统计表

正式表  
手球  
男子预赛  
轮次 4组别 A  
场次 16201606016-14-1/2  
徐闻县体育中心体育馆  
24/10/2016 13:30

号码	姓名	远射	近射	边射	快攻	突破	任意	7M	合计	%	助攻	失误	警告	2'	取消	时间
<b>北京队(北京)</b>																
<i>(场上队员)</i>																
3	王超		2/3		2/2	1/1			5/6	83.3%						00:39:32
6	解建飞		1/1						1/1	100%		1				00:15:59
8	王鹏									0.0%						00:11:22
9	刘振	0/1	2/2						2/3	66.7%						00:25:52
10	成亚		3/6		1/1				4/7	57.1%		1				00:23:39
11	蒋维一		1/3		2/3				3/6	50.0%		1	1			00:43:39
12	孟辉									0.0%	3	2				00:45:29
16	刘迈科									0.0%	1					00:14:31
21	胡瀛	0/2	1/1		1/1	2/2			4/6	66.7%	1		1			00:41:17
23	王军程	2/4	0/2			1/1	1/1	1/2	5/10	50.0%		1				00:42:04
25	马明辉		0/1	0/1	1/1				1/3	33.3%				1		00:43:41
29	杜龙飞		1/2						1/2	50.0%						00:18:26
33	冯宁									0.0%						00:00:00
77	朱昕晨	0/1	0/1			1/1		1/1	2/4	50.0%		1				00:20:20
78	张骥		1/1						1/1	100%		2				00:23:25
83	潘天									0.0%						00:08:31
<b>合计</b>		2/8	12/23	0/1	7/8	5/5	1/1	2/3	29/49	59.2%	5	9	3			
<i>(守门员)</i>																
12	孟辉	5/6	4/6	1/1	3/7	0/2	0/1	0/2	13/25	52.0%	3	2				00:45:29
16	刘迈科	5/5			0/1	0/1			5/7	71.4%	1					00:14:31
<b>合计</b>		10/11	4/6	1/1	3/8	0/3	0/1	0/2	18/32	56.3%	4	2				

场上队员：得分/射门

守门员：救球/射门

全队合计	得分	被救	射失	击柱	封球	合计	%
远射	2	2	3	1		8	25.0%
近射	12	6	1	4		23	52.2%
边射		1				1	0.0%
快攻	7		1			8	87.5%
突破	5					5	100.0%
任意	1					1	100.0%
7M	2			1		3	66.7%





## 2016年全国男子手球锦标赛

## 个人/全队技术统计表

正式表  
手球  
男子预赛  
轮次 4组别 A  
场次 16201606016-14-2/2  
徐闻县体育中心体育馆  
24/10/2016 13:30

号码	姓名	远射	近射	边射	快攻	突破	任意	7M	合计	%	助攻	失误	警告	2'	取消	时间
<b>新疆队(新疆)</b>																
<i>(上场队员)</i>																
1	宋晓晨									0.0%	4					01:00:00
5	徐伟		0/2		1/3				1/5	20.0%		1				00:56:46
7	林豪文	0/6				1/1	1/1		2/8	25.0%		1		1		00:47:06
8	刘文宇		1/1						1/1	100%			1			00:10:33
9	姜春晖				0/1				0/1	0.0%						00:36:32
10	王钟彬	0/6	0/1		1/1				1/8	12.5%		1				00:36:45
13	苏兴伟									0.0%						00:00:00
15	王维东		0/2	0/1	1/1				1/4	25.0%						00:19:41
17	胡晋铭									0.0%	1					00:48:44
18	姜帅									0.0%						00:00:00
19	李龙吉	0/4	0/3			1/1		2/2	3/10	30.0%		3				00:45:38
20	赵元	1/4	1/1		2/2	1/1			5/8	62.5%		3		1		00:50:57
24	王泽川									0.0%						00:06:50

<b>合计</b>		1/20	2/10	0/1	5/8	3/3	1/1	2/2	14/45	31.1%	5	9	1	2		
<i>(守门员)</i>																

1	宋晓晨	2/4	6/18	1/1	0/7	0/5	0/1	0/2	9/38	23.7%	4					01:00:00
---	-----	-----	------	-----	-----	-----	-----	-----	------	-------	---	--	--	--	--	----------

<b>合计</b>		2/4	6/18	1/1	0/7	0/5	0/1	0/2	9/38	23.7%	4					
-----------	--	-----	------	-----	-----	-----	-----	-----	------	-------	---	--	--	--	--	--

场上队员：得分/射门

守门员：救球/射门

全队合计	得分	被救	射失	击柱	封球	合计	%
远射	1	10	2	1	6	20	5.0%
近射	2	4	2	1	1	10	20.0%
边射		1				1	0.0%
快攻	5	3				8	62.5%
突破	3					3	100.0%
任意	1					1	100.0%
7M	2					2	100.0%





2016年全国男子手球锦标赛

图式射门区域统计

轮次 4 场次 16

201606016-41-1/1

北京队

3 王超	6 解建飞	8 王鹏	9 刘振	10 成亚	11 蒋维一	12 孟辉	16 刘迈科																																																																								
<table border="1"><tr><td></td><td>1</td><td>1</td></tr><tr><td></td><td></td><td></td></tr><tr><td>1</td><td>2</td><td></td></tr></table>		1	1				1	2		<table border="1"><tr><td></td><td></td><td>1</td></tr><tr><td></td><td></td><td></td></tr><tr><td></td><td></td><td></td></tr></table>			1							<table border="1"><tr><td></td><td></td><td></td></tr><tr><td></td><td></td><td></td></tr><tr><td></td><td></td><td></td></tr></table>										<table border="1"><tr><td></td><td></td><td>1</td></tr><tr><td></td><td></td><td></td></tr><tr><td>1</td><td></td><td></td></tr></table>			1				1			<table border="1"><tr><td>1</td><td>2</td><td></td></tr><tr><td></td><td></td><td>1</td></tr><tr><td></td><td></td><td></td></tr></table>	1	2				1				<table border="1"><tr><td>1</td><td></td><td>1</td></tr><tr><td></td><td></td><td></td></tr><tr><td></td><td></td><td>1</td></tr></table>	1		1						1	<table border="1"><tr><td></td><td></td><td></td></tr><tr><td></td><td></td><td></td></tr><tr><td></td><td></td><td></td></tr></table>										<table border="1"><tr><td></td><td></td><td></td></tr><tr><td></td><td></td><td></td></tr><tr><td></td><td></td><td></td></tr></table>									
	1	1																																																																													
1	2																																																																														
		1																																																																													
		1																																																																													
1																																																																															
1	2																																																																														
		1																																																																													
1		1																																																																													
		1																																																																													
Post - 1 Miss - 0 Block - 0	Post - 0 Miss - 0 Block - 0	Post - 0 Miss - 0 Block - 0	Post - 0 Miss - 1 Block - 0	Post - 1 Miss - 0 Block - 0	Post - 1 Miss - 2 Block - 0	Post - 0 Miss - 0 Block - 0	Post - 0 Miss - 0 Block - 0																																																																								
21 胡瀛	23 王军程	25 马明辉	29 杜龙飞	33 冯宁	77 朱昕晨	78 张骥	83 潘天																																																																								
<table border="1"><tr><td></td><td></td><td>1</td></tr><tr><td>2</td><td></td><td>1</td></tr><tr><td></td><td></td><td></td></tr></table>			1	2		1				<table border="1"><tr><td></td><td></td><td>1</td></tr><tr><td></td><td></td><td>1</td></tr><tr><td>2</td><td></td><td>1</td></tr></table>			1			1	2		1	<table border="1"><tr><td></td><td></td><td>1</td></tr><tr><td></td><td></td><td></td></tr><tr><td></td><td></td><td></td></tr></table>			1							<table border="1"><tr><td></td><td></td><td>1</td></tr><tr><td></td><td></td><td></td></tr><tr><td></td><td></td><td></td></tr></table>			1							<table border="1"><tr><td></td><td></td><td></td></tr><tr><td></td><td></td><td></td></tr><tr><td></td><td></td><td></td></tr></table>										<table border="1"><tr><td></td><td></td><td></td></tr><tr><td>1</td><td></td><td>1</td></tr><tr><td></td><td></td><td></td></tr></table>				1		1				<table border="1"><tr><td>1</td><td></td><td></td></tr><tr><td></td><td></td><td></td></tr><tr><td></td><td></td><td></td></tr></table>	1									<table border="1"><tr><td></td><td></td><td></td></tr><tr><td></td><td></td><td></td></tr><tr><td></td><td></td><td></td></tr></table>									
		1																																																																													
2		1																																																																													
		1																																																																													
		1																																																																													
2		1																																																																													
		1																																																																													
		1																																																																													
1		1																																																																													
1																																																																															
Post - 1 Miss - 1 Block - 0	Post - 1 Miss - 1 Block - 0	Post - 1 Miss - 0 Block - 0	Post - 0 Miss - 0 Block - 0	Post - 0 Miss - 0 Block - 0	Post - 0 Miss - 0 Block - 0	Post - 0 Miss - 0 Block - 0	Post - 0 Miss - 0 Block - 0																																																																								

12 孟辉

0/1	0/1	0/1
3/4	1/1	3/4
2/5	3/5	1/3

16 刘迈科

0/1		2/3
1/1	1/1	
		1/1

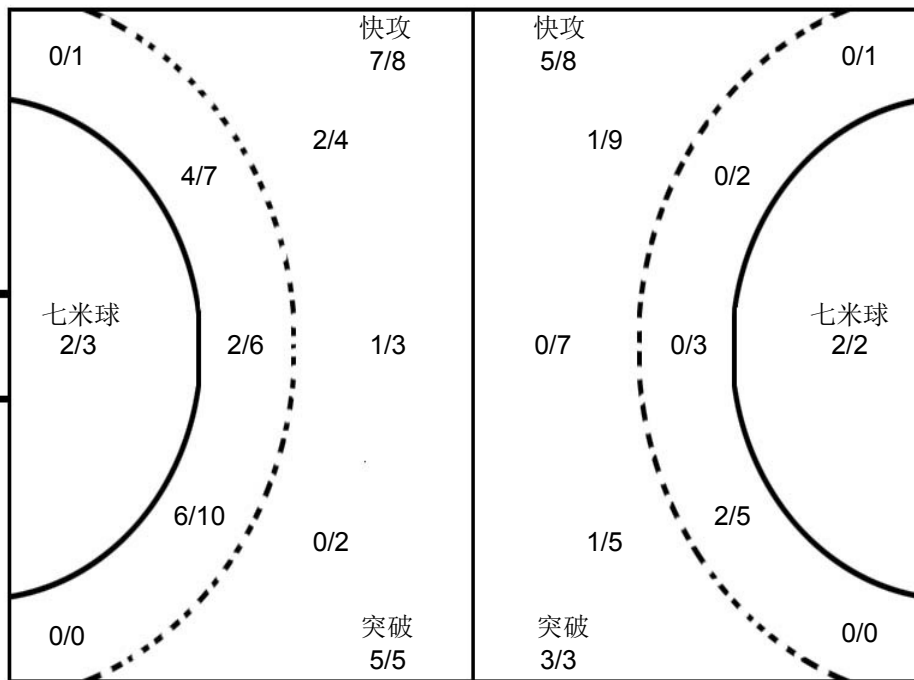
1 宋晓晨

0/3	0/3	1/9
1/4	4/4	0/4
1/5	2/4	0/2



新疆队

1 宋晓晨	5 徐伟	7 林豪文	8 刘文字	9 姜春晖	10 王钟彬	13 苏兴伟	15 王维东																																																																								
<table border="1"><tr><td></td><td></td><td></td></tr><tr><td></td><td></td><td></td></tr><tr><td></td><td></td><td></td></tr></table>										<table border="1"><tr><td>1</td><td></td><td></td></tr><tr><td></td><td></td><td></td></tr><tr><td></td><td></td><td></td></tr></table>	1									<table border="1"><tr><td></td><td></td><td></td></tr><tr><td></td><td></td><td></td></tr><tr><td>2</td><td></td><td></td></tr></table>							2			<table border="1"><tr><td></td><td></td><td>1</td></tr><tr><td></td><td></td><td></td></tr><tr><td></td><td></td><td></td></tr></table>			1							<table border="1"><tr><td></td><td></td><td></td></tr><tr><td></td><td></td><td></td></tr><tr><td></td><td></td><td></td></tr></table>										<table border="1"><tr><td></td><td></td><td>1</td></tr><tr><td></td><td></td><td></td></tr><tr><td></td><td></td><td></td></tr></table>			1							<table border="1"><tr><td></td><td></td><td></td></tr><tr><td></td><td></td><td></td></tr><tr><td></td><td></td><td></td></tr></table>										<table border="1"><tr><td></td><td></td><td></td></tr><tr><td></td><td></td><td></td></tr><tr><td>1</td><td></td><td></td></tr></table>							1		
1																																																																															
2																																																																															
		1																																																																													
		1																																																																													
1																																																																															
Post - 0 Miss - 0 Block - 0	Post - 1 Miss - 0 Block - 0	Post - 1 Miss - 1 Block - 2	Post - 0 Miss - 0 Block - 0	Post - 0 Miss - 0 Block - 0	Post - 0 Miss - 0 Block - 3	Post - 0 Miss - 0 Block - 0	Post - 0 Miss - 1 Block - 0																																																																								
17 胡晋铭	18 姜帅	19 李龙吉	20 赵元	24 王泽川																																																																											
<table border="1"><tr><td></td><td></td><td></td></tr><tr><td></td><td></td><td></td></tr><tr><td></td><td></td><td></td></tr></table>										<table border="1"><tr><td></td><td></td><td></td></tr><tr><td></td><td></td><td></td></tr><tr><td></td><td></td><td></td></tr></table>										<table border="1"><tr><td></td><td>1</td><td></td></tr><tr><td></td><td></td><td></td></tr><tr><td>1</td><td></td><td>1</td></tr></table>		1					1		1	<table border="1"><tr><td>2</td><td></td><td>1</td></tr><tr><td></td><td></td><td></td></tr><tr><td>1</td><td></td><td>1</td></tr></table>	2		1				1		1	<table border="1"><tr><td></td><td></td><td></td></tr><tr><td></td><td></td><td></td></tr><tr><td></td><td></td><td></td></tr></table>										<table border="1"><tr><td></td><td></td><td></td></tr><tr><td></td><td></td><td></td></tr><tr><td></td><td></td><td></td></tr></table>										<table border="1"><tr><td></td><td></td><td></td></tr><tr><td></td><td></td><td></td></tr><tr><td></td><td></td><td></td></tr></table>										<table border="1"><tr><td></td><td></td><td></td></tr><tr><td></td><td></td><td></td></tr><tr><td></td><td></td><td></td></tr></table>									
	1																																																																														
1		1																																																																													
2		1																																																																													
1		1																																																																													
Post - 0 Miss - 0 Block - 0	Post - 0 Miss - 0 Block - 0	Post - 0 Miss - 2 Block - 1	Post - 0 Miss - 0 Block - 1	Post - 0 Miss - 0 Block - 0																																																																											

注释: Post=击柱 Miss=射失 Block=被封





预赛 Group A

男子 全国比赛

2016年全国男子手球锦标赛

Team A				Team B				Match Number													
A 解放军队				B 江苏队				17													
played in		in the hall		on		at		Spectators													
China		徐闻县体育中心体育		24/10/2016		15:10 hours															
Half-time (30')	A	B	End of playing time	A	B	1st extra time	A	B	2nd extra time	A	B	After penalty throws	A	B							
	4	13		17	23																
Number of 7 m	A	Team time-out			Full name of players and officials	Team time-out			B	Number of 7 m											
		1	2	3		1	2	3													
	1/2	08:43	21:20				30:04	30:04	4/4												
No.	Team A					G	W	2'	D	DR	No.	Team B					G	W	2'	D	DR
1	李梓宁										1	徐畅									
2	范保坤										4	张家纬						1			
4	曹作亮					2		1			5	闫亮									
5	张昌轲										6	赵晨					1				
6	吴昊					2					7	徐奕飞					4				
7	姜钦										8	周小坚					1	1			
8	王烁					2	1	1			9	周傲					2				
9	毕晓晨					5					10	郝可鑫					1				
11	肖东洋										12	王权									
12	姜明										15	李安					7				
14	孙耀琦					2	1				16	张帅									
15	杨帆					2		1			17	王伟强					4				
16	丛霖										18	赵楠					2				
18	王晓龙					2	1				20	顾艳超									
20	刘智洋										21	刘江					1	2			
											22	张瑞恒									
B	张敬敏 (主教练)										B	闫威名 (主教练)									
C	王学力										C	贾淑君									
D	刘捷										D	叶强									
E	刘军										E	王建国									
A	Signature of Responsible Official of the Teams (Off. A)																			B	
TP	Remarks of Referee / CHA Official																			TP	

Signatures

Referees	王科 (CHN)	程钰锋 (CHN)		
Techn. Delegates	王洋 (CHN)			
CHA Official	倪震 (CHN)			

Note: Number of 7m Throws Awarded to Team A and B, Goals (G), Warnings (W), Suspensions (2), Direct Disqualification (D), Disqualification with Report (DR) and Team Penalty (TP).

Table Officials: 梁小熹 刘正松 Statisticians: 周亚桥 张程秀子

Printed by PHMS Copyright: IHF / CHA 24/10/2016 16:41:32

Longman Sportsoft handball@126.com





2016年全国男子手球锦标赛  
竞赛技术统计(媒体表)

预赛	组别	A	轮次	4	场次	17
----	----	---	----	---	----	----

徐闻县体育中心体育馆

24/10/2016

201606017-51-1/1

解放军队	解放军	17	vs	23	江苏	江苏队
<b>4 : 13</b>						

裁判员	王科 (CHN)	/	程钰锋 (CHN)
-----	----------	---	-----------

解放军		远射	近射	边射	快攻	突破	任意球	7m球	合计	%	助攻	失误	警告	2'	D & DR	解放军	比赛进程	江苏				
主教练: 张敬敏																						
1	李祥宁																0	01:14	1	15	李安	
2	范保坤																1	04:29	1			
4	曹作亮	1/8				1/1			2/9	22.2		6		1			1	06:05	2	8	周小坚	
5	张昌轲																1	07:45	3	15	李安	
6	吴昊	0/1	2/3		0/1				2/5	40.0		1					1	08:34	4	15	李安	
7	姜钦																1	09:08	5	15	李安	
8	王烁	1/2		0/3				1/2	2/7	28.6		1	1	1			1	09:51	6	6	赵晨	
9	毕晓晨	1/2	3/3	1/3	0/1				5/9	55.6	1	2					2	13:24	6			
11	肖东洋																2	14:29	7	10	郝可鑫	
12	姜明																2	18:30	8	15	李安	
14	孙耀琦		2/2					2/2	2/2	100				1			2	20:16	9	15	李安	
15	杨帆	0/3	1/1			1/1		2/5	40.0		2	1					2	21:14	10	15	李安	
16	丛霖																3	21:46	10			
18	王晓龙	0/4	2/2		0/1			2/7	28.6		1	1	1				4	22:55	10			
20	刘智洋																4	24:44	11	18	赵楠	
运动员 合计		3/20	10/11	1/6	0/3	2/2	1/2	17/44	38.6		4	12	3	3			4	25:21	12	7	徐奕飞	
16	丛霖	6/7	2/5	1/5	3/13	1/2	0/4	13/36	36.1								4	27:38	13	7	徐奕飞	
守门员 合计		6/7	2/5	1/5	3/13	1/2	0/4	13/36	36.1													
江苏		远射	近射	边射	快攻	突破	任意球	7m球	合计	%	助攻	失误	警告	2'	D & DR							
教练: 闫威名																						
1	徐畅																5	02:21	13			
4	张家纬				0/1			0/1	0.0		1	1	1				5	03:08	14	9	周傲	
5	闫亮																5	03:35	15	17	王伟强	
6	赵晨		0/1		1/1			1/2	50.0		1						5	04:30	16	17	王伟强	
7	徐奕飞		0/2	2/2	2/2			4/6	66.7			2					6	04:51	16			
8	周小坚		1/1					1/1	100					1			6	06:07	16			
9	周傲	0/2			1/2			1/1	40.0			2					7	06:41	17	17	王伟强	
10	郝可鑫	0/1				1/1		1/2	50.0								8	07:09	17			
12	王权																8	08:27	18	21	刘江	
15	李安	0/1		1/1	3/3			3/3	7/8	87.5							9	09:44	18			
16	张帅																10	11:12	18			
17	王伟强		1/1	1/2	2/3			4/6	66.7		1	1					10	11:56	19	17	王伟强	
18	赵楠	1/4	1/1		0/1			2/6	33.3		2	1					10	14:26	20	18	赵楠	
20	顾艳超	0/2				0/1		0/3	0.0			3					11	16:11	20			
21	刘江	0/1			1/1			1/2	50.0					2			11	16:11	20			
22	张瑞恒																12	18:02	20			
运动员 合计		1/11	3/6	4/5	10/14	1/2	4/4	23/42	54.8		8	14	1	3			13	18:15	20			
1	徐畅	1/3	0/4				1/1	2/8	25.0								13	18:48	21	7	徐奕飞	
12	王权	5/5	0/2	1/1	1/1	0/1	0/1	7/11	63.6		3						14	19:30	21			
16	张帅	1/2	0/4	1/2	1/1	0/1		3/10	30.0								15	21:41	21			
守门员 合计		7/10	0/10	2/3	2/2	0/2	1/2	12/29	41.4		3						15	23:19	22	7	徐奕飞	

场上队员: 得分 / 射门

守门员: 救球 / 射门

快攻	Fast Break		突破	Breakthrough		任意球	Free Throw		7M球	7M Throw		助攻	Assist
警告	Warning		失误	Error		2'	Suspension		D	取消资格		DR	取消资格+报告





## 2016年全国男子手球锦标赛 图式比赛技术统计表

轮次 4

场次 17

201606017-21-1/1

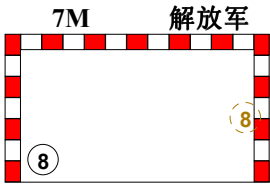
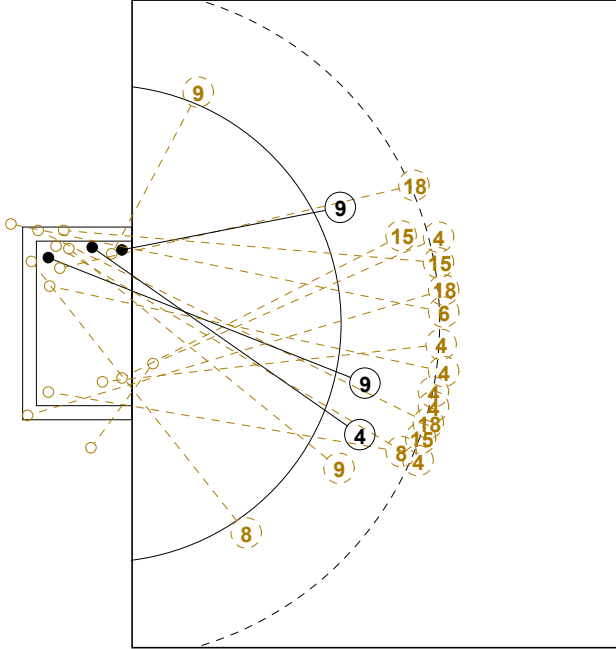

**1st Half  
4 : 13**

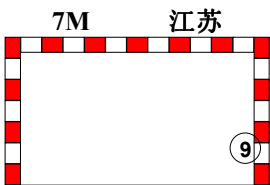
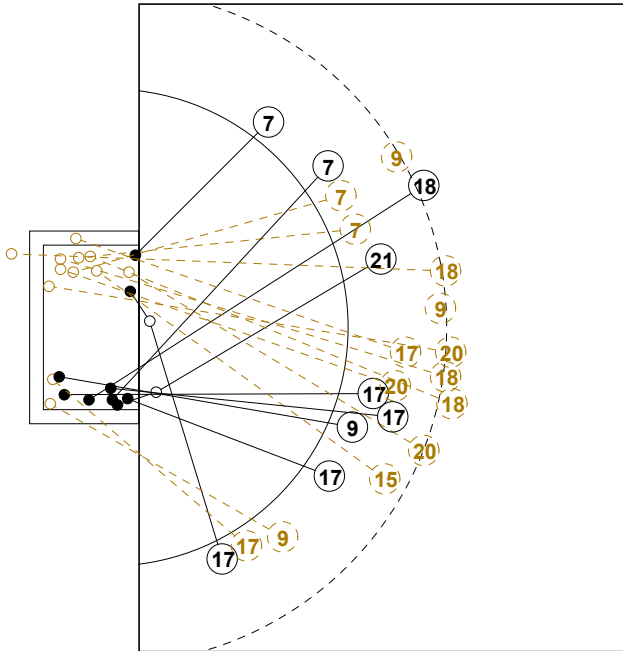
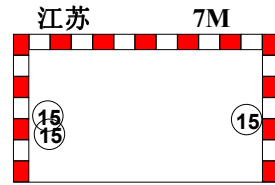
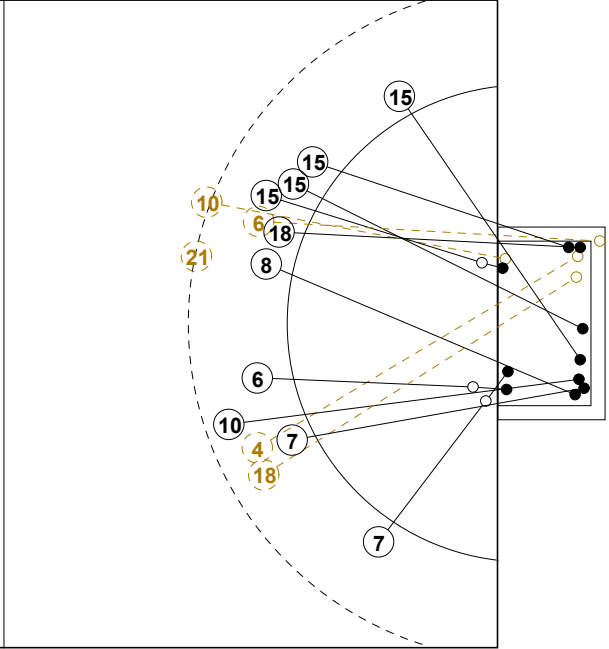

**2nd Half  
23 : 17**

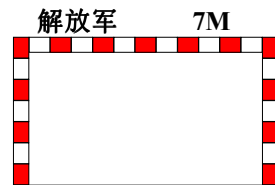
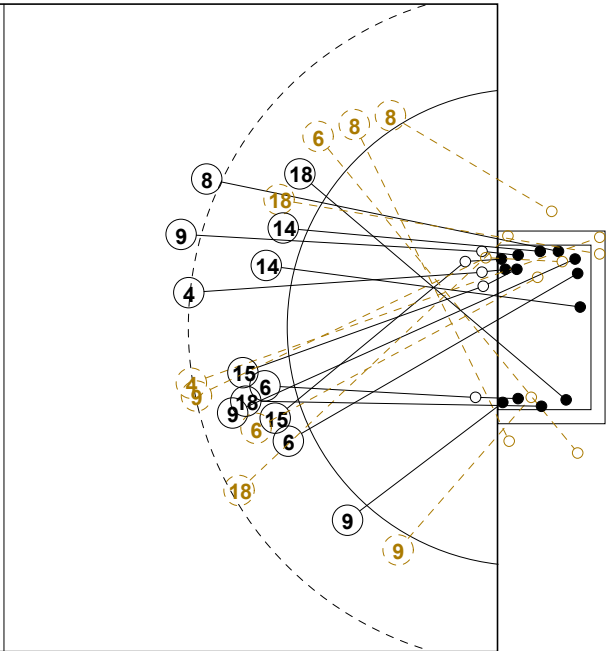





## 2016年全国男子手球锦标赛

## 个人/全队技术统计表

正式表  
手球  
男子预赛  
轮次 4组别 A  
场次 17201606017-14-1/2  
徐闻县体育中心体育馆  
24/10/2016 15:10

号码	姓名	远射	近射	边射	快攻	突破	任意	7M	合计	%	助攻	失误	警告	2'	取消	时间
<b>解放军队(解放军)</b>																
<i>(场上队员)</i>																
1	李梓宁									0.0%						00:00:00
2	范保坤									0.0%						00:00:00
4	曹作亮	1/8				1/1			2/9	22.2%		6		1		01:00:00
5	张昌轲									0.0%						00:00:00
6	吴昊	0/1	2/3		0/1				2/5	40.0%		1				00:27:13
7	姜钦									0.0%						00:00:00
8	王烁	1/2		0/3				1/2	2/7	28.6%		1	1	1		01:00:00
9	毕晓晨	1/2	3/3	1/3	0/1				5/9	55.6%	1	2				01:00:00
11	肖东洋									0.0%						00:00:00
12	姜明									0.0%						00:00:00
14	孙耀琦		2/2						2/2	100%			1			00:43:08
15	杨帆	0/3	1/1			1/1			2/5	40.0%	2	1		1		01:00:00
16	丛霖									0.0%						01:00:00
18	王晓龙	0/4	2/2		0/1				2/7	28.6%	1	1	1			00:49:37
20	刘智洋									0.0%						00:00:00
<b>合计</b>		3/20	10/11	1/6	0/3	2/2		1/2	17/44	38.6%	4	12	3	3		
<i>(守门员)</i>																
16	丛霖	6/7	2/5	1/5	3/13	1/2		0/4	13/36	36.1%						01:00:00
<b>合计</b>																
<b>合计</b>		6/7	2/5	1/5	3/13	1/2		0/4	13/36	36.1%						

场上队员：得分/射门

守门员：救球/射门

全队合计	得分	被救	射失	击柱	封球	合计	%
远射	3	7	2	5	3	20	15.0%
近射	10		1			11	90.9%
边射	1	2	2	1		6	16.7%
快攻		2		1		3	0.0%
突破	2					2	100.0%
任意							0.0%
7M	1	1				2	50.0%





## 2016年全国男子手球锦标赛

## 个人/全队技术统计表

正式表  
手球  
男子预赛  
轮次 4组别 A  
场次 17201606017-14-2/2  
徐闻县体育中心体育馆  
24/10/2016 15:10

号码	姓名	远射	近射	边射	快攻	突破	任意	7M	合计	%	助攻	失误	警告	2'	取消	时间
<b>江苏队(江苏)</b>																
<i>(上场队员)</i>																
1	徐畅									0.0%						00:17:46
4	张家纬				0/1				0/1	0.0%	1	1	1			00:21:22
5	闫亮									0.0%						00:21:21
6	赵晨		0/1		1/1				1/2	50.0%	1					00:22:17
7	徐奕飞		0/2	2/2	2/2				4/6	66.7%		2				00:38:38
8	周小坚		1/1						1/1	100%				1		00:23:21
9	周傲	0/2			1/2			1/1	2/5	40.0%		2				00:30:35
10	郝可鑫	0/1				1/1			1/2	50.0%		2				00:22:17
12	王权									0.0%	3					00:23:34
15	李安	0/1		1/1	3/3			3/3	7/8	87.5%						00:22:30
16	张帅									0.0%						00:18:40
17	王伟强		1/1	1/2	2/3				4/6	66.7%	1	1				00:36:50
18	赵楠	1/4	1/1		0/1				2/6	33.3%	2	1				00:46:21
20	顾艳超	0/2				0/1			0/3	0.0%		3				00:37:43
21	刘江	0/1			1/1				1/2	50.0%		2		2		00:36:37
22	张瑞恒									0.0%						00:00:00
<b>合计</b>		1/11	3/6	4/5	10/14	1/2		4/4	23/42	54.8%	8	14	1	3		
<i>(守门员)</i>																
1	徐畅	1/3	0/4					1/1	2/8	25.0%						00:17:46
12	王权	5/5	0/2	1/1	1/1	0/1		0/1	7/11	63.6%	3					00:23:34
16	张帅	1/2	0/4	1/2	1/1	0/1			3/10	30.0%						00:18:40
<b>合计</b>		7/10	0/10	2/3	2/2	0/2		1/2	12/29	41.4%	3					

场上队员：得分/射门

守门员：救球/射门

全队合计	得分	被救	射失	击柱	封球	合计	%
远射	1	6	1		3	11	9.1%
近射	3	2		1		6	50.0%
边射	4	1				5	80.0%
快攻	10	3		1		14	71.4%
突破	1	1				2	50.0%
任意							0.0%
7M	4					4	100.0%





### 2016年全国男子手球锦标赛

#### 图式射门区域统计

轮次 4 场次 17

201606017-41-1/1

### 解放军队

1 李梓宁	2 范保坤	4 曹作亮	5 张昌轲	6 吴昊	7 姜钦	8 王烁	9 毕晓晨																																																																								
<table border="1"><tr><td></td><td></td><td></td></tr><tr><td></td><td></td><td></td></tr><tr><td></td><td></td><td></td></tr></table>										<table border="1"><tr><td></td><td></td><td></td></tr><tr><td></td><td></td><td></td></tr><tr><td></td><td></td><td></td></tr></table>										<table border="1"><tr><td></td><td></td><td></td></tr><tr><td></td><td></td><td>1</td></tr><tr><td>1</td><td></td><td></td></tr></table>						1	1			<table border="1"><tr><td></td><td></td><td></td></tr><tr><td></td><td></td><td></td></tr><tr><td></td><td></td><td></td></tr></table>										<table border="1"><tr><td>1</td><td></td><td></td></tr><tr><td></td><td></td><td></td></tr><tr><td></td><td></td><td>1</td></tr></table>	1								1	<table border="1"><tr><td></td><td></td><td></td></tr><tr><td></td><td></td><td></td></tr><tr><td></td><td></td><td></td></tr></table>										<table border="1"><tr><td></td><td></td><td></td></tr><tr><td>1</td><td></td><td></td></tr><tr><td>1</td><td></td><td></td></tr></table>				1			1			<table border="1"><tr><td></td><td></td><td></td></tr><tr><td>1</td><td></td><td></td></tr><tr><td></td><td></td><td>2</td></tr></table>				1					2
		1																																																																													
1																																																																															
1																																																																															
		1																																																																													
1																																																																															
1																																																																															
1																																																																															
		2																																																																													
Post - 0 Miss - 0 Block - 0	Post - 0 Miss - 0 Block - 0	Post - 1 Miss - 1 Block - 2	Post - 0 Miss - 0 Block - 0	Post - 0 Miss - 2 Block - 0	Post - 0 Miss - 0 Block - 0	Post - 1 Miss - 2 Block - 0	Post - 0 Miss - 0 Block - 0																																																																								
11 肖东洋	12 姜明	14 孙耀琦	15 杨帆	16 丛霖	18 王晓龙	20 刘智洋																																																																									
<table border="1"><tr><td></td><td></td><td></td></tr><tr><td></td><td></td><td></td></tr><tr><td></td><td></td><td></td></tr></table>										<table border="1"><tr><td></td><td></td><td></td></tr><tr><td></td><td></td><td></td></tr><tr><td></td><td></td><td></td></tr></table>										<table border="1"><tr><td></td><td>1</td><td></td></tr><tr><td>1</td><td></td><td></td></tr><tr><td></td><td></td><td></td></tr></table>		1		1						<table border="1"><tr><td></td><td></td><td></td></tr><tr><td></td><td></td><td></td></tr><tr><td>2</td><td></td><td></td></tr></table>							2			<table border="1"><tr><td></td><td></td><td></td></tr><tr><td></td><td></td><td></td></tr><tr><td></td><td></td><td></td></tr></table>										<table border="1"><tr><td></td><td></td><td>1</td></tr><tr><td></td><td></td><td>1</td></tr><tr><td></td><td></td><td></td></tr></table>			1			1				<table border="1"><tr><td></td><td></td><td></td></tr><tr><td></td><td></td><td></td></tr><tr><td></td><td></td><td></td></tr></table>																			
	1																																																																														
1																																																																															
2																																																																															
		1																																																																													
		1																																																																													
Post - 0 Miss - 0 Block - 0	Post - 0 Miss - 0 Block - 0	Post - 0 Miss - 0 Block - 0	Post - 1 Miss - 0 Block - 1	Post - 0 Miss - 0 Block - 0	Post - 4 Miss - 0 Block - 0	Post - 0 Miss - 0 Block - 0																																																																									

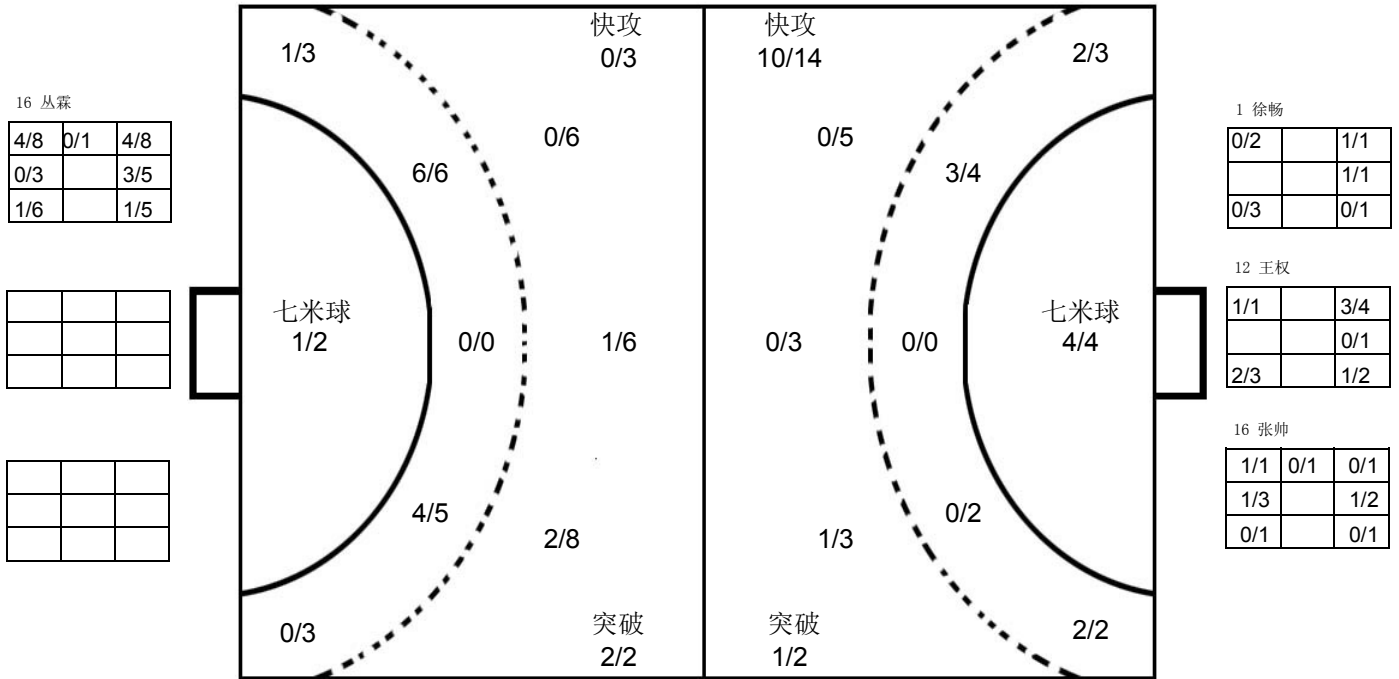

### 江苏队

1 徐畅	4 张家伟	5 闫亮	6 赵晨	7 徐奕飞	8 周小坚	9 周傲	10 郝可鑫																																																																								
<table border="1"><tr><td></td><td></td><td></td></tr><tr><td></td><td></td><td></td></tr><tr><td></td><td></td><td></td></tr></table>										<table border="1"><tr><td></td><td></td><td></td></tr><tr><td></td><td></td><td></td></tr><tr><td></td><td></td><td></td></tr></table>										<table border="1"><tr><td></td><td></td><td></td></tr><tr><td></td><td></td><td></td></tr><tr><td></td><td></td><td></td></tr></table>										<table border="1"><tr><td></td><td></td><td></td></tr><tr><td></td><td></td><td>1</td></tr><tr><td></td><td></td><td></td></tr></table>						1				<table border="1"><tr><td></td><td></td><td>1</td></tr><tr><td>1</td><td></td><td>2</td></tr><tr><td></td><td></td><td></td></tr></table>			1	1		2				<table border="1"><tr><td></td><td></td><td></td></tr><tr><td></td><td></td><td></td></tr><tr><td></td><td></td><td></td></tr></table>										<table border="1"><tr><td>1</td><td></td><td></td></tr><tr><td></td><td></td><td>1</td></tr><tr><td></td><td></td><td></td></tr></table>	1					1				<table border="1"><tr><td></td><td></td><td></td></tr><tr><td></td><td></td><td></td></tr><tr><td></td><td></td><td></td></tr></table>									
		1																																																																													
		1																																																																													
1		2																																																																													
1																																																																															
		1																																																																													
Post - 0 Miss - 0 Block - 0	Post - 0 Miss - 0 Block - 0	Post - 0 Miss - 0 Block - 0	Post - 1 Miss - 0 Block - 0	Post - 0 Miss - 0 Block - 0	Post - 0 Miss - 0 Block - 0	Post - 0 Miss - 0 Block - 2	Post - 0 Miss - 0 Block - 0																																																																								
12 王权	15 李安	16 张帅	17 王伟强	18 赵楠	20 顾艳超	21 刘江	22 张瑞恒																																																																								
<table border="1"><tr><td></td><td></td><td></td></tr><tr><td></td><td></td><td></td></tr><tr><td></td><td></td><td></td></tr></table>										<table border="1"><tr><td>1</td><td>1</td><td>1</td></tr><tr><td>2</td><td></td><td>1</td></tr><tr><td>1</td><td></td><td></td></tr></table>	1	1	1	2		1	1			<table border="1"><tr><td></td><td></td><td></td></tr><tr><td></td><td></td><td></td></tr><tr><td></td><td></td><td></td></tr></table>										<table border="1"><tr><td>1</td><td></td><td></td></tr><tr><td></td><td></td><td></td></tr><tr><td>2</td><td></td><td>1</td></tr></table>	1						2		1	<table border="1"><tr><td>1</td><td></td><td></td></tr><tr><td>1</td><td></td><td></td></tr><tr><td></td><td></td><td></td></tr></table>	1			1						<table border="1"><tr><td></td><td></td><td></td></tr><tr><td></td><td></td><td></td></tr><tr><td></td><td></td><td></td></tr></table>										<table border="1"><tr><td></td><td></td><td></td></tr><tr><td></td><td></td><td></td></tr><tr><td>1</td><td></td><td></td></tr></table>							1			<table border="1"><tr><td></td><td></td><td></td></tr><tr><td></td><td></td><td></td></tr><tr><td></td><td></td><td></td></tr></table>									
1	1	1																																																																													
2		1																																																																													
1																																																																															
1																																																																															
2		1																																																																													
1																																																																															
1																																																																															
1																																																																															
Post - 0 Miss - 0 Block - 0	Post - 0 Miss - 0 Block - 0	Post - 0 Miss - 0 Block - 0	Post - 1 Miss - 0 Block - 0	Post - 0 Miss - 1 Block - 0	Post - 0 Miss - 0 Block - 0	Post - 0 Miss - 0 Block - 1	Post - 0 Miss - 0 Block - 0																																																																								

注释: Post=击柱 Miss=射失 Block=被封





预赛 Group B

男子 全国比赛

2016年全国男子手球锦标赛

Team A				Team B				Match Number													
A 广东队				B 四川队				18													
played in		in the hall		on		at		Spectators													
China		徐闻县体育中心体育		24/10/2016		16:50 hours															
Half-time (30')	A	B	End of playing time	A	B	1st extra time	A	B	2nd extra time	A	B	After penalty throws	A	B							
	13	11		35	30																
Number of 7 m	A	Team time-out			Full name of players and officials						Team time-out			B	Number of 7 m						
		1	2	3							1	2	3								
	1/1	21:50	44:50	52:42							54:21	1/2									
No.	Team A					G	W	2'	D	DR	No.	Team B					G	W	2'	D	DR
1	王泽润										1	罗尧尧					5				
2	孙江山					4					3	刘赵梁					3				
3	曲汝洋					3					7	仇瑞祥									
4	李卓洋										8	谢庆龙					6				
5	侯生升					9					9	许翔宇					5				
7	付文博					5					10	徐彦昊									
8	于彦江										11	张天豪					2				
10	周仲坤							1			12	丁大伟									
11	房友屯					1	1				13	尹文珂					1				
13	王立隆					1					15	刘劲松					3	1			
15	张建杰					1					16	宋继强									
16	马跃										18	任启双						1			
17	李中洲					8					19	庞连康					2				
20	黄培杰										20	徐逸									
84	王伟					3	1				21	马光					3	1			
											22	张睿梁									
B	王锋 (主教练)										B	张文韬 (主教练)									
C	刘康伶						1				D	胡俊杰									
D	张广建																				
E	王永存																				
A	Signature of Responsible Official of the Teams (Off. A)																		B		
TP	Remarks of Referee / CHA Official																		TP		

Signatures

Referees	王亚光 (CHN)	刘晓辉 (CHN)		
Techn. Delegates	许宜扬 (CHN)			
CHA Official	刘凤娟 (CHN)			

Note: Number of 7m Throws Awarded to Team A and B, Goals (G), Warnings (W), Suspensions (2), Direct Disqualification (D), Disqualification with Report (DR) and Team Penalty (TP).

Table Officials: 齐红梅 丛艳霞 Statisticians: 张程秀子 周亚桥



## 2016年全国男子手球锦标赛 竞赛技术统计(媒体表)

预赛	组别	B	轮次	4	场次	18
----	----	---	----	---	----	----

徐闻县体育中心体育馆

24/10/2016

201606018-51-1/1

广东队	广东	35	vs	30	四川	四川队
<b>13 : 11</b>						

裁判员	王亚光 (CHN)	/	刘晓辉 (CHN)
-----	-----------	---	-----------

广东		远	近	边	快	突	任意	7m	合计	%	助攻	失误	警告	2'	D & DR	比赛进程	
主教练：王锋		射	射	射	攻	破	球	球								广东	四川
1	王泽润															1st Half	
2	孙江山	0/2	4/4			0/1			4/7	57.1	2					0 01:18	1 8 谢庆龙
3	曲汝洋		3/4						3/4	75.0		1				0 02:59	2 11 张天豪
4	李卓洋															1 03:39	2 2 侯生升
5	侯生升	1/1	1/1	4/4	3/3				9/9	100		2				2 05:21	2 3 8 谢庆龙
7	付云博		3/3		1/2			1/1	5/6	83.3	1	2				3 08:42	3 3 10:12
8	于彦江															4 11:33	3 4 11:40
10	周仲坤															5 12:47	4 4 17:44
11	房友屯		1/1						1/1	100		1	1			6 15:16	5 3 刘赵梁
13	王立隆		0/2	0/2	1/1				1/5	20.0						7 16:00	5 7 8 谢庆龙
15	张建杰	1/2							1/2	50.0		2				8 17:44	6 6 15 刘劲松
16	马跃															9 20:02	6 7 15 刘劲松
17	李中洲	6/9	1/2		1/2				8/13	61.5		6				10 21:41	8 8 15 刘劲松
20	黄培杰															11 22:52	8 9 许翔宇
84	王伟	0/1	2/2		1/1				3/4	75.0	1	1	1			12 26:19	9 9 许翔宇
<b>运动员 合计</b>		<b>8/15</b>	<b>15/19</b>	<b>4/6</b>	<b>7/9</b>	<b>0/1</b>		<b>1/1</b>	<b>35/51</b>	<b>68.6</b>	<b>4</b>	<b>15</b>	<b>2</b>	<b>1</b>		12 27:33	10 9 许翔宇
1	王泽润	0/3	0/1					0/1	0/5	0.0						12 28:38	11 21 马光
16	马跃	2/8	3/20	0/1	1/2	1/1			7/32	21.9						13 29:29	11
<b>守门员 合计</b>		<b>2/11</b>	<b>3/21</b>	<b>0/1</b>	<b>1/2</b>	<b>1/1</b>		<b>0/1</b>	<b>7/37</b>	<b>18.9</b>						2nd Half	
<b>四川</b>		远	近	边	快	突	任意	7m	合计	%	助攻	失误	警告	2'	D & DR		
<b>教练：张文韬</b>		射	射	射	攻	破	球	球									
1	罗尧尧	4/7	1/1		0/1				5/9	55.6	1					13 00:28	12 21 马光
3	刘赵梁		2/3		1/1				3/4	75.0		3				14 02:27	12 12 84 王伟
7	仇瑞祥											1				14 03:01	13 1 罗尧尧
8	谢庆龙	1/1	5/6		0/1				6/8	75.0	1					14 03:31	14 3 刘赵梁
9	许翔宇	2/3	3/4						5/7	71.4		2				15 04:19	14 17 李中洲
10	徐彦昊											1				15 04:29	15 21 马光
11	张天豪		1/2					1/1	2/3	66.7		2				16 04:58	15 17 李中洲
12	丁大伟															17 05:43	15 15 84 王伟
13	尹文珂		1/1						0/1	1/2	50.0					17 06:45	16 8 谢庆龙
15	刘劲松	0/1	3/4						3/5	60.0			1			17 08:02	17 11 张天豪
16	宋继强											1				17 08:34	18 1 罗尧尧
18	任启双															18 08:51	18 8 谢庆龙
19	庞连康	0/2	1/1	1/1		0/1			2/5	40.0		1				18 09:26	19 8 谢庆龙
20	徐逸															19 09:33	19 5 侯生升
21	马光	2/5	1/1						3/6	50.0	1	2	1			20 10:12	19 5 侯生升
22	张春梁															21 11:48	19 17 李中洲
<b>运动员 合计</b>		<b>9/19</b>	<b>18/23</b>	<b>1/1</b>	<b>1/3</b>	<b>0/1</b>		<b>1/2</b>	<b>30/49</b>	<b>61.2</b>	<b>4</b>	<b>13</b>	<b>3</b>			21 13:21	20 9 许翔宇
12	丁大伟	2/4	2/13	0/3	1/7			0/1	5/28	17.9	1					21 14:40	21 9 许翔宇
16	宋继强	0/6	1/5	0/1	0/1				1/13	7.7		1				22 15:17	21 17 李中洲
<b>守门员 合计</b>		<b>2/10</b>	<b>3/18</b>	<b>0/4</b>	<b>1/8</b>			<b>0/1</b>	<b>6/41</b>	<b>14.6</b>	<b>1</b>	<b>1</b>				22 16:11	22 1 罗尧尧

场上队员：得分 / 射门

守门员：救球 / 射门

快攻	Fast Break	突破	Breakthrough	任意球	Free Throw	7M球	7M Throw	助攻	Assist
警告	Warning	失误	Error	2'	Suspension	D	取消资格	DR	取消资格+报告





### 2016年全国男子手球锦标赛 图式比赛技术统计表

轮次 4

场次 18

201606018-21-1/1

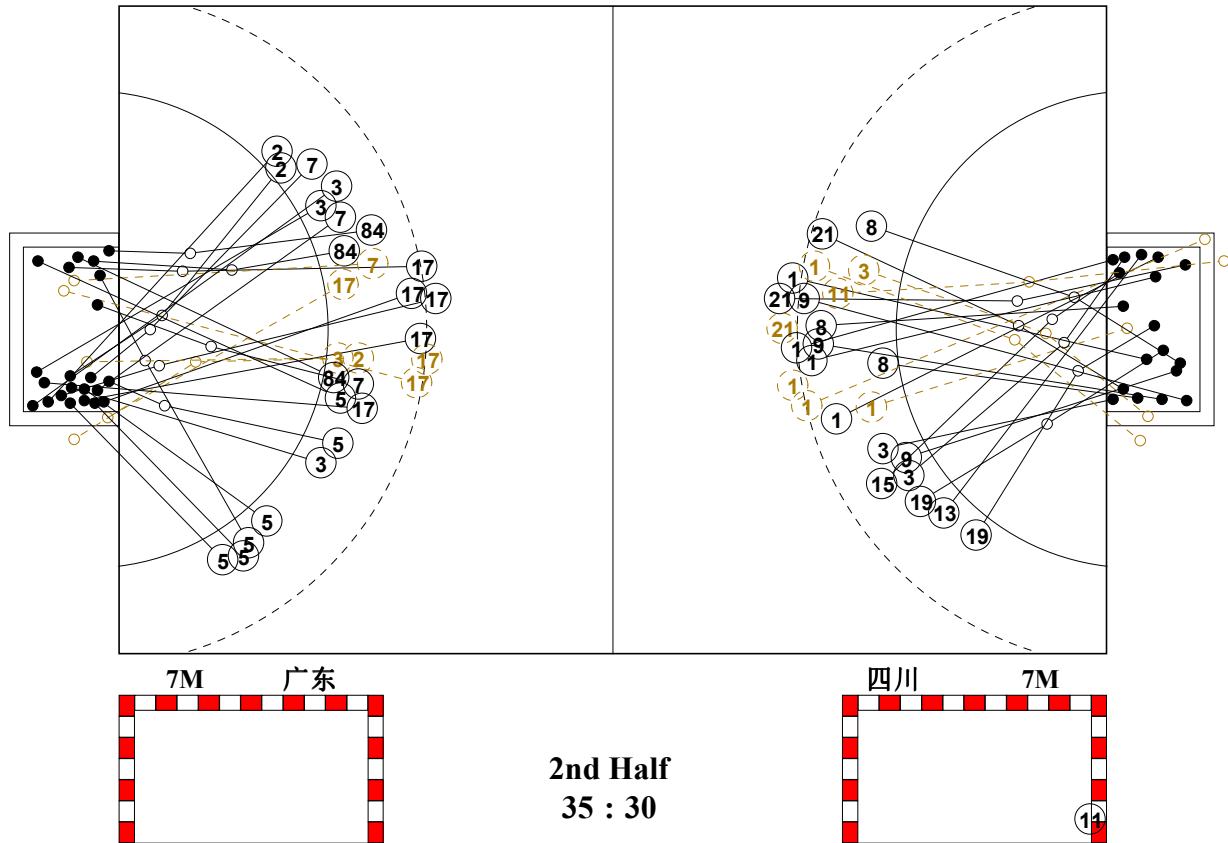
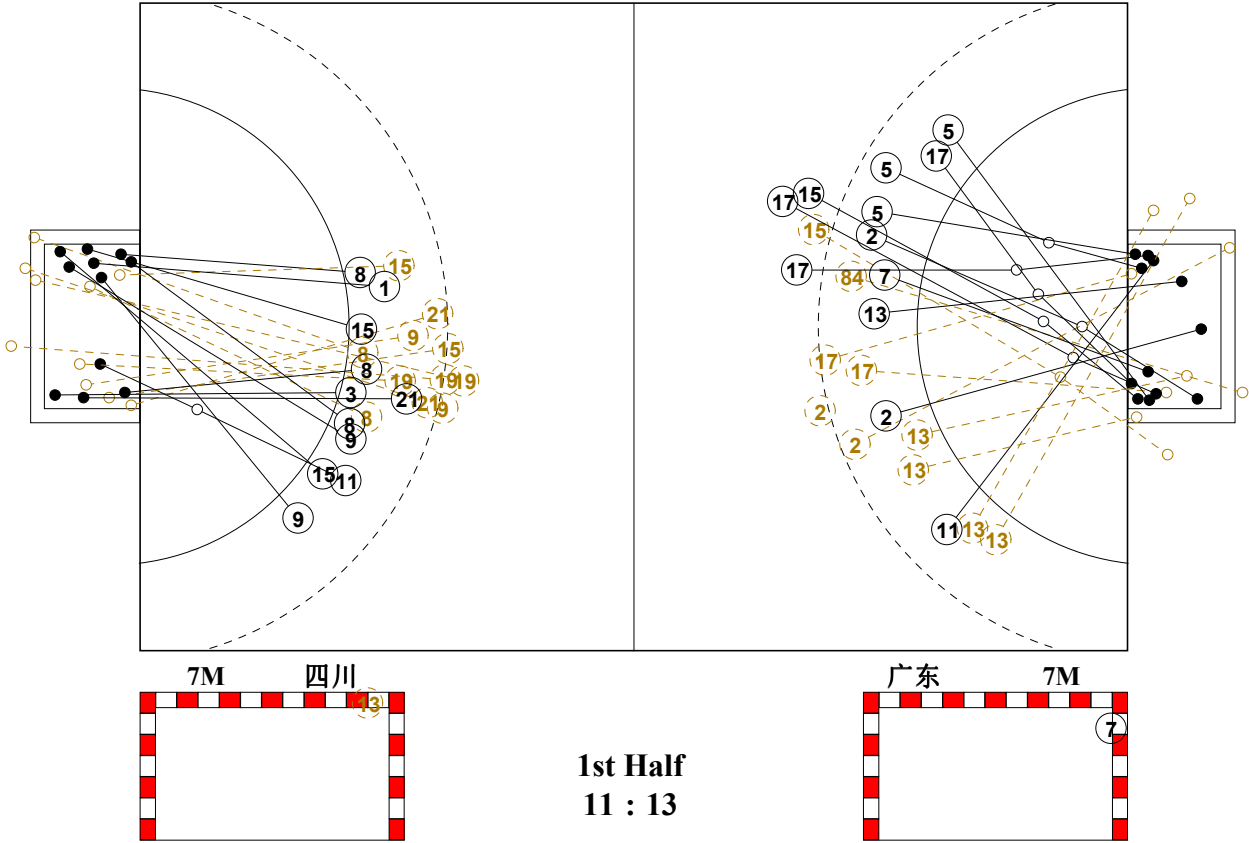



## 2016年全国男子手球锦标赛

## 个人/全队技术统计表

正式表  
手球  
男子预赛  
轮次 4组别 B  
场次 18201606018-14-1/2  
徐闻县体育中心体育馆  
24/10/2016 16:50

号码	姓名	远射	近射	边射	快攻	突破	任意	7M	合计	%	助攻	失误	警告	2'	取消	时间
<b>广东队(广东)</b>																
<i>(场上队员)</i>																
1	王泽润									0.0%						00:09:06
2	孙江山	0/2	4/4			0/1			4/7	57.1%	2					00:43:53
3	曲汝洋		3/4						3/4	75.0%		1				00:35:02
4	李卓洋									0.0%						00:00:00
5	侯生升	1/1	1/1	4/4	3/3				9/9	100%		2				01:00:00
7	付云博		3/3		1/2			1/1	5/6	83.3%	1	2				00:58:00
8	于彦江									0.0%						00:00:00
10	周仲坤									0.0%				1		00:14:36
11	房友屯		1/1						1/1	100%		1	1			00:17:48
13	王立隆		0/2	0/2	1/1				1/5	20.0%						00:12:11
15	张建杰	1/2							1/2	50.0%		2				00:11:02
16	马跃									0.0%						00:50:54
17	李中洲	6/9	1/2		1/2				8/13	61.5%		6				01:00:00
20	黄培杰									0.0%						00:00:00
84	王伟	0/1	2/2		1/1				3/4	75.0%	1	1	1			00:45:23
<b>合计</b>		8/15	15/19	4/6	7/9	0/1		1/1	35/51	68.6%	4	15	2	1		
<i>(守门员)</i>																
1	王泽润	0/3	0/1					0/1	0/5	0.0%						00:09:06
16	马跃	2/8	3/20	0/1	1/2	1/1			7/32	21.9%						00:50:54
<b>合计</b>		2/11	3/21	0/1	1/2	1/1		0/1	7/37	18.9%						

场上队员：得分/射门

守门员：救球/射门

全队合计	得分	被救	射失	击柱	封球	合计	%
远射	8	2	2	1	2	15	53.3%
近射	15	3		1		19	78.9%
边射	4		2			6	66.7%
快攻	7	1		1		9	77.8%
突破			1			1	0.0%
任意							0.0%
7M	1					1	100.0%





## 2016年全国男子手球锦标赛

## 个人/全队技术统计表

正式表  
手球  
男子预赛  
轮次 4组别 B  
场次 18201606018-14-2/2  
徐闻县体育中心体育馆  
24/10/2016 16:50

号码	姓名	远射	近射	边射	快攻	突破	任意	7M	合计	%	助攻	失误	警告	2'	取消	时间
<b>四川队(四川)</b>																
<i>(上场队员)</i>																
1	罗尧尧	4/7	1/1		0/1				5/9	55.6%	1					00:33:01
3	刘赵梁		2/3		1/1				3/4	75.0%		3				00:33:42
7	仇瑞祥									0.0%		1				00:16:09
8	谢庆龙	1/1	5/6		0/1				6/8	75.0%	1					00:38:58
9	许翔宇	2/3	3/4						5/7	71.4%		2				00:31:11
10	徐彦昊									0.0%		1				00:14:57
11	张天豪		1/2					1/1	2/3	66.7%		2				00:49:19
12	丁大伟									0.0%	1					00:36:42
13	尹文珂		1/1					0/1	1/2	50.0%						00:30:58
15	刘劲松	0/1	3/4						3/5	60.0%			1			00:23:14
16	宋继强									0.0%		1				00:23:18
18	任启双									0.0%			1			00:20:47
19	庞连康	0/2	1/1	1/1		0/1			2/5	40.0%		1				00:33:59
20	徐逸									0.0%						00:00:00
21	马光	2/5	1/1						3/6	50.0%	1	2	1			00:33:01
22	张春梁									0.0%						00:00:00
<b>合计</b>		9/19	18/23	1/1	1/3	0/1		1/2	30/49	61.2%	4	13	3			
<i>(守门员)</i>																
12	丁大伟	2/4	2/13	0/3	1/7			0/1	5/28	17.9%	1					00:36:42
16	宋继强	0/6	1/5	0/1	0/1				1/13	7.7%		1				00:23:18
<b>合计</b>		2/10	3/18	0/4	1/8			0/1	6/41	14.6%	1	1				

场上队员：得分/射门

守门员：救球/射门

全队合计	得分	被救	射失	击柱	封球	合计	%
远射	9	2	3	2	3	19	47.4%
近射	18	3	1	1		23	78.3%
边射	1					1	100.0%
快攻	1	1		1		3	33.3%
突破		1				1	0.0%
任意							0.0%
7M	1			1		2	50.0%







### 2016年全国男子手球锦标赛

#### 图式射门区域统计

轮次 4 场次 18

201606018-41-1/1

## 广东队

1 王泽润	2 孙江山	3 曲汝洋	4 李卓洋	5 侯生升	7 付文博	8 于彦江	10 周仲坤																																																																								
<table border="1"><tr><td></td><td></td><td></td></tr><tr><td></td><td></td><td></td></tr><tr><td></td><td></td><td></td></tr></table>										<table border="1"><tr><td>1</td><td>1</td><td>1</td></tr><tr><td>1</td><td></td><td></td></tr><tr><td></td><td></td><td></td></tr></table>	1	1	1	1						<table border="1"><tr><td>2</td><td></td><td></td></tr><tr><td>1</td><td></td><td></td></tr><tr><td></td><td></td><td></td></tr></table>	2			1						<table border="1"><tr><td></td><td></td><td></td></tr><tr><td></td><td></td><td></td></tr><tr><td></td><td></td><td></td></tr></table>										<table border="1"><tr><td></td><td></td><td>1</td></tr><tr><td>2</td><td></td><td></td></tr><tr><td>4</td><td></td><td>2</td></tr></table>			1	2			4		2	<table border="1"><tr><td></td><td></td><td>1</td></tr><tr><td></td><td></td><td></td></tr><tr><td>2</td><td>1</td><td>1</td></tr></table>			1				2	1	1	<table border="1"><tr><td></td><td></td><td></td></tr><tr><td></td><td></td><td></td></tr><tr><td></td><td></td><td></td></tr></table>										<table border="1"><tr><td></td><td></td><td></td></tr><tr><td></td><td></td><td></td></tr><tr><td></td><td></td><td></td></tr></table>									
1	1	1																																																																													
1																																																																															
2																																																																															
1																																																																															
		1																																																																													
2																																																																															
4		2																																																																													
		1																																																																													
2	1	1																																																																													
Post - 0 Miss - 0 Block - 0	Post - 1 Miss - 1 Block - 1	Post - 0 Miss - 0 Block - 0	Post - 0 Miss - 0 Block - 0	Post - 0 Miss - 0 Block - 0	Post - 0 Miss - 0 Block - 0	Post - 0 Miss - 0 Block - 0	Post - 0 Miss - 0 Block - 0																																																																								
11 房友屯	13 王立隆	15 张建杰	16 马跃	17 李中洲	20 黄培杰	84 王伟																																																																									
<table border="1"><tr><td></td><td></td><td></td></tr><tr><td></td><td></td><td></td></tr><tr><td>1</td><td></td><td></td></tr></table>							1			<table border="1"><tr><td></td><td></td><td></td></tr><tr><td>1</td><td></td><td></td></tr><tr><td></td><td></td><td></td></tr></table>				1						<table border="1"><tr><td></td><td></td><td></td></tr><tr><td></td><td></td><td></td></tr><tr><td></td><td></td><td>1</td></tr></table>									1	<table border="1"><tr><td></td><td></td><td></td></tr><tr><td></td><td></td><td></td></tr><tr><td></td><td></td><td></td></tr></table>										<table border="1"><tr><td>1</td><td></td><td></td></tr><tr><td>2</td><td></td><td>1</td></tr><tr><td>2</td><td></td><td>2</td></tr></table>	1			2		1	2		2	<table border="1"><tr><td></td><td></td><td></td></tr><tr><td></td><td></td><td></td></tr><tr><td></td><td></td><td></td></tr></table>										<table border="1"><tr><td></td><td></td><td></td></tr><tr><td></td><td></td><td>1</td></tr><tr><td></td><td></td><td>2</td></tr></table>						1			2	<table border="1"><tr><td></td><td></td><td></td></tr><tr><td></td><td></td><td></td></tr><tr><td></td><td></td><td></td></tr></table>									
1																																																																															
1																																																																															
		1																																																																													
1																																																																															
2		1																																																																													
2		2																																																																													
		1																																																																													
		2																																																																													
Post - 0 Miss - 0 Block - 0	Post - 1 Miss - 2 Block - 0	Post - 0 Miss - 1 Block - 0	Post - 0 Miss - 0 Block - 0	Post - 1 Miss - 0 Block - 1	Post - 0 Miss - 0 Block - 0	Post - 0 Miss - 1 Block - 0																																																																									

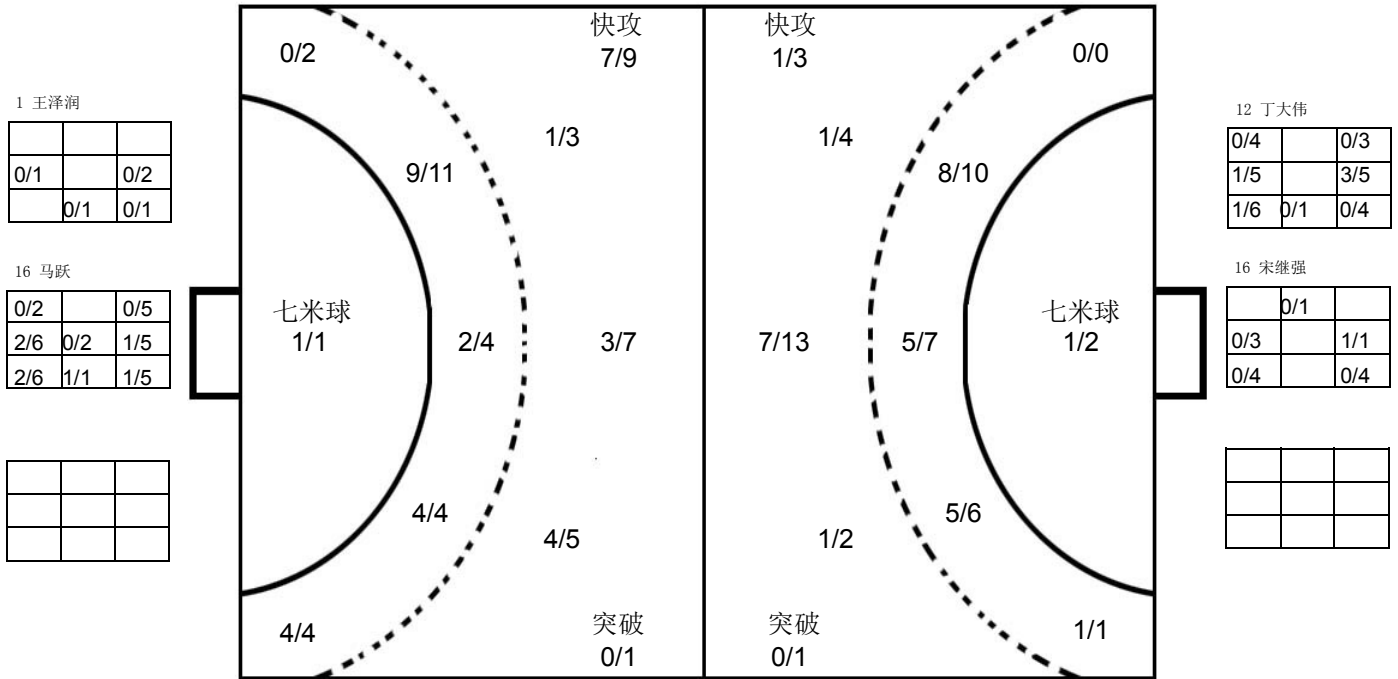

## 四川队

1 罗尧尧	3 刘赵梁	7 仇瑞祥	8 谢庆龙	9 许翔宇	10 徐彦昊	11 张天豪	12 丁大伟																																																																								
<table border="1"><tr><td></td><td></td><td></td></tr><tr><td>2</td><td></td><td>2</td></tr><tr><td>1</td><td></td><td></td></tr></table>				2		2	1			<table border="1"><tr><td>1</td><td></td><td></td></tr><tr><td></td><td></td><td></td></tr><tr><td>1</td><td></td><td>1</td></tr></table>	1						1		1	<table border="1"><tr><td></td><td></td><td></td></tr><tr><td></td><td></td><td></td></tr><tr><td></td><td></td><td></td></tr></table>										<table border="1"><tr><td></td><td></td><td>1</td></tr><tr><td></td><td></td><td>1</td></tr><tr><td>1</td><td>1</td><td>2</td></tr></table>			1			1	1	1	2	<table border="1"><tr><td></td><td></td><td>3</td></tr><tr><td></td><td></td><td>2</td></tr><tr><td></td><td></td><td></td></tr></table>			3			2				<table border="1"><tr><td></td><td></td><td></td></tr><tr><td></td><td></td><td></td></tr><tr><td></td><td></td><td></td></tr></table>										<table border="1"><tr><td></td><td></td><td></td></tr><tr><td>1</td><td></td><td></td></tr><tr><td></td><td></td><td>1</td></tr></table>				1					1	<table border="1"><tr><td></td><td></td><td></td></tr><tr><td></td><td></td><td></td></tr><tr><td></td><td></td><td></td></tr></table>									
2		2																																																																													
1																																																																															
1																																																																															
1		1																																																																													
		1																																																																													
		1																																																																													
1	1	2																																																																													
		3																																																																													
		2																																																																													
1																																																																															
		1																																																																													
Post - 1 Miss - 1 Block - 1	Post - 1 Miss - 0 Block - 0	Post - 0 Miss - 0 Block - 0	Post - 1 Miss - 0 Block - 0	Post - 0 Miss - 0 Block - 1	Post - 0 Miss - 0 Block - 0	Post - 0 Miss - 1 Block - 0	Post - 0 Miss - 0 Block - 0																																																																								
13 尹文珂	15 刘劲松	16 宋继强	18 任启双	19 庞连康	20 徐逸	21 马光	22 张睿梁																																																																								
<table border="1"><tr><td></td><td></td><td></td></tr><tr><td>1</td><td></td><td></td></tr><tr><td></td><td></td><td></td></tr></table>				1						<table border="1"><tr><td></td><td></td><td>1</td></tr><tr><td></td><td></td><td>1</td></tr><tr><td>1</td><td></td><td></td></tr></table>			1			1	1			<table border="1"><tr><td></td><td></td><td></td></tr><tr><td></td><td></td><td></td></tr><tr><td></td><td></td><td></td></tr></table>										<table border="1"><tr><td></td><td></td><td></td></tr><tr><td></td><td></td><td></td></tr><tr><td></td><td></td><td></td></tr></table>										<table border="1"><tr><td></td><td></td><td></td></tr><tr><td></td><td></td><td></td></tr><tr><td>2</td><td></td><td></td></tr></table>							2			<table border="1"><tr><td></td><td></td><td></td></tr><tr><td></td><td></td><td></td></tr><tr><td></td><td></td><td></td></tr></table>										<table border="1"><tr><td></td><td></td><td></td></tr><tr><td>1</td><td></td><td></td></tr><tr><td>1</td><td></td><td></td></tr></table>				1			1			<table border="1"><tr><td></td><td></td><td></td></tr><tr><td></td><td></td><td></td></tr><tr><td></td><td></td><td>1</td></tr></table>									1
1																																																																															
		1																																																																													
		1																																																																													
1																																																																															
2																																																																															
1																																																																															
1																																																																															
		1																																																																													
Post - 1 Miss - 0 Block - 0	Post - 0 Miss - 0 Block - 0	Post - 0 Miss - 0 Block - 0	Post - 0 Miss - 0 Block - 0	Post - 1 Miss - 1 Block - 0	Post - 0 Miss - 0 Block - 0	Post - 0 Miss - 1 Block - 1	Post - 0 Miss - 0 Block - 0																																																																								

注释: Post=击柱 Miss=射失 Block=被封





预赛 Group B

男子 全国比赛

2016年全国男子手球锦标赛

Team A				Team B				Match Number													
A 天津队				B 山东队				19													
played in		in the hall		on		at		Spectators													
China		徐闻县体育中心体育		24/10/2016		19:00		hours													
Half-time (30')	A	B	End of playing time	A	B	1st extra time	A	B	2nd extra time	A	B	After penalty throws	A	B							
	13	13		23	30																
Number of 7 m	A	Team time-out			Full name of players and officials						Team time-out			B	Number of 7 m						
		1	2	3							1	2	3								
	4/5	12:10	12:14	52:05									0/0								
No.	Team A					G	W	2'	D	DR	No.	Team B					G	W	2'	D	DR
1	刘宗其										3	尹杰									
2	李岳朋					2	1				4	田瑞									
4	李松浩										5	潘翔					1				
6	王子欣										6	李朝鹏					1				
7	张青					8	1	1			9	赵鑫					8				
8	曹悦					6					10	赵建强									
9	吴明远					2					11	宋朋强					4				
11	王毅										12	崔剑									
12	杨峻										13	刘晓									
13	许松										15	张继伟					1				
14	田剑侠					2			1		16	于性哲									
16	刘海亮										17	王旭东					4	1	2		
17	周群					3		1			19	李语庆					8		1		
18	王晓琪										21	翟乾坤					3				
21	潘玉帅										27	于亚男									
22	魏雨童																				
A	贾守信										A	markovic尼克									
B	杜瑞军 (主教练)										B	王鸿斌 (主教练)									
D	潘玉强										C	刘桂妮									
E	贾宁										D	邢建刚									
A	Signature of Responsible Official of the Teams (Off. A)																			B	
TP	Remarks of Referee / CHA Official																			TP	

Signatures

Referees	李兆蒙 (CHN)	周云磊 (CHN)		
Techn. Delegates	许宜扬 (CHN)			
CHA Official	刘凤娟 (CHN)			

Note: Number of 7m Throws Awarded to Team A and B, Goals (G), Warnings (W), Suspensions (2), Direct Disqualification (D), Disqualification with Report (DR) and Team Penalty (TP).

Table Officials: 刘宇阳

鲍瑛

Statisticians: 李双

周亚桥





## 2016年全国男子手球锦标赛 竞赛技术统计(媒体表)

预赛	组别	B	轮次	4	场次	19
----	----	---	----	---	----	----

徐闻县体育中心体育馆

24/10/2016

201606019-51-1/1

天津队	天津	23	vs	30	山东	山东队
13 : 13						

裁判员	李兆蒙 (CHN)	/	周云磊 (CHN)
-----	-----------	---	-----------

天津													天津		比赛 进程		山东	
远射	近射	边射	快攻	突破	任意球	7m球	合计	%	助攻	失误	警告	2'	D & DR	天津	山东			
主教练：杜瑞军													1st Half					
1 刘宗其									1					8 曹悦	1 02:44	0		
2 李岳朋	2/2						2/2	100			1			19 李语庆	1 04:33	1		
4 李松浩														7 张青	2 05:01	1		
6 王子欣		0/2	0/1				0/3	0.0						17 周群	3 06:07	1		
7 张青	6/14			2/2			8/16	50.0	3	5	1	1		2 李岳朋	4 07:58	1		
8 曹悦	2/7	2/4	1/1		0/1	1/1	6/14	42.9		5				4 09:42	2 19 李语庆	4 11:35	3 11 宋朋强	
9 吴明远				1/1		1/1	2/2	100		1				4 15:15	4 17 王旭东	4 16:30	5 19 李语庆	
11 王毅														4 16:54	6 19 李语庆	4 17:36	7 19 李语庆	
12 杨峻														7 张青	5 18:50	7		
13 许松	0/1	0/2	0/2				0/5	0.0		1				5 19:27	8 17 王旭东	6 20:09	8	
14 田剑侠	0/1	0/1				2/3	2/5	40.0		3			1	7 张青	6 20:46	8		
16 刘海亮														14 田剑侠	7 20:46	8		
17 周群	1/1	2/2					3/3	100		2		1		7 张青	7 21:53	9 11 宋朋强		
18 王晓琪														8 曹悦	8 22:07	9		
21 潘玉帅														9 吴明远	9 22:46	9		
22 魏雨童														7 张青	9 23:30	10 21 翟乾坤		
<b>运动员 合计</b>	<b>11/26</b>	<b>4/11</b>	<b>1/4</b>	<b>3/3</b>	<b>0/1</b>	<b>4/5</b>	<b>23/50</b>	<b>46.0</b>	<b>4</b>	<b>17</b>	<b>2</b>	<b>2</b>	<b>1</b>	8 曹悦	10 23:57	10		
1 刘宗其	6/15	6/13	0/3	1/9	1/1		14/41	34.1	1					7 张青	11 24:39	10		
12 杨峻	0/1	2/4					2/5	40.0						8 曹悦	12 25:20	10		
<b>守门员 合计</b>	<b>6/16</b>	<b>8/17</b>	<b>0/3</b>	<b>1/9</b>	<b>1/1</b>		<b>16/46</b>	<b>34.8</b>	<b>1</b>					12 26:40	11 9 赵鑫	12 28:10	12 17 王旭东	
													12 28:34	13 11 宋朋强				
													13 29:52	13				
													2nd Half					
													9 吴明远	14 01:26	13			
													8 曹悦	15 02:57	13			
													7 张青	16 05:21	13			
													14 田剑侠	17 07:52	13			
													17 周群	17 08:07	14 17 王旭东			
													7 张青	17 08:43	15 5 潘翔			
													7 张青	17 10:59	16 6 李朝鹏			
													17 周群	18 12:08	16			
													7 张青	19 13:28	16			
														19 14:06	17 9 赵鑫			
														19 14:53	18 9 赵鑫			
														19 15:35	19 19 李语庆			
														19 16:30	20 15 张继伟			
													17 周群	20 16:57	20			
														20 17:33	21 9 赵鑫			
													7 张青	20 18:27	22 19 李语庆			
														21 18:55	22			
														21 21:24	23 9 赵鑫			
													8 曹悦	21 22:51	24 21 翟乾坤			
														22 23:28	24			
														22 23:56	25 21 翟乾坤			
														22 24:52	26 9 赵鑫			
														22 26:31	27 9 赵鑫			
														22 27:19	28 19 李语庆			
													2 李岳朋	23 28:24	28			
														23 29:14	29 11 宋朋强			
														23 30:00	30 9 赵鑫			

场上队员：得分 / 射门

守门员：救球 / 射门

快攻	Fast Break	突破	Breakthrough	任意球	Free Throw	7M球	7M Throw	助攻	Assist
警告	Warning	失误	Error	2'	Suspension	D	取消资格	DR	取消资格+报告





## 2016年全国男子手球锦标赛 图式比赛技术统计表

轮次 4

场次 19

201606019-21-1/1

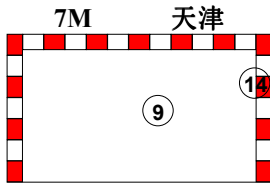
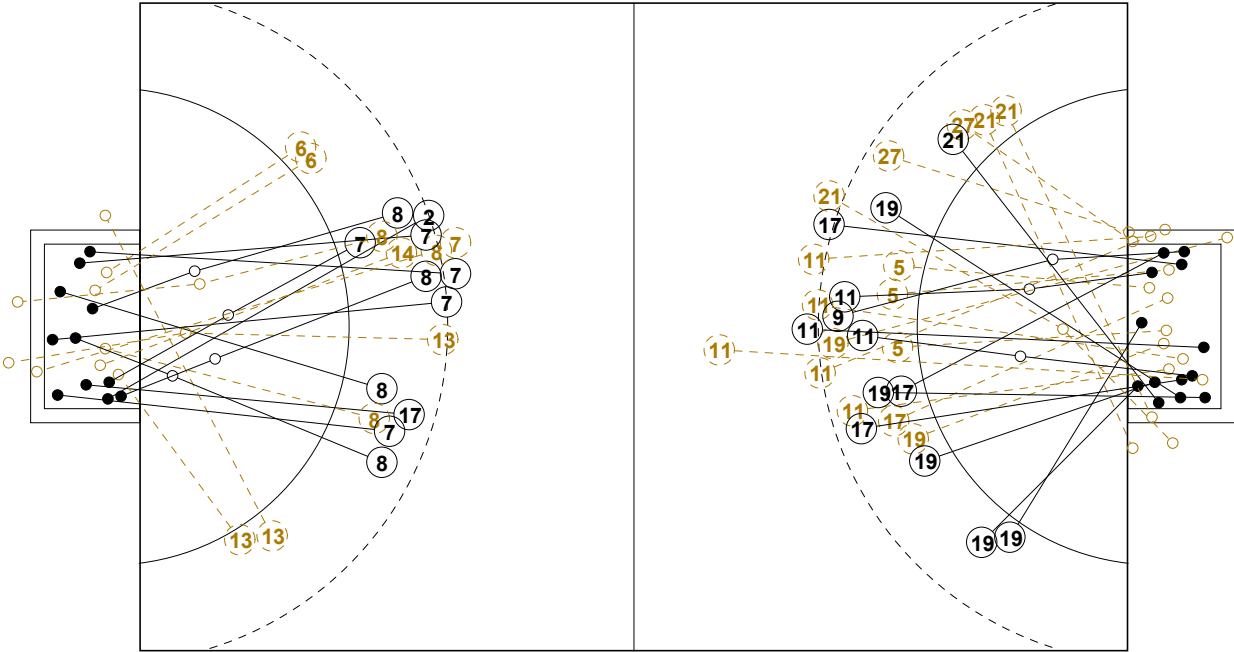

1st Half  
13 : 13

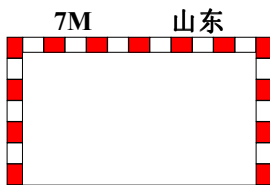
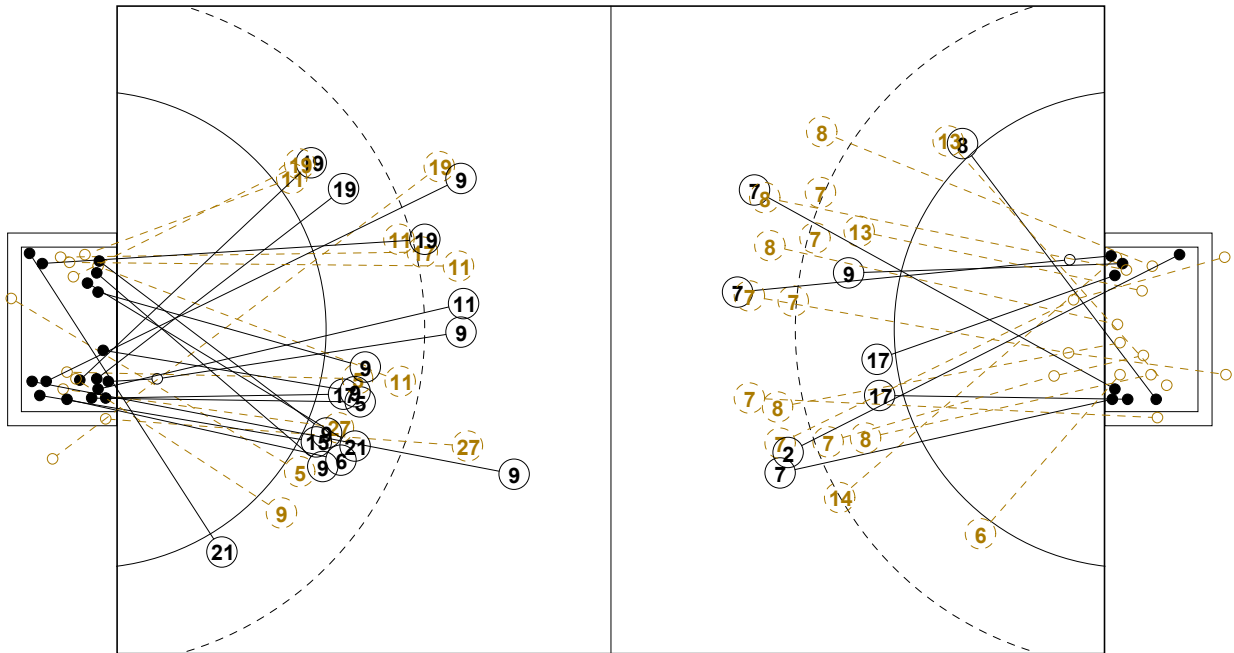
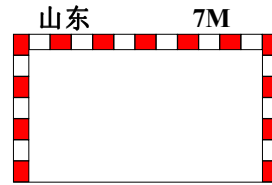

2nd Half  
30 : 23

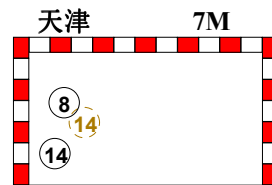



## 2016年全国男子手球锦标赛

## 个人/全队技术统计表

正式表  
手球  
男子预赛  
轮次 4组别 B  
场次 19201606019-14-1/2  
徐闻县体育中心体育馆  
24/10/2016 19:00

号码	姓名	远射	近射	边射	快攻	突破	任意	7M	合计	%	助攻	失误	警告	2'	取消	时间
<b>天津队(天津)</b>																
<i>(场上队员)</i>																
1	刘宗其									0.0%	1					00:54:41
2	李岳朋	2/2							2/2	100%			1			00:59:35
4	李松浩									0.0%						00:00:00
6	王子欣		0/2	0/1					0/3	0.0%						00:25:31
7	张青	6/14			2/2				8/16	50.0%	3	5	1	1		00:54:20
8	曹悦	2/7	2/4	1/1		0/1		1/1	6/14	42.9%		5				00:58:37
9	吴明远					1/1		1/1	2/2	100%		1				00:34:27
11	王毅									0.0%						00:07:05
12	杨峻									0.0%						00:05:19
13	许松	0/1	0/2	0/2					0/5	0.0%		1				00:30:33
14	田剑侠	0/1	0/1					2/3	2/5	40.0%		3		1		00:27:23
16	刘海亮									0.0%						00:00:00
17	周群	1/1	2/2						3/3	100%		2		1		01:00:00
18	王晓琪									0.0%						00:01:58
21	潘玉帅									0.0%						00:00:00
22	魏雨童									0.0%						00:00:00
<b>合计</b>		11/26	4/11	1/4	3/3	0/1		4/5	23/50	46.0%	4	17	2	2	1	
<i>(守门员)</i>																
1	刘宗其	6/15	6/13	0/3	1/9	1/1			14/41	34.1%	1					00:54:41
12	杨峻	0/1	2/4						2/5	40.0%						00:05:19
<b>合计</b>		6/16	8/17	0/3	1/9	1/1			16/46	34.8%	1					

场上队员：得分/射门

守门员：救球/射门

全队合计	得分	被救	射失	击柱	封球	合计	%
远射	11	6	3	2	4	26	42.3%
近射	4	6	1			11	36.4%
边射	1	2	1			4	25.0%
快攻	3					3	100.0%
突破		1				1	0.0%
任意							0.0%
7M	4	1				5	80.0%





## 2016年全国男子手球锦标赛

## 个人/全队技术统计表

正式表  
手球  
男子预赛  
轮次 4组别 B  
场次 19201606019-14-2/2  
徐闻县体育中心体育馆  
24/10/2016 19:00

号码	姓名	远射	近射	边射	快攻	突破	任意	7M	合计	%	助攻	失误	警告	2'	取消	时间
<b>山东队(山东)</b>																
<i>(上场队员)</i>																
3	尹杰									0.0%						00:01:28
4	田瑞									0.0%						00:00:00
5	潘翔		1/6						1/6	16.7%		1				00:47:39
6	李朝鹏		1/1						1/1	100%	1					00:18:33
9	赵鑫	4/4	2/3		2/2				8/9	88.9%	1	1				00:28:10
10	赵建强									0.0%						00:02:59
11	宋朋强	3/11	0/1		1/1				4/13	30.8%	4	2				00:55:05
12	崔剑									0.0%	1					00:16:09
13	刘晓									0.0%		1				00:25:36
15	张继伟		1/1						1/1	100%						00:09:04
16	于性哲									0.0%	2					00:43:51
17	王旭东	2/3	2/2			0/1			4/6	66.7%	1	1	1	2		00:33:46
19	李语庆	1/3	0/1	2/2	5/6				8/12	66.7%	2			1		00:58:19
21	翟乾坤	0/1	2/2	1/3					3/6	50.0%						00:41:22
27	于亚男	0/2	0/2						0/4	0.0%		1				00:36:24
<b>合计</b>		10/24	9/19	3/5	8/9	0/1			30/58	51.7%	12	7	1	3		
<i>(守门员)</i>																
12	崔剑	3/5	3/4	1/1				1/1	8/11	72.7%	1					00:16:09
16	于性哲	3/12	3/6	1/2	0/3	1/1		0/4	8/28	28.6%	2					00:43:51
<b>合计</b>		6/17	6/10	2/3	0/3	1/1		1/5	16/39	41.0%	3					

场上队员：得分/射门

守门员：救球/射门

全队合计	得分	被救	射失	击柱	封球	合计	%
远射	10	6	2	5	1	24	41.7%
近射	9	8		2		19	47.4%
边射	3		1	1		5	60.0%
快攻	8	1				9	88.9%
突破		1				1	0.0%
任意							0.0%
7M							0.0%





2016年全国男子手球锦标赛

图式射门区域统计

轮次 4 场次 19

201606019-41-1/1

天津队

1 刘宗其	2 李岳朋	4 李松浩	6 王子欣	7 张青	8 曹悦	9 吴明远	11 王毅																																																																								
<table border="1"><tr><td></td><td></td><td></td></tr><tr><td></td><td></td><td></td></tr><tr><td></td><td></td><td></td></tr></table>										<table border="1"><tr><td>1</td><td></td><td></td></tr><tr><td>1</td><td></td><td></td></tr><tr><td></td><td></td><td></td></tr></table>	1			1						<table border="1"><tr><td></td><td></td><td></td></tr><tr><td></td><td></td><td></td></tr><tr><td></td><td></td><td></td></tr></table>										<table border="1"><tr><td></td><td></td><td></td></tr><tr><td></td><td></td><td></td></tr><tr><td></td><td></td><td></td></tr></table>										<table border="1"><tr><td>1</td><td>1</td><td></td></tr><tr><td></td><td></td><td>2</td></tr><tr><td>2</td><td></td><td>2</td></tr></table>	1	1				2	2		2	<table border="1"><tr><td>1</td><td>1</td><td>1</td></tr><tr><td></td><td>1</td><td>1</td></tr><tr><td>1</td><td></td><td></td></tr></table>	1	1	1		1	1	1			<table border="1"><tr><td></td><td></td><td></td></tr><tr><td></td><td>1</td><td></td></tr><tr><td></td><td></td><td></td></tr></table>					1					<table border="1"><tr><td></td><td></td><td></td></tr><tr><td></td><td></td><td></td></tr><tr><td></td><td></td><td></td></tr></table>									
1																																																																															
1																																																																															
1	1																																																																														
		2																																																																													
2		2																																																																													
1	1	1																																																																													
	1	1																																																																													
1																																																																															
	1																																																																														
Post - 0 Miss - 0 Block - 0	Post - 0 Miss - 0 Block - 0	Post - 0 Miss - 0 Block - 0	Post - 0 Miss - 0 Block - 0	Post - 1 Miss - 2 Block - 4	Post - 1 Miss - 1 Block - 0	Post - 0 Miss - 0 Block - 0	Post - 0 Miss - 0 Block - 0																																																																								
12 杨峻	13 许松	14 田剑侠	16 刘海亮	17 周群	18 王晓琪	21 潘玉帅	22 魏雨童																																																																								
<table border="1"><tr><td></td><td></td><td></td></tr><tr><td></td><td></td><td></td></tr><tr><td></td><td></td><td></td></tr></table>										<table border="1"><tr><td></td><td></td><td></td></tr><tr><td></td><td></td><td></td></tr><tr><td></td><td></td><td></td></tr></table>										<table border="1"><tr><td></td><td></td><td>1</td></tr><tr><td></td><td></td><td></td></tr><tr><td>1</td><td></td><td></td></tr></table>			1				1			<table border="1"><tr><td></td><td></td><td></td></tr><tr><td></td><td></td><td></td></tr><tr><td></td><td></td><td></td></tr></table>										<table border="1"><tr><td>1</td><td></td><td></td></tr><tr><td></td><td></td><td></td></tr><tr><td>1</td><td></td><td>1</td></tr></table>	1						1		1	<table border="1"><tr><td></td><td></td><td></td></tr><tr><td></td><td></td><td></td></tr><tr><td></td><td></td><td></td></tr></table>										<table border="1"><tr><td></td><td></td><td></td></tr><tr><td></td><td></td><td></td></tr><tr><td></td><td></td><td></td></tr></table>										<table border="1"><tr><td></td><td></td><td></td></tr><tr><td></td><td></td><td></td></tr><tr><td></td><td></td><td></td></tr></table>									
		1																																																																													
1																																																																															
1																																																																															
1		1																																																																													
Post - 0 Miss - 0 Block - 0	Post - 0 Miss - 2 Block - 0	Post - 0 Miss - 0 Block - 0	Post - 0 Miss - 0 Block - 0	Post - 0 Miss - 0 Block - 0	Post - 0 Miss - 0 Block - 0	Post - 0 Miss - 0 Block - 0	Post - 0 Miss - 0 Block - 0																																																																								

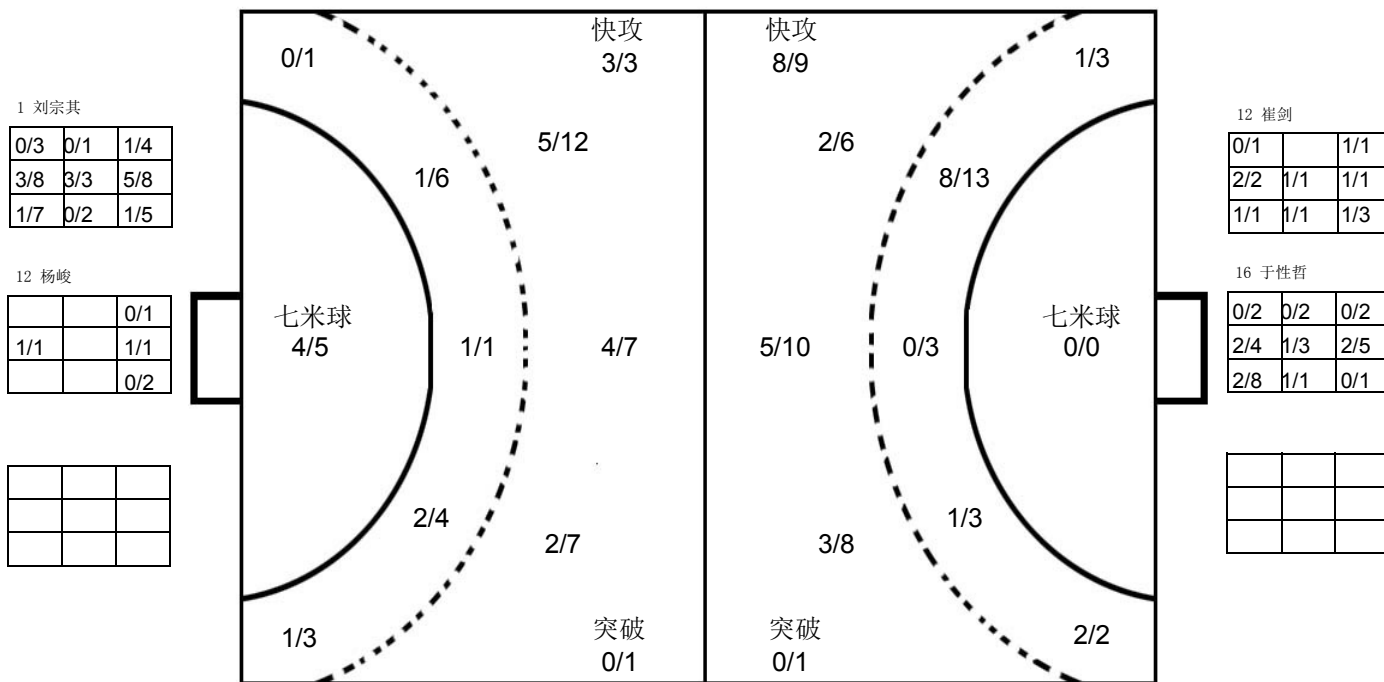

山东队

3 尹杰	4 田瑞	5 潘翔	6 李朝鹏	9 赵鑫	10 赵建强	11 宋朋强	12 崔剑																																																																								
<table border="1"><tr><td></td><td></td><td></td></tr><tr><td></td><td></td><td></td></tr><tr><td></td><td></td><td></td></tr></table>										<table border="1"><tr><td></td><td></td><td></td></tr><tr><td></td><td></td><td></td></tr><tr><td></td><td></td><td></td></tr></table>										<table border="1"><tr><td></td><td></td><td></td></tr><tr><td></td><td></td><td></td></tr><tr><td>1</td><td></td><td></td></tr></table>							1			<table border="1"><tr><td></td><td></td><td></td></tr><tr><td>1</td><td></td><td></td></tr><tr><td></td><td></td><td></td></tr></table>				1						<table border="1"><tr><td>2</td><td></td><td></td></tr><tr><td>1</td><td></td><td></td></tr><tr><td>1</td><td>1</td><td>3</td></tr></table>	2			1			1	1	3	<table border="1"><tr><td></td><td></td><td></td></tr><tr><td></td><td></td><td></td></tr><tr><td></td><td></td><td></td></tr></table>										<table border="1"><tr><td></td><td>1</td><td>1</td></tr><tr><td></td><td></td><td></td></tr><tr><td>2</td><td></td><td></td></tr></table>		1	1				2			<table border="1"><tr><td></td><td></td><td></td></tr><tr><td></td><td></td><td></td></tr><tr><td></td><td></td><td></td></tr></table>									
1																																																																															
1																																																																															
2																																																																															
1																																																																															
1	1	3																																																																													
	1	1																																																																													
2																																																																															
Post - 0 Miss - 0 Block - 0	Post - 0 Miss - 0 Block - 0	Post - 1 Miss - 0 Block - 0	Post - 0 Miss - 0 Block - 0	Post - 0 Miss - 0 Block - 0	Post - 0 Miss - 0 Block - 0	Post - 2 Miss - 0 Block - 1	Post - 0 Miss - 0 Block - 0																																																																								
13 刘晓	15 张继伟	16 于性哲	17 王旭东	19 李语庆	21 翟乾坤	27 于亚男																																																																									
<table border="1"><tr><td></td><td></td><td></td></tr><tr><td></td><td></td><td></td></tr><tr><td></td><td></td><td></td></tr></table>										<table border="1"><tr><td>1</td><td></td><td></td></tr><tr><td></td><td></td><td></td></tr><tr><td></td><td></td><td></td></tr></table>	1									<table border="1"><tr><td></td><td></td><td></td></tr><tr><td></td><td></td><td></td></tr><tr><td></td><td></td><td></td></tr></table>										<table border="1"><tr><td></td><td></td><td></td></tr><tr><td>2</td><td></td><td>1</td></tr><tr><td>1</td><td></td><td></td></tr></table>				2		1	1			<table border="1"><tr><td></td><td></td><td>2</td></tr><tr><td>1</td><td></td><td>1</td></tr><tr><td>1</td><td>1</td><td>2</td></tr></table>			2	1		1	1	1	2	<table border="1"><tr><td></td><td></td><td>1</td></tr><tr><td></td><td></td><td>1</td></tr><tr><td></td><td></td><td>1</td></tr></table>			1			1			1	<table border="1"><tr><td></td><td></td><td></td></tr><tr><td></td><td></td><td></td></tr><tr><td></td><td></td><td></td></tr></table>										<table border="1"><tr><td></td><td></td><td></td></tr><tr><td></td><td></td><td></td></tr><tr><td></td><td></td><td></td></tr></table>									
1																																																																															
2		1																																																																													
1																																																																															
		2																																																																													
1		1																																																																													
1	1	2																																																																													
		1																																																																													
		1																																																																													
		1																																																																													
Post - 0 Miss - 0 Block - 0	Post - 0 Miss - 0 Block - 0	Post - 0 Miss - 0 Block - 0	Post - 0 Miss - 0 Block - 0	Post - 1 Miss - 1 Block - 0	Post - 1 Miss - 2 Block - 0	Post - 3 Miss - 0 Block - 0																																																																									

注释: Post=击柱 Miss=射失 Block=被封





预赛 Group B

男子 全国比赛

2016年全国男子手球锦标赛

Team A										Team B										Match Number											
A 浙江队										B 上海队										20											
played in China										in the hall 徐闻县体育中心体育										on 24/10/2016		at 20:40 hours		Spectators							
Half-time (30')		A 3		B 20		End of playing time		A 3		B 20		1st extra time		A		B		2nd extra time		A		B		After penalty throws		A		B			
Number of 7 m		A 0/0		Team time-out			Full name of players and officials										Team time-out			B 1/1		Number of 7 m									
		1	2	3	12:06	17:50																									
No.	Team A										G	W	2'	D	DR	No.	Team B										G	W	2'	D	DR
1	李欢欢															1	张峥														
2	郑尧俊											1				2	张文斌										3	1			
3	李恩铭										1					3	赵时俊										1				
5	林先方															4	徐俊吉														
7	金杰															7	吴双										3				
8	王浩															8	钱为玮										9				
9	李家乐															10	董凯										1				
10	罗明杰										1	1				11	蒋承骅														
11	陈渝天															12	周哲韬														
14	虞勇灿										1					14	沈吉磊										3				
15	张佩力															15	朱世杰														
18	倪陈辉											1				17	贺政														
19	徐正飞															18	马麟晓														
24	毛军伟															33	吴璟														
B	柳佳 (主教练)															A	吴龙基 (主教练)														
C	项建生															B	张勇军														
																C	金迪琦														
																E	杨时														
A											Signature of Responsible Official of the Teams (Off. A)																				B
TP	Remarks of Referee / CHA Official																														TP

Signatures

Referees: 徐健 (CHN)      曹宏俊 (CHN)

Techn. Delegates: 王洋 (CHN)

CHA Official: 倪震 (CHN)

Note: Number of 7m Throws Awarded to Team A and B, Goals (G), Warnings (W), Suspensions (2), Direct Disqualification (D), Disqualification with Report (DR) and Team Penalty (TP).

Table Officials: 刘宇阳

鲍瑀

Statisticians: 李双

周亚桥

Printed by PHMS Copyright: IHF / CHA 24/10/2016 21:14:30

Longman Sportsoft



handball@126.com





### 2016年全国男子手球锦标赛 竞赛技术统计(媒体表)

预赛	组别	<b>B</b>	轮次	<b>4</b>	场次	<b>20</b>
徐闻县体育中心体育馆			24/10/2016		201606020-51-1/1	
浙江队		<b>浙江</b>	<b>3</b>	vs	<b>20</b>	上海队
				<b>3 : 20</b>		

裁判员	徐健 (CHN)	/	曹宏俊 (CHN)
-----	----------	---	-----------

浙江		远射	近射	边射	快攻	突破	任意球	7m球	合计	%	助攻	失误	警告	2'	D & DR	浙江	比赛进程	上海	
主教练: 柳佳																			
1	李欢欢															10	罗明杰	1st Half	
2	郑尧俊	0/3	0/1					0/4	0.0			4	1			1	00:51	0	
3	李恩铭		1/2	0/1				1/3	33.3							3	05:12	1	
5	林先方		0/1					0/1	0.0			3				2	06:03	2	
7	金杰															14	07:56	3	
8	王浩															8	08:35	3	
9	李家乐															4	09:40	8	
10	罗明杰	1/4						1/4	25.0			9	1			5	10:07	14	
11	陈渝天															6	12:00	6	
14	虞勇灿		1/1					1/1	100							7	12:48	7	
15	张佩力															8	13:54	8	
18	倪陈辉	0/2						0/2	0.0			1	1			9	15:55	9	
19	徐正飞															10	17:11	10	
24	毛军伟															11	17:44	11	
运动员 合计		1/9	2/5	0/1				3/15	20.0			18	3			12	18:19	12	
15	张佩力	2/6	1/4	3/5	0/9	0/1	0/1	6/26	23.1							7	19:14	12	
守门员 合计		2/6	1/4	3/5	0/9	0/1	0/1	6/26	23.1								8	20:35	13
上海		远射	近射	边射	快攻	突破	任意球	7m球	合计	%	助攻	失误	警告	2'	D & DR				
教练: 吴龙基																			
1	张崢											1							
2	张文斌		1/1		1/1	1/1		3/3	100		1	2	1						
3	赵时俊			1/1				1/1	100										
4	徐俊吉																		
7	吴双			0/2	3/3			3/5	60.0			2							
8	钱为玮	1/1	2/2	1/3	5/5			9/11	81.8										
10	董凯	1/1	0/1					1/2	50.0			2							
11	蒋承骅										1								
12	周哲韬																		
14	沈吉磊	2/5						1/1	3/6	50.0	1								
15	朱世杰																		
17	贺政																		
18	马麟晓																		
33	吴璟																		
运动员 合计		4/7	3/4	2/6	9/9	1/1	1/1	20/28	71.4		4	6	1						
1	张崢	5/6	2/4					7/10	70.0		1								
守门员 合计		5/6	2/4					7/10	70.0		1								

场上队员: 得分 / 射门

守门员: 救球 / 射门

快攻	Fast Break		突破	Breakthrough		任意球	Free Throw		7M球	7M Throw		助攻	Assist
警告	Warning		失误	Error		2'	Suspension		D	取消资格		DR	取消资格+报告



### 2016年全国男子手球锦标赛 图式比赛技术统计表

轮次 4

场次 20

201606020-21-1/1

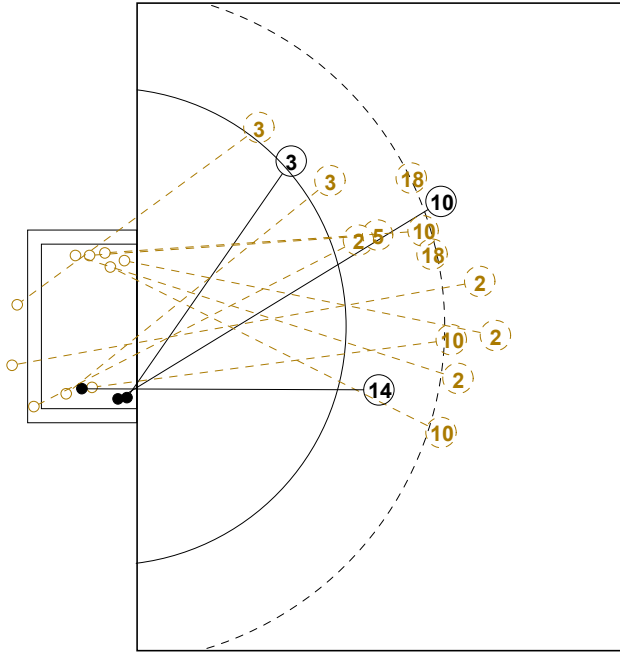

7M 浙江

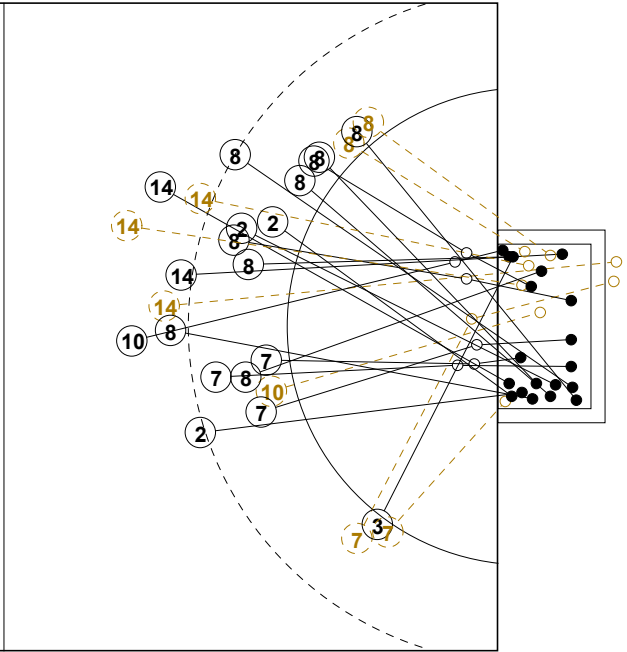
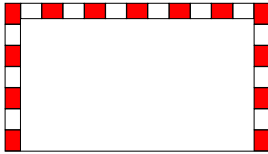

上海 7M

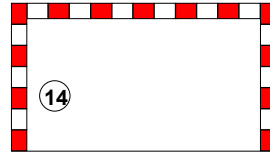

1st Half  
3 : 20

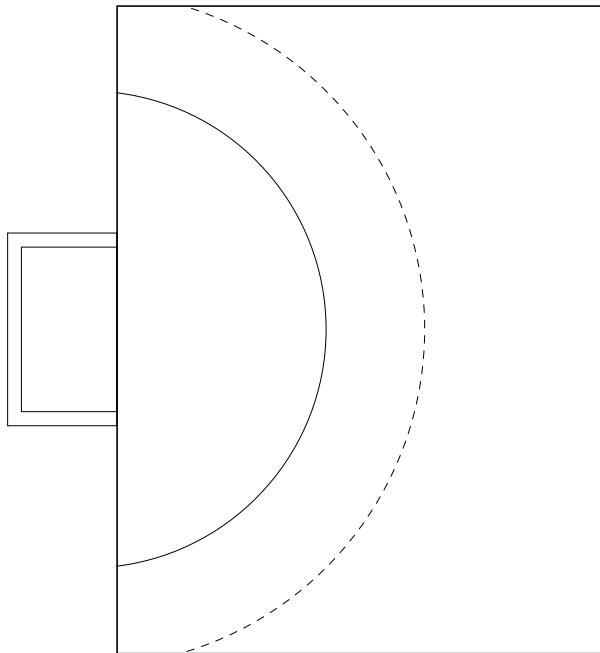

7M 上海

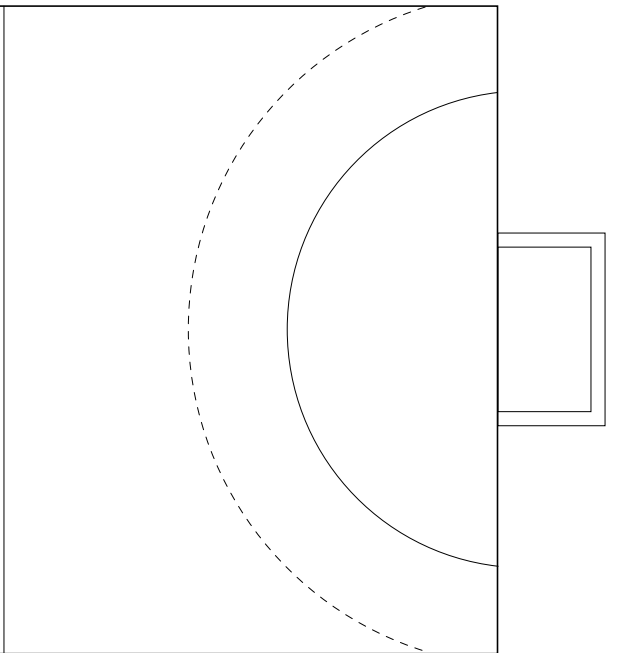
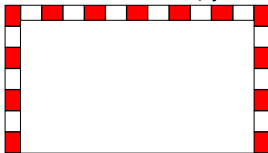

浙江 7M



2nd Half  
20 : 3



## 2016年全国男子手球锦标赛

## 个人/全队技术统计表

正式表  
手球  
男子预赛  
轮次 4组别 B  
场次 20201606020-14-1/2  
徐闻县体育中心体育馆  
24/10/2016 20:40

号码	姓名	远射	近射	边射	快攻	突破	任意	7M	合计	%	助攻	失误	警告	2'	取消	时间
<b>浙江队(浙江)</b>																
<i>(场上队员)</i>																
1	李欢欢									0.0%						00:17:21
2	郑尧俊	0/3	0/1						0/4	0.0%		4	1			00:23:41
3	李恩铭		1/2	0/1					1/3	33.3%						00:14:52
5	林先方		0/1						0/1	0.0%		3				00:14:14
7	金杰									0.0%						00:00:52
8	王浩									0.0%						00:00:00
9	李家乐									0.0%						00:04:44
10	罗明杰	1/4							1/4	25.0%		9	1			00:29:07
11	陈渝天									0.0%						00:09:34
14	虞勇灿		1/1						1/1	100%						00:00:30
15	张佩力									0.0%						00:30:00
18	倪陈辉	0/2							0/2	0.0%		1	1			00:30:00
19	徐正飞									0.0%		1				00:24:54
24	毛军伟									0.0%						00:00:00
<b>合计</b>																
<i>(守门员)</i>																
15	张佩力	2/6	1/4	3/5	0/9	0/1		0/1	6/26	23.1%						00:30:00
<b>合计</b>																
2/6 1/4 3/5 0/9 0/1 0/1 6/26 23.1%																

场上队员：得分/射门

守门员：救球/射门

全队合计	得分	被救	射失	击柱	封球	合计	%
远射	1	5	1		2	9	11.1%
近射	2	2		1		5	40.0%
边射			1			1	0.0%
快攻							0.0%
突破							0.0%
任意							0.0%
7M							0.0%





## 2016年全国男子手球锦标赛

## 个人/全队技术统计表

正式表  
手球  
男子预赛  
轮次 4组别 B  
场次 20201606020-14-2/2  
徐闻县体育中心体育馆  
24/10/2016 20:40

号码	姓名	远射	近射	边射	快攻	突破	任意	7M	合计	%	助攻	失误	警告	2'	取消	时间
<b>上海队(上海)</b>																
<i>(上场队员)</i>																
1	张崢									0.0%	1					00:30:00
2	张文斌		1/1		1/1	1/1			3/3	100%	1	2	1			00:28:10
3	赵时俊			1/1					1/1	100%						00:04:47
4	徐俊吉									0.0%						00:00:13
7	吴双			0/2	3/3				3/5	60.0%		2				00:30:00
8	钱为玮	1/1	2/2	1/3	5/5				9/11	81.8%						00:30:00
10	董凯	1/1	0/1						1/2	50.0%		2				00:30:00
11	蒋承骅									0.0%	1					00:26:56
12	周哲韬									0.0%						00:00:00
14	沈吉磊	2/5						1/1	3/6	50.0%	1					00:30:00
15	朱世杰									0.0%						00:01:50
17	贺政									0.0%						00:00:00
18	马麟晓									0.0%						00:00:00
33	吴璟									0.0%						00:00:00
<b>合计</b>																
<i>(守门员)</i>																
1	张崢	5/6	2/4						7/10	70.0%	1					00:30:00
<b>合计</b>																

场上队员：得分/射门

守门员：救球/射门

全队合计	得分	被救	射失	击柱	封球	合计	%
远射	4	2	1			7	57.1%
近射	3	1				4	75.0%
边射	2	3	1			6	33.3%
快攻	9					9	100.0%
突破	1					1	100.0%
任意							0.0%
7M	1					1	100.0%





2016年全国男子手球锦标赛

图式射门区域统计

轮次 4 场次 20

201606020-41-1/1

浙江队

1 李欢欢	2 郑尧俊	3 李恩铭	5 林先方	7 金杰	8 王浩	9 李家乐	10 罗明杰																																																																								
<table border="1"><tr><td></td><td></td><td></td></tr><tr><td></td><td></td><td></td></tr><tr><td></td><td></td><td></td></tr></table>										<table border="1"><tr><td></td><td></td><td></td></tr><tr><td></td><td></td><td></td></tr><tr><td></td><td></td><td></td></tr></table>										<table border="1"><tr><td></td><td></td><td></td></tr><tr><td></td><td></td><td></td></tr><tr><td></td><td>1</td><td></td></tr></table>								1		<table border="1"><tr><td></td><td></td><td></td></tr><tr><td></td><td></td><td></td></tr><tr><td></td><td></td><td></td></tr></table>										<table border="1"><tr><td></td><td></td><td></td></tr><tr><td></td><td></td><td></td></tr><tr><td></td><td></td><td></td></tr></table>										<table border="1"><tr><td></td><td></td><td></td></tr><tr><td></td><td></td><td></td></tr><tr><td></td><td></td><td></td></tr></table>										<table border="1"><tr><td></td><td></td><td></td></tr><tr><td></td><td></td><td></td></tr><tr><td></td><td></td><td></td></tr></table>										<table border="1"><tr><td></td><td></td><td></td></tr><tr><td></td><td></td><td></td></tr><tr><td></td><td></td><td></td></tr></table>									
	1																																																																														
Post - 0 Miss - 0 Block - 0	Post - 1 Miss - 1 Block - 0	Post - 0 Miss - 1 Block - 0	Post - 0 Miss - 0 Block - 0	Post - 0 Miss - 0 Block - 0	Post - 0 Miss - 0 Block - 0	Post - 0 Miss - 0 Block - 0	Post - 0 Miss - 0 Block - 0																																																																								
11 陈渝天	14 虞勇灿	15 张佩力	18 倪陈辉	19 徐正飞	24 毛军伟																																																																										
<table border="1"><tr><td></td><td></td><td></td></tr><tr><td></td><td></td><td></td></tr><tr><td></td><td></td><td></td></tr></table>										<table border="1"><tr><td></td><td></td><td></td></tr><tr><td></td><td>1</td><td></td></tr><tr><td></td><td></td><td></td></tr></table>					1					<table border="1"><tr><td></td><td></td><td></td></tr><tr><td></td><td></td><td></td></tr><tr><td></td><td></td><td></td></tr></table>										<table border="1"><tr><td></td><td></td><td></td></tr><tr><td></td><td></td><td></td></tr><tr><td></td><td></td><td></td></tr></table>										<table border="1"><tr><td></td><td></td><td></td></tr><tr><td></td><td></td><td></td></tr><tr><td></td><td></td><td></td></tr></table>										<table border="1"><tr><td></td><td></td><td></td></tr><tr><td></td><td></td><td></td></tr><tr><td></td><td></td><td></td></tr></table>																													
	1																																																																														
Post - 0 Miss - 0 Block - 0	Post - 0 Miss - 0 Block - 0	Post - 0 Miss - 0 Block - 0	Post - 0 Miss - 0 Block - 2	Post - 0 Miss - 0 Block - 0	Post - 0 Miss - 0 Block - 0																																																																										

15 张佩力

0/1	0/2	0/3
2/5	1/1	0/4
2/5		1/5



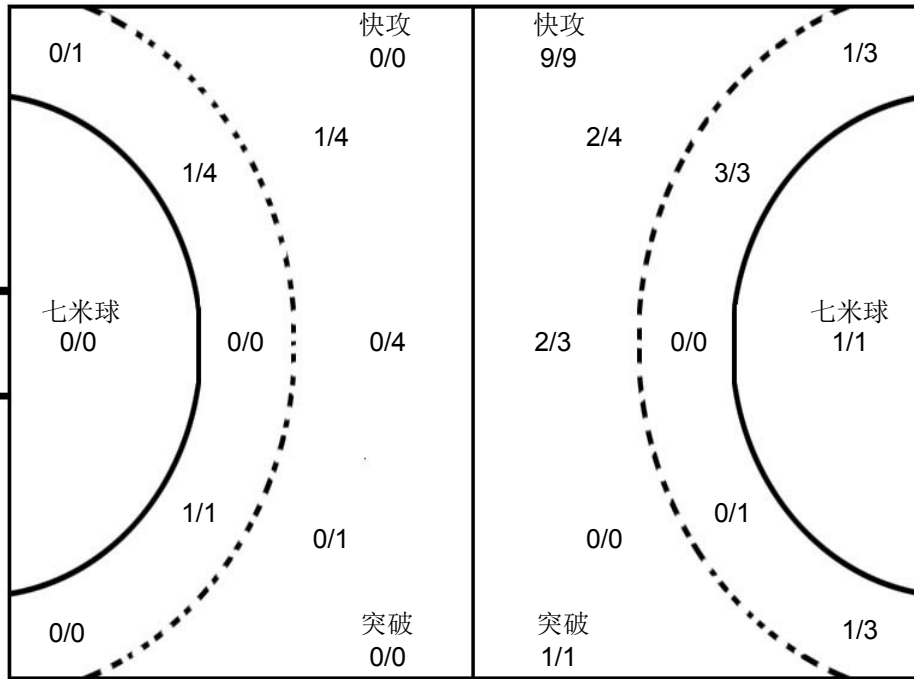

1 张崢

1/1		
1/2		3/3
0/2		2/2



上海队

1 张崢	2 张文斌	3 赵时俊	4 徐俊吉	7 吴双	8 钱为玮	10 董凯	11 蒋承骅																																																																								
<table border="1"><tr><td></td><td></td><td></td></tr><tr><td></td><td></td><td></td></tr><tr><td></td><td></td><td></td></tr></table>										<table border="1"><tr><td></td><td></td><td></td></tr><tr><td></td><td></td><td>1</td></tr><tr><td></td><td></td><td>2</td></tr></table>						1			2	<table border="1"><tr><td></td><td></td><td></td></tr><tr><td></td><td></td><td></td></tr><tr><td></td><td>1</td><td></td></tr></table>								1		<table border="1"><tr><td></td><td></td><td></td></tr><tr><td></td><td></td><td></td></tr><tr><td></td><td></td><td></td></tr></table>										<table border="1"><tr><td></td><td>1</td><td>1</td></tr><tr><td></td><td></td><td></td></tr><tr><td></td><td></td><td>1</td></tr></table>		1	1						1	<table border="1"><tr><td></td><td>1</td><td>2</td></tr><tr><td></td><td>2</td><td>3</td></tr><tr><td></td><td>1</td><td></td></tr></table>		1	2		2	3		1		<table border="1"><tr><td></td><td></td><td></td></tr><tr><td></td><td></td><td></td></tr><tr><td></td><td></td><td></td></tr></table>										<table border="1"><tr><td></td><td></td><td></td></tr><tr><td></td><td></td><td></td></tr><tr><td></td><td></td><td></td></tr></table>									
		1																																																																													
		2																																																																													
	1																																																																														
	1	1																																																																													
		1																																																																													
	1	2																																																																													
	2	3																																																																													
	1																																																																														
Post - 0 Miss - 0 Block - 0	Post - 0 Miss - 0 Block - 0	Post - 0 Miss - 0 Block - 0	Post - 0 Miss - 0 Block - 0	Post - 0 Miss - 1 Block - 0	Post - 0 Miss - 0 Block - 0	Post - 0 Miss - 0 Block - 0	Post - 0 Miss - 0 Block - 0																																																																								
12 周哲韬	14 沈吉磊	15 朱世杰	17 贺政	18 马麟晓	33 吴璟																																																																										
<table border="1"><tr><td></td><td></td><td></td></tr><tr><td></td><td></td><td></td></tr><tr><td></td><td></td><td></td></tr></table>										<table border="1"><tr><td></td><td>1</td><td></td></tr><tr><td></td><td>1</td><td></td></tr><tr><td></td><td></td><td>1</td></tr></table>		1			1				1	<table border="1"><tr><td></td><td></td><td></td></tr><tr><td></td><td></td><td></td></tr><tr><td></td><td></td><td></td></tr></table>										<table border="1"><tr><td></td><td></td><td></td></tr><tr><td></td><td></td><td></td></tr><tr><td></td><td></td><td></td></tr></table>										<table border="1"><tr><td></td><td></td><td></td></tr><tr><td></td><td></td><td></td></tr><tr><td></td><td></td><td></td></tr></table>										<table border="1"><tr><td></td><td></td><td></td></tr><tr><td></td><td></td><td></td></tr><tr><td></td><td></td><td></td></tr></table>																													
	1																																																																														
	1																																																																														
		1																																																																													
Post - 0 Miss - 0 Block - 0	Post - 0 Miss - 1 Block - 0	Post - 0 Miss - 0 Block - 0	Post - 0 Miss - 0 Block - 0	Post - 0 Miss - 0 Block - 0	Post - 0 Miss - 0 Block - 0																																																																										

注释: Post=击柱 Miss=射失 Block=被封





预赛 Group B

男子 全国比赛

2016年全国男子手球锦标赛

Team A A 四川队				Team B B 浙江队				Match Number <b>21</b>													
played in China		in the hall 徐闻县体育中心体育		on 25/10/2016		at 13:30 hours		Spectators													
Half-time (30')	A 20	B 5	End of playing time	A 20	B 5	1st extra time	A	B	2nd extra time	A	B	After penalty throws	A	B							
Number of 7 m	A 0/0	Team time-out			Full name of players and officials				Team time-out			B 0/0	Number of 7 m								
		1	2	3					1	2	3										
No.	Team A					G	W	2'	D	DR	No.	Team B					G	W	2'	D	DR
1	罗尧尧										1	李欢欢					2	1			
3	刘赵梁					3					2	郑尧俊									
7	仇瑞祥					3					3	李恩铭									
8	谢庆龙					4					5	林先方									
9	许翔宇					1					7	金杰					1				
10	徐彦昊										8	王浩									
11	张天豪					5					9	李家乐					1				
13	尹文珂					3					10	罗明杰					1				
15	刘劲松										11	陈渝天									
16	宋继强										14	虞勇灿									
18	任启双										15	张佩力									
19	庞连康										18	倪陈辉									
20	徐逸					1					19	徐正飞									
21	马光										24	毛军伟									
22	张睿梁																				
B	张文韬 (主教练)										B	柳佳 (主教练)									
D	胡俊杰										C	项建生									
A	Signature of Responsible Official of the Teams (Off. A)																		B		
TP	Remarks of Referee / CHA Official																		TP		

Signatures

Referees: 丛艳霞 (CHN)      王亚光 (CHN)

Techn. Delegates: 王洋 (CHN)

CHA Official: 程钰峰 (CHN)

Note: Number of 7m Throws Awarded to Team A and B, Goals (G), Warnings (W), Suspensions (2'), Direct Disqualification (D), Disqualification with Report (DR) and Team Penalty (TP).

Table Officials: 严璐      刘正松      Statisticians: 李双      张程秀子

Printed by PHMS      Copyright: IHF / CHA      25/10/2016 14:02:30

Longman Sportsoft            handball@126.com



## 2016年全国男子手球锦标赛 竞赛技术统计(媒体表)

<b>预赛</b>	组别	<b>B</b>	轮次	<b>5</b>	场次	<b>21</b>
徐闻县体育中心体育馆			25/10/2016		201606021-51-1/1	
四川队	<i>四川</i>	<b>20</b>	vs	<b>5</b>	<i>浙江</i>	浙江队
			<b>20 : 5</b>			

裁判员	丛艳霞 (CHN)	/	王亚光 (CHN)
-----	-----------	---	-----------

<i>四川</i>		远	近	边	快	突	任意	7m	合计	%	助攻	失误	警告	2'	D & DR	<i>四川</i>	比赛 进程	<i>浙江</i>
主教练：张文韬		射	射	射	攻	破	球	球										
1	罗尧尧															11	张天豪	1 02:50 0
3	刘赵梁		0/2		1/1	2/2			3/5	60.0	2	2				13	尹文珂	2 04:16 0
7	仇瑞祥	1/1	1/1		1/2				3/4	75.0						8	谢庆龙	3 05:22 0
8	谢庆龙		1/1		3/4				4/5	80.0		1				3	刘赵梁	4 07:00 0
9	许翔宇	1/1							1/1	100	1	2				8	谢庆龙	5 07:56 0
10	徐彦昊															7	仇瑞祥	6 09:07 0
11	张天豪		3/3	1/1	1/2				5/6	83.3	1	2				8	谢庆龙	7 11:39 0
13	尹文珂		1/1	1/1	1/1				3/3	100	1	1				8	谢庆龙	8 12:27 0
15	刘劲松															11	张天豪	9 14:29 0
16	宋继强															11	张天豪	10 15:14 0
18	任启双															3	刘赵梁	11 17:35 0
19	庞连康															11	徐逸	11 19:35 1 10 罗明杰
20	徐逸			1/1	0/1				1/2	50.0		1				20	徐逸	12 20:22 1
21	马光															7	仇瑞祥	13 21:07 1
22	张春梁	0/1							0/1	0.0	2					11	张天豪	14 22:08 1
<b>运动员 合计</b>		<b>2/3</b>	<b>6/8</b>	<b>3/3</b>	<b>7/11</b>	<b>2/2</b>			<b>20/27</b>	<b>74.1</b>	<b>7</b>	<b>9</b>				15	张天豪	15 23:16 1
22	张春梁	9/11	1/4	2/2					12/17	70.6	2					11	张天豪	15 23:55 2 1 李欢欢
<b>守门员 合计</b>		<b>9/11</b>	<b>1/4</b>	<b>2/2</b>					<b>12/17</b>	<b>70.6</b>	<b>2</b>					11	张天豪	16 24:13 2 9 李家乐
<i>浙江</i>		远	近	边	快	突	任意	7m	合计	%	助攻	失误	警告	2'	D & DR			
教练：柳佳		射	射	射	攻	破	球	球										
1	李欢欢		2/3						2/3	66.7			1					
2	郑尧俊	0/1							0/1	0.0		2						
3	李恩铭											1						
5	林先方																	
7	金杰	1/2		0/1					1/3	33.3	1	2						
8	王浩																	
9	李家乐		1/1						1/1	100		2						
10	罗明杰	1/8							1/8	12.5	1	3						
11	陈渝天																	
14	虞勇灿																	
15	张佩力																	
18	倪陈辉	0/1		0/2					0/3	0.0		4						
19	徐正飞	0/1							0/1	0.0		3						
24	毛军伟																	
<b>运动员 合计</b>		<b>2/13</b>	<b>3/4</b>	<b>0/3</b>					<b>5/20</b>	<b>25.0</b>	<b>2</b>	<b>17</b>	<b>1</b>					
8	王浩		1/3		0/1				1/4	25.0								
15	张佩力	1/3	0/4	0/3	1/7	0/2			2/19	10.5								
<b>守门员 合计</b>		<b>1/3</b>	<b>1/7</b>	<b>0/3</b>	<b>1/8</b>	<b>0/2</b>			<b>3/23</b>	<b>13.0</b>								

场上队员：得分 / 射门

守门员：救球 / 射门

快攻	Fast Break		突破	Breakthrough		任意球	Free Throw		7M球	7M Throw		助攻	Assist
警告	Warning		失误	Error		2'	Suspension		D	取消资格		DR	取消资格+报告



### 2016年全国男子手球锦标赛 图式比赛技术统计表

轮次 5

场次 21

201606021-21-1/1

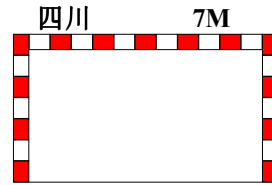
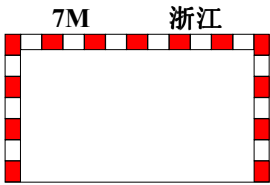
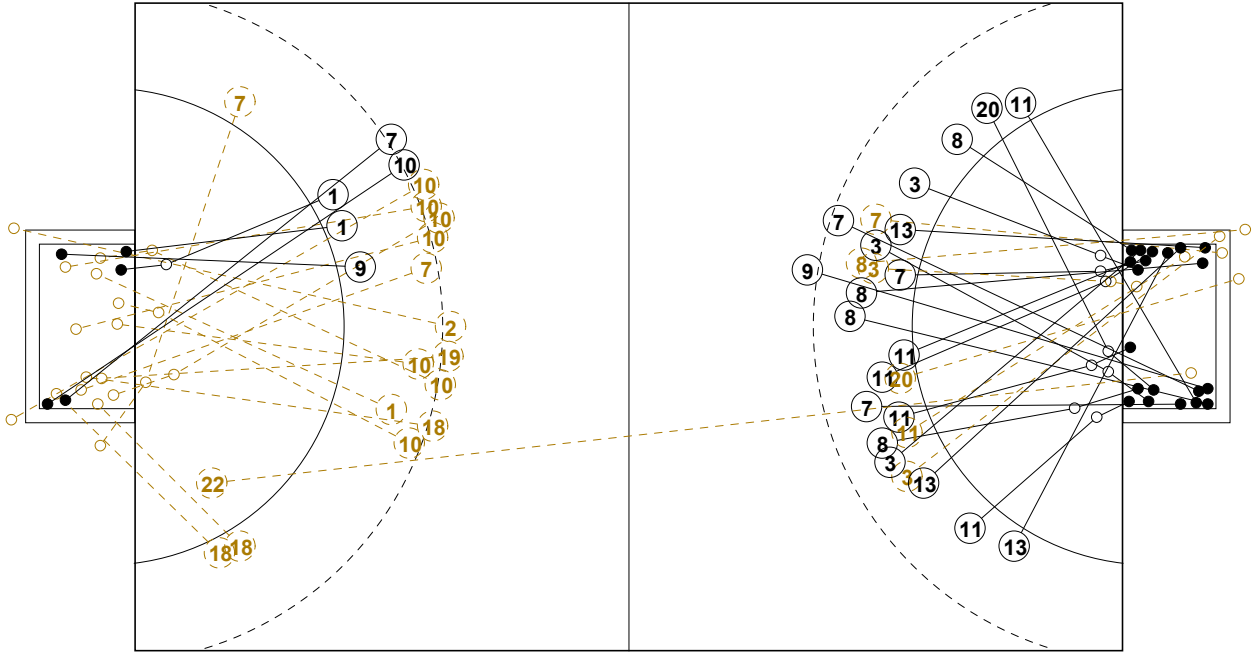

1st Half  
5 : 20

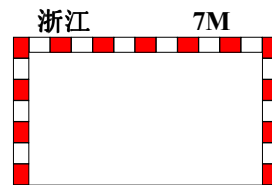
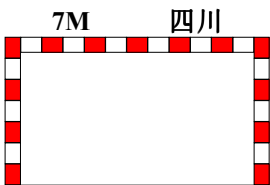
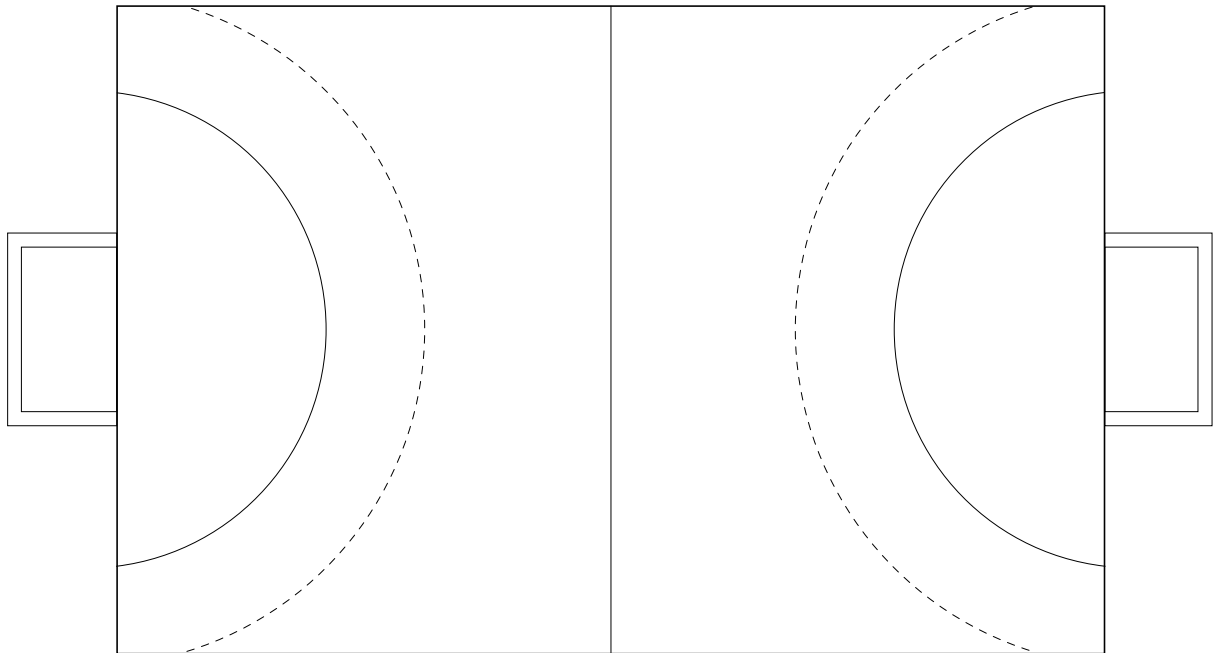

2nd Half  
20 : 5





## 2016年全国男子手球锦标赛

## 个人/全队技术统计表

正式表  
手球  
男子预赛  
轮次 5组别 B  
场次 21201606021-14-1/2  
徐闻县体育中心体育馆  
25/10/2016 13:30

号码	姓名	远射	近射	边射	快攻	突破	任意	7M	合计	%	助攻	失误	警告	2'	取消	时间
<b>四川队(四川)</b>																
<i>(场上队员)</i>																
1	罗尧尧									0.0%						00:00:00
3	刘赵梁		0/2		1/1	2/2			3/5	60.0%	2	2				00:30:00
7	仇瑞祥	1/1	1/1		1/2				3/4	75.0%						00:30:00
8	谢庆龙		1/1		3/4				4/5	80.0%		1				00:15:16
9	许翔宇	1/1							1/1	100%	1	2				00:30:00
10	徐彦昊									0.0%						00:00:00
11	张天豪		3/3	1/1	1/2				5/6	83.3%	1	2				00:30:00
13	尹文珂		1/1	1/1	1/1				3/3	100%	1	1				00:30:00
15	刘劲松									0.0%						00:00:00
16	宋继强									0.0%						00:00:00
18	任启双									0.0%						00:00:00
19	庞连康									0.0%						00:00:00
20	徐逸			1/1	0/1				1/2	50.0%		1				00:14:42
21	马光									0.0%						00:00:00
22	张春梁	0/1							0/1	0.0%	2					00:30:00
<b>合计</b>		2/3	6/8	3/3	7/11	2/2			20/27	74.1%	7	9				
<i>(守门员)</i>																
22	张春梁	9/11	1/4	2/2					12/17	70.6%	2					00:30:00
<b>合计</b>		9/11	1/4	2/2					12/17	70.6%	2					

场上队员：得分/射门

守门员：救球/射门

全队合计	得分	被救	射失	击柱	封球	合计	%
远射	2	1				3	66.7%
近射	6	1		1		8	75.0%
边射	3					3	100.0%
快攻	7	1	2	1		11	63.6%
突破	2					2	100.0%
任意							0.0%
7M							0.0%





## 2016年全国男子手球锦标赛

## 个人/全队技术统计表

正式表  
手球  
男子预赛  
轮次 5组别 B  
场次 21201606021-14-2/2  
徐闻县体育中心体育馆  
25/10/2016 13:30

号码	姓名	远射	近射	边射	快攻	突破	任意	7M	合计	%	助攻	失误	警告	2'	取消	时间
<b>浙江队(浙江)</b>																
<i>(上场队员)</i>																
1	李欢欢		2/3						2/3	66.7%			1			00:20:21
2	郑尧俊	0/1							0/1	0.0%		2				00:21:32
3	李恩铭									0.0%		1				00:07:28
5	林先方									0.0%						00:00:00
7	金杰	1/2		0/1					1/3	33.3%	1	2				00:16:04
8	王浩									0.0%						00:02:35
9	李家乐		1/1						1/1	100%		2				00:14:50
10	罗明杰	1/8							1/8	12.5%	1	3				00:30:00
11	陈渝天									0.0%						00:00:00
14	虞勇灿									0.0%						00:09:38
15	张佩力									0.0%						00:27:25
18	倪陈辉	0/1		0/2					0/3	0.0%		4				00:30:00
19	徐正飞	0/1							0/1	0.0%		3				00:30:00
24	毛军伟									0.0%						00:00:00
<b>合计</b>																
<i>(守门员)</i>																
8	王浩		1/3			0/1			1/4	25.0%						00:02:35
15	张佩力	1/3	0/4	0/3	1/7	0/2			2/19	10.5%						00:27:25
<b>合计</b>																

场上队员：得分/射门

守门员：救球/射门

全队合计	得分	被救	射失	击柱	封球	合计	%
远射	2	9	2			13	15.4%
近射	3	1				4	75.0%
边射		2	1			3	0.0%
快攻							0.0%
突破							0.0%
任意							0.0%
7M							0.0%





2016年全国男子手球锦标赛

图式射门区域统计

轮次 5 场次 21

201606021-41-1/1

四川队

1 罗尧尧	3 刘赵梁	7 仇瑞祥	8 谢庆龙	9 许翔宇	10 徐彦昊	11 张天豪	13 尹文珂																																																																								
<table border="1"><tr><td></td><td></td><td></td></tr><tr><td></td><td></td><td></td></tr><tr><td></td><td></td><td></td></tr></table>										<table border="1"><tr><td></td><td></td><td></td></tr><tr><td></td><td></td><td></td></tr><tr><td>2</td><td></td><td>1</td></tr></table>							2		1	<table border="1"><tr><td></td><td></td><td>1</td></tr><tr><td></td><td></td><td>1</td></tr><tr><td>1</td><td></td><td></td></tr></table>			1			1	1			<table border="1"><tr><td>1</td><td></td><td>1</td></tr><tr><td></td><td></td><td></td></tr><tr><td>1</td><td></td><td>1</td></tr></table>	1		1				1		1	<table border="1"><tr><td></td><td></td><td>1</td></tr><tr><td></td><td></td><td></td></tr><tr><td></td><td></td><td></td></tr></table>			1							<table border="1"><tr><td></td><td></td><td></td></tr><tr><td></td><td></td><td></td></tr><tr><td></td><td></td><td></td></tr></table>										<table border="1"><tr><td></td><td></td><td>1</td></tr><tr><td></td><td></td><td></td></tr><tr><td>2</td><td>1</td><td>1</td></tr></table>			1				2	1	1	<table border="1"><tr><td>1</td><td></td><td></td></tr><tr><td>2</td><td></td><td></td></tr><tr><td></td><td></td><td></td></tr></table>	1			2					
2		1																																																																													
		1																																																																													
		1																																																																													
1																																																																															
1		1																																																																													
1		1																																																																													
		1																																																																													
		1																																																																													
2	1	1																																																																													
1																																																																															
2																																																																															
Post - 0 Miss - 0 Block - 0	Post - 1 Miss - 0 Block - 0	Post - 1 Miss - 0 Block - 0	Post - 0 Miss - 1 Block - 0	Post - 0 Miss - 0 Block - 0	Post - 0 Miss - 0 Block - 0	Post - 0 Miss - 0 Block - 0	Post - 0 Miss - 0 Block - 0																																																																								
15 刘劲松	16 宋继强	18 任启双	19 庞连康	20 徐逸	21 马光	22 张睿梁																																																																									
<table border="1"><tr><td></td><td></td><td></td></tr><tr><td></td><td></td><td></td></tr><tr><td></td><td></td><td></td></tr></table>										<table border="1"><tr><td></td><td></td><td></td></tr><tr><td></td><td></td><td></td></tr><tr><td></td><td></td><td></td></tr></table>										<table border="1"><tr><td></td><td></td><td></td></tr><tr><td></td><td></td><td></td></tr><tr><td></td><td></td><td></td></tr></table>										<table border="1"><tr><td></td><td></td><td></td></tr><tr><td></td><td></td><td></td></tr><tr><td></td><td></td><td></td></tr></table>										<table border="1"><tr><td></td><td></td><td>1</td></tr><tr><td></td><td></td><td></td></tr><tr><td></td><td></td><td></td></tr></table>			1							<table border="1"><tr><td></td><td></td><td></td></tr><tr><td></td><td></td><td></td></tr><tr><td></td><td></td><td></td></tr></table>										<table border="1"><tr><td></td><td></td><td></td></tr><tr><td></td><td></td><td></td></tr><tr><td></td><td></td><td></td></tr></table>										<table border="1"><tr><td></td><td></td><td></td></tr><tr><td></td><td></td><td></td></tr><tr><td></td><td></td><td></td></tr></table>									
		1																																																																													
Post - 0 Miss - 0 Block - 0	Post - 0 Miss - 0 Block - 0	Post - 0 Miss - 0 Block - 0	Post - 0 Miss - 0 Block - 0	Post - 0 Miss - 1 Block - 0	Post - 0 Miss - 0 Block - 0	Post - 0 Miss - 0 Block - 0																																																																									

22 张睿梁

1/3		1/2
4/4	1/1	2/2
1/1	2/2	0/2



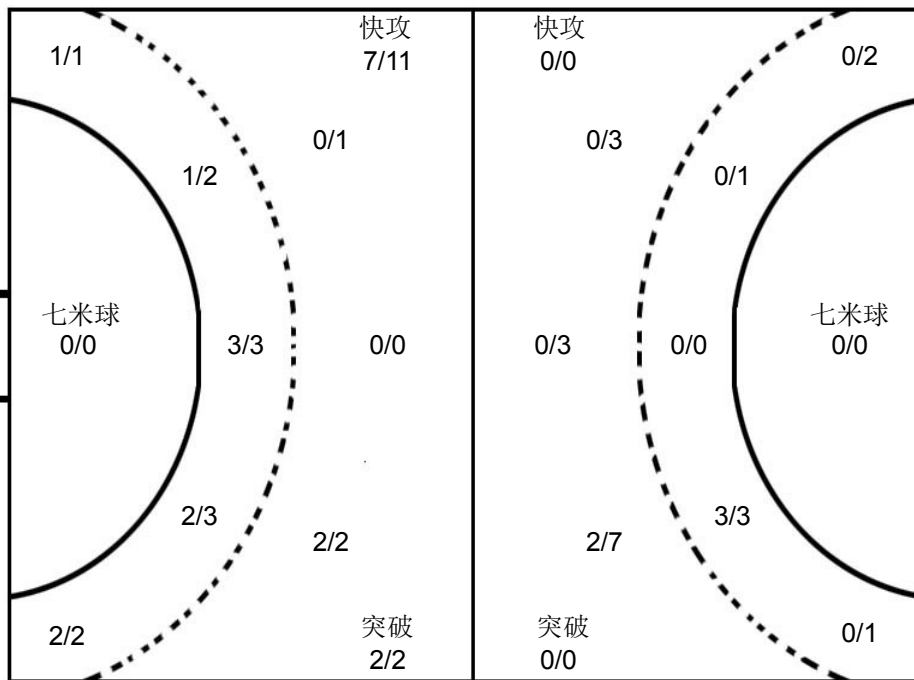

8 王浩

		0/1
1/2	0/1	

15 张佩力

1/3		1/5
0/2		0/1
0/5		0/3

浙江队

1 李欢欢	2 郑尧俊	3 李恩铭	5 林先方	7 金杰	8 王浩	9 李家乐	10 罗明杰																																																																								
<table border="1"><tr><td></td><td></td><td></td></tr><tr><td></td><td></td><td></td></tr><tr><td></td><td></td><td></td></tr></table>										<table border="1"><tr><td></td><td></td><td></td></tr><tr><td></td><td></td><td></td></tr><tr><td></td><td></td><td></td></tr></table>										<table border="1"><tr><td></td><td></td><td></td></tr><tr><td></td><td></td><td></td></tr><tr><td></td><td></td><td></td></tr></table>										<table border="1"><tr><td></td><td></td><td></td></tr><tr><td></td><td></td><td></td></tr><tr><td></td><td></td><td></td></tr></table>										<table border="1"><tr><td>1</td><td></td><td></td></tr><tr><td></td><td></td><td></td></tr><tr><td></td><td></td><td></td></tr></table>	1									<table border="1"><tr><td></td><td></td><td></td></tr><tr><td></td><td></td><td></td></tr><tr><td></td><td></td><td></td></tr></table>										<table border="1"><tr><td></td><td></td><td>1</td></tr><tr><td></td><td></td><td></td></tr><tr><td></td><td></td><td></td></tr></table>			1							<table border="1"><tr><td>1</td><td></td><td></td></tr><tr><td></td><td></td><td></td></tr><tr><td></td><td></td><td></td></tr></table>	1								
1																																																																															
		1																																																																													
1																																																																															
Post - 0 Miss - 0 Block - 0	Post - 0 Miss - 1 Block - 0	Post - 0 Miss - 0 Block - 0	Post - 0 Miss - 0 Block - 0	Post - 0 Miss - 1 Block - 0	Post - 0 Miss - 0 Block - 0	Post - 0 Miss - 0 Block - 0	Post - 0 Miss - 1 Block - 0																																																																								
11 陈渝天	14 虞勇灿	15 张佩力	18 倪陈辉	19 徐正飞	24 毛军伟																																																																										
<table border="1"><tr><td></td><td></td><td></td></tr><tr><td></td><td></td><td></td></tr><tr><td></td><td></td><td></td></tr></table>										<table border="1"><tr><td></td><td></td><td></td></tr><tr><td></td><td></td><td></td></tr><tr><td></td><td></td><td></td></tr></table>										<table border="1"><tr><td></td><td></td><td></td></tr><tr><td></td><td></td><td></td></tr><tr><td></td><td></td><td></td></tr></table>										<table border="1"><tr><td></td><td></td><td></td></tr><tr><td></td><td></td><td></td></tr><tr><td></td><td></td><td></td></tr></table>										<table border="1"><tr><td></td><td></td><td></td></tr><tr><td></td><td></td><td></td></tr><tr><td></td><td></td><td></td></tr></table>										<table border="1"><tr><td></td><td></td><td></td></tr><tr><td></td><td></td><td></td></tr><tr><td></td><td></td><td></td></tr></table>										<table border="1"><tr><td></td><td></td><td></td></tr><tr><td></td><td></td><td></td></tr><tr><td></td><td></td><td></td></tr></table>										<table border="1"><tr><td></td><td></td><td></td></tr><tr><td></td><td></td><td></td></tr><tr><td></td><td></td><td></td></tr></table>									
Post - 0 Miss - 0 Block - 0	Post - 0 Miss - 0 Block - 0	Post - 0 Miss - 0 Block - 0	Post - 0 Miss - 0 Block - 0	Post - 0 Miss - 0 Block - 0	Post - 0 Miss - 0 Block - 0	Post - 0 Miss - 0 Block - 0	Post - 0 Miss - 0 Block - 0																																																																								

注释: Post=击柱 Miss=射失 Block=被封





预赛 Group B

男子 全国比赛

2016年全国男子手球锦标赛

Team A A 天津队				Team B B 上海队				Match Number <b>22</b>													
played in China		in the hall 徐闻县体育中心体育		on 25/10/2016		at 15:10 hours		Spectators													
Half-time (30')	A 7	B 9	End of playing time	A 23	B 22	1st extra time	A	B	2nd extra time	A	B	After penalty throws	A	B							
Number of 7 m	A 3 / 5	Team time-out 1 25:46 2 54:49 3		Full name of players and officials				Team time-out 1 16:29 2 47:58 3 59:07			B 5 / 5	Number of 7 m									
No.	Team A					G	W	2'	D	DR	No.	Team B					G	W	2'	D	DR
1	刘宗其										1	张峥									
2	李岳朋					4					2	张文斌									
4	李松浩										3	赵时俊					1	1			
6	王子欣					2					4	徐俊吉					5				
7	张青					9					8	钱为玮					5	1			
8	曹悦					2					10	董凯									
9	吴明远										11	蒋承骅					2	1	1		
11	王毅										12	周哲韬									
12	杨峻										14	沈吉磊									
13	许松					2					15	朱世杰					2				
16	刘海亮										16	朱春雷									
17	周群					1	1				17	贺政					2				
18	王晓琪										18	马麟晓					4				
21	潘玉帅										33	吴璟					1				
22	魏雨童					3															
A	贾守信										A	吴龙基 (主教练)					1				
B	杜瑞军 (主教练)										B	张勇军									
D	潘玉强										C	金迪琦									
E	贾宁										E	杨时									
A	Signature of Responsible Official of the Teams (Off. A)																			B	
TP	Remarks of Referee / CHA Official																			TP	

Signatures

Referees	王科 (CHN)	倪震 (CHN)		
Techn. Delegates	王洋 (CHN)			
CHA Official	程钰峰 (CHN)			

Note: Number of 7m Throws Awarded to Team A and B, Goals (G), Warnings (W), Suspensions (2'), Direct Disqualification (D), Disqualification with Report (DR) and Team Penalty (TP).

Table Officials: 刘宇阳

鲍瑀

Statisticians: 李双

张程秀子

Printed by PHMS Copyright: IHF / CHA 25/10/2016 16:34:25

Longman Sportsoft



handball@126.com

2016年全国男子手球锦标赛  
竞赛技术统计(媒体表)

预赛	组别	B	轮次	5	场次	22
徐闻县体育中心体育馆			25/10/2016		201606022-51-1/1	
天津队	天津	23	vs	22	上海	上海队
7 : 9						

裁判员	王科 (CHN)					/	倪震 (CHN)				
-----	----------	--	--	--	--	---	----------	--	--	--	--

天津		远射	近射	边射	快攻	突破	任意球	7m球	合计	%	助攻	失误	警告	2'	D & DR	天津	比赛进程	上海
主教练: 杜瑞军																	1st Half	
1	刘宗其										1					2	李岳朋	1 00:37 0
2	李岳朋	3/5	1/2		0/1			4/8	50.0	1	3					1		1 01:17 1 贺政
4	李松浩										2					7	张青	2 04:11 1 17
6	王子欣		1/1		1/1			2/2	100	1						2		2 04:53 2 8 钱为玮
7	张青	3/5	4/4				0/1	2/3	69.2	1	1					2		2 07:08 3 15 朱世杰
8	曹悦	0/1	0/1			1/1		1/2	40.0	1	2					7	张青	3 09:27 3
9	吴明远			0/1	0/1			0/2	0.0							8	曹悦	4 11:20 3
11	王毅															4		4 12:10 4 3 赵时俊
12	杨峻															4		4 14:15 5 4 徐俊吉
13	许松			1/3	1/1			2/4	50.0		1					5	张青	5 15:04 5
16	刘海亮															8	曹悦	6 18:14 5
17	周群		1/1					1/1	100		1	1				7	李岳朋	7 19:28 5
18	王晓琪															7		7 21:01 6 17 贺政
21	潘玉帅															7		7 24:15 7 8 钱为玮
22	魏雨童		1/1			2/2		3/3	100							7		7 28:38 8 4 徐俊吉
																7		7 30:00 9 33 吴璟
																	2nd Half	
运动员 合计		6/11	8/10	1/4	2/4	3/3	0/1	3/5	23/38	60.5	5	10	1			7		7 00:28 10 15 朱世杰
1	刘宗其	3/6	1/5	1/6	1/1	1/3		0/3	7/24	29.2	1					7		7 02:59 11 4 徐俊吉
12	杨峻	0/1	0/1		0/1	1/1		0/2	1/6	16.7						7		7 04:18 12 8 钱为玮
守门员 合计		3/7	1/6	1/6	1/2	2/4		0/5	8/30	26.7	1					7	张青	8 05:25 12
																9	张青	9 07:17 12
																9		9 08:00 13 11 蒋承骅
																22	魏雨童	10 08:19 13
																10		10 09:24 14 4 徐俊吉
																22	魏雨童	11 09:48 14
																11		11 10:41 15 4 徐俊吉
																2	李岳朋	12 13:04 15
																7	张青	13 14:40 15
																13	许松	13 16:04 16 18 马麟晓
																6	王子欣	14 16:43 16
																16	王子欣	15 17:26 16
																22	魏雨童	16 19:03 16
																16		16 19:47 17 8 钱为玮
																7	张青	17 20:14 17
																17		17 20:51 18 18 马麟晓
																7	张青	18 22:29 18
																18		18 23:54 19 8 钱为玮
																18		18 24:45 20 18 马麟晓
																18		18 25:35 21 11 蒋承骅
																6	王子欣	19 25:53 21
																19		19 26:30 22 18 马麟晓
																17	周群	20 26:54 22
																2	李岳朋	21 28:23 22
																13	许松	22 29:00 22
																7	张青	23 30:00 22

场上队员: 得分 / 射门

守门员: 救球 / 射门

快攻	Fast Break		突破	Breakthrough		任意球	Free Throw		7M球	7M Throw		助攻	Assist
警告	Warning		失误	Error		2'	Suspension		D	取消资格		DR	取消资格+报告





### 2016年全国男子手球锦标赛 图式比赛技术统计表

轮次 5

场次 22

201606022-21-1/1

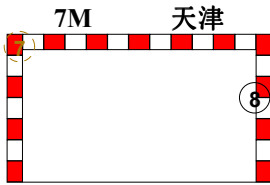
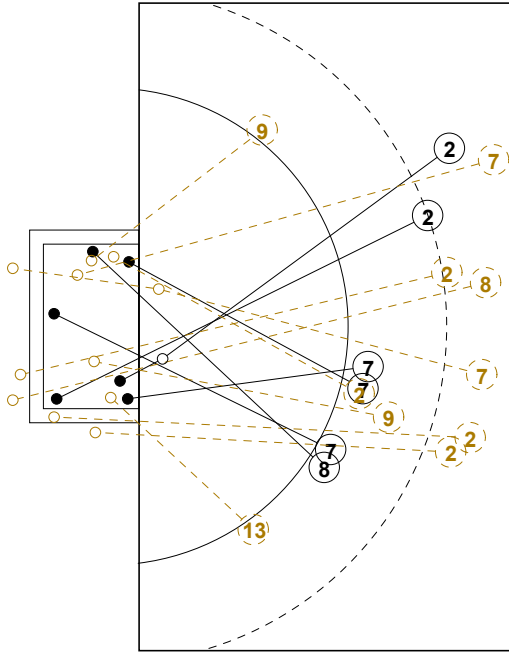

1st Half  
7 : 9

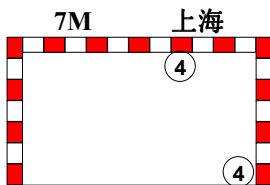
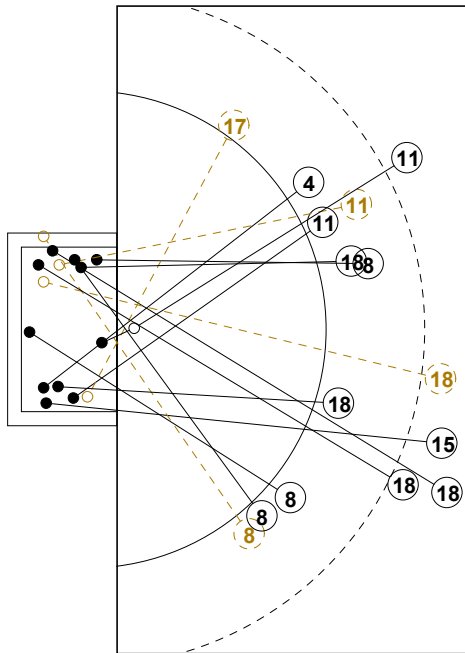
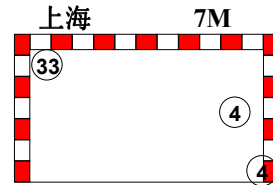
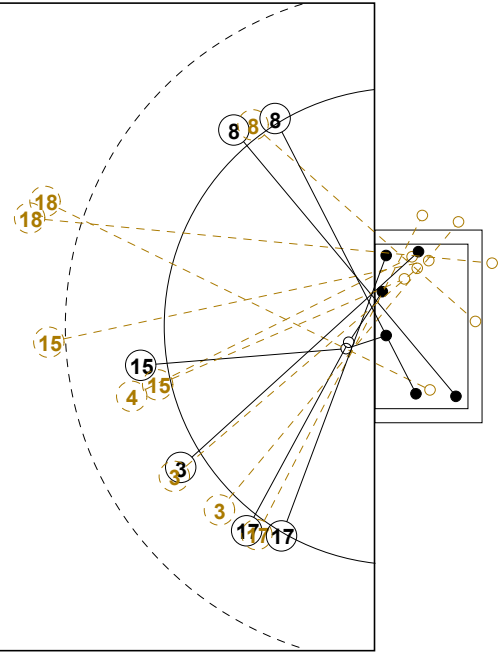

2nd Half  
22 : 23

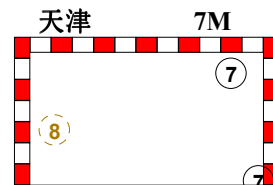
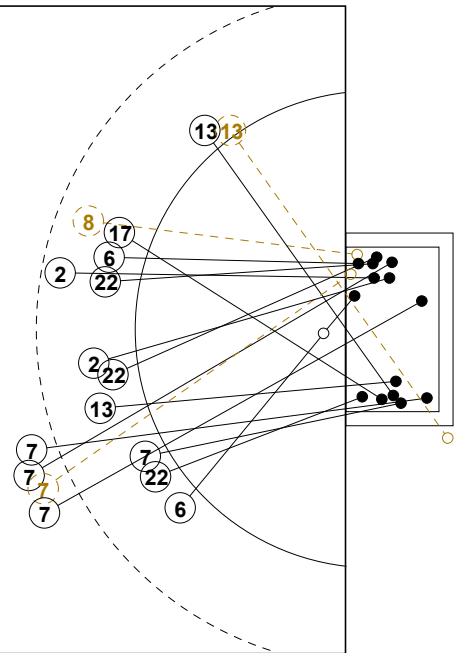



## 2016年全国男子手球锦标赛

## 个人/全队技术统计表

正式表  
手球  
男子预赛  
轮次 5组别 B  
场次 22201606022-14-1/2  
徐闻县体育中心体育馆  
25/10/2016 15:10

号码	姓名	远射	近射	边射	快攻	突破	任意	7M	合计	%	助攻	失误	警告	2'	取消	时间
<b>天津队(天津)</b>																
<i>(场上队员)</i>																
1	刘宗其									0.0%	1					00:46:57
2	李岳朋	3/5	1/2		0/1				4/8	50.0%	1	3				00:56:23
4	李松浩									0.0%		2				00:04:48
6	王子欣		1/1		1/1				2/2	100%	1					00:57:19
7	张青	3/5	4/4				0/1	2/3	9/13	69.2%	1	1				00:47:46
8	曹悦	0/1	0/1			1/1		1/2	2/5	40.0%	1	2				00:58:46
9	吴明远			0/1	0/1				0/2	0.0%						00:02:40
11	王毅									0.0%						00:01:04
12	杨峻									0.0%						00:13:03
13	许松			1/3	1/1				2/4	50.0%		1				01:00:00
16	刘海亮									0.0%						00:00:00
17	周群		1/1						1/1	100%		1	1			00:46:08
18	王晓琪									0.0%						00:00:00
21	潘玉帅									0.0%						00:00:00
22	魏雨童		1/1			2/2			3/3	100%						00:24:49
<b>合计</b>		6/11	8/10	1/4	2/4	3/3	0/1	3/5	23/38	60.5%	5	10	1			
<i>(守门员)</i>																
1	刘宗其	3/6	1/5	1/6	1/1	1/3		0/3	7/24	29.2%	1					00:46:57
12	杨峻	0/1	0/1		0/1	1/1		0/2	1/6	16.7%						00:13:03
<b>合计</b>		3/7	1/6	1/6	1/2	2/4		0/5	8/30	26.7%	1					

场上队员：得分/射门

守门员：救球/射门

全队合计	得分	被救	射失	击柱	封球	合计	%
远射	6	1	3	1		11	54.5%
近射	8	2				10	80.0%
边射	1	2	1			4	25.0%
快攻	2	1	1			4	50.0%
突破	3					3	100.0%
任意		1				1	0.0%
7M	3	1		1		5	60.0%





## 2016年全国男子手球锦标赛

## 个人/全队技术统计表

正式表  
手球  
男子预赛  
轮次 5组别 B  
场次 22201606022-14-2/2  
徐闻县体育中心体育馆  
25/10/2016 15:10

号码	姓名	远射	近射	边射	快攻	突破	任意	7M	合计	%	助攻	失误	警告	2'	取消	时间
<b>上海队(上海)</b>																
<i>(上场队员)</i>																
1	张崢									0.0%						00:04:07
2	张文斌									0.0%						00:00:00
3	赵时俊		0/1			1/2			1/3	33.3%	1	2	1			00:24:55
4	徐俊吉		1/1		0/1			4/4	5/6	83.3%		2				00:59:10
8	钱为玮		1/1	3/5	1/1				5/7	71.4%		1	1			00:59:27
10	董凯									0.0%						00:00:00
11	蒋承骅	1/1	1/1			0/1			2/3	66.7%	3		1	1		00:47:53
12	周哲韬									0.0%						00:55:53
14	沈吉磊									0.0%						00:00:00
15	朱世杰	1/2	1/2						2/4	50.0%		6				00:40:20
16	朱春雷									0.0%						00:00:00
17	贺政			2/4					2/4	50.0%	2	2				01:00:00
18	马麟晓	2/5	1/1			1/1			4/7	57.1%	2	2				01:00:00
33	吴璟							1/1	1/1	100%						00:00:48
<b>合计</b>		4/8	5/7	5/9	1/2	2/4		5/5	22/35	62.9%	8	15	3	1		
<i>(守门员)</i>																
1	张崢	0/1						1/4	1/5	20.0%						00:04:07
12	周哲韬	1/6	2/10	2/3	1/3	0/3	1/1		7/26	26.9%						00:55:53
<b>合计</b>		1/7	2/10	2/3	1/3	0/3	1/1	1/4	8/31	25.8%						

场上队员：得分/射门

守门员：救球/射门

全队合计	得分	被救	射失	击柱	封球	合计	%
远射	4	3	1			8	50.0%
近射	5	1	1			7	71.4%
边射	5	1	1	2		9	55.6%
快攻	1	1				2	50.0%
突破	2	2				4	50.0%
任意							0.0%
7M	5					5	100.0%







### 2016年全国男子手球锦标赛

#### 图式射门区域统计

轮次 5 场次 22

201606022-41-1/1

## 天津队

1 刘宗其	2 李岳朋	4 李松浩	6 王子欣	7 张青	8 曹悦	9 吴明远	11 王毅																																																																								
<table border="1"><tr><td></td><td></td><td></td></tr><tr><td></td><td></td><td></td></tr><tr><td></td><td></td><td></td></tr></table>										<table border="1"><tr><td>1</td><td></td><td></td></tr><tr><td>1</td><td></td><td></td></tr><tr><td>2</td><td></td><td></td></tr></table>	1			1			2			<table border="1"><tr><td></td><td></td><td></td></tr><tr><td></td><td></td><td></td></tr><tr><td></td><td></td><td></td></tr></table>										<table border="1"><tr><td></td><td></td><td></td></tr><tr><td></td><td></td><td></td></tr><tr><td>2</td><td></td><td></td></tr></table>							2			<table border="1"><tr><td></td><td>2</td><td>2</td></tr><tr><td>1</td><td></td><td>1</td></tr><tr><td>1</td><td></td><td>2</td></tr></table>		2	2	1		1	1		2	<table border="1"><tr><td></td><td></td><td>1</td></tr><tr><td></td><td></td><td>1</td></tr><tr><td></td><td></td><td></td></tr></table>			1			1				<table border="1"><tr><td></td><td></td><td></td></tr><tr><td></td><td></td><td></td></tr><tr><td></td><td></td><td></td></tr></table>										<table border="1"><tr><td></td><td></td><td></td></tr><tr><td></td><td></td><td></td></tr><tr><td></td><td></td><td></td></tr></table>									
1																																																																															
1																																																																															
2																																																																															
2																																																																															
	2	2																																																																													
1		1																																																																													
1		2																																																																													
		1																																																																													
		1																																																																													
Post - 0 Miss - 0 Block - 0	Post - 1 Miss - 2 Block - 0	Post - 0 Miss - 0 Block - 0	Post - 0 Miss - 0 Block - 0	Post - 1 Miss - 1 Block - 0	Post - 0 Miss - 1 Block - 0	Post - 0 Miss - 0 Block - 0	Post - 0 Miss - 0 Block - 0																																																																								
12 杨峻	13 许松	16 刘海亮	17 周群	18 王晓琪	21 潘玉帅	22 魏雨童																																																																									
<table border="1"><tr><td></td><td></td><td></td></tr><tr><td></td><td></td><td></td></tr><tr><td></td><td></td><td></td></tr></table>										<table border="1"><tr><td></td><td></td><td>2</td></tr><tr><td></td><td></td><td></td></tr><tr><td></td><td></td><td></td></tr></table>			2							<table border="1"><tr><td></td><td></td><td></td></tr><tr><td></td><td></td><td></td></tr><tr><td></td><td></td><td></td></tr></table>										<table border="1"><tr><td></td><td></td><td>1</td></tr><tr><td></td><td></td><td></td></tr><tr><td></td><td></td><td></td></tr></table>			1							<table border="1"><tr><td></td><td></td><td></td></tr><tr><td></td><td></td><td></td></tr><tr><td></td><td></td><td></td></tr></table>										<table border="1"><tr><td></td><td></td><td></td></tr><tr><td></td><td></td><td></td></tr><tr><td></td><td></td><td></td></tr></table>										<table border="1"><tr><td></td><td>1</td><td></td></tr><tr><td></td><td></td><td></td></tr><tr><td>1</td><td></td><td>1</td></tr></table>		1					1		1	<table border="1"><tr><td></td><td></td><td></td></tr><tr><td></td><td></td><td></td></tr><tr><td></td><td></td><td></td></tr></table>									
		2																																																																													
		1																																																																													
	1																																																																														
1		1																																																																													
Post - 0 Miss - 0 Block - 0	Post - 0 Miss - 1 Block - 0	Post - 0 Miss - 0 Block - 0	Post - 0 Miss - 0 Block - 0	Post - 0 Miss - 0 Block - 0	Post - 0 Miss - 0 Block - 0	Post - 0 Miss - 0 Block - 0																																																																									

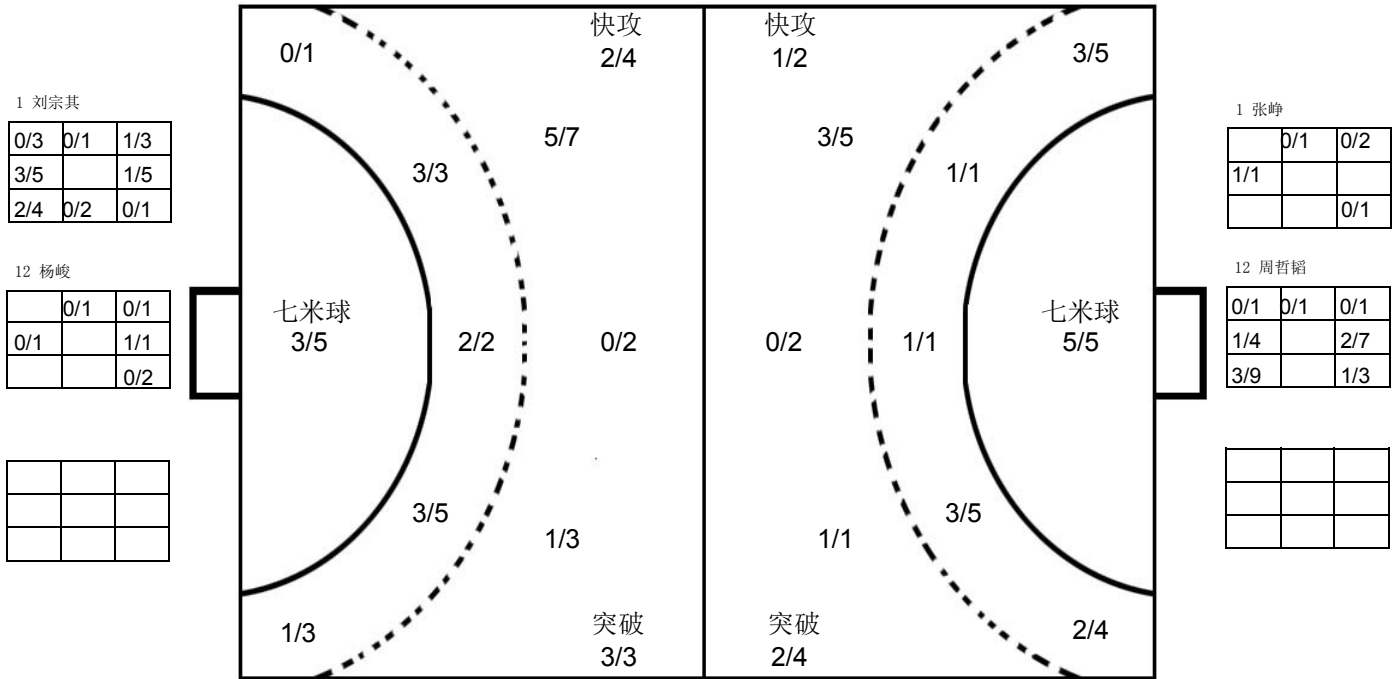

## 上海队

1 张峥	2 张文斌	3 赵时俊	4 徐俊吉	8 钱为玮	10 董凯	11 蒋承骅	12 周哲韬																																																																								
<table border="1"><tr><td></td><td></td><td></td></tr><tr><td></td><td></td><td></td></tr><tr><td></td><td></td><td></td></tr></table>										<table border="1"><tr><td></td><td></td><td></td></tr><tr><td></td><td></td><td></td></tr><tr><td></td><td></td><td></td></tr></table>										<table border="1"><tr><td></td><td></td><td></td></tr><tr><td>1</td><td></td><td></td></tr><tr><td></td><td></td><td></td></tr></table>				1						<table border="1"><tr><td>1</td><td>1</td><td></td></tr><tr><td></td><td></td><td>1</td></tr><tr><td></td><td></td><td>2</td></tr></table>	1	1				1			2	<table border="1"><tr><td></td><td>1</td><td>1</td></tr><tr><td></td><td></td><td>2</td></tr><tr><td></td><td></td><td>1</td></tr></table>		1	1			2			1	<table border="1"><tr><td></td><td></td><td></td></tr><tr><td></td><td></td><td></td></tr><tr><td></td><td></td><td></td></tr></table>										<table border="1"><tr><td></td><td></td><td></td></tr><tr><td>1</td><td></td><td></td></tr><tr><td></td><td></td><td></td></tr></table>				1						<table border="1"><tr><td></td><td></td><td></td></tr><tr><td></td><td></td><td></td></tr><tr><td></td><td></td><td></td></tr></table>									
1																																																																															
1	1																																																																														
		1																																																																													
		2																																																																													
	1	1																																																																													
		2																																																																													
		1																																																																													
1																																																																															
Post - 0 Miss - 0 Block - 0	Post - 0 Miss - 0 Block - 0	Post - 0 Miss - 1 Block - 0	Post - 0 Miss - 0 Block - 0	Post - 2 Miss - 0 Block - 0	Post - 0 Miss - 0 Block - 0	Post - 0 Miss - 0 Block - 0	Post - 0 Miss - 0 Block - 0																																																																								
14 沈吉磊	15 朱世杰	16 朱春雷	17 贺政	18 马麟晓	33 吴璟																																																																										
<table border="1"><tr><td></td><td></td><td></td></tr><tr><td></td><td></td><td></td></tr><tr><td></td><td></td><td></td></tr></table>										<table border="1"><tr><td></td><td>1</td><td></td></tr><tr><td></td><td></td><td></td></tr><tr><td></td><td>1</td><td></td></tr></table>		1						1		<table border="1"><tr><td></td><td></td><td></td></tr><tr><td></td><td></td><td></td></tr><tr><td></td><td></td><td></td></tr></table>										<table border="1"><tr><td></td><td></td><td></td></tr><tr><td></td><td></td><td></td></tr><tr><td>2</td><td></td><td></td></tr></table>							2			<table border="1"><tr><td></td><td></td><td>2</td></tr><tr><td>1</td><td></td><td>1</td></tr><tr><td></td><td></td><td></td></tr></table>			2	1		1				<table border="1"><tr><td></td><td>1</td><td></td></tr><tr><td></td><td></td><td></td></tr><tr><td></td><td></td><td></td></tr></table>		1								<table border="1"><tr><td></td><td></td><td></td></tr><tr><td></td><td></td><td></td></tr><tr><td></td><td></td><td></td></tr></table>										<table border="1"><tr><td></td><td></td><td></td></tr><tr><td></td><td></td><td></td></tr><tr><td></td><td></td><td></td></tr></table>									
	1																																																																														
	1																																																																														
2																																																																															
		2																																																																													
1		1																																																																													
	1																																																																														
Post - 0 Miss - 0 Block - 0	Post - 0 Miss - 0 Block - 0	Post - 0 Miss - 0 Block - 0	Post - 0 Miss - 1 Block - 0	Post - 0 Miss - 1 Block - 0	Post - 0 Miss - 0 Block - 0																																																																										

注释: Post=击柱 Miss=射失 Block=被封





预赛 Group B

男子 全国比赛

2016年全国男子手球锦标赛

Team A A 山东队				Team B B 广东队				Match Number <b>23</b>													
played in China		in the hall 徐闻县体育中心体育		on 25/10/2016		at 16:50 hours		Spectators													
Half-time (30')	A 18	B 11	End of playing time	A 29	B 14	1st extra time	A	B	2nd extra time	A	B	After penalty throws	A	B							
Number of 7 m	A 1 / 1	Team time-out 1 2 3 40:53			Full name of players and officials				Team time-out 1 2 3 21:34			B 3 / 3	Number of 7 m								
No.	Team A					G	W	2'	D	DR	No.	Team B					G	W	2'	D	DR
3	尹杰										1	王泽润									
4	田瑞					2					2	孙江山					2				
5	潘翔					2	1				3	曲汝洋					3				
6	李朝鹏										4	李卓洋					2				
9	赵鑫					1					5	侯生升					1				
10	赵建强										7	付云博					1				
11	宋朋强					2					8	于彦江									
12	崔剑										10	周仲坤									
13	刘晓					6					11	房友屯									
15	张继伟					2		1			13	王立隆									
16	于性哲										15	张建杰									
17	王旭东					1					16	马跃									
19	李语庆					7	1				17	李中洲					3				
21	翟乾坤					3					20	黄培杰									
27	于亚男					3	1				84	王伟					2	1			
A	markovic尼克										B	王锋 (主教练)									
B	王鸿斌 (主教练)										C	刘康伶									
C	刘桂妮										D	张广建									
D	邢建刚										E	王永存									
A	Signature of Responsible Official of the Teams (Off. A)																		B		
TP	Remarks of Referee / CHA Official																		TP		

Signatures

Referees: 李兆蒙 (CHN) 马晓晔 (CHN)

Techn. Delegates: 许宜扬 (CHN)

CHA Official: 刘凤娟 (CHN)

Note: Number of 7m Throws Awarded to Team A and B, Goals (G), Warnings (W), Suspensions (2'), Direct Disqualification (D), Disqualification with Report (DR) and Team Penalty (TP).

Table Officials: 刘宇阳 鲍瑛 Statisticians: 张程秀子 李双

Printed by PHMS Copyright: IHF / CHA 25/10/2016 17:53:43

Longman Sportsoft handball@126.com





## 2016年全国男子手球锦标赛 竞赛技术统计(媒体表)

预赛	组别	B	轮次	5	场次	23
----	----	---	----	---	----	----

徐闻县体育中心体育馆

25/10/2016

201606023-51-1/1

山东队	山东	29	vs	14	广东	广东队
18 : 11						

裁判员	李兆蒙 (CHN)	/	马晓晔 (CHN)
-----	-----------	---	-----------

山东		远射	近射	边射	快攻	突破	任意球	7m球	合计	%	助攻	失误	警告	2'	D & DR	比赛进程	
主教练：王鸿斌																山东	广东
3	尹杰															13	刘晓
4	田瑞			2/2				2/2	100							1	00:30
5	潘翔		2/2					2/2	100				1			1	01:03
6	李朝鹏										2					84	王伟
9	赵鑫	0/1	1/1					1/2	50.0		2	1				13	刘晓
10	赵建强										1					3	03:14
11	宋朋强	2/3					0/1	2/4	50.0		2	1				19	李语庆
12	崔剑											1				21	翟乾坤
13	刘晓	2/4	3/3			1/1		6/8	75.0							4	05:25
15	张继伟		1/1		1/1			2/2	100					1		4	06:45
16	于性哲															17	李中洲
17	王旭东	1/1						1/1	100		1	1				11	宋朋强
19	李语庆			3/4	2/2	1/1	1/1	7/8	87.5			1	1			5	08:05
21	翟乾坤	1/1			2/2			3/3	100							6	08:44
27	于亚男		2/2		1/1			3/3	100		2	2	1			6	09:42
<b>运动员 合计</b>		6/10	9/9	5/6	6/6	2/2	0/1	1/1	29/35	82.9	10	7	3	1		7	10:38
12	崔剑	2/3	3/5	4/5	0/2	0/4		0/1	9/20	45.0			1			13	刘晓
16	于性哲		0/1					0/2	0/3	0.0						12	翟乾坤
<b>守门员 合计</b>		2/3	3/6	4/5	0/2	0/4		0/3	9/23	39.1		1				12	翟乾坤
广东		远射	近射	边射	快攻	突破	任意球	7m球	合计	%	助攻	失误	警告	2'	D & DR		
教练：王锋																	
1	王泽润																
2	孙江山	0/1						2/2	2/3	66.7							
3	曲汝洋			0/1		3/3		3/4	75.0			1					
4	李卓洋	0/1	1/2	0/1		1/1		2/5	40.0								
5	侯生升		1/2	0/2				1/4	25.0								
7	付文博				1/1			1/1	100			3					
8	于彦江																
10	周仲坤												2				
11	房友屯																
13	王立隆																
15	张建杰	0/1	0/1					0/2	0.0			2					
16	马跃	0/1						0/1	0.0			1					
17	李中洲	1/5	0/1		1/1		1/1	3/8	37.5		2	1					
20	黄培杰																
84	王伟		1/1	1/1				2/2	100			1	1				
<b>运动员 合计</b>		1/9	3/7	1/5	2/2	4/4		3/3	14/30	46.7	2	11	1				
1	王泽润		0/3	0/1	0/2			0/1	0/7	0.0							
16	马跃	2/8	0/6	0/4	0/4	0/2		2/24	8.3			1					
<b>守门员 合计</b>		2/8	0/9	0/5	0/6	0/2		0/1	2/31	6.5		1					

场上队员：得分 / 射门

守门员：救球 / 射门

快攻	Fast Break	突破	Breakthrough	任意球	Free Throw	7M球	7M Throw	助攻	Assist
警告	Warning	失误	Error	2'	Suspension	D	取消资格	DR	取消资格+报告





### 2016年全国男子手球锦标赛 图式比赛技术统计表

轮次 5

场次 23

201606023-21-1/1

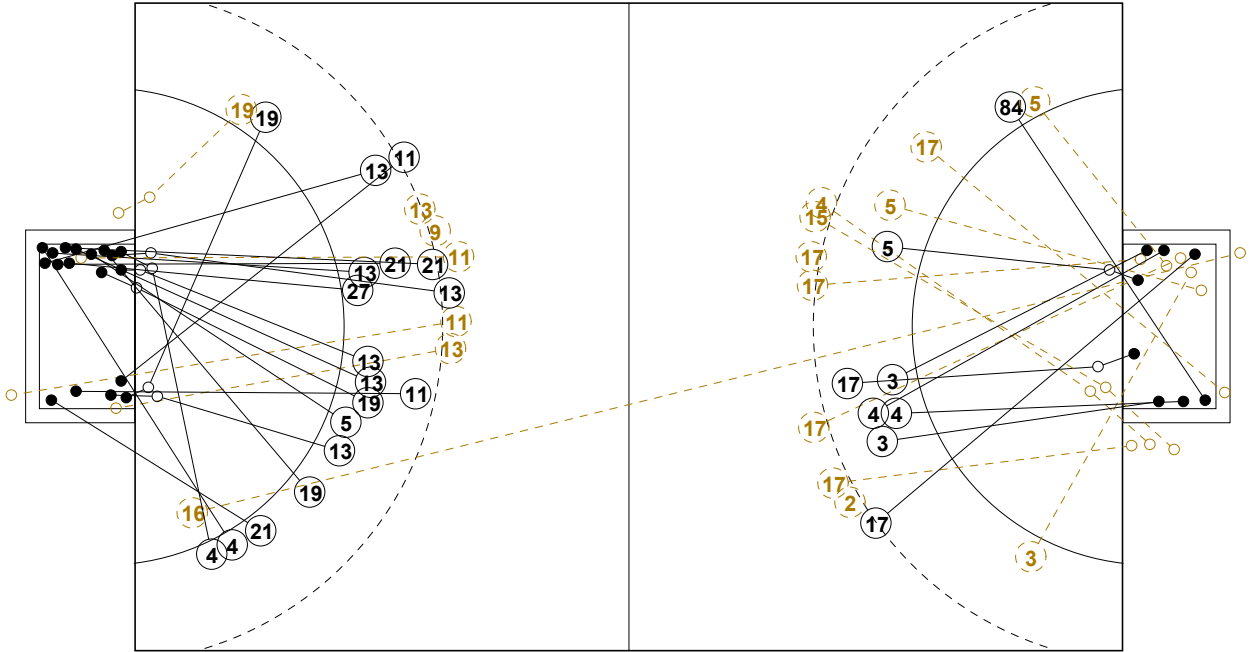

7M 山东

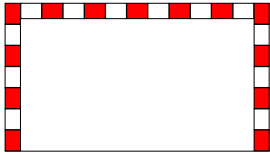

广东 7M

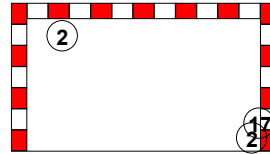

1st Half  
18 : 11

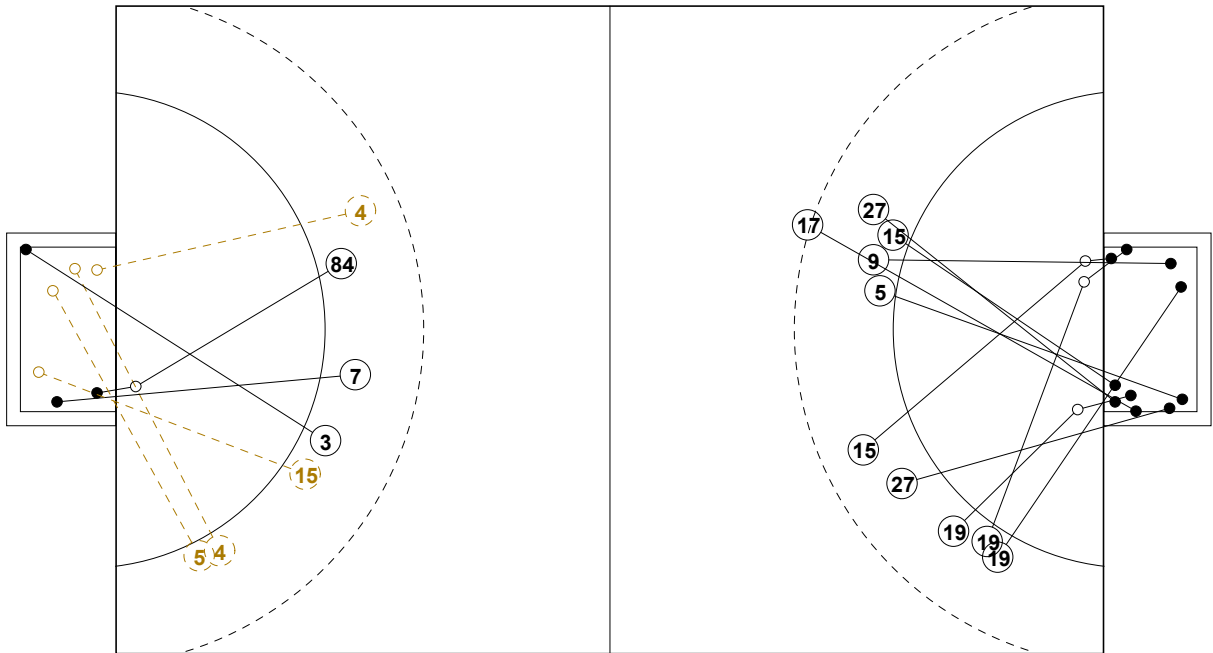

7M 广东

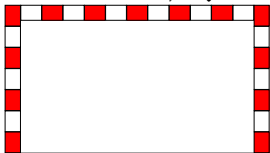

山东 7M

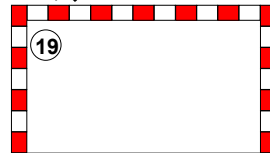

2nd Half  
14 : 29



## 2016年全国男子手球锦标赛

## 个人/全队技术统计表

正式表  
手球  
男子预赛  
轮次 5组别 B  
场次 23201606023-14-1/2  
徐闻县体育中心体育馆  
25/10/2016 16:50

号码	姓名	远射	近射	边射	快攻	突破	任意	7M	合计	%	助攻	失误	警告	2'	取消	时间
<b>山东队(山东)</b>																
<i>(场上队员)</i>																
3	尹杰									0.0%						00:01:44
4	田瑞			2/2					2/2	100%						00:19:04
5	潘翔		2/2						2/2	100%			1			00:24:31
6	李朝鹏									0.0%	2					00:23:56
9	赵鑫	0/1	1/1						1/2	50.0%	2	1				00:19:43
10	赵建强									0.0%	1					00:03:04
11	宋朋强	2/3					0/1		2/4	50.0%	2	1				00:13:51
12	崔剑									0.0%		1				00:39:32
13	刘晓	2/4	3/3			1/1			6/8	75.0%						00:19:25
15	张继伟		1/1		1/1				2/2	100%				1		00:18:04
16	于性哲									0.0%						00:03:37
17	王旭东	1/1							1/1	100%	1	1				00:23:44
19	李语庆			3/4	2/2	1/1		1/1	7/8	87.5%		1	1			00:38:15
21	翟乾坤	1/1			2/2				3/3	100%						00:24:04
27	于亚男		2/2		1/1				3/3	100%	2	2	1			00:28:44
<b>合计</b>		6/10	9/9	5/6	6/6	2/2	0/1	1/1	29/35	82.9%	10	7	3	1		
<i>(守门员)</i>																
12	崔剑	2/3	3/5	4/5	0/2	0/4		0/1	9/20	45.0%		1				00:39:32
16	于性哲		0/1					0/2	0/3	0.0%						00:03:37
<b>合计</b>		2/3	3/6	4/5	0/2	0/4		0/3	9/23	39.1%		1				

场上队员：得分/射门

守门员：救球/射门

全队合计	得分	被救	射失	击柱	封球	合计	%
远射	6	2			2	10	60.0%
近射	9					9	100.0%
边射	5		1			6	83.3%
快攻	6					6	100.0%
突破	2					2	100.0%
任意			1			1	0.0%
7M	1					1	100.0%





## 2016年全国男子手球锦标赛

## 个人/全队技术统计表

正式表  
手球  
男子预赛  
轮次 5组别 B  
场次 23201606023-14-2/2  
徐闻县体育中心体育馆  
25/10/2016 16:50

号码	姓名	远射	近射	边射	快攻	突破	任意	7M	合计	%	助攻	失误	警告	2'	取消	时间
<b>广东队(广东)</b>																
<i>(上场队员)</i>																
1	王泽润									0.0%						00:07:27
2	孙江山	0/1						2/2	2/3	66.7%						00:36:24
3	曲汝洋			0/1		3/3			3/4	75.0%		1				00:23:51
4	李卓洋	0/1	1/2	0/1		1/1			2/5	40.0%						00:29:54
5	侯生升		1/2	0/2					1/4	25.0%						00:28:48
7	付云博					1/1			1/1	100%		3				00:36:05
8	于彦江									0.0%						00:00:00
10	周仲坤									0.0%		2				00:14:17
11	房友屯									0.0%						00:00:00
13	王立隆									0.0%						00:03:27
15	张建杰	0/1	0/1						0/2	0.0%		2				00:10:40
16	马跃	0/1							0/1	0.0%		1				00:35:42
17	李中洲	1/5	0/1		1/1			1/1	3/8	37.5%	2	1				00:35:31
20	黄培杰									0.0%						00:01:38
84	王伟		1/1	1/1					2/2	100%		1	1			00:37:11
<b>合计</b>		1/9	3/7	1/5	2/2	4/4		3/3	14/30	46.7%	2	11	1			
<i>(守门员)</i>																
1	王泽润		0/3	0/1	0/2			0/1	0/7	0.0%						00:07:27
16	马跃	2/8	0/6	0/4	0/4	0/2			2/24	8.3%		1				00:35:42
<b>合计</b>		2/8	0/9	0/5	0/6	0/2		0/1	2/31	6.5%		1				

场上队员：得分/射门

守门员：救球/射门

全队合计	得分	被救	射失	击柱	封球	合计	%
远射	1	2	4		2	9	11.1%
近射	3	3		1		7	42.9%
边射	1	4				5	20.0%
快攻	2					2	100.0%
突破	4					4	100.0%
任意							0.0%
7M	3					3	100.0%





### 2016年全国男子手球锦标赛

#### 图式射门区域统计

轮次 5 场次 23

201606023-41-1/1

## 山东队

3 尹杰	4 田瑞	5 潘翔	6 李朝鹏	9 赵鑫	10 赵建强	11 宋朋强	12 崔剑																																																																								
<table border="1"><tr><td></td><td></td><td></td></tr><tr><td></td><td></td><td></td></tr><tr><td></td><td></td><td></td></tr></table>										<table border="1"><tr><td></td><td></td><td>1</td></tr><tr><td></td><td></td><td></td></tr><tr><td></td><td></td><td>1</td></tr></table>			1						1	<table border="1"><tr><td></td><td></td><td>1</td></tr><tr><td></td><td></td><td></td></tr><tr><td></td><td></td><td>1</td></tr></table>			1						1	<table border="1"><tr><td></td><td></td><td></td></tr><tr><td></td><td></td><td></td></tr><tr><td></td><td></td><td></td></tr></table>										<table border="1"><tr><td>1</td><td></td><td></td></tr><tr><td></td><td></td><td></td></tr><tr><td></td><td></td><td></td></tr></table>	1									<table border="1"><tr><td></td><td></td><td></td></tr><tr><td></td><td></td><td></td></tr><tr><td></td><td></td><td></td></tr></table>										<table border="1"><tr><td></td><td></td><td></td></tr><tr><td>1</td><td></td><td></td></tr><tr><td></td><td></td><td></td></tr></table>				1						<table border="1"><tr><td></td><td></td><td></td></tr><tr><td></td><td></td><td></td></tr><tr><td></td><td></td><td></td></tr></table>									
		1																																																																													
		1																																																																													
		1																																																																													
		1																																																																													
1																																																																															
1																																																																															
Post - 0 Miss - 0 Block - 0	Post - 0 Miss - 0 Block - 0	Post - 0 Miss - 0 Block - 0	Post - 0 Miss - 0 Block - 0	Post - 0 Miss - 0 Block - 1	Post - 0 Miss - 0 Block - 0	Post - 0 Miss - 1 Block - 0	Post - 0 Miss - 0 Block - 0																																																																								
13 刘晓	15 张继伟	16 于性哲	17 王旭东	19 李语庆	21 翟乾坤	27 于亚男																																																																									
<table border="1"><tr><td></td><td></td><td>2</td></tr><tr><td></td><td></td><td>1</td></tr><tr><td>1</td><td></td><td>2</td></tr></table>			2			1	1		2	<table border="1"><tr><td></td><td></td><td></td></tr><tr><td></td><td></td><td></td></tr><tr><td></td><td></td><td></td></tr></table>										<table border="1"><tr><td></td><td></td><td></td></tr><tr><td></td><td></td><td></td></tr><tr><td></td><td></td><td></td></tr></table>										<table border="1"><tr><td></td><td></td><td>1</td></tr><tr><td></td><td></td><td></td></tr><tr><td></td><td></td><td></td></tr></table>			1							<table border="1"><tr><td>2</td><td></td><td></td></tr><tr><td></td><td></td><td>1</td></tr><tr><td>2</td><td></td><td>2</td></tr></table>	2					1	2		2	<table border="1"><tr><td>1</td><td></td><td>2</td></tr><tr><td></td><td></td><td></td></tr><tr><td></td><td></td><td></td></tr></table>	1		2							<table border="1"><tr><td></td><td></td><td>2</td></tr><tr><td></td><td></td><td></td></tr><tr><td></td><td></td><td>1</td></tr></table>			2						1	<table border="1"><tr><td></td><td></td><td></td></tr><tr><td></td><td></td><td></td></tr><tr><td></td><td></td><td></td></tr></table>									
		2																																																																													
		1																																																																													
1		2																																																																													
		1																																																																													
2																																																																															
		1																																																																													
2		2																																																																													
1		2																																																																													
		2																																																																													
		1																																																																													
Post - 0 Miss - 0 Block - 1	Post - 0 Miss - 0 Block - 0	Post - 0 Miss - 0 Block - 0	Post - 0 Miss - 0 Block - 0	Post - 0 Miss - 1 Block - 0	Post - 0 Miss - 0 Block - 0	Post - 0 Miss - 0 Block - 0																																																																									

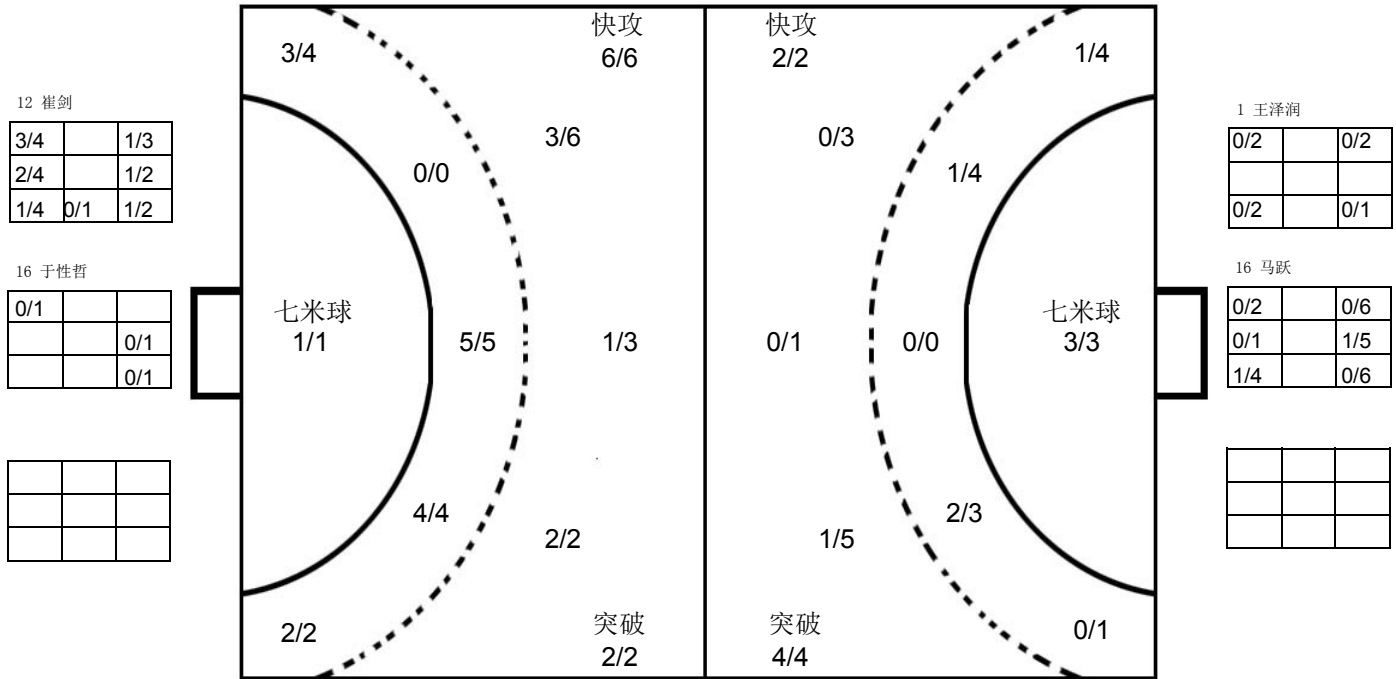

## 广东队

1 王泽润	2 孙江山	3 曲汝洋	4 李卓洋	5 侯生升	7 付云博	8 于彦江	10 周仲坤																																																																								
<table border="1"><tr><td></td><td></td><td></td></tr><tr><td></td><td></td><td></td></tr><tr><td></td><td></td><td></td></tr></table>										<table border="1"><tr><td>1</td><td></td><td></td></tr><tr><td></td><td></td><td></td></tr><tr><td></td><td></td><td>1</td></tr></table>	1								1	<table border="1"><tr><td></td><td></td><td>1</td></tr><tr><td></td><td></td><td></td></tr><tr><td>1</td><td></td><td></td></tr></table>			1				1			<table border="1"><tr><td></td><td></td><td></td></tr><tr><td>1</td><td></td><td>1</td></tr><tr><td></td><td></td><td></td></tr></table>				1		1				<table border="1"><tr><td></td><td></td><td></td></tr><tr><td></td><td></td><td></td></tr><tr><td>1</td><td></td><td></td></tr></table>							1			<table border="1"><tr><td></td><td></td><td></td></tr><tr><td>1</td><td></td><td></td></tr><tr><td></td><td></td><td></td></tr></table>				1						<table border="1"><tr><td></td><td></td><td></td></tr><tr><td></td><td></td><td></td></tr><tr><td></td><td></td><td></td></tr></table>										<table border="1"><tr><td></td><td></td><td></td></tr><tr><td></td><td></td><td></td></tr><tr><td></td><td></td><td></td></tr></table>									
1																																																																															
		1																																																																													
		1																																																																													
1																																																																															
1		1																																																																													
1																																																																															
1																																																																															
Post - 0 Miss - 0 Block - 0	Post - 0 Miss - 0 Block - 1	Post - 0 Miss - 0 Block - 0	Post - 0 Miss - 1 Block - 0	Post - 0 Miss - 0 Block - 0	Post - 0 Miss - 0 Block - 0	Post - 0 Miss - 0 Block - 0	Post - 0 Miss - 0 Block - 0																																																																								
11 房友屯	13 王立隆	15 张建杰	16 马跃	17 李中洲	20 黄培杰	84 王伟																																																																									
<table border="1"><tr><td></td><td></td><td></td></tr><tr><td></td><td></td><td></td></tr><tr><td></td><td></td><td></td></tr></table>										<table border="1"><tr><td></td><td></td><td></td></tr><tr><td></td><td></td><td></td></tr><tr><td></td><td></td><td></td></tr></table>										<table border="1"><tr><td></td><td></td><td></td></tr><tr><td></td><td></td><td></td></tr><tr><td></td><td></td><td></td></tr></table>										<table border="1"><tr><td></td><td></td><td></td></tr><tr><td></td><td></td><td></td></tr><tr><td></td><td></td><td></td></tr></table>										<table border="1"><tr><td>1</td><td></td><td></td></tr><tr><td></td><td></td><td></td></tr><tr><td></td><td>1</td><td>1</td></tr></table>	1							1	1	<table border="1"><tr><td></td><td></td><td></td></tr><tr><td></td><td></td><td></td></tr><tr><td></td><td></td><td></td></tr></table>										<table border="1"><tr><td></td><td></td><td>1</td></tr><tr><td></td><td></td><td></td></tr><tr><td>1</td><td></td><td></td></tr></table>			1				1			<table border="1"><tr><td></td><td></td><td></td></tr><tr><td></td><td></td><td></td></tr><tr><td></td><td></td><td></td></tr></table>									
1																																																																															
	1	1																																																																													
		1																																																																													
1																																																																															
Post - 0 Miss - 0 Block - 0	Post - 0 Miss - 0 Block - 0	Post - 0 Miss - 1 Block - 0	Post - 0 Miss - 1 Block - 0	Post - 1 Miss - 1 Block - 1	Post - 0 Miss - 0 Block - 0	Post - 0 Miss - 0 Block - 0																																																																									

注释: Post=击柱 Miss=射失 Block=被封





预赛 Group A

男子 全国比赛

2016年全国男子手球锦标赛

Team A <b>A 解放军队</b>				Team B <b>B 安徽队</b>				Match Number <b>24</b>													
played in China		in the hall 徐闻县体育中心体育		on 25/10/2016		at 19:00 hours		Spectators													
Half-time (30')	<b>A</b> 11	<b>B</b> 12	End of playing time	<b>A</b> 25	<b>B</b> 24	1st extra time	<b>A</b>	<b>B</b>	2nd extra time	<b>A</b>	<b>B</b>	After penalty throws	<b>A</b>	<b>B</b>							
Number of 7 m	<b>A</b> 4 / 5	Team time-out 1 04:27 2 54:32 3 59:27			Full name of players and officials				Team time-out 1 26:08 2 40:46 3 56:41			<b>B</b> 0 / 0	Number of 7 m								
No.	Team <b>A</b>					G	W	2'	D	DR	No.	Team <b>B</b>					G	W	2'	D	DR
1	李梓宁										1	郭世伟					2				
2	范保坤										2	金永峰									
4	曹作亮					6					3	陈强龙									
5	张昌轲										5	史小帆					4				
6	吴昊										7	姚雄敏					2				
7	姜钦					2	1				8	董智景					2				
8	王烁					9					9	陈开勇					3	1			
9	毕晓晨					1					10	严龙									
11	肖东洋										11	黎涛					1				
12	姜明										12	曾献辰									
14	孙耀琦					1	1	1			17	王巨柱					6		1		
15	杨帆										18	李双					2		1		
16	丛霖										19	何山									
18	王晓龙					6					21	李明					1				
20	刘智洋										22	王金宇									
											23	于敏清					1	1	1		
<b>B</b>	张敬敏 (主教练)										<b>A</b>	韦中平									
<b>C</b>	王学力										<b>B</b>	沈强 (主教练)									
<b>D</b>	刘捷										<b>C</b>	吴翔									
<b>E</b>	刘军										<b>D</b>	陈玉翔									
<b>A</b>	Signature of Responsible Official of the Teams (Off. A)																			<b>B</b>	
TP	Remarks of Referee / CHA Official																			TP	

Signatures

Referees	徐健 (CHN)	曹宏俊 (CHN)		
Techn. Delegates	倪震 (CHN)			
CHA Official	王科 (CHN)			

Note: Number of 7m Throws Awarded to Team A and B, Goals (G), Warnings (W), Suspensions (2'), Direct Disqualification (D), Disqualification with Report (DR) and Team Penalty (TP).

Table Officials: 梁小熹

伍豪

Statisticians: 周亚桥

李双

Printed by PHMS Copyright: IHF / CHA 25/10/2016 20:33:27

Longman Sportsoft



handball@126.com





## 2016年全国男子手球锦标赛 竞赛技术统计(媒体表)

预赛	组别	A	轮次	5	场次	24
----	----	---	----	---	----	----

徐闻县体育中心体育馆

25/10/2016

201606024-51-1/1

解放军队	<b>解放军</b>	<b>25</b>	vs	<b>24</b>	安徽	安徽队
<b>11 : 12</b>						

裁判员	徐健 (CHN)	/	曹宏俊 (CHN)
-----	----------	---	-----------

解放军		远	近	边	快	突	任意	7m	合计	%	助攻	失误	警告	2'	D & DR	解放军		比赛进程		安徽		
主教练：张敬敏		射	射	射	攻	破	球	球														
1	李祥宁															0	00:59	1	11	黎涛		
2	范保坤															0	01:42	2	7	姚雄敏		
4	曹作亮	3/8	2/3		1/1				6/12	50.0		1				0	03:26	3	18	李双		
5	张昌珂															0	04:17	4	7	姚雄敏		
6	吴昊	0/1	0/1					0/2	0.0		1					8	王烁	1	05:30	4		
7	姜钦	1/1	0/1		1/1			2/3	66.7				1			18	王晓龙	2	07:55	4		
8	王烁	2/5	1/1		2/2			4/4	9/12	75.0		6				8	王烁	3	08:32	4		
9	毕晓晨	1/1	0/2	0/1				1/4	25.0		1					18	王晓龙	4	09:56	4		
11	肖东洋															4	曹作亮	5	11:51	4		
12	姜明															8	王烁	6	14:26	4		
14	孙耀琦		1/3													6	王烁	6	14:59	5	9	陈开勇
15	杨帆															6	王烁	6	16:04	6	5	史小帆
16	丛霖															6	王烁	6	16:51	7	17	王巨柱
18	王晓龙	0/4	2/6	1/2		3/3		0/1	6/16	37.5		2				18	王晓龙	7	18:08	7		
20	刘智洋															7	王烁	7	18:46	8	17	王巨柱
<b>运动员 合计</b>		<b>7/20</b>	<b>6/17</b>	<b>1/3</b>	<b>4/4</b>	<b>3/3</b>		<b>4/5</b>	<b>25/52</b>	<b>48.1</b>		<b>13</b>	<b>2</b>	<b>1</b>		7	姜钦	8	19:31	9	21	李明
16	丛霖	6/15	5/13	3/4	1/3	1/5			16/40	40.0						7	王烁	7	20:17	10	1	郭世伟
<b>守门员 合计</b>		<b>6/15</b>	<b>5/13</b>	<b>3/4</b>	<b>1/3</b>	<b>1/5</b>			<b>16/40</b>	<b>40.0</b>						14	孙耀琦	7	23:53	11	17	王巨柱
																7	姜钦	8	25:23	11		
																8	王烁	9	25:58	11		
																4	曹作亮	10	27:15	11		
																4	曹作亮	11	28:10	11		
																4	曹作亮	11	29:13	12	9	陈开勇
																2nd Half						
																4	曹作亮	12	00:37	12		
																12	王烁	12	01:01	13	5	史小帆
																12	王烁	12	01:43	14	8	董智景
																13	孙耀琦	13	02:42	14		
																13	王烁	13	03:12	15	17	王巨柱
																13	王烁	13	05:16	16	1	郭世伟
																18	王晓龙	14	05:45	16		
																8	王烁	15	07:05	16		
																8	王烁	16	08:19	16		
																7	姜钦	17	10:38	16		
																8	王烁	18	12:08	16		
																18	王晓龙	18	13:16	17	8	董智景
																18	王晓龙	18	14:24	18	9	陈开勇
																18	王晓龙	18	16:38	19	18	李双
																18	王晓龙	18	17:32	20	5	史小帆
																9	毕晓晨	19	17:58	20		
																18	王晓龙	19	18:38	21	5	史小帆
																18	王晓龙	20	19:02	21		
																18	王晓龙	20	19:32	22	17	王巨柱
																8	王烁	21	20:18	22		
																18	王晓龙	21	23:45	23	23	于敏清
																18	王晓龙	22	24:49	23		
																4	曹作亮	23	25:28	23		
																8	王烁	24	26:40	23		
																4	曹作亮	25	28:20	23		
																4	曹作亮	25	29:43	24	17	王巨柱

场上队员：得分 / 射门

守门员：救球 / 射门

快攻	Fast Break		突破	Breakthrough		任意球	Free Throw		7M球	7M Throw		助攻	Assist
警告	Warning		失误	Error		2'	Suspension		D	取消资格		DR	取消资格+报告



### 2016年全国男子手球锦标赛 图式比赛技术统计表

轮次 5

场次 24

201606024-21-1/1

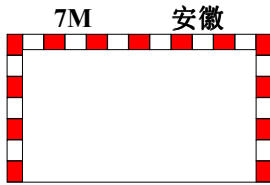
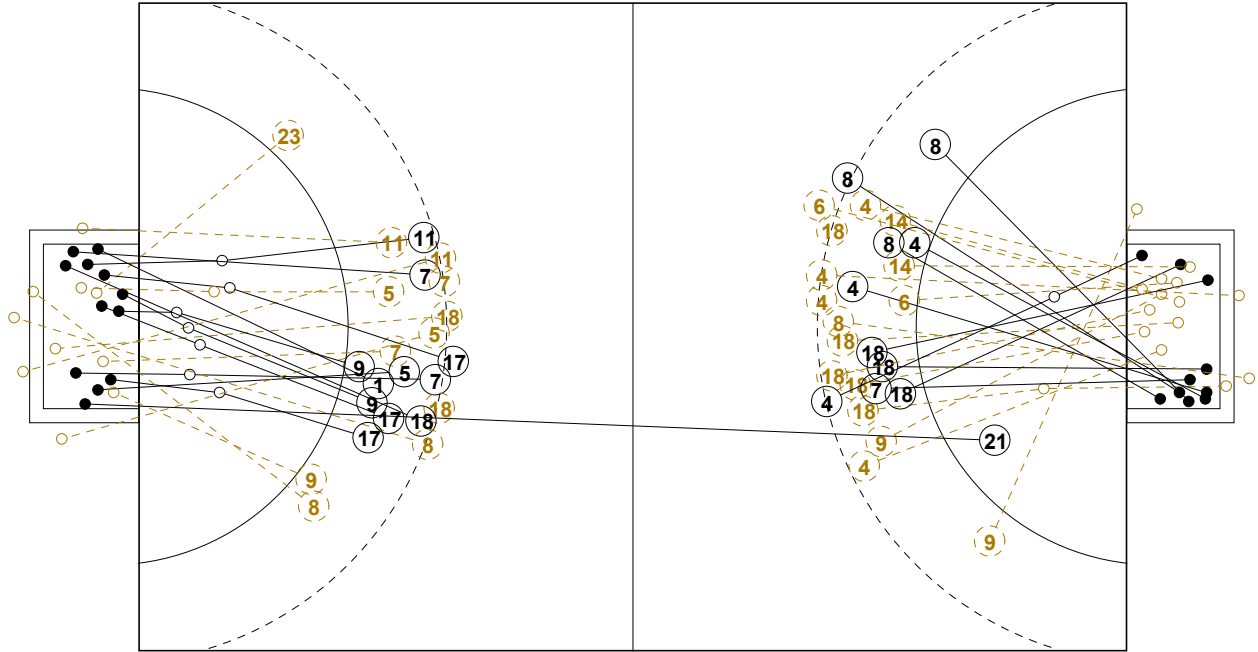

1st Half  
12 : 11

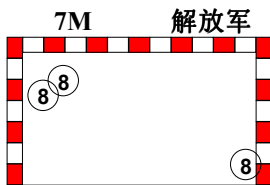
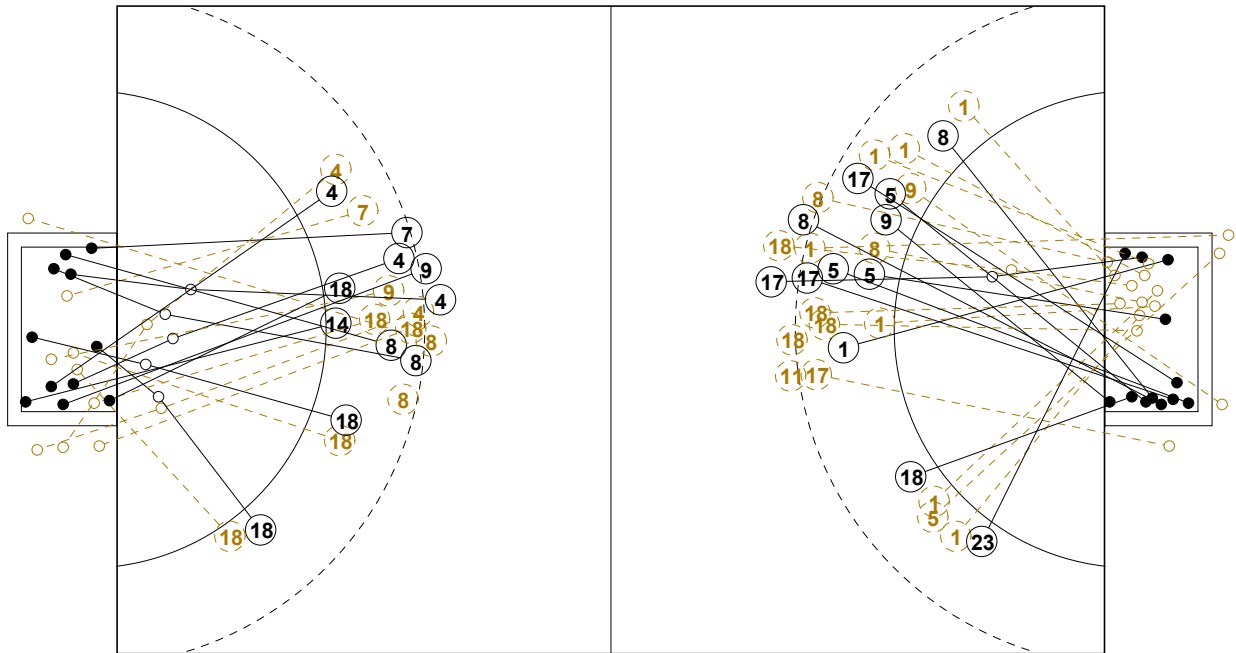
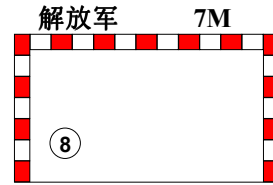

2nd Half  
25 : 24

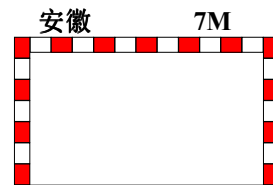



## 2016年全国男子手球锦标赛

## 个人/全队技术统计表

正式表  
手球  
男子预赛  
轮次 5组别 A  
场次 24201606024-14-1/2  
徐闻县体育中心体育馆  
25/10/2016 19:00

号码	姓名	远射	近射	边射	快攻	突破	任意	7M	合计	%	助攻	失误	警告	2'	取消	时间
<b>解放军队(解放军)</b>																
<i>(场上队员)</i>																
1	李梓宁									0.0%						00:00:00
2	范保坤									0.0%						00:00:00
4	曹作亮	3/8	2/3		1/1				6/12	50.0%	1					01:00:00
5	张昌轲									0.0%						00:00:00
6	吴昊	0/1	0/1						0/2	0.0%	1					00:43:09
7	姜钦	1/1	0/1		1/1				2/3	66.7%			1			00:44:37
8	王烁	2/5	1/1		2/2			4/4	9/12	75.0%	6					01:00:00
9	毕晓晨	1/1	0/2	0/1					1/4	25.0%	1					01:00:00
11	肖东洋									0.0%						00:00:00
12	姜明									0.0%						00:00:00
14	孙耀琦		1/3						1/3	33.3%	2	1	1			01:00:00
15	杨帆									0.0%						00:00:00
16	丛霖									0.0%						01:00:00
18	王晓龙	0/4	2/6	1/2		3/3		0/1	6/16	37.5%	2					00:30:58
20	刘智洋									0.0%						00:00:00
<b>合计</b>		7/20	6/17	1/3	4/4	3/3		4/5	25/52	48.1%	13	2	1			
<i>(守门员)</i>																
16	丛霖	6/15	5/13	3/4	1/3	1/5			16/40	40.0%						01:00:00
<b>合计</b>																
<b>合计</b>		6/15	5/13	3/4	1/3	1/5			16/40	40.0%						

场上队员：得分/射门

守门员：救球/射门

全队合计	得分	被救	射失	击柱	封球	合计	%
远射	7	5	5		3	20	35.0%
近射	6	9	1	1		17	35.3%
边射	1	1	1			3	33.3%
快攻	4					4	100.0%
突破	3					3	100.0%
任意							0.0%
7M	4		1			5	80.0%





## 2016年全国男子手球锦标赛

## 个人/全队技术统计表

正式表  
手球  
男子预赛  
轮次 5组别 A  
场次 24201606024-14-2/2  
徐闻县体育中心体育馆  
25/10/2016 19:00

号码	姓名	远射	近射	边射	快攻	突破	任意	7M	合计	%	助攻	失误	警告	2'	取消	时间
<b>安徽队(安徽)</b>																
<i>(上场队员)</i>																
1	郭世伟	0/2	1/2	0/2	1/2	0/1			2/9	22.2%						00:44:35
2	金永峰									0.0%						00:00:00
3	陈强龙									0.0%						00:00:00
5	史小帆	0/1	2/4			2/2			4/7	57.1%						00:37:48
7	姚雄敏	2/3	0/1						2/4	50.0%						00:13:57
8	董智景	1/3	1/2			0/1			2/6	33.3%	1	4				00:50:15
9	陈开勇		3/5						3/5	60.0%		2	1			01:00:00
10	严龙									0.0%						00:00:00
11	黎涛	1/3	0/1						1/4	25.0%		1				00:41:27
12	曾献辰									0.0%						00:00:00
17	王巨柱	3/4			1/1	2/2			6/7	85.7%				1		00:35:26
18	李双	1/7	1/1						2/8	25.0%	1	4		1		00:54:21
19	何山									0.0%						00:00:00
21	李明	1/1							1/1	100%		2				01:00:00
22	王金宇									0.0%						00:00:00
23	于敏清			1/2					1/2	50.0%			1	1		00:21:47
<b>合计</b>		9/24	8/16	1/4	2/3	4/6			24/53	45.3%	2	13	2	3		
<i>(守门员)</i>																
21	李明	5/12	9/15	1/2	0/4	0/3		0/4	15/40	37.5%		2				01:00:00
<b>合计</b>																
		5/12	9/15	1/2	0/4	0/3		0/4	15/40	37.5%		2				

场上队员：得分/射门

守门员：救球/射门

全队合计	得分	被救	射失	击柱	封球	合计	%
远射	9	6	5		4	24	37.5%
近射	8	5	2	1		16	50.0%
边射	1	3				4	25.0%
快攻	2	1				3	66.7%
突破	4	1		1		6	66.7%
任意							0.0%
7M							0.0%





2016年全国男子手球锦标赛

图式射门区域统计

轮次 5 场次 24

201606024-41-1/1

解放军队

1 李梓宁	2 范保坤	4 曹作亮	5 张昌轲	6 吴昊	7 姜钦	8 王烁	9 毕晓晨																																																																								
<table border="1"><tr><td></td><td></td><td></td></tr><tr><td></td><td></td><td></td></tr><tr><td></td><td></td><td></td></tr></table>										<table border="1"><tr><td></td><td></td><td></td></tr><tr><td></td><td></td><td></td></tr><tr><td></td><td></td><td></td></tr></table>										<table border="1"><tr><td>1</td><td></td><td>2</td></tr><tr><td>1</td><td></td><td>1</td></tr><tr><td>1</td><td></td><td></td></tr></table>	1		2	1		1	1			<table border="1"><tr><td></td><td></td><td></td></tr><tr><td></td><td></td><td></td></tr><tr><td></td><td></td><td></td></tr></table>										<table border="1"><tr><td></td><td></td><td></td></tr><tr><td></td><td></td><td></td></tr><tr><td></td><td></td><td></td></tr></table>										<table border="1"><tr><td></td><td></td><td>1</td></tr><tr><td></td><td></td><td></td></tr><tr><td></td><td></td><td>1</td></tr></table>			1						1	<table border="1"><tr><td>2</td><td></td><td>2</td></tr><tr><td>1</td><td></td><td>3</td></tr><tr><td></td><td></td><td>1</td></tr></table>	2		2	1		3			1	<table border="1"><tr><td></td><td></td><td></td></tr><tr><td>1</td><td></td><td></td></tr><tr><td></td><td></td><td></td></tr></table>				1					
1		2																																																																													
1		1																																																																													
1																																																																															
		1																																																																													
		1																																																																													
2		2																																																																													
1		3																																																																													
		1																																																																													
1																																																																															
Post - 0 Miss - 0 Block - 0	Post - 0 Miss - 0 Block - 0	Post - 0 Miss - 3 Block - 1	Post - 0 Miss - 0 Block - 0	Post - 0 Miss - 0 Block - 0	Post - 0 Miss - 0 Block - 0	Post - 0 Miss - 2 Block - 1	Post - 0 Miss - 1 Block - 0																																																																								
11 肖东洋	12 姜明	14 孙耀琦	15 杨帆	16 丛霖	18 王晓龙	20 刘智洋																																																																									
<table border="1"><tr><td></td><td></td><td></td></tr><tr><td></td><td></td><td></td></tr><tr><td></td><td></td><td></td></tr></table>										<table border="1"><tr><td></td><td></td><td></td></tr><tr><td></td><td></td><td></td></tr><tr><td></td><td></td><td></td></tr></table>										<table border="1"><tr><td>1</td><td></td><td></td></tr><tr><td></td><td></td><td></td></tr><tr><td></td><td></td><td></td></tr></table>	1									<table border="1"><tr><td></td><td></td><td></td></tr><tr><td></td><td></td><td></td></tr><tr><td></td><td></td><td></td></tr></table>										<table border="1"><tr><td></td><td></td><td></td></tr><tr><td></td><td></td><td></td></tr><tr><td></td><td></td><td></td></tr></table>										<table border="1"><tr><td>1</td><td>1</td><td>1</td></tr><tr><td>1</td><td></td><td></td></tr><tr><td>1</td><td>1</td><td></td></tr></table>	1	1	1	1			1	1		<table border="1"><tr><td></td><td></td><td></td></tr><tr><td></td><td></td><td></td></tr><tr><td></td><td></td><td></td></tr></table>										<table border="1"><tr><td></td><td></td><td></td></tr><tr><td></td><td></td><td></td></tr><tr><td></td><td></td><td></td></tr></table>									
1																																																																															
1	1	1																																																																													
1																																																																															
1	1																																																																														
Post - 0 Miss - 0 Block - 0	Post - 0 Miss - 0 Block - 0	Post - 0 Miss - 0 Block - 0	Post - 0 Miss - 0 Block - 0	Post - 0 Miss - 0 Block - 0	Post - 1 Miss - 2 Block - 1	Post - 0 Miss - 0 Block - 0																																																																									

16 丛霖

0/2	1/1	0/5
4/7	4/6	2/8
4/6	1/2	0/3



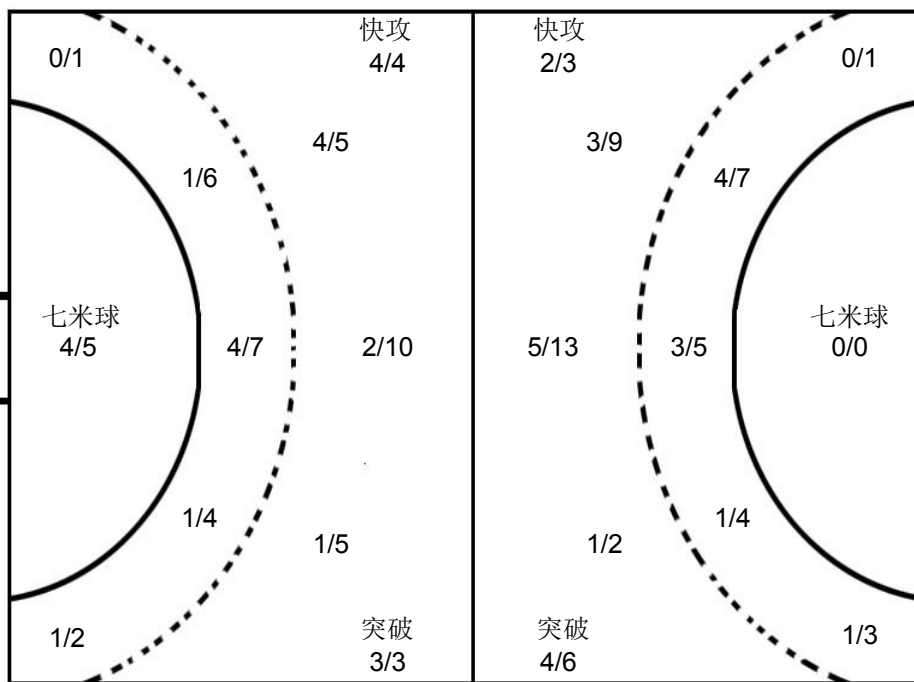

21 李明

2/7	0/1	0/6
4/8	4/4	1/5
2/4	2/3	0/2



安徽队

1 郭世伟	2 金永峰	3 陈强龙	5 史小帆	7 姚雄敏	8 董智景	9 陈开勇	10 严龙																																																																								
<table border="1"><tr><td>1</td><td></td><td></td></tr><tr><td></td><td></td><td>1</td></tr><tr><td></td><td></td><td></td></tr></table>	1					1				<table border="1"><tr><td></td><td></td><td></td></tr><tr><td></td><td></td><td></td></tr><tr><td></td><td></td><td></td></tr></table>										<table border="1"><tr><td></td><td></td><td></td></tr><tr><td></td><td></td><td></td></tr><tr><td></td><td></td><td></td></tr></table>										<table border="1"><tr><td></td><td></td><td>1</td></tr><tr><td>1</td><td>1</td><td>1</td></tr><tr><td></td><td></td><td></td></tr></table>			1	1	1	1				<table border="1"><tr><td>1</td><td></td><td>1</td></tr><tr><td></td><td></td><td></td></tr><tr><td></td><td></td><td></td></tr></table>	1		1							<table border="1"><tr><td></td><td></td><td></td></tr><tr><td></td><td></td><td>2</td></tr><tr><td></td><td></td><td></td></tr></table>						2				<table border="1"><tr><td></td><td></td><td></td></tr><tr><td></td><td></td><td></td></tr><tr><td></td><td>1</td><td>2</td></tr></table>								1	2	<table border="1"><tr><td></td><td></td><td></td></tr><tr><td></td><td></td><td></td></tr><tr><td></td><td></td><td></td></tr></table>									
1																																																																															
		1																																																																													
		1																																																																													
1	1	1																																																																													
1		1																																																																													
		2																																																																													
	1	2																																																																													
Post - 0 Miss - 1 Block - 0	Post - 0 Miss - 0 Block - 0	Post - 0 Miss - 0 Block - 0	Post - 0 Miss - 2 Block - 0	Post - 0 Miss - 0 Block - 1	Post - 1 Miss - 1 Block - 0	Post - 0 Miss - 1 Block - 0	Post - 0 Miss - 0 Block - 0																																																																								
11 黎涛	12 曾献辰	17 王巨柱	18 李双	19 何山	21 李明	22 王金宇	23 于敏清																																																																								
<table border="1"><tr><td></td><td></td><td></td></tr><tr><td></td><td></td><td>1</td></tr><tr><td></td><td></td><td></td></tr></table>						1				<table border="1"><tr><td></td><td></td><td></td></tr><tr><td></td><td></td><td></td></tr><tr><td></td><td></td><td></td></tr></table>										<table border="1"><tr><td></td><td></td><td>2</td></tr><tr><td>1</td><td>1</td><td>1</td></tr><tr><td>1</td><td></td><td></td></tr></table>			2	1	1	1	1			<table border="1"><tr><td></td><td></td><td>1</td></tr><tr><td></td><td></td><td></td></tr><tr><td></td><td></td><td>1</td></tr></table>			1						1	<table border="1"><tr><td></td><td></td><td></td></tr><tr><td></td><td></td><td></td></tr><tr><td></td><td></td><td></td></tr></table>										<table border="1"><tr><td></td><td></td><td></td></tr><tr><td>1</td><td></td><td></td></tr><tr><td></td><td></td><td></td></tr></table>				1						<table border="1"><tr><td></td><td></td><td></td></tr><tr><td></td><td></td><td></td></tr><tr><td></td><td></td><td></td></tr></table>										<table border="1"><tr><td></td><td></td><td></td></tr><tr><td></td><td></td><td></td></tr><tr><td></td><td></td><td></td></tr></table>									
		1																																																																													
		2																																																																													
1	1	1																																																																													
1																																																																															
		1																																																																													
		1																																																																													
1																																																																															
Post - 1 Miss - 1 Block - 1	Post - 0 Miss - 0 Block - 0	Post - 0 Miss - 1 Block - 0	Post - 0 Miss - 0 Block - 2	Post - 0 Miss - 0 Block - 0	Post - 0 Miss - 0 Block - 0	Post - 0 Miss - 0 Block - 0	Post - 0 Miss - 0 Block - 0																																																																								

注释: Post=击柱 Miss=射失 Block=被封





预赛 Group A

男子 全国比赛

2016年全国男子手球锦标赛

Team A										Team B										Match Number											
A 江苏队										B 北京队										25											
played in China										in the hall 徐闻县体育中心体育										on 25/10/2016		at 20:40 hours		Spectators							
Half-time (30')		A 14		B 11		End of playing time		A 27		B 18		1st extra time		A		B		2nd extra time		A		B		After penalty throws		A		B			
Number of 7 m		A 1/2		Team time-out			Full name of players and officials										Team time-out			B 1/1		Number of 7 m									
				1	2	3											1	2	3												
No.	Team A										G	W	2'	D	DR	No.	Team B										G	W	2'	D	DR
1	徐畅															3	王超										1				
4	张家纬										4					6	解建飞										2	1			
5	闫亮										1	1				8	王鹏												1		
6	赵晨										5					9	刘振										3				
7	徐奕飞										3					10	成亚														
8	周小坚										3		1			11	蒋维一														
9	周傲															12	孟辉														
10	郝可鑫															16	刘迈科														
12	王权															21	胡瀛										2				
15	李安										6					23	王军程										1		1		
16	张帅															25	马明辉										5				
17	王伟强										2					29	杜龙飞										1				
18	赵楠										1		1			33	冯宁														
20	顾艳超															77	朱昕晨										1		1		
21	刘江										2					78	张骥										2				
22	张瑞恒															83	潘天											1			
B	闫威名 (主教练)															A	安福田														
C	贾淑君															B	郑永利 (主教练)														
D	叶强															C	陈璇														
E	王建国																														
A										Signature of Responsible Official of the Teams (Off. A)										B											
TP	Remarks of Referee / CHA Official																				TP										

Signatures

Referees: 尹静阳 (CHN) 刘禹 (CHN)

Techn. Delegates: 许宜扬 (CHN)

CHA Official: 刘凤娟 (CHN)

Note: Number of 7m Throws Awarded to Team A and B, Goals (G), Warnings (W), Suspensions (2), Direct Disqualification (D), Disqualification with Report (DR) and Team Penalty (TP).

Table Officials: 梁小熹

伍豪

Statisticians: 李双

周亚桥

Printed by PHMS Copyright: IHF / CHA 25/10/2016 22:18:27

Longman Sportsoft



handball@126.com



## 2016年全国男子手球锦标赛 竞赛技术统计(媒体表)

预赛	组别	A	轮次	5	场次	25
----	----	---	----	---	----	----

徐闻县体育中心体育馆

25/10/2016

201606025-51-1/1

江苏队	江苏	27	vs	18	北京	北京队
14 : 11						

裁判员	尹静阳 (CHN)	/	刘禹 (CHN)
-----	-----------	---	----------

江苏		远	近	边	快	突	任意	7m	合计	%	助攻	失误	警告	2'	D & DR	江苏		比赛 进程	北京	
主教练： 闫威名		射	射	射	攻	破	球	球												
1	徐畅																	1st Half		
4	张家纬	3/6	1/1						4/7	57.1	6	1						01:20	0	
5	闫亮		1/2						1/2	50.0			1					01:53	1	25 马明辉
6	赵晨	3/6			1/1		1/1		5/8	62.5	4	3						03:32	1	
7	徐奕飞		1/1	1/1	1/1				3/3	100								03:59	2	78 张骥
8	周小坚	0/1	3/4						3/5	60.0		1			1			05:00	2	
9	周傲																	06:51	2	
10	郝可鑫	0/3							0/3	0.0	1	2						06:59	3	78 张骥
12	王权																	07:42	4	9 刘振
15	李安	0/1	1/1		4/5			1/1	6/8	75.0	1							08:10	4	
16	张帅																	09:31	5	25 马明辉
17	王伟强				2/2				2/2	100		3						10:07	5	
18	赵楠	0/1	1/4						1/5	20.0								10:59	5	
20	顾艳超	0/1							0/1	0.0	1	2						13:49	6	25 马明辉
21	刘江		2/4					0/1	2/5	40.0	3							14:38	6	
22	张瑞恒																	16:13	7	9 刘振
<b>运动员 合计</b>		6/19	10/17	1/1	8/9		1/1	1/2	27/49	55.1	16	13	1	2				16:30	8	6 解建飞
1	徐畅		0/1	0/1				0/2	0/2	0.0								18:08	8	
12	王权	4/10	2/7	3/6	0/1			0/1	9/25	36.0		1						18:52	9	23 王军程
<b>守门员 合计</b>		4/10	2/8	3/7	0/1			0/1	9/27	33.3		1						20:23	10	9 刘振
<b>北京</b>		远	近	边	快	突	任意	7m	合计	%	助攻	失误	警告	2'	D & DR			2nd Half		
<b>教练： 郑永利</b>		射	射	射	攻	破	球	球												
3	王超			1/2					1/2	50.0								01:44	12	77 朱昕晨
6	解建飞	0/2	1/1	0/1	1/1				2/5	40.0	1		1					02:51	12	
8	王鹏		0/1						0/1	0.0				1				04:09	13	29 杜龙飞
9	刘振	2/6						1/1	3/7	42.9	2	1						05:36	13	
10	成亚	0/1							0/1	0.0		2						06:16	14	6 解建飞
11	蒋维一																	07:12	14	
12	孟辉																	07:55	14	
16	刘迈科																	11:06	15	25 马明辉
21	胡瀛	0/1	2/2						2/3	66.7								11:46	15	
23	王军程	1/4							1/4	25.0	1	2		1				15:37	15	
25	马明辉		3/4	2/2					5/6	83.3		1						18:25	15	
29	杜龙飞		0/1	1/2					1/3	33.3								19:02	15	
33	冯宁																	21:02	15	
77	朱昕晨	1/1							1/1	100	1	3		1				22:13	15	
78	张骥	2/6							2/6	33.3		5						24:51	15	
83	潘天																	25:20	16	21 胡瀛
<b>运动员 合计</b>		6/21	6/9	4/7	1/1			1/1	18/39	46.2	5	20	2	3				26:57	16	
12	孟辉	1/2	1/5						2/7	28.6								27:39	17	3 王超
16	刘迈科	4/9	3/9	0/1	1/9		0/1	1/2	9/31	29.0		1						28:17	18	25 马明辉
<b>守门员 合计</b>		5/11	4/14	0/1	1/9		0/1	1/2	11/38	28.9		1						29:46	18	

场上队员： 得分 / 射门

守门员： 救球 / 射门

快攻	Fast Break	突破	Breakthrough	任意球	Free Throw	7M球	7M Throw	助攻	Assist
警告	Warning	失误	Error	2'	Suspension	D	取消资格	DR	取消资格+报告





### 2016年全国男子手球锦标赛 图式比赛技术统计表

轮次 5

场次 25

201606025-21-1/1

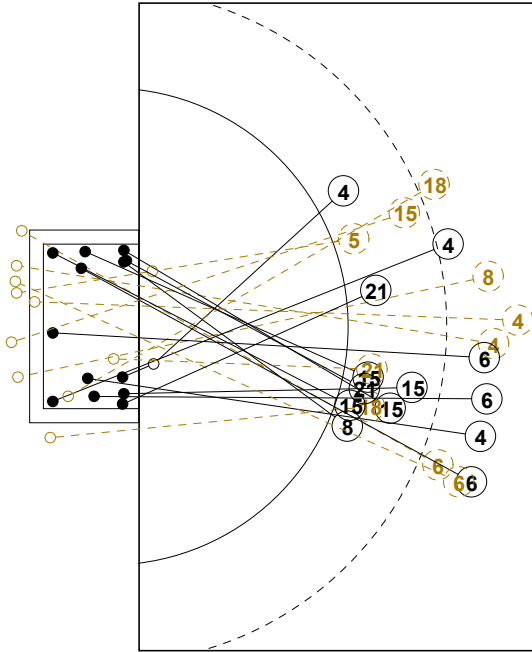

7M 江苏

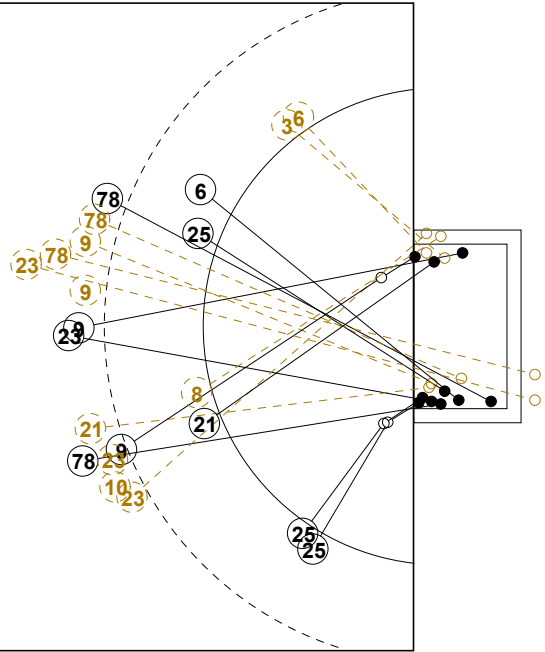
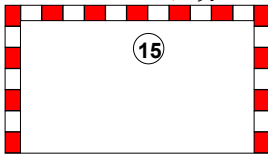

北京 7M



1st Half  
14 : 11

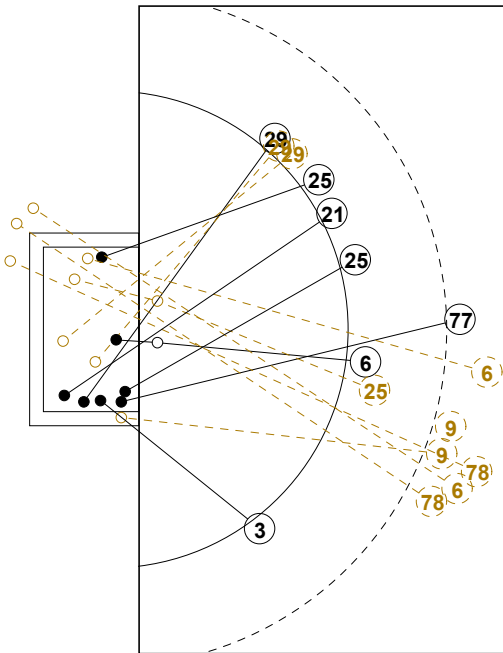

7M 北京

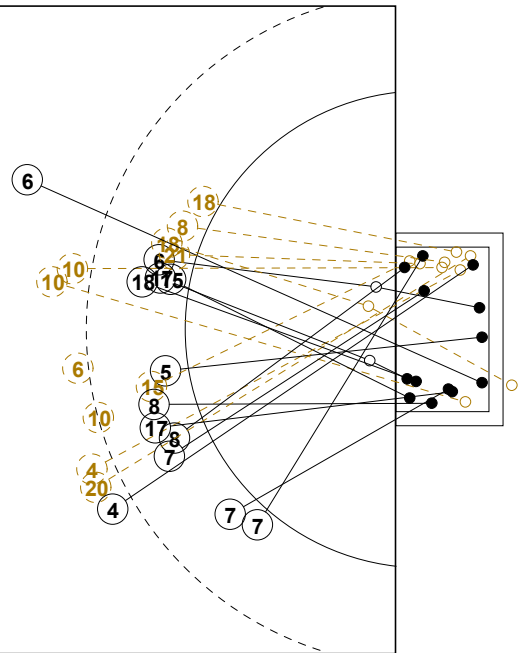
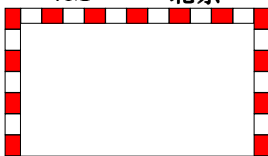

江苏 7M



2nd Half  
18 : 27





## 2016年全国男子手球锦标赛

## 个人/全队技术统计表

正式表  
手球  
男子预赛  
轮次 5组别 A  
场次 25201606025-14-1/2  
徐闻县体育中心体育馆  
25/10/2016 20:40

号码	姓名	远射	近射	边射	快攻	突破	任意	7M	合计	%	助攻	失误	警告	2'	取消	时间
<b>江苏队(江苏)</b>																
<i>(场上队员)</i>																
1	徐畅									0.0%						00:03:41
4	张家纬	3/6	1/1						4/7	57.1%	6	1				01:09:40
5	闫亮		1/2						1/2	50.0%			1			00:38:26
6	赵晨	3/6			1/1		1/1		5/8	62.5%	4	3				00:52:43
7	徐奕飞		1/1	1/1	1/1				3/3	100%						00:19:22
8	周小坚	0/1	3/4						3/5	60.0%		1		1		00:54:24
9	周傲									0.0%						00:01:37
10	郝可鑫	0/3							0/3	0.0%	1	2				00:24:21
12	王权									0.0%		1				00:56:19
15	李安	0/1	1/1		4/5			1/1	6/8	75.0%	1					00:40:38
16	张帅									0.0%						00:00:00
17	王伟强				2/2				2/2	100%		3				00:18:42
18	赵楠	0/1	1/4						1/5	20.0%		2		1		00:37:58
20	顾艳超	0/1							0/1	0.0%	1					00:03:19
21	刘江		2/4					0/1	2/5	40.0%	3					00:22:42
22	张瑞恒									0.0%						00:00:00
<b>合计</b>		6/19	10/17	1/1	8/9		1/1	1/2	27/49	55.1%	16	13	1	2		
<i>(守门员)</i>																
1	徐畅		0/1	0/1					0/2	0.0%						00:03:41
12	王权	4/10	2/7	3/6	0/1			0/1	9/25	36.0%		1				00:56:19
<b>合计</b>		4/10	2/8	3/7	0/1			0/1	9/27	33.3%		1				

场上队员：得分/射门

守门员：救球/射门

全队合计	得分	被救	射失	击柱	封球	合计	%
远射	6	5	5	1	2	19	31.6%
近射	10	4	3			17	58.8%
边射	1					1	100.0%
快攻	8	1				9	88.9%
突破							0.0%
任意	1					1	100.0%
7M	1	1				2	50.0%





## 2016年全国男子手球锦标赛

## 个人/全队技术统计表

正式表  
手球  
男子预赛  
轮次 5组别 A  
场次 25201606025-14-2/2  
徐闻县体育中心体育馆  
25/10/2016 20:40

号码	姓名	远射	近射	边射	快攻	突破	任意	7M	合计	%	助攻	失误	警告	2'	取消	时间
<b>北京队(北京)</b>																
<i>(上场队员)</i>																
3	王超			1/2					1/2	50.0%		2				00:39:14
6	解建飞	0/2	1/1	0/1	1/1				2/5	40.0%	1		1			00:40:14
8	王鹏		0/1						0/1	0.0%				1		00:18:39
9	刘振	2/6						1/1	3/7	42.9%	2	1				00:56:23
10	成亚	0/1							0/1	0.0%		2				00:12:23
11	蒋维一									0.0%						00:30:02
12	孟辉									0.0%						00:12:55
16	刘迈科									0.0%		1				00:47:05
21	胡瀛	0/1	2/2						2/3	66.7%		3				00:36:31
23	王军程	1/4							1/4	25.0%	1	2		1		00:08:59
25	马明辉		3/4	2/2					5/6	83.3%		1				00:20:09
29	杜龙飞		0/1	1/2					1/3	33.3%						00:24:02
33	冯宁									0.0%						00:00:00
77	朱昕晨	1/1							1/1	100%	1	3		1		00:19:56
78	张骥	2/6							2/6	33.3%		5				00:28:54
83	潘天									0.0%			1			00:07:28
<b>合计</b>		6/21	6/9	4/7	1/1			1/1	18/39	46.2%	5	20	2	3		
<i>(守门员)</i>																
12	孟辉	1/2	1/5						2/7	28.6%						00:12:55
16	刘迈科	4/9	3/9	0/1	1/9		0/1	1/2	9/31	29.0%		1				00:47:05
<b>合计</b>		5/11	4/14	0/1	1/9		0/1	1/2	11/38	28.9%		1				

场上队员：得分/射门

守门员：救球/射门

全队合计	得分	被救	射失	击柱	封球	合计	%
远射	6	4	5	2	4	21	28.6%
近射	6	2		1		9	66.7%
边射	4	3				7	57.1%
快攻	1					1	100.0%
突破							0.0%
任意							0.0%
7M	1					1	100.0%





2016年全国男子手球锦标赛

图式射门区域统计

轮次 5 场次 25

201606025-41-1/1

江苏队

1 徐畅	4 张家纬	5 闫亮	6 赵晨	7 徐奕飞	8 周小坚	9 周傲	10 郝可鑫																																																																								
<table border="1"><tr><td></td><td></td><td></td></tr><tr><td></td><td></td><td></td></tr><tr><td></td><td></td><td></td></tr></table>										<table border="1"><tr><td>2</td><td></td><td></td></tr><tr><td>1</td><td></td><td></td></tr><tr><td>1</td><td></td><td></td></tr></table>	2			1			1			<table border="1"><tr><td></td><td>1</td><td></td></tr><tr><td></td><td></td><td></td></tr><tr><td></td><td></td><td></td></tr></table>		1								<table border="1"><tr><td></td><td>2</td><td>1</td></tr><tr><td>1</td><td></td><td>1</td></tr><tr><td></td><td></td><td></td></tr></table>		2	1	1		1				<table border="1"><tr><td></td><td></td><td></td></tr><tr><td></td><td></td><td>1</td></tr><tr><td>2</td><td></td><td></td></tr></table>						1	2			<table border="1"><tr><td></td><td></td><td></td></tr><tr><td></td><td></td><td>1</td></tr><tr><td>1</td><td></td><td>1</td></tr></table>						1	1		1	<table border="1"><tr><td></td><td></td><td></td></tr><tr><td></td><td></td><td></td></tr><tr><td></td><td></td><td></td></tr></table>										<table border="1"><tr><td></td><td></td><td></td></tr><tr><td></td><td></td><td></td></tr><tr><td></td><td></td><td></td></tr></table>									
2																																																																															
1																																																																															
1																																																																															
	1																																																																														
	2	1																																																																													
1		1																																																																													
		1																																																																													
2																																																																															
		1																																																																													
1		1																																																																													
Post - 0 Miss - 0 Block - 0	Post - 1 Miss - 1 Block - 0	Post - 0 Miss - 1 Block - 0	Post - 0 Miss - 2 Block - 1	Post - 0 Miss - 0 Block - 0	Post - 0 Miss - 1 Block - 0	Post - 0 Miss - 0 Block - 0	Post - 0 Miss - 0 Block - 1																																																																								
12 王权	15 李安	16 张帅	17 王伟强	18 赵楠	20 顾艳超	21 刘江	22 张瑞恒																																																																								
<table border="1"><tr><td></td><td></td><td></td></tr><tr><td></td><td></td><td></td></tr><tr><td></td><td></td><td></td></tr></table>										<table border="1"><tr><td></td><td>1</td><td>1</td></tr><tr><td></td><td></td><td>1</td></tr><tr><td>1</td><td></td><td>2</td></tr></table>		1	1			1	1		2	<table border="1"><tr><td></td><td></td><td></td></tr><tr><td></td><td></td><td></td></tr><tr><td></td><td></td><td></td></tr></table>										<table border="1"><tr><td></td><td></td><td></td></tr><tr><td></td><td></td><td>1</td></tr><tr><td></td><td></td><td>1</td></tr></table>						1			1	<table border="1"><tr><td></td><td></td><td></td></tr><tr><td></td><td></td><td></td></tr><tr><td></td><td></td><td>1</td></tr></table>									1	<table border="1"><tr><td></td><td></td><td></td></tr><tr><td></td><td></td><td></td></tr><tr><td></td><td></td><td></td></tr></table>										<table border="1"><tr><td></td><td></td><td></td></tr><tr><td></td><td></td><td></td></tr><tr><td>1</td><td></td><td>1</td></tr></table>							1		1	<table border="1"><tr><td></td><td></td><td></td></tr><tr><td></td><td></td><td></td></tr><tr><td></td><td></td><td></td></tr></table>									
	1	1																																																																													
		1																																																																													
1		2																																																																													
		1																																																																													
		1																																																																													
		1																																																																													
1		1																																																																													
Post - 0 Miss - 0 Block - 0	Post - 0 Miss - 1 Block - 0	Post - 0 Miss - 0 Block - 0	Post - 0 Miss - 0 Block - 0	Post - 0 Miss - 2 Block - 0	Post - 0 Miss - 0 Block - 0	Post - 0 Miss - 0 Block - 0	Post - 0 Miss - 0 Block - 0																																																																								

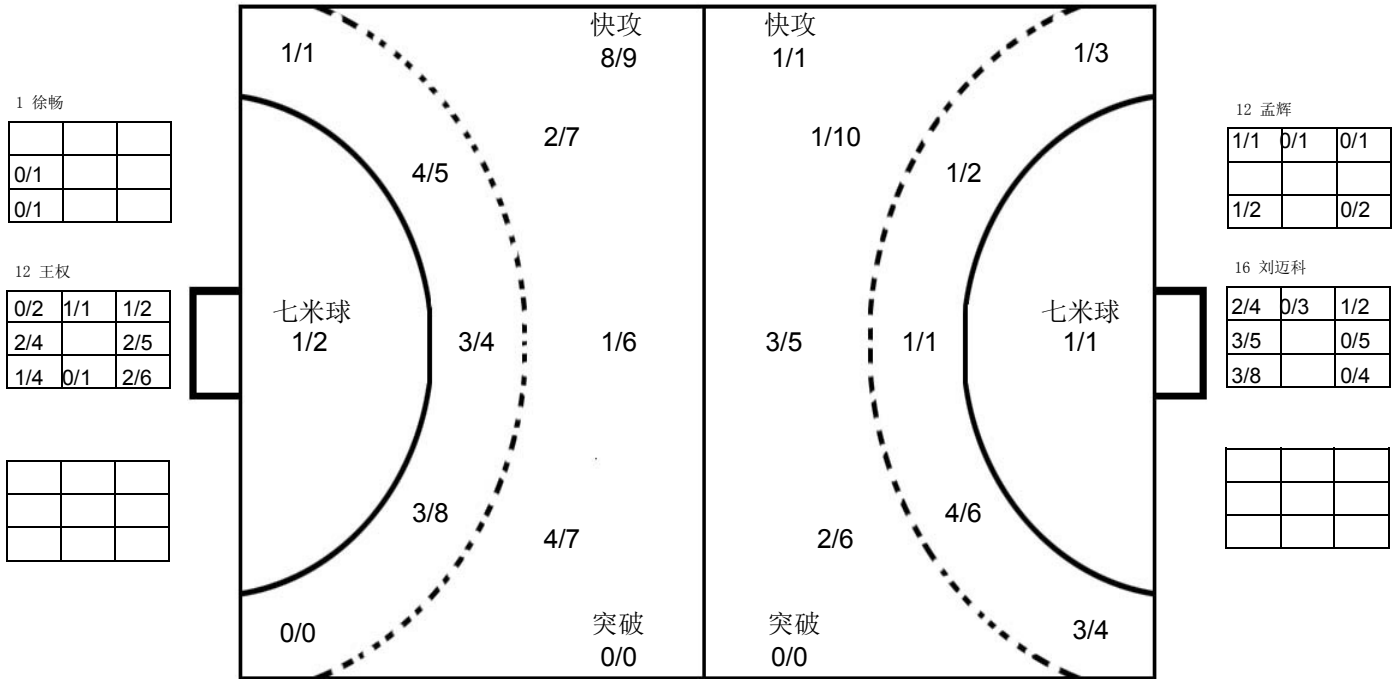

北京队

3 王超	6 解建飞	8 王鹏	9 刘振	10 成亚	11 蒋维一	12 孟辉	16 刘迈科																																																																								
<table border="1"><tr><td></td><td></td><td></td></tr><tr><td>1</td><td></td><td></td></tr><tr><td></td><td></td><td></td></tr></table>				1						<table border="1"><tr><td></td><td></td><td></td></tr><tr><td></td><td></td><td>1</td></tr><tr><td></td><td>1</td><td></td></tr></table>						1		1		<table border="1"><tr><td></td><td></td><td></td></tr><tr><td></td><td></td><td></td></tr><tr><td></td><td></td><td></td></tr></table>										<table border="1"><tr><td>1</td><td></td><td></td></tr><tr><td>1</td><td></td><td></td></tr><tr><td>1</td><td></td><td></td></tr></table>	1			1			1			<table border="1"><tr><td></td><td></td><td></td></tr><tr><td></td><td></td><td></td></tr><tr><td></td><td></td><td></td></tr></table>										<table border="1"><tr><td></td><td></td><td></td></tr><tr><td></td><td></td><td></td></tr><tr><td></td><td></td><td></td></tr></table>										<table border="1"><tr><td></td><td></td><td></td></tr><tr><td></td><td></td><td></td></tr><tr><td></td><td></td><td></td></tr></table>										<table border="1"><tr><td></td><td></td><td></td></tr><tr><td></td><td></td><td></td></tr><tr><td></td><td></td><td></td></tr></table>									
1																																																																															
		1																																																																													
	1																																																																														
1																																																																															
1																																																																															
1																																																																															
Post - 0 Miss - 0 Block - 0	Post - 0 Miss - 1 Block - 0	Post - 1 Miss - 0 Block - 0	Post - 1 Miss - 0 Block - 2	Post - 0 Miss - 0 Block - 1	Post - 0 Miss - 0 Block - 0	Post - 0 Miss - 0 Block - 0	Post - 0 Miss - 0 Block - 0																																																																								
21 胡瀛	23 王军程	25 马明辉	29 杜龙飞	33 冯宁	77 朱昕晨	78 张骥	83 潘天																																																																								
<table border="1"><tr><td>1</td><td></td><td></td></tr><tr><td></td><td></td><td></td></tr><tr><td>1</td><td></td><td></td></tr></table>	1						1			<table border="1"><tr><td></td><td></td><td></td></tr><tr><td></td><td></td><td></td></tr><tr><td></td><td></td><td>1</td></tr></table>									1	<table border="1"><tr><td></td><td></td><td></td></tr><tr><td></td><td></td><td>2</td></tr><tr><td>1</td><td></td><td>2</td></tr></table>						2	1		2	<table border="1"><tr><td>1</td><td></td><td></td></tr><tr><td></td><td></td><td></td></tr><tr><td></td><td></td><td></td></tr></table>	1									<table border="1"><tr><td></td><td></td><td></td></tr><tr><td></td><td></td><td></td></tr><tr><td></td><td></td><td></td></tr></table>										<table border="1"><tr><td></td><td></td><td></td></tr><tr><td></td><td></td><td></td></tr><tr><td>1</td><td></td><td></td></tr></table>							1			<table border="1"><tr><td></td><td></td><td>1</td></tr><tr><td></td><td></td><td></td></tr><tr><td></td><td></td><td>1</td></tr></table>			1						1	<table border="1"><tr><td></td><td></td><td></td></tr><tr><td></td><td></td><td></td></tr><tr><td></td><td></td><td></td></tr></table>									
1																																																																															
1																																																																															
		1																																																																													
		2																																																																													
1		2																																																																													
1																																																																															
1																																																																															
		1																																																																													
		1																																																																													
Post - 0 Miss - 0 Block - 0	Post - 1 Miss - 1 Block - 1	Post - 0 Miss - 0 Block - 0	Post - 0 Miss - 0 Block - 0	Post - 0 Miss - 0 Block - 0	Post - 0 Miss - 0 Block - 0	Post - 0 Miss - 3 Block - 0	Post - 0 Miss - 0 Block - 0																																																																								

注释: Post=击柱 Miss=射失 Block=被封





四分之一决赛

男子 全国比赛

2016年全国男子手球锦标赛

Team A <b>A 江苏队</b>				Team B <b>B 上海队</b>				Match Number <b>26</b>													
played in China		in the hall 徐闻县体育中心体育		on 27/10/2016		at 14:00 hours		Spectators													
Half-time (30')	<b>A</b> 13	<b>B</b> 5	End of playing time	<b>A</b> 29	<b>B</b> 20	1st extra time	<b>A</b>	<b>B</b>	2nd extra time	<b>A</b>	<b>B</b>	After penalty throws	<b>A</b>	<b>B</b>							
Number of 7 m	<b>A</b> 1 / 1	Team time-out 1 2 3 26:40			Full name of players and officials				Team time-out 1 2 3 13:28 51:37			<b>B</b> 0 / 1	Number of 7 m								
No.	Team <b>A</b>					G	W	2'	D	DR	No.	Team <b>B</b>					G	W	2'	D	DR
1	徐畅										1	张峥									
4	张家纬					2	1				2	张文斌									
5	闫亮					1	1				3	赵时俊					3	1	1		
6	赵晨					4					4	徐俊吉					2				
7	徐奕飞					3					8	钱为玮					6		1		
8	周小坚					2					10	董凯									
9	周傲					2					11	蒋承骅					1				
10	郝可鑫					3					12	周哲韬									
12	王权										14	沈吉磊					3	1			
15	李安					2					15	朱世杰						1			
16	张帅										16	朱春雷									
17	王伟强					2					17	贺政									
18	赵楠					2		1			18	马麟晓					1				
20	顾艳超					3					33	吴璟					4				
21	刘江					3	1														
22	张瑞恒																				
<b>B</b>	闫威名 (主教练)										<b>A</b>	吴龙基 (主教练)									
<b>C</b>	贾淑君										<b>B</b>	张勇军									
<b>D</b>	叶强										<b>C</b>	金迪琦									
<b>E</b>	王建国										<b>E</b>	杨时									
<b>A</b>	Signature of Responsible Official of the Teams (Off. A)																			<b>B</b>	
TP	Remarks of Referee / CHA Official																			TP	

Signatures

Referees: 尹静阳 (CHN) 马晓晔 (CHN)

Techn. Delegates: 刘禹 (CHN)

CHA Official: 倪震 (CHN)

Note: Number of 7m Throws Awarded to Team A and B, Goals (G), Warnings (W), Suspensions (2'), Direct Disqualification (D), Disqualification with Report (DR) and Team Penalty (TP).

Table Officials: 鲍瑀

刘宇阳

Statisticians: 李双

周亚桥

Printed by PHMS Copyright: IHF / CHA 27/10/2016 15:18:28

Longman Sportsoft



handball@126.com

2016年全国男子手球锦标赛  
竞赛技术统计(媒体表)

四分之一决赛	组别	X	轮次	6	场次	26
徐闻县体育中心体育馆			27/10/2016		201606026-51-1/1	
江苏队	江苏	29	vs	20	上海	上海队
13 : 5						

裁判员		尹静阳 (CHN)											马晓晔 (CHN)																		
<b>江苏</b>		远射	近射	边射	快攻	突破	任意球	7m球	合计	%	助攻	失误	警告	2'	D & DR	<b>江苏</b>		比赛进程		<b>上海</b>											
主教练： 闫威名																1st Half															
1	徐畅															8	周小坚	1	00:36	0											
4	张家纬	0/2	1/1		0/1	1/1		2/5	40.0			2	1			1	赵时俊	1	03:09	1	3										
5	闫亮		1/1					1/1	100			2	1			2	赵晨	2	04:25	2	11										
6	赵晨	2/2			2/2	0/1		4/5	80.0	1	1					3	赵晨	3	06:37	3	4										
7	徐奕飞			2/3	1/2			3/5	60.0							4	徐俊吉	4	07:51	3	3										
8	周小坚		2/2		0/1			2/3	66.7							5	周小坚	5	10:31	3	3										
9	周傲	0/1			1/2	1/1		2/4	50.0							6	周小坚	6	12:06	3	3										
10	郝可鑫	2/3					1/1	3/4	75.0							7	郝可鑫	7	14:51	3	3										
12	王权															8	郝可鑫	8	17:45	4	4										
15	李安				2/3			2/3	66.7							9	郝可鑫	9	19:10	4	4										
16	张帅															10	郝可鑫	10	19:51	4	4										
17	王伟强	0/1			0/1	1/1		1/1	2/4	50.0						11	郝可鑫	11	24:03	4	4										
18	赵楠		1/1		1/2	0/1		2/4	50.0	3	3			1		12	郝可鑫	12	25:29	4	4										
20	顾艳超	1/1	1/2	1/1		0/1		3/5	60.0	2	3					13	郝可鑫	13	28:52	5	8										
21	刘江	1/1	2/2					3/3	100			1	1			21	刘江	13	29:42	5	5										
22	张瑞恒															2nd Half															
<b>运动员 合计</b>		6/11	8/9	3/4	4/10	6/8	1/3	1/1	29/46	63.0	9	18	3	1		5	闫亮	14	02:01	5	5										
1	徐畅	2/3	0/3	2/4	0/4	0/2		1/1	5/17	29.4						14	吴璟	14	02:33	6	33										
12	王权	3/4	1/4	4/7	1/2			9/17	52.9	1	1					14	钱为玮	14	02:57	7	8										
<b>守门员 合计</b>		5/7	1/7	6/11	1/6	0/2		1/1	14/34	41.2	1	1				15	王伟强	15	03:39	7	7										
<b>上海</b>		远射	近射	边射	快攻	突破	任意球	7m球	合计	%	助攻	失误	警告	2'	D & DR	15	钱为玮	15	04:32	8	8										
教练： 吴龙基																15	赵时俊	15	05:36	9	3										
1	张峥															16	徐俊吉	16	07:04	9	9										
2	张文斌															17	徐奕飞	17	08:12	9	9										
3	赵时俊	0/1		2/3	1/1	0/1		0/1	3/7	42.9	1	3	1	1		17	徐奕飞	17	09:15	10	14										
4	徐俊吉		2/3						2/3	66.7						18	徐奕飞	18	09:25	10	10										
8	钱为玮	0/1	2/2	1/3	3/3				6/9	66.7						18	徐奕飞	18	10:04	11	14										
10	董凯															19	徐奕飞	19	12:32	11	11										
11	蒋承骅	1/1		0/1				1/2	50.0			2				19	徐奕飞	19	13:07	12	14										
12	周哲韬															20	徐奕飞	20	13:46	12	12										
14	沈吉磊	0/4		1/1		2/2		3/7	42.9			1	1			20	徐奕飞	20	14:25	13	33										
15	朱世杰	0/4						0/4	0.0	1	3	1				21	徐奕飞	21	15:57	14	33										
16	朱春雷															21	徐奕飞	21	16:34	14	14										
17	贺政			0/2	0/1			0/3	0.0			1				21	徐奕飞	21	17:12	15	33										
18	马麟晓	1/8		0/1				1/9	11.1	5	3					22	徐奕飞	22	18:37	16	18										
33	吴璟		2/2	1/1	1/1			4/4	100							22	徐奕飞	22	18:48	16	16										
<b>运动员 合计</b>		2/19	6/7	5/12	5/6	2/3		0/1	20/48	41.7	7	20	3	2		23	徐奕飞	23	20:48	16	16										
1	张峥	1/6	1/9	0/3	3/6	1/5		0/1	6/30	20.0						24	徐奕飞	24	21:21	16	16										
12	周哲韬	0/1			0/1	0/2	0/1	0/5	0.0							25	徐奕飞	25	22:03	16	16										
<b>守门员 合计</b>		1/7	1/9	0/3	3/7	1/7	0/1	0/1	6/35	17.1						25	徐奕飞	25	22:52	17	4										

场上队员： 得分 / 射门

守门员： 救球 / 射门

快攻	Fast Break		突破	Breakthrough		任意球	Free Throw		7M球	7M Throw		助攻	Assist
警告	Warning		失误	Error		2'	Suspension		D	取消资格		DR	取消资格+报告





### 2016年全国男子手球锦标赛 图式比赛技术统计表

轮次 6

场次 26

201606026-21-1/1

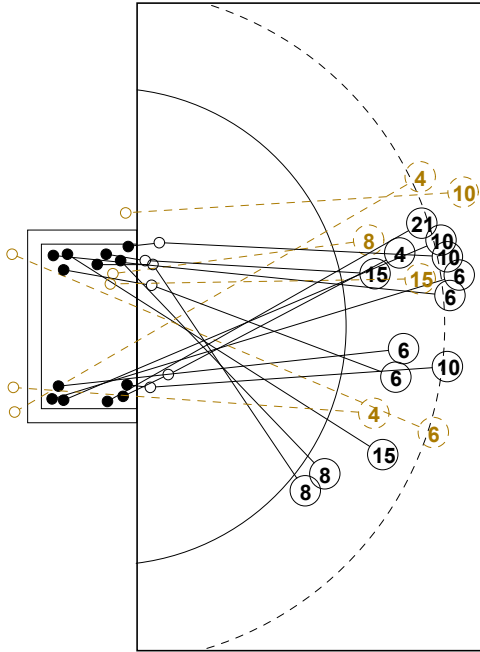

7M 江苏

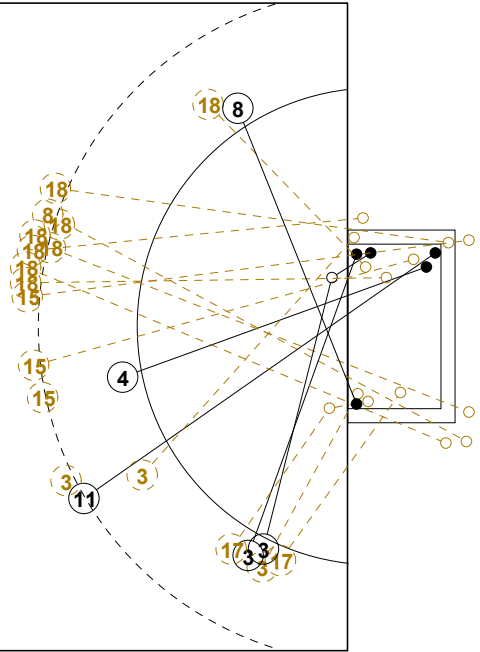
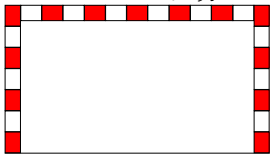

上海 7M

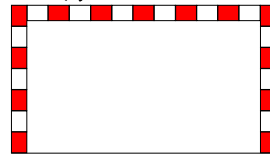

1st Half  
13 : 5

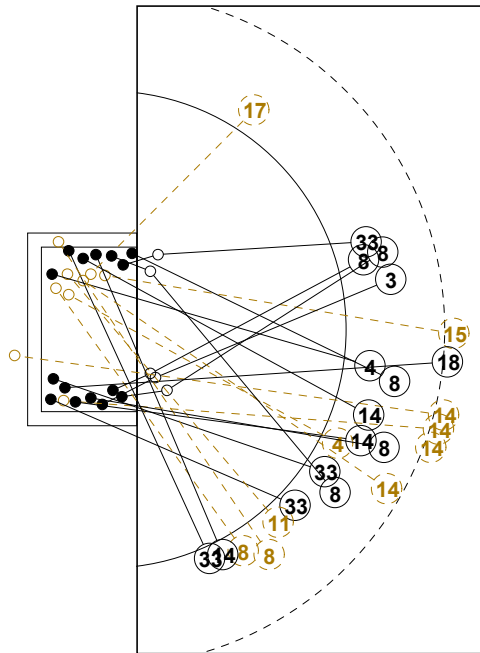

7M 上海

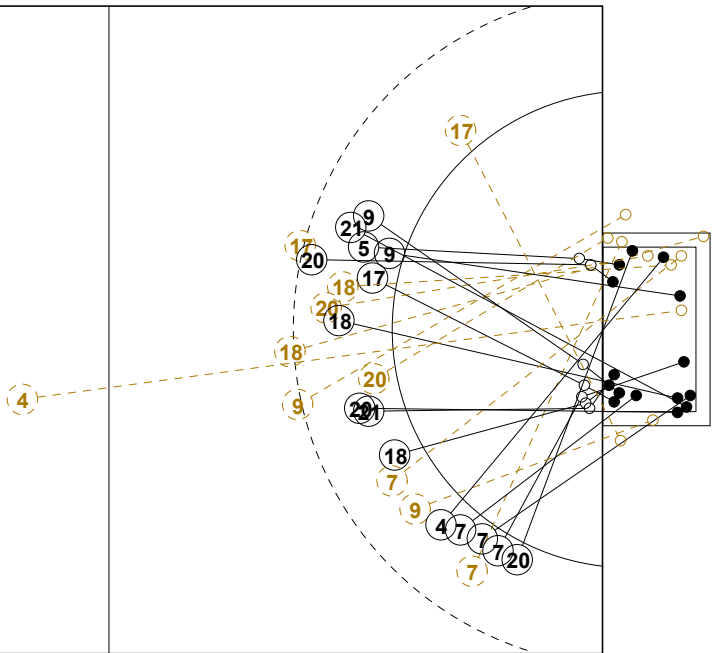
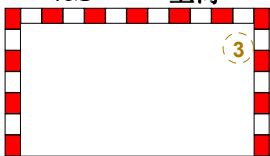

江苏 7M



2nd Half  
20 : 29



## 2016年全国男子手球锦标赛

## 个人/全队技术统计表

正式表  
手球  
男子四分之一决赛  
轮次 6组别 X  
场次 26201606026-14-1/2  
徐闻县体育中心体育馆  
27/10/2016 14:00

号码	姓名	远射	近射	边射	快攻	突破	任意	7M	合计	%	助攻	失误	警告	2'	取消	时间
<b>江苏队(江苏)</b>																
<i>(场上队员)</i>																
1	徐畅									0.0%		1				00:22:31
4	张家纬	0/2	1/1		0/1	1/1			2/5	40.0%		2	1			00:27:11
5	闫亮		1/1						1/1	100%		2	1			00:32:03
6	赵晨	2/2				2/2	0/1		4/5	80.0%	1	1				00:26:40
7	徐奕飞			2/3	1/2				3/5	60.0%						00:33:13
8	周小坚		2/2		0/1				2/3	66.7%		4				00:26:45
9	周傲	0/1			1/2	1/1			2/4	50.0%						00:15:26
10	郝可鑫	2/3					1/1		3/4	75.0%						00:12:01
12	王权									0.0%	1					00:36:58
15	李安				2/3				2/3	66.7%	2	1				00:27:03
16	张帅									0.0%						00:00:00
17	王伟强	0/1			0/1	1/1		1/1	2/4	50.0%						00:33:20
18	赵楠		1/1			1/2	0/1		2/4	50.0%	3	3		1		00:54:19
20	顾艳超	1/1	1/2	1/1		0/1			3/5	60.0%	2	3				00:32:57
21	刘江	1/1	2/2						3/3	100%		1	1			00:38:27
22	张瑞恒									0.0%						00:00:00
<b>合计</b>		6/11	8/9	3/4	4/10	6/8	1/3	1/1	29/46	63.0%	9	18	3	1		
<i>(守门员)</i>																
1	徐畅	2/3	0/3	2/4	0/4	0/2		1/1	5/17	29.4%		1				00:22:31
12	王权	3/4	1/4	4/7	1/2				9/17	52.9%	1					00:36:58
<b>合计</b>		5/7	1/7	6/11	1/6	0/2		1/1	14/34	41.2%	1	1				

场上队员：得分/射门

守门员：救球/射门

全队合计	得分	被救	射失	击柱	封球	合计	%
远射	6	1	3		1	11	54.5%
近射	8	1				9	88.9%
边射	3			1		4	75.0%
快攻	4	3	2	1		10	40.0%
突破	6	1		1		8	75.0%
任意	1		1	1		3	33.3%
7M	1					1	100.0%





## 2016年全国男子手球锦标赛

## 个人/全队技术统计表

正式表  
手球  
男子四分之一决赛  
轮次 6组别 X  
场次 26201606026-14-2/2  
徐闻县体育中心体育馆  
27/10/2016 14:00

号码	姓名	远射	近射	边射	快攻	突破	任意	7M	合计	%	助攻	失误	警告	2'	取消	时间
<b>上海队(上海)</b>																
<i>(上场队员)</i>																
1	张崢									0.0%						00:49:19
2	张文斌									0.0%						00:00:00
3	赵时俊	0/1		2/3	1/1	0/1		0/1	3/7	42.9%	1	3	1	1		00:43:33
4	徐俊吉		2/3						2/3	66.7%		7				00:40:18
8	钱为玮	0/1	2/2	1/3	3/3				6/9	66.7%				1		01:00:00
10	董凯									0.0%						00:00:00
11	蒋承骅	1/1		0/1					1/2	50.0%		2				00:53:38
12	周哲韬									0.0%						00:10:41
14	沈吉磊	0/4		1/1		2/2			3/7	42.9%		1	1			00:19:09
15	朱世杰	0/4							0/4	0.0%	1	3	1			00:45:09
16	朱春雷									0.0%						00:00:00
17	贺政			0/2	0/1				0/3	0.0%		1				00:22:23
18	马麟晓	1/8		0/1					1/9	11.1%	5	3				00:55:16
33	吴璟		2/2	1/1	1/1				4/4	100%						00:19:39
<b>合计</b>		2/19	6/7	5/12	5/6	2/3		0/1	20/48	41.7%	7	20	3	2		
<i>(守门员)</i>																
1	张崢	1/6	1/9	0/3	3/6	1/5		0/1	6/30	20.0%						00:49:19
12	周哲韬	0/1			0/1	0/2	0/1		0/5	0.0%						00:10:41
<b>合计</b>		1/7	1/9	0/3	3/7	1/7	0/1	0/1	6/35	17.1%						

场上队员：得分/射门

守门员：救球/射门

全队合计	得分	被救	射失	击柱	封球	合计	%
远射	2	5	6	1	5	19	10.5%
近射	6	1				7	85.7%
边射	5	6		1		12	41.7%
快攻	5	1				6	83.3%
突破	2			1		3	66.7%
任意							0.0%
7M		1				1	0.0%







### 2016年全国男子手球锦标赛

#### 图式射门区域统计

轮次 6 场次 26

201606026-41-1/1

## 江苏队

1 徐畅	4 张家伟	5 闫亮	6 赵晨	7 徐奕飞	8 周小坚	9 周傲	10 郝可鑫																																																																								
<table border="1"><tr><td></td><td></td><td></td></tr><tr><td></td><td></td><td></td></tr><tr><td></td><td></td><td></td></tr></table>										<table border="1"><tr><td></td><td></td><td></td></tr><tr><td>1</td><td></td><td></td></tr><tr><td>1</td><td></td><td></td></tr></table>				1			1			<table border="1"><tr><td></td><td></td><td></td></tr><tr><td></td><td></td><td></td></tr><tr><td>1</td><td></td><td></td></tr></table>							1			<table border="1"><tr><td>2</td><td></td><td>2</td></tr><tr><td></td><td></td><td></td></tr><tr><td></td><td></td><td></td></tr></table>	2		2							<table border="1"><tr><td></td><td></td><td>2</td></tr><tr><td></td><td></td><td>1</td></tr><tr><td></td><td></td><td></td></tr></table>			2			1				<table border="1"><tr><td></td><td></td><td></td></tr><tr><td></td><td></td><td>1</td></tr><tr><td></td><td></td><td>1</td></tr></table>						1			1	<table border="1"><tr><td>1</td><td></td><td></td></tr><tr><td></td><td></td><td></td></tr><tr><td></td><td></td><td>1</td></tr></table>	1								1	<table border="1"><tr><td>1</td><td></td><td></td></tr><tr><td></td><td></td><td></td></tr><tr><td>1</td><td></td><td>1</td></tr></table>	1						1		1
1																																																																															
1																																																																															
1																																																																															
2		2																																																																													
		2																																																																													
		1																																																																													
		1																																																																													
		1																																																																													
1																																																																															
		1																																																																													
1																																																																															
1		1																																																																													
Post - 0 Miss - 0 Block - 0	Post - 0 Miss - 2 Block - 0	Post - 0 Miss - 0 Block - 0	Post - 0 Miss - 1 Block - 0	Post - 1 Miss - 0 Block - 0	Post - 0 Miss - 0 Block - 0	Post - 1 Miss - 1 Block - 0	Post - 0 Miss - 1 Block - 0																																																																								
12 王权	15 李安	16 张帅	17 王伟强	18 赵楠	20 顾艳超	21 刘江	22 张瑞恒																																																																								
<table border="1"><tr><td></td><td></td><td></td></tr><tr><td></td><td></td><td></td></tr><tr><td></td><td></td><td></td></tr></table>										<table border="1"><tr><td></td><td></td><td>1</td></tr><tr><td></td><td></td><td></td></tr><tr><td></td><td></td><td>1</td></tr></table>			1						1	<table border="1"><tr><td></td><td></td><td></td></tr><tr><td></td><td></td><td></td></tr><tr><td></td><td></td><td></td></tr></table>										<table border="1"><tr><td></td><td></td><td>1</td></tr><tr><td></td><td></td><td></td></tr><tr><td></td><td></td><td>1</td></tr></table>			1						1	<table border="1"><tr><td></td><td></td><td>1</td></tr><tr><td></td><td></td><td></td></tr><tr><td></td><td></td><td>1</td></tr></table>			1						1	<table border="1"><tr><td></td><td></td><td>1</td></tr><tr><td></td><td></td><td></td></tr><tr><td>2</td><td></td><td></td></tr></table>			1				2			<table border="1"><tr><td></td><td></td><td>1</td></tr><tr><td></td><td></td><td></td></tr><tr><td>1</td><td></td><td>1</td></tr></table>			1				1		1	<table border="1"><tr><td></td><td></td><td></td></tr><tr><td></td><td></td><td></td></tr><tr><td></td><td></td><td></td></tr></table>									
		1																																																																													
		1																																																																													
		1																																																																													
		1																																																																													
		1																																																																													
		1																																																																													
		1																																																																													
2																																																																															
		1																																																																													
1		1																																																																													
Post - 0 Miss - 0 Block - 0	Post - 0 Miss - 0 Block - 0	Post - 0 Miss - 0 Block - 0	Post - 0 Miss - 1 Block - 1	Post - 1 Miss - 0 Block - 0	Post - 1 Miss - 0 Block - 0	Post - 0 Miss - 0 Block - 0	Post - 0 Miss - 0 Block - 0																																																																								

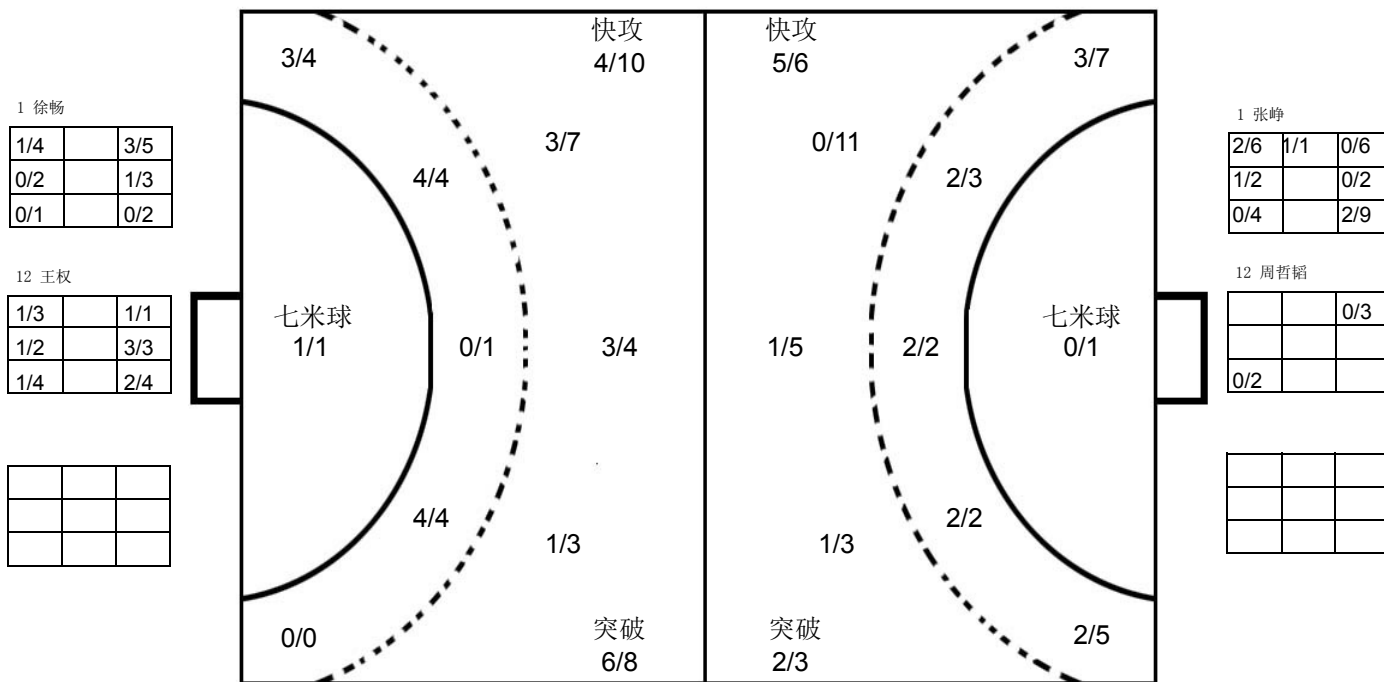

## 上海队

1 张峥	2 张文斌	3 赵时俊	4 徐俊吉	8 钱为玮	10 董凯	11 蒋承骅	12 周哲韬																																																																								
<table border="1"><tr><td></td><td></td><td></td></tr><tr><td></td><td></td><td></td></tr><tr><td></td><td></td><td></td></tr></table>										<table border="1"><tr><td></td><td></td><td></td></tr><tr><td></td><td></td><td></td></tr><tr><td></td><td></td><td></td></tr></table>										<table border="1"><tr><td></td><td></td><td></td></tr><tr><td>1</td><td></td><td></td></tr><tr><td>2</td><td></td><td></td></tr></table>				1			2			<table border="1"><tr><td>1</td><td></td><td>1</td></tr><tr><td></td><td></td><td></td></tr><tr><td></td><td></td><td></td></tr></table>	1		1							<table border="1"><tr><td></td><td></td><td></td></tr><tr><td>1</td><td></td><td></td></tr><tr><td>2</td><td></td><td>3</td></tr></table>				1			2		3	<table border="1"><tr><td></td><td></td><td></td></tr><tr><td></td><td></td><td></td></tr><tr><td></td><td></td><td></td></tr></table>										<table border="1"><tr><td>1</td><td></td><td></td></tr><tr><td></td><td></td><td></td></tr><tr><td></td><td></td><td></td></tr></table>	1									<table border="1"><tr><td></td><td></td><td></td></tr><tr><td></td><td></td><td></td></tr><tr><td></td><td></td><td></td></tr></table>									
1																																																																															
2																																																																															
1		1																																																																													
1																																																																															
2		3																																																																													
1																																																																															
Post - 0 Miss - 0 Block - 0	Post - 0 Miss - 0 Block - 0	Post - 1 Miss - 0 Block - 1	Post - 0 Miss - 0 Block - 0	Post - 1 Miss - 1 Block - 0	Post - 0 Miss - 0 Block - 0	Post - 0 Miss - 0 Block - 0	Post - 0 Miss - 0 Block - 0																																																																								
14 沈吉磊	15 朱世杰	16 朱春雷	17 贺政	18 马麟晓	33 吴璟																																																																										
<table border="1"><tr><td></td><td></td><td></td></tr><tr><td>1</td><td></td><td>2</td></tr><tr><td></td><td></td><td></td></tr></table>				1		2				<table border="1"><tr><td></td><td></td><td></td></tr><tr><td></td><td></td><td></td></tr><tr><td></td><td></td><td></td></tr></table>										<table border="1"><tr><td></td><td></td><td></td></tr><tr><td></td><td></td><td></td></tr><tr><td></td><td></td><td></td></tr></table>										<table border="1"><tr><td></td><td></td><td></td></tr><tr><td></td><td></td><td></td></tr><tr><td></td><td></td><td></td></tr></table>										<table border="1"><tr><td></td><td></td><td></td></tr><tr><td>1</td><td></td><td></td></tr><tr><td></td><td></td><td></td></tr></table>				1						<table border="1"><tr><td></td><td></td><td></td></tr><tr><td>2</td><td></td><td>1</td></tr><tr><td></td><td></td><td>1</td></tr></table>				2		1			1	<table border="1"><tr><td></td><td></td><td></td></tr><tr><td></td><td></td><td></td></tr><tr><td></td><td></td><td></td></tr></table>										<table border="1"><tr><td></td><td></td><td></td></tr><tr><td></td><td></td><td></td></tr><tr><td></td><td></td><td></td></tr></table>									
1		2																																																																													
1																																																																															
2		1																																																																													
		1																																																																													
Post - 0 Miss - 1 Block - 1	Post - 0 Miss - 1 Block - 1	Post - 0 Miss - 0 Block - 0	Post - 0 Miss - 0 Block - 0	Post - 1 Miss - 3 Block - 2	Post - 0 Miss - 0 Block - 0																																																																										

注释: Post=击柱 Miss=射失 Block=被封





四分之一决赛

男子 全国比赛

2016年全国男子手球锦标赛

Team A										Team B										Match Number									
A 天津队										B 解放军队										27									
played in					in the hall					on					at					Spectators									
China					徐闻县体育中心体育					27/10/2016					15:40 hours														
Half-time (30')		A		B		End of playing time		A		B		1st extra time		A		B		2nd extra time		A		B		After penalty		A		B	
		14		13				28		19																			
Number of 7 m		A		Team time-out			Full name of players and officials										Team time-out			B		Number of 7 m							
5 / 6		1		44:03													13:54			46:31		2 / 3							
No.	Team A									G	W	2'	D	DR	No.	Team B									G	W	2'	D	DR
1	刘宗其														1	李梓宁													
2	李岳朋									4		1			2	范保坤													
4	李松浩														4	曹作亮									5	1			
6	王子欣									1					5	张昌轲													
7	张青									7		1			6	吴昊										1	1		
8	曹悦									3	1	1			7	姜钦									2				
9	吴明远														8	王烁									3				
11	王毅									2					9	毕晓晨									3	1	1		
12	杨峻														11	肖东洋													
13	许松									7					12	姜明													
14	田剑侠									3					14	孙耀琦									2		1		
16	刘海亮														15	杨帆													
17	周群									1					16	丛霖													
18	王晓琪														18	王晓龙									4				
21	潘玉帅														20	刘智洋													
22	魏雨童																												
A	贾守信														B	张敬敏 (主教练)													
B	杜瑞军 (主教练)														C	王学力													
D	潘玉强														D	刘捷													
E	贾宁														E	刘军													
A										Signature of Responsible Official of the Teams (Off. A)										B									
TP	Remarks of Referee / CHA Official																			TP									

Signatures

Referees: 王科 (CHN)      李兆蒙 (CHN)

Techn. Delegates: 曹宏俊 (CHN)

CHA Official: 徐健 (CHN)

Note: Number of 7m Throws Awarded to Team A and B, Goals (G), Warnings (W), Suspensions (2), Direct Disqualification (D), Disqualification with Report (DR) and Team Penalty (TP).





2016年全国男子手球锦标赛 竞赛技术统计(媒体表)

四分之一决赛 组别 X 轮次 6 场次 27

徐闻县体育中心体育馆

27/10/2016

201606027-51-1/1

天津队 天津 28 vs 19 解放军 解放军队 14:13

裁判员 王科 (CHN) / 李兆蒙 (CHN)

Main statistics table with columns for players, shots, goals, assists, etc. for both teams.

场上队员: 得分 / 射门

守门员: 救球 / 射门

Legend table for abbreviations like Fast Break, Breakthrough, Free Throw, etc.





### 2016年全国男子手球锦标赛 图式比赛技术统计表

轮次 6

场次 27

201606027-21-1/1

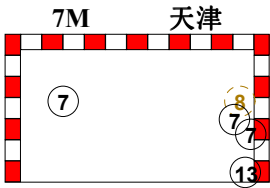
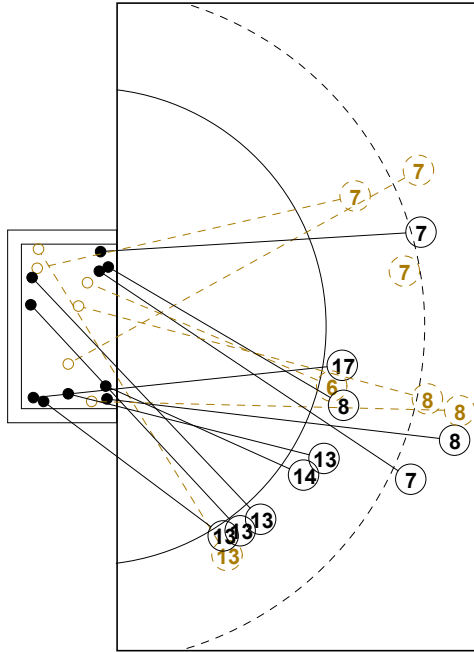

1st Half  
14 : 13

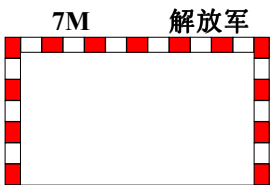
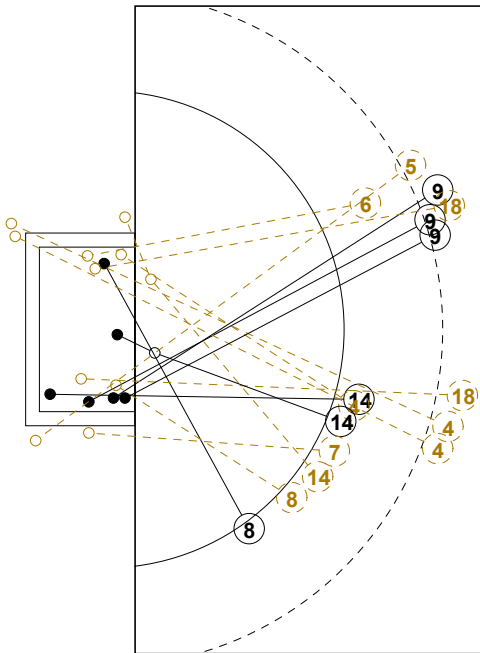
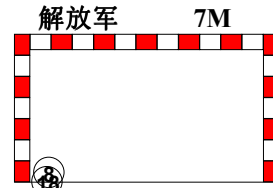
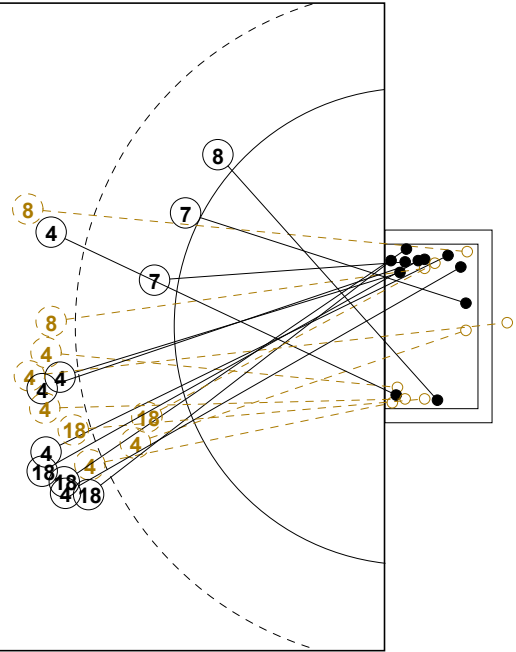

2nd Half  
19 : 28

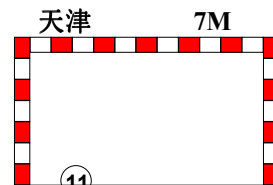
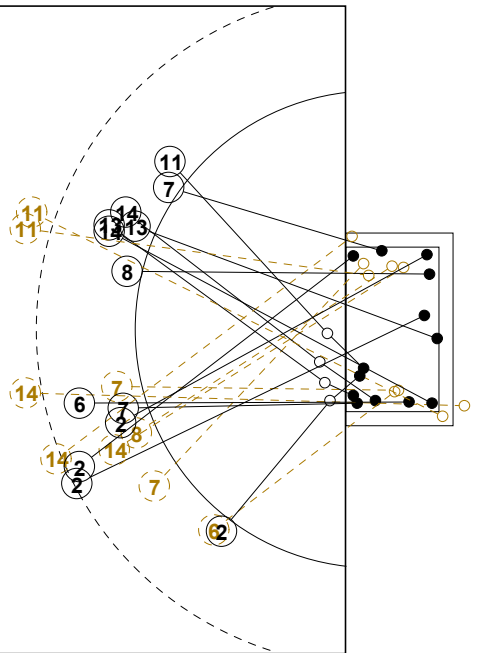



## 2016年全国男子手球锦标赛

## 个人/全队技术统计表

正式表  
手球  
男子四分之一决赛  
轮次 6组别 X  
场次 27201606027-14-1/2  
徐闻县体育中心体育馆  
27/10/2016 15:40

号码	姓名	远射	近射	边射	快攻	突破	任意	7M	合计	%	助攻	失误	警告	2'	取消	时间
<b>天津队(天津)</b>																
<i>(场上队员)</i>																
1	刘宗其									0.0%						00:58:43
2	李岳朋	2/2	1/1	1/1					4/4	100%	1	1		1		00:43:56
4	李松浩									0.0%						00:00:00
6	王子欣		0/1	0/1	1/1				1/3	33.3%						00:54:19
7	张青	2/4	2/4			0/1		3/3	7/12	58.3%	1	1		1		00:45:10
8	曹悦	1/2	2/3				0/1	0/1	3/7	42.9%			1	1		00:50:33
9	吴明远									0.0%		1				00:01:27
11	王毅	0/2	1/1					1/1	2/4	50.0%						00:05:05
12	杨峻									0.0%						00:01:17
13	许松		2/2	3/4	1/1			1/1	7/8	87.5%						00:55:16
14	田剑侠	0/2	2/3			1/1			3/6	50.0%		2				00:38:38
16	刘海亮									0.0%						00:00:00
17	周群		1/1						1/1	100%		1				00:53:51
18	王晓琪									0.0%						00:05:18
21	潘玉帅									0.0%						00:00:00
22	魏雨童									0.0%						00:06:09
<b>合计</b>		5/12	11/16	4/6	2/2	1/2	0/1	5/6	28/45	62.2%	2	6	1	3		
<i>(守门员)</i>																
1	刘宗其	8/17	4/9	0/1		1/2	0/1	0/2	13/32	40.6%						00:58:43
12	杨峻									0.0%						00:01:17
<b>合计</b>		8/17	4/9	0/1		1/2	0/1	0/2	13/32	40.6%						

场上队员：得分/射门

守门员：救球/射门

全队合计	得分	被救	射失	击柱	封球	合计	%
远射	5	3	1	2	1	12	41.7%
近射	11	5				16	68.8%
边射	4	2				6	66.7%
快攻	2					2	100.0%
突破	1	1				2	50.0%
任意		1				1	0.0%
7M	5	1				6	83.3%





## 2016年全国男子手球锦标赛

## 个人/全队技术统计表

正式表  
手球  
男子四分之一决赛  
轮次 6组别 X  
场次 27201606027-14-2/2  
徐闻县体育中心体育馆  
27/10/2016 15:40

号码	姓名	远射	近射	边射	快攻	突破	任意	7M	合计	%	助攻	失误	警告	2'	取消	时间
<b>解放军队(解放军)</b>																
<i>(上场队员)</i>																
1	李梓宁									0.0%						00:00:20
2	范保坤									0.0%						00:00:00
4	曹作亮	3/8	0/2			1/1	1/2		5/13	38.5%	2	1	1			00:54:31
5	张昌轲				0/1				0/1	0.0%						00:05:28
6	吴昊		0/1						0/1	0.0%		1	1	1		00:32:43
7	姜钦		2/3						2/3	66.7%	1	2				01:00:00
8	王烁	0/2	1/1	1/1		0/1		1/2	3/7	42.9%		2				00:58:21
9	毕晓晨	3/3							3/3	100%	1	1	1	1		01:00:00
11	肖东洋									0.0%						00:01:38
12	姜明									0.0%						00:06:44
14	孙耀琦		2/3						2/3	66.7%				1		00:59:06
15	杨帆									0.0%						00:00:00
16	丛霖									0.0%						00:52:22
18	王晓龙	3/6	0/1					1/1	4/8	50.0%		2				00:27:28
20	刘智洋									0.0%						00:00:00
<b>合计</b>		9/19	5/11	1/1	0/1	1/2	1/2	2/3	19/39	48.7%	4	9	3	3		
<i>(守门员)</i>																
1	李梓宁							0/1	0/1	0.0%						00:00:20
12	姜明	1/1	0/1	0/1				0/1	1/4	25.0%						00:06:44
16	丛霖	2/7	5/15	2/5	0/2	1/2	1/1	1/4	12/36	33.3%						00:52:22
<b>合计</b>		3/8	5/16	2/6	0/2	1/2	1/1	1/6	13/41	31.7%						

场上队员：得分/射门

守门员：救球/射门

全队合计	得分	被救	射失	击柱	封球	合计	%
远射	9	8	2			19	47.4%
近射	5	4	2			11	45.5%
边射	1					1	100.0%
快攻			1			1	0.0%
突破	1	1				2	50.0%
任意	1		1			2	50.0%
7M	2		1			3	66.7%





### 2016年全国男子手球锦标赛

#### 图式射门区域统计

轮次 6 场次 27

201606027-41-1/1

## 天津队

1 刘宗其	2 李岳朋	4 李松浩	6 王子欣	7 张青	8 曹悦	9 吴明远	11 王毅																																																																								
<table border="1"><tr><td></td><td></td><td></td></tr><tr><td></td><td></td><td></td></tr><tr><td></td><td></td><td></td></tr></table>										<table border="1"><tr><td>1</td><td>1</td><td></td></tr><tr><td></td><td></td><td></td></tr><tr><td>1</td><td></td><td>1</td></tr></table>	1	1					1		1	<table border="1"><tr><td></td><td></td><td></td></tr><tr><td></td><td></td><td></td></tr><tr><td></td><td></td><td></td></tr></table>										<table border="1"><tr><td></td><td></td><td>1</td></tr><tr><td></td><td></td><td></td></tr><tr><td></td><td></td><td></td></tr></table>			1							<table border="1"><tr><td>1</td><td></td><td></td></tr><tr><td>1</td><td></td><td>2</td></tr><tr><td></td><td></td><td>3</td></tr></table>	1			1		2			3	<table border="1"><tr><td>1</td><td></td><td></td></tr><tr><td></td><td></td><td></td></tr><tr><td>1</td><td></td><td>1</td></tr></table>	1						1		1	<table border="1"><tr><td></td><td></td><td></td></tr><tr><td></td><td></td><td></td></tr><tr><td></td><td></td><td></td></tr></table>										<table border="1"><tr><td></td><td></td><td></td></tr><tr><td></td><td></td><td></td></tr><tr><td>1</td><td></td><td>1</td></tr></table>							1		1
1	1																																																																														
1		1																																																																													
		1																																																																													
1																																																																															
1		2																																																																													
		3																																																																													
1																																																																															
1		1																																																																													
1		1																																																																													
Post - 0 Miss - 0 Block - 0	Post - 0 Miss - 0 Block - 0	Post - 0 Miss - 0 Block - 0	Post - 0 Miss - 0 Block - 0	Post - 0 Miss - 0 Block - 1	Post - 0 Miss - 0 Block - 0	Post - 0 Miss - 0 Block - 0	Post - 1 Miss - 0 Block - 0																																																																								
12 杨峻	13 许松	14 田剑侠	16 刘海亮	17 周群	18 王晓琪	21 潘玉帅	22 魏雨童																																																																								
<table border="1"><tr><td></td><td></td><td></td></tr><tr><td></td><td></td><td></td></tr><tr><td></td><td></td><td></td></tr></table>										<table border="1"><tr><td>1</td><td>2</td><td>1</td></tr><tr><td>1</td><td></td><td></td></tr><tr><td></td><td></td><td>2</td></tr></table>	1	2	1	1					2	<table border="1"><tr><td></td><td></td><td>1</td></tr><tr><td></td><td></td><td></td></tr><tr><td>1</td><td></td><td>1</td></tr></table>			1				1		1	<table border="1"><tr><td></td><td></td><td></td></tr><tr><td></td><td></td><td></td></tr><tr><td></td><td></td><td></td></tr></table>										<table border="1"><tr><td>1</td><td></td><td></td></tr><tr><td></td><td></td><td></td></tr><tr><td></td><td></td><td></td></tr></table>	1									<table border="1"><tr><td></td><td></td><td></td></tr><tr><td></td><td></td><td></td></tr><tr><td></td><td></td><td></td></tr></table>										<table border="1"><tr><td></td><td></td><td></td></tr><tr><td></td><td></td><td></td></tr><tr><td></td><td></td><td></td></tr></table>										<table border="1"><tr><td></td><td></td><td></td></tr><tr><td></td><td></td><td></td></tr><tr><td></td><td></td><td></td></tr></table>									
1	2	1																																																																													
1																																																																															
		2																																																																													
		1																																																																													
1		1																																																																													
1																																																																															
Post - 0 Miss - 0 Block - 0	Post - 0 Miss - 0 Block - 0	Post - 1 Miss - 1 Block - 0	Post - 0 Miss - 0 Block - 0	Post - 0 Miss - 0 Block - 0	Post - 0 Miss - 0 Block - 0	Post - 0 Miss - 0 Block - 0	Post - 0 Miss - 0 Block - 0																																																																								

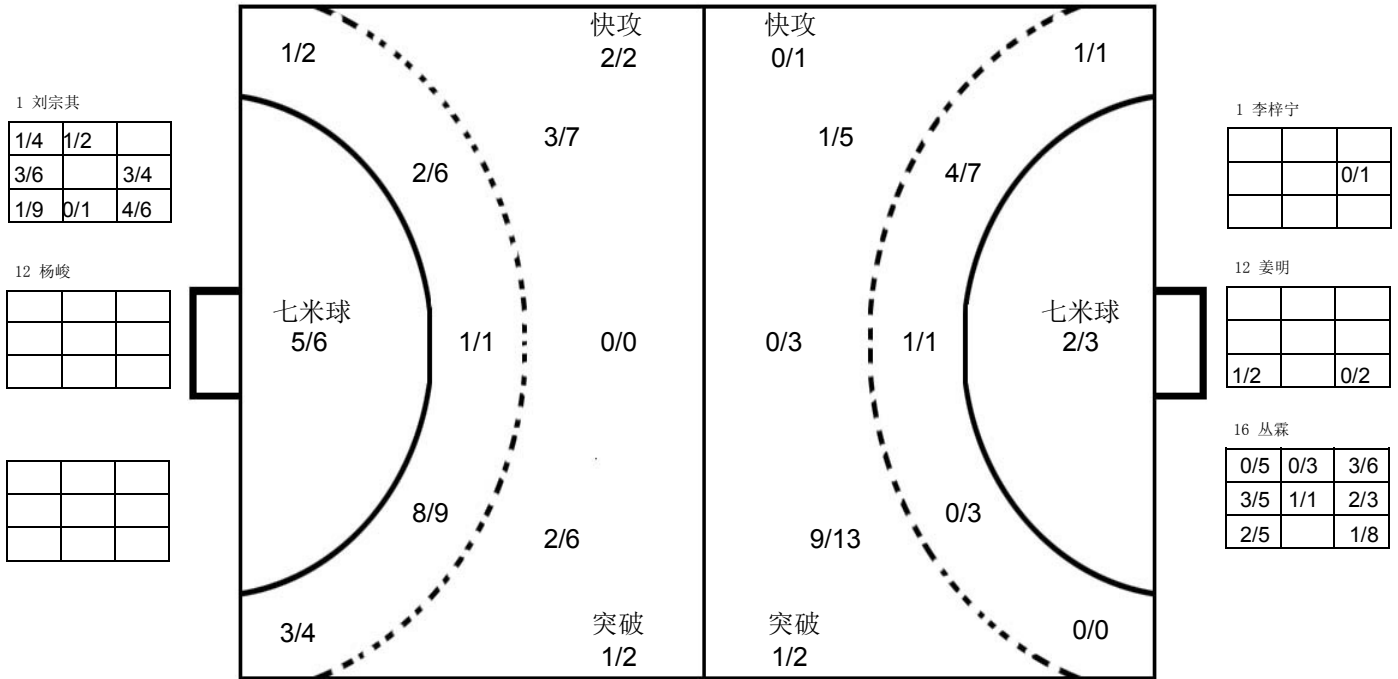

## 解放军队

1 李梓宁	2 范保坤	4 曹作亮	5 张昌柯	6 吴昊	7 姜钦	8 王烁	9 毕晓晨																																																																								
<table border="1"><tr><td></td><td></td><td></td></tr><tr><td></td><td></td><td></td></tr><tr><td></td><td></td><td></td></tr></table>										<table border="1"><tr><td></td><td></td><td></td></tr><tr><td></td><td></td><td></td></tr><tr><td></td><td></td><td></td></tr></table>										<table border="1"><tr><td>2</td><td></td><td></td></tr><tr><td>1</td><td></td><td></td></tr><tr><td>1</td><td></td><td>1</td></tr></table>	2			1			1		1	<table border="1"><tr><td></td><td></td><td></td></tr><tr><td></td><td></td><td></td></tr><tr><td></td><td></td><td></td></tr></table>										<table border="1"><tr><td></td><td></td><td></td></tr><tr><td></td><td></td><td></td></tr><tr><td></td><td></td><td></td></tr></table>										<table border="1"><tr><td></td><td>1</td><td></td></tr><tr><td></td><td></td><td></td></tr><tr><td>1</td><td></td><td></td></tr></table>		1					1			<table border="1"><tr><td></td><td></td><td></td></tr><tr><td></td><td></td><td>1</td></tr><tr><td>1</td><td></td><td>1</td></tr></table>						1	1		1	<table border="1"><tr><td></td><td></td><td></td></tr><tr><td></td><td></td><td></td></tr><tr><td>1</td><td></td><td></td></tr></table>							1		
2																																																																															
1																																																																															
1		1																																																																													
	1																																																																														
1																																																																															
		1																																																																													
1		1																																																																													
1																																																																															
Post - 0 Miss - 0 Block - 0	Post - 0 Miss - 0 Block - 0	Post - 0 Miss - 3 Block - 0	Post - 0 Miss - 1 Block - 0	Post - 0 Miss - 0 Block - 0	Post - 0 Miss - 1 Block - 0	Post - 0 Miss - 1 Block - 0	Post - 0 Miss - 0 Block - 0																																																																								
11 肖东洋	12 姜明	14 孙耀琦	15 杨帆	16 丛霖	18 王晓龙	20 刘智洋																																																																									
<table border="1"><tr><td></td><td></td><td></td></tr><tr><td></td><td></td><td></td></tr><tr><td></td><td></td><td></td></tr></table>										<table border="1"><tr><td></td><td></td><td></td></tr><tr><td></td><td></td><td></td></tr><tr><td></td><td></td><td></td></tr></table>										<table border="1"><tr><td>1</td><td></td><td></td></tr><tr><td></td><td></td><td></td></tr><tr><td></td><td>1</td><td></td></tr></table>	1							1		<table border="1"><tr><td></td><td></td><td></td></tr><tr><td></td><td></td><td></td></tr><tr><td></td><td></td><td></td></tr></table>										<table border="1"><tr><td></td><td></td><td></td></tr><tr><td></td><td></td><td></td></tr><tr><td></td><td></td><td></td></tr></table>										<table border="1"><tr><td></td><td></td><td></td></tr><tr><td>1</td><td></td><td></td></tr><tr><td>3</td><td></td><td></td></tr></table>				1			3			<table border="1"><tr><td></td><td></td><td></td></tr><tr><td></td><td></td><td></td></tr><tr><td></td><td></td><td></td></tr></table>										<table border="1"><tr><td></td><td></td><td></td></tr><tr><td></td><td></td><td></td></tr><tr><td></td><td></td><td></td></tr></table>									
1																																																																															
	1																																																																														
1																																																																															
3																																																																															
Post - 0 Miss - 0 Block - 0	Post - 0 Miss - 0 Block - 0	Post - 0 Miss - 1 Block - 0	Post - 0 Miss - 0 Block - 0	Post - 0 Miss - 0 Block - 0	Post - 0 Miss - 0 Block - 0	Post - 0 Miss - 0 Block - 0																																																																									

注释: Post=击柱 Miss=射失 Block=被封





四分之一决赛

男子 全国比赛

2016年全国男子手球锦标赛

Team A										Team B										Match Number																	
A 北京队										B 广东队										28																	
played in China										in the hall 徐闻县体育中心体育										on 27/10/2016		at 19:00 hours		Spectators													
Half-time (30')		A 10		B 7		End of playing time		A 22		B 21		1st extra time		A		B		2nd extra time		A		B		After penalty throws		A		B									
Number of 7 m		A 4 / 4		Team time-out			Full name of players and officials										Team time-out			B 3 / 5		Number of 7 m															
			1	2	3												1	2	3																		
		19:21	54:26																																		
No.	Team A										G	W	2'	D	DR	No.	Team B										G	W	2'	D	DR						
3	王超										1		1			1	王泽润																				
6	解建飞										5	1				2	孙江山										3										
8	王鹏												1			3	曲汝洋										4	1									
9	刘振										4					4	李卓洋										2		1								
10	成亚										2					5	侯生升										1										
11	蒋维一										1					7	付文博										2										
12	孟辉															8	于彦江																				
16	刘迈科															10	周仲坤																				
21	胡瀛															11	房友屯																				
23	王军程															13	王立隆																				
25	马明辉										2		1			15	张建杰																				
29	杜龙飞										1					16	马跃																				
33	冯宁															17	李中洲										7	1									
77	朱昕晨										1		1			20	黄培杰																				
78	张骥										5					84	王伟										2		2								
83	潘天																																				
A	安福田															B	王锋 (主教练)																				
B	郑永利 (主教练)															C	刘康伶																				
C	陈璇															D	张广建																				
																E	王永存																				
A											Signature of Responsible Official of the Teams (Off. A)																				B						
TP	Remarks of Referee / CHA Official																														TP						

Signatures

Referees: 周云磊 (CHN)      程钰锋 (CHN)

Techn. Delegates: 许宜扬 (CHN)

CHA Official: 刘凤娟 (CHN)

Note: Number of 7m Throws Awarded to Team A and B, Goals (G), Warnings (W), Suspensions (2), Direct Disqualification (D), Disqualification with Report (DR) and Team Penalty (TP).

Table Officials: 刘正松      伍豪      Statisticians: 周亚桥      李双

Printed by PHMS Copyright: IHF / CHA 27/10/2016 20:35:11

Longman Sportsoft           handball@126.com





### 2016年全国男子手球锦标赛 竞赛技术统计(媒体表)

四分之一决赛	组别	X	轮次	6	场次	28
--------	----	---	----	---	----	----

徐闻县体育中心体育馆

27/10/2016

201606028-51-1/1

北京队	北京	22	vs	21	广东	广东队
10 : 7						

裁判员	周云磊 (CHN)	/	程钰锋 (CHN)
-----	-----------	---	-----------

北京		远射	近射	边射	快攻	突破	任意球	7m球	合计	%	助攻	失误	警告	2'	D & DR	北京		比赛进程	广东
主教练: 郑永利																			
3	王超			1/2					1/2	50.0				1			9	刘振	1 00:32 0
6	解建飞	2/2	1/1	1/2			1/2		5/7	71.4	1		1				9	刘振	2 03:09 0
8	王鹏													1			25	马明辉	3 03:47 0
9	刘振	0/2	1/2			2/2		1/1	4/7	57.1							10	成亚	4 04:53 0
10	成亚	2/2	0/1						2/3	66.7		2					10	成亚	4 05:32 1 3 曲汝洋
11	蒋维一		1/1						1/1	100		1					11	蒋维一	5 06:33 1 1
12	孟辉																6	解建飞	6 08:26 2 2
16	刘迈科											1					7	解建飞	7 12:52 2 2
21	胡瀛											1					78	张骥	8 15:00 2 2
23	王军程	0/1						0/1	0/1	0.0							8	解建飞	8 16:01 3 2 孙江山
25	马明辉	0/1	1/2	0/1	1/1			2/5	40.0								8	解建飞	8 16:49 4 4 李卓洋
29	杜龙飞		1/1					1/1	100								6	解建飞	9 20:07 4 4
33	冯宁																9	解建飞	9 21:44 5 17 李中洲
77	朱昕晨	0/2	0/1			1/1		1/4	25.0	1				1			9	解建飞	9 22:46 6 2 孙江山
78	张骥		2/3				0/1	3/3	5/7	71.4	1	3					9	解建飞	9 24:21 7 2 孙江山
83	潘天																3	王超	10 25:37 7 7
<b>运动员 合计</b>		4/10	7/12	2/5	1/1	3/3	1/3	4/4	22/38	57.9	3	8	1	4					
12	孟辉							0/1	0/1	0.0							2nd Half		
16	刘迈科	4/8	4/11	2/2	0/4	1/4	1/3	12/32	37.5			1					10	解建飞	10 01:00 8 3 曲汝洋
<b>守门员 合计</b>		4/8	4/11	2/2	0/4	1/4	1/4	12/33	36.4			1					10	解建飞	10 02:56 9 3 曲汝洋
<b>广东</b>		远射	近射	边射	快攻	突破	任意球	7m球	合计	%	助攻	失误	警告	2'	D & DR				
教练: 王锋																			
1	王泽润																		
2	孙江山		1/1		1/1			1/3	3/5	60.0									
3	曲汝洋	1/3	1/2		1/1	1/1		4/7	57.1	1	3	1							
4	李卓洋	1/5	0/2		1/1			2/8	25.0					1					
5	侯生升		1/1					1/1	100										
7	付云博			0/2		2/3		2/5	40.0	1									
8	于彦江																		
10	周仲坤																		
11	房友屯																		
13	王立隆																		
15	张建杰																		
16	马跃											1							
17	李中洲	2/6	2/3		1/1	0/1		2/2	7/13	53.8	1		1						
20	黄培杰																		
84	王伟		2/2					2/2	100										
<b>运动员 合计</b>		4/14	7/11	0/2	4/4	3/5		3/5	21/41	51.2	3	4	2	3					
16	马跃	3/7	4/11	2/4	0/1	0/3	1/2	0/4	10/32	31.3		1							
<b>守门员 合计</b>		3/7	4/11	2/4	0/1	0/3	1/2	0/4	10/32	31.3		1							

场上队员: 得分 / 射门

守门员: 救球 / 射门

快攻	Fast Break	突破	Breakthrough	任意球	Free Throw	7M球	7M Throw	助攻	Assist
警告	Warning	失误	Error	2'	Suspension	D	取消资格	DR	取消资格+报告





### 2016年全国男子手球锦标赛 图式比赛技术统计表

轮次 6

场次 28

201606028-21-1/1

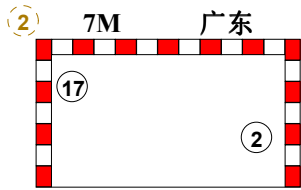
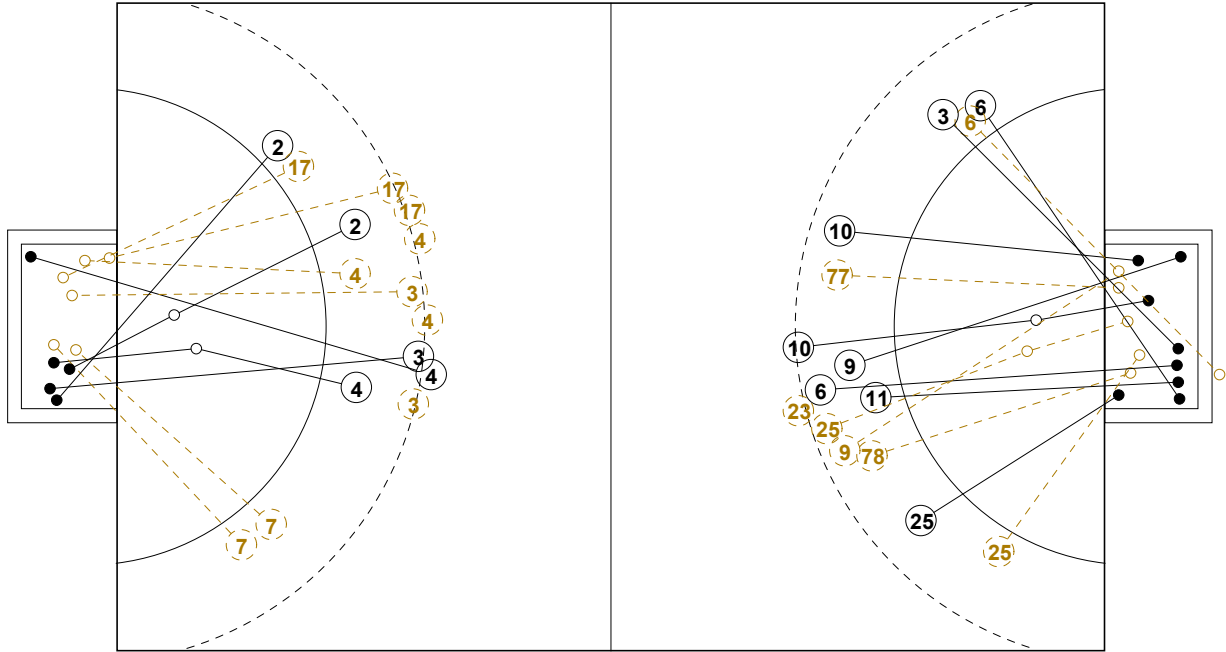

1st Half  
7 : 10

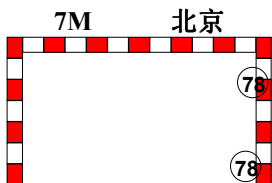
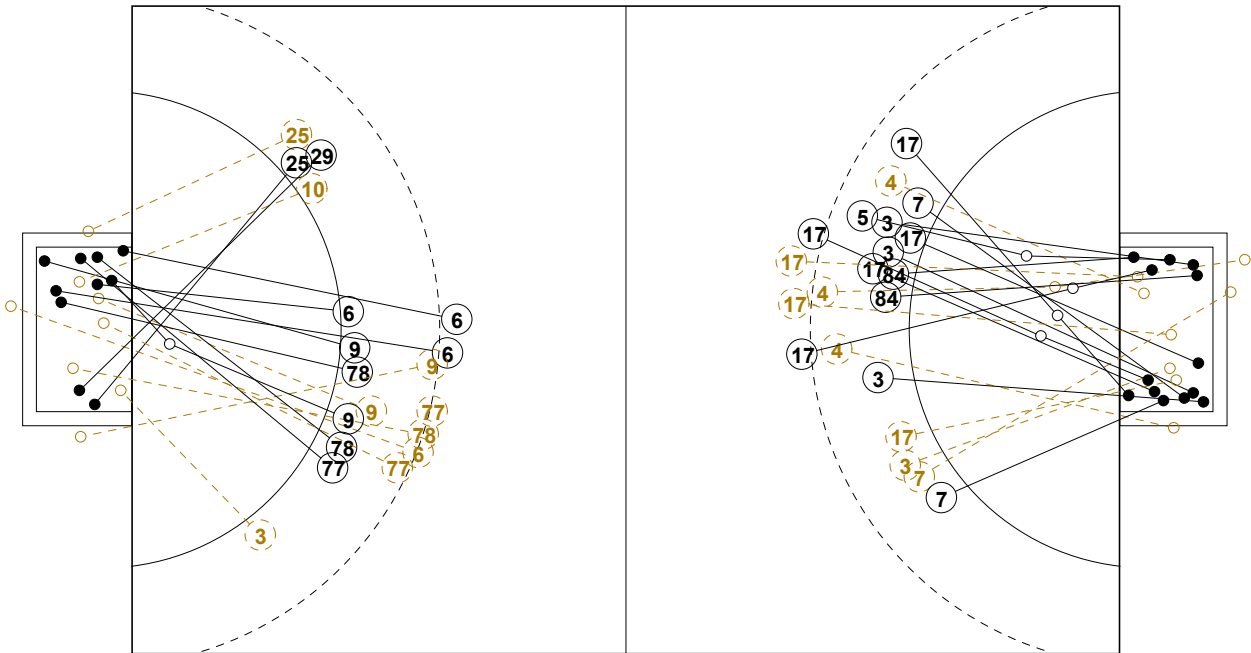
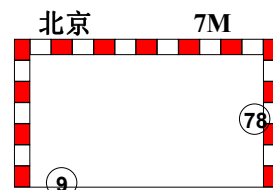

2nd Half  
22 : 21

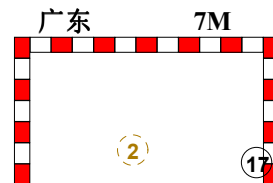



## 2016年全国男子手球锦标赛

## 个人/全队技术统计表

正式表  
手球  
男子四分之一决赛  
轮次 6组别 X  
场次 28201606028-14-1/2  
徐闻县体育中心体育馆  
27/10/2016 19:00

号码	姓名	远射	近射	边射	快攻	突破	任意	7M	合计	%	助攻	失误	警告	2'	取消	时间
<b>北京队(北京)</b>																
<i>(场上队员)</i>																
3	王超			1/2					1/2	50.0%				1		00:23:16
6	解建飞	2/2	1/1	1/2			1/2		5/7	71.4%	1		1		00:59:56	
8	王鹏									0.0%				1	00:19:12	
9	刘振	0/2	1/2			2/2		1/1	4/7	57.1%					00:55:58	
10	成亚	2/2	0/1						2/3	66.7%		2			00:37:49	
11	蒋维一		1/1						1/1	100%		1			00:38:10	
12	孟辉									0.0%					00:00:37	
16	刘迈科									0.0%		1			00:59:23	
21	胡瀛									0.0%		1			00:07:40	
23	王军程	0/1							0/1	0.0%					00:00:04	
25	马明辉	0/1	1/2	0/1	1/1				2/5	40.0%				1	00:40:17	
29	杜龙飞		1/1						1/1	100%					00:02:49	
33	冯宁									0.0%					00:00:00	
77	朱昕晨	0/2	0/1			1/1			1/4	25.0%	1			1	00:20:45	
78	张骥		2/3				0/1	3/3	5/7	71.4%	1	3			00:31:14	
83	潘天									0.0%					00:19:59	
<b>合计</b>		4/10	7/12	2/5	1/1	3/3	1/3	4/4	22/38	57.9%	3	8	1	4		
<i>(守门员)</i>																
12	孟辉							0/1	0/1	0.0%						00:00:37
16	刘迈科	4/8	4/11	2/2	0/4	1/4		1/3	12/32	37.5%		1			00:59:23	
<b>合计</b>		4/8	4/11	2/2	0/4	1/4		1/4	12/33	36.4%		1				

场上队员：得分/射门

守门员：救球/射门

全队合计	得分	被救	射失	击柱	封球	合计	%
远射	4	3	1		2	10	40.0%
近射	7	4		1		12	58.3%
边射	2	2	1			5	40.0%
快攻	1					1	100.0%
突破	3					3	100.0%
任意	1	1	1			3	33.3%
7M	4					4	100.0%





## 2016年全国男子手球锦标赛

## 个人/全队技术统计表

正式表  
手球  
男子四分之一决赛  
轮次 6组别 X  
场次 28201606028-14-2/2  
徐闻县体育中心体育馆  
27/10/2016 19:00

号码	姓名	远射	近射	边射	快攻	突破	任意	7M	合计	%	助攻	失误	警告	2'	取消	时间
<b>广东队(广东)</b>																
<i>(上场队员)</i>																
1	王泽润									0.0%						00:00:00
2	孙江山		1/1		1/1			1/3	3/5	60.0%						00:56:43
3	曲汝洋	1/3	1/2		1/1	1/1			4/7	57.1%	1	3	1			00:49:36
4	李卓洋	1/5	0/2		1/1				2/8	25.0%				1		00:52:41
5	侯生升		1/1						1/1	100%						00:46:20
7	付云博			0/2		2/3			2/5	40.0%	1					00:40:39
8	于彦江									0.0%						00:00:00
10	周仲坤									0.0%						00:00:00
11	房友屯									0.0%						00:00:00
13	王立隆									0.0%						00:00:00
15	张建杰									0.0%						00:00:00
16	马跃									0.0%		1				01:00:00
17	李中洲	2/6	2/3		1/1	0/1		2/2	7/13	53.8%	1		1			00:57:23
20	黄培杰									0.0%						00:00:00
84	王伟		2/2						2/2	100%				2		00:56:19
<b>合计</b>		4/14	7/11	0/2	4/4	3/5		3/5	21/41	51.2%	3	4	2	3		
<i>(守门员)</i>																
16	马跃	3/7	4/11	2/4	0/1	0/3	1/2	0/4	10/32	31.3%		1				01:00:00
<b>合计</b>		3/7	4/11	2/4	0/1	0/3	1/2	0/4	10/32	31.3%		1				

场上队员：得分/射门

守门员：救球/射门

全队合计	得分	被救	射失	击柱	封球	合计	%
远射	4	4	1	1	4	14	28.6%
近射	7	4				11	63.6%
边射		2				2	0.0%
快攻	4					4	100.0%
突破	3	1	1			5	60.0%
任意							0.0%
7M	3	1	1			5	60.0%





### 2016年全国男子手球锦标赛

#### 图式射门区域统计

轮次 6 场次 28

201606028-41-1/1

## 北京队

3 王超	6 解建飞	8 王鹏	9 刘振	10 成亚	11 蒋维一	12 孟辉	16 刘迈科																																																																								
<table border="1"><tr><td>1</td><td></td><td></td></tr><tr><td></td><td></td><td></td></tr><tr><td></td><td></td><td></td></tr></table>	1									<table border="1"><tr><td></td><td>3</td><td></td></tr><tr><td></td><td>1</td><td></td></tr><tr><td></td><td>1</td><td></td></tr></table>		3			1			1		<table border="1"><tr><td></td><td></td><td></td></tr><tr><td></td><td></td><td></td></tr><tr><td></td><td></td><td></td></tr></table>										<table border="1"><tr><td>1</td><td></td><td>1</td></tr><tr><td></td><td></td><td></td></tr><tr><td>1</td><td></td><td>1</td></tr></table>	1		1				1		1	<table border="1"><tr><td></td><td></td><td></td></tr><tr><td>1</td><td>1</td><td></td></tr><tr><td></td><td></td><td></td></tr></table>				1	1					<table border="1"><tr><td></td><td></td><td>1</td></tr><tr><td></td><td></td><td></td></tr><tr><td></td><td></td><td></td></tr></table>			1							<table border="1"><tr><td></td><td></td><td></td></tr><tr><td></td><td></td><td></td></tr><tr><td></td><td></td><td></td></tr></table>										<table border="1"><tr><td></td><td></td><td></td></tr><tr><td></td><td></td><td></td></tr><tr><td></td><td></td><td></td></tr></table>									
1																																																																															
	3																																																																														
	1																																																																														
	1																																																																														
1		1																																																																													
1		1																																																																													
1	1																																																																														
		1																																																																													
Post - 0 Miss - 0 Block - 0	Post - 0 Miss - 2 Block - 0	Post - 0 Miss - 0 Block - 0	Post - 0 Miss - 1 Block - 0	Post - 0 Miss - 0 Block - 0	Post - 0 Miss - 0 Block - 0	Post - 0 Miss - 0 Block - 0	Post - 0 Miss - 0 Block - 0																																																																								
21 胡瀛	23 王军程	25 马明辉	29 杜龙飞	33 冯宁	77 朱昕晨	78 张骥	83 潘天																																																																								
<table border="1"><tr><td></td><td></td><td></td></tr><tr><td></td><td></td><td></td></tr><tr><td></td><td></td><td></td></tr></table>										<table border="1"><tr><td></td><td></td><td></td></tr><tr><td></td><td></td><td></td></tr><tr><td></td><td></td><td></td></tr></table>										<table border="1"><tr><td>1</td><td></td><td></td></tr><tr><td></td><td></td><td></td></tr><tr><td></td><td></td><td>1</td></tr></table>	1								1	<table border="1"><tr><td>1</td><td></td><td></td></tr><tr><td></td><td></td><td></td></tr><tr><td></td><td></td><td></td></tr></table>	1									<table border="1"><tr><td></td><td></td><td></td></tr><tr><td></td><td></td><td></td></tr><tr><td></td><td></td><td></td></tr></table>										<table border="1"><tr><td></td><td></td><td></td></tr><tr><td></td><td></td><td>1</td></tr><tr><td></td><td></td><td></td></tr></table>						1				<table border="1"><tr><td></td><td>1</td><td>1</td></tr><tr><td></td><td></td><td>2</td></tr><tr><td></td><td></td><td>1</td></tr></table>		1	1			2			1	<table border="1"><tr><td></td><td></td><td></td></tr><tr><td></td><td></td><td></td></tr><tr><td></td><td></td><td></td></tr></table>									
1																																																																															
		1																																																																													
1																																																																															
		1																																																																													
	1	1																																																																													
		2																																																																													
		1																																																																													
Post - 0 Miss - 0 Block - 0	Post - 0 Miss - 0 Block - 1	Post - 1 Miss - 0 Block - 0	Post - 0 Miss - 0 Block - 0	Post - 0 Miss - 0 Block - 0	Post - 0 Miss - 0 Block - 1	Post - 0 Miss - 0 Block - 0	Post - 0 Miss - 0 Block - 0																																																																								

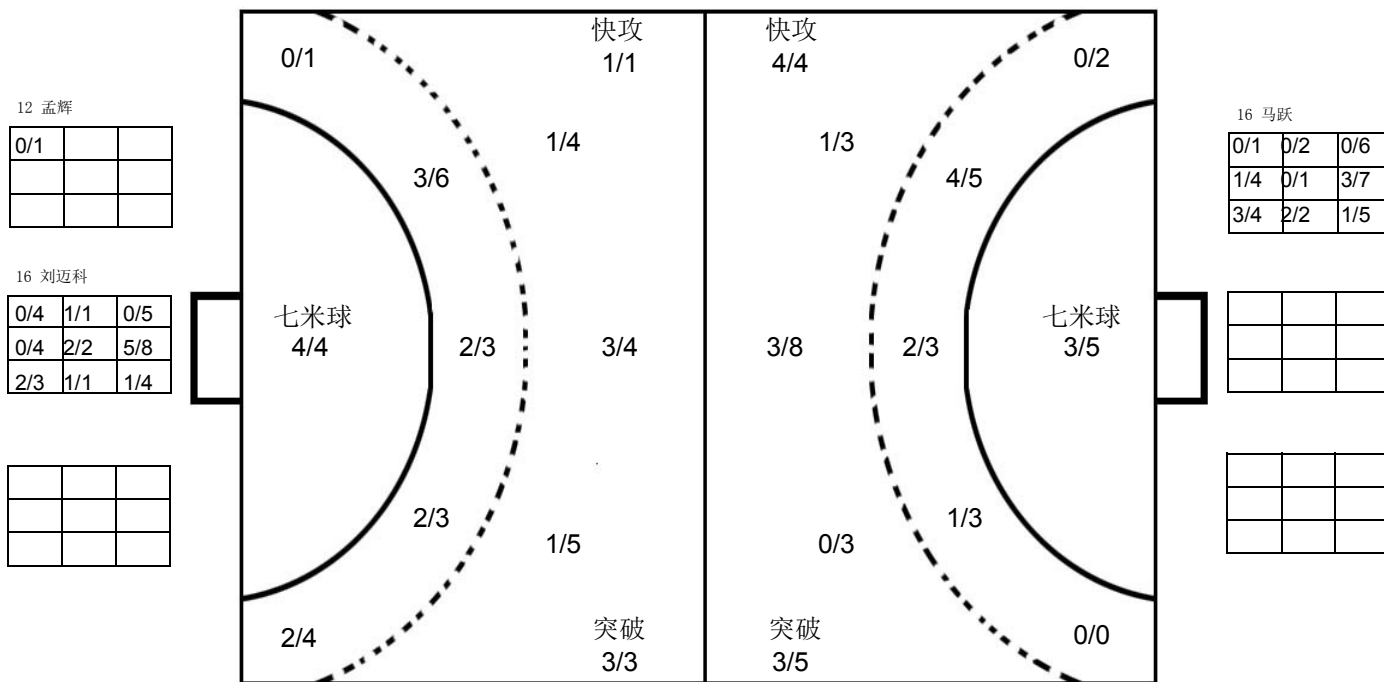

## 广东队

1 王泽润	2 孙江山	3 曲汝洋	4 李卓洋	5 侯生升	7 付云博	8 于彦江	10 周仲坤																																																																								
<table border="1"><tr><td></td><td></td><td></td></tr><tr><td></td><td></td><td></td></tr><tr><td></td><td></td><td></td></tr></table>										<table border="1"><tr><td></td><td>2</td><td>1</td></tr><tr><td></td><td></td><td></td></tr><tr><td></td><td></td><td></td></tr></table>		2	1							<table border="1"><tr><td>2</td><td></td><td>2</td></tr><tr><td></td><td></td><td></td></tr><tr><td></td><td></td><td></td></tr></table>	2		2							<table border="1"><tr><td>1</td><td></td><td>1</td></tr><tr><td></td><td></td><td></td></tr><tr><td></td><td></td><td></td></tr></table>	1		1							<table border="1"><tr><td></td><td></td><td></td></tr><tr><td>1</td><td></td><td></td></tr><tr><td></td><td></td><td></td></tr></table>				1						<table border="1"><tr><td></td><td></td><td>1</td></tr><tr><td></td><td></td><td>1</td></tr><tr><td></td><td></td><td></td></tr></table>			1			1				<table border="1"><tr><td></td><td></td><td></td></tr><tr><td></td><td></td><td></td></tr><tr><td></td><td></td><td></td></tr></table>										<table border="1"><tr><td></td><td></td><td></td></tr><tr><td></td><td></td><td></td></tr><tr><td></td><td></td><td></td></tr></table>									
	2	1																																																																													
2		2																																																																													
1		1																																																																													
1																																																																															
		1																																																																													
		1																																																																													
Post - 0 Miss - 0 Block - 0	Post - 0 Miss - 1 Block - 0	Post - 0 Miss - 0 Block - 1	Post - 1 Miss - 1 Block - 2	Post - 0 Miss - 0 Block - 0	Post - 0 Miss - 1 Block - 0	Post - 0 Miss - 0 Block - 0	Post - 0 Miss - 0 Block - 0																																																																								
11 房友屯	13 王立隆	15 张建杰	16 马跃	17 李中洲	20 黄培杰	84 王伟																																																																									
<table border="1"><tr><td></td><td></td><td></td></tr><tr><td></td><td></td><td></td></tr><tr><td></td><td></td><td></td></tr></table>										<table border="1"><tr><td></td><td></td><td></td></tr><tr><td></td><td></td><td></td></tr><tr><td></td><td></td><td></td></tr></table>										<table border="1"><tr><td></td><td></td><td></td></tr><tr><td></td><td></td><td></td></tr><tr><td></td><td></td><td></td></tr></table>										<table border="1"><tr><td></td><td></td><td></td></tr><tr><td></td><td></td><td></td></tr><tr><td></td><td></td><td></td></tr></table>										<table border="1"><tr><td>1</td><td></td><td>1</td></tr><tr><td>1</td><td></td><td>1</td></tr><tr><td></td><td></td><td>3</td></tr></table>	1		1	1		1			3	<table border="1"><tr><td></td><td></td><td></td></tr><tr><td></td><td></td><td></td></tr><tr><td></td><td></td><td></td></tr></table>										<table border="1"><tr><td>1</td><td></td><td></td></tr><tr><td></td><td></td><td></td></tr><tr><td>1</td><td></td><td></td></tr></table>	1						1			<table border="1"><tr><td></td><td></td><td></td></tr><tr><td></td><td></td><td></td></tr><tr><td></td><td></td><td></td></tr></table>									
1		1																																																																													
1		1																																																																													
		3																																																																													
1																																																																															
1																																																																															
Post - 0 Miss - 0 Block - 0	Post - 0 Miss - 0 Block - 0	Post - 0 Miss - 0 Block - 0	Post - 0 Miss - 0 Block - 0	Post - 0 Miss - 0 Block - 1	Post - 0 Miss - 0 Block - 0	Post - 0 Miss - 0 Block - 0																																																																									

注释: Post=击柱 Miss=射失 Block=被封





四分之一决赛

男子 全国比赛

2016年全国男子手球锦标赛

Team A										Team B										Match Number											
A 山东队										B 安徽队										29											
played in					in the hall					on					at					Spectators											
China					徐闻县体育中心体育					27/10/2016					20:40 hours																
Half-time (30')		A		B		End of playing time		A		B		1st extra time		A		B		2nd extra time		A		B		After penalty		A		B			
		24		12		40		23																							
Number of 7 m		A		Team time-out			Full name of players and officials										Team time-out			B		Number of 7 m									
1 / 1		1															11:56			54:39		1 / 1									
No.	Team A										G	W	2'	D	DR	No.	Team B										G	W	2'	D	DR
3	尹杰										2					1	郭世伟										2	1			
4	田瑞										2					2	金永峰														
5	潘翔										6		1			3	陈强龙										2				
6	李朝鹏										4		1			5	史小帆										1				
9	赵鑫										4					7	姚雄敏										2				
10	赵建强										2					8	董智景										1				
11	宋朋强										2					9	陈开勇										4	1	1		
12	崔剑															10	严龙														
13	刘晓										4					11	黎涛										2				
15	张继伟										3		1			12	曾献辰														
16	于性哲															17	王巨柱										2				
17	王旭东										2		1			18	李双										6				
19	李语庆										4					19	何山														
21	翟乾坤										3					21	李明														
27	于亚男										2					22	王金宇														
																23	于敏清										1				
A	markovic尼克															A	韦中平														
B	王鸿斌 (主教练)															B	沈强 (主教练)														
C	刘桂妮															C	吴翔														
D	邢建刚															D	陈玉翔														
A										Signature of Responsible Official of the Teams (Off. A)										B											
TP	Remarks of Referee / CHA Official																				TP										

Signatures

Referees: 丛艳霞 (CHN)      王洋 (CHN)

Techn. Delegates: 李兆蒙 (CHN)

CHA Official: 王科 (CHN)

Note: Number of 7m Throws Awarded to Team A and B, Goals (G), Warnings (W), Suspensions (2), Direct Disqualification (D), Disqualification with Report (DR) and Team Penalty (TP).

Table Officials: 梁小熹

伍豪

Statisticians: 李双

张程秀子

Printed by PHMS Copyright: IHF / CHA 27/10/2016 22:02:42

Longman Sportsoft



handball@126.com



2016年全国男子手球锦标赛  
竞赛技术统计(媒体表)

四分之一决赛 组别 X 轮次 6 场次 29

徐闻县体育中心体育馆

27/10/2016

201606029-51-1/1

山东队 山东 40 vs 23 安徽 安徽队 24:12

裁判员 丛艳霞 (CHN) / 王洋 (CHN)

Main statistics table for Shandong and Anhui teams, including player names, positions, and various performance metrics like goals, assists, and suspensions.

场上队员: 得分 / 射门

守门员: 救球 / 射门

Legend table for abbreviations: 快攻 (Fast Break), 突破 (Breakthrough), 任意球 (Free Throw), 7M球 (7M Throw), 助攻 (Assist), 警告 (Warning), 失误 (Error), 2' (Suspension), D (取消资格), DR (取消资格+报告).





### 2016年全国男子手球锦标赛 图式比赛技术统计表

轮次 6

场次 29

201606029-21-1/1

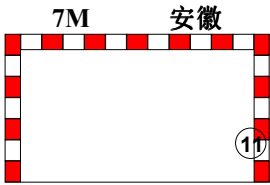
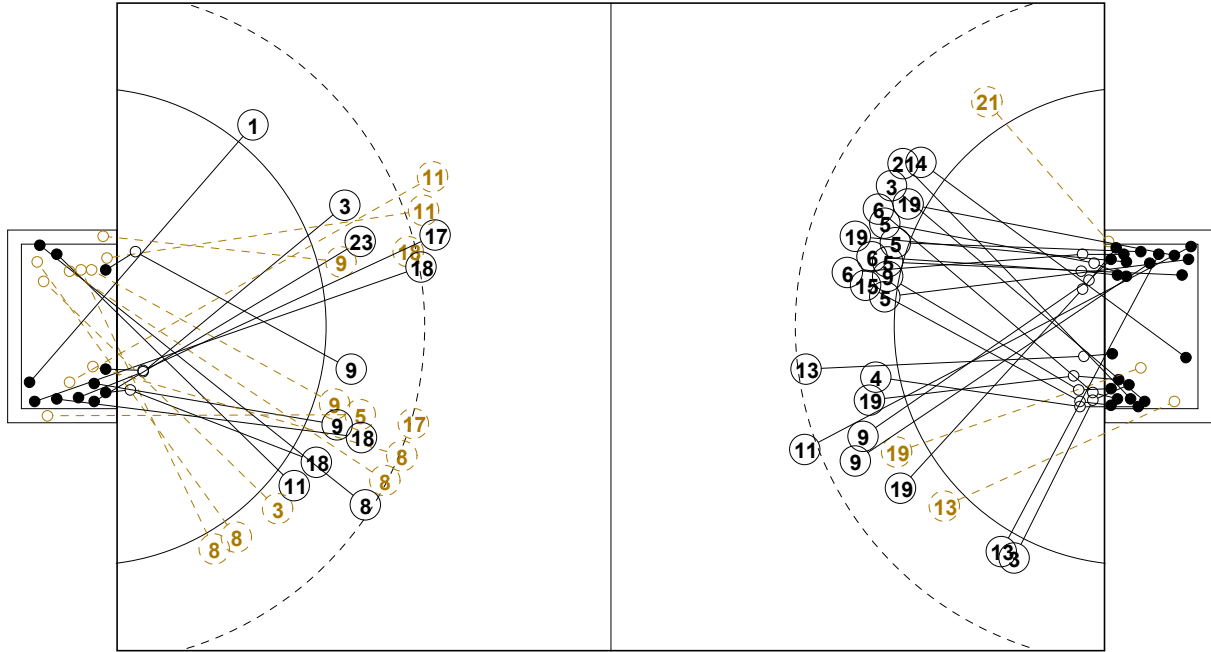

1st Half  
12 : 24

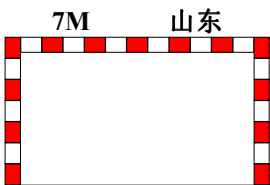
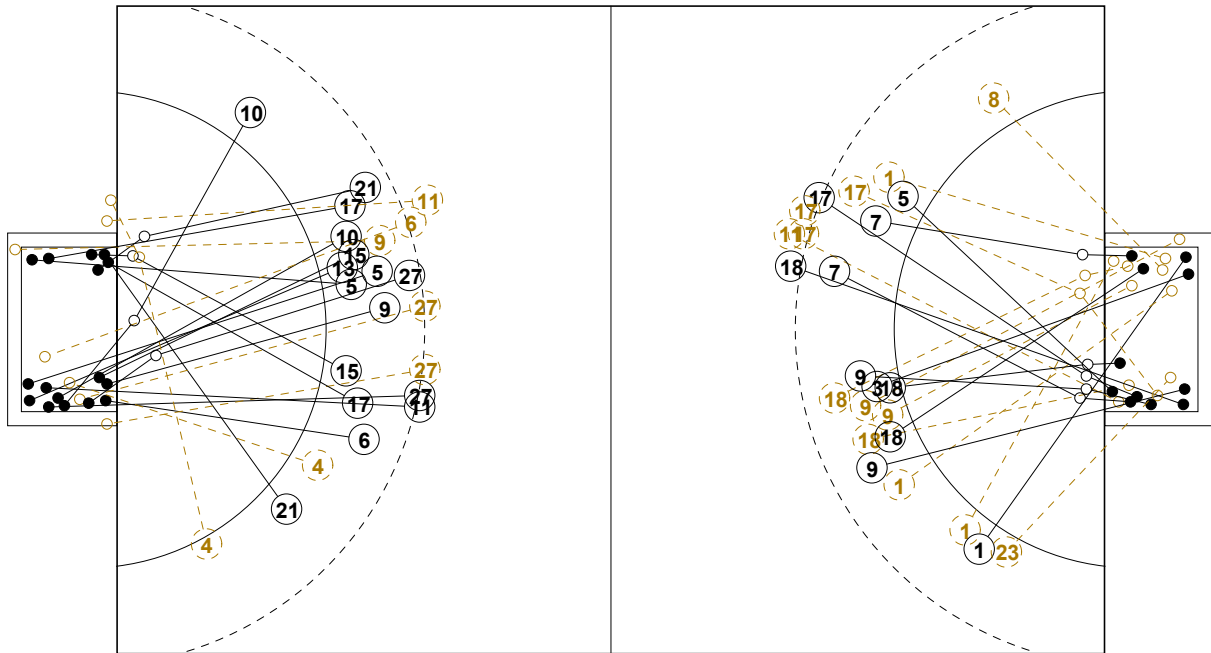
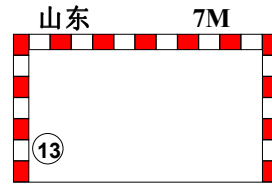

2nd Half  
40 : 23

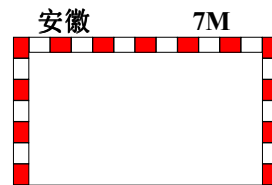





## 2016年全国男子手球锦标赛

## 个人/全队技术统计表

正式表  
手球  
男子四分之一决赛  
轮次 6组别 X  
场次 29201606029-14-1/2  
徐闻县体育中心体育馆  
27/10/2016 20:40

号码	姓名	远射	近射	边射	快攻	突破	任意	7M	合计	%	助攻	失误	警告	2'	取消	时间
<b>山东队(山东)</b>																
<i>(场上队员)</i>																
3	尹杰			1/1	1/1				2/2	100%		1				00:31:45
4	田瑞		0/1	0/1	2/2				2/4	50.0%						00:23:12
5	潘翔		4/4		1/1	1/1			6/6	100%		3		1		00:17:34
6	李朝鹏	0/1	4/4						4/5	80.0%	3	3		1		00:43:05
9	赵鑫	1/1			1/1	2/3			4/5	80.0%	2	4				00:33:34
10	赵建强		1/1	1/1					2/2	100%	1	2				00:08:07
11	宋朋强	2/3							2/3	66.7%						00:24:29
12	崔剑									0.0%						00:30:00
13	刘晓	1/1	1/2	1/1				1/1	4/5	80.0%	1	1				00:34:43
15	张继伟		3/3						3/3	100%		2		1		00:42:09
16	于性哲									0.0%	2	1				00:30:00
17	王旭东		1/1		1/1				2/2	100%	1	1		1		00:25:12
19	李语庆		1/2		2/2	1/1			4/5	80.0%	1					00:20:07
21	翟乾坤			0/1	2/2	1/1			3/4	75.0%		1				00:29:08
27	于亚男	1/3			1/1				2/4	50.0%	1	1				00:26:23
<b>合计</b>		5/9	15/18	3/5	11/11	5/6		1/1	40/50	80.0%	12	20		4		
<i>(守门员)</i>																
12	崔剑	2/4	2/6	2/2	3/5	1/4			10/21	47.6%						00:30:00
16	于性哲	4/7	2/7	2/3	0/2			0/1	8/20	40.0%	2	1				00:30:00
<b>合计</b>		6/11	4/13	4/5	3/7	1/4		0/1	18/41	43.9%	2	1				

场上队员：得分/射门

守门员：救球/射门

全队合计	得分	被救	射失	击柱	封球	合计	%
远射	5	2	1	1		9	55.6%
近射	15	3				18	83.3%
边射	3		1	1		5	60.0%
快攻	11					11	100.0%
突破	5			1		6	83.3%
任意							0.0%
7M	1					1	100.0%





## 2016年全国男子手球锦标赛

## 个人/全队技术统计表

正式表  
手球  
男子四分之一决赛  
轮次 6组别 X  
场次 29201606029-14-2/2  
徐闻县体育中心体育馆  
27/10/2016 20:40

号码	姓名	远射	近射	边射	快攻	突破	任意	7M	合计	%	助攻	失误	警告	2'	取消	时间
<b>安徽队(安徽)</b>																
<i>(上场队员)</i>																
1	郭世伟			1/1	0/2	1/2			2/5	40.0%		2	1			00:29:06
2	金永峰									0.0%		1				00:21:20
3	陈强龙		2/3						2/3	66.7%		1				00:25:26
5	史小帆					1/2			1/2	50.0%	1					00:32:04
7	姚雄敏		1/1			1/1			2/2	100%	1	2				00:15:18
8	董智景	1/3		0/3					1/6	16.7%		1				00:38:37
9	陈开勇		1/5		3/3				4/8	50.0%		1	1	1		00:38:28
10	严龙									0.0%	1	2				00:08:53
11	黎涛	0/3	1/1					1/1	2/5	40.0%	1	2				00:40:38
12	曾献辰									0.0%	1					00:35:02
17	王巨柱	2/6							2/6	33.3%	2	4				00:30:51
18	李双	2/3	4/5		0/1				6/9	66.7%	4	5				00:49:15
19	何山									0.0%						00:00:00
21	李明									0.0%						00:24:58
22	王金宇									0.0%						00:00:00
23	于敏清			0/1	1/1				1/2	50.0%	2					00:29:13
<b>合计</b>		5/15	9/15	1/5	4/7	3/5		1/1	23/48	47.9%	13	21	2	1		
<i>(守门员)</i>																
12	曾献辰	2/5	1/8	0/1	0/7	0/1		0/1	3/23	13.0%	1					00:35:02
21	李明	0/2	2/10	0/2	0/4	0/4			2/22	9.1%						00:24:58
<b>合计</b>		2/7	3/18	0/3	0/11	0/5		0/1	5/45	11.1%	1					

场上队员：得分/射门

守门员：救球/射门

全队合计	得分	被救	射失	击柱	封球	合计	%
远射	5	6			4	15	33.3%
近射	9	4		2		15	60.0%
边射	1	4				5	20.0%
快攻	4	3				7	57.1%
突破	3	1		1		5	60.0%
任意							0.0%
7M	1					1	100.0%





2016年全国男子手球锦标赛

图式射门区域统计

轮次 6 场次 29

201606029-41-1/1

山东队

3 尹杰	4 田瑞	5 潘翔	6 李朝鹏	9 赵鑫	10 赵建强	11 宋朋强	12 崔剑																																																																								
<table border="1"><tr><td></td><td></td><td></td></tr><tr><td></td><td></td><td>1</td></tr><tr><td></td><td></td><td>1</td></tr></table>						1			1	<table border="1"><tr><td></td><td></td><td>1</td></tr><tr><td></td><td></td><td>1</td></tr><tr><td></td><td></td><td></td></tr></table>			1			1				<table border="1"><tr><td>3</td><td></td><td>1</td></tr><tr><td>1</td><td></td><td></td></tr><tr><td>1</td><td></td><td></td></tr></table>	3		1	1			1			<table border="1"><tr><td></td><td></td><td></td></tr><tr><td></td><td></td><td></td></tr><tr><td>3</td><td></td><td>1</td></tr></table>							3		1	<table border="1"><tr><td></td><td></td><td></td></tr><tr><td>1</td><td></td><td></td></tr><tr><td>2</td><td></td><td>1</td></tr></table>				1			2		1	<table border="1"><tr><td></td><td></td><td></td></tr><tr><td>2</td><td></td><td></td></tr><tr><td></td><td></td><td></td></tr></table>				2						<table border="1"><tr><td></td><td></td><td></td></tr><tr><td>2</td><td></td><td></td></tr><tr><td></td><td></td><td></td></tr></table>				2						<table border="1"><tr><td></td><td></td><td></td></tr><tr><td></td><td></td><td></td></tr><tr><td></td><td></td><td></td></tr></table>									
		1																																																																													
		1																																																																													
		1																																																																													
		1																																																																													
3		1																																																																													
1																																																																															
1																																																																															
3		1																																																																													
1																																																																															
2		1																																																																													
2																																																																															
2																																																																															
Post - 0 Miss - 0 Block - 0	Post - 0 Miss - 1 Block - 0	Post - 0 Miss - 0 Block - 0	Post - 0 Miss - 0 Block - 0	Post - 1 Miss - 0 Block - 0	Post - 0 Miss - 0 Block - 0	Post - 0 Miss - 1 Block - 0	Post - 0 Miss - 0 Block - 0																																																																								
13 刘晓	15 张继伟	16 于性哲	17 王旭东	19 李语庆	21 翟乾坤	27 于亚男																																																																									
<table border="1"><tr><td>1</td><td></td><td></td></tr><tr><td>1</td><td></td><td></td></tr><tr><td>1</td><td>1</td><td></td></tr></table>	1			1			1	1		<table border="1"><tr><td></td><td></td><td></td></tr><tr><td></td><td></td><td></td></tr><tr><td>1</td><td></td><td>2</td></tr></table>							1		2	<table border="1"><tr><td></td><td></td><td></td></tr><tr><td></td><td></td><td></td></tr><tr><td></td><td></td><td></td></tr></table>										<table border="1"><tr><td></td><td></td><td>1</td></tr><tr><td></td><td></td><td></td></tr><tr><td></td><td></td><td>1</td></tr></table>			1						1	<table border="1"><tr><td>1</td><td></td><td></td></tr><tr><td></td><td></td><td></td></tr><tr><td>2</td><td></td><td>1</td></tr></table>	1						2		1	<table border="1"><tr><td></td><td></td><td></td></tr><tr><td></td><td></td><td></td></tr><tr><td></td><td></td><td>3</td></tr></table>									3	<table border="1"><tr><td></td><td></td><td></td></tr><tr><td>1</td><td></td><td></td></tr><tr><td>1</td><td></td><td></td></tr></table>				1			1			<table border="1"><tr><td></td><td></td><td></td></tr><tr><td></td><td></td><td></td></tr><tr><td></td><td></td><td></td></tr></table>									
1																																																																															
1																																																																															
1	1																																																																														
1		2																																																																													
		1																																																																													
		1																																																																													
1																																																																															
2		1																																																																													
		3																																																																													
1																																																																															
1																																																																															
Post - 0 Miss - 0 Block - 0	Post - 0 Miss - 0 Block - 0	Post - 0 Miss - 0 Block - 0	Post - 0 Miss - 0 Block - 0	Post - 0 Miss - 0 Block - 0	Post - 1 Miss - 0 Block - 0	Post - 1 Miss - 0 Block - 0																																																																									

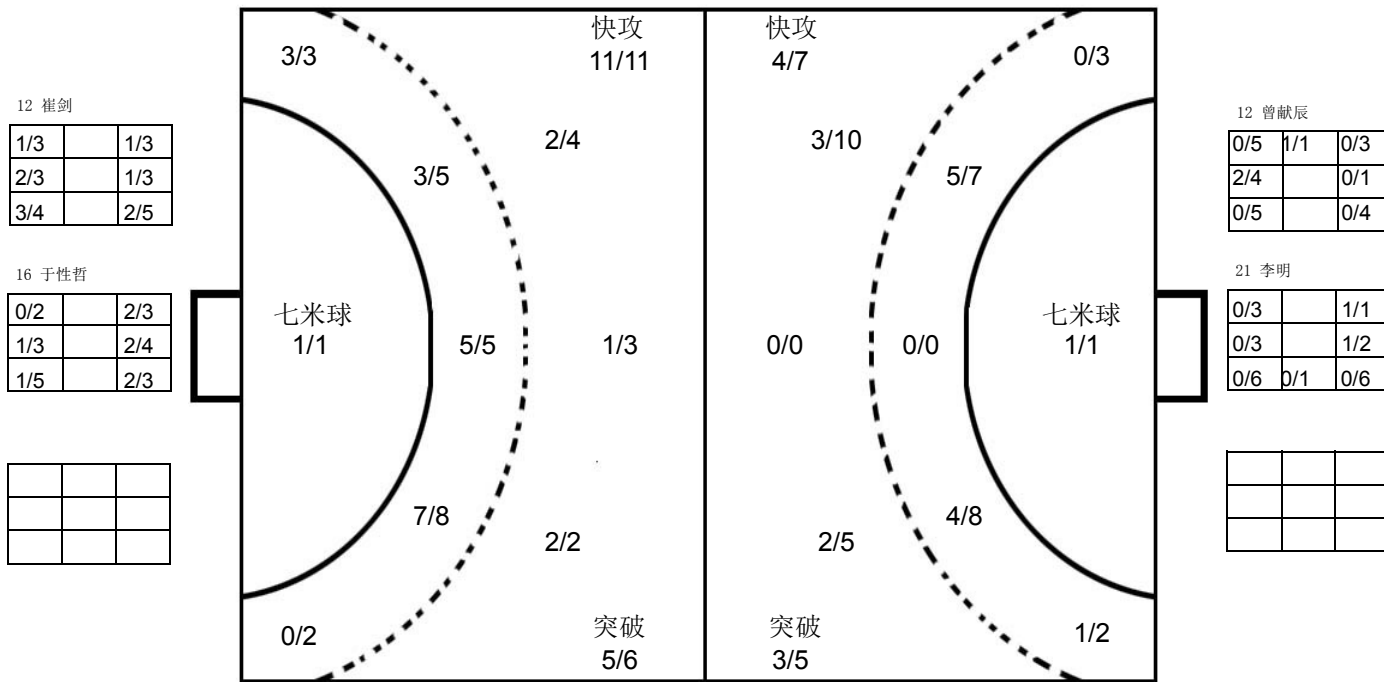

安徽队

1 郭世伟	2 金永峰	3 陈强龙	5 史小帆	7 姚雄敏	8 董智景	9 陈开勇	10 严龙																																																																								
<table border="1"><tr><td>2</td><td></td><td></td></tr><tr><td></td><td></td><td></td></tr><tr><td></td><td></td><td></td></tr></table>	2									<table border="1"><tr><td></td><td></td><td></td></tr><tr><td></td><td></td><td></td></tr><tr><td></td><td></td><td></td></tr></table>										<table border="1"><tr><td>1</td><td></td><td></td></tr><tr><td>1</td><td></td><td></td></tr><tr><td></td><td></td><td></td></tr></table>	1			1						<table border="1"><tr><td></td><td></td><td></td></tr><tr><td></td><td></td><td></td></tr><tr><td></td><td></td><td>1</td></tr></table>									1	<table border="1"><tr><td></td><td></td><td></td></tr><tr><td></td><td></td><td></td></tr><tr><td>1</td><td></td><td>1</td></tr></table>							1		1	<table border="1"><tr><td></td><td></td><td></td></tr><tr><td></td><td></td><td></td></tr><tr><td></td><td></td><td>1</td></tr></table>									1	<table border="1"><tr><td></td><td></td><td></td></tr><tr><td></td><td></td><td></td></tr><tr><td>1</td><td></td><td>1</td></tr></table>							1		1	<table border="1"><tr><td></td><td></td><td></td></tr><tr><td></td><td></td><td></td></tr><tr><td></td><td></td><td></td></tr></table>									
2																																																																															
1																																																																															
1																																																																															
		1																																																																													
1		1																																																																													
		1																																																																													
1		1																																																																													
Post - 0 Miss - 0 Block - 0	Post - 0 Miss - 0 Block - 0	Post - 0 Miss - 0 Block - 0	Post - 1 Miss - 0 Block - 0	Post - 0 Miss - 0 Block - 0	Post - 0 Miss - 0 Block - 0	Post - 0 Miss - 0 Block - 0	Post - 2 Miss - 0 Block - 0	Post - 0 Miss - 0 Block - 0																																																																							
11 黎涛	12 曾献辰	17 王巨柱	18 李双	19 何山	21 李明	22 王金宇	23 于敏清																																																																								
<table border="1"><tr><td></td><td></td><td></td></tr><tr><td></td><td></td><td>2</td></tr><tr><td></td><td></td><td></td></tr></table>						2				<table border="1"><tr><td></td><td></td><td></td></tr><tr><td></td><td></td><td></td></tr><tr><td></td><td></td><td></td></tr></table>										<table border="1"><tr><td></td><td></td><td></td></tr><tr><td></td><td></td><td>1</td></tr><tr><td>1</td><td></td><td></td></tr></table>						1	1			<table border="1"><tr><td>1</td><td></td><td>1</td></tr><tr><td>2</td><td></td><td></td></tr><tr><td>1</td><td></td><td>1</td></tr></table>	1		1	2			1		1	<table border="1"><tr><td></td><td></td><td></td></tr><tr><td></td><td></td><td></td></tr><tr><td></td><td></td><td></td></tr></table>										<table border="1"><tr><td></td><td></td><td></td></tr><tr><td></td><td></td><td></td></tr><tr><td></td><td></td><td></td></tr></table>										<table border="1"><tr><td></td><td></td><td></td></tr><tr><td></td><td></td><td></td></tr><tr><td></td><td></td><td></td></tr></table>										<table border="1"><tr><td></td><td></td><td></td></tr><tr><td></td><td></td><td></td></tr><tr><td>1</td><td></td><td></td></tr></table>							1		
		2																																																																													
		1																																																																													
1																																																																															
1		1																																																																													
2																																																																															
1		1																																																																													
1																																																																															
Post - 0 Miss - 0 Block - 0	Post - 0 Miss - 0 Block - 0	Post - 0 Miss - 0 Block - 3	Post - 0 Miss - 0 Block - 1	Post - 0 Miss - 0 Block - 0	Post - 0 Miss - 0 Block - 0	Post - 0 Miss - 0 Block - 0	Post - 0 Miss - 0 Block - 0																																																																								

注释: Post=击柱 Miss=射失 Block=被封





9-10名

男子 全国比赛

2016年全国男子手球锦标赛

Team A <b>A 新疆队</b>				Team B <b>B 四川队</b>				Match Number <b>30</b>													
played in China		in the hall 徐闻县体育中心体育		on 28/10/2016		at 13:30 hours		Spectators													
Half-time (30')	<b>A</b> 10	<b>B</b> 8	End of playing time	<b>A</b> 25	<b>B</b> 26	1st extra time	<b>A</b>	<b>B</b>	2nd extra time	<b>A</b>	<b>B</b>	After penalty throws	<b>A</b>	<b>B</b>							
Number of 7 m	<b>A</b> 5 / 7	Team time-out 1 17:36 2 45:12 3 58:49			Full name of players and officials				Team time-out 1 50:49 3			<b>B</b> 6 / 10	Number of 7 m								
No.	Team <b>A</b>					G	W	2'	D	DR	No.	Team <b>B</b>					G	W	2'	D	DR
1	宋晓晨										1	罗尧尧						1			
5	徐伟					1					3	刘赵梁					2				
7	林豪文					8					7	仇瑞祥					5				
8	刘文字										8	谢庆龙					1				
9	姜春晖										9	许翔宇					4				
10	王钟彬					7	1	1			10	徐彦昊									
13	苏兴伟										11	张天豪					1	1			
15	王维东						1				12	丁大伟									
17	胡晋铭					1		2			13	尹文珂					3				
18	姜帅										15	刘劲松					2				
19	李龙吉					7					16	宋继强									
20	赵元					1	1				18	任启双					1				
24	王泽川							1			19	庞连康					4		2		
											20	徐逸									
											21	马光					3	1	1		
											22	张睿梁									
<b>A</b>	孔德宾 (主教练)										<b>B</b>	张文韬 (主教练)					1				
<b>B</b>	陈鹏波										<b>D</b>	胡俊杰									
<b>C</b>	孙均鹏																				
<b>A</b>	Signature of Responsible Official of the Teams (Off. A)																			<b>B</b>	
TP	Remarks of Referee / CHA Official																			TP	

Signatures

Referees	严璐 (CHN)	王亚光 (CHN)		
Techn. Delegates	王洋 (CHN)			
CHA Official	李兆蒙 (CHN)			

Note: Number of 7m Throws Awarded to Team A and B, Goals (G), Warnings (W), Suspensions (2'), Direct Disqualification (D), Disqualification with Report (DR) and Team Penalty (TP).

Table Officials: 梁小熹 刘正松 Statisticians: 周亚桥 李双

Printed by PHMS Copyright: IHF / CHA 28/10/2016 15:02:52

Longman Sportsoft  handball@126.com



### 2016年全国男子手球锦标赛 竞赛技术统计(媒体表)

<b>9-10名</b>	组别	<b>C</b>	轮次	<b>7</b>	场次	<b>30</b>
徐闻县体育中心体育馆			28/10/2016		201606030-51-1/1	
<b>新疆队</b>	<b>新疆</b>	<b>25</b>	vs	<b>26</b>	<b>四川</b>	四川队
<b>10 : 8</b>						

裁判员	严璐 (CHN)	/	王亚光 (CHN)
-----	----------	---	-----------

新疆													比赛进程			四川																																																																																																																																																							
													1st Half																																																																																																																																																										
远射	近射	边射	快攻	突破	任意球	7m球	合计	%	助攻	失误	警告	2'	D & DR																																																																																																																																																										
主教练：孔德宾																																																																																																																																																																							
1 宋晓晨										2				10 王钟彬	1	03:18	0	13 尹文珂	1	05:35	1	17 胡晋铭	2	05:56	1	10 王钟彬	3	08:27	1	10 王钟彬	4	10:11	1	20 赵元	5	11:18	1	7 林豪文	5	14:17	2	11 张天豪	6	15:05	2	6 姜春晖	6	17:02	3	3 刘赵梁	6	22:38	4	9 许翔宇	7	23:19	4	19 李龙吉	8	24:46	4	10 王钟彬	8	26:04	5	19 庞连康	8	27:13	6	21 马光	8	27:13	6	7 林豪文	9	27:43	6	7 林豪文	10	28:21	6	19 庞连康	10	29:08	7	19 庞连康	10	29:48	8	21 马光	10	29:48	8																																																																										
运动员 合计													10/22 5/14 1/2 3/3 1/2 5/7 25/50 50.0 8 3 4																																																																																																																																																										
1 宋晓晨	2/8	5/13	1/1	0/4	0/2	3/9	11/37	29.7		2																																																																																																																																																													
守门员 合计													2/8 5/13 1/1 0/4 0/2 3/9 11/37 29.7																																																																																																																																																										
四川													2nd Half			四川																																																																																																																																																							
远射	近射	边射	快攻	突破	任意球	7m球	合计	%	助攻	失误	警告	2'	D & DR																																																																																																																																																										
教练：张文韬																																																																																																																																																																							
1 罗尧尧										1	1			10 王钟彬	10	00:34	9	9 许翔宇	11	01:14	9	7 林豪文	11	01:49	10	7 仇瑞祥	12	02:27	10	19 李龙吉	12	02:40	11	19 庞连康	12	03:35	12	13 尹文珂	12	04:39	13	7 仇瑞祥	7	05:21	13	7 林豪文	13	06:42	14	7 仇瑞祥	13	08:37	15	15 刘劲松	13	08:37	15	7 林豪文	14	11:21	15	19 李龙吉	15	12:37	15	7 林豪文	15	14:03	16	13 尹文珂	15	14:20	17	9 许翔宇	15	15:00	18	8 谢庆龙	15	15:00	18	7 林豪文	16	15:52	18	10 王钟彬	16	17:40	19	19 庞连康	16	17:40	19	19 庞连康	17	18:23	19	5 徐伟	17	18:53	20	15 刘劲松	18	19:08	20	10 王钟彬	18	21:38	21	7 仇瑞祥	18	21:38	21	19 李龙吉	19	22:09	21	19 李龙吉	20	23:28	21	7 仇瑞祥	20	23:59	22	7 仇瑞祥	19	25:00	22	19 李龙吉	22	26:20	22	22 26:32	23	3 刘赵梁	22	27:20	24	21 马光	22	27:20	24	10 王钟彬	23	27:56	24	10 王钟彬	23	28:26	25	9 许翔宇	24	29:06	25	7 林豪文	24	29:31	26	18 任启双	24	29:31	26	7 林豪文	25	29:53	26
运动员 合计													6/11 8/19 0/1 4/5 2/2 6/10 26/48 54.2 10 2 4																																																																																																																																																										
12 丁大伟	4/9	5/8	0/1	0/2	0/1	2/6	11/26	42.3		1																																																																																																																																																													
16 宋继强	2/7	2/4	0/1	0/1	1/1	0/1	5/15	33.3																																																																																																																																																															
守门员 合计													6/16 7/12 0/1 0/3 1/2 2/7 16/41 39.0																																																																																																																																																										

场上队员：得分 / 射门

守门员：救球 / 射门

快攻	Fast Break	突破	Breakthrough	任意球	Free Throw	7M球	7M Throw	助攻	Assist
警告	Warning	失误	Error	2'	Suspension	D	取消资格	DR	取消资格+报告



### 2016年全国男子手球锦标赛 图式比赛技术统计表

轮次 7

场次 30

201606030-21-1/1

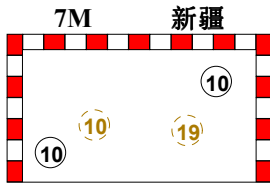
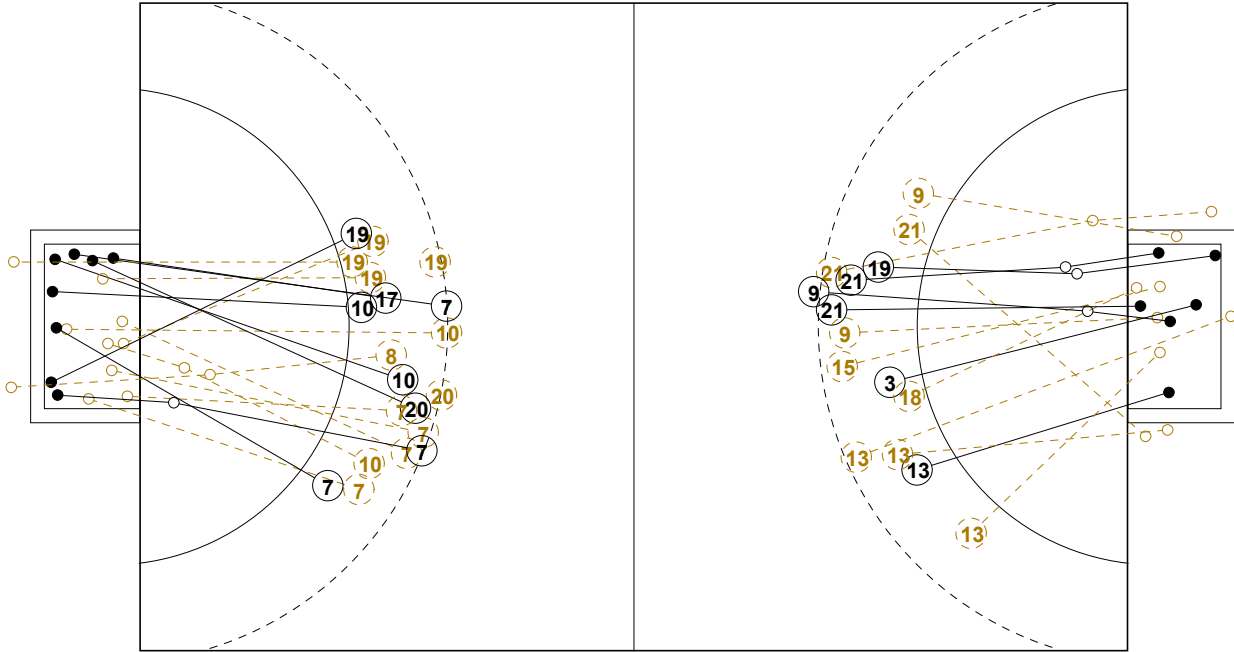

1st Half  
10 : 8

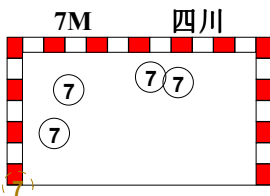
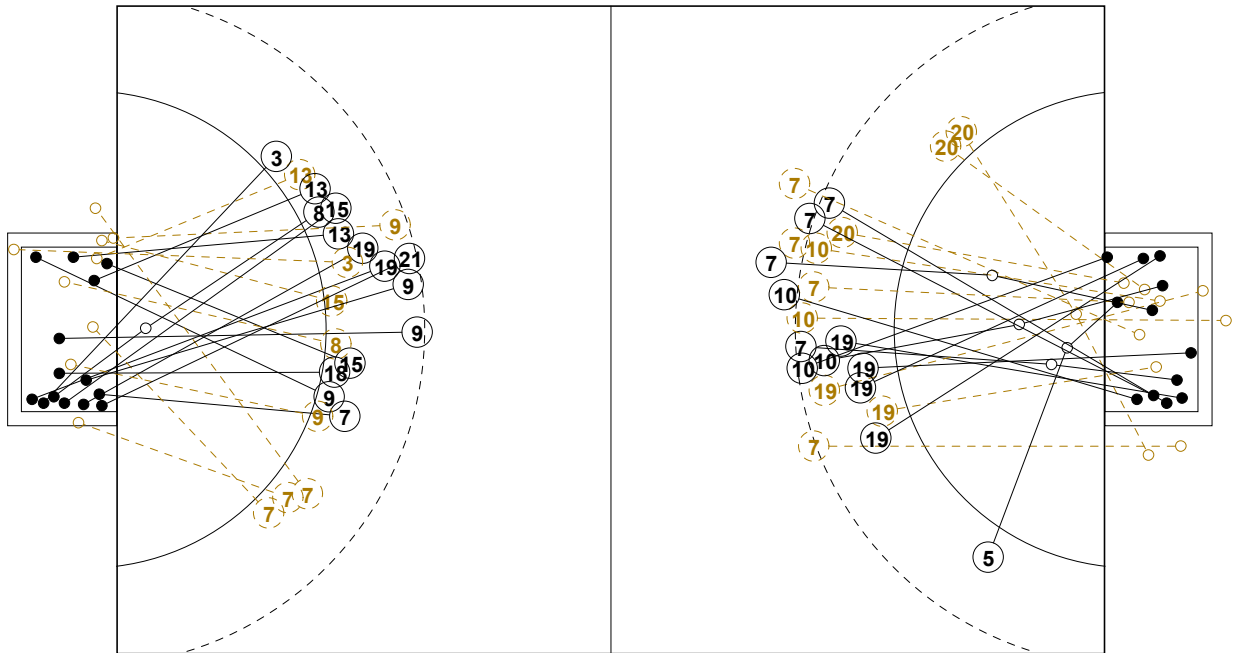
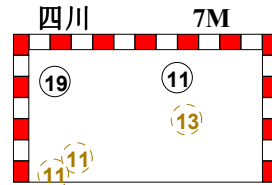

2nd Half  
26 : 25

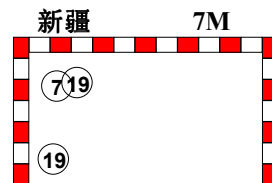



## 2016年全国男子手球锦标赛

## 个人/全队技术统计表

正式表  
手球  
男子9-10名  
轮次 7组别 C  
场次 30201606030-14-1/2  
徐闻县体育中心体育馆  
28/10/2016 13:30

号码	姓名	远射	近射	边射	快攻	突破	任意	7M	合计	%	助攻	失误	警告	2'	取消	时间
<b>新疆队(新疆)</b>																
<i>(场上队员)</i>																
1	宋晓晨									0.0%		2				01:00:00
5	徐伟			1/1					1/1	100%						00:52:32
7	林豪文	6/12	0/2		1/1			1/1	8/16	50.0%		1				00:51:48
8	刘文字		0/1						0/1	0.0%		1				00:11:26
9	姜春晖									0.0%						00:00:00
10	王钟彬	3/6	0/1		2/2			2/3	7/12	58.3%		1	1	1		00:50:48
13	苏兴伟									0.0%						00:00:00
15	王维东									0.0%			1			00:11:16
17	胡晋铭		1/1						1/1	100%				2		00:53:27
18	姜帅									0.0%						00:03:07
19	李龙吉	0/2	4/7			1/2		2/3	7/14	50.0%		2				00:45:46
20	赵元	1/2	0/2	0/1					1/5	20.0%			1			00:59:57
24	王泽川									0.0%		1		1		00:18:50
<b>合计</b>																
<i>(守门员)</i>																
1	宋晓晨	2/8	5/13	1/1	0/4	0/2		3/9	11/37	29.7%		2				01:00:00
<b>合计</b>																

场上队员：得分/射门

守门员：救球/射门

全队合计	得分	被救	射失	击柱	封球	合计	%
远射	10	6	2	1	3	22	45.5%
近射	5	7	2			14	35.7%
边射	1		1			2	50.0%
快攻	3					3	100.0%
突破	1	1				2	50.0%
任意							0.0%
7M	5	2				7	71.4%





## 2016年全国男子手球锦标赛

## 个人/全队技术统计表

正式表  
手球  
男子9-10名  
轮次 7组别 C  
场次 30201606030-14-2/2  
徐闻县体育中心体育馆  
28/10/2016 13:30

号码	姓名	远射	近射	边射	快攻	突破	任意	7M	合计	%	助攻	失误	警告	2'	取消	时间
<b>四川队(四川)</b>																
<i>(上场队员)</i>																
1	罗尧尧									0.0%		1	1			00:20:42
3	刘赵梁		1/1		1/2				2/3	66.7%		1				00:32:28
7	仇瑞祥		0/3			1/1		4/5	5/9	55.6%						00:28:53
8	谢庆龙		1/2						1/2	50.0%						00:22:57
9	许翔宇	3/5	0/2			1/1			4/8	50.0%		1				00:46:36
10	徐彦昊									0.0%						00:00:00
11	张天豪							1/3	1/3	33.3%				1		00:22:45
12	丁大伟									0.0%						00:35:40
13	尹文珂	0/1	0/2	0/1	3/3			0/1	3/8	37.5%		1				00:23:32
15	刘劲松	0/1	2/3						2/4	50.0%		1				00:36:23
16	宋继强									0.0%						00:24:20
18	任启双		1/2						1/2	50.0%		1				00:39:41
19	庞连康		3/3					1/1	4/4	100%		3		2		00:51:56
20	徐逸									0.0%						00:00:00
21	马光	3/4	0/1						3/5	60.0%		1	1	1		00:33:18
22	张春梁									0.0%						00:00:00
<b>合计</b>		6/11	8/19	0/1	4/5	2/2		6/10	26/48	54.2%		10	2	4		
<i>(守门员)</i>																
12	丁大伟	4/9	5/8		0/2	0/1		2/6	11/26	42.3%						00:35:40
16	宋继强	2/7	2/4	0/1	0/1	1/1		0/1	5/15	33.3%						00:24:20
<b>合计</b>		6/16	7/12	0/1	0/3	1/2		2/7	16/41	39.0%						

场上队员：得分/射门

守门员：救球/射门

全队合计	得分	被救	射失	击柱	封球	合计	%
远射	6	2	1	2		11	54.5%
近射	8	5	3	3		19	42.1%
边射		1				1	0.0%
快攻	4			1		5	80.0%
突破	2					2	100.0%
任意							0.0%
7M	6	3		1		10	60.0%







2016年全国男子手球锦标赛

图式射门区域统计

轮次 7 场次 30

201606030-41-1/1

新疆队

1 宋晓晨	5 徐伟	7 林豪文	8 刘文宇	9 姜春晖	10 王钟彬	13 苏兴伟	15 王维东																																																																								
<table border="1"><tr><td></td><td></td><td></td></tr><tr><td></td><td></td><td></td></tr><tr><td></td><td></td><td></td></tr></table>										<table border="1"><tr><td></td><td></td><td></td></tr><tr><td></td><td></td><td></td></tr><tr><td></td><td>1</td><td></td></tr></table>								1		<table border="1"><tr><td>2</td><td>1</td><td>3</td></tr><tr><td></td><td>1</td><td>1</td></tr><tr><td></td><td></td><td></td></tr></table>	2	1	3		1	1				<table border="1"><tr><td></td><td></td><td></td></tr><tr><td></td><td></td><td></td></tr><tr><td></td><td></td><td></td></tr></table>										<table border="1"><tr><td></td><td></td><td></td></tr><tr><td></td><td></td><td></td></tr><tr><td></td><td></td><td></td></tr></table>										<table border="1"><tr><td></td><td></td><td>3</td></tr><tr><td>1</td><td></td><td>1</td></tr><tr><td>2</td><td></td><td></td></tr></table>			3	1		1	2			<table border="1"><tr><td></td><td></td><td></td></tr><tr><td></td><td></td><td></td></tr><tr><td></td><td></td><td></td></tr></table>										<table border="1"><tr><td></td><td></td><td></td></tr><tr><td></td><td></td><td></td></tr><tr><td></td><td></td><td></td></tr></table>									
	1																																																																														
2	1	3																																																																													
	1	1																																																																													
		3																																																																													
1		1																																																																													
2																																																																															
Post - 0 Miss - 0 Block - 0	Post - 0 Miss - 0 Block - 0	Post - 0 Miss - 1 Block - 1	Post - 0 Miss - 1 Block - 0	Post - 0 Miss - 0 Block - 0	Post - 0 Miss - 1 Block - 0	Post - 0 Miss - 0 Block - 0	Post - 0 Miss - 0 Block - 0																																																																								
17 胡晋铭	18 姜帅	19 李龙吉	20 赵元	24 王泽川																																																																											
<table border="1"><tr><td></td><td></td><td></td></tr><tr><td></td><td></td><td></td></tr><tr><td></td><td></td><td>1</td></tr></table>									1	<table border="1"><tr><td></td><td></td><td></td></tr><tr><td></td><td></td><td></td></tr><tr><td></td><td></td><td></td></tr></table>										<table border="1"><tr><td>2</td><td>1</td><td>1</td></tr><tr><td>2</td><td></td><td></td></tr><tr><td>1</td><td></td><td></td></tr></table>	2	1	1	2			1			<table border="1"><tr><td></td><td></td><td></td></tr><tr><td></td><td></td><td>1</td></tr><tr><td></td><td></td><td></td></tr></table>						1				<table border="1"><tr><td></td><td></td><td></td></tr><tr><td></td><td></td><td></td></tr><tr><td></td><td></td><td></td></tr></table>										<table border="1"><tr><td></td><td></td><td></td></tr><tr><td></td><td></td><td></td></tr><tr><td></td><td></td><td></td></tr></table>										<table border="1"><tr><td></td><td></td><td></td></tr><tr><td></td><td></td><td></td></tr><tr><td></td><td></td><td></td></tr></table>										<table border="1"><tr><td></td><td></td><td></td></tr><tr><td></td><td></td><td></td></tr><tr><td></td><td></td><td></td></tr></table>									
		1																																																																													
2	1	1																																																																													
2																																																																															
1																																																																															
		1																																																																													
Post - 0 Miss - 0 Block - 0	Post - 0 Miss - 0 Block - 0	Post - 1 Miss - 1 Block - 1	Post - 0 Miss - 1 Block - 1	Post - 0 Miss - 0 Block - 0																																																																											

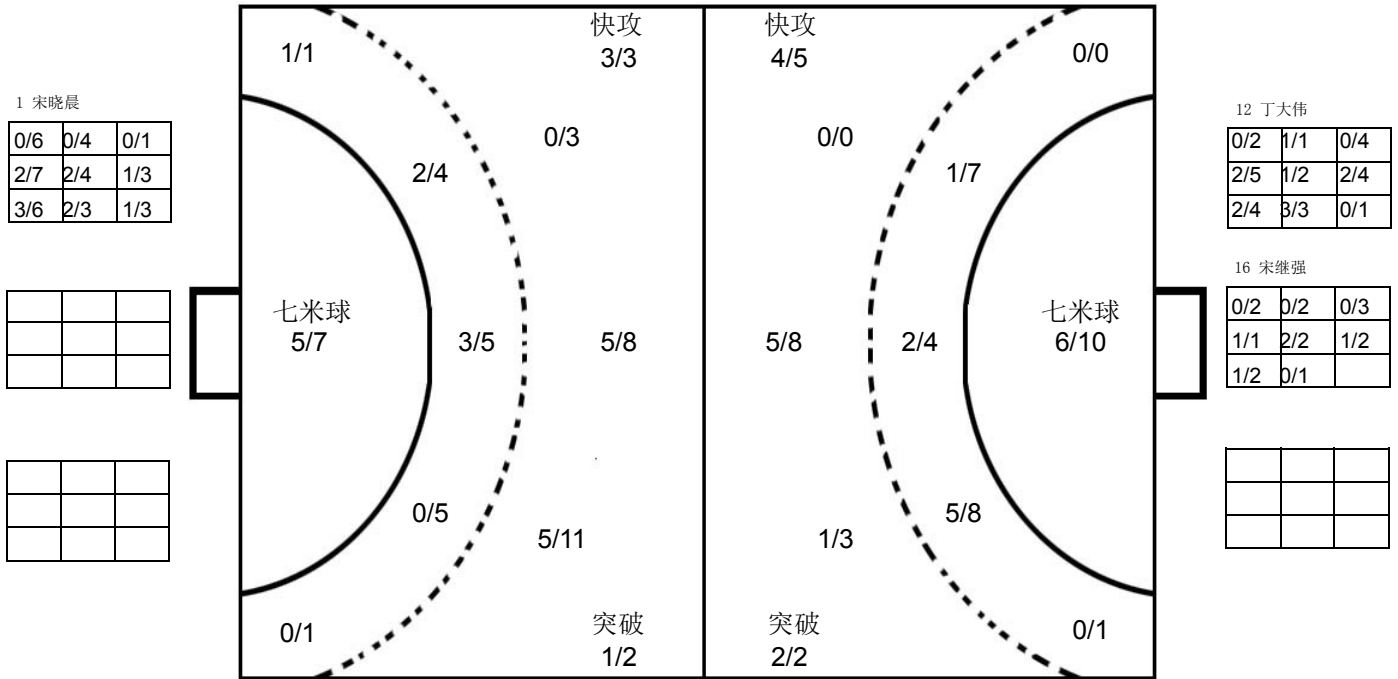

四川队

1 罗尧尧	3 刘赵梁	7 仇瑞祥	8 谢庆龙	9 许翔宇	10 徐彦昊	11 张天豪	12 丁大伟																																																																								
<table border="1"><tr><td></td><td></td><td></td></tr><tr><td></td><td></td><td></td></tr><tr><td></td><td></td><td></td></tr></table>										<table border="1"><tr><td>1</td><td>1</td><td></td></tr><tr><td></td><td></td><td></td></tr><tr><td></td><td></td><td></td></tr></table>	1	1								<table border="1"><tr><td>1</td><td>2</td><td></td></tr><tr><td>1</td><td></td><td></td></tr><tr><td>1</td><td></td><td></td></tr></table>	1	2		1			1			<table border="1"><tr><td>1</td><td></td><td></td></tr><tr><td></td><td></td><td></td></tr><tr><td></td><td></td><td></td></tr></table>	1									<table border="1"><tr><td></td><td></td><td>1</td></tr><tr><td></td><td>2</td><td></td></tr><tr><td>1</td><td></td><td></td></tr></table>			1		2		1			<table border="1"><tr><td></td><td></td><td></td></tr><tr><td></td><td></td><td></td></tr><tr><td></td><td></td><td></td></tr></table>										<table border="1"><tr><td></td><td>1</td><td></td></tr><tr><td></td><td></td><td></td></tr><tr><td></td><td></td><td></td></tr></table>		1								<table border="1"><tr><td></td><td></td><td></td></tr><tr><td></td><td></td><td></td></tr><tr><td></td><td></td><td></td></tr></table>									
1	1																																																																														
1	2																																																																														
1																																																																															
1																																																																															
1																																																																															
		1																																																																													
	2																																																																														
1																																																																															
	1																																																																														
Post - 0 Miss - 0 Block - 0	Post - 1 Miss - 0 Block - 0	Post - 2 Miss - 1 Block - 0	Post - 0 Miss - 0 Block - 0	Post - 2 Miss - 0 Block - 0	Post - 0 Miss - 0 Block - 0	Post - 0 Miss - 0 Block - 0	Post - 0 Miss - 0 Block - 0																																																																								
13 尹文珂	15 刘劲松	16 宋继强	18 任启双	19 庞连康	20 徐逸	21 马光	22 张睿梁																																																																								
<table border="1"><tr><td></td><td></td><td></td></tr><tr><td></td><td></td><td>2</td></tr><tr><td></td><td></td><td>1</td></tr></table>						2			1	<table border="1"><tr><td></td><td>1</td><td></td></tr><tr><td></td><td></td><td></td></tr><tr><td></td><td></td><td>1</td></tr></table>		1							1	<table border="1"><tr><td></td><td></td><td></td></tr><tr><td></td><td></td><td></td></tr><tr><td></td><td></td><td></td></tr></table>										<table border="1"><tr><td></td><td></td><td></td></tr><tr><td></td><td>1</td><td></td></tr><tr><td></td><td></td><td></td></tr></table>					1					<table border="1"><tr><td>3</td><td></td><td></td></tr><tr><td>1</td><td></td><td></td></tr><tr><td></td><td></td><td></td></tr></table>	3			1						<table border="1"><tr><td></td><td></td><td></td></tr><tr><td></td><td></td><td></td></tr><tr><td></td><td></td><td></td></tr></table>										<table border="1"><tr><td></td><td></td><td></td></tr><tr><td>1</td><td></td><td></td></tr><tr><td>1</td><td>1</td><td></td></tr></table>				1			1	1		<table border="1"><tr><td></td><td></td><td></td></tr><tr><td></td><td></td><td></td></tr><tr><td></td><td></td><td></td></tr></table>									
		2																																																																													
		1																																																																													
	1																																																																														
		1																																																																													
	1																																																																														
3																																																																															
1																																																																															
1																																																																															
1	1																																																																														
Post - 1 Miss - 1 Block - 0	Post - 1 Miss - 0 Block - 0	Post - 0 Miss - 0 Block - 0	Post - 0 Miss - 0 Block - 0	Post - 0 Miss - 0 Block - 0	Post - 0 Miss - 0 Block - 0	Post - 0 Miss - 2 Block - 0	Post - 0 Miss - 0 Block - 0																																																																								

注释: Post=击柱 Miss=射失 Block=被封





5-8名

男子 全国比赛

2016年全国男子手球锦标赛

Team A										Team B										Match Number									
A 上海队										B 解放军队										31									
played in					in the hall					on					at					Spectators									
China					徐闻县体育中心体育					28/10/2016					15:10 hours														
Half-time (30')		A		B		End of playing time		A		B		1st extra time		A		B		2nd extra time		A		B		After penalty		A		B	
		14		9		22		17																					
Number of 7 m		A		Team time-out			Full name of players and officials										Team time-out			B		Number of 7 m							
5 / 6		1		2		3												1		2		3		4 / 4					
		24:57		42:48														06:05											
No.	Team A									G	W	2'	D	DR	No.	Team B									G	W	2'	D	DR
1	张崢														1	李梓宁													
2	张文斌														2	范保坤													
3	赵时俊									2					4	曹作亮									1		2		
4	徐俊吉									4	1				5	张昌轲													
8	钱为玮									4					6	吴昊									1	1			
10	董凯														7	姜钦									1				
11	蒋承骅									1					8	王烁									2				
12	周哲韬														9	毕晓晨									2				
14	沈吉磊														11	肖东洋													
15	朱世杰									7		2			12	姜明													
16	朱春雷														14	孙耀琦									1	1			
17	贺政									1	1				15	杨帆													
18	马麟晓									1					16	丛霖													
33	吴璟									2					18	王晓龙									9	1			
															20	刘智洋													
A	吴龙基 (主教练)														B	张敬敏 (主教练)													
B	张勇军														C	王学力													
C	金迪琦														D	刘捷													
E	杨时														E	刘军													
A										Signature of Responsible Official of the Teams (Off. A)										B									
TP	Remarks of Referee / CHA Official																			TP									

Signatures

Referees	周云磊 (CHN)	程钰锋 (CHN)		
Techn. Delegates	李兆蒙 (CHN)			
CHA Official	许宣扬 (CHN)			

Note: Number of 7m Throws Awarded to Team A and B, Goals (G), Warnings (W), Suspensions (2), Direct Disqualification (D), Disqualification with Report (DR) and Team Penalty (TP).

Table Officials: 梁小熹

伍豪

Statisticians: 李双

周亚桥





2016年全国男子手球锦标赛  
竞赛技术统计(媒体表)

5-8名	组别	X	轮次	7	场次	31
------	----	---	----	---	----	----

徐闻县体育中心体育馆

28/10/2016

201606031-51-1/1

上海队	上海	22	vs	17	解放军	解放军队
14 : 9						

裁判员	周云磊 (CHN)	/	程钰锋 (CHN)
-----	-----------	---	-----------

上海		远射	近射	边射	快攻	突破	任意球	7m球	合计	%	助攻	失误	警告	2'	D & DR	上海	比赛进程	解放军
主教练：吴龙基																		
1	张崢															15	朱世杰	1 01:03 0
2	张文斌															4	徐俊吉	2 02:28 0
3	赵时俊							2/2	2/2	100						15	朱世杰	3 05:55 1
4	徐俊吉							2/3	4/6	66.7		1	1			4	徐俊吉	4 06:54 1
8	钱为玮	1/2	1/1	1/1	1/1				4/5	80.0						8	钱为玮	4 07:46 2 18 王晓龙
10	董凯															11	蒋承骅	4 09:57 3 18 王晓龙
11	蒋承骅	0/1	1/2						1/3	33.3	1	2				7	马麟晓	5 10:48 3
12	周哲韬															11	朱世杰	6 11:33 3
14	沈吉磊															7	蒋承骅	7 13:12 3
15	朱世杰	1/5	4/5			2/3			7/13	53.8				2		7	蒋承骅	7 14:06 4 18 王晓龙
16	朱春雷															7	蒋承骅	7 15:09 5 18 王晓龙
17	贺政															15	朱世杰	8 15:56 5
18	马麟晓	0/9	1/1													4	徐俊吉	9 16:56 5
33	吴璟		1/1													3	赵时俊	10 18:16 5
<b>运动员 合计</b>		2/17	9/12	3/5	1/1	2/3		5/6	22/44	50.0	3	9	2	2		10	朱世杰	10 18:46 6 18 王晓龙
1	张崢							0/2	0/2	0.0						15	朱世杰	10 19:13 6
12	周哲韬	4/8	3/9	2/3	0/1	0/1		0/2	9/24	37.5		1				15	朱世杰	11 19:39 7 18 王晓龙
<b>守门员 合计</b>		4/8	3/9	2/3	0/1	0/1		0/4	9/26	34.6		1				8	钱为玮	12 21:01 7
<b>解放军</b>																15	朱世杰	13 22:53 7
教练：张敬敏																13	朱世杰	13 23:27 8 4 曹作亮
1	李梓宁															17	贺政	14 24:25 8
2	范保坤															14	贺政	14 26:09 9 18 王晓龙
4	曹作亮	0/8	1/3													4	徐俊吉	15 00:29 9
5	张昌轲															15	朱世杰	15 03:38 10 18 王晓龙
6	吴昊		1/1						1/1	100			1			15	朱世杰	15 04:36 11 18 王晓龙
7	姜钦	0/2				1/1			1/3	33.3	1	1				15	朱世杰	16 06:45 11
8	王烁	1/1	1/1						2/2	100	1	2				17	钱为玮	17 07:31 11
9	毕晓晨	1/2	1/1	0/3					2/6	33.3						17	钱为玮	17 08:31 12 7 姜钦
11	肖东洋															33	吴璟	18 09:29 12
12	姜明															18	吴璟	18 13:34 13 14 孙耀琦
14	孙耀琦		1/1						1/1	100		1	1			18	吴璟	18 16:47 14 8 王烁
15	杨帆															19	吴璟	19 17:47 14
16	丛霖															19	吴璟	19 19:26 15 9 毕晓晨
18	王晓龙	2/6	1/2	1/1	1/1			4/4	9/14	64.3		4	1			8	钱为玮	20 20:19 15
20	刘智洋															20	朱世杰	20 20:58 16 8 王烁
<b>运动员 合计</b>		4/19	6/9	1/4	1/1	1/1		4/4	17/38	44.7	2	14	3	2		15	朱世杰	21 26:21 16
1	李梓宁	2/2	0/4					0/1	2/7	28.6						3	赵时俊	22 28:55 16
12	姜明							0/1	0/1	0.0								22 29:55 17 6 吴昊
16	丛霖	3/5	1/6	1/4	0/1	1/3		1/4	7/23	30.4								
<b>守门员 合计</b>		5/7	1/10	1/4	0/1	1/3		1/6	9/31	29.0								

场上队员：得分 / 射门

守门员：救球 / 射门

快攻	Fast Break		突破	Breakthrough		任意球	Free Throw		7M球	7M Throw		助攻	Assist
警告	Warning		失误	Error		2'	Suspension		D	取消资格		DR	取消资格+报告





### 2016年全国男子手球锦标赛 图式比赛技术统计表

轮次 7

场次 31

201606031-21-1/1

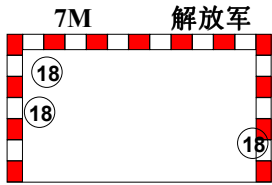
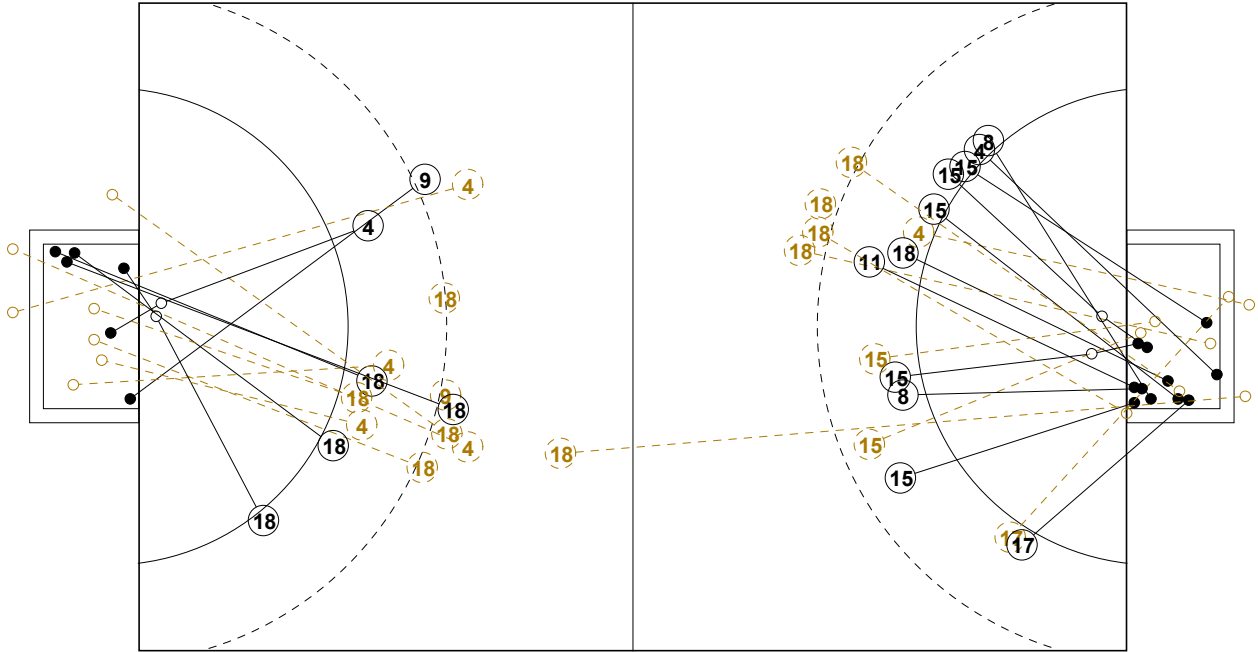

1st Half  
9 : 14

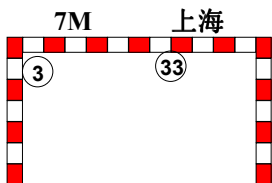
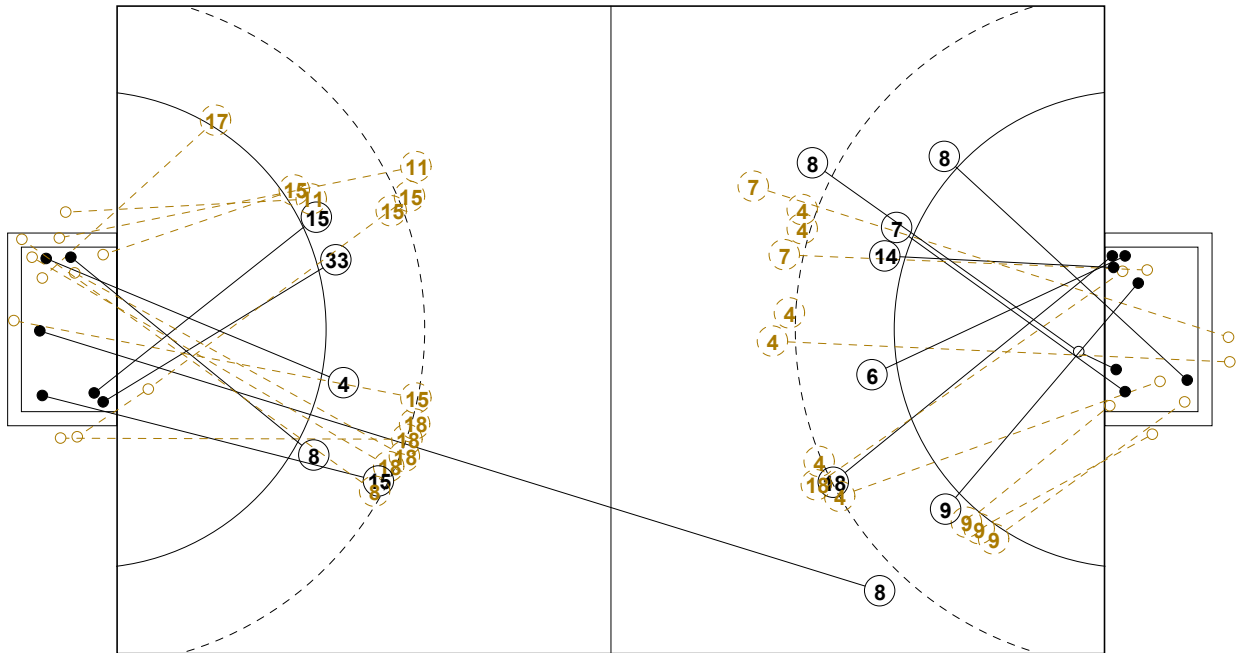
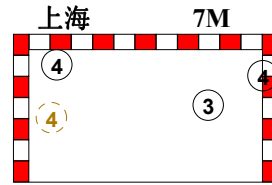

2nd Half  
22 : 17

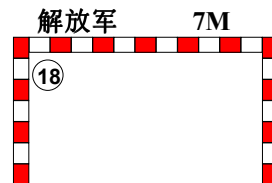



## 2016年全国男子手球锦标赛

## 个人/全队技术统计表

正式表  
手球  
男子5-8名  
轮次 7组别 X  
场次 31201606031-14-1/2  
徐闻县体育中心体育馆  
28/10/2016 15:10

号码	姓名	远射	近射	边射	快攻	突破	任意	7M	合计	%	助攻	失误	警告	2'	取消	时间
<b>上海队(上海)</b>																
<i>(场上队员)</i>																
1	张崢									0.0%						00:00:23
2	张文斌									0.0%						00:00:00
3	赵时俊							2/2	2/2	100%						00:18:12
4	徐俊吉		1/2	1/1				2/3	4/6	66.7%		1	1			00:45:19
8	钱为玮	1/2	1/1	1/1	1/1				4/5	80.0%		1				01:00:00
10	董凯									0.0%						00:00:00
11	蒋承骅	0/1	1/2						1/3	33.3%	1	2				00:49:06
12	周哲韬									0.0%		1				00:59:37
14	沈吉磊									0.0%						00:00:37
15	朱世杰	1/5	4/5			2/3			7/13	53.8%		2		2		01:00:00
16	朱春雷									0.0%						00:00:00
17	贺政			1/3					1/3	33.3%			1			00:52:25
18	马麟晓	0/9	1/1						1/10	10.0%	2	2				00:59:22
33	吴璟		1/1					1/1	2/2	100%						00:14:38
<b>合计</b>		2/17	9/12	3/5	1/1	2/3		5/6	22/44	50.0%	3	9	2	2		
<i>(守门员)</i>																
1	张崢							0/2	0/2	0.0%						00:00:23
12	周哲韬	4/8	3/9	2/3	0/1	0/1		0/2	9/24	37.5%		1				00:59:37
<b>合计</b>		4/8	3/9	2/3	0/1	0/1		0/4	9/26	34.6%		1				

场上队员：得分/射门

守门员：救球/射门

全队合计	得分	被救	射失	击柱	封球	合计	%
远射	2	5	3	4	3	17	11.8%
近射	9	1	2			12	75.0%
边射	3	1		1		5	60.0%
快攻	1					1	100.0%
突破	2	1				3	66.7%
任意							0.0%
7M	5	1				6	83.3%





## 2016年全国男子手球锦标赛

## 个人/全队技术统计表

正式表  
手球  
男子5-8名  
轮次 7组别 X  
场次 31201606031-14-2/2  
徐闻县体育中心体育馆  
28/10/2016 15:10

号码	姓名	远射	近射	边射	快攻	突破	任意	7M	合计	%	助攻	失误	警告	2'	取消	时间
<b>解放军队(解放军)</b>																
<i>(上场队员)</i>																
1	李梓宁									0.0%						00:09:33
2	范保坤									0.0%						00:00:00
4	曹作亮	0/8	1/3						1/11	9.1%		4		2		01:00:00
5	张昌轲									0.0%						00:00:00
6	吴昊		1/1						1/1	100%			1			00:28:59
7	姜钦	0/2				1/1			1/3	33.3%	1	1				01:00:00
8	王烁	1/1	1/1						2/2	100%	1	2				01:00:00
9	毕晓晨	1/2	1/1	0/3					2/6	33.3%		2				01:00:00
11	肖东洋									0.0%						00:00:00
12	姜明									0.0%						00:00:14
14	孙耀琦		1/1						1/1	100%		1	1			01:00:00
15	杨帆									0.0%						00:00:00
16	丛霖									0.0%						00:50:13
18	王晓龙	2/6	1/2	1/1	1/1			4/4	9/14	64.3%		4	1			00:30:25
20	刘智洋									0.0%						00:00:00
<b>合计</b>		4/19	6/9	1/4	1/1	1/1		4/4	17/38	44.7%	2	14	3	2		
<i>(守门员)</i>																
1	李梓宁	2/2	0/4					0/1	2/7	28.6%						00:09:33
12	姜明							0/1	0/1	0.0%						00:00:14
16	丛霖	3/5	1/6	1/4	0/1	1/3		1/4	7/23	30.4%						00:50:13
<b>合计</b>		5/7	1/10	1/4	0/1	1/3		1/6	9/31	29.0%						

场上队员：得分/射门

守门员：救球/射门

全队合计	得分	被救	射失	击柱	封球	合计	%
远射	4	4	5		6	19	21.1%
近射	6	3				9	66.7%
边射	1	2	1			4	25.0%
快攻	1					1	100.0%
突破	1					1	100.0%
任意							0.0%
7M	4					4	100.0%





### 2016年全国男子手球锦标赛

#### 图式射门区域统计

轮次 7 场次 31

201606031-41-1/1

## 上海队

1 张峥	2 张文斌	3 赵时俊	4 徐俊吉	8 钱为玮	10 董凯	11 蒋承骅	12 周哲韬																																																																								
<table border="1"><tr><td></td><td></td><td></td></tr><tr><td></td><td></td><td></td></tr><tr><td></td><td></td><td></td></tr></table>										<table border="1"><tr><td></td><td></td><td></td></tr><tr><td></td><td></td><td></td></tr><tr><td></td><td></td><td></td></tr></table>										<table border="1"><tr><td>1</td><td></td><td></td></tr><tr><td></td><td></td><td>1</td></tr><tr><td></td><td></td><td></td></tr></table>	1					1				<table border="1"><tr><td>1</td><td></td><td>3</td></tr><tr><td></td><td></td><td></td></tr><tr><td></td><td></td><td></td></tr></table>	1		3							<table border="1"><tr><td></td><td>1</td><td></td></tr><tr><td></td><td></td><td>1</td></tr><tr><td></td><td></td><td>2</td></tr></table>		1				1			2	<table border="1"><tr><td></td><td></td><td></td></tr><tr><td></td><td></td><td></td></tr><tr><td></td><td></td><td></td></tr></table>										<table border="1"><tr><td></td><td></td><td></td></tr><tr><td></td><td></td><td>1</td></tr><tr><td></td><td></td><td></td></tr></table>						1				<table border="1"><tr><td></td><td></td><td></td></tr><tr><td></td><td></td><td></td></tr><tr><td></td><td></td><td></td></tr></table>									
1																																																																															
		1																																																																													
1		3																																																																													
	1																																																																														
		1																																																																													
		2																																																																													
		1																																																																													
Post - 0 Miss - 0 Block - 0	Post - 0 Miss - 0 Block - 0	Post - 0 Miss - 0 Block - 0	Post - 0 Miss - 1 Block - 0	Post - 1 Miss - 0 Block - 0	Post - 0 Miss - 0 Block - 0	Post - 1 Miss - 1 Block - 0	Post - 0 Miss - 0 Block - 0																																																																								
14 沈吉磊	15 朱世杰	16 朱春雷	17 贺政	18 马麟晓	33 吴璟																																																																										
<table border="1"><tr><td></td><td></td><td></td></tr><tr><td></td><td></td><td></td></tr><tr><td></td><td></td><td></td></tr></table>										<table border="1"><tr><td>1</td><td>1</td><td></td></tr><tr><td></td><td></td><td>1</td></tr><tr><td>1</td><td>2</td><td>1</td></tr></table>	1	1				1	1	2	1	<table border="1"><tr><td></td><td></td><td></td></tr><tr><td></td><td></td><td></td></tr><tr><td></td><td></td><td></td></tr></table>										<table border="1"><tr><td></td><td></td><td>1</td></tr><tr><td></td><td></td><td></td></tr><tr><td></td><td></td><td></td></tr></table>			1							<table border="1"><tr><td></td><td></td><td></td></tr><tr><td></td><td></td><td>1</td></tr><tr><td></td><td></td><td></td></tr></table>						1				<table border="1"><tr><td></td><td>1</td><td></td></tr><tr><td></td><td></td><td></td></tr><tr><td>1</td><td></td><td></td></tr></table>		1					1																						
1	1																																																																														
		1																																																																													
1	2	1																																																																													
		1																																																																													
		1																																																																													
	1																																																																														
1																																																																															
Post - 0 Miss - 0 Block - 0	Post - 1 Miss - 1 Block - 1	Post - 0 Miss - 0 Block - 0	Post - 1 Miss - 0 Block - 0	Post - 1 Miss - 2 Block - 2	Post - 0 Miss - 0 Block - 0																																																																										

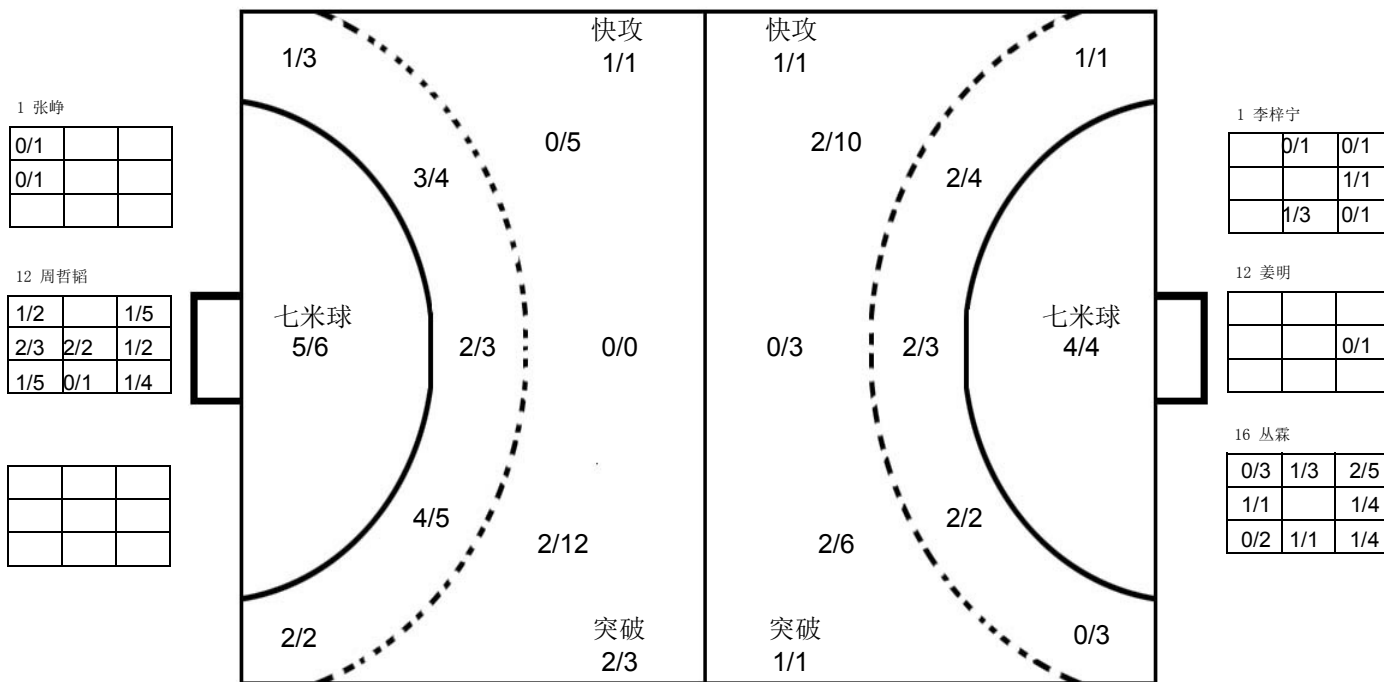

## 解放军队

1 李梓宁	2 范保坤	4 曹作亮	5 张昌柯	6 吴昊	7 姜钦	8 王烁	9 毕晓晨																																																																								
<table border="1"><tr><td></td><td></td><td></td></tr><tr><td></td><td></td><td></td></tr><tr><td></td><td></td><td></td></tr></table>										<table border="1"><tr><td></td><td></td><td></td></tr><tr><td></td><td></td><td></td></tr><tr><td></td><td></td><td></td></tr></table>										<table border="1"><tr><td></td><td></td><td></td></tr><tr><td></td><td></td><td>1</td></tr><tr><td></td><td></td><td></td></tr></table>						1				<table border="1"><tr><td></td><td></td><td></td></tr><tr><td></td><td></td><td></td></tr><tr><td></td><td></td><td></td></tr></table>										<table border="1"><tr><td></td><td></td><td></td></tr><tr><td></td><td></td><td></td></tr><tr><td>1</td><td></td><td></td></tr></table>							1			<table border="1"><tr><td></td><td></td><td></td></tr><tr><td></td><td></td><td>1</td></tr><tr><td></td><td></td><td></td></tr></table>						1				<table border="1"><tr><td></td><td></td><td>1</td></tr><tr><td></td><td></td><td></td></tr><tr><td></td><td></td><td></td></tr></table>			1							<table border="1"><tr><td></td><td></td><td></td></tr><tr><td></td><td></td><td>1</td></tr><tr><td></td><td></td><td></td></tr></table>						1			
		1																																																																													
1																																																																															
		1																																																																													
		1																																																																													
		1																																																																													
Post - 0 Miss - 0 Block - 0	Post - 0 Miss - 0 Block - 0	Post - 0 Miss - 3 Block - 4	Post - 0 Miss - 0 Block - 0	Post - 0 Miss - 0 Block - 0	Post - 0 Miss - 1 Block - 0	Post - 0 Miss - 0 Block - 0	Post - 0 Miss - 1 Block - 1																																																																								
11 肖东洋	12 姜明	14 孙耀琦	15 杨帆	16 丛霖	18 王晓龙	20 刘智洋																																																																									
<table border="1"><tr><td></td><td></td><td></td></tr><tr><td></td><td></td><td></td></tr><tr><td></td><td></td><td></td></tr></table>										<table border="1"><tr><td></td><td></td><td></td></tr><tr><td></td><td></td><td></td></tr><tr><td></td><td></td><td></td></tr></table>										<table border="1"><tr><td></td><td></td><td></td></tr><tr><td></td><td></td><td></td></tr><tr><td>1</td><td></td><td></td></tr></table>							1			<table border="1"><tr><td></td><td></td><td></td></tr><tr><td></td><td></td><td></td></tr><tr><td></td><td></td><td></td></tr></table>										<table border="1"><tr><td></td><td></td><td></td></tr><tr><td></td><td></td><td></td></tr><tr><td></td><td></td><td></td></tr></table>										<table border="1"><tr><td>2</td><td></td><td>3</td></tr><tr><td>1</td><td></td><td>1</td></tr><tr><td>1</td><td></td><td>1</td></tr></table>	2		3	1		1	1		1	<table border="1"><tr><td></td><td></td><td></td></tr><tr><td></td><td></td><td></td></tr><tr><td></td><td></td><td></td></tr></table>										<table border="1"><tr><td></td><td></td><td></td></tr><tr><td></td><td></td><td></td></tr><tr><td></td><td></td><td></td></tr></table>									
1																																																																															
2		3																																																																													
1		1																																																																													
1		1																																																																													
Post - 0 Miss - 0 Block - 0	Post - 0 Miss - 0 Block - 0	Post - 0 Miss - 0 Block - 0	Post - 0 Miss - 0 Block - 0	Post - 0 Miss - 0 Block - 0	Post - 0 Miss - 1 Block - 1	Post - 0 Miss - 0 Block - 0																																																																									

注释: Post=击柱 Miss=射失 Block=被封





5-8名

男子 全国比赛

2016年全国男子手球锦标赛

Team A A 广东队				Team B B 安徽队				Match Number <b>32</b>													
played in China		in the hall 徐闻县体育中心体育		on 28/10/2016		at 16:50 hours		Spectators													
Half-time (30')	A 15	B 14	End of playing time	A 30	B 23	1st extra time	A	B	2nd extra time	A	B	After penalty throws	A	B							
Number of 7 m	A 1/2	Team time-out			Full name of players and officials				Team time-out			B 1/1	Number of 7 m								
		1 15:54	2 43:56	3 56:31					1 27:55	2 41:06	3 53:24										
No.	Team A					G	W	2'	D	DR	No.	Team B					G	W	2'	D	DR
1	王泽润										1	郭世伟									
2	孙江山					5					2	金永峰									
3	曲汝洋					6					3	陈强龙					1				
4	李卓洋					3					5	史小帆									
5	侯生升					2					7	姚雄敏					1				
7	付云博					1	1				8	董智景					4	1			
8	于彦江										9	陈开勇					1				
10	周仲坤										10	严龙									
11	房友屯										11	黎涛					5				
13	王立隆										12	曾献辰									
15	张建杰										17	王巨柱					8				
16	马跃										18	李双					1	1			
17	李中洲					11	1				19	何山									
20	黄培杰										21	李明									
84	王伟					2					22	王金宇									
											23	于敏清					2				
B	王锋 (主教练)										A	韦中平									
C	刘康伶										B	沈强 (主教练)									
D	张广建										C	吴翔									
E	王永存										D	陈玉翔									
A	Signature of Responsible Official of the Teams (Off. A)																			B	
TP	Remarks of Referee / CHA Official																			TP	

Signatures

Referees	徐健 (CHN)	曹宏俊 (CHN)		
Techn. Delegates	王洋 (CHN)			
CHA Official	刘凤娟 (CHN)			

Note: Number of 7m Throws Awarded to Team A and B, Goals (G), Warnings (W), Suspensions (2'), Direct Disqualification (D), Disqualification with Report (DR) and Team Penalty (TP).

Table Officials: 伍豪

刘正松

Statisticians: 周亚桥

李双





2016年全国男子手球锦标赛  
竞赛技术统计(媒体表)

5-8名	组别	X	轮次	7	场次	32
------	----	---	----	---	----	----

徐闻县体育中心体育馆

28/10/2016

201606032-51-1/1

广东队	广东	30	vs	23	安徽	安徽队
15 : 14						

裁判员	徐健 (CHN)	/	曹宏俊 (CHN)
-----	----------	---	-----------

广东		远射	近射	边射	快攻	突破	任意球	7m球	合计	%	助攻	失误	警告	2'	D & DR	广东	比赛进程	安徽
主教练：王锋																		
1	王泽润																	
2	孙江山		2/4	3/3				0/1	5/8	62.5	1	2						
3	曲汝洋		1/3		4/5	1/1			6/9	66.7		3						
4	李卓洋	2/3	1/4						3/7	42.9		2						
5	侯生升		1/1	0/1	1/1				2/3	66.7		2						
7	付云博		0/1					1/1	1/2	50.0		3	1					
8	于彦江																	
10	周仲坤																	
11	房友屯																	
13	王立隆																	
15	张建杰																	
16	马跃																	
17	李中洲	3/4	7/9		1/1	0/1	0/2		11/17	64.7		1	1					
20	黄培杰																	
84	王伟		2/2						2/2	100		1						
运动员 合计		5/7	14/24	3/4	6/7	1/2	0/2	1/2	30/48	62.5	1	14	2					
1	王泽润		0/1		0/1			0/2	0/2	0.0								
16	马跃	2/11	4/10	0/1	0/2	0/2		0/1	6/27	22.2								
守门员 合计		2/11	4/11	0/1	0/3	0/2		0/1	6/29	20.7								
安徽		远射	近射	边射	快攻	突破	任意球	7m球	合计	%	助攻	失误	警告	2'	D & DR			
教练：沈强																		
1	郭世伟																	
2	金永峰																	
3	陈强龙		1/1						1/1	100								
5	史小帆	0/1	0/1						0/2	0.0		2						
7	姚雄敏		1/3						1/3	33.3		2						
8	董智景	2/2	0/1	0/1	1/1	1/1			4/6	66.7		2	1					
9	陈开勇		0/1		1/1				1/2	50.0								
10	严龙																	
11	黎涛	1/1	3/3	0/1	1/1				5/6	83.3		4						
12	曾献辰										1							
17	王巨柱	5/9	1/2			1/1		1/1	8/13	61.5	1	6						
18	李双	1/3	0/1						1/4	25.0	1	4	1					
19	何山																	
21	李明																	
22	王金宇																	
23	于敏清		1/1	1/1					2/2	100		1						
运动员 合计		9/16	7/14	1/3	3/3	2/2		1/1	23/39	59.0	3	21	2					
12	曾献辰	0/1	1/2	1/2	0/2				2/7	28.6	1							
21	李明	1/5	7/20	0/2	0/4	1/2	2/2	1/2	12/37	32.4								
守门员 合计		1/6	8/22	1/4	0/6	1/2	2/2	1/2	14/44	31.8	1							

场上队员：得分 / 射门

守门员：救球 / 射门

快攻	Fast Break		突破	Breakthrough		任意球	Free Throw		7M球	7M Throw		助攻	Assist
警告	Warning		失误	Error		2'	Suspension		D	取消资格		DR	取消资格+报告





## 2016年全国男子手球锦标赛 图式比赛技术统计表

轮次 7

场次 32

201606032-21-1/1

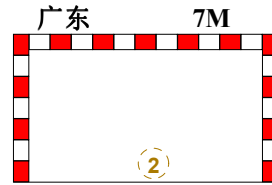
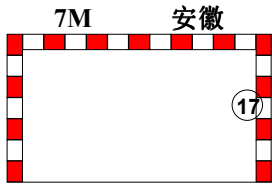
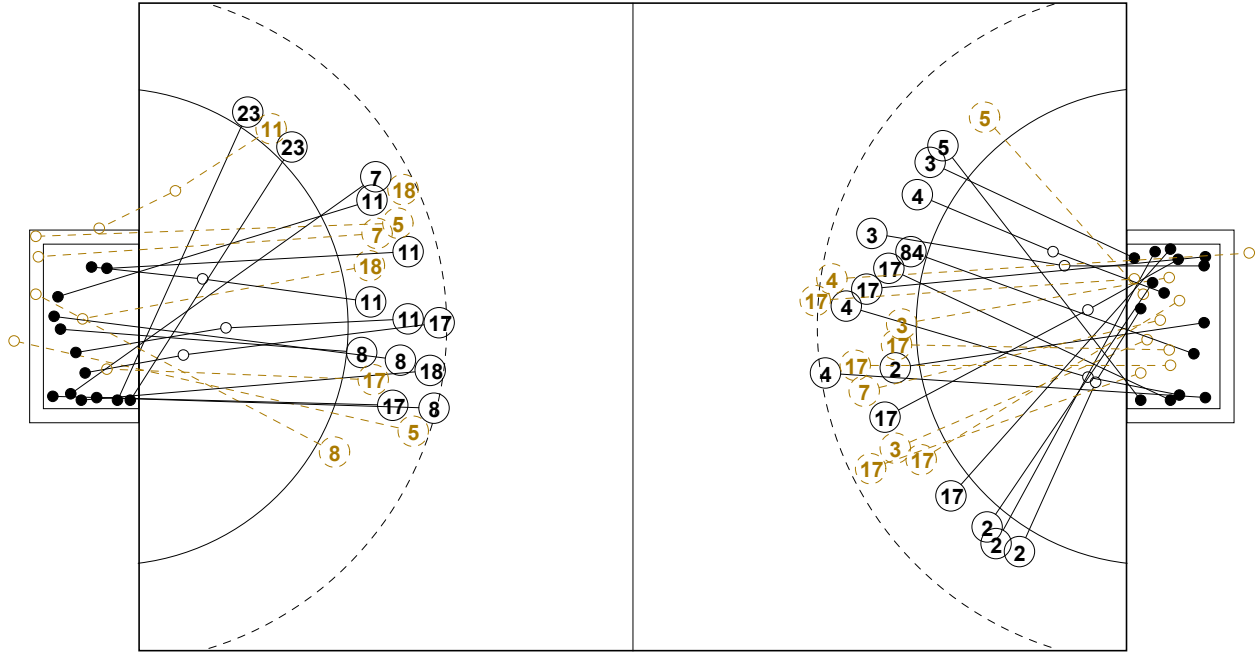

1st Half  
14 : 15

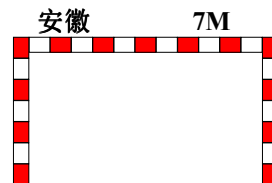
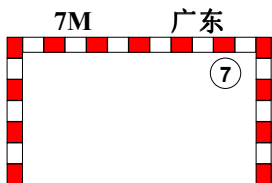
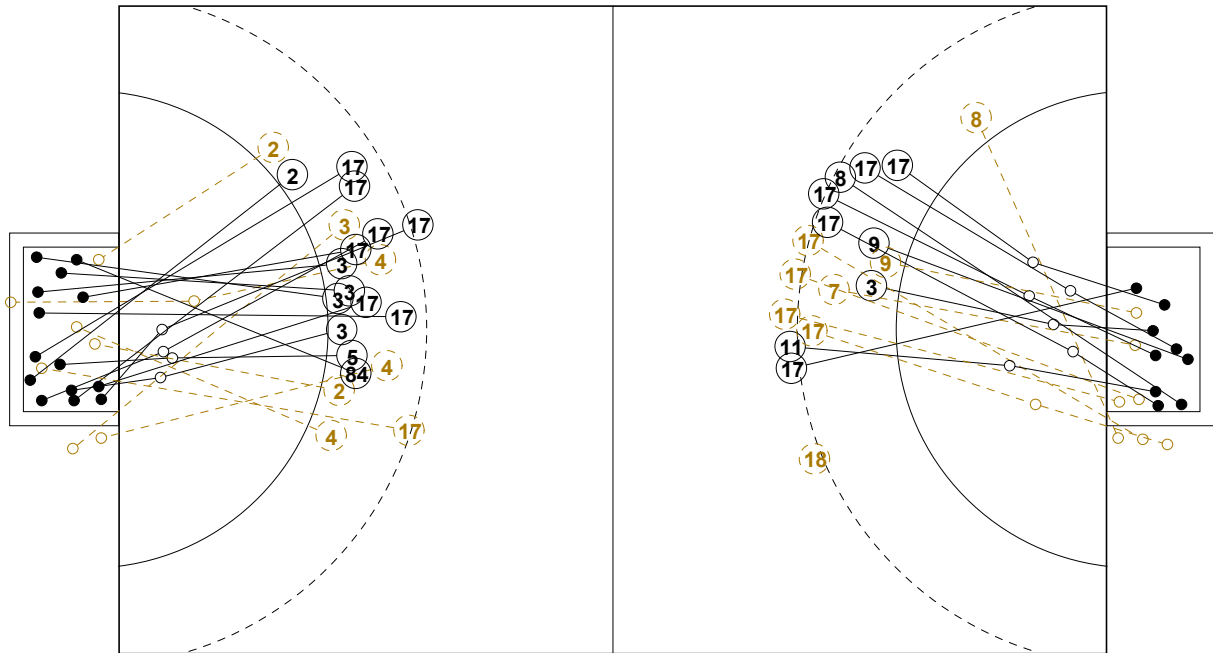

2nd Half  
30 : 23



## 2016年全国男子手球锦标赛

## 个人/全队技术统计表

正式表  
手球  
男子5-8名  
轮次 7组别 X  
场次 32201606032-14-1/2  
徐闻县体育中心体育馆  
28/10/2016 16:50

号码	姓名	远射	近射	边射	快攻	突破	任意	7M	合计	%	助攻	失误	警告	2'	取消	时间
<b>广东队(广东)</b>																
<i>(场上队员)</i>																
1	王泽润									0.0%						00:03:50
2	孙江山		2/4	3/3				0/1	5/8	62.5%	1	2				00:56:39
3	曲汝洋		1/3		4/5	1/1			6/9	66.7%		3				00:45:41
4	李卓洋	2/3	1/4						3/7	42.9%		2				00:52:04
5	侯生升		1/1	0/1	1/1				2/3	66.7%		2				00:55:55
7	付云博		0/1					1/1	1/2	50.0%		3	1			00:32:37
8	于彦江									0.0%						00:00:00
10	周仲坤									0.0%						00:00:00
11	房友屯									0.0%						00:00:00
13	王立隆									0.0%						00:02:50
15	张建杰									0.0%						00:00:00
16	马跃									0.0%						00:56:10
17	李中洲	3/4	7/9		1/1	0/1	0/2		11/17	64.7%		1	1			00:56:45
20	黄培杰									0.0%						00:00:00
84	王伟		2/2						2/2	100%		1				00:56:32
<b>合计</b>		5/7	14/24	3/4	6/7	1/2	0/2	1/2	30/48	62.5%	1	14	2			
<i>(守门员)</i>																
1	王泽润		0/1		0/1				0/2	0.0%						00:03:50
16	马跃	2/11	4/10	0/1	0/2	0/2		0/1	6/27	22.2%						00:56:10
<b>合计</b>		2/11	4/11	0/1	0/3	0/2		0/1	6/29	20.7%						

场上队员：得分/射门

守门员：救球/射门

全队合计	得分	被救	射失	击柱	封球	合计	%
远射	5	1	1			7	71.4%
近射	14	8	1	1		24	58.3%
边射	3	1				4	75.0%
快攻	6		1			7	85.7%
突破	1	1				2	50.0%
任意		2				2	0.0%
7M	1	1				2	50.0%





## 2016年全国男子手球锦标赛

## 个人/全队技术统计表

正式表  
手球  
男子5-8名  
轮次 7组别 X  
场次 32201606032-14-2/2  
徐闻县体育中心体育馆  
28/10/2016 16:50

号码	姓名	远射	近射	边射	快攻	突破	任意	7M	合计	%	助攻	失误	警告	2'	取消	时间
<b>安徽队(安徽)</b>																
<i>(上场队员)</i>																
1	郭世伟									0.0%						00:03:29
2	金永峰									0.0%						00:00:00
3	陈强龙		1/1						1/1	100%						00:20:38
5	史小帆	0/1	0/1						0/2	0.0%		2				00:30:18
7	姚雄敏		1/3						1/3	33.3%		2				00:27:11
8	董智景	2/2	0/1	0/1	1/1	1/1			4/6	66.7%		2	1			00:54:42
9	陈开勇		0/1		1/1				1/2	50.0%						00:50:41
10	严龙									0.0%						00:00:00
11	黎涛	1/1	3/3	0/1	1/1				5/6	83.3%		4				00:49:13
12	曾献辰									0.0%	1					00:08:28
17	王巨柱	5/9	1/2			1/1		1/1	8/13	61.5%	1	6				00:35:37
18	李双	1/3	0/1						1/4	25.0%	1	4	1			00:54:04
19	何山									0.0%						00:00:00
21	李明									0.0%						00:51:32
22	王金宇									0.0%						00:00:00
23	于敏清		1/1	1/1					2/2	100%		1				00:33:22
<b>合计</b>		9/16	7/14	1/3	3/3	2/2		1/1	23/39	59.0%	3	21	2			
<i>(守门员)</i>																
12	曾献辰	0/1	1/2	1/2	0/2				2/7	28.6%	1					00:08:28
21	李明	1/5	7/20	0/2	0/4	1/2	2/2	1/2	12/37	32.4%						00:51:32
<b>合计</b>		1/6	8/22	1/4	0/6	1/2	2/2	1/2	14/44	31.8%	1					

场上队员：得分/射门

守门员：救球/射门

全队合计	得分	被救	射失	击柱	封球	合计	%
远射	9	2	3		2	16	56.3%
近射	7	4		3		14	50.0%
边射	1		1	1		3	33.3%
快攻	3					3	100.0%
突破	2					2	100.0%
任意							0.0%
7M	1					1	100.0%





### 2016年全国男子手球锦标赛

#### 图式射门区域统计

轮次 7 场次 32

201606032-41-1/1

## 广东队

1 王泽润	2 孙江山	3 曲汝洋	4 李卓洋	5 侯生升	7 付文博	8 于彦江	10 周仲坤																																																																								
<table border="1"><tr><td></td><td></td><td></td></tr><tr><td></td><td></td><td></td></tr><tr><td></td><td></td><td></td></tr></table>										<table border="1"><tr><td>1</td><td>1</td><td></td></tr><tr><td></td><td></td><td></td></tr><tr><td>2</td><td>1</td><td></td></tr></table>	1	1					2	1		<table border="1"><tr><td>1</td><td></td><td>2</td></tr><tr><td>1</td><td></td><td>1</td></tr><tr><td>1</td><td></td><td></td></tr></table>	1		2	1		1	1			<table border="1"><tr><td></td><td></td><td>1</td></tr><tr><td>1</td><td></td><td>1</td></tr><tr><td></td><td></td><td></td></tr></table>			1	1		1				<table border="1"><tr><td></td><td></td><td></td></tr><tr><td>1</td><td></td><td></td></tr><tr><td></td><td></td><td>1</td></tr></table>				1					1	<table border="1"><tr><td></td><td></td><td>1</td></tr><tr><td></td><td></td><td></td></tr><tr><td></td><td></td><td></td></tr></table>			1							<table border="1"><tr><td></td><td></td><td></td></tr><tr><td></td><td></td><td></td></tr><tr><td></td><td></td><td></td></tr></table>										<table border="1"><tr><td></td><td></td><td></td></tr><tr><td></td><td></td><td></td></tr><tr><td></td><td></td><td></td></tr></table>									
1	1																																																																														
2	1																																																																														
1		2																																																																													
1		1																																																																													
1																																																																															
		1																																																																													
1		1																																																																													
1																																																																															
		1																																																																													
		1																																																																													
Post - 0 Miss - 0 Block - 0	Post - 0 Miss - 0 Block - 0	Post - 0 Miss - 1 Block - 0	Post - 1 Miss - 2 Block - 0	Post - 0 Miss - 0 Block - 0	Post - 0 Miss - 0 Block - 0	Post - 0 Miss - 0 Block - 0	Post - 0 Miss - 0 Block - 0																																																																								
11 房友屯	13 王立隆	15 张建杰	16 马跃	17 李中洲	20 黄培杰	84 王伟																																																																									
<table border="1"><tr><td></td><td></td><td></td></tr><tr><td></td><td></td><td></td></tr><tr><td></td><td></td><td></td></tr></table>										<table border="1"><tr><td></td><td></td><td></td></tr><tr><td></td><td></td><td></td></tr><tr><td></td><td></td><td></td></tr></table>										<table border="1"><tr><td></td><td></td><td></td></tr><tr><td></td><td></td><td></td></tr><tr><td></td><td></td><td></td></tr></table>										<table border="1"><tr><td></td><td></td><td></td></tr><tr><td></td><td></td><td></td></tr><tr><td></td><td></td><td></td></tr></table>										<table border="1"><tr><td>2</td><td>2</td><td></td></tr><tr><td>3</td><td></td><td>2</td></tr><tr><td>2</td><td></td><td></td></tr></table>	2	2		3		2	2			<table border="1"><tr><td></td><td></td><td></td></tr><tr><td></td><td></td><td></td></tr><tr><td></td><td></td><td></td></tr></table>										<table border="1"><tr><td></td><td>1</td><td></td></tr><tr><td></td><td></td><td>1</td></tr><tr><td></td><td></td><td></td></tr></table>		1				1				<table border="1"><tr><td></td><td></td><td></td></tr><tr><td></td><td></td><td></td></tr><tr><td></td><td></td><td></td></tr></table>									
2	2																																																																														
3		2																																																																													
2																																																																															
	1																																																																														
		1																																																																													
Post - 0 Miss - 0 Block - 0	Post - 0 Miss - 0 Block - 0	Post - 0 Miss - 0 Block - 0	Post - 0 Miss - 0 Block - 0	Post - 0 Miss - 0 Block - 0	Post - 0 Miss - 0 Block - 0	Post - 0 Miss - 0 Block - 0																																																																									

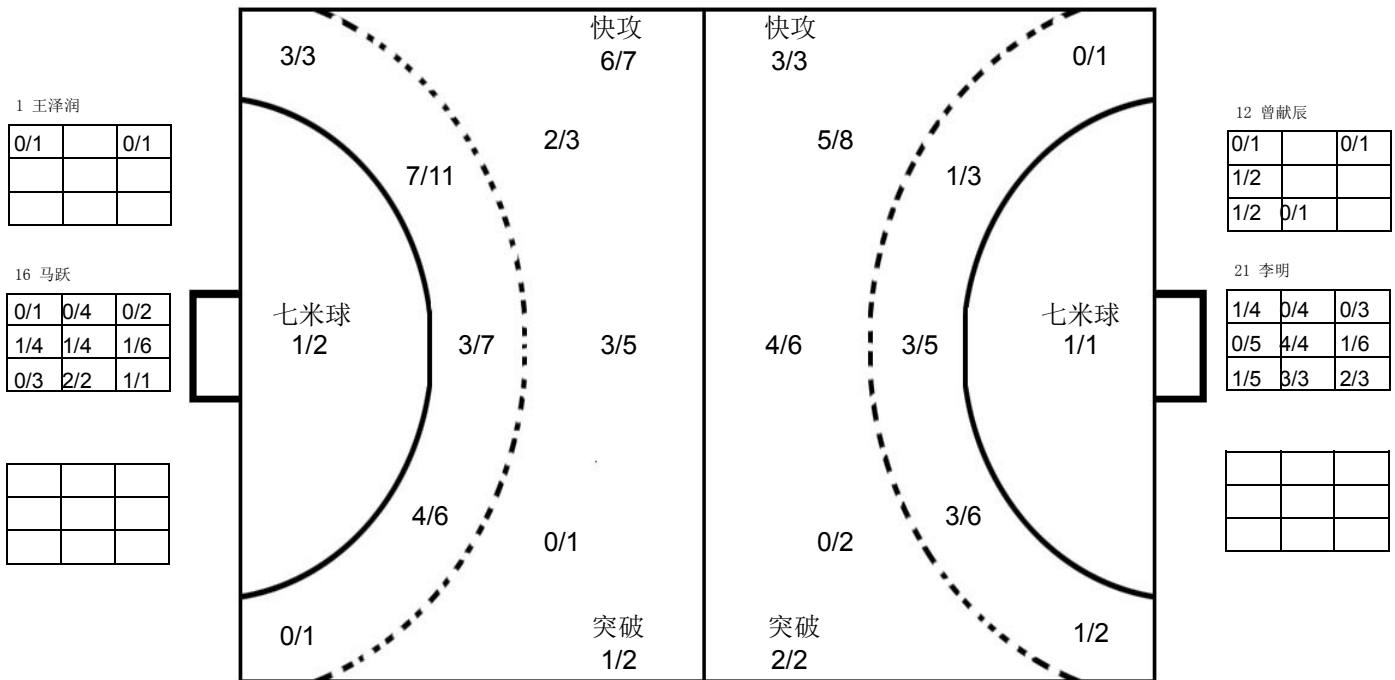

## 安徽队

1 郭世伟	2 金永峰	3 陈强龙	5 史小帆	7 姚雄敏	8 董智景	9 陈开勇	10 严龙																																																																								
<table border="1"><tr><td></td><td></td><td></td></tr><tr><td></td><td></td><td></td></tr><tr><td></td><td></td><td></td></tr></table>										<table border="1"><tr><td></td><td></td><td></td></tr><tr><td></td><td></td><td></td></tr><tr><td></td><td></td><td></td></tr></table>										<table border="1"><tr><td></td><td></td><td></td></tr><tr><td></td><td>1</td><td></td></tr><tr><td></td><td></td><td></td></tr></table>					1					<table border="1"><tr><td></td><td></td><td></td></tr><tr><td></td><td></td><td></td></tr><tr><td></td><td></td><td></td></tr></table>										<table border="1"><tr><td>1</td><td></td><td></td></tr><tr><td></td><td></td><td></td></tr><tr><td></td><td></td><td></td></tr></table>	1									<table border="1"><tr><td></td><td>2</td><td>1</td></tr><tr><td>1</td><td></td><td></td></tr><tr><td></td><td></td><td></td></tr></table>		2	1	1						<table border="1"><tr><td></td><td></td><td>1</td></tr><tr><td></td><td></td><td></td></tr><tr><td></td><td></td><td></td></tr></table>			1							<table border="1"><tr><td></td><td></td><td></td></tr><tr><td></td><td></td><td></td></tr><tr><td></td><td></td><td></td></tr></table>									
	1																																																																														
1																																																																															
	2	1																																																																													
1																																																																															
		1																																																																													
Post - 0 Miss - 0 Block - 0	Post - 0 Miss - 0 Block - 0	Post - 0 Miss - 0 Block - 0	Post - 1 Miss - 1 Block - 0	Post - 1 Miss - 0 Block - 0	Post - 1 Miss - 1 Block - 0	Post - 0 Miss - 0 Block - 0	Post - 0 Miss - 0 Block - 0																																																																								
11 黎涛	12 曾献辰	17 王巨柱	18 李双	19 何山	21 李明	22 王金宇	23 于敏清																																																																								
<table border="1"><tr><td></td><td>1</td><td>1</td></tr><tr><td></td><td></td><td>3</td></tr><tr><td></td><td></td><td></td></tr></table>		1	1			3				<table border="1"><tr><td></td><td></td><td></td></tr><tr><td></td><td></td><td></td></tr><tr><td></td><td></td><td></td></tr></table>										<table border="1"><tr><td>1</td><td>1</td><td></td></tr><tr><td>1</td><td>2</td><td>2</td></tr><tr><td>1</td><td></td><td></td></tr></table>	1	1		1	2	2	1			<table border="1"><tr><td>1</td><td></td><td></td></tr><tr><td></td><td></td><td></td></tr><tr><td></td><td></td><td></td></tr></table>	1									<table border="1"><tr><td></td><td></td><td></td></tr><tr><td></td><td></td><td></td></tr><tr><td></td><td></td><td></td></tr></table>										<table border="1"><tr><td></td><td></td><td></td></tr><tr><td></td><td></td><td></td></tr><tr><td></td><td></td><td></td></tr></table>										<table border="1"><tr><td></td><td></td><td></td></tr><tr><td></td><td></td><td></td></tr><tr><td></td><td></td><td></td></tr></table>										<table border="1"><tr><td></td><td></td><td></td></tr><tr><td></td><td></td><td></td></tr><tr><td></td><td></td><td></td></tr></table>									
	1	1																																																																													
		3																																																																													
1	1																																																																														
1	2	2																																																																													
1																																																																															
1																																																																															
Post - 1 Miss - 0 Block - 0	Post - 0 Miss - 0 Block - 0	Post - 0 Miss - 2 Block - 0	Post - 0 Miss - 0 Block - 2	Post - 0 Miss - 0 Block - 0	Post - 0 Miss - 0 Block - 0	Post - 0 Miss - 0 Block - 0	Post - 0 Miss - 0 Block - 0																																																																								

注释: Post=击柱 Miss=射失 Block=被封





半决赛  
男子 全国比赛

2016年全国男子手球锦标赛

Team A <b>A 江苏队</b>				Team B <b>B 天津队</b>				Match Number <b>33</b>													
played in China		in the hall 徐闻县体育中心体育		on 28/10/2016		at 19:00 hours		Spectators													
Half-time (30')	<b>A</b> 16	<b>B</b> 5	End of playing time	<b>A</b> 30	<b>B</b> 19	1st extra time	<b>A</b>	<b>B</b>	2nd extra time	<b>A</b>	<b>B</b>	After penalty throws	<b>A</b>	<b>B</b>							
Number of 7 m	<b>A</b> 0 / 1	Team time-out 1 18:45 2 52:50 3			Full name of players and officials				Team time-out 1 05:00 2 50:55 3			<b>B</b> 2 / 5	Number of 7 m								
No.	Team <b>A</b>					G	W	2'	D	DR	No.	Team <b>B</b>					G	W	2'	D	DR
1	徐畅										1	刘宗其									
4	张家纬					1	1				2	李岳朋					1	1			
5	闫亮					1					4	李松浩									
6	赵晨					3					6	王子欣					2				
7	徐奕飞					5		1			7	张青					2				
8	周小坚					2					8	曹悦					5	1			
9	周傲										9	吴明远								1	
10	郝可鑫					2					11	王毅					3				
12	王权										12	杨峻									
15	李安					6					13	许松					3				
16	张帅										14	田剑侠									
17	王伟强					3					16	刘海亮									
18	赵楠					2		1			17	周群									
20	顾艳超					3					18	王晓琪					1				
21	刘江					2	1				21	潘玉帅									
22	张瑞恒										22	魏雨童					2				
<b>B</b>	闫威名 (主教练)										<b>A</b>	贾守信									
<b>C</b>	贾淑君										<b>B</b>	杜瑞军 (主教练)									
<b>D</b>	叶强										<b>D</b>	潘玉强									
<b>E</b>	王建国										<b>E</b>	贾宁									
<b>A</b>	Signature of Responsible Official of the Teams (Off. A)																			<b>B</b>	
TP	Remarks of Referee / CHA Official																			TP	

Signatures

Referees: 刘禹 (CHN) 许翔 (CHN)

Techn. Delegates: 李兆蒙 (CHN)

CHA Official: 王科 (CHN)

Note: Number of 7m Throws Awarded to Team A and B, Goals (G), Warnings (W), Suspensions (2'), Direct Disqualification (D), Disqualification with Report (DR) and Team Penalty (TP).

Table Officials: 刘宇阳 鲍瑛 Statisticians: 张程秀子 李双



2016年全国男子手球锦标赛  
竞赛技术统计(媒体表)

半决赛	组别	X	轮次	7	场次	33
徐闻县体育中心体育馆			28/10/2016		201606033-51-1/1	
江苏队		江苏	30	vs	19	天津
		16:5				天津队

裁判员	刘禹 (CHN)			/	许翔 (CHN)		
-----	----------	--	--	---	----------	--	--

江苏		远	近	边	快	突	任意	7m	合计	%	助攻	失误	警告	2'	D & DR	江苏		比赛	天津			
主教练: 闫威名		射	射	射	攻	破	球	球	球							进程						
1	徐畅															15	李安	0	00:46	1	8	曹悦
4	张家纬		1/2						1/2	50.0	1	1	1			15	李安	1	01:10	1		
5	闫亮	0/1			1/1				1/2	50.0						15	李安	2	03:03	1		
6	赵晨	2/2					1/1		3/3	100		2				15	李安	3	04:58	1		
7	徐奕飞		1/1	2/2	1/1	1/1			5/5	100		1		1		4	张家纬	4	06:19	1		
8	周小坚		2/2						2/2	100	1	3				18	赵楠	5	08:55	1		
9	周傲		0/2		0/1			0/1	0/4	0.0		1				5	闫亮	6	09:37	1		
10	郝可鑫	0/3	1/1				1/1		2/5	40.0		3				15	李安	7	11:22	1		
12	王权	0/1							0/1	0.0						8	周小坚	8	13:27	1		
15	李安	0/2	3/3		3/4				6/9	66.7		1				8	周小坚	8	15:32	2	7	张青
16	张帅										1					8	周小坚	9	15:56	2		
17	王伟强		2/3		1/2				3/5	60.0						15	李安	10	17:23	2		
18	赵楠	0/1	2/3	0/1					2/5	40.0	3	3		1		10	李安	10	18:35	3	13	许松
20	顾艳超	2/3	1/2						3/5	60.0	3	1				10	李安	10	19:33	4	8	曹悦
21	刘江		2/2						2/2	100		1	1			21	刘江	11	21:22	4		
22	张瑞恒															6	赵晨	12	22:37	4		
运动员 合计		4/13	15/21	2/3	6/9	1/1	2/2	0/1	30/50	60.0	9	17	2	2		6	赵晨	13	23:22	4		
1	徐畅	2/7	2/7	1/1	0/2			1/3	6/20	30.0						6	赵晨	13	24:11	5	13	许松
12	王权	3/3	1/2	0/2	0/1			1/1	5/9	55.6						15	李安	14	24:55	5		
16	张帅	4/5							4/5	80.0	1					15	李安	15	25:48	5		
守门员 合计		9/15	3/9	1/3	0/3			2/4	15/34	44.1	1					17	王伟强	16	28:17	5		
天津		远	近	边	快	突	任意	7m	合计	%	助攻	失误	警告	2'	D & DR							
教练: 杜瑞军		射	射	射	攻	破	球	球	球													
1	刘宗其															20	顾艳超	17	00:25	5		
2	李岳朋		1/1						1/1	100		2	1			17	王伟强	17	01:01	6	8	曹悦
4	李松浩		0/2						0/2	0.0		1				17	王伟强	17	03:11	7	7	张青
6	王子欣		1/1					1/1	2/2	100		1				21	刘江	18	05:09	7		
7	张青	1/6			1/1				2/7	28.6	1	1				7	徐奕飞	18	06:23	8	8	曹悦
8	曹悦	3/8	1/2					1/1	5/11	45.5						19	王伟强	19	06:59	8		
9	吴明远		0/1	0/1					0/2	0.0				1		19	王伟强	19	07:55	9	8	曹悦
11	王毅	1/5	1/2		1/1			0/2	3/10	30.0	1					20	顾艳超	20	09:50	9		
12	杨峻															7	徐奕飞	20	13:00	10	13	许松
13	许松			2/2	1/1				3/3	100		2				7	徐奕飞	21	13:50	10		
14	田剑侠	0/4	0/1					0/1	0/6	0.0						7	徐奕飞	22	15:45	10		
16	刘海亮															22	顾艳超	22	16:46	11	2	李岳朋
17	周群											1				22	顾艳超	22	17:20	12	11	王毅
18	王晓琪	1/4			0/1				1/5	20.0	2	1				7	徐奕飞	23	18:04	12		
21	潘玉帅															18	赵楠	23	21:32	13	6	王子欣
22	魏雨童		2/2						2/2	100						20	顾艳超	24	22:25	14	18	王晓琪
运动员 合计		6/27	6/12	2/3	3/4			2/5	19/51	37.3	4	14	2	1		20	顾艳超	24	23:09	14		
1	刘宗其		0/2						0/2	0.0						17	王伟强	25	23:41	14		
12	杨峻	3/7	5/18	1/3	2/8	0/1	0/2		11/39	28.2		1				20	顾艳超	26	24:05	15	11	王毅
守门员 合计		3/7	5/20	1/3	2/8	0/1	0/2		11/41	26.8		1				10	郝可鑫	26	24:47	15		

场上队员: 得分 / 射门

守门员: 救球 / 射门

快攻	Fast Break		突破	Breakthrough		任意球	Free Throw		7M球	7M Throw		助攻	Assist
警告	Warning		失误	Error		2'	Suspension		D	取消资格		DR	取消资格+报告





### 2016年全国男子手球锦标赛 图式比赛技术统计表

轮次 7

场次 33

201606033-21-1/1

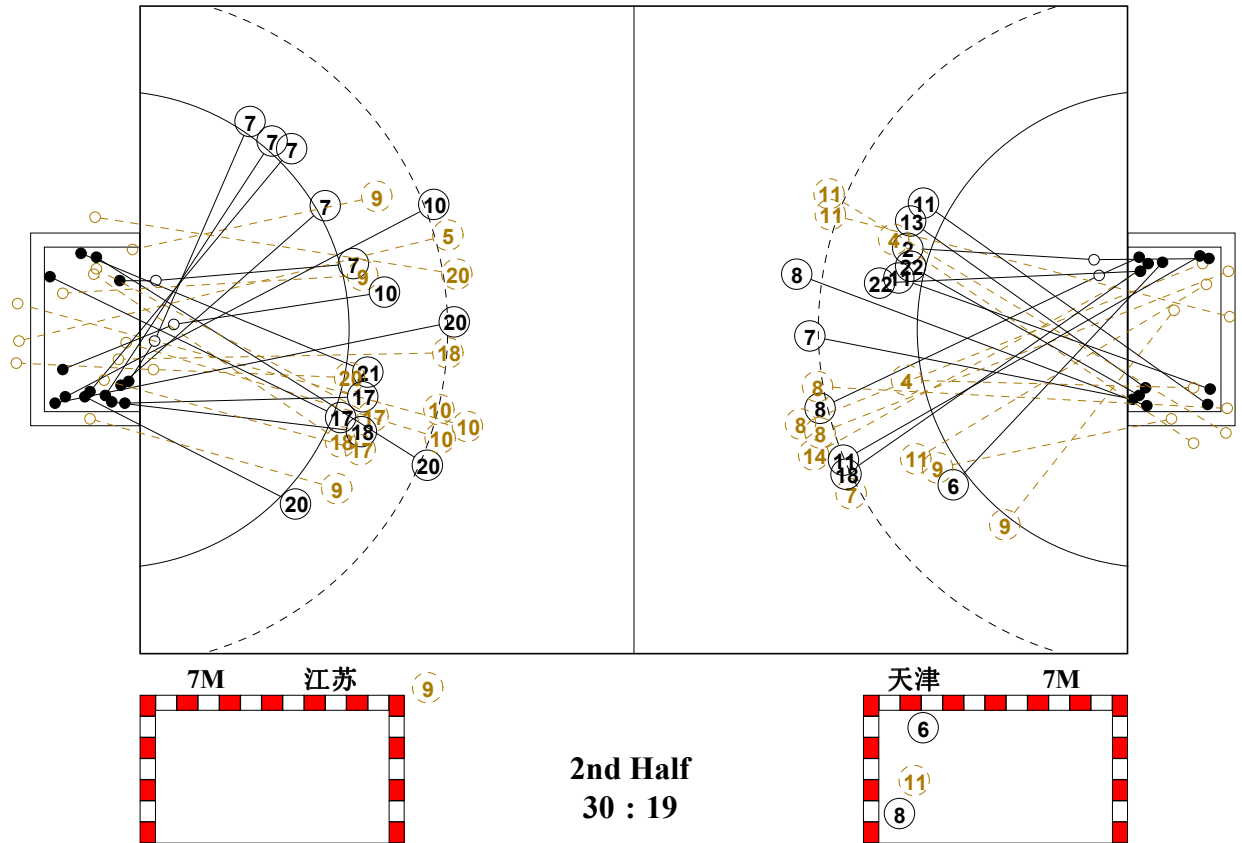
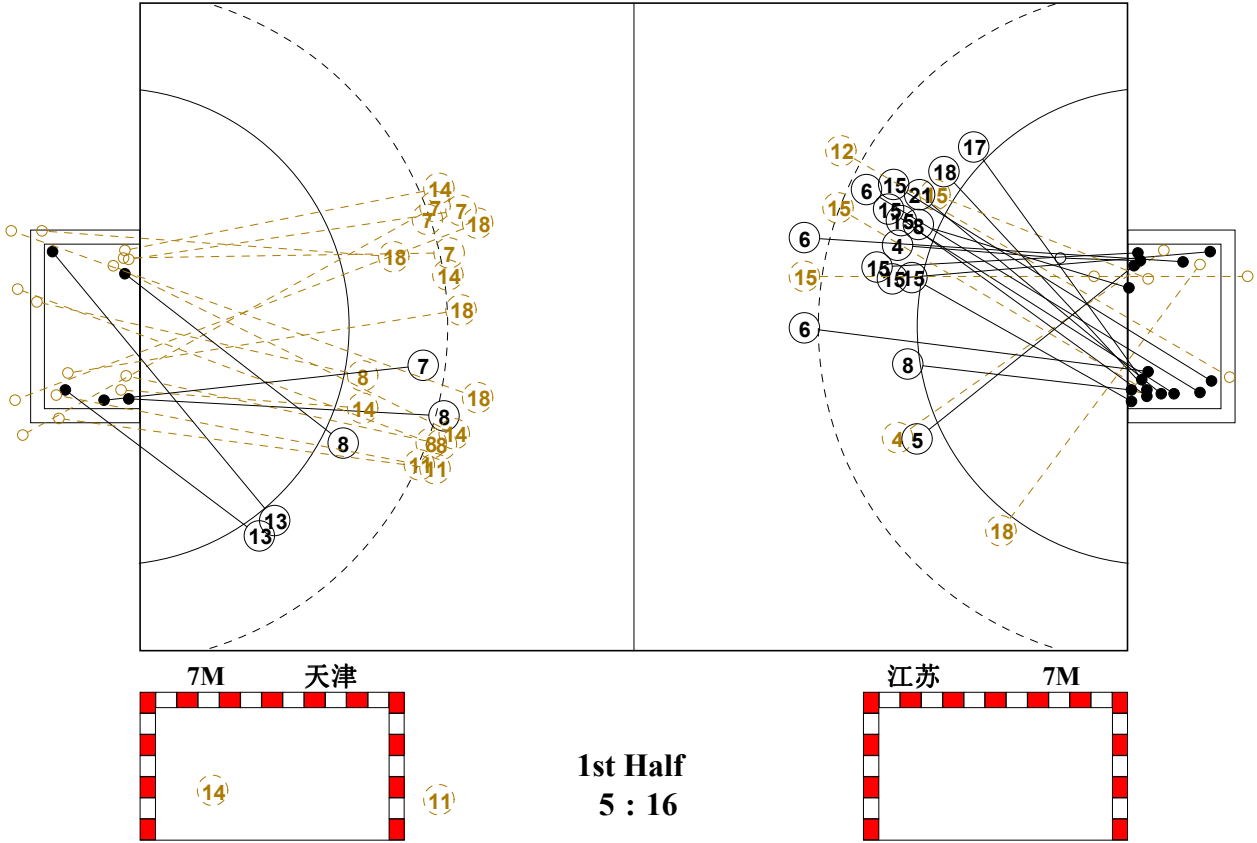





## 2016年全国男子手球锦标赛

## 个人/全队技术统计表

正式表  
手球  
男子半决赛  
轮次 7组别 X  
场次 33201606033-14-1/2  
徐闻县体育中心体育馆  
28/10/2016 19:00

号码	姓名	远射	近射	边射	快攻	突破	任意	7M	合计	%	助攻	失误	警告	2'	取消	时间
<b>江苏队(江苏)</b>																
<i>(场上队员)</i>																
1	徐畅									0.0%						00:30:00
4	张家纬		1/2						1/2	50.0%	1	1	1			00:24:16
5	闫亮	0/1			1/1				1/2	50.0%						00:20:52
6	赵晨	2/2					1/1		3/3	100%		2				00:27:58
7	徐奕飞		1/1	2/2	1/1	1/1			5/5	100%		1		1		00:35:43
8	周小坚		2/2						2/2	100%	1	3				00:26:17
9	周傲		0/2		0/1			0/1	0/4	0.0%		1				00:15:26
10	郝可鑫	0/3	1/1				1/1		2/5	40.0%		3				00:26:33
12	王权	0/1							0/1	0.0%						00:17:28
15	李安	0/2	3/3		3/4				6/9	66.7%		1				00:28:33
16	张帅									0.0%	1					00:12:32
17	王伟强		2/3		1/2				3/5	60.0%						00:52:49
18	赵楠	0/1	2/3	0/1					2/5	40.0%	3	3		1		00:45:41
20	顾艳超	2/3	1/2						3/5	60.0%	3	1				00:31:59
21	刘江		2/2						2/2	100%		1	1			00:45:01
22	张瑞恒									0.0%						00:00:00
<b>合计</b>		4/13	15/21	2/3	6/9	1/1	2/2	0/1	30/50	60.0%	9	17	2	2		
<i>(守门员)</i>																
1	徐畅	2/7	2/7	1/1	0/2			1/3	6/20	30.0%						00:30:00
12	王权	3/3	1/2	0/2	0/1			1/1	5/9	55.6%						00:17:28
16	张帅	4/5							4/5	80.0%	1					00:12:32
<b>合计</b>		9/15	3/9	1/3	0/3			2/4	15/34	44.1%	1					

场上队员：得分/射门

守门员：救球/射门

全队合计	得分	被救	射失	击柱	封球	合计	%
远射	4	3	4	1	1	13	30.8%
近射	15	5	1			21	71.4%
边射	2	1				3	66.7%
快攻	6	2		1		9	66.7%
突破	1					1	100.0%
任意	2					2	100.0%
7M			1			1	0.0%





## 2016年全国男子手球锦标赛

## 个人/全队技术统计表

正式表  
手球  
男子半决赛  
轮次 7组别 X  
场次 33201606033-14-2/2  
徐闻县体育中心体育馆  
28/10/2016 19:00

号码	姓名	远射	近射	边射	快攻	突破	任意	7M	合计	%	助攻	失误	警告	2'	取消	时间
<b>天津队(天津)</b>																
<i>(上场队员)</i>																
1	刘宗其									0.0%						00:03:09
2	李岳朋		1/1						1/1	100%		2	1			00:38:25
4	李松浩		0/2						0/2	0.0%		1				00:11:50
6	王子欣		1/1					1/1	2/2	100%		1				00:55:18
7	张青	1/6			1/1				2/7	28.6%	1	1				00:46:49
8	曹悦	3/8	1/2					1/1	5/11	45.5%		3	1			00:39:53
9	吴明远		0/1	0/1					0/2	0.0%				1		00:19:46
11	王毅	1/5	1/2		1/1			0/2	3/10	30.0%	1					00:22:26
12	杨峻									0.0%		1				00:56:51
13	许松			2/2	1/1				3/3	100%		2				00:44:51
14	田剑侠	0/4	0/1					0/1	0/6	0.0%						00:33:03
16	刘海亮									0.0%						00:00:00
17	周群									0.0%		1				00:10:20
18	王晓琪	1/4			0/1				1/5	20.0%	2	1				00:24:02
21	潘玉帅									0.0%						00:00:00
22	魏雨童		2/2						2/2	100%		1				00:32:05
<b>合计</b>		6/27	6/12	2/3	3/4			2/5	19/51	37.3%	4	14	2	1		
<i>(守门员)</i>																
1	刘宗其		0/2						0/2	0.0%						00:03:09
12	杨峻	3/7	5/18	1/3	2/8	0/1	0/2		11/39	28.2%		1				00:56:51
<b>合计</b>		3/7	5/20	1/3	2/8	0/1	0/2		11/41	26.8%		1				

场上队员：得分/射门

守门员：救球/射门

全队合计	得分	被救	射失	击柱	封球	合计	%
远射	6	9	5	4	3	27	22.2%
近射	6	3	1	2		12	50.0%
边射	2	1				3	66.7%
快攻	3			1		4	75.0%
突破							0.0%
任意							0.0%
7M	2	2	1			5	40.0%





### 2016年全国男子手球锦标赛

#### 图式射门区域统计

轮次 7 场次 33

201606033-41-1/1

## 江苏队

1 徐畅	4 张家纬	5 闫亮	6 赵晨	7 徐奕飞	8 周小坚	9 周傲	10 郝可鑫																																																																								
<table border="1"><tr><td></td><td></td><td></td></tr><tr><td></td><td></td><td></td></tr><tr><td></td><td></td><td></td></tr></table>										<table border="1"><tr><td></td><td></td><td></td></tr><tr><td></td><td></td><td></td></tr><tr><td>1</td><td></td><td></td></tr></table>							1			<table border="1"><tr><td></td><td></td><td></td></tr><tr><td></td><td></td><td></td></tr><tr><td>1</td><td></td><td></td></tr></table>							1			<table border="1"><tr><td></td><td></td><td>1</td></tr><tr><td>1</td><td></td><td></td></tr><tr><td></td><td></td><td>1</td></tr></table>			1	1					1	<table border="1"><tr><td></td><td></td><td></td></tr><tr><td></td><td></td><td></td></tr><tr><td>2</td><td></td><td></td></tr></table>							2			<table border="1"><tr><td></td><td></td><td></td></tr><tr><td></td><td></td><td></td></tr><tr><td>2</td><td></td><td>1</td></tr></table>							2		1	<table border="1"><tr><td></td><td></td><td></td></tr><tr><td></td><td></td><td></td></tr><tr><td>1</td><td></td><td>1</td></tr></table>							1		1	<table border="1"><tr><td></td><td></td><td></td></tr><tr><td></td><td></td><td></td></tr><tr><td></td><td></td><td></td></tr></table>									
1																																																																															
1																																																																															
		1																																																																													
1																																																																															
		1																																																																													
2																																																																															
2		1																																																																													
1		1																																																																													
Post - 0 Miss - 0 Block - 0	Post - 0 Miss - 0 Block - 0	Post - 0 Miss - 1 Block - 0	Post - 0 Miss - 0 Block - 0	Post - 0 Miss - 0 Block - 0	Post - 0 Miss - 0 Block - 0	Post - 1 Miss - 1 Block - 0	Post - 0 Miss - 1 Block - 1																																																																								
12 王权	15 李安	16 张帅	17 王伟强	18 赵楠	20 顾艳超	21 刘江	22 张瑞恒																																																																								
<table border="1"><tr><td></td><td></td><td></td></tr><tr><td></td><td></td><td></td></tr><tr><td></td><td></td><td></td></tr></table>										<table border="1"><tr><td>1</td><td></td><td>1</td></tr><tr><td></td><td></td><td>1</td></tr><tr><td>1</td><td></td><td>2</td></tr></table>	1		1			1	1		2	<table border="1"><tr><td></td><td></td><td></td></tr><tr><td></td><td></td><td></td></tr><tr><td></td><td></td><td></td></tr></table>										<table border="1"><tr><td></td><td></td><td>1</td></tr><tr><td>1</td><td></td><td>1</td></tr><tr><td></td><td></td><td></td></tr></table>			1	1		1				<table border="1"><tr><td></td><td></td><td></td></tr><tr><td></td><td></td><td></td></tr><tr><td>1</td><td></td><td>1</td></tr></table>							1		1	<table border="1"><tr><td>1</td><td></td><td></td></tr><tr><td>1</td><td></td><td>1</td></tr><tr><td></td><td></td><td></td></tr></table>	1			1		1				<table border="1"><tr><td></td><td></td><td></td></tr><tr><td></td><td></td><td></td></tr><tr><td></td><td></td><td>2</td></tr></table>									2	<table border="1"><tr><td></td><td></td><td></td></tr><tr><td></td><td></td><td></td></tr><tr><td></td><td></td><td></td></tr></table>									
1		1																																																																													
		1																																																																													
1		2																																																																													
		1																																																																													
1		1																																																																													
1		1																																																																													
1																																																																															
1		1																																																																													
		2																																																																													
Post - 1 Miss - 0 Block - 0	Post - 0 Miss - 1 Block - 0	Post - 0 Miss - 0 Block - 0	Post - 0 Miss - 0 Block - 0	Post - 0 Miss - 0 Block - 0	Post - 0 Miss - 2 Block - 0	Post - 0 Miss - 0 Block - 0	Post - 0 Miss - 0 Block - 0																																																																								

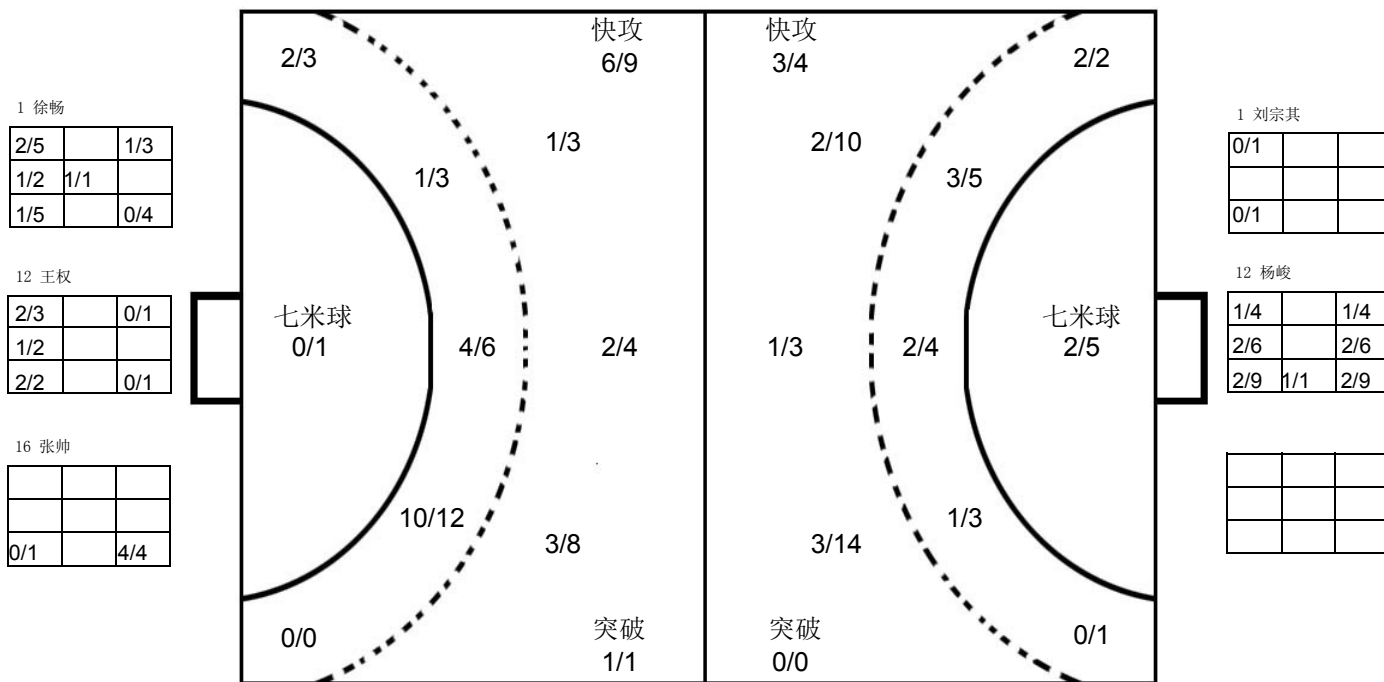

## 天津队

1 刘宗其	2 李岳朋	4 李松浩	6 王子欣	7 张青	8 曹悦	9 吴明远	11 王毅																																																																								
<table border="1"><tr><td></td><td></td><td></td></tr><tr><td></td><td></td><td></td></tr><tr><td></td><td></td><td></td></tr></table>										<table border="1"><tr><td>1</td><td></td><td></td></tr><tr><td></td><td></td><td></td></tr><tr><td></td><td></td><td></td></tr></table>	1									<table border="1"><tr><td></td><td></td><td></td></tr><tr><td></td><td></td><td></td></tr><tr><td></td><td></td><td></td></tr></table>										<table border="1"><tr><td></td><td></td><td>1</td></tr><tr><td>1</td><td></td><td></td></tr><tr><td></td><td></td><td></td></tr></table>			1	1						<table border="1"><tr><td></td><td></td><td></td></tr><tr><td></td><td></td><td></td></tr><tr><td>1</td><td></td><td>1</td></tr></table>							1		1	<table border="1"><tr><td></td><td></td><td></td></tr><tr><td></td><td></td><td></td></tr><tr><td>3</td><td></td><td>2</td></tr></table>							3		2	<table border="1"><tr><td></td><td></td><td></td></tr><tr><td></td><td></td><td></td></tr><tr><td></td><td></td><td></td></tr></table>										<table border="1"><tr><td>1</td><td></td><td>2</td></tr><tr><td></td><td></td><td></td></tr><tr><td></td><td></td><td></td></tr></table>	1		2						
1																																																																															
		1																																																																													
1																																																																															
1		1																																																																													
3		2																																																																													
1		2																																																																													
Post - 0 Miss - 0 Block - 0	Post - 0 Miss - 0 Block - 0	Post - 0 Miss - 1 Block - 0	Post - 0 Miss - 0 Block - 0	Post - 0 Miss - 1 Block - 2	Post - 3 Miss - 1 Block - 0	Post - 1 Miss - 0 Block - 0	Post - 2 Miss - 2 Block - 0																																																																								
12 杨峻	13 许松	14 田剑侠	16 刘海亮	17 周群	18 王晓琪	21 潘玉帅	22 魏雨童																																																																								
<table border="1"><tr><td></td><td></td><td></td></tr><tr><td></td><td></td><td></td></tr><tr><td></td><td></td><td></td></tr></table>										<table border="1"><tr><td>1</td><td></td><td>1</td></tr><tr><td></td><td></td><td></td></tr><tr><td></td><td></td><td>1</td></tr></table>	1		1						1	<table border="1"><tr><td></td><td></td><td></td></tr><tr><td></td><td></td><td></td></tr><tr><td></td><td></td><td></td></tr></table>										<table border="1"><tr><td></td><td></td><td></td></tr><tr><td></td><td></td><td></td></tr><tr><td></td><td></td><td></td></tr></table>										<table border="1"><tr><td></td><td></td><td></td></tr><tr><td></td><td></td><td></td></tr><tr><td></td><td></td><td></td></tr></table>										<table border="1"><tr><td></td><td></td><td></td></tr><tr><td></td><td></td><td></td></tr><tr><td>1</td><td></td><td></td></tr></table>							1			<table border="1"><tr><td></td><td></td><td></td></tr><tr><td></td><td></td><td></td></tr><tr><td></td><td></td><td></td></tr></table>										<table border="1"><tr><td></td><td></td><td></td></tr><tr><td></td><td></td><td></td></tr><tr><td>1</td><td></td><td>1</td></tr></table>							1		1
1		1																																																																													
		1																																																																													
1																																																																															
1		1																																																																													
Post - 0 Miss - 0 Block - 0	Post - 0 Miss - 0 Block - 0	Post - 0 Miss - 0 Block - 1	Post - 0 Miss - 0 Block - 0	Post - 0 Miss - 0 Block - 0	Post - 1 Miss - 2 Block - 0	Post - 0 Miss - 0 Block - 0	Post - 0 Miss - 0 Block - 0																																																																								

注释: Post=击柱 Miss=射失 Block=被封



半决赛  
男子 全国比赛

2016年全国男子手球锦标赛

Team A <b>A 北京队</b>				Team B <b>B 山东队</b>				Match Number <b>34</b>													
played in China		in the hall 徐闻县体育中心体育		on 28/10/2016		at 20:40 hours		Spectators													
Half-time (30')	<b>A</b> 8	<b>B</b> 10	End of playing time	<b>A</b> 18	<b>B</b> 27	1st extra time	<b>A</b>	<b>B</b>	2nd extra time	<b>A</b>	<b>B</b>	After penalty throws	<b>A</b>	<b>B</b>							
Number of 7 m	<b>A</b> 3/4	Team time-out			Full name of players and officials				Team time-out			<b>B</b> 1/1	Number of 7 m								
		1 16:15	2 50:32	3					1 23:43	2 43:00	3 55:17										
No.	Team <b>A</b>					G	W	2'	D	DR	No.	Team <b>B</b>					G	W	2'	D	DR
3	王超					1					3	尹杰									
6	解建飞					1	1	1			4	田瑞									
8	王鹏						1				5	潘翔					5				
9	刘振					1					6	李朝鹏					1				
10	成亚					2	1				9	赵鑫					3				
11	蒋维一					2		2			10	赵建强									
12	孟辉										11	宋朋强					3				
16	刘迈科										12	崔剑									
21	胡瀛					5					13	刘晓					2				
23	王军程										15	张继伟					1				
25	马明辉					1					16	于性哲									
29	杜龙飞										17	王旭东					1	1			
33	冯宁										19	李语庆					5		1		
77	朱昕晨					4		1			21	翟乾坤					4				1
78	张骥					1					27	于亚男					2	1			
83	潘天																				
A	安福田										A	markovic尼克									
B	郑永利 (主教练)										B	王鸿斌 (主教练)									
C	陈璇										C	刘桂妮									
											D	邢建刚									
<b>A</b>	Signature of Responsible Official of the Teams (Off. A)																			<b>B</b>	
TP	Remarks of Referee / CHA Official																			TP	

Signatures

Referees	尹静阳 (CHN)	倪震 (CHN)		
Techn. Delegates	王科 (CHN)			
CHA Official	许宜扬 (CHN)			

Note: Number of 7m Throws Awarded to Team A and B, Goals (G), Warnings (W), Suspensions (2'), Direct Disqualification (D), Disqualification with Report (DR) and Team Penalty (TP).

Table Officials: 刘宇阳 鲍瑛 Statisticians: 张程秀子 李双



2016年全国男子手球锦标赛  
竞赛技术统计(媒体表)

半决赛 组别 X 轮次 7 场次 34

徐闻县体育中心体育馆 28/10/2016 201606034-51-1/1  
北京队 北京 18 vs 27 山东 山东队  
8 : 10

裁判员 尹静阳 (CHN) / 倪震 (CHN)

Main statistics table for Beijing and Shandong teams, including columns for distance, shot type, goals, assists, and suspensions.

场上队员: 得分 / 射门 守门员: 救球 / 射门  
Fast Break, Breakthrough, Free Throw, 7M Throw, Assist, Warning, Error, 2', Suspension, D, 取消资格, DR, 取消资格+报告



### 2016年全国男子手球锦标赛 图式比赛技术统计表

轮次 7

场次 34

201606034-21-1/1

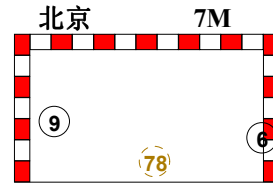
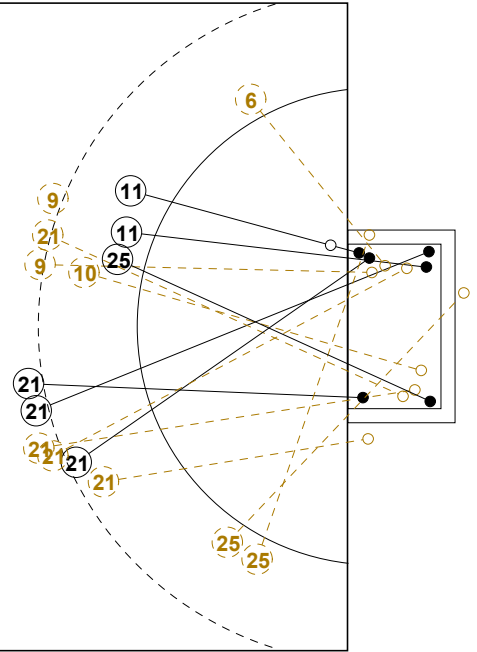
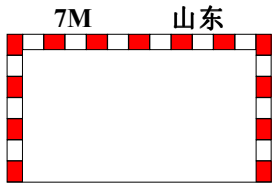
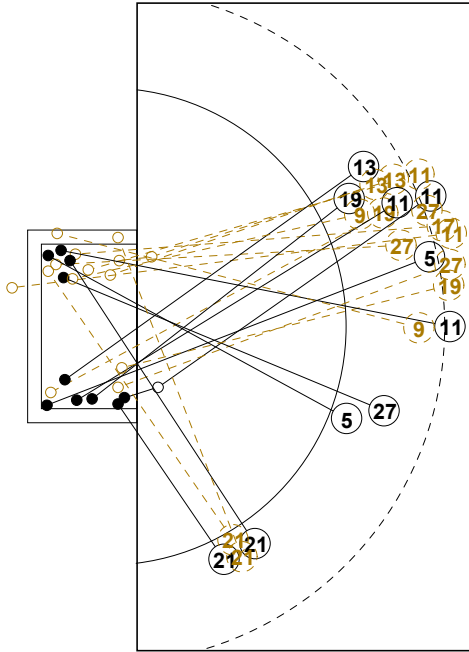

1st Half  
10 : 8

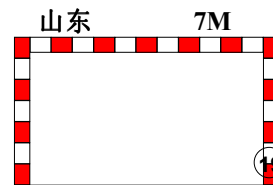
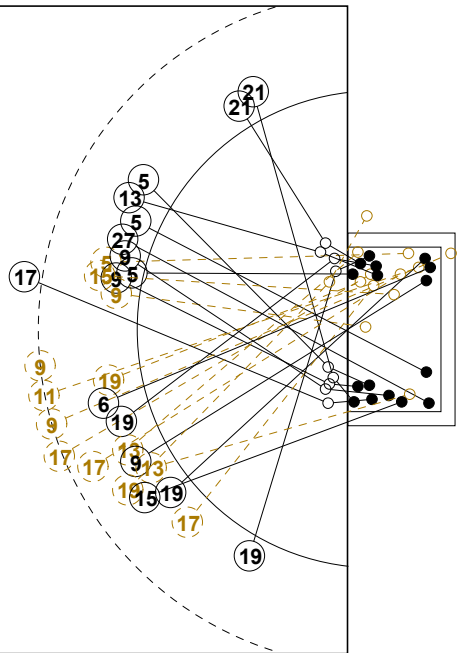
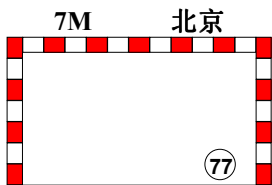
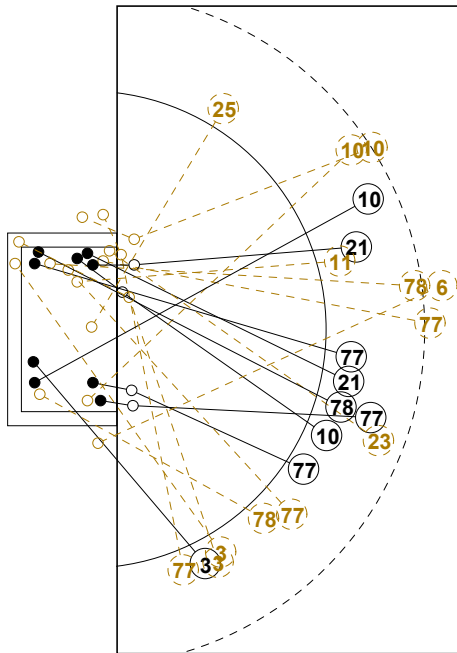

2nd Half  
18 : 27



## 2016年全国男子手球锦标赛

## 个人/全队技术统计表

正式表  
手球  
男子半决赛  
轮次 7组别 X  
场次 34201606034-14-1/2  
徐闻县体育中心体育馆  
28/10/2016 20:40

号码	姓名	远射	近射	边射	快攻	突破	任意	7M	合计	%	助攻	失误	警告	2'	取消	时间
<b>北京队(北京)</b>																
<i>(场上队员)</i>																
3	王超			1/3					1/3	33.3%						00:30:00
6	解建飞	0/1		0/1				1/1	1/3	33.3%			1	1		00:53:48
8	王鹏									0.0%			1			00:19:38
9	刘振	0/2						1/1	1/3	33.3%		1				00:22:11
10	成亚	0/2	1/2			1/1			2/5	40.0%	1	2	1			00:48:02
11	蒋维一		2/3						2/3	66.7%		1		2		00:43:10
12	孟辉									0.0%						00:04:30
16	刘迈科									0.0%		1				00:55:30
21	胡瀛	3/7	2/2						5/9	55.6%		3				00:32:22
23	王军程	0/1							0/1	0.0%						00:07:17
25	马明辉			0/3	1/1				1/4	25.0%						00:34:43
29	杜龙飞									0.0%		1				00:01:52
33	冯宁									0.0%						00:05:05
77	朱昕晨	0/1	1/2	0/1		2/2		1/1	4/7	57.1%	2	3		1		00:22:23
78	张骥	0/1	1/1	0/1				0/1	1/4	25.0%		3				00:24:56
83	潘天									0.0%						00:11:26
<b>合计</b>		3/15	7/10	1/9	1/1	3/3		3/4	18/42	42.9%	3	15	3	4		
<i>(守门员)</i>																
12	孟辉		2/2			0/3			2/5	40.0%						00:04:30
16	刘迈科	8/11	4/12	1/6	3/7	2/4	0/1	0/1	18/42	42.9%		1				00:55:30
<b>合计</b>		8/11	6/14	1/6	3/10	2/4	0/1	0/1	20/47	42.6%		1				

场上队员：得分/射门

守门员：救球/射门

全队合计	得分	被救	射失	击柱	封球	合计	%
远射	3	8	3		1	15	20.0%
近射	7	3				10	70.0%
边射	1	3	2	3		9	11.1%
快攻	1					1	100.0%
突破	3					3	100.0%
任意							0.0%
7M	3	1				4	75.0%





## 2016年全国男子手球锦标赛

## 个人/全队技术统计表

正式表  
手球  
男子半决赛  
轮次 7组别 X  
场次 34201606034-14-2/2  
徐闻县体育中心体育馆  
28/10/2016 20:40

号码	姓名	远射	近射	边射	快攻	突破	任意	7M	合计	%	助攻	失误	警告	2'	取消	时间
<b>山东队(山东)</b>																
<i>(上场队员)</i>																
3	尹杰									0.0%						00:00:00
4	田瑞									0.0%						00:00:00
5	潘翔	1/1	4/5						5/6	83.3%						00:46:06
6	李朝鹏				1/1				1/1	100%	2					00:17:00
9	赵鑫	0/3	1/2		2/2	0/1			3/8	37.5%	3	1				00:29:59
10	赵建强									0.0%						00:00:00
11	宋朋强	1/4				1/1	1/1		3/6	50.0%	1	3				00:49:40
12	崔剑									0.0%						00:14:21
13	刘晓	0/1	2/4			0/1			2/6	33.3%						00:25:36
15	张继伟		0/1		1/1				1/2	50.0%						00:10:12
16	于性哲									0.0%						00:45:39
17	王旭东	1/4	0/1						1/5	20.0%		2	1			00:34:22
19	李语庆	0/1	1/2	1/1	2/4			1/1	5/9	55.6%		1		1		01:00:00
21	翟乾坤			4/6					4/6	66.7%	1				1	00:43:00
27	于亚男	0/2			1/2	1/1			2/5	40.0%			1			00:43:33
<b>合计</b>		3/16	8/15	5/7	7/10	2/4	1/1	1/1	27/54	50.0%	7	7	2	1	1	
<i>(守门员)</i>																
12	崔剑	2/2	2/3	1/1		0/1			5/7	71.4%						00:14:21
16	于性哲	6/9	1/7	2/3	0/1	0/2		1/4	10/26	38.5%						00:45:39
<b>合计</b>		8/11	3/10	3/4	0/1	0/3		1/4	15/33	45.5%						

场上队员：得分/射门

守门员：救球/射门

全队合计	得分	被救	射失	击柱	封球	合计	%
远射	3	8	1	2	2	16	18.8%
近射	8	6	1			15	53.3%
边射	5	1		1		7	71.4%
快攻	7	3				10	70.0%
突破	2	2				4	50.0%
任意	1					1	100.0%
7M	1					1	100.0%







### 2016年全国男子手球锦标赛

#### 图式射门区域统计

轮次 7 场次 34

201606034-41-1/1

## 北京队

3 王超 1	6 解建飞 1	8 王鹏	9 刘振 1	10 成亚 1 1	11 蒋维一 1 1	12 孟辉	16 刘迈科
Post - 2 Miss - 0 Block - 0	Post - 0 Miss - 1 Block - 0	Post - 0 Miss - 0 Block - 0	Post - 0 Miss - 0 Block - 1	Post - 0 Miss - 1 Block - 0	Post - 0 Miss - 0 Block - 0	Post - 0 Miss - 0 Block - 0	Post - 0 Miss - 0 Block - 0
21 胡瀛 1 1 3	23 王军程	25 马明辉 1	29 杜龙飞	33 冯宁	77 朱昕晨 2 1	78 张骥 1	83 潘天
Post - 0 Miss - 1 Block - 0	Post - 0 Miss - 0 Block - 0	Post - 1 Miss - 1 Block - 0	Post - 0 Miss - 0 Block - 0	Post - 0 Miss - 0 Block - 0	Post - 0 Miss - 1 Block - 0	Post - 0 Miss - 0 Block - 0	Post - 0 Miss - 0 Block - 0

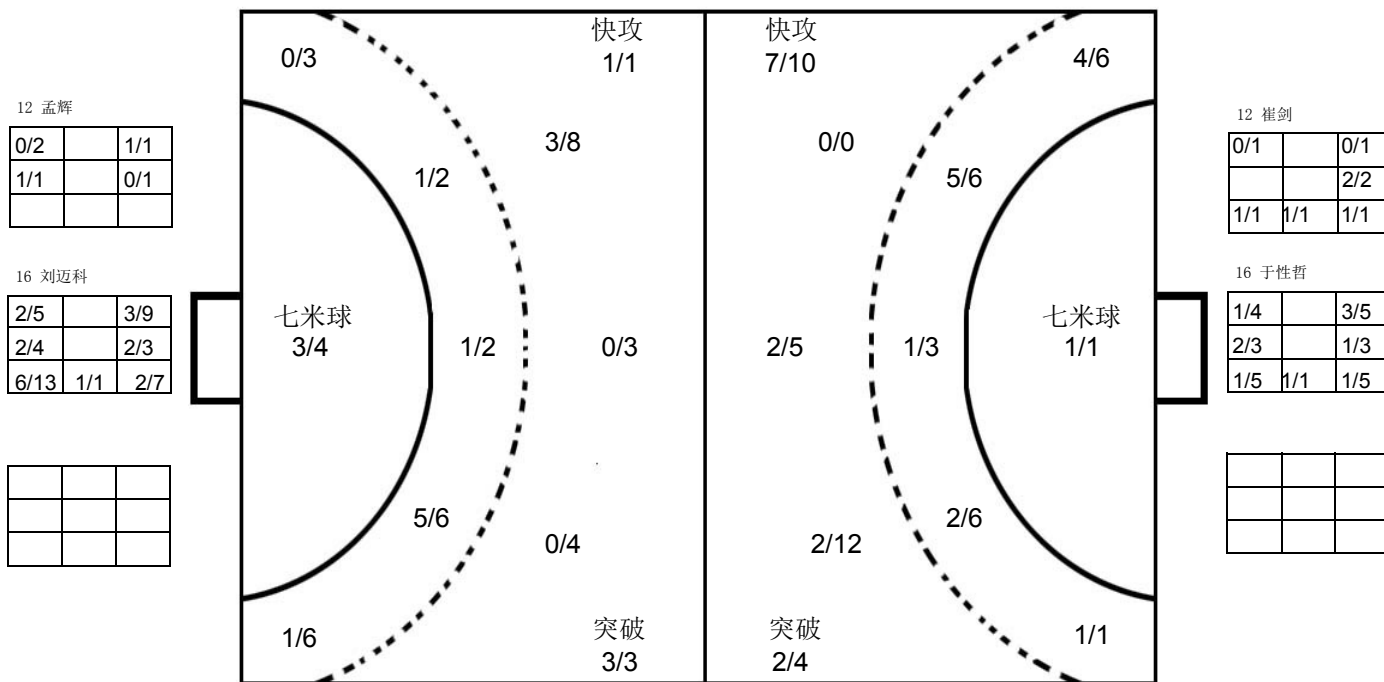

## 山东队

3 尹杰	4 田瑞	5 潘翔 1 2	6 李朝鹏 1	9 赵鑫 1 1	10 赵建强 1 1	11 宋朋强 1 1	12 崔剑
Post - 0 Miss - 0 Block - 0	Post - 0 Miss - 0 Block - 0	Post - 0 Miss - 0 Block - 0	Post - 0 Miss - 0 Block - 0	Post - 2 Miss - 0 Block - 1	Post - 0 Miss - 0 Block - 0	Post - 0 Miss - 1 Block - 0	Post - 0 Miss - 0 Block - 0
13 刘晓 1 1	15 张继伟 1	16 于性哲	17 王旭东 1	19 李语庆 1 1 2 1	21 翟乾坤 2 1	27 于亚男 2	
Post - 0 Miss - 0 Block - 0	Post - 0 Miss - 0 Block - 0	Post - 0 Miss - 0 Block - 0	Post - 0 Miss - 0 Block - 0	Post - 0 Miss - 1 Block - 0	Post - 1 Miss - 0 Block - 0	Post - 0 Miss - 0 Block - 1	

注释: Post=击柱 Miss=射失 Block=被封





7-8名

男子 全国比赛

2016年全国男子手球锦标赛

Team A <b>A 解放军队</b>				Team B <b>B 安徽队</b>				Match Number <b>35</b>													
played in China		in the hall 徐闻县体育中心体育		on 29/10/2016		at 10:00 hours		Spectators													
Half-time (30')	<b>A</b> 13	<b>B</b> 13	End of playing time	<b>A</b> 24	<b>B</b> 27	1st extra time	<b>A</b>	<b>B</b>	2nd extra time	<b>A</b>	<b>B</b>	After penalty throws	<b>A</b>	<b>B</b>							
Number of 7 m	<b>A</b> 2/3	Team time-out 1 2 3 51:16			Full name of players and officials				Team time-out 1 2 3 24:10			<b>B</b> 2/4	Number of 7 m								
No.	Team <b>A</b>					G	W	2'	D	DR	No.	Team <b>B</b>					G	W	2'	D	DR
1	李梓宁										1	郭世伟					3				
2	范保坤					1					2	金永峰									
4	曹作亮										3	陈强龙					1				
5	张昌轲					3					5	史小帆					1				
6	吴昊					3					7	姚雄敏					4				
7	姜钦					3	1	1			8	董智景					2				
8	王烁										9	陈开勇					3	1			
9	毕晓晨					4					10	严龙									
11	肖东洋					5					11	黎涛									
12	姜明										12	曾献辰									
14	孙耀琦					4		1			17	王巨柱					6				
15	杨帆										18	李双					3				
16	丛霖										19	何山									
18	王晓龙										21	李明									
20	刘智洋					1	1				22	王金宇									
											23	于敏清					4	1			
<b>B</b>	张敬敏 (主教练)										<b>A</b>	韦中平									
<b>C</b>	王学力										<b>B</b>	沈强 (主教练)									
<b>D</b>	刘捷										<b>C</b>	吴翔									
<b>E</b>	刘军										<b>D</b>	陈玉翔									
<b>A</b>	Signature of Responsible Official of the Teams (Off. A)																			<b>B</b>	
TP	Remarks of Referee / CHA Official																			TP	

Signatures

Referees	程钰锋 (CHN)	周云磊 (CHN)		
Techn. Delegates	曹宏俊 (CHN)			
CHA Official	徐健 (CHN)			

Note: Number of 7m Throws Awarded to Team A and B, Goals (G), Warnings (W), Suspensions (2'), Direct Disqualification (D), Disqualification with Report (DR) and Team Penalty (TP).

Table Officials: 伍豪

刘晓辉

Statisticians: 周亚桥

李双





## 2016年全国男子手球锦标赛 竞赛技术统计(媒体表)

7-8名	组别	<b>X</b>	轮次	<b>7</b>	场次	<b>35</b>
------	----	----------	----	----------	----	-----------

徐闻县体育中心体育馆

29/10/2016

201606035-51-1/1

解放军队	<b>解放军</b>	<b>24</b>	vs	<b>27</b>	<b>安徽</b>	安徽队
<b>13 : 13</b>						

裁判员	程钰锋 (CHN)	/	周云磊 (CHN)
-----	-----------	---	-----------

解放军		远	近	边	快	突	任意	7m	合计	%	助攻	失误	警告	2'	D & DR	比赛进程	
主教练：张敬敏		射	射	射	攻	破	球	球								解放军	安徽
1	李祥宁															9	毕晓晨
2	范保坤			1/1				1/1	100		2					1	02:48
4	曹作亮															1	04:25
5	张昌轲	1/3	1/3			1/1		3/7	42.9							2	05:39
6	吴昊	2/5	1/2					3/7	42.9		3					3	07:24
7	姜钦	1/4	1/2			1/1		3/7	42.9	2	1	1	1			4	08:33
8	王烁															2	09:52
9	毕晓晨	0/1	2/2					2/3	4/6	66.7	1	1				3	10:41
11	肖东洋	1/3	3/4		1/1			5/8	62.5	2	1					6	11:22
12	姜明															7	12:02
14	孙耀琦		4/7					4/7	57.1		1			1		5	13:51
15	杨帆															6	14:49
16	丛霖															7	17:33
18	王晓龙															7	17:52
20	刘智洋	0/2			1/2			1/4	25.0		4	1				8	19:22
<b>运动员 合计</b>		5/18	12/20	1/1	2/3	2/2		2/3	24/47	51.1	5	13	2	2		9	20:52
1	李祥宁	4/5	6/16	1/1	0/2	1/2		2/3	14/29	48.3						10	21:40
12	姜明	2/5	3/5	1/1	0/5	1/2		0/1	7/19	36.8						11	22:23
<b>守门员 合计</b>		6/10	9/21	2/2	0/7	2/4		2/4	21/48	43.8						10	22:53
安徽		远	近	边	快	突	任意	7m	合计	%	助攻	失误	警告	2'	D & DR	比赛进程	
教练：沈强		射	射	射	攻	破	球	球								解放军	安徽
1	郭世伟		1/3		2/2			3/5	60.0			1				13	01:57
2	金永峰															13	02:58
3	陈强龙		1/1					1/1	100							14	03:41
5	史小帆	0/1	0/1			1/1		0/1	1/4	25.0						15	05:18
7	姚雄敏		1/1		1/1	1/2		1/1	4/5	80.0		1				15	07:40
8	董智景	0/1	1/4	0/1	1/1			2/7	28.6	1	1					16	09:03
9	陈开勇		3/5					3/5	60.0		1	1	1			17	11:18
10	严龙															16	13:00
11	黎涛	0/2	0/1					0/3	0.0		2					17	13:44
12	曾献辰															17	15:04
17	王巨柱	2/6	2/3		1/1			1/2	6/12	50.0						18	18:09
18	李双	1/2	2/2			0/1		3/5	60.0	2	4					18	18:48
19	何山															19	19:34
21	李明										1					20	20:31
22	王金宇															20	21:07
23	于敏清	1/1	1/1	0/2	2/2			4/6	66.7		1	1				21	21:59
<b>运动员 合计</b>		4/13	12/22	0/3	7/7	2/4		2/4	27/53	50.9	4	11	2			22	23:37
21	李明	6/11	4/16	0/1	1/3	0/2		1/3	12/36	33.3	1					23	25:17
<b>守门员 合计</b>		6/11	4/16	0/1	1/3	0/2		1/3	12/36	33.3	1					24	26:14

场上队员：得分 / 射门

守门员：救球 / 射门

快攻	Fast Break	突破	Breakthrough	任意球	Free Throw	7M球	7M Throw	助攻	Assist
警告	Warning	失误	Error	2'	Suspension	D	取消资格	DR	取消资格+报告





### 2016年全国男子手球锦标赛 图式比赛技术统计表

轮次 7

场次 35

201606035-21-1/1

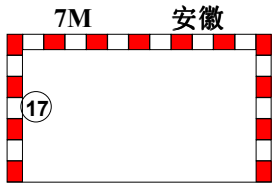
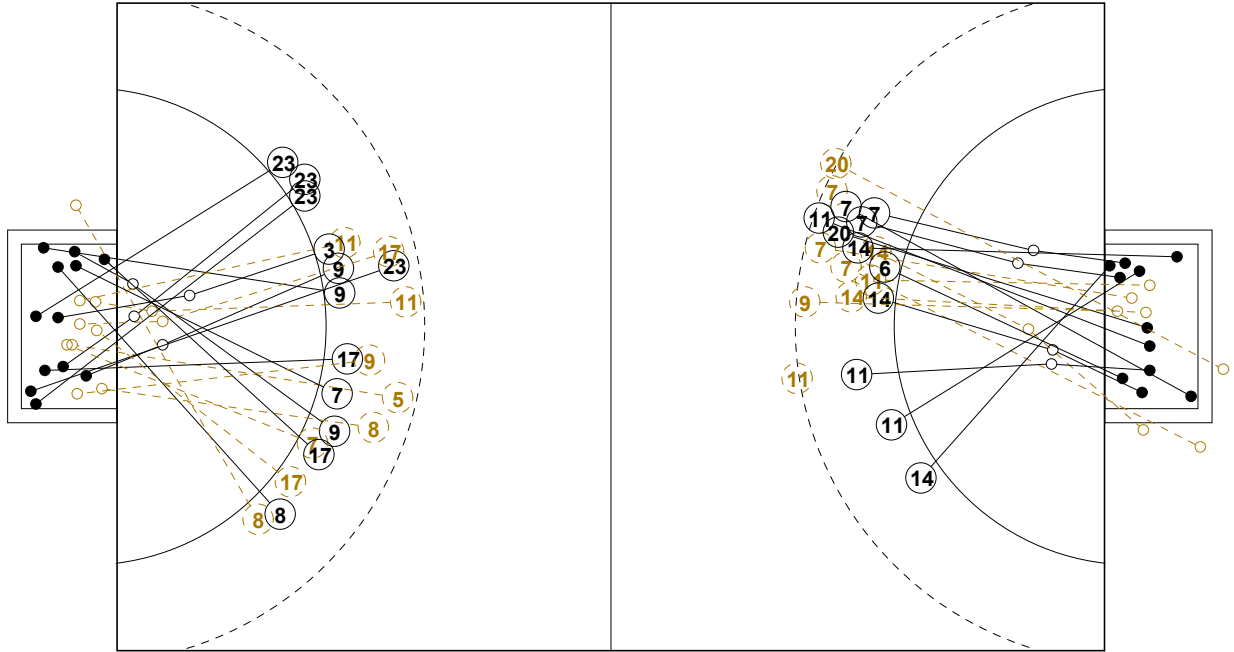

1st Half  
13 : 13

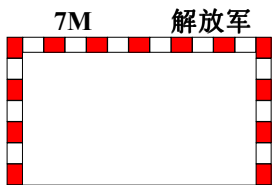
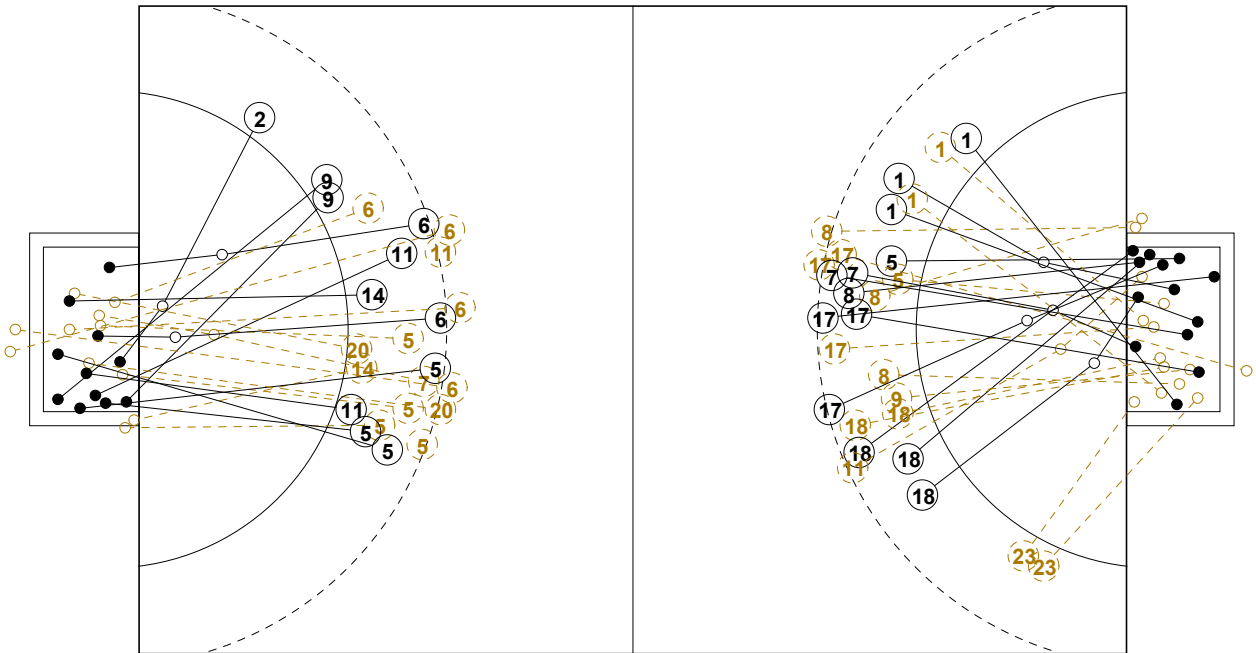
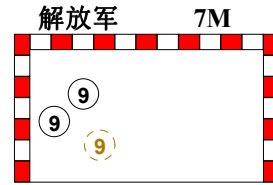

2nd Half  
24 : 27

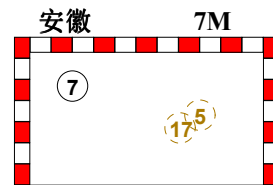



## 2016年全国男子手球锦标赛

## 个人/全队技术统计表

正式表  
手球  
男子7-8名  
轮次 7组别 X  
场次 35201606035-14-1/2  
徐闻县体育中心体育馆  
29/10/2016 10:00

号码	姓名	远射	近射	边射	快攻	突破	任意	7M	合计	%	助攻	失误	警告	2'	取消	时间
<b>解放军队(解放军)</b>																
<i>(场上队员)</i>																
1	李梓宁									0.0%						01:01:04
2	范保坤			1/1					1/1	100%		2				00:19:57
4	曹作亮									0.0%						00:00:00
5	张昌轲	1/3	1/3			1/1			3/7	42.9%						00:18:53
6	吴昊	2/5	1/2						3/7	42.9%		3				00:59:26
7	姜钦	1/4	1/2			1/1			3/7	42.9%	2	1	1	1		00:39:44
8	王烁									0.0%						00:00:00
9	毕晓晨	0/1	2/2					2/3	4/6	66.7%	1	1				00:41:10
11	肖东洋	1/3	3/4		1/1				5/8	62.5%	2	1				00:59:28
12	姜明									0.0%						00:23:06
14	孙耀琦		4/7						4/7	57.1%		1		1		00:57:01
15	杨帆									0.0%						00:00:00
16	丛霖									0.0%						00:00:00
18	王晓龙									0.0%						00:00:00
20	刘智洋	0/2			1/2				1/4	25.0%		4	1			00:59:23
<b>合计</b>		5/18	12/20	1/1	2/3	2/2		2/3	24/47	51.1%	5	13	2	2		
<i>(守门员)</i>																
1	李梓宁	4/5	6/16	1/1	0/2	1/2		2/3	14/29	48.3%						01:01:04
12	姜明	2/5	3/5	1/1	0/5	1/2		0/1	7/19	36.8%						00:23:06
<b>合计</b>		6/10	9/21	2/2	0/7	2/4		2/4	21/48	43.8%						

场上队员：得分/射门

守门员：救球/射门

全队合计	得分	被救	射失	击柱	封球	合计	%
远射	5	6	3		4	18	27.8%
近射	12	4	2	2		20	60.0%
边射	1					1	100.0%
快攻	2	1				3	66.7%
突破	2					2	100.0%
任意							0.0%
7M	2	1				3	66.7%





## 2016年全国男子手球锦标赛

## 个人/全队技术统计表

正式表  
手球  
男子7-8名  
轮次 7组别 X  
场次 35201606035-14-2/2  
徐闻县体育中心体育馆  
29/10/2016 10:00

号码	姓名	远射	近射	边射	快攻	突破	任意	7M	合计	%	助攻	失误	警告	2'	取消	时间
<b>安徽队(安徽)</b>																
<i>(上场队员)</i>																
1	郭世伟		1/3		2/2				3/5	60.0%						00:20:20
2	金永峰									0.0%		1				00:03:02
3	陈强龙		1/1						1/1	100%						00:20:27
5	史小帆	0/1	0/1			1/1		0/1	1/4	25.0%						00:33:20
7	姚雄敏		1/1		1/1	1/2		1/1	4/5	80.0%		1				00:30:33
8	董智景	0/1	1/4	0/1	1/1				2/7	28.6%	1	1				00:46:44
9	陈开勇		3/5						3/5	60.0%		1	1			00:54:10
10	严龙									0.0%						00:00:00
11	黎涛	0/2	0/1						0/3	0.0%		2				00:31:22
12	曾献辰									0.0%						00:00:00
17	王巨柱	2/6	2/3		1/1			1/2	6/12	50.0%						00:28:16
18	李双	1/2	2/2			0/1			3/5	60.0%	2	4				00:50:43
19	何山									0.0%						00:00:00
21	李明									0.0%	1					01:24:10
22	王金宇									0.0%						00:00:00
23	于敏清	1/1	1/1	0/2	2/2				4/6	66.7%		1	1			00:35:44
<b>合计</b>		4/13	12/22	0/3	7/7	2/4		2/4	27/53	50.9%	4	11	2			
<i>(守门员)</i>																
21	李明	6/11	4/16	0/1	1/3	0/2		1/3	12/36	33.3%	1					01:24:10
<b>合计</b>																
<b>合计</b>		6/11	4/16	0/1	1/3	0/2		1/3	12/36	33.3%	1					

场上队员：得分/射门

守门员：救球/射门

全队合计	得分	被救	射失	击柱	封球	合计	%
远射	4	6	2		1	13	30.8%
近射	12	9	1			22	54.5%
边射		2	1			3	0.0%
快攻	7					7	100.0%
突破	2	2				4	50.0%
任意							0.0%
7M	2	2				4	50.0%





### 2016年全国男子手球锦标赛

#### 图式射门区域统计

轮次 7 场次 35

201606035-41-1/1

## 解放军队

1 李梓宁	2 范保坤	4 曹作亮	5 张昌柯	6 吴昊	7 姜钦	8 王烁	9 毕晓晨																																																																														
<table border="1"><tr><td></td><td></td><td></td></tr><tr><td></td><td></td><td></td></tr><tr><td></td><td></td><td></td></tr></table>										<table border="1"><tr><td></td><td></td><td></td></tr><tr><td>1</td><td></td><td></td></tr><tr><td></td><td></td><td></td></tr></table>				1						<table border="1"><tr><td></td><td></td><td></td></tr><tr><td></td><td></td><td></td></tr><tr><td></td><td></td><td></td></tr></table>										<table border="1"><tr><td></td><td>1</td><td></td></tr><tr><td>2</td><td></td><td></td></tr><tr><td></td><td></td><td></td></tr></table>		1		2						<table border="1"><tr><td></td><td></td><td></td></tr><tr><td></td><td>1</td><td></td></tr><tr><td></td><td></td><td>2</td></tr></table>					1				2	<table border="1"><tr><td></td><td></td><td></td></tr><tr><td></td><td></td><td>1</td></tr><tr><td>2</td><td></td><td></td></tr></table>						1	2			<table border="1"><tr><td></td><td></td><td></td></tr><tr><td></td><td></td><td></td></tr><tr><td></td><td></td><td></td></tr></table>										<table border="1"><tr><td></td><td></td><td></td></tr><tr><td></td><td></td><td></td></tr><tr><td>2</td><td></td><td></td></tr><tr><td>1</td><td></td><td></td></tr><tr><td>1</td><td></td><td></td></tr></table>							2			1			1		
1																																																																																					
	1																																																																																				
2																																																																																					
	1																																																																																				
		2																																																																																			
		1																																																																																			
2																																																																																					
2																																																																																					
1																																																																																					
1																																																																																					
Post - 0 Miss - 0 Block - 0	Post - 0 Miss - 0 Block - 0	Post - 0 Miss - 0 Block - 0	Post - 1 Miss - 0 Block - 1	Post - 0 Miss - 2 Block - 0	Post - 0 Miss - 1 Block - 1	Post - 0 Miss - 0 Block - 0	Post - 0 Miss - 0 Block - 0																																																																														
11 肖东洋	12 姜明	14 孙耀琦	15 杨帆	16 丛霖	18 王晓龙	20 刘智洋																																																																															
<table border="1"><tr><td></td><td></td><td></td></tr><tr><td>3</td><td>1</td><td>1</td></tr><tr><td></td><td></td><td></td></tr></table>				3	1	1				<table border="1"><tr><td></td><td></td><td></td></tr><tr><td></td><td></td><td></td></tr><tr><td></td><td></td><td></td></tr></table>										<table border="1"><tr><td></td><td>1</td><td>1</td></tr><tr><td></td><td></td><td>1</td></tr><tr><td>1</td><td></td><td></td></tr></table>		1	1			1	1			<table border="1"><tr><td></td><td></td><td></td></tr><tr><td></td><td></td><td></td></tr><tr><td></td><td></td><td></td></tr></table>										<table border="1"><tr><td></td><td></td><td></td></tr><tr><td></td><td></td><td></td></tr><tr><td></td><td></td><td></td></tr></table>										<table border="1"><tr><td></td><td></td><td></td></tr><tr><td></td><td></td><td></td></tr><tr><td></td><td></td><td></td></tr></table>										<table border="1"><tr><td></td><td></td><td></td></tr><tr><td></td><td>1</td><td></td></tr><tr><td></td><td></td><td></td></tr></table>					1					<table border="1"><tr><td></td><td></td><td></td></tr><tr><td></td><td></td><td></td></tr><tr><td></td><td></td><td></td></tr></table>															
3	1	1																																																																																			
	1	1																																																																																			
		1																																																																																			
1																																																																																					
	1																																																																																				
Post - 0 Miss - 0 Block - 2	Post - 0 Miss - 0 Block - 0	Post - 1 Miss - 1 Block - 0	Post - 0 Miss - 0 Block - 0	Post - 0 Miss - 0 Block - 0	Post - 0 Miss - 0 Block - 0	Post - 0 Miss - 1 Block - 0																																																																															

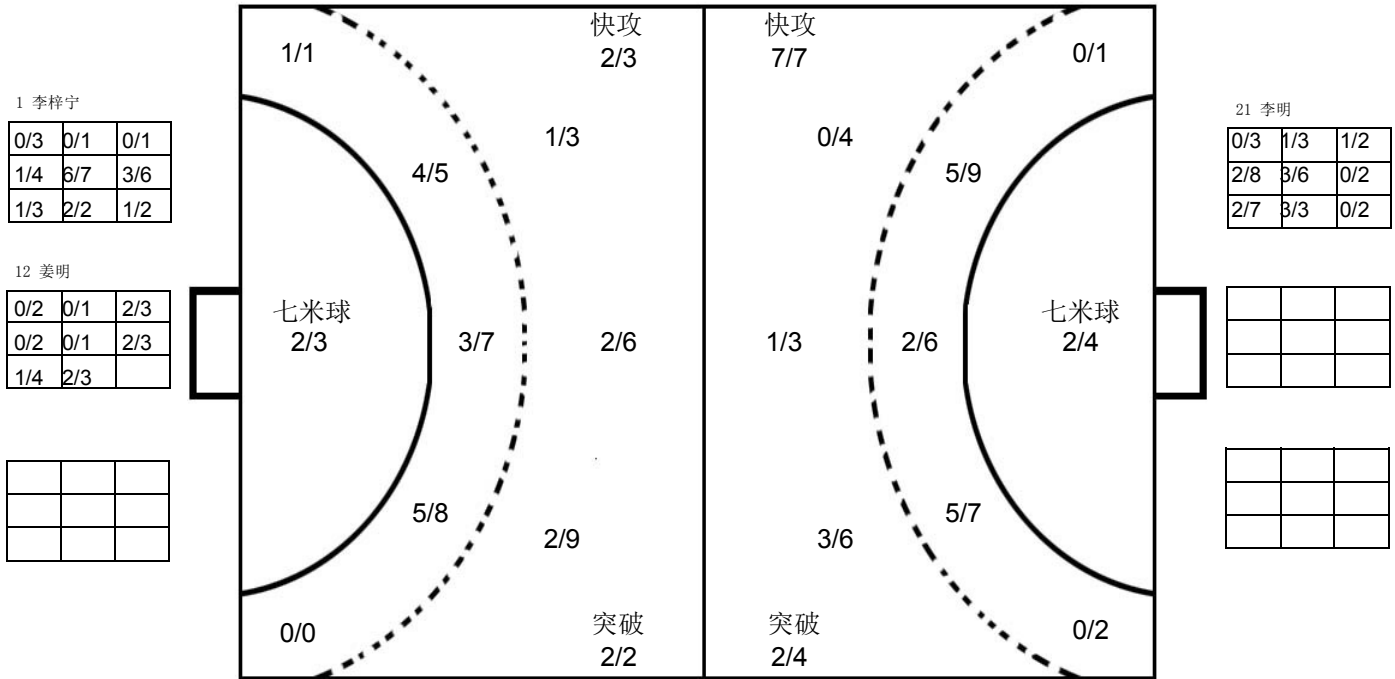

## 安徽队

1 郭世伟	2 金永峰	3 陈强龙	5 史小帆	7 姚雄敏	8 董智景	9 陈开勇	10 严龙																																																																								
<table border="1"><tr><td></td><td>1</td><td></td></tr><tr><td>1</td><td></td><td>1</td></tr><tr><td></td><td></td><td></td></tr></table>		1		1		1				<table border="1"><tr><td></td><td></td><td></td></tr><tr><td></td><td></td><td></td></tr><tr><td></td><td></td><td></td></tr></table>										<table border="1"><tr><td></td><td></td><td></td></tr><tr><td></td><td>1</td><td></td></tr><tr><td></td><td></td><td></td></tr></table>					1					<table border="1"><tr><td></td><td></td><td></td></tr><tr><td>1</td><td></td><td></td></tr><tr><td></td><td></td><td></td></tr></table>				1						<table border="1"><tr><td></td><td></td><td></td></tr><tr><td></td><td>1</td><td>1</td></tr><tr><td></td><td>1</td><td></td></tr></table>					1	1		1		<table border="1"><tr><td></td><td></td><td></td></tr><tr><td></td><td></td><td>1</td></tr><tr><td>1</td><td></td><td></td></tr></table>						1	1			<table border="1"><tr><td></td><td></td><td></td></tr><tr><td></td><td></td><td>1</td></tr><tr><td></td><td></td><td></td></tr></table>						1				<table border="1"><tr><td></td><td></td><td></td></tr><tr><td></td><td></td><td></td></tr><tr><td></td><td></td><td></td></tr></table>									
	1																																																																														
1		1																																																																													
	1																																																																														
1																																																																															
	1	1																																																																													
	1																																																																														
		1																																																																													
1																																																																															
		1																																																																													
Post - 0 Miss - 0 Block - 0	Post - 0 Miss - 0 Block - 0	Post - 0 Miss - 0 Block - 0	Post - 0 Miss - 0 Block - 0	Post - 0 Miss - 0 Block - 0	Post - 0 Miss - 3 Block - 0	Post - 0 Miss - 0 Block - 0	Post - 0 Miss - 0 Block - 0																																																																								
11 黎涛	12 曾献辰	17 王巨柱	18 李双	19 何山	21 李明	22 王金宇	23 于敏清																																																																								
<table border="1"><tr><td></td><td></td><td></td></tr><tr><td></td><td></td><td></td></tr><tr><td></td><td></td><td></td></tr></table>										<table border="1"><tr><td></td><td></td><td></td></tr><tr><td></td><td></td><td></td></tr><tr><td></td><td></td><td></td></tr></table>										<table border="1"><tr><td></td><td>2</td><td>1</td></tr><tr><td>2</td><td></td><td></td></tr><tr><td></td><td></td><td>1</td></tr></table>		2	1	2					1	<table border="1"><tr><td></td><td></td><td></td></tr><tr><td></td><td></td><td></td></tr><tr><td>3</td><td></td><td></td></tr></table>							3			<table border="1"><tr><td></td><td></td><td></td></tr><tr><td></td><td></td><td></td></tr><tr><td></td><td></td><td></td></tr></table>										<table border="1"><tr><td></td><td></td><td></td></tr><tr><td></td><td></td><td></td></tr><tr><td></td><td></td><td></td></tr></table>										<table border="1"><tr><td></td><td></td><td></td></tr><tr><td></td><td></td><td></td></tr><tr><td></td><td></td><td></td></tr></table>										<table border="1"><tr><td></td><td>2</td><td>1</td></tr><tr><td></td><td></td><td></td></tr><tr><td>1</td><td></td><td></td></tr></table>		2	1				1		
	2	1																																																																													
2																																																																															
		1																																																																													
3																																																																															
	2	1																																																																													
1																																																																															
Post - 0 Miss - 0 Block - 0	Post - 0 Miss - 0 Block - 0	Post - 0 Miss - 1 Block - 1	Post - 0 Miss - 0 Block - 0	Post - 0 Miss - 0 Block - 0	Post - 0 Miss - 0 Block - 0	Post - 0 Miss - 0 Block - 0	Post - 0 Miss - 0 Block - 0																																																																								

注释: Post=击柱 Miss=射失 Block=被封





5-6名

男子 全国比赛

2016年全国男子手球锦标赛

Team A A 上海队				Team B B 广东队				Match Number <b>36</b>													
played in China		in the hall 徐闻县体育中心体育		on 29/10/2016		at 13:00 hours		Spectators													
Half-time (30')	A 11	B 16	End of playing time	A 22	B 30	1st extra time	A	B	2nd extra time	A	B	After penalty throws	A	B							
Number of 7 m	A 1/2	Team time-out 1 13:45 2 33:55 3			Full name of players and officials				Team time-out 1 22:09 2 37:24 3			B 0/2	Number of 7 m								
No.	Team A					G	W	2'	D	DR	No.	Team B					G	W	2'	D	DR
1	张崢										1	王泽润									
2	张文斌										2	孙江山					3				
3	赵时俊					1					3	曲汝洋					8				
4	徐俊吉					3	1	1			4	李卓洋					1				
8	钱为玮					8					5	侯生升					4				
10	董凯										7	付云博					1				
11	蒋承骅					1					8	于彦江									
12	周哲韬										10	周仲坤									
14	沈吉磊					1					11	房友屯					1				
15	朱世杰					1	1	1			13	王立隆									
16	朱春雷										15	张建杰					1				
17	贺政					2		1			16	马跃									
18	马麟晓					5	1				17	李中洲					9	1			
33	吴璟										20	黄培杰									
											84	王伟					2		1		
A	吴龙基 (主教练)					1					B	王锋 (主教练)									
B	张勇军										C	刘康伶									
C	金迪琦										D	张广建									
E	杨时										E	王永存									
A	Signature of Responsible Official of the Teams (Off. A)																		B		
TP	Remarks of Referee / CHA Official																		TP		

Signatures

Referees	尹静阳 (CHN)	马晓晔 (CHN)		
Techn. Delegates	王洋 (CHN)			
CHA Official	倪震 (CHN)			

Note: Number of 7m Throws Awarded to Team A and B, Goals (G), Warnings (W), Suspensions (2'), Direct Disqualification (D), Disqualification with Report (DR) and Team Penalty (TP).

Table Officials: 鲍瑀

刘宇阳

Statisticians: 李双

张程秀子







## 2016年全国男子手球锦标赛 竞赛技术统计(媒体表)

5-6名	组别	<b>X</b>	轮次	<b>8</b>	场次	<b>36</b>
------	----	----------	----	----------	----	-----------

徐闻县体育中心体育馆

29/10/2016

201606036-51-1/1

上海队	<b>上海</b>	<b>22</b>	vs	<b>30</b>	<b>广东</b>	广东队
<b>11 : 16</b>						

裁判员	尹静阳 (CHN)	/	马晓晔 (CHN)
-----	-----------	---	-----------

上海		远射	近射	边射	快攻	突破	任意球	7m球	合计	%	助攻	失误	警告	2'	D & DR	比赛进程	
主教练： 吴龙基																	
1	张峥																0 01:16 1 2 孙江山
2	张文斌																0 04:59 2 3 曲汝洋
3	赵时俊		1/2					1/2	50.0		5						1 02:45 2 2 3 曲汝洋
4	徐俊吉		2/5					3/7	42.9				1	1			1 03:36 3 17 李中洲
8	钱为玮		2/3	3/4	3/3		0/1	8/11	72.7								2 04:57 3 3 3 曲汝洋
10	董凯																3 05:38 3 3 3 曲汝洋
11	蒋承骅		1/1					1/1	100	1							4 06:22 4 4 4 李卓洋
12	周哲韬																4 06:51 4 4 4 李卓洋
14	沈吉磊		1/1					1/1	100								5 12:02 5 17 李中洲
15	朱世杰	0/2	0/1			1/1		1/4	25.0	1	1	1	1	1			5 12:50 6 5 侯生升
16	朱春雷																5 13:34 7 17 李中洲
17	贺政		1/1	1/2		0/1		2/4	50.0	1							5 14:19 8 7 付云博
18	马麟晓	3/6	1/1			1/1	0/1	5/9	55.6	2	5	1					6 14:24 8 8 8 李卓洋
33	吴璟																5 12:02 5 17 李中洲
<b>运动员 合计</b>		3/8	9/15	4/6	3/3	2/3	0/2	1/2	22/39	56.4	5	11	3	3			5 12:50 6 5 侯生升
1	张峥	0/1	0/1					1/1	1/3	33.3							5 13:34 7 17 李中洲
12	周哲韬	1/4	6/18	0/5	0/5	0/3		7/35	20.0								5 14:19 8 7 付云博
<b>守门员 合计</b>		1/5	6/19	0/5	0/5	0/3		1/1	8/38	21.1							6 14:24 8 8 8 李卓洋
广东		远射	近射	边射	快攻	突破	任意球	7m球	合计	%	助攻	失误	警告	2'	D & DR	比赛进程	
教练： 王锋																	
1	王泽润																11 00:52 17 17 李中洲
2	孙江山		0/1	3/3				0/1	3/5	60.0							11 00:52 17 17 李中洲
3	曲汝洋	1/1	4/4		1/1	2/2			8/8	100	3	1					12 01:37 17 17 李中洲
4	李卓洋	0/2	1/3						1/5	20.0	1	1					12 02:25 18 3 曲汝洋
5	侯生升		0/1	2/2	2/2			4/5	80.0		1						12 03:04 19 5 侯生升
7	付云博				1/1			0/1	1/2	50.0							12 03:53 20 5 侯生升
8	于彦江																13 04:25 20 5 侯生升
10	周仲坤																13 05:51 21 84 王伟
11	房友屯		1/1					1/1	100			1					13 05:51 21 84 王伟
13	王立隆																14 06:27 21 84 王伟
15	张建杰	0/1				1/1		1/2	50.0								15 07:18 21 84 王伟
16	马跃										1						15 07:47 22 17 李中洲
17	李中洲	3/5	5/7		1/1			9/13	69.2		2	3	1				15 10:46 23 3 曲汝洋
20	黄培杰												1				15 10:46 23 3 曲汝洋
84	王伟	0/1	2/2					2/3	66.7			1		1			15 13:51 24 3 曲汝洋
<b>运动员 合计</b>		4/10	13/19	5/5	5/5	3/3	0/2	30/44	68.2	8	8	1	1				15 14:55 25 2 孙江山
16	马跃	0/3	5/14	1/5	0/3	1/3	2/2	10/32	31.3	1							15 16:55 26 3 曲汝洋
<b>守门员 合计</b>		0/3	5/14	1/5	0/3	1/3	2/2	10/32	31.3	1							15 18:23 27 17 李中洲

场上队员： 得分 / 射门

守门员： 救球 / 射门

快攻	Fast Break	突破	Breakthrough	任意球	Free Throw	7M球	7M Throw	助攻	Assist
警告	Warning	失误	Error	2'	Suspension	D	取消资格	DR	取消资格+报告





### 2016年全国男子手球锦标赛 图式比赛技术统计表

轮次 8

场次 36

201606036-21-1/1

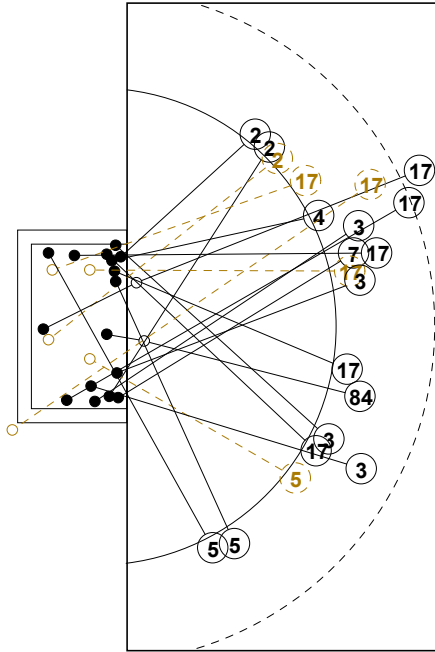

7M 广东

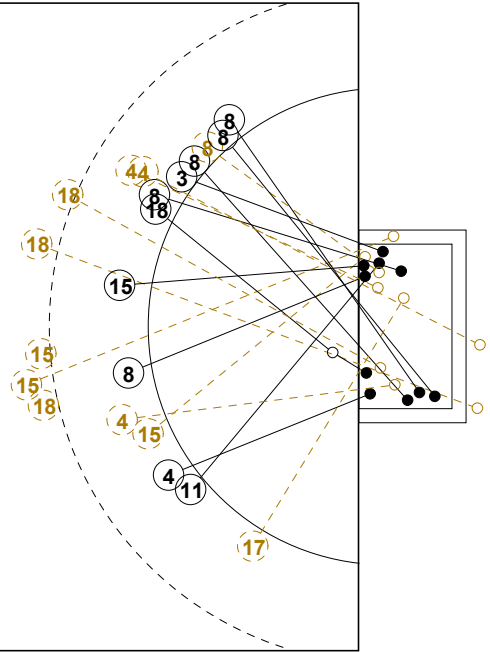
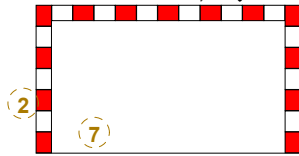

上海 7M

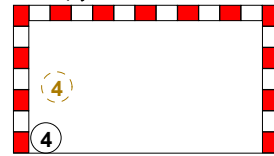

1st Half  
16 : 11

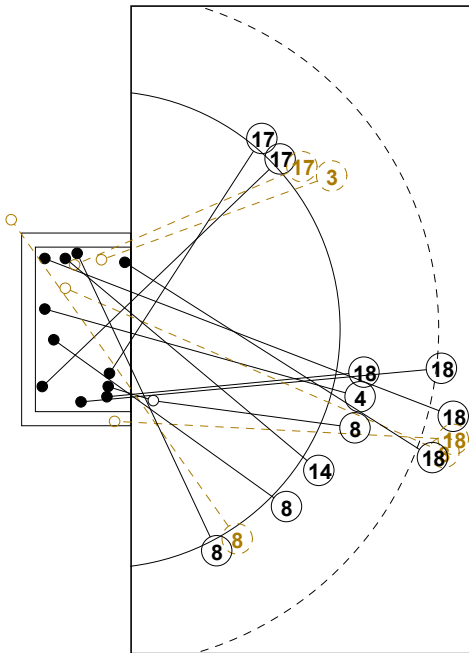

7M 上海

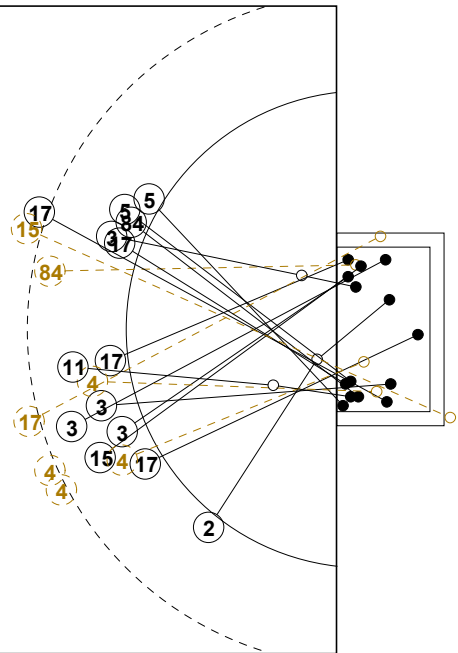
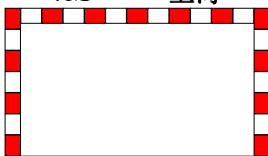

广东 7M

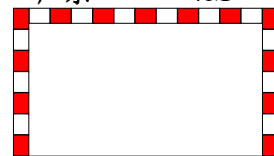

2nd Half  
22 : 30



## 2016年全国男子手球锦标赛

## 个人/全队技术统计表

正式表  
手球  
男子5-6名  
轮次 8组别 X  
场次 36201606036-14-1/2  
徐闻县体育中心体育馆  
29/10/2016 13:00

号码	姓名	远射	近射	边射	快攻	突破	任意	7M	合计	%	助攻	失误	警告	2'	取消	时间
<b>上海队(上海)</b>																
<i>(场上队员)</i>																
1	张崢									0.0%						00:03:27
2	张文斌									0.0%						00:00:00
3	赵时俊		1/2						1/2	50.0%		5				00:11:01
4	徐俊吉		2/5					1/2	3/7	42.9%			1	1		00:40:04
8	钱为玮		2/3	3/4	3/3		0/1		8/11	72.7%						01:00:00
10	董凯									0.0%						00:00:00
11	蒋承骅		1/1						1/1	100%	1					00:46:52
12	周哲韬									0.0%						00:56:33
14	沈吉磊		1/1						1/1	100%						00:03:34
15	朱世杰	0/2	0/1			1/1			1/4	25.0%	1	1	1	1		00:45:24
16	朱春雷									0.0%						00:00:00
17	贺政		1/1	1/2		0/1			2/4	50.0%	1			1		00:58:31
18	马麟晓	3/6	1/1			1/1	0/1		5/9	55.6%	2	5	1			01:00:00
33	吴璟									0.0%						00:20:49

<b>合计</b>		3/8	9/15	4/6	3/3	2/3	0/2	1/2	22/39	56.4%	5	11	3	3		
<i>(守门员)</i>																
1	张崢	0/1	0/1					1/1	1/3	33.3%						00:03:27
12	周哲韬	1/4	6/18	0/5	0/5	0/3			7/35	20.0%						00:56:33

<b>合计</b>		1/5	6/19	0/5	0/5	0/3		1/1	8/38	21.1%					
-----------	--	-----	------	-----	-----	-----	--	-----	------	-------	--	--	--	--	--

场上队员：得分/射门

守门员：救球/射门

全队合计	得分	被救	射失	击柱	封球	合计	%
远射	3		1	2	2	8	37.5%
近射	9	5	1			15	60.0%
边射	4	1	1			6	66.7%
快攻	3					3	100.0%
突破	2	1				3	66.7%
任意		2				2	0.0%
7M	1	1				2	50.0%





## 2016年全国男子手球锦标赛

## 个人/全队技术统计表

正式表  
手球  
男子5-6名  
轮次 8组别 X  
场次 36201606036-14-2/2  
徐闻县体育中心体育馆  
29/10/2016 13:00

号码	姓名	远射	近射	边射	快攻	突破	任意	7M	合计	%	助攻	失误	警告	2'	取消	时间
<b>广东队(广东)</b>																
<i>(上场队员)</i>																
1	王泽润									0.0%						00:00:00
2	孙江山		0/1	3/3				0/1	3/5	60.0%						00:51:20
3	曲汝洋	1/1	4/4		1/1	2/2			8/8	100%	3	1				00:35:25
4	李卓洋	0/2	1/3						1/5	20.0%	1	1				00:42:11
5	侯生升		0/1	2/2	2/2				4/5	80.0%	1					00:50:30
7	付云博				1/1			0/1	1/2	50.0%						00:33:21
8	于彦江									0.0%						00:00:00
10	周仲坤									0.0%						00:11:02
11	房友屯		1/1						1/1	100%		1				00:08:40
13	王立隆									0.0%						00:02:14
15	张建杰	0/1				1/1			1/2	50.0%						00:12:02
16	马跃									0.0%	1					01:00:00
17	李中洲	3/5	5/7		1/1				9/13	69.2%	2	3	1			00:53:12
20	黄培杰									0.0%		1				00:09:29
84	王伟	0/1	2/2						2/3	66.7%		1		1		00:49:57
<b>合计</b>		4/10	13/19	5/5	5/5	3/3		0/2	30/44	68.2%	8	8	1	1		
<i>(守门员)</i>																
16	马跃	0/3	5/14	1/5	0/3	1/3	2/2	1/2	10/32	31.3%	1					01:00:00
<b>合计</b>		0/3	5/14	1/5	0/3	1/3	2/2	1/2	10/32	31.3%	1					

场上队员：得分/射门

守门员：救球/射门

全队合计	得分	被救	射失	击柱	封球	合计	%
远射	4	1	2	1	2	10	40.0%
近射	13	6				19	68.4%
边射	5					5	100.0%
快攻	5					5	100.0%
突破	3					3	100.0%
任意							0.0%
7M		1	1			2	0.0%





### 2016年全国男子手球锦标赛

#### 图式射门区域统计

轮次 8 场次 36

201606036-41-1/1

## 上海队

1 张峥	2 张文斌	3 赵时俊	4 徐俊吉	8 钱为玮	10 董凯	11 蒋承骅	12 周哲韬																																																																								
<table border="1"><tr><td></td><td></td><td></td></tr><tr><td></td><td></td><td></td></tr><tr><td></td><td></td><td></td></tr></table>										<table border="1"><tr><td></td><td></td><td></td></tr><tr><td></td><td></td><td></td></tr><tr><td></td><td></td><td></td></tr></table>										<table border="1"><tr><td></td><td></td><td></td></tr><tr><td></td><td></td><td></td></tr><tr><td>1</td><td></td><td></td></tr></table>							1			<table border="1"><tr><td></td><td>1</td><td></td></tr><tr><td></td><td></td><td></td></tr><tr><td>1</td><td></td><td>1</td></tr></table>		1					1		1	<table border="1"><tr><td></td><td>1</td><td>1</td></tr><tr><td>1</td><td></td><td>3</td></tr><tr><td>2</td><td></td><td></td></tr></table>		1	1	1		3	2			<table border="1"><tr><td></td><td></td><td></td></tr><tr><td></td><td></td><td></td></tr><tr><td></td><td></td><td></td></tr></table>										<table border="1"><tr><td></td><td></td><td></td></tr><tr><td></td><td></td><td></td></tr><tr><td>1</td><td></td><td></td></tr></table>							1			<table border="1"><tr><td></td><td></td><td></td></tr><tr><td></td><td></td><td></td></tr><tr><td></td><td></td><td></td></tr></table>									
1																																																																															
	1																																																																														
1		1																																																																													
	1	1																																																																													
1		3																																																																													
2																																																																															
1																																																																															
Post - 0 Miss - 0 Block - 0	Post - 0 Miss - 0 Block - 0	Post - 0 Miss - 0 Block - 0	Post - 0 Miss - 1 Block - 0	Post - 0 Miss - 1 Block - 0	Post - 0 Miss - 0 Block - 0	Post - 0 Miss - 0 Block - 0	Post - 0 Miss - 0 Block - 0																																																																								
14 沈吉磊	15 朱世杰	16 朱春雷	17 贺政	18 马麟晓	33 吴璟																																																																										
<table border="1"><tr><td></td><td></td><td>1</td></tr><tr><td></td><td></td><td></td></tr><tr><td></td><td></td><td></td></tr></table>			1							<table border="1"><tr><td></td><td></td><td></td></tr><tr><td></td><td></td><td></td></tr><tr><td>1</td><td></td><td></td></tr></table>							1			<table border="1"><tr><td></td><td></td><td></td></tr><tr><td></td><td></td><td></td></tr><tr><td></td><td></td><td></td></tr></table>										<table border="1"><tr><td>1</td><td></td><td></td></tr><tr><td></td><td></td><td></td></tr><tr><td>1</td><td></td><td></td></tr></table>	1						1			<table border="1"><tr><td></td><td></td><td>1</td></tr><tr><td>1</td><td></td><td></td></tr><tr><td>1</td><td></td><td>2</td></tr></table>			1	1			1		2	<table border="1"><tr><td></td><td></td><td></td></tr><tr><td></td><td></td><td></td></tr><tr><td></td><td></td><td></td></tr></table>										<table border="1"><tr><td></td><td></td><td></td></tr><tr><td></td><td></td><td></td></tr><tr><td></td><td></td><td></td></tr></table>										<table border="1"><tr><td></td><td></td><td></td></tr><tr><td></td><td></td><td></td></tr><tr><td></td><td></td><td></td></tr></table>									
		1																																																																													
1																																																																															
1																																																																															
1																																																																															
		1																																																																													
1																																																																															
1		2																																																																													
Post - 0 Miss - 0 Block - 0	Post - 1 Miss - 0 Block - 1	Post - 0 Miss - 0 Block - 0	Post - 0 Miss - 0 Block - 0	Post - 1 Miss - 1 Block - 1	Post - 0 Miss - 0 Block - 0																																																																										

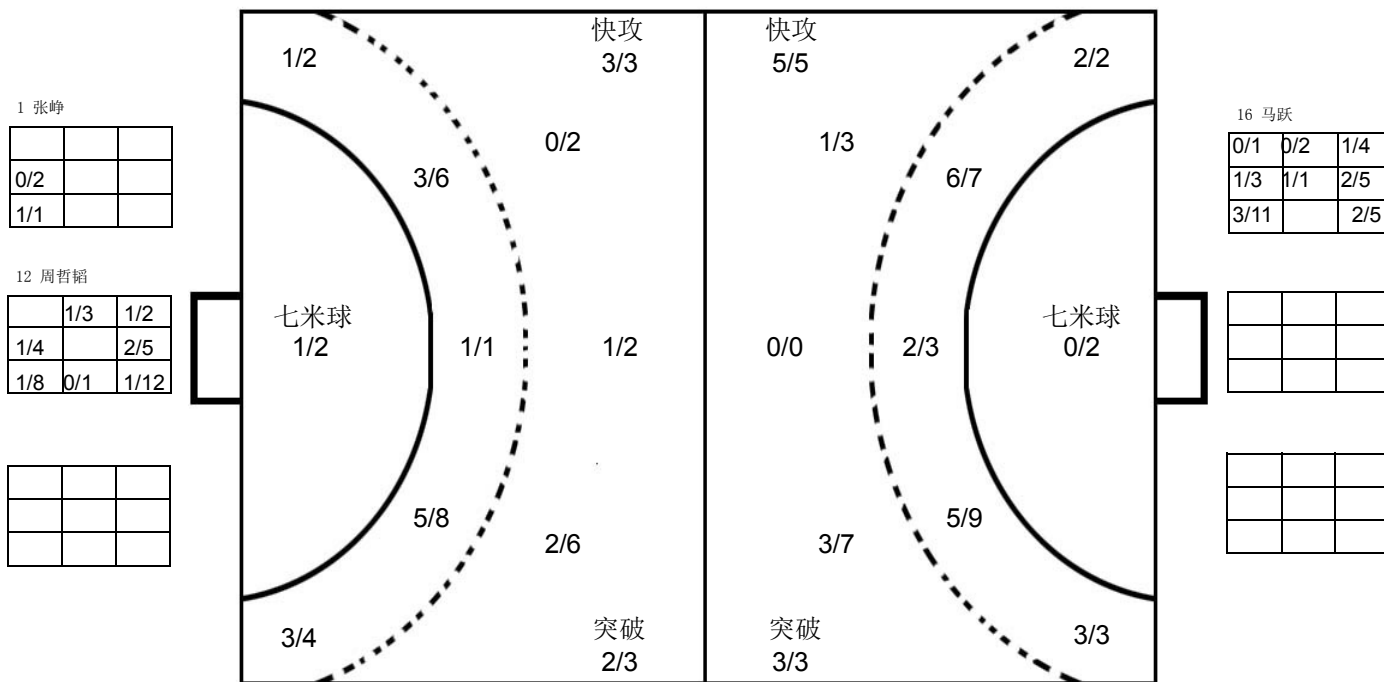

## 广东队

1 王泽润	2 孙江山	3 曲汝洋	4 李卓洋	5 侯生升	7 付云博	8 于彦江	10 周仲坤																																																																								
<table border="1"><tr><td></td><td></td><td></td></tr><tr><td></td><td></td><td></td></tr><tr><td></td><td></td><td></td></tr></table>										<table border="1"><tr><td></td><td></td><td></td></tr><tr><td>1</td><td></td><td></td></tr><tr><td>1</td><td></td><td>1</td></tr></table>				1			1		1	<table border="1"><tr><td></td><td></td><td></td></tr><tr><td>3</td><td></td><td>1</td></tr><tr><td>3</td><td></td><td>1</td></tr></table>				3		1	3		1	<table border="1"><tr><td></td><td></td><td></td></tr><tr><td></td><td></td><td></td></tr><tr><td></td><td></td><td>1</td></tr></table>									1	<table border="1"><tr><td></td><td></td><td>1</td></tr><tr><td></td><td></td><td></td></tr><tr><td></td><td></td><td>3</td></tr></table>			1						3	<table border="1"><tr><td></td><td></td><td></td></tr><tr><td></td><td></td><td></td></tr><tr><td>1</td><td></td><td></td></tr></table>							1			<table border="1"><tr><td></td><td></td><td></td></tr><tr><td></td><td></td><td></td></tr><tr><td></td><td></td><td></td></tr></table>										<table border="1"><tr><td></td><td></td><td></td></tr><tr><td></td><td></td><td></td></tr><tr><td></td><td></td><td></td></tr></table>									
1																																																																															
1		1																																																																													
3		1																																																																													
3		1																																																																													
		1																																																																													
		1																																																																													
		3																																																																													
1																																																																															
Post - 0 Miss - 0 Block - 0	Post - 0 Miss - 1 Block - 0	Post - 0 Miss - 0 Block - 0	Post - 0 Miss - 0 Block - 2	Post - 0 Miss - 0 Block - 0	Post - 0 Miss - 0 Block - 0	Post - 0 Miss - 0 Block - 0	Post - 0 Miss - 0 Block - 0																																																																								
11 房友屯	13 王立隆	15 张建杰	16 马跃	17 李中洲	20 黄培杰	84 王伟																																																																									
<table border="1"><tr><td></td><td></td><td></td></tr><tr><td></td><td></td><td></td></tr><tr><td></td><td></td><td>1</td></tr></table>									1	<table border="1"><tr><td></td><td></td><td></td></tr><tr><td></td><td></td><td></td></tr><tr><td></td><td></td><td></td></tr></table>										<table border="1"><tr><td></td><td></td><td></td></tr><tr><td></td><td></td><td></td></tr><tr><td>1</td><td></td><td></td></tr></table>							1			<table border="1"><tr><td></td><td></td><td></td></tr><tr><td></td><td></td><td></td></tr><tr><td></td><td></td><td></td></tr></table>										<table border="1"><tr><td></td><td>2</td><td></td></tr><tr><td>1</td><td></td><td>2</td></tr><tr><td>1</td><td></td><td>3</td></tr></table>		2		1		2	1		3	<table border="1"><tr><td></td><td></td><td></td></tr><tr><td></td><td></td><td></td></tr><tr><td></td><td></td><td></td></tr></table>										<table border="1"><tr><td></td><td></td><td></td></tr><tr><td></td><td></td><td></td></tr><tr><td></td><td>1</td><td>1</td></tr></table>								1	1	<table border="1"><tr><td></td><td></td><td></td></tr><tr><td></td><td></td><td></td></tr><tr><td></td><td></td><td></td></tr></table>									
		1																																																																													
1																																																																															
	2																																																																														
1		2																																																																													
1		3																																																																													
	1	1																																																																													
Post - 0 Miss - 0 Block - 0	Post - 0 Miss - 0 Block - 0	Post - 0 Miss - 1 Block - 0	Post - 0 Miss - 0 Block - 0	Post - 1 Miss - 1 Block - 0	Post - 0 Miss - 0 Block - 0	Post - 0 Miss - 0 Block - 0																																																																									

注释: Post=击柱 Miss=射失 Block=被封



3-4名

男子 全国比赛

2016年全国男子手球锦标赛

Team A A 天津队				Team B B 北京队				Match Number <b>37</b>													
played in China		in the hall 徐闻县体育中心体育		on 29/10/2016		at 14:40 hours		Spectators													
Half-time (30')	A 11	B 11	End of playing time	A 24	B 22	1st extra time	A	B	2nd extra time	A	B	After penalty throws	A	B							
Number of 7 m	A 2/2	Team time-out 1 19:16 2 42:02 3 59:29			Full name of players and officials				Team time-out 1 07:47 2 54:30 3			B 2/4	Number of 7 m								
No.	Team A					G	W	2'	D	DR	No.	Team B					G	W	2'	D	DR
1	刘宗其										3	王超					2				
2	李岳朋							1			6	解建飞					2	1	1		
4	李松浩										8	王鹏									
6	王子欣					5					9	刘振									
7	张青					6	1				10	成亚					5				
8	曹悦					10					11	蒋维一					1				
9	吴明远										12	孟辉									
11	王毅										16	刘迈科									
12	杨峻										21	胡瀛					4				
13	许松					1					23	王军程					1		1		
14	田剑侠					1	1	1			25	马明辉						1			
16	刘海亮										29	杜龙飞					4				
17	周群					1	1				33	冯宁									
18	王晓琪										77	朱昕晨									
22	魏雨童										78	张骥					3				
											83	潘天									
A	贾守信										A	安福田									
B	杜瑞军 (主教练)										B	郑永利 (主教练)									
D	潘玉强										C	陈璇									
E	贾宁																				
A	Signature of Responsible Official of the Teams (Off. A)																			B	
TP	Remarks of Referee / CHA Official																			TP	

Signatures

Referees	刘禹 (CHN)	许翔 (CHN)		
Techn. Delegates	刘凤娟 (CHN)			
CHA Official	许宜扬 (CHN)			

Note: Number of 7m Throws Awarded to Team A and B, Goals (G), Warnings (W), Suspensions (2'), Direct Disqualification (D), Disqualification with Report (DR) and Team Penalty (TP).

Table Officials: 梁小熹 伍豪

Statisticians: 张程秀子

李双



### 2016年全国男子手球锦标赛 竞赛技术统计(媒体表)

3-4名	组别	X	轮次	8	场次	37
------	----	---	----	---	----	----

徐闻县体育中心体育馆

29/10/2016

201606037-51-1/1

天津队	天津	24	vs	22	北京	北京队
<b>11 : 11</b>						

裁判员	刘禹 (CHN)	/	许翔 (CHN)
-----	----------	---	----------

天津		远	近	边	快	突	任意	7m	合计	%	助攻	失误	警告	2'	D & DR	天津		比赛进程	北京	
主教练: 杜瑞军		射	射	射	攻	破	球	球												
1	刘宗其										1							1st Half	1 23 王军程	
2	李岳朋	0/1	0/2			0/1		0/4	0.0		1			1			00:29	1 02:49	1	
4	李松浩																	03:28	2 04:14	1
6	王子欣		2/3	1/2	2/2			5/7	71.4									04:30	3 09:50	1
7	张青	1/3	2/4		1/1	2/3		6/11	54.5		2		1					11:38	2 13:17	6 解建飞
8	曹悦	5/10	1/3		1/1	1/1		2/2	10/17	58.8	1	1						13:56	3 15:28	3
9	吴明远																	16:02	4 18:10	4 3 王超
11	王毅																	18:34	5 19:09	5 21 胡瀛
12	杨峻																	22:25	7 23:45	7 21 胡瀛
13	许松	0/1	1/1					1/2	50.0		2							27:01	8 29:32	8 29 杜龙飞
14	田剑侠	0/1	1/2					1/3	33.3				1	1				27:29	9 28:04	9 78 张骥
16	刘海亮																	28:04	10 28:56	10 11 蒋维一
17	周群		1/2					1/2	50.0		1	1						29:32	11 30:00	11 78 张骥
18	王晓琪																			
22	魏雨童																			
<b>运动员 合计</b>		<b>6/16</b>	<b>8/17</b>	<b>1/2</b>	<b>4/4</b>	<b>3/5</b>	<b></b>	<b>2/2</b>	<b>24/46</b>	<b>52.2</b>	<b>2</b>	<b>7</b>	<b>3</b>	<b>2</b>	<b></b>	<b></b>				
1	刘宗其	3/7	0/6	0/2	1/2	1/3	0/1	5/21	23.8		1							01:02	11 02:13	11
12	杨峻	1/3	2/3	0/1				3/7	42.9									02:49	12 03:48	12 21 胡瀛
16	刘海亮							1/3	33.3									05:05	12 05:38	13 10 成亚
<b>守门员 合计</b>		<b>4/10</b>	<b>2/9</b>	<b>0/3</b>	<b>1/2</b>	<b>1/3</b>	<b>0/1</b>	<b>1/3</b>	<b>9/31</b>	<b>29.0</b>	<b>1</b>	<b></b>	<b></b>	<b></b>	<b></b>	<b></b>		07:20	14 08:07	14 10 成亚
<b>北京</b>		<b>远</b>	<b>近</b>	<b>边</b>	<b>快</b>	<b>突</b>	<b>任意</b>	<b>7m</b>	<b>合计</b>	<b>%</b>	<b>助攻</b>	<b>失误</b>	<b>警告</b>	<b>2'</b>	<b>D &amp; DR</b>					
<b>教练: 郑永利</b>		<b>射</b>	<b>射</b>	<b>射</b>	<b>攻</b>	<b>破</b>	<b>球</b>	<b>球</b>	<b></b>	<b></b>	<b></b>	<b></b>	<b></b>	<b></b>	<b></b>					
3	王超		1/2		1/2			2/4	50.0											
6	解建飞		1/1					1/2	2/3	66.7			1	1						
8	王鹏																			
9	刘振																			
10	成亚	1/2	2/3			2/3		0/1	5/9	55.6	1	1								
11	蒋维一		1/2					1/2	50.0											
12	孟辉										1	1								
16	刘迈科										1									
21	胡瀛	2/4	1/2	1/1				4/7	57.1			2								
23	王军程	1/3					0/1	1/4	25.0			2		1						
25	马明辉		0/1	0/1				0/2	0.0					1						
29	杜龙飞		1/1	2/2			1/1	4/4	100											
33	冯宁																			
77	朱昕晨																			
78	张骥	2/2	0/1					1/1	3/4	75.0	1	3								
83	潘天																			
<b>运动员 合计</b>		<b>6/11</b>	<b>7/13</b>	<b>3/4</b>	<b>1/2</b>	<b>2/3</b>	<b>1/2</b>	<b>2/4</b>	<b>22/39</b>	<b>56.4</b>	<b>4</b>	<b>10</b>	<b>2</b>	<b>2</b>	<b></b>	<b></b>				
12	孟辉	2/2	1/3		0/2			3/7	42.9		1	1								
16	刘迈科	3/9	2/8	1/2	0/2	1/4		0/2	7/27	25.9	1									
<b>守门员 合计</b>		<b>5/11</b>	<b>3/11</b>	<b>1/2</b>	<b>0/4</b>	<b>1/4</b>	<b></b>	<b>0/2</b>	<b>10/34</b>	<b>29.4</b>	<b>2</b>	<b>1</b>	<b></b>	<b></b>	<b></b>	<b></b>				

场上队员: 得分 / 射门

守门员: 救球 / 射门

快攻	Fast Break		突破	Breakthrough		任意球	Free Throw		7m球	7M Throw		助攻	Assist
警告	Warning		失误	Error		2'	Suspension		D	取消资格		DR	取消资格+报告





### 2016年全国男子手球锦标赛 图式比赛技术统计表

轮次 8

场次 37

201606037-21-1/1

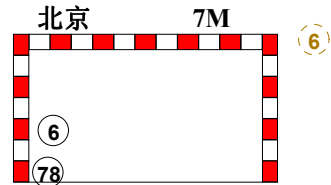
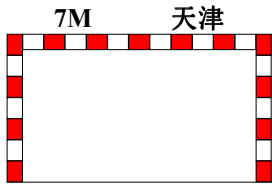
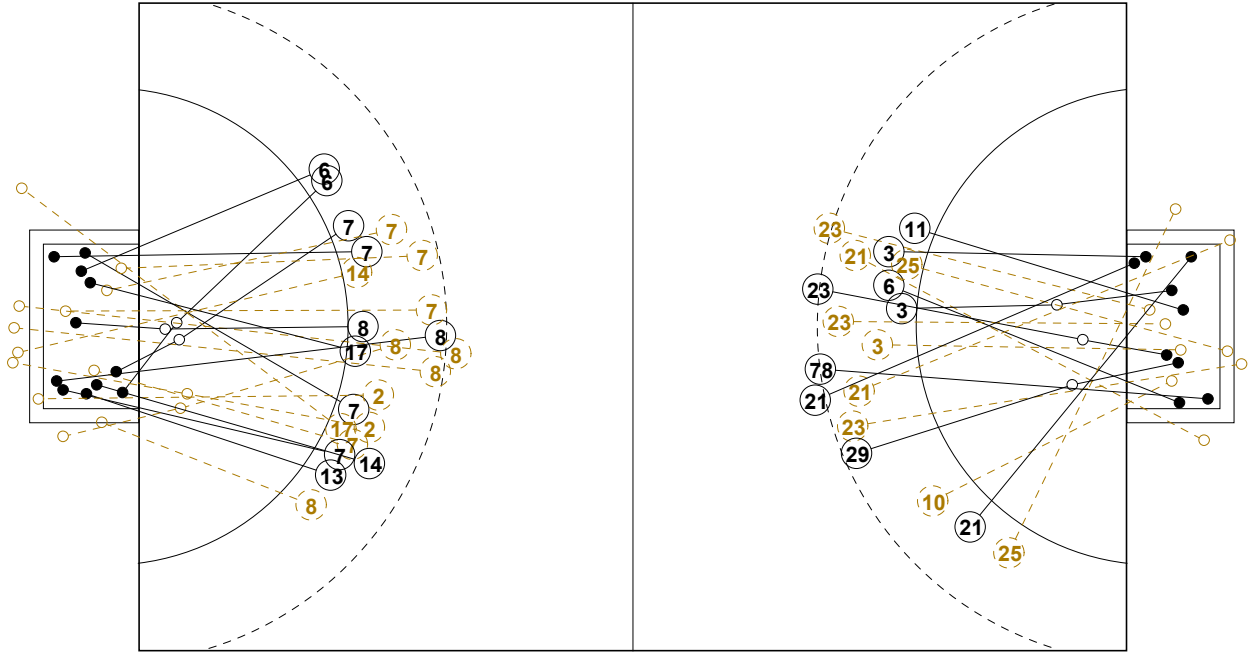

1st Half  
11 : 11

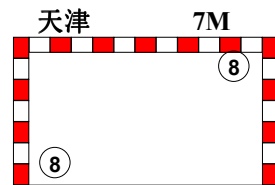
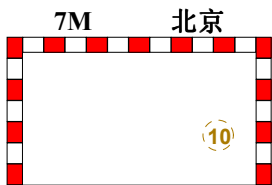
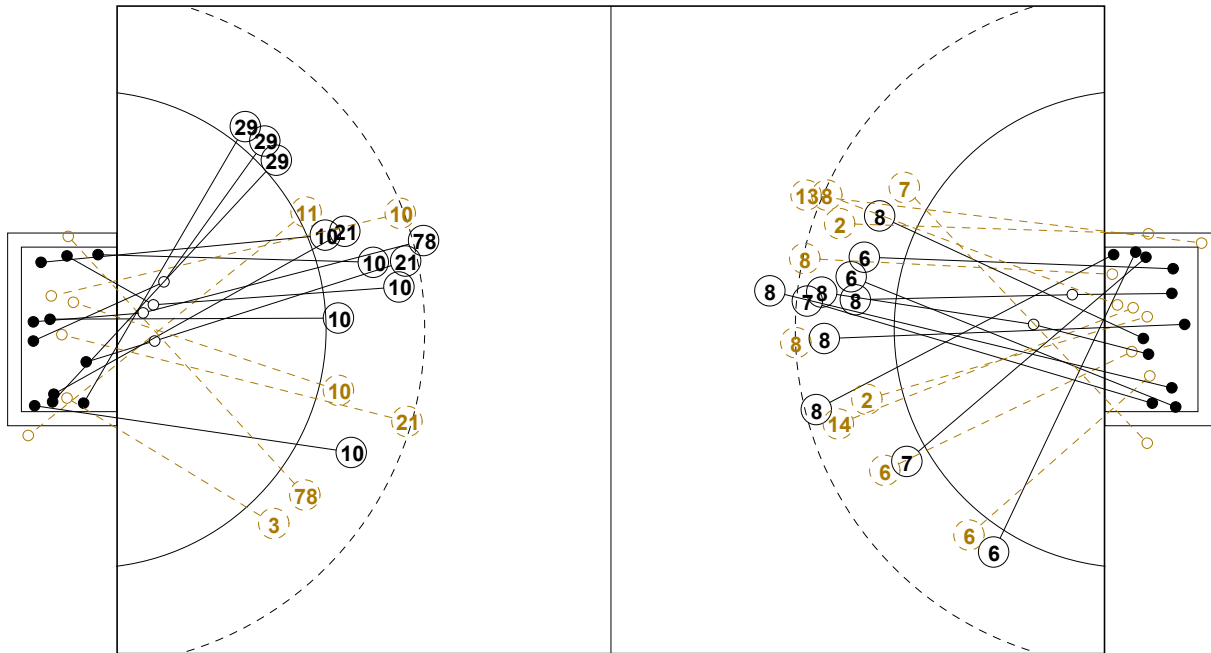

2nd Half  
22 : 24





## 2016年全国男子手球锦标赛

## 个人/全队技术统计表

正式表  
手球  
男子3-4名  
轮次 8组别 X  
场次 37201606037-14-1/2  
徐闻县体育中心体育馆  
29/10/2016 14:40

号码	姓名	远射	近射	边射	快攻	突破	任意	7M	合计	%	助攻	失误	警告	2'	取消	时间
<b>天津队(天津)</b>																
<i>(场上队员)</i>																
1	刘宗其									0.0%	1					00:44:24
2	李岳朋	0/1	0/2			0/1			0/4	0.0%		1		1		00:46:08
4	李松浩									0.0%						00:00:00
6	王子欣		2/3	1/2	2/2				5/7	71.4%						01:00:00
7	张青	1/3	2/4		1/1	2/3			6/11	54.5%		2		1		00:57:59
8	曹悦	5/10	1/3		1/1	1/1		2/2	10/17	58.8%	1	1				01:01:58
9	吴明远									0.0%						00:00:00
11	王毅									0.0%						00:08:38
12	杨峻									0.0%						00:14:45
13	许松	0/1	1/1						1/2	50.0%		2				00:51:21
14	田剑侠	0/1	1/2						1/3	33.3%				1	1	00:19:32
16	刘海亮									0.0%						00:00:51
17	周群		1/2						1/2	50.0%		1		1		01:00:00
18	王晓琪									0.0%						00:00:00
22	魏雨童									0.0%						00:00:00
<b>合计</b>		6/16	8/17	1/2	4/4	3/5		2/2	24/46	52.2%	2	7	3	2		
<i>(守门员)</i>																
1	刘宗其	3/7	0/6	0/2	1/2	1/3	0/1		5/21	23.8%	1					00:44:24
12	杨峻	1/3	2/3	0/1					3/7	42.9%						00:14:45
16	刘海亮							1/3	1/3	33.3%						00:00:51
<b>合计</b>		4/10	2/9	0/3	1/2	1/3	0/1	1/3	9/31	29.0%	1					

场上队员：得分/射门

守门员：救球/射门

全队合计	得分	被救	射失	击柱	封球	合计	%
远射	6	5	2	2	1	16	37.5%
近射	8	3	4	2		17	47.1%
边射	1	1				2	50.0%
快攻	4					4	100.0%
突破	3	1	1			5	60.0%
任意							0.0%
7M	2					2	100.0%





## 2016年全国男子手球锦标赛

## 个人/全队技术统计表

正式表  
手球  
男子3-4名  
轮次 8组别 X  
场次 37201606037-14-2/2  
徐闻县体育中心体育馆  
29/10/2016 14:40

号码	姓名	远射	近射	边射	快攻	突破	任意	7M	合计	%	助攻	失误	警告	2'	取消	时间
<b>北京队(北京)</b>																
<i>(上场队员)</i>																
3	王超		1/2		1/2				2/4	50.0%						00:58:13
6	解建飞		1/1					1/2	2/3	66.7%			1	1		00:41:24
8	王鹏									0.0%						00:26:53
9	刘振									0.0%						00:05:05
10	成亚	1/2	2/3			2/3		0/1	5/9	55.6%	1	1				00:26:41
11	蒋维一		1/2						1/2	50.0%		1				00:26:28
12	孟辉									0.0%	1	1				00:13:15
16	刘迈科									0.0%	1					00:46:45
21	胡瀛	2/4	1/2	1/1					4/7	57.1%		2				00:51:07
23	王军程	1/3					0/1		1/4	25.0%		2		1		00:35:22
25	马明辉		0/1	0/1					0/2	0.0%			1			00:27:43
29	杜龙飞		1/1	2/2			1/1		4/4	100%						00:33:58
33	冯宁									0.0%						00:00:00
77	朱昕晨									0.0%						00:00:00
78	张骥	2/2	0/1					1/1	3/4	75.0%	1	3				00:24:14
83	潘天									0.0%						00:00:00
<b>合计</b>		6/11	7/13	3/4	1/2	2/3	1/2	2/4	22/39	56.4%	4	10	2	2		
<i>(守门员)</i>																
12	孟辉	2/2	1/3		0/2				3/7	42.9%	1	1				00:13:15
16	刘迈科	3/9	2/8	1/2	0/2	1/4		0/2	7/27	25.9%	1					00:46:45
<b>合计</b>		5/11	3/11	1/2	0/4	1/4		0/2	10/34	29.4%	2	1				

场上队员：得分/射门

守门员：救球/射门

全队合计	得分	被救	射失	击柱	封球	合计	%
远射	6	4	1			11	54.5%
近射	7	2	1	3		13	53.8%
边射	3		1			4	75.0%
快攻	1	1				2	50.0%
突破	2	1				3	66.7%
任意	1		1			2	50.0%
7M	2	1	1			4	50.0%





2016年全国男子手球锦标赛

图式射门区域统计

轮次 8 场次 37

201606037-41-1/1

天津队

1 刘宗其	2 李岳朋	4 李松浩	6 王子欣	7 张青	8 曹悦	9 吴明远	11 王毅																																																																								
<table border="1"><tr><td></td><td></td><td></td></tr><tr><td></td><td></td><td></td></tr><tr><td></td><td></td><td></td></tr></table>										<table border="1"><tr><td></td><td></td><td></td></tr><tr><td></td><td></td><td></td></tr><tr><td></td><td></td><td></td></tr></table>										<table border="1"><tr><td></td><td></td><td></td></tr><tr><td></td><td></td><td></td></tr><tr><td></td><td></td><td></td></tr></table>										<table border="1"><tr><td>1</td><td></td><td>1</td></tr><tr><td>1</td><td></td><td>1</td></tr><tr><td>1</td><td></td><td></td></tr></table>	1		1	1		1	1			<table border="1"><tr><td>1</td><td></td><td>1</td></tr><tr><td>1</td><td></td><td>2</td></tr><tr><td>1</td><td></td><td></td></tr></table>	1		1	1		2	1			<table border="1"><tr><td>2</td><td>2</td><td>2</td></tr><tr><td></td><td>2</td><td></td></tr><tr><td>2</td><td></td><td></td></tr></table>	2	2	2		2		2			<table border="1"><tr><td></td><td></td><td></td></tr><tr><td></td><td></td><td></td></tr><tr><td></td><td></td><td></td></tr></table>										<table border="1"><tr><td></td><td></td><td></td></tr><tr><td></td><td></td><td></td></tr><tr><td></td><td></td><td></td></tr></table>									
1		1																																																																													
1		1																																																																													
1																																																																															
1		1																																																																													
1		2																																																																													
1																																																																															
2	2	2																																																																													
	2																																																																														
2																																																																															
Post - 0 Miss - 0 Block - 0	Post - 2 Miss - 1 Block - 0	Post - 0 Miss - 0 Block - 0	Post - 0 Miss - 0 Block - 0	Post - 0 Miss - 1 Block - 0	Post - 1 Miss - 3 Block - 1	Post - 0 Miss - 0 Block - 0	Post - 0 Miss - 0 Block - 0																																																																								
12 杨峻	13 许松	14 田剑侠	16 刘海亮	17 周群	18 王晓琪	22 魏雨童																																																																									
<table border="1"><tr><td></td><td></td><td></td></tr><tr><td></td><td></td><td></td></tr><tr><td></td><td></td><td></td></tr></table>										<table border="1"><tr><td>1</td><td></td><td></td></tr><tr><td></td><td></td><td></td></tr><tr><td></td><td></td><td></td></tr></table>	1									<table border="1"><tr><td>1</td><td></td><td></td></tr><tr><td></td><td></td><td></td></tr><tr><td></td><td></td><td></td></tr></table>	1									<table border="1"><tr><td></td><td></td><td></td></tr><tr><td></td><td></td><td></td></tr><tr><td></td><td></td><td></td></tr></table>										<table border="1"><tr><td></td><td></td><td>1</td></tr><tr><td></td><td></td><td></td></tr><tr><td></td><td></td><td></td></tr></table>			1							<table border="1"><tr><td></td><td></td><td></td></tr><tr><td></td><td></td><td></td></tr><tr><td></td><td></td><td></td></tr></table>										<table border="1"><tr><td></td><td></td><td></td></tr><tr><td></td><td></td><td></td></tr><tr><td></td><td></td><td></td></tr></table>										<table border="1"><tr><td></td><td></td><td></td></tr><tr><td></td><td></td><td></td></tr><tr><td></td><td></td><td></td></tr></table>									
1																																																																															
1																																																																															
		1																																																																													
Post - 0 Miss - 0 Block - 0	Post - 1 Miss - 0 Block - 0	Post - 0 Miss - 1 Block - 0	Post - 0 Miss - 0 Block - 0	Post - 0 Miss - 1 Block - 0	Post - 0 Miss - 0 Block - 0	Post - 0 Miss - 0 Block - 0																																																																									

1 刘宗其

0/3	0/1	0/2
0/2	3/4	1/5
0/2	1/1	0/1

12 杨峻

0/1	0/2	1/1
1/1	1/1	
0/1		

16 刘海亮

0/1		1/1
0/1		

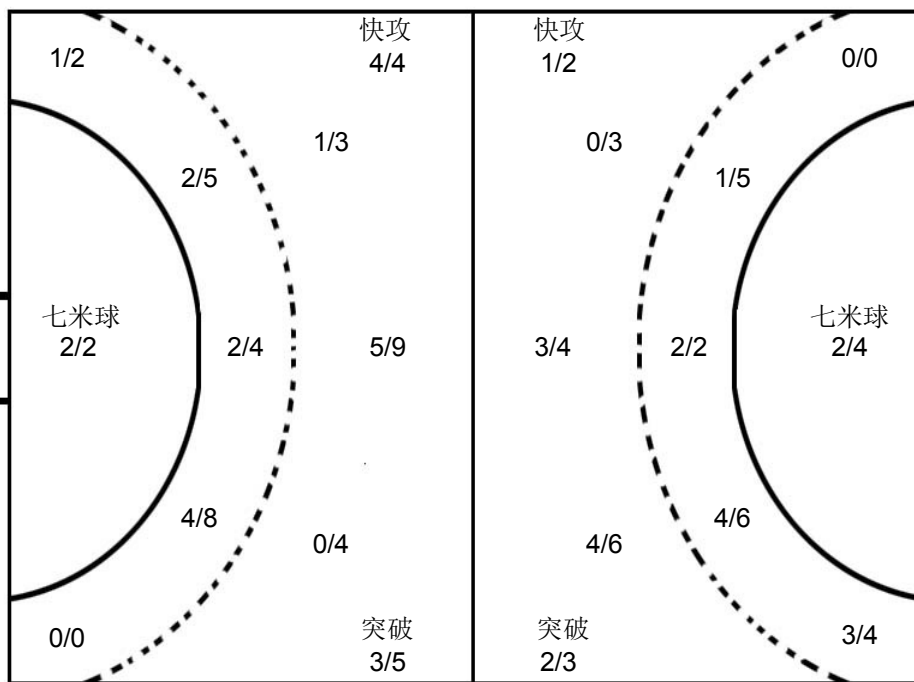

12 孟辉

	1/2	0/1
0/1		1/2
		1/1

16 刘迈科

0/4	0/1	0/3
1/4	1/3	1/4
1/5	3/3	

北京队

3 王超	6 解建飞	8 王鹏	9 刘振	10 成亚	11 蒋维一	12 孟辉	16 刘迈科																																																																								
<table border="1"><tr><td>1</td><td></td><td></td></tr><tr><td>1</td><td></td><td></td></tr><tr><td></td><td></td><td></td></tr></table>	1			1						<table border="1"><tr><td>1</td><td></td><td>1</td></tr><tr><td></td><td></td><td></td></tr><tr><td></td><td></td><td></td></tr></table>	1		1							<table border="1"><tr><td></td><td></td><td></td></tr><tr><td></td><td></td><td></td></tr><tr><td></td><td></td><td></td></tr></table>										<table border="1"><tr><td></td><td></td><td></td></tr><tr><td></td><td></td><td></td></tr><tr><td></td><td></td><td></td></tr></table>										<table border="1"><tr><td>1</td><td>1</td><td>1</td></tr><tr><td></td><td></td><td>1</td></tr><tr><td></td><td></td><td>1</td></tr></table>	1	1	1			1			1	<table border="1"><tr><td></td><td>1</td><td></td></tr><tr><td></td><td></td><td></td></tr><tr><td></td><td></td><td></td></tr></table>		1								<table border="1"><tr><td></td><td></td><td></td></tr><tr><td></td><td></td><td></td></tr><tr><td></td><td></td><td></td></tr></table>										<table border="1"><tr><td></td><td></td><td></td></tr><tr><td></td><td></td><td></td></tr><tr><td></td><td></td><td></td></tr></table>									
1																																																																															
1																																																																															
1		1																																																																													
1	1	1																																																																													
		1																																																																													
		1																																																																													
	1																																																																														
Post - 0 Miss - 0 Block - 0	Post - 0 Miss - 1 Block - 0	Post - 0 Miss - 0 Block - 0	Post - 0 Miss - 0 Block - 0	Post - 0 Miss - 0 Block - 0	Post - 0 Miss - 1 Block - 0	Post - 0 Miss - 0 Block - 0	Post - 0 Miss - 0 Block - 0																																																																								
21 胡灏	23 王军程	25 马明辉	29 杜龙飞	33 冯宁	77 朱昕晨	78 张骥	83 潘天																																																																								
<table border="1"><tr><td>2</td><td></td><td></td></tr><tr><td></td><td></td><td></td></tr><tr><td>2</td><td></td><td></td></tr></table>	2						2			<table border="1"><tr><td></td><td></td><td>1</td></tr><tr><td></td><td></td><td></td></tr><tr><td></td><td></td><td></td></tr></table>			1							<table border="1"><tr><td></td><td></td><td></td></tr><tr><td></td><td></td><td></td></tr><tr><td></td><td></td><td></td></tr></table>										<table border="1"><tr><td>1</td><td>1</td><td></td></tr><tr><td>1</td><td></td><td>1</td></tr><tr><td></td><td></td><td></td></tr></table>	1	1		1		1				<table border="1"><tr><td></td><td></td><td></td></tr><tr><td></td><td></td><td></td></tr><tr><td></td><td></td><td></td></tr></table>										<table border="1"><tr><td></td><td></td><td></td></tr><tr><td></td><td></td><td></td></tr><tr><td></td><td></td><td></td></tr></table>										<table border="1"><tr><td></td><td>1</td><td>1</td></tr><tr><td></td><td></td><td></td></tr><tr><td>1</td><td></td><td></td></tr></table>		1	1				1			<table border="1"><tr><td></td><td></td><td></td></tr><tr><td></td><td></td><td></td></tr><tr><td></td><td></td><td></td></tr></table>									
2																																																																															
2																																																																															
		1																																																																													
1	1																																																																														
1		1																																																																													
	1	1																																																																													
1																																																																															
Post - 1 Miss - 1 Block - 0	Post - 0 Miss - 1 Block - 0	Post - 1 Miss - 1 Block - 0	Post - 0 Miss - 0 Block - 0	Post - 0 Miss - 0 Block - 0	Post - 0 Miss - 0 Block - 0	Post - 1 Miss - 0 Block - 0	Post - 0 Miss - 0 Block - 0																																																																								

注释: Post=击柱 Miss=射失 Block=被封





决赛  
男子 全国比赛

2016年全国男子手球锦标赛

Team A <b>A 江苏队</b>				Team B <b>B 山东队</b>				Match Number <b>38</b>													
played in China		in the hall 徐闻县体育中心体育		on 29/10/2016		at 16:20 hours		Spectators													
Half-time (30')	<b>A</b> 10	<b>B</b> 12	End of playing time	<b>A</b> 25	<b>B</b> 22	1st extra time	<b>A</b>	<b>B</b>	2nd extra time	<b>A</b>	<b>B</b>	After penalty throws	<b>A</b>	<b>B</b>							
Number of 7 m	<b>A</b> 2/3	Team time-out			Full name of players and officials				Team time-out			<b>B</b> 3/3	Number of 7 m								
		1 17:12	2 50:37	3 59:47					1 14:33	2 37:44	3 56:56										
No.	Team <b>A</b>					G	W	2'	D	DR	No.	Team <b>B</b>					G	W	2'	D	DR
1	徐畅										3	尹杰									
4	张家纬					4	1				4	田瑞								1	
5	闫亮					1					5	潘翔					1			1	
6	赵晨					6	1	1			6	李朝鹏					2				
7	徐奕飞										9	赵鑫					4	1			
8	周小坚					5					10	赵建强									
9	周傲										11	宋朋强									
10	郝可鑫					2					12	崔剑									
12	王权								1		13	刘晓					3				
15	李安					5					15	张继伟					2				
16	张帅										16	于性哲									
17	王伟强										17	王旭东					2			2	
18	赵楠					1					19	李语庆					5			1	
20	顾艳超										27	于亚男					3	1			
21	刘江					1															
B	闫威名 (主教练)										A	markovic尼克									
C	贾淑君										B	王鸿斌 (主教练)									
D	叶强										C	刘桂妮									
E	王建国										D	邢建刚									
<b>A</b>	Signature of Responsible Official of the Teams (Off. A)																			<b>B</b>	
TP	Remarks of Referee / CHA Official																			TP	

Signatures

Referees	王科 (CHN)	李兆蒙 (CHN)		
Techn. Delegates	刘凤娟 (CHN)			
CHA Official	许宜扬 (CHN)			

Note: Number of 7m Throws Awarded to Team A and B, Goals (G), Warnings (W), Suspensions (2'), Direct Disqualification (D), Disqualification with Report (DR) and Team Penalty (TP).

Table Officials: 梁小熹 王亚光 Statisticians: 张程秀子 李双



2016年全国男子手球锦标赛  
竞赛技术统计(媒体表)

决赛 组别 X 轮次 8 场次 38

徐闻县体育中心体育馆

29/10/2016

201606038-51-1/1

江苏队 江苏 25 vs 22 山东 山东队  
10:12

裁判员 王科 (CHN) / 李兆蒙 (CHN)

Main statistics table for Jiangsu and Shandong teams, including player names, positions, and various performance metrics like goals, assists, and suspensions.

场上队员: 得分 / 射门

守门员: 救球 / 射门

Legend table for abbreviations used in the statistics, such as Fast Break, Breakthrough, Free Throw, etc.





### 2016年全国男子手球锦标赛 图式比赛技术统计表

轮次 8

场次 38

201606038-21-1/1

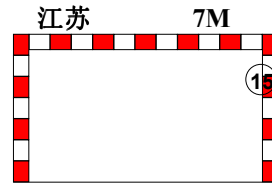
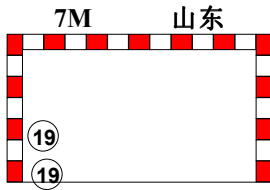
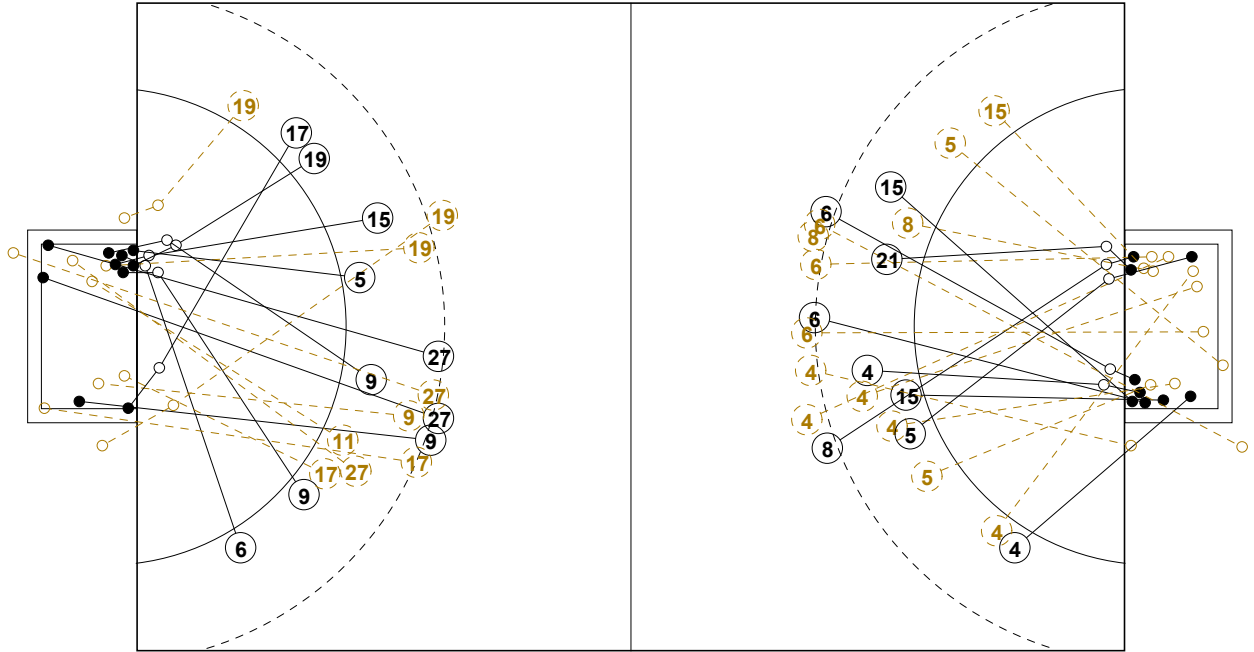

1st Half  
12 : 10

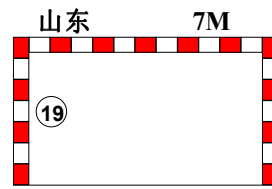
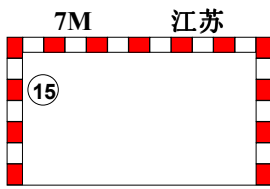
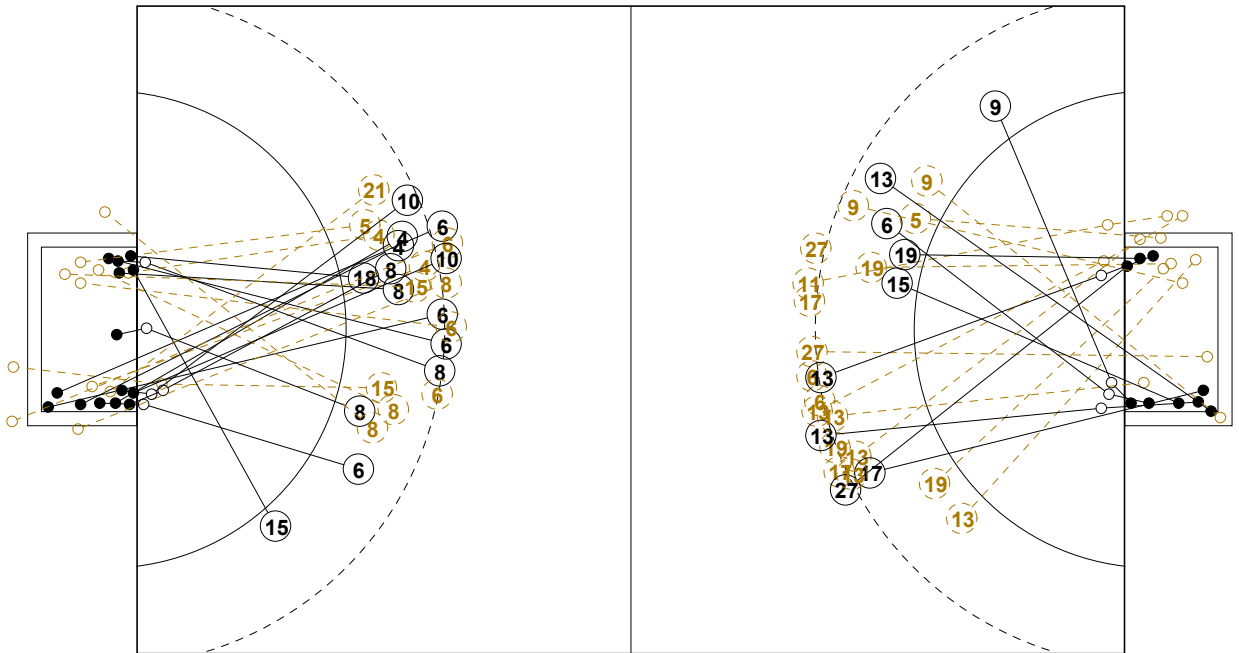

2nd Half  
25 : 22



## 2016年全国男子手球锦标赛

## 个人/全队技术统计表

正式表  
手球  
男子决赛  
轮次 8组别 X  
场次 38201606038-14-1/2  
徐闻县体育中心体育馆  
29/10/2016 16:20

号码	姓名	远射	近射	边射	快攻	突破	任意	7M	合计	%	助攻	失误	警告	2'	取消	时间
<b>江苏队(江苏)</b>																
<i>(场上队员)</i>																
1	徐畅									0.0%						00:02:13
4	张家纬	0/3	1/3	1/1	0/2	2/2			4/11	36.4%	2	3	1			01:00:00
5	闫亮		1/3		0/1				1/4	25.0%						00:27:42
6	赵晨	2/6			1/1		3/5		6/12	50.0%		2	1	1		00:54:24
7	徐奕飞									0.0%						00:00:00
8	周小坚	2/4	2/3		1/2	0/1			5/10	50.0%		4				00:56:26
9	周傲									0.0%						00:00:00
10	郝可鑫	2/2							2/2	100%						00:07:42
12	王权									0.0%				1		00:57:47
15	李安		1/2	1/2	1/1	0/1		2/3	5/9	55.6%	3	1				00:54:05
16	张帅									0.0%						00:00:00
17	王伟强									0.0%						00:00:47
18	赵楠		1/1						1/1	100%		2				00:50:52
20	顾艳超									0.0%		1				00:03:32
21	刘江		0/1		1/1				1/2	50.0%	2	2				00:42:19
<b>合计</b>		6/15	6/13	2/3	4/8	2/4	3/5	2/3	25/51	49.0%	7	15	2	2		
<i>(守门员)</i>																
1	徐畅	0/1	0/1					0/1	0/3	0.0%						00:02:13
12	王权	6/13	4/4	0/2	0/6	2/4		0/2	12/31	38.7%				1		00:57:47
<b>合计</b>		6/14	4/5	0/2	0/6	2/4		0/3	12/34	35.3%				1		

场上队员：得分/射门

守门员：救球/射门

全队合计	得分	被救	射失	击柱	封球	合计	%
远射	6	4	2	1	2	15	40.0%
近射	6	5	1	1		13	46.2%
边射	2	1				3	66.7%
快攻	4	4				8	50.0%
突破	2	1	1			4	50.0%
任意	3	1	1			5	60.0%
7M	2		1			3	66.7%





## 2016年全国男子手球锦标赛

## 个人/全队技术统计表

正式表  
手球  
男子决赛  
轮次 8组别 X  
场次 38201606038-14-2/2  
徐闻县体育中心体育馆  
29/10/2016 16:20

号码	姓名	远射	近射	边射	快攻	突破	任意	7M	合计	%	助攻	失误	警告	2'	取消	时间
<b>山东队(山东)</b>																
<i>(上场队员)</i>																
3	尹杰									0.0%						00:00:00
4	田瑞									0.0%				1		00:04:17
5	潘翔		0/1		1/1				1/2	50.0%				1		00:39:13
6	李朝鹏	0/2		1/1		1/1			2/4	50.0%	1	1				00:58:46
9	赵鑫	1/3	0/1	1/1	1/1	1/1			4/7	57.1%		4	1			00:40:45
10	赵建强									0.0%						00:00:00
11	宋朋强	0/1	0/1						0/2	0.0%		1				00:36:57
12	崔剑									0.0%						00:16:37
13	刘晓	3/7	0/1						3/8	37.5%	1	1				00:27:02
15	张继伟		1/1		1/1				2/2	100%		1				00:21:13
16	于性哲									0.0%						00:43:23
17	王旭东	1/4	0/1		1/1				2/6	33.3%		1		2		00:32:19
19	李语庆	0/3	0/1	0/1	2/2	0/1		3/3	5/11	45.5%		2		1		01:00:00
27	于亚男	3/6				0/1			3/7	42.9%		3	1			00:39:24
<b>合计</b>																
<i>(守门员)</i>																
12	崔剑	1/3	1/3	0/1	1/2	1/1	0/1	0/1	4/12	33.3%						00:16:37
16	于性哲	3/7	4/8	1/2	3/6	0/2	1/3	0/1	12/29	41.4%						00:43:23
<b>合计</b>																

场上队员：得分/射门

守门员：救球/射门

全队合计	得分	被救	射失	击柱	封球	合计	%
远射	8	6	4	1	7	26	30.8%
近射	1	4		2		7	14.3%
边射	2		1			3	66.7%
快攻	6					6	100.0%
突破	2	2				4	50.0%
任意							0.0%
7M	3					3	100.0%







### 2016年全国男子手球锦标赛

#### 图式射门区域统计

轮次 8 场次 38

201606038-41-1/1

## 江苏队

1 徐畅	4 张家纬	5 闫亮	6 赵晨	7 徐奕飞	8 周小坚	9 周傲	10 郝可鑫																																																																								
<table border="1"><tr><td></td><td></td><td></td></tr><tr><td></td><td></td><td></td></tr><tr><td></td><td></td><td></td></tr></table>										<table border="1"><tr><td></td><td></td><td>1</td></tr><tr><td>1</td><td></td><td></td></tr><tr><td>1</td><td></td><td>1</td></tr></table>			1	1			1		1	<table border="1"><tr><td>1</td><td></td><td></td></tr><tr><td></td><td></td><td></td></tr><tr><td></td><td></td><td></td></tr></table>	1									<table border="1"><tr><td>2</td><td></td><td></td></tr><tr><td>1</td><td></td><td></td></tr><tr><td></td><td></td><td>3</td></tr></table>	2			1					3	<table border="1"><tr><td></td><td></td><td></td></tr><tr><td></td><td></td><td></td></tr><tr><td></td><td></td><td></td></tr></table>										<table border="1"><tr><td></td><td></td><td></td></tr><tr><td></td><td></td><td></td></tr><tr><td>2</td><td>1</td><td>2</td></tr></table>							2	1	2	<table border="1"><tr><td></td><td></td><td></td></tr><tr><td></td><td></td><td></td></tr><tr><td></td><td></td><td></td></tr></table>										<table border="1"><tr><td></td><td></td><td></td></tr><tr><td></td><td></td><td></td></tr><tr><td>2</td><td></td><td></td></tr></table>							2		
		1																																																																													
1																																																																															
1		1																																																																													
1																																																																															
2																																																																															
1																																																																															
		3																																																																													
2	1	2																																																																													
2																																																																															
Post - 0 Miss - 0 Block - 0	Post - 0 Miss - 1 Block - 0	Post - 1 Miss - 0 Block - 0	Post - 0 Miss - 2 Block - 1	Post - 0 Miss - 0 Block - 0	Post - 1 Miss - 1 Block - 1	Post - 0 Miss - 0 Block - 0	Post - 0 Miss - 0 Block - 0																																																																								
12 王权	15 李安	16 张帅	17 王伟强	18 赵楠	20 顾艳超	21 刘江																																																																									
<table border="1"><tr><td></td><td></td><td></td></tr><tr><td></td><td></td><td></td></tr><tr><td></td><td></td><td></td></tr></table>										<table border="1"><tr><td>1</td><td></td><td>1</td></tr><tr><td></td><td></td><td>1</td></tr><tr><td></td><td></td><td>2</td></tr></table>	1		1			1			2	<table border="1"><tr><td></td><td></td><td></td></tr><tr><td></td><td></td><td></td></tr><tr><td></td><td></td><td></td></tr></table>										<table border="1"><tr><td></td><td></td><td></td></tr><tr><td></td><td></td><td></td></tr><tr><td></td><td></td><td></td></tr></table>										<table border="1"><tr><td></td><td></td><td></td></tr><tr><td></td><td></td><td></td></tr><tr><td></td><td></td><td>1</td></tr></table>									1	<table border="1"><tr><td></td><td></td><td></td></tr><tr><td></td><td></td><td></td></tr><tr><td></td><td></td><td></td></tr></table>										<table border="1"><tr><td></td><td></td><td></td></tr><tr><td></td><td></td><td></td></tr><tr><td>1</td><td></td><td></td></tr></table>							1			<table border="1"><tr><td></td><td></td><td></td></tr><tr><td></td><td></td><td></td></tr><tr><td></td><td></td><td></td></tr></table>									
1		1																																																																													
		1																																																																													
		2																																																																													
		1																																																																													
1																																																																															
Post - 0 Miss - 0 Block - 0	Post - 0 Miss - 2 Block - 0	Post - 0 Miss - 0 Block - 0	Post - 0 Miss - 0 Block - 0	Post - 0 Miss - 0 Block - 0	Post - 0 Miss - 0 Block - 0	Post - 0 Miss - 0 Block - 0																																																																									

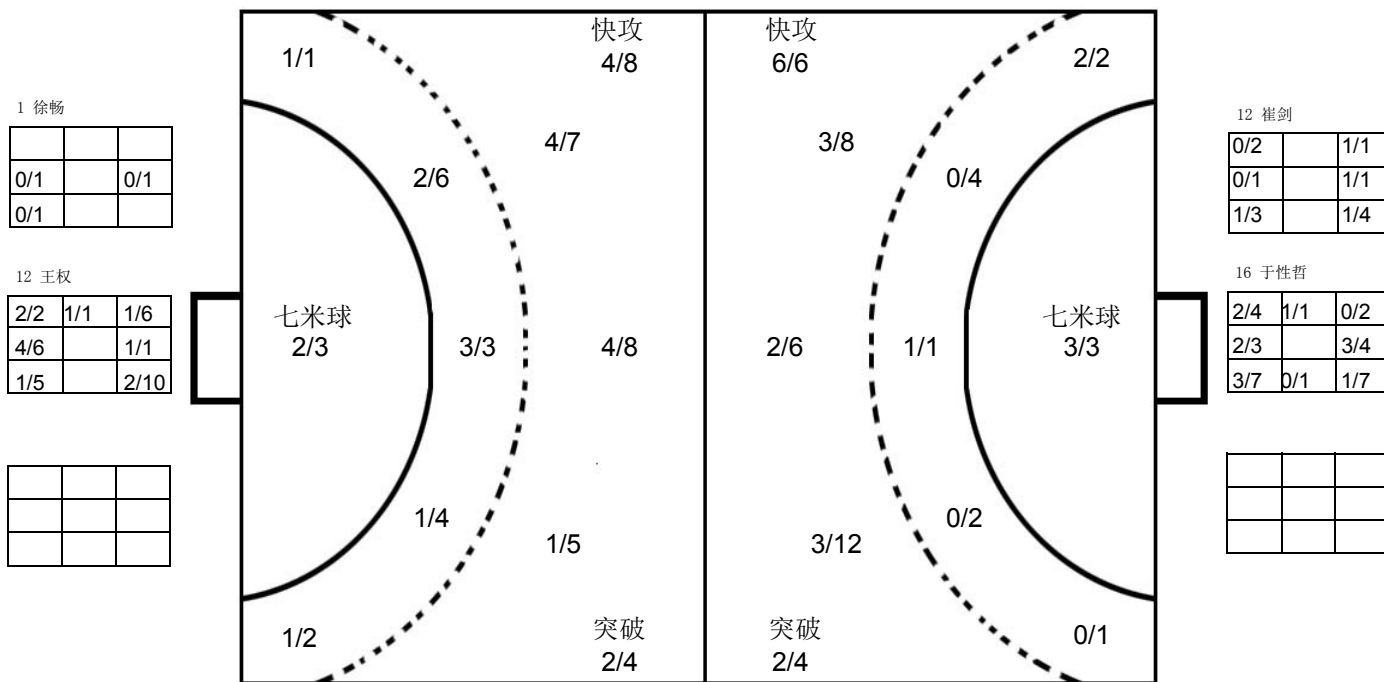

## 山东队

3 尹杰	4 田瑞	5 潘翔	6 李朝鹏	9 赵鑫	10 赵建强	11 宋朋强	12 崔剑																																																																								
<table border="1"><tr><td></td><td></td><td></td></tr><tr><td></td><td></td><td></td></tr><tr><td></td><td></td><td></td></tr></table>										<table border="1"><tr><td></td><td></td><td></td></tr><tr><td></td><td></td><td></td></tr><tr><td></td><td></td><td></td></tr></table>										<table border="1"><tr><td></td><td></td><td></td></tr><tr><td></td><td></td><td></td></tr><tr><td></td><td></td><td>1</td></tr></table>									1	<table border="1"><tr><td></td><td></td><td></td></tr><tr><td></td><td></td><td></td></tr><tr><td></td><td></td><td>2</td></tr></table>									2	<table border="1"><tr><td></td><td></td><td></td></tr><tr><td>1</td><td></td><td></td></tr><tr><td></td><td></td><td>3</td></tr></table>				1					3	<table border="1"><tr><td></td><td></td><td></td></tr><tr><td></td><td></td><td></td></tr><tr><td></td><td></td><td></td></tr></table>										<table border="1"><tr><td></td><td></td><td></td></tr><tr><td></td><td></td><td></td></tr><tr><td></td><td></td><td></td></tr></table>										<table border="1"><tr><td></td><td></td><td></td></tr><tr><td></td><td></td><td></td></tr><tr><td></td><td></td><td></td></tr></table>									
		1																																																																													
		2																																																																													
1																																																																															
		3																																																																													
Post - 0 Miss - 0 Block - 0	Post - 0 Miss - 0 Block - 0	Post - 1 Miss - 0 Block - 0	Post - 0 Miss - 0 Block - 2	Post - 1 Miss - 0 Block - 0	Post - 0 Miss - 0 Block - 0	Post - 0 Miss - 1 Block - 0	Post - 0 Miss - 0 Block - 0																																																																								
13 刘晓	15 张继伟	16 于性哲	17 王旭东	19 李语庆	27 于亚男																																																																										
<table border="1"><tr><td></td><td></td><td>2</td></tr><tr><td></td><td></td><td></td></tr><tr><td>1</td><td></td><td></td></tr></table>			2				1			<table border="1"><tr><td></td><td></td><td></td></tr><tr><td></td><td></td><td>1</td></tr><tr><td></td><td></td><td>1</td></tr></table>						1			1	<table border="1"><tr><td></td><td></td><td></td></tr><tr><td></td><td></td><td></td></tr><tr><td></td><td></td><td></td></tr></table>										<table border="1"><tr><td></td><td></td><td></td></tr><tr><td></td><td></td><td>1</td></tr><tr><td>1</td><td></td><td></td></tr></table>						1	1			<table border="1"><tr><td></td><td></td><td></td></tr><tr><td>2</td><td></td><td></td></tr><tr><td>2</td><td></td><td>1</td></tr></table>				2			2		1	<table border="1"><tr><td></td><td></td><td></td></tr><tr><td></td><td></td><td>2</td></tr><tr><td>1</td><td></td><td></td></tr></table>						2	1			<table border="1"><tr><td></td><td></td><td></td></tr><tr><td></td><td></td><td></td></tr><tr><td></td><td></td><td></td></tr></table>										<table border="1"><tr><td></td><td></td><td></td></tr><tr><td></td><td></td><td></td></tr><tr><td></td><td></td><td></td></tr></table>									
		2																																																																													
1																																																																															
		1																																																																													
		1																																																																													
		1																																																																													
1																																																																															
2																																																																															
2		1																																																																													
		2																																																																													
1																																																																															
Post - 1 Miss - 1 Block - 1	Post - 0 Miss - 0 Block - 0	Post - 0 Miss - 0 Block - 0	Post - 0 Miss - 0 Block - 2	Post - 0 Miss - 2 Block - 1	Post - 0 Miss - 1 Block - 1																																																																										

注释: Post=击柱 Miss=射失 Block=被封





## 2016年全国男子手球锦标赛

## 比赛进程表

正式表  
手球  
男子决赛  
轮次 8组别 X  
场次 38201606038-13-1/6  
徐闻县体育中心体育馆  
29/10/2016 16:20

时间	队员	动作	比分	队员	动作
<b>江苏队</b>			<b>上半时</b>		
<b>山东队</b>					
00:55	12 王权	被射入	0 - 1	27 于亚男	左远射 得分
01:29	4 张家纬	近射 得分	1 - 1	16 于性哲	被射入
02:04	12 王权	被射入	1 - 2	9 赵鑫	左远射 得分
02:46	6 赵晨	任意球 被救		16 于性哲	挡住球
03:11	4 张家纬	右边射 得分	2 - 2	16 于性哲	被射入
03:19				27 于亚男	移动 失误
03:45	12 王权	挡住球		27 于亚男	突破 被救
03:57	8 周小坚	近射 被救		16 于性哲	挡住球
03:58	21 刘江	助攻			
04:14	12 王权	被射入	2 - 3	6 李朝鹏	左边射 得分
04:54	4 张家纬	传球失误		9 赵鑫	断球
04:56				9 赵鑫	快攻 运球失误
05:00	6 赵晨	中远射 得分	3 - 3	16 于性哲	被射入
05:40	12 王权	被射入	3 - 4	9 赵鑫	突破 得分
05:42	4 张家纬	警告			
06:00				9 赵鑫	警告
06:28	21 刘江	传球失误		15 张继伟	断球
06:36	8 周小坚	断球		13 刘晓	快攻 传球失误
06:42	6 赵晨	快攻 进攻犯规		5 潘翔	造犯规
07:24	8 周小坚	右远射 得分	4 - 4	16 于性哲	被射入
07:52	21 刘江	断球		9 赵鑫	传球失误
07:58	15 李安	一传快攻 得分	5 - 4	16 于性哲	被射入
07:59	21 刘江	助攻			
08:28				27 于亚男	运球失误
08:38	4 张家纬	短传快攻 被救		16 于性哲	挡住球
09:27	21 刘江	使被罚7M球		27 于亚男	造7M
09:46	12 王权	被射入	5 - 5	19 李语庆	7M球 得分
10:20	15 李安	左边射 被救		16 于性哲	挡住球
10:56	15 李安	近射 得分	6 - 5	16 于性哲	被射入
11:40	12 王权	挡住球		17 王旭东	左远射 被救
12:06	4 张家纬	近射 被救		16 于性哲	挡住球
12:19	8 周小坚	断球		19 李语庆	传球失误
12:26	8 周小坚	快攻 侵区			
12:34	12 王权	挡住球		9 赵鑫	左远射 被救
13:19	6 赵晨	造7M		17 王旭东	使被罚7M球
13:20		裁判暂停			
13:20				17 王旭东	罚出场2分钟
13:23	15 李安	7M球 得分	7 - 5	16 于性哲	被射入
14:25	15 李安	顶贴 成功			
14:33					球队暂停





## 2016年全国男子手球锦标赛

## 比赛进程表

正式表  
手球  
男子决赛  
轮次 8组别 X  
场次 38201606038-13-2/6  
徐闻县体育中心体育馆  
29/10/2016 16:20

时间	队员	动作	比分	队员	动作
<b>江苏队</b>			<b>上半时</b>		
<b>山东队</b>					
14:33	6 赵晨	警告			
15:24				19 李语庆	右远射 射失
15:41	8 周小坚	传球失误			
15:48	12 王权	被射入	<b>7 - 6</b>	9 赵鑫	一传快攻 得分
16:26	4 张家纬	中远射 射失			
16:42	12 王权	挡住球		19 李语庆	右远射 被救
17:05	8 周小坚	左远射 被封		5 潘翔	封球
17:12		球队暂停			
17:17	6 赵晨	任意球 得分	<b>8 - 6</b>	16 于性哲	被射入
17:58	21 刘江	造犯规		17 王旭东	进攻犯规
18:24	18 赵楠	四步			
18:57	18 赵楠	使被罚7M球		27 于亚男	造7M
19:18	12 王权	被射入	<b>8 - 7</b>	19 李语庆	7M球 得分
19:57	4 张家纬	右远射 被救		16 于性哲	挡住球
20:06	12 王权	挡住球		17 王旭东	近射 被救
20:16	5 闫亮	近射 被救		16 于性哲	挡住球
20:40	21 刘江	接球失误		6 李朝鹏	抢球
20:47	12 王权	被射入	<b>8 - 8</b>	5 潘翔	短传快攻 得分
21:01		裁判暂停			
21:06	6 赵晨	任意球 射失			
21:16				19 李语庆	右边射 射失
21:46	4 张家纬	近射 被救		16 于性哲	挡住球
21:53	12 王权	被射入	<b>8 - 9</b>	15 张继伟	短传快攻 得分
22:22	4 张家纬	接球失误		27 于亚男	抢球
22:30	12 王权	被射入	<b>8 - 10</b>	17 王旭东	短传快攻 得分
23:01	8 周小坚	接球失误		19 李语庆	抢球
23:09	12 王权	被射入	<b>8 - 11</b>	19 李语庆	短传快攻 得分
24:01		裁判暂停			
24:18		裁判暂停			
24:18				17 王旭东	罚出场2分钟
24:28	6 赵晨	传球失误			
24:58	12 王权	被射入	<b>8 - 12</b>	27 于亚男	中远射 得分
25:16	5 闫亮	近射 得分	<b>9 - 12</b>	16 于性哲	被射入
25:18	4 张家纬	助攻			
25:53				27 于亚男	左远射 射失
26:06	5 闫亮	近射 击柱			
26:08	15 李安	助攻			
26:44	18 赵楠	造犯规		27 于亚男	进攻犯规
27:32	18 赵楠	传球失误		19 李语庆	断球
27:43				19 李语庆	其它失误





## 2016年全国男子手球锦标赛

## 比赛进程表

正式表  
手球  
男子决赛  
轮次 8组别 X  
场次 38201606038-13-3/6  
徐闻县体育中心体育馆  
29/10/2016 16:20

时间	队员	动作	比分	队员	动作
<b>江苏队</b>			<b>上半时</b>		
<b>山东队</b>					
27:53		裁判暂停			
28:01	20 顾艳超	传球失误			
28:08	8 周小坚	断球		15 张继伟	快攻 传球失误
28:19				27 于亚男	警告
28:24		裁判暂停			
28:30	6 赵晨	中远射 被救		16 于性哲	挡住球
29:08	12 王权	挡住球		11 宋朋强	近射 被救
29:18	8 周小坚	传球失误			
29:25	15 李安	断球		9 赵鑫	快攻 传球失误
29:34	21 刘江	一传快攻 得分	<b>10 - 12</b>	16 于性哲	被射入
29:36	15 李安	助攻			



## 2016年全国男子手球锦标赛

## 比赛进程表

正式表  
手球  
男子决赛  
轮次 8组别 X  
场次 38201606038-13-4/6  
徐闻县体育中心体育馆  
29/10/2016 16:20

时间	队员	动作	比分	队员	动作
<b>江苏队</b>			<b>下半时</b>		
<b>山东队</b>					
00:43	4 张家纬	突破 得分	11 - 12	16 于性哲	被射入
01:47	12 王权	挡住球		13 刘晓	近射 被救
02:07	4 张家纬	右远射 被救		16 于性哲	挡住球
02:19	15 李安	近射 射失			
02:33	6 赵晨	任意球 得分	12 - 12	16 于性哲	被射入
03:23	6 赵晨	封球		19 李语庆	右远射 被封
04:05		裁判暂停			
04:10	6 赵晨	造7M		5 潘翔	使被罚7M球
04:11		裁判暂停			
04:11				5 潘翔	罚出场2分钟
04:16	15 李安	7M球 射失			
04:22	15 李安	其它失误			
04:53				11 宋朋强	四步
05:11	8 周小坚	中远射 得分	13 - 12	16 于性哲	被射入
05:41				11 宋朋强	中远射 射失
06:15	6 赵晨	中远射 得分	14 - 12	16 于性哲	被射入
07:08	6 赵晨	封球		17 王旭东	右远射 被封
07:26	8 周小坚	封球		17 王旭东	中远射 被封
07:29	15 李安	抢球		9 赵鑫	接球失误
07:35	8 周小坚	一传快攻 得分	15 - 12	16 于性哲	被射入
07:37	15 李安	助攻			
07:44					球队暂停
08:05				27 于亚男	传球失误
08:41	8 周小坚	中远射 击柱			
09:20	12 王权	挡住球		27 于亚男	中远射 被救
09:28	5 闫亮	短传快攻 被救		16 于性哲	挡住球
09:39	12 王权	挡住球		19 李语庆	近射 被救
09:48	8 周小坚	短传快攻 被救		16 于性哲	挡住球
10:01	5 闫亮	封球		6 李朝鹏	右远射 被封
10:32	5 闫亮	封球		6 李朝鹏	中远射 被封
10:37				13 刘晓	右远射 射失
11:08	4 张家纬	突破 得分	16 - 12	16 于性哲	被射入
11:09		裁判暂停			
11:09				4 田瑞	罚出场2分钟
11:42	12 王权	挡住球		19 李语庆	突破 被救
12:24				5 潘翔	近射 击柱
12:26				6 李朝鹏	助攻
12:44	8 周小坚	近射 得分	17 - 12	16 于性哲	被射入
12:46	4 张家纬	助攻			
13:31	12 王权	被射入	17 - 13	13 刘晓	右远射 得分





## 2016年全国男子手球锦标赛

## 比赛进程表

正式表  
手球  
男子决赛  
轮次 8组别 X  
场次 38201606038-13-5/6  
徐闻县体育中心体育馆  
29/10/2016 16:20

时间	队员	动作	比分	队员	动作
<b>江苏队</b>			<b>下半时</b>		
<b>山东队</b>					
13:55	4 张家纬	一传快攻 被救		12 崔剑	挡住球
14:02	12 王权	被射入	17 - 14	19 李语庆	短传快攻 得分
14:45	10 郝可鑫	右远射 得分	18 - 14	12 崔剑	被射入
15:11	12 王权	挡住球		13 刘晓	右远射 被救
15:27	5 闫亮	使被罚7M球		15 张继伟	造7M
15:28		裁判暂停			
15:28	12 王权	罚出场2分钟			
15:31	1 徐畅	被射入	18 - 15	19 李语庆	7M球 得分
16:10	6 赵晨	中远射 被救		12 崔剑	挡住球
16:17	18 赵楠	近射 得分	19 - 15	12 崔剑	被射入
16:42	1 徐畅	被射入	19 - 16	27 于亚男	右远射 得分
17:22	6 赵晨	左远射 被封		15 张继伟	封球
17:33	1 徐畅	被射入	19 - 17	15 张继伟	近射 得分
17:35				13 刘晓	助攻
18:10	8 周小坚	近射 得分	20 - 17	12 崔剑	被射入
18:39				13 刘晓	右远射 击柱
18:51		裁判暂停			
19:09	12 王权	被射入	20 - 18	9 赵鑫	左边射 得分
19:43	15 李安	左边射 得分	21 - 18	12 崔剑	被射入
19:51		裁判暂停			
19:51	6 赵晨	罚出场2分钟			
20:07				6 李朝鹏	接球失误
20:37		球队暂停			
21:13	8 周小坚	造7M		17 王旭东	使被罚7M球
21:37	15 李安	7M球 得分	22 - 18	12 崔剑	被射入
22:02	6 赵晨	短传快攻 得分	23 - 18	12 崔剑	被射入
22:34	12 王权	被射入	23 - 19	13 刘晓	中远射 得分
23:05	4 张家纬	传球失误			
23:14	12 王权	被射入	23 - 20	6 李朝鹏	突破 得分
23:21	4 张家纬	顶贴 失误			
23:58	15 李安	突破 被救		12 崔剑	挡住球
24:09	12 王权	被射入	23 - 21	17 王旭东	右远射 得分
24:15		裁判暂停			
24:49	8 周小坚	突破 射失			
25:41	6 赵晨	封球		13 刘晓	右远射 被封
26:47	6 赵晨	任意球 得分	24 - 21	12 崔剑	被射入
26:56					球队暂停
27:17	12 王权	被射入	24 - 22	13 刘晓	左远射 得分
27:46	21 刘江	近射 被救		12 崔剑	挡住球
28:03				9 赵鑫	近射 击柱





## 2016年全国男子手球锦标赛

## 比赛进程表

正式表  
手球  
男子决赛  
轮次 8组别 X  
场次 38201606038-13-6/6  
徐闻县体育中心体育馆  
29/10/2016 16:20

时间	队员	动作	比分	队员	动作
<b>江苏队</b>			<b>下半场</b>		
<b>山东队</b>					
28:16		裁判暂停			
28:27	8 周小坚	封球		27 于亚男	左远射 被封
28:46		裁判暂停			
28:46				19 李语庆	罚出场2分钟
28:54	6 赵晨	右远射 射失			
29:22	12 王权	挡住球		9 赵鑫	左远射 被救
29:47		球队暂停			
29:58	10 郝可鑫	右远射 得分	<b>25 - 22</b>	12 崔剑	被射入