

2016

2016年全国男子手球超级杯赛

# 成绩与技术统计数据册

2016



2016

数据由PHMS收集生成



PHMS 国际手球联合会官方技术统计系统

# 目录

## 1 比赛结果

- 1) 名次
- 2) 场次成绩
- 3) 分组成绩

## 2 运动员排名

- 1) 得分
- 2) 助攻
- 3) 封球
- 4) 防守
- 5) 失误
- 6) 受罚

## 3 守门员排名

- 1) 救球
- 2) 救 7M 球

## 4 球队累计表

## 5 球队受罚表

## 6 球队信息

- 1) 球队名单
- 2) 个人/全队技术累计表
- 3) 球队射门区域累计

## 7 比赛统计数据

- 1) 比赛记录表
- 2) 比赛统计(媒体表)
- 3) 每场个人/全队技术统计表
- 4) 图式统计表
- 5) 每场射门区域统计
- 6) 比赛进程表(决赛场次)

注：如需更多比赛统计数据，请通过以下电邮联络：[handball@126.com](mailto:handball@126.com)



“绿叶集团”杯2016年全国男子手球超级杯赛  
排名表

正式表  
手球  
男子

截止至第 18场

2016082016080181204  
China  
2016/11/26 14:30:00

奖牌	排名	编码	队名
Gold	1	江苏	江苏
Silver	2	天津	天津
Bronze	3	安徽	安徽
	4	上海	上海
	5	广东	广东
	6	北京	北京





“绿叶集团”杯2016年全国男子手球超级杯赛  
场次成绩

正式表  
手球  
男子

截止至第18场

201608018-1203-1/1  
江苏苏州  
2016/11/26 14:30:00

日期	时间	场次	体育馆	组别	球队	成绩 (半时)	阶段
26/11/16	10:00	16	苏州市体育中心	X	广东-北京	31-30 (13-16)	5-6名
	13:00	17	苏州市体育中心	X	安徽-上海	33-27 (17-14)	3-4名
	14:30	18	苏州市体育中心	X	江苏-天津	29-20 (15-11)	决赛





“绿叶集团”杯2016年全国男子手球超级杯赛

正式表  
手球  
男子

分组成绩

201608-1202-1/1

江苏苏州

截止至第 18 场

2016/11/20

组别: X 预赛

名次	球队	积	场	胜	平	负	得分	失分	净胜
1	江苏	12	6	6	0	0	162	106	56
2	天津	8	6	4	0	2	148	125	23
3	安徽	8	6	4	0	2	167	170	-3
4	上海	4	6	2	0	4	172	169	3
5	广东	4	6	2	0	4	138	173	-35
6	北京	0	6	0	0	6	129	173	-44

球队	江苏	天津	安徽	上海	广东	北京
江苏		26-19	30-21	25-24	30-15	22-7
天津	19-26		31-19	29-26	22-7	27-18
安徽	21-30	19-31		30-28	31-27	33-27
上海	24-25	26-29	28-30		37-28	30-24
广东	15-30	7-22	27-31	28-37		30-23
北京	7-22	18-27	27-33	24-30	23-30	

名次	球队	积	场	胜	平	负	得分	失分	净胜

球队						

名次	球队	积	场	胜	平	负	得分	失分	净胜

球队						

名次	球队	积	场	胜	平	负	得分	失分	净胜

球队						

Legend: 积 = 积分 场 = 已比赛场次 胜 = 胜场 平 = 平场 负 = 负场  
得分 = 得分累计 失分 = 失分累计 净胜 = 净胜分





## “绿叶集团”杯2016年全国男子手球超级杯赛

得分排名表(场上队员)

正式表  
手球  
男子截止至第 18场  
按总得分201608018-1601-1/2  
江苏苏州  
20/11/2016 13:00

排序	号码	姓名	球队	远射	近射	边射	快攻	突破	任意	7M	合计	%	助攻	场数
1	14	沈吉磊	上海	13-30	9-15	1-1	1-1	21-24	1-2	5-8	51-81	63.0	4	6
2	20	黄培杰	广东	8-19	6-13	1-1	6-10	8-12	1-1	13-15	43-71	60.6	20	6
3	8	曹悦	天津	18-41	7-9	1-1	2-4	7-9	0-0	3-4	38-68	55.9	6	6
4	8	董智景	安徽	10-17	6-9	3-10	9-13	6-8	0-0	1-1	35-58	60.3	0	6
5	8	钱为玮	上海	4-10	4-8	12-19	11-13	1-5	0-2	1-1	33-58	56.9	3	6
6	7	张青	天津	14-31	2-6	2-2	4-5	7-8	0-0	3-4	32-56	57.1	6	6
7	4	徐俊吉	上海	0-1	20-22	0-2	7-7	0-0	0-0	0-0	27-32	84.4	3	6
8	6	赵晨	江苏	12-19	6-8	0-0	2-2	3-5	4-7	0-0	27-41	65.9	14	6
9	17	王伟强	江苏	0-1	1-3	4-6	12-17	3-3	0-0	5-6	25-36	69.4	1	6
10	10	周仲坤	广东	16-36	4-11	0-0	1-3	2-4	0-0	1-2	24-56	42.9	5	6
11	17	王巨柱	安徽	12-33	0-1	1-2	3-3	5-5	1-1	1-1	23-46	50.0	12	6
12	13	许松	天津	0-6	1-2	5-11	15-16	0-0	0-0	0-0	21-35	60.0	8	6
13	18	赵楠	江苏	7-14	7-14	1-2	3-3	3-6	0-0	0-1	21-40	52.5	8	6
14	15	张建杰	广东	6-32	6-10	0-1	4-5	4-6	1-5	0-1	21-60	35.0	2	6
15	3	吴锐樊	北京	0-0	4-5	4-13	11-15	0-0	0-0	1-1	20-34	58.8	0	6
16	11	黎涛	安徽	1-10	1-1	4-6	3-5	4-5	0-0	7-8	20-35	57.1	6	6
17	29	逯明松	北京	9-20	6-8	1-2	1-1	2-3	0-1	1-2	20-37	54.1	4	6
18	26	姚雪岩	广东	4-10	14-22	0-0	1-2	0-1	1-6	0-0	20-41	48.8	4	6
19	23	陈旭	北京	10-28	1-9	0-0	3-6	5-7	1-2	0-0	20-52	38.5	8	6
20	9	陈开勇	安徽	0-0	11-16	0-2	7-11	0-0	1-2	0-0	19-31	61.3	2	6
21	18	李双	安徽	8-19	2-4	1-2	4-5	4-7	0-1	0-0	19-38	50.0	7	6
22	4	张家纬	江苏	3-5	3-4	1-1	5-7	4-5	0-1	2-2	18-25	72.0	5	6
23	21	刘江	江苏	1-6	3-5	0-0	9-10	5-5	0-0	0-0	18-26	69.2	6	6
24	1	郭世伟	安徽	4-7	1-5	0-1	5-6	6-7	0-0	0-1	16-27	59.3	3	6
25	10	郝可鑫	江苏	11-18	0-0	0-0	1-1	0-1	1-1	2-3	15-24	62.5	4	6
26	6	王子欣	天津	2-5	5-7	1-5	5-11	0-0	0-0	0-0	13-28	46.4	0	6
27	18	马麟晓	上海	6-24	1-4	0-0	2-3	3-3	0-0	1-1	13-35	37.1	24	6
28	20	王鹏皓	北京	0-4	3-6	2-8	2-2	0-0	0-0	5-6	12-26	46.2	0	6
29	6	赵一涵	北京	1-11	4-12	1-2	0-0	6-11	0-0	0-0	12-36	33.3	2	6
30	7	徐奕飞	江苏	0-1	3-3	2-4	5-7	1-1	0-2	0-0	11-18	61.1	1	6
31	19	蒋慧捷	上海	0-0	2-3	7-13	1-3	1-1	0-0	0-0	11-20	55.0	0	6
32	12	王雨	广东	0-0	3-5	4-8	2-5	1-1	0-0	0-0	10-19	52.6	4	6
33	35	金永峰	安徽	6-14	2-3	1-1	0-1	1-1	0-0	0-0	10-20	50.0	1	6
34	18	高玉杰	广东	0-1	0-1	4-11	5-7	1-1	0-0	0-0	10-21	47.6	1	6
35	11	蒋承骅	上海	2-5	3-7	1-3	1-1	2-2	1-2	0-1	10-21	47.6	5	6
36	13	王立隆	广东	0-3	4-6	3-7	2-4	1-1	0-0	0-1	10-22	45.5	0	6
37	22	魏雨童	天津	0-0	7-7	0-0	2-2	0-0	0-0	0-0	9-9	100.0	1	6
38	17	周群	天津	0-0	9-10	0-0	0-0	0-0	0-0	0-0	9-10	90.0	0	6
39	9	李旭	北京	0-0	5-6	0-1	4-6	0-0	0-0	0-0	9-13	69.2	1	5
40	8	赵文宣	北京	1-2	8-14	0-0	0-0	0-0	0-0	0-0	9-16	56.3	0	6
41	5	史小帆	安徽	6-11	2-5	0-0	1-1	0-0	0-0	0-0	9-17	52.9	1	6
42	23	于敏清	安徽	2-2	1-1	2-4	3-4	0-0	0-0	0-0	8-11	72.7	1	6
43	8	周小坚	江苏	0-2	4-8	0-0	2-3	1-1	0-0	1-1	8-15	53.3	5	5
44	78	王哲一	北京	0-0	1-4	4-7	3-5	0-0	0-0	0-0	8-16	50.0	0	6
45	2	李岳朋	天津	3-10	3-7	1-2	0-1	1-2	0-0	0-0	8-22	36.4	8	6
46	5	闫亮	江苏	0-0	5-5	1-1	1-2	0-0	0-0	0-0	7-8	87.5	3	6
47	2	张文斌	上海	3-3	0-0	0-1	1-1	3-3	0-0	0-0	7-8	87.5	2	6





## “绿叶集团”杯2016年全国男子手球超级杯赛

得分排名表(场上队员)

正式表  
手球  
男子截止至第 18场  
按助攻201608018-1610-1/2  
江苏苏州  
20/11/2016 13:00

排序	号码	姓名	球队	远射	近射	边射	快攻	突破	任意	7M	合计	%	助攻	场数
1	18	马麟晓	上海	6-24	1-4	0-0	2-3	3-3	0-0	1-1	13-35	37.1	24	6
2	20	黄培杰	广东	8-19	6-13	1-1	6-10	8-12	1-1	13-15	43-71	60.6	20	6
3	6	赵晨	江苏	12-19	6-8	0-0	2-2	3-5	4-7	0-0	27-41	65.9	14	6
4	17	王巨柱	安徽	12-33	0-1	1-2	3-3	5-5	1-1	1-1	23-46	50.0	12	6
5	21	李明	安徽	0-0	0-0	0-0	0-0	0-0	0-0	0-0	0-0	0.0	11	6
6	14	田剑侠	天津	3-5	1-2	2-2	0-0	1-1	0-0	0-0	7-10	70.0	9	6
7	13	许松	天津	0-6	1-2	5-11	15-16	0-0	0-0	0-0	21-35	60.0	8	6
8	18	赵楠	江苏	7-14	7-14	1-2	3-3	3-6	0-0	0-1	21-40	52.5	8	6
9	23	陈旭	北京	10-28	1-9	0-0	3-6	5-7	1-2	0-0	20-52	38.5	8	6
10	2	李岳朋	天津	3-10	3-7	1-2	0-1	1-2	0-0	0-0	8-22	36.4	8	6
11	1	张峥	上海	1-1	0-0	0-0	0-0	0-0	0-0	0-0	1-1	100.0	8	6
12	18	李双	安徽	8-19	2-4	1-2	4-5	4-7	0-1	0-0	19-38	50.0	7	6
13	8	曹悦	天津	18-41	7-9	1-1	2-4	7-9	0-0	3-4	38-68	55.9	6	6
14	7	张青	天津	14-31	2-6	2-2	4-5	7-8	0-0	3-4	32-56	57.1	6	6
15	11	黎涛	安徽	1-10	1-1	4-6	3-5	4-5	0-0	7-8	20-35	57.1	6	6
16	21	刘江	江苏	1-6	3-5	0-0	9-10	5-5	0-0	0-0	18-26	69.2	6	6
17	12	孔祥杰	北京	0-0	0-0	0-0	0-0	0-0	0-0	0-0	0-0	0.0	6	6
18	12	王权	江苏	0-1	0-0	0-0	0-0	0-0	0-0	0-0	0-1	0.0	6	6
19	10	周仲坤	广东	16-36	4-11	0-0	1-3	2-4	0-0	1-2	24-56	42.9	5	6
20	4	张家纬	江苏	3-5	3-4	1-1	5-7	4-5	0-1	2-2	18-25	72.0	5	6
21	11	蒋承骅	上海	2-5	3-7	1-3	1-1	2-2	1-2	0-1	10-21	47.6	5	6
22	8	周小坚	江苏	0-2	4-8	0-0	2-3	1-1	0-0	1-1	8-15	53.3	5	5
23	1	刘宗其	天津	0-0	0-0	0-0	0-0	0-0	0-0	0-0	0-0	0.0	5	6
24	14	沈吉磊	上海	13-30	9-15	1-1	1-1	21-24	1-2	5-8	51-81	63.0	4	6
25	29	逯明松	北京	9-20	6-8	1-2	1-1	2-3	0-1	1-2	20-37	54.1	4	6
26	26	姚雪岩	广东	4-10	14-22	0-0	1-2	0-1	1-6	0-0	20-41	48.8	4	6
27	10	郝可鑫	江苏	11-18	0-0	0-0	1-1	0-1	1-1	2-3	15-24	62.5	4	6
28	12	王雨	广东	0-0	3-5	4-8	2-5	1-1	0-0	0-0	10-19	52.6	4	6
29	7	卞友山	北京	0-1	4-7	0-0	1-1	2-2	0-0	0-0	7-11	63.6	4	6
30	17	袁振典	北京	1-3	0-1	0-0	0-0	4-5	0-0	0-0	5-9	55.6	4	6
31	35	高云健	北京	0-0	0-0	0-0	0-0	0-0	0-0	0-0	0-0	0.0	4	6
32	8	钱为玮	上海	4-10	4-8	12-19	11-13	1-5	0-2	1-1	33-58	56.9	3	6
33	4	徐俊吉	上海	0-1	20-22	0-2	7-7	0-0	0-0	0-0	27-32	84.4	3	6
34	1	郭世伟	安徽	4-7	1-5	0-1	5-6	6-7	0-0	0-1	16-27	59.3	3	6
35	5	闫亮	江苏	0-0	5-5	1-1	1-2	0-0	0-0	0-0	7-8	87.5	3	6
36	10	李明远	北京	2-13	2-5	0-0	0-0	0-2	0-0	0-0	4-20	20.0	3	6
37	25	程海津	北京	0-1	0-0	0-0	1-1	0-0	0-0	0-1	1-3	33.3	3	6
38	15	张建杰	广东	6-32	6-10	0-1	4-5	4-6	1-5	0-1	21-60	35.0	2	6
39	9	陈开勇	安徽	0-0	11-16	0-2	7-11	0-0	1-2	0-0	19-31	61.3	2	6
40	6	赵一涵	北京	1-11	4-12	1-2	0-0	6-11	0-0	0-0	12-36	33.3	2	6
41	2	张文斌	上海	3-3	0-0	0-1	1-1	3-3	0-0	0-0	7-8	87.5	2	6
42	3	陈强龙	安徽	0-0	4-5	0-0	2-4	0-0	0-0	0-0	6-9	66.7	2	6
43	22	任启双	江苏	0-0	6-9	0-0	0-2	0-0	0-0	0-0	6-11	54.5	2	6
44	4	李松浩	天津	0-1	0-0	1-3	0-0	1-2	0-0	1-1	3-7	42.9	2	6
45	11	马益奎	江苏	0-1	1-2	0-0	0-0	1-1	0-0	0-0	2-4	50.0	2	6
46	1	徐畅	江苏	0-0	0-0	0-0	0-0	0-0	0-0	0-0	0-0	0.0	2	6
47	17	王伟强	江苏	0-1	1-3	4-6	12-17	3-3	0-0	5-6	25-36	69.4	1	6





**“绿叶集团”杯2016年全国男子手球超级杯赛**  
得分排名表(场上队员)

正式表  
手球  
男子

截止至第 18场  
按封球

201608018-1611-1/2  
江苏苏州  
20/11/2016 13:00

名次	号码	姓名	球队	抢球	断球	造失误	造犯规	合计	封球	场数
1	6	赵晨	江苏	2	1	0	0	3	15	6
2	5	闫亮	江苏	0	3	1	0	4	13	6
3	21	刘江	江苏	2	3	0	1	6	9	6
4	26	姚雪岩	广东	0	2	0	2	4	7	6
5	4	徐俊吉	上海	0	3	1	0	4	6	6
6	11	蒋承骅	上海	1	4	0	0	5	6	6
7	9	陈开勇	安徽	0	4	0	0	4	5	6
8	3	陈强龙	安徽	1	4	0	1	6	4	6
9	7	卞友山	北京	0	4	1	2	7	4	6
10	18	李双	安徽	1	4	2	0	7	3	6
11	25	程海津	北京	2	5	0	0	7	3	6
12	8	曹悦	天津	0	8	1	0	9	3	6
13	8	周小坚	江苏	0	1	1	0	2	2	5
14	23	陈旭	北京	1	2	0	0	3	2	6
15	18	马麟晓	上海	2	5	0	2	9	2	6
16	10	郝可鑫	江苏	0	2	0	0	2	2	6
17	2	李岳朋	天津	1	4	0	1	6	2	6
18	4	张家纬	江苏	1	4	1	0	6	2	6
19	9	李旭	北京	0	1	1	1	3	1	5
20	10	周仲坤	广东	0	3	0	0	3	1	6
21	22	任启双	江苏	1	0	0	0	1	1	6
22	8	董智景	安徽	2	5	0	0	7	1	6
23	4	李松浩	天津	0	2	0	0	2	1	6
24	3	吴锐樊	北京	0	0	1	0	1	1	6
25	14	沈吉磊	上海	1	0	1	4	6	1	6
26	17	周群	天津	0	2	2	2	6	1	6
27	15	李加昌	江苏	0	0	0	0	0	0	5
28	24	徐安格	安徽	0	1	0	0	1	0	5
29	12	周哲韬	上海	0	0	0	0	0	0	5
30	3	赵时俊	上海	0	0	0	0	0	0	5
31	21	李明	安徽	0	0	0	0	0	0	6
32	35	高云健	北京	0	0	0	0	0	0	6
33	5	史小帆	安徽	0	2	0	1	3	0	6
34	12	孔祥杰	北京	0	0	0	0	0	0	6
35	18	温新宇	北京	0	0	0	0	0	0	6
36	14	田剑侠	天津	0	2	0	0	2	0	6
37	8	赵文宣	北京	0	0	0	2	2	0	6
38	16	刘海亮	天津	0	0	0	0	0	0	6
39	22	魏雨童	天津	0	0	0	0	0	0	6
40	29	逯明松	北京	1	1	0	1	3	0	6
41	35	金永峰	安徽	0	2	0	0	2	0	6
42	26	杨政	北京	0	0	0	0	0	0	6
43	17	王巨柱	安徽	1	0	0	1	2	0	6
44	11	黎涛	安徽	2	6	1	0	9	0	6
45	1	郭世伟	安徽	0	3	0	0	3	0	6
46	6	赵一涵	北京	1	1	0	0	2	0	6
47	10	严龙	安徽	0	0	0	0	0	0	6
48	10	李明远	北京	0	1	0	0	1	0	6







“绿叶集团”杯2016年全国男子手球超级杯赛  
得分排名表(场上队员)

正式表  
手球  
男子

截止至第 18场  
按防守

201608018-1612-1/2  
江苏苏州  
20/11/2016 13:00

名次	号码	姓名	球队	抢球	断球	造失误	造犯规	合计	封球	场数
1	20	黄培杰	广东	3	6	2	3	14	0	6
2	8	钱为玮	上海	3	6	1	1	11	0	6
3	18	马麟晓	上海	2	5	0	2	9	2	6
4	13	许松	天津	1	7	1	0	9	0	6
5	8	曹悦	天津	0	8	1	0	9	3	6
6	11	黎涛	安徽	2	6	1	0	9	0	6
7	13	耿畅	江苏	1	4	0	2	7	0	6
8	7	卞友山	北京	0	4	1	2	7	4	6
9	25	程海津	北京	2	5	0	0	7	3	6
10	18	李双	安徽	1	4	2	0	7	3	6
11	18	高玉杰	广东	0	4	1	2	7	0	6
12	8	董智景	安徽	2	5	0	0	7	1	6
13	7	张青	天津	0	5	0	2	7	0	6
14	15	张建杰	广东	1	6	0	0	7	0	6
15	2	李岳朋	天津	1	4	0	1	6	2	6
16	3	陈强龙	安徽	1	4	0	1	6	4	6
17	17	王伟强	江苏	0	5	1	0	6	0	6
18	12	王雨	广东	1	4	1	0	6	0	6
19	21	刘江	江苏	2	3	0	1	6	9	6
20	14	沈吉磊	上海	1	0	1	4	6	1	6
21	4	张家纬	江苏	1	4	1	0	6	2	6
22	17	周群	天津	0	2	2	2	6	1	6
23	13	王立隆	广东	0	3	1	1	5	0	6
24	11	蒋承骅	上海	1	4	0	0	5	6	6
25	6	王子欣	天津	1	3	0	1	5	0	6
26	9	吴明远	天津	0	4	1	0	5	0	6
27	26	姚雪岩	广东	0	2	0	2	4	7	6
28	5	闫亮	江苏	0	3	1	0	4	13	6
29	23	于敏清	安徽	2	2	0	0	4	0	6
30	4	徐俊吉	上海	0	3	1	0	4	6	6
31	9	陈开勇	安徽	0	4	0	0	4	5	6
32	18	赵楠	江苏	1	0	2	1	4	0	6
33	6	赵晨	江苏	2	1	0	0	3	15	6
34	29	逯明松	北京	1	1	0	1	3	0	6
35	7	徐奕飞	江苏	0	2	0	1	3	0	6
36	5	史小帆	安徽	0	2	0	1	3	0	6
37	2	张文斌	上海	1	1	1	0	3	0	6
38	10	周仲坤	广东	0	3	0	0	3	1	6
39	23	陈旭	北京	1	2	0	0	3	2	6
40	1	郭世伟	安徽	0	3	0	0	3	0	6
41	19	蒋慧捷	上海	0	3	0	0	3	0	6
42	9	李旭	北京	0	1	1	1	3	1	5
43	10	董凯	上海	0	2	0	0	2	0	6
44	4	李松浩	天津	0	2	0	0	2	1	6
45	14	田剑侠	天津	0	2	0	0	2	0	6
46	17	王巨柱	安徽	1	0	0	1	2	0	6
47	17	袁振典	北京	0	1	1	0	2	0	6
48	7	吴双	上海	0	2	0	0	2	0	6





## “绿叶集团”杯2016年全国男子手球超级杯赛

### 得分排名表(场上队员)

正式表  
手球  
男子截止至第 18场  
失误排名表201608018-1613-1/2  
江苏苏州  
20/11/2016 13:00

排序	号码	姓名	球队	传失	接失	两次	四步	侵区	撞人	其它	合计	场数
1	20	黄培杰	广东	17	2	4	2	0	0	0	25	6
2	10	周仲坤	广东	13	2	3	2	0	1	0	21	6
3	6	赵一涵	北京	7	6	2	3	1	2	0	21	6
4	11	黎涛	安徽	9	6	1	0	2	1	0	19	6
5	15	张建杰	广东	12	1	1	1	2	1	0	18	6
6	23	陈旭	北京	13	0	1	2	2	0	0	18	6
7	14	沈吉磊	上海	5	2	3	2	1	4	0	17	6
8	18	李双	安徽	7	1	2	2	1	3	0	16	6
9	26	姚雪岩	广东	3	3	2	2	3	2	1	16	6
10	17	袁振典	北京	11	1	2	1	0	1	0	16	6
11	6	赵晨	江苏	9	1	2	2	0	1	0	15	6
12	8	曹悦	天津	6	3	1	3	1	0	1	15	6
13	7	张青	天津	3	1	1	4	2	2	1	14	6
14	5	史小帆	安徽	9	1	1	0	1	1	1	14	6
15	18	马麟晓	上海	8	1	0	2	0	2	0	13	6
16	10	李明远	北京	9	2	2	0	0	0	0	13	6
17	18	赵楠	江苏	6	3	2	1	0	0	0	12	6
18	17	王伟强	江苏	3	1	1	1	5	0	0	11	6
19	11	蒋承骅	上海	6	2	1	1	1	0	0	11	6
20	8	钱为玮	上海	6	0	0	3	0	1	0	10	6
21	8	董智景	安徽	3	2	0	0	2	1	2	10	6
22	14	田剑侠	天津	6	0	3	0	0	1	0	10	6
23	29	逯明松	北京	6	3	1	0	0	0	0	10	6
24	2	李岳朋	天津	5	1	2	1	0	0	0	9	6
25	4	徐俊吉	上海	2	4	0	0	2	0	1	9	6
26	13	许松	天津	6	2	0	0	0	1	0	9	6
27	21	刘江	江苏	5	1	0	1	0	0	1	8	6
28	7	卞友山	北京	3	1	1	0	2	1	0	8	6
29	13	耿畅	江苏	3	2	2	0	1	0	0	8	6
30	19	蒋慧捷	上海	2	3	0	0	1	2	0	8	6
31	9	吴明远	天津	3	0	0	0	3	1	0	7	6
32	6	王子欣	天津	2	1	2	1	0	1	0	7	6
33	17	高天伦	上海	4	1	0	0	1	0	1	7	6
34	23	于敏清	安徽	4	0	1	0	1	0	0	6	6
35	4	张家纬	江苏	2	0	1	0	2	1	0	6	6
36	20	王鹏皓	北京	1	2	1	0	1	0	0	5	6
37	22	任启双	江苏	0	2	0	0	3	0	0	5	6
38	3	赵时俊	上海	4	0	0	0	0	1	0	5	5
39	2	张文斌	上海	3	0	1	0	0	0	0	4	6
40	18	高玉杰	广东	1	1	0	2	0	0	0	4	6
41	3	陈强龙	安徽	3	1	0	0	0	0	0	4	6
42	10	郝可鑫	江苏	3	0	0	1	0	0	0	4	6
43	35	金永峰	安徽	2	0	2	0	0	0	0	4	6
44	1	郭世伟	安徽	1	0	2	1	0	0	0	4	6
45	17	王巨柱	安徽	3	1	0	0	0	0	0	4	6
46	17	周群	天津	0	1	0	0	2	1	0	4	6
47	21	李明	安徽	4	0	0	0	0	0	0	4	6
48	7	徐奕飞	江苏	2	1	1	0	0	0	0	4	6





## “绿叶集团”杯2016年全国男子手球超级杯赛

## 得分排名表(场上队员)

正式表  
手球  
男子截止至第 18场  
受罚排名表201608018-1614-1/2  
江苏苏州  
20/11/2016 13:00

排序	号码	姓名	球队	警告	罚2分钟	D+DR	场数
1	9	李旭	北京	2	0	1	5
2	18	赵楠	江苏	0	6	0	6
3	25	程海津	北京	3	5	0	6
4	17	袁振典	北京	1	4	0	6
5	14	沈吉磊	上海	5	3	0	6
6	8	曹悦	天津	5	3	0	6
7	17	周群	天津	3	3	0	6
8	15	张建杰	广东	2	3	0	6
9	12	王雨	广东	2	3	0	6
10	26	姚雪岩	广东	2	3	0	6
11	11	蒋承骅	上海	1	3	0	6
12	8	董智景	安徽	0	3	0	6
13	18	李双	安徽	5	2	0	6
14	18	马麟晓	上海	3	2	0	6
15	8	钱为玮	上海	1	2	0	6
16	5	闫亮	江苏	0	2	0	6
17	20	王鹏皓	北京	0	2	0	6
18	35	金永峰	安徽	0	2	0	6
19	11	马益奎	江苏	0	2	0	6
20	24	徐安格	安徽	0	2	0	5
21	3	陈强龙	安徽	4	1	0	6
22	22	任启双	江苏	4	1	0	6
23	7	张青	天津	3	1	0	6
24	23	陈旭	北京	3	1	0	6
25	10	周仲坤	广东	3	1	0	6
26	21	刘江	江苏	3	1	0	6
27	18	高玉杰	广东	2	1	0	6
28	6	赵一涵	北京	2	1	0	6
29	9	陈开勇	安徽	2	1	0	6
30	22	魏雨童	天津	1	1	0	6
31	20	黄培杰	广东	1	1	0	6
32	6	赵晨	江苏	1	1	0	6
33	2	李岳朋	天津	1	1	0	6
34	8	赵文宣	北京	1	1	0	6
35	13	王立隆	广东	1	1	0	6
36	9	吴明远	天津	0	1	0	6
37	10	李明远	北京	0	1	0	6
38	21	潘玉帅	天津	0	1	0	6
39	14	田剑侠	天津	0	1	0	6
40	23	于敏清	安徽	0	1	0	6
41	6	王子欣	天津	0	1	0	6
42	7	徐奕飞	江苏	0	1	0	6
43	13	何磊	安徽	0	1	0	6
44	10	董凯	上海	0	1	0	6
45	4	徐俊吉	上海	3	0	0	6
46	29	逯明松	北京	2	0	0	6
47	3	吴锐樊	北京	2	0	0	6
48	4	张家纬	江苏	1	0	0	6





## “绿叶集团”杯2016年全国男子手球超级杯赛

排名表(守门员)

正式表  
手球  
男子截止至第 18场  
得分排名表201608018-1701-1/1  
江苏苏州  
20/11/2016 13:00

排序	号码	姓名	球队	远射	近射	边射	快攻	突破	任意	7M	合计	%	助攻	场数
1	1	张峥	上海	26-70	26-61	10-20	11-48	9-34	1-2	2-9	85-244	34.8	8	6
2	21	李明	安徽	18-55	15-48	16-36	10-40	5-25	4-8	0-2	68-214	31.8	11	6
3	1	王泽润	广东	15-42	19-65	12-31	8-48	3-32	0-1	6-17	63-236	26.7	1	6
4	12	孔祥杰	北京	21-42	9-33	7-15	6-26	3-17	1-2	2-8	49-143	34.3	6	6
5	12	王权	江苏	22-45	9-23	8-12	6-13	2-13	0-0	1-6	48-112	42.9	6	6
6	1	刘宗其	天津	17-29	10-29	4-14	5-13	3-15	4-7	0-3	43-110	39.1	5	6
7	1	徐畅	江苏	9-20	8-20	3-5	6-12	2-9	3-3	1-5	32-74	43.2	2	6
8	12	杨峻	天津	6-15	8-18	7-13	4-21	1-9	1-3	1-7	28-86	32.6	1	6
9	35	高云健	北京	9-30	8-32	2-8	4-19	2-7	0-0	0-8	25-104	24.0	4	6
10	12	曾献辰	安徽	3-8	2-8	0-1	0-2	1-3	2-2	4-12	12-36	33.3	0	6
11	22	张润明	上海	0-5	1-2	0-1	0-0	0-1	0-1	0-1	1-11	9.1	0	6
12	1	郭世伟	安徽	0-0	0-0	0-0	0-0	0-0	0-0	0-0	0-0	0.0	0	6



## “绿叶集团”杯2016年全国男子手球超级杯赛

排名表(守门员)

正式表  
手球  
男子截止至第 18场  
7M球得分排名表201608018-1703-1/1  
江苏苏州  
20/11/2016 13:00

排序	号码	姓名	球队	远射	近射	边射	快攻	突破	任意	7M	合计	%	助攻	场数
1	1	王泽润	广东	15-42	19-65	12-31	8-48	3-32	0-1	6-17	63-236	35.3	1	6
2	12	曾献辰	安徽	3-8	2-8	0-1	0-2	1-3	2-2	4-12	12-36	33.3	0	6
3	12	孔祥杰	北京	21-42	9-33	7-15	6-26	3-17	1-2	2-8	49-143	25.0	6	6
4	1	张峥	上海	26-70	26-61	10-20	11-48	9-34	1-2	2-9	85-244	22.2	8	6
5	1	徐畅	江苏	9-20	8-20	3-5	6-12	2-9	3-3	1-5	32-74	20.0	2	6
6	12	王权	江苏	22-45	9-23	8-12	6-13	2-13	0-0	1-6	48-112	16.7	6	6
7	12	杨峻	天津	6-15	8-18	7-13	4-21	1-9	1-3	1-7	28-86	14.3	1	6
8	1	郭世伟	安徽	0-0	0-0	0-0	0-0	0-0	0-0	0-0	0-0	0.0	0	6
9	22	张润明	上海	0-5	1-2	0-1	0-0	0-1	0-1	0-1	1-11	0.0	0	6
10	21	李明	安徽	18-55	15-48	16-36	10-40	5-25	4-8	0-2	68-214	0.0	11	6
11	1	刘宗其	天津	17-29	10-29	4-14	5-13	3-15	4-7	0-3	43-110	0.0	5	6
12	35	高云健	北京	9-30	8-32	2-8	4-19	2-7	0-0	0-8	25-104	0.0	4	6



## “绿叶集团”杯2016年全国男子手球超级杯赛

攻防成功率统计总表

20160818-3102-1/1

26/11/16

江苏苏州

序号	球队	比分	进攻成功率												助攻	防守成功率											
			阵地进攻			一传快攻			短传快攻			合计				多打少		少打多		封打抢断	守门员	对方射失	对方失误	合计	%		
			得分	进攻	%	得分	进攻	%	得分	进攻	%	得分	进攻	%		得分	进攻	%	得分							进攻	%
1	安徽	167 : 170	130	319	40.8	19	29	65.5	18	41	43.9	167	389	42.9	12	17	70.6	9	14	64.3	46	61	80	33	36	210	53.4
2	北京	129 : 173	103	336	30.7	12	18	66.7	14	30	46.7	129	384	33.6	12	19	63.2	8	22	36.4	39	43	74	40	41	198	51.8
3	广东	138 : 173	117	330	35.5	11	16	68.8	10	32	31.3	138	378	36.5	14	24	58.3	8	18	44.4	37	54	63	36	28	181	50.0
4	江苏	162 : 106	121	267	45.3	23	31	74.2	18	42	42.9	162	340	47.6	11	15	73.3	9	16	56.3	59	91	80	39	7	217	59.1
5	上海	172 : 169	145	337	43.0	13	19	68.4	14	32	43.8	172	388	44.3	24	35	68.6	2	3	66.7	50	60	86	32	25	203	52.5
6	天津	148 : 125	118	295	40.0	25	31	80.6	5	15	33.3	148	341	43.4	10	17	58.8	9	17	52.9	46	58	71	31	37	197	59.9

注释：进攻 = 进攻次数（射门 + 进攻失误） 对方射失 = 对方射门失误（射失 + 击柱） 防守成功率% = 本方防守合计 / 对方进攻合计



## “绿叶集团”杯2016年全国男子手球超级杯赛

防守技术统计总表

20160818-3402-1/1

26/11/2016

江苏苏州

场次	球队	比分	防守成功						防守（成功：失误）						处罚				守门员				
			封球	抢球	断球	造失	造犯	合计	选位	顶贴	观察	移动	换防	其他	合计	警告 2'	取消	DR	合计	救球	射门	%	
1	安徽	167: 170	13	9	33	3	3	61	0:0	0:0	0:0	0:1	0:0	0:0	0:1	13	13	0	0	26	80	250	32.00
2	北京	129: 173	11	6	16	4	6	43	0:0	0:0	0:0	0:2	0:1	0:0	0:3	17	15	1	0	33	74	247	29.96
3	广东	138: 173	8	5	28	5	8	54	0:0	0:0	0:3	0:0	0:0	0:0	0:3	13	13	0	0	26	63	236	26.69
4	江苏	162: 106	44	8	26	7	6	91	0:0	0:1	0:0	0:0	0:0	0:0	0:2	10	14	0	0	24	80	186	43.01
5	上海	172: 169	15	8	26	4	7	60	0:0	0:5	0:1	0:0	0:0	0:0	0:7	15	11	0	0	26	86	255	33.73
6	天津	148: 125	7	3	37	5	6	58	0:0	0:3	0:4	0:1	0:0	0:0	0:8	14	13	0	0	27	71	196	36.22

注释：造失 = 造对方失误    造犯 = 造对方犯规    DR = 取消资格+报告



“绿叶集团”杯2016年全国男子手球超级杯赛  
球队名单(媒体表)

江苏

201608000-53-1/1

号码	姓名	位置	生日	年龄	俱乐部	身高 (CM)	体重 (KG)	总场次	总进球
1	徐畅	守门员	22/03/1994	22		198	99		
4	张家纬	右后卫	25/09/1992	24		193	90		
5	闫亮	右后卫	23/01/1985	31		202	93		
6	赵晨	左后卫	24/06/1989	27		202	108		
7	徐奕飞	右边锋	13/03/1993	23		182	85		
8	周小坚	底线	13/01/1985	31		198	115		
9	任超凡	中后卫							
10	郝可鑫	中后卫	15/01/1986	30		197	105		
11	马益奎	左边锋							
12	王权	守门员	21/11/1992	23		204	107		
13	耿畅	中后卫							
15	李加昌	左边锋	01/07/1989	27		183	85		
17	王伟强	左边锋	07/01/1993	23		175	75		
18	赵楠	右边锋	07/05/1993	23		188	90		
21	刘江	底线	23/03/1993	23		196	91		
22	任启双	底线							
平均				25.6		193.2	95.3		

## 替换队员

编码	姓名	职务
A	钱红	领队
B	闫威名	主教练
C	贾淑君	教练
D	叶强	教练
E	王建国	医生







## “绿叶集团”杯2016年全国男子手球超级杯赛

个人/全队技术累计表

正式表  
手球  
男子

截至第 18场

201608018-15-1/1  
江苏苏州  
26/11/2016 14:30

号码	姓名	远射	近射	边射	快攻	突破	任意	7M	合计	%	助攻	失误	警告	2'	取消	场次	时间
<b>江苏</b>																	
<i>(场上队员)</i>																	
1	徐畅									0.0%	2					6	01:46:44
4	张家纬	3/5	3/4	1/1	5/7	4/5	0/1	2/2	18/25	72.0%	5	6	1			6	02:52:41
5	闫亮		5/5	1/1	1/2				7/8	87.5%	3	3		2		6	02:15:28
6	赵晨	12/19	6/8		2/2	3/5	4/7		27/41	65.9%	14	15	1	1		6	03:52:08
7	徐奕飞	0/1	3/3	2/4	5/7	1/1	0/2		11/18	61.1%	1	4		1		6	02:36:12
8	周小坚	0/2	4/8		2/3	1/1		1/1	8/15	53.3%	5	4	1			5	01:51:55
9	任超凡		1/1			0/1			1/2	50.0%						6	00:23:08
10	郝可鑫	11/18			1/1	0/1	1/1	2/3	15/24	62.5%	4	4				6	01:23:57
11	马益奎	0/1	1/2			1/1			2/4	50.0%	2	2		2		6	01:10:22
12	王权	0/1							0/1	0.0%	6	2				6	03:35:25
13	耿畅		0/1		1/1	0/1		2/2	3/5	60.0%		8				6	00:58:56
15	李加昌									0.0%						5	00:00:00
17	王伟强	0/1	1/3	4/6	12/17	3/3		5/6	25/36	69.4%	1	11				6	04:48:22
18	赵楠	7/14	7/14	1/2	3/3	3/6		0/1	21/40	52.5%	8	12		6		6	04:57:20
21	刘江	1/6	3/5		9/10	5/5			18/26	69.2%	6	8	3	1		6	03:33:04
22	任启双		6/9		0/2				6/11	54.5%	2	5	4	1		6	01:51:03

**合计**

34/68 40/63 9/14 41/55 21/30 5/11 12/15 162/256 63.3% 59 84 10 14 94

*(守门员)*

1	徐畅	9/20	8/20	3/5	6/12	2/9	3/3	1/5	32/74	43.2%	2					6	01:46:44
12	王权	22/45	9/23	8/12	6/13	2/13		1/6	48/112	42.9%	6	2				6	03:35:25

**合计**

31/65 17/43 11/17 12/25 4/22 3/3 2/11 80/186 43.0% 8 2 12

场上队员：得分/射门

守门员：救球/射门

全队合计	进球	被救	射失	击柱	封球	合计	%
远射	34	16	9	4	5	68	50.0%
近射	40	17	4	2		63	63.5%
边射	9	3	1	1		14	64.3%
快攻	41	9	1	4		55	74.5%
突破	21	6	1	2		30	70.0%
任意	5	4	1	1		11	45.5%
7M	12	2		1		15	80.0%

**已打比赛**

阶段	场次	对手	比分
预赛	1	广东	30:15 (14:12)
预赛	5	上海	25:24 (14:13)
预赛	7	安徽	30:21 (19:10)
预赛	11	北京	22:7 (18:6)
预赛	15	天津	26:19 (14:7)
决赛	18	天津	29:20 (15:11)





“绿叶集团”杯2016年全国男子手球超级杯赛

图式射门区域累计

截止至第18场

201608018-42-1/1

江苏

Table of player statistics for Jiangsu team, including names like 徐畅, 张家纬, 闫亮, etc., and their respective performance metrics in a grid format.

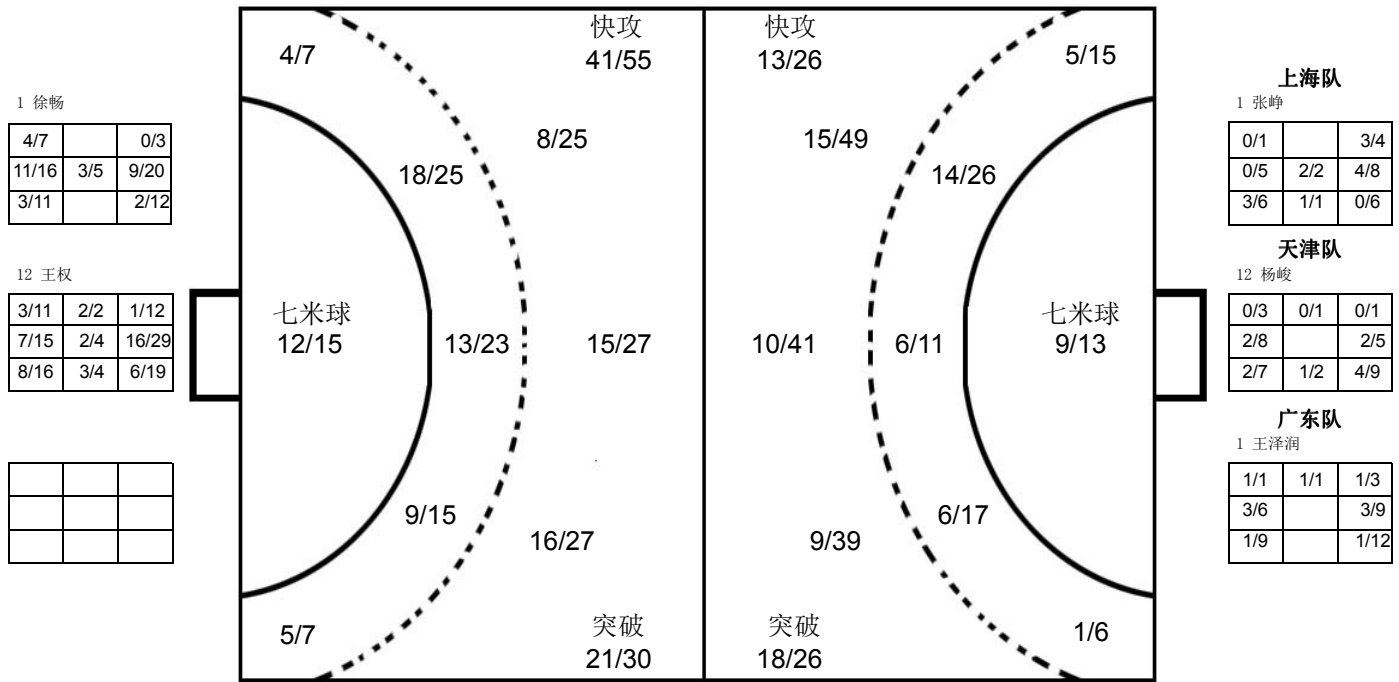

Table of player statistics for the opponent team (对手), including names like 曹悦, 沈吉磊, 郭世伟, etc., and their performance metrics.

注释: Post=击柱 Miss=射失 Block=被封





**“绿叶集团”杯2016年全国男子手球超级杯赛**  
**球队名单(媒体表)**

天津

201608000-53-1/1

号码	姓名	位置	生日	年龄	俱乐部	身高 (CM)	体重 (KG)	总场次	总进球
1	刘宗其	守门员	31/03/1991	25	天津	191	88		
2	李岳朋	后卫	04/12/1986	29	天津	194	95		
4	李松浩	后卫	25/01/1993	23	天津	194	90		
6	王子欣	边锋	17/11/1995	21	天津	190	88		
7	张青	后卫	16/04/1989	27	天津	190	100		
8	曹悦	后卫	23/05/1993	23	天津	200	100		
9	吴明远	边锋	21/03/1996	20	天津	188	85		
12	杨峻	守门员	24/09/1995	21	天津	198	89		
13	许松	边锋	02/04/1992	24	天津	185	82		
14	田剑侠	中后卫	03/09/1986	30	天津	190	90		
16	刘海亮	守门员	07/08/1990	26	天津	193	88		
17	周群	底线	04/04/1994	22	天津	195	100		
21	潘玉帅	左后卫	20/11/1997	19	天津	196	90		
22	魏雨童	底线	05/10/1996	20	天津	197	95		
平均				23.6		192.9	91.4		

## 替换队员

编码	姓名	职务
A	贾守信	领队
B	杜瑞军	主教练
C	孟凡钢	教练
D	潘玉强	教练





## “绿叶集团”杯2016年全国男子手球超级杯赛

个人/全队技术累计表

正式表  
手球  
男子

截至第 18场

201608018-15-1/1  
江苏苏州  
26/11/2016 14:30

号码	姓名	远射	近射	边射	快攻	突破	任意	7M	合计	%	助攻	失误	警告	2'	取消	场次	时间
<b>天津</b>																	
<i>(场上队员)</i>																	
1	刘宗其									0.0%	5					6	03:06:45
2	李岳朋	3/10	3/7	1/2	0/1	1/2			8/22	36.4%	8	9	1	1		6	04:04:15
4	李松浩	0/1		1/3		1/2		1/1	3/7	42.9%	2	3				6	01:18:33
6	王子欣	2/5	5/7	1/5	5/11				13/28	46.4%		7		1		6	04:56:53
7	张青	14/31	2/6	2/2	4/5	7/8		3/4	32/56	57.1%	6	14	3	1		6	04:44:05
8	曹悦	18/41	7/9	1/1	2/4	7/9		3/4	38/68	55.9%	6	15	5	3		6	04:35:38
9	吴明远		1/3	1/2	2/2	1/1		2/3	7/11	63.6%		7		1		6	01:43:43
12	杨峻									0.0%	1					6	02:23:15
13	许松	0/6	1/2	5/11	15/16				21/35	60.0%	8	9	1			6	04:29:42
14	田剑侠	3/5	1/2	2/2		1/1			7/10	70.0%	9	10		1		6	01:56:02
16	刘海亮									0.0%						6	00:00:30
17	周群		9/10						9/10	90.0%		4	3	3		6	03:19:21
21	潘玉帅	0/1	1/1		0/1				1/3	33.3%		2		1		6	00:30:04
22	魏雨童		7/7		2/2				9/9	100%	1	2	1	1		6	02:01:05

<b>合计</b>		40/100	37/54	14/28	30/42	18/23		9/12	148/259	57.1%	46	82	14	13		84	
-----------	--	--------	-------	-------	-------	-------	--	------	---------	-------	----	----	----	----	--	----	--

*(守门员)*

1	刘宗其	17/29	10/29	4/14	5/13	3/15	4/7	0/3	43/110	39.1%	5					6	03:06:45
12	杨峻	6/15	8/18	7/13	4/21	1/9	1/3	1/7	28/86	32.6%	1					6	02:23:15

<b>合计</b>		23/44	18/47	11/27	9/34	4/24	5/10	1/10	71/196	36.2%	6					12	
-----------	--	-------	-------	-------	------	------	------	------	--------	-------	---	--	--	--	--	----	--

场上队员：得分/射门

守门员：救球/射门

全队合计	进球	被救	射失	击柱	封球	合计	%
远射	40	21	10	5	24	100	40.0%
近射	37	9	3	1	4	54	68.5%
边射	14	8	4	2		28	50.0%
快攻	30	12				42	71.4%
突破	18	1	2	2		23	78.3%
任意							0.0%
7M	9	2		1		12	75.0%

已打比赛

阶段	场次	对手	比分
预赛	2	安徽	31:19 (14:7)
预赛	4	广东	22:7 (22:7)
预赛	8	北京	27:18 (13:8)
预赛	10	上海	29:26 (14:15)
预赛	15	江苏	19:26 (7:14)
决赛	18	江苏	20:29 (11:15)





“绿叶集团”杯2016年全国男子手球超级杯赛

图式射门区域累计

截止至第18场

201608018-42-1/1

天津

Player statistics for Tianjin team including names like 刘宗其, 李岳朋, 李松浩, etc., with 3x3 grid data and Post-Miss-Block counts.

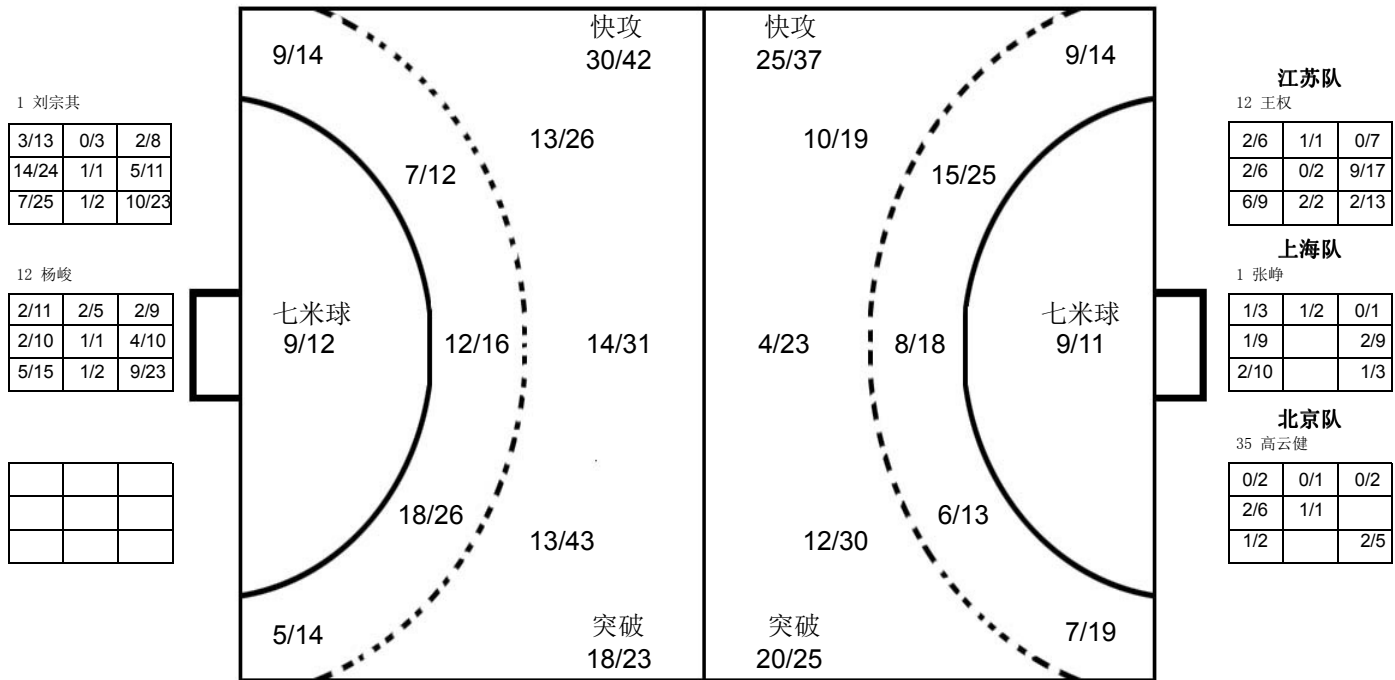

Opponent statistics (对手) for Jiangsu, Shanghai, and Beijing teams, including player names and 3x3 grid data.

注释: Post=击柱 Miss=射失 Block=被封



**“绿叶集团”杯2016年全国男子手球超级杯赛**  
**球队名单(媒体表)**

安徽

201608000-53-1/1

号码	姓名	位置	生日	年龄	俱乐部	身高 (CM)	体重 (KG)	总场次	总进球
1	郭世伟	右边锋	18/02/1997	19		180	70		
3	陈强龙	底线	11/11/1995	21		195	90		
5	史小帆	左后卫	15/03/1995	21		195	75		
7	姚雄敏	后卫	17/02/1993	23		184	80		
8	董智景	左边锋	15/10/1993	23		190	83		
9	陈开勇	底线	18/02/1996	20		192	102		
10	严龙	左边锋	22/05/1994	22		190	75		
11	黎涛	右后卫	28/10/1994	22		187	86		
12	曾献辰	守门员	29/06/1990	26		191	92		
13	何磊	左边锋	22/02/1994	22		188	75		
17	王巨柱	左后卫	17/08/1997	19		194	80		
18	李双	右后卫	07/02/1997	19		192	75		
21	李明	守门员	04/05/1997	19		195	85		
23	于敏清	右边锋	18/05/1991	25		189	80		
24	徐安格	右边锋	05/02/1998	18		185	85		
35	金永峰	底线	06/06/1999	17		189	90		
<b>平均</b>				21.0		189.8	82.7		

## 替换队员

编码	姓名	职务
A	韦中平	领队
B	沈强	主教练
C	吴翔	教练
D	陈玉翔	医生





## “绿叶集团”杯2016年全国男子手球超级杯赛

个人/全队技术累计表

正式表  
手球  
男子201608017-15-1/1  
江苏苏州  
26/11/2016 13:00

截至第 17场

号码	姓名	远射	近射	边射	快攻	突破	任意	7M	合计	%	助攻	失误	警告	2'	取消	场次	时间
<b>安徽</b>																	
<i>(场上队员)</i>																	
1	郭世伟	4/7	1/5	0/1	5/6	6/7		0/1	16/27	59.3%	3	4	1			6	02:51:10
3	陈强龙		4/5		2/4				6/9	66.7%	2	4	4	1		6	03:55:15
5	史小帆	6/11	2/5		1/1				9/17	52.9%	1	14				6	03:56:01
7	姚雄敏									0.0%						6	00:00:00
8	董智景	10/17	6/9	3/10	9/13	6/8		1/1	35/58	60.3%		10		3		6	05:22:52
9	陈开勇		11/16	0/2	7/11		1/2		19/31	61.3%	2	3	2	1		6	02:58:29
10	严龙									0.0%						6	00:00:00
11	黎涛	1/10	1/1	4/6	3/5	4/5		7/8	20/35	57.1%	6	19	1			6	04:32:11
12	曾献辰									0.0%						6	00:45:59
13	何磊		0/1			1/1			1/2	50.0%				1		6	00:18:15
17	王巨柱	12/33	0/1	1/2	3/3	5/5	1/1	1/1	23/46	50.0%	12	4				6	02:12:28
18	李双	8/19	2/4	1/2	4/5	4/7	0/1		19/38	50.0%	7	16	5	2		6	04:30:53
21	李明									0.0%	11	4				6	05:36:20
23	于敏清	2/2	1/1	2/4	3/4				8/11	72.7%	1	6		1		6	02:37:27
24	徐安格	1/3	0/1						1/4	25.0%		3		2		5	01:06:36
35	金永峰	6/14	2/3	1/1	0/1	1/1			10/20	50.0%	1	4		2		6	01:30:21

<b>合计</b>	50/116	30/52	12/28	37/53	27/34	2/4	9/11	167/298	56.0%	46	91	13	13			95
-----------	--------	-------	-------	-------	-------	-----	------	---------	-------	----	----	----	----	--	--	----

*(守门员)*

1	郭世伟									0.0%		1				6	00:48:50
12	曾献辰	3/8	2/8	0/1	0/2	1/3	2/2	4/12	12/36	33.3%						6	00:45:59
21	李明	18/55	15/48	16/36	10/40	5/25	4/8	0/2	68/214	31.8%	11	4				6	05:36:20

<b>合计</b>	21/63	17/56	16/37	10/42	6/28	6/10	4/14	80/250	32.0%	11	5					18
-----------	-------	-------	-------	-------	------	------	------	--------	-------	----	---	--	--	--	--	----

场上队员：得分/射门

守门员：救球/射门

全队合计	进球	被救	射失	击柱	封球	合计	%
远射	50	30	11	9	16	116	43.1%
近射	30	17	5			52	57.7%
边射	12	10	3	3		28	42.9%
快攻	37	13	2	1		53	69.8%
突破	27	6	1			34	79.4%
任意	2	1		1		4	50.0%
7M	9	2				11	81.8%

已打比赛

阶段	场次	对手	比分
预赛	2	天津	19:31 (7:14)
预赛	6	北京	33:27 (14:12)
预赛	7	江苏	21:30 (10:19)
预赛	12	广东	31:27 (18:9)
预赛	13	上海	30:28 (16:15)
3-4名	17	上海	33:27 (17:14)





“绿叶集团”杯2016年全国男子手球超级杯赛

图式射门区域累计

截止至第17场

201608018-42-1/1

安徽

Table of player statistics for Anhui team, including names like 郭世伟, 陈强龙, 史小帆, etc., and their respective performance metrics in a grid format.

Statistics for player 郭世伟 (Guo Shiwei).

Statistics for player 曾献辰 (Zeng Xianchen).

Statistics for player 李明 (Li Ming).

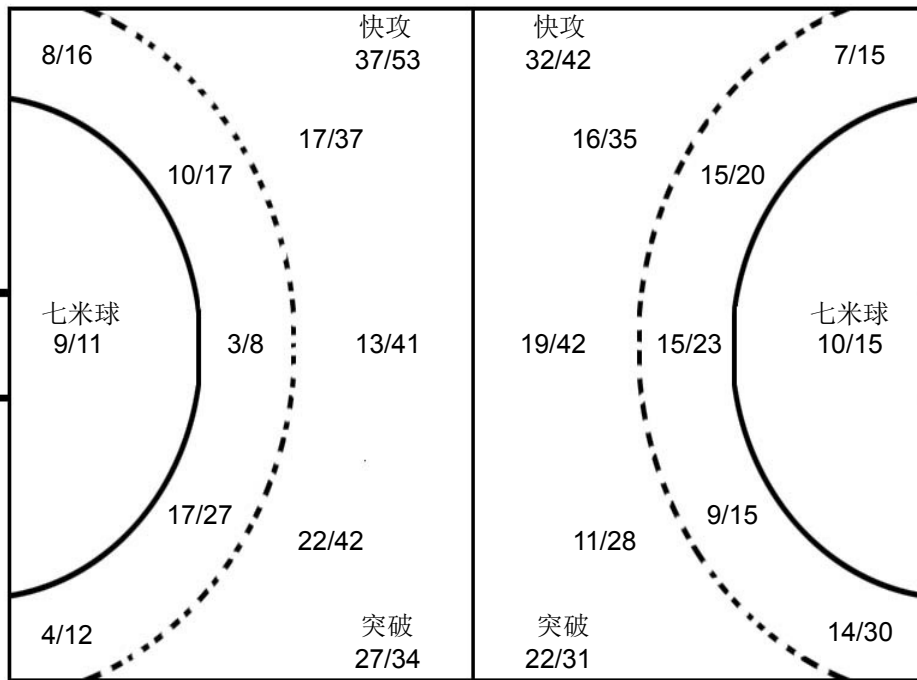

Statistics for Shanghai team (上海队) player 张崢 (Zhang Zhong).

Statistics for Tianjin team (天津队) player 刘宗其 (Liu Zongqi).

Statistics for Jiangsu team (江苏队) player 王权 (Wang Quan).

对手

Table of player statistics for the opponent team, including names like 钱为玮, 张青, 黄培杰, etc., and their performance metrics.

注释: Post=击柱 Miss=射失 Block=被封







**“绿叶集团”杯2016年全国男子手球超级杯赛**  
**球队名单(媒体表)**

上海

201608000-53-1/1

号码	姓名	位置	生日	年龄	俱乐部	身高 (CM)	体重 (KG)	总场次	总进球
1	张崢	守门员	01/04/1988	28		190	90		
2	张文斌	中后卫	14/01/1995	21		185	80		
3	赵时俊	右后卫	07/10/1991	25		184	88		
4	徐俊吉	底线	23/05/1989	27		198	108		
7	吴双	左后卫	12/02/1998	18		193	95		
8	钱为玮	左边锋	17/11/1988	28		192	80		
10	董凯	底线	23/10/1995	21		195	90		
11	蒋承骅	底线	20/01/1991	25		197	110		
12	周哲韬	守门员	13/03/1995	21		190	83		
14	沈吉磊	左后卫	25/04/1995	21		191	86		
15	蒋嘉敏	底线							
16	朱春雷	守门员	19/04/1984	32		196	87		
17	高天伦	右边锋							
18	马麟晓	中后卫	03/09/1989	27		192	88		
19	蒋慧捷	左后卫	12/05/1995	21		188	87		
22	张润明	守门员	12/05/1998	18		181	82		
<b>平均</b>				23.8		190.9	89.6		

## 替换队员

编码	姓名	职务
A	吴璟	主教练
B	张勇军	领队
C	金迪琦	教练
D	杨时	医生





## “绿叶集团”杯2016年全国男子手球超级杯赛

个人/全队技术累计表

正式表  
手球  
男子201608017-15-1/1  
江苏苏州  
26/11/2016 13:00

截至第 17场

号码	姓名	远射	近射	边射	快攻	突破	任意	7M	合计	%	助攻	失误	警告	2'	取消	场次	时间
<b>上海</b>																	
<i>(场上队员)</i>																	
1	张崢	1/1							1/1	100%	8	1				6	05:42:39
2	张文斌	3/3		0/1	1/1	3/3			7/8	87.5%	2	4				6	01:14:25
3	赵时俊	3/5	0/1	2/3	0/2	1/2			6/13	46.2%	1	5	1			5	01:51:42
4	徐俊吉	0/1	20/22	0/2	7/7				27/32	84.4%	3	9	3			6	04:53:30
7	吴双		1/1		2/2				3/3	100%		2				6	00:35:37
8	钱为玮	4/10	4/8	12/19	11/13	1/5	0/2	1/1	33/58	56.9%	3	10	1	2		6	04:49:21
10	董凯	1/3	1/1		0/1			2/3	4/8	50.0%		2		1		6	01:08:00
11	蒋承骅	2/5	3/7	1/3	1/1	2/2	1/2	0/1	10/21	47.6%	5	11	1	3		6	05:26:39
12	周哲韬									0.0%						5	00:00:00
14	沈吉磊	13/30	9/15	1/1	1/1	21/24	1/2	5/8	51/81	63.0%	4	17	5	3		6	04:46:49
15	蒋嘉敏			0/1					0/1	0.0%						6	00:00:45
16	朱春雷									0.0%						6	00:00:00
17	高天伦	0/1	0/3	5/12	1/2				6/18	33.3%		7				6	02:00:27
18	马麟晓	6/24	1/4		2/3	3/3		1/1	13/35	37.1%	24	13	3	2		6	04:38:52
19	蒋慧捷		2/3	7/13	1/3	1/1			11/20	55.0%		8	1			6	04:48:29
22	张润明									0.0%						6	00:17:21

**合计**

33/83 41/65 28/55 27/36 32/40 2/6 9/14 172/299 57.5% 50 89 15 11 94

*(守门员)*

1	张崢	26/70	26/61	10/20	11/48	9/34	1/2	2/9	85/244	34.8%	8	1				6	05:42:39
22	张润明	0/5	1/2	0/1		0/1	0/1	0/1	1/11	9.1%						6	00:17:21

**合计**

26/75 27/63 10/21 11/48 9/35 1/3 2/10 86/255 33.7% 8 1 12

场上队员：得分/射门

守门员：救球/射门

全队合计	进球	被救	射失	击柱	封球	合计	%
远射	33	20	8	8	14	83	39.8%
近射	41	20	2	1	1	65	63.1%
边射	28	20	5	2		55	50.9%
快攻	27	7	2			36	75.0%
突破	32	5	1	2		40	80.0%
任意	2	4				6	33.3%
7M	9	4		1		14	64.3%

**已打比赛**

阶段	场次	对手	比分
预赛	3	北京	30:24 (16:12)
预赛	5	江苏	24:25 (13:14)
预赛	9	广东	37:28 (16:14)
预赛	10	天津	26:29 (15:14)
预赛	13	安徽	28:30 (15:16)
3-4名	17	安徽	27:33 (14:17)





“绿叶集团”杯2016年全国男子手球超级杯赛

图式射门区域累计

截止至第17场

201608018-42-1/1

上海

Table with 16 columns representing players (1-16) and 3 rows of statistics for each player, including Post, Miss, and Block counts.

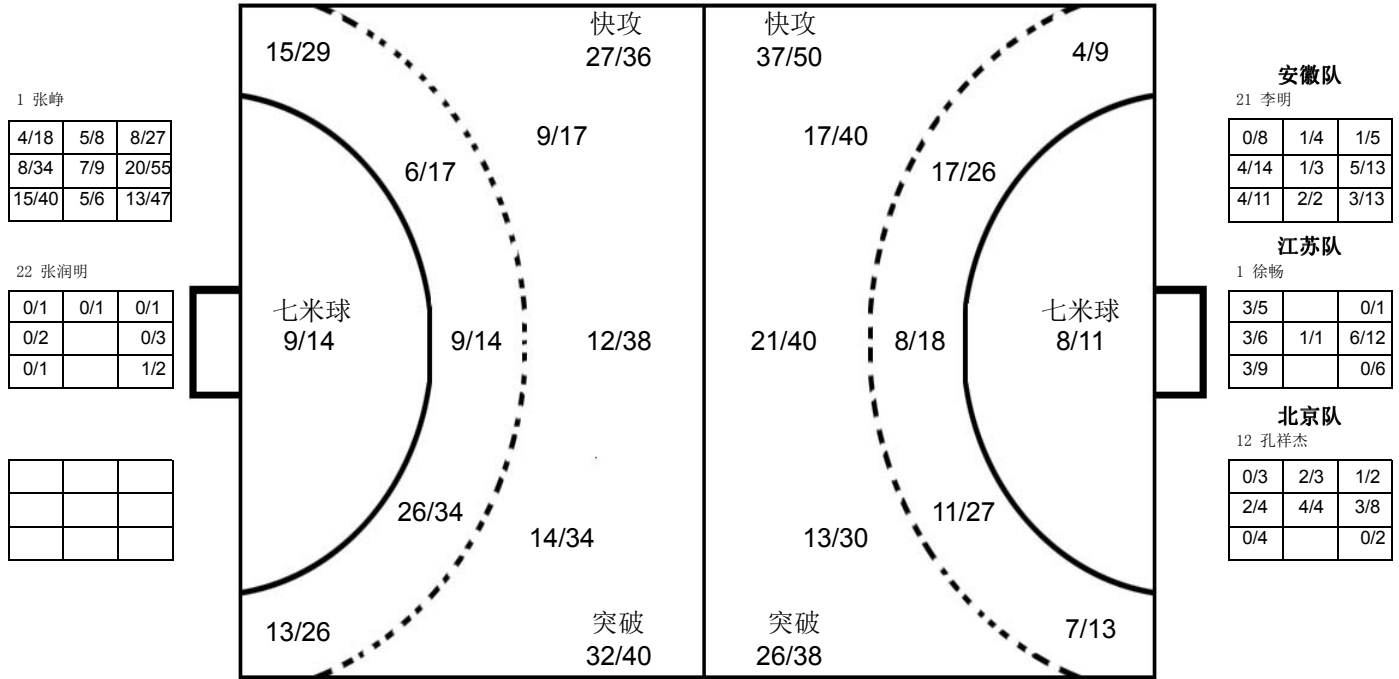

Table with 16 columns representing players from various teams (Anhui, Jiangsu, Tianjin, Guangdong, Beijing) and 3 rows of statistics for each player.

注释: Post=击柱 Miss=射失 Block=被封





“绿叶集团”杯2016年全国男子手球超级杯赛  
球队名单(媒体表)

广东

201608000-53-1/1

号码	姓名	位置	生日	年龄	俱乐部	身高 (CM)	体重 (KG)	总场次	总进球
1	王泽润	守门员	19/02/1998	18	广东省黄村体育训练中心	197			
10	周仲坤	左后卫	02/01/1997	19	广东省黄村体育训练中心	199			
11	房友屯	左边锋	03/01/1995	21	广东省黄村体育训练中心	185			
12	王雨	右后卫	21/06/1995	21	广东省黄村体育训练中心	193			
13	王立隆	后卫	04/01/1995	21	广东省黄村体育训练中心	185			
15	张建杰	左后卫	29/10/1997	19	广东省黄村体育训练中心	192			
18	高玉杰	左后卫	16/10/1998	18	广东省黄村体育训练中心	192			
20	黄培杰	中后卫	15/01/1998	18	广东省黄村体育训练中心	197			
26	姚雪岩	底线	14/11/1996	20	广东省黄村体育训练中心	198			
平均				19.4		193.1			

替换队员

编码	姓名	职务
A	李晓忠	领队
B	刘康伶	主教练
C	刘文宁	教练
D	王永存	医生





## “绿叶集团”杯2016年全国男子手球超级杯赛

个人/全队技术累计表

正式表  
手球  
男子

截至第 16场

201608016-15-1/1  
江苏苏州  
26/11/2016 10:00

号码	姓名	远射	近射	边射	快攻	突破	任意	7M	合计	%	助攻	失误	警告	2'	取消	场次	时间
<b>广东</b>																	
<i>(场上队员)</i>																	
1	王泽润									0.0%	1	1				6	05:37:26
10	周仲坤	16/36	4/11		1/3	2/4		1/2	24/56	42.9%	5	21	3	1		6	05:25:15
12	王雨		3/5	4/8	2/5	1/1			10/19	52.6%	4	3	2	3		6	05:29:12
13	王立隆	0/3	4/6	3/7	2/4	1/1		0/1	10/22	45.5%			1	1		6	03:16:42
15	张建杰	6/32	6/10	0/1	4/5	4/6	1/5	0/1	21/60	35.0%	2	18	2	3		6	05:47:53
18	高玉杰	0/1	0/1	4/11	5/7	1/1			10/21	47.6%	1	4	2	1		6	02:31:10
20	黄培杰	8/19	6/13	1/1	6/10	8/12	1/1	13/15	43/71	60.6%	20	25	1	1		6	05:18:50
26	姚雪岩	4/10	14/22		1/2	0/1	1/6		20/41	48.8%	4	16	2	3		6	05:29:13
<b>合计</b>																	
		34/101	37/68	12/28	21/36	17/26	3/12	14/19	138/290	47.6%	37	88	13	13		48	
<i>(守门员)</i>																	
1		15/42	19/65	12/31	8/48	3/32	0/1	6/17	63/236	26.7%	1	1				6	05:37:26
<b>合计</b>																	
		15/42	19/65	12/31	8/48	3/32	0/1	6/17	63/236	26.7%	1	1				6	

场上队员：得分/射门

守门员：救球/射门

全队合计	进球	被救	射失	击柱	封球	合计	%
远射	34	32	15	7	13	101	33.7%
近射	37	22	6	1	2	68	54.4%
边射	12	13	2	1		28	42.9%
快攻	21	12	2	1		36	58.3%
突破	17	6		3		26	65.4%
任意	3	6	3			12	25.0%
7M	14	3	1	1		19	73.7%

## 已打比赛

阶段	场次	对手	比分
预赛	1	江苏	15:30 (12:14)
预赛	4	天津	7:22 (7:22)
预赛	9	上海	28:37 (14:16)
预赛	12	安徽	27:31 (9:18)
预赛	14	北京	30:23 (15:10)
5-6名	16	北京	31:30 (13:16)





“绿叶集团”杯2016年全国男子手球超级杯赛

图式射门区域累计

截止至第16场

201608018-42-1/1

广东

1 王泽润	10 周仲坤	12 王雨	13 王立隆	15 张建杰	18 高玉杰	20 黄培杰	26 姚雪岩																																																																								
<table border="1"><tr><td></td><td></td><td></td></tr><tr><td></td><td></td><td></td></tr><tr><td></td><td></td><td></td></tr></table>										<table border="1"><tr><td>4</td><td></td><td>4</td></tr><tr><td>1</td><td>1</td><td>5</td></tr><tr><td>5</td><td></td><td>4</td></tr></table>	4		4	1	1	5	5		4	<table border="1"><tr><td>2</td><td></td><td>2</td></tr><tr><td>1</td><td>1</td><td>2</td></tr><tr><td>1</td><td></td><td>1</td></tr></table>	2		2	1	1	2	1		1	<table border="1"><tr><td></td><td></td><td>1</td></tr><tr><td>4</td><td>1</td><td>1</td></tr><tr><td>1</td><td>2</td><td></td></tr></table>			1	4	1	1	1	2		<table border="1"><tr><td>1</td><td>2</td><td>3</td></tr><tr><td>4</td><td></td><td>2</td></tr><tr><td>2</td><td></td><td>7</td></tr></table>	1	2	3	4		2	2		7	<table border="1"><tr><td>3</td><td>1</td><td></td></tr><tr><td>1</td><td></td><td>2</td></tr><tr><td>3</td><td></td><td></td></tr></table>	3	1		1		2	3			<table border="1"><tr><td></td><td></td><td>6</td></tr><tr><td>4</td><td></td><td>3</td></tr><tr><td>14</td><td>1</td><td></td></tr></table>			6	4		3	14	1		<table border="1"><tr><td>1</td><td></td><td>1</td></tr><tr><td>4</td><td>1</td><td>3</td></tr><tr><td>4</td><td></td><td>6</td></tr></table>	1		1	4	1	3	4		6
4		4																																																																													
1	1	5																																																																													
5		4																																																																													
2		2																																																																													
1	1	2																																																																													
1		1																																																																													
		1																																																																													
4	1	1																																																																													
1	2																																																																														
1	2	3																																																																													
4		2																																																																													
2		7																																																																													
3	1																																																																														
1		2																																																																													
3																																																																															
		6																																																																													
4		3																																																																													
14	1																																																																														
1		1																																																																													
4	1	3																																																																													
4		6																																																																													
Post - 0 Miss - 0 Block - 0	Post - 4 Miss - 4 Block - 7	Post - 0 Miss - 2 Block - 0	Post - 0 Miss - 3 Block - 0	Post - 2 Miss - 10 Block - 6	Post - 2 Miss - 0 Block - 0	Post - 5 Miss - 5 Block - 1	Post - 1 Miss - 5 Block - 1																																																																								

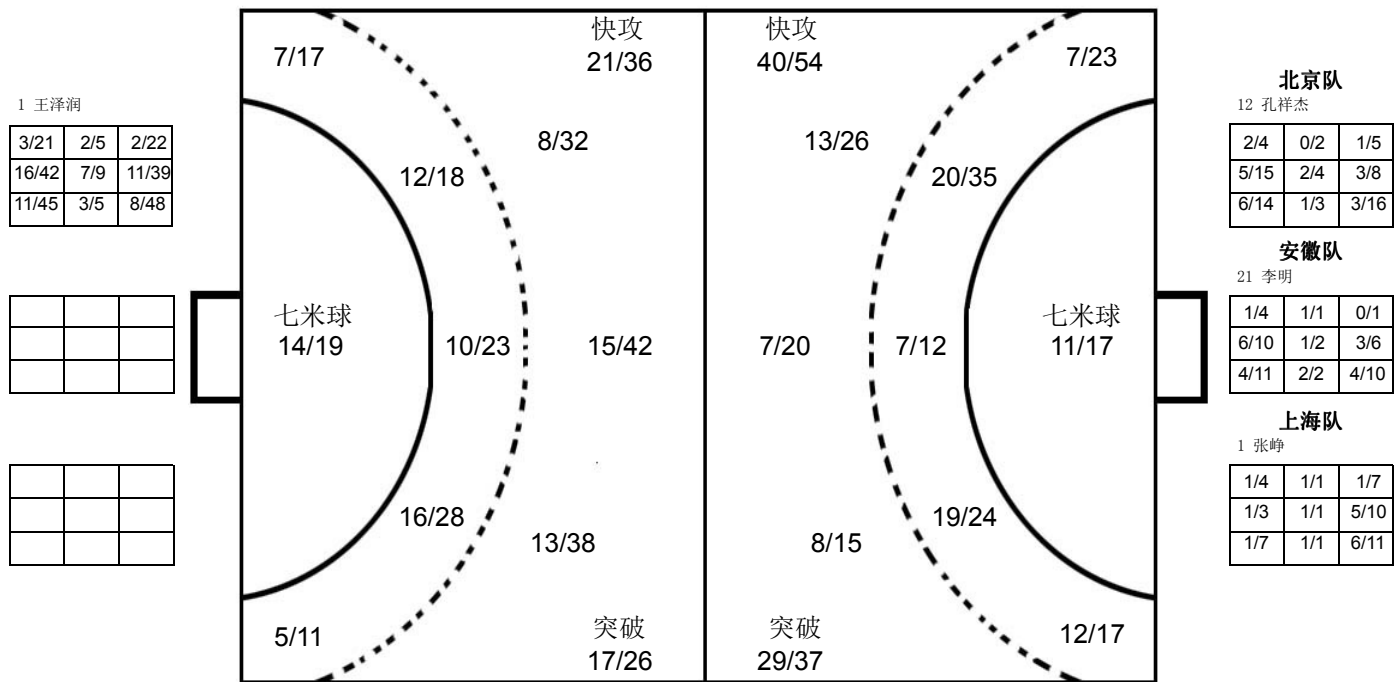
对手

上海 14 沈吉磊	北京 29 逯明松	安徽 8 董智景	北京 20 王鹏皓	北京 6 赵一涵	江苏 17 王伟强	上海 8 钱为玮	北京 8 赵文宣																																																																								
<table border="1"><tr><td>1</td><td></td><td>2</td></tr><tr><td>1</td><td></td><td>3</td></tr><tr><td>2</td><td>1</td><td>2</td></tr></table>	1		2	1		3	2	1	2	<table border="1"><tr><td>2</td><td></td><td>1</td></tr><tr><td>3</td><td></td><td>2</td></tr><tr><td>2</td><td></td><td>1</td></tr></table>	2		1	3		2	2		1	<table border="1"><tr><td>1</td><td>1</td><td>1</td></tr><tr><td>2</td><td>1</td><td></td></tr><tr><td>2</td><td></td><td>1</td></tr></table>	1	1	1	2	1		2		1	<table border="1"><tr><td>1</td><td></td><td>1</td></tr><tr><td>1</td><td></td><td>1</td></tr><tr><td>3</td><td></td><td>2</td></tr></table>	1		1	1		1	3		2	<table border="1"><tr><td>2</td><td></td><td>2</td></tr><tr><td>1</td><td></td><td></td></tr><tr><td>3</td><td></td><td></td></tr></table>	2		2	1			3			<table border="1"><tr><td></td><td></td><td></td></tr><tr><td>1</td><td></td><td>2</td></tr><tr><td>2</td><td></td><td>2</td></tr></table>				1		2	2		2	<table border="1"><tr><td>1</td><td>1</td><td>2</td></tr><tr><td></td><td></td><td>2</td></tr><tr><td>1</td><td></td><td></td></tr></table>	1	1	2			2	1			<table border="1"><tr><td>2</td><td></td><td></td></tr><tr><td>2</td><td></td><td>1</td></tr><tr><td></td><td></td><td>1</td></tr></table>	2			2		1			1
1		2																																																																													
1		3																																																																													
2	1	2																																																																													
2		1																																																																													
3		2																																																																													
2		1																																																																													
1	1	1																																																																													
2	1																																																																														
2		1																																																																													
1		1																																																																													
1		1																																																																													
3		2																																																																													
2		2																																																																													
1																																																																															
3																																																																															
1		2																																																																													
2		2																																																																													
1	1	2																																																																													
		2																																																																													
1																																																																															
2																																																																															
2		1																																																																													
		1																																																																													
Post - 1 Miss - 0 Block - 1	Post - 1 Miss - 1 Block - 1	Post - 1 Miss - 2 Block - 0	Post - 2 Miss - 2 Block - 0	Post - 1 Miss - 0 Block - 1	Post - 2 Miss - 0 Block - 0	Post - 1 Miss - 0 Block - 0	Post - 0 Miss - 1 Block - 1																																																																								
上海 4 徐俊吉	北京 7 卞友山	北京 23 陈旭	天津 7 张青	天津 9 吴明远	天津 13 许松	安徽 11 黎涛	安徽 23 于敏清																																																																								
<table border="1"><tr><td></td><td>1</td><td>2</td></tr><tr><td>1</td><td></td><td>1</td></tr><tr><td></td><td></td><td>1</td></tr></table>		1	2	1		1			1	<table border="1"><tr><td></td><td></td><td>1</td></tr><tr><td></td><td>1</td><td></td></tr><tr><td>1</td><td></td><td>2</td></tr></table>			1		1		1		2	<table border="1"><tr><td></td><td></td><td></td></tr><tr><td>2</td><td></td><td></td></tr><tr><td>2</td><td></td><td>1</td></tr></table>				2			2		1	<table border="1"><tr><td>1</td><td></td><td>1</td></tr><tr><td>1</td><td></td><td></td></tr><tr><td>1</td><td></td><td>1</td></tr></table>	1		1	1			1		1	<table border="1"><tr><td></td><td></td><td></td></tr><tr><td>2</td><td></td><td>1</td></tr><tr><td></td><td></td><td>2</td></tr></table>				2		1			2	<table border="1"><tr><td></td><td></td><td></td></tr><tr><td>2</td><td></td><td></td></tr><tr><td>2</td><td></td><td>1</td></tr></table>				2			2		1	<table border="1"><tr><td>2</td><td></td><td></td></tr><tr><td></td><td></td><td>1</td></tr><tr><td></td><td></td><td>1</td></tr></table>	2					1			1	<table border="1"><tr><td></td><td></td><td></td></tr><tr><td></td><td></td><td>1</td></tr><tr><td>1</td><td></td><td>2</td></tr></table>						1	1		2
	1	2																																																																													
1		1																																																																													
		1																																																																													
		1																																																																													
	1																																																																														
1		2																																																																													
2																																																																															
2		1																																																																													
1		1																																																																													
1																																																																															
1		1																																																																													
2		1																																																																													
		2																																																																													
2																																																																															
2		1																																																																													
2																																																																															
		1																																																																													
		1																																																																													
		1																																																																													
1		2																																																																													
Post - 0 Miss - 0 Block - 0	Post - 0 Miss - 1 Block - 0	Post - 1 Miss - 1 Block - 0	Post - 0 Miss - 0 Block - 0	Post - 0 Miss - 0 Block - 0	Post - 0 Miss - 1 Block - 0	Post - 1 Miss - 0 Block - 0	Post - 0 Miss - 0 Block - 0																																																																								

注释: Post=击柱 Miss=射失 Block=被封





**“绿叶集团”杯2016年全国男子手球超级杯赛**  
**球队名单(媒体表)**

北京

201608000-53-1/1

号码	姓名	位置	生日	年龄	俱乐部	身高 (CM)	体重 (KG)	总场次	总进球
3	吴锐樊	左边锋	11/01/2000	16	北京男子手球队	183	75		
6	赵一涵	右后卫	23/10/1997	19	北京男子手球队	190	85		
7	卞友山	底线	15/03/1999	17	北京男子手球队	190	85		
8	赵文宣	底线	10/06/1999	17	北京男子手球队	187	80		
9	李旭	左后卫	16/02/1997	19	北京男子手球队	186	90		
10	李明远	中后卫	24/01/1998	18	北京男子手球队	187	75		
12	孔祥杰	守门员	02/03/1992	24	北京男子手球队	195	92		
17	袁振典	左边锋	03/08/1998	18	北京男子手球队	185	80		
18	温新宇	底线	08/02/1999	17	北京男子手球队	190	85		
20	王鹏皓	右边锋	03/09/1997	19	北京男子手球队	190	80		
23	陈旭	左后卫	22/03/1998	18	北京男子手球队	192	80		
25	程海津	右边锋	23/05/1999	17	北京男子手球队	200	88		
26	杨政	左边锋	22/01/1998	18	北京男子手球队	187	79		
29	逯明松	右后卫	11/02/1998	18	北京男子手球队	192	80		
35	高云健	守门员	26/11/1999	16	北京男子手球队	188	80		
78	王哲一	右边锋	14/06/1999	17	北京男子手球队	185	70		
平均				18.0		189.2	81.5		

## 替换队员

编码	姓名	职务
A	孙铁	领队
B	吴健	主教练
C	刘彦坤	教练
D	陈璇	医生





## “绿叶集团”杯2016年全国男子手球超级杯赛

个人/全队技术累计表

正式表  
手球  
男子201608016-15-1/1  
江苏苏州  
26/11/2016 10:00

截至第 16场

号码	姓名	远射	近射	边射	快攻	突破	任意	7M	合计	%	助攻	失误	警告	2'	取消	场次	时间
<b>北京</b>																	
<i>(场上队员)</i>																	
3	吴锐樊		4/5	4/13	11/15			1/1	20/34	58.8%		2	2			6	03:58:11
6	赵一涵	1/11	4/12	1/2		6/11			12/36	33.3%	2	21	2	1		6	04:09:54
7	卞友山	0/1	4/7		1/1	2/2			7/11	63.6%	4	8	1			6	02:20:04
8	赵文宣	1/2	8/14						9/16	56.3%		2	1	1		6	02:04:56
9	李旭		5/6	0/1	4/6				9/13	69.2%	1	4	2		1	5	03:07:47
10	李明远	2/13	2/5			0/2			4/20	20.0%	3	13		1		6	01:51:33
12	孔祥杰									0.0%	6	3				6	03:42:15
17	袁振典	1/3	0/1			4/5			5/9	55.6%	4	16	1	4		6	01:19:47
18	温新宇		1/1					1/3	2/4	50.0%		1				6	00:11:20
20	王鹏皓	0/4	3/6	2/8	2/2			5/6	12/26	46.2%		5		2		6	02:36:46
23	陈旭	10/28	1/9		3/6	5/7	1/2		20/52	38.5%	8	18	3	1		6	03:54:59
25	程海津	0/1			1/1			0/1	1/3	33.3%	3	1	3	5		6	02:34:18
26	杨政									0.0%						6	00:04:41
29	逯明松	9/20	6/8	1/2	1/1	2/3	0/1	1/2	20/37	54.1%	4	10	2			6	04:01:49
35	高云健									0.0%	4	1				6	02:14:24
78	王哲一		1/4	4/7	3/5				8/16	50.0%		2				6	01:59:27

<b>合计</b>	24/83	39/78	12/33	26/37	19/30	1/3	8/13	129/277	46.6%	39	107	17	15	1	95
-----------	-------	-------	-------	-------	-------	-----	------	---------	-------	----	-----	----	----	---	----

*(守门员)*

12	孔祥杰	21/42	9/33	7/15	6/26	3/17	1/2	2/8	49/143	34.3%	6	3				6	03:42:15
35	高云健	9/30	8/32	2/8	4/19	2/7		0/8	25/104	24.0%	4	1				6	02:14:24

<b>合计</b>	30/72	17/65	9/23	10/45	5/24	1/2	2/16	74/247	30.0%	10	4				12
-----------	-------	-------	------	-------	------	-----	------	--------	-------	----	---	--	--	--	----

场上队员：得分/射门

守门员：救球/射门

全队合计	进球	被救	射失	击柱	封球	合计	%
远射	24	27	6	8	18	83	28.9%
近射	39	30	4	4	1	78	50.0%
边射	12	15	3	3		33	36.4%
快攻	26	7	2	2		37	70.3%
突破	19	7	1	3		30	63.3%
任意	1	1	1			3	33.3%
7M	8	4	1			13	61.5%

已打比赛

阶段	场次	对手	比分
预赛	3	上海	24:30 (12:16)
预赛	6	安徽	27:33 (12:14)
预赛	8	天津	18:27 (8:13)
预赛	11	江苏	7:22 (6:18)
预赛	14	广东	23:30 (10:15)
5-6名	16	广东	30:31 (16:13)







“绿叶集团”杯2016年全国男子手球超级杯赛

图式射门区域累计

截止至第16场

201608018-42-1/1

北京

Table listing player statistics for Beijing team, including names like 3 吴锐樊, 6 赵一涵, 7 卞友山, etc., with their respective goal counts in different positions.

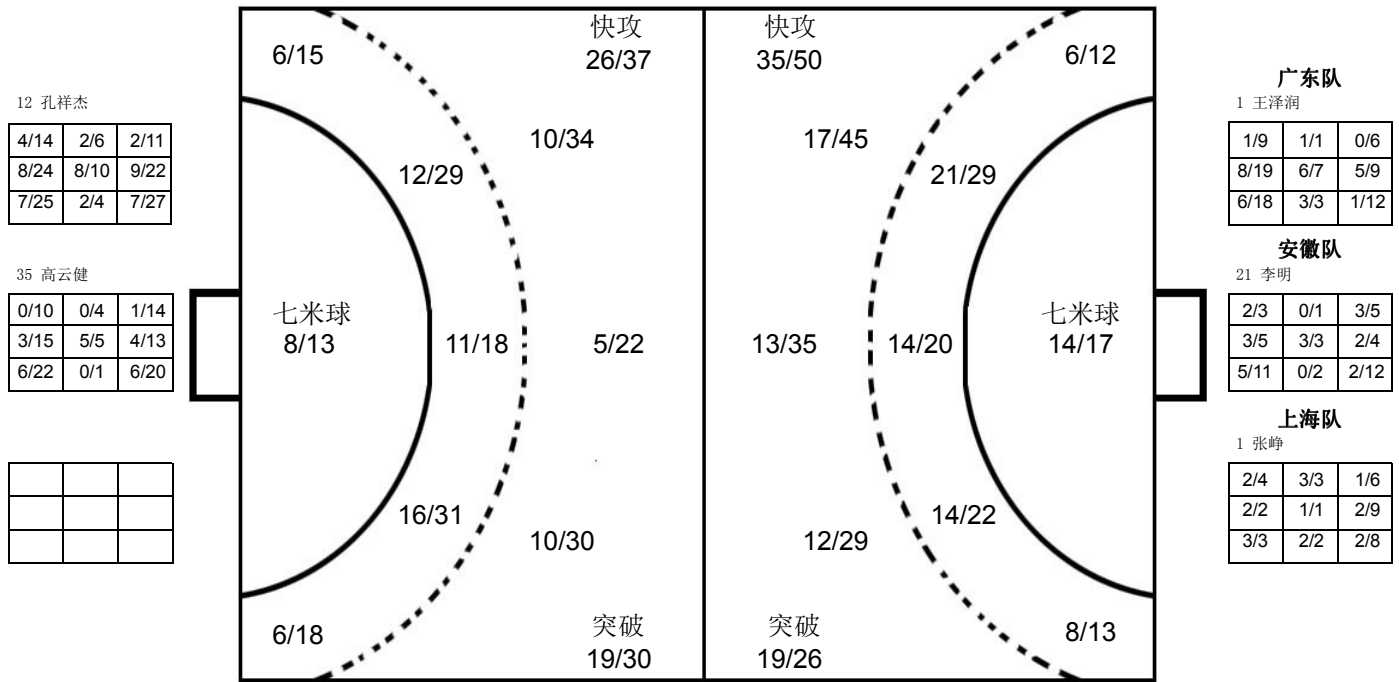

对手

Table listing player statistics for the opponent team, including names like 20 黄培杰, 14 沈吉磊, 13 王立隆, etc., with their respective goal counts.

注释: Post=击柱 Miss=射失 Block=被封





预赛 Group X

男子 全国杯赛

“绿叶集团”杯2016年全国男子手球超级杯赛

Team A					Team B					Match Number											
A 江苏					B 广东					1											
played in			in the hall			on			at		Spectators										
China			苏州市体育中心			20/11/2016			13:00		hours										
Half-time (30')	A	B	End of playing time		A	B	1st extra time		A	B	After penalty										
	14	12	30 15																		
Number of 7 m	A	Team time-out			Full name of players and officials						Team time-out			B	Number of 7 m						
		1	2	3							1	2	3								
	4 / 5													2 / 3							
No.	Team A					G	W	2'	D	DR	No.	Team B					G	W	2'	D	DR
1	徐畅										1	王泽润									
4	张家纬					1					10	周仲坤					5				
5	闫亮					4					12	王雨					2	1			
6	赵晨					4					13	王立隆									
7	徐奕飞					3					15	张建杰					2				
8	周小坚					3	1				18	高玉杰									
9	任超凡										20	黄培杰					4	1			
10	郝可鑫										26	姚雪岩					2				
11	马益奎					2															
12	王权																				
13	耿畅					1															
17	王伟强					7															
18	赵楠					3		2													
21	刘江					2															
22	任启双						1														
B	闫威名 (主教练)										B	刘康伶 (主教练)									
E	王建国										C	刘文宁									
A					Signature of Responsible Official of the Teams (Off. A)										B						
TP	Remarks of Referee / CHA Official																			TP	

Signatures

Referees	李典 (CHN)	倪震 (CHN)		
Techn. Delegates	于中迅 (CHN)	柴业宏 (CHN)		
CHA Official				

Note: Number of 7m Throws Awarded to Team A and B, Goals (G), Warnings (W), Suspensions (2), Direct Disqualification (D), Disqualification with Report (DR) and Team Penalty (TP).

Table Officials: 黄岩 石震坤 Statisticians: 王玮 王羚





### “绿叶集团”杯2016年全国男子手球超级杯赛 竞赛技术统计(媒体表)

预赛	组别	X	轮次	1	场次	1
苏州市体育中心			20/11/2016		201608001-51-1/1	
江苏	江苏	30	vs	15	广东	广东
			14 : 12			

裁判员		李典 (CHN)											倪震 (CHN)										
江苏		远射	近射	边射	快攻	突破	任意球	7m球	合计	%	助攻	失误	警告	2'	D & DR	江苏	比赛进程	广东					
主教练： 闫威名																							
1	徐畅																						
4	张家纬	0/1				1/2		1/3	33.3	2	1												
5	闫亮		3/3	1/1				4/4	100	2													
6	赵晨	1/1	2/3			1/1		4/5	80.0	3	1												
7	徐奕飞	0/1	2/2		1/1			3/4	75.0														
8	周小坚	0/1	1/2			1/1	1/1	3/5	60.0	3		1											
9	任超凡																						
10	郝可鑫																						
11	马益奎			1/1		1/1		2/2	100	2	1												
12	王权	0/1						0/1	0.0	1													
13	耿畅						1/1	1/1	100		3												
17	王伟强			0/1	4/7	1/1		2/2	7/11	63.6		1											
18	赵楠		1/2		1/1	1/1		0/1	3/5	60.0	1	1		2									
21	刘江				1/2	1/1		2/3	66.7	1													
22	任启双									1	1	1											
运动员 合计		1/5	10/13	1/2	7/11	7/8		4/5	30/44	68.2	16	9	2	2									
1	徐畅	2/6	2/5	1/2	1/2	0/2	2/2	0/1	8/20	40.0													
12	王权	6/7	1/1	1/1		0/1		0/1	8/11	72.7	1												
守门员 合计		8/13	3/6	2/3	1/2	0/3	2/2	0/2	16/31	51.6	1												
广东		远射	近射	边射	快攻	突破	任意球	7m球	合计	%	助攻	失误	警告	2'	D & DR								
教练： 刘康伶																							
1	王泽润										1												
10	周仲坤	4/11			0/1	1/1		0/1	5/14	35.7		3											
12	王雨		1/1	1/1	0/1				2/3	66.7			1										
13	王立隆		0/1						0/1	0.0													
15	张建杰	1/5	1/3	0/1			0/1		2/10	20.0	1	6											
18	高玉杰			0/2					0/2	0.0													
20	黄培杰	0/1	0/2			2/4		2/2	4/9	44.4	1	4	1										
26	姚雪岩	0/3	1/1		1/1		0/1		2/6	33.3	1	1											
运动员 合计		5/20	3/8	1/4	1/3	3/5	0/2	2/3	15/45	33.3	4	14	2										
1	王泽润	3/4	3/13	0/1	3/10	1/8		1/5	11/41	26.8	1												
守门员 合计		3/4	3/13	0/1	3/10	1/8		1/5	11/41	26.8	1												

场上队员： 得分 / 射门

守门员： 救球 / 射门

快攻	Fast Break		突破	Breakthrough		任意球	Free Throw		7M球	7M Throw		助攻	Assist
警告	Warning		失误	Error		2'	Suspension		D	取消资格		DR	取消资格+报告





## “绿叶集团”杯2016年全国男子手球超级杯赛 图式比赛技术统计表

轮次 1

场次 1

201608001-21-1/1

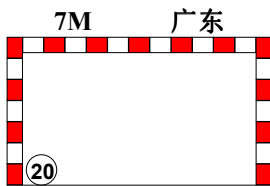
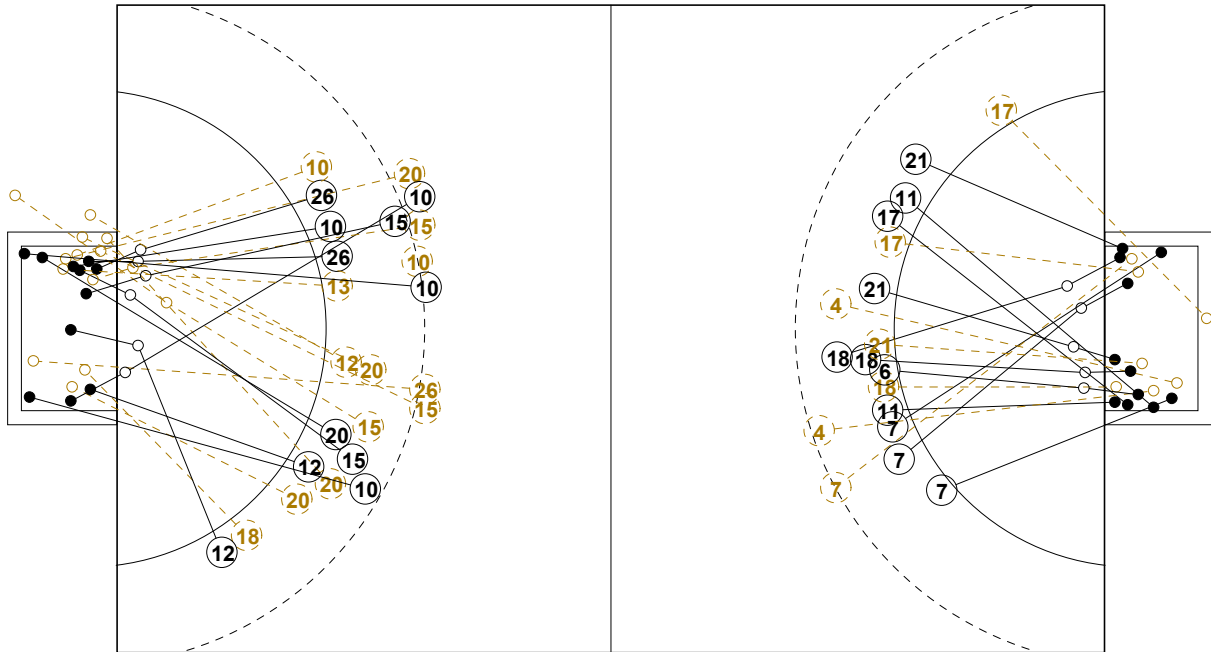

1st Half  
12 : 14

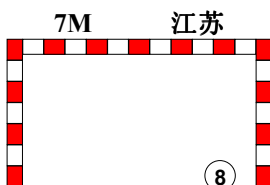
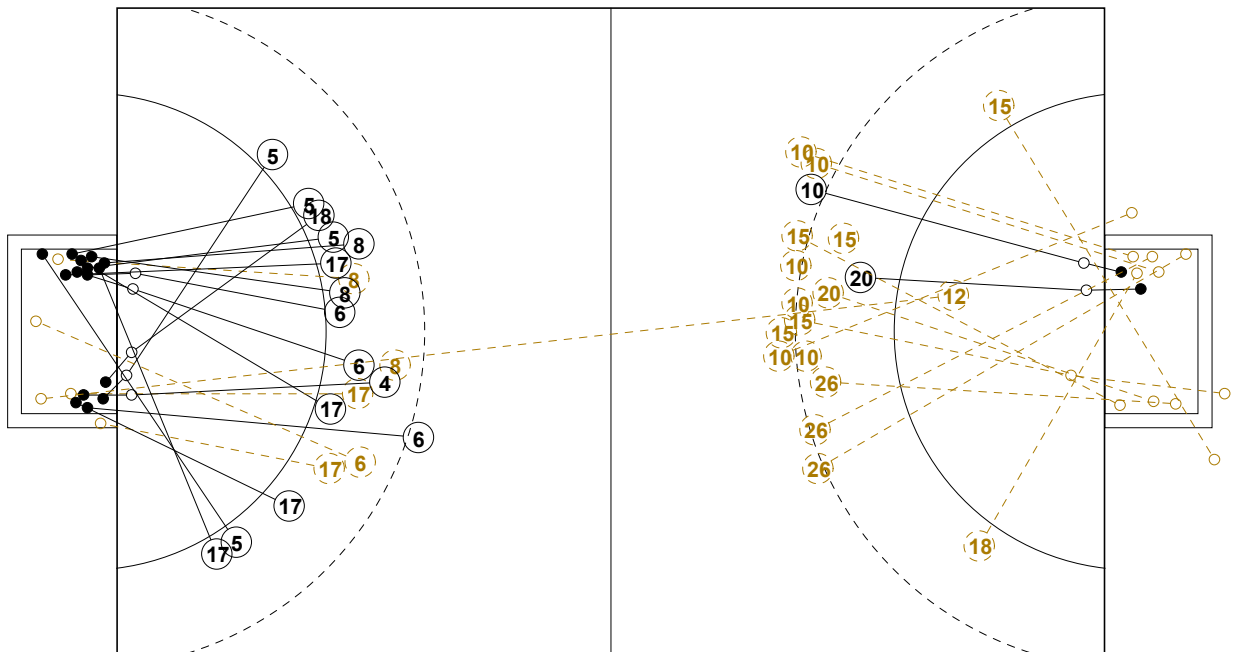
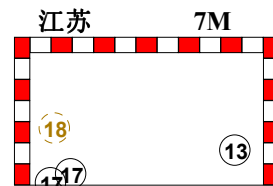

2nd Half  
30 : 15

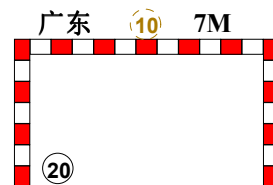



## “绿叶集团”杯2016年全国男子手球超级杯赛

## 个人/全队技术统计表

正式表  
手球  
男子预赛  
轮次 1组别 X  
场次 1201608001-14-1/2  
苏州市体育中心  
20/11/2016 13:00

号码	姓名	远射	近射	边射	快攻	突破	任意	7M	合计	%	助攻	失误	警告	2'	取消	时间
<b>江苏(江苏)</b>																
<i>(场上队员)</i>																
1	徐畅									0.0%						00:30:00
4	张家纬	0/1				1/2			1/3	33.3%	2	1				00:33:13
5	闫亮		3/3	1/1					4/4	100%	2					00:18:43
6	赵晨	1/1	2/3			1/1			4/5	80.0%	3	1				00:33:04
7	徐奕飞	0/1	2/2		1/1				3/4	75.0%						00:18:30
8	周小坚	0/1	1/2			1/1		1/1	3/5	60.0%	3		1			00:32:49
9	任超凡									0.0%						00:00:00
10	郝可鑫									0.0%						00:00:00
11	马益奎		1/1			1/1			2/2	100%	2	1				00:14:20
12	王权	0/1							0/1	0.0%	1					00:18:43
13	耿畅							1/1	1/1	100%		3				00:13:52
17	王伟强			0/1	4/7	1/1		2/2	7/11	63.6%		1				00:48:43
18	赵楠		1/2		1/1	1/1		0/1	3/5	60.0%	1	1		2		00:45:42
21	刘江				1/2	1/1			2/3	66.7%	1					00:17:21
22	任启双									0.0%	1	1	1			00:15:53
<b>合计</b>		1/5	10/13	1/2	7/11	7/8		4/5	30/44	68.2%	16	9	2	2		
<i>(守门员)</i>																
1	徐畅	2/6	2/5	1/2	1/2	0/2	2/2	0/1	8/20	40.0%						00:30:00
12	王权	6/7	1/1	1/1		0/1		0/1	8/11	72.7%	1					00:18:43
<b>合计</b>		8/13	3/6	2/3	1/2	0/3	2/2	0/2	16/31	51.6%	1					

场上队员：得分/射门

守门员：救球/射门

全队合计	得分	被救	射失	击柱	封球	合计	%
远射	1	3			1	5	20.0%
近射	10	3				13	76.9%
边射	1			1		2	50.0%
快攻	7	3		1		11	63.6%
突破	7	1				8	87.5%
任意							0.0%
7M	4	1				5	80.0%





## “绿叶集团”杯2016年全国男子手球超级杯赛

## 个人/全队技术统计表

正式表  
手球  
男子预赛  
轮次 1组别 X  
场次 1201608001-14-2/2  
苏州市体育中心  
20/11/2016 13:00

号码	姓名	远射	近射	边射	快攻	突破	任意	7M	合计	%	助攻	失误	警告	2'	取消	时间
<b>广东(广东)</b>																
<i>(上场队员)</i>																
1	王泽润									0.0%	1					00:48:43
10	周仲坤	4/11			0/1	1/1		0/1	5/14	35.7%		3				00:48:43
12	王雨		1/1	1/1	0/1				2/3	66.7%			1			00:48:43
13	王立隆		0/1						0/1	0.0%						00:34:07
15	张建杰	1/5	1/3	0/1			0/1		2/10	20.0%	1	6				00:44:34
18	高玉杰			0/2					0/2	0.0%						00:22:19
20	黄培杰	0/1	0/2			2/4		2/2	4/9	44.4%	1	4	1			00:45:06
26	姚雪岩	0/3	1/1		1/1		0/1		2/6	33.3%	1	1				00:48:43

<b>合计</b>		5/20	3/8	1/4	1/3	3/5	0/2	2/3	15/45	33.3%	4	14	2			
<i>(守门员)</i>																

1		3/4	3/13	0/1	3/10	1/8		1/5	11/41	26.8%	1					00:48:43
---	--	-----	------	-----	------	-----	--	-----	-------	-------	---	--	--	--	--	----------

<b>合计</b>		3/4	3/13	0/1	3/10	1/8		1/5	11/41	26.8%	1					
-----------	--	-----	------	-----	------	-----	--	-----	-------	-------	---	--	--	--	--	--

场上队员：得分/射门

守门员：救球/射门

全队合计	得分	被救	射失	击柱	封球	合计	%
远射	5	8	2		5	20	25.0%
近射	3	3	1		1	8	37.5%
边射	1	2	1			4	25.0%
快攻	1	1	1			3	33.3%
突破	3			2		5	60.0%
任意		2				2	0.0%
7M	2		1			3	66.7%





“绿叶集团”杯2016年全国男子手球超级杯赛

图式射门区域统计

轮次 1 场次 1

201608001-41-1/1

江苏

1 徐畅	4 张家纬	5 闫亮	6 赵晨	7 徐奕飞	8 周小坚	9 任超凡	10 郝可鑫																																																																								
<table border="1"><tr><td></td><td></td><td></td></tr><tr><td></td><td></td><td></td></tr><tr><td></td><td></td><td></td></tr></table>										<table border="1"><tr><td></td><td></td><td></td></tr><tr><td>1</td><td></td><td></td></tr><tr><td></td><td></td><td></td></tr></table>				1						<table border="1"><tr><td></td><td></td><td>1</td></tr><tr><td></td><td></td><td>1</td></tr><tr><td>1</td><td></td><td>1</td></tr></table>			1			1	1		1	<table border="1"><tr><td></td><td></td><td></td></tr><tr><td></td><td></td><td>2</td></tr><tr><td>1</td><td></td><td>1</td></tr></table>						2	1		1	<table border="1"><tr><td></td><td></td><td>1</td></tr><tr><td>1</td><td></td><td></td></tr><tr><td>1</td><td></td><td></td></tr></table>			1	1			1			<table border="1"><tr><td></td><td></td><td></td></tr><tr><td></td><td></td><td></td></tr><tr><td></td><td></td><td>3</td></tr></table>									3	<table border="1"><tr><td></td><td></td><td></td></tr><tr><td></td><td></td><td></td></tr><tr><td></td><td></td><td></td></tr></table>										<table border="1"><tr><td></td><td></td><td></td></tr><tr><td></td><td></td><td></td></tr><tr><td></td><td></td><td></td></tr></table>									
1																																																																															
		1																																																																													
		1																																																																													
1		1																																																																													
		2																																																																													
1		1																																																																													
		1																																																																													
1																																																																															
1																																																																															
		3																																																																													
Post - 0 Miss - 0 Block - 0	Post - 0 Miss - 0 Block - 0	Post - 0 Miss - 0 Block - 0	Post - 0 Miss - 0 Block - 0	Post - 0 Miss - 0 Block - 0	Post - 0 Miss - 0 Block - 1	Post - 0 Miss - 0 Block - 0	Post - 0 Miss - 0 Block - 0																																																																								
11 马益奎	12 王权	13 耿畅	17 王伟强	18 赵楠	21 刘江	22 任启双																																																																									
<table border="1"><tr><td></td><td></td><td></td></tr><tr><td></td><td></td><td>1</td></tr><tr><td></td><td></td><td>1</td></tr></table>						1			1	<table border="1"><tr><td></td><td></td><td></td></tr><tr><td></td><td></td><td></td></tr><tr><td></td><td></td><td></td></tr></table>										<table border="1"><tr><td></td><td></td><td></td></tr><tr><td></td><td></td><td></td></tr><tr><td></td><td></td><td>1</td></tr></table>									1	<table border="1"><tr><td></td><td></td><td></td></tr><tr><td>1</td><td></td><td>2</td></tr><tr><td>2</td><td></td><td>2</td></tr></table>				1		2	2		2	<table border="1"><tr><td></td><td></td><td></td></tr><tr><td></td><td></td><td></td></tr><tr><td>2</td><td></td><td>1</td></tr></table>							2		1	<table border="1"><tr><td></td><td></td><td></td></tr><tr><td></td><td></td><td></td></tr><tr><td>1</td><td></td><td>1</td></tr></table>							1		1	<table border="1"><tr><td></td><td></td><td></td></tr><tr><td></td><td></td><td></td></tr><tr><td></td><td></td><td></td></tr></table>										<table border="1"><tr><td></td><td></td><td></td></tr><tr><td></td><td></td><td></td></tr><tr><td></td><td></td><td></td></tr></table>									
		1																																																																													
		1																																																																													
		1																																																																													
1		2																																																																													
2		2																																																																													
2		1																																																																													
1		1																																																																													
Post - 0 Miss - 0 Block - 0	Post - 0 Miss - 0 Block - 0	Post - 0 Miss - 0 Block - 0	Post - 2 Miss - 0 Block - 0	Post - 0 Miss - 0 Block - 0	Post - 0 Miss - 0 Block - 0	Post - 0 Miss - 0 Block - 0																																																																									

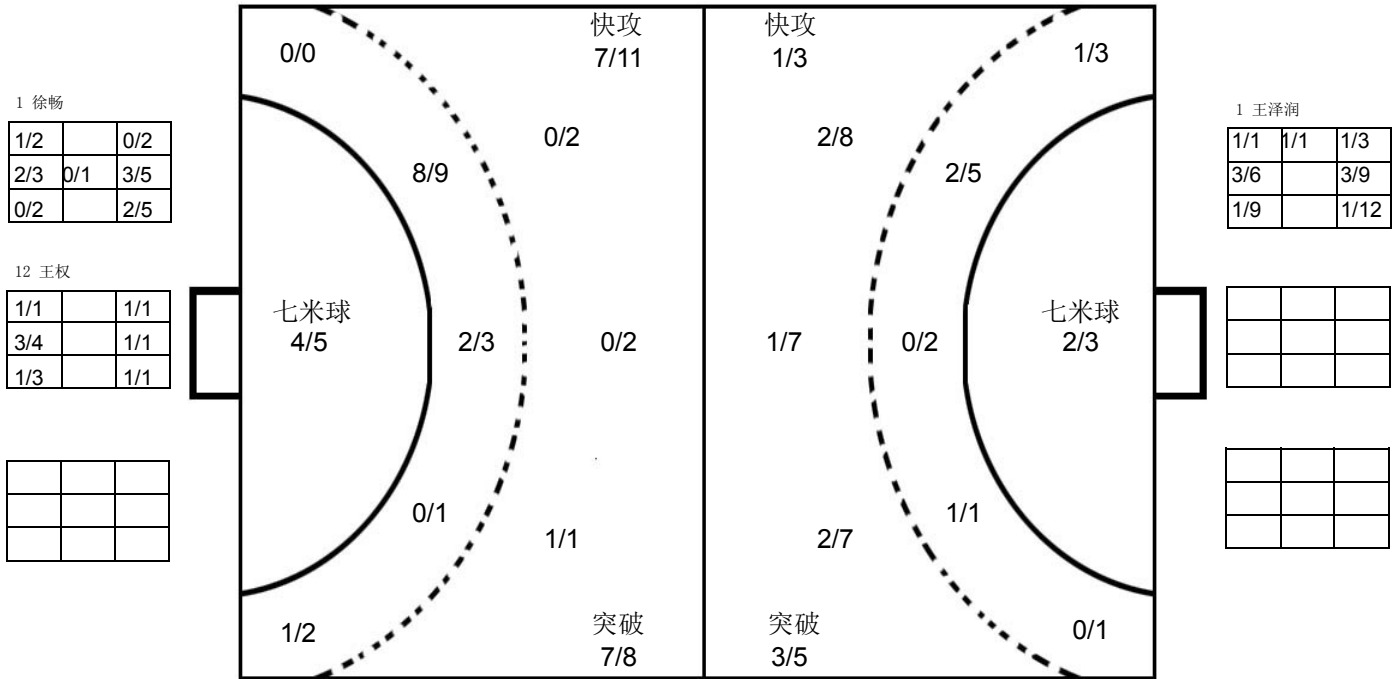

广东

1 王泽润	10 周仲坤	12 王雨	13 王立隆	15 张建杰	18 高玉杰	20 黄培杰	26 姚雪岩																																																																								
<table border="1"><tr><td></td><td></td><td></td></tr><tr><td></td><td></td><td></td></tr><tr><td></td><td></td><td></td></tr></table>										<table border="1"><tr><td></td><td>1</td><td>1</td></tr><tr><td></td><td>1</td><td>1</td></tr><tr><td></td><td>1</td><td></td></tr></table>		1	1		1	1		1		<table border="1"><tr><td></td><td></td><td></td></tr><tr><td></td><td>1</td><td></td></tr><tr><td>1</td><td></td><td></td></tr></table>					1		1			<table border="1"><tr><td></td><td></td><td></td></tr><tr><td></td><td></td><td></td></tr><tr><td></td><td></td><td></td></tr></table>										<table border="1"><tr><td></td><td></td><td></td></tr><tr><td></td><td></td><td>1</td></tr><tr><td></td><td></td><td>1</td></tr></table>						1			1	<table border="1"><tr><td></td><td></td><td></td></tr><tr><td></td><td></td><td></td></tr><tr><td></td><td></td><td></td></tr></table>										<table border="1"><tr><td></td><td></td><td>1</td></tr><tr><td></td><td>1</td><td></td></tr><tr><td>2</td><td></td><td></td></tr></table>			1		1		2			<table border="1"><tr><td></td><td></td><td></td></tr><tr><td></td><td></td><td></td></tr><tr><td></td><td></td><td>2</td></tr></table>									2
	1	1																																																																													
	1	1																																																																													
	1																																																																														
	1																																																																														
1																																																																															
		1																																																																													
		1																																																																													
		1																																																																													
	1																																																																														
2																																																																															
		2																																																																													
Post - 0 Miss - 0 Block - 0	Post - 0 Miss - 2 Block - 4	Post - 0 Miss - 1 Block - 0	Post - 0 Miss - 0 Block - 0	Post - 0 Miss - 3 Block - 2	Post - 0 Miss - 0 Block - 0	Post - 2 Miss - 0 Block - 0	Post - 0 Miss - 0 Block - 0																																																																								
<table border="1"><tr><td></td><td></td><td></td></tr><tr><td></td><td></td><td></td></tr><tr><td></td><td></td><td></td></tr></table>										<table border="1"><tr><td></td><td></td><td></td></tr><tr><td></td><td></td><td></td></tr><tr><td></td><td></td><td></td></tr></table>										<table border="1"><tr><td></td><td></td><td></td></tr><tr><td></td><td></td><td></td></tr><tr><td></td><td></td><td></td></tr></table>										<table border="1"><tr><td></td><td></td><td></td></tr><tr><td></td><td></td><td></td></tr><tr><td></td><td></td><td></td></tr></table>										<table border="1"><tr><td></td><td></td><td></td></tr><tr><td></td><td></td><td></td></tr><tr><td></td><td></td><td></td></tr></table>										<table border="1"><tr><td></td><td></td><td></td></tr><tr><td></td><td></td><td></td></tr><tr><td></td><td></td><td></td></tr></table>										<table border="1"><tr><td></td><td></td><td></td></tr><tr><td></td><td></td><td></td></tr><tr><td></td><td></td><td></td></tr></table>										<table border="1"><tr><td></td><td></td><td></td></tr><tr><td></td><td></td><td></td></tr><tr><td></td><td></td><td></td></tr></table>									

注释: Post=击柱 Miss=射失 Block=被封





预赛 Group X

男子 全国杯赛

“绿叶集团”杯2016年全国男子手球超级杯赛

Team A <b>A 天津</b>				Team B <b>B 安徽</b>				Match Number <b>2</b>													
played in China		in the hall 苏州市体育中心		on 20/11/2016		at 14:30 hours		Spectators													
Half-time (30')	<b>A</b> 14	<b>B</b> 7	End of playing time	<b>A</b> 31	<b>B</b> 19	1st extra time	<b>A</b>	<b>B</b>	2nd extra time	<b>A</b>	<b>B</b>	After penalty throws	<b>A</b>	<b>B</b>							
Number of 7 m	<b>A</b> 2/2	Team time-out 1 13:43 2 58:45 3			Full name of players and officials				Team time-out 1 19:39 2 25:25 3			<b>B</b> 2/2	Number of 7 m								
No.	Team <b>A</b>					G	W	2'	D	DR	No.	Team <b>B</b>					G	W	2'	D	DR
1	刘宗其										1	郭世伟									
2	李岳朋					1					3	陈强龙					2				
4	李松浩										5	史小帆									
6	王子欣					2					7	姚雄敏									
7	张青					11					8	董智景					3		1		
8	曹悦					7	1				9	陈开勇					3	1	1		
9	吴明远										10	严龙									
12	杨峻										11	黎涛					1				
13	许松					6					12	曾献辰									
14	田剑侠					3					13	何磊									
16	刘海亮										17	王巨柱					7				
17	周群					1					18	李双					3				
21	潘玉帅										21	李明									
22	魏雨童										23	于敏清									
											35	金永峰									
A	贾守信										A	韦中平									
B	杜瑞军 (主教练)										B	沈强 (主教练)									
C	孟凡钢										C	吴翔									
											D	陈玉翔									
<b>A</b>	Signature of Responsible Official of the Teams (Off. A)										<b>B</b>										
TP	Remarks of Referee / CHA Official										TP										

Signatures

Referees	徐健 (CHN)	曹宏俊 (CHN)		
Techn. Delegates	于中迅 (CHN)	李之文 (CHN)		
CHA Official				

Note: Number of 7m Throws Awarded to Team A and B, Goals (G), Warnings (W), Suspensions (2'), Direct Disqualification (D), Disqualification with Report (DR) and Team Penalty (TP).

Table Officials: 黄岩

石震坤

Statisticians: 王玲

王玮

Printed by PHMS Copyright: IHF/CHA 20/11/2016 15:52:10

Longman Sportsoft



handball@126.com





## “绿叶集团”杯2016年全国男子手球超级杯赛 竞赛技术统计(媒体表)

预赛	组别	X	轮次	1	场次	2
苏州市体育中心			20/11/2016		201608002-51-1/1	
天津		天津		31	vs	19 安徽
			14 : 7		安徽	

裁判员	徐健 (CHN)				/	曹宏俊 (CHN)			
-----	----------	--	--	--	---	-----------	--	--	--

天津		远	近	边	快	突	任意	7m	合计	%	助攻	失误	警告	2'	D & DR	比赛进程	
主教练：杜瑞军		射	射	射	攻	破	球	球								天津	安徽
1	刘宗其															0 00:37	1 8 董智景
2	李岳朋	1/1				0/1			1/2	50.0						1 00:50	1
4	李松浩			0/1					0/1	0.0		1				2 03:15	1
6	王子欣		2/2	0/1					2/3	66.7						2 03:37	2 18 李双
7	张青	5/7		1/1	2/2	1/1		2/2	11/13	84.6		4				3 05:05	3 11 黎涛
8	曹悦	4/5	1/1	1/1	1/3	0/1			7/11	63.6	3	3	1			4 09:49	3
9	吴明远															5 11:46	3
12	杨峻															5 13:33	4 17 王巨柱
13	许松	0/1		2/2	4/4				6/7	85.7	1					6 15:19	4
14	田剑侠	2/2	1/1						3/3	100	2	2				7 17:42	4
16	刘海亮															8 20:06	4
17	周群		1/1						1/1	100		2				9 20:52	4
21	潘玉帅															10 24:04	4
22	魏雨童															11 24:25	4
<b>运动员 合计</b>		12/16	5/5	4/6	7/9	1/3		2/2	31/41	75.6	6	12	1			12 25:19	4
1	刘宗其	6/10	1/2	1/2	0/1	1/3	1/2		10/20	50.0						13 26:03	5 17 王巨柱
12	杨峻		0/2		0/2	1/3	0/1	0/2	1/10	10.0						13 26:33	5
<b>守门员 合计</b>		6/10	1/4	1/2	0/3	2/6	1/3	0/2	11/30	36.7						13 27:11	6 9 陈开勇
																14 27:42	6
																14 29:37	7 17 王巨柱
																2nd Half	
																14 00:38	8 3 陈强龙
																15 01:03	8
																16 02:28	8
																17 03:38	8
																17 04:18	9 18 李双
																18 04:49	9
																18 05:02	10 17 王巨柱
																19 05:48	10
																20 06:55	10
																21 08:14	10
																21 09:11	11 8 董智景
																21 10:36	12 9 陈开勇
																22 11:30	12
																22 12:48	12
																23 13:24	13 3 陈强龙
																23 15:07	14 9 陈开勇
																24 15:37	14
																25 16:57	14
																25 17:51	15 17 王巨柱
																26 18:58	15
																26 19:41	16 18 李双
																27 20:16	16
																28 23:21	16
																29 24:54	16
																29 26:50	17 8 董智景
																30 27:35	17
																30 28:30	18 17 王巨柱
																31 29:10	18
																31 29:42	19 17 王巨柱

场上队员：得分 / 射门

守门员：救球 / 射门

快攻	Fast Break	突破	Breakthrough	任意球	Free Throw	7M球	7M Throw	助攻	Assist
警告	Warning	失误	Error	2'	Suspension	D	取消资格	DR	取消资格+报告





# “绿叶集团”杯2016年全国男子手球超级杯赛 图式比赛技术统计表

轮次 1

场次 2

201608002-21-1/1

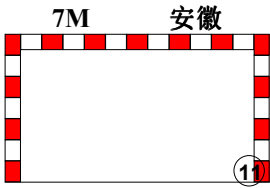
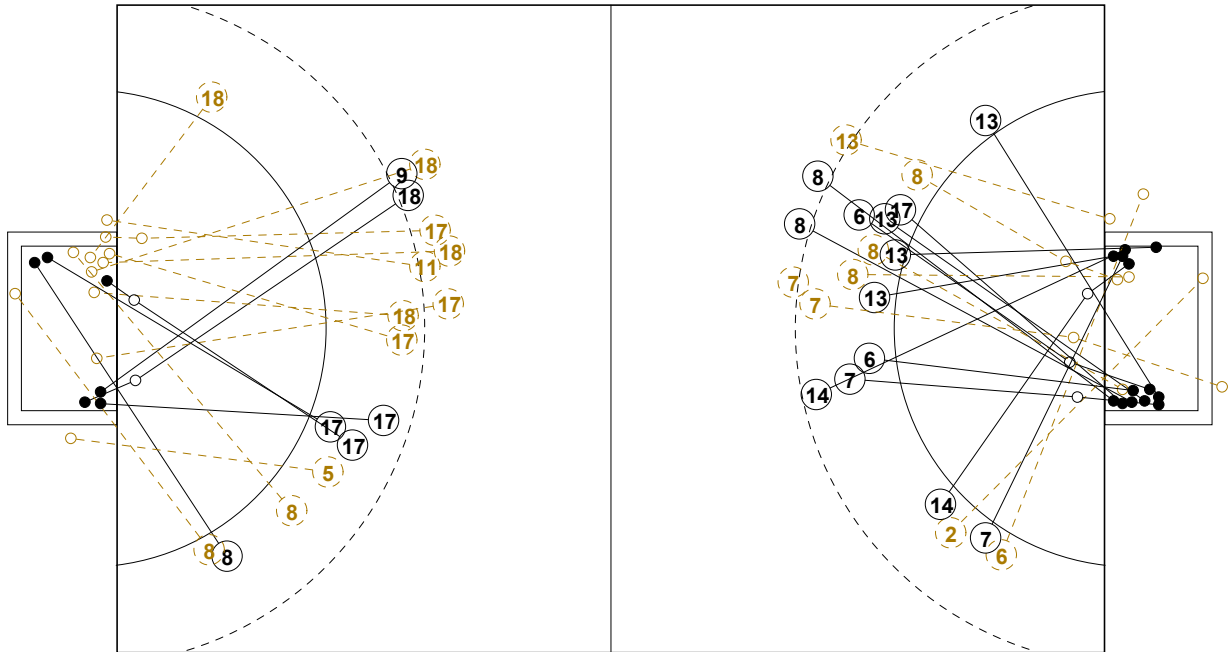

1st Half  
7 : 14

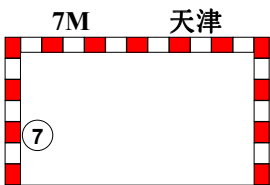
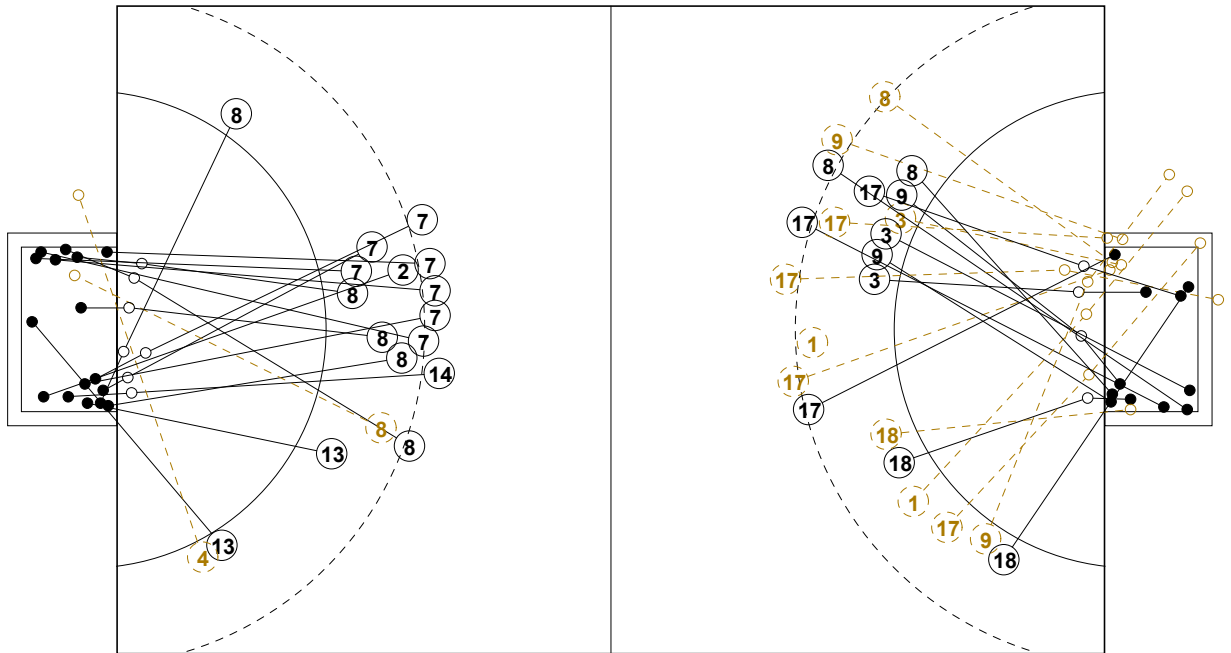
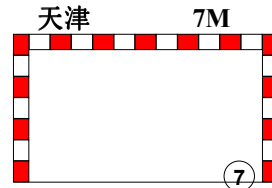

2nd Half  
31 : 19

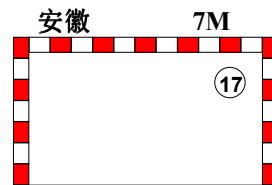



## “绿叶集团”杯2016年全国男子手球超级杯赛

## 个人/全队技术统计表

正式表  
手球  
男子预赛  
轮次 1组别 X  
场次 2201608002-14-1/2  
苏州市体育中心  
20/11/2016 14:30

号码	姓名	远射	近射	边射	快攻	突破	任意	7M	合计	%	助攻	失误	警告	2'	取消	时间
<b>天津(天津)</b>																
<i>(场上队员)</i>																
1	刘宗其									0.0%						00:39:13
2	李岳朋	1/1				0/1			1/2	50.0%						00:49:10
4	李松浩			0/1					0/1	0.0%		1				00:15:33
6	王子欣		2/2	0/1					2/3	66.7%						00:46:20
7	张青	5/7		1/1	2/2	1/1		2/2	11/13	84.6%		4				01:06:48
8	曹悦	4/5	1/1	1/1	1/3	0/1			7/11	63.6%	3	3	1			00:57:54
9	吴明远									0.0%						00:13:40
12	杨峻									0.0%						00:20:47
13	许松	0/1		2/2	4/4				6/7	85.7%	1					00:45:16
14	田剑侠	2/2	1/1						3/3	100%	2	2				00:26:28
16	刘海亮									0.0%						00:00:30
17	周群		1/1						1/1	100%		2				00:34:34
21	潘玉帅									0.0%						00:00:00
22	魏雨童									0.0%						00:29:53

<b>合计</b>		12/16	5/5	4/6	7/9	1/3		2/2	31/41	75.6%	6	12	1			
<i>(守门员)</i>																
1	刘宗其	6/10	1/2	1/2	0/1	1/3	1/2		10/20	50.0%						00:39:13
12	杨峻		0/2		0/2	1/3	0/1	0/2	1/10	10.0%						00:20:47

<b>合计</b>		6/10	1/4	1/2	0/3	2/6	1/3	0/2	11/30	36.7%						
-----------	--	------	-----	-----	-----	-----	-----	-----	-------	-------	--	--	--	--	--	--

场上队员：得分/射门

守门员：救球/射门

全队合计	得分	被救	射失	击柱	封球	合计	%
远射	12	1	2		1	16	75.0%
近射	5					5	100.0%
边射	4		2			6	66.7%
快攻	7	2				9	77.8%
突破	1	1		1		3	33.3%
任意							0.0%
7M	2					2	100.0%





## “绿叶集团”杯2016年全国男子手球超级杯赛

## 个人/全队技术统计表

正式表  
手球  
男子预赛  
轮次 1组别 X  
场次 2201608002-14-2/2  
苏州市体育中心  
20/11/2016 14:30

号码	姓名	远射	近射	边射	快攻	突破	任意	7M	合计	%	助攻	失误	警告	2'	取消	时间
<b>安徽(安徽)</b>																
<i>(上场队员)</i>																
1	郭世伟	0/1	0/1						0/2	0.0%	1		1			00:24:53
3	陈强龙		2/3						2/3	66.7%		2				00:40:37
5	史小帆		0/1						0/1	0.0%	1	4				00:39:28
7	姚雄敏									0.0%						00:00:00
8	董智景	1/2		1/2	1/1	0/1			3/6	50.0%		2		1		00:53:55
9	陈开勇		1/1	0/1	1/1		1/2		3/5	60.0%		1	1	1		00:41:35
10	严龙									0.0%						00:00:00
11	黎涛	0/1						1/1	1/2	50.0%		3				00:26:40
12	曾献辰									0.0%						00:12:12
13	何磊									0.0%						00:00:00
17	王巨柱	2/8		0/1	1/1	2/2	1/1	1/1	7/14	50.0%	2	2				00:44:18
18	李双	1/3		0/1		2/3	0/1		3/8	37.5%		4				00:56:35
21	李明									0.0%	1					00:47:48
23	于敏清									0.0%		1				00:25:34
35	金永峰									0.0%						00:00:00
<b>合计</b>		4/15	3/6	1/5	3/3	4/6	2/4	2/2	19/41	46.3%	5	19	2	2		
<i>(守门员)</i>																
12	曾献辰	0/3			0/1	0/1		0/2	0/7	0.0%						00:12:12
21	李明	1/10	0/5	0/4	2/8	1/1			4/28	14.3%	1					00:47:48
<b>合计</b>		1/13	0/5	0/4	2/9	1/2		0/2	4/35	11.4%	1					

场上队员：得分/射门

守门员：救球/射门

全队合计	得分	被救	射失	击柱	封球	合计	%
远射	4	6	2	2	1	15	26.7%
近射	3	1	2			6	50.0%
边射	1	1	1	2		5	20.0%
快攻	3					3	100.0%
突破	4	2				6	66.7%
任意	2	1		1		4	50.0%
7M	2					2	100.0%





“绿叶集团”杯2016年全国男子手球超级杯赛

图式射门区域统计

轮次 1 场次 2

201608002-41-1/1

天津

1 刘宗其	2 李岳朋	4 李松浩	6 王子欣	7 张青	8 曹悦	9 吴明远	12 杨峻																																																																								
<table border="1"><tr><td></td><td></td><td></td></tr><tr><td></td><td></td><td></td></tr><tr><td></td><td></td><td></td></tr></table>										<table border="1"><tr><td>1</td><td></td><td></td></tr><tr><td></td><td></td><td></td></tr><tr><td></td><td></td><td></td></tr></table>	1									<table border="1"><tr><td></td><td></td><td></td></tr><tr><td></td><td></td><td></td></tr><tr><td></td><td></td><td></td></tr></table>										<table border="1"><tr><td></td><td></td><td></td></tr><tr><td></td><td></td><td>1</td></tr><tr><td></td><td></td><td>1</td></tr></table>						1			1	<table border="1"><tr><td></td><td></td><td>2</td></tr><tr><td>2</td><td></td><td>2</td></tr><tr><td>3</td><td></td><td>2</td></tr></table>			2	2		2	3		2	<table border="1"><tr><td></td><td></td><td></td></tr><tr><td></td><td>1</td><td>2</td></tr><tr><td>2</td><td></td><td>2</td></tr></table>					1	2	2		2	<table border="1"><tr><td></td><td></td><td></td></tr><tr><td></td><td></td><td></td></tr><tr><td></td><td></td><td></td></tr></table>										<table border="1"><tr><td></td><td></td><td></td></tr><tr><td></td><td></td><td></td></tr><tr><td></td><td></td><td></td></tr></table>									
1																																																																															
		1																																																																													
		1																																																																													
		2																																																																													
2		2																																																																													
3		2																																																																													
	1	2																																																																													
2		2																																																																													
Post - 0 Miss - 0 Block - 0	Post - 1 Miss - 0 Block - 0	Post - 0 Miss - 1 Block - 0	Post - 0 Miss - 1 Block - 0	Post - 0 Miss - 1 Block - 1	Post - 0 Miss - 0 Block - 0	Post - 0 Miss - 0 Block - 0	Post - 0 Miss - 0 Block - 0																																																																								
13 许松	14 田剑侠	16 刘海亮	17 周群	21 潘玉帅	22 魏雨童																																																																										
<table border="1"><tr><td></td><td>1</td><td></td></tr><tr><td>1</td><td></td><td>2</td></tr><tr><td>2</td><td></td><td></td></tr></table>		1		1		2	2			<table border="1"><tr><td></td><td></td><td></td></tr><tr><td>1</td><td></td><td></td></tr><tr><td>2</td><td></td><td></td></tr></table>				1			2			<table border="1"><tr><td></td><td></td><td></td></tr><tr><td></td><td></td><td></td></tr><tr><td></td><td></td><td></td></tr></table>										<table border="1"><tr><td></td><td></td><td></td></tr><tr><td></td><td></td><td></td></tr><tr><td></td><td></td><td>1</td></tr></table>									1	<table border="1"><tr><td></td><td></td><td></td></tr><tr><td></td><td></td><td></td></tr><tr><td></td><td></td><td></td></tr></table>										<table border="1"><tr><td></td><td></td><td></td></tr><tr><td></td><td></td><td></td></tr><tr><td></td><td></td><td></td></tr></table>																													
	1																																																																														
1		2																																																																													
2																																																																															
1																																																																															
2																																																																															
		1																																																																													
Post - 0 Miss - 1 Block - 0	Post - 0 Miss - 0 Block - 0	Post - 0 Miss - 0 Block - 0	Post - 0 Miss - 0 Block - 0	Post - 0 Miss - 0 Block - 0	Post - 0 Miss - 0 Block - 0																																																																										

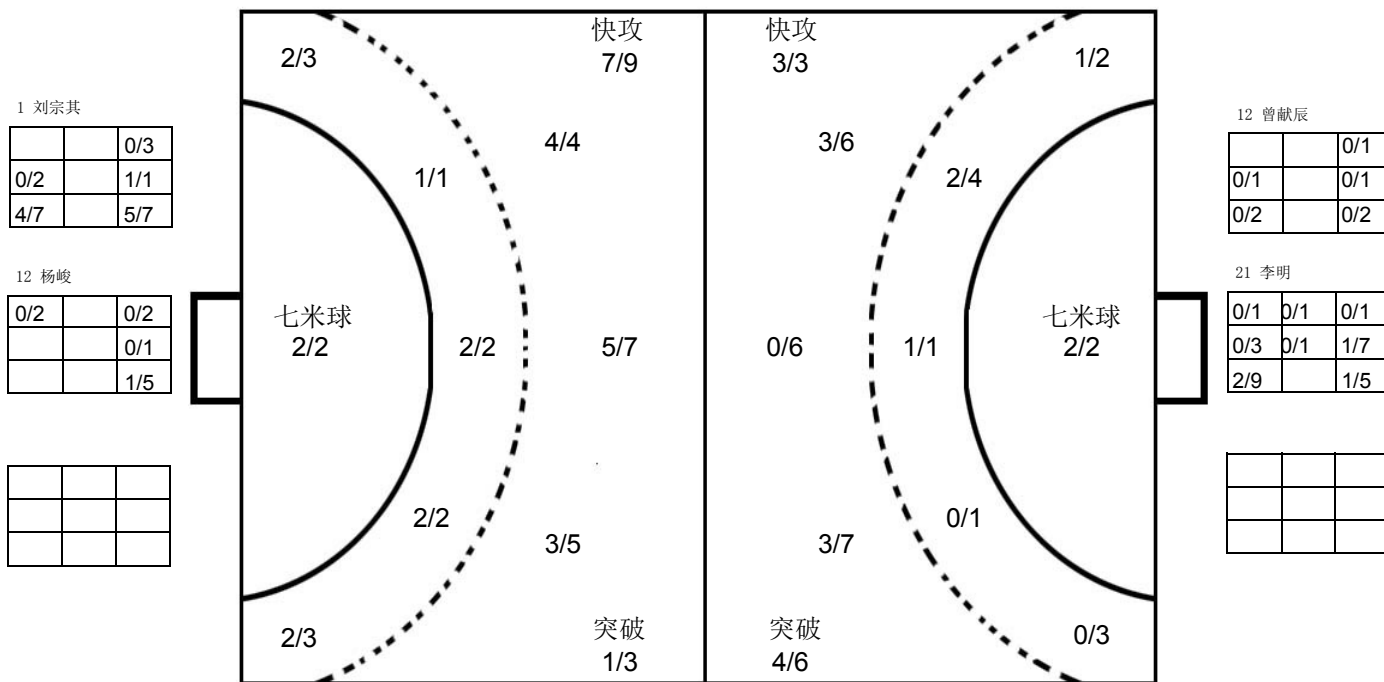

安徽

1 郭世伟	3 陈强龙	5 史小帆	7 姚雄敏	8 董智景	9 陈开勇	10 严龙	11 黎涛																																																																								
<table border="1"><tr><td></td><td></td><td></td></tr><tr><td></td><td></td><td></td></tr><tr><td></td><td></td><td></td></tr></table>										<table border="1"><tr><td></td><td></td><td>1</td></tr><tr><td>1</td><td></td><td></td></tr><tr><td></td><td></td><td></td></tr></table>			1	1						<table border="1"><tr><td></td><td></td><td></td></tr><tr><td></td><td></td><td></td></tr><tr><td></td><td></td><td></td></tr></table>										<table border="1"><tr><td></td><td></td><td></td></tr><tr><td></td><td></td><td></td></tr><tr><td></td><td></td><td></td></tr></table>										<table border="1"><tr><td></td><td></td><td>2</td></tr><tr><td></td><td></td><td>1</td></tr><tr><td></td><td></td><td></td></tr></table>			2			1				<table border="1"><tr><td></td><td></td><td></td></tr><tr><td></td><td></td><td></td></tr><tr><td>1</td><td></td><td>2</td></tr></table>							1		2	<table border="1"><tr><td></td><td></td><td></td></tr><tr><td></td><td></td><td></td></tr><tr><td></td><td></td><td></td></tr></table>										<table border="1"><tr><td></td><td></td><td></td></tr><tr><td></td><td></td><td></td></tr><tr><td></td><td></td><td>1</td></tr></table>									1
		1																																																																													
1																																																																															
		2																																																																													
		1																																																																													
1		2																																																																													
		1																																																																													
Post - 0 Miss - 1 Block - 1	Post - 0 Miss - 0 Block - 0	Post - 0 Miss - 1 Block - 0	Post - 0 Miss - 0 Block - 0	Post - 1 Miss - 0 Block - 0	Post - 1 Miss - 1 Block - 0	Post - 0 Miss - 0 Block - 0	Post - 0 Miss - 1 Block - 0																																																																								
12 曾献辰	13 何磊	17 王巨柱	18 李双	21 李明	23 于敏清	35 金永峰																																																																									
<table border="1"><tr><td></td><td></td><td></td></tr><tr><td></td><td></td><td></td></tr><tr><td></td><td></td><td></td></tr></table>										<table border="1"><tr><td></td><td></td><td></td></tr><tr><td></td><td></td><td></td></tr><tr><td></td><td></td><td></td></tr></table>										<table border="1"><tr><td></td><td>1</td><td>2</td></tr><tr><td></td><td></td><td>1</td></tr><tr><td>2</td><td></td><td>1</td></tr></table>		1	2			1	2		1	<table border="1"><tr><td></td><td>1</td><td></td></tr><tr><td></td><td>1</td><td></td></tr><tr><td></td><td></td><td>1</td></tr></table>		1			1				1	<table border="1"><tr><td></td><td></td><td></td></tr><tr><td></td><td></td><td></td></tr><tr><td></td><td></td><td></td></tr></table>										<table border="1"><tr><td></td><td></td><td></td></tr><tr><td></td><td></td><td></td></tr><tr><td></td><td></td><td></td></tr></table>										<table border="1"><tr><td></td><td></td><td></td></tr><tr><td></td><td></td><td></td></tr><tr><td></td><td></td><td></td></tr></table>																			
	1	2																																																																													
		1																																																																													
2		1																																																																													
	1																																																																														
	1																																																																														
		1																																																																													
Post - 0 Miss - 0 Block - 0	Post - 0 Miss - 0 Block - 0	Post - 3 Miss - 1 Block - 0	Post - 0 Miss - 0 Block - 0	Post - 0 Miss - 0 Block - 0	Post - 0 Miss - 0 Block - 0	Post - 0 Miss - 0 Block - 0																																																																									

注释: Post=击柱 Miss=射失 Block=被封





预赛 Group X

男子 全国杯赛

“绿叶集团”杯2016年全国男子手球超级杯赛

Team A <b>A 北京</b>				Team B <b>B 上海</b>				Match Number <b>3</b>											
played in China		in the hall 苏州市体育中心		on 20/11/2016		at 16:00 hours		Spectators											
Half-time (30')	<b>A</b> 12	<b>B</b> 16	End of playing time	<b>A</b> 24	<b>B</b> 30	1st extra time	<b>A</b>	<b>B</b>	2nd extra time	<b>A</b>	<b>B</b>	After penalty throws	<b>A</b>	<b>B</b>					
Number of 7 m	<b>A</b> 1 / 1	Team time-out			Full name of players and officials				Team time-out			<b>B</b> 1 / 1	Number of 7 m						
		1	2	3					1	2	3								
		15:48	39:48	56:15					19:52	50:03									
No.	Team <b>A</b>				G	W	2'	D	DR	No.	Team <b>B</b>				G	W	2'	D	DR
3	吴锐樊				5					1	张峥				1				
6	赵一涵				1	1	1			2	张文斌				2				
7	卞友山				1					3	赵时俊								
8	赵文宣				1					4	徐俊吉				5				
9	李旭				4					7	吴双								
10	李明远						1			8	钱为玮				4				
12	孔祥杰									10	董凯								
17	袁振典				1		2			11	蒋承骅								
18	温新宇									12	周哲韬								
20	王鹏皓				2					14	沈吉磊				13	1			
23	陈旭				7	1				15	蒋嘉敏								
25	程海津						1	1		16	朱春雷								
26	杨政									17	高天伦								
29	逯明松				1					18	马麟晓				2				
35	高云健									19	蒋慧捷				3	1			
78	王哲一				1					22	张润明								
A	孙铁									A	吴璟 (主教练)								
B	吴健 (主教练)									B	张勇军								
C	刘彦坤									C	金迪琦								
D	陈璇									D	杨时								
<b>A</b>	Signature of Responsible Official of the Teams (Off. A)																<b>B</b>		
TP	Remarks of Referee / CHA Official																TP		

Signatures

Referees	王科 (CHN)	张栋 (CHN)		
Techn. Delegates	李之文 (CHN)	柴业宏 (CHN)		
CHA Official				

Note: Number of 7m Throws Awarded to Team A and B, Goals (G), Warnings (W), Suspensions (2'), Direct Disqualification (D), Disqualification with Report (DR) and Team Penalty (TP).

Table Officials: 宣海波

许栋梁

Statisticians: 王玮

王聆

Printed by PHMS Copyright: IHF / CHA 20/11/2016 17:29:44

Longman Sportsoft



handball@126.com



### “绿叶集团”杯2016年全国男子手球超级杯赛 竞赛技术统计(媒体表)

预赛	组别	X	轮次	1	场次	3
苏州市体育中心			20/11/2016		201608003-51-1/1	
北京	北京	24	vs	30	上海	上海
<b>12 : 16</b>						

裁判员		王科 (CHN)											张栋 (CHN)										
北京		远射	近射	边射	快攻	突破	任意球	7m球	合计	%	助攻	失误	警告	2'	D & DR	北京	比赛进程	上海					
主教练: 吴健																							
3	吴锐樊		2/2	0/1	3/4			5/7	71.4		1												
6	赵一涵	0/2	0/6			1/1		1/9	11.1	1	4	1	1										
7	卞友山					1/1		1/1	100														
8	赵文宣	1/1						1/1	100														
9	李旭		2/3		2/2			4/5	80.0	1	2												
10	李明远	0/1						0/1	0.0		2		1										
12	孔祥杰										1												
17	袁振典		0/1			1/1		1/2	50.0	1	1		2										
18	温新宇																						
20	王鹏皓		1/2					1/1	2/3	66.7		2											
23	陈旭	3/7	0/4		2/4	2/3		7/18	38.9	3	3	1											
25	程海洋												1	1									
26	杨政																						
29	逯明松	1/1				0/1		1/2	50.0	1	4												
35	高云健																						
78	王哲一			1/1				1/1	100														
<b>运动员 合计</b>		<b>5/12</b>	<b>5/18</b>	<b>1/2</b>	<b>7/10</b>	<b>5/7</b>	<b>1/1</b>	<b>24/50</b>	<b>48.0</b>	<b>8</b>	<b>19</b>	<b>3</b>	<b>5</b>										
12	孔祥杰	4/7	5/8	2/5	0/4	1/6		12/30	40.0	1													
35	高云健	1/4	2/6		0/1	0/3	0/1	3/15	20.0														
<b>守门员 合计</b>		<b>5/11</b>	<b>7/14</b>	<b>2/5</b>	<b>0/5</b>	<b>1/9</b>	<b>0/1</b>	<b>15/45</b>	<b>33.3</b>	<b>1</b>													
上海		远射	近射	边射	快攻	突破	任意球	7m球	合计	%	助攻	失误	警告	2'	D & DR								
教练: 吴璟																							
1	张峥	1/1						1/1	100														
2	张文斌					2/2		2/2	100		1												
3	赵时俊																						
4	徐俊吉		4/4		1/1			5/5	100	1	2												
7	吴双																						
8	钱为玮	0/1		1/4	3/3	0/1		4/9	44.4		2												
10	董凯	0/1						0/1	0.0		1												
11	蒋承骅		0/2					0/2	0.0	1	1												
12	周哲韬																						
14	沈吉磊	3/8	3/5		1/1	5/5	1/1	13/20	65.0	1	4	1											
15	蒋嘉敏																						
16	朱春雷																						
17	高天伦		0/2					0/2	0.0														
18	马麟晓	2/5	0/1					2/6	33.3	4	2												
19	蒋慧捷		0/1	2/2		1/1		3/4	75.0		2	1											
22	张润明																						
<b>运动员 合计</b>		<b>6/16</b>	<b>7/15</b>	<b>3/6</b>	<b>5/5</b>	<b>8/9</b>	<b>1/1</b>	<b>30/52</b>	<b>57.7</b>	<b>7</b>	<b>15</b>	<b>2</b>											
1	张峥	1/5	12/16	1/1	2/9	2/6	0/1	18/38	47.4														
22	张润明	0/1	0/1	0/1		0/1		0/4	0.0														
<b>守门员 合计</b>		<b>1/6</b>	<b>12/17</b>	<b>1/2</b>	<b>2/9</b>	<b>2/7</b>	<b>0/1</b>	<b>18/42</b>	<b>42.9</b>														

场上队员: 得分 / 射门

守门员: 救球 / 射门

快攻	Fast Break		突破	Breakthrough		任意球	Free Throw		7M球	7M Throw		助攻	Assist
警告	Warning		失误	Error		2'	Suspension		D	取消资格		DR	取消资格+报告





# “绿叶集团”杯2016年全国男子手球超级杯赛 图式比赛技术统计表

轮次 1

场次 3

201608003-21-1/1

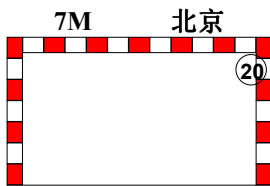
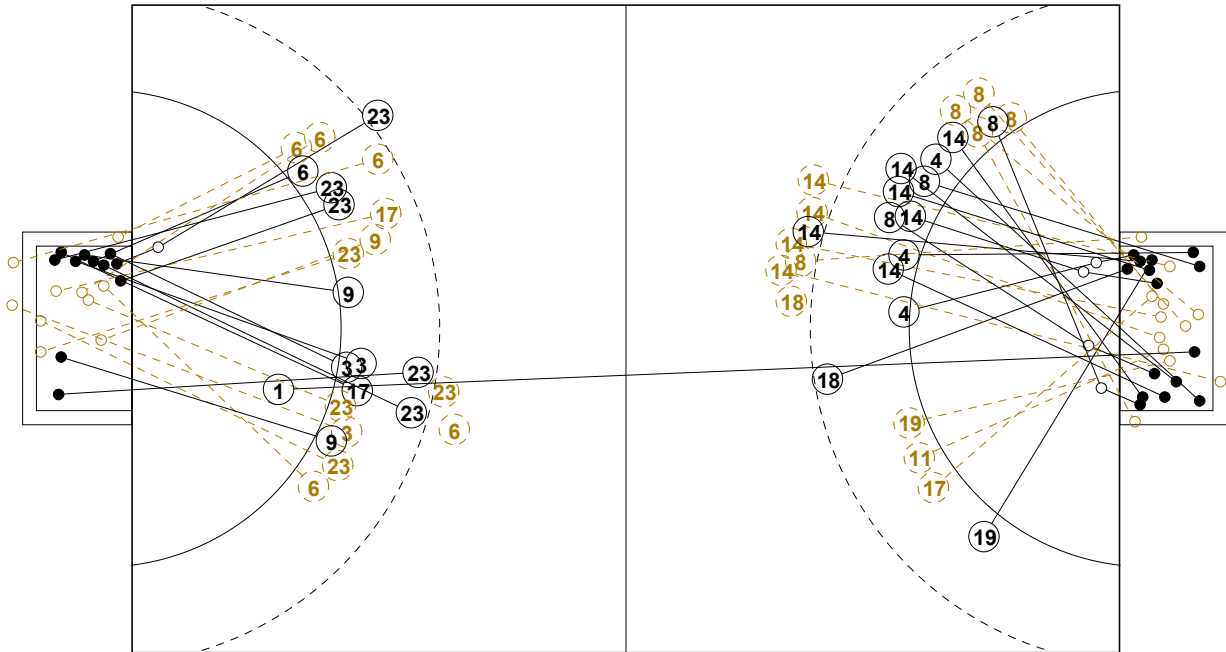

1st Half  
12 : 16

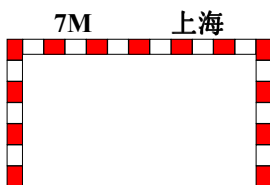
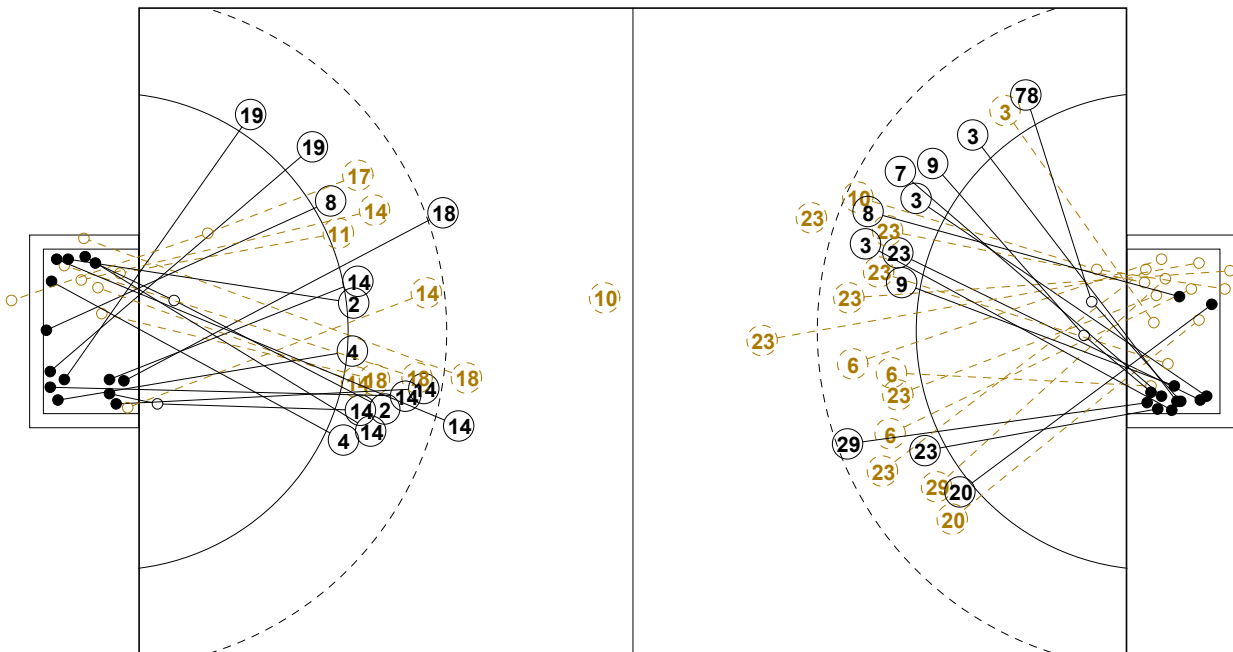
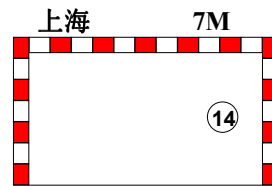

2nd Half  
30 : 24

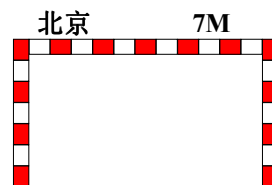





## “绿叶集团”杯2016年全国男子手球超级杯赛

## 个人/全队技术统计表

正式表  
手球  
男子预赛  
轮次 1组别 X  
场次 3201608003-14-1/2  
苏州市体育中心  
20/11/2016 16:00

号码	姓名	远射	近射	边射	快攻	突破	任意	7M	合计	%	助攻	失误	警告	2'	取消	时间
<b>北京(北京)</b>																
<i>(场上队员)</i>																
3	吴锐樊		2/2	0/1	3/4				5/7	71.4%		1				00:52:06
6	赵一涵	0/2	0/6			1/1			1/9	11.1%	1	4	1	1		00:53:56
7	卞友山					1/1			1/1	100%						00:02:25
8	赵文宣	1/1							1/1	100%						00:02:52
9	李旭		2/3		2/2				4/5	80.0%	1	2				00:57:33
10	李明远	0/1							0/1	0.0%		2		1		00:23:31
12	孔祥杰									0.0%	1					00:38:50
17	袁振典		0/1			1/1			1/2	50.0%	1	1		2		00:06:11
18	温新宇									0.0%						00:00:00
20	王鹏皓		1/2					1/1	2/3	66.7%		2				00:11:37
23	陈旭	3/7	0/4		2/4	2/3			7/18	38.9%	3	3	1			00:57:43
25	程海津									0.0%			1	1		00:30:12
26	杨政									0.0%						00:00:00
29	逮明松	1/1				0/1			1/2	50.0%	1	4				00:55:23
35	高云健									0.0%						00:21:10
78	王哲一			1/1					1/1	100%						00:04:54
<b>合计</b>		5/12	5/18	1/2	7/10	5/7		1/1	24/50	48.0%	8	19	3	5		
<i>(守门员)</i>																
12	孔祥杰	4/7	5/8	2/5	0/4	1/6			12/30	40.0%	1					00:38:50
35	高云健	1/4	2/6		0/1	0/3		0/1	3/15	20.0%						00:21:10
<b>合计</b>																
		5/11	7/14	2/5	0/5	1/9		0/1	15/45	33.3%	1					

场上队员：得分/射门

守门员：救球/射门

全队合计	得分	被救	射失	击柱	封球	合计	%
远射	5	1	1	2	3	12	41.7%
近射	5	12		1		18	27.8%
边射	1	1				2	50.0%
快攻	7	2	1			10	70.0%
突破	5	2				7	71.4%
任意							0.0%
7M	1					1	100.0%





## “绿叶集团”杯2016年全国男子手球超级杯赛

## 个人/全队技术统计表

正式表  
手球  
男子预赛  
轮次 1组别 X  
场次 3201608003-14-2/2  
苏州市体育中心  
20/11/2016 16:00

号码	姓名	远射	近射	边射	快攻	突破	任意	7M	合计	%	助攻	失误	警告	2'	取消	时间
<b>上海(上海)</b>																
<i>(上场队员)</i>																
1	张崢	1/1							1/1	100%						00:55:42
2	张文斌					2/2			2/2	100%		1				00:11:55
3	赵时俊									0.0%						00:00:00
4	徐俊吉		4/4		1/1				5/5	100%	1	2				00:48:47
7	吴双									0.0%						00:00:00
8	钱为玮	0/1		1/4	3/3	0/1			4/9	44.4%		2				00:38:04
10	董凯	0/1							0/1	0.0%		1				00:11:10
11	蒋承骅		0/2						0/2	0.0%	1	1				01:00:00
12	周哲韬									0.0%						00:00:00
14	沈吉磊	3/8	3/5		1/1	5/5		1/1	13/20	65.0%	1	4	1			00:57:36
15	蒋嘉敏									0.0%						00:00:00
16	朱春雷									0.0%						00:00:00
17	高天伦		0/2						0/2	0.0%						00:21:52
18	马麟晓	2/5	0/1						2/6	33.3%	4	2				00:50:24
19	蒋慧捷		0/1	2/2		1/1			3/4	75.0%		2	1			01:00:00
22	张润明									0.0%						00:04:18
<b>合计</b>		6/16	7/15	3/6	5/5	8/9		1/1	30/52	57.7%	7	15	2			
<i>(守门员)</i>																
1	张崢	1/5	12/16	1/1	2/9	2/6		0/1	18/38	47.4%						00:55:42
22	张润明	0/1	0/1	0/1		0/1			0/4	0.0%						00:04:18
<b>合计</b>		1/6	12/17	1/2	2/9	2/7		0/1	18/42	42.9%						

场上队员：得分/射门

守门员：救球/射门

全队合计	得分	被救	射失	击柱	封球	合计	%
远射	6	5		3	2	16	37.5%
近射	7	7	1			15	46.7%
边射	3	2		1		6	50.0%
快攻	5					5	100.0%
突破	8	1				9	88.9%
任意							0.0%
7M	1					1	100.0%





### “绿叶集团”杯2016年全国男子手球超级杯赛

图式射门区域统计

轮次 1 场次 3

201608003-41-1/1

## 北京

3 吴锐樊	6 赵一涵	7 卞友山	8 赵文宣	9 李旭	10 李明远	12 孔祥杰	17 袁振典																																																																								
<table border="1"><tr><td></td><td></td><td>1</td></tr><tr><td></td><td></td><td>3</td></tr><tr><td></td><td></td><td>1</td></tr></table>			1			3			1	<table border="1"><tr><td></td><td></td><td></td></tr><tr><td></td><td></td><td>1</td></tr><tr><td></td><td></td><td></td></tr></table>						1				<table border="1"><tr><td></td><td></td><td></td></tr><tr><td></td><td></td><td>1</td></tr><tr><td></td><td></td><td></td></tr></table>						1				<table border="1"><tr><td></td><td></td><td></td></tr><tr><td>1</td><td></td><td></td></tr><tr><td></td><td></td><td></td></tr></table>				1						<table border="1"><tr><td></td><td></td><td></td></tr><tr><td></td><td></td><td>2</td></tr><tr><td></td><td></td><td>1</td></tr></table>						2			1	<table border="1"><tr><td></td><td></td><td></td></tr><tr><td></td><td></td><td></td></tr><tr><td></td><td></td><td></td></tr></table>										<table border="1"><tr><td></td><td></td><td></td></tr><tr><td></td><td></td><td></td></tr><tr><td></td><td></td><td></td></tr></table>										<table border="1"><tr><td></td><td></td><td></td></tr><tr><td></td><td></td><td>1</td></tr><tr><td></td><td></td><td></td></tr></table>						1			
		1																																																																													
		3																																																																													
		1																																																																													
		1																																																																													
		1																																																																													
1																																																																															
		2																																																																													
		1																																																																													
		1																																																																													
Post - 0 Miss - 1 Block - 0	Post - 1 Miss - 1 Block - 1	Post - 0 Miss - 0 Block - 0	Post - 0 Miss - 0 Block - 0	Post - 0 Miss - 0 Block - 0	Post - 1 Miss - 0 Block - 0	Post - 0 Miss - 0 Block - 0	Post - 0 Miss - 0 Block - 0																																																																								
18 温新宇	20 王鹏皓	23 陈旭	25 程海津	26 杨政	29 逯明松	35 高云健	78 王哲一																																																																								
<table border="1"><tr><td></td><td></td><td></td></tr><tr><td></td><td></td><td></td></tr><tr><td></td><td></td><td></td></tr></table>										<table border="1"><tr><td></td><td>1</td><td>1</td></tr><tr><td></td><td></td><td></td></tr><tr><td></td><td></td><td></td></tr></table>		1	1							<table border="1"><tr><td>1</td><td></td><td>2</td></tr><tr><td></td><td></td><td>1</td></tr><tr><td></td><td></td><td>3</td></tr></table>	1		2			1			3	<table border="1"><tr><td></td><td></td><td></td></tr><tr><td></td><td></td><td></td></tr><tr><td></td><td></td><td></td></tr></table>										<table border="1"><tr><td></td><td></td><td></td></tr><tr><td></td><td></td><td></td></tr><tr><td></td><td></td><td></td></tr></table>										<table border="1"><tr><td></td><td></td><td></td></tr><tr><td></td><td></td><td></td></tr><tr><td></td><td></td><td>1</td></tr></table>									1	<table border="1"><tr><td></td><td></td><td></td></tr><tr><td></td><td></td><td></td></tr><tr><td></td><td></td><td></td></tr></table>										<table border="1"><tr><td></td><td></td><td></td></tr><tr><td></td><td></td><td>1</td></tr><tr><td></td><td></td><td></td></tr></table>						1			
	1	1																																																																													
1		2																																																																													
		1																																																																													
		3																																																																													
		1																																																																													
		1																																																																													
Post - 0 Miss - 0 Block - 0	Post - 0 Miss - 0 Block - 0	Post - 1 Miss - 0 Block - 2	Post - 0 Miss - 0 Block - 0	Post - 0 Miss - 0 Block - 0	Post - 0 Miss - 0 Block - 0	Post - 0 Miss - 0 Block - 0	Post - 0 Miss - 0 Block - 0																																																																								

12 孔祥杰

0/3	2/3	1/2
2/4	4/4	3/8
0/4		0/2

35 高云健

0/3	0/1	0/3
	1/1	0/1
1/5		1/1

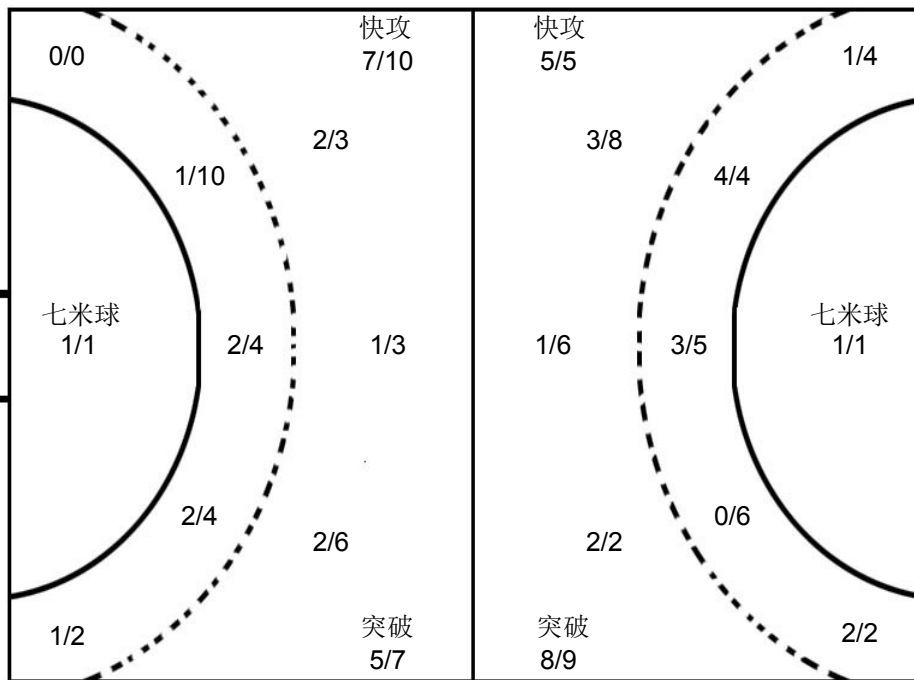
1 张崢

2/4	3/3	1/6
2/2	1/1	2/9
3/3	2/2	2/8

22 张润明

	0/1	
0/1		0/2

## 上海

1 张崢	2 张文斌	3 赵时俊	4 徐俊吉	7 吴双	8 钱为玮	10 董凯	11 蒋承骅																																																																								
<table border="1"><tr><td></td><td>1</td><td></td></tr><tr><td></td><td></td><td></td></tr><tr><td></td><td></td><td></td></tr></table>		1								<table border="1"><tr><td></td><td></td><td>1</td></tr><tr><td></td><td></td><td>1</td></tr><tr><td></td><td></td><td></td></tr></table>			1			1				<table border="1"><tr><td></td><td></td><td></td></tr><tr><td></td><td></td><td></td></tr><tr><td></td><td></td><td></td></tr></table>										<table border="1"><tr><td>2</td><td></td><td>2</td></tr><tr><td></td><td></td><td></td></tr><tr><td>1</td><td></td><td></td></tr></table>	2		2				1			<table border="1"><tr><td></td><td></td><td></td></tr><tr><td></td><td></td><td></td></tr><tr><td></td><td></td><td></td></tr></table>										<table border="1"><tr><td>1</td><td>1</td><td></td></tr><tr><td></td><td></td><td>1</td></tr><tr><td></td><td></td><td>1</td></tr></table>	1	1				1			1	<table border="1"><tr><td></td><td></td><td></td></tr><tr><td></td><td></td><td></td></tr><tr><td></td><td></td><td></td></tr></table>										<table border="1"><tr><td></td><td></td><td></td></tr><tr><td></td><td></td><td></td></tr><tr><td></td><td></td><td></td></tr></table>									
	1																																																																														
		1																																																																													
		1																																																																													
2		2																																																																													
1																																																																															
1	1																																																																														
		1																																																																													
		1																																																																													
Post - 0 Miss - 0 Block - 0	Post - 0 Miss - 0 Block - 0	Post - 0 Miss - 0 Block - 0	Post - 0 Miss - 0 Block - 0	Post - 0 Miss - 0 Block - 0	Post - 2 Miss - 0 Block - 0	Post - 0 Miss - 0 Block - 1	Post - 0 Miss - 0 Block - 0																																																																								
12 周哲韬	14 沈吉磊	15 蒋嘉敏	16 朱春雷	17 高天伦	18 马麟晓	19 蒋慧捷	22 张润明																																																																								
<table border="1"><tr><td></td><td></td><td></td></tr><tr><td></td><td></td><td></td></tr><tr><td></td><td></td><td></td></tr></table>										<table border="1"><tr><td>1</td><td></td><td>1</td></tr><tr><td>1</td><td></td><td>4</td></tr><tr><td>5</td><td></td><td>1</td></tr></table>	1		1	1		4	5		1	<table border="1"><tr><td></td><td></td><td></td></tr><tr><td></td><td></td><td></td></tr><tr><td></td><td></td><td></td></tr></table>										<table border="1"><tr><td></td><td></td><td></td></tr><tr><td></td><td></td><td></td></tr><tr><td></td><td></td><td></td></tr></table>										<table border="1"><tr><td></td><td></td><td></td></tr><tr><td></td><td></td><td></td></tr><tr><td></td><td></td><td></td></tr></table>										<table border="1"><tr><td></td><td></td><td></td></tr><tr><td></td><td></td><td></td></tr><tr><td>2</td><td></td><td></td></tr></table>							2			<table border="1"><tr><td>2</td><td></td><td></td></tr><tr><td>1</td><td></td><td></td></tr><tr><td></td><td></td><td></td></tr></table>	2			1						<table border="1"><tr><td></td><td></td><td></td></tr><tr><td></td><td></td><td></td></tr><tr><td></td><td></td><td></td></tr></table>									
1		1																																																																													
1		4																																																																													
5		1																																																																													
2																																																																															
2																																																																															
1																																																																															
Post - 0 Miss - 0 Block - 0	Post - 1 Miss - 0 Block - 0	Post - 0 Miss - 0 Block - 0	Post - 0 Miss - 0 Block - 0	Post - 0 Miss - 1 Block - 0	Post - 1 Miss - 0 Block - 1	Post - 0 Miss - 0 Block - 0	Post - 0 Miss - 0 Block - 0																																																																								

注释: Post=击柱 Miss=射失 Block=被封



预赛 Group X

男子 全国杯赛

“绿叶集团”杯2016年全国男子手球超级杯赛

Team A A 广东				Team B B 天津				Match Number 4													
played in China		in the hall 苏州市体育中心		on 21/11/2016		at 13:00 hours		Spectators													
Half-time (30')	A 7	B 22	End of playing time	A 7	B 22	1st extra time	A	B	2nd extra time	A	B	After penalty throws	A	B							
Number of 7 m	A 1/1	Team time-out 1 17:46 2 21:12 3			Full name of players and officials				Team time-out 1 2 3			B 1/1	Number of 7 m								
No.	Team A					G	W	2'	D	DR	No.	Team B					G	W	2'	D	DR
1	王泽润										1	刘宗其									
10	周仲坤					1					2	李岳朋									
12	王雨					1					4	李松浩					1				
13	王立隆						1	1			6	王子欣							1		
15	张建杰					1					7	张青					5				
18	高玉杰						1				8	曹悦					4	1			
20	黄培杰					3					9	吴明远					5				
26	姚雪岩					1					12	杨峻									
											13	许松					5				
											14	田剑侠									
											16	刘海亮									
											17	周群						1			
											21	潘玉帅					1		1		
											22	魏雨童					1				
B	刘康伶 (主教练)										A	贾守信									
C	刘文宁										B	杜瑞军 (主教练)									
											C	孟凡钢									
A	Signature of Responsible Official of the Teams (Off. A)																		B		
TP	Remarks of Referee / CHA Official																		TP		

Signatures

Referees: 徐健 (CHN) 曹宏俊 (CHN)

Techn. Delegates: 李之文 (CHN) 于中迅 (CHN)

CHA Official:

Note: Number of 7m Throws Awarded to Team A and B, Goals (G), Warnings (W), Suspensions (2'), Direct Disqualification (D), Disqualification with Report (DR) and Team Penalty (TP).

Table Officials: 宣海波

许栋梁

Statisticians: 王玲

王玮

Printed by PHMS Copyright: IHF / CHA 21/11/2016 13:35:20

Longman Sportsoft



handball@126.com





# “绿叶集团”杯2016年全国男子手球超级杯赛 图式比赛技术统计表

轮次 2

场次 4

201608004-21-1/1

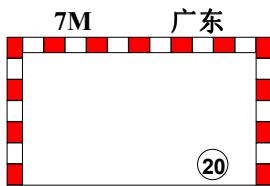
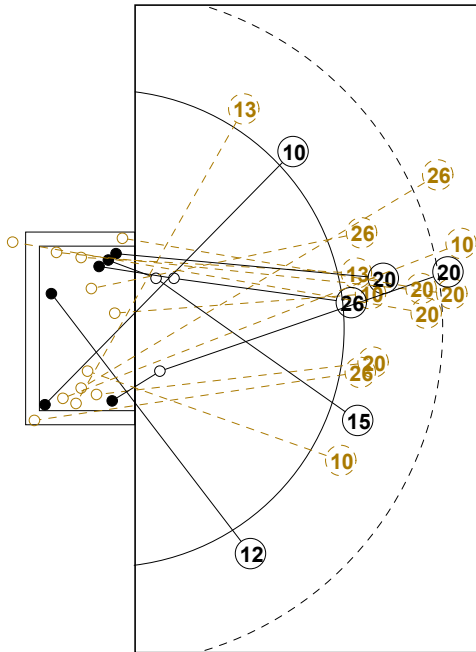

1st Half  
7 : 22

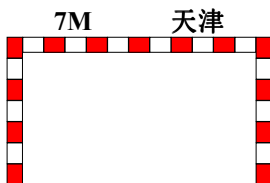
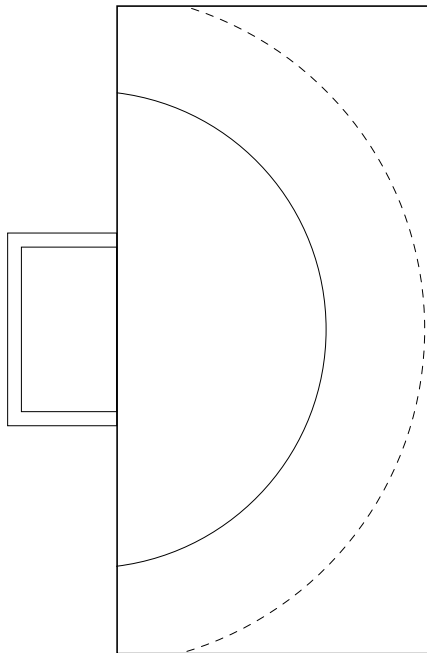
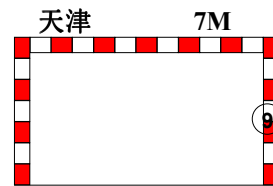
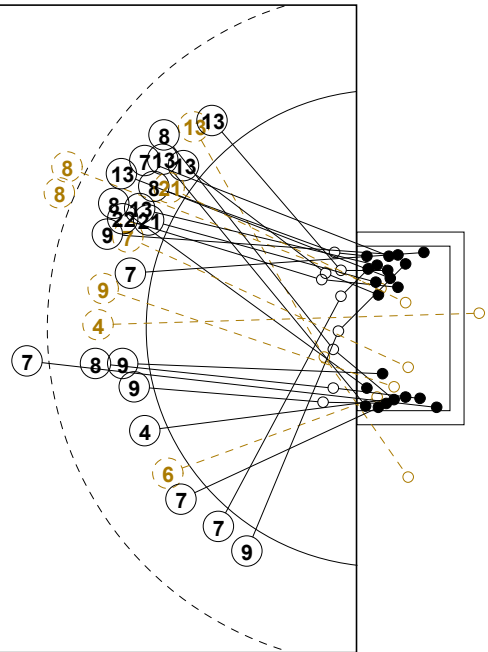

2nd Half  
22 : 7

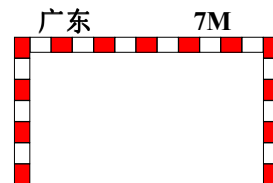
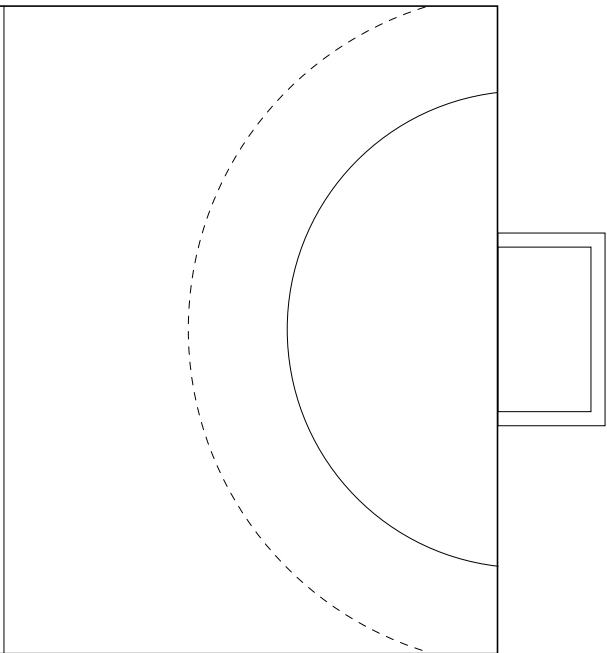



## “绿叶集团”杯2016年全国男子手球超级杯赛

## 个人/全队技术统计表

正式表  
手球  
男子预赛  
轮次 2组别 X  
场次 4201608004-14-1/2  
苏州市体育中心  
21/11/2016 13:00

号码	姓名	远射	近射	边射	快攻	突破	任意	7M	合计	%	助攻	失误	警告	2'	取消	时间
<b>广东(广东)</b>																
<i>(场上队员)</i>																
1	王泽润									0.0%						00:30:00
10	周仲坤	0/1	1/2			0/1			1/4	25.0%	1	6				00:30:00
12	王雨			1/1					1/1	100%	1					00:30:00
13	王立隆			0/1	0/1				0/2	0.0%			1	1		00:22:33
15	张建杰		1/1						1/1	100%	1	1				00:30:00
18	高玉杰									0.0%			1			00:07:26
20	黄培杰	1/4			0/1	1/1		1/1	3/7	42.9%	1	4				00:30:00
26	姚雪岩		1/2		0/1		0/1		1/4	25.0%		4				00:30:00
<b>合计</b>																
<i>(守门员)</i>																
1		1/2	1/5	0/2	3/11	0/6		0/1	5/27	18.5%						00:30:00
<b>合计</b>																

场上队员：得分/射门

守门员：救球/射门

全队合计	得分	被救	射失	击柱	封球	合计	%
远射	1	2	1	1		5	20.0%
近射	3	1		1		5	60.0%
边射	1	1				2	50.0%
快攻		3				3	0.0%
突破	1	1				2	50.0%
任意		1				1	0.0%
7M	1					1	100.0%





## “绿叶集团”杯2016年全国男子手球超级杯赛

## 个人/全队技术统计表

正式表  
手球  
男子预赛  
轮次 2组别 X  
场次 4201608004-14-2/2  
苏州市体育中心  
21/11/2016 13:00

号码	姓名	远射	近射	边射	快攻	突破	任意	7M	合计	%	助攻	失误	警告	2'	取消	时间
<b>天津(天津)</b>																
<i>(上场队员)</i>																
1	刘宗其									0.0%	3					00:29:50
2	李岳朋									0.0%		1				00:15:56
4	李松浩					1/2			1/2	50.0%	1					00:06:15
6	王子欣				0/1				0/1	0.0%		1		1		00:15:01
7	张青	1/1		1/1	1/2	2/2			5/6	83.3%						00:23:44
8	曹悦	0/2	1/1			3/3			4/6	66.7%	2	2	1			00:30:00
9	吴明远		1/2	1/1	2/2			1/1	5/6	83.3%						00:14:57
12	杨峻									0.0%						00:00:10
13	许松		0/1		5/5				5/6	83.3%		1				00:19:58
14	田剑侠									0.0%	1					00:14:02
16	刘海亮									0.0%						00:00:00
17	周群									0.0%			1			00:11:56
21	潘玉帅		1/1		0/1				1/2	50.0%		1		1		00:09:58
22	魏雨童		1/1						1/1	100%	1					00:18:03
<b>合计</b>		1/3	4/6	2/2	8/11	6/7		1/1	22/30	73.3%	8	6	2	2		
<i>(守门员)</i>																
1	刘宗其	2/3	1/4	1/2	3/3	1/2	1/1		9/15	60.0%	3					00:29:50
12	杨峻							0/1	0/1	0.0%						00:00:10
<b>合计</b>		2/3	1/4	1/2	3/3	1/2	1/1	0/1	9/16	56.3%	3					

场上队员：得分/射门

守门员：救球/射门

全队合计	得分	被救	射失	击柱	封球	合计	%
远射	1	1			1	3	33.3%
近射	4	1	1			6	66.7%
边射	2					2	100.0%
快攻	8	3				11	72.7%
突破	6		1			7	85.7%
任意							0.0%
7M	1					1	100.0%







### “绿叶集团”杯2016年全国男子手球超级杯赛

图式射门区域统计

轮次 2 场次 4

201608004-41-1/1

## 广东

1 王泽润	10 周仲坤	12 王雨	13 王立隆	15 张建杰	18 高玉杰	20 黄培杰	26 姚雪岩																																																																								
<table border="1"><tr><td></td><td></td><td></td></tr><tr><td></td><td></td><td></td></tr><tr><td></td><td></td><td></td></tr></table>										<table border="1"><tr><td>1</td><td></td><td></td></tr><tr><td></td><td></td><td></td></tr><tr><td></td><td></td><td></td></tr></table>	1									<table border="1"><tr><td></td><td></td><td>1</td></tr><tr><td></td><td></td><td></td></tr><tr><td></td><td></td><td></td></tr></table>			1							<table border="1"><tr><td></td><td></td><td></td></tr><tr><td></td><td></td><td></td></tr><tr><td></td><td></td><td></td></tr></table>										<table border="1"><tr><td></td><td></td><td></td></tr><tr><td></td><td></td><td></td></tr><tr><td></td><td></td><td>1</td></tr></table>									1	<table border="1"><tr><td></td><td></td><td></td></tr><tr><td></td><td></td><td></td></tr><tr><td></td><td></td><td></td></tr></table>										<table border="1"><tr><td></td><td></td><td></td></tr><tr><td>1</td><td></td><td>2</td></tr><tr><td></td><td></td><td></td></tr></table>				1		2				<table border="1"><tr><td></td><td></td><td></td></tr><tr><td></td><td></td><td></td></tr><tr><td></td><td></td><td>1</td></tr></table>									1
1																																																																															
		1																																																																													
		1																																																																													
1		2																																																																													
		1																																																																													
Post - 0 Miss - 0 Block - 0	Post - 0 Miss - 0 Block - 0	Post - 0 Miss - 0 Block - 0	Post - 0 Miss - 0 Block - 0	Post - 0 Miss - 0 Block - 0	Post - 0 Miss - 0 Block - 0	Post - 1 Miss - 1 Block - 0	Post - 1 Miss - 0 Block - 0																																																																								

<table border="1"><tr><td></td><td></td><td></td></tr><tr><td></td><td></td><td></td></tr><tr><td></td><td></td><td></td></tr></table>										<table border="1"><tr><td></td><td></td><td></td></tr><tr><td></td><td></td><td></td></tr><tr><td></td><td></td><td></td></tr></table>										<table border="1"><tr><td></td><td></td><td></td></tr><tr><td></td><td></td><td></td></tr><tr><td></td><td></td><td></td></tr></table>										<table border="1"><tr><td></td><td></td><td></td></tr><tr><td></td><td></td><td></td></tr><tr><td></td><td></td><td></td></tr></table>										<table border="1"><tr><td></td><td></td><td></td></tr><tr><td></td><td></td><td></td></tr><tr><td></td><td></td><td></td></tr></table>										<table border="1"><tr><td></td><td></td><td></td></tr><tr><td></td><td></td><td></td></tr><tr><td></td><td></td><td></td></tr></table>										<table border="1"><tr><td></td><td></td><td></td></tr><tr><td></td><td></td><td></td></tr><tr><td></td><td></td><td></td></tr></table>										<table border="1"><tr><td></td><td></td><td></td></tr><tr><td></td><td></td><td></td></tr><tr><td></td><td></td><td></td></tr></table>									

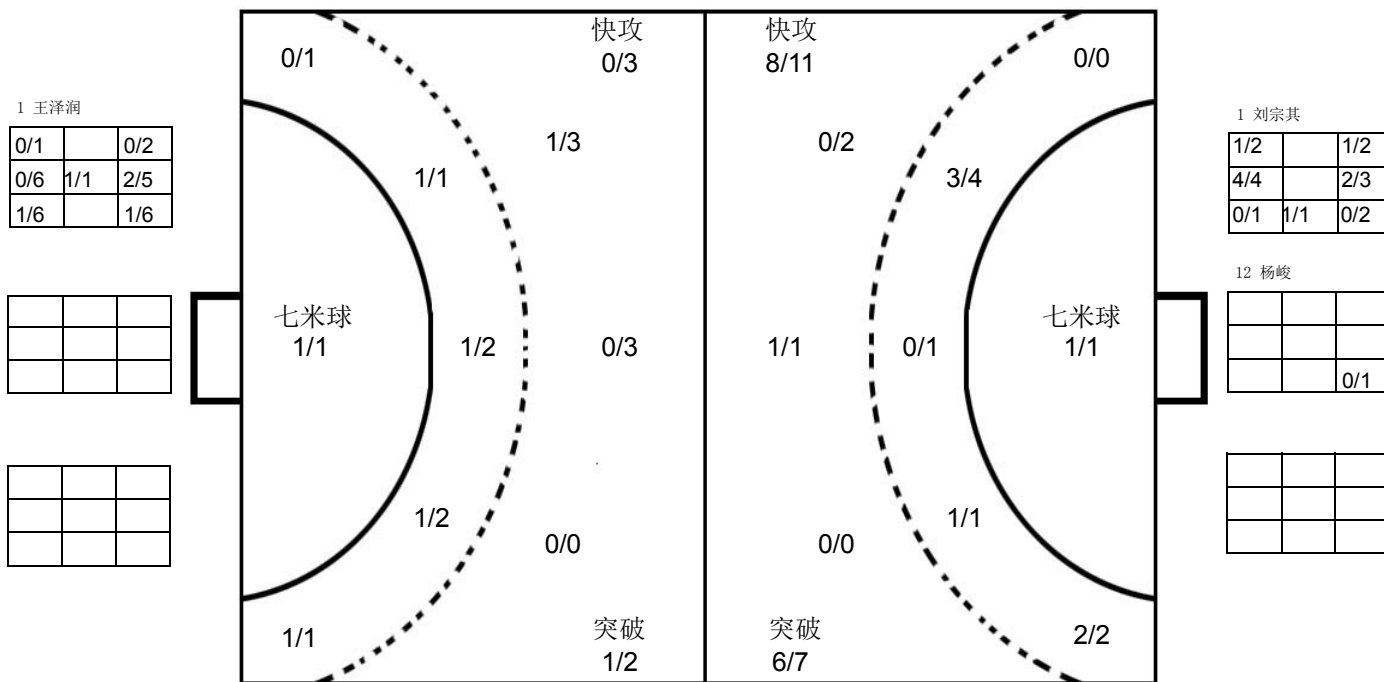

## 天津

1 刘宗其	2 李岳朋	4 李松浩	6 王子欣	7 张青	8 曹悦	9 吴明远	12 杨峻																																																																								
<table border="1"><tr><td></td><td></td><td></td></tr><tr><td></td><td></td><td></td></tr><tr><td></td><td></td><td></td></tr></table>										<table border="1"><tr><td></td><td></td><td></td></tr><tr><td></td><td></td><td></td></tr><tr><td></td><td></td><td></td></tr></table>										<table border="1"><tr><td></td><td></td><td>1</td></tr><tr><td></td><td></td><td></td></tr><tr><td></td><td></td><td></td></tr></table>			1							<table border="1"><tr><td></td><td></td><td></td></tr><tr><td></td><td></td><td></td></tr><tr><td></td><td></td><td></td></tr></table>										<table border="1"><tr><td>1</td><td></td><td>1</td></tr><tr><td>1</td><td></td><td></td></tr><tr><td>1</td><td></td><td>1</td></tr></table>	1		1	1			1		1	<table border="1"><tr><td></td><td></td><td>1</td></tr><tr><td></td><td></td><td>1</td></tr><tr><td>1</td><td></td><td>1</td></tr></table>			1			1	1		1	<table border="1"><tr><td></td><td>2</td><td></td></tr><tr><td></td><td></td><td>1</td></tr><tr><td></td><td></td><td>2</td></tr></table>		2				1			2	<table border="1"><tr><td></td><td></td><td></td></tr><tr><td></td><td></td><td></td></tr><tr><td></td><td></td><td></td></tr></table>									
		1																																																																													
1		1																																																																													
1																																																																															
1		1																																																																													
		1																																																																													
		1																																																																													
1		1																																																																													
	2																																																																														
		1																																																																													
		2																																																																													
Post - 0 Miss - 0 Block - 0	Post - 0 Miss - 0 Block - 0	Post - 0 Miss - 1 Block - 0	Post - 0 Miss - 0 Block - 0	Post - 0 Miss - 0 Block - 0	Post - 0 Miss - 0 Block - 1	Post - 0 Miss - 0 Block - 0	Post - 0 Miss - 0 Block - 0																																																																								
13 许松	14 田剑侠	16 刘海亮	17 周群	21 潘玉帅	22 魏雨童																																																																										
<table border="1"><tr><td></td><td></td><td></td></tr><tr><td>2</td><td></td><td></td></tr><tr><td>2</td><td></td><td>1</td></tr></table>				2			2		1	<table border="1"><tr><td></td><td></td><td></td></tr><tr><td></td><td></td><td></td></tr><tr><td></td><td></td><td></td></tr></table>										<table border="1"><tr><td></td><td></td><td></td></tr><tr><td></td><td></td><td></td></tr><tr><td></td><td></td><td></td></tr></table>										<table border="1"><tr><td></td><td></td><td></td></tr><tr><td></td><td></td><td></td></tr><tr><td></td><td></td><td></td></tr></table>										<table border="1"><tr><td></td><td></td><td></td></tr><tr><td></td><td></td><td></td></tr><tr><td>1</td><td></td><td></td></tr></table>							1			<table border="1"><tr><td></td><td></td><td></td></tr><tr><td></td><td></td><td></td></tr><tr><td></td><td></td><td></td></tr></table>										<table border="1"><tr><td></td><td></td><td></td></tr><tr><td></td><td></td><td></td></tr><tr><td></td><td></td><td></td></tr></table>										<table border="1"><tr><td></td><td></td><td></td></tr><tr><td></td><td></td><td></td></tr><tr><td></td><td></td><td></td></tr></table>									
2																																																																															
2		1																																																																													
1																																																																															
Post - 0 Miss - 1 Block - 0	Post - 0 Miss - 0 Block - 0	Post - 0 Miss - 0 Block - 0	Post - 0 Miss - 0 Block - 0	Post - 0 Miss - 0 Block - 0	Post - 0 Miss - 0 Block - 0																																																																										

注释: Post=击柱 Miss=射失 Block=被封





预赛 Group X

男子 全国杯赛

“绿叶集团”杯2016年全国男子手球超级杯赛

Team A A 上海				Team B B 江苏				Match Number <b>5</b>													
played in China		in the hall 苏州市体育中心		on 21/11/2016		at 14:30 hours		Spectators													
Half-time (30')	A 13	B 14	End of playing time	A 24	B 25	1st extra time	A	B	2nd extra time	A	B	After penalty throws	A	B							
Number of 7 m	A 2/3	Team time-out			Full name of players and officials				Team time-out			B 1/1	Number of 7 m								
No.	Team A					G	W	2'	D	DR	No.	Team B					G	W	2'	D	DR
1	张崢										1	徐畅									
2	张文斌					2					4	张家纬									
3	赵时俊					1					5	闫亮									
4	徐俊吉					3					6	赵晨					1				
7	吴双					2					7	徐奕飞					2				
8	钱为玮					3					8	周小坚									
10	董凯					1		1			9	任超凡									
11	蒋承骅					1		1			10	郝可鑫					9				
12	周哲韬										11	马益奎							2		
14	沈吉磊					9	1				12	王权									
15	蒋嘉敏										13	耿畅									
16	朱春雷										15	李加昌									
17	高天伦					1					17	王伟强					3				
18	马麟晓										18	赵楠					6		2		
19	蒋慧捷					1					21	刘江					4		1		
22	张润明										22	任启双						1			
A	吴璟 (主教练)										B	闫威名 (主教练)									
B	张勇军										E	王建国									
C	金迪琦																				
D	杨时																				
A	Signature of Responsible Official of the Teams (Off. A)																		B		
TP	Remarks of Referee / CHA Official																		TP		

Signatures

Referees	刘书勇 (CHN)	王洋 (CHN)		
Techn. Delegates	李之文 (CHN)	王科 (CHN)		
CHA Official				

Note: Number of 7m Throws Awarded to Team A and B, Goals (G), Warnings (W), Suspensions (2'), Direct Disqualification (D), Disqualification with Report (DR) and Team Penalty (TP).

Table Officials: 宣海波

许栋梁

Statisticians: 王玮

王聆

Printed by PHMS Copyright: IHF/CHA 21/11/2016 15:39:30

Longman Sportsoft



handball@126.com



## “绿叶集团”杯2016年全国男子手球超级杯赛 竞赛技术统计(媒体表)

预赛	组别	X	轮次	2	场次	5	
苏州市体育中心			21/11/2016		201608005-51-1/1		
上海		上海		24	vs	25 江苏	
				13 : 14			江苏

裁判员	刘书勇 (CHN)			/	王洋 (CHN)		
-----	-----------	--	--	---	----------	--	--

上海		远射	近射	边射	快攻	突破	任意球	7m球	合计	%	助攻	失误	警告	2'	D & DR	上海		江苏					
主教练： 吴璟																比赛进程							
1	张峥										4					1st Half		0	00:54	1	10	郝可鑫	
2	张文斌	1/1			1/1				2/2	100	1					14	沈吉磊	1	01:22	1	1	赵楠	
3	赵时俊	0/1				1/1			1/2	50.0		1				14	沈吉磊	2	03:03	2	18	郝可鑫	
4	徐俊吉		2/2		1/1				3/3	100		2				11	蒋承骅	3	04:05	3	10	郝可鑫	
7	吴双		1/1		1/1				2/2	100		1				14	沈吉磊	4	06:01	4	10	郝可鑫	
8	钱为玮	1/2	1/3	1/1	0/1	0/1			3/8	37.5						4	徐俊吉	5	06:41	4	4		
10	董凯							1/1	1/1	100				1		5	钱为玮	5	07:46	5	21	刘江	
11	蒋承骅		1/1						1/1	100		1		1		5	董凯	6	08:41	6	21	刘江	
12	周哲韬															5	蒋慧捷	7	10:25	7	18	赵楠	
14	沈吉磊	5/12	1/1			2/3	0/1	1/2	9/19	47.4	1	5	1			8	钱为玮	7	12:26	7	7		
15	蒋嘉敏															19	蒋慧捷	8	12:57	7	7		
16	朱春雷															8	钱为玮	9	13:38	8	21	刘江	
17	高天伦			0/1	1/2				1/3	33.3		1				4	徐俊吉	8	14:36	8	8		
18	马麟晓	0/2	0/1						0/3	0.0	4	4				14	沈吉磊	9	15:44	9	10	郝可鑫	
19	蒋慧捷		1/1	0/1	0/1				1/3	33.3		3				14	沈吉磊	9	16:08	9	10	郝可鑫	
22	张润明															17	高天伦	9	19:13	10	10	郝可鑫	
运动员 合计		7/18	7/10	1/3	4/7	3/5	0/1	2/3	24/47	51.1	10	18	1	2		10	董凯	9	20:28	11	10	郝可鑫	
1	张峥	6/13	2/4	1/2	1/6	3/7	0/1		13/33	39.4	4					10	董凯	10	22:40	11	11		
22	张润明	0/4	1/1					0/1	1/6	16.7						10	董凯	10	24:46	12	10	郝可鑫	
守门员 合计		6/17	3/5	1/2	1/6	3/7	0/1	0/1	14/39	35.9	4					11	董凯	11	25:19	12	10	郝可鑫	
江苏		远射	近射	边射	快攻	突破	任意球	7m球	合计	%	助攻	失误	警告	2'	D & DR	11		25:40		13		10	
教练： 闫威名																12		27:50		14		郝可鑫	
1	徐畅										2					13		28:24		14		郝可鑫	
4	张家纬															13		29:16		14			
5	闫亮											1				2nd Half							
6	赵晨	0/2					1/2		1/4	25.0	2					8	钱为玮	13	02:15	15	18	赵楠	
7	徐奕飞			0/1	2/3				2/4	50.0						14	沈吉磊	14	03:04	15	15		
8	周小坚											1				14	沈吉磊	14	03:27	16	18	赵楠	
9	任超凡					0/1			0/1	0.0						14	沈吉磊	14	04:56	17	21	刘江	
10	郝可鑫	8/13						1/1	9/14	64.3	1	1				3	赵时俊	14	05:51	18	7	徐奕飞	
11	马益奎		0/1						0/1	0.0						14	沈吉磊	15	06:43	18	7	徐奕飞	
12	王权															8	钱为玮	16	08:02	18	18		
13	耿畅		0/1			0/1			0/2	0.0		3				17	高天伦	17	10:08	18	18		
15	李加昌															17	高天伦	17	10:42	19	18	赵楠	
17	王伟强			1/1	1/1	1/1			3/3	100		2				17	高天伦	17	12:54	20	18	赵楠	
18	赵楠	3/5	2/5		1/3	1/3			6/13	46.2		3		2		18	董凯	18	13:35	20	20		
21	刘江	0/3	0/1		2/2	2/2			4/8	50.0		2		1		18	董凯	18	17:06	21	6	赵晨	
22	任启双												1			14	沈吉磊	19	18:58	21	21		
运动员 合计		11/23	2/8	1/2	5/6	4/8	1/2	1/1	25/50	50.0	5	15	1	5		14	沈吉磊	20	20:13	21	21		
1	徐畅	4/11	3/10	2/3	3/7	2/5	1/1	1/3	16/40	40.0	2					20	沈吉磊	20	21:36	22	17	王伟强	
12	王权															20	沈吉磊	20	22:19	23	17	王伟强	
守门员 合计		4/11	3/10	2/3	3/7	2/5	1/1	1/3	16/40	40.0	2					20	沈吉磊	20	23:51	24	7	徐奕飞	

场上队员： 得分 / 射门

守门员： 救球 / 射门

快攻	Fast Break	突破	Breakthrough	任意球	Free Throw	7M球	7M Throw	助攻	Assist
警告	Warning	失误	Error	2'	Suspension	D	取消资格	DR	取消资格+报告





## “绿叶集团”杯2016年全国男子手球超级杯赛 图式比赛技术统计表

轮次 2

场次 5

201608005-21-1/1

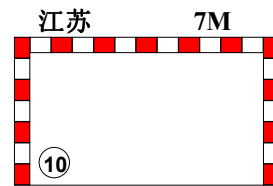
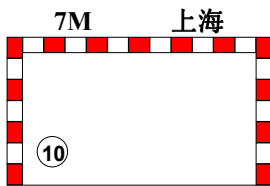
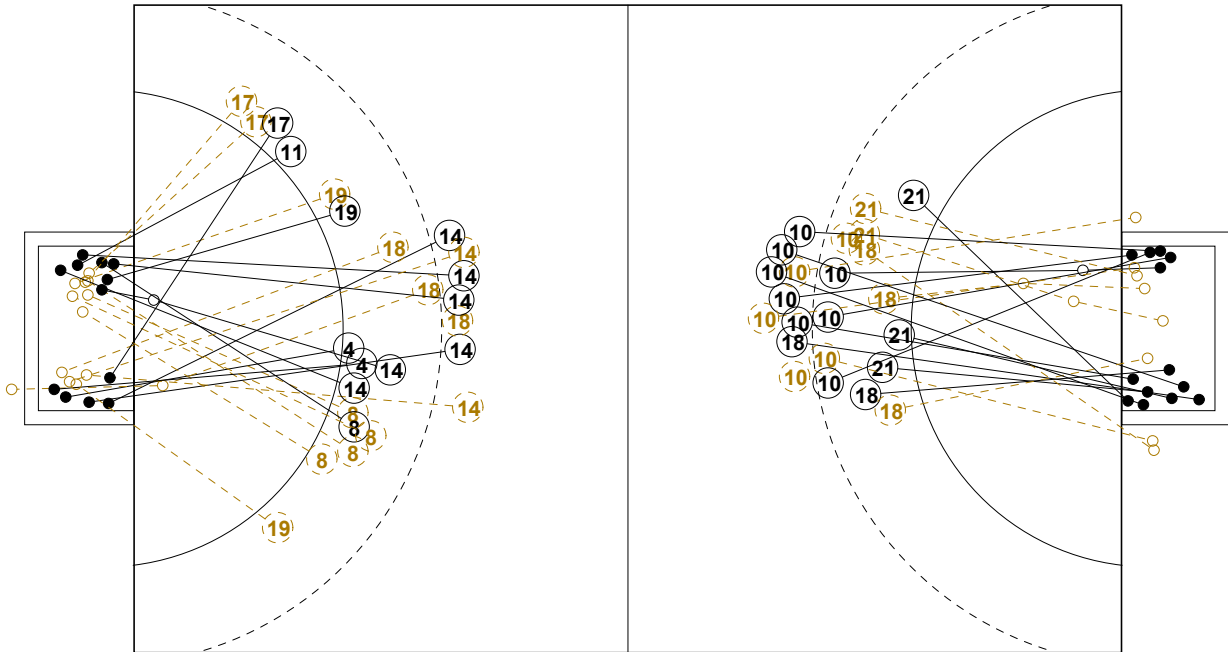

**1st Half**  
**13 : 14**

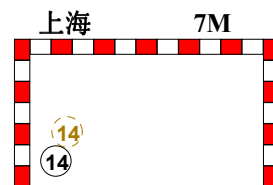
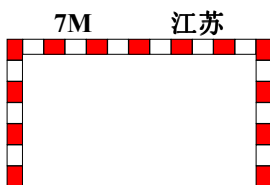
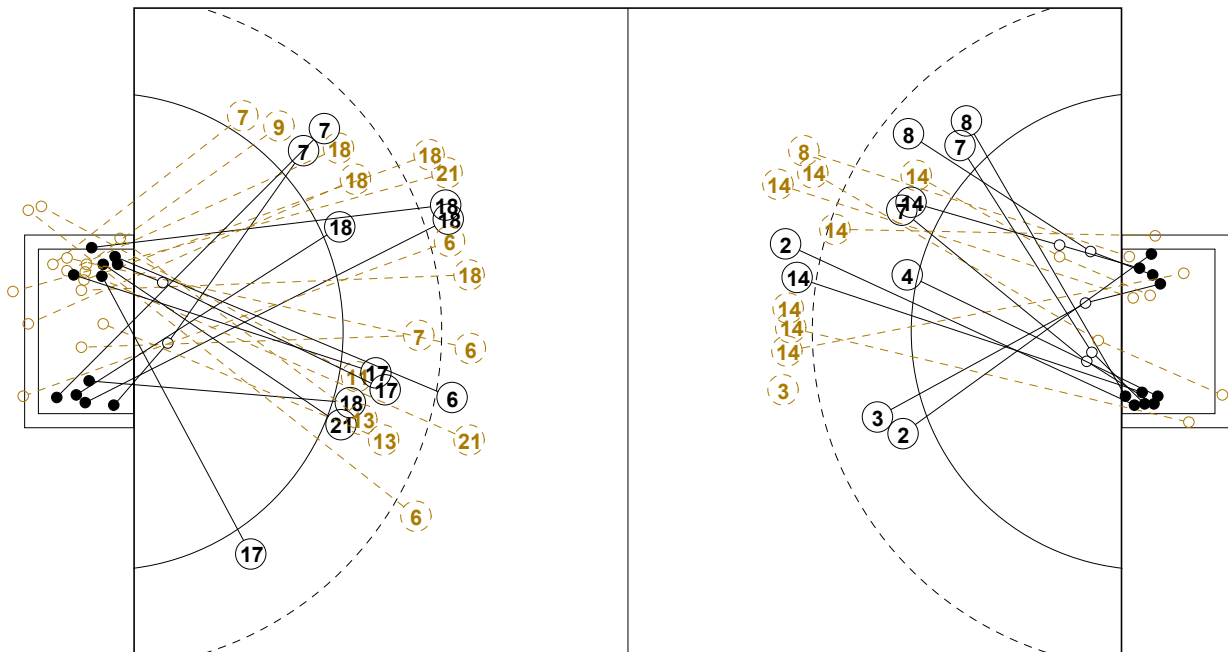

**2nd Half**  
**25 : 24**



## “绿叶集团”杯2016年全国男子手球超级杯赛

## 个人/全队技术统计表

正式表  
手球  
男子预赛  
轮次 2组别 X  
场次 5201608005-14-1/2  
苏州市体育中心  
21/11/2016 14:30

号码	姓名	远射	近射	边射	快攻	突破	任意	7M	合计	%	助攻	失误	警告	2'	取消	时间
<b>上海(上海)</b>																
<i>(场上队员)</i>																
1	张崢									0.0%	4					00:51:01
2	张文斌	1/1			1/1				2/2	100%	1					00:18:37
3	赵时俊	0/1				1/1			1/2	50.0%		1				00:13:06
4	徐俊吉		2/2		1/1				3/3	100%		2				00:33:26
7	吴双		1/1		1/1				2/2	100%		1				00:12:50
8	钱为玮	1/2	1/3	1/1	0/1	0/1			3/8	37.5%						00:37:25
10	董凯							1/1	1/1	100%				1		00:27:34
11	蒋承骅		1/1						1/1	100%		1		1		00:35:25
12	周哲韬									0.0%						00:00:00
14	沈吉磊	5/12	1/1			2/3	0/1	1/2	9/19	47.4%	1	5	1			00:57:12
15	蒋嘉敏									0.0%						00:00:00
16	朱春雷									0.0%						00:00:00
17	高天伦			0/1	1/2				1/3	33.3%		1				00:20:06
18	马麟晓	0/2	0/1						0/3	0.0%	4	4				00:42:53
19	蒋慧捷		1/1	0/1	0/1				1/3	33.3%		3				00:59:32
22	张润明									0.0%						00:08:59
<b>合计</b>		7/18	7/10	1/3	4/7	3/5	0/1	2/3	24/47	51.1%	10	18	1	2		
<i>(守门员)</i>																
1	张崢	6/13	2/4	1/2	1/6	3/7	0/1		13/33	39.4%	4					00:51:01
22	张润明	0/4	1/1					0/1	1/6	16.7%						00:08:59
<b>合计</b>		6/17	3/5	1/2	1/6	3/7	0/1	0/1	14/39	35.9%	4					

场上队员：得分/射门

守门员：救球/射门

全队合计	得分	被救	射失	击柱	封球	合计	%
远射	7	4	1	3	3	18	38.9%
近射	7	3				10	70.0%
边射	1	2				3	33.3%
快攻	4	3				7	57.1%
突破	3	2				5	60.0%
任意		1				1	0.0%
7M	2	1				3	66.7%





## “绿叶集团”杯2016年全国男子手球超级杯赛

## 个人/全队技术统计表

正式表  
手球  
男子预赛  
轮次 2组别 X  
场次 5201608005-14-2/2  
苏州市体育中心  
21/11/2016 14:30

号码	姓名	远射	近射	边射	快攻	突破	任意	7M	合计	%	助攻	失误	警告	2'	取消	时间
<b>江苏(江苏)</b>																
<i>(上场队员)</i>																
1	徐畅									0.0%	2					00:57:02
4	张家纬									0.0%						00:03:44
5	闫亮									0.0%		1				00:03:56
6	赵晨	0/2					1/2		1/4	25.0%	2					00:23:59
7	徐奕飞			0/1	2/3				2/4	50.0%						01:00:00
8	周小坚									0.0%		1				00:02:37
9	任超凡					0/1			0/1	0.0%						00:03:24
10	郝可鑫	8/13						1/1	9/14	64.3%	1	1				00:30:00
11	马益奎		0/1						0/1	0.0%				2		00:26:02
12	王权									0.0%						00:02:58
13	耿畅		0/1			0/1			0/2	0.0%		3				00:15:04
15	李加昌									0.0%						00:00:00
17	王伟强			1/1	1/1	1/1			3/3	100%		2				01:00:00
18	赵楠	3/5	2/5			1/3			6/13	46.2%		3		2		00:52:41
21	刘江	0/3	0/1		2/2	2/2			4/8	50.0%		2		1		00:44:55
22	任启双									0.0%		2	1			00:32:15
<b>合计</b>		11/23	2/8	1/2	5/6	4/8	1/2	1/1	25/50	50.0%	5	15	1	5		
<i>(守门员)</i>																
1	徐畅	4/11	3/10	2/3	3/7	2/5	1/1	1/3	16/40	40.0%	2					00:57:02
12	王权									0.0%						00:02:58
<b>合计</b>		4/11	3/10	2/3	3/7	2/5	1/1	1/3	16/40	40.0%	2					

场上队员：得分/射门

守门员：救球/射门

全队合计	得分	被救	射失	击柱	封球	合计	%
远射	11	6	3	1	2	23	47.8%
近射	2	3	2	1		8	25.0%
边射	1	1				2	50.0%
快攻	5	1				6	83.3%
突破	4	3		1		8	50.0%
任意	1		1			2	50.0%
7M	1					1	100.0%





### “绿叶集团”杯2016年全国男子手球超级杯赛

图式射门区域统计

轮次 2 场次 5

201608005-41-1/1

## 上海

1 张峥	2 张文斌	3 赵时俊	4 徐俊吉	7 吴双	8 钱为玮	10 董凯	11 蒋承骅																																																																								
<table border="1"><tr><td></td><td></td><td></td></tr><tr><td></td><td></td><td></td></tr><tr><td></td><td></td><td></td></tr></table>										<table border="1"><tr><td></td><td></td><td></td></tr><tr><td></td><td></td><td></td></tr><tr><td>1</td><td></td><td>1</td></tr></table>							1		1	<table border="1"><tr><td></td><td></td><td></td></tr><tr><td></td><td></td><td></td></tr><tr><td>1</td><td></td><td></td></tr></table>							1			<table border="1"><tr><td></td><td>2</td><td></td></tr><tr><td></td><td></td><td></td></tr><tr><td></td><td></td><td>1</td></tr></table>		2							1	<table border="1"><tr><td></td><td></td><td></td></tr><tr><td></td><td></td><td></td></tr><tr><td></td><td></td><td>1</td></tr></table>									1	<table border="1"><tr><td></td><td></td><td></td></tr><tr><td></td><td></td><td></td></tr><tr><td>1</td><td></td><td>1</td></tr></table>							1		1	<table border="1"><tr><td></td><td></td><td></td></tr><tr><td></td><td></td><td></td></tr><tr><td>1</td><td></td><td></td></tr></table>							1			<table border="1"><tr><td></td><td></td><td></td></tr><tr><td></td><td></td><td></td></tr><tr><td></td><td></td><td>1</td></tr></table>									1
1		1																																																																													
1																																																																															
	2																																																																														
		1																																																																													
		1																																																																													
1		1																																																																													
1																																																																															
		1																																																																													
Post - 0 Miss - 0 Block - 0	Post - 0 Miss - 0 Block - 0	Post - 0 Miss - 0 Block - 1	Post - 0 Miss - 0 Block - 0	Post - 0 Miss - 0 Block - 0	Post - 0 Miss - 0 Block - 0	Post - 0 Miss - 0 Block - 0	Post - 0 Miss - 0 Block - 0																																																																								
12 周哲韬	14 沈吉磊	15 蒋嘉敏	16 朱春雷	17 高天伦	18 马麟晓	19 蒋慧捷	22 张润明																																																																								
<table border="1"><tr><td></td><td></td><td></td></tr><tr><td></td><td></td><td></td></tr><tr><td></td><td></td><td></td></tr></table>										<table border="1"><tr><td></td><td></td><td>1</td></tr><tr><td>1</td><td></td><td>2</td></tr><tr><td>3</td><td></td><td>2</td></tr></table>			1	1		2	3		2	<table border="1"><tr><td></td><td></td><td></td></tr><tr><td></td><td></td><td></td></tr><tr><td></td><td></td><td></td></tr></table>										<table border="1"><tr><td></td><td></td><td></td></tr><tr><td></td><td></td><td></td></tr><tr><td></td><td></td><td></td></tr></table>										<table border="1"><tr><td></td><td></td><td></td></tr><tr><td></td><td></td><td></td></tr><tr><td>1</td><td></td><td></td></tr></table>							1			<table border="1"><tr><td></td><td></td><td></td></tr><tr><td></td><td></td><td></td></tr><tr><td></td><td></td><td></td></tr></table>										<table border="1"><tr><td></td><td></td><td></td></tr><tr><td></td><td></td><td></td></tr><tr><td></td><td></td><td>1</td></tr></table>									1	<table border="1"><tr><td></td><td></td><td></td></tr><tr><td></td><td></td><td></td></tr><tr><td></td><td></td><td></td></tr></table>									
		1																																																																													
1		2																																																																													
3		2																																																																													
1																																																																															
		1																																																																													
Post - 0 Miss - 0 Block - 0	Post - 3 Miss - 0 Block - 1	Post - 0 Miss - 0 Block - 0	Post - 0 Miss - 0 Block - 0	Post - 0 Miss - 0 Block - 0	Post - 0 Miss - 1 Block - 1	Post - 0 Miss - 0 Block - 0	Post - 0 Miss - 0 Block - 0																																																																								

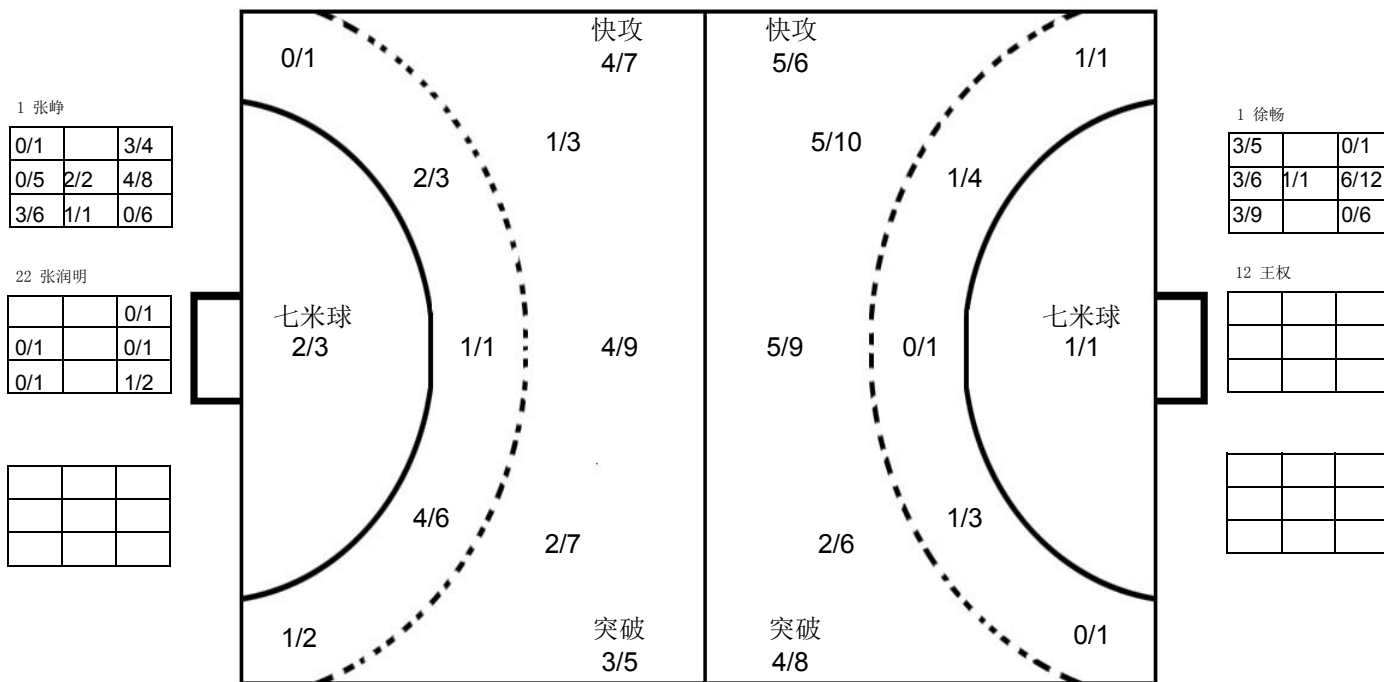

## 江苏

1 徐畅	4 张家伟	5 闫亮	6 赵晨	7 徐奕飞	8 周小坚	9 任超凡	10 郝可鑫																																																																								
<table border="1"><tr><td></td><td></td><td></td></tr><tr><td></td><td></td><td></td></tr><tr><td></td><td></td><td></td></tr></table>										<table border="1"><tr><td></td><td></td><td></td></tr><tr><td></td><td></td><td></td></tr><tr><td></td><td></td><td></td></tr></table>										<table border="1"><tr><td></td><td></td><td></td></tr><tr><td></td><td></td><td></td></tr><tr><td></td><td></td><td></td></tr></table>										<table border="1"><tr><td></td><td></td><td></td></tr><tr><td></td><td></td><td></td></tr><tr><td></td><td></td><td>1</td></tr></table>									1	<table border="1"><tr><td>1</td><td></td><td></td></tr><tr><td></td><td></td><td></td></tr><tr><td>1</td><td></td><td></td></tr></table>	1						1			<table border="1"><tr><td></td><td></td><td></td></tr><tr><td></td><td></td><td></td></tr><tr><td></td><td></td><td></td></tr></table>										<table border="1"><tr><td></td><td></td><td></td></tr><tr><td></td><td></td><td></td></tr><tr><td></td><td></td><td></td></tr></table>										<table border="1"><tr><td></td><td></td><td>1</td></tr><tr><td>3</td><td></td><td></td></tr><tr><td>3</td><td></td><td>2</td></tr></table>			1	3			3		2
		1																																																																													
1																																																																															
1																																																																															
		1																																																																													
3																																																																															
3		2																																																																													
Post - 0 Miss - 0 Block - 0	Post - 0 Miss - 0 Block - 0	Post - 0 Miss - 0 Block - 0	Post - 1 Miss - 1 Block - 0	Post - 0 Miss - 0 Block - 0	Post - 0 Miss - 0 Block - 0	Post - 0 Miss - 0 Block - 0	Post - 0 Miss - 2 Block - 2																																																																								
11 马益奎	12 王权	13 耿畅	15 李加昌	17 王伟强	18 赵楠	21 刘江	22 任启双																																																																								
<table border="1"><tr><td></td><td></td><td></td></tr><tr><td></td><td></td><td></td></tr><tr><td></td><td></td><td></td></tr></table>										<table border="1"><tr><td></td><td></td><td></td></tr><tr><td></td><td></td><td></td></tr><tr><td></td><td></td><td></td></tr></table>										<table border="1"><tr><td></td><td></td><td></td></tr><tr><td></td><td></td><td></td></tr><tr><td></td><td></td><td></td></tr></table>										<table border="1"><tr><td></td><td></td><td></td></tr><tr><td></td><td></td><td></td></tr><tr><td></td><td></td><td></td></tr></table>										<table border="1"><tr><td></td><td></td><td></td></tr><tr><td></td><td></td><td></td></tr><tr><td></td><td></td><td>2</td></tr></table>									2	<table border="1"><tr><td></td><td></td><td>1</td></tr><tr><td>3</td><td></td><td>2</td></tr><tr><td></td><td></td><td></td></tr></table>			1	3		2				<table border="1"><tr><td></td><td></td><td></td></tr><tr><td></td><td></td><td></td></tr><tr><td></td><td></td><td>1</td></tr></table>									1	<table border="1"><tr><td></td><td></td><td></td></tr><tr><td></td><td></td><td></td></tr><tr><td></td><td></td><td>3</td></tr></table>									3
		2																																																																													
		1																																																																													
3		2																																																																													
		1																																																																													
		3																																																																													
Post - 0 Miss - 1 Block - 0	Post - 0 Miss - 0 Block - 0	Post - 1 Miss - 0 Block - 0	Post - 0 Miss - 0 Block - 0	Post - 0 Miss - 0 Block - 0	Post - 1 Miss - 1 Block - 0	Post - 0 Miss - 1 Block - 0	Post - 0 Miss - 0 Block - 0																																																																								

注释: Post=击柱 Miss=射失 Block=被封





预赛 Group X

男子 全国杯赛

“绿叶集团”杯2016年全国男子手球超级杯赛

Team A					Team B					Match Number											
A 安徽					B 北京					6											
played in			in the hall			on			at		Spectators										
China			苏州市体育中心			21/11/2016			16:00 hours												
Half-time (30')	A	B	End of playing time		A	B	1st extra time		A	B	After penalty										
	14	12	33 27																		
Number of 7 m	A	Team time-out			Full name of players and officials						Team time-out			B	Number of 7 m						
		1	2	3							1	2	3								
	1/1	43:02									10:33			1/4							
No.	Team A					G	W	2'	D	DR	No.	Team B					G	W	2'	D	DR
1	郭世伟					3					3	吴锐樊					7				
3	陈强龙										6	赵一涵					1				
5	史小帆					2					7	卞友山					1				
7	姚雄敏										8	赵文宣					1				
8	董智景					7		1			9	李旭					2				
9	陈开勇					6					10	李明远					1				
10	严龙										12	孔祥杰									
11	黎涛					1					17	袁振典					4	1	1		
12	曾献辰										18	温新宇					2				
13	何磊							1			20	王鹏皓							2		
17	王巨柱										23	陈旭					2				
18	李双					5	1	1			25	程海津					1	1	1		
21	李明										26	杨政									
23	于敏清					1					29	逯明松					2				
24	徐安格					1					35	高云健									
35	金永峰					7					78	王哲一					3				
A	韦中平										B	吴健 (主教练)									
B	沈强 (主教练)										C	刘彦坤									
C	吴翔										D	陈璇									
D	陈玉翔																				
A	Signature of Responsible Official of the Teams (Off. A)										B										
TP	Remarks of Referee / CHA Official																			TP	

Signatures

Referees: 李典 (CHN)      倪震 (CHN)

Techn. Delegates: 李之文 (CHN)      于中迅 (CHN)

CHA Official: \_\_\_\_\_

Note: Number of 7m Throws Awarded to Team A and B, Goals (G), Warnings (W), Suspensions (2), Direct Disqualification (D), Disqualification with Report (DR) and Team Penalty (TP).







“绿叶集团”杯2016年全国男子手球超级杯赛  
竞赛技术统计(媒体表)

预赛 组别 X 轮次 2 场次 6

苏州市体育中心

21/11/2016

201608006-51-1/1

安徽 安徽 33 vs 27 北京 北京 14:12

裁判员 李典 (CHN) / 倪震 (CHN)

Main statistics table with columns for player name, position, and various performance metrics (shots, goals, assists, etc.) for both teams.

场上队员: 得分 / 射门

守门员: 救球 / 射门

Legend table for abbreviations: 快攻 (Fast Break), 突破 (Breakthrough), 任意球 (Free Throw), 7M球 (7M Throw), 助攻 (Assist), 警告 (Warning), 失误 (Error), 2' (Suspension), D (取消资格 - Disqualification), DR (取消资格+报告 - Disqualification+Report).





## “绿叶集团”杯2016年全国男子手球超级杯赛 图式比赛技术统计表

轮次 2

场次 6

201608006-21-1/1

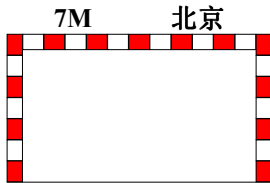
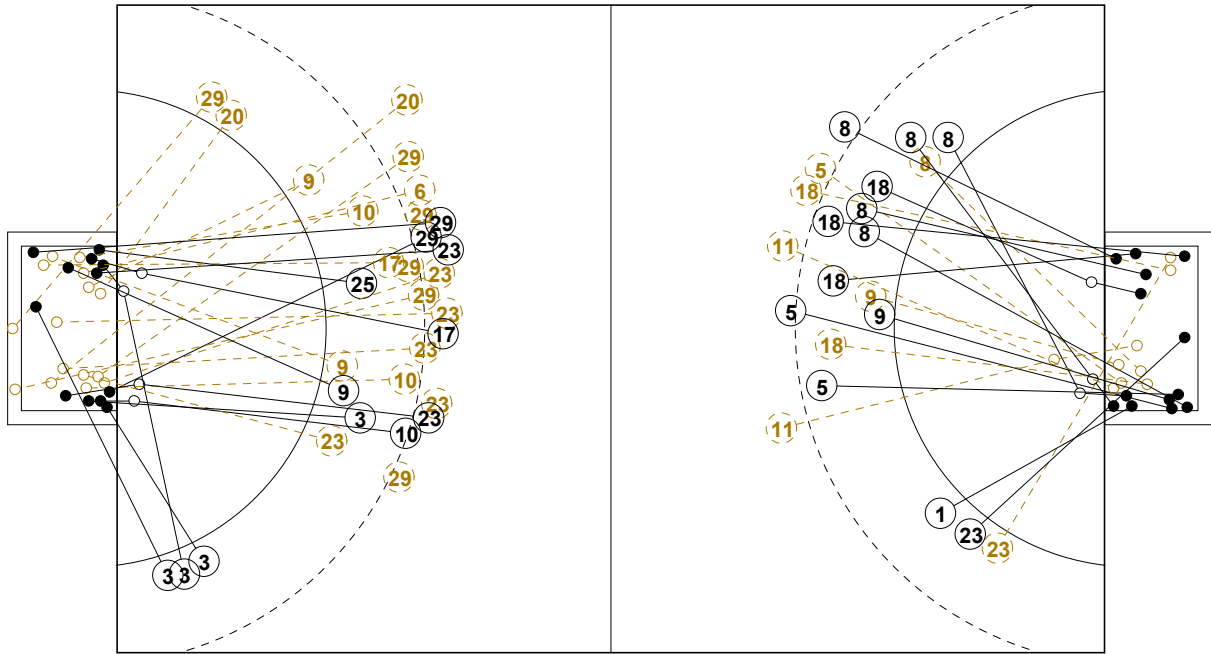

1st Half  
12 : 14

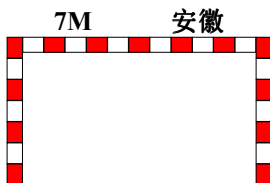
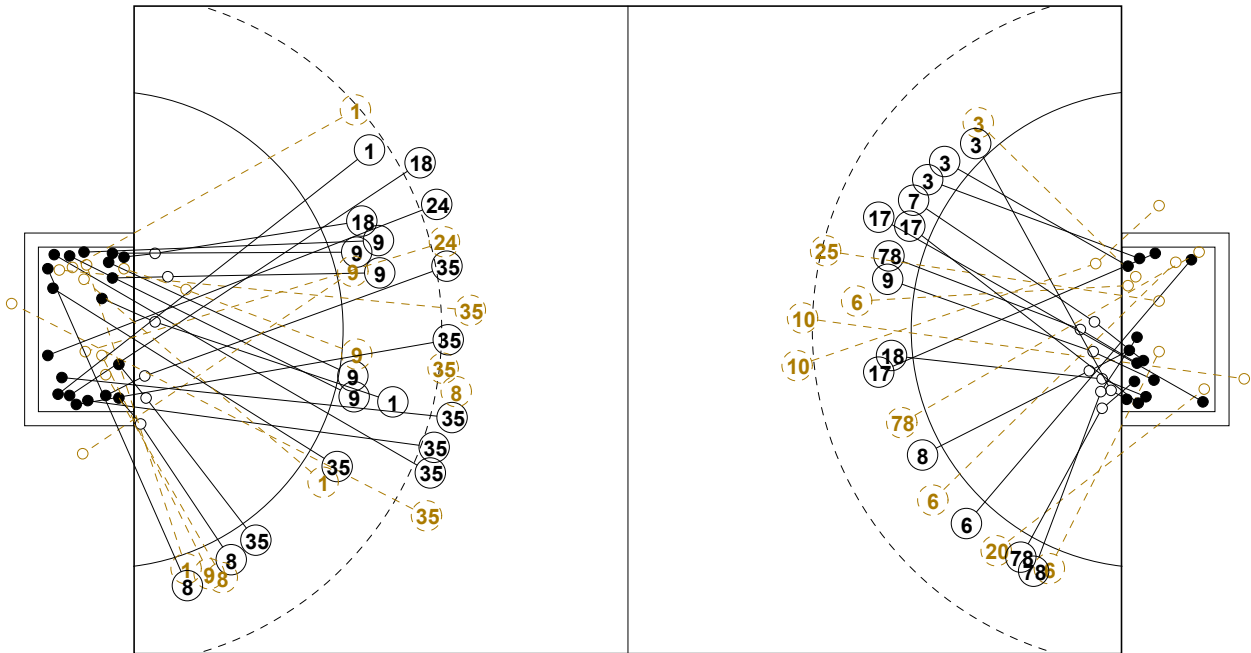
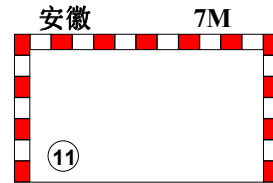

2nd Half  
33 : 27

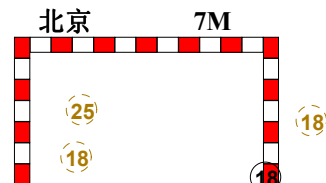



## “绿叶集团”杯2016年全国男子手球超级杯赛

## 个人/全队技术统计表

正式表  
手球  
男子预赛  
轮次 2组别 X  
场次 6201608006-14-1/2  
苏州市体育中心  
21/11/2016 16:00

号码	姓名	远射	近射	边射	快攻	突破	任意	7M	合计	%	助攻	失误	警告	2'	取消	时间
<b>安徽(安徽)</b>																
<i>(场上队员)</i>																
1	郭世伟	1/2	1/2		1/1	0/1			3/6	50.0%	1					00:35:39
3	陈强龙									0.0%		1				00:27:23
5	史小帆	2/3							2/3	66.7%		2				00:40:58
7	姚雄敏									0.0%						00:00:00
8	董智景	1/2	1/1	1/2	1/2	3/3			7/10	70.0%		1		1		00:50:51
9	陈开勇		4/6	0/1	2/3				6/10	60.0%	1					00:41:49
10	严龙									0.0%						00:00:00
11	黎涛	0/2						1/1	1/3	33.3%	1	1				00:26:02
12	曾献辰									0.0%						00:01:06
13	何磊									0.0%				1		00:05:06
17	王巨柱									0.0%						00:00:00
18	李双	2/3			1/1	2/3			5/7	71.4%	2	5	1	1		01:00:00
21	李明									0.0%	2					00:58:54
23	于敏清			0/1	1/1				1/2	50.0%						00:24:21
24	徐安格	1/2							1/2	50.0%		2				00:22:50
35	金永峰	5/8	1/1	1/1					7/10	70.0%	1	1				00:24:15
<b>合计</b>		12/22	7/10	2/5	6/8	5/7		1/1	33/53	62.3%	8	13	1	3		
<i>(守门员)</i>																
12	曾献辰		0/1					2/2	2/3	66.7%						00:01:06
21	李明	7/12	2/7	4/10	4/9	2/5	1/2	0/1	20/46	43.5%	2					00:58:54
<b>合计</b>		7/12	2/8	4/10	4/9	2/5	1/2	2/3	22/49	44.9%	2					

场上队员：得分/射门

守门员：救球/射门

全队合计	得分	被救	射失	击柱	封球	合计	%
远射	12	7	1		2	22	54.5%
近射	7	3				10	70.0%
边射	2	3				5	40.0%
快攻	6	1	1			8	75.0%
突破	5	2				7	71.4%
任意							0.0%
7M	1					1	100.0%





## “绿叶集团”杯2016年全国男子手球超级杯赛

## 个人/全队技术统计表

正式表  
手球  
男子预赛  
轮次 2组别 X  
场次 6201608006-14-2/2  
苏州市体育中心  
21/11/2016 16:00

号码	姓名	远射	近射	边射	快攻	突破	任意	7M	合计	%	助攻	失误	警告	2'	取消	时间
<b>北京(北京)</b>																
<i>(上场队员)</i>																
3	吴锐樊		1/1	3/4	3/3				7/8	87.5%		1				00:56:03
6	赵一涵	0/1	0/2	1/2					1/5	20.0%		3				00:38:06
7	卞友山		1/1						1/1	100%						00:20:44
8	赵文宣		1/1						1/1	100%						00:13:13
9	李旭		1/1		1/3				2/4	50.0%		1				00:39:09
10	李明远	1/4				0/1			1/5	20.0%		1				00:11:47
12	孔祥杰									0.0%						00:29:42
17	袁振典	1/1				3/4			4/5	80.0%	2	5	1	1		00:28:07
18	温新宇		1/1					1/3	2/4	50.0%						00:00:46
20	王鹏皓	0/1		0/2					0/3	0.0%				2		00:22:12
23	陈旭	1/4			0/1		1/2		2/7	28.6%		2				00:46:51
25	程海津	0/1			1/1			0/1	1/3	33.3%	2	1	1	1		00:27:07
26	杨政									0.0%						00:03:54
29	逯明松	2/7		0/1					2/8	25.0%						00:30:00
35	高云健									0.0%	1					00:30:18
78	王哲一		1/1	2/2	0/1				3/4	75.0%						00:22:19
<b>合计</b>		5/19	6/8	6/11	5/9	3/5	1/2	1/4	27/58	46.6%	5	14	2	4		
<i>(守门员)</i>																
12	孔祥杰	4/8	1/3	1/1	1/4	1/5			8/21	38.1%						00:29:42
35	高云健	3/11	2/7	2/4	0/3	1/2		0/1	8/28	28.6%	1					00:30:18
<b>合计</b>		7/19	3/10	3/5	1/7	2/7		0/1	16/49	32.7%	1					

场上队员：得分/射门

守门员：救球/射门

全队合计	得分	被救	射失	击柱	封球	合计	%
远射	5	7	2	1	4	19	26.3%
近射	6	2				8	75.0%
边射	6	4		1		11	54.5%
快攻	5	4				9	55.6%
突破	3	2				5	60.0%
任意	1	1				2	50.0%
7M	1	2	1			4	25.0%





### “绿叶集团”杯2016年全国男子手球超级杯赛

图式射门区域统计

轮次 2 场次 6

201608006-41-1/1

## 安徽

1 郭世伟 1 1 1	3 陈强龙	5 史小帆 2	7 姚雄敏	8 董智景 1 2 2	9 陈开勇 2 1 3	10 严龙	11 黎涛 1
Post - 0 Miss - 0 Block - 0	Post - 0 Miss - 0 Block - 0	Post - 0 Miss - 0 Block - 0	Post - 0 Miss - 0 Block - 0	Post - 0 Miss - 0 Block - 1	Post - 0 Miss - 1 Block - 0	Post - 0 Miss - 0 Block - 0	Post - 0 Miss - 0 Block - 0
12 曾献辰	13 何磊	17 王巨柱	18 李双 2 2 1	21 李明	23 于敏清 1	24 徐安格 1	35 金永峰 1 2 2
Post - 0 Miss - 0 Block - 0	Post - 0 Miss - 0 Block - 0	Post - 0 Miss - 0 Block - 0	Post - 0 Miss - 0 Block - 0	Post - 0 Miss - 0 Block - 0	Post - 0 Miss - 0 Block - 0	Post - 0 Miss - 0 Block - 0	Post - 0 Miss - 1 Block - 1

12 曾献辰 1/1 1/1	21 李明 2/3 0/1 3/5 3/5 3/3 2/4 5/11 0/2 2/12

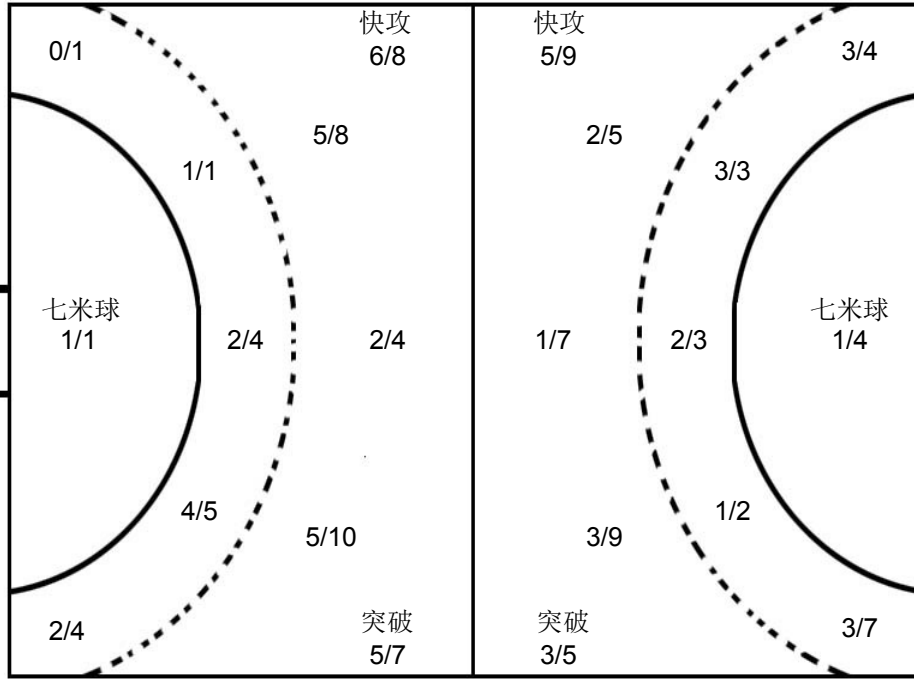

12 孔祥杰 2/3 0/1 0/4 0/3 1/1 2/2 0/1 3/6	35 高云健 0/3 0/1 1/5 0/2 2/2 3/5 1/5 1/5

## 北京

3 吴锐樊 1 4 2	6 赵一涵 1	7 卞友山 1	8 赵文宣 1	9 李旭 2	10 李明远 1	12 孔祥杰	17 袁振典 1 1 2
Post - 0 Miss - 0 Block - 0	Post - 0 Miss - 0 Block - 0	Post - 0 Miss - 0 Block - 0	Post - 0 Miss - 0 Block - 0	Post - 0 Miss - 0 Block - 0	Post - 0 Miss - 2 Block - 0	Post - 0 Miss - 0 Block - 0	Post - 0 Miss - 0 Block - 0
18 温新宇 2	20 王鹏皓	23 陈旭 1 1	25 程海津 1	26 杨政	29 逯明松 1 1	35 高云健	78 王哲一 1 2
Post - 0 Miss - 1 Block - 0	Post - 0 Miss - 0 Block - 0	Post - 0 Miss - 0 Block - 1	Post - 0 Miss - 0 Block - 0	Post - 0 Miss - 0 Block - 0	Post - 2 Miss - 0 Block - 3	Post - 0 Miss - 0 Block - 0	Post - 0 Miss - 0 Block - 0

注释: Post=击柱 Miss=射失 Block=被封





预赛 Group X

男子 全国杯赛

“绿叶集团”杯2016年全国男子手球超级杯赛

Team A <b>A 江苏</b>				Team B <b>B 安徽</b>				Match Number <b>7</b>													
played in China		in the hall 苏州市体育中心		on 22/11/2016		at 13:00 hours		Spectators													
Half-time (30')	<b>A</b> 19	<b>B</b> 10	End of playing time	<b>A</b> 30	<b>B</b> 21	1st extra time	<b>A</b>	<b>B</b>	2nd extra time	<b>A</b>	<b>B</b>	After penalty throws	<b>A</b>	<b>B</b>							
Number of 7 m	<b>A</b> 1 / 1	Team time-out 1 2 3 54:43			Full name of players and officials				Team time-out 1 2 3 22:30 46:51			<b>B</b> 3 / 3	Number of 7 m								
No.	Team <b>A</b>					G	W	2'	D	DR	No.	Team <b>B</b>					G	W	2'	D	DR
1	徐畅										1	郭世伟					7				
4	张家纬										3	陈强龙						1	1		
5	闫亮					1					5	史小帆									
6	赵晨					8	1				7	姚雄敏									
7	徐奕飞					4		1			8	董智景					3				
8	周小坚										9	陈开勇					1				
9	任超凡					1					10	严龙									
10	郝可鑫										11	黎涛					5				
11	马益奎										12	曾献辰									
12	王权										13	何磊					1				
13	耿畅					2					17	王巨柱									
15	李加昌										18	李双					2	1			
17	王伟强					3					21	李明									
18	赵楠					4		1			23	于敏清									
21	刘江					3	1				24	徐安格								1	
22	任启双					4	1				35	金永峰					2			1	
<b>B</b>	闫威名 (主教练)										<b>A</b>	韦中平									
<b>E</b>	王建国										<b>B</b>	沈强 (主教练)									
											<b>C</b>	吴翔									
											<b>D</b>	陈玉翔									
<b>A</b>	Signature of Responsible Official of the Teams (Off. A)										<b>B</b>										
TP	Remarks of Referee / CHA Official										TP										

Signatures

Referees	刘书勇 (CHN)	张栋 (CHN)		
Techn. Delegates	李之文 (CHN)	于中迅 (CHN)		
CHA Official				

Note: Number of 7m Throws Awarded to Team A and B, Goals (G), Warnings (W), Suspensions (2'), Direct Disqualification (D), Disqualification with Report (DR) and Team Penalty (TP).

Table Officials: 宣海波

许栋梁

Statisticians: 王玲

王玮

Printed by PHMS Copyright: IHF / CHA 22/11/2016 14:13:45

Longman Sportsoft



handball@126.com





### “绿叶集团”杯2016年全国男子手球超级杯赛 图式比赛技术统计表

轮次 3

场次 7

201608007-21-1/1

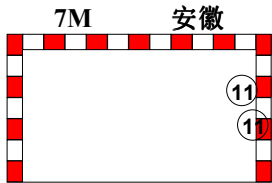
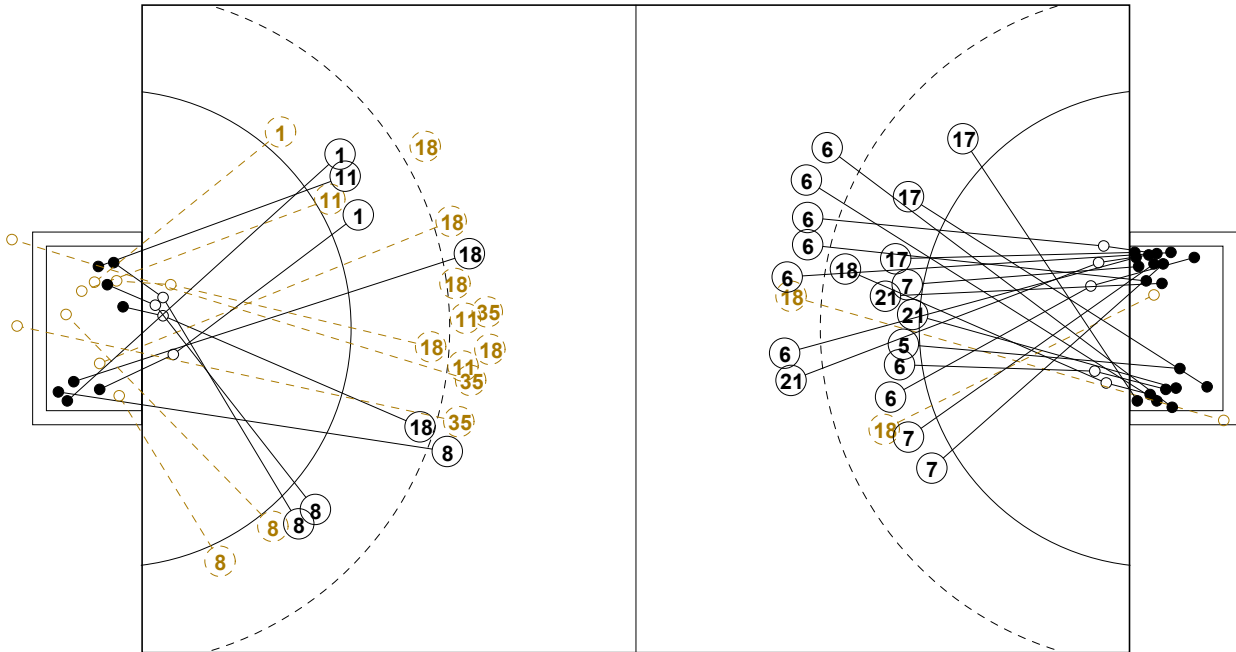

1st Half  
10 : 19

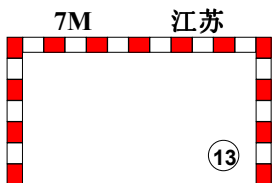
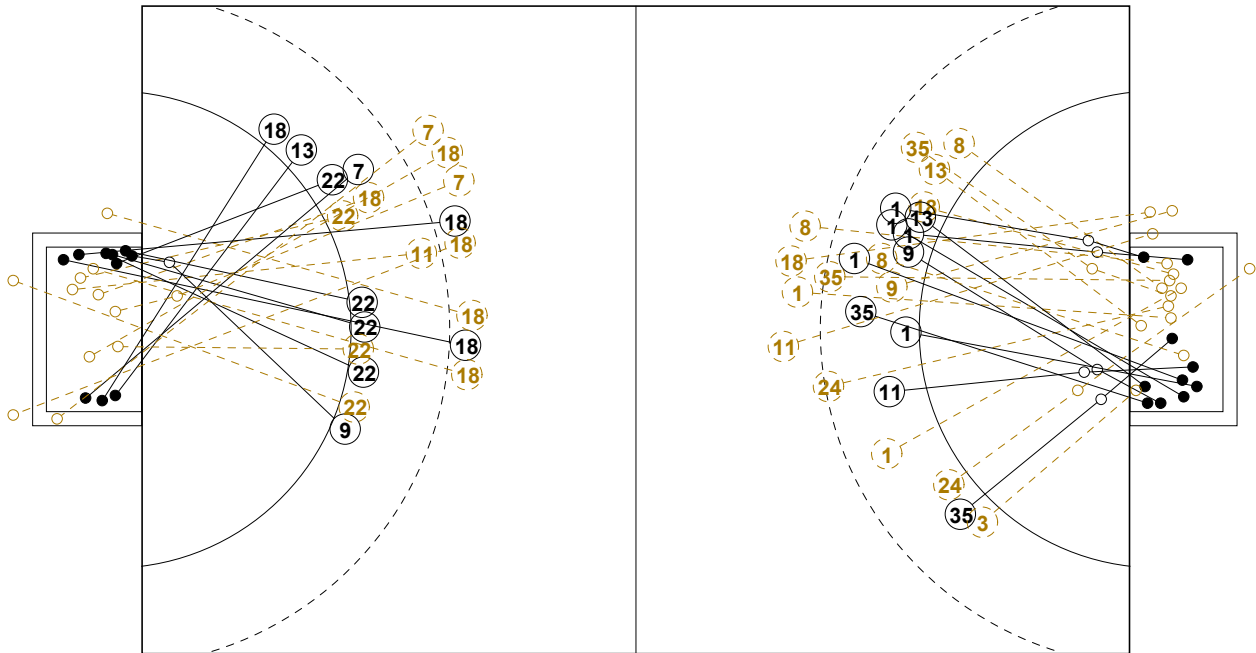
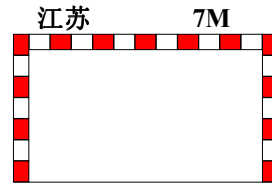

2nd Half  
30 : 21

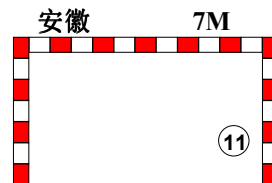





## “绿叶集团”杯2016年全国男子手球超级杯赛

## 个人/全队技术统计表

正式表  
手球  
男子预赛  
轮次 3组别 X  
场次 7201608007-14-1/2  
苏州市体育中心  
22/11/2016 13:00

号码	姓名	远射	近射	边射	快攻	突破	任意	7M	合计	%	助攻	失误	警告	2'	取消	时间
<b>江苏(江苏)</b>																
<i>(场上队员)</i>																
1	徐畅									0.0%						00:19:42
4	张家纬									0.0%						00:00:00
5	闫亮		1/1						1/1	100%						00:22:38
6	赵晨	4/4	1/1			1/1	2/2		8/8	100%	1	2	1			00:30:00
7	徐奕飞		1/1		2/2	1/1	0/2		4/6	66.7%	1	4		1		01:00:00
8	周小坚									0.0%						00:00:00
9	任超凡		1/1						1/1	100%						00:19:44
10	郝可鑫									0.0%						00:00:00
11	马益奎	0/1							0/1	0.0%		1				00:30:00
12	王权									0.0%	1					00:40:18
13	耿畅				1/1			1/1	2/2	100%		2				00:30:00
15	李加昌									0.0%						00:00:00
17	王伟强		1/1		2/2				3/3	100%		4				00:30:00
18	赵楠	3/8	0/1	1/1		0/1			4/11	36.4%	3	5		1		01:10:27
21	刘江	1/1	1/1		1/1				3/3	100%	4	2	1			00:40:14
22	任启双		4/7						4/7	57.1%	1		1			00:37:21
<b>合计</b>		8/14	10/14	1/1	6/6	2/3	2/4	1/1	30/43	69.8%	11	20	3	2		
<i>(守门员)</i>																
1	徐畅	3/3	3/5		2/3	0/2		0/1	8/14	57.1%						00:19:42
12	王权	2/6	1/3	3/3	2/4	1/6		0/2	9/24	37.5%	1					00:40:18
<b>合计</b>		5/9	4/8	3/3	4/7	1/8		0/3	17/38	44.7%	1					

场上队员：得分/射门

守门员：救球/射门

全队合计	得分	被救	射失	击柱	封球	合计	%
远射	8	3	2	1		14	57.1%
近射	10	3	1			14	71.4%
边射	1					1	100.0%
快攻	6					6	100.0%
突破	2	1				3	66.7%
任意	2	1		1		4	50.0%
7M	1					1	100.0%





## “绿叶集团”杯2016年全国男子手球超级杯赛

## 个人/全队技术统计表

正式表  
手球  
男子预赛  
轮次 3组别 X  
场次 7201608007-14-2/2  
苏州市体育中心  
22/11/2016 13:00

号码	姓名	远射	近射	边射	快攻	突破	任意	7M	合计	%	助攻	失误	警告	2'	取消	时间
<b>安徽(安徽)</b>																
<i>(上场队员)</i>																
1	郭世伟	1/2	0/1	0/1	3/3	3/3			7/10	70.0%		1				00:48:50
3	陈强龙				0/1				0/1	0.0%			1	1		00:50:05
5	史小帆									0.0%						00:23:04
7	姚雄敏									0.0%						00:00:00
8	董智景	1/2	2/3	0/2	0/1				3/8	37.5%		2				00:44:14
9	陈开勇		1/2						1/2	50.0%		1				00:27:45
10	严龙									0.0%						00:00:00
11	黎涛	0/3			0/1	2/2		3/3	5/9	55.6%	1	5				00:42:41
12	曾献辰									0.0%						00:30:00
13	何磊		0/1			1/1			1/2	50.0%						00:13:09
17	王巨柱									0.0%						00:00:00
18	李双	2/7			0/1	0/1			2/9	22.2%		1	1			00:40:35
21	李明									0.0%						00:30:00
23	于敏清									0.0%		2				00:18:03
24	徐安格	0/1	0/1						0/2	0.0%		1		1		00:23:11
35	金永峰	0/4	1/2			1/1			2/7	28.6%		1		1		00:27:47
<b>合计</b>		4/19	4/10	0/3	3/7	7/8		3/3	21/50	42.0%	1	14	2	3		
<i>(守门员)</i>																
1	郭世伟									0.0%		1				00:48:50
12	曾献辰	3/5	2/7	0/1	0/1	1/2	1/1	0/1	7/18	38.9%						00:30:00
21	李明	0/6	1/6		0/5	0/1	0/2		1/20	5.0%						00:30:00
<b>合计</b>		3/11	3/13	0/1	0/6	1/3	1/3	0/1	8/38	21.1%		1				

场上队员：得分/射门

守门员：救球/射门

全队合计	得分	被救	射失	击柱	封球	合计	%
远射	4	5	3	1	6	19	21.1%
近射	4	4	2			10	40.0%
边射		3				3	0.0%
快攻	3	4				7	42.9%
突破	7	1				8	87.5%
任意							0.0%
7M	3					3	100.0%





“绿叶集团”杯2016年全国男子手球超级杯赛

图式射门区域统计

轮次 3 场次 7

201608007-41-1/1

江苏

1 徐畅	4 张家纬	5 闫亮	6 赵晨	7 徐奕飞	8 周小坚	9 任超凡	10 郝可鑫																																																																								
<table border="1"><tr><td></td><td></td><td></td></tr><tr><td></td><td></td><td></td></tr><tr><td></td><td></td><td></td></tr></table>										<table border="1"><tr><td></td><td></td><td></td></tr><tr><td></td><td></td><td></td></tr><tr><td></td><td></td><td></td></tr></table>										<table border="1"><tr><td></td><td></td><td></td></tr><tr><td></td><td></td><td>1</td></tr><tr><td></td><td></td><td></td></tr></table>						1				<table border="1"><tr><td>1</td><td></td><td></td></tr><tr><td>1</td><td></td><td>2</td></tr><tr><td>3</td><td></td><td>1</td></tr></table>	1			1		2	3		1	<table border="1"><tr><td></td><td></td><td></td></tr><tr><td>2</td><td></td><td></td></tr><tr><td>2</td><td></td><td></td></tr></table>				2			2			<table border="1"><tr><td></td><td></td><td></td></tr><tr><td></td><td></td><td></td></tr><tr><td></td><td></td><td></td></tr></table>										<table border="1"><tr><td></td><td></td><td></td></tr><tr><td></td><td></td><td></td></tr><tr><td></td><td></td><td>1</td></tr></table>									1	<table border="1"><tr><td></td><td></td><td></td></tr><tr><td></td><td></td><td></td></tr><tr><td></td><td></td><td></td></tr></table>									
		1																																																																													
1																																																																															
1		2																																																																													
3		1																																																																													
2																																																																															
2																																																																															
		1																																																																													
Post - 0 Miss - 0 Block - 0	Post - 0 Miss - 0 Block - 0	Post - 0 Miss - 0 Block - 0	Post - 0 Miss - 0 Block - 0	Post - 1 Miss - 0 Block - 0	Post - 0 Miss - 0 Block - 0	Post - 0 Miss - 0 Block - 0	Post - 0 Miss - 0 Block - 0																																																																								
11 马益奎	12 王权	13 耿畅	15 李加昌	17 王伟强	18 赵楠	21 刘江	22 任启双																																																																								
<table border="1"><tr><td></td><td></td><td></td></tr><tr><td></td><td></td><td></td></tr><tr><td></td><td></td><td></td></tr></table>										<table border="1"><tr><td></td><td></td><td></td></tr><tr><td></td><td></td><td></td></tr><tr><td></td><td></td><td></td></tr></table>										<table border="1"><tr><td></td><td></td><td></td></tr><tr><td></td><td></td><td></td></tr><tr><td>1</td><td></td><td>1</td></tr></table>							1		1	<table border="1"><tr><td></td><td></td><td></td></tr><tr><td></td><td></td><td></td></tr><tr><td></td><td></td><td></td></tr></table>										<table border="1"><tr><td></td><td></td><td>1</td></tr><tr><td></td><td></td><td></td></tr><tr><td>1</td><td></td><td>1</td></tr></table>			1				1		1	<table border="1"><tr><td></td><td></td><td>2</td></tr><tr><td>1</td><td></td><td></td></tr><tr><td></td><td></td><td>1</td></tr></table>			2	1					1	<table border="1"><tr><td></td><td></td><td></td></tr><tr><td>1</td><td></td><td>1</td></tr><tr><td>1</td><td></td><td></td></tr></table>				1		1	1			<table border="1"><tr><td></td><td></td><td></td></tr><tr><td></td><td></td><td>1</td></tr><tr><td></td><td></td><td>3</td></tr></table>						1			3
1		1																																																																													
		1																																																																													
1		1																																																																													
		2																																																																													
1																																																																															
		1																																																																													
1		1																																																																													
1																																																																															
		1																																																																													
		3																																																																													
Post - 0 Miss - 0 Block - 0	Post - 0 Miss - 0 Block - 0	Post - 0 Miss - 0 Block - 0	Post - 0 Miss - 0 Block - 0	Post - 0 Miss - 0 Block - 0	Post - 1 Miss - 2 Block - 0	Post - 0 Miss - 0 Block - 0	Post - 0 Miss - 1 Block - 0																																																																								

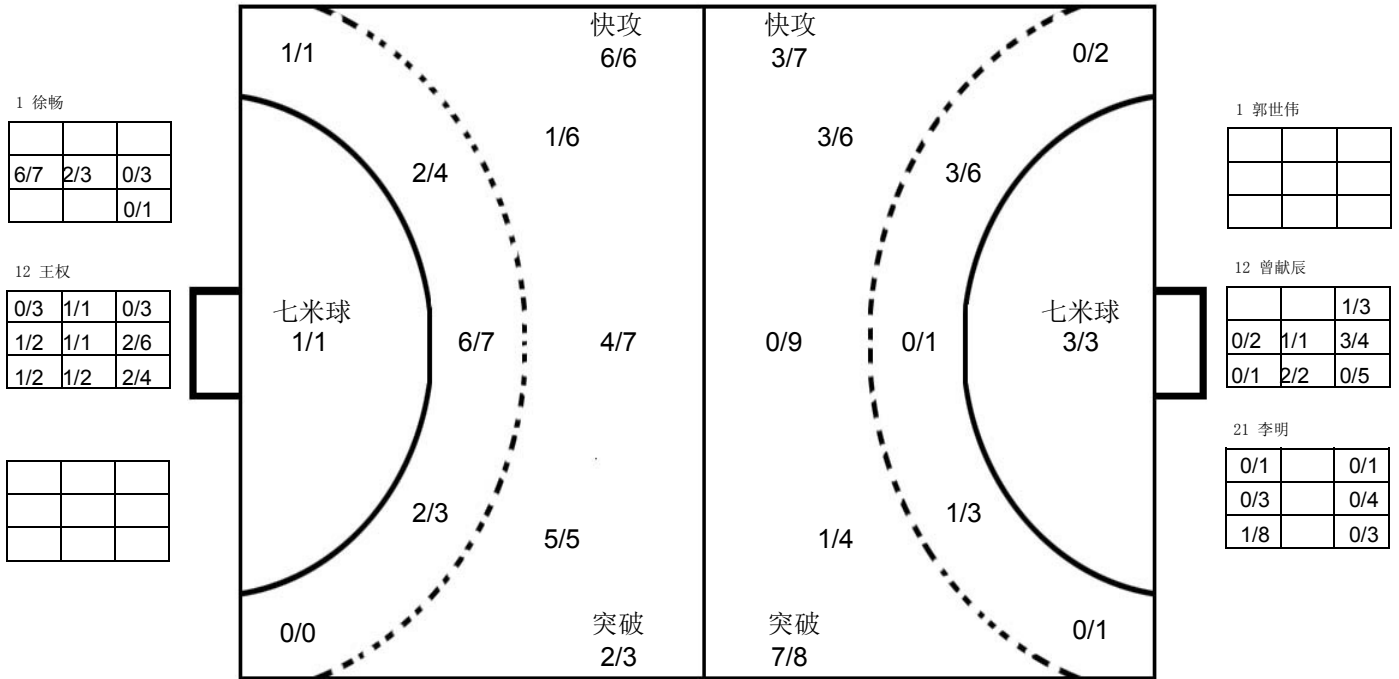

安徽

1 郭世伟	3 陈强龙	5 史小帆	7 姚雄敏	8 董智景	9 陈开勇	10 严龙	11 黎涛																																																																								
<table border="1"><tr><td>1</td><td></td><td>1</td></tr><tr><td>2</td><td></td><td>2</td></tr><tr><td>1</td><td></td><td></td></tr></table>	1		1	2		2	1			<table border="1"><tr><td></td><td></td><td></td></tr><tr><td></td><td></td><td></td></tr><tr><td></td><td></td><td></td></tr></table>										<table border="1"><tr><td></td><td></td><td></td></tr><tr><td></td><td></td><td></td></tr><tr><td></td><td></td><td></td></tr></table>										<table border="1"><tr><td></td><td></td><td></td></tr><tr><td></td><td></td><td></td></tr><tr><td></td><td></td><td></td></tr></table>										<table border="1"><tr><td>1</td><td></td><td></td></tr><tr><td></td><td></td><td>1</td></tr><tr><td></td><td></td><td>1</td></tr></table>	1					1			1	<table border="1"><tr><td></td><td></td><td></td></tr><tr><td></td><td></td><td>1</td></tr><tr><td></td><td></td><td></td></tr></table>						1				<table border="1"><tr><td></td><td></td><td></td></tr><tr><td></td><td></td><td></td></tr><tr><td></td><td></td><td></td></tr></table>										<table border="1"><tr><td></td><td></td><td>2</td></tr><tr><td></td><td></td><td>3</td></tr><tr><td></td><td></td><td></td></tr></table>			2			3			
1		1																																																																													
2		2																																																																													
1																																																																															
1																																																																															
		1																																																																													
		1																																																																													
		1																																																																													
		2																																																																													
		3																																																																													
Post - 0 Miss - 0 Block - 0	Post - 0 Miss - 0 Block - 0	Post - 0 Miss - 0 Block - 0	Post - 0 Miss - 0 Block - 0	Post - 0 Miss - 0 Block - 0	Post - 0 Miss - 1 Block - 0	Post - 0 Miss - 0 Block - 0	Post - 1 Miss - 0 Block - 2																																																																								
12 曾献辰	13 何磊	17 王巨柱	18 李双	21 李明	23 于敏清	24 徐安格	35 金永峰																																																																								
<table border="1"><tr><td></td><td></td><td></td></tr><tr><td></td><td></td><td></td></tr><tr><td></td><td></td><td></td></tr></table>										<table border="1"><tr><td></td><td></td><td></td></tr><tr><td></td><td></td><td>1</td></tr><tr><td></td><td></td><td></td></tr></table>						1				<table border="1"><tr><td></td><td></td><td></td></tr><tr><td></td><td></td><td></td></tr><tr><td></td><td></td><td></td></tr></table>										<table border="1"><tr><td>1</td><td></td><td></td></tr><tr><td></td><td></td><td>1</td></tr><tr><td></td><td></td><td></td></tr></table>	1					1				<table border="1"><tr><td></td><td></td><td></td></tr><tr><td></td><td></td><td></td></tr><tr><td></td><td></td><td></td></tr></table>										<table border="1"><tr><td></td><td></td><td></td></tr><tr><td></td><td></td><td></td></tr><tr><td></td><td></td><td></td></tr></table>										<table border="1"><tr><td></td><td></td><td></td></tr><tr><td></td><td></td><td></td></tr><tr><td></td><td></td><td></td></tr></table>										<table border="1"><tr><td></td><td></td><td></td></tr><tr><td></td><td></td><td>1</td></tr><tr><td></td><td></td><td>1</td></tr></table>						1			1
		1																																																																													
1																																																																															
		1																																																																													
		1																																																																													
		1																																																																													
Post - 0 Miss - 0 Block - 0	Post - 0 Miss - 0 Block - 0	Post - 0 Miss - 0 Block - 0	Post - 0 Miss - 1 Block - 3	Post - 0 Miss - 0 Block - 0	Post - 0 Miss - 0 Block - 0	Post - 0 Miss - 1 Block - 0	Post - 0 Miss - 2 Block - 1																																																																								

注释: Post=击柱 Miss=射失 Block=被封





预赛 Group X

男子 全国杯赛

“绿叶集团”杯2016年全国男子手球超级杯赛

Team A <b>A 天津</b>				Team B <b>B 北京</b>				Match Number <b>8</b>													
played in China		in the hall 苏州市体育中心		on 22/11/2016		at 14:30 hours		Spectators													
Half-time (30')	<b>A</b> 13	<b>B</b> 8	End of playing time	<b>A</b> 27	<b>B</b> 18	1st extra time	<b>A</b>	<b>B</b>	2nd extra time	<b>A</b>	<b>B</b>	After penalty throws	<b>A</b>	<b>B</b>							
Number of 7 m	<b>A</b> 3 / 4	Team time-out			Full name of players and officials				Team time-out			<b>B</b> 1 / 1	Number of 7 m								
		1	2	3					1	2	3										
		50:31							14:05	47:59	57:19										
No.	Team <b>A</b>					G	W	2'	D	DR	No.	Team <b>B</b>					G	W	2'	D	DR
1	刘宗其										3	吴锐樊					5	1			
2	李岳朋										6	赵一涵					1				
4	李松浩					2					7	卞友山									
6	王子欣					5					8	赵文宣					1				
7	张青					4					9	李旭						1			
8	曹悦					4	1				10	李明远									
9	吴明远					2		1			12	孔祥杰									
12	杨峻										17	袁振典							1		
13	许松					3					18	温新宇									
14	田剑侠										20	王鹏皓					1				
16	刘海亮										23	陈旭					4		1		
17	周群										25	程海津							1		
21	潘玉帅										26	杨政									
22	魏雨童					7	1				29	逯明松					5	1			
											35	高云健									
											78	王哲一					1				
<b>A</b>	贾守信										<b>B</b>	吴健 (主教练)									
<b>B</b>	杜瑞军 (主教练)										<b>C</b>	刘彦坤									
<b>C</b>	孟凡钢										<b>D</b>	陈璇									
<b>A</b>	Signature of Responsible Official of the Teams (Off. A)																			<b>B</b>	
TP	Remarks of Referee / CHA Official																			TP	

Signatures

Referees	王科 (CHN)	王洋 (CHN)		
Techn. Delegates	于中迅 (CHN)	柴业宏 (CHN)		
CHA Official				

Note: Number of 7m Throws Awarded to Team A and B, Goals (G), Warnings (W), Suspensions (2'), Direct Disqualification (D), Disqualification with Report (DR) and Team Penalty (TP).

Table Officials: 黄岩

石震坤

Statisticians: 王玮

王聆





## “绿叶集团”杯2016年全国男子手球超级杯赛 竞赛技术统计(媒体表)

预赛	组别	X	轮次	3	场次	8
苏州市体育中心			22/11/2016		201608008-51-1/1	
天津		天津	27	vs	18	北京
				13 : 8		

裁判员	王科 (CHN)					/	王洋 (CHN)				
-----	----------	--	--	--	--	---	----------	--	--	--	--

天津													天津		北京			
主教练：杜瑞军													比赛进程		北京			
远射	近射	边射	快攻	突破	任意球	7m球	合计	%	助攻	失误	警告	2'	D & DR					
1 刘宗其														7 张青	1	02:29	0	
2 李岳朋									1					7 张青	2	05:01	0	
4 李松浩	0/1		1/1			1/1	2/3	66.7	1	2				7 张青	3	07:37	1	
6 王子欣	2/3	0/1	1/1	2/4			5/9	55.6		1				13 许松	4	08:18	1	
7 张青	2/2	1/1		1/1	0/1		4/5	80.0	2					8 曹悦	5	09:23	1	
8 曹悦	2/5	1/2								2	1			7 张青	6	10:46	1	
9 吴明远		0/1	0/1		1/1	1/2	2/5	40.0		6		1		6 王子欣	6	11:24	2	
12 杨峻														22 魏雨童	7	13:03	2	
13 许松	0/2		0/1	3/4			3/7	42.9	2	3				6 王子欣	8	13:57	2	
14 田剑侠									4	1				22 魏雨童	9	17:18	2	
16 刘海亮														22 魏雨童	10	18:34	2	
17 周群														9 吴明远	11	19:27	2	
21 潘玉帅	0/1						0/1	0.0		1				6 王子欣	12	21:27	2	
22 魏雨童		5/5		2/2			7/7	100		1	1			12 许松	12	22:11	3	
<b>运动员 合计</b>	<b>6/14</b>	<b>7/10</b>	<b>2/4</b>	<b>8/11</b>	<b>1/2</b>	<b>3/4</b>	<b>27/45</b>	<b>60.0</b>	<b>11</b>	<b>18</b>	<b>2</b>	<b>1</b>		12 许松	12	24:34	4	
1 刘宗其	3/4	2/2	2/4	0/1			5/7	71.4						12 魏雨童	13	25:41	5	
12 杨峻	4/8	1/4	2/5	1/4	0/2	0/1	8/24	33.3	1					9 吴明远	12	26:22	6	
<b>守门员 合计</b>	<b>7/12</b>	<b>3/6</b>	<b>2/5</b>	<b>1/5</b>	<b>0/2</b>	<b>0/1</b>	<b>13/31</b>	<b>41.9</b>	<b>1</b>					6 王子欣	12	28:39	7	
<b>北京</b>													2nd Half					
教练：吴健													14 李松浩		14 06:06		8	
3 吴锐樊		1/1	1/2	2/4		1/1	5/8	62.5						14 李松浩	14	07:05	9	
6 赵一涵	0/1				1/1		1/2	50.0		1				22 魏雨童	15	07:50	9	
7 卞友山										2				22 魏雨童	16	10:11	9	
8 赵文宣		1/4					1/4	25.0						9 吴明远	17	11:22	9	
9 李旭														22 魏雨童	17	11:38	10	
10 李明远	0/2						0/2	0.0		2				22 魏雨童	18	11:56	10	
12 孔祥杰										1				22 魏雨童	18	12:27	11	
17 袁振典	0/1						0/1	0.0	1	5		1		6 王子欣	19	14:30	11	
18 温新宇														22 魏雨童	19	16:28	12	
20 王鹏皓	0/1		1/2				1/3	33.3		1				20 魏雨童	20	17:54	12	
23 陈旭	2/8	0/2		1/1	1/1		4/12	33.3	3	4		1		6 王子欣	20	19:09	13	
25 程海津														20 魏雨童	20	19:54	14	
26 杨政														13 许松	21	22:06	14	
29 逯明松	3/4	1/1	1/1				5/6	83.3	1	4	1			4 李松浩	22	23:10	14	
35 高云健									2					13 许松	23	23:55	14	
78 王哲一			0/1	1/1			1/2	50.0		1				23 魏雨童	23	24:15	15	
<b>运动员 合计</b>	<b>5/17</b>	<b>3/8</b>	<b>3/6</b>	<b>4/6</b>	<b>2/2</b>	<b>1/1</b>	<b>18/40</b>	<b>45.0</b>	<b>9</b>	<b>21</b>	<b>3</b>	<b>3</b>		8 曹悦	24	24:37	15	
12 孔祥杰	1/4	1/4	1/2	2/7		1/3	6/20	30.0	2	1				24 李松浩	24	25:53	16	
35 高云健	3/6	2/6	0/1	1/4	0/1	0/1	6/19	31.6	2					8 曹悦	25	27:35	17	
<b>守门员 合计</b>	<b>4/10</b>	<b>3/10</b>	<b>1/3</b>	<b>3/11</b>	<b>0/1</b>	<b>1/4</b>	<b>12/39</b>	<b>30.8</b>	<b>4</b>	<b>1</b>				8 曹悦	26	28:46	17	
场上队员：得分 / 射门													27 魏雨童		27 29:36		17	
守门员：救球 / 射门													18 29:51		8		3 吴锐樊	

快攻	Fast Break	突破	Breakthrough	任意球	Free Throw	7M球	7M Throw	助攻	Assist
警告	Warning	失误	Error	2'	Suspension	D	取消资格	DR	取消资格+报告





### “绿叶集团”杯2016年全国男子手球超级杯赛 图式比赛技术统计表

轮次 3

场次 8

201608008-21-1/1

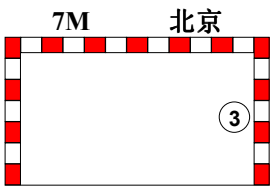
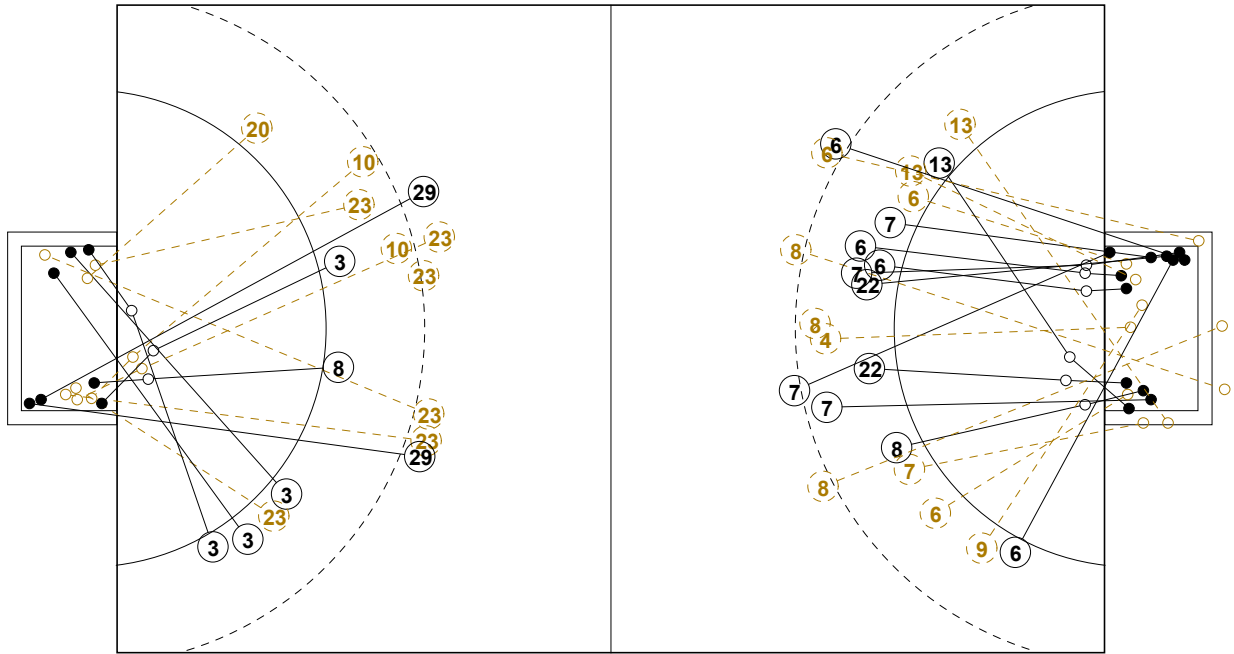

1st Half  
8 : 13

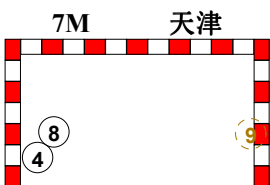
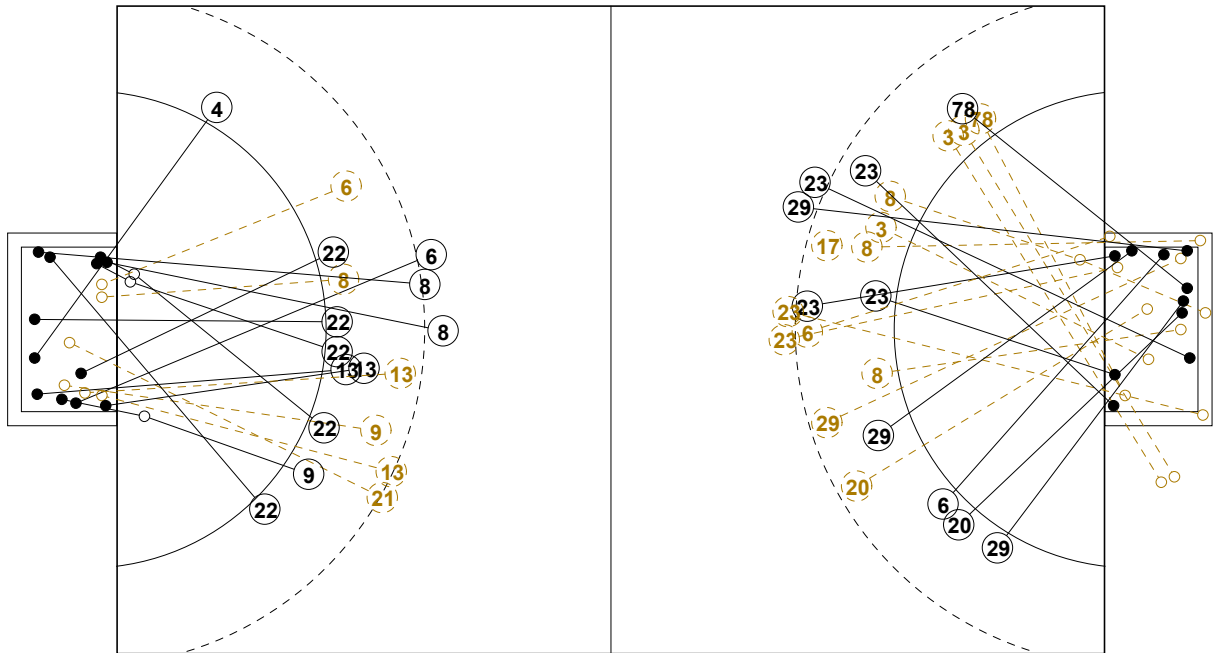
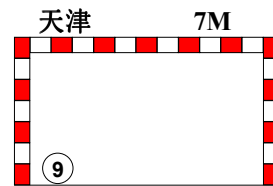

2nd Half  
27 : 18

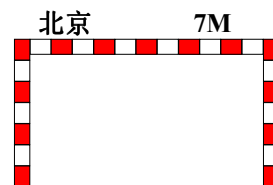



## “绿叶集团”杯2016年全国男子手球超级杯赛

## 个人/全队技术统计表

正式表  
手球  
男子预赛  
轮次 3组别 X  
场次 8201608008-14-1/2  
苏州市体育中心  
22/11/2016 14:30

号码	姓名	远射	近射	边射	快攻	突破	任意	7M	合计	%	助攻	失误	警告	2'	取消	时间
<b>天津(天津)</b>																
<i>(场上队员)</i>																
1	刘宗其									0.0%						00:14:05
2	李岳朋									0.0%	1					00:18:36
4	李松浩	0/1		1/1				1/1	2/3	66.7%	1	2				00:45:55
6	王子欣	2/3	0/1	1/1	2/4				5/9	55.6%		1				01:00:00
7	张青	2/2	1/1		1/1	0/1			4/5	80.0%	2					00:14:05
8	曹悦	2/5	1/2					1/1	4/8	50.0%		2	1			00:44:33
9	吴明远		0/1	0/1		1/1		1/2	2/5	40.0%		6		1		01:02:26
12	杨峻									0.0%	1					00:45:55
13	许松	0/2		0/1	3/4				3/7	42.9%	2	3				00:35:21
14	田剑侠									0.0%	4	1				00:15:23
16	刘海亮									0.0%						00:00:00
17	周群									0.0%		1				00:11:28
21	潘玉帅	0/1							0/1	0.0%		1				00:20:06
22	魏雨童		5/5		2/2				7/7	100%		1	1			00:48:31
<b>合计</b>		6/14	7/10	2/4	8/11	1/2		3/4	27/45	60.0%	11	18	2	1		
<i>(守门员)</i>																
1	刘宗其	3/4	2/2		0/1				5/7	71.4%						00:14:05
12	杨峻	4/8	1/4	2/5	1/4	0/2		0/1	8/24	33.3%	1					00:45:55
<b>合计</b>		7/12	3/6	2/5	1/5	0/2		0/1	13/31	41.9%	1					

场上队员：得分/射门

守门员：救球/射门

全队合计	得分	被救	射失	击柱	封球	合计	%
远射	6	4	2	1	1	14	42.9%
近射	7	3				10	70.0%
边射	2	1		1		4	50.0%
快攻	8	3				11	72.7%
突破	1			1		2	50.0%
任意							0.0%
7M	3	1				4	75.0%





## “绿叶集团”杯2016年全国男子手球超级杯赛

## 个人/全队技术统计表

正式表  
手球  
男子预赛  
轮次 3组别 X  
场次 8201608008-14-2/2  
苏州市体育中心  
22/11/2016 14:30

号码	姓名	远射	近射	边射	快攻	突破	任意	7M	合计	%	助攻	失误	警告	2'	取消	时间
<b>北京(北京)</b>																
<i>(上场队员)</i>																
3	吴锐樊		1/1	1/2	2/4			1/1	5/8	62.5%			1			00:40:22
6	赵一涵	0/1				1/1			1/2	50.0%		1				00:19:34
7	卞友山									0.0%		2				00:16:48
8	赵文宣		1/4						1/4	25.0%						00:17:22
9	李旭									0.0%			1			00:36:06
10	李明远	0/2							0/2	0.0%		2				00:06:39
12	孔祥杰									0.0%	2	1				00:30:41
17	袁振典	0/1							0/1	0.0%	1	5		1		00:26:22
18	温新宇									0.0%						00:00:00
20	王鹏皓	0/1		1/2					1/3	33.3%		1				00:49:07
23	陈旭	2/8	0/2		1/1	1/1			4/12	33.3%	3	4		1		01:00:00
25	程海津									0.0%				1		00:25:49
26	杨政									0.0%						00:00:02
29	逯明松	3/4	1/1	1/1					5/6	83.3%	1	4	1			00:40:49
35	高云健									0.0%	2					00:29:19
78	王哲一			0/1	1/1				1/2	50.0%		1				00:19:37
<b>合计</b>		5/17	3/8	3/6	4/6	2/2		1/1	18/40	45.0%	9	21	3	3		
<i>(守门员)</i>																
12	孔祥杰	1/4	1/4	1/2	2/7			1/3	6/20	30.0%	2	1				00:30:41
35	高云健	3/6	2/6	0/1	1/4	0/1		0/1	6/19	31.6%	2					00:29:19
<b>合计</b>		4/10	3/10	1/3	3/11	0/1		1/4	12/39	30.8%	4	1				

场上队员：得分/射门

守门员：救球/射门

全队合计	得分	被救	射失	击柱	封球	合计	%
远射	5	7		2	3	17	29.4%
近射	3	3		2		8	37.5%
边射	3	2	1			6	50.0%
快攻	4	1	1			6	66.7%
突破	2					2	100.0%
任意							0.0%
7M	1					1	100.0%







### “绿叶集团”杯2016年全国男子手球超级杯赛

图式射门区域统计

轮次 3 场次 8

201608008-41-1/1

## 天津

1 刘宗其	2 李岳朋	4 李松浩	6 王子欣	7 张青	8 曹悦	9 吴明远	12 杨峻																																																																								
<table border="1"><tr><td></td><td></td><td></td></tr><tr><td></td><td></td><td></td></tr><tr><td></td><td></td><td></td></tr></table>										<table border="1"><tr><td></td><td></td><td></td></tr><tr><td></td><td></td><td></td></tr><tr><td></td><td></td><td></td></tr></table>										<table border="1"><tr><td>1</td><td></td><td></td></tr><tr><td></td><td></td><td></td></tr><tr><td>1</td><td></td><td></td></tr></table>	1						1			<table border="1"><tr><td>2</td><td></td><td></td></tr><tr><td>1</td><td></td><td></td></tr><tr><td>2</td><td></td><td></td></tr></table>	2			1			2			<table border="1"><tr><td>1</td><td></td><td></td></tr><tr><td>1</td><td></td><td>1</td></tr><tr><td>1</td><td></td><td></td></tr></table>	1			1		1	1			<table border="1"><tr><td></td><td></td><td>1</td></tr><tr><td>1</td><td></td><td>1</td></tr><tr><td></td><td></td><td>1</td></tr></table>			1	1		1			1	<table border="1"><tr><td></td><td></td><td></td></tr><tr><td>1</td><td></td><td></td></tr><tr><td></td><td></td><td></td></tr></table>				1						<table border="1"><tr><td></td><td></td><td></td></tr><tr><td></td><td></td><td></td></tr><tr><td></td><td></td><td></td></tr></table>									
1																																																																															
1																																																																															
2																																																																															
1																																																																															
2																																																																															
1																																																																															
1		1																																																																													
1																																																																															
		1																																																																													
1		1																																																																													
		1																																																																													
1																																																																															
Post - 0 Miss - 0 Block - 0	Post - 0 Miss - 0 Block - 0	Post - 0 Miss - 0 Block - 0	Post - 1 Miss - 0 Block - 0	Post - 1 Miss - 0 Block - 0	Post - 0 Miss - 2 Block - 1	Post - 0 Miss - 0 Block - 0	Post - 0 Miss - 0 Block - 0																																																																								
13 许松	14 田剑侠	16 刘海亮	17 周群	21 潘玉帅	22 魏雨童																																																																										
<table border="1"><tr><td>1</td><td></td><td></td></tr><tr><td></td><td></td><td></td></tr><tr><td>1</td><td></td><td>1</td></tr></table>	1						1		1	<table border="1"><tr><td></td><td></td><td></td></tr><tr><td></td><td></td><td></td></tr><tr><td></td><td></td><td></td></tr></table>										<table border="1"><tr><td></td><td></td><td></td></tr><tr><td></td><td></td><td></td></tr><tr><td></td><td></td><td></td></tr></table>										<table border="1"><tr><td></td><td></td><td></td></tr><tr><td></td><td></td><td></td></tr><tr><td></td><td></td><td></td></tr></table>										<table border="1"><tr><td></td><td></td><td></td></tr><tr><td></td><td></td><td></td></tr><tr><td></td><td></td><td></td></tr></table>										<table border="1"><tr><td>1</td><td>1</td><td>1</td></tr><tr><td>1</td><td></td><td></td></tr><tr><td></td><td></td><td>3</td></tr></table>	1	1	1	1					3	<table border="1"><tr><td></td><td></td><td></td></tr><tr><td></td><td></td><td></td></tr><tr><td></td><td></td><td></td></tr></table>										<table border="1"><tr><td></td><td></td><td></td></tr><tr><td></td><td></td><td></td></tr><tr><td></td><td></td><td></td></tr></table>									
1																																																																															
1		1																																																																													
1	1	1																																																																													
1																																																																															
		3																																																																													
Post - 1 Miss - 0 Block - 0	Post - 0 Miss - 0 Block - 0	Post - 0 Miss - 0 Block - 0	Post - 0 Miss - 0 Block - 0	Post - 0 Miss - 0 Block - 0	Post - 0 Miss - 0 Block - 0																																																																										

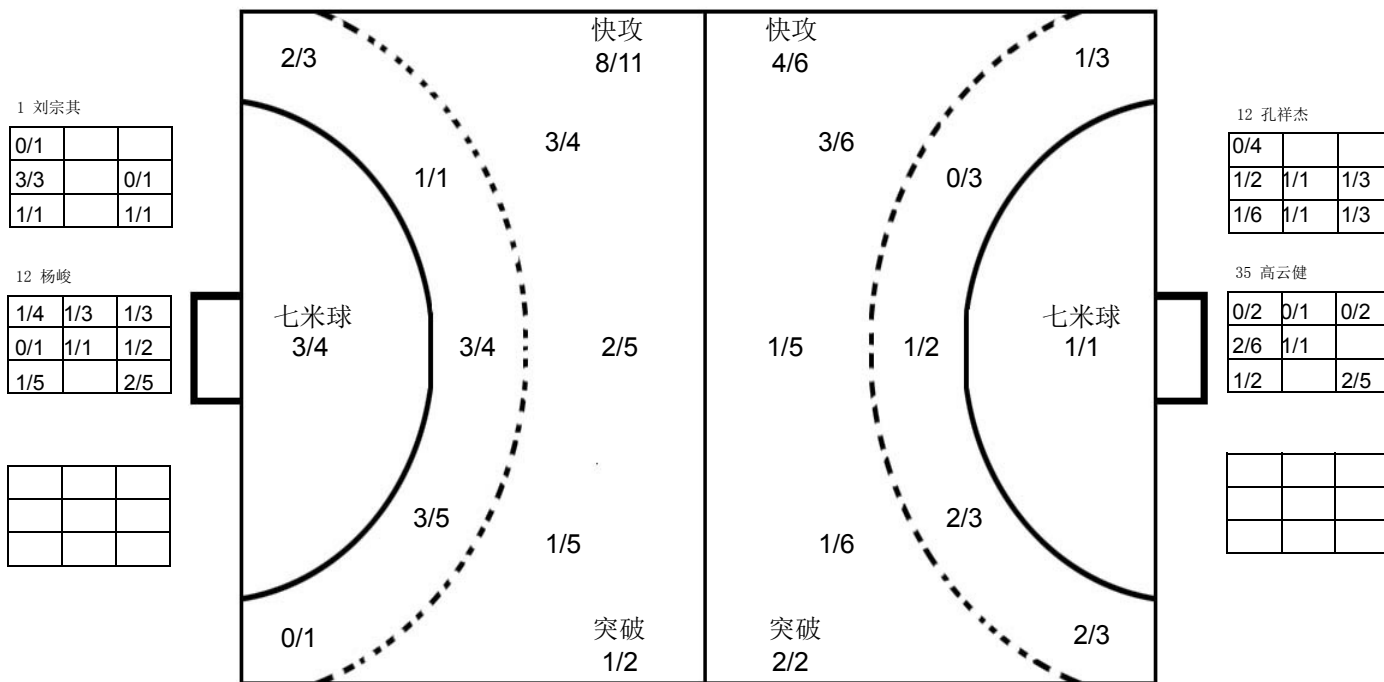

## 北京

3 吴锐樊	6 赵一涵	7 卞友山	8 赵文宣	9 李旭	10 李明远	12 孔祥杰	17 袁振典																																																																								
<table border="1"><tr><td></td><td></td><td>1</td></tr><tr><td></td><td></td><td>2</td></tr><tr><td>1</td><td></td><td>1</td></tr></table>			1			2	1		1	<table border="1"><tr><td></td><td></td><td></td></tr><tr><td>1</td><td></td><td></td></tr><tr><td></td><td></td><td></td></tr></table>				1						<table border="1"><tr><td></td><td></td><td></td></tr><tr><td></td><td></td><td></td></tr><tr><td></td><td></td><td></td></tr></table>										<table border="1"><tr><td></td><td></td><td></td></tr><tr><td></td><td></td><td></td></tr><tr><td>1</td><td></td><td></td></tr></table>							1			<table border="1"><tr><td></td><td></td><td></td></tr><tr><td></td><td></td><td></td></tr><tr><td></td><td></td><td></td></tr></table>										<table border="1"><tr><td></td><td></td><td></td></tr><tr><td></td><td></td><td></td></tr><tr><td></td><td></td><td></td></tr></table>										<table border="1"><tr><td></td><td></td><td></td></tr><tr><td></td><td></td><td></td></tr><tr><td></td><td></td><td></td></tr></table>										<table border="1"><tr><td></td><td></td><td></td></tr><tr><td></td><td></td><td></td></tr><tr><td></td><td></td><td></td></tr></table>									
		1																																																																													
		2																																																																													
1		1																																																																													
1																																																																															
1																																																																															
Post - 0 Miss - 2 Block - 0	Post - 1 Miss - 0 Block - 0	Post - 0 Miss - 0 Block - 0	Post - 2 Miss - 0 Block - 0	Post - 0 Miss - 0 Block - 0	Post - 0 Miss - 0 Block - 1	Post - 0 Miss - 0 Block - 0	Post - 0 Miss - 0 Block - 1																																																																								
18 温新宇	20 王鹏皓	23 陈旭	25 程海津	26 杨政	29 逯明松	35 高云健	78 王哲一																																																																								
<table border="1"><tr><td></td><td></td><td></td></tr><tr><td></td><td></td><td></td></tr><tr><td></td><td></td><td></td></tr></table>										<table border="1"><tr><td></td><td></td><td>1</td></tr><tr><td></td><td></td><td></td></tr><tr><td></td><td></td><td></td></tr></table>			1							<table border="1"><tr><td></td><td></td><td>1</td></tr><tr><td></td><td></td><td></td></tr><tr><td>1</td><td></td><td>2</td></tr></table>			1				1		2	<table border="1"><tr><td></td><td></td><td></td></tr><tr><td></td><td></td><td></td></tr><tr><td></td><td></td><td></td></tr></table>										<table border="1"><tr><td></td><td></td><td></td></tr><tr><td></td><td></td><td></td></tr><tr><td></td><td></td><td></td></tr></table>										<table border="1"><tr><td>3</td><td>1</td><td></td></tr><tr><td></td><td></td><td></td></tr><tr><td>1</td><td></td><td></td></tr></table>	3	1					1			<table border="1"><tr><td></td><td></td><td></td></tr><tr><td></td><td></td><td></td></tr><tr><td></td><td></td><td></td></tr></table>										<table border="1"><tr><td></td><td></td><td></td></tr><tr><td></td><td></td><td></td></tr><tr><td></td><td></td><td></td></tr></table>									
		1																																																																													
		1																																																																													
1		2																																																																													
3	1																																																																														
1																																																																															
Post - 0 Miss - 0 Block - 0	Post - 0 Miss - 0 Block - 0	Post - 1 Miss - 0 Block - 1	Post - 0 Miss - 0 Block - 0	Post - 0 Miss - 0 Block - 0	Post - 0 Miss - 0 Block - 0	Post - 0 Miss - 0 Block - 0	Post - 0 Miss - 0 Block - 0																																																																								

注释: Post=击柱 Miss=射失 Block=被封



预赛 Group X

男子 全国杯赛

“绿叶集团”杯2016年全国男子手球超级杯赛

Team A A 广东				Team B B 上海				Match Number 9													
played in China		in the hall 苏州市体育中心		on 22/11/2016		at 16:00 hours		Spectators													
Half-time (30')	A 14	B 16	End of playing time	A 28	B 37	1st extra time	A	B	2nd extra time	A	B	After penalty throws	A	B							
Number of 7 m	A 2 / 4	Team time-out 1 22:57 2 44:34 3			Full name of players and officials				Team time-out 1 29:18 2 3			B 1 / 3	Number of 7 m								
No.	Team A					G	W	2'	D	DR	No.	Team B					G	W	2'	D	DR
1	王泽润										1	张峥									
10	周仲坤					6	1				2	张文斌					3				
12	王雨					2					3	赵时俊					4	1			
13	王立隆										4	徐俊吉					6	1			
15	张建杰					7		1			7	吴双					1				
18	高玉杰					2	1	1			8	钱为玮					7				
20	黄培杰					6		1			10	董凯					1				
26	姚雪岩					5					11	蒋承骅							1		
											12	周哲韬									
											14	沈吉磊					12	1			
											15	蒋嘉敏									
											16	朱春雷									
											17	高天伦					2				
											18	马麟晓									
											19	蒋慧捷					1				
											22	张润明									
B	刘康伶 (主教练)										A	吴璟 (主教练)									
C	刘文宁										B	张勇军									
											C	金迪琦									
											D	杨时									
A	Signature of Responsible Official of the Teams (Off. A)																		B		
TP	Remarks of Referee / CHA Official																		TP		

Signatures

Referees	李典 (CHN)	倪震 (CHN)		
Techn. Delegates	李之文 (CHN)	柴业宏 (CHN)		
CHA Official				

Note: Number of 7m Throws Awarded to Team A and B, Goals (G), Warnings (W), Suspensions (2'), Direct Disqualification (D), Disqualification with Report (DR) and Team Penalty (TP).

Table Officials: 黄岩 石震坤 Statisticians: 王玮 王聆

Printed by PHMS Copyright: IHF / CHA 22/11/2016 17:24:12

Longman Sportsoft  handball@126.com



## “绿叶集团”杯2016年全国男子手球超级杯赛 竞赛技术统计(媒体表)

<b>预赛</b>	组别	<b>X</b>	轮次	<b>3</b>	场次	<b>9</b>
苏州市体育中心			22/11/2016		201608009-51-1/1	
广东	广东	<b>28</b>	vs	<b>37</b>	上海	上海
<b>14 : 16</b>						

裁判员		李典 (CHN)											/	倪震 (CHN)																	
广东		远射	近射	边射	快攻	突破	任意球	7m球	合计	%	助攻	失误	警告	2'	D & DR	比赛进程		广东		上海											
主教练：刘康伶																1st Half															
1	王泽润															0	00:52	1	19	蒋慧捷											
10	周仲坤	4/8	0/2		1/1	1/2		6/13	46.2	2	3	1			1	01:53	1														
12	王雨			1/2		1/1		2/3	66.7						2	02:34	1														
13	王立隆														2	02:56	2	3	赵时俊												
15	张建杰	1/3	1/2		3/3	2/4	0/1	7/13	53.8					1	3	03:04	2														
18	高玉杰			1/2	1/2			2/4	50.0				1	1	4	04:03	2														
20	黄培杰	1/4	0/3		2/2	1/1	2/3	6/13	46.2	2	6		1	1	4	05:40	3	14	沈吉磊												
26	姚雪岩	1/2	3/4			0/1	1/2	5/9	55.6	1	3				4	07:50	4	14	沈吉磊												
<b>运动员 合计</b>		<b>7/17</b>	<b>4/11</b>	<b>2/4</b>	<b>7/8</b>	<b>5/9</b>	<b>1/2</b>	<b>2/4</b>	<b>28/55</b>	<b>50.9</b>	<b>5</b>	<b>12</b>	<b>2</b>	<b>3</b>		5	09:05	5	14	沈吉磊											
1	王泽润	0/9	2/9	4/14	1/7	0/3	0/1	2/3	9/46	19.6						5	11:32	6	4	徐俊吉											
<b>守门员 合计</b>		<b>0/9</b>	<b>2/9</b>	<b>4/14</b>	<b>1/7</b>	<b>0/3</b>	<b>0/1</b>	<b>2/3</b>	<b>9/46</b>	<b>19.6</b>						6	12:45	7	14	沈吉磊											
<b>上海</b>																2nd Half															
教练：吴璟																14	01:32	17	14	沈吉磊											
1	张峥															14	02:14	18	4	徐俊吉											
2	张文斌	2/2				1/1		3/3	100	1	3				15	02:28	18														
3	赵时俊	2/3		2/2	0/2	0/1		4/8	50.0	1	3	1			15	02:59	19	14	沈吉磊												
4	徐俊吉		3/3	0/1	3/3			6/7	85.7	2		1			16	04:28	19														
7	吴双				1/1			1/1	100						16	06:19	20	8	钱为玮												
8	钱为玮		1/2	4/6	2/2			7/10	70.0	1					17	06:50	20														
10	董凯		1/1		0/1			1/2	50.0						17	07:24	21	3	赵时俊												
11	蒋承骅													1	17	08:30	22	14	沈吉磊												
12	周哲韬														18	08:58	22														
14	沈吉磊	5/7	2/3	1/1		2/2	1/1	1/3	12/17	70.6	1	3	1		18	09:30	23	14	沈吉磊												
15	蒋嘉敏			0/1				0/1	0.0						19	10:08	23														
16	朱春雷														19	10:37	24	14	沈吉磊												
17	高天伦			2/2											19	11:57	25	8	钱为玮												
18	马麟晓														20	12:12	25														
19	蒋慧捷			1/3											20	13:24	26	14	沈吉磊												
22	张润明														21	14:32	27	8	钱为玮												
<b>运动员 合计</b>		<b>9/12</b>	<b>7/9</b>	<b>10/16</b>	<b>6/9</b>	<b>3/4</b>	<b>1/1</b>	<b>1/3</b>	<b>37/54</b>	<b>68.5</b>	<b>8</b>	<b>14</b>	<b>3</b>	<b>1</b>		21	15:10	28	4	徐俊吉											
1	张峥	5/12	5/9	2/4	1/8	3/8	1/1	1/3	18/45	40.0	1					22	15:48	28													
22	张润明						0/1	0/1	0.0						20	16:21	29	2	张文斌												
<b>守门员 合计</b>		<b>5/12</b>	<b>5/9</b>	<b>2/4</b>	<b>1/8</b>	<b>3/8</b>	<b>1/2</b>	<b>1/3</b>	<b>18/46</b>	<b>39.1</b>	<b>1</b>					20	16:28	29													

场上队员：得分 / 射门

守门员：救球 / 射门

快攻	Fast Break		突破	Breakthrough		任意球	Free Throw		7M球	7M Throw		助攻	Assist
警告	Warning		失误	Error		2'	Suspension		D	取消资格		DR	取消资格+报告





## “绿叶集团”杯2016年全国男子手球超级杯赛 图式比赛技术统计表

轮次 3

场次 9

201608009-21-1/1

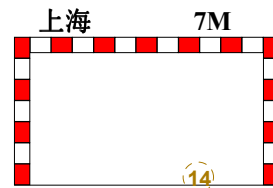
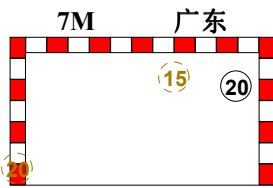
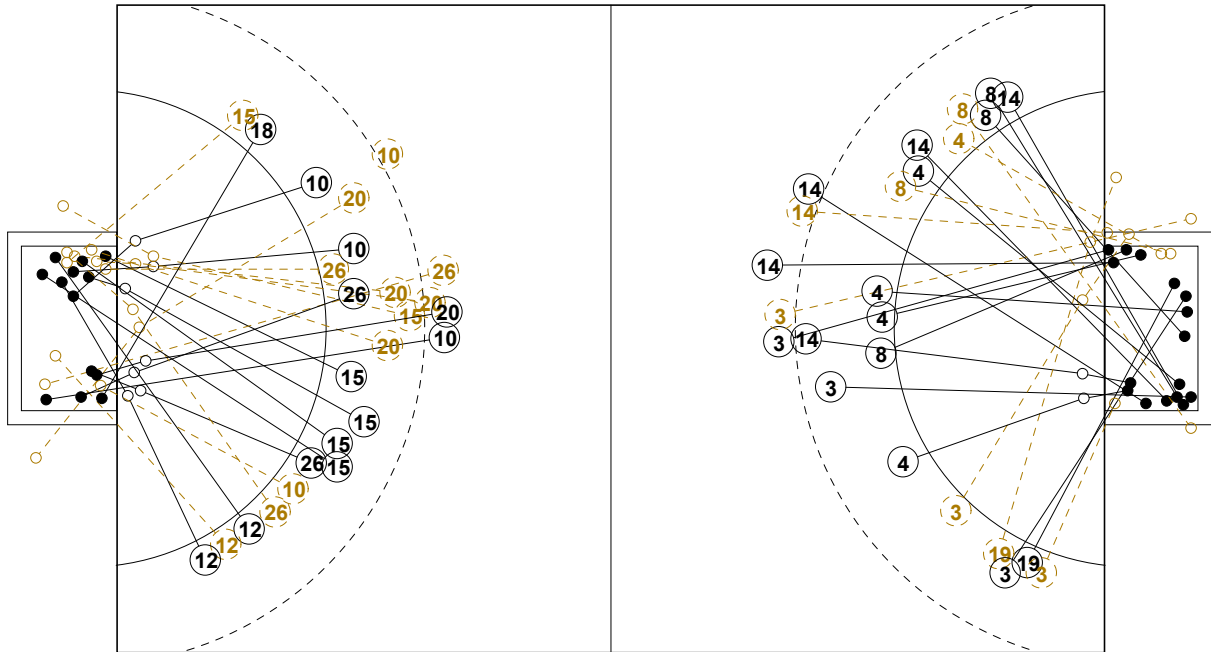

**1st Half**  
**14 : 16**

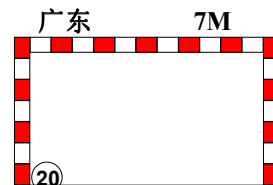
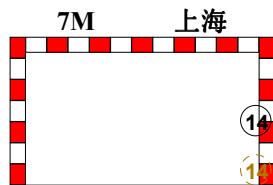
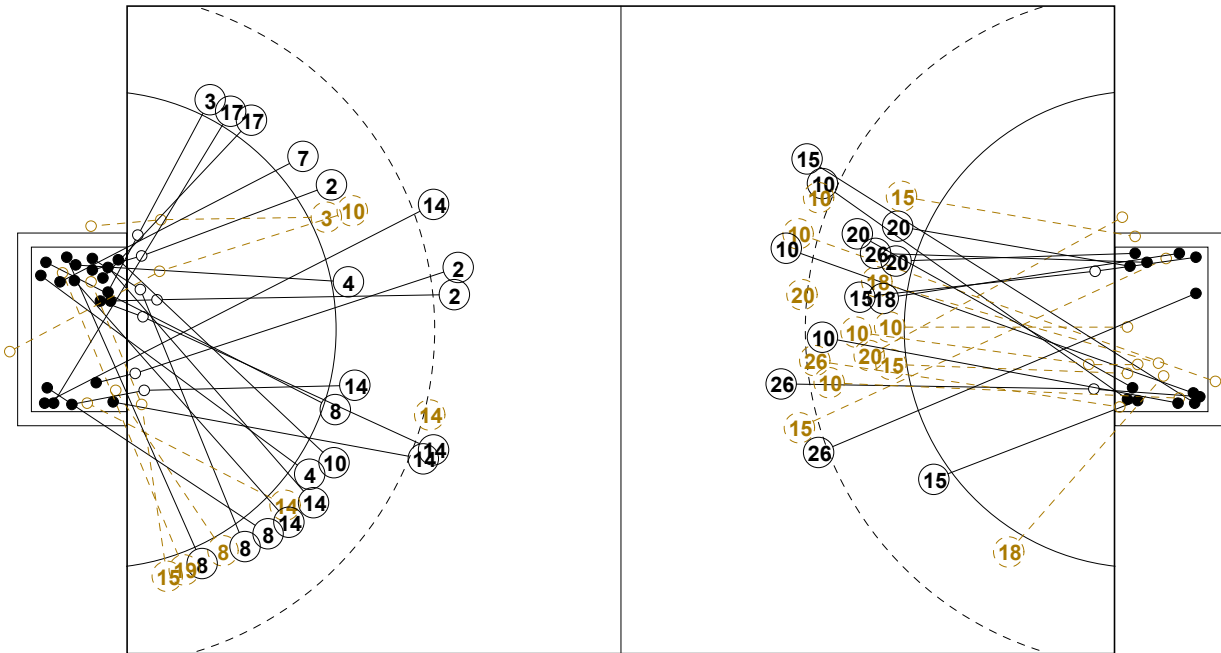

**2nd Half**  
**37 : 28**



## “绿叶集团”杯2016年全国男子手球超级杯赛

## 个人/全队技术统计表

正式表  
手球  
男子预赛  
轮次 3组别 X  
场次 9201608009-14-1/2  
苏州市体育中心  
22/11/2016 16:00

号码	姓名	远射	近射	边射	快攻	突破	任意	7M	合计	%	助攻	失误	警告	2'	取消	时间
<b>广东(广东)</b>																
<i>(场上队员)</i>																
1	王泽润									0.0%						01:00:00
10	周仲坤	4/8	0/2		1/1	1/2			6/13	46.2%	2	3	1			01:00:00
12	王雨			1/2		1/1			2/3	66.7%						01:00:00
13	王立隆									0.0%						00:15:05
15	张建杰	1/3	1/2		3/3	2/4		0/1	7/13	53.8%				1		01:00:00
18	高玉杰			1/2	1/2				2/4	50.0%			1	1		00:44:53
20	黄培杰	1/4	0/3		2/2	1/1		2/3	6/13	46.2%	2	6		1		01:00:00
26	姚雪岩	1/2	3/4			0/1	1/2		5/9	55.6%	1	3				01:00:00
<b>合计</b>																
<i>(守门员)</i>																
1		0/9	2/9	4/14	1/7	0/3	0/1	2/3	9/46	19.6%						01:00:00
<b>合计</b>																

场上队员：得分/射门

守门员：救球/射门

全队合计	得分	被救	射失	击柱	封球	合计	%
远射	7	5	1	1	3	17	41.2%
近射	4	5	2			11	36.4%
边射	2	2				4	50.0%
快攻	7	1				8	87.5%
突破	5	3		1		9	55.6%
任意	1	1				2	50.0%
7M	2	1		1		4	50.0%





## “绿叶集团”杯2016年全国男子手球超级杯赛

## 个人/全队技术统计表

正式表  
手球  
男子预赛  
轮次 3组别 X  
场次 9201608009-14-2/2  
苏州市体育中心  
22/11/2016 16:00

号码	姓名	远射	近射	边射	快攻	突破	任意	7M	合计	%	助攻	失误	警告	2'	取消	时间
<b>上海(上海)</b>																
<i>(上场队员)</i>																
1	张崢									0.0%	1					00:55:56
2	张文斌	2/2				1/1			3/3	100%	1	3				00:15:26
3	赵时俊	2/3		2/2	0/2	0/1			4/8	50.0%	1	3	1			00:49:43
4	徐俊吉		3/3	0/1	3/3				6/7	85.7%	2		1			00:50:35
7	吴双				1/1				1/1	100%						00:07:10
8	钱为玮		1/2	4/6	2/2				7/10	70.0%	1					00:49:04
10	董凯		1/1		0/1				1/2	50.0%						00:09:24
11	蒋承骅									0.0%		2		1		00:44:34
12	周哲韬									0.0%						00:00:00
14	沈吉磊	5/7	2/3	1/1		2/2	1/1	1/3	12/17	70.6%	1	3	1			00:59:08
15	蒋嘉敏			0/1					0/1	0.0%						00:00:45
16	朱春雷									0.0%						00:00:00
17	高天伦			2/2					2/2	100%						00:10:53
18	马麟晓									0.0%	1	3				00:23:57
19	蒋慧捷			1/3					1/3	33.3%						00:38:53
22	张润明									0.0%						00:04:04
<b>合计</b>		9/12	7/9	10/16	6/9	3/4	1/1	1/3	37/54	68.5%	8	14	3	1		
<i>(守门员)</i>																
1	张崢	5/12	5/9	2/4	1/8	3/8	1/1	1/3	18/45	40.0%	1					00:55:56
22	张润明						0/1		0/1	0.0%						00:04:04
<b>合计</b>		5/12	5/9	2/4	1/8	3/8	1/2	1/3	18/46	39.1%	1					

场上队员：得分/射门

守门员：救球/射门

全队合计	得分	被救	射失	击柱	封球	合计	%
远射	9		1	1	1	12	75.0%
近射	7	2				9	77.8%
边射	10	4	1	1		16	62.5%
快攻	6	1	2			9	66.7%
突破	3			1		4	75.0%
任意	1					1	100.0%
7M	1	2				3	33.3%





### “绿叶集团”杯2016年全国男子手球超级杯赛

图式射门区域统计

轮次 3 场次 9

201608009-41-1/1

## 广东

1 王泽润	10 周仲坤	12 王雨	13 王立隆	15 张建杰	18 高玉杰	20 黄培杰	26 姚雪岩																																																																								
<table border="1"><tr><td></td><td></td><td></td></tr><tr><td></td><td></td><td></td></tr><tr><td></td><td></td><td></td></tr></table>										<table border="1"><tr><td>1</td><td></td><td>2</td></tr><tr><td></td><td></td><td>2</td></tr><tr><td></td><td></td><td>1</td></tr></table>	1		2			2			1	<table border="1"><tr><td></td><td></td><td></td></tr><tr><td></td><td></td><td>2</td></tr><tr><td></td><td></td><td></td></tr></table>						2				<table border="1"><tr><td></td><td></td><td></td></tr><tr><td></td><td></td><td></td></tr><tr><td></td><td></td><td></td></tr></table>										<table border="1"><tr><td>1</td><td></td><td>2</td></tr><tr><td></td><td></td><td>1</td></tr><tr><td></td><td></td><td>3</td></tr></table>	1		2			1			3	<table border="1"><tr><td>1</td><td></td><td></td></tr><tr><td></td><td></td><td></td></tr><tr><td>1</td><td></td><td></td></tr></table>	1						1			<table border="1"><tr><td></td><td></td><td>1</td></tr><tr><td></td><td></td><td></td></tr><tr><td>4</td><td></td><td>1</td></tr></table>			1				4		1	<table border="1"><tr><td>1</td><td></td><td>1</td></tr><tr><td></td><td></td><td>2</td></tr><tr><td>1</td><td></td><td></td></tr></table>	1		1			2	1		
1		2																																																																													
		2																																																																													
		1																																																																													
		2																																																																													
1		2																																																																													
		1																																																																													
		3																																																																													
1																																																																															
1																																																																															
		1																																																																													
4		1																																																																													
1		1																																																																													
		2																																																																													
1																																																																															
Post - 0 Miss - 0 Block - 0	Post - 1 Miss - 0 Block - 2	Post - 0 Miss - 0 Block - 0	Post - 0 Miss - 0 Block - 0	Post - 1 Miss - 1 Block - 0	Post - 0 Miss - 0 Block - 0	Post - 1 Miss - 2 Block - 1	Post - 0 Miss - 0 Block - 0																																																																								

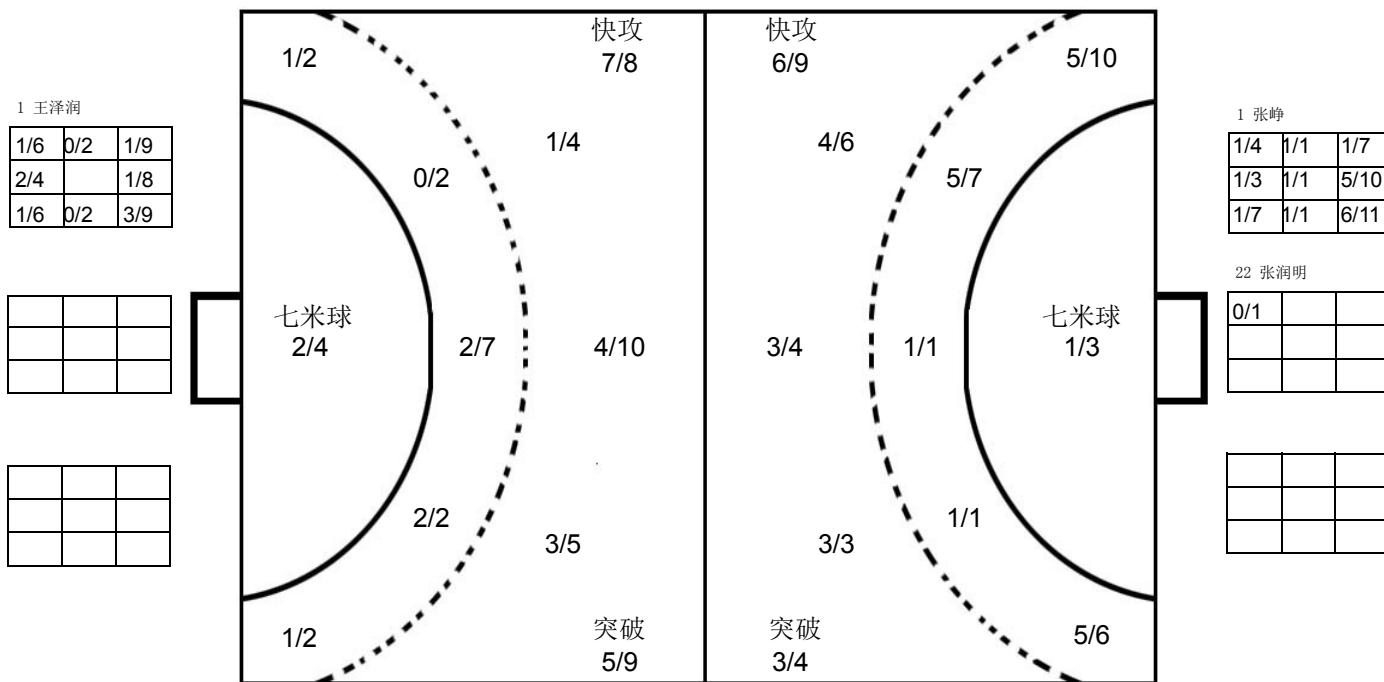
## 上海

1 张峻	2 张文斌	3 赵时俊	4 徐俊吉	7 吴双	8 钱为玮	10 董凯	11 蒋承骅																																																																								
<table border="1"><tr><td></td><td></td><td></td></tr><tr><td></td><td></td><td></td></tr><tr><td></td><td></td><td></td></tr></table>										<table border="1"><tr><td></td><td></td><td>1</td></tr><tr><td>1</td><td>1</td><td></td></tr></table>			1	1	1		<table border="1"><tr><td>1</td><td></td><td>1</td></tr><tr><td></td><td></td><td></td></tr><tr><td>1</td><td></td><td>1</td></tr></table>	1		1				1		1	<table border="1"><tr><td></td><td>1</td><td>2</td></tr><tr><td>1</td><td></td><td>1</td></tr><tr><td></td><td></td><td>1</td></tr></table>		1	2	1		1			1	<table border="1"><tr><td></td><td></td><td>1</td></tr><tr><td></td><td></td><td></td></tr><tr><td></td><td></td><td></td></tr></table>			1							<table border="1"><tr><td>1</td><td>1</td><td>2</td></tr><tr><td></td><td></td><td>2</td></tr><tr><td>1</td><td></td><td></td></tr></table>	1	1	2			2	1			<table border="1"><tr><td></td><td></td><td></td></tr><tr><td></td><td></td><td></td></tr><tr><td></td><td></td><td>1</td></tr></table>									1	<table border="1"><tr><td></td><td></td><td></td></tr><tr><td></td><td></td><td></td></tr><tr><td></td><td></td><td></td></tr></table>												
		1																																																																													
1	1																																																																														
1		1																																																																													
1		1																																																																													
	1	2																																																																													
1		1																																																																													
		1																																																																													
		1																																																																													
1	1	2																																																																													
		2																																																																													
1																																																																															
		1																																																																													
Post - 0 Miss - 0 Block - 0	Post - 0 Miss - 0 Block - 0	Post - 1 Miss - 2 Block - 0	Post - 0 Miss - 0 Block - 0	Post - 0 Miss - 0 Block - 0	Post - 1 Miss - 0 Block - 0	Post - 0 Miss - 1 Block - 0	Post - 0 Miss - 0 Block - 0																																																																								
12 周哲韬	14 沈吉磊	15 蒋嘉敏	16 朱春雷	17 高天伦	18 马麟晓	19 蒋慧捷	22 张润明																																																																								
<table border="1"><tr><td></td><td></td><td></td></tr><tr><td></td><td></td><td></td></tr><tr><td></td><td></td><td></td></tr></table>										<table border="1"><tr><td>1</td><td></td><td>2</td></tr><tr><td>1</td><td></td><td>3</td></tr><tr><td>2</td><td>1</td><td>2</td></tr></table>	1		2	1		3	2	1	2	<table border="1"><tr><td></td><td></td><td></td></tr><tr><td></td><td></td><td></td></tr><tr><td></td><td></td><td></td></tr></table>										<table border="1"><tr><td></td><td></td><td></td></tr><tr><td></td><td></td><td></td></tr><tr><td></td><td></td><td></td></tr></table>										<table border="1"><tr><td>1</td><td></td><td></td></tr><tr><td></td><td></td><td></td></tr><tr><td></td><td></td><td>1</td></tr></table>	1								1	<table border="1"><tr><td></td><td></td><td></td></tr><tr><td></td><td></td><td></td></tr><tr><td></td><td></td><td></td></tr></table>										<table border="1"><tr><td>1</td><td></td><td></td></tr><tr><td></td><td></td><td></td></tr><tr><td></td><td></td><td></td></tr></table>	1									<table border="1"><tr><td></td><td></td><td></td></tr><tr><td></td><td></td><td></td></tr><tr><td></td><td></td><td></td></tr></table>									
1		2																																																																													
1		3																																																																													
2	1	2																																																																													
1																																																																															
		1																																																																													
1																																																																															
Post - 0 Miss - 0 Block - 0	Post - 1 Miss - 0 Block - 1	Post - 0 Miss - 0 Block - 0	Post - 0 Miss - 0 Block - 0	Post - 0 Miss - 0 Block - 0	Post - 0 Miss - 0 Block - 0	Post - 0 Miss - 1 Block - 0	Post - 0 Miss - 0 Block - 0																																																																								

注释: Post=击柱 Miss=射失 Block=被封





预赛 Group X

男子 全国杯赛

“绿叶集团”杯2016年全国男子手球超级杯赛

Team A <b>A 天津</b>				Team B <b>B 上海</b>				Match Number <b>10</b>													
played in China		in the hall 苏州市体育中心		on 24/11/2016		at 13:00 hours		Spectators													
Half-time (30')	<b>A</b> 14	<b>B</b> 15	End of playing time	<b>A</b> 29	<b>B</b> 26	1st extra time	<b>A</b>	<b>B</b>	2nd extra time	<b>A</b>	<b>B</b>	After penalty throws	<b>A</b>	<b>B</b>							
Number of 7 m	<b>A</b> 1/1	Team time-out 1 14:08 2 56:52 3			Full name of players and officials				Team time-out 1 26:10 2 47:03 3			<b>B</b> 1/2	Number of 7 m								
No.	Team <b>A</b>					G	W	2'	D	DR	No.	Team <b>B</b>					G	W	2'	D	DR
1	刘宗其										1	张峥									
2	李岳朋					4					2	张文斌									
4	李松浩										3	赵时俊					1				
6	王子欣					2					4	徐俊吉					5	1			
7	张青					5	1	1			7	吴双									
8	曹悦					9	1	2			8	钱为玮					6				
9	吴明远										10	董凯									
12	杨峻										11	蒋承骅					3				
13	许松										12	周哲韬									
14	田剑侠					4					14	沈吉磊					7	1	1		
16	刘海亮										15	蒋嘉敏									
17	周群					5	1	2			16	朱春雷									
21	潘玉帅										17	高天伦									
22	魏雨童										18	马麟晓					2	1			
											19	蒋慧捷					2				
											22	张润明									
<b>A</b>	贾守信										<b>A</b>	吴璟 (主教练)									
<b>B</b>	杜瑞军 (主教练)										<b>B</b>	张勇军									
<b>C</b>	孟凡钢										<b>C</b>	金迪琦									
											<b>D</b>	杨时									
<b>A</b>	Signature of Responsible Official of the Teams (Off. A)																			<b>B</b>	
TP	Remarks of Referee / CHA Official																			TP	

Signatures

Referees	王科 (CHN)	张耿 (CHN)		
Techn. Delegates	李之文 (CHN)	柴业宏 (CHN)		
CHA Official				

Note: Number of 7m Throws Awarded to Team A and B, Goals (G), Warnings (W), Suspensions (2'), Direct Disqualification (D), Disqualification with Report (DR) and Team Penalty (TP).

Table Officials: 宣海波 石震坤 Statisticians: 王玲 王玮

Printed by PHMS Copyright: IHF / CHA 24/11/2016 14:17:59

Longman Sportsoft  handball@126.com





### “绿叶集团”杯2016年全国男子手球超级杯赛 竞赛技术统计(媒体表)

预赛	组别	X	轮次	4	场次	10
----	----	---	----	---	----	----

苏州市体育中心

24/11/2016

201608010-51-1/1

天津	天津	29	vs	26	上海	上海
		14 : 15				

裁判员	王科 (CHN)	/	张耿 (CHN)
-----	----------	---	----------

天津		远射	近射	边射	快攻	突破	任意球	7m球	合计	%	助攻	失误	警告	2'	D & DR	天津	比赛进程	上海
主教练：杜瑞军																		
1	刘宗其										1					8	曹悦	1 00:40 0
2	李岳朋	1/1	3/4	0/1					4/6	66.7	1					2	李岳朋	2 02:00 0
4	李松浩															2		2 03:11 1 4 徐俊吉
6	王子欣		1/1	0/1	1/1				2/3	66.7		1				2		2 04:26 2 19 蒋慧捷
7	张青	1/1	1/1			3/3			5/5	100	2	4	1	1		3		3 04:57 2
8	曹悦	2/6	3/3		1/1	2/3		1/1	9/14	64.3	1		1	2		4		3 08:22 3 4 徐俊吉
9	吴明远															4		4 08:57 3
12	杨峻															4		4 09:38 4 14 沈吉磊
13	许松			0/2					0/2	0.0		1				4		4 11:47 5 14 沈吉磊
14	田剑侠	1/2		2/2		1/1			4/5	80.0	2	4				4		4 13:32 6 11 蒋承骅
16	刘海亮															5		5 14:12 6
17	周群		5/5						5/5	100			1	2		5		5 15:00 7 4 徐俊吉
21	潘玉帅															5		5 16:46 8 11 蒋承骅
22	魏雨童															5		5 17:50 9 14 沈吉磊
<b>运动员 合计</b>		<b>5/10</b>	<b>13/14</b>	<b>2/6</b>	<b>2/2</b>	<b>6/7</b>		<b>1/1</b>	<b>29/40</b>	<b>72.5</b>	<b>7</b>	<b>10</b>	<b>3</b>	<b>5</b>		6		6 18:42 9
1	刘宗其	2/3	4/11	2/7	0/1	1/5		0/1	9/28	32.1	1					6		6 19:05 10 4 徐俊吉
12	杨峻	2/3	1/3	3/4	2/3	0/1	0/1		8/15	53.3						6		6 19:42 10
<b>守门员 合计</b>		<b>4/6</b>	<b>5/14</b>	<b>5/11</b>	<b>2/4</b>	<b>1/6</b>	<b>0/1</b>	<b>0/1</b>	<b>17/43</b>	<b>39.5</b>	<b>1</b>					7		7 20:12 11 18 马麟晓
<b>上海</b>		<b>远射</b>	<b>近射</b>	<b>边射</b>	<b>快攻</b>	<b>突破</b>	<b>任意球</b>	<b>7m球</b>	<b>合计</b>	<b>%</b>	<b>助攻</b>	<b>失误</b>	<b>警告</b>	<b>2'</b>	<b>D &amp; DR</b>			
教练：吴璟																		
1	张崢										1					8		8 20:47 11
2	张文斌															8		8 21:40 12 8 钱为玮
3	赵时俊	1/1	0/1	0/1					1/3	33.3		1				8		8 22:38 12
4	徐俊吉	0/1	5/5	0/1					5/7	71.4			1			8		8 23:07 13
7	吴双															8		8 23:51 17
8	钱为玮		1/1	4/4	1/2				6/7	85.7		1				8		8 04:32 18 11 蒋承骅
10	董凯															8		8 04:56 18
11	蒋承骅	1/3	0/2	1/3			1/1	0/1	3/10	30.0	2	2				8		8 06:24 19
12	周哲韬															8		8 08:00 19 8 钱为玮
14	沈吉磊		3/6			4/5			7/11	63.6	1	1	1	1		8		8 08:24 19
15	蒋嘉敏															8		8 08:09 20 3 赵时俊
16	朱春雷															8		8 08:24 19
17	高天伦															8		8 09:51 21 18 马麟晓
18	马麟晓	0/2	0/1			1/1		1/1	2/5	40.0	7	2	1			8		8 11:00 22 8 钱为玮
19	蒋慧捷			1/3	1/2				2/5	40.0						8		8 12:02 22
22	张润明															8		8 12:38 23 4 徐俊吉
<b>运动员 合计</b>		<b>2/7</b>	<b>9/16</b>	<b>6/12</b>	<b>2/4</b>	<b>5/6</b>	<b>1/1</b>	<b>1/2</b>	<b>26/48</b>	<b>54.2</b>	<b>11</b>	<b>7</b>	<b>3</b>	<b>1</b>		14		14 00:34 16 14 沈吉磊
1	张崢	4/9	0/13	4/6	0/2	0/6		0/1	8/37	21.6	1					14		14 01:43 17 8 钱为玮
<b>守门员 合计</b>		<b>4/9</b>	<b>0/13</b>	<b>4/6</b>	<b>0/2</b>	<b>0/6</b>		<b>0/1</b>	<b>8/37</b>	<b>21.6</b>	<b>1</b>					14		14 02:59 17

场上队员：得分 / 射门

守门员：救球 / 射门

快攻	Fast Break		突破	Breakthrough		任意球	Free Throw		7M球	7M Throw		助攻	Assist
警告	Warning		失误	Error		2'	Suspension		D	取消资格		DR	取消资格+报告





# “绿叶集团”杯2016年全国男子手球超级杯赛 图式比赛技术统计表

轮次 4

场次 10

201608010-21-1/1

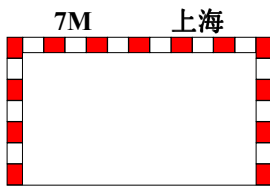
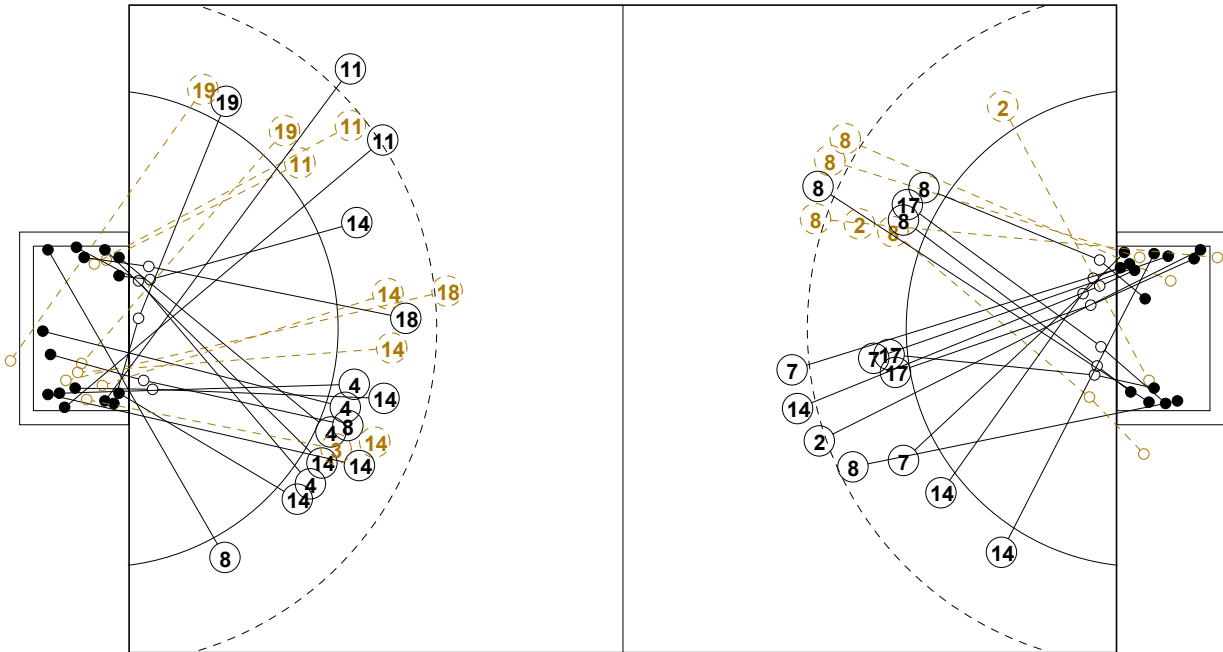

1st Half  
15 : 14

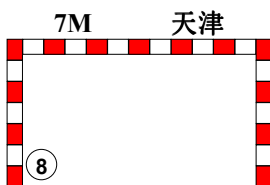
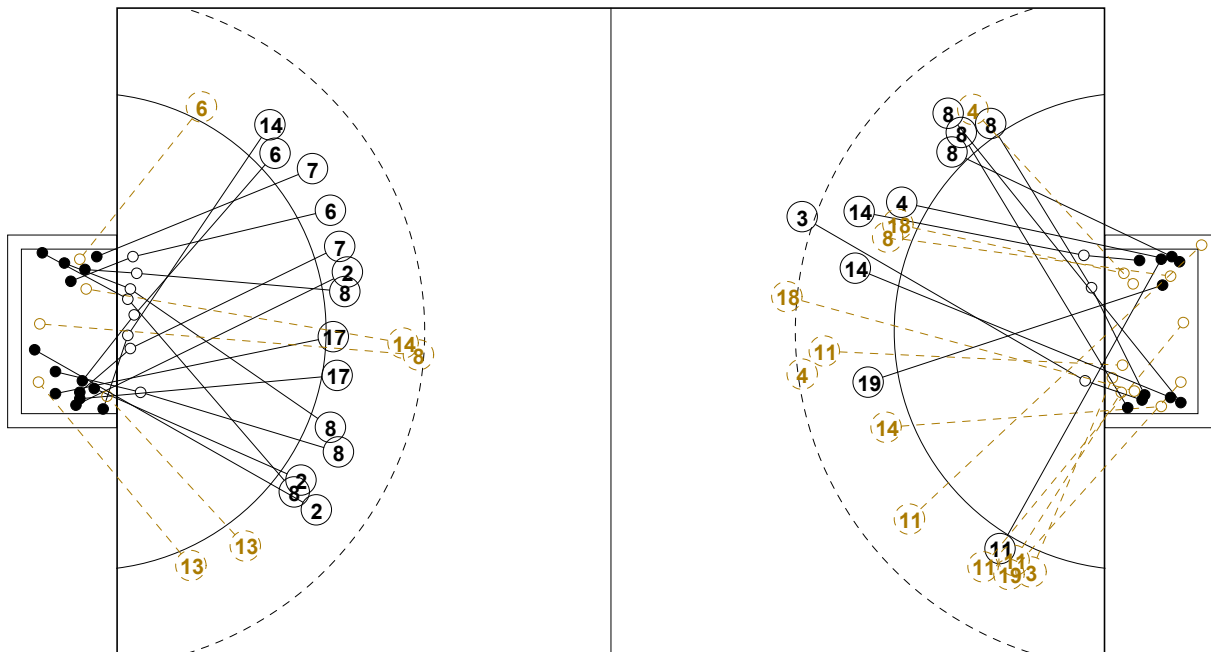
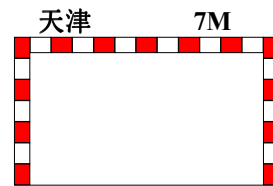

2nd Half  
29 : 26

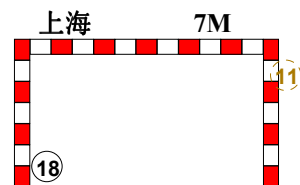



## “绿叶集团”杯2016年全国男子手球超级杯赛

## 个人/全队技术统计表

正式表  
手球  
男子预赛  
轮次 4组别 X  
场次 10201608010-14-1/2  
苏州市体育中心  
24/11/2016 13:00

号码	姓名	远射	近射	边射	快攻	突破	任意	7M	合计	%	助攻	失误	警告	2'	取消	时间
<b>天津(天津)</b>																
<i>(场上队员)</i>																
1	刘宗其									0.0%	1					00:36:59
2	李岳朋	1/1	3/4	0/1					4/6	66.7%	1					00:43:59
4	李松浩									0.0%						00:00:00
6	王子欣		1/1	0/1	1/1				2/3	66.7%		1				01:00:00
7	张青	1/1	1/1			3/3			5/5	100%	2	4	1	1		01:00:00
8	曹悦	2/6	3/3		1/1	2/3		1/1	9/14	64.3%	1		1	2		01:00:00
9	吴明远									0.0%						00:00:00
12	杨峻									0.0%						00:23:01
13	许松			0/2					0/2	0.0%		1				01:00:00
14	田剑侠	1/2		2/2		1/1			4/5	80.0%	2	4				00:29:33
16	刘海亮									0.0%						00:00:00
17	周群		5/5						5/5	100%			1	2		00:45:44
21	潘玉帅									0.0%						00:00:00
22	魏雨童									0.0%						00:00:00

<b>合计</b>		5/10	13/14	2/6	2/2	6/7		1/1	29/40	72.5%	7	10	3	5		
<i>(守门员)</i>																
1	刘宗其	2/3	4/11	2/7	0/1	1/5		0/1	9/28	32.1%	1					00:36:59
12	杨峻	2/3	1/3	3/4	2/3	0/1	0/1		8/15	53.3%						00:23:01

<b>合计</b>		4/6	5/14	5/11	2/4	1/6	0/1	0/1	17/43	39.5%	1					
-----------	--	-----	------	------	-----	-----	-----	-----	-------	-------	---	--	--	--	--	--

场上队员：得分/射门

守门员：救球/射门

全队合计	得分	被救	射失	击柱	封球	合计	%
远射	5	4		1		10	50.0%
近射	13				1	14	92.9%
边射	2	4				6	33.3%
快攻	2					2	100.0%
突破	6		1			7	85.7%
任意							0.0%
7M	1					1	100.0%





## “绿叶集团”杯2016年全国男子手球超级杯赛

## 个人/全队技术统计表

正式表  
手球  
男子预赛  
轮次 4组别 X  
场次 10201608010-14-2/2  
苏州市体育中心  
24/11/2016 13:00

号码	姓名	远射	近射	边射	快攻	突破	任意	7M	合计	%	助攻	失误	警告	2'	取消	时间
<b>上海(上海)</b>																
<i>(上场队员)</i>																
1	张崢									0.0%	1					01:00:00
2	张文斌									0.0%						00:00:00
3	赵时俊	1/1	0/1	0/1					1/3	33.3%		1				00:48:53
4	徐俊吉	0/1	5/5	0/1					5/7	71.4%			1			01:00:00
7	吴双									0.0%						00:00:00
8	钱为玮		1/1	4/4	1/2				6/7	85.7%		1				01:00:00
10	董凯									0.0%						00:00:00
11	蒋承骅	1/3	0/2	1/3			1/1	0/1	3/10	30.0%	2	2				01:00:00
12	周哲韬									0.0%						00:00:00
14	沈吉磊		3/6			4/5			7/11	63.6%	1	1	1	1		00:57:36
15	蒋嘉敏									0.0%						00:00:00
16	朱春雷									0.0%						00:00:00
17	高天伦									0.0%						00:00:00
18	马麟晓	0/2	0/1			1/1		1/1	2/5	40.0%	7	2	1			01:00:00
19	蒋慧捷			1/3	1/2				2/5	40.0%						00:24:07
22	张润明									0.0%						00:00:00
<b>合计</b>		2/7	9/16	6/12	2/4	5/6	1/1	1/2	26/48	54.2%	11	7	3	1		
<i>(守门员)</i>																
1	张崢	4/9	0/13	4/6	0/2	0/6		0/1	8/37	21.6%	1					01:00:00
<b>合计</b>																
		4/9	0/13	4/6	0/2	0/6		0/1	8/37	21.6%	1					

场上队员：得分/射门

守门员：救球/射门

全队合计	得分	被救	射失	击柱	封球	合计	%
远射	2	4			1	7	28.6%
近射	9	5		1	1	16	56.3%
边射	6	5	1			12	50.0%
快攻	2	2				4	50.0%
突破	5	1				6	83.3%
任意	1					1	100.0%
7M	1			1		2	50.0%





“绿叶集团”杯2016年全国男子手球超级杯赛

图式射门区域统计

轮次 4 场次 10

201608010-41-1/1

天津

1 刘宗其	2 李岳朋	4 李松浩	6 王子欣	7 张青	8 曹悦	9 吴明远	12 杨峻																																																																								
<table border="1"><tr><td></td><td></td><td></td></tr><tr><td></td><td></td><td></td></tr><tr><td></td><td></td><td></td></tr></table>										<table border="1"><tr><td>1</td><td>1</td><td></td></tr><tr><td>1</td><td></td><td></td></tr><tr><td>1</td><td></td><td></td></tr></table>	1	1		1			1			<table border="1"><tr><td></td><td></td><td></td></tr><tr><td></td><td></td><td></td></tr><tr><td></td><td></td><td></td></tr></table>										<table border="1"><tr><td></td><td></td><td></td></tr><tr><td>1</td><td></td><td>1</td></tr><tr><td></td><td></td><td></td></tr></table>				1		1				<table border="1"><tr><td></td><td></td><td></td></tr><tr><td>2</td><td></td><td></td></tr><tr><td>2</td><td></td><td>1</td></tr></table>				2			2		1	<table border="1"><tr><td></td><td></td><td>1</td></tr><tr><td>1</td><td></td><td>4</td></tr><tr><td>2</td><td></td><td>1</td></tr></table>			1	1		4	2		1	<table border="1"><tr><td></td><td></td><td></td></tr><tr><td></td><td></td><td></td></tr><tr><td></td><td></td><td></td></tr></table>										<table border="1"><tr><td></td><td></td><td></td></tr><tr><td></td><td></td><td></td></tr><tr><td></td><td></td><td></td></tr></table>									
1	1																																																																														
1																																																																															
1																																																																															
1		1																																																																													
2																																																																															
2		1																																																																													
		1																																																																													
1		4																																																																													
2		1																																																																													
Post - 0 Miss - 0 Block - 0	Post - 0 Miss - 0 Block - 1	Post - 0 Miss - 0 Block - 0	Post - 0 Miss - 0 Block - 0	Post - 0 Miss - 0 Block - 0	Post - 1 Miss - 1 Block - 0	Post - 0 Miss - 0 Block - 0	Post - 0 Miss - 0 Block - 0																																																																								
13 许松	14 田剑侠	16 刘海亮	17 周群	21 潘玉帅	22 魏雨童																																																																										
<table border="1"><tr><td></td><td></td><td></td></tr><tr><td></td><td></td><td></td></tr><tr><td></td><td></td><td></td></tr></table>										<table border="1"><tr><td>1</td><td></td><td></td></tr><tr><td></td><td></td><td></td></tr><tr><td>3</td><td></td><td></td></tr></table>	1						3			<table border="1"><tr><td></td><td></td><td></td></tr><tr><td></td><td></td><td></td></tr><tr><td></td><td></td><td></td></tr></table>										<table border="1"><tr><td>1</td><td></td><td></td></tr><tr><td>2</td><td></td><td>2</td></tr><tr><td></td><td></td><td></td></tr></table>	1			2		2				<table border="1"><tr><td></td><td></td><td></td></tr><tr><td></td><td></td><td></td></tr><tr><td></td><td></td><td></td></tr></table>										<table border="1"><tr><td></td><td></td><td></td></tr><tr><td></td><td></td><td></td></tr><tr><td></td><td></td><td></td></tr></table>																													
1																																																																															
3																																																																															
1																																																																															
2		2																																																																													
Post - 0 Miss - 0 Block - 0	Post - 0 Miss - 0 Block - 0	Post - 0 Miss - 0 Block - 0	Post - 0 Miss - 0 Block - 0	Post - 0 Miss - 0 Block - 0	Post - 0 Miss - 0 Block - 0																																																																										

1 刘宗其

1/5	0/2	0/1
3/6		1/4
1/4		3/6

12 杨峻

1/2	1/1	1/3
0/1		1/2
2/3		2/3

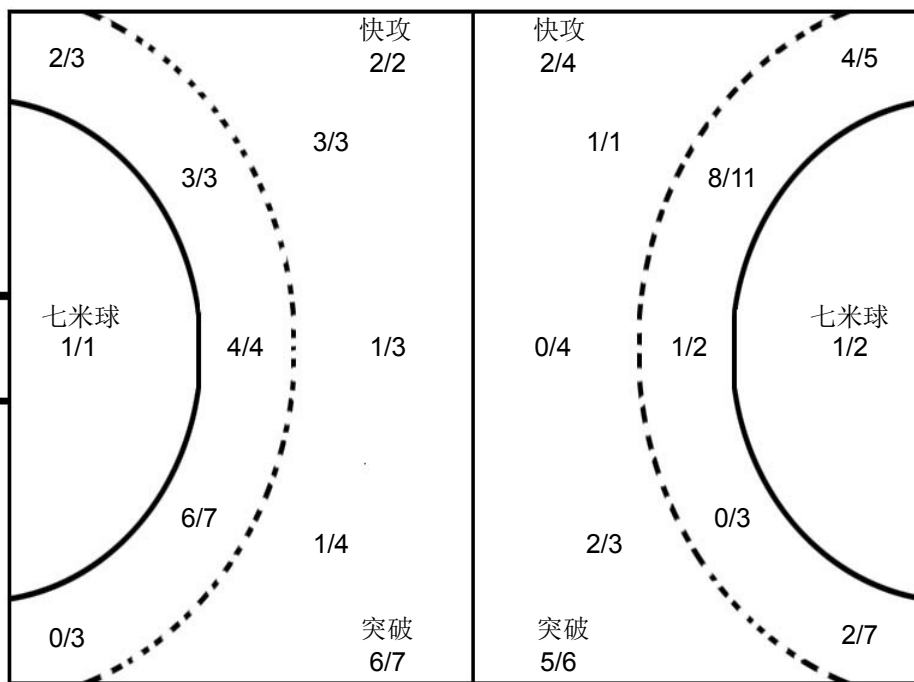
1 张峻

1/3	1/2	0/1
1/9		2/9
2/10		1/3



上海

1 张峻	2 张文斌	3 赵时俊	4 徐俊吉	7 吴双	8 钱为玮	10 董凯	11 蒋承骅																																																																								
<table border="1"><tr><td></td><td></td><td></td></tr><tr><td></td><td></td><td></td></tr><tr><td></td><td></td><td></td></tr></table>										<table border="1"><tr><td></td><td></td><td></td></tr><tr><td></td><td></td><td></td></tr><tr><td></td><td></td><td></td></tr></table>										<table border="1"><tr><td></td><td></td><td></td></tr><tr><td></td><td></td><td>1</td></tr><tr><td></td><td></td><td></td></tr></table>						1				<table border="1"><tr><td>2</td><td>1</td><td></td></tr><tr><td></td><td></td><td>1</td></tr><tr><td></td><td></td><td>1</td></tr></table>	2	1				1			1	<table border="1"><tr><td></td><td></td><td></td></tr><tr><td></td><td></td><td></td></tr><tr><td></td><td></td><td></td></tr></table>										<table border="1"><tr><td>1</td><td>1</td><td>2</td></tr><tr><td></td><td></td><td>1</td></tr><tr><td></td><td></td><td>1</td></tr></table>	1	1	2			1			1	<table border="1"><tr><td></td><td></td><td></td></tr><tr><td></td><td></td><td></td></tr><tr><td></td><td></td><td></td></tr></table>										<table border="1"><tr><td>1</td><td></td><td></td></tr><tr><td>1</td><td></td><td></td></tr><tr><td>1</td><td></td><td></td></tr></table>	1			1			1		
		1																																																																													
2	1																																																																														
		1																																																																													
		1																																																																													
1	1	2																																																																													
		1																																																																													
		1																																																																													
1																																																																															
1																																																																															
1																																																																															
Post - 0 Miss - 0 Block - 0	Post - 0 Miss - 0 Block - 0	Post - 0 Miss - 0 Block - 0	Post - 0 Miss - 0 Block - 1	Post - 0 Miss - 0 Block - 0	Post - 0 Miss - 0 Block - 0	Post - 0 Miss - 0 Block - 0	Post - 2 Miss - 0 Block - 0																																																																								
12 周哲韬	14 沈吉磊	15 蒋嘉敏	16 朱春雷	17 高天伦	18 马麟晓	19 蒋慧捷	22 张润明																																																																								
<table border="1"><tr><td></td><td></td><td></td></tr><tr><td></td><td></td><td></td></tr><tr><td></td><td></td><td></td></tr></table>										<table border="1"><tr><td>1</td><td></td><td>1</td></tr><tr><td>2</td><td></td><td></td></tr><tr><td>1</td><td></td><td>2</td></tr></table>	1		1	2			1		2	<table border="1"><tr><td></td><td></td><td></td></tr><tr><td></td><td></td><td></td></tr><tr><td></td><td></td><td></td></tr></table>										<table border="1"><tr><td></td><td></td><td></td></tr><tr><td></td><td></td><td></td></tr><tr><td></td><td></td><td></td></tr></table>										<table border="1"><tr><td></td><td></td><td></td></tr><tr><td></td><td></td><td></td></tr><tr><td></td><td></td><td></td></tr></table>										<table border="1"><tr><td></td><td></td><td>1</td></tr><tr><td></td><td></td><td></td></tr><tr><td>1</td><td></td><td></td></tr></table>			1				1			<table border="1"><tr><td>1</td><td></td><td></td></tr><tr><td>1</td><td></td><td></td></tr><tr><td></td><td></td><td></td></tr></table>	1			1						<table border="1"><tr><td></td><td></td><td></td></tr><tr><td></td><td></td><td></td></tr><tr><td></td><td></td><td></td></tr></table>									
1		1																																																																													
2																																																																															
1		2																																																																													
		1																																																																													
1																																																																															
1																																																																															
1																																																																															
Post - 0 Miss - 0 Block - 0	Post - 0 Miss - 0 Block - 1	Post - 0 Miss - 0 Block - 0	Post - 0 Miss - 0 Block - 0	Post - 0 Miss - 0 Block - 0	Post - 0 Miss - 0 Block - 0	Post - 0 Miss - 1 Block - 0	Post - 0 Miss - 0 Block - 0																																																																								

注释: Post=击柱 Miss=射失 Block=被封





预赛 Group X

男子 全国杯赛

“绿叶集团”杯2016年全国男子手球超级杯赛

Team A <b>A 北京</b>				Team B <b>B 江苏</b>				Match Number <b>11</b>													
played in China		in the hall 苏州市体育中心		on 24/11/2016		at 14:30 hours		Spectators													
Half-time (30')	<b>A</b> 6	<b>B</b> 18	End of playing time	<b>A</b> 7	<b>B</b> 22	1st extra time	<b>A</b>	<b>B</b>	2nd extra time	<b>A</b>	<b>B</b>	After penalty throws	<b>A</b>	<b>B</b>							
Number of 7 m	<b>A</b> 0/0	Team time-out 1 10:15 2 3			Full name of players and officials				Team time-out 1 2 3			<b>B</b> 2/3	Number of 7 m								
No.	Team <b>A</b>					G	W	2'	D	DR	No.	Team <b>B</b>					G	W	2'	D	DR
3	吴锐樊										1	徐畅									
6	赵一涵					1	1				4	张家纬					2				
7	卞友山										5	闫亮					1				
8	赵文宣										6	赵晨					3				
9	李旭					1					7	徐奕飞									
10	李明远					2					9	任超凡									
12	孔祥杰										10	郝可鑫					4				
17	袁振典										11	马益奎									
18	温新宇										12	王权									
20	王鹏皓										13	耿畅									
23	陈旭					2	1				15	李加昌									
25	程海津										17	王伟强					4				
26	杨政										18	赵楠					3				
29	逯明松					1					21	刘江					3	1			
35	高云健										22	任启双					2	1	1		
78	王哲一																				
B	吴健 (主教练)										B	闫威名 (主教练)									
C	刘彦坤										C	贾淑君									
D	陈璇										E	王建国									
<b>A</b>	Signature of Responsible Official of the Teams (Off. A)																		<b>B</b>		
TP	Remarks of Referee / CHA Official																		TP		

Signatures

Referees	张栋 (CHN)	王洋 (CHN)		
Techn. Delegates	于中迅 (CHN)	柴业宏 (CHN)		
CHA Official				

Note: Number of 7m Throws Awarded to Team A and B, Goals (G), Warnings (W), Suspensions (2'), Direct Disqualification (D), Disqualification with Report (DR) and Team Penalty (TP).

Table Officials: 宣海波

许栋梁

Statisticians: 王玮

王聆

Printed by PHMS Copyright: IHF/CHA 24/11/2016 15:20:13

Longman Sportsoft



handball@126.com



“绿叶集团”杯2016年全国男子手球超级杯赛  
竞赛技术统计(媒体表)

预赛	组别	X	轮次	4	场次	11
----	----	---	----	---	----	----

苏州市体育中心

24/11/2016

201608011-51-1/1

北京	北京	7	vs	22	江苏	江苏
				6 : 18		

裁判员	张栋 (CHN)	/	王洋 (CHN)
-----	----------	---	----------

北京		远射	近射	边射	快攻	突破	任意球	7m球	合计	%	助攻	失误	警告	2'	D & DR	北京	比赛进程	江苏
主教练：吴健																		
3	吴锐樊			0/1					0/1	0.0			1					
6	赵一涵	1/5				0/2			1/7	14.3	1	4	1					
7	卞友山											1						
8	赵文宣																	
9	李旭		1/1						1/1	100		1						
10	李明远	0/1	2/3			0/1			2/5	40.0		1						
12	孔祥杰																	
17	袁振典											3						
18	温新宇											1						
20	王鹏皓	0/1							0/1	0.0		1						
23	陈旭	1/4	1/2						2/6	33.3		3	1					
25	程海洋																	
26	杨政																	
29	逯明松	0/1	0/1			1/1			1/3	33.3	1							
35	高云健											1						
78	王哲一																	
运动员 合计		2/12	4/7	0/1		1/4			7/24	29.2	2	16	3					
12	孔祥杰							0/1	0/1	0.0								
35	高云健	0/5	0/7	0/1	2/9	1/1		0/1	3/24	12.5		1						
守门员 合计		0/5	0/7	0/1	2/9	1/1		0/2	3/25	12.0		1						

江苏		远射	近射	边射	快攻	突破	任意球	7m球	合计	%	助攻	失误	警告	2'	D & DR			
教练：闫威名																		
1	徐畅																	
4	张家伟		1/1		1/2				2/3	66.7	1	1						
5	闫亮				1/1				1/1	100	1							
6	赵晨	2/5	1/1			0/2			3/8	37.5	2							
7	徐奕飞																	
9	任超凡																	
10	郝可鑫	3/3						1/1	4/4	100	1							
11	马益奎																	
12	王权										4							
13	耿畅																	
15	李加昌																	
17	王伟强			1/1	2/3			1/2	4/6	66.7		3						
18	赵楠		2/2		1/1				3/3	100	1	1						
21	刘江	0/1	1/1		2/2				3/4	75.0			1					
22	任启双		2/2		0/2				2/4	50.0		2	1	1				
运动员 合计		5/9	7/7	1/1	7/11	0/2		2/3	22/33	66.7	10	7	2	1				
12	王权	3/5	2/6	1/1		1/2			7/14	50.0	4							
守门员 合计		3/5	2/6	1/1		1/2			7/14	50.0	4							

北京	江苏
1st Half	
0	00:46 1 6 赵晨
0	02:03 2 6 赵晨
0	02:58 3 21 刘江
23	陈旭 1 03:12 3
1	04:44 4 21 刘江
6	赵一涵 2 05:08 4
2	05:35 5 17 王伟强
2	10:08 6 5 闫亮
2	11:39 7 21 刘江
29	逯明松 3 12:40 7
3	13:17 8 10 郝可鑫
3	16:12 9 18 赵楠
3	16:48 10 18 赵楠
9	李旭 4 17:49 10
4	18:32 11 10 郝可鑫
4	19:34 12 17 王伟强
23	陈旭 5 20:03 12
5	22:20 13 18 赵楠
10	李明远 6 24:32 13
6	24:51 14 17 王伟强
6	26:40 15 10 郝可鑫
6	27:34 16 4 张家伟
6	27:58 17 4 张家伟
6	29:10 18 10 郝可鑫
2nd Half	
10	李明远 6 00:53 19 22 任启双
7	01:23 19
7	01:30 20 6 赵晨
7	02:35 21 22 任启双
7	03:20 22 17 王伟强

场上队员：得分 / 射门

守门员：救球 / 射门

快攻	Fast Break	突破	Breakthrough	任意球	Free Throw	7M球	7M Throw	助攻	Assist
警告	Warning	失误	Error	2'	Suspension	D	取消资格	DR	取消资格+报告





# “绿叶集团”杯2016年全国男子手球超级杯赛 图式比赛技术统计表

轮次 4

场次 11

201608011-21-1/1

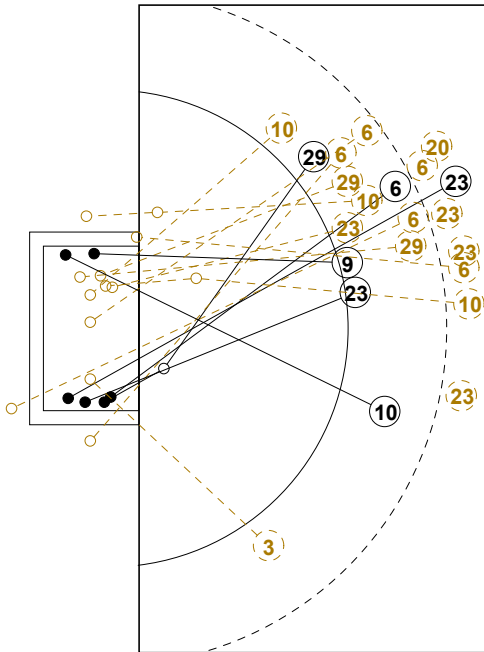

7M 北京

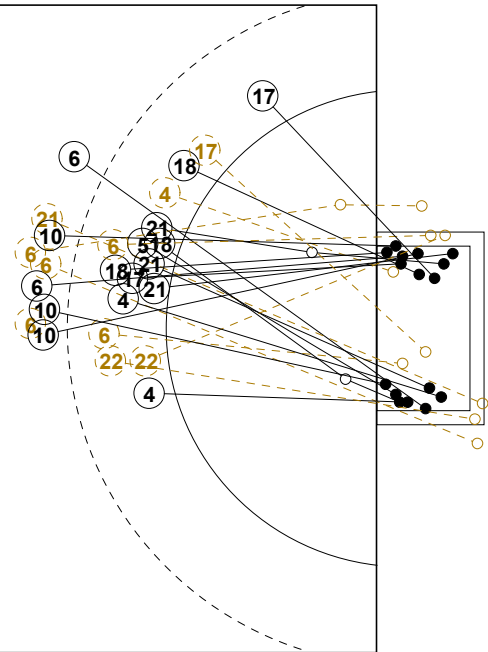
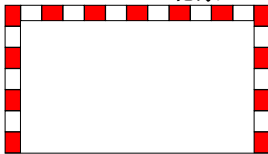

江苏 7M

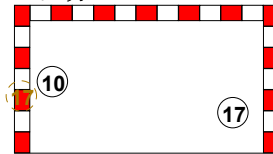

1st Half  
6 : 18

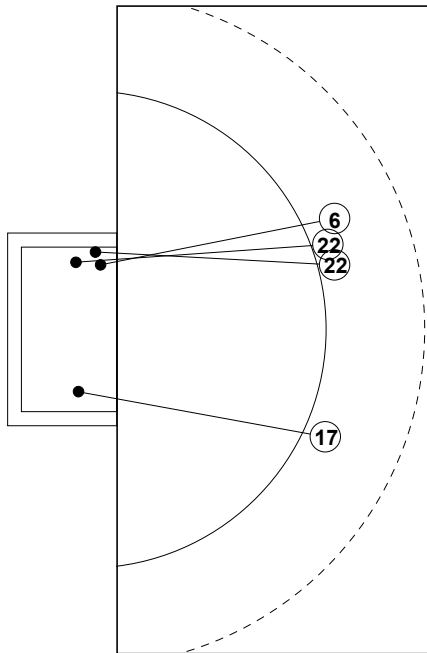

7M 江苏

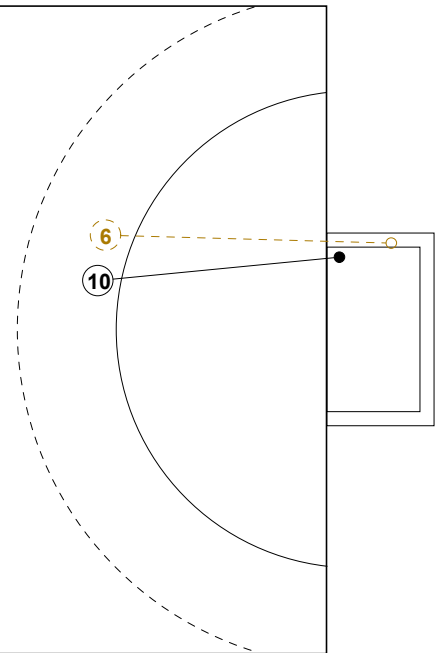

北京 7M

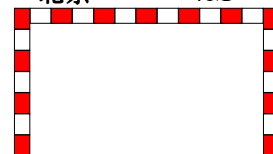

2nd Half  
22 : 7





## “绿叶集团”杯2016年全国男子手球超级杯赛

## 个人/全队技术统计表

正式表  
手球  
男子预赛  
轮次 4组别 X  
场次 11201608011-14-1/2  
苏州市体育中心  
24/11/2016 14:30

号码	姓名	远射	近射	边射	快攻	突破	任意	7M	合计	%	助攻	失误	警告	2'	取消	时间
<b>北京(北京)</b>																
<i>(场上队员)</i>																
3	吴锐樊			0/1					0/1	0.0%			1			00:23:05
6	赵一涵	1/5				0/2			1/7	14.3%	1	4	1			00:33:26
7	卞友山									0.0%		1				00:07:25
8	赵文宣									0.0%						00:00:00
9	李旭		1/1						1/1	100%		1				00:26:45
10	李明远	0/1	2/3			0/1			2/5	40.0%		1				00:15:04
12	孔祥杰									0.0%						00:00:06
17	袁振典									0.0%		3				00:09:34
18	温新宇									0.0%		1				00:10:34
20	王鹏皓	0/1							0/1	0.0%		1				00:08:30
23	陈旭	1/4	1/2						2/6	33.3%		3	1			00:22:51
25	程海津									0.0%						00:07:57
26	杨政									0.0%						00:00:45
29	逮明松	0/1	0/1			1/1			1/3	33.3%	1					00:24:56
35	高云健									0.0%		1				00:33:20
78	王哲一									0.0%						00:09:32
<b>合计</b>		2/12	4/7	0/1		1/4			7/24	29.2%	2	16	3			
<i>(守门员)</i>																
12	孔祥杰							0/1	0/1	0.0%						00:00:06
35	高云健	0/5	0/7	0/1	2/9	1/1		0/1	3/24	12.5%		1				00:33:20
<b>合计</b>		0/5	0/7	0/1	2/9	1/1		0/2	3/25	12.0%		1				

场上队员：得分/射门

守门员：救球/射门

全队合计	得分	被救	射失	击柱	封球	合计	%
远射	2	3	1	1	5	12	16.7%
近射	4	2	1			7	57.1%
边射		1				1	0.0%
快攻							0.0%
突破	1	1	1	1		4	25.0%
任意							0.0%
7M							0.0%





## “绿叶集团”杯2016年全国男子手球超级杯赛

## 个人/全队技术统计表

正式表  
手球  
男子预赛  
轮次 4组别 X  
场次 11201608011-14-2/2  
苏州市体育中心  
24/11/2016 14:30

号码	姓名	远射	近射	边射	快攻	突破	任意	7M	合计	%	助攻	失误	警告	2'	取消	时间
<b>江苏(江苏)</b>																
<i>(上场队员)</i>																
1	徐畅									0.0%						00:00:00
4	张家纬		1/1		1/2				2/3	66.7%	1	1				00:33:26
5	闫亮				1/1				1/1	100%	1					00:11:42
6	赵晨	2/5	1/1			0/2			3/8	37.5%	2					00:32:43
7	徐奕飞									0.0%						00:00:00
9	任超凡									0.0%						00:00:00
10	郝可鑫	3/3						1/1	4/4	100%	1					00:21:42
11	马益奎									0.0%						00:00:00
12	王权									0.0%	4					00:33:26
13	耿畅									0.0%						00:00:00
15	李加昌									0.0%						00:00:00
17	王伟强			1/1	2/3			1/2	4/6	66.7%		3				00:33:26
18	赵楠		2/2		1/1				3/3	100%	1	1				00:33:26
21	刘江	0/1	1/1		2/2				3/4	75.0%			1			00:13:24
22	任启双		2/2		0/2				2/4	50.0%		2	1	1		00:20:42
<b>合计</b>		5/9	7/7	1/1	7/11	0/2		2/3	22/33	66.7%	10	7	2	1		
<i>(守门员)</i>																
12	王权	3/5	2/6	1/1		1/2			7/14	50.0%	4					00:33:26
<b>合计</b>																
		3/5	2/6	1/1		1/2			7/14	50.0%	4					

场上队员：得分/射门

守门员：救球/射门

全队合计	得分	被救	射失	击柱	封球	合计	%
远射	5		2	1	1	9	55.6%
近射	7					7	100.0%
边射	1					1	100.0%
快攻	7	2		2		11	63.6%
突破		1		1		2	0.0%
任意							0.0%
7M	2			1		3	66.7%





### “绿叶集团”杯2016年全国男子手球超级杯赛

图式射门区域统计

轮次 4 场次 11

201608011-41-1/1

## 北京

3 吴锐樊	6 赵一涵	7 卞友山	8 赵文宣	9 李旭	10 李明远	12 孔祥杰	17 袁振典																																																																								
<table border="1"><tr><td></td><td></td><td></td></tr><tr><td></td><td></td><td></td></tr><tr><td></td><td></td><td></td></tr></table>										<table border="1"><tr><td></td><td></td><td></td></tr><tr><td>1</td><td></td><td></td></tr><tr><td></td><td></td><td></td></tr></table>				1						<table border="1"><tr><td></td><td></td><td></td></tr><tr><td></td><td></td><td></td></tr><tr><td></td><td></td><td></td></tr></table>										<table border="1"><tr><td></td><td></td><td></td></tr><tr><td></td><td></td><td></td></tr><tr><td></td><td></td><td></td></tr></table>										<table border="1"><tr><td></td><td></td><td></td></tr><tr><td></td><td></td><td>1</td></tr><tr><td></td><td></td><td></td></tr></table>						1				<table border="1"><tr><td></td><td></td><td></td></tr><tr><td></td><td></td><td></td></tr><tr><td></td><td></td><td></td></tr></table>										<table border="1"><tr><td></td><td></td><td></td></tr><tr><td></td><td></td><td></td></tr><tr><td></td><td></td><td></td></tr></table>										<table border="1"><tr><td></td><td></td><td></td></tr><tr><td></td><td></td><td></td></tr><tr><td></td><td></td><td></td></tr></table>									
1																																																																															
		1																																																																													
Post - 0 Miss - 0 Block - 0	Post - 2 Miss - 2 Block - 1	Post - 0 Miss - 0 Block - 0	Post - 0 Miss - 0 Block - 0	Post - 0 Miss - 0 Block - 0	Post - 0 Miss - 1 Block - 0	Post - 0 Miss - 0 Block - 0	Post - 0 Miss - 0 Block - 0																																																																								
18 温新宇	20 王鹏皓	23 陈旭	25 程海津	26 杨政	29 逯明松	35 高云健	78 王哲一																																																																								
<table border="1"><tr><td></td><td></td><td></td></tr><tr><td></td><td></td><td></td></tr><tr><td></td><td></td><td></td></tr></table>										<table border="1"><tr><td></td><td></td><td></td></tr><tr><td></td><td></td><td></td></tr><tr><td></td><td></td><td></td></tr></table>										<table border="1"><tr><td></td><td></td><td></td></tr><tr><td>1</td><td></td><td></td></tr><tr><td>1</td><td></td><td></td></tr></table>				1			1			<table border="1"><tr><td></td><td></td><td></td></tr><tr><td></td><td></td><td></td></tr><tr><td></td><td></td><td></td></tr></table>										<table border="1"><tr><td></td><td></td><td></td></tr><tr><td></td><td></td><td></td></tr><tr><td></td><td></td><td></td></tr></table>										<table border="1"><tr><td></td><td></td><td></td></tr><tr><td></td><td></td><td></td></tr><tr><td></td><td></td><td></td></tr></table>										<table border="1"><tr><td></td><td></td><td></td></tr><tr><td></td><td></td><td></td></tr><tr><td></td><td></td><td></td></tr></table>										<table border="1"><tr><td></td><td></td><td></td></tr><tr><td></td><td></td><td></td></tr><tr><td></td><td></td><td></td></tr></table>									
1																																																																															
1																																																																															
Post - 0 Miss - 0 Block - 0	Post - 0 Miss - 0 Block - 1	Post - 0 Miss - 0 Block - 3	Post - 0 Miss - 0 Block - 0	Post - 0 Miss - 0 Block - 0	Post - 0 Miss - 0 Block - 0	Post - 0 Miss - 0 Block - 0	Post - 0 Miss - 0 Block - 0																																																																								

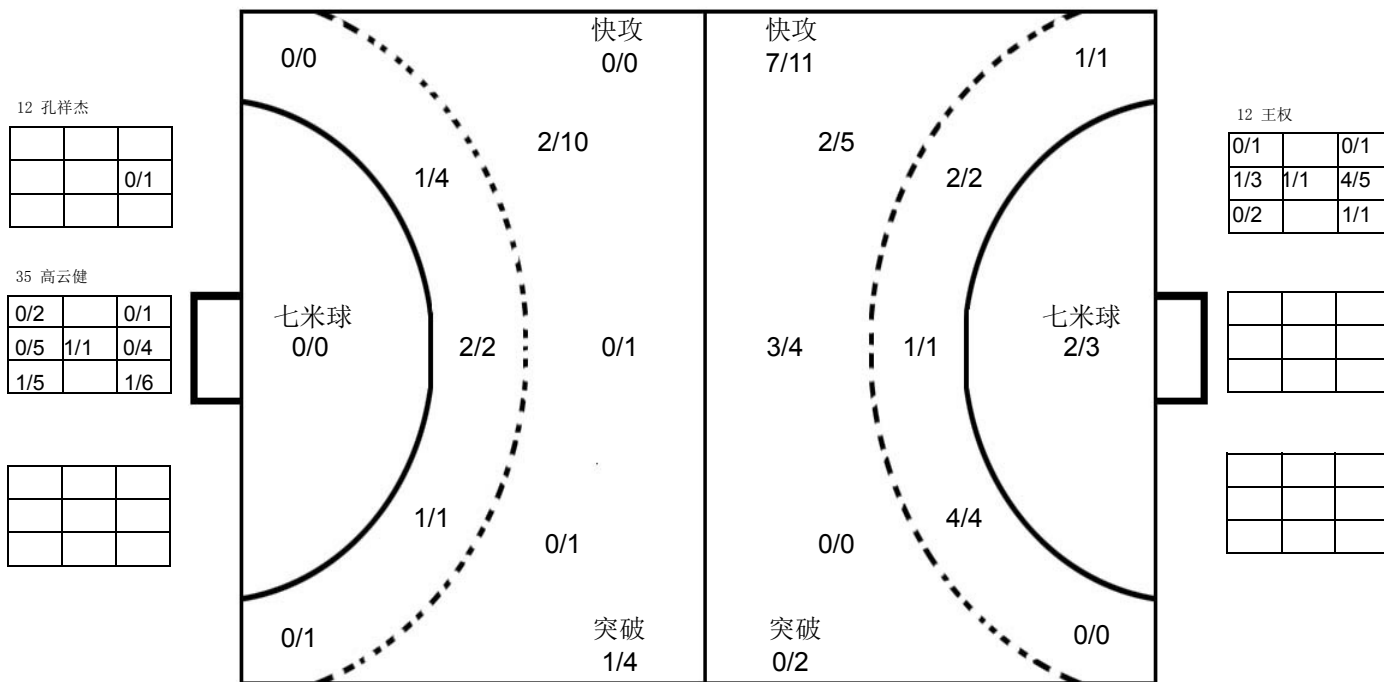

## 江苏

1 徐畅	4 张家伟	5 闫亮	6 赵晨	7 徐奕飞	9 任超凡	10 郝可鑫	11 马益奎																																																																											
<table border="1"><tr><td></td><td></td><td></td></tr><tr><td></td><td></td><td></td></tr><tr><td></td><td></td><td></td></tr></table>										<table border="1"><tr><td></td><td></td><td></td></tr><tr><td></td><td></td><td>1</td></tr><tr><td></td><td></td><td>1</td></tr></table>						1			1	<table border="1"><tr><td></td><td></td><td></td></tr><tr><td></td><td></td><td></td></tr><tr><td></td><td></td><td>1</td></tr></table>									1	<table border="1"><tr><td></td><td></td><td></td></tr><tr><td></td><td></td><td></td></tr><tr><td>1</td><td></td><td>1</td></tr></table>							1		1	<table border="1"><tr><td></td><td></td><td></td></tr><tr><td></td><td></td><td></td></tr><tr><td></td><td></td><td></td></tr></table>										<table border="1"><tr><td></td><td></td><td></td></tr><tr><td></td><td></td><td></td></tr><tr><td></td><td></td><td></td></tr></table>										<table border="1"><tr><td></td><td></td><td></td></tr><tr><td></td><td></td><td></td></tr><tr><td>2</td><td></td><td></td></tr><tr><td>1</td><td></td><td>1</td></tr></table>							2			1		1	<table border="1"><tr><td></td><td></td><td></td></tr><tr><td></td><td></td><td></td></tr><tr><td></td><td></td><td></td></tr></table>									
		1																																																																																
		1																																																																																
		1																																																																																
1		1																																																																																
2																																																																																		
1		1																																																																																
Post - 0 Miss - 0 Block - 0	Post - 0 Miss - 0 Block - 0	Post - 0 Miss - 0 Block - 0	Post - 1 Miss - 2 Block - 1	Post - 0 Miss - 0 Block - 0	Post - 0 Miss - 0 Block - 0	Post - 0 Miss - 0 Block - 0	Post - 0 Miss - 0 Block - 0																																																																											
12 王权	13 耿畅	15 李加昌	17 王伟强	18 赵楠	21 刘江	22 任启双																																																																												
<table border="1"><tr><td></td><td></td><td></td></tr><tr><td></td><td></td><td></td></tr><tr><td></td><td></td><td></td></tr></table>										<table border="1"><tr><td></td><td></td><td></td></tr><tr><td></td><td></td><td></td></tr><tr><td></td><td></td><td></td></tr></table>										<table border="1"><tr><td></td><td></td><td></td></tr><tr><td></td><td></td><td></td></tr><tr><td></td><td></td><td></td></tr></table>										<table border="1"><tr><td></td><td></td><td></td></tr><tr><td>2</td><td></td><td>1</td></tr><tr><td>1</td><td></td><td></td></tr></table>				2		1	1			<table border="1"><tr><td></td><td></td><td></td></tr><tr><td>1</td><td></td><td></td></tr><tr><td>1</td><td></td><td>1</td></tr></table>				1			1		1	<table border="1"><tr><td></td><td></td><td></td></tr><tr><td>2</td><td></td><td></td></tr><tr><td></td><td></td><td>1</td></tr></table>				2					1	<table border="1"><tr><td></td><td></td><td></td></tr><tr><td></td><td></td><td></td></tr><tr><td></td><td></td><td>1</td></tr></table>									1	<table border="1"><tr><td></td><td></td><td></td></tr><tr><td></td><td></td><td></td></tr><tr><td></td><td></td><td></td></tr></table>												
2		1																																																																																
1																																																																																		
1																																																																																		
1		1																																																																																
2																																																																																		
		1																																																																																
		1																																																																																
Post - 0 Miss - 0 Block - 0	Post - 0 Miss - 0 Block - 0	Post - 0 Miss - 0 Block - 0	Post - 1 Miss - 0 Block - 0	Post - 0 Miss - 0 Block - 0	Post - 1 Miss - 0 Block - 0	Post - 2 Miss - 0 Block - 0																																																																												

注释: Post=击柱 Miss=射失 Block=被封



预赛 Group X

男子 全国杯赛

“绿叶集团”杯2016年全国男子手球超级杯赛

Team A A 安徽				Team B B 广东				Match Number <b>12</b>													
played in China		in the hall 苏州市体育中心		on 24/11/2016		at 16:00 hours		Spectators													
Half-time (30')	A 18	B 9	End of playing time	A 31	B 27	1st extra time	A	B	2nd extra time	A	B	After penalty throws	A	B							
Number of 7 m	A 0 / 1	Team time-out 1 2 3 54:58			Full name of players and officials				Team time-out 1 2 3 11:32 37:03 43:17			B 2 / 3	Number of 7 m								
No.	Team A					G	W	2'	D	DR	No.	Team B					G	W	2'	D	DR
1	郭世伟					3					1	王泽润									
3	陈强龙					3	1				10	周仲坤					5	1			
5	史小帆					3					12	王雨					1				
7	姚雄敏										13	王立隆									
8	董智景					9					15	张建杰					4	1	2		
9	陈开勇										18	高玉杰					4				
10	严龙										20	黄培杰					10				
11	黎涛					4	1				26	姚雪岩					3	1			
12	曾献辰																				
13	何磊																				
17	王巨柱					3															
18	李双					1	1	1													
21	李明																				
23	于敏清					4															
24	徐安格								1												
35	金永峰					1		1													
A	韦中平										B	刘康伶 (主教练)									
B	沈强 (主教练)										C	刘文宁									
C	吴翔																				
D	陈玉翔																				
A	Signature of Responsible Official of the Teams (Off. A)										B										
TP	Remarks of Referee / CHA Official										TP										

Signatures

Referees	徐健 (CHN)	曹宏俊 (CHN)		
Techn. Delegates	李长海 (CHN)	于中迅 (CHN)		
CHA Official				

Note: Number of 7m Throws Awarded to Team A and B, Goals (G), Warnings (W), Suspensions (2'), Direct Disqualification (D), Disqualification with Report (DR) and Team Penalty (TP).

Table Officials: 宣海波 许栋梁 Statisticians: 王玲 王玮

Printed by PHMS Copyright: IHF / CHA 24/11/2016 17:12:24

Longman Sportsoft  handball@126.com



## “绿叶集团”杯2016年全国男子手球超级杯赛 竞赛技术统计(媒体表)

<b>预赛</b>	组别	<b>X</b>	轮次	<b>4</b>	场次	<b>12</b>
苏州市体育中心			24/11/2016		201608012-51-1/1	
安徽	<b>安徽</b>	<b>31</b>	vs	<b>27</b>	广东	广东
			<b>18 : 9</b>			

裁判员	徐健 (CHN)			/	曹宏俊 (CHN)		
-----	----------	--	--	---	-----------	--	--

安徽		远	近	边	快	突	任意	7m	合计	%	助攻	失误	警告	2'	D & DR	比赛进程	
主教练：沈强		射	射	射	攻	破	球	球								安徽	广东
1	郭世伟		0/1		0/1	3/3		0/1	3/6	50.0		2				11 黎涛	1 00:24 0
3	陈强龙		1/1		2/2				3/3	100	2		1			3 陈强龙	2 03:38 0
5	史小帆	1/1	1/1		1/1				3/3	100		2				5 史小帆	3 05:35 0
7	姚雄敏															17 王巨柱	4 06:22 1 15 张建杰
8	董智景	2/3	2/3	0/3	4/4	1/2			9/15	60.0		3				23 于敏清	5 08:02 1
9	陈开勇															5 史小帆	6 09:55 1
10	严龙															3 陈强龙	7 10:43 1
11	黎涛	1/1		3/3	0/1				4/5	80.0	1	2	1			11 黎涛	8 11:12 1
12	曾献辰															8 董智景	9 12:14 1
13	何磊															9 陈强龙	10 14:09 2
17	王巨柱	1/5			1/1	1/1			3/7	42.9	4					11 黎涛	11 17:04 3 10 周仲坤
18	李双	1/2							1/2	50.0	1	1	1	1		8 董智景	12 18:12 3
21	李明										2	1				23 于敏清	13 19:54 3
23	于敏清	2/2		1/1	1/1				4/4	100	1	3				17 王巨柱	13 21:21 4 20 黄培杰
24	徐安格														1	17 王巨柱	14 21:48 4
35	金永峰	1/2							1/2	50.0		2			1	17 王巨柱	15 22:41 4
<b>运动员 合计</b>		9/16	4/6	4/7	9/11	5/6		0/1	31/47	66.0	11	16	3	3		8 董智景	16 23:50 4
12	曾献辰							1/3	1/3	33.3						17 于敏清	17 25:36 4
21	李明	3/11	9/16	5/7	3/7	1/4	1/2		22/47	46.8	2	1				17 王巨柱	17 26:53 5 12 王雨
<b>守门员 合计</b>		3/11	9/16	5/7	3/7	1/4	1/2	1/3	23/50	46.0	2	1				17 于敏清	17 27:23 6 10 周仲坤
<b>广东</b>		远	近	边	快	突	任意	7m	合计	%	助攻	失误	警告	2'	D & DR	2nd Half	
教练：刘康伶		射	射	射	攻	破	球	球								8 董智景	19 01:06 9
1	王泽润															35 金永峰	20 02:11 9
10	周仲坤	4/7	1/4						5/11	45.5		3	1			8 董智景	20 02:40 10 20 黄培杰
12	王雨		1/1	0/3					1/4	25.0	1	1				8 董智景	21 04:31 10
13	王立隆		0/1	0/2					0/3	0.0						21 于敏清	21 05:08 11 20 黄培杰
15	张建杰	1/4	1/2		0/1	1/1	1/2		4/10	40.0		3	1	2		21 于敏清	21 06:38 12 18 高玉杰
18	高玉杰		0/1	2/4	2/3				4/8	50.0						21 于敏清	21 08:29 13 26 姚雪岩
20	黄培杰	2/2	2/3		2/3	2/3		2/3	10/14	71.4	5	7				21 于敏清	21 09:08 14 20 黄培杰
26	姚雪岩	1/1	2/4				0/1		3/6	50.0		2	1			1 郭世伟	21 09:58 14
<b>运动员 合计</b>		8/14	7/16	2/9	4/7	3/4	1/3	2/3	27/56	48.2	6	16	3	2		1 郭世伟	22 10:29 15 20 黄培杰
1	王泽润	2/11	2/6	1/5	1/10	0/5		1/1	7/38	18.4						8 董智景	22 11:55 16 10 周仲坤
<b>守门员 合计</b>		2/11	2/6	1/5	1/10	0/5		1/1	7/38	18.4						24 黎涛	24 13:48 17 18 高玉杰

场上队员：得分 / 射门

守门员：救球 / 射门

快攻	Fast Break	突破	Breakthrough	任意球	Free Throw	7M球	7M Throw	助攻	Assist
警告	Warning	失误	Error	2'	Suspension	D	取消资格	DR	取消资格+报告





# “绿叶集团”杯2016年全国男子手球超级杯赛 图式比赛技术统计表

轮次 4

场次 12

201608012-21-1/1

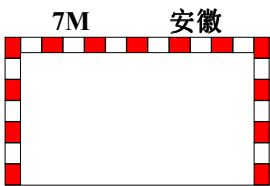
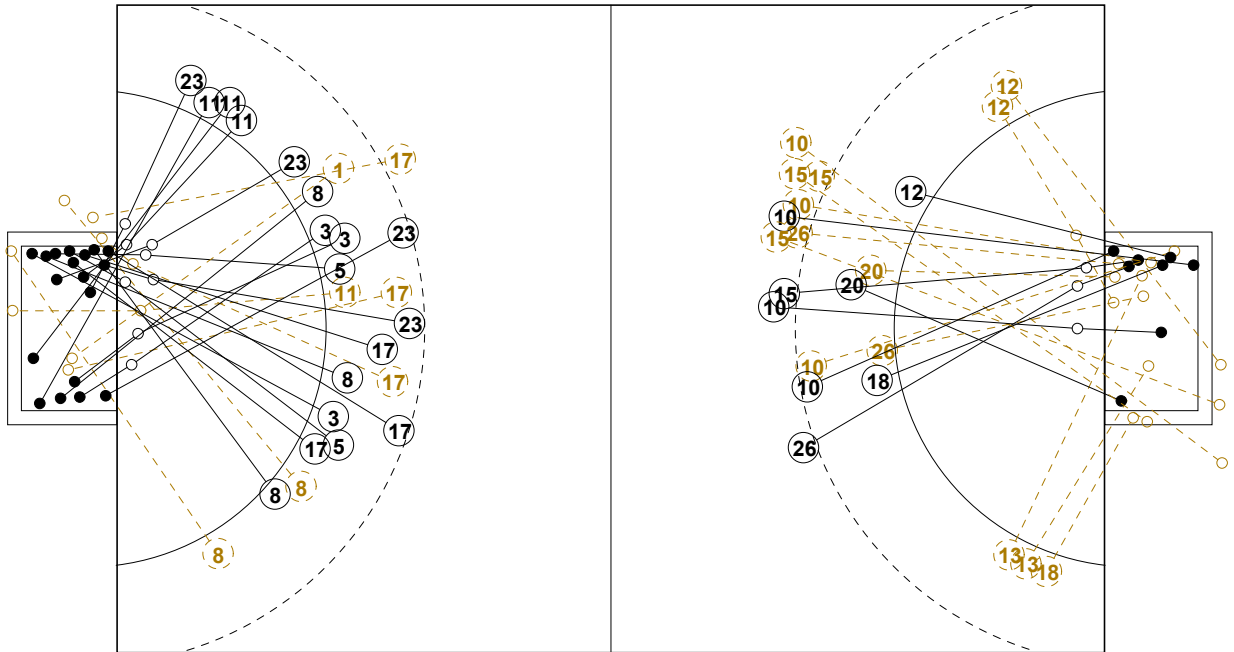

1st Half  
18 : 9

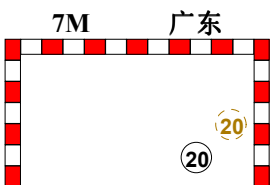
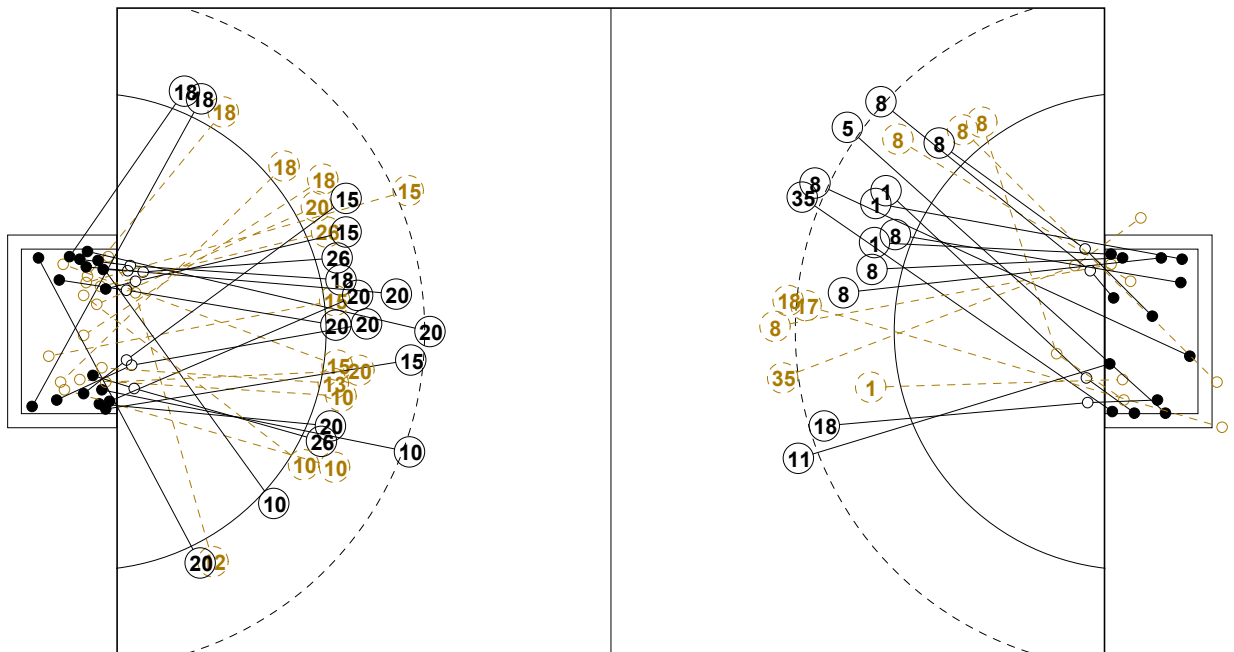
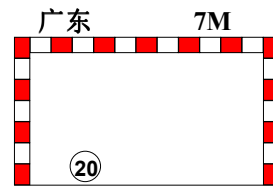

2nd Half  
27 : 31

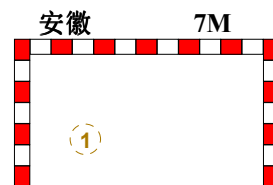



## “绿叶集团”杯2016年全国男子手球超级杯赛

## 个人/全队技术统计表

正式表  
手球  
男子预赛  
轮次 4组别 X  
场次 12201608012-14-1/2  
苏州市体育中心  
24/11/2016 16:00

号码	姓名	远射	近射	边射	快攻	突破	任意	7M	合计	%	助攻	失误	警告	2'	取消	时间
<b>安徽(安徽)</b>																
<i>(场上队员)</i>																
1	郭世伟		0/1		0/1	3/3		0/1	3/6	50.0%		2				00:39:17
3	陈强龙		1/1		2/2				3/3	100%	2		1			00:39:11
5	史小帆	1/1	1/1		1/1				3/3	100%		2				00:39:11
7	姚雄敏									0.0%						00:00:00
8	董智景	2/3	2/3	0/3	4/4	1/2			9/15	60.0%		3				01:00:00
9	陈开勇									0.0%						00:00:00
10	严龙									0.0%						00:00:00
11	黎涛	1/1		3/3	0/1				4/5	80.0%	1	2	1			01:00:00
12	曾献辰									0.0%						00:00:26
13	何磊									0.0%						00:00:00
17	王巨柱	1/5			1/1	1/1			3/7	42.9%	4					00:16:18
18	李双	1/2							1/2	50.0%	1	1	1	1		00:22:55
21	李明									0.0%	2	1				00:59:34
23	于敏清	2/2		1/1	1/1				4/4	100%	1	3				00:37:14
24	徐安格									0.0%					1	00:20:35
35	金永峰	1/2							1/2	50.0%		2		1		00:26:41
<b>合计</b>		9/16	4/6	4/7	9/11	5/6		0/1	31/47	66.0%	11	16	3	3		
<i>(守门员)</i>																
12	曾献辰							1/3	1/3	33.3%						00:00:26
21	李明	3/11	9/16	5/7	3/7	1/4	1/2		22/47	46.8%	2	1				00:59:34
<b>合计</b>		3/11	9/16	5/7	3/7	1/4	1/2	1/3	23/50	46.0%	2	1				

场上队员：得分/射门

守门员：救球/射门

全队合计	得分	被救	射失	击柱	封球	合计	%
远射	9	2	3	1	1	16	56.3%
近射	4	2				6	66.7%
边射	4	1	1	1		7	57.1%
快攻	9	1		1		11	81.8%
突破	5		1			6	83.3%
任意							0.0%
7M		1				1	0.0%





## “绿叶集团”杯2016年全国男子手球超级杯赛

## 个人/全队技术统计表

正式表  
手球  
男子预赛  
轮次 4组别 X  
场次 12201608012-14-2/2  
苏州市体育中心  
24/11/2016 16:00

号码	姓名	远射	近射	边射	快攻	突破	任意	7M	合计	%	助攻	失误	警告	2'	取消	时间
<b>广东(广东)</b>																
<i>(上场队员)</i>																
1	王泽润									0.0%						01:00:00
10	周仲坤	4/7	1/4						5/11	45.5%		3	1			01:00:00
12	王雨		1/1	0/3					1/4	25.0%	1	1				00:59:59
13	王立隆		0/1	0/2					0/3	0.0%						00:24:27
15	张建杰	1/4	1/2		0/1	1/1	1/2		4/10	40.0%		3	1	2		01:22:49
18	高玉杰		0/1	2/4	2/3				4/8	50.0%						00:35:51
20	黄培杰	2/2	2/3		2/3	2/3		2/3	10/14	71.4%	5	7				01:00:00
26	姚雪岩	1/1	2/4				0/1		3/6	50.0%		2	1			01:00:00
<b>合计</b>																
<i>(守门员)</i>																
1		2/11	2/6	1/5	1/10	0/5		1/1	7/38	18.4%						01:00:00
<b>合计</b>																
2/11 2/6 1/5 1/10 0/5 1/1 7/38 18.4%																

场上队员：得分/射门

守门员：救球/射门

全队合计	得分	被救	射失	击柱	封球	合计	%
远射	8	3	1	1	1	14	57.1%
近射	7	9				16	43.8%
边射	2	5	1	1		9	22.2%
快攻	4	3				7	57.1%
突破	3	1				4	75.0%
任意	1	1	1			3	33.3%
7M	2	1				3	66.7%







“绿叶集团”杯2016年全国男子手球超级杯赛

图式射门区域统计

轮次 4 场次 12

201608012-41-1/1

安徽

1 郭世伟	3 陈强龙	5 史小帆	7 姚雄敏	8 董智景	9 陈开勇	10 严龙	11 黎涛
1	2			1 1 1			2
				2 1			
1				2			1
1							1
Post - 0 Miss - 0 Block - 0	Post - 0 Miss - 0 Block - 0	Post - 0 Miss - 0 Block - 0	Post - 0 Miss - 0 Block - 0	Post - 1 Miss - 2 Block - 0	Post - 0 Miss - 0 Block - 0	Post - 0 Miss - 0 Block - 0	Post - 1 Miss - 0 Block - 0
12 曾献辰	13 何磊	17 王巨柱	18 李双	21 李明	23 于敏清	24 徐安格	35 金永峰
		2	1				
		1			1		1
					1	2	
Post - 0 Miss - 0 Block - 0	Post - 0 Miss - 0 Block - 0	Post - 1 Miss - 2 Block - 0	Post - 0 Miss - 0 Block - 1	Post - 0 Miss - 0 Block - 0	Post - 0 Miss - 0 Block - 0	Post - 0 Miss - 0 Block - 0	Post - 0 Miss - 1 Block - 0

12 曾献辰			
		1/1	
0/1		0/1	

21 李明	1/4	1/1	0/1
	6/10	1/2	3/6
	4/11	2/2	4/10

1 王泽润	0/4	0/1	0/2
	3/7	0/1	0/8
	2/6		2/9

广东

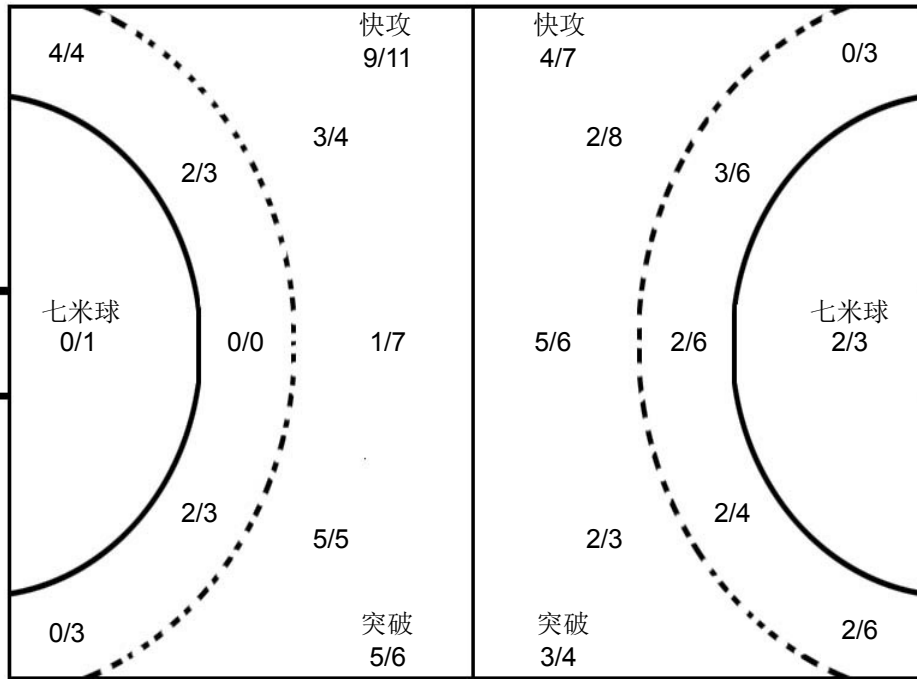
1 王泽润	10 周仲坤	12 王雨	13 王立隆	15 张建杰	18 高玉杰	20 黄培杰	26 姚雪岩
	1	1		2	1	1	
					1	2	
	2			1			2
						3	4
Post - 0 Miss - 0 Block - 0	Post - 0 Miss - 1 Block - 0	Post - 0 Miss - 1 Block - 0	Post - 0 Miss - 0 Block - 0	Post - 1 Miss - 1 Block - 1	Post - 1 Miss - 0 Block - 0	Post - 0 Miss - 0 Block - 0	Post - 0 Miss - 0 Block - 0

注释: Post=击柱 Miss=射失 Block=被封





预赛 Group X

男子 全国杯赛

“绿叶集团”杯2016年全国男子手球超级杯赛

Team A <b>A 上海</b>		Team B <b>B 安徽</b>		Match Number <b>13</b>										
played in China		in the hall 苏州市体育中心		on 25/11/2016										
				at 13:00 hours										
Spectators														
Half-time (30')	<b>A</b> 15	<b>B</b> 16	End of playing time	<b>A</b> 28	<b>B</b> 30									
1st extra time				2nd extra time										
				After penalty throws										
Number of 7 m	<b>A</b> 2 / 3	Team time-out		Team time-out										
		1 20:18 2 53:47 3		1 2 3 51:14										
Full name of players and officials														
No.	Team <b>A</b>				Team <b>B</b>				G	W	2'	D	DR	
1	张峥				1 郭世伟				2					
2	张文斌				3 陈强龙				1	1				
4	徐俊吉				5 史小帆				3					
7	吴双				7 姚雄敏									
8	钱为玮				8 董智景				7					
10	董凯				9 陈开勇				1					
11	蒋承骅				10 严龙									
12	周哲韬				11 黎涛				5					
14	沈吉磊				12 曾献辰									
15	蒋嘉敏				13 何磊									
16	朱春雷				17 王巨柱				3					
17	高天伦				18 李双				5	1				
18	马麟晓				21 李明									
19	蒋慧捷				23 于敏清				3					
22	张润明				24 徐安格									
					35 金永峰									
A	吴璟 (主教练)				A 韦中平									
B	张勇军				B 沈强 (主教练)									
C	金迪琦				C 吴翔									
D	杨时				D 陈玉翔									
Signature of Responsible Official of the Teams (Off. A)													B	
TP	Remarks of Referee / CHA Official												TP	

Signatures

Referees	张耿 (CHN)	张栋 (CHN)		
Techn. Delegates	李长海 (CHN)	李之文 (CHN)		
CHA Official				

Note: Number of 7m Throws Awarded to Team A and B, Goals (G), Warnings (W), Suspensions (2'), Direct Disqualification (D), Disqualification with Report (DR) and Team Penalty (TP).

Table Officials: 黄岩

石震坤

Statisticians: 王玮

王聆





## “绿叶集团”杯2016年全国男子手球超级杯赛 竞赛技术统计(媒体表)

<b>预赛</b>	组别	<b>X</b>	轮次	<b>5</b>	场次	<b>13</b>
苏州市体育中心			25/11/2016		201608013-51-1/1	
上海	上海	<b>28</b>	vs	<b>30</b>	安徽	安徽
<b>15 : 16</b>						

裁判员		张耿 (CHN)											/	张栋 (CHN)																	
<b>上海</b>		远射	近射	边射	快攻	突破	任意球	7m球	合计	%	助攻	失误	警告	2'	D & DR	<b>上海</b>		比赛进程											<b>安徽</b>		
主教练： 吴璟															1st Half																
1	张崢										1	1				0	02:44	1	18	李双											
2	张文斌			0/1				0/1	0.0							0	05:14	2	5	史小帆											
4	徐俊吉		2/2					2/2	100		2	1				1	06:42	2													
7	吴双										1	1				2	07:27	2													
8	钱为玮	3/7	1/2		5/5	0/2	0/2	1/1	10/19	52.6	1	4	1			3	07:52	3	8	董智景											
10	董凯	1/2						1/2	2/4	50.0		1				4	08:24	4													
11	蒋承骅	1/1	1/1		1/1	1/1	0/1	4/5	80.0			2				5	09:34	5	3	陈强龙											
12	周哲韬															6	09:42	6	18	李双											
14	沈吉磊															7	11:25	6													
15	蒋嘉敏															8	12:52	6													
16	朱春雷															9	13:56	7	8	董智景											
17	高天伦	0/1	0/1	1/4												10	14:33	8	18	李双											
18	马麟晓	3/10	1/1		2/2	2/2		8/15	53.3	2	1	1				11	15:37	8													
19	蒋慧捷			1/1				1/1	100			1				12	17:27	8													
22	张润明															13	18:27	9	18	李双											
<b>运动员 合计</b>		8/21	5/7	2/6	8/8	3/5	0/3	2/3	28/53	52.8	4	18	3			14	19:10	10	23	于敏清											
1	张崢	6/16	0/6	1/3	5/13	1/4		0/1	13/43	30.2	1	1				15	20:07	11	5	史小帆											
<b>守门员 合计</b>		6/16	0/6	1/3	5/13	1/4		0/1	13/43	30.2	1	1				16	22:14	12	11	黎涛											
<b>安徽</b>		远射	近射	边射	快攻	突破	任意球	7m球	合计	%	助攻	失误	警告	2'	D & DR	2nd Half															
教练： 沈强															16																
1	郭世伟	2/2						2/2	100	1	1					16	01:22	16													
3	陈强龙		1/1		0/1			1/2	50.0		1	1	1			17	01:41	16													
5	史小帆	2/4	1/2					3/6	50.0			3				18	06:02	17	11	黎涛											
7	姚雄敏															19	06:30	17													
8	董智景	2/5	1/1	1/1	2/4	1/1		7/12	58.3		2					18	07:06	18	23	于敏清											
9	陈开勇		1/1		0/1			1/2	50.0	1						19	07:58	19	23	于敏清											
10	严龙															20	08:47	19													
11	黎涛	0/3	1/1		1/1	2/3		1/1	5/9	55.6	2	6				20	09:13	20	8	董智景											
12	曾献辰															21	09:26	20													
13	何磊															22	10:36	21	11	黎涛											
17	王巨柱	2/8			1/1			3/9	33.3	2	2					23	11:10	21													
18	李双	2/3			3/3			5/6	83.3	1	3	1				24	11:36	21													
21	李明															25	14:12	22	17	王巨柱											
23	于敏清		1/1	1/2	1/2			3/5	60.0							26	15:00	22													
24	徐安格															27	16:24	22													
35	金永峰				0/1			0/1	0.0							28	20:29	23	17	王巨柱											
<b>运动员 合计</b>		10/25	6/7	2/3	8/14	3/4		1/1	30/54	55.6	11	20	2			29	21:12	23	8	董智景											
12	曾献辰						1/1	1/2	2/3	66.7						30	21:28	24	8	董智景											
21	李明	4/12	1/6	2/4	0/8	0/3	2/2	0/1	9/36	25.0	4	2				25	23:06	25	1	郭世伟											
<b>守门员 合计</b>		4/12	1/6	2/4	0/8	0/3	3/3	1/3	11/39	28.2	4	2				26	24:49	26	8	董智景											

场上队员： 得分 / 射门

守门员： 救球 / 射门

快攻	Fast Break	突破	Breakthrough	任意球	Free Throw	7M球	7M Throw	助攻	Assist
警告	Warning	失误	Error	2'	Suspension	D	取消资格	DR	取消资格+报告





# “绿叶集团”杯2016年全国男子手球超级杯赛 图式比赛技术统计表

轮次 5

场次 13

201608013-21-1/1

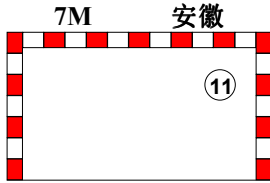
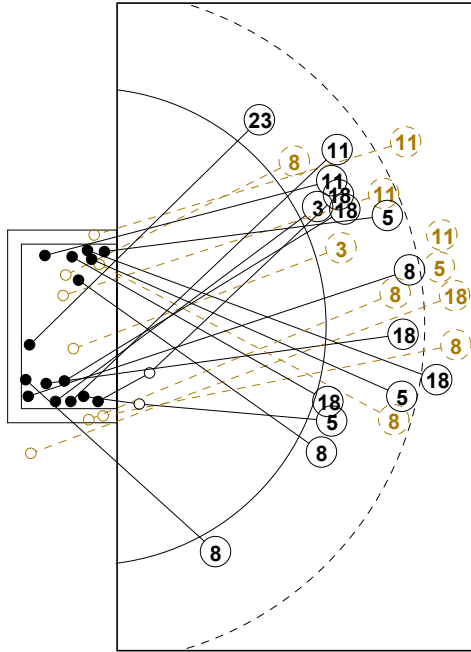

1st Half  
16 : 15

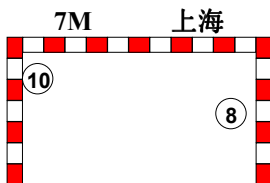
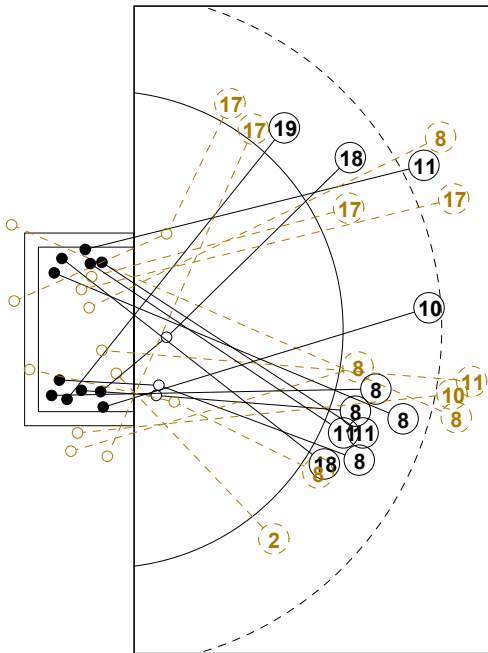
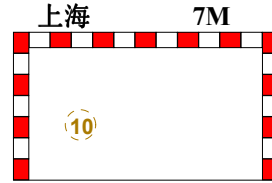
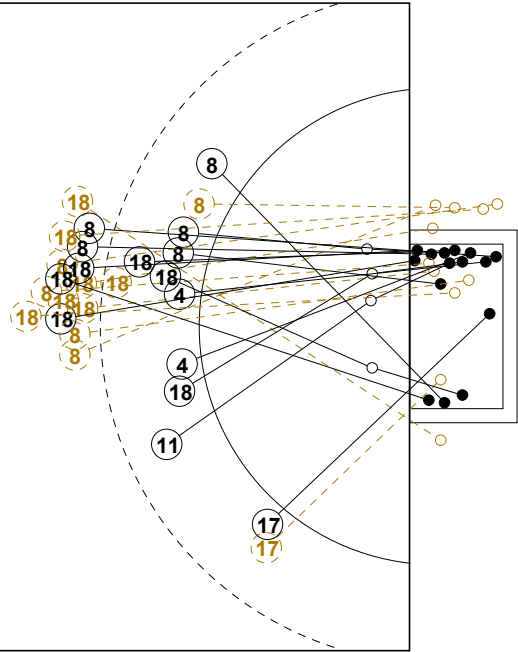

2nd Half  
28 : 30

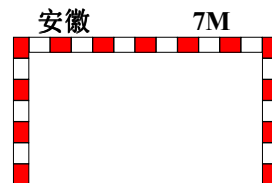
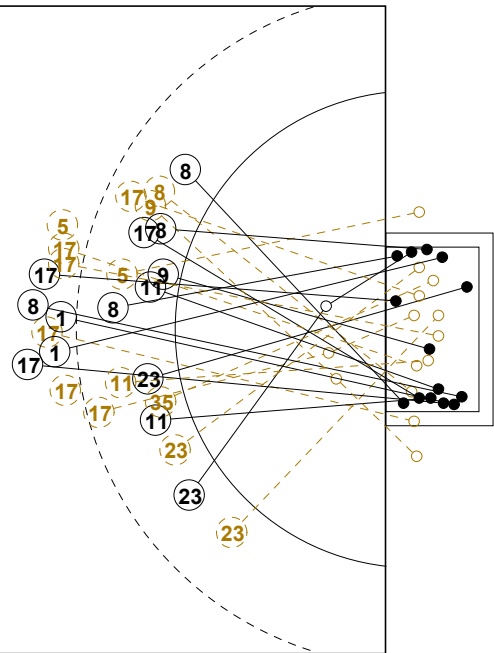



## “绿叶集团”杯2016年全国男子手球超级杯赛

## 个人/全队技术统计表

正式表  
手球  
男子预赛  
轮次 5组别 X  
场次 13201608013-14-1/2  
苏州市体育中心  
25/11/2016 13:00

号码	姓名	远射	近射	边射	快攻	突破	任意	7M	合计	%	助攻	失误	警告	2'	取消	时间
<b>上海(上海)</b>																
<i>(场上队员)</i>																
1	张崢									0.0%	1	1				01:00:00
2	张文斌			0/1					0/1	0.0%						00:28:27
4	徐俊吉		2/2						2/2	100%		2	1			00:40:42
7	吴双									0.0%		1				00:15:37
8	钱为玮	3/7	1/2		5/5	0/2	0/2	1/1	10/19	52.6%	1	4	1			00:44:48
10	董凯	1/2						1/2	2/4	50.0%		1				00:19:52
11	蒋承骅	1/1	1/1		1/1	1/1	0/1		4/5	80.0%		2				01:06:40
12	周哲韬									0.0%						00:00:00
14	沈吉磊									0.0%						00:00:00
15	蒋嘉敏									0.0%						00:00:00
16	朱春雷									0.0%						00:00:00
17	高天伦	0/1	0/1	1/4					1/6	16.7%		5				00:48:56
18	马麟晓	3/10	1/1		2/2	2/2			8/15	53.3%	2	1	1			00:41:38
19	蒋慧捷			1/1					1/1	100%		1				01:00:00
22	张润明									0.0%						00:00:00
<b>合计</b>		8/21	5/7	2/6	8/8	3/5	0/3	2/3	28/53	52.8%	4	18	3			
<i>(守门员)</i>																
1	张崢	6/16	0/6	1/3	5/13	1/4		0/1	13/43	30.2%	1	1				01:00:00
<b>合计</b>		6/16	0/6	1/3	5/13	1/4		0/1	13/43	30.2%	1	1				

场上队员：得分/射门

守门员：救球/射门

全队合计	得分	被救	射失	击柱	封球	合计	%
远射	8	4	6	1	2	21	38.1%
近射	5	1	1			7	71.4%
边射	2	2	2			6	33.3%
快攻	8					8	100.0%
突破	3		1	1		5	60.0%
任意		3				3	0.0%
7M	2	1				3	66.7%





## “绿叶集团”杯2016年全国男子手球超级杯赛

## 个人/全队技术统计表

正式表  
手球  
男子预赛  
轮次 5组别 X  
场次 13201608013-14-2/2  
苏州市体育中心  
25/11/2016 13:00

号码	姓名	远射	近射	边射	快攻	突破	任意	7M	合计	%	助攻	失误	警告	2'	取消	时间
<b>安徽(安徽)</b>																
<i>(上场队员)</i>																
1	郭世伟	2/2							2/2	100%	1	1				00:16:23
3	陈强龙		1/1		0/1				1/2	50.0%		1	1			00:46:46
5	史小帆	2/4	1/2						3/6	50.0%		3				00:48:21
7	姚雄敏									0.0%						00:00:00
8	董智景	2/5	1/1	1/1	2/4	1/1			7/12	58.3%		2				01:00:00
9	陈开勇		1/1		0/1				1/2	50.0%	1					00:13:13
10	严龙									0.0%						00:00:00
11	黎涛	0/3	1/1		1/1	2/3		1/1	5/9	55.6%	2	6				00:56:48
12	曾献辰									0.0%						00:01:30
13	何磊									0.0%						00:00:00
17	王巨柱	2/8			1/1				3/9	33.3%	2	2				00:27:52
18	李双	2/3			3/3				5/6	83.3%	1	3	1			00:32:08
21	李明									0.0%	4	2				01:20:49
23	于敏清		1/1	1/2	1/2				3/5	60.0%						00:45:06
24	徐安格									0.0%						00:00:00
35	金永峰				0/1				0/1	0.0%						00:11:38
<b>合计</b>		10/25	6/7	2/3	8/14	3/4		1/1	30/54	55.6%	11	20	2			
<i>(守门员)</i>																
12	曾献辰						1/1	1/2	2/3	66.7%						00:01:30
21	李明	4/12	1/6	2/4	0/8	0/3	2/2	0/1	9/36	25.0%	4	2				01:20:49
<b>合计</b>		4/12	1/6	2/4	0/8	0/3	3/3	1/3	11/39	28.2%	4	2				

场上队员：得分/射门

守门员：救球/射门

全队合计	得分	被救	射失	击柱	封球	合计	%
远射	10	6	1	4	4	25	40.0%
近射	6		1			7	85.7%
边射	2	1				3	66.7%
快攻	8	5	1			14	57.1%
突破	3	1				4	75.0%
任意							0.0%
7M	1					1	100.0%





“绿叶集团”杯2016年全国男子手球超级杯赛

图式射门区域统计

轮次 5 场次 13

201608013-41-1/1

上海

1 张峥	2 张文斌	4 徐俊吉	7 吴双	8 钱为玮	10 董凯	11 蒋承骅	12 周哲韬																																																																								
<table border="1"><tr><td></td><td></td><td></td></tr><tr><td></td><td></td><td></td></tr><tr><td></td><td></td><td></td></tr></table>										<table border="1"><tr><td></td><td></td><td></td></tr><tr><td></td><td></td><td></td></tr><tr><td></td><td></td><td></td></tr></table>										<table border="1"><tr><td>1</td><td></td><td></td></tr><tr><td>1</td><td></td><td></td></tr><tr><td></td><td></td><td></td></tr></table>	1			1						<table border="1"><tr><td></td><td></td><td></td></tr><tr><td></td><td></td><td></td></tr><tr><td></td><td></td><td></td></tr></table>										<table border="1"><tr><td>3</td><td></td><td>1</td></tr><tr><td>3</td><td></td><td>2</td></tr><tr><td>1</td><td></td><td></td></tr></table>	3		1	3		2	1			<table border="1"><tr><td>1</td><td></td><td></td></tr><tr><td></td><td></td><td></td></tr><tr><td></td><td></td><td></td></tr></table>	1									<table border="1"><tr><td></td><td></td><td></td></tr><tr><td>1</td><td></td><td>3</td></tr><tr><td></td><td></td><td></td></tr></table>				1		3				<table border="1"><tr><td></td><td></td><td></td></tr><tr><td></td><td></td><td></td></tr><tr><td></td><td></td><td></td></tr></table>									
1																																																																															
1																																																																															
3		1																																																																													
3		2																																																																													
1																																																																															
1																																																																															
1		3																																																																													
Post - 0 Miss - 0 Block - 0	Post - 0 Miss - 0 Block - 0	Post - 0 Miss - 0 Block - 0	Post - 0 Miss - 0 Block - 0	Post - 1 Miss - 5 Block - 0	Post - 0 Miss - 1 Block - 0	Post - 0 Miss - 0 Block - 0	Post - 0 Miss - 0 Block - 0																																																																								
14 沈吉磊	15 蒋嘉敏	16 朱春雷	17 高天伦	18 马麟晓	19 蒋慧捷	22 张润明																																																																									
<table border="1"><tr><td></td><td></td><td></td></tr><tr><td></td><td></td><td></td></tr><tr><td></td><td></td><td></td></tr></table>										<table border="1"><tr><td></td><td></td><td></td></tr><tr><td></td><td></td><td></td></tr><tr><td></td><td></td><td></td></tr></table>										<table border="1"><tr><td></td><td></td><td></td></tr><tr><td></td><td></td><td></td></tr><tr><td></td><td></td><td></td></tr></table>										<table border="1"><tr><td></td><td>1</td><td></td></tr><tr><td></td><td></td><td></td></tr><tr><td></td><td></td><td></td></tr></table>		1								<table border="1"><tr><td></td><td></td><td>1</td></tr><tr><td>3</td><td></td><td>1</td></tr><tr><td>2</td><td></td><td>1</td></tr></table>			1	3		1	2		1	<table border="1"><tr><td>1</td><td></td><td></td></tr><tr><td></td><td></td><td></td></tr><tr><td></td><td></td><td></td></tr></table>	1									<table border="1"><tr><td></td><td></td><td></td></tr><tr><td></td><td></td><td></td></tr><tr><td></td><td></td><td></td></tr></table>										<table border="1"><tr><td></td><td></td><td></td></tr><tr><td></td><td></td><td></td></tr><tr><td></td><td></td><td></td></tr></table>									
	1																																																																														
		1																																																																													
3		1																																																																													
2		1																																																																													
1																																																																															
Post - 0 Miss - 0 Block - 0	Post - 0 Miss - 0 Block - 0	Post - 0 Miss - 0 Block - 0	Post - 0 Miss - 2 Block - 0	Post - 1 Miss - 2 Block - 2	Post - 0 Miss - 0 Block - 0	Post - 0 Miss - 0 Block - 0																																																																									

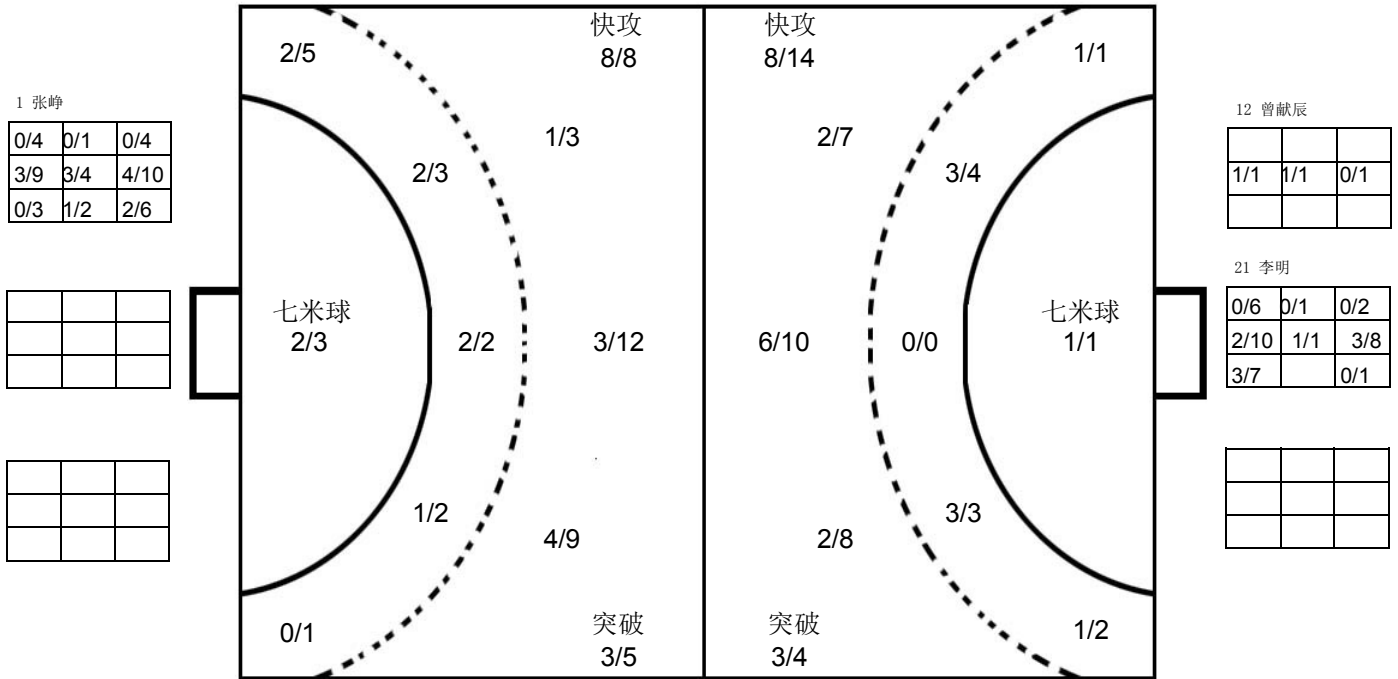

安徽

1 郭世伟	3 陈强龙	5 史小帆	7 姚雄敏	8 董智景	9 陈开勇	10 严龙	11 黎涛																																																																								
<table border="1"><tr><td></td><td></td><td>1</td></tr><tr><td>1</td><td></td><td></td></tr><tr><td></td><td></td><td></td></tr></table>			1	1						<table border="1"><tr><td></td><td></td><td></td></tr><tr><td>1</td><td></td><td></td></tr><tr><td></td><td></td><td></td></tr></table>				1						<table border="1"><tr><td></td><td></td><td></td></tr><tr><td>1</td><td></td><td></td></tr><tr><td></td><td></td><td>2</td></tr></table>				1					2	<table border="1"><tr><td></td><td></td><td></td></tr><tr><td></td><td></td><td></td></tr><tr><td></td><td></td><td></td></tr></table>										<table border="1"><tr><td>2</td><td></td><td>1</td></tr><tr><td>1</td><td></td><td>1</td></tr><tr><td>1</td><td></td><td>1</td></tr></table>	2		1	1		1	1		1	<table border="1"><tr><td></td><td></td><td></td></tr><tr><td></td><td>1</td><td></td></tr><tr><td></td><td></td><td></td></tr></table>					1					<table border="1"><tr><td></td><td></td><td></td></tr><tr><td></td><td></td><td></td></tr><tr><td></td><td></td><td></td></tr></table>										<table border="1"><tr><td></td><td></td><td>2</td></tr><tr><td>1</td><td></td><td>2</td></tr><tr><td></td><td></td><td></td></tr></table>			2	1		2			
		1																																																																													
1																																																																															
1																																																																															
1																																																																															
		2																																																																													
2		1																																																																													
1		1																																																																													
1		1																																																																													
	1																																																																														
		2																																																																													
1		2																																																																													
Post - 0 Miss - 0 Block - 0	Post - 0 Miss - 0 Block - 0	Post - 0 Miss - 1 Block - 2	Post - 0 Miss - 0 Block - 0	Post - 2 Miss - 0 Block - 0	Post - 0 Miss - 1 Block - 0	Post - 0 Miss - 0 Block - 0	Post - 1 Miss - 0 Block - 1																																																																								
12 曾献辰	13 何磊	17 王巨柱	18 李双	21 李明	23 于敏清	24 徐安格	35 金永峰																																																																								
<table border="1"><tr><td></td><td></td><td></td></tr><tr><td></td><td></td><td></td></tr><tr><td></td><td></td><td></td></tr></table>										<table border="1"><tr><td></td><td></td><td></td></tr><tr><td></td><td></td><td></td></tr><tr><td></td><td></td><td></td></tr></table>										<table border="1"><tr><td></td><td></td><td></td></tr><tr><td></td><td></td><td>2</td></tr><tr><td></td><td>1</td><td></td></tr></table>						2		1		<table border="1"><tr><td>1</td><td></td><td></td></tr><tr><td>1</td><td></td><td>1</td></tr><tr><td>1</td><td></td><td>1</td></tr></table>	1			1		1	1		1	<table border="1"><tr><td></td><td></td><td></td></tr><tr><td></td><td></td><td></td></tr><tr><td></td><td></td><td></td></tr></table>										<table border="1"><tr><td>1</td><td>1</td><td></td></tr><tr><td></td><td></td><td></td></tr><tr><td>1</td><td></td><td></td></tr></table>	1	1					1			<table border="1"><tr><td></td><td></td><td></td></tr><tr><td></td><td></td><td></td></tr><tr><td></td><td></td><td></td></tr></table>										<table border="1"><tr><td></td><td></td><td></td></tr><tr><td></td><td></td><td></td></tr><tr><td></td><td></td><td></td></tr></table>									
		2																																																																													
	1																																																																														
1																																																																															
1		1																																																																													
1		1																																																																													
1	1																																																																														
1																																																																															
Post - 0 Miss - 0 Block - 0	Post - 0 Miss - 0 Block - 0	Post - 1 Miss - 0 Block - 1	Post - 0 Miss - 1 Block - 0	Post - 0 Miss - 0 Block - 0	Post - 0 Miss - 0 Block - 0	Post - 0 Miss - 0 Block - 0	Post - 0 Miss - 0 Block - 0																																																																								

注释: Post=击柱 Miss=射失 Block=被封





预赛 Group X

男子 全国杯赛

“绿叶集团”杯2016年全国男子手球超级杯赛

Team A <b>A 北京</b>				Team B <b>B 广东</b>				Match Number <b>14</b>													
played in China		in the hall 苏州市体育中心		on 25/11/2016		at 14:30 hours		Spectators													
Half-time (30')	<b>A</b> 10	<b>B</b> 15	End of playing time	<b>A</b> 23	<b>B</b> 30	1st extra time	<b>A</b>	<b>B</b>	2nd extra time	<b>A</b>	<b>B</b>	After penalty throws	<b>A</b>	<b>B</b>							
Number of 7 m	<b>A</b> 4 / 4	Team time-out			Full name of players and officials				Team time-out			<b>B</b> 3 / 3	Number of 7 m								
	1 12:58	2 36:08	3 55:37					1	2 42:40	3											
No.	Team <b>A</b>					G	W	2'	D	DR	No.	Team <b>B</b>					G	W	2'	D	DR
3	吴锐樊										1	王泽润									
6	赵一涵					4					10	周仲坤					4		1		
7	卞友山										12	王雨					2	1	2		
8	赵文宣					2					13	王立隆					2				
9	李旭					2	1		1		15	张建杰					5				
10	李明远										18	高玉杰					3				
12	孔祥杰										20	黄培杰					11				
17	袁振典										26	姚雪岩					3	1	2		
18	温新宇																				
20	王鹏皓					7															
23	陈旭					5	1														
25	程海津																				
26	杨政																				
29	逯明松					2	1														
35	高云健																				
78	王哲一					1															
B	吴健 (主教练)										B	刘康伶 (主教练)									
C	刘彦坤										C	刘文宁									
D	陈璇																				
<b>A</b>	Signature of Responsible Official of the Teams (Off. A)																		<b>B</b>		
TP	Remarks of Referee / CHA Official																		TP		

Signatures

Referees	李典 (CHN)	倪震 (CHN)		
Techn. Delegates	于中迅 (CHN)	柴业宏 (CHN)		
CHA Official				

Note: Number of 7m Throws Awarded to Team A and B, Goals (G), Warnings (W), Suspensions (2'), Direct Disqualification (D), Disqualification with Report (DR) and Team Penalty (TP).

Table Officials: 黄岩 石震坤 Statisticians: 王玲 王玮

Printed by PHMS Copyright: IHF / CHA 25/11/2016 15:49:36

Longman Sportsoft handball@126.com





“绿叶集团”杯2016年全国男子手球超级杯赛 竞赛技术统计(媒体表)

预赛 组别 X 轮次 5 场次 14

苏州市体育中心

25/11/2016

201608014-51-1/1

北京 北京 23 vs 30 广东 广东 10:15

裁判员 李典 (CHN) / 倪震 (CHN)

Main statistics table with columns for players, shots, goals, assists, and game progress for Beijing and Guangdong teams.

场上队员: 得分 / 射门

守门员: 救球 / 射门

Legend table for abbreviations: 快攻 (Fast Break), 突破 (Breakthrough), 任意球 (Free Throw), 7M球 (7M Throw), 助攻 (Assist), 警告 (Warning), 失误 (Error), 2' (Suspension), D (取消资格), DR (取消资格+报告)





# "绿叶集团"杯2016年全国男子手球超级杯赛

## 图式比赛技术统计表

轮次 5

场次 14

201608014-21-1/1

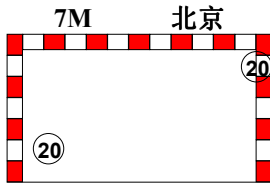
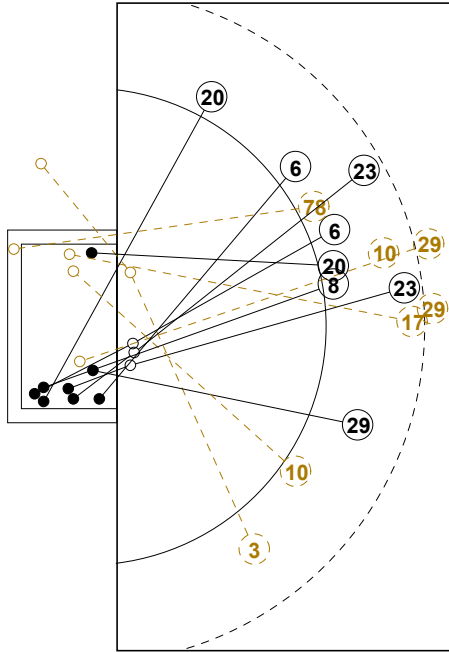

1st Half  
10 : 15

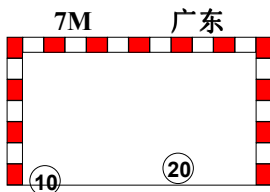
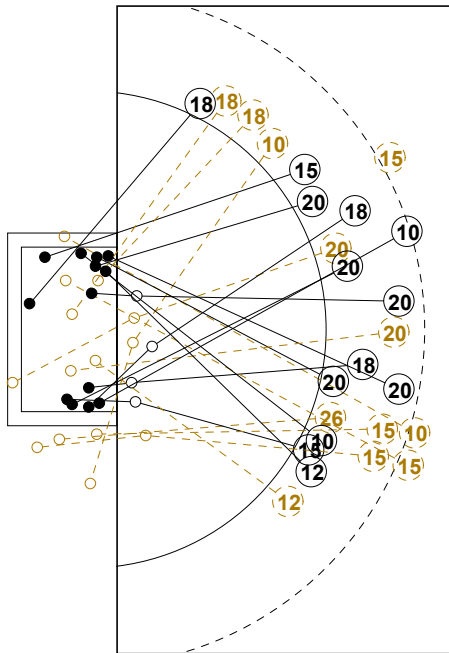
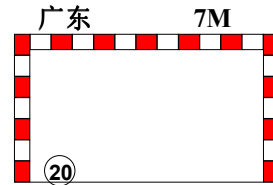
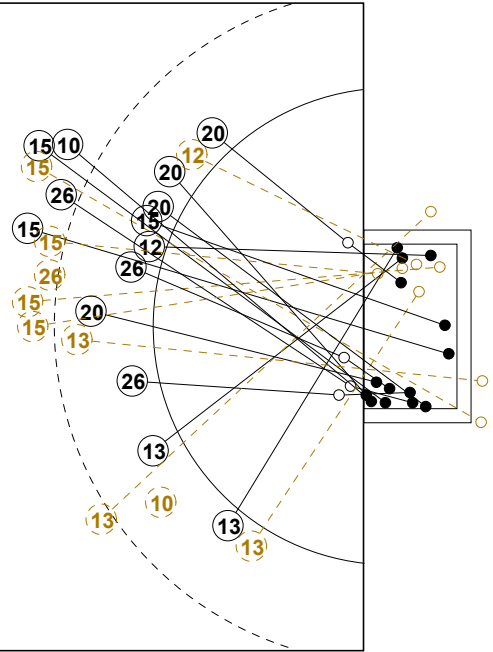

2nd Half  
30 : 23

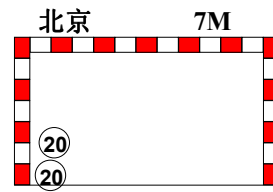
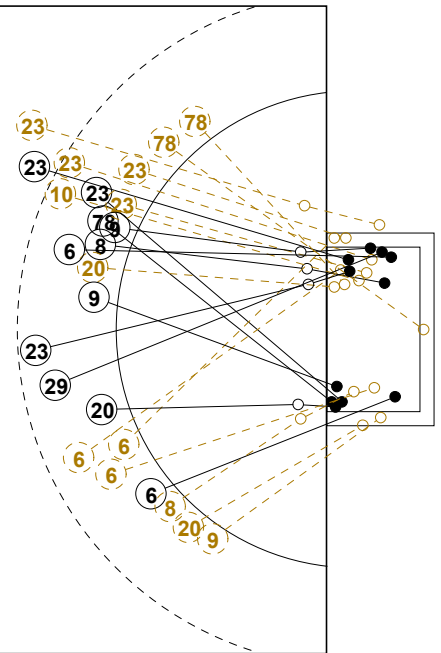



## “绿叶集团”杯2016年全国男子手球超级杯赛

## 个人/全队技术统计表

正式表  
手球  
男子预赛  
轮次 5组别 X  
场次 14201608014-14-1/2  
苏州市体育中心  
25/11/2016 14:30

号码	姓名	远射	近射	边射	快攻	突破	任意	7M	合计	%	助攻	失误	警告	2'	取消	时间
<b>北京(北京)</b>																
<i>(场上队员)</i>																
3	吴锐樊			0/1					0/1	0.0%						00:18:14
6	赵一涵		1/1			3/6			4/7	57.1%		4				00:47:20
7	卞友山									0.0%	1	2				00:22:42
8	赵文宣		2/3						2/3	66.7%		1				00:21:29
9	李旭		1/1	0/1	1/1				2/3	66.7%			1	1		00:28:14
10	李明远	0/1	0/2						0/3	0.0%	1	3				00:22:28
12	孔祥杰									0.0%	2	1				00:49:54
17	袁振典	0/1							0/1	0.0%		2				00:09:33
18	温新宇									0.0%						00:00:00
20	王鹏皓		1/2	1/2	1/1			4/4	7/9	77.8%		1				00:52:21
23	陈旭	3/5	0/1			2/3			5/9	55.6%	2	6	1			00:47:34
25	程海津									0.0%						00:26:21
26	杨政									0.0%						00:00:00
29	逮明松	0/2	1/1			1/1			2/4	50.0%		2	1			00:20:41
35	高云健									0.0%						00:10:06
78	王哲一		0/1	0/1	1/2				1/4	25.0%						00:41:26
<b>合计</b>		3/9	6/12	1/5	3/4	6/10		4/4	23/44	52.3%	6	22	3	1		
<i>(守门员)</i>																
12	孔祥杰	4/9	0/7	3/5	1/7	0/2	1/1	0/1	9/32	28.1%	2	1				00:49:54
35	高云健	0/2	1/3	0/1				0/2	1/8	12.5%						00:10:06
<b>合计</b>		4/11	1/10	3/6	1/7	0/2	1/1	0/3	10/40	25.0%	2	1				

场上队员：得分/射门

守门员：救球/射门

全队合计	得分	被救	射失	击柱	封球	合计	%
远射	3	4	1		1	9	33.3%
近射	6	4		1	1	12	50.0%
边射	1	1	1	2		5	20.0%
快攻	3			1		4	75.0%
突破	6	2		2		10	60.0%
任意							0.0%
7M	4					4	100.0%





## “绿叶集团”杯2016年全国男子手球超级杯赛

## 个人/全队技术统计表

正式表  
手球  
男子预赛  
轮次 5组别 X  
场次 14201608014-14-2/2  
苏州市体育中心  
25/11/2016 14:30

号码	姓名	远射	近射	边射	快攻	突破	任意	7M	合计	%	助攻	失误	警告	2'	取消	时间
<b>广东(广东)</b>																
<i>(上场队员)</i>																
1	王泽润									0.0%		1				01:00:00
10	周仲坤	2/3	1/2		0/1			1/1	4/7	57.1%		3		1		01:00:00
12	王雨		1/2		1/2				2/4	50.0%	1	2	1	2		01:00:00
13	王立隆	0/2	1/1	1/2					2/5	40.0%						00:30:00
15	张建杰	2/9	1/1		1/1	1/1	0/1		5/13	38.5%		5				01:00:00
18	高玉杰			1/3	2/2				3/5	60.0%	1	4				00:30:00
20	黄培杰	2/3	3/3	1/1	2/3	1/1		2/2	11/13	84.6%	7	2				01:00:00
26	姚雪岩	1/2	2/3						3/5	60.0%	1	3	1	2		01:00:00
<b>合计</b>																
<i>(守门员)</i>																
1		4/7	4/10	1/2	0/3	2/8		0/4	11/34	32.4%		1				01:00:00
<b>合计</b>																

场上队员：得分/射门

守门员：救球/射门

全队合计	得分	被救	射失	击柱	封球	合计	%
远射	7	4	5	1	2	19	36.8%
近射	9	1	1		1	12	75.0%
边射	3	3				6	50.0%
快攻	6	1	1	1		9	66.7%
突破	2					2	100.0%
任意		1				1	0.0%
7M	3					3	100.0%





### “绿叶集团”杯2016年全国男子手球超级杯赛

图式射门区域统计

轮次 5 场次 14

201608014-41-1/1

## 北京

3 吴锐樊	6 赵一涵	7 卞友山	8 赵文宣	9 李旭	10 李明远	12 孔祥杰	17 袁振典																																																																								
<table border="1"><tr><td></td><td></td><td></td></tr><tr><td></td><td></td><td></td></tr><tr><td></td><td></td><td></td></tr></table>										<table border="1"><tr><td>2</td><td></td><td>1</td></tr><tr><td></td><td></td><td></td></tr><tr><td>1</td><td></td><td></td></tr></table>	2		1				1			<table border="1"><tr><td></td><td></td><td></td></tr><tr><td></td><td></td><td></td></tr><tr><td></td><td></td><td></td></tr></table>										<table border="1"><tr><td>1</td><td></td><td></td></tr><tr><td>1</td><td></td><td></td></tr><tr><td></td><td></td><td></td></tr></table>	1			1						<table border="1"><tr><td>1</td><td></td><td></td></tr><tr><td></td><td></td><td></td></tr><tr><td></td><td></td><td>1</td></tr></table>	1								1	<table border="1"><tr><td></td><td></td><td></td></tr><tr><td></td><td></td><td></td></tr><tr><td></td><td></td><td></td></tr></table>										<table border="1"><tr><td></td><td></td><td></td></tr><tr><td></td><td></td><td></td></tr><tr><td></td><td></td><td></td></tr></table>										<table border="1"><tr><td></td><td></td><td></td></tr><tr><td></td><td></td><td></td></tr><tr><td></td><td></td><td></td></tr></table>									
2		1																																																																													
1																																																																															
1																																																																															
1																																																																															
1																																																																															
		1																																																																													
Post - 0 Miss - 1 Block - 0	Post - 1 Miss - 0 Block - 0	Post - 0 Miss - 0 Block - 0	Post - 0 Miss - 0 Block - 0	Post - 1 Miss - 0 Block - 0	Post - 0 Miss - 0 Block - 1	Post - 0 Miss - 0 Block - 0	Post - 0 Miss - 0 Block - 0																																																																								
18 温新宇	20 王鹏皓	23 陈旭	25 程海津	26 杨政	29 逯明松	35 高云健	78 王哲一																																																																								
<table border="1"><tr><td></td><td></td><td></td></tr><tr><td></td><td></td><td></td></tr><tr><td></td><td></td><td></td></tr></table>										<table border="1"><tr><td>1</td><td></td><td>1</td></tr><tr><td>1</td><td></td><td></td></tr><tr><td>2</td><td></td><td>2</td></tr></table>	1		1	1			2		2	<table border="1"><tr><td></td><td></td><td></td></tr><tr><td>2</td><td></td><td></td></tr><tr><td>2</td><td></td><td>1</td></tr></table>				2			2		1	<table border="1"><tr><td></td><td></td><td></td></tr><tr><td></td><td></td><td></td></tr><tr><td></td><td></td><td></td></tr></table>										<table border="1"><tr><td></td><td></td><td></td></tr><tr><td></td><td></td><td></td></tr><tr><td></td><td></td><td></td></tr></table>										<table border="1"><tr><td></td><td></td><td></td></tr><tr><td>1</td><td></td><td></td></tr><tr><td>1</td><td></td><td></td></tr></table>				1			1			<table border="1"><tr><td></td><td></td><td></td></tr><tr><td></td><td></td><td></td></tr><tr><td></td><td></td><td></td></tr></table>										<table border="1"><tr><td></td><td></td><td></td></tr><tr><td></td><td></td><td></td></tr><tr><td></td><td></td><td>1</td></tr></table>									1
1		1																																																																													
1																																																																															
2		2																																																																													
2																																																																															
2		1																																																																													
1																																																																															
1																																																																															
		1																																																																													
Post - 0 Miss - 0 Block - 0	Post - 1 Miss - 0 Block - 0	Post - 1 Miss - 1 Block - 0	Post - 0 Miss - 0 Block - 0	Post - 0 Miss - 0 Block - 0	Post - 0 Miss - 0 Block - 1	Post - 0 Miss - 0 Block - 0	Post - 2 Miss - 0 Block - 0																																																																								

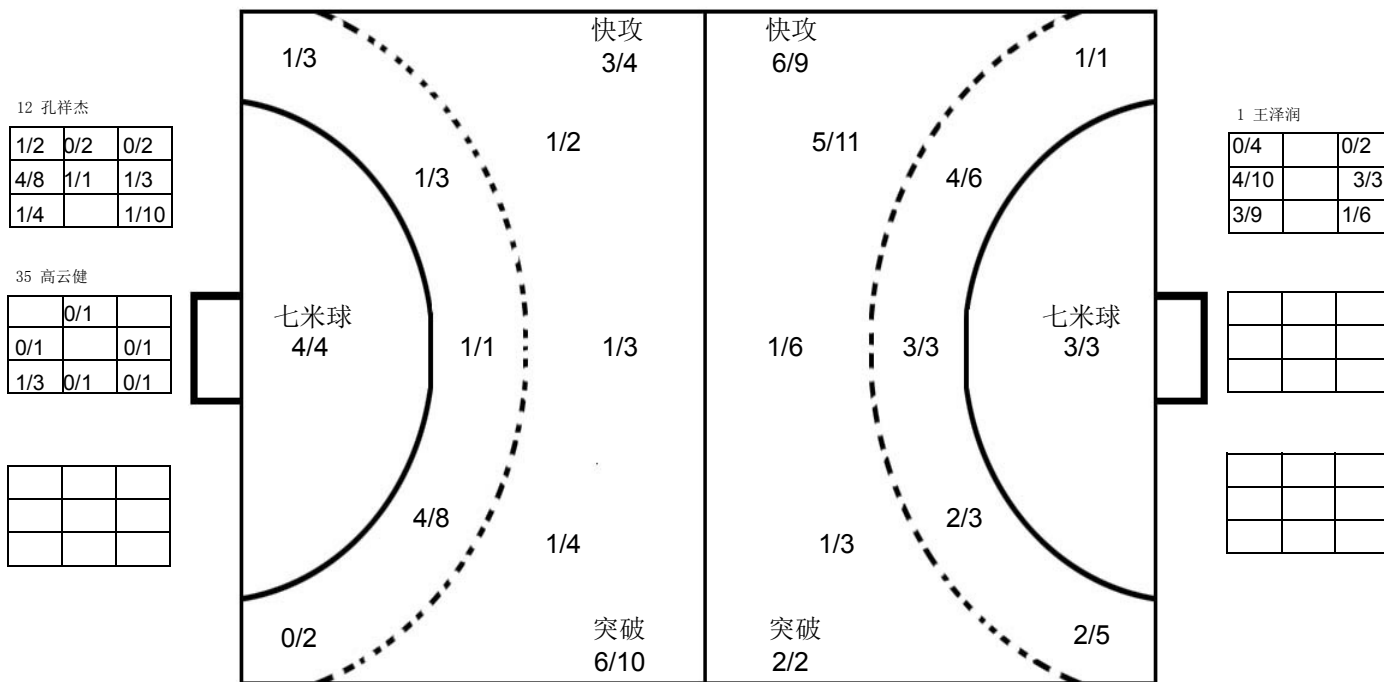

## 广东

1 王泽润	10 周仲坤	12 王雨	13 王立隆	15 张建杰	18 高玉杰	20 黄培杰	26 姚雪岩																																																																								
<table border="1"><tr><td></td><td></td><td></td></tr><tr><td></td><td></td><td></td></tr><tr><td></td><td></td><td></td></tr></table>										<table border="1"><tr><td></td><td></td><td></td></tr><tr><td></td><td></td><td>1</td></tr><tr><td>2</td><td></td><td>1</td></tr></table>						1	2		1	<table border="1"><tr><td>1</td><td></td><td></td></tr><tr><td></td><td></td><td></td></tr><tr><td></td><td></td><td>1</td></tr></table>	1								1	<table border="1"><tr><td></td><td></td><td></td></tr><tr><td>2</td><td></td><td></td></tr><tr><td></td><td></td><td></td></tr></table>				2						<table border="1"><tr><td></td><td>2</td><td>1</td></tr><tr><td>1</td><td></td><td></td></tr><tr><td></td><td></td><td>1</td></tr></table>		2	1	1					1	<table border="1"><tr><td></td><td>1</td><td></td></tr><tr><td></td><td></td><td></td></tr><tr><td>2</td><td></td><td></td></tr></table>		1					2			<table border="1"><tr><td></td><td></td><td></td></tr><tr><td>2</td><td></td><td>1</td></tr><tr><td>1</td><td>1</td><td>6</td></tr></table>				2		1	1	1	6	<table border="1"><tr><td></td><td></td><td></td></tr><tr><td></td><td></td><td>2</td></tr><tr><td></td><td></td><td>1</td></tr></table>						2			1
		1																																																																													
2		1																																																																													
1																																																																															
		1																																																																													
2																																																																															
	2	1																																																																													
1																																																																															
		1																																																																													
	1																																																																														
2																																																																															
2		1																																																																													
1	1	6																																																																													
		2																																																																													
		1																																																																													
Post - 0 Miss - 0 Block - 0	Post - 1 Miss - 1 Block - 1	Post - 0 Miss - 0 Block - 0	Post - 0 Miss - 2 Block - 0	Post - 0 Miss - 3 Block - 1	Post - 0 Miss - 0 Block - 0	Post - 1 Miss - 0 Block - 0	Post - 0 Miss - 1 Block - 1																																																																								

注释: Post=击柱 Miss=射失 Block=被封





预赛 Group X

男子 全国杯赛

“绿叶集团”杯2016年全国男子手球超级杯赛

Team A <b>A 江苏</b>				Team B <b>B 天津</b>				Match Number <b>15</b>													
played in China		in the hall 苏州市体育中心		on 25/11/2016		at 16:00 hours		Spectators													
Half-time (30')	<b>A</b> 14	<b>B</b> 7	End of playing time	<b>A</b> 26	<b>B</b> 19	1st extra time	<b>A</b>	<b>B</b>	2nd extra time	<b>A</b>	<b>B</b>	After penalty throws	<b>A</b>	<b>B</b>							
Number of 7 m	<b>A</b> 2 / 2	Team time-out 1 2 3			Full name of players and officials				Team time-out 1 2 3			<b>B</b> 1 / 2	Number of 7 m								
No.	Team <b>A</b>					G	W	2'	D	DR	No.	Team <b>B</b>					G	W	2'	D	DR
1	徐畅										1	刘宗其									
4	张家纬					5	1				2	李岳朋					2	1	1		
5	闫亮					1		2			4	李松浩									
6	赵晨					7		1			6	王子欣					2				
7	徐奕飞					2					7	张青					4	1			
8	周小坚					1					8	曹悦					5				
9	任超凡										9	吴明远									
10	郝可鑫					1					12	杨峻									
11	马益奎										13	许松					4	1			
12	王权										14	田剑侠									
13	耿畅										16	刘海亮									
15	李加昌										17	周群					2		1		
17	王伟强					3					21	潘玉帅									
18	赵楠					3					22	魏雨童							1		
21	刘江					3	1														
22	任启双																				
<b>B</b>	闫威名 (主教练)										<b>A</b>	贾守信									
<b>C</b>	贾淑君										<b>B</b>	杜瑞军 (主教练)									
<b>E</b>	王建国										<b>C</b>	孟凡钢									
<b>A</b>	Signature of Responsible Official of the Teams (Off. A)																			<b>B</b>	
TP	Remarks of Referee / CHA Official																			TP	

Signatures

Referees	刘书勇 (CHN)	王洋 (CHN)		
Techn. Delegates	于中迅 (CHN)	柴业宏 (CHN)		
CHA Official				

Note: Number of 7m Throws Awarded to Team A and B, Goals (G), Warnings (W), Suspensions (2'), Direct Disqualification (D), Disqualification with Report (DR) and Team Penalty (TP).

Table Officials: 宣海波

许栋梁

Statisticians: 王玲

王玮

Printed by PHMS Copyright: IHF / CHA 25/11/2016 17:25:43

Longman Sportsoft



handball@126.com



“绿叶集团”杯2016年全国男子手球超级杯赛  
竞赛技术统计(媒体表)

预赛	组别	X	轮次	5	场次	15
----	----	---	----	---	----	----

苏州市体育中心

25/11/2016

201608015-51-1/1

江苏	江苏	26	vs	19	天津	天津
		14:7				

裁判员	刘书勇 (CHN)	/	王洋 (CHN)
-----	-----------	---	----------

江苏		远射	近射	边射	快攻	突破	任意球	7m球	合计	%	助攻	失误	警告	2'	D & DR	江苏	比赛进程	天津
主教练: 闫威名																	1st Half	
1	徐畅															5	闫亮	0 03:05 1 8 曹悦
4	张家纬	0/1		1/1	2/3	2/2			5/7	71.4		1	1			1	03:48	1 1 张青
5	闫亮		1/1						1/1	100		2		2		6	赵晨	2 05:07 2 7 张青
6	赵晨	2/4	2/2		1/1	1/1	1/2		7/10	70.0	3	8		1		21	刘江	3 06:34 2 13 许松
7	徐奕飞			2/3	0/1				2/4	50.0						4	张家纬	4 09:55 3 4 张家纬
8	周小坚		1/3						1/3	33.3	1	1				5	11:00	3 4 13 许松
9	任超凡															5	13:58	4 4 13 许松
10	郝可鑫	0/2					1/1		1/3	33.3	1	2				6	15:15	4 4 13 许松
11	马益奎															17	王伟强	7 16:25 4 4 13 许松
12	王权											2				17	王伟强	8 17:13 4 4 13 许松
13	耿畅															17	王伟强	8 17:13 4 4 13 许松
15	李加昌															4	张家纬	9 17:57 4 4 13 许松
17	王伟强	0/1	0/1		1/2			2/2	3/6	50.0	1	1				9	20:27	5 2 李岳朋
18	赵楠	1/1	1/1			1/1		3/3	100	100	1	1				6	赵晨	10 20:52 5 5 2 李岳朋
21	刘江	0/1	1/1		1/1	1/1		3/4	75.0	75.0	1	1	1			4	张家纬	11 21:29 5 5 2 李岳朋
22	任启双															21	刘江	12 22:10 5 5 2 李岳朋
运动员 合计		3/10	6/9	3/4	5/8	5/5	2/3	2/2	26/41	63.4	8	19	2	3		8	周小坚	13 24:49 5 5 2 李岳朋
1	徐畅															6	赵晨	14 24:49 6 6 7 张青
12	王权	5/13	1/6	2/3	2/4	0/2		0/1	10/29	34.5		2				14	29:28	7 7 张青
守门员 合计		5/13	1/6	2/3	2/4	0/2		0/1	10/29	34.5		2				2nd Half		
天津		远射	近射	边射	快攻	突破	任意球	7m球	合计	%	助攻	失误	警告	2'	D & DR	14	01:02	8 6 王子欣
教练: 杜瑞军																15	01:07	8 6 王子欣
1	刘宗其										1					16	02:10	8 6 王子欣
2	李岳朋	1/5	0/1			1/1			2/7	28.6	3	2	1	1		16	03:23	9 13 许松
4	李松浩															18	03:31	9 13 许松
6	王子欣	0/2	2/2	0/2	0/2				2/8	25.0		3				17	04:18	10 7 张青
7	张青	3/8	0/2					1/2	4/12	33.3		3	1			4	05:54	10 7 张青
8	曹悦	4/7				1/1			5/8	62.5		4				18	06:47	10 7 张青
9	吴明远											1				10	10:11	10 7 张青
12	杨峻															20	10:40	11 8 曹悦
13	许松	0/2	1/1	1/2	2/2				4/7	57.1	3	3	1			20	13:11	12 8 曹悦
14	田剑侠	0/1	0/1						0/2	0.0		2				21	13:57	12 8 曹悦
16	刘海亮															18	14:42	13 6 王子欣
17	周群		2/2						2/2	100		1		1		7	15:00	13 6 王子欣
21	潘玉帅															22	16:27	14 8 曹悦
22	魏雨童											1		1		21	16:38	14 8 曹悦
运动员 合计		8/25	5/9	1/4	2/4	2/2		1/2	19/46	41.3	7	20	3	3		23	17:14	15 8 曹悦
1	刘宗其	4/6	2/7	0/3	2/3	0/4	1/3	0/1	9/27	33.3	1					23	19:56	16 17 周群
12	杨峻	0/1	0/1		0/4	0/1		0/1	0/8	0.0						23	21:32	17 7 张青
守门员 合计		4/7	2/8	0/3	2/7	0/5	1/3	0/2	9/35	25.7	1					23	22:14	18 13 许松

场上队员: 得分 / 射门

守门员: 救球 / 射门

快攻	Fast Break	突破	Breakthrough	任意球	Free Throw	7M球	7M Throw	助攻	Assist
警告	Warning	失误	Error	2'	Suspension	D	取消资格	DR	取消资格+报告





## “绿叶集团”杯2016年全国男子手球超级杯赛 图式比赛技术统计表

轮次 5

场次 15

201608015-21-1/1

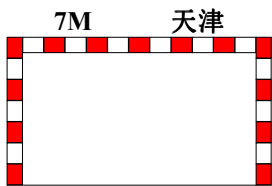
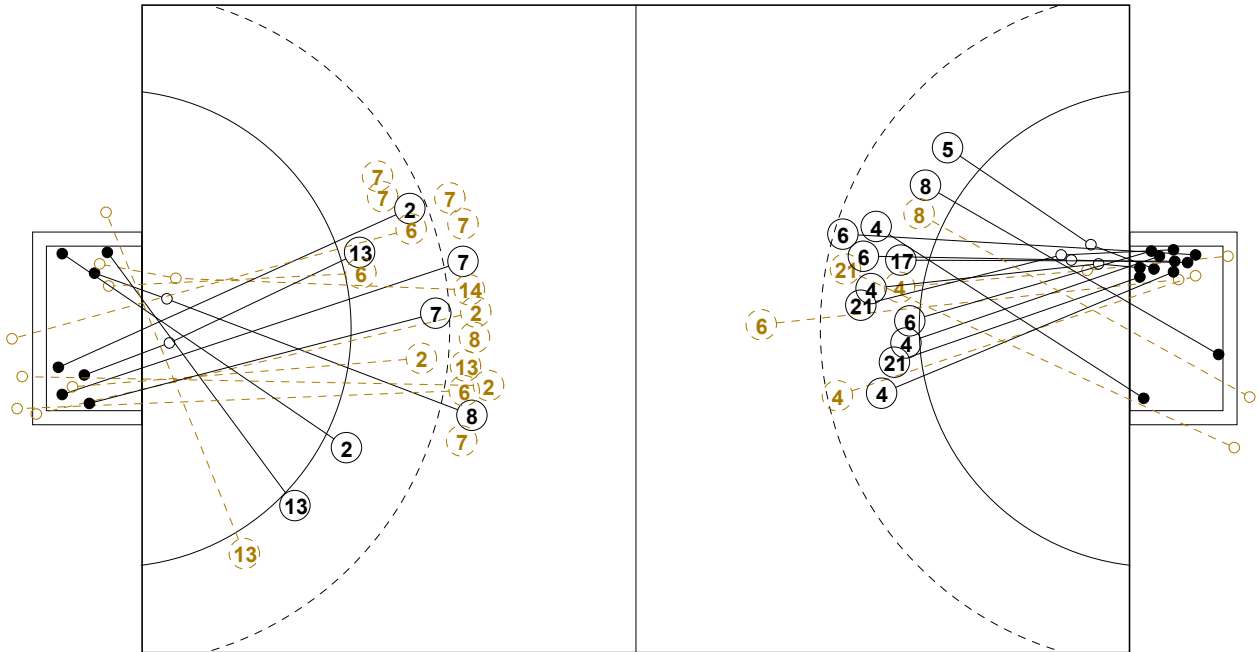

**1st Half**  
7 : 14

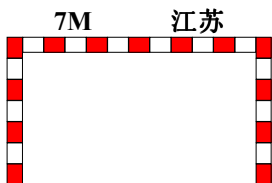
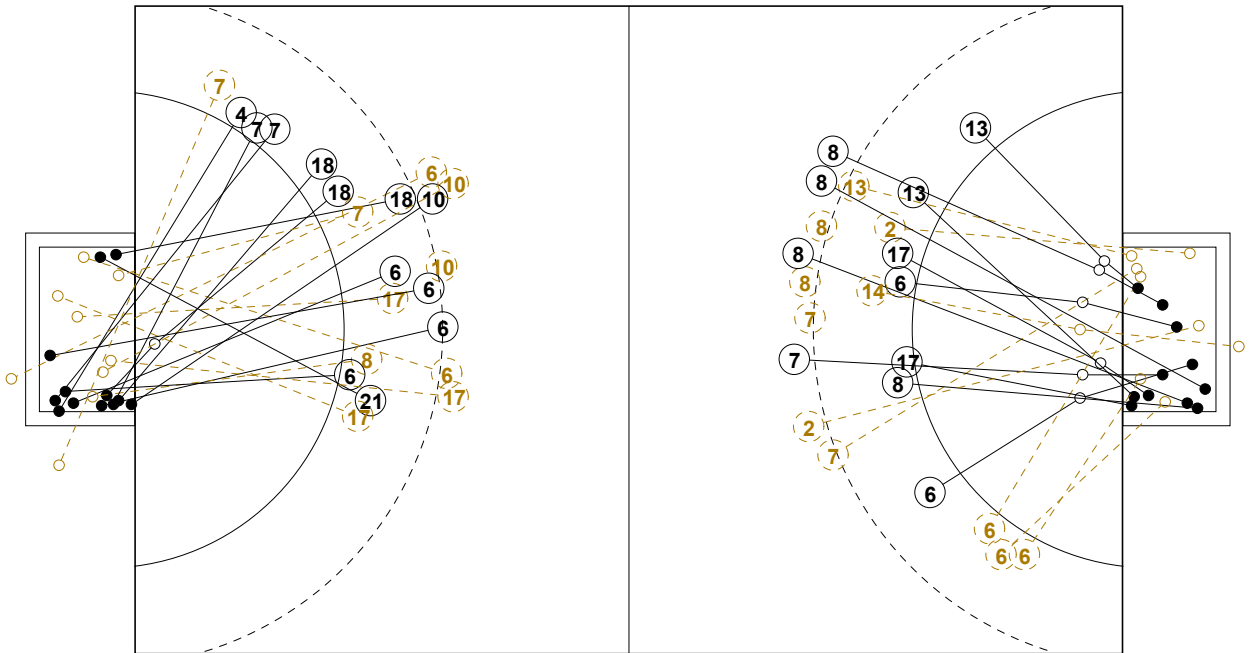
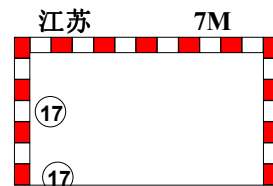

**2nd Half**  
26 : 19

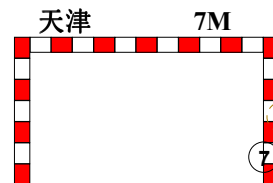





## “绿叶集团”杯2016年全国男子手球超级杯赛

## 个人/全队技术统计表

正式表  
手球  
男子预赛  
轮次 5组别 X  
场次 15201608015-14-1/2  
苏州市体育中心  
25/11/2016 16:00

号码	姓名	远射	近射	边射	快攻	突破	任意	7M	合计	%	助攻	失误	警告	2'	取消	时间
<b>江苏(江苏)</b>																
<i>(场上队员)</i>																
1	徐畅									0.0%						00:00:00
4	张家纬	0/1		1/1	2/3	2/2			5/7	71.4%		1	1			00:42:18
5	闫亮		1/1						1/1	100%		2		2		00:39:23
6	赵晨	2/4	2/2		1/1	1/1	1/2		7/10	70.0%	3	8		1		00:49:58
7	徐奕飞			2/3	0/1				2/4	50.0%						00:17:42
8	周小坚		1/3						1/3	33.3%	1	1				00:25:59
9	任超凡									0.0%						00:00:00
10	郝可鑫	0/2					1/1		1/3	33.3%	1	2				00:22:46
11	马益奎									0.0%						00:00:00
12	王权									0.0%		2				01:00:00
13	耿畅									0.0%						00:00:00
15	李加昌									0.0%						00:00:00
17	王伟强	0/1	0/1		1/2			2/2	3/6	50.0%	1	1				00:56:13
18	赵楠	1/1	1/1			1/1			3/3	100%	1	1				00:51:23
21	刘江	0/1	1/1		1/1	1/1			3/4	75.0%	1	1	1			00:49:13
22	任启双									0.0%						00:04:52
<b>合计</b>		3/10	6/9	3/4	5/8	5/5	2/3	2/2	26/41	63.4%	8	19	2	3		
<i>(守门员)</i>																
1	徐畅									0.0%						00:00:00
12	王权	5/13	1/6	2/3	2/4	0/2		0/1	10/29	34.5%		2				01:00:00
<b>合计</b>		5/13	1/6	2/3	2/4	0/2		0/1	10/29	34.5%		2				

场上队员：得分/射门

守门员：救球/射门

全队合计	得分	被救	射失	击柱	封球	合计	%
远射	3	4	2		1	10	30.0%
近射	6	2	1			9	66.7%
边射	3		1			4	75.0%
快攻	5	2		1		8	62.5%
突破	5					5	100.0%
任意	2	1				3	66.7%
7M	2					2	100.0%





## “绿叶集团”杯2016年全国男子手球超级杯赛

## 个人/全队技术统计表

正式表  
手球  
男子预赛  
轮次 5组别 X  
场次 15201608015-14-2/2  
苏州市体育中心  
25/11/2016 16:00

号码	姓名	远射	近射	边射	快攻	突破	任意	7M	合计	%	助攻	失误	警告	2'	取消	时间
<b>天津(天津)</b>																
<i>(上场队员)</i>																
1	刘宗其									0.0%	1					00:46:19
2	李岳朋	1/5	0/1			1/1			2/7	28.6%	3	2	1	1		01:00:00
4	李松浩									0.0%						00:00:00
6	王子欣	0/2	2/2	0/2	0/2				2/8	25.0%		3				01:00:00
7	张青	3/8	0/2					1/2	4/12	33.3%		3	1			00:59:28
8	曹悦	4/7				1/1			5/8	62.5%		4				00:24:27
9	吴明远									0.0%		1				00:12:40
12	杨峻									0.0%						00:13:41
13	许松	0/2	1/1	1/2	2/2				4/7	57.1%	3	3	1			01:00:00
14	田剑侠	0/1	0/1						0/2	0.0%		2				00:22:47
16	刘海亮									0.0%						00:00:00
17	周群		2/2						2/2	100%		1		1		00:52:28
21	潘玉帅									0.0%						00:00:00
22	魏雨童									0.0%		1		1		00:07:51
<b>合计</b>		8/25	5/9	1/4	2/4	2/2		1/2	19/46	41.3%	7	20	3	3		
<i>(守门员)</i>																
1	刘宗其	4/6	2/7	0/3	2/3	0/4	1/3	0/1	9/27	33.3%	1					00:46:19
12	杨峻	0/1	0/1		0/4	0/1		0/1	0/8	0.0%						00:13:41
<b>合计</b>		4/7	2/8	0/3	2/7	0/5	1/3	0/2	9/35	25.7%	1					

场上队员：得分/射门

守门员：救球/射门

全队合计	得分	被救	射失	击柱	封球	合计	%
远射	8	5	3	1	8	25	32.0%
近射	5	1	1		2	9	55.6%
边射	1	2	1			4	25.0%
快攻	2	2				4	50.0%
突破	2					2	100.0%
任意							0.0%
7M	1			1		2	50.0%





“绿叶集团”杯2016年全国男子手球超级杯赛

图式射门区域统计

轮次 5 场次 15

201608015-41-1/1

江苏

1 徐畅	4 张家纬	5 闫亮	6 赵晨	7 徐奕飞	8 周小坚	9 任超凡	10 郝可鑫																																																																								
<table border="1"><tr><td></td><td></td><td></td></tr><tr><td></td><td></td><td></td></tr><tr><td></td><td></td><td></td></tr></table>										<table border="1"><tr><td>1</td><td></td><td></td></tr><tr><td>1</td><td></td><td></td></tr><tr><td>2</td><td></td><td>1</td></tr></table>	1			1			2		1	<table border="1"><tr><td></td><td></td><td></td></tr><tr><td></td><td></td><td></td></tr><tr><td></td><td></td><td></td></tr></table>										<table border="1"><tr><td>2</td><td>1</td><td></td></tr><tr><td>3</td><td></td><td></td></tr><tr><td>1</td><td></td><td></td></tr></table>	2	1		3			1			<table border="1"><tr><td>1</td><td></td><td></td></tr><tr><td></td><td></td><td></td></tr><tr><td></td><td></td><td></td></tr></table>	1									<table border="1"><tr><td></td><td>1</td><td></td></tr><tr><td></td><td></td><td></td></tr><tr><td></td><td></td><td></td></tr></table>		1								<table border="1"><tr><td></td><td></td><td></td></tr><tr><td></td><td></td><td></td></tr><tr><td></td><td></td><td></td></tr></table>										<table border="1"><tr><td></td><td></td><td></td></tr><tr><td></td><td></td><td></td></tr><tr><td>1</td><td></td><td></td></tr></table>							1		
1																																																																															
1																																																																															
2		1																																																																													
2	1																																																																														
3																																																																															
1																																																																															
1																																																																															
	1																																																																														
1																																																																															
Post - 0 Miss - 0 Block - 0	Post - 1 Miss - 0 Block - 0	Post - 0 Miss - 0 Block - 0	Post - 0 Miss - 1 Block - 0	Post - 0 Miss - 1 Block - 0	Post - 0 Miss - 1 Block - 0	Post - 0 Miss - 0 Block - 0	Post - 0 Miss - 0 Block - 1																																																																								
11 马益奎	12 王权	13 耿畅	15 李加昌	17 王伟强	18 赵楠	21 刘江	22 任启双																																																																								
<table border="1"><tr><td></td><td></td><td></td></tr><tr><td></td><td></td><td></td></tr><tr><td></td><td></td><td></td></tr></table>										<table border="1"><tr><td></td><td></td><td></td></tr><tr><td></td><td></td><td></td></tr><tr><td></td><td></td><td></td></tr></table>										<table border="1"><tr><td></td><td></td><td></td></tr><tr><td></td><td></td><td></td></tr><tr><td></td><td></td><td></td></tr></table>										<table border="1"><tr><td></td><td></td><td></td></tr><tr><td></td><td></td><td></td></tr><tr><td></td><td></td><td></td></tr></table>										<table border="1"><tr><td>2</td><td></td><td></td></tr><tr><td>1</td><td></td><td></td></tr><tr><td></td><td></td><td></td></tr></table>	2			1						<table border="1"><tr><td></td><td></td><td></td></tr><tr><td>2</td><td></td><td>1</td></tr><tr><td></td><td></td><td></td></tr></table>				2		1				<table border="1"><tr><td></td><td></td><td></td></tr><tr><td>1</td><td></td><td>1</td></tr><tr><td>1</td><td></td><td></td></tr></table>				1		1	1			<table border="1"><tr><td></td><td></td><td></td></tr><tr><td></td><td></td><td></td></tr><tr><td></td><td></td><td></td></tr></table>									
2																																																																															
1																																																																															
2		1																																																																													
1		1																																																																													
1																																																																															
Post - 0 Miss - 0 Block - 0	Post - 0 Miss - 0 Block - 0	Post - 0 Miss - 0 Block - 0	Post - 0 Miss - 0 Block - 0	Post - 0 Miss - 0 Block - 0	Post - 0 Miss - 0 Block - 0	Post - 0 Miss - 1 Block - 0	Post - 0 Miss - 0 Block - 0																																																																								

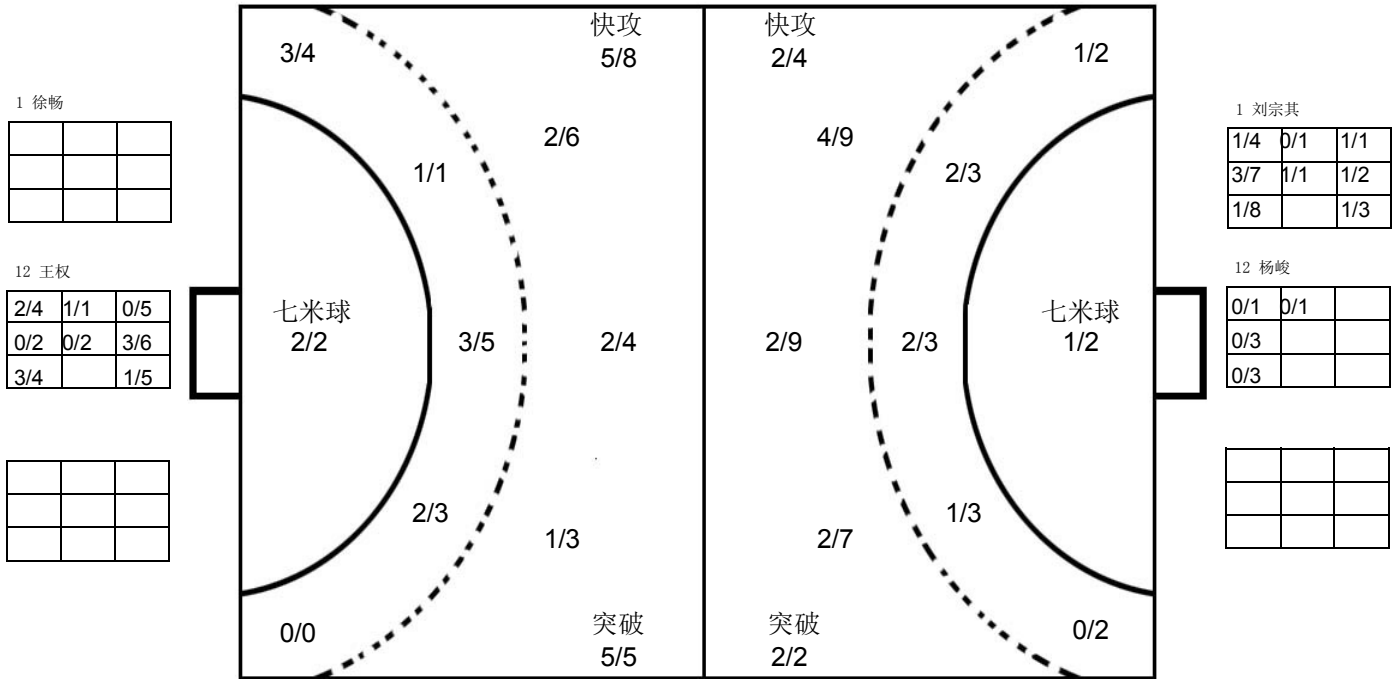

天津

1 刘宗其	2 李岳朋	4 李松浩	6 王子欣	7 张青	8 曹悦	9 吴明远	12 杨峻																																																																								
<table border="1"><tr><td></td><td></td><td></td></tr><tr><td></td><td></td><td></td></tr><tr><td></td><td></td><td></td></tr></table>										<table border="1"><tr><td>1</td><td></td><td>1</td></tr><tr><td></td><td></td><td></td></tr><tr><td></td><td></td><td></td></tr></table>	1		1							<table border="1"><tr><td></td><td></td><td></td></tr><tr><td></td><td></td><td></td></tr><tr><td></td><td></td><td></td></tr></table>										<table border="1"><tr><td></td><td></td><td>1</td></tr><tr><td></td><td>1</td><td></td></tr><tr><td></td><td></td><td></td></tr></table>			1		1					<table border="1"><tr><td>1</td><td></td><td></td></tr><tr><td>1</td><td></td><td>1</td></tr><tr><td></td><td></td><td>1</td></tr></table>	1			1		1			1	<table border="1"><tr><td></td><td></td><td>3</td></tr><tr><td></td><td>1</td><td>1</td></tr><tr><td></td><td></td><td></td></tr></table>			3		1	1				<table border="1"><tr><td></td><td></td><td></td></tr><tr><td></td><td></td><td></td></tr><tr><td></td><td></td><td></td></tr></table>										<table border="1"><tr><td></td><td></td><td></td></tr><tr><td></td><td></td><td></td></tr><tr><td></td><td></td><td></td></tr></table>									
1		1																																																																													
		1																																																																													
	1																																																																														
1																																																																															
1		1																																																																													
		1																																																																													
		3																																																																													
	1	1																																																																													
Post - 0 Miss - 0 Block - 0	Post - 1 Miss - 1 Block - 0	Post - 0 Miss - 0 Block - 0	Post - 0 Miss - 2 Block - 0	Post - 1 Miss - 0 Block - 6	Post - 0 Miss - 0 Block - 3	Post - 0 Miss - 0 Block - 0	Post - 0 Miss - 0 Block - 0																																																																								
13 许松	14 田剑侠	16 刘海亮	17 周群	21 潘玉帅	22 魏雨童																																																																										
<table border="1"><tr><td></td><td></td><td></td></tr><tr><td>1</td><td></td><td>1</td></tr><tr><td>1</td><td></td><td>1</td></tr></table>				1		1	1		1	<table border="1"><tr><td></td><td></td><td></td></tr><tr><td></td><td></td><td></td></tr><tr><td></td><td></td><td></td></tr></table>										<table border="1"><tr><td></td><td></td><td></td></tr><tr><td></td><td></td><td></td></tr><tr><td></td><td></td><td></td></tr></table>										<table border="1"><tr><td></td><td></td><td></td></tr><tr><td></td><td></td><td></td></tr><tr><td></td><td></td><td>2</td></tr></table>									2	<table border="1"><tr><td></td><td></td><td></td></tr><tr><td></td><td></td><td></td></tr><tr><td></td><td></td><td></td></tr></table>										<table border="1"><tr><td></td><td></td><td></td></tr><tr><td></td><td></td><td></td></tr><tr><td></td><td></td><td></td></tr></table>										<table border="1"><tr><td></td><td></td><td></td></tr><tr><td></td><td></td><td></td></tr><tr><td></td><td></td><td></td></tr></table>										<table border="1"><tr><td></td><td></td><td></td></tr><tr><td></td><td></td><td></td></tr><tr><td></td><td></td><td></td></tr></table>									
1		1																																																																													
1		1																																																																													
		2																																																																													
Post - 0 Miss - 1 Block - 1	Post - 0 Miss - 1 Block - 0	Post - 0 Miss - 0 Block - 0	Post - 0 Miss - 0 Block - 0	Post - 0 Miss - 0 Block - 0	Post - 0 Miss - 0 Block - 0																																																																										

注释: Post=击柱 Miss=射失 Block=被封





5-6名

男子 全国杯赛

“绿叶集团”杯2016年全国男子手球超级杯赛

Team A <b>A 广东</b>				Team B <b>B 北京</b>				Match Number <b>16</b>													
played in China		in the hall 苏州市体育中心		on 26/11/2016		at 10:00 hours		Spectators													
Half-time (30')	<b>A</b> 13	<b>B</b> 16	End of playing time	<b>A</b> 27	<b>B</b> 27	1st extra time	<b>A</b> 31	<b>B</b> 30	2nd extra time	<b>A</b>	<b>B</b>	After penalty throws	<b>A</b>	<b>B</b>							
Number of 7 m	<b>A</b> 4 / 5	Team time-out 1 13:13 2 44:54 3 59:14			Full name of players and officials				Team time-out 1 21:34 2 48:21 3 59:46			<b>B</b> 1 / 3	Number of 7 m								
No.	Team <b>A</b>					G	W	2'	D	DR	No.	Team <b>B</b>					G	W	2'	D	DR
1	王泽润										3	吴锐樊					3				
10	周仲坤					3	1				6	赵一涵					4				
12	王雨					2		1			7	卞友山					5	1			
13	王立隆					8					8	赵文宣					4	1	1		
15	张建杰					2	1				10	李明远					1				
18	高玉杰					1					12	孔祥杰									
20	黄培杰					9					17	袁振典									
26	姚雪岩					6		1			18	温新宇									
											20	王鹏皓					2				
											23	陈旭									
											25	程海津						1	2		
											26	杨政									
											29	逯明松					9				
											35	高云健									
											78	王哲一					2				
<b>B</b>	刘康伶 (主教练)										<b>B</b>	吴健 (主教练)									
<b>C</b>	刘文宁										<b>C</b>	刘彦坤									
											<b>D</b>	陈璇									
<b>A</b>	Signature of Responsible Official of the Teams (Off. A)																			<b>B</b>	
TP	Remarks of Referee / CHA Official																			TP	

Signatures

Referees	徐健 (CHN)	曹宏俊 (CHN)		
Techn. Delegates	于中迅 (CHN)	柴业宏 (CHN)		
CHA Official				

Note: Number of 7m Throws Awarded to Team A and B, Goals (G), Warnings (W), Suspensions (2'), Direct Disqualification (D), Disqualification with Report (DR) and Team Penalty (TP).

Table Officials: 黄岩 石震坤 Statisticians: 王玮 王聆

Printed by PHMS Copyright: IHF / CHA 26/11/2016 12:29:40

Longman Sportsoft  handball@126.com



## “绿叶集团”杯2016年全国男子手球超级杯赛 竞赛技术统计(媒体表)

5-6名		组别	X	轮次	6	场次	16
苏州市体育中心				26/11/2016		201608016-51-1/1	
广东		广东	31	vs	30	北京	北京
				<b>13 : 16</b>			

裁判员	徐健 (CHN)				/	曹宏俊 (CHN)			
-----	----------	--	--	--	---	-----------	--	--	--

广东		远	近	边	快	突	任意	7m	合计	%	助攻	失误	警告	2'	D & DR	比赛进程	
主教练：刘康伶		射	射	射	攻	破	球	球								广东	北京
1	王泽润															0	02:13 1 29 逯明松
10	周仲坤	2/6	1/1						3/7	42.9	2	3	1			0	03:40 2 20 王鹏皓
12	王雨		0/1	1/1	1/2				2/4	50.0	1			1		0	04:41 3 7 卞友山
13	王立隆	0/1	3/3	2/2	2/3	1/1		0/1	8/11	72.7						0	06:10 4 8 赵文宣
15	张建杰	1/11	1/1				0/1		2/13	15.4		3	1			0	08:09 5 3 吴锐樊
18	高玉杰	0/1				1/1			1/2	50.0						1	08:57 5 5 姚雪岩
20	黄培杰	2/5	1/2		0/1	1/2	1/1	4/4	9/15	60.0	4	2				2	11:44 6 6 赵一涵
26	姚雪岩	1/2	5/8				0/1		6/11	54.5	1	3		1		2	13:09 7 8 赵文宣
<b>运动员 合计</b>		<b>6/26</b>	<b>11/16</b>	<b>3/3</b>	<b>3/6</b>	<b>3/4</b>	<b>1/3</b>	<b>4/5</b>	<b>31/63</b>	<b>49.2</b>	<b>8</b>	<b>11</b>	<b>2</b>	<b>2</b>		5	15:08 7 7 姚雪岩
1	王泽润	5/9	7/22	6/7	0/7	0/2		2/3	20/50	40.0						5	16:12 8 29 逯明松
<b>守门员 合计</b>		<b>5/9</b>	<b>7/22</b>	<b>6/7</b>	<b>0/7</b>	<b>0/2</b>		<b>2/3</b>	<b>20/50</b>	<b>40.0</b>						5	17:14 9 6 赵一涵
<b>北京</b>		远	近	边	快	突	任意	7m	合计	%	助攻	失误	警告	2'	D & DR		
教练：吴健		射	射	射	攻	破	球	球									
3	吴锐樊		0/1	0/4	3/4				3/9	33.3						6	17:47 9 6 赵一涵
6	赵一涵	0/2	3/3			1/1			4/6	66.7		5				6	18:02 10 6 赵一涵
7	卞友山	0/1	3/6		1/1	1/1			5/9	55.6	3	3	1			7	19:46 10 20 黄培杰
8	赵文宣	0/1	4/6						4/7	57.1		1	1	1		7	20:14 11 29 逯明松
10	李明远	1/4							1/4	25.0	2	4				7	20:30 12 3 吴锐樊
12	孔祥杰											1	1			8	20:44 12 20 黄培杰
17	袁振典															9	21:48 12 20 黄培杰
18	温新宇															9	22:15 13 8 赵文宣
20	王鹏皓	0/1	1/2	0/2	1/1			0/1	2/7	28.6						10	23:03 13 10 周仲坤
23	陈旭															10	24:24 14 10 李明远
25	程海洋										1		1	2		11	25:06 14 26 姚雪岩
26	杨政															11	25:26 15 7 卞友山
29	逯明松	3/5	4/5		1/1		0/1	1/2	9/14	64.3	1					12	25:38 15 13 王立隆
35	高云健										1					13	26:59 15 20 黄培杰
78	王哲一		0/2	1/2	1/1				2/5	40.0		1				13	29:12 16 29 逯明松
<b>运动员 合计</b>		<b>4/14</b>	<b>15/25</b>	<b>1/8</b>	<b>7/8</b>	<b>2/2</b>	<b>0/1</b>	<b>1/3</b>	<b>30/61</b>	<b>49.2</b>	<b>9</b>	<b>15</b>	<b>3</b>	<b>3</b>		13	00:21 17 7 卞友山
12	孔祥杰	8/14	2/11	0/2	2/4	1/4	0/1	1/3	14/39	35.9	1	1				13	00:45 17 13 王立隆
35	高云健	2/2	1/3	0/1	1/2			0/2	4/10	40.0	1					15	01:39 18 29 逯明松
<b>守门员 合计</b>		<b>10/16</b>	<b>3/14</b>	<b>0/3</b>	<b>3/6</b>	<b>1/4</b>	<b>0/1</b>	<b>1/5</b>	<b>18/49</b>	<b>36.7</b>	<b>2</b>	<b>1</b>				15	02:38 19 29 逯明松
场上队员：得分 / 射门																守门员：救球 / 射门	
快攻	Fast Break		突破	Breakthrough	任意球	Free Throw	7M球	7M Throw		助攻	Assist						
警告	Warning		失误	Error	2'	Suspension	D	取消资格		DR	取消资格+报告						

Ext. 1-1	7	00:44	28	78	王哲一	10	周仲坤	28	02:23	28					
	28	04:53	29	78	王哲一										
Ext. 1-2	12	王雨	29	01:06	29	26	姚雪岩	30	03:57	29	13	王立隆	31	04:26	29
	13	王立隆	31	04:49	30	6	赵一涵								





## “绿叶集团”杯2016年全国男子手球超级杯赛 图式比赛技术统计表

轮次 6

场次 16

201608016-21-1/1

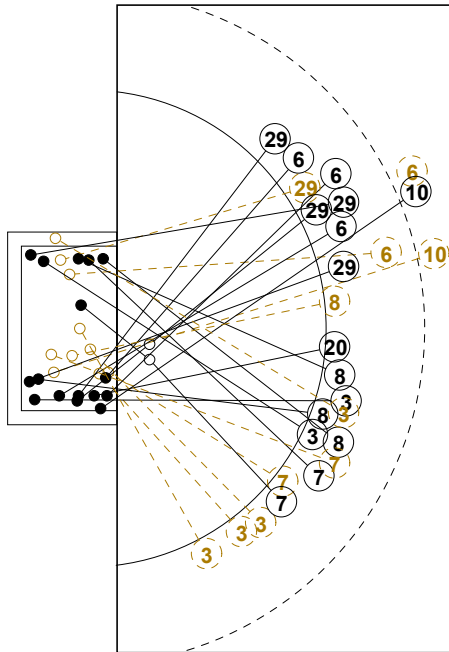

7M 北京

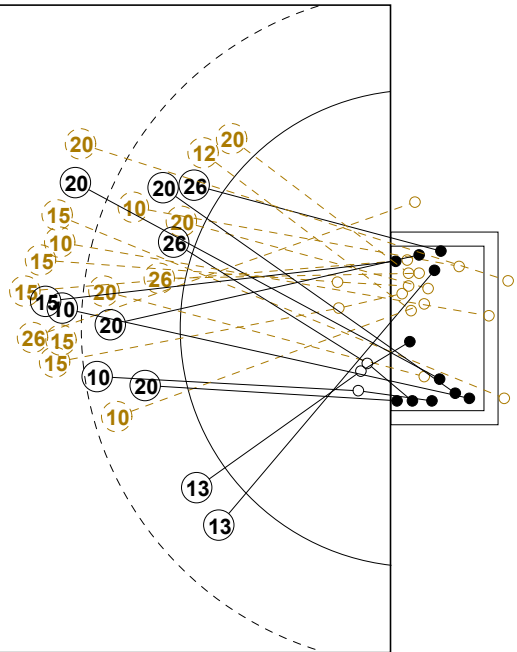
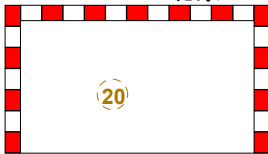

广东 7M

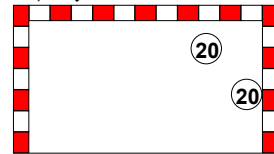

1st Half  
16 : 13

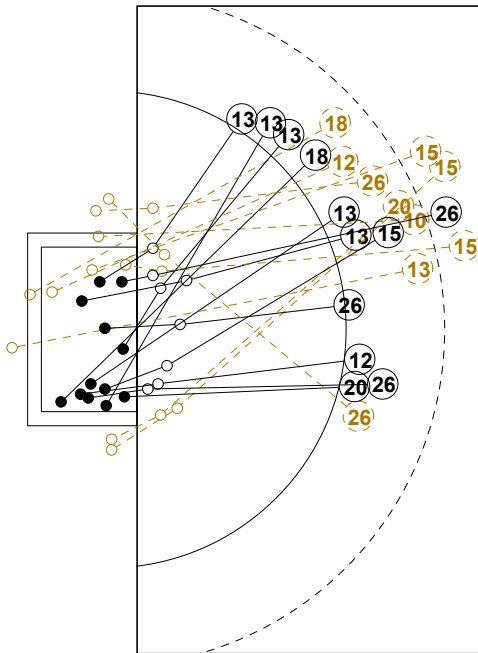

7M 广东

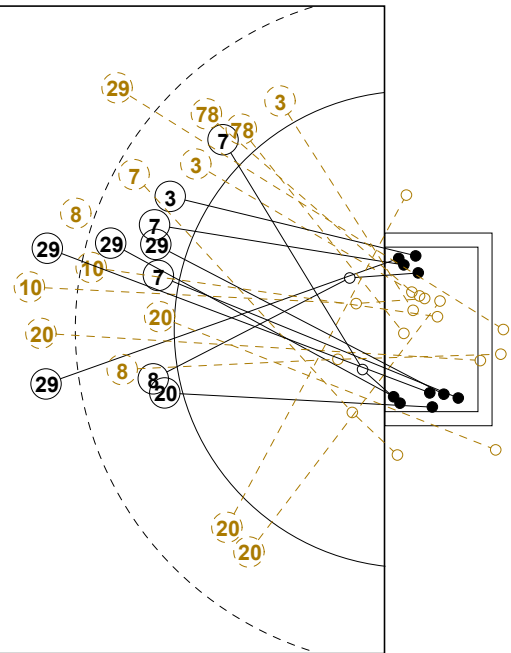
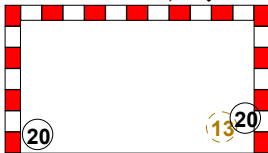

北京 7M

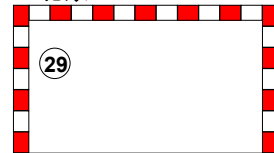

2nd Half  
27 : 27



### “绿叶集团”杯2016年全国男子手球超级杯赛 图式比赛技术统计表

轮次 6

场次 16

201608016-21-1/1

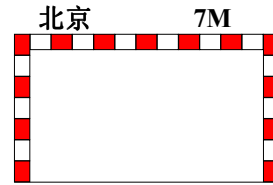
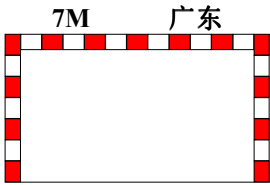
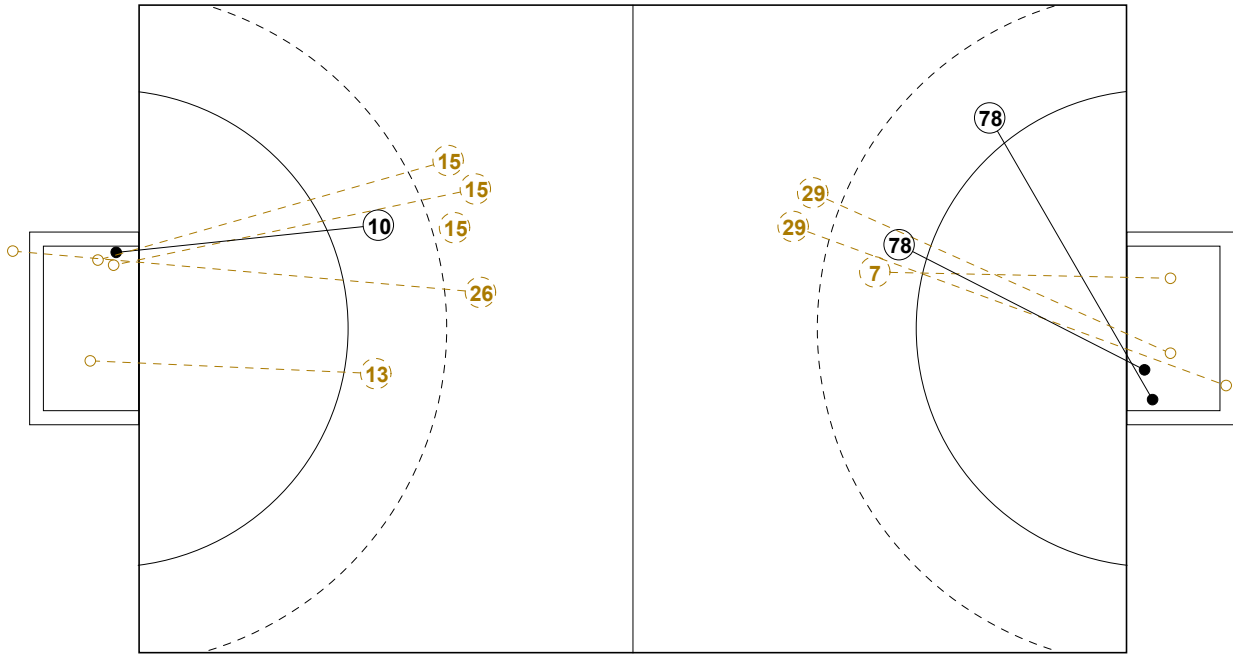

Extra 1-1  
28 : 29

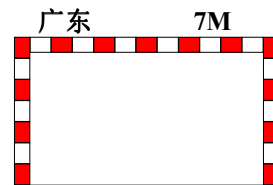
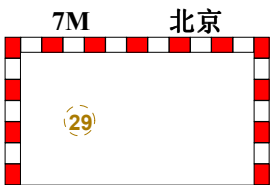
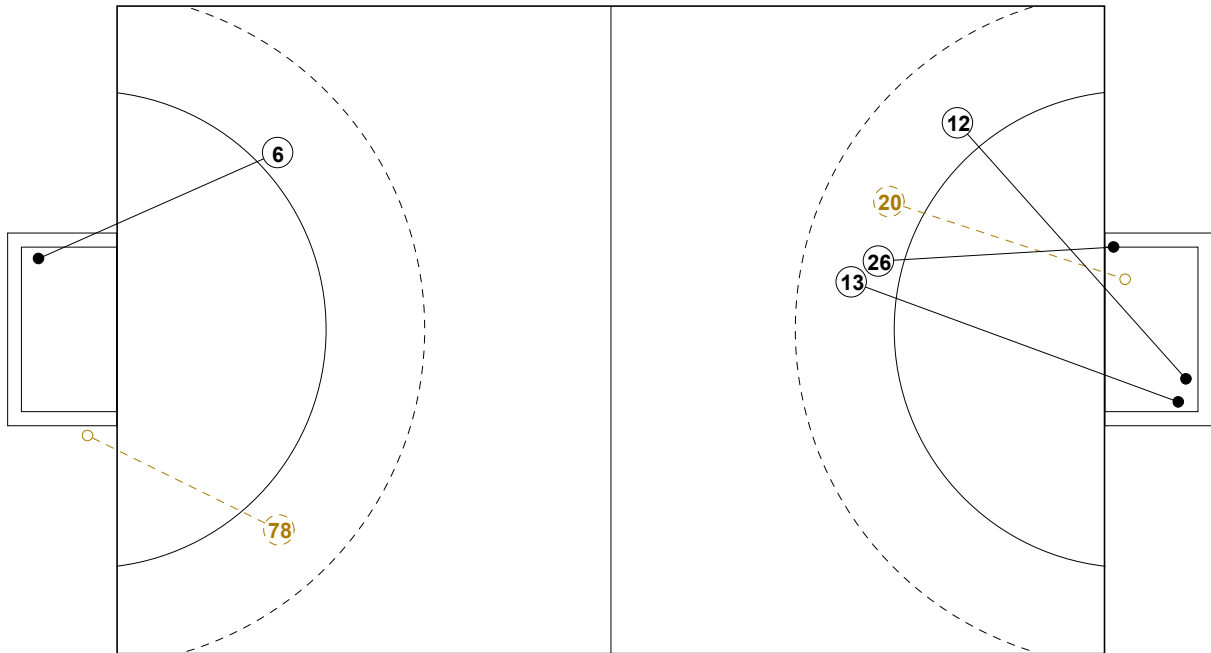

Extra 1-2  
30 : 31



## “绿叶集团”杯2016年全国男子手球超级杯赛

## 个人/全队技术统计表

正式表  
手球  
男子5-6名  
轮次 6组别 X  
场次 16201608016-14-1/2  
苏州市体育中心  
26/11/2016 10:00

号码	姓名	远射	近射	边射	快攻	突破	任意	7M	合计	%	助攻	失误	警告	2'	取消	时间
<b>广东(广东)</b>																
<i>(场上队员)</i>																
1	王泽润									0.0%						01:18:43
10	周仲坤	2/6	1/1						3/7	42.9%	2	3	1			01:06:32
12	王雨		0/1	1/1	1/2				2/4	50.0%	1			1		01:10:30
13	王立隆	0/1	3/3	2/2	2/3	1/1		0/1	8/11	72.7%						01:10:30
15	张建杰	1/11	1/1				0/1		2/13	15.4%		3	1			01:10:30
18	高玉杰	0/1				1/1			1/2	50.0%						00:10:41
20	黄培杰	2/5	1/2		0/1	1/2	1/1	4/4	9/15	60.0%	4	2				01:03:44
26	姚雪岩	1/2	5/8				0/1		6/11	54.5%	1	3		1		01:10:30
<b>合计</b>																
<i>(守门员)</i>																
1		5/9	7/22	6/7	0/7	0/2		2/3	20/50	40.0%						01:18:43
<b>合计</b>																

场上队员：得分/射门

守门员：救球/射门

全队合计	得分	被救	射失	击柱	封球	合计	%
远射	6	10	5	3	2	26	23.1%
近射	11	3	2			16	68.8%
边射	3					3	100.0%
快攻	3	3				6	50.0%
突破	3	1				4	75.0%
任意	1		2			3	33.3%
7M	4	1				5	80.0%







## “绿叶集团”杯2016年全国男子手球超级杯赛

## 个人/全队技术统计表

正式表  
手球  
男子5-6名  
轮次 6组别 X  
场次 16201608016-14-2/2  
苏州市体育中心  
26/11/2016 10:00

号码	姓名	远射	近射	边射	快攻	突破	任意	7M	合计	%	助攻	失误	警告	2'	取消	时间
<b>北京(北京)</b>																
<i>(上场队员)</i>																
3	吴锐樊		0/1	0/4	3/4				3/9	33.3%						00:48:21
6	赵一涵	0/2	3/3			1/1			4/6	66.7%		5				00:57:32
7	卞友山	0/1	3/6		1/1	1/1			5/9	55.6%	3	3	1			01:10:00
8	赵文宣	0/1	4/6						4/7	57.1%		1	1	1		01:10:00
10	李明远	1/4							1/4	25.0%	2	4				00:32:04
12	孔祥杰									0.0%	1	1				01:13:02
17	袁振典									0.0%						00:00:00
18	温新宇									0.0%						00:00:00
20	王鹏皓	0/1	1/2	0/2	1/1			0/1	2/7	28.6%						00:12:59
23	陈旭									0.0%						00:00:00
25	程海津									0.0%	1		1	2		00:36:52
26	杨政									0.0%						00:00:00
29	逯明松	3/5	4/5		1/1		0/1	1/2	9/14	64.3%	1					01:10:00
35	高云健									0.0%	1					00:10:11
78	王哲一		0/2	1/2	1/1				2/5	40.0%		1				00:21:39
<b>合计</b>		4/14	15/25	1/8	7/8	2/2	0/1	1/3	30/61	49.2%	9	15	3	3		
<i>(守门员)</i>																
12	孔祥杰	8/14	2/11	0/2	2/4	1/4	0/1	1/3	14/39	35.9%	1	1				01:13:02
35	高云健	2/2	1/3	0/1	1/2			0/2	4/10	40.0%	1					00:10:11
<b>合计</b>		10/16	3/14	0/3	3/6	1/4	0/1	1/5	18/49	36.7%	2	1				

场上队员：得分/射门

守门员：救球/射门

全队合计	得分	被救	射失	击柱	封球	合计	%
远射	4	5	1	2	2	14	28.6%
近射	15	7	3			25	60.0%
边射	1	6	1			8	12.5%
快攻	7			1		8	87.5%
突破	2					2	100.0%
任意			1			1	0.0%
7M	1	2				3	33.3%





### “绿叶集团”杯2016年全国男子手球超级杯赛

图式射门区域统计

轮次 6 场次 16

201608016-41-1/1

## 广东

1 王泽润	10 周仲坤	12 王雨	13 王立隆	15 张建杰	18 高玉杰	20 黄培杰	26 姚雪岩																																																																								
<table border="1"><tr><td></td><td></td><td></td></tr><tr><td></td><td></td><td></td></tr><tr><td></td><td></td><td></td></tr></table>										<table border="1"><tr><td></td><td></td><td>1</td></tr><tr><td></td><td></td><td>1</td></tr><tr><td></td><td></td><td>1</td></tr></table>			1			1			1	<table border="1"><tr><td></td><td></td><td>1</td></tr><tr><td>1</td><td></td><td></td></tr><tr><td></td><td></td><td></td></tr></table>			1	1						<table border="1"><tr><td></td><td></td><td>1</td></tr><tr><td>2</td><td>1</td><td>1</td></tr><tr><td>1</td><td>2</td><td></td></tr></table>			1	2	1	1	1	2		<table border="1"><tr><td></td><td></td><td></td></tr><tr><td>1</td><td></td><td></td></tr><tr><td>1</td><td></td><td></td></tr></table>				1			1			<table border="1"><tr><td></td><td></td><td></td></tr><tr><td>1</td><td></td><td></td></tr><tr><td></td><td></td><td></td></tr></table>				1						<table border="1"><tr><td></td><td></td><td>2</td></tr><tr><td></td><td></td><td>2</td></tr><tr><td>3</td><td></td><td>2</td></tr></table>			2			2	3		2	<table border="1"><tr><td></td><td></td><td></td></tr><tr><td>2</td><td>1</td><td></td></tr><tr><td>1</td><td></td><td>2</td></tr></table>				2	1		1		2
		1																																																																													
		1																																																																													
		1																																																																													
		1																																																																													
1																																																																															
		1																																																																													
2	1	1																																																																													
1	2																																																																														
1																																																																															
1																																																																															
1																																																																															
		2																																																																													
		2																																																																													
3		2																																																																													
2	1																																																																														
1		2																																																																													
Post - 0 Miss - 0 Block - 0	Post - 2 Miss - 0 Block - 0	Post - 0 Miss - 0 Block - 0	Post - 0 Miss - 1 Block - 0	Post - 0 Miss - 2 Block - 2	Post - 1 Miss - 0 Block - 0	Post - 0 Miss - 2 Block - 0	Post - 0 Miss - 4 Block - 0																																																																								

<table border="1"><tr><td></td><td></td><td></td></tr><tr><td></td><td></td><td></td></tr><tr><td></td><td></td><td></td></tr></table>										<table border="1"><tr><td></td><td></td><td></td></tr><tr><td></td><td></td><td></td></tr><tr><td></td><td></td><td></td></tr></table>										<table border="1"><tr><td></td><td></td><td></td></tr><tr><td></td><td></td><td></td></tr><tr><td></td><td></td><td></td></tr></table>										<table border="1"><tr><td></td><td></td><td></td></tr><tr><td></td><td></td><td></td></tr><tr><td></td><td></td><td></td></tr></table>										<table border="1"><tr><td></td><td></td><td></td></tr><tr><td></td><td></td><td></td></tr><tr><td></td><td></td><td></td></tr></table>										<table border="1"><tr><td></td><td></td><td></td></tr><tr><td></td><td></td><td></td></tr><tr><td></td><td></td><td></td></tr></table>										<table border="1"><tr><td></td><td></td><td></td></tr><tr><td></td><td></td><td></td></tr><tr><td></td><td></td><td></td></tr></table>										<table border="1"><tr><td></td><td></td><td></td></tr><tr><td></td><td></td><td></td></tr><tr><td></td><td></td><td></td></tr></table>									

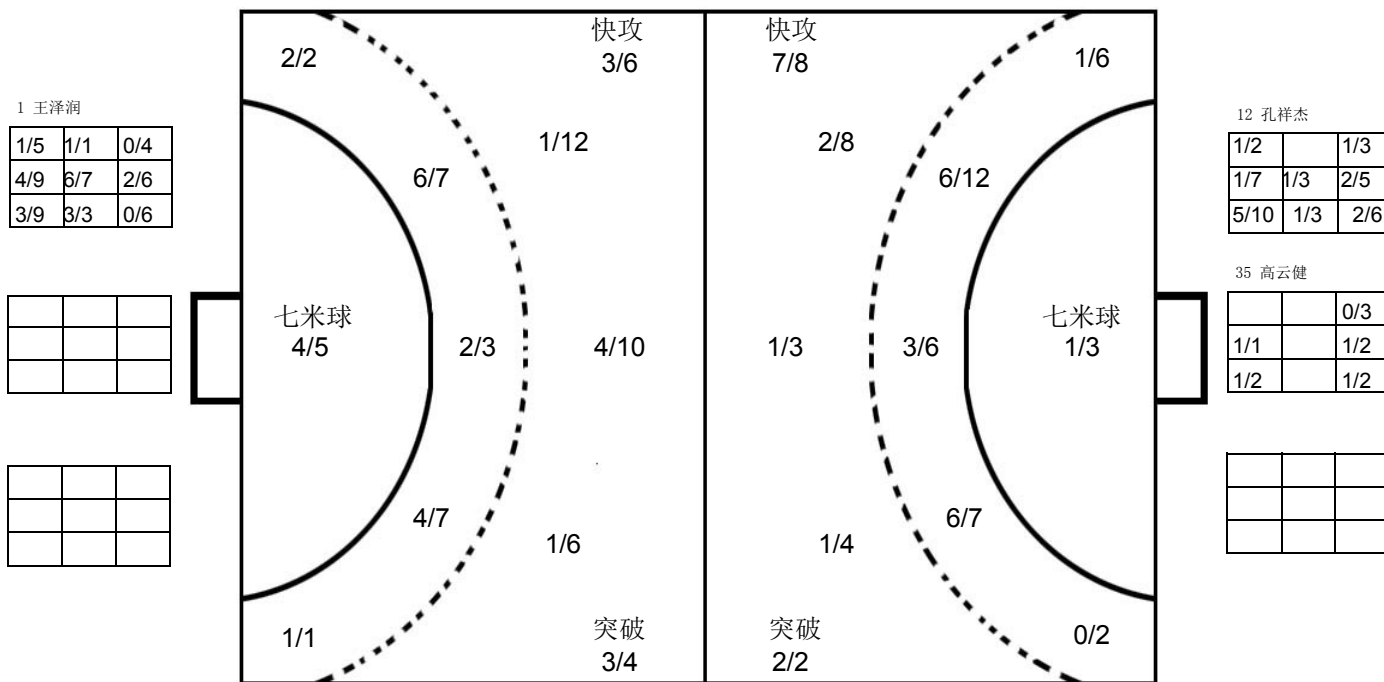

## 北京

3 吴锐樊	6 赵一涵	7 卞友山	8 赵文宣	10 李明远	12 孔祥杰	17 袁振典	18 温新宇																																																																								
<table border="1"><tr><td>1</td><td></td><td>1</td></tr><tr><td>1</td><td></td><td></td></tr><tr><td></td><td></td><td></td></tr></table>	1		1	1						<table border="1"><tr><td></td><td></td><td>1</td></tr><tr><td>1</td><td></td><td></td></tr><tr><td>2</td><td></td><td></td></tr></table>			1	1			2			<table border="1"><tr><td></td><td></td><td>1</td></tr><tr><td></td><td>1</td><td></td></tr><tr><td>1</td><td></td><td>2</td></tr></table>			1		1		1		2	<table border="1"><tr><td>1</td><td></td><td></td></tr><tr><td>1</td><td></td><td>1</td></tr><tr><td></td><td></td><td>1</td></tr></table>	1			1		1			1	<table border="1"><tr><td></td><td></td><td></td></tr><tr><td></td><td></td><td></td></tr><tr><td>1</td><td></td><td></td></tr></table>							1			<table border="1"><tr><td></td><td></td><td></td></tr><tr><td></td><td></td><td></td></tr><tr><td></td><td></td><td></td></tr></table>										<table border="1"><tr><td></td><td></td><td></td></tr><tr><td></td><td></td><td></td></tr><tr><td></td><td></td><td></td></tr></table>										<table border="1"><tr><td></td><td></td><td></td></tr><tr><td></td><td></td><td></td></tr><tr><td></td><td></td><td></td></tr></table>									
1		1																																																																													
1																																																																															
		1																																																																													
1																																																																															
2																																																																															
		1																																																																													
	1																																																																														
1		2																																																																													
1																																																																															
1		1																																																																													
		1																																																																													
1																																																																															
20 王鹏皓	23 陈旭	25 程海津	26 杨政	29 逯明松	35 高云健	78 王哲一																																																																									
<table border="1"><tr><td></td><td></td><td></td></tr><tr><td></td><td></td><td>1</td></tr><tr><td>1</td><td></td><td></td></tr></table>						1	1			<table border="1"><tr><td></td><td></td><td></td></tr><tr><td></td><td></td><td></td></tr><tr><td></td><td></td><td></td></tr></table>										<table border="1"><tr><td></td><td></td><td></td></tr><tr><td></td><td></td><td></td></tr><tr><td></td><td></td><td></td></tr></table>										<table border="1"><tr><td></td><td></td><td></td></tr><tr><td></td><td></td><td></td></tr><tr><td></td><td></td><td></td></tr></table>										<table border="1"><tr><td>2</td><td></td><td>1</td></tr><tr><td>2</td><td></td><td>2</td></tr><tr><td>1</td><td></td><td>1</td></tr></table>	2		1	2		2	1		1	<table border="1"><tr><td></td><td></td><td></td></tr><tr><td></td><td></td><td></td></tr><tr><td></td><td></td><td></td></tr></table>										<table border="1"><tr><td></td><td></td><td></td></tr><tr><td></td><td></td><td></td></tr><tr><td></td><td></td><td>2</td></tr></table>									2	<table border="1"><tr><td></td><td></td><td></td></tr><tr><td></td><td></td><td></td></tr><tr><td></td><td></td><td></td></tr></table>									
		1																																																																													
1																																																																															
2		1																																																																													
2		2																																																																													
1		1																																																																													
		2																																																																													
Post - 1 Miss - 0 Block - 0	Post - 0 Miss - 0 Block - 1	Post - 0 Miss - 1 Block - 0	Post - 0 Miss - 1 Block - 1	Post - 0 Miss - 0 Block - 0	Post - 0 Miss - 0 Block - 0	Post - 0 Miss - 0 Block - 0	Post - 0 Miss - 0 Block - 0																																																																								
Post - 1 Miss - 2 Block - 0	Post - 0 Miss - 0 Block - 0	Post - 0 Miss - 0 Block - 0	Post - 0 Miss - 0 Block - 0	Post - 1 Miss - 1 Block - 0	Post - 0 Miss - 0 Block - 0	Post - 0 Miss - 1 Block - 0																																																																									

注释: Post=击柱 Miss=射失 Block=被封





3-4名

男子 全国杯赛

“绿叶集团”杯2016年全国男子手球超级杯赛

Team A A 安徽				Team B B 上海				Match Number <b>17</b>													
played in China		in the hall 苏州市体育中心		on 26/11/2016		at 13:00 hours		Spectators													
Half-time (30')	A 17	B 14	End of playing time	A 33	B 27	1st extra time	A	B	2nd extra time	A	B	After penalty throws	A	B							
Number of 7 m	A 2/3	Team time-out 1 08:07 2 42:33 3			Full name of players and officials				Team time-out 1 11:55 2 24:22 3			B 2/2	Number of 7 m								
No.	Team A					G	W	2'	D	DR	No.	Team B					G	W	2'	D	DR
1	郭世伟					1					1	张峥									
3	陈强龙						1				2	张文斌									
5	史小帆					1					3	赵时俊									
7	姚雄敏										4	徐俊吉					6				
8	董智景					6		1			7	吴双									
9	陈开勇					8	1				8	钱为玮					3		2		
10	严龙										10	董凯									
11	黎涛					4					11	蒋承骅					2	1	1		
12	曾献辰										14	沈吉磊					10	1	2		
13	何磊										15	蒋嘉敏									
17	王巨柱					10					16	朱春雷									
18	李双					3	1				17	高天伦					2				
21	李明										18	马麟晓					1	1	2		
23	于敏清							1			19	蒋慧捷					3				
24	徐安格										22	张润明									
35	金永峰																				
A	韦中平										A	吴璟 (主教练)					1				
B	沈强 (主教练)										B	张勇军									
C	吴翔										C	金迪琦									
D	陈玉翔										D	杨时									
A	Signature of Responsible Official of the Teams (Off. A)																			B	
TP	Remarks of Referee / CHA Official																			TP	

Signatures

Referees	刘书勇 (CHN)	张栋 (CHN)		
Techn. Delegates	李长海 (CHN)	李之文 (CHN)		
CHA Official				

Note: Number of 7m Throws Awarded to Team A and B, Goals (G), Warnings (W), Suspensions (2'), Direct Disqualification (D), Disqualification with Report (DR) and Team Penalty (TP).

Table Officials: 许栋梁 宣海波 Statisticians: 王羚 王玮



## “绿叶集团”杯2016年全国男子手球超级杯赛 竞赛技术统计(媒体表)

3-4名	组别	X	轮次	6	场次	17
苏州市体育中心			26/11/2016		201608017-51-1/1	
安徽	安徽	33	vs	27	上海	上海
17 : 14						

裁判员	刘书勇 (CHN)	/	张栋 (CHN)
-----	-----------	---	----------

安徽														比赛进程		上海		
主教练：沈强																		
	远射	近射	边射	快攻	突破	任意球	7m球	合计	%	助攻	失误	警告	2'	D & DR				
1 郭世伟				1/1				1/1	100									
3 陈强龙												1						
5 史小帆	1/3	0/1						1/4	25.0		3							
7 姚雄敏																		
8 董智景	3/3	0/1		1/1	1/1		1/1	6/7	85.7				1					
9 陈开勇		4/6		4/6				8/12	66.7		1	1						
10 严龙																		
11 黎涛			1/3	2/2			1/2	4/7	57.1	1	2							
12 曾献辰																		
13 何磊																		
17 王巨柱	7/12	0/1	1/1		2/2			10/16	62.5	4								
18 李双	0/1	2/4	1/1					3/6	50.0	3	2	1						
21 李明										2	1							
23 于敏清														1				
24 徐安格																		
35 金永峰																		
<b>运动员 合计</b>	<b>11/19</b>	<b>6/13</b>	<b>3/5</b>	<b>8/10</b>	<b>3/3</b>		<b>2/3</b>	<b>33/53</b>	<b>62.3</b>	<b>10</b>	<b>9</b>	<b>3</b>	<b>2</b>					
12 曾献辰							0/2	0/2	0.0									
21 李明	3/4	2/8	5/11	1/3	1/11			12/37	32.4	2	1							
<b>守门员 合计</b>	<b>3/4</b>	<b>2/8</b>	<b>5/11</b>	<b>1/3</b>	<b>1/11</b>		<b>0/2</b>	<b>12/39</b>	<b>30.8</b>	<b>2</b>	<b>1</b>							
上海																		
教练：吴璟																		
	远射	近射	边射	快攻	突破	任意球	7m球	合计	%	助攻	失误	警告	2'	D & DR				
1 张峥										1								
2 张文斌																		
3 赵时俊																		
4 徐俊吉		4/6		2/2				6/8	75.0		3							
7 吴双																		
8 钱为玮			2/4		1/1			3/5	60.0	1	3		2					
10 董凯																		
11 蒋承骅	0/1	1/1			1/1		2/3	66.7	66.7	2	3	1	1					
14 沈吉磊	0/3				8/9		2/2	10/14	71.4		4	1	2					
15 蒋嘉敏																		
16 朱春雷																		
17 高天伦			2/5				2/5	40.0	40.0		1							
18 马麟晓	1/5			0/1			1/6	16.7	16.7	6	1	1	2					
19 蒋慧捷		1/1	2/3				3/4	75.0	75.0		2							
22 张润明																		
<b>运动员 合计</b>	<b>1/9</b>	<b>6/8</b>	<b>6/12</b>	<b>2/3</b>	<b>10/11</b>		<b>2/2</b>	<b>27/45</b>	<b>60.0</b>	<b>10</b>	<b>17</b>	<b>3</b>	<b>7</b>					
1 张峥	4/15	7/13	1/4	2/10	0/3		1/3	15/48	31.3	1								
<b>守门员 合计</b>	<b>4/15</b>	<b>7/13</b>	<b>1/4</b>	<b>2/10</b>	<b>0/3</b>		<b>1/3</b>	<b>15/48</b>	<b>31.3</b>	<b>1</b>								

场上队员：得分 / 射门

守门员：救球 / 射门

快攻	Fast Break		突破	Breakthrough		任意球	Free Throw		7M球	7M Throw		助攻	Assist
警告	Warning		失误	Error		2'	Suspension		D	取消资格		DR	取消资格+报告





# “绿叶集团”杯2016年全国男子手球超级杯赛 图式比赛技术统计表

轮次 6

场次 17

201608017-21-1/1

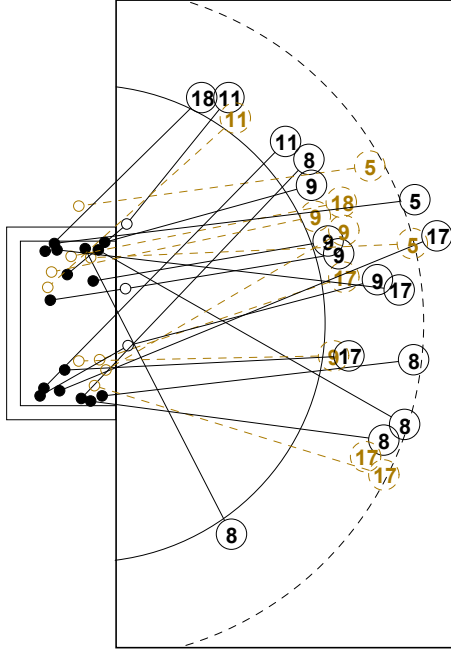

7M 安徽

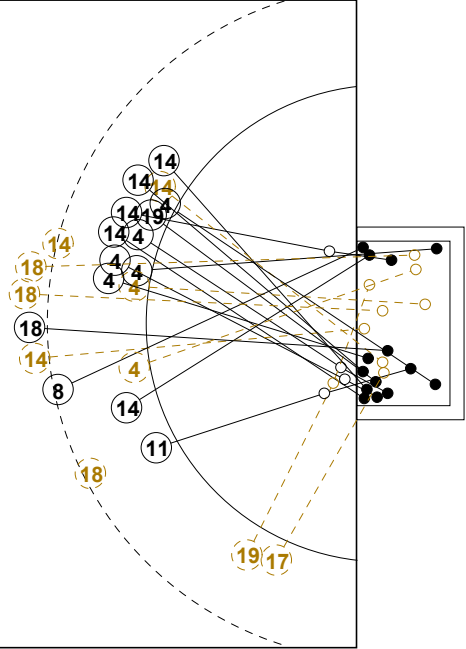
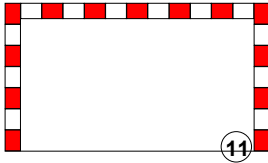

上海 7M

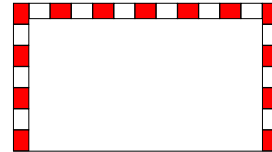

1st Half  
17 : 14

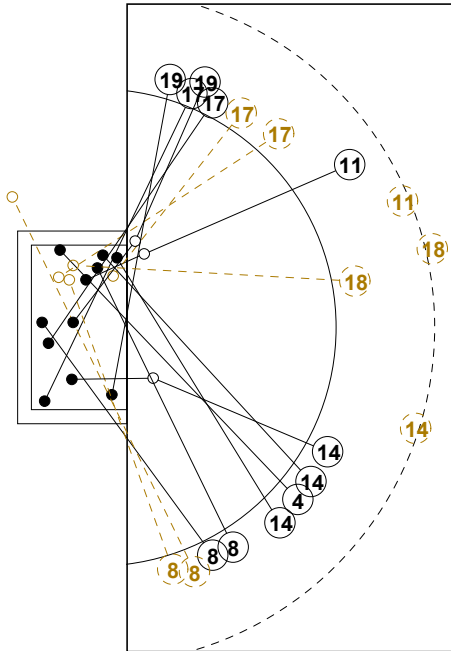

7M 上海

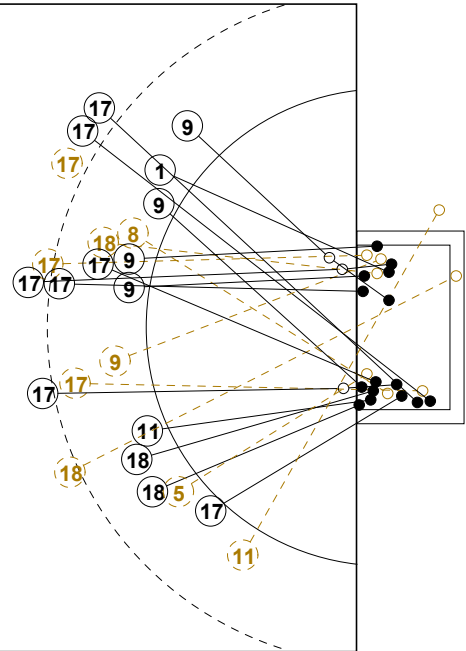
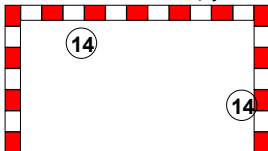

安徽 7M

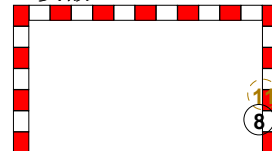

2nd Half  
27 : 33



## “绿叶集团”杯2016年全国男子手球超级杯赛

## 个人/全队技术统计表

正式表  
手球  
男子3-4名  
轮次 6组别 X  
场次 17201608017-14-1/2  
苏州市体育中心  
26/11/2016 13:00

号码	姓名	远射	近射	边射	快攻	突破	任意	7M	合计	%	助攻	失误	警告	2'	取消	时间
<b>安徽(安徽)</b>																
<i>(场上队员)</i>																
1	郭世伟				1/1				1/1	100%						00:06:08
3	陈强龙									0.0%			1			00:31:13
5	史小帆	1/3	0/1						1/4	25.0%		3				00:44:59
7	姚雄敏									0.0%						00:00:00
8	董智景	3/3	0/1		1/1	1/1		1/1	6/7	85.7%				1		00:53:52
9	陈开勇		4/6		4/6				8/12	66.7%		1	1			00:54:07
10	严龙									0.0%						00:00:00
11	黎涛			1/3	2/2			1/2	4/7	57.1%	1	2				01:00:00
12	曾献辰									0.0%						00:00:45
13	何磊									0.0%						00:00:00
17	王巨柱	7/12	0/1	1/1		2/2			10/16	62.5%	4					00:44:00
18	李双	0/1	2/4	1/1					3/6	50.0%	3	2	1			00:58:40
21	李明									0.0%	2	1				00:59:15
23	于敏清									0.0%				1		00:07:09
24	徐安格									0.0%						00:00:00
35	金永峰									0.0%						00:00:00
<b>合计</b>		11/19	6/13	3/5	8/10	3/3		2/3	33/53	62.3%	10	9	3	2		
<i>(守门员)</i>																
12	曾献辰							0/2	0/2	0.0%						00:00:45
21	李明	3/4	2/8	5/11	1/3	1/11			12/37	32.4%	2	1				00:59:15
<b>合计</b>		3/4	2/8	5/11	1/3	1/11		0/2	12/39	30.8%	2	1				

场上队员：得分/射门

守门员：救球/射门

全队合计	得分	被救	射失	击柱	封球	合计	%
远射	11	4	1	1	2	19	57.9%
近射	6	7				13	46.2%
边射	3	1	1			5	60.0%
快攻	8	2				10	80.0%
突破	3					3	100.0%
任意							0.0%
7M	2	1				3	66.7%





## “绿叶集团”杯2016年全国男子手球超级杯赛

## 个人/全队技术统计表

正式表  
手球  
男子3-4名  
轮次 6组别 X  
场次 17201608017-14-2/2  
苏州市体育中心  
26/11/2016 13:00

号码	姓名	远射	近射	边射	快攻	突破	任意	7M	合计	%	助攻	失误	警告	2'	取消	时间
<b>上海(上海)</b>																
<i>(上场队员)</i>																
1	张崢									0.0%	1					01:00:00
2	张文斌									0.0%						00:00:00
3	赵时俊									0.0%						00:00:00
4	徐俊吉		4/6		2/2				6/8	75.0%		3				01:00:00
7	吴双									0.0%						00:00:00
8	钱为玮			2/4		1/1			3/5	60.0%	1	3		2		01:00:00
10	董凯									0.0%						00:00:00
11	蒋承骅	0/1	1/1			1/1			2/3	66.7%	2	3	1	1		01:00:00
14	沈吉磊	0/3				8/9		2/2	10/14	71.4%		4	1	2		00:55:17
15	蒋嘉敏									0.0%						00:00:00
16	朱春雷									0.0%						00:00:00
17	高天伦			2/5					2/5	40.0%		1				00:18:40
18	马麟晓	1/5			0/1				1/6	16.7%	6	1	1	2		01:00:00
19	蒋慧捷		1/1	2/3					3/4	75.0%		2				00:45:57
22	张润明									0.0%						00:00:00
<b>合计</b>		1/9	6/8	6/12	2/3	10/11		2/2	27/45	60.0%	10	17	3	7		
<i>(守门员)</i>																
1	张崢	4/15	7/13	1/4	2/10	0/3		1/3	15/48	31.3%	1					01:00:00
<b>合计</b>		4/15	7/13	1/4	2/10	0/3		1/3	15/48	31.3%	1					

场上队员：得分/射门

守门员：救球/射门

全队合计	得分	被救	射失	击柱	封球	合计	%
远射	1	3			5	9	11.1%
近射	6	2				8	75.0%
边射	6	5	1			12	50.0%
快攻	2	1				3	66.7%
突破	10	1				11	90.9%
任意							0.0%
7M	2					2	100.0%





### “绿叶集团”杯2016年全国男子手球超级杯赛

图式射门区域统计

轮次 6 场次 17

201608017-41-1/1

#### 安徽

1 郭世伟	3 陈强龙	5 史小帆	7 姚雄敏	8 董智景	9 陈开勇	10 严龙	11 黎涛																																																																								
<table border="1"><tr><td>1</td><td></td><td></td></tr><tr><td></td><td></td><td></td></tr><tr><td></td><td></td><td></td></tr></table>	1									<table border="1"><tr><td></td><td></td><td></td></tr><tr><td></td><td></td><td></td></tr><tr><td></td><td></td><td></td></tr></table>										<table border="1"><tr><td></td><td></td><td>1</td></tr><tr><td></td><td></td><td></td></tr><tr><td></td><td></td><td></td></tr></table>			1							<table border="1"><tr><td></td><td></td><td></td></tr><tr><td></td><td></td><td></td></tr><tr><td></td><td></td><td></td></tr></table>										<table border="1"><tr><td>1</td><td></td><td></td></tr><tr><td>2</td><td></td><td>3</td></tr><tr><td></td><td></td><td></td></tr></table>	1			2		3				<table border="1"><tr><td>1</td><td>1</td><td></td></tr><tr><td></td><td>1</td><td></td></tr><tr><td>2</td><td></td><td>3</td></tr></table>	1	1			1		2		3	<table border="1"><tr><td></td><td></td><td></td></tr><tr><td></td><td></td><td></td></tr><tr><td></td><td></td><td></td></tr></table>										<table border="1"><tr><td></td><td></td><td>1</td></tr><tr><td></td><td></td><td></td></tr><tr><td></td><td></td><td>1</td></tr></table>			1						1
1																																																																															
		1																																																																													
1																																																																															
2		3																																																																													
1	1																																																																														
	1																																																																														
2		3																																																																													
		1																																																																													
		1																																																																													
Post - 0 Miss - 0 Block - 0	Post - 0 Miss - 0 Block - 0	Post - 0 Miss - 1 Block - 0	Post - 0 Miss - 0 Block - 0	Post - 0 Miss - 0 Block - 0	Post - 0 Miss - 0 Block - 0	Post - 0 Miss - 0 Block - 0	Post - 0 Miss - 1 Block - 0																																																																								
12 曾献辰	13 何磊	17 王巨柱	18 李双	21 李明	23 于敏清	24 徐安格	35 金永峰																																																																								
<table border="1"><tr><td></td><td></td><td></td></tr><tr><td></td><td></td><td></td></tr><tr><td></td><td></td><td></td></tr></table>										<table border="1"><tr><td></td><td></td><td></td></tr><tr><td></td><td></td><td></td></tr><tr><td></td><td></td><td></td></tr></table>										<table border="1"><tr><td></td><td></td><td>1</td></tr><tr><td>3</td><td></td><td>4</td></tr><tr><td>1</td><td></td><td>1</td></tr></table>			1	3		4	1		1	<table border="1"><tr><td></td><td></td><td>1</td></tr><tr><td></td><td></td><td></td></tr><tr><td></td><td></td><td>2</td></tr></table>			1						2	<table border="1"><tr><td></td><td></td><td></td></tr><tr><td></td><td></td><td></td></tr><tr><td></td><td></td><td></td></tr></table>										<table border="1"><tr><td></td><td></td><td></td></tr><tr><td></td><td></td><td></td></tr><tr><td></td><td></td><td></td></tr></table>										<table border="1"><tr><td></td><td></td><td></td></tr><tr><td></td><td></td><td></td></tr><tr><td></td><td></td><td></td></tr></table>										<table border="1"><tr><td></td><td></td><td></td></tr><tr><td></td><td></td><td></td></tr><tr><td></td><td></td><td></td></tr></table>									
		1																																																																													
3		4																																																																													
1		1																																																																													
		1																																																																													
		2																																																																													
Post - 0 Miss - 0 Block - 0	Post - 0 Miss - 0 Block - 0	Post - 0 Miss - 0 Block - 2	Post - 1 Miss - 0 Block - 0	Post - 0 Miss - 0 Block - 0	Post - 0 Miss - 0 Block - 0	Post - 0 Miss - 0 Block - 0	Post - 0 Miss - 0 Block - 0																																																																								

12 曾献辰

0/1		
		0/1

21 李明

0/2	1/3	1/3
2/4	0/2	2/5
1/4	2/2	3/12

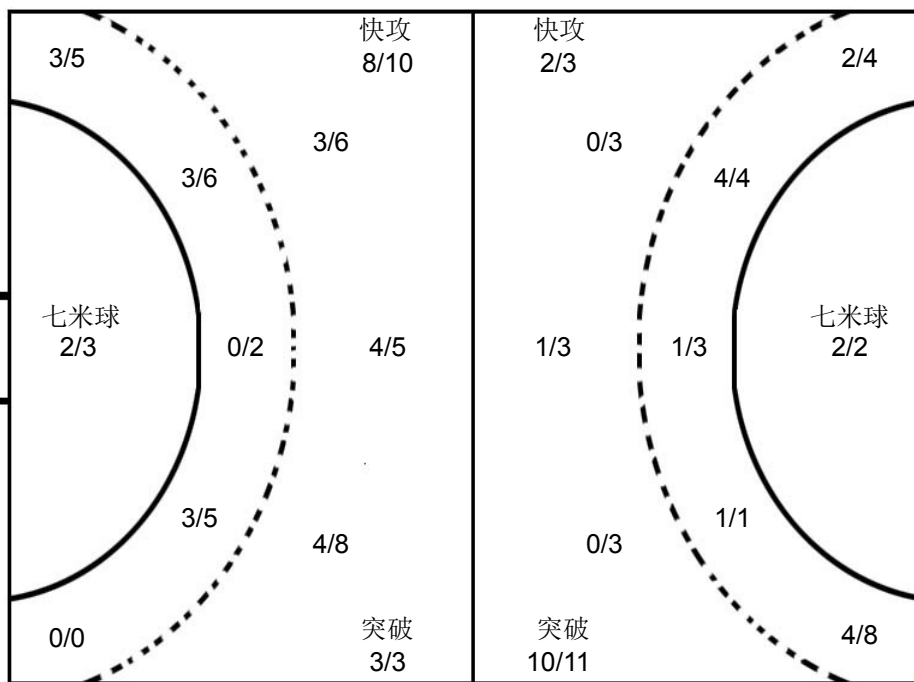
1 张崢

0/2	0/1	3/5
1/6	0/1	3/9
6/11		2/13



#### 上海

1 张崢	2 张文斌	3 赵时俊	4 徐俊吉	7 吴双	8 钱为玮	10 董凯	11 蒋承骅																																																																								
<table border="1"><tr><td></td><td></td><td></td></tr><tr><td></td><td></td><td></td></tr><tr><td></td><td></td><td></td></tr></table>										<table border="1"><tr><td></td><td></td><td></td></tr><tr><td></td><td></td><td></td></tr><tr><td></td><td></td><td></td></tr></table>										<table border="1"><tr><td></td><td></td><td></td></tr><tr><td></td><td></td><td></td></tr><tr><td></td><td></td><td></td></tr></table>										<table border="1"><tr><td>1</td><td></td><td>2</td></tr><tr><td></td><td></td><td>1</td></tr><tr><td></td><td></td><td>2</td></tr></table>	1		2			1			2	<table border="1"><tr><td></td><td></td><td></td></tr><tr><td></td><td></td><td></td></tr><tr><td></td><td></td><td></td></tr></table>										<table border="1"><tr><td></td><td>1</td><td></td></tr><tr><td>1</td><td></td><td>1</td></tr><tr><td></td><td></td><td></td></tr></table>		1		1		1				<table border="1"><tr><td></td><td></td><td></td></tr><tr><td></td><td></td><td></td></tr><tr><td></td><td></td><td></td></tr></table>										<table border="1"><tr><td></td><td></td><td>2</td></tr><tr><td></td><td></td><td></td></tr><tr><td></td><td></td><td></td></tr></table>			2						
1		2																																																																													
		1																																																																													
		2																																																																													
	1																																																																														
1		1																																																																													
		2																																																																													
Post - 0 Miss - 0 Block - 0	Post - 0 Miss - 0 Block - 0	Post - 0 Miss - 0 Block - 0	Post - 0 Miss - 0 Block - 0	Post - 0 Miss - 0 Block - 0	Post - 0 Miss - 1 Block - 0	Post - 0 Miss - 0 Block - 0	Post - 0 Miss - 0 Block - 1																																																																								
14 沈吉磊	15 蒋嘉敏	16 朱春雷	17 高天伦	18 马麟晓	19 蒋慧捷	22 张润明																																																																									
<table border="1"><tr><td>1</td><td></td><td></td></tr><tr><td>2</td><td></td><td>1</td></tr><tr><td>1</td><td></td><td>5</td></tr></table>	1			2		1	1		5	<table border="1"><tr><td></td><td></td><td></td></tr><tr><td></td><td></td><td></td></tr><tr><td></td><td></td><td></td></tr></table>										<table border="1"><tr><td></td><td></td><td></td></tr><tr><td></td><td></td><td></td></tr><tr><td></td><td></td><td></td></tr></table>										<table border="1"><tr><td>1</td><td>1</td><td></td></tr><tr><td></td><td></td><td></td></tr><tr><td></td><td></td><td></td></tr></table>	1	1								<table border="1"><tr><td></td><td></td><td></td></tr><tr><td></td><td>1</td><td></td></tr><tr><td></td><td></td><td></td></tr></table>					1					<table border="1"><tr><td></td><td></td><td></td></tr><tr><td></td><td>1</td><td></td></tr><tr><td>1</td><td></td><td>1</td></tr></table>					1		1		1	<table border="1"><tr><td></td><td></td><td></td></tr><tr><td></td><td></td><td></td></tr><tr><td></td><td></td><td></td></tr></table>										<table border="1"><tr><td></td><td></td><td></td></tr><tr><td></td><td></td><td></td></tr><tr><td></td><td></td><td></td></tr></table>									
1																																																																															
2		1																																																																													
1		5																																																																													
1	1																																																																														
	1																																																																														
	1																																																																														
1		1																																																																													
Post - 0 Miss - 0 Block - 2	Post - 0 Miss - 0 Block - 0	Post - 0 Miss - 0 Block - 0	Post - 0 Miss - 0 Block - 0	Post - 0 Miss - 0 Block - 2	Post - 0 Miss - 0 Block - 0	Post - 0 Miss - 0 Block - 0																																																																									

注释: Post=击柱 Miss=射失 Block=被封





## “绿叶集团”杯2016年全国男子手球超级杯赛

## 比赛进程表

正式表  
手球  
男子3-4名  
轮次 6组别 X  
场次 17201608017-13-1/6  
苏州市体育中心  
26/11/2016 13:00

时间	队员	动作	比分	队员	动作
<b>安徽</b>			<b>上半时</b>		
<b>上海</b>					
00:33	21 李明	被射入	0 - 1	14 沈吉磊	突破 得分
00:37	3 陈强龙	警告			
01:11	8 董智景	中远射 得分	1 - 1	1 张崢	被射入
01:57	21 李明	被射入	1 - 2	4 徐俊吉	近射 得分
02:22	8 董智景	左远射 得分	2 - 2	1 张崢	被射入
03:02	8 董智景	断球		8 钱为玮	传球失误
03:07	8 董智景	一传快攻 得分	3 - 2	1 张崢	被射入
03:19	21 李明	被射入	3 - 3	14 沈吉磊	突破 得分
03:27		裁判暂停			
03:27	23 于敏清	罚出场2分钟			
04:24	11 黎涛	侵区			
04:56	21 李明	被射入	3 - 4	14 沈吉磊	突破 得分
05:36	5 史小帆	右远射 射失			
05:48	21 李明	挡住球		19 蒋慧捷	右边射 被救
06:19				14 沈吉磊	警告
06:49	17 王巨柱	左远射 被救		1 张崢	挡住球
07:01	21 李明	被射入	3 - 5	4 徐俊吉	近射 得分
07:03				18 马麟晓	助攻
07:32				11 蒋承骅	警告
08:05	17 王巨柱	近射 被救		1 张崢	挡住球
08:07		裁判暂停			
08:06	21 李明	被射入	3 - 6	4 徐俊吉	一传快攻 得分
08:06				18 马麟晓	助攻
08:07		球队暂停			
08:26	11 黎涛	传球失误		8 钱为玮	断球
09:11	21 李明	被射入	3 - 7	14 沈吉磊	突破 得分
09:22	18 李双	近射 被救		1 张崢	挡住球
09:55	21 李明	挡住球		14 沈吉磊	突破 被救
10:00	9 陈开勇	造7M		18 马麟晓	使被罚7M球
10:30	11 黎涛	7M球 得分	4 - 7	1 张崢	被射入
11:13	3 陈强龙	断球		11 蒋承骅	传球失误
11:22	11 黎涛	短传快攻 得分	5 - 7	1 张崢	被射入
11:43	21 李明	挡住球		14 沈吉磊	中远射 被救
11:48	9 陈开勇	近射 得分	6 - 7	1 张崢	被射入
11:53	21 李明	助攻			
11:55					球队暂停
12:23	21 李明	被射入	6 - 8	19 蒋慧捷	近射 得分
12:25				18 马麟晓	助攻
12:45	11 黎涛	右边射 得分	7 - 8	1 张崢	被射入
13:37	21 李明	被射入	7 - 9	11 蒋承骅	突破 得分





## “绿叶集团”杯2016年全国男子手球超级杯赛

## 比赛进程表

正式表  
手球  
男子3-4名  
轮次 6组别 X  
场次 17201608017-13-2/6  
苏州市体育中心  
26/11/2016 13:00

时间	队员	动作	比分	队员	动作
<b>安徽</b>			<b>上半时</b>		
<b>上海</b>					
13:48	8 董智景	突破 得分	8 - 9	1 张崢	被射入
14:30	21 李明	被射入	8 - 10	14 沈吉磊	突破 得分
14:33	9 陈开勇	警告			
15:03		裁判暂停			
15:03				8 钱为玮	罚出场2分钟
15:20	8 董智景	左远射 得分	9 - 10	1 张崢	被射入
15:57	18 李双	警告			
16:16				18 马麟晓	四步
16:23	9 陈开勇	一传快攻 得分	10 - 10	1 张崢	被射入
16:25	18 李双	助攻			
17:01	21 李明	挡住球		4 徐俊吉	近射 被救
17:02				11 蒋承骅	助攻
17:10	18 李双	右边射 得分	11 - 10	1 张崢	被射入
17:51	18 李双	断球		14 沈吉磊	传球失误
17:58	9 陈开勇	近射 被救		1 张崢	挡住球
18:00	18 李双	助攻			
18:09	21 李明	被射入	11 - 11	4 徐俊吉	短传快攻 得分
18:42	5 史小帆	传球失误			
18:59	21 李明	被射入	11 - 12	4 徐俊吉	近射 得分
19:02				8 钱为玮	助攻
19:31	5 史小帆	右远射 得分	12 - 12	1 张崢	被射入
20:12	21 李明	被射入	12 - 13	18 马麟晓	中远射 得分
20:25	5 史小帆	进攻犯规		14 沈吉磊	造犯规
20:47				14 沈吉磊	侵区
21:01	9 陈开勇	近射 被救		1 张崢	挡住球
21:03	17 王巨柱	助攻			
21:26	17 王巨柱	左远射 被封		18 马麟晓	封球
21:55	17 王巨柱	右远射 得分	13 - 13	1 张崢	被射入
22:06		裁判暂停			
22:31	21 李明	挡住球		18 马麟晓	左远射 被救
22:38	5 史小帆	右远射 被救		1 张崢	挡住球
23:08	9 陈开勇	封球		14 沈吉磊	左远射 被封
23:15	9 陈开勇	一传快攻 得分	14 - 13	1 张崢	被射入
23:20	21 李明	助攻			
23:43	8 董智景	封球		18 马麟晓	右远射 被封
23:48	5 史小帆	造犯规		19 蒋慧捷	进攻犯规
23:54		裁判暂停			
23:54				11 蒋承骅	罚出场2分钟
24:03		裁判暂停			
24:03	17 王巨柱	突破 得分	15 - 13	1 张崢	被射入





## “绿叶集团”杯2016年全国男子手球超级杯赛

## 比赛进程表

正式表  
手球  
男子3-4名  
轮次 6组别 X  
场次 17201608017-13-3/6  
苏州市体育中心  
26/11/2016 13:00

时间	队员	动作	比分	队员	动作			
<b>安徽</b>			<b>上半时</b>			<b>上海</b>		
24:22					球队暂停			
24:55	21 李明	被射入	<b>15 - 14</b>	8 钱为玮	突破 得分			
25:12	11 黎涛	右边射 被救		1 张崢	挡住球			
26:17	9 陈开勇	断球		19 蒋慧捷	传球失误			
26:21	9 陈开勇	一传快攻 被救		1 张崢	挡住球			
27:53	21 李明	挡住球		17 高天伦	右边射 被救			
28:02	21 李明	挡住球		18 马麟晓	中远射 被救			
28:06	9 陈开勇	断球		11 蒋承骅	传球失误			
28:10	9 陈开勇	一传快攻 得分	<b>16 - 14</b>	1 张崢	被射入			
28:28				4 徐俊吉	接球失误			
29:07	17 王巨柱	中远射 得分	<b>17 - 14</b>	1 张崢	被射入			
29:59	21 李明	挡住球		4 徐俊吉	近射 被救			
30:00				18 马麟晓	助攻			
00:00				18 马麟晓	警告			
00:00				18 马麟晓	罚出场2分钟			



## “绿叶集团”杯2016年全国男子手球超级杯赛

## 比赛进程表

正式表  
手球  
男子3-4名  
轮次 6组别 X  
场次 17201608017-13-4/6  
苏州市体育中心  
26/11/2016 13:00

时间	队员	动作	比分	队员	动作
<b>安徽</b>			<b>下 半 时</b>		
<b>上海</b>					
00:17	17 王巨柱	中远射 被救		1 张崢	挡住球
00:36	9 陈开勇	断球		11 蒋承骅	传球失误
00:36	11 黎涛	短传快攻 得分	18 - 14	1 张崢	被射入
01:02		裁判暂停			
01:11	21 李明	被射入	18 - 15	11 蒋承骅	近射 得分
02:04	17 王巨柱	左远射 被救		1 张崢	挡住球
02:22	18 李双	近射 得分	19 - 15	1 张崢	被射入
03:00	21 李明	被射入	19 - 16	8 钱为玮	左边射 得分
03:12	8 董智景	近射 被救		1 张崢	挡住球
03:33	8 董智景	断球		17 高天伦	传球失误
03:39	21 李明	挡住球		17 高天伦	右边射 被救
03:43	18 李双	近射 被救		1 张崢	挡住球
04:35		裁判暂停			
04:35	8 董智景	罚出场2分钟			
04:50	21 李明	被射入	19 - 17	17 高天伦	右边射 得分
05:34	17 王巨柱	左远射 得分	20 - 17	1 张崢	被射入
06:04	21 李明	被射入	20 - 18	17 高天伦	右边射 得分
06:04				18 马麟晓	助攻
06:28		裁判暂停			
06:28	5 史小帆	造7M		18 马麟晓	使被罚7M球
06:28				18 马麟晓	罚出场2分钟
06:34	11 黎涛	7M球 被救		1 张崢	挡住球
07:03	8 董智景	抢球		4 徐俊吉	接球失误
07:12		裁判暂停			
07:12				8 钱为玮	罚出场2分钟
07:29		裁判暂停			
07:29	5 史小帆	造7M		14 沈吉磊	使被罚7M球
07:29				14 沈吉磊	罚出场2分钟
07:29		裁判暂停			
07:39	8 董智景	7M球 得分	21 - 18	1 张崢	被射入
08:08	18 李双	四步			
08:54	9 陈开勇	一传快攻 被救		1 张崢	挡住球
09:03	11 黎涛	助攻			
09:04		裁判暂停			
09:19				1 吴璟	警告
09:53	11 黎涛	抢球		4 徐俊吉	接球失误
10:22	9 陈开勇	近射 得分	22 - 18	1 张崢	被射入
10:24	17 王巨柱	助攻			
10:50	21 李明	被射入	22 - 19	14 沈吉磊	突破 得分
11:19	18 李双	近射 得分	23 - 19	1 张崢	被射入



## “绿叶集团”杯2016年全国男子手球超级杯赛

## 比赛进程表

正式表  
手球  
男子3-4名  
轮次 6组别 X  
场次 17201608017-13-5/6  
苏州市体育中心  
26/11/2016 13:00

时间	队员	动作	比分	队员	动作
<b>安徽</b>			<b>下半时</b>		
<b>上海</b>					
11:55	3 陈强龙	造犯规		8 钱为玮	进攻犯规
12:33		球队暂停			
12:58	17 王巨柱	右远射 得分	<b>24 - 19</b>	1 张崢	被射入
13:45	18 李双	封球		18 马麟晓	右远射 被封
14:08	5 史小帆	近射 被救		1 张崢	挡住球
14:22	21 李明	挡住球		17 高天伦	右边射 被救
14:24				11 蒋承骅	助攻
14:28	9 陈开勇	一传快攻 得分	<b>25 - 19</b>	1 张崢	被射入
14:31	18 李双	助攻			
14:56	9 陈开勇	封球		11 蒋承骅	右远射 被封
15:34	21 李明	被射入	<b>25 - 20</b>	8 钱为玮	左边射 得分
16:03	17 王巨柱	左远射 被封		4 徐俊吉	封球
16:39	9 陈开勇	接球失误			
16:48	21 李明	被射入	<b>25 - 21</b>	4 徐俊吉	近射 得分
16:51				1 张崢	助攻
17:24	17 王巨柱	右边射 得分	<b>26 - 21</b>	1 张崢	被射入
17:54		裁判暂停			
17:54				14 沈吉磊	罚出场2分钟
18:23	17 王巨柱	左远射 得分	<b>27 - 21</b>	1 张崢	被射入
19:12	21 李明	被射入	<b>27 - 22</b>	19 蒋慧捷	右边射 得分
19:49	5 史小帆	传球失误		4 徐俊吉	断球
20:21				8 钱为玮	左边射 射失
20:57	11 黎涛	右边射 射失			
21:08	21 李明	被射入	<b>27 - 23</b>	14 沈吉磊	突破 得分
21:10		裁判暂停			
22:06	17 王巨柱	中远射 得分	<b>28 - 23</b>	1 张崢	被射入
22:17				14 沈吉磊	运球失误
22:22	9 陈开勇	近射 得分	<b>29 - 23</b>	1 张崢	被射入
22:23	17 王巨柱	助攻			
22:56	3 陈强龙	使被罚7M球		14 沈吉磊	造7M
23:17	12 曾献辰	被射入	<b>29 - 24</b>	14 沈吉磊	7M球 得分
23:30		裁判暂停			
24:10	9 陈开勇	近射 得分	<b>30 - 24</b>	1 张崢	被射入
24:18	17 王巨柱	助攻			
24:43	21 李明	挡住球		8 钱为玮	左边射 被救
24:49	21 李明	快攻 传球失误			
24:54	21 李明	挡住球		18 马麟晓	短传快攻 被救
25:00	1 郭世伟	短传快攻 得分	<b>31 - 24</b>	1 张崢	被射入
25:24	9 陈开勇	封球		14 沈吉磊	左远射 被封
25:44	21 李明	被射入	<b>31 - 25</b>	19 蒋慧捷	右边射 得分



## “绿叶集团”杯2016年全国男子手球超级杯赛

## 比赛进程表

正式表  
手球  
男子3-4名  
轮次 6组别 X  
场次 17201608017-13-6/6  
苏州市体育中心  
26/11/2016 13:00

时间	队员	动作	比分	队员	动作			
<b>安徽</b>			<b>下半时</b>			<b>上海</b>		
25:47				18 马麟晓	助攻			
26:04	18 李双	运球失误		4 徐俊吉	造失误			
26:11	3 陈强龙	使被罚7M球		8 钱为玮	快攻 造7M			
26:33	12 曾献辰	被射入	<b>31 - 26</b>	14 沈吉磊	7M球 得分			
27:25	18 李双	右远射 击柱						
27:36				8 钱为玮	传球失误			
27:57	17 王巨柱	突破 得分	<b>32 - 26</b>	1 张崢	被射入			
28:37		裁判暂停						
29:01	11 黎涛	断球		14 沈吉磊	传球失误			
29:26	17 王巨柱	中远射 得分	<b>33 - 26</b>	1 张崢	被射入			
29:59	21 李明	被射入	<b>33 - 27</b>	14 沈吉磊	突破 得分			



决赛  
男子 全国杯赛

“绿叶集团”杯2016年全国男子手球超级杯赛

Team A <b>A 江苏</b>				Team B <b>B 天津</b>				Match Number <b>18</b>													
played in China		in the hall 苏州市体育中心		on 26/11/2016		at 14:30 hours		Spectators													
Half-time (30')	<b>A</b> 15	<b>B</b> 11	End of playing time	<b>A</b> 29	<b>B</b> 20	1st extra time	<b>A</b>	<b>B</b>	2nd extra time	<b>A</b>	<b>B</b>	After penalty throws	<b>A</b>	<b>B</b>							
Number of 7 m	<b>A</b> 2/3	Team time-out			Full name of players and officials				Team time-out			<b>B</b> 1/2	Number of 7 m								
		1	2	3					1	2	3										
		24:13							13:10	36:45	40:26										
No.	Team <b>A</b>					G	W	2'	D	DR	No.	Team <b>B</b>					G	W	2'	D	DR
1	徐畅										1	刘宗其									
4	张家纬					10					2	李岳朋					1				
5	闫亮										4	李松浩									
6	赵晨					4					6	王子欣					2				
7	徐奕飞										7	张青					3	1			
8	周小坚					4					8	曹悦					9	1	1		
9	任超凡										9	吴明远									
10	郝可鑫					1					12	杨峻									
11	马益奎										13	许松					3				
12	王权										14	田剑侠								1	
13	耿畅										16	刘海亮									
15	李加昌										17	周群					1	1			
17	王伟强					5					21	潘玉帅									
18	赵楠					2		1			22	魏雨童					1				
21	刘江					3															
22	任启双																				
<b>B</b>	闫威名 (主教练)										<b>A</b>	贾守信									
<b>C</b>	贾淑君										<b>B</b>	杜瑞军 (主教练)									
<b>E</b>	王建国										<b>C</b>	孟凡钢									
<b>A</b>	Signature of Responsible Official of the Teams (Off. A)																			<b>B</b>	
TP	Remarks of Referee / CHA Official																			TP	

Signatures

Referees	王科 (CHN)	张耿 (CHN)		
Techn. Delegates	李长海 (CHN)	于中迅 (CHN)		
CHA Official				

Note: Number of 7m Throws Awarded to Team A and B, Goals (G), Warnings (W), Suspensions (2'), Direct Disqualification (D), Disqualification with Report (DR) and Team Penalty (TP).

Table Officials: 许栋梁 宣海波 Statisticians: 王玲 王玮

Printed by PHMS Copyright: IHF/CHA 26/11/2016 15:56:12

Longman Sportsoft  handball@126.com



## “绿叶集团”杯2016年全国男子手球超级杯赛 竞赛技术统计(媒体表)

<b>决赛</b>		组别	<b>X</b>	轮次	<b>6</b>	场次	<b>18</b>
苏州市体育中心			26/11/2016			201608018-51-1/1	
江苏		<b>江苏</b>	<b>29</b>	vs	<b>20</b>	天津	天津
				<b>15 : 11</b>			

裁判员	王科 (CHN)					/	张耿 (CHN)				
-----	----------	--	--	--	--	---	----------	--	--	--	--

江苏		远射	近射	边射	快攻	突破	任意球	7m球	合计	%	助攻	失误	警告	2'	D & DR	江苏		比赛进程	天津		
主教练： 闫威名																					
1	徐畅																	00:40	1	8	曹悦
4	张家纬	3/3	2/3		2/2	1/1	0/1	2/2	10/12	83.3	2	3						01:16	1		
5	闫亮				0/1				0/1	0.0								01:59	2	13	
6	赵晨	3/3	0/1		1/1		0/1		4/6	66.7	3	4						03:06	2		
7	徐奕飞																	05:14	3	6	
8	周小坚	0/1	2/3		2/3				4/7	57.1	1	2						06:15	3	3	
9	任超凡																	07:57	4	8	
10	郝可鑫				1/1	0/1		0/1	1/3	33.3	1	1						08:40	5	8	
11	马益奎																	09:16	6	5	
12	王权																	09:59	5	5	
13	耿畅																	11:49	5		
15	李加昌																	13:09	5		
17	王伟强		0/1	2/3	2/2	1/1		5/7	71.4									13:53	6	8	
18	赵楠		1/3	0/1	1/1				2/5	40.0	2	1		1				14:11	6		
21	刘江		0/1		2/2	1/1		3/4	75.0									14:29	6		
22	任启双																	15:49	7	13	
<b>运动员 合计</b>		<b>6/7</b>	<b>5/12</b>	<b>2/4</b>	<b>11/13</b>	<b>3/4</b>	<b>0/2</b>	<b>2/3</b>	<b>29/45</b>	<b>64.4</b>	<b>9</b>	<b>14</b>		<b>1</b>				16:14	7		
12	王权	6/14	4/7	1/4	2/5	0/2		1/2	14/34	41.2								17:16	7		
<b>守门员 合计</b>		<b>6/14</b>	<b>4/7</b>	<b>1/4</b>	<b>2/5</b>	<b>0/2</b>	<b>1/2</b>	<b>14/34</b>	<b>41.2</b>									17:18	7		
/																					
天津		远射	近射	边射	快攻	突破	任意球	7m球	合计	%	助攻	失误	警告	2'	D & DR	江苏		比赛进程	天津		
教练： 杜瑞军																					
1	刘宗其								1/7	14.3	3	6						00:21	11		
2	李岳朋	0/3	0/2	1/1	0/1													01:25	12	8	
4	李松浩			0/1					0/1	0.0								02:37	12		
6	王子欣		0/1		2/3				2/4	50.0		1						03:31	13	13	
7	张青	2/12	0/2			1/1			3/15	20.0	2	3	1					05:32	13		
8	曹悦	6/16	1/2			1/1		1/2	9/21	42.9		4	1	1				06:43	13		
9	吴明远																	07:55	14	22	
12	杨峻																	08:04	14		
13	许松	0/1		2/4	1/1				3/6	50.0	2	1						08:52	14		
14	田剑侠											1		1				09:35	14		
16	刘海亮																	10:24	14		
17	周群		1/2						1/2	50.0				1				11:07	14		
21	潘玉帅																	12:42	15	7	
22	魏雨童		1/1						1/1	100								15:25	16	8	
<b>运动员 合计</b>		<b>8/32</b>	<b>3/10</b>	<b>3/6</b>	<b>3/5</b>	<b>2/2</b>	<b>1/2</b>	<b>20/57</b>	<b>35.1</b>	<b>7</b>	<b>16</b>	<b>3</b>	<b>2</b>					16:36	17	8	
1	刘宗其	0/3	0/3		0/4	0/1	1/1	0/1	1/13	7.7								17:09	17		
12	杨峻	0/3	6/8	2/4	1/8	0/2	1/1	1/2	11/28	39.3								18:44	17		
<b>守门员 合计</b>		<b>0/6</b>	<b>6/11</b>	<b>2/4</b>	<b>1/12</b>	<b>0/3</b>	<b>2/2</b>	<b>1/3</b>	<b>12/41</b>	<b>29.3</b>								21:34	18	2	

场上队员： 得分 / 射门

守门员： 救球 / 射门

快攻	Fast Break	突破	Breakthrough	任意球	Free Throw	7M球	7M Throw	助攻	Assist
警告	Warning	失误	Error	2'	Suspension	D	取消资格	DR	取消资格+报告







## “绿叶集团”杯2016年全国男子手球超级杯赛 图式比赛技术统计表

轮次 6

场次 18

201608018-21-1/1

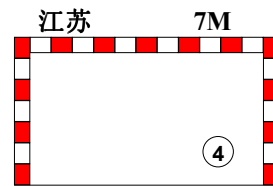
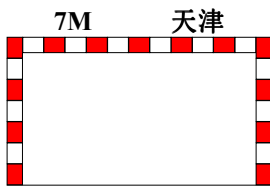
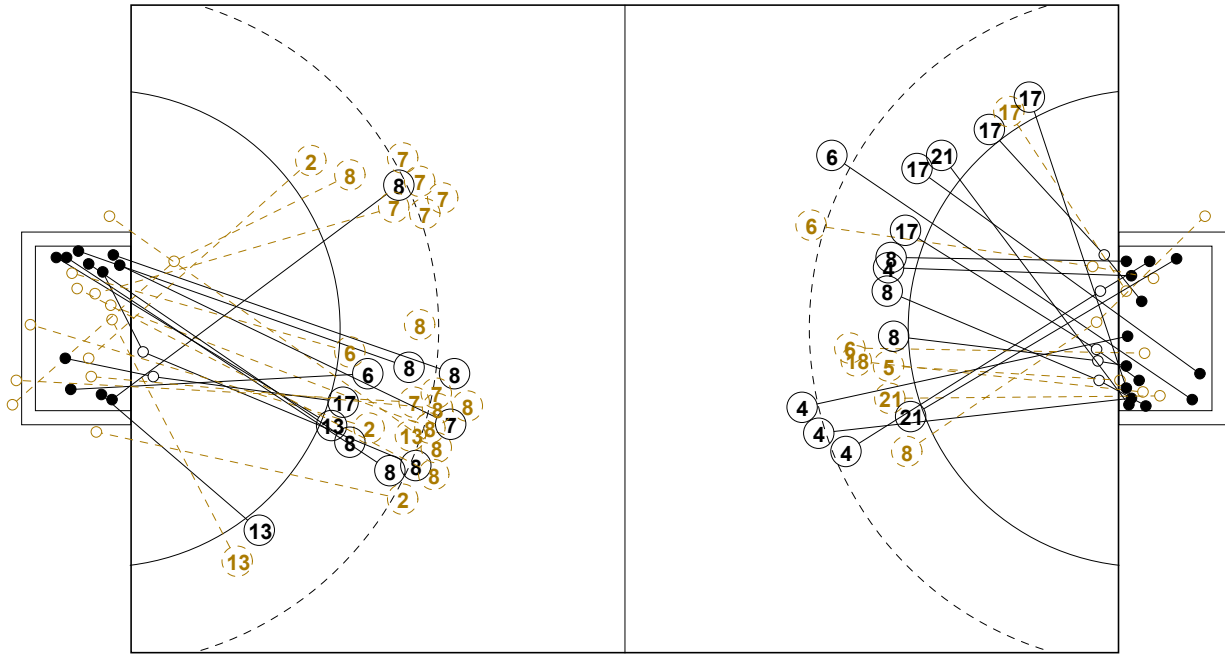

**1st Half**  
11 : 15

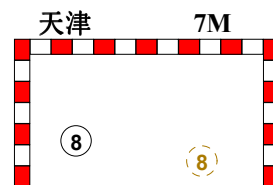
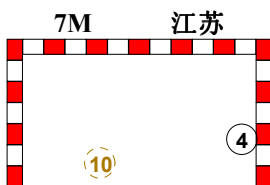
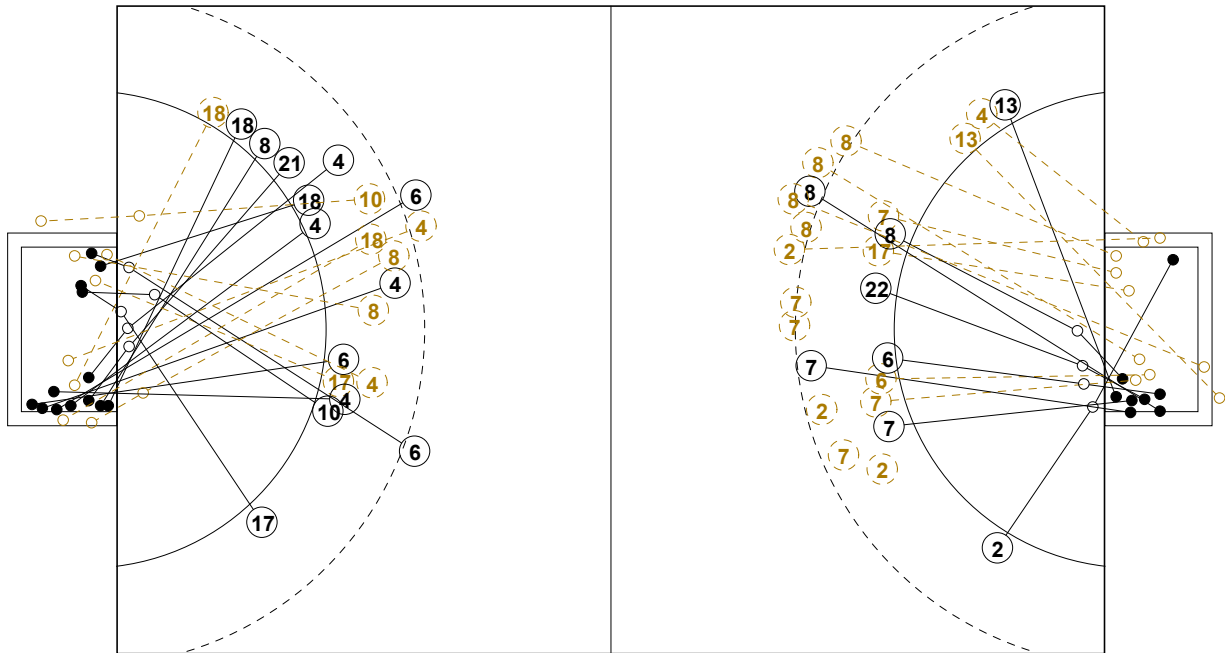

**2nd Half**  
29 : 20



## “绿叶集团”杯2016年全国男子手球超级杯赛

## 个人/全队技术统计表

正式表  
手球  
男子决赛  
轮次 6组别 X  
场次 18201608018-14-1/2  
苏州市体育中心  
26/11/2016 14:30

号码	姓名	远射	近射	边射	快攻	突破	任意	7M	合计	%	助攻	失误	警告	2'	取消	时间
<b>江苏(江苏)</b>																
<i>(场上队员)</i>																
1	徐畅									0.0%						00:00:00
4	张家纬	3/3	2/3		2/2	1/1	0/1	2/2	10/12	83.3%	2	3				01:00:00
5	闫亮				0/1				0/1	0.0%						00:39:06
6	赵晨	3/3	0/1		1/1		0/1		4/6	66.7%	3	4				01:02:24
7	徐奕飞									0.0%						00:00:00
8	周小坚	0/1	2/3		2/3				4/7	57.1%	1	2				00:50:30
9	任超凡									0.0%						00:00:00
10	郝可鑫				1/1	0/1		0/1	1/3	33.3%	1	1				00:09:29
11	马益奎									0.0%						00:00:00
12	王权									0.0%						01:00:00
13	耿畅									0.0%						00:00:00
15	李加昌									0.0%						00:00:00
17	王伟强		0/1	2/3	2/2	1/1			5/7	71.4%						01:00:00
18	赵楠		1/3	0/1	1/1				2/5	40.0%	2	1		1		00:43:41
21	刘江		0/1		2/2	1/1			3/4	75.0%		3				00:47:57
22	任启双									0.0%						00:00:00
<b>合计</b>		6/7	5/12	2/4	11/13	3/4	0/2	2/3	29/45	64.4%	9	14		1		
<i>(守门员)</i>																
12	王权	6/14	4/7	1/4	2/5	0/2		1/2	14/34	41.2%						01:00:00
<hr/>																
<b>合计</b>		6/14	4/7	1/4	2/5	0/2		1/2	14/34	41.2%						

场上队员：得分/射门

守门员：救球/射门

全队合计	得分	被救	射失	击柱	封球	合计	%
远射	6			1		7	85.7%
近射	5	6		1		12	41.7%
边射	2	2				4	50.0%
快攻	11	1	1			13	84.6%
突破	3		1			4	75.0%
任意		2				2	0.0%
7M	2	1				3	66.7%





## “绿叶集团”杯2016年全国男子手球超级杯赛

## 个人/全队技术统计表

正式表  
手球  
男子决赛  
轮次 6组别 X  
场次 18201608018-14-2/2  
苏州市体育中心  
26/11/2016 14:30

号码	姓名	远射	近射	边射	快攻	突破	任意	7M	合计	%	助攻	失误	警告	2'	取消	时间
<b>天津(天津)</b>																
<i>(上场队员)</i>																
1	刘宗其									0.0%						00:20:19
2	李岳朋	0/3	0/2	1/1	0/1				1/7	14.3%	3	6				00:56:34
4	李松浩			0/1					0/1	0.0%						00:10:50
6	王子欣		0/1		2/3				2/4	50.0%		1				00:55:32
7	张青	2/12	0/2			1/1			3/15	20.0%	2	3	1			01:00:00
8	曹悦	6/16	1/2			1/1		1/2	9/21	42.9%		4	1	1		00:58:44
9	吴明远									0.0%						00:00:00
12	杨峻									0.0%						00:39:41
13	许松	0/1		2/4	1/1				3/6	50.0%	2	1				00:49:07
14	田剑侠									0.0%		1		1		00:07:49
16	刘海亮									0.0%						00:00:00
17	周群		1/2						1/2	50.0%			1			00:43:11
21	潘玉帅									0.0%						00:00:00
22	魏雨童		1/1						1/1	100%						00:16:47
<b>合计</b>		8/32	3/10	3/6	3/5	2/2		1/2	20/57	35.1%	7	16	3	2		
<i>(守门员)</i>																
1	刘宗其	0/3	0/3		0/4	0/1	1/1	0/1	1/13	7.7%						00:20:19
12	杨峻	0/3	6/8	2/4	1/8	0/2	1/1	1/2	11/28	39.3%						00:39:41
<b>合计</b>		0/6	6/11	2/4	1/12	0/3	2/2	1/3	12/41	29.3%						

场上队员：得分/射门

守门员：救球/射门

全队合计	得分	被救	射失	击柱	封球	合计	%
远射	8	6	3	2	13	32	25.0%
近射	3	4	1	1	1	10	30.0%
边射	3	1	1	1		6	50.0%
快攻	3	2				5	60.0%
突破	2					2	100.0%
任意							0.0%
7M	1	1				2	50.0%





“绿叶集团”杯2016年全国男子手球超级杯赛

图式射门区域统计

轮次 6 场次 18

201608018-41-1/1

江苏

1 徐畅	4 张家纬	5 闫亮	6 赵晨	7 徐奕飞	8 周小坚	9 任超凡	10 郝可鑫																																																																								
<table border="1"><tr><td></td><td></td><td></td></tr><tr><td></td><td></td><td></td></tr><tr><td></td><td></td><td></td></tr></table>										<table border="1"><tr><td>2</td><td></td><td></td></tr><tr><td>2</td><td></td><td>1</td></tr><tr><td>2</td><td>1</td><td>2</td></tr></table>	2			2		1	2	1	2	<table border="1"><tr><td></td><td></td><td></td></tr><tr><td></td><td></td><td></td></tr><tr><td></td><td></td><td></td></tr></table>										<table border="1"><tr><td>1</td><td></td><td>1</td></tr><tr><td>1</td><td></td><td></td></tr><tr><td></td><td></td><td>1</td></tr></table>	1		1	1					1	<table border="1"><tr><td></td><td></td><td></td></tr><tr><td></td><td></td><td></td></tr><tr><td></td><td></td><td></td></tr></table>										<table border="1"><tr><td></td><td></td><td></td></tr><tr><td></td><td></td><td></td></tr><tr><td>2</td><td></td><td>2</td></tr></table>							2		2	<table border="1"><tr><td></td><td></td><td></td></tr><tr><td></td><td></td><td></td></tr><tr><td></td><td></td><td></td></tr></table>										<table border="1"><tr><td></td><td></td><td></td></tr><tr><td></td><td></td><td></td></tr><tr><td></td><td></td><td>1</td></tr></table>									1
2																																																																															
2		1																																																																													
2	1	2																																																																													
1		1																																																																													
1																																																																															
		1																																																																													
2		2																																																																													
		1																																																																													
Post - 0 Miss - 0 Block - 0	Post - 0 Miss - 0 Block - 0	Post - 0 Miss - 0 Block - 0	Post - 0 Miss - 0 Block - 0	Post - 0 Miss - 0 Block - 0	Post - 1 Miss - 1 Block - 0	Post - 0 Miss - 0 Block - 0	Post - 0 Miss - 1 Block - 0																																																																								
11 马益奎	12 王权	13 耿畅	15 李加昌	17 王伟强	18 赵楠	21 刘江	22 任启双																																																																								
<table border="1"><tr><td></td><td></td><td></td></tr><tr><td></td><td></td><td></td></tr><tr><td></td><td></td><td></td></tr></table>										<table border="1"><tr><td></td><td></td><td></td></tr><tr><td></td><td></td><td></td></tr><tr><td></td><td></td><td></td></tr></table>										<table border="1"><tr><td></td><td></td><td></td></tr><tr><td></td><td></td><td></td></tr><tr><td></td><td></td><td></td></tr></table>										<table border="1"><tr><td></td><td></td><td></td></tr><tr><td></td><td></td><td></td></tr><tr><td></td><td></td><td></td></tr></table>										<table border="1"><tr><td></td><td></td><td>1</td></tr><tr><td></td><td></td><td>1</td></tr><tr><td>1</td><td></td><td>2</td></tr></table>			1			1	1		2	<table border="1"><tr><td></td><td></td><td></td></tr><tr><td></td><td></td><td></td></tr><tr><td>1</td><td></td><td>1</td></tr></table>							1		1	<table border="1"><tr><td></td><td></td><td></td></tr><tr><td>1</td><td></td><td></td></tr><tr><td>1</td><td></td><td>1</td></tr></table>				1			1		1	<table border="1"><tr><td></td><td></td><td></td></tr><tr><td></td><td></td><td></td></tr><tr><td></td><td></td><td></td></tr></table>									
		1																																																																													
		1																																																																													
1		2																																																																													
1		1																																																																													
1																																																																															
1		1																																																																													
Post - 0 Miss - 0 Block - 0	Post - 0 Miss - 0 Block - 0	Post - 0 Miss - 0 Block - 0	Post - 0 Miss - 0 Block - 0	Post - 0 Miss - 0 Block - 0	Post - 1 Miss - 0 Block - 0	Post - 0 Miss - 0 Block - 0	Post - 0 Miss - 0 Block - 0																																																																								

12 王权

0/2		0/2
2/4		6/11
3/5	2/2	1/8



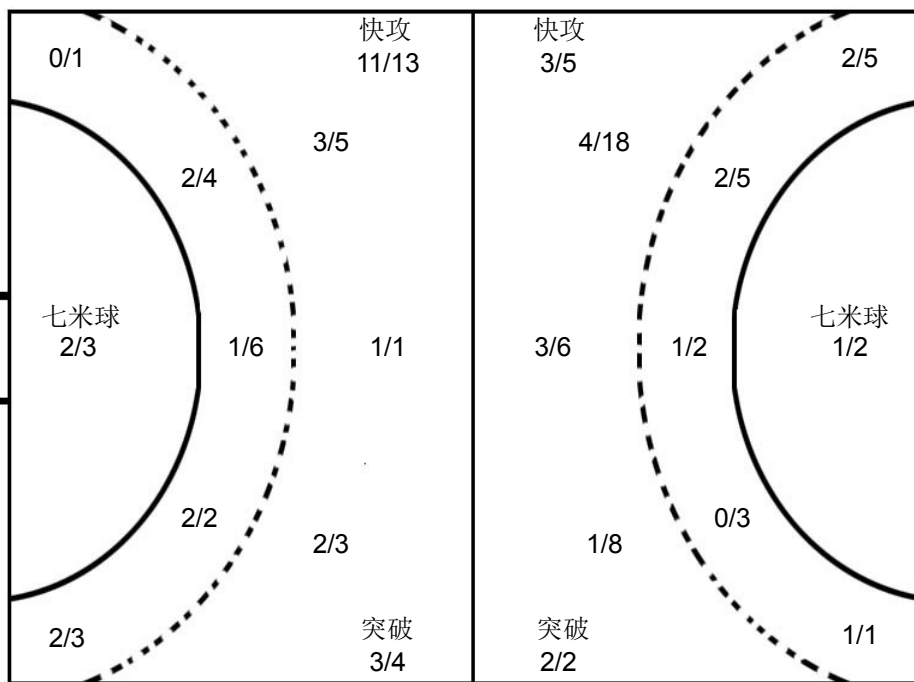

1 刘宗其

0/1		0/1
1/2		
0/4	0/1	0/4

12 杨峻

0/2		0/1
2/5		2/5
2/4	1/2	4/9

天津

1 刘宗其	2 李岳朋	4 李松浩	6 王子欣	7 张青	8 曹悦	9 吴明远	12 杨峻																																																																								
<table border="1"><tr><td></td><td></td><td></td></tr><tr><td></td><td></td><td></td></tr><tr><td></td><td></td><td></td></tr></table>										<table border="1"><tr><td>1</td><td></td><td></td></tr><tr><td></td><td></td><td></td></tr><tr><td></td><td></td><td></td></tr></table>	1									<table border="1"><tr><td></td><td></td><td></td></tr><tr><td></td><td></td><td></td></tr><tr><td></td><td></td><td></td></tr></table>										<table border="1"><tr><td></td><td></td><td></td></tr><tr><td>1</td><td></td><td>1</td></tr><tr><td></td><td></td><td></td></tr></table>				1		1				<table border="1"><tr><td></td><td></td><td></td></tr><tr><td></td><td></td><td></td></tr><tr><td></td><td></td><td>3</td></tr></table>									3	<table border="1"><tr><td></td><td></td><td>1</td></tr><tr><td>1</td><td></td><td>3</td></tr><tr><td>1</td><td></td><td>3</td></tr></table>			1	1		3	1		3	<table border="1"><tr><td></td><td></td><td></td></tr><tr><td></td><td></td><td></td></tr><tr><td></td><td></td><td></td></tr></table>										<table border="1"><tr><td></td><td></td><td></td></tr><tr><td></td><td></td><td></td></tr><tr><td></td><td></td><td></td></tr></table>									
1																																																																															
1		1																																																																													
		3																																																																													
		1																																																																													
1		3																																																																													
1		3																																																																													
Post - 0 Miss - 0 Block - 0	Post - 2 Miss - 1 Block - 2	Post - 1 Miss - 0 Block - 0	Post - 0 Miss - 0 Block - 0	Post - 0 Miss - 1 Block - 8	Post - 1 Miss - 2 Block - 3	Post - 0 Miss - 0 Block - 0	Post - 0 Miss - 0 Block - 0																																																																								
13 许松	14 田剑侠	16 刘海亮	17 周群	21 潘玉帅	22 魏雨童																																																																										
<table border="1"><tr><td></td><td></td><td>1</td></tr><tr><td></td><td></td><td></td></tr><tr><td>1</td><td></td><td>1</td></tr></table>			1				1		1	<table border="1"><tr><td></td><td></td><td></td></tr><tr><td></td><td></td><td></td></tr><tr><td></td><td></td><td></td></tr></table>										<table border="1"><tr><td></td><td></td><td></td></tr><tr><td></td><td></td><td></td></tr><tr><td></td><td></td><td></td></tr></table>										<table border="1"><tr><td></td><td></td><td></td></tr><tr><td>1</td><td></td><td></td></tr><tr><td></td><td></td><td></td></tr></table>				1						<table border="1"><tr><td></td><td></td><td></td></tr><tr><td></td><td></td><td></td></tr><tr><td></td><td></td><td></td></tr></table>										<table border="1"><tr><td></td><td></td><td></td></tr><tr><td></td><td></td><td></td></tr><tr><td></td><td></td><td>1</td></tr></table>									1	<table border="1"><tr><td></td><td></td><td></td></tr><tr><td></td><td></td><td></td></tr><tr><td></td><td></td><td></td></tr></table>										<table border="1"><tr><td></td><td></td><td></td></tr><tr><td></td><td></td><td></td></tr><tr><td></td><td></td><td></td></tr></table>									
		1																																																																													
1		1																																																																													
1																																																																															
		1																																																																													
Post - 0 Miss - 1 Block - 1	Post - 0 Miss - 0 Block - 0	Post - 0 Miss - 0 Block - 0	Post - 0 Miss - 0 Block - 0	Post - 0 Miss - 0 Block - 0	Post - 0 Miss - 0 Block - 0																																																																										

注释: Post=击柱 Miss=射失 Block=被封





## “绿叶集团”杯2016年全国男子手球超级杯赛

## 比赛进程表

正式表  
手球  
男子决赛  
轮次 6组别 X  
场次 18201608018-13-1/6  
苏州市体育中心  
26/11/2016 14:30

时间	队员	动作	比分	队员	动作			
<b>江苏</b>			<b>上半时</b>			<b>天津</b>		
00:40	12 王权	被射入	0 - 1	8 曹悦	中远射 得分			
01:16	4 张家纬	右远射 得分	1 - 1	1 刘宗其	被射入			
01:59	12 王权	被射入	1 - 2	13 许松	左边射 得分			
02:02				2 李岳朋	助攻			
03:06	8 周小坚	近射 得分	2 - 2	1 刘宗其	被射入			
03:08	6 赵晨	助攻						
03:15				7 张青	四步			
04:00	4 张家纬	运球失误						
04:23	12 王权	挡住球		13 许松	左边射 被救			
04:31	6 赵晨	进攻犯规		17 周群	造犯规			
04:42	12 王权	挡住球		8 曹悦	左远射 被救			
05:06	21 刘江	传球失误		7 张青	断球			
05:14	12 王权	被射入	2 - 3	6 王子欣	短传快攻 得分			
05:33				8 曹悦	警告			
05:47	8 周小坚	侵区						
06:11	18 赵楠	抢球		6 王子欣	接球失误			
06:15	4 张家纬	近射 得分	3 - 3	1 刘宗其	被射入			
06:50				2 李岳朋	左远射 射失			
07:20	6 赵晨	任意球 被救		1 刘宗其	挡住球			
07:57	12 王权	被射入	3 - 4	8 曹悦	中远射 得分			
08:04	6 赵晨	运球失误						
08:40	12 王权	被射入	3 - 5	8 曹悦	左远射 得分			
09:16	4 张家纬	右远射 得分	4 - 5	1 刘宗其	被射入			
09:49				7 张青	左远射 射失			
09:59	8 周小坚	近射 得分	5 - 5	1 刘宗其	被射入			
10:01	4 张家纬	助攻						
10:42	21 刘江	封球		7 张青	右远射 被封			
10:46				2 李岳朋	运球失误			
11:26	17 王伟强	造7M		17 周群	使被罚7M球			
11:28				17 周群	警告			
11:49	4 张家纬	7M球 得分	6 - 5	1 刘宗其	被射入			
12:30	21 刘江	封球		7 张青	右远射 被封			
13:05	4 张家纬	断球		2 李岳朋	传球失误			
13:09	17 王伟强	短传快攻 得分	7 - 5	1 刘宗其	被射入			
13:10					球队暂停			
13:53	12 王权	被射入	7 - 6	8 曹悦	左远射 得分			
14:11	4 张家纬	突破 得分	8 - 6	1 刘宗其	被射入			
14:22				2 李岳朋	近射 击柱			
14:29	17 王伟强	一传快攻 得分	9 - 6	1 刘宗其	被射入			
14:33				7 张青	警告			



## “绿叶集团”杯2016年全国男子手球超级杯赛

## 比赛进程表

正式表  
手球  
男子决赛  
轮次 6组别 X  
场次 18201608018-13-2/6  
苏州市体育中心  
26/11/2016 14:30

时间	队员	动作	比分	队员	动作			
<b>江苏</b>			<b>上半时</b>			<b>天津</b>		
15:04				2 李岳朋	接球失误			
15:45	4 张家纬	传球失误		8 曹悦	断球			
15:49	12 王权	被射入	9 - 7	13 许松	一传快攻 得分			
15:52				2 李岳朋	助攻			
16:14		裁判暂停						
16:14	17 王伟强	左边射 得分	10 - 7	12 杨峻	被射入			
16:14				14 田剑侠	罚出场2分钟			
16:50	5 闫亮	封球		8 曹悦	左远射 被封			
16:53				8 曹悦	近射 射失			
17:16	6 赵晨	左远射 得分	11 - 7	12 杨峻	被射入			
17:57				8 曹悦	左远射 射失			
18:23	21 刘江	近射 被救		12 杨峻	挡住球			
18:35	12 王权	被射入	11 - 8	8 曹悦	突破 得分			
18:46	17 王伟强	左边射 被救		12 杨峻	挡住球			
19:27	12 王权	被射入	11 - 9	7 张青	左远射 得分			
19:37	21 刘江	突破 得分	12 - 9	12 杨峻	被射入			
20:43	12 王权	被射入	12 - 10	8 曹悦	右远射 得分			
20:58	21 刘江	传球失误		2 李岳朋	断球			
21:38		裁判暂停						
21:54	21 刘江	封球		7 张青	右远射 被封			
22:10	12 王权	挡住球		7 张青	右远射 被救			
22:28		裁判暂停						
22:56	12 王权	挡住球		6 王子欣	近射 被救			
23:01				13 许松	助攻			
23:06	5 闫亮	短传快攻 被救		12 杨峻	挡住球			
23:53	6 赵晨	封球		7 张青	左远射 被封			
24:04				2 李岳朋	传球失误			
24:13		球队暂停						
24:37	6 赵晨	近射 被救		12 杨峻	挡住球			
24:57	18 赵楠	近射 被救		12 杨峻	挡住球			
25:44	6 赵晨	封球		8 曹悦	中远射 被封			
26:11	8 周小坚	一传快攻 得分	13 - 10	12 杨峻	被射入			
26:13	6 赵晨	助攻						
26:24	12 王权	挡住球		8 曹悦	左远射 被救			
26:33	8 周小坚	短传快攻 射失						
27:13	21 刘江	封球		7 张青	右远射 被封			
27:28	8 周小坚	造失误		2 李岳朋	运球失误			
27:36	21 刘江	短传快攻 得分	14 - 10	12 杨峻	被射入			
28:07	5 闫亮	封球		13 许松	左远射 被封			
28:30	12 王权	被射入	14 - 11	17 周群	近射 得分			





## “绿叶集团”杯2016年全国男子手球超级杯赛

## 比赛进程表

正式表  
手球  
男子决赛  
轮次 6组别 X  
场次 18201608018-13-3/6  
苏州市体育中心  
26/11/2016 14:30

时间	队员	动作	比分	队员	动作
<b>江苏</b>			<b>上半时</b>		
			<b>天津</b>		
28:32				13 许松	助攻
28:38	8 周小坚	传球失误		17 周群	断球
28:44	12 王权	挡住球		2 李岳朋	短传快攻 被救
29:01	12 王权	挡住球		8 曹悦	左远射 被救
29:08		裁判暂停			
29:22				8 曹悦	罚出场2分钟
29:41	17 王伟强	左边射 得分	<b>15 - 11</b>	12 杨峻	被射入



## “绿叶集团”杯2016年全国男子手球超级杯赛

## 比赛进程表

正式表  
手球  
男子决赛  
轮次 6组别 X  
场次 18201608018-13-4/6  
苏州市体育中心  
26/11/2016 14:30

时间	队员	动作	比分	队员	动作
<b>江苏</b>			<b>下半时</b>		
<b>天津</b>					
00:21	6 赵晨	左远射 得分	16 - 11	12 杨峻	被射入
01:21		裁判暂停			
01:21	18 赵楠	使被罚7M球		17 周群	造7M
01:21	18 赵楠	罚出场2分钟			
01:25	12 王权	被射入	16 - 12	8 曹悦	7M球 得分
02:30		裁判暂停			
02:37	6 赵晨	右远射 得分	17 - 12	12 杨峻	被射入
03:31	12 王权	被射入	17 - 13	13 许松	左边射 得分
04:22	6 赵晨	传球失误			
04:31	21 刘江	使被罚7M球		2 李岳朋	造7M
04:49	12 王权	挡住球		8 曹悦	7M球 被救
05:16	6 赵晨	传球失误			
05:26	12 王权	挡住球		17 周群	近射 被救
05:28				7 张青	助攻
05:32	8 周小坚	一传快攻 得分	18 - 13	1 刘宗其	被射入
05:34	4 张家纬	助攻			
06:05				8 曹悦	四步
06:13	21 刘江	快攻 接球失误			
06:36				8 曹悦	传球失误
06:43	21 刘江	短传快攻 得分	19 - 13	1 刘宗其	被射入
06:45					球队暂停
07:23		裁判暂停			
07:45	5 闫亮	封球		8 曹悦	左远射 被封
07:55	12 王权	被射入	19 - 14	22 魏雨童	近射 得分
07:57				7 张青	助攻
08:04	4 张家纬	中远射 得分	20 - 14	1 刘宗其	被射入
08:44				14 田剑侠	运球失误
08:52	18 赵楠	短传快攻 得分	21 - 14	12 杨峻	被射入
09:21				13 许松	接球失误
09:35	18 赵楠	近射 得分	22 - 14	12 杨峻	被射入
09:37	6 赵晨	助攻			
09:40				13 许松	漏防 失误
10:24	17 王伟强	断球		8 曹悦	传球失误
10:24	6 赵晨	短传快攻 得分	23 - 14	12 杨峻	被射入
10:26					球队暂停
11:02	5 闫亮	封球		7 张青	中远射 被封
11:07	4 张家纬	一传快攻 得分	24 - 14	12 杨峻	被射入
11:09	18 赵楠	助攻			
11:49				4 李松浩	左边射 击柱
12:28	18 赵楠	近射 击柱			







## “绿叶集团”杯2016年全国男子手球超级杯赛

## 比赛进程表

正式表  
手球  
男子决赛  
轮次 6组别 X  
场次 18201608018-13-5/6  
苏州市体育中心  
26/11/2016 14:30

时间	队员	动作	比分	队员	动作
<b>江苏</b>			<b>下半时</b>		
<b>天津</b>					
12:42	12 王权	被射入	24 - 15	7 张青	突破 得分
12:44	6 赵晨	顶贴 失误			
13:13	17 王伟强	近射 被救		12 杨峻	挡住球
14:14	6 赵晨	封球		2 李岳朋	右远射 被封
14:20	12 王权	挡住球		7 张青	近射 被救
14:39	8 周小坚	右远射 击柱			
15:21	12 王权	挡住球		8 曹悦	左远射 被救
15:25	12 王权	被射入	24 - 16	8 曹悦	近射 得分
15:34	18 赵楠	右边射 被救		12 杨峻	挡住球
16:18	6 赵晨	封球		2 李岳朋	近射 被封
16:36	12 王权	被射入	24 - 17	8 曹悦	左远射 得分
17:09	4 张家纬	近射 得分	25 - 17	12 杨峻	被射入
17:22				2 李岳朋	传球失误
17:47	8 周小坚	近射 被救		12 杨峻	挡住球
17:56	6 赵晨	封球		7 张青	右远射 被封
18:39				7 张青	其它失误
18:44	4 张家纬	一传快攻 得分	26 - 17	12 杨峻	被射入
18:46	8 周小坚	助攻			
19:31				2 李岳朋	左远射 击柱
19:34	4 张家纬	快攻 传球失误		8 曹悦	断球
20:03	12 王权	挡住球		7 张青	近射 被救
20:25	4 张家纬	造7M		8 曹悦	使被罚7M球
20:28	18 赵楠	助攻			
20:43	10 郝可鑫	7M球 被救		12 杨峻	挡住球
21:34	12 王权	被射入	26 - 18	2 李岳朋	右边射 得分
22:06	4 张家纬	近射 被救		12 杨峻	挡住球
22:42	5 闫亮	封球		7 张青	中远射 被封
23:02				8 曹悦	左远射 击柱
23:38	17 王伟强	突破 得分	27 - 18	12 杨峻	被射入
24:22	10 郝可鑫	断球		8 曹悦	传球失误
24:30	10 郝可鑫	一传快攻 得分	28 - 18	12 杨峻	被射入
25:01	21 刘江	断球		7 张青	传球失误
25:08		裁判暂停			
25:37	21 刘江	造7M		6 王子欣	使被罚7M球
25:45	10 郝可鑫	助攻			
25:57	4 张家纬	7M球 得分	29 - 18	12 杨峻	被射入
26:29	12 王权	被射入	29 - 19	7 张青	中远射 得分
26:55	10 郝可鑫	传球失误		2 李岳朋	断球
27:46				13 许松	左边射 射失
28:23	10 郝可鑫	突破 射失			



## “绿叶集团”杯2016年全国男子手球超级杯赛

## 比赛进程表

正式表  
手球  
男子决赛  
轮次 6组别 X  
场次 18201608018-13-6/6  
苏州市体育中心  
26/11/2016 14:30

时间	队员	动作	比分	队员	动作
<b>江苏</b>		<b>下半时</b>		<b>天津</b>	
28:43	12 王权	挡住球		8 曹悦	左远射 被救
29:16	18 赵楠	传球失误		17 周群	断球
29:22	12 王权	挡住球		6 王子欣	短传快攻 被救
29:39	4 张家纬	任意球 被救		12 杨峻	挡住球
29:47	12 王权	被射入	<b>29 - 20</b>	6 王子欣	一传快攻 得分
29:49				2 李岳朋	助攻