

2017



# 第十三届全国运动会女子手球决赛

# 成绩与技术统计数据册

2017



2017

010101010101100

数据由PHMS收集生成



PHMS 国际手球联合会官方技术统计系统

# 成绩与技术统计数据册目录

## 1 比赛结果

- 1) 名次
- 2) 场次成绩
- 3) 分组成绩

## 2 运动员排名

- 1) 得分
- 2) 助攻
- 3) 封球
- 4) 防守
- 5) 失误
- 6) 受罚

## 3 守门员排名

- 1) 救球
- 2) 救 7M 球

## 4 球队累计表

## 5 球队受罚表

## 6 球队信息

- 1) 球队名单
- 2) 个人/全队技术累计表
- 3) 球队射门区域累计

## 7 比赛统计数据

- 1) 比赛记录表
- 2) 比赛统计(媒体表)
- 3) 每场个人/全队技术统计表
- 4) 图式统计表
- 5) 每场射门区域统计
- 6) 比赛进程表(决赛场次)

注：如需更多比赛统计数据，请通过以下电邮联络：[handball@126.com](mailto:handball@126.com)

第十三届全国运动会女子手球决赛

PHMS Pictorial Handball Match Statistics

IHF Official System

大赛名次

手球  
女子

截止至第24场

天津  
2017-09-07

奖牌	名次	缩写	队名
金牌	1	江苏	江苏
银牌	2	安徽	安徽
铜牌	3	上海	上海
	4	广东	广东
	5	山东	山东
	6	北京	北京
	7	新疆	新疆
	8	天津	天津

第十三届全国运动会女子手球决赛

PHMS Pictorial Handball Match Statistics

IHF Official System

获奖队员名单

手球  
女子

天津  
2017-09-07

金牌	银牌	铜牌
江苏-江苏	安徽-安徽	上海-上海
1 陆婷	1 司艳	1 许沫
3 张海侠	3 李兵	2 周蕾
4 赵佳芹	5 班晨晨	3 王嘉怡
7 周琦	6 沈萍	5 郭威
8 乔如	7 赵江川	6 黄妍
9 莫蒙蒙	8 徐仕媛	7 车婉茹
11 于源源	10 孙来苗	8 吴茵
12 黄霞	13 陶丹扬	9 武娜娜
13 黄慧影	14 刘晓妹	10 斯文
16 王小华	15 王婵婵	11 孙梦颖
17 修丽杰	16 朱莉珍	12 郑冯
18 韦秋香	17 周婷	13 徐娟
19 李薇薇	20 周雪婷	17 居晔
23 王书慧	21 李瑶	18 沙正文
33 金梦青	23 张天洁	19 印尼
69 蓝小玲	41 杜机娟	23 都好



## 第十三届全国运动会女子手球决赛

PHMS Pictorial Handball Match Statistics

IHF Official System

## 场次成绩

手球 女子 截止至第24场 天津 2017-09-07

日期	时间	场次	体育馆	组别	球队	成绩 (半时)	阶段
04-09-17	14:00	13	天津师范大学体育馆	X	安徽-新疆	32-14 (17-5)	四分之一决赛
	15:45	14	天津师范大学体育馆	X	广东-山东	22-17 (10-12)	四分之一决赛
	17:30	15	天津师范大学体育馆	X	上海-北京	29-19 (15-5)	四分之一决赛
	19:15	16	天津师范大学体育馆	X	江苏-天津	36-12 (19-5)	四分之一决赛
05-09-17	14:00	17	天津师范大学体育馆	X	新疆-山东	18-19 (5-9)	5-8名
	15:45	18	天津师范大学体育馆	X	北京-天津	28-22 (13-7)	5-8名
	17:30	19	天津师范大学体育馆	X	安徽-广东	35-24 (21-13)	半决赛
	19:15	20	天津师范大学体育馆	X	上海-江苏	20-25 (11-17)	半决赛
07-09-17	14:00	21	天津师范大学体育馆	X	新疆-天津	25-20 (15-11)	7-8名
	15:45	22	天津师范大学体育馆	X	山东-北京	23-22 (15-12)	5-6名
	17:30	23	天津师范大学体育馆	X	广东-上海	27-30 (14-14)	3-4名
	19:15	24	天津师范大学体育馆	X	安徽-江苏	26-30 (12-12)	决赛

## 第十三届全国运动会女子手球决赛

**PHMS** Pictorial Handball Match Statistics

**IHF** Official System

## 分组成绩

 手球  
 女子

截止至第24场

 天津  
 2017-09-07

组别: A 预赛

名次	球队	积	场	胜	平	负	得分	失分	净胜
1	安徽	6	3	3	0	0	99	72	27
2	上海	4	3	2	0	1	89	71	18
3	山东	2	3	1	0	2	68	72	-4
4	天津	0	3	0	0	3	62	103	-41

球队	安徽	上海	山东	天津
安徽		28-26	29-21	42-25
上海	26-28		28-21	35-22
山东	21-29	21-28		26-15
天津	25-42	22-35	15-26	

组别: B 预赛

名次	球队	积	场	胜	平	负	得分	失分	净胜
1	江苏	6	3	3	0	0	92	59	33
2	广东	4	3	2	0	1	78	70	8
3	北京	2	3	1	0	2	72	82	-10
4	新疆	0	3	0	0	3	54	85	-31

球队	江苏	广东	北京	新疆
江苏		30-19	33-24	29-16
广东	19-30		30-21	29-19
北京	24-33	21-30		27-19
新疆	16-29	19-29	19-27	

Legend:

积	积分	■	已比赛场次	胜	胜场	平	平场
负	负场	■	得分累计	失分	失分累计	净胜	净胜分

## 第十三届全国运动会女子手球决赛

PHMS Pictorial Handball Match Statistics

IHF Official System

## 得分排名表(场上队员)

 手球 截止至第24场 天津  
 女子 按总得分排序 2017-09-07

排序	号码	姓名	球队	远射	近射	边射	快攻	突破	任意	七米	合计	%	助攻	场数
1	41	杜机娟	安徽	0-0	2-3	12-17	17-19	0-0	0-0	18-22	49-61	80.3	1	6
2	9	韦宝桂	广东	16-35	7-12	1-3	4-5	3-3	1-3	13-18	45-79	57.0	8	6
3	9	武娜娜	上海	1-2	6-7	9-15	14-16	3-3	0-0	0-0	33-43	76.7	2	6
4	6	沈萍	安徽	9-18	10-17	1-1	3-4	0-0	3-3	5-6	31-49	63.3	2	6
5	28	刘金兰	广东	0-0	0-2	17-24	4-8	0-0	0-0	10-15	31-49	63.3	3	6
6	9	袁玉	天津	3-12	9-19	5-5	5-10	7-10	0-1	1-2	30-59	50.8	3	6
7	2	林燕群	山东	13-39	5-9	2-2	1-1	6-9	0-5	3-4	30-69	43.5	5	6
8	69	蓝小玲	江苏	8-20	7-10	2-3	7-9	3-5	2-3	0-0	29-50	58.0	5	6
9	11	孙梦颖	上海	11-20	7-11	1-5	1-3	6-8	1-2	0-1	27-50	54.0	4	6
10	8	王彬	山东	2-10	2-6	3-3	1-1	2-2	1-2	15-17	26-41	63.4	3	6
11	28	闫美珠	北京	14-29	0-3	2-3	0-0	2-2	3-4	5-5	26-46	56.5	3	6
12	33	金梦青	江苏	3-6	2-3	4-10	9-12	0-1	1-1	6-7	25-40	62.5	6	6
13	14	刘晓妹	安徽	7-22	5-7	0-2	0-0	8-9	4-6	1-2	25-48	52.1	18	6
14	24	郝佳楠	北京	12-40	7-11	0-1	1-2	5-7	0-3	0-0	25-64	39.1	11	6
15	23	周梦雪	天津	7-28	8-16	1-2	1-3	4-5	0-2	3-6	24-62	38.7	12	6
16	4	赵佳芹	江苏	6-13	4-6	0-0	3-3	9-11	0-0	1-1	23-34	67.6	15	6
17	10	刘莎	北京	0-1	3-3	7-11	1-3	2-2	0-0	9-9	22-29	75.9	1	6
18	3	张海侠	江苏	1-1	5-7	7-12	9-13	0-0	0-0	0-0	22-33	66.7	1	6
19	19	李薇薇	江苏	3-10	4-8	1-1	3-3	3-3	1-2	7-8	22-35	62.9	1	6
20	18	崔娟	新疆	12-34	4-10	0-0	0-0	4-5	0-0	2-3	22-52	42.3	3	6
21	8	吴茵	上海	6-19	3-7	1-1	0-2	5-5	1-1	4-4	20-39	51.3	19	6
22	3	安妮	广东	5-16	2-7	0-2	2-2	11-13	0-0	0-0	20-40	50.0	9	6
23	93	张婷婷	新疆	3-21	5-8	0-0	1-1	3-7	1-3	7-8	20-48	41.7	8	6
24	21	李瑶	安徽	2-10	6-13	1-1	4-8	4-6	0-0	2-2	19-40	47.5	7	6
25	6	阿热孜古丽	新疆	0-0	12-20	1-1	4-4	0-0	0-0	1-2	18-27	66.7	0	6
26	10	张文慧	天津	0-0	16-21	0-0	1-2	0-0	0-0	0-0	17-23	73.9	2	6
27	10	史小军	广东	3-8	6-9	0-0	3-4	5-6	0-0	0-0	17-27	63.0	6	6
28	2	周蕾	上海	0-0	6-11	5-11	5-6	1-1	0-0	0-0	17-29	58.6	3	6
29	11	吕青纹	山东	1-6	2-2	6-6	7-9	0-0	0-0	0-0	16-23	69.6	4	6
30	7	吴志娟	新疆	0-0	3-6	8-13	5-5	0-0	0-0	0-0	16-24	66.7	1	6
31	17	修丽杰	江苏	3-12	9-11	0-1	2-4	1-2	0-0	1-1	16-31	51.6	1	6
32	21	锁珊珊	新疆	8-26	2-7	2-2	1-1	0-0	0-1	3-4	16-41	39.0	4	6
33	8	乔如	江苏	0-0	11-14	0-0	3-4	0-0	0-0	1-1	15-19	78.9	1	6
34	13	陶丹扬	安徽	0-0	1-1	2-5	12-16	0-0	0-0	0-0	15-22	68.2	3	6
35	69	石梓薇	北京	7-20	6-11	0-1	1-1	1-1	0-0	0-0	15-34	44.1	3	6
36	3	李兵	安徽	2-4	2-7	0-1	3-4	7-9	0-0	0-0	14-25	56.0	7	6
37	6	黄妍	上海	3-20	2-5	1-3	0-0	3-3	1-3	4-7	14-41	34.1	4	6
38	3	王晓梅	天津	6-28	1-7	0-0	0-0	1-2	0-1	6-7	14-45	31.1	4	6
39	28	崔金娜	山东	0-0	12-15	0-0	0-0	1-1	0-0	0-0	13-16	81.3	1	6
40	5	班晨晨	安徽	0-1	9-11	0-1	2-4	1-1	0-0	1-2	13-20	65.0	3	6

## 第十三届全国运动会女子手球决赛

PHMS Pictorial Handball Match Statistics

IHF Official System

## 得分排名表(场上队员)

 手球 截止至第24场 天津  
 女子 按助攻次数排序 2017-09-07

排序	号码	姓名	球队	远射	近射	边射	快攻	突破	任意	七米	合计	%	助攻	场数
1	8	吴茵	上海	6-19	3-7	1-1	0-2	5-5	1-1	4-4	20-39	51.3	19	6
2	14	刘晓妹	安徽	7-22	5-7	0-2	0-0	8-9	4-6	1-2	25-48	52.1	18	6
3	3	季小桐	北京	2-11	7-10	1-2	0-0	0-0	1-1	1-1	12-25	48.0	17	6
4	4	赵佳芹	江苏	6-13	4-6	0-0	3-3	9-11	0-0	1-1	23-34	67.6	15	6
5	23	周梦雪	天津	7-28	8-16	1-2	1-3	4-5	0-2	3-6	24-62	38.7	12	6
6	24	郝佳楠	北京	12-40	7-11	0-1	1-2	5-7	0-3	0-0	25-64	39.1	11	6
7	1	司艳	安徽	0-0	0-0	0-0	0-0	0-0	0-0	0-0	0-0	0	11	6
8	3	安妮	广东	5-16	2-7	0-2	2-2	11-13	0-0	0-0	20-40	50.0	9	6
9	9	韦宝桂	广东	16-35	7-12	1-3	4-5	3-3	1-3	13-18	45-79	57.0	8	6
10	93	张婷婷	新疆	3-21	5-8	0-0	1-1	3-7	1-3	7-8	20-48	41.7	8	6
11	1	许沫	上海	0-0	0-0	0-0	0-0	0-0	0-0	0-0	0-0	0	8	6
12	21	李瑶	安徽	2-10	6-13	1-1	4-8	4-6	0-0	2-2	19-40	47.5	7	6
13	3	李兵	安徽	2-4	2-7	0-1	3-4	7-9	0-0	0-0	14-25	56.0	7	6
14	17	周婷	安徽	3-6	5-9	0-0	1-1	4-6	0-0	0-0	13-22	59.1	7	6
15	18	舒文琪	天津	6-24	1-4	0-2	1-1	0-0	0-1	3-5	11-37	29.7	7	6
16	33	金梦青	江苏	3-6	2-3	4-10	9-12	0-1	1-1	6-7	25-40	62.5	6	6
17	10	史小军	广东	3-8	6-9	0-0	3-4	5-6	0-0	0-0	17-27	63.0	6	6
18	16	王小华	江苏	0-0	0-0	0-0	0-0	0-0	0-0	0-0	0-0	0	6	6
19	2	林燕群	山东	13-39	5-9	2-2	1-1	6-9	0-5	3-4	30-69	43.5	5	6
20	69	蓝小玲	江苏	8-20	7-10	2-3	7-9	3-5	2-3	0-0	29-50	58.0	5	6
21	16	朱莉珍	安徽	0-0	0-0	0-0	0-0	0-0	0-0	0-0	0-0	0	5	6
22	11	孙梦颖	上海	11-20	7-11	1-5	1-3	6-8	1-2	0-1	27-50	54.0	4	6
23	11	吕青纹	山东	1-6	2-2	6-6	7-9	0-0	0-0	0-0	16-23	69.6	4	6
24	21	锁珊珊	新疆	8-26	2-7	2-2	1-1	0-0	0-1	3-4	16-41	39.0	4	6
25	6	黄妍	上海	3-20	2-5	1-3	0-0	3-3	1-3	4-7	14-41	34.1	4	6
26	3	王晓梅	天津	6-28	1-7	0-0	0-0	1-2	0-1	6-7	14-45	31.1	4	6
27	19	印尼	上海	4-9	1-4	1-1	0-0	0-2	0-1	0-1	6-18	33.3	4	6
28	22	朱赞	山东	0-0	0-0	0-0	0-0	0-0	0-0	0-0	0-0	0	4	6
29	28	刘金兰	广东	0-0	0-2	17-24	4-8	0-0	0-0	10-15	31-49	63.3	3	6
30	9	袁玉	天津	3-12	9-19	5-5	5-10	7-10	0-1	1-2	30-59	50.8	3	6
31	8	王彬	山东	2-10	2-6	3-3	1-1	2-2	1-2	15-17	26-41	63.4	3	6
32	28	闫美珠	北京	14-29	0-3	2-3	0-0	2-2	3-4	5-5	26-46	56.5	3	6
33	18	崔娟	新疆	12-34	4-10	0-0	0-0	4-5	0-0	2-3	22-52	42.3	3	6
34	2	周蕾	上海	0-0	6-11	5-11	5-6	1-1	0-0	0-0	17-29	58.6	3	6
35	13	陶丹扬	安徽	0-0	1-1	2-5	12-16	0-0	0-0	0-0	15-22	68.2	3	6
36	69	石梓薇	北京	7-20	6-11	0-1	1-1	1-1	0-0	0-0	15-34	44.1	3	6
37	5	班晨晨	安徽	0-1	9-11	0-1	2-4	1-1	0-0	1-2	13-20	65.0	3	6
38	33	王彩琳	山东	2-8	3-7	0-1	2-2	4-7	1-2	0-1	12-28	42.9	3	6
39	11	蔡雪洁	天津	3-7	2-5	1-1	3-3	0-0	0-0	0-0	9-16	56.3	3	6
40	3	葛立双	新疆	1-9	0-6	0-0	1-1	4-4	0-0	0-1	6-21	28.6	3	6

## 第十三届全国运动会女子手球决赛

PHMS Pictorial Handball Match Statistics

IHF Official System

## 得分排名表(场上队员)

 手球 截止至第24场 天津  
 女子 按封球次数排序 2017-09-07

名次	号码	姓名	球队	抢球	断球	造失误	造犯规	合计	封球	场数
1	18	沙正文	上海	0	2	0	0	2	11	6
2	8	乔如	江苏	0	3	2	3	8	8	6
3	69	蓝小玲	江苏	1	2	1	2	6	7	6
4	28	闫美珠	北京	1	1	0	1	3	6	6
5	3	李兵	安徽	0	4	0	8	12	6	6
6	6	沈萍	安徽	0	3	0	3	6	6	6
7	23	王如	广东	0	1	0	2	3	6	6
8	6	阿热孜古丽	新疆	1	7	0	2	10	5	6
9	17	戴莹莹	新疆	0	0	0	0	0	5	6
10	19	李薇薇	江苏	1	1	0	1	3	4	6
11	17	周婷	安徽	0	1	0	0	1	4	6
12	28	崔金娜	山东	0	0	0	1	1	4	6
13	8	吴茵	上海	0	3	1	8	12	4	6
14	15	吴作扬	山东	1	1	0	1	3	3	6
15	14	刘晓妹	安徽	0	3	3	2	8	3	6
16	5	班晨晨	安徽	0	1	1	0	2	3	6
17	33	金梦青	江苏	0	3	0	1	4	2	6
18	28	刘金兰	广东	0	2	0	2	4	2	6
19	23	都好	上海	0	0	0	0	0	2	6
20	7	刘彤	广东	0	0	0	2	2	2	6
21	15	郝泽荣	北京	0	0	0	1	1	2	6
22	21	李瑶	安徽	0	2	0	3	5	2	6
23	20	李军政	广东	0	3	0	0	3	2	6
24	10	张文慧	天津	0	3	0	2	5	2	6
25	13	徐娟	上海	0	0	0	0	0	1	6
26	6	刘亚男	北京	0	1	0	0	1	1	6
27	3	季小桐	北京	2	1	0	2	5	1	6
28	2	周蕾	上海	0	1	0	8	9	1	6
29	4	赵佳芹	江苏	3	5	1	3	12	1	6
30	10	刘莎	北京	0	1	1	2	4	1	6
31	21	锁珊珊	新疆	2	4	0	0	6	1	6
32	10	斯文	上海	0	0	0	1	1	1	6
33	33	王彩琳	山东	1	2	2	0	5	1	6
34	69	石梓薇	北京	0	3	0	0	3	1	6
35	18	崔娟	新疆	0	1	0	1	2	1	6
36	17	居晔	上海	0	0	0	0	0	1	6
37	10	史小军	广东	1	2	0	6	9	1	6
38	11	蔡雪洁	天津	0	5	0	1	6	1	6
39	93	张婷婷	新疆	1	4	0	0	5	1	6
40	19	邝雪花	广东	0	1	0	1	2	1	6

## 第十三届全国运动会女子手球决赛

PHMS Pictorial Handball Match Statistics

IHF Official System

## 得分排名表(场上队员)

 手球 截止至第24场 天津  
 女子 按防守成功总数排序 2017-09-07

名次	号码	姓名	球队	抢球	断球	造失误	造犯规	合计	封球	场数
1	11	孙梦颖	上海	2	6	1	4	13	0	6
2	4	赵佳芹	江苏	3	5	1	3	12	1	6
3	3	李兵	安徽	0	4	0	8	12	6	6
4	8	吴茵	上海	0	3	1	8	12	4	6
5	6	阿热孜古丽	新疆	1	7	0	2	10	5	6
6	2	周蕾	上海	0	1	0	8	9	1	6
7	9	袁玉	天津	0	5	2	2	9	0	6
8	3	张海侠	江苏	1	5	0	3	9	0	6
9	10	史小军	广东	1	2	0	6	9	1	6
10	8	乔如	江苏	0	3	2	3	8	8	6
11	14	刘晓妹	安徽	0	3	3	2	8	3	6
12	15	兰姝娇	新疆	1	5	1	1	8	0	6
13	24	郝佳楠	北京	5	2	0	0	7	0	6
14	11	吕青纹	山东	0	5	0	1	6	0	6
15	21	锁珊珊	新疆	2	4	0	0	6	1	6
16	11	蔡雪洁	天津	0	5	0	1	6	1	6
17	69	蓝小玲	江苏	1	2	1	2	6	7	6
18	6	沈萍	安徽	0	3	0	3	6	6	6
19	3	季小桐	北京	2	1	0	2	5	1	6
20	7	吴志娟	新疆	0	3	0	2	5	0	6
21	22	李海鸥	北京	0	1	0	4	5	1	6
22	9	韦宝桂	广东	1	2	0	2	5	0	6
23	33	王彩琳	山东	1	2	2	0	5	1	6
24	10	张文慧	天津	0	3	0	2	5	2	6
25	21	李瑶	安徽	0	2	0	3	5	2	6
26	93	张婷婷	新疆	1	4	0	0	5	1	6
27	2	林燕群	山东	0	3	0	2	5	0	6
28	9	武娜娜	上海	0	2	0	2	4	0	6
29	28	刘金兰	广东	0	2	0	2	4	2	6
30	17	修丽杰	江苏	1	1	1	1	4	0	6
31	11	于源源	江苏	1	3	0	0	4	0	6
32	10	刘莎	北京	0	1	1	2	4	1	6
33	33	金梦青	江苏	0	3	0	1	4	2	6
34	19	李薇薇	江苏	1	1	0	1	3	4	6
35	69	石梓薇	北京	0	3	0	0	3	1	6
36	19	姜伟珊	山东	0	2	1	0	3	0	6
37	20	李军政	广东	0	3	0	0	3	2	6
38	28	闫美珠	北京	1	1	0	1	3	6	6
39	15	吴作扬	山东	1	1	0	1	3	3	6
40	23	王如	广东	0	1	0	2	3	6	6

## 第十三届全国运动会女子手球决赛

PHMS Pictorial Handball Match Statistics

IHF Official System

## 得分排名表(场上队员)

 手球 截止至第24场 天津  
 女子 按失误总数排序 2017-09-07

排序	号码	姓名	球队	传失	接失	两次	四步	侵区	进犯	其它	合计	场数
1	23	周梦雪	天津	17	2	4	6	0	1	0	30	6
2	21	李瑶	安徽	16	3	1	1	0	2	0	23	6
3	24	郝佳楠	北京	11	1	1	4	2	2	1	22	6
4	93	张婷婷	新疆	16	2	0	0	0	2	1	21	6
5	9	袁玉	天津	10	4	1	5	0	1	0	21	6
6	18	崔娟	新疆	6	3	3	3	1	1	1	18	6
7	9	韦宝桂	广东	9	3	0	1	0	4	0	17	6
8	33	王彩琳	山东	8	0	0	0	0	8	0	16	6
9	6	沈萍	安徽	9	1	0	0	0	4	1	15	6
10	8	王彬	山东	7	0	0	3	1	3	1	15	6
11	69	石梓薇	北京	5	3	1	4	0	1	1	15	6
12	69	蓝小玲	江苏	6	4	1	0	0	3	0	14	6
13	11	孙梦颖	上海	5	3	2	0	0	4	0	14	6
14	19	李薇薇	江苏	4	0	2	2	0	6	0	14	6
15	18	舒文琪	天津	6	1	1	2	1	2	0	13	6
16	3	安妮	广东	8	0	0	1	0	4	0	13	6
17	3	季小桐	北京	7	0	0	4	0	2	0	13	6
18	2	林燕群	山东	9	0	0	2	0	0	0	11	6
19	6	阿热孜古丽	新疆	1	2	0	0	6	1	0	10	6
20	21	锁珊珊	新疆	6	2	1	1	0	0	0	10	6
21	10	史小军	广东	4	0	0	0	2	4	0	10	6
22	11	魏梦庭	广东	4	0	2	1	0	1	1	9	6
23	17	聂晓雪	天津	3	1	2	1	2	0	0	9	6
24	15	吴作扬	山东	5	1	1	0	0	2	0	9	6
25	7	刘彤	广东	4	2	0	2	0	1	0	9	6
26	14	刘晓妹	安徽	3	0	0	3	0	1	1	8	6
27	8	吴茵	上海	6	1	0	0	0	1	0	8	6
28	11	蔡雪洁	天津	4	2	1	0	0	1	0	8	6
29	15	兰姝娇	新疆	3	0	0	1	2	1	0	7	6
30	3	葛立双	新疆	2	0	1	1	1	2	0	7	6
31	19	邝雪花	广东	1	1	1	0	0	4	0	7	6
32	3	王晓梅	天津	6	0	0	0	0	1	0	7	6
33	10	张文慧	天津	3	1	0	0	2	1	0	7	6
34	23	赵小颖	北京	4	1	0	1	0	1	0	7	6
35	28	闫美珠	北京	2	4	0	1	0	0	0	7	6
36	15	郝泽荣	北京	0	4	1	0	1	0	0	6	6
37	28	崔金娜	山东	1	0	0	0	0	5	0	6	6
38	41	杜机娟	安徽	2	0	1	0	1	2	0	6	6
39	10	刘莎	北京	1	1	0	1	1	2	0	6	6
40	23	王如	广东	1	0	1	0	3	1	0	6	6

## 第十三届全国运动会女子手球决赛

PHMS Pictorial Handball Match Statistics

IHF Official System

## 得分排名表(场上队员)

 手球 截止至第24场 天津  
 女子 接受罚次数排序 2017-09-07

排序	号码	姓名	球队	警告	罚2分钟	D	DR	场数
1	93	张婷婷	新疆	4	5	0	0	6
2	6	阿热孜古丽	新疆	3	5	0	0	6
3	15	吴作扬	山东	0	5	0	0	6
4	7	刘彤	广东	5	4	0	0	6
5	10	张文慧	天津	4	4	0	0	6
6	17	修丽杰	江苏	4	4	0	0	6
7	33	王彩琳	山东	2	4	0	0	6
8	8	张慧	天津	2	4	0	0	5
9	3	李兵	安徽	0	4	0	0	6
10	10	刘莎	北京	5	3	0	0	6
11	69	石梓薇	北京	3	3	0	0	6
12	20	张悦	山东	3	3	0	0	6
13	21	李瑶	安徽	2	3	0	0	6
14	21	锁珊珊	新疆	1	3	0	0	6
15	10	斯文	上海	1	3	0	0	6
16	8	吴茵	上海	1	3	0	0	6
17	15	郝泽荣	北京	1	3	0	0	6
18	23	徐悦	山东	1	3	0	0	6
19	10	史小军	广东	3	2	0	0	6
20	28	闫美珠	北京	3	2	0	0	6
21	23	王如	广东	3	2	0	0	6
22	2	周蕾	上海	3	2	0	0	6
23	2	林燕群	山东	2	2	0	0	6
24	18	崔娟	新疆	2	2	0	0	6
25	14	刘晓妹	安徽	2	2	0	0	6
26	11	蔡雪洁	天津	2	2	0	0	6
27	23	周梦雪	天津	2	2	0	0	6
28	28	刘金兰	广东	2	2	0	0	6
29	17	戴莹莹	新疆	1	2	0	0	6
30	5	班晨晨	安徽	1	2	0	0	6
31	69	蓝小玲	江苏	1	2	0	0	6
32	19	邝雪花	广东	1	2	0	0	6
33	8	乔如	江苏	1	2	0	0	6
34	13	陶丹扬	安徽	1	2	0	0	6
35	11	魏梦庭	广东	0	2	0	0	6
36	6	王莎莎	山东	0	2	0	0	6
37	17	居晔	上海	0	2	0	0	6
38	6	刘亚男	北京	0	2	0	0	6
39	19	印尼	上海	0	2	0	0	6
40	4	赵佳芹	江苏	4	1	0	0	6



## 第十三届全国运动会女子手球决赛

PHMS Pictorial Handball Match Statistics

IHF Official System

## 排名表(守门员)

 手球 截止至第24场 天津  
 女子 按总救球数排序 2017-09-07

排序	号码	姓名	球队	远射	近射	边射	快攻	突破	任意	七米	得分	%	助攻	场数
1	1	司艳	安徽	36-55	21-48	9-27	2-8	1-10	1-4	1-11	71-163	43.6	11	6
2	32	杨雨柔	新疆	17-38	24-64	10-22	7-34	2-13	0-4	4-14	64-189	33.9	0	6
3	1	许沫	上海	21-38	11-39	5-17	4-15	6-22	2-4	3-15	52-150	34.7	8	6
4	16	王小华	江苏	18-34	12-35	13-27	5-13	0-8	2-4	1-8	51-129	39.5	6	6
5	16	王海叶	北京	13-33	9-38	11-28	7-31	3-11	2-2	3-14	48-157	30.6	1	6
6	16	王选	天津	12-27	17-43	7-23	5-38	2-14	2-3	2-17	47-165	28.5	1	6
7	26	马晓卉	广东	14-31	9-28	5-14	7-25	3-17	1-2	3-17	42-134	31.3	1	6
8	22	朱贇	山东	19-33	8-26	3-12	4-17	3-10	1-7	1-9	39-114	34.2	4	6
9	16	朱莉珍	安徽	14-22	14-27	2-8	0-0	0-5	0-0	4-19	34-81	42.0	5	6
10	22	刘晓玉	广东	11-22	8-19	1-5	2-7	1-12	2-2	0-1	25-68	36.8	3	6
11	1	陆婷	江苏	13-24	4-10	4-7	0-2	0-5	0-0	3-6	24-54	44.4	3	6
12	1	路畅	山东	4-13	6-17	6-10	2-8	2-14	0-0	2-12	22-74	29.7	0	6
13	1	张莉	天津	8-15	6-21	5-10	1-13	0-4	1-2	1-11	22-76	28.9	0	6
14	12	郑冯	上海	3-18	4-14	1-2	2-6	1-3	0-1	3-14	14-58	24.1	0	6
15	47	刘泽	北京	5-11	1-11	2-5	1-6	1-5	0-1	1-6	11-45	24.4	0	6
16	10	李静	新疆	3-8	0-4	1-4	2-8	0-2	0-0	2-13	8-39	20.5	0	6
17	12	黄霞	江苏	1-3	4-6	0-0	1-1	0-0	1-1	0-5	7-16	43.8	2	6
18	1	宋嘉蕾	北京	0-2	2-5	1-3	4-7	0-1	0-1	0-1	7-20	35.0	1	5
19	16	李娟	广东	1-2	2-7	1-1	0-0	0-2	0-0	2-11	6-23	26.1	2	6
20	12	王欣冉	天津	0-3	2-9	1-2	1-7	1-2	0-0	0-2	5-25	20.0	0	6
21	8	徐仕媛	安徽	1-1	1-2	0-0	0-0	1-1	0-0	0-0	3-4	75.0	0	6
22	12	张苑琳	山东	0-0	0-0	0-0	0-0	0-0	0-0	2-6	2-6	33.3	0	6

**第十三届全国运动会女子手球决赛**
**PHMS** Pictorial Handball Match Statistics

**IHF** Official System

**排名表(守门员)**

 手球 截止至第24场 天津  
 女子 按救七米球数排序 2017-09-07

排序	号码	姓名	球队	远射	近射	边射	快攻	突破	任意	七米	得分	%	助攻	场数
1	32	杨雨柔	新疆	17-38	24-64	10-22	7-34	2-13	0-4	4-14	64-189	28.6	0	6
2	16	朱莉珍	安徽	14-22	14-27	2-8	0-0	0-5	0-0	4-19	34-81	21.1	5	6
3	1	陆婷	江苏	13-24	4-10	4-7	0-2	0-5	0-0	3-6	24-54	50.0	3	6
4	16	王海叶	北京	13-33	9-38	11-28	7-31	3-11	2-2	3-14	48-157	21.4	1	6
5	12	郑冯	上海	3-18	4-14	1-2	2-6	1-3	0-1	3-14	14-58	21.4	0	6
6	1	许沫	上海	21-38	11-39	5-17	4-15	6-22	2-4	3-15	52-150	20.0	8	6
7	26	马晓卉	广东	14-31	9-28	5-14	7-25	3-17	1-2	3-17	42-134	17.6	1	6
8	12	张苑琳	山东	0-0	0-0	0-0	0-0	0-0	0-0	2-6	2-6	33.3	0	6
9	16	李娟	广东	1-2	2-7	1-1	0-0	0-2	0-0	2-11	6-23	18.2	2	6
10	1	路畅	山东	4-13	6-17	6-10	2-8	2-14	0-0	2-12	22-74	16.7	0	6
11	10	李静	新疆	3-8	0-4	1-4	2-8	0-2	0-0	2-13	8-39	15.4	0	6
12	16	王选	天津	12-27	17-43	7-23	5-38	2-14	2-3	2-17	47-165	11.8	1	6
13	47	刘泽	北京	5-11	1-11	2-5	1-6	1-5	0-1	1-6	11-45	16.7	0	6
14	16	王小华	江苏	18-34	12-35	13-27	5-13	0-8	2-4	1-8	51-129	12.5	6	6
15	22	朱赟	山东	19-33	8-26	3-12	4-17	3-10	1-7	1-9	39-114	11.1	4	6
16	1	司艳	安徽	36-55	21-48	9-27	2-8	1-10	1-4	1-11	71-163	9.1	11	6
17	1	张莉	天津	8-15	6-21	5-10	1-13	0-4	1-2	1-11	22-76	9.1	0	6
18	8	徐仕媛	安徽	1-1	1-2	0-0	0-0	1-1	0-0	0-0	3-4	0	0	6
19	22	刘晓玉	广东	11-22	8-19	1-5	2-7	1-12	2-2	0-1	25-68	0.0	3	6
20	1	宋嘉蕾	北京	0-2	2-5	1-3	4-7	0-1	0-1	0-1	7-20	0.0	1	5
21	12	王欣冉	天津	0-3	2-9	1-2	1-7	1-2	0-0	0-2	5-25	0.0	0	6
22	12	黄霞	江苏	1-3	4-6	0-0	1-1	0-0	1-1	0-5	7-16	0.0	2	6

**第十三届全国运动会女子手球决赛**
**PHMS** Pictorial Handball Match Statistics

**IHF** Official System

**攻防成功率统计总表**

 手球  
 女子

截止至第24场

 天津  
 2017-09-07

序号	球队	比分	进攻成功率															助攻	防守成功率								
			阵地进攻			一传快攻			短传快攻			合计			多打少				少打多			封打抢断	守门员	对方射失	对方失误	合计	%
			得分	进攻	%	得分	进攻	%	得分	进攻	%	得分	进攻	%	得分	进攻	%		得分	进攻	%						
1	安徽	192:140	145	304	47.7	30	41	73.2	17	39	43.6	192	384	50.0	20	31	64.5	11	21	52.4	67	62	108	48	47	265	65.4
2	北京	141:156	136	344	39.5	3	5	60.0	2	5	40.0	141	354	39.8	20	31	64.5	3	15	20.0	41	43	66	34	37	180	53.6
3	广东	151:152	134	328	40.9	9	16	56.3	8	24	33.3	151	368	41.0	18	30	60.0	12	20	60.0	35	44	73	46	40	203	57.2
4	江苏	183:117	136	293	46.4	22	31	71.0	25	44	56.8	183	368	49.7	14	27	51.9	9	22	40.9	43	75	82	50	50	257	68.7
5	山东	127:134	113	283	39.9	7	10	70.0	7	13	53.8	127	306	41.5	16	30	53.3	14	22	63.6	24	38	63	33	34	168	55.3
6	上海	168:142	138	306	45.1	17	21	81.0	13	30	43.3	168	357	47.1	22	28	78.6	14	24	58.3	47	67	66	43	38	214	60.1
7	天津	116:192	102	342	29.8	7	11	63.6	7	22	31.8	116	375	30.9	14	27	51.9	5	14	35.7	35	30	74	41	37	182	48.7
8	新疆	111:156	96	318	30.2	7	8	87.5	8	18	44.4	111	344	32.3	13	24	54.2	5	15	33.3	23	50	72	31	43	196	55.7

注释:

进攻	进攻次数 (射门 + 进攻失误)	对方射失	对方射门失误 (射失 + 击柱)	防守成功率%	本方防守合计 / 对方进攻合计
----	------------------	------	------------------	--------	-----------------

## 第十三届全国运动会女子手球决赛

PHMS Pictorial Handball Match Statistics

IHF Official System

## 防守技术统计总表

 手球  
 女子

截止至第24场

 天津  
 2017-09-07

序号	球队	比分	防守成功						防守(成功 : 失误)							处罚					守门员		
			封球	抢球	断球	造失	造犯	合计	选位	顶贴	观察	移动	换防	其他	合计	警告	2'	取消	DR	合计	救球	射门	%
1	安徽	192:140	24	1	15	6	16	62	0:1	0:10	0:5	0:8	0:0	0:0	0:24	15	17	0	0	32	108	248	43.5
2	北京	141:156	13	8	10	2	10	43	0:7	0:16	0:0	0:6	0:1	0:0	0:30	14	16	0	0	30	66	222	29.7
3	广东	151:152	14	2	13	0	15	44	0:2	0:26	0:2	0:12	0:2	0:0	0:44	17	15	0	0	32	73	225	32.4
4	江苏	183:117	22	8	26	5	14	75	0:2	0:5	0:2	0:4	0:0	0:0	0:13	14	17	0	0	31	82	199	41.2
5	山东	127:134	8	4	15	3	8	38	0:3	0:17	0:2	0:1	0:0	0:0	0:23	15	21	0	0	36	63	194	32.5
6	上海	168:142	21	2	18	2	24	67	0:5	0:13	0:5	0:5	0:1	0:0	0:29	14	16	0	0	30	66	208	31.7
7	天津	116:192	3	1	18	2	6	30	0:5	0:11	0:4	0:8	0:0	0:0	0:28	14	15	0	0	29	74	266	27.8
8	新疆	111:156	13	5	24	1	7	50	0:1	0:8	0:4	0:1	0:0	0:0	0:14	15	22	0	0	37	72	228	31.6

注释:

造失	造对方失误	造犯	造对方犯规	DR	取消资格+报告
----	-------	----	-------	----	---------

## 第十三届全国运动会女子手球决赛

PHMS Pictorial Handball Match Statistics

IHF Official System

## 球队名单

江苏

天津

2017-08-31

号码	姓名	位置	生日	年龄	俱乐部	身高 (CM)	体重 (KG)	国际场次	国际进球
1	陆婷	守门员	08/01/1986	31		183	69		
3	张海侠	右边锋	10/02/1995	22		175	63		
4	赵佳芹	中后卫	22/01/1986	31		174	67		
7	周琦	右后卫	14/01/1995	22		178	68		
8	乔如	底线	05/01/1995	22		182	85		
9	莫蒙蒙	底线	06/01/1995	22		178	77		
11	于源源	左边锋	30/01/1995	22		173	66		
12	黄霞	守门员	19/01/1995	22		178	58		
13	黄慧影	左边锋	09/02/1998	19		175	60		
16	王小华	守门员	15/04/1993	24		186	74		
17	修丽杰	右后卫	18/04/1988	29		178	73		
18	韦秋香	右边锋	15/02/1986	31		176	65		
19	李薇薇	左后卫	07/07/1982	35		178	70		
23	王书慧	左后卫	12/07/1993	24		179	70		
33	金梦青	中后卫	29/05/1995	22		172	65		
69	蓝小玲	左后卫	22/05/1993	24		180	70		
	平均			25.1		177.8	68.8		

编码	姓名	职务
B	金甲洙	主教练
C	马彪	教练
D	刘凯	医生
A	姚治前	领队
E	李海鹰	工作人员

## 第十三届全国运动会女子手球决赛

PHMS Pictorial Handball Match Statistics

IHF Official System

 手球  
 女子

## 个人/全队技术累计表

 天津  
 2017-09-07

截止至第24场

号码	姓名	远射	近射	边射	快攻	突破	任意	七米	合计	%	助攻	失误	警告	2'	取消	场次	时间
<b>江苏</b>																	
<b>(场上队员)</b>																	
1	陆婷										3					6	01:53:19
3	张海侠	1/1	5/7	7/12	9/13				22/33	66.7%	1	4	1			6	04:15:17
4	赵佳芹	6/13	4/6		3/3	9/11		1/1	23/34	67.6%	15	4	4	1		6	04:52:18
7	周琦	1/3							1/3	33.3%				1		6	00:27:46
8	乔如		11/14		3/4			1/1	15/19	78.9%	1	3	1	2		6	03:15:46
9	莫蒙蒙		2/3		2/5				4/8	50.0%		4	1	1		6	02:21:50
11	于源源		1/1	3/9	1/2	1/1			6/13	46.2%	1	4		1		6	02:30:23
12	黄霞										2	1				6	00:20:55
13	黄慧影			0/2	3/3				3/5	60.0%						6	00:11:02
16	王小华										6	1		1		6	03:45:46
17	修丽杰	3/12	9/11	0/1	2/4	1/2		1/1	16/31	51.6%	1	5	4	4		6	04:01:53
18	韦秋香	0/2	1/1	2/5	3/5	1/1		1/2	8/16	50.0%	1	1	1	1		6	01:39:53
19	李薇薇	3/10	4/8	1/1	3/3	3/3	1/2	7/8	22/35	62.9%	1	14		1		6	02:04:33
23	王书慧	3/8	3/4	0/1	2/2		0/1	1/1	9/17	52.9%		5	2			6	00:56:37
33	金梦青	3/6	2/3	4/10	9/12	0/1	1/1	6/7	25/40	62.5%	6	4		1		6	04:17:46
69	蓝小玲	8/20	7/10	2/3	7/9	3/5	2/3		29/50	58.0%	5	14	1	2		6	04:29:02
	<b>合计</b>	<b>28/75</b>	<b>49/68</b>	<b>19/44</b>	<b>47/65</b>	<b>18/24</b>	<b>4/7</b>	<b>18/21</b>	<b>183/304</b>	<b>60.2%</b>	<b>43</b>	<b>64</b>	<b>14</b>	<b>17</b>		<b>96</b>	
<b>(守门员)</b>																	
1	陆婷	13/24	4/10	4/7	0/2	0/5		3/6	24/54	44.4%	3					6	01:53:19
12	黄霞	1/3	4/6		1/1		1/1	0/5	7/16	43.8%	2	1				6	00:20:55
16	王小华	18/34	12/35	13/27	5/13	0/8	2/4	1/8	51/129	39.5%	6	1		1		6	03:45:46
	<b>合计</b>	<b>32/61</b>	<b>20/51</b>	<b>17/34</b>	<b>6/16</b>	<b>0/13</b>	<b>3/5</b>	<b>4/19</b>	<b>82/199</b>	<b>41.2%</b>	<b>11</b>	<b>2</b>		<b>1</b>		<b>18</b>	

场上队员：得分/射门

守门员：救球/射门

## 已打比赛

全队合计	进球	被救	射失	击柱	封球	合计	%	阶段	场次	对手	比分
远射	28	23	6	9	9	75	37.3%	预赛	3	新疆	29:16 (12:9)
近射	49	11	5	3		68	72.1%	预赛	7	北京	33:24 (19:9)
边射	19	17	3	5		44	43.2%	预赛	12	广东	30:19 (18:7)
快攻	47	13		5		65	72.3%	四分之一决赛	16	天津	36:12 (19:5)
突破	18	4		2		24	75.0%	半决赛	20	上海	25:20 (17:11)
任意	4	3				7	57.1%	决赛	24	安徽	30:26 (12:12)
七米	18	3				21	85.7%				

第十三届全国运动会女子手球决赛

PHMS Pictorial Handball Match Statistics

IHF Official System

图式射门区域累计

手球  
女子

截止至第24场

天津  
2017-09-07

江苏

1 陆婷 Post - 0 Miss - 0 Block - 0	3 张海侠 Post - 1 Miss - 0 Block - 0	4 赵佳芹 Post - 2 Miss - 2 Block - 2	7 周琦 Post - 2 Miss - 0 Block - 0	8 乔如 Post - 1 Miss - 0 Block - 0	9 莫蒙蒙 Post - 1 Miss - 0 Block - 0	11 于源源 Post - 1 Miss - 1 Block - 0	12 黄霞 Post - 0 Miss - 0 Block - 0
13 黄慧影 Post - 1 Miss - 0 Block - 0	16 王小华 Post - 0 Miss - 0 Block - 0	17 修丽杰 Post - 2 Miss - 1 Block - 1	18 韦秋香 Post - 3 Miss - 0 Block - 1	19 李薇薇 Post - 4 Miss - 4 Block - 0	23 王书慧 Post - 0 Miss - 1 Block - 2	33 金梦青 Post - 2 Miss - 2 Block - 3	69 蓝小玲 Post - 4 Miss - 3 Block - 0

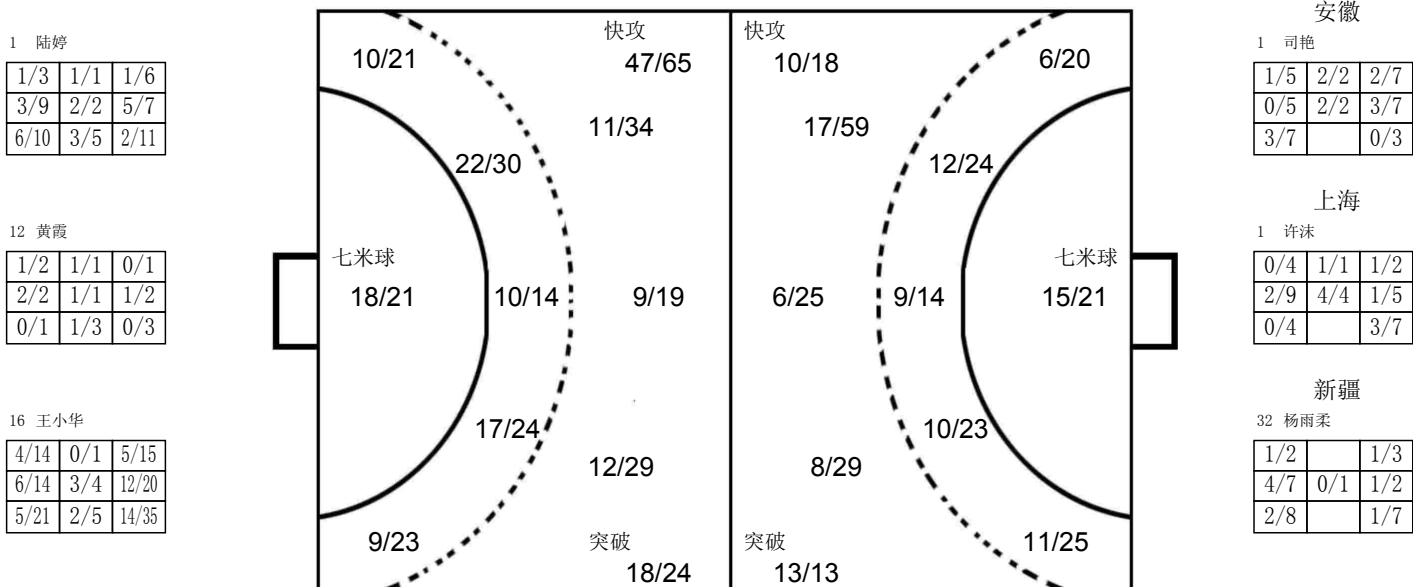

OPPONENT

安徽 6 沈萍 Post - 1 Miss - 0 Block - 1	安徽 41 杜机娟 Post - 1 Miss - 1 Block - 0	广东 28 刘金兰 Post - 0 Miss - 0 Block - 0	北京 24 郝佳楠 Post - 0 Miss - 2 Block - 2	北京 69 石梓薇 Post - 1 Miss - 0 Block - 2	广东 10 史小军 Post - 0 Miss - 1 Block - 0	上海 9 武娜娜 Post - 0 Miss - 1 Block - 0	天津 23 周梦雪 Post - 0 Miss - 1 Block - 1
新疆 7 吴志娟 Post - 0 Miss - 0 Block - 0	安徽 14 刘晓妹 Post - 0 Miss - 1 Block - 1	安徽 17 周婷 Post - 1 Miss - 0 Block - 0	北京 15 郝泽荣 Post - 0 Miss - 0 Block - 0	广东 9 韦宝桂 Post - 1 Miss - 0 Block - 2	广东 19 邝雪花 Post - 0 Miss - 0 Block - 0	上海 5 郭威 Post - 0 Miss - 0 Block - 0	上海 8 吴茵 Post - 1 Miss - 2 Block - 2



## 第十三届全国运动会女子手球决赛

PHMS Pictorial Handball Match Statistics

IHF Official System

## 球队名单

安徽

天津

2017-08-31

号码	姓名	位置	生日	年龄	俱乐部	身高 (CM)	体重 (KG)	国际场次	国际进球
1	司艳	守门员	09/12/1989	27	安徽	183	70		
3	李兵	底线	21/07/1980	37	安徽	180	69		
5	班晨晨	右后卫	06/06/1991	26	安徽	185	85		
6	沈萍	中后卫	04/07/1983	34	安徽	182	77		
7	赵江川	右后卫	24/02/1985	32	安徽	177	73		
8	徐仕媛	守门员	23/05/1997	20	安徽	180	78		
10	孙来苗	底线	08/04/1981	36	安徽	182	70		
13	陶丹扬	右边锋	30/10/1991	25	安徽	171	61		
14	刘晓妹	中后卫	02/05/1985	32	安徽	178	76		
15	王婵婵	右边锋	18/07/1983	34	安徽	174	73		
16	朱莉珍	守门员	18/02/1974	43	安徽	181	65		
17	周婷	左边锋	27/03/1987	30	安徽	182	70		
20	周雪婷	左边锋	04/01/1996	21	安徽	175	67		
21	李瑶	后卫	07/06/1992	25	安徽	172	60		
23	张天洁	左边锋	30/11/1991	25	安徽	186	75		
41	杜机娟	右边锋	12/08/1989	28	安徽	178	68		
	平均			29.7		179.1	71.1		

编码	姓名	职务
A	吴疆	领队
B	吴立军	主教练
C	杨桂东	教练
E	张国遂	医生
D	陆广红	教练



## 第十三届全国运动会女子手球决赛

PHMS Pictorial Handball Match Statistics

IHF Official System

 手球  
 女子

## 个人/全队技术累计表

 天津  
 2017-09-07

截止至第24场

号码	姓名	远射	近射	边射	快攻	突破	任意	七米	合计	%	助攻	失误	警告	2'	取消	场次	时间
<b>安徽</b>																	
<b>(场上队员)</b>																	
1	司艳										11	1				6	04:17:38
3	李兵	2/4	2/7	0/1	3/4	7/9			14/25	56.0%	7	5		4		6	04:16:09
5	班晨晨	0/1	9/11	0/1	2/4	1/1		1/2	13/20	65.0%	3	1	1	2		6	02:00:25
6	沈萍	9/18	10/17	1/1	3/4		3/3	5/6	31/49	63.3%	2	15	3	1		6	04:20:24
7	赵江川	1/1	2/3		1/2	1/2			5/8	62.5%	1	2				6	00:50:48
8	徐仕媛															6	00:04:48
10	孙来苗		1/1	0/2	1/1			1/2	3/6	50.0%		2	1			6	01:12:39
13	陶丹扬		1/1	2/5	12/16				15/22	68.2%	3	2	1	2		6	03:27:46
14	刘晓妹	7/22	5/7	0/2		8/9	4/6	1/2	25/48	52.1%	18	8	2	2		6	04:40:38
15	王婵婵			2/3	2/4				4/7	57.1%	2	1	1			6	02:08:00
16	朱莉珍										5	2				6	01:37:34
17	周婷	3/6	5/9		1/1	4/6			13/22	59.1%	7	5	2	1		6	03:41:25
20	周雪婷			0/1	1/1				1/2	50.0%		1		1		6	00:25:55
21	李瑶	2/10	6/13	1/1	4/8	4/6		2/2	19/40	47.5%	7	23	2	3		6	04:13:56
23	张天洁															6	00:11:20
41	杜机娟		2/3	12/17	17/19			18/22	49/61	80.3%	1	6	2	1		6	04:17:45
	<b>合计</b>	<b>24/62</b>	<b>43/72</b>	<b>18/34</b>	<b>47/64</b>	<b>25/33</b>	<b>7/9</b>	<b>28/36</b>	<b>192/310</b>	<b>61.9%</b>	<b>67</b>	<b>74</b>	<b>15</b>	<b>17</b>		<b>96</b>	
<b>(守门员)</b>																	
1	司艳	36/55	21/48	9/27	2/8	1/10	1/4	1/11	71/163	43.6%	11	1				6	04:17:38
8	徐仕媛	1/1	1/2			1/1			3/4	75.0%						6	00:04:48
16	朱莉珍	14/22	14/27	2/8		0/5		4/19	34/81	42.0%	5	2				6	01:37:34
	<b>合计</b>	<b>51/78</b>	<b>36/77</b>	<b>11/35</b>	<b>2/8</b>	<b>2/16</b>	<b>1/4</b>	<b>5/30</b>	<b>108/248</b>	<b>43.5%</b>	<b>16</b>	<b>3</b>				<b>18</b>	

场上队员：得分/射门

守门员：救球/射门

已打比赛

全队合计	进球	被救	射失	击柱	封球	合计	%	阶段	场次	对手	比分
远射	24	19	7	5	7	62	38.7%	预赛	1	天津	42:25 (29:13)
近射	43	18	3	8		72	59.7%	预赛	5	山东	29:21 (16:10)
边射	18	10	4	2		34	52.9%	预赛	10	上海	28:26 (10:9)
快攻	47	12	1	4		64	73.4%	四分之一决赛	13	新疆	32:14 (17:5)
突破	25	2	3	3		33	75.8%	半决赛	19	广东	35:24 (21:13)
任意	7	1	1			9	77.8%	决赛	24	江苏	26:30 (12:12)
七米	28	5	2	1		36	77.8%				

第十三届全国运动会女子手球决赛

PHMS Pictorial Handball Match Statistics

IHF Official System

图式射门区域累计

手球  
女子

截止至第24场

天津  
2017-09-07

安徽

1 司艳 Post - 0 Miss - 0 Block - 0	3 李兵 Post - 4 Miss - 2 Block - 0	5 班晨晨 Post - 2 Miss - 1 Block - 0	6 沈萍 Post - 3 Miss - 2 Block - 1	7 赵江川 Post - 1 Miss - 0 Block - 0	8 徐仕媛 Post - 0 Miss - 0 Block - 0	10 孙来苗 Post - 1 Miss - 0 Block - 0	13 陶丹扬 Post - 2 Miss - 1 Block - 0
14 刘晓妹 Post - 2 Miss - 5 Block - 3	15 王婷婷 Post - 0 Miss - 1 Block - 0	16 朱莉珍 Post - 0 Miss - 0 Block - 0	17 周婷 Post - 4 Miss - 1 Block - 1	20 周雪婷 Post - 0 Miss - 0 Block - 0	21 李瑶 Post - 3 Miss - 4 Block - 2	23 张天洁 Post - 0 Miss - 0 Block - 0	41 杜机娟 Post - 1 Miss - 4 Block - 0

1 司艳
9/18 5/8 6/20
14/25 9/9 10/21
11/32 4/9 3/21

8 徐仕媛
1/1 0/1
1/1 1/1

16 朱莉珍
1/6 4/5 3/15
3/7 3/3 5/10
4/11 2/3 9/21

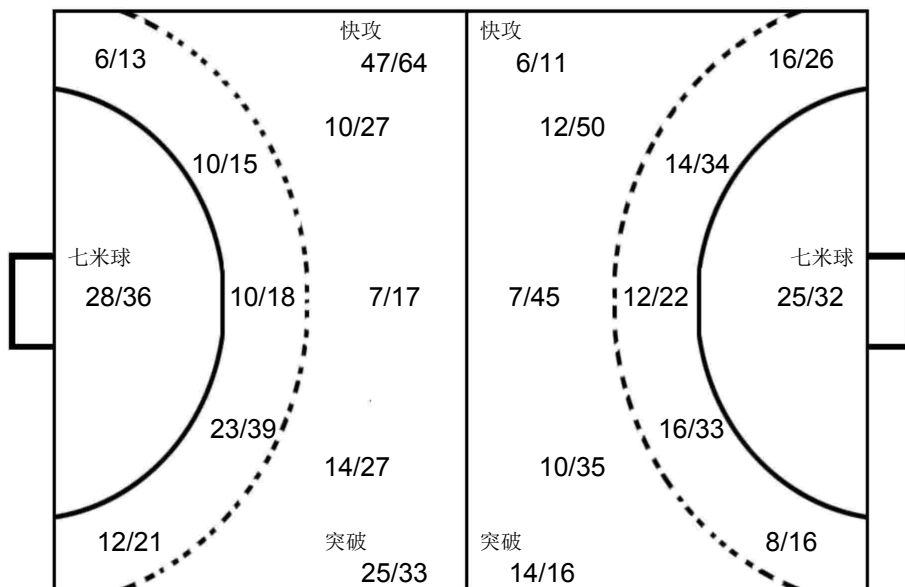

上海
1 许沫
0/3 0/2 0/4
3/7 1/1 2/7
1/6 4/4 1/6

江苏
16 王小华
1/5 0/1 1/4
1/2 1/1 2/3
1/6 1/2 2/7

新疆
32 杨雨柔
2/7 1/4
2/4 4/7
0/3 0/6

OPPONENT

广东 9 韦宝桂 Post - 0 Miss - 1 Block - 2	天津 9 袁玉 Post - 2 Miss - 0 Block - 0	上海 11 孙梦颖 Post - 1 Miss - 0 Block - 1	新疆 18 崔娟 Post - 2 Miss - 0 Block - 0	上海 8 吴茵 Post - 2 Miss - 0 Block - 1	江苏 19 李薇薇 Post - 0 Miss - 1 Block - 0	江苏 69 蓝小玲 Post - 1 Miss - 0 Block - 0	山东 8 王彬 Post - 2 Miss - 0 Block - 0
广东 28 刘金兰 Post - 0 Miss - 1 Block - 0	江苏 4 赵佳芹 Post - 0 Miss - 0 Block - 0	天津 10 张文慧 Post - 0 Miss - 0 Block - 0	江苏 8 乔如 Post - 1 Miss - 0 Block - 0	上海 5 郭威 Post - 0 Miss - 0 Block - 0	天津 23 周梦雪 Post - 1 Miss - 0 Block - 1	广东 3 安妮 Post - 0 Miss - 1 Block - 0	江苏 3 张海侠 Post - 0 Miss - 0 Block - 0



## 第十三届全国运动会女子手球决赛

PHMS Pictorial Handball Match Statistics

IHF Official System

## 球队名单

上海

天津

2017-08-31

号码	姓名	位置	生日	年龄	俱乐部	身高 (CM)	体重 (KG)	国际场次	国际进球
1	许沫	守门员	02/03/1990	27		183	68		
2	周蕾	右边锋	25/10/1994	22		172	75		
3	王嘉怡	右边锋	02/08/1999	18		169	64		
5	郭威	中后卫	10/08/1984	33		181	72		
6	黄妍	左后卫	29/11/1993	23		185	71		
7	车婉茹	底线	23/11/1988	28		179	75		
8	吴茵	中后卫	13/04/1988	29		175	68		
9	武娜娜	左边锋	04/03/1990	27		176	66		
10	斯文	右后卫	14/12/1990	26		171	67		
11	孙梦颖	右后卫	11/04/1990	27		177	73		
12	郑冯	守门员	14/10/1993	23		181	71		
13	徐娟	中后卫	25/11/1993	23		176	65		
17	居晔	左边锋	27/07/1994	23		173	72		
18	沙正文	底线	18/06/1990	27		191	88		
19	印尼	左后卫	23/06/1992	25		182	74		
23	都好	底线	18/11/1994	22		177	73		
	平均			25.2		178.0	71.4		

编码	姓名	职务
A	孙琦敏	领队
B	陈进培	主教练
C	贺业磊	教练
D	金钟顺	教练
E	郑明星	工作人员
F	孙宇翔	医生

## 第十三届全国运动会女子手球决赛

PHMS Pictorial Handball Match Statistics

IHF Official System

 手球  
 女子

## 个人/全队技术累计表

 天津  
 2017-09-07

截止至第24场

号码	姓名	远射	近射	边射	快攻	突破	任意	七米	合计	%	助攻	失误	警告	2'	取消	场次	时间
上海																	
(场上队员)																	
1	许沫										8	2				6	04:29:58
2	周蕾		6/11	5/11	5/6	1/1			17/29	58.6%	3	4	3	2		6	04:00:13
3	王嘉怡	2/2	1/1				0/1	1/1	4/5	80.0%		1				6	00:28:01
5	郭威							9/13	9/13	69.2%		4				6	00:47:22
6	黄妍	3/20	2/5	1/3		3/3	1/3	4/7	14/41	34.1%	4	6				6	03:16:56
7	车婉茹		1/2					9/12	10/14	71.4%						6	00:23:44
8	吴茵	6/19	3/7	1/1	0/2	5/5	1/1	4/4	20/39	51.3%	19	8	1	3		6	04:47:16
9	武娜娜	1/2	6/7	9/15	14/16	3/3			33/43	76.7%	2	4	3	1		6	05:33:01
10	斯文	1/2	2/3	4/4	3/4	2/2			12/15	80.0%	2		1	3		6	02:12:18
11	孙梦颖	11/20	7/11	1/5	1/3	6/8	1/2	0/1	27/50	54.0%	4	14	1	1		6	05:31:22
12	郑冯															6	01:30:02
13	徐娟	0/2	0/2		3/3	1/2	1/1		5/10	50.0%		4	1	1		6	01:14:24
17	居晔			0/1	2/2				2/3	66.7%				2		6	00:36:35
18	沙正文		6/14	0/1	1/1				7/16	43.8%	1	3	4	1		6	03:47:48
19	印尼	4/9	1/4	1/1		0/2	0/1	0/1	6/18	33.3%	4	4		2		6	01:39:20
23	都好		1/3		1/2				2/5	40.0%		2				6	01:19:57
	合计	28/76	36/70	22/42	30/39	21/26	4/9	27/39	168/301	55.8%	47	56	14	16		96	
(守门员)																	
1	许沫	21/38	11/39	5/17	4/15	6/22	2/4	3/15	52/150	34.7%	8	2				6	04:29:58
12	郑冯	3/18	4/14	1/2	2/6	1/3	0/1	3/14	14/58	24.1%						6	01:30:02
	合计	24/56	15/53	6/19	6/21	7/25	2/5	6/29	66/208	31.7%	8	2				12	

场上队员：得分/射门

守门员：救球/射门

已打比赛

全队合计	进球	被救	射失	击柱	封球	合计	%	阶段	场次	对手	比分
远射	28	20	5	12	11	76	36.8%	预赛	2	山东	28:21 (19:9)
近射	36	23	6	4	1	70	51.4%	预赛	6	天津	35:22 (20:10)
边射	22	14	3	3		42	52.4%	预赛	10	安徽	26:28 (9:10)
快攻	30	8	1			39	76.9%	四分之一决赛	15	北京	29:19 (15:5)
突破	21	5				26	80.8%	半决赛	20	江苏	20:25 (11:17)
任意	4	3	1	1		9	44.4%	3-4名	23	广东	30:27 (14:14)
七米	27	9		3		39	69.2%				

第十三届全国运动会女子手球决赛

PHMS Pictorial Handball Match Statistics

IHF Official System

图式射门区域累计

手球  
女子

截止至第24场

天津  
2017-09-07

上海

1 许沫 Post - 0 Miss - 0 Block - 0	2 周蕾 Post - 1 Miss - 2 Block - 0	3 王嘉怡 Post - 0 Miss - 1 Block - 0	5 郭威 Post - 0 Miss - 0 Block - 0	6 黄妍 Post - 7 Miss - 4 Block - 2	7 车婉茹 Post - 2 Miss - 0 Block - 0	8 吴茵 Post - 4 Miss - 2 Block - 4	9 武娜娜 Post - 3 Miss - 1 Block - 0
10 斯文 Post - 0 Miss - 1 Block - 0	11 孙梦颖 Post - 3 Miss - 0 Block - 3	12 郑冯 Post - 0 Miss - 0 Block - 0	13 徐娟 Post - 0 Miss - 1 Block - 2	17 居晔 Post - 0 Miss - 0 Block - 0	18 沙正文 Post - 1 Miss - 2 Block - 0	19 印尼 Post - 1 Miss - 2 Block - 1	23 都好 Post - 1 Miss - 0 Block - 0

1/15	1/3	3/17
11/28	6/6	15/31
3/19	6/7	6/24

2/8	1/2	1/7
2/15	1/1	3/8
2/10	2/2	0/5

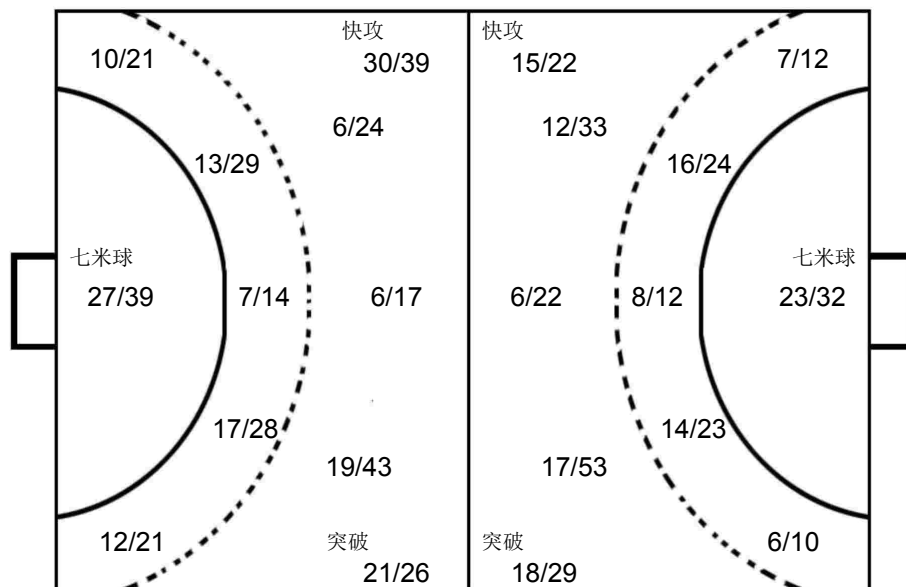

天津

16 王选		
1/5	1/3	
4/9	4/4	4/9
2/11	3/3	1/7

广东

26 马晓卉		
0/3	1/2	1/3
2/6	1/1	2/8
5/10	1/2	1/4

安徽

1 司艳		
2/3	1/1	1/4
4/7	2/2	1/3
0/6	1/2	0/6

OPPONENT

2 林燕群 Post - 2 Miss - 1 Block - 3	41 杜机娟 Post - 0 Miss - 1 Block - 0	9 韦宝桂 Post - 2 Miss - 0 Block - 2	28 刘金兰 Post - 0 Miss - 1 Block - 0	4 赵佳芹 Post - 1 Miss - 0 Block - 1	10 张文慧 Post - 0 Miss - 0 Block - 0	23 周梦雪 Post - 1 Miss - 1 Block - 0	6 沈萍 Post - 0 Miss - 0 Block - 0
3 季小桐 Post - 0 Miss - 1 Block - 0	10 史小军 Post - 0 Miss - 0 Block - 0	69 蓝小玲 Post - 0 Miss - 1 Block - 0	21 李瑶 Post - 1 Miss - 1 Block - 0	3 安妮 Post - 1 Miss - 1 Block - 1	3 张海侠 Post - 1 Miss - 0 Block - 0	9 袁玉 Post - 1 Miss - 1 Block - 0	14 刘晓妹 Post - 1 Miss - 0 Block - 2



## 第十三届全国运动会女子手球决赛

PHMS Pictorial Handball Match Statistics

IHF Official System

## 球队名单

广东

天津

2017-08-31

号码	姓名	位置	生日	年龄	俱乐部	身高 (CM)	体重 (KG)	国际场次	国际进球
2	王彤羽	中后卫	28/06/1997	20		168	58		
3	安妮	左后卫	11/06/1987	30		180	77		
5	李纯	底线	26/03/1997	20		185	74		
7	刘彤	左边锋	03/06/1993	24		175	66		
8	李诗棋	右后卫	17/01/1997	20		164	58		
9	韦宝桂	右后卫	20/03/1990	27		179	70		
10	史小军	右边锋	21/05/1986	31		178	75		
11	魏梦庭	中后卫	01/09/1989	27		176	68		
15	杨慧	右边锋	13/09/1998	18		172	60		
16	李娟	守门员	10/05/1989	28		179	66		
19	邝雪花	右后卫	19/09/1992	24		180	73		
20	李军政	左边锋	25/03/1991	26		180	75		
22	刘晓玉	守门员	09/01/1993	24		182	72		
23	王如	底线	30/04/1988	29		180	77		
26	马晓卉	守门员	04/08/1993	24		180	90		
28	刘金兰	左边锋	14/11/1985	31		173	73		
	平均			25.2		176.9	70.8		

编码	姓名	职务
B	黄炳春	教练
C	李玉玲	教练
D	郭艳辉	主教练
E	赵善良	医生
A	李细利	领队

## 第十三届全国运动会女子手球决赛

PHMS Pictorial Handball Match Statistics

IHF Official System

 手球  
 女子

## 个人/全队技术累计表

 天津  
 2017-09-07

截止至第24场

号码	姓名	远射	近射	边射	快攻	突破	任意	七米	合计	%	助攻	失误	警告	2'	取消	场次	时间
<b>广东</b>																	
<b>(场上队员)</b>																	
2	王彤羽	1/4	0/1			1/1		1/1	3/7	42.9%		1				6	00:12:47
3	安妮	5/16	2/7	0/2	2/2	11/13			20/40	50.0%	9	13	2			6	04:49:28
5	李纯															6	00:00:00
7	刘彤	0/1	3/4	3/8	1/5			0/1	7/19	36.8%	1	9	5	4		6	05:29:28
8	李诗棋		1/1	0/3					1/4	25.0%		2				6	01:01:54
9	韦宝桂	16/35	7/12	1/3	4/5	3/3	1/3	13/18	45/79	57.0%	8	17				6	05:07:36
10	史小军	3/8	6/9		3/4	5/6			17/27	63.0%	6	10	3	2		6	03:35:59
11	魏梦庭	2/17	2/4		0/1				4/22	18.2%		9		2		6	02:08:05
15	杨慧			0/1					0/1	0.0%						6	00:14:06
16	李娟											2				6	00:18:31
19	邝雪花	0/1	6/11						6/12	50.0%		7	1	2		6	02:49:22
20	李军政		2/2	1/5	2/3				5/10	50.0%		3	1	1		6	02:02:10
22	刘晓玉										3	1				6	02:07:03
23	王如	2/2	8/10		1/1	1/1			12/14	85.7%	2	6	3	2		6	04:14:29
26	马晓卉	0/1							0/1	0.0%	1	1				6	03:34:26
28	刘金兰		0/2	17/24	4/8			10/15	31/49	63.3%	3	4	2	2		6	04:45:47
	<b>合计</b>	<b>29/85</b>	<b>37/63</b>	<b>22/46</b>	<b>17/29</b>	<b>21/24</b>	<b>1/3</b>	<b>24/35</b>	<b>151/285</b>	<b>53.0%</b>	<b>35</b>	<b>83</b>	<b>17</b>	<b>15</b>		<b>96</b>	
<b>(守门员)</b>																	
16	李娟	1/2	2/7	1/1		0/2		2/11	6/23	26.1%	2					6	00:18:31
22	刘晓玉	11/22	8/19	1/5	2/7	1/12	2/2	0/1	25/68	36.8%	3	1				6	02:07:03
26	马晓卉	14/31	9/28	5/14	7/25	3/17	1/2	3/17	42/134	31.3%	1	1				6	03:34:26
	<b>合计</b>	<b>26/55</b>	<b>19/54</b>	<b>7/20</b>	<b>9/32</b>	<b>4/31</b>	<b>3/4</b>	<b>5/29</b>	<b>73/225</b>	<b>32.4%</b>	<b>6</b>	<b>2</b>				<b>18</b>	

场上队员：得分/射门

守门员：救球/射门

## 已打比赛

全队合计	进球	被救	射失	击柱	封球	合计	%	阶段	场次	对手	比分
远射	29	17	10	11	18	85	34.1%	预赛	4	北京	30:21 (18:11)
近射	37	16	3	7		63	58.7%	预赛	8	新疆	29:19 (14:13)
边射	22	16	3	4		45	48.9%	预赛	12	江苏	19:30 (7:18)
快攻	17	8	1	3		29	58.6%	四分之一决赛	14	山东	22:17 (10:12)
突破	21	2		1		24	87.5%	半决赛	19	安徽	24:35 (13:21)
任意	1	1		1		3	33.3%	3-4名	23	上海	27:30 (14:14)
七米	24	6	4	1		35	68.6%				

第十三届全国运动会女子手球决赛

PHMS Pictorial Handball Match Statistics

IHF Official System

图式射门区域累计

手球  
女子

截止至第24场

天津  
2017-09-07

广东

2 王彤羽 1 2 Post - 0 Miss - 0 Block - 0	3 安妮 2 5 2 2 4 1 4 Post - 5 Miss - 6 Block - 1	5 李纯 Post - 0 Miss - 0 Block - 0	7 刘彤 1 1 1 4 Post - 4 Miss - 0 Block - 1	8 李诗棋 1 Post - 1 Miss - 1 Block - 0	9 韦宝桂 6 1 10 4 10 3 3 8 Post - 5 Miss - 3 Block - 9	10 史小军 2 3 1 7 4 Post - 1 Miss - 3 Block - 1	11 魏梦庭 1 2 1 Post - 5 Miss - 2 Block - 5
15 杨慧 Post - 0 Miss - 0 Block - 0	16 李娟 Post - 0 Miss - 0 Block - 0	19 邱雪花 2 1 1 1 1 Post - 2 Miss - 0 Block - 1	20 李军政 4 1 Post - 0 Miss - 2 Block - 0	22 刘晓玉 Post - 0 Miss - 0 Block - 0	23 王如 1 2 1 4 2 2 Post - 2 Miss - 0 Block - 0	26 马晓卉 Post - 1 Miss - 0 Block - 0	28 刘金兰 2 3 5 2 5 9 1 4 Post - 2 Miss - 4 Block - 0

16 李娟

0/4		1/2
2/4	1/1	0/2
2/3	0/1	0/6

22 刘晓玉

0/6	1/1	3/10
4/12	3/4	9/12
2/9	1/3	2/11

26 马晓卉

3/16	3/4	2/14
4/18	6/6	4/16
11/34	4/6	5/20

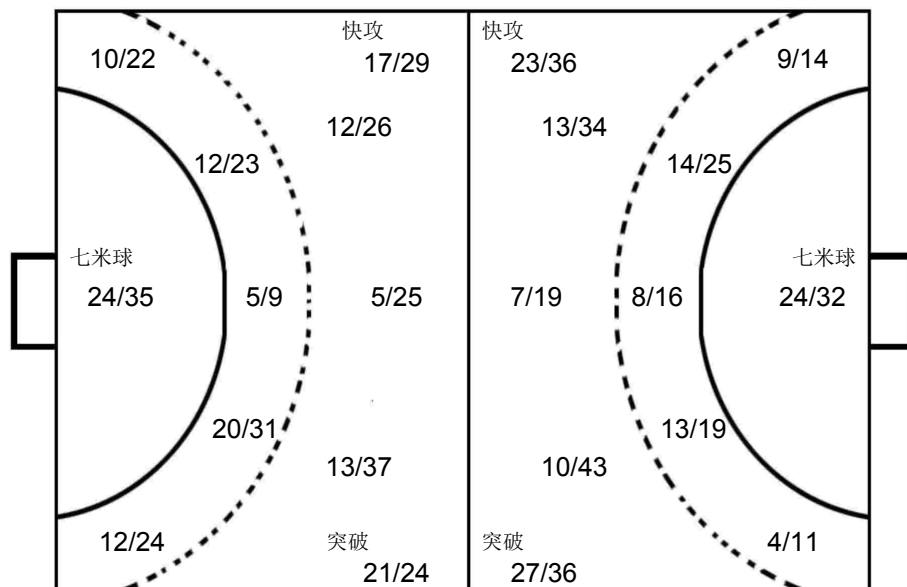

安徽

16 朱莉珍

0/1	2/3	1/5
3/3	2/2	1/3
2/2	2/2	1/4

新疆

32 杨雨柔

0/3	1/3	3/9
4/8	1/1	0/1
2/6	0/1	0/3

上海

1 许沫

0/3		1/4
2/4	1/1	5/8
0/6	0/1	0/5

OPPONENT

安徽 41 杜机娟 1 1 1 4 1 2 Post - 0 Miss - 0 Block - 0	上海 9 武娜娜 1 1 2 2 1 2 Post - 0 Miss - 0 Block - 0	安徽 6 沈萍 3 1 1 1 Post - 1 Miss - 0 Block - 0	上海 8 吴茵 1 1 1 2 1 Post - 1 Miss - 0 Block - 1	安徽 13 陶丹扬 1 1 3 Post - 1 Miss - 0 Block - 0	安徽 21 李瑶 1 2 1 1 Post - 2 Miss - 0 Block - 1	北京 28 闫美珠 3 2 Post - 0 Miss - 0 Block - 0	江苏 69 蓝小玲 1 1 1 1 1 Post - 1 Miss - 1 Block - 0
山东 2 林燕群 1 1 1 2 Post - 1 Miss - 2 Block - 1	山东 8 王彬 1 1 3 Post - 0 Miss - 1 Block - 1	上海 11 孙梦颖 1 2 1 1 Post - 2 Miss - 0 Block - 0	新疆 18 崔娟 1 1 1 1 1 Post - 1 Miss - 1 Block - 1	北京 10 刘莎 1 3 Post - 0 Miss - 0 Block - 0	北京 24 郝佳楠 1 1 2 Post - 4 Miss - 2 Block - 1	江苏 4 赵佳芹 1 3 Post - 0 Miss - 1 Block - 0	江苏 19 李薇薇 1 2 Post - 2 Miss - 0 Block - 0





## 第十三届全国运动会女子手球决赛

PHMS Pictorial Handball Match Statistics

IHF Official System

## 球队名单

山东

天津

2017-08-31

号码	姓名	位置	生日	年龄	俱乐部	身高 (CM)	体重 (KG)	国际场次	国际进球
1	路畅	守门员	06/04/1998	19		181	72		
2	林燕群	右后卫	16/05/1996	21		177	67		
6	王莎莎	后卫	08/01/1987	30		180	78		
8	王彬	中后卫	06/09/1993	23		177	68		
10	田秀秀	左后卫	13/01/1996	21		174	70		
11	吕青纹	左边锋	22/05/1998	19		170	66		
12	张苑琳	守门员	18/08/1996	21		181	70		
15	吴作扬	左后卫	18/06/1994	23		188	80		
19	姜伟珊	左边锋	22/01/1997	20		172	69		
20	张悦	右边锋	09/02/1995	22		175	72		
22	朱赟	守门员	01/07/1989	28		180	71		
23	徐悦	底线	22/02/1998	19		177	71		
28	崔金娜	底线	23/07/1992	25		182	73		
29	刘婵	右边锋	10/08/1998	19		180	72		
33	王彩琳	右后卫	20/04/1995	22		175	68		
77	穆庆丛	底线	26/05/1997	20		179	82		
	平均			22.0		178.0	71.8		

编码	姓名	职务
B	马海湧	主教练
C	徐强	教练
D	孔德宾	教练
E	王日东	医生
A	杜晓青	领队

## 第十三届全国运动会女子手球决赛

PHMS Pictorial Handball Match Statistics

IHF Official System

 手球 女子 个人/全队技术累计表  
 截止至第24场 天津 2017-09-07

号码	姓名	远射	近射	边射	快攻	突破	任意	七米	合计	%	助攻	失误	警告	2'	取消	场次	时间
<b>山东</b>																	
<b>(场上队员)</b>																	
1	刘畅															6	02:29:03
2	林燕群	13/39	5/9	2/2	1/1	6/9	0/5	3/4	30/69	43.5%	5	11	2	2		6	04:15:27
6	王莎莎											1		2		6	00:43:23
8	王彬	2/10	2/6	3/3	1/1	2/2	1/2	15/17	26/41	63.4%	3	15				6	02:46:48
10	田秀秀							5/8	5/8	62.5%						3	00:33:24
11	吕青纹	1/6	2/2	6/6	7/9				16/23	69.6%	4	1	1			6	03:59:32
12	张苑琳															6	00:04:08
15	吴作扬	2/15	3/4			1/3			6/22	27.3%	3	9		5		6	02:19:49
19	姜伟珊	1/1		3/4	1/1				5/6	83.3%		2	1			6	01:40:31
20	张悦		0/1	6/9	2/3	1/1			9/14	64.3%		5	3	3		6	04:49:58
22	朱赟										4	1				6	03:26:49
23	徐悦	0/1							0/1	0.0%	1		1	3		6	02:13:29
28	崔金娜		12/15			1/1			13/16	81.3%	1	6	4	1		6	04:23:56
29	刘婵	3/5	0/2						3/7	42.9%		1				2	00:44:20
33	王彩琳	2/8	3/7	0/1	2/2	4/7	1/2	0/1	12/28	42.9%	3	16	2	4		6	04:23:41
77	穆庆丛		2/2		0/1				2/3	66.7%			1	1		6	01:36:45
	<b>合计</b>	<b>24/85</b>	<b>29/48</b>	<b>20/25</b>	<b>14/18</b>	<b>15/23</b>	<b>2/9</b>	<b>23/30</b>	<b>127/238</b>	<b>53.4%</b>	<b>24</b>	<b>68</b>	<b>15</b>	<b>21</b>		<b>89</b>	
<b>(守门员)</b>																	
1	刘畅	4/13	6/17	6/10	2/8	2/14		2/12	22/74	29.7%						6	02:29:03
12	张苑琳							2/6	2/6	33.3%						6	00:04:08
22	朱赟	19/33	8/26	3/12	4/17	3/10	1/7	1/9	39/114	34.2%	4	1				6	03:26:49
	<b>合计</b>	<b>23/46</b>	<b>14/43</b>	<b>9/22</b>	<b>6/25</b>	<b>5/24</b>	<b>1/7</b>	<b>5/27</b>	<b>63/194</b>	<b>32.5%</b>	<b>4</b>	<b>1</b>				<b>18</b>	

场上队员：得分/射门

守门员：救球/射门

## 已打比赛

全队合计	进球	被救	射失	击柱	封球	合计	%	阶段	场次	对手	比分
远射	24	27	9	6	19	85	28.2%	预赛	2	上海	21:28 (9:19)
近射	29	14	3	2		48	60.4%	预赛	5	安徽	21:29 (10:16)
边射	20	1	3	1		25	80.0%	预赛	9	天津	26:15 (12:7)
快攻	14	2	2			18	77.8%	四分之一决赛	14	广东	17:22 (12:10)
突破	15	6		2		23	65.2%	5-8名	17	新疆	19:18 (9:5)
任意	2	3	4			9	22.2%	5-6名	22	北京	23:22 (15:12)
七米	23	3	2	2		30	76.7%				

第十三届全国运动会女子手球决赛

PHMS Pictorial Handball Match Statistics

IHF Official System

图式射门区域累计

手球  
女子

截止至第24场

天津  
2017-09-07

山东

1 路畅 Post - 0 Miss - 0 Block - 0	2 林燕群 Post - 3 Miss - 9 Block - 10	6 王莎莎 Post - 0 Miss - 0 Block - 0	8 王彬 Post - 3 Miss - 2 Block - 1	10 田秀秀 Post - 2 Miss - 1 Block - 0	11 吕青纹 Post - 0 Miss - 1 Block - 1	12 张苑琳 Post - 0 Miss - 0 Block - 0	15 吴作扬 Post - 2 Miss - 2 Block - 4
19 姜伟珊 Post - 0 Miss - 1 Block - 0	20 张悦 Post - 1 Miss - 1 Block - 0	22 朱贇 Post - 0 Miss - 0 Block - 0	23 徐悦 Post - 0 Miss - 0 Block - 0	28 崔金娜 Post - 0 Miss - 0 Block - 0	29 刘婵 Post - 1 Miss - 0 Block - 0	33 王彩琳 Post - 1 Miss - 5 Block - 3	77 穆庆丛 Post - 0 Miss - 1 Block - 0

1 路畅	1/4	0/3	3/10
	4/12	0/1	7/16
	2/10	3/5	2/13

12 张苑琳			0/2
	0/1		0/1
	2/2		

22 朱贇	3/12	0/1	6/21
	10/20		6/17
	6/16	2/3	6/24

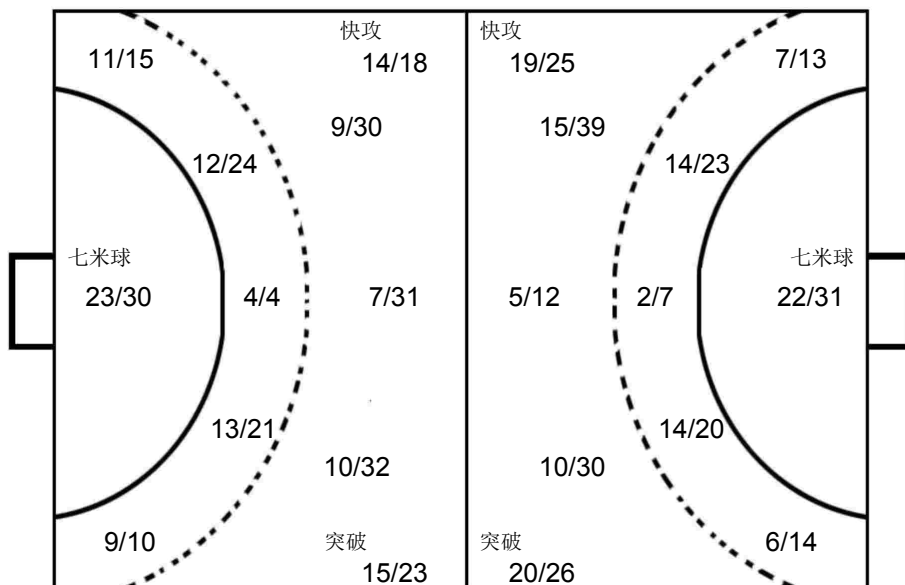

新疆	32 杨雨柔	1/5	1/3
		1/5	1/4
		3/5	2/4

上海	1 许沫	0/2	0/1
		2/4	4/6
		1/2	1/1

北京	16 王海叶	2/3	2/6
		0/6	1/4
		1/5	2/3

OPPONENT

安徽 41 杜机娟 Post - 0 Miss - 1 Block - 0	安徽 14 刘晓妹 Post - 0 Miss - 2 Block - 0	广东 9 韦宝桂 Post - 1 Miss - 0 Block - 1	北京 28 闫美珠 Post - 0 Miss - 1 Block - 1	上海 6 黄妍 Post - 3 Miss - 1 Block - 0	上海 9 武娜娜 Post - 0 Miss - 0 Block - 0	天津 3 王晓梅 Post - 0 Miss - 1 Block - 1	新疆 93 张婷婷 Post - 1 Miss - 0 Block - 0
安徽 17 周婷 Post - 1 Miss - 0 Block - 0	北京 10 刘莎 Post - 0 Miss - 0 Block - 0	北京 24 郝佳楠 Post - 1 Miss - 0 Block - 2	上海 11 孙梦颖 Post - 0 Miss - 0 Block - 2	新疆 6 阿热孜古丽 Post - 0 Miss - 0 Block - 0	安徽 6 沈萍 Post - 0 Miss - 1 Block - 0	广东 3 安妮 Post - 1 Miss - 1 Block - 0	广东 10 史小军 Post - 0 Miss - 0 Block - 0



## 第十三届全国运动会女子手球决赛

PHMS Pictorial Handball Match Statistics

IHF Official System

## 球队名单

北京

天津

2017-08-31

号码	姓名	位置	生日	年龄	俱乐部	身高 (CM)	体重 (KG)	国际场次	国际进球
1	宋嘉蕾	守门员	25/01/1995	22		190	76		
3	季小桐	后卫	12/10/1994	22		177	65		
6	刘亚男	底线	27/04/1986	31		175	68		
8	杨铭豫	右边锋	22/08/1993	24		177	70		
9	宋建军	左后卫	01/08/1997	20		180	72		
10	刘莎	左边锋	05/06/1992	25		170	65		
11	纪婉	左边锋	26/01/1995	22		168	62		
15	郝泽荣	底线	22/04/1998	19		185	80		
16	王海叶	守门员	03/07/1991	26		178	64		
22	李海鸥	底线	08/07/1990	27		177	66		
23	赵小颖	左后卫	03/05/1991	26		180	75		
24	郝佳楠	后卫	28/05/1992	25		178	73		
27	曹芳鸣	右边锋	27/04/1995	22		164	65		
28	闫美珠	右后卫	28/01/1989	28		191	78		
47	刘泽	守门员	30/05/1994	23		178	65		
69	石梓薇	后卫	25/09/1996	20		178	70		
	平均			23.9		177.9	69.6		

编码	姓名	职务
A	蔡建国	领队
B	宋刚	主教练
C	关宏波	教练
E	王长林	医生
D	李翼	教练

## 第十三届全国运动会女子手球决赛

PHMS Pictorial Handball Match Statistics

IHF Official System

 手球  
 女子

## 个人/全队技术累计表

 天津  
 2017-09-07

截止至第24场

号码	姓名	远射	近射	边射	快攻	突破	任意	七米	合计	%	助攻	失误	警告	2'	取消	场次	时间
北京																	
(场上队员)																	
1	宋嘉蕾										1					5	00:23:43
3	季小桐	2/11	7/10	1/2			1/1	1/1	12/25	48.0%	17	13			1	6	02:54:05
6	刘亚男		2/3	0/1					2/4	50.0%					2	6	01:03:15
8	杨铭豫		1/1	1/4	1/1				3/6	50.0%		2	1			6	02:12:06
9	宋建军							1/2	1/2	50.0%						6	00:00:19
10	刘莎	0/1	3/3	7/11	1/3	2/2		9/9	22/29	75.9%	1	6	5	3		6	04:09:52
11	纪婉		1/1	1/2	1/1				3/4	75.0%		1		1		6	01:42:55
15	郝泽荣	0/2	6/12	1/1				2/5	9/20	45.0%	1	6	1	3		6	03:02:02
16	王海叶										1	1				6	04:20:57
22	李海鸥	0/1	9/14						9/15	60.0%	1		1			6	04:04:28
23	赵小颖	1/9	2/3					8/9	11/21	52.4%	2	7				6	01:10:31
24	郝佳楠	12/40	7/11	0/1	1/2	5/7	0/3		25/64	39.1%	11	22		1		6	04:54:55
27	曹芳鸣			3/3					3/3	100%		1				6	01:14:07
28	闫美珠	14/29	0/3	2/3		2/2	3/4	5/5	26/46	56.5%	3	7	3	2		6	04:35:18
47	刘泽															6	01:15:03
69	石梓薇	7/20	6/11	0/1	1/1	1/1			15/34	44.1%	3	15	3	3		6	04:51:46
	合计	36/113	44/72	16/29	5/8	10/12	4/8	26/31	141/273	51.6%	41	81	14	16		95	

(守门员)

1	宋嘉蕾	0/2	2/5	1/3	4/7	0/1	0/1	0/1	7/20	35.0%	1					5	00:23:43
16	王海叶	13/33	9/38	11/28	7/31	3/11	2/2	3/14	48/157	30.6%	1	1				6	04:20:57
47	刘泽	5/11	1/11	2/5	1/6	1/5	0/1	1/6	11/45	24.4%						6	01:15:03
	合计	18/46	12/54	14/36	12/44	4/17	2/4	4/21	66/222	29.7%	2	1				17	

场上队员：得分/射门

守门员：救球/射门

已打比赛

全队合计	进球	被救	射失	击柱	封球	合计	%	阶段	场次	对手	比分
远射	36	33	10	13	21	113	31.9%	预赛	4	广东	21:30 (11:18)
近射	44	22	2	3	1	72	61.1%	预赛	7	江苏	24:33 (9:19)
边射	16	11	1	1		29	55.2%	预赛	11	新疆	27:19 (11:8)
快攻	5	3				8	62.5%	四分之一决赛	15	上海	19:29 (5:15)
突破	10	1		1		12	83.3%	5-8名	18	天津	28:22 (13:7)
任意	4		3	1		8	50.0%	5-6名	22	山东	22:23 (12:15)
七米	26	3	1	1		31	83.9%				

第十三届全国运动会女子手球决赛

PHMS Pictorial Handball Match Statistics

IHF Official System

图式射门区域累计

手球  
女子

截止至第24场

天津  
2017-09-07

北京

1 宋嘉蕾 Post - 0 Miss - 0 Block - 0	3 季小桐 Post - 3 Miss - 2 Block - 0	6 刘亚男 Post - 0 Miss - 0 Block - 0	8 杨铭豫 Post - 1 Miss - 0 Block - 0	9 宋建军 Post - 0 Miss - 0 Block - 0	10 刘莎 Post - 0 Miss - 1 Block - 0	11 纪婉 Post - 0 Miss - 0 Block - 0	15 郝泽荣 Post - 2 Miss - 1 Block - 0
16 王海叶 Post - 0 Miss - 0 Block - 0	22 李海鸥 Post - 0 Miss - 2 Block - 0	23 赵小颖 Post - 0 Miss - 1 Block - 5	24 郝佳楠 Post - 7 Miss - 8 Block - 9	27 曹芳鸣 Post - 0 Miss - 0 Block - 0	28 闫美珠 Post - 3 Miss - 2 Block - 4	47 刘泽 Post - 0 Miss - 0 Block - 0	69 石梓薇 Post - 4 Miss - 0 Block - 4

1 宋嘉蕾
1/5 0/1 1/1
1/4 1/1
0/4 2/2 1/2

16 王海叶
3/15 2/6 4/18
10/26 1/1 6/25
10/35 4/7 8/24

47 刘泽
0/5 0/2 0/3
2/8 1/5
3/9 0/1 5/12

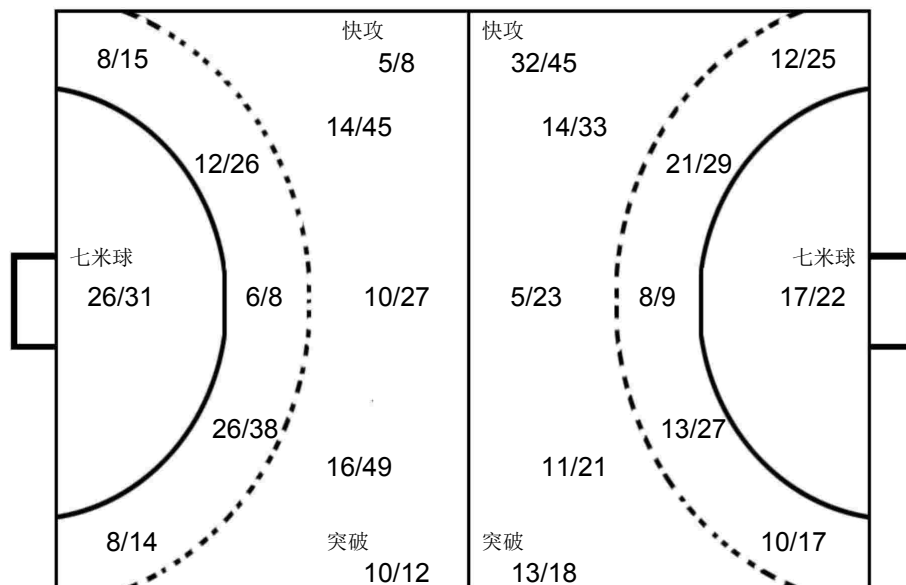

江苏

16 王小华
1/2 1/6
0/1 0/1 7/8
2/5 0/1 3/8

天津

16 王选
2/3 3/4
2/5 2/2 3/4
1/4 1/6

新疆

32 杨雨柔
1/2 1/4
2/5 3/6
1/5 2/10

OPPONENT

江苏 33 金梦青 Post - 0 Miss - 0 Block - 0	山东 8 王彬 Post - 0 Miss - 1 Block - 0	广东 9 韦宝桂 Post - 0 Miss - 1 Block - 0	山东 11 吕青纹 Post - 0 Miss - 0 Block - 0	广东 3 安妮 Post - 0 Miss - 1 Block - 0	上海 9 武娜娜 Post - 0 Miss - 0 Block - 0	天津 9 袁玉 Post - 0 Miss - 1 Block - 1	新疆 7 吴志娟 Post - 1 Miss - 0 Block - 0
江苏 69 蓝小玲 Post - 1 Miss - 1 Block - 0	上海 2 周蕾 Post - 0 Miss - 0 Block - 0	天津 23 周梦雪 Post - 0 Miss - 0 Block - 1	广东 28 刘金兰 Post - 0 Miss - 1 Block - 0	江苏 4 赵佳芹 Post - 0 Miss - 0 Block - 0	江苏 17 修丽杰 Post - 1 Miss - 1 Block - 0	山东 20 张悦 Post - 0 Miss - 1 Block - 0	上海 3 王嘉怡 Post - 0 Miss - 1 Block - 0



## 第十三届全国运动会女子手球决赛

PHMS Pictorial Handball Match Statistics

IHF Official System

## 球队名单

天津

2017-08-31

新疆

号码	姓名	位置	生日	年龄	俱乐部	身高 (CM)	体重 (KG)	国际场次	国际进球
3	葛立双	中后卫	01/02/1998	19		170	63		
5	于千添	中后卫	30/12/2000	16		181	60		
6	阿热孜古丽	底线	10/03/1992	25		182	75		
7	吴志娟	右边锋	03/05/1989	28		173	63		
10	李静	守门员	15/12/1991	25		175	62		
11	陈培培	右边锋	03/04/1993	24		174	69		
12	艾敏	底线	19/11/1997	19		175	70		
15	兰姝娇	左边锋	13/10/1998	18		173	65		
17	戴莹莹	底线	10/07/1994	23		176	69		
18	崔娟	左后卫	01/01/1988	29		176	64		
21	锁珊珊	左后卫	27/01/1997	20		178	66		
23	张艺璇	左边锋	11/08/1997	20		165	52		
26	宋婷婷	右后卫	26/02/1991	26		178	69		
27	谢辰辰	中后卫	06/01/1993	24		178	70		
32	杨雨柔	守门员	16/07/1996	21		186	80		
93	张婷婷	右后卫	03/09/1996	20		181	70		
	平均			22.3		176.3	66.7		

编码	姓名	职务
A	刁继平	领队
B	于涛	主教练
C	李天坐	医生
D	马玲	工作人员

## 第十三届全国运动会女子手球决赛

PHMS Pictorial Handball Match Statistics

IHF Official System

 手球 女子 个人/全队技术累计表  
 截止至第24场  
 天津 2017-09-07

号码	姓名	远射	近射	边射	快攻	突破	任意	七米	合计	%	助攻	失误	警告	2'	取消	场次	时间
<b>新疆</b>																	
<b>(场上队员)</b>																	
3	葛立双	1/9	0/6		1/1	4/4		0/1	6/21	28.6%	3	7		1		6	01:57:18
5	于千添	0/1							0/1	0.0%						6	00:01:30
6	阿热孜古丽		12/20	1/1	4/4			1/2	18/27	66.7%		10	3	5		6	04:31:15
7	吴志娟		3/6	8/13	5/5				16/24	66.7%	1	3	1	1		6	05:02:09
10	李静															6	00:47:07
11	陈培培													1		6	00:12:46
12	艾敏															6	00:03:25
15	兰姝娇		2/4	3/13	2/2				7/19	36.8%	1	7	2	1		6	04:46:03
17	戴莹莹		1/5		1/1				2/6	33.3%	1	3	1	2		6	02:20:32
18	崔娟	12/34	4/10			4/5		2/3	22/52	42.3%	3	18	2	2		6	04:27:06
21	锁珊珊	8/26	2/7	2/2	1/1		0/1	3/4	16/41	39.0%	4	10	1	3		6	04:40:35
23	张艺璇	0/1		0/3					0/4	0.0%		1				6	01:34:54
26	宋婷婷	2/5	1/1		0/1				3/7	42.9%	1	3	1	1		6	00:59:02
27	谢辰辰	0/3	0/1					1/1	1/5	20.0%	1	3				6	00:32:46
32	杨雨柔											3				6	05:12:53
93	张婷婷	3/21	5/8		1/1	3/7	1/3	7/8	20/48	41.7%	8	21	4	5		6	04:57:29
<b>合计</b>		<b>26/100</b>	<b>30/68</b>	<b>14/32</b>	<b>15/16</b>	<b>11/16</b>	<b>1/4</b>	<b>14/19</b>	<b>111/255</b>	<b>43.5%</b>	<b>23</b>	<b>89</b>	<b>15</b>	<b>22</b>		<b>96</b>	
<b>(守门员)</b>																	
10	李静	3/8	0/4	1/4	2/8	0/2		2/13	8/39	20.5%						6	00:47:07
32	杨雨柔	17/38	24/64	10/22	7/34	2/13	0/4	4/14	64/189	33.9%		3				6	05:12:53
<b>合计</b>		<b>20/46</b>	<b>24/68</b>	<b>11/26</b>	<b>9/42</b>	<b>2/15</b>	<b>0/4</b>	<b>6/27</b>	<b>72/228</b>	<b>31.6%</b>		<b>3</b>				<b>12</b>	

场上队员：得分/射门

守门员：救球/射门

已打比赛

全队合计	进球	被救	射失	击柱	封球	合计	%	阶段	场次	对手	比分
远射	26	41	8	13	12	100	26.0%	预赛	3	江苏	16:29 (9:12)
近射	30	28	2	8		68	44.1%	预赛	8	广东	19:29 (13:14)
边射	14	11	2	5		32	43.8%	预赛	11	北京	19:27 (8:11)
快攻	15	1				16	93.8%	四分之一决赛	13	安徽	14:32 (5:17)
突破	11	3	2			16	68.8%	5-8名	17	山东	18:19 (5:9)
任意	1	2	1			4	25.0%	7-8名	21	天津	25:20 (15:11)
七米	14	4	1			19	73.7%				



第十三届全国运动会女子手球决赛

PHMS Pictorial Handball Match Statistics

IHF Official System

图式射门区域累计

手球  
女子

截止至第24场

天津  
2017-09-07

新疆

3 葛双双 1 1 2 Post - 0 Miss - 2 Block - 0	5 于千添 Post - 0 Miss - 0 Block - 0	6 阿热孜古丽 1 1 1 1 3 3 5 7 7 Post - 1 Miss - 0 Block - 0	7 吴志娟 4 1 2 2 3 4 Post - 4 Miss - 0 Block - 0	10 李静 Post - 0 Miss - 0 Block - 0	11 陈培培 Post - 0 Miss - 0 Block - 0	12 艾敏 Post - 0 Miss - 0 Block - 0	15 兰姝娇 2 1 1 4 4 Post - 3 Miss - 1 Block - 0
17 戴莹莹 2 Post - 1 Miss - 0 Block - 0	18 崔娟 1 1 4 4 4 4 2 6 6 Post - 6 Miss - 3 Block - 4	21 锁珊珊 2 3 3 4 1 3 3 1 2 2 Post - 7 Miss - 3 Block - 3	23 张艺璇 Post - 1 Miss - 1 Block - 0	26 宋婷婷 2 1 1 Post - 1 Miss - 0 Block - 1	27 谢辰辰 1 Post - 0 Miss - 1 Block - 0	32 杨雨柔 Post - 0 Miss - 0 Block - 0	93 张婷婷 4 1 1 3 3 3 2 7 7 Post - 2 Miss - 5 Block - 4

10 李静

0/5	0/2	0/7
3/6	1/1	2/7
1/7		1/4

32 杨雨柔

5/20	1/3	8/27
19/39	2/3	13/28
9/31	1/2	6/36

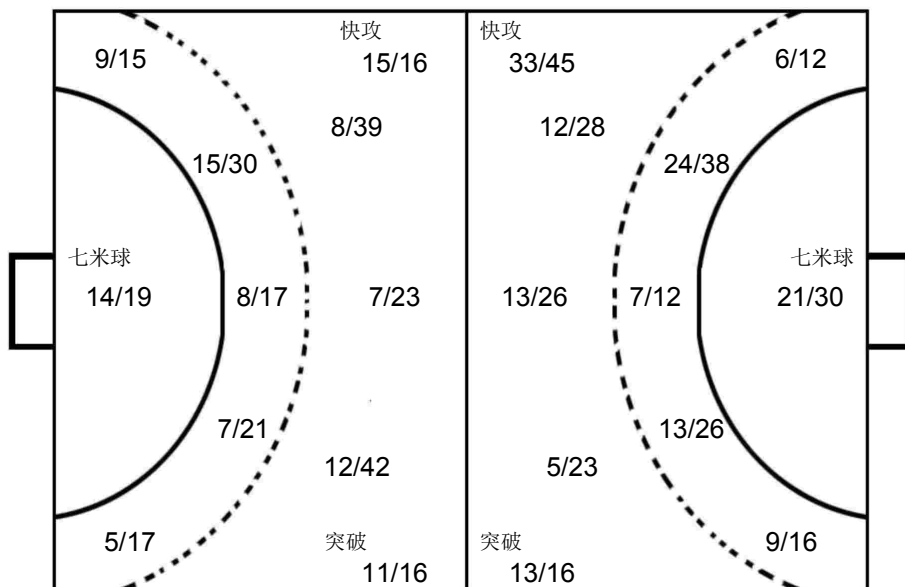

北京  
16 王海叶

0/1	1/3	1/3
3/4	1/1	2/5
3/8	1/1	3/7

安徽  
1 司艳

2/2	1/2	1/1
3/3	1/1	1/1
4/5		1/3

安徽  
16 朱莉珍

0/1		2/4
0/2	1/1	2/3
1/1		6/9

OPPONENT

北京 24 郝佳楠 2 2 5 Post - 2 Miss - 0 Block - 0	广东 9 韦宝桂 1 3 3 1 1 1 Post - 1 Miss - 1 Block - 2	广东 28 刘金兰 1 2 2 1 3 3 Post - 1 Miss - 0 Block - 0	安徽 5 班晨晨 2 1 1 1 1 1 Post - 0 Miss - 0 Block - 0	北京 10 刘莎 1 1 1 1 2 2 Post - 0 Miss - 0 Block - 0	山东 8 王彬 1 1 1 1 1 2 Post - 0 Miss - 0 Block - 0	江苏 19 李薇薇 1 1 1 1 1 1 Post - 0 Miss - 3 Block - 0	江苏 69 蓝小玲 1 1 1 3 1 1 Post - 1 Miss - 0 Block - 0
山东 2 林燕群 3 1 1 Post - 0 Miss - 0 Block - 3	天津 3 王晓梅 1 2 2 1 1 1 Post - 2 Miss - 0 Block - 1	安徽 13 陶丹扬 2 2 2 Post - 0 Miss - 1 Block - 0	安徽 41 杜机娟 1 2 2 Post - 0 Miss - 0 Block - 0	广东 10 史小军 1 1 1 2 1 1 Post - 0 Miss - 0 Block - 0	江苏 17 修丽杰 1 2 2 1 2 2 Post - 0 Miss - 0 Block - 0	天津 18 舒文琪 1 3 3 Post - 1 Miss - 1 Block - 0	安徽 14 刘晓妹 1 1 1 Post - 0 Miss - 0 Block - 0



## 第十三届全国运动会女子手球决赛

PHMS Pictorial Handball Match Statistics

IHF Official System

## 球队名单

天津

天津

2017-08-31

号码	姓名	位置	生日	年龄	俱乐部	身高 (CM)	体重 (KG)	国际场次	国际进球
1	张莉	守门员	13/12/1991	25		183	78		
3	王晓梅	右后卫	21/05/1995	22		181	86		
5	丁丽洁	底线	20/01/1998	19		175	63		
6	窦海乐	右边锋	28/12/2001	15		178	76		
7	张心茹	底线	13/11/1999	17		173	65		
8	张慧	右边锋	10/12/1999	17		174	62		
9	袁玉	中后卫	08/05/1998	19		165	56		
10	张文慧	底线	21/04/1998	19		177	67		
11	蔡雪洁	左后卫	10/02/1997	20		176	60		
12	王欣冉	守门员	04/07/1999	18		182	82		
14	刘洁	中后卫	14/03/1999	18		175	62		
15	李窈窈	右后卫	29/06/1999	18		176	64		
16	王选	守门员	15/06/1999	18		174	70		
17	聂晓雪	左边锋	19/03/1999	18		174	61		
18	舒文琪	右后卫	06/05/1999	18		175	63		
23	周梦雪	右后卫	20/02/2000	17		178	70		
	平均			18.6		176.0	67.8		

编码	姓名	职务
A	付明双	领队
B	王明星	主教练
C	岳连娥	教练
D	张圆圆	医生

**第十三届全国运动会女子手球决赛**
**PHMS** Pictorial Handball Match Statistics

**IHF** Official System

 手球  
 女子

**个人/全队技术累计表**

 天津  
 2017-09-07

截止至第24场

号码	姓名	远射	近射	边射	快攻	突破	任意	七米	合计	%	助攻	失误	警告	2'	取消	场次	时间
<b>天津</b>																	
<b>(场上队员)</b>																	
1	张莉															6	01:55:45
3	王晓梅	6/28	1/7			1/2	0/1	6/7	14/45	31.1%	4	7				6	02:16:23
5	丁丽洁	0/2	1/2	0/1	0/1				1/6	16.7%	1	2	1			6	01:53:29
6	窦海乐															6	00:00:00
7	张心茹	0/2	0/1	0/1				1/2	1/6	16.7%		1	1			6	00:24:28
8	张慧		1/3	1/2	1/2	1/1			4/8	50.0%	1	2	2	4		5	04:07:01
9	袁玉	3/12	9/19	5/5	5/10	7/10	0/1	1/2	30/59	50.8%	3	21		1		6	05:06:29
10	张文慧		16/21		1/2				17/23	73.9%	2	7	4	4		6	05:29:57
11	蔡雪洁	3/7	2/5	1/1	3/3				9/16	56.3%	3	8	2	2		6	03:26:14
12	王欣冉															6	00:30:55
14	刘洁										1	2				6	00:17:38
16	王选										1					6	03:33:20
17	聂晓雪	0/1	2/2	0/5	2/2	1/1			5/11	45.5%		9	2	1		6	02:38:53
18	舒文琪	6/24	1/4	0/2	1/1		0/1	3/5	11/37	29.7%	7	13		1		6	03:09:08
23	周梦雪	7/28	8/16	1/2	1/3	4/5	0/2	3/6	24/62	38.7%	12	30	2	2		6	04:56:31
	<b>合计</b>	<b>25/104</b>	<b>41/80</b>	<b>8/19</b>	<b>14/24</b>	<b>14/19</b>	<b>0/5</b>	<b>14/22</b>	<b>116/273</b>	<b>42.5%</b>	<b>35</b>	<b>102</b>	<b>14</b>	<b>15</b>		<b>89</b>	
<b>(守门员)</b>																	
1	张莉	8/15	6/21	5/10	1/13	0/4	1/2	1/11	22/76	28.9%						6	01:55:45
12	王欣冉	0/3	2/9	1/2	1/7	1/2		0/2	5/25	20.0%						6	00:30:55
16	王选	12/27	17/43	7/23	5/38	2/14	2/3	2/17	47/165	28.5%	1					6	03:33:20
	<b>合计</b>	<b>20/45</b>	<b>25/73</b>	<b>13/35</b>	<b>7/58</b>	<b>3/20</b>	<b>3/5</b>	<b>3/30</b>	<b>74/266</b>	<b>27.8%</b>	<b>1</b>					<b>18</b>	

场上队员：得分/射门

守门员：救球/射门

已打比赛

全队合计	进球	被救	射失	击柱	封球	合计	%	阶段	场次	对手	比分
远射	25	34	18	7	20	104	24.0%	预赛	1	安徽	25:42 (13:29)
近射	41	33	2	4		80	51.3%	预赛	6	上海	22:35 (10:20)
边射	8	8	3			19	42.1%	预赛	9	山东	15:26 (7:12)
快攻	14	10				24	58.3%	四分之一决赛	16	江苏	12:36 (5:19)
突破	14	4		1		19	73.7%	5-8名	18	北京	22:28 (7:13)
任意		2	3			5	0.0%	7-8名	21	新疆	20:25 (11:15)
七米	14	5	2	1		22	63.6%				

第十三届全国运动会女子手球决赛

PHMS Pictorial Handball Match Statistics

IHF Official System

图式射门区域累计

手球  
女子

截止至第24场

天津  
2017-09-07

天津

1 张莉 Post - 0 Miss - 0 Block - 0	3 王晓梅 Post - 4 Miss - 6 Block - 5	5 丁丽洁 Post - 0 Miss - 3 Block - 0	6 窦海乐 Post - 0 Miss - 0 Block - 0	7 张心茹 Post - 0 Miss - 2 Block - 1	8 张慧 Post - 0 Miss - 1 Block - 0	9 袁玉 Post - 3 Miss - 3 Block - 4	10 张文慧 Post - 0 Miss - 0 Block - 0
11 蔡雪洁 Post - 0 Miss - 0 Block - 1	12 王欣冉 Post - 0 Miss - 0 Block - 0	14 刘洁 Post - 0 Miss - 0 Block - 0	16 王选 Post - 0 Miss - 0 Block - 0	17 聂晓雪 Post - 0 Miss - 1 Block - 1	18 舒文琪 Post - 4 Miss - 5 Block - 2	23 周梦雪 Post - 2 Miss - 7 Block - 6	

1 张莉
4/10 0/1 0/5
2/9 3/4 5/15
3/15 2/2 3/15

12 王欣冉
0/2
0/4 1/3
3/8 1/4 0/4

16 王选
3/14 0/4 2/8
9/27 8/8 11/33
5/28 4/6 5/37

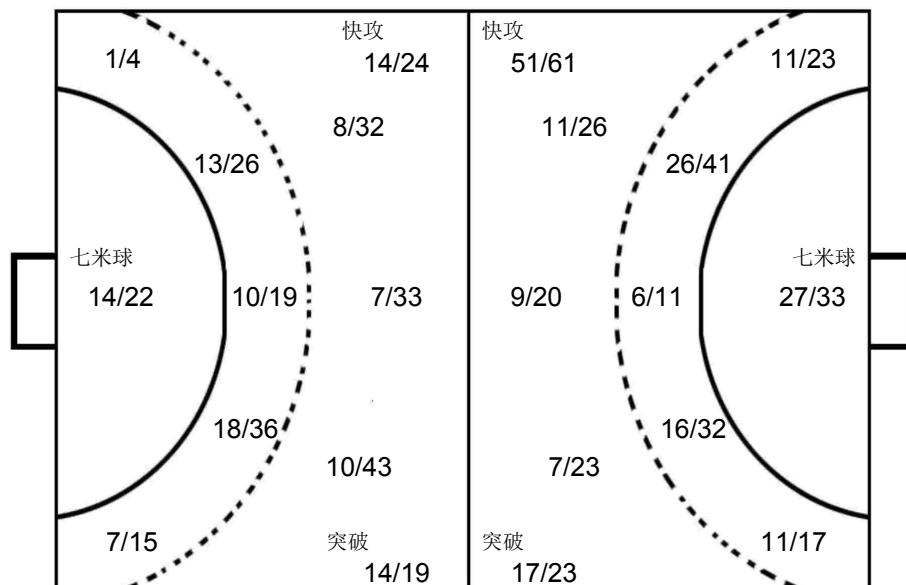

安徽
1 司徒
1/1 1/1 1/2
4/4 2/2 3/6
3/7 1/3 1/5

山东
22 朱赞
1/3 0/1 2/4
6/6 2/7
3/3 1/1 1/3

新疆
32 杨雨柔
0/1 1/4
6/10 1/1 4/8
1/4 1/1 1/6

OPPONENT

安徽 41 杜机娟 Post - 0 Miss - 1 Block - 0	江苏 3 张海侠 Post - 0 Miss - 0 Block - 0	北京 28 闫美珠 Post - 1 Miss - 0 Block - 0	新疆 6 阿热孜古丽 Post - 0 Miss - 0 Block - 0	安徽 13 陶丹扬 Post - 0 Miss - 0 Block - 0	山东 11 吕青纹 Post - 0 Miss - 1 Block - 0	安徽 21 李瑶 Post - 0 Miss - 1 Block - 0	北京 10 刘莎 Post - 0 Miss - 1 Block - 0
江苏 18 韦秋香 Post - 0 Miss - 0 Block - 0	江苏 33 金梦青 Post - 1 Miss - 0 Block - 1	山东 2 林燕群 Post - 0 Miss - 3 Block - 0	上海 2 周蕾 Post - 1 Miss - 1 Block - 0	上海 9 武娜娜 Post - 1 Miss - 0 Block - 0	新疆 93 张婷婷 Post - 1 Miss - 0 Block - 0	安徽 6 沈萍 Post - 0 Miss - 1 Block - 0	安徽 14 刘晓妹 Post - 0 Miss - 0 Block - 0



**PHMS** Pictorial Handball Match Statistics

**IHF** Official System

Team A					Team B					Match Number											
A 天津					B 安徽					<b>1</b>											
Played in			in the hall			on			at			Spectators									
天津			天津师范大学体育馆			2017-08-31			14:00			hours									
Half-time(30')	A	B	End of playing time		A	B	1st extra time		A	B	2nd extra time		A	B	After penalty throws		A	B			
	13	29	25		42																
Number of 7 m	A	Team time-out			Full name of players and officials						Team time-out			B	Number of 7 m						
	3/3	1	2	3							1	2	3	3/5							
No.	Team A					G	W	2'	D	DR	No.	Team B					G	W	2'	D	DR
1	张莉										1	司艳									
3	王晓梅					2					3	李兵					3				
5	丁丽洁						1				5	班晨晨					3	1			
6	窦海乐										6	沈萍					4	1			
7	张心茹										7	赵江川					3				
9	袁玉					11		1			8	徐仕媛									
10	张文慧					5					10	孙来苗									
11	蔡雪洁					1	1				13	陶丹扬					6				
12	王欣冉										14	刘晓妹					4				
14	刘洁										15	王婵婵					1	1			
16	王选										16	朱莉珍									
17	聂晓雪					2	1				17	周婷					2				
18	舒文琪										20	周雪婷									
23	周梦雪					4		1			21	李瑶					5				
											23	张天洁									
											41	杜机娟					11				
A	付明双										A	吴疆									
B	王明星 (主教练)										B	吴立军 (主教练)									
C	岳连娥										C	杨桂东									
D	张圆圆										E	张国遂									
Signatures of responsables for the teams (Off.A)																				B	
TP	Remarks of referees / HF Official																		TP		

Signatures

Referees	张栋 (CHN)	张斌 (CHN)		
T.D.	刘凤娟 (CHN)	高斌 (CHN)		
CHA Off.				

Note: Number of 7m Throws Awarded to Team A and B, Goals (G), Warnings (W), Suspensions (2'), Direct Disqualification (D), Disqualification With Report (DR) and Team Penalty (TP).

Table Officials: 张智伟 谷瑶 Statisticians: 周强 杜宪

### 第十三届全国运动会女子手球决赛

**PHMS** Pictorial Handball Match Statistics

**IHF** Official System

#### 竞赛技术统计

 手球 预赛 组别 A 天津师范大学体育馆  
 女子 轮次 1 场次 1 2017-08-31 14:00

 Referees: 张栋 (CHN) / 张斌 (CHN) Result: 25:42(13:29)  
 Teams: 天津(天津) VS 安徽(安徽)

天津		远射	近射	边射	快攻	突破	任意球	7m球	合计	%	助攻	失误	警告	2'	D+DR	天津	比赛进程	安徽
主教练: 王明星																	1st Half	
1	张莉															10	0 00:26	1 41 杜机娟
3	王晓梅	0/7	0/4					2/2	2/13	15.4	2	3				1 00:49	1	
5	丁丽洁											1	1			1 01:00	2 3 李兵	
6	窦海乐															1 01:31	3 13 陶丹扬	
7	张心茹	0/1								0.0		1				1 02:08	4 13 陶丹扬	
9	袁玉		4/8	4/4	2/2	1/1		11/15	73.3	1				1		2 02:42	4	
10	张文慧		5/5					5/5	100	1	1					2 03:06	5 6 沈萍	
11	蔡雪洁	0/2	0/1	1/1				1/4	25.0	2	1	1				2 04:04	6 41 杜机娟	
12	王欣冉															2 04:33	6	
14	刘洁										1					3 04:43	7 6 沈萍	
16	王选															3 05:16	8 41 杜机娟	
17	聂晓雪	0/1	1/1			1/1		2/3	66.7		3	1				3 05:46	9 41 杜机娟	
18	舒文琪	0/6						0/6	0.0			3				4 06:02	9	
23	周梦雪	1/6	2/4					1/1	4/11	36.4	2	7		1		4 06:23	10 13 陶丹扬	
运动员	合计	1/23	12/23	5/5	2/2	2/2		3/3	25/58	43.1	9	20	3	2		4 07:11	11 21 李瑶	
1	张莉	0/1	2/8	2/2	1/4	0/2		0/1	5/18	27.8						5 08:34	11	
16	王选	1/2	2/9	1/6	1/11	0/3	0/1	1/3	6/35	17.1						5 09:06	12 14 刘晓妹	
守门员	合计	1/3	4/17	3/8	2/15	0/5	0/1	1/4	11/53	20.8						6 10:02	12	
安徽																6 10:34	13 14 刘晓妹	
主教练: 吴立军																6 11:04	14 41 杜机娟	
1	司艳										6					6 13:09	15 41 杜机娟	
3	李兵		0/2		1/2	2/3				42.9	2	1				6 13:40	16 41 杜机娟	
5	班晨晨	0/1	3/4		0/1					50.0			1			6 14:21	17 6 沈萍	
6	沈萍		2/4		1/1			1/1	4/6	66.7			1			6 14:57	18 41 杜机娟	
7	赵江川		1/2		1/2	1/2			3/6	50.0		2				7 16:38	18	
8	徐仕媛															8 17:03	18	
10	孙来苗			0/2								1				8 17:31	19 14 刘晓妹	
13	陶丹扬		1/1	1/1	4/4				6/6	100	1	1				8 17:51	20 41 杜机娟	
14	刘晓妹	1/1	1/1			1/1	1/1	0/1	4/5	80.0	8					8 18:36	21 3 李兵	
15	王姗姗				1/1				1/1	100			1			9 20:10	21	
16	朱莉珍															9 20:23	22 3 李兵	
17	周婷	0/1	2/2							66.7	3	1				9 21:25	23 41 杜机娟	
20	周雪婷			0/1					0/1	0.0		1				9 21:54	24 13 陶丹扬	
21	李瑶	1/2	3/4			1/2			5/8	62.5	2	1				10 22:26	24	
23	张天洁															11 23:36	24	
41	杜机娟			4/5	5/5			2/3	11/13	84.6		1				11 24:40	25 5 班晨晨	
运动员	合计	2/5	13/20	5/9	13/16	5/8	1/1	3/5	42/64	65.6	22	9	3			11 26:16	26 41 杜机娟	
1	司艳	11/11	6/12	0/5	0/2			0/1	17/31	54.8	6					12 26:57	26	
16	朱莉珍	1/2	2/8			0/2		0/2	3/14	21.4						12 27:21	27 21 李瑶	
守门员	合计	12/13	8/20	0/5	0/2	0/2		0/3	20/45	44.4	6					12 28:11	28 17 周婷	
																12 28:49	29 15 王姗姗	
																13 29:53	29	
																2nd Half		
															9	14 01:41	29	
																14 01:57	30 21 李瑶	
															9	15 02:01	30	
															10	16 04:47	30	
																16 05:40	31 21 李瑶	
															9	17 06:40	31	
																17 07:25	32 21 李瑶	
																17 08:24	33 7 赵江川	
															23	18 10:41	33	
																18 11:35	34 7 赵江川	
															10	19 12:19	34	
																19 12:43	35 7 赵江川	
															23	20 14:08	35	
																20 14:55	36 6 沈萍	
															10	20 16:05	37 5 班晨晨	
																21 16:39	37	
																21 17:11	38 17 周婷	
															9	22 17:23	38	
															23	23 20:40	38	
															10	24 21:52	38	
																24 21:57	39 5 班晨晨	
																24 23:00	40 14 刘晓妹	
																24 23:39	41 13 陶丹扬	
																24 24:52	42 13 陶丹扬	
															11	25 25:29	42	

场上队员: 得分 / 射门		守门员: 救球 / 射门	
D	取消资格	DR	取消资格+报告

## 第十三届全国运动会女子手球决赛

PHMS Pictorial Handball Match Statistics

IHF Official System

## 个人/全队技术统计表

 手球 预赛 组别 A 天津师范大学体育馆  
 女子 轮次 1 场次 1 2017-08-31 14:00

号码	姓名	远射	近射	边射	快攻	突破	任意	七米	合计	%	助攻	失误	警告	2'	取消	时间
天津(天津)																
(场上队员)																
1	张莉									0.0%						00:30:00
3	王晓梅	0/7	0/4					2/2	2/13	15.4%	2	3				00:27:52
5	丁丽洁									0.0%		1	1			00:55:54
6	窦海乐									0.0%						00:00:00
7	张心茹	0/1							0/1	0.0%		1				00:14:56
9	袁玉		4/8	4/4	2/2	1/1			11/15	73.3%	1			1		00:54:58
10	张文慧		5/5						5/5	100%	1	1				01:00:00
11	蔡雪洁	0/2	0/1	1/1					1/4	25.0%	2	1	1			00:35:10
12	王欣冉									0.0%						00:00:00
14	刘洁									0.0%	1					00:05:01
16	王选									0.0%						00:30:00
17	聂晓雪	0/1	1/1			1/1			2/3	66.7%		3	1			00:24:12
18	舒文琪	0/6							0/6	0.0%		3				00:21:40
23	周梦雪	1/6	2/4					1/1	4/11	36.4%	2	7		1		01:00:00
	合计	1/23	12/23	5/5	2/2	2/2		3/3	25/58	43.1%	9	20	3	2		
(守门员)																
1	张莉	0/1	2/8	2/2	1/4	0/2		0/1	5/18	27.8%						00:30:00
16	王选	1/2	2/9	1/6	1/11	0/3	0/1	1/3	6/35	17.1%						00:30:00
	合计	1/3	4/17	3/8	2/15	0/5	0/1	1/4	11/53	20.8%						

场上队员： 得分/射门

守门员： 救球/射门

全队合计	得分	被救	射失	击柱	封球	合计	%
远射	1	12	2	2	6	23	4.3%
近射	12	8		3		23	52.2%
边射	5					5	100.0%
快攻	2					2	100.0%
突破	2					2	100.0%
任意							0.0%
七米	3					3	100.0%

## 第十三届全国运动会女子手球决赛

PHMS Pictorial Handball Match Statistics

IHF Official System

## 个人/全队技术统计表

 手球 预赛 组别 A 天津师范大学体育馆  
 女子 轮次 1 场次 1 2017-08-31 14:00

号码	姓名	远射	近射	边射	快攻	突破	任意	七米	合计	%	助攻	失误	警告	2'	取消	时间
<b>安徽(安徽)</b>																
<b>(场上队员)</b>																
1	司艳									0.0%	6					00:34:50
3	李兵		0/2		1/2	2/3			3/7	42.9%	2	1				00:37:18
5	班晨晨	0/1	3/4		0/1				3/6	50.0%			1			00:25:18
6	沈萍		2/4		1/1			1/1	4/6	66.7%			1			00:29:15
7	赵江川		1/2		1/2	1/2			3/6	50.0%		2				00:30:00
8	徐仕媛									0.0%						00:00:00
10	孙来苗			0/2					0/2	0.0%		1				00:18:47
13	陶丹扬		1/1	1/1	4/4				6/6	100%	1	1				00:35:49
14	刘晓妹	1/1	1/1			1/1	1/1	0/1	4/5	80.0%	8					00:41:16
15	王婵婵				1/1				1/1	100%			1			00:24:08
16	朱莉珍									0.0%						00:25:10
17	周婷	0/1	2/2						2/3	66.7%	3	1				00:34:12
20	周雪婷			0/1					0/1	0.0%		1				00:11:11
21	李瑶	1/2	3/4			1/2			5/8	62.5%	2	1				00:42:24
23	张天洁									0.0%						00:00:00
41	杜机娟			4/5	5/5			2/3	11/13	84.6%		1				00:30:00
	<b>合计</b>	<b>2/5</b>	<b>13/20</b>	<b>5/9</b>	<b>13/16</b>	<b>5/8</b>	<b>1/1</b>	<b>3/5</b>	<b>42/64</b>	<b>65.6%</b>	<b>22</b>	<b>9</b>	<b>3</b>			
<b>(守门员)</b>																
1	司艳	11/11	6/12	0/5	0/2			0/1	17/31	54.8%	6					00:34:50
16	朱莉珍	1/2	2/8			0/2		0/2	3/14	21.4%						00:25:10
	<b>合计</b>	<b>12/13</b>	<b>8/20</b>	<b>0/5</b>	<b>0/2</b>	<b>0/2</b>		<b>0/3</b>	<b>20/45</b>	<b>44.4%</b>	<b>6</b>					

场上队员：得分/射门

守门员：救球/射门

全队合计	得分	被救	射失	击柱	封球	合计	%
远射	2	1	1	1		5	40.0%
近射	13	4	1	2		20	65.0%
边射	5	3		1		9	55.6%
快攻	13	2		1		16	81.3%
突破	5		1	2		8	62.5%
任意	1					1	100.0%
七米	3	1	1			5	60.0%



第十三届全国运动会女子手球决赛

PHMS Pictorial Handball Match Statistics

IHF Official System

图式比赛技术统计表

手球  
女子

预赛  
轮次 1

组别 A  
场次 1

天津师范大学体育馆  
2017-08-31 14:00

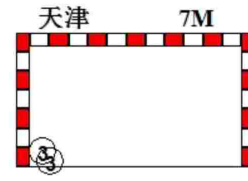
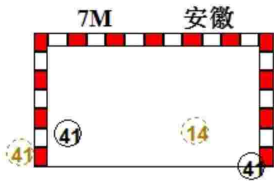
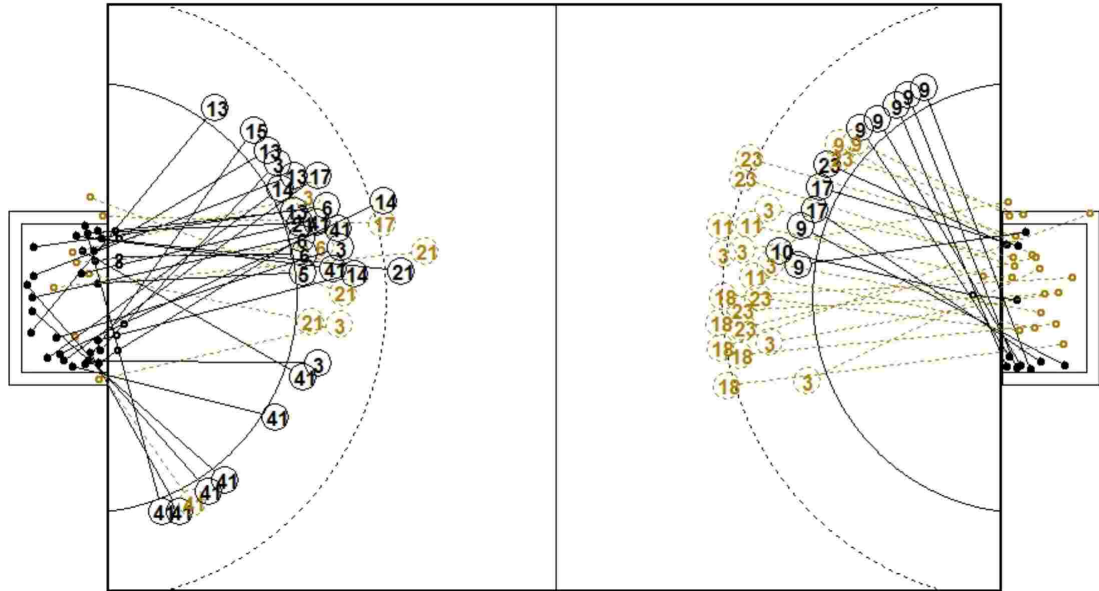

1st Half  
29 : 13

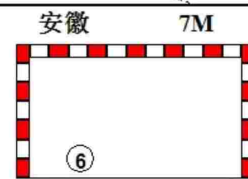
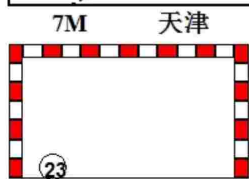
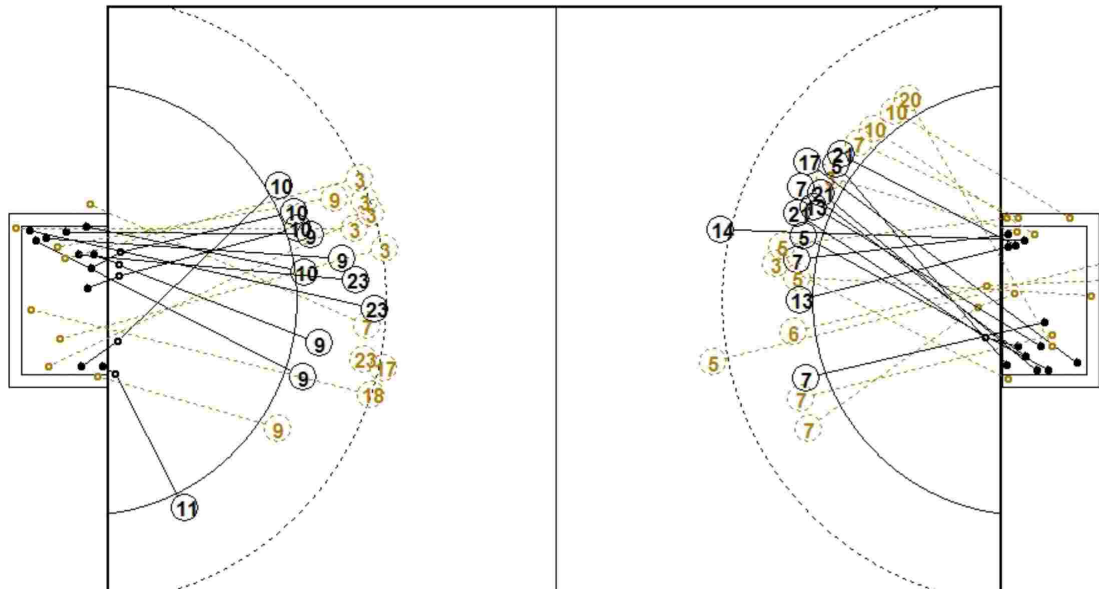

2nd Half  
25 : 42

第十三届全国运动会女子手球决赛

PHMS Pictorial Handball Match Statistics

IHF Official System

图式射门区域统计

手球  
女子

预赛  
轮次 1

组别 A  
场次 1

天津师范大学体育馆  
2017-08-31 14:00

天津

1 张莉	3 王晓梅	5 丁丽洁	6 窦海乐	7 张心茹	9 袁玉	10 张文慧	11 蔡雪洁																																																																								
<table border="1"><tr><td></td><td></td><td></td></tr><tr><td></td><td></td><td></td></tr><tr><td></td><td></td><td></td></tr></table>										<table border="1"><tr><td></td><td></td><td></td></tr><tr><td>2</td><td></td><td></td></tr><tr><td></td><td></td><td></td></tr></table>				2						<table border="1"><tr><td></td><td></td><td></td></tr><tr><td></td><td></td><td></td></tr><tr><td></td><td></td><td></td></tr></table>										<table border="1"><tr><td></td><td></td><td></td></tr><tr><td></td><td></td><td></td></tr><tr><td></td><td></td><td></td></tr></table>										<table border="1"><tr><td></td><td></td><td></td></tr><tr><td></td><td></td><td></td></tr><tr><td></td><td></td><td></td></tr></table>										<table border="1"><tr><td></td><td></td><td>3</td></tr><tr><td></td><td></td><td>2</td></tr><tr><td>1</td><td></td><td>5</td></tr></table>			3			2	1		5	<table border="1"><tr><td></td><td></td><td></td></tr><tr><td></td><td></td><td></td></tr><tr><td>1</td><td>2</td><td>2</td></tr></table>							1	2	2	<table border="1"><tr><td></td><td></td><td></td></tr><tr><td></td><td></td><td></td></tr><tr><td>1</td><td></td><td></td></tr></table>							1		
2																																																																															
		3																																																																													
		2																																																																													
1		5																																																																													
1	2	2																																																																													
1																																																																															
Post - 0 Miss - 0 Block - 0	Post - 1 Miss - 1 Block - 2	Post - 0 Miss - 0 Block - 0	Post - 0 Miss - 0 Block - 0	Post - 0 Miss - 1 Block - 0	Post - 2 Miss - 0 Block - 0	Post - 0 Miss - 0 Block - 0	Post - 0 Miss - 0 Block - 1																																																																								
12 王欣冉	14 刘洁	16 王选	17 聂晓雪	18 舒文琪	23 周梦雪																																																																										
<table border="1"><tr><td></td><td></td><td></td></tr><tr><td></td><td></td><td></td></tr><tr><td></td><td></td><td></td></tr></table>										<table border="1"><tr><td></td><td></td><td></td></tr><tr><td></td><td></td><td></td></tr><tr><td></td><td></td><td></td></tr></table>										<table border="1"><tr><td></td><td></td><td></td></tr><tr><td></td><td></td><td></td></tr><tr><td></td><td></td><td></td></tr></table>										<table border="1"><tr><td></td><td></td><td>1</td></tr><tr><td></td><td></td><td>1</td></tr><tr><td>1</td><td></td><td></td></tr></table>			1			1	1			<table border="1"><tr><td></td><td></td><td></td></tr><tr><td></td><td></td><td></td></tr><tr><td></td><td></td><td></td></tr></table>										<table border="1"><tr><td></td><td></td><td>1</td></tr><tr><td></td><td></td><td>1</td></tr><tr><td>2</td><td></td><td></td></tr></table>			1			1	2																						
		1																																																																													
		1																																																																													
1																																																																															
		1																																																																													
		1																																																																													
2																																																																															
Post - 0 Miss - 0 Block - 0	Post - 0 Miss - 0 Block - 0	Post - 0 Miss - 0 Block - 0	Post - 0 Miss - 0 Block - 1	Post - 1 Miss - 0 Block - 1	Post - 1 Miss - 0 Block - 1																																																																										

1 □□

		0/1
1/1	0/1	2/5
1/6	1/1	0/3

16 □□

0/2	0/4	0/1
1/6	2/2	2/3
0/6	1/3	0/8

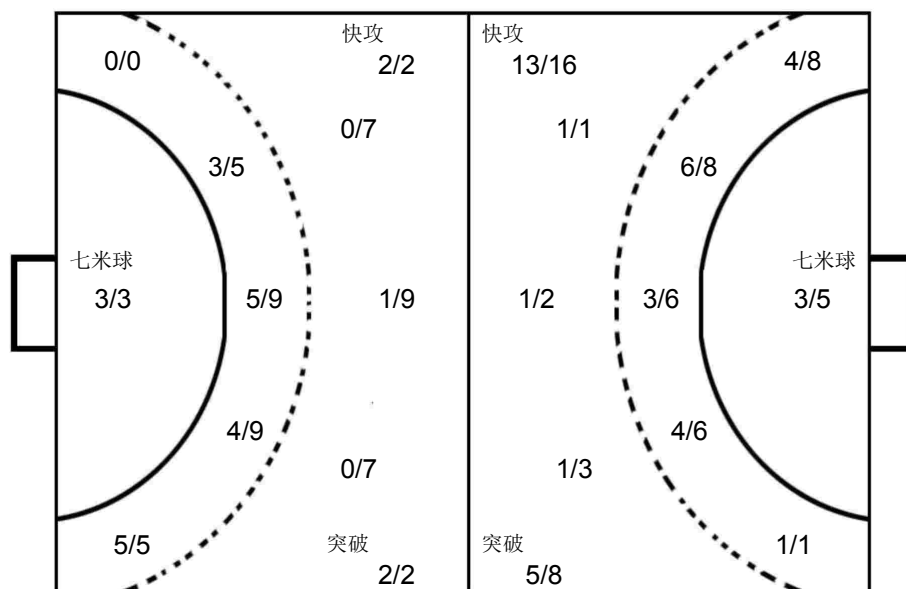

1 □□

1/1	1/1	1/2
4/4	2/2	3/6
3/7	1/3	1/5

16 □□□

	2/2	0/3
		1/2
0/4		0/3

安徽

1 司艳	3 李兵	5 班晨晨	6 沈萍	7 赵江川	8 徐仕媛	10 孙来苗	13 陶丹扬																																																																								
<table border="1"><tr><td></td><td></td><td></td></tr><tr><td></td><td></td><td></td></tr><tr><td></td><td></td><td></td></tr></table>										<table border="1"><tr><td></td><td></td><td></td></tr><tr><td>1</td><td></td><td></td></tr><tr><td>2</td><td></td><td></td></tr></table>				1			2			<table border="1"><tr><td></td><td></td><td></td></tr><tr><td></td><td></td><td>1</td></tr><tr><td></td><td>1</td><td>1</td></tr></table>						1		1	1	<table border="1"><tr><td></td><td></td><td>1</td></tr><tr><td></td><td></td><td></td></tr><tr><td>2</td><td></td><td>1</td></tr></table>			1				2		1	<table border="1"><tr><td></td><td></td><td></td></tr><tr><td></td><td>1</td><td></td></tr><tr><td>1</td><td></td><td>1</td></tr></table>					1		1		1	<table border="1"><tr><td></td><td></td><td></td></tr><tr><td></td><td></td><td></td></tr><tr><td></td><td></td><td></td></tr></table>										<table border="1"><tr><td></td><td></td><td></td></tr><tr><td></td><td></td><td></td></tr><tr><td></td><td></td><td></td></tr></table>										<table border="1"><tr><td></td><td>1</td><td>1</td></tr><tr><td></td><td></td><td>1</td></tr><tr><td>1</td><td></td><td>2</td></tr></table>		1	1			1	1		2
1																																																																															
2																																																																															
		1																																																																													
	1	1																																																																													
		1																																																																													
2		1																																																																													
	1																																																																														
1		1																																																																													
	1	1																																																																													
		1																																																																													
1		2																																																																													
Post - 0 Miss - 0 Block - 0	Post - 2 Miss - 0 Block - 0	Post - 2 Miss - 1 Block - 0	Post - 0 Miss - 1 Block - 0	Post - 1 Miss - 0 Block - 0	Post - 0 Miss - 0 Block - 0	Post - 1 Miss - 0 Block - 0	Post - 0 Miss - 0 Block - 0																																																																								
14 刘晓妹	15 王婷婷	16 朱莉珍	17 周婷	20 周雪婷	21 李瑶	23 张天洁	41 杜娟娟																																																																								
<table border="1"><tr><td>1</td><td></td><td></td></tr><tr><td>1</td><td></td><td></td></tr><tr><td>2</td><td></td><td></td></tr></table>	1			1			2			<table border="1"><tr><td></td><td></td><td></td></tr><tr><td></td><td></td><td></td></tr><tr><td>1</td><td></td><td></td></tr></table>							1			<table border="1"><tr><td></td><td></td><td></td></tr><tr><td></td><td></td><td></td></tr><tr><td></td><td></td><td></td></tr></table>										<table border="1"><tr><td></td><td></td><td>1</td></tr><tr><td>1</td><td></td><td></td></tr><tr><td></td><td></td><td></td></tr></table>			1	1						<table border="1"><tr><td></td><td></td><td></td></tr><tr><td></td><td></td><td></td></tr><tr><td></td><td></td><td></td></tr></table>										<table border="1"><tr><td></td><td></td><td>1</td></tr><tr><td></td><td></td><td>2</td></tr><tr><td>1</td><td>1</td><td></td></tr></table>			1			2	1	1		<table border="1"><tr><td></td><td></td><td></td></tr><tr><td></td><td></td><td></td></tr><tr><td></td><td></td><td></td></tr></table>										<table border="1"><tr><td></td><td>3</td><td></td></tr><tr><td>2</td><td></td><td>1</td></tr><tr><td>1</td><td></td><td>4</td></tr></table>		3		2		1	1		4
1																																																																															
1																																																																															
2																																																																															
1																																																																															
		1																																																																													
1																																																																															
		1																																																																													
		2																																																																													
1	1																																																																														
	3																																																																														
2		1																																																																													
1		4																																																																													
Post - 0 Miss - 0 Block - 0	Post - 0 Miss - 0 Block - 0	Post - 0 Miss - 0 Block - 0	Post - 1 Miss - 0 Block - 0	Post - 0 Miss - 0 Block - 0	Post - 0 Miss - 1 Block - 0	Post - 0 Miss - 0 Block - 0	Post - 0 Miss - 1 Block - 0																																																																								

**PHMS** Pictorial Handball Match Statistics

**IHF** Official System

Team A					Team B					Match Number								
A 山东					B 上海					<b>2</b>								
Played in			in the hall			on			at			Spectators						
天津			天津师范大学体育馆			2017-08-31			15:45			hours						
Half-time(30')	A	B	End of playing time		A	B	1st extra time		A	B	2nd extra time		A	B	After penalty throws		A	B
	9	19	21 28															
Number of 7 m	A	Team time-out			Full name of players and officials						Team time-out			B	Number of 7 m			
	3/4	1	2	3							1	2	3	2/4				
		07:36									25:43	50:49						

No.	Team A	G	W	2'	D	DR	No.	Team B	G	W	2'	D	DR
1	路畅						1	许沫					
2	林燕群	13					2	周蕾	3	1			
6	王莎莎						3	王嘉怡					
8	王彬	1					5	郭威					
10	田秀秀						6	黄妍	7				
11	吕青纹		1				7	车婉茹					
12	张苑琳						8	吴茵	2	1			
15	吴作扬			1			9	武娜娜	6		1		
19	姜伟珊	2					10	斯文	2		1		
20	张悦		1				11	孙梦颖	4				
22	朱赟						12	郑冯					
23	徐悦			1			13	徐娟					
28	崔金娜	1	1				17	居晔			1		
29	刘婵	2					18	沙正文	3	1			
33	王彩琳	2		1			19	印尼					
77	穆庆丛						23	都好	1				
B	马海湧 (主教练)						A	孙琦敏					
C	徐强						B	陈进培 (主教练)	1				
D	孔德宾						C	贺业磊					
E	王日东						D	金钟顺					
A	Signatures of responsables for the teams (Off.A)												B
TP	Remarks of referees / HF Official												TP

Signatures

Referees ALEXEI. COVALCIUC (MDA)

IGOR. COVALCIUC (MDA)

T.D. 刘凤娟 (CHN)

高斌 (CHN)

CHA Off.

Note: Number of 7m Throws Awarded to Team A and B, Goals (G), Warnings (W), Suspensions (2'), Direct Disqualification (D), Disqualification With Report (DR) and Team Penalty (TP).

Table Officials: 翟延露

刘菡蕊

Statisticians: 李双

王玮

第十三届全国运动会女子手球决赛

PHMS Pictorial Handball Match Statistics

IHF Official System

竞赛技术统计

手球 预赛 组别 A 天津师范大学体育馆  
女子 轮次 1 场次 2 2017-08-31 15:45

Referees: ALEXEI. COVALCIUC (MDA) / IGOR. COVALCIUC (MDA) Result: 21:28 (9:19)  
Teams: 山东(山东) VS 上海(上海)

山东		远	近	边	快	突	任意	7m	合计	%	助攻	失误	警告	2'	D+DR
主教练: 马海湧		射	射	射	攻	破	球	球							
1	路畅														
2	林燕群	7/17	1/1	1/1		2/2		2/2	13/23	56.5	1				
6	王莎莎														
8	王彬	0/1	0/2					1/1	1/4	25.0		4			
10	田秀秀														
11	吕青纹	0/1							0/1	0.0			1		
12	张苑琳														
15	吴作扬	0/1				0/1			0/2	0.0		2		1	
19	姜伟珊	1/1			1/1				2/2	100		2			
20	张悦											2	1		
22	朱贇														
23	徐悦	0/1							0/1	0.0				1	
28	崔金娜		1/1					1/1	1/1	100		2	1		
29	刘婵	2/2	0/1						2/3	66.7		1			
33	王彩琳	2/4	0/1					0/1	2/6	33.3				1	
77	穆庆丛														
运动员 合计		12/28	2/6	1/1	1/1	2/3		3/4	21/43	48.8	1	13	3	3	
1	路畅	1/3	5/11	1/4	1/1	0/5		1/1	9/25	36.0					
12	张苑琳														
22	朱贇	1/3	0/3	1/3	0/3			0/2	2/14	14.3					
守门员 合计		2/6	5/14	2/7	1/4	0/5		1/3	11/39	28.2					
上海		远	近	边	快	突	任意	7m	合计	%	助攻	失误	警告	2'	D+DR
主教练: 陈进培		射	射	射	攻	破	球	球							
1	许沫										4				
2	周蕾		1/2	1/2		1/1			3/5	60.0	1	1	1		
3	王嘉怡														
5	郭威							0/1	0/1	0.0					
6	黄妍	2/4	1/2	1/2		1/1	0/1	2/3	7/13	53.8	1	2			
7	车婉茹		0/1						0/1	0.0					
8	吴茵	0/1	1/2			1/1			2/4	50.0	4	2	1		
9	武娜娜		1/1	2/2	3/4				6/7	85.7		2		1	
10	斯文			1/1		1/1			2/2	100				1	
11	孙梦颖	2/4	1/1			1/1			4/6	66.7		1			
12	郑冯														
13	徐娟											1			
17	居晔													1	
18	沙正文		3/4						3/4	75.0			1		
19	印尼														
23	都好		1/2						1/2	50.0					
运动员 合计		4/9	9/15	5/7	3/4	5/5	0/1	2/4	28/45	62.2	10	9	3	3	
1	许沫	6/10	1/3	0/1		1/3		1/2	9/19	47.4	4				
12	郑冯	2/10	1/1		0/1			0/2	3/14	21.4					
守门员 合计		8/20	2/4	0/1	0/1	1/3		1/4	12/33	36.4	4				

山东	比赛进程	上海
1st Half		
0	00:42	1 11 孙梦颖
0	02:32	2 11 孙梦颖
0	04:38	3 6 黄妍
0	07:26	4 8 吴茵
2	林燕群	1 08:13 4
	1 08:42	5 6 黄妍
	1 11:42	6 6 黄妍
	1 12:34	7 9 武娜娜
	1 13:03	8 9 武娜娜
2	林燕群	2 14:12 8
	2 15:03	9 9 武娜娜
2	林燕群	3 15:44 9
2	林燕群	4 18:05 9
	4 18:37	10 9 武娜娜
	4 19:20	11 11 孙梦颖
	4 19:39	12 9 武娜娜
2	林燕群	5 20:57 12
	5 21:24	13 8 吴茵
2	林燕群	6 23:06 13
	6 24:44	14 6 黄妍
8	王彬	7 25:32 14
	7 26:07	15 2 周蕾
33	王彩琳	8 26:55 15
	8 27:26	16 18 沙正文
	8 28:53	17 18 沙正文
	8 29:13	18 10 斯文
2	林燕群	9 29:45 18
	9 30:00	19 11 孙梦颖
2nd Half		
28	崔金娜	10 00:27 19
2	林燕群	10 05:49 20 10 斯文
	11 06:33	20
	11 06:59	21 18 沙正文
	11 08:19	22 23 都好
	11 09:39	23 2 周蕾
19	姜伟珊	12 10:34 23
	12 13:25	24 6 黄妍
2	林燕群	13 14:15 24
2	林燕群	14 17:25 24
	14 17:57	25 9 武娜娜
29	刘婵	15 18:12 25
2	林燕群	16 19:43 25
19	姜伟珊	17 20:42 25
2	林燕群	18 21:58 25
	18 23:07	26 2 周蕾
	18 24:50	27 6 黄妍
29	刘婵	19 25:32 27
33	王彩琳	20 26:36 27
	20 27:18	28 6 黄妍
2	林燕群	21 29:08 28

场上队员: 得分 / 射门

守门员: 救球 / 射门

D	取消资格	DR	取消资格+报告
---	------	----	---------

## 第十三届全国运动会女子手球决赛

PHMS Pictorial Handball Match Statistics

IHF Official System

## 个人/全队技术统计表

 手球 预赛 组别 A 天津师范大学体育馆  
 女子 轮次 1 场次 2 2017-08-31 15:45

号码	姓名	远射	近射	边射	快攻	突破	任意	七米	合计	%	助攻	失误	警告	2'	取消	时间
山东(山东)																
(场上队员)																
1	刘畅									0.0%						00:40:01
2	林燕群	7/17	1/1	1/1		2/2		2/2	13/23	56.5%	1					00:50:51
6	王莎莎									0.0%						00:00:00
8	王彬	0/1	0/2					1/1	1/4	25.0%		4				00:34:17
10	田秀秀									0.0%						00:00:00
11	吕青纹	0/1							0/1	0.0%			1			00:30:00
12	张苑琳									0.0%						00:00:10
15	吴作扬	0/1				0/1			0/2	0.0%		2		1		00:27:02
19	姜伟珊	1/1			1/1				2/2	100%		2				00:30:00
20	张悦									0.0%		2	1			00:55:03
22	朱贇									0.0%						00:19:49
23	徐悦	0/1							0/1	0.0%				1		00:26:52
28	崔金娜		1/1						1/1	100%		2	1			00:41:01
29	刘婵	2/2	0/1						2/3	66.7%		1				00:13:03
33	王彩琳	2/4	0/1					0/1	2/6	33.3%				1		00:34:01
77	穆庆丛									0.0%						00:17:11
	合计	12/28	2/6	1/1	1/1	2/3		3/4	21/43	48.8%	1	13	3	3		
(守门员)																
1	刘畅	1/3	5/11	1/4	1/1	0/5		1/1	9/25	36.0%						00:40:01
12	张苑琳									0.0%						00:00:10
22	朱贇	1/3	0/3	1/3	0/3			0/2	2/14	14.3%						00:19:49
	合计	2/6	5/14	2/7	1/4	0/5		1/3	11/39	28.2%						

场上队员：得分/射门

守门员：救球/射门

全队合计	得分	被救	射失	击柱	封球	合计	%
远射	12	8	1	2	5	28	42.9%
近射	2	2	1	1		6	33.3%
边射	1					1	100.0%
快攻	1					1	100.0%
突破	2	1				3	66.7%
任意							0.0%
七米	3	1				4	75.0%

## 第十三届全国运动会女子手球决赛

PHMS Pictorial Handball Match Statistics

IHF Official System

## 个人/全队技术统计表

 手球 预赛 组别 A 天津师范大学体育馆  
 女子 轮次 1 场次 2 2017-08-31 15:45

号码	姓名	远射	近射	边射	快攻	突破	任意	七米	合计	%	助攻	失误	警告	2'	取消	时间
上海(上海)																
(场上队员)																
1	许沫									0.0%	4					00:39:38
2	周蕾		1/2	1/2		1/1			3/5	60.0%	1	1	1			00:38:21
3	王嘉怡									0.0%						00:00:00
5	郭威							0/1	0/1	0.0%						00:00:07
6	黄妍	2/4	1/2	1/2		1/1	0/1	2/3	7/13	53.8%	1	2				00:59:52
7	车婉茹		0/1						0/1	0.0%						00:00:30
8	吴茵	0/1	1/2			1/1			2/4	50.0%	4	2	1			00:44:33
9	武娜娜		1/1	2/2	3/4				6/7	85.7%		2		1		00:50:14
10	斯文			1/1		1/1			2/2	100%				1		00:20:44
11	孙梦颖	2/4	1/1			1/1			4/6	66.7%		1				01:00:00
12	郑冯									0.0%						00:20:22
13	徐娟									0.0%		1				00:11:40
17	居晔									0.0%				1		00:11:35
18	沙正文		3/4						3/4	75.0%			1			00:37:17
19	印尼									0.0%						00:00:00
23	都好		1/2						1/2	50.0%						00:18:00
	合计	4/9	9/15	5/7	3/4	5/5	0/1	2/4	28/45	62.2%	10	9	3	3		
(守门员)																
1	许沫	6/10	1/3	0/1		1/3		1/2	9/19	47.4%	4					00:39:38
12	郑冯	2/10	1/1		0/1			0/2	3/14	21.4%						00:20:22
	合计	8/20	2/4	0/1	0/1	1/3		1/4	12/33	36.4%	4					

场上队员：得分/射门

守门员：救球/射门

全队合计	得分	被救	射失	击柱	封球	合计	%
远射	4	2		1	2	9	44.4%
近射	9	5	1			15	60.0%
边射	5	2				7	71.4%
快攻	3	1				4	75.0%
突破	5					5	100.0%
任意				1		1	0.0%
七米	2	1		1		4	50.0%

第十三届全国运动会女子手球决赛

PHMS Pictorial Handball Match Statistics

IHF Official System

图式比赛技术统计表

手球  
女子

预赛  
轮次 1

组别 A  
场次 2

天津师范大学体育馆  
2017-08-31 15:45

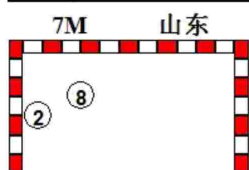
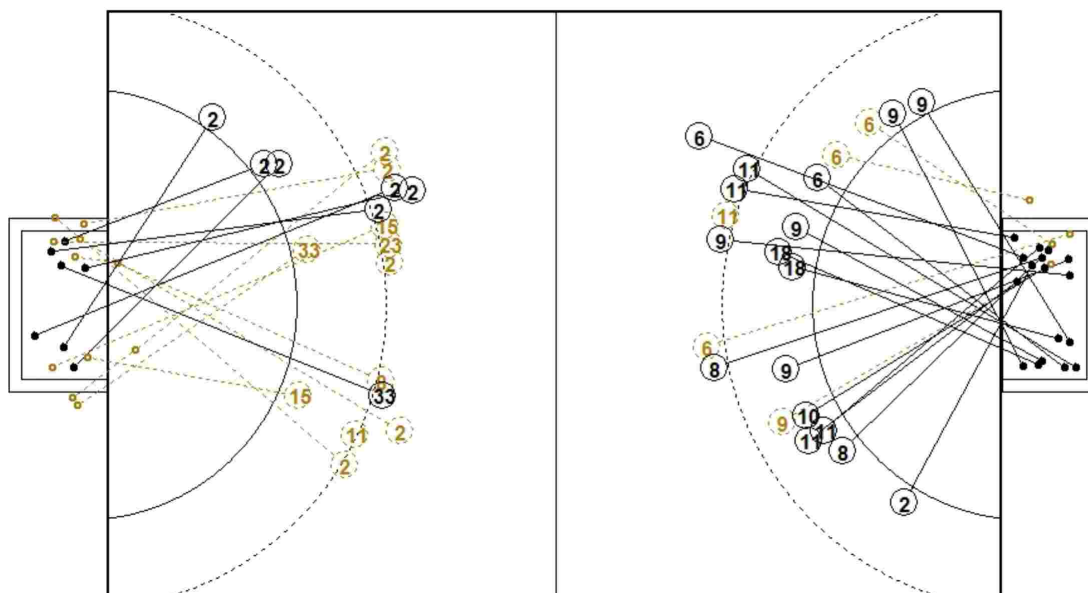

1st Half  
9 : 19

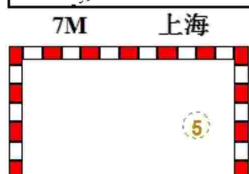
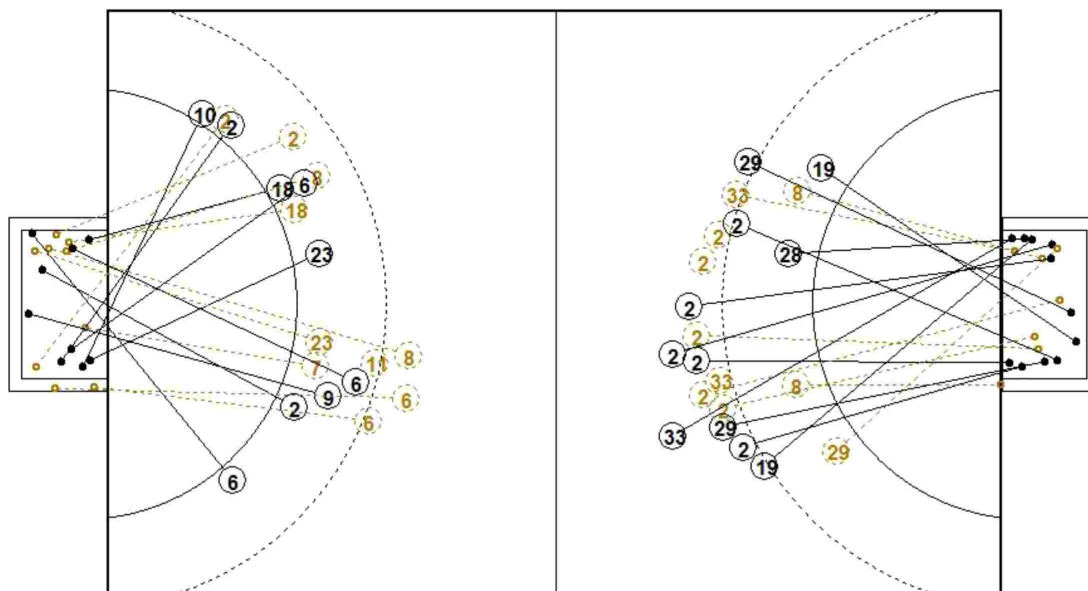
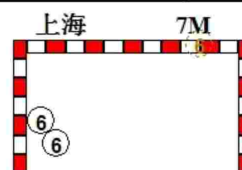

2nd Half  
28 : 21





第十三届全国运动会女子手球决赛

PHMS Pictorial Handball Match Statistics

IHF Official System

图式射门区域统计

手球  
女子

预赛  
轮次 1

组别 A  
场次 2

天津师范大学体育馆  
2017-08-31 15:45

山东

1 路畅	2 林燕群	6 王莎莎	8 王彬	10 田秀秀	11 吕青纹	12 张苑琳	15 吴作扬																																																																								
<table border="1"><tr><td></td><td></td><td></td></tr><tr><td></td><td></td><td></td></tr><tr><td></td><td></td><td></td></tr></table>										<table border="1"><tr><td>1</td><td></td><td>2</td></tr><tr><td>6</td><td></td><td>1</td></tr><tr><td></td><td></td><td>3</td></tr></table>	1		2	6		1			3	<table border="1"><tr><td></td><td></td><td></td></tr><tr><td></td><td></td><td></td></tr><tr><td></td><td></td><td></td></tr></table>										<table border="1"><tr><td>1</td><td></td><td></td></tr><tr><td></td><td></td><td></td></tr><tr><td></td><td></td><td></td></tr></table>	1									<table border="1"><tr><td></td><td></td><td></td></tr><tr><td></td><td></td><td></td></tr><tr><td></td><td></td><td></td></tr></table>										<table border="1"><tr><td></td><td></td><td></td></tr><tr><td></td><td></td><td></td></tr><tr><td></td><td></td><td></td></tr></table>										<table border="1"><tr><td></td><td></td><td></td></tr><tr><td></td><td></td><td></td></tr><tr><td></td><td></td><td></td></tr></table>										<table border="1"><tr><td></td><td></td><td></td></tr><tr><td></td><td></td><td></td></tr><tr><td></td><td></td><td></td></tr></table>									
1		2																																																																													
6		1																																																																													
		3																																																																													
1																																																																															
Post - 0 Miss - 0 Block - 0	Post - 2 Miss - 1 Block - 3	Post - 0 Miss - 0 Block - 0	Post - 1 Miss - 0 Block - 0	Post - 0 Miss - 0 Block - 0	Post - 0 Miss - 0 Block - 1	Post - 0 Miss - 0 Block - 0	Post - 0 Miss - 0 Block - 0																																																																								
19 姜伟珊	20 张悦	22 朱赟	23 徐悦	28 崔金娜	29 刘婵	33 王彩琳	77 穆庆丛																																																																								
<table border="1"><tr><td></td><td></td><td>1</td></tr><tr><td>1</td><td></td><td></td></tr><tr><td></td><td></td><td></td></tr></table>			1	1						<table border="1"><tr><td></td><td></td><td></td></tr><tr><td></td><td></td><td></td></tr><tr><td></td><td></td><td></td></tr></table>										<table border="1"><tr><td></td><td></td><td></td></tr><tr><td></td><td></td><td></td></tr><tr><td></td><td></td><td></td></tr></table>										<table border="1"><tr><td></td><td></td><td></td></tr><tr><td></td><td></td><td></td></tr><tr><td></td><td></td><td></td></tr></table>										<table border="1"><tr><td></td><td></td><td></td></tr><tr><td>1</td><td></td><td></td></tr><tr><td></td><td></td><td></td></tr></table>				1						<table border="1"><tr><td></td><td>1</td><td></td></tr><tr><td></td><td></td><td>1</td></tr><tr><td></td><td></td><td></td></tr></table>		1				1				<table border="1"><tr><td></td><td></td><td>1</td></tr><tr><td></td><td></td><td></td></tr><tr><td></td><td></td><td></td></tr></table>			1							<table border="1"><tr><td></td><td></td><td></td></tr><tr><td></td><td></td><td></td></tr><tr><td></td><td></td><td></td></tr></table>									
		1																																																																													
1																																																																															
1																																																																															
	1																																																																														
		1																																																																													
		1																																																																													
Post - 0 Miss - 0 Block - 0	Post - 0 Miss - 0 Block - 0	Post - 0 Miss - 0 Block - 0	Post - 0 Miss - 0 Block - 0	Post - 0 Miss - 0 Block - 0	Post - 0 Miss - 0 Block - 0	Post - 0 Miss - 1 Block - 1	Post - 0 Miss - 0 Block - 0																																																																								

1 □□

1/1	0/1	2/5
1/6		4/6
0/3	1/2	0/1

12 □□□

22 □□

1/3		0/3
1/4		0/1
0/2		0/1

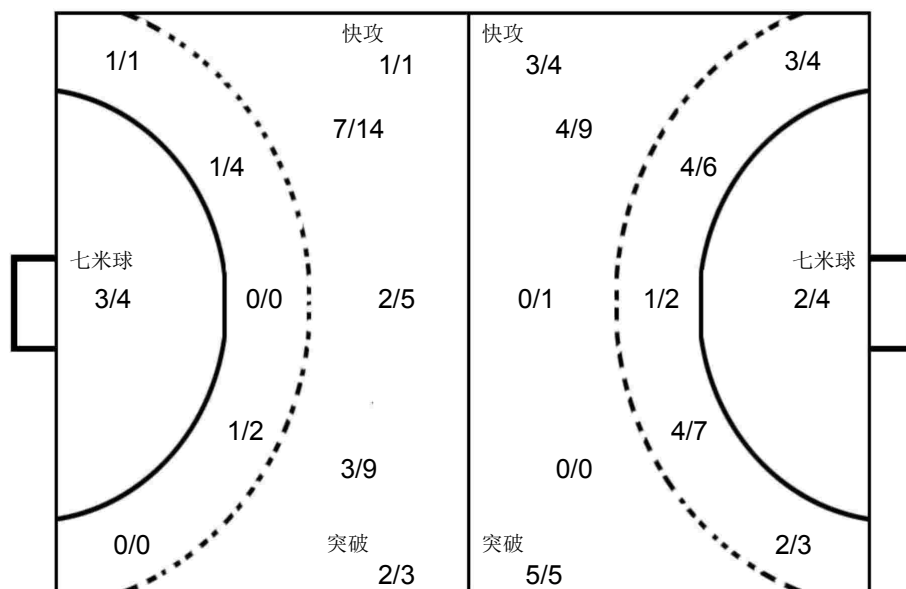

1 □□

0/2		0/1
2/4		4/6
1/2	1/1	1/3

12 □□

1/1	1/2	0/2
0/5		0/1
1/2		0/1

上海

1 许沫	2 周蕾	3 王嘉怡	5 郭威	6 黄妍	7 车婉茹	8 吴茵	9 武娜娜																																																																								
<table border="1"><tr><td></td><td></td><td></td></tr><tr><td></td><td></td><td></td></tr><tr><td></td><td></td><td></td></tr></table>										<table border="1"><tr><td></td><td></td><td>1</td></tr><tr><td>2</td><td></td><td></td></tr><tr><td></td><td></td><td></td></tr></table>			1	2						<table border="1"><tr><td></td><td></td><td></td></tr><tr><td></td><td></td><td></td></tr><tr><td></td><td></td><td></td></tr></table>										<table border="1"><tr><td></td><td></td><td></td></tr><tr><td></td><td></td><td></td></tr><tr><td></td><td></td><td></td></tr></table>										<table border="1"><tr><td></td><td></td><td>2</td></tr><tr><td>2</td><td></td><td>1</td></tr><tr><td>2</td><td></td><td></td></tr></table>			2	2		1	2			<table border="1"><tr><td></td><td></td><td></td></tr><tr><td></td><td></td><td></td></tr><tr><td></td><td></td><td></td></tr></table>										<table border="1"><tr><td></td><td></td><td></td></tr><tr><td>2</td><td></td><td></td></tr><tr><td></td><td></td><td></td></tr></table>				2						<table border="1"><tr><td>2</td><td>1</td><td>1</td></tr><tr><td></td><td></td><td>1</td></tr><tr><td></td><td></td><td>1</td></tr></table>	2	1	1			1			1
		1																																																																													
2																																																																															
		2																																																																													
2		1																																																																													
2																																																																															
2																																																																															
2	1	1																																																																													
		1																																																																													
		1																																																																													
Post - 0 Miss - 0 Block - 0	Post - 0 Miss - 0 Block - 0	Post - 0 Miss - 0 Block - 0	Post - 0 Miss - 0 Block - 0	Post - 3 Miss - 1 Block - 0	Post - 0 Miss - 0 Block - 0	Post - 0 Miss - 0 Block - 0	Post - 0 Miss - 0 Block - 0																																																																								
10 斯文	11 孙梦颖	12 郑冯	13 徐娟	17 居晔	18 沙正文	19 印尼	23 都好																																																																								
<table border="1"><tr><td></td><td></td><td></td></tr><tr><td>1</td><td></td><td></td></tr><tr><td>1</td><td></td><td></td></tr></table>				1			1			<table border="1"><tr><td></td><td></td><td>1</td></tr><tr><td>1</td><td></td><td></td></tr><tr><td>1</td><td>1</td><td></td></tr></table>			1	1			1	1		<table border="1"><tr><td></td><td></td><td></td></tr><tr><td></td><td></td><td></td></tr><tr><td></td><td></td><td></td></tr></table>										<table border="1"><tr><td></td><td></td><td></td></tr><tr><td></td><td></td><td></td></tr><tr><td></td><td></td><td></td></tr></table>										<table border="1"><tr><td></td><td></td><td></td></tr><tr><td></td><td></td><td></td></tr><tr><td></td><td></td><td></td></tr></table>										<table border="1"><tr><td></td><td></td><td>1</td></tr><tr><td></td><td></td><td>1</td></tr><tr><td></td><td></td><td>1</td></tr></table>			1			1			1	<table border="1"><tr><td></td><td></td><td></td></tr><tr><td></td><td></td><td></td></tr><tr><td></td><td></td><td></td></tr></table>										<table border="1"><tr><td></td><td></td><td></td></tr><tr><td></td><td></td><td></td></tr><tr><td>1</td><td></td><td></td></tr></table>							1		
1																																																																															
1																																																																															
		1																																																																													
1																																																																															
1	1																																																																														
		1																																																																													
		1																																																																													
		1																																																																													
1																																																																															
Post - 0 Miss - 0 Block - 0	Post - 0 Miss - 0 Block - 2	Post - 0 Miss - 0 Block - 0	Post - 0 Miss - 0 Block - 0	Post - 0 Miss - 0 Block - 0	Post - 0 Miss - 0 Block - 0	Post - 0 Miss - 0 Block - 0	Post - 0 Miss - 0 Block - 0																																																																								



**PHMS** Pictorial Handball Match Statistics

**IHF** Official System

Team A					Team B					Match Number				
A 江苏					B 新疆					<b>3</b>				
Played in			in the hall			on			at			Spectators		
天津			天津师范大学体育馆			2017-08-31			17:30			hours		
Half-time(30')	A	B	End of playing time	A	B	1st extra time	A	B	2nd extra time	A	B	After penalty throws	A	B
	12	9		29	16									
Number of 7 m	A	Team time-out			Full name of players and officials					Team time-out			B	Number of 7 m
	3/3	1	2	3						1	2	3	B	
										16:00	40:21	52:15	1/2	

No.	Team A	G	W	2'	D	DR	No.	Team B	G	W	2'	D	DR
1	陆婷						3	葛立双	3				
3	张海侠	3					5	于千添					
4	赵佳芹	2	1				6	阿热孜古丽	2	1	1		
7	周琦	1					7	吴志娟	4				
8	乔如	3					10	李静					
9	莫蒙蒙			1			11	陈培培					
11	于源源	1					12	艾敏					
12	黄霞						15	兰姝娇		1			
13	黄慧影	1					17	戴莹莹	1		1		
16	王小华						18	崔娟	3				
17	修丽杰	4		1			21	锁珊珊	3				
18	韦秋香						23	张艺璇					
19	李薇薇	5					26	宋婷婷					
23	王书慧	1					27	谢辰辰					
33	金梦青	3					32	杨雨柔					
69	蓝小玲	5					93	张婷婷		1			
B	金甲洙 (主教练)		1				A	刁继平					
C	马彪						B	于涛 (主教练)					
D	刘凯						C	李天坐					
A		Signatures of responsables for the teams (Off.A)											B
TP	Remarks of referees / HF Official												TP

Signatures

Referees 陈晓波 (CHN)

王洋 (CHN)

T.D. 张春生 (CHN)

吴国忠 (CHN)

CHA Off.

Note: Number of 7m Throws Awarded to Team A and B, Goals (G), Warnings (W), Suspensions (2'), Direct Disqualification (D), Disqualification With Report (DR) and Team Penalty (TP).

Table Officials: 张智伟

谷瑶

Statisticians: 杜宪

周强

第十三届全国运动会女子手球决赛

PHMS Pictorial Handball Match Statistics

IHF Official System

竞赛技术统计

手球  
女子

预赛  
轮次 1

组别 B  
场次 3

天津师范大学体育馆  
2017-08-31 17:30

Referees: 陈晓波 (CHN) / 王洋 (CHN)  
Teams: 江苏(江苏) VS 新疆(新疆)

Result: 29:16 (12:9)

江苏		远	近	边	快	突	任意	7m	合计	%	助攻	失误	警告	2'	D+DR
主教练: 金甲洙		射	射	射	攻	破	球	球							
1	陆婷														
3	张海侠			1/3	2/2				3/5	60.0		1			
4	赵佳芹	0/3	0/1		1/1	1/1			2/6	33.3	3		1		
7	周琦	1/1							1/1	100					
8	乔如		3/4						3/4	75.0	1	1			
9	莫蒙蒙				0/1				0/1	0.0		1		1	
11	于源源			0/1	1/1				1/2	50.0	1				
12	黄霞														
13	黄慧影				1/1				1/1	100					
16	王小华														
17	修丽杰	0/2	3/4		1/2				4/8	50.0		1		1	
18	韦秋香			0/1					0/1	0.0					
19	李薇薇	1/1	0/3	1/1	1/1			2/2	5/8	62.5		1			
23	王书慧	0/1			1/1				1/2	50.0		1			
33	金梦青	1/1		1/2				1/1	3/4	75.0	2				
69	蓝小玲	1/3	1/1		2/2	1/2			5/8	62.5		3			
运动员 合计		4/12	7/13	3/8	10/12	2/3		3/3	29/51	56.9	7	9	1	2	
1	陆婷	3/7	2/4	2/2	0/1	0/2			7/16	43.8					
12	黄霞														
16	王小华	2/3	2/3	2/5	0/1		1/1	0/1	7/14	50.0					
守门员 合计		5/10	4/7	4/7	0/2	0/2	1/1	0/1	14/30	46.7					

新疆		远	近	边	快	突	任意	7m	合计	%	助攻	失误	警告	2'	D+DR
主教练: 于涛		射	射	射	攻	破	球	球							
3	葛立双	1/3	0/1			2/2			3/6	50.0		1			
5	于千添														
6	阿热孜古丽		1/3		1/1				2/4	50.0		2	1	1	
7	吴志娟			3/4	1/1				4/5	80.0					
10	李静														
11	陈培培														
12	艾敏														
15	兰姝娇			0/4					0/4	0.0		2	1		
17	戴莹莹		1/1						1/1	100				1	
18	崔娟	2/6	0/2					1/1	3/9	33.3	1	4			
21	锁珊珊	2/4	1/1						3/5	60.0		4			
23	张艺璇	0/1		0/1					0/2	0.0					
26	宋婷婷										1	2			
27	谢辰辰											2			
32	杨雨柔														
93	张婷婷	0/2					0/2	0/1	0/5	0.0		7	1		
运动员 合计		5/16	3/8	3/9	2/2	2/2	0/2	1/2	16/41	39.0	2	24	3	2	
10	李静	2/4	0/1	1/2	1/3	0/1		0/2	4/13	30.8					
32	杨雨柔	3/5	2/8	3/5	1/9	1/2		0/1	10/30	33.3					
守门员 合计		5/9	2/9	4/7	2/12	1/3		0/3	14/43	32.6					

江苏	比赛进程	新疆
1st Half		
0	00:50	1 7 吴志娟
69 蓝小玲	1 04:06	1
3 张海侠	2 04:41	1
2	07:10	2 21 锁珊珊
8 乔如	3 07:50	2
3	10:56	3 18 崔娟
17 修丽杰	4 11:24	3
4	14:40	4 18 崔娟
69 蓝小玲	5 15:01	4
19 李薇薇	6 16:00	4
3 张海侠	7 17:21	4
7	19:01	5 3 葛立双
11 于源源	8 20:23	5
3 张海侠	9 21:04	5
9	21:47	6 3 葛立双
19 李薇薇	10 24:25	6
10	26:18	7 21 锁珊珊
69 蓝小玲	11 26:40	7
11	27:24	8 17 戴莹莹
11	28:12	9 3 葛立双
17 修丽杰	12 28:30	9
2nd Half		
19 李薇薇	13 00:54	9
19 李薇薇	14 01:57	9
17 修丽杰	15 02:51	9
69 蓝小玲	16 04:32	9
8 乔如	17 05:29	9
8 乔如	18 06:48	9
19 李薇薇	19 08:27	9
33 金梦青	20 09:58	9
20	11:35	10 6 阿热孜古丽
20	13:32	11 7 吴志娟
33 金梦青	21 13:47	11
4 赵佳芹	22 14:26	11
22	14:58	12 7 吴志娟
23 王书慧	23 15:13	12
23	16:28	13 21 锁珊珊
23	18:14	14 6 阿热孜古丽
17 修丽杰	24 18:25	14
24	18:50	15 7 吴志娟
33 金梦青	25 18:57	15
69 蓝小玲	26 21:01	15
13 黄慧影	27 23:53	15
27	26:36	16 18 崔娟
7 周琦	28 26:54	16
4 赵佳芹	29 28:44	16

场上队员: 得分 / 射门

守门员: 救球 / 射门

D	取消资格	DR	取消资格+报告
---	------	----	---------

## 第十三届全国运动会女子手球决赛

PHMS Pictorial Handball Match Statistics

IHF Official System

## 个人/全队技术统计表

 手球 预赛 组别 B 天津师范大学体育馆  
 女子 轮次 1 场次 3 2017-08-31 17:30

号码	姓名	远射	近射	边射	快攻	突破	任意	七米	合计	%	助攻	失误	警告	2'	取消	时间
江苏(江苏)																
(场上队员)																
1	陆婷									0.0%						00:40:03
3	张海侠			1/3	2/2				3/5	60.0%		1				00:59:29
4	赵佳芹	0/3	0/1		1/1	1/1			2/6	33.3%	3		1			00:53:47
7	周琦	1/1							1/1	100%						00:03:41
8	乔如		3/4						3/4	75.0%	1	1				00:07:24
9	莫蒙蒙				0/1				0/1	0.0%		1		1		00:23:05
11	于源源			0/1	1/1				1/2	50.0%	1					00:32:01
12	黄霞									0.0%						00:00:18
13	黄慧影				1/1				1/1	100%						00:06:54
16	王小华									0.0%						00:19:39
17	修丽杰	0/2	3/4		1/2				4/8	50.0%		1		1		00:52:49
18	韦秋香			0/1					0/1	0.0%						00:00:09
19	李薇薇	1/1	0/3	1/1	1/1			2/2	5/8	62.5%		1				00:15:34
23	王书慧	0/1			1/1				1/2	50.0%		1				00:05:01
33	金梦青	1/1		1/2				1/1	3/4	75.0%	2					00:24:13
69	蓝小玲	1/3	1/1		2/2	1/2			5/8	62.5%		3				00:45:32
	合计	4/12	7/13	3/8	10/12	2/3		3/3	29/51	56.9%	7	9	1	2		

## (守门员)

1	陆婷	3/7	2/4	2/2	0/1	0/2			7/16	43.8%						00:40:03
12	黄霞									0.0%						00:00:18
16	王小华	2/3	2/3	2/5	0/1		1/1	0/1	7/14	50.0%						00:19:39
	合计	5/10	4/7	4/7	0/2	0/2	1/1	0/1	14/30	46.7%						

场上队员：得分/射门

守门员：救球/射门

全队合计	得分	被救	射失	击柱	封球	合计	%
远射	4	5	1	1	1	12	33.3%
近射	7	2	3	1		13	53.8%
边射	3	4	1			8	37.5%
快攻	10	2				12	83.3%
突破	2	1				3	66.7%
任意							0.0%
七米	3					3	100.0%

## 第十三届全国运动会女子手球决赛

PHMS Pictorial Handball Match Statistics

IHF Official System

## 个人/全队技术统计表

 手球 预赛 组别 B 天津师范大学体育馆  
 女子 轮次 1 场次 3 2017-08-31 17:30

号码	姓名	远射	近射	边射	快攻	突破	任意	七米	合计	%	助攻	失误	警告	2'	取消	时间
<b>新疆(新疆)</b>																
<b>(场上队员)</b>																
3	葛立双	1/3	0/1			2/2			3/6	50.0%		1				00:31:16
5	于千添									0.0%						00:00:00
6	阿热孜古丽		1/3		1/1				2/4	50.0%		2	1	1		00:35:45
7	吴志娟			3/4	1/1				4/5	80.0%						00:46:02
10	李静									0.0%						00:18:06
11	陈培培									0.0%						00:00:00
12	艾敏									0.0%						00:00:00
15	兰姝娇			0/4					0/4	0.0%		2	1			00:47:36
17	戴莹莹		1/1						1/1	100%				1		00:32:29
18	崔娟	2/6	0/2					1/1	3/9	33.3%	1	4				00:40:44
21	锁珊珊	2/4	1/1						3/5	60.0%		4				00:33:33
23	张艺璇	0/1		0/1					0/2	0.0%						00:25:45
26	宋婷婷									0.0%	1	2				00:12:47
27	谢辰辰									0.0%		2				00:08:26
32	杨雨柔									0.0%						00:41:54
93	张婷婷	0/2				0/2	0/1	0/1	0/5	0.0%		7	1			00:44:34
	<b>合计</b>	<b>5/16</b>	<b>3/8</b>	<b>3/9</b>	<b>2/2</b>	<b>2/2</b>	<b>0/2</b>	<b>1/2</b>	<b>16/41</b>	<b>39.0%</b>	<b>2</b>	<b>24</b>	<b>3</b>	<b>2</b>		
<b>(守门员)</b>																
10	李静	2/4	0/1	1/2	1/3	0/1		0/2	4/13	30.8%						00:18:06
32	杨雨柔	3/5	2/8	3/5	1/9	1/2		0/1	10/30	33.3%						00:41:54
	<b>合计</b>	<b>5/9</b>	<b>2/9</b>	<b>4/7</b>	<b>2/12</b>	<b>1/3</b>		<b>0/3</b>	<b>14/43</b>	<b>32.6%</b>						

场上队员：得分/射门

守门员：救球/射门

全队合计	得分	被救	射失	击柱	封球	合计	%
远射	5	5	2	2	2	16	31.3%
近射	3	4		1		8	37.5%
边射	3	4	1	1		9	33.3%
快攻	2					2	100.0%
突破	2					2	100.0%
任意		1	1			2	0.0%
七米	1		1			2	50.0%

第十三届全国运动会女子手球决赛

PHMS Pictorial Handball Match Statistics

IHF Official System

图式比赛技术统计表

手球  
女子

预赛  
轮次 1

组别 B  
场次 3

天津师范大学体育馆  
2017-08-31 17:30

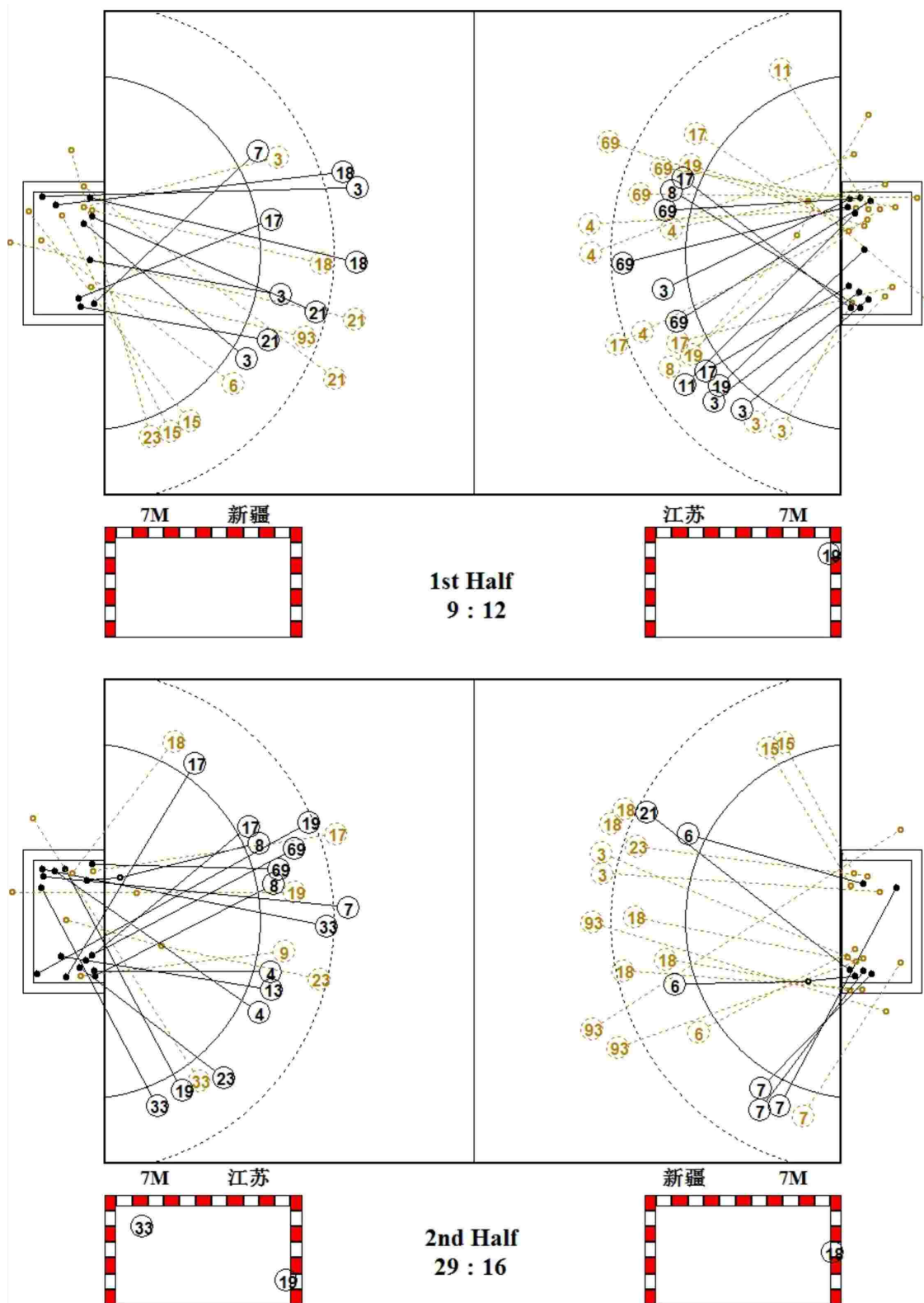

第十三届全国运动会女子手球决赛

PHMS Pictorial Handball Match Statistics

IHF Official System

图式射门区域统计

手球  
女子

预赛  
轮次 1

组别 B  
场次 3

天津师范大学体育馆  
2017-08-31 17:30

江苏

1 陆婷	3 张海侠	4 赵佳芹	7 周琦	8 乔如	9 莫蒙蒙	11 于源源	12 黄霞																																																																								
<table border="1"><tr><td></td><td></td><td></td></tr><tr><td></td><td></td><td></td></tr><tr><td></td><td></td><td></td></tr></table>										<table border="1"><tr><td></td><td></td><td></td></tr><tr><td></td><td></td><td>1</td></tr><tr><td>1</td><td></td><td>1</td></tr></table>						1	1		1	<table border="1"><tr><td></td><td></td><td>1</td></tr><tr><td></td><td></td><td></td></tr><tr><td>1</td><td></td><td></td></tr></table>			1				1			<table border="1"><tr><td></td><td></td><td>1</td></tr><tr><td></td><td></td><td></td></tr><tr><td></td><td></td><td></td></tr></table>			1							<table border="1"><tr><td></td><td></td><td></td></tr><tr><td></td><td></td><td></td></tr><tr><td>1</td><td></td><td>2</td></tr></table>							1		2	<table border="1"><tr><td></td><td></td><td></td></tr><tr><td></td><td></td><td></td></tr><tr><td></td><td></td><td></td></tr></table>										<table border="1"><tr><td></td><td></td><td></td></tr><tr><td></td><td></td><td></td></tr><tr><td>1</td><td></td><td></td></tr></table>							1			<table border="1"><tr><td></td><td></td><td></td></tr><tr><td></td><td></td><td></td></tr><tr><td></td><td></td><td></td></tr></table>									
		1																																																																													
1		1																																																																													
		1																																																																													
1																																																																															
		1																																																																													
1		2																																																																													
1																																																																															
Post - 0 Miss - 0 Block - 0	Post - 0 Miss - 0 Block - 0	Post - 1 Miss - 1 Block - 1	Post - 0 Miss - 0 Block - 0	Post - 0 Miss - 0 Block - 0	Post - 0 Miss - 0 Block - 0	Post - 0 Miss - 0 Block - 0	Post - 0 Miss - 0 Block - 0																																																																								
13 黄慧影	16 王小华	17 修丽杰	18 韦秋香	19 李薇薇	23 王书慧	33 金梦青	69 蓝小玲																																																																								
<table border="1"><tr><td>1</td><td></td><td></td></tr><tr><td></td><td></td><td></td></tr><tr><td></td><td></td><td></td></tr></table>	1									<table border="1"><tr><td></td><td></td><td></td></tr><tr><td></td><td></td><td></td></tr><tr><td></td><td></td><td></td></tr></table>										<table border="1"><tr><td></td><td></td><td></td></tr><tr><td>1</td><td></td><td></td></tr><tr><td>1</td><td></td><td>2</td></tr></table>				1			1		2	<table border="1"><tr><td></td><td></td><td></td></tr><tr><td></td><td></td><td></td></tr><tr><td></td><td></td><td></td></tr></table>										<table border="1"><tr><td>1</td><td></td><td>1</td></tr><tr><td></td><td>1</td><td>1</td></tr><tr><td></td><td></td><td>1</td></tr></table>	1		1		1	1			1	<table border="1"><tr><td></td><td></td><td></td></tr><tr><td>1</td><td></td><td></td></tr><tr><td></td><td></td><td></td></tr></table>				1						<table border="1"><tr><td>1</td><td></td><td>2</td></tr><tr><td></td><td></td><td></td></tr><tr><td></td><td></td><td></td></tr></table>	1		2							<table border="1"><tr><td></td><td></td><td></td></tr><tr><td>1</td><td></td><td></td></tr><tr><td>3</td><td></td><td>1</td></tr></table>				1			3		1
1																																																																															
1																																																																															
1		2																																																																													
1		1																																																																													
	1	1																																																																													
		1																																																																													
1																																																																															
1		2																																																																													
1																																																																															
3		1																																																																													
Post - 0 Miss - 0 Block - 0	Post - 0 Miss - 0 Block - 0	Post - 0 Miss - 0 Block - 0	Post - 0 Miss - 0 Block - 0	Post - 0 Miss - 3 Block - 0	Post - 0 Miss - 0 Block - 0	Post - 0 Miss - 1 Block - 0	Post - 1 Miss - 0 Block - 0																																																																								

1 □□

	1/1	0/2
1/3		1/1
2/3	0/1	2/5

12 □□

16 □□□

0/1		1/1
1/1		0/2
1/2		4/7

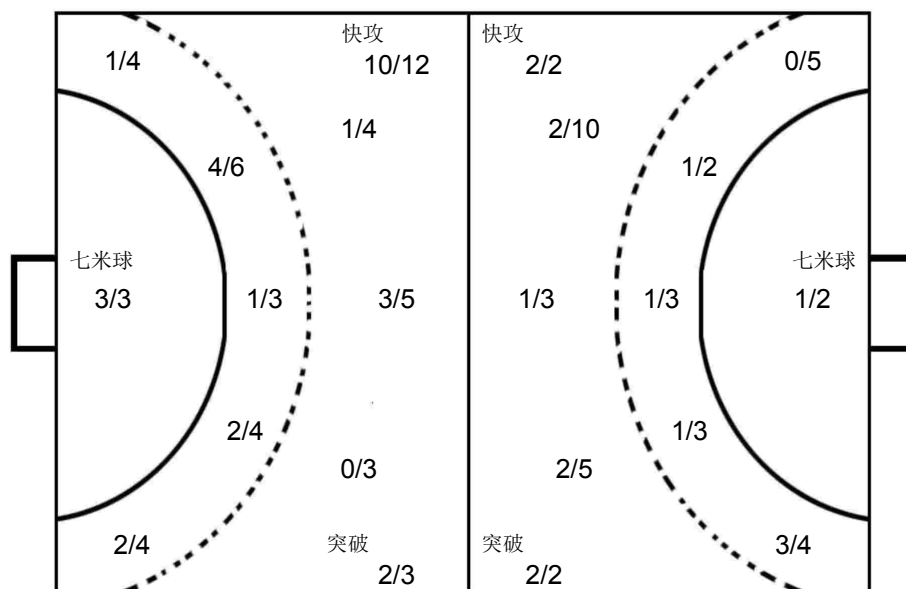

10 □□

0/1		0/3
1/2	1/1	1/2
0/2		1/2

32 □□□

1/2		1/3
4/7	0/1	1/2
2/8		1/7

新疆

3 葛立双	5 于千添	6 阿热孜古丽	7 吴志娟	10 李静	11 陈培培	12 艾敏	15 兰姝娇																																																																								
<table border="1"><tr><td></td><td></td><td>1</td></tr><tr><td></td><td></td><td></td></tr><tr><td>1</td><td></td><td>1</td></tr></table>			1				1		1	<table border="1"><tr><td></td><td></td><td></td></tr><tr><td></td><td></td><td></td></tr><tr><td></td><td></td><td></td></tr></table>										<table border="1"><tr><td></td><td></td><td></td></tr><tr><td>1</td><td></td><td>1</td></tr><tr><td></td><td></td><td></td></tr></table>				1		1				<table border="1"><tr><td>1</td><td></td><td></td></tr><tr><td></td><td></td><td>1</td></tr><tr><td>1</td><td></td><td>1</td></tr></table>	1					1	1		1	<table border="1"><tr><td></td><td></td><td></td></tr><tr><td></td><td></td><td></td></tr><tr><td></td><td></td><td></td></tr></table>										<table border="1"><tr><td></td><td></td><td></td></tr><tr><td></td><td></td><td></td></tr><tr><td></td><td></td><td></td></tr></table>										<table border="1"><tr><td></td><td></td><td></td></tr><tr><td></td><td></td><td></td></tr><tr><td></td><td></td><td></td></tr></table>										<table border="1"><tr><td></td><td></td><td></td></tr><tr><td></td><td></td><td></td></tr><tr><td></td><td></td><td></td></tr></table>									
		1																																																																													
1		1																																																																													
1		1																																																																													
1																																																																															
		1																																																																													
1		1																																																																													
Post - 0 Miss - 0 Block - 0	Post - 0 Miss - 0 Block - 0	Post - 0 Miss - 0 Block - 0	Post - 0 Miss - 0 Block - 0	Post - 0 Miss - 0 Block - 0	Post - 0 Miss - 0 Block - 0	Post - 0 Miss - 0 Block - 0	Post - 1 Miss - 0 Block - 0																																																																								
17 戴莹莹	18 崔娟	21 锁珊珊	23 张艺璇	26 宋婷婷	27 谢辰辰	32 杨雨柔	93 张婷婷																																																																								
<table border="1"><tr><td>1</td><td></td><td></td></tr><tr><td></td><td></td><td></td></tr><tr><td></td><td></td><td></td></tr></table>	1									<table border="1"><tr><td></td><td></td><td>1</td></tr><tr><td></td><td></td><td>1</td></tr><tr><td></td><td></td><td>1</td></tr></table>			1			1			1	<table border="1"><tr><td></td><td></td><td></td></tr><tr><td>1</td><td></td><td></td></tr><tr><td></td><td></td><td>2</td></tr></table>				1					2	<table border="1"><tr><td></td><td></td><td></td></tr><tr><td></td><td></td><td></td></tr><tr><td></td><td></td><td></td></tr></table>										<table border="1"><tr><td></td><td></td><td></td></tr><tr><td></td><td></td><td></td></tr><tr><td></td><td></td><td></td></tr></table>										<table border="1"><tr><td></td><td></td><td></td></tr><tr><td></td><td></td><td></td></tr><tr><td></td><td></td><td></td></tr></table>										<table border="1"><tr><td></td><td></td><td></td></tr><tr><td></td><td></td><td></td></tr><tr><td></td><td></td><td></td></tr></table>										<table border="1"><tr><td></td><td></td><td></td></tr><tr><td></td><td></td><td></td></tr><tr><td></td><td></td><td></td></tr></table>									
1																																																																															
		1																																																																													
		1																																																																													
		1																																																																													
1																																																																															
		2																																																																													
Post - 0 Miss - 0 Block - 0	Post - 2 Miss - 0 Block - 2	Post - 1 Miss - 1 Block - 0	Post - 0 Miss - 1 Block - 0	Post - 0 Miss - 0 Block - 0	Post - 0 Miss - 0 Block - 0	Post - 0 Miss - 0 Block - 0	Post - 0 Miss - 3 Block - 0																																																																								

**PHMS** Pictorial Handball Match Statistics

**IHF** Official System

Team A					Team B					Match Number								
A 广东					B 北京					<b>4</b>								
Played in			in the hall			on			at			Spectators						
天津			天津师范大学体育馆			2017-08-31			19:15			hours						
Half-time(30')	A	B	End of playing time		A	B	1st extra time		A	B	2nd extra time		A	B	After penalty throws		A	B
	18	11	30		21													
Number of 7 m	A	Team time-out			Full name of players and officials						Team time-out			B	Number of 7 m			
	3/3	1	2	3							1	2	3	B				
		25:38									07:51	35:45		2/5				

No.	Team A	G	W	2'	D	DR	No.	Team B	G	W	2'	D	DR
2	王彤羽						1	宋嘉蕾					
3	安妮	6					3	季小桐					
5	李纯						6	刘亚男	1		1		
7	刘彤	2	1				8	杨铭豫					
8	李诗棋						9	宋建军					
9	韦宝桂	7					10	刘莎	4	1	1		
10	史小军	1					11	纪婉	2		1		
11	魏梦庭	3		1			15	郝泽荣		1	1		
15	杨慧						16	王海叶					
16	李娟						22	李海鸥	1				
19	邝雪花	1		1			23	赵小颖	3				
20	李军政	3	1				24	郝佳楠	4				
22	刘晓玉						27	曹芳鸣					
23	王如	3					28	闫美珠	5				
26	马晓卉						47	刘泽					
28	刘金兰	4	1				69	石梓薇	1				
B	黄炳春						A	蔡建国					
C	李玉玲						B	宋刚 (主教练)					
D	郭艳辉 (主教练)						C	关宏波					
E	赵善良						E	王长林					
A		Signatures of responsables for the teams (Off.A)											B
TP	Remarks of referees / HF Official												TP

Signatures

Referees BALAZS. MARTON (HUN)

PETER. HORVATH (HUN)

T.D. 张春生 (CHN)

柴业宏 (CHN)

CHA Off.

Note: Number of 7m Throws Awarded to Team A and B, Goals (G), Warnings (W), Suspensions (2'), Direct Disqualification (D), Disqualification With Report (DR) and Team Penalty (TP).

Table Officials: 翟延露

刘菡蕊

Statisticians: 王玮

李双

### 第十三届全国运动会女子手球决赛

**PHMS** Pictorial Handball Match Statistics

**IHF** Official System

#### 竞赛技术统计

 手球  
 女子

 预赛  
 轮次 1

 组别 B  
 场次 4

 天津师范大学体育馆  
 2017-08-31 19:15

Referees: BALAZS. MARTON (HUN) / PETER. HORVATH (HUN)

Result: 30:21(18:11)

Teams: 广东(广东) VS 北京(北京)

广东		远	近	边	快	突	任意	7m	合计	%	助攻	失误	警告	2'	D+DR	广东	比赛 进程	北京
主教练: 郭艳辉		射	射	射	攻	破	球	球										
2	王彤羽																	
3	安妮	1/2	2/2		2/2	1/1			6/7	85.7	1							
5	李纯																	
7	刘彤	0/1		2/4					2/5	40.0		2	1					
8	李诗棋			0/1					0/1	0.0								
9	韦宝桂	1/2	2/2	1/2	1/1	1/1		1/1	7/9	77.8	3	1						
10	史小军	0/2	0/1		1/1				1/4	25.0	2	2						
11	魏梦庭	1/1	2/2						3/3	100				1				
15	杨慧			0/1					0/1	0.0								
16	李娟										2							
19	邝雪花		1/2						1/2	50.0		3		1				
20	李军政		2/2		1/2				3/4	75.0		2	1					
22	刘晓玉										2							
23	王如		3/4						3/4	75.0								
26	马晓卉																	
28	刘金兰		0/1	1/1	1/4			2/2	4/8	50.0				1				
运动员	合计	3/8	12/16	4/9	6/10	2/2		3/3	30/48	62.5	10	12	3	2				
16	李娟		2/4			0/1		1/2	3/7	42.9	2							
22	刘晓玉	1/2	2/4	0/2	0/1	0/2		0/1	3/12	25.0	2							
26	马晓卉	3/9	0/1	1/1	1/1	0/1		1/1	6/14	42.9								
守门员	合计	4/11	4/9	1/3	1/2	0/4		2/4	12/33	36.4	4							
北京		远	近	边	快	突	任意	7m	合计	%	助攻	失误	警告	2'	D+DR			
主教练: 宋刚		射	射	射	攻	破	球	球										
1	宋嘉蕾								0/1	0.0		2						
3	季小桐		0/1						1/1	100				1				
6	刘亚男		1/1						0/2	0.0		1						
8	杨铭豫			0/2														
9	宋建军																	
10	刘莎		1/1	1/1		1/1		1/1	4/4	100		1	1	1				
11	纪婉			1/1	1/1				2/2	100				1				
15	郝泽荣	0/1						0/2	0/3	0.0				1	1			
16	王海叶																	
22	李海鸣		1/1						1/1	100								
23	赵小颖	0/5	2/3					1/2	3/10	30.0		3						
24	郝佳楠	2/9	0/1		0/1	2/3			4/14	28.6	2	5						
27	曹芳鸣																	
28	闫美珠	5/7	0/1						5/8	62.5		1						
47	刘泽																	
69	石梓薇					1/1			1/1	100	1	1						
运动员	合计	7/22	5/9	2/4	1/2	4/5		2/5	21/47	44.7	3	14	2	4				
1	宋嘉蕾		1/3	1/1	2/4				4/8	50.0								
16	王海叶	0/3	0/9	3/7	1/4	0/1		0/2	4/26	15.4								
47	刘泽		0/1		1/2	0/1		0/1	1/5	20.0								
守门员	合计	0/3	1/13	4/8	4/10	0/2		0/3	9/39	23.1								

场上队员: 得分 / 射门

守门员: 救球 / 射门

D	取消资格	DR	取消资格+报告
---	------	----	---------



## 第十三届全国运动会女子手球决赛

PHMS Pictorial Handball Match Statistics

IHF Official System

## 个人/全队技术统计表

 手球 预赛 组别 B 天津师范大学体育馆  
 女子 轮次 1 场次 4 2017-08-31 19:15

号码	姓名	远射	近射	边射	快攻	突破	任意	七米	合计	%	助攻	失误	警告	2'	取消	时间
广东(广东)																
(场上队员)																
2	王彤羽									0.0%						00:00:00
3	安妮	1/2	2/2		2/2	1/1			6/7	85.7%	1					00:46:34
5	李纯									0.0%						00:00:00
7	刘彤	0/1		2/4					2/5	40.0%		2	1			00:53:17
8	李诗棋			0/1					0/1	0.0%						00:07:34
9	韦宝桂	1/2	2/2	1/2	1/1	1/1		1/1	7/9	77.8%	3	1				00:47:24
10	史小军	0/2	0/1		1/1				1/4	25.0%	2	2				00:16:16
11	魏梦庭	1/1	2/2						3/3	100%				1		00:25:57
15	杨慧			0/1					0/1	0.0%						00:06:42
16	李娟									0.0%	2					00:07:47
19	邝雪花		1/2						1/2	50.0%		3		1		00:43:39
20	李军政		2/2		1/2				3/4	75.0%		2	1			00:24:48
22	刘晓玉									0.0%	2					00:26:22
23	王如		3/4						3/4	75.0%		2				00:35:10
26	马晓卉									0.0%						00:25:51
28	刘金兰		0/1	1/1	1/4			2/2	4/8	50.0%			1			00:52:26
	合计	3/8	12/16	4/9	6/10	2/2		3/3	30/48	62.5%	10	12	3	2		
(守门员)																
16	李娟		2/4			0/1		1/2	3/7	42.9%	2					00:07:47
22	刘晓玉	1/2	2/4	0/2	0/1	0/2		0/1	3/12	25.0%	2					00:26:22
26	马晓卉	3/9	0/1	1/1	1/1	0/1		1/1	6/14	42.9%						00:25:51
	合计	4/11	4/9	1/3	1/2	0/4		2/4	12/33	36.4%	4					

场上队员：得分/射门

守门员：救球/射门

全队合计	得分	被救	射失	击柱	封球	合计	%
远射	3		2	1	2	8	37.5%
近射	12	1	2	1		16	75.0%
边射	4	4	1			9	44.4%
快攻	6	4				10	60.0%
突破	2					2	100.0%
任意							0.0%
七米	3					3	100.0%

## 第十三届全国运动会女子手球决赛

PHMS Pictorial Handball Match Statistics

IHF Official System

## 个人/全队技术统计表

 手球 预赛 组别 B 天津师范大学体育馆  
 女子 轮次 1 场次 4 2017-08-31 19:15

号码	姓名	远射	近射	边射	快攻	突破	任意	七米	合计	%	助攻	失误	警告	2'	取消	时间
北京(北京)																
(场上队员)																
1	宋嘉蕾									0.0%						00:09:36
3	季小桐		0/1						0/1	0.0%		2				00:15:52
6	刘亚男		1/1						1/1	100%				1		00:13:12
8	杨铭豫			0/2					0/2	0.0%		1				00:35:45
9	宋建军									0.0%						00:00:00
10	刘莎		1/1	1/1		1/1		1/1	4/4	100%		1	1	1		00:35:50
11	纪婉			1/1	1/1				2/2	100%				1		00:23:40
15	郝泽荣	0/1						0/2	0/3	0.0%			1	1		00:37:55
16	王海叶									0.0%						00:35:11
22	李海鸥		1/1						1/1	100%						00:27:03
23	赵小颖	0/5	2/3					1/2	3/10	30.0%		3				00:24:08
24	郝佳楠	2/9	0/1		0/1	2/3			4/14	28.6%	2	5				00:50:40
27	曹芳鸣									0.0%						00:24:15
28	闫美珠	5/7	0/1						5/8	62.5%		1				00:35:45
47	刘泽									0.0%						00:15:13
69	石梓薇					1/1			1/1	100%	1	1				00:35:45
	合计	7/22	5/9	2/4	1/2	4/5		2/5	21/47	44.7%	3	14	2	4		

## (守门员)

1	宋嘉蕾		1/3	1/1	2/4				4/8	50.0%						00:09:36
16	王海叶	0/3	0/9	3/7	1/4	0/1		0/2	4/26	15.4%						00:35:11
47	刘泽		0/1		1/2	0/1		0/1	1/5	20.0%						00:15:13
	合计	0/3	1/13	4/8	4/10	0/2		0/3	9/39	23.1%						

场上队员： 得分/射门

守门员： 救球/射门

全队合计	得分	被救	射失	击柱	封球	合计	%
远射	7	4	3	3	5	22	31.8%
近射	5	4				9	55.6%
边射	2	1		1		4	50.0%
快攻	1	1				2	50.0%
突破	4			1		5	80.0%
任意							0.0%
七米	2	2	1			5	40.0%

第十三届全国运动会女子手球决赛

PHMS Pictorial Handball Match Statistics

IHF Official System

图式比赛技术统计表

手球  
女子

预赛  
轮次 1

组别 B  
场次 4

天津师范大学体育馆  
2017-08-31 19:15

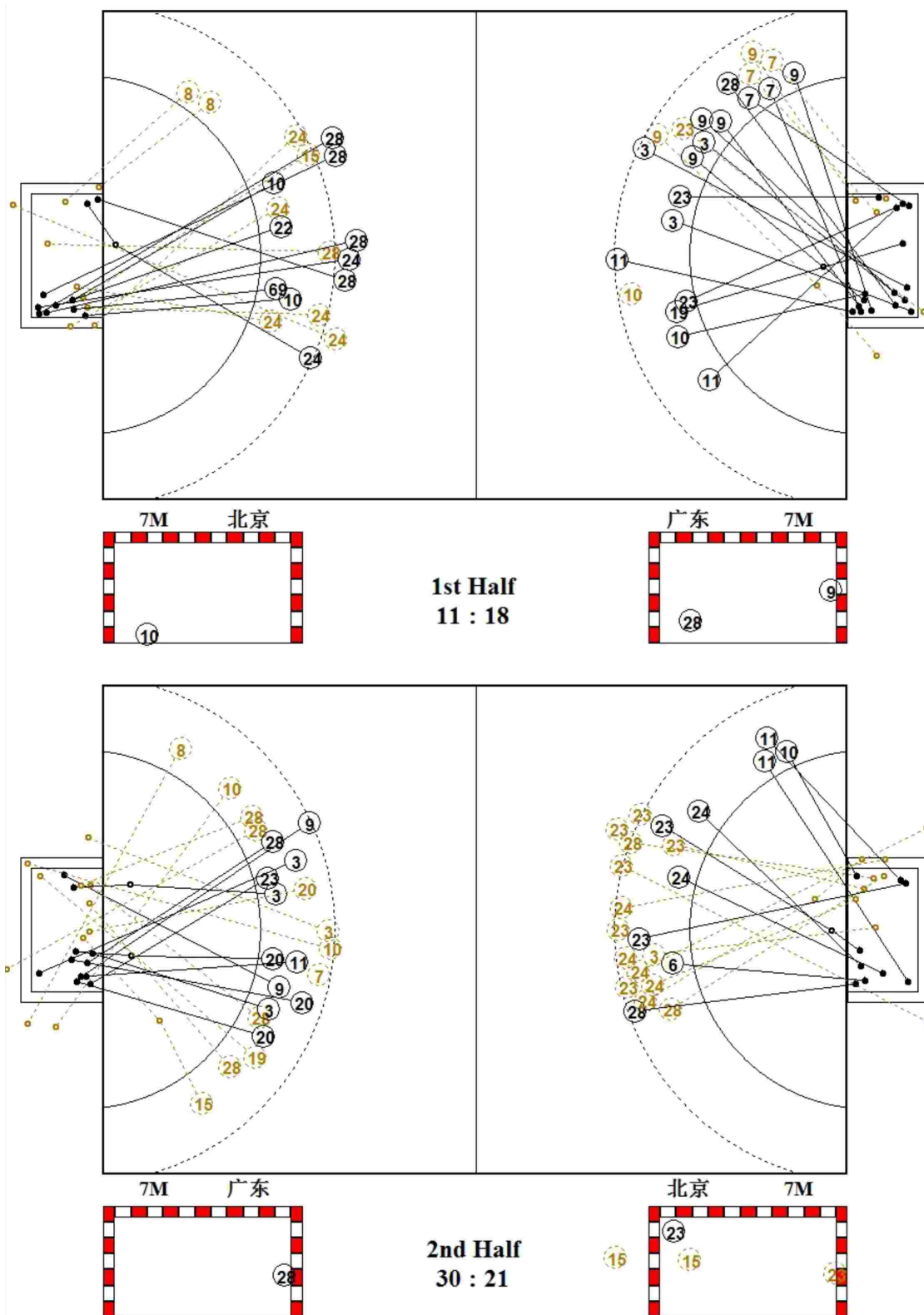

第十三届全国运动会女子手球决赛

PHMS Pictorial Handball Match Statistics

IHF Official System

图式射门区域统计

手球  
女子

预赛  
轮次 1

组别 B  
场次 4

天津师范大学体育馆  
2017-08-31 19:15

广东

2 王彤羽	3 安妮	5 李纯	7 刘彤	8 李诗棋	9 韦宝桂	10 史小军	11 魏梦庭																																																																								
<table border="1"><tr><td></td><td></td><td></td></tr><tr><td></td><td></td><td></td></tr><tr><td></td><td></td><td></td></tr></table>										<table border="1"><tr><td>1</td><td></td><td>3</td></tr><tr><td></td><td></td><td>1</td></tr><tr><td>1</td><td></td><td></td></tr></table>	1		3			1	1			<table border="1"><tr><td></td><td></td><td></td></tr><tr><td></td><td></td><td></td></tr><tr><td></td><td></td><td></td></tr></table>										<table border="1"><tr><td>1</td><td></td><td></td></tr><tr><td></td><td></td><td></td></tr><tr><td></td><td></td><td>1</td></tr></table>	1								1	<table border="1"><tr><td></td><td></td><td></td></tr><tr><td></td><td></td><td></td></tr><tr><td></td><td></td><td></td></tr></table>										<table border="1"><tr><td></td><td></td><td>1</td></tr><tr><td></td><td></td><td>3</td></tr><tr><td>1</td><td></td><td>2</td></tr></table>			1			3	1		2	<table border="1"><tr><td></td><td></td><td></td></tr><tr><td></td><td></td><td></td></tr><tr><td></td><td></td><td>1</td></tr></table>									1	<table border="1"><tr><td>1</td><td></td><td></td></tr><tr><td></td><td></td><td></td></tr><tr><td>1</td><td></td><td>1</td></tr></table>	1						1		1
1		3																																																																													
		1																																																																													
1																																																																															
1																																																																															
		1																																																																													
		1																																																																													
		3																																																																													
1		2																																																																													
		1																																																																													
1																																																																															
1		1																																																																													
Post - 0 Miss - 0 Block - 0	Post - 0 Miss - 1 Block - 0	Post - 0 Miss - 0 Block - 0	Post - 0 Miss - 0 Block - 1	Post - 0 Miss - 1 Block - 0	Post - 0 Miss - 1 Block - 0	Post - 1 Miss - 1 Block - 1	Post - 0 Miss - 0 Block - 0																																																																								
15 杨慧	16 李娟	19 邝雪花	20 李军政	22 刘晓玉	23 王如	26 马晓卉	28 刘金兰																																																																								
<table border="1"><tr><td></td><td></td><td></td></tr><tr><td></td><td></td><td></td></tr><tr><td></td><td></td><td></td></tr></table>										<table border="1"><tr><td></td><td></td><td></td></tr><tr><td></td><td></td><td></td></tr><tr><td></td><td></td><td></td></tr></table>										<table border="1"><tr><td></td><td>1</td><td></td></tr><tr><td></td><td></td><td></td></tr><tr><td></td><td></td><td></td></tr></table>		1								<table border="1"><tr><td>3</td><td></td><td></td></tr><tr><td></td><td></td><td></td></tr><tr><td></td><td></td><td></td></tr></table>	3									<table border="1"><tr><td></td><td></td><td></td></tr><tr><td></td><td></td><td></td></tr><tr><td></td><td></td><td></td></tr></table>										<table border="1"><tr><td>1</td><td></td><td></td></tr><tr><td>1</td><td></td><td></td></tr><tr><td>1</td><td></td><td></td></tr></table>	1			1			1			<table border="1"><tr><td></td><td></td><td></td></tr><tr><td></td><td></td><td></td></tr><tr><td></td><td></td><td></td></tr></table>										<table border="1"><tr><td></td><td></td><td>1</td></tr><tr><td></td><td></td><td>1</td></tr><tr><td>2</td><td></td><td></td></tr></table>			1			1	2		
	1																																																																														
3																																																																															
1																																																																															
1																																																																															
1																																																																															
		1																																																																													
		1																																																																													
2																																																																															
Post - 0 Miss - 0 Block - 0	Post - 0 Miss - 0 Block - 0	Post - 0 Miss - 0 Block - 0	Post - 0 Miss - 0 Block - 0	Post - 0 Miss - 0 Block - 0	Post - 1 Miss - 0 Block - 0	Post - 0 Miss - 0 Block - 0	Post - 0 Miss - 1 Block - 0																																																																								

16 □□		
0/2		
1/1		0/1
2/2		0/1

22 □□□		
0/2		0/1
2/3	1/1	
0/2	0/1	0/2

26 □□□		
0/4	1/1	
1/2		2/2
2/3		0/2

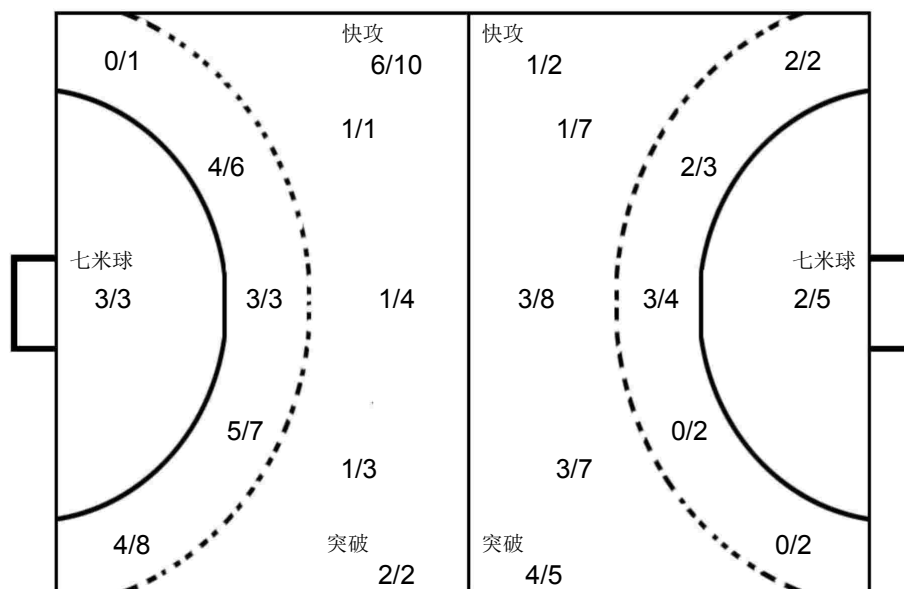

1 □□□		
0/1		1/1
0/2		
0/1	2/2	1/1

16 □□□		
0/3	0/1	0/5
2/3		0/4
1/4		1/6

47 □□		
0/1		0/1
0/2		1/1

北京

1 宋嘉蕾	3 季小桐	6 刘亚男	8 杨铭豫	9 宋建军	10 刘莎	11 纪婉	15 郝泽荣																																																																											
<table border="1"><tr><td></td><td></td><td></td></tr><tr><td></td><td></td><td></td></tr><tr><td></td><td></td><td></td></tr></table>										<table border="1"><tr><td></td><td></td><td></td></tr><tr><td></td><td></td><td></td></tr><tr><td></td><td></td><td></td></tr></table>										<table border="1"><tr><td></td><td></td><td></td></tr><tr><td></td><td></td><td></td></tr><tr><td></td><td></td><td>1</td></tr></table>									1	<table border="1"><tr><td></td><td></td><td></td></tr><tr><td></td><td></td><td></td></tr><tr><td></td><td></td><td></td></tr></table>										<table border="1"><tr><td></td><td></td><td></td></tr><tr><td></td><td></td><td></td></tr><tr><td></td><td></td><td></td></tr></table>										<table border="1"><tr><td></td><td></td><td></td></tr><tr><td></td><td></td><td></td></tr><tr><td>1</td><td></td><td></td></tr><tr><td>3</td><td></td><td></td></tr></table>							1			3			<table border="1"><tr><td>1</td><td></td><td>1</td></tr><tr><td></td><td></td><td></td></tr><tr><td></td><td></td><td></td></tr></table>	1		1							<table border="1"><tr><td></td><td></td><td></td></tr><tr><td></td><td></td><td></td></tr><tr><td></td><td></td><td></td></tr></table>									
		1																																																																																
1																																																																																		
3																																																																																		
1		1																																																																																
Post - 0 Miss - 0 Block - 0	Post - 0 Miss - 0 Block - 0	Post - 0 Miss - 0 Block - 0	Post - 1 Miss - 0 Block - 0	Post - 0 Miss - 0 Block - 0	Post - 0 Miss - 0 Block - 0	Post - 0 Miss - 0 Block - 0	Post - 0 Miss - 1 Block - 0																																																																											
16 王海叶	22 李海鸥	23 赵小颖	24 郝佳楠	27 曹芳鸣	28 闫美珠	47 刘泽	69 石梓薇																																																																											
<table border="1"><tr><td></td><td></td><td></td></tr><tr><td></td><td></td><td></td></tr><tr><td></td><td></td><td></td></tr></table>										<table border="1"><tr><td>1</td><td></td><td></td></tr><tr><td></td><td></td><td></td></tr><tr><td></td><td></td><td></td></tr></table>	1									<table border="1"><tr><td>2</td><td></td><td></td></tr><tr><td></td><td></td><td></td></tr><tr><td></td><td></td><td>1</td></tr></table>	2								1	<table border="1"><tr><td>1</td><td></td><td></td></tr><tr><td></td><td></td><td>1</td></tr><tr><td></td><td></td><td>2</td></tr></table>	1					1			2	<table border="1"><tr><td></td><td></td><td></td></tr><tr><td></td><td></td><td></td></tr><tr><td></td><td></td><td></td></tr></table>										<table border="1"><tr><td>3</td><td></td><td></td></tr><tr><td></td><td></td><td></td></tr><tr><td></td><td></td><td>2</td></tr></table>	3								2	<table border="1"><tr><td></td><td></td><td></td></tr><tr><td></td><td></td><td></td></tr><tr><td></td><td></td><td></td></tr></table>										<table border="1"><tr><td></td><td></td><td></td></tr><tr><td></td><td></td><td></td></tr><tr><td>1</td><td></td><td></td></tr></table>							1					
1																																																																																		
2																																																																																		
		1																																																																																
1																																																																																		
		1																																																																																
		2																																																																																
3																																																																																		
		2																																																																																
1																																																																																		
Post - 0 Miss - 0 Block - 0	Post - 0 Miss - 0 Block - 0	Post - 0 Miss - 1 Block - 4	Post - 4 Miss - 2 Block - 1	Post - 0 Miss - 0 Block - 0	Post - 0 Miss - 0 Block - 0	Post - 0 Miss - 0 Block - 0	Post - 0 Miss - 0 Block - 0																																																																											

**PHMS** Pictorial Handball Match Statistics

**IHF** Official System

Team A					Team B					Match Number					
A 安徽					B 山东					<b>5</b>					
Played in			in the hall			on			at			Spectators			
天津			天津师范大学体育馆			2017-09-01			14:00			hours			
Half-time(30')	A	B	End of playing time	A	B	1st extra time	A	B	2nd extra time	A	B	After penalty throws	A	B	
	16	10		29	21										
Number of 7 m	A	Team time-out			Full name of players and officials						Team time-out			B	Number of 7 m
	4/6	1	2	3							1	2	3	5/6	
			46:59						17:32						

No.	Team A	G	W	2'	D	DR	No.	Team B	G	W	2'	D	DR
1	司艳						1	刘畅					
3	李兵	2		1			2	林燕群	2		1		
5	班晨晨			1			6	王莎莎					
6	沈萍	3					8	王彬	6				
7	赵江川						10	田秀秀	2				
8	徐仕媛						11	吕青纹					
10	孙来苗						12	张苑琳					
13	陶丹扬						15	吴作扬	3		1		
14	刘晓妹	9		1			19	姜伟珊	2				
15	王婵婵						20	张悦	1	1			
16	朱莉珍						22	朱赟					
17	周婷	4	1	1			23	徐悦		1	1		
20	周雪婷						28	崔金娜	3	1			
21	李瑶	1	1	2			29	刘婵	1				
23	张天洁						33	王彩琳	1		1		
41	杜机娟	10	1				77	穆庆丛					
A	吴疆						B	马海湧 (主教练)					
B	吴立军 (主教练)						C	徐强					
C	杨桂东						D	孔德宾					
E	张国遂						E	王日东					
A	Signatures of responsables for the teams (Off.A)												B
TP	Remarks of referees / HF Official												TP

Signatures

Referees BALAZS. MARTON (HUN)

PETER. HORVATH (HUN)

T.D. 刘凤娟 (CHN)

高斌 (CHN)

CHA Off.

Note: Number of 7m Throws Awarded to Team A and B, Goals (G), Warnings (W), Suspensions (2'), Direct Disqualification (D), Disqualification With Report (DR) and Team Penalty (TP).

Table Officials: 翟延露

刘菡蕊

Statisticians: 杜宪

周强

**第十三届全国运动会女子手球决赛**
**PHMS** Pictorial Handball Match Statistics

**IHF** Official System

**竞赛技术统计**

 手球  
 女子

 预赛  
 轮次 2

 组别 A  
 场次 5

 天津师范大学体育馆  
 2017-09-01 14:00

Referees: BALAZS. MARTON (HUN) / PETER. HORVATH (HUN)

Result: 29:21(16:10)

Teams: 安徽(安徽) VS 山东(山东)

安徽		远	近	边	快	突	任意	7m	合计	%	助攻	失误	警告	2'	D+DR	安徽	比赛	山东
主教练: 吴立军		射	射	射	攻	破	球	球								进程		
1	司艳															1st Half		
3	李兵	1/2	1/1						2/3	66.7				1		1	00:28	0
5	班晨晨										1			1		02:31	1	8 王彬
6	沈萍	1/2	1/3		1/1				3/6	50.0		3				02:53	1	28 崔金娜
7	赵江川															03:38	3	20 张悦
8	徐仕媛															06:15	3	
10	孙来苗							0/1	0/1	0.0						07:41	4	2 林燕群
13	陶丹扬			0/1					0/1	0.0	2					08:25	4	15 吴作扬
14	刘晓妹	2/4	1/1			3/4	2/2	1/1	9/12	75.0	4	1		1		08:58	5	15 吴作扬
15	王婷婷															09:11	5	
16	朱莉珍															10:52	6	8 王彬
17	周婷	1/1	1/2			2/2			4/5	80.0	1	1	1	1		11:59	7	8 王彬
20	周雪婷															14:30	7	
21	李瑶	0/1		1/1	0/1	0/1			1/4	25.0		3	1	2		15:53	7	
23	张天洁															16:27	7	
41	杜机娟		1/1	0/1	6/6			3/4	10/12	83.3		2	1			17:17	7	
运动员	合计	5/10	5/8	1/3	7/8	5/7	2/2	4/6	29/44	65.9	8	10	3	6		18:52	7	
1	司艳	5/7	1/5	0/1	0/1	1/3		0/4	7/21	33.3						20:26	8	10 田秀秀
16	朱莉珍	1/2	1/3	0/2		0/1		0/1	2/9	22.2						22:20	8	10 田秀秀
守门员	合计	6/9	2/8	0/3	0/1	1/4		0/5	9/30	30.0						23:07	8	33 王彩琳
山东		远	近	边	快	突	任意	7m	合计	%	助攻	失误	警告	2'	D+DR			
主教练: 马海湧		射	射	射	攻	破	球	球										
1	路畅															2nd Half		
2	林燕群	0/5	1/1			1/1	0/2		2/9	22.2	1	2		1		00:28	10	
6	王莎莎															02:36	11	2 林燕群
8	王彬	1/4	1/3	1/1				3/3	6/11	54.5	1	3				04:16	11	
10	田秀秀							2/3	2/3	66.7						05:07	11	
11	吕青纹	0/1							0/1	0.0						07:48	12	19 姜伟珊
12	张苑琳															09:02	13	8 王彬
15	吴作扬	1/6	1/1			1/2			3/9	33.3	1	1		1		11:13	13	
19	姜伟珊			2/2					2/2	100						12:30	13	
20	张悦				1/1				1/1	100			1			13:44	13	
22	朱贇															15:22	14	10 田秀秀
23	徐悦													1	1	17:40	14	
28	崔金娜		3/3					3/3	3/3	100		1	1			18:05	15	29 刘婵
29	刘婵	1/3	0/1					1/4	25.0							18:22	15	
33	王彩琳	0/1				1/1		1/2	50.0		2	3		1		18:52	16	8 王彬
77	穆庆丛															19:47	16	
运动员	合计	3/20	6/9	3/3	1/1	3/4	0/2	5/6	21/45	46.7	5	10	3	4		21:25	16	
1	路畅	1/2	1/1	1/1	0/3	0/1		0/2	3/10	30.0						21:57	17	15 吴作扬
12	张苑琳							1/2	1/2	50.0						23:39	17	
22	朱贇	1/5	1/6	1/2	1/5	1/5	0/2	0/1	5/26	19.2						24:35	18	28 崔金娜
守门员	合计	2/7	2/7	2/3	1/8	1/6	0/2	1/5	9/38	23.7						26:30	19	15 吴作扬
14	刘晓妹															27:29	19	
14	刘晓妹															28:02	20	28 崔金娜
14	刘晓妹															28:13	20	
14	刘晓妹															29:20	21	19 姜伟珊

场上队员: 得分 / 射门

守门员: 救球 / 射门

D	取消资格	DR	取消资格+报告

## 第十三届全国运动会女子手球决赛

PHMS Pictorial Handball Match Statistics

IHF Official System

## 个人/全队技术统计表

 手球 预赛 组别 A 天津师范大学体育馆  
 女子 轮次 2 场次 5 2017-09-01 14:00

号码	姓名	远射	近射	边射	快攻	突破	任意	七米	合计	%	助攻	失误	警告	2'	取消	时间
<b>安徽(安徽)</b>																
<b>(场上队员)</b>																
1	司艳									0.0%						00:47:54
3	李兵	1/2	1/1						2/3	66.7%				1		00:44:03
5	班晨晨									0.0%	1			1		00:23:19
6	沈萍	1/2	1/3		1/1				3/6	50.0%		3				00:42:33
7	赵江川									0.0%						00:00:00
8	徐仕媛									0.0%						00:00:00
10	孙来苗							0/1	0/1	0.0%						00:18:36
13	陶丹扬			0/1					0/1	0.0%	2					00:34:03
14	刘晓妹	2/4	1/1			3/4	2/2	1/1	9/12	75.0%	4	1		1		00:49:21
15	王婵婵									0.0%						00:23:20
16	朱莉珍									0.0%						00:12:06
17	周婷	1/1	1/2			2/2			4/5	80.0%	1	1	1	1		00:52:31
20	周雪婷									0.0%						00:00:00
21	李瑶	0/1		1/1	0/1	0/1			1/4	25.0%		3	1	2		00:45:14
23	张天洁									0.0%						00:00:00
41	杜机娟		1/1	0/1	6/6			3/4	10/12	83.3%		2	1			00:20:57
<b>合计</b>		<b>5/10</b>	<b>5/8</b>	<b>1/3</b>	<b>7/8</b>	<b>5/7</b>	<b>2/2</b>	<b>4/6</b>	<b>29/44</b>	<b>65.9%</b>	<b>8</b>	<b>10</b>	<b>3</b>	<b>6</b>		
<b>(守门员)</b>																
1	司艳	5/7	1/5	0/1	0/1	1/3		0/4	7/21	33.3%						00:47:54
16	朱莉珍	1/2	1/3	0/2		0/1		0/1	2/9	22.2%						00:12:06
<b>合计</b>		<b>6/9</b>	<b>2/8</b>	<b>0/3</b>	<b>0/1</b>	<b>1/4</b>		<b>0/5</b>	<b>9/30</b>	<b>30.0%</b>						

场上队员：得分/射门

守门员：救球/射门

全队合计	得分	被救	射失	击柱	封球	合计	%
远射	5	2	2	1		10	50.0%
近射	5	2		1		8	62.5%
边射	1	2				3	33.3%
快攻	7	1				8	87.5%
突破	5	1	1			7	71.4%
任意	2					2	100.0%
七米	4	1	1			6	66.7%

## 第十三届全国运动会女子手球决赛

PHMS Pictorial Handball Match Statistics

IHF Official System

## 个人/全队技术统计表

 手球 预赛 组别 A 天津师范大学体育馆  
 女子 轮次 2 场次 5 2017-09-01 14:00

号码	姓名	远射	近射	边射	快攻	突破	任意	七米	合计	%	助攻	失误	警告	2'	取消	时间
山东(山东)																
(场上队员)																
1	路畅									0.0%						00:22:12
2	林燕群	0/5	1/1			1/1	0/2		2/9	22.2%	1	2		1		00:37:33
6	王莎莎									0.0%						00:00:00
8	王彬	1/4	1/3	1/1				3/3	6/11	54.5%	1	3				00:48:32
10	田秀秀							2/3	2/3	66.7%						00:31:04
11	吕青纹	0/1							0/1	0.0%						00:00:00
12	张苑琳									0.0%						00:03:16
15	吴作扬	1/6	1/1			1/2			3/9	33.3%	1	1		1		00:26:53
19	姜伟珊			2/2					2/2	100%						00:30:00
20	张悦				1/1				1/1	100%			1			00:28:42
22	朱贇									0.0%						00:34:32
23	徐悦									0.0%			1	1		00:45:40
28	崔金娜		3/3						3/3	100%		1	1			00:24:08
29	刘婵	1/3	0/1						1/4	25.0%						00:31:17
33	王彩琳	0/1				1/1			1/2	50.0%	2	3		1		00:25:34
77	穆庆丛									0.0%						00:25:48
合计		3/20	6/9	3/3	1/1	3/4	0/2	5/6	21/45	46.7%	5	10	3	4		

## (守门员)

1	路畅	1/2	1/1	1/1	0/3	0/1		0/2	3/10	30.0%						00:22:12
12	张苑琳							1/2	1/2	50.0%						00:03:16
22	朱贇	1/5	1/6	1/2	1/5	1/5	0/2	0/1	5/26	19.2%						00:34:32
合计		2/7	2/7	2/3	1/8	1/6	0/2	1/5	9/38	23.7%						

场上队员： 得分/射门

守门员： 救球/射门

全队合计	得分	被救	射失	击柱	封球	合计	%
远射	3	6	3	2	6	20	15.0%
近射	6	2		1		9	66.7%
边射	3					3	100.0%
快攻	1					1	100.0%
突破	3	1				4	75.0%
任意			2			2	0.0%
七米	5			1		6	83.3%



第十三届全国运动会女子手球决赛

PHMS Pictorial Handball Match Statistics

IHF Official System

图式比赛技术统计表

手球  
女子

预赛  
轮次 2

组别 A  
场次 5

天津师范大学体育馆  
2017-09-01 14:00

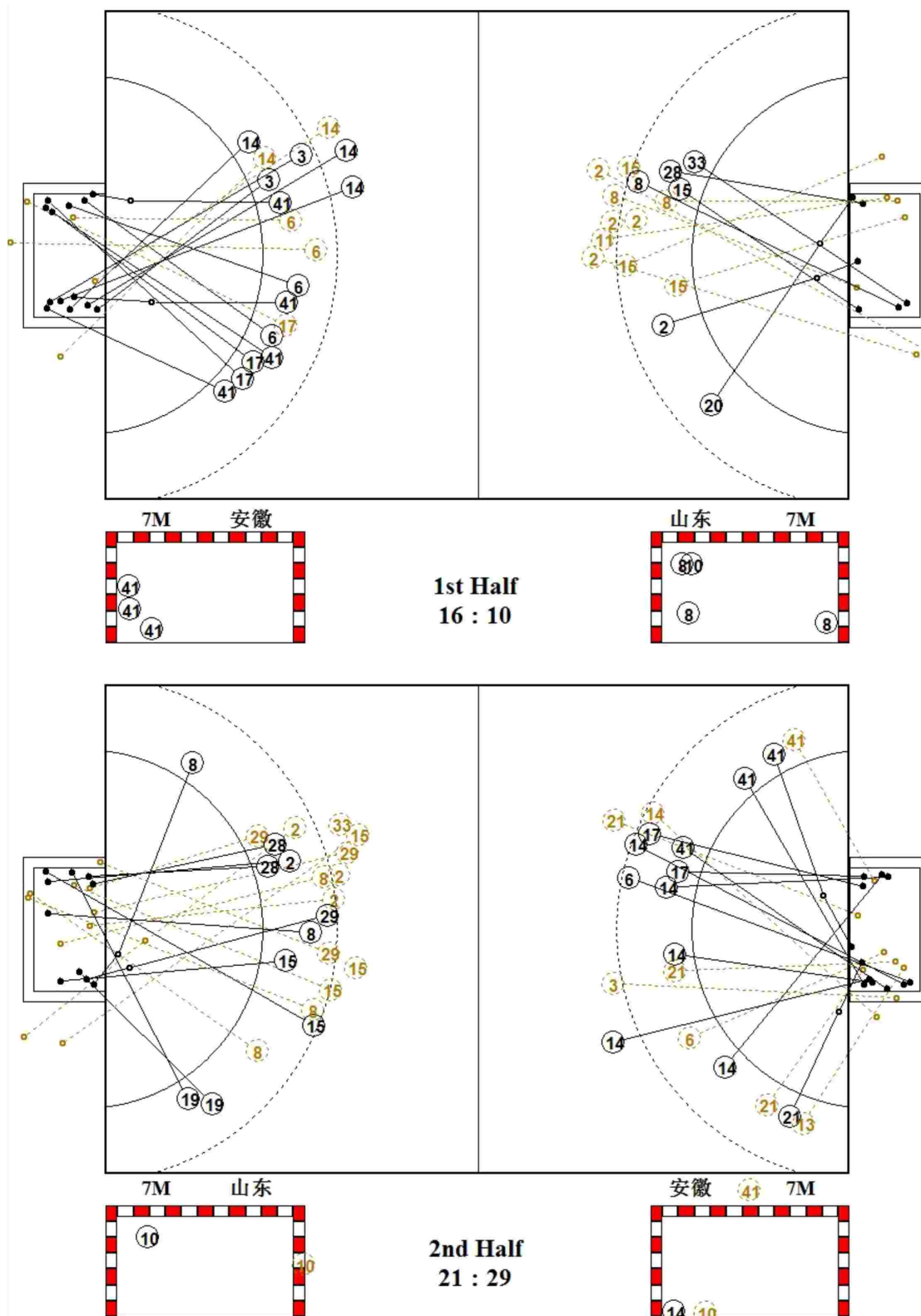

第十三届全国运动会女子手球决赛

PHMS Pictorial Handball Match Statistics

IHF Official System

图式射门区域统计

手球  
女子

预赛  
轮次 2

组别 A  
场次 5

天津师范大学体育馆  
2017-09-01 14:00

安徽

1 司艳 <table border="1"><tr><td></td><td></td><td></td></tr><tr><td></td><td></td><td></td></tr><tr><td></td><td></td><td></td></tr></table> Post - 0 Miss - 0 Block - 0										3 李兵 <table border="1"><tr><td>1</td><td></td><td></td></tr><tr><td></td><td></td><td></td></tr><tr><td>1</td><td></td><td></td></tr></table> Post - 1 Miss - 0 Block - 0	1						1			5 班晨晨 <table border="1"><tr><td></td><td></td><td></td></tr><tr><td></td><td></td><td></td></tr><tr><td></td><td></td><td></td></tr></table> Post - 0 Miss - 0 Block - 0										6 沈萍 <table border="1"><tr><td></td><td></td><td>1</td></tr><tr><td></td><td></td><td>1</td></tr><tr><td></td><td></td><td>1</td></tr></table> Post - 0 Miss - 1 Block - 0			1			1			1	7 赵江川 <table border="1"><tr><td></td><td></td><td></td></tr><tr><td></td><td></td><td></td></tr><tr><td></td><td></td><td></td></tr></table> Post - 0 Miss - 0 Block - 0										8 徐仕媛 <table border="1"><tr><td></td><td></td><td></td></tr><tr><td></td><td></td><td></td></tr><tr><td></td><td></td><td></td></tr></table> Post - 0 Miss - 0 Block - 0										10 孙来苗 <table border="1"><tr><td></td><td></td><td></td></tr><tr><td></td><td></td><td></td></tr><tr><td></td><td></td><td></td></tr></table> Post - 0 Miss - 0 Block - 0										13 陶丹扬 <table border="1"><tr><td></td><td></td><td></td></tr><tr><td></td><td></td><td></td></tr><tr><td></td><td></td><td></td></tr></table> Post - 0 Miss - 0 Block - 0									
1																																																																															
1																																																																															
		1																																																																													
		1																																																																													
		1																																																																													
14 刘晓妹 <table border="1"><tr><td></td><td></td><td>1</td></tr><tr><td>4</td><td></td><td>1</td></tr><tr><td>2</td><td></td><td>1</td></tr></table> Post - 0 Miss - 2 Block - 0			1	4		1	2		1	15 王婷婷 <table border="1"><tr><td></td><td></td><td></td></tr><tr><td></td><td></td><td></td></tr><tr><td></td><td></td><td></td></tr></table> Post - 0 Miss - 0 Block - 0										16 朱莉珍 <table border="1"><tr><td></td><td></td><td></td></tr><tr><td></td><td></td><td></td></tr><tr><td></td><td></td><td></td></tr></table> Post - 0 Miss - 0 Block - 0										17 周婷 <table border="1"><tr><td></td><td></td><td>2</td></tr><tr><td></td><td></td><td></td></tr><tr><td>2</td><td></td><td></td></tr></table> Post - 1 Miss - 0 Block - 0			2				2			20 周雪婷 <table border="1"><tr><td></td><td></td><td></td></tr><tr><td></td><td></td><td></td></tr><tr><td></td><td></td><td></td></tr></table> Post - 0 Miss - 0 Block - 0										21 李瑶 <table border="1"><tr><td></td><td></td><td></td></tr><tr><td></td><td></td><td></td></tr><tr><td></td><td></td><td>1</td></tr></table> Post - 0 Miss - 0 Block - 0									1	23 张天洁 <table border="1"><tr><td></td><td></td><td></td></tr><tr><td></td><td></td><td></td></tr><tr><td></td><td></td><td></td></tr></table> Post - 0 Miss - 0 Block - 0										41 杜机娟 <table border="1"><tr><td>1</td><td></td><td>1</td></tr><tr><td>3</td><td></td><td>1</td></tr><tr><td>1</td><td>1</td><td>2</td></tr></table> Post - 0 Miss - 1 Block - 0	1		1	3		1	1	1	2
		1																																																																													
4		1																																																																													
2		1																																																																													
		2																																																																													
2																																																																															
		1																																																																													
1		1																																																																													
3		1																																																																													
1	1	2																																																																													

1 □□

2/4	0/1	0/3
1/3	1/1	
0/3	2/3	1/3

16 □□□

0/1		0/1
0/1		1/2
0/1		1/3

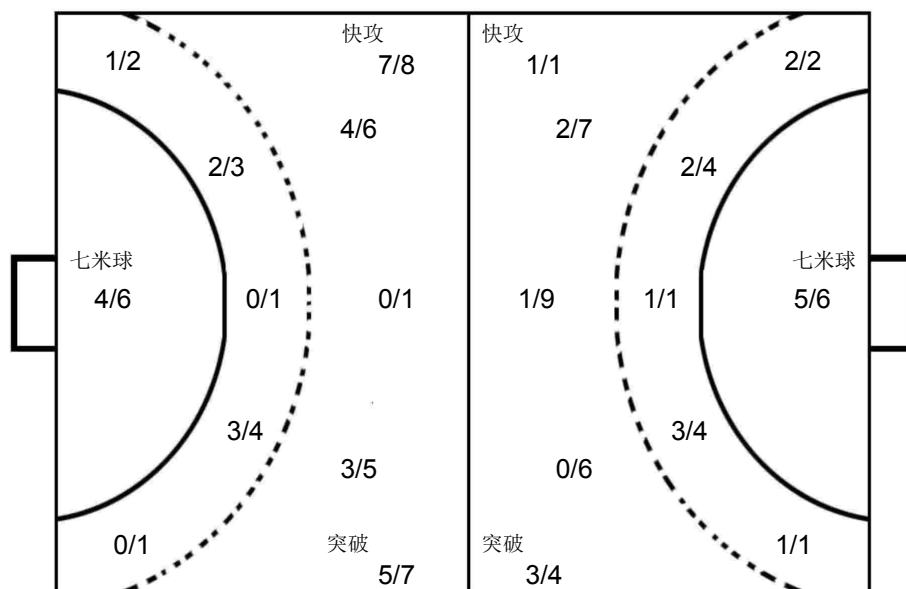

1 □□

0/2		1/2
0/1		1/3
0/1	1/1	

12 □□□

0/1		
1/1		

22 □□

		1/5
1/6		1/2
1/6	0/1	1/6

山东

1 路畅 <table border="1"><tr><td></td><td></td><td></td></tr><tr><td></td><td></td><td></td></tr><tr><td></td><td></td><td></td></tr></table> Post - 0 Miss - 0 Block - 0										2 林燕群 <table border="1"><tr><td></td><td></td><td>1</td></tr><tr><td></td><td></td><td></td></tr><tr><td>1</td><td></td><td></td></tr></table> Post - 0 Miss - 3 Block - 3			1				1			6 王莎莎 <table border="1"><tr><td></td><td></td><td></td></tr><tr><td></td><td></td><td></td></tr><tr><td></td><td></td><td></td></tr></table> Post - 0 Miss - 0 Block - 0										8 王彬 <table border="1"><tr><td>1</td><td>1</td><td>1</td></tr><tr><td>1</td><td></td><td></td></tr><tr><td>1</td><td></td><td>1</td></tr></table> Post - 2 Miss - 0 Block - 0	1	1	1	1			1		1	10 田秀秀 <table border="1"><tr><td>2</td><td></td><td></td></tr><tr><td></td><td></td><td></td></tr><tr><td></td><td></td><td></td></tr></table> Post - 1 Miss - 0 Block - 0	2									11 吕青纹 <table border="1"><tr><td></td><td></td><td></td></tr><tr><td></td><td></td><td></td></tr><tr><td></td><td></td><td></td></tr></table> Post - 0 Miss - 0 Block - 0										12 张苑琳 <table border="1"><tr><td></td><td></td><td></td></tr><tr><td></td><td></td><td></td></tr><tr><td></td><td></td><td></td></tr></table> Post - 0 Miss - 0 Block - 0										15 吴作扬 <table border="1"><tr><td></td><td></td><td>1</td></tr><tr><td>1</td><td></td><td></td></tr><tr><td></td><td></td><td>1</td></tr></table> Post - 0 Miss - 2 Block - 2			1	1					1
		1																																																																													
1																																																																															
1	1	1																																																																													
1																																																																															
1		1																																																																													
2																																																																															
		1																																																																													
1																																																																															
		1																																																																													
19 姜伟珊 <table border="1"><tr><td></td><td></td><td></td></tr><tr><td>1</td><td></td><td>1</td></tr><tr><td></td><td></td><td></td></tr></table> Post - 0 Miss - 0 Block - 0				1		1				20 张悦 <table border="1"><tr><td></td><td></td><td></td></tr><tr><td></td><td></td><td></td></tr><tr><td>1</td><td></td><td></td></tr></table> Post - 0 Miss - 0 Block - 0							1			22 朱赞 <table border="1"><tr><td></td><td></td><td></td></tr><tr><td></td><td></td><td></td></tr><tr><td></td><td></td><td></td></tr></table> Post - 0 Miss - 0 Block - 0										23 徐悦 <table border="1"><tr><td></td><td></td><td></td></tr><tr><td></td><td></td><td></td></tr><tr><td></td><td></td><td></td></tr></table> Post - 0 Miss - 0 Block - 0										28 崔金娜 <table border="1"><tr><td></td><td></td><td></td></tr><tr><td></td><td></td><td></td></tr><tr><td>1</td><td></td><td>2</td></tr></table> Post - 0 Miss - 0 Block - 0							1		2	29 刘婵 <table border="1"><tr><td></td><td></td><td></td></tr><tr><td></td><td></td><td></td></tr><tr><td>1</td><td></td><td></td></tr></table> Post - 1 Miss - 0 Block - 0							1			33 王彩琳 <table border="1"><tr><td></td><td></td><td>1</td></tr><tr><td></td><td></td><td></td></tr><tr><td></td><td></td><td></td></tr></table> Post - 0 Miss - 0 Block - 1			1							77 穆庆丛 <table border="1"><tr><td></td><td></td><td></td></tr><tr><td></td><td></td><td></td></tr><tr><td></td><td></td><td></td></tr></table> Post - 0 Miss - 0 Block - 0									
1		1																																																																													
1																																																																															
1		2																																																																													
1																																																																															
		1																																																																													

**PHMS** Pictorial Handball Match Statistics

**IHF** Official System

Team A					Team B					Match Number								
A 上海					B 天津					<b>6</b>								
Played in			in the hall			on			at			Spectators						
天津			天津师范大学体育馆			2017-09-01			15:45			hours						
Half-time(30')	A	B	End of playing time		A	B	1st extra time		A	B	2nd extra time		A	B	After penalty throws		A	B
	20	10	35		22													
Number of 7 m	A	Team time-out			Full name of players and officials						Team time-out			B	Number of 7 m			
	6/7	1	2	3							1	2	3	48:05		4/5		

No.	Team A	G	W	2'	D	DR	No.	Team B	G	W	2'	D	DR
1	许沫						1	张莉					
2	周蕾	5		1			3	王晓梅					
3	王嘉怡						5	丁丽洁					
5	郭威	2					6	窦海乐					
6	黄妍	3					7	张心茹	1				
7	车婉茹	3					8	张慧			2		
8	吴茵	1		1			9	袁玉	4				
9	武娜娜	5					10	张文慧	6	1			
10	斯文	4	1	1			11	蔡雪洁	3				
11	孙梦颖	4		1			12	王欣冉					
12	郑冯						14	刘洁					
13	徐娟	1					16	王选					
17	居晔	2					17	聂晓雪					
18	沙正文	3					18	舒文琪	2				
19	印尼	1					23	周梦雪	6				
23	都好	1											
A	孙琦敏						A	付明双					
B	陈进培 (主教练)						B	王明星 (主教练)					
C	贺业磊						C	岳连娥					
D	金钟顺						D	张圆圆					
A	Signatures of responsables for the teams (Off.A)												B
TP	Remarks of referees / HF Official												TP

	Referees	徐健 (CHN)	曹宏俊 (CHN)
	T.D.	刘凤娟 (CHN)	柴业宏 (CHN)
	CHA Off.		

Note: Number of 7m Throws Awarded to Team A and B, Goals (G), Warnings (W), Suspensions (2'), Direct Disqualification (D), Disqualification With Report (DR) and Team Penalty (TP).

Table Officials: 翟延露

刘茵蕊

Statisticians: 王玮

杜宪

### 第十三届全国运动会女子手球决赛

PHMS Pictorial Handball Match Statistics

IHF Official System

#### 竞赛技术统计

手球  
女子

预赛  
轮次 2

组别 A  
场次 6

天津师范大学体育馆  
2017-09-01 15:45

Referees: 徐健 (CHN) / 曹宏俊 (CHN)

Result: 35:22(20:10)

Teams: 上海(上海) VS 天津(天津)

上海		远射	近射	边射	快攻	突破	任意球	7m球	合计	%	助攻	失误	警告	2'	D+DR
主教练: 陈进培															
1	许沫														
2	周蕾		3/6	0/2	2/3				5/11	45.5				1	
3	王嘉怡														
5	郭威							2/3	2/3	66.7					
6	黄妍	0/3		0/1		2/2		1/1	3/7	42.9	1				
7	车婉茹							3/3	3/3	100					
8	吴茵	1/1			0/1				1/2	50.0	3	1		1	
9	武娜娜	1/2		2/2	2/2				5/6	83.3					
10	斯文		2/2		2/2				4/4	100			1	1	
11	孙梦颖	3/4	0/3	0/1	1/2				4/10	40.0	2	1		1	
12	郑冯														
13	徐娟		0/1			1/1			1/2	50.0					
17	居晔			0/1	2/2				2/3	66.7					
18	沙正文		2/3		1/1				3/4	75.0	1				
19	印尼	1/2	0/1			0/1	0/1		1/5	20.0	2	1			
23	都好				1/2				1/2	50.0		1			
运动员 合计		6/12	7/16	2/7	11/15	3/4	0/1	6/7	35/62	56.5	9	4	1	4	
1	许沫	2/3	1/5	1/1	1/2	1/3		0/1	6/15	40.0					
12	郑冯	0/3	2/7		1/2	1/2		0/3	4/17	23.5					
守门员 合计		2/6	3/12	1/1	2/4	2/5		0/4	10/32	31.3					
天津		远射	近射	边射	快攻	突破	任意球	7m球	合计	%	助攻	失误	警告	2'	D+DR
主教练: 王明星															
1	张莉														
3	王晓梅	0/2							0/2	0.0					
5	丁丽洁	0/1	0/1	0/1	0/1				0/4	0.0	1	1			
6	窦海乐														
7	张心茹		0/1					1/2	1/3	33.3					
8	张慧		0/1						0/1	0.0	1			2	
9	袁玉	0/2	1/1		1/2	2/4			4/9	44.4		5			
10	张文慧		5/6		1/1				6/7	85.7		2	1		
11	蔡雪洁	2/2	1/1						3/3	100	1	3			
12	王欣冉														
14	刘洁														
16	王选														
17	聂晓雪											2			
18	舒文琪	1/5		0/1				1/1	2/7	28.6					
23	周梦雪	1/3	2/2			1/2		2/2	6/9	66.7	6	5			
运动员 合计		4/15	9/13	0/2	2/4	3/6		4/5	22/45	48.9	9	18	1	2	
1	张莉	0/1			0/1			0/2	0/4	0.0					
16	王选	3/8	6/13	4/6	4/14	1/4	1/1	1/5	20/51	39.2					
守门员 合计		3/9	6/13	4/6	4/15	1/4	1/1	1/7	20/55	36.4					

上海	比赛进程	天津
1st Half		
6 黄妍	1 01:06	0
9 武娜娜	2 02:05	0
2 周蕾	3 02:31	0
3 周蕾	3 03:03	1 9 袁玉
2 周蕾	4 03:29	1
4 黄妍	4 06:47	2 10 张文慧
6 黄妍	5 08:24	2
11 孙梦颖	6 10:13	2
8 吴茵	7 11:20	2
7 吴茵	7 12:09	3 7 张心茹
10 斯文	8 12:44	3
18 沙正文	9 13:33	3
18 沙正文	9 14:08	4 18 舒文琪
10 斯文	10 14:55	4
10 斯文	10 15:05	5 10 张文慧
5 郭威	11 15:34	5
5 郭威	12 17:54	5
12 沙正文	12 18:11	6 10 张文慧
18 沙正文	13 18:36	6
13 孙梦颖	13 19:12	7 10 张文慧
11 孙梦颖	14 20:07	7
6 黄妍	15 20:45	7
2 周蕾	16 21:23	7
11 孙梦颖	17 23:21	7
17 孙梦颖	17 23:32	8 23 周梦雪
17 武娜娜	17 25:07	9 18 舒文琪
9 武娜娜	18 25:54	9
2 周蕾	19 26:44	9
9 武娜娜	19 27:27	10 11 蔡雪洁
9 武娜娜	20 29:17	10
2nd Half		
7 车婉茹	21 01:09	10
21 车婉茹	21 02:24	11 10 张文慧
7 车婉茹	22 03:10	11
22 郭威	22 03:55	12 10 张文慧
5 郭威	23 04:44	12
23 郭威	23 05:18	13 9 袁玉
11 孙梦颖	24 05:57	13
9 武娜娜	25 06:45	13
25 郭威	25 07:26	14 23 周梦雪
25 郭威	25 08:34	15 23 周梦雪
25 郭威	25 08:54	16 9 袁玉
23 都好	26 10:36	16
26 都好	26 11:56	17 23 周梦雪
7 车婉茹	27 12:40	17
2 周蕾	28 13:51	17
28 郭威	28 14:39	18 9 袁玉
9 武娜娜	29 14:56	18
29 郭威	29 15:44	19 11 蔡雪洁
13 徐娟	30 20:53	19
10 斯文	31 22:22	19
31 郭威	31 23:04	20 23 周梦雪
31 郭威	31 24:47	21 23 周梦雪
19 印尼	32 25:12	21
17 居晔	33 25:50	21
10 斯文	34 26:49	21
17 居晔	35 27:21	21
35 郭威	35 29:32	22 11 蔡雪洁

场上队员: 得分 / 射门

守门员: 救球 / 射门

D	取消资格	DR	取消资格+报告
---	------	----	---------

## 第十三届全国运动会女子手球决赛

PHMS Pictorial Handball Match Statistics

IHF Official System

## 个人/全队技术统计表

 手球 预赛 组别 A 天津师范大学体育馆  
 女子 轮次 2 场次 6 2017-09-01 15:45

号码	姓名	远射	近射	边射	快攻	突破	任意	七米	合计	%	助攻	失误	警告	2'	取消	时间
上海(上海)																
(场上队员)																
1	许沫									0.0%						00:29:38
2	周蕾		3/6	0/2	2/3				5/11	45.5%				1		00:42:02
3	王嘉怡									0.0%						00:07:58
5	郭威							2/3	2/3	66.7%						00:03:49
6	黄妍	0/3		0/1		2/2		1/1	3/7	42.9%	1					00:34:14
7	车婉茹							3/3	3/3	100%						00:01:45
8	吴茵	1/1			0/1				1/2	50.0%	3	1		1		00:39:42
9	武娜娜	1/2		2/2	2/2				5/6	83.3%						00:51:06
10	斯文		2/2		2/2				4/4	100%			1	1		00:22:32
11	孙梦颖	3/4	0/3	0/1	1/2				4/10	40.0%	2	1		1		00:46:10
12	郑冯									0.0%						00:30:22
13	徐娟		0/1			1/1			1/2	50.0%						00:15:26
17	居晔			0/1	2/2				2/3	66.7%						00:13:37
18	沙正文		2/3		1/1				3/4	75.0%	1					00:30:27
19	印尼	1/2	0/1			0/1	0/1		1/5	20.0%	2	1				00:20:45
23	都好				1/2				1/2	50.0%		1				00:29:31
	合计	6/12	7/16	2/7	11/15	3/4	0/1	6/7	35/62	56.5%	9	4	1	4		
(守门员)																
1	许沫	2/3	1/5	1/1	1/2	1/3		0/1	6/15	40.0%						00:29:38
12	郑冯	0/3	2/7		1/2	1/2		0/3	4/17	23.5%						00:30:22
	合计	2/6	3/12	1/1	2/4	2/5		0/4	10/32	31.3%						

场上队员：得分/射门

守门员：救球/射门

全队合计	得分	被救	射失	击柱	封球	合计	%
远射	6	3		3		12	50.0%
近射	7	6	2	1		16	43.8%
边射	2	4	1			7	28.6%
快攻	11	4				15	73.3%
突破	3	1				4	75.0%
任意		1				1	0.0%
七米	6	1				7	85.7%

**第十三届全国运动会女子手球决赛**
**PHMS** Pictorial Handball Match Statistics

**IHF** Official System

**个人/全队技术统计表**

 手球 预赛 组别 A 天津师范大学体育馆  
 女子 轮次 2 场次 6 2017-09-01 15:45

号码	姓名	远射	近射	边射	快攻	突破	任意	七米	合计	%	助攻	失误	警告	2'	取消	时间
<b>天津(天津)</b>																
<b>(场上队员)</b>																
1	张莉									0.0%						00:04:10
3	王晓梅	0/2							0/2	0.0%						00:16:33
5	丁丽洁	0/1	0/1	0/1	0/1				0/4	0.0%	1	1				00:44:27
6	窦海乐									0.0%						00:00:00
7	张心茹		0/1					1/2	1/3	33.3%						00:02:25
8	张慧		0/1						0/1	0.0%	1			2		00:46:54
9	袁玉	0/2	1/1		1/2	2/4			4/9	44.4%		5				00:56:48
10	张文慧		5/6		1/1				6/7	85.7%		2	1			01:00:00
11	蔡雪洁	2/2	1/1						3/3	100%	1	3				00:30:57
12	王欣冉									0.0%						00:00:00
14	刘洁									0.0%						00:00:00
16	王选									0.0%						00:55:50
17	聂晓雪									0.0%		2				00:04:23
18	舒文琪	1/5		0/1				1/1	2/7	28.6%						00:37:16
23	周梦雪	1/3	2/2			1/2		2/2	6/9	66.7%	6	5				00:59:38
<b>合计</b>		4/15	9/13	0/2	2/4	3/6		4/5	22/45	48.9%	9	18	1	2		
<b>(守门员)</b>																
1	张莉	0/1			0/1			0/2	0/4	0.0%						00:04:10
16	王选	3/8	6/13	4/6	4/14	1/4	1/1	1/5	20/51	39.2%						00:55:50
<b>合计</b>		3/9	6/13	4/6	4/15	1/4	1/1	1/7	20/55	36.4%						

场上队员：得分/射门

守门员：救球/射门

全队合计	得分	被救	射失	击柱	封球	合计	%
远射	4	2	8	1		15	26.7%
近射	9	3	1			13	69.2%
边射		1	1			2	0.0%
快攻	2	2				4	50.0%
突破	3	2		1		6	50.0%
任意							0.0%
七米	4		1			5	80.0%

第十三届全国运动会女子手球决赛

PHMS Pictorial Handball Match Statistics

IHF Official System

图式比赛技术统计表

手球  
女子

预赛  
轮次 2

组别 A  
场次 6

天津师范大学体育馆  
2017-09-01 15:45

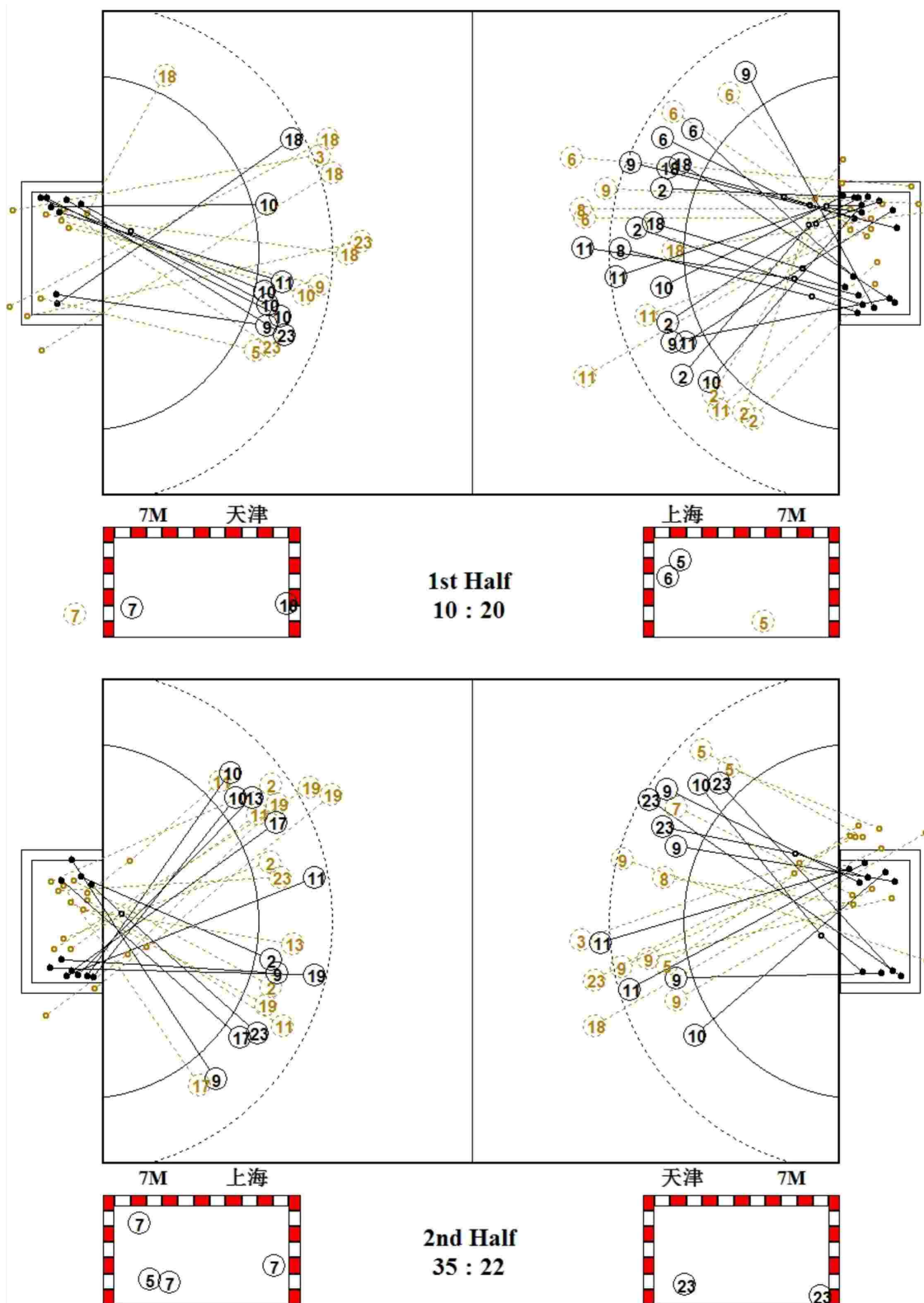



第十三届全国运动会女子手球决赛

PHMS Pictorial Handball Match Statistics

IHF Official System

图式射门区域统计

手球  
女子

预赛  
轮次 2

组别 A  
场次 6

天津师范大学体育馆  
2017-09-01 15:45

上海

1 许沫 <table border="1"><tr><td></td><td></td><td></td></tr><tr><td></td><td></td><td></td></tr><tr><td></td><td></td><td></td></tr></table> Post - 0 Miss - 0 Block - 0										2 周蕾 <table border="1"><tr><td></td><td></td><td></td></tr><tr><td>1</td><td></td><td>1</td></tr><tr><td>2</td><td></td><td>1</td></tr></table> Post - 1 Miss - 1 Block - 0				1		1	2		1	3 王嘉怡 <table border="1"><tr><td></td><td></td><td></td></tr><tr><td></td><td></td><td></td></tr><tr><td></td><td></td><td></td></tr></table> Post - 0 Miss - 0 Block - 0										5 郭威 <table border="1"><tr><td>1</td><td></td><td></td></tr><tr><td></td><td></td><td></td></tr><tr><td>1</td><td></td><td></td></tr></table> Post - 0 Miss - 0 Block - 0	1						1			6 黄妍 <table border="1"><tr><td></td><td></td><td></td></tr><tr><td>1</td><td></td><td></td></tr><tr><td>1</td><td></td><td>1</td></tr></table> Post - 1 Miss - 0 Block - 0				1			1		1	7 车婉茹 <table border="1"><tr><td>1</td><td></td><td></td></tr><tr><td></td><td></td><td>1</td></tr><tr><td>1</td><td></td><td></td></tr></table> Post - 0 Miss - 0 Block - 0	1					1	1			8 吴茵 <table border="1"><tr><td></td><td></td><td></td></tr><tr><td></td><td></td><td></td></tr><tr><td></td><td></td><td>1</td></tr></table> Post - 0 Miss - 0 Block - 0									1	9 武娜娜 <table border="1"><tr><td>1</td><td></td><td>1</td></tr><tr><td>1</td><td></td><td>2</td></tr><tr><td></td><td></td><td></td></tr></table> Post - 1 Miss - 0 Block - 0	1		1	1		2			
1		1																																																																													
2		1																																																																													
1																																																																															
1																																																																															
1																																																																															
1		1																																																																													
1																																																																															
		1																																																																													
1																																																																															
		1																																																																													
1		1																																																																													
1		2																																																																													
10 斯文 <table border="1"><tr><td>1</td><td></td><td></td></tr><tr><td>3</td><td></td><td></td></tr><tr><td></td><td></td><td></td></tr></table> Post - 0 Miss - 0 Block - 0	1			3						11 孙梦颖 <table border="1"><tr><td>1</td><td></td><td></td></tr><tr><td>1</td><td></td><td></td></tr><tr><td>1</td><td></td><td>1</td></tr></table> Post - 0 Miss - 0 Block - 0	1			1			1		1	12 郑冯 <table border="1"><tr><td></td><td></td><td></td></tr><tr><td></td><td></td><td></td></tr><tr><td></td><td></td><td></td></tr></table> Post - 0 Miss - 0 Block - 0										13 徐娟 <table border="1"><tr><td></td><td></td><td></td></tr><tr><td>1</td><td></td><td></td></tr><tr><td></td><td></td><td></td></tr></table> Post - 0 Miss - 0 Block - 0				1						17 居晔 <table border="1"><tr><td></td><td></td><td></td></tr><tr><td>1</td><td></td><td>1</td></tr><tr><td></td><td></td><td></td></tr></table> Post - 0 Miss - 0 Block - 0				1		1				18 沙正文 <table border="1"><tr><td></td><td></td><td>1</td></tr><tr><td></td><td></td><td></td></tr><tr><td>1</td><td></td><td>1</td></tr></table> Post - 0 Miss - 1 Block - 0			1				1		1	19 印尼 <table border="1"><tr><td>1</td><td></td><td></td></tr><tr><td></td><td></td><td></td></tr><tr><td></td><td></td><td></td></tr></table> Post - 1 Miss - 1 Block - 0	1									23 都好 <table border="1"><tr><td></td><td></td><td></td></tr><tr><td></td><td></td><td></td></tr><tr><td></td><td></td><td>1</td></tr></table> Post - 0 Miss - 0 Block - 0									1
1																																																																															
3																																																																															
1																																																																															
1																																																																															
1		1																																																																													
1																																																																															
1		1																																																																													
		1																																																																													
1		1																																																																													
1																																																																															
		1																																																																													

1 □□

1/2		1/4
0/2		3/5
		1/2

12 □□

1/3		0/2
1/3		0/3
1/4	1/1	0/1

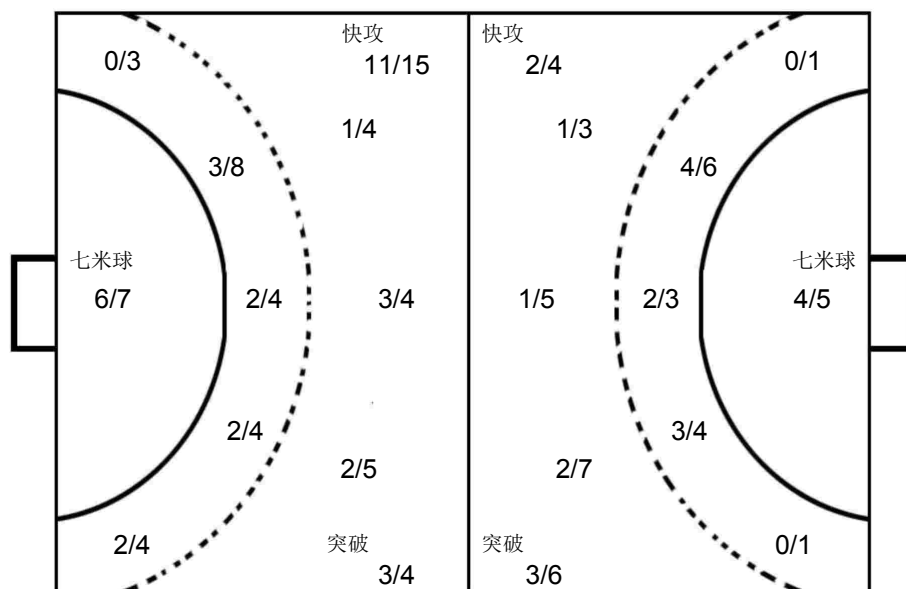

1 □□

0/1		
0/2		
0/1		

16 □□

1/5		1/3
4/9	4/4	4/9
2/11	3/3	1/7

天津

1 张莉 <table border="1"><tr><td></td><td></td><td></td></tr><tr><td></td><td></td><td></td></tr><tr><td></td><td></td><td></td></tr></table> Post - 0 Miss - 0 Block - 0										3 王晓梅 <table border="1"><tr><td></td><td></td><td></td></tr><tr><td></td><td></td><td></td></tr><tr><td></td><td></td><td></td></tr></table> Post - 0 Miss - 2 Block - 0										5 丁丽洁 <table border="1"><tr><td></td><td></td><td></td></tr><tr><td></td><td></td><td></td></tr><tr><td></td><td></td><td></td></tr></table> Post - 0 Miss - 3 Block - 0										6 窦海乐 <table border="1"><tr><td></td><td></td><td></td></tr><tr><td></td><td></td><td></td></tr><tr><td></td><td></td><td></td></tr></table> Post - 0 Miss - 0 Block - 0										7 张心茹 <table border="1"><tr><td></td><td></td><td></td></tr><tr><td>1</td><td></td><td></td></tr><tr><td></td><td></td><td></td></tr></table> Post - 0 Miss - 1 Block - 0				1						8 张慧 <table border="1"><tr><td></td><td></td><td></td></tr><tr><td></td><td></td><td></td></tr><tr><td></td><td></td><td></td></tr></table> Post - 0 Miss - 0 Block - 0										9 袁玉 <table border="1"><tr><td>2</td><td></td><td></td></tr><tr><td></td><td></td><td>1</td></tr><tr><td>1</td><td></td><td></td></tr></table> Post - 1 Miss - 1 Block - 0	2					1	1			10 张文慧 <table border="1"><tr><td>1</td><td></td><td>3</td></tr><tr><td></td><td></td><td>1</td></tr><tr><td></td><td></td><td>1</td></tr></table> Post - 0 Miss - 0 Block - 0	1		3			1			1
1																																																																															
2																																																																															
		1																																																																													
1																																																																															
1		3																																																																													
		1																																																																													
		1																																																																													
11 蔡雪洁 <table border="1"><tr><td></td><td></td><td></td></tr><tr><td>1</td><td></td><td>1</td></tr><tr><td>1</td><td></td><td></td></tr></table> Post - 0 Miss - 0 Block - 0				1		1	1			12 王欣冉 <table border="1"><tr><td></td><td></td><td></td></tr><tr><td></td><td></td><td></td></tr><tr><td></td><td></td><td></td></tr></table> Post - 0 Miss - 0 Block - 0										14 刘洁 <table border="1"><tr><td></td><td></td><td></td></tr><tr><td></td><td></td><td></td></tr><tr><td></td><td></td><td></td></tr></table> Post - 0 Miss - 0 Block - 0										16 王选 <table border="1"><tr><td></td><td></td><td></td></tr><tr><td></td><td></td><td></td></tr><tr><td></td><td></td><td></td></tr></table> Post - 0 Miss - 0 Block - 0										17 聂晓雪 <table border="1"><tr><td></td><td></td><td></td></tr><tr><td></td><td></td><td></td></tr><tr><td></td><td></td><td></td></tr></table> Post - 0 Miss - 0 Block - 0										18 舒文琪 <table border="1"><tr><td></td><td></td><td></td></tr><tr><td>1</td><td></td><td>1</td></tr><tr><td></td><td></td><td></td></tr></table> Post - 0 Miss - 3 Block - 0				1		1				23 周梦雪 <table border="1"><tr><td></td><td></td><td>2</td></tr><tr><td>1</td><td></td><td>1</td></tr><tr><td>1</td><td></td><td>1</td></tr></table> Post - 1 Miss - 1 Block - 0			2	1		1	1		1										
1		1																																																																													
1																																																																															
1		1																																																																													
		2																																																																													
1		1																																																																													
1		1																																																																													





Team A					Team B					Match Number											
A 北京					B 江苏					<b>7</b>											
Played in			in the hall			on			at			Spectators									
天津			天津师范大学体育馆			2017-09-01			17:30			hours									
Half-time(30')	A	B	End of playing time		A	B	1st extra time		A	B	2nd extra time		A	B	After penalty throws		A	B			
	9	19	24	33																	
Number of 7 m	A	Team time-out			Full name of players and officials						Team time-out			B	Number of 7 m						
	3/3	1	2	3							1	2	3	44:56		3/3					
	16:06	57:34																			
No.	Team A					G	W	2'	D	DR	No.	Team B					G	W	2'	D	DR
1	宋嘉蕾										1	陆婷									
3	季小桐					2					3	张海侠					3				
6	刘亚男										4	赵佳芹					4	1			
8	杨铭豫					1					7	周琦									
9	宋建军					1					8	乔如					1				
10	刘莎					2	1				9	莫蒙蒙					2				
11	纪婉					1					11	于源源					1		1		
15	郝泽荣					3					12	黄霞									
16	王海叶										13	黄慧影									
22	李海鸥					1					16	王小华									
23	赵小颖					2					17	修丽杰					4				
24	郝佳楠					4		1			18	韦秋香							1		
27	曹芳鸣					2					19	李薇薇					2				
28	闫美珠					1	1				23	王书慧					3	1			
47	刘泽										33	金梦青					8				
69	石梓薇					4	1				69	蓝小玲					5	1			
A	蔡建国										B	金甲洙 (主教练)									
B	宋刚 (主教练)										C	马彪									
C	关宏波										D	刘凯									
E	王长林																				
					Signatures of responsables for the teams (Off.A)																
TP	Remarks of referees / HF Official															TP					

Referees	刘禹 (CHN)	许翔 (CHN)	
T.D.	张春生 (CHN)	吴国忠 (CHN)	
CHA Off.			

Note: Number of 7m Throws Awarded to Team A and B, Goals (G), Warnings (W), Suspensions (2'), Direct Disqualification (D), Disqualification With Report (DR) and Team Penalty (TP).

Table Officials: 张智伟 谷瑶

Statisticians: 李双

王玮

**第十三届全国运动会女子手球决赛**
**PHMS** Pictorial Handball Match Statistics

**IHF** Official System

**竞赛技术统计**

 手球 预赛 组别 B 天津师范大学体育馆  
 女子 轮次 2 场次 7 2017-09-01 17:30

 Referees: 刘禹 (CHN) / 许翔 (CHN) Result: 24:33 (9:19)  
 Teams: 北京(北京) VS 江苏(江苏)

北京		远	近	边	快	突	任意	7m	合计	%	助攻	失误	警告	2'	D+DR	北京 江苏	
主教练: 宋刚		射	射	射	攻	破	球	球								比赛	进程
1	宋嘉蕾										1					10	刘莎
3	季小桐	0/2	2/2						2/4	50.0	2	1				1	00:52
6	刘亚男															1	01:22
8	杨铭豫			1/2					1/2	50.0						1	02:39
9	宋建军							1/1	1/1	100						2	03:33
10	刘莎		1/1	1/2	0/2				2/5	40.0			1			2	05:08
11	纪婉		1/1						1/1	100						2	06:52
15	郝泽荣	0/1	2/2					1/1	3/4	75.0		1				3	07:21
16	王海叶															3	07:35
22	李海鸥		1/2						1/2	50.0						3	09:08
23	赵小颖	1/2						1/1	2/3	66.7	2	2				4	10:19
24	郝佳楠	4/13							4/13	30.8	1	5		1		4	10:28
27	曹芳鸣			2/2					2/2	100		1				4	13:07
28	闫美珠	1/3	0/1						1/4	25.0			1			4	13:53
47	刘泽															4	16:04
69	石梓薇	2/6	2/3						4/9	44.4		3	1			4	17:10
运动员	合计	8/27	9/12	4/6	0/2			3/3	24/50	48.0	6	14	3	1		4	17:57
1	宋嘉蕾	0/1	1/2	0/1	2/3	0/1			3/8	37.5	1					4	19:10
16	王海叶	0/2	0/5	1/1	2/7			0/2	3/17	17.6						4	19:10
47	刘泽	3/5	1/5	0/2	0/3	0/1	0/1	0/1	4/18	22.2						4	19:10
守门员	合计	3/8	2/12	1/4	4/13	0/2	0/1	0/3	10/43	23.3	1					5	19:32
江苏		远	近	边	快	突	任意	7m	合计	%	助攻	失误	警告	2'	D+DR	2nd Half	
主教练: 金甲洙		射	射	射	攻	破	球	球								3	季小桐
1	陆婷										1					10	01:05
3	张海侠		1/1	1/2	1/3				3/6	50.0		1				10	01:50
4	赵佳芹	2/2	1/1			1/1			4/4	100	4		1			11	02:39
7	周琦	0/2							0/2	0.0						12	03:54
8	乔如		1/2						1/2	50.0						12	04:18
9	莫蒙蒙		1/1		1/2				2/3	66.7						13	04:24
11	于源源			1/1					1/1	100						14	05:52
12	黄霞															14	06:17
13	黄慧影															14	07:24
16	王小华															15	08:39
17	修丽杰	1/2	1/2			1/1		1/1	4/6	66.7	1	2				16	09:35
18	韦秋香	0/1							0/1	0.0						16	10:19
19	李薇薇	0/3	2/2						2/5	40.0	1	1				17	11:00
23	王书慧	1/4	2/3						3/7	42.9			1			18	12:10
33	金梦青				5/6		1/1	2/2	8/9	88.9	2	1				19	14:51
69	蓝小玲	1/2	1/1	1/1	2/3				5/7	71.4		2	1			19	15:29
运动员	合计	5/16	10/13	3/4	9/14	2/2	1/1	3/3	33/53	62.3	11	9	3	2		20	15:55
1	陆婷	4/7		0/1				0/1	4/9	44.4	1					20	16:23
12	黄霞							0/1	0/1	0.0				1		21	16:55
16	王小华	9/14	1/10	2/5	2/2			0/1	14/32	43.8	2					22	17:54
守门员	合计	13/21	1/10	2/6	2/2			0/3	18/42	42.9	3					22	20:59
																22	22:14
																23	23:01
																23	23:09
																24	23:50
																24	25:11
																24	27:26
																24	28:15
																24	29:52

场上队员: 得分 / 射门

守门员: 救球 / 射门

D	取消资格	DR	取消资格+报告
---	------	----	---------



## 第十三届全国运动会女子手球决赛

PHMS Pictorial Handball Match Statistics

IHF Official System

## 个人/全队技术统计表

 手球 预赛 组别 B 天津师范大学体育馆  
 女子 轮次 2 场次 7 2017-09-01 17:30

号码	姓名	远射	近射	边射	快攻	突破	任意	七米	合计	%	助攻	失误	警告	2'	取消	时间
北京(北京)																
(场上队员)																
1	宋嘉蕾									0.0%	1					00:09:51
3	季小桐	0/2	2/2						2/4	50.0%	2	1				00:20:05
6	刘亚男									0.0%						00:00:00
8	杨铭豫			1/2					1/2	50.0%						00:19:25
9	宋建军							1/1	1/1	100%						00:00:06
10	刘莎		1/1	1/2	0/2				2/5	40.0%			1			00:29:54
11	纪婉		1/1						1/1	100%						00:30:00
15	郝泽荣	0/1	2/2					1/1	3/4	75.0%		1				00:47:06
16	王海叶									0.0%						00:20:09
22	李海鸥		1/2						1/2	50.0%						00:23:28
23	赵小颖	1/2						1/1	2/3	66.7%	2	2				00:30:00
24	郝佳楠	4/13							4/13	30.8%	1	5		1		00:48:56
27	曹芳鸣			2/2					2/2	100%		1				00:30:00
28	闫美珠	1/3	0/1						1/4	25.0%		1	1			00:30:00
47	刘泽									0.0%						00:30:00
69	石梓薇	2/6	2/3						4/9	44.4%		3	1			00:50:57
	合计	8/27	9/12	4/6	0/2			3/3	24/50	48.0%	6	14	3	1		

## (守门员)

1	宋嘉蕾	0/1	1/2	0/1	2/3	0/1			3/8	37.5%	1					00:09:51
16	王海叶	0/2	0/5	1/1	2/7			0/2	3/17	17.6%						00:20:09
47	刘泽	3/5	1/5	0/2	0/3	0/1	0/1	0/1	4/18	22.2%						00:30:00
	合计	3/8	2/12	1/4	4/13	0/2	0/1	0/3	10/43	23.3%	1					

场上队员： 得分/射门

守门员： 救球/射门

全队合计	得分	被救	射失	击柱	封球	合计	%
远射	8	13	2		4	27	29.6%
近射	9	1		1	1	12	75.0%
边射	4	2				6	66.7%
快攻		2				2	0.0%
突破							0.0%
任意							0.0%
七米	3					3	100.0%

## 第十三届全国运动会女子手球决赛

PHMS Pictorial Handball Match Statistics

IHF Official System

## 个人/全队技术统计表

 手球 预赛 组别 B 天津师范大学体育馆  
 女子 轮次 2 场次 7 2017-09-01 17:30

号码	姓名	远射	近射	边射	快攻	突破	任意	七米	合计	%	助攻	失误	警告	2'	取消	时间
江苏(江苏)																
(场上队员)																
1	陆婷									0.0%	1					00:15:04
3	张海侠		1/1	1/2	1/3				3/6	50.0%		1				00:45:04
4	赵佳芹	2/2	1/1			1/1			4/4	100%	4		1			00:45:04
7	周琦	0/2							0/2	0.0%						00:07:26
8	乔如		1/2						1/2	50.0%						00:34:46
9	莫蒙蒙		1/1		1/2				2/3	66.7%						00:40:51
11	于源源			1/1					1/1	100%				1		00:16:33
12	黄霞									0.0%						00:00:11
13	黄慧影									0.0%						00:00:00
16	王小华									0.0%	2					00:44:45
17	修丽杰	1/2	1/2			1/1		1/1	4/6	66.7%	1	2				00:45:04
18	韦秋香	0/1							0/1	0.0%				1		00:14:56
19	李薇薇	0/3	2/2						2/5	40.0%	1	1				00:14:56
23	王书慧	1/4	2/3						3/7	42.9%		2	1			00:17:03
33	金梦青				5/6		1/1	2/2	8/9	88.9%	2	1				00:58:58
69	蓝小玲	1/2	1/1	1/1	2/3				5/7	71.4%		2	1			00:19:07
	合计	5/16	10/13	3/4	9/14	2/2	1/1	3/3	33/53	62.3%	11	9	3	2		

## (守门员)

1	陆婷	4/7		0/1				0/1	4/9	44.4%	1					00:15:04
12	黄霞							0/1	0/1	0.0%						00:00:11
16	王小华	9/14	1/10	2/5	2/2			0/1	14/32	43.8%	2					00:44:45
	合计	13/21	1/10	2/6	2/2			0/3	18/42	42.9%	3					

场上队员：得分/射门

守门员：救球/射门

全队合计	得分	被救	射失	击柱	封球	合计	%
远射	5	3	1	4	3	16	31.3%
近射	10	2	1			13	76.9%
边射	3	1				4	75.0%
快攻	9	4		1		14	64.3%
突破	2					2	100.0%
任意	1					1	100.0%
七米	3					3	100.0%

第十三届全国运动会女子手球决赛

PHMS Pictorial Handball Match Statistics

IHF Official System

图式比赛技术统计表

手球  
女子

预赛  
轮次 2

组别 B  
场次 7

天津师范大学体育馆  
2017-09-01 17:30

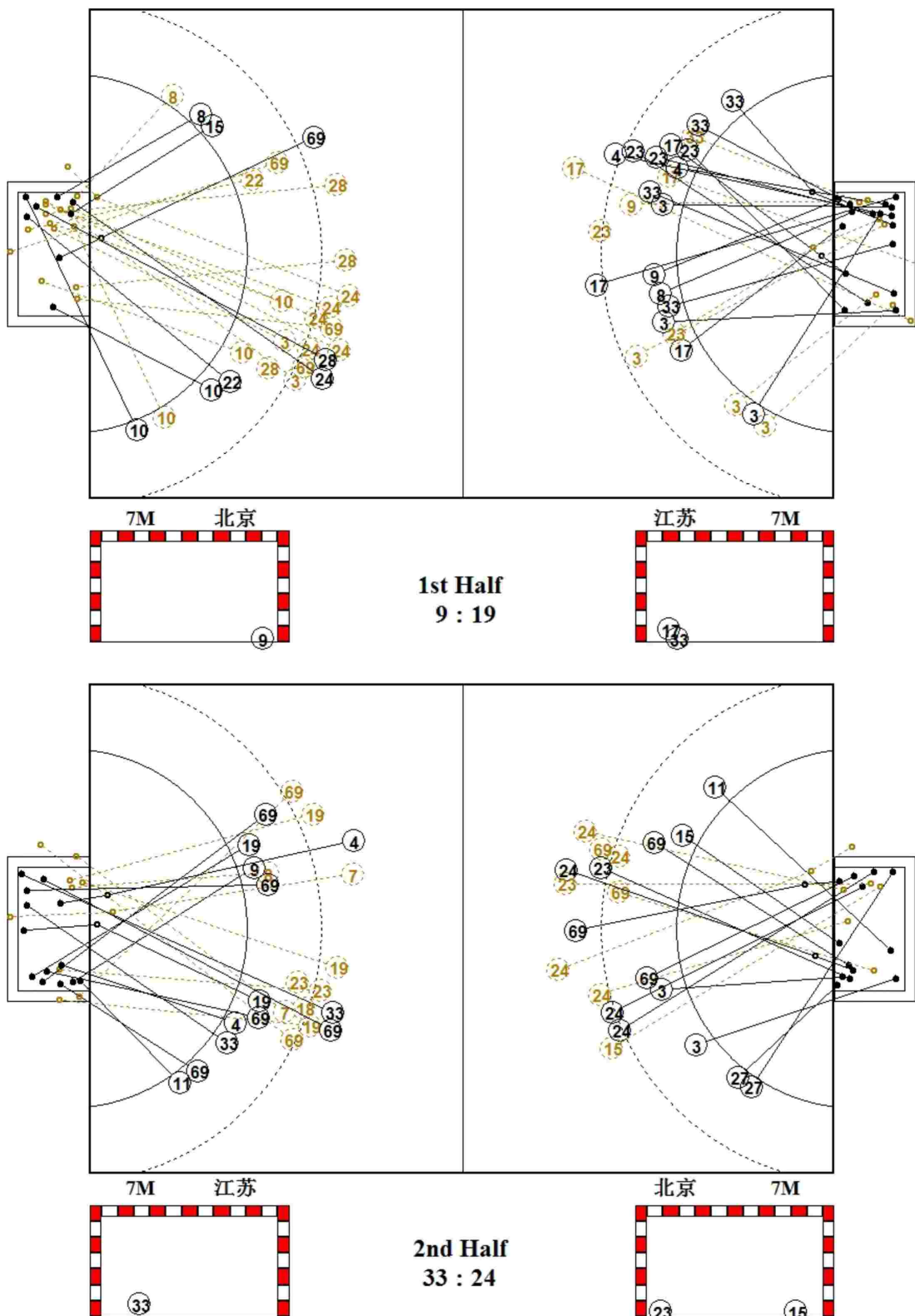

第十三届全国运动会女子手球决赛

PHMS Pictorial Handball Match Statistics

IHF Official System

图式射门区域统计

手球  
女子

预赛  
轮次 2

组别 B  
场次 7

天津师范大学体育馆  
2017-09-01 17:30

北京

1 宋嘉蕾 <table border="1"><tr><td></td><td></td><td></td></tr><tr><td></td><td></td><td></td></tr><tr><td></td><td></td><td></td></tr></table> Post - 0 Miss - 0 Block - 0										3 季小桐 <table border="1"><tr><td></td><td></td><td>1</td></tr><tr><td></td><td></td><td></td></tr><tr><td></td><td></td><td>1</td></tr></table> Post - 0 Miss - 0 Block - 0			1						1	6 刘亚男 <table border="1"><tr><td></td><td></td><td></td></tr><tr><td></td><td></td><td></td></tr><tr><td></td><td></td><td></td></tr></table> Post - 0 Miss - 0 Block - 0										8 杨铭豫 <table border="1"><tr><td></td><td></td><td></td></tr><tr><td></td><td></td><td>1</td></tr><tr><td></td><td></td><td></td></tr></table> Post - 0 Miss - 0 Block - 0						1				9 宋建军 <table border="1"><tr><td></td><td></td><td></td></tr><tr><td></td><td></td><td></td></tr><tr><td></td><td></td><td>1</td></tr></table> Post - 0 Miss - 0 Block - 0									1	10 刘莎 <table border="1"><tr><td></td><td></td><td>1</td></tr><tr><td></td><td></td><td></td></tr><tr><td></td><td></td><td></td></tr></table> Post - 0 Miss - 0 Block - 0			1							11 纪婉 <table border="1"><tr><td></td><td></td><td>1</td></tr><tr><td></td><td></td><td></td></tr><tr><td></td><td></td><td></td></tr></table> Post - 0 Miss - 0 Block - 0			1							15 郝泽荣 <table border="1"><tr><td></td><td></td><td></td></tr><tr><td></td><td></td><td></td></tr><tr><td></td><td>1</td><td>2</td></tr></table> Post - 0 Miss - 0 Block - 0								1	2
		1																																																																													
		1																																																																													
		1																																																																													
		1																																																																													
		1																																																																													
		1																																																																													
	1	2																																																																													
16 王海叶 <table border="1"><tr><td></td><td></td><td></td></tr><tr><td></td><td></td><td></td></tr><tr><td></td><td></td><td></td></tr></table> Post - 0 Miss - 0 Block - 0										22 李海鸥 <table border="1"><tr><td></td><td></td><td>1</td></tr><tr><td></td><td></td><td></td></tr><tr><td></td><td></td><td></td></tr></table> Post - 0 Miss - 0 Block - 0			1							23 赵小颖 <table border="1"><tr><td></td><td></td><td></td></tr><tr><td></td><td></td><td></td></tr><tr><td>1</td><td></td><td>1</td></tr></table> Post - 0 Miss - 0 Block - 0							1		1	24 郝佳楠 <table border="1"><tr><td></td><td></td><td></td></tr><tr><td></td><td></td><td></td></tr><tr><td>2</td><td></td><td>2</td></tr></table> Post - 0 Miss - 2 Block - 2							2		2	27 曹芳鸣 <table border="1"><tr><td>1</td><td></td><td></td></tr><tr><td></td><td></td><td></td></tr><tr><td></td><td></td><td>1</td></tr></table> Post - 0 Miss - 0 Block - 0	1								1	28 闫美珠 <table border="1"><tr><td></td><td></td><td>1</td></tr><tr><td></td><td></td><td></td></tr><tr><td></td><td></td><td></td></tr></table> Post - 0 Miss - 0 Block - 1			1							47 刘泽 <table border="1"><tr><td></td><td></td><td></td></tr><tr><td></td><td></td><td></td></tr><tr><td></td><td></td><td></td></tr></table> Post - 0 Miss - 0 Block - 0										69 石梓薇 <table border="1"><tr><td></td><td></td><td></td></tr><tr><td></td><td></td><td></td></tr><tr><td>2</td><td></td><td>1</td></tr></table> Post - 1 Miss - 0 Block - 2							2		1
		1																																																																													
1		1																																																																													
2		2																																																																													
1																																																																															
		1																																																																													
		1																																																																													
2		1																																																																													

1 □□□

1/4		
1/1		1/1
0/1		0/1

16 □□□

0/3	0/1	1/3
2/3		0/1
0/5	0/1	

47 □□

0/2	0/1	0/3
1/4		0/2
0/3		3/3

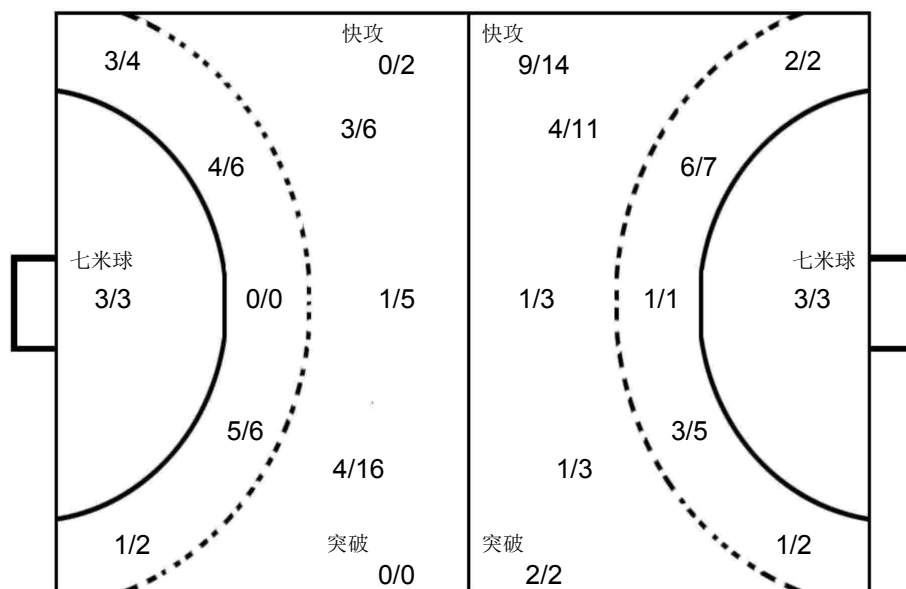

1 □□

1/1		
1/3		
1/1	1/1	0/3

12 □□

		0/1

16 □□□

1/2		1/6
0/1	0/1	7/8
2/5	0/1	3/8

江苏

1 陆婷 <table border="1"><tr><td></td><td></td><td></td></tr><tr><td></td><td></td><td></td></tr><tr><td></td><td></td><td></td></tr></table> Post - 0 Miss - 0 Block - 0										3 张海侠 <table border="1"><tr><td>2</td><td></td><td>1</td></tr><tr><td></td><td></td><td></td></tr><tr><td></td><td></td><td></td></tr></table> Post - 0 Miss - 0 Block - 0	2		1							4 赵佳芹 <table border="1"><tr><td>2</td><td></td><td></td></tr><tr><td>1</td><td></td><td>1</td></tr><tr><td></td><td></td><td></td></tr></table> Post - 0 Miss - 0 Block - 0	2			1		1				7 周琦 <table border="1"><tr><td></td><td></td><td></td></tr><tr><td></td><td></td><td></td></tr><tr><td></td><td></td><td></td></tr></table> Post - 2 Miss - 0 Block - 0										8 乔如 <table border="1"><tr><td></td><td></td><td></td></tr><tr><td></td><td></td><td></td></tr><tr><td>1</td><td></td><td></td></tr></table> Post - 0 Miss - 0 Block - 0							1			9 莫蒙蒙 <table border="1"><tr><td></td><td></td><td></td></tr><tr><td></td><td></td><td></td></tr><tr><td>2</td><td></td><td></td></tr></table> Post - 0 Miss - 0 Block - 0							2			11 于源源 <table border="1"><tr><td></td><td></td><td></td></tr><tr><td></td><td></td><td></td></tr><tr><td>1</td><td></td><td></td></tr></table> Post - 0 Miss - 0 Block - 0							1			12 黄霞 <table border="1"><tr><td></td><td></td><td></td></tr><tr><td></td><td></td><td></td></tr><tr><td></td><td></td><td></td></tr></table> Post - 0 Miss - 0 Block - 0									
2		1																																																																													
2																																																																															
1		1																																																																													
1																																																																															
2																																																																															
1																																																																															
13 黄慧影 <table border="1"><tr><td></td><td></td><td></td></tr><tr><td></td><td></td><td></td></tr><tr><td></td><td></td><td></td></tr></table> Post - 0 Miss - 0 Block - 0										16 王小华 <table border="1"><tr><td></td><td></td><td></td></tr><tr><td></td><td></td><td></td></tr><tr><td></td><td></td><td></td></tr></table> Post - 0 Miss - 0 Block - 0										17 修丽杰 <table border="1"><tr><td>1</td><td></td><td></td></tr><tr><td></td><td></td><td></td></tr><tr><td>2</td><td>1</td><td></td></tr></table> Post - 1 Miss - 1 Block - 0	1						2	1		18 韦秋香 <table border="1"><tr><td></td><td></td><td></td></tr><tr><td></td><td></td><td></td></tr><tr><td></td><td></td><td></td></tr></table> Post - 0 Miss - 0 Block - 1										19 李薇薇 <table border="1"><tr><td>1</td><td>1</td><td></td></tr><tr><td></td><td></td><td></td></tr><tr><td></td><td></td><td></td></tr></table> Post - 1 Miss - 0 Block - 0	1	1								23 王书慧 <table border="1"><tr><td></td><td></td><td></td></tr><tr><td>1</td><td></td><td>1</td></tr><tr><td></td><td></td><td>1</td></tr></table> Post - 0 Miss - 0 Block - 2				1		1			1	33 金梦青 <table border="1"><tr><td>1</td><td>1</td><td>3</td></tr><tr><td></td><td></td><td></td></tr><tr><td>3</td><td></td><td></td></tr></table> Post - 0 Miss - 0 Block - 0	1	1	3				3			69 蓝小玲 <table border="1"><tr><td>1</td><td></td><td>1</td></tr><tr><td>2</td><td></td><td>1</td></tr><tr><td></td><td></td><td></td></tr></table> Post - 1 Miss - 1 Block - 0	1		1	2		1			
1																																																																															
2	1																																																																														
1	1																																																																														
1		1																																																																													
		1																																																																													
1	1	3																																																																													
3																																																																															
1		1																																																																													
2		1																																																																													

**PHMS** Pictorial Handball Match Statistics

**IHF** Official System

Team A					Team B					Match Number				
A 新疆					B 广东					<b>8</b>				
Played in			in the hall			on		at		Spectators				
天津			天津师范大学体育馆			2017-09-01		19:15		hours				
Half-time(30')	A	B	End of playing time	A	B	1st extra time	A	B	2nd extra time	A	B	After penalty throws	A	B
	13	14		19	29									
Number of 7 m	A	Team time-out			Full name of players and officials					Team time-out			B	Number of 7 m
	0/0	1	2	3						1	2	3	7/11	
		13:50	43:34	47:40						56:14				

No.	Team A	G	W	2'	D	DR	No.	Team B	G	W	2'	D	DR
3	葛立双			1			2	王彤羽	3				
5	于千添						3	安妮	3				
6	阿热孜古丽	1		1			5	李纯					
7	吴志娟	3					7	刘彤	1	1			
10	李静						8	李诗棋					
11	陈培培						9	韦宝桂	8				
12	艾敏						10	史小军	4	1	1		
15	兰姝娇	1					11	魏梦庭					
17	戴莹莹		1				15	杨慧					
18	崔娟	5					16	李娟					
21	锁珊珊	4	1	1			19	邝雪花	1				
23	张艺璇						20	李军政					
26	宋婷婷	1					22	刘晓玉					
27	谢辰辰						23	王如	2		1		
32	杨雨柔						26	马晓卉					
93	张婷婷	4	1	2			28	刘金兰	7				
A	刁继平		1				B	黄炳春					
B	于涛 (主教练)						C	李玉玲					
C	李天坐						D	郭艳辉 (主教练)					
							E	赵善良					
A		Signatures of responsables for the teams (Off.A)											B
TP	Remarks of referees / HF Official												TP

	Referees	ALEXEI. COVALCIUC (MDA)	IGOR. COVALCIUC (MDA)	
	T.D.	张春生 (CHN)	高斌 (CHN)	
	CHA Off.			

Note: Number of 7m Throws Awarded to Team A and B, Goals (G), Warnings (W), Suspensions (2'), Direct Disqualification (D), Disqualification With Report (DR) and Team Penalty (TP).

Table Officials: 张智伟      谷瑶      Statisticians: 周强      李双

**第十三届全国运动会女子手球决赛**
**PHMS** Pictorial Handball Match Statistics

**IHF** Official System

**竞赛技术统计**

 手球  
 女子

 预赛  
 轮次 2

 组别 B  
 场次 8

 天津师范大学体育馆  
 2017-09-01 19:15

Referees: ALEXEI. COVALCIUC (MDA) / IGOR. COVALCIUC (MDA)

Result: 19:29(13:14)

Teams: 新疆(新疆) VS 广东(广东)

新疆		远	近	边	快	突	任意	7m	合计	%	助攻	失误	警告	2'	D+DR
主教练: 于涛		射	射	射	攻	破	球	球							
3	葛立双		0/1						0/1	0.0	1	2		1	
5	于千添														
6	阿热孜古丽		1/2						1/2	50.0		3		1	
7	吴志娟		1/1	2/2					3/3	100		1			
10	李静														
11	陈培培														
12	艾敏														
15	兰姝娇			1/2					1/2	50.0		1			
17	戴莹莹		0/1						0/1	0.0			1		
18	崔娟	2/4	0/2			3/4			5/10	50.0		2			
21	锁珊珊	4/7	0/2						4/9	44.4	1	1	1	1	
23	张艺璇														
26	宋婷婷	0/2	1/1		0/1				1/4	25.0					
27	谢辰辰														
32	杨雨柔											1			
93	张婷婷	1/3	1/2			2/2			4/7	57.1	1	3	1	2	
运动员 合计		7/16	4/12	3/4	0/1	5/6			19/39	48.7	3	14	3	5	
10	李静	0/1				0/1		0/3	0/5	0.0					
32	杨雨柔	2/6	4/10	2/4	1/4	0/4	0/1	2/6	11/35	31.4		1			
守门员 合计		2/7	4/10	2/4	1/4	0/5	0/1	2/9	11/40	27.5		1			

广东		远	近	边	快	突	任意	7m	合计	%	助攻	失误	警告	2'	D+DR
主教练: 郭桦辉		射	射	射	攻	破	球	球							
2	王彤羽	1/1	0/1			1/1		1/1	3/4	75.0					
3	安妮	1/2	0/1	0/1		2/2			3/6	50.0	2				
5	李纯														
7	刘彤				1/2				1/2	50.0		1	1		
8	李诗棋														
9	韦宝桂	3/5	1/4		2/2		1/1	1/4	8/16	50.0		5			
10	史小军		2/2			2/2			4/4	100	1	2	1	1	
11	魏梦庭	0/2							0/2	0.0					
15	杨慧														
16	李娟														
19	邝雪花		1/1						1/1	100					
20	李军政														
22	刘晓玉										1				
23	王如		2/2						2/2	100		1		1	
26	马晓卉										1				
28	刘金兰		0/1	2/3	0/1			5/6	7/11	63.6	1				
运动员 合计		5/10	6/12	2/4	3/5	5/5	1/1	7/11	29/48	60.4	6	9	2	2	
22	刘晓玉	2/6	4/5	0/2		0/3			6/16	37.5	1				
26	马晓卉	1/4	2/5	1/2	1/1	0/2			5/14	35.7	1				
守门员 合计		3/10	6/10	1/4	1/1	0/5			11/30	36.7	2				

新疆	比赛进程	广东
1st Half		
93 张婷婷	1 00:31 0	
18 崔娟	2 00:51 0	
	2 02:56 1 19 邝雪花	
	2 03:36 2 7 刘彤	
7 吴志娟	3 04:01 2	
	3 04:50 3 9 韦宝桂	
	3 05:34 4 28 刘金兰	
18 崔娟	4 06:23 4	
93 张婷婷	5 07:03 4	
	5 10:03 5 28 刘金兰	
	5 12:58 6 9 韦宝桂	
	5 14:42 7 28 刘金兰	
93 张婷婷	6 16:00 7	
	6 16:32 8 3 安妮	
	6 19:36 9 23 王如	
21 锁珊珊	7 20:03 9	
	7 20:48 10 9 韦宝桂	
15 兰姝娇	8 21:33 10	
	8 22:04 11 3 安妮	
18 崔娟	9 22:11 11	
	9 22:48 12 9 韦宝桂	
6 阿热孜古丽	10 23:36 12	
7 吴志娟	11 24:57 12	
	11 25:50 13 28 刘金兰	
21 锁珊珊	12 28:13 13	
	12 28:43 14 28 刘金兰	
7 吴志娟	13 29:30 14	
2nd Half		
18 崔娟	14 02:44 14	
	14 04:08 15 3 安妮	
21 锁珊珊	15 05:19 15	
	15 06:14 16 9 韦宝桂	
93 张婷婷	16 06:42 16	
	16 07:16 17 23 王如	
	16 12:43 18 10 史小军	
	16 13:21 19 10 史小军	
	16 15:48 20 9 韦宝桂	
	16 17:05 21 28 刘金兰	
	16 17:40 22 9 韦宝桂	
26 宋婷婷	17 18:04 22	
	17 18:51 23 10 史小军	
	17 21:00 24 10 史小军	
	17 22:13 25 28 刘金兰	
	17 24:27 26 9 韦宝桂	
18 崔娟	18 27:17 26	
	18 27:49 27 2 王彤羽	
21 锁珊珊	19 28:16 27	
	19 28:58 28 2 王彤羽	
	19 30:00 29 2 王彤羽	

场上队员: 得分 / 射门

守门员: 救球 / 射门

D	取消资格	DR	取消资格+报告



## 第十三届全国运动会女子手球决赛

PHMS Pictorial Handball Match Statistics

IHF Official System

## 个人/全队技术统计表

 手球 预赛 组别 B 天津师范大学体育馆  
 女子 轮次 2 场次 8 2017-09-01 19:15

号码	姓名	远射	近射	边射	快攻	突破	任意	七米	合计	%	助攻	失误	警告	2'	取消	时间
<b>新疆(新疆)</b>																
<b>(场上队员)</b>																
3	葛立双		0/1						0/1	0.0%	1	2		1		00:04:41
5	于千添									0.0%						00:00:00
6	阿热孜古丽		1/2						1/2	50.0%		3		1		00:48:23
7	吴志娟		1/1	2/2					3/3	100%		1				00:56:32
10	李静									0.0%						00:03:15
11	陈培培									0.0%						00:00:00
12	艾敏									0.0%						00:00:00
15	兰姝娇			1/2					1/2	50.0%		1				00:53:34
17	戴莹莹		0/1						0/1	0.0%			1			00:16:23
18	崔娟	2/4	0/2			3/4			5/10	50.0%		2				00:50:20
21	锁珊珊	4/7	0/2						4/9	44.4%	1	1	1	1		00:56:21
23	张艺璇									0.0%						00:06:02
26	宋婷婷	0/2	1/1		0/1				1/4	25.0%						00:17:31
27	谢辰辰									0.0%						00:03:01
32	杨雨柔									0.0%		1				00:56:45
93	张婷婷	1/3	1/2			2/2			4/7	57.1%	1	3	1	2		00:46:30
	<b>合计</b>	<b>7/16</b>	<b>4/12</b>	<b>3/4</b>	<b>0/1</b>	<b>5/6</b>			<b>19/39</b>	<b>48.7%</b>	<b>3</b>	<b>14</b>	<b>3</b>	<b>5</b>		
<b>(守门员)</b>																
10	李静	0/1				0/1		0/3	0/5	0.0%						00:03:15
32	杨雨柔	2/6	4/10	2/4	1/4	0/4	0/1	2/6	11/35	31.4%		1				00:56:45
	<b>合计</b>	<b>2/7</b>	<b>4/10</b>	<b>2/4</b>	<b>1/4</b>	<b>0/5</b>	<b>0/1</b>	<b>2/9</b>	<b>11/40</b>	<b>27.5%</b>		<b>1</b>				

场上队员：得分/射门

守门员：救球/射门

全队合计	得分	被救	射失	击柱	封球	合计	%
远射	7	3		3	3	16	43.8%
近射	4	6		2		12	33.3%
边射	3	1				4	75.0%
快攻		1				1	0.0%
突破	5		1			6	83.3%
任意							0.0%
七米							0.0%

**第十三届全国运动会女子手球决赛**
**PHMS** Pictorial Handball Match Statistics

**IHF** Official System

**个人/全队技术统计表**

 手球 预赛 组别 B 天津师范大学体育馆  
 女子 轮次 2 场次 8 2017-09-01 19:15

号码	姓名	远射	近射	边射	快攻	突破	任意	七米	合计	%	助攻	失误	警告	2'	取消	时间
<b>广东(广东)</b>																
<b>(场上队员)</b>																
2	王彤羽	1/1	0/1			1/1		1/1	3/4	75.0%						00:03:41
3	安妮	1/2	0/1	0/1		2/2			3/6	50.0%	2					00:55:19
5	李纯									0.0%						00:00:00
7	刘彤				1/2				1/2	50.0%		1	1			00:56:14
8	李诗棋									0.0%						00:03:39
9	韦宝桂	3/5	1/4		2/2		1/1	1/4	8/16	50.0%		5				00:52:45
10	史小军		2/2			2/2			4/4	100%	1	2	1	1		00:42:48
11	魏梦庭	0/2							0/2	0.0%						00:23:13
15	杨慧									0.0%						00:03:41
16	李娟									0.0%						00:00:00
19	邝雪花		1/1						1/1	100%						00:22:20
20	李军政									0.0%						00:03:40
22	刘晓玉									0.0%	1					00:27:12
23	王如		2/2						2/2	100%		1		1		00:50:52
26	马晓卉									0.0%	1					00:32:48
28	刘金兰		0/1	2/3	0/1			5/6	7/11	63.6%	1					00:56:14
	<b>合计</b>	<b>5/10</b>	<b>6/12</b>	<b>2/4</b>	<b>3/5</b>	<b>5/5</b>	<b>1/1</b>	<b>7/11</b>	<b>29/48</b>	<b>60.4%</b>	<b>6</b>	<b>9</b>	<b>2</b>	<b>2</b>		
<b>(守门员)</b>																
22	刘晓玉	2/6	4/5	0/2		0/3			6/16	37.5%	1					00:27:12
26	马晓卉	1/4	2/5	1/2	1/1	0/2			5/14	35.7%	1					00:32:48
	<b>合计</b>	<b>3/10</b>	<b>6/10</b>	<b>1/4</b>	<b>1/1</b>	<b>0/5</b>			<b>11/30</b>	<b>36.7%</b>	<b>2</b>					

场上队员：得分/射门

守门员：救球/射门

全队合计	得分	被救	射失	击柱	封球	合计	%
远射	5	2			3	10	50.0%
近射	6	4		2		12	50.0%
边射	2	2				4	50.0%
快攻	3	1		1		5	60.0%
突破	5					5	100.0%
任意	1					1	100.0%
七米	7	2	1	1		11	63.6%

第十三届全国运动会女子手球决赛

PHMS Pictorial Handball Match Statistics

IHF Official System

图式比赛技术统计表

手球  
女子

预赛  
轮次 2

组别 B  
场次 8

天津师范大学体育馆  
2017-09-01 19:15

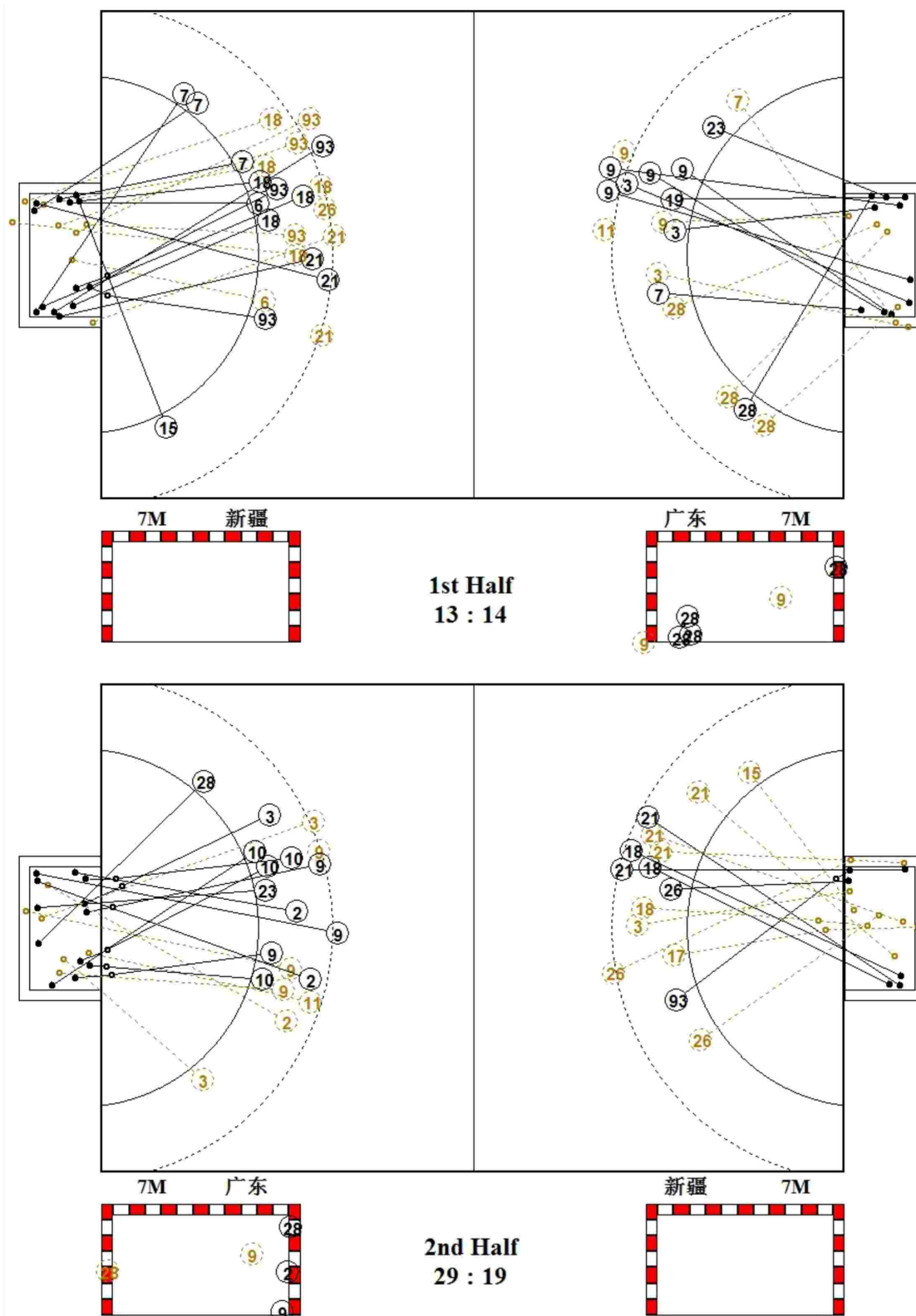

第十三届全国运动会女子手球决赛

PHMS Pictorial Handball Match Statistics

IHF Official System

图式射门区域统计

手球  
女子

预赛  
轮次 2

组别 B  
场次 8

天津师范大学体育馆  
2017-09-01 19:15

新疆

3 葛立双 <table border="1"><tr><td></td><td></td><td></td></tr><tr><td></td><td></td><td></td></tr><tr><td></td><td></td><td></td></tr></table> Post - 0 Miss - 0 Block - 0										5 于千添 <table border="1"><tr><td></td><td></td><td></td></tr><tr><td></td><td></td><td></td></tr><tr><td></td><td></td><td></td></tr></table> Post - 0 Miss - 0 Block - 0										6 阿热孜古丽 <table border="1"><tr><td></td><td></td><td></td></tr><tr><td></td><td></td><td>1</td></tr><tr><td></td><td></td><td></td></tr></table> Post - 0 Miss - 0 Block - 0						1				7 吴志娟 <table border="1"><tr><td>1</td><td></td><td>1</td></tr><tr><td></td><td></td><td>1</td></tr><tr><td></td><td></td><td></td></tr></table> Post - 0 Miss - 0 Block - 0	1		1			1				10 李静 <table border="1"><tr><td></td><td></td><td></td></tr><tr><td></td><td></td><td></td></tr><tr><td></td><td></td><td></td></tr></table> Post - 0 Miss - 0 Block - 0										11 陈培培 <table border="1"><tr><td></td><td></td><td></td></tr><tr><td></td><td></td><td></td></tr><tr><td></td><td></td><td></td></tr></table> Post - 0 Miss - 0 Block - 0										12 艾敏 <table border="1"><tr><td></td><td></td><td></td></tr><tr><td></td><td></td><td></td></tr><tr><td></td><td></td><td></td></tr></table> Post - 0 Miss - 0 Block - 0										15 兰姝娇 <table border="1"><tr><td></td><td></td><td></td></tr><tr><td></td><td></td><td>1</td></tr><tr><td></td><td></td><td></td></tr></table> Post - 0 Miss - 0 Block - 0						1			
		1																																																																													
1		1																																																																													
		1																																																																													
		1																																																																													
17 戴莹莹 <table border="1"><tr><td></td><td></td><td></td></tr><tr><td></td><td></td><td></td></tr><tr><td></td><td></td><td></td></tr></table> Post - 1 Miss - 0 Block - 0										18 崔娟 <table border="1"><tr><td>1</td><td></td><td>1</td></tr><tr><td>1</td><td></td><td>1</td></tr><tr><td></td><td></td><td>1</td></tr></table> Post - 1 Miss - 1 Block - 1	1		1	1		1			1	21 锁珊珊 <table border="1"><tr><td>1</td><td></td><td>2</td></tr><tr><td>1</td><td></td><td></td></tr><tr><td></td><td></td><td></td></tr></table> Post - 2 Miss - 0 Block - 1	1		2	1						23 张艺璇 <table border="1"><tr><td></td><td></td><td></td></tr><tr><td></td><td></td><td></td></tr><tr><td></td><td></td><td></td></tr></table> Post - 0 Miss - 0 Block - 0										26 宋婷婷 <table border="1"><tr><td></td><td></td><td></td></tr><tr><td></td><td></td><td></td></tr><tr><td>1</td><td></td><td></td></tr></table> Post - 1 Miss - 0 Block - 1							1			27 谢辰辰 <table border="1"><tr><td></td><td></td><td></td></tr><tr><td></td><td></td><td></td></tr><tr><td></td><td></td><td></td></tr></table> Post - 0 Miss - 0 Block - 0										32 杨雨柔 <table border="1"><tr><td></td><td></td><td></td></tr><tr><td></td><td></td><td></td></tr><tr><td></td><td></td><td></td></tr></table> Post - 0 Miss - 0 Block - 0										93 张婷婷 <table border="1"><tr><td>1</td><td></td><td></td></tr><tr><td>1</td><td></td><td></td></tr><tr><td>2</td><td></td><td></td></tr></table> Post - 0 Miss - 0 Block - 0	1			1			2		
1		1																																																																													
1		1																																																																													
		1																																																																													
1		2																																																																													
1																																																																															
1																																																																															
1																																																																															
1																																																																															
2																																																																															

10 □□

		0/1
		0/2
0/1		0/1

32 □□□

0/3	1/3	3/9
4/8	1/1	0/1
2/6	0/1	0/3

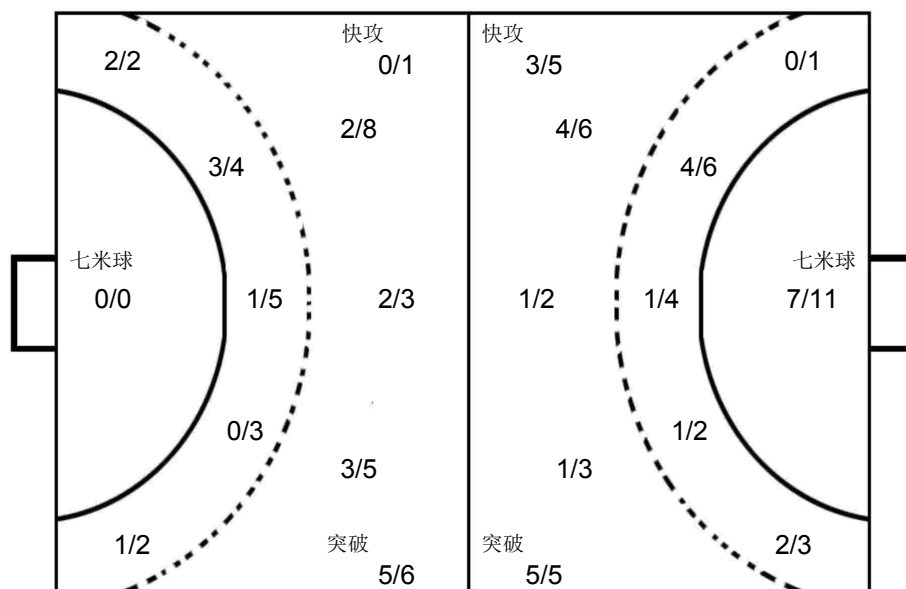

22 □□□

0/3		2/4
0/2	1/1	2/4
0/1		1/1

26 □□□

0/1	1/1	0/2
0/1	2/2	0/2
1/3	1/1	0/1

广东

2 王彤羽 <table border="1"><tr><td></td><td></td><td>1</td></tr><tr><td></td><td></td><td>2</td></tr><tr><td></td><td></td><td></td></tr></table> Post - 0 Miss - 0 Block - 0			1			2				3 安妮 <table border="1"><tr><td></td><td></td><td>1</td></tr><tr><td>1</td><td></td><td></td></tr><tr><td></td><td></td><td>1</td></tr></table> Post - 1 Miss - 0 Block - 0			1	1					1	5 李纯 <table border="1"><tr><td></td><td></td><td></td></tr><tr><td></td><td></td><td></td></tr><tr><td></td><td></td><td></td></tr></table> Post - 0 Miss - 0 Block - 0										7 刘彤 <table border="1"><tr><td></td><td></td><td></td></tr><tr><td></td><td></td><td></td></tr><tr><td></td><td></td><td>1</td></tr></table> Post - 1 Miss - 0 Block - 0									1	8 李诗棋 <table border="1"><tr><td></td><td></td><td></td></tr><tr><td></td><td></td><td></td></tr><tr><td></td><td></td><td></td></tr></table> Post - 0 Miss - 0 Block - 0										9 韦宝桂 <table border="1"><tr><td>1</td><td></td><td>3</td></tr><tr><td>1</td><td></td><td>1</td></tr><tr><td></td><td>1</td><td>1</td></tr></table> Post - 1 Miss - 1 Block - 2	1		3	1		1		1	1	10 史小军 <table border="1"><tr><td>1</td><td></td><td></td></tr><tr><td></td><td></td><td></td></tr><tr><td>2</td><td></td><td>1</td></tr></table> Post - 0 Miss - 0 Block - 0	1						2		1	11 魏梦庭 <table border="1"><tr><td></td><td></td><td></td></tr><tr><td></td><td></td><td></td></tr><tr><td></td><td></td><td></td></tr></table> Post - 0 Miss - 0 Block - 1									
		1																																																																													
		2																																																																													
		1																																																																													
1																																																																															
		1																																																																													
		1																																																																													
1		3																																																																													
1		1																																																																													
	1	1																																																																													
1																																																																															
2		1																																																																													
15 杨慧 <table border="1"><tr><td></td><td></td><td></td></tr><tr><td></td><td></td><td></td></tr><tr><td></td><td></td><td></td></tr></table> Post - 0 Miss - 0 Block - 0										16 李娟 <table border="1"><tr><td></td><td></td><td></td></tr><tr><td></td><td></td><td></td></tr><tr><td></td><td></td><td></td></tr></table> Post - 0 Miss - 0 Block - 0										19 邝雪花 <table border="1"><tr><td>1</td><td></td><td></td></tr><tr><td></td><td></td><td></td></tr><tr><td></td><td></td><td></td></tr></table> Post - 0 Miss - 0 Block - 0	1									20 李军政 <table border="1"><tr><td></td><td></td><td></td></tr><tr><td></td><td></td><td></td></tr><tr><td></td><td></td><td></td></tr></table> Post - 0 Miss - 0 Block - 0										22 刘晓玉 <table border="1"><tr><td></td><td></td><td></td></tr><tr><td></td><td></td><td></td></tr><tr><td></td><td></td><td></td></tr></table> Post - 0 Miss - 0 Block - 0										23 王如 <table border="1"><tr><td></td><td>1</td><td></td></tr><tr><td>1</td><td></td><td></td></tr><tr><td></td><td></td><td></td></tr></table> Post - 0 Miss - 0 Block - 0		1		1						26 马晓卉 <table border="1"><tr><td></td><td></td><td></td></tr><tr><td></td><td></td><td></td></tr><tr><td></td><td></td><td></td></tr></table> Post - 0 Miss - 0 Block - 0										28 刘金兰 <table border="1"><tr><td></td><td>1</td><td>2</td></tr><tr><td>1</td><td></td><td></td></tr><tr><td>3</td><td></td><td></td></tr></table> Post - 1 Miss - 0 Block - 0		1	2	1			3		
1																																																																															
	1																																																																														
1																																																																															
	1	2																																																																													
1																																																																															
3																																																																															

**PHMS** Pictorial Handball Match Statistics

**IHF** Official System

Team A A 山东					Team B B 天津					Match Number <b>9</b>											
Played in 天津			in the hall 天津师范大学体育馆			on 2017-09-02		at 14:00		hours spectators											
Half-time(30')	A 12	B 7	End of playing time	A 26	B 15	1st extra time	A	B	2nd extra time	A	B	After penalty throws	A	B							
Number of 7 m	A 3/5	Team time-out			Full name of players and officials					Team time-out			B 3/4	Number of 7 m							
		1 21:56	2	3						1 18:02	2 45:55	3									
No.	Team A					G	W	2'	D	DR	No.	Team B					G	W	2'	D	DR
1	路畅										1	张莉									
2	林燕群					5	1				3	王晓梅					6				
6	王莎莎										5	丁丽洁									
8	王彬										6	窦海乐									
10	田秀秀					3					7	张心茹									
11	吕青纹					6					8	张慧					1	1			
12	张苑琳										9	袁玉					3				
15	吴作扬					2		3			10	张文慧						1	1		
19	姜伟珊										11	蔡雪洁					1		2		
20	张悦					3					12	王欣冉									
22	朱赟										14	刘洁									
23	徐悦										16	王选									
28	崔金娜					3					17	聂晓雪					1	1			
33	王彩琳					3					18	舒文琪									
77	穆庆丛					1	1				23	周梦雪					3				
B	马海湧 (主教练)										A	付明双									
C	徐强										B	王明星 (主教练)									
D	孔德宾										C	岳连娥									
E	王日东										D	张圆圆									
A	Signatures of responsables for the teams (Off.A)															B					
TP	Remarks of referees / HF Official															TP					

Signatures

Referees	张耿 (CHN)	马晓晔 (CHN)		
T.D.	刘凤娟 (CHN)	高斌 (CHN)		
CHA Off.				

Note: Number of 7m Throws Awarded to Team A and B, Goals (G), Warnings (W), Suspensions (2'), Direct Disqualification (D), Disqualification With Report (DR) and Team Penalty (TP).

Table Officials: 齐红梅

翟延露

Statisticians: 王玮

李双

### 第十三届全国运动会女子手球决赛

**PHMS** Pictorial Handball Match Statistics

**IHF** Official System

#### 竞赛技术统计

 手球 预赛 组别 A 天津师范大学体育馆  
 女子 轮次 3 场次 9 2017-09-02 14:00

 Referees: 张耿 (CHN) / 马晓晔 (CHN) Result: 26:15 (12:7)  
 Teams: 山东(山东) VS 天津(天津)

山东														比赛进程		天津	
主教练: 马海湧														1st Half			
远射	近射	边射	快攻	突破	任意球	7m球	合计	%	助攻	失误	警告	2'	D+DR	山东	天津		
1	刘畅																
2	林燕群	2/6	1/4		1/1	1/1	0/1	5/13	38.5	1	4	1		2	林燕群		
6	王莎莎													10	田秀秀		
8	王彬													11	吕青纹		
10	田秀秀						3/5	3/5	60.0					4	06:59		
11	吕青纹	0/1		2/2	4/5			6/8	75.0	2				9	袁玉		
12	张苑琳													2	林燕群		
15	吴作扬	0/2	2/2					2/4	50.0		4		3	33	王彩琳		
19	姜伟珊													11	吕青纹		
20	张悦		0/1	3/3				3/4	75.0					8	吕青纹		
22	朱贇									2				8	15:00		
23	徐悦													9	16:22		
28	崔金娜		2/2			1/1		3/3	100					11	吕青纹		
33	王彩琳		1/1		1/1	1/1		3/3	100		3			10	18:52		
77	穆庆丛		1/1	0/1				1/2	50.0			1		10	20:49		
运动员 合计		2/9	7/11	5/5	6/8	3/3	0/1	3/5	26/42	61.9	5	11	2	3	11	21:27	
1	刘畅	0/1						0/1	0/2	0.0					11	22:28	
12	张苑琳							0/1	0/1	0.0					11	23:09	
22	朱贇	7/11	4/7		3/6	1/2	1/1	0/1	16/28	57.1	2				15	29:46	
守门员 合计		7/12	4/7		3/6	1/2	1/1	0/3	16/31	51.6	2				15	00:23	

天津														2nd Half			
主教练: 王明星																	
远射	近射	边射	快攻	突破	任意球	7m球	合计	%	助攻	失误	警告	2'	D+DR	山东	天津		
1	张莉																
3	王晓梅	3/6			1/2	0/1	2/2	6/11	54.5					15	吴作扬		
5	丁丽洁													15	01:50		
6	窦海乐													33	王彩琳		
7	张心茹			0/1	1/1									2	林燕群		
8	张慧							1/2	50.0		1	1		11	吕青纹		
9	袁玉	1/3	1/2		0/1		1/1	3/7	42.9	1	3			17	04:28		
10	张文慧		0/2					0/2	0.0	1	2	1	1	17	05:17		
11	蔡雪洁	0/1	0/1	1/1				1/3	33.3					8	3 王晓梅		
12	王欣冉													17	08:55		
14	刘洁													9	3 王晓梅		
16	王选									1				18	09:40		
17	聂晓雪				1/1			1/1	100			1		18	10:26		
18	舒文琪	0/1						0/1	0.0					19	11:10		
23	周梦雪	1/6	2/2		0/2	0/2	0/1	3/13	23.1		7			20	15:05		
运动员 合计		5/17	3/7	0/1	3/6	1/2	0/3	3/4	15/40	37.5	3	13	3	3	20	17:59	
1	张莉							0/1	0/1	0.0					21	18:34	
16	王选	4/6	2/9	0/5	0/6	0/3	1/1	0/2	7/32	21.9	1				21	19:19	
守门员 合计		4/6	2/9	0/5	0/6	0/3	1/1	0/3	7/33	21.2	1				22	21:01	

场上队员: 得分 / 射门

守门员: 救球 / 射门

D	取消资格	DR	取消资格+报告
---	------	----	---------



## 第十三届全国运动会女子手球决赛

PHMS Pictorial Handball Match Statistics

IHF Official System

## 个人/全队技术统计表

 手球 预赛 组别 A 天津师范大学体育馆  
 女子 轮次 3 场次 9 2017-09-02 14:00

号码	姓名	远射	近射	边射	快攻	突破	任意	七米	合计	%	助攻	失误	警告	2'	取消	时间
<b>山东(山东)</b>																
<b>(场上队员)</b>																
1	路畅									0.0%						00:02:40
2	林燕群	2/6	1/4		1/1	1/1	0/1		5/13	38.5%	1	4	1			00:44:48
6	王莎莎									0.0%						00:00:00
8	王彬									0.0%						00:02:11
10	田秀秀							3/5	3/5	60.0%						00:02:20
11	吕青纹	0/1		2/2	4/5				6/8	75.0%	2					00:30:00
12	张苑琳									0.0%						00:00:10
15	吴作扬	0/2	2/2						2/4	50.0%		4		3		00:34:19
19	姜伟珊									0.0%						00:02:21
20	张悦		0/1	3/3					3/4	75.0%						00:27:39
22	朱贇									0.0%	2					00:57:10
23	徐悦									0.0%						00:11:58
28	崔金娜		2/2			1/1			3/3	100%						00:35:42
33	王彩琳		1/1		1/1	1/1			3/3	100%		3				00:56:32
77	穆庆丛		1/1		0/1				1/2	50.0%			1			00:28:36
	<b>合计</b>	<b>2/9</b>	<b>7/11</b>	<b>5/5</b>	<b>6/8</b>	<b>3/3</b>	<b>0/1</b>	<b>3/5</b>	<b>26/42</b>	<b>61.9%</b>	<b>5</b>	<b>11</b>	<b>2</b>	<b>3</b>		
<b>(守门员)</b>																
1	路畅	0/1						0/1	0/2	0.0%						00:02:40
12	张苑琳							0/1	0/1	0.0%						00:00:10
22	朱贇	7/11	4/7		3/6	1/2	1/1	0/1	16/28	57.1%	2					00:57:10
	<b>合计</b>	<b>7/12</b>	<b>4/7</b>		<b>3/6</b>	<b>1/2</b>	<b>1/1</b>	<b>0/3</b>	<b>16/31</b>	<b>51.6%</b>	<b>2</b>					

场上队员： 得分/射门

守门员： 救球/射门

全队合计	得分	被救	射失	击柱	封球	合计	%
远射	2	4	1	1	1	9	22.2%
近射	7	2	2			11	63.6%
边射	5					5	100.0%
快攻	6		2			8	75.0%
突破	3					3	100.0%
任意		1				1	0.0%
七米	3		1	1		5	60.0%

## 第十三届全国运动会女子手球决赛

PHMS Pictorial Handball Match Statistics

IHF Official System

## 个人/全队技术统计表

 手球 预赛 组别 A 天津师范大学体育馆  
 女子 轮次 3 场次 9 2017-09-02 14:00

号码	姓名	远射	近射	边射	快攻	突破	任意	七米	合计	%	助攻	失误	警告	2'	取消	时间
天津(天津)																
(场上队员)																
1	张莉									0.0%						00:00:49
3	王晓梅	3/6				1/2	0/1	2/2	6/11	54.5%						00:34:11
5	丁丽洁									0.0%						00:00:00
6	窦海乐									0.0%						00:00:00
7	张心茹									0.0%						00:00:00
8	张慧			0/1	1/1				1/2	50.0%		1	1			00:28:04
9	袁玉	1/3	1/2		0/1			1/1	3/7	42.9%	1	3				00:27:21
10	张文慧		0/2						0/2	0.0%	1	2	1	1		00:29:57
11	蔡雪洁	0/1	0/1		1/1				1/3	33.3%				2		00:45:26
12	王欣冉									0.0%						00:00:00
14	刘洁									0.0%						00:00:00
16	王选									0.0%	1					00:59:11
17	聂晓雪				1/1				1/1	100%			1			00:21:41
18	舒文琪	0/1							0/1	0.0%						00:12:59
23	周梦雪	1/6	2/2		0/2		0/2	0/1	3/13	23.1%		7				00:23:03
合计		5/17	3/7	0/1	3/6	1/2	0/3	3/4	15/40	37.5%	3	13	3	3		
(守门员)																
1	张莉							0/1	0/1	0.0%						00:00:49
16	王选	4/6	2/9	0/5	0/6	0/3	1/1	0/2	7/32	21.9%	1					00:59:11
合计		4/6	2/9	0/5	0/6	0/3	1/1	0/3	7/33	21.2%	1					

场上队员：得分/射门

守门员：救球/射门

全队合计	得分	被救	射失	击柱	封球	合计	%
远射	5	7	2	1	2	17	29.4%
近射	3	4				7	42.9%
边射			1			1	0.0%
快攻	3	3				6	50.0%
突破	1	1				2	50.0%
任意			2			3	0.0%
七米	3		1			4	75.0%



第十三届全国运动会女子手球决赛

PHMS Pictorial Handball Match Statistics

IHF Official System

图式比赛技术统计表

手球  
女子

预赛  
轮次 3

组别 A  
场次 9

天津师范大学体育馆  
2017-09-02 14:00

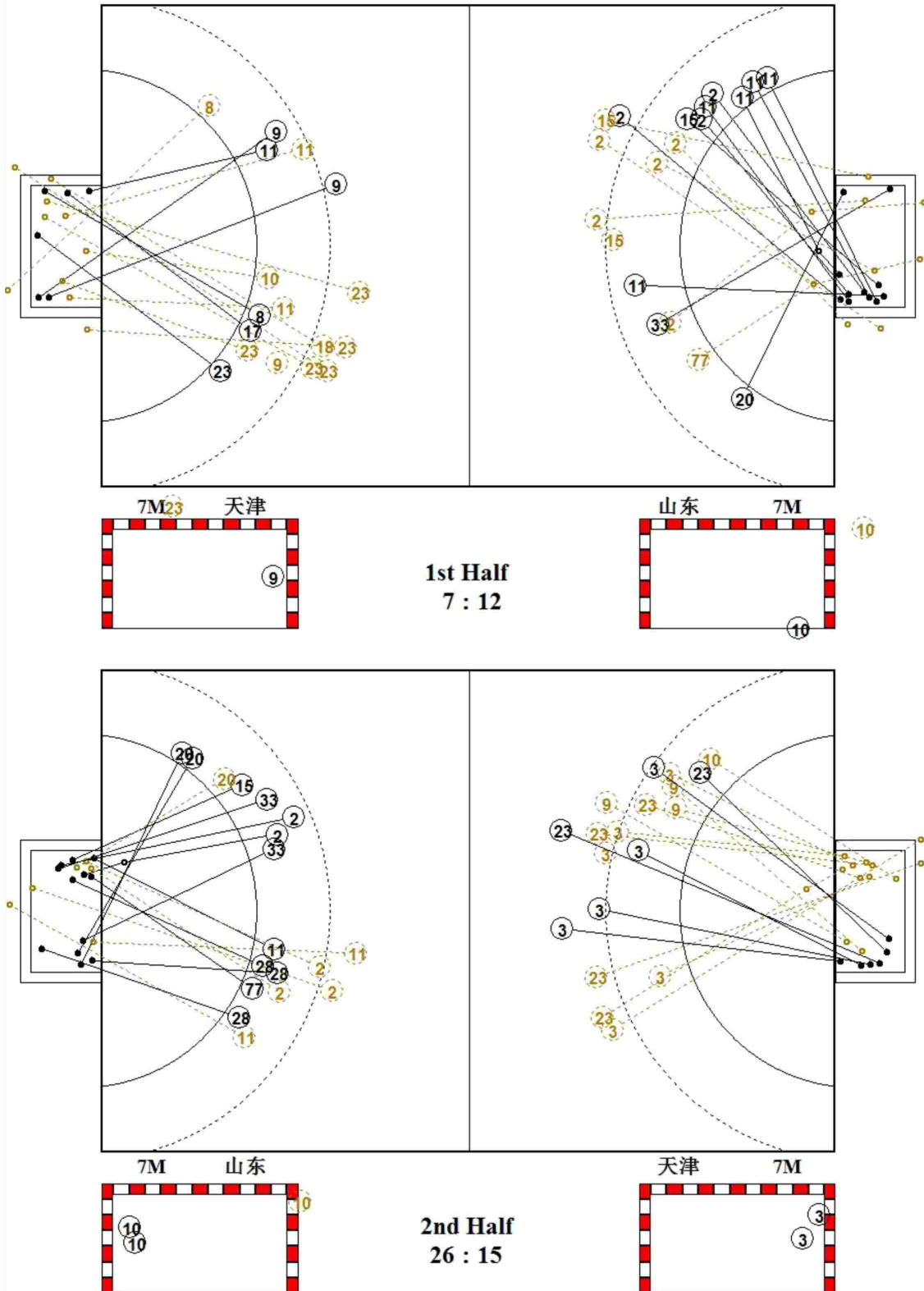

第十三届全国运动会女子手球决赛

PHMS Pictorial Handball Match Statistics

IHF Official System

图式射门区域统计

手球  
女子

预赛  
轮次 3

组别 A  
场次 9

天津师范大学体育馆  
2017-09-02 14:00

山东

1 路畅 Post - 0 Miss - 0 Block - 0	2 林燕群 Post - 0 Miss - 3 Block - 0 2 3	6 王莎莎 Post - 0 Miss - 0 Block - 0	8 王彬 Post - 0 Miss - 0 Block - 0	10 田秀秀 Post - 1 Miss - 1 Block - 0 1 1 1	11 吕青纹 Post - 0 Miss - 1 Block - 0 1 2 3	12 张苑琳 Post - 0 Miss - 0 Block - 0	15 吴作扬 Post - 1 Miss - 0 Block - 1 2
19 姜伟珊 Post - 0 Miss - 0 Block - 0	20 张悦 Post - 0 Miss - 0 Block - 0 1 2	22 朱赟 Post - 0 Miss - 0 Block - 0	23 徐悦 Post - 0 Miss - 0 Block - 0	28 崔金娜 Post - 0 Miss - 0 Block - 0 1 1	33 王彩琳 Post - 0 Miss - 0 Block - 0 1 1	77 穆庆丛 Post - 0 Miss - 1 Block - 0 1	

1 □□ 0/1 0/1
--------------------

12 □□□ 0/1
---------------

22 □□ 1/3 0/1 2/4 6/6 2/7 3/3 1/1 1/3
--

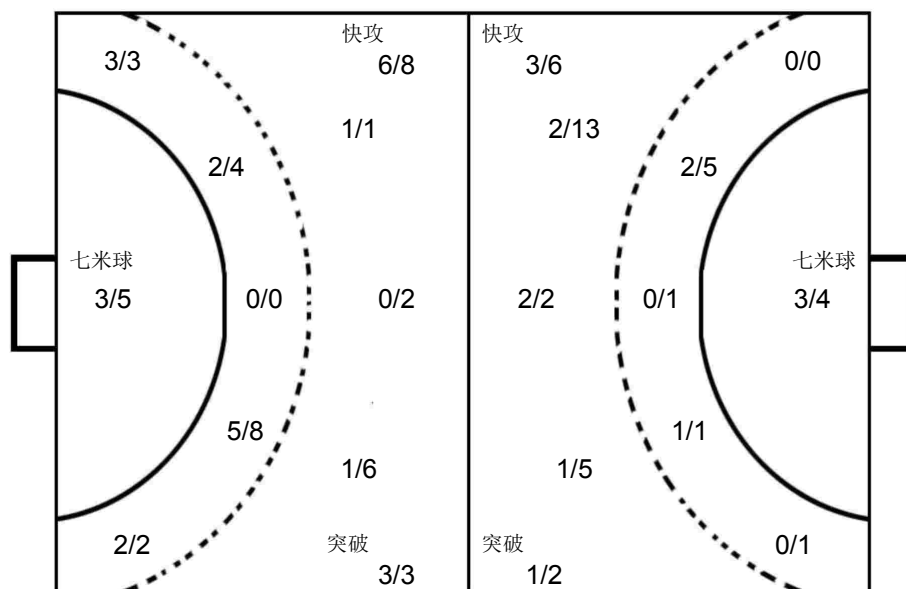

1 □□ 0/1
-------------

16 □□ 0/2 1/2 1/3 2/10 1/5 2/10
--

天津

1 张莉 Post - 0 Miss - 0 Block - 0	3 王晓梅 Post - 0 Miss - 1 Block - 1 2 3 1	5 丁丽洁 Post - 0 Miss - 0 Block - 0	6 窦海乐 Post - 0 Miss - 0 Block - 0	7 张心茹 Post - 0 Miss - 0 Block - 0	8 张慧 Post - 0 Miss - 1 Block - 0 1	9 袁玉 Post - 0 Miss - 0 Block - 1 2 1	10 张文慧 Post - 0 Miss - 0 Block - 0
11 蔡雪洁 Post - 0 Miss - 0 Block - 0 1	12 王欣冉 Post - 0 Miss - 0 Block - 0	14 刘洁 Post - 0 Miss - 0 Block - 0	16 王选 Post - 0 Miss - 0 Block - 0	17 聂晓雪 Post - 0 Miss - 0 Block - 0 1	18 舒文琪 Post - 1 Miss - 0 Block - 0	23 周梦雪 Post - 0 Miss - 4 Block - 0 1 1 1	

Team A					Team B					Match Number											
A 安徽					B 上海					<b>10</b>											
Played in			in the hall			on			at			Spectators									
天津			天津师范大学体育馆			2017-09-02			15:45			hours									
Half-time(30')	A	B	End of playing time	A	B	1st extra time	A	B	2nd extra time	A	B	After penalty throws	A	B							
	10	9		23	23								28	26							
Number of 7 m	A	Team time-out			Full name of players and officials						Team time-out			B	Number of 7 m						
	7/8	1	2	3							1	2	3	8/12							
			51:43	57:52					22:44	59:35											
No.	Team A					G	W	2'	D	DR	No.	Team B					G	W	2'	D	DR
1	司艳										1	许沫									
3	李兵					2		1			2	周蕾					1				
5	班晨晨					1					3	王嘉怡									
6	沈萍					5	1				5	郭威					4				
7	赵江川										6	黄妍					2				
8	徐仕媛										7	车婉茹					1				
10	孙来苗					1					8	吴茵					7		1		
13	陶丹扬										9	武娜娜					3	1			
14	刘晓妹					3	1				10	斯文									
15	王婵婵										11	孙梦颖					8				
16	朱莉珍										12	郑冯									
17	周婷					3					13	徐娟									
20	周雪婷										17	居晔									
21	李瑶					4					18	沙正文						1			
23	张天洁										19	印尼									
41	杜机娟					9	1				23	都好									
A	吴疆										A	孙琦敏									
B	吴立军 (主教练)										B	陈进培 (主教练)									
C	杨桂东										C	贺业磊									
E	张国遂										D	金钟顺									
Signatures of responsables for the teams (Off.A)																				B	
TP	Remarks of referees / HF Official																		TP		

Referees	ALEXEI. COVALCIUC (MDA)	IGOR. COVALCIUC (MDA)		
T.D.	刘凤娟 (CHN)	高斌 (CHN)		
CHA Off.				

Note: Number of 7m Throws Awarded to Team A and B, Goals (G), Warnings (W), Suspensions (2'), Direct Disqualification (D), Disqualification With Report (DR) and Team Penalty (TP).

Table Officials: 谷瑶

张智伟

Statisticians: 周强

杜宪

**第十三届全国运动会女子手球决赛**
**PHMS** Pictorial Handball Match Statistics

**IHF** Official System

**竞赛技术统计**

 手球  
 女子

 预赛  
 轮次 3

 组别 A  
 场次 10

 天津师范大学体育馆  
 2017-09-02 15:45

Referees: ALEXEI. COVALCIUC (MDA) / IGOR. COVALCIUC (MDA)

Result: 28:26 (10:9)

Teams: 安徽(安徽) VS 上海(上海)

安徽		远	近	边	快	突	任意	7m	合计	%	助攻	失误	警告	2'	D+DR	安徽	比赛 进程	上海
主教练: 吴立军		射	射	射	攻	破	球	球										
1	司艳																	
3	李兵	1/2	0/2			1/2			2/6	33.3		1		1			0 02:09	1 6 黄妍
5	班晨晨							1/1	1/1	100							1 05:12	1 郭威
6	沈萍		2/3	1/1			1/1	1/1	5/6	83.3		2	1				2 10:29	2 5 郭威
7	赵江川																2 11:53	3 5 郭威
8	徐仕媛																3 14:33	3 3 吴茵
10	孙来苗							1/1	1/1	100							4 15:25	4 8 吴茵
13	陶丹扬																4 16:32	5 6 黄妍
14	刘晓妹	1/6	1/3			1/1	0/1		3/11	27.3	3	3	1				5 18:58	5 孙梦颖
15	王婷婷										1						5 20:03	6 11 孙梦颖
16	朱莉珍																6 20:12	6 刘悦妹
17	周婷	1/2	1/2			1/2			3/6	50.0		1					7 22:04	6 杜机娟
20	周雪婷																8 22:17	6 杜机娟
21	李瑶	0/1	0/2		2/2	1/1		1/1	4/7	57.1		2					9 24:05	7 2 周蕾
23	张天洁																9 24:44	7 杜机娟
41	杜机娟		1/1	3/4	2/2			3/4	9/11	81.8		1	1				10 27:47	8 5 郭威
运动员	合计	3/11	5/13	4/5	4/4	4/6	1/2	7/8	28/49	57.1	4	10	3	1			10 29:34	9 11 孙梦颖
1	司艳	3/8	4/6	3/8	0/1	0/2	1/4	1/5	12/34	35.3							11 01:46	9 杜机娟
16	朱莉珍							3/7	3/7	42.9							11 02:19	10 11 孙梦颖
守门员	合计	3/8	4/6	3/8	0/1	0/2	1/4	4/12	15/41	36.6							12 02:30	10 周婷
上海		远	近	边	快	突	任意	7m	合计	%	助攻	失误	警告	2'	D+DR			
主教练: 陈进培		射	射	射	攻	破	球	球										
1	许沫										1	1						
2	周蕾			1/2					1/2	50.0								
3	王嘉怡																	
5	郭威							4/5	4/5	80.0								
6	黄妍	0/8	0/2				1/2	1/3	2/15	13.3	1	2						
7	车婉茹							1/1	1/1	100								
8	吴茵	2/5	0/1	1/1		1/1	1/1	2/2	7/11	63.6	3	2		1				
9	武娜娜			2/6	1/1				3/7	42.9			1					
10	斯文																	
11	孙梦颖	3/3	2/3	1/2		1/1	1/1	0/1	8/11	72.7		4						
12	郑冯																	
13	徐娟																	
17	居晔																	
18	沙正文		0/2						0/2	0.0		1	1					
19	印尼																	
23	都好																	
运动员	合计	5/16	2/8	5/11	1/1	2/2	3/4	8/12	26/54	48.1	5	10	2	1				
1	许沫	3/6	6/11	0/4	0/4	1/5	1/2	1/8	12/40	30.0	1	1						
守门员	合计	3/6	6/11	0/4	0/4	1/5	1/2	1/8	12/40	30.0	1	1						

场上队员: 得分 / 射门

守门员: 救球 / 射门

D	取消资格	DR	取消资格+报告
---	------	----	---------

## 第十三届全国运动会女子手球决赛

PHMS Pictorial Handball Match Statistics

IHF Official System

## 个人/全队技术统计表

 手球 预赛 组别 A 天津师范大学体育馆  
 女子 轮次 3 场次 10 2017-09-02 15:45

号码	姓名	远射	近射	边射	快攻	突破	任意	七米	合计	%	助攻	失误	警告	2'	取消	时间
<b>安徽(安徽)</b>																
<b>(场上队员)</b>																
1	司艳									0.0%						00:58:40
3	李兵	1/2	0/2			1/2			2/6	33.3%		1		1		01:00:00
5	班晨晨							1/1	1/1	100%						00:01:33
6	沈萍		2/3	1/1			1/1	1/1	5/6	83.3%		2	1			00:57:04
7	赵江川									0.0%						00:00:00
8	徐仕媛									0.0%						00:00:00
10	孙来苗							1/1	1/1	100%						00:00:00
13	陶丹扬									0.0%						00:13:58
14	刘晓妹	1/6	1/3			1/1	0/1		3/11	27.3%	3	3	1			00:55:10
15	王婵婵									0.0%	1					00:17:24
16	朱莉珍									0.0%						00:01:20
17	周婷	1/2	1/2			1/2			3/6	50.0%		1				00:45:06
20	周雪婷									0.0%						00:00:00
21	李瑶	0/1	0/2		2/2	1/1		1/1	4/7	57.1%		2				00:49:32
23	张天洁									0.0%						00:00:00
41	杜机娟		1/1	3/4	2/2			3/4	9/11	81.8%		1	1			01:00:00
	<b>合计</b>	<b>3/11</b>	<b>5/13</b>	<b>4/5</b>	<b>4/4</b>	<b>4/6</b>	<b>1/2</b>	<b>7/8</b>	<b>28/49</b>	<b>57.1%</b>	<b>4</b>	<b>10</b>	<b>3</b>	<b>1</b>		
<b>(守门员)</b>																
1	司艳	3/8	4/6	3/8	0/1	0/2	1/4	1/5	12/34	35.3%						00:58:40
16	朱莉珍							3/7	3/7	42.9%						00:01:20
	<b>合计</b>	<b>3/8</b>	<b>4/6</b>	<b>3/8</b>	<b>0/1</b>	<b>0/2</b>	<b>1/4</b>	<b>4/12</b>	<b>15/41</b>	<b>36.6%</b>						

场上队员：得分/射门

守门员：救球/射门

全队合计	得分	被救	射失	击柱	封球	合计	%
远射	3	3	2	1	2	11	27.3%
近射	5	6		2		13	38.5%
边射	4		1			5	80.0%
快攻	4					4	100.0%
突破	4	1		1		6	66.7%
任意	1	1				2	50.0%
七米	7	1				8	87.5%

## 第十三届全国运动会女子手球决赛

PHMS Pictorial Handball Match Statistics

IHF Official System

## 个人/全队技术统计表

 手球 预赛 组别 A 天津师范大学体育馆  
 女子 轮次 3 场次 10 2017-09-02 15:45

号码	姓名	远射	近射	边射	快攻	突破	任意	七米	合计	%	助攻	失误	警告	2'	取消	时间
上海(上海)																
(场上队员)																
1	许沫									0.0%	1	1				01:00:00
2	周蕾			1/2					1/2	50.0%						00:53:49
3	王嘉怡									0.0%						00:00:00
5	郭威							4/5	4/5	80.0%						00:01:49
6	黄妍	0/8	0/2			1/2	1/3		2/15	13.3%	1	2				01:00:00
7	车婉茹							1/1	1/1	100%						00:00:00
8	吴茵	2/5	0/1	1/1		1/1	1/1	2/2	7/11	63.6%	3	2		1		00:59:10
9	武娜娜			2/6	1/1				3/7	42.9%			1			01:00:00
10	斯文									0.0%						00:05:36
11	孙梦颖	3/3	2/3	1/2		1/1	1/1	0/1	8/11	72.7%		4				00:58:35
12	郑冯									0.0%						00:00:00
13	徐娟									0.0%						00:00:00
17	居晔									0.0%						00:00:43
18	沙正文		0/2						0/2	0.0%		1	1			00:50:48
19	印尼									0.0%						00:00:00
23	都好									0.0%						00:08:42
	合计	5/16	2/8	5/11	1/1	2/2	3/4	8/12	26/54	48.1%	5	10	2	1		
(守门员)																
1	许沫	3/6	6/11	0/4	0/4	1/5	1/2	1/8	12/40	30.0%	1	1				01:00:00
	合计	3/6	6/11	0/4	0/4	1/5	1/2	1/8	12/40	30.0%	1	1				

场上队员：得分/射门

守门员：救球/射门

全队合计	得分	被救	射失	击柱	封球	合计	%
远射	5	3	3	2	3	16	31.3%
近射	2	4		1	1	8	25.0%
边射	5	3		3		11	45.5%
快攻	1					1	100.0%
突破	2					2	100.0%
任意	3	1				4	75.0%
七米	8	4				12	66.7%

第十三届全国运动会女子手球决赛

PHMS Pictorial Handball Match Statistics

IHF Official System

图式比赛技术统计表

手球  
女子

预赛  
轮次 3

组别 A  
场次 10

天津师范大学体育馆  
2017-09-02 15:45

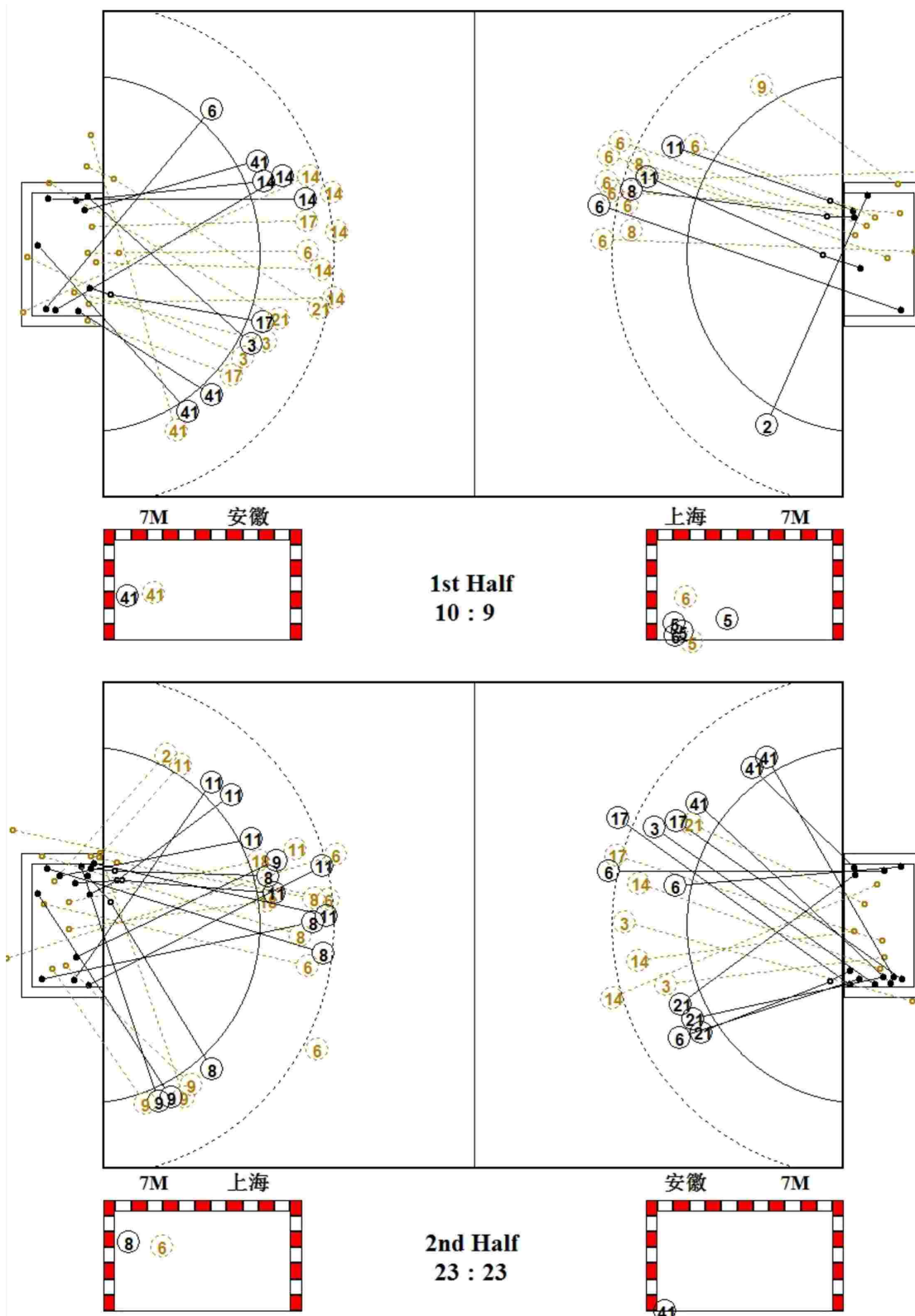

第十三届全国运动会女子手球决赛

PICTORIAL MATCH STATISTICS

HANDBALL  
女子

预赛  
ROUND 3

GROUP A  
MATCH 10

天津师范大学体育馆  
2017-09-02 15:45

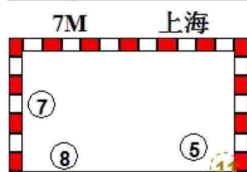
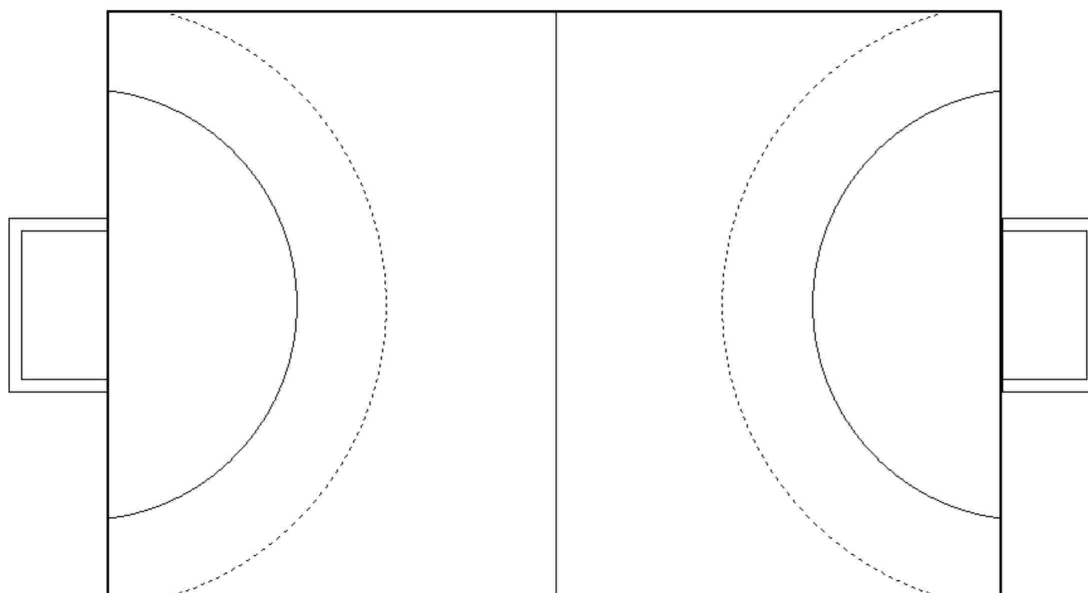

**7M-Throw**  
**26 : 28**

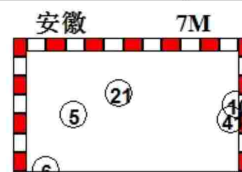



第十三届全国运动会女子手球决赛

PHMS Pictorial Handball Match Statistics

IHF Official System

图式射门区域统计

手球  
女子

预赛  
轮次 3

组别 A  
场次 10

天津师范大学体育馆  
2017-09-02 15:45

安徽

1 司艳	3 李兵	5 班晨晨	6 沈萍	7 赵江川	8 徐仕媛	10 孙来苗	13 陶丹扬																																																																								
<table border="1"><tr><td></td><td></td><td></td></tr><tr><td></td><td></td><td>1</td></tr><tr><td></td><td></td><td>1</td></tr></table>						1			1	<table border="1"><tr><td></td><td></td><td></td></tr><tr><td></td><td></td><td>1</td></tr><tr><td></td><td></td><td>1</td></tr></table>						1			1	<table border="1"><tr><td></td><td></td><td></td></tr><tr><td>1</td><td></td><td></td></tr><tr><td></td><td></td><td></td></tr></table>				1						<table border="1"><tr><td>2</td><td></td><td></td></tr><tr><td>1</td><td></td><td></td></tr><tr><td>1</td><td></td><td>1</td></tr></table>	2			1			1		1	<table border="1"><tr><td></td><td></td><td></td></tr><tr><td></td><td></td><td></td></tr><tr><td></td><td></td><td></td></tr></table>										<table border="1"><tr><td></td><td></td><td></td></tr><tr><td></td><td></td><td></td></tr><tr><td></td><td></td><td></td></tr></table>										<table border="1"><tr><td></td><td></td><td></td></tr><tr><td></td><td></td><td>1</td></tr><tr><td></td><td></td><td></td></tr></table>						1				<table border="1"><tr><td></td><td></td><td></td></tr><tr><td></td><td></td><td></td></tr><tr><td></td><td></td><td></td></tr></table>									
		1																																																																													
		1																																																																													
		1																																																																													
		1																																																																													
1																																																																															
2																																																																															
1																																																																															
1		1																																																																													
		1																																																																													
14 刘晓妹	15 王婷婷	16 朱莉珍	17 周婷	20 周雪婷	21 李瑶	23 张天洁	41 杜机娟																																																																								
<table border="1"><tr><td>1</td><td></td><td>1</td></tr><tr><td></td><td></td><td>1</td></tr><tr><td></td><td></td><td></td></tr></table>	1		1			1				<table border="1"><tr><td></td><td></td><td></td></tr><tr><td></td><td></td><td></td></tr><tr><td></td><td></td><td></td></tr></table>										<table border="1"><tr><td></td><td></td><td></td></tr><tr><td></td><td></td><td></td></tr><tr><td></td><td></td><td></td></tr></table>										<table border="1"><tr><td></td><td></td><td>1</td></tr><tr><td></td><td></td><td></td></tr><tr><td>1</td><td></td><td>1</td></tr></table>			1				1		1	<table border="1"><tr><td></td><td></td><td></td></tr><tr><td></td><td></td><td></td></tr><tr><td></td><td></td><td></td></tr></table>										<table border="1"><tr><td></td><td>1</td><td></td></tr><tr><td></td><td></td><td>1</td></tr><tr><td>1</td><td></td><td>1</td></tr></table>		1				1	1		1	<table border="1"><tr><td></td><td></td><td></td></tr><tr><td></td><td></td><td></td></tr><tr><td></td><td></td><td></td></tr></table>										<table border="1"><tr><td></td><td>1</td><td>2</td></tr><tr><td>2</td><td></td><td>1</td></tr><tr><td>2</td><td></td><td>1</td></tr></table>		1	2	2		1	2		1
1		1																																																																													
		1																																																																													
		1																																																																													
1		1																																																																													
	1																																																																														
		1																																																																													
1		1																																																																													
	1	2																																																																													
2		1																																																																													
2		1																																																																													
Post - 0 Miss - 0 Block - 0	Post - 1 Miss - 1 Block - 0	Post - 0 Miss - 0 Block - 0	Post - 0 Miss - 0 Block - 0	Post - 0 Miss - 0 Block - 0	Post - 0 Miss - 0 Block - 0	Post - 0 Miss - 0 Block - 0	Post - 0 Miss - 0 Block - 0																																																																								
Post - 1 Miss - 0 Block - 2	Post - 0 Miss - 0 Block - 0	Post - 0 Miss - 0 Block - 0	Post - 1 Miss - 0 Block - 0	Post - 0 Miss - 0 Block - 0	Post - 1 Miss - 1 Block - 0	Post - 0 Miss - 0 Block - 0	Post - 0 Miss - 1 Block - 0																																																																								

1 □□

2/3	1/1	1/4
4/7	2/2	1/3
0/6	1/2	0/6

16 □□□

1/2		
0/1		
1/2	0/1	1/1

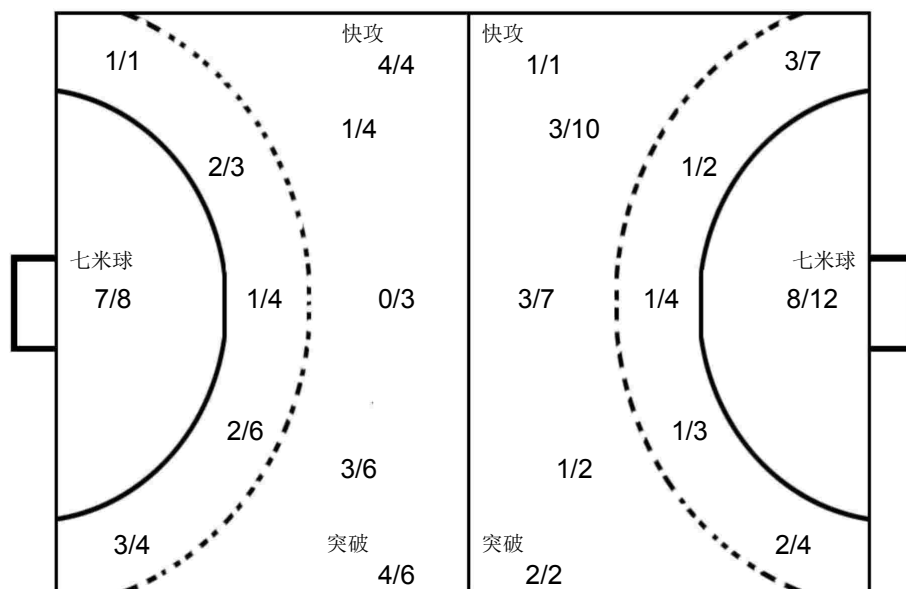

1 □□

0/3	0/2	0/4
3/7	1/1	2/7
1/6	4/4	1/6

上海

1 许沫	2 周蕾	3 王嘉怡	5 郭威	6 黄妍	7 车婉茹	8 吴茵	9 武娜娜																																																																								
<table border="1"><tr><td></td><td></td><td></td></tr><tr><td></td><td></td><td></td></tr><tr><td></td><td></td><td></td></tr></table>										<table border="1"><tr><td></td><td></td><td></td></tr><tr><td>1</td><td></td><td></td></tr><tr><td></td><td></td><td></td></tr></table>				1						<table border="1"><tr><td></td><td></td><td></td></tr><tr><td></td><td></td><td></td></tr><tr><td></td><td></td><td></td></tr></table>										<table border="1"><tr><td></td><td></td><td></td></tr><tr><td>2</td><td>1</td><td>1</td></tr><tr><td></td><td></td><td></td></tr></table>				2	1	1				<table border="1"><tr><td></td><td></td><td>1</td></tr><tr><td></td><td></td><td></td></tr><tr><td></td><td></td><td></td></tr></table>			1							<table border="1"><tr><td></td><td></td><td></td></tr><tr><td>1</td><td></td><td></td></tr><tr><td></td><td></td><td></td></tr></table>				1						<table border="1"><tr><td></td><td></td><td></td></tr><tr><td>2</td><td></td><td>1</td></tr><tr><td></td><td></td><td></td></tr></table>				2		1				<table border="1"><tr><td></td><td></td><td></td></tr><tr><td>1</td><td></td><td>1</td></tr><tr><td></td><td></td><td></td></tr></table>				1		1			
1																																																																															
2	1	1																																																																													
		1																																																																													
1																																																																															
2		1																																																																													
1		1																																																																													
10 斯文	11 孙梦颖	12 郑冯	13 徐娟	17 居晔	18 沙正文	19 印尼	23 都好																																																																								
<table border="1"><tr><td></td><td></td><td></td></tr><tr><td></td><td></td><td></td></tr><tr><td></td><td></td><td></td></tr></table>										<table border="1"><tr><td></td><td></td><td>2</td></tr><tr><td>1</td><td></td><td></td></tr><tr><td>2</td><td>1</td><td>2</td></tr></table>			2	1			2	1	2	<table border="1"><tr><td></td><td></td><td></td></tr><tr><td></td><td></td><td></td></tr><tr><td></td><td></td><td></td></tr></table>										<table border="1"><tr><td></td><td></td><td></td></tr><tr><td></td><td></td><td></td></tr><tr><td></td><td></td><td></td></tr></table>										<table border="1"><tr><td></td><td></td><td></td></tr><tr><td></td><td></td><td></td></tr><tr><td></td><td></td><td></td></tr></table>										<table border="1"><tr><td></td><td></td><td></td></tr><tr><td></td><td></td><td></td></tr><tr><td></td><td></td><td></td></tr></table>										<table border="1"><tr><td></td><td></td><td></td></tr><tr><td></td><td></td><td></td></tr><tr><td></td><td></td><td></td></tr></table>										<table border="1"><tr><td></td><td></td><td></td></tr><tr><td></td><td></td><td></td></tr><tr><td></td><td></td><td></td></tr></table>									
		2																																																																													
1																																																																															
2	1	2																																																																													
Post - 0 Miss - 0 Block - 0	Post - 0 Miss - 0 Block - 0	Post - 0 Miss - 0 Block - 0	Post - 0 Miss - 0 Block - 0	Post - 1 Miss - 3 Block - 2	Post - 0 Miss - 0 Block - 0	Post - 2 Miss - 0 Block - 1	Post - 2 Miss - 0 Block - 0																																																																								
Post - 0 Miss - 0 Block - 0	Post - 1 Miss - 0 Block - 1	Post - 0 Miss - 0 Block - 0	Post - 0 Miss - 0 Block - 0	Post - 0 Miss - 0 Block - 0	Post - 0 Miss - 0 Block - 0	Post - 0 Miss - 0 Block - 0	Post - 0 Miss - 0 Block - 0																																																																								

**PHMS** Pictorial Handball Match Statistics

**IHF** Official System

Team A					Team B					Match Number											
A 新疆					B 北京					<b>11</b>											
Played in			in the hall			on			at			Spectators									
天津			天津师范大学体育馆			2017-09-02			17:30			hours									
Half-time(30')	A	B	End of playing time		A	B	1st extra time		A	B	2nd extra time		A	B	After penalty throws		A	B			
	8	11			19	27															
Number of 7 m	A	Team time-out			Full name of players and officials						Team time-out			B	Number of 7 m						
	3/4	1	2	3							1	2	3	B							
		23:42	48:51								16:43	45:04	59:32	4/4							
No.	Team A					G	W	2'	D	DR	No.	Team B					G	W	2'	D	DR
3	葛立双					1					1	宋嘉蕾									
5	于千添										3	季小桐					1		1		
6	阿热孜古丽					2					6	刘亚男									
7	吴志娟					6	1				8	杨铭豫					1	1			
10	李静										9	宋建军									
11	陈培培										10	刘莎					6	1	1		
12	艾敏										11	纪婉									
15	兰姝娇					1	1				15	郝泽荣					3				
17	戴莹莹										16	王海叶									
18	崔娟					1					22	李海鸥					2				
21	锁珊珊					4		1			23	赵小颖									
23	张艺璇										24	郝佳楠					9				
26	宋婷婷					2	1				27	曹芳鸣									
27	谢辰辰										28	闫美珠					2	1			
32	杨雨柔										47	刘泽									
93	张婷婷					2		2			69	石梓薇					3				
A	刁继平										A	蔡建国									
B	于涛 (主教练)										B	宋刚 (主教练)									
C	李天坐										C	关宏波									
											E	王长林									
A	Signatures of responsables for the teams (Off.A)															B					
TP	Remarks of referees / HF Official															TP					

Signatures

Referees BALAZS. MARTON (HUN)

PETER. HORVATH (HUN)

T.D. 张春生 (CHN)

吴国忠 (CHN)

CHA Off.

Note: Number of 7m Throws Awarded to Team A and B, Goals (G), Warnings (W), Suspensions (2'), Direct Disqualification (D), Disqualification With Report (DR) and Team Penalty (TP).

Table Officials: 刘菡蕊

翟延露

Statisticians: 李双

王玮

**第十三届全国运动会女子手球决赛**
**PHMS** Pictorial Handball Match Statistics

**IHF** Official System

**竞赛技术统计**

 手球  
 女子

 预赛  
 轮次 3

 组别 B  
 场次 11

 天津师范大学体育馆  
 2017-09-02 17:30

Referees: BALAZS. MARTON (HUN) / PETER. HORVATH (HUN)

Result: 19:27 (8:11)

Teams: 新疆(新疆) VS 北京(北京)

新疆		远	近	边	快	突	任意	7m	合计	%	助攻	失误	警告	2'	D+DR
主教练: 于涛		射	射	射	攻	破	球	球							
3	葛立双					1/1			1/1	100					
5	于千添														
6	阿热孜古丽		1/4					1/1	2/5	40.0					
7	吴志娟		1/3	1/2	4/4				6/9	66.7		1	1		
10	李静														
11	陈培培														
12	艾敏														
15	兰姝娇		1/1	0/3					1/4	25.0		1	1		
17	戴莹莹		0/2						0/2	0.0		3			
18	崔娟	1/5						0/1	1/6	16.7		4			
21	锁珊珊	0/3	0/1	2/2			0/1	2/2	4/9	44.4	2	1		1	
23	张艺璇														
26	宋婷婷	2/2							2/2	100		1	1		
27	谢辰辰											1			
32	杨雨柔														
93	张婷婷	1/3	1/1			0/1			2/5	40.0	3	2		2	
运动员	合计	4/13	4/12	3/7	4/4	1/2	0/1	3/4	19/43	44.2	5	14	3	3	
10	李静	0/1						0/4	0/5	0.0					
32	杨雨柔	4/10	4/15	2/4	0/2	0/1			10/32	31.3					
守门员	合计	4/11	4/15	2/4	0/2	0/1		0/4	10/37	27.0					

北京		远	近	边	快	突	任意	7m	合计	%	助攻	失误	警告	2'	D+DR
主教练: 宋刚		射	射	射	攻	破	球	球							
1	宋嘉蕾														
3	季小桐	0/1	1/1	0/1					1/3	33.3	5	2		1	
6	刘亚男														
8	杨铭豫				1/1				1/1	100			1		
9	宋建军														
10	刘莎		1/1	2/4				3/3	6/8	75.0	1	1	1	1	
11	纪婉														
15	郝泽荣		2/4					1/1	3/5	60.0					
16	王海叶														
22	李海鸥		2/3						2/3	66.7					
23	赵小颖														
24	郝佳楠	5/8	3/3			1/1	0/1		9/13	69.2	3	5			
27	曹芳鸣														
28	闫美珠	2/6	0/1						2/7	28.6	1	2	1		
47	刘泽														
69	石梓薇	0/1	2/3		1/1				3/5	60.0	1	3			
运动员	合计	7/16	11/16	2/5	2/2	1/1	0/1	4/4	27/45	60.0	11	13	3	2	
1	宋嘉蕾							0/1	0/1	0.0					
16	王海叶	6/10	5/9	3/6	0/4	0/1	1/1	0/2	15/33	45.5					
47	刘泽							1/1	1/1	100					
守门员	合计	6/10	5/9	3/6	0/4	0/1	1/1	1/4	16/35	45.7					

新疆	比赛进程	北京
1st Half		
21 锁珊珊	1 01:04 0	
	1 01:34 1 28 闫美珠	
21 锁珊珊	2 02:54 1	
7 吴志娟	3 04:23 1	
	3 06:27 2 22 李海鸥	
	3 07:13 3 8 杨铭豫	
	3 08:10 4 28 闫美珠	
7 吴志娟	4 08:49 4	
	4 11:24 5 10 刘莎	
21 锁珊珊	5 12:32 5	
	5 13:05 6 10 刘莎	
93 张婷婷	6 15:48 6	
6 阿热孜古丽	7 17:42 6	
	7 18:10 7 69 石梓薇	
	7 19:51 8 24 郝佳楠	
7 吴志娟	8 20:45 8	
	8 23:39 9 3 季小桐	
	8 25:09 10 10 刘莎	
	8 29:52 11 10 刘莎	
2nd Half		
	8 01:11 12 69 石梓薇	
7 吴志娟	9 01:59 12	
	9 04:21 13 24 郝佳楠	
7 吴志娟	10 05:19 13	
	10 06:07 14 24 郝佳楠	
	10 07:32 15 24 郝佳楠	
26 宋婷婷	11 08:49 15	
	11 09:29 16 24 郝佳楠	
26 宋婷婷	12 10:02 16	
	12 10:36 17 24 郝佳楠	
	12 12:31 18 24 郝佳楠	
6 阿热孜古丽	13 14:07 18	
	13 14:50 19 15 郝泽荣	
21 锁珊珊	14 16:26 19	
	14 18:27 20 22 李海鸥	
18 崔娟	15 20:43 20	
	15 21:25 21 10 刘莎	
7 吴志娟	16 21:55 21	
	16 22:26 22 10 刘莎	
	16 23:54 23 24 郝佳楠	
	16 24:05 24 69 石梓薇	
3 葛立双	17 24:36 24	
	17 25:13 25 24 郝佳楠	
	17 27:33 26 15 郝泽荣	
93 张婷婷	18 28:48 26	
15 兰姝娇	19 29:32 26	
	19 30:00 27 15 郝泽荣	

场上队员: 得分 / 射门

守门员: 救球 / 射门

D	取消资格	DR	取消资格+报告
---	------	----	---------



## 第十三届全国运动会女子手球决赛

PHMS Pictorial Handball Match Statistics

IHF Official System

## 个人/全队技术统计表

 手球 预赛 组别 B 天津师范大学体育馆  
 女子 轮次 3 场次 11 2017-09-02 17:30

号码	姓名	远射	近射	边射	快攻	突破	任意	七米	合计	%	助攻	失误	警告	2'	取消	时间
<b>新疆(新疆)</b>																
<b>(场上队员)</b>																
3	葛立双					1/1			1/1	100%						00:05:51
5	于千添									0.0%						00:00:00
6	阿热孜古丽		1/4					1/1	2/5	40.0%						00:43:03
7	吴志娟		1/3	1/2	4/4				6/9	66.7%		1	1			00:59:29
10	李静									0.0%						00:04:36
11	陈培培									0.0%						00:00:00
12	艾敏									0.0%						00:00:00
15	兰姝娇		1/1	0/3					1/4	25.0%		1	1			00:50:54
17	戴莹莹		0/2						0/2	0.0%		3				00:27:17
18	崔娟	1/5						0/1	1/6	16.7%		4				00:45:29
21	锁珊珊	0/3	0/1	2/2			0/1	2/2	4/9	44.4%	2	1		1		00:59:24
23	张艺璇									0.0%						00:09:26
26	宋婷婷	2/2							2/2	100%		1	1			00:13:25
27	谢辰辰									0.0%		1				00:02:42
32	杨雨柔									0.0%						00:55:24
93	张婷婷	1/3	1/1			0/1			2/5	40.0%	3	2		2		00:58:46
	<b>合计</b>	<b>4/13</b>	<b>4/12</b>	<b>3/7</b>	<b>4/4</b>	<b>1/2</b>	<b>0/1</b>	<b>3/4</b>	<b>19/43</b>	<b>44.2%</b>	<b>5</b>	<b>14</b>	<b>3</b>	<b>3</b>		
<b>(守门员)</b>																
10	李静	0/1						0/4	0/5	0.0%						00:04:36
32	杨雨柔	4/10	4/15	2/4	0/2	0/1			10/32	31.3%						00:55:24
	<b>合计</b>	<b>4/11</b>	<b>4/15</b>	<b>2/4</b>	<b>0/2</b>	<b>0/1</b>		<b>0/4</b>	<b>10/37</b>	<b>27.0%</b>						

场上队员：得分/射门

守门员：救球/射门

全队合计	得分	被救	射失	击柱	封球	合计	%
远射	4	6	1		2	13	30.8%
近射	4	5		3		12	33.3%
边射	3	3		1		7	42.9%
快攻	4					4	100.0%
突破	1		1			2	50.0%
任意		1				1	0.0%
七米	3	1				4	75.0%

## 第十三届全国运动会女子手球决赛

PHMS Pictorial Handball Match Statistics

IHF Official System

## 个人/全队技术统计表

 手球 预赛 组别 B 天津师范大学体育馆  
 女子 轮次 3 场次 11 2017-09-02 17:30

号码	姓名	远射	近射	边射	快攻	突破	任意	七米	合计	%	助攻	失误	警告	2'	取消	时间
<b>北京(北京)</b>																
<b>(场上队员)</b>																
1	宋嘉蕾									0.0%						00:00:13
3	季小桐	0/1	1/1	0/1					1/3	33.3%	5	2		1		00:37:04
6	刘亚男									0.0%						00:14:42
8	杨铭豫				1/1				1/1	100%			1			00:22:22
9	宋建军									0.0%						00:00:00
10	刘莎		1/1	2/4				3/3	6/8	75.0%	1	1	1	1		00:56:29
11	纪婉									0.0%						00:00:00
15	郝泽荣		2/4					1/1	3/5	60.0%						00:08:35
16	王海叶									0.0%						00:58:48
22	李海鸥		2/3						2/3	66.7%						00:51:38
23	赵小颖									0.0%						00:00:00
24	郝佳楠	5/8	3/3			1/1	0/1		9/13	69.2%	3	5				00:47:21
27	曹芳鸣									0.0%						00:00:00
28	闫美珠	2/6	0/1						2/7	28.6%	1	2	1			00:59:42
47	刘泽									0.0%						00:00:42
69	石梓薇	0/1	2/3		1/1				3/5	60.0%	1	3				00:59:40
	<b>合计</b>	<b>7/16</b>	<b>11/16</b>	<b>2/5</b>	<b>2/2</b>	<b>1/1</b>	<b>0/1</b>	<b>4/4</b>	<b>27/45</b>	<b>60.0%</b>	<b>11</b>	<b>13</b>	<b>3</b>	<b>2</b>		
<b>(守门员)</b>																
1	宋嘉蕾							0/1	0/1	0.0%						00:00:13
16	王海叶	6/10	5/9	3/6	0/4	0/1	1/1	0/2	15/33	45.5%						00:58:48
47	刘泽							1/1	1/1	100%						00:00:42
	<b>合计</b>	<b>6/10</b>	<b>5/9</b>	<b>3/6</b>	<b>0/4</b>	<b>0/1</b>	<b>1/1</b>	<b>1/4</b>	<b>16/35</b>	<b>45.7%</b>						

场上队员： 得分/射门

守门员： 救球/射门

全队合计	得分	被救	射失	击柱	封球	合计	%
远射	7	4		4	1	16	43.8%
近射	11	4	1			16	68.8%
边射	2	2	1			5	40.0%
快攻	2					2	100.0%
突破	1					1	100.0%
任意				1		1	0.0%
七米	4					4	100.0%

第十三届全国运动会女子手球决赛

PHMS Pictorial Handball Match Statistics

IHF Official System

图式比赛技术统计表

手球  
女子

预赛  
轮次 3

组别 B  
场次 11

天津师范大学体育馆  
2017-09-02 17:30

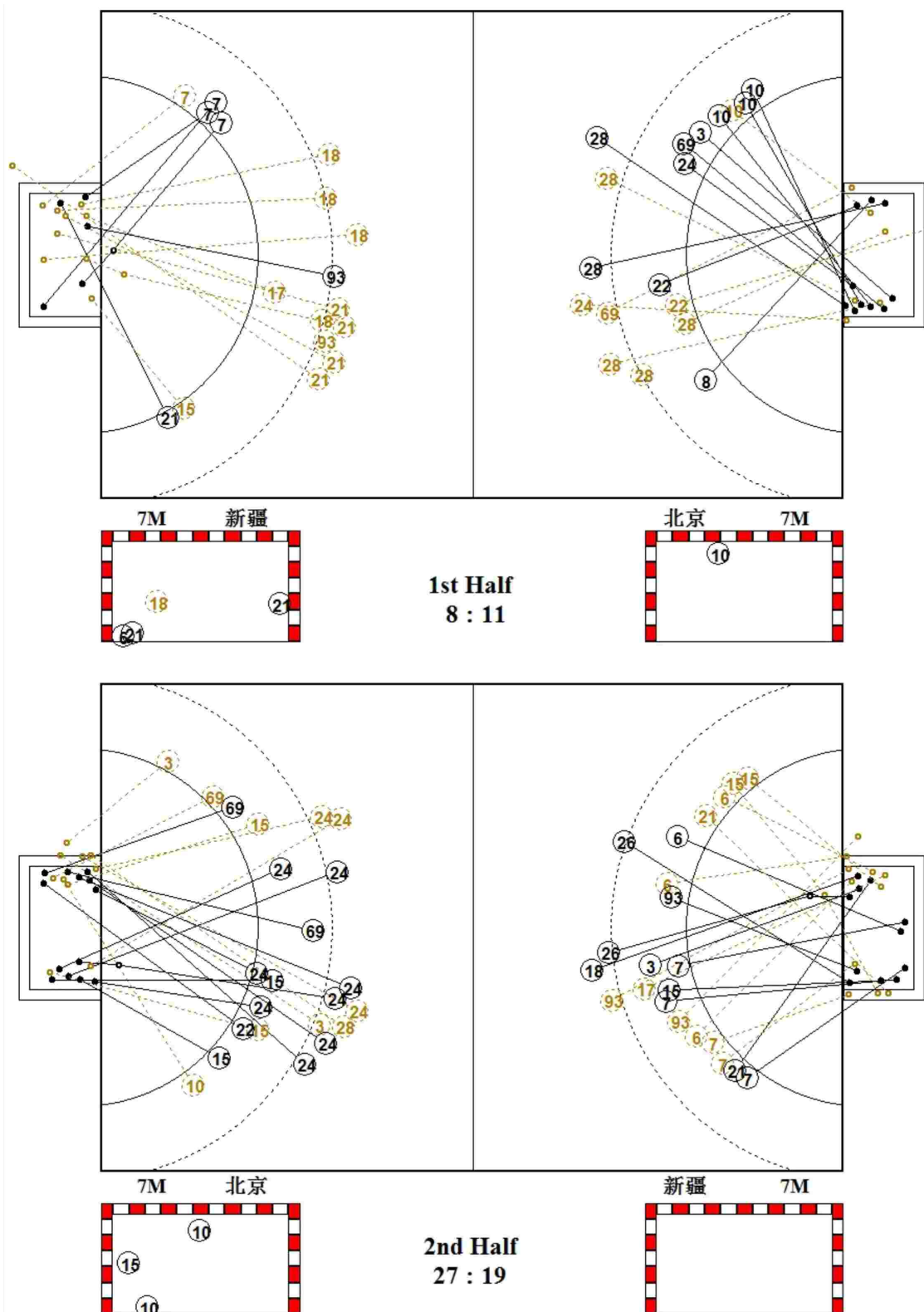

第十三届全国运动会女子手球决赛

PHMS Pictorial Handball Match Statistics

IHF Official System

图式射门区域统计

手球  
女子

预赛  
轮次 3

组别 B  
场次 11

天津师范大学体育馆  
2017-09-02 17:30

新疆

3 葛立双 Post - 0 Miss - 0 Block - 0	5 于千添 Post - 0 Miss - 0 Block - 0	6 阿热孜古丽 Post - 1 Miss - 0 Block - 0	7 吴志娟 Post - 1 Miss - 0 Block - 0	10 李静 Post - 0 Miss - 0 Block - 0	11 陈培培 Post - 0 Miss - 0 Block - 0	12 艾敏 Post - 0 Miss - 0 Block - 0	15 兰姝娇 Post - 1 Miss - 0 Block - 0
17 戴莹莹 Post - 0 Miss - 0 Block - 0	18 崔娟 Post - 0 Miss - 0 Block - 1	21 锁珊珊 Post - 1 Miss - 1 Block - 0	23 张艺璇 Post - 0 Miss - 0 Block - 0	26 宋婷婷 Post - 0 Miss - 0 Block - 0	27 谢辰辰 Post - 0 Miss - 0 Block - 0	32 杨雨柔 Post - 0 Miss - 0 Block - 0	93 张婷婷 Post - 0 Miss - 1 Block - 1

10 □□
0/1 0/1
0/2
0/1

32 □□□
1/2 1/4
2/5 3/6
1/5 2/10

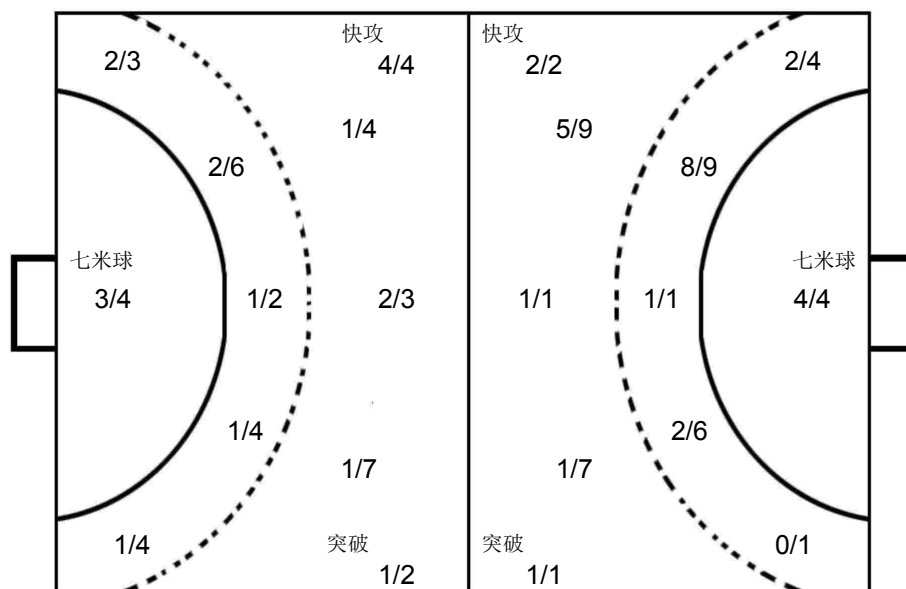

1 □□□
0/1

16 □□□
0/1 1/3 1/3
3/4 1/1 2/5
3/8 1/1 3/7

47 □□
1/1

北京

1 宋嘉蕾 Post - 0 Miss - 0 Block - 0	3 季小桐 Post - 1 Miss - 1 Block - 0	6 刘亚男 Post - 0 Miss - 0 Block - 0	8 杨铭豫 Post - 0 Miss - 0 Block - 0	9 宋建军 Post - 0 Miss - 0 Block - 0	10 刘莎 Post - 0 Miss - 0 Block - 0	11 纪婉 Post - 0 Miss - 0 Block - 0	15 郝泽荣 Post - 0 Miss - 0 Block - 0
16 王海叶 Post - 0 Miss - 0 Block - 0	22 李海鸥 Post - 0 Miss - 1 Block - 0	23 赵小颖 Post - 0 Miss - 0 Block - 0	24 郝佳楠 Post - 2 Miss - 0 Block - 0	27 曹芳鸣 Post - 0 Miss - 0 Block - 0	28 闫美珠 Post - 1 Miss - 0 Block - 1	47 刘泽 Post - 0 Miss - 0 Block - 0	69 石梓薇 Post - 1 Miss - 0 Block - 0

**PHMS** Pictorial Handball Match Statistics

**IHF** Official System

Team A					Team B					Match Number											
A 江苏					B 广东					<b>12</b>											
Played in			in the hall			on			at			Spectators									
天津			天津师范大学体育馆			2017-09-02			19:15			hours									
Half-time(30')	A	B	End of playing time		A	B	1st extra time		A	B	2nd extra time		A	B	After penalty throws		A	B			
	18	7	30		19																
Number of 7 m	A	Team time-out			Full name of players and officials						Team time-out			B	Number of 7 m						
	4/5	1	2	3							1	2	3	09:37				3/4			
<b>No.</b>	<b>Team A</b>					<b>G</b>	<b>W</b>	<b>2'</b>	<b>D</b>	<b>DR</b>	<b>No.</b>	<b>Team B</b>					<b>G</b>	<b>W</b>	<b>2'</b>	<b>D</b>	<b>DR</b>
1	陆婷										2	王彤羽									
3	张海侠					1					3	安妮					1	1			
4	赵佳芹					4		1			5	李纯									
7	周琦										7	刘彤					1				
8	乔如					3					8	李诗棋									
9	莫蒙蒙					1					9	韦宝桂					3				
11	于源源					2					10	史小军					4				
12	黄霞										11	魏梦庭							1		
13	黄慧影										15	杨慧									
16	王小华										16	李娟									
17	修丽杰					2	1				19	邝雪花					3	1			
18	韦秋香					1	1				20	李军政					1				
19	李薇薇					4		1			22	刘晓玉									
23	王书慧					3					23	王如					1				
33	金梦青					4					26	马晓卉									
69	蓝小玲					5					28	刘金兰					5	1			
B	金甲洙 (主教练)										B	黄炳春									
C	马彪										C	李玉玲									
D	刘凯										D	郭艳辉 (主教练)									
											E	赵善良									
A	Signatures of responsables for the teams (Off.A)										B										
TP	Remarks of referees / HF Official										TP										

Signatures

Referees ALEXEI. COVALCIUC (MDA)

IGOR. COVALCIUC (MDA)

T.D. 张春生 (CHN)

柴业宏 (CHN)

CHA Off.

Note: Number of 7m Throws Awarded to Team A and B, Goals (G), Warnings (W), Suspensions (2'), Direct Disqualification (D), Disqualification With Report (DR) and Team Penalty (TP).

Table Officials: 谷瑶

张智伟

Statisticians: 杜宪

周强



### 第十三届全国运动会女子手球决赛

**PHMS** Pictorial Handball Match Statistics

**IHF** Official System

#### 竞赛技术统计

 手球  
 女子

 预赛  
 轮次 3

 组别 B  
 场次 12

 天津师范大学体育馆  
 2017-09-02 19:15

Referees: ALEXEI. COVALCIUC (MDA) / IGOR. COVALCIUC (MDA)

Result: 30:19 (18:7)

Teams: 江苏(江苏) VS 广东(广东)

江苏														江苏		比赛进程		广东	
主教练: 金甲洙																			
	远射	近射	边射	快攻	突破	任意球	7m球	合计	%	助攻	失误	警告	2'	D+DR					
1 陆婷																			
3 张海侠		1/2						1/2	50.0	1	2								
4 赵佳芹	1/2	1/1			2/2			4/5	80.0	2			1						
7 周琦																			
8 乔如		2/2		1/1				3/3	100										
9 莫蒙蒙		0/1		1/2				1/3	33.3										
11 于源源		1/1	1/2					2/3	66.7										
12 黄霞																			
13 黄慧影																			
16 王小华										2									
17 修丽杰	1/3	1/1	0/1	0/1	0/1			2/7	28.6		1	1							
18 韦秋香			0/1	0/1			1/2	1/4	25.0			1							
19 李薇薇	0/2			2/2	1/1	0/1	1/1	4/7	57.1		2		1						
23 王书慧	1/1	1/1					1/1	3/3	100		1								
33 金梦青			0/2	3/4			1/1	4/7	57.1	1									
69 蓝小玲	3/5	1/2				1/1		5/8	62.5		2								
运动员 合计	6/13	8/11	1/6	7/11	3/4	1/2	4/5	30/52	57.7	6	8	2	2						
1 陆婷	0/1	0/2	0/1		0/1			0/5	0.0										
12 黄霞							0/2	0/2	0.0										
16 王小华	1/2	1/3	4/8	0/3	0/1	1/1	1/2	8/20	40.0	2									
守门员 合计	1/3	1/5	4/9	0/3	0/2	1/1	1/4	8/27	29.6	2									
广东														江苏		比赛进程		广东	
主教练: 郭艳辉																			
	远射	近射	边射	快攻	突破	任意球	7m球	合计	%	助攻	失误	警告	2'	D+DR					
2 王彤羽																			
3 安妮	1/4	0/1						1/5	20.0	2	5	1							
5 李纯																			
7 刘彤			1/3	0/1				1/4	25.0		3								
8 李诗棋			0/1					0/1	0.0		1								
9 韦宝桂	1/4					0/2	2/2	3/8	37.5	1	3								
10 史小军	0/1	1/1		2/2	1/1			4/5	80.0										
11 魏梦庭	0/8							0/8	0.0		4		1						
15 杨慧																			
16 李娟																			
19 邝雪花		3/4						3/4	75.0			1							
20 李军政			0/3	1/1				1/4	25.0		1								
22 刘晓玉																			
23 王如					1/1			1/1	100	1									
26 马晓卉	0/1							0/1	0.0										
28 刘金兰			4/6				1/2	5/8	62.5			1							
运动员 合计	2/18	4/6	5/13	3/4	2/2	0/2	3/4	19/49	38.8	4	17	3	1						
16 李娟	1/2	0/3	1/1		0/1		1/3	3/10	30.0										
26 马晓卉	2/7	1/6	2/3	2/9	0/2	1/2	0/2	8/31	25.8										
守门员 合计	3/9	1/9	3/4	2/9	0/3	1/2	1/5	11/41	26.8										

场上队员: 得分 / 射门

守门员: 救球 / 射门

D	取消资格	DR	取消资格+报告
---	------	----	---------

## 第十三届全国运动会女子手球决赛

PHMS Pictorial Handball Match Statistics

IHF Official System

## 个人/全队技术统计表

 手球 预赛 组别 B 天津师范大学体育馆  
 女子 轮次 3 场次 12 2017-09-02 19:15

号码	姓名	远射	近射	边射	快攻	突破	任意	七米	合计	%	助攻	失误	警告	2'	取消	时间
江苏(江苏)																
(场上队员)																
1	陆婷									0.0%						00:19:51
3	张海侠		1/2						1/2	50.0%	1	2				00:25:27
4	赵佳芹	1/2	1/1			2/2			4/5	80.0%	2			1		00:45:44
7	周琦									0.0%						00:03:39
8	乔如		2/2		1/1				3/3	100%						00:25:26
9	莫蒙蒙		0/1		1/2				1/3	33.3%						00:33:27
11	于源源		1/1	1/2					2/3	66.7%						00:14:59
12	黄霞									0.0%						00:00:28
13	黄慧影									0.0%						00:00:00
16	王小华									0.0%	2					00:39:41
17	修丽杰	1/3	1/1	0/1	0/1	0/1			2/7	28.6%		1	1			00:38:44
18	韦秋香			0/1	0/1			1/2	1/4	25.0%				1		00:34:31
19	李薇薇	0/2			2/2	1/1	0/1	1/1	4/7	57.1%		2		1		00:33:33
23	王书慧	1/1	1/1					1/1	3/3	100%		1				00:08:47
33	金梦青			0/2	3/4			1/1	4/7	57.1%	1					00:44:46
69	蓝小玲	3/5	1/2				1/1		5/8	62.5%		2				00:50:35
	合计	6/13	8/11	1/6	7/11	3/4	1/2	4/5	30/52	57.7%	6	8	2	2		

## (守门员)

1	陆婷	0/1	0/2	0/1		0/1			0/5	0.0%						00:19:51
12	黄霞							0/2	0/2	0.0%						00:00:28
16	王小华	1/2	1/3	4/8	0/3	0/1	1/1	1/2	8/20	40.0%	2					00:39:41
	合计	1/3	1/5	4/9	0/3	0/2	1/1	1/4	8/27	29.6%	2					

场上队员：得分/射门

守门员：救球/射门

全队合计	得分	被救	射失	击柱	封球	合计	%
远射	6	3	2	2		13	46.2%
近射	8	1		2		11	72.7%
边射	1	3	1	1		6	16.7%
快攻	7	2		2		11	63.6%
突破	3			1		4	75.0%
任意	1	1				2	50.0%
七米	4	1				5	80.0%

## 第十三届全国运动会女子手球决赛

PHMS Pictorial Handball Match Statistics

IHF Official System

## 个人/全队技术统计表

 手球 预赛 组别 B 天津师范大学体育馆  
 女子 轮次 3 场次 12 2017-09-02 19:15

号码	姓名	远射	近射	边射	快攻	突破	任意	七米	合计	%	助攻	失误	警告	2'	取消	时间
广东(广东)																
(场上队员)																
2	王彤羽									0.0%						00:02:09
3	安妮	1/4	0/1						1/5	20.0%	2	5	1			00:40:19
5	李纯									0.0%						00:00:00
7	刘彤			1/3	0/1				1/4	25.0%		3				00:52:53
8	李诗棋			0/1					0/1	0.0%		1				00:07:06
9	韦宝桂	1/4					0/2	2/2	3/8	37.5%	1	3				00:45:27
10	史小军	0/1	1/1		2/2	1/1			4/5	80.0%						00:25:28
11	魏梦庭	0/8							0/8	0.0%		4		1		00:34:08
15	杨慧									0.0%						00:00:00
16	李娟									0.0%						00:09:49
19	邝雪花		3/4						3/4	75.0%			1			00:38:52
20	李军政			0/3	1/1				1/4	25.0%		1				00:37:15
22	刘晓玉									0.0%						00:00:00
23	王如					1/1			1/1	100%	1					00:36:08
26	马晓卉	0/1							0/1	0.0%						00:50:11
28	刘金兰			4/6				1/2	5/8	62.5%			1			00:39:43
合计		2/18	4/6	5/13	3/4	2/2	0/2	3/4	19/49	38.8%	4	17	3	1		
(守门员)																
16	李娟	1/2	0/3	1/1		0/1		1/3	3/10	30.0%						00:09:49
26	马晓卉	2/7	1/6	2/3	2/9	0/2	1/2	0/2	8/31	25.8%						00:50:11
合计		3/9	1/9	3/4	2/9	0/3	1/2	1/5	11/41	26.8%						

场上队员：得分/射门

守门员：救球/射门

全队合计	得分	被救	射失	击柱	封球	合计	%
远射	2	1	3	7	5	18	11.1%
近射	4	1		1		6	66.7%
边射	5	4	2	2		13	38.5%
快攻	3			1		4	75.0%
突破	2					2	100.0%
任意		1		1		2	0.0%
七米	3	1				4	75.0%

图式比赛技术统计表

手球  
女子

预赛  
轮次 3

组别 B  
场次 12

天津师范大学体育馆  
2017-09-02 19:15

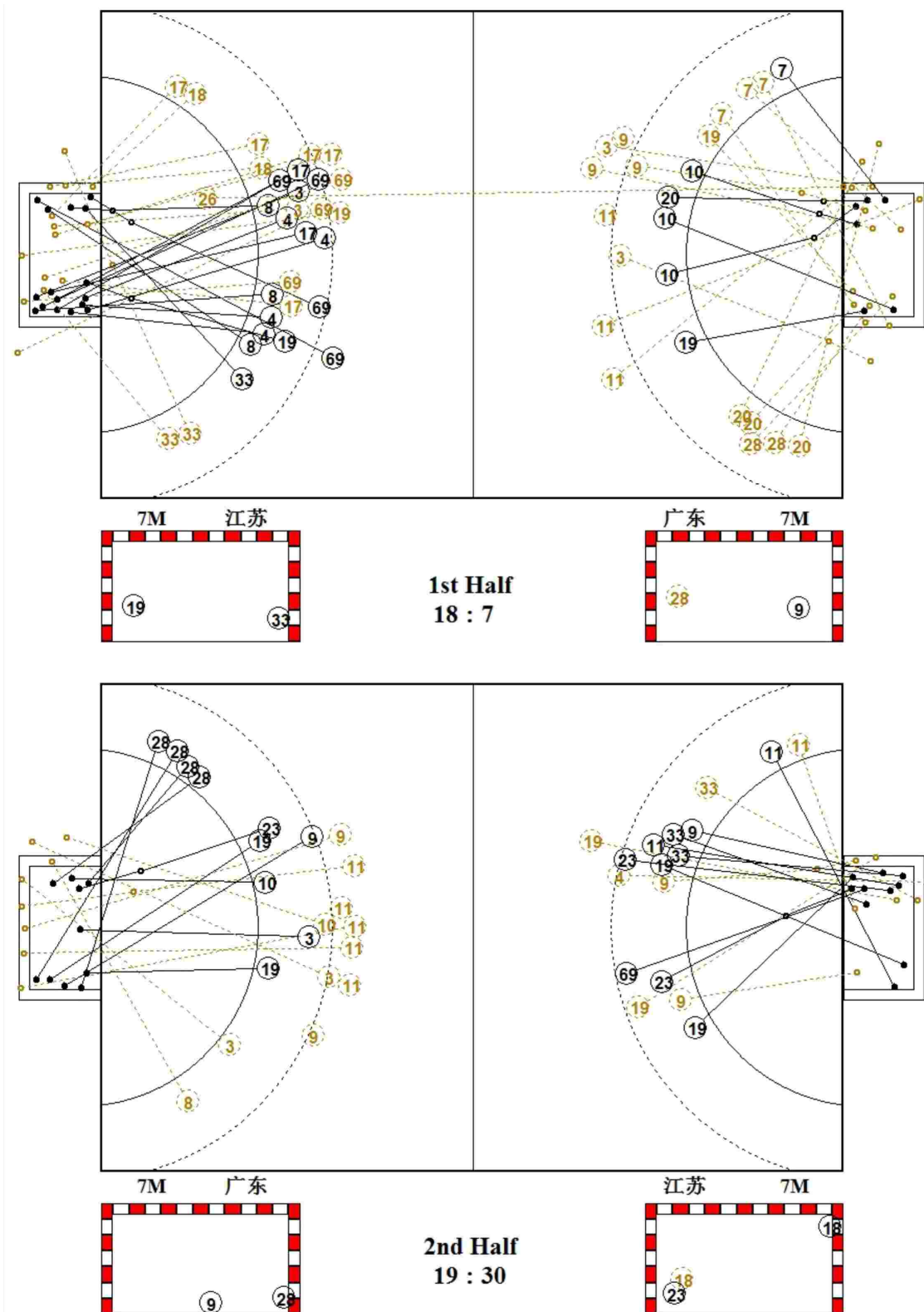

第十三届全国运动会女子手球决赛

PHMS Pictorial Handball Match Statistics

IHF Official System

图式射门区域统计

手球  
女子

预赛  
轮次 3

组别 B  
场次 12

天津师范大学体育馆  
2017-09-02 19:15

江苏

1 陆婷	3 张海侠	4 赵佳芹	7 周琦	8 乔如	9 莫蒙蒙	11 于源源	12 黄霞																																																																								
<table border="1"><tr><td></td><td></td><td></td></tr><tr><td></td><td></td><td></td></tr><tr><td></td><td></td><td></td></tr></table>										<table border="1"><tr><td>1</td><td></td><td></td></tr><tr><td></td><td></td><td></td></tr><tr><td></td><td></td><td></td></tr></table>	1									<table border="1"><tr><td></td><td></td><td></td></tr><tr><td>1</td><td></td><td></td></tr><tr><td>3</td><td></td><td></td></tr></table>				1			3			<table border="1"><tr><td></td><td></td><td></td></tr><tr><td></td><td></td><td></td></tr><tr><td></td><td></td><td></td></tr></table>										<table border="1"><tr><td>1</td><td></td><td>1</td></tr><tr><td></td><td></td><td>1</td></tr><tr><td></td><td></td><td></td></tr></table>	1		1			1				<table border="1"><tr><td></td><td></td><td></td></tr><tr><td>1</td><td></td><td></td></tr><tr><td></td><td></td><td></td></tr></table>				1						<table border="1"><tr><td>1</td><td></td><td>1</td></tr><tr><td></td><td></td><td></td></tr><tr><td></td><td></td><td></td></tr></table>	1		1							<table border="1"><tr><td></td><td></td><td></td></tr><tr><td></td><td></td><td></td></tr><tr><td></td><td></td><td></td></tr></table>									
1																																																																															
1																																																																															
3																																																																															
1		1																																																																													
		1																																																																													
1																																																																															
1		1																																																																													
13 黄慧影	16 王小华	17 修丽杰	18 韦秋香	19 李薇薇	23 王书慧	33 金梦青	69 蓝小玲																																																																								
<table border="1"><tr><td></td><td></td><td></td></tr><tr><td></td><td></td><td></td></tr><tr><td></td><td></td><td></td></tr></table>										<table border="1"><tr><td></td><td></td><td></td></tr><tr><td></td><td></td><td></td></tr><tr><td></td><td></td><td></td></tr></table>										<table border="1"><tr><td>1</td><td></td><td></td></tr><tr><td>1</td><td></td><td></td></tr><tr><td></td><td></td><td></td></tr></table>	1			1						<table border="1"><tr><td></td><td></td><td>1</td></tr><tr><td></td><td></td><td></td></tr><tr><td></td><td></td><td></td></tr></table>			1							<table border="1"><tr><td></td><td></td><td>1</td></tr><tr><td>1</td><td></td><td></td></tr><tr><td>2</td><td></td><td></td></tr></table>			1	1			2			<table border="1"><tr><td>1</td><td></td><td></td></tr><tr><td></td><td></td><td></td></tr><tr><td>2</td><td></td><td></td></tr></table>	1						2			<table border="1"><tr><td>1</td><td></td><td></td></tr><tr><td>1</td><td></td><td></td></tr><tr><td></td><td></td><td>2</td></tr></table>	1			1					2	<table border="1"><tr><td>1</td><td></td><td>1</td></tr><tr><td>1</td><td></td><td></td></tr><tr><td>1</td><td></td><td>1</td></tr></table>	1		1	1			1		1
1																																																																															
1																																																																															
		1																																																																													
		1																																																																													
1																																																																															
2																																																																															
1																																																																															
2																																																																															
1																																																																															
1																																																																															
		2																																																																													
1		1																																																																													
1																																																																															
1		1																																																																													
Post - 0 Miss - 0 Block - 0	Post - 0 Miss - 0 Block - 0	Post - 0 Miss - 1 Block - 0	Post - 0 Miss - 0 Block - 0	Post - 0 Miss - 0 Block - 0	Post - 1 Miss - 0 Block - 0	Post - 0 Miss - 0 Block - 0	Post - 0 Miss - 0 Block - 0																																																																								
Post - 0 Miss - 0 Block - 0	Post - 0 Miss - 0 Block - 0	Post - 1 Miss - 0 Block - 0	Post - 2 Miss - 0 Block - 0	Post - 2 Miss - 0 Block - 0	Post - 0 Miss - 0 Block - 0	Post - 1 Miss - 1 Block - 0	Post - 1 Miss - 1 Block - 0																																																																								

1 □□

0/1		0/1
		0/1
0/1	0/1	

12 □□

	0/1	0/1

16 □□□

1/2		1/2
2/5		1/2
1/4		2/5

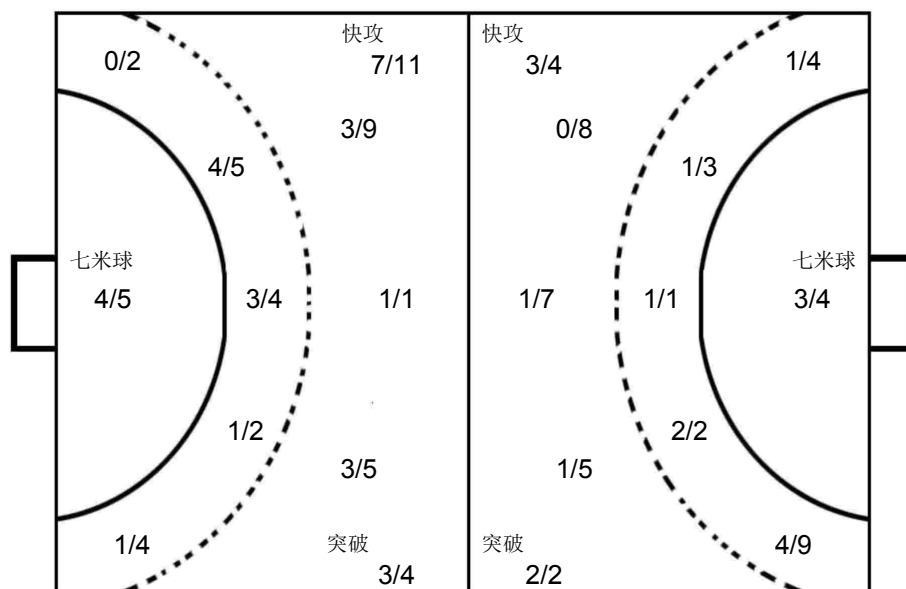

16 □□

0/2		1/2
1/3	1/1	0/1
0/1		

26 □□□

3/8		1/5
1/5		
0/7	1/1	2/5

广东

2 王彤羽	3 安妮	5 李纯	7 刘彤	8 李诗棋	9 韦宝桂	10 史小军	11 魏梦庭																																																																								
<table border="1"><tr><td></td><td></td><td></td></tr><tr><td></td><td></td><td></td></tr><tr><td></td><td></td><td></td></tr></table>										<table border="1"><tr><td></td><td></td><td></td></tr><tr><td></td><td>1</td><td></td></tr><tr><td></td><td></td><td></td></tr></table>					1					<table border="1"><tr><td></td><td></td><td></td></tr><tr><td></td><td></td><td></td></tr><tr><td></td><td></td><td></td></tr></table>										<table border="1"><tr><td></td><td></td><td></td></tr><tr><td>1</td><td></td><td></td></tr><tr><td></td><td></td><td></td></tr></table>				1						<table border="1"><tr><td></td><td></td><td></td></tr><tr><td></td><td></td><td></td></tr><tr><td></td><td></td><td></td></tr></table>										<table border="1"><tr><td></td><td></td><td>1</td></tr><tr><td>1</td><td></td><td>1</td></tr><tr><td></td><td>1</td><td></td></tr></table>			1	1		1		1		<table border="1"><tr><td></td><td></td><td>1</td></tr><tr><td></td><td></td><td></td></tr><tr><td>2</td><td></td><td></td></tr></table>			1				2			<table border="1"><tr><td></td><td></td><td></td></tr><tr><td></td><td></td><td></td></tr><tr><td></td><td></td><td></td></tr></table>									
	1																																																																														
1																																																																															
		1																																																																													
1		1																																																																													
	1																																																																														
		1																																																																													
2																																																																															
15 杨慧	16 李娟	19 邝雪花	20 李军政	22 刘晓玉	23 王如	26 马晓卉	28 刘金兰																																																																								
<table border="1"><tr><td></td><td></td><td></td></tr><tr><td></td><td></td><td></td></tr><tr><td></td><td></td><td></td></tr></table>										<table border="1"><tr><td></td><td></td><td></td></tr><tr><td></td><td></td><td></td></tr><tr><td></td><td></td><td></td></tr></table>										<table border="1"><tr><td></td><td></td><td></td></tr><tr><td>1</td><td></td><td></td></tr><tr><td>1</td><td></td><td>1</td></tr></table>				1			1		1	<table border="1"><tr><td></td><td></td><td></td></tr><tr><td>1</td><td></td><td></td></tr><tr><td></td><td></td><td></td></tr></table>				1						<table border="1"><tr><td></td><td></td><td></td></tr><tr><td></td><td></td><td></td></tr><tr><td></td><td></td><td></td></tr></table>										<table border="1"><tr><td></td><td></td><td></td></tr><tr><td></td><td></td><td></td></tr><tr><td></td><td></td><td>1</td></tr></table>									1	<table border="1"><tr><td></td><td></td><td></td></tr><tr><td></td><td></td><td></td></tr><tr><td></td><td></td><td></td></tr></table>										<table border="1"><tr><td></td><td></td><td>1</td></tr><tr><td>1</td><td></td><td></td></tr><tr><td></td><td></td><td>2</td></tr></table>			1	1					2
1																																																																															
1		1																																																																													
1																																																																															
		1																																																																													
		1																																																																													
1																																																																															
		2																																																																													
Post - 0 Miss - 0 Block - 0	Post - 2 Miss - 2 Block - 0	Post - 0 Miss - 0 Block - 0	Post - 2 Miss - 0 Block - 0	Post - 1 Miss - 0 Block - 0	Post - 1 Miss - 0 Block - 2	Post - 0 Miss - 1 Block - 0	Post - 5 Miss - 0 Block - 3																																																																								
Post - 0 Miss - 0 Block - 0	Post - 0 Miss - 0 Block - 0	Post - 0 Miss - 0 Block - 0	Post - 0 Miss - 2 Block - 0	Post - 0 Miss - 0 Block - 0	Post - 0 Miss - 0 Block - 0	Post - 1 Miss - 0 Block - 0	Post - 0 Miss - 0 Block - 0																																																																								

Team A					Team B					Match Number								
A 安徽					B 新疆					<b>13</b>								
Played in			in the hall			on			at			Spectators						
天津			天津师范大学体育馆			2017-09-04			14:00			hours						
Half-time(30')	A	B	End of playing time		A	B	1st extra time		A	B	2nd extra time		A	B	After penalty throws		A	B
	17	5	32		14													
Number of 7 m	A	Team time-out			Full name of players and officials						Team time-out			B	Number of 7 m			
	2/3	1	2	3							1	2	3	B				
											06:04	22:17		1/1				

No.	Team A	G	W	2'	D	DR	No.	Team B	G	W	2'	D	DR
1	司艳						3	葛立双					
3	李兵	2		1			5	于千添					
5	班晨晨	6					6	阿热孜古丽	2	1			
6	沈萍	2		1			7	吴志娟					
7	赵江川	2					10	李静					
8	徐仕媛						11	陈培培			1		
10	孙来苗	2	1				12	艾敏					
13	陶丹扬	4					15	兰姝娇					
14	刘晓妹	3					17	戴莹莹			1		
15	王婵婵	3					18	崔娟	8				
16	朱莉珍						21	锁珊珊	1		1		
17	周婷	1					23	张艺璇					
20	周雪婷	1		1			26	宋婷婷					
21	李瑶	2					27	谢辰辰					
23	张天洁						32	杨雨柔					
41	杜机娟	4					93	张婷婷	3		1		
A	吴疆						A	刁继平					
B	吴立军 (主教练)						B	于涛 (主教练)					
C	杨桂东						C	李天坐					
E	张国遂												
A	Signatures of responsables for the teams (Off.A)												B
TP	Remarks of referees / HF Official												TP

Referees	李兆蒙 (CHN)	马晓晔 (CHN)	
T.D.	高斌 (CHN)	吴国忠 (CHN)	
CHA Off.			

Note: Number of 7m Throws Awarded to Team A and B, Goals (G), Warnings (W), Suspensions (2'), Direct Disqualification (D), Disqualification With Report (DR) and Team Penalty (TP).

Table Officials: 刘菡蕊      翟延露      Statisticians: 杜宪      周强

**第十三届全国运动会女子手球决赛**
**PHMS** Pictorial Handball Match Statistics

**IHF** Official System

**竞赛技术统计**

 手球  
 女子

 四分之一决赛  
 轮次 4

 组别 X  
 场次 13

 天津师范大学体育馆  
 2017-09-04 14:00

Referees: 李兆蒙 (CHN) / 马晓晔 (CHN)

Result: 32:14 (17:5)

Teams: 安徽(安徽) VS 新疆(新疆)

安徽		远	近	边	快	突	任意	7m	合计	%	助攻	失误	警告	2'	D+DR	安徽	比赛 进程	新疆
主教练: 吴立军		射	射	射	攻	破	球	球										
1	司艳										4	1						
3	李兵		1/1		1/1				2/2	100		2		1				
5	班晨晨		4/5		2/2			0/1	6/8	75.0	2							
6	沈萍	2/5			0/1				2/6	33.3		1		1				
7	赵江川	1/1	1/1						2/2	100	1							
8	徐仕媛																	
10	孙来苗		1/1		1/1				2/2	100		1	1					
13	陶丹扬			1/1	3/4				4/5	80.0		1						
14	刘晓妹		1/1			1/1	1/1		3/3	100	2	1						
15	王婷婷			2/2	1/1				3/3	100		1						
16	朱莉珍										2	2						
17	周婷		1/1						1/1	100	1							
20	周雪婷				1/1				1/1	100				1				
21	李瑶	0/4	0/2		1/2			1/1	2/9	22.2	2	5						
23	张天洁																	
41	杜机娟			1/2	2/4			1/1	4/7	57.1								
运动员 合计		3/10	9/12	4/5	12/17	1/1	1/1	2/3	32/49	65.3	14	15	1	3				
1	司艳	9/10	4/7	1/1					14/18	77.8	4	1						
8	徐仕媛	1/1	1/2			1/1			3/4	75.0								
16	朱莉珍	7/12	5/8					0/1	12/21	57.1	2	2						
守门员 合计		17/23	10/17	1/1		1/1		0/1	29/43	67.4	6	3						
新疆		远	近	边	快	突	任意	7m	合计	%	助攻	失误	警告	2'	D+DR			
主教练: 于涛		射	射	射	攻	破	球	球										
3	葛立双	0/5	0/4						0/9	0.0	2	2						
5	于千添																	
6	阿热孜古丽		2/3						2/3	66.7		1	1					
7	吴志娟			0/1					0/1	0.0								
10	李静																	
11	陈培培													1				
12	艾敏																	
15	兰姝娇		0/1	0/1					0/2	0.0								
17	戴莹莹		0/1						0/1	0.0				1				
18	崔娟	5/10	3/5						8/15	53.3	1	4						
21	锁珊珊	1/7							1/7	14.3		1		1				
23	张艺璇			0/2					0/2	0.0								
26	宋婷婷																	
27	谢辰辰	0/3	0/1						0/4	0.0	1							
32	杨雨柔											1						
93	张婷婷	0/7	2/4			0/1		1/1	3/13	23.1		3		1				
运动员 合计		6/32	7/19	0/4		0/1		1/1	14/57	24.6	4	12	1	4				
10	李静	1/2	0/3	0/2	1/5			1/1	3/13	23.1								
32	杨雨柔	4/6	2/8	1/3	2/10	0/1	0/1	0/2	9/31	29.0		1						
守门员 合计		5/8	2/11	1/5	3/15	0/1	0/1	1/3	12/44	27.3		1						

场上队员: 得分 / 射门

守门员: 救球 / 射门

D	取消资格	DR	取消资格+报告
---	------	----	---------

## 第十三届全国运动会女子手球决赛

PHMS Pictorial Handball Match Statistics

IHF Official System

## 个人/全队技术统计表

 手球 四分之一决赛 组别 X 天津师范大学体育馆  
 女子 轮次 4 场次 13 2017-09-04 14:00

号码	姓名	远射	近射	边射	快攻	突破	任意	七米	合计	%	助攻	失误	警告	2'	取消	时间
<b>安徽(安徽)</b>																
<b>(场上队员)</b>																
1	司艳									0.0%	4	1				00:24:17
3	李兵		1/1		1/1				2/2	100%		2		1		00:21:31
5	班晨晨		4/5		2/2			0/1	6/8	75.0%	2					00:36:15
6	沈萍	2/5			0/1				2/6	33.3%		1		1		00:23:44
7	赵江川	1/1	1/1						2/2	100%	1					00:20:48
8	徐仕媛									0.0%						00:04:48
10	孙来苗		1/1		1/1				2/2	100%		1	1			00:27:11
13	陶丹扬			1/1	3/4				4/5	80.0%		1				00:45:31
14	刘晓妹		1/1			1/1	1/1		3/3	100%	2	1				00:33:37
15	王婵婵			2/2	1/1				3/3	100%		1				00:32:48
16	朱莉珍									0.0%	2	2				00:30:55
17	周婷		1/1						1/1	100%	1					00:30:00
20	周雪婷				1/1				1/1	100%				1		00:14:44
21	李瑶	0/4	0/2		1/2			1/1	2/9	22.2%	2	5				00:35:32
23	张天洁									0.0%						00:11:20
41	杜机娟			1/2	2/4			1/1	4/7	57.1%						00:26:48
	<b>合计</b>	<b>3/10</b>	<b>9/12</b>	<b>4/5</b>	<b>12/17</b>	<b>1/1</b>	<b>1/1</b>	<b>2/3</b>	<b>32/49</b>	<b>65.3%</b>	<b>14</b>	<b>15</b>	<b>1</b>	<b>3</b>		

## (守门员)

1	司艳	9/10	4/7	1/1					14/18	77.8%	4	1				00:24:17
8	徐仕媛	1/1	1/2			1/1			3/4	75.0%						00:04:48
16	朱莉珍	7/12	5/8					0/1	12/21	57.1%	2	2				00:30:55
	<b>合计</b>	<b>17/23</b>	<b>10/17</b>	<b>1/1</b>		<b>1/1</b>		<b>0/1</b>	<b>29/43</b>	<b>67.4%</b>	<b>6</b>	<b>3</b>				

场上队员：得分/射门

守门员：救球/射门

全队合计	得分	被救	射失	击柱	封球	合计	%
远射	3	5	1		1	10	30.0%
近射	9	2	1			12	75.0%
边射	4	1				5	80.0%
快攻	12	3	1	1		17	70.6%
突破	1					1	100.0%
任意	1					1	100.0%
七米	2	1				3	66.7%



## 第十三届全国运动会女子手球决赛

PHMS Pictorial Handball Match Statistics

IHF Official System

## 个人/全队技术统计表

 手球 四分之一决赛 组别 X 天津师范大学体育馆  
 女子 轮次 4 场次 13 2017-09-04 14:00

号码	姓名	远射	近射	边射	快攻	突破	任意	七米	合计	%	助攻	失误	警告	2'	取消	时间
<b>新疆(新疆)</b>																
<b>(场上队员)</b>																
3	葛立双	0/5	0/4						0/9	0.0%	2	2				00:41:37
5	于千添									0.0%						00:00:00
6	阿热孜古丽		2/3						2/3	66.7%		1	1			00:25:37
7	吴志娟			0/1					0/1	0.0%						00:30:45
10	李静									0.0%						00:20:24
11	陈培培									0.0%				1		00:12:46
12	艾敏									0.0%						00:03:25
15	兰姝娇		0/1	0/1					0/2	0.0%						00:23:54
17	戴莹莹		0/1						0/1	0.0%				1		00:35:03
18	崔娟	5/10	3/5						8/15	53.3%	1	4				00:34:13
21	锁珊珊	1/7							1/7	14.3%		1		1		00:36:44
23	张艺璇			0/2					0/2	0.0%						00:44:09
26	宋婷婷									0.0%						00:01:37
27	谢辰辰	0/3	0/1						0/4	0.0%	1					00:16:28
32	杨雨柔									0.0%		1				00:39:36
93	张婷婷	0/7	2/4			0/1		1/1	3/13	23.1%		3		1		00:53:07
	<b>合计</b>	<b>6/32</b>	<b>7/19</b>	<b>0/4</b>		<b>0/1</b>		<b>1/1</b>	<b>14/57</b>	<b>24.6%</b>	<b>4</b>	<b>12</b>	<b>1</b>	<b>4</b>		
<b>(守门员)</b>																
10	李静	1/2	0/3	0/2	1/5			1/1	3/13	23.1%						00:20:24
32	杨雨柔	4/6	2/8	1/3	2/10	0/1	0/1	0/2	9/31	29.0%		1				00:39:36
	<b>合计</b>	<b>5/8</b>	<b>2/11</b>	<b>1/5</b>	<b>3/15</b>	<b>0/1</b>	<b>0/1</b>	<b>1/3</b>	<b>12/44</b>	<b>27.3%</b>		<b>1</b>				

场上队员：得分/射门

守门员：救球/射门

全队合计	得分	被救	射失	击柱	封球	合计	%
远射	6	17	3	2	4	32	18.8%
近射	7	10	2			19	36.8%
边射		1	1	2		4	0.0%
快攻							0.0%
突破		1				1	0.0%
任意							0.0%
七米	1					1	100.0%

第十三届全国运动会女子手球决赛

PHMS Pictorial Handball Match Statistics

IHF Official System

图式比赛技术统计表

手球  
女子

四分之一决赛  
轮次 4

组别 X  
场次 13

天津师范大学体育馆  
2017-09-04 14:00

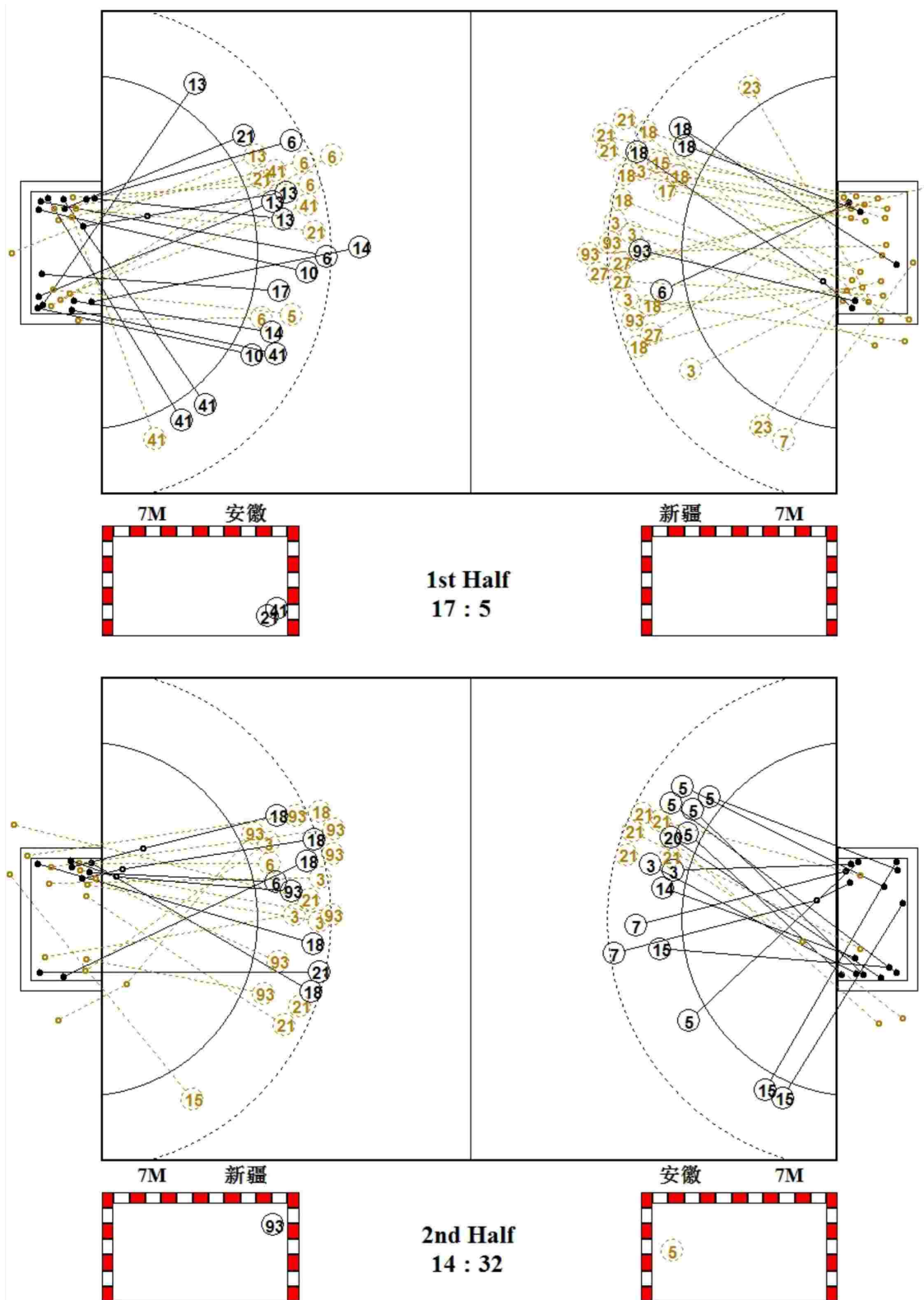

第十三届全国运动会女子手球决赛

PHMS Pictorial Handball Match Statistics

IHF Official System

图式射门区域统计

手球  
女子

四分之一决赛  
轮次 4

组别 X  
场次 13

天津师范大学体育馆  
2017-09-04 14:00

安徽

1 司艳	3 李兵	5 班晨晨	6 沈萍	7 赵江川	8 徐仕媛	10 孙来苗	13 陶丹扬																																																																								
<table border="1"><tr><td></td><td></td><td></td></tr><tr><td></td><td></td><td></td></tr><tr><td></td><td></td><td></td></tr></table>										<table border="1"><tr><td></td><td></td><td></td></tr><tr><td></td><td></td><td></td></tr><tr><td>1</td><td></td><td>1</td></tr></table>							1		1	<table border="1"><tr><td>2</td><td></td><td>1</td></tr><tr><td></td><td></td><td>1</td></tr><tr><td>1</td><td></td><td>1</td></tr></table>	2		1			1	1		1	<table border="1"><tr><td></td><td></td><td>1</td></tr><tr><td></td><td></td><td></td></tr><tr><td></td><td></td><td>1</td></tr></table>			1						1	<table border="1"><tr><td></td><td></td><td></td></tr><tr><td></td><td></td><td></td></tr><tr><td>2</td><td></td><td></td></tr></table>							2			<table border="1"><tr><td></td><td></td><td></td></tr><tr><td></td><td></td><td></td></tr><tr><td></td><td></td><td></td></tr></table>										<table border="1"><tr><td>1</td><td></td><td>1</td></tr><tr><td></td><td></td><td></td></tr><tr><td></td><td></td><td></td></tr></table>	1		1							<table border="1"><tr><td>2</td><td></td><td></td></tr><tr><td></td><td></td><td></td></tr><tr><td></td><td></td><td>2</td></tr></table>	2								2
1		1																																																																													
2		1																																																																													
		1																																																																													
1		1																																																																													
		1																																																																													
		1																																																																													
2																																																																															
1		1																																																																													
2																																																																															
		2																																																																													
Post - 0 Miss - 0 Block - 0	Post - 0 Miss - 0 Block - 0	Post - 0 Miss - 0 Block - 0	Post - 1 Miss - 0 Block - 0	Post - 0 Miss - 0 Block - 0	Post - 0 Miss - 0 Block - 0	Post - 0 Miss - 0 Block - 0	Post - 0 Miss - 1 Block - 0																																																																								
14 刘晓妹	15 王婷婷	16 朱莉珍	17 周婷	20 周雪婷	21 李瑶	23 张天洁	41 杜机娟																																																																								
<table border="1"><tr><td></td><td></td><td></td></tr><tr><td>1</td><td></td><td></td></tr><tr><td>1</td><td></td><td>1</td></tr></table>				1			1		1	<table border="1"><tr><td>1</td><td>1</td><td>1</td></tr><tr><td></td><td></td><td></td></tr><tr><td></td><td></td><td></td></tr></table>	1	1	1							<table border="1"><tr><td></td><td></td><td></td></tr><tr><td></td><td></td><td></td></tr><tr><td></td><td></td><td></td></tr></table>										<table border="1"><tr><td>1</td><td></td><td></td></tr><tr><td></td><td></td><td></td></tr><tr><td></td><td></td><td></td></tr></table>	1									<table border="1"><tr><td></td><td></td><td></td></tr><tr><td></td><td></td><td>1</td></tr><tr><td></td><td></td><td></td></tr></table>						1				<table border="1"><tr><td></td><td></td><td></td></tr><tr><td></td><td></td><td>1</td></tr><tr><td></td><td></td><td>1</td></tr></table>						1			1	<table border="1"><tr><td></td><td></td><td></td></tr><tr><td></td><td></td><td></td></tr><tr><td></td><td></td><td></td></tr></table>										<table border="1"><tr><td></td><td></td><td>1</td></tr><tr><td>1</td><td></td><td>2</td></tr><tr><td></td><td></td><td></td></tr></table>			1	1		2			
1																																																																															
1		1																																																																													
1	1	1																																																																													
1																																																																															
		1																																																																													
		1																																																																													
		1																																																																													
		1																																																																													
1		2																																																																													
Post - 0 Miss - 0 Block - 0	Post - 0 Miss - 0 Block - 0	Post - 0 Miss - 0 Block - 0	Post - 0 Miss - 0 Block - 0	Post - 0 Miss - 0 Block - 0	Post - 0 Miss - 2 Block - 1	Post - 0 Miss - 0 Block - 0	Post - 0 Miss - 0 Block - 0																																																																								

1 □□

2/2	1/2	1/1
3/3	1/1	1/1
4/5		1/3

8 □□□

1/1		
		0/1
1/1		1/1

16 □□□

0/1		2/4
0/2	1/1	2/3
1/1		6/9

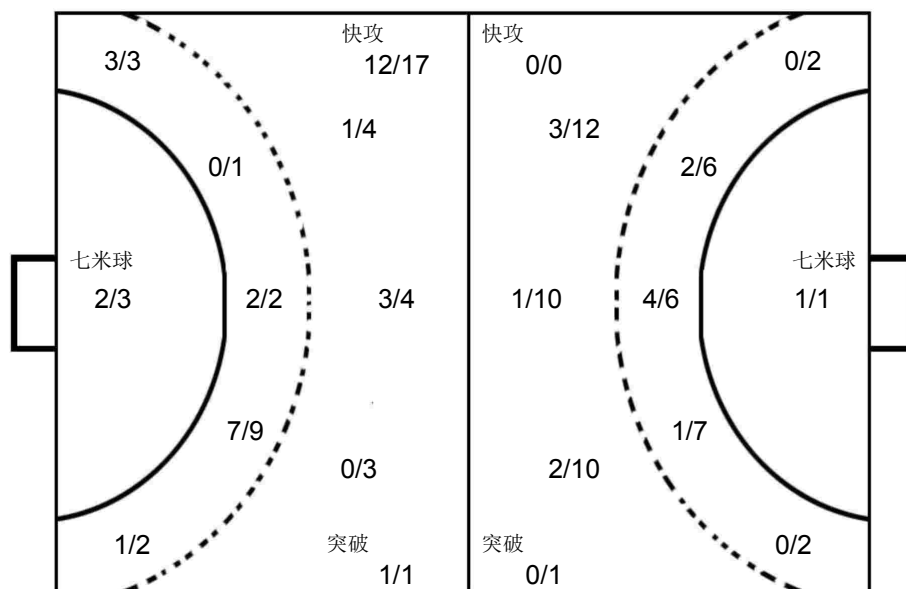

10 □□

0/2	0/1	0/2
2/2		1/3
0/2		0/1

32 □□□

2/7		1/4
2/4		4/7
0/3		0/6

新疆

3 葛立双	5 于千添	6 阿热孜古丽	7 吴志娟	10 李静	11 陈培培	12 艾敏	15 兰姝娇																																																																								
<table border="1"><tr><td></td><td></td><td></td></tr><tr><td></td><td></td><td></td></tr><tr><td></td><td></td><td></td></tr></table>										<table border="1"><tr><td></td><td></td><td></td></tr><tr><td></td><td></td><td></td></tr><tr><td></td><td></td><td></td></tr></table>										<table border="1"><tr><td></td><td></td><td></td></tr><tr><td></td><td></td><td></td></tr><tr><td>1</td><td></td><td>1</td></tr></table>							1		1	<table border="1"><tr><td></td><td></td><td></td></tr><tr><td></td><td></td><td></td></tr><tr><td></td><td></td><td></td></tr></table>										<table border="1"><tr><td></td><td></td><td></td></tr><tr><td></td><td></td><td></td></tr><tr><td></td><td></td><td></td></tr></table>										<table border="1"><tr><td></td><td></td><td></td></tr><tr><td></td><td></td><td></td></tr><tr><td></td><td></td><td></td></tr></table>										<table border="1"><tr><td></td><td></td><td></td></tr><tr><td></td><td></td><td></td></tr><tr><td></td><td></td><td></td></tr></table>										<table border="1"><tr><td></td><td></td><td></td></tr><tr><td></td><td></td><td></td></tr><tr><td></td><td></td><td></td></tr></table>									
1		1																																																																													
Post - 0 Miss - 2 Block - 0	Post - 0 Miss - 0 Block - 0	Post - 0 Miss - 0 Block - 0	Post - 1 Miss - 0 Block - 0	Post - 0 Miss - 0 Block - 0	Post - 0 Miss - 0 Block - 0	Post - 0 Miss - 0 Block - 0	Post - 0 Miss - 1 Block - 0																																																																								
17 戴莹莹	18 崔娟	21 锁珊珊	23 张艺璇	26 宋婷婷	27 谢辰辰	32 杨雨柔	93 张婷婷																																																																								
<table border="1"><tr><td></td><td></td><td></td></tr><tr><td></td><td></td><td></td></tr><tr><td></td><td></td><td></td></tr></table>										<table border="1"><tr><td></td><td>1</td><td>1</td></tr><tr><td>2</td><td></td><td>1</td></tr><tr><td></td><td></td><td>3</td></tr></table>		1	1	2		1			3	<table border="1"><tr><td>1</td><td></td><td></td></tr><tr><td></td><td></td><td></td></tr><tr><td></td><td></td><td></td></tr></table>	1									<table border="1"><tr><td></td><td></td><td></td></tr><tr><td></td><td></td><td></td></tr><tr><td></td><td></td><td></td></tr></table>										<table border="1"><tr><td></td><td></td><td></td></tr><tr><td></td><td></td><td></td></tr><tr><td></td><td></td><td></td></tr></table>										<table border="1"><tr><td></td><td></td><td></td></tr><tr><td></td><td></td><td></td></tr><tr><td></td><td></td><td></td></tr></table>										<table border="1"><tr><td></td><td></td><td></td></tr><tr><td></td><td></td><td></td></tr><tr><td></td><td></td><td></td></tr></table>										<table border="1"><tr><td></td><td></td><td>1</td></tr><tr><td></td><td></td><td>1</td></tr><tr><td></td><td></td><td>1</td></tr></table>			1			1			1
	1	1																																																																													
2		1																																																																													
		3																																																																													
1																																																																															
		1																																																																													
		1																																																																													
		1																																																																													
Post - 0 Miss - 0 Block - 0	Post - 2 Miss - 0 Block - 0	Post - 0 Miss - 1 Block - 1	Post - 1 Miss - 0 Block - 0	Post - 0 Miss - 0 Block - 0	Post - 0 Miss - 1 Block - 0	Post - 0 Miss - 0 Block - 0	Post - 0 Miss - 1 Block - 3																																																																								

Team A					Team B					Match Number											
A 广东					B 山东					<b>14</b>											
Played in			in the hall			on			at			Spectators									
天津			天津师范大学体育馆			2017-09-04			15:45			hours									
Half-time(30')	A	B	End of playing time		A	B	1st extra time		A	B	2nd extra time		A	B	After penalty throws		A	B			
	10	12	22		17																
Number of 7 m	A	Team time-out			Full name of players and officials						Team time-out			B	Number of 7 m						
	4/6	1	2	3							1	2	3	B							
		13:56	41:59	55:06							21:22	43:57	57:53	5/7							
No.	Team A					G	W	2'	D	DR	No.	Team B					G	W	2'	D	DR
2	王彤羽										1	路畅									
3	安妮					3	1				2	林燕群					5		1		
5	李纯										6	王莎莎									
7	刘彤					1	1	1			8	王彬					5				
8	李诗棋										11	吕青纹					1				
9	韦宝桂					9					12	张苑琳									
10	史小军					3					15	吴作扬					1				
11	魏梦庭										19	姜伟珊									
15	杨慧										20	张悦						1	2		
16	李娟										22	朱赟									
19	邝雪花							1			23	徐悦									
20	李军政							1			28	崔金娜					3		1		
22	刘晓玉										33	王彩琳					2	1			
23	王如					3	1	1			77	穆庆丛							1		
26	马晓卉																				
28	刘金兰					3		2													
B	黄炳春										B	马海湧 (主教练)									
C	李玉玲										C	徐强									
D	郭艳辉 (主教练)										D	孔德宾									
E	赵善良										E	王日东									
A	Signatures of responsables for the teams (Off.A)															B					
TP	Remarks of referees / HF Official															TP					

	Signatures														
Referees	ALEXEI. COVALCIUC (MDA)					IGOR. COVALCIUC (MDA)									
T.D.	刘凤娟 (CHN)					高斌 (CHN)									
CHA Off.															

Note: Number of 7m Throws Awarded to Team A and B, Goals (G), Warnings (W), Suspensions (2'), Direct Disqualification (D), Disqualification With Report (DR) and Team Penalty (TP).

Table Officials: 齐红梅 张智伟 Statisticians: 李双 王玮

**第十三届全国运动会女子手球决赛**
**PHMS** Pictorial Handball Match Statistics

**IHF** Official System

**竞赛技术统计**

 手球  
 女子

 四分之一决赛  
 轮次 2

 组别 X  
 场次 14

 天津师范大学体育馆  
 2017-09-04 15:45

Referees: ALEXEI. COVALCIUC (MDA) / IGOR. COVALCIUC (MDA)

Result: 22:17(10:12)

Teams: 广东(广东) VS 山东(山东)

广东		远	近	边	快	突	任意	7m	合计	%	助攻	失误	警告	2'	D+DR	广东	比赛 进程	山东
主教练: 郭艳辉		射	射	射	攻	破	球	球										
2	王彤羽																	
3	安妮	0/2	0/1			3/3			3/6	50.0		4	1					
5	李纯																	
7	刘彤		1/1	0/1					1/2	50.0		1	1	1				
8	李诗棋																	
9	韦宝桂	4/5	2/2	0/1	0/1			3/4	9/13	69.2	2	1						
10	史小军	1/1				2/3			3/4	75.0	2	2						
11	魏梦庭											1						
15	杨慧																	
16	李娟																	
19	邝雪花																	
20	李军政																	
22	刘晓玉																	
23	王如	1/1	1/1		1/1				3/3	100	1		1	1				
26	马晓卉																	
28	刘金兰			0/2	2/2			1/2	3/6	50.0		1		2				
运动员 合计		6/9	4/5	0/4	3/4	5/6		4/6	22/34	64.7	5	10	3	6				
16	李娟							0/3	0/3	0.0								
22	刘晓玉	5/7	2/7			0/1	1/1		8/16	50.0								
26	马晓卉	0/1	0/1	0/1		1/2		1/3	2/8	25.0								
守门员 合计		5/8	2/8	0/1		1/3	1/1	1/6	10/27	37.0								
山东		远	近	边	快	突	任意	7m	合计	%	助攻	失误	警告	2'	D+DR	广东	比赛 进程	山东
主教练: 马海涛		射	射	射	攻	破	球	球										
1	路畅																	
2	林燕群	2/6	1/2			2/4	0/2	0/1	5/15	33.3	2	1		1				
6	王莎莎											1						
8	王彬	0/2						5/6	5/8	62.5		4						
11	吕青纹			1/1					1/1	100								
12	张苑琳																	
15	吴作扬	1/4							1/4	25.0	1							
19	姜伟珊																	
20	张悦			0/1					0/1	0.0		1	1	2				
22	朱赞																	
23	徐悦																	
28	崔金娜		3/4						3/4	75.0		1		1				
33	王彩琳		2/2						2/2	100		4	1					
77	穆庆丛																	
运动员 合计		3/12	6/8	1/2		2/4	0/2	5/7	17/35	48.6	3	12	2	5				
1	路畅	1/6	0/3	1/1	1/4	1/5		0/2	4/21	19.0								
12	张苑琳							1/3	1/3	33.3								
守门员 合计		1/6	0/3	1/1	1/4	1/5		1/5	5/24	20.8								

场上队员: 得分 / 射门

守门员: 救球 / 射门

D	取消资格	DR	取消资格+报告
---	------	----	---------

**第十三届全国运动会女子手球决赛**
**PHMS** Pictorial Handball Match Statistics

**IHF** Official System

**个人/全队技术统计表**

 手球 四分之一决赛 组别 X  
 女子 轮次 2 场次 14  
 天津师范大学体育馆  
 2017-09-04 15:45

号码	姓名	远射	近射	边射	快攻	突破	任意	七米	合计	%	助攻	失误	警告	2'	取消	时间
<b>广东(广东)</b>																
<b>(场上队员)</b>																
2	王彤羽									0.0%						00:00:00
3	安妮	0/2	0/1			3/3			3/6	50.0%	4	1				00:58:13
5	李纯									0.0%						00:00:00
7	刘彤		1/1	0/1					1/2	50.0%	1	1	1			01:00:00
8	李诗棋									0.0%						00:00:00
9	韦宝桂	4/5	2/2	0/1	0/1			3/4	9/13	69.2%	2	1				01:00:00
10	史小军	1/1				2/3			3/4	75.0%	2	2				00:26:40
11	魏梦庭									0.0%	1					00:09:46
15	杨慧									0.0%						00:00:30
16	李娟									0.0%						00:00:23
19	邝雪花									0.0%				1		00:20:49
20	李军政									0.0%				1		00:15:02
22	刘晓玉									0.0%						00:44:39
23	王如	1/1	1/1		1/1				3/3	100%	1		1	1		01:00:00
26	马晓卉									0.0%						00:14:58
28	刘金兰			0/2	2/2			1/2	3/6	50.0%		1		2		00:45:57
<b>合计</b>		<b>6/9</b>	<b>4/5</b>	<b>0/4</b>	<b>3/4</b>	<b>5/6</b>		<b>4/6</b>	<b>22/34</b>	<b>64.7%</b>	<b>5</b>	<b>10</b>	<b>3</b>	<b>6</b>		
<b>(守门员)</b>																
16	李娟							0/3	0/3	0.0%						00:00:23
22	刘晓玉	5/7	2/7			0/1	1/1		8/16	50.0%						00:44:39
26	马晓卉	0/1	0/1	0/1		1/2		1/3	2/8	25.0%						00:14:58
<b>合计</b>		<b>5/8</b>	<b>2/8</b>	<b>0/1</b>		<b>1/3</b>	<b>1/1</b>	<b>1/6</b>	<b>10/27</b>	<b>37.0%</b>						

场上队员： 得分/射门

守门员： 救球/射门

全队合计	得分	被救	射失	击柱	封球	合计	%
远射	6	1		1	1	9	66.7%
近射	4		1			5	80.0%
边射		1		2		3	0.0%
快攻	3	1				4	75.0%
突破	5	1				6	83.3%
任意							0.0%
七米	4	1	1			6	66.7%

## 第十三届全国运动会女子手球决赛

PHMS Pictorial Handball Match Statistics

IHF Official System

## 个人/全队技术统计表

 手球 四分之一决赛 组别 X 天津师范大学体育馆  
 女子 轮次 2 场次 14 2017-09-04 15:45

号码	姓名	远射	近射	边射	快攻	突破	任意	七米	合计	%	助攻	失误	警告	2'	取消	时间
山东(山东)																
(场上队员)																
1	路畅									0.0%						00:59:28
2	林燕群	2/6	1/2			2/4	0/2	0/1	5/15	33.3%	2	1		1		00:58:08
6	王莎莎									0.0%		1				00:22:30
8	王彬	0/2						5/6	5/8	62.5%		4				00:15:16
11	吕青纹			1/1					1/1	100%						00:59:32
12	张苑琳									0.0%						00:00:32
15	吴作扬	1/4							1/4	25.0%	1					00:36:03
19	姜伟珊									0.0%						00:00:00
20	张悦			0/1					0/1	0.0%		1	1	2		00:58:47
22	朱赞									0.0%						00:00:00
23	徐悦									0.0%						00:00:00
28	崔金娜		3/4						3/4	75.0%		1		1		00:58:21
33	王彩琳		2/2						2/2	100%		4	1			00:40:43
77	穆庆丛									0.0%				1		00:13:51
合计		3/12	6/8	1/2		2/4	0/2	5/7	17/35	48.6%	3	12	2	5		
(守门员)																
1	路畅	1/6	0/3	1/1	1/4	1/5		0/2	4/21	19.0%						00:59:28
12	张苑琳							1/3	1/3	33.3%						00:00:32
合计		1/6	0/3	1/1	1/4	1/5		1/5	5/24	20.8%						

场上队员： 得分/射门

守门员： 救球/射门

全队合计	得分	被救	射失	击柱	封球	合计	%
远射	3	5	1	1	2	12	25.0%
近射	6	2				8	75.0%
边射	1			1		2	50.0%
快攻							0.0%
突破	2	1		1		4	50.0%
任意		1	1			2	0.0%
七米	5	1	1			7	71.4%

第十三届全国运动会女子手球决赛

PHMS Pictorial Handball Match Statistics

IHF Official System

图式比赛技术统计表

手球  
女子

四分之一决赛  
轮次 2

组别 X  
场次 14

天津师范大学体育馆  
2017-09-04 15:45

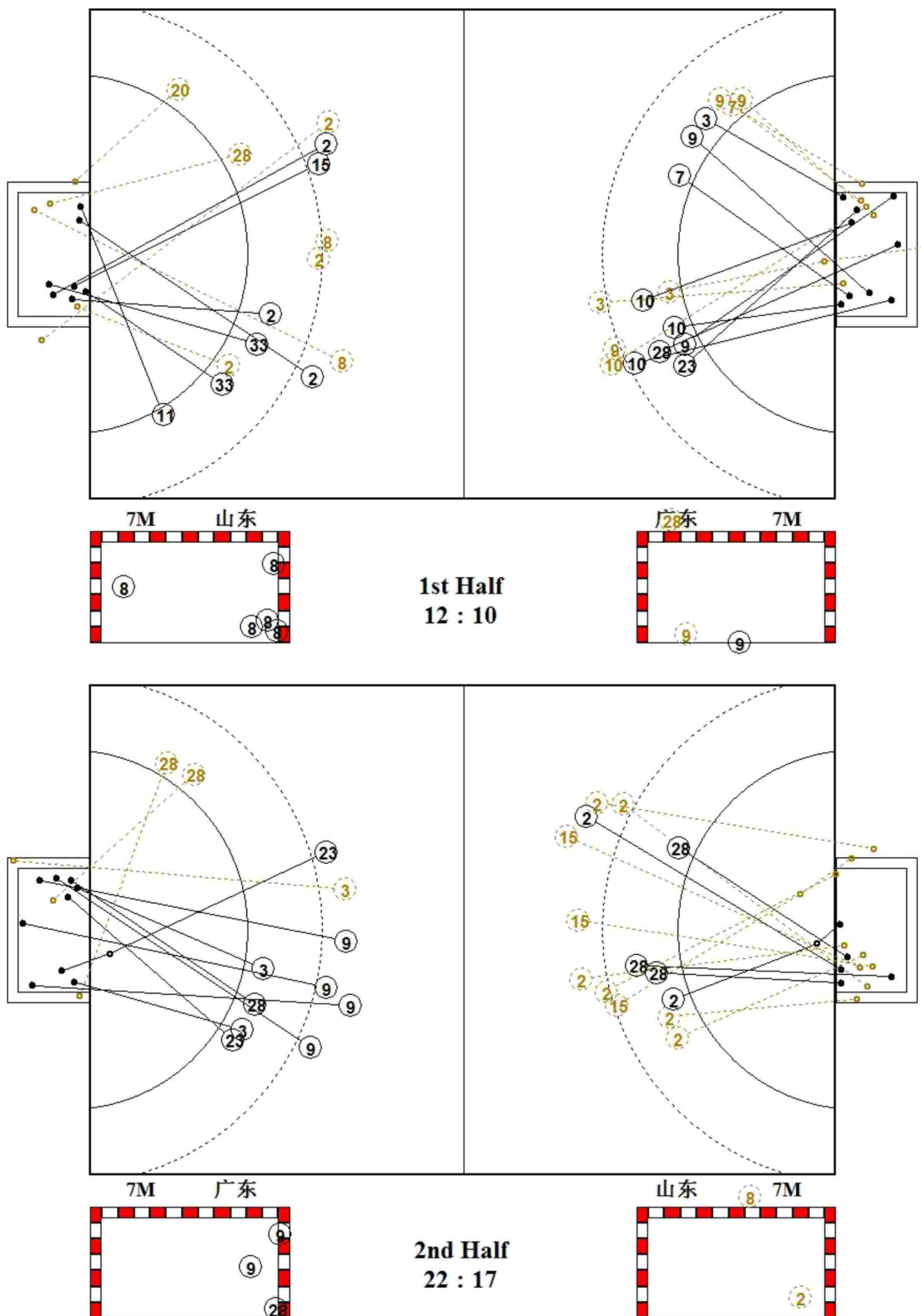



第十三届全国运动会女子手球决赛

PHMS Pictorial Handball Match Statistics

IHF Official System

图式射门区域统计

手球  
女子

四分之一决赛  
轮次 2

组别 X  
场次 14

天津师范大学体育馆  
2017-09-04 15:45

广东

2 王彤羽 <table border="1"><tr><td></td><td></td><td></td></tr><tr><td></td><td></td><td></td></tr><tr><td></td><td></td><td></td></tr></table> Post - 0 Miss - 0 Block - 0										3 安妮 <table border="1"><tr><td></td><td></td><td></td></tr><tr><td></td><td></td><td></td></tr><tr><td>2</td><td></td><td>1</td></tr></table> Post - 1 Miss - 1 Block - 0							2		1	5 李纯 <table border="1"><tr><td></td><td></td><td></td></tr><tr><td></td><td></td><td></td></tr><tr><td></td><td></td><td></td></tr></table> Post - 0 Miss - 0 Block - 0										7 刘彤 <table border="1"><tr><td></td><td></td><td></td></tr><tr><td></td><td></td><td></td></tr><tr><td></td><td></td><td>1</td></tr></table> Post - 0 Miss - 0 Block - 0									1	8 李诗棋 <table border="1"><tr><td></td><td></td><td></td></tr><tr><td></td><td></td><td></td></tr><tr><td></td><td></td><td></td></tr></table> Post - 0 Miss - 0 Block - 0										9 韦宝桂 <table border="1"><tr><td>2</td><td>1</td><td>2</td></tr><tr><td></td><td></td><td>3</td></tr><tr><td></td><td>1</td><td></td></tr></table> Post - 1 Miss - 0 Block - 1	2	1	2			3		1		10 史小军 <table border="1"><tr><td></td><td></td><td>1</td></tr><tr><td></td><td></td><td></td></tr><tr><td>1</td><td></td><td>1</td></tr></table> Post - 0 Miss - 0 Block - 0			1				1		1	11 魏梦庭 <table border="1"><tr><td></td><td></td><td></td></tr><tr><td></td><td></td><td></td></tr><tr><td></td><td></td><td></td></tr></table> Post - 0 Miss - 0 Block - 0									
2		1																																																																													
		1																																																																													
2	1	2																																																																													
		3																																																																													
	1																																																																														
		1																																																																													
1		1																																																																													
15 杨慧 <table border="1"><tr><td></td><td></td><td></td></tr><tr><td></td><td></td><td></td></tr><tr><td></td><td></td><td></td></tr></table> Post - 0 Miss - 0 Block - 0										16 李娟 <table border="1"><tr><td></td><td></td><td></td></tr><tr><td></td><td></td><td></td></tr><tr><td></td><td></td><td></td></tr></table> Post - 0 Miss - 0 Block - 0										19 邝雪花 <table border="1"><tr><td></td><td></td><td></td></tr><tr><td></td><td></td><td></td></tr><tr><td></td><td></td><td></td></tr></table> Post - 0 Miss - 0 Block - 0										20 李军政 <table border="1"><tr><td></td><td></td><td></td></tr><tr><td></td><td></td><td></td></tr><tr><td></td><td></td><td></td></tr></table> Post - 0 Miss - 0 Block - 0										22 刘晓玉 <table border="1"><tr><td></td><td></td><td></td></tr><tr><td></td><td></td><td></td></tr><tr><td></td><td></td><td></td></tr></table> Post - 0 Miss - 0 Block - 0										23 王如 <table border="1"><tr><td></td><td></td><td></td></tr><tr><td>1</td><td></td><td></td></tr><tr><td>1</td><td></td><td>1</td></tr></table> Post - 0 Miss - 0 Block - 0				1			1		1	26 马晓卉 <table border="1"><tr><td></td><td></td><td></td></tr><tr><td></td><td></td><td></td></tr><tr><td></td><td></td><td></td></tr></table> Post - 0 Miss - 0 Block - 0										28 刘金兰 <table border="1"><tr><td></td><td>1</td><td></td></tr><tr><td></td><td></td><td></td></tr><tr><td></td><td></td><td>2</td></tr></table> Post - 1 Miss - 1 Block - 0		1							2
1																																																																															
1		1																																																																													
	1																																																																														
		2																																																																													

16 □□

		0/3

22 □□□

		1/2
0/2		5/5
1/1	1/2	0/4

26 □□□

		0/1
0/1		
1/4		1/2

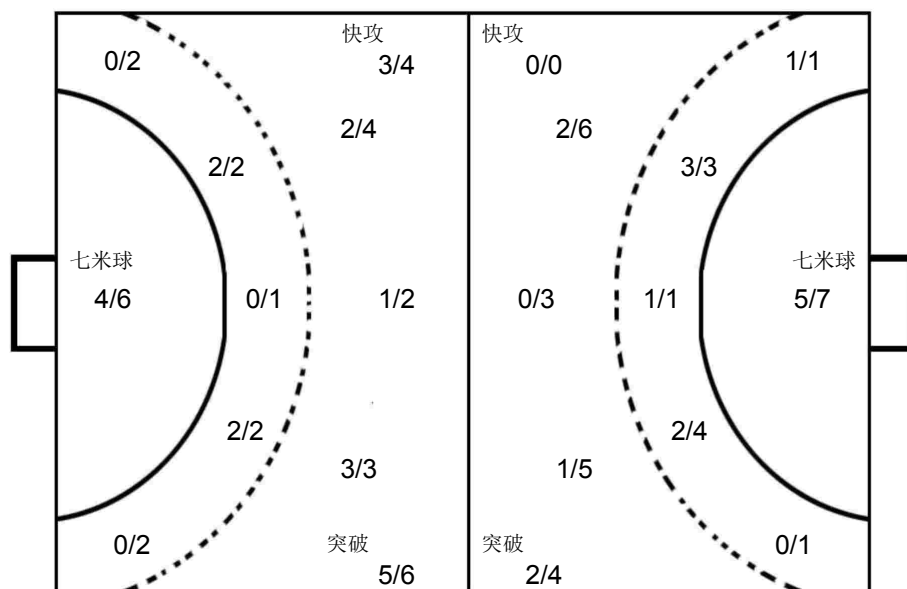

1 □□

0/1	0/2	0/1
2/3		1/3
0/3	0/1	1/7

12 □□□

		0/1
		0/1
1/1		

山东

1 路畅 <table border="1"><tr><td></td><td></td><td></td></tr><tr><td></td><td></td><td></td></tr><tr><td></td><td></td><td></td></tr></table> Post - 0 Miss - 0 Block - 0										2 林燕群 <table border="1"><tr><td></td><td></td><td></td></tr><tr><td>1</td><td></td><td></td></tr><tr><td>1</td><td>1</td><td>2</td></tr></table> Post - 1 Miss - 2 Block - 1				1			1	1	2	6 王莎莎 <table border="1"><tr><td></td><td></td><td></td></tr><tr><td></td><td></td><td></td></tr><tr><td></td><td></td><td></td></tr></table> Post - 0 Miss - 0 Block - 0										8 王彬 <table border="1"><tr><td></td><td></td><td>1</td></tr><tr><td>1</td><td></td><td></td></tr><tr><td></td><td></td><td>3</td></tr></table> Post - 0 Miss - 1 Block - 1			1	1					3	11 吕青纹 <table border="1"><tr><td></td><td></td><td></td></tr><tr><td></td><td></td><td></td></tr><tr><td></td><td></td><td>1</td></tr></table> Post - 0 Miss - 0 Block - 0									1	12 张苑琳 <table border="1"><tr><td></td><td></td><td></td></tr><tr><td></td><td></td><td></td></tr><tr><td></td><td></td><td></td></tr></table> Post - 0 Miss - 0 Block - 0										15 吴作扬 <table border="1"><tr><td></td><td></td><td></td></tr><tr><td></td><td></td><td></td></tr><tr><td>1</td><td></td><td></td></tr></table> Post - 1 Miss - 0 Block - 0							1			19 姜伟珊 <table border="1"><tr><td></td><td></td><td></td></tr><tr><td></td><td></td><td></td></tr><tr><td></td><td></td><td></td></tr></table> Post - 0 Miss - 0 Block - 0									
1																																																																															
1	1	2																																																																													
		1																																																																													
1																																																																															
		3																																																																													
		1																																																																													
1																																																																															
20 张悦 <table border="1"><tr><td></td><td></td><td></td></tr><tr><td></td><td></td><td></td></tr><tr><td></td><td></td><td></td></tr></table> Post - 1 Miss - 0 Block - 0										22 朱赞 <table border="1"><tr><td></td><td></td><td></td></tr><tr><td></td><td></td><td></td></tr><tr><td></td><td></td><td></td></tr></table> Post - 0 Miss - 0 Block - 0										23 徐悦 <table border="1"><tr><td></td><td></td><td></td></tr><tr><td></td><td></td><td></td></tr><tr><td></td><td></td><td></td></tr></table> Post - 0 Miss - 0 Block - 0										28 崔金娜 <table border="1"><tr><td></td><td></td><td>1</td></tr><tr><td></td><td></td><td></td></tr><tr><td></td><td></td><td>2</td></tr></table> Post - 0 Miss - 0 Block - 0			1						2	33 王彩琳 <table border="1"><tr><td></td><td></td><td></td></tr><tr><td>1</td><td></td><td></td></tr><tr><td>1</td><td></td><td></td></tr></table> Post - 0 Miss - 0 Block - 0				1			1			77 穆庆丛 <table border="1"><tr><td></td><td></td><td></td></tr><tr><td></td><td></td><td></td></tr><tr><td></td><td></td><td></td></tr></table> Post - 0 Miss - 0 Block - 0																													
		1																																																																													
		2																																																																													
1																																																																															
1																																																																															

Team A				Team B				Match Number													
A 上海				B 北京				<b>15</b>													
Played in		in the hall		on		at		Spectators													
天津		天津师范大学体育馆		2017-09-04		17:30		hours													
Half-time(30')	A	B	End of playing time	A	B	1st extra time	A	B	2nd extra time	A	B	After penalty throws	A	B							
	15	5	29	19																	
Number of 7 m	A	Team time-out			Full name of players and officials						Team time-out			B	Number of 7 m						
	2/4	1	2	3							1	2	3	4/6							
<b>No.</b>	<b>Team A</b>					<b>G</b>	<b>W</b>	<b>2'</b>	<b>D</b>	<b>DR</b>	<b>No.</b>	<b>Team B</b>					<b>G</b>	<b>W</b>	<b>2'</b>	<b>D</b>	<b>DR</b>
1	许沫										1	宋嘉蕾									
2	周蕾					5	1				3	季小桐					5				
3	王嘉怡					4					6	刘亚男									
5	郭威										8	杨铭豫					1				
6	黄妍										9	宋建军									
7	车婉茹					2					10	刘莎					1				
8	吴茵					1					11	纪婉									
9	武娜娜					6	1				15	郝泽荣					1		1		
10	斯文					3					16	王海叶									
11	孙梦颖					3	1				22	李海鸥									
12	郑冯										23	赵小颖					1				
13	徐娟					2					24	郝佳楠					3				
17	居晔										27	曹芳鸣					1				
18	沙正文							1			28	闫美珠					3	1	1		
19	印尼					3		2			47	刘泽									
23	都好										69	石梓薇					3		2		
A	孙琦敏										A	蔡建国									
B	陈进培 (主教练)										B	宋刚 (主教练)									
C	贺业磊										C	关宏波									
D	金钟顺										E	王长林									
Signatures of responsables for the teams (Off.A)																				B	
TP	Remarks of referees / HF Official																		TP		

Signatures			
Referees	BALAZS. MARTON (HUN)	PETER. HORVATH (HUN)	
T.D.	张春生 (CHN)	柴业宏 (CHN)	
CHA Off.			

Note: Number of 7m Throws Awarded to Team A and B, Goals (G), Warnings (W), Suspensions (2'), Direct Disqualification (D), Disqualification With Report (DR) and Team Penalty (TP).

Table Officials: 刘菡蕊      翟延露      Statisticians: 王玮      李双

### 第十三届全国运动会女子手球决赛

**PHMS** Pictorial Handball Match Statistics

**IHF** Official System

#### 竞赛技术统计

 手球 四分之一决赛 组别 X 天津师范大学体育馆  
 女子 轮次 4 场次 15 2017-09-04 17:30

 Referees: BALAZS. MARTON (HUN) / PETER. HORVATH (HUN) Result: 29:19 (15:5)  
 Teams: 上海(上海) VS 北京(北京)

上海		远	近	边	快	突	任意	7m	合计	%	助攻	失误	警告	2'	D+DR	上海		比赛	北京			
主教练: 陈进培		射	射	射	攻	破	球	球								进程						
1	许沫										2					1st Half		0	01:14	1	10	刘莎
2	周蕾		1/1	1/2	3/3				5/6	83.3	2	1	1			0		06:43	2	28	闫美珠	
3	王嘉怡	2/2	1/1				0/1	1/1	4/5	80.0		1				13		徐娟	1	09:08	2	
5	郭威											2				2		周蕾	2	10:15	2	
6	黄妍															9		武娜娜	3	11:46	2	
7	车婉茹		1/1					1/2	2/3	66.7						7		车婉茹	4	13:17	2	
8	吴茵	1/2							1/2	50.0	1					9		武娜娜	5	14:10	2	
9	武娜娜		1/1	1/2	3/4	1/1			6/8	75.0	2	1	1			2		周蕾	6	15:04	2	
10	斯文	0/1		2/2		1/1			3/4	75.0	1					9		武娜娜	7	15:49	2	
11	孙梦颖	2/2	1/1			0/1			3/4	75.0		1	1			11		孙梦颖	8	17:12	2	
12	郑冯															19		印尼	9	19:55	2	
13	徐娟	0/1	0/1		1/1		1/1		2/4	50.0		2				2		周蕾	10	20:22	2	
17	居晔															10		武娜娜	10	21:17	3	
18	沙正文		0/1	0/1					0/2	0.0						11		孙梦颖	11	22:54	3	
19	印尼	2/3	1/1					0/1	3/5	60.0		1				19		印尼	12	26:47	4	
23	都好		0/1						0/1	0.0		1				2		周蕾	13	27:21	4	
运动员	合计	7/11	6/9	4/7	7/8	2/3	1/2	2/4	29/44	65.9	8	10	3	3		9		武娜娜	13	27:52	5	
1	许沫	4/6	0/1					0/1	4/8	50.0	2					11		孙梦颖	14	28:22	5	
12	郑冯	0/4	1/6	1/2	0/1		0/1	1/4	3/18	16.7						11		孙梦颖	15	29:51	5	
守门员	合计	4/10	1/7	1/2	0/1		0/1	1/5	7/26	26.9	2					2nd Half						
北京		远	近	边	快	突	任意	7m	合计	%	助攻	失误	警告	2'	D+DR	8		吴茵	16	00:28	5	
主教练: 宋刚		射	射	射	攻	破	球	球								16		01:30	6	23	赵小颖	
1	宋嘉蕾															16		04:34	7	69	石梓薇	
3	季小桐	1/3	2/2				1/1	1/1	5/7	71.4	3	3				2		周蕾	17	05:14	7	
6	刘亚男															17		05:43	8	8	杨铭豫	
8	杨铭豫		1/1						1/1	100		1				10		斯文	18	07:31	8	
9	宋建军							0/1	0/1	0.0						3		王嘉怡	19	10:02	8	
10	刘莎							1/1	1/1	100						9		武娜娜	20	10:55	8	
11	纪婉			0/1					0/1	0.0		1				20		12:15	9	3	季小桐	
15	郝泽荣		1/2					0/1	1/3	33.3		2		1		11		孙梦颖	21	12:46	9	
16	王海叶															21		13:48	10	15	郝泽荣	
22	李海鸥															21		14:30	11	69	石梓薇	
23	赵小颖	0/2						1/1	1/3	33.3		2				3		王嘉怡	22	15:03	11	
24	郝佳楠	0/5	2/2		1/1		0/1		3/9	33.3		2				13		徐娟	23	16:21	11	
27	曹芳鸣			1/1					1/1	100						10		斯文	23	16:21	11	
28	闫美珠	2/7						1/1	3/8	37.5		1	1	1		10		斯文	23	16:48	12	
47	刘泽															10		斯文	24	17:57	12	
69	石梓薇	3/6							3/6	50.0		3		2		3		王嘉怡	24	18:30	13	
运动员	合计	6/23	6/7	1/2	1/1		1/2	4/6	19/41	46.3	3	17	1	4		19		印尼	25	19:07	13	
1	宋嘉蕾	0/1		0/1			0/1	0/3	0/3	0.0						19		印尼	25	19:36	14	
16	王海叶	0/2	0/1	1/3	1/7			1/2	3/15	20.0		1				10		斯文	26	20:00	14	
47	刘泽	2/6	0/5	2/3	0/1	1/3		0/1	5/19	26.3						7		车婉茹	26	21:00	15	
守门员	合计	2/9	0/6	3/7	1/8	1/3	0/1	1/3	8/37	21.6		1				3		王嘉怡	26	21:00	15	
																26		20:00	14	69	石梓薇	
																10		斯文	27	23:41	15	
																7		车婉茹	27	24:51	16	
																3		王嘉怡	27	25:26	17	
																28		28:02	17	24	郝佳楠	
																28		28:53	18	3	季小桐	
																29		29:29	18			
																29		30:00	19	3	季小桐	

场上队员: 得分 / 射门

守门员: 救球 / 射门

D	取消资格	DR	取消资格+报告
---	------	----	---------



## 第十三届全国运动会女子手球决赛

PHMS Pictorial Handball Match Statistics

IHF Official System

## 个人/全队技术统计表

 手球 四分之一决赛 组别 X 天津师范大学体育馆  
 女子 轮次 4 场次 15 2017-09-04 17:30

号码	姓名	远射	近射	边射	快攻	突破	任意	七米	合计	%	助攻	失误	警告	2'	取消	时间
上海(上海)																
(场上队员)																
1	许沫									0.0%	2					00:29:22
2	周蕾		1/1	1/2	3/3				5/6	83.3%	2	1	1			00:39:56
3	王嘉怡	2/2	1/1				0/1	1/1	4/5	80.0%		1				00:20:03
5	郭威									0.0%		2				00:08:53
6	黄妍									0.0%						00:00:00
7	车婉茹		1/1					1/2	2/3	66.7%						00:19:34
8	吴茵	1/2							1/2	50.0%	1					00:35:46
9	武娜娜		1/1	1/2	3/4	1/1			6/8	75.0%	2	1	1			00:52:41
10	斯文	0/1		2/2		1/1			3/4	75.0%	1					00:30:00
11	孙梦颖	2/2	1/1			0/1			3/4	75.0%		1	1			00:48:38
12	郑冯									0.0%						00:30:38
13	徐娟	0/1	0/1		1/1		1/1		2/4	50.0%		2				00:24:33
17	居晔									0.0%						00:00:30
18	沙正文		0/1	0/1					0/2	0.0%				1		00:16:56
19	印尼	2/3	1/1					0/1	3/5	60.0%		1		2		00:29:09
23	都好		0/1						0/1	0.0%		1				00:23:44
	合计	7/11	6/9	4/7	7/8	2/3	1/2	2/4	29/44	65.9%	8	10	3	3		
(守门员)																
1	许沫	4/6	0/1					0/1	4/8	50.0%	2					00:29:22
12	郑冯	0/4	1/6	1/2	0/1		0/1	1/4	3/18	16.7%						00:30:38
	合计	4/10	1/7	1/2	0/1		0/1	1/5	7/26	26.9%	2					

场上队员：得分/射门

守门员：救球/射门

全队合计	得分	被救	射失	击柱	封球	合计	%
远射	7	2	1		1	11	63.6%
近射	6		2	1		9	66.7%
边射	4	3				7	57.1%
快攻	7	1				8	87.5%
突破	2	1				3	66.7%
任意	1		1			2	50.0%
七米	2	1		1		4	50.0%

## 第十三届全国运动会女子手球决赛

PHMS Pictorial Handball Match Statistics

IHF Official System

## 个人/全队技术统计表

 手球 四分之一决赛 组别 X 天津师范大学体育馆  
 女子 轮次 4 场次 15 2017-09-04 17:30

号码	姓名	远射	近射	边射	快攻	突破	任意	七米	合计	%	助攻	失误	警告	2'	取消	时间
北京(北京)																
(场上队员)																
1	宋嘉蕾									0.0%						00:04:03
3	季小桐	1/3	2/2				1/1	1/1	5/7	71.4%	3	3				00:43:24
6	刘亚男									0.0%						00:18:26
8	杨铭豫		1/1						1/1	100%		1				00:21:40
9	宋建军							0/1	0/1	0.0%						00:00:13
10	刘莎							1/1	1/1	100%		1				00:21:58
11	纪婉			0/1					0/1	0.0%		1				00:38:02
15	郝泽荣		1/2					0/1	1/3	33.3%		2		1		00:34:48
16	王海叶									0.0%		1				00:27:06
22	李海鸥									0.0%						00:24:35
23	赵小颖	0/2						1/1	1/3	33.3%		2				00:15:13
24	郝佳楠	0/5	2/2		1/1		0/1		3/9	33.3%		2				00:50:31
27	曹芳鸣			1/1					1/1	100%						00:19:52
28	闫美珠	2/7						1/1	3/8	37.5%		1	1	1		00:30:00
47	刘泽									0.0%						00:28:51
69	石梓薇	3/6							3/6	50.0%		3		2		00:40:47
	合计	6/23	6/7	1/2	1/1		1/2	4/6	19/41	46.3%	3	17	1	4		

## (守门员)

1	宋嘉蕾	0/1		0/1			0/1		0/3	0.0%						00:04:03
16	王海叶	0/2	0/1	1/3	1/7			1/2	3/15	20.0%		1				00:27:06
47	刘泽	2/6	0/5	2/3	0/1	1/3		0/1	5/19	26.3%						00:28:51
	合计	2/9	0/6	3/7	1/8	1/3	0/1	1/3	8/37	21.6%		1				

场上队员：得分/射门

守门员：救球/射门

全队合计	得分	被救	射失	击柱	封球	合计	%
远射	6	4	3	3	7	23	26.1%
近射	6	1				7	85.7%
边射	1	1				2	50.0%
快攻	1					1	100.0%
突破							0.0%
任意	1		1			2	50.0%
七米	4	1		1		6	66.7%

第十三届全国运动会女子手球决赛

PHMS Pictorial Handball Match Statistics

IHF Official System

图式比赛技术统计表

手球  
女子

四分之一决赛  
轮次 4

组别 X  
场次 15

天津师范大学体育馆  
2017-09-04 17:30

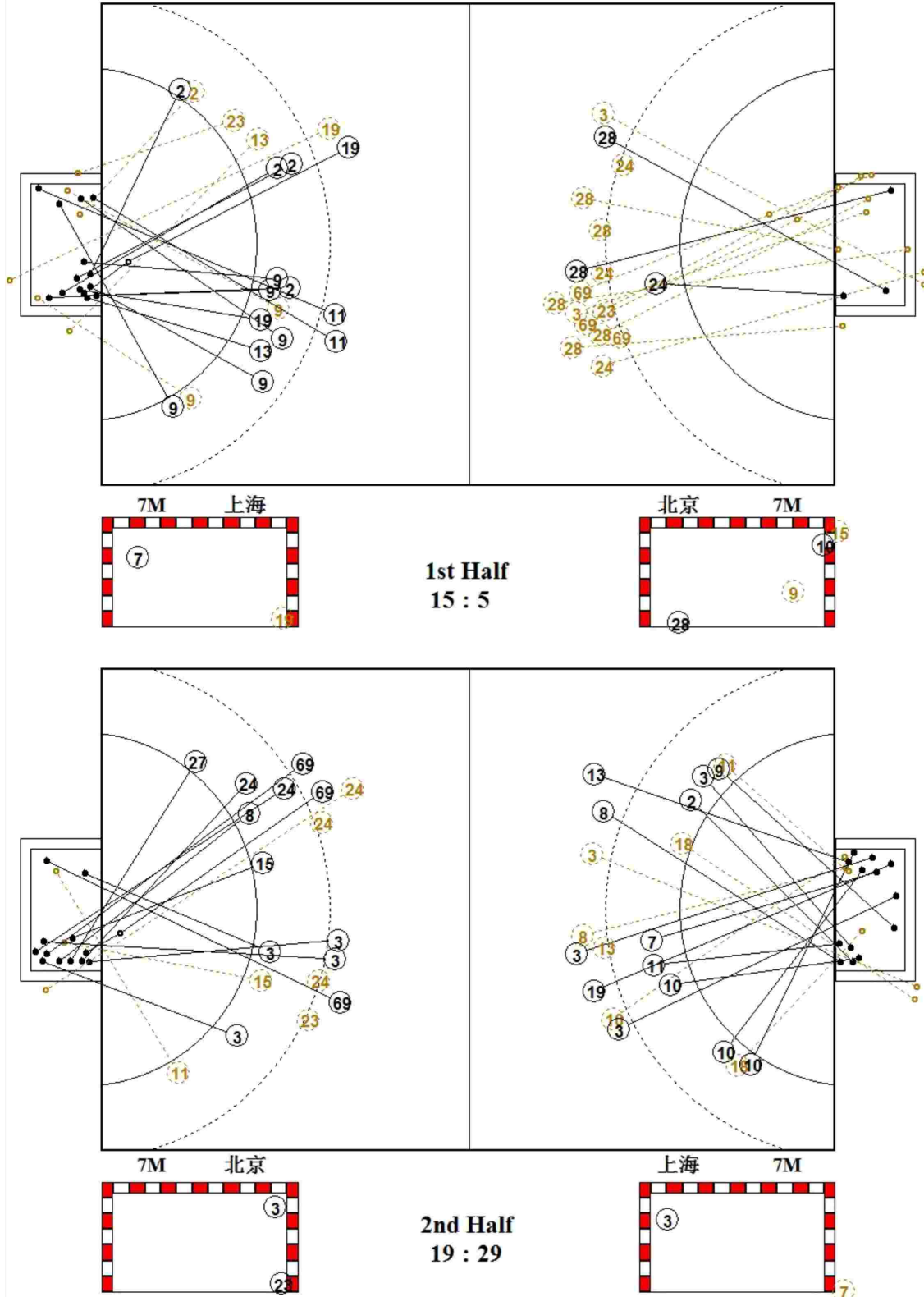

第十三届全国运动会女子手球决赛

PHMS Pictorial Handball Match Statistics

IHF Official System

图式射门区域统计

手球  
女子

四分之一决赛  
轮次 4

组别 X  
场次 15

天津师范大学体育馆  
2017-09-04 17:30

上海

1 许沫 <table border="1"><tr><td></td><td></td><td></td></tr><tr><td></td><td></td><td></td></tr><tr><td></td><td></td><td></td></tr></table> Post - 0 Miss - 0 Block - 0										2 周蕾 <table border="1"><tr><td>1</td><td></td><td></td></tr><tr><td>2</td><td></td><td></td></tr><tr><td>1</td><td></td><td>1</td></tr></table> Post - 0 Miss - 0 Block - 0	1			2			1		1	3 王嘉怡 <table border="1"><tr><td>1</td><td>1</td><td></td></tr><tr><td>1</td><td></td><td></td></tr><tr><td></td><td></td><td>1</td></tr></table> Post - 0 Miss - 1 Block - 0	1	1		1					1	5 郭威 <table border="1"><tr><td></td><td></td><td></td></tr><tr><td></td><td></td><td></td></tr><tr><td></td><td></td><td></td></tr></table> Post - 0 Miss - 0 Block - 0										6 黄妍 <table border="1"><tr><td></td><td></td><td></td></tr><tr><td></td><td></td><td></td></tr><tr><td></td><td></td><td></td></tr></table> Post - 0 Miss - 0 Block - 0										7 车婉茹 <table border="1"><tr><td>1</td><td></td><td></td></tr><tr><td>1</td><td></td><td></td></tr><tr><td></td><td></td><td></td></tr></table> Post - 1 Miss - 0 Block - 0	1			1						8 吴茵 <table border="1"><tr><td></td><td></td><td></td></tr><tr><td></td><td></td><td></td></tr><tr><td></td><td></td><td>1</td></tr></table> Post - 0 Miss - 0 Block - 0									1	9 武娜娜 <table border="1"><tr><td></td><td>1</td><td></td></tr><tr><td></td><td></td><td>1</td></tr><tr><td>2</td><td>1</td><td>1</td></tr></table> Post - 0 Miss - 0 Block - 0		1				1	2	1	1
1																																																																															
2																																																																															
1		1																																																																													
1	1																																																																														
1																																																																															
		1																																																																													
1																																																																															
1																																																																															
		1																																																																													
	1																																																																														
		1																																																																													
2	1	1																																																																													
10 斯文 <table border="1"><tr><td></td><td></td><td></td></tr><tr><td>1</td><td></td><td>1</td></tr><tr><td>1</td><td></td><td></td></tr></table> Post - 0 Miss - 0 Block - 0				1		1	1			11 孙梦颖 <table border="1"><tr><td></td><td></td><td>1</td></tr><tr><td></td><td></td><td></td></tr><tr><td></td><td></td><td>2</td></tr></table> Post - 0 Miss - 0 Block - 0			1						2	12 郑冯 <table border="1"><tr><td></td><td></td><td></td></tr><tr><td></td><td></td><td></td></tr><tr><td></td><td></td><td></td></tr></table> Post - 0 Miss - 0 Block - 0										13 徐娟 <table border="1"><tr><td></td><td></td><td></td></tr><tr><td></td><td></td><td></td></tr><tr><td>2</td><td></td><td></td></tr></table> Post - 0 Miss - 1 Block - 1							2			17 居晔 <table border="1"><tr><td></td><td></td><td></td></tr><tr><td></td><td></td><td></td></tr><tr><td></td><td></td><td></td></tr></table> Post - 0 Miss - 0 Block - 0										18 沙正文 <table border="1"><tr><td></td><td></td><td></td></tr><tr><td></td><td></td><td></td></tr><tr><td></td><td></td><td></td></tr></table> Post - 0 Miss - 1 Block - 0										19 印尼 <table border="1"><tr><td>1</td><td></td><td></td></tr><tr><td></td><td></td><td></td></tr><tr><td>2</td><td></td><td></td></tr></table> Post - 0 Miss - 1 Block - 0	1						2			23 都好 <table border="1"><tr><td></td><td></td><td></td></tr><tr><td></td><td></td><td></td></tr><tr><td></td><td></td><td></td></tr></table> Post - 1 Miss - 0 Block - 0									
1		1																																																																													
1																																																																															
		1																																																																													
		2																																																																													
2																																																																															
1																																																																															
2																																																																															

1 □□

0/1		0/2
2/2		
1/1	1/1	0/1

12 □□

0/4		0/2
1/4		2/2
0/4		0/2

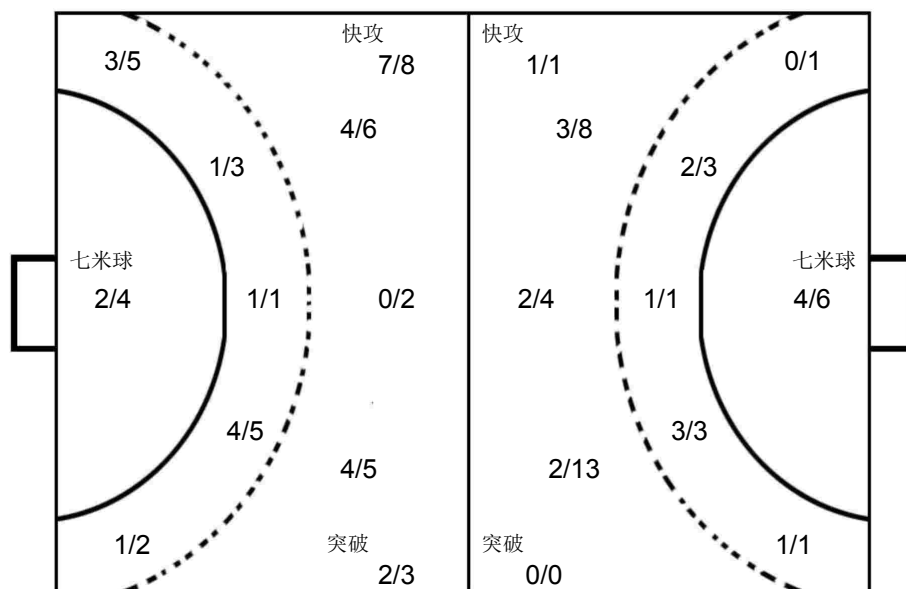

1 □□□

	0/1	
0/1		
0/1		

16 □□□

1/2		0/1
0/2		1/2
0/6		1/2

47 □□

0/3	0/1	
0/2		1/2
3/4	0/1	1/6

北京

1 宋嘉蕾 <table border="1"><tr><td></td><td></td><td></td></tr><tr><td></td><td></td><td></td></tr><tr><td></td><td></td><td></td></tr></table> Post - 0 Miss - 0 Block - 0										3 季小桐 <table border="1"><tr><td>2</td><td></td><td>1</td></tr><tr><td>1</td><td></td><td>1</td></tr><tr><td></td><td></td><td></td></tr></table> Post - 0 Miss - 1 Block - 0	2		1	1		1				6 刘亚男 <table border="1"><tr><td></td><td></td><td></td></tr><tr><td></td><td></td><td></td></tr><tr><td></td><td></td><td></td></tr></table> Post - 0 Miss - 0 Block - 0										8 杨铭豫 <table border="1"><tr><td></td><td></td><td></td></tr><tr><td>1</td><td></td><td></td></tr><tr><td></td><td></td><td></td></tr></table> Post - 0 Miss - 0 Block - 0				1						9 宋建军 <table border="1"><tr><td></td><td></td><td></td></tr><tr><td></td><td></td><td></td></tr><tr><td></td><td></td><td></td></tr></table> Post - 0 Miss - 0 Block - 0										10 刘莎 <table border="1"><tr><td></td><td></td><td>1</td></tr><tr><td></td><td></td><td></td></tr><tr><td></td><td></td><td></td></tr></table> Post - 0 Miss - 0 Block - 0			1							11 纪婉 <table border="1"><tr><td></td><td></td><td></td></tr><tr><td></td><td></td><td></td></tr><tr><td></td><td></td><td></td></tr></table> Post - 0 Miss - 0 Block - 0										15 郝泽荣 <table border="1"><tr><td></td><td></td><td></td></tr><tr><td>1</td><td></td><td></td></tr><tr><td></td><td></td><td></td></tr></table> Post - 1 Miss - 0 Block - 0				1					
2		1																																																																													
1		1																																																																													
1																																																																															
		1																																																																													
1																																																																															
16 王海叶 <table border="1"><tr><td></td><td></td><td></td></tr><tr><td></td><td></td><td></td></tr><tr><td></td><td></td><td></td></tr></table> Post - 0 Miss - 0 Block - 0										22 李海鸥 <table border="1"><tr><td></td><td></td><td></td></tr><tr><td></td><td></td><td></td></tr><tr><td></td><td></td><td></td></tr></table> Post - 0 Miss - 0 Block - 0										23 赵小颖 <table border="1"><tr><td></td><td></td><td></td></tr><tr><td></td><td></td><td>1</td></tr><tr><td></td><td></td><td></td></tr></table> Post - 0 Miss - 0 Block - 1						1				24 郝佳楠 <table border="1"><tr><td>1</td><td></td><td></td></tr><tr><td>1</td><td></td><td>1</td></tr><tr><td></td><td></td><td></td></tr></table> Post - 0 Miss - 2 Block - 4	1			1		1				27 曹芳鸣 <table border="1"><tr><td></td><td></td><td></td></tr><tr><td>1</td><td></td><td></td></tr><tr><td></td><td></td><td></td></tr></table> Post - 0 Miss - 0 Block - 0				1						28 闫美珠 <table border="1"><tr><td>1</td><td></td><td>1</td></tr><tr><td>1</td><td></td><td></td></tr><tr><td></td><td></td><td></td></tr></table> Post - 1 Miss - 1 Block - 1	1		1	1						47 刘泽 <table border="1"><tr><td></td><td></td><td></td></tr><tr><td></td><td></td><td></td></tr><tr><td></td><td></td><td></td></tr></table> Post - 0 Miss - 0 Block - 0										69 石梓薇 <table border="1"><tr><td>1</td><td></td><td>1</td></tr><tr><td>1</td><td></td><td></td></tr><tr><td></td><td></td><td></td></tr></table> Post - 2 Miss - 0 Block - 1	1		1	1					
		1																																																																													
1																																																																															
1		1																																																																													
1																																																																															
1		1																																																																													
1																																																																															
1		1																																																																													
1																																																																															

Team A					Team B					Match Number								
A 江苏					B 天津					<b>16</b>								
Played in			in the hall			on			at			Spectators						
天津			天津师范大学体育馆			2017-09-04			19:15			hours						
Half-time(30')	A	B	End of playing time		A	B	1st extra time		A	B	2nd extra time		A	B	After penalty throws		A	B
	19	5	36		12													
Number of 7 m	A	Team time-out			Full name of players and officials						Team time-out			B	Number of 7 m			
	2/2	1	2	3							1	2	3	0/1				

No.	Team A	G	W	2'	D	DR	No.	Team B	G	W	2'	D	DR
1	陆婷						1	张莉					
3	张海侠	8		1			3	王晓梅					
4	赵佳芹	1					5	丁丽洁					
7	周琦			1			6	窦海乐					
8	乔如	2					7	张心茹		1			
9	莫蒙蒙	1	1				8	张慧					
11	于源源	2					9	袁玉	3				
12	黄霞						10	张文慧	2				
13	黄慧影	2					11	蔡雪洁	2				
16	王小华						12	王欣冉					
17	修丽杰	2	1				14	刘洁					
18	韦秋香	5					16	王选					
19	李薇薇	3					17	聂晓雪					
23	王书慧	2	1				18	舒文琪	1		1		
33	金梦青	5					23	周梦雪	4	1			
69	蓝小玲	3											
A	姚治前						A	付明双					
B	金甲洙 (主教练)						B	王明星 (主教练)					
C	马彪						C	岳连娥					
D	刘凯						D	张圆圆					
A		Signatures of responsables for the teams (Off.A)											B
TP	Remarks of referees / HF Official												TP

	Referees	叶霄雪 (CHN)	张之伟 (CHN)	
	T.D.	张春生 (CHN)	柴业宏 (CHN)	
	CHA Off.			

Note: Number of 7m Throws Awarded to Team A and B, Goals (G), Warnings (W), Suspensions (2'), Direct Disqualification (D), Disqualification With Report (DR) and Team Penalty (TP).

Table Officials: 谷瑶                      张智伟                      Statisticians: 周强                      杜宪



## 第十三届全国运动会女子手球决赛

PHMS Pictorial Handball Match Statistics

IHF Official System

### 竞赛技术统计

手球  
女子

四分之一决赛  
轮次 4

组别 X  
场次 16

天津师范大学体育馆  
2017-09-04 19:15

Referees: 叶霄雪 (CHN) / 张之伟 (CHN) Result: 36:12 (19:5)  
Teams: 江苏(江苏) VS 天津(天津)

江苏		远射	近射	边射	快攻	突破	任意球	7m球	合计	%	助攻	失误	警告	2'	D+DR
主教练:	金甲洙														
1	陆婷										2				
3	张海侠	1/1		2/2	5/5				8/8	100				1	
4	赵佳芹	1/1							1/1	100	1	1			
7	周琦													1	
8	乔如		0/1		1/1			1/1	2/3	66.7		1			
9	莫蒙蒙		1/1						1/1	100		3	1		
11	于源源			1/3	0/1	1/1			2/5	40.0		2			
12	黄霞										2	1			
13	黄慧影			0/2	2/2				2/4	50.0					
16	王小华										1				
17	修丽杰	1/3			1/1				2/4	50.0		1	1		
18	韦秋香	0/1	1/1	1/1	3/3				5/6	83.3	1	1			
19	李薇薇	1/2					1/1	1/1	3/4	75.0					
23	王书慧	1/2		0/1	1/1		0/1		2/5	40.0		1	1		
33	金梦青	2/3	2/2	0/1	1/1	0/1			5/8	62.5	1	2			
69	蓝小玲	0/2	1/1	1/1		1/1			3/5	60.0	2	1			
运动员	合计	7/15	5/6	5/11	14/15	2/3	1/2	2/2	36/54	66.7	10	14	3	2	
1	陆婷	4/5	1/2	1/2	0/1	0/2		1/1	7/13	53.8	2				
12	黄霞	1/3	4/6		1/1		1/1		7/11	63.6	2	1			
16	王小华	1/1	3/4	2/2		0/1			6/8	75.0	1				
守门员	合计	6/9	8/12	3/4	1/2	0/3	1/1	1/1	20/32	62.5	5	1			

江苏	比赛进程	天津
	1st Half	
11	于源源	1 00:43 0
33	金梦青	2 01:32 0
17	修丽杰	3 02:07 0
3	张海侠	4 02:59 0
69	蓝小玲	5 05:46 0
3	张海侠	6 07:04 0
	6 07:46 1	23 周梦雪
4	赵佳芹	7 08:19 1
3	张海侠	8 10:24 1
	8 10:59 2	9 袁玉
3	张海侠	9 11:27 2
33	金梦青	10 15:48 2
11	于源源	11 16:37 2
33	金梦青	12 17:57 2
9	莫蒙蒙	13 19:06 2
3	张海侠	14 19:48 2
19	李薇薇	15 21:49 2
3	张海侠	16 22:53 2
19	李薇薇	17 24:23 2
19	李薇薇	18 25:51 2
	18 26:30 3	10 张文慧
	18 27:28 4	9 袁玉
13	黄慧影	19 29:09 4
	19 29:45 5	9 袁玉
	2nd Half	
	19 01:41 6	23 周梦雪
8	乔如	20 02:07 6
3	张海侠	21 03:21 6
8	乔如	22 04:27 6
	22 05:04 7	23 周梦雪
3	张海侠	23 05:53 7
69	蓝小玲	24 08:43 7
	24 10:13 8	23 周梦雪
18	韦秋香	25 10:46 8
69	蓝小玲	26 12:35 8
18	韦秋香	27 15:13 8
33	金梦青	28 17:18 8
18	韦秋香	29 18:04 8
18	韦秋香	30 19:46 8
33	金梦青	31 21:13 8
17	修丽杰	32 22:59 8
	32 23:24 9	11 蔡雪洁
	32 24:09 10	18 舒文琪
	32 25:39 11	10 张文慧
23	王书慧	33 26:25 11
18	韦秋香	34 27:04 11
23	王书慧	35 27:50 11
	35 29:11 12	11 蔡雪洁
13	黄慧影	36 30:00 12

场上队员: 得分 / 射门

守门员: 救球 / 射门

D	取消资格	DR	取消资格+报告
---	------	----	---------

## 第十三届全国运动会女子手球决赛

PHMS Pictorial Handball Match Statistics

IHF Official System

## 个人/全队技术统计表

 手球 四分之一决赛 组别 X 天津师范大学体育馆  
 女子 轮次 4 场次 16 2017-09-04 19:15

号码	姓名	远射	近射	边射	快攻	突破	任意	七米	合计	%	助攻	失误	警告	2'	取消	时间
江苏(江苏)																
(场上队员)																
1	陆婷									0.0%	2					00:18:56
3	张海侠	1/1		2/2	5/5				8/8	100%				1		00:35:25
4	赵佳芹	1/1							1/1	100%	1	1				00:27:43
7	周琦									0.0%				1		00:13:00
8	乔如		0/1		1/1			1/1	2/3	66.7%		1				00:16:33
9	莫蒙蒙		1/1						1/1	100%		3	1			00:35:33
11	于源源			1/3	0/1	1/1			2/5	40.0%		2				00:51:00
12	黄霞									0.0%	2	1				00:19:33
13	黄慧影			0/2	2/2				2/4	50.0%						00:04:08
16	王小华									0.0%	1					00:21:31
17	修丽杰	1/3			1/1				2/4	50.0%		1	1			00:29:39
18	韦秋香	0/1	1/1	1/1	3/3				5/6	83.3%	1	1				00:20:17
19	李薇薇	1/2					1/1	1/1	3/4	75.0%						00:21:46
23	王书慧	1/2		0/1	1/1		0/1		2/5	40.0%		1	1			00:25:46
33	金梦青	2/3	2/2	0/1	1/1	0/1			5/8	62.5%	1	2				00:37:31
69	蓝小玲	0/2	1/1	1/1		1/1			3/5	60.0%	2	1				00:41:09
	合计	7/15	5/6	5/11	14/15	2/3	1/2	2/2	36/54	66.7%	10	14	3	2		
(守门员)																
1	陆婷	4/5	1/2	1/2	0/1	0/2		1/1	7/13	53.8%	2					00:18:56
12	黄霞	1/3	4/6		1/1		1/1		7/11	63.6%	2	1				00:19:33
16	王小华	1/1	3/4	2/2		0/1			6/8	75.0%	1					00:21:31
	合计	6/9	8/12	3/4	1/2	0/3	1/1	1/1	20/32	62.5%	5	1				

场上队员：得分/射门

守门员：救球/射门

全队合计	得分	被救	射失	击柱	封球	合计	%
远射	7	5	1	1	1	15	46.7%
近射	5	1				6	83.3%
边射	5	3	1	2		11	45.5%
快攻	14	1				15	93.3%
突破	2	1				3	66.7%
任意	1	1				2	50.0%
七米	2					2	100.0%

## 第十三届全国运动会女子手球决赛

PHMS Pictorial Handball Match Statistics

IHF Official System

## 个人/全队技术统计表

 手球 四分之一决赛 组别 X 天津师范大学体育馆  
 女子 轮次 4 场次 16 2017-09-04 19:15

号码	姓名	远射	近射	边射	快攻	突破	任意	七米	合计	%	助攻	失误	警告	2'	取消	时间
天津(天津)																
(场上队员)																
1	张莉									0.0%						00:30:06
3	王晓梅	0/3	0/2						0/5	0.0%						00:24:23
5	丁丽洁									0.0%						00:00:00
6	窦海乐									0.0%						00:00:00
7	张心茹	0/1		0/1					0/2	0.0%			1			00:07:07
8	张慧									0.0%						01:00:00
9	袁玉	0/2	0/3		1/1	2/2			3/8	37.5%	1	4				00:47:22
10	张文慧		2/3		0/1				2/4	50.0%						01:00:00
11	蔡雪洁	1/2	1/2						2/4	50.0%		3				00:39:00
12	王欣冉									0.0%						00:14:31
14	刘洁									0.0%		2				00:12:37
16	王选									0.0%						00:15:23
17	聂晓雪			0/2					0/2	0.0%		1				00:33:12
18	舒文琪	1/5	0/1				0/1		1/7	14.3%	3	2		1		00:35:13
23	周梦雪	1/5	1/3	1/1		1/1		0/1	4/11	36.4%	1	5	1			00:40:36
合计		3/18	4/14	1/4	1/2	3/3	0/1	0/1	12/43	27.9%	5	17	2	1		
(守门员)																
1	张莉	5/7	1/4	1/4	0/5		1/2	0/2	8/24	33.3%						00:30:06
12	王欣冉	0/2	0/1	1/2	1/5	1/2			3/12	25.0%						00:14:31
16	王选	0/3	0/1	1/2	0/5	0/1			1/12	8.3%						00:15:23
合计		5/12	1/6	3/8	1/15	1/3	1/2	0/2	12/48	25.0%						

场上队员：得分/射门

守门员：救球/射门

全队合计	得分	被救	射失	击柱	封球	合计	%
远射	3	6	3	1	5	18	16.7%
近射	4	8	1	1		14	28.6%
边射	1	3				4	25.0%
快攻	1	1				2	50.0%
突破	3					3	100.0%
任意		1				1	0.0%
七米		1				1	0.0%

第十三届全国运动会女子手球决赛

PHMS Pictorial Handball Match Statistics

IHF Official System

图式比赛技术统计表

手球  
女子

四分之一决赛  
轮次 4

组别 X  
场次 16

天津师范大学体育馆  
2017-09-04 19:15

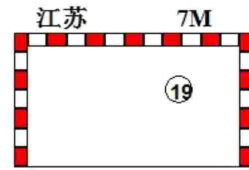
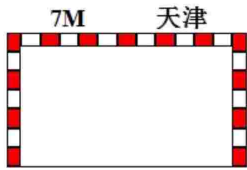
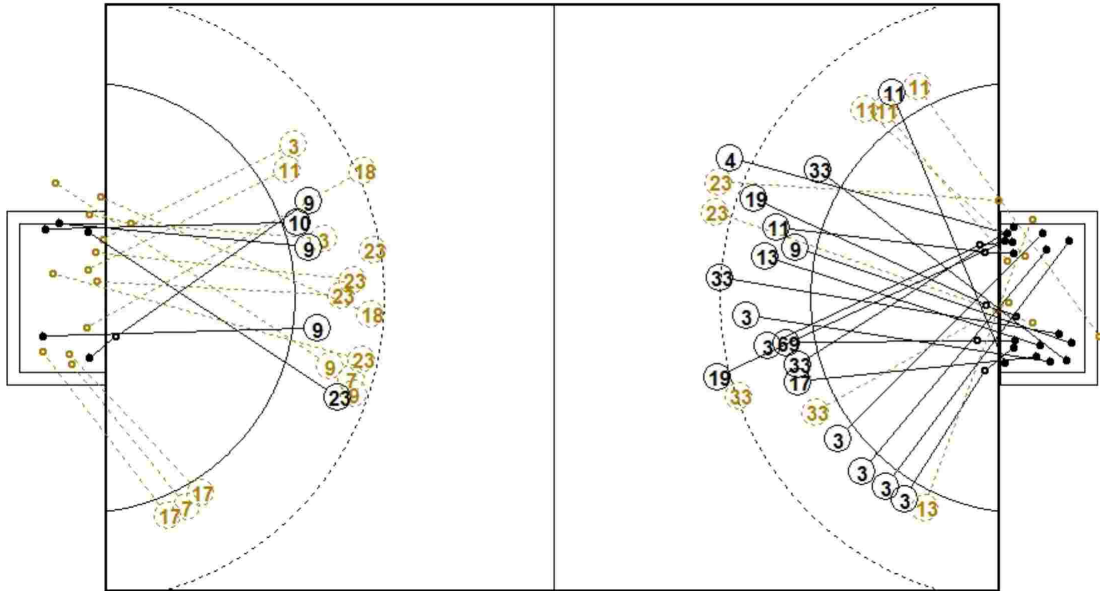

1st Half  
5 : 19

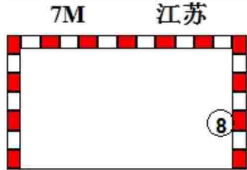
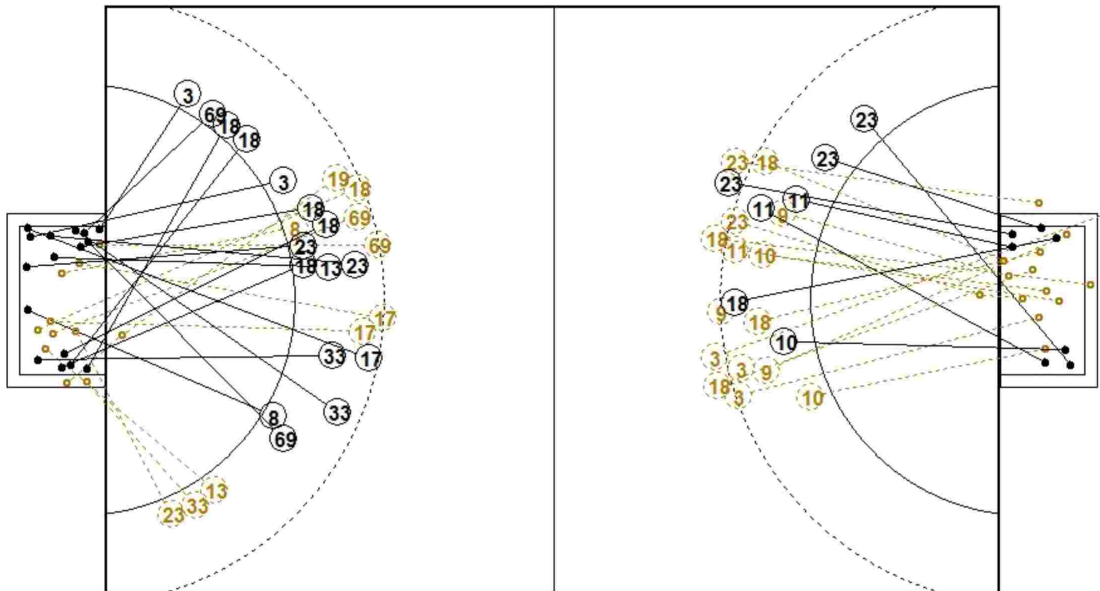

2nd Half  
36 : 12

第十三届全国运动会女子手球决赛

PHMS Pictorial Handball Match Statistics

IHF Official System

图式射门区域统计

手球  
女子

四分之一决赛  
轮次 4

组别 X  
场次 16

天津师范大学体育馆  
2017-09-04 19:15

江苏

1 陆婷 <table border="1"><tr><td></td><td></td><td></td></tr><tr><td></td><td></td><td></td></tr><tr><td></td><td></td><td></td></tr></table> Post - 0 Miss - 0 Block - 0										3 张海侠 <table border="1"><tr><td>1</td><td></td><td>1</td></tr><tr><td>2</td><td></td><td>1</td></tr><tr><td>1</td><td></td><td>2</td></tr></table> Post - 0 Miss - 0 Block - 0	1		1	2		1	1		2	4 赵佳芹 <table border="1"><tr><td></td><td></td><td></td></tr><tr><td></td><td></td><td></td></tr><tr><td>1</td><td></td><td></td></tr></table> Post - 0 Miss - 0 Block - 0							1			7 周琦 <table border="1"><tr><td></td><td></td><td></td></tr><tr><td></td><td></td><td></td></tr><tr><td></td><td></td><td></td></tr></table> Post - 0 Miss - 0 Block - 0										8 乔如 <table border="1"><tr><td></td><td>1</td><td></td></tr><tr><td></td><td></td><td>1</td></tr><tr><td></td><td></td><td></td></tr></table> Post - 0 Miss - 0 Block - 0		1				1				9 莫蒙蒙 <table border="1"><tr><td></td><td></td><td>1</td></tr><tr><td></td><td></td><td></td></tr><tr><td></td><td></td><td></td></tr></table> Post - 0 Miss - 0 Block - 0			1							11 于源源 <table border="1"><tr><td></td><td></td><td></td></tr><tr><td></td><td></td><td></td></tr><tr><td>1</td><td></td><td>1</td></tr></table> Post - 0 Miss - 1 Block - 0							1		1	12 黄霞 <table border="1"><tr><td></td><td></td><td></td></tr><tr><td></td><td></td><td></td></tr><tr><td></td><td></td><td></td></tr></table> Post - 0 Miss - 0 Block - 0									
1		1																																																																													
2		1																																																																													
1		2																																																																													
1																																																																															
	1																																																																														
		1																																																																													
		1																																																																													
1		1																																																																													
13 黄慧影 <table border="1"><tr><td></td><td></td><td>2</td></tr><tr><td></td><td></td><td></td></tr><tr><td></td><td></td><td></td></tr></table> Post - 1 Miss - 0 Block - 0			2							16 王小华 <table border="1"><tr><td></td><td></td><td></td></tr><tr><td></td><td></td><td></td></tr><tr><td></td><td></td><td></td></tr></table> Post - 0 Miss - 0 Block - 0										17 修丽杰 <table border="1"><tr><td></td><td></td><td>1</td></tr><tr><td></td><td></td><td>1</td></tr><tr><td></td><td></td><td></td></tr></table> Post - 0 Miss - 0 Block - 0			1			1				18 韦秋香 <table border="1"><tr><td></td><td></td><td></td></tr><tr><td>3</td><td></td><td></td></tr><tr><td>1</td><td></td><td>1</td></tr></table> Post - 0 Miss - 0 Block - 0				3			1		1	19 李薇薇 <table border="1"><tr><td></td><td></td><td>1</td></tr><tr><td></td><td></td><td></td></tr><tr><td>1</td><td>1</td><td></td></tr></table> Post - 1 Miss - 0 Block - 0			1				1	1		23 王书慧 <table border="1"><tr><td></td><td></td><td>1</td></tr><tr><td></td><td></td><td>1</td></tr><tr><td></td><td></td><td></td></tr></table> Post - 0 Miss - 1 Block - 0			1			1				33 金梦青 <table border="1"><tr><td>1</td><td></td><td>2</td></tr><tr><td></td><td></td><td>1</td></tr><tr><td>1</td><td></td><td></td></tr></table> Post - 1 Miss - 0 Block - 1	1		2			1	1			69 蓝小玲 <table border="1"><tr><td></td><td></td><td></td></tr><tr><td></td><td></td><td></td></tr><tr><td></td><td></td><td>3</td></tr></table> Post - 0 Miss - 0 Block - 0									3
		2																																																																													
		1																																																																													
		1																																																																													
3																																																																															
1		1																																																																													
		1																																																																													
1	1																																																																														
		1																																																																													
		1																																																																													
1		2																																																																													
		1																																																																													
1																																																																															
		3																																																																													

1 □□

0/1		0/2
1/2	1/1	1/2
2/3	2/2	

12 □□

1/2	1/1	0/1
2/2	1/1	1/2
0/1	1/1	

16 □□□

1/1		
1/1	1/1	
0/1		3/4

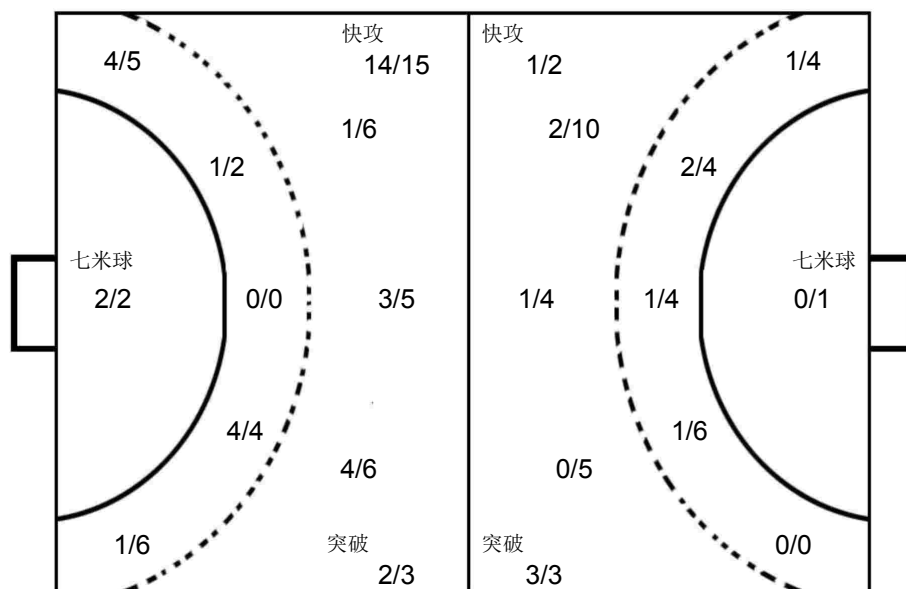

1 □□

2/3	0/1	0/3
1/3	2/2	1/4
0/2		2/6

12 □□□

		0/2
0/2		
2/5	1/2	0/1

16 □□

0/1		0/2
1/2		0/4
0/1		0/2

天津

1 张莉 <table border="1"><tr><td></td><td></td><td></td></tr><tr><td></td><td></td><td></td></tr><tr><td></td><td></td><td></td></tr></table> Post - 0 Miss - 0 Block - 0										3 王晓梅 <table border="1"><tr><td></td><td></td><td></td></tr><tr><td></td><td></td><td></td></tr><tr><td></td><td></td><td></td></tr></table> Post - 1 Miss - 1 Block - 1										5 丁丽洁 <table border="1"><tr><td></td><td></td><td></td></tr><tr><td></td><td></td><td></td></tr><tr><td></td><td></td><td></td></tr></table> Post - 0 Miss - 0 Block - 0										6 窦海乐 <table border="1"><tr><td></td><td></td><td></td></tr><tr><td></td><td></td><td></td></tr><tr><td></td><td></td><td></td></tr></table> Post - 0 Miss - 0 Block - 0										7 张心茹 <table border="1"><tr><td></td><td></td><td></td></tr><tr><td></td><td></td><td></td></tr><tr><td></td><td></td><td></td></tr></table> Post - 0 Miss - 0 Block - 1										8 张慧 <table border="1"><tr><td></td><td></td><td></td></tr><tr><td></td><td></td><td></td></tr><tr><td></td><td></td><td></td></tr></table> Post - 0 Miss - 0 Block - 0										9 袁玉 <table border="1"><tr><td>1</td><td></td><td></td></tr><tr><td></td><td></td><td>1</td></tr><tr><td>1</td><td></td><td></td></tr></table> Post - 0 Miss - 1 Block - 2	1					1	1			10 张文慧 <table border="1"><tr><td></td><td></td><td>2</td></tr><tr><td></td><td></td><td></td></tr><tr><td></td><td></td><td></td></tr></table> Post - 0 Miss - 0 Block - 0			2						
1																																																																															
		1																																																																													
1																																																																															
		2																																																																													
11 蔡雪洁 <table border="1"><tr><td></td><td></td><td>1</td></tr><tr><td>1</td><td></td><td></td></tr><tr><td></td><td></td><td></td></tr></table> Post - 0 Miss - 0 Block - 0			1	1						12 王欣冉 <table border="1"><tr><td></td><td></td><td></td></tr><tr><td></td><td></td><td></td></tr><tr><td></td><td></td><td></td></tr></table> Post - 0 Miss - 0 Block - 0										14 刘洁 <table border="1"><tr><td></td><td></td><td></td></tr><tr><td></td><td></td><td></td></tr><tr><td></td><td></td><td></td></tr></table> Post - 0 Miss - 0 Block - 0										16 王选 <table border="1"><tr><td></td><td></td><td></td></tr><tr><td></td><td></td><td></td></tr><tr><td></td><td></td><td></td></tr></table> Post - 0 Miss - 0 Block - 0										17 聂晓雪 <table border="1"><tr><td></td><td></td><td></td></tr><tr><td></td><td></td><td></td></tr><tr><td></td><td></td><td></td></tr></table> Post - 0 Miss - 0 Block - 0										18 舒文琪 <table border="1"><tr><td>1</td><td></td><td></td></tr><tr><td></td><td></td><td></td></tr><tr><td></td><td></td><td></td></tr></table> Post - 1 Miss - 1 Block - 0	1									23 周梦雪 <table border="1"><tr><td></td><td></td><td>1</td></tr><tr><td>1</td><td></td><td></td></tr><tr><td>1</td><td></td><td>1</td></tr></table> Post - 0 Miss - 1 Block - 1			1	1			1		1										
		1																																																																													
1																																																																															
1																																																																															
		1																																																																													
1																																																																															
1		1																																																																													

**PHMS** Pictorial Handball Match Statistics

**IHF** Official System

Team A				Team B				Match Number													
A 新疆				B 山东				<b>17</b>													
Played in		in the hall		on		at		Spectators													
天津		天津师范大学体育馆		2017-09-05		14:00		hours													
Half-time(30')	A	B	End of playing time	A	B	1st extra time	A	B	2nd extra time	A	B	After penalty throws	A	B							
	5	9	18	19																	
Number of 7 m	A	Team time-out			Full name of players and officials						Team time-out			B	Number of 7 m						
	4/6	1	2	3							1	2	3	3/4							
		15:57	43:53	58:49					26:06	53:53	59:50										
No.	Team A					G	W	2'	D	DR	No.	Team B					G	W	2'	D	DR
3	葛立双										1	路畅									
5	于千添										2	林燕群					5	1			
6	阿热孜古丽					4	1	1			6	王莎莎							1		
7	吴志娟										8	王彬					6				
10	李静										11	吕青纹					2				
11	陈培培										12	张苑琳									
12	艾敏										15	吴作扬									
15	兰姝娇					3		1			19	姜伟珊									
17	戴莹莹										20	张悦					1		1		
18	崔娟					2	1				22	朱赟									
21	锁珊珊					2					23	徐悦							1		
23	张艺璇										28	崔金娜					1	1			
26	宋婷婷							1			33	王彩琳					3	1	1		
27	谢辰辰					1					77	穆庆丛					1				
32	杨雨柔																				
93	张婷婷					6	1														
A	刁继平										B	马海湧 (主教练)					1				
B	于涛 (主教练)										C	徐强									
C	李天坐										D	孔德宾									
											E	王日东									
A	Signatures of responsables for the teams (Off.A)														B						
TP	Remarks of referees / HF Official														TP						
Signatures																					
Referees	BALAZS. MARTON (HUN)					PETER. HORVATH (HUN)															
T.D.	张春生 (CHN)					柴业宏 (CHN)															
CHA Off.																					

Note: Number of 7m Throws Awarded to Team A and B, Goals (G), Warnings (W), Suspensions (2'), Direct Disqualification (D), Disqualification With Report (DR) and Team Penalty (TP).

Table Officials: 刘菡蕊

翟延露

Statisticians: 杜宪

周强

### 第十三届全国运动会女子手球决赛

PHMS Pictorial Handball Match Statistics IHF Official System

#### 竞赛技术统计

手球 5-8名 组别 X 天津师范大学体育馆  
女子 轮次 5 场次 17 2017-09-05 14:00

Referees: BALAZS. MARTON (HUN) / PETER. HORVATH (HUN) Result: 18:19(5:9)  
Teams: 新疆(新疆) VS 山东(山东)

新疆		远射	近射	边射	快攻	突破	任意球	7m球	合计	%	助攻	失误	警告	2'	D+DR
主教练: 于涛															
3	葛立双														
5	于千添														
6	阿热孜古丽		3/3	1/1				0/1	4/5	80.0		3	1	1	
7	吴志娟			0/1					0/1	0.0	1	1			
10	李静														
11	陈培培														
12	艾敏														
15	兰姝娇		1/2	2/3					3/5	60.0		1		1	
17	戴莹莹										1				
18	崔娟	1/6	1/1						2/7	28.6		1	1		
21	锁珊珊	0/4	1/1		1/1			0/1	2/7	28.6					
23	张艺璇														
26	宋婷婷	0/1							0/1	0.0				1	
27	谢辰辰							1/1	1/1	100					
32	杨雨柔														
93	张婷婷	1/3			1/1	0/2	1/1	3/3	6/10	60.0	3	2	1		
运动员 合计		2/14	6/7	3/5	2/2	0/2	1/1	4/6	18/37	48.6	5	8	3	3	
10	李静							0/2	0/2	0.0					
32	杨雨柔	1/3	4/9	1/5	1/2	1/3	0/2	1/2	9/26	34.6					
守门员 合计		1/3	4/9	1/5	1/2	1/3	0/2	1/4	9/28	32.1					

山东		远射	近射	边射	快攻	突破	任意球	7m球	合计	%	助攻	失误	警告	2'	D+DR
主教练: 马海湧															
1	路畅														
2	林燕群	2/5	1/1	1/1				1/1	5/8	62.5		4	1		
6	王莎莎													1	
8	王彬	0/1	1/1	1/1		1/1	1/1	2/3	6/8	75.0	1	3			
11	吕青纹		1/1	1/1					2/2	100	1	1			
12	张苑琳														
15	吴作扬											1			
19	姜伟珊														
20	张悦			1/2	0/1				1/3	33.3		1		1	
22	朱贇										1				
23	徐悦													1	
28	崔金娜		1/3					1/3	3/3	33.3			1		
33	王彩琳	0/1	0/2		1/1	1/3	1/2		3/9	33.3		3	1	1	
77	穆庆丛		1/1						1/1	100					
运动员 合计		2/7	5/9	4/5	1/2	2/4	2/3	3/4	19/34	55.9	3	13	3	4	
1	路畅		0/2	1/1		1/1		1/3	3/7	42.9					
22	朱贇	5/7	0/4	0/3	0/2	1/1	0/1	1/3	7/21	33.3	1				
守门员 合计		5/7	0/6	1/4	0/2	2/2	0/1	2/6	10/28	35.7	1				

新疆	比赛进程	山东
1st Half		
15 兰姝娇	1 03:38 0	
	1 05:08 1 33 王彩琳	
93 张婷婷	2 08:11 1	
	2 09:31 2 2 林燕群	
	2 13:46 3 8 王彬	
93 张婷婷	3 17:31 3	
	3 18:53 4 8 王彬	
	3 22:17 5 8 王彬	
	3 23:06 6 33 王彩琳	
18 崔娟	4 23:44 6	
	4 24:10 7 77 穆庆丛	
27 谢辰辰	5 25:16 7	
	5 26:24 8 11 吕青纹	
	5 28:48 9 33 王彩琳	
2nd Half		
	5 01:03 10 2 林燕群	
93 张婷婷	6 02:05 10	
6 阿热孜古丽	7 03:19 10	
21 锁珊珊	8 04:34 10	
	8 05:09 11 2 林燕群	
93 张婷婷	9 06:04 11	
	9 07:23 12 8 王彬	
93 张婷婷	10 08:53 12	
6 阿热孜古丽	11 10:15 12	
	11 10:45 13 11 吕青纹	
	11 11:55 14 8 王彬	
93 张婷婷	12 16:02 14	
	12 16:51 15 2 林燕群	
6 阿热孜古丽	13 17:14 15	
	13 17:48 16 20 张悦	
21 锁珊珊	14 18:16 16	
	14 19:00 17 2 林燕群	
15 兰姝娇	15 20:16 17	
	15 20:46 18 28 崔金娜	
15 兰姝娇	16 22:29 18	
6 阿热孜古丽	17 23:23 18	
18 崔娟	18 25:14 18	
	18 25:58 19 8 王彬	

场上队员: 得分 / 射门

守门员: 救球 / 射门

D	取消资格	DR	取消资格+报告
---	------	----	---------



## 第十三届全国运动会女子手球决赛

PHMS Pictorial Handball Match Statistics

IHF Official System

## 个人/全队技术统计表

 手球 5-8名 组别 X 天津师范大学体育馆  
 女子 轮次 5 场次 17 2017-09-05 14:00

号码	姓名	远射	近射	边射	快攻	突破	任意	七米	合计	%	助攻	失误	警告	2'	取消	时间
<b>新疆(新疆)</b>																
<b>(场上队员)</b>																
3	葛立双									0.0%						00:00:06
5	于千添									0.0%						00:00:00
6	阿热孜古丽	3/3	1/1					0/1	4/5	80.0%	3	1	1			01:00:00
7	吴志娟			0/1					0/1	0.0%	1	1				00:54:46
10	李静									0.0%						00:00:30
11	陈培培									0.0%						00:00:00
12	艾敏									0.0%						00:00:00
15	兰姝娇		1/2	2/3					3/5	60.0%	1		1			00:59:40
17	戴莹莹									0.0%	1					00:12:09
18	崔娟	1/6	1/1						2/7	28.6%		1	1			00:44:50
21	锁珊珊	0/4	1/1		1/1			0/1	2/7	28.6%						00:57:50
23	张艺璇									0.0%						00:00:00
26	宋婷婷	0/1							0/1	0.0%				1		00:13:42
27	谢辰辰							1/1	1/1	100%						00:02:09
32	杨雨柔									0.0%						00:59:30
93	张婷婷	1/3			1/1	0/2	1/1	3/3	6/10	60.0%	3	2	1			00:54:05
	<b>合计</b>	<b>2/14</b>	<b>6/7</b>	<b>3/5</b>	<b>2/2</b>	<b>0/2</b>	<b>1/1</b>	<b>4/6</b>	<b>18/37</b>	<b>48.6%</b>	<b>5</b>	<b>8</b>	<b>3</b>	<b>3</b>		
<b>(守门员)</b>																
10	李静							0/2	0/2	0.0%						00:00:30
32	杨雨柔	1/3	4/9	1/5	1/2	1/3	0/2	1/2	9/26	34.6%						00:59:30
	<b>合计</b>	<b>1/3</b>	<b>4/9</b>	<b>1/5</b>	<b>1/2</b>	<b>1/3</b>	<b>0/2</b>	<b>1/4</b>	<b>9/28</b>	<b>32.1%</b>						

场上队员：得分/射门

守门员：救球/射门

全队合计	得分	被救	射失	击柱	封球	合计	%
远射	2	5	1	5	1	14	14.3%
近射	6			1		7	85.7%
边射	3	1		1		5	60.0%
快攻	2					2	100.0%
突破		2				2	0.0%
任意	1					1	100.0%
七米	4	2				6	66.7%



## 第十三届全国运动会女子手球决赛

PHMS Pictorial Handball Match Statistics

IHF Official System

## 个人/全队技术统计表

 手球 5-8名 组别 X 天津师范大学体育馆  
 女子 轮次 5 场次 17 2017-09-05 14:00

号码	姓名	远射	近射	边射	快攻	突破	任意	七米	合计	%	助攻	失误	警告	2'	取消	时间
山东(山东)																
(场上队员)																
1	路畅									0.0%						00:08:39
2	林燕群	2/5	1/1	1/1				1/1	5/8	62.5%		4	1			01:00:00
6	王莎莎									0.0%				1		00:11:16
8	王彬	0/1	1/1	1/1		1/1	1/1	2/3	6/8	75.0%	1	3				00:31:43
11	吕青纹		1/1	1/1					2/2	100%	1	1				01:00:00
12	张苑琳									0.0%						00:00:00
15	吴作扬									0.0%		1				00:01:07
19	姜伟珊									0.0%						00:00:00
20	张悦			1/2	0/1				1/3	33.3%		1		1		01:00:00
22	朱贇									0.0%	1					00:51:21
23	徐悦									0.0%				1		00:28:24
28	崔金娜		1/3						1/3	33.3%			1			00:50:34
33	王彩琳	0/1	0/2		1/1	1/3	1/2		3/9	33.3%		3	1	1		00:48:51
77	穆庆丛		1/1						1/1	100%						00:05:31
	合计	2/7	5/9	4/5	1/2	2/4	2/3	3/4	19/34	55.9%	3	13	3	4		
(守门员)																
1	路畅		0/2	1/1		1/1		1/3	3/7	42.9%						00:08:39
22	朱贇	5/7	0/4	0/3	0/2	1/1	0/1	1/3	7/21	33.3%	1					00:51:21
	合计	5/7	0/6	1/4	0/2	2/2	0/1	2/6	10/28	35.7%	1					

场上队员：得分/射门

守门员：救球/射门

全队合计	得分	被救	射失	击柱	封球	合计	%
远射	2	1	1		3	7	28.6%
近射	5	4				9	55.6%
边射	4	1				5	80.0%
快攻	1	1				2	50.0%
突破	2	1		1		4	50.0%
任意	2		1			3	66.7%
七米	3	1				4	75.0%

图式比赛技术统计表

手球  
女子

5-8名  
轮次 5

组别 X  
场次 17

天津师范大学体育馆  
2017-09-05 14:00

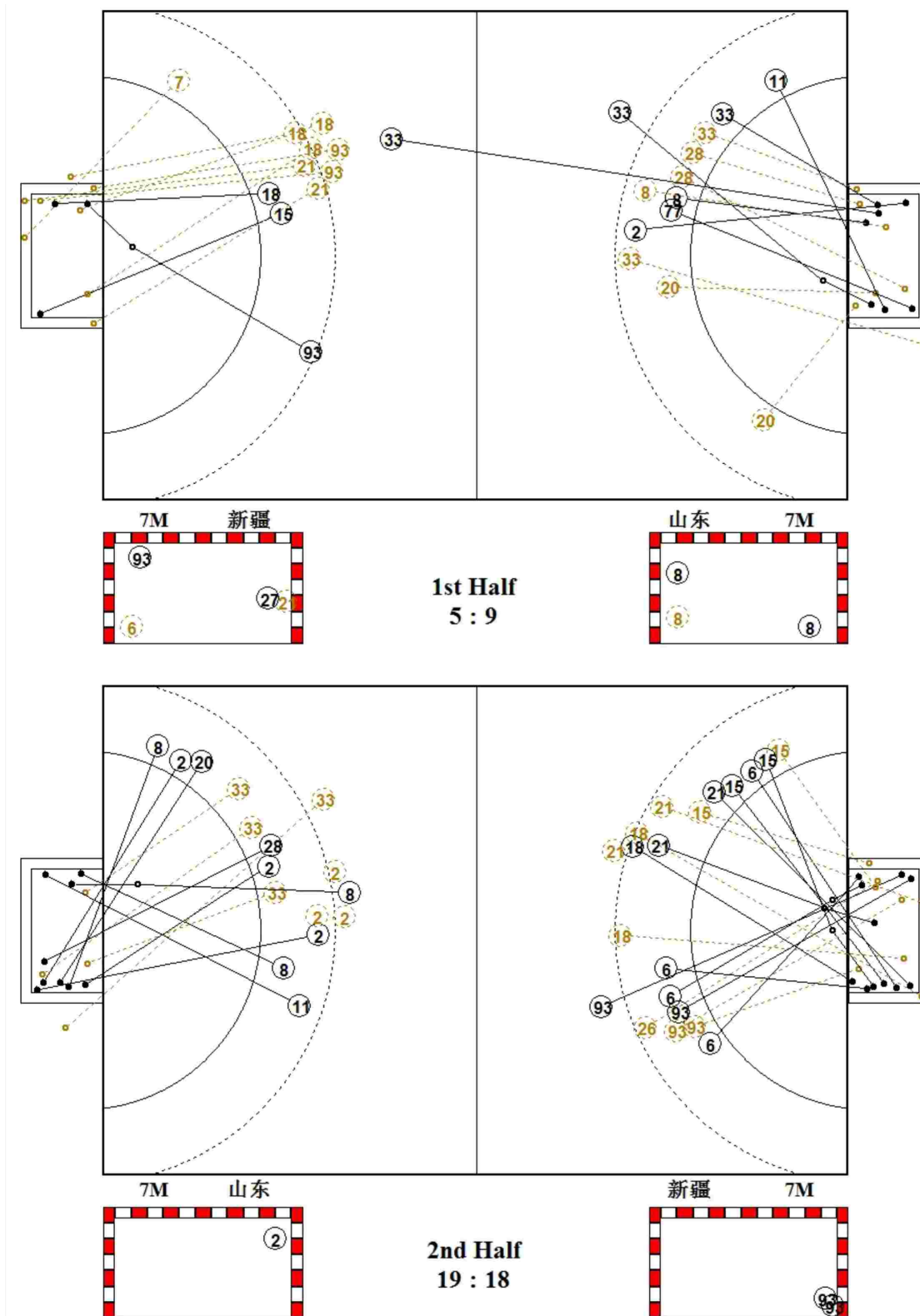

第十三届全国运动会女子手球决赛

PHMS Pictorial Handball Match Statistics

IHF Official System

图式射门区域统计

手球  
女子

5-8名  
轮次 5

组别 X  
场次 17

天津师范大学体育馆  
2017-09-05 14:00

新疆

3 葛立双 <table border="1"><tr><td></td><td></td><td></td></tr><tr><td></td><td></td><td></td></tr><tr><td></td><td></td><td></td></tr></table> Post - 0 Miss - 0 Block - 0										5 于千添 <table border="1"><tr><td></td><td></td><td></td></tr><tr><td></td><td></td><td></td></tr><tr><td></td><td></td><td></td></tr></table> Post - 0 Miss - 0 Block - 0										6 阿热孜古丽 <table border="1"><tr><td></td><td></td><td>1</td></tr><tr><td></td><td></td><td></td></tr><tr><td>2</td><td></td><td>1</td></tr></table> Post - 0 Miss - 0 Block - 0			1				2		1	7 吴志娟 <table border="1"><tr><td></td><td></td><td></td></tr><tr><td></td><td></td><td></td></tr><tr><td></td><td></td><td></td></tr></table> Post - 1 Miss - 0 Block - 0										10 李静 <table border="1"><tr><td></td><td></td><td></td></tr><tr><td></td><td></td><td></td></tr><tr><td></td><td></td><td></td></tr></table> Post - 0 Miss - 0 Block - 0										11 陈培培 <table border="1"><tr><td></td><td></td><td></td></tr><tr><td></td><td></td><td></td></tr><tr><td></td><td></td><td></td></tr></table> Post - 0 Miss - 0 Block - 0										12 艾敏 <table border="1"><tr><td></td><td></td><td></td></tr><tr><td></td><td></td><td></td></tr><tr><td></td><td></td><td></td></tr></table> Post - 0 Miss - 0 Block - 0										15 兰姝娇 <table border="1"><tr><td>1</td><td></td><td></td></tr><tr><td></td><td></td><td></td></tr><tr><td></td><td></td><td>2</td></tr></table> Post - 1 Miss - 0 Block - 0	1								2
		1																																																																													
2		1																																																																													
1																																																																															
		2																																																																													
17 戴莹莹 <table border="1"><tr><td></td><td></td><td></td></tr><tr><td></td><td></td><td></td></tr><tr><td></td><td></td><td></td></tr></table> Post - 0 Miss - 0 Block - 0										18 崔娟 <table border="1"><tr><td></td><td></td><td>1</td></tr><tr><td></td><td></td><td></td></tr><tr><td></td><td></td><td>1</td></tr></table> Post - 1 Miss - 1 Block - 0			1						1	21 锁珊珊 <table border="1"><tr><td></td><td></td><td>1</td></tr><tr><td></td><td>1</td><td></td></tr><tr><td></td><td></td><td></td></tr></table> Post - 3 Miss - 0 Block - 1			1		1					23 张艺璇 <table border="1"><tr><td></td><td></td><td></td></tr><tr><td></td><td></td><td></td></tr><tr><td></td><td></td><td></td></tr></table> Post - 0 Miss - 0 Block - 0										26 宋婷婷 <table border="1"><tr><td></td><td></td><td></td></tr><tr><td></td><td></td><td></td></tr><tr><td></td><td></td><td></td></tr></table> Post - 0 Miss - 0 Block - 0										27 谢辰辰 <table border="1"><tr><td></td><td></td><td></td></tr><tr><td></td><td></td><td></td></tr><tr><td></td><td></td><td>1</td></tr></table> Post - 0 Miss - 0 Block - 0									1	32 杨雨柔 <table border="1"><tr><td></td><td></td><td></td></tr><tr><td></td><td></td><td></td></tr><tr><td></td><td></td><td></td></tr></table> Post - 0 Miss - 0 Block - 0										93 张婷婷 <table border="1"><tr><td>3</td><td></td><td></td></tr><tr><td></td><td></td><td></td></tr><tr><td></td><td></td><td>3</td></tr></table> Post - 1 Miss - 0 Block - 0	3								3
		1																																																																													
		1																																																																													
		1																																																																													
	1																																																																														
		1																																																																													
3																																																																															
		3																																																																													

10 □□
0/1
0/1

32 □□□
1/5
1/5
3/5
1/3
1/4
2/4

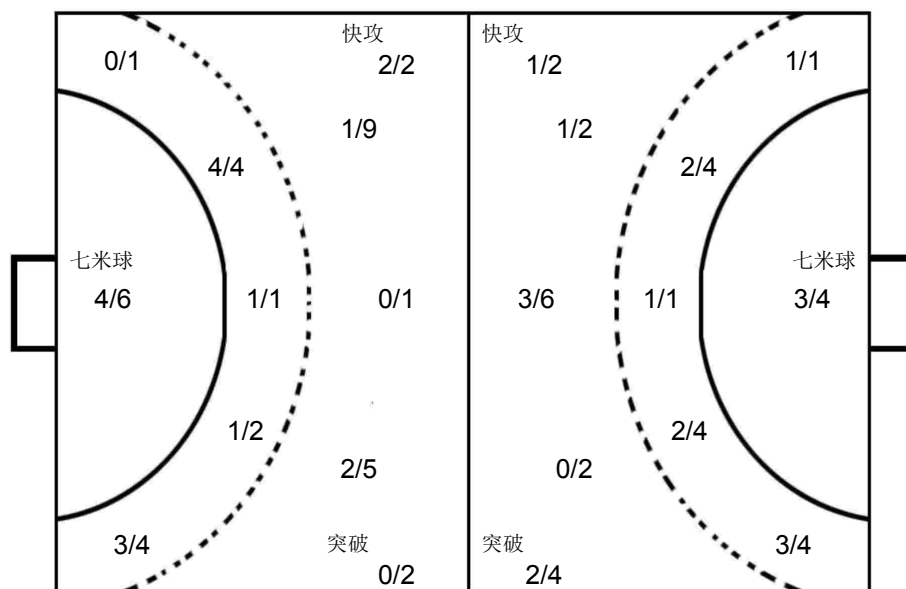

1 □□
1/1
0/1
0/1
1/1
1/3

22 □□
1/5
1/1
1/3
2/5
1/3
1/4

山东

1 路畅 <table border="1"><tr><td></td><td></td><td></td></tr><tr><td></td><td></td><td></td></tr><tr><td></td><td></td><td></td></tr></table> Post - 0 Miss - 0 Block - 0										2 林燕群 <table border="1"><tr><td>3</td><td></td><td>1</td></tr><tr><td></td><td></td><td></td></tr><tr><td>1</td><td></td><td></td></tr></table> Post - 0 Miss - 0 Block - 3	3		1				1			6 王莎莎 <table border="1"><tr><td></td><td></td><td></td></tr><tr><td></td><td></td><td></td></tr><tr><td></td><td></td><td></td></tr></table> Post - 0 Miss - 0 Block - 0										8 王彬 <table border="1"><tr><td>1</td><td></td><td></td></tr><tr><td>1</td><td></td><td>1</td></tr><tr><td>1</td><td></td><td>2</td></tr></table> Post - 0 Miss - 0 Block - 0	1			1		1	1		2	11 吕青纹 <table border="1"><tr><td></td><td></td><td>1</td></tr><tr><td></td><td></td><td></td></tr><tr><td></td><td></td><td>1</td></tr></table> Post - 0 Miss - 0 Block - 0			1						1	12 张苑琳 <table border="1"><tr><td></td><td></td><td></td></tr><tr><td></td><td></td><td></td></tr><tr><td></td><td></td><td></td></tr></table> Post - 0 Miss - 0 Block - 0										15 吴作扬 <table border="1"><tr><td></td><td></td><td></td></tr><tr><td></td><td></td><td></td></tr><tr><td></td><td></td><td></td></tr></table> Post - 0 Miss - 0 Block - 0										19 姜伟珊 <table border="1"><tr><td></td><td></td><td></td></tr><tr><td></td><td></td><td></td></tr><tr><td></td><td></td><td></td></tr></table> Post - 0 Miss - 0 Block - 0									
3		1																																																																													
1																																																																															
1																																																																															
1		1																																																																													
1		2																																																																													
		1																																																																													
		1																																																																													
20 张悦 <table border="1"><tr><td></td><td></td><td></td></tr><tr><td>1</td><td></td><td></td></tr><tr><td></td><td></td><td></td></tr></table> Post - 0 Miss - 0 Block - 0				1						22 朱赞 <table border="1"><tr><td></td><td></td><td></td></tr><tr><td></td><td></td><td></td></tr><tr><td></td><td></td><td></td></tr></table> Post - 0 Miss - 0 Block - 0										23 徐悦 <table border="1"><tr><td></td><td></td><td></td></tr><tr><td></td><td></td><td></td></tr><tr><td></td><td></td><td></td></tr></table> Post - 0 Miss - 0 Block - 0										28 崔金娜 <table border="1"><tr><td>1</td><td></td><td></td></tr><tr><td></td><td></td><td></td></tr><tr><td></td><td></td><td></td></tr></table> Post - 0 Miss - 0 Block - 0	1									33 王彩琳 <table border="1"><tr><td></td><td></td><td></td></tr><tr><td>2</td><td></td><td>1</td></tr><tr><td></td><td></td><td></td></tr></table> Post - 1 Miss - 2 Block - 0				2		1				77 穆庆丛 <table border="1"><tr><td></td><td></td><td>1</td></tr><tr><td></td><td></td><td></td></tr><tr><td></td><td></td><td></td></tr></table> Post - 0 Miss - 0 Block - 0			1																										
1																																																																															
1																																																																															
2		1																																																																													
		1																																																																													

**PHMS** Pictorial Handball Match Statistics

**IHF** Official System

Team A					Team B					Match Number								
A 北京					B 天津					<b>18</b>								
Played in			in the hall			on			at			Spectators						
天津			天津师范大学体育馆			2017-09-05			15:45			hours						
Half-time(30')	A	B	End of playing time		A	B	1st extra time		A	B	2nd extra time		A	B	After penalty throws		A	B
	13	7	28		22													
Number of 7 m	A	Team time-out			Full name of players and officials						Team time-out			B	Number of 7 m			
	8/8	1	2	3							1	2	3	2/4				
		19:55	44:41	58:50														

No.	Team A	G	W	2'	D	DR	No.	Team B	G	W	2'	D	DR
1	宋嘉蕾						1	张莉					
3	季小桐	3					3	王晓梅	1				
6	刘亚男	1		1			5	丁丽洁					
8	杨铭豫						6	窦海乐					
9	宋建军						7	张心茹					
10	刘莎	5	1				8	张慧	2	1	2		
11	纪婉						9	袁玉	6				
15	郝泽荣	1					10	张文慧	2	1	1		
16	王海叶						11	蔡雪洁					
22	李海鸥	3					12	王欣冉					
23	赵小颖	3					14	刘洁					
24	郝佳楠	1					16	王选					
27	曹芳鸣						17	聂晓雪	2		1		
28	闫美珠	7					18	舒文琪	4				
47	刘泽						23	周梦雪	5	1	1		
69	石梓薇	4	1										
A	蔡建国						A	付明双					
B	宋刚 (主教练)						B	王明星 (主教练)	1				
C	关宏波						C	岳连娥					
E	王长林		1				D	张圆圆					
A		Signatures of responsables for the teams (Off.A)											B
TP	Remarks of referees / HF Official												TP

	Referees	程钰峰 (CHN)	周云磊 (CHN)
	T.D.	吴国忠 (CHN)	柴业宏 (CHN)
	CHA Off.		

Note: Number of 7m Throws Awarded to Team A and B, Goals (G), Warnings (W), Suspensions (2'), Direct Disqualification (D), Disqualification With Report (DR) and Team Penalty (TP).

Table Officials: 谷瑶                      张智伟                      Statisticians: 李双                      王玮

**第十三届全国运动会女子手球决赛**
**PHMS** Pictorial Handball Match Statistics

**IHF** Official System

**竞赛技术统计**

 手球  
 女子

 5-8名  
 轮次 5

 组别 X  
 场次 18

 天津师范大学体育馆  
 2017-09-05 15:45

Referees: 程钰峰 (CHN) / 周云磊 (CHN)

Result: 28:22 (13:7)

Teams: 北京(北京) VS 天津(天津)

北京		远	近	边	快	突	任意	7m	合计	%	助攻	失误	警告	2'	D+DR
主教练: 宋刚		射	射	射	攻	破	球	球							
1	宋嘉蕾														
3	季小桐	1/3	2/4						3/7	42.9	5	3			
6	刘亚男		1/2	0/1					1/3	33.3				1	
8	杨铭豫														
9	宋建军														
10	刘莎	0/1		2/3		1/1		2/2	5/7	71.4		1	1		
11	纪婉														
15	郝泽荣		1/2						1/2	50.0	1	2			
16	王海叶														
22	李海鸥		3/6						3/6	50.0					
23	赵小颖							3/3	3/3	100					
24	郝佳楠	0/2	1/1			0/1	0/1		1/5	20.0	1				
27	曹芳鸣														
28	闫美珠	3/4		1/1				3/3	7/8	87.5	1	1			
47	刘泽														
69	石梓薇	2/4	2/5						4/9	44.4	1	2	1		
运动员	合计	6/14	10/20	3/5		1/2	0/1	8/8	28/50	56.0	9	9	2	1	
16	王海叶	4/11	2/9	3/5	2/3	1/4		2/4	14/36	38.9					
守门员	合计	4/11	2/9	3/5	2/3	1/4		2/4	14/36	38.9					

天津		远	近	边	快	突	任意	7m	合计	%	助攻	失误	警告	2'	D+DR
主教练: 王明星		射	射	射	攻	破	球	球							
1	张莉														
3	王晓梅	0/4						1/1	1/5	20.0					
5	丁丽洁														
6	窦海乐														
7	张心茹														
8	张慧			1/1		1/1			2/2	100			1	2	
9	袁玉	2/4	3/3	1/1	0/2	0/1	0/1	0/1	6/13	46.2		4			
10	张文慧		2/2						2/2	100			1	1	
11	蔡雪洁														
12	王欣冉														
14	刘洁														
16	王选														
17	聂晓雪		1/1	0/3	1/1				2/5	40.0		2		1	
18	舒文琪	3/4	0/1					1/1	4/6	66.7	1	4			
23	周梦雪	2/3	1/2	0/1		2/2		0/1	5/9	55.6	2	3	1	1	
运动员	合计	7/15	7/9	2/6	1/3	3/4	0/1	2/4	22/42	52.4	3	13	3	5	
1	张莉	0/2	1/5	1/2				0/2	2/11	18.2					
12	王欣冉		1/6					0/1	1/7	14.3					
16	王选	2/6	7/8	1/3		1/2		0/5	11/24	45.8					
守门员	合计	2/8	9/19	2/5		1/2		0/8	14/42	33.3					

北京	比赛 进程	天津
1st Half		
10 刘莎	1 00:56	0
28 闫美珠	2 02:05	0
	2 03:12	1 17 聂晓雪
24 郝佳楠	3 05:32	1
	3 06:47	2 23 周梦雪
10 刘莎	4 07:16	2
	4 07:53	3 9 袁玉
28 闫美珠	5 08:26	3
69 石梓薇	6 11:48	3
22 李海鸥	7 13:40	3
	7 13:51	4 23 周梦雪
	7 15:21	5 18 舒文琪
23 赵小颖	8 16:24	5
	8 18:02	6 23 周梦雪
28 闫美珠	9 19:03	6
3 季小桐	10 21:03	6
22 李海鸥	11 21:43	6
	11 24:16	7 18 舒文琪
23 赵小颖	12 28:24	7
22 李海鸥	13 29:53	7
2nd Half		
	13 01:47	8 9 袁玉
28 闫美珠	14 02:20	8
3 季小桐	15 02:57	8
15 郝泽荣	16 03:58	8
69 石梓薇	17 04:48	8
	17 06:20	9 8 张慧
3 季小桐	18 07:03	9
	18 07:33	10 10 张文慧
	18 08:07	11 17 聂晓雪
6 刘亚男	19 09:00	11
	19 09:15	12 10 张文慧
69 石梓薇	20 09:46	12
28 闫美珠	21 12:06	12
	21 12:37	13 9 袁玉
	21 14:31	14 8 张慧
10 刘莎	22 15:19	14
	22 16:00	15 23 周梦雪
28 闫美珠	23 17:28	15
	23 18:05	16 3 王晓梅
23 赵小颖	24 18:41	16
	24 19:08	17 9 袁玉
	24 19:46	18 9 袁玉
	24 20:59	19 18 舒文琪
10 刘莎	25 21:39	19
	25 22:17	20 18 舒文琪
28 闫美珠	26 24:37	20
	26 25:54	21 23 周梦雪
69 石梓薇	27 26:50	21
10 刘莎	28 29:26	21
	28 30:00	22 9 袁玉

场上队员: 得分 / 射门

守门员: 救球 / 射门

D	取消资格	DR	取消资格+报告

## 第十三届全国运动会女子手球决赛

PHMS Pictorial Handball Match Statistics

IHF Official System

## 个人/全队技术统计表

 手球 5-8名 组别 X 天津师范大学体育馆  
 女子 轮次 5 场次 18 2017-09-05 15:45

号码	姓名	远射	近射	边射	快攻	突破	任意	七米	合计	%	助攻	失误	警告	2'	取消	时间
北京(北京)																
(场上队员)																
1	宋嘉蕾									0.0%						00:00:00
3	季小桐	1/3	2/4						3/7	42.9%	5	3				00:32:21
6	刘亚男		1/2	0/1					1/3	33.3%				1		00:12:19
8	杨铭豫									0.0%						00:18:23
9	宋建军									0.0%						00:00:00
10	刘莎	0/1		2/3		1/1		2/2	5/7	71.4%		1	1			00:53:41
11	纪婉									0.0%						00:03:56
15	郝泽荣		1/2						1/2	50.0%	1	2				00:31:21
16	王海叶									0.0%						01:00:00
22	李海鸥		3/6						3/6	50.0%						00:59:36
23	赵小颖							3/3	3/3	100%						00:00:29
24	郝佳楠	0/2	1/1			0/1	0/1		1/5	20.0%	1					00:37:27
27	曹芳鸣									0.0%						00:00:00
28	闫美珠	3/4		1/1				3/3	7/8	87.5%	1	1				00:59:51
47	刘泽									0.0%						00:00:00
69	石梓薇	2/4	2/5						4/9	44.4%	1	2	1			00:50:07
	合计	6/14	10/20	3/5		1/2	0/1	8/8	28/50	56.0%	9	9	2	1		
(守门员)																
16	王海叶	4/11	2/9	3/5	2/3	1/4		2/4	14/36	38.9%						01:00:00
	合计	4/11	2/9	3/5	2/3	1/4		2/4	14/36	38.9%						

场上队员：得分/射门

守门员：救球/射门

全队合计	得分	被救	射失	击柱	封球	合计	%
远射	6	2	2	3	1	14	42.9%
近射	10	9	1			20	50.0%
边射	3	2				5	60.0%
快攻							0.0%
突破	1	1				2	50.0%
任意			1			1	0.0%
七米	8					8	100.0%

**第十三届全国运动会女子手球决赛**
**PHMS** Pictorial Handball Match Statistics

**IHF** Official System

**个人/全队技术统计表**

 手球 5-8名 组别 X 天津师范大学体育馆  
 女子 轮次 5 场次 18 2017-09-05 15:45

号码	姓名	远射	近射	边射	快攻	突破	任意	七米	合计	%	助攻	失误	警告	2'	取消	时间
<b>天津(天津)</b>																
<b>(场上队员)</b>																
1	张莉									0.0%						00:20:29
3	王晓梅	0/4						1/1	1/5	20.0%						00:08:09
5	丁丽洁									0.0%						00:00:00
6	窦海乐									0.0%						00:00:00
7	张心茹									0.0%						00:00:00
8	张慧			1/1		1/1			2/2	100%			1	2		01:00:00
9	袁玉	2/4	3/3	1/1	0/2	0/1	0/1	0/1	6/13	46.2%		4				01:00:00
10	张文慧		2/2						2/2	100%			1	1		01:00:00
11	蔡雪洁									0.0%						00:19:30
12	王欣冉									0.0%						00:09:03
14	刘洁									0.0%						00:00:00
16	王选									0.0%						00:30:28
17	聂晓雪		1/1	0/3	1/1				2/5	40.0%		2		1		00:58:12
18	舒文琪	3/4	0/1					1/1	4/6	66.7%	1	4				00:39:37
23	周梦雪	2/3	1/2	0/1		2/2		0/1	5/9	55.6%	2	3	1	1		00:59:53
<b>合计</b>		<b>7/15</b>	<b>7/9</b>	<b>2/6</b>	<b>1/3</b>	<b>3/4</b>	<b>0/1</b>	<b>2/4</b>	<b>22/42</b>	<b>52.4%</b>	<b>3</b>	<b>13</b>	<b>3</b>	<b>5</b>		
<b>(守门员)</b>																
1	张莉	0/2	1/5	1/2				0/2	2/11	18.2%						00:20:29
12	王欣冉		1/6					0/1	1/7	14.3%						00:09:03
16	王选	2/6	7/8	1/3		1/2		0/5	11/24	45.8%						00:30:28
<b>合计</b>		<b>2/8</b>	<b>9/19</b>	<b>2/5</b>		<b>1/2</b>		<b>0/8</b>	<b>14/42</b>	<b>33.3%</b>						

场上队员：得分/射门

守门员：救球/射门

全队合计	得分	被救	射失	击柱	封球	合计	%
远射	7	4	1		3	15	46.7%
近射	7	2				9	77.8%
边射	2	3	1			6	33.3%
快攻	1	2				3	33.3%
突破	3	1				4	75.0%
任意			1			1	0.0%
七米	2	2				4	50.0%

第十三届全国运动会女子手球决赛

PHMS Pictorial Handball Match Statistics

IHF Official System

图式比赛技术统计表

手球  
女子

5-8名  
轮次 5

组别 X  
场次 18

天津师范大学体育馆  
2017-09-05 15:45

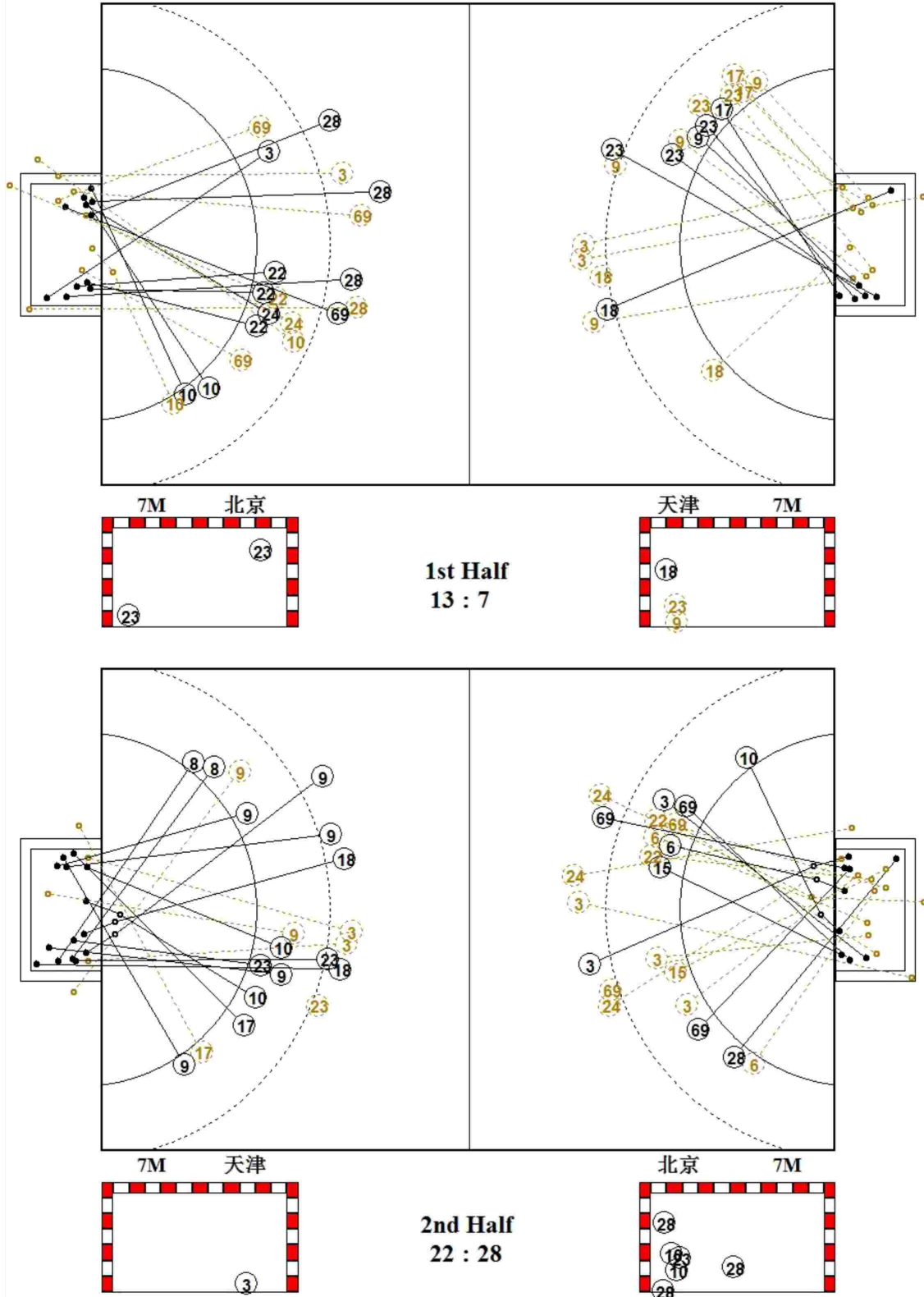



第十三届全国运动会女子手球决赛

PHMS Pictorial Handball Match Statistics

IHF Official System

图式射门区域统计

手球  
女子

5-8名  
轮次 5

组别 X  
场次 18

天津师范大学体育馆  
2017-09-05 15:45

北京

1 宋嘉蕾	3 季小桐	6 刘亚男	8 杨铭豫	9 宋建军	10 刘莎	11 纪婉	15 郝泽荣																																																																								
<table border="1"><tr><td></td><td></td><td></td></tr><tr><td></td><td></td><td></td></tr><tr><td></td><td></td><td></td></tr></table>										<table border="1"><tr><td>1</td><td></td><td></td></tr><tr><td></td><td></td><td>1</td></tr><tr><td>1</td><td></td><td></td></tr></table>	1					1	1			<table border="1"><tr><td></td><td></td><td></td></tr><tr><td></td><td></td><td></td></tr><tr><td></td><td>1</td><td></td></tr></table>								1		<table border="1"><tr><td></td><td></td><td></td></tr><tr><td></td><td></td><td></td></tr><tr><td></td><td></td><td></td></tr></table>										<table border="1"><tr><td></td><td></td><td></td></tr><tr><td></td><td></td><td></td></tr><tr><td></td><td></td><td></td></tr></table>										<table border="1"><tr><td></td><td></td><td></td></tr><tr><td>1</td><td></td><td></td></tr><tr><td>1</td><td></td><td>3</td></tr></table>				1			1		3	<table border="1"><tr><td></td><td></td><td></td></tr><tr><td></td><td></td><td></td></tr><tr><td></td><td></td><td></td></tr></table>										<table border="1"><tr><td></td><td></td><td></td></tr><tr><td></td><td></td><td></td></tr><tr><td></td><td></td><td>1</td></tr></table>									1
1																																																																															
		1																																																																													
1																																																																															
	1																																																																														
1																																																																															
1		3																																																																													
		1																																																																													
Post - 0 Miss - 0 Block - 0	Post - 2 Miss - 0 Block - 0	Post - 0 Miss - 0 Block - 0	Post - 0 Miss - 0 Block - 0	Post - 0 Miss - 0 Block - 0	Post - 0 Miss - 1 Block - 0	Post - 0 Miss - 0 Block - 0	Post - 0 Miss - 0 Block - 0																																																																								
16 王海叶	22 李海鸥	23 赵小颖	24 郝佳楠	27 曹芳鸣	28 闫美珠	47 刘泽	69 石梓薇																																																																								
<table border="1"><tr><td></td><td></td><td></td></tr><tr><td></td><td></td><td></td></tr><tr><td></td><td></td><td></td></tr></table>										<table border="1"><tr><td>1</td><td></td><td></td></tr><tr><td>2</td><td></td><td></td></tr><tr><td></td><td></td><td></td></tr></table>	1			2						<table border="1"><tr><td></td><td></td><td>1</td></tr><tr><td>1</td><td></td><td></td></tr><tr><td>1</td><td></td><td></td></tr></table>			1	1			1			<table border="1"><tr><td></td><td></td><td></td></tr><tr><td></td><td></td><td></td></tr><tr><td></td><td></td><td>1</td></tr></table>									1	<table border="1"><tr><td></td><td></td><td></td></tr><tr><td></td><td></td><td></td></tr><tr><td></td><td></td><td></td></tr></table>										<table border="1"><tr><td>2</td><td></td><td></td></tr><tr><td>1</td><td></td><td></td></tr><tr><td>1</td><td>1</td><td>2</td></tr></table>	2			1			1	1	2	<table border="1"><tr><td></td><td></td><td></td></tr><tr><td></td><td></td><td></td></tr><tr><td></td><td></td><td></td></tr></table>										<table border="1"><tr><td></td><td></td><td></td></tr><tr><td></td><td></td><td>1</td></tr><tr><td>2</td><td></td><td>1</td></tr></table>						1	2		1
1																																																																															
2																																																																															
		1																																																																													
1																																																																															
1																																																																															
		1																																																																													
2																																																																															
1																																																																															
1	1	2																																																																													
		1																																																																													
2		1																																																																													
Post - 0 Miss - 0 Block - 0	Post - 0 Miss - 1 Block - 0	Post - 0 Miss - 0 Block - 0	Post - 0 Miss - 2 Block - 0	Post - 0 Miss - 0 Block - 0	Post - 1 Miss - 0 Block - 0	Post - 0 Miss - 0 Block - 0	Post - 0 Miss - 0 Block - 1																																																																								

16 □□□

0/3	1/1	
3/8		2/9
5/7	1/2	2/6

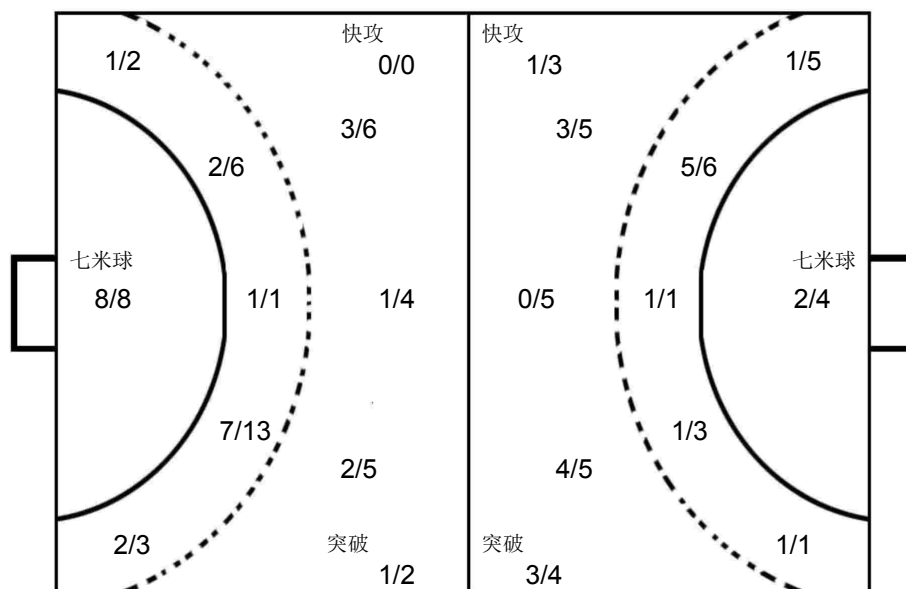

1 □□

0/2		0/1
0/1		
1/5	1/1	0/1

12 □□□

		1/2
0/1	0/2	0/2

16 □□

2/3		
2/5	2/2	3/4
1/4		1/6

天津

1 张莉	3 王晓梅	5 丁丽洁	6 襄海乐	7 张心茹	8 张慧	9 袁玉	10 张文慧																																																																								
<table border="1"><tr><td></td><td></td><td></td></tr><tr><td></td><td></td><td></td></tr><tr><td></td><td></td><td></td></tr></table>										<table border="1"><tr><td></td><td></td><td></td></tr><tr><td></td><td></td><td>1</td></tr><tr><td></td><td></td><td></td></tr></table>						1				<table border="1"><tr><td></td><td></td><td></td></tr><tr><td></td><td></td><td></td></tr><tr><td></td><td></td><td></td></tr></table>										<table border="1"><tr><td></td><td></td><td></td></tr><tr><td></td><td></td><td></td></tr><tr><td></td><td></td><td></td></tr></table>										<table border="1"><tr><td></td><td></td><td></td></tr><tr><td></td><td></td><td></td></tr><tr><td></td><td></td><td></td></tr></table>										<table border="1"><tr><td>2</td><td></td><td></td></tr><tr><td></td><td></td><td></td></tr><tr><td></td><td></td><td></td></tr></table>	2									<table border="1"><tr><td>1</td><td></td><td></td></tr><tr><td></td><td></td><td>4</td></tr><tr><td>1</td><td></td><td></td></tr></table>	1					4	1			<table border="1"><tr><td></td><td></td><td></td></tr><tr><td></td><td></td><td></td></tr><tr><td></td><td></td><td>1</td></tr></table>									1
		1																																																																													
2																																																																															
1																																																																															
		4																																																																													
1																																																																															
		1																																																																													
Post - 0 Miss - 0 Block - 0	Post - 0 Miss - 1 Block - 0	Post - 0 Miss - 0 Block - 0	Post - 0 Miss - 0 Block - 0	Post - 0 Miss - 0 Block - 0	Post - 0 Miss - 0 Block - 0	Post - 0 Miss - 1 Block - 1	Post - 0 Miss - 0 Block - 0																																																																								
11 蔡雪洁	12 王欣冉	14 刘洁	16 王选	17 聂晓雪	18 舒文琪	23 周梦雪																																																																									
<table border="1"><tr><td></td><td></td><td></td></tr><tr><td></td><td></td><td></td></tr><tr><td></td><td></td><td></td></tr></table>										<table border="1"><tr><td></td><td></td><td></td></tr><tr><td></td><td></td><td></td></tr><tr><td></td><td></td><td></td></tr></table>										<table border="1"><tr><td></td><td></td><td></td></tr><tr><td></td><td></td><td></td></tr><tr><td></td><td></td><td></td></tr></table>										<table border="1"><tr><td></td><td></td><td></td></tr><tr><td></td><td></td><td></td></tr><tr><td></td><td></td><td></td></tr></table>										<table border="1"><tr><td></td><td></td><td>1</td></tr><tr><td></td><td></td><td>1</td></tr><tr><td></td><td></td><td></td></tr></table>			1			1				<table border="1"><tr><td>2</td><td></td><td></td></tr><tr><td>1</td><td></td><td></td></tr><tr><td>1</td><td></td><td></td></tr></table>	2			1			1			<table border="1"><tr><td></td><td></td><td></td></tr><tr><td>2</td><td></td><td>2</td></tr><tr><td></td><td></td><td>1</td></tr></table>				2		2			1										
		1																																																																													
		1																																																																													
2																																																																															
1																																																																															
1																																																																															
2		2																																																																													
		1																																																																													
Post - 0 Miss - 0 Block - 0	Post - 0 Miss - 0 Block - 0	Post - 0 Miss - 0 Block - 0	Post - 0 Miss - 0 Block - 0	Post - 0 Miss - 1 Block - 0	Post - 0 Miss - 0 Block - 1	Post - 0 Miss - 0 Block - 1																																																																									

**PHMS** Pictorial Handball Match Statistics

**IHF** Official System

Team A					Team B					Match Number											
A 安徽					B 广东					<b>19</b>											
Played in			in the hall			on			at			Spectators									
天津			天津师范大学体育馆			2017-09-05			17:30			hours									
Half-time(30')	A	B	End of playing time		A	B	1st extra time		A	B	2nd extra time		A	B	After penalty throws		A	B			
	21	13	35		24																
Number of 7 m	A	Team time-out			Full name of players and officials						Team time-out			B	Number of 7 m						
	7/7	1	2	3							1	2	3	B							
		24:08	38:14								06:14	41:58		4/6							
No.	Team A					G	W	2'	D	DR	No.	Team B					G	W	2'	D	DR
1	司艳										2	王彤羽									
3	李兵					3					3	安妮					3				
5	班晨晨					3		1			5	李纯									
6	沈萍					6	1				7	刘彤					1	1	1		
7	赵江川										8	李诗棋					1				
8	徐仕媛										9	韦宝桂					11				
10	孙来苗										10	史小军						1	1		
13	陶丹扬					5	1	1			11	魏梦庭					1				
14	刘晓妹					3	1				15	杨慧									
15	王婵婵										16	李娟									
16	朱莉珍										19	邝雪花					1				
17	周婷										20	李军政									
20	周雪婷										22	刘晓玉									
21	李瑶					5					23	王如					1	1			
23	张天洁										26	马晓卉									
41	杜机娟					10					28	刘金兰					5				
A	吴疆										B	黄炳春									
B	吴立军 (主教练)										C	李玉玲									
C	杨桂东										D	郭艳辉 (主教练)									
E	张国遂										E	赵善良									
A	Signatures of responsables for the teams (Off.A)														B						
TP	Remarks of referees / HF Official														TP						

Signatures

Referees BALAZS. MARTON (HUN)

PETER. HORVATH (HUN)

T.D. 刘凤娟 (CHN)

高斌 (CHN)

CHA Off.

Note: Number of 7m Throws Awarded to Team A and B, Goals (G), Warnings (W), Suspensions (2'), Direct Disqualification (D), Disqualification With Report (DR) and Team Penalty (TP).

Table Officials: 齐红梅

翟延露

Statisticians: 周强

杜宪

**第十三届全国运动会女子手球决赛**
**PHMS** Pictorial Handball Match Statistics

**IHF** Official System

**竞赛技术统计**

 手球  
 女子

 半决赛  
 轮次 5

 组别 X  
 场次 19

 天津师范大学体育馆  
 2017-09-05 17:30

Referees: BALAZS. MARTON (HUN) / PETER. HORVATH (HUN)

Result: 35:24 (21:13)

Teams: 安徽(安徽) VS 广东(广东)

安徽		远	近	边	快	突	任意	7m	合计	%	助攻	失误	警告	2'	D+DR	安徽		比赛	广东
主教练: 吴立军		射	射	射	攻	破	球	球								进程			
1	司艳										1					13	陶丹扬	1 00:43	0
3	李兵				1/1	2/2			3/3	100	5					21	李瑶	1 01:13	1 9 韦宝桂
5	班晨晨		2/2	0/1	0/1	1/1			3/5	60.0		1		1		3	李兵	2 01:56	1
6	沈萍	2/4	2/3		1/1			1/1	6/9	66.7	1	4	1			3	李兵	3 03:13	1
7	赵江川															13	陶丹扬	4 05:26	2 8 李诗棋
8	徐仕媛															14	刘晓妹	5 05:53	2
10	孙来苗															14	刘晓妹	6 06:44	2
13	陶丹扬				5/7				5/7	71.4			1	1		6	杜机娟	6 07:01	3 9 韦宝桂
14	刘晓妹	1/6				2/2	0/1		3/9	33.3		1	1			41	杜机娟	7 07:44	3
15	王婷婷			0/1	0/1				0/2	0.0						41	杜机娟	8 09:25	3
16	朱莉珍										3					14	刘晓妹	9 11:37	3
17	周婷	0/1				0/1			0/2	0.0	1	1				41	杜机娟	10 12:35	3
20	周雪婷															10	杜机娟	10 12:35	3
21	李瑶	1/2	2/4		1/3	1/1			5/10	50.0	3	5				10	杜机娟	10 12:35	3
23	张天洁															10	杜机娟	10 12:35	3
41	杜机娟		0/1	2/2	2/2			6/6	10/11	90.9	1	1				10	杜机娟	10 12:35	3
运动员	合计	4/13	6/10	2/4	10/16	6/7	0/1	7/7	35/58	60.3	15	13	3	2		10	杜机娟	10 12:35	3
1	司艳	5/11	2/7	0/1	1/1	0/1			8/21	38.1	1					11	沈萍	11 13:25	4
16	朱莉珍	5/6	6/6	2/6		0/2		1/5	14/25	56.0	3					11	沈萍	11 14:19	5 7 刘彤
守门员	合计	10/17	8/13	2/7	1/1	0/3		1/5	22/46	47.8	4					21	李瑶	12 14:49	5
广东		远	近	边	快	突	任意	7m	合计	%	助攻	失误	警告	2'	D+DR				
主教练: 郭艳辉		射	射	射	攻	破	球	球											
2	王彤羽	0/3							0/3	0.0		1				22	李兵	22 01:16	13
3	安妮	0/2	0/2	0/1		3/3			3/8	37.5		2				22	李兵	22 03:08	14 19 邝雪花
5	李纯															22	李兵	22 04:21	15 9 韦宝桂
7	刘彤		1/2					0/1	1/3	33.3		1	1	1		22	李兵	22 05:52	16 11 魏梦庭
8	李诗棋		1/1	0/1					1/2	50.0		1				22	李兵	22 07:45	17 28 刘金兰
9	韦宝桂	6/13	1/2					4/4	11/19	57.9		3				23	李兵	23 08:32	17
10	史小军	0/1	0/1		0/1				0/3	0.0	1	1	1	1		41	杜机娟	24 08:58	17
11	魏梦庭	1/5	0/2		0/1				1/8	12.5		4				13	陶丹扬	25 09:43	17
15	杨慧															5	班晨晨	26 11:03	17
16	李娟															13	陶丹扬	27 11:46	17
19	邝雪花	0/1	1/4						1/5	20.0		4				27	陶丹扬	27 11:46	17
20	李军政															27	陶丹扬	27 12:22	18 28 刘金兰
22	刘晓玉															27	陶丹扬	27 13:36	19 9 韦宝桂
23	王如		1/1						1/1	100		1	1			5	班晨晨	28 14:38	19
26	马晓卉															28	班晨晨	28 15:24	20 9 韦宝桂
28	刘金兰			5/5				0/1	5/6	83.3	2	2				21	李瑶	29 15:52	20
运动员	合计	7/25	5/15	5/7	0/2	3/3		4/6	24/58	41.4	3	20	3	2		21	李瑶	29 17:09	21 28 刘金兰
16	李娟							0/2	0/2	0.0						6	沈萍	30 18:50	21
22	刘晓玉	2/5	0/1	1/1	2/6	0/4			5/17	29.4						41	杜机娟	31 21:33	21
26	马晓卉	3/4	2/7	0/2	2/8	0/2		0/5	7/28	25.0						31	杜机娟	31 22:10	22 3 安妮
守门员	合计	5/9	2/8	1/3	4/14	0/6		0/7	12/47	25.5						21	李瑶	32 23:16	22
																32	陶丹扬	32 24:11	23 28 刘金兰
																6	沈萍	33 25:53	23
																6	沈萍	34 26:22	23
																34	沈萍	34 28:27	24 3 安妮
																13	陶丹扬	35 29:51	24

场上队员: 得分 / 射门

守门员: 救球 / 射门

D	取消资格	DR	取消资格+报告
---	------	----	---------

## 第十三届全国运动会女子手球决赛

PHMS Pictorial Handball Match Statistics

IHF Official System

## 个人/全队技术统计表

 手球 半决赛 组别 X 天津师范大学体育馆  
 女子 轮次 5 场次 19 2017-09-05 17:30

号码	姓名	远射	近射	边射	快攻	突破	任意	七米	合计	%	助攻	失误	警告	2'	取消	时间
<b>安徽(安徽)</b>																
<b>(场上队员)</b>																
1	司艳									0.0%	1					00:35:33
3	李兵				1/1	2/2			3/3	100%	5					00:38:47
5	班晨晨		2/2	0/1	0/1	1/1			3/5	60.0%		1		1		00:31:00
6	沈萍	2/4	2/3		1/1			1/1	6/9	66.7%	1	4	1			00:51:00
7	赵江川									0.0%						00:00:00
8	徐仕媛									0.0%						00:00:00
10	孙来苗									0.0%						00:05:42
13	陶丹扬				5/7				5/7	71.4%			1	1		00:51:46
14	刘晓妹	1/6				2/2	0/1		3/9	33.3%		1	1			00:48:45
15	王婵婵			0/1	0/1				0/2	0.0%						00:08:14
16	朱莉珍									0.0%	3					00:24:27
17	周婷	0/1				0/1			0/2	0.0%	1	1				00:14:06
20	周雪婷									0.0%						00:00:00
21	李瑶	1/2	2/4		1/3	1/1			5/10	50.0%	3	5				00:50:34
23	张天洁									0.0%						00:00:00
41	杜机娟		0/1	2/2	2/2			6/6	10/11	90.9%	1	1				01:00:00
	<b>合计</b>	<b>4/13</b>	<b>6/10</b>	<b>2/4</b>	<b>10/16</b>	<b>6/7</b>	<b>0/1</b>	<b>7/7</b>	<b>35/58</b>	<b>60.3%</b>	<b>15</b>	<b>13</b>	<b>3</b>	<b>2</b>		
<b>(守门员)</b>																
1	司艳	5/11	2/7	0/1	1/1	0/1			8/21	38.1%	1					00:35:33
16	朱莉珍	5/6	6/6	2/6		0/2		1/5	14/25	56.0%	3					00:24:27
	<b>合计</b>	<b>10/17</b>	<b>8/13</b>	<b>2/7</b>	<b>1/1</b>	<b>0/3</b>		<b>1/5</b>	<b>22/46</b>	<b>47.8%</b>	<b>4</b>					

场上队员：得分/射门

守门员：救球/射门

全队合计	得分	被救	射失	击柱	封球	合计	%
远射	4	5	1	1	2	13	30.8%
近射	6	2		2		10	60.0%
边射	2	1	1			4	50.0%
快攻	10	4		2		16	62.5%
突破	6		1			7	85.7%
任意			1			1	0.0%
七米	7					7	100.0%

**第十三届全国运动会女子手球决赛**
**PHMS** Pictorial Handball Match Statistics

**IHF** Official System

**个人/全队技术统计表**

 手球 半决赛 组别 X 天津师范大学体育馆  
 女子 轮次 5 场次 19 2017-09-05 17:30

号码	姓名	远射	近射	边射	快攻	突破	任意	七米	合计	%	助攻	失误	警告	2'	取消	时间
<b>广东(广东)</b>																
<b>(场上队员)</b>																
2	王彤羽	0/3							0/3	0.0%		1				00:06:57
3	安妮	0/2	0/2	0/1		3/3			3/8	37.5%		2				00:32:39
5	李纯									0.0%						00:00:00
7	刘彤		1/2					0/1	1/3	33.3%		1	1	1		01:01:18
8	李诗棋		1/1	0/1					1/2	50.0%		1				00:43:35
9	韦宝桂	6/13	1/2					4/4	11/19	57.9%		3				00:47:05
10	史小军	0/1	0/1		0/1				0/3	0.0%	1	1	1	1		00:44:47
11	魏梦庭	1/5	0/2		0/1				1/8	12.5%		4				00:29:23
15	杨慧									0.0%						00:03:13
16	李娟									0.0%						00:00:19
19	邝雪花	0/1	1/4						1/5	20.0%		4				00:42:02
20	李军政									0.0%						00:18:42
22	刘晓玉									0.0%						00:18:53
23	王如		1/1						1/1	100%		1	1			00:17:23
26	马晓卉									0.0%						00:40:48
28	刘金兰			5/5				0/1	5/6	83.3%	2	2				00:36:42
	<b>合计</b>	<b>7/25</b>	<b>5/15</b>	<b>5/7</b>	<b>0/2</b>	<b>3/3</b>		<b>4/6</b>	<b>24/58</b>	<b>41.4%</b>	<b>3</b>	<b>20</b>	<b>3</b>	<b>2</b>		
<b>(守门员)</b>																
16	李娟							0/2	0/2	0.0%						00:00:19
22	刘晓玉	2/5	0/1	1/1	2/6	0/4			5/17	29.4%						00:18:53
26	马晓卉	3/4	2/7	0/2	2/8	0/2		0/5	7/28	25.0%						00:40:48
	<b>合计</b>	<b>5/9</b>	<b>2/8</b>	<b>1/3</b>	<b>4/14</b>	<b>0/6</b>		<b>0/7</b>	<b>12/47</b>	<b>25.5%</b>						

场上队员： 得分/射门

守门员： 救球/射门

全队合计	得分	被救	射失	击柱	封球	合计	%
远射	7	10	4		4	25	28.0%
近射	5	8		2		15	33.3%
边射	5	2				7	71.4%
快攻		1	1			2	0.0%
突破	3					3	100.0%
任意							0.0%
七米	4	1	1			6	66.7%

第十三届全国运动会女子手球决赛

PHMS Pictorial Handball Match Statistics

IHF Official System

图式比赛技术统计表

手球  
女子

半决赛  
轮次 5

组别 X  
场次 19

天津师范大学体育馆  
2017-09-05 17:30

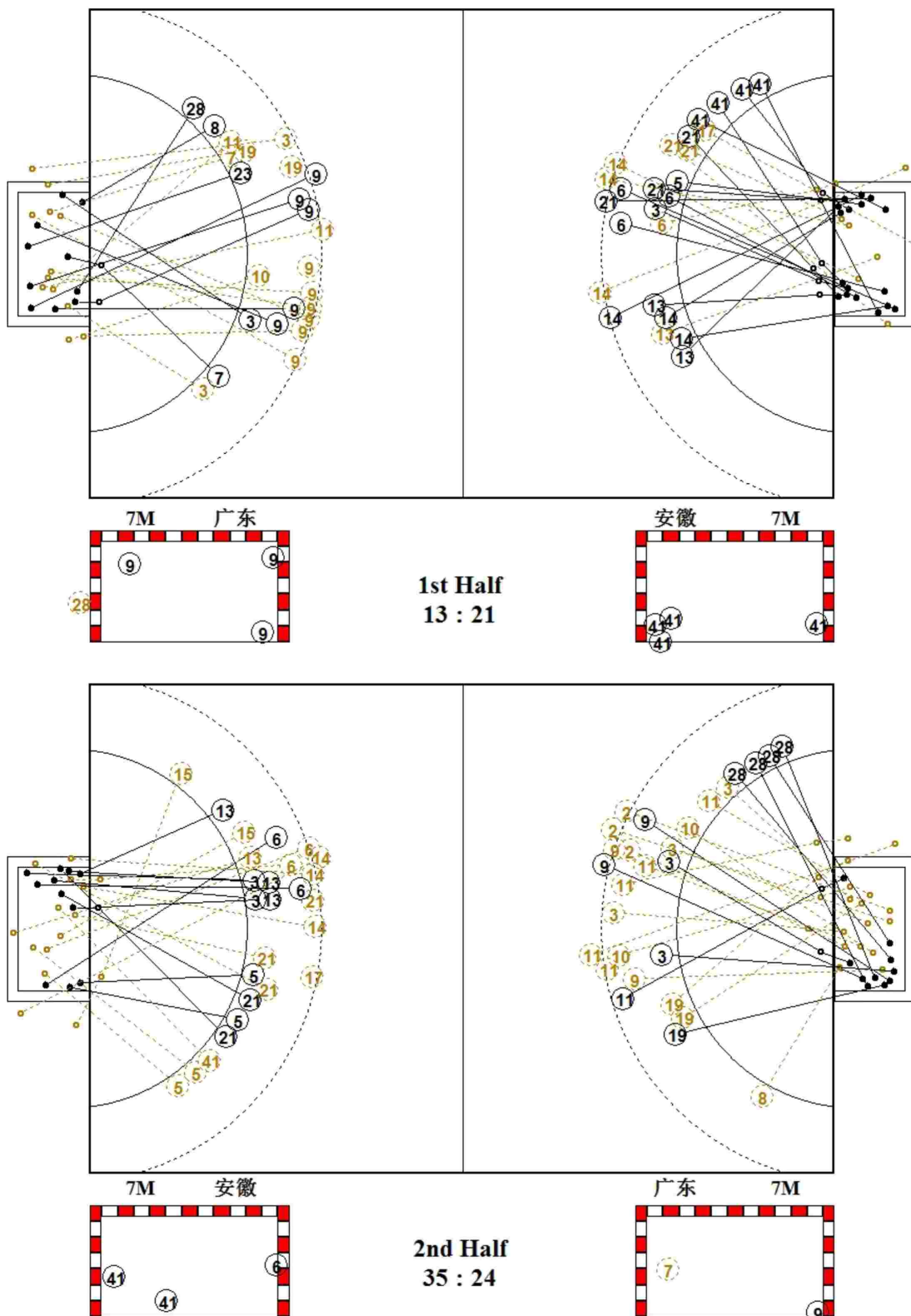

第十三届全国运动会女子手球决赛

PHMS Pictorial Handball Match Statistics

IHF Official System

图式射门区域统计

手球  
女子

半决赛  
轮次 5

组别 X  
场次 19

天津师范大学体育馆  
2017-09-05 17:30

安徽

1 司艳	3 李兵	5 班晨晨	6 沈萍	7 赵江川	8 徐仕媛	10 孙来苗	13 陶丹扬																																																																								
<table border="1"><tr><td></td><td></td><td></td></tr><tr><td></td><td></td><td></td></tr><tr><td></td><td></td><td></td></tr></table>										<table border="1"><tr><td></td><td></td><td>1</td></tr><tr><td></td><td></td><td>1</td></tr><tr><td></td><td></td><td>1</td></tr></table>			1			1			1	<table border="1"><tr><td></td><td></td><td></td></tr><tr><td>1</td><td></td><td></td></tr><tr><td>2</td><td></td><td></td></tr></table>				1			2			<table border="1"><tr><td></td><td></td><td>3</td></tr><tr><td>1</td><td></td><td>1</td></tr><tr><td></td><td></td><td>1</td></tr></table>			3	1		1			1	<table border="1"><tr><td></td><td></td><td></td></tr><tr><td></td><td></td><td></td></tr><tr><td></td><td></td><td></td></tr></table>										<table border="1"><tr><td></td><td></td><td></td></tr><tr><td></td><td></td><td></td></tr><tr><td></td><td></td><td></td></tr></table>										<table border="1"><tr><td></td><td></td><td></td></tr><tr><td></td><td></td><td></td></tr><tr><td></td><td></td><td></td></tr></table>										<table border="1"><tr><td></td><td></td><td></td></tr><tr><td></td><td></td><td></td></tr><tr><td>1</td><td>1</td><td>3</td></tr></table>							1	1	3
		1																																																																													
		1																																																																													
		1																																																																													
1																																																																															
2																																																																															
		3																																																																													
1		1																																																																													
		1																																																																													
1	1	3																																																																													
Post - 0 Miss - 0 Block - 0	Post - 0 Miss - 0 Block - 0	Post - 0 Miss - 0 Block - 0	Post - 1 Miss - 0 Block - 0	Post - 0 Miss - 0 Block - 0	Post - 0 Miss - 0 Block - 0	Post - 0 Miss - 0 Block - 0	Post - 1 Miss - 0 Block - 0																																																																								
14 刘晓妹	15 王婷婷	16 朱莉珍	17 周婷	20 周雪婷	21 李瑶	23 张天洁	41 杜机娟																																																																								
<table border="1"><tr><td></td><td></td><td>1</td></tr><tr><td>1</td><td></td><td></td></tr><tr><td>1</td><td></td><td></td></tr></table>			1	1			1			<table border="1"><tr><td></td><td></td><td></td></tr><tr><td></td><td></td><td></td></tr><tr><td></td><td></td><td></td></tr></table>										<table border="1"><tr><td></td><td></td><td></td></tr><tr><td></td><td></td><td></td></tr><tr><td></td><td></td><td></td></tr></table>										<table border="1"><tr><td></td><td></td><td></td></tr><tr><td></td><td></td><td></td></tr><tr><td></td><td></td><td></td></tr></table>										<table border="1"><tr><td></td><td></td><td></td></tr><tr><td></td><td></td><td></td></tr><tr><td></td><td></td><td></td></tr></table>										<table border="1"><tr><td></td><td></td><td></td></tr><tr><td>1</td><td></td><td>2</td></tr><tr><td>1</td><td></td><td>1</td></tr></table>				1		2	1		1	<table border="1"><tr><td></td><td></td><td></td></tr><tr><td></td><td></td><td></td></tr><tr><td></td><td></td><td></td></tr></table>										<table border="1"><tr><td>1</td><td></td><td></td></tr><tr><td>1</td><td></td><td>1</td></tr><tr><td>4</td><td>1</td><td>2</td></tr></table>	1			1		1	4	1	2
		1																																																																													
1																																																																															
1																																																																															
1		2																																																																													
1		1																																																																													
1																																																																															
1		1																																																																													
4	1	2																																																																													
Post - 1 Miss - 2 Block - 0	Post - 0 Miss - 1 Block - 0	Post - 0 Miss - 0 Block - 0	Post - 0 Miss - 1 Block - 1	Post - 0 Miss - 0 Block - 0	Post - 2 Miss - 0 Block - 1	Post - 0 Miss - 0 Block - 0	Post - 0 Miss - 0 Block - 0																																																																								

1 □□

1/3	0/1	1/3
2/3	1/1	2/4
1/4	0/1	0/1

16 □□□

0/1	2/3	1/5
3/3	2/2	1/3
2/2	2/2	1/4

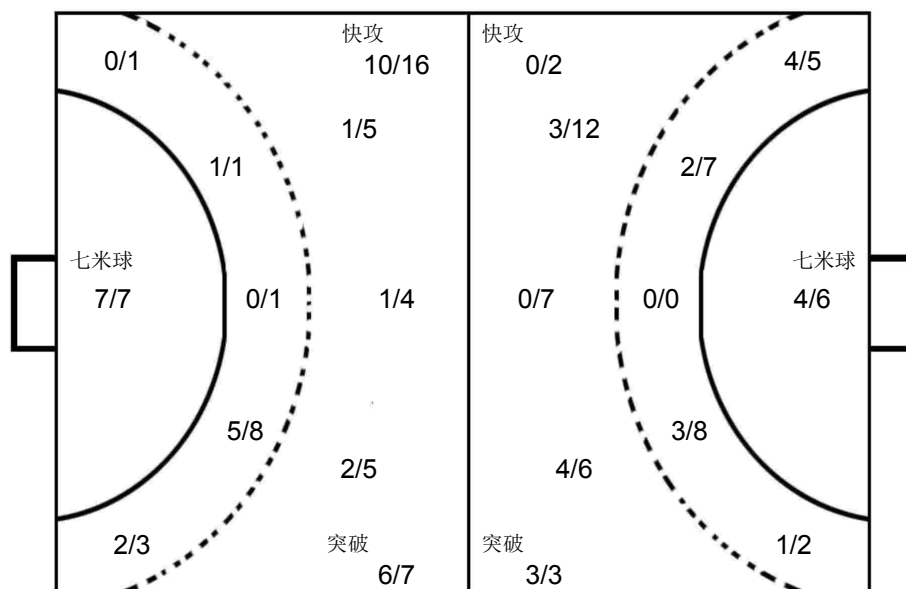

16 □□

	0/1	0/1

22 □□□

0/1	1/1	0/2
1/3	1/1	1/2
0/4		1/3

26 □□□

		0/3
0/3	3/3	0/4
2/7	1/2	1/6

广东

2 王彤羽	3 安妮	5 李纯	7 刘彤	8 李诗棋	9 韦宝桂	10 史小军	11 魏梦庭																																																																								
<table border="1"><tr><td></td><td></td><td></td></tr><tr><td></td><td></td><td></td></tr><tr><td></td><td></td><td></td></tr></table>										<table border="1"><tr><td></td><td></td><td>1</td></tr><tr><td></td><td></td><td>1</td></tr><tr><td></td><td></td><td>1</td></tr></table>			1			1			1	<table border="1"><tr><td></td><td></td><td></td></tr><tr><td></td><td></td><td></td></tr><tr><td></td><td></td><td></td></tr></table>										<table border="1"><tr><td></td><td></td><td></td></tr><tr><td></td><td></td><td></td></tr><tr><td>1</td><td></td><td></td></tr></table>							1			<table border="1"><tr><td></td><td></td><td></td></tr><tr><td></td><td></td><td></td></tr><tr><td></td><td></td><td>1</td></tr></table>									1	<table border="1"><tr><td>3</td><td></td><td>3</td></tr><tr><td>1</td><td></td><td>1</td></tr><tr><td>1</td><td></td><td>2</td></tr></table>	3		3	1		1	1		2	<table border="1"><tr><td></td><td></td><td></td></tr><tr><td></td><td></td><td></td></tr><tr><td></td><td></td><td></td></tr></table>										<table border="1"><tr><td></td><td></td><td></td></tr><tr><td></td><td></td><td></td></tr><tr><td>1</td><td></td><td></td></tr></table>							1		
		1																																																																													
		1																																																																													
		1																																																																													
1																																																																															
		1																																																																													
3		3																																																																													
1		1																																																																													
1		2																																																																													
1																																																																															
Post - 0 Miss - 0 Block - 0	Post - 0 Miss - 1 Block - 0	Post - 0 Miss - 0 Block - 0	Post - 0 Miss - 0 Block - 0	Post - 0 Miss - 0 Block - 0	Post - 0 Miss - 1 Block - 2	Post - 0 Miss - 1 Block - 0	Post - 0 Miss - 2 Block - 1																																																																								
15 杨慧	16 李娟	19 邱雪花	20 李军政	22 刘晓玉	23 王如	26 马晓卉	28 刘金兰																																																																								
<table border="1"><tr><td></td><td></td><td></td></tr><tr><td></td><td></td><td></td></tr><tr><td></td><td></td><td></td></tr></table>										<table border="1"><tr><td></td><td></td><td></td></tr><tr><td></td><td></td><td></td></tr><tr><td></td><td></td><td></td></tr></table>										<table border="1"><tr><td></td><td></td><td>1</td></tr><tr><td></td><td></td><td></td></tr><tr><td></td><td></td><td></td></tr></table>			1							<table border="1"><tr><td></td><td></td><td></td></tr><tr><td></td><td></td><td></td></tr><tr><td></td><td></td><td></td></tr></table>										<table border="1"><tr><td></td><td></td><td></td></tr><tr><td></td><td></td><td></td></tr><tr><td></td><td></td><td></td></tr></table>										<table border="1"><tr><td></td><td></td><td></td></tr><tr><td></td><td></td><td></td></tr><tr><td></td><td>1</td><td></td></tr></table>								1		<table border="1"><tr><td></td><td></td><td></td></tr><tr><td></td><td></td><td></td></tr><tr><td></td><td></td><td></td></tr></table>										<table border="1"><tr><td></td><td>1</td><td>1</td></tr><tr><td></td><td></td><td>2</td></tr><tr><td>1</td><td></td><td></td></tr></table>		1	1			2	1		
		1																																																																													
	1																																																																														
	1	1																																																																													
		2																																																																													
1																																																																															
Post - 0 Miss - 0 Block - 0	Post - 0 Miss - 0 Block - 0	Post - 2 Miss - 0 Block - 1	Post - 0 Miss - 0 Block - 0	Post - 0 Miss - 0 Block - 0	Post - 0 Miss - 0 Block - 0	Post - 0 Miss - 0 Block - 0	Post - 0 Miss - 1 Block - 0																																																																								

**第十三届全国运动会女子手球决赛**
**PHMS** Pictorial Handball Match Statistics

**IHF** Official System

**比赛进程表**

 手球 半决赛 组别 X  
 女子 轮次 5 场次 19  
 天津奥体中心体育馆  
 2017-09-05 17:30

时间	队员	动作	比分	队员	动作			
<b>安徽</b>			<b>上半时</b>			<b>广东</b>		
00:38	3 李兵	封球	0-0	9 韦宝桂	中远射 被封			
00:43	13 陶丹扬	一传快攻 得分	1-0	22 刘晓玉	被射入			
00:47	21 李瑶	助攻						
01:13	1 司艳	被射入	1-1	9 韦宝桂	右远射 得分			
01:39	21 李瑶	近射 击柱						
01:46				9 韦宝桂	四步			
01:56	21 李瑶	一传快攻 得分	2-1	22 刘晓玉	被射入			
01:58	41 杜机娟	助攻						
02:50				11 魏梦庭	四步			
03:13	3 李兵	突破 得分	3-1	22 刘晓玉	被射入			
03:15				19 邝雪花	顶贴 失误			
03:20	1 司艳	挡住球		11 魏梦庭	短传快攻 被救			
03:25	13 陶丹扬	一传快攻 被救		22 刘晓玉	挡住球			
03:30	3 李兵	助攻						
03:45	14 刘晓妹	警告						
04:15	1 司艳	被射入	3-2	8 李诗棋	近射 得分			
04:34	6 沈萍	近射 击柱						
04:37	3 李兵	助攻						
05:20				9 韦宝桂	左远射 射失			
05:26	13 陶丹扬	一传快攻 得分	4-2	22 刘晓玉	被射入			
05:29	1 司艳	助攻						
05:43	21 李瑶	造犯规		19 邝雪花	进攻犯规			
05:53	14 刘晓妹	突破 得分	5-2	22 刘晓玉	被射入			
05:56				7 刘彤	顶贴 失误			
06:14					球队暂停			
06:33	1 司艳	挡住球		9 韦宝桂	中远射 被救			
06:44	14 刘晓妹	右远射 得分	6-2	22 刘晓玉	被射入			
06:47	3 李兵	使被罚7M球		3 安妮	造7M			
06:55		裁判暂停						
07:01	16 朱莉珍	被射入	6-3	9 韦宝桂	7M球 得分			
07:14	6 沈萍	造7M		7 刘彤	使被罚7M球			
07:18				7 刘彤	警告			
07:28		裁判暂停						
07:44	41 杜机娟	7M球 得分	7-3	26 马晓卉	被射入			
08:05	6 沈萍	封球		19 邝雪花	右远射 被封			
08:10	6 沈萍	造犯规		19 邝雪花	进攻犯规			
08:41	14 刘晓妹	四步						
09:11				19 邝雪花	接球失误			
09:25	41 杜机娟	短传快攻 得分	8-3	22 刘晓玉	被射入			
10:09	3 李兵	造犯规		3 安妮	进攻犯规			
10:33				23 王如	警告			



## 第十三届全国运动会女子手球决赛

PHMS Pictorial Handball Match Statistics

IHF Official System

## 比赛进程表

 手球 半决赛 组别 X  
 女子 轮次 5 场次 19  
 八津卅卅八手球月 馆  
 2017-09-05 17:30

时间	队员	动作	比分	队员	动作			
安徽			上半时			广东		
10:50	14 刘晓妹	左远射 被救	8-3	22 刘晓玉	挡住球			
11:25	1 司艳	挡住球		9 韦宝桂	左远射 被救			
11:29	21 李瑶	造犯规		8 李诗棋	进攻犯规			
11:37	14 刘晓妹	突破 得分	9-3	22 刘晓玉	被射入			
11:38				7 刘彤	顶贴 失误			
11:50				23 王如	侵区			
12:03	3 李兵	造7M		7 刘彤	使被罚7M球			
12:30		裁判暂停						
12:35	41 杜机娟	7M球 得分	10-3	26 马晓卉	被射入			
13:17	1 司艳	被射入	10-4	9 韦宝桂	左远射 得分			
13:25	6 沈萍	左远射 得分	11-4	22 刘晓玉	被射入			
13:28				10 史小军	警告			
13:53	1 司艳	挡住球		9 韦宝桂	左远射 被救			
14:06	21 李瑶	传球失误						
14:19	1 司艳	被射入	11-5	7 刘彤	近射 得分			
14:23	13 陶丹扬	警告						
14:49	21 李瑶	左远射 得分	12-5	22 刘晓玉	被射入			
15:00				3 安妮	右远射 射失			
15:21	6 沈萍	传球失误						
15:23	6 沈萍	其它失误						
15:37	13 陶丹扬	使被罚7M球		28 刘金兰	造7M			
15:38	13 陶丹扬	移动 失误						
15:42		裁判暂停						
15:49	16 朱莉珍	被射入	12-6	9 韦宝桂	7M球 得分			
16:23	21 李瑶	突破 得分	13-6	26 马晓卉	被射入			
16:30				28 刘金兰	顶贴 失误			
16:49	6 沈萍	使被罚7M球		10 史小军	造7M			
16:49	6 沈萍	警告						
16:50		裁判暂停						
16:53	6 沈萍	逃位 失误						
17:02				28 刘金兰	7M球 射失			
17:20	14 刘晓妹	左远射 被救		26 马晓卉	挡住球			
17:29	1 司艳	挡住球		7 刘彤	近射 被救			
17:29				28 刘金兰	助攻			
17:30		裁判暂停						
17:46				9 韦宝桂	接球失误			
18:13	41 杜机娟	左边射 得分	14-6	26 马晓卉	被射入			
18:37				10 史小军	侵区			
18:46	41 杜机娟	短传快攻 得分	15-6	26 马晓卉	被射入			
19:22	1 司艳	挡住球		9 韦宝桂	左远射 被救			
19:40	6 沈萍	中远射 得分	16-6	26 马晓卉	被射入			

## 第十三届全国运动会女子手球决赛

PHMS Pictorial Handball Match Statistics

IHF Official System

## 比赛进程表

 手球 半决赛 组别 X  
 女子 轮次 5 场次 19  
 八津津世八手球月 馆  
 2017-09-05 17:30

时间	队员	动作	比分	队员	动作			
<b>安徽</b>			<b>上半时</b>			<b>广东</b>		
20:00	1 司艳	被射入	16-7	23 王如	近射 得分			
20:03				10 史小军	助攻			
20:09	6 沈萍	漏防 失误						
20:13	21 李瑶	造7M		10 史小军	使被罚7M球			
20:22		裁判暂停						
20:32				10 史小军	罚出场2分钟			
20:35	41 杜机娟	7M球 得分	17-7	16 李娟	被射入			
21:04	1 司艳	被射入	17-8	9 韦宝桂	近射 得分			
21:16	21 李瑶	传球失误						
22:00		裁判暂停						
22:11	5 班晨晨	罚出场2分钟						
22:27	1 司艳	挡住球		3 安妮	近射 被救			
22:36	6 沈萍	传球失误		28 刘金兰	断球			
22:47				10 史小军	一传快攻 射失			
22:51				28 刘金兰	助攻			
23:24	6 沈萍	近射 得分	18-8	26 马晓卉	被射入			
23:27	21 李瑶	助攻						
23:33				23 王如	漏防 失误			
23:43	1 司艳	被射入	18-9	9 韦宝桂	右远射 得分			
24:08		球队暂停						
24:30	41 杜机娟	左边射 得分	19-9	26 马晓卉	被射入			
24:33	21 李瑶	助攻						
25:02	1 司艳	被射入	19-10	9 韦宝桂	右远射 得分			
25:21	14 刘晓妹	中远射 射失						
25:48				19 邝雪花	近射 击柱			
25:54	1 司艳	被射入	19-11	28 刘金兰	右边射 得分			
26:36	41 杜机娟	造7M		19 邝雪花	使被罚7M球			
26:50				19 邝雪花	换防 失误			
26:57	41 杜机娟	7M球 得分	20-11	26 马晓卉	被射入			
27:33	1 司艳	挡住球		11 魏梦庭	中远射 被救			
27:45	21 李瑶	近射 被救		26 马晓卉	挡住球			
28:31	1 司艳	被射入	20-12	3 安妮	突破 得分			
28:34	6 沈萍	顶贴 失误						
28:58	17 周婷	突破 射失						
29:28				28 刘金兰	快攻 传球失误			
29:36	5 班晨晨	近射 得分	21-12	26 马晓卉	被射入			
29:40	17 周婷	助攻						
29:46	6 沈萍	使被罚7M球		3 安妮	造7M			
29:58		裁判暂停						
30:00	16 朱莉珍	被射入	21-13	9 韦宝桂	7M球 得分			

## 第十三届全国运动会女子手球决赛

PHMS Pictorial Handball Match Statistics

IHF Official System

## 比赛进程表

 手球 半决赛 组别 X  
 女子 轮次 5 场次 19  
 八津卅卅八子卅卅  
 2017-09-05 17:30

时间	队员	动作	比分	队员	动作
安徽			广东		
00:25	17 周婷	四步	21-13		
01:08				11 魏梦庭	左远射 射失
01:16	3 李兵	短传快攻 得分	22-13	26 马晓卉	被射入
01:47	5 班晨晨	封球		9 韦宝桂	左远射 被封
01:59				19 邝雪花	近射 击柱
02:03	5 班晨晨	快攻 运球失误			
02:08				7 刘彤	快攻 四步
02:53	21 李瑶	中远射 被封		10 史小军	封球
03:08	1 司艳	被射入	22-14	19 邝雪花	近射 得分
03:37	17 周婷	左远射 被封		19 邝雪花	封球
03:44		裁判暂停			
03:55				7 刘彤	罚出场2分钟
04:02	21 李瑶	进攻犯规		19 邝雪花	造犯规
04:21	1 司艳	被射入	22-15	9 韦宝桂	左远射 得分
04:48	15 王婵婵	右边射 射失			
05:24	17 周婷	断球		11 魏梦庭	传球失误
05:31	41 杜机娟	快攻 传球失误			
05:52	1 司艳	被射入	22-16	11 魏梦庭	右远射 得分
06:43	6 沈萍	右远射 被救		26 马晓卉	挡住球
07:32	5 班晨晨	造失误		28 刘金兰	运球失误
07:37	15 王婵婵	一传快攻 被救		26 马晓卉	挡住球
07:39	3 李兵	助攻			
07:45	16 朱莉珍	被射入	22-17	28 刘金兰	左边射 得分
08:14		球队暂停			
08:32	3 李兵	突破 得分	23-17	26 马晓卉	被射入
08:40				19 邝雪花	选位 失误
08:47	16 朱莉珍	挡住球		3 安妮	左边射 被救
08:48	14 刘晓妹	造7M		10 史小军	使被罚7M球
08:50		裁判暂停			
08:58	41 杜机娟	7M球 得分	24-17	16 李娟	被射入
09:38	16 朱莉珍	挡住球		3 安妮	中远射 被救
09:43	13 陶丹扬	一传快攻 得分	25-17	26 马晓卉	被射入
09:46	16 朱莉珍	助攻			
10:17	5 班晨晨	封球		11 魏梦庭	中远射 被封
10:38	16 朱莉珍	挡住球		10 史小军	中远射 被封
11:03	5 班晨晨	近射 得分	26-17	26 马晓卉	被射入
11:04	3 李兵	助攻			
11:12				10 史小军	移动 失误
11:39				11 魏梦庭	运球失误
11:46	13 陶丹扬	一传快攻 得分	27-17	26 马晓卉	被射入
11:50	6 沈萍	助攻			

### 第十三届全国运动会女子手球决赛

PHMS Pictorial Handball Match Statistics

IHF Official System

#### 比赛进程表

手球 半决赛 组别 X 八件四世八子牌月  
女子 轮次 5 场次 19 馆  
2017-09-05 17:30

时间	队员	动作	比分	队员	动作
安徽			广东		
11:58			27-17		球队暂停
12:22	16 朱莉珍	被射入	27-18	28 刘金兰	左边射 得分
13:25	14 刘晓妹	中远射 被救		22 刘晓玉	挡住球
13:30	13 陶丹扬	使被罚7M球		28 刘金兰	快攻 造7M
13:31		裁判暂停			
13:32	13 陶丹扬	罚出场2分钟			
13:36	16 朱莉珍	被射入	27-19	9 韦宝桂	7M球 得分
14:13	5 班晨晨	左边射 被救		22 刘晓玉	挡住球
14:19	41 杜机娟	造失误		19 邝雪花	运球失误
14:25	5 班晨晨	一传快攻 被救		22 刘晓玉	挡住球
14:28	3 李兵	助攻			
14:30	3 李兵	断球		9 韦宝桂	传球失误
14:38	5 班晨晨	突破 得分	28-19	22 刘晓玉	被射入
14:41				19 邝雪花	顶贴 失误
14:47	16 朱莉珍	挡住球		19 邝雪花	近射 被救
15:24	16 朱莉珍	被射入	28-20	9 韦宝桂	左远射 得分
15:52	21 李瑶	近射 得分	29-20	22 刘晓玉	被射入
16:30	16 朱莉珍	挡住球		11 魏梦庭	近射 被救
16:35	16 朱莉珍	挡住球		10 史小军	近射 被救
17:09	16 朱莉珍	被射入	29-21	28 刘金兰	左边射 得分
17:47	6 沈萍	右远射 被救		26 马晓卉	挡住球
18:16	16 朱莉珍	挡住球		9 韦宝桂	近射 被救
18:35	16 朱莉珍	挡住球		8 李诗棋	右边射 被救
18:50	6 沈萍	近射 得分	30-21	26 马晓卉	被射入
19:34	41 杜机娟	使被罚7M球		8 李诗棋	造7M
20:18	16 朱莉珍	挡住球		7 刘彤	7M球 被救
20:53	41 杜机娟	近射 被救		26 马晓卉	挡住球
21:08	16 朱莉珍	挡住球		3 安妮	近射 被救
21:19	3 李兵	造7M		8 李诗棋	使被罚7M球
21:33	41 杜机娟	7M球 得分	31-21	26 马晓卉	被射入
22:10	16 朱莉珍	被射入	31-22	3 安妮	突破 得分
22:22	14 刘晓妹	移动 失误			
22:26	6 沈萍	传球失误			
22:46	16 朱莉珍	挡住球		11 魏梦庭	近射 被救
22:55	13 陶丹扬	一传快攻 击柱			
22:56	16 朱莉珍	助攻			
23:00				11 魏梦庭	运球失误
23:16	21 李瑶	近射 得分	32-22	26 马晓卉	被射入
24:11	16 朱莉珍	被射入	32-23	28 刘金兰	左边射 得分
24:38	21 李瑶	四步			
24:55				2 王彤羽	四步

第十三届全国运动会女子手球决赛

PHMS Pictorial Handball Match Statistics

IHF Official System

比赛进程表

手球 半决赛 组别 X  
女子 轮次 5 场次 19  
八津开世八子球月 馆  
2017-09-05 17:30

时间	队员	动作	比分	队员	动作
安徽			广东		
下半时					
25:04	21 李瑶	短传快攻 被救	32-23	26 马晓卉	挡住球
25:30	14 刘晓妹	右远射 击柱			
25:36	10 孙来苗	造7M		2 王彤羽	使被罚7M球
25:45				2 王彤羽	移动 失误
25:53	6 沈萍	7M球 得分	33-23	26 马晓卉	被射入
26:15	16 朱莉珍	挡住球		2 王彤羽	左远射 被救
26:22	6 沈萍	一传快攻 得分	34-23	26 马晓卉	被射入
27:05	16 朱莉珍	挡住球		2 王彤羽	左远射 被救
27:28	14 刘晓妹	任意球 射失			
28:27	16 朱莉珍	被射入	34-24	3 安妮	突破 得分
28:38	6 沈萍	漏防 失误			
28:52	21 李瑶	传球失误		19 邝雪花	断球
28:58				3 安妮	快攻 传球失误
29:07	21 李瑶	短传快攻 击柱			
29:42	16 朱莉珍	挡住球		2 王彤羽	左远射 被救
29:51	13 陶丹扬	一传快攻 得分	35-24	26 马晓卉	被射入
29:53	16 朱莉珍	助攻			
30:00		裁判暂停			
30:00				11 魏梦庭	中远射 射失

Team A					Team B					Match Number											
A 上海					B 江苏					<b>20</b>											
Played in			in the hall			on			at			Spectators									
天津			天津师范大学体育馆			2017-09-05			19:15			hours									
Half-time(30')	A	B	End of playing time		A	B	1st extra time		A	B	2nd extra time		A	B	After penalty throws		A	B			
	11	17	20		25																
Number of 7 m	A	Team time-out			Full name of players and officials						Team time-out			B	Number of 7 m						
	3/4	1	2	3							1	2	3	B							
		08:02	45:34	52:00							19:44	47:40	56:55	2/4							
No.	Team A					G	W	2'	D	DR	No.	Team B					G	W	2'	D	DR
1	许沫										1	陆婷									
2	周蕾					2		1			3	张海侠					4				
3	王嘉怡										4	赵佳芹					7	1			
5	郭威					3					7	周琦									
6	黄妍					2					8	乔如					2		1		
7	车婉茹										9	莫蒙蒙									
8	吴茵					3		1			11	于源源									
9	武娜娜					4	1				12	黄霞									
10	斯文					2		1			13	黄慧影									
11	孙梦颖					3					16	王小华									
12	郑冯										17	修丽杰					3	1			
13	徐娟					1		1			18	韦秋香									
17	居晔										19	李薇薇					2				
18	沙正文							1			23	王书慧									
19	印尼										33	金梦青					2		1		
23	都好										69	蓝小玲					5		2		
A	孙琦敏										A	姚治前									
B	陈进培 (主教练)						1				B	金甲洙 (主教练)									
C	贺业磊										C	马彪									
D	金钟顺										D	刘凯									
A	Signatures of responsables for the teams (Off.A)														B						
TP	Remarks of referees / HF Official														TP						

Signatures

Referees ALEXEI. COVALCIUC (MDA)

IGOR. COVALCIUC (MDA)

T.D. 刘凤娟 (CHN)

高斌 (CHN)

CHA Off.

Note: Number of 7m Throws Awarded to Team A and B, Goals (G), Warnings (W), Suspensions (2'), Direct Disqualification (D), Disqualification With Report (DR) and Team Penalty (TP).

Table Officials: 谷瑶

张智伟

Statisticians: 王玮

李双

**第十三届全国运动会女子手球决赛**
**PHMS** Pictorial Handball Match Statistics

**IHF** Official System

**竞赛技术统计**

 手球  
 女子

 半决赛  
 轮次 5

 组别 X  
 场次 20

 天津师范大学体育馆  
 2017-09-05 19:15

Referees: ALEXEI.COVALCIUC (MDA) / IGOR.COVALCIUC (MDA)

Result: 20:25(11:17)

Teams: 上海(上海) VS 江苏(江苏)

上海		远射	近射	边射	快攻	突破	任意球	7m球	合计	%	助攻	失误	警告	2'	D+DR	上海	比赛进程	江苏
主教练: 陈进培																	1st Half	
1	许沫										1					0	00:33	1 17 修丽杰
2	周蕾		1/2	1/2				2/4	50.0		1		1			0	01:33	2 17 修丽杰
3	王嘉怡															1	02:10	2
5	郭威							3/4	75.0		2					2	02:49	2
6	黄妍	1/4	1/1					2/5	40.0	1	2					2	03:57	3 8 乔如
7	车婉茹															2	05:59	4 17 修丽杰
8	吴茵	2/6	1/2		0/1			3/9	33.3	2	3		1			3	06:36	4
9	武娜娜		2/3	1/2	1/1			4/6	66.7		1	1				3	07:09	5 4 赵佳芹
10	斯文	1/1	0/1		1/1			2/3	66.7					1		3	07:42	6 69 蓝小玲
11	孙梦颖	0/2	1/1	0/1	0/1	2/2		3/7	42.9	1	4					3	08:47	7 33 金梦青
12	郑冯															3	10:17	8 69 蓝小玲
13	徐娟	0/1			1/1			1/2	50.0		1			1		4	10:57	8
17	居晔															5	12:05	8
18	沙正文		0/2					0/2	0.0				1			5	13:00	9 19 李薇薇
19	印尼															6	14:10	9
23	都好															7	15:20	9
运动员 合计		4/14	6/12	2/5	3/5	2/2		3/4	20/42	47.6	5	14	2	4		7	17:58	10 3 张海侠
1	许沫	4/5	1/11	1/2	2/7	2/7	1/2	1/2	12/36	33.3	1					8	18:43	10
12	郑冯				1/1			1/2	2/3	66.7						8	22:07	11 69 蓝小玲
守门员 合计		4/5	1/11	1/2	3/8	2/7	1/2	2/4	14/39	35.9	1					9	22:53	11
江苏																9	23:10	12 4 赵佳芹
主教练: 金甲洙																9	24:08	13 69 蓝小玲
1	陆婷															10	25:08	13
3	张海侠		3/3	0/1	1/2			4/6	66.7							10	25:58	14 4 赵佳芹
4	赵佳芹	1/2	1/1		1/1	4/6		7/10	70.0	2	2	1				10	27:40	15 19 李薇薇
7	周琦															10	28:24	16 4 赵佳芹
8	乔如		1/1		1/1			2/2	100					1		11	29:20	16
9	莫蒙蒙															11	29:37	17 3 张海侠
11	于源源			0/1				0/1	0.0		2					12	00:24	17
12	黄霞															8	01:41	17
13	黄慧影															9	04:21	17
16	王小华															14	04:54	18 3 张海侠
17	修丽杰	0/2	3/3					3/5	60.0				1			9	10:47	18
18	韦秋香															15	11:44	19 8 乔如
19	李薇薇	0/1				1/1		1/2	50.0		4					16	12:11	19
23	王书慧															9	12:40	19
33	金梦青	0/2	0/1	1/1	0/1			1/2	2/7	28.6	1			1		17	14:15	20 4 赵佳芹
69	蓝小玲	0/3	2/2		2/3	0/1	1/2	5/11	45.5	1	2			2		18	16:23	20
运动员 合计		1/10	10/11	1/3	5/8	5/8	1/2	2/4	25/46	54.3	3	11	2	4		19	17:30	20
1	陆婷	2/2	1/1	1/1				1/3	5/7	71.4						19	21:07	21 4 赵佳芹
16	王小华	2/6	3/9	0/2	1/4	0/2		0/1	6/24	25.0						19	21:53	22 3 张海侠
守门员 合计		4/8	4/10	1/3	1/4	0/2		1/4	11/31	35.5						20	24:19	22
																20	24:53	23 69 蓝小玲
																20	28:35	24 33 金梦青
																20	29:54	25 4 赵佳芹

场上队员: 得分 / 射门

守门员: 救球 / 射门

D	取消资格	DR	取消资格+报告
---	------	----	---------

## 第十三届全国运动会女子手球决赛

PHMS Pictorial Handball Match Statistics

IHF Official System

## 个人/全队技术统计表

 手球 半决赛 组别 X 天津师范大学体育馆  
 女子 轮次 5 场次 20 2017-09-05 19:15

号码	姓名	远射	近射	边射	快攻	突破	任意	七米	合计	%	助攻	失误	警告	2'	取消	时间
上海(上海)																
(场上队员)																
1	许沫									0.0%	1					00:58:58
2	周蕾		1/2	1/2					2/4	50.0%		1		1		00:33:02
3	王嘉怡									0.0%						00:00:00
5	郭威							3/4	3/4	75.0%		2				00:20:44
6	黄妍	1/4	1/1						2/5	40.0%	1	2				00:40:17
7	车婉茹									0.0%						00:00:00
8	吴茵	2/6	1/2		0/1				3/9	33.3%	2	3		1		00:56:55
9	武娜娜		2/3	1/2	1/1				4/6	66.7%		1	1			00:59:00
10	斯文	1/1	0/1		1/1				2/3	66.7%				1		00:26:30
11	孙梦颖	0/2	1/1	0/1	0/1	2/2			3/7	42.9%	1	4				00:59:07
12	郑冯									0.0%						00:01:02
13	徐娟	0/1			1/1				1/2	50.0%		1		1		00:09:48
17	居晔									0.0%						00:00:00
18	沙正文		0/2						0/2	0.0%			1			00:51:33
19	印尼									0.0%						00:00:00
23	都好									0.0%						00:00:00
	合计	4/14	6/12	2/5	3/5	2/2		3/4	20/42	47.6%	5	14	2	4		
(守门员)																
1	许沫	4/5	1/11	1/2	2/7	2/7	1/2	1/2	12/36	33.3%	1					00:58:58
12	郑冯				1/1			1/2	2/3	66.7%						00:01:02
	合计	4/5	1/11	1/2	3/8	2/7	1/2	2/4	14/39	35.9%	1					

场上队员：得分/射门

守门员：救球/射门

全队合计	得分	被救	射失	击柱	封球	合计	%
远射	4	4	1	2	3	14	28.6%
近射	6	4	1	1		12	50.0%
边射	2	1	2			5	40.0%
快攻	3	1	1			5	60.0%
突破	2					2	100.0%
任意							0.0%
七米	3	1				4	75.0%



## 第十三届全国运动会女子手球决赛

PHMS Pictorial Handball Match Statistics

IHF Official System

## 个人/全队技术统计表

 手球 半决赛 组别 X 天津师范大学体育馆  
 女子 轮次 5 场次 20 2017-09-05 19:15

号码	姓名	远射	近射	边射	快攻	突破	任意	七米	合计	%	助攻	失误	警告	2'	取消	时间
江苏(江苏)																
(场上队员)																
1	陆婷									0.0%						00:13:21
3	张海侠		3/3	0/1	1/2				4/6	66.7%						01:00:00
4	赵佳芹	1/2	1/1		1/1	4/6			7/10	70.0%	2	2	1			01:00:00
7	周琦									0.0%						00:00:00
8	乔如		1/1		1/1				2/2	100%				1		00:54:33
9	莫蒙蒙									0.0%						00:00:00
11	于源源			0/1					0/1	0.0%	2					00:20:23
12	黄霞									0.0%						00:00:00
13	黄慧影									0.0%						00:00:00
16	王小华									0.0%						00:46:39
17	修丽杰	0/2	3/3						3/5	60.0%			1			00:43:11
18	韦秋香									0.0%						00:00:00
19	李薇薇	0/1				1/1		1/2	2/4	50.0%		4				00:15:16
23	王书慧									0.0%						00:00:00
33	金梦青	0/2	0/1	1/1	0/1			1/2	2/7	28.6%		1		1		00:47:46
69	蓝小玲	0/3	2/2		2/3	0/1	1/2		5/11	45.5%	1	2		2		00:56:09
合计		1/10	10/11	1/3	5/8	5/8	1/2	2/4	25/46	54.3%	3	11	2	4		
(守门员)																
1	陆婷	2/2	1/1	1/1				1/3	5/7	71.4%						00:13:21
16	王小华	2/6	3/9	0/2	1/4	0/2		0/1	6/24	25.0%						00:46:39
合计		4/8	4/10	1/3	1/4	0/2		1/4	11/31	35.5%						

场上队员：得分/射门

守门员：救球/射门

全队合计	得分	被救	射失	击柱	封球	合计	%
远射	1	4	1		4	10	10.0%
近射	10	1				11	90.9%
边射	1	1		1		3	33.3%
快攻	5	3				8	62.5%
突破	5	2		1		8	62.5%
任意	1	1				2	50.0%
七米	2	2				4	50.0%

第十三届全国运动会女子手球决赛

PHMS Pictorial Handball Match Statistics

IHF Official System

图式比赛技术统计表

手球  
女子

半决赛  
轮次 5

组别 X  
场次 20

天津师范大学体育馆  
2017-09-05 19:15

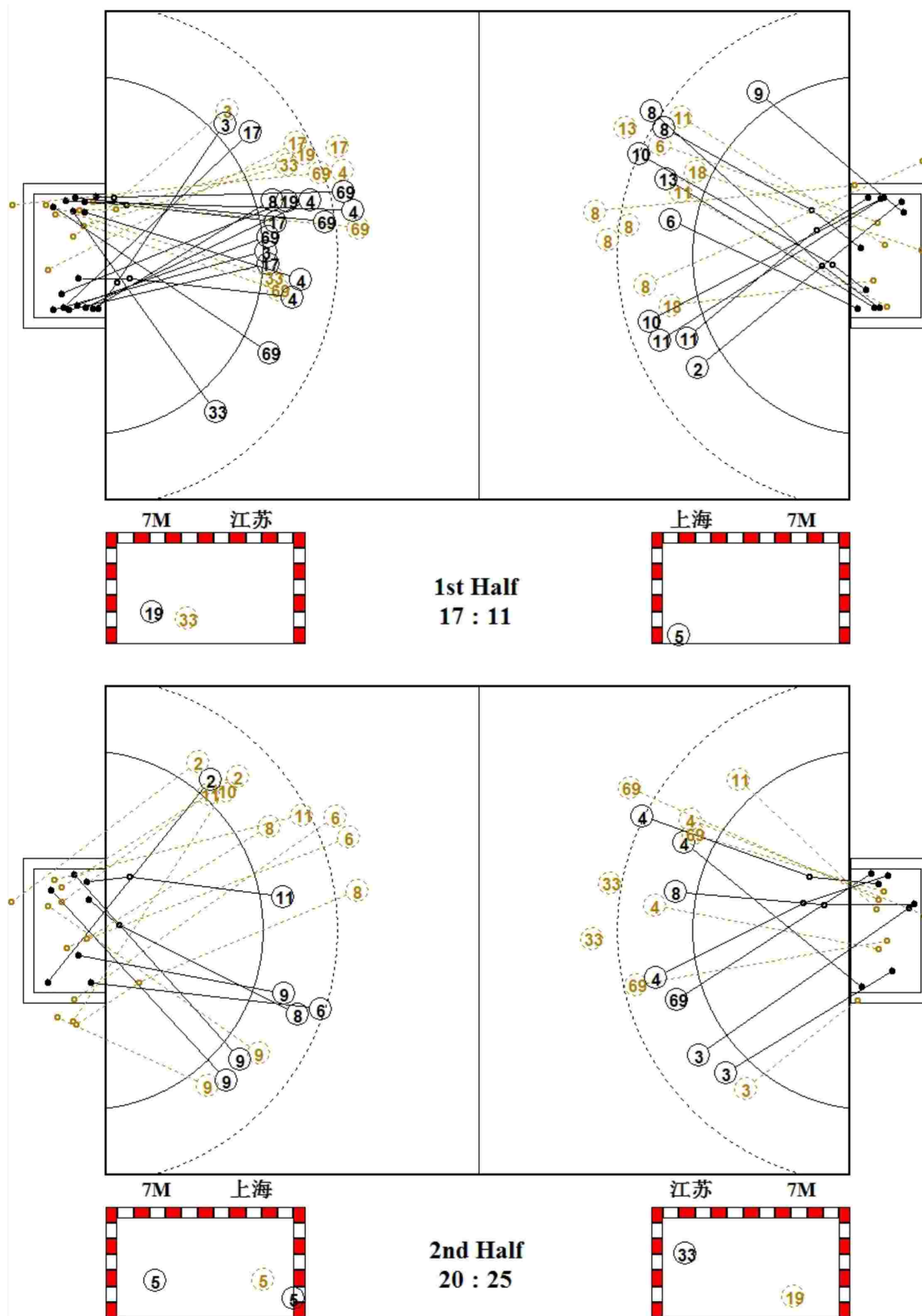

第十三届全国运动会女子手球决赛

PHMS Pictorial Handball Match Statistics

IHF Official System

图式射门区域统计

手球  
女子

半决赛  
轮次 5

组别 X  
场次 20

天津师范大学体育馆  
2017-09-05 19:15

上海

1 许沫 <table border="1"><tr><td></td><td></td><td></td></tr><tr><td></td><td></td><td></td></tr><tr><td></td><td></td><td></td></tr></table> Post - 0 Miss - 0 Block - 0										2 周蕾 <table border="1"><tr><td>2</td><td></td><td></td></tr><tr><td></td><td></td><td></td></tr><tr><td></td><td></td><td></td></tr></table> Post - 0 Miss - 1 Block - 0	2									3 王嘉怡 <table border="1"><tr><td></td><td></td><td></td></tr><tr><td></td><td></td><td></td></tr><tr><td></td><td></td><td></td></tr></table> Post - 0 Miss - 0 Block - 0										5 郭威 <table border="1"><tr><td></td><td></td><td></td></tr><tr><td>1</td><td></td><td></td></tr><tr><td>1</td><td></td><td>1</td></tr></table> Post - 0 Miss - 0 Block - 0				1			1		1	6 黄妍 <table border="1"><tr><td></td><td></td><td></td></tr><tr><td></td><td></td><td></td></tr><tr><td>1</td><td></td><td>1</td></tr></table> Post - 1 Miss - 0 Block - 0							1		1	7 车婉茹 <table border="1"><tr><td></td><td></td><td></td></tr><tr><td></td><td></td><td></td></tr><tr><td></td><td></td><td></td></tr></table> Post - 0 Miss - 0 Block - 0										8 吴茵 <table border="1"><tr><td></td><td></td><td></td></tr><tr><td></td><td></td><td>1</td></tr><tr><td></td><td>1</td><td>1</td></tr></table> Post - 1 Miss - 2 Block - 2						1		1	1	9 武娜娜 <table border="1"><tr><td>1</td><td></td><td>1</td></tr><tr><td>1</td><td></td><td>1</td></tr><tr><td></td><td></td><td></td></tr></table> Post - 0 Miss - 1 Block - 0	1		1	1		1			
2																																																																															
1																																																																															
1		1																																																																													
1		1																																																																													
		1																																																																													
	1	1																																																																													
1		1																																																																													
1		1																																																																													
10 斯文 <table border="1"><tr><td></td><td></td><td></td></tr><tr><td>1</td><td></td><td></td></tr><tr><td></td><td></td><td>1</td></tr></table> Post - 0 Miss - 1 Block - 0				1					1	11 孙梦颖 <table border="1"><tr><td></td><td></td><td></td></tr><tr><td>1</td><td></td><td></td></tr><tr><td>1</td><td></td><td>1</td></tr></table> Post - 0 Miss - 0 Block - 0				1			1		1	12 郑冯 <table border="1"><tr><td></td><td></td><td></td></tr><tr><td></td><td></td><td></td></tr><tr><td></td><td></td><td></td></tr></table> Post - 0 Miss - 0 Block - 0										13 徐娟 <table border="1"><tr><td></td><td></td><td></td></tr><tr><td></td><td></td><td>1</td></tr><tr><td></td><td></td><td></td></tr></table> Post - 0 Miss - 0 Block - 1						1				17 居晔 <table border="1"><tr><td></td><td></td><td></td></tr><tr><td></td><td></td><td></td></tr><tr><td></td><td></td><td></td></tr></table> Post - 0 Miss - 0 Block - 0										18 沙正文 <table border="1"><tr><td></td><td></td><td></td></tr><tr><td></td><td></td><td></td></tr><tr><td></td><td></td><td></td></tr></table> Post - 1 Miss - 0 Block - 0										19 印尼 <table border="1"><tr><td></td><td></td><td></td></tr><tr><td></td><td></td><td></td></tr><tr><td></td><td></td><td></td></tr></table> Post - 0 Miss - 0 Block - 0										23 都好 <table border="1"><tr><td></td><td></td><td></td></tr><tr><td></td><td></td><td></td></tr><tr><td></td><td></td><td></td></tr></table> Post - 0 Miss - 0 Block - 0									
1																																																																															
		1																																																																													
1																																																																															
1		1																																																																													
		1																																																																													

1 □□

0/4	1/1	1/2
2/9	4/4	1/5
0/4		3/7

12 □□

		1/1
0/1		
	1/1	

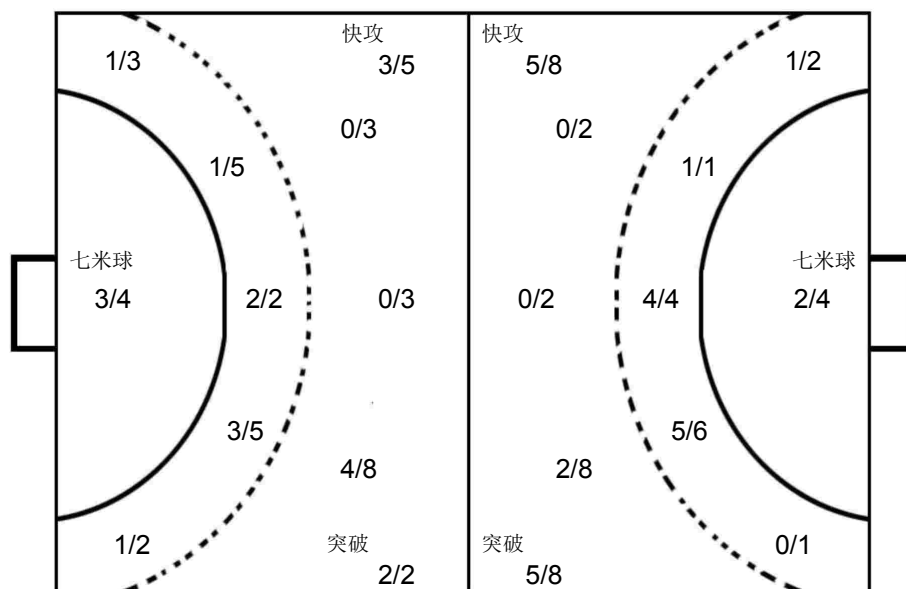

1 □□

		1/1
0/1	1/1	3/3
		0/1

16 □□□

0/3		1/2
1/4	1/1	2/5
0/3	1/2	0/4

江苏

1 陆婷 <table border="1"><tr><td></td><td></td><td></td></tr><tr><td></td><td></td><td></td></tr><tr><td></td><td></td><td></td></tr></table> Post - 0 Miss - 0 Block - 0										3 张海侠 <table border="1"><tr><td>2</td><td></td><td></td></tr><tr><td></td><td></td><td>1</td></tr><tr><td>1</td><td></td><td></td></tr></table> Post - 1 Miss - 0 Block - 0	2					1	1			4 赵佳芹 <table border="1"><tr><td></td><td></td><td></td></tr><tr><td>3</td><td></td><td>1</td></tr><tr><td>1</td><td></td><td>2</td></tr></table> Post - 1 Miss - 0 Block - 1				3		1	1		2	7 周琦 <table border="1"><tr><td></td><td></td><td></td></tr><tr><td></td><td></td><td></td></tr><tr><td></td><td></td><td></td></tr></table> Post - 0 Miss - 0 Block - 0										8 乔如 <table border="1"><tr><td>1</td><td></td><td></td></tr><tr><td></td><td></td><td></td></tr><tr><td>1</td><td></td><td></td></tr></table> Post - 0 Miss - 0 Block - 0	1						1			9 莫蒙蒙 <table border="1"><tr><td></td><td></td><td></td></tr><tr><td></td><td></td><td></td></tr><tr><td></td><td></td><td></td></tr></table> Post - 0 Miss - 0 Block - 0										11 于源源 <table border="1"><tr><td></td><td></td><td></td></tr><tr><td></td><td></td><td></td></tr><tr><td></td><td></td><td></td></tr></table> Post - 0 Miss - 0 Block - 0										12 黄霞 <table border="1"><tr><td></td><td></td><td></td></tr><tr><td></td><td></td><td></td></tr><tr><td></td><td></td><td></td></tr></table> Post - 0 Miss - 0 Block - 0									
2																																																																															
		1																																																																													
1																																																																															
3		1																																																																													
1		2																																																																													
1																																																																															
1																																																																															
13 黄慧影 <table border="1"><tr><td></td><td></td><td></td></tr><tr><td></td><td></td><td></td></tr><tr><td></td><td></td><td></td></tr></table> Post - 0 Miss - 0 Block - 0										16 王小华 <table border="1"><tr><td></td><td></td><td></td></tr><tr><td></td><td></td><td></td></tr><tr><td></td><td></td><td></td></tr></table> Post - 0 Miss - 0 Block - 0										17 修丽杰 <table border="1"><tr><td></td><td></td><td></td></tr><tr><td>2</td><td></td><td></td></tr><tr><td></td><td></td><td>1</td></tr></table> Post - 0 Miss - 0 Block - 1				2					1	18 韦秋香 <table border="1"><tr><td></td><td></td><td></td></tr><tr><td></td><td></td><td></td></tr><tr><td></td><td></td><td></td></tr></table> Post - 0 Miss - 0 Block - 0										19 李薇薇 <table border="1"><tr><td></td><td></td><td></td></tr><tr><td></td><td></td><td></td></tr><tr><td>2</td><td></td><td></td></tr></table> Post - 0 Miss - 0 Block - 0							2			23 王书慧 <table border="1"><tr><td></td><td></td><td></td></tr><tr><td></td><td></td><td></td></tr><tr><td></td><td></td><td></td></tr></table> Post - 0 Miss - 0 Block - 0										33 金梦青 <table border="1"><tr><td></td><td></td><td></td></tr><tr><td>1</td><td></td><td></td></tr><tr><td></td><td></td><td>1</td></tr></table> Post - 0 Miss - 0 Block - 2				1					1	69 蓝小玲 <table border="1"><tr><td></td><td></td><td>1</td></tr><tr><td>1</td><td></td><td>1</td></tr><tr><td>1</td><td></td><td>1</td></tr></table> Post - 0 Miss - 1 Block - 0			1	1		1	1		1
2																																																																															
		1																																																																													
2																																																																															
1																																																																															
		1																																																																													
		1																																																																													
1		1																																																																													
1		1																																																																													

**第十三届全国运动会女子手球决赛**
**PHMS** Pictorial Handball Match Statistics

**IHF** Official System

**比赛进程表**

 手球 半决赛 组别 X  
 女子 轮次 5 场次 20  
 天津奥体中心体育馆  
 2017-09-05 19:15

时间	队员	动作	比分	队员	动作
上海			上半时		
江苏					
00:33	1 许沫	被射入	0-1	17 修丽杰	近射 得分
01:21	6 黄妍	左远射 被救		16 王小华	挡住球
01:33	1 许沫	被射入	0-2	17 修丽杰	近射 得分
01:37				4 赵佳芹	助攻
02:10	2 周蕾	近射 得分	1-2	16 王小华	被射入
02:43	1 许沫	挡住球		33 金梦青	近射 被救
02:49	13 徐娟	短传快攻 得分	2-2	16 王小华	被射入
03:43	11 孙梦颖	断球		4 赵佳芹	传球失误
03:51	11 孙梦颖	快攻 运球失误		8 乔如	造失误
03:57	1 许沫	被射入	2-3	8 乔如	短传快攻 得分
04:26				17 修丽杰	警告
04:58	11 孙梦颖	传球失误			
05:28	1 许沫	挡住球		69 蓝小玲	任意球 被救
05:49	18 沙正文	近射 被救		16 王小华	挡住球
05:50	11 孙梦颖	助攻			
05:59	1 许沫	被射入	2-4	17 修丽杰	近射 得分
06:02	2 周蕾	漏防 失误			
06:06				4 赵佳芹	助攻
06:36	9 武娜娜	左边射 得分	3-4	16 王小华	被射入
07:09	1 许沫	被射入	3-5	4 赵佳芹	右远射 得分
07:32	8 吴茵	传球失误		4 赵佳芹	断球
07:42	1 许沫	被射入	3-6	69 蓝小玲	短传快攻 得分
08:02		球队暂停			
08:19	6 黄妍	传球失误		4 赵佳芹	断球
08:47	1 许沫	被射入	3-7	33 金梦青	左边射 得分
09:32	11 孙梦颖	左远射 被救		16 王小华	挡住球
09:35	2 周蕾	侵区			
10:17	1 许沫	被射入	3-8	69 蓝小玲	任意球 得分
10:57	8 吴茵	左远射 得分	4-8	16 王小华	被射入
11:16				69 蓝小玲	右远射 射失
12:05	11 孙梦颖	突破 得分	5-8	16 王小华	被射入
12:10				69 蓝小玲	移动 失误
12:12				4 赵佳芹	警告
13:00	1 许沫	被射入	5-9	19 李薇薇	突破 得分
13:07	10 斯文	顶贴 失误			
13:27		裁判暂停			
13:47				69 蓝小玲	罚出场2分钟
14:10	6 黄妍	近射 得分	6-9	16 王小华	被射入
14:35	1 许沫	挡住球		19 李薇薇	右远射 被救
14:55	18 沙正文	造7M		19 李薇薇	使被罚7M球
15:20	5 郭威	7M球 得分	7-9	16 王小华	被射入

**第十三届全国运动会女子手球决赛**
**PHMS** Pictorial Handball Match Statistics

**IHF** Official System

**比赛进程表**

 手球 半决赛 组别 X  
 女子 轮次 5 场次 20  
 天津奥林匹克体育中心 2017-09-05 19:15

时间	队员	动作	比分	队员	动作
上海			上半时		
江苏					
15:54	9 武娜娜	警告	7-9		
16:19	8 吴茵	封球		4 赵佳芹	右远射 被封
16:56	11 孙梦颖	运球失误		8 乔如	造失误
17:05	1 许沫	挡住球		3 张海侠	短传快攻 被救
17:47	8 吴茵	左远射 击柱			
17:58	1 许沫	被射入	7-10	3 张海侠	近射 得分
18:02				69 蓝小玲	助攻
18:08	9 武娜娜	选位 失误			
18:43	8 吴茵	左远射 得分	8-10	16 王小华	被射入
19:40	18 沙正文	封球		17 修丽杰	右远射 被封
19:44					球队暂停
20:07		裁判暂停			
20:08	18 沙正文	使被罚7M球		8 乔如	造7M
20:08	18 沙正文	警告			
20:15	12 郑冯	挡住球		33 金梦青	7M球 被救
20:23		裁判暂停			
20:23	2 周蕾	罚出场2分钟			
20:38	11 孙梦颖	断球		4 赵佳芹	传球失误
20:44	11 孙梦颖	一传快攻 被救		16 王小华	挡住球
20:52	12 郑冯	挡住球		69 蓝小玲	短传快攻 被救
21:31	8 吴茵	中远射 被封		69 蓝小玲	封球
21:37	1 许沫	挡住球		33 金梦青	一传快攻 被救
22:07	1 许沫	被射入	8-11	69 蓝小玲	近射 得分
22:35	5 郭威	进攻犯规		17 修丽杰	造犯规
22:47	1 许沫	挡住球		17 修丽杰	右远射 被救
22:53	10 斯文	一传快攻 得分	9-11	16 王小华	被射入
22:56	1 许沫	助攻			
23:10	1 许沫	被射入	9-12	4 赵佳芹	突破 得分
23:15	8 吴茵	漏防 失误			
23:58	18 沙正文	近射 击柱			
23:59	8 吴茵	助攻			
24:08	1 许沫	被射入	9-13	69 蓝小玲	短传快攻 得分
24:42	8 吴茵	中远射 被封		8 乔如	封球
25:08	10 斯文	左远射 得分	10-13	16 王小华	被射入
25:58	1 许沫	被射入	10-14	4 赵佳芹	突破 得分
26:23	18 沙正文	顶贴 失误			
26:56	8 吴茵	传球失误		4 赵佳芹	断球
27:01				11 于源源	快攻 接球失误
27:09	8 吴茵	短传快攻 射失			
27:34	18 沙正文	使被罚7M球		8 乔如	造7M
27:34		裁判暂停			

第十三届全国运动会女子手球决赛

PHMS Pictorial Handball Match Statistics

IHF Official System

比赛进程表

手球 半决赛 组别 X 八件型也八子件月  
女子 轮次 5 场次 20 馆  
2017-09-05 19:15

时间	队员	动作	比分	队员	动作			
上海			上半时			江苏		
27:40	12 郑冯	被射入	10-15	19 李薇薇	7M球 得分			
28:13	5 郭威	其它失误						
28:24	1 许沫	被射入	10-16	4 赵佳芹	突破 得分			
28:30	18 沙正文	选位 失误						
29:20	11 孙梦颖	突破 得分	11-16	16 王小华	被射入			
29:37	1 许沫	被射入	11-17	3 张海侠	近射 得分			
29:57		裁判暂停						
30:00	13 徐娟	左远射 被封		33 金梦青	封球			

**第十三届全国运动会女子手球决赛**
**PHMS** Pictorial Handball Match Statistics

**IHF** Official System

**比赛进程表**

 手球 半决赛 组别 X  
 女子 轮次 5 场次 20  
 天津奥林匹克体育中心 2017-09-05 19:15

时间	队员	动作	比分	队员	动作
上海			江苏		
00:24	2 周蕾	右边射 得分	12-17	16 王小华	被射入
01:06	9 武娜娜	造犯规		19 李薇薇	进攻犯规
01:41	8 吴茵	近射 得分	13-17	16 王小华	被射入
02:43	8 吴茵	造犯规		19 李薇薇	进攻犯规
03:39	6 黄妍	右远射 击柱			
03:42	9 武娜娜	近射 被救		16 王小华	挡住球
04:01	1 许沫	挡住球		69 蓝小玲	左远射 被救
04:01		裁判暂停			
04:01				69 蓝小玲	罚出场2分钟
04:21	9 武娜娜	近射 得分	14-17	16 王小华	被射入
04:54	1 许沫	被射入	14-18	3 张海侠	近射 得分
05:20	2 周蕾	右边射 射失			
06:20	2 周蕾	造犯规		19 李薇薇	进攻犯规
06:57	8 吴茵	近射 被救		16 王小华	挡住球
07:30		裁判暂停			
07:35	8 吴茵	罚出场2分钟			
07:45	18 沙正文	封球		33 金梦青	左远射 被封
07:54	2 周蕾	造犯规		33 金梦青	进攻犯规
08:40		裁判暂停			
08:43				8 乔如	罚出场2分钟
09:23		裁判暂停			
09:23	B 陈进培	警告			
09:31		裁判暂停			
09:31				33 金梦青	罚出场2分钟
09:39	13 徐娟	传球失误		11 于源源	断球
10:08	8 吴茵	造犯规		69 蓝小玲	进攻犯规
10:47	9 武娜娜	近射 得分	15-18	16 王小华	被射入
11:45		裁判暂停			
11:44	1 许沫	被射入	15-19	8 乔如	近射 得分
11:44	13 徐娟	罚出场2分钟			
12:05	18 沙正文	造7M		8 乔如	使被罚7M球
12:05		裁判暂停			
12:11	5 郭威	7M球 得分	16-19	1 陆婷	被射入
12:20	1 许沫	挡住球		69 蓝小玲	右远射 被救
12:26	6 黄妍	快攻 传球失误		4 赵佳芹	断球
12:36	6 黄妍	断球		11 于源源	快攻 传球失误
12:40	9 武娜娜	一传快攻 得分	17-19	16 王小华	被射入
12:42	6 黄妍	助攻			
12:46	11 孙梦颖	抢球		69 蓝小玲	接球失误
13:35		裁判暂停			
13:51	11 孙梦颖	进攻犯规		4 赵佳芹	造犯规

**第十三届全国运动会女子手球决赛**
**PHMS** Pictorial Handball Match Statistics

**IHF** Official System

**比赛进程表**

 手球 半决赛 组别 X  
 女子 轮次 5 场次 20  
 天津奥林匹克体育中心 2017-09-05 19:15

时间	队员	动作	比分	队员	动作
上海			江苏		
14:15	1 许沫	被射入	17-20	4 赵佳芹	突破 得分
14:40	10 斯文	近射 射失			
15:24	18 沙正文	封球		33 金梦青	中远射 被封
15:34		球队暂停			
16:23	6 黄妍	左远射 得分	18-20	16 王小华	被射入
16:33	1 许沫	挡住球		11 于源源	左边射 被救
17:30	11 孙梦颖	近射 得分	19-20	16 王小华	被射入
17:33	8 吴茵	助攻			
17:40					球队暂停
18:05				3 张海侠	右边射 击柱
19:01	11 孙梦颖	造7M		4 赵佳芹	使被罚7M球
19:27	5 郭威	7M球 被救		1 陆婷	挡住球
20:09		裁判暂停			
20:08	10 斯文	罚出场2分钟			
20:15	1 许沫	挡住球		4 赵佳芹	突破 被救
20:20	5 郭威	顶贴 失误			
20:58	11 孙梦颖	右远射 被救		1 陆婷	挡住球
21:07	1 许沫	被射入	19-21	4 赵佳芹	短传快攻 得分
21:40	9 武娜娜	左边射 射失			
21:53	1 许沫	被射入	19-22	3 张海侠	短传快攻 得分
22:00		球队暂停			
22:36	9 武娜娜	传球失误			
23:00	18 沙正文	使被罚7M球		69 蓝小玲	造7M
23:18	1 许沫	挡住球		19 李薇薇	7M球 被救
23:51	11 孙梦颖	造7M		33 金梦青	使被罚7M球
24:19	5 郭威	7M球 得分	20-22	1 陆婷	被射入
24:53	1 许沫	被射入	20-23	69 蓝小玲	近射 得分
25:20	11 孙梦颖	右边射 被救		1 陆婷	挡住球
25:49	8 吴茵	造犯规		19 李薇薇	进攻犯规
26:01	8 吴茵	进攻犯规		33 金梦青	造犯规
26:43				4 赵佳芹	突破 击柱
26:51	6 黄妍	右远射 被救		1 陆婷	挡住球
26:55					球队暂停
27:28	1 许沫	挡住球		69 蓝小玲	突破 被救
27:58	2 周蕾	近射 被救		1 陆婷	挡住球
28:15	2 周蕾	使被罚7M球		69 蓝小玲	造7M
28:35	1 许沫	被射入	20-24	33 金梦青	7M球 得分
29:14	8 吴茵	中远射 射失			
29:54	1 许沫	被射入	20-25	4 赵佳芹	近射 得分
29:54		裁判暂停			



**PHMS** Pictorial Handball Match Statistics

**IHF** Official System

Team A					Team B					Match Number											
A 新疆					B 天津					<b>21</b>											
Played in			in the hall			on			at			Spectators									
天津			天津师范大学体育馆			2017-09-07			14:00			hours									
Half-time(30')	A	B	End of playing time		A	B	1st extra time		A	B	2nd extra time		A	B	After penalty throws		A	B			
	15	11			25	20															
Number of 7 m	A	Team time-out			Full name of players and officials						Team time-out			B	Number of 7 m						
	5/6	1	2	3							1	2	3	2/5							
		24:21	52:35								20:32										
No.	Team A					G	W	2'	D	DR	No.	Team B					G	W	2'	D	DR
3	葛立双					2					1	张莉									
5	于千添										3	王晓梅					5				
6	阿热孜古丽					7		2			5	丁丽洁					1				
7	吴志娟					3		1			6	窦海乐									
10	李静										7	张心茹									
11	陈培培										8	张慧					1				
12	艾敏										9	袁玉					3				
15	兰姝娇					2					10	张文慧					2	1	2		
17	戴莹莹					1					11	蔡雪洁					2	1			
18	崔娟					3	1	2			12	王欣冉									
21	锁珊珊					2					14	刘洁									
23	张艺璇										16	王选									
26	宋婷婷										17	聂晓雪									
27	谢辰辰										18	舒文琪					4				
32	杨雨柔										23	周梦雪					2				
93	张婷婷					5	1														
A	刁继平										A	付明双									
B	于涛 (主教练)										B	王明星 (主教练)									
C	李天坐										C	岳连娥									
											D	张圆圆									
A											Signatures of responsables for the teams (Off.A)										B
TP	Remarks of referees / HF Official																				TP

Referees	李兆蒙 (CHN)	周云磊 (CHN)	
T.D.	张春生 (CHN)	柴业宏 (CHN)	
CHA Off.			

Note: Number of 7m Throws Awarded to Team A and B, Goals (G), Warnings (W), Suspensions (2'), Direct Disqualification (D), Disqualification With Report (DR) and Team Penalty (TP).

Table Officials: 翟延露

齐红梅

Statisticians: 王玮

李双

**第十三届全国运动会女子手球决赛**
**PHMS** Pictorial Handball Match Statistics

**IHF** Official System

**竞赛技术统计**

 手球  
 女子

 7-8名  
 轮次 6

 组别 X  
 场次 21

 天津师范大学体育馆  
 2017-09-07 14:00

Referees: 李兆蒙 (CHN) / 周云磊 (CHN)

Result: 25:20(15:11)

Teams: 新疆(新疆) VS 天津(天津)

新疆		远	近	边	快	突	任意	7m	合计	%	助攻	失误	警告	2'	D+DR
主教练: 于涛		射	射	射	攻	破	球	球							
3	葛立双	0/1			1/1	1/1		0/1	2/4	50.0		2			
5	于千添	0/1							0/1	0.0					
6	阿热孜古丽		4/5		3/3				7/8	87.5	1		2		
7	吴志娟		1/2	2/3					3/5	60.0			1		
10	李静														
11	陈培培														
12	艾敏														
15	兰姝娇				2/2				2/2	100	1	2			
17	戴莹莹				1/1				1/1	100					
18	崔娟	1/3				1/1		1/1	3/5	60.0	1	3	1	2	
21	锁珊珊	1/1	0/2					1/1	2/4	50.0	1	3			
23	张艺璇											1			
26	宋婷婷														
27	谢辰辰														
32	杨雨柔											1			
93	张婷婷	0/3	1/1			1/1		3/3	5/8	62.5	1	4	1		
运动员	合计	2/9	6/10	2/3	7/7	3/3		5/6	25/38	65.8	4	17	2	5	
10	李静							1/1	1/1	100					
32	杨雨柔	3/8	8/14	1/1	2/7	0/2		1/3	15/35	42.9		1			
守门员	合计	3/8	8/14	1/1	2/7	0/2		2/4	16/36	44.4		1			

天津		远	近	边	快	突	任意	7m	合计	%	助攻	失误	警告	2'	D+DR
主教练: 王明星		射	射	射	攻	破	球	球							
1	张莉														
3	王晓梅	3/6	1/1					1/2	5/9	55.6	2	4			
5	丁丽洁	0/1	1/1						1/2	50.0					
6	窦海乐														
7	张心茹														
8	张慧		1/2		0/1				1/3	33.3		1			
9	袁玉	0/1	0/2		1/2	2/2			3/7	42.9		5			
10	张文慧		2/3						2/3	66.7		2	1	2	
11	蔡雪洁				2/2				2/2	100		1	1		
12	王欣冉														
14	刘洁														
16	王选														
17	聂晓雪											1			
18	舒文琪	1/3	1/2	0/1	1/1			1/3	4/10	40.0	3	4			
23	周梦雪	1/5	0/3		1/1				2/9	22.2	1	3			
运动员	合计	5/16	6/14	0/1	5/7	2/2		2/5	20/45	44.4	6	21	2	2	
1	张莉	3/4	2/4	1/2	0/3	0/2		1/3	7/18	38.9					
12	王欣冉	0/1	1/2		0/2			0/1	1/6	16.7					
16	王选	2/2	0/3	0/1	0/2	0/1		0/2	2/11	18.2					
守门员	合计	5/7	3/9	1/3	0/7	0/3		1/6	10/35	28.6					

新疆	比赛进程	天津
1st Half		
0	02:29	1 18 舒文琪
7 吴志娟	1 05:16	1
	1 06:00	2 9 袁玉
	1 06:25	3 11 蔡雪洁
6 阿热孜古丽	2 06:49	3
93 张婷婷	3 07:11	3
	3 07:20	4 10 张文慧
93 张婷婷	4 08:11	4
93 张婷婷	5 09:21	4
6 阿热孜古丽	6 11:40	4
	6 13:10	5 9 袁玉
93 张婷婷	7 14:16	5
	7 14:38	6 18 舒文琪
17 戴莹莹	8 17:00	6
18 崔娟	9 18:57	6
6 阿热孜古丽	10 20:18	6
7 吴志娟	11 21:53	6
18 崔娟	12 23:01	6
	12 24:21	7 18 舒文琪
6 阿热孜古丽	13 25:02	7
15 兰姝娇	14 25:29	7
	14 25:52	8 10 张文慧
	14 27:27	9 8 张慧
	14 28:10	10 3 王晓梅
93 张婷婷	15 29:03	10
	15 29:41	11 3 王晓梅
2nd Half		
21 锁珊珊	16 03:20	12
3 葛立双	17 05:07	12
6 阿热孜古丽	18 06:14	12
21 锁珊珊	19 07:20	12
	19 10:13	13 18 舒文琪
3 葛立双	20 10:38	13
15 兰姝娇	21 11:22	13
	21 12:35	14 23 周梦雪
6 阿热孜古丽	22 16:32	14
	22 17:58	15 3 王晓梅
	22 19:04	16 9 袁玉
	22 22:30	17 3 王晓梅
18 崔娟	23 22:55	17
	23 23:24	18 5 丁丽洁
6 阿热孜古丽	24 25:14	18
	24 26:33	19 23 周梦雪
7 吴志娟	25 28:09	19
	25 29:06	20 3 王晓梅

场上队员: 得分 / 射门

守门员: 救球 / 射门

D	取消资格	DR	取消资格+报告

## 第十三届全国运动会女子手球决赛

PHMS Pictorial Handball Match Statistics

IHF Official System

## 个人/全队技术统计表

 手球 7-8名 组别 X 天津师范大学体育馆  
 女子 轮次 6 场次 21 2017-09-07 14:00

号码	姓名	远射	近射	边射	快攻	突破	任意	七米	合计	%	助攻	失误	警告	2'	取消	时间
<b>新疆(新疆)</b>																
<b>(场上队员)</b>																
3	葛立双	0/1			1/1	1/1		0/1	2/4	50.0%		2				00:33:47
5	于千添	0/1							0/1	0.0%						00:01:30
6	阿热孜古丽		4/5		3/3				7/8	87.5%		1		2		00:58:27
7	吴志娟		1/2	2/3					3/5	60.0%				1		00:54:35
10	李静									0.0%						00:00:16
11	陈培培									0.0%						00:00:00
12	艾敏									0.0%						00:00:00
15	兰姝娇				2/2				2/2	100%	1	2				00:50:25
17	戴莹莹				1/1				1/1	100%						00:17:11
18	崔娟	1/3				1/1		1/1	3/5	60.0%	1	3	1	2		00:51:30
21	锁珊珊	1/1	0/2					1/1	2/4	50.0%	1	3				00:36:43
23	张艺璇									0.0%		1				00:09:32
26	宋婷婷									0.0%						00:00:00
27	谢辰辰									0.0%						00:00:00
32	杨雨柔									0.0%		1				00:59:44
93	张婷婷	0/3	1/1			1/1		3/3	5/8	62.5%	1	4	1			00:40:27
	<b>合计</b>	<b>2/9</b>	<b>6/10</b>	<b>2/3</b>	<b>7/7</b>	<b>3/3</b>		<b>5/6</b>	<b>25/38</b>	<b>65.8%</b>	<b>4</b>	<b>17</b>	<b>2</b>	<b>5</b>		
<b>(守门员)</b>																
10	李静							1/1	1/1	100%						00:00:16
32	杨雨柔	3/8	8/14	1/1	2/7	0/2		1/3	15/35	42.9%		1				00:59:44
	<b>合计</b>	<b>3/8</b>	<b>8/14</b>	<b>1/1</b>	<b>2/7</b>	<b>0/2</b>		<b>2/4</b>	<b>16/36</b>	<b>44.4%</b>		<b>1</b>				

场上队员：得分/射门

守门员：救球/射门

全队合计	得分	被救	射失	击柱	封球	合计	%
远射	2	5	1	1		9	22.2%
近射	6	3		1		10	60.0%
边射	2	1				3	66.7%
快攻	7					7	100.0%
突破	3					3	100.0%
任意							0.0%
七米	5	1				6	83.3%

**第十三届全国运动会女子手球决赛**
**PHMS** Pictorial Handball Match Statistics

**IHF** Official System

**个人/全队技术统计表**

 手球 7-8名 组别 X 天津师范大学体育馆  
 女子 轮次 6 场次 21 2017-09-07 14:00

号码	姓名	远射	近射	边射	快攻	突破	任意	七米	合计	%	助攻	失误	警告	2'	取消	时间
<b>天津(天津)</b>																
<b>(场上队员)</b>																
1	张莉									0.0%						00:30:11
3	王晓梅	3/6	1/1					1/2	5/9	55.6%	2	4				00:25:15
5	丁丽洁	0/1	1/1						1/2	50.0%						00:13:08
6	窦海乐									0.0%						00:00:00
7	张心茹									0.0%						00:00:00
8	张慧		1/2		0/1				1/3	33.3%		1				00:52:03
9	袁玉	0/1	0/2		1/2	2/2			3/7	42.9%		5				01:00:00
10	张文慧		2/3						2/3	66.7%		2	1	2		01:00:00
11	蔡雪洁				2/2				2/2	100%		1	1			00:36:11
12	王欣冉									0.0%						00:07:21
14	刘洁									0.0%						00:00:00
16	王选									0.0%						00:22:28
17	聂晓雪									0.0%		1				00:17:13
18	舒文琪	1/3	1/2	0/1	1/1			1/3	4/10	40.0%	3	4				00:42:23
23	周梦雪	1/5	0/3		1/1				2/9	22.2%	1	3				00:53:21
<b>合计</b>		<b>5/16</b>	<b>6/14</b>	<b>0/1</b>	<b>5/7</b>	<b>2/2</b>		<b>2/5</b>	<b>20/45</b>	<b>44.4%</b>	<b>6</b>	<b>21</b>	<b>2</b>	<b>2</b>		
<b>(守门员)</b>																
1	张莉	3/4	2/4	1/2	0/3	0/2		1/3	7/18	38.9%						00:30:11
12	王欣冉	0/1	1/2		0/2			0/1	1/6	16.7%						00:07:21
16	王选	2/2	0/3	0/1	0/2	0/1		0/2	2/11	18.2%						00:22:28
<b>合计</b>		<b>5/7</b>	<b>3/9</b>	<b>1/3</b>	<b>0/7</b>	<b>0/3</b>		<b>1/6</b>	<b>10/35</b>	<b>28.6%</b>						

场上队员：得分/射门

守门员：救球/射门

全队合计	得分	被救	射失	击柱	封球	合计	%
远射	5	3	2	2	4	16	31.3%
近射	6	8				14	42.9%
边射		1				1	0.0%
快攻	5	2				7	71.4%
突破	2					2	100.0%
任意							0.0%
七米	2	2		1		5	40.0%

第十三届全国运动会女子手球决赛

PHMS Pictorial Handball Match Statistics

IHF Official System

图式比赛技术统计表

手球  
女子

7-8名  
轮次 6

组别 X  
场次 21

天津师范大学体育馆  
2017-09-07 14:00

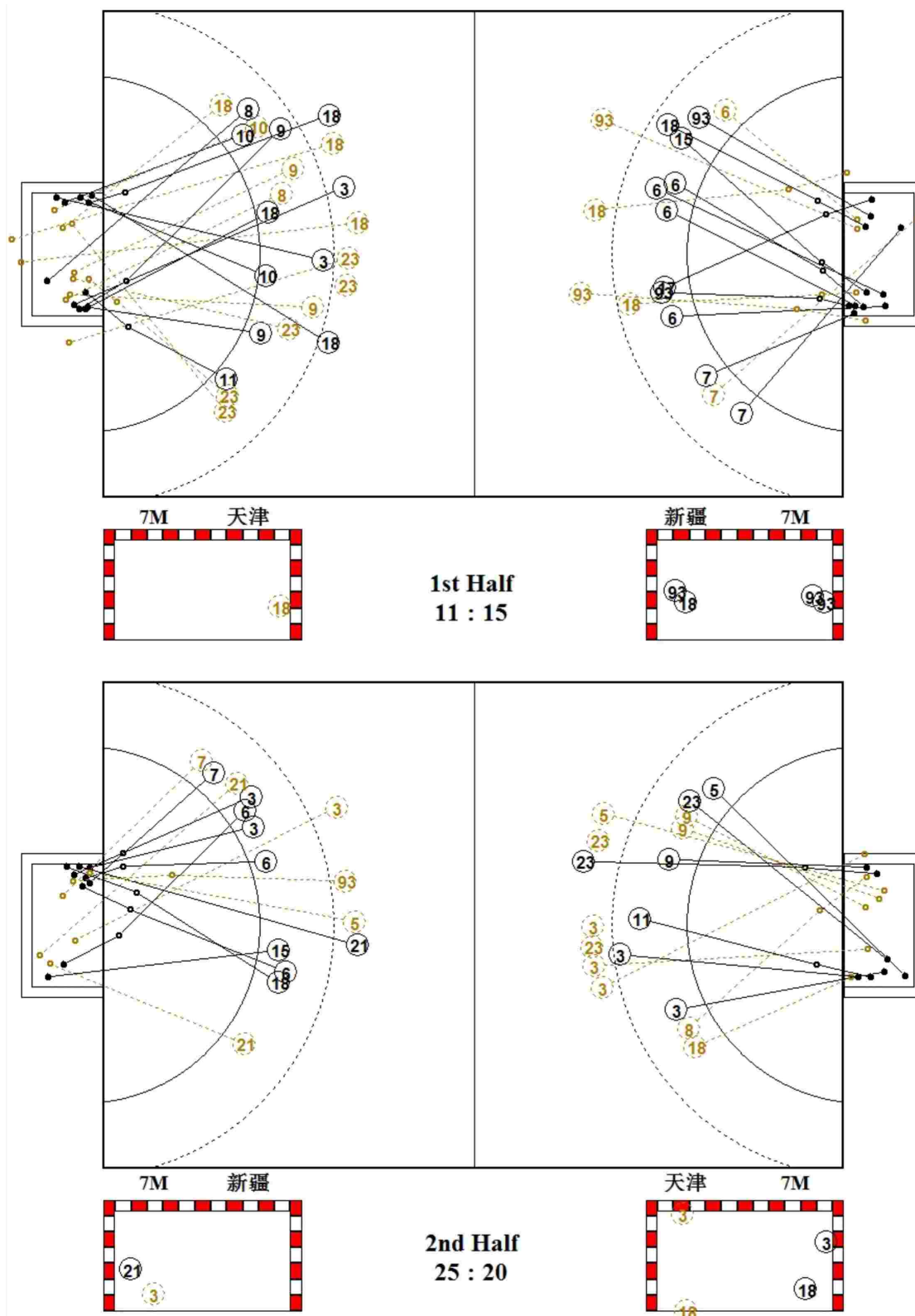

第十三届全国运动会女子手球决赛

PHMS Pictorial Handball Match Statistics

IHF Official System

图式射门区域统计

手球  
女子

7-8名  
轮次 6

组别 X  
场次 21

天津师范大学体育馆  
2017-09-07 14:00

新疆

3 葛立双	5 于千添	6 阿热孜古丽	7 吴志娟	10 李静	11 陈培培	12 艾敏	15 兰姝娇																																																																								
<table border="1"><tr><td></td><td></td><td></td></tr><tr><td></td><td></td><td>1</td></tr><tr><td></td><td></td><td>1</td></tr></table>						1			1	<table border="1"><tr><td></td><td></td><td></td></tr><tr><td></td><td></td><td></td></tr><tr><td></td><td></td><td></td></tr></table>										<table border="1"><tr><td></td><td></td><td></td></tr><tr><td>1</td><td></td><td>2</td></tr><tr><td></td><td></td><td>4</td></tr></table>				1		2			4	<table border="1"><tr><td>1</td><td></td><td></td></tr><tr><td></td><td></td><td></td></tr><tr><td></td><td></td><td>2</td></tr></table>	1								2	<table border="1"><tr><td></td><td></td><td></td></tr><tr><td></td><td></td><td></td></tr><tr><td></td><td></td><td></td></tr></table>										<table border="1"><tr><td></td><td></td><td></td></tr><tr><td></td><td></td><td></td></tr><tr><td></td><td></td><td></td></tr></table>										<table border="1"><tr><td></td><td></td><td></td></tr><tr><td></td><td></td><td></td></tr><tr><td></td><td></td><td></td></tr></table>										<table border="1"><tr><td></td><td></td><td></td></tr><tr><td>1</td><td></td><td></td></tr><tr><td></td><td></td><td>1</td></tr></table>				1					1
		1																																																																													
		1																																																																													
1		2																																																																													
		4																																																																													
1																																																																															
		2																																																																													
1																																																																															
		1																																																																													
Post - 0 Miss - 0 Block - 0	Post - 0 Miss - 0 Block - 0	Post - 0 Miss - 0 Block - 0	Post - 1 Miss - 0 Block - 0	Post - 0 Miss - 0 Block - 0	Post - 0 Miss - 0 Block - 0	Post - 0 Miss - 0 Block - 0	Post - 0 Miss - 0 Block - 0																																																																								
17 戴莹莹	18 崔娟	21 锁珊珊	23 张艺璇	26 宋婷婷	27 谢辰辰	32 杨雨柔	93 张婷婷																																																																								
<table border="1"><tr><td>1</td><td></td><td></td></tr><tr><td></td><td></td><td></td></tr><tr><td></td><td></td><td></td></tr></table>	1									<table border="1"><tr><td>1</td><td></td><td>1</td></tr><tr><td>1</td><td></td><td></td></tr><tr><td></td><td></td><td></td></tr></table>	1		1	1						<table border="1"><tr><td>1</td><td></td><td>1</td></tr><tr><td></td><td></td><td></td></tr><tr><td></td><td></td><td></td></tr></table>	1		1							<table border="1"><tr><td></td><td></td><td></td></tr><tr><td></td><td></td><td></td></tr><tr><td></td><td></td><td></td></tr></table>										<table border="1"><tr><td></td><td></td><td></td></tr><tr><td></td><td></td><td></td></tr><tr><td></td><td></td><td></td></tr></table>										<table border="1"><tr><td></td><td></td><td></td></tr><tr><td></td><td></td><td></td></tr><tr><td></td><td></td><td></td></tr></table>										<table border="1"><tr><td></td><td></td><td></td></tr><tr><td></td><td></td><td></td></tr><tr><td></td><td></td><td></td></tr></table>										<table border="1"><tr><td></td><td></td><td></td></tr><tr><td>2</td><td></td><td>2</td></tr><tr><td></td><td></td><td>1</td></tr></table>				2		2			1
1																																																																															
1		1																																																																													
1																																																																															
1		1																																																																													
2		2																																																																													
		1																																																																													
Post - 0 Miss - 0 Block - 0	Post - 0 Miss - 1 Block - 0	Post - 0 Miss - 0 Block - 0	Post - 0 Miss - 0 Block - 0	Post - 0 Miss - 0 Block - 0	Post - 0 Miss - 0 Block - 0	Post - 0 Miss - 0 Block - 0	Post - 1 Miss - 0 Block - 0																																																																								

10 □□

1/1		

32 □□□

0/1		1/4
6/10	1/1	4/8
1/4	1/1	1/6

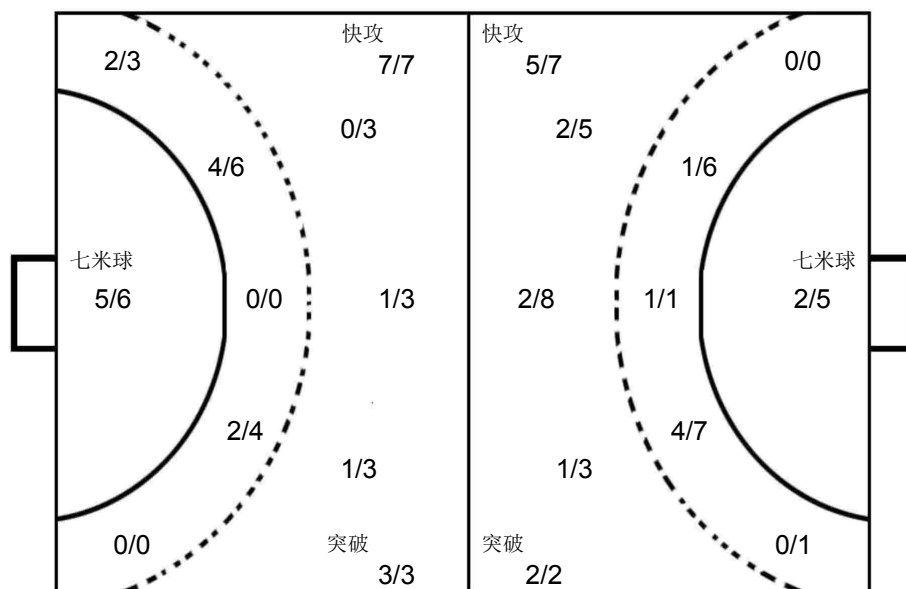

1 □□

2/3		
0/2	1/1	2/6
1/1		1/5

12 □□□

0/2		0/1
1/2		0/1

16 □□

0/1		
0/2		0/3
1/1		1/4

天津

1 张莉	3 王晓梅	5 丁丽洁	6 窦海乐	7 张心茹	8 张慧	9 袁玉	10 张文慧																																																																								
<table border="1"><tr><td></td><td></td><td></td></tr><tr><td></td><td></td><td></td></tr><tr><td></td><td></td><td></td></tr></table>										<table border="1"><tr><td></td><td></td><td>2</td></tr><tr><td>1</td><td></td><td>1</td></tr><tr><td></td><td></td><td>1</td></tr></table>			2	1		1			1	<table border="1"><tr><td></td><td></td><td>1</td></tr><tr><td></td><td></td><td></td></tr><tr><td></td><td></td><td></td></tr></table>			1							<table border="1"><tr><td></td><td></td><td></td></tr><tr><td></td><td></td><td></td></tr><tr><td></td><td></td><td></td></tr></table>										<table border="1"><tr><td></td><td></td><td></td></tr><tr><td></td><td></td><td></td></tr><tr><td></td><td></td><td></td></tr></table>										<table border="1"><tr><td>1</td><td></td><td></td></tr><tr><td></td><td></td><td></td></tr><tr><td></td><td></td><td></td></tr></table>	1									<table border="1"><tr><td></td><td></td><td></td></tr><tr><td>2</td><td></td><td></td></tr><tr><td>1</td><td></td><td></td></tr></table>				2			1			<table border="1"><tr><td></td><td></td><td></td></tr><tr><td></td><td></td><td>1</td></tr><tr><td></td><td></td><td>1</td></tr></table>						1			1
		2																																																																													
1		1																																																																													
		1																																																																													
		1																																																																													
1																																																																															
2																																																																															
1																																																																															
		1																																																																													
		1																																																																													
Post - 0 Miss - 0 Block - 0	Post - 2 Miss - 0 Block - 1	Post - 0 Miss - 0 Block - 0	Post - 0 Miss - 0 Block - 0	Post - 0 Miss - 0 Block - 0	Post - 0 Miss - 0 Block - 0	Post - 0 Miss - 0 Block - 0	Post - 0 Miss - 0 Block - 0																																																																								
11 蔡雪洁	12 王欣冉	14 刘洁	16 王选	17 聂晓雪	18 舒文琪	23 周梦雪																																																																									
<table border="1"><tr><td></td><td></td><td>1</td></tr><tr><td>1</td><td></td><td></td></tr><tr><td></td><td></td><td></td></tr></table>			1	1						<table border="1"><tr><td></td><td></td><td></td></tr><tr><td></td><td></td><td></td></tr><tr><td></td><td></td><td></td></tr></table>										<table border="1"><tr><td></td><td></td><td></td></tr><tr><td></td><td></td><td></td></tr><tr><td></td><td></td><td></td></tr></table>										<table border="1"><tr><td></td><td></td><td></td></tr><tr><td></td><td></td><td></td></tr><tr><td></td><td></td><td></td></tr></table>										<table border="1"><tr><td></td><td></td><td></td></tr><tr><td></td><td></td><td></td></tr><tr><td></td><td></td><td></td></tr></table>										<table border="1"><tr><td></td><td></td><td></td></tr><tr><td>1</td><td></td><td>3</td></tr><tr><td></td><td></td><td></td></tr></table>				1		3				<table border="1"><tr><td></td><td></td><td>1</td></tr><tr><td></td><td></td><td>1</td></tr><tr><td></td><td></td><td></td></tr></table>			1			1													
		1																																																																													
1																																																																															
1		3																																																																													
		1																																																																													
		1																																																																													
Post - 0 Miss - 0 Block - 0	Post - 0 Miss - 0 Block - 0	Post - 0 Miss - 0 Block - 0	Post - 0 Miss - 0 Block - 0	Post - 0 Miss - 0 Block - 0	Post - 1 Miss - 1 Block - 0	Post - 0 Miss - 1 Block - 3																																																																									

**PHMS** Pictorial Handball Match Statistics

**IHF** Official System

Team A					Team B					Match Number											
A 山东					B 北京					<b>22</b>											
Played in			in the hall			on		at		Spectators											
天津			天津师范大学体育馆			2017-09-07		15:45		hours											
Half-time(30')	A	B	End of playing time	A	B	1st extra time	A	B	2nd extra time	A	B	After penalty throws	A	B							
	15	12		23	22																
Number of 7 m	A	Team time-out			Full name of players and officials					Team time-out			B	Number of 7 m							
	4/4	1	2	3						1	2	3	5/5								
		26:24	44:32	59:31					12:28	49:59											
No.	Team A					G	W	2'	D	DR	No.	Team B					G	W	2'	D	DR
1	路畅										3	季小桐					1				
2	林燕群										6	刘亚男									
6	王莎莎							1			8	杨铭豫									
8	王彬					8					9	宋建军									
11	吕青纹					7					10	刘莎					4	1	1		
12	张苑琳										11	纪婉									
15	吴作扬										15	郝泽荣					1		1		
19	姜伟珊					1	1				16	王海叶									
20	张悦					4					22	李海鸥					2	1			
22	朱赟										23	赵小颖					2				
23	徐悦										24	郝佳楠					4				
28	崔金娜					2	1				27	曹芳鸣									
33	王彩琳					1		1			28	闫美珠					8		1		
77	穆庆丛										47	刘泽									
											69	石梓薇						1	1		
B	马海湧 (主教练)							1			A	蔡建国									
C	徐强										B	宋刚 (主教练)									
D	孔德宾										C	关宏波									
E	王日东										E	王长林									
A	Signatures of responsables for the teams (Off.A)															B					
TP	Remarks of referees / HF Official															TP					

Signatures

Referees	刘禹 (CHN)	许翔 (CHN)		
T.D.	张春生 (CHN)	柴业宏 (CHN)		
CHA Off.				

Note: Number of 7m Throws Awarded to Team A and B, Goals (G), Warnings (W), Suspensions (2'), Direct Disqualification (D), Disqualification With Report (DR) and Team Penalty (TP).

Table Officials: 张智伟 谷瑶

Statisticians: 杜宪 周强

**第十三届全国运动会女子手球决赛**
**PHMS** Pictorial Handball Match Statistics

**IHF** Official System

**竞赛技术统计**

 手球  
 女子

 5-6名  
 轮次 6

 组别 X  
 场次 22

 天津师范大学体育馆  
 2017-09-07 15:45

Referees: 刘禹 (CHN) / 许翔 (CHN)

Result: 23:22(15:12)

Teams: 山东(山东) VS 北京(北京)

山东		远	近	边	快	突	任意	7m	合计	%	助攻	失误	警告	2'	D+DR
主教练: 马海湧		射	射	射	攻	破	球	球							
1	路畅														
2	林燕群					0/1			0/1	0.0					
6	王莎莎													1	
8	王彬	1/2		1/1	1/1	1/1	0/1	4/4	8/10	80.0	1	1			
11	吕青纹	1/3	1/1	2/2	3/4				7/10	70.0	1				
12	张苑琳														
15	吴作扬	0/2	0/1						0/3	0.0	1	1			
19	姜伟珊			1/2					1/2	50.0			1		
20	张悦			2/3	1/1	1/1			4/5	80.0		1			
22	朱贇										1	1			
23	徐悦										1				
28	崔金娜		2/2						2/2	100	1	2	1		
33	王彩琳	0/2	0/1	0/1		1/2			1/6	16.7	1	3		1	
77	穆庆丛														
运动员 合计		2/9	3/5	6/9	5/6	3/5	0/1	4/4	23/39	59.0	7	9	2	2	
1	路畅	1/1		2/3		0/2		0/3	3/9	33.3					
22	朱贇	5/7	3/6	1/4	0/1	0/2	0/3	0/2	9/25	36.0	1	1			
守门员 合计		6/8	3/6	3/7	0/1	0/4	0/3	0/5	12/34	35.3	1	1			

北京		远	近	边	快	突	任意	7m	合计	%	助攻	失误	警告	2'	D+DR
主教练: 宋刚		射	射	射	攻	破	球	球							
3	季小桐	0/2		1/1					1/3	33.3	2	2			
6	刘亚男														
8	杨铭豫														
9	宋建军														
10	刘莎			1/1	1/1			2/2	4/4	100		2	1	1	
11	纪婉														
15	郝泽荣		0/2	1/1					1/3	33.3		1		1	
16	王海叶										1				
22	李海鸥	0/1	2/2						2/3	66.7	1		1		
23	赵小颖								2/2	100					
24	郝佳楠	1/3	1/4	0/1		2/2			4/10	40.0	4	5			
27	曹芳鸣														
28	闫美珠	1/2		1/2		2/2	3/4	1/1	8/11	72.7	1	1		1	
47	刘泽														
69	石梓薇	0/3		0/1					0/4	0.0		3	1	1	
运动员 合计		2/11	3/8	4/7	1/1	4/4	3/4	5/5	22/40	55.0	9	14	3	4	
16	王海叶	3/5	2/5	0/6	1/6	2/5	1/1	0/2	9/30	30.0	1				
47	刘泽							0/2	0/2	0.0					
守门员 合计		3/5	2/5	0/6	1/6	2/5	1/1	0/4	9/32	28.1	1				

山东	比赛 进程	北京
1st Half		
0	00:32	1 22 李海鸥
20 张悦	1 01:45	1
8 王彬	2 03:35	1
	2 05:45	2 24 郝佳楠
	2 06:29	3 10 刘莎
20 张悦	3 07:00	3
8 王彬	4 08:29	3
	4 08:58	4 24 郝佳楠
	4 10:50	5 28 闫美珠
11 吕青纹	5 11:10	5
	5 12:48	6 28 闫美珠
11 吕青纹	6 14:17	6
8 王彬	7 15:29	6
8 王彬	8 16:58	6
	8 18:17	7 23 赵小颖
	8 19:10	8 15 郝泽荣
20 张悦	9 19:39	8
11 吕青纹	10 21:04	8
	10 22:19	9 10 刘莎
8 王彬	11 23:43	9
11 吕青纹	12 24:30	9
	12 26:05	10 24 郝佳楠
28 崔金娜	13 26:41	10
	13 27:31	11 28 闫美珠
11 吕青纹	14 27:58	11
11 吕青纹	15 29:08	11
	15 29:58	12 10 刘莎
2nd Half		
19 姜伟珊	16 00:24	12
	16 01:01	13 10 刘莎
8 王彬	17 02:20	13
	17 04:22	14 28 闫美珠
8 王彬	18 05:17	14
20 张悦	19 07:10	14
	19 08:10	15 23 赵小颖
	19 08:53	16 28 闫美珠
8 王彬	20 09:55	16
	20 10:20	17 22 李海鸥
	20 13:21	18 28 闫美珠
	20 14:15	19 28 闫美珠
	20 15:29	20 28 闫美珠
33 王彩琳	21 15:58	20
	21 23:09	21 24 郝佳楠
28 崔金娜	22 23:56	21
11 吕青纹	23 28:50	21
	23 29:59	22 3 季小桐

场上队员: 得分 / 射门

守门员: 救球 / 射门

D	取消资格	DR	取消资格+报告



## 第十三届全国运动会女子手球决赛

PHMS Pictorial Handball Match Statistics

IHF Official System

## 个人/全队技术统计表

 手球 5-6名 组别 X 天津师范大学体育馆  
 女子 轮次 6 场次 22 2017-09-07 15:45

号码	姓名	远射	近射	边射	快攻	突破	任意	七米	合计	%	助攻	失误	警告	2'	取消	时间
山东(山东)																
(场上队员)																
1	路畅									0.0%						00:16:03
2	林燕群					0/1			0/1	0.0%						00:04:07
6	王莎莎									0.0%				1		00:09:37
8	王彬	1/2		1/1	1/1	1/1	0/1	4/4	8/10	80.0%	1	1				00:34:49
11	吕青纹	1/3	1/1	2/2	3/4				7/10	70.0%	1					01:00:00
12	张苑琳									0.0%						00:00:00
15	吴作扬	0/2	0/1						0/3	0.0%	1	1				00:14:25
19	姜伟珊			1/2					1/2	50.0%			1			00:38:10
20	张悦			2/3	1/1	1/1			4/5	80.0%		1				00:59:47
22	朱贇									0.0%	1	1				00:43:57
23	徐悦									0.0%	1					00:20:35
28	崔金娜		2/2						2/2	100%	1	2	1			00:54:10
33	王彩琳	0/2	0/1	0/1		1/2			1/6	16.7%	1	3		1		00:58:00
77	穆庆丛									0.0%						00:05:48
	合计	2/9	3/5	6/9	5/6	3/5	0/1	4/4	23/39	59.0%	7	9	2	2		
(守门员)																
1	路畅	1/1		2/3		0/2		0/3	3/9	33.3%						00:16:03
22	朱贇	5/7	3/6	1/4	0/1	0/2	0/3	0/2	9/25	36.0%	1	1				00:43:57
	合计	6/8	3/6	3/7	0/1	0/4	0/3	0/5	12/34	35.3%	1	1				

场上队员：得分/射门

守门员：救球/射门

全队合计	得分	被救	射失	击柱	封球	合计	%
远射	2	3	2		2	9	22.2%
近射	3	2				5	60.0%
边射	6		3			9	66.7%
快攻	5	1				6	83.3%
突破	3	2				5	60.0%
任意		1				1	0.0%
七米	4					4	100.0%

## 第十三届全国运动会女子手球决赛

PHMS Pictorial Handball Match Statistics

IHF Official System

## 个人/全队技术统计表

 手球 5-6名 组别 X 天津师范大学体育馆  
 女子 轮次 6 场次 22 2017-09-07 15:45

号码	姓名	远射	近射	边射	快攻	突破	任意	七米	合计	%	助攻	失误	警告	2'	取消	时间
<b>北京(北京)</b>																
<b>(场上队员)</b>																
3	季小桐	0/2		1/1					1/3	33.3%	2	2				00:25:19
6	刘亚男									0.0%						00:04:36
8	杨铭豫									0.0%						00:14:31
9	宋建军									0.0%						00:00:00
10	刘莎			1/1	1/1			2/2	4/4	100%		2	1	1		00:52:00
11	纪婉									0.0%						00:07:17
15	郝泽荣		0/2	1/1					1/3	33.3%		1		1		00:22:17
16	王海叶									0.0%	1					00:59:43
22	李海鸥	0/1	2/2						2/3	66.7%	1		1			00:58:08
23	赵小颖							2/2	2/2	100%						00:00:41
24	郝佳楠	1/3	1/4	0/1		2/2			4/10	40.0%	4	5				01:00:00
27	曹芳鸣									0.0%						00:00:00
28	闫美珠	1/2		1/2		2/2	3/4	1/1	8/11	72.7%	1	1		1		01:00:00
47	刘泽									0.0%						00:00:17
69	石梓薇	0/3		0/1					0/4	0.0%		3	1	1		00:54:30
<b>合计</b>		<b>2/11</b>	<b>3/8</b>	<b>4/7</b>	<b>1/1</b>	<b>4/4</b>	<b>3/4</b>	<b>5/5</b>	<b>22/40</b>	<b>55.0%</b>	<b>9</b>	<b>14</b>	<b>3</b>	<b>4</b>		
<b>(守门员)</b>																
16	王海叶	3/5	2/5	0/6	1/6	2/5	1/1	0/2	9/30	30.0%	1					00:59:43
47	刘泽							0/2	0/2	0.0%						00:00:17
<b>合计</b>		<b>3/5</b>	<b>2/5</b>	<b>0/6</b>	<b>1/6</b>	<b>2/5</b>	<b>1/1</b>	<b>0/4</b>	<b>9/32</b>	<b>28.1%</b>	<b>1</b>					

场上队员：得分/射门

守门员：救球/射门

全队合计	得分	被救	射失	击柱	封球	合计	%
远射	2	6			3	11	18.2%
近射	3	3		2		8	37.5%
边射	4	3				7	57.1%
快攻	1					1	100.0%
突破	4					4	100.0%
任意	3		1			4	75.0%
七米	5					5	100.0%

第十三届全国运动会女子手球决赛

PHMS Pictorial Handball Match Statistics

IHF Official System

图式比赛技术统计表

手球  
女子

5-6名  
轮次 6

组别 X  
场次 22

天津师范大学体育馆  
2017-09-07 15:45

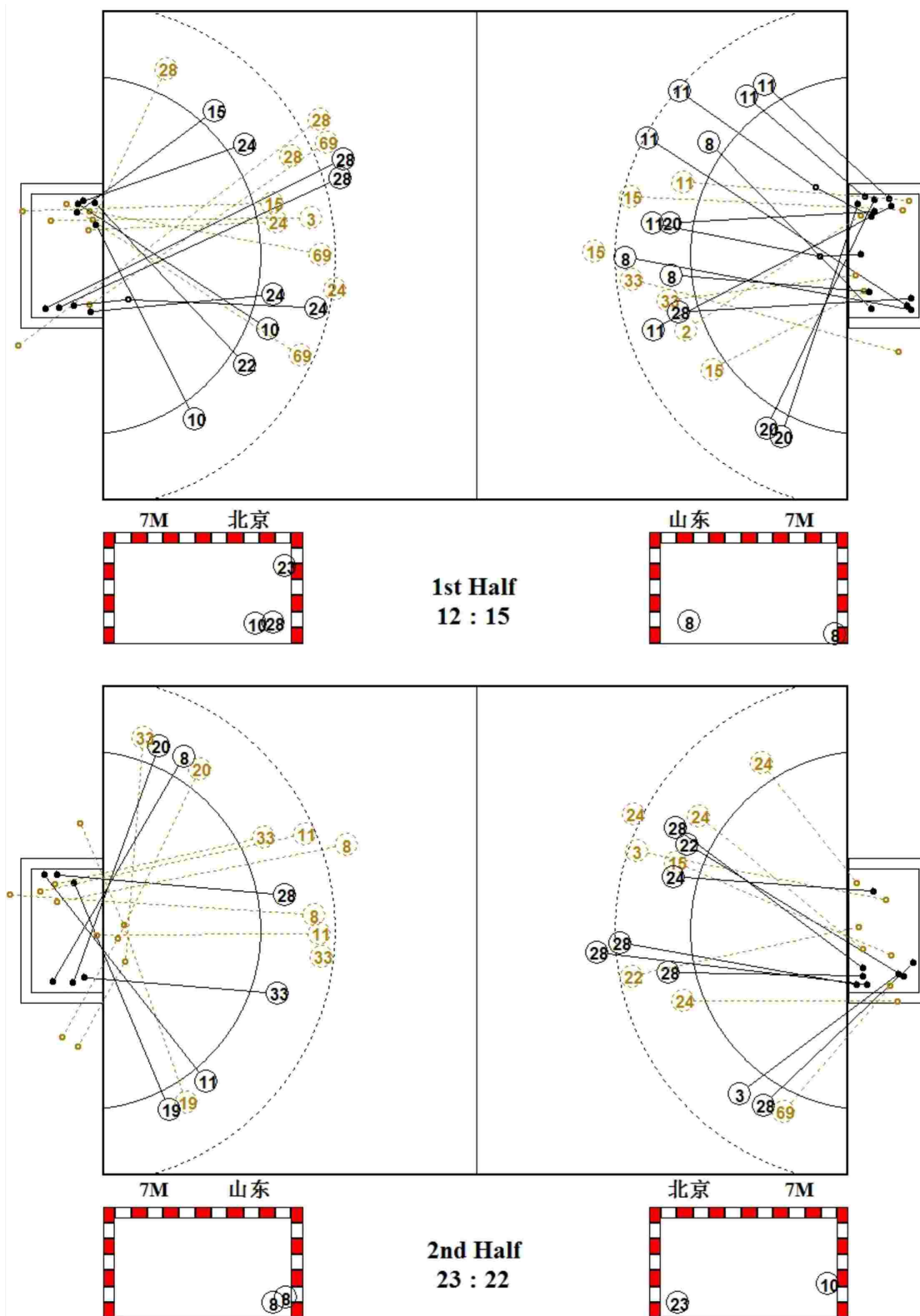

第十三届全国运动会女子手球决赛

PHMS Pictorial Handball Match Statistics

IHF Official System

图式射门区域统计

手球  
女子

5-6名  
轮次 6

组别 X  
场次 22

天津师范大学体育馆  
2017-09-07 15:45

山东

1 路畅 <table border="1"><tr><td></td><td></td><td></td></tr><tr><td></td><td></td><td></td></tr><tr><td></td><td></td><td></td></tr></table> Post - 0 Miss - 0 Block - 0										2 林燕群 <table border="1"><tr><td></td><td></td><td></td></tr><tr><td></td><td></td><td></td></tr><tr><td></td><td></td><td></td></tr></table> Post - 0 Miss - 0 Block - 0										6 王莎莎 <table border="1"><tr><td></td><td></td><td></td></tr><tr><td></td><td></td><td></td></tr><tr><td></td><td></td><td></td></tr></table> Post - 0 Miss - 0 Block - 0										8 王彬 <table border="1"><tr><td>1</td><td></td><td>1</td></tr><tr><td></td><td></td><td>1</td></tr><tr><td>1</td><td></td><td>4</td></tr></table> Post - 0 Miss - 1 Block - 0	1		1			1	1		4	11 吕青纹 <table border="1"><tr><td></td><td></td><td>2</td></tr><tr><td>3</td><td></td><td></td></tr><tr><td>1</td><td>1</td><td></td></tr></table> Post - 0 Miss - 0 Block - 0			2	3			1	1		12 张苑琳 <table border="1"><tr><td></td><td></td><td></td></tr><tr><td></td><td></td><td></td></tr><tr><td></td><td></td><td></td></tr></table> Post - 0 Miss - 0 Block - 0										15 吴作扬 <table border="1"><tr><td></td><td></td><td></td></tr><tr><td></td><td></td><td></td></tr><tr><td></td><td></td><td></td></tr></table> Post - 0 Miss - 0 Block - 1										19 姜伟珊 <table border="1"><tr><td></td><td></td><td></td></tr><tr><td></td><td></td><td></td></tr><tr><td></td><td></td><td>1</td></tr></table> Post - 0 Miss - 1 Block - 0									1
1		1																																																																													
		1																																																																													
1		4																																																																													
		2																																																																													
3																																																																															
1	1																																																																														
		1																																																																													
20 张悦 <table border="1"><tr><td></td><td></td><td></td></tr><tr><td>3</td><td></td><td></td></tr><tr><td>1</td><td></td><td></td></tr></table> Post - 0 Miss - 1 Block - 0				3			1			22 朱贇 <table border="1"><tr><td></td><td></td><td></td></tr><tr><td></td><td></td><td></td></tr><tr><td></td><td></td><td></td></tr></table> Post - 0 Miss - 0 Block - 0										23 徐悦 <table border="1"><tr><td></td><td></td><td></td></tr><tr><td></td><td></td><td></td></tr><tr><td></td><td></td><td></td></tr></table> Post - 0 Miss - 0 Block - 0										28 崔金娜 <table border="1"><tr><td></td><td></td><td>1</td></tr><tr><td></td><td></td><td>1</td></tr><tr><td></td><td></td><td></td></tr></table> Post - 0 Miss - 0 Block - 0			1			1				33 王彩琳 <table border="1"><tr><td></td><td></td><td></td></tr><tr><td></td><td></td><td></td></tr><tr><td>1</td><td></td><td></td></tr></table> Post - 0 Miss - 2 Block - 1							1			77 穆庆丛 <table border="1"><tr><td></td><td></td><td></td></tr><tr><td></td><td></td><td></td></tr><tr><td></td><td></td><td></td></tr></table> Post - 0 Miss - 0 Block - 0																													
3																																																																															
1																																																																															
		1																																																																													
		1																																																																													
1																																																																															

1 □□

		0/1
0/1		1/2
1/2	1/1	0/2

22 □□

0/1		1/4
1/3		2/4
1/2	1/1	3/10

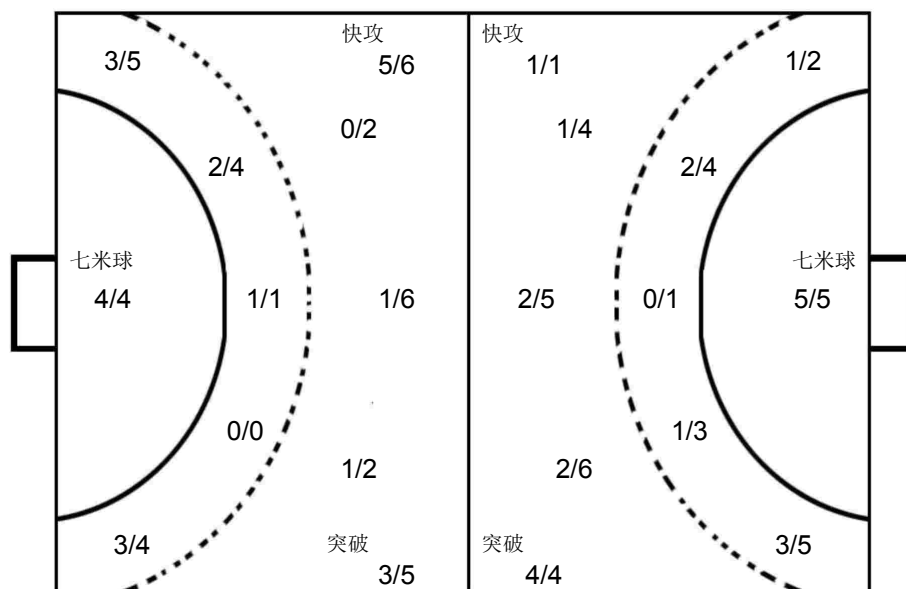

16 □□□

2/3		2/6
0/6		1/4
1/5	2/3	1/3

47 □□

		0/2

北京

3 季小桐 <table border="1"><tr><td></td><td></td><td>1</td></tr><tr><td></td><td></td><td></td></tr><tr><td></td><td></td><td></td></tr></table> Post - 0 Miss - 0 Block - 0			1							6 刘亚男 <table border="1"><tr><td></td><td></td><td></td></tr><tr><td></td><td></td><td></td></tr><tr><td></td><td></td><td></td></tr></table> Post - 0 Miss - 0 Block - 0										8 杨铭豫 <table border="1"><tr><td></td><td></td><td></td></tr><tr><td></td><td></td><td></td></tr><tr><td></td><td></td><td></td></tr></table> Post - 0 Miss - 0 Block - 0										9 宋建军 <table border="1"><tr><td></td><td></td><td></td></tr><tr><td></td><td></td><td></td></tr><tr><td></td><td></td><td></td></tr></table> Post - 0 Miss - 0 Block - 0										10 刘莎 <table border="1"><tr><td></td><td></td><td></td></tr><tr><td></td><td></td><td>2</td></tr><tr><td></td><td></td><td>2</td></tr></table> Post - 0 Miss - 0 Block - 0						2			2	11 纪婉 <table border="1"><tr><td></td><td></td><td></td></tr><tr><td></td><td></td><td></td></tr><tr><td></td><td></td><td></td></tr></table> Post - 0 Miss - 0 Block - 0										15 郝泽荣 <table border="1"><tr><td></td><td></td><td></td></tr><tr><td></td><td></td><td>1</td></tr><tr><td></td><td></td><td></td></tr></table> Post - 1 Miss - 0 Block - 0						1				16 王海叶 <table border="1"><tr><td></td><td></td><td></td></tr><tr><td></td><td></td><td></td></tr><tr><td></td><td></td><td></td></tr></table> Post - 0 Miss - 0 Block - 0									
		1																																																																													
		2																																																																													
		2																																																																													
		1																																																																													
22 李海鸥 <table border="1"><tr><td></td><td></td><td>1</td></tr><tr><td></td><td></td><td>1</td></tr><tr><td></td><td></td><td></td></tr></table> Post - 0 Miss - 0 Block - 0			1			1				23 赵小颖 <table border="1"><tr><td></td><td></td><td>1</td></tr><tr><td></td><td></td><td></td></tr><tr><td>1</td><td></td><td></td></tr></table> Post - 0 Miss - 0 Block - 0			1				1			24 郝佳楠 <table border="1"><tr><td>2</td><td></td><td></td></tr><tr><td>1</td><td></td><td>1</td></tr><tr><td></td><td></td><td></td></tr></table> Post - 1 Miss - 0 Block - 2	2			1		1				27 曹芳鸣 <table border="1"><tr><td></td><td></td><td></td></tr><tr><td></td><td></td><td></td></tr><tr><td></td><td></td><td></td></tr></table> Post - 0 Miss - 0 Block - 0										28 闫美珠 <table border="1"><tr><td>1</td><td></td><td>1</td></tr><tr><td>1</td><td></td><td></td></tr><tr><td></td><td></td><td>5</td></tr></table> Post - 0 Miss - 1 Block - 1	1		1	1					5	47 刘泽 <table border="1"><tr><td></td><td></td><td></td></tr><tr><td></td><td></td><td></td></tr><tr><td></td><td></td><td></td></tr></table> Post - 0 Miss - 0 Block - 0										69 石梓薇 <table border="1"><tr><td></td><td></td><td></td></tr><tr><td></td><td></td><td></td></tr><tr><td></td><td></td><td></td></tr></table> Post - 0 Miss - 0 Block - 0																			
		1																																																																													
		1																																																																													
		1																																																																													
1																																																																															
2																																																																															
1		1																																																																													
1		1																																																																													
1																																																																															
		5																																																																													

**PHMS** Pictorial Handball Match Statistics

**IHF** Official System

Team A				Team B				Match Number							
A 广东				B 上海				<b>23</b>							
Played in		in the hall		on		at		Spectators							
天津		天津师范大学体育馆		2017-09-07		17:30		hours							
Half-time(30')	A	B	End of playing time	A	B	1st extra time	A	B	2nd extra time	A	B	After penalty throws	A	B	
	14	14	27	30											
Number of 7 m	A	Team time-out			Full name of players and officials						Team time-out			B	Number of 7 m
	3/5	1	2	3							1	2	3	6/8	
		14:38	35:29	57:54					27:36	54:12	58:53				

No.	Team A	G	W	2'	D	DR	No.	Team B	G	W	2'	D	DR
2	王彤羽						1	许沫					
3	安妮	4					2	周蕾	1	1			
5	李纯						3	王嘉怡					
7	刘彤	1	1	2			5	郭威					
8	李诗棋						6	黄妍					
9	韦宝桂	7					7	车婉茹	4				
10	史小军	5	1				8	吴茵	6				
11	魏梦庭						9	武娜娜	9				
15	杨慧						10	斯文	1				
16	李娟						11	孙梦颖	5				
19	邝雪花						12	郑冯					
20	李军政	1					13	徐娟	1	1			
22	刘晓玉						17	居晔			1		
23	王如	2	1				18	沙正文	1	1			
26	马晓卉						19	印尼	2				
28	刘金兰	7					23	都好					
B	黄炳春						A	孙琦敏					
C	李玉玲						B	陈进培 (主教练)					
D	郭艳辉 (主教练)						C	贺业磊					
E	赵善良						D	金钟顺					
A	Signatures of responsables for the teams (Off.A)												B
TP	Remarks of referees / HF Official												TP

	Signatures											
Referees	ALEXEI. COVALCIUC (MDA)				IGOR. COVALCIUC (MDA)							
T.D.	刘凤娟 (CHN)				高斌 (CHN)							
CHA Off.												

Note: Number of 7m Throws Awarded to Team A and B, Goals (G), Warnings (W), Suspensions (2'), Direct Disqualification (D), Disqualification With Report (DR) and Team Penalty (TP).

Table Officials: 翟延露

齐红梅

Statisticians: 李双

王玮

### 第十三届全国运动会女子手球决赛

**PHMS** Pictorial Handball Match Statistics **IHF** Official System

#### 竞赛技术统计

手球 3-4名 组别 X 天津师范大学体育馆  
女子 轮次 6 场次 23 2017-09-07 17:30

Referees: ALEXEI. COVALCIUC (MDA) / IGOR. COVALCIUC (MDA) Result: 27:30(14:14)  
Teams: 广东(广东) VS 上海(上海)

广东		远	近	边	快	突	任意	7m	合计	%	助攻	失误	警告	2'	D+DR	广东	比赛	上海
主教练: 郭艳辉		射	射	射	攻	破	球	球								进程		
2	王彤羽															0	00:42	1 11 孙梦颖
3	安妮	2/4				2/4			4/8	50.0	4	2				0	01:21	2 7 车婉茹
5	李纯															1	01:45	2
7	刘彤		1/1		0/2				1/3	33.3	1	1	1	2		2	02:43	2
8	李诗棋															3	04:07	2
9	韦宝桂	1/6	1/2		1/1	2/2		2/3	7/14	50.0	2	4				4	06:30	2
10	史小军	2/3	3/4						5/7	71.4		3	1			5	09:14	3
11	魏梦庭	0/1							0/1	0.0						6	09:54	4 8 吴茵
15	杨慧															6	10:50	5 13 徐娟
16	李娟															7	11:32	5
19	邝雪花															7	12:02	6 9 武娜娜
20	李军政			1/2					1/2	50.0						7	14:06	7 7 车婉茹
22	刘晓玉											1				8	14:53	7
26	马晓卉	1/1	1/2						2/3	66.7		2	1			8	16:23	8 11 孙梦颖
28	刘金兰			5/7	1/1			1/2	7/10	70.0		1				9	17:13	8
运动员	合计	6/15	6/9	6/9	2/4	4/6		3/5	27/48	56.3	7	15	3	2		9	18:49	9 11 孙梦颖
16	李娟							0/1	0/1	0.0						10	20:40	9
22	刘晓玉	1/2	0/2			1/2	1/1		3/7	42.9		1				10	21:47	10 2 周蕾
26	马晓卉	5/6	4/8	1/5	1/6	2/8		1/6	14/39	35.9		1				11	22:13	10
守门员	合计	6/8	4/10	1/5	1/6	3/10	1/1	1/7	17/47	36.2		2				11	23:14	11 11 孙梦颖
上海		远	近	边	快	突	任意	7m	合计	%	助攻	失误	警告	2'	D+DR			
主教练: 陈进培		射	射	射	攻	破	球	球										
1	许沫											1				11	25:03	13 9 武娜娜
2	周蕾			1/1					1/1	100		1	1			12	26:29	13
3	王嘉怡															13	27:31	13
5	郭威															14	28:21	13
6	黄妍	0/1							0/1	0.0						14	28:35	14 9 武娜娜
7	车婉茹							4/6	4/6	66.7						15	29:03	15
8	吴茵	0/4	1/2			3/3		2/2	6/11	54.5	6					16	00:24	14
9	武娜娜		2/2	1/1	4/4	2/2			9/9	100						16	02:00	15 8 吴茵
10	斯文			1/1	0/1				1/2	50.0	1					17	02:51	15
11	孙梦颖	1/5	2/2	0/1		2/3	0/1		5/12	41.7	1	3				17	03:38	16 10 斯文
12	郑冯															17	04:40	17 9 武娜娜
13	徐娟				1/1	0/1			1/2	50.0						17	05:20	18 9 武娜娜
17	居晔													1		17	06:40	19 9 武娜娜
18	沙正文		1/2						1/2	50.0		2	1			18	07:21	19
19	印尼	1/4	0/2	1/1		0/1			2/8	25.0	2	2				18	11:09	20 11 孙梦颖
23	都好															19	11:40	20
运动员	合计	2/14	6/10	4/5	5/6	7/10	0/1	6/8	30/54	55.6	10	9	3	1		19	12:17	21 8 吴茵
1	许沫	2/8	2/8	3/9	1/2	1/4		0/1	9/32	28.1		1				20	12:24	21
12	郑冯	1/1			0/1	0/1		1/3	2/6	33.3						20	13:31	22 8 吴茵
守门员	合计	3/9	2/8	3/9	1/3	1/5		1/4	11/38	28.9		1				21	13:53	22
2nd Half																		
9 韦宝桂 15 00:24 14																		
9 韦宝桂 16 01:30 14																		
3 安妮 14 28:21 13																		
9 韦宝桂 17 02:51 15																		
9 韦宝桂 17 03:38 16 10 斯文																		
17 04:40 17 9 武娜娜																		
17 05:20 18 9 武娜娜																		
17 06:40 19 9 武娜娜																		
28 刘金兰 18 07:21 19																		
9 韦宝桂 19 11:40 20																		
10 史小军 20 12:24 21																		
20 李军政 21 13:53 22																		
28 刘金兰 22 14:30 22																		
10 史小军 22 15:16 23 8 吴茵																		
23 16:05 23																		
23 16:46 24 19 印尼																		
3 安妮 24 17:18 24																		
7 刘彤 25 17:41 24																		
9 韦宝桂 26 19:04 24																		
26 21:57 25 9 武娜娜																		
26 23:10 26 9 武娜娜																		
26 24:46 27 8 吴茵																		
23 王如 27 25:15 27																		
27 25:27 28 19 印尼																		
27 26:50 29 9 武娜娜																		
27 29:41 30 7 车婉茹																		

场上队员: 得分 / 射门 守门员: 救球 / 射门

D	取消资格	DR	取消资格+报告
---	------	----	---------

## 第十三届全国运动会女子手球决赛

PHMS Pictorial Handball Match Statistics

IHF Official System

## 个人/全队技术统计表

 手球 3-4名 组别 X 天津师范大学体育馆  
 女子 轮次 6 场次 23 2017-09-07 17:30

号码	姓名	远射	近射	边射	快攻	突破	任意	七米	合计	%	助攻	失误	警告	2'	取消	时间
广东(广东)																
(场上队员)																
2	王彤羽									0.0%						00:00:00
3	安妮	2/4				2/4			4/8	50.0%	4	2				00:56:24
5	李纯									0.0%						00:00:00
7	刘彤		1/1		0/2				1/3	33.3%	1	1	1	2		00:45:46
8	李诗棋									0.0%						00:00:00
9	韦宝桂	1/6	1/2		1/1	2/2		2/3	7/14	50.0%	2	4				00:54:55
10	史小军	2/3	3/4						5/7	71.4%		3	1			01:00:00
11	魏梦庭	0/1							0/1	0.0%						00:05:38
15	杨慧									0.0%						00:00:00
16	李娟									0.0%						00:00:13
19	邝雪花									0.0%						00:01:40
20	李军政			1/2					1/2	50.0%						00:22:43
22	刘晓玉									0.0%		1				00:09:57
23	王如	1/1	1/2						2/3	66.7%		2	1			00:54:56
26	马晓卉									0.0%		1				00:49:50
28	刘金兰			5/7	1/1			1/2	7/10	70.0%		1				00:54:45
	合计	6/15	6/9	6/9	2/4	4/6		3/5	27/48	56.3%	7	15	3	2		
(守门员)																
16	李娟							0/1	0/1	0.0%						00:00:13
22	刘晓玉	1/2	0/2			1/2	1/1		3/7	42.9%		1				00:09:57
26	马晓卉	5/6	4/8	1/5	1/6	2/8		1/6	14/39	35.9%		1				00:49:50
	合计	6/8	4/10	1/5	1/6	3/10	1/1	1/7	17/47	36.2%		2				

场上队员：得分/射门

守门员：救球/射门

全队合计	得分	被救	射失	击柱	封球	合计	%
远射	6	3	1	2	3	15	40.0%
近射	6	2		1		9	66.7%
边射	6	3				9	66.7%
快攻	2	1		1		4	50.0%
突破	4	1		1		6	66.7%
任意							0.0%
七米	3	1	1			5	60.0%

## 第十三届全国运动会女子手球决赛

PHMS Pictorial Handball Match Statistics

IHF Official System

## 个人/全队技术统计表

 手球 3-4名 组别 X 天津师范大学体育馆  
 女子 轮次 6 场次 23 2017-09-07 17:30

号码	姓名	远射	近射	边射	快攻	突破	任意	七米	合计	%	助攻	失误	警告	2'	取消	时间
上海(上海)																
(场上队员)																
1	许沫									0.0%		1				00:52:22
2	周蕾			1/1					1/1	100%		1	1			00:33:03
3	王嘉怡									0.0%						00:00:00
5	郭威									0.0%						00:12:00
6	黄妍	0/1							0/1	0.0%						00:02:33
7	车婉茹							4/6	4/6	66.7%						00:01:55
8	吴茵	0/4	1/2			3/3		2/2	6/11	54.5%	6					00:51:10
9	武娜娜		2/2	1/1	4/4	2/2			9/9	100%						01:00:00
10	斯文			1/1	0/1				1/2	50.0%	1					00:26:56
11	孙梦颖	1/5	2/2	0/1		2/3	0/1		5/12	41.7%	1	3				00:58:52
12	郑冯									0.0%						00:07:38
13	徐娟				1/1	0/1			1/2	50.0%			1			00:12:57
17	居晔									0.0%				1		00:10:10
18	沙正文		1/2						1/2	50.0%		2	1			00:40:47
19	印尼	1/4	0/2	1/1		0/1			2/8	25.0%	2	2				00:49:26
23	都好									0.0%						00:00:00
	合计	2/14	6/10	4/5	5/6	7/10	0/1	6/8	30/54	55.6%	10	9	3	1		
(守门员)																
1	许沫	2/8	2/8	3/9	1/2	1/4		0/1	9/32	28.1%		1				00:52:22
12	郑冯	1/1			0/1	0/1		1/3	2/6	33.3%						00:07:38
	合计	3/9	2/8	3/9	1/3	1/5		1/4	11/38	28.9%		1				

场上队员：得分/射门

守门员：救球/射门

全队合计	得分	被救	射失	击柱	封球	合计	%
远射	2	6		4	2	14	14.3%
近射	6	4				10	60.0%
边射	4	1				5	80.0%
快攻	5	1				6	83.3%
突破	7	3				10	70.0%
任意		1				1	0.0%
七米	6	1		1		8	75.0%



第十三届全国运动会女子手球决赛

PHMS Pictorial Handball Match Statistics

IHF Official System

图式比赛技术统计表

手球  
女子

3-4名  
轮次 6

组别 X  
场次 23

天津师范大学体育馆  
2017-09-07 17:30

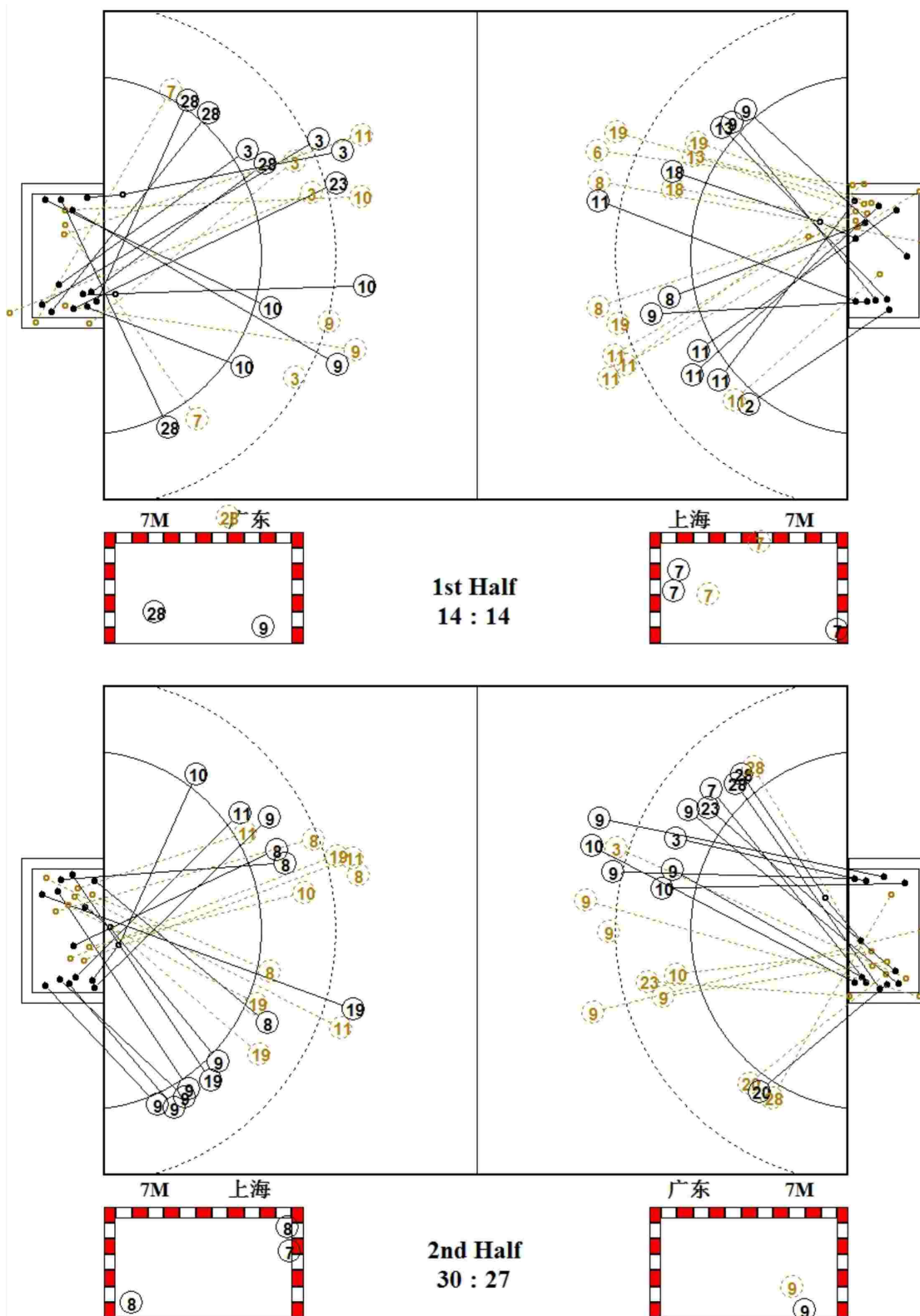

第十三届全国运动会女子手球决赛

PHMS Pictorial Handball Match Statistics

IHF Official System

图式射门区域统计

手球  
女子

3-4名  
轮次 6

组别 X  
场次 23

天津师范大学体育馆  
2017-09-07 17:30

广东

2 王彤羽 <table border="1"><tr><td></td><td></td><td></td></tr><tr><td></td><td></td><td></td></tr><tr><td></td><td></td><td></td></tr></table> Post - 0 Miss - 0 Block - 0										3 安妮 <table border="1"><tr><td>1</td><td></td><td></td></tr><tr><td>1</td><td></td><td></td></tr><tr><td>1</td><td></td><td>1</td></tr></table> Post - 1 Miss - 1 Block - 1	1			1			1		1	5 李纯 <table border="1"><tr><td></td><td></td><td></td></tr><tr><td></td><td></td><td></td></tr><tr><td></td><td></td><td></td></tr></table> Post - 0 Miss - 0 Block - 0										7 刘彤 <table border="1"><tr><td></td><td></td><td></td></tr><tr><td></td><td></td><td></td></tr><tr><td></td><td></td><td>1</td></tr></table> Post - 1 Miss - 0 Block - 0									1	8 李诗棋 <table border="1"><tr><td></td><td></td><td></td></tr><tr><td></td><td></td><td></td></tr><tr><td></td><td></td><td></td></tr></table> Post - 0 Miss - 0 Block - 0										9 韦宝桂 <table border="1"><tr><td></td><td></td><td>1</td></tr><tr><td>1</td><td></td><td>1</td></tr><tr><td>1</td><td></td><td>3</td></tr></table> Post - 2 Miss - 0 Block - 2			1	1		1	1		3	10 史小军 <table border="1"><tr><td>1</td><td></td><td>1</td></tr><tr><td></td><td></td><td></td></tr><tr><td>2</td><td></td><td>1</td></tr></table> Post - 0 Miss - 0 Block - 0	1		1				2		1	11 魏梦庭 <table border="1"><tr><td></td><td></td><td></td></tr><tr><td></td><td></td><td></td></tr><tr><td></td><td></td><td></td></tr></table> Post - 0 Miss - 0 Block - 0									
1																																																																															
1																																																																															
1		1																																																																													
		1																																																																													
		1																																																																													
1		1																																																																													
1		3																																																																													
1		1																																																																													
2		1																																																																													
15 杨慧 <table border="1"><tr><td></td><td></td><td></td></tr><tr><td></td><td></td><td></td></tr><tr><td></td><td></td><td></td></tr></table> Post - 0 Miss - 0 Block - 0										16 李娟 <table border="1"><tr><td></td><td></td><td></td></tr><tr><td></td><td></td><td></td></tr><tr><td></td><td></td><td></td></tr></table> Post - 0 Miss - 0 Block - 0										19 邝雪花 <table border="1"><tr><td></td><td></td><td></td></tr><tr><td></td><td></td><td></td></tr><tr><td></td><td></td><td></td></tr></table> Post - 0 Miss - 0 Block - 0										20 李军政 <table border="1"><tr><td></td><td></td><td></td></tr><tr><td></td><td></td><td></td></tr><tr><td></td><td></td><td>1</td></tr></table> Post - 0 Miss - 0 Block - 0									1	22 刘晓玉 <table border="1"><tr><td></td><td></td><td></td></tr><tr><td></td><td></td><td></td></tr><tr><td></td><td></td><td></td></tr></table> Post - 0 Miss - 0 Block - 0										23 王如 <table border="1"><tr><td></td><td></td><td>1</td></tr><tr><td>1</td><td></td><td></td></tr><tr><td></td><td></td><td></td></tr></table> Post - 1 Miss - 0 Block - 0			1	1						26 马晓卉 <table border="1"><tr><td></td><td></td><td></td></tr><tr><td></td><td></td><td></td></tr><tr><td></td><td></td><td></td></tr></table> Post - 0 Miss - 0 Block - 0										28 刘金兰 <table border="1"><tr><td>1</td><td></td><td></td></tr><tr><td>1</td><td></td><td>2</td></tr><tr><td>2</td><td>1</td><td></td></tr></table> Post - 0 Miss - 1 Block - 0	1			1		2	2	1	
		1																																																																													
		1																																																																													
1																																																																															
1																																																																															
1		2																																																																													
2	1																																																																														

16 □□

		0/1

22 □□□

		0/1
1/2	0/1	1/1
1/1		0/1

26 □□□

0/3	1/2	1/3
2/6	1/1	2/8
5/10	1/2	1/4

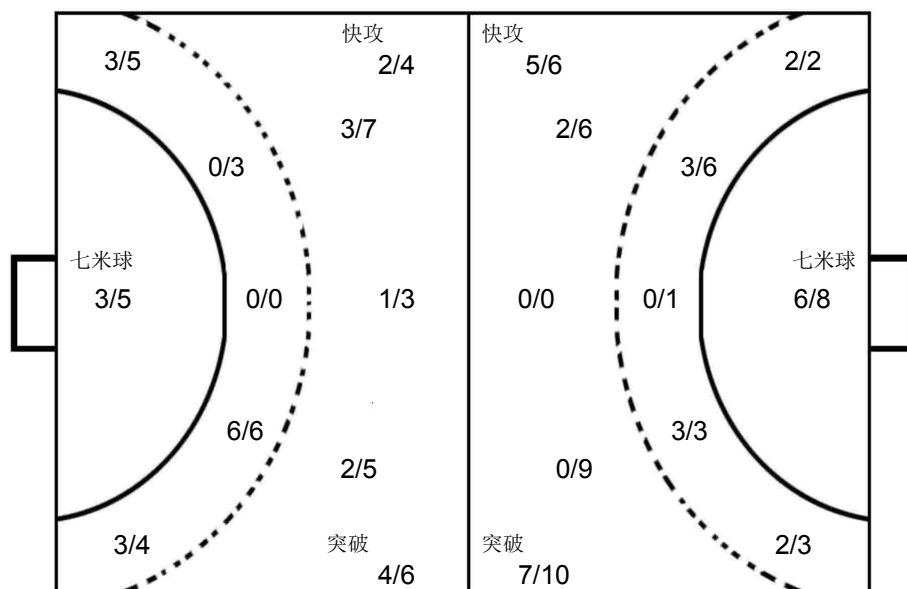

1 □□

0/3		1/4
2/4	1/1	5/8
0/6	0/1	0/5

12 □□

0/2	1/1	1/2
		0/1

上海

1 许沫 <table border="1"><tr><td></td><td></td><td></td></tr><tr><td></td><td></td><td></td></tr><tr><td></td><td></td><td></td></tr></table> Post - 0 Miss - 0 Block - 0										2 周蕾 <table border="1"><tr><td></td><td></td><td></td></tr><tr><td></td><td></td><td>1</td></tr><tr><td></td><td></td><td></td></tr></table> Post - 0 Miss - 0 Block - 0						1				3 王嘉怡 <table border="1"><tr><td></td><td></td><td></td></tr><tr><td></td><td></td><td></td></tr><tr><td></td><td></td><td></td></tr></table> Post - 0 Miss - 0 Block - 0										5 郭威 <table border="1"><tr><td></td><td></td><td></td></tr><tr><td></td><td></td><td></td></tr><tr><td></td><td></td><td></td></tr></table> Post - 0 Miss - 0 Block - 0										6 黄妍 <table border="1"><tr><td></td><td></td><td></td></tr><tr><td></td><td></td><td></td></tr><tr><td></td><td></td><td></td></tr></table> Post - 1 Miss - 0 Block - 0										7 车婉茹 <table border="1"><tr><td>1</td><td></td><td>1</td></tr><tr><td>1</td><td></td><td></td></tr><tr><td></td><td></td><td>1</td></tr></table> Post - 1 Miss - 0 Block - 0	1		1	1					1	8 吴茵 <table border="1"><tr><td></td><td></td><td>1</td></tr><tr><td></td><td>1</td><td>1</td></tr><tr><td>2</td><td></td><td>1</td></tr></table> Post - 1 Miss - 0 Block - 1			1		1	1	2		1	9 武娜娜 <table border="1"><tr><td>1</td><td>1</td><td></td></tr><tr><td>2</td><td></td><td>2</td></tr><tr><td>1</td><td></td><td>2</td></tr></table> Post - 0 Miss - 0 Block - 0	1	1		2		2	1		2
		1																																																																													
1		1																																																																													
1																																																																															
		1																																																																													
		1																																																																													
	1	1																																																																													
2		1																																																																													
1	1																																																																														
2		2																																																																													
1		2																																																																													
10 斯文 <table border="1"><tr><td></td><td></td><td></td></tr><tr><td></td><td></td><td></td></tr><tr><td>1</td><td></td><td></td></tr></table> Post - 0 Miss - 0 Block - 0							1			11 孙梦颖 <table border="1"><tr><td>1</td><td></td><td></td></tr><tr><td>2</td><td></td><td></td></tr><tr><td>1</td><td></td><td>1</td></tr></table> Post - 2 Miss - 0 Block - 0	1			2			1		1	12 郑冯 <table border="1"><tr><td></td><td></td><td></td></tr><tr><td></td><td></td><td></td></tr><tr><td></td><td></td><td></td></tr></table> Post - 0 Miss - 0 Block - 0										13 徐娟 <table border="1"><tr><td></td><td></td><td></td></tr><tr><td></td><td></td><td></td></tr><tr><td></td><td></td><td>1</td></tr></table> Post - 0 Miss - 0 Block - 0									1	17 居晔 <table border="1"><tr><td></td><td></td><td></td></tr><tr><td></td><td></td><td></td></tr><tr><td></td><td></td><td></td></tr></table> Post - 0 Miss - 0 Block - 0										18 沙正文 <table border="1"><tr><td></td><td></td><td></td></tr><tr><td></td><td></td><td></td></tr><tr><td></td><td></td><td>1</td></tr></table> Post - 0 Miss - 0 Block - 0									1	19 印尼 <table border="1"><tr><td></td><td></td><td>1</td></tr><tr><td></td><td></td><td>1</td></tr><tr><td></td><td></td><td></td></tr></table> Post - 0 Miss - 0 Block - 1			1			1				23 都好 <table border="1"><tr><td></td><td></td><td></td></tr><tr><td></td><td></td><td></td></tr><tr><td></td><td></td><td></td></tr></table> Post - 0 Miss - 0 Block - 0									
1																																																																															
1																																																																															
2																																																																															
1		1																																																																													
		1																																																																													
		1																																																																													
		1																																																																													
		1																																																																													

## 第十三届全国运动会女子手球决赛

PHMS Pictorial Handball Match Statistics

IHF Official System

## 比赛进程表

 手球 3-4名 组别 X  
 女子 轮次 6 场次 23  
 天津奥林匹克体育中心 2017-09-07 17:30

时间	队员	动作	比分	队员	动作
广东			上半时		
上海					
00:28	23 王如	警告	0-0		
00:42	26 马晓卉	被射入	0-1	11 孙梦颖	突破 得分
00:44	7 刘彤	顶贴 失误			
01:01	9 韦宝桂	左远射 被封		18 沙正文	封球
01:11	7 刘彤	使被罚7M球		9 武娜娜	造7M
01:12	7 刘彤	警告			
01:17		裁判暂停			
01:21	16 李娟	被射入	0-2	7 车婉茹	7M球 得分
01:45	10 史小军	近射 得分	1-2	1 许沫	被射入
01:47	7 刘彤	助攻			
01:50				9 武娜娜	选位 失误
02:17				6 黄妍	左远射 击柱
02:25	10 史小军	进攻犯规		8 吴茵	造犯规
02:31	3 安妮	断球		2 周蕾	快攻 传球失误
02:32	3 安妮	助攻			
02:43	28 刘金兰	一传快攻 得分	2-2	1 许沫	被射入
03:31	23 王如	造犯规		11 孙梦颖	进攻犯规
03:58	28 刘金兰	传球失误			
04:04				1 许沫	快攻 传球失误
04:07	28 刘金兰	右边射 得分	3-2	1 许沫	被射入
04:15	3 安妮	助攻			
04:47	26 马晓卉	挡住球		11 孙梦颖	右远射 被救
05:21	26 马晓卉	挡住球		8 吴茵	右远射 被救
05:43	10 史小军	右远射 被救		1 许沫	挡住球
06:30	10 史小军	近射 得分	4-2	1 许沫	被射入
06:32				2 周蕾	漏防 失误
07:00	26 马晓卉	被射入	4-3	18 沙正文	近射 得分
07:03				8 吴茵	助攻
07:05	23 王如	换防 失误			
07:32				2 周蕾	警告
08:03	28 刘金兰	右边射 得分	5-3	1 许沫	被射入
08:31				11 孙梦颖	传球失误
08:35				18 沙正文	警告
09:14	3 安妮	右远射 得分	6-3	1 许沫	被射入
09:38	26 马晓卉	挡住球		13 徐娟	突破 被救
09:40	28 刘金兰	顶贴 失误			
09:46	10 史小军	快攻 进攻犯规		2 周蕾	造犯规
09:54	26 马晓卉	被射入	6-4	8 吴茵	突破 得分
09:56	28 刘金兰	顶贴 失误			
10:42	23 王如	传球失误		8 吴茵	断球
10:50	26 马晓卉	被射入	6-5	13 徐娟	一传快攻 得分

## 第十三届全国运动会女子手球决赛

PHMS Pictorial Handball Match Statistics

IHF Official System

## 比赛进程表

 手球 3-4名 组别 X  
 女子 轮次 6 场次 23  
 八津卅卅八子卅卅  
 2017-09-07 17:30

时间	队员	动作	比分	队员	动作
广东			上半时	上海	
10:53			6-5	8 吴茵	助攻
11:17	23 王如	造7M		13 徐娟	使被罚7M球
11:19		裁判暂停			
11:26				13 徐娟	警告
11:32	28 刘金兰	7M球 得分	7-5	12 郑冯	被射入
12:02	26 马晓卉	被射入	7-6	9 武娜娜	近射 得分
12:05				11 孙梦颖	助攻
12:10	28 刘金兰	移动 失误			
12:42	9 韦宝桂	左远射 被救		1 许沫	挡住球
13:12	23 王如	封球		19 印尼	右远射 被封
13:18	7 刘彤	短传快攻 被救		1 许沫	挡住球
13:47	7 刘彤	使被罚7M球		18 沙正文	造7M
13:49				8 吴茵	助攻
13:54	10 史小军	警告			
14:06	26 马晓卉	被射入	7-7	7 车婉茹	7M球 得分
14:38		球队暂停			
14:53	23 王如	右远射 得分	8-7	1 许沫	被射入
15:25				19 印尼	四步
15:40	3 安妮	突破 击柱			
15:42				9 武娜娜	顶贴 失误
15:53				8 吴茵	左远射 击柱
16:16	3 安妮	右远射 射失			
16:23	26 马晓卉	被射入	8-8	11 孙梦颖	左远射 得分
16:25	9 韦宝桂	移动 失误			
17:13	10 史小军	中远射 得分	9-8	1 许沫	被射入
17:22				11 孙梦颖	右远射 击柱
17:29	23 王如	使被罚7M球		18 沙正文	造7M
17:53				7 车婉茹	7M球 击柱
18:03	9 韦宝桂	进攻犯规		2 周蕾	造犯规
18:34	26 马晓卉	挡住球		19 印尼	突破 被救
18:36	28 刘金兰	顶贴 失误			
18:49	26 马晓卉	被射入	9-9	11 孙梦颖	近射 得分
18:51	9 韦宝桂	移动 失误			
19:45	9 韦宝桂	进攻犯规		2 周蕾	造犯规
20:01	26 马晓卉	挡住球		11 孙梦颖	右边射 被救
20:40	3 安妮	右远射 得分	10-9	1 许沫	被射入
21:08				11 孙梦颖	右远射 击柱
21:17	7 刘彤	短传快攻 击柱			
21:47	26 马晓卉	被射入	10-10	2 周蕾	右边射 得分
21:49				8 吴茵	助攻
22:13	28 刘金兰	左边射 得分	11-10	1 许沫	被射入

**第十三届全国运动会女子手球决赛**
**PHMS** Pictorial Handball Match Statistics

**IHF** Official System

**比赛进程表**

 手球 3-4名 组别 X  
 女子 轮次 6 场次 23  
 天津奥林匹克体育中心 2017-09-07 17:30

时间	队员	动作	比分	队员	动作			
<b>广东</b>			<b>上半时</b>			<b>上海</b>		
22:46	26 马晓卉	挡住球	11-10	19 印尼	左远射 被救			
22:49				18 沙正文	侵区			
23:03	3 安妮	四步						
23:14	26 马晓卉	被射入	11-11	11 孙梦颖	突破 得分			
23:16	28 刘金兰	顶贴 失误						
23:52	11 魏梦庭	右远射 被救		12 郑冯	挡住球			
23:58		裁判暂停						
23:58	7 刘彤	使被罚7M球		8 吴茵	快攻 造7M			
23:58	7 刘彤	罚出场2分钟						
24:03	26 马晓卉	被射入	11-12	7 车婉茹	7M球 得分			
24:57	3 安妮	左远射 被封		2 周蕾	封球			
25:03	26 马晓卉	被射入	11-13	9 武娜娜	短传快攻 得分			
26:14	10 史小军	造7M		9 武娜娜	使被罚7M球			
26:29	9 韦宝桂	7M球 得分	12-13	12 郑冯	被射入			
26:51				19 印尼	助攻			
27:19				18 沙正文	接球失误			
27:31	9 韦宝桂	短传快攻 得分	13-13	12 郑冯	被射入			
27:36					球队暂停			
27:54	26 马晓卉	挡住球		18 沙正文	近射 被救			
27:56				8 吴茵	助攻			
28:21	3 安妮	突破 得分	14-13	12 郑冯	被射入			
28:24				2 周蕾	顶贴 失误			
28:35	26 马晓卉	被射入	14-14	9 武娜娜	短传快攻 得分			
29:00	10 史小军	传球失误		5 郭威	断球			
29:18	7 刘彤	使被罚7M球		19 印尼	造7M			
29:43	26 马晓卉	挡住球		7 车婉茹	7M球 被救			
29:56	9 韦宝桂	造7M		2 周蕾	使被罚7M球			
30:00	28 刘金兰	7M球 射失						

## 第十三届全国运动会女子手球决赛

PHMS Pictorial Handball Match Statistics

IHF Official System

## 比赛进程表

 手球 3-4名 组别 X  
 女子 轮次 6 场次 23  
 天津奥林匹克体育中心 2017-09-07 17:30

时间	队员	动作	比分	队员	动作
广东			下半场		
00:24	9 韦宝桂	近射 得分	15-14	1 许沫	被射入
00:29				8 吴茵	移动 失误
00:56	26 马晓卉	挡住球		11 孙梦颖	左远射 被救
01:30	9 韦宝桂	左远射 得分	16-14	1 许沫	被射入
02:00	26 马晓卉	被射入	16-15	8 吴茵	突破 得分
02:02	28 刘金兰	顶贴 失误			
02:08	7 刘彤	快攻 传球失误			
02:13	28 刘金兰	断球		11 孙梦颖	快攻 传球失误
02:51	9 韦宝桂	突破 得分	17-15	1 许沫	被射入
02:53				2 周蕾	顶贴 失误
03:09		裁判暂停			
03:21	7 刘彤	罚出场2分钟			
03:38	26 马晓卉	被射入	17-16	10 斯文	右边射 得分
04:26	9 韦宝桂	右远射 击柱			
04:40	26 马晓卉	被射入	17-17	9 武娜娜	左边射 得分
04:42				8 吴茵	助攻
05:13	3 安妮	传球失误		19 印尼	断球
05:17				19 印尼	助攻
05:20	26 马晓卉	被射入	17-18	9 武娜娜	突破 得分
05:29		球队暂停			
06:01	3 安妮	突破 被救		1 许沫	挡住球
06:04				17 居晔	顶贴 失误
06:40	26 马晓卉	被射入	17-19	9 武娜娜	突破 得分
06:42	3 安妮	顶贴 失误			
07:21	28 刘金兰	左边射 得分	18-19	1 许沫	被射入
07:29		裁判暂停			
07:57	22 刘晓玉	挡住球		19 印尼	右远射 被救
08:30		裁判暂停			
09:03	20 李军政	右边射 被救		1 许沫	挡住球
09:05	20 李军政	断球		19 印尼	快攻 传球失误
09:10		裁判暂停			
09:11				17 居晔	罚出场2分钟
09:28	9 韦宝桂	进攻犯规		5 郭威	造犯规
10:33	22 刘晓玉	挡住球		11 孙梦颖	任意球 被救
10:37	22 刘晓玉	快攻 传球失误			
11:09	22 刘晓玉	被射入	18-20	11 孙梦颖	近射 得分
11:31	10 史小军	造7M		11 孙梦颖	使被罚7M球
11:40	9 韦宝桂	7M球 得分	19-20	1 许沫	被射入
12:17	22 刘晓玉	被射入	19-21	8 吴茵	突破 得分
12:24	10 史小军	左远射 得分	20-21	1 许沫	被射入
13:16	20 李军政	使被罚7M球		19 印尼	造7M

### 第十三届全国运动会女子手球决赛

PHMS Pictorial Handball Match Statistics

IHF Official System

#### 比赛进程表

手球 3-4名 组别 X  
女子 轮次 6 场次 23  
天津奥林匹克体育中心 2017-09-07 17:30

时间	队员	动作	比分	队员	动作
广东			上海		
下半场			下半场		
13:27		裁判暂停	20-21		
13:31	26 马晓卉	被射入	20-22	8 吴茵	7M球 得分
13:53	20 李军政	右边射 得分	21-22	1 许沫	被射入
14:18	22 刘晓玉	挡住球		11 孙梦颖	突破 被救
14:20	23 王如	顶贴 失误			
14:30	28 刘金兰	左边射 得分	22-22	1 许沫	被射入
15:16	22 刘晓玉	被射入	22-23	8 吴茵	近射 得分
15:19	9 韦宝桂	移动 失误			
16:05	10 史小军	近射 得分	23-23	1 许沫	被射入
16:07	3 安妮	助攻			
16:09				18 沙正文	换防 失误
16:46	22 刘晓玉	被射入	23-24	19 印尼	左远射 得分
17:18	3 安妮	突破 得分	24-24	1 许沫	被射入
17:20				9 武娜娜	移动 失误
17:30	26 马晓卉	挡住球		19 印尼	近射 被救
17:32	7 刘彤	移动 失误			
17:41	7 刘彤	近射 得分	25-24	1 许沫	被射入
17:43	9 韦宝桂	助攻			
17:54	26 马晓卉	挡住球		8 吴茵	右远射 被救
19:04	9 韦宝桂	突破 得分	26-24	1 许沫	被射入
19:10				10 斯文	顶贴 失误
20:07	26 马晓卉	挡住球		19 印尼	近射 被救
21:00	28 刘金兰	左边射 被救		1 许沫	挡住球
21:03	3 安妮	助攻			
21:23	9 韦宝桂	中远射 被封		18 沙正文	封球
21:49	9 韦宝桂	中远射 击柱			
21:57	26 马晓卉	被射入	26-25	9 武娜娜	短传快攻 得分
22:08	10 史小军	近射 被救		1 许沫	挡住球
22:19	26 马晓卉	挡住球		10 斯文	短传快攻 被救
22:59	9 韦宝桂	进攻犯规		11 孙梦颖	造犯规
23:10	26 马晓卉	被射入	26-26	9 武娜娜	短传快攻 得分
23:43	23 王如	近射 击柱			
23:45				10 斯文	移动 失误
24:12					球队暂停
24:34	9 韦宝桂	使被罚7M球		11 孙梦颖	造7M
24:46	26 马晓卉	被射入	26-27	8 吴茵	7M球 得分
25:15	23 王如	近射 得分	27-27	1 许沫	被射入
25:16	9 韦宝桂	助攻			
25:27	26 马晓卉	被射入	27-28	19 印尼	左边射 得分
26:21	9 韦宝桂	近射 被救		1 许沫	挡住球
26:50	26 马晓卉	被射入	27-29	9 武娜娜	近射 得分

第十三届全国运动会女子手球决赛

PHMS Pictorial Handball Match Statistics

IHF Official System

比赛进程表

手球 3-4名 组别 X  
女子 轮次 6 场次 23  
八件型池八子件月 馆  
2017-09-07 17:30

时间	队员	动作	比分	队员	动作
广东			上海		
27:52			27-29		
		裁判暂停			
27:54		球队暂停			
28:02	28 刘金兰	右边射 被救		1 许沫	挡住球
28:39	23 王如	封球		8 吴茵	右远射 被封
28:44	26 马晓卉	快攻 传球失误			
28:53					球队暂停
29:15	26 马晓卉	挡住球		8 吴茵	近射 被救
29:16				10 斯文	助攻
29:25	23 王如	运球失误		8 吴茵	造失误
29:33	10 史小军	使被罚7M球		9 武娜娜	快攻 造7M
29:36		裁判暂停			
29:41	26 马晓卉	被射入	27-30	7 车婉茹	7M球 得分
29:58	3 安妮	造7M		18 沙正文	使被罚7M球
30:00	9 韦宝桂	7M球 被救		12 郑冯	挡住球



**PHMS** Pictorial Handball Match Statistics

**IHF** Official System

Team A					Team B					Match Number											
A 安徽					B 江苏					<b>24</b>											
Played in			in the hall			on			at			Spectators									
天津			天津师范大学体育馆			2017-09-07			19:15			hours									
Half-time(30')	A	B	End of playing time		A	B	1st extra time		A	B	2nd extra time		A	B	After penalty throws		A	B			
	12	12	26		30																
Number of 7 m	A	Team time-out			Full name of players and officials						Team time-out			B	Number of 7 m						
	5/7	1	2	3							1	2	3	B							
		24:28	43:56	54:53							22:14	51:53	57:43	4/4							
No.	Team A					G	W	2'	D	DR	No.	Team B					G	W	2'	D	DR
1	司艳										1	陆婷									
3	李兵					2		1			3	张海侠					3				
5	班晨晨										4	赵佳芹					5	1			
6	沈萍					11					7	周琦									
7	赵江川										8	乔如					4	1	1		
8	徐仕媛										9	莫蒙蒙									
10	孙来苗										11	于源源									
13	陶丹扬							1			12	黄霞									
14	刘晓妹					3		1			13	黄慧影									
15	王婵婵										16	王小华							1		
16	朱莉珍										17	修丽杰					1	1	3		
17	周婷					3	1				18	韦秋香					2				
20	周雪婷										19	李薇薇					6				
21	李瑶					2	1	1			23	王书慧									
23	张天洁										33	金梦青					3				
41	杜机娟					5		1			69	蓝小玲					6				
A	吴疆										A	姚治前									
B	吴立军 (主教练)										B	金甲洙 (主教练)									
C	杨桂东										C	马彪									
E	张国遂										D	刘凯									
A	Signatures of responsables for the teams (Off.A)																			B	
TP	Remarks of referees / HF Official																			TP	

Signatures

Referees BALAZS. MARTON (HUN)

PETER. HORVATH (HUN)

T.D. 刘凤娟 (CHN)

高斌 (CHN)

CHA Off.

Note: Number of 7m Throws Awarded to Team A and B, Goals (G), Warnings (W), Suspensions (2'), Direct Disqualification (D), Disqualification With Report (DR) and Team Penalty (TP).

Table Officials: 张智伟

谷瑶

Statisticians: 周强

杜宪

**第十三届全国运动会女子手球决赛**
**PHMS** Pictorial Handball Match Statistics

**IHF** Official System

**竞赛技术统计**

 手球  
 女子

 决赛  
 轮次 6

 组别 X  
 场次 24

 天津师范大学体育馆  
 2017-09-07 19:15

Referees: BALAZS. MARTON (HUN) / PETER. HORVATH (HUN)

Result: 26:30(12:12)

Teams: 安徽(安徽) VS 江苏(江苏)

安徽		远	近	边	快	突	任意	7m	合计	%	助攻	失误	警告	2'	D+DR	安徽	比赛 进程	江苏
主教练: 吴立军		射	射	射	攻	破	球	球										
1	司艳															41	杜机娟	1 01:27 0
3	李兵		0/1	0/1		2/2			2/4	50.0		1		1			1 02:18 1 3 张海侠	
5	班晨晨																1 02:54 2 69 蓝小玲	
6	沈萍	4/7	3/4				2/2	2/3	11/16	68.8	1	5					1 05:37 3 19 李薇薇	
7	赵江川																41 杜机娟	
8	徐仕媛																2 06:11 3	
10	孙来苗																41 杜机娟	
13	陶丹扬			0/2	0/1				0/3	0.0							3 07:58 3	
14	刘晓妹	2/5	1/1	0/2					3/8	37.5	1	2		1			3 李兵	
15	王婷婷				0/1				0/1	0.0	1						4 09:50 3	
16	朱莉珍																4 11:44 4 19 李薇薇	
17	周婷	1/1	0/2		1/1	1/1			3/5	60.0	1	1	1				4 14:20 5 3 张海侠	
20	周雪婷																6 沈萍	
21	李瑶		1/1			1/1			2/2	100		7	1	1			21 李瑶	
23	张天洁																6 16:16 5	
41	杜机娟			2/3				3/4	5/7	71.4		1		1			6 16:28 6 3 张海侠	
运动员	合计	7/13	5/9	2/8	1/3	4/4	2/2	5/7	26/46	56.5	4	17	2	5			41 杜机娟	
1	司艳	3/8	4/11	5/11	1/3	0/4		0/1	13/38	34.2							7 18:15 6	
16	朱莉珍		0/2					0/3	0/5	0.0							7 19:13 7 8 乔如	
守门员	合计	3/8	4/13	5/11	1/3	0/4		0/4	13/43	30.2							7 22:27 8 69 蓝小玲	
江苏		远	近	边	快	突	任意	7m	合计	%	助攻	失误	警告	2'	D+DR			
主教练: 金甲洙		射	射	射	攻	破	球	球										
1	陆婷															21	李瑶	12 01:57 13 69 蓝小玲
3	张海侠		0/1	3/4	0/1				3/6	50.0							13 02:40 13	
4	赵佳芹	1/3	1/2		1/1	1/1		1/1	5/8	62.5	3	1	1				13 02:55 14 18 韦秋香	
7	周琦																6 沈萍	
8	乔如		4/4		0/1				4/5	80.0		1	1	1			6 沈萍	
9	莫蒙蒙																6 沈萍	
11	于源源			0/1					0/1	0.0							6 沈萍	
12	黄霞																6 沈萍	
13	黄慧影																6 沈萍	
16	王小华										1	1		1			6 沈萍	
17	修丽杰		1/1						1/1	100			1	3			6 沈萍	
18	韦秋香			1/2	0/1	1/1			2/4	50.0							6 沈萍	
19	李薇薇	1/1	2/3			1/1		2/2	6/7	85.7		6					6 沈萍	
23	王书慧																6 沈萍	
33	金梦青			2/4				1/1	3/5	60.0							6 沈萍	
69	蓝小玲	3/5	1/3	0/1	1/1	1/1			6/11	54.5	2	4					6 沈萍	
运动员	合计	5/9	9/14	6/12	2/5	4/4		4/4	30/48	62.5	6	13	3	5				
1	陆婷	0/2	0/1					1/1	1/4	25.0								
12	黄霞							0/2	0/2	0.0								
16	王小华	3/8	2/6	3/5	2/3	0/4	0/2	0/3	10/31	32.3	1	1		1				
守门员	合计	3/10	2/7	3/5	2/3	0/4	0/2	1/6	11/37	29.7	1	1		1				

场上队员: 得分 / 射门

守门员: 救球 / 射门

D	取消资格	DR	取消资格+报告
---	------	----	---------

## 第十三届全国运动会女子手球决赛

PHMS Pictorial Handball Match Statistics

IHF Official System

## 个人/全队技术统计表

 手球 决赛 组别 X  
 女子 轮次 6 场次 24  
 天津师范大学体育馆  
 2017-09-07 19:15

号码	姓名	远射	近射	边射	快攻	突破	任意	七米	合计	%	助攻	失误	警告	2'	取消	时间
<b>安徽(安徽)</b>																
<b>(场上队员)</b>																
1	司艳									0.0%						00:56:24
3	李兵		0/1	0/1		2/2			2/4	50.0%		1		1		00:54:30
5	班晨晨									0.0%						00:03:00
6	沈萍	4/7	3/4				2/2	2/3	11/16	68.8%	1	5				00:56:48
7	赵江川									0.0%						00:00:00
8	徐仕媛									0.0%						00:00:00
10	孙来苗									0.0%						00:02:23
13	陶丹扬			0/2	0/1				0/3	0.0%				1		00:26:39
14	刘晓妹	2/5	1/1	0/2					3/8	37.5%	1	2		1		00:52:29
15	王婵婵				0/1				0/1	0.0%	1					00:22:06
16	朱莉珍									0.0%						00:03:36
17	周婷	1/1	0/2		1/1	1/1			3/5	60.0%	1	1	1			00:45:30
20	周雪婷									0.0%						00:00:00
21	李瑶		1/1			1/1			2/2	100%		7	1	1		00:30:40
23	张天洁									0.0%						00:00:00
41	杜机娟			2/3				3/4	5/7	71.4%		1		1		01:00:00
	<b>合计</b>	<b>7/13</b>	<b>5/9</b>	<b>2/8</b>	<b>1/3</b>	<b>4/4</b>	<b>2/2</b>	<b>5/7</b>	<b>26/46</b>	<b>56.5%</b>	<b>4</b>	<b>17</b>	<b>2</b>	<b>5</b>		
<b>(守门员)</b>																
1	司艳	3/8	4/11	5/11	1/3	0/4		0/1	13/38	34.2%						00:56:24
16	朱莉珍		0/2					0/3	0/5	0.0%						00:03:36
	<b>合计</b>	<b>3/8</b>	<b>4/13</b>	<b>5/11</b>	<b>1/3</b>	<b>0/4</b>		<b>0/4</b>	<b>13/43</b>	<b>30.2%</b>						

场上队员：得分/射门

守门员：救球/射门

全队合计	得分	被救	射失	击柱	封球	合计	%
远射	7	3		1	2	13	53.8%
近射	5	2	1	1		9	55.6%
边射	2	3	2	1		8	25.0%
快攻	1	2				3	33.3%
突破	4					4	100.0%
任意	2					2	100.0%
七米	5	1		1		7	71.4%

## 第十三届全国运动会女子手球决赛

PHMS Pictorial Handball Match Statistics

IHF Official System

## 个人/全队技术统计表

 手球 决赛 组别 X  
 女子 轮次 6 场次 24  
 天津师范大学体育馆  
 2017-09-07 19:15

号码	姓名	远射	近射	边射	快攻	突破	任意	七米	合计	%	助攻	失误	警告	2'	取消	时间
江苏(江苏)																
(场上队员)																
1	陆婷									0.0%						00:06:04
3	张海侠		0/1	3/4	0/1				3/6	50.0%						00:29:52
4	赵佳芹	1/3	1/2		1/1	1/1		1/1	5/8	62.5%	3	1	1			01:00:00
7	周琦									0.0%						00:00:00
8	乔如		4/4		0/1				4/5	80.0%		1	1	1		00:57:04
9	莫蒙蒙									0.0%						00:08:54
11	于源源			0/1					0/1	0.0%						00:15:27
12	黄霞									0.0%						00:00:25
13	黄慧影									0.0%						00:00:00
16	王小华									0.0%	1	1		1		00:53:31
17	修丽杰		1/1						1/1	100%			1	3		00:32:26
18	韦秋香			1/2	0/1	1/1			2/4	50.0%						00:30:00
19	李薇薇	1/1	2/3			1/1		2/2	6/7	85.7%		6				00:23:28
23	王书慧									0.0%						00:00:00
33	金梦青			2/4				1/1	3/5	60.0%						00:44:32
69	蓝小玲	3/5	1/3	0/1	1/1	1/1			6/11	54.5%	2	4				00:56:30
	合计	5/9	9/14	6/12	2/5	4/4		4/4	30/48	62.5%	6	13	3	5		

## (守门员)

1	陆婷	0/2	0/1					1/1	1/4	25.0%						00:06:04
12	黄霞							0/2	0/2	0.0%						00:00:25
16	王小华	3/8	2/6	3/5	2/3	0/4	0/2	0/3	10/31	32.3%	1	1		1		00:53:31
	合计	3/10	2/7	3/5	2/3	0/4	0/2	1/6	11/37	29.7%	1	1		1		

场上队员：得分/射门

守门员：救球/射门

全队合计	得分	被救	射失	击柱	封球	合计	%
远射	5	3		1		9	55.6%
近射	9	4	1			14	64.3%
边射	6	5		1		12	50.0%
快攻	2	1		2		5	40.0%
突破	4					4	100.0%
任意							0.0%
七米	4					4	100.0%

第十三届全国运动会女子手球决赛

PHMS Pictorial Handball Match Statistics

IHF Official System

图式比赛技术统计表

手球  
女子

决赛  
轮次 6

组别 X  
场次 24

天津师范大学体育馆  
2017-09-07 19:15

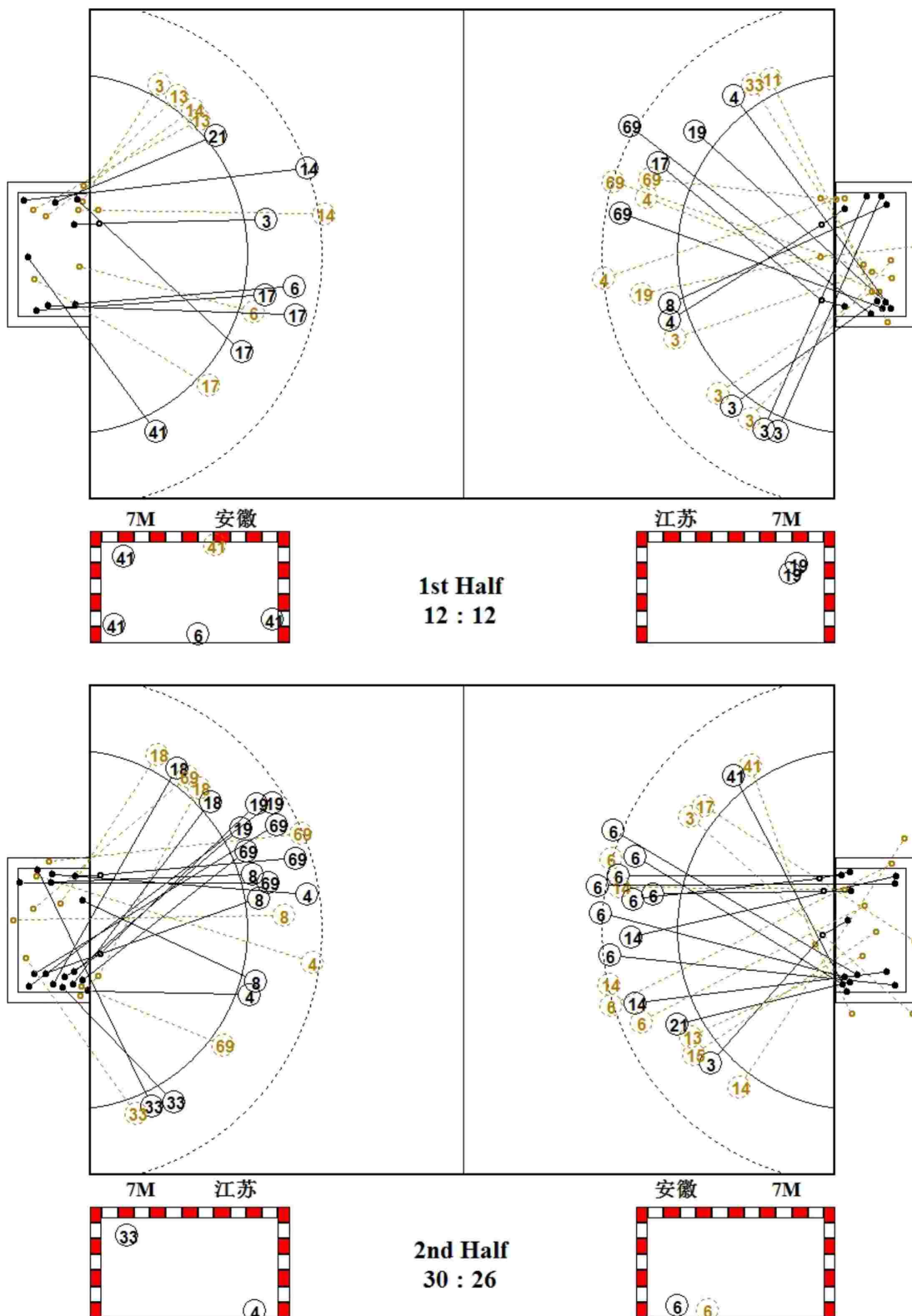

第十三届全国运动会女子手球决赛

PHMS Pictorial Handball Match Statistics

IHF Official System

图式射门区域统计

手球  
女子

决赛  
轮次 6

组别 X  
场次 24

天津师范大学体育馆  
2017-09-07 19:15

安徽

1 司艳 <table border="1"><tr><td></td><td></td><td></td></tr><tr><td></td><td></td><td></td></tr><tr><td></td><td></td><td></td></tr></table> Post - 0 Miss - 0 Block - 0										3 李兵 <table border="1"><tr><td></td><td></td><td></td></tr><tr><td></td><td>1</td><td>1</td></tr><tr><td></td><td></td><td></td></tr></table> Post - 0 Miss - 1 Block - 0					1	1				5 班晨晨 <table border="1"><tr><td></td><td></td><td></td></tr><tr><td></td><td></td><td></td></tr><tr><td></td><td></td><td></td></tr></table> Post - 0 Miss - 0 Block - 0										6 沈萍 <table border="1"><tr><td>1</td><td></td><td>1</td></tr><tr><td></td><td></td><td></td></tr><tr><td>5</td><td>1</td><td>3</td></tr></table> Post - 1 Miss - 0 Block - 1	1		1				5	1	3	7 赵江川 <table border="1"><tr><td></td><td></td><td></td></tr><tr><td></td><td></td><td></td></tr><tr><td></td><td></td><td></td></tr></table> Post - 0 Miss - 0 Block - 0										8 徐仕媛 <table border="1"><tr><td></td><td></td><td></td></tr><tr><td></td><td></td><td></td></tr><tr><td></td><td></td><td></td></tr></table> Post - 0 Miss - 0 Block - 0										10 孙来苗 <table border="1"><tr><td></td><td></td><td></td></tr><tr><td></td><td></td><td></td></tr><tr><td></td><td></td><td></td></tr></table> Post - 0 Miss - 0 Block - 0										13 陶丹扬 <table border="1"><tr><td></td><td></td><td></td></tr><tr><td></td><td></td><td></td></tr><tr><td></td><td></td><td></td></tr></table> Post - 1 Miss - 0 Block - 0									
	1	1																																																																													
1		1																																																																													
5	1	3																																																																													
14 刘晓妹 <table border="1"><tr><td>1</td><td></td><td>2</td></tr><tr><td></td><td></td><td></td></tr><tr><td></td><td></td><td></td></tr></table> Post - 0 Miss - 1 Block - 1	1		2							15 王婷婷 <table border="1"><tr><td></td><td></td><td></td></tr><tr><td></td><td></td><td></td></tr><tr><td></td><td></td><td></td></tr></table> Post - 0 Miss - 0 Block - 0										16 朱莉珍 <table border="1"><tr><td></td><td></td><td></td></tr><tr><td></td><td></td><td></td></tr><tr><td></td><td></td><td></td></tr></table> Post - 0 Miss - 0 Block - 0										17 周婷 <table border="1"><tr><td>1</td><td></td><td></td></tr><tr><td>1</td><td></td><td></td></tr><tr><td></td><td></td><td>1</td></tr></table> Post - 1 Miss - 0 Block - 0	1			1					1	20 周雪婷 <table border="1"><tr><td></td><td></td><td></td></tr><tr><td></td><td></td><td></td></tr><tr><td></td><td></td><td></td></tr></table> Post - 0 Miss - 0 Block - 0										21 李瑶 <table border="1"><tr><td></td><td></td><td></td></tr><tr><td></td><td></td><td>1</td></tr><tr><td></td><td></td><td>1</td></tr></table> Post - 0 Miss - 0 Block - 0						1			1	23 张天洁 <table border="1"><tr><td></td><td></td><td></td></tr><tr><td></td><td></td><td></td></tr><tr><td></td><td></td><td></td></tr></table> Post - 0 Miss - 0 Block - 0										41 杜机娟 <table border="1"><tr><td>1</td><td>1</td><td></td></tr><tr><td></td><td></td><td></td></tr><tr><td>1</td><td></td><td>2</td></tr></table> Post - 1 Miss - 1 Block - 0	1	1					1		2
1		2																																																																													
1																																																																															
1																																																																															
		1																																																																													
		1																																																																													
		1																																																																													
1	1																																																																														
1		2																																																																													

1 □□

1/5	2/2	2/7
0/5	2/2	3/7
3/7		0/3

16 □□□

0/1		0/2
0/1		0/1

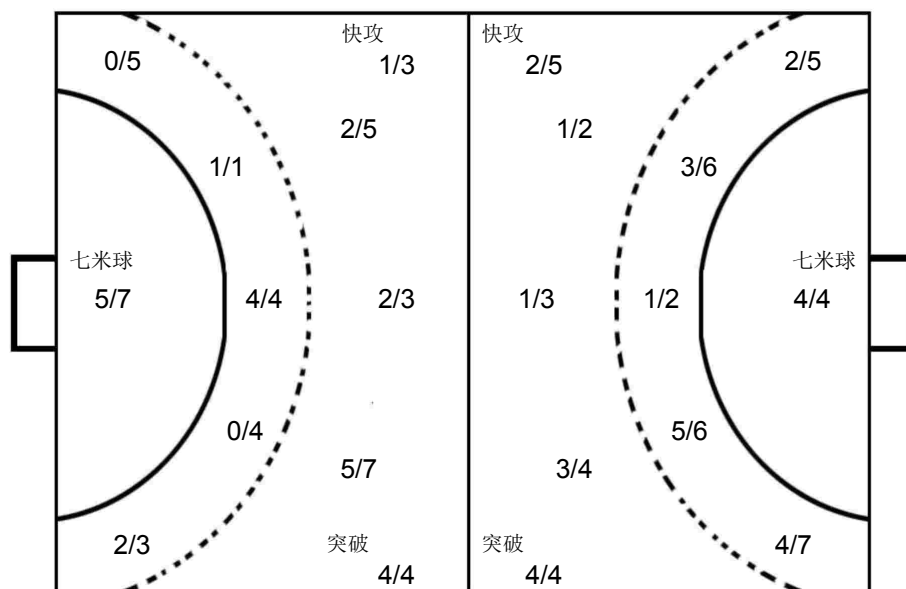

1 □□

1/2		0/2

12 □□

	0/1	0/1

16 □□□

1/5	0/1	1/4
1/2	1/1	2/3
1/6	1/2	2/7

江苏

1 陆婷 <table border="1"><tr><td></td><td></td><td></td></tr><tr><td></td><td></td><td></td></tr><tr><td></td><td></td><td></td></tr></table> Post - 0 Miss - 0 Block - 0										3 张海侠 <table border="1"><tr><td>1</td><td></td><td></td></tr><tr><td>1</td><td></td><td>1</td></tr><tr><td></td><td></td><td></td></tr></table> Post - 0 Miss - 0 Block - 0	1			1		1				4 赵佳芹 <table border="1"><tr><td></td><td></td><td>1</td></tr><tr><td></td><td></td><td>1</td></tr><tr><td>2</td><td></td><td>1</td></tr></table> Post - 0 Miss - 0 Block - 0			1			1	2		1	7 周琦 <table border="1"><tr><td></td><td></td><td></td></tr><tr><td></td><td></td><td></td></tr><tr><td></td><td></td><td></td></tr></table> Post - 0 Miss - 0 Block - 0										8 乔如 <table border="1"><tr><td>1</td><td></td><td></td></tr><tr><td>1</td><td></td><td>1</td></tr><tr><td></td><td></td><td>1</td></tr></table> Post - 1 Miss - 0 Block - 0	1			1		1			1	9 莫蒙蒙 <table border="1"><tr><td></td><td></td><td></td></tr><tr><td></td><td></td><td></td></tr><tr><td></td><td></td><td></td></tr></table> Post - 0 Miss - 0 Block - 0										11 于源源 <table border="1"><tr><td></td><td></td><td></td></tr><tr><td></td><td></td><td></td></tr><tr><td></td><td></td><td></td></tr></table> Post - 1 Miss - 0 Block - 0										12 黄霞 <table border="1"><tr><td></td><td></td><td></td></tr><tr><td></td><td></td><td></td></tr><tr><td></td><td></td><td></td></tr></table> Post - 0 Miss - 0 Block - 0									
1																																																																															
1		1																																																																													
		1																																																																													
		1																																																																													
2		1																																																																													
1																																																																															
1		1																																																																													
		1																																																																													
13 黄慧影 <table border="1"><tr><td></td><td></td><td></td></tr><tr><td></td><td></td><td></td></tr><tr><td></td><td></td><td></td></tr></table> Post - 0 Miss - 0 Block - 0										16 王小华 <table border="1"><tr><td></td><td></td><td></td></tr><tr><td></td><td></td><td></td></tr><tr><td></td><td></td><td></td></tr></table> Post - 0 Miss - 0 Block - 0										17 修丽杰 <table border="1"><tr><td></td><td></td><td></td></tr><tr><td></td><td></td><td></td></tr><tr><td></td><td></td><td>1</td></tr></table> Post - 0 Miss - 0 Block - 0									1	18 韦秋香 <table border="1"><tr><td></td><td></td><td></td></tr><tr><td>1</td><td></td><td></td></tr><tr><td>1</td><td></td><td></td></tr></table> Post - 1 Miss - 0 Block - 0				1			1			19 李薇薇 <table border="1"><tr><td>1</td><td></td><td>3</td></tr><tr><td>1</td><td></td><td></td></tr><tr><td>1</td><td></td><td></td></tr></table> Post - 0 Miss - 1 Block - 0	1		3	1			1			23 王书慧 <table border="1"><tr><td></td><td></td><td></td></tr><tr><td></td><td></td><td></td></tr><tr><td></td><td></td><td></td></tr></table> Post - 0 Miss - 0 Block - 0										33 金梦青 <table border="1"><tr><td>1</td><td></td><td>1</td></tr><tr><td>1</td><td></td><td></td></tr><tr><td></td><td></td><td></td></tr></table> Post - 0 Miss - 0 Block - 0	1		1	1						69 蓝小玲 <table border="1"><tr><td>1</td><td></td><td>2</td></tr><tr><td></td><td></td><td>1</td></tr><tr><td>1</td><td></td><td>1</td></tr></table> Post - 1 Miss - 0 Block - 0	1		2			1	1		1
		1																																																																													
1																																																																															
1																																																																															
1		3																																																																													
1																																																																															
1																																																																															
1		1																																																																													
1																																																																															
1		2																																																																													
		1																																																																													
1		1																																																																													

**第十三届全国运动会女子手球决赛**
**PHMS** Pictorial Handball Match Statistics

**IHF** Official System

**比赛进程表**

 手球 决赛 组别 X  
 女子 轮次 6 场次 24  
 八津卅卅八手球月 馆  
 2017-09-07 19:15

时间	队员	动作	比分	队员	动作
<b>安徽</b>			<b>上半时</b>		
00:32	1 司艳	挡住球	0-0	4 赵佳芹	中远射 被救
01:15	13 陶丹扬	右边射 击柱			
01:17	3 李兵	造7M		4 赵佳芹	使被罚7M球
01:18				4 赵佳芹	警告
01:22		裁判暂停			
01:27	41 杜机娟	7M球 得分	1-0	12 黄霞	被射入
02:18	1 司艳	被射入	1-1	3 张海侠	右边射 得分
02:45	6 沈萍	传球失误		17 修丽杰	断球
02:54	1 司艳	被射入	1-2	69 蓝小玲	一传快攻 得分
03:31	14 刘晓妹	中远射 被救		16 王小华	挡住球
03:37	6 沈萍	造犯规		69 蓝小玲	快攻 进攻犯规
04:02	14 刘晓妹	右边射 被救		16 王小华	挡住球
04:08		裁判暂停			
04:15	3 李兵	罚出场2分钟			
04:36	1 司艳	挡住球		69 蓝小玲	近射 被救
05:23	41 杜机娟	运球失误			
05:37	1 司艳	被射入	1-3	19 李薇薇	突破 得分
05:44	14 刘晓妹	顶贴 失误			
05:55	41 杜机娟	造7M		17 修丽杰	使被罚7M球
06:03		裁判暂停			
06:07				17 修丽杰	警告
06:11	41 杜机娟	7M球 得分	2-3	16 王小华	被射入
06:49	21 李瑶	警告			
07:07	1 司艳	挡住球		4 赵佳芹	近射 被救
07:10				8 乔如	侵区
07:58	41 杜机娟	左边射 得分	3-3	16 王小华	被射入
08:32				19 李薇薇	近射 射失
09:19		裁判暂停			
09:23				17 修丽杰	罚出场2分钟
09:50	3 李兵	突破 得分	4-3	16 王小华	被射入
09:56				69 蓝小玲	顶贴 失误
10:56				11 于源源	左边射 击柱
11:14	13 陶丹扬	右边射 被救		16 王小华	挡住球
11:40		裁判暂停			
11:42	13 陶丹扬	使被罚7M球		69 蓝小玲	造7M
11:42	13 陶丹扬	罚出场2分钟			
11:44	16 朱莉珍	被射入	4-4	19 李薇薇	7M球 得分
12:24	3 李兵	右边射 被救		16 王小华	挡住球
12:32	1 司艳	挡住球		3 张海侠	右边射 被救
13:04		裁判暂停			
13:38	6 沈萍	进攻犯规		8 乔如	造犯规

## 第十三届全国运动会女子手球决赛

PHMS Pictorial Handball Match Statistics

IHF Official System

## 比赛进程表

手球 女子 决赛 轮次 6 组别 X 场次 24 天津奥体中心体育馆 2017-09-07 19:15

时间	队员	动作	比分	队员	动作
安徽			上半时		
14:16	1 司艳	挡住球	4-4	69 蓝小玲	左远射 被救
14:20	1 司艳	被射入	4-5	3 张海侠	右边射 得分
14:38	6 沈萍	近射 得分	5-5	16 王小华	被射入
15:05	21 李瑶	断球		69 蓝小玲	传球失误
15:12	3 李兵	快攻 进攻犯规		3 张海侠	造犯规
15:20		裁判暂停			
15:26	41 杜机娟	罚出场2分钟			
15:47	3 李兵	造犯规		19 李薇薇	进攻犯规
16:16	21 李瑶	突破 得分	6-5	16 王小华	被射入
16:18				4 赵佳芹	顶贴 失误
16:28	1 司艳	被射入	6-6	3 张海侠	右边射 得分
16:30				69 蓝小玲	助攻
17:06	14 刘晓妹	传球失误		69 蓝小玲	断球
17:22				16 王小华	快攻 传球失误
17:57	15 王婵婵	造7M		4 赵佳芹	使被罚7M球
18:02				4 赵佳芹	移动 失误
18:15	41 杜机娟	7M球 得分	7-6	16 王小华	被射入
18:49	17 周婷	警告			
19:13	1 司艳	被射入	7-7	8 乔如	近射 得分
19:35	6 沈萍	进攻犯规		69 蓝小玲	造犯规
19:58				19 李薇薇	传球失误
20:16	21 李瑶	传球失误			
20:37	41 杜机娟	断球		19 李薇薇	传球失误
21:02	6 沈萍	传球失误			
21:12				19 李薇薇	传球失误
21:48	21 李瑶	传球失误		3 张海侠	断球
22:14					球队暂停
22:27	1 司艳	被射入	7-8	69 蓝小玲	左远射 得分
23:03				8 乔如	警告
23:49	17 周婷	突破 得分	8-8	16 王小华	被射入
23:51				17 修丽杰	顶贴 失误
23:54	1 司艳	被射入	8-9	17 修丽杰	近射 得分
24:01		裁判暂停			
24:01	21 李瑶	罚出场2分钟			
24:28		球队暂停			
24:43	17 周婷	近射 被救		16 王小华	挡住球
24:53				69 蓝小玲	传球失误
25:38	6 沈萍	近射 被救		16 王小华	挡住球
25:41	14 刘晓妹	助攻			
25:47	1 司艳	被射入	8-10	4 赵佳芹	短传快攻 得分
26:20	14 刘晓妹	右远射 得分	9-10	16 王小华	被射入



第十三届全国运动会女子手球决赛

PHMS Pictorial Handball Match Statistics

IHF Official System

比赛进程表

手球 女子	决赛 轮次	6	组别 X 场次	24	八津津世八子球日 馆	2017-09-07 19:15
时间	队员	动作	比分	队员	动作	
安徽			上半时	江苏		
26:31	6 沈萍	使被罚7M球	9-10	69 蓝小玲	造7M	
26:32		裁判暂停				
26:37	16 朱莉珍	被射入	9-11	19 李薇薇	7M球 得分	
27:07	21 李瑶	接球失误		4 赵佳芹	抢球	
27:13	1 司艳	挡住球		3 张海侠	一传快攻 被救	
27:17				4 赵佳芹	助攻	
27:23	17 周婷	短传快攻 得分	10-11	16 王小华	被射入	
27:35	1 司艳	挡住球		33 金梦青	左边射 被救	
27:59	17 周婷	左远射 得分	11-11	16 王小华	被射入	
28:28	1 司艳	挡住球		3 张海侠	近射 被救	
28:56	41 杜机娟	造7M		3 张海侠	使被罚7M球	
29:13	41 杜机娟	7M球 击柱				
29:18		裁判暂停				
29:18				16 王小华	罚出场2分钟	
29:23	6 沈萍	7M球 得分	12-11	12 黄霞	被射入	
29:50	1 司艳	被射入	12-12	4 赵佳芹	突破 得分	
29:56	6 沈萍	顶贴 失误				
29:59		裁判暂停				
30:00	21 李瑶	接球失误				

## 第十三届全国运动会女子手球决赛

PHMS Pictorial Handball Match Statistics

IHF Official System

## 比赛进程表

手球 女子 决赛 轮次 6 组别 X 场次 24 八津卅卅八子卅卅月 馆 2017-09-07 19:15

时间	队员	动作	比分	队员	动作
安徽			江苏		
下半时			下半时		
00:00		裁判暂停	12-12		
00:31	41 杜机娟	左边射 射失			
00:49	15 王婵婵	造失误		19 李薇薇	运球失误
00:59	21 李瑶	接球失误		69 蓝小玲	抢球
01:57	1 司艳	被射入	12-13	69 蓝小玲	右远射 得分
02:27	14 刘晓妹	右远射 被封		69 蓝小玲	封球
02:40	21 李瑶	近射 得分	13-13	1 陆婷	被射入
02:42	15 王婵婵	助攻			
02:55	1 司艳	被射入	13-14	18 韦秋香	右边射 得分
02:56				4 赵佳芹	助攻
03:16	6 沈萍	左远射 被封		69 蓝小玲	封球
03:51		裁判暂停			
03:50				17 修丽杰	罚出场2分钟
03:52		裁判暂停			
04:04	6 沈萍	左远射 得分	14-14	1 陆婷	被射入
05:00				69 蓝小玲	右远射 击柱
05:21	6 沈萍	中远射 得分	15-14	1 陆婷	被射入
05:40	1 司艳	挡住球		69 蓝小玲	右边射 被救
05:49	21 李瑶	快攻 运球失误		69 蓝小玲	造失误
05:56				18 韦秋香	短传快攻 击柱
06:37		裁判暂停			
06:54	6 沈萍	任意球 得分	16-14	16 王小华	被射入
07:00		裁判暂停			
07:00	14 刘晓妹	罚出场2分钟			
07:11	6 沈萍	使被罚7M球		69 蓝小玲	造7M
07:12		裁判暂停			
07:18	16 朱莉珍	被射入	16-15	33 金梦青	7M球 得分
08:05	3 李兵	突破 得分	17-15	16 王小华	被射入
08:16	1 司艳	被射入	17-16	33 金梦青	左边射 得分
08:49	21 李瑶	传球失误			
09:35	1 司艳	被射入	17-17	69 蓝小玲	近射 得分
09:59	14 刘晓妹	右边射 射失			
10:01	17 周婷	助攻			
10:16	14 刘晓妹	使被罚7M球		69 蓝小玲	造7M
10:18		裁判暂停			
10:28	1 司艳	被射入	17-18	4 赵佳芹	7M球 得分
10:54	17 周婷	造7M		9 莫蒙蒙	使被罚7M球
11:15	6 沈萍	7M球 得分	18-18	16 王小华	被射入
11:46	1 司艳	被射入	18-19	69 蓝小玲	突破 得分
11:47	6 沈萍	顶贴 失误			
11:55	17 周婷	近射 击柱			

## 第十三届全国运动会女子手球决赛

PHMS Pictorial Handball Match Statistics

IHF Official System

## 比赛进程表

手球 女子 决赛 轮次 6 组别 X 场次 24 八件四世八子牌月 馆 2017-09-07 19:15

时间	队员	动作	比分	队员	动作
安徽			江苏		
下半场					
12:24	1 司艳	被射入	18-20	19 李薇薇	近射 得分
13:11	6 沈萍	进攻犯规		8 乔如	造犯规
13:51	1 司艳	被射入	18-21	8 乔如	近射 得分
13:53				69 蓝小玲	助攻
13:56		球队暂停			
14:40	6 沈萍	任意球 得分	19-21	16 王小华	被射入
15:14	1 司艳	被射入	19-22	4 赵佳芹	中远射 得分
15:43	14 刘晓妹	右远射 得分	20-22	16 王小华	被射入
16:14	16 朱莉珍	被射入	20-23	19 李薇薇	近射 得分
17:02	3 李兵	造7M		4 赵佳芹	使被罚7M球
17:05	6 沈萍	助攻			
17:11		裁判暂停			
17:27	6 沈萍	7M球 被救		1 陆婷	挡住球
17:57		裁判暂停			
18:18	16 朱莉珍	被射入	20-24	8 乔如	近射 得分
18:20				4 赵佳芹	助攻
18:38	6 沈萍	左远射 得分	21-24	16 王小华	被射入
19:11		裁判暂停			
19:30	1 司艳	被射入	21-25	69 蓝小玲	右远射 得分
19:39	17 周婷	进攻犯规		8 乔如	造犯规
20:05	1 司艳	挡住球		18 韦秋香	右边射 被救
20:22	41 杜机娟	左边射 得分	22-25	16 王小华	被射入
20:51	1 司艳	挡住球		4 赵佳芹	中远射 被救
21:16	14 刘晓妹	近射 得分	23-25	16 王小华	被射入
21:53					球队暂停
22:07	3 李兵	造犯规		19 李薇薇	进攻犯规
22:35	14 刘晓妹	左远射 被救		16 王小华	挡住球
23:09	1 司艳	被射入	23-26	33 金梦青	左边射 得分
23:27	14 刘晓妹	四步			
24:07	1 司艳	被射入	23-27	4 赵佳芹	近射 得分
24:35	3 李兵	近射 射失			
24:46	1 司艳	被射入	23-28	19 李薇薇	右远射 得分
24:53		球队暂停			
25:11		裁判暂停			
25:12				8 乔如	罚出场2分钟
25:22	6 沈萍	左远射 得分	24-28	16 王小华	被射入
25:58	3 李兵	造犯规		69 蓝小玲	进攻犯规
26:07	13 陶丹扬	短传快攻 被救		16 王小华	挡住球
26:38	1 司艳	挡住球		33 金梦青	左边射 被救
26:50	6 沈萍	右远射 击柱			
27:23	6 沈萍	右远射 被救		16 王小华	挡住球

第十三届全国运动会女子手球决赛

PHMS Pictorial Handball Match Statistics

IHF Official System

比赛进程表

手球 女子 决赛 轮次 6 组别 X 场次 24 八运场馆 2017-09-07 19:15

时间	队员	动作	比分	队员	动作
安徽			江苏		
下半场			下半场		
27:43			24-28		球队暂停
28:16	1 司艳	被射入	24-29	18 韦秋香	突破 得分
28:20	41 杜机娟	顶贴 失误			
28:29	6 沈萍	近射 得分	25-29	16 王小华	被射入
28:57	1 司艳	挡住球		69 蓝小玲	近射 被救
29:00	1 司艳	被射入	25-30	8 乔如	近射 得分
29:13		裁判暂停			
29:18				17 修丽杰	罚出场2分钟
29:26	6 沈萍	近射 得分	26-30	16 王小华	被射入
29:44				4 赵佳芹	传球失误
29:52	15 王婵婵	短传快攻 被救		16 王小华	挡住球
29:57				8 乔如	一传快攻 击柱
30:00				16 王小华	助攻