

2017
2017年男子手球国家队俱乐部联赛

成绩与技术统计数据册

武汉赛区



中国手球协会

CHINESE HANDBALL ASSOCIATION

数据由PHMS收集生成
PHMS国际手球联合会官方技术统计系统



Result Book Contents

1 Ranking summary

- 1) Final Standings
- 2) Medallists
- 3) Result Summary
- 4) Group Results

2 Top Scorer

- 1) Score
- 2) Assistant
- 3) Blocks
- 4) Defense
- 5) Errors
- 6) Punishments

3 Top Goalkeeper

- 1) Total Saved
- 2) 7M Saved

4 Top Team

5 Team Fair Play

6 Team Info

- 1) Team Roster
- 2) Indv./Team Total
- 3) Team Total Shot Spot

7 Match Data

- 1) Match Report
- 2) Match Statistics
- 3) Indv./Team Statistics
- 4) Pictorial Reports
- 5) Match Shot Spot
- 6) Match Process (finals)

2017年男子手球国家队俱乐部联赛(武汉赛区)

大赛名次

手球
男子

湖北武汉
2017-12-22

截止至第6场

奖牌	名次	缩写	队名
Gold	1	虎队	中国男子手球国家队俱乐部虎队
Silver	2	豹队	中国男子手球国家队俱乐部豹队
Bronze	3	龙队	中国男子手球国家队俱乐部龙队
	4	狮队	中国男子手球国家队俱乐部狮队

获奖队员名单

手球
男子

湖北武汉
2017-12-22

金牌	银牌	铜牌
虎队-中国男子手球国家队俱乐部虎队	豹队-中国男子手球国家队俱乐部豹队	龙队-中国男子手球国家队俱乐部龙队
17 成亚	1 王浣	32 蒋维一
18 王晓琪	2 胡晋铭	33 尹杰
19 刘振	3 曲汝洋	35 李双
20 王毅	5 赵楠	36 张家纬
21 沈吉磊	6 赵晨	37 林豪文
22 魏雨童	7 解建飞	38 王巨柱
23 曹悦	8 谢庆龙	39 朱世杰
25 王杰缘	9 贺政	50 李明
26 徐畅	10 刘赵梁	51 王军程
27 许松	11 胡瀛	52 马明辉
28 郭世伟	13 陈旭	53 傅俊雄
29 周傲	15 张建杰	55 于性哲
30 王权	16 顾艳超	56 李朝鹏
31 王伟	26 徐畅	57 董智景
	68 王帅	
	替换队员	
	12 周哲韬	

2017年男子手球国家队俱乐部联赛(武汉赛区)

PHMS Pictorial Handball Match Statistics

IHF Official System

分组成绩

 手球
 男子

截止至第6场

 湖北武汉
 2017-12-22

组别: X 预赛

名次	球队	积	场	胜	平	负	得分	失分	净胜
1	虎队	6	3	3	0	0	91	75	16
2	豹队	4	3	2	0	1	90	81	9
3	龙队	2	3	1	0	2	71	85	-14
4	狮队	0	3	0	0	3	71	82	-11

球队	虎队	豹队	龙队	狮队
虎队		28-27	33-22	30-26
豹队	27-28		32-28	31-25
龙队	22-33	28-32		21-20
狮队	26-30	25-31	20-21	

Legend:

积	积分	■	已比赛场次	胜	胜场	平	平场
负	负场	得分	得分累计	失分	失分累计	净胜	净胜分

2017年男子手球国家队俱乐部联赛(武汉赛区)

PHMS Pictorial Handball Match Statistics

IHF Official System

得分排名表(场上队员)

手球男子 截止至第6场 按总得分排序 湖北武汉 2017-12-22

排序	号码	姓名	球队	远射	近射	边射	快攻	突破	任意	七米	合计	%	助攻	场数
1	23	曹悦	虎队	5-15	6-8	0-0	1-1	6-7	0-1	2-3	20-35	57.1	5	3
2	6	赵晨	豹队	8-25	4-5	0-0	1-1	4-4	1-2	1-1	19-38	50.0	10	3
3	3	曲汝洋	豹队	4-5	2-4	2-4	2-4	3-4	0-0	5-6	18-27	66.7	6	3
4	70	于亚男	狮队	13-22	1-3	0-0	0-0	2-3	1-1	0-0	17-29	58.6	3	3
5	19	刘振	虎队	7-9	1-4	0-0	0-0	0-0	0-0	8-9	16-22	72.7	15	3
6	25	王杰缘	虎队	0-0	1-2	6-9	3-6	1-1	0-0	3-3	14-21	66.7	0	3
7	27	许松	虎队	0-0	1-2	6-8	5-8	1-1	0-0	0-1	13-20	65.0	3	3
8	33	尹杰	龙队	4-8	0-0	2-4	0-1	4-4	0-0	3-5	13-22	59.1	2	3
9	56	李朝鹏	龙队	4-10	2-2	0-1	2-2	3-4	0-1	2-4	13-24	54.2	2	3
10	8	谢庆龙	豹队	0-1	10-13	0-0	2-2	0-0	0-0	0-0	12-16	75.0	0	3
11	15	张建杰	豹队	2-3	1-1	2-6	3-3	2-2	0-0	2-2	12-17	70.6	2	3
12	71	王伟强	狮队	2-4	1-2	5-11	4-5	0-0	0-0	0-0	12-22	54.5	0	3
13	32	蒋维一	龙队	1-2	8-10	0-0	2-3	0-0	0-0	0-0	11-15	73.3	2	3
14	17	成亚	虎队	4-8	5-5	0-0	1-1	0-1	0-0	0-0	10-15	66.7	9	3
15	51	王军程	龙队	6-17	2-2	0-1	0-0	2-4	0-1	0-0	10-25	40.0	6	3
16	69	刘晓	狮队	1-15	0-1	1-2	0-0	1-1	0-0	7-7	10-26	38.5	4	3
17	9	贺政	豹队	0-1	0-1	3-5	1-3	0-0	0-0	4-5	8-15	53.3	0	3
18	66	宋朋强	狮队	3-8	1-3	0-0	0-0	4-4	0-1	0-0	8-16	50.0	3	3
19	28	郭世伟	虎队	2-6	1-3	0-0	1-1	2-3	0-1	0-0	6-14	42.9	3	3
20	58	张继伟	狮队	0-1	4-6	0-0	1-1	0-0	0-0	0-0	5-8	62.5	1	3
21	39	朱世杰	龙队	2-3	0-0	0-1	0-0	3-6	0-0	0-0	5-10	50.0	1	3
22	35	李双	龙队	2-6	2-3	1-1	0-0	0-0	0-1	0-0	5-11	45.5	2	3
23	16	顾艳超	豹队	2-8	2-3	0-0	0-1	1-2	0-0	0-0	5-14	35.7	3	3
24	31	王伟	虎队	0-0	4-14	0-0	1-1	0-0	0-0	0-0	5-15	33.3	0	3
25	10	刘赵梁	豹队	1-2	1-1	1-1	1-1	0-0	0-0	0-0	4-5	80.0	1	3
26	52	马明辉	龙队	1-1	1-1	1-2	1-1	0-0	0-0	0-0	4-5	80.0	0	3
27	60	王鹏皓	狮队	1-2	0-0	0-0	0-1	0-0	0-0	3-3	4-6	66.7	0	3
28	20	王毅	虎队	0-0	2-2	1-2	1-1	0-0	0-0	0-1	4-6	66.7	0	3
29	38	王巨柱	龙队	1-4	0-0	2-3	0-0	1-1	0-0	0-0	4-8	50.0	0	3
30	57	董智景	龙队	0-1	0-0	1-5	3-4	0-0	0-0	0-0	4-10	40.0	1	3
31	63	谢基伟	狮队	4-10	0-0	0-0	0-1	0-0	0-0	0-0	4-11	36.4	2	3
32	13	陈旭	豹队	0-0	1-5	2-5	1-2	0-0	0-0	0-0	4-12	33.3	1	3
33	67	马昌震	狮队	0-0	2-2	0-0	1-1	0-1	0-0	0-0	3-4	75.0	1	3
34	11	胡瀛	豹队	2-3	1-3	0-0	0-0	0-1	0-0	0-0	3-7	42.9	0	3
35	65	黎涛	狮队	0-1	0-0	1-4	1-1	0-0	0-0	1-1	3-7	42.9	1	3
36	5	赵楠	豹队	1-6	1-3	0-0	1-2	0-0	0-0	0-1	3-12	25.0	8	3
37	61	庞连康	狮队	1-1	0-0	0-0	0-0	1-1	0-0	0-0	2-2	100.0	0	3
38	29	周傲	虎队	1-2	0-0	0-0	0-0	0-0	0-0	1-1	2-3	66.7	1	3
39	62	闫炳旗	狮队	0-0	0-0	0-1	1-2	1-1	0-0	0-0	2-4	50.0	1	3
40	2	胡晋铭	豹队	0-0	1-1	0-0	0-0	0-0	0-0	0-0	1-1	100.0	0	3
41	53	傅俊雄	龙队	0-0	0-0	1-1	0-0	0-0	0-0	0-0	1-1	100.0	0	3



得分排名表(场上队员)

手球 截止至第6场 湖北武汉
男子 按总得分排序 2017-12-22

排序	号码	姓名	球队	远射	近射	边射	快攻	突破	任意	七米	合计	%	助攻	场数
42	30	王权	虎队	0-0	0-0	0-0	0-0	0-0	0-0	1-1	1-1	100.0	3	3

2017年男子手球国家队俱乐部联赛(武汉赛区)

PHMS Pictorial Handball Match Statistics

IHF Official System

得分排名表(场上队员)

手球男子 截止至第6场 助攻次数排序 湖北武汉 2017-12-22

排序	号码	姓名	球队	远射	近射	边射	快攻	突破	任意	七米	合计	%	助攻	场数
1	19	刘振	虎队	7-9	1-4	0-0	0-0	0-0	0-0	8-9	16-22	72.7	15	3
2	6	赵晨	豹队	8-25	4-5	0-0	1-1	4-4	1-2	1-1	19-38	50.0	10	3
3	17	成亚	虎队	4-8	5-5	0-0	1-1	0-1	0-0	0-0	10-15	66.7	9	3
4	5	赵楠	豹队	1-6	1-3	0-0	1-2	0-0	0-0	0-1	3-12	25.0	8	3
5	3	曲汝洋	豹队	4-5	2-4	2-4	2-4	3-4	0-0	5-6	18-27	66.7	6	3
6	51	王军程	龙队	6-17	2-2	0-1	0-0	2-4	0-1	0-0	10-25	40.0	6	3
7	23	曹悦	虎队	5-15	6-8	0-0	1-1	6-7	0-1	2-3	20-35	57.1	5	3
8	69	刘晓	狮队	1-15	0-1	1-2	0-0	1-1	0-0	7-7	10-26	38.5	4	3
9	70	于亚男	狮队	13-22	1-3	0-0	0-0	2-3	1-1	0-0	17-29	58.6	3	3
10	27	许松	虎队	0-0	1-2	6-8	5-8	1-1	0-0	0-1	13-20	65.0	3	3
11	66	宋朋强	狮队	3-8	1-3	0-0	0-0	4-4	0-1	0-0	8-16	50.0	3	3
12	28	郭世伟	虎队	2-6	1-3	0-0	1-1	2-3	0-1	0-0	6-14	42.9	3	3
13	16	顾艳超	豹队	2-8	2-3	0-0	0-1	1-2	0-0	0-0	5-14	35.7	3	3
14	30	王权	虎队	0-0	0-0	0-0	0-0	0-0	0-0	1-1	1-1	100.0	3	3
15	33	尹杰	龙队	4-8	0-0	2-4	0-1	4-4	0-0	3-5	13-22	59.1	2	3
16	56	李朝鹏	龙队	4-10	2-2	0-1	2-2	3-4	0-1	2-4	13-24	54.2	2	3
17	15	张建杰	豹队	2-3	1-1	2-6	3-3	2-2	0-0	2-2	12-17	70.6	2	3
18	32	蒋维一	龙队	1-2	8-10	0-0	2-3	0-0	0-0	0-0	11-15	73.3	2	3
19	35	李双	龙队	2-6	2-3	1-1	0-0	0-0	0-1	0-0	5-11	45.5	2	3
20	63	谢基伟	狮队	4-10	0-0	0-0	0-1	0-0	0-0	0-0	4-11	36.4	2	3
21	59	魏昂	狮队	0-1	0-0	0-1	1-2	0-0	0-0	0-0	1-4	25.0	2	3
22	55	于性哲	龙队	0-0	0-0	0-0	0-1	0-0	0-0	0-0	0-1	0.0	2	3
23	58	张继伟	狮队	0-1	4-6	0-0	1-1	0-0	0-0	0-0	5-8	62.5	1	3
24	39	朱世杰	龙队	2-3	0-0	0-1	0-0	3-6	0-0	0-0	5-10	50.0	1	3
25	10	刘赵梁	豹队	1-2	1-1	1-1	1-1	0-0	0-0	0-0	4-5	80.0	1	3
26	57	董智景	龙队	0-1	0-0	1-5	3-4	0-0	0-0	0-0	4-10	40.0	1	3
27	13	陈旭	豹队	0-0	1-5	2-5	1-2	0-0	0-0	0-0	4-12	33.3	1	3
28	67	马昌震	狮队	0-0	2-2	0-0	1-1	0-1	0-0	0-0	3-4	75.0	1	3
29	65	黎涛	狮队	0-1	0-0	1-4	1-1	0-0	0-0	1-1	3-7	42.9	1	3
30	29	周傲	虎队	1-2	0-0	0-0	0-0	0-0	0-0	1-1	2-3	66.7	1	3
31	62	闫炳旗	狮队	0-0	0-0	0-1	1-2	1-1	0-0	0-0	2-4	50.0	1	3
32	7	解建飞	豹队	0-2	0-0	0-0	0-1	0-0	0-0	1-2	1-5	20.0	1	3
33	1	王泷	豹队	0-0	0-0	0-0	0-0	0-0	0-0	0-0	0-0	0	1	3
34	25	王杰缘	虎队	0-0	1-2	6-9	3-6	1-1	0-0	3-3	14-21	66.7	0	3
35	8	谢庆龙	豹队	0-1	10-13	0-0	2-2	0-0	0-0	0-0	12-16	75.0	0	3
36	71	王伟强	狮队	2-4	1-2	5-11	4-5	0-0	0-0	0-0	12-22	54.5	0	3
37	9	贺政	豹队	0-1	0-1	3-5	1-3	0-0	0-0	4-5	8-15	53.3	0	3
38	31	王伟	虎队	0-0	4-14	0-0	1-1	0-0	0-0	0-0	5-15	33.3	0	3
39	52	马明辉	龙队	1-1	1-1	1-2	1-1	0-0	0-0	0-0	4-5	80.0	0	3
40	60	王鹏皓	狮队	1-2	0-0	0-0	0-1	0-0	0-0	3-3	4-6	66.7	0	3
41	20	王毅	虎队	0-0	2-2	1-2	1-1	0-0	0-0	0-1	4-6	66.7	0	3

2017年男子手球国家队俱乐部联赛(武汉赛区)

PHMS Pictorial Handball Match Statistics

IHF Official System

得分排名表(场上队员)

 手球
男子

 截止至第6场
按封球次数排序

 湖北武汉
2017-12-22

名次	号码	姓名	球队	抢球	断球	造失误	造犯规	合计	封球	场数
1	6	赵晨	豹队	0	2	0	0	2	5	3
2	31	王伟	虎队	0	0	0	0	0	5	3
3	32	蒋维一	龙队	0	3	0	1	4	4	3
4	23	曹悦	虎队	1	4	0	0	5	4	3
5	58	张继伟	狮队	0	1	0	0	1	4	3
6	57	董智景	龙队	0	2	0	2	4	2	3
7	53	傅俊雄	龙队	1	1	0	1	3	2	3
8	33	尹杰	龙队	0	3	0	0	3	1	3
9	8	谢庆龙	豹队	1	0	0	2	3	1	3
10	70	于亚男	狮队	0	1	0	0	1	1	3
11	66	宋朋强	狮队	0	1	0	0	1	1	3
12	26	徐畅	豹队	0	0	0	0	0	0	1
13	68	王帅	豹队	0	0	0	0	0	0	2
14	27	许松	虎队	0	2	1	1	4	0	3
15	28	郭世伟	虎队	0	1	0	0	1	0	3
16	11	胡瀛	豹队	0	0	0	0	0	0	3
17	17	成亚	虎队	1	2	0	2	5	0	3
18	21	沈吉磊	虎队	0	0	0	0	0	0	3
19	15	张建杰	豹队	0	2	0	0	2	0	3
20	18	王晓琪	虎队	0	0	0	0	0	0	3
21	25	王杰缘	虎队	0	3	0	0	3	0	3
22	13	陈旭	豹队	0	0	0	0	0	0	3
23	10	刘赵梁	豹队	0	3	0	0	3	0	3
24	9	贺政	豹队	0	3	0	0	3	0	3
25	16	顾艳超	豹队	0	1	0	1	2	0	3
26	5	赵楠	豹队	1	2	1	1	5	0	3
27	7	解建飞	豹队	0	2	0	1	3	0	3
28	3	曲汝洋	豹队	1	1	0	0	2	0	3
29	55	于性哲	龙队	0	0	0	0	0	0	3
30	2	胡晋铭	豹队	0	0	0	0	0	0	3
31	1	王洸	豹队	0	0	0	0	0	0	3
32	20	王毅	虎队	0	0	0	0	0	0	3
33	38	王巨柱	龙队	0	0	0	0	0	0	3
34	61	庞连康	狮队	0	0	0	0	0	0	3
35	65	黎涛	狮队	0	1	0	1	2	0	3
36	67	马昌震	狮队	0	1	0	0	1	0	3
37	69	刘晓	狮队	0	2	0	0	2	0	3
38	68	王帅	狮队	0	0	0	0	0	0	3
39	72	刘迈科	狮队	0	0	0	0	0	0	3
40	63	谢基伟	狮队	0	3	1	0	4	0	3



2017年男子手球国家队俱乐部联赛(武汉赛区)

PHMS Pictorial Handball Match Statistics

IHF Official System

得分排名表(场上队员)

 手球
男子

 截止至第6场
按防守成功总数排序

 湖北武汉
2017-12-22

名次	号码	姓名	球队	抢球	断球	造失误	造犯规	合计	封球	场数
1	5	赵楠	豹队	1	2	1	1	5	0	3
2	23	曹悦	虎队	1	4	0	0	5	4	3
3	17	成亚	虎队	1	2	0	2	5	0	3
4	71	王伟强	狮队	2	1	2	0	5	0	3
5	57	董智景	龙队	0	2	0	2	4	2	3
6	56	李朝鹏	龙队	0	3	1	0	4	0	3
7	32	蒋维一	龙队	0	3	0	1	4	4	3
8	63	谢基伟	狮队	0	3	1	0	4	0	3
9	27	许松	虎队	0	2	1	1	4	0	3
10	33	尹杰	龙队	0	3	0	0	3	1	3
11	10	刘赵梁	豹队	0	3	0	0	3	0	3
12	25	王杰缘	虎队	0	3	0	0	3	0	3
13	8	谢庆龙	豹队	1	0	0	2	3	1	3
14	53	傅俊雄	龙队	1	1	0	1	3	2	3
15	19	刘振	虎队	0	1	0	2	3	0	3
16	9	贺政	豹队	0	3	0	0	3	0	3
17	7	解建飞	豹队	0	2	0	1	3	0	3
18	3	曲汝洋	豹队	1	1	0	0	2	0	3
19	51	王军程	龙队	0	1	0	1	2	0	3
20	39	朱世杰	龙队	1	0	1	0	2	0	3
21	16	顾艳超	豹队	0	1	0	1	2	0	3
22	35	李双	龙队	2	0	0	0	2	0	3
23	6	赵晨	豹队	0	2	0	0	2	5	3
24	69	刘晓	狮队	0	2	0	0	2	0	3
25	65	黎涛	狮队	0	1	0	1	2	0	3
26	15	张建杰	豹队	0	2	0	0	2	0	3
27	66	宋朋强	狮队	0	1	0	0	1	1	3
28	70	于亚男	狮队	0	1	0	0	1	1	3
29	58	张继伟	狮队	0	1	0	0	1	4	3
30	28	郭世伟	虎队	0	1	0	0	1	0	3
31	67	马昌震	狮队	0	1	0	0	1	0	3
32	59	魏昂	狮队	1	0	0	0	1	0	3
33	36	张家纬	龙队	0	1	0	0	1	0	3
34	11	胡瀛	豹队	0	0	0	0	0	0	3
35	1	王洧	豹队	0	0	0	0	0	0	3
36	13	陈旭	豹队	0	0	0	0	0	0	3
37	20	王毅	虎队	0	0	0	0	0	0	3
38	55	于性哲	龙队	0	0	0	0	0	0	3
39	2	胡晋铭	豹队	0	0	0	0	0	0	3
40	60	王鹏皓	狮队	0	0	0	0	0	0	3



2017年男子手球国家队俱乐部联赛(武汉赛区)

PHMS Pictorial Handball Match Statistics

IHF Official System

得分排名表(场上队员)

 手球
男子

 截止至第6场
按失误总数排序

 湖北武汉
2017-12-22

排序	号码	姓名	球队	传失	接失	两次	四步	侵区	进犯	其它	合计	场数
1	56	李朝鹏	龙队	5	2	1	0	0	2	0	10	3
2	33	尹杰	龙队	5	1	1	1	0	1	0	9	3
3	19	刘振	虎队	8	1	0	0	0	0	0	9	3
4	70	于亚男	狮队	6	1	0	0	0	1	0	8	3
5	66	宋朋强	狮队	5	1	0	1	0	0	0	7	3
6	28	郭世伟	虎队	2	2	2	0	1	0	0	7	3
7	5	赵楠	豹队	3	1	0	0	0	2	1	7	3
8	16	顾艳超	豹队	4	0	1	1	0	0	0	6	3
9	38	王巨柱	龙队	3	1	1	0	0	0	0	5	3
10	32	蒋维一	龙队	3	2	0	0	0	0	0	5	3
11	63	谢基伟	狮队	4	0	0	0	0	1	0	5	3
12	51	王军程	龙队	1	0	1	2	0	0	1	5	3
13	6	赵晨	豹队	3	1	1	0	0	0	0	5	3
14	58	张继伟	狮队	1	0	1	0	1	2	0	5	3
15	17	成亚	虎队	3	0	1	0	0	0	0	4	3
16	25	王杰缘	虎队	3	0	0	0	0	1	0	4	3
17	27	许松	虎队	1	2	0	1	0	0	0	4	3
18	9	贺政	豹队	3	0	0	0	1	0	0	4	3
19	39	朱世杰	龙队	2	1	0	0	0	1	0	4	3
20	8	谢庆龙	豹队	0	0	1	1	0	2	0	4	3
21	23	曹悦	虎队	1	1	0	1	0	1	0	4	3
22	15	张建杰	豹队	1	1	0	0	1	0	0	3	3
23	10	刘赵梁	豹队	2	0	0	0	1	0	0	3	3
24	67	马昌震	狮队	1	0	0	0	2	0	0	3	3
25	65	黎涛	狮队	2	0	0	0	1	0	0	3	3
26	71	王伟强	狮队	2	0	0	0	1	0	0	3	3
27	31	王伟	虎队	0	0	0	0	1	0	1	2	3
28	35	李双	龙队	0	1	0	0	0	1	0	2	3
29	69	刘晓	狮队	0	0	0	2	0	0	0	2	3
30	62	闫炳旗	狮队	1	0	0	0	1	0	0	2	3
31	59	魏昂	狮队	0	1	0	0	0	1	0	2	3
32	36	张家纬	龙队	0	2	0	0	0	0	0	2	3
33	52	马明辉	龙队	2	0	0	0	0	0	0	2	3
34	57	董智景	龙队	2	0	0	0	0	0	0	2	3
35	3	曲汝洋	豹队	0	1	0	0	0	0	0	1	3
36	11	胡瀛	豹队	1	0	0	0	0	0	0	1	3
37	72	刘迈科	狮队	1	0	0	0	0	0	0	1	3
38	13	陈旭	豹队	1	0	0	0	0	0	0	1	3
39	53	傅俊雄	龙队	1	0	0	0	0	0	0	1	3
40	68	王帅	豹队	1	0	0	0	0	0	0	1	2



2017年男子手球国家队俱乐部联赛(武汉赛区)

PHMS Pictorial Handball Match Statistics

IHF Official System

得分排名表(场上队员)

 手球
男子

 截止至第6场
接受罚次数排序

 湖北武汉
2017-12-22

排序	号码	姓名	球队	警告	罚2分钟	D	DR	场数
1	31	王伟	虎队	2	3	0	0	3
2	58	张继伟	狮队	2	3	0	0	3
3	23	曹悦	虎队	1	2	0	0	3
4	69	刘晓	狮队	1	2	0	0	3
5	39	朱世杰	龙队	0	2	0	0	3
6	3	曲汝洋	豹队	0	2	0	0	3
7	5	赵楠	豹队	0	2	0	0	3
8	7	解建飞	豹队	3	1	0	0	3
9	8	谢庆龙	豹队	2	1	0	0	3
10	32	蒋维一	龙队	1	1	0	0	3
11	56	李朝鹏	龙队	1	1	0	0	3
12	67	马昌震	狮队	0	1	0	0	3
13	9	贺政	豹队	0	1	0	0	3
14	25	王杰缘	虎队	0	1	0	0	3
15	20	王毅	虎队	0	1	0	0	3
16	21	沈吉磊	虎队	0	1	0	0	3
17	62	闫炳旗	狮队	0	1	0	0	3
18	28	郭世伟	虎队	2	0	0	0	3
19	17	成亚	虎队	1	0	0	0	3
20	57	董智景	龙队	1	0	0	0	3
21	36	张家纬	龙队	1	0	0	0	3
22	15	张建杰	豹队	1	0	0	0	3
23	66	宋朋强	狮队	1	0	0	0	3
24	65	黎涛	狮队	1	0	0	0	3
25	2	胡晋铭	豹队	0	0	0	0	3
26	27	许松	虎队	0	0	0	0	3
27	55	于性哲	龙队	0	0	0	0	3
28	10	刘赵梁	豹队	0	0	0	0	3
29	16	顾艳超	豹队	0	0	0	0	3
30	18	王晓琪	虎队	0	0	0	0	3
31	11	胡瀛	豹队	0	0	0	0	3
32	13	陈旭	豹队	0	0	0	0	3
33	6	赵晨	豹队	0	0	0	0	3
34	1	王澆	豹队	0	0	0	0	3
35	33	尹杰	龙队	0	0	0	0	3
36	70	于亚男	狮队	0	0	0	0	3
37	61	庞连康	狮队	0	0	0	0	3
38	68	王帅	狮队	0	0	0	0	3
39	72	刘迈科	狮队	0	0	0	0	3
40	63	谢基伟	狮队	0	0	0	0	3



2017年男子手球国家队俱乐部联赛(武汉赛区)

PHMS Pictorial Handball Match Statistics

IHF Official System

排名表(守门员)

 手球 男子
 截止至第6场
 按总救球数排序
 湖北武汉
 2017-12-22

排序	号码	姓名	球队	远射	近射	边射	快攻	突破	任意	七米	得分	%	助攻	场数
1	30	王权	虎队	23-45	10-23	6-12	4-10	3-17	0-0	3-10	49-117	41.9	3	3
2	55	于性哲	龙队	8-24	9-28	13-23	1-12	1-11	1-1	0-8	33-107	30.8	2	3
3	72	刘迈科	狮队	11-18	8-25	0-5	6-13	2-10	0-1	2-11	29-83	34.9	0	3
4	1	王泷	豹队	15-34	3-13	5-17	2-7	2-4	2-3	0-7	29-85	34.1	1	3
5	68	王帅	狮队	6-13	4-10	1-4	1-8	2-6	0-0	0-1	14-42	33.3	0	3
6	68	王帅	豹队	4-8	1-2	1-3	0-3	1-1	0-0	1-1	8-18	44.4	0	2
7	26	徐畅	豹队	3-10	1-2	0-0	1-2	0-2	0-0	0-4	5-20	25.0	0	1
8	26	徐畅	虎队	1-1	0-1	2-2	0-1	1-2	0-0	0-4	4-11	36.4	0	3
9	50	李明	龙队	2-5	0-2	0-0	1-2	0-1	0-0	0-4	3-14	21.4	0	3

2017年男子手球国家队俱乐部联赛(武汉赛区)

PHMS Pictorial Handball Match Statistics

IHF Official System

排名表(守门员)

 手球 男子
 截止至第6场
 按救七米球数排序
 湖北武汉
 2017-12-22

排序	号码	姓名	球队	远射	近射	边射	快攻	突破	任意	七米	得分	%	助攻	场数
1	30	王权	虎队	23-45	10-23	6-12	4-10	3-17	0-0	3-10	49-117	30.0	3	3
2	72	刘迈科	狮队	11-18	8-25	0-5	6-13	2-10	0-1	2-11	29-83	18.2	0	3
3	68	王帅	豹队	4-8	1-2	1-3	0-3	1-1	0-0	1-1	8-18	100.0	0	2
4	68	王帅	狮队	6-13	4-10	1-4	1-8	2-6	0-0	0-1	14-42	0.0	0	3
5	26	徐畅	豹队	3-10	1-2	0-0	1-2	0-2	0-0	0-4	5-20	0.0	0	1
6	26	徐畅	虎队	1-1	0-1	2-2	0-1	1-2	0-0	0-4	4-11	0.0	0	3
7	50	李明	龙队	2-5	0-2	0-0	1-2	0-1	0-0	0-4	3-14	0.0	0	3
8	1	王泷	豹队	15-34	3-13	5-17	2-7	2-4	2-3	0-7	29-85	0.0	1	3
9	55	于性哲	龙队	8-24	9-28	13-23	1-12	1-11	1-1	0-8	33-107	0.0	2	3

2017年男子手球国家队俱乐部联赛(武汉赛区)

PHMS Pictorial Handball Match Statistics

IHF Official System

攻防成功率统计总表

 手球
 男子

截止至第6场

 湖北武汉
 2017-12-22

序号	球队	比分	进攻成功率												助攻	防守成功率											
			阵地进攻			一传快攻			短传快攻			合计				多打少			少打多			封打抢断	守门员	对方射失	对方失误	合计	%
			得分	进攻	%	得分	进攻	%	得分	进攻	%	得分	进攻	%		得分	进攻	%	得分	进攻	%						
1	豹队	90:81	78	180	43.3	6	8	75.0	6	17	35.3	90	205	43.9	15	23	65.2	1	6	16.7	33	31	42	22	16	111	57.8
2	虎队	91:75	78	165	47.3	8	11	72.7	5	9	55.6	91	186	48.9	10	12	83.3	6	10	60.0	39	30	53	18	17	118	61.1
3	龙队	71:85	63	171	36.8	4	9	44.4	4	8	50.0	71	188	37.8	10	15	66.7	3	6	50.0	18	34	36	15	18	103	54.8
4	狮队	71:82	62	158	39.2	1	3	33.3	8	19	42.1	71	180	39.4	4	6	66.7	6	15	40.0	18	24	43	19	18	104	55.9

注释:

进攻	进攻次数 (射门 + 进攻失误)	对方射失	对方射门失误 (射失 + 击柱)	防守成功率%	本方防守合计 / 对方进攻合计
----	------------------	------	------------------	--------	-----------------

2017年男子手球国家队俱乐部联赛(武汉赛区)

PHMS Pictorial Handball Match Statistics

IHF Official System

防守技术统计总表

 手球
男子

截止至第6场

 湖北武汉
2017-12-22

序号	球队	比分	防守成功						防守(成功 : 失误)							处罚					守门员			
			封球	抢球	断球	造失	造犯	合计	选位	顶贴	观察	移动	换防	其他	合计	警告	2'	取消	DR	合计	救球	射门	%	
1	豹队	90:81	6	3	16	1	5	31	0:0	0:0	0:0	0:0	0:0	0:0	0:0	0:0	6	7	0	0	13	42	123	34.1
2	虎队	91:75	9	2	13	1	5	30	0:0	0:0	0:0	0:0	0:0	0:0	0:0	0:0	6	8	0	0	14	53	128	41.4
3	龙队	71:85	9	4	14	2	5	34	0:0	0:0	0:0	0:0	0:0	0:0	0:0	0:0	4	4	0	0	8	36	121	29.8
4	狮队	71:82	6	3	11	3	1	24	0:0	0:0	0:0	0:0	0:0	0:0	0:0	0:0	5	7	0	0	12	43	125	34.4

注释:

造失	造对方失误	造犯	造对方犯规	DR	取消资格+报告
----	-------	----	-------	----	---------

2017年男子手球国家队俱乐部联赛(武汉赛区)

球队名单

中国男子手球国家队俱乐部虎队

湖北武汉

2017-12-20

号码	姓名	位置	生日	年龄	俱乐部	身高 (CM)	体重 (KG)	国际场次	国际进球
17	成亚	右后卫	14/06/1990	27		187	90		
18	王晓琪	右边锋	20/03/1997	20		191	90		
19	刘振	中后卫	14/02/1988	29		183	93		
20	王毅	左边锋	28/02/1995	22		194	90		
21	沈吉磊	左后卫	25/04/1995	22		191	88		
22	魏雨童	底线	05/10/1996	21		195	93		
23	曹悦	左后卫	23/05/1993	24		200	100		
25	王杰缘	右边锋	16/07/1994	23		180	75		
26	徐畅	守门员	22/03/1994	23		200	98		
27	许松	左边锋	02/04/1992	25		185	75		
28	郭世伟	中后卫	18/02/1997	20		183	80		
29	周傲	中后卫	08/09/1999	18		183	70		
30	王权	守门员	21/11/1992	25		205	110		
31	王伟	底线	18/11/1985	32		200	100		
	平均			23.6		191.2	89.4		

编码	姓名	职务
A	高恒勤	主教练
C	刘捷	教练
D	叶强	教练
B	王心东	领队
E	陈璇	医生

2017年男子手球国家队俱乐部联赛(武汉赛区)

PHMS Pictorial Handball Match Statistics

IHF Official System

手球 男子 个人/全队技术累计表 截止至第6场 湖北武汉 2017-12-22

号码	姓名	远射	近射	边射	快攻	突破	任意	七米	合计	%	助攻	失误	警告	2'	取消	场次	时间
中国男子手球国家队俱乐部虎队																	
(场上队员)																	
17	成亚	4/8	5/5		1/1	0/1			10/15	66.7%	9	4	1			3	02:01:20
18	王晓琪															3	00:03:52
19	刘振	7/9	1/4					8/9	16/22	72.7%	15	9				3	02:48:05
20	王毅		2/2	1/2	1/1			0/1	4/6	66.7%				1		3	01:04:39
21	沈吉磊													1		3	00:06:08
22	魏雨童															3	00:21:37
23	曹悦	5/15	6/8		1/1	6/7	0/1	2/3	20/35	57.1%	5	4	1	2		3	02:43:15
25	王杰缘		1/2	6/9	3/6	1/1		3/3	14/21	66.7%		4		1		3	01:56:08
26	徐畅															3	00:08:17
27	许松		1/2	6/8	5/8	1/1		0/1	13/20	65.0%	3	4				3	02:26:34
28	郭世伟	2/6	1/3		1/1	2/3	0/1		6/14	42.9%	3	7	2			3	01:48:44
29	周傲	1/2						1/1	2/3	66.7%	1					3	00:10:15
30	王权							1/1	1/1	100%	3					3	02:51:43
31	王伟		4/14		1/1				5/15	33.3%		2	2	3		3	02:27:18
	合计	19/40	21/40	13/19	13/19	10/13	0/2	15/19	91/152	59.9%	39	34	6	8		42	
(守门员)																	
26	徐畅	1/1	0/1	2/2	0/1	1/2		0/4	4/11	36.4%						3	00:08:17
30	王权	23/45	10/23	6/12	4/10	3/17		3/10	49/117	41.9%	3					3	02:51:43
	合计	24/46	10/24	8/14	4/11	4/19		3/14	53/128	41.4%	3					6	

场上队员：得分/射门

守门员：救球/射门

已打比赛

全队合计	进球	被救	射失	击柱	封球	合计	%	阶段	场次	对手	比分
远射	19	10	4	5	2	40	47.5%	预赛	2	豹队	28:27 (12:9)
近射	21	13	4	2		40	52.5%	预赛	3	狮队	30:26 (13:16)
边射	13	3	1	2		19	68.4%	预赛	6	龙队	33:22 (13:12)
快攻	13	3		2	1	19	68.4%				
突破	10	3				13	76.9%				
任意		1	1			2	0.0%				
七米	15	3	1			19	78.9%				

图式射门区域累计

手球
男子

截止至第6场

湖北武汉
2017-12-22

中国男子手球国家队俱乐部虎队

17 成亚 4 1 1 2 1 1 Post - 1 Miss - 0 Block - 2	18 王晓琪 Post - 0 Miss - 0 Block - 0	19 刘振 3 1 1 3 4 4 Post - 2 Miss - 2 Block - 0	20 王毅 1 1 1 1 1 Post - 1 Miss - 0 Block - 0	21 沈吉磊 Post - 0 Miss - 0 Block - 0	22 魏雨童 Post - 0 Miss - 0 Block - 0	23 曹悦 3 2 4 1 6 4 Post - 1 Miss - 3 Block - 0	25 王杰缘 2 5 3 3 1 Post - 1 Miss - 1 Block - 1
26 徐畅 Post - 0 Miss - 0 Block - 0	27 许松 1 1 1 4 6 Post - 2 Miss - 1 Block - 0	28 郭世伟 2 1 3 Post - 2 Miss - 3 Block - 0	29 周傲 1 1 Post - 0 Miss - 0 Block - 0	30 王权 1 Post - 0 Miss - 0 Block - 0	31 王伟 1 1 2 1 Post - 1 Miss - 1 Block - 0		

26 徐畅	1/2	0/1
0/1	1/2	
1/2	1/3	

30 王权	5/10	4/6	2/11
13/21	2/3	13/23	
4/20	2/3	4/20	

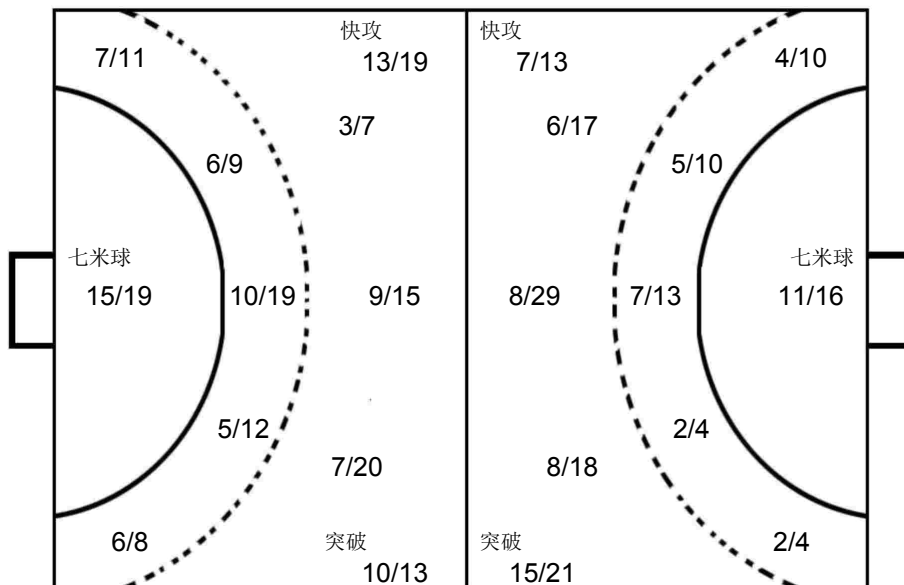

狮队

72 刘迈科	3/6	0/2	2/6
3/6	0/1	1/7	
3/10		3/6	

豹队

1 王澍	0/4	0/1	2/6
1/4		4/8	
1/6		2/9	

龙队

55 于性哲	0/8	1/1	1/5
1/3	2/2	1/3	
2/4		0/8	

OPPONENT

6 赵晨 (豹队) 1 1 1 4 3 Post - 0 Miss - 1 Block - 2	70 于亚男 (狮队) 2 1 2 1 Post - 0 Miss - 0 Block - 0	66 宋朋强 (狮队) 3 2 Post - 0 Miss - 0 Block - 0	71 王伟强 (狮队) 1 2 1 1 Post - 0 Miss - 0 Block - 0	3 曲汝洋 (豹队) 3 Post - 0 Miss - 2 Block - 0	33 尹杰 (龙队) 2 1 1 1 Post - 1 Miss - 0 Block - 1	69 刘晓 (狮队) 1 1 2 Post - 0 Miss - 3 Block - 2	8 谢庆龙 (豹队) 2 1 Post - 0 Miss - 0 Block - 0
9 贺政 (豹队) 2 1 Post - 1 Miss - 0 Block - 0	11 胡瀛 (豹队) 1 1 1 1 Post - 0 Miss - 0 Block - 0	32 蒋维一 (龙队) 1 1 1 Post - 0 Miss - 0 Block - 0	35 李双 (龙队) 1 1 1 1 Post - 0 Miss - 0 Block - 0	39 朱世杰 (龙队) 1 1 Post - 0 Miss - 0 Block - 0	56 李朝鹏 (龙队) 3 Post - 0 Miss - 1 Block - 0	15 张建杰 (豹队) 1 1 Post - 0 Miss - 0 Block - 0	38 王巨柱 (龙队) 1 1 Post - 0 Miss - 0 Block - 2

2017年男子手球国家队俱乐部联赛(武汉赛区)

球队名单

湖北武汉

中国男子手球国家队俱乐部豹队

2017-12-20

号码	姓名	位置	生日	年龄	俱乐部	身高 (CM)	体重 (KG)	国际场次	国际进球
1	王泷	守门员	27/11/1985	32		195	100		
2	胡晋铭	底线	09/02/1997	20		197	110		
3	曲汝洋	后卫	07/01/1989	28		185	83		
5	赵楠	右后卫	07/05/1993	24		187	88		
6	赵晨	左后卫	24/06/1989	28		203	110		
7	解建飞	左边锋	10/09/1989	28		198	105		
8	谢庆龙	底线	24/10/2000	17		190	112		
9	贺政	右边锋	20/08/1996	21		185	80		
10	刘赵梁	右边锋	04/07/1997	20		186	84		
11	胡瀛	右后卫	21/07/1987	30		188	100		
13	陈旭	左边锋	22/03/1998	19		192	95		
15	张建杰	左后卫	29/10/1997	20		196	97		
16	顾艳超	后卫	16/01/1993	24		188	85		
26	徐畅	守门员	22/03/1994	23		200	98		
68	王帅	守门员	30/09/1997	20		193	97		
	平均			23.6		192.2	96.3		

编码	姓名	职务
A	郑永利	主教练
C	叶强	教练
D	陈璇	医生
B	王心东	领队

2017年男子手球国家队俱乐部联赛(武汉赛区)

PHMS Pictorial Handball Match Statistics

IHF Official System

手球 男子 个人/全队技术累计表 截止至第6场 湖北武汉 2017-12-22

号码	姓名	远射	近射	边射	快攻	突破	任意	七米	合计	%	助攻	失误	警告	2'	取消	场次	时间
中国男子手球国家队俱乐部豹队																	
(场上队员)																	
1	王澍										1					3	02:06:10
2	胡晋铭		1/1						1/1	100%						3	00:29:50
3	曲汝洋	4/5	2/4	2/4	2/4	3/4		5/6	18/27	66.7%	6	1		2		3	01:54:13
5	赵楠	1/6	1/3		1/2			0/1	3/12	25.0%	8	7		2		3	02:04:16
6	赵晨	8/25	4/5		1/1	4/4	1/2	1/1	19/38	50.0%	10	5				3	02:02:09
7	解建飞	0/2			0/1			1/2	1/5	20.0%	1		3	1		3	01:08:23
8	谢庆龙	0/1	10/13		2/2				12/16	75.0%		4	2	1		3	02:12:15
9	贺政	0/1	0/1	3/5	1/3			4/5	8/15	53.3%		4		1		3	02:14:04
10	刘赵梁	1/2	1/1	1/1	1/1				4/5	80.0%	1	3				3	00:36:57
11	胡瀛	2/3	1/3			0/1			3/7	42.9%		1				3	00:53:12
13	陈旭		1/5	2/5	1/2				4/12	33.3%	1	1				3	01:21:44
15	张建杰	2/3	1/1	2/6	3/3	2/2		2/2	12/17	70.6%	2	3	1			3	01:20:23
16	顾艳超	2/8	2/3		0/1	1/2			5/14	35.7%	3	6				3	01:38:29
26	徐畅															1	00:30:00
68	王帅											1				2	00:23:50
	合计	20/56	24/40	10/21	12/20	10/13	1/2	13/17	90/169	53.3%	33	36	6	7		42	

(守门员)

1	王澍	15/34	3/13	5/17	2/7	2/4	2/3	0/7	29/85	34.1%	1					3	02:06:10
26	徐畅	3/10	1/2		1/2	0/2		0/4	5/20	25.0%						1	00:30:00
68	王帅	4/8	1/2	1/3	0/3	1/1		1/1	8/18	44.4%		1				2	00:23:50
	合计	22/52	5/17	6/20	3/12	3/7	2/3	1/12	42/123	34.1%	1	1				6	

场上队员：得分/射门

守门员：救球/射门

已打比赛

全队合计	进球	被救	射失	击柱	封球	合计	%	阶段	场次	对手	比分
远射	20	21	4	2	9	56	35.7%	预赛	2	虎队	27:28 (9:12)
近射	24	12	1	3		40	60.0%	预赛	4	龙队	32:28 (18:14)
边射	10	7	3	1		21	47.6%	预赛	5	狮队	31:25 (15:10)
快攻	12	8				20	60.0%				
突破	10	2	1			13	76.9%				
任意	1		1			2	50.0%				
七米	13	2	2			17	76.5%				

图式射门区域累计

手球
男子

截止至第6场

湖北武汉
2017-12-22

中国男子手球国家队俱乐部豹队

1 王澆	2 胡晋铭	3 曲汝洋	5 赵楠	6 赵晨	7 解建飞	8 谢庆龙	9 贺政																																																																											
<table border="1"><tr><td></td><td></td><td></td></tr><tr><td></td><td></td><td></td></tr><tr><td></td><td></td><td></td></tr></table>										<table border="1"><tr><td></td><td></td><td></td></tr><tr><td></td><td></td><td></td></tr><tr><td>1</td><td></td><td></td></tr></table>							1			<table border="1"><tr><td></td><td></td><td>2</td></tr><tr><td>3</td><td></td><td>3</td></tr><tr><td>7</td><td></td><td>3</td></tr></table>			2	3		3	7		3	<table border="1"><tr><td></td><td></td><td></td></tr><tr><td></td><td></td><td></td></tr><tr><td></td><td></td><td>3</td></tr></table>									3	<table border="1"><tr><td>1</td><td></td><td>5</td></tr><tr><td>1</td><td></td><td>2</td></tr><tr><td>5</td><td></td><td>5</td></tr></table>	1		5	1		2	5		5	<table border="1"><tr><td></td><td></td><td></td></tr><tr><td></td><td></td><td></td></tr><tr><td></td><td></td><td>1</td></tr></table>									1	<table border="1"><tr><td></td><td></td><td>3</td></tr><tr><td>1</td><td></td><td>1</td></tr><tr><td>2</td><td></td><td>5</td></tr></table>			3	1		1	2		5	<table border="1"><tr><td></td><td></td><td></td></tr><tr><td></td><td></td><td></td></tr><tr><td>3</td><td></td><td>2</td></tr><tr><td>1</td><td></td><td>2</td></tr></table>							3		2	1		2
1																																																																																		
		2																																																																																
3		3																																																																																
7		3																																																																																
		3																																																																																
1		5																																																																																
1		2																																																																																
5		5																																																																																
		1																																																																																
		3																																																																																
1		1																																																																																
2		5																																																																																
3		2																																																																																
1		2																																																																																
Post - 0 Miss - 0 Block - 0	Post - 0 Miss - 0 Block - 0	Post - 1 Miss - 3 Block - 0	Post - 1 Miss - 2 Block - 1	Post - 0 Miss - 2 Block - 4	Post - 0 Miss - 0 Block - 1	Post - 0 Miss - 0 Block - 0	Post - 1 Miss - 1 Block - 0																																																																											
10 刘赵梁	11 胡瀛	13 陈旭	15 张建杰	16 顾艳超	26 徐畅	68 王帅																																																																												
<table border="1"><tr><td>1</td><td></td><td></td></tr><tr><td>1</td><td></td><td></td></tr><tr><td>1</td><td></td><td>1</td></tr></table>	1			1			1		1	<table border="1"><tr><td></td><td>1</td><td></td></tr><tr><td>1</td><td></td><td></td></tr><tr><td></td><td></td><td>1</td></tr></table>		1		1					1	<table border="1"><tr><td></td><td></td><td>1</td></tr><tr><td>1</td><td></td><td></td></tr><tr><td></td><td></td><td>2</td></tr></table>			1	1					2	<table border="1"><tr><td>1</td><td></td><td>2</td></tr><tr><td></td><td></td><td>4</td></tr><tr><td>1</td><td></td><td>4</td></tr></table>	1		2			4	1		4	<table border="1"><tr><td>1</td><td></td><td>1</td></tr><tr><td></td><td></td><td>1</td></tr><tr><td>1</td><td></td><td>1</td></tr></table>	1		1			1	1		1	<table border="1"><tr><td></td><td></td><td></td></tr><tr><td></td><td></td><td></td></tr><tr><td></td><td></td><td></td></tr></table>										<table border="1"><tr><td></td><td></td><td></td></tr><tr><td></td><td></td><td></td></tr><tr><td></td><td></td><td></td></tr></table>																						
1																																																																																		
1																																																																																		
1		1																																																																																
	1																																																																																	
1																																																																																		
		1																																																																																
		1																																																																																
1																																																																																		
		2																																																																																
1		2																																																																																
		4																																																																																
1		4																																																																																
1		1																																																																																
		1																																																																																
1		1																																																																																
Post - 0 Miss - 0 Block - 0	Post - 1 Miss - 0 Block - 0	Post - 1 Miss - 0 Block - 0	Post - 0 Miss - 1 Block - 1	Post - 1 Miss - 3 Block - 2	Post - 0 Miss - 0 Block - 0	Post - 0 Miss - 0 Block - 0																																																																												

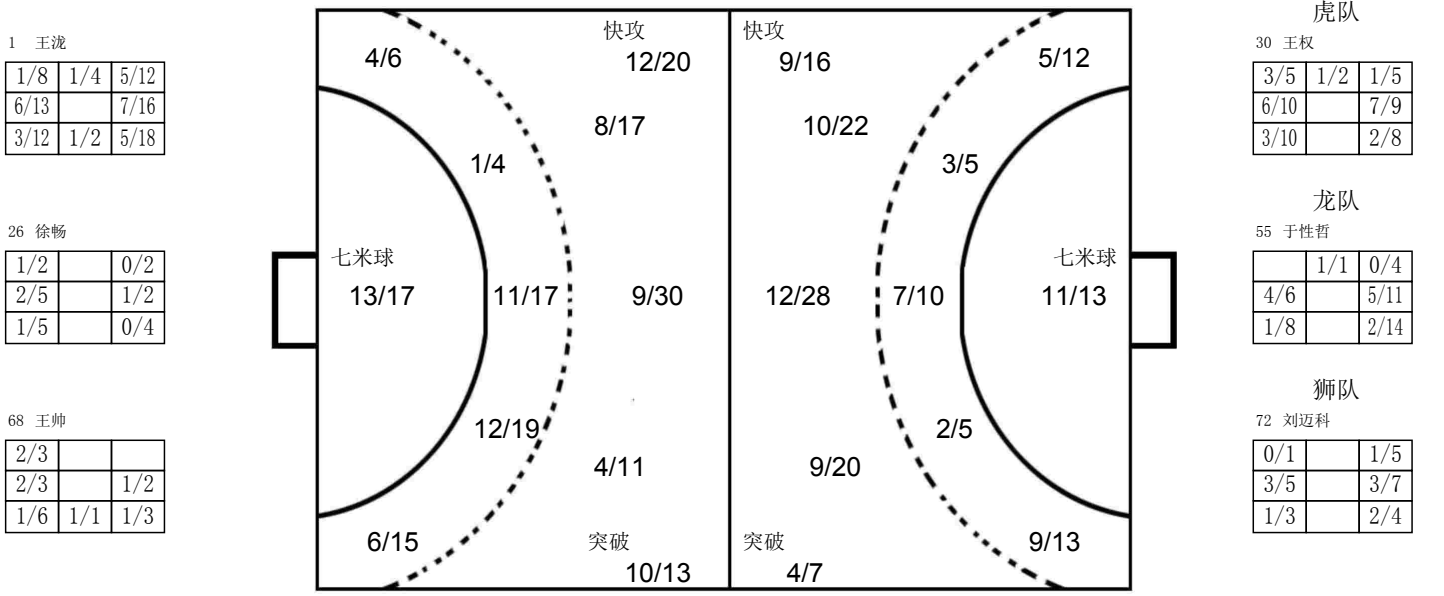

OPPONENT

19 刘振	23 曹悦	25 王杰缘	27 许松	32 蒋维一	51 王军程	56 李朝鹏	70 于亚男																																																																											
<table border="1"><tr><td></td><td></td><td>1</td></tr><tr><td>1</td><td></td><td>1</td></tr><tr><td>1</td><td></td><td>2</td></tr></table>			1	1		1	1		2	<table border="1"><tr><td>2</td><td>1</td><td></td></tr><tr><td></td><td></td><td></td></tr><tr><td>2</td><td></td><td>1</td></tr></table>	2	1					2		1	<table border="1"><tr><td>1</td><td></td><td>2</td></tr><tr><td>2</td><td></td><td>1</td></tr><tr><td></td><td></td><td></td></tr></table>	1		2	2		1				<table border="1"><tr><td></td><td></td><td>1</td></tr><tr><td></td><td></td><td></td></tr><tr><td>2</td><td></td><td>3</td></tr></table>			1				2		3	<table border="1"><tr><td></td><td>1</td><td></td></tr><tr><td>1</td><td></td><td></td></tr><tr><td>2</td><td>1</td><td>1</td></tr></table>		1		1			2	1	1	<table border="1"><tr><td></td><td></td><td>1</td></tr><tr><td></td><td></td><td></td></tr><tr><td>1</td><td></td><td>2</td></tr><tr><td></td><td></td><td>1</td></tr></table>			1				1		2			1	<table border="1"><tr><td></td><td>1</td><td></td></tr><tr><td>1</td><td></td><td>2</td></tr><tr><td></td><td></td><td>1</td></tr></table>		1		1		2			1	<table border="1"><tr><td>1</td><td></td><td>1</td></tr><tr><td>1</td><td></td><td></td></tr><tr><td></td><td></td><td>2</td></tr></table>	1		1	1					2
		1																																																																																
1		1																																																																																
1		2																																																																																
2	1																																																																																	
2		1																																																																																
1		2																																																																																
2		1																																																																																
		1																																																																																
2		3																																																																																
	1																																																																																	
1																																																																																		
2	1	1																																																																																
		1																																																																																
1		2																																																																																
		1																																																																																
	1																																																																																	
1		2																																																																																
		1																																																																																
1		1																																																																																
1																																																																																		
		2																																																																																
Post - 1 Miss - 1 Block - 0	Post - 1 Miss - 2 Block - 0	Post - 0 Miss - 1 Block - 1	Post - 1 Miss - 1 Block - 0	Post - 0 Miss - 0 Block - 0	Post - 0 Miss - 0 Block - 0	Post - 1 Miss - 0 Block - 0	Post - 0 Miss - 0 Block - 1																																																																											
33 尹杰	60 王鹏皓	63 谢基伟	52 马明辉	67 马昌震	35 李双	61 庞连康	66 宋朋强																																																																											
<table border="1"><tr><td>2</td><td></td><td>1</td></tr><tr><td></td><td></td><td></td></tr><tr><td></td><td></td><td>1</td></tr></table>	2		1						1	<table border="1"><tr><td>1</td><td></td><td></td></tr><tr><td>1</td><td></td><td></td></tr><tr><td></td><td></td><td>2</td></tr></table>	1			1					2	<table border="1"><tr><td></td><td></td><td></td></tr><tr><td>2</td><td></td><td></td></tr><tr><td>2</td><td></td><td></td></tr></table>				2			2			<table border="1"><tr><td>1</td><td></td><td></td></tr><tr><td>1</td><td></td><td></td></tr><tr><td>1</td><td></td><td>1</td></tr></table>	1			1			1		1	<table border="1"><tr><td></td><td></td><td></td></tr><tr><td></td><td></td><td></td></tr><tr><td>2</td><td></td><td>1</td></tr></table>							2		1	<table border="1"><tr><td></td><td></td><td></td></tr><tr><td></td><td></td><td></td></tr><tr><td>1</td><td></td><td>1</td></tr></table>							1		1	<table border="1"><tr><td></td><td></td><td>1</td></tr><tr><td></td><td></td><td></td></tr><tr><td></td><td></td><td>1</td></tr></table>			1						1	<table border="1"><tr><td></td><td></td><td></td></tr><tr><td></td><td></td><td></td></tr><tr><td>1</td><td></td><td>1</td></tr></table>							1		1			
2		1																																																																																
		1																																																																																
1																																																																																		
1																																																																																		
		2																																																																																
2																																																																																		
2																																																																																		
1																																																																																		
1																																																																																		
1		1																																																																																
2		1																																																																																
1		1																																																																																
		1																																																																																
		1																																																																																
1		1																																																																																
Post - 1 Miss - 1 Block - 0	Post - 0 Miss - 0 Block - 0	Post - 1 Miss - 2 Block - 1	Post - 1 Miss - 0 Block - 0	Post - 0 Miss - 0 Block - 0	Post - 0 Miss - 0 Block - 0	Post - 0 Miss - 0 Block - 0	Post - 0 Miss - 0 Block - 0																																																																											

2017年男子手球国家队俱乐部联赛(武汉赛区)

球队名单

湖北武汉

中国男子手球国家队俱乐部龙队

2017-12-20

号码	姓名	位置	生日	年龄	俱乐部	身高 (CM)	体重 (KG)	国际场次	国际进球
32	蒋维一	底线	27/06/1987	30		198	105		
33	尹杰	右边锋	06/03/1993	24		184	90		
35	李双	右后卫	10/02/1997	20		192	80		
36	张家纬	右后卫	25/09/1992	25		193	95		
37	林豪文	左边锋	21/12/1997	19		191	96		
38	王巨柱	左后卫	17/08/1997	20		194	80		
39	朱世杰	后卫	20/05/1995	22		188	90		
50	李明	守门员	04/05/1997	20		195	85		
51	王军程	左后卫	11/10/1995	22		198	90		
52	马明辉	右边锋	16/07/1994	23		198	86		
53	傅俊雄	底线	20/01/1995	22		195	96		
55	于性哲	守门员	25/06/1993	24		191	92		
56	李朝鹏	后卫	05/12/1992	25		188	100		
57	董智景	左边锋	15/10/1993	24		190	83		
	平均			22.9		192.5	90.6		

编码	姓名	职务
A	沈强	主教练
C	杨桂东	教练
D	陈璇	医生
B	王心东	领队

2017年男子手球国家队俱乐部联赛(武汉赛区)

PHMS Pictorial Handball Match Statistics

IHF Official System

手球男子		个人/全队技术累计表													湖北武汉 2017-12-22		
		截止至第6场															
号码	姓名	远射	近射	边射	快攻	突破	任意	七米	合计	%	助攻	失误	警告	2'	取消	场次	时间
中国男子手球国家队俱乐部龙队																	
(场上队员)																	
32	蒋维一	1/2	8/10		2/3				11/15	73.3%	2	5	1	1		3	02:13:43
33	尹杰	4/8		2/4	0/1	4/4		3/5	13/22	59.1%	2	9				3	02:51:13
35	李双	2/6	2/3	1/1			0/1		5/11	45.5%	2	2				3	01:39:33
36	张家纬	0/4							0/4	0.0%		2	1			3	00:14:21
37	林豪文	0/1	1/1	0/2					1/4	25.0%						3	00:44:33
38	王巨柱	1/4		2/3		1/1			4/8	50.0%		5				3	00:48:23
39	朱世杰	2/3		0/1		3/6			5/10	50.0%	1	4		2		3	01:20:41
50	李明				0/1				0/1	0.0%						3	00:14:04
51	王军程	6/17	2/2	0/1		2/4	0/1		10/25	40.0%	6	5				3	02:11:27
52	马明辉	1/1	1/1	1/2	1/1				4/5	80.0%		2				3	01:10:30
53	傅俊雄			1/1					1/1	100%		1				3	00:48:51
55	于性哲				0/1				0/1	0.0%	2					3	02:45:56
56	李朝鹏	4/10	2/2	0/1	2/2	3/4	0/1	2/4	13/24	54.2%	2	10	1	1		3	02:09:33
57	董智景	0/1		1/5	3/4				4/10	40.0%	1	2	1			3	01:41:37
合计		21/57	16/19	8/21	8/13	13/19	0/3	5/9	71/141	50.4%	18	47	4	4		42	
(守门员)																	
50	李明	2/5	0/2		1/2	0/1		0/4	3/14	21.4%						3	00:14:04
55	于性哲	8/24	9/28	13/23	1/12	1/11	1/1	0/8	33/107	30.8%	2					3	02:45:56
合计		10/29	9/30	13/23	2/14	1/12	1/1	0/12	36/121	29.8%	2					6	

场上队员：得分/射门

守门员：救球/射门

已打比赛

全队合计	进球	被救	射失	击柱	封球	合计	%	阶段	场次	对手	比分
远射	21	20	3	3	10	57	36.8%	预赛	1	狮队	21:20 (10:7)
近射	16	3				19	84.2%	预赛	4	豹队	28:32 (14:18)
边射	8	9		4		21	38.1%	预赛	6	虎队	22:33 (12:13)
快攻	8	2	3			13	61.5%				
突破	13	5	1			19	68.4%				
任意		1	1	1		3	0.0%				
七米	5	1		3		9	55.6%				

图式射门区域累计

手球
男子

截止至第6场

湖北武汉
2017-12-22

中国男子手球国家队俱乐部龙队

32 蒋维一 <table border="1"><tr><td></td><td>1</td><td>1</td></tr><tr><td>2</td><td></td><td></td></tr><tr><td>3</td><td>1</td><td>3</td></tr></table> Post - 1 Miss - 0 Block - 0		1	1	2			3	1	3	33 尹杰 <table border="1"><tr><td>4</td><td>1</td><td>3</td></tr><tr><td>1</td><td></td><td></td></tr><tr><td></td><td></td><td>4</td></tr></table> Post - 2 Miss - 1 Block - 1	4	1	3	1					4	35 李双 <table border="1"><tr><td></td><td></td><td></td></tr><tr><td></td><td></td><td>1</td></tr><tr><td>2</td><td></td><td>2</td></tr></table> Post - 0 Miss - 1 Block - 1						1	2		2	36 张家纬 <table border="1"><tr><td></td><td></td><td></td></tr><tr><td></td><td></td><td></td></tr><tr><td></td><td></td><td></td></tr></table> Post - 0 Miss - 0 Block - 3										37 林豪文 <table border="1"><tr><td></td><td></td><td></td></tr><tr><td></td><td></td><td></td></tr><tr><td></td><td></td><td>1</td></tr></table> Post - 2 Miss - 0 Block - 0									1	38 王巨柱 <table border="1"><tr><td></td><td></td><td>1</td></tr><tr><td></td><td></td><td></td></tr><tr><td>2</td><td></td><td>1</td></tr></table> Post - 0 Miss - 0 Block - 2			1				2		1	39 朱世杰 <table border="1"><tr><td></td><td></td><td></td></tr><tr><td></td><td>1</td><td></td></tr><tr><td>2</td><td></td><td>2</td></tr></table> Post - 0 Miss - 0 Block - 1					1		2		2	50 李明 <table border="1"><tr><td></td><td></td><td></td></tr><tr><td></td><td></td><td></td></tr><tr><td></td><td></td><td></td></tr></table> Post - 0 Miss - 1 Block - 0									
	1	1																																																																													
2																																																																															
3	1	3																																																																													
4	1	3																																																																													
1																																																																															
		4																																																																													
		1																																																																													
2		2																																																																													
		1																																																																													
		1																																																																													
2		1																																																																													
	1																																																																														
2		2																																																																													
51 王军程 <table border="1"><tr><td></td><td></td><td>2</td></tr><tr><td>2</td><td>1</td><td>3</td></tr><tr><td>1</td><td></td><td>1</td></tr></table> Post - 1 Miss - 2 Block - 1			2	2	1	3	1		1	52 马明辉 <table border="1"><tr><td>1</td><td></td><td></td></tr><tr><td>1</td><td></td><td></td></tr><tr><td>1</td><td></td><td>1</td></tr></table> Post - 1 Miss - 0 Block - 0	1			1			1		1	53 傅俊雄 <table border="1"><tr><td></td><td></td><td></td></tr><tr><td></td><td></td><td>1</td></tr><tr><td></td><td></td><td></td></tr></table> Post - 0 Miss - 0 Block - 0						1				55 于性哲 <table border="1"><tr><td></td><td></td><td></td></tr><tr><td></td><td></td><td></td></tr><tr><td></td><td></td><td></td></tr></table> Post - 0 Miss - 1 Block - 0										56 李朝鹏 <table border="1"><tr><td></td><td>1</td><td>1</td></tr><tr><td>3</td><td></td><td>5</td></tr><tr><td>1</td><td></td><td>2</td></tr></table> Post - 2 Miss - 2 Block - 1		1	1	3		5	1		2	57 董智景 <table border="1"><tr><td></td><td></td><td></td></tr><tr><td></td><td></td><td>1</td></tr><tr><td>3</td><td></td><td></td></tr></table> Post - 2 Miss - 0 Block - 0						1	3																						
		2																																																																													
2	1	3																																																																													
1		1																																																																													
1																																																																															
1																																																																															
1		1																																																																													
		1																																																																													
	1	1																																																																													
3		5																																																																													
1		2																																																																													
		1																																																																													
3																																																																															

50 李明

1/2	0/2	0/3
		2/3
0/2		0/2

55 于性哲

0/11	2/2	2/11
6/13	2/3	11/20
7/20	0/1	3/26

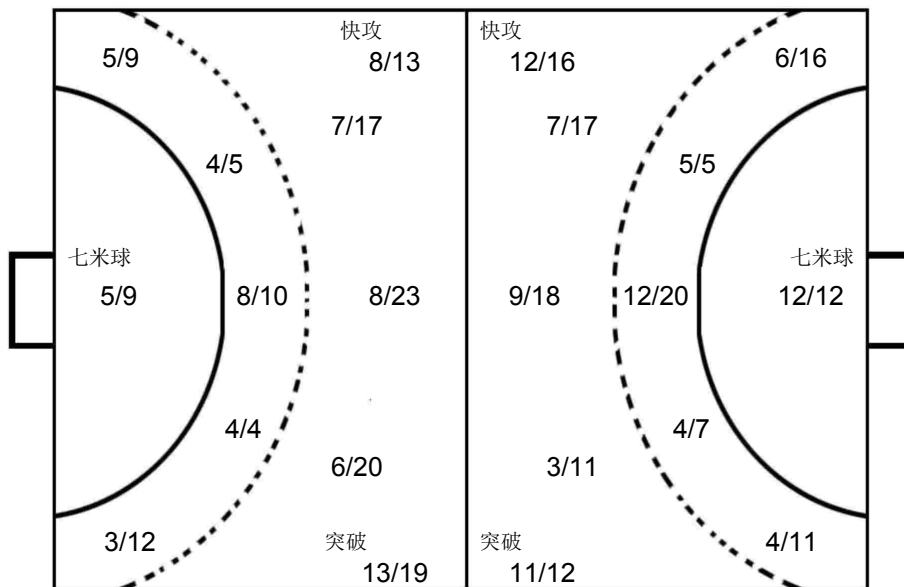

虎队

30 王权

1/2	2/2	0/4
2/3	1/2	2/6
1/5		2/6

豹队

1 王涛

1/3	1/3	2/4
2/4		1/4
0/2	0/1	2/6

狮队

68 王帅

3/3	0/1	1/2
1/4		0/1
3/5		0/3

OPPONENT

虎队 25 王杰缘 <table border="1"><tr><td>1</td><td></td><td>3</td></tr><tr><td>1</td><td></td><td>2</td></tr><tr><td>1</td><td></td><td></td></tr></table> Post - 1 Miss - 0 Block - 0	1		3	1		2	1			豹队 3 曲汝洋 <table border="1"><tr><td></td><td></td><td>1</td></tr><tr><td>1</td><td></td><td></td></tr><tr><td>4</td><td></td><td>1</td></tr></table> Post - 0 Miss - 0 Block - 0			1	1			4		1	豹队 15 张建杰 <table border="1"><tr><td></td><td></td><td>1</td></tr><tr><td></td><td></td><td>2</td></tr><tr><td></td><td></td><td>3</td></tr></table> Post - 0 Miss - 0 Block - 1			1			2			3	虎队 17 成亚 <table border="1"><tr><td>4</td><td>1</td><td></td></tr><tr><td></td><td></td><td></td></tr><tr><td></td><td></td><td>1</td></tr></table> Post - 0 Miss - 0 Block - 1	4	1							1	虎队 23 曹悦 <table border="1"><tr><td></td><td></td><td>2</td></tr><tr><td>1</td><td></td><td></td></tr><tr><td>1</td><td></td><td>2</td></tr></table> Post - 0 Miss - 0 Block - 0			2	1			1		2	豹队 6 赵晨 <table border="1"><tr><td></td><td></td><td>1</td></tr><tr><td></td><td></td><td>2</td></tr><tr><td>1</td><td></td><td>1</td></tr></table> Post - 0 Miss - 0 Block - 2			1			2	1		1	狮队 69 刘晓 <table border="1"><tr><td></td><td></td><td>1</td></tr><tr><td>1</td><td></td><td></td></tr><tr><td>2</td><td></td><td>1</td></tr></table> Post - 0 Miss - 0 Block - 0			1	1			2		1	豹队 70 于亚男 <table border="1"><tr><td>1</td><td></td><td>1</td></tr><tr><td>2</td><td></td><td>1</td></tr><tr><td></td><td></td><td></td></tr></table> Post - 2 Miss - 1 Block - 2	1		1	2		1			
1		3																																																																													
1		2																																																																													
1																																																																															
		1																																																																													
1																																																																															
4		1																																																																													
		1																																																																													
		2																																																																													
		3																																																																													
4	1																																																																														
		1																																																																													
		2																																																																													
1																																																																															
1		2																																																																													
		1																																																																													
		2																																																																													
1		1																																																																													
		1																																																																													
1																																																																															
2		1																																																																													
1		1																																																																													
2		1																																																																													
狮队 71 王伟强 <table border="1"><tr><td>2</td><td></td><td></td></tr><tr><td></td><td></td><td>1</td></tr><tr><td>1</td><td>1</td><td></td></tr></table> Post - 0 Miss - 0 Block - 0	2					1	1	1		豹队 8 谢庆龙 <table border="1"><tr><td></td><td></td><td></td></tr><tr><td></td><td></td><td></td></tr><tr><td>1</td><td></td><td>3</td></tr></table> Post - 0 Miss - 0 Block - 0							1		3	豹队 9 贺政 <table border="1"><tr><td></td><td></td><td></td></tr><tr><td>1</td><td></td><td>1</td></tr><tr><td></td><td></td><td>2</td></tr></table> Post - 0 Miss - 1 Block - 0				1		1			2	虎队 27 许松 <table border="1"><tr><td>1</td><td></td><td></td></tr><tr><td></td><td></td><td></td></tr><tr><td></td><td></td><td>3</td></tr></table> Post - 1 Miss - 0 Block - 0	1								3	豹队 16 顾艳超 <table border="1"><tr><td></td><td></td><td>1</td></tr><tr><td></td><td></td><td>1</td></tr><tr><td>1</td><td></td><td></td></tr></table> Post - 1 Miss - 0 Block - 1			1			1	1			虎队 19 刘振 <table border="1"><tr><td>1</td><td></td><td></td></tr><tr><td></td><td></td><td></td></tr><tr><td>1</td><td></td><td>1</td></tr></table> Post - 1 Miss - 0 Block - 0	1						1		1	虎队 28 郭世伟 <table border="1"><tr><td>1</td><td></td><td></td></tr><tr><td></td><td></td><td></td></tr><tr><td></td><td></td><td>2</td></tr></table> Post - 1 Miss - 0 Block - 0	1								2	狮队 58 张继伟 <table border="1"><tr><td></td><td></td><td></td></tr><tr><td></td><td>1</td><td></td></tr><tr><td>1</td><td></td><td>1</td></tr></table> Post - 0 Miss - 0 Block - 0					1		1		1
2																																																																															
		1																																																																													
1	1																																																																														
1		3																																																																													
1		1																																																																													
		2																																																																													
1																																																																															
		3																																																																													
		1																																																																													
		1																																																																													
1																																																																															
1																																																																															
1		1																																																																													
1																																																																															
		2																																																																													
	1																																																																														
1		1																																																																													



2017年男子手球国家队俱乐部联赛(武汉赛区)

PHMS Pictorial Handball Match Statistics

IHF Official System

球队名单

湖北武汉

中国男子手球国家队俱乐部狮队

2017-12-20

号码	姓名	位置	生日	年龄	俱乐部	身高 (CM)	体重 (KG)	国际场次	国际进球
58	张继伟	底线	02/02/1993	24		203	115		
59	魏昂	左边锋	29/12/1994	22		188	82		
60	王鹏皓	右边锋	03/09/1997	20		192	87		
61	庞连康	左后卫	02/07/1996	21		192	97		
62	闫炳旗	右边锋	30/01/1992	25		189	75		
63	谢基伟	后卫	19/02/1994	23		186	90		
65	黎涛	右边锋	28/10/1994	23		187	90		
66	宋朋强	后卫	12/02/1987	30		193	93		
67	马昌震	底线	19/05/1995	22		191	101		
68	王帅	守门员	30/09/1997	20		193	97		
69	刘晓	右后卫	30/03/1992	25		192	108		
70	于亚男	左后卫	25/11/1990	27		190	101		
71	王伟强	左边锋	07/01/1993	24		176	75		
72	刘迈科	守门员	28/07/1994	23		190	108		
	平均			23.5		190.1	94.2		

编码	姓名	职务
A	王鸿斌	主教练
C	杜长义	教练
D	杨桂东	教练
B	王心东	领队
E	陈璇	医生

2017年男子手球国家队俱乐部联赛(武汉赛区)

PHMS Pictorial Handball Match Statistics

IHF Official System

手球 男子 个人/全队技术累计表 截止至第6场 湖北武汉 2017-12-22

号码	姓名	远射	近射	边射	快攻	突破	任意	七米	合计	%	助攻	失误	警告	2'	取消	场次	时间
中国男子手球国家队俱乐部狮队																	
(场上队员)																	
58	张继伟	0/1	4/6		1/1				5/8	62.5%	1	5	2	3		3	01:59:42
59	魏昂	0/1		0/1	1/2				1/4	25.0%	2	2				3	00:24:19
60	王鹏皓	1/2			0/1			3/3	4/6	66.7%						3	00:18:08
61	庞连康	1/1				1/1			2/2	100%						3	00:24:20
62	闫炳旗			0/1	1/2	1/1			2/4	50.0%	1	2		1		3	01:09:05
63	谢基伟	4/10			0/1				4/11	36.4%	2	5				3	00:53:22
65	黎涛	0/1		1/4	1/1			1/1	3/7	42.9%	1	3	1			3	01:55:14
66	宋朋强	3/8	1/3			4/4	0/1		8/16	50.0%	3	7	1			3	01:56:44
67	马昌震		2/2		1/1	0/1			3/4	75.0%	1	3		1		3	01:19:51
68	王帅															3	01:00:00
69	刘晓	1/15	0/1	1/2		1/1		7/7	10/26	38.5%	4	2	1	2		3	02:29:02
70	于亚男	13/22	1/3			2/3	1/1		17/29	58.6%	3	8				3	02:33:28
71	王伟强	2/4	1/2	5/11	4/5				12/22	54.5%		3				3	02:33:28
72	刘迈科											1				3	02:00:00
合计		25/65	9/17	7/19	9/14	9/11	1/2	11/11	71/139	51.1%	18	41	5	7		42	
(守门员)																	
68	王帅	6/13	4/10	1/4	1/8	2/6		0/1	14/42	33.3%						3	01:00:00
72	刘迈科	11/18	8/25	0/5	6/13	2/10	0/1	2/11	29/83	34.9%		1				3	02:00:00
合计		17/31	12/35	1/9	7/21	4/16	0/1	2/12	43/125	34.4%		1				6	

场上队员：得分/射门

守门员：救球/射门

已打比赛

全队合计	进球	被救	射失	击柱	封球	合计	%	阶段	场次	对手	比分
远射	25	22	6	4	8	65	38.5%	预赛	1	龙队	20:21 (7:10)
近射	9	8				17	52.9%	预赛	3	虎队	26:30 (16:13)
边射	7	9	1	2		19	36.8%	预赛	5	豹队	25:31 (10:15)
快攻	9	3	2			14	64.3%				
突破	9	2				11	81.8%				
任意	1	1				2	50.0%				
七米	11					11	100.0%				



图式射门区域累计

手球
男子

截止至第6场

湖北武汉
2017-12-22

中国男子手球国家队俱乐部狮队

58 张继伟	59 魏昂	60 王鹏皓	61 虎连康	62 闫炳旗	63 谢基伟	65 黎涛	66 宋朋强																																																																								
<table border="1"><tr><td></td><td>1</td><td></td></tr><tr><td></td><td>1</td><td></td></tr><tr><td>1</td><td></td><td>2</td></tr></table>		1			1		1		2	<table border="1"><tr><td></td><td></td><td></td></tr><tr><td></td><td></td><td>1</td></tr><tr><td></td><td></td><td></td></tr></table>						1				<table border="1"><tr><td>1</td><td></td><td></td></tr><tr><td>1</td><td></td><td></td></tr><tr><td></td><td></td><td>2</td></tr></table>	1			1					2	<table border="1"><tr><td></td><td></td><td>1</td></tr><tr><td></td><td></td><td></td></tr><tr><td></td><td></td><td>1</td></tr></table>			1						1	<table border="1"><tr><td></td><td></td><td>1</td></tr><tr><td></td><td></td><td></td></tr><tr><td>1</td><td></td><td></td></tr></table>			1				1			<table border="1"><tr><td></td><td></td><td></td></tr><tr><td>2</td><td></td><td></td></tr><tr><td>2</td><td></td><td></td></tr></table>				2			2			<table border="1"><tr><td></td><td></td><td>1</td></tr><tr><td></td><td></td><td>1</td></tr><tr><td></td><td></td><td>1</td></tr></table>			1			1			1	<table border="1"><tr><td></td><td></td><td></td></tr><tr><td>1</td><td></td><td>2</td></tr><tr><td>3</td><td></td><td>2</td></tr></table>				1		2	3		2
	1																																																																														
	1																																																																														
1		2																																																																													
		1																																																																													
1																																																																															
1																																																																															
		2																																																																													
		1																																																																													
		1																																																																													
		1																																																																													
1																																																																															
2																																																																															
2																																																																															
		1																																																																													
		1																																																																													
		1																																																																													
1		2																																																																													
3		2																																																																													
Post - 0 Miss - 0 Block - 0	Post - 1 Miss - 2 Block - 0	Post - 0 Miss - 0 Block - 0	Post - 0 Miss - 0 Block - 0	Post - 0 Miss - 0 Block - 0	Post - 1 Miss - 2 Block - 2	Post - 2 Miss - 0 Block - 0	Post - 0 Miss - 1 Block - 0																																																																								
67 马昌震	68 王帅	69 刘晓	70 于亚男	71 王伟强	72 刘迈科																																																																										
<table border="1"><tr><td></td><td></td><td></td></tr><tr><td></td><td></td><td></td></tr><tr><td>2</td><td></td><td>1</td></tr></table>							2		1	<table border="1"><tr><td></td><td></td><td></td></tr><tr><td></td><td></td><td></td></tr><tr><td></td><td></td><td></td></tr></table>										<table border="1"><tr><td>1</td><td></td><td>2</td></tr><tr><td>1</td><td></td><td>1</td></tr><tr><td>2</td><td></td><td>3</td></tr></table>	1		2	1		1	2		3	<table border="1"><tr><td>2</td><td></td><td>3</td></tr><tr><td>5</td><td></td><td>2</td></tr><tr><td>2</td><td></td><td>3</td></tr></table>	2		3	5		2	2		3	<table border="1"><tr><td>3</td><td></td><td></td></tr><tr><td>1</td><td></td><td>3</td></tr><tr><td>2</td><td>2</td><td>1</td></tr></table>	3			1		3	2	2	1	<table border="1"><tr><td></td><td></td><td></td></tr><tr><td></td><td></td><td></td></tr><tr><td></td><td></td><td></td></tr></table>																													
2		1																																																																													
1		2																																																																													
1		1																																																																													
2		3																																																																													
2		3																																																																													
5		2																																																																													
2		3																																																																													
3																																																																															
1		3																																																																													
2	2	1																																																																													
Post - 0 Miss - 0 Block - 0	Post - 0 Miss - 0 Block - 0	Post - 0 Miss - 3 Block - 3	Post - 2 Miss - 1 Block - 3	Post - 0 Miss - 0 Block - 0	Post - 0 Miss - 0 Block - 0																																																																										

68 王帅

3/5	0/1	2/5
3/9		3/6
3/6		0/10

72 刘迈科

3/7	0/2	4/13
6/12	0/2	5/17
5/16		6/14

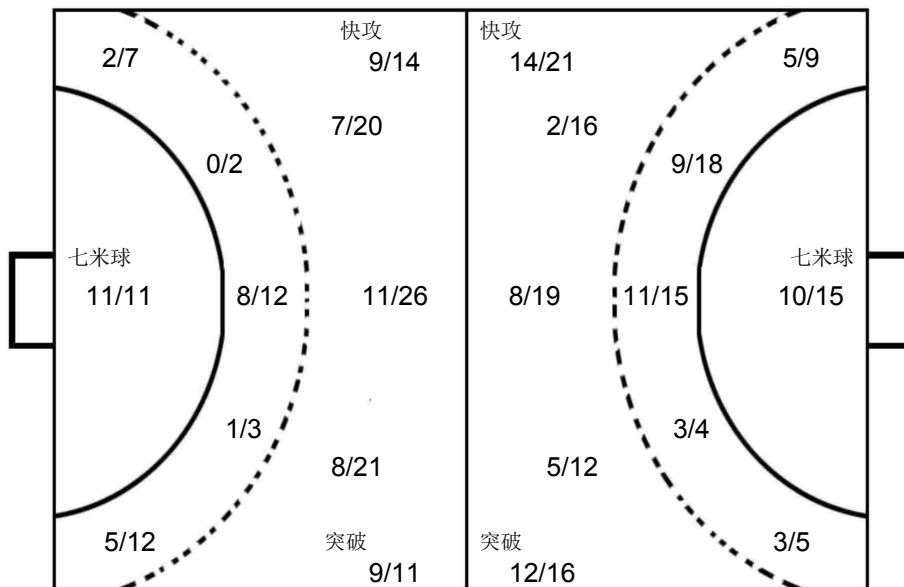

虎队

30 王权

1/3	1/2	1/2
5/8	1/1	4/8
0/5	2/3	0/6

龙队

55 于性哲

0/3		1/2
1/4	0/1	5/6
4/8	0/1	1/4

豹队

1 王澍

0/1		1/2
3/5		2/4
2/4	1/1	1/3

OPPONENT

23 曹悦 (虎队)	19 刘振 (虎队)	3 曲汝洋 (豹队)	8 谢庆龙 (豹队)	56 李朝鹏 (龙队)	6 赵晨 (豹队)	10 刘赵梁 (豹队)	15 张建杰 (豹队)																																																																								
<table border="1"><tr><td>1</td><td>1</td><td>2</td></tr><tr><td></td><td></td><td></td></tr><tr><td>3</td><td></td><td>1</td></tr></table>	1	1	2				3		1	<table border="1"><tr><td>2</td><td></td><td></td></tr><tr><td></td><td></td><td>2</td></tr><tr><td>2</td><td></td><td>1</td></tr></table>	2					2	2		1	<table border="1"><tr><td></td><td></td><td>1</td></tr><tr><td>2</td><td></td><td>1</td></tr><tr><td></td><td></td><td>2</td></tr></table>			1	2		1			2	<table border="1"><tr><td></td><td></td><td>1</td></tr><tr><td>1</td><td></td><td>1</td></tr><tr><td>1</td><td></td><td>1</td></tr></table>			1	1		1	1		1	<table border="1"><tr><td></td><td></td><td>1</td></tr><tr><td>2</td><td></td><td></td></tr><tr><td>1</td><td></td><td>1</td></tr></table>			1	2			1		1	<table border="1"><tr><td></td><td></td><td>3</td></tr><tr><td></td><td></td><td></td></tr><tr><td></td><td></td><td>1</td></tr></table>			3						1	<table border="1"><tr><td>1</td><td></td><td></td></tr><tr><td>1</td><td></td><td></td></tr><tr><td>1</td><td></td><td>1</td></tr></table>	1			1			1		1	<table border="1"><tr><td></td><td></td><td></td></tr><tr><td></td><td></td><td>2</td></tr><tr><td>1</td><td></td><td>1</td></tr></table>						2	1		1
1	1	2																																																																													
3		1																																																																													
2																																																																															
		2																																																																													
2		1																																																																													
		1																																																																													
2		1																																																																													
		2																																																																													
		1																																																																													
1		1																																																																													
1		1																																																																													
		1																																																																													
2																																																																															
1		1																																																																													
		3																																																																													
		1																																																																													
1																																																																															
1																																																																															
1		1																																																																													
		2																																																																													
1		1																																																																													
17 成亚 (虎队)	33 尹杰 (龙队)	13 陈旭 (豹队)	20 王毅 (虎队)	27 许松 (虎队)	31 王伟 (虎队)	51 王军程 (龙队)	57 董智景 (龙队)																																																																								
<table border="1"><tr><td></td><td></td><td>1</td></tr><tr><td>2</td><td></td><td>1</td></tr><tr><td></td><td></td><td></td></tr></table>			1	2		1				<table border="1"><tr><td></td><td>1</td><td>1</td></tr><tr><td></td><td></td><td></td></tr><tr><td></td><td></td><td>2</td></tr></table>		1	1						2	<table border="1"><tr><td></td><td></td><td>1</td></tr><tr><td>1</td><td></td><td></td></tr><tr><td></td><td></td><td>1</td></tr></table>			1	1					1	<table border="1"><tr><td>1</td><td>1</td><td></td></tr><tr><td></td><td>1</td><td></td></tr><tr><td></td><td></td><td></td></tr></table>	1	1			1					<table border="1"><tr><td></td><td></td><td></td></tr><tr><td></td><td></td><td>1</td></tr><tr><td>2</td><td></td><td></td></tr></table>						1	2			<table border="1"><tr><td></td><td></td><td>1</td></tr><tr><td>1</td><td></td><td>1</td></tr><tr><td></td><td></td><td></td></tr></table>			1	1		1				<table border="1"><tr><td></td><td></td><td></td></tr><tr><td>1</td><td>1</td><td>1</td></tr><tr><td></td><td></td><td></td></tr></table>				1	1	1				<table border="1"><tr><td></td><td></td><td></td></tr><tr><td></td><td></td><td>1</td></tr><tr><td>2</td><td></td><td></td></tr></table>						1	2		
		1																																																																													
2		1																																																																													
	1	1																																																																													
		2																																																																													
		1																																																																													
1																																																																															
		1																																																																													
1	1																																																																														
	1																																																																														
		1																																																																													
2																																																																															
		1																																																																													
1		1																																																																													
1	1	1																																																																													
		1																																																																													
2																																																																															
Post - 0 Miss - 1 Block - 0	Post - 0 Miss - 1 Block - 0	Post - 1 Miss - 1 Block - 0	Post - 0 Miss - 0 Block - 0	Post - 1 Miss - 1 Block - 1	Post - 0 Miss - 1 Block - 0	Post - 0 Miss - 0 Block - 0	Post - 0 Miss - 1 Block - 0																																																																								
Post - 0 Miss - 0 Block - 0	Post - 0 Miss - 0 Block - 0	Post - 1 Miss - 0 Block - 0	Post - 1 Miss - 0 Block - 0	Post - 0 Miss - 0 Block - 0	Post - 1 Miss - 0 Block - 0	Post - 1 Miss - 0 Block - 1	Post - 1 Miss - 0 Block - 0																																																																								



Team A	Team B	Match Number
A 中国男子手球国家队俱乐部龙队	B 中国男子手球国家队俱乐部狮队	1

Played in	in the hall	on	at	Spectators
湖北武汉	武汉体院体育馆	2017-12-20	19:30 hours	

Half-time(30')	A	B	End of playing time	A	B	1st extra time	A	B	2nd extra time	A	B	After penalty throws	A	B
	10	7		21	20									

Number of 7 m	A	Team time-out			Full name of players and officials	Team time-out			B	Number of 7 m
	2/3	1	2	3		1	2	3	3/3	
		11:32	50:04			24:29	36:12			

No.	Team A	G	W	2'	D	DR	No.	Team B	G	W	2'	D	DR
32	蒋维一	2		1			58	张继伟	3	1			
33	尹杰	4					59	魏昂					
35	李双						60	王鹏皓					
36	张家纬		1				61	庞连康					
37	林豪文						62	闫炳旗	1				
38	王巨柱	1					63	谢基伟					
39	朱世杰	1		1			65	黎涛	1				
50	李明						66	宋朋强					
51	王军程	3					67	马昌震					
52	马明辉	1					68	王帅					
53	傅俊雄	1					69	刘晓	5		1		
55	于性哲						70	于亚男	5				
56	李朝鹏	5					71	王伟强	5				
57	董智景	3					72	刘迈科					

A	沈强 (主教练)						A	王鸿斌 (主教练)					
B	王心东						B	王心东					
C	杨桂东						C	杜长义					
D	陈璇						D	杨桂东					
							E	陈璇					

A	Signatures of responsables for the teams (Off.A)	B
---	--	---

TP	Remarks of referees / HF Official	TP

Signatures			
Referees	程钰峰 (CHN)	周云磊 (CHN)	
T.D.	吴瑞亭 (CHN)	许宜扬 (CHN)	
CHA Off.			

Note: Number of 7m Throws Awarded to Team A and B, Goals (G), Warnings (W), Suspensions (2'), Direct Disqualification (D), Disqualification With Report (DR) and Team Penalty (TP).

Table Officials: 许翔 刘禹 Statisticians: 王梓衡 沈家洛

2017年男子手球国家队俱乐部联赛(武汉赛区)

PHMS Pictorial Handball Match Statistics

IHF Official System

竞赛技术统计

 手球
男子

 预赛
轮次 1

 组别 X
场次 1

 武汉体院体育馆
2017-12-20 19:30

Referees: 程钰峰 (CHN) / 周云磊 (CHN)

Result: 21:20 (10:7)

Teams: 中国男子手球国家队俱乐部龙队(龙队) VS 中国男子手球国家队俱乐部狮队(狮队)

龙队		远	近	边	快	突	任意	7m	合计	%	助攻	失误	警告	2'	D+DR	龙队	比赛 进程	狮队	
主教练: 沈强		射	射	射	攻	破	球	球											
32	蒋维一	0/1	1/1		1/1				2/3	66.7	1	3		1		32	蒋维一	1 03:17 0	
33	尹杰	2/3		0/1		1/1		1/1	4/6	66.7		2				56	李朝鹏	1 04:37 1 69 刘晓	
35	李双	0/1					0/1		0/2	0.0								2 06:21 2 71 王伟强	
36	张家纬	0/4							0/4	0.0		2	1					2 07:16 3 71 王伟强	
37	林豪文															56	李朝鹏	2 10:57 4 70 于亚男	
38	王巨柱	1/1							1/1	100		2						3 13:23 4	
39	朱世杰					1/2			1/2	50.0				1				3 14:42 5 71 王伟强	
50	李明																	4 16:54 5	
51	王军程	0/6	2/2			1/1	0/1		3/10	30.0	3							4 17:43 6 69 刘晓	
52	马明辉		1/1						1/1	100		1						5 18:20 6	
53	傅俊雄			1/1					1/1	100								6 23:43 6	
55	于性哲										2							7 24:24 6	
56	李朝鹏	1/4	1/1			2/2		1/2	5/9	55.6		5						8 25:22 6	
57	董智景	0/1		1/2	2/3				3/6	50.0								9 27:17 6	
运动员	合计	4/21	5/5	2/4	3/4	5/6	0/2	2/3	21/45	46.7	6	15	1	2				9 28:41 7 69 刘晓	
50	李明	1/3			1/1			0/1	2/5	40.0								10 29:55 7	
55	于性哲	3/6	2/6	6/10	0/3	0/1	1/1	0/2	12/29	41.4	2							11 00:35 7	
守门员	合计	4/9	2/6	6/10	1/4	0/1	1/1	0/3	14/34	41.2	2							12 01:10 7	
狮队		远	近	边	快	突	任意	7m	合计	%	助攻	失误	警告	2'	D+DR	龙队	比赛 进程	狮队	
主教练: 王鸿斌		射	射	射	攻	破	球	球											
58	张继伟	0/1	3/4						3/5	60.0	1	3	1						11 00:35 7
59	魏昂			0/1					0/1	0.0	1								12 01:10 7
60	王鹏皓																		12 03:49 8 62 闫炳旗
61	庞连康																		13 04:28 8
62	闫炳旗			0/1	1/1				1/2	50.0									14 05:49 8
63	谢基伟	0/1							0/1	0.0		2							15 06:02 8
65	黎涛	0/1		1/4					1/5	20.0	1	1							15 06:41 9 71 王伟强
66	宋朋强	0/2	0/1				0/1		0/4	0.0	1	2							16 07:12 9
67	马昌震											1							16 10:37 10 58 张继伟
68	王帅																		16 11:31 11 58 张继伟
69	刘晓	1/2		1/1				3/3	5/6	83.3	2	1		1					17 12:06 11
70	于亚男	3/8	1/1			1/1			5/10	50.0	2	1							17 12:39 12 69 刘晓
71	王伟强	1/1		2/6	2/3				5/10	50.0		3							18 13:21 12
72	刘迈科																		19 16:06 12
运动员	合计	5/16	4/6	4/13	3/4	1/1	0/1	3/3	20/44	45.5	8	15	1	1					19 16:37 13 70 于亚男
68	王帅	6/9	0/2	1/1	0/3	1/4			8/19	42.1									19 18:45 14 70 于亚男
72	刘迈科	3/4	0/3	0/2	1/1	0/2		0/2	4/14	28.6		1							19 20:04 15 65 黎涛
守门员	合计	9/13	0/5	1/3	1/4	1/6		0/2	12/33	36.4		1							20 20:30 15
																			20 20:59 16 69 刘晓
																			20 22:35 17 70 于亚男
																			20 25:19 18 70 于亚男
																			21 27:03 18
																			21 27:13 19 58 张继伟
																			21 29:47 20 71 王伟强

场上队员: 得分 / 射门

守门员: 救球 / 射门

D	取消资格	DR	取消资格+报告
---	------	----	---------



2017年男子手球国家队俱乐部联赛(武汉赛区)

PHMS Pictorial Handball Match Statistics

IHF Official System

个人/全队技术统计表

手球 男子 预赛 轮次 1 组别 X 场次 1 武汉体院体育馆 2017-12-20 19:30

号码	姓名	远射	近射	边射	快攻	突破	任意	七米	合计	%	助攻	失误	警告	2'	取消	时间
中国男子手球国家队俱乐部龙队(龙队)																
(场上队员)																
32	蒋维一	0/1	1/1		1/1				2/3	66.7%	1	3		1		00:45:50
33	尹杰	2/3		0/1		1/1		1/1	4/6	66.7%		2				00:56:39
35	李双	0/1					0/1		0/2	0.0%						00:17:20
36	张家纬	0/4							0/4	0.0%		2	1			00:14:21
37	林豪文									0.0%						00:19:05
38	王巨柱	1/1							1/1	100%		2				00:18:16
39	朱世杰					1/2			1/2	50.0%				1		00:16:02
50	李明									0.0%						00:04:31
51	王军程	0/6	2/2			1/1	0/1		3/10	30.0%	3					00:37:02
52	马明辉		1/1						1/1	100%		1				00:29:33
53	傅俊雄			1/1					1/1	100%						00:14:54
55	于性哲									0.0%	2					00:55:29
56	李朝鹏	1/4	1/1			2/2		1/2	5/9	55.6%		5				00:45:09
57	董智景	0/1		1/2	2/3				3/6	50.0%						00:41:52
	合计	4/21	5/5	2/4	3/4	5/6	0/2	2/3	21/45	46.7%	6	15	1	2		
(守门员)																
50	李明	1/3			1/1			0/1	2/5	40.0%						00:04:31
55	于性哲	3/6	2/6	6/10	0/3	0/1	1/1	0/2	12/29	41.4%	2					00:55:29
	合计	4/9	2/6	6/10	1/4	0/1	1/1	0/3	14/34	41.2%	2					

场上队员：得分/射门

守门员：救球/射门

全队合计	得分	被救	射失	击柱	封球	合计	%
远射	4	9	1	1	6	21	19.0%
近射	5					5	100.0%
边射	2	1		1		4	50.0%
快攻	3	1				4	75.0%
突破	5	1				6	83.3%
任意			1	1		2	0.0%
七米	2			1		3	66.7%

2017年男子手球国家队俱乐部联赛(武汉赛区)

PHMS Pictorial Handball Match Statistics

IHF Official System

个人/全队技术统计表

 手球 男子 预赛 轮次 1 组别 X 场次 1 武汉体院体育馆
 2017-12-20 19:30

号码	姓名	远射	近射	边射	快攻	突破	任意	七米	合计	%	助攻	失误	警告	2'	取消	时间
中国男子手球国家队俱乐部狮队(狮队)																
(场上队员)																
58	张继伟	0/1	3/4						3/5	60.0%	1	3	1			00:46:33
59	魏昂			0/1					0/1	0.0%	1					00:06:12
60	王鹏皓									0.0%						00:00:00
61	庞连康									0.0%						00:06:12
62	闫炳旗			0/1	1/1				1/2	50.0%						00:08:35
63	谢基伟	0/1							0/1	0.0%		2				00:20:40
65	黎涛	0/1		1/4					1/5	20.0%	1	1				01:18:39
66	宋朋强	0/2	0/1				0/1		0/4	0.0%	1	2				00:17:56
67	马昌震									0.0%		1				00:12:41
68	王帅									0.0%						00:29:47
69	刘晓	1/2		1/1				3/3	5/6	83.3%	2	1		1		00:53:48
70	于亚男	3/8	1/1			1/1			5/10	50.0%	2	1				00:53:48
71	王伟强	1/1		2/6	2/3				5/10	50.0%		3				00:53:48
72	刘迈科									0.0%		1				00:30:13
	合计	5/16	4/6	4/13	3/4	1/1	0/1	3/3	20/44	45.5%	8	15	1	1		
(守门员)																
68	王帅	6/9	0/2	1/1	0/3	1/4			8/19	42.1%						00:29:47
72	刘迈科	3/4	0/3	0/2	1/1	0/2		0/2	4/14	28.6%		1				00:30:13
	合计	9/13	0/5	1/3	1/4	1/6		0/2	12/33	36.4%		1				

场上队员： 得分/射门

守门员： 救球/射门

全队合计	得分	被救	射失	击柱	封球	合计	%
远射	5	4	2	2	3	16	31.3%
近射	4	2				6	66.7%
边射	4	6	1	2		13	30.8%
快攻	3	1				4	75.0%
突破	1					1	100.0%
任意		1				1	0.0%
七米	3					3	100.0%

图式比赛技术统计表

手球
男子

预赛
轮次 1

组别 X
场次 1

武汉体院体育馆
2017-12-20 19:30

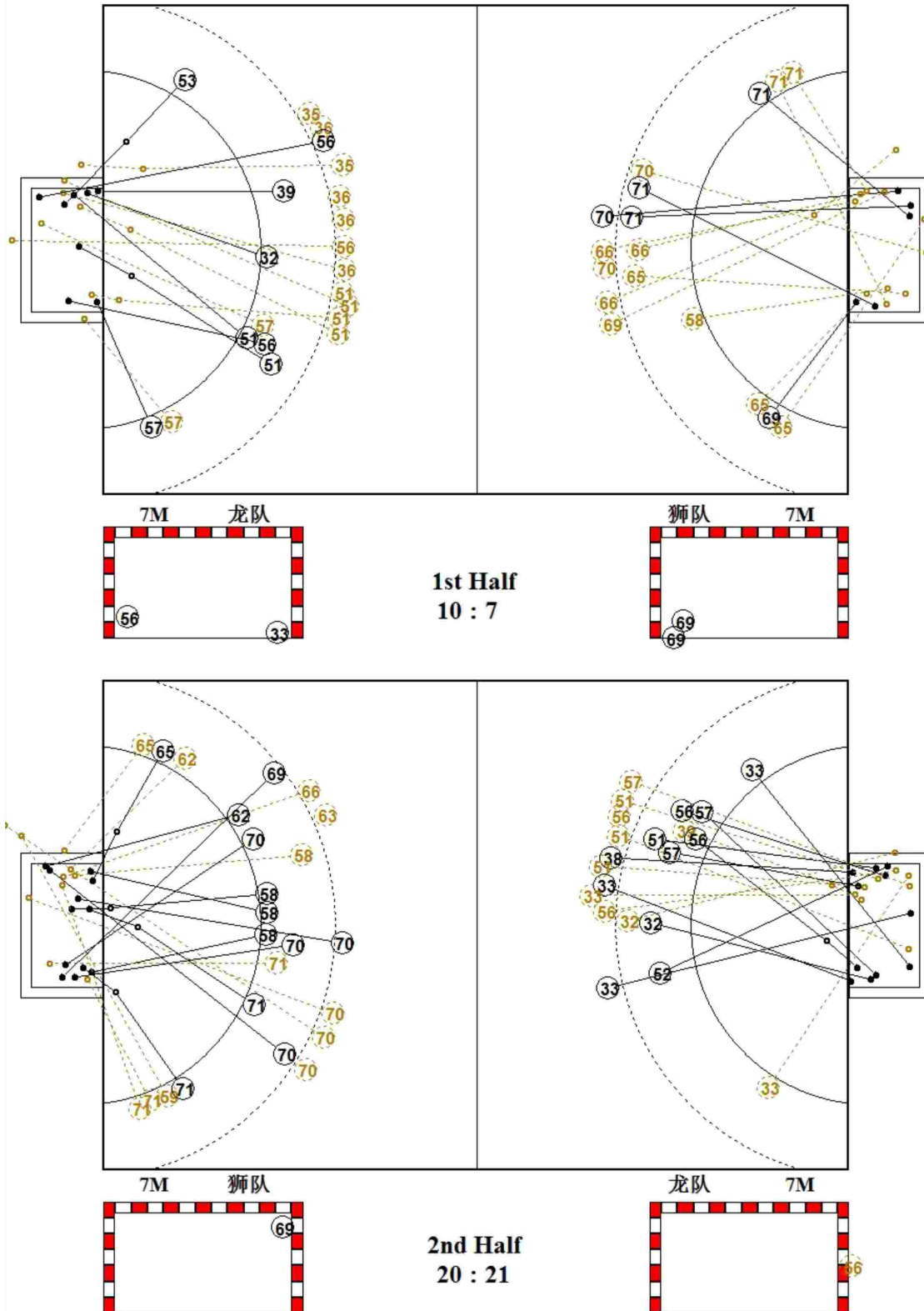

图式射门区域统计

手球
男子

预赛
轮次 1

组别 X
场次 1

武汉体院体育馆
2017-12-20 19:30

中国男子手球国家队俱乐部龙队

32 蒋维一	33 尹杰	35 李双	36 张家纬	37 林豪文	38 王巨柱	39 朱世杰	50 李明																																																																								
<table border="1"><tr><td></td><td></td><td></td></tr><tr><td></td><td></td><td>2</td></tr><tr><td></td><td></td><td></td></tr></table>						2				<table border="1"><tr><td></td><td>1</td><td>1</td></tr><tr><td></td><td></td><td>2</td></tr><tr><td></td><td></td><td></td></tr></table>		1	1			2				<table border="1"><tr><td></td><td></td><td></td></tr><tr><td></td><td></td><td></td></tr><tr><td></td><td></td><td></td></tr></table>										<table border="1"><tr><td></td><td></td><td></td></tr><tr><td></td><td></td><td></td></tr><tr><td></td><td></td><td></td></tr></table>										<table border="1"><tr><td></td><td></td><td></td></tr><tr><td></td><td></td><td></td></tr><tr><td></td><td></td><td></td></tr></table>										<table border="1"><tr><td></td><td></td><td></td></tr><tr><td>1</td><td></td><td></td></tr><tr><td></td><td></td><td></td></tr></table>				1						<table border="1"><tr><td></td><td></td><td></td></tr><tr><td></td><td></td><td>1</td></tr><tr><td></td><td></td><td></td></tr></table>						1				<table border="1"><tr><td></td><td></td><td></td></tr><tr><td></td><td></td><td></td></tr><tr><td></td><td></td><td></td></tr></table>									
		2																																																																													
	1	1																																																																													
		2																																																																													
1																																																																															
		1																																																																													

Post - 1 Miss - 0 Block - 0 Post - 0 Miss - 0 Block - 0 Post - 0 Miss - 1 Block - 1 Post - 0 Miss - 0 Block - 3 Post - 0 Miss - 0 Block - 0 Post - 0 Miss - 0 Block - 0 Post - 0 Miss - 0 Block - 0 Post - 0 Miss - 0 Block - 0

51 王军程	52 马明辉	53 傅俊雄	55 于性哲	56 李朝鹏	57 董智景																																																						
<table border="1"><tr><td>1</td><td>1</td><td>1</td></tr><tr><td></td><td></td><td></td></tr><tr><td></td><td></td><td></td></tr></table>	1	1	1							<table border="1"><tr><td>1</td><td></td><td></td></tr><tr><td></td><td></td><td></td></tr><tr><td></td><td></td><td></td></tr></table>	1									<table border="1"><tr><td></td><td></td><td></td></tr><tr><td></td><td></td><td>1</td></tr><tr><td></td><td></td><td></td></tr></table>						1				<table border="1"><tr><td></td><td></td><td></td></tr><tr><td></td><td></td><td></td></tr><tr><td></td><td></td><td></td></tr></table>										<table border="1"><tr><td></td><td></td><td>1</td></tr><tr><td>2</td><td></td><td></td></tr><tr><td>1</td><td></td><td>1</td></tr></table>			1	2			1		1	<table border="1"><tr><td></td><td></td><td></td></tr><tr><td></td><td></td><td>1</td></tr><tr><td>2</td><td></td><td></td></tr></table>						1	2		
1	1	1																																																									
1																																																											
		1																																																									
		1																																																									
2																																																											
1		1																																																									
		1																																																									
2																																																											

Post - 1 Miss - 0 Block - 1 Post - 0 Miss - 0 Block - 0 Post - 0 Miss - 0 Block - 0 Post - 0 Miss - 0 Block - 0 Post - 1 Miss - 1 Block - 1 Post - 1 Miss - 0 Block - 0

50 □□

1/1		0/2
		1/2

55 □□□

0/3		1/2
1/4	0/1	5/6
4/8	0/1	1/4

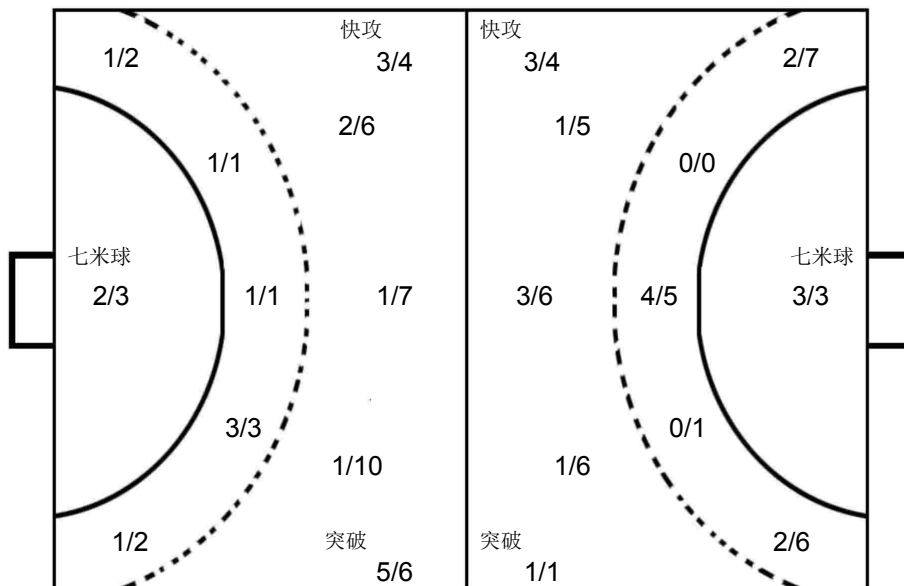

68 □□

3/3	0/1	1/2
1/4		0/1
3/5		0/3

72 □□□

		1/2
0/1	0/1	1/3
1/3		1/4

中国男子手球国家队俱乐部狮队

58 张继伟	59 魏昂	60 王鹏皓	61 庞连康	62 闫炳旗	63 谢基伟	65 黎涛	66 宋朋强																																																																								
<table border="1"><tr><td></td><td></td><td></td></tr><tr><td></td><td>1</td><td></td></tr><tr><td>1</td><td></td><td>1</td></tr></table>					1		1		1	<table border="1"><tr><td></td><td></td><td></td></tr><tr><td></td><td></td><td></td></tr><tr><td></td><td></td><td></td></tr></table>										<table border="1"><tr><td></td><td></td><td></td></tr><tr><td></td><td></td><td></td></tr><tr><td></td><td></td><td></td></tr></table>										<table border="1"><tr><td></td><td></td><td></td></tr><tr><td></td><td></td><td></td></tr><tr><td></td><td></td><td></td></tr></table>										<table border="1"><tr><td></td><td></td><td>1</td></tr><tr><td></td><td></td><td></td></tr><tr><td></td><td></td><td></td></tr></table>			1							<table border="1"><tr><td></td><td></td><td></td></tr><tr><td></td><td></td><td></td></tr><tr><td></td><td></td><td></td></tr></table>										<table border="1"><tr><td></td><td></td><td></td></tr><tr><td></td><td></td><td>1</td></tr><tr><td></td><td></td><td></td></tr></table>						1				<table border="1"><tr><td></td><td></td><td></td></tr><tr><td></td><td></td><td></td></tr><tr><td></td><td></td><td></td></tr></table>									
	1																																																																														
1		1																																																																													
		1																																																																													
		1																																																																													

Post - 0 Miss - 0 Block - 0 Post - 0 Miss - 1 Block - 0 Post - 0 Miss - 0 Block - 0 Post - 0 Miss - 0 Block - 0 Post - 0 Miss - 0 Block - 0 Post - 0 Miss - 0 Block - 1 Post - 2 Miss - 0 Block - 0 Post - 0 Miss - 1 Block - 0

67 马昌震	68 王帅	69 刘晓	70 于亚男	71 王伟强	72 刘迈科																																																						
<table border="1"><tr><td></td><td></td><td></td></tr><tr><td></td><td></td><td></td></tr><tr><td></td><td></td><td></td></tr></table>										<table border="1"><tr><td></td><td></td><td></td></tr><tr><td></td><td></td><td></td></tr><tr><td></td><td></td><td></td></tr></table>										<table border="1"><tr><td></td><td></td><td>1</td></tr><tr><td>1</td><td></td><td></td></tr><tr><td>2</td><td></td><td>1</td></tr></table>			1	1			2		1	<table border="1"><tr><td>1</td><td></td><td>1</td></tr><tr><td>2</td><td></td><td>1</td></tr><tr><td></td><td></td><td></td></tr></table>	1		1	2		1				<table border="1"><tr><td>2</td><td></td><td></td></tr><tr><td></td><td></td><td>1</td></tr><tr><td>1</td><td>1</td><td></td></tr></table>	2					1	1	1		<table border="1"><tr><td></td><td></td><td></td></tr><tr><td></td><td></td><td></td></tr><tr><td></td><td></td><td></td></tr></table>									
		1																																																									
1																																																											
2		1																																																									
1		1																																																									
2		1																																																									
2																																																											
		1																																																									
1	1																																																										

Post - 0 Miss - 0 Block - 0 Post - 0 Miss - 0 Block - 0 Post - 0 Miss - 0 Block - 0 Post - 2 Miss - 1 Block - 2 Post - 0 Miss - 0 Block - 0 Post - 0 Miss - 0 Block - 0

Team A					Team B					Match Number											
A 中国男子手球国家队俱乐部虎队					B 中国男子手球国家队俱乐部豹队					2											
Played in			in the hall			on			at			Spectators									
湖北武汉			武汉体院体育馆			2017-12-20			21:10			hours									
Half-time(30')	A	B	End of playing time		A	B	1st extra time		A	B	2nd extra time		A	B	After penalty throws						
	12	9	24	24									28	27							
Number of 7 m	A	Team time-out			Full name of players and officials						Team time-out			B	Number of 7 m						
	6/7	1	2	3							1	2	3	5/8							
		11:02	35:55						18:02	50:49											
No.	Team A					G	W	2'	D	DR	No.	Team B					G	W	2'	D	DR
17	成亚										1	王洸									
18	王晓琪										2	胡晋铭									
19	刘振					6					3	曲汝洋					5		1		
20	王毅					1					5	赵楠							1		
21	沈吉磊										6	赵晨					10				
22	魏雨童										7	解建飞						1			
23	曹悦					6	1	1			8	谢庆龙					3		1		
25	王杰缘					6					9	贺政					3				
26	徐畅										10	刘赵梁									
27	许松					6					11	胡瀛					3				
28	郭世伟					1	1				13	陈旭									
29	周傲										15	张建杰					2				
30	王权					1					16	顾艳超					1				
31	王伟					1		3			68	王帅									
A	高恒勤 (主教练)										A	郑永利 (主教练)									
C	刘捷										C	叶强									
D	叶强																				
A	Signatures of responsables for the teams (Off.A)										B										
TP	Remarks of referees / HF Official										TP										

	Signatures											
Referees	许翔 (CHN)					刘禹 (CHN)						
T.D.	吴瑞亭 (CHN)					许宜扬 (CHN)						
CHA Off.												

Note: Number of 7m Throws Awarded to Team A and B, Goals (G), Warnings (W), Suspensions (2'), Direct Disqualification (D), Disqualification With Report (DR) and Team Penalty (TP).

Table Officials: 周云磊 程钰峰 Statisticians: 沈家洛 王梓衡

2017年男子手球国家队俱乐部联赛(武汉赛区)

PHMS Pictorial Handball Match Statistics

IHF Official System

竞赛技术统计

 手球
男子

 预赛
轮次 1

 组别 X
场次 2

 武汉体院体育馆
2017-12-20 21:10

 Referees: 许翔 (CHN) / 刘禹 (CHN) Result: 28:27 (12:9)
 Teams: 中国男子手球国家队俱乐部虎队(虎队) VS 中国男子手球国家队俱乐部豹队(豹队)

虎队		远	近	边	快	突	任意	7m	合计	%	助攻	失误	警告	2'	D+DR	豹队
主教练: 高恒勤		射	射	射	攻	破	球	球								比赛 进程
17	成亚	0/2							0/2	0.0	1	1				19 刘振
18	王晓琪															1 02:53 0
19	刘振	3/5						3/3	6/8	75.0	5	3				1 03:06 1 6 赵晨
20	王毅				1/1				1/1	100						1 05:31 2 3 曲汝洋
21	沈吉磊															25 王杰缘
22	魏雨童															2 06:06 2
23	曹悦	2/8	2/3			1/1	0/1	1/1	6/14	42.9	1	2	1	1		27 许松
25	王杰缘		0/1	5/7	0/2			1/1	6/11	54.5		4				23 曹悦
26	徐畅															27 许松
27	许松		1/1	3/5	2/2			0/1	6/9	66.7	2	1				19 刘振
28	郭世伟	1/3	0/1						1/4	25.0	3	3	1			19 刘振
29	周傲															7 13:29 2
30	王权							1/1	1/1	100	1					7 14:01 3 9 贺政
31	王伟		1/3						1/3	33.3				3		27 许松
运动员	合计	6/18	4/9	8/12	3/5	1/1	0/1	6/7	28/53	52.8	13	14	2	4		27 许松
26	徐畅							0/1	0/1	0.0						12 00:50 10 9 贺政
30	王权	12/21	4/10	1/4	3/5	1/3		2/6	23/49	46.9	1					12 01:29 11 3 曲汝洋
守门员	合计	12/21	4/10	1/4	3/5	1/3		2/7	23/50	46.0	1					23 曹悦
2nd Half																
豹队		远	近	边	快	突	任意	7m	合计	%	助攻	失误	警告	2'	D+DR	
主教练: 郑永利		射	射	射	攻	破	球	球								
1	王澍										1					12 02:50 10 9 贺政
2	胡晋铭															12 01:29 11 3 曲汝洋
3	曲汝洋	1/2	0/1	0/1	1/1	1/1		2/3	5/9	55.6	1			1		13 03:07 11
5	赵楠	0/4	0/1						0/5	0.0	1	2		1		25 王杰缘
6	赵晨	5/14	3/3			1/1		1/1	10/19	52.6	7	1				14 04:24 11
7	解建飞	0/1			0/1			0/1	0/3	0.0			1			14 04:52 12 6 赵晨
8	谢庆龙		2/4		1/1			3/5	60.0							15 05:20 12
9	贺政		0/1	2/2	0/1			1/2	3/6	50.0		2				15 05:28 13 11 胡瀛
10	刘赵梁	0/1							0/1	0.0		1				15 08:36 14 8 谢庆龙
11	胡瀛	2/2	1/2			0/1		3/5	60.0							16 09:05 14
13	陈旭															16 09:44 15 15 张建杰
15	张建杰			1/1				1/1	2/2	100		1				17 10:29 15
16	顾艳超	1/4	0/1		0/1	0/1		1/7	14.3		1					17 11:08 16 6 赵晨
68	王帅															17 12:25 17 6 赵晨
运动员	合计	9/28	6/13	3/4	2/5	2/4		5/8	27/62	43.5	11	7	1	3		18 14:05 17
1	王澍	5/11	2/6	1/9	1/4	0/1	1/1	0/6	10/38	26.3	1					18 14:14 18 6 赵晨
68	王帅			1/1				1/1	2/2	100						19 14:53 18
守门员	合计	5/11	2/6	2/10	1/4	0/1	1/1	1/7	12/40	30.0	1					19 17:44 19 3 曲汝洋
7M																
19	刘振															20 18:23 19
23	曹悦															20 19:16 20 6 赵晨
25	王杰缘															21 19:28 20
30	王权															21 21:11 21 6 赵晨
7M																
19	刘振															21 22:02 22 6 赵晨
23	曹悦															22 22:42 22
25	王杰缘															23 曹悦
30	王权															23 曹悦
7M																
19	刘振															23 24:40 22
23	曹悦															23 25:34 23 3 曲汝洋
25	王杰缘															24 26:00 23
30	王权															24 27:15 24 6 赵晨

场上队员: 得分 / 射门

守门员: 救球 / 射门

D	取消资格	DR	取消资格+报告
---	------	----	---------



2017年男子手球国家队俱乐部联赛(武汉赛区)

PHMS Pictorial Handball Match Statistics

IHF Official System

个人/全队技术统计表

手球 男子 预赛 轮次 1 组别 X 场次 2 武汉体院体育馆 2017-12-20 21:10

号码	姓名	远射	近射	边射	快攻	突破	任意	七米	合计	%	助攻	失误	警告	2'	取消	时间
中国男子手球国家队俱乐部虎队(虎队)																
(场上队员)																
17	成亚	0/2							0/2	0.0%	1	1				00:13:58
18	王晓琪									0.0%						00:00:00
19	刘振	3/5						3/3	6/8	75.0%	5	3				01:00:00
20	王毅				1/1				1/1	100%						00:15:26
21	沈吉磊									0.0%						00:02:16
22	魏雨童									0.0%						00:14:20
23	曹悦	2/8	2/3			1/1	0/1	1/1	6/14	42.9%	1	2	1	1		00:57:29
25	王杰缘		0/1	5/7	0/2			1/1	6/11	54.5%		4				01:00:00
26	徐畅									0.0%						00:00:03
27	许松		1/1	3/5	2/2			0/1	6/9	66.7%	2	1				01:00:00
28	郭世伟	1/3	0/1						1/4	25.0%	3	3	1			00:41:13
29	周傲									0.0%						00:00:00
30	王权							1/1	1/1	100%	1					00:59:57
31	王伟		1/3						1/3	33.3%				3		00:34:36
	合计	6/18	4/9	8/12	3/5	1/1	0/1	6/7	28/53	52.8%	13	14	2	4		
(守门员)																
26	徐畅							0/1	0/1	0.0%						00:00:03
30	王权	12/21	4/10	1/4	3/5	1/3		2/6	23/49	46.9%	1					00:59:57
	合计	12/21	4/10	1/4	3/5	1/3		2/7	23/50	46.0%	1					

场上队员： 得分/射门

守门员： 救球/射门

全队合计	得分	被救	射失	击柱	封球	合计	%
远射	6	5	2	4	1	18	33.3%
近射	4	2	3			9	44.4%
边射	8	2	1	1		12	66.7%
快攻	3	1			1	5	60.0%
突破	1					1	100.0%
任意		1				1	0.0%
七米	6	1				7	85.7%

2017年男子手球国家队俱乐部联赛(武汉赛区)

PHMS Pictorial Handball Match Statistics

IHF Official System

个人/全队技术统计表

手球 男子 预赛 轮次 1 组别 X 场次 2 武汉体院体育馆 2017-12-20 21:10

号码	姓名	远射	近射	边射	快攻	突破	任意	七米	合计	%	助攻	失误	警告	2'	取消	时间
中国男子手球国家队俱乐部豹队(豹队)																
(场上队员)																
1	王澆									0.0%	1					00:56:10
2	胡晋铭									0.0%						00:00:04
3	曲汝洋	1/2	0/1	0/1	1/1	1/1		2/3	5/9	55.6%	1			1		00:43:10
5	赵楠	0/4	0/1						0/5	0.0%	1	2		1		00:37:16
6	赵晨	5/14	3/3			1/1		1/1	10/19	52.6%	7	1				00:50:55
7	解建飞	0/1			0/1			0/1	0/3	0.0%			1			00:19:30
8	谢庆龙		2/4		1/1				3/5	60.0%				1		00:54:51
9	贺政		0/1	2/2	0/1			1/2	3/6	50.0%		2				00:51:16
10	刘赵梁	0/1							0/1	0.0%		1				00:09:09
11	胡瀛	2/2	1/2			0/1			3/5	60.0%						00:22:21
13	陈旭									0.0%						00:02:06
15	张建杰			1/1				1/1	2/2	100%		1				00:24:01
16	顾艳超	1/4	0/1		0/1	0/1			1/7	14.3%	1					00:43:52
68	王帅									0.0%						00:03:50
	合计	9/28	6/13	3/4	2/5	2/4		5/8	27/62	43.5%	11	7	1	3		
(守门员)																
1	王澆	5/11	2/6	1/9	1/4	0/1	1/1	0/6	10/38	26.3%	1					00:56:10
68	王帅			1/1				1/1	2/2	100%						00:03:50
	合计	5/11	2/6	2/10	1/4	0/1	1/1	1/7	12/40	30.0%	1					

场上队员：得分/射门

守门员：救球/射门

全队合计	得分	被救	射失	击柱	封球	合计	%
远射	9	12	3		4	28	32.1%
近射	6	4	1	2		13	46.2%
边射	3	1				4	75.0%
快攻	2	3				5	40.0%
突破	2	1	1			4	50.0%
任意							0.0%
七米	5	2	1			8	62.5%



图式比赛技术统计表

手球
男子

预赛
轮次 1

组别 X
场次 2

武汉体院体育馆
2017-12-20 21:10

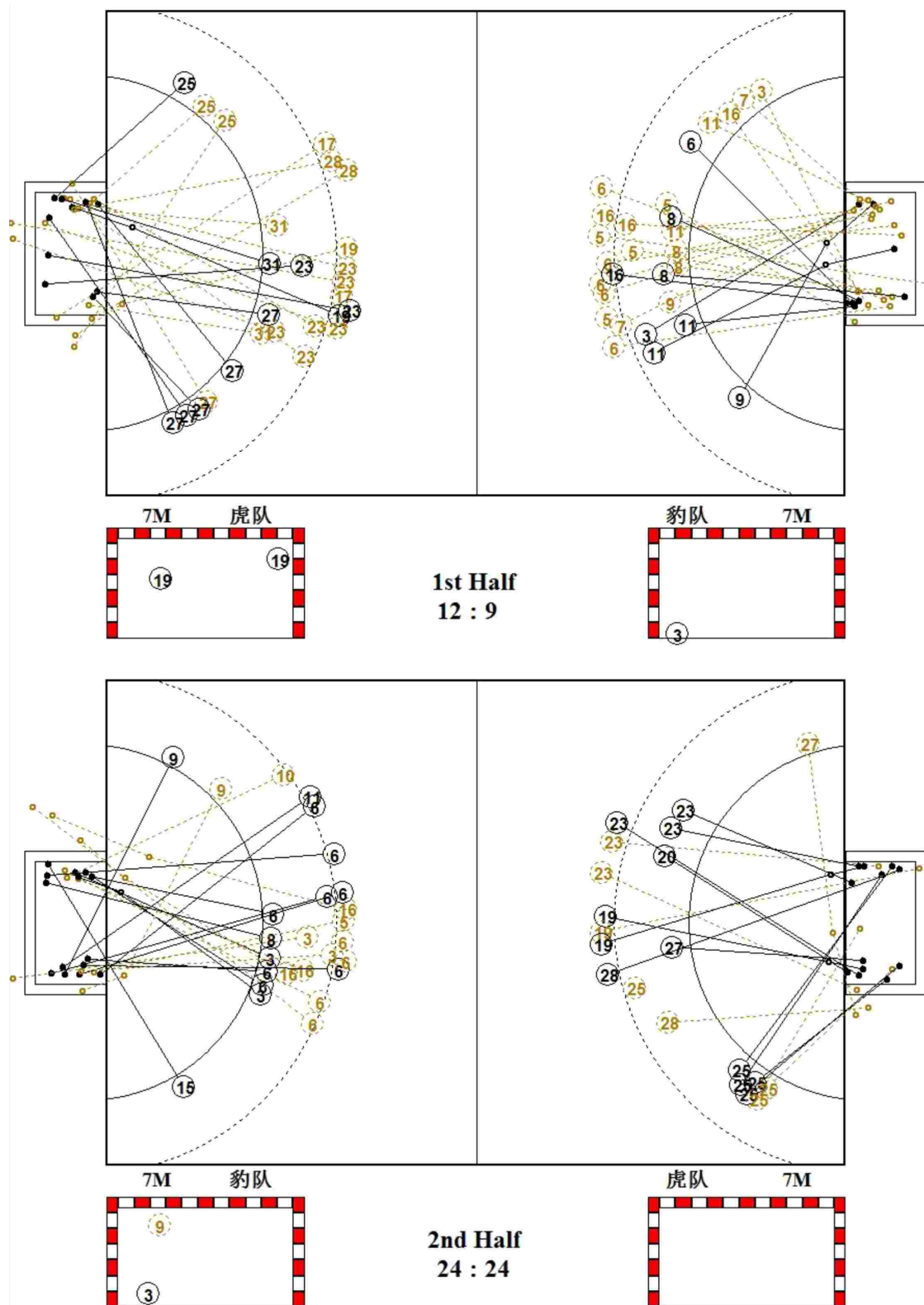

PICTORIAL MATCH STATISTICS

HANDBALL
男子

预赛
ROUND 1

GROUP X
MATCH 2

武汉体院体育馆
2017-12-20 21:10

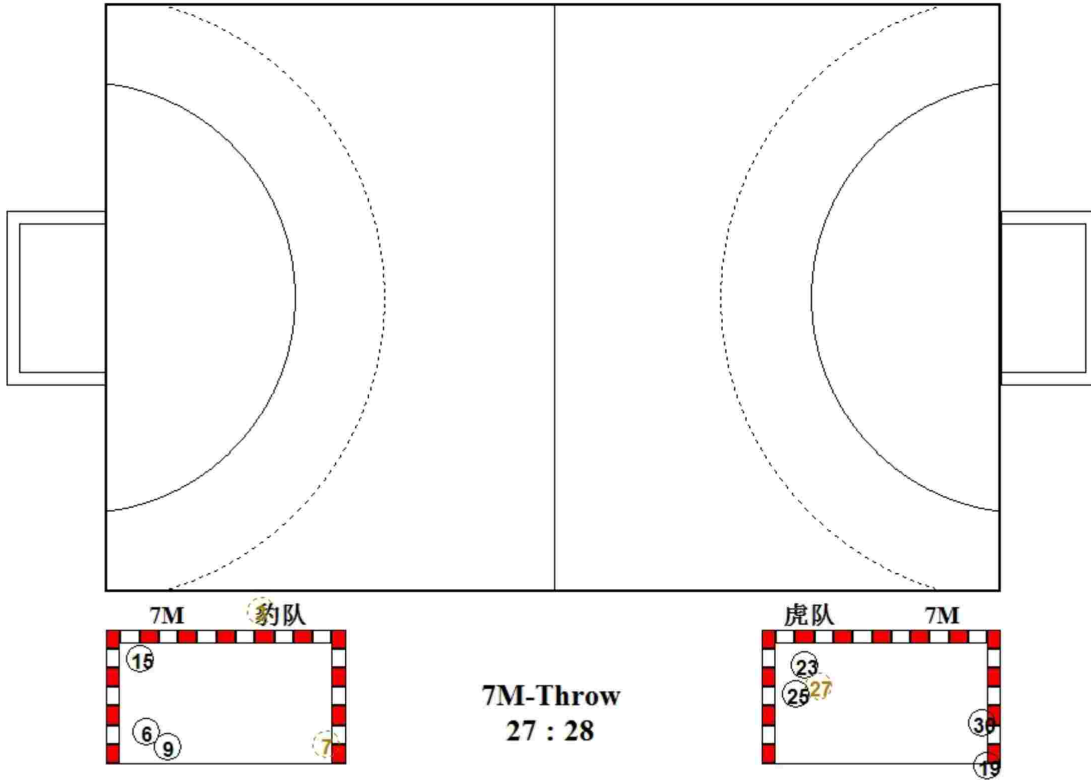

图式射门区域统计

手球
男子

预赛
轮次 1

组别 X
场次 2

武汉体院体育馆
2017-12-20 21:10

中国男子手球国家队俱乐部虎队

17 成亚 <table border="1"><tr><td></td><td></td><td></td></tr><tr><td></td><td></td><td></td></tr><tr><td></td><td></td><td></td></tr></table> Post - 1 Miss - 0 Block - 1										18 王晓琪 <table border="1"><tr><td></td><td></td><td></td></tr><tr><td></td><td></td><td></td></tr><tr><td></td><td></td><td></td></tr></table> Post - 0 Miss - 0 Block - 0										19 刘振 <table border="1"><tr><td></td><td></td><td>1</td></tr><tr><td>1</td><td></td><td>1</td></tr><tr><td>1</td><td></td><td>2</td></tr></table> Post - 1 Miss - 1 Block - 0			1	1		1	1		2	20 王毅 <table border="1"><tr><td></td><td></td><td></td></tr><tr><td></td><td></td><td></td></tr><tr><td></td><td></td><td>1</td></tr></table> Post - 0 Miss - 0 Block - 0									1	21 沈吉磊 <table border="1"><tr><td></td><td></td><td></td></tr><tr><td></td><td></td><td></td></tr><tr><td></td><td></td><td></td></tr></table> Post - 0 Miss - 0 Block - 0										22 魏雨童 <table border="1"><tr><td></td><td></td><td></td></tr><tr><td></td><td></td><td></td></tr><tr><td></td><td></td><td></td></tr></table> Post - 0 Miss - 0 Block - 0										23 曹悦 <table border="1"><tr><td>2</td><td>1</td><td></td></tr><tr><td></td><td></td><td></td></tr><tr><td>2</td><td></td><td>1</td></tr></table> Post - 1 Miss - 2 Block - 0	2	1					2		1	25 王杰缘 <table border="1"><tr><td>1</td><td></td><td>2</td></tr><tr><td>2</td><td></td><td>1</td></tr><tr><td></td><td></td><td></td></tr></table> Post - 0 Miss - 1 Block - 1	1		2	2		1			
		1																																																																													
1		1																																																																													
1		2																																																																													
		1																																																																													
2	1																																																																														
2		1																																																																													
1		2																																																																													
2		1																																																																													
26 徐畅 <table border="1"><tr><td></td><td></td><td></td></tr><tr><td></td><td></td><td></td></tr><tr><td></td><td></td><td></td></tr></table> Post - 0 Miss - 0 Block - 0										27 许松 <table border="1"><tr><td></td><td></td><td>1</td></tr><tr><td></td><td></td><td></td></tr><tr><td>2</td><td></td><td>3</td></tr></table> Post - 1 Miss - 1 Block - 0			1				2		3	28 郭世伟 <table border="1"><tr><td>1</td><td></td><td></td></tr><tr><td></td><td></td><td></td></tr><tr><td></td><td></td><td></td></tr></table> Post - 1 Miss - 1 Block - 0	1									29 周傲 <table border="1"><tr><td></td><td></td><td></td></tr><tr><td></td><td></td><td></td></tr><tr><td></td><td></td><td></td></tr></table> Post - 0 Miss - 0 Block - 0										30 王权 <table border="1"><tr><td></td><td></td><td></td></tr><tr><td></td><td></td><td>1</td></tr><tr><td></td><td></td><td></td></tr></table> Post - 0 Miss - 0 Block - 0						1				31 王伟 <table border="1"><tr><td></td><td></td><td></td></tr><tr><td></td><td></td><td>1</td></tr><tr><td></td><td></td><td></td></tr></table> Post - 0 Miss - 0 Block - 0						1																							
		1																																																																													
2		3																																																																													
1																																																																															
		1																																																																													
		1																																																																													

26 □□

0/1		

30 □□

3/5	1/2	1/5
6/10		7/9
3/10		2/8

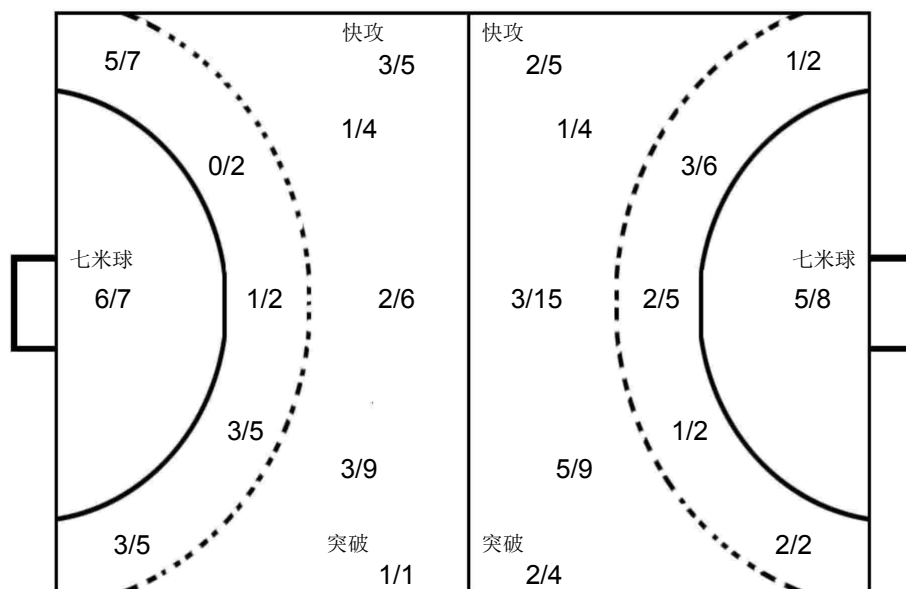

1 □□

0/4	0/1	2/6
1/4		4/8
1/6		2/9

68 □□

1/1		
	1/1	

中国男子手球国家队俱乐部豹队

1 王澍 <table border="1"><tr><td></td><td></td><td></td></tr><tr><td></td><td></td><td></td></tr><tr><td></td><td></td><td></td></tr></table> Post - 0 Miss - 0 Block - 0										2 胡晋铭 <table border="1"><tr><td></td><td></td><td></td></tr><tr><td></td><td></td><td></td></tr><tr><td></td><td></td><td></td></tr></table> Post - 0 Miss - 0 Block - 0										3 曲汝洋 <table border="1"><tr><td></td><td></td><td></td></tr><tr><td></td><td></td><td>2</td></tr><tr><td>3</td><td></td><td></td></tr></table> Post - 0 Miss - 2 Block - 0						2	3			5 赵楠 <table border="1"><tr><td></td><td></td><td></td></tr><tr><td></td><td></td><td></td></tr><tr><td></td><td></td><td></td></tr></table> Post - 1 Miss - 1 Block - 1										6 赵晨 <table border="1"><tr><td>1</td><td></td><td>1</td></tr><tr><td>1</td><td></td><td></td></tr><tr><td>4</td><td></td><td>3</td></tr></table> Post - 0 Miss - 1 Block - 2	1		1	1			4		3	7 解建飞 <table border="1"><tr><td></td><td></td><td></td></tr><tr><td></td><td></td><td></td></tr><tr><td></td><td></td><td></td></tr></table> Post - 0 Miss - 0 Block - 0										8 谢庆龙 <table border="1"><tr><td></td><td></td><td>2</td></tr><tr><td></td><td></td><td></td></tr><tr><td></td><td></td><td>1</td></tr></table> Post - 0 Miss - 0 Block - 0			2						1	9 贺政 <table border="1"><tr><td></td><td></td><td></td></tr><tr><td>2</td><td></td><td></td></tr><tr><td>1</td><td></td><td></td></tr></table> Post - 1 Miss - 0 Block - 0				2			1		
		2																																																																													
3																																																																															
1		1																																																																													
1																																																																															
4		3																																																																													
		2																																																																													
		1																																																																													
2																																																																															
1																																																																															
10 刘赵梁 <table border="1"><tr><td></td><td></td><td></td></tr><tr><td></td><td></td><td></td></tr><tr><td></td><td></td><td></td></tr></table> Post - 0 Miss - 0 Block - 0										11 胡瀛 <table border="1"><tr><td></td><td>1</td><td></td></tr><tr><td>1</td><td></td><td></td></tr><tr><td></td><td></td><td>1</td></tr></table> Post - 0 Miss - 0 Block - 0		1		1					1	13 陈旭 <table border="1"><tr><td></td><td></td><td></td></tr><tr><td></td><td></td><td></td></tr><tr><td></td><td></td><td></td></tr></table> Post - 0 Miss - 0 Block - 0										15 张建杰 <table border="1"><tr><td>1</td><td></td><td>1</td></tr><tr><td></td><td></td><td></td></tr><tr><td></td><td></td><td></td></tr></table> Post - 0 Miss - 0 Block - 0	1		1							16 顾艳超 <table border="1"><tr><td></td><td></td><td></td></tr><tr><td></td><td></td><td></td></tr><tr><td></td><td></td><td>1</td></tr></table> Post - 0 Miss - 2 Block - 1									1	68 王帅 <table border="1"><tr><td></td><td></td><td></td></tr><tr><td></td><td></td><td></td></tr><tr><td></td><td></td><td></td></tr></table> Post - 0 Miss - 0 Block - 0																													
	1																																																																														
1																																																																															
		1																																																																													
1		1																																																																													
		1																																																																													

Team A					Team B					Match Number											
A 中国男子手球国家队俱乐部狮队					B 中国男子手球国家队俱乐部虎队					3											
Played in		in the hall			on		at		Spectators												
湖北武汉		武汉体院体育馆			2017-12-21		14:30		hours												
Half-time(30')	A	B	End of playing time	A	B	1st extra time	A	B	2nd extra time	A	B	After penalty throws	A	B							
	16	13	26 30																		
Number of 7 m	A	Team time-out			Full name of players and officials					Team time-out			B	Number of 7 m							
	4/4	1	2	3						1	2	3	5/8								
			46:07				10:00	48:10													
No.	Team A					G	W	2'	D	DR	No.	Team B					G	W	2'	D	DR
58	张继伟					2	1				17	成亚					4	1			
59	魏昂										18	王晓琪									
60	王鹏皓										19	刘振					7				
61	庞连康										20	王毅					3				
62	闫炳旗							1			21	沈吉磊									
63	谢基伟										22	魏雨童									
65	黎涛					1					23	曹悦					8				
66	宋朋强					6	1				25	王杰缘									
67	马昌震										26	徐畅									
68	王帅										27	许松					3				
69	刘晓					4	1	1			28	郭世伟					2				
70	于亚男					7					29	周傲									
71	王伟强					6					30	王权									
72	刘迈科										31	王伟					3	1			
A	王鸿斌 (主教练)										A	高恒勤 (主教练)									
C	杜长义										C	刘捷									
											D	叶强									
											E	陈璇									
A	Signatures of responsables for the teams (Off.A)														B						
TP	Remarks of referees / HF Official														TP						

Signatures

Referees	刘禹 (CHN)	许翔 (CHN)		
T.D.	吴瑞亭 (CHN)	许宜扬 (CHN)		
CHA Off.				

Note: Number of 7m Throws Awarded to Team A and B, Goals (G), Warnings (W), Suspensions (2'), Direct Disqualification (D), Disqualification With Report (DR) and Team Penalty (TP).

Table Officials: 程钰峰

周云磊

Statisticians: 沈家洛

王梓衡

2017年男子手球国家队俱乐部联赛(武汉赛区)

PHMS Pictorial Handball Match Statistics

IHF Official System

竞赛技术统计

 手球
男子

 预赛
轮次 2

 组别 X
场次 3

 武汉体院体育馆
2017-12-21 14:30

Referees: 刘禹 (CHN) / 许翔 (CHN)

Result: 26:30(16:13)

Teams: 中国男子手球国家队俱乐部狮队(狮队) VS 中国男子手球国家队俱乐部虎队(虎队)

狮队		远	近	边	快	突	任意	7m	合计	%	助攻	失误	警告	2'	D+DR	狮队	比赛 进程	虎队
主教练: 王鸿斌		射	射	射	攻	破	球	球										
58	张继伟		1/2		1/1				2/3	66.7		2	1				00:33	1 27 许松
59	魏昂																01:11	1
60	王鹏皓																02:37	1
61	庞连康																03:50	1
62	闫炳旗				0/1				0/1	0.0		1		1			06:48	2 17 成亚
63	谢基伟																07:30	2
65	黎涛				1/1				1/1	100		1					10:25	3 23 曹悦
66	宋朋强	1/2	1/1			4/4			6/7	85.7	2	5	1				11:06	4 17 成亚
67	马昌震					0/1			0/1	0.0							11:26	5 19 刘振
68	王帅																13:58	5
69	刘晓	0/9	0/1					4/4	4/14	28.6	2	1	1	1			16:25	5
70	于亚男	6/7	0/2			1/2			7/11	63.6		4					17:34	6 27 许松
71	王伟强	1/2	1/2	2/3	2/2				6/9	66.7							18:27	6
72	刘迈科																21:09	6
运动员	合计	8/20	3/8	2/3	4/5	5/7		4/4	26/47	55.3	4	14	3	2			21:48	6
68	王帅							0/1	0/1	0.0							22:28	7 23 曹悦
72	刘迈科	2/7	7/15	0/2	2/7	2/7		2/6	15/44	34.1							22:48	8 20 王毅
守门员	合计	2/7	7/15	0/2	2/7	2/7		2/7	15/45	33.3							24:23	9 20 王毅
虎队		远	近	边	快	突	任意	7m	合计	%	助攻	失误	警告	2'	D+DR			
主教练: 高恒勤		射	射	射	攻	破	球	球										
17	成亚	2/2	1/1		1/1	0/1			4/5	80.0	4	3	1				01:25	14 19 刘振
18	王晓琪																03:16	15 27 许松
19	刘振	3/3	0/2					4/5	7/10	70.0	5	3					04:49	16 23 曹悦
20	王毅		2/2	1/2				0/1	3/5	60.0							05:24	16
21	沈吉磊																08:48	16
22	魏雨童																10:19	17 23 曹悦
23	曹悦	0/3	2/3			5/5		1/2	8/13	61.5	2						11:59	18 19 刘振
25	王杰缘																12:44	18
26	徐畅																14:25	18
27	许松		0/1	1/1	2/4				3/6	50.0		1					14:55	19 31 王伟
28	郭世伟	0/1	1/2		1/1	0/1	0/1		2/6	33.3		2					15:45	20 17 成亚
29	周傲										1						17:15	20
30	王权																17:48	20
31	王伟		2/5		1/1				3/6	50.0		1	1				18:28	21 28 郭世伟
运动员	合计	5/9	8/16	2/3	5/7	5/7	0/1	5/8	30/51	58.8	12	10	2				18:43	21
26	徐畅	1/1			0/1			0/2	1/4	25.0							18:50	22 17 成亚
30	王权	6/14	5/8	1/3	1/4	2/7		0/2	15/38	39.5							20:09	22
守门员	合计	7/15	5/8	1/3	1/5	2/7		0/4	16/42	38.1							21:38	23 23 曹悦
																	22:17	23
																	22:41	24 19 刘振
																	23:16	24
																	24:25	25 19 刘振
																	25:13	26 20 王毅
																	25:53	27 28 郭世伟
																	27:25	28 19 刘振
																	28:56	29 23 曹悦
																	29:48	30 31 王伟

场上队员: 得分 / 射门

守门员: 救球 / 射门

D	取消资格	DR	取消资格+报告
---	------	----	---------



2017年男子手球国家队俱乐部联赛(武汉赛区)

PHMS Pictorial Handball Match Statistics

IHF Official System

个人/全队技术统计表

 手球 男子 预赛 轮次 2 组别 X 场次 3 武汉体院体育馆
 2017-12-21 14:30

号码	姓名	远射	近射	边射	快攻	突破	任意	七米	合计	%	助攻	失误	警告	2'	取消	时间
中国男子手球国家队俱乐部狮队(狮队)																
(场上队员)																
58	张继伟		1/2		1/1				2/3	66.7%		2	1			00:51:00
59	魏昂									0.0%						00:00:00
60	王鹏皓									0.0%						00:00:00
61	庞连康									0.0%						00:00:00
62	闫炳旗					0/1			0/1	0.0%		1		1		00:42:22
63	谢基伟									0.0%						00:00:50
65	黎涛				1/1				1/1	100%		1				00:17:35
66	宋朋强	1/2	1/1			4/4			6/7	85.7%	2	5	1			00:59:08
67	马昌震					0/1			0/1	0.0%						00:07:10
68	王帅									0.0%						00:00:13
69	刘晓	0/9	0/1					4/4	4/14	28.6%	2	1	1	1		01:00:00
70	于亚男	6/7	0/2			1/2			7/11	63.6%		4				01:00:00
71	王伟强	1/2	1/2	2/3	2/2				6/9	66.7%						01:00:00
72	刘迈科									0.0%						00:59:47
	合计	8/20	3/8	2/3	4/5	5/7		4/4	26/47	55.3%	4	14	3	2		
(守门员)																
68	王帅							0/1	0/1	0.0%						00:00:13
72	刘迈科	2/7	7/15	0/2	2/7	2/7		2/6	15/44	34.1%						00:59:47
	合计	2/7	7/15	0/2	2/7	2/7		2/7	15/45	33.3%						

场上队员： 得分/射门

守门员： 救球/射门

全队合计	得分	被救	射失	击柱	封球	合计	%
远射	8	7	3		2	20	40.0%
近射	3	5				8	37.5%
边射	2	1				3	66.7%
快攻	4	1				5	80.0%
突破	5	2				7	71.4%
任意							0.0%
七米	4					4	100.0%

2017年男子手球国家队俱乐部联赛(武汉赛区)

PHMS Pictorial Handball Match Statistics

IHF Official System

个人/全队技术统计表

手球 男子 预赛 轮次 2 组别 X 场次 3 武汉体院体育馆 2017-12-21 14:30

号码	姓名	远射	近射	边射	快攻	突破	任意	七米	合计	%	助攻	失误	警告	2'	取消	时间
中国男子手球国家队俱乐部虎队(虎队)																
(场上队员)																
17	成亚	2/2	1/1		1/1	0/1			4/5	80.0%	4	3	1			01:00:00
18	王晓琪									0.0%						00:00:00
19	刘振	3/3	0/2					4/5	7/10	70.0%	5	3				00:53:20
20	王毅		2/2	1/2				0/1	3/5	60.0%						00:30:40
21	沈吉磊									0.0%						00:00:00
22	魏雨童									0.0%						00:00:00
23	曹悦	0/3	2/3			5/5		1/2	8/13	61.5%	2					00:52:40
25	王杰缘									0.0%						00:00:00
26	徐畅									0.0%						00:01:48
27	许松		0/1	1/1	2/4				3/6	50.0%		1				01:00:00
28	郭世伟	0/1	1/2		1/1	0/1	0/1		2/6	33.3%		2				00:37:37
29	周傲									0.0%	1					00:05:02
30	王权									0.0%						00:58:12
31	王伟		2/5		1/1				3/6	50.0%		1	1			01:00:00
	合计	5/9	8/16	2/3	5/7	5/7	0/1	5/8	30/51	58.8%	12	10	2			
(守门员)																
26	徐畅	1/1			0/1			0/2	1/4	25.0%						00:01:48
30	王权	6/14	5/8	1/3	1/4	2/7		0/2	15/38	39.5%						00:58:12
	合计	7/15	5/8	1/3	1/5	2/7		0/4	16/42	38.1%						

场上队员： 得分/射门

守门员： 救球/射门

全队合计	得分	被救	射失	击柱	封球	合计	%
远射	5	2	2			9	55.6%
近射	8	7		1		16	50.0%
边射	2			1		3	66.7%
快攻	5	2				7	71.4%
突破	5	2				7	71.4%
任意			1			1	0.0%
七米	5	2	1			8	62.5%

图式比赛技术统计表

手球
男子

预赛
轮次 2

组别 X
场次 3

武汉体院体育馆
2017-12-21 14:30

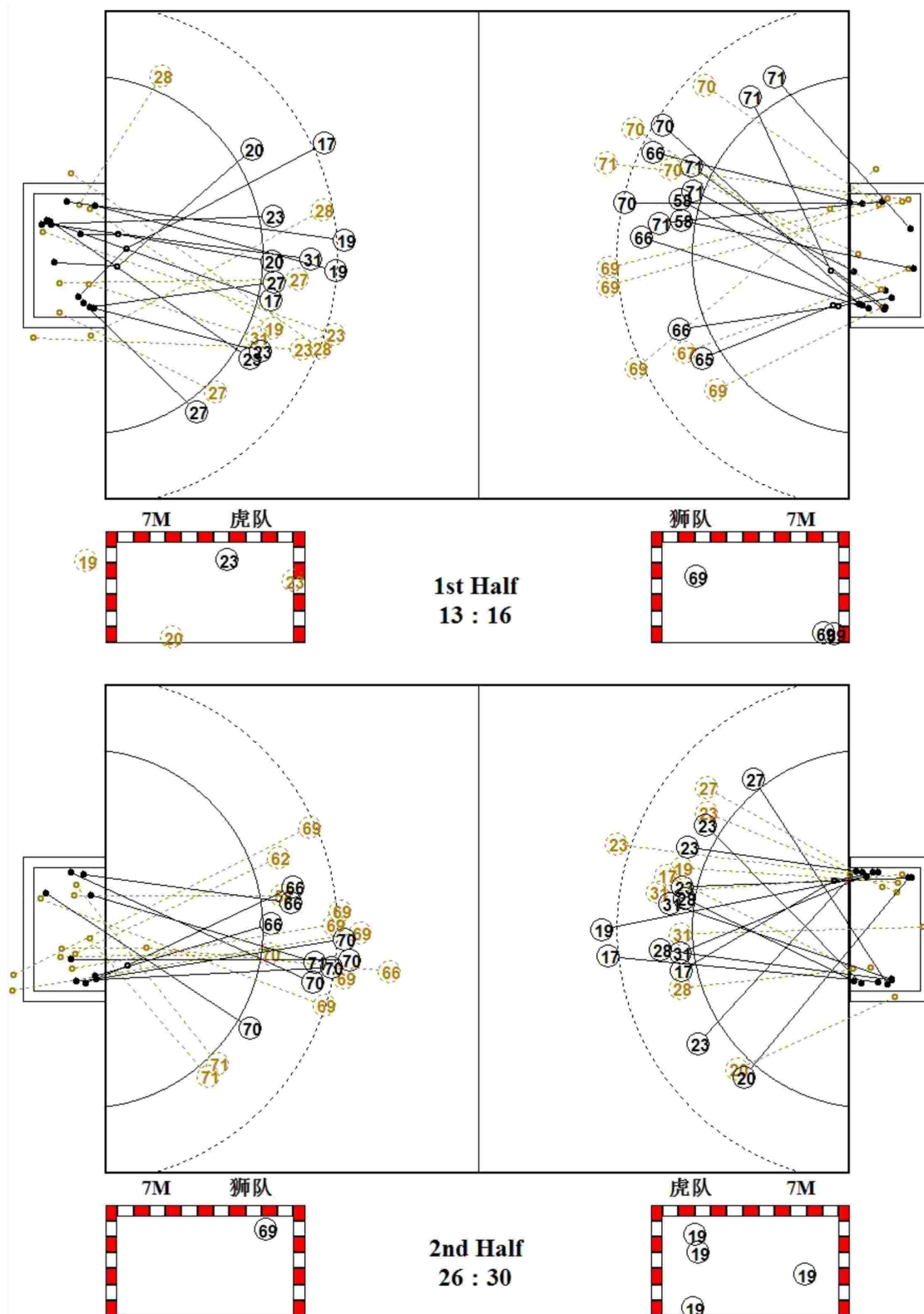

图式射门区域统计

手球
男子

预赛
轮次 2

组别 X
场次 3

武汉体院体育馆
2017-12-21 14:30

中国男子手球国家队俱乐部狮队

58 张继伟	59 魏昂	60 王鹏皓	61 虎连康	62 闫炳旗	63 谢基伟	65 黎涛	66 宋朋强																																																																								
<table border="1"><tr><td></td><td>1</td><td></td></tr><tr><td></td><td></td><td></td></tr><tr><td></td><td></td><td>1</td></tr></table>		1							1	<table border="1"><tr><td></td><td></td><td></td></tr><tr><td></td><td></td><td></td></tr><tr><td></td><td></td><td></td></tr></table>										<table border="1"><tr><td></td><td></td><td></td></tr><tr><td></td><td></td><td></td></tr><tr><td></td><td></td><td></td></tr></table>										<table border="1"><tr><td></td><td></td><td></td></tr><tr><td></td><td></td><td></td></tr><tr><td></td><td></td><td></td></tr></table>										<table border="1"><tr><td></td><td></td><td></td></tr><tr><td></td><td></td><td></td></tr><tr><td></td><td></td><td></td></tr></table>										<table border="1"><tr><td></td><td></td><td></td></tr><tr><td></td><td></td><td></td></tr><tr><td></td><td></td><td>1</td></tr></table>									1	<table border="1"><tr><td></td><td></td><td></td></tr><tr><td></td><td></td><td></td></tr><tr><td>3</td><td></td><td>2</td></tr></table>							3		2	<table border="1"><tr><td></td><td></td><td></td></tr><tr><td></td><td></td><td></td></tr><tr><td></td><td></td><td>1</td></tr></table>									1
	1																																																																														
		1																																																																													
		1																																																																													
3		2																																																																													
		1																																																																													
Post - 0 Miss - 0 Block - 0	Post - 0 Miss - 0 Block - 0	Post - 0 Miss - 0 Block - 0	Post - 0 Miss - 0 Block - 0	Post - 0 Miss - 0 Block - 0	Post - 0 Miss - 0 Block - 0	Post - 0 Miss - 0 Block - 0	Post - 0 Miss - 0 Block - 0																																																																								
67 马昌震	68 王帅	69 刘晓	70 于亚男	71 王伟强	72 刘迈科																																																																										
<table border="1"><tr><td></td><td></td><td></td></tr><tr><td></td><td></td><td></td></tr><tr><td></td><td></td><td></td></tr></table>										<table border="1"><tr><td></td><td></td><td></td></tr><tr><td></td><td></td><td></td></tr><tr><td></td><td></td><td></td></tr></table>										<table border="1"><tr><td>1</td><td></td><td>1</td></tr><tr><td></td><td></td><td></td></tr><tr><td></td><td></td><td>2</td></tr></table>	1		1						2	<table border="1"><tr><td></td><td></td><td>1</td></tr><tr><td>2</td><td></td><td>1</td></tr><tr><td>2</td><td></td><td>1</td></tr></table>			1	2		1	2		1	<table border="1"><tr><td>1</td><td></td><td></td></tr><tr><td>1</td><td></td><td>2</td></tr><tr><td></td><td>1</td><td>1</td></tr></table>	1			1		2		1	1	<table border="1"><tr><td></td><td></td><td></td></tr><tr><td></td><td></td><td></td></tr><tr><td></td><td></td><td></td></tr></table>																													
1		1																																																																													
		2																																																																													
		1																																																																													
2		1																																																																													
2		1																																																																													
1																																																																															
1		2																																																																													
	1	1																																																																													
Post - 0 Miss - 0 Block - 0	Post - 0 Miss - 0 Block - 0	Post - 0 Miss - 3 Block - 2	Post - 0 Miss - 0 Block - 0	Post - 0 Miss - 0 Block - 0	Post - 0 Miss - 0 Block - 0																																																																										

68 □□									
<table border="1"><tr><td>0/1</td><td></td><td></td></tr><tr><td></td><td></td><td></td></tr><tr><td></td><td></td><td></td></tr></table>	0/1								
0/1									

72 □□□									
<table border="1"><tr><td>3/6</td><td>0/2</td><td>2/6</td></tr><tr><td>3/6</td><td>0/1</td><td>1/7</td></tr><tr><td>3/10</td><td></td><td>3/6</td></tr></table>	3/6	0/2	2/6	3/6	0/1	1/7	3/10		3/6
3/6	0/2	2/6							
3/6	0/1	1/7							
3/10		3/6							

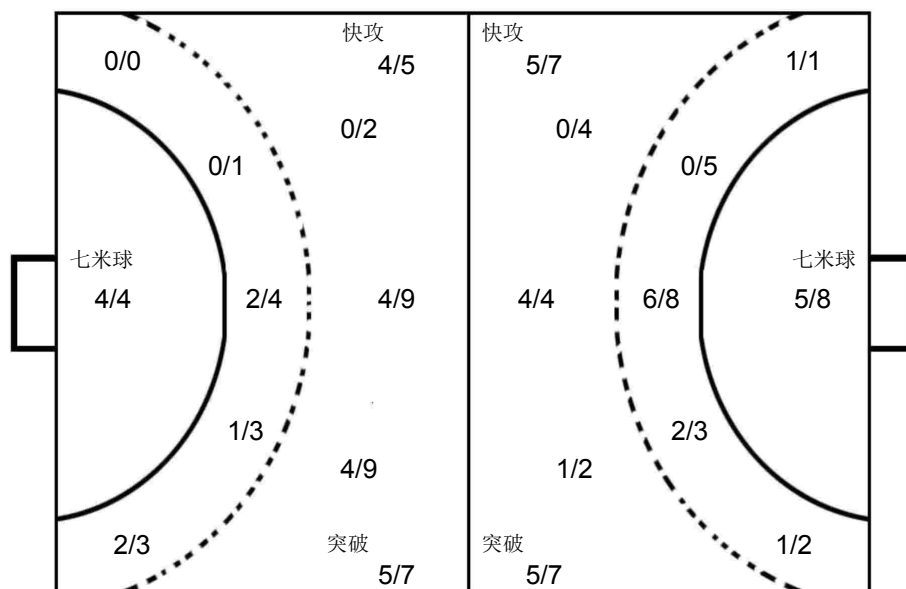

26 □□									
<table border="1"><tr><td>1/1</td><td></td><td>0/1</td></tr><tr><td></td><td></td><td>0/1</td></tr><tr><td></td><td></td><td>0/1</td></tr></table>	1/1		0/1			0/1			0/1
1/1		0/1							
		0/1							
		0/1							

30 □□									
<table border="1"><tr><td>1/3</td><td>1/2</td><td>1/2</td></tr><tr><td>5/8</td><td>1/1</td><td>4/8</td></tr><tr><td>0/5</td><td>2/3</td><td>0/6</td></tr></table>	1/3	1/2	1/2	5/8	1/1	4/8	0/5	2/3	0/6
1/3	1/2	1/2							
5/8	1/1	4/8							
0/5	2/3	0/6							

中国男子手球国家队俱乐部虎队

17 成亚	18 王晓琪	19 刘振	20 王毅	21 沈吉磊	22 魏雨童	23 曹悦	25 王杰缘																																																																								
<table border="1"><tr><td></td><td></td><td>1</td></tr><tr><td>2</td><td></td><td>1</td></tr><tr><td></td><td></td><td></td></tr></table>			1	2		1				<table border="1"><tr><td></td><td></td><td></td></tr><tr><td></td><td></td><td></td></tr><tr><td></td><td></td><td></td></tr></table>										<table border="1"><tr><td>2</td><td></td><td></td></tr><tr><td></td><td></td><td>2</td></tr><tr><td>2</td><td></td><td>1</td></tr></table>	2					2	2		1	<table border="1"><tr><td>1</td><td>1</td><td></td></tr><tr><td></td><td>1</td><td></td></tr><tr><td></td><td></td><td></td></tr></table>	1	1			1					<table border="1"><tr><td></td><td></td><td></td></tr><tr><td></td><td></td><td></td></tr><tr><td></td><td></td><td></td></tr></table>										<table border="1"><tr><td></td><td></td><td></td></tr><tr><td></td><td></td><td></td></tr><tr><td></td><td></td><td></td></tr></table>										<table border="1"><tr><td>1</td><td>1</td><td>2</td></tr><tr><td></td><td></td><td></td></tr><tr><td>3</td><td></td><td>1</td></tr></table>	1	1	2				3		1	<table border="1"><tr><td></td><td></td><td></td></tr><tr><td></td><td></td><td></td></tr><tr><td></td><td></td><td></td></tr></table>									
		1																																																																													
2		1																																																																													
2																																																																															
		2																																																																													
2		1																																																																													
1	1																																																																														
	1																																																																														
1	1	2																																																																													
3		1																																																																													
Post - 0 Miss - 0 Block - 0	Post - 0 Miss - 0 Block - 0	Post - 0 Miss - 1 Block - 0	Post - 1 Miss - 0 Block - 0	Post - 0 Miss - 0 Block - 0	Post - 0 Miss - 0 Block - 0	Post - 0 Miss - 1 Block - 0	Post - 0 Miss - 0 Block - 0																																																																								
26 徐畅	27 许松	28 郭世伟	29 周傲	30 王权	31 王伟																																																																										
<table border="1"><tr><td></td><td></td><td></td></tr><tr><td></td><td></td><td></td></tr><tr><td></td><td></td><td></td></tr></table>										<table border="1"><tr><td></td><td></td><td>1</td></tr><tr><td>2</td><td></td><td></td></tr><tr><td></td><td></td><td></td></tr></table>			1	2						<table border="1"><tr><td></td><td></td><td>1</td></tr><tr><td></td><td></td><td>1</td></tr><tr><td></td><td></td><td></td></tr></table>			1			1				<table border="1"><tr><td></td><td></td><td></td></tr><tr><td></td><td></td><td></td></tr><tr><td></td><td></td><td></td></tr></table>										<table border="1"><tr><td></td><td></td><td></td></tr><tr><td></td><td></td><td></td></tr><tr><td></td><td></td><td></td></tr></table>										<table border="1"><tr><td></td><td></td><td>1</td></tr><tr><td>1</td><td></td><td>1</td></tr><tr><td></td><td></td><td></td></tr></table>			1	1		1																							
		1																																																																													
2																																																																															
		1																																																																													
		1																																																																													
		1																																																																													
1		1																																																																													
Post - 0 Miss - 0 Block - 0	Post - 0 Miss - 0 Block - 0	Post - 0 Miss - 2 Block - 0	Post - 0 Miss - 0 Block - 0	Post - 0 Miss - 0 Block - 0	Post - 1 Miss - 0 Block - 0																																																																										

Team A					Team B					Match Number											
A 中国男子手球国家队俱乐部豹队					B 中国男子手球国家队俱乐部龙队					4											
Played in			in the hall			on			at			Spectators									
湖北武汉			武汉体院体育馆			2017-12-21			16:10			hours									
Half-time(30')	A	B	End of playing time		A	B	1st extra time		A	B	2nd extra time		A	B	After penalty throws		A	B			
	18	14	32		28																
Number of 7 m	A	Team time-out			Full name of players and officials						Team time-out			B	Number of 7 m						
	5/5	1	2	3							1	2	3	B							
		21:51	42:36	57:26							07:11			1/2							
No.	Team A					G	W	2'	D	DR	No.	Team B					G	W	2'	D	DR
1	王洸										32	蒋维一					6	1			
2	胡晋铭					1					33	尹杰					4				
3	曲汝洋					7		1			35	李双					2				
5	赵楠					1		1			36	张家纬									
6	赵晨					5					37	林豪文									
7	解建飞							1			38	王巨柱					1				
8	谢庆龙					4	1				39	朱世杰					1				
9	贺政					4					50	李明									
10	刘赵梁										51	王军程					5				
11	胡瀛										52	马明辉					3				
13	陈旭					1					53	傅俊雄									
15	张建杰					6	1				55	于性哲									
16	顾艳超					3					56	李朝鹏					5	1	1		
68	王帅										57	董智景					1				
A	郑永利 (主教练)										A	沈强 (主教练)									
C	叶强										C	杨桂东									
											D	陈璇									
A											Signatures of responsables for the teams (Off.A)										B
TP	Remarks of referees / HF Official																				TP

Signatures

Referees 李兆蒙 (CHN)

张斌 (CHN)

T.D. 吴瑞亭 (CHN)

许宜扬 (CHN)

CHA Off.

Note: Number of 7m Throws Awarded to Team A and B, Goals (G), Warnings (W), Suspensions (2'), Direct Disqualification (D), Disqualification With Report (DR) and Team Penalty (TP).

Table Officials: 刘禹

许翔

Statisticians: 王梓衡

沈家洛

2017年男子手球国家队俱乐部联赛(武汉赛区)

PHMS Pictorial Handball Match Statistics

IHF Official System

竞赛技术统计

手球 男子 预赛 轮次 2 组别 X 场次 4 武汉体院体育馆 2017-12-21 16:10

Referees: 李兆蒙 (CHN) / 张斌 (CHN) Result: 32:28(18:14)

Teams: 中国男子手球国家队俱乐部豹队(豹队) VS 中国男子手球国家队俱乐部龙队(龙队)

豹队		远射	近射	边射	快攻	突破	任意球	7m球	合计	%	助攻	失误	警告	2'	D+DR
主教练: 郑永利															
1	王澍														
2	胡晋铭		1/1					1/1	100						
3	曲汝洋	1/1		1/1	1/1	1/1		3/3	7/7	100	2	1		1	
5	赵楠	1/1			0/1			1/2	50.0		2	1		1	
6	赵晨	2/5			1/1	2/2		5/8	62.5		1	3			
7	解建飞	0/1						0/1	0.0				1		
8	谢庆龙	0/1	4/5					4/6	66.7			3	1		
9	贺政	0/1		1/3	1/1			2/2	4/7	57.1		1			
10	刘赵梁														
11	胡瀛	0/1	0/1					0/2	0.0			1			
13	陈旭		1/2	0/2				1/4	25.0			1			
15	张建杰	1/2	1/1	1/4	1/1	2/2		6/10	60.0	1	1	1			
16	顾艳超	1/3	1/1			1/1		3/5	60.0	2	5				
68	王帅											1			
运动员 合计		6/16	8/11	3/10	4/5	6/6		5/5	32/53	60.4	8	18	3	2	
1	王澍	2/10	1/6	2/5	1/2	2/2	1/1	0/1	9/27	33.3					
68	王帅	4/8	1/2	0/2	0/3	1/1		6/16	37.5			1			
守门员 合计		6/18	2/8	2/7	1/5	3/3	1/1	0/1	15/43	34.9		1			

豹队	比赛进程	龙队
1st Half		
8 谢庆龙	1 01:31	0
9 贺政	2 02:43	0
3 曲汝洋	2 03:17	1 32 蒋维一
3 曲汝洋	3 05:34	1
3 曲汝洋	4 07:02	1
15 张建杰	5 08:00	1
15 张建杰	6 08:40	1
6 赵晨	6 08:55	2 33 尹杰
6 赵晨	6 11:11	3 51 王军程
16 顾艳超	7 12:22	3
7 顾艳超	7 12:45	4 32 蒋维一
8 谢庆龙	8 13:08	4
15 张建杰	9 14:08	4
3 曲汝洋	10 15:28	4
10 胡晋铭	10 16:32	5 32 蒋维一
3 曲汝洋	11 17:24	5
2 胡晋铭	12 18:26	5
12 胡晋铭	12 18:59	6 56 李朝鹏
3 曲汝洋	13 19:38	6
13 曲汝洋	13 19:57	7 33 尹杰
13 曲汝洋	13 21:06	8 56 李朝鹏
16 顾艳超	14 22:19	8
14 顾艳超	14 22:44	9 52 马明辉
14 顾艳超	14 23:30	10 51 王军程
8 谢庆龙	15 25:37	10
15 王军程	15 26:59	11 51 王军程
15 王军程	15 28:06	12 32 蒋维一
15 王军程	15 28:26	13 51 王军程
13 陈旭	16 28:41	13
16 顾艳超	16 29:05	14 39 朱世杰
16 顾艳超	17 29:41	14
6 赵晨	18 30:00	14
2nd Half		
5 赵楠	19 00:42	14
19 赵楠	19 02:28	15 32 蒋维一
6 赵晨	20 03:40	15
20 赵晨	20 04:34	16 51 王军程
6 赵晨	21 05:30	16
21 赵晨	21 07:59	17 33 尹杰
21 赵晨	21 09:45	18 56 李朝鹏
21 赵晨	21 11:19	19 33 尹杰
21 赵晨	21 12:11	20 35 李双
15 张建杰	22 12:56	20
15 张建杰	23 14:23	20
23 张建杰	23 15:02	21 38 王巨柱
15 张建杰	24 15:39	21
24 张建杰	24 17:57	22 32 蒋维一
6 赵晨	25 18:39	22
25 赵晨	25 19:41	23 56 李朝鹏
25 赵晨	25 20:01	24 57 董智景
9 贺政	26 20:48	24
9 贺政	27 21:49	24
27 贺政	27 22:35	25 52 马明辉
6 赵晨	28 23:05	25
9 贺政	29 24:13	25
3 曲汝洋	30 24:56	25
30 曲汝洋	30 25:11	26 52 马明辉
8 谢庆龙	31 25:50	26
31 谢庆龙	31 27:02	27 56 李朝鹏
3 曲汝洋	32 28:34	27
32 曲汝洋	32 28:52	28 35 李双

场上队员: 得分 / 射门

守门员: 救球 / 射门

D	取消资格	DR	取消资格+报告
---	------	----	---------



2017年男子手球国家队俱乐部联赛(武汉赛区)

PHMS Pictorial Handball Match Statistics

IHF Official System

个人/全队技术统计表

手球 男子 预赛 轮次 2 组别 X 场次 4 武汉体院体育馆 2017-12-21 16:10

号码	姓名	远射	近射	边射	快攻	突破	任意	七米	合计	%	助攻	失误	警告	2'	取消	时间
中国男子手球国家队俱乐部豹队(豹队)																
(场上队员)																
1	王澆									0.0%						00:40:00
2	胡晋铭		1/1						1/1	100%						00:06:24
3	曲汝洋	1/1		1/1	1/1	1/1		3/3	7/7	100%	2	1		1		00:41:24
5	赵楠	1/1				0/1			1/2	50.0%	2	1		1		00:45:31
6	赵晨	2/5			1/1	2/2			5/8	62.5%	1	3				00:30:56
7	解建飞	0/1							0/1	0.0%			1			00:31:01
8	谢庆龙	0/1	4/5						4/6	66.7%		3	1			00:44:57
9	贺政	0/1		1/3	1/1			2/2	4/7	57.1%		1				00:52:13
10	刘赵梁									0.0%						00:07:45
11	胡瀛	0/1	0/1						0/2	0.0%		1				00:14:26
13	陈旭		1/2	0/2					1/4	25.0%		1				00:19:38
15	张建杰	1/2	1/1	1/4	1/1	2/2			6/10	60.0%	1	1	1			00:39:23
16	顾艳超	1/3	1/1			1/1			3/5	60.0%	2	5				00:24:29
68	王帅									0.0%		1				00:20:00
	合计	6/16	8/11	3/10	4/5	6/6		5/5	32/53	60.4%	8	18	3	2		
(守门员)																
1	王澆	2/10	1/6	2/5	1/2	2/2	1/1	0/1	9/27	33.3%						00:40:00
68	王帅	4/8	1/2	0/2	0/3	1/1			6/16	37.5%		1				00:20:00
	合计	6/18	2/8	2/7	1/5	3/3	1/1	0/1	15/43	34.9%		1				

场上队员：得分/射门

守门员：救球/射门

全队合计	得分	被救	射失	击柱	封球	合计	%
远射	6	3		2	5	16	37.5%
近射	8	3				11	72.7%
边射	3	6	1			10	30.0%
快攻	4	1				5	80.0%
突破	6					6	100.0%
任意							0.0%
七米	5					5	100.0%

2017年男子手球国家队俱乐部联赛(武汉赛区)

PHMS Pictorial Handball Match Statistics

IHF Official System

个人/全队技术统计表

 手球 男子 预赛 轮次 2 组别 X 场次 4 武汉体院体育馆
 2017-12-21 16:10

号码	姓名	远射	近射	边射	快攻	突破	任意	七米	合计	%	助攻	失误	警告	2'	取消	时间
中国男子手球国家队俱乐部龙队(龙队)																
(场上队员)																
32	蒋维一		5/6			1/2			6/8	75.0%	1	2	1			00:49:17
33	尹杰	2/4		2/2	0/1			0/1	4/8	50.0%	1	4				00:54:34
35	李双		1/2	1/1					2/3	66.7%	1					00:22:13
36	张家纬									0.0%						00:00:00
37	林豪文			0/1					0/1	0.0%						00:13:07
38	王巨柱	0/1		1/1					1/2	50.0%						00:12:14
39	朱世杰	1/2				0/1			1/3	33.3%		2				00:18:12
50	李明									0.0%						00:00:11
51	王军程	5/7				0/1			5/8	62.5%	2	2				00:50:56
52	马明辉	1/1		1/2	1/1				3/4	75.0%		1				00:40:57
53	傅俊雄									0.0%						00:12:14
55	于性哲									0.0%						00:59:49
56	李朝鹏	3/5		0/1	1/1	0/1	0/1	1/1	5/10	50.0%	2	2	1	1		00:43:28
57	董智景			0/2	1/1				1/3	33.3%		2				00:41:30
	合计	12/20	6/8	5/10	4/6	0/3	0/1	1/2	28/50	56.0%	7	15	2	1		
(守门员)																
50	李明							0/1	0/1	0.0%						00:00:11
55	于性哲	3/9	3/11	6/9	1/5	0/6		0/4	13/44	29.5%						00:59:49
	合计	3/9	3/11	6/9	1/5	0/6		0/5	13/45	28.9%						

场上队员：得分/射门

守门员：救球/射门

全队合计	得分	被救	射失	击柱	封球	合计	%
远射	12	6		1	1	20	60.0%
近射	6	2				8	75.0%
边射	5	2		3		10	50.0%
快攻	4	1	1			6	66.7%
突破		3				3	0.0%
任意		1				1	0.0%
七米	1			1		2	50.0%

图式比赛技术统计表

手球
男子

预赛
轮次 2

组别 X
场次 4

武汉体院体育馆
2017-12-21 16:10

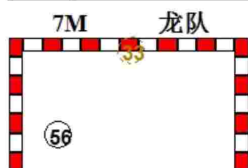
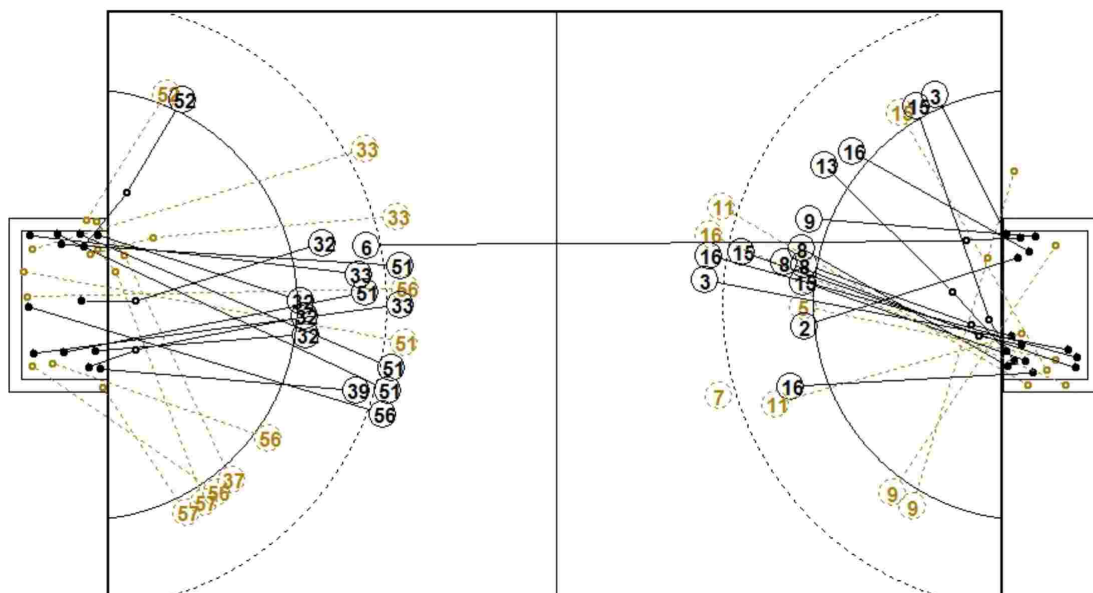

1st Half
14 : 18

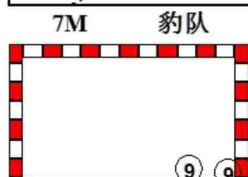
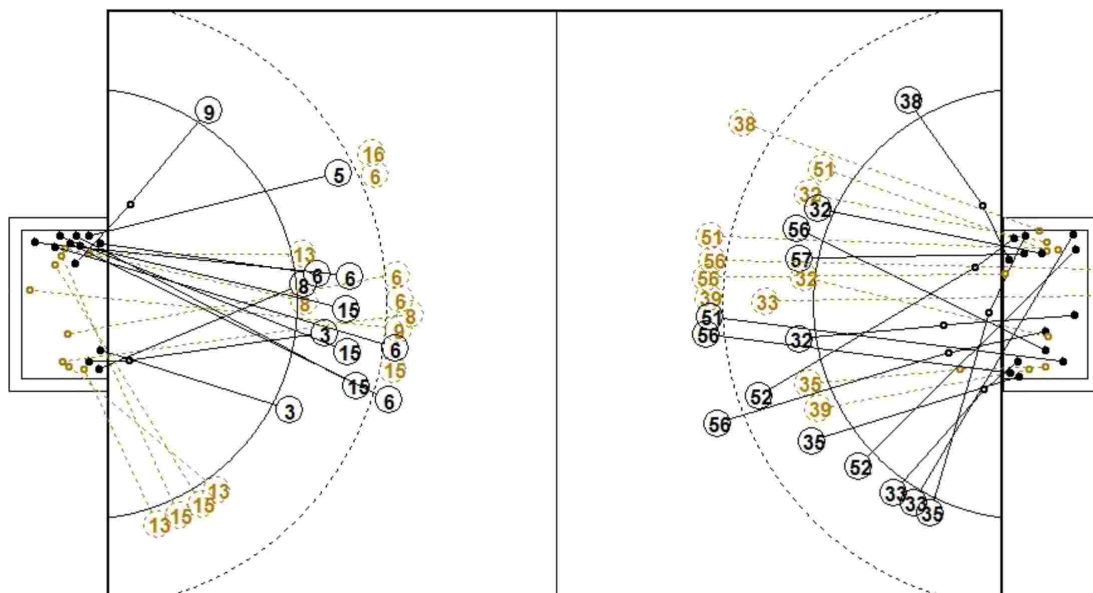
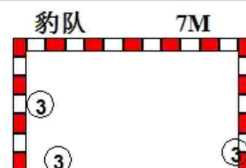

2nd Half
32 : 28

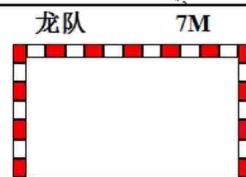

图式射门区域统计

手球
男子

预赛
轮次 2

组别 X
场次 4

武汉体院体育馆
2017-12-21 16:10

中国男子手球国家队俱乐部豹队

1 王澍	2 胡晋铭	3 曲汝洋	5 赵楠	6 赵晨	7 解建飞	8 谢庆龙	9 贺政																																																																											
<table border="1"><tr><td></td><td></td><td></td></tr><tr><td></td><td></td><td></td></tr><tr><td></td><td></td><td></td></tr></table>										<table border="1"><tr><td></td><td></td><td></td></tr><tr><td></td><td></td><td></td></tr><tr><td>1</td><td></td><td></td></tr></table>							1			<table border="1"><tr><td></td><td></td><td>1</td></tr><tr><td>1</td><td></td><td></td></tr><tr><td>4</td><td></td><td>1</td></tr></table>			1	1			4		1	<table border="1"><tr><td></td><td></td><td></td></tr><tr><td></td><td></td><td></td></tr><tr><td></td><td></td><td>1</td></tr></table>									1	<table border="1"><tr><td></td><td></td><td>1</td></tr><tr><td></td><td></td><td>2</td></tr><tr><td>1</td><td></td><td>1</td></tr></table>			1			2	1		1	<table border="1"><tr><td></td><td></td><td></td></tr><tr><td></td><td></td><td></td></tr><tr><td></td><td></td><td></td></tr></table>										<table border="1"><tr><td></td><td></td><td></td></tr><tr><td></td><td></td><td></td></tr><tr><td>1</td><td></td><td>3</td></tr></table>							1		3	<table border="1"><tr><td></td><td></td><td></td></tr><tr><td></td><td></td><td></td></tr><tr><td>1</td><td></td><td>1</td></tr><tr><td></td><td></td><td>2</td></tr></table>							1		1			2
1																																																																																		
		1																																																																																
1																																																																																		
4		1																																																																																
		1																																																																																
		1																																																																																
		2																																																																																
1		1																																																																																
1		3																																																																																
1		1																																																																																
		2																																																																																
Post - 0 Miss - 0 Block - 0	Post - 0 Miss - 0 Block - 0	Post - 0 Miss - 0 Block - 0	Post - 0 Miss - 0 Block - 0	Post - 0 Miss - 0 Block - 2	Post - 0 Miss - 0 Block - 1	Post - 0 Miss - 0 Block - 0	Post - 0 Miss - 1 Block - 0																																																																											
10 刘赵梁	11 胡瀛	13 陈旭	15 张建杰	16 顾艳超	68 王帅																																																																													
<table border="1"><tr><td></td><td></td><td></td></tr><tr><td></td><td></td><td></td></tr><tr><td></td><td></td><td></td></tr></table>										<table border="1"><tr><td></td><td></td><td></td></tr><tr><td></td><td></td><td></td></tr><tr><td></td><td></td><td></td></tr></table>										<table border="1"><tr><td></td><td></td><td></td></tr><tr><td></td><td></td><td></td></tr><tr><td></td><td></td><td>1</td></tr></table>									1	<table border="1"><tr><td></td><td></td><td>1</td></tr><tr><td></td><td></td><td>2</td></tr><tr><td></td><td></td><td>3</td></tr></table>			1			2			3	<table border="1"><tr><td></td><td></td><td>1</td></tr><tr><td></td><td></td><td>1</td></tr><tr><td>1</td><td></td><td></td></tr></table>			1			1	1			<table border="1"><tr><td></td><td></td><td></td></tr><tr><td></td><td></td><td></td></tr><tr><td></td><td></td><td></td></tr></table>																																
		1																																																																																
		1																																																																																
		2																																																																																
		3																																																																																
		1																																																																																
		1																																																																																
1																																																																																		
Post - 0 Miss - 0 Block - 0	Post - 1 Miss - 0 Block - 0	Post - 0 Miss - 0 Block - 0	Post - 0 Miss - 0 Block - 1	Post - 1 Miss - 0 Block - 1	Post - 0 Miss - 0 Block - 0																																																																													

1 □□

1/3	1/3	2/4
2/4		1/4
0/2	0/1	2/6

68 □□

1/2		
2/3		1/2
1/6		1/3

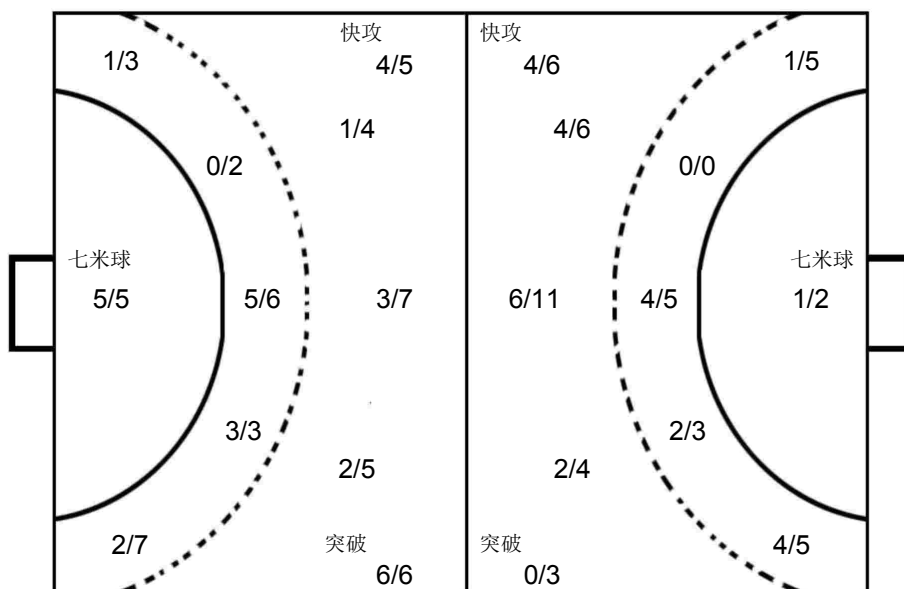

50 □□

0/1		

55 □□□

	1/1	0/4
4/6		5/11
1/8		2/14

中国男子手球国家队俱乐部龙队

32 蒋维一	33 尹杰	35 李双	36 张家纬	37 林豪文	38 王巨柱	39 朱世杰	50 李明																																																																								
<table border="1"><tr><td></td><td>1</td><td></td></tr><tr><td>1</td><td></td><td></td></tr><tr><td>2</td><td>1</td><td>1</td></tr></table>		1		1			2	1	1	<table border="1"><tr><td>2</td><td></td><td>1</td></tr><tr><td></td><td></td><td></td></tr><tr><td></td><td></td><td>1</td></tr></table>	2		1						1	<table border="1"><tr><td></td><td></td><td></td></tr><tr><td></td><td></td><td></td></tr><tr><td>1</td><td></td><td>1</td></tr></table>							1		1	<table border="1"><tr><td></td><td></td><td></td></tr><tr><td></td><td></td><td></td></tr><tr><td></td><td></td><td></td></tr></table>										<table border="1"><tr><td></td><td></td><td></td></tr><tr><td></td><td></td><td></td></tr><tr><td></td><td></td><td></td></tr></table>										<table border="1"><tr><td></td><td></td><td></td></tr><tr><td></td><td></td><td></td></tr><tr><td>1</td><td></td><td></td></tr></table>							1			<table border="1"><tr><td></td><td></td><td></td></tr><tr><td></td><td></td><td></td></tr><tr><td>1</td><td></td><td></td></tr></table>							1			<table border="1"><tr><td></td><td></td><td></td></tr><tr><td></td><td></td><td></td></tr><tr><td></td><td></td><td></td></tr></table>									
	1																																																																														
1																																																																															
2	1	1																																																																													
2		1																																																																													
		1																																																																													
1		1																																																																													
1																																																																															
1																																																																															
Post - 0 Miss - 0 Block - 0	Post - 1 Miss - 1 Block - 0	Post - 0 Miss - 0 Block - 0	Post - 0 Miss - 0 Block - 0	Post - 1 Miss - 0 Block - 0	Post - 0 Miss - 0 Block - 0	Post - 0 Miss - 0 Block - 1	Post - 0 Miss - 0 Block - 0																																																																								
51 王军程	52 马明辉	53 傅俊雄	55 于性哲	56 李朝鹏	57 董智景																																																																										
<table border="1"><tr><td></td><td></td><td>1</td></tr><tr><td>1</td><td></td><td>2</td></tr><tr><td></td><td></td><td>1</td></tr></table>			1	1		2			1	<table border="1"><tr><td>1</td><td></td><td></td></tr><tr><td></td><td></td><td></td></tr><tr><td>1</td><td></td><td>1</td></tr></table>	1						1		1	<table border="1"><tr><td></td><td></td><td></td></tr><tr><td></td><td></td><td></td></tr><tr><td></td><td></td><td></td></tr></table>										<table border="1"><tr><td></td><td></td><td></td></tr><tr><td></td><td></td><td></td></tr><tr><td></td><td></td><td></td></tr></table>										<table border="1"><tr><td></td><td>1</td><td></td></tr><tr><td>1</td><td></td><td>2</td></tr><tr><td></td><td></td><td>1</td></tr></table>		1		1		2			1	<table border="1"><tr><td></td><td></td><td></td></tr><tr><td></td><td></td><td></td></tr><tr><td>1</td><td></td><td></td></tr></table>							1																						
		1																																																																													
1		2																																																																													
		1																																																																													
1																																																																															
1		1																																																																													
	1																																																																														
1		2																																																																													
		1																																																																													
1																																																																															
Post - 0 Miss - 0 Block - 0	Post - 1 Miss - 0 Block - 0	Post - 0 Miss - 0 Block - 0	Post - 0 Miss - 0 Block - 0	Post - 1 Miss - 0 Block - 0	Post - 1 Miss - 0 Block - 0																																																																										



Team A	Team B	Match Number
A 中国男子手球国家队俱乐部狮队	B 中国男子手球国家队俱乐部豹队	5

Played in	in the hall	on	at	Spectators
湖北武汉	武汉体院体育馆	2017-12-22	14:30 hours	

Half-time(30')	A	B	End of playing time	A	B	1st extra time	A	B	2nd extra time	A	B	After penalty throws	A	B
	10	15	25	31										

Number of 7 m	A	Team time-out			Full name of players and officials	Team time-out			B	Number of 7 m
	4/4	1	2	3		1	2	3	3/4	
			50:20			27:54	47:50	55:58		

No.	Team A	G	W	2'	D	DR	No.	Team B	G	W	2'	D	DR
58	张继伟			3			1	王洸					
59	魏昂	1					2	胡晋铭					
60	王鹏皓	4					3	曲汝洋	6				
61	庞连康	2					5	赵楠	2				
62	闫炳旗	1					6	赵晨	4				
63	谢基伟	4					7	解建飞	1	1	1		
65	黎涛	1	1				8	谢庆龙	5	1			
66	宋朋强	2					9	贺政	1		1		
67	马昌震	3		1			10	刘赵梁	4				
68	王帅						11	胡瀛					
69	刘晓	1					13	陈旭	3				
70	于亚男	5					15	张建杰	4				
71	王伟强	1					16	顾艳超	1				
72	刘迈科						26	徐畅					

A	王鸿斌 (主教练)						A	郑永利 (主教练)					
C	杜长义						C	叶强					
D	杨桂东						D	陈璇					

	Signatures of responsables for the teams (Off.A)	
--	--	--

A			B
TP	Remarks of referees / HF Official		TP

Signatures			
Referees	程钰峰 (CHN)	周云磊 (CHN)	
T.D.	吴瑞亭 (CHN)	许宜扬 (CHN)	
CHA Off.			

Note: Number of 7m Throws Awarded to Team A and B, Goals (G), Warnings (W), Suspensions (2'), Direct Disqualification (D), Disqualification With Report (DR) and Team Penalty (TP).

Table Officials: 刘禹 许翔 Statisticians: 沈家洛 王梓衡

2017年男子手球国家队俱乐部联赛(武汉赛区)
PHMS Pictorial Handball Match Statistics

IHF Official System

竞赛技术统计

手球 男子 预赛 轮次 3 组别 X 场次 5 武汉体院体育馆 2017-12-22 14:30

Referees: 程钰峰 (CHN) / 周云磊 (CHN) Result: 25:31(10:15)

Teams: 中国男子手球国家队俱乐部狮队(狮队) VS 中国男子手球国家队俱乐部豹队(豹队)

狮队		远	近	边	快	突	任意	7m	合计	%	助攻	失误	警告	2'	D+DR
主教练: 王鸿斌		射	射	射	攻	破	球	球							
58	张继伟													3	
59	魏昂	0/1			1/2				1/3	33.3	1	2			
60	王鹏皓	1/2			0/1			3/3	4/6	66.7					
61	庞连康	1/1				1/1			2/2	100					
62	闫炳旗					1/1			1/1	100	1	1			
63	谢基伟	4/9			0/1				4/10	40.0	2	3			
65	黎涛							1/1	1/1	100		1	1		
66	宋朋强	2/4	0/1						2/5	40.0					
67	马昌震		2/2		1/1				3/3	100	1	2		1	
68	王帅														
69	刘晓	0/4		0/1		1/1			1/6	16.7					
70	于亚男	4/7					1/1		5/8	62.5	1	3			
71	王伟强	0/1		1/2					1/3	33.3					
72	刘迈科														
运动员 合计		12/29	2/3	1/3	2/5	3/3	1/1	4/4	25/48	52.1	6	12	1	4	
68	王帅	0/4	4/8	0/3	1/5	1/2			6/22	27.3					
72	刘迈科	6/7	1/7	0/1	3/5	0/1	0/1	0/3	10/25	40.0					
守门员 合计		6/11	5/15	0/4	4/10	1/3	0/1	0/3	16/47	34.0					
豹队		远	近	边	快	突	任意	7m	合计	%	助攻	失误	警告	2'	D+DR
主教练: 郑永利		射	射	射	攻	破	球	球							
1	王澍														
2	胡晋铭														
3	曲汝洋	2/2	2/3	1/2	0/2	1/2			6/11	54.5	3				
5	赵楠	0/1	1/2		1/1			0/1	2/5	40.0	5	4			
6	赵晨	1/6	1/2			1/1	1/2		4/11	36.4	2	1			
7	解建飞							1/1	1/1	100	1		1	1	
8	谢庆龙		4/4		1/1				5/5	100		1	1		
9	贺政				0/1			1/1	1/2	50.0		1		1	
10	刘赵梁	1/1	1/1	1/1	1/1				4/4	100	1	2			
11	胡瀛														
13	陈旭		0/3	2/3	1/2				3/8	37.5	1				
15	张建杰	1/1		0/1	2/2			1/1	4/5	80.0	1	1			
16	顾艳超	0/1	1/1						1/2	50.0		1			
26	徐畅														
运动员 合计		5/12	10/16	4/7	6/10	2/3	1/2	3/4	31/54	57.4	14	11	2	2	
1	王澍	8/13	0/1	2/3	0/1	0/1	0/1		10/20	50.0					
26	徐畅	3/10	1/2		1/2	0/2		0/4	5/20	25.0					
守门员 合计		11/23	1/3	2/3	1/3	0/3	0/1	0/4	15/40	37.5					

狮队	比赛进程	豹队
1st Half		
0	01:04	1 15 张建杰
0	02:12	2 15 张建杰
69	刘晓	1 02:42 2
1	03:10	3 3 曲汝洋
70	于亚男	2 04:51 3
2	06:07	4 6 赵晨
70	于亚男	3 06:32 4
3	07:07	5 8 谢庆龙
3	08:58	6 9 贺政
66	宋朋强	4 09:39 6
67	马昌震	5 10:48 6
5	10:53	7 8 谢庆龙
70	于亚男	6 11:36 7
6	11:50	8 13 陈旭
6	15:25	9 8 谢庆龙
6	17:53	10 6 赵晨
70	于亚男	7 20:36 10
7	22:06	11 6 赵晨
7	23:51	12 7 解建飞
63	谢基伟	8 24:13 12
8	25:24	13 8 谢庆龙
8	25:58	14 15 张建杰
71	王伟强	9 26:21 14
67	马昌震	10 27:09 14
10	28:43	15 16 顾艳超
2nd Half		
10	01:07	16 3 曲汝洋
10	02:21	17 3 曲汝洋
61	庞连康	11 03:00 17
11	03:12	18 10 刘赵梁
62	闫炳旗	12 05:40 18
59	魏昂	13 06:14 18
13	06:34	19 3 曲汝洋
13	07:52	20 13 陈旭
60	王鹏皓	14 08:29 20
14	10:41	21 8 谢庆龙
61	庞连康	15 11:43 21
15	12:24	22 3 曲汝洋
63	谢基伟	16 12:48 22
67	马昌震	17 13:48 22
17	14:10	23 10 刘赵梁
17	15:32	24 10 刘赵梁
60	王鹏皓	18 16:03 24
18	17:05	25 6 赵晨
63	谢基伟	19 17:23 25
63	谢基伟	20 17:43 25
60	王鹏皓	21 18:16 25
21	19:00	26 5 赵楠
60	王鹏皓	22 19:39 26
22	23:17	27 13 陈旭
22	23:32	28 3 曲汝洋
22	24:05	29 5 赵楠
22	24:40	30 10 刘赵梁
66	宋朋强	23 25:42 30
70	于亚男	24 27:05 30
24	27:35	31 15 张建杰
65	黎涛	25 28:38 31

场上队员: 得分 / 射门

守门员: 救球 / 射门

D	取消资格	DR	取消资格+报告
---	------	----	---------



2017年男子手球国家队俱乐部联赛(武汉赛区)

PHMS Pictorial Handball Match Statistics

IHF Official System

个人/全队技术统计表

手球 男子 预赛 轮次 3 组别 X 场次 5 武汉体院体育馆 2017-12-22 14:30

号码	姓名	远射	近射	边射	快攻	突破	任意	七米	合计	%	助攻	失误	警告	2'	取消	时间
中国男子手球国家队俱乐部狮队(狮队)																
(场上队员)																
58	张继伟									0.0%				3		00:22:09
59	魏昂	0/1			1/2				1/3	33.3%	1	2				00:18:07
60	王鹏皓	1/2			0/1			3/3	4/6	66.7%						00:18:08
61	庞连康	1/1				1/1			2/2	100%						00:18:08
62	闫炳旗					1/1			1/1	100%	1	1				00:18:08
63	谢基伟	4/9			0/1				4/10	40.0%	2	3				00:31:52
65	黎涛							1/1	1/1	100%		1	1			00:19:00
66	宋朋强	2/4	0/1						2/5	40.0%						00:39:40
67	马昌震		2/2		1/1				3/3	100%	1	2		1		01:00:00
68	王帅									0.0%						00:30:00
69	刘晓	0/4		0/1		1/1			1/6	16.7%						00:35:14
70	于亚男	4/7					1/1		5/8	62.5%	1	3				00:39:40
71	王伟强	0/1		1/2					1/3	33.3%						00:39:40
72	刘迈科									0.0%						00:30:00
合计		12/29	2/3	1/3	2/5	3/3	1/1	4/4	25/48	52.1%	6	12	1	4		
(守门员)																
68	王帅	0/4	4/8	0/3	1/5	1/2			6/22	27.3%						00:30:00
72	刘迈科	6/7	1/7	0/1	3/5	0/1	0/1	0/3	10/25	40.0%						00:30:00
合计		6/11	5/15	0/4	4/10	1/3	0/1	0/3	16/47	34.0%						

场上队员： 得分/射门

守门员： 救球/射门

全队合计	得分	被救	射失	击柱	封球	合计	%
远射	12	11	1	2	3	29	41.4%
近射	2	1				3	66.7%
边射	1	2				3	33.3%
快攻	2	1	2			5	40.0%
突破	3					3	100.0%
任意	1					1	100.0%
七米	4					4	100.0%

2017年男子手球国家队俱乐部联赛(武汉赛区)

PHMS Pictorial Handball Match Statistics

IHF Official System

个人/全队技术统计表

 手球 男子 预赛 轮次 3 组别 X 场次 5 武汉体院体育馆
 2017-12-22 14:30

号码	姓名	远射	近射	边射	快攻	突破	任意	七米	合计	%	助攻	失误	警告	2'	取消	时间
中国男子手球国家队俱乐部豹队(豹队)																
(场上队员)																
1	王泷									0.0%						00:30:00
2	胡晋铭									0.0%						00:23:22
3	曲汝洋	2/2	2/3	1/2	0/2	1/2			6/11	54.5%	3					00:29:39
5	赵楠	0/1	1/2		1/1			0/1	2/5	40.0%	5	4				00:41:29
6	赵晨	1/6	1/2			1/1	1/2		4/11	36.4%	2	1				00:40:18
7	解建飞							1/1	1/1	100%	1		1	1		00:17:52
8	谢庆龙		4/4		1/1				5/5	100%		1	1			00:32:27
9	贺政				0/1			1/1	1/2	50.0%		1		1		00:30:35
10	刘赵梁	1/1	1/1	1/1	1/1				4/4	100%	1	2				00:20:03
11	胡瀛									0.0%						00:16:25
13	陈旭		0/3	2/3	1/2				3/8	37.5%	1					01:00:00
15	张建杰	1/1		0/1	2/2			1/1	4/5	80.0%	1	1				00:16:59
16	顾艳超	0/1	1/1						1/2	50.0%		1				00:30:08
26	徐畅									0.0%						00:30:00
	合计	5/12	10/16	4/7	6/10	2/3	1/2	3/4	31/54	57.4%	14	11	2	2		
(守门员)																
1	王泷	8/13	0/1	2/3	0/1	0/1	0/1		10/20	50.0%						00:30:00
26	徐畅	3/10	1/2		1/2	0/2		0/4	5/20	25.0%						00:30:00
	合计	11/23	1/3	2/3	1/3	0/3	0/1	0/4	15/40	37.5%						

场上队员：得分/射门

守门员：救球/射门

全队合计	得分	被救	射失	击柱	封球	合计	%
远射	5	6	1			12	41.7%
近射	10	5		1		16	62.5%
边射	4		2	1		7	57.1%
快攻	6	4				10	60.0%
突破	2	1				3	66.7%
任意	1		1			2	50.0%
七米	3		1			4	75.0%

图式比赛技术统计表

手球
男子

预赛
轮次 3

组别 X
场次 5

武汉体院体育馆
2017-12-22 14:30

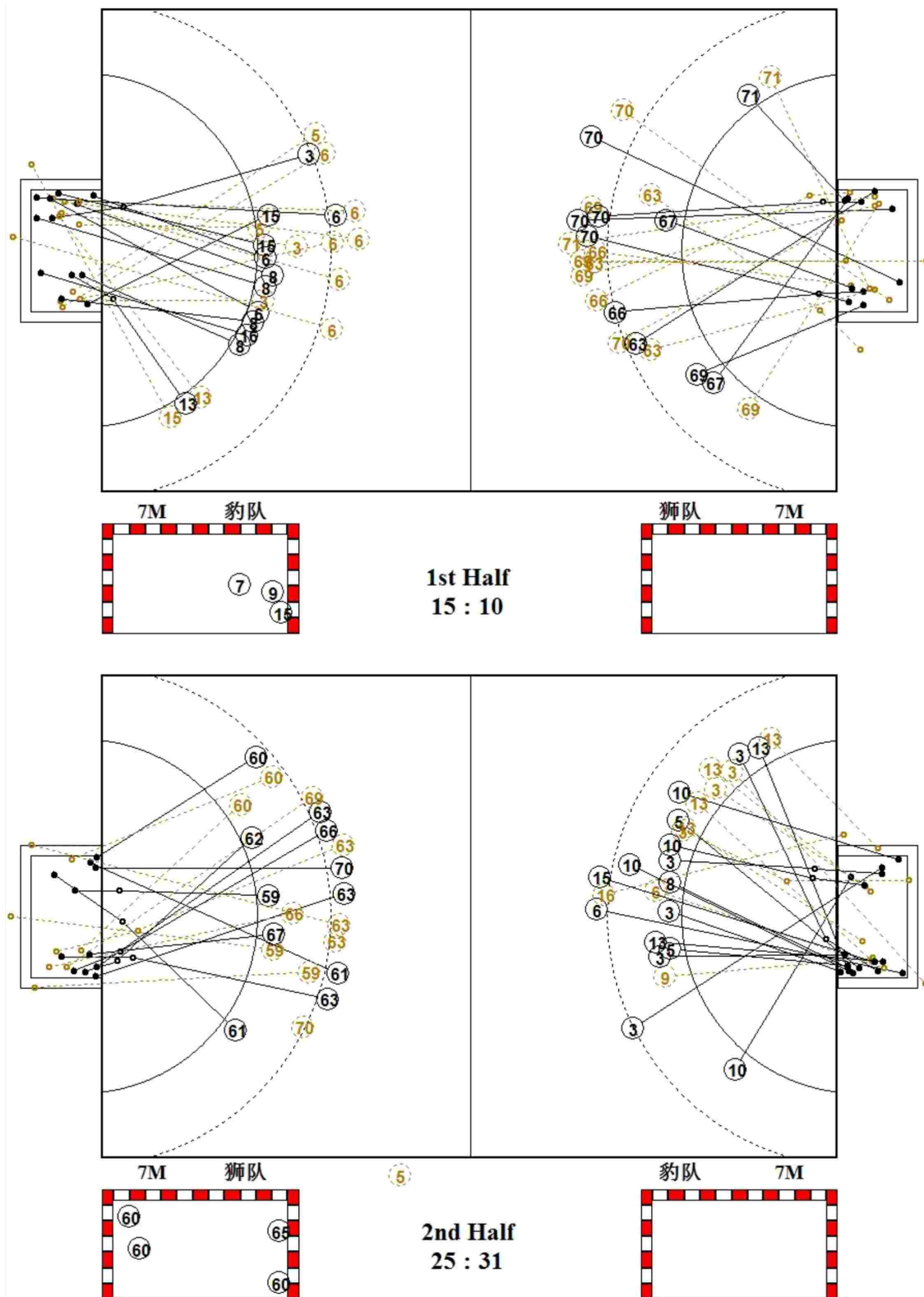

图式射门区域统计

手球
男子

预赛
轮次 3

组别 X
场次 5

武汉体院体育馆
2017-12-22 14:30

中国男子手球国家队俱乐部狮队

58 张继伟	59 魏昂	60 王鹏皓	61 虎连康	62 闫炳旗	63 谢基伟	65 黎涛	66 宋朋强																																																																								
<table border="1"><tr><td></td><td></td><td></td></tr><tr><td></td><td></td><td></td></tr><tr><td></td><td></td><td></td></tr></table>										<table border="1"><tr><td></td><td></td><td></td></tr><tr><td></td><td></td><td>1</td></tr><tr><td></td><td></td><td></td></tr></table>						1				<table border="1"><tr><td>1</td><td></td><td></td></tr><tr><td>1</td><td></td><td></td></tr><tr><td></td><td></td><td>2</td></tr></table>	1			1					2	<table border="1"><tr><td></td><td></td><td>1</td></tr><tr><td></td><td></td><td></td></tr><tr><td></td><td></td><td>1</td></tr></table>			1						1	<table border="1"><tr><td></td><td></td><td></td></tr><tr><td></td><td></td><td></td></tr><tr><td>1</td><td></td><td></td></tr></table>							1			<table border="1"><tr><td></td><td></td><td></td></tr><tr><td>2</td><td></td><td></td></tr><tr><td>2</td><td></td><td></td></tr></table>				2			2			<table border="1"><tr><td></td><td></td><td>1</td></tr><tr><td></td><td></td><td></td></tr><tr><td></td><td></td><td></td></tr></table>			1							<table border="1"><tr><td></td><td></td><td></td></tr><tr><td>1</td><td></td><td></td></tr><tr><td></td><td></td><td>1</td></tr></table>				1					1
		1																																																																													
1																																																																															
1																																																																															
		2																																																																													
		1																																																																													
		1																																																																													
1																																																																															
2																																																																															
2																																																																															
		1																																																																													
1																																																																															
		1																																																																													
Post - 0 Miss - 0 Block - 0	Post - 1 Miss - 1 Block - 0	Post - 0 Miss - 0 Block - 0	Post - 0 Miss - 0 Block - 0	Post - 0 Miss - 0 Block - 0	Post - 1 Miss - 2 Block - 1	Post - 0 Miss - 0 Block - 0	Post - 0 Miss - 0 Block - 0																																																																								
67 马昌震	68 王帅	69 刘晓	70 于亚男	71 王伟强	72 刘迈科																																																																										
<table border="1"><tr><td></td><td></td><td></td></tr><tr><td>2</td><td></td><td>1</td></tr><tr><td></td><td></td><td></td></tr></table>				2		1				<table border="1"><tr><td></td><td></td><td></td></tr><tr><td></td><td></td><td></td></tr><tr><td></td><td></td><td></td></tr></table>										<table border="1"><tr><td></td><td></td><td></td></tr><tr><td></td><td></td><td>1</td></tr><tr><td></td><td></td><td></td></tr></table>						1				<table border="1"><tr><td>1</td><td></td><td>1</td></tr><tr><td>1</td><td></td><td></td></tr><tr><td></td><td></td><td>2</td></tr></table>	1		1	1					2	<table border="1"><tr><td></td><td></td><td></td></tr><tr><td></td><td></td><td></td></tr><tr><td>1</td><td></td><td></td></tr></table>							1			<table border="1"><tr><td></td><td></td><td></td></tr><tr><td></td><td></td><td></td></tr><tr><td></td><td></td><td></td></tr></table>																													
2		1																																																																													
		1																																																																													
1		1																																																																													
1																																																																															
		2																																																																													
1																																																																															
Post - 0 Miss - 0 Block - 0	Post - 0 Miss - 0 Block - 0	Post - 0 Miss - 0 Block - 1	Post - 0 Miss - 0 Block - 1	Post - 0 Miss - 0 Block - 0	Post - 0 Miss - 0 Block - 0																																																																										

68 □□		
0/1		1/3
2/5		3/5
0/1		0/7

72 □□□		
0/1		1/5
3/5		3/7
1/3		2/4

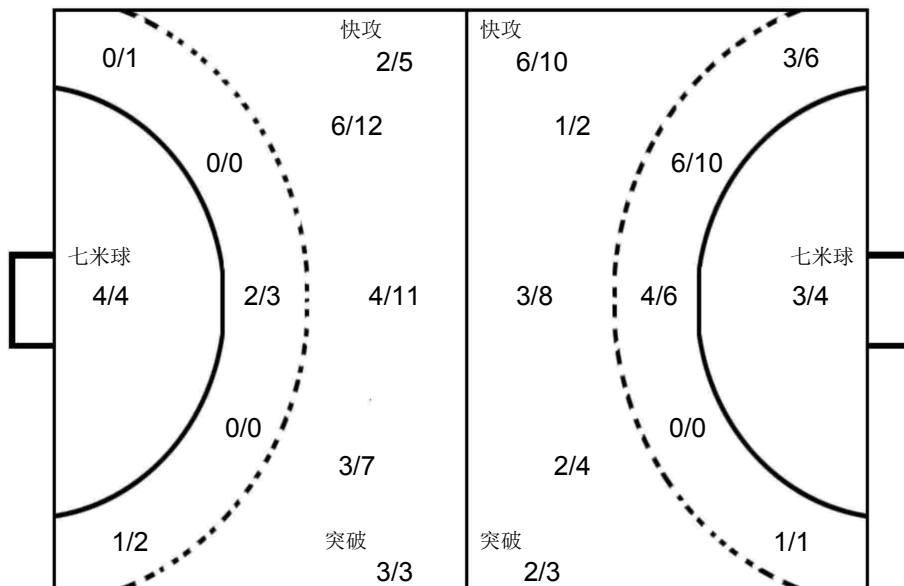

1 □□		
0/1		1/2
3/5		2/4
2/4	1/1	1/3

26 □□		
1/2		0/2
2/5		1/2
1/5		0/4

中国男子手球国家队俱乐部豹队

1 王澍	2 胡晋铭	3 曲汝洋	5 赵楠	6 赵晨	7 解建飞	8 谢庆龙	9 贺政																																																																								
<table border="1"><tr><td></td><td></td><td></td></tr><tr><td></td><td></td><td></td></tr><tr><td></td><td></td><td></td></tr></table>										<table border="1"><tr><td></td><td></td><td></td></tr><tr><td></td><td></td><td></td></tr><tr><td></td><td></td><td></td></tr></table>										<table border="1"><tr><td></td><td></td><td>1</td></tr><tr><td>2</td><td></td><td>1</td></tr><tr><td></td><td></td><td>2</td></tr></table>			1	2		1			2	<table border="1"><tr><td></td><td></td><td></td></tr><tr><td></td><td></td><td></td></tr><tr><td></td><td></td><td>2</td></tr></table>									2	<table border="1"><tr><td></td><td></td><td>3</td></tr><tr><td></td><td></td><td></td></tr><tr><td></td><td></td><td>1</td></tr></table>			3						1	<table border="1"><tr><td></td><td></td><td></td></tr><tr><td></td><td></td><td>1</td></tr><tr><td></td><td></td><td></td></tr></table>						1				<table border="1"><tr><td></td><td></td><td>1</td></tr><tr><td>1</td><td></td><td>1</td></tr><tr><td>1</td><td></td><td>1</td></tr></table>			1	1		1	1		1	<table border="1"><tr><td></td><td></td><td></td></tr><tr><td></td><td></td><td>1</td></tr><tr><td></td><td></td><td></td></tr></table>						1			
		1																																																																													
2		1																																																																													
		2																																																																													
		2																																																																													
		3																																																																													
		1																																																																													
		1																																																																													
		1																																																																													
1		1																																																																													
1		1																																																																													
		1																																																																													
Post - 0 Miss - 0 Block - 0	Post - 0 Miss - 0 Block - 0	Post - 1 Miss - 1 Block - 0	Post - 0 Miss - 1 Block - 0	Post - 0 Miss - 1 Block - 0	Post - 0 Miss - 0 Block - 0	Post - 0 Miss - 0 Block - 0	Post - 0 Miss - 0 Block - 0																																																																								
10 刘赵梁	11 胡瀛	13 陈旭	15 张建杰	16 顾艳超	26 徐畅																																																																										
<table border="1"><tr><td>1</td><td></td><td></td></tr><tr><td>1</td><td></td><td></td></tr><tr><td>1</td><td></td><td>1</td></tr></table>	1			1			1		1	<table border="1"><tr><td></td><td></td><td></td></tr><tr><td></td><td></td><td></td></tr><tr><td></td><td></td><td></td></tr></table>										<table border="1"><tr><td></td><td></td><td>1</td></tr><tr><td>1</td><td></td><td></td></tr><tr><td></td><td></td><td>1</td></tr></table>			1	1					1	<table border="1"><tr><td></td><td></td><td></td></tr><tr><td></td><td></td><td>2</td></tr><tr><td>1</td><td></td><td>1</td></tr></table>						2	1		1	<table border="1"><tr><td>1</td><td></td><td></td></tr><tr><td></td><td></td><td></td></tr><tr><td></td><td></td><td></td></tr></table>	1									<table border="1"><tr><td></td><td></td><td></td></tr><tr><td></td><td></td><td></td></tr><tr><td></td><td></td><td></td></tr></table>																													
1																																																																															
1																																																																															
1		1																																																																													
		1																																																																													
1																																																																															
		1																																																																													
		2																																																																													
1		1																																																																													
1																																																																															
Post - 0 Miss - 0 Block - 0	Post - 0 Miss - 0 Block - 0	Post - 1 Miss - 0 Block - 0	Post - 0 Miss - 1 Block - 0	Post - 0 Miss - 1 Block - 0	Post - 0 Miss - 0 Block - 0																																																																										



Team A					Team B					Match Number											
A 中国男子手球国家队俱乐部龙队					B 中国男子手球国家队俱乐部虎队					6											
Played in			in the hall			on			at			Spectators									
湖北武汉			武汉体院体育馆			2017-12-22			16:10			hours									
Half-time(30')	A	B	End of playing time		A	B	1st extra time		A	B	2nd extra time		A	B	After penalty throws		A	B			
	12	13			22	33															
Number of 7 m	A	Team time-out			Full name of players and officials						Team time-out			B	Number of 7 m						
	2/4	1	2	3							1	2	3	B							
		10:11	37:01								50:06	56:08	4/4								
No.	Team A					G	W	2'	D	DR	No.	Team B					G	W	2'	D	DR
32	蒋维一					3					17	成亚					6				
33	尹杰					5					18	王晓琪									
35	李双					3					19	刘振					3				
36	张家纬										20	王毅							1		
37	林豪文					1					21	沈吉磊							1		
38	王巨柱					2					22	魏雨童									
39	朱世杰					3		1			23	曹悦					6		1		
50	李明										25	王杰缘					8		1		
51	王军程					2					26	徐畅									
52	马明辉										27	许松					4				
53	傅俊雄										28	郭世伟					3	1			
55	于性哲										29	周傲					2				
56	李朝鹏					3					30	王权									
57	董智景						1				31	王伟					1	1			
A	沈强 (主教练)										A	高恒勤 (主教练)									
C	杨桂东										C	刘捷									
D	陈璇										D	叶强									
A	Signatures of responsables for the teams (Off.A)															B					
TP	Remarks of referees / HF Official															TP					

Signatures

Referees 李兆蒙 (CHN)

张斌 (CHN)

T.D. 吴瑞亭 (CHN)

许宜扬 (CHN)

CHA Off.

Note: Number of 7m Throws Awarded to Team A and B, Goals (G), Warnings (W), Suspensions (2'), Direct Disqualification (D), Disqualification With Report (DR) and Team Penalty (TP).

Table Officials: 刘禹

许翔

Statisticians: 王梓衡

沈家洛

2017年男子手球国家队俱乐部联赛(武汉赛区)

PHMS Pictorial Handball Match Statistics

IHF Official System

竞赛技术统计

手球 男子 预赛 轮次 3 组别 X 场次 6 武汉体院体育馆 2017-12-22 16:10

 Referees: 李兆蒙 (CHN) / 张斌 (CHN) Result: 22:33(12:13)
 Teams: 中国男子手球国家队俱乐部龙队(龙队) VS 中国男子手球国家队俱乐部虎队(虎队)

龙队		远	近	边	快	突	任意	7m	合计	%	助攻	失误	警告	2'	D+DR
主教练: 沈强		射	射	射	攻	破	球	球							
32 蒋维一		1/1	2/3						3/4	75.0					
33 尹杰		0/1		0/1		3/3		2/3	5/8	62.5	1	3			
35 李双		2/5	1/1						3/6	50.0	1	2			
36 张家纬															
37 林豪文		0/1	1/1	0/1					1/3	33.3					
38 王巨柱		0/2		1/2		1/1			2/5	40.0		3			
39 朱世杰		1/1		0/1		2/3			3/5	60.0	1	2		1	
50 李明					0/1				0/1	0.0					
51 王军程		1/4		0/1		1/2			2/7	28.6	1	3			
52 马明辉															
53 傅俊雄												1			
55 于性哲					0/1				0/1	0.0					
56 李朝鹏		0/1	1/1		1/1	1/1		0/1	3/5	60.0		3			
57 董智景				0/1					0/1	0.0	1		1		
运动员 合计		5/16	5/6	1/7	1/3	8/10		2/4	22/46	47.8	5	17	1	1	
50 李明		1/2	0/2		0/1	0/1		0/2	1/8	12.5					
55 于性哲		2/9	4/11	1/4	0/4	1/4		0/2	8/34	23.5					
守门员 合计		3/11	4/13	1/4	0/5	1/5		0/4	9/42	21.4					

龙队	比赛 进程	虎队
1st Half		
33 尹杰	1 00:50 0	
56 李朝鹏	2 01:44 0	
32 蒋维一	3 03:28 0	
	3 04:03 1 23 曹悦	
32 蒋维一	4 05:09 1	
	4 06:46 2 25 王杰缘	
	4 08:55 3 19 刘振	
	4 09:43 4 19 刘振	
35 李双	5 10:24 4	
51 王军程	6 11:22 4	
	6 11:51 5 17 成亚	
	6 13:24 6 17 成亚	
32 蒋维一	7 13:56 6	
	7 15:03 7 17 成亚	
33 尹杰	8 15:36 7	
51 王军程	9 18:39 7	
	9 18:51 8 17 成亚	
	9 20:06 9 17 成亚	
	9 23:13 10 25 王杰缘	
33 尹杰	10 23:46 10	
39 朱世杰	11 25:22 10	
	11 25:59 11 28 郭世伟	
	11 27:03 12 17 成亚	
56 李朝鹏	12 27:37 12	
	12 28:30 13 25 王杰缘	
2nd Half		
	12 01:15 14 25 王杰缘	
	12 01:53 15 27 许松	
39 朱世杰	13 02:29 15	
	13 03:48 16 27 许松	
	13 04:58 17 31 王伟	
	13 06:56 18 25 王杰缘	
	13 08:38 19 23 曹悦	
	13 09:13 20 25 王杰缘	
56 李朝鹏	14 10:20 20	
	14 10:54 21 27 许松	
35 李双	15 11:35 21	
33 尹杰	16 13:14 21	
35 李双	17 14:48 21	
	17 15:00 22 28 郭世伟	
38 王巨柱	18 15:36 22	
	18 17:09 23 23 曹悦	
38 王巨柱	19 18:05 23	
	19 19:24 24 25 王杰缘	
39 朱世杰	20 19:43 24	
	20 20:08 25 25 王杰缘	
	20 20:36 26 27 许松	
	20 21:24 27 19 刘振	
	20 22:21 28 23 曹悦	
	20 22:57 29 23 曹悦	
	20 25:15 30 23 曹悦	
	20 26:24 31 28 郭世伟	
33 尹杰	21 26:48 31	
	21 27:23 32 29 周傲	
	21 28:51 33 29 周傲	
37 林豪文	22 29:25 33	

虎队		远	近	边	快	突	任意	7m	合计	%	助攻	失误	警告	2'	D+DR
主教练: 高恒勤		射	射	射	攻	破	球	球							
17 成亚		2/4	4/4						6/8	75.0	4				
18 王晓琪															
19 刘振		1/1	1/2					1/1	3/4	75.0	5	3			
20 王毅														1	
21 沈吉磊														1	
22 魏雨童															
23 曹悦		3/4	2/2		1/1	0/1			6/8	75.0	2	2		1	
25 王杰缘			1/1	1/2	3/4	1/1		2/2	8/10	80.0				1	
26 徐畅															
27 许松				2/2	1/2	1/1			4/5	80.0	1	2			
28 郭世伟		1/2				2/2			3/4	75.0		2	1		
29 周傲		1/2						1/1	2/3	66.7					
30 王权											2				
31 王伟			1/6						1/6	16.7		1	1		
运动员 合计		8/13	9/15	3/4	5/7	4/5		4/4	33/48	68.8	14	10	2	4	
26 徐畅			0/1	2/2		1/2		0/1	3/6	50.0					
30 王权		5/10	1/5	4/5	0/1	0/7		1/2	11/30	36.7	2				
守门员 合计		5/10	1/6	6/7	0/1	1/9		1/3	14/36	38.9	2				

场上队员: 得分 / 射门

守门员: 救球 / 射门

D	取消资格	DR	取消资格+报告
---	------	----	---------

2017年男子手球国家队俱乐部联赛(武汉赛区)

PHMS Pictorial Handball Match Statistics

IHF Official System

个人/全队技术统计表

手球 男子 预赛 轮次 3 组别 X 场次 6 武汉体院体育馆 2017-12-22 16:10

号码	姓名	远射	近射	边射	快攻	突破	任意	七米	合计	%	助攻	失误	警告	2'	取消	时间
中国男子手球国家队俱乐部龙队(龙队)																
(场上队员)																
32	蒋维一	1/1	2/3						3/4	75.0%						00:38:36
33	尹杰	0/1		0/1		3/3		2/3	5/8	62.5%	1	3				01:00:00
35	李双	2/5	1/1						3/6	50.0%	1	2				01:00:00
36	张家纬									0.0%						00:00:00
37	林豪文	0/1	1/1	0/1					1/3	33.3%						00:12:21
38	王巨柱	0/2		1/2		1/1			2/5	40.0%		3				00:17:53
39	朱世杰	1/1		0/1		2/3			3/5	60.0%	1	2		1		00:46:27
50	李明				0/1				0/1	0.0%						00:09:22
51	王军程	1/4		0/1		1/2			2/7	28.6%	1	3				00:43:29
52	马明辉									0.0%						00:00:00
53	傅俊雄									0.0%		1				00:21:43
55	于性哲				0/1				0/1	0.0%						00:50:38
56	李朝鹏	0/1	1/1		1/1	1/1		0/1	3/5	60.0%		3				00:40:56
57	董智景			0/1					0/1	0.0%	1		1			00:18:15
	合计	5/16	5/6	1/7	1/3	8/10		2/4	22/46	47.8%	5	17	1	1		
(守门员)																
50	李明	1/2	0/2		0/1	0/1		0/2	1/8	12.5%						00:09:22
55	于性哲	2/9	4/11	1/4	0/4	1/4		0/2	8/34	23.5%						00:50:38
	合计	3/11	4/13	1/4	0/5	1/5		0/4	9/42	21.4%						

场上队员： 得分/射门

守门员： 救球/射门

全队合计	得分	被救	射失	击柱	封球	合计	%
远射	5	5	2	1	3	16	31.3%
近射	5	1				6	83.3%
边射	1	6				7	14.3%
快攻	1		2			3	33.3%
突破	8	1	1			10	80.0%
任意							0.0%
七米	2	1		1		4	50.0%

2017年男子手球国家队俱乐部联赛(武汉赛区)

PHMS Pictorial Handball Match Statistics

IHF Official System

个人/全队技术统计表

 手球 男子 预赛 轮次 3 组别 X 场次 6 武汉体院体育馆
 2017-12-22 16:10

号码	姓名	远射	近射	边射	快攻	突破	任意	七米	合计	%	助攻	失误	警告	2'	取消	时间
中国男子手球国家队俱乐部虎队(虎队)																
(场上队员)																
17	成亚	2/4	4/4						6/8	75.0%	4					00:47:22
18	王晓琪									0.0%						00:03:52
19	刘振	1/1	1/2					1/1	3/4	75.0%	5	3				00:54:45
20	王毅									0.0%				1		00:18:33
21	沈吉磊									0.0%				1		00:03:52
22	魏雨童									0.0%						00:07:17
23	曹悦	3/4	2/2		1/1	0/1			6/8	75.0%	2	2		1		00:53:06
25	王杰缘		1/1	1/2	3/4	1/1		2/2	8/10	80.0%				1		00:56:08
26	徐畅									0.0%						00:06:26
27	许松			2/2	1/2	1/1			4/5	80.0%	1	2				00:26:34
28	郭世伟	1/2				2/2			3/4	75.0%		2	1			00:29:54
29	周傲	1/2						1/1	2/3	66.7%						00:05:13
30	王权									0.0%	2					00:53:34
31	王伟		1/6						1/6	16.7%		1	1			00:52:42
	合计	8/13	9/15	3/4	5/7	4/5		4/4	33/48	68.8%	14	10	2	4		
(守门员)																
26	徐畅		0/1	2/2		1/2		0/1	3/6	50.0%						00:06:26
30	王权	5/10	1/5	4/5	0/1	0/7		1/2	11/30	36.7%	2					00:53:34
	合计	5/10	1/6	6/7	0/1	1/9		1/3	14/36	38.9%	2					

场上队员： 得分/射门

守门员： 救球/射门

全队合计	得分	被救	射失	击柱	封球	合计	%
远射	8	3		1	1	13	61.5%
近射	9	4	1	1		15	60.0%
边射	3	1				4	75.0%
快攻	5			2		7	71.4%
突破	4	1				5	80.0%
任意							0.0%
七米	4					4	100.0%

图式比赛技术统计表

手球
男子

预赛
轮次 3

组别 X
场次 6

武汉体院体育馆
2017-12-22 16:10

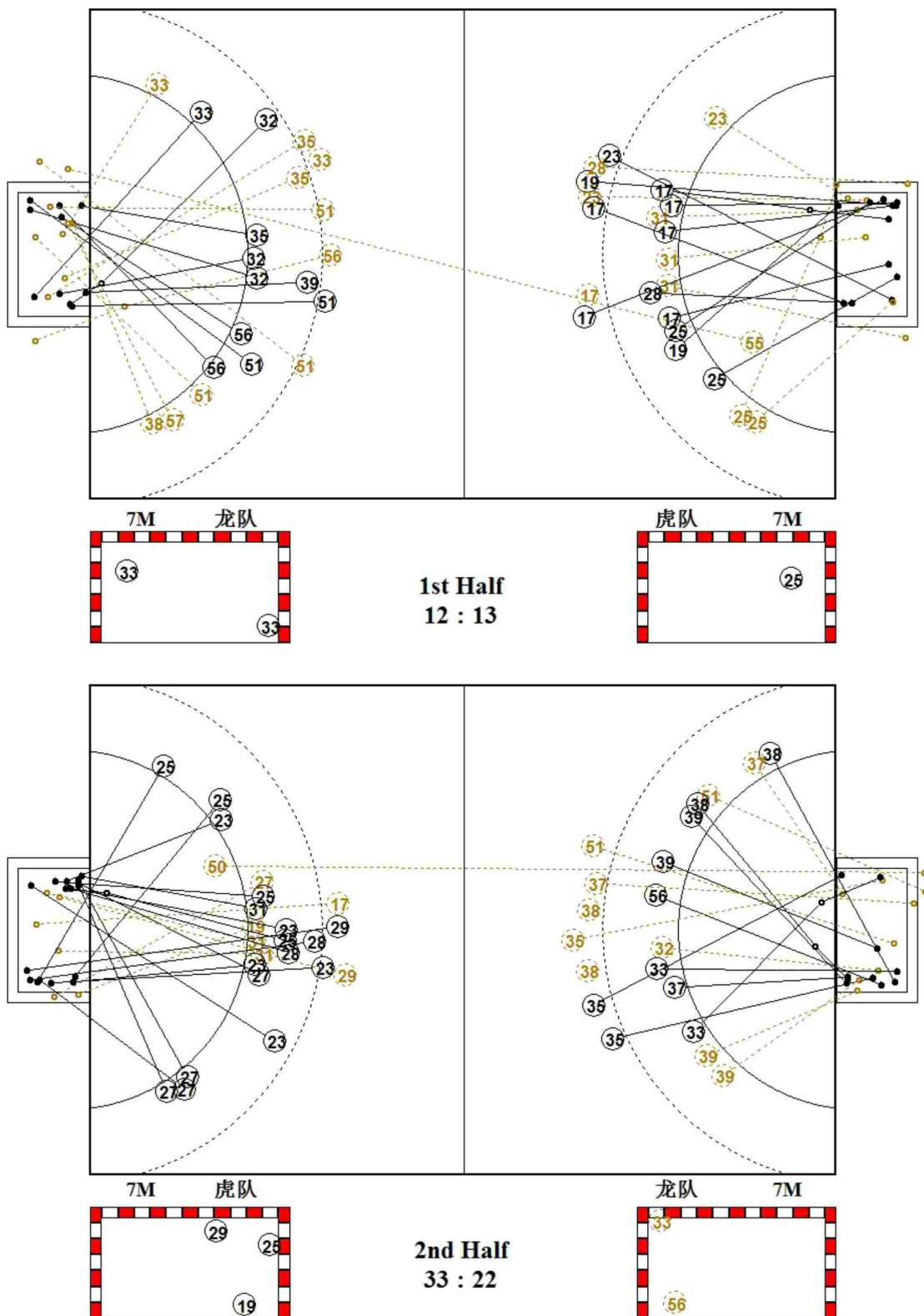

图式射门区域统计

手球
男子

预赛
轮次 3

组别 X
场次 6

武汉体院体育馆
2017-12-22 16:10

中国男子手球国家队俱乐部龙队

32 蒋维一 <table border="1"><tr><td></td><td></td><td>1</td></tr><tr><td>1</td><td></td><td></td></tr><tr><td>1</td><td></td><td></td></tr></table> Post - 0 Miss - 0 Block - 0			1	1			1			33 尹杰 <table border="1"><tr><td>2</td><td></td><td>1</td></tr><tr><td>1</td><td></td><td></td></tr><tr><td></td><td></td><td>1</td></tr></table> Post - 1 Miss - 0 Block - 1	2		1	1					1	35 李双 <table border="1"><tr><td></td><td></td><td></td></tr><tr><td></td><td></td><td>1</td></tr><tr><td>1</td><td></td><td>1</td></tr></table> Post - 0 Miss - 0 Block - 0						1	1		1	36 张家纬 <table border="1"><tr><td></td><td></td><td></td></tr><tr><td></td><td></td><td></td></tr><tr><td></td><td></td><td></td></tr></table> Post - 0 Miss - 0 Block - 0										37 林豪文 <table border="1"><tr><td></td><td></td><td></td></tr><tr><td></td><td></td><td></td></tr><tr><td></td><td></td><td>1</td></tr></table> Post - 1 Miss - 0 Block - 0									1	38 王巨柱 <table border="1"><tr><td></td><td></td><td>1</td></tr><tr><td></td><td></td><td></td></tr><tr><td></td><td></td><td>1</td></tr></table> Post - 0 Miss - 0 Block - 2			1						1	39 朱世杰 <table border="1"><tr><td></td><td></td><td></td></tr><tr><td></td><td>1</td><td></td></tr><tr><td>1</td><td></td><td>1</td></tr></table> Post - 0 Miss - 0 Block - 0					1		1		1	50 李明 <table border="1"><tr><td></td><td></td><td></td></tr><tr><td></td><td></td><td></td></tr><tr><td></td><td></td><td></td></tr></table> Post - 0 Miss - 1 Block - 0									
		1																																																																													
1																																																																															
1																																																																															
2		1																																																																													
1																																																																															
		1																																																																													
		1																																																																													
1		1																																																																													
		1																																																																													
		1																																																																													
		1																																																																													
	1																																																																														
1		1																																																																													
51 王军程 <table border="1"><tr><td></td><td></td><td>1</td></tr><tr><td></td><td></td><td></td></tr><tr><td>1</td><td></td><td></td></tr></table> Post - 0 Miss - 2 Block - 0			1				1			52 马明辉 <table border="1"><tr><td></td><td></td><td></td></tr><tr><td></td><td></td><td></td></tr><tr><td></td><td></td><td></td></tr></table> Post - 0 Miss - 0 Block - 0										53 傅俊雄 <table border="1"><tr><td></td><td></td><td></td></tr><tr><td></td><td></td><td></td></tr><tr><td></td><td></td><td></td></tr></table> Post - 0 Miss - 0 Block - 0										55 于性哲 <table border="1"><tr><td></td><td></td><td></td></tr><tr><td></td><td></td><td></td></tr><tr><td></td><td></td><td></td></tr></table> Post - 0 Miss - 1 Block - 0										56 李朝鹏 <table border="1"><tr><td></td><td></td><td></td></tr><tr><td></td><td></td><td></td></tr><tr><td></td><td></td><td>3</td></tr></table> Post - 0 Miss - 1 Block - 0									3	57 董智景 <table border="1"><tr><td></td><td></td><td></td></tr><tr><td></td><td></td><td></td></tr><tr><td></td><td></td><td></td></tr></table> Post - 0 Miss - 0 Block - 0																													
		1																																																																													
1																																																																															
		3																																																																													

50 □□
0/1 0/2 0/1
1/1
0/1 0/2

55 □□□
0/8 1/1 1/5
1/3 2/2 1/3
2/4 0/8

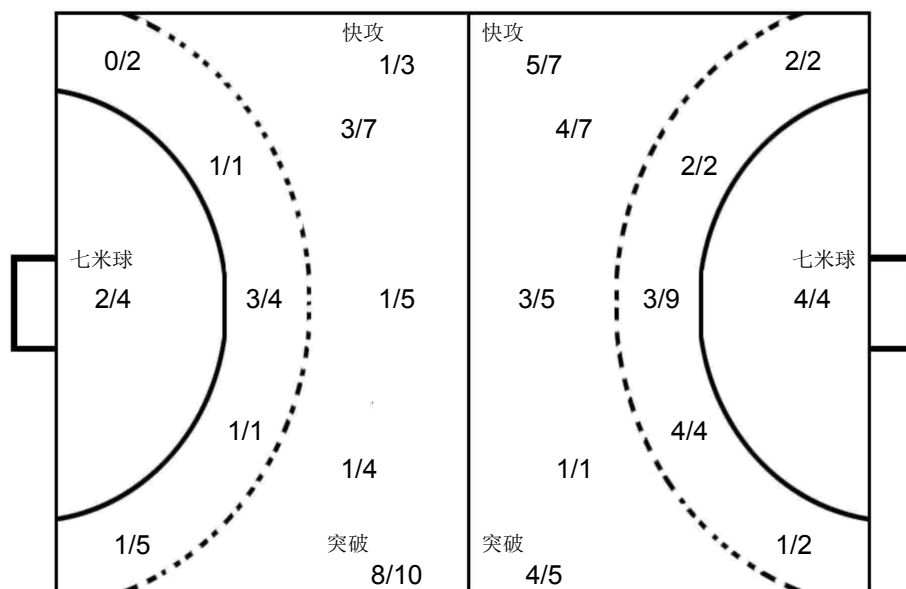

26 □□
0/1
0/1 1/1
1/1 1/2

30 □□
1/2 2/2 0/4
2/3 1/2 2/6
1/5 2/6

中国男子手球国家队俱乐部虎队

17 成亚 <table border="1"><tr><td>4</td><td>1</td><td></td></tr><tr><td></td><td></td><td></td></tr><tr><td></td><td></td><td>1</td></tr></table> Post - 0 Miss - 0 Block - 1	4	1							1	18 王晓琪 <table border="1"><tr><td></td><td></td><td></td></tr><tr><td></td><td></td><td></td></tr><tr><td></td><td></td><td></td></tr></table> Post - 0 Miss - 0 Block - 0										19 刘振 <table border="1"><tr><td>1</td><td></td><td></td></tr><tr><td></td><td></td><td></td></tr><tr><td>1</td><td></td><td>1</td></tr></table> Post - 1 Miss - 0 Block - 0	1						1		1	20 王毅 <table border="1"><tr><td></td><td></td><td></td></tr><tr><td></td><td></td><td></td></tr><tr><td></td><td></td><td></td></tr></table> Post - 0 Miss - 0 Block - 0										21 沈吉磊 <table border="1"><tr><td></td><td></td><td></td></tr><tr><td></td><td></td><td></td></tr><tr><td></td><td></td><td></td></tr></table> Post - 0 Miss - 0 Block - 0										22 魏雨童 <table border="1"><tr><td></td><td></td><td></td></tr><tr><td></td><td></td><td></td></tr><tr><td></td><td></td><td></td></tr></table> Post - 0 Miss - 0 Block - 0										23 曹悦 <table border="1"><tr><td></td><td></td><td>2</td></tr><tr><td>1</td><td></td><td></td></tr><tr><td>1</td><td></td><td>2</td></tr></table> Post - 0 Miss - 0 Block - 0			2	1			1		2	25 王杰缘 <table border="1"><tr><td>1</td><td></td><td>3</td></tr><tr><td>1</td><td></td><td>2</td></tr><tr><td>1</td><td></td><td></td></tr></table> Post - 1 Miss - 0 Block - 0	1		3	1		2	1		
4	1																																																																														
		1																																																																													
1																																																																															
1		1																																																																													
		2																																																																													
1																																																																															
1		2																																																																													
1		3																																																																													
1		2																																																																													
1																																																																															
26 徐畅 <table border="1"><tr><td></td><td></td><td></td></tr><tr><td></td><td></td><td></td></tr><tr><td></td><td></td><td></td></tr></table> Post - 0 Miss - 0 Block - 0										27 许松 <table border="1"><tr><td>1</td><td></td><td></td></tr><tr><td></td><td></td><td></td></tr><tr><td></td><td></td><td>3</td></tr></table> Post - 1 Miss - 0 Block - 0	1								3	28 郭世伟 <table border="1"><tr><td>1</td><td></td><td></td></tr><tr><td></td><td></td><td></td></tr><tr><td></td><td></td><td>2</td></tr></table> Post - 1 Miss - 0 Block - 0	1								2	29 周傲 <table border="1"><tr><td>1</td><td>1</td><td></td></tr><tr><td></td><td></td><td></td></tr><tr><td></td><td></td><td></td></tr></table> Post - 0 Miss - 0 Block - 0	1	1								30 王权 <table border="1"><tr><td></td><td></td><td></td></tr><tr><td></td><td></td><td></td></tr><tr><td></td><td></td><td></td></tr></table> Post - 0 Miss - 0 Block - 0										31 王伟 <table border="1"><tr><td></td><td></td><td></td></tr><tr><td></td><td></td><td></td></tr><tr><td></td><td></td><td>1</td></tr></table> Post - 0 Miss - 1 Block - 0									1																				
1																																																																															
		3																																																																													
1																																																																															
		2																																																																													
1	1																																																																														
		1																																																																													