

2019  
2019年全国男子手球冠军杯赛

# 成绩与技术统计数据册

重庆万州



## 中国手球协会

CHINESE HANDBALL ASSOCIATION

数据由PHMS收集生成  
PHMS国际手球联合会官方技术统计系统



## 成绩与技术统计数据册目录

- 1 比赛结果
  - 1) 名次
  - 2) 获奖队员名单
  - 3) 场次成绩
  - 4) 分组成绩
- 2 运动员排名
  - 1) 得分
  - 2) 助攻
  - 3) 封球
  - 4) 防守
  - 5) 失误
  - 6) 受罚
- 3 守门员排名
  - 1) 救球
  - 2) 救7M球
- 4 球队总体比较
- 5 球队受罚表
- 6 球队累计
  - 1) 球队名单
  - 2) 个人/全队技术累计表
  - 3) 图式射门区域累计
- 7 每场比赛统计
  - 1) 比赛报告表
  - 2) 竞赛技术统计表
  - 3) 个人/全队技术统计表
  - 4) 图式比赛技术统计
  - 5) 图式射门区域统计
  - 6) 比赛进程表(决赛场次)

注：如需更多比赛统计数据，请通过以下电邮联络：[handball@126.com](mailto:handball@126.com)

## 2019年全国男子手球冠军杯赛

PHMS Pictorial Handball Match Statistics

IHF Official System

### 大赛名次

手球  
男子

截止至第33场

重庆万州  
2019-04-16

奖牌	名次	缩写	队名
Gold	1	江苏	江苏队
Silver	2	北京	北京队
Bronze	3	天津	天津队
	4	安徽	安徽队
	5	广东	广东队
	6	上海	上海队
	7	山东	山东队
	8	山西	山西队
	9	陕西	陕西队
	10	四川	四川队

获奖队员名单

手球  
男子

重庆万州  
2019-04-16

金牌	银牌	铜牌
江苏-江苏队	北京-北京队	天津-天津队
1 宋继强	3 逯明松	1 何喜年
3 周悦骅	6 解建飞	3 魏雨童
4 张家纬	7 马昌震	4 刘雪东
6 赵晨	10 成亚	5 王毅
7 周傲	11 赵文宣	6 赵晨阳
8 谢庆龙	12 高云健	7 张青
11 张天豪	13 王军鸣	8 王晓琪
12 王权	16 刘迈科	9 王子欣
16 张帅	18 傅俊雄	10 苏尧
18 赵楠	22 王超	11 吴明远
19 庞连康	23 王军程	13 许松
20 顾艳超	25 王鹏皓	14 王维先
21 刘江	26 魏昂	15 周群
25 王杰缘	27 闫炳旗	16 刘宗其
27 王伟强	32 蒋维一	20 张闻乾
30 吴龙瑞	33 陈旭	86 田剑侠
替换队员	替换队员	替换队员
5 许翔宇	9 吴锐樊	2 曹悦
22 罗尧尧	24 刘帅	12 杨峻

## 2019年全国男子手球冠军杯赛

PHMS Pictorial Handball Match Statistics

IHF Official System

### 场次成绩

手球 男子 截止至第33场 重庆万州 2019-04-16

日期	时间	场次	体育馆	组别	球队	成绩 (半时)	阶段
13-04-19	13:00	21	万州体育馆	X	安徽-上海	25-24 (12-11)	四分之一决赛
	14:30	22	万州体育馆	X	山东-北京	20-22 (11-12)	四分之一决赛
	16:00	23	万州体育馆	X	广东-天津	23-26 (8-12)	四分之一决赛
	17:30	24	万州体育馆	X	江苏-山西	34-23 (15-15)	四分之一决赛
14-04-19	13:00	26	万州体育馆	X	上海-山东	23-21 (12-12)	5-8名
	14:30	27	万州体育馆	X	广东-山西	27-21 (15-8)	5-8名
	16:00	28	万州体育馆	X	安徽-北京	19-23 (12-14)	半决赛
	17:30	29	万州体育馆	X	天津-江苏	16-23 (5-13)	半决赛
16-04-19	09:30	30	万州体育馆	X	山东-山西	24-17 (10-10)	7-8名
	13:00	31	万州体育馆	X	上海-广东	22-27 (11-14)	5-6名
	14:30	32	万州体育馆	X	安徽-天津	32-33 (14-13)	3-4名
	16:00	33	万州体育馆	X	北京-江苏	17-23 (9-12)	决赛

## 2019年全国男子手球冠军杯赛

PHMS Pictorial Handball Match Statistics

IHF Official System

### 分组成绩

手球  
男子

截止至第33场

重庆万州  
2019-04-16

组别: A 预赛

名次	球队	积	场	胜	平	负	得分	失分	净胜
1	安徽	8	4	4	0	0	116	87	29
2	广东	6	4	3	0	1	102	95	7
3	北京	4	4	2	0	2	118	87	31
4	山西	2	4	1	0	3	90	124	-34
5	陕西	0	4	0	0	4	92	125	-33

球队	安徽	广东	北京	山西	陕西
安徽		27-26	23-22	34-23	32-16
广东	26-27		21-20	24-22	31-26
北京	22-23	20-21		41-18	35-25
山西	23-34	22-24	18-41		27-25
陕西	16-32	26-31	25-35	25-27	

组别: B 预赛

名次	球队	积	场	胜	平	负	得分	失分	净胜
1	江苏	8	4	4	0	0	139	87	52
2	山东	6	4	3	0	1	111	77	34
3	天津	4	4	2	0	2	100	85	15
4	上海	2	4	1	0	3	87	116	-29
5	四川	0	4	0	0	4	73	145	-72

球队	江苏	山东	天津	上海	四川
江苏		26-25	34-22	39-18	40-22
山东	25-26		19-17	31-21	36-13
天津	22-34	17-19		26-14	35-18
上海	18-39	21-31	14-26		34-20
四川	22-40	13-36	18-35	20-34	

Legend:

积	积分	■	已比赛场次	胜	胜场	平	平场
负	负场	得分	得分累计	失分	失分累计	净胜	净胜分

## 2019年全国男子手球冠军杯赛

PHMS Pictorial Handball Match Statistics

IHF Official System

### 得分排名表(场上队员)

手球男子 截止至第33场 按总得分排序 重庆万州 2019-04-16

排序	号码	姓名	球队	远射	近射	边射	快攻	突破	任意	七米	合计	%	助攻	场数
1	14	杨毅	山西	20-57	9-19	0-2	1-1	6-15	2-3	6-8	44-105	41.9	7	7
2	7	张青	天津	9-24	7-10	0-0	3-4	4-4	0-0	14-16	37-58	63.8	3	7
3	6	赵晨	江苏	20-34	6-7	0-0	0-0	4-4	2-4	0-1	32-50	64.0	17	6
4	10	朱世杰	上海	13-30	4-10	1-1	1-2	8-10	1-2	3-6	31-61	50.8	14	7
5	25	王杰缘	江苏	0-0	3-4	11-17	10-10	0-0	0-0	6-10	30-41	73.2	1	7
6	5	贺政	上海	7-22	8-13	4-5	4-5	4-6	0-4	3-4	30-59	50.8	3	7
7	18	李双	安徽	12-27	6-9	0-1	7-7	4-7	0-0	0-0	29-51	56.9	9	7
8	22	黄培杰	广东	1-11	6-10	3-6	3-4	13-20	0-0	3-5	29-56	51.8	8	7
9	6	毕晓晨	广东	7-17	8-16	3-6	4-8	4-6	0-0	3-5	29-58	50.0	0	7
10	10	周仲坤	广东	11-19	5-11	0-2	3-3	3-3	0-1	6-9	28-48	58.3	2	7
11	10	成亚	北京	2-15	3-8	0-1	8-9	6-6	0-1	9-11	28-51	54.9	11	7
12	8	高震东	上海	0-9	8-12	9-13	4-7	4-7	0-0	2-2	27-50	54.0	3	7
13	31	于亚男	山东	13-31	3-6	0-2	4-4	3-3	0-1	4-5	27-52	51.9	3	7
14	6	盖秀越	山西	0-2	2-4	14-21	8-8	1-1	0-0	1-2	26-38	68.4	2	7
15	15	张建杰	广东	10-34	6-11	0-0	2-4	8-9	0-2	0-0	26-60	43.3	6	7
16	7	任健豪	山西	4-10	9-19	0-2	3-7	9-11	0-0	0-1	25-50	50.0	7	7
17	9	王子欣	天津	4-7	1-3	9-14	8-10	1-2	1-1	0-0	24-37	64.9	7	7
18	8	董智景	安徽	0-2	0-1	6-11	8-10	3-4	0-0	5-5	22-33	66.7	2	7
19	4	王巨柱	安徽	13-19	4-6	0-0	0-0	1-4	2-2	2-2	22-33	66.7	1	7
20	8	谢庆龙	江苏	0-1	18-27	0-0	2-3	2-3	0-0	0-0	22-34	64.7	2	7
21	6	董佳辉	四川	3-26	10-14	0-0	2-3	7-8	0-3	0-1	22-55	40.0	1	4
22	7	王立隆	广东	0-0	0-0	7-8	10-13	4-4	0-0	0-0	21-25	84.0	3	7
23	23	王军程	北京	12-30	2-6	0-1	0-0	2-3	2-4	3-3	21-47	44.7	5	7
24	6	李朝鹏	山东	5-10	5-7	2-3	3-3	4-4	0-0	1-2	20-29	69.0	4	7
25	15	陈冉	陕西	1-1	4-6	10-19	3-6	1-1	0-0	1-3	20-36	55.6	0	4
26	13	许松	天津	0-5	2-3	5-13	10-13	3-4	0-0	0-2	20-40	50.0	5	7
27	7	周傲	江苏	1-5	6-9	0-0	5-7	5-6	0-0	2-3	19-30	63.3	6	7
28	19	李语庆	山东	0-0	2-2	3-7	10-12	0-0	0-0	3-4	18-25	72.0	0	7
29	11	张天豪	江苏	1-1	6-7	5-9	6-9	0-0	0-0	0-0	18-26	69.2	3	7
30	8	王晓琪	天津	5-10	3-5	3-4	2-2	1-3	1-1	3-3	18-28	64.3	2	7
31	4	张家纬	江苏	8-14	6-9	0-0	0-3	3-5	0-0	1-1	18-32	56.3	4	7
32	1	郭世伟	安徽	6-16	4-6	0-0	2-2	5-7	0-0	1-3	18-34	52.9	1	7
33	33	陈旭	北京	3-17	5-10	0-0	4-4	6-7	0-0	0-0	18-38	47.4	3	7
34	86	田剑侠	天津	1-16	2-5	0-0	1-1	13-18	0-1	1-1	18-42	42.9	10	7
35	15	张继伟	山东	0-0	15-24	0-0	1-4	1-1	0-1	0-0	17-30	56.7	1	7
36	7	林豪文	山东	5-10	5-10	2-4	2-3	3-3	0-1	0-0	17-31	54.8	3	7
37	20	顾艳超	江苏	5-15	6-15	0-0	1-2	5-6	0-0	0-0	17-38	44.7	6	6
38	10	严龙	安徽	0-0	1-2	6-11	5-6	0-0	0-0	4-5	16-24	66.7	1	7
39	30	徐俊吉	上海	0-0	11-18	0-1	1-1	0-0	0-0	4-7	16-27	59.3	0	7
40	10	王凯强	陕西	3-15	6-8	0-0	3-3	4-7	0-0	0-0	16-33	48.5	4	4

## 2019年全国男子手球冠军杯赛

PHMS Pictorial Handball Match Statistics

IHF Official System

### 得分排名表(场上队员)

手球男子 截止至第33场 助攻次数排序 重庆万州 2019-04-16

排序	号码	姓名	球队	远射	近射	边射	快攻	突破	任意	七米	合计	%	助攻	场数
1	6	赵晨	江苏	20-34	6-7	0-0	0-0	4-4	2-4	0-1	32-50	64.0	17	6
2	10	朱世杰	上海	13-30	4-10	1-1	1-2	8-10	1-2	3-6	31-61	50.8	14	7
3	10	成亚	北京	2-15	3-8	0-1	8-9	6-6	0-1	9-11	28-51	54.9	11	7
4	86	田剑侠	天津	1-16	2-5	0-0	1-1	13-18	0-1	1-1	18-42	42.9	10	7
5	3	刘赵梁	陕西	3-8	1-5	0-0	1-1	8-9	1-2	0-0	14-25	56.0	10	4
6	18	李双	安徽	12-27	6-9	0-1	7-7	4-7	0-0	0-0	29-51	56.9	9	7
7	22	黄培杰	广东	1-11	6-10	3-6	3-4	13-20	0-0	3-5	29-56	51.8	8	7
8	14	杨毅	山西	20-57	9-19	0-2	1-1	6-15	2-3	6-8	44-105	41.9	7	7
9	7	任健豪	山西	4-10	9-19	0-2	3-7	9-11	0-0	0-1	25-50	50.0	7	7
10	9	王子欣	天津	4-7	1-3	9-14	8-10	1-2	1-1	0-0	24-37	64.9	7	7
11	12	王权	江苏	0-0	0-0	0-0	0-0	0-0	0-0	0-0	0-0	0	7	7
12	12	于性哲	山东	0-0	0-0	0-0	0-0	0-0	0-0	0-0	0-0	0	7	7
13	15	张建杰	广东	10-34	6-11	0-0	2-4	8-9	0-2	0-0	26-60	43.3	6	7
14	7	周傲	江苏	1-5	6-9	0-0	5-7	5-6	0-0	2-3	19-30	63.3	6	7
15	20	顾艳超	江苏	5-15	6-15	0-0	1-2	5-6	0-0	0-0	17-38	44.7	6	6
16	13	刘晓	山东	8-22	3-7	1-1	0-1	2-4	0-0	0-0	14-35	40.0	6	7
17	23	王军程	北京	12-30	2-6	0-1	0-0	2-3	2-4	3-3	21-47	44.7	5	7
18	13	许松	天津	0-5	2-3	5-13	10-13	3-4	0-0	0-2	20-40	50.0	5	7
19	18	傅俊雄	北京	2-7	4-5	0-0	0-0	3-5	0-0	2-4	11-21	52.4	5	7
20	17	王旭东	山东	0-4	1-5	1-2	1-1	0-1	0-0	1-1	4-14	28.6	5	7
21	6	李朝鹏	山东	5-10	5-7	2-3	3-3	4-4	0-0	1-2	20-29	69.0	4	7
22	4	张家纬	江苏	8-14	6-9	0-0	0-3	3-5	0-0	1-1	18-32	56.3	4	7
23	10	王凯强	陕西	3-15	6-8	0-0	3-3	4-7	0-0	0-0	16-33	48.5	4	4
24	30	吴龙瑞	江苏	2-2	1-3	0-0	3-3	5-7	0-0	1-4	12-19	63.2	4	6
25	14	冼鹏飞	四川	3-10	2-4	0-0	1-2	4-4	0-0	0-1	10-21	47.6	4	4
26	34	王钟彬	山东	0-1	1-2	1-1	2-2	2-3	0-0	3-3	9-12	75.0	4	7
27	12	曾献辰	安徽	0-0	0-0	0-0	0-0	0-0	0-0	0-0	0-0	0	4	7
28	1	宋晓晨	山东	0-0	0-0	0-0	0-0	0-0	0-0	0-0	0-0	0	4	7
29	7	张青	天津	9-24	7-10	0-0	3-4	4-4	0-0	14-16	37-58	63.8	3	7
30	5	贺政	上海	7-22	8-13	4-5	4-5	4-6	0-4	3-4	30-59	50.8	3	7
31	8	高震东	上海	0-9	8-12	9-13	4-7	4-7	0-0	2-2	27-50	54.0	3	7
32	31	于亚男	山东	13-31	3-6	0-2	4-4	3-3	0-1	4-5	27-52	51.9	3	7
33	7	王立隆	广东	0-0	0-0	7-8	10-13	4-4	0-0	0-0	21-25	84.0	3	7
34	11	张天豪	江苏	1-1	6-7	5-9	6-9	0-0	0-0	0-0	18-26	69.2	3	7
35	33	陈旭	北京	3-17	5-10	0-0	4-4	6-7	0-0	0-0	18-38	47.4	3	7
36	7	林豪文	山东	5-10	5-10	2-4	2-3	3-3	0-1	0-0	17-31	54.8	3	7
37	19	庞连康	江苏	3-7	7-10	0-1	0-0	5-6	0-0	0-0	15-24	62.5	3	7
38	13	王军鸣	北京	6-11	1-4	0-0	1-1	2-2	1-1	2-3	13-22	59.1	3	7
39	13	杜忠浩	山西	6-16	2-5	0-0	0-0	0-2	1-1	1-1	10-25	40.0	3	7
40	10	赵建强	山东	0-0	1-1	2-5	4-6	0-0	0-0	1-2	8-14	57.1	3	7



## 2019年全国男子手球冠军杯赛

PHMS Pictorial Handball Match Statistics

IHF Official System

### 得分排名表(场上队员)

手球  
男子

截止至第33场  
按封球次数排序

重庆万州  
2019-04-16

名次	号码	姓名	球队	抢球	断球	造失误	造犯规	合计	封球	场数
1	15	张继伟	山东	0	0	0	3	3	11	7
2	6	赵晨	江苏	0	0	0	0	0	9	6
3	18	李双	安徽	3	7	2	4	16	9	7
4	20	顾艳超	江苏	0	4	0	3	7	7	6
5	21	刘江	江苏	0	4	0	0	4	7	7
6	24	徐安格	安徽	4	0	0	1	5	7	7
7	18	傅俊雄	北京	1	2	0	2	5	7	7
8	11	宋朋强	山东	1	2	0	0	3	6	7
9	10	周仲坤	广东	1	4	0	3	8	6	7
10	6	解建飞	北京	1	3	0	0	4	5	7
11	11	吴夏冰	山西	0	5	0	1	6	4	7
12	32	蒋维一	北京	1	2	0	1	4	4	7
13	19	庞连康	江苏	1	2	1	0	4	4	7
14	6	李朝鹏	山东	0	2	1	0	3	4	7
15	33	陈旭	北京	1	0	1	1	3	3	7
16	17	王旭东	山东	0	0	0	0	0	3	7
17	30	徐俊吉	上海	0	1	0	0	1	3	7
18	8	谢庆龙	江苏	1	2	2	1	6	3	7
19	13	刘晓	山东	0	3	0	2	5	3	7
20	15	周群	天津	0	3	0	2	5	3	7
21	12	王雨	广东	2	4	0	0	6	3	7
22	27	胡晋铭	山东	0	0	0	3	3	3	7
23	11	张领	陕西	0	0	1	1	2	2	4
24	4	张家纬	江苏	0	1	0	0	1	2	7
25	9	赵元	山东	0	0	0	2	2	2	7
26	18	姚雪岩	广东	0	2	0	1	3	2	7
27	7	马昌震	北京	0	1	0	1	2	2	7
28	3	魏雨童	天津	2	3	1	0	6	2	7
29	13	王军鸣	北京	0	0	0	0	0	2	7
30	24	高玉杰	广东	2	4	0	1	7	2	7
31	10	王凯强	陕西	0	1	0	0	1	1	4
32	8	季雨	陕西	2	4	1	0	7	1	4
33	2	张宏运	四川	0	0	0	0	0	1	4
34	6	董佳辉	四川	1	2	1	0	4	1	4
35	3	逯明松	北京	0	1	0	0	1	1	7
36	5	史小帆	安徽	0	1	0	1	2	1	7
37	10	严龙	安徽	0	0	1	1	2	1	7
38	14	杨毅	山西	1	2	0	0	3	1	7
39	10	成亚	北京	2	2	0	2	6	1	7
40	10	王洋	山西	0	1	0	1	2	1	7



2019年全国男子手球冠军杯赛

PHMS Pictorial Handball Match Statistics

IHF Official System

得分排名表(场上队员)

手球  
男子

截止至第33场  
按防守成功总数排序

重庆万州  
2019-04-16

名次	号码	姓名	球队	抢球	断球	造失误	造犯规	合计	封球	场数
1	18	李双	安徽	3	7	2	4	16	9	7
2	13	许松	天津	2	6	4	1	13	0	7
3	10	朱世杰	上海	1	7	2	1	11	1	7
4	10	周仲坤	广东	1	4	0	3	8	6	7
5	7	王立隆	广东	1	6	0	0	7	1	7
6	8	王晓琪	天津	1	5	0	1	7	1	7
7	6	盖秀越	山西	4	3	0	0	7	0	7
8	8	董智景	安徽	1	3	1	2	7	0	7
9	7	任健豪	山西	0	5	0	2	7	1	7
10	24	高玉杰	广东	2	4	0	1	7	2	7
11	20	顾艳超	江苏	0	4	0	3	7	7	6
12	8	季雨	陕西	2	4	1	0	7	1	4
13	8	谢庆龙	江苏	1	2	2	1	6	3	7
14	22	黄培杰	广东	0	5	1	0	6	0	7
15	12	王雨	广东	2	4	0	0	6	3	7
16	3	魏雨童	天津	2	3	1	0	6	2	7
17	10	成亚	北京	2	2	0	2	6	1	7
18	6	毕晓晨	广东	1	2	1	2	6	0	7
19	11	吴夏冰	山西	0	5	0	1	6	4	7
20	21	张昌轲	广东	0	2	2	2	6	1	7
21	18	傅俊雄	北京	1	2	0	2	5	7	7
22	7	周傲	江苏	1	4	0	0	5	1	7
23	19	李语庆	山东	0	2	0	3	5	0	7
24	86	田剑侠	天津	1	2	0	2	5	1	7
25	15	周群	天津	0	3	0	2	5	3	7
26	7	姚雄敏	安徽	0	4	0	1	5	0	7
27	9	王子欣	天津	1	4	0	0	5	0	7
28	24	徐安格	安徽	4	0	0	1	5	7	7
29	25	王杰缘	江苏	0	1	1	3	5	0	7
30	26	魏昂	北京	2	3	0	0	5	0	7
31	13	刘晓	山东	0	3	0	2	5	3	7
32	3	刘赵梁	陕西	0	5	0	0	5	0	4
33	5	马益奎	陕西	0	1	1	3	5	0	4
34	5	贺政	上海	0	3	0	1	4	0	7
35	11	张天豪	江苏	0	4	0	0	4	0	7
36	21	刘江	江苏	0	4	0	0	4	7	7
37	8	高震东	上海	0	3	1	0	4	0	7
38	18	赵楠	江苏	0	2	1	1	4	1	7
39	6	解建飞	北京	1	3	0	0	4	5	7
40	18	董凯	上海	1	2	0	1	4	0	7

2019年全国男子手球冠军杯赛

PHMS Pictorial Handball Match Statistics

IHF Official System

得分排名表(场上队员)

手球  
男子

截止至第33场  
按失误总数排序

重庆万州  
2019-04-16

排序	号码	姓名	球队	传失	接失	两次	四步	侵区	进犯	其它	合计	场数
1	10	朱世杰	上海	19	2	2	8	0	0	0	31	7
2	14	杨毅	山西	16	4	4	1	0	1	0	26	7
3	3	刘赵梁	陕西	11	1	4	3	0	1	3	23	4
4	86	田剑侠	天津	7	1	4	2	0	5	1	20	7
5	33	陈旭	北京	10	0	2	2	1	3	0	18	7
6	9	左典	四川	5	2	4	2	1	2	2	18	4
7	7	任健豪	山西	11	1	0	2	1	0	2	17	7
8	5	贺政	上海	6	2	2	2	1	2	2	17	7
9	18	李双	安徽	7	4	1	1	0	2	0	15	7
10	14	洗鹏飞	四川	8	2	1	3	0	1	0	15	4
11	15	薛瑞寒	山西	5	0	1	2	1	3	1	13	7
12	23	王军程	北京	8	0	2	1	0	0	2	13	7
13	30	徐俊吉	上海	3	4	0	0	1	3	2	13	7
14	10	王凯强	陕西	6	5	0	1	0	0	1	13	4
15	13	刘晓	山东	7	2	1	1	0	0	1	12	7
16	6	李朝鹏	山东	7	2	1	0	0	1	1	12	7
17	7	张青	天津	4	1	0	2	1	3	1	12	7
18	13	杜忠浩	山西	5	4	1	1	0	0	1	12	7
19	8	高震东	上海	6	2	0	0	0	1	2	11	7
20	9	王子欣	天津	6	1	1	1	2	0	0	11	7
21	24	徐安格	安徽	1	4	0	0	1	5	0	11	7
22	10	成亚	北京	7	2	0	0	0	2	0	11	7
23	20	顾艳超	江苏	6	0	1	1	0	2	1	11	6
24	8	季雨	陕西	4	5	0	0	0	1	1	11	4
25	8	罗霖泽	四川	5	3	0	1	0	2	0	11	4
26	7	姚雄敏	安徽	6	2	1	0	0	1	0	10	7
27	8	王晓琪	天津	6	0	0	2	1	1	0	10	7
28	7	曾繁泳	四川	3	4	2	0	0	1	0	10	4
29	26	魏昂	北京	3	3	0	0	2	1	0	9	7
30	6	毕晓晨	广东	0	1	6	1	0	0	1	9	7
31	11	房友屯	广东	6	2	0	1	0	0	0	9	7
32	13	许松	天津	2	2	1	2	1	1	0	9	7
33	15	张建杰	广东	1	2	2	3	0	1	0	9	7
34	22	黄培杰	广东	4	2	1	0	1	1	0	9	7
35	3	张立成	上海	1	1	1	4	1	0	1	9	6
36	6	董佳辉	四川	5	2	1	0	0	0	1	9	4
37	7	周文龙	上海	5	0	1	1	0	1	0	8	7
38	6	盖秀越	山西	3	3	0	1	0	0	1	8	7
39	32	蒋维一	北京	0	4	0	0	2	2	0	8	7
40	13	王军鸣	北京	4	2	0	0	0	1	1	8	7

## 2019年全国男子手球冠军杯赛

PHMS Pictorial Handball Match Statistics

IHF Official System

### 得分排名表(场上队员)

手球男子 截止至第33场 接受罚次数排序 重庆万州 2019-04-16

排序	号码	姓名	球队	警告	罚2分钟	D	DR	场数
1	6	李朝鹏	山东	1	3	1	0	7
2	7	马昌震	北京	3	1	1	0	7
3	14	杨毅	山西	1	0	1	0	7
4	18	傅俊雄	北京	1	0	1	0	7
5	23	吴双	上海	1	0	1	0	5
6	3	李朗轩	四川	1	0	1	0	4
7	24	徐安格	安徽	4	9	0	0	7
8	18	李双	安徽	4	7	0	0	7
9	3	魏雨童	天津	2	7	0	0	7
10	11	吴夏冰	山西	3	6	0	0	7
11	24	高玉杰	广东	1	5	0	0	7
12	4	刘文东	山西	1	5	0	0	7
13	5	马益奎	陕西	2	4	0	0	4
14	10	朱世杰	上海	1	4	0	0	7
15	15	张继伟	山东	5	3	0	0	7
16	8	高震东	上海	3	3	0	0	7
17	6	解建飞	北京	2	3	0	0	7
18	86	田剑侠	天津	2	3	0	0	7
19	6	毕晓晨	广东	1	3	0	0	7
20	7	张青	天津	1	3	0	0	7
21	11	蒋慧捷	上海	0	3	0	0	7
22	21	张昌轲	广东	0	3	0	0	7
23	4	高天伦	上海	0	3	0	0	7
24	22	王超	北京	0	3	0	0	7
25	10	苏尧	天津	0	3	0	0	7
26	11	张领	陕西	0	3	0	0	4
27	6	董佳辉	四川	0	3	0	0	4
28	15	周群	天津	3	2	0	0	7
29	17	王旭东	山东	3	2	0	0	7
30	10	周仲坤	广东	3	2	0	0	7
31	9	金永峰	安徽	2	2	0	0	7
32	11	房友屯	广东	2	2	0	0	7
33	9	王子欣	天津	1	2	0	0	7
34	33	陈旭	北京	1	2	0	0	7
35	12	王雨	广东	1	2	0	0	7
36	21	刘江	江苏	1	2	0	0	7
37	7	任健豪	山西	1	2	0	0	7
38	7	林豪文	山东	0	2	0	0	7
39	13	王军鸣	北京	0	2	0	0	7
40	27	闫炳旗	北京	0	2	0	0	7



## 2019年全国男子手球冠军杯赛

PHMS Pictorial Handball Match Statistics

IHF Official System

### 排名表(守门员)

手球 男子 截止至第33场 按总救球数排序 重庆万州 2019-04-16

排序	号码	姓名	球队	远射	近射	边射	快攻	突破	任意	七米	得分	%	助攻	场数
1	16	刘迈科	北京	33-59	25-59	15-26	7-25	8-28	3-3	3-11	94-211	44.5	3	7
2	12	韩乐斌	山西	16-43	15-54	16-39	6-30	6-27	2-4	3-11	64-208	30.8	1	7
3	1	何喜年	天津	22-50	16-41	7-18	9-33	4-29	2-5	3-11	63-187	33.7	1	7
4	12	于性哲	山东	22-48	17-39	11-19	4-17	4-12	1-3	2-13	61-151	40.4	7	7
5	12	王权	江苏	26-46	19-37	3-14	1-9	2-10	1-1	3-10	55-127	43.3	7	7
6	1	张崢	上海	17-33	20-51	8-25	3-32	6-33	0-0	1-12	55-186	29.6	3	7
7	21	李明	安徽	23-46	6-38	12-35	3-13	2-17	3-6	3-24	52-179	29.1	3	7
8	14	王泽润	广东	7-18	16-33	8-16	5-20	4-22	1-4	1-10	42-123	34.1	0	7
9	19	王帅	广东	8-20	15-36	3-12	3-17	7-22	0-0	6-18	42-125	33.6	2	7
10	22	张睿梁	陕西	6-16	9-35	9-21	6-22	4-19	0-0	1-6	35-119	29.4	1	4
11	16	张帅	江苏	15-31	7-20	1-9	2-9	3-8	1-2	2-5	31-84	36.9	3	7
12	12	周哲韬	上海	8-10	9-25	2-10	2-13	3-9	0-1	2-4	26-72	36.1	1	5
13	12	戴景伟	四川	3-8	8-31	2-11	6-22	2-18	0-1	3-4	24-95	25.3	2	4
14	12	曾献辰	安徽	12-25	2-11	1-6	0-3	3-9	1-1	2-6	21-61	34.4	4	7
15	1	宋晓晨	山东	7-19	7-20	5-10	2-9	0-7	0-0	0-5	21-70	30.0	4	7
16	16	刘宗其	天津	4-10	1-9	3-8	2-10	1-9	0-0	7-11	18-57	31.6	2	7
17	1	鲁世豪	山西	3-12	11-34	2-6	1-14	0-7	0-0	1-10	18-83	21.7	0	7
18	17	叶康全	四川	3-10	8-29	2-14	2-26	1-8	0-0	1-4	17-91	18.7	0	4
19	1	宋继强	江苏	5-9	4-11	1-3	1-3	0-3	0-0	0-0	11-29	37.9	0	7
20	1	陈昊	陕西	0-16	5-12	3-4	1-13	0-4	0-0	1-2	10-51	19.6	0	4
21	12	高云健	北京	2-5	4-15	0-6	2-7	1-3	0-0	0-5	9-41	22.0	0	7
22	16	张逸豪	上海	0-1	0-6	1-2	0-2	1-3	0-0	1-1	3-15	20.0	0	4
23	16	王虹翔	山西	0-0	0-0	0-0	0-0	0-0	0-0	0-0	0-0	0	0	7
24	1	郭世伟	安徽	0-0	0-0	0-0	0-0	0-0	0-0	0-0	0-0	0	0	7

## 2019年全国男子手球冠军杯赛

PHMS Pictorial Handball Match Statistics

IHF Official System

### 排名表(守门员)

手球  
男子

截止至第33场  
按救七米球数排序

重庆万州  
2019-04-16

排序	号码	姓名	球队	远射	近射	边射	快攻	突破	任意	七米	得分	%	助攻	场数
1	16	刘宗其	天津	4-10	1-9	3-8	2-10	1-9	0-0	7-11	18-57	63.6	2	7
2	19	王帅	广东	8-20	15-36	3-12	3-17	7-22	0-0	6-18	42-125	33.3	2	7
3	12	戴景伟	四川	3-8	8-31	2-11	6-22	2-18	0-1	3-4	24-95	75.0	2	4
4	12	王权	江苏	26-46	19-37	3-14	1-9	2-10	1-1	3-10	55-127	30.0	7	7
5	16	刘迈科	北京	33-59	25-59	15-26	7-25	8-28	3-3	3-11	94-211	27.3	3	7
6	12	韩乐斌	山西	16-43	15-54	16-39	6-30	6-27	2-4	3-11	64-208	27.3	1	7
7	1	何喜年	天津	22-50	16-41	7-18	9-33	4-29	2-5	3-11	63-187	27.3	1	7
8	21	李明	安徽	23-46	6-38	12-35	3-13	2-17	3-6	3-24	52-179	12.5	3	7
9	12	周哲韬	上海	8-10	9-25	2-10	2-13	3-9	0-1	2-4	26-72	50.0	1	5
10	16	张帅	江苏	15-31	7-20	1-9	2-9	3-8	1-2	2-5	31-84	40.0	3	7
11	12	曾献辰	安徽	12-25	2-11	1-6	0-3	3-9	1-1	2-6	21-61	33.3	4	7
12	12	于性哲	山东	22-48	17-39	11-19	4-17	4-12	1-3	2-13	61-151	15.4	7	7
13	16	张逸豪	上海	0-1	0-6	1-2	0-2	1-3	0-0	1-1	3-15	100.0	0	4
14	1	陈昊	陕西	0-16	5-12	3-4	1-13	0-4	0-0	1-2	10-51	50.0	0	4
15	17	叶康全	四川	3-10	8-29	2-14	2-26	1-8	0-0	1-4	17-91	25.0	0	4
16	22	张睿梁	陕西	6-16	9-35	9-21	6-22	4-19	0-0	1-6	35-119	16.7	1	4
17	14	王泽润	广东	7-18	16-33	8-16	5-20	4-22	1-4	1-10	42-123	10.0	0	7
18	1	鲁世豪	山西	3-12	11-34	2-6	1-14	0-7	0-0	1-10	18-83	10.0	0	7
19	1	张峥	上海	17-33	20-51	8-25	3-32	6-33	0-0	1-12	55-186	8.3	3	7
20	1	宋继强	江苏	5-9	4-11	1-3	1-3	0-3	0-0	0-0	11-29	0	0	7
21	16	王虹翔	山西	0-0	0-0	0-0	0-0	0-0	0-0	0-0	0-0	0	0	7
22	1	郭世伟	安徽	0-0	0-0	0-0	0-0	0-0	0-0	0-0	0-0	0	0	7
23	1	宋晓晨	山东	7-19	7-20	5-10	2-9	0-7	0-0	0-5	21-70	0.0	4	7
24	12	高云健	北京	2-5	4-15	0-6	2-7	1-3	0-0	0-5	9-41	0.0	0	7

2019年全国男子手球冠军杯赛

PHMS Pictorial Handball Match Statistics

IHF Official System

攻防成功率统计总表

手球  
男子

截止至第33场

重庆万州  
2019-04-16

序号	球队	比分	进攻成功率															助攻	防守成功率								
			阵地进攻			一传快攻			短传快攻			合计			多打少				少打多			封打抢断	守门员	对方射失	对方失误	合计	%
			得分	进攻	%	得分	进攻	%	得分	进攻	%	得分	进攻	%	得分	进攻	%		得分	进攻	%						
1	安徽	192:167	150	340	44.1	16	21	76.2	26	38	68.4	192	399	48.1	15	30	50.0	14	25	56.0	28	67	73	32	65	237	58.7
2	北京	180:149	145	345	42.0	13	15	86.7	22	35	62.9	180	395	45.6	20	33	60.6	11	19	57.9	38	62	103	53	30	248	62.5
3	广东	179:164	147	343	42.9	16	21	76.2	16	34	47.1	179	398	45.0	20	36	55.6	13	21	61.9	25	71	84	36	51	242	59.6
4	江苏	219:143	177	345	51.3	25	32	78.1	17	40	42.5	219	417	52.5	17	28	60.7	6	10	60.0	60	80	97	54	53	284	66.5
5	山东	176:139	138	314	43.9	15	18	83.3	23	46	50.0	176	378	46.6	8	19	42.1	13	21	61.9	47	67	82	55	57	261	65.3
6	山西	151:209	133	390	34.1	8	12	66.7	10	25	40.0	151	427	35.4	14	20	70.0	9	16	56.3	25	36	82	36	46	200	48.9
7	陕西	92:125	84	236	35.6	3	4	75.0	5	11	45.5	92	251	36.7	15	19	78.9	6	11	54.5	18	33	45	26	19	123	49.6
8	上海	156:189	134	367	36.5	11	14	78.6	11	36	30.6	156	417	37.4	18	37	48.6	10	15	66.7	30	38	84	44	47	213	53.0
9	四川	73:145	60	234	25.6	9	11	81.8	4	13	30.8	73	258	28.3	3	14	21.4	3	4	75.0	10	17	41	23	27	108	42.7
10	天津	175:163	144	349	41.3	15	19	78.9	16	30	53.3	175	398	44.0	19	29	65.5	13	22	59.1	33	55	81	44	49	229	58.4

注释:

进攻	进攻次数 (射门 + 进攻失误)	对方射失	对方射门失误 (射失 + 击柱)	防守成功率%	本方防守合计 / 对方进攻合计
----	------------------	------	------------------	--------	-----------------

2019年全国男子手球冠军杯赛

PHMS Pictorial Handball Match Statistics

IHF Official System

防守技术统计总表

手球  
男子

截止至第33场

重庆万州  
2019-04-16

序号	球队	比分	防守成功						防守(成功:失误)							处罚					守门员			
			封球	抢球	断球	造失	造犯	合计	选位	顶贴	观察	移动	换防	其他	合计	警告	2'	取消	DR	合计	救球	射门	%	
1	安徽	192:167	18	11	21	4	13	67	1:0	0:2	0:0	0:0	0:0	0:0	0:0	1:2	14	20	0	0	34	73	240	30.4
2	北京	180:149	25	10	18	1	8	62	0:0	0:0	0:0	0:0	0:0	0:0	0:0	0:0	14	17	2	0	33	103	252	40.9
3	广东	179:164	16	8	32	5	10	71	0:0	0:0	0:0	0:0	0:0	0:0	0:0	0:0	12	20	0	0	32	84	248	33.9
4	江苏	219:143	34	4	29	5	8	80	0:0	0:0	0:0	0:0	0:0	0:0	0:0	0:0	12	7	0	0	19	97	240	40.4
5	山东	176:139	35	3	13	2	14	67	0:0	0:0	0:0	0:0	0:0	0:0	0:0	0:0	12	17	1	0	30	82	221	37.1
6	山西	151:209	7	6	16	2	5	36	0:0	0:0	0:0	0:0	0:0	0:0	0:0	0:0	12	18	1	0	31	82	291	28.2
7	陕西	92:125	4	5	17	3	4	33	0:0	0:0	0:0	0:0	0:0	0:0	0:0	0:0	4	11	0	0	15	45	170	26.5
8	上海	156:189	4	4	21	4	5	38	0:0	0:0	0:0	0:0	0:0	0:0	0:0	0:0	9	15	1	0	25	84	273	30.8
9	四川	73:145	2	2	10	3	0	17	0:0	0:0	0:0	0:0	0:0	0:0	0:0	0:0	3	6	1	0	10	41	186	22.0
10	天津	175:163	8	10	26	5	6	55	0:0	0:0	0:0	0:0	0:0	0:0	0:0	0:0	9	23	0	0	32	81	244	33.2

注释:

造失	造对方失误	造犯	造对方犯规	DR	取消资格+报告
----	-------	----	-------	----	---------



2019年全国男子手球冠军杯赛

PHMS Pictorial Handball Match Statistics

IHF Official System

球队名单

重庆万州

江苏队

2019-04-07

号码	姓名	位置	生日	年龄	俱乐部	身高 (CM)	体重 (KG)	国际场次	国际进球
1	宋继强	守门员	22/03/1997	22					
3	周悦骅	边锋	02/06/2002	16					
4	张家纬	右后卫	25/09/1992	26		193	85		
6	赵晨	左后卫	24/06/1989	29		202	110		
7	周傲	后卫	08/09/1999	19		183	72		
8	谢庆龙	底线	24/10/2000	18		193	100		
11	张天豪	边锋	02/06/1998	20		185	78		
12	王权	守门员	21/11/1992	26		205	110		
16	张帅	守门员	11/05/1994	24		190	70		
18	赵楠	边锋	07/05/1993	25		180	65		
19	庞连康	左后卫	02/07/1996	22		190	85		
20	顾艳超	后卫	06/01/1993	26		190	60		
21	刘江	底线	23/03/1993	26		195	71		
25	王杰缘	边锋	16/01/1995	24		180	62		
27	王伟强	边锋	07/01/1993	26		180	74		
30	吴龙瑞	左后卫	02/10/1989	29					
	平均			23.6		189.7	80.2		

编码	姓名	职务
A	闫威名	主教练
B	叶强	教练
C	贾淑君	教练
E	王建国	医生
D	钱红	领队

## 2019年全国男子手球冠军杯赛

PHMS Pictorial Handball Match Statistics

IHF Official System

手球  
男子

### 个人/全队技术累计表

重庆万州  
2019-04-16

截止至第33场

号码	姓名	远射	近射	边射	快攻	突破	任意	七米	合计	%	助攻	失误	警告	2'	取消	场次	时间
江苏队																	
(场上队员)																	
1	宋继强															7	00:51:19
3	周悦骅							0/2	0/2	0.0%		1		1		3	00:16:26
4	张家纬	8/14	6/9		0/3	3/5		1/1	18/32	56.3%	4	4	3	1		7	03:48:23
6	赵晨	20/34	6/7			4/4	2/4	0/1	32/50	64.0%	17	3		1		6	03:24:45
7	周傲	1/5	6/9		5/7	5/6		2/3	19/30	63.3%	6	4				7	02:11:55
8	谢庆龙	0/1	18/27		2/3	2/3			22/34	64.7%	2	6	3			7	04:36:27
11	张天豪	1/1	6/7	5/9	6/9				18/26	69.2%	3	5				7	02:33:05
12	王权											7	1			7	03:54:56
16	张帅											3	1			7	02:13:30
18	赵楠	1/2	3/7	2/3	4/6	1/1			11/19	57.9%	2	6				7	03:22:51
19	庞连康	3/7	7/10	0/1		5/6			15/24	62.5%	3	6	1	1		7	02:45:46
20	顾艳超	5/15	6/15		1/2	5/6			17/38	44.7%	6	11	2			6	04:12:08
21	刘江		11/12		3/6				14/18	77.8%	2	3	1	2		7	03:15:07
25	王杰缘		3/4	11/17	10/10			6/10	30/41	73.2%	1	2	1			7	05:03:16
27	王伟强		2/3	1/6	8/11				11/20	55.0%		5	1	1		7	04:26:19
30	吴龙瑞	2/2	1/3		3/3	5/7		1/4	12/19	63.2%	4	6				6	02:15:01
	合计	41/81	75/113	19/36	42/60	30/38	2/4	10/21	219/353	62.0%	60	64	12	7		105	
(守门员)																	
1	宋继强	5/9	4/11	1/3	1/3	0/3			11/29	37.9%						7	00:51:19
12	王权	26/46	19/37	3/14	1/9	2/10	1/1	3/10	55/127	43.3%	7	1				7	03:54:56
16	张帅	15/31	7/20	1/9	2/9	3/8	1/2	2/5	31/84	36.9%	3	1				7	02:13:30
	合计	46/86	30/68	5/26	4/21	5/21	2/3	5/15	97/240	40.4%	10	2				21	

场上队员：得分/射门

守门员：救球/射门

已打比赛

全队合计	进球	被救	射失	击柱	封球	合计	%	阶段	场次	对手	比分
远射	41	18	9	6	7	81	50.6%	预赛	7	上海	39:18 (16:10)
近射	75	29	5	2	2	113	66.4%	预赛	11	山东	26:25 (17:12)
边射	19	7	4	6		36	52.8%	预赛	14	四川	40:22 (23:11)
快攻	42	11	2	5		60	70.0%	预赛	18	天津	34:22 (14:8)
突破	30	4	3	1		38	78.9%	四分之一决赛	24	山西	34:23 (15:15)
任意	2		2			4	50.0%	半决赛	29	天津	23:16 (13:5)
七米	10	8	1	2		21	47.6%	决赛	33	北京	23:17 (12:9)

图式射门区域累计

手球  
男子

截止至第33场

重庆万州  
2019-04-16

江苏队

1 宋继强 [ ] [ ] [ ] [ ] [ ] [ ] Post - 0 Miss - 0 Block - 0	3 周悦骅 [ ] [ ] [ ] [ ] [ ] [ ] Post - 0 Miss - 0 Block - 0	4 张家纬 7 [ ] 3 [ ] [ ] 1 2 3 2 Post - 1 Miss - 2 Block - 2	6 赵晨 7 1 7 4 [ ] [ ] 10 [ ] 3 Post - 2 Miss - 6 Block - 1	7 周傲 3 [ ] 1 2 [ ] 1 1 5 6 Post - 1 Miss - 0 Block - 2	8 谢庆龙 7 [ ] 6 3 [ ] 2 1 1 2 Post - 0 Miss - 1 Block - 0	11 张天豪 3 [ ] 3 1 1 3 2 2 3 Post - 3 Miss - 3 Block - 0	12 王权 [ ] [ ] [ ] [ ] [ ] [ ] Post - 0 Miss - 0 Block - 0
16 张帅 [ ] [ ] [ ] [ ] [ ] [ ] Post - 0 Miss - 0 Block - 0	18 赵楠 3 [ ] 2 [ ] [ ] 2 [ ] 2 2 Post - 1 Miss - 0 Block - 0	19 庞连康 2 [ ] 6 [ ] [ ] 2 1 2 2 Post - 3 Miss - 4 Block - 1	20 顾艳超 3 [ ] 3 5 [ ] 4 1 1 [ ] Post - 2 Miss - 5 Block - 3	21 刘江 2 [ ] 2 1 [ ] 2 2 2 3 Post - 0 Miss - 1 Block - 0	25 王杰缘 3 [ ] 5 4 [ ] 3 4 4 7 Post - 5 Miss - 2 Block - 0	27 王伟强 [ ] [ ] 4 2 [ ] 1 2 1 1 Post - 4 Miss - 0 Block - 0	30 吴龙瑞 2 1 4 [ ] 1 1 3 [ ] [ ] Post - 0 Miss - 2 Block - 0

1 宋继强	3/6	1/1	2/4
	1/4	2/2	1/2
	1/4	0/2	0/4

12 王权	5/9	7/8	5/13
	12/25	4/4	7/23
	6/20	3/8	6/17

16 张帅	2/11	2/5	3/18
	8/12	3/4	4/11
	5/13	2/6	2/4

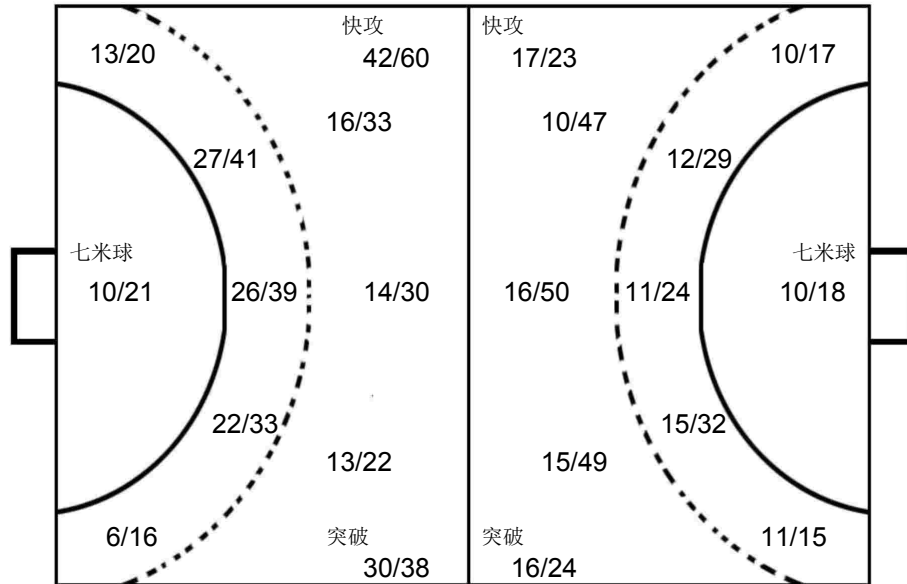

天津	1 何喜年	0/8	0/10
		2/6	3/3
		3/7	0/6
			2/8

山东	12 于性哲	0/4	0/7
		4/7	2/2
		1/4	1/1
			1/3

北京	16 刘迈科	2/7	2/3
		2/5	2/2
		0/1	1/1
			1/4

OPPONENT

山东 31 于亚男 2 [ ] 2 2 [ ] 1 2 [ ] [ ] Post - 2 Miss - 1 Block - 4	天津 9 王子欣 [ ] [ ] 1 2 [ ] 2 2 1 [ ] Post - 1 Miss - 0 Block - 0	山西 14 杨毅 [ ] [ ] 1 1 [ ] [ ] [ ] 3 2 Post - 0 Miss - 1 Block - 1	四川 6 董佳辉 1 1 3 1 [ ] [ ] [ ] 1 [ ] Post - 1 Miss - 2 Block - 1	天津 8 王晓琪 1 [ ] 1 1 [ ] 1 1 [ ] 2 Post - 0 Miss - 0 Block - 1	山东 13 刘晓 [ ] [ ] [ ] 3 [ ] 1 1 [ ] 1 Post - 0 Miss - 1 Block - 0	上海 10 朱世杰 [ ] [ ] 2 1 [ ] [ ] 3 [ ] [ ] Post - 0 Miss - 1 Block - 2	北京 10 成亚 1 [ ] [ ] 1 [ ] [ ] [ ] 1 1 Post - 0 Miss - 1 Block - 1
山西 6 盖秀越 2 [ ] [ ] [ ] [ ] [ ] 2 [ ] [ ] Post - 0 Miss - 0 Block - 0	山西 15 薛瑞寒 2 [ ] [ ] [ ] [ ] [ ] 1 1 [ ] Post - 1 Miss - 0 Block - 3	上海 5 贺政 1 [ ] [ ] [ ] [ ] [ ] [ ] 1 2 Post - 2 Miss - 3 Block - 2	上海 8 高震东 1 [ ] 1 [ ] [ ] 1 [ ] [ ] 1 Post - 0 Miss - 0 Block - 0	四川 7 曾繁泳 1 [ ] 1 [ ] [ ] [ ] [ ] 1 1 Post - 0 Miss - 1 Block - 0	天津 3 魏雨童 [ ] [ ] [ ] 2 1 1 [ ] [ ] [ ] Post - 0 Miss - 1 Block - 0	天津 5 王毅 [ ] [ ] 1 [ ] [ ] 2 [ ] [ ] 1 Post - 1 Miss - 2 Block - 2	天津 13 许松 [ ] [ ] 1 1 [ ] 1 [ ] [ ] 1 Post - 0 Miss - 2 Block - 0



2019年全国男子手球冠军杯赛

PHMS Pictorial Handball Match Statistics

IHF Official System

球队名单

重庆万州

北京队

2019-04-07

号码	姓名	位置	生日	年龄	俱乐部	身高 (CM)	体重 (KG)	国际场次	国际进球
3	逯明松	右后卫	11/02/1998	21	北京男子手球队	192	85		
6	解建飞	右后卫	10/09/1989	29	北京男子手球队	198	100		
7	马昌震	底线	19/05/1995	23	北京男子手球队	188	95		
10	成亚	中后卫	14/06/1990	28	北京男子手球队	190	95		
11	赵文宣	底线	10/06/1996	22	北京男子手球队	190	100		
12	高云健	守门员	26/11/1999	19	北京男子手球队	190	90		
13	王军鸣	中后卫	27/11/1985	33	北京男子手球队	193	115		
16	刘迈科	守门员	28/07/1994	24	北京男子手球队	188	100		
18	傅俊雄	底线	20/01/1995	24	北京男子手球队	195	96		
22	王超	左边锋	12/11/1991	27	北京男子手球队	183	84		
23	王军程	左后卫	11/10/1995	23	北京男子手球队	195	88		
25	王鹏皓	右边锋	03/09/1997	21	北京男子手球队	190	85		
26	魏昂	左边锋	29/12/1994	24	北京男子手球队	186	88		
27	闫炳旗	右边锋	30/01/1992	27	北京男子手球队	187	90		
32	蒋维一	底线	27/06/1987	31	北京男子手球队	195	100		
33	陈旭	左后卫	22/03/1998	21	北京男子手球队	190	90		
	平均			24.8		190.6	93.8		

编码	姓名	职务
A	郑永利	主教练
B	孟辉	领队
E	陈璇	医生

## 2019年全国男子手球冠军杯赛

PHMS Pictorial Handball Match Statistics

IHF Official System

### 个人/全队技术累计表

手球男子 截止至第33场 重庆万州 2019-04-16

号码	姓名	远射	近射	边射	快攻	突破	任意	七米	合计	%	助攻	失误	警告	2'	取消	场次	时间
<b>北京队</b>																	
<b>(场上队员)</b>																	
3	逯明松	4/6	3/3	2/3	2/2	3/3			14/17	82.4%	2	4	1			7	01:47:59
6	解建飞				1/1		0/1	6/6	7/8	87.5%		1	2	3		7	02:10:52
7	马昌震		7/8	1/2	1/1				9/11	81.8%	1	5	3	1	1	7	02:36:00
10	成亚	2/15	3/8	0/1	8/9	6/6	0/1	9/11	28/51	54.9%	11	11	2	1		7	05:49:10
11	赵文宣		3/3		2/2				5/5	100%				1		7	00:29:46
12	高云健															7	01:05:59
13	王军鸣	6/11	1/4		1/1	2/2	1/1	2/3	13/22	59.1%	3	8		2		7	02:03:13
16	刘迈科										3					7	05:54:01
18	傅俊雄	2/7	4/5			3/5		2/4	11/21	52.4%	5	5	1		1	7	01:57:54
22	王超		5/5	5/7	2/3				12/15	80.0%	2	6		3		7	04:10:37
23	王军程	12/30	2/6	0/1		2/3	2/4	3/3	21/47	44.7%	5	13	1			7	03:51:53
25	王鹏皓		0/1	0/3	3/4				3/8	37.5%		3				7	01:17:14
26	魏昂		3/5	3/6	7/8	1/1			14/20	70.0%		9	1			7	02:53:59
27	闫炳旗	1/1	4/6	7/10	2/2			0/1	14/20	70.0%	1	3		2		7	04:36:32
32	蒋维一	0/1	8/13		2/2	1/1	0/1		11/18	61.1%	2	8	3	1		7	04:19:41
33	陈旭	3/17	5/10		4/4	6/7			18/38	47.4%	3	18	1	2		7	04:09:12
	<b>合计</b>	<b>30/88</b>	<b>48/77</b>	<b>18/33</b>	<b>35/39</b>	<b>24/28</b>	<b>3/8</b>	<b>22/28</b>	<b>180/301</b>	<b>59.8%</b>	<b>38</b>	<b>94</b>	<b>14</b>	<b>17</b>	<b>2</b>	<b>112</b>	
<b>(守门员)</b>																	
12	高云健	2/5	4/15	0/6	2/7	1/3		0/5	9/41	22.0%						7	01:05:59
16	刘迈科	33/59	25/59	15/26	7/25	8/28	3/3	3/11	94/211	44.5%	3					7	05:54:01
	<b>合计</b>	<b>35/64</b>	<b>29/74</b>	<b>15/32</b>	<b>9/32</b>	<b>9/31</b>	<b>3/3</b>	<b>3/16</b>	<b>103/252</b>	<b>40.9%</b>	<b>3</b>					<b>14</b>	

场上队员：得分/射门

守门员：救球/射门

已打比赛

全队合计	进球	被救	射失	击柱	封球	合计	%	阶段	场次	对手	比分
远射	30	24	15	3	16	88	34.1%	预赛	1	陕西	35:25 (23:9)
近射	48	18	4	6	1	77	62.3%	预赛	6	山西	41:18 (19:5)
边射	18	9	2	4		33	54.5%	预赛	16	安徽	22:23 (9:10)
快攻	35	4				39	89.7%	预赛	20	广东	20:21 (10:13)
突破	24	4				28	85.7%	四分之一决赛	22	山东	22:20 (12:11)
任意	3	4	1			8	37.5%	半决赛	28	安徽	23:19 (14:12)
七米	22	4	1	1		28	78.6%	决赛	33	江苏	17:23 (9:12)

图式射门区域累计

手球  
男子

重庆万州  
2019-04-16

截止至第33场

北京队

3 逯明松	6 解建飞	7 马昌震	10 成亚	11 赵文宣	12 高云健	13 王军鸣	16 刘迈科																																																																								
<table border="1"><tr><td>6</td><td>1</td><td>3</td></tr><tr><td>2</td><td></td><td>2</td></tr><tr><td></td><td></td><td></td></tr></table>	6	1	3	2		2				<table border="1"><tr><td></td><td></td><td>2</td></tr><tr><td></td><td></td><td>1</td></tr><tr><td>3</td><td></td><td>1</td></tr></table>			2			1	3		1	<table border="1"><tr><td></td><td></td><td>1</td></tr><tr><td></td><td></td><td>2</td></tr><tr><td>4</td><td></td><td>2</td></tr></table>			1			2	4		2	<table border="1"><tr><td>5</td><td></td><td>1</td></tr><tr><td>3</td><td></td><td>3</td></tr><tr><td>5</td><td>2</td><td>9</td></tr></table>	5		1	3		3	5	2	9	<table border="1"><tr><td></td><td>1</td><td></td></tr><tr><td></td><td></td><td></td></tr><tr><td>3</td><td></td><td>1</td></tr></table>		1					3		1	<table border="1"><tr><td></td><td></td><td></td></tr><tr><td></td><td></td><td></td></tr><tr><td></td><td></td><td></td></tr></table>										<table border="1"><tr><td>1</td><td></td><td></td></tr><tr><td>1</td><td>2</td><td>2</td></tr><tr><td>2</td><td>1</td><td>4</td></tr></table>	1			1	2	2	2	1	4	<table border="1"><tr><td></td><td></td><td></td></tr><tr><td></td><td></td><td></td></tr><tr><td></td><td></td><td></td></tr></table>									
6	1	3																																																																													
2		2																																																																													
		2																																																																													
		1																																																																													
3		1																																																																													
		1																																																																													
		2																																																																													
4		2																																																																													
5		1																																																																													
3		3																																																																													
5	2	9																																																																													
	1																																																																														
3		1																																																																													
1																																																																															
1	2	2																																																																													
2	1	4																																																																													
Post - 1 Miss - 1 Block - 0	Post - 0 Miss - 1 Block - 0	Post - 0 Miss - 0 Block - 0	Post - 2 Miss - 7 Block - 6	Post - 0 Miss - 0 Block - 0	Post - 0 Miss - 0 Block - 0	Post - 1 Miss - 1 Block - 2	Post - 0 Miss - 0 Block - 0																																																																								
18 傅俊雄	22 王超	23 王军程	25 王鹏皓	26 魏昂	27 闫炳旗	32 蒋维一	33 陈旭																																																																								
<table border="1"><tr><td>2</td><td></td><td>2</td></tr><tr><td>1</td><td>1</td><td>1</td></tr><tr><td>3</td><td></td><td>1</td></tr></table>	2		2	1	1	1	3		1	<table border="1"><tr><td>2</td><td></td><td>3</td></tr><tr><td>4</td><td></td><td>1</td></tr><tr><td>2</td><td></td><td></td></tr></table>	2		3	4		1	2			<table border="1"><tr><td>3</td><td></td><td>8</td></tr><tr><td>1</td><td></td><td>2</td></tr><tr><td>2</td><td></td><td>5</td></tr></table>	3		8	1		2	2		5	<table border="1"><tr><td></td><td></td><td>2</td></tr><tr><td>1</td><td></td><td></td></tr><tr><td></td><td></td><td></td></tr></table>			2	1						<table border="1"><tr><td>1</td><td>2</td><td>2</td></tr><tr><td>4</td><td></td><td>2</td></tr><tr><td></td><td>1</td><td>2</td></tr></table>	1	2	2	4		2		1	2	<table border="1"><tr><td>1</td><td></td><td>1</td></tr><tr><td>4</td><td></td><td>7</td></tr><tr><td>1</td><td></td><td></td></tr></table>	1		1	4		7	1			<table border="1"><tr><td>1</td><td></td><td>3</td></tr><tr><td></td><td></td><td>3</td></tr><tr><td>1</td><td>2</td><td>1</td></tr></table>	1		3			3	1	2	1	<table border="1"><tr><td>4</td><td></td><td>5</td></tr><tr><td>1</td><td></td><td>2</td></tr><tr><td>2</td><td></td><td>4</td></tr></table>	4		5	1		2	2		4
2		2																																																																													
1	1	1																																																																													
3		1																																																																													
2		3																																																																													
4		1																																																																													
2																																																																															
3		8																																																																													
1		2																																																																													
2		5																																																																													
		2																																																																													
1																																																																															
1	2	2																																																																													
4		2																																																																													
	1	2																																																																													
1		1																																																																													
4		7																																																																													
1																																																																															
1		3																																																																													
		3																																																																													
1	2	1																																																																													
4		5																																																																													
1		2																																																																													
2		4																																																																													
Post - 0 Miss - 1 Block - 3	Post - 0 Miss - 0 Block - 0	Post - 2 Miss - 5 Block - 5	Post - 0 Miss - 1 Block - 0	Post - 2 Miss - 1 Block - 0	Post - 1 Miss - 0 Block - 0	Post - 1 Miss - 0 Block - 0	Post - 4 Miss - 5 Block - 1																																																																								

12 高云健

1/5		1/6
0/5		3/9
1/9	1/1	2/6

16 刘迈科

8/23	6/9	10/41
17/36	9/10	15/33
13/22	9/14	7/23

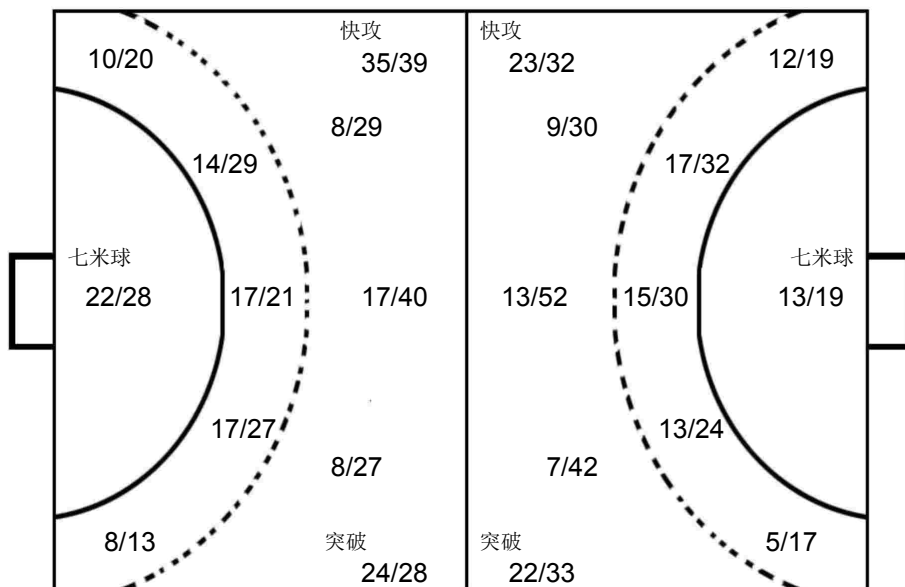

安徽

21 李明

1/5		3/9
3/7	1/2	3/8
3/7		1/7

山东

12 于性哲

1/2		4/5
0/2	3/3	0/2
0/2		2/13

江苏

12 王权

2/3		2/2
2/4	2/2	0/2
2/6	0/3	0/1

OPPONENT

广东	陕西	安徽	安徽	安徽	山东	陕西	安徽																																																																								
22 黄培杰	9 陈孝天	1 郭世伟	5 史小帆	11 黎涛	6 李朝鹏	15 陈冉	7 姚雄敏																																																																								
<table border="1"><tr><td></td><td></td><td>4</td></tr><tr><td>1</td><td></td><td></td></tr><tr><td>1</td><td>2</td><td></td></tr></table>			4	1			1	2		<table border="1"><tr><td>1</td><td></td><td>3</td></tr><tr><td>1</td><td></td><td></td></tr><tr><td>2</td><td></td><td>1</td></tr></table>	1		3	1			2		1	<table border="1"><tr><td>2</td><td></td><td>3</td></tr><tr><td></td><td></td><td></td></tr><tr><td></td><td></td><td>1</td></tr></table>	2		3						1	<table border="1"><tr><td></td><td>1</td><td>2</td></tr><tr><td>2</td><td></td><td>1</td></tr><tr><td></td><td></td><td></td></tr></table>		1	2	2		1				<table border="1"><tr><td>1</td><td></td><td>1</td></tr><tr><td>3</td><td></td><td>1</td></tr><tr><td></td><td></td><td></td></tr></table>	1		1	3		1				<table border="1"><tr><td></td><td></td><td>1</td></tr><tr><td></td><td></td><td>1</td></tr><tr><td>1</td><td>1</td><td>2</td></tr></table>			1			1	1	1	2	<table border="1"><tr><td></td><td></td><td>1</td></tr><tr><td>2</td><td></td><td>2</td></tr><tr><td>1</td><td></td><td></td></tr></table>			1	2		2	1			<table border="1"><tr><td></td><td></td><td>2</td></tr><tr><td>2</td><td></td><td></td></tr><tr><td></td><td></td><td>1</td></tr></table>			2	2					1
		4																																																																													
1																																																																															
1	2																																																																														
1		3																																																																													
1																																																																															
2		1																																																																													
2		3																																																																													
		1																																																																													
	1	2																																																																													
2		1																																																																													
1		1																																																																													
3		1																																																																													
		1																																																																													
		1																																																																													
1	1	2																																																																													
		1																																																																													
2		2																																																																													
1																																																																															
		2																																																																													
2																																																																															
		1																																																																													
Post - 0 Miss - 0 Block - 1	Post - 1 Miss - 0 Block - 2	Post - 1 Miss - 3 Block - 0	Post - 0 Miss - 0 Block - 1	Post - 1 Miss - 1 Block - 0	Post - 0 Miss - 0 Block - 1	Post - 1 Miss - 0 Block - 0	Post - 1 Miss - 0 Block - 0																																																																								
安徽	安徽	广东	江苏	安徽	广东	江苏	江苏																																																																								
8 董智景	18 李双	6 毕晓晨	25 王杰缘	10 严龙	15 张建杰	8 谢庆龙	20 顾艳超																																																																								
<table border="1"><tr><td>1</td><td></td><td>1</td></tr><tr><td></td><td></td><td>2</td></tr><tr><td></td><td></td><td>1</td></tr></table>	1		1			2			1	<table border="1"><tr><td>1</td><td></td><td>1</td></tr><tr><td>1</td><td></td><td>2</td></tr><tr><td></td><td></td><td></td></tr></table>	1		1	1		2				<table border="1"><tr><td>1</td><td>1</td><td></td></tr><tr><td>1</td><td></td><td>1</td></tr><tr><td>1</td><td></td><td></td></tr></table>	1	1		1		1	1			<table border="1"><tr><td>2</td><td></td><td></td></tr><tr><td></td><td></td><td></td></tr><tr><td>1</td><td></td><td>2</td></tr></table>	2						1		2	<table border="1"><tr><td></td><td></td><td></td></tr><tr><td>3</td><td></td><td></td></tr><tr><td></td><td>1</td><td></td></tr></table>				3				1		<table border="1"><tr><td></td><td></td><td>1</td></tr><tr><td></td><td></td><td></td></tr><tr><td>1</td><td></td><td>2</td></tr></table>			1				1		2	<table border="1"><tr><td></td><td></td><td>3</td></tr><tr><td></td><td></td><td></td></tr><tr><td></td><td></td><td>1</td></tr></table>			3						1	<table border="1"><tr><td></td><td></td><td>1</td></tr><tr><td>2</td><td></td><td>1</td></tr><tr><td></td><td></td><td></td></tr></table>			1	2		1			
1		1																																																																													
		2																																																																													
		1																																																																													
1		1																																																																													
1		2																																																																													
1	1																																																																														
1		1																																																																													
1																																																																															
2																																																																															
1		2																																																																													
3																																																																															
	1																																																																														
		1																																																																													
1		2																																																																													
		3																																																																													
		1																																																																													
		1																																																																													
2		1																																																																													
Post - 0 Miss - 0 Block - 0	Post - 1 Miss - 3 Block - 2	Post - 0 Miss - 2 Block - 0	Post - 0 Miss - 0 Block - 0	Post - 0 Miss - 0 Block - 0	Post - 0 Miss - 1 Block - 3	Post - 0 Miss - 0 Block - 0	Post - 1 Miss - 0 Block - 1																																																																								



2019年全国男子手球冠军杯赛

PHMS Pictorial Handball Match Statistics

IHF Official System

球队名单

重庆万州

天津队

2019-04-07

号码	姓名	位置	生日	年龄	俱乐部	身高 (CM)	体重 (KG)	国际场次	国际进球
1	何喜年	守门员	02/01/2000	19	天津	202	108		
3	魏雨童	底线	05/10/1996	22	天津	197	100		
4	刘雪东	左后卫	11/09/2000	18	天津	195	85		
5	王毅	左边锋	28/02/1995	24	天津	195	95		
6	赵晨阳	底线	31/01/2001	18	天津	191	88		
7	张青	右后卫	16/04/1989	29	天津	194	110		
8	王晓琪	右边锋	20/03/1997	22	天津	192	90		
9	王子欣	右后卫	17/10/1995	23	天津	193	88		
10	苏尧	左边锋	26/08/2000	18	天津	187	86		
11	吴明远	右边锋	21/03/1996	23	天津	190	83		
13	许松	中后卫	02/04/1992	27	天津	185	80		
14	王维先	右边锋	28/03/2000	19	天津	184	78		
15	周群	底线	04/03/1994	25	天津	194	105		
16	刘宗其	守门员	31/03/1991	28	天津	190	88		
20	张闻乾	左边锋	28/07/1999	19	天津	189	75		
86	田剑侠	中后卫	03/09/1986	32	天津	190	95		
	平均			22.9		191.8	90.9		

编码	姓名	职务
A	贾守信	领队
B	杜瑞军	主教练
D	李志成	教练
E	王文龙	医生
C	孟凡钢	教练

## 2019年全国男子手球冠军杯赛

PHMS Pictorial Handball Match Statistics

IHF Official System

手球 男子 个人/全队技术累计表 截止至第33场 重庆万州 2019-04-16

号码	姓名	远射	近射	边射	快攻	突破	任意	七米	合计	%	助攻	失误	警告	2'	取消	场次	时间
<b>天津队</b>																	
<b>(场上队员)</b>																	
1	何喜年										1	3				7	05:26:34
3	魏雨童		9/11		0/2	1/1			10/14	71.4%		4	2	7		7	04:33:34
4	刘雪东	0/2	1/2			1/1	0/1	1/2	3/8	37.5%		3				7	00:37:47
5	王毅	3/18	6/9		1/1	2/2	0/2	3/6	15/38	39.5%	2	8		1		7	03:37:40
6	赵晨阳	2/2	1/2	0/1	1/2	2/4			6/11	54.5%						7	00:43:52
7	张青	9/24	7/10		3/4	4/4		14/16	37/58	63.8%	3	12	1	3		7	05:04:49
8	王晓琪	5/10	3/5	3/4	2/2	1/3	1/1	3/3	18/28	64.3%	2	10		1		7	03:11:16
9	王子欣	4/7	1/3	9/14	8/10	1/2	1/1		24/37	64.9%	7	11	1	2		7	06:29:46
10	苏尧	2/2	4/5	2/2	2/2	1/1			11/12	91.7%	1	5		3		7	02:08:02
11	吴明远															7	00:07:54
13	许松	0/5	2/3	5/13	10/13	3/4		0/2	20/40	50.0%	5	9				7	05:09:16
14	王维先		0/2		2/2				2/4	50.0%				1		7	00:25:50
15	周群	0/1	9/12		1/1				10/14	71.4%		4	3	2		7	04:00:16
16	刘宗其										2					7	01:28:20
20	张闻乾		0/1	1/1					1/2	50.0%		1				6	00:18:40
86	田剑侠	1/16	2/5		1/1	13/18	0/1	1/1	18/42	42.9%	10	20	2	3		7	04:57:59
<b>合计</b>		<b>26/87</b>	<b>45/70</b>	<b>20/35</b>	<b>31/40</b>	<b>29/40</b>	<b>2/6</b>	<b>22/30</b>	<b>175/308</b>	<b>56.8%</b>	<b>33</b>	<b>90</b>	<b>9</b>	<b>23</b>		<b>111</b>	
<b>(守门员)</b>																	
1	何喜年	22/50	16/41	7/18	9/33	4/29	2/5	3/11	63/187	33.7%	1	3				7	05:26:34
16	刘宗其	4/10	1/9	3/8	2/10	1/9		7/11	18/57	31.6%	2					7	01:28:20
<b>合计</b>		<b>26/60</b>	<b>17/50</b>	<b>10/26</b>	<b>11/43</b>	<b>5/38</b>	<b>2/5</b>	<b>10/22</b>	<b>81/244</b>	<b>33.2%</b>	<b>3</b>	<b>3</b>				<b>14</b>	

场上队员：得分/射门

守门员：救球/射门

已打比赛

全队合计	进球	被救	射失	击柱	封球	合计	%	阶段	场次	对手	比分
远射	26	29	14	4	14	87	29.9%	预赛	3	上海	26:14 (11:5)
近射	45	16	6	2	1	70	64.3%	预赛	8	四川	35:18 (17:9)
边射	20	7	2	6		35	57.1%	预赛	13	山东	17:19 (6:6)
快攻	31	7	1	1		40	77.5%	预赛	18	江苏	22:34 (8:14)
突破	29	7		4		40	72.5%	四分之一决赛	23	广东	26:23 (12:8)
任意	2	1	2	1		6	33.3%	半决赛	29	江苏	16:23 (5:13)
七米	22	7	1			30	73.3%	3-4名	32	安徽	33:32 (13:14)



图式射门区域累计

手球  
男子

截止至第33场

重庆万州  
2019-04-16

天津队

1 何喜年 Post - 0 Miss - 0 Block - 0	3 魏雨童 Post - 0 Miss - 1 Block - 0	4 刘雪东 Post - 0 Miss - 3 Block - 0	5 王毅 Post - 4 Miss - 3 Block - 6	6 赵晨阳 Post - 1 Miss - 1 Block - 0	7 张青 Post - 2 Miss - 5 Block - 4	8 王晓琪 Post - 2 Miss - 2 Block - 1	9 王子欣 Post - 2 Miss - 1 Block - 0
10 苏尧 Post - 0 Miss - 1 Block - 0	11 吴明远 Post - 0 Miss - 0 Block - 0	13 许松 Post - 5 Miss - 2 Block - 0	14 王维先 Post - 0 Miss - 0 Block - 0	15 周群 Post - 1 Miss - 2 Block - 0	16 刘宗其 Post - 0 Miss - 0 Block - 0	20 张闻乾 Post - 0 Miss - 1 Block - 0	86 田剑侠 Post - 1 Miss - 4 Block - 4

1 何喜年	3/29	3/5	5/30
	10/30	4/4	21/40
	10/22	1/9	6/18

16 刘宗其	0/11		0/7
	6/17		2/6
	5/9	1/1	4/6

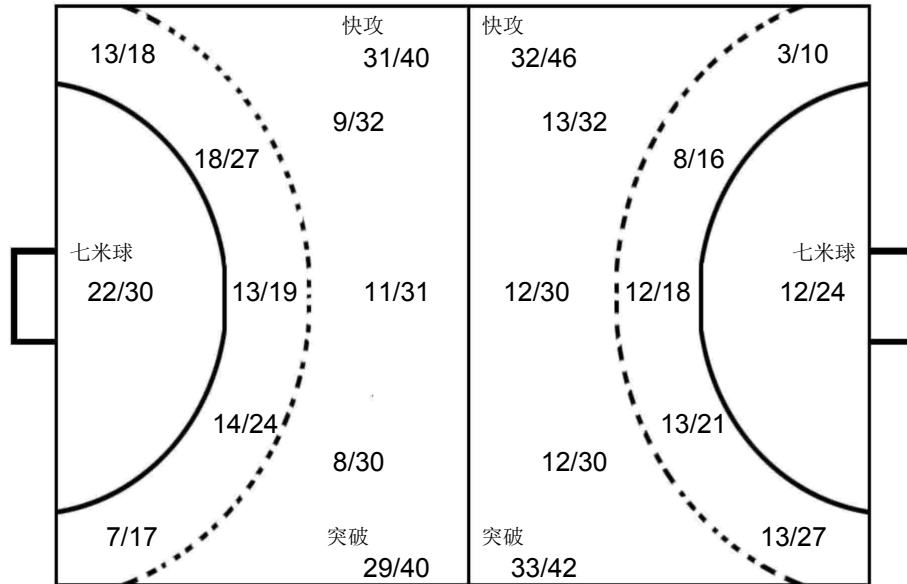

江苏	12 王权	2/2	1/4
		2/7	1/1
		2/7	1/1
		2/8	3/6

山东	12 于性哲	2/7	2/2
		5/10	1/1
		2/5	0/1
		0/1	0/1

上海	12 周哲韬	0/2	1/9
		2/5	1/1
		2/6	2/2
		1/4	1/2

OPPONENT

江苏 25 王杰缘 Post - 2 Miss - 1 Block - 0	江苏 6 赵晨 Post - 1 Miss - 2 Block - 0	江苏 20 顾艳超 Post - 1 Miss - 1 Block - 0	安徽 18 李双 Post - 1 Miss - 0 Block - 0	江苏 8 谢庆龙 Post - 0 Miss - 1 Block - 0	江苏 30 吴龙瑞 Post - 0 Miss - 0 Block - 0	广东 15 张建杰 Post - 1 Miss - 0 Block - 1	安徽 4 王巨柱 Post - 0 Miss - 0 Block - 2
安徽 8 董智景 Post - 0 Miss - 1 Block - 0	安徽 24 徐安格 Post - 0 Miss - 0 Block - 0	江苏 4 张家伟 Post - 0 Miss - 1 Block - 0	山东 31 于亚男 Post - 1 Miss - 0 Block - 2	四川 8 罗霖泽 Post - 1 Miss - 1 Block - 0	四川 9 左典 Post - 1 Miss - 0 Block - 0	安徽 1 郭世伟 Post - 0 Miss - 0 Block - 0	广东 12 王雨 Post - 0 Miss - 0 Block - 0



2019年全国男子手球冠军杯赛

PHMS Pictorial Handball Match Statistics

IHF Official System

球队名单

重庆万州

安徽队

2019-04-07

号码	姓名	位置	生日	年龄	俱乐部	身高 (CM)	体重 (KG)	国际场次	国际进球
1	郭世伟	后卫	18/02/1997	22		180	70		
4	王巨柱	左后卫	17/08/1997	21		194	80		
5	史小帆	左后卫	15/03/1995	24		195	75		
6	叶志伟	左后卫	07/03/2000	19		189	80		
7	姚雄敏	左后卫	17/02/1993	26		192	102		
8	董智景	左边锋	15/10/1993	25		190	83		
9	金永峰	左后卫	06/06/1999	19		189	90		
10	严龙	后卫	22/05/1994	24		190	75		
11	黎涛	右后卫	28/10/1994	24		187	86		
12	曾献辰	守门员	29/06/1990	28		191	92		
18	李双	右后卫	07/02/1997	22		192	75		
21	李明	守门员	04/05/1997	21		195	85		
23	张鹏	后卫	12/03/1998	21		184	80		
24	徐安格	右边锋	05/02/1998	21		185	85		
26	饶原源	中后卫	08/09/2001	17		183	80		
27	王东昇	底线	22/03/2002	17		198	100		
	平均			21.9		189.6	83.6		

编码	姓名	职务
C	黄红	教练
B	Vladimir Stanojevic	主教练
E	刘汉杰	医生
D	王来黔	教练
A	吴翔	领队

## 2019年全国男子手球冠军杯赛

PHMS Pictorial Handball Match Statistics

IHF Official System

手球  
男子

### 个人/全队技术累计表

重庆万州  
2019-04-16

截止至第33场

号码	姓名	远射	近射	边射	快攻	突破	任意	七米	合计	%	助攻	失误	警告	2'	取消	场次	时间
<b>安徽队</b>																	
<b>(场上队员)</b>																	
1	郭世伟	6/16	4/6		2/2	5/7		1/3	18/34	52.9%	1	6				7	02:39:49
4	王巨柱	13/19	4/6			1/4	2/2	2/2	22/33	66.7%	1	4				7	02:05:39
5	史小帆	2/4	1/3		2/2	5/7			10/16	62.5%		1	1			7	01:24:31
6	叶志伟		1/1		0/1			0/1	1/3	33.3%		2				7	00:20:29
7	姚雄敏	4/6	1/3		3/4	7/11			15/24	62.5%		10				7	03:39:51
8	董智景	0/2	0/1	6/11	8/10	3/4		5/5	22/33	66.7%	2	3				7	03:54:56
9	金永峰	3/14	0/5	0/1		3/5			6/25	24.0%	3	5	2	2		7	04:11:40
10	严龙		1/2	6/11	5/6			4/5	16/24	66.7%	1	1	2	1		7	03:20:52
11	黎涛	0/1	1/2	8/15	5/5				14/23	60.9%	1	7	1			7	04:08:26
12	曾献辰										4	3				7	02:01:06
18	李双	12/27	6/9	0/1	7/7	4/7			29/51	56.9%	9	15	4	7		7	06:45:05
21	李明										3	1				7	05:08:54
23	张鹏		4/5	6/12	5/8				15/25	60.0%	1	2				7	02:40:38
24	徐安格		9/12	1/1	3/3				13/16	81.3%		11	4	9		7	06:49:01
26	饶原源	0/3			2/2	2/2		7/11	11/18	61.1%	2	2				7	00:33:50
27	王东昇											1		1		7	00:16:19
<b>合计</b>		<b>40/92</b>	<b>32/55</b>	<b>27/52</b>	<b>42/50</b>	<b>30/47</b>	<b>2/2</b>	<b>19/27</b>	<b>192/325</b>	<b>59.1%</b>	<b>28</b>	<b>74</b>	<b>14</b>	<b>20</b>		<b>112</b>	
<b>(守门员)</b>																	
1	郭世伟											1				7	00:27:27
12	曾献辰	12/25	2/11	1/6	0/3	3/9	1/1	2/6	21/61	34.4%	4	3				7	02:01:06
21	李明	23/46	6/38	12/35	3/13	2/17	3/6	3/24	52/179	29.1%	3	1				7	05:08:54
<b>合计</b>		<b>35/71</b>	<b>8/49</b>	<b>13/41</b>	<b>3/16</b>	<b>5/26</b>	<b>4/7</b>	<b>5/30</b>	<b>73/240</b>	<b>30.4%</b>	<b>7</b>	<b>5</b>				<b>21</b>	

场上队员：得分/射门

守门员：救球/射门

已打比赛

全队合计	进球	被救	射失	击柱	封球	合计	%	阶段	场次	对手	比分
远射	40	23	13	6	10	92	43.5%	预赛	2	山西	34:23 (17:12)
近射	32	21		2		55	58.2%	预赛	9	广东	27:26 (11:10)
边射	27	15	5	5		52	51.9%	预赛	16	北京	23:22 (10:9)
快攻	42	7		1		50	84.0%	预赛	19	陕西	32:16 (16:10)
突破	30	13	2	2		47	63.8%	四分之一决赛	21	上海	25:24 (12:11)
任意	2					2	100.0%	半决赛	28	北京	19:23 (12:14)
七米	19	2	4	2		27	70.4%	3-4名	32	天津	32:33 (14:13)

图式射门区域累计

手球  
男子

截止至第33场

重庆万州  
2019-04-16

安徽队

1 郭世伟 4 1 3 4 2 2 2 Post - 1 Miss - 6 Block - 0	4 王巨柱 4 6 2 1 7 1 1 Post - 1 Miss - 1 Block - 2	5 史小帆 1 2 2 1 1 1 2 Post - 1 Miss - 0 Block - 1	6 叶志伟 1 1 1 Post - 1 Miss - 0 Block - 0	7 姚雄敏 1 4 4 2 2 1 1 Post - 1 Miss - 0 Block - 0	8 董智景 3 2 6 1 3 3 4 Post - 1 Miss - 4 Block - 0	9 金永峰 3 1 1 1 Post - 2 Miss - 5 Block - 3	10 严龙 1 4 5 2 1 1 2 Post - 1 Miss - 0 Block - 0
11 黎涛 4 1 1 6 1 1 Post - 2 Miss - 3 Block - 0	12 曾献辰 Post - 0 Miss - 0 Block - 0	18 李双 7 5 8 5 2 1 1 Post - 3 Miss - 3 Block - 3	21 李明 Post - 0 Miss - 0 Block - 0	23 张鹏 3 2 1 5 4 Post - 2 Miss - 0 Block - 0	24 徐安格 3 4 4 1 1 Post - 1 Miss - 0 Block - 0	26 饶原源 3 4 1 1 1 1 Post - 1 Miss - 2 Block - 1	27 王东昇 Post - 0 Miss - 0 Block - 0

1 郭世伟

12 曾献辰
1/9 4/4 2/8
6/14 1/2 2/9
3/10 1/2 1/3

21 李明
2/24 1/2 6/29
10/34 7/10 9/30
11/26 2/6 4/18

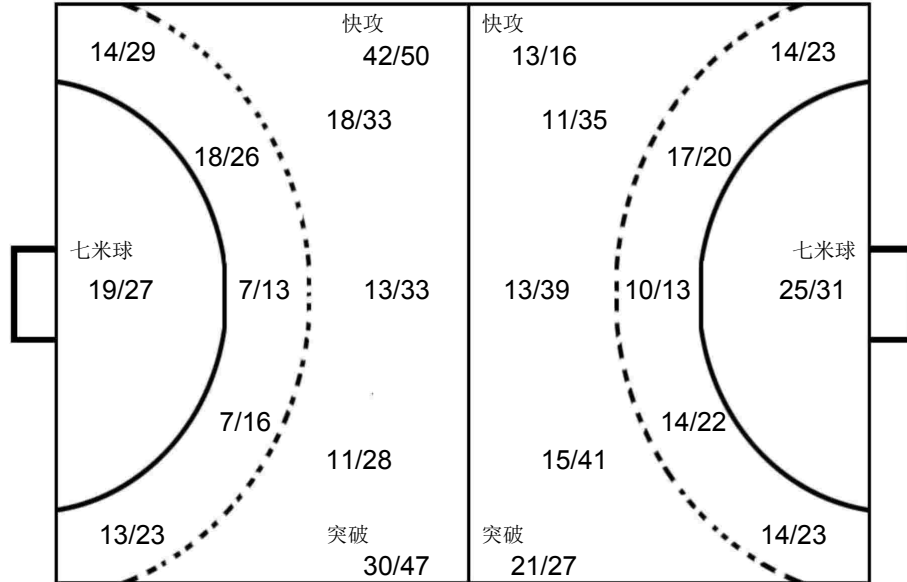

北京

16 刘迈科
0/6 0/1 4/14
7/18 4/4 5/14
6/6 1/2 1/4

山西

12 韩乐斌
2/7 0/1 3/9
4/8 1/2 0/6
0/4 1/4

天津

1 何喜年
1/6 0/1 1/5
3/6 4/9
0/2 0/1 0/2

OPPONENT

天津 7 张青 1 3 4 3 1 Post - 1 Miss - 0 Block - 0	北京 10 成亚 1 2 2 3 1 2 Post - 0 Miss - 1 Block - 4	北京 33 陈旭 2 4 2 1 2 Post - 1 Miss - 1 Block - 0	北京 23 王军程 1 2 1 1 1 2 Post - 1 Miss - 0 Block - 1	上海 30 徐俊吉 1 2 1 2 1 Post - 0 Miss - 0 Block - 0	广东 10 周仲坤 1 1 1 1 2 1 Post - 0 Miss - 1 Block - 0	山西 13 杜忠浩 1 2 1 1 1 Post - 0 Miss - 1 Block - 1	山西 14 杨毅 1 2 1 1 Post - 0 Miss - 2 Block - 2
上海 5 贺政 2 1 1 1 Post - 0 Miss - 3 Block - 0	上海 10 朱世杰 2 1 2 Post - 0 Miss - 0 Block - 0	天津 9 王子欣 1 1 2 2 Post - 0 Miss - 1 Block - 0	天津 13 许松 1 3 1 Post - 2 Miss - 0 Block - 0	北京 22 王超 1 1 2 1 Post - 0 Miss - 0 Block - 0	北京 27 闫炳旗 1 1 2 1 Post - 1 Miss - 0 Block - 0	广东 6 毕晓晨 3 1 1 Post - 0 Miss - 1 Block - 0	广东 15 张建杰 1 1 2 Post - 0 Miss - 0 Block - 0



2019年全国男子手球冠军杯赛

PHMS Pictorial Handball Match Statistics

IHF Official System

球队名单

重庆万州

广东队

2019-04-07

号码	姓名	位置	生日	年龄	俱乐部	身高 (CM)	体重 (KG)	国际场次	国际进球
2	孙江山	底线	08/10/1992	26	广东省黄村体育训练中心. 路环四庙队	199	95		
6	毕晓晨	左边锋	23/03/1995	24	广东省黄村体育训练中心. 路环四庙队	187	80		
7	王立隆	右边锋	04/01/1995	24	广东省黄村体育训练中心. 路环四庙队	196	88		
9	范保坤	中后卫	01/01/1999	20	广东省黄村体育训练中心. 路环四庙队	193	88		
10	周仲坤	左边锋	02/01/1997	22	广东省黄村体育训练中心. 路环四庙队	197	85		
11	房友屯	右边锋	03/02/1994	25	广东省黄村体育训练中心. 路环四庙队	182	90		
12	王雨	底线	21/06/1995	23	广东省黄村体育训练中心. 路环四庙队	191	85		
14	王泽润	守门员	19/02/1998	21	广东省黄村体育训练中心. 路环四庙队	192	90		
15	张建杰	左后卫	29/10/1997	21	广东省黄村体育训练中心. 路环四庙队	194	79		
18	姚雪岩	右后卫	19/11/1996	22	广东省黄村体育训练中心. 路环四庙队	202	96		
19	王帅	守门员	03/09/1997	21	广东省黄村体育训练中心. 路环四庙队	196	95		
21	张昌轲	中后卫	13/03/1999	20	广东省黄村体育训练中心. 路环四庙队	185	75		
22	黄培杰	左边锋	15/01/1998	21	广东省黄村体育训练中心. 路环四庙队	177	70		
24	高玉杰	左边锋	16/10/1998	20	广东省黄村体育训练中心. 路环四庙队	190	80		
31	陈元祖	左边锋	06/06/2001	17	广东省黄村体育训练中心. 路环四庙队	185	86		
32	罗柏涵	左后卫	20/02/2000	19	广东省黄村体育训练中心. 路环四庙队	193	95		
	平均			21.6		191.2	86.1		

编码	姓名	职务
A	曲汝洋	领队
B	刘康伶	主教练
C	郭艳辉	教练
E	贾章志	医生

## 2019年全国男子手球冠军杯赛

PHMS Pictorial Handball Match Statistics

IHF Official System

手球  
男子

### 个人/全队技术累计表

重庆万州  
2019-04-16

截止至第33场

号码	姓名	远射	近射	边射	快攻	突破	任意	七米	合计	%	助攻	失误	警告	2'	取消	场次	时间
<b>广东队</b>																	
<b>(场上队员)</b>																	
2	孙江山		1/1					2/2	3/3	100%						6	00:13:23
6	毕晓晨	7/17	8/16	3/6	4/8	4/6		3/5	29/58	50.0%		9	1	3		7	06:02:30
7	王立隆			7/8	10/13	4/4			21/25	84.0%	3	6	1	1		7	04:16:19
9	范保坤															7	00:08:40
10	周仲坤	11/19	5/11	0/2	3/3	3/3	0/1	6/9	28/48	58.3%	2	8	3	2		7	05:55:46
11	房友屯	1/3	1/3	0/1	2/2				4/9	44.4%		9	2	2		7	02:41:32
12	王雨	0/3	2/2	5/9	5/6	3/3			15/23	65.2%	1	6	1	2		7	04:58:53
14	王泽润															7	03:32:03
15	张建杰	10/34	6/11		2/4	8/9	0/2		26/60	43.3%	6	9	1	1		7	04:50:18
18	姚雪岩	1/4	5/6				1/1		7/11	63.6%	2	3	2			7	03:00:07
19	王帅										2	3				7	03:27:57
21	张昌轲	0/3	4/5		1/1			1/2	6/11	54.5%		4		3		7	01:42:39
22	黄培杰	1/11	6/10	3/6	3/4	13/20		3/5	29/56	51.8%	8	9		1		7	04:13:07
24	高玉杰	6/12	1/2	0/1	2/5	2/3			11/23	47.8%	1	5	1	5		7	03:38:51
31	陈元祖															1	00:02:40
32	罗柏涵															4	00:03:01
<b>合计</b>		<b>37/106</b>	<b>39/67</b>	<b>18/33</b>	<b>32/46</b>	<b>37/48</b>	<b>1/4</b>	<b>15/23</b>	<b>179/327</b>	<b>54.7%</b>	<b>25</b>	<b>71</b>	<b>12</b>	<b>20</b>		<b>102</b>	
<b>(守门员)</b>																	
14	王泽润	7/18	16/33	8/16	5/20	4/22	1/4	1/10	42/123	34.1%						7	03:32:03
19	王帅	8/20	15/36	3/12	3/17	7/22		6/18	42/125	33.6%	2	3				7	03:27:57
<b>合计</b>		<b>15/38</b>	<b>31/69</b>	<b>11/28</b>	<b>8/37</b>	<b>11/44</b>	<b>1/4</b>	<b>7/28</b>	<b>84/248</b>	<b>33.9%</b>	<b>2</b>	<b>3</b>				<b>14</b>	

场上队员：得分/射门

守门员：救球/射门

已打比赛

全队合计	进球	被救	射失	击柱	封球	合计	%	阶段	场次	对手	比分
远射	37	35	18	3	13	106	34.9%	预赛	5	陕西	31:26 (14:12)
近射	39	20	4	3	1	67	58.2%	预赛	9	安徽	26:27 (10:11)
边射	18	12	1	2		33	54.5%	预赛	15	山西	24:22 (11:10)
快攻	32	10	1	3		46	69.6%	预赛	20	北京	21:20 (13:10)
突破	37	6	2	3		48	77.1%	四分之一决赛	23	天津	23:26 (8:12)
任意	1	1	1	1		4	25.0%	5-8名	27	山西	27:21 (15:8)
七米	15	6	2			23	65.2%	5-6名	31	上海	27:22 (14:11)



图式射门区域累计

手球  
男子

截止至第33场

重庆万州  
2019-04-16

广东队

2 孙江山 3 Post - 0 Miss - 0 Block - 0	6 毕晓晨 11 1 3 7 1 3 2 Post - 0 Miss - 7 Block - 0	7 王立隆 6 2 2 2 4 Post - 2 Miss - 0 Block - 0	9 范保坤 Post - 0 Miss - 0 Block - 0	10 周仲坤 4 1 2 2 2 3 9 1 4 Post - 2 Miss - 5 Block - 1	11 房友屯 2 1 Post - 0 Miss - 0 Block - 0	12 王雨 3 3 2 2 1 Post - 1 Miss - 4 Block - 0	14 王泽润 Post - 0 Miss - 0 Block - 0
15 张建杰 2 1 7 2 2 3 4 Post - 2 Miss - 6 Block - 4	18 姚雪岩 1 3 1 Post - 0 Miss - 1 Block - 1	19 王帅 Post - 0 Miss - 0 Block - 0	21 张昌柯 1 3 1 Post - 0 Miss - 1 Block - 2	22 黄培杰 3 1 10 1 3 2 4 Post - 7 Miss - 4 Block - 3	24 高玉杰 2 3 1 2 Post - 1 Miss - 1 Block - 3	31 陈元祖 Post - 0 Miss - 0 Block - 0	32 罗柏涵 Post - 0 Miss - 0 Block - 0

14 王泽润
4/18 1/10 3/19
13/23 3/3 7/19
6/14 2/4 3/13

19 王帅
1/20 2/4 4/15
6/22 6/8 12/21
7/16 1/3 3/16

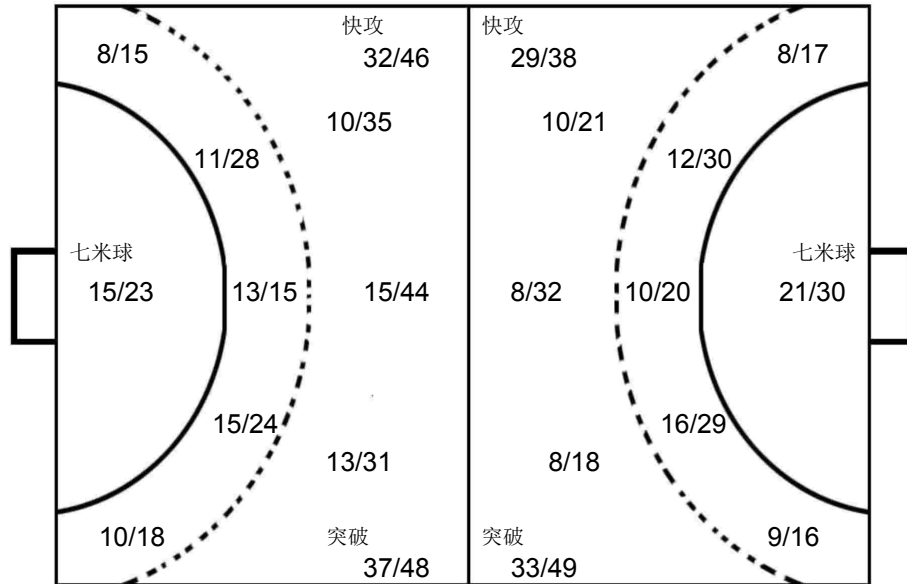

山西
12 韩乐斌
2/18 3/4 3/13
4/8 3/3 7/11
1/6 0/3 0/5

北京
16 刘迈科
1/3 2/3 1/7
3/5 1/2 3/5
1/4 3/5 1/3

安徽
21 李明
0/4 0/1 2/5
2/5 1/2 3/7
4/8 1/3 1/4

OPPONENT

山西 14 杨毅 1 1 5 1 4 1 5 Post - 0 Miss - 8 Block - 2	上海 8 高震东 1 2 1 1 1 4 Post - 1 Miss - 0 Block - 2	山西 7 任健豪 2 1 2 1 2 Post - 0 Miss - 3 Block - 3	安徽 4 王巨柱 1 1 1 1 3 Post - 0 Miss - 0 Block - 0	山西 6 盖秀越 1 2 2 2 Post - 0 Miss - 0 Block - 0	天津 86 田剑侠 2 1 2 1 1 Post - 0 Miss - 0 Block - 0	陕西 10 王凯强 3 2 Post - 0 Miss - 0 Block - 0	陕西 15 陈冉 1 1 1 2 1 Post - 0 Miss - 0 Block - 0
陕西 11 张领 1 1 2 1 Post - 1 Miss - 0 Block - 0	天津 13 许松 1 2 2 Post - 0 Miss - 0 Block - 0	安徽 1 郭世伟 1 2 1 Post - 0 Miss - 3 Block - 0	安徽 18 李双 2 2 Post - 0 Miss - 0 Block - 1	北京 3 逯明松 1 1 1 1 Post - 1 Miss - 0 Block - 0	北京 26 魏昂 1 2 1 Post - 0 Miss - 0 Block - 0	山西 15 薛瑞寒 2 1 1 Post - 0 Miss - 1 Block - 3	陕西 3 刘赵梁 2 1 1 Post - 0 Miss - 0 Block - 0



2019年全国男子手球冠军杯赛

PHMS Pictorial Handball Match Statistics

IHF Official System

球队名单

重庆万州

上海队

2019-04-07

号码	姓名	位置	生日	年龄	俱乐部	身高 (CM)	体重 (KG)	国际场次	国际进球
1	张崢	守门员	01/04/1988	31		190	90		
3	张立成	后卫	20/09/2000	18		180	76		
4	高天伦	右边锋	15/04/1997	21		186	84		
5	贺政	右后卫	20/08/1996	22		186	86		
7	周文龙	左后卫	12/01/1995	24		194	90		
8	高震东	左后卫	05/02/2000	19		188	85		
10	朱世杰	后卫	20/05/1995	23		187	86		
11	蒋慧捷	左边锋	23/10/1995	23		190	87		
12	周哲韬	守门员	25/04/1995	23		191	85		
13	谢智超	右边锋	21/03/1998	21		193	90		
15	庄旭杰	边锋	27/02/1999	20		186	75		
16	张逸豪	守门员	06/09/2000	18		192	85		
18	董凯	底线	08/01/1996	23		188	96		
20	蒋承骅	底线	20/01/1991	28		197	120		
23	吴双	底线	06/02/1999	20		194	82		
30	徐俊吉	底线	23/05/1989	29		198	116		
	平均			22.7		190.0	89.6		

编码	姓名	职务
A	吴璟	主教练
B	金迪琦	教练
C	张勇军	教练
D	杨时	医生



## 2019年全国男子手球冠军杯赛

PHMS Pictorial Handball Match Statistics

IHF Official System

手球 男子 个人/全队技术累计表 截止至第33场 重庆万州 2019-04-16

号码	姓名	远射	近射	边射	快攻	突破	任意	七米	合计	%	助攻	失误	警告	2'	取消	场次	时间
上海队																	
(场上队员)																	
1	张崢										3	1				7	04:37:08
3	张立成		0/1	0/1	2/3	2/4		0/1	4/10	40.0%	2	9				6	01:29:54
4	高天伦	0/1	3/4	2/5	0/2				5/12	41.7%	1	2		3		7	02:54:47
5	贺政	7/22	8/13	4/5	4/5	4/6	0/4	3/4	30/59	50.8%	3	17		2		7	05:03:28
7	周文龙	4/18	1/8	1/2		6/7	1/1		13/36	36.1%	2	8	1			7	02:53:54
8	高震东	0/9	8/12	9/13	4/7	4/7		2/2	27/50	54.0%	3	11	3	3		7	05:46:01
10	朱世杰	13/30	4/10	1/1	1/2	8/10	1/2	3/6	31/61	50.8%	14	31	1	4		7	07:00:00
11	蒋慧捷	0/1	2/3	6/10	2/3				10/17	58.8%		3		3		7	03:53:44
12	周哲韬										1					5	02:03:44
13	谢智超			2/6					2/6	33.3%	1	1				5	00:27:48
15	庄旭杰		0/1	2/4	2/2				4/7	57.1%						7	00:25:39
16	张逸豪															4	00:19:08
18	董凯	0/1	4/6		0/1			0/1	4/9	44.4%		4	1			7	02:03:29
20	蒋承骅											1				6	01:08:30
23	吴双	1/1	2/3	1/3	6/9				10/16	62.5%		6	1		1	5	03:08:10
30	徐俊吉		11/18	0/1	1/1			4/7	16/27	59.3%		13	2			7	05:43:45
合计		25/83	43/79	28/51	22/35	24/34	2/7	12/21	156/310	50.3%	30	107	9	15	1	101	
(守门员)																	
1	张崢	17/33	20/51	8/25	3/32	6/33		1/12	55/186	29.6%	3	1				7	04:37:08
12	周哲韬	8/10	9/25	2/10	2/13	3/9	0/1	2/4	26/72	36.1%	1					5	02:03:44
16	张逸豪	0/1	0/6	1/2	0/2	1/3		1/1	3/15	20.0%						4	00:19:08
合计		25/44	29/82	11/37	5/47	10/45	0/1	4/17	84/273	30.8%	4	1				16	

场上队员：得分/射门

守门员：救球/射门

已打比赛

全队合计	进球	被救	射失	击柱	封球	合计	%	阶段	场次	对手	比分
远射	25	20	12	7	19	83	30.1%	预赛	3	天津	14:26 (5:11)
近射	43	22	8	4	2	79	54.4%	预赛	7	江苏	18:39 (10:16)
边射	28	16	5	2		51	54.9%	预赛	12	四川	34:20 (13:12)
快攻	22	9	3	1		35	62.9%	预赛	17	山东	21:31 (6:13)
突破	24	7	1	2		34	70.6%	四分之一决赛	21	安徽	24:25 (11:12)
任意	2	2	3			7	28.6%	5-8名	26	山东	23:21 (12:12)
七米	12	7		2		21	57.1%	5-6名	31	广东	22:27 (11:14)



图式射门区域累计

手球  
男子

重庆万州  
2019-04-16

截止至第33场

上海队

1 张峥	3 张立成	4 高天伦	5 贺政	7 周文龙	8 高震东	10 朱世杰	11 蒋慧捷																																																																								
<table border="1"><tr><td></td><td></td><td></td></tr><tr><td></td><td></td><td></td></tr><tr><td></td><td></td><td></td></tr></table>										<table border="1"><tr><td></td><td></td><td>1</td></tr><tr><td>2</td><td></td><td></td></tr><tr><td>1</td><td></td><td></td></tr></table>			1	2			1			<table border="1"><tr><td></td><td></td><td></td></tr><tr><td>1</td><td></td><td></td></tr><tr><td>2</td><td></td><td>2</td></tr></table>				1			2		2	<table border="1"><tr><td>11</td><td>1</td><td>3</td></tr><tr><td>6</td><td></td><td>3</td></tr><tr><td>2</td><td>1</td><td>3</td></tr></table>	11	1	3	6		3	2	1	3	<table border="1"><tr><td>3</td><td></td><td>3</td></tr><tr><td></td><td></td><td>2</td></tr><tr><td>3</td><td></td><td>2</td></tr></table>	3		3			2	3		2	<table border="1"><tr><td>2</td><td>1</td><td>6</td></tr><tr><td>1</td><td></td><td>5</td></tr><tr><td>4</td><td>1</td><td>7</td></tr></table>	2	1	6	1		5	4	1	7	<table border="1"><tr><td>1</td><td>1</td><td>7</td></tr><tr><td>1</td><td></td><td>4</td></tr><tr><td>6</td><td>3</td><td>8</td></tr></table>	1	1	7	1		4	6	3	8	<table border="1"><tr><td></td><td></td><td></td></tr><tr><td>3</td><td></td><td>1</td></tr><tr><td>2</td><td>2</td><td>2</td></tr></table>				3		1	2	2	2
		1																																																																													
2																																																																															
1																																																																															
1																																																																															
2		2																																																																													
11	1	3																																																																													
6		3																																																																													
2	1	3																																																																													
3		3																																																																													
		2																																																																													
3		2																																																																													
2	1	6																																																																													
1		5																																																																													
4	1	7																																																																													
1	1	7																																																																													
1		4																																																																													
6	3	8																																																																													
3		1																																																																													
2	2	2																																																																													
Post - 0 Miss - 0 Block - 0	Post - 2 Miss - 0 Block - 0	Post - 0 Miss - 1 Block - 0	Post - 3 Miss - 8 Block - 6	Post - 2 Miss - 3 Block - 4	Post - 2 Miss - 4 Block - 3	Post - 3 Miss - 6 Block - 8	Post - 1 Miss - 2 Block - 0																																																																								
12 周哲韬	13 谢智超	15 庄旭杰	16 张逸豪	18 董凯	20 蒋承骅	23 吴双	30 徐俊吉																																																																								
<table border="1"><tr><td></td><td></td><td></td></tr><tr><td></td><td></td><td></td></tr><tr><td></td><td></td><td></td></tr></table>										<table border="1"><tr><td>1</td><td></td><td></td></tr><tr><td></td><td></td><td></td></tr><tr><td>1</td><td></td><td></td></tr></table>	1						1			<table border="1"><tr><td>1</td><td></td><td>1</td></tr><tr><td></td><td></td><td></td></tr><tr><td>1</td><td></td><td>1</td></tr></table>	1		1				1		1	<table border="1"><tr><td></td><td></td><td></td></tr><tr><td></td><td></td><td></td></tr><tr><td></td><td></td><td></td></tr></table>										<table border="1"><tr><td></td><td></td><td>2</td></tr><tr><td></td><td></td><td></td></tr><tr><td>1</td><td></td><td>1</td></tr></table>			2				1		1	<table border="1"><tr><td></td><td></td><td></td></tr><tr><td></td><td></td><td></td></tr><tr><td></td><td></td><td></td></tr></table>										<table border="1"><tr><td>3</td><td>1</td><td>1</td></tr><tr><td>1</td><td></td><td>2</td></tr><tr><td>2</td><td></td><td></td></tr></table>	3	1	1	1		2	2			<table border="1"><tr><td>3</td><td></td><td>3</td></tr><tr><td>3</td><td></td><td>2</td></tr><tr><td>3</td><td>1</td><td>1</td></tr></table>	3		3	3		2	3	1	1
1																																																																															
1																																																																															
1		1																																																																													
1		1																																																																													
		2																																																																													
1		1																																																																													
3	1	1																																																																													
1		2																																																																													
2																																																																															
3		3																																																																													
3		2																																																																													
3	1	1																																																																													
Post - 0 Miss - 0 Block - 0	Post - 0 Miss - 2 Block - 0	Post - 2 Miss - 0 Block - 0	Post - 0 Miss - 0 Block - 0	Post - 1 Miss - 2 Block - 0	Post - 0 Miss - 0 Block - 0	Post - 0 Miss - 1 Block - 0	Post - 2 Miss - 3 Block - 0																																																																								

1 张峥

5/28	2/4	8/36
10/28	1/1	10/19
9/25	3/10	7/35

12 周哲韬

1/4	1/1	2/16
7/12	1/1	4/12
6/11	2/7	2/8

16 张逸豪

0/1		1/3
1/1		0/2
	0/3	1/5

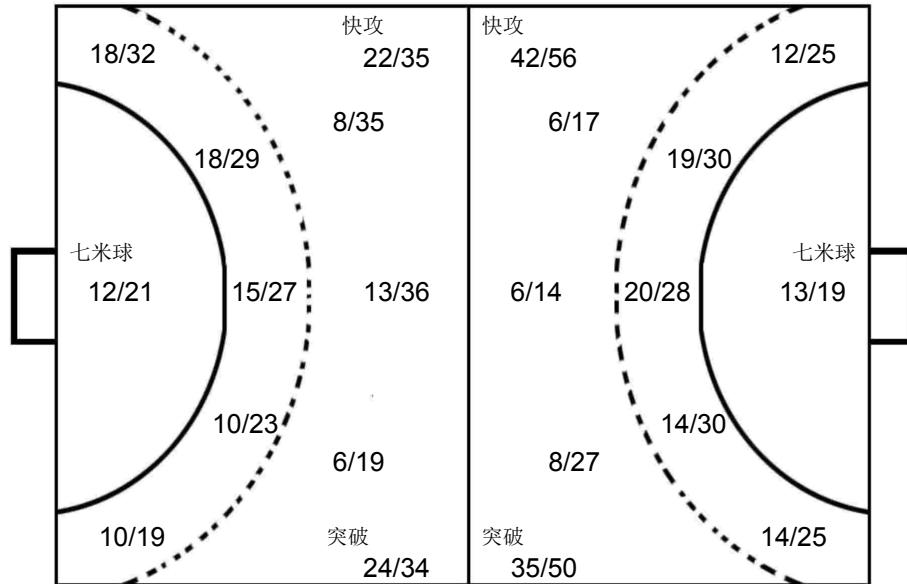

山东

12 于性哲

0/6	0/1	3/4
4/4	1/1	3/9
3/6	0/1	3/10

天津

1 何喜年

1/4	3/3	2/3
1/2		3/5
3/6	0/1	1/4

江苏

12 王权

0/1	1/1	2/5
2/2		2/4
2/2	1/2	0/3

OPPONENT

安徽 8 董智景	山东 7 林豪文	广东 7 王立隆	山东 6 李朝鹏	四川 6 董佳辉	江苏 25 王杰缘	山东 31 于亚男	山东 34 王钟彬																																																																								
<table border="1"><tr><td>2</td><td></td><td>3</td></tr><tr><td>1</td><td></td><td></td></tr><tr><td></td><td>2</td><td>1</td></tr></table>	2		3	1				2	1	<table border="1"><tr><td>3</td><td></td><td>3</td></tr><tr><td></td><td></td><td>1</td></tr><tr><td>1</td><td></td><td>1</td></tr></table>	3		3			1	1		1	<table border="1"><tr><td>1</td><td></td><td>2</td></tr><tr><td></td><td></td><td></td></tr><tr><td></td><td>1</td><td>3</td></tr></table>	1		2					1	3	<table border="1"><tr><td></td><td></td><td></td></tr><tr><td>2</td><td></td><td>3</td></tr><tr><td></td><td></td><td>2</td></tr></table>				2		3			2	<table border="1"><tr><td>1</td><td></td><td>1</td></tr><tr><td>1</td><td></td><td></td></tr><tr><td></td><td></td><td>4</td></tr></table>	1		1	1					4	<table border="1"><tr><td></td><td></td><td></td></tr><tr><td>2</td><td></td><td>1</td></tr><tr><td></td><td>1</td><td>2</td></tr></table>				2		1		1	2	<table border="1"><tr><td>1</td><td>1</td><td>1</td></tr><tr><td>2</td><td></td><td></td></tr><tr><td></td><td></td><td>1</td></tr></table>	1	1	1	2					1	<table border="1"><tr><td>1</td><td></td><td>2</td></tr><tr><td>1</td><td></td><td></td></tr><tr><td>1</td><td></td><td>1</td></tr></table>	1		2	1			1		1
2		3																																																																													
1																																																																															
	2	1																																																																													
3		3																																																																													
		1																																																																													
1		1																																																																													
1		2																																																																													
	1	3																																																																													
2		3																																																																													
		2																																																																													
1		1																																																																													
1																																																																															
		4																																																																													
2		1																																																																													
	1	2																																																																													
1	1	1																																																																													
2																																																																															
		1																																																																													
1		2																																																																													
1																																																																															
1		1																																																																													
Post - 0 Miss - 1 Block - 0	Post - 2 Miss - 1 Block - 0	Post - 2 Miss - 0 Block - 0	Post - 1 Miss - 0 Block - 0	Post - 0 Miss - 0 Block - 1	Post - 1 Miss - 0 Block - 0	Post - 1 Miss - 1 Block - 1	Post - 0 Miss - 0 Block - 0																																																																								
广东 22 黄培杰	江苏 19 庞连康	江苏 21 刘江	山东 19 李语庆	山东 27 胡晋铭	四川 14 洗鹏飞	天津 9 王子欣	天津 13 许松																																																																								
<table border="1"><tr><td></td><td></td><td>1</td></tr><tr><td></td><td></td><td>2</td></tr><tr><td></td><td></td><td>2</td></tr></table>			1			2			2	<table border="1"><tr><td></td><td></td><td>3</td></tr><tr><td></td><td></td><td></td></tr><tr><td></td><td>1</td><td>1</td></tr></table>			3					1	1	<table border="1"><tr><td></td><td></td><td>2</td></tr><tr><td></td><td></td><td>1</td></tr><tr><td>1</td><td>1</td><td></td></tr></table>			2			1	1	1		<table border="1"><tr><td>1</td><td>1</td><td>1</td></tr><tr><td></td><td></td><td></td></tr><tr><td>1</td><td></td><td>1</td></tr></table>	1	1	1				1		1	<table border="1"><tr><td>1</td><td></td><td>2</td></tr><tr><td></td><td></td><td></td></tr><tr><td>2</td><td></td><td></td></tr></table>	1		2				2			<table border="1"><tr><td>1</td><td></td><td>1</td></tr><tr><td>1</td><td></td><td></td></tr><tr><td></td><td></td><td>2</td></tr></table>	1		1	1					2	<table border="1"><tr><td>2</td><td></td><td>1</td></tr><tr><td>1</td><td></td><td></td></tr><tr><td>1</td><td></td><td></td></tr></table>	2		1	1			1			<table border="1"><tr><td>1</td><td></td><td>2</td></tr><tr><td>1</td><td></td><td></td></tr><tr><td>1</td><td></td><td></td></tr></table>	1		2	1			1		
		1																																																																													
		2																																																																													
		2																																																																													
		3																																																																													
	1	1																																																																													
		2																																																																													
		1																																																																													
1	1																																																																														
1	1	1																																																																													
1		1																																																																													
1		2																																																																													
2																																																																															
1		1																																																																													
1																																																																															
		2																																																																													
2		1																																																																													
1																																																																															
1																																																																															
1		2																																																																													
1																																																																															
1																																																																															
Post - 1 Miss - 0 Block - 0	Post - 0 Miss - 0 Block - 1	Post - 0 Miss - 0 Block - 0	Post - 0 Miss - 0 Block - 0	Post - 0 Miss - 0 Block - 0	Post - 0 Miss - 1 Block - 1	Post - 0 Miss - 0 Block - 0	Post - 1 Miss - 0 Block - 0																																																																								



2019年全国男子手球冠军杯赛

PHMS Pictorial Handball Match Statistics

IHF Official System

球队名单

重庆万州

山东队

2019-04-07

号码	姓名	位置	生日	年龄	俱乐部	身高 (CM)	体重 (KG)	国际场次	国际进球
1	宋晓晨	守门员	03/12/1996	22	山东男子手球队	192	96		
6	李朝鹏	中后卫	05/12/1992	26	山东男子手球队	185	95		
7	林豪文	左后卫	21/12/1997	21	山东男子手球队	188	105		
8	王炳华	右后卫	10/05/1991	27	山东男子手球队	194	100		
9	赵元	右后卫	13/02/1997	22	山东男子手球队	193	90		
10	赵建强	右后卫	30/03/1992	27	山东男子手球队	194	85		
11	宋朋强	中后卫	12/02/1987	32	山东男子手球队	194	92		
12	于性哲	守门员	25/06/1993	25	山东男子手球队	196	100		
13	刘晓	右后卫	30/03/1992	27	山东男子手球队	191	98		
15	张继伟	底线	02/02/1993	26	山东男子手球队	203	110		
17	王旭东	右后卫	06/12/1989	29	山东男子手球队	190	98		
19	李语庆	右边锋	07/03/1990	29	山东男子手球队	180	75		
21	姜春辉	右后卫	27/03/1995	24	山东男子手球队	193	96		
27	胡晋铭	底线	02/09/1997	21	山东男子手球队	197	113		
31	于亚男	左后卫	25/11/1990	28	山东男子手球队	190	105		
34	王钟彬	中后卫	29/11/1996	22	山东男子手球队	188	87		
	平均			25.5		191.8	96.6		

编码	姓名	职务
B	王鸿斌	主教练
C	金京男	教练
D	刘桂妮	教练
E	林配永	医生
A	杨跃东	领队

## 2019年全国男子手球冠军杯赛

PHMS Pictorial Handball Match Statistics

IHF Official System

手球 男子 个人/全队技术累计表 截止至第33场 重庆万州 2019-04-16

号码	姓名	远射	近射	边射	快攻	突破	任意	七米	合计	%	助攻	失误	警告	2'	取消	场次	时间
<b>山东队</b>																	
<b>(场上队员)</b>																	
1	宋晓晨										4					7	02:21:24
6	李朝鹏	5/10	5/7	2/3	3/3	4/4		1/2	20/29	69.0%	4	12	1	3	1	7	03:48:58
7	林豪文	5/10	5/10	2/4	2/3	3/3	0/1		17/31	54.8%	3	5		2		7	02:28:44
8	王炳华	0/5	4/5		2/2	1/1			7/13	53.8%	2	2		1		7	02:02:59
9	赵元	1/1	0/4	1/3		2/2	0/1		4/11	36.4%	2	4		1		7	01:44:06
10	赵建强		1/1	2/5	4/6			1/2	8/14	57.1%	3	2				7	02:00:05
11	宋朋强	3/7	2/3	1/3	1/2	4/6			11/21	52.4%	2	2	1	1		7	03:39:40
12	于性哲										7					7	04:24:19
13	刘晓	8/22	3/7	1/1	0/1	2/4			14/35	40.0%	6	12	1			7	04:26:25
15	张继伟		15/24		1/4	1/1	0/1		17/30	56.7%	1	7	5	3		7	04:57:17
17	王旭东	0/4	1/5	1/2	1/1	0/1		1/1	4/14	28.6%	5	7	3	2		7	02:35:04
19	李语庆		2/2	3/7	10/12			3/4	18/25	72.0%		3		1		7	04:10:16
21	姜春辉			3/6	4/4				7/10	70.0%		1				7	01:37:42
27	胡晋铭		8/9		4/5			1/1	13/15	86.7%	1	1		2		7	02:03:07
31	于亚男	13/31	3/6	0/2	4/4	3/3	0/1	4/5	27/52	51.9%	3	5	1			7	03:06:55
34	王钟彬	0/1	1/2	1/1	2/2	2/3		3/3	9/12	75.0%	4	3		1		7	01:42:47
	<b>合计</b>	<b>35/91</b>	<b>50/85</b>	<b>17/37</b>	<b>38/49</b>	<b>22/28</b>	<b>0/4</b>	<b>14/18</b>	<b>176/312</b>	<b>56.4%</b>	<b>47</b>	<b>66</b>	<b>12</b>	<b>17</b>	<b>1</b>	<b>112</b>	
<b>(守门员)</b>																	
1	宋晓晨	7/19	7/20	5/10	2/9	0/7		0/5	21/70	30.0%	4					7	02:21:24
12	于性哲	22/48	17/39	11/19	4/17	4/12	1/3	2/13	61/151	40.4%	7					7	04:24:19
	<b>合计</b>	<b>29/67</b>	<b>24/59</b>	<b>16/29</b>	<b>6/26</b>	<b>4/19</b>	<b>1/3</b>	<b>2/18</b>	<b>82/221</b>	<b>37.1%</b>	<b>11</b>					<b>14</b>	

场上队员：得分/射门

守门员：救球/射门

已打比赛

全队合计	进球	被救	射失	击柱	封球	合计	%	阶段	场次	对手	比分
远射	35	27	10	7	12	91	38.5%	预赛	4	四川	36:13 (17:6)
近射	50	27	2	6		85	58.8%	预赛	11	江苏	25:26 (12:17)
边射	17	14	2	4		37	45.9%	预赛	13	天津	19:17 (6:6)
快攻	38	8	2	1		49	77.6%	预赛	17	上海	31:21 (13:6)
突破	22	2	1	3		28	78.6%	四分之一决赛	22	北京	20:22 (11:12)
任意		4				4	0.0%	5-8名	26	上海	21:23 (12:12)
七米	14	4				18	77.8%	7-8名	30	山西	24:17 (10:10)

图式射门区域累计

手球  
男子

截止至第33场

重庆万州  
2019-04-16

山东队

1 宋晓晨	6 李朝鹏	7 林豪文	8 王炳华	9 赵元	10 赵建强	11 宋朋强	12 于性哲																																																																								
<table border="1"><tr><td></td><td></td><td></td></tr><tr><td></td><td></td><td></td></tr><tr><td></td><td></td><td></td></tr></table>										<table border="1"><tr><td>1</td><td></td><td>1</td></tr><tr><td>3</td><td></td><td>7</td></tr><tr><td>1</td><td>1</td><td>6</td></tr></table>	1		1	3		7	1	1	6	<table border="1"><tr><td>4</td><td></td><td>5</td></tr><tr><td>1</td><td></td><td>2</td></tr><tr><td>1</td><td></td><td>4</td></tr></table>	4		5	1		2	1		4	<table border="1"><tr><td>1</td><td></td><td>3</td></tr><tr><td></td><td></td><td></td></tr><tr><td></td><td>2</td><td>1</td></tr></table>	1		3					2	1	<table border="1"><tr><td></td><td></td><td>3</td></tr><tr><td>1</td><td></td><td></td></tr><tr><td></td><td></td><td></td></tr></table>			3	1						<table border="1"><tr><td>4</td><td></td><td>1</td></tr><tr><td>2</td><td></td><td></td></tr><tr><td></td><td></td><td>1</td></tr></table>	4		1	2					1	<table border="1"><tr><td>2</td><td></td><td>2</td></tr><tr><td>2</td><td></td><td>1</td></tr><tr><td>2</td><td></td><td>2</td></tr></table>	2		2	2		1	2		2	<table border="1"><tr><td></td><td></td><td></td></tr><tr><td></td><td></td><td></td></tr><tr><td></td><td></td><td></td></tr></table>									
1		1																																																																													
3		7																																																																													
1	1	6																																																																													
4		5																																																																													
1		2																																																																													
1		4																																																																													
1		3																																																																													
	2	1																																																																													
		3																																																																													
1																																																																															
4		1																																																																													
2																																																																															
		1																																																																													
2		2																																																																													
2		1																																																																													
2		2																																																																													
Post - 0 Miss - 0 Block - 0	Post - 1 Miss - 1 Block - 2	Post - 4 Miss - 2 Block - 0	Post - 1 Miss - 1 Block - 0	Post - 1 Miss - 0 Block - 0	Post - 0 Miss - 1 Block - 0	Post - 1 Miss - 2 Block - 0	Post - 0 Miss - 0 Block - 0																																																																								
13 刘晓	15 张继伟	17 王旭东	19 李语庆	21 姜春辉	27 胡晋铭	31 于亚男	34 王钟彬																																																																								
<table border="1"><tr><td>2</td><td></td><td></td></tr><tr><td>5</td><td></td><td>1</td></tr><tr><td>2</td><td>1</td><td>3</td></tr></table>	2			5		1	2	1	3	<table border="1"><tr><td>5</td><td>1</td><td>3</td></tr><tr><td>2</td><td></td><td>2</td></tr><tr><td>2</td><td>1</td><td>1</td></tr></table>	5	1	3	2		2	2	1	1	<table border="1"><tr><td>2</td><td></td><td></td></tr><tr><td>1</td><td></td><td>1</td></tr><tr><td></td><td></td><td></td></tr></table>	2			1		1				<table border="1"><tr><td>3</td><td>1</td><td>2</td></tr><tr><td>2</td><td></td><td>3</td></tr><tr><td>3</td><td>1</td><td>3</td></tr></table>	3	1	2	2		3	3	1	3	<table border="1"><tr><td></td><td>1</td><td>4</td></tr><tr><td>1</td><td></td><td></td></tr><tr><td></td><td></td><td>1</td></tr></table>		1	4	1					1	<table border="1"><tr><td>2</td><td>1</td><td>3</td></tr><tr><td>1</td><td></td><td>3</td></tr><tr><td>2</td><td>1</td><td></td></tr></table>	2	1	3	1		3	2	1		<table border="1"><tr><td>6</td><td>1</td><td>6</td></tr><tr><td>5</td><td></td><td>3</td></tr><tr><td>5</td><td></td><td>1</td></tr></table>	6	1	6	5		3	5		1	<table border="1"><tr><td>1</td><td></td><td>5</td></tr><tr><td>1</td><td></td><td></td></tr><tr><td>1</td><td></td><td>1</td></tr></table>	1		5	1			1		1
2																																																																															
5		1																																																																													
2	1	3																																																																													
5	1	3																																																																													
2		2																																																																													
2	1	1																																																																													
2																																																																															
1		1																																																																													
3	1	2																																																																													
2		3																																																																													
3	1	3																																																																													
	1	4																																																																													
1																																																																															
		1																																																																													
2	1	3																																																																													
1		3																																																																													
2	1																																																																														
6	1	6																																																																													
5		3																																																																													
5		1																																																																													
1		5																																																																													
1																																																																															
1		1																																																																													
Post - 4 Miss - 4 Block - 1	Post - 3 Miss - 2 Block - 0	Post - 0 Miss - 1 Block - 2	Post - 0 Miss - 0 Block - 0	Post - 1 Miss - 1 Block - 0	Post - 0 Miss - 0 Block - 0	Post - 4 Miss - 2 Block - 7	Post - 1 Miss - 0 Block - 0																																																																								

1 宋晓晨

4/14	3/4	2/12
2/7	1/1	3/8
1/11	4/7	1/6

12 于性哲

3/21	0/1	10/20
14/25	7/8	10/24
9/20	2/5	6/27

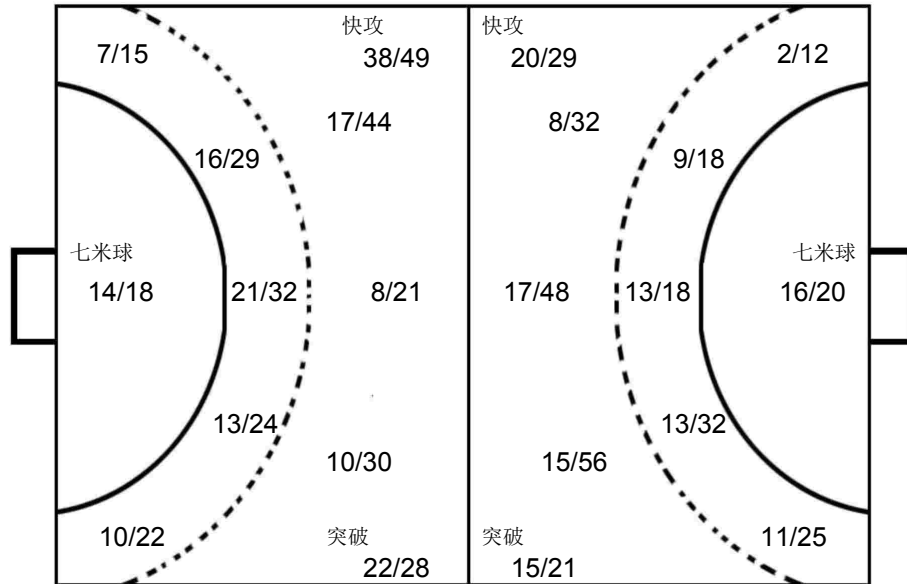

上海

1 张峥

3/13	0/2	3/15
6/16	1/1	3/7
3/8		2/11

江苏

12 王权

3/5	1/2	0/2
6/12		1/6
0/5	1/1	1/3

北京

16 刘迈科

	2/2	1/6
1/1		3/8
3/6	1/2	2/8

OPPONENT

上海 5 贺政	上海 10 朱世杰	江苏 6 赵晨	天津 7 张青	北京 10 成亚	江苏 4 张家纬	山西 14 杨毅	北京 13 王军鸣																																																																								
<table border="1"><tr><td>6</td><td>1</td><td>2</td></tr><tr><td>2</td><td></td><td>2</td></tr><tr><td>1</td><td></td><td>1</td></tr></table>	6	1	2	2		2	1		1	<table border="1"><tr><td></td><td>1</td><td>3</td></tr><tr><td></td><td></td><td>2</td></tr><tr><td>2</td><td>2</td><td>4</td></tr></table>		1	3			2	2	2	4	<table border="1"><tr><td>3</td><td></td><td>2</td></tr><tr><td>3</td><td></td><td></td></tr><tr><td>2</td><td></td><td>1</td></tr></table>	3		2	3			2		1	<table border="1"><tr><td>3</td><td></td><td></td></tr><tr><td>3</td><td></td><td></td></tr><tr><td>3</td><td></td><td>1</td></tr></table>	3			3			3		1	<table border="1"><tr><td>2</td><td></td><td></td></tr><tr><td></td><td></td><td></td></tr><tr><td></td><td></td><td>4</td></tr></table>	2								4	<table border="1"><tr><td>2</td><td></td><td>1</td></tr><tr><td></td><td></td><td>1</td></tr><tr><td>1</td><td></td><td>1</td></tr></table>	2		1			1	1		1	<table border="1"><tr><td></td><td></td><td>2</td></tr><tr><td></td><td></td><td>1</td></tr><tr><td></td><td>2</td><td>1</td></tr></table>			2			1		2	1	<table border="1"><tr><td></td><td></td><td></td></tr><tr><td>1</td><td></td><td></td></tr><tr><td></td><td></td><td>3</td></tr></table>				1					3
6	1	2																																																																													
2		2																																																																													
1		1																																																																													
	1	3																																																																													
		2																																																																													
2	2	4																																																																													
3		2																																																																													
3																																																																															
2		1																																																																													
3																																																																															
3																																																																															
3		1																																																																													
2																																																																															
		4																																																																													
2		1																																																																													
		1																																																																													
1		1																																																																													
		2																																																																													
		1																																																																													
	2	1																																																																													
1																																																																															
		3																																																																													
江苏 25 王杰缘	山西 7 任健豪	上海 23 吴双	四川 6 董佳辉	北京 6 解建飞	北京 7 马昌震	北京 33 陈旭	江苏 8 谢庆龙																																																																								
<table border="1"><tr><td></td><td></td><td>3</td></tr><tr><td></td><td></td><td>1</td></tr><tr><td></td><td></td><td></td></tr></table>			3			1				<table border="1"><tr><td>1</td><td></td><td>1</td></tr><tr><td>1</td><td></td><td>1</td></tr><tr><td></td><td></td><td></td></tr></table>	1		1	1		1				<table border="1"><tr><td>1</td><td></td><td></td></tr><tr><td></td><td></td><td>1</td></tr><tr><td>2</td><td></td><td></td></tr></table>	1					1	2			<table border="1"><tr><td></td><td></td><td>2</td></tr><tr><td></td><td></td><td>1</td></tr><tr><td></td><td>1</td><td></td></tr></table>			2			1		1		<table border="1"><tr><td></td><td></td><td></td></tr><tr><td></td><td></td><td>1</td></tr><tr><td>1</td><td></td><td>1</td></tr></table>						1	1		1	<table border="1"><tr><td></td><td></td><td>1</td></tr><tr><td></td><td></td><td></td></tr><tr><td>1</td><td></td><td>1</td></tr></table>			1				1		1	<table border="1"><tr><td>1</td><td></td><td></td></tr><tr><td></td><td></td><td></td></tr><tr><td></td><td></td><td>2</td></tr></table>	1								2	<table border="1"><tr><td></td><td></td><td></td></tr><tr><td>1</td><td></td><td></td></tr><tr><td></td><td></td><td>2</td></tr></table>				1					2
		3																																																																													
		1																																																																													
1		1																																																																													
1		1																																																																													
1																																																																															
		1																																																																													
2																																																																															
		2																																																																													
		1																																																																													
	1																																																																														
		1																																																																													
1		1																																																																													
		1																																																																													
1		1																																																																													
1																																																																															
		2																																																																													
1																																																																															
		2																																																																													
Post - 1 Miss - 2 Block - 4	Post - 2 Miss - 1 Block - 5	Post - 1 Miss - 2 Block - 1	Post - 0 Miss - 1 Block - 2	Post - 1 Miss - 3 Block - 0	Post - 0 Miss - 1 Block - 1	Post - 2 Miss - 2 Block - 2	Post - 0 Miss - 0 Block - 0																																																																								
Post - 0 Miss - 1 Block - 0	Post - 0 Miss - 1 Block - 1	Post - 0 Miss - 1 Block - 0	Post - 2 Miss - 3 Block - 5	Post - 0 Miss - 0 Block - 0	Post - 0 Miss - 0 Block - 0	Post - 2 Miss - 0 Block - 0	Post - 0 Miss - 0 Block - 0																																																																								



2019年全国男子手球冠军杯赛

PHMS Pictorial Handball Match Statistics

IHF Official System

球队名单

重庆万州

山西队

2019-04-07

号码	姓名	位置	生日	年龄	俱乐部	身高 (CM)	体重 (KG)	国际场次	国际进球
1	鲁世豪	守门员	24/04/2001	17		195	80		
2	张智超	守门员	01/01/2001	18		182	87		
3	龙俊皓	左后卫	26/11/2001	17		196	81		
4	刘文东	左边锋	27/03/2001	18		190	95		
5	王宇恒	左后卫	03/02/2001	18		180	80		
6	盖秀越	守门员	16/11/2000	18		183	75		
7	任健豪	右后卫	15/10/1999	19		186	76		
9	辛浩乐	后卫	02/09/2001	17		183	77		
10	王洋	右后卫	06/02/2000	19		185	78		
11	吴夏冰	左后卫	29/06/2001	17		191	92		
12	韩乐斌	中后卫	16/06/2000	18		192	90		
13	杜忠浩	后卫	29/07/2001	17		186	85		
14	杨毅	左后卫	14/08/2001	17		186	80		
15	薛瑞寒	右边锋	11/02/2001	18		180	100		
16	王虹翔	左后卫	14/05/2002	16		192	90		
18	张禹琛	右边锋	30/01/2002	17		170	80		
	平均			17.6		186.1	84.1		

编码	姓名	职务
A	张栋	领队
B	赵鑫	主教练
C	霖配永	医生

## 2019年全国男子手球冠军杯赛

PHMS Pictorial Handball Match Statistics

IHF Official System

手球 男子 个人/全队技术累计表 截止至第33场 重庆万州 2019-04-16

号码	姓名	远射	近射	边射	快攻	突破	任意	七米	合计	%	助攻	失误	警告	2'	取消	场次	时间
<b>山西队</b>																	
<b>(场上队员)</b>																	
1	鲁世豪											1				7	01:38:24
2	张智超		2/5	3/6					5/11	45.5%	2	2			2	7	02:27:59
3	龙俊皓													1		7	00:00:00
4	刘文东		3/6	1/2	1/2				5/10	50.0%	1	3	1	5		7	03:09:31
5	王宇恒	3/9	3/8	1/1		1/1		1/1	9/20	45.0%		7		1		7	02:44:56
6	盖秀越	0/2	2/4	14/21	8/8	1/1		1/2	26/38	68.4%	2	8	1			7	06:31:02
7	任健豪	4/10	9/19	0/2	3/7	9/11		0/1	25/50	50.0%	7	17	1	2		7	05:13:33
9	辛浩乐															7	00:10:14
10	王洋	0/1	0/2	3/7	3/3				6/13	46.2%	1	2	3			7	04:23:04
11	吴夏冰		5/11	1/1	1/1				7/13	53.8%		5	3	6		7	05:16:25
12	韩乐斌										1	3				7	05:20:50
13	杜忠浩	6/16	2/5			0/2	1/1	1/1	10/25	40.0%	3	12		1		7	02:12:17
14	杨毅	20/57	9/19	0/2	1/1	6/15	2/3	6/8	44/105	41.9%	7	26	1		1	7	05:30:32
15	薛瑞寒	2/16	8/18	0/1	1/4	3/4			14/43	32.6%	1	13	2			7	03:58:21
16	王虹翔															7	00:15:09
18	张禹琛															7	00:00:00
<b>合计</b>		35/111	43/97	23/43	18/26	20/34	3/4	9/13	151/328	46.0%	25	99	12	18	1	112	
<b>(守门员)</b>																	
1	鲁世豪	3/12	11/34	2/6	1/14	0/7		1/10	18/83	21.7%		1				7	01:38:24
12	韩乐斌	16/43	15/54	16/39	6/30	6/27	2/4	3/11	64/208	30.8%	1	3				7	05:20:50
16	王虹翔															7	00:00:46
<b>合计</b>		19/55	26/88	18/45	7/44	6/34	2/4	4/21	82/291	28.2%	1	4				21	

场上队员：得分/射门

守门员：救球/射门

已打比赛

全队合计	进球	被救	射失	击柱	封球	合计	%	阶段	场次	对手	比分
远射	35	27	15	7	27	111	31.5%	预赛	2	安徽	23:34 (12:17)
近射	43	35	12	3	4	97	44.3%	预赛	6	北京	18:41 (5:19)
边射	23	14	4	2		43	53.5%	预赛	10	陕西	27:25 (11:10)
快攻	18	7		1		26	69.2%	预赛	15	广东	22:24 (10:11)
突破	20	9	5			34	58.8%	四分之一决赛	24	江苏	23:34 (15:15)
任意	3		1			4	75.0%	5-8名	27	广东	21:27 (8:15)
七米	9	4				13	69.2%	7-8名	30	山东	17:24 (10:10)

图式射门区域累计

手球  
男子

截止至第33场

重庆万州  
2019-04-16

山西队

1 鲁世豪 [ ] [ ] [ ] [ ] [ ] [ ] Post - 0 Miss - 0 Block - 0	2 张智超 4 [ ] [ ] [ ] [ ] [ ] [ ] [ ] [ ] Post - 1 Miss - 0 Block - 1	3 龙俊皓 [ ] [ ] [ ] [ ] [ ] [ ] [ ] [ ] [ ] Post - 0 Miss - 0 Block - 0	4 刘文东 1 [ ] [ ] 2 [ ] [ ] [ ] [ ] [ ] [ ] Post - 1 Miss - 1 Block - 0	5 王宇恒 1 [ ] [ ] 3 [ ] [ ] 1 2 [ ] [ ] 2 Post - 1 Miss - 3 Block - 1	6 盖秀越 6 [ ] [ ] 6 4 [ ] [ ] 4 5 [ ] [ ] [ ] Post - 1 Miss - 2 Block - 0	7 任健豪 5 [ ] [ ] 2 5 [ ] [ ] 5 1 [ ] [ ] 3 Post - 1 Miss - 5 Block - 4	9 辛浩乐 [ ] [ ] [ ] [ ] [ ] [ ] [ ] [ ] [ ] Post - 0 Miss - 0 Block - 0
10 王洋 1 [ ] [ ] [ ] 1 [ ] [ ] [ ] 2 [ ] [ ] [ ] 2 Post - 0 Miss - 2 Block - 0	11 吴夏冰 2 [ ] [ ] [ ] [ ] [ ] [ ] 1 [ ] [ ] 2 Post - 0 Miss - 1 Block - 0	12 韩乐斌 [ ] [ ] [ ] [ ] [ ] [ ] [ ] [ ] [ ] Post - 0 Miss - 0 Block - 0	13 杜忠浩 1 [ ] [ ] 4 1 [ ] [ ] 2 1 [ ] [ ] 1 Post - 2 Miss - 3 Block - 4	14 杨毅 3 [ ] [ ] 11 4 [ ] [ ] 6 3 [ ] [ ] 5 10 Post - 3 Miss - 16 Block - 12	15 薛瑞寒 4 [ ] [ ] 1 [ ] [ ] [ ] 2 3 [ ] [ ] 1 2 Post - 3 Miss - 4 Block - 9	16 王虹翔 [ ] [ ] [ ] [ ] [ ] [ ] [ ] [ ] [ ] Post - 0 Miss - 0 Block - 0	18 张禹琛 [ ] [ ] [ ] [ ] [ ] [ ] [ ] [ ] [ ] Post - 0 Miss - 0 Block - 0

1 鲁世豪

2/13	1/2	3/12
1/9	2/3	4/13
1/14	1/7	3/10

12 韩乐斌

7/42	3/6	10/38
15/29	11/12	9/23
5/27	2/10	2/21

16 王虹翔

[ ]	[ ]	[ ]
[ ]	[ ]	[ ]
[ ]	[ ]	[ ]

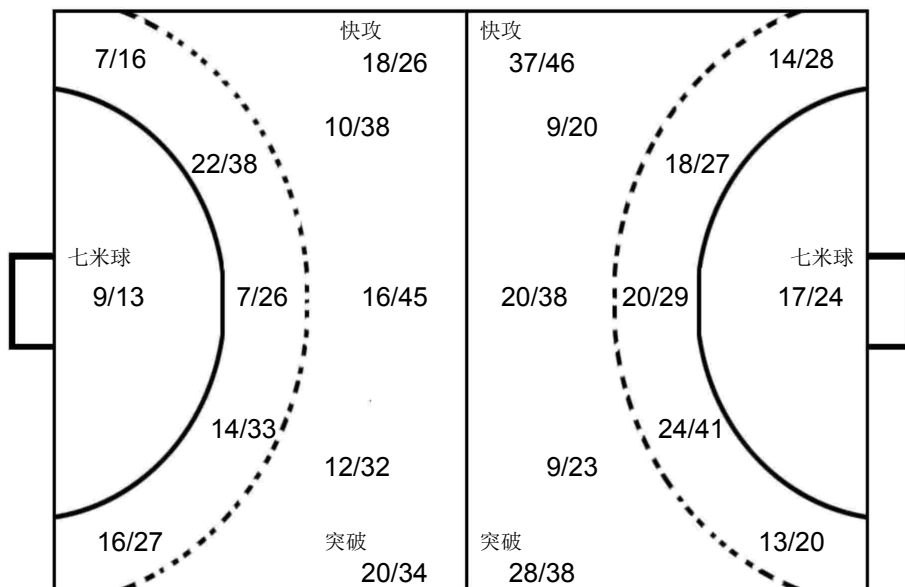

广东

19 王帅

0/7	1/1	4/7
1/5	5/6	6/10
2/2	0/1	0/7

陕西

22 张睿梁

2/5	0/1	1/6
1/3	2/2	4/9
2/7	1/2	0/5

山东

1 宋晓晨

3/5	3/3	1/4
1/3	[ ]	1/5
0/2	3/5	0/2

OPPONENT

山东 15 张继伟 3 [ ] [ ] 2 1 [ ] [ ] 1 2 [ ] [ ] [ ] Post - 0 Miss - 0 Block - 0	广东 6 毕晓晨 4 [ ] [ ] 1 2 [ ] [ ] 1 [ ] [ ] [ ] Post - 0 Miss - 1 Block - 0	广东 7 王立隆 3 [ ] [ ] 2 [ ] [ ] [ ] 1 [ ] [ ] [ ] 1 Post - 0 Miss - 0 Block - 0	广东 10 周仲坤 1 [ ] [ ] 1 [ ] [ ] [ ] 1 3 [ ] [ ] [ ] 1 Post - 1 Miss - 1 Block - 1	安徽 4 王巨柱 1 [ ] [ ] 2 [ ] [ ] [ ] 2 1 [ ] [ ] [ ] 1 Post - 1 Miss - 1 Block - 0	北京 23 王军程 1 [ ] [ ] 2 1 [ ] [ ] 1 1 [ ] [ ] [ ] 1 Post - 0 Miss - 0 Block - 0	广东 15 张建杰 1 [ ] [ ] 2 1 [ ] [ ] 1 1 [ ] [ ] [ ] Post - 1 Miss - 4 Block - 0	广东 22 黄培杰 2 [ ] [ ] 2 [ ] [ ] [ ] 1 [ ] [ ] [ ] Post - 2 Miss - 1 Block - 1
江苏 6 赵晨 1 [ ] [ ] [ ] [ ] [ ] [ ] 4 [ ] [ ] [ ] 1 Post - 0 Miss - 1 Block - 0	陕西 3 刘赵梁 3 [ ] [ ] 2 1 [ ] [ ] [ ] [ ] [ ] [ ] Post - 0 Miss - 0 Block - 1	北京 27 闫炳旗 [ ] [ ] [ ] 1 1 [ ] [ ] [ ] 3 [ ] [ ] [ ] Post - 0 Miss - 0 Block - 0	江苏 7 周傲 [ ] [ ] [ ] [ ] 1 [ ] [ ] [ ] 1 [ ] [ ] [ ] 2 Post - 1 Miss - 0 Block - 0	江苏 25 王杰缘 [ ] [ ] [ ] 1 1 [ ] [ ] [ ] 3 [ ] [ ] [ ] Post - 2 Miss - 0 Block - 0	山东 8 王炳华 1 [ ] [ ] [ ] 1 [ ] [ ] [ ] [ ] [ ] [ ] 2 1 Post - 0 Miss - 0 Block - 0	陕西 10 王凯强 1 [ ] [ ] [ ] 3 [ ] [ ] [ ] 1 [ ] [ ] [ ] Post - 0 Miss - 0 Block - 0	陕西 15 陈冉 [ ] [ ] [ ] 1 [ ] [ ] [ ] 1 [ ] [ ] [ ] 2 Post - 0 Miss - 0 Block - 0





2019年全国男子手球冠军杯赛

PHMS Pictorial Handball Match Statistics

IHF Official System

球队名单

重庆万州

陕西队

2019-04-07

号码	姓名	位置	生日	年龄	俱乐部	身高 (CM)	体重 (KG)	国际场次	国际进球
1	陈昊	守门员	05/01/2002	17		196	80		
2	王柏淇	边锋	11/09/1996	22		187	61		
3	刘赵梁	边锋	04/07/1997	21		185	70		
4	李佳	边锋	23/12/2002	16		178	72		
5	马益奎	底线	22/09/1999	19		190	75		
6	刘世昌	右后卫	16/11/2001	17		196	85		
8	季雨	后卫	25/12/2000	18		188	73		
9	陈孝天	边锋	16/02/2001	18		190	78		
10	王凯强	左后卫	08/02/2001	18		189	65		
11	张领	左后卫	19/01/2001	18		192	90		
12	赵凯	守门员	24/03/2000	19					
13	隋家乐	边锋	24/04/2001	17		180	70		
15	陈冉	边锋	23/02/2001	18		195	130		
17	耿畅	后卫	19/10/1999	19		189	75		
18	刘文星	边锋	07/05/2002	16		173	61		
22	张睿梁	守门员	09/06/1998	20		189	87		
	平均			18.3		187.8	78.1		

编码	姓名	职务
B	郝可鑫	
C	李安	
E	王建国	医生

## 2019年全国男子手球冠军杯赛

PHMS Pictorial Handball Match Statistics

IHF Official System

手球  
男子

### 个人/全队技术累计表

重庆万州  
2019-04-16

截止至第33场

号码	姓名	远射	近射	边射	快攻	突破	任意	七米	合计	%	助攻	失误	警告	2'	取消	场次	时间
<b>陕西队</b>																	
<b>(场上队员)</b>																	
1	陈昊															4	01:15:40
2	王柏淇											1				3	00:02:50
3	刘赵梁	3/8	1/5		1/1	8/9	1/2		14/25	56.0%	10	23		2		4	02:27:29
4	李佳	0/2		2/3					2/5	40.0%	1	1	1			4	00:44:24
5	马益奎		9/15	1/1		1/1			11/17	64.7%	1	7	2	4		4	03:51:32
6	刘世昌	1/1		4/7					5/8	62.5%		2				4	02:55:30
8	季雨	1/7	4/6			1/4			6/17	35.3%	1	11	1	1		4	02:39:08
9	陈孝天	3/8	2/4		1/1		0/2	2/2	8/17	47.1%		4				2	00:53:57
10	王凯强	3/15	6/8		3/3	4/7			16/33	48.5%	4	13				4	03:49:28
11	张领	0/6	0/4			0/1		10/12	10/23	43.5%		5		3		4	02:30:56
12	赵凯															4	00:00:00
13	隋家乐															4	00:00:00
15	陈冉	1/1	4/6	10/19	3/6	1/1		1/3	20/36	55.6%		3		1		4	03:59:56
17	耿畅															4	00:00:00
18	刘文星															4	00:00:00
22	张春梁										1					4	02:44:20
<b>合计</b>		<b>12/48</b>	<b>26/48</b>	<b>17/30</b>	<b>8/11</b>	<b>15/23</b>	<b>1/4</b>	<b>13/17</b>	<b>92/181</b>	<b>50.8%</b>	<b>18</b>	<b>70</b>	<b>4</b>	<b>11</b>		<b>61</b>	
<b>(守门员)</b>																	
1	陈昊	0/16	5/12	3/4	1/13	0/4		1/2	10/51	19.6%						4	01:15:40
22	张春梁	6/16	9/35	9/21	6/22	4/19		1/6	35/119	29.4%	1					4	02:44:20
<b>合计</b>		<b>6/32</b>	<b>14/47</b>	<b>12/25</b>	<b>7/35</b>	<b>4/23</b>		<b>2/8</b>	<b>45/170</b>	<b>26.5%</b>	<b>1</b>					<b>8</b>	

场上队员：得分/射门

守门员：救球/射门

已打比赛

全队合计	进球	被救	射失	击柱	封球	合计	%	阶段	场次	对手	比分
远射	12	18	6	3	9	48	25.0%	预赛	1	北京	25:35 (9:23)
近射	26	18	1	3		48	54.2%	预赛	5	广东	26:31 (12:14)
边射	17	11	1	1		30	56.7%	预赛	10	山西	25:27 (10:11)
快攻	8	3				11	72.7%	预赛	19	安徽	16:32 (10:16)
突破	15	8				23	65.2%				
任意	1	2		1		4	25.0%				
七米	13	3	1			17	76.5%				

图式射门区域累计

手球  
男子

截止至第33场

重庆万州  
2019-04-16

陕西队

1 陈昊 0/0 0/0 0/0 Post - 0 Miss - 0 Block - 0	2 王柏淇 0/0 0/0 0/0 Post - 0 Miss - 0 Block - 0	3 刘赵梁 6/4 1/1 3/0 Post - 2 Miss - 0 Block - 2	4 李佳 0/0 0/0 0/0 Post - 1 Miss - 0 Block - 0	5 马益奎 2/1 1/2 1/4 Post - 0 Miss - 0 Block - 0	6 刘世昌 1/1 1/2 0/0 Post - 1 Miss - 0 Block - 0	8 季雨 3/0 0/2 1/0 Post - 0 Miss - 3 Block - 1	9 陈孝天 1/1 0/1 3/0 Post - 1 Miss - 0 Block - 2
10 王凯强 2/8 1/1 1/3 Post - 0 Miss - 2 Block - 2	11 张领 3/0 0/1 3/3 Post - 2 Miss - 3 Block - 2	12 赵凯 0/0 0/0 0/0 Post - 0 Miss - 0 Block - 0	13 隋家乐 0/0 0/0 0/0 Post - 0 Miss - 0 Block - 0	15 陈冉 1/3 5/3 4/1 3/3 Post - 1 Miss - 1 Block - 0	17 耿畅 0/0 0/0 0/0 Post - 0 Miss - 0 Block - 0	18 刘文星 0/0 0/0 0/0 Post - 0 Miss - 0 Block - 0	22 张睿梁 0/0 0/0 0/0 Post - 0 Miss - 0 Block - 0

1 陈昊	0/5	2/12
	1/9	5/13
	1/6	1/2 0/4

22 张睿梁	3/16	0/1	4/18
	3/14	5/7	11/27
	4/14	1/7	4/15

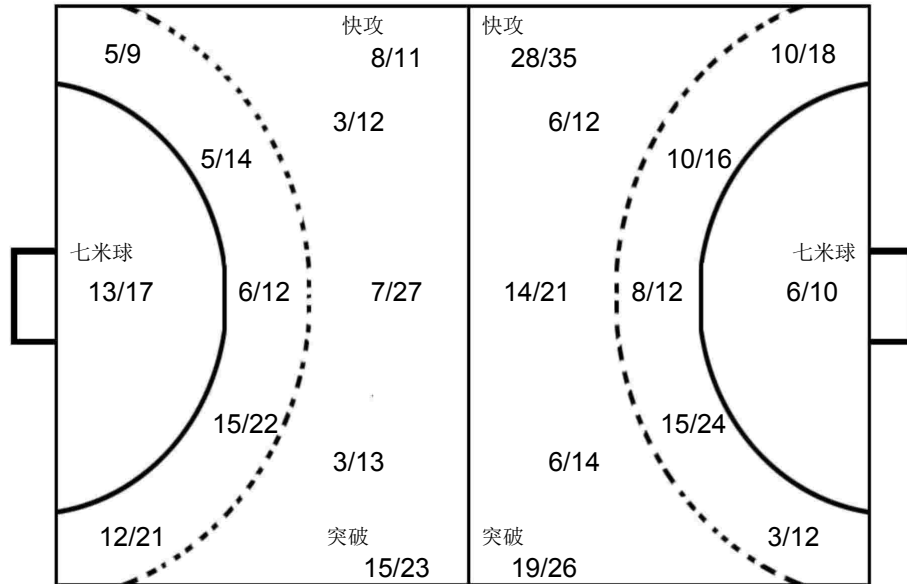

山西	12 韩乐斌	2/8	2/7
		4/8	6/6 1/3
		3/5	2/3 0/4

北京	16 刘迈科	4/5	1/4
		4/7	1/1 1/2
		1/3	3/3 1/2

安徽	12 曾献辰	1/5	3/3
		2/5	1/2 2/3
		2/4	1/1

OPPONENT

安徽 23 张鹏 0/0 0/0 2/1 Post - 1 Miss - 0 Block - 0	广东 10 周仲坤 2/1 0/1 2/1 Post - 0 Miss - 2 Block - 0	山西 7 任健豪 1/1 0/2 1/1 Post - 1 Miss - 0 Block - 0	山西 14 杨毅 1/0 0/1 2/2 Post - 0 Miss - 1 Block - 1	安徽 18 李双 1/3 0/1 1/1 Post - 1 Miss - 0 Block - 0	北京 3 逯明松 3/1 0/2 0/0 Post - 0 Miss - 1 Block - 0	北京 18 傅俊雄 0/0 1/1 2/1 Post - 0 Miss - 1 Block - 0	广东 6 毕晓晨 0/0 3/1 0/0 Post - 0 Miss - 2 Block - 0
山西 6 盖秀越 1/1 0/2 0/0 Post - 0 Miss - 0 Block - 0	安徽 26 饶原源 1/1 0/1 2/1 Post - 1 Miss - 0 Block - 1	北京 22 王超 1/1 0/1 2/1 Post - 0 Miss - 0 Block - 0	广东 24 高玉杰 1/0 0/2 0/0 Post - 1 Miss - 0 Block - 1	安徽 5 史小帆 0/0 0/0 2/0 Post - 1 Miss - 0 Block - 0	北京 10 成亚 1/1 0/1 1/1 Post - 0 Miss - 0 Block - 0	北京 23 王军程 1/0 0/2 0/1 Post - 0 Miss - 1 Block - 0	北京 26 魏昂 1/0 0/1 1/1 Post - 0 Miss - 0 Block - 0



2019年全国男子手球冠军杯赛

PHMS Pictorial Handball Match Statistics

IHF Official System

球队名单

重庆万州

四川队

2019-04-07

号码	姓名	位置	生日	年龄	俱乐部	身高 (CM)	体重 (KG)	国际场次	国际进球
2	张宏运	左后卫	30/01/2000	19	四川省 手曲棒垒球运动管理中心	204	85		
3	李朗轩	中后卫	24/02/2003	16	四川省 手曲棒垒球运动管理中心	185	80		
6	董佳辉	左后卫	28/02/2002	17	四川省 手曲棒垒球运动管理中心	193	90		
7	曾繁泳	中后卫	12/08/2001	17	四川省 手曲棒垒球运动管理中心	171	64		
8	罗霖泽	右边锋	18/08/2001	17	四川省 手曲棒垒球运动管理中心	171	62		
9	左典	后卫	08/04/2002	16	四川省 手曲棒垒球运动管理中心	174	65		
10	李剑琛	底线	11/01/2001	18	四川省 手曲棒垒球运动管理中心	172	65		
11	江成腾	底线	14/11/2002	16	四川省 手曲棒垒球运动管理中心	197	80		
12	戴景伟	守门员	26/09/2002	16	四川省 手曲棒垒球运动管理中心	190	110		
14	洗鹏飞	右后卫	18/09/2001	17	四川省 手曲棒垒球运动管理中心	192	82		
17	叶康全	守门员	28/10/2000	18	四川省 手曲棒垒球运动管理中心	193	90		
	平均			17.0		185.6	79.4		

编码	姓名	职务
A	李中洲	领队
B	王伟	主教练
C	张广建	教练

## 2019年全国男子手球冠军杯赛

PHMS Pictorial Handball Match Statistics

IHF Official System

手球  
男子

### 个人/全队技术累计表

重庆万州  
2019-04-16

截止至第33场

号码	姓名	远射	近射	边射	快攻	突破	任意	七米	合计	%	助攻	失误	警告	2'	取消	场次	时间
<b>四川队</b>																	
<b>(场上队员)</b>																	
2	张宏运	0/1	5/9						5/10	50.0%		4	2	1		4	03:27:51
3	李朗轩	3/13	1/2		1/1			0/2	5/18	27.8%		8	1		1	4	02:06:43
6	董佳辉	3/26	10/14		2/3	7/8	0/3	0/1	22/55	40.0%	1	9		3		4	03:33:45
7	曾繁泳		1/1	5/10	4/4				10/15	66.7%		10		1		4	03:31:10
8	罗霖泽		1/1	7/16	3/6				11/23	47.8%	1	11		1		4	03:13:47
9	左典	3/10	1/10	0/1		3/5			7/26	26.9%	2	18				4	03:13:31
10	李剑琛		0/1	0/3	2/2			1/1	3/7	42.9%		2				4	01:22:36
11	江成腾															1	00:05:34
12	戴景伟										2	3				4	02:00:34
14	洗鹏飞	3/10	2/4		1/2	4/4		0/1	10/21	47.6%	4	15				4	03:27:17
15	金硕		0/1						0/1	0.0%		1				1	00:07:20
17	叶康全											1				4	01:59:31
<b>合计</b>		<b>12/60</b>	<b>21/43</b>	<b>12/30</b>	<b>13/18</b>	<b>14/17</b>	<b>0/3</b>	<b>1/5</b>	<b>73/176</b>	<b>41.5%</b>	<b>10</b>	<b>82</b>	<b>3</b>	<b>6</b>	<b>1</b>	<b>42</b>	
<b>(守门员)</b>																	
12	戴景伟	3/8	8/31	2/11	6/22	2/18	0/1	3/4	24/95	25.3%	2	3				4	02:00:34
17	叶康全	3/10	8/29	2/14	2/26	1/8		1/4	17/91	18.7%		1				4	01:59:31
<b>合计</b>		<b>6/18</b>	<b>16/60</b>	<b>4/25</b>	<b>8/48</b>	<b>3/26</b>	<b>0/1</b>	<b>4/8</b>	<b>41/186</b>	<b>22.0%</b>	<b>2</b>	<b>4</b>				<b>8</b>	

场上队员：得分/射门

守门员：救球/射门

已打比赛

全队合计	进球	被救	射失	击柱	封球	合计	%	阶段	场次	对手	比分
远射	12	21	10	2	15	60	20.0%	预赛	4	山东	13:36 (6:17)
近射	21	18	2	2		43	48.8%	预赛	8	天津	18:35 (9:17)
边射	12	10	7	1		30	40.0%	预赛	12	上海	20:34 (12:13)
快攻	13	2	2	1		18	72.2%	预赛	14	江苏	22:40 (11:23)
突破	14	2		1		17	82.4%				
任意		1		2		3	0.0%				
七米	1	1	1	2		5	20.0%				

图式射门区域累计

手球  
男子

截止至第33场

重庆万州  
2019-04-16

四川队

2 张宏运 1 1 2	3 李朗轩 1 2 1 1	6 董佳辉 3 1 7 2 2 2 5	7 曾繁泳 3 1 2 1 1	8 罗霖泽 2 2 2 3 2	9 左典 2 3 2	10 李剑琛 1 2	11 江成腾
Post - 1 Miss - 0 Block - 0	Post - 2 Miss - 4 Block - 2	Post - 3 Miss - 6 Block - 8	Post - 0 Miss - 3 Block - 0	Post - 2 Miss - 3 Block - 0	Post - 3 Miss - 0 Block - 1	Post - 0 Miss - 2 Block - 0	Post - 0 Miss - 0 Block - 0
12 戴景伟 1 1	14 洗鹏飞 1 3 1 2 3	15 金硕	17 叶康全				
Post - 0 Miss - 0 Block - 0	Post - 0 Miss - 4 Block - 4	Post - 0 Miss - 0 Block - 0	Post - 0 Miss - 0 Block - 0				

2/18	0/2	2/21
3/11	1/1	9/15
2/11	1/4	4/12

1/12	2/3	1/15
3/19	1/3	2/13
4/8	0/4	3/14

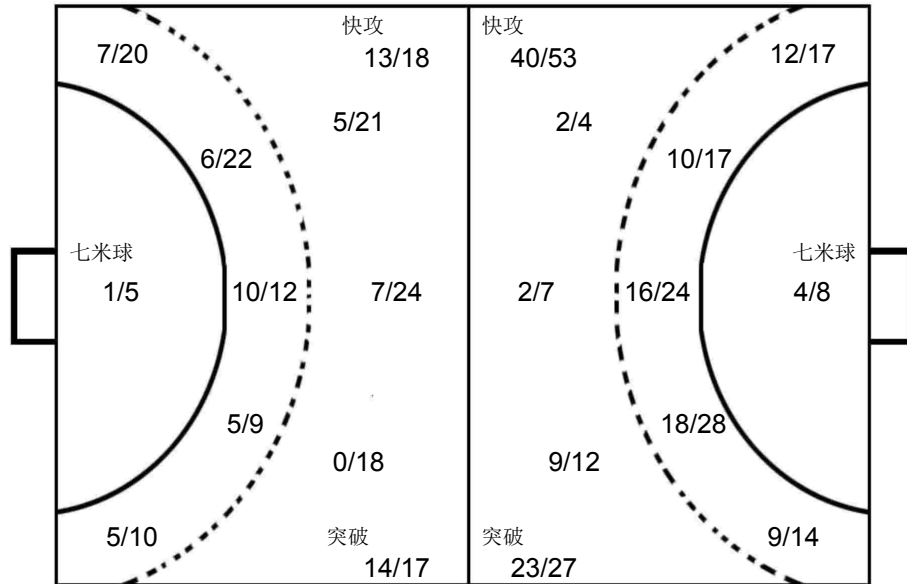

上海

1 张崢	1/4	1/4
	3/5	5/6
	1/4	1/1 3/8

山东

12 于性哲	0/2	1/2
	1/2	1/2
	3/3	1/2

山东

1 宋晓晨	1/2	1/3
	1/1	2/3
	1/1	1/3

OPPONENT

江苏 11 张天豪 2 2 1 1 2 1 1	江苏 7 周傲 1 1 1 1 2 2	上海 8 高震东 3 2 1 2	山东 19 李语庆 2 1 1 1 1	山东 27 胡晋铭 1 1 1 2 1	上海 5 贺政 2 1 3	上海 7 周文龙 1 3 1	江苏 18 赵楠 2 1 1 1 1
Post - 3 Miss - 1 Block - 0	Post - 0 Miss - 0 Block - 1	Post - 0 Miss - 0 Block - 1	Post - 0 Miss - 0 Block - 0	Post - 0 Miss - 0 Block - 0	Post - 0 Miss - 0 Block - 0	Post - 1 Miss - 0 Block - 0	Post - 0 Miss - 0 Block - 0
江苏 19 庞连康 1 1 1 1	江苏 21 刘江 1 1 3	天津 5 王毅 1 2 1	天津 7 张青 1 1 2 1 1	天津 8 王晓琪 2 1 1 1 1	天津 10 苏尧 1 1 2 1	江苏 30 吴龙瑞 1 1 1	山东 6 李朝鹏 1 1 2
Post - 0 Miss - 1 Block - 0	Post - 0 Miss - 0 Block - 0	Post - 0 Miss - 0 Block - 0	Post - 0 Miss - 0 Block - 0	Post - 1 Miss - 1 Block - 0	Post - 0 Miss - 0 Block - 0	Post - 0 Miss - 1 Block - 0	Post - 0 Miss - 0 Block - 0



Team A				Team B				Match Number													
A 北京队				B 陕西队				1													
Played in		in the hall		on		at		Spectators													
重庆万州		万州体育馆		2019-04-07		13:00		hours													
Half-time(30')	A	B	End of playing time	A	B	1st extra time	A	B	2nd extra time	A	B	After penalty throws	A	B							
	23	9	35	25																	
Number of 7 m	A	Team time-out			Full name of players and officials						Team time-out			B	Number of 7 m						
	2/3	1	2	3							1	2	3	4/4							
			41:45						16:59												
No.	Team A					G	W	2'	D	DR	No.	Team B					G	W	2'	D	DR
3	逯明松					6		1			1	陈昊									
6	解建飞										2	王柏淇									
7	马昌震					1	1	1			3	刘赵梁									
10	成亚					4	1				4	李佳									
11	赵文宣					2					5	马益奎					3				
12	高云健										6	刘世昌					1				
13	王军鸣					1					8	季雨					3				
16	刘迈科										9	陈孝天					8				
18	傅俊雄					6			1		10	王凯强					2				
22	王超					5		1			11	张领					2		1		
23	王军程					4					12	赵凯									
25	王鹏皓					1					13	隋家乐									
26	魏昂					4					15	陈冉					6		1		
27	闫炳旗							1			17	耿畅									
32	蒋维一					1					18	刘文星									
33	陈旭							1			22	张睿梁									
A	郑永利 (主教练)										B	郝可鑫									
B	孟辉										C	李安									
D	陈璇																				
A	Signatures of responsables for the teams (Off.A)														B						
TP	Remarks of referees / HF Official														TP						

Signatures

Referees	张之伟 (CHN)	康曦 (CHN)		
T.D.	李之文 (CHN)	张春生 (CHN)		
CHA Off.				

Note: Number of 7m Throws Awarded to Team A and B, Goals (G), Warnings (W), Suspensions (2'), Direct Disqualification (D), Disqualification With Report (DR) and Team Penalty (TP).

Table Officials: 鲍瑀

刘宇阳

Statisticians: 谢杨

赵悦





2019年全国男子手球冠军杯赛

PHMS Pictorial Handball Match Statistics

IHF Official System

个人/全队技术统计表

手球 男子 预赛 轮次 1 组别 A 场次 1 万州体育馆 2019-04-07 13:00

号码	姓名	远射	近射	边射	快攻	突破	任意	七米	合计	%	助攻	失误	警告	2'	取消	时间
北京队(北京)																
(场上队员)																
3	逯明松	2/4	2/2			2/2			6/8	75.0%	1	2		1		00:35:04
6	解建飞									0.0%		1				00:07:16
7	马昌震		1/1						1/1	100%	1	1	1	1		00:41:21
10	成亚	1/1	0/1		2/2	1/1			4/5	80.0%	2		1			00:24:54
11	赵文宣		2/2						2/2	100%						00:04:50
12	高云健									0.0%						00:18:36
13	王军鸣		0/1			1/1			1/2	50.0%		2				00:20:21
16	刘迈科									0.0%	1					00:41:24
18	傅俊雄	0/1	2/3			2/3		2/3	6/10	60.0%	3				1	00:39:38
22	王超		1/1	3/5	1/1				5/7	71.4%				1		00:42:47
23	王军程	3/4	1/1						4/5	80.0%	1	1				00:22:26
25	王鹏皓			0/2	1/2				1/4	25.0%		1				00:43:50
26	魏昂					4/5			4/5	80.0%		2				00:17:48
27	闫炳旗									0.0%				1		00:16:07
32	蒋维一		1/2						1/2	50.0%	1					00:13:11
33	陈旭									0.0%	1	3		1		00:30:00
	合计	6/10	10/14	3/7	8/10	6/7		2/3	35/51	68.6%	11	13	2	5	1	
(守门员)																
12	高云健		2/6	0/4	0/2			0/4	2/16	12.5%						00:18:36
16	刘迈科	5/8	5/12	1/1	1/1	3/4	1/1		16/27	59.3%	1					00:41:24
	合计	5/8	7/18	1/5	1/3	3/4	1/1	0/4	18/43	41.9%	1					

场上队员：得分/射门

守门员：救球/射门

全队合计	得分	被救	射失	击柱	封球	合计	%
远射	6	1	3			10	60.0%
近射	10	4				14	71.4%
边射	3	3	1			7	42.9%
快攻	8	2				10	80.0%
突破	6	1				7	85.7%
任意							0.0%
七米	2	1				3	66.7%

## 2019年全国男子手球冠军杯赛

PHMS Pictorial Handball Match Statistics

IHF Official System

### 个人/全队技术统计表

手球 男子 预赛 轮次 1 组别 A 场次 1 万州体育馆 2019-04-07 13:00

号码	姓名	远射	近射	边射	快攻	突破	任意	七米	合计	%	助攻	失误	警告	2'	取消	时间
陕西队(陕西)																
(场上队员)																
1	陈昊									0.0%						00:23:23
2	王柏淇									0.0%						00:00:00
3	刘赵梁		0/1						0/1	0.0%	3	1				00:30:00
4	李佳									0.0%						00:00:00
5	马益奎		3/5						3/5	60.0%		3				00:54:59
6	刘世昌			1/2					1/2	50.0%		1				00:42:27
8	季雨	0/4	3/4			0/2			3/10	30.0%	1	2				00:43:25
9	陈孝天	3/8	2/4		1/1		0/2	2/2	8/17	47.1%		4				00:47:25
10	王凯强	0/2	1/3			1/2			2/7	28.6%	1	5				00:52:27
11	张领	0/1	0/1					2/2	2/4	50.0%				1		00:29:06
12	赵凯									0.0%						00:00:00
13	隋家乐									0.0%						00:00:00
15	陈冉		2/3	3/3	1/2				6/8	75.0%				1		01:00:00
17	耿畅									0.0%						00:00:00
18	刘文星									0.0%						00:00:00
22	张春梁									0.0%						00:36:37
合计		3/15	11/21	4/5	2/3	1/4	0/2	4/4	25/54	46.3%	5	16		2		
(守门员)																
1	陈昊	0/4	2/6	1/1	1/5	0/1		0/1	4/18	22.2%						00:23:23
22	张春梁	1/3	2/8	2/5	1/5	1/6		1/2	8/29	27.6%						00:36:37
合计		1/7	4/14	3/6	2/10	1/7		1/3	12/47	25.5%						

场上队员：得分/射门

守门员：救球/射门

全队合计	得分	被救	射失	击柱	封球	合计	%
远射	3	5	3		4	15	20.0%
近射	11	7		3		21	52.4%
边射	4	1				5	80.0%
快攻	2	1				3	66.7%
突破	1	3				4	25.0%
任意		1		1		2	0.0%
七米	4					4	100.0%

图式比赛技术统计表

手球  
男子

预赛  
轮次 1

组别 A  
场次 1

万州体育馆  
2019-04-07 13:00

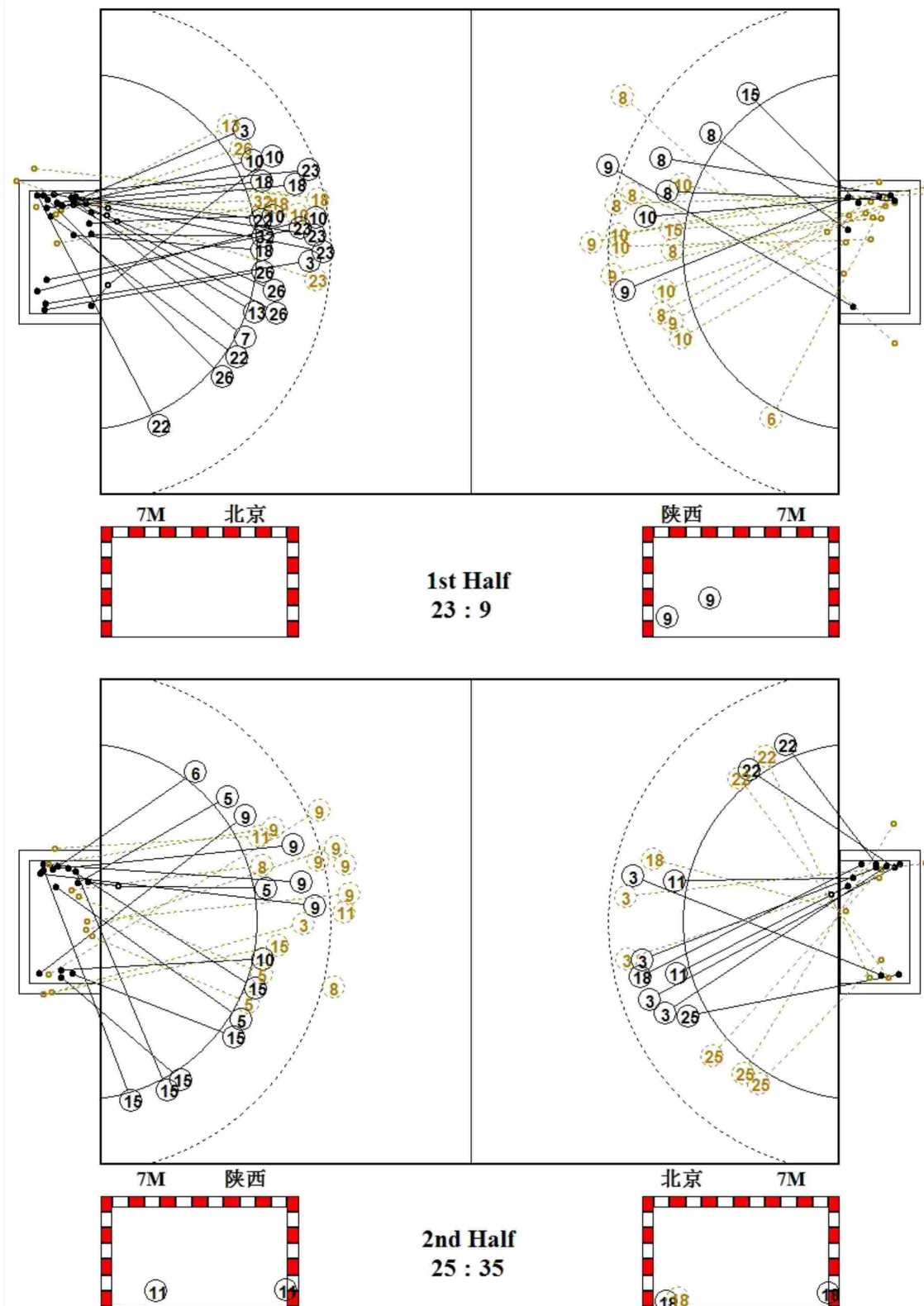

图式射门区域统计

手球  
男子

预赛  
轮次 1

组别 A  
场次 1

万州体育馆  
2019-04-07 13:00

北京队

3 透明松 3 1 2 Post - 0 Miss - 1 Block - 0	6 解建飞 Post - 0 Miss - 0 Block - 0	7 马昌震 Post - 0 Miss - 0 Block - 0	10 成亚 1 1 1 Post - 0 Miss - 0 Block - 0	11 赵文宣 2 Post - 0 Miss - 0 Block - 0	12 高云健 Post - 0 Miss - 0 Block - 0	13 王军鸣 1 Post - 0 Miss - 0 Block - 0	16 刘迈科 Post - 0 Miss - 0 Block - 0
18 傅俊雄 1 1 1 2 1 Post - 0 Miss - 1 Block - 0	22 王超 1 1 2 1 Post - 0 Miss - 0 Block - 0	23 王军程 1 2 1 Post - 0 Miss - 1 Block - 0	25 王鹏皓 1 Post - 0 Miss - 1 Block - 0	26 魏昂 1 1 1 1 Post - 0 Miss - 0 Block - 0	27 闫炳旗 Post - 0 Miss - 0 Block - 0	32 蒋维一 1 Post - 0 Miss - 0 Block - 0	33 陈旭 Post - 0 Miss - 0 Block - 0

12 高云健 0/2 0/2 0/3 1/1 1/4
---

16 刘迈科 4/5 4/7 1/3 1/1 3/3 1/2
--

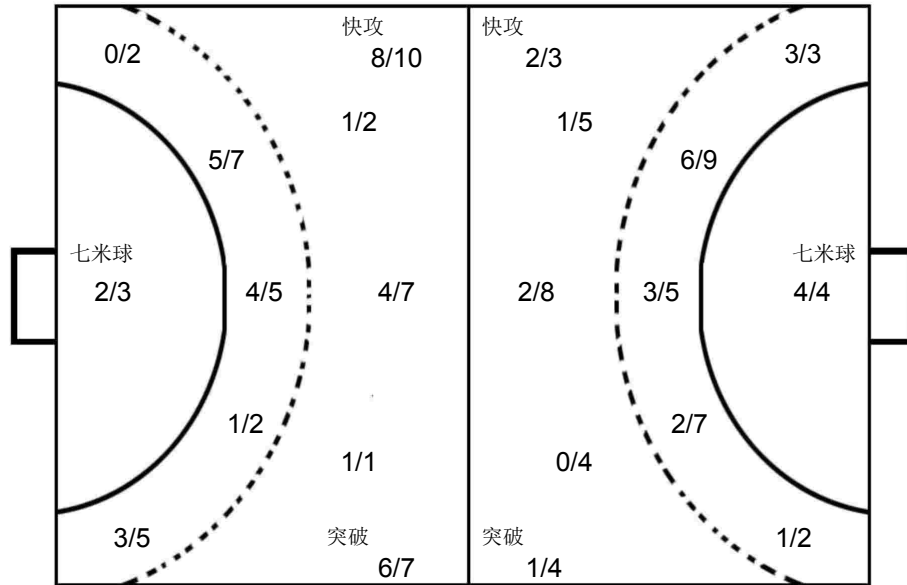

1 陈昊 0/1 1/1 0/3 1/5 1/4 0/2
--

22 张睿梁 0/6 1/3 1/3 1/2 1/4 4/9 0/2
---

陕西队

1 陈昊 Post - 0 Miss - 0 Block - 0	2 王柏淇 Post - 0 Miss - 0 Block - 0	3 刘赵梁 Post - 1 Miss - 0 Block - 0	4 李佳 Post - 0 Miss - 0 Block - 0	5 马益奎 1 2 Post - 0 Miss - 0 Block - 0	6 刘世昌 1 Post - 0 Miss - 0 Block - 0	8 季雨 2 1 Post - 0 Miss - 2 Block - 1	9 陈孝天 1 1 2 3 1 Post - 1 Miss - 0 Block - 2
10 王凯强 2 Post - 0 Miss - 1 Block - 0	11 张领 1 1 Post - 1 Miss - 0 Block - 1	12 赵凯 Post - 0 Miss - 0 Block - 0	13 隋家乐 Post - 0 Miss - 0 Block - 0	15 陈冉 1 2 1 Post - 1 Miss - 0 Block - 0	17 耿畅 Post - 0 Miss - 0 Block - 0	18 刘文星 Post - 0 Miss - 0 Block - 0	22 张睿梁 Post - 0 Miss - 0 Block - 0



Team A					Team B					Match Number											
A 安徽队					B 山西队					<b>2</b>											
Played in			in the hall			on		at		Spectators											
重庆万州			万州体育馆			2019-04-07		14:30		hours											
Half-time(30')	A	B	End of playing time	A	B	1st extra time	A	B	2nd extra time	A	B	After penalty throws	A	B							
	17	12	34	23																	
Number of 7 m	A	Team time-out			Full name of players and officials					Team time-out			B	Number of 7 m							
	2/2	1	2	3						1	2	3	B								
		29:28							13:16	53:44		1/1									
No.	Team A					G	W	2'	D	DR	No.	Team B					G	W	2'	D	DR
1	郭世伟					1					1	鲁世豪									
4	王巨柱					7					2	张智超					1				
5	史小帆										3	龙俊皓									
6	叶志伟										4	刘文东							1		
7	姚雄敏					3					5	王宇恒									
8	董智景					1					6	盖秀越					4				
9	金永峰					3					7	任健豪					1		1		
10	严龙					4	1				9	辛浩乐									
11	黎涛					3					10	王洋					2	1			
12	曾献辰										11	吴夏冰					3		2		
18	李双					3	1	1			12	韩乐斌									
21	李明										13	杜忠浩					6				
23	张鹏					3					14	杨毅					5				
24	徐安格					4	1	1			15	薛瑞寒					1				
26	饶原源					2					16	王虹翔									
27	王东昇										18	张禹琛									
A	吴翔										A	张栋									
B	Vladimir Stanojevic (主教练)										B	赵鑫 (主教练)									
C	黄红										C	霖配永									
E	刘汉杰																				
A	Signatures of responsables for the teams (Off.A)															B					
TP	Remarks of referees / HF Official															TP					

Signatures

Referees	周胜锋 (CHN)	张智伟 (CHN)		
T.D.	吴国忠 (CHN)	倪震 (CHN)		
CHA Off.				

Note: Number of 7m Throws Awarded to Team A and B, Goals (G), Warnings (W), Suspensions (2'), Direct Disqualification (D), Disqualification With Report (DR) and Team Penalty (TP).

Table Officials: 刘明华

黄一凡

Statisticians: 周亚桥

谢杨

2019年全国男子手球冠军杯赛

PHMS Pictorial Handball Match Statistics

IHF Official System

竞赛技术统计

手球 男子 预赛 轮次 1 组别 A 场次 2 万州体育馆 2019-04-07 14:30

Referees: 周胜锋 (CHN) / 张智伟 (CHN) Result: 34:23 (17:12)  
Teams: 安徽队(安徽) VS 山西队(山西)

安徽		远	近	边	快	突	任意	7m	合计	%	助攻	失误	警告	2'	D+DR
主教练: Vladimir Stanojevic		射	射	射	攻	破	球	球							
1	郭世伟	0/1			1/1				1/2	50.0		1			
4	王巨柱	4/7	2/2			1/1			7/10	70.0	1	3			
5	史小帆														
6	叶志伟											1			
7	姚雄敏	1/1				2/3			3/4	75.0		1			
8	董智景				1/1				1/1	100	1				
9	金永峰	2/5		0/1		1/1			3/7	42.9	2				
10	严龙			3/5	1/1				4/6	66.7			1		
11	黎涛			2/2	1/1				3/3	100					
12	曾献辰										3	2			
18	李双	0/1		0/1	1/1	2/3			3/6	50.0		1	1	1	
21	李明														
23	张鹏			1/1	2/2				3/3	100					
24	徐安格		3/4		1/1				4/5	80.0		2	1	1	
26	饶原源	0/1						2/2	2/3	66.7					
27	王东昇														
运动员	合计	7/16	5/6	6/10	8/8	6/8		2/2	34/50	68.0	7	11	3	2	
12	曾献辰	3/9	0/3	0/1		1/2			4/15	26.7	3	2			
21	李明	1/4		5/10	0/1	0/1	0/1	0/1	6/18	33.3					
守门员	合计	4/13	0/3	5/11	0/1	1/3	0/1	0/1	10/33	30.3	3	2			

安徽	比赛进程	山西
1st Half		
0	02:02	1 14 杨毅
7	姚雄敏	1 02:36 1
24	徐安格	2 03:24 1
2	05:41	2 14 杨毅
10	严龙	3 06:44 2
3	07:24	3 10 王洋
7	姚雄敏	4 07:34 3
4	08:27	4 6 盖秀越
4	08:52	5 10 王洋
11	黎涛	5 09:51 5
11	黎涛	6 11:14 5
18	李双	7 12:06 5
18	李双	8 13:08 5
11	黎涛	9 14:06 5
24	徐安格	10 15:33 5
10	严龙	11 16:50 5
11	17:12	6 6 盖秀越
4	王巨柱	12 17:48 6
12	18:37	7 13 杜忠浩
23	张鹏	13 19:18 7
23	张鹏	14 19:59 7
1	郭世伟	15 22:49 7
15	23:42	8 14 杨毅
15	24:57	9 6 盖秀越
15	25:47	10 13 杜忠浩
10	严龙	16 26:31 10
16	27:29	11 13 杜忠浩
16	28:23	12 6 盖秀越
4	王巨柱	17 29:50 12
2nd Half		
17	01:21	13 11 吴夏冰
18	李双	18 03:41 13
18	04:15	14 7 任健豪
7	姚雄敏	19 04:24 14
4	王巨柱	20 06:19 14
20	06:50	15 14 杨毅
23	张鹏	21 08:24 15
21	08:48	16 13 杜忠浩
4	王巨柱	22 09:28 16
26	饶原源	23 11:08 16
23	11:57	17 11 吴夏冰
23	13:15	18 13 杜忠浩
4	王巨柱	24 13:53 18
4	王巨柱	25 14:37 18
25	15:53	19 11 吴夏冰
4	王巨柱	26 16:28 19
8	董智景	27 16:50 19
9	金永峰	28 19:01 19
28	20:26	20 15 薛瑞寒
24	徐安格	29 21:27 20
29	22:12	21 13 杜忠浩
9	金永峰	30 22:53 21
24	徐安格	31 23:34 21
31	24:27	22 2 张智超
10	严龙	32 25:56 22
9	金永峰	33 27:11 22
26	饶原源	34 28:59 22
34	29:35	23 14 杨毅

场上队员: 得分 / 射门

守门员: 救球 / 射门

D	取消资格	DR	取消资格+报告
---	------	----	---------



## 2019年全国男子手球冠军杯赛

PHMS Pictorial Handball Match Statistics

IHF Official System

### 个人/全队技术统计表

手球 男子 预赛 轮次 1 组别 A 场次 2 万州体育馆 2019-04-07 14:30

号码	姓名	远射	近射	边射	快攻	突破	任意	七米	合计	%	助攻	失误	警告	2'	取消	时间
<b>安徽队(安徽)</b>																
<b>(场上队员)</b>																
1	郭世伟	0/1			1/1				1/2	50.0%		1				00:16:50
4	王巨柱	4/7	2/2			1/1			7/10	70.0%	1	3				00:41:58
5	史小帆									0.0%						00:00:47
6	叶志伟									0.0%		1				00:06:07
7	姚雄敏	1/1				2/3			3/4	75.0%		1				00:25:55
8	董智景				1/1				1/1	100%	1					00:19:27
9	金永峰	2/5		0/1		1/1			3/7	42.9%	2					00:38:16
10	严龙			3/5	1/1				4/6	66.7%			1			00:39:28
11	黎涛			2/2	1/1				3/3	100%						00:25:54
12	曾献辰									0.0%	3	2				00:30:00
18	李双	0/1		0/1	1/1	2/3			3/6	50.0%		1	1	1		00:48:48
21	李明									0.0%						00:30:00
23	张鹏			1/1	2/2				3/3	100%						00:32:31
24	徐安格		3/4		1/1				4/5	80.0%		2	1	1		00:56:42
26	饶原源	0/1						2/2	2/3	66.7%						00:06:05
27	王东昇									0.0%						00:03:15
<b>合计</b>		<b>7/16</b>	<b>5/6</b>	<b>6/10</b>	<b>8/8</b>	<b>6/8</b>		<b>2/2</b>	<b>34/50</b>	<b>68.0%</b>	<b>7</b>	<b>11</b>	<b>3</b>	<b>2</b>		
<b>(守门员)</b>																
12	曾献辰	3/9	0/3	0/1		1/2			4/15	26.7%	3	2				00:30:00
21	李明	1/4		5/10	0/1	0/1	0/1	0/1	6/18	33.3%						00:30:00
<b>合计</b>		<b>4/13</b>	<b>0/3</b>	<b>5/11</b>	<b>0/1</b>	<b>1/3</b>	<b>0/1</b>	<b>0/1</b>	<b>10/33</b>	<b>30.3%</b>	<b>3</b>	<b>2</b>				

场上队员：得分/射门

守门员：救球/射门

全队合计	得分	被救	射失	击柱	封球	合计	%
远射	7	4	3	1	1	16	43.8%
近射	5	1				6	83.3%
边射	6	4				10	60.0%
快攻	8					8	100.0%
突破	6	2				8	75.0%
任意							0.0%
七米	2					2	100.0%

2019年全国男子手球冠军杯赛

PHMS Pictorial Handball Match Statistics

IHF Official System

个人/全队技术统计表

手球 男子 预赛 轮次 1 组别 A 场次 2 万州体育馆 2019-04-07 14:30

号码	姓名	远射	近射	边射	快攻	突破	任意	七米	合计	%	助攻	失误	警告	2'	取消	时间
山西队(山西)																
(场上队员)																
1	鲁世豪									0.0%						00:03:12
2	张智超		1/1						1/1	100%						00:20:56
3	龙俊皓									0.0%						00:00:00
4	刘文东									0.0%		1		1		00:24:31
5	王宇恒	0/1							0/1	0.0%						00:10:36
6	盖秀越	0/1		3/5	1/1				4/7	57.1%		1				00:59:57
7	任健豪			0/1		1/1			1/2	50.0%		3		1		00:45:46
9	辛浩乐									0.0%						00:00:00
10	王洋			2/3					2/3	66.7%		1	1			00:39:01
11	吴夏冰		2/3	1/1					3/4	75.0%		2		2		00:45:45
12	韩乐斌									0.0%		1				00:56:48
13	杜忠浩	6/8	0/1						6/9	66.7%	1	4				00:37:03
14	杨毅	2/7	0/1	0/1		1/2	1/1	1/1	5/13	38.5%	1	3				00:53:56
15	薛瑞寒	1/2		0/1					1/3	33.3%	1	1				00:21:40
16	王虹翔									0.0%						00:00:00
18	张禹琛									0.0%						00:00:00
合计		9/19	3/6	6/12	1/1	2/3	1/1	1/1	23/43	53.5%	3	17	1	4		

(守门员)

1	鲁世豪		0/1			0/2		0/1	0/4	0.0%						00:03:12
12	韩乐斌	4/11	1/5	4/10	0/8	2/6		0/1	11/41	26.8%		1				00:56:48
合计		4/11	1/6	4/10	0/8	2/8		0/2	11/45	24.4%		1				

场上队员：得分/射门

守门员：救球/射门

全队合计	得分	被救	射失	击柱	封球	合计	%
远射	9	4	3		3	19	47.4%
近射	3		3			6	50.0%
边射	6	5	1			12	50.0%
快攻	1					1	100.0%
突破	2	1				3	66.7%
任意	1					1	100.0%
七米	1					1	100.0%



图式比赛技术统计表

手球  
男子

预赛  
轮次 1

组别 A  
场次 2

万州体育馆  
2019-04-07 14:30

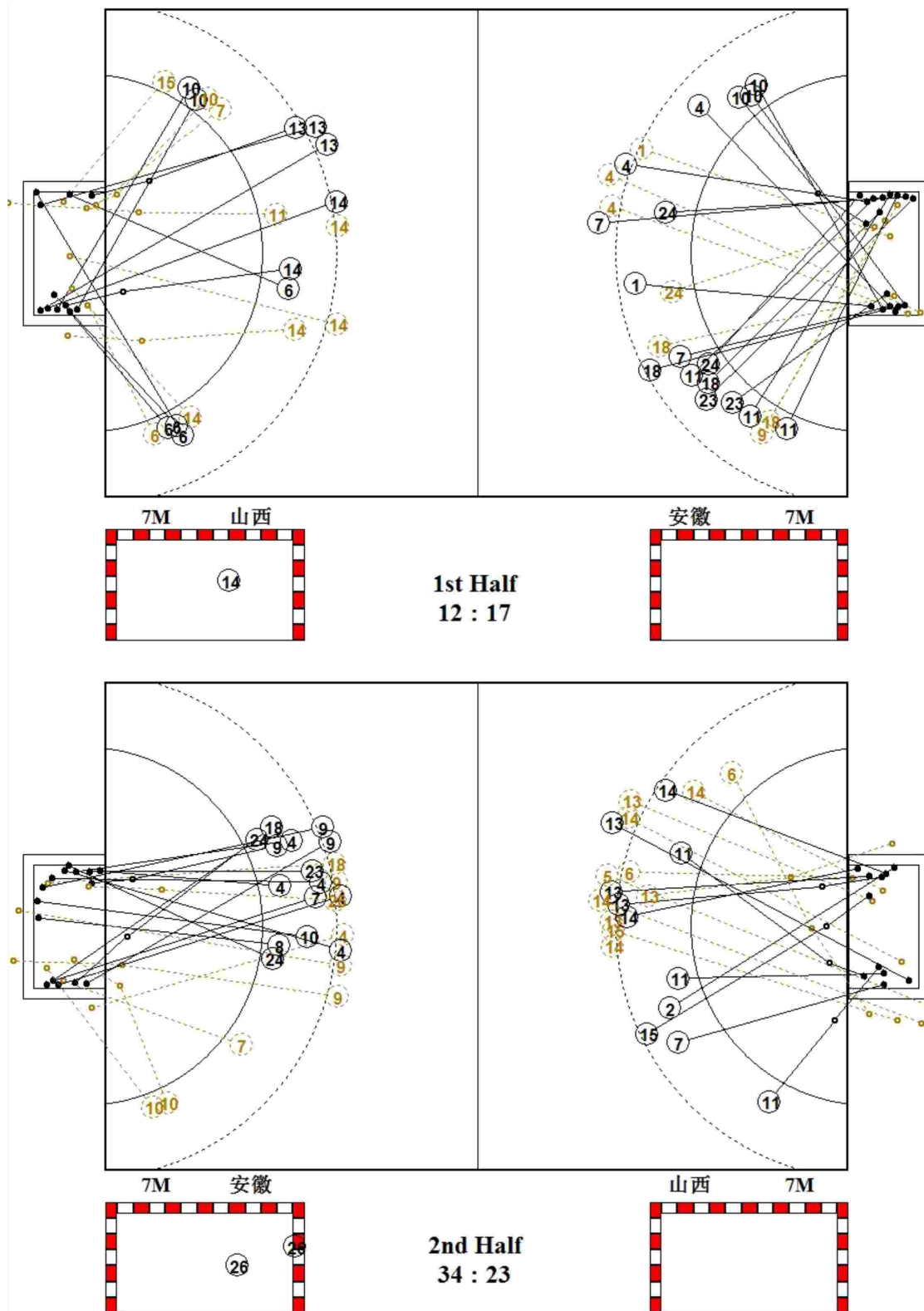

图式射门区域统计

手球  
男子

预赛  
轮次 1

组别 A  
场次 2

万州体育馆  
2019-04-07 14:30

安徽队

1 郭世伟	4 王巨柱	5 史小帆	6 叶志伟	7 姚雄敏	8 董智景	9 金永峰	10 严龙																																																																								
<table border="1"><tr><td></td><td></td><td></td></tr><tr><td></td><td></td><td>1</td></tr><tr><td></td><td></td><td></td></tr></table>						1				<table border="1"><tr><td>1</td><td></td><td>2</td></tr><tr><td></td><td></td><td>2</td></tr><tr><td>1</td><td></td><td>1</td></tr></table>	1		2			2	1		1	<table border="1"><tr><td></td><td></td><td></td></tr><tr><td></td><td></td><td></td></tr><tr><td></td><td></td><td></td></tr></table>										<table border="1"><tr><td></td><td></td><td></td></tr><tr><td></td><td></td><td></td></tr><tr><td></td><td></td><td></td></tr></table>										<table border="1"><tr><td>1</td><td></td><td></td></tr><tr><td>1</td><td></td><td>1</td></tr><tr><td></td><td></td><td></td></tr></table>	1			1		1				<table border="1"><tr><td></td><td>1</td><td></td></tr><tr><td></td><td></td><td></td></tr><tr><td></td><td></td><td></td></tr></table>		1								<table border="1"><tr><td></td><td></td><td>1</td></tr><tr><td></td><td></td><td></td></tr><tr><td>1</td><td></td><td>1</td></tr></table>			1				1		1	<table border="1"><tr><td></td><td></td><td>2</td></tr><tr><td></td><td></td><td>1</td></tr><tr><td>1</td><td></td><td></td></tr></table>			2			1	1		
		1																																																																													
1		2																																																																													
		2																																																																													
1		1																																																																													
1																																																																															
1		1																																																																													
	1																																																																														
		1																																																																													
1		1																																																																													
		2																																																																													
		1																																																																													
1																																																																															
Post - 0 Miss - 0 Block - 0	Post - 1 Miss - 1 Block - 0	Post - 0 Miss - 0 Block - 0	Post - 0 Miss - 0 Block - 0	Post - 0 Miss - 0 Block - 0	Post - 0 Miss - 0 Block - 0	Post - 0 Miss - 2 Block - 1	Post - 0 Miss - 0 Block - 0																																																																								
11 黎涛	12 曾献辰	18 李双	21 李明	23 张鹏	24 徐安格	26 饶原源	27 王东昇																																																																								
<table border="1"><tr><td>1</td><td></td><td></td></tr><tr><td>2</td><td></td><td></td></tr><tr><td></td><td></td><td></td></tr></table>	1			2						<table border="1"><tr><td></td><td></td><td></td></tr><tr><td></td><td></td><td></td></tr><tr><td></td><td></td><td></td></tr></table>										<table border="1"><tr><td></td><td></td><td>1</td></tr><tr><td>2</td><td></td><td></td></tr><tr><td></td><td></td><td></td></tr></table>			1	2						<table border="1"><tr><td></td><td></td><td></td></tr><tr><td></td><td></td><td></td></tr><tr><td></td><td></td><td></td></tr></table>										<table border="1"><tr><td>1</td><td></td><td></td></tr><tr><td></td><td></td><td>1</td></tr><tr><td></td><td></td><td>1</td></tr></table>	1					1			1	<table border="1"><tr><td>2</td><td></td><td></td></tr><tr><td></td><td></td><td>1</td></tr><tr><td>1</td><td></td><td></td></tr></table>	2					1	1			<table border="1"><tr><td></td><td></td><td>1</td></tr><tr><td></td><td>1</td><td></td></tr><tr><td></td><td></td><td></td></tr></table>			1		1					<table border="1"><tr><td></td><td></td><td></td></tr><tr><td></td><td></td><td></td></tr><tr><td></td><td></td><td></td></tr></table>									
1																																																																															
2																																																																															
		1																																																																													
2																																																																															
1																																																																															
		1																																																																													
		1																																																																													
2																																																																															
		1																																																																													
1																																																																															
		1																																																																													
	1																																																																														
Post - 0 Miss - 0 Block - 0	Post - 0 Miss - 0 Block - 0	Post - 0 Miss - 0 Block - 0	Post - 0 Miss - 0 Block - 0	Post - 0 Miss - 0 Block - 0	Post - 0 Miss - 0 Block - 0	Post - 0 Miss - 0 Block - 0	Post - 0 Miss - 0 Block - 0																																																																								

12 曾献辰

0/1		1/2
2/4		0/3
1/4		0/1

21 李明

0/4		0/2
1/4	1/2	1/2
1/1		2/3

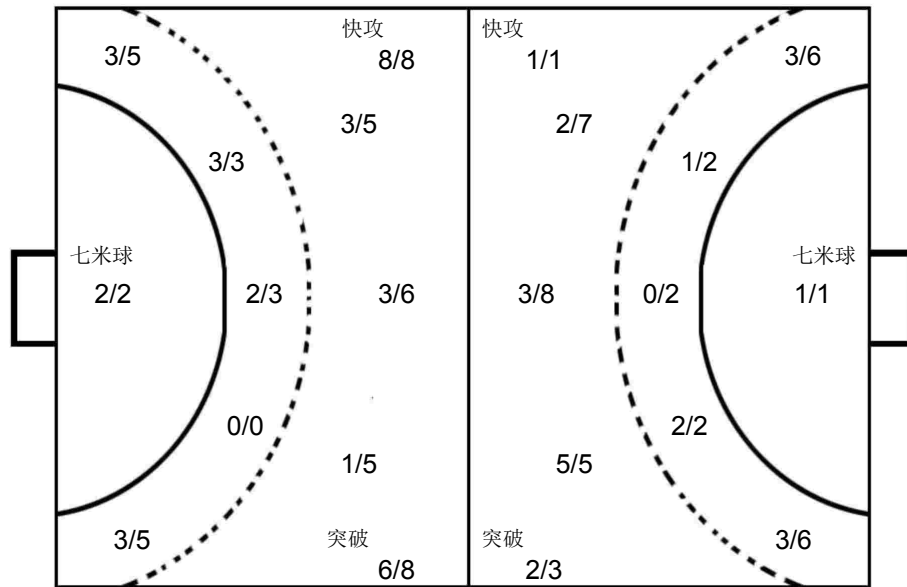

1 鲁世豪

0/1		0/1
0/1		0/1

12 韩乐斌

2/7	0/1	3/9
4/8	1/2	0/6
0/4		1/4

山西队

1 鲁世豪	2 张智超	3 龙俊皓	4 刘文东	5 王宇恒	6 盖秀越	7 任健豪	9 辛浩乐																																																																								
<table border="1"><tr><td></td><td></td><td></td></tr><tr><td></td><td></td><td></td></tr><tr><td></td><td></td><td></td></tr></table>										<table border="1"><tr><td>1</td><td></td><td></td></tr><tr><td></td><td></td><td></td></tr><tr><td></td><td></td><td></td></tr></table>	1									<table border="1"><tr><td></td><td></td><td></td></tr><tr><td></td><td></td><td></td></tr><tr><td></td><td></td><td></td></tr></table>										<table border="1"><tr><td></td><td></td><td></td></tr><tr><td></td><td></td><td></td></tr><tr><td></td><td></td><td></td></tr></table>										<table border="1"><tr><td></td><td></td><td></td></tr><tr><td></td><td></td><td></td></tr><tr><td></td><td></td><td></td></tr></table>										<table border="1"><tr><td>1</td><td></td><td>1</td></tr><tr><td>1</td><td></td><td>1</td></tr><tr><td></td><td></td><td></td></tr></table>	1		1	1		1				<table border="1"><tr><td></td><td></td><td>1</td></tr><tr><td></td><td></td><td></td></tr><tr><td></td><td></td><td></td></tr></table>			1							<table border="1"><tr><td></td><td></td><td></td></tr><tr><td></td><td></td><td></td></tr><tr><td></td><td></td><td></td></tr></table>									
1																																																																															
1		1																																																																													
1		1																																																																													
		1																																																																													
Post - 0 Miss - 0 Block - 0	Post - 0 Miss - 0 Block - 0	Post - 0 Miss - 0 Block - 0	Post - 0 Miss - 0 Block - 0	Post - 0 Miss - 1 Block - 0	Post - 0 Miss - 1 Block - 0	Post - 0 Miss - 0 Block - 0	Post - 0 Miss - 0 Block - 0																																																																								
10 王洋	11 吴夏冰	12 韩乐斌	13 杜忠浩	14 杨毅	15 薛瑞寒	16 王虹翔	18 张禹琛																																																																								
<table border="1"><tr><td>1</td><td></td><td></td></tr><tr><td>1</td><td></td><td></td></tr><tr><td></td><td></td><td></td></tr></table>	1			1						<table border="1"><tr><td></td><td></td><td>2</td></tr><tr><td></td><td></td><td>1</td></tr><tr><td></td><td></td><td></td></tr></table>			2			1				<table border="1"><tr><td></td><td></td><td></td></tr><tr><td></td><td></td><td></td></tr><tr><td></td><td></td><td></td></tr></table>										<table border="1"><tr><td>1</td><td></td><td>2</td></tr><tr><td>1</td><td></td><td>1</td></tr><tr><td>1</td><td></td><td>1</td></tr></table>	1		2	1		1	1		1	<table border="1"><tr><td>1</td><td></td><td></td></tr><tr><td>2</td><td>1</td><td></td></tr><tr><td>1</td><td></td><td></td></tr></table>	1			2	1		1			<table border="1"><tr><td></td><td></td><td></td></tr><tr><td></td><td></td><td></td></tr><tr><td></td><td></td><td></td></tr></table>										<table border="1"><tr><td></td><td></td><td></td></tr><tr><td></td><td></td><td></td></tr><tr><td></td><td></td><td></td></tr></table>										<table border="1"><tr><td></td><td></td><td></td></tr><tr><td></td><td></td><td></td></tr><tr><td></td><td></td><td></td></tr></table>									
1																																																																															
1																																																																															
		2																																																																													
		1																																																																													
1		2																																																																													
1		1																																																																													
1		1																																																																													
1																																																																															
2	1																																																																														
1																																																																															
Post - 0 Miss - 0 Block - 0	Post - 0 Miss - 1 Block - 0	Post - 0 Miss - 0 Block - 0	Post - 0 Miss - 1 Block - 1	Post - 0 Miss - 2 Block - 2	Post - 0 Miss - 1 Block - 0	Post - 0 Miss - 0 Block - 0	Post - 0 Miss - 0 Block - 0																																																																								



Team A A 天津队	Team B B 上海队	Match Number <b>3</b>
-----------------	-----------------	--------------------------

Played in 重庆万州	in the hall 万州体育馆	on 2019-04-07	at 16:00	hours	Spectators
-------------------	----------------------	------------------	-------------	-------	------------

Half-time(30')	A 11	B 5	End of playing time	A 26	B 14	1st extra time	A	B	2nd extra time	A	B	After penalty throws	A	B
----------------	---------	--------	---------------------	---------	---------	----------------	---	---	----------------	---	---	----------------------	---	---

Number of 7 m	A 4/6	Team time-out			Full name of players and officials						Team time-out			B 2/4	Number of 7 m
		1	2	3							1	2	3		
			48:15								22:28				

No.	Team A	G	W	2'	D	DR	No.	Team B	G	W	2'	D	DR
1	何喜年						1	张峥					
3	魏雨童	3		1			3	张立成					
4	刘雪东						4	高天伦	1				
5	王毅	1					5	贺政			1		
6	赵晨阳	1					7	周文龙	4	1			
7	张青	4		1			8	高震东	1				
8	王晓琪	3					10	朱世杰	4				
9	王子欣	5	1	1			11	蒋慧捷	1		2		
10	苏尧	3		1			12	周哲韬					
11	吴明远						15	庄旭杰					
13	许松	5					16	张逸豪					
14	王维先						18	董凯					
15	周群		1				20	蒋承骅					
16	刘宗其						23	吴双	2				
86	田剑侠	1					30	徐俊吉	1				
A	贾守信						A	吴璟 (主教练)					
B	杜瑞军 (主教练)						B	金迪琦					
D	李志成						C	张勇军					
E	王文龙						D	杨时					

A	Signatures of responsables for the teams (Off.A)	B
---	--	---

TP	Remarks of referees / HF Official	TP
----	-----------------------------------	----

Signatures			
Referees	王雨洋 (CHN)	严璐 (CHN)	
T.D.	李之文 (CHN)	倪震 (CHN)	
CHA Off.			

Note: Number of 7m Throws Awarded to Team A and B, Goals (G), Warnings (W), Suspensions (2'), Direct Disqualification (D), Disqualification With Report (DR) and Team Penalty (TP).

Table Officials: 鲍瑀                      刘宇阳                      Statisticians: 赵悦                      周亚桥

2019年全国男子手球冠军杯赛

PHMS Pictorial Handball Match Statistics

IHF Official System

竞赛技术统计

手球 男子 预赛 轮次 1 组别 B 场次 3 万州体育馆 2019-04-07 16:00

Referees: 王雨洋 (CHN) / 严璐 (CHN) Result: 26:14 (11:5)  
Teams: 天津队(天津) VS 上海队(上海)

天津		远射	近射	边射	快攻	突破	任意球	7m球	合计	%	助攻	失误	警告	2'	D+DR	天津	比赛进程	上海
主教练: 杜瑞军																	1st Half	
1	何喜年											1				3	魏雨童 0 02:29	1 7 周文龙
3	魏雨童		3/3		0/1			3/4	75.0		2			1		3	魏雨童 1 03:02	1 10 朱世杰
4	刘雪东		0/1				0/1	0/2	0.0							7	张青 1 03:49	2 7 周文龙
5	王毅	1/2	0/1				0/1	1/4	25.0	2						3	魏雨童 2 04:55	3 7 周文龙
6	赵晨阳		1/1					1/1	100							5	王毅 3 05:52	4 3
7	张青	1/4				1/1	2/2	4/7	57.1		1			1		9	王子欣 4 08:51	3 3
8	王晓琪	0/2	1/1			0/1	2/2	3/6	50.0		2					9	王子欣 5 11:16	3 3
9	王子欣			2/2	3/3			5/5	100	1	1	1	1			9	王子欣 6 12:47	3 3
10	苏尧		2/2	1/1				3/3	100					1		13	许松 6 13:33	4 11 蒋慧捷
11	吴明远															13	许松 7 16:02	4 30 徐俊吉
13	许松		1/1	0/1	4/4			5/6	83.3							13	许松 8 20:40	5 5
14	王维先															7	张青 9 21:45	5 5
15	周群											1				86	田剑侠 10 25:31	5 5
16	刘宗其															13	许松 11 29:55	5 5
86	田剑侠	0/2	0/1			1/2		1/5	20.0	1	1					2nd Half		
运动员 合计	2/10	8/11	3/4	7/8	2/4		4/6	26/43	60.5	4	8	2	4			13	许松 12 00:55	5 5
1	何喜年	5/9	2/5	4/5	2/4	0/1	1/2	0/2	14/28	50.0		1				7	张青 12 02:43	6 23 吴双
16	刘宗其							2/2	100							8	王晓琪 13 03:48	6 6
守门员 合计	5/9	2/5	4/5	2/4	0/1	1/2	2/4	16/30	53.3		1					13	许松 13 04:39	7 7 周文龙
上海		远射	近射	边射	快攻	突破	任意球	7m球	合计	%	助攻	失误	警告	2'	D+DR	8	王晓琪 14 05:13	7 7
主教练: 吴璟																9	王子欣 15 07:20	7 7
1	张峥															9	王子欣 16 08:04	7 7
3	张立成															10	苏尧 16 09:33	8 10 朱世杰
4	高天伦		1/1	0/1	0/1			1/3	33.3							10	苏尧 17 11:01	8 8
5	贺政						0/1	0/1	0.0		6			1		17	11:38	9 23 吴双
7	周文龙	2/7	0/1			1/1	1/1	4/10	40.0		1	1				7	张青 18 12:14	9 9
8	高震东	0/1	1/1	0/2				1/4	25.0							9	王子欣 19 14:13	9 9
10	朱世杰	2/6	1/1				0/1	1/1	4/9	44.4	1	4				9	王子欣 19 14:28	10 8 高震东
11	蒋慧捷		0/1	0/2	1/1			1/4	25.0							3	魏雨童 20 15:03	10 10
12	周哲韬										1					20	16:50	11 7 周文龙
15	庄旭杰															20	18:05	12 10 朱世杰
16	张逸豪															8	王晓琪 21 19:24	12 12
18	董凯															21	19:55	13 10 朱世杰
20	蒋承骅															8	王晓琪 22 22:08	13 13
23	吴双			1/2	1/2			2/4	50.0							9	王子欣 23 22:51	13 13
30	徐俊吉		0/1					1/2	33.3							10	苏尧 24 25:24	13 13
运动员 合计	4/14	3/6	1/7	2/4	1/1	1/2	2/4	14/38	36.8	2	13	1	3			10	苏尧 25 27:13	13 13
1	张峥		0/1		0/1	0/1		0/2	0.0							6	赵晨阳 26 29:55	14 4 高天伦
12	周哲韬	4/6	2/9	0/3	1/7	1/2		2/4	10/31	32.3	1							
守门员 合计	4/6	2/10	0/3	1/8	1/3		2/6	10/36	27.8	1								

场上队员: 得分 / 射门 守门员: 救球 / 射门

D	取消资格	DR	取消资格+报告
---	------	----	---------

## 2019年全国男子手球冠军杯赛

PHMS Pictorial Handball Match Statistics

IHF Official System

### 个人/全队技术统计表

手球 男子 预赛 轮次 1 组别 B 场次 3 万州体育馆 2019-04-07 16:00

号码	姓名	远射	近射	边射	快攻	突破	任意	七米	合计	%	助攻	失误	警告	2'	取消	时间
天津队(天津)																
(场上队员)																
1	何喜年									0.0%		1				00:57:20
3	魏雨童		3/3			0/1			3/4	75.0%		2		1		01:00:00
4	刘雪东		0/1					0/1	0/2	0.0%						00:06:09
5	王毅	1/2	0/1					0/1	1/4	25.0%	2					00:22:17
6	赵晨阳		1/1						1/1	100%						00:00:00
7	张青	1/4				1/1		2/2	4/7	57.1%		1		1		00:41:22
8	王晓琪	0/2	1/1			0/1		2/2	3/6	50.0%		2				00:34:21
9	王子欣			2/2	3/3				5/5	100%	1	1	1	1		00:58:48
10	苏尧		2/2	1/1					3/3	100%				1		00:33:41
11	吴明远									0.0%						00:00:00
13	许松		1/1	0/1	4/4				5/6	83.3%						00:26:11
14	王维先									0.0%						00:11:25
15	周群									0.0%			1			00:26:03
16	刘宗其									0.0%						00:02:40
86	田剑侠	0/2	0/1			1/2			1/5	20.0%	1	1				00:38:47
合计		2/10	8/11	3/4	7/8	2/4		4/6	26/43	60.5%	4	8	2	4		
(守门员)																
1	何喜年	5/9	2/5	4/5	2/4	0/1	1/2	0/2	14/28	50.0%		1				00:57:20
16	刘宗其							2/2	2/2	100%						00:02:40
合计		5/9	2/5	4/5	2/4	0/1	1/2	2/4	16/30	53.3%		1				

场上队员：得分/射门

守门员：救球/射门

全队合计	得分	被救	射失	击柱	封球	合计	%
远射	2	4	3	1		10	20.0%
近射	8	2	1			11	72.7%
边射	3			1		4	75.0%
快攻	7	1				8	87.5%
突破	2	1		1		4	50.0%
任意							0.0%
七米	4	2				6	66.7%

2019年全国男子手球冠军杯赛

PHMS Pictorial Handball Match Statistics

IHF Official System

个人/全队技术统计表

手球 男子 预赛 轮次 1 组别 B 场次 3 万州体育馆 2019-04-07 16:00

号码	姓名	远射	近射	边射	快攻	突破	任意	七米	合计	%	助攻	失误	警告	2'	取消	时间
上海队(上海)																
(场上队员)																
1	张崢									0.0%						00:05:51
3	张立成									0.0%		1				00:05:49
4	高天伦		1/1	0/1	0/1				1/3	33.3%						00:09:12
5	贺政							0/1	0/1	0.0%		6		1		00:47:14
7	周文龙	2/7	0/1			1/1	1/1		4/10	40.0%		1	1			00:52:13
8	高震东	0/1	1/1	0/2					1/4	25.0%						00:18:48
10	朱世杰	2/6	1/1				0/1	1/1	4/9	44.4%	1	4				01:00:00
11	蒋慧捷		0/1	0/2	1/1				1/4	25.0%		1		2		00:45:21
12	周哲韬									0.0%	1					00:54:09
15	庄旭杰									0.0%						00:00:00
16	张逸豪									0.0%						00:00:00
18	董凯									0.0%						00:17:56
20	蒋承骅									0.0%						00:00:00
23	吴双			1/2	1/2				2/4	50.0%						01:00:00
30	徐俊吉		0/1					1/2	1/3	33.3%						00:45:00
合计		4/14	3/6	1/7	2/4	1/1	1/2	2/4	14/38	36.8%	2	13	1	3		
(守门员)																
1	张崢		0/1		0/1	0/1		0/2	0/5	0.0%						00:05:51
12	周哲韬	4/6	2/9	0/3	1/7	1/2		2/4	10/31	32.3%	1					00:54:09
合计		4/6	2/10	0/3	1/8	1/3		2/6	10/36	27.8%	1					

场上队员：得分/射门

守门员：救球/射门

全队合计	得分	被救	射失	击柱	封球	合计	%
远射	4	5	2	2	1	14	28.6%
近射	3	2		1		6	50.0%
边射	1	4	1	1		7	14.3%
快攻	2	2				4	50.0%
突破	1					1	100.0%
任意	1	1				2	50.0%
七米	2	2				4	50.0%

图式比赛技术统计表

手球  
男子

预赛  
轮次 1

组别 B  
场次 3

万州体育馆  
2019-04-07 16:00

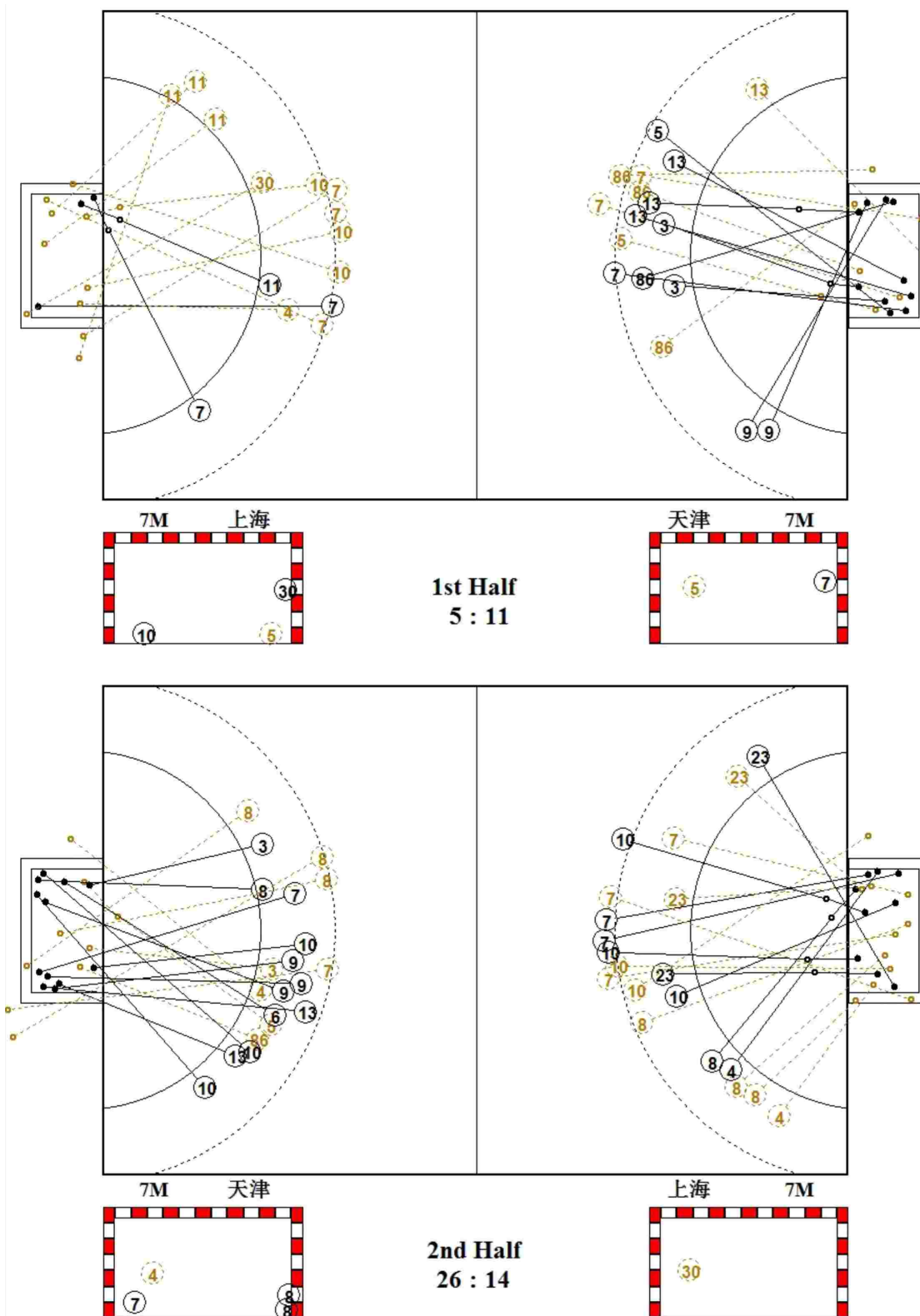

图式射门区域统计

手球  
男子

预赛  
轮次 1

组别 B  
场次 3

万州体育馆  
2019-04-07 16:00

天津队

1 何喜年 <table border="1"><tr><td></td><td></td><td></td></tr><tr><td></td><td></td><td></td></tr><tr><td></td><td></td><td></td></tr></table> Post - 0 Miss - 0 Block - 0										3 魏雨童 <table border="1"><tr><td></td><td></td><td></td></tr><tr><td></td><td></td><td>1</td></tr><tr><td></td><td></td><td>2</td></tr></table> Post - 0 Miss - 0 Block - 0						1			2	4 刘雪东 <table border="1"><tr><td></td><td></td><td></td></tr><tr><td></td><td></td><td></td></tr><tr><td></td><td></td><td></td></tr></table> Post - 0 Miss - 1 Block - 0										5 王毅 <table border="1"><tr><td></td><td></td><td></td></tr><tr><td></td><td></td><td>1</td></tr><tr><td></td><td></td><td></td></tr></table> Post - 0 Miss - 0 Block - 0						1				6 赵晨阳 <table border="1"><tr><td></td><td></td><td></td></tr><tr><td></td><td></td><td>1</td></tr><tr><td></td><td></td><td></td></tr></table> Post - 0 Miss - 0 Block - 0						1				7 张青 <table border="1"><tr><td>1</td><td></td><td>2</td></tr><tr><td></td><td></td><td></td></tr><tr><td>1</td><td></td><td></td></tr></table> Post - 1 Miss - 1 Block - 0	1		2				1			8 王晓琪 <table border="1"><tr><td></td><td></td><td>1</td></tr><tr><td></td><td></td><td></td></tr><tr><td></td><td></td><td>2</td></tr></table> Post - 1 Miss - 1 Block - 0			1						2	9 王子欣 <table border="1"><tr><td>2</td><td></td><td>1</td></tr><tr><td>1</td><td></td><td></td></tr><tr><td>1</td><td></td><td></td></tr></table> Post - 0 Miss - 0 Block - 0	2		1	1			1		
		1																																																																													
		2																																																																													
		1																																																																													
		1																																																																													
1		2																																																																													
1																																																																															
		1																																																																													
		2																																																																													
2		1																																																																													
1																																																																															
1																																																																															
10 苏尧 <table border="1"><tr><td></td><td></td><td>2</td></tr><tr><td>1</td><td></td><td></td></tr><tr><td></td><td></td><td></td></tr></table> Post - 0 Miss - 0 Block - 0			2	1						11 吴明远 <table border="1"><tr><td></td><td></td><td></td></tr><tr><td></td><td></td><td></td></tr><tr><td></td><td></td><td></td></tr></table> Post - 0 Miss - 0 Block - 0										13 许松 <table border="1"><tr><td>1</td><td></td><td>2</td></tr><tr><td>1</td><td></td><td></td></tr><tr><td>1</td><td></td><td></td></tr></table> Post - 1 Miss - 0 Block - 0	1		2	1			1			14 王维先 <table border="1"><tr><td></td><td></td><td></td></tr><tr><td></td><td></td><td></td></tr><tr><td></td><td></td><td></td></tr></table> Post - 0 Miss - 0 Block - 0										15 周群 <table border="1"><tr><td></td><td></td><td></td></tr><tr><td></td><td></td><td></td></tr><tr><td></td><td></td><td></td></tr></table> Post - 0 Miss - 0 Block - 0										16 刘宗其 <table border="1"><tr><td></td><td></td><td></td></tr><tr><td></td><td></td><td></td></tr><tr><td></td><td></td><td></td></tr></table> Post - 0 Miss - 0 Block - 0										86 田剑侠 <table border="1"><tr><td></td><td></td><td></td></tr><tr><td>1</td><td></td><td></td></tr><tr><td></td><td></td><td></td></tr></table> Post - 0 Miss - 1 Block - 0				1															
		2																																																																													
1																																																																															
1		2																																																																													
1																																																																															
1																																																																															
1																																																																															

1 何喜年

1/4	3/3	2/3
1/2		3/5
3/6	0/1	1/4

16 刘宗其

1/1		
		1/1

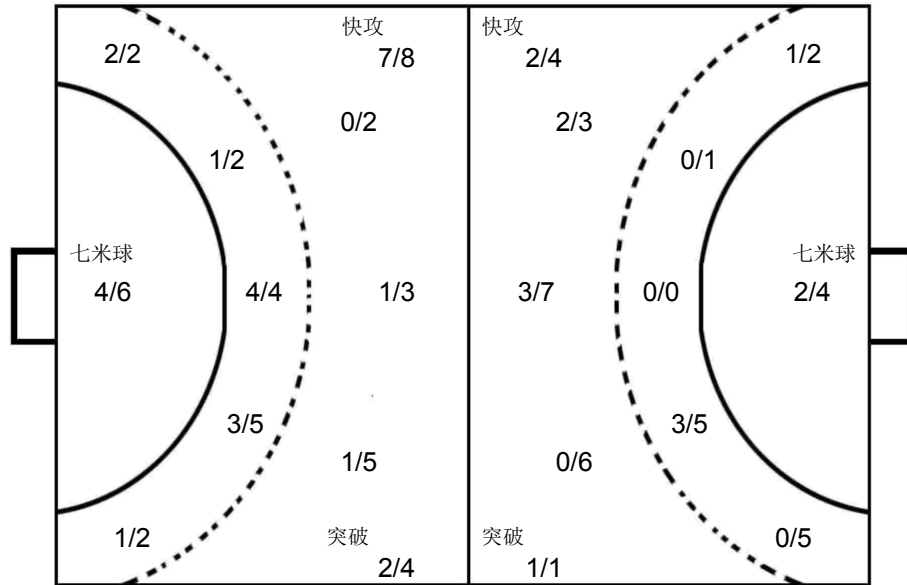

1 张崢

0/2		
		0/3

12 周哲韬

0/2		1/9
2/5	1/1	1/4
2/6	2/2	1/2

上海队

1 张崢 <table border="1"><tr><td></td><td></td><td></td></tr><tr><td></td><td></td><td></td></tr><tr><td></td><td></td><td></td></tr></table> Post - 0 Miss - 0 Block - 0										3 张立成 <table border="1"><tr><td></td><td></td><td></td></tr><tr><td></td><td></td><td></td></tr><tr><td></td><td></td><td></td></tr></table> Post - 0 Miss - 0 Block - 0										4 高天伦 <table border="1"><tr><td></td><td></td><td></td></tr><tr><td></td><td></td><td>1</td></tr><tr><td></td><td></td><td></td></tr></table> Post - 0 Miss - 0 Block - 0						1				5 贺政 <table border="1"><tr><td></td><td></td><td></td></tr><tr><td></td><td></td><td></td></tr><tr><td></td><td></td><td></td></tr></table> Post - 0 Miss - 0 Block - 0										7 周文龙 <table border="1"><tr><td>2</td><td></td><td></td></tr><tr><td>1</td><td></td><td>1</td></tr><tr><td></td><td></td><td></td></tr></table> Post - 1 Miss - 1 Block - 1	2			1		1				8 高震东 <table border="1"><tr><td></td><td></td><td></td></tr><tr><td></td><td></td><td></td></tr><tr><td>1</td><td></td><td></td></tr></table> Post - 1 Miss - 0 Block - 0							1			10 朱世杰 <table border="1"><tr><td>1</td><td></td><td></td></tr><tr><td>1</td><td>1</td><td>1</td></tr><tr><td></td><td></td><td></td></tr></table> Post - 1 Miss - 1 Block - 0	1			1	1	1				11 蒋慧捷 <table border="1"><tr><td></td><td></td><td></td></tr><tr><td></td><td></td><td></td></tr><tr><td></td><td></td><td>1</td></tr></table> Post - 0 Miss - 1 Block - 0									1
		1																																																																													
2																																																																															
1		1																																																																													
1																																																																															
1																																																																															
1	1	1																																																																													
		1																																																																													
12 周哲韬 <table border="1"><tr><td></td><td></td><td></td></tr><tr><td></td><td></td><td></td></tr><tr><td></td><td></td><td></td></tr></table> Post - 0 Miss - 0 Block - 0										15 庄旭杰 <table border="1"><tr><td></td><td></td><td></td></tr><tr><td></td><td></td><td></td></tr><tr><td></td><td></td><td></td></tr></table> Post - 0 Miss - 0 Block - 0										16 张逸豪 <table border="1"><tr><td></td><td></td><td></td></tr><tr><td></td><td></td><td></td></tr><tr><td></td><td></td><td></td></tr></table> Post - 0 Miss - 0 Block - 0										18 董凯 <table border="1"><tr><td></td><td></td><td></td></tr><tr><td></td><td></td><td></td></tr><tr><td></td><td></td><td></td></tr></table> Post - 0 Miss - 0 Block - 0										20 蒋承骅 <table border="1"><tr><td></td><td></td><td></td></tr><tr><td></td><td></td><td></td></tr><tr><td></td><td></td><td></td></tr></table> Post - 0 Miss - 0 Block - 0										23 吴双 <table border="1"><tr><td></td><td></td><td>1</td></tr><tr><td></td><td></td><td>1</td></tr><tr><td></td><td></td><td></td></tr></table> Post - 0 Miss - 0 Block - 0			1			1				30 徐俊吉 <table border="1"><tr><td></td><td></td><td></td></tr><tr><td></td><td></td><td></td></tr><tr><td></td><td></td><td>1</td></tr></table> Post - 1 Miss - 0 Block - 0									1										
		1																																																																													
		1																																																																													
		1																																																																													



Team A					Team B					Match Number											
A 山东队					B 四川队					4											
Played in			in the hall			on			at			Spectators									
重庆万州			万州体育馆			2019-04-07			17:30			hours									
Half-time(30')	A	B	End of playing time		A	B	1st extra time		A	B	2nd extra time		A	B	After penalty throws						
	17	6	36		13																
Number of 7 m	A	Team time-out			Full name of players and officials						Team time-out			B	Number of 7 m						
	0/0	1	2	3							1	2	3	0/0							
No.	Team A					G	W	2'	D	DR	No.	Team B					G	W	2'	D	DR
1	宋晓晨										2	张宏运					1				
6	李朝鹏					4		1			3	李朗轩					1				
7	林豪文					1					6	董佳辉					4				
8	王炳华										7	曾繁泳					1				
9	赵元					2		1			8	罗霖泽					2				
10	赵建强					3					9	左典					1				
11	宋朋强					1					10	李剑琛					1				
12	于性哲										12	戴景伟									
13	刘晓					1					14	洗鹏飞					2				
15	张继伟					1	1				15	金硕									
17	王旭东					1	1	1			17	叶康全									
19	李语庆					6		1													
21	姜春辉					4															
27	胡晋铭					6															
31	于亚男					4															
34	王钟彬					2															
B	王鸿斌 (主教练)										A	李中洲									
C	金京男										B	王伟 (主教练)									
D	刘桂妮										C	张广建									
E	林配永																				
A	Signatures of responsables for the teams (Off.A)															B					
TP	Remarks of referees / HF Official															TP					

Signatures

Referees	林子健 (CHN)	陈常增 (CHN)		
T.D.	郭剑 (CHN)	张春生 (CHN)		
CHA Off.				

Note: Number of 7m Throws Awarded to Team A and B, Goals (G), Warnings (W), Suspensions (2'), Direct Disqualification (D), Disqualification With Report (DR) and Team Penalty (TP).

Table Officials: 刘明华

黄一凡

Statisticians: 谢杨

赵悦

### 2019年全国男子手球冠军杯赛

PHMS Pictorial Handball Match Statistics

IHF Official System

#### 竞赛技术统计

手球 男子      预赛 轮次 1      组别 B 场次 4      万州体育馆 2019-04-07 17:30

Referees: 林子健 (CHN) / 陈常增 (CHN)      Result: 36:13 (17:6)  
Teams: 山东队(山东) VS 四川队(四川)

山东		远	近	边	快	突	任意	7m	合计	%	助攻	失误	警告	2'	D+DR
主教练: 王鸿斌		射	射	射	攻	破	球	球							
1	宋晓晨										3				
6	李朝鹏	1/1	2/2	1/1					4/4	100	2	1		1	
7	林豪文	0/1	0/1	1/1					1/3	33.3		1			
8	王炳华														
9	赵元		0/3			2/2			2/5	40.0				1	
10	赵建强		1/1	1/3	1/2				3/6	50.0					
11	宋朋强			1/1					1/1	100					
12	于性哲										2				
13	刘晓	0/1	1/2						1/3	33.3	2	2			
15	张继伟		1/4						1/4	25.0		1	1		
17	王旭东				1/1				1/1	100	2	1	1	1	
19	李语庆			0/1	6/6				6/7	85.7		1		1	
21	姜春辉			2/2	2/2				4/4	100					
27	胡晋铭		4/4		2/3				6/7	85.7					
31	于亚男		2/2	0/1	2/2				4/5	80.0	1				
34	王钟彬		1/1		1/1	0/1			2/3	66.7	2				
运动员 合计		1/3	12/20	6/10	15/17	2/3			36/53	67.9	14	7	2	4	
1	宋晓晨	2/3	4/5	2/3		0/3			8/14	57.1	3				
12	于性哲	0/2	7/10	1/1	0/2				8/15	53.3	2				
守门员 合计		2/5	11/15	3/4	0/2	0/3			16/29	55.2	5				

山东	比赛进程	四川
1st Half		
0	01:42	1 9 左典
6	李朝鹏	1 02:16 1
6	李朝鹏	2 05:33 1
19	李语庆	3 06:29 1
		3 07:11 2 6 董佳辉
19	李语庆	4 09:28 2
17	王旭东	5 10:19 2
		5 11:11 3 6 董佳辉
19	李语庆	6 11:59 3
		6 13:58 4 6 董佳辉
31	于亚男	7 15:54 4
19	李语庆	8 16:40 4
11	宋朋强	9 17:33 4
31	于亚男	10 18:13 4
31	于亚男	11 19:51 4
		11 20:35 5 8 罗霖泽
6	李朝鹏	12 21:58 5
19	李语庆	13 24:25 5
19	李语庆	14 25:09 5
31	于亚男	15 26:00 5
		15 26:38 6 14 洗鹏飞
6	李朝鹏	16 27:41 6
15	张继伟	17 29:48 6
2nd Half		
27	胡晋铭	18 01:43 6
27	胡晋铭	19 02:34 6
9	赵元	20 05:07 6
		20 05:31 7 10 李剑琛
27	胡晋铭	21 05:57 7
		21 06:28 8 6 董佳辉
7	林豪文	22 06:59 8
27	胡晋铭	23 08:41 8
34	王钟彬	24 11:24 8
		24 12:44 9 2 张宏运
10	赵建强	25 14:53 9
27	胡晋铭	26 16:46 9
		26 17:55 10 7 曾繁泳
10	赵建强	27 18:32 10
21	姜春辉	28 21:05 10
21	姜春辉	29 22:36 10
		29 23:02 11 3 李朗轩
		29 23:32 12 8 罗霖泽
34	王钟彬	30 23:52 12
9	赵元	31 24:25 12
21	姜春辉	32 25:22 12
		32 25:52 13 14 洗鹏飞
13	刘晓	33 26:24 13
10	赵建强	34 27:24 13
21	姜春辉	35 28:12 13
27	胡晋铭	36 29:32 13

场上队员: 得分 / 射门

守门员: 救球 / 射门

D	取消资格	DR	取消资格+报告
---	------	----	---------



2019年全国男子手球冠军杯赛

PHMS Pictorial Handball Match Statistics

IHF Official System

个人/全队技术统计表

手球 男子 预赛 轮次 1 组别 B 场次 4 万州体育馆 2019-04-07 17:30

号码	姓名	远射	近射	边射	快攻	突破	任意	七米	合计	%	助攻	失误	警告	2'	取消	时间
山东队(山东)																
(场上队员)																
1	宋晓晨									0.0%	3					00:31:47
6	李朝鹏	1/1	2/2	1/1					4/4	100%	2	1		1		00:31:49
7	林豪文	0/1	0/1	1/1					1/3	33.3%		1				00:21:41
8	王炳华									0.0%						00:00:00
9	赵元		0/3			2/2			2/5	40.0%				1		00:24:29
10	赵建强		1/1	1/3	1/2				3/6	50.0%						00:30:00
11	宋朋强			1/1					1/1	100%						00:30:00
12	于性哲									0.0%	2					00:28:13
13	刘晓	0/1	1/2						1/3	33.3%	2	2				00:30:00
15	张继伟		1/4						1/4	25.0%		1	1			00:29:06
17	王旭东				1/1				1/1	100%	2	1	1	1		00:30:00
19	李语庆			0/1	6/6				6/7	85.7%		1		1		00:30:00
21	姜春辉			2/2	2/2				4/4	100%						00:13:40
27	胡晋铭		4/4		2/3				6/7	85.7%						00:28:58
31	于亚男		2/2	0/1	2/2				4/5	80.0%	1					00:30:00
34	王钟彬		1/1		1/1	0/1			2/3	66.7%	2					00:30:00
	合计	1/3	12/20	6/10	15/17	2/3			36/53	67.9%	14	7	2	4		
(守门员)																
1	宋晓晨	2/3	4/5	2/3		0/3			8/14	57.1%	3					00:31:47
12	于性哲	0/2	7/10	1/1	0/2				8/15	53.3%	2					00:28:13
	合计	2/5	11/15	3/4	0/2	0/3			16/29	55.2%	5					

场上队员：得分/射门

守门员：救球/射门

全队合计	得分	被救	射失	击柱	封球	合计	%
远射	1	2				3	33.3%
近射	12	5		3		20	60.0%
边射	6	4				10	60.0%
快攻	15	2				17	88.2%
突破	2			1		3	66.7%
任意							0.0%
七米							0.0%

## 2019年全国男子手球冠军杯赛

PHMS Pictorial Handball Match Statistics

IHF Official System

### 个人/全队技术统计表

手球 男子 预赛 轮次 1 组别 B 场次 4 万州体育馆 2019-04-07 17:30

号码	姓名	远射	近射	边射	快攻	突破	任意	七米	合计	%	助攻	失误	警告	2'	取消	时间
四川队(四川)																
(场上队员)																
2	张宏运		1/2						1/2	50.0%		1				00:50:21
3	李朗轩	1/3	0/1						1/4	25.0%		3				00:21:40
6	董佳辉	0/7	2/5			2/2	0/2		4/16	25.0%		6				00:55:39
7	曾繁泳		1/1	0/1					1/2	50.0%		3				00:44:50
8	罗霖泽			1/3	1/1				2/4	50.0%		2				00:46:21
9	左典	1/4	0/5						1/9	11.1%	2	2				00:43:46
10	李剑琛			0/2	1/1				1/3	33.3%						00:29:51
12	戴景伟									0.0%						00:20:46
14	洗鹏飞	1/4	0/1			1/1			2/6	33.3%		1				01:00:00
15	金硕		0/1						0/1	0.0%		1				00:07:20
17	叶康全									0.0%						00:39:14
合计		3/18	4/16	1/6	2/2	3/3	0/2		13/47	27.7%	2	19				
(守门员)																
12	戴景伟	2/2	1/5	2/5	2/7	0/1			7/20	35.0%						00:20:46
17	叶康全	0/1	4/12	2/5	0/10	0/1			6/29	20.7%						00:39:14
合计		2/3	5/17	4/10	2/17	0/2			13/49	26.5%						

场上队员： 得分/射门

守门员： 救球/射门

全队合计	得分	被救	射失	击柱	封球	合计	%
远射	3	2	4	1	8	18	16.7%
近射	4	11	1			16	25.0%
边射	1	3	2			6	16.7%
快攻	2					2	100.0%
突破	3					3	100.0%
任意				2		2	0.0%
七米							0.0%

图式比赛技术统计表

手球  
男子

预赛  
轮次 1

组别 B  
场次 4

万州体育馆  
2019-04-07 17:30

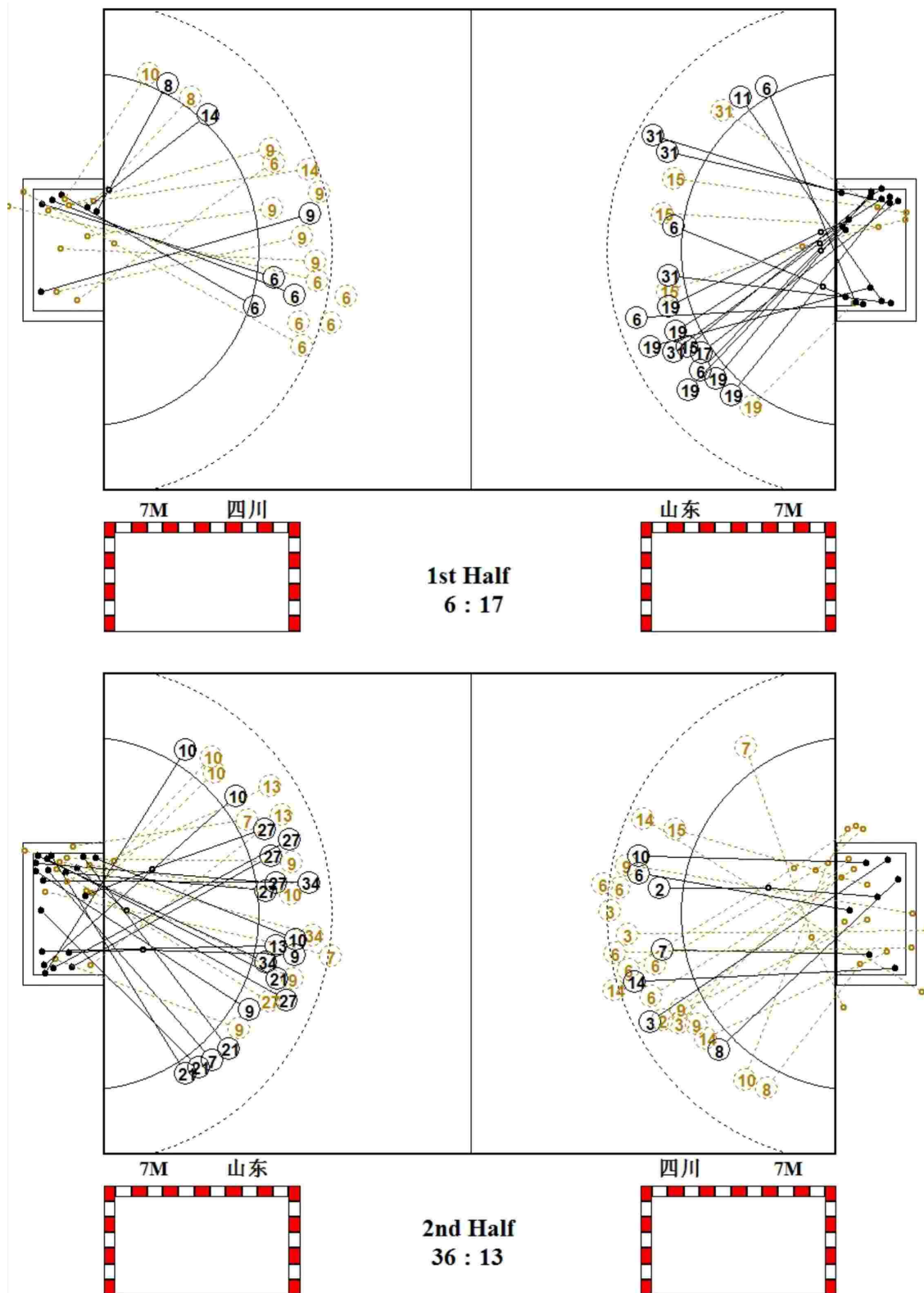

图式射门区域统计

手球  
男子

预赛  
轮次 1

组别 B  
场次 4

万州体育馆  
2019-04-07 17:30

山东队

1 宋晓晨	6 李朝鹏	7 林豪文	8 王炳华	9 赵元	10 赵建强	11 宋朋强	12 于性哲																																																																								
<table border="1"><tr><td></td><td></td><td></td></tr><tr><td></td><td></td><td></td></tr><tr><td></td><td></td><td></td></tr></table>										<table border="1"><tr><td></td><td></td><td></td></tr><tr><td>1</td><td></td><td>1</td></tr><tr><td></td><td></td><td>2</td></tr></table>				1		1			2	<table border="1"><tr><td></td><td></td><td>1</td></tr><tr><td></td><td></td><td></td></tr><tr><td></td><td></td><td></td></tr></table>			1							<table border="1"><tr><td></td><td></td><td></td></tr><tr><td></td><td></td><td></td></tr><tr><td></td><td></td><td></td></tr></table>										<table border="1"><tr><td></td><td></td><td>1</td></tr><tr><td>1</td><td></td><td></td></tr><tr><td></td><td></td><td></td></tr></table>			1	1						<table border="1"><tr><td>2</td><td></td><td></td></tr><tr><td></td><td></td><td></td></tr><tr><td></td><td></td><td>1</td></tr></table>	2								1	<table border="1"><tr><td></td><td></td><td>1</td></tr><tr><td></td><td></td><td></td></tr><tr><td></td><td></td><td></td></tr></table>			1							<table border="1"><tr><td></td><td></td><td></td></tr><tr><td></td><td></td><td></td></tr><tr><td></td><td></td><td></td></tr></table>									
1		1																																																																													
		2																																																																													
		1																																																																													
		1																																																																													
1																																																																															
2																																																																															
		1																																																																													
		1																																																																													
Post - 0 Miss - 0 Block - 0	Post - 0 Miss - 0 Block - 0	Post - 1 Miss - 0 Block - 0	Post - 0 Miss - 0 Block - 0	Post - 0 Miss - 0 Block - 0	Post - 0 Miss - 0 Block - 0	Post - 0 Miss - 0 Block - 0	Post - 0 Miss - 0 Block - 0																																																																								
13 刘晓	15 张继伟	17 王旭东	19 李语庆	21 姜春辉	27 胡晋铭	31 于亚男	34 王钟彬																																																																								
<table border="1"><tr><td>1</td><td></td><td></td></tr><tr><td></td><td></td><td></td></tr><tr><td></td><td></td><td></td></tr></table>	1									<table border="1"><tr><td>1</td><td></td><td></td></tr><tr><td></td><td></td><td></td></tr><tr><td></td><td></td><td></td></tr></table>	1									<table border="1"><tr><td>1</td><td></td><td></td></tr><tr><td></td><td></td><td></td></tr><tr><td></td><td></td><td></td></tr></table>	1									<table border="1"><tr><td>2</td><td></td><td></td></tr><tr><td>1</td><td></td><td>1</td></tr><tr><td>1</td><td>1</td><td></td></tr></table>	2			1		1	1	1		<table border="1"><tr><td></td><td>1</td><td>2</td></tr><tr><td></td><td></td><td></td></tr><tr><td></td><td></td><td>1</td></tr></table>		1	2						1	<table border="1"><tr><td>1</td><td></td><td>1</td></tr><tr><td>1</td><td></td><td>2</td></tr><tr><td></td><td>1</td><td></td></tr></table>	1		1	1		2		1		<table border="1"><tr><td>1</td><td></td><td>1</td></tr><tr><td></td><td></td><td></td></tr><tr><td>2</td><td></td><td></td></tr></table>	1		1				2			<table border="1"><tr><td></td><td></td><td>2</td></tr><tr><td></td><td></td><td></td></tr><tr><td></td><td></td><td></td></tr></table>			2						
1																																																																															
1																																																																															
1																																																																															
2																																																																															
1		1																																																																													
1	1																																																																														
	1	2																																																																													
		1																																																																													
1		1																																																																													
1		2																																																																													
	1																																																																														
1		1																																																																													
2																																																																															
		2																																																																													
Post - 0 Miss - 0 Block - 0	Post - 2 Miss - 0 Block - 0	Post - 0 Miss - 0 Block - 0	Post - 0 Miss - 0 Block - 0	Post - 0 Miss - 0 Block - 0	Post - 0 Miss - 0 Block - 0	Post - 0 Miss - 0 Block - 0	Post - 1 Miss - 0 Block - 0																																																																								

1 宋晓晨

1/2		1/3
1/1	1/1	2/3
	1/1	1/3

12 于性哲

0/2		1/2
1/2	1/2	1/2
3/3	1/2	

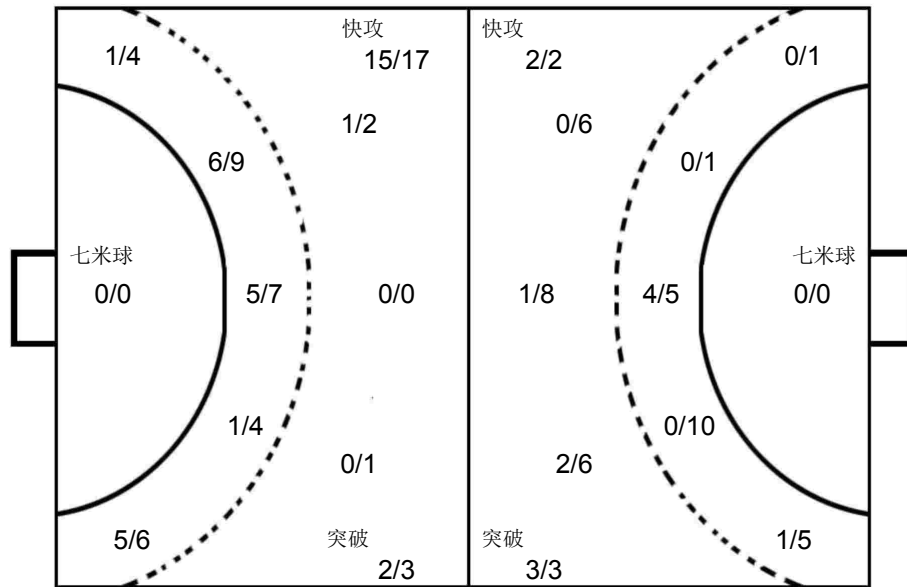

12 戴景伟

0/4	0/1	2/7
		1/1
1/1	1/2	2/4

17 叶康全

1/6		0/4
2/6		2/6
0/3	0/1	1/3

四川队

2 张宏运	3 李朗轩	6 董佳辉	7 曾繁泳	8 罗霖泽	9 左典	10 李剑琛	12 戴景伟																																																																								
<table border="1"><tr><td></td><td></td><td></td></tr><tr><td>1</td><td></td><td></td></tr><tr><td></td><td></td><td></td></tr></table>				1						<table border="1"><tr><td>1</td><td></td><td></td></tr><tr><td></td><td></td><td></td></tr><tr><td></td><td></td><td></td></tr></table>	1									<table border="1"><tr><td></td><td></td><td>2</td></tr><tr><td></td><td></td><td>1</td></tr><tr><td></td><td>1</td><td></td></tr></table>			2			1		1		<table border="1"><tr><td></td><td></td><td></td></tr><tr><td></td><td></td><td>1</td></tr><tr><td></td><td></td><td></td></tr></table>						1				<table border="1"><tr><td>1</td><td></td><td></td></tr><tr><td></td><td></td><td></td></tr><tr><td></td><td></td><td>1</td></tr></table>	1								1	<table border="1"><tr><td>1</td><td></td><td></td></tr><tr><td></td><td></td><td></td></tr><tr><td></td><td></td><td></td></tr></table>	1									<table border="1"><tr><td></td><td></td><td></td></tr><tr><td>1</td><td></td><td></td></tr><tr><td></td><td></td><td></td></tr></table>				1						<table border="1"><tr><td></td><td></td><td></td></tr><tr><td></td><td></td><td></td></tr><tr><td></td><td></td><td></td></tr></table>									
1																																																																															
1																																																																															
		2																																																																													
		1																																																																													
	1																																																																														
		1																																																																													
1																																																																															
		1																																																																													
1																																																																															
1																																																																															
Post - 0 Miss - 0 Block - 0	Post - 0 Miss - 1 Block - 1	Post - 2 Miss - 3 Block - 5	Post - 0 Miss - 1 Block - 0	Post - 0 Miss - 0 Block - 0	Post - 1 Miss - 0 Block - 1	Post - 0 Miss - 1 Block - 0	Post - 0 Miss - 0 Block - 0																																																																								
14 洗鹏飞	15 金硕	17 叶康全																																																																													
<table border="1"><tr><td></td><td></td><td>1</td></tr><tr><td></td><td></td><td></td></tr><tr><td></td><td></td><td>1</td></tr></table>			1						1	<table border="1"><tr><td></td><td></td><td></td></tr><tr><td></td><td></td><td></td></tr><tr><td></td><td></td><td></td></tr></table>										<table border="1"><tr><td></td><td></td><td></td></tr><tr><td></td><td></td><td></td></tr><tr><td></td><td></td><td></td></tr></table>																																																											
		1																																																																													
		1																																																																													
Post - 0 Miss - 1 Block - 1	Post - 0 Miss - 0 Block - 0	Post - 0 Miss - 0 Block - 0																																																																													



**PHMS** Pictorial Handball Match Statistics **IHF** Official System

Team A <b>A 陕西队</b>	Team B <b>B 广东队</b>	Match Number <b>5</b>
------------------------	------------------------	--------------------------

Played in 重庆万州	in the hall 万州体育馆	on 2019-04-08	at 13:00	hours	Spectators
-------------------	----------------------	------------------	-------------	-------	------------

Half-time(30')	A 12	B 14	End of playing time	A 26	B 31	1st extra time	A	B	2nd extra time	A	B	After penalty throws	A	B
----------------	---------	---------	---------------------	---------	---------	----------------	---	---	----------------	---	---	----------------------	---	---

Number of 7 m	A 5/5	Team time-out			Full name of players and officials						Team time-out			B 1/2	Number of 7 m
		1	2	3							1	2	3		
			38:00								17:45	48:52			

No.	Team A	G	W	2'	D	DR	No.	Team B	G	W	2'	D	DR
1	陈昊						6	毕晓晨	6				
2	王柏洪						7	王立隆	2				
3	刘赵梁	4		2			9	范保坤					
4	李佳						10	周仲坤	7	1			
5	马益奎	2		2			11	房友屯	3	1			
6	刘世昌	2					12	王雨	1				
8	季雨	1					14	王泽润					
9	陈孝天						15	张建杰	2				
10	王凯强	6					18	姚雪岩	2	1			
11	张领	5		1			19	王帅					
12	赵凯						21	张昌轲			1		
13	隋家乐						22	黄培杰	3				
15	陈冉	6					24	高玉杰	5				
17	耿畅						31	陈元祖					
18	刘文星						32	罗柏涵					
22	张睿梁												
B	郝可鑫						A	曲汝洋					
C	李安						B	刘康伶 (主教练)	1				
							C	郭艳辉					
							E	贾章志					

A	Signatures of responsables for the teams (Off.A)	B
---	--	---

TP	Remarks of referees / HF Official	TP

Signatures			
Referees	张智伟 (CHN)	黄一凡 (CHN)	
T.D.	郭剑 (CHN)	张春生 (CHN)	
CHA Off.			

Note: Number of 7m Throws Awarded to Team A and B, Goals (G), Warnings (W), Suspensions (2'), Direct Disqualification (D), Disqualification With Report (DR) and Team Penalty (TP).

Table Officials: 张之伟                      康曦                      Statisticians: 周亚桥                      赵悦

## 2019年全国男子手球冠军杯赛

### 竞赛技术统计

手球 男子                                      预赛 轮次 2                                      组别 A 场次 5                                      万州体育馆 2019-04-08 13:00

Referees: 张智伟 (CHN) / 黄一凡 (CHN)                                      Result: 26:31(12:14)  
Teams: 陕西队(陕西) VS 广东队(广东)

陕西		远	近	边	快	突	任意	7m	合计	%	助攻	失误	警告	2'	D+DR	陕西      比赛进程      广东	
主教练: 王建国		射	射	射	攻	破	球	球									
1	陈昊															1st Half	
2	王柏淇															10 王凯强 1 01:43 0	
3	刘赵梁	0/1	0/2		1/1	3/3			4/7	57.1	2	9		2		5 马益奎 2 02:52 0	
4	李佳															3 刘赵梁 3 04:07 0	
5	马益奎		2/3						2/3	66.7	1	3		2		3 刘赵梁 4 05:35 0	
6	刘世昌	1/1		1/2					2/3	66.7		1				4 06:30 1 6 毕晓晨	
8	季雨					1/1			1/1	100		1				4 07:57 2 24 高玉杰	
9	陈孝天															10 王凯强 5 08:09 2	
10	王凯强	0/1	1/1		3/3	2/3			6/8	75.0	2	3				5 08:32 3 11 房友屯	
11	张颌	0/1	0/2					5/5	5/8	62.5		2		1		5 08:48 4 11 房友屯	
12	赵凯															11 张颌 6 09:47 4	
13	隋家乐															6 11:59 5 10 周仲坤	
15	陈冉	1/1	1/1	3/6		1/1			6/9	66.7		1				8 季雨 7 12:33 5	
17	耿畅															7 12:58 6 18 姚雪岩	
18	刘文星															5 马益奎 8 14:34 6	
22	张睿梁															8 15:03 7 10 周仲坤	
运动员 合计		2/5	4/9	4/8	4/4	7/8		5/5	26/39	66.7	5	20		5		9 15:46 7	
1	陈昊	0/10	2/5	2/3	0/6	0/3		1/1	5/28	17.9						11 张颌 10 17:03 7	
22	张睿梁	3/6	1/3		1/2	0/1		0/1	5/13	38.5						10 18:00 8 6 毕晓晨	
守门员 合计		3/16	3/8	2/3	1/8	0/4		1/2	10/41	24.4						10 18:44 9 7 王立隆	
广东		远	近	边	快	突	任意	7m	合计	%	助攻	失误	警告	2'	D+DR		
主教练: 刘康伶		射	射	射	攻	破	球	球									
6	毕晓晨	2/3	2/3	0/2	1/2			1/1	6/11	54.5						10 21:58 10 7 王立隆	
7	王立隆				2/2				2/2	100	3					11 张颌 11 23:24 10	
9	范保坤															11 24:08 11 24 高玉杰	
10	周仲坤	5/7			1/1	1/1			7/9	77.8	1	2	1			11 26:03 12 24 高玉杰	
11	房友屯	1/1	1/2		1/1				3/4	75.0		3	1			11 26:38 13 10 周仲坤	
12	王雨	0/1		1/1					1/2	50.0						11 28:20 14 24 高玉杰	
14	王泽润															12 29:39 14	
15	张建杰	0/1			1/1	1/1			2/3	66.7	1	2				2nd Half	
18	姚雪岩	1/1	1/1						2/2	100		2	1			12 00:28 15 6 毕晓晨	
19	王帅															13 01:02 15	
21	张昌轲	0/1							0/1	0.0		1		1		11 张颌 14 02:58 16	
22	黄培杰	0/3	1/2	0/1	1/1	1/2		0/1	3/10	30.0						15 陈冉 15 05:02 16	
24	高玉杰	4/5	0/1	0/1		1/2			5/9	55.6						16 05:41 16	
31	陈元祖															16 06:11 17 6 毕晓晨	
32	罗柏涵															16 08:14 18 22 黄培杰	
运动员 合计		13/23	5/9	1/5	7/8	4/6		1/2	31/53	58.5	6	10	3	1		16 09:36 19 6 毕晓晨	
14	王泽润		2/4	3/4	0/1	1/4		0/3	6/16	37.5						17 10:14 19	
19	王帅	2/4	3/5	0/3	0/3	0/4		0/2	5/21	23.8	1					17 10:43 20 10 周仲坤	
守门员 合计		2/4	5/9	3/7	0/4	1/8		0/5	11/37	29.7	1					18 11:02 20	

场上队员: 得分 / 射门                                      守门员: 救球 / 射门

D	取消资格	DR	取消资格+报告
---	------	----	---------



2019年全国男子手球冠军杯赛

PHMS Pictorial Handball Match Statistics

IHF Official System

个人/全队技术统计表

手球 男子 预赛 轮次 2 组别 A 场次 5 万州体育馆 2019-04-08 13:00

号码	姓名	远射	近射	边射	快攻	突破	任意	七米	合计	%	助攻	失误	警告	2'	取消	时间
陕西队(陕西)																
(场上队员)																
1	陈昊									0.0%						00:44:24
2	王柏淇									0.0%						00:00:00
3	刘赵梁	0/1	0/2		1/1	3/3			4/7	57.1%	2	9		2		00:44:30
4	李佳									0.0%						00:01:07
5	马益奎		2/3						2/3	66.7%	1	3		2		00:56:45
6	刘世昌	1/1		1/2					2/3	66.7%		1				00:53:01
8	季雨					1/1			1/1	100%		1				00:39:41
9	陈孝天									0.0%						00:06:32
10	王凯强	0/1	1/1		3/3	2/3			6/8	75.0%	2	3				00:57:04
11	张领	0/1	0/2					5/5	5/8	62.5%		2		1		00:38:30
12	赵凯									0.0%						00:00:00
13	隋家乐									0.0%						00:00:00
15	陈冉	1/1	1/1	3/6		1/1			6/9	66.7%		1				01:00:00
17	耿畅									0.0%						00:00:00
18	刘文星									0.0%						00:00:00
22	张睿梁									0.0%						00:15:36
	合计	2/5	4/9	4/8	4/4	7/8		5/5	26/39	66.7%	5	20		5		
(守门员)																
1	陈昊	0/10	2/5	2/3	0/6	0/3		1/1	5/28	17.9%						00:44:24
22	张睿梁	3/6	1/3		1/2	0/1		0/1	5/13	38.5%						00:15:36
	合计	3/16	3/8	2/3	1/8	0/4		1/2	10/41	24.4%						

场上队员：得分/射门

守门员：救球/射门

全队合计	得分	被救	射失	击柱	封球	合计	%
远射	2	2		1		5	40.0%
近射	4	5				9	44.4%
边射	4	3		1		8	50.0%
快攻	4					4	100.0%
突破	7	1				8	87.5%
任意							0.0%
七米	5					5	100.0%

2019年全国男子手球冠军杯赛

PHMS Pictorial Handball Match Statistics

IHF Official System

个人/全队技术统计表

手球 男子 预赛 轮次 2 组别 A 场次 5 万州体育馆 2019-04-08 13:00

号码	姓名	远射	近射	边射	快攻	突破	任意	七米	合计	%	助攻	失误	警告	2'	取消	时间
广东队(广东)																
(场上队员)																
6	毕晓晨	2/3	2/3	0/2	1/2			1/1	6/11	54.5%						00:47:21
7	王立隆				2/2				2/2	100%	3					00:37:10
9	范保坤									0.0%						00:06:08
10	周仲坤	5/7			1/1	1/1			7/9	77.8%	1	2	1			00:53:49
11	房友屯	1/1	1/2		1/1				3/4	75.0%		3	1			00:27:13
12	王雨	0/1		1/1					1/2	50.0%						00:12:30
14	王泽润									0.0%						00:19:26
15	张建杰	0/1			1/1	1/1			2/3	66.7%	1	2				00:24:31
18	姚雪岩	1/1	1/1						2/2	100%		2	1			00:38:09
19	王帅									0.0%	1					00:40:34
21	张昌轲	0/1							0/1	0.0%		1		1		00:19:53
22	黄培杰	0/3	1/2	0/1	1/1	1/2		0/1	3/10	30.0%						00:55:02
24	高玉杰	4/5	0/1	0/1		1/2			5/9	55.6%						00:31:40
31	陈元祖									0.0%						00:02:40
32	罗柏涵									0.0%						00:03:01
合计		13/23	5/9	1/5	7/8	4/6		1/2	31/53	58.5%	6	10	3	1		
(守门员)																
14	王泽润		2/4	3/4	0/1	1/4		0/3	6/16	37.5%						00:19:26
19	王帅	2/4	3/5	0/3	0/3	0/4		0/2	5/21	23.8%	1					00:40:34
合计		2/4	5/9	3/7	0/4	1/8		0/5	11/37	29.7%	1					

场上队员：得分/射门

守门员：救球/射门

全队合计	得分	被救	射失	击柱	封球	合计	%
远射	13	3	5		2	23	56.5%
近射	5	3		1		9	55.6%
边射	1	2	1	1		5	20.0%
快攻	7	1				8	87.5%
突破	4			2		6	66.7%
任意							0.0%
七米	1	1				2	50.0%

图式比赛技术统计表

手球  
男子

预赛  
轮次 2

组别 A  
场次 5

万州体育馆  
2019-04-08 13:00

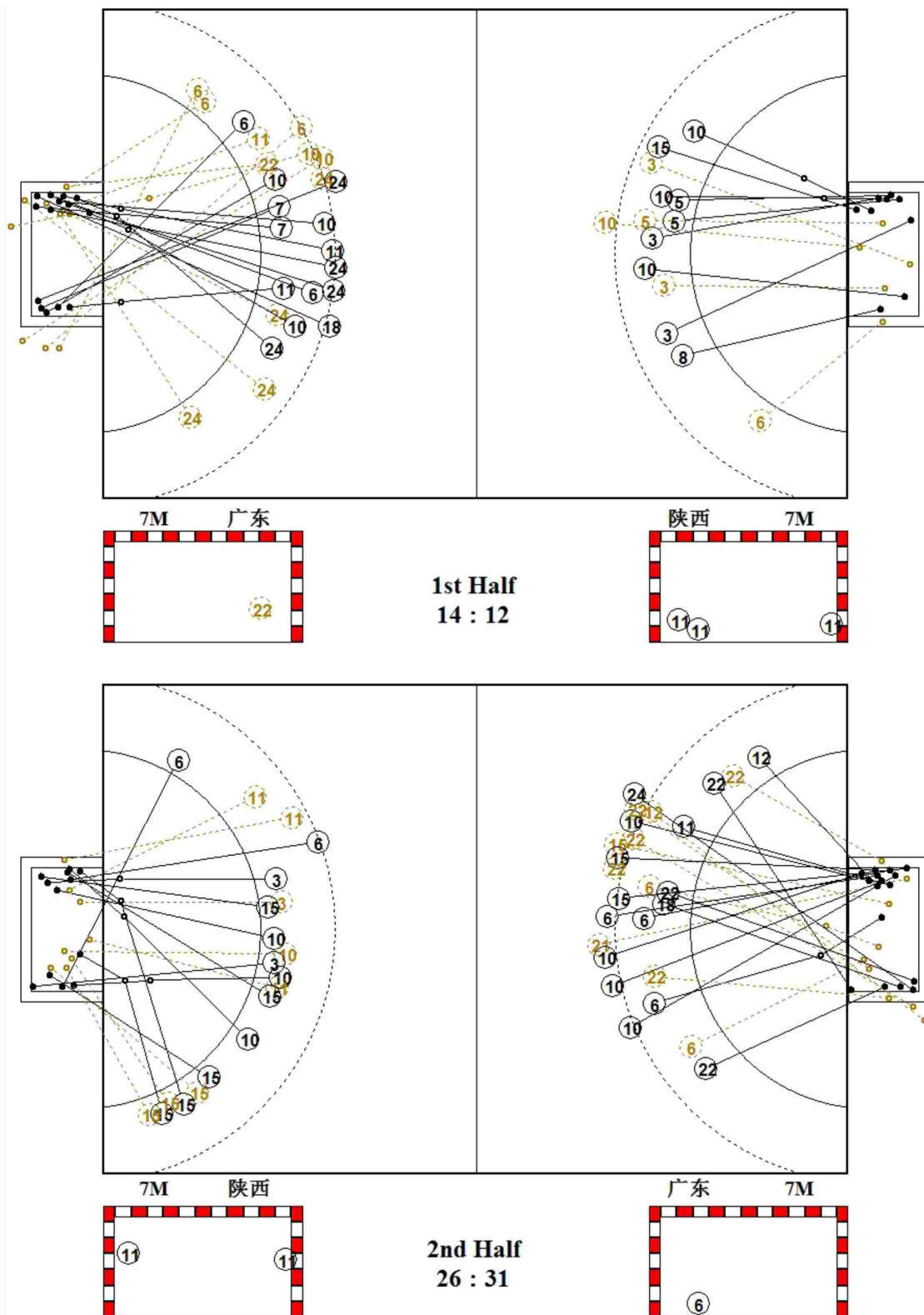

图式射门区域统计

手球  
男子

预赛  
轮次 2

组别 A  
场次 5

万州体育馆  
2019-04-08 13:00

陕西队

1 陈昊	2 王柏淇	3 刘赵梁	4 李佳	5 马益奎	6 刘世昌	8 季雨	9 陈孝天																																																																								
<table border="1"><tr><td></td><td></td><td></td></tr><tr><td></td><td></td><td></td></tr><tr><td></td><td></td><td></td></tr></table>										<table border="1"><tr><td></td><td></td><td></td></tr><tr><td></td><td></td><td></td></tr><tr><td></td><td></td><td></td></tr></table>										<table border="1"><tr><td>2</td><td></td><td>1</td></tr><tr><td>1</td><td></td><td></td></tr><tr><td></td><td></td><td></td></tr></table>	2		1	1						<table border="1"><tr><td></td><td></td><td></td></tr><tr><td></td><td></td><td></td></tr><tr><td></td><td></td><td></td></tr></table>										<table border="1"><tr><td>1</td><td></td><td></td></tr><tr><td>1</td><td></td><td></td></tr><tr><td></td><td></td><td></td></tr></table>	1			1						<table border="1"><tr><td></td><td></td><td></td></tr><tr><td>1</td><td></td><td>1</td></tr><tr><td></td><td></td><td></td></tr></table>				1		1				<table border="1"><tr><td></td><td></td><td></td></tr><tr><td></td><td></td><td>1</td></tr><tr><td></td><td></td><td></td></tr></table>						1				<table border="1"><tr><td></td><td></td><td></td></tr><tr><td></td><td></td><td></td></tr><tr><td></td><td></td><td></td></tr></table>									
2		1																																																																													
1																																																																															
1																																																																															
1																																																																															
1		1																																																																													
		1																																																																													
10 王凯强	11 张领	12 赵凯	13 隋家乐	15 陈冉	17 耿畅	18 刘文星	22 张睿梁																																																																								
<table border="1"><tr><td></td><td></td><td>1</td></tr><tr><td>3</td><td></td><td>2</td></tr><tr><td></td><td></td><td></td></tr></table>			1	3		2				<table border="1"><tr><td>1</td><td></td><td></td></tr><tr><td></td><td></td><td>1</td></tr><tr><td>2</td><td></td><td>1</td></tr></table>	1					1	2		1	<table border="1"><tr><td></td><td></td><td></td></tr><tr><td></td><td></td><td></td></tr><tr><td></td><td></td><td></td></tr></table>										<table border="1"><tr><td></td><td></td><td></td></tr><tr><td></td><td></td><td></td></tr><tr><td></td><td></td><td></td></tr></table>										<table border="1"><tr><td>1</td><td></td><td>1</td></tr><tr><td></td><td></td><td>1</td></tr><tr><td>2</td><td></td><td>1</td></tr></table>	1		1			1	2		1	<table border="1"><tr><td></td><td></td><td></td></tr><tr><td></td><td></td><td></td></tr><tr><td></td><td></td><td></td></tr></table>										<table border="1"><tr><td></td><td></td><td></td></tr><tr><td></td><td></td><td></td></tr><tr><td></td><td></td><td></td></tr></table>										<table border="1"><tr><td></td><td></td><td></td></tr><tr><td></td><td></td><td></td></tr><tr><td></td><td></td><td></td></tr></table>									
		1																																																																													
3		2																																																																													
1																																																																															
		1																																																																													
2		1																																																																													
1		1																																																																													
		1																																																																													
2		1																																																																													
Post - 0 Miss - 0 Block - 0	Post - 0 Miss - 0 Block - 0	Post - 0 Miss - 0 Block - 0	Post - 0 Miss - 0 Block - 0	Post - 0 Miss - 0 Block - 0	Post - 1 Miss - 0 Block - 0	Post - 0 Miss - 0 Block - 0	Post - 0 Miss - 0 Block - 0																																																																								

1 陈昊									
<table border="1"><tr><td>0/4</td><td></td><td>1/6</td></tr><tr><td>0/5</td><td></td><td>4/9</td></tr><tr><td>0/2</td><td></td><td>0/2</td></tr></table>	0/4		1/6	0/5		4/9	0/2		0/2
0/4		1/6							
0/5		4/9							
0/2		0/2							

22 张睿梁									
<table border="1"><tr><td>1/2</td><td></td><td>0/2</td></tr><tr><td>1/4</td><td>1/2</td><td></td></tr><tr><td>0/1</td><td></td><td>2/2</td></tr></table>	1/2		0/2	1/4	1/2		0/1		2/2
1/2		0/2							
1/4	1/2								
0/1		2/2							

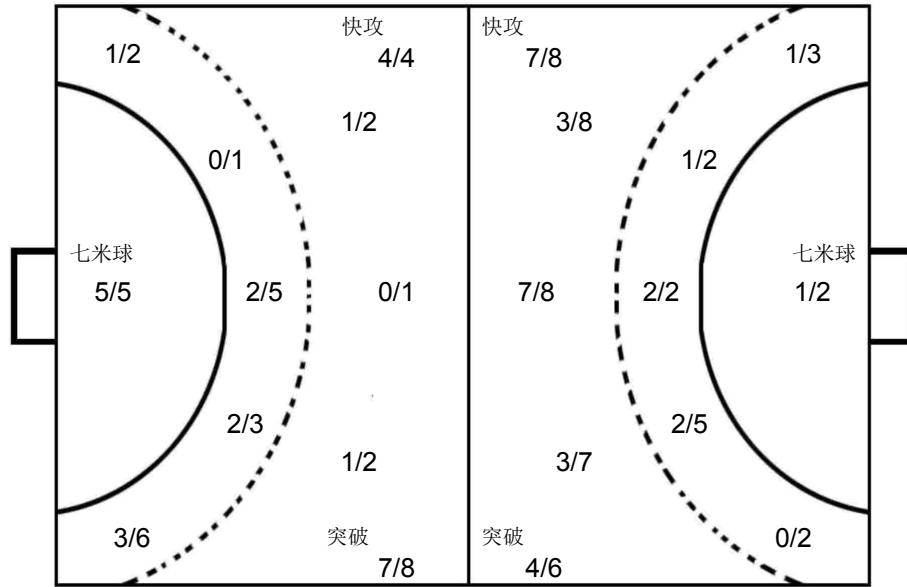

14 王泽润									
<table border="1"><tr><td>1/4</td><td></td><td>0/1</td></tr><tr><td>3/4</td><td></td><td>1/5</td></tr><tr><td>0/1</td><td>1/1</td><td></td></tr></table>	1/4		0/1	3/4		1/5	0/1	1/1	
1/4		0/1							
3/4		1/5							
0/1	1/1								

19 王帅									
<table border="1"><tr><td>0/2</td><td>1/1</td><td>0/2</td></tr><tr><td>1/6</td><td></td><td>1/3</td></tr><tr><td>0/3</td><td>1/1</td><td>1/3</td></tr></table>	0/2	1/1	0/2	1/6		1/3	0/3	1/1	1/3
0/2	1/1	0/2							
1/6		1/3							
0/3	1/1	1/3							

广东队

6 毕晓晨	7 王立隆	9 范保坤	10 周仲坤	11 房友屯	12 王雨	14 王泽润	15 张建杰																																																																								
<table border="1"><tr><td></td><td></td><td>1</td></tr><tr><td>3</td><td>1</td><td></td></tr><tr><td>1</td><td></td><td></td></tr></table>			1	3	1		1			<table border="1"><tr><td>1</td><td></td><td>1</td></tr><tr><td></td><td></td><td></td></tr><tr><td></td><td></td><td></td></tr></table>	1		1							<table border="1"><tr><td></td><td></td><td></td></tr><tr><td></td><td></td><td></td></tr><tr><td></td><td></td><td></td></tr></table>										<table border="1"><tr><td>2</td><td></td><td></td></tr><tr><td>1</td><td></td><td>1</td></tr><tr><td>2</td><td></td><td>1</td></tr></table>	2			1		1	2		1	<table border="1"><tr><td></td><td></td><td></td></tr><tr><td>2</td><td></td><td>1</td></tr><tr><td></td><td></td><td></td></tr></table>				2		1				<table border="1"><tr><td></td><td></td><td></td></tr><tr><td>1</td><td></td><td></td></tr><tr><td></td><td></td><td></td></tr></table>				1						<table border="1"><tr><td></td><td></td><td></td></tr><tr><td></td><td></td><td></td></tr><tr><td></td><td></td><td></td></tr></table>										<table border="1"><tr><td>1</td><td></td><td></td></tr><tr><td>1</td><td></td><td></td></tr><tr><td></td><td></td><td></td></tr></table>	1			1					
		1																																																																													
3	1																																																																														
1																																																																															
1		1																																																																													
2																																																																															
1		1																																																																													
2		1																																																																													
2		1																																																																													
1																																																																															
1																																																																															
1																																																																															
18 姚雪岩	19 王帅	21 张昌柯	22 黄培杰	24 高玉杰	31 陈元祖	32 罗柏涵																																																																									
<table border="1"><tr><td></td><td></td><td>2</td></tr><tr><td></td><td></td><td></td></tr><tr><td></td><td></td><td></td></tr></table>			2							<table border="1"><tr><td></td><td></td><td></td></tr><tr><td></td><td></td><td></td></tr><tr><td></td><td></td><td></td></tr></table>										<table border="1"><tr><td></td><td></td><td></td></tr><tr><td></td><td></td><td></td></tr><tr><td></td><td></td><td></td></tr></table>										<table border="1"><tr><td></td><td></td><td>1</td></tr><tr><td></td><td></td><td>1</td></tr><tr><td></td><td></td><td>1</td></tr></table>			1			1			1	<table border="1"><tr><td>1</td><td></td><td>2</td></tr><tr><td></td><td></td><td>2</td></tr><tr><td></td><td></td><td></td></tr></table>	1		2			2				<table border="1"><tr><td></td><td></td><td></td></tr><tr><td></td><td></td><td></td></tr><tr><td></td><td></td><td></td></tr></table>										<table border="1"><tr><td></td><td></td><td></td></tr><tr><td></td><td></td><td></td></tr><tr><td></td><td></td><td></td></tr></table>																			
		2																																																																													
		1																																																																													
		1																																																																													
		1																																																																													
1		2																																																																													
		2																																																																													
Post - 0 Miss - 2 Block - 0	Post - 0 Miss - 0 Block - 0	Post - 0 Miss - 0 Block - 0	Post - 0 Miss - 2 Block - 0	Post - 0 Miss - 0 Block - 0	Post - 0 Miss - 1 Block - 0	Post - 0 Miss - 0 Block - 0	Post - 0 Miss - 0 Block - 0																																																																								



Team A A 山西队				Team B B 北京队				Match Number <b>6</b>			
-----------------	--	--	--	-----------------	--	--	--	--------------------------	--	--	--

Played in 重庆万州	in the hall 万州体育馆	on 2019-04-08	at 14:30	hours	Speakers
-------------------	----------------------	------------------	-------------	-------	----------

Half-time(30')	A 5	B 19	End of playing time	A 18	B 41	1st extra time	A	B	2nd extra time	A	B	After penalty throws	A	B
----------------	--------	---------	---------------------	---------	---------	----------------	---	---	----------------	---	---	----------------------	---	---

Number of 7 m	A 1/1	Team time-out			Full name of players and officials	Team time-out			B 3/3	Number of 7 m
	1	2	3	1		2	3			

No.	Team A	G	W	2'	D	DR	No.	Team B	G	W	2'	D	DR
1	鲁世豪						3	逯明松	4				
2	张智超	1		1			6	解建飞	1				
3	龙俊皓			1			7	马昌震	2				
4	刘文东	1		1			10	成亚	2				
5	王宇恒	3					11	赵文宣	2		1		
6	盖秀越	4					12	高云健					
7	任健豪	4					13	王军鸣	2				
9	辛浩乐						16	刘迈科					
10	王洋						18	傅俊雄	3				
11	吴夏冰		1				22	王超	2				
12	韩乐斌						23	王军程	7				
13	杜忠浩						25	王鹏皓	2				
14	杨毅	1			1		26	魏昂	3				
15	薛瑞寒	4					27	闫炳旗	5				
16	王虹翔						32	蒋维一	3		1		
18	张禹琛						33	陈旭	3				
A	张栋						A	郑永利 (主教练)					
B	赵鑫 (主教练)						B	孟辉					
C	霖配永						E	陈璇					

A	Signatures of responsables for the teams (Off.A)												B
---	--	--	--	--	--	--	--	--	--	--	--	--	---

TP	Remarks of referees / HF Official													TP
----	-----------------------------------	--	--	--	--	--	--	--	--	--	--	--	--	----

Referees	周云磊 (CHN)	伍豪 (CHN)		
T.D.	郭剑 (CHN)	张春生 (CHN)		
CHA Off.				

Note: Number of 7m Throws Awarded to Team A and B, Goals (G), Warnings (W), Suspensions (2'), Direct Disqualification (D), Disqualification With Report (DR) and Team Penalty (TP).

Table Officials: 周胜锋 陈常增 Statisticians: 赵悦 谢杨



## 2019年全国男子手球冠军杯赛

PHMS Pictorial Handball Match Statistics

IHF Official System

### 个人/全队技术统计表

手球 男子 预赛 轮次 2 组别 A 场次 6 万州体育馆 2019-04-08 14:30

号码	姓名	远射	近射	边射	快攻	突破	任意	七米	合计	%	助攻	失误	警告	2'	取消	时间
山西队(山西)																
(场上队员)																
1	鲁世豪									0.0%		1				00:41:36
2	张智超		1/2						1/2	50.0%				1		00:23:51
3	龙俊皓									0.0%				1		00:00:00
4	刘文东			1/2					1/2	50.0%				1		00:34:00
5	王宇恒	2/4	0/3			1/1			3/8	37.5%		2				00:39:00
6	盖秀越	0/1	1/1	1/3	1/1			1/1	4/7	57.1%		2				01:00:00
7	任健豪	1/2	2/2			1/1			4/5	80.0%	1	2				00:40:38
9	辛浩乐									0.0%						00:10:14
10	王洋		0/2	0/1					0/3	0.0%	1					00:44:17
11	吴夏冰		0/2						0/2	0.0%			1			00:25:59
12	韩乐斌									0.0%						00:18:24
13	杜忠浩	0/4	0/2			0/1			0/7	0.0%	2	2				00:39:06
14	杨毅	1/8							1/8	12.5%		1		1		00:20:59
15	薛瑞寒	1/3	2/4		0/1	1/1			4/9	44.4%		4				00:21:49
16	王虹翔									0.0%						00:00:00
18	张禹琛									0.0%						00:00:00
合计		5/22	6/18	2/6	1/2	3/4		1/1	18/53	34.0%	4	14	1	3	1	
(守门员)																
1	鲁世豪	1/4	3/13	1/3	0/8	0/4		0/3	5/35	14.3%		1				00:41:36
12	韩乐斌	0/4	0/2	0/2	0/2		0/1		0/11	0.0%						00:18:24
合计		1/8	3/15	1/5	0/10	0/4	0/1	0/3	5/46	10.9%		1				

场上队员：得分/射门

守门员：救球/射门

全队合计	得分	被救	射失	击柱	封球	合计	%
远射	5	3	4	3	7	22	22.7%
近射	6	6	4		2	18	33.3%
边射	2	2	1	1		6	33.3%
快攻	1	1				2	50.0%
突破	3		1			4	75.0%
任意							0.0%
七米	1					1	100.0%

## 2019年全国男子手球冠军杯赛

PHMS Pictorial Handball Match Statistics

IHF Official System

### 个人/全队技术统计表

手球男子 预赛轮次 2 组别 A 场次 6 万州体育馆 2019-04-08 14:30

号码	姓名	远射	近射	边射	快攻	突破	任意	七米	合计	%	助攻	失误	警告	2'	取消	时间
北京队(北京)																
(场上队员)																
3	逯明松	2/2		1/1		1/1			4/4	100%	1	1				00:25:18
6	解建飞					1/1			1/1	100%						00:13:08
7	马昌震	2/2							2/2	100%						00:15:39
10	成亚		0/1			2/2			2/3	66.7%	2	1				00:34:45
11	赵文宣		1/1			1/1			2/2	100%				1		00:16:24
12	高云健									0.0%						00:30:37
13	王军鸣							2/2	2/2	100%						00:17:40
16	刘迈科									0.0%	1					00:29:23
18	傅俊雄	1/1	1/1			1/1			3/3	100%	1					00:35:15
22	王超		2/2						2/2	100%		1				00:19:31
23	王军程	4/5				1/1	1/1	1/1	7/8	87.5%	1	1				00:29:11
25	王鹏皓		0/1	0/1	2/2				2/4	50.0%		2				00:25:14
26	魏昂		2/3	1/2					3/5	60.0%		1				00:40:26
27	闫炳旗		1/1	2/2	2/2				5/5	100%		1				00:34:43
32	蒋维一		2/3			1/1			3/4	75.0%		1		1		00:27:53
33	陈旭		1/3			1/1	1/1		3/5	60.0%	2	2				00:24:09
合计		7/8	12/18	4/6	10/10	4/4	1/1	3/3	41/50	82.0%	8	11		2		
(守门员)																
12	高云健	1/4	2/8	0/2	1/1	0/2		0/1	4/18	22.2%						00:30:37
16	刘迈科	2/4	4/4	2/2	0/1	0/1			8/12	66.7%	1					00:29:23
合计		3/8	6/12	2/4	1/2	0/3		0/1	12/30	40.0%	1					

场上队员：得分/射门

守门员：救球/射门

全队合计	得分	被救	射失	击柱	封球	合计	%
远射	7	1				8	87.5%
近射	12	3	2	1		18	66.7%
边射	4	1		1		6	66.7%
快攻	10					10	100.0%
突破	4					4	100.0%
任意	1					1	100.0%
七米	3					3	100.0%



图式比赛技术统计表

手球  
男子

预赛  
轮次 2

组别 A  
场次 6

万州体育馆  
2019-04-08 14:30

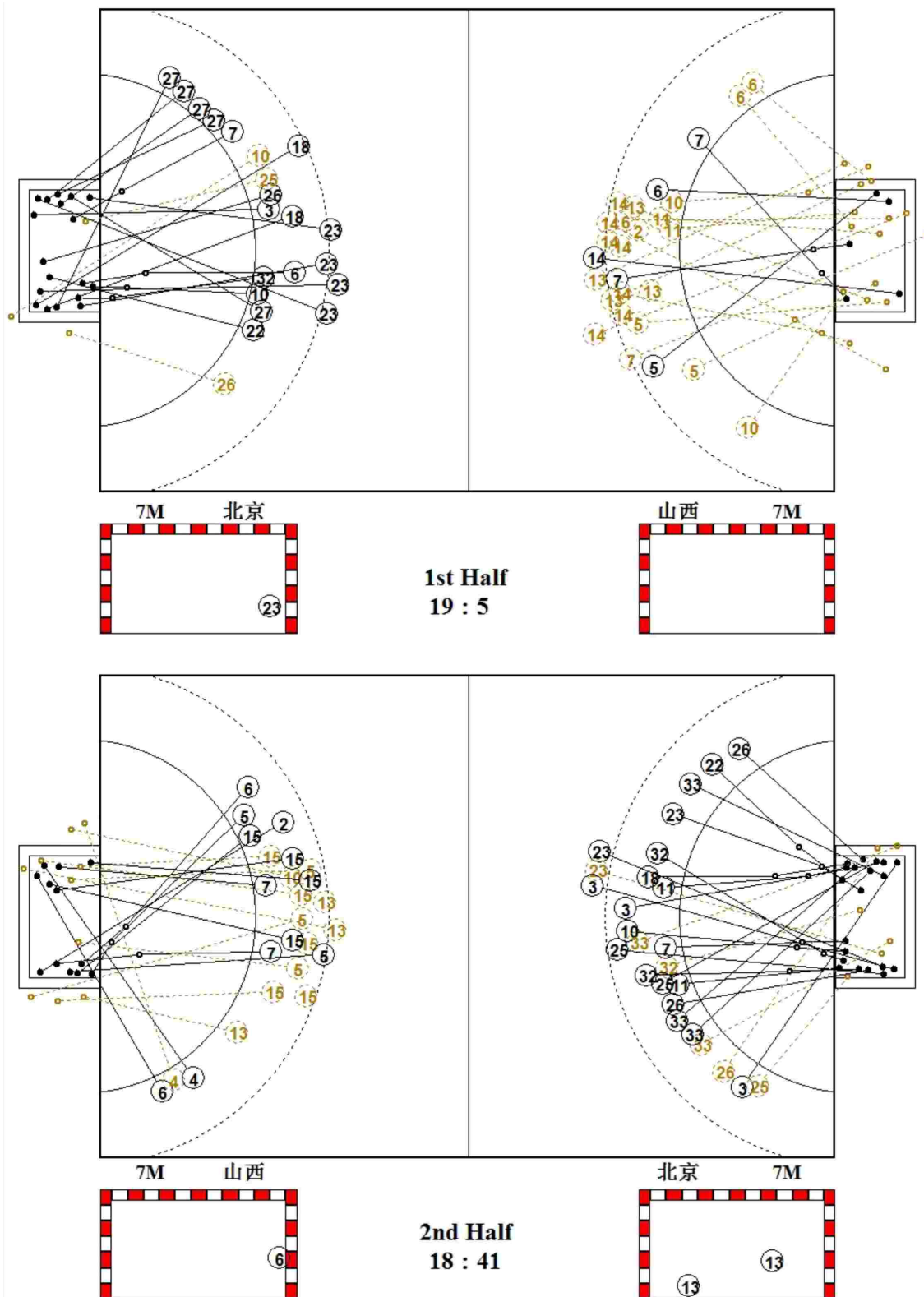

图式射门区域统计

手球  
男子

预赛  
轮次 2

组别 A  
场次 6

万州体育馆  
2019-04-08 14:30

山西队

1 鲁世豪 Post - 0 Miss - 0 Block - 0	2 张智超 Post - 0 Miss - 0 Block - 1	3 龙俊皓 Post - 0 Miss - 0 Block - 0	4 刘文东 Post - 0 Miss - 1 Block - 0	5 王宇恒 Post - 0 Miss - 1 Block - 0	6 盖秀越 Post - 1 Miss - 0 Block - 0	7 任健豪 Post - 0 Miss - 1 Block - 0	9 辛浩乐 Post - 0 Miss - 0 Block - 0
10 王洋 Post - 0 Miss - 2 Block - 0	11 吴夏冰 Post - 0 Miss - 0 Block - 0	12 韩乐斌 Post - 0 Miss - 0 Block - 0	13 杜忠浩 Post - 2 Miss - 2 Block - 2	14 杨毅 Post - 1 Miss - 2 Block - 4	15 薛瑞寒 Post - 0 Miss - 1 Block - 2	16 王虹翔 Post - 0 Miss - 0 Block - 0	18 张禹琛 Post - 0 Miss - 0 Block - 0

1 鲁世豪		
0/5	2/6	
0/4	1/2	0/6
0/6		2/6

12 韩乐斌		
0/2	0/1	0/2
0/1		0/1
0/3		0/1

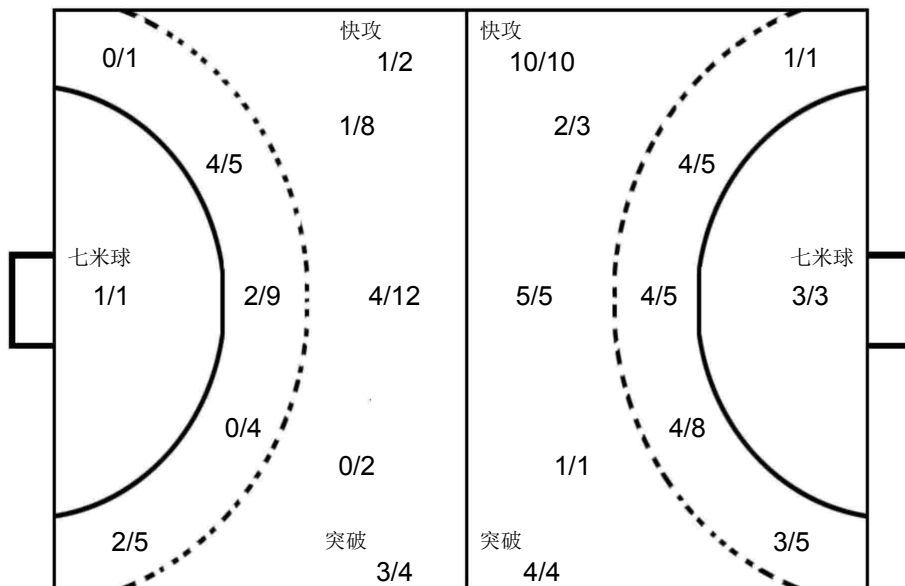

12 高云健	
0/1	1/4
0/3	1/4
1/4	1/2

16 刘迈科		
1/2	1/2	
	1/1	2/2
2/2	0/1	1/2

北京队

3 逯明松 Post - 0 Miss - 0 Block - 0	6 解建飞 Post - 0 Miss - 0 Block - 0	7 马昌震 Post - 0 Miss - 0 Block - 0	10 成亚 Post - 0 Miss - 1 Block - 0	11 赵文宣 Post - 0 Miss - 0 Block - 0	12 高云健 Post - 0 Miss - 0 Block - 0	13 王军鸣 Post - 0 Miss - 0 Block - 0	16 刘迈科 Post - 0 Miss - 0 Block - 0
18 傅俊雄 Post - 0 Miss - 0 Block - 0	22 王超 Post - 0 Miss - 0 Block - 0	23 王军程 Post - 0 Miss - 0 Block - 0	25 王鹏皓 Post - 0 Miss - 0 Block - 0	26 魏昂 Post - 1 Miss - 1 Block - 0	27 闫炳旗 Post - 0 Miss - 0 Block - 0	32 蒋维一 Post - 0 Miss - 0 Block - 0	33 陈旭 Post - 1 Miss - 0 Block - 0



Team A	Team B	Match Number
A 上海队	B 江苏队	<b>7</b>

Played in	in the hall	on	at	Spepectors
重庆万州	万州体育馆	2019-04-08	16:00	hours

Half-time(30')	A	B	End of playing time	A	B	1st extra time	A	B	2nd extra time	A	B	After penalty throws	A	B
	10	16		18	39									

Number of 7 m	A	Team time-out			Full name of players and officials	Team time-out			B	Number of 7 m
	1/2	1	2	3		1	2	3	3/4	
		14:28	44:56			23:09	40:42			

No.	Team A	G	W	2'	D	DR	No.	Team B	G	W	2'	D	DR
1	张峥						1	宋继强					
3	张立成						3	周悦骅					
4	高天伦						4	张家纬	3				
5	贺政	4					6	赵晨	4				
7	周文龙	3					7	周傲	4				
8	高震东	4	1				8	谢庆龙	3				
10	朱世杰	6					11	张天豪	1				
11	蒋慧捷						12	王权					
15	庄旭杰						16	张帅					
16	张逸豪						18	赵楠	3				
18	董凯		1				19	庞连康	5				
23	吴双						20	顾艳超	2	1			
30	徐俊吉	1					21	刘江	5		1		
							25	王杰缘	6				
							27	王伟强	3				
							30	吴龙瑞					
A	吴璟 (主教练)						A	闫威名 (主教练)					
B	金迪琦						B	叶强					
C	张勇军						C	贾淑君					
							E	王建国					

A	Signatures of responsables for the teams (Off.A)	B
---	--	---

TP	Remarks of referees / HF Official	TP

Signatures			
Referees	鲍瑀 (CHN)	刘宇阳 (CHN)	
T.D.	李之文 (CHN)	倪震 (CHN)	
CHA Off.			

Note: Number of 7m Throws Awarded to Team A and B, Goals (G), Warnings (W), Suspensions (2'), Direct Disqualification (D), Disqualification With Report (DR) and Team Penalty (TP).

Table Officials: 张之伟                      康曦                      Statisticians: 谢杨                      周亚桥

## 2019年全国男子手球冠军杯赛

**PHMS** Pictorial Handball Match Statistics

**IHF** Official System

### 竞赛技术统计

手球 男子	预赛 轮次 2	组别 B 场次 7	万州体育馆 2019-04-08 16:00
----------	------------	--------------	---------------------------

Referees: 鲍瑀 (CHN) / 刘宇阳 (CHN)	Result: 18:39(10:16)
--------------------------------	----------------------

Teams: 上海队(上海) VS 江苏队(江苏)
---------------------------

上海		远	近	边	快	突	任意	7m	合计	%	助攻	失误	警告	2'	D+DR
主教练: 吴璟		射	射	射	攻	破	球	球							
1	张峥														
3	张立成		0/1		0/1				0/2	0.0		3			
4	高天伦														
5	贺政	1/7	1/4	1/1		1/2			4/14	28.6		2			
7	周文龙	1/5	0/4			2/3			3/12	25.0	1	2			
8	高震东	0/1	0/1	3/4	1/1				4/7	57.1	1	1	1		
10	朱世杰	3/5	2/4			1/1		0/1	6/11	54.5	2	6			
11	蒋慧捷			0/1					0/1	0.0					
15	庄旭杰														
16	张逸豪														
18	董凯		0/1						0/1	0.0			1		
23	吴双														
30	徐俊吉		0/2					1/1	1/3	33.3		2			
运动员 合计		5/18	3/17	4/6	1/2	4/6		1/2	18/51	35.3	4	16	2		
1	张峥	1/6	4/12	1/5	2/6	1/7		0/3	9/39	23.1					
16	张逸豪		0/5	0/1	0/2	1/2		1/1	2/11	18.2					
守门员 合计		1/6	4/17	1/6	2/8	2/9		1/4	11/50	22.0					

江苏		远	近	边	快	突	任意	7m	合计	%	助攻	失误	警告	2'	D+DR
主教练: 闫威名		射	射	射	攻	破	球	球							
1	宋继强														
3	周悦骅														
4	张家纬	2/2	0/1		0/1	1/1			3/5	60.0		1			
6	赵晨	2/3	1/1			1/1			4/5	80.0	4				
7	周傲		1/1		1/1	1/2		1/1	4/5	80.0	1				
8	谢庆龙		2/3			1/1			3/4	75.0	1	2			
11	张天豪			1/1					1/1	100		1			
12	王权											1			
16	张帅														
18	赵楠		1/2	1/2	1/2				3/6	50.0	1				
19	庞连康	0/1	3/3			2/2			5/6	83.3	1	1			
20	顾艳超	1/1	0/1			1/2			2/4	50.0	1	1	1		
21	刘江		4/5		1/1				5/6	83.3		1		1	
25	王杰缘		1/1	3/4				2/2	6/7	85.7	1	1			
27	王伟强			0/2	3/4				3/6	50.0		1			
30	吴龙瑞					0/1		0/1	0/2	0.0	1	1			
运动员 合计		5/7	13/18	5/9	6/9	7/10		3/4	39/57	68.4	11	11	1	1	
1	宋继强	1/1	3/4	1/1					5/6	83.3					
12	王权	2/3	5/7	1/4		1/4		1/2	10/20	50.0		1			
16	张帅	2/6	1/1	0/1	1/2	0/1			4/11	36.4					
守门员 合计		5/10	9/12	2/6	1/2	1/5		1/2	19/37	51.4		1			

上海	比赛 进程	江苏
1st Half		
0	00:38	1 20 顾艳超
5	贺政 1 01:23	1
7	周文龙 2 02:24	1
2	03:12	2 25 王杰缘
5	贺政 3 03:57	2
3	06:00	3 6 赵晨
3	07:41	4 25 王杰缘
10	朱世杰 4 08:28	4
4	10:44	5 8 谢庆龙
4	12:08	6 8 谢庆龙
4	13:17	7 20 顾艳超
4	14:13	8 25 王杰缘
4	15:36	9 27 王伟强
30	徐俊吉 5 16:57	9
5	17:12	10 8 谢庆龙
5	18:08	11 4 张家纬
10	朱世杰 6 20:10	11
8	高震东 7 21:21	11
7	21:38	12 6 赵晨
7	22:25	13 4 张家纬
7	23:34	14 21 刘江
8	高震东 8 24:14	14
8	25:26	15 18 赵楠
7	周文龙 9 26:03	15
5	贺政 10 27:37	15
10	28:30	16 11 张天豪
2nd Half		
10	01:06	17 27 王伟强
10	02:04	18 25 王杰缘
10	03:23	18
11	04:06	19 25 王杰缘
10	05:05	19
12	05:13	20 25 王杰缘
12	06:32	21 4 张家纬
10	07:32	21
13	07:46	22 6 赵晨
13	08:57	23 27 王伟强
13	09:33	24 6 赵晨
8	高震东 14 10:35	24
14	11:05	25 19 庞连康
14	12:08	26 19 庞连康
5	贺政 15 12:35	26
7	周文龙 16 13:39	26
16	14:01	27 21 刘江
8	高震东 17 15:49	27
17	18:35	28 7 周傲
17	19:15	29 21 刘江
17	19:59	30 19 庞连康
17	21:00	31 21 刘江
10	朱世杰 18 21:54	31
18	22:06	32 19 庞连康
18	22:52	33 18 赵楠
18	24:34	34 21 刘江
18	25:24	35 7 周傲
18	26:41	36 7 周傲
18	28:08	37 19 庞连康
18	29:09	38 7 周傲
18	29:39	39 18 赵楠

场上队员: 得分 / 射门

守门员: 救球 / 射门

D	取消资格	DR	取消资格+报告
---	------	----	---------



2019年全国男子手球冠军杯赛

PHMS Pictorial Handball Match Statistics

IHF Official System

个人/全队技术统计表

手球 男子 预赛 轮次 2 组别 B 场次 7 万州体育馆 2019-04-08 16:00

号码	姓名	远射	近射	边射	快攻	突破	任意	七米	合计	%	助攻	失误	警告	2'	取消	时间
上海队(上海)																
(场上队员)																
1	张崢									0.0%						00:50:17
3	张立成		0/1		0/1				0/2	0.0%		3				00:22:07
4	高天伦									0.0%						00:05:34
5	贺政	1/7	1/4	1/1		1/2			4/14	28.6%		2				01:00:00
7	周文龙	1/5	0/4			2/3			3/12	25.0%	1	2				00:48:48
8	高震东	0/1	0/1	3/4	1/1				4/7	57.1%	1	1	1			01:00:00
10	朱世杰	3/5	2/4			1/1		0/1	6/11	54.5%	2	6				01:00:00
11	蒋慧捷			0/1					0/1	0.0%						00:40:36
15	庄旭杰									0.0%						00:02:35
16	张逸豪									0.0%						00:09:43
18	董凯		0/1						0/1	0.0%			1			00:18:33
23	吴双									0.0%						00:00:00
30	徐俊吉		0/2					1/1	1/3	33.3%		2				00:41:24
合计		5/18	3/17	4/6	1/2	4/6		1/2	18/51	35.3%	4	16	2			
(守门员)																
1	张崢	1/6	4/12	1/5	2/6	1/7		0/3	9/39	23.1%						00:50:17
16	张逸豪		0/5	0/1	0/2	1/2		1/1	2/11	18.2%						00:09:43
合计		1/6	4/17	1/6	2/8	2/9		1/4	11/50	22.0%						

场上队员： 得分/射门

守门员： 救球/射门

全队合计	得分	被救	射失	击柱	封球	合计	%
远射	5	5	2	1	5	18	27.8%
近射	3	9	3	1	1	17	17.6%
边射	4	2				6	66.7%
快攻	1	1				2	50.0%
突破	4	1		1		6	66.7%
任意							0.0%
七米	1	1				2	50.0%

2019年全国男子手球冠军杯赛

PHMS Pictorial Handball Match Statistics

IHF Official System

个人/全队技术统计表

手球 男子 预赛 轮次 2 组别 B 场次 7 万州体育馆 2019-04-08 16:00

号码	姓名	远射	近射	边射	快攻	突破	任意	七米	合计	%	助攻	失误	警告	2'	取消	时间
江苏队(江苏)																
(场上队员)																
1	宋继强									0.0%						00:11:32
3	周悦骅									0.0%						00:00:00
4	张家纬	2/2	0/1		0/1	1/1			3/5	60.0%		1				00:33:51
6	赵晨	2/3	1/1			1/1			4/5	80.0%	4					00:33:51
7	周傲		1/1		1/1	1/2		1/1	4/5	80.0%	1					00:19:14
8	谢庆龙		2/3			1/1			3/4	75.0%	1	2				00:34:00
11	张天豪			1/1					1/1	100%		1				00:25:22
12	王权									0.0%		1				00:30:00
16	张帅									0.0%						00:18:28
18	赵楠		1/2	1/2	1/2				3/6	50.0%	1					00:23:38
19	庞连康	0/1	3/3			2/2			5/6	83.3%	1	1				00:25:55
20	顾艳超	1/1	0/1			1/2			2/4	50.0%	1	1	1			00:35:19
21	刘江		4/5		1/1				5/6	83.3%		1		1		00:26:04
25	王杰缘		1/1	3/4				2/2	6/7	85.7%	1	1				00:43:12
27	王伟强			0/2	3/4				3/6	50.0%		1				00:34:08
30	吴龙瑞					0/1		0/1	0/2	0.0%	1	1				00:25:07
	合计	5/7	13/18	5/9	6/9	7/10		3/4	39/57	68.4%	11	11	1	1		

(守门员)

1	宋继强	1/1	3/4	1/1					5/6	83.3%						00:11:32
12	王权	2/3	5/7	1/4		1/4		1/2	10/20	50.0%		1				00:30:00
16	张帅	2/6	1/1	0/1	1/2	0/1			4/11	36.4%						00:18:28
	合计	5/10	9/12	2/6	1/2	1/5		1/2	19/37	51.4%		1				

场上队员：得分/射门

守门员：救球/射门

全队合计	得分	被救	射失	击柱	封球	合计	%
远射	5	1			1	7	71.4%
近射	13	4	1			18	72.2%
边射	5	1		3		9	55.6%
快攻	6	2		1		9	66.7%
突破	7	2	1			10	70.0%
任意							0.0%
七米	3	1				4	75.0%

图式比赛技术统计表

手球  
男子

预赛  
轮次 2

组别 B  
场次 7

万州体育馆  
2019-04-08 16:00

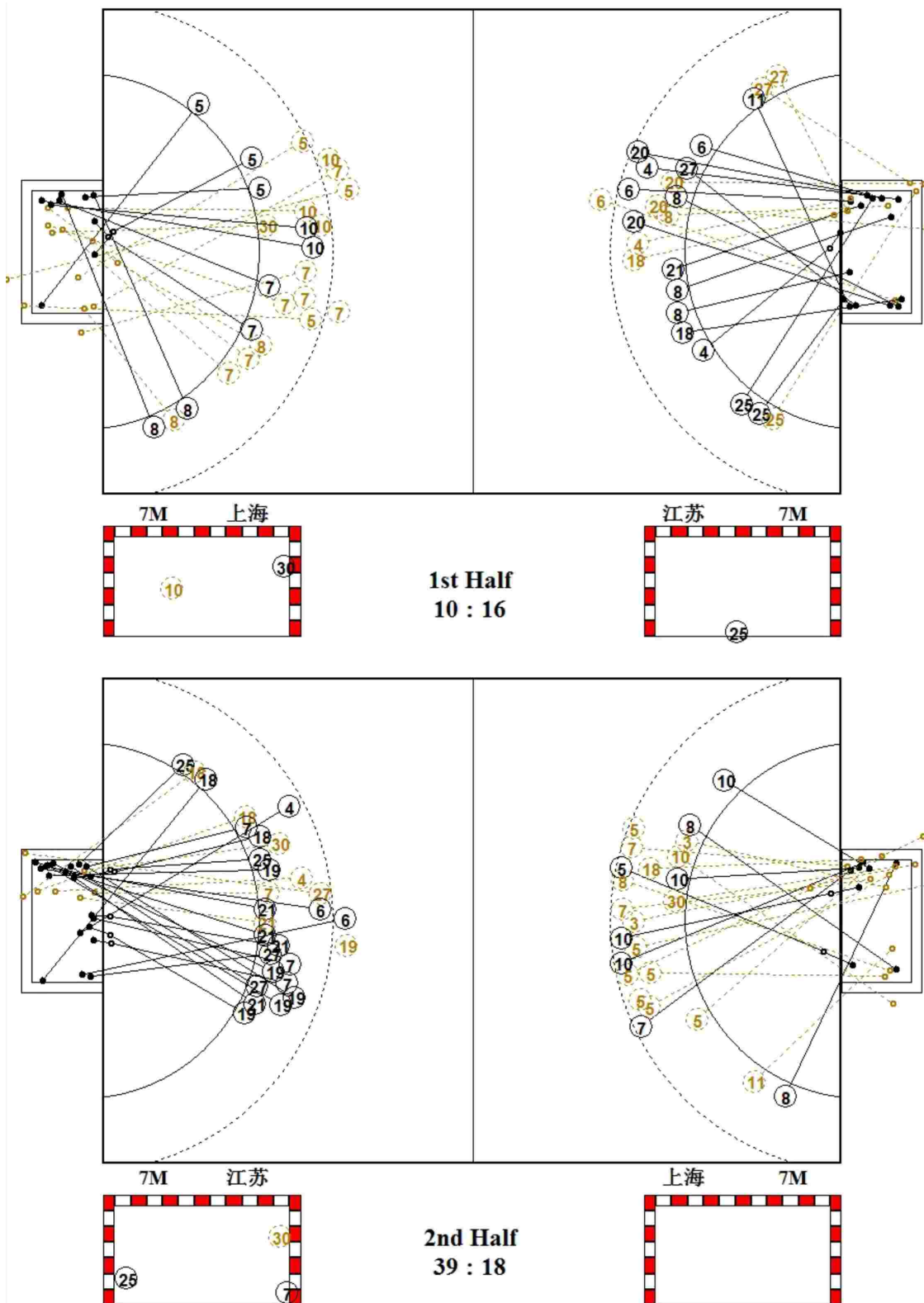

图式射门区域统计

手球  
男子

预赛  
轮次 2

组别 B  
场次 7

万州体育馆  
2019-04-08 16:00

上海队

1 张峥	3 张立成	4 高天伦	5 贺政	7 周文龙	8 高震东	10 朱世杰	11 蒋慧捷																																																																								
<table border="1"><tr><td></td><td></td><td></td></tr><tr><td></td><td></td><td></td></tr><tr><td></td><td></td><td></td></tr></table>										<table border="1"><tr><td></td><td></td><td></td></tr><tr><td></td><td></td><td></td></tr><tr><td></td><td></td><td></td></tr></table>										<table border="1"><tr><td></td><td></td><td></td></tr><tr><td></td><td></td><td></td></tr><tr><td></td><td></td><td></td></tr></table>										<table border="1"><tr><td>1</td><td></td><td></td></tr><tr><td></td><td></td><td></td></tr><tr><td></td><td>1</td><td>2</td></tr></table>	1							1	2	<table border="1"><tr><td></td><td></td><td></td></tr><tr><td></td><td></td><td>1</td></tr><tr><td>1</td><td></td><td>1</td></tr></table>						1	1		1	<table border="1"><tr><td>1</td><td></td><td>1</td></tr><tr><td></td><td></td><td>1</td></tr><tr><td></td><td></td><td>1</td></tr></table>	1		1			1			1	<table border="1"><tr><td></td><td></td><td>2</td></tr><tr><td>1</td><td></td><td></td></tr><tr><td>3</td><td></td><td></td></tr></table>			2	1			3			<table border="1"><tr><td></td><td></td><td></td></tr><tr><td></td><td></td><td></td></tr><tr><td></td><td></td><td></td></tr></table>									
1																																																																															
	1	2																																																																													
		1																																																																													
1		1																																																																													
1		1																																																																													
		1																																																																													
		1																																																																													
		2																																																																													
1																																																																															
3																																																																															
Post - 0 Miss - 0 Block - 0	Post - 1 Miss - 0 Block - 0	Post - 0 Miss - 0 Block - 0	Post - 2 Miss - 3 Block - 2	Post - 0 Miss - 1 Block - 2	Post - 0 Miss - 0 Block - 0	Post - 0 Miss - 1 Block - 2	Post - 0 Miss - 0 Block - 0																																																																								
15 庄旭杰	16 张逸豪	18 董凯	23 吴双	30 徐俊吉																																																																											
<table border="1"><tr><td></td><td></td><td></td></tr><tr><td></td><td></td><td></td></tr><tr><td></td><td></td><td></td></tr></table>										<table border="1"><tr><td></td><td></td><td></td></tr><tr><td></td><td></td><td></td></tr><tr><td></td><td></td><td></td></tr></table>										<table border="1"><tr><td></td><td></td><td></td></tr><tr><td></td><td></td><td></td></tr><tr><td></td><td></td><td></td></tr></table>										<table border="1"><tr><td></td><td></td><td></td></tr><tr><td></td><td></td><td></td></tr><tr><td></td><td></td><td></td></tr></table>										<table border="1"><tr><td></td><td></td><td>1</td></tr><tr><td></td><td></td><td></td></tr><tr><td></td><td></td><td></td></tr></table>			1																																				
		1																																																																													
Post - 0 Miss - 0 Block - 0	Post - 0 Miss - 0 Block - 0	Post - 0 Miss - 0 Block - 0	Post - 0 Miss - 0 Block - 0	Post - 0 Miss - 0 Block - 0																																																																											

1 张峥

1/3		3/11
0/4		0/2
3/7	0/5	2/7

16 张逸豪

0/1		1/2
		0/2
	0/3	1/3

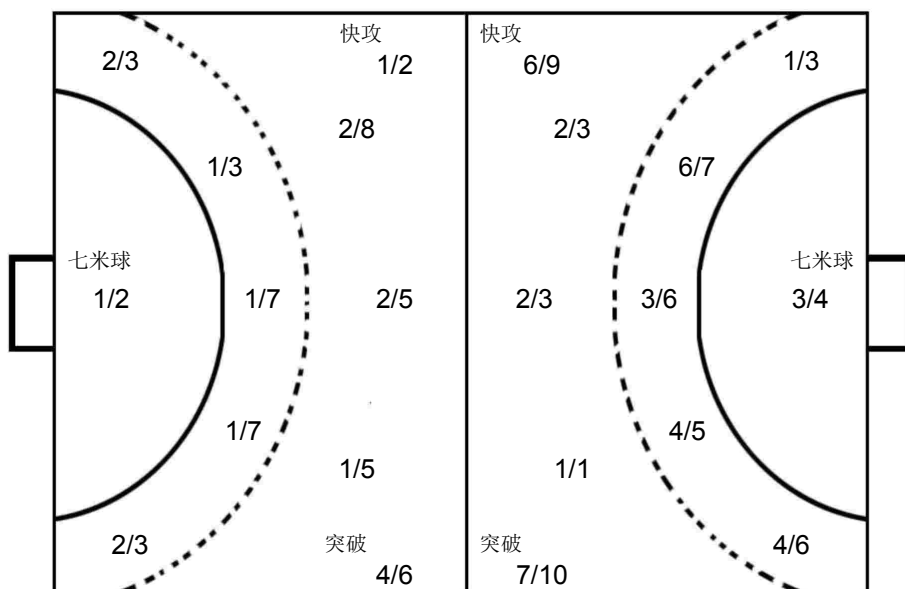

1 宋继强

2/2		2/2
0/1		
1/1		

12 王权

0/1	1/1	2/5
2/2		2/4
2/2	1/2	0/3

16 张帅

0/1		0/1
2/2		1/1
1/5		0/1

江苏队

1 宋继强	3 周悦骅	4 张家纬	6 赵晨	7 周傲	8 谢庆龙	11 张天豪	12 王权																																																																								
<table border="1"><tr><td></td><td></td><td></td></tr><tr><td></td><td></td><td></td></tr><tr><td></td><td></td><td></td></tr></table>										<table border="1"><tr><td></td><td></td><td></td></tr><tr><td></td><td></td><td></td></tr><tr><td></td><td></td><td></td></tr></table>										<table border="1"><tr><td>1</td><td></td><td></td></tr><tr><td></td><td></td><td></td></tr><tr><td></td><td>2</td><td></td></tr></table>	1							2		<table border="1"><tr><td></td><td></td><td>1</td></tr><tr><td>1</td><td></td><td></td></tr><tr><td>2</td><td></td><td></td></tr></table>			1	1			2			<table border="1"><tr><td></td><td></td><td></td></tr><tr><td></td><td></td><td></td></tr><tr><td>2</td><td>2</td><td></td></tr></table>							2	2		<table border="1"><tr><td>1</td><td></td><td>1</td></tr><tr><td></td><td></td><td></td></tr><tr><td></td><td>1</td><td></td></tr></table>	1		1					1		<table border="1"><tr><td></td><td></td><td></td></tr><tr><td></td><td></td><td></td></tr><tr><td></td><td></td><td>1</td></tr></table>									1	<table border="1"><tr><td></td><td></td><td></td></tr><tr><td></td><td></td><td></td></tr><tr><td></td><td></td><td></td></tr></table>									
1																																																																															
	2																																																																														
		1																																																																													
1																																																																															
2																																																																															
2	2																																																																														
1		1																																																																													
	1																																																																														
		1																																																																													
Post - 0 Miss - 0 Block - 0	Post - 0 Miss - 0 Block - 0	Post - 0 Miss - 0 Block - 0	Post - 0 Miss - 0 Block - 0	Post - 0 Miss - 0 Block - 0	Post - 0 Miss - 0 Block - 0	Post - 0 Miss - 0 Block - 0	Post - 0 Miss - 0 Block - 0																																																																								
16 张帅	18 赵楠	19 庞连康	20 顾艳超	21 刘江	25 王杰缘	27 王伟强	30 吴龙瑞																																																																								
<table border="1"><tr><td></td><td></td><td></td></tr><tr><td></td><td></td><td></td></tr><tr><td></td><td></td><td></td></tr></table>										<table border="1"><tr><td>1</td><td></td><td>1</td></tr><tr><td></td><td></td><td>1</td></tr><tr><td></td><td></td><td></td></tr></table>	1		1			1				<table border="1"><tr><td></td><td></td><td>3</td></tr><tr><td></td><td></td><td></td></tr><tr><td></td><td>1</td><td>1</td></tr></table>			3					1	1	<table border="1"><tr><td></td><td></td><td>1</td></tr><tr><td>1</td><td></td><td></td></tr><tr><td></td><td></td><td></td></tr></table>			1	1						<table border="1"><tr><td></td><td></td><td>2</td></tr><tr><td></td><td></td><td>1</td></tr><tr><td>1</td><td>1</td><td></td></tr></table>			2			1	1	1		<table border="1"><tr><td>2</td><td></td><td>1</td></tr><tr><td></td><td>1</td><td>2</td></tr><tr><td></td><td></td><td></td></tr></table>	2		1		1	2				<table border="1"><tr><td></td><td></td><td></td></tr><tr><td></td><td></td><td>1</td></tr><tr><td>1</td><td></td><td>1</td></tr></table>						1	1		1	<table border="1"><tr><td></td><td></td><td></td></tr><tr><td></td><td></td><td></td></tr><tr><td></td><td></td><td></td></tr></table>									
1		1																																																																													
		1																																																																													
		3																																																																													
	1	1																																																																													
		1																																																																													
1																																																																															
		2																																																																													
		1																																																																													
1	1																																																																														
2		1																																																																													
	1	2																																																																													
		1																																																																													
1		1																																																																													
Post - 0 Miss - 0 Block - 0	Post - 1 Miss - 0 Block - 0	Post - 0 Miss - 0 Block - 1	Post - 0 Miss - 2 Block - 0	Post - 0 Miss - 0 Block - 0	Post - 1 Miss - 0 Block - 0	Post - 2 Miss - 0 Block - 0	Post - 0 Miss - 0 Block - 0																																																																								





Team A A 四川队	Team B B 天津队	Match Number <b>8</b>
-----------------	-----------------	--------------------------

Played in 重庆万州	in the hall 万州体育馆	on 2019-04-08	at 17:30	hours	Spectators
-------------------	----------------------	------------------	-------------	-------	------------

Half-time(30')	A 9	B 17	End of playing time	A 18	B 35	1st extra time	A	B	2nd extra time	A	B	After penalty throws	A	B
----------------	--------	---------	---------------------	---------	---------	----------------	---	---	----------------	---	---	----------------------	---	---

Number of 7 m	A 1/2	Team time-out			Full name of players and officials	Team time-out			B 4/4	Number of 7 m
	1 24:10	2 38:02	3 57:27	1 20:18		2 44:02	3			

No.	Team A	G	W	2'	D	DR	No.	Team B	G	W	2'	D	DR
2	张宏运		1	1			1	何喜年					
3	李朗轩	1					3	魏雨童	3	1			
6	董佳辉	4		2			4	刘雪东	3				
7	曾繁泳	2		1			5	王毅	5				
8	罗霖泽	5					6	赵晨阳	2				
9	左典	5					7	张青	5				
10	李剑琛	1					8	王晓琪	5				
12	戴景伟						9	王子欣	1				
14	洗鹏飞						10	苏尧	5		1		
17	叶康全						11	吴明远					
							13	许松	1				
							14	王维先	2		1		
							15	周群	2				
							16	刘宗其					
							20	张闻乾	1				
							86	田剑侠		1			
A	李中洲						A	贾守信	1				
B	王伟 (主教练)						B	杜瑞军 (主教练)					
C	张广建						D	李志成					
							E	王文龙					

A	Signatures of responsables for the teams (Off.A)	B
---	--	---

TP	Remarks of referees / HF Official	TP
----	-----------------------------------	----

Signatures			
Referees	刘明华 (CHN)	张晓虎 (CHN)	
T.D.	吴国忠 (CHN)	倪震 (CHN)	
CHA Off.			

Note: Number of 7m Throws Awarded to Team A and B, Goals (G), Warnings (W), Suspensions (2'), Direct Disqualification (D), Disqualification With Report (DR) and Team Penalty (TP).

Table Officials: 周胜锋      陈常增      Statisticians: 周亚桥      谢杨

## 竞赛技术统计

手球  
男子

预赛  
轮次 2

组别 B  
场次 8

万州体育馆  
2019-04-08 17:30

Referees:	刘明华 (CHN) / 张晓虎 (CHN)	Result:	18:35 (9:17)
Teams:	四川队(四川) VS 天津队(天津)		

四川														比赛进程																											
主教练: 王伟														四川														天津													
远射	近射	边射	快攻	突破	任意球	7m球	合计	%	助攻	失误	警告	2'	D+DR	Ist Half																											
2		0/1					0/1	0.0		2	1	1			0	01:11	1	5	王毅																						
3	0/2		1/1				1/3	33.3		1					0	02:37	2	9	王子欣																						
6	0/7	1/1		2/2	1/1		4/12	33.3				2			0	04:23	3	7	张青																						
7			0/1	2/2			2/3	66.7				1			6	05:58																									
8			4/7	1/2			5/9	55.6	1	5					2	06:57	4	13	许松																						
9	1/3	1/1	0/1		3/4		5/9	55.6		6					2	08:55	5	7	张青																						
10		0/1	0/1				1/1	1/3	33.3						2	10:32	6	8	王晓琪																						
12															2	11:40	7	7	张青																						
14															8	12:26	8	3	魏雨童																						
17															9	13:01	8																								
<b>运动员 合计</b>	<b>1/12</b>	<b>2/4</b>	<b>4/10</b>	<b>6/7</b>	<b>4/5</b>	<b>1/2</b>	<b>18/40</b>	<b>45.0</b>	<b>3</b>	<b>21</b>	<b>1</b>	<b>4</b>			9	13:35	8																								
12	0/3	3/9	0/1	0/3	1/6	0/1	4/24	16.7		1	2				5	14:02	9	7	张青																						
17	2/3	0/2	0/1	0/6	0/2		2/17	11.8							8	14:31	9																								
<b>守门员 合计</b>	<b>2/6</b>	<b>3/11</b>	<b>0/2</b>	<b>0/9</b>	<b>1/8</b>	<b>0/1</b>	<b>6/41</b>	<b>14.6</b>	<b>1</b>	<b>2</b>					6	15:00	10	3	魏雨童																						
<b>天津</b>														<b>2nd Half</b>																											
主教练: 杜瑞军														四川														天津													
远射	近射	边射	快攻	突破	任意球	7m球	合计	%	助攻	失误	警告	2'	D+DR	Ist Half																											
1															9	25:07	14																								
3		3/4					3/4	75.0				1			9	25:23	15	10	苏尧																						
4		1/1			1/1		1/1	100		1					9	28:13	16	5	王毅																						
5	1/1	1/1			2/2		1/1	100							9	29:26	17	14	王维先																						
6				1/1	1/1		2/2	100							9	01:08	18	15	周群																						
7	0/1	1/1		1/1	1/1		2/2	83.3	1	1					9	01:41	19	15	周群																						
8	2/2	0/1	0/1	1/1	1/1	1/1	5/7	71.4							9	02:58	20	10	苏尧																						
9			0/1	1/1	0/1		1/3	33.3	1	2					9	05:40	21	10	苏尧																						
10	1/1	1/1		2/2	1/1		5/5	100	1	3		1			9	06:35	22	7	张青																						
11															10	08:32	22																								
13			1/2	0/1			1/3	33.3				1			10	08:56	23	8	王晓琪																						
14		0/2		2/2			2/4	50.0							10	09:21	24	20	张闻乾																						
15		1/1		1/1			2/2	100							9	10:16	24																								
16															9	11:20	24																								
20		0/1	1/1				1/2	50.0		1					12	11:24	25	4	刘雪东																						
86	0/1						0/1	0.0	1	2	1				6	12:02	25																								
<b>运动员 合计</b>	<b>4/6</b>	<b>8/13</b>	<b>2/5</b>	<b>9/10</b>	<b>7/8</b>	<b>1/1</b>	<b>4/4</b>	<b>35/47</b>	<b>74.5</b>	<b>5</b>	<b>14</b>	<b>2</b>	<b>2</b>		13	13:05	26	8	王晓琪																						
1	5/5	1/3	1/3	0/4	0/1		7/16	43.8							9	13:09	26																								
16	2/3	1/1	1/3	1/3	0/3		1/2	6/15	40.0	1					7	15:52	26																								
<b>守门员 合计</b>	<b>7/8</b>	<b>2/4</b>	<b>2/6</b>	<b>1/7</b>	<b>0/4</b>	<b>1/2</b>	<b>13/31</b>	<b>41.9</b>	<b>1</b>						15	18:07	27	10	苏尧																						
															15	18:55	28	8	王晓琪																						
															15	19:56	29	6	赵晨阳																						
															15	21:26	30	14	王维先																						
															8	22:00	30																								
															16	23:29	31	4	刘雪东																						
															8	25:06	31																								
															17	25:50	32	8	王晓琪																						
															10	26:23	32																								
															18	26:44	33	10	苏尧																						
															18	28:54	34	4	刘雪东																						
															18	29:50	35	6	赵晨阳																						

场上队员: 得分 / 射门

守门员: 救球 / 射门

D	取消资格	DR	取消资格+报告
---	------	----	---------

2019年全国男子手球冠军杯赛

PHMS Pictorial Handball Match Statistics

IHF Official System

个人/全队技术统计表

手球 男子 预赛 轮次 2 组别 B 场次 8 万州体育馆 2019-04-08 17:30

号码	姓名	远射	近射	边射	快攻	突破	任意	七米	合计	%	助攻	失误	警告	2'	取消	时间
四川队(四川)																
(场上队员)																
2	张宏运		0/1						0/1	0.0%		2	1	1		00:46:33
3	李朗轩	0/2			1/1				1/3	33.3%	1					00:52:29
6	董佳辉	0/7	1/1		2/2	1/1		0/1	4/12	33.3%				2		01:01:15
7	曾繁泳			0/1	2/2				2/3	66.7%		2		1		01:00:00
8	罗霖泽			4/7	1/2				5/9	55.6%	1	5				00:53:27
9	左典	1/3	1/1	0/1		3/4			5/9	55.6%		6				00:47:38
10	李剑琛		0/1	0/1				1/1	1/3	33.3%						00:20:17
12	戴景伟									0.0%	1	2				00:40:56
14	洗鹏飞									0.0%	1	3				00:30:14
17	叶康全									0.0%						00:19:24
合计		1/12	2/4	4/10	6/7	4/5		1/2	18/40	45.0%	3	21	1	4		
(守门员)																
12	戴景伟	0/3	3/9	0/1	0/3	1/6	0/1	0/1	4/24	16.7%	1	2				00:40:56
17	叶康全	2/3	0/2	0/1	0/6	0/2		0/3	2/17	11.8%						00:19:24
合计		2/6	3/11	0/2	0/9	1/8	0/1	0/4	6/41	14.6%	1	2				

场上队员：得分/射门

守门员：救球/射门

全队合计	得分	被救	射失	击柱	封球	合计	%
远射	1	7	3		1	12	8.3%
近射	2	2				4	50.0%
边射	4	2	3	1		10	40.0%
快攻	6	1				7	85.7%
突破	4			1		5	80.0%
任意							0.0%
七米	1	1				2	50.0%

2019年全国男子手球冠军杯赛

PHMS Pictorial Handball Match Statistics

IHF Official System

个人/全队技术统计表

手球 男子 预赛 轮次 2 组别 B 场次 8 万州体育馆 2019-04-08 17:30

号码	姓名	远射	近射	边射	快攻	突破	任意	七米	合计	%	助攻	失误	警告	2'	取消	时间
天津队(天津)																
(场上队员)																
1	何喜年									0.0%						00:30:00
3	魏雨童		3/4						3/4	75.0%			1			00:30:00
4	刘雪东		1/1			1/1		1/1	3/3	100%		1				00:21:50
5	王毅	1/1	1/1			2/2		1/1	5/5	100%		1				00:20:15
6	赵晨阳				1/1	1/1			2/2	100%						00:10:11
7	张青	0/1	1/1		1/1	1/1		2/2	5/6	83.3%	1	1				00:36:55
8	王晓琪	2/2	0/1	0/1	1/1	1/1	1/1		5/7	71.4%		2				00:41:19
9	王子欣			0/1	1/1	0/1			1/3	33.3%	1	2				00:42:26
10	苏尧	1/1	1/1		2/2	1/1			5/5	100%	1	3		1		00:41:01
11	吴明远									0.0%						00:07:54
13	许松			1/2	0/1				1/3	33.3%		1				00:34:26
14	王维先		0/2		2/2				2/4	50.0%				1		00:14:25
15	周群		1/1		1/1				2/2	100%						00:19:25
16	刘宗其									0.0%	1					00:30:00
20	张闻乾		0/1	1/1					1/2	50.0%		1				00:18:40
86	田剑侠	0/1							0/1	0.0%	1	2	1			00:21:12
	合计	4/6	8/13	2/5	9/10	7/8	1/1	4/4	35/47	74.5%	5	14	2	2		
(守门员)																
1	何喜年	5/5	1/3	1/3	0/4	0/1			7/16	43.8%						00:30:00
16	刘宗其	2/3	1/1	1/3	1/3	0/3		1/2	6/15	40.0%	1					00:30:00
	合计	7/8	2/4	2/6	1/7	0/4		1/2	13/31	41.9%	1					

场上队员：得分/射门

守门员：救球/射门

全队合计	得分	被救	射失	击柱	封球	合计	%
远射	4	2				6	66.7%
近射	8	3	2			13	61.5%
边射	2			3		5	40.0%
快攻	9			1		10	90.0%
突破	7	1				8	87.5%
任意	1					1	100.0%
七米	4					4	100.0%

图式比赛技术统计表

手球  
男子

预赛  
轮次 2

组别 B  
场次 8

万州体育馆  
2019-04-08 17:30

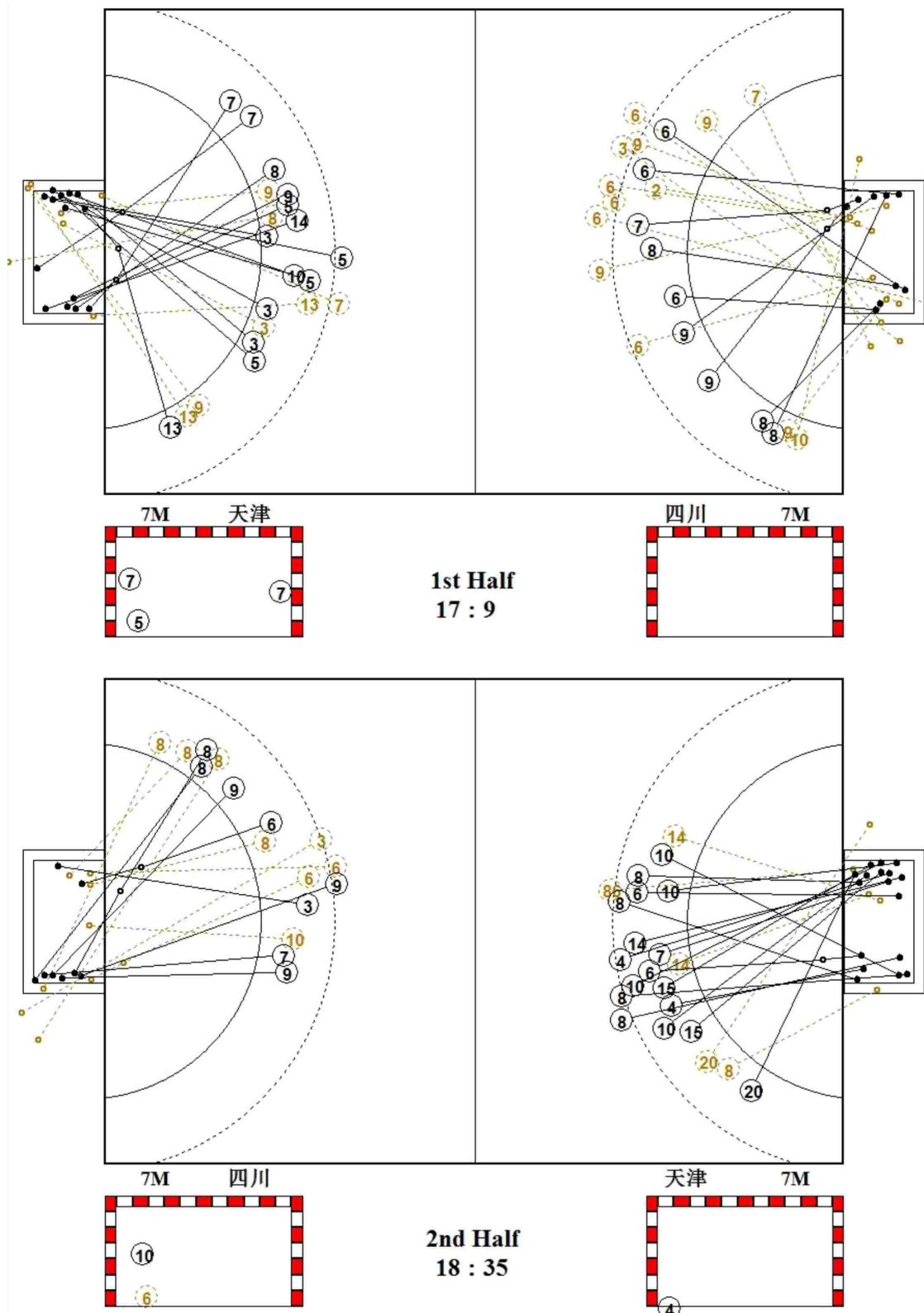

图式射门区域统计

手球  
男子

预赛  
轮次 2

组别 B  
场次 8

万州体育馆  
2019-04-08 17:30

四川队

2 张宏运	3 李朗轩	6 董佳辉	7 曾繁泳	8 罗霖泽	9 左典	10 李剑琛	12 戴景伟																																																																								
<table border="1"><tr><td></td><td></td><td></td></tr><tr><td></td><td></td><td></td></tr><tr><td></td><td></td><td></td></tr></table>										<table border="1"><tr><td></td><td></td><td>1</td></tr><tr><td></td><td></td><td></td></tr><tr><td></td><td></td><td></td></tr></table>			1							<table border="1"><tr><td>1</td><td></td><td>1</td></tr><tr><td></td><td></td><td>1</td></tr><tr><td></td><td></td><td>1</td></tr></table>	1		1			1			1	<table border="1"><tr><td>1</td><td></td><td></td></tr><tr><td></td><td></td><td></td></tr><tr><td>1</td><td></td><td></td></tr></table>	1						1			<table border="1"><tr><td>1</td><td></td><td>1</td></tr><tr><td>2</td><td></td><td>1</td></tr><tr><td></td><td></td><td></td></tr></table>	1		1	2		1				<table border="1"><tr><td>1</td><td></td><td></td></tr><tr><td>3</td><td></td><td></td></tr><tr><td>1</td><td></td><td></td></tr></table>	1			3			1			<table border="1"><tr><td></td><td></td><td></td></tr><tr><td>1</td><td></td><td></td></tr><tr><td></td><td></td><td></td></tr></table>				1						<table border="1"><tr><td></td><td></td><td></td></tr><tr><td></td><td></td><td></td></tr><tr><td></td><td></td><td></td></tr></table>									
		1																																																																													
1		1																																																																													
		1																																																																													
		1																																																																													
1																																																																															
1																																																																															
1		1																																																																													
2		1																																																																													
1																																																																															
3																																																																															
1																																																																															
1																																																																															
Post - 0 Miss - 0 Block - 0	Post - 0 Miss - 2 Block - 0	Post - 0 Miss - 1 Block - 1	Post - 0 Miss - 1 Block - 0	Post - 1 Miss - 1 Block - 0	Post - 1 Miss - 0 Block - 0	Post - 0 Miss - 1 Block - 0	Post - 0 Miss - 0 Block - 0																																																																								

14 洗鹏飞	17 叶康全																		
<table border="1"><tr><td></td><td></td><td></td></tr><tr><td></td><td></td><td></td></tr><tr><td></td><td></td><td></td></tr></table>										<table border="1"><tr><td></td><td></td><td></td></tr><tr><td></td><td></td><td></td></tr><tr><td></td><td></td><td></td></tr></table>									
Post - 0 Miss - 0 Block - 0	Post - 0 Miss - 0 Block - 0																		

12 戴景伟						
<table border="1"><tr><td>0/4</td><td>0/5</td></tr><tr><td>1/4</td><td>1/1</td></tr><tr><td>0/4</td><td>2/4</td></tr></table>	0/4	0/5	1/4	1/1	0/4	2/4
0/4	0/5					
1/4	1/1					
0/4	2/4					

17 叶康全									
<table border="1"><tr><td>0/1</td><td>0/1</td><td>0/1</td></tr><tr><td>0/6</td><td></td><td>0/3</td></tr><tr><td>1/2</td><td></td><td>1/3</td></tr></table>	0/1	0/1	0/1	0/6		0/3	1/2		1/3
0/1	0/1	0/1							
0/6		0/3							
1/2		1/3							

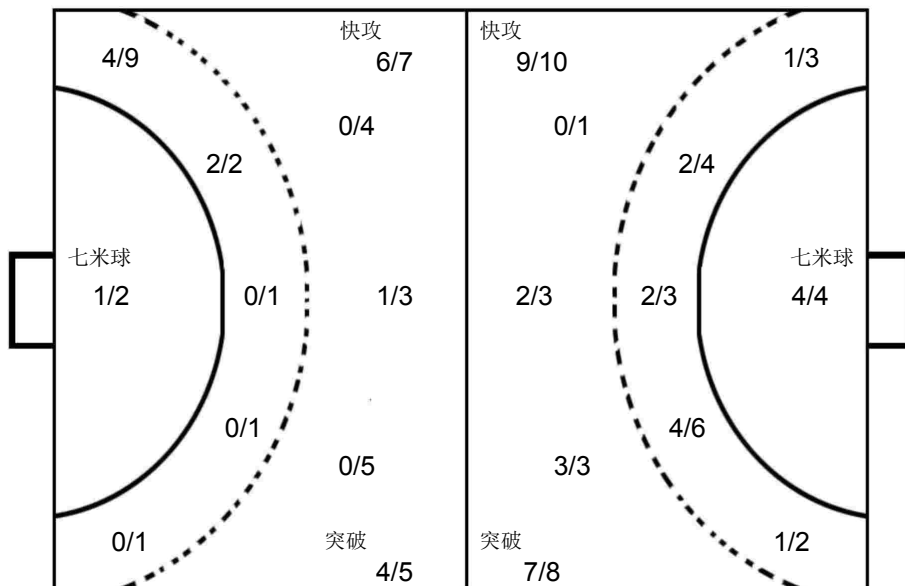

1 何喜年						
<table border="1"><tr><td>0/1</td><td>1/3</td></tr><tr><td>1/3</td><td>1/1</td></tr><tr><td>2/4</td><td>2/4</td></tr></table>	0/1	1/3	1/3	1/1	2/4	2/4
0/1	1/3					
1/3	1/1					
2/4	2/4					

16 刘宗其						
<table border="1"><tr><td>0/3</td><td>0/1</td></tr><tr><td>0/4</td><td>1/1</td></tr><tr><td>2/2</td><td>2/3</td></tr></table>	0/3	0/1	0/4	1/1	2/2	2/3
0/3	0/1					
0/4	1/1					
2/2	2/3					

天津队

1 何喜年	3 魏雨童	4 刘雪东	5 王毅	6 赵晨阳	7 张青	8 王晓琪	9 王子欣																																																																								
<table border="1"><tr><td></td><td></td><td></td></tr><tr><td></td><td></td><td></td></tr><tr><td></td><td></td><td></td></tr></table>										<table border="1"><tr><td></td><td></td><td>2</td></tr><tr><td></td><td></td><td>1</td></tr><tr><td></td><td></td><td></td></tr></table>			2			1				<table border="1"><tr><td>1</td><td></td><td></td></tr><tr><td></td><td></td><td></td></tr><tr><td>1</td><td></td><td>1</td></tr></table>	1						1		1	<table border="1"><tr><td></td><td></td><td>1</td></tr><tr><td>1</td><td></td><td>2</td></tr><tr><td>1</td><td></td><td></td></tr></table>			1	1		2	1			<table border="1"><tr><td>1</td><td></td><td></td></tr><tr><td></td><td></td><td></td></tr><tr><td></td><td></td><td>1</td></tr></table>	1								1	<table border="1"><tr><td></td><td>1</td><td></td></tr><tr><td>2</td><td></td><td>1</td></tr><tr><td>1</td><td></td><td></td></tr></table>		1		2		1	1			<table border="1"><tr><td></td><td></td><td>2</td></tr><tr><td>1</td><td></td><td></td></tr><tr><td>1</td><td></td><td>1</td></tr></table>			2	1			1		1	<table border="1"><tr><td></td><td></td><td></td></tr><tr><td>1</td><td></td><td></td></tr><tr><td></td><td></td><td></td></tr></table>				1					
		2																																																																													
		1																																																																													
1																																																																															
1		1																																																																													
		1																																																																													
1		2																																																																													
1																																																																															
1																																																																															
		1																																																																													
	1																																																																														
2		1																																																																													
1																																																																															
		2																																																																													
1																																																																															
1		1																																																																													
1																																																																															
Post - 0 Miss - 0 Block - 0	Post - 0 Miss - 0 Block - 0	Post - 0 Miss - 0 Block - 0	Post - 0 Miss - 0 Block - 0	Post - 0 Miss - 0 Block - 0	Post - 0 Miss - 0 Block - 0	Post - 1 Miss - 1 Block - 0	Post - 1 Miss - 0 Block - 0																																																																								
10 苏尧	11 吴明远	13 许松	14 王维先	15 周群	16 刘宗其	20 张闻乾	86 田剑侠																																																																								
<table border="1"><tr><td>1</td><td></td><td>1</td></tr><tr><td>2</td><td></td><td>1</td></tr><tr><td></td><td></td><td></td></tr></table>	1		1	2		1				<table border="1"><tr><td></td><td></td><td></td></tr><tr><td></td><td></td><td></td></tr><tr><td></td><td></td><td></td></tr></table>										<table border="1"><tr><td></td><td></td><td></td></tr><tr><td></td><td></td><td></td></tr><tr><td></td><td></td><td>1</td></tr></table>									1	<table border="1"><tr><td>2</td><td></td><td></td></tr><tr><td></td><td></td><td></td></tr><tr><td></td><td></td><td></td></tr></table>	2									<table border="1"><tr><td></td><td></td><td></td></tr><tr><td>2</td><td></td><td></td></tr><tr><td></td><td></td><td></td></tr></table>				2						<table border="1"><tr><td></td><td></td><td></td></tr><tr><td></td><td></td><td></td></tr><tr><td></td><td></td><td></td></tr></table>										<table border="1"><tr><td></td><td></td><td></td></tr><tr><td></td><td></td><td></td></tr><tr><td>1</td><td></td><td></td></tr></table>							1			<table border="1"><tr><td></td><td></td><td></td></tr><tr><td></td><td></td><td></td></tr><tr><td></td><td></td><td></td></tr></table>									
1		1																																																																													
2		1																																																																													
		1																																																																													
2																																																																															
2																																																																															
1																																																																															
Post - 0 Miss - 0 Block - 0	Post - 0 Miss - 0 Block - 0	Post - 2 Miss - 0 Block - 0	Post - 0 Miss - 0 Block - 0	Post - 0 Miss - 0 Block - 0	Post - 0 Miss - 0 Block - 0	Post - 0 Miss - 1 Block - 0	Post - 0 Miss - 0 Block - 0																																																																								



Team A					Team B					Match Number											
A 广东队					B 安徽队					<b>9</b>											
Played in			in the hall			on			at			Spectators									
重庆万州			万州体育馆			2019-04-09			13:00			hours									
Half-time(30')	A	B	End of playing time	A	B	1st extra time	A	B	2nd extra time	A	B	After penalty throws	A	B							
	10	11	23	23									26	27							
Number of 7 m	A	Team time-out			Full name of players and officials					Team time-out			B	Number of 7 m							
	7/9	1	2	3						1	2	3	7/8								
		27:27	38:10	56:59					28:59	51:31											
No.	Team A					G	W	2'	D	DR	No.	Team B					G	W	2'	D	DR
2	孙江山					1					1	郭世伟					4				
6	毕晓晨					4					4	王巨柱					7				
7	王立隆					1	1	1			5	史小帆									
9	范保坤										6	叶志伟									
10	周仲坤					6	1				7	姚雄敏									
11	房友屯							1			8	董智景					1				
12	王雨										9	金永峰									
14	王泽润										10	严龙					3		1		
15	张建杰					4					11	黎涛					1				
18	姚雪岩					2					12	曾献辰									
19	王帅										18	李双					4	1	1		
21	张昌轲					2					21	李明									
22	黄培杰					4					23	张鹏					3				
24	高玉杰					2		1			24	徐安格					1		2		
32	罗柏涵										26	饶原源					3				
											27	王东昇									
A	曲汝洋										A	吴翔									
B	刘康伶 (主教练)										B	Vladimir Stanojevic (主教练)									
C	郭艳辉										C	黄红									
E	贾章志										E	刘汉杰									
A	Signatures of responsables for the teams (Off.A)															B					
TP	Remarks of referees / HF Official															TP					

Signatures

Referees	周云磊 (CHN)	伍豪 (CHN)		
T.D.	吴国忠 (CHN)	倪震 (CHN)		
CHA Off.				

Note: Number of 7m Throws Awarded to Team A and B, Goals (G), Warnings (W), Suspensions (2'), Direct Disqualification (D), Disqualification With Report (DR) and Team Penalty (TP).

Table Officials: 黄一凡

张晓虎

Statisticians: 赵悦

谢杨

### 2019年全国男子手球冠军杯赛

**PHMS** Pictorial Handball Match Statistics

**IHF** Official System

#### 竞赛技术统计

 手球  
男子

 预赛  
轮次 3

 组别 A  
场次 9

 万州体育馆  
2019-04-09 13:00

Referees: 周云磊 (CHN) / 伍豪 (CHN)

Result: 26:27(10:11)

Teams: 广东队(广东) VS 安徽队(安徽)

广东		远	近	边	快	突	任意	7m	合计	%	助攻	失误	警告	2'	D+DR
主教练: 刘康伶		射	射	射	攻	破	球	球							
2	孙江山							1/1	1/1	100					
6	毕晓晨		2/2	1/2				1/2	4/6	66.7					
7	王立隆			1/1					1/1	100			1	1	
9	范保坤														
10	周仲坤	2/5	0/1			1/1	0/1	3/3	6/11	54.5			1		
11	房友屯	0/1							0/1	0.0		1		1	
12	王雨														
14	王泽润														
15	张建杰	2/4	1/2			1/1	0/1		4/8	50.0	1	1			
18	姚雪岩	0/2	2/2						2/4	50.0					
19	王帅														
21	张昌轲	0/1	2/3					0/1	2/5	40.0		2			
22	黄培杰		1/1	1/1				2/2	4/4	100		1			
24	高玉杰	2/5						2/5	2/5	40.0		1		1	
32	罗柏涵														
运动员	合计	6/18	8/11	3/4		2/2	0/2	7/9	26/46	56.5	1	6	2	3	
14	王泽润			1/2	1/2		0/1	0/3	2/8	25.0					
19	王帅	1/6	2/7	0/1	1/5	2/4		1/5	7/28	25.0					
守门员	合计	1/6	2/7	1/3	2/7	2/4	0/1	1/8	9/36	25.0					

安徽		远	近	边	快	突	任意	7m	合计	%	助攻	失误	警告	2'	D+DR
主教练: Vladimir Stanojevic		射	射	射	攻	破	球	球							
1	郭世伟	0/3	1/1			2/2		1/1	4/7	57.1					
4	王巨柱	4/4	1/1			0/1	1/1	1/1	7/8	87.5					
5	史小帆														
6	叶志伟														
7	姚雄敏					0/1			0/1	0.0		1			
8	董智景			0/1	0/1			1/1	1/3	33.3					
9	金永峰	0/2	0/1						0/3	0.0	1	1			
10	严龙				2/3			1/1	3/4	75.0				1	
11	黎涛				1/1				1/2	50.0					
12	曾献辰														
18	李双	1/2	2/2		1/1				4/5	80.0	1	3	1	1	
21	李明										2				
23	张鹏			2/3	1/2				3/5	60.0		1			
24	徐安格		1/1						1/1	100		1		2	
26	饶源源							3/4	3/4	75.0					
27	王东昇														
运动员	合计	5/11	5/7	2/4	5/8	2/4	1/1	7/8	27/43	62.8	4	7	1	4	
12	曾献辰							0/1	0/1	0.0					
21	李明	9/15	2/10	1/4		0/2	1/1	1/7	14/39	35.9	2				
守门员	合计	9/15	2/10	1/4		0/2	1/1	1/8	14/40	35.0	2				

广东	比赛 进程	安徽
1st Half		
6 毕晓晨	1 01:09 0	
	1 05:10 1 4 王巨柱	
24 高玉杰	2 05:41 1	
	2 07:49 2 26 饶源源	
15 张建杰	3 12:00 2	
10 周仲坤	4 12:41 2	
	4 13:18 3 18 李双	
	4 15:42 4 4 王巨柱	
15 张建杰	5 16:19 4	
18 姚雪岩	6 17:48 4	
	6 18:37 5 4 王巨柱	
7 王立隆	7 20:08 5	
	7 20:54 6 1 郭世伟	
10 周仲坤	8 21:03 6	
	8 21:41 7 18 李双	
6 毕晓晨	9 22:17 7	
	9 23:09 8 26 饶源源	
15 张建杰	10 25:55 8	
	10 26:11 9 4 王巨柱	
	10 27:10 10 11 黎涛	
	10 29:44 11 24 徐安格	
2nd Half		
21 张昌轲	11 01:04 11	
	11 01:34 12 1 郭世伟	
15 张建杰	12 02:15 12	
21 张昌轲	13 03:25 12	
	13 04:20 13 10 严龙	
22 黄培杰	14 05:06 13	
	14 07:37 14 18 李双	
	14 08:54 15 18 李双	
6 毕晓晨	15 09:21 15	
	15 10:00 16 23 张鹏	
10 周仲坤	16 11:03 16	
	16 11:48 17 1 郭世伟	
	16 12:31 18 10 严龙	
24 高玉杰	17 13:08 18	
	17 13:42 19 4 王巨柱	
10 周仲坤	18 16:36 19	
	18 17:27 20 23 张鹏	
22 黄培杰	19 18:47 20	
6 毕晓晨	20 20:30 20	
10 周仲坤	21 23:06 20	
	21 23:55 21 4 王巨柱	
22 黄培杰	22 24:57 21	
	22 26:46 22 23 张鹏	
18 姚雪岩	23 27:50 22	
	23 28:44 23 26 饶源源	
7M		
22 黄培杰	24 00:00 23	
10 周仲坤	25 00:00 23	
	25 00:00 24 10 严龙	
	25 00:00 25 4 王巨柱	
	25 00:00 26 8 董智景	
2 孙江山	26 00:00 26	
	26 00:00 27 1 郭世伟	

场上队员: 得分 / 射门

守门员: 救球 / 射门

D	取消资格	DR	取消资格+报告
---	------	----	---------





## 2019年全国男子手球冠军杯赛

PHMS Pictorial Handball Match Statistics

IHF Official System

### 个人/全队技术统计表

手球 男子 预赛 轮次 3 组别 A 场次 9 万州体育馆 2019-04-09 13:00

号码	姓名	远射	近射	边射	快攻	突破	任意	七米	合计	%	助攻	失误	警告	2'	取消	时间
广东队(广东)																
(场上队员)																
2	孙江山							1/1	1/1	100%						00:07:21
6	毕晓晨		2/2	1/2				1/2	4/6	66.7%						01:00:00
7	王立隆			1/1					1/1	100%			1	1		00:09:40
9	范保坤									0.0%						00:00:00
10	周仲坤	2/5	0/1			1/1	0/1	3/3	6/11	54.5%			1			00:53:26
11	房友屯	0/1							0/1	0.0%		1		1		00:41:23
12	王雨									0.0%						00:16:23
14	王泽润									0.0%						00:13:21
15	张建杰	2/4	1/2			1/1	0/1		4/8	50.0%	1	1				00:26:59
18	姚雪岩	0/2	2/2						2/4	50.0%						00:46:14
19	王帅									0.0%						00:46:39
21	张昌轲	0/1	2/3					0/1	2/5	40.0%		2				00:21:49
22	黄培杰		1/1	1/1				2/2	4/4	100%		1				00:43:13
24	高玉杰	2/5							2/5	40.0%		1		1		00:32:57
32	罗柏涵									0.0%						00:00:00
合计		6/18	8/11	3/4		2/2	0/2	7/9	26/46	56.5%	1	6	2	3		
(守门员)																
14	王泽润			1/2	1/2		0/1	0/3	2/8	25.0%						00:13:21
19	王帅	1/6	2/7	0/1	1/5	2/4		1/5	7/28	25.0%						00:46:39
合计		1/6	2/7	1/3	2/7	2/4	0/1	1/8	9/36	25.0%						

场上队员：得分/射门

守门员：救球/射门

全队合计	得分	被救	射失	击柱	封球	合计	%
远射	6	9			3	18	33.3%
近射	8	2			1	11	72.7%
边射	3	1				4	75.0%
快攻							0.0%
突破	2					2	100.0%
任意		1	1			2	0.0%
七米	7	1	1			9	77.8%

## 2019年全国男子手球冠军杯赛

PHMS Pictorial Handball Match Statistics

IHF Official System

### 个人/全队技术统计表

手球 男子 预赛 轮次 3 组别 A 场次 9 万州体育馆 2019-04-09 13:00

号码	姓名	远射	近射	边射	快攻	突破	任意	七米	合计	%	助攻	失误	警告	2'	取消	时间
安徽队(安徽)																
(场上队员)																
1	郭世伟	0/3	1/1			2/2		1/1	4/7	57.1%						00:23:49
4	王巨柱	4/4	1/1			0/1	1/1	1/1	7/8	87.5%						00:47:00
5	史小帆									0.0%						00:00:00
6	叶志伟									0.0%						00:00:00
7	姚雄敏					0/1			0/1	0.0%		1				00:19:56
8	董智景			0/1	0/1			1/1	1/3	33.3%						00:15:47
9	金永峰	0/2	0/1						0/3	0.0%	1	1				00:31:56
10	严龙					2/3		1/1	3/4	75.0%				1		00:40:24
11	黎涛		0/1		1/1				1/2	50.0%						00:33:47
12	曾献辰									0.0%						00:00:36
18	李双	1/2	2/2		1/1				4/5	80.0%	1	3	1	1		01:00:00
21	李明									0.0%	2					00:59:24
23	张鹏			2/3	1/2				3/5	60.0%		1				00:24:50
24	徐安格		1/1						1/1	100%		1		2		01:00:00
26	饶原源							3/4	3/4	75.0%						00:00:44
27	王东昇									0.0%						00:00:56
合计		5/11	5/7	2/4	5/8	2/4	1/1	7/8	27/43	62.8%	4	7	1	4		

#### (守门员)

12	曾献辰							0/1	0/1	0.0%						00:00:36
21	李明	9/15	2/10	1/4		0/2	1/1	1/7	14/39	35.9%	2					00:59:24
合计		9/15	2/10	1/4		0/2	1/1	1/8	14/40	35.0%	2					

场上队员：得分/射门

守门员：救球/射门

全队合计	得分	被救	射失	击柱	封球	合计	%
远射	5	1	4		1	11	45.5%
近射	5	2				7	71.4%
边射	2	1	1			4	50.0%
快攻	5	2		1		8	62.5%
突破	2	2				4	50.0%
任意	1					1	100.0%
七米	7	1				8	87.5%

图式比赛技术统计表

手球  
男子

预赛  
轮次 3

组别 A  
场次 9

万州体育馆  
2019-04-09 13:00

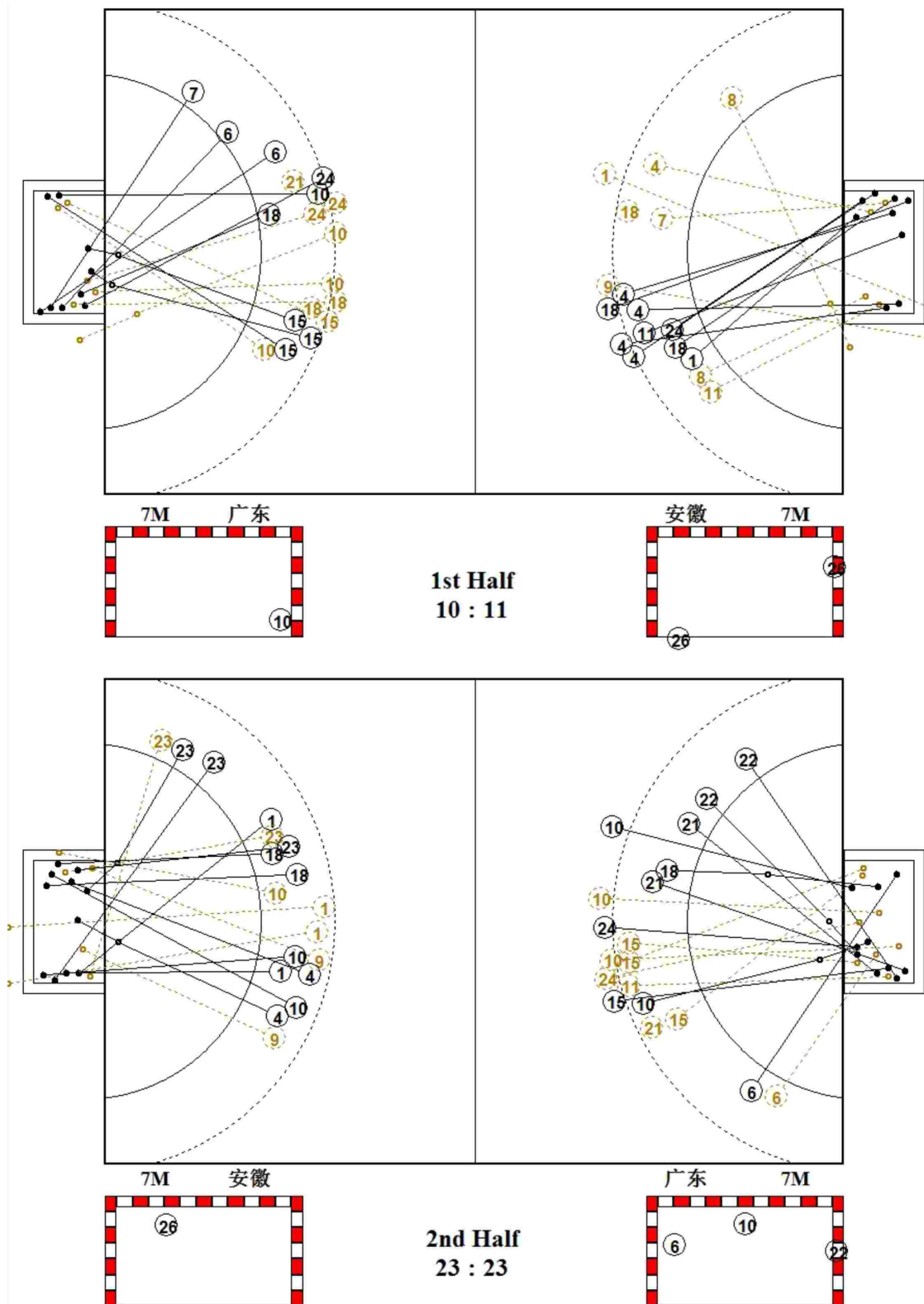

PICTORIAL MATCH STATISTICS

HANDBALL  
男子

预赛  
ROUND 3

GROUP A  
MATCH 9

万州体育馆  
2019-04-09 13:00

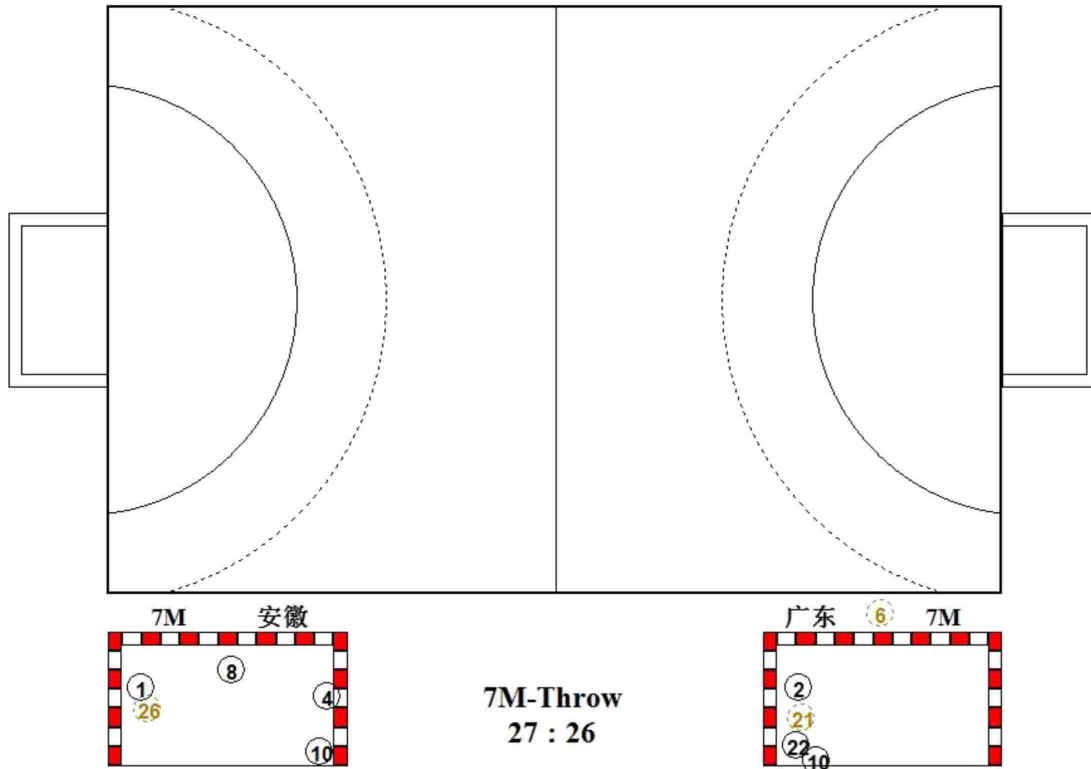

图式射门区域统计

手球  
男子

预赛  
轮次 3

组别 A  
场次 9

万州体育馆  
2019-04-09 13:00

广东队

2 孙江山	6 毕晓晨	7 王立隆	9 范保坤	10 周仲坤	11 房友屯	12 王雨	14 王泽润																																																																								
<table border="1"><tr><td>1</td><td></td><td></td></tr><tr><td></td><td></td><td></td></tr><tr><td></td><td></td><td></td></tr></table>	1									<table border="1"><tr><td>3</td><td></td><td></td></tr><tr><td>1</td><td></td><td></td></tr><tr><td></td><td></td><td></td></tr></table>	3			1						<table border="1"><tr><td>1</td><td></td><td></td></tr><tr><td></td><td></td><td></td></tr><tr><td></td><td></td><td></td></tr></table>	1									<table border="1"><tr><td></td><td></td><td></td></tr><tr><td></td><td></td><td></td></tr><tr><td></td><td></td><td></td></tr></table>										<table border="1"><tr><td></td><td>1</td><td></td></tr><tr><td></td><td>1</td><td>1</td></tr><tr><td>2</td><td></td><td>1</td></tr></table>		1			1	1	2		1	<table border="1"><tr><td></td><td></td><td></td></tr><tr><td></td><td></td><td></td></tr><tr><td></td><td></td><td></td></tr></table>										<table border="1"><tr><td></td><td></td><td></td></tr><tr><td></td><td></td><td></td></tr><tr><td></td><td></td><td></td></tr></table>										<table border="1"><tr><td></td><td></td><td></td></tr><tr><td></td><td></td><td></td></tr><tr><td></td><td></td><td></td></tr></table>									
1																																																																															
3																																																																															
1																																																																															
1																																																																															
	1																																																																														
	1	1																																																																													
2		1																																																																													
15 张建杰	18 姚雪岩	19 王帅	21 张昌轲	22 黄培杰	24 高玉杰	32 罗柏涵																																																																									
<table border="1"><tr><td></td><td></td><td>1</td></tr><tr><td></td><td></td><td>1</td></tr><tr><td></td><td>2</td><td></td></tr></table>			1			1		2		<table border="1"><tr><td></td><td></td><td></td></tr><tr><td>2</td><td></td><td></td></tr><tr><td></td><td></td><td></td></tr></table>				2						<table border="1"><tr><td></td><td></td><td></td></tr><tr><td></td><td></td><td></td></tr><tr><td></td><td></td><td></td></tr></table>										<table border="1"><tr><td></td><td></td><td>1</td></tr><tr><td></td><td></td><td>1</td></tr><tr><td></td><td></td><td></td></tr></table>			1			1				<table border="1"><tr><td></td><td></td><td>1</td></tr><tr><td></td><td></td><td>1</td></tr><tr><td>1</td><td></td><td>1</td></tr></table>			1			1	1		1	<table border="1"><tr><td></td><td></td><td></td></tr><tr><td></td><td></td><td></td></tr><tr><td></td><td></td><td></td></tr></table>										<table border="1"><tr><td></td><td></td><td></td></tr><tr><td></td><td></td><td></td></tr><tr><td></td><td></td><td></td></tr></table>																			
		1																																																																													
		1																																																																													
	2																																																																														
2																																																																															
		1																																																																													
		1																																																																													
		1																																																																													
		1																																																																													
1		1																																																																													
14 王泽润																																																																															
<table border="1"><tr><td>0/2</td><td></td><td></td></tr><tr><td></td><td></td><td>1/4</td></tr><tr><td>1/2</td><td></td><td></td></tr></table>	0/2					1/4	1/2																																																																								
0/2																																																																															
		1/4																																																																													
1/2																																																																															
19 王帅																																																																															
<table border="1"><tr><td>0/5</td><td>0/2</td><td>0/5</td></tr><tr><td>3/6</td><td>0/1</td><td>1/2</td></tr><tr><td>1/3</td><td></td><td>2/4</td></tr></table>	0/5	0/2	0/5	3/6	0/1	1/2	1/3		2/4																																																																						
0/5	0/2	0/5																																																																													
3/6	0/1	1/2																																																																													
1/3		2/4																																																																													

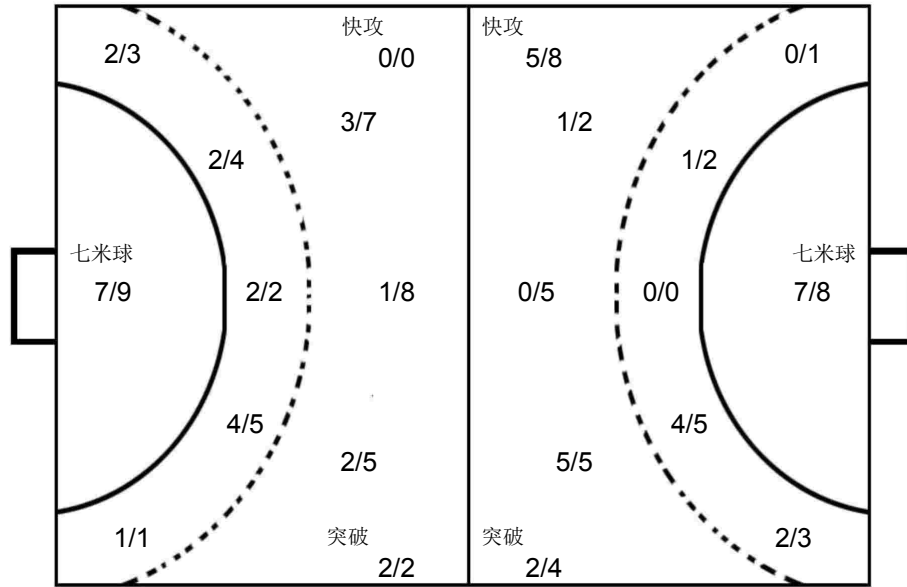

安徽队

1 郭世伟	4 王巨柱	5 史小帆	6 叶志伟	7 姚雄敏	8 董智景	9 金永峰	10 严龙																																																																								
<table border="1"><tr><td>1</td><td></td><td></td></tr><tr><td>2</td><td></td><td></td></tr><tr><td>1</td><td></td><td></td></tr></table>	1			2			1			<table border="1"><tr><td>1</td><td></td><td>1</td></tr><tr><td>1</td><td>1</td><td>3</td></tr><tr><td></td><td></td><td></td></tr></table>	1		1	1	1	3				<table border="1"><tr><td></td><td></td><td></td></tr><tr><td></td><td></td><td></td></tr><tr><td></td><td></td><td></td></tr></table>										<table border="1"><tr><td></td><td></td><td></td></tr><tr><td></td><td></td><td></td></tr><tr><td></td><td></td><td></td></tr></table>										<table border="1"><tr><td></td><td></td><td></td></tr><tr><td></td><td></td><td></td></tr><tr><td></td><td></td><td></td></tr></table>										<table border="1"><tr><td></td><td>1</td><td></td></tr><tr><td></td><td></td><td></td></tr><tr><td></td><td></td><td></td></tr></table>		1								<table border="1"><tr><td></td><td></td><td></td></tr><tr><td></td><td></td><td></td></tr><tr><td></td><td></td><td></td></tr></table>										<table border="1"><tr><td>1</td><td></td><td>1</td></tr><tr><td></td><td></td><td></td></tr><tr><td></td><td></td><td>1</td></tr></table>	1		1						1
1																																																																															
2																																																																															
1																																																																															
1		1																																																																													
1	1	3																																																																													
	1																																																																														
1		1																																																																													
		1																																																																													
11 黎涛	12 曾献辰	18 李双	21 李明	23 张鹏	24 徐安格	26 饶原源	27 王东昇																																																																								
<table border="1"><tr><td></td><td>1</td><td></td></tr><tr><td></td><td></td><td></td></tr><tr><td></td><td></td><td></td></tr></table>		1								<table border="1"><tr><td></td><td></td><td></td></tr><tr><td></td><td></td><td></td></tr><tr><td></td><td></td><td></td></tr></table>										<table border="1"><tr><td>2</td><td></td><td>2</td></tr><tr><td></td><td></td><td></td></tr><tr><td></td><td></td><td></td></tr></table>	2		2							<table border="1"><tr><td></td><td></td><td></td></tr><tr><td></td><td></td><td></td></tr><tr><td></td><td></td><td></td></tr></table>										<table border="1"><tr><td>1</td><td></td><td></td></tr><tr><td></td><td></td><td>1</td></tr><tr><td></td><td></td><td>1</td></tr></table>	1					1			1	<table border="1"><tr><td></td><td></td><td></td></tr><tr><td></td><td></td><td></td></tr><tr><td></td><td></td><td></td></tr></table>										<table border="1"><tr><td>1</td><td></td><td>1</td></tr><tr><td></td><td></td><td></td></tr><tr><td></td><td></td><td></td></tr></table>	1		1							<table border="1"><tr><td></td><td></td><td></td></tr><tr><td></td><td></td><td></td></tr><tr><td></td><td></td><td></td></tr></table>									
	1																																																																														
2		2																																																																													
1																																																																															
		1																																																																													
		1																																																																													
1		1																																																																													



**PHMS** Pictorial Handball Match Statistics **IHF** Official System

Team A A 陕西队				Team B B 山西队				Match Number <b>10</b>			
-----------------	--	--	--	-----------------	--	--	--	---------------------------	--	--	--

Played in 重庆万州	in the hall 万州体育馆	on 2019-04-09	at 14:30	hours	Spepectors
-------------------	----------------------	------------------	-------------	-------	------------

Half-time(30')	A 10	B 11	End of playing time	A 25	B 27	1st extra time	A	B	2nd extra time	A	B	After penalty throws	A	B
----------------	---------	---------	---------------------	---------	---------	----------------	---	---	----------------	---	---	----------------------	---	---

Number of 7 m 4/8	Team time-out			Full name of players and officials	Team time-out			B 1/1	Number of 7 m
	1	2	3		1	2	3		

No.	Team A	G	W	2'	D	DR	No.	Team B	G	W	2'	D	DR
1	陈昊						1	鲁世豪					
2	王柏洪						2	张智超			1		
3	刘赵梁	6					3	龙俊皓					
4	李佳						4	刘文东			1		
5	马益奎	4	1	1			5	王宇恒	1				
6	刘世昌	1					6	盖秀越	6				
8	季雨	1	1	1			7	任健豪	7		1		
10	王凯强	5					9	辛浩乐					
11	张领	3		1			10	王洋	3	1			
12	赵凯						11	吴夏冰	1		2		
13	隋家乐						12	韩乐斌					
15	陈冉	5					13	杜忠浩	2				
17	耿畅						14	杨毅	7	1			
18	刘文星						15	薛瑞寒		1			
22	张睿梁						16	王虹翔					
							18	张禹琛					
B	郝可鑫						A	张栋					
C	李安						B	赵鑫 (主教练)	1				
							C	霖配永					

A	Signatures of responsables for the teams (Off.A)												B
---	--	--	--	--	--	--	--	--	--	--	--	--	---

TP	Remarks of referees / HF Official													TP
----	-----------------------------------	--	--	--	--	--	--	--	--	--	--	--	--	----

Referees	周胜锋 (CHN)	张智伟 (CHN)		
T.D.	吴国忠 (CHN)	倪震 (CHN)		
CHA Off.				

Note: Number of 7m Throws Awarded to Team A and B, Goals (G), Warnings (W), Suspensions (2'), Direct Disqualification (D), Disqualification With Report (DR) and Team Penalty (TP).

Table Officials: 张之伟 林子建 Statisticians: 谢杨 周亚桥

2019年全国男子手球冠军杯赛

竞赛技术统计

手球 男子      预赛 轮次 3      组别 A 场次 10      万州体育馆 2019-04-09 14:30

Referees: 周胜锋 (CHN) / 张智伟 (CHN)      Result: 25:27(10:11)  
Teams: 陕西队(陕西) VS 山西队(山西)

陕西		远射	近射	边射	快攻	突破	任意球	7m球	合计	%	助攻	失误	警告	2'	D+DR
主教练: 王建国															
1	陈昊														
2	王柏淇											1			
3	刘赵梁	1/3	1/2			3/3	1/2		6/10	60.0	4	6			
4	李佳														
5	马益奎		3/4			1/1			4/5	80.0		1	1	1	
6	刘世昌			1/2					1/2	50.0					
8	季雨		1/2			0/1			1/3	33.3		2	1	1	
10	王凯强	1/3	3/3			1/2			5/8	62.5		1			
11	张领	0/1						3/5	3/6	50.0				1	
12	赵凯														
13	隋家乐														
15	陈冉		1/2	2/7	1/2			1/3	5/14	35.7					
17	耿畅														
18	刘文星														
22	张春梁														
运动员 合计		2/7	9/13	3/9	1/2	5/7	1/2	4/8	25/48	52.1	5	11	2	3	
22	张春梁	0/3	4/13	4/10	2/6	3/7		0/1	13/40	32.5	1				
守门员 合计		0/3	4/13	4/10	2/6	3/7		0/1	13/40	32.5	1				

山西		远射	近射	边射	快攻	突破	任意球	7m球	合计	%	助攻	失误	警告	2'	D+DR
主教练: 赵鑫															
1	鲁世豪														
2	张智超			0/2					0/2	0.0		1		1	
3	龙俊皓														
4	刘文帝		0/1		0/1				0/2	0.0				1	
5	王宇恒		0/1	1/1					1/2	50.0		3			
6	盖秀越		0/1	4/4	2/2				6/7	85.7		3			
7	任健豪	1/1	3/6	0/1	0/1	3/3			7/12	58.3		2		1	
9	辛浩乐														
10	王洋			1/2	2/2				3/4	75.0			1		
11	吴夏冰		1/1						1/1	100				2	
12	韩乐斌											1			
13	杜忠浩		2/2						2/2	100		2			
14	杨毅	2/4	3/3			1/4		1/1	7/12	58.3	1	1	1		
15	薛瑞寒	0/1							0/1	0.0		1	1		
16	王虹翔														
18	张禹琛														
运动员 合计		3/6	9/15	6/10	4/6	4/7		1/1	27/45	60.0	1	14	3	5	
1	鲁世豪							1/2	1/2	50.0					
12	韩乐斌	4/6	4/13	6/9	1/2	2/7	1/2	2/5	20/44	45.5		1			
守门员 合计		4/6	4/13	6/9	1/2	2/7	1/2	3/7	21/46	45.7		1			

陕西	比赛进程	山西
1st Half		
5 马益奎	1 01:53 0	
	1 02:20 1 14 杨毅	
	1 02:54 2 6 盖秀越	
	1 04:20 3 6 盖秀越	
	1 05:02 4 7 任健豪	
3 刘赵梁	2 06:13 4	
	2 06:40 5 10 王洋	
5 马益奎	3 06:56 5	
	3 09:23 6 7 任健豪	
11 张领	4 10:32 6	
11 张领	5 13:06 6	
	5 13:44 7 6 盖秀越	
3 刘赵梁	6 14:25 7	
	6 14:52 8 6 盖秀越	
	6 15:55 9 10 王洋	
5 马益奎	7 16:21 9	
5 马益奎	8 17:27 9	
15 陈冉	9 22:01 9	
	9 22:42 10 6 盖秀越	
	9 25:09 11 14 杨毅	
15 陈冉	10 26:32 11	
2nd Half		
	10 01:48 12 7 任健豪	
	10 02:42 13 14 杨毅	
	10 03:17 14 10 王洋	
10 王凯强	11 04:14 14	
10 王凯强	12 06:59 14	
	12 08:05 15 14 杨毅	
10 王凯强	13 08:21 15	
	13 08:32 16 7 任健豪	
	13 10:06 17 14 杨毅	
3 刘赵梁	14 10:43 17	
8 季雨	15 11:40 17	
	15 12:43 18 14 杨毅	
15 陈冉	16 13:53 18	
15 陈冉	17 14:23 18	
	17 14:38 19 7 任健豪	
10 王凯强	18 15:30 19	
6 刘世昌	19 16:13 19	
	19 18:21 20 7 任健豪	
	19 18:42 21 14 杨毅	
11 张领	20 19:14 21	
	20 19:40 22 5 王宇恒	
10 王凯强	21 20:05 22	
	21 22:31 23 6 盖秀越	
15 陈冉	22 24:52 23	
	22 26:56 24 7 任健豪	
3 刘赵梁	23 27:15 24	
	23 27:40 25 13 杜忠浩	
	23 28:26 26 11 吴夏冰	
3 刘赵梁	24 28:45 26	
3 刘赵梁	25 29:50 26	
	25 29:59 27 13 杜忠浩	

场上队员: 得分 / 射门

守门员: 救球 / 射门

D	取消资格	DR	取消资格+报告
---	------	----	---------



2019年全国男子手球冠军杯赛

PHMS Pictorial Handball Match Statistics

IHF Official System

个人/全队技术统计表

手球 男子 预赛 轮次 3 组别 A 场次 10 万州体育馆 2019-04-09 14:30

号码	姓名	远射	近射	边射	快攻	突破	任意	七米	合计	%	助攻	失误	警告	2'	取消	时间
陕西队(陕西)																
(场上队员)																
1	陈昊									0.0%						00:00:00
2	王柏淇									0.0%		1				00:02:50
3	刘赵梁	1/3	1/2			3/3	1/2		6/10	60.0%	4	6				00:38:01
4	李佳									0.0%						00:00:00
5	马益奎		3/4			1/1			4/5	80.0%		1	1	1		00:59:48
6	刘世昌			1/2					1/2	50.0%						00:59:48
8	季雨		1/2			0/1			1/3	33.3%		2	1	1		00:46:31
10	王凯强	1/3	3/3			1/2			5/8	62.5%		1				00:59:57
11	张领	0/1						3/5	3/6	50.0%				1		00:31:51
12	赵凯									0.0%						00:00:00
13	隋家乐									0.0%						00:00:00
15	陈冉		1/2	2/7	1/2			1/3	5/14	35.7%						00:59:56
17	耿畅									0.0%						00:00:00
18	刘文星									0.0%						00:00:00
22	张睿梁									0.0%	1					01:00:00
合计		2/7	9/13	3/9	1/2	5/7	1/2	4/8	25/48	52.1%	5	11	2	3		
(守门员)																
22	张睿梁	0/3	4/13	4/10	2/6	3/7		0/1	13/40	32.5%	1					01:00:00
合计		0/3	4/13	4/10	2/6	3/7		0/1	13/40	32.5%	1					

场上队员：得分/射门

守门员：救球/射门

全队合计	得分	被救	射失	击柱	封球	合计	%
远射	2	4			1	7	28.6%
近射	9	4				13	69.2%
边射	3	6				9	33.3%
快攻	1	1				2	50.0%
突破	5	2				7	71.4%
任意	1	1				2	50.0%
七米	4	3	1			8	50.0%



## 2019年全国男子手球冠军杯赛

PHMS Pictorial Handball Match Statistics

IHF Official System

### 个人/全队技术统计表

手球 男子 预赛 轮次 3 组别 A 场次 10 万州体育馆 2019-04-09 14:30

号码	姓名	远射	近射	边射	快攻	突破	任意	七米	合计	%	助攻	失误	警告	2'	取消	时间
山西队(山西)																
(场上队员)																
1	鲁世豪									0.0%						00:00:42
2	张智超			0/2					0/2	0.0%	1			1		00:12:57
3	龙俊皓									0.0%						00:00:00
4	刘文东		0/1		0/1				0/2	0.0%				1		00:12:55
5	王宇恒		0/1	1/1					1/2	50.0%	3					00:25:40
6	盖秀越		0/1	4/4	2/2				6/7	85.7%	3					00:55:24
7	任健豪	1/1	3/6	0/1	0/1	3/3			7/12	58.3%	2			1		01:00:00
9	辛浩乐									0.0%						00:00:00
10	王洋			1/2	2/2				3/4	75.0%			1			00:47:03
11	吴夏冰		1/1						1/1	100%				2		00:47:04
12	韩乐斌									0.0%	1					00:59:18
13	杜忠浩		2/2						2/2	100%	2					00:23:49
14	杨毅	2/4	3/3			1/4		1/1	7/12	58.3%	1	1	1			01:00:00
15	薛瑞寒	0/1							0/1	0.0%	1	1				00:14:57
16	王虹翔									0.0%						00:00:00
18	张禹琛									0.0%						00:00:00
合计		3/6	9/15	6/10	4/6	4/7		1/1	27/45	60.0%	1	14	3	5		
(守门员)																
1	鲁世豪							1/2	1/2	50.0%						00:00:42
12	韩乐斌	4/6	4/13	6/9	1/2	2/7	1/2	2/5	20/44	45.5%	1					00:59:18
合计		4/6	4/13	6/9	1/2	2/7	1/2	3/7	21/46	45.7%	1					

场上队员：得分/射门

守门员：救球/射门

全队合计	得分	被救	射失	击柱	封球	合计	%
远射	3		1	1	1	6	50.0%
近射	9	4		2		15	60.0%
边射	6	4				10	60.0%
快攻	4	2				6	66.7%
突破	4	3				7	57.1%
任意							0.0%
七米	1					1	100.0%

图式比赛技术统计表

手球  
男子

预赛  
轮次 3

组别 A  
场次 10

万州体育馆  
2019-04-09 14:30

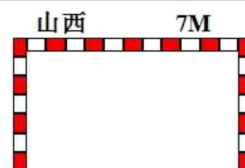
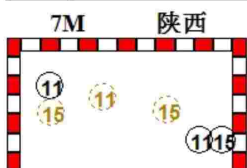
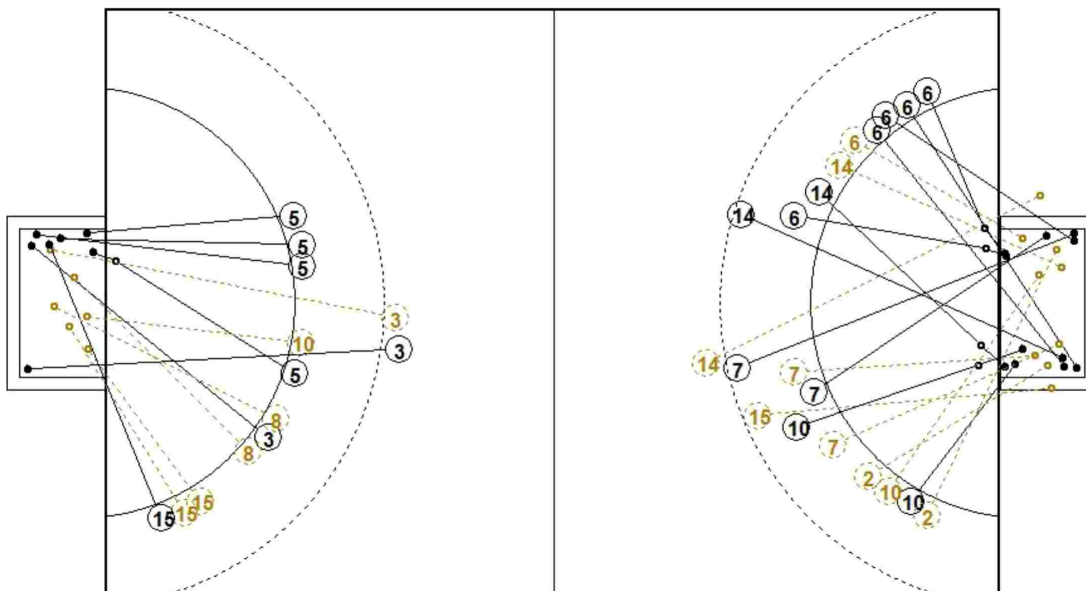

1st Half  
10 : 11

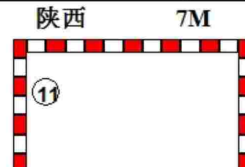
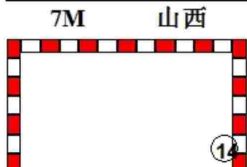
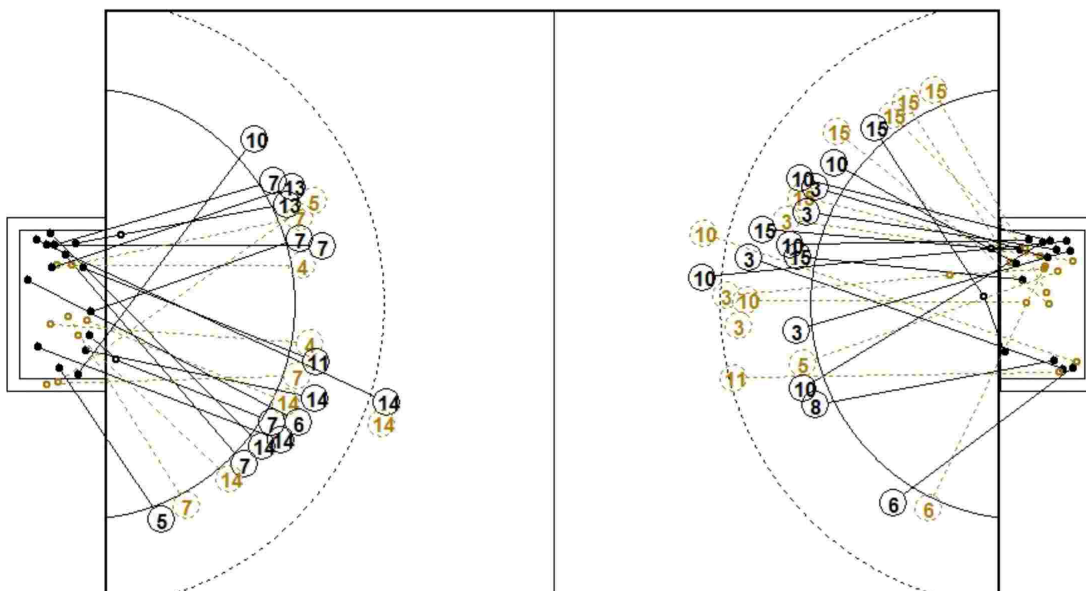

2nd Half  
27 : 25

图式射门区域统计

手球  
男子

预赛  
轮次 3

组别 A  
场次 10

万州体育馆  
2019-04-09 14:30

陕西队

1 陈昊 <table border="1"><tr><td></td><td></td><td></td></tr><tr><td></td><td></td><td></td></tr><tr><td></td><td></td><td></td></tr></table> Post - 0 Miss - 0 Block - 0										2 王柏淇 <table border="1"><tr><td></td><td></td><td></td></tr><tr><td></td><td></td><td></td></tr><tr><td></td><td></td><td></td></tr></table> Post - 0 Miss - 0 Block - 0										3 刘赵梁 <table border="1"><tr><td>3</td><td></td><td>2</td></tr><tr><td>1</td><td></td><td></td></tr><tr><td></td><td></td><td></td></tr></table> Post - 0 Miss - 0 Block - 1	3		2	1						4 李佳 <table border="1"><tr><td></td><td></td><td></td></tr><tr><td></td><td></td><td></td></tr><tr><td></td><td></td><td></td></tr></table> Post - 0 Miss - 0 Block - 0										5 马益奎 <table border="1"><tr><td></td><td></td><td>1</td></tr><tr><td></td><td></td><td>1</td></tr><tr><td></td><td></td><td>2</td></tr></table> Post - 0 Miss - 0 Block - 0			1			1			2	6 刘世昌 <table border="1"><tr><td></td><td></td><td>1</td></tr><tr><td></td><td></td><td></td></tr><tr><td></td><td></td><td></td></tr></table> Post - 0 Miss - 0 Block - 0			1							8 季雨 <table border="1"><tr><td></td><td></td><td></td></tr><tr><td></td><td></td><td>1</td></tr><tr><td></td><td></td><td></td></tr></table> Post - 0 Miss - 0 Block - 0						1				10 王凯强 <table border="1"><tr><td>1</td><td></td><td></td></tr><tr><td>3</td><td></td><td></td></tr><tr><td>1</td><td></td><td></td></tr></table> Post - 0 Miss - 0 Block - 0	1			3			1		
3		2																																																																													
1																																																																															
		1																																																																													
		1																																																																													
		2																																																																													
		1																																																																													
		1																																																																													
1																																																																															
3																																																																															
1																																																																															
11 张领 <table border="1"><tr><td>2</td><td></td><td></td></tr><tr><td></td><td></td><td></td></tr><tr><td></td><td></td><td>1</td></tr></table> Post - 0 Miss - 1 Block - 0	2								1	12 赵凯 <table border="1"><tr><td></td><td></td><td></td></tr><tr><td></td><td></td><td></td></tr><tr><td></td><td></td><td></td></tr></table> Post - 0 Miss - 0 Block - 0										13 隋家乐 <table border="1"><tr><td></td><td></td><td></td></tr><tr><td></td><td></td><td></td></tr><tr><td></td><td></td><td></td></tr></table> Post - 0 Miss - 0 Block - 0										15 陈冉 <table border="1"><tr><td></td><td></td><td>1</td></tr><tr><td></td><td></td><td></td></tr><tr><td>1</td><td>1</td><td>2</td></tr></table> Post - 0 Miss - 0 Block - 0			1				1	1	2	17 耿畅 <table border="1"><tr><td></td><td></td><td></td></tr><tr><td></td><td></td><td></td></tr><tr><td></td><td></td><td></td></tr></table> Post - 0 Miss - 0 Block - 0										18 刘文星 <table border="1"><tr><td></td><td></td><td></td></tr><tr><td></td><td></td><td></td></tr><tr><td></td><td></td><td></td></tr></table> Post - 0 Miss - 0 Block - 0										22 张睿梁 <table border="1"><tr><td></td><td></td><td></td></tr><tr><td></td><td></td><td></td></tr><tr><td></td><td></td><td></td></tr></table> Post - 0 Miss - 0 Block - 0																			
2																																																																															
		1																																																																													
		1																																																																													
1	1	2																																																																													

22 张睿梁

2/5	0/1	1/6
1/3	2/2	4/9
2/7	1/2	0/5

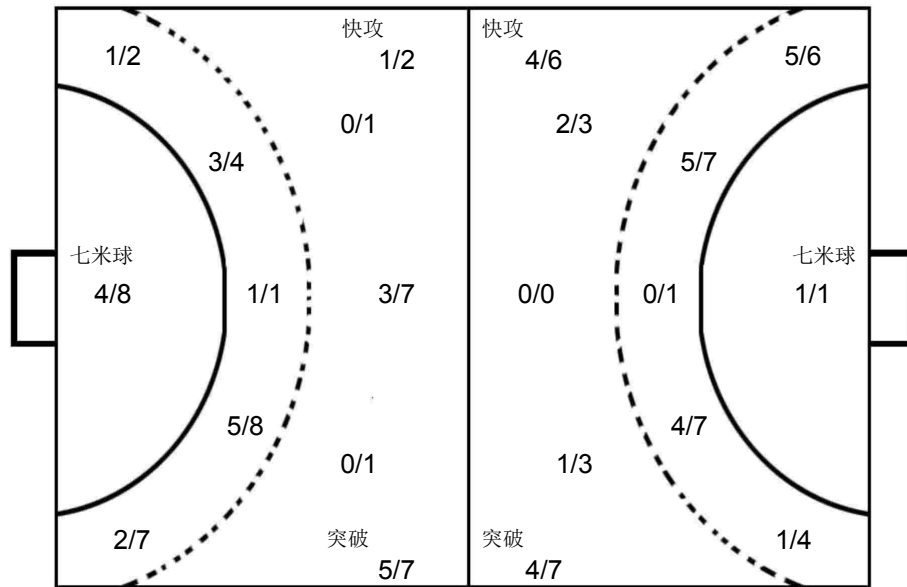

1 鲁世豪

	1/1	
		0/1

12 韩乐斌

2/8		2/7
4/8	6/6	1/3
3/5	2/3	0/4

山西队

1 鲁世豪 <table border="1"><tr><td></td><td></td><td></td></tr><tr><td></td><td></td><td></td></tr><tr><td></td><td></td><td></td></tr></table> Post - 0 Miss - 0 Block - 0										2 张智超 <table border="1"><tr><td></td><td></td><td></td></tr><tr><td></td><td></td><td></td></tr><tr><td></td><td></td><td></td></tr></table> Post - 0 Miss - 0 Block - 0										3 龙俊皓 <table border="1"><tr><td></td><td></td><td></td></tr><tr><td></td><td></td><td></td></tr><tr><td></td><td></td><td></td></tr></table> Post - 0 Miss - 0 Block - 0										4 刘文东 <table border="1"><tr><td></td><td></td><td></td></tr><tr><td></td><td></td><td></td></tr><tr><td></td><td></td><td></td></tr></table> Post - 0 Miss - 0 Block - 0										5 王宇恒 <table border="1"><tr><td></td><td></td><td></td></tr><tr><td>1</td><td></td><td></td></tr><tr><td></td><td></td><td></td></tr></table> Post - 1 Miss - 0 Block - 0				1						6 盖秀越 <table border="1"><tr><td>1</td><td>1</td><td>2</td></tr><tr><td></td><td></td><td></td></tr><tr><td>2</td><td></td><td></td></tr></table> Post - 0 Miss - 0 Block - 0	1	1	2				2			7 任健豪 <table border="1"><tr><td>1</td><td></td><td>1</td></tr><tr><td>1</td><td></td><td>2</td></tr><tr><td>1</td><td>1</td><td></td></tr></table> Post - 1 Miss - 0 Block - 0	1		1	1		2	1	1		9 辛浩乐 <table border="1"><tr><td></td><td></td><td></td></tr><tr><td></td><td></td><td></td></tr><tr><td></td><td></td><td></td></tr></table> Post - 0 Miss - 0 Block - 0									
1																																																																															
1	1	2																																																																													
2																																																																															
1		1																																																																													
1		2																																																																													
1	1																																																																														
10 王洋 <table border="1"><tr><td></td><td></td><td></td></tr><tr><td></td><td></td><td></td></tr><tr><td>1</td><td></td><td>2</td></tr></table> Post - 0 Miss - 0 Block - 0							1		2	11 吴夏冰 <table border="1"><tr><td></td><td></td><td></td></tr><tr><td></td><td></td><td></td></tr><tr><td></td><td></td><td>1</td></tr></table> Post - 0 Miss - 0 Block - 0									1	12 韩乐斌 <table border="1"><tr><td></td><td></td><td></td></tr><tr><td></td><td></td><td></td></tr><tr><td></td><td></td><td></td></tr></table> Post - 0 Miss - 0 Block - 0										13 杜忠浩 <table border="1"><tr><td></td><td></td><td></td></tr><tr><td></td><td></td><td></td></tr><tr><td></td><td></td><td>2</td></tr></table> Post - 0 Miss - 0 Block - 0									2	14 杨毅 <table border="1"><tr><td>1</td><td></td><td>2</td></tr><tr><td></td><td></td><td>1</td></tr><tr><td>1</td><td></td><td>2</td></tr></table> Post - 0 Miss - 1 Block - 1	1		2			1	1		2	15 薛瑞寒 <table border="1"><tr><td></td><td></td><td></td></tr><tr><td></td><td></td><td></td></tr><tr><td></td><td></td><td></td></tr></table> Post - 1 Miss - 0 Block - 0										16 王虹翔 <table border="1"><tr><td></td><td></td><td></td></tr><tr><td></td><td></td><td></td></tr><tr><td></td><td></td><td></td></tr></table> Post - 0 Miss - 0 Block - 0										18 张禹琛 <table border="1"><tr><td></td><td></td><td></td></tr><tr><td></td><td></td><td></td></tr><tr><td></td><td></td><td></td></tr></table> Post - 0 Miss - 0 Block - 0									
1		2																																																																													
		1																																																																													
		2																																																																													
1		2																																																																													
		1																																																																													
1		2																																																																													



Team A					Team B					Match Number											
A 江苏队					B 山东队					11											
Played in			in the hall			on			at			Spectators									
重庆万州			万州体育馆			2019-04-09			16:00			hours									
Half-time(30')	A	B	End of playing time	A	B	1st extra time	A	B	2nd extra time	A	B	After penalty throws	A	B							
	17	12	26	25																	
Number of 7 m	A	Team time-out			Full name of players and officials					Team time-out			B	Number of 7 m							
	2/2	1	2	3						1	2	3	3/4								
		22:07	50:36	59:31						14:14	52:11	58:57									
No.	Team A					G	W	2'	D	DR	No.	Team B					G	W	2'	D	DR
1	宋继强										1	宋晓晨									
4	张家纬					6	1				6	李朝鹏					2		2		
6	赵晨					11					7	林豪文									
7	周傲										8	王炳华					1				
8	谢庆龙					3	1				9	赵元									
11	张天豪										10	赵建强									
12	王权										11	宋朋强					3				
16	张帅										12	于性哲									
18	赵楠										13	刘晓					6				
19	庞连康										15	张继伟						1	2		
20	顾艳超					1					17	王旭东						1			
21	刘江										19	李语庆					3				
25	王杰缘					4	1				21	姜春辉									
27	王伟强					1					27	胡晋铭					1				
30	吴龙瑞										31	于亚男					9	1			
											34	王钟彬									
A	闫威名 (主教练)										B	王鸿斌 (主教练)									
B	叶强										C	金京男									
C	贾淑君										D	刘桂妮									
E	王建国										E	林配永									
A	Signatures of responsables for the teams (Off.A)										B										
TP	Remarks of referees / HF Official										TP										

Signatures

Referees	王雨洋 (CHN)	严璐 (CHN)		
T.D.	李之文 (CHN)	张春生 (CHN)		
CHA Off.				

Note: Number of 7m Throws Awarded to Team A and B, Goals (G), Warnings (W), Suspensions (2'), Direct Disqualification (D), Disqualification With Report (DR) and Team Penalty (TP).

Table Officials: 黄一凡

张晓虎

Statisticians: 周亚桥

谢杨

2019年全国男子手球冠军杯赛

PHMS Pictorial Handball Match Statistics

IHF Official System

竞赛技术统计

手球  
男子

预赛  
轮次 3

组别 B  
场次 11

万州体育馆  
2019-04-09 16:00

Referees: 王雨洋 (CHN) / 严璐 (CHN) Result: 26:25(17:12)  
Teams: 江苏队(江苏) VS 山东队(山东)

江苏		远	近	边	快	突	任意	7m	合计	%	助攻	失误	警告	2'	D+DR
主教练: 闫威名		射	射	射	攻	破	球	球							
1	宋继强														
4	张家纬	4/7	2/3			0/1			6/11	54.5			1		
6	赵晨	8/14	0/1			2/2	1/1		11/18	61.1	3	2			
7	周傲														
8	谢庆龙		3/5						3/5	60.0		1	1		
11	张天豪														
12	王权										2				
16	张帅														
18	赵楠														
19	庞连康														
20	顾艳超	0/6	1/1						1/7	14.3	1	2			
21	刘江														
25	王杰缘			1/4	1/1			2/2	4/7	57.1			1		
27	王伟强			0/1	1/1				1/2	50.0					
30	吴龙瑞											1			
运动员	合计	12/27	6/10	1/5	2/2	2/3	1/1	2/2	26/50	52.0	6	6	3		
12	王权	6/19	4/8		1/2	1/3		1/4	13/36	36.1	2				
16	张帅	1/2			0/1				1/3	33.3					
守门员	合计	7/21	4/8		1/3	1/3		1/4	14/39	35.9	2				

山东		远	近	边	快	突	任意	7m	合计	%	助攻	失误	警告	2'	D+DR
主教练: 王鸿斌		射	射	射	攻	破	球	球							
1	宋晓晨														
6	李朝鹏	1/3	1/2						2/5	40.0	3		2		
7	林豪文														
8	王炳华				1/1				1/1	100	1				
9	赵元														
10	赵建强														
11	宋朋强	0/1	1/1	0/1	1/2	1/2			3/7	42.9	1				
12	于性哲														
13	刘晓	4/7	1/3			1/1			6/11	54.5					
15	张继伟												1	2	
17	王旭东	0/2	0/2						0/4	0.0	1	2	1		
19	李语庆							3/4	3/4	75.0					
21	姜春辉														
27	胡晋铭		1/1						1/1	100	1				
31	于亚男	9/18							9/18	50.0			1		
34	王钟彬														
运动员	合计	14/31	4/9	0/1	2/3	2/3		3/4	25/51	49.0	1	8	3	4	
1	宋晓晨	0/1				0/1			0/2	0.0					
12	于性哲	7/18	4/10	3/4	0/2	0/1	0/1	0/2	14/38	36.8					
守门员	合计	7/19	4/10	3/4	0/2	0/2	0/1	0/2	14/40	35.0					

江苏	比赛进程	山东
1st Half		
4 张家纬	1 00:59 0	
	1 01:31 1 31 于亚男	
8 谢庆龙	2 02:59 1	
25 王杰缘	3 03:44 1	
4 张家纬	4 05:10 1	
	4 05:43 2 31 于亚男	
4 张家纬	5 07:25 2	
	5 08:07 3 31 于亚男	
6 赵晨	6 08:44 3	
	6 10:15 4 19 李语庆	
4 张家纬	7 12:07 4	
27 王伟强	8 14:52 4	
	8 15:19 5 31 于亚男	
20 顾艳超	9 16:08 5	
	9 17:01 6 11 宋朋强	
25 王杰缘	10 18:07 6	
6 赵晨	11 18:57 6	
6 赵晨	12 19:57 6	
6 赵晨	13 20:49 6	
	13 21:59 7 31 于亚男	
6 赵晨	14 22:26 7	
	14 23:08 8 13 刘晓	
25 王杰缘	15 24:06 8	
	15 24:44 9 31 于亚男	
	15 26:28 10 13 刘晓	
	15 28:39 11 19 李语庆	
6 赵晨	16 28:54 11	
	16 29:34 12 13 刘晓	
6 赵晨	17 29:58 12	
2nd Half		
	17 01:24 13 13 刘晓	
8 谢庆龙	18 01:57 13	
	18 02:42 14 31 于亚男	
	18 03:55 15 27 胡晋铭	
4 张家纬	19 05:48 15	
	19 07:24 16 11 宋朋强	
	19 08:48 17 11 宋朋强	
6 赵晨	20 09:23 17	
6 赵晨	21 10:01 17	
	21 11:11 18 31 于亚男	
6 赵晨	22 12:33 18	
	22 13:33 19 19 李语庆	
25 王杰缘	23 14:30 19	
	23 15:00 20 13 刘晓	
	23 18:00 21 8 王炳华	
	23 19:37 22 6 李朝鹏	
8 谢庆龙	24 21:54 22	
	24 22:37 23 31 于亚男	
	24 23:54 24 13 刘晓	
4 张家纬	25 24:03 24	
6 赵晨	26 27:01 24	
	26 29:11 25 6 李朝鹏	

场上队员: 得分 / 射门

守门员: 救球 / 射门

D	取消资格	DR	取消资格+报告
---	------	----	---------

2019年全国男子手球冠军杯赛

PHMS Pictorial Handball Match Statistics

IHF Official System

个人/全队技术统计表

手球 男子 预赛 轮次 3 组别 B 场次 11 万州体育馆 2019-04-09 16:00

号码	姓名	远射	近射	边射	快攻	突破	任意	七米	合计	%	助攻	失误	警告	2'	取消	时间
江苏队(江苏)																
(场上队员)																
1	宋继强									0.0%						00:00:00
4	张家纬	4/7	2/3			0/1			6/11	54.5%			1			00:48:16
6	赵晨	8/14	0/1			2/2	1/1		11/18	61.1%	3	2				00:51:25
7	周傲									0.0%						00:00:00
8	谢庆龙		3/5						3/5	60.0%		1	1			00:50:09
11	张天豪									0.0%						00:00:00
12	王权									0.0%	2					00:54:24
16	张帅									0.0%						00:05:36
18	赵楠									0.0%						00:11:19
19	庞连康									0.0%						00:08:01
20	顾艳超	0/6	1/1						1/7	14.3%	1	2				00:53:23
21	刘江									0.0%						00:10:03
25	王杰缘			1/4	1/1			2/2	4/7	57.1%			1			01:00:00
27	王伟强			0/1	1/1				1/2	50.0%						01:00:00
30	吴龙瑞									0.0%		1				00:06:40
合计		12/27	6/10	1/5	2/2	2/3	1/1	2/2	26/50	52.0%	6	6	3			
(守门员)																
12	王权	6/19	4/8		1/2	1/3		1/4	13/36	36.1%	2					00:54:24
16	张帅	1/2			0/1				1/3	33.3%						00:05:36
合计		7/21	4/8		1/3	1/3		1/4	14/39	35.9%	2					

场上队员：得分/射门

守门员：救球/射门

全队合计	得分	被救	射失	击柱	封球	合计	%
远射	12	7	3	1	4	27	44.4%
近射	6	4				10	60.0%
边射	1	3	1			5	20.0%
快攻	2					2	100.0%
突破	2		1			3	66.7%
任意	1					1	100.0%
七米	2					2	100.0%

## 2019年全国男子手球冠军杯赛

PHMS Pictorial Handball Match Statistics

IHF Official System

### 个人/全队技术统计表

手球 男子 预赛 轮次 3 组别 B 场次 11 万州体育馆 2019-04-09 16:00

号码	姓名	远射	近射	边射	快攻	突破	任意	七米	合计	%	助攻	失误	警告	2'	取消	时间
山东队(山东)																
(场上队员)																
1	宋晓晨									0.0%						00:02:58
6	李朝鹏	1/3	1/2						2/5	40.0%		3		2		00:51:50
7	林豪文									0.0%						00:04:00
8	王炳华					1/1			1/1	100%		1				00:11:59
9	赵元									0.0%						00:00:00
10	赵建强									0.0%						00:00:00
11	宋朋强	0/1	1/1	0/1	1/2	1/2			3/7	42.9%		1				01:00:00
12	于性哲									0.0%						00:57:02
13	刘晓	4/7	1/3			1/1			6/11	54.5%						00:41:51
15	张继伟									0.0%			1	2		00:58:01
17	王旭东	0/2	0/2						0/4	0.0%	1	2	1			00:18:03
19	李语庆							3/4	3/4	75.0%						01:00:00
21	姜春辉									0.0%						00:00:00
27	胡晋铭		1/1						1/1	100%		1				00:02:06
31	于亚男	9/18							9/18	50.0%			1			00:47:29
34	王钟彬									0.0%						00:00:00
合计		14/31	4/9	0/1	2/3	2/3		3/4	25/51	49.0%	1	8	3	4		
(守门员)																
1	宋晓晨	0/1				0/1			0/2	0.0%						00:02:58
12	于性哲	7/18	4/10	3/4	0/2	0/1	0/1	0/2	14/38	36.8%						00:57:02
合计		7/19	4/10	3/4	0/2	0/2	0/1	0/2	14/40	35.0%						

场上队员：得分/射门

守门员：救球/射门

全队合计	得分	被救	射失	击柱	封球	合计	%
远射	14	7	2	2	6	31	45.2%
近射	4	4	1			9	44.4%
边射				1		1	0.0%
快攻	2	1				3	66.7%
突破	2	1				3	66.7%
任意							0.0%
七米	3	1				4	75.0%

图式比赛技术统计表

手球  
男子

预赛  
轮次 3

组别 B  
场次 11

万州体育馆  
2019-04-09 16:00

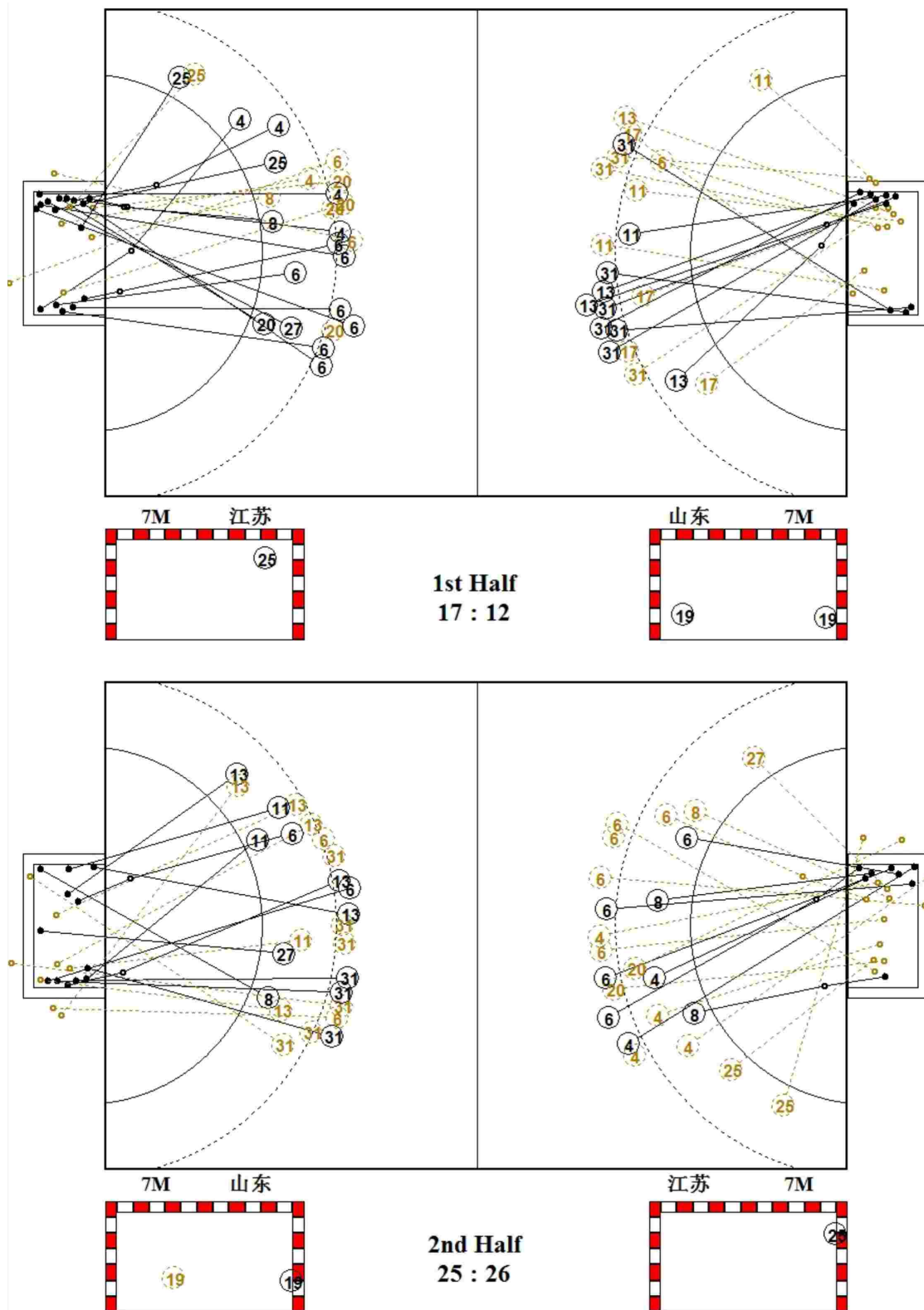



图式射门区域统计

手球  
男子

预赛  
轮次 3

组别 B  
场次 11

万州体育馆  
2019-04-09 16:00

江苏队

1 宋继强 Post - 0 Miss - 0 Block - 0	4 张家纬 Post - 0 Miss - 1 Block - 1	6 赵晨 Post - 1 Miss - 2 Block - 1	7 周傲 Post - 0 Miss - 0 Block - 0	8 谢庆龙 Post - 0 Miss - 0 Block - 0	11 张天豪 Post - 0 Miss - 0 Block - 0	12 王权 Post - 0 Miss - 0 Block - 0	16 张帅 Post - 0 Miss - 0 Block - 0
18 赵楠 Post - 0 Miss - 0 Block - 0	19 庞连康 Post - 0 Miss - 0 Block - 0	20 顾艳超 Post - 0 Miss - 1 Block - 2	21 刘江 Post - 0 Miss - 0 Block - 0	25 王杰缘 Post - 0 Miss - 1 Block - 0	27 王伟强 Post - 0 Miss - 0 Block - 0	30 吴龙瑞 Post - 0 Miss - 0 Block - 0	

12 王权
3/5 1/2 0/2
6/12 1/6
0/5 1/1 1/3

16 张帅
1/2 0/1

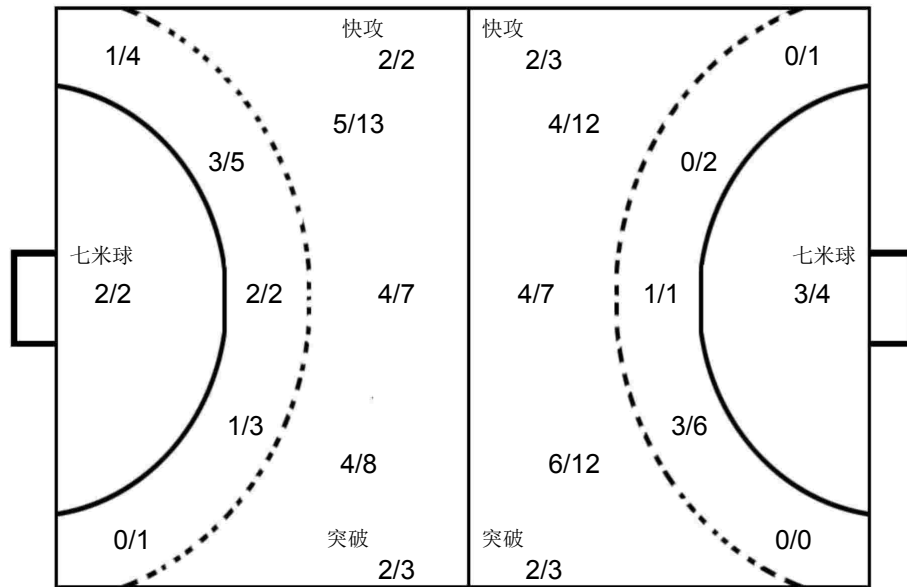

1 宋晓晨
0/1
0/1

12 于性哲
0/4 0/7
4/7 2/2 5/10
1/4 1/1 1/3

山东队

1 宋晓晨 Post - 0 Miss - 0 Block - 0	6 李朝鹏 Post - 0 Miss - 1 Block - 1	7 林豪文 Post - 0 Miss - 0 Block - 0	8 王炳华 Post - 0 Miss - 0 Block - 0	9 赵元 Post - 0 Miss - 0 Block - 0	10 赵建强 Post - 0 Miss - 0 Block - 0	11 宋朋强 Post - 1 Miss - 0 Block - 0	12 于性哲 Post - 0 Miss - 0 Block - 0
13 刘晓 Post - 0 Miss - 1 Block - 0	15 张继伟 Post - 0 Miss - 0 Block - 0	17 王旭东 Post - 0 Miss - 0 Block - 1	19 李语庆 Post - 0 Miss - 0 Block - 0	21 姜春辉 Post - 0 Miss - 0 Block - 0	27 胡晋铭 Post - 0 Miss - 0 Block - 0	31 于亚男 Post - 2 Miss - 1 Block - 4	34 王钟彬 Post - 0 Miss - 0 Block - 0



Team A					Team B					Match Number											
A 上海队					B 四川队					<b>12</b>											
Played in			in the hall			on			at			Spectators									
重庆万州			万州体育馆			2019-04-09			17:30			hours									
Half-time(30')	A	B	End of playing time		A	B	1st extra time		A	B	2nd extra time		A	B	After penalty throws						
	13	12	34		20																
Number of 7 m	A	Team time-out			Full name of players and officials						Team time-out			B	Number of 7 m						
	0/1	1	2	3							1	2	3	B							
		16:32									25:21	47:54	58:41	0/1							
No.	Team A					G	W	2'	D	DR	No.	Team B					G	W	2'	D	DR
1	张峥										2	张宏运					3				
3	张立成					3					3	李朗轩						1			
4	高天伦							1			6	董佳辉					7				
5	贺政					6					7	曾繁泳					3				
7	周文龙					6					8	罗霖泽					2		1		
8	高震东					8	1				9	左典									
10	朱世杰						1	1			10	李剑琛									
11	蒋慧捷					3		1			12	戴景伟									
12	周哲韬										14	沈鹏飞					5				
13	谢智超										17	叶康全									
15	庄旭杰					4															
16	张逸豪																				
18	董凯					2															
20	蒋承骅																				
30	徐俊吉					2															
A	吴璟 (主教练)										A	李中洲									
B	金迪琦										B	王伟 (主教练)					1				
C	张勇军										C	张广建									
D	杨时																				
A	Signatures of responsables for the teams (Off.A)															B					
TP	Remarks of referees / HF Official															TP					

Signatures

Referees	康曦 (CHN)	陈常增 (CHN)		
T.D.	郭剑 (CHN)	张春生 (CHN)		
CHA Off.				

Note: Number of 7m Throws Awarded to Team A and B, Goals (G), Warnings (W), Suspensions (2'), Direct Disqualification (D), Disqualification With Report (DR) and Team Penalty (TP).

Table Officials: 张之伟

林子建

Statisticians: 赵悦

周亚桥

## 2019年全国男子手球冠军杯赛

PHMS Pictorial Handball Match Statistics

IHF Official System

### 竞赛技术统计

手球  
男子

预赛  
轮次 3

组别 B  
场次 12

万州体育馆  
2019-04-09 17:30

Referees:	康曦 (CHN) / 陈常增 (CHN)	Result:	34:20(13:12)
Teams:	上海队(上海) VS 四川队(四川)		

上海														上海		四川		
主教练: 吴璟														比赛进程				
	远射	近射	边射	快攻	突破	任意球	7m球	合计	%	助攻	失误	警告	2'	D+DR	1st Half			
1 张峥										2					8 高震东	1 02:16	0	
3 张立成				1/1	2/2		0/1	3/4	75.0	2	2				8 高震东	1 03:18	1	7 曾繁泳
4 高天伦										1			1		8 高震东	2 03:31	1	
5 贺政		2/2	2/2	1/2	1/2			6/8	75.0						30 徐俊吉	3 04:13	1	
7 周文龙	1/3	1/3	1/1		3/3			6/10	60.0	1	2				3 07:00	2	14 洗鹏飞	
8 高震东	0/1	3/3	2/2	1/3	2/2			8/11	72.7			1			8 高震东	3 07:59	3	7 曾繁泳
10 朱世杰		0/1			0/1			0/2	0.0	3	3	1	1		4 08:40	3		
11 蒋慧捷			3/3	0/1				3/4	75.0				1		4 09:32	4	14 洗鹏飞	
12 周哲韬															4 11:24	5	6 董佳辉	
13 谢智超															5 11:47	5		
15 庄旭杰			2/3	2/2				4/5	80.0						5 12:26	6	2 张宏运	
16 张逸豪															6 12:48	6		
18 董凯	0/1	2/2		0/1				2/4	50.0		1				6 13:19	7	7 曾繁泳	
20 蒋承骅															7 13:48	7		
30 徐俊吉		2/5						2/5	40.0		2				8 15:23	7		
运动员 合计	1/5	10/16	10/11	5/10	8/10		0/1	34/53	64.2	9	10	2	3		8 16:52	8	8 罗霖泽	
1 张峥	5/6	5/13	3/6	0/2	2/5			15/32	46.9	2					7 周文龙	9 17:32	8	
16 张逸豪	0/1	0/1	1/1		0/1			1/4	25.0						5 贺政	10 17:59	8	
守门员 合计	5/7	5/14	4/7	0/2	2/6			16/36	44.4	2					10 19:12	9	6 董佳辉	
														2nd Half				
														11 蒋慧捷	14 00:14	12		
														8 高震东	14 00:54	13	14 洗鹏飞	
														5 贺政	15 01:12	13		
														8 高震东	16 03:43	13		
														8 高震东	17 04:58	13		
														7 周文龙	18 05:30	13		
														8 高震东	18 06:05	14	14 洗鹏飞	
														11 蒋慧捷	19 06:33	14		
														18 董凯	19 07:21	15	6 董佳辉	
														7 周文龙	20 07:57	15		
														18 董凯	21 08:47	15		
														8 高震东	22 10:22	15		
														8 高震东	23 11:14	15		
														5 贺政	23 12:47	16	8 罗霖泽	
														15 庄旭杰	24 14:32	16		
														15 庄旭杰	25 16:15	16		
														15 庄旭杰	26 17:24	16		
														3 张立成	27 18:56	16		
														15 庄旭杰	28 19:53	16		
														18 董凯	28 20:27	17	2 张宏运	
														8 高震东	29 22:30	17		
														8 高震东	30 23:52	17		
														3 张立成	30 24:02	18	6 董佳辉	
														15 庄旭杰	31 26:24	18		
														3 张立成	32 27:18	18		
														3 张立成	32 27:57	19	6 董佳辉	
														8 高震东	33 29:06	19		
														8 高震东	33 29:41	20	6 董佳辉	
														8 高震东	34 29:55	20		

场上队员: 得分 / 射门

守门员: 救球 / 射门

D	取消资格	DR	取消资格+报告
---	------	----	---------

## 2019年全国男子手球冠军杯赛

PHMS Pictorial Handball Match Statistics

IHF Official System

### 个人/全队技术统计表

手球 男子 预赛 轮次 3 组别 B 场次 12 万州体育馆 2019-04-09 17:30

号码	姓名	远射	近射	边射	快攻	突破	任意	七米	合计	%	助攻	失误	警告	2'	取消	时间
上海队(上海)																
(场上队员)																
1	张崢									0.0%	2					00:50:35
3	张立成				1/1	2/2		0/1	3/4	75.0%	2	2				00:15:25
4	高天伦									0.0%	1			1		00:27:25
5	贺政		2/2	2/2	1/2	1/2			6/8	75.0%						00:37:41
7	周文龙	1/3	1/3	1/1		3/3			6/10	60.0%	1	2				00:47:25
8	高震东	0/1	3/3	2/2	1/3	2/2			8/11	72.7%			1			01:00:00
10	朱世杰		0/1			0/1			0/2	0.0%	3	3	1	1		01:00:00
11	蒋慧捷			3/3	0/1				3/4	75.0%				1		00:27:48
12	周哲韬									0.0%						00:00:00
13	谢智超									0.0%						00:00:00
15	庄旭杰			2/3	2/2				4/5	80.0%						00:12:22
16	张逸豪									0.0%						00:09:25
18	董凯	0/1	2/2		0/1				2/4	50.0%		1				00:29:05
20	蒋承骅									0.0%						00:00:00
30	徐俊吉		2/5						2/5	40.0%		2				00:42:32
合计		1/5	10/16	10/11	5/10	8/10		0/1	34/53	64.2%	9	10	2	3		
(守门员)																
1	张崢	5/6	5/13	3/6	0/2	2/5			15/32	46.9%	2					00:50:35
16	张逸豪	0/1	0/1	1/1		0/1			1/4	25.0%						00:09:25
合计		5/7	5/14	4/7	0/2	2/6			16/36	44.4%	2					

场上队员：得分/射门

守门员：救球/射门

全队合计	得分	被救	射失	击柱	封球	合计	%
远射	1	1	1	1	1	5	20.0%
近射	10	4	2			16	62.5%
边射	10			1		11	90.9%
快攻	5	3	2			10	50.0%
突破	8	2				10	80.0%
任意							0.0%
七米		1				1	0.0%

## 2019年全国男子手球冠军杯赛

PHMS Pictorial Handball Match Statistics

IHF Official System

### 个人/全队技术统计表

手球 男子 预赛 轮次 3 组别 B 场次 12 万州体育馆 2019-04-09 17:30

号码	姓名	远射	近射	边射	快攻	突破	任意	七米	合计	%	助攻	失误	警告	2'	取消	时间
<b>四川队(四川)</b>																
<b>(场上队员)</b>																
2	张宏运		3/5						3/5	60.0%						00:56:14
3	李朗轩	0/1							0/1	0.0%			1			00:18:10
6	董佳辉	1/4	4/5			2/3			7/12	58.3%		1				00:45:09
7	曾繁泳			2/3	1/1				3/4	75.0%		2				00:55:22
8	罗霖泽		1/1	1/5	0/2				2/8	25.0%		3		1		01:00:00
9	左典	0/2	0/3			0/1			0/6	0.0%		4				01:00:00
10	李剑琛									0.0%		1				00:07:25
12	戴景伟									0.0%	1	1				00:21:33
14	洗鹏飞	1/2	1/1		1/1	2/2		0/1	5/7	71.4%	2	3				00:57:18
17	叶康全									0.0%		1				00:38:27
<b>合计</b>		<b>2/9</b>	<b>9/15</b>	<b>3/8</b>	<b>2/4</b>	<b>4/6</b>		<b>0/1</b>	<b>20/43</b>	<b>46.5%</b>	<b>3</b>	<b>16</b>	<b>1</b>	<b>1</b>		
<b>(守门员)</b>																
12	戴景伟		1/4	0/3	2/6	1/6		1/1	5/20	25.0%	1	1				00:21:33
17	叶康全	1/2	3/10	0/7	1/2	1/4			6/25	24.0%		1				00:38:27
<b>合计</b>		<b>1/2</b>	<b>4/14</b>	<b>0/10</b>	<b>3/8</b>	<b>2/10</b>		<b>1/1</b>	<b>11/45</b>	<b>24.4%</b>	<b>1</b>	<b>2</b>				

场上队员：得分/射门

守门员：救球/射门

全队合计	得分	被救	射失	击柱	封球	合计	%
远射	2	5			2	9	22.2%
近射	9	5		1		15	60.0%
边射	3	4	1			8	37.5%
快攻	2		1	1		4	50.0%
突破	4	2				6	66.7%
任意							0.0%
七米			1			1	0.0%

图式比赛技术统计表

手球  
男子

预赛  
轮次 3

组别 B  
场次 12

万州体育馆  
2019-04-09 17:30

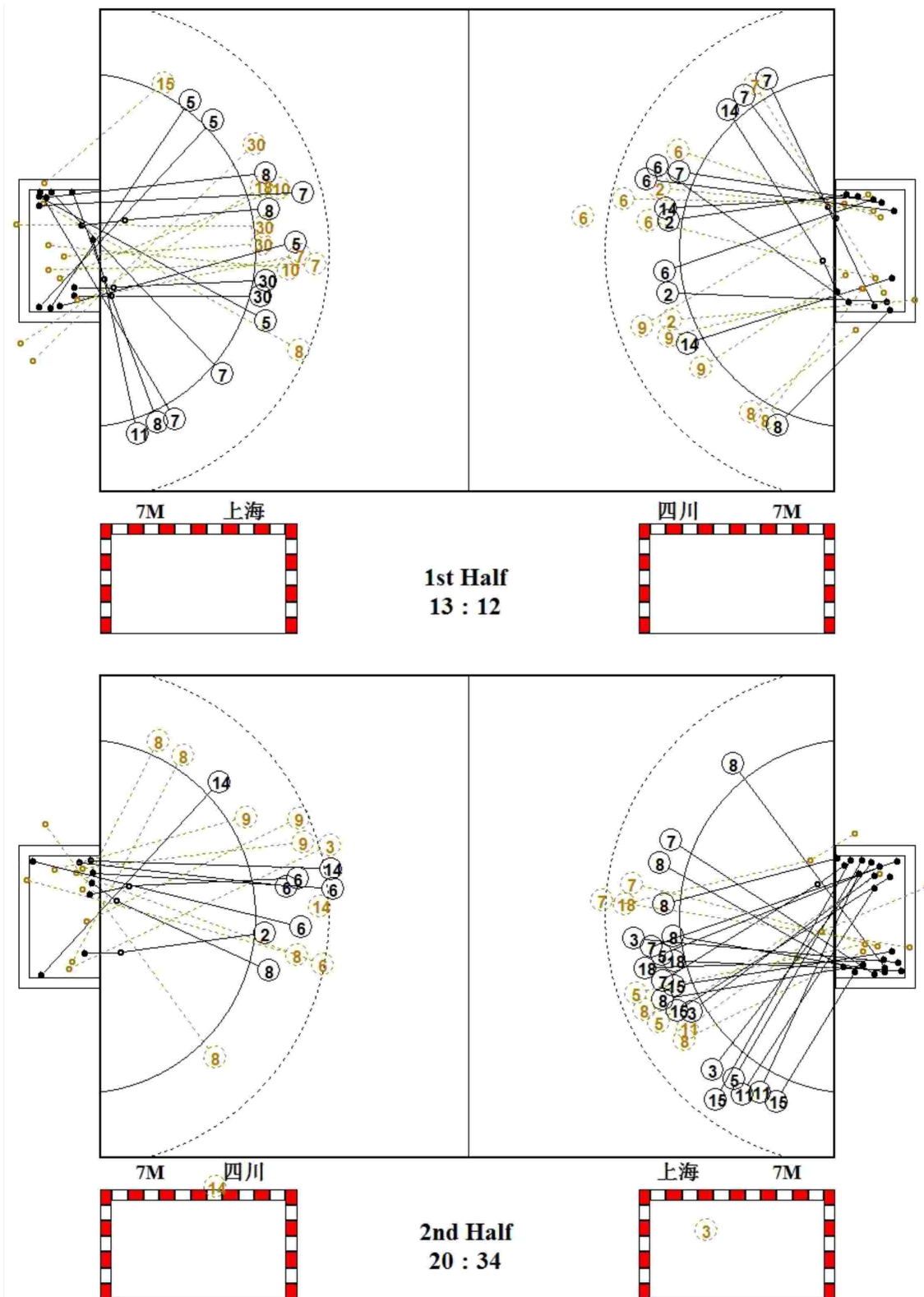

图式射门区域统计

手球  
男子

预赛  
轮次 3

组别 B  
场次 12

万州体育馆  
2019-04-09 17:30

上海队

1 张峥	3 张立成	4 高天伦	5 贺政	7 周文龙	8 高震东	10 朱世杰	11 蒋慧捷																																																																								
<table border="1"><tr><td></td><td></td><td></td></tr><tr><td></td><td></td><td></td></tr><tr><td></td><td></td><td></td></tr></table>										<table border="1"><tr><td></td><td></td><td>1</td></tr><tr><td>2</td><td></td><td></td></tr><tr><td></td><td></td><td></td></tr></table>			1	2						<table border="1"><tr><td></td><td></td><td></td></tr><tr><td></td><td></td><td></td></tr><tr><td></td><td></td><td></td></tr></table>										<table border="1"><tr><td>2</td><td></td><td>1</td></tr><tr><td>3</td><td></td><td></td></tr><tr><td></td><td></td><td></td></tr></table>	2		1	3						<table border="1"><tr><td>1</td><td></td><td>3</td></tr><tr><td></td><td></td><td>1</td></tr><tr><td>1</td><td></td><td></td></tr></table>	1		3			1	1			<table border="1"><tr><td></td><td></td><td>3</td></tr><tr><td></td><td></td><td>2</td></tr><tr><td>1</td><td></td><td>2</td></tr></table>			3			2	1		2	<table border="1"><tr><td></td><td></td><td></td></tr><tr><td></td><td></td><td></td></tr><tr><td></td><td></td><td></td></tr></table>										<table border="1"><tr><td></td><td></td><td></td></tr><tr><td>2</td><td></td><td></td></tr><tr><td></td><td>1</td><td></td></tr></table>				2				1	
		1																																																																													
2																																																																															
2		1																																																																													
3																																																																															
1		3																																																																													
		1																																																																													
1																																																																															
		3																																																																													
		2																																																																													
1		2																																																																													
2																																																																															
	1																																																																														
Post - 0 Miss - 0 Block - 0	Post - 0 Miss - 0 Block - 0	Post - 0 Miss - 0 Block - 0	Post - 0 Miss - 0 Block - 0	Post - 1 Miss - 0 Block - 0	Post - 0 Miss - 0 Block - 1	Post - 0 Miss - 0 Block - 0	Post - 0 Miss - 1 Block - 0																																																																								
12 周哲韬	13 谢智超	15 庄旭杰	16 张逸豪	18 董凯	20 蒋承骅	30 徐俊吉																																																																									
<table border="1"><tr><td></td><td></td><td></td></tr><tr><td></td><td></td><td></td></tr><tr><td></td><td></td><td></td></tr></table>										<table border="1"><tr><td></td><td></td><td></td></tr><tr><td></td><td></td><td></td></tr><tr><td></td><td></td><td></td></tr></table>										<table border="1"><tr><td>1</td><td></td><td>1</td></tr><tr><td></td><td></td><td></td></tr><tr><td>1</td><td></td><td>1</td></tr></table>	1		1				1		1	<table border="1"><tr><td></td><td></td><td></td></tr><tr><td></td><td></td><td></td></tr><tr><td></td><td></td><td></td></tr></table>										<table border="1"><tr><td></td><td></td><td>2</td></tr><tr><td></td><td></td><td></td></tr><tr><td></td><td></td><td></td></tr></table>			2							<table border="1"><tr><td></td><td></td><td></td></tr><tr><td></td><td></td><td></td></tr><tr><td></td><td></td><td></td></tr></table>										<table border="1"><tr><td></td><td></td><td></td></tr><tr><td>2</td><td></td><td></td></tr><tr><td></td><td></td><td></td></tr></table>				2															
1		1																																																																													
1		1																																																																													
		2																																																																													
2																																																																															
Post - 0 Miss - 0 Block - 0	Post - 0 Miss - 0 Block - 0	Post - 1 Miss - 0 Block - 0	Post - 0 Miss - 0 Block - 0	Post - 0 Miss - 2 Block - 0	Post - 0 Miss - 0 Block - 0	Post - 0 Miss - 2 Block - 0																																																																									

1 张峥

1/4		1/4
3/5		5/6
1/4	1/1	3/8

16 张逸豪

		0/1
1/1		
		0/2

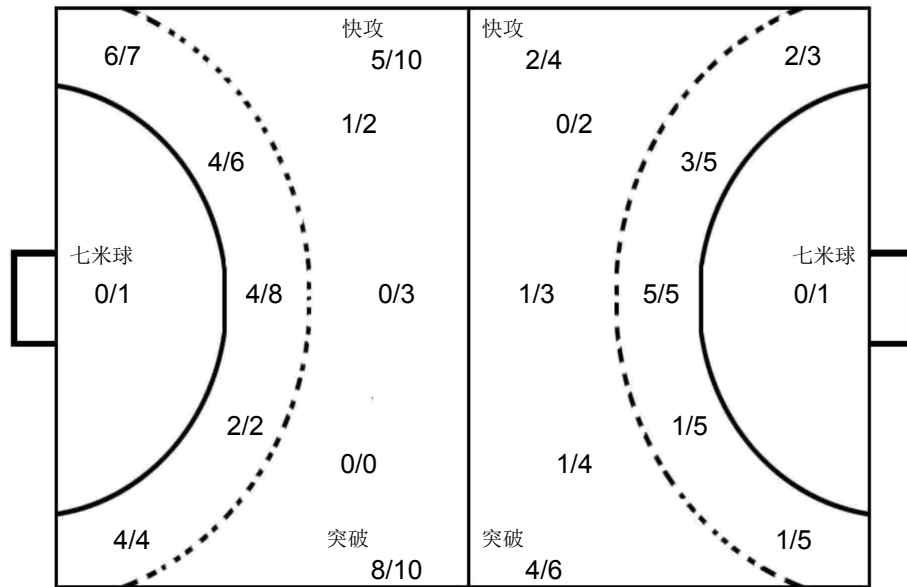

12 戴景伟

1/1		0/5
1/4		3/5
0/3		0/2

17 叶康全

0/4	2/2	1/7
1/7	1/1	0/1
1/1	0/1	0/1

四川队

2 张宏运	3 李朗轩	6 董佳辉	7 曾繁泳	8 罗霖泽	9 左典	10 李剑琛	12 戴景伟																																																																								
<table border="1"><tr><td></td><td></td><td>1</td></tr><tr><td>2</td><td></td><td></td></tr><tr><td></td><td></td><td></td></tr></table>			1	2						<table border="1"><tr><td></td><td></td><td></td></tr><tr><td></td><td></td><td></td></tr><tr><td></td><td></td><td></td></tr></table>										<table border="1"><tr><td>1</td><td></td><td>1</td></tr><tr><td>1</td><td></td><td>4</td></tr><tr><td></td><td></td><td></td></tr></table>	1		1	1		4				<table border="1"><tr><td>1</td><td></td><td></td></tr><tr><td></td><td></td><td>1</td></tr><tr><td>1</td><td></td><td></td></tr></table>	1					1	1			<table border="1"><tr><td></td><td></td><td>1</td></tr><tr><td></td><td></td><td></td></tr><tr><td></td><td></td><td>1</td></tr></table>			1						1	<table border="1"><tr><td></td><td></td><td></td></tr><tr><td></td><td></td><td></td></tr><tr><td></td><td></td><td></td></tr></table>										<table border="1"><tr><td></td><td></td><td></td></tr><tr><td></td><td></td><td></td></tr><tr><td></td><td></td><td></td></tr></table>										<table border="1"><tr><td></td><td></td><td></td></tr><tr><td></td><td></td><td></td></tr><tr><td></td><td></td><td></td></tr></table>									
		1																																																																													
2																																																																															
1		1																																																																													
1		4																																																																													
1																																																																															
		1																																																																													
1																																																																															
		1																																																																													
		1																																																																													
Post - 1 Miss - 0 Block - 0	Post - 0 Miss - 0 Block - 0	Post - 0 Miss - 0 Block - 1	Post - 0 Miss - 0 Block - 0	Post - 1 Miss - 2 Block - 0	Post - 0 Miss - 0 Block - 0	Post - 0 Miss - 0 Block - 0	Post - 0 Miss - 0 Block - 0																																																																								
14 洗鹏飞	17 叶康全																																																																														
<table border="1"><tr><td>1</td><td></td><td>1</td></tr><tr><td>1</td><td></td><td></td></tr><tr><td></td><td></td><td>2</td></tr></table>	1		1	1					2	<table border="1"><tr><td></td><td></td><td></td></tr><tr><td></td><td></td><td></td></tr><tr><td></td><td></td><td></td></tr></table>																																																																					
1		1																																																																													
1																																																																															
		2																																																																													
Post - 0 Miss - 1 Block - 1	Post - 0 Miss - 0 Block - 0																																																																														



Team A					Team B					Match Number											
A 山东队					B 天津队					13											
Played in			in the hall			on			at			Spectators									
重庆万州			万州体育馆			2019-04-10			13:00			hours									
Half-time(30')	A	B	End of playing time		A	B	1st extra time		A	B	2nd extra time		A	B	After penalty throws						
	6	6	15		15									19		17					
Number of 7 m	A	Team time-out			Full name of players and officials						Team time-out			B	Number of 7 m						
	5/7	1	2	3							1	2	3	5/7							
		06:11	45:03	58:53							22:50	59:47									
No.	Team A					G	W	2'	D	DR	No.	Team B					G	W	2'	D	DR
1	宋晓晨										1	何喜年									
6	李朝鹏					1	1		1		3	魏雨童							1		
7	林豪文					1					4	刘雪东									
8	王炳华										5	王毅									
9	赵元					1					6	赵晨阳									
10	赵建强					1					7	张青					10	1	1		
11	宋朋强					2					8	王晓琪									
12	于性哲										9	王子欣					2				
13	刘晓					2					10	苏尧							1		
15	张继伟						1				11	吴明远									
17	王旭东					3	1	1			13	许松									
19	李语庆					2					14	王维先									
21	姜春辉										15	周群					2				
27	胡晋铭										16	刘宗其									
31	于亚男					5					20	张闻乾									
34	王钟彬					1					86	田剑侠					3	1			
B	王鸿斌 (主教练)										A	贾守信									
C	金京男										B	杜瑞军 (主教练)									
D	刘桂妮										D	李志成									
E	林配永										E	王文龙									
A	Signatures of responsables for the teams (Off.A)															B					
TP	Remarks of referees / HF Official															TP					

Signatures

Referees	王雨洋 (CHN)	严璐 (CHN)		
T.D.	郭剑 (CHN)	陈少波 (CHN)		
CHA Off.				

Note: Number of 7m Throws Awarded to Team A and B, Goals (G), Warnings (W), Suspensions (2'), Direct Disqualification (D), Disqualification With Report (DR) and Team Penalty (TP).

Table Officials: 周胜锋 张智伟 Statisticians: 周亚桥 赵悦



2019年全国男子手球冠军杯赛

PHMS Pictorial Handball Match Statistics

IHF Official System

竞赛技术统计

手球 男子 预赛 山东队(山东) VS 天津队(天津) 组别 B 场次 13 万州体育馆 2019-04-10 13:00

Referees: 王雨洋 (CHN) / 严璐 (CHN) Result: 19:17(6:6)  
Teams: 山东队(山东) VS 天津队(天津)

山东		远射	近射	边射	快攻	突破	任意球	7m球	合计	%	助攻	失误	警告	2'	D+DR
主教练: 王鸿斌															
1	宋晓晨														
6	李朝鹏	1/1						1/1	100		3	1		1	
7	林豪文			0/1	1/1			1/2	50.0						
8	王炳华	0/1						0/1	0.0						
9	赵元	1/1					0/1	1/2	50.0		1				
10	赵建强							1/2	50.0						
11	宋朋强	0/1				2/2		2/3	66.7	1	1				
12	于性哲										2				
13	刘晓	0/1		1/1		1/1		2/3	66.7						
15	张继伟		0/2		0/1			0/3	0.0	1	1	1			
17	王旭东	0/1	1/2	1/1		0/1		1/1	3/6	50.0	1	1	1	1	
19	李语庆			1/1	1/2			2/3	66.7		1				
21	姜春辉														
27	胡晋铭														
31	于亚男	1/4	0/2			2/2		2/3	5/11	45.5	2	3			
34	王钟彬							1/1	100						
运动员 合计		3/10	1/6	3/4	2/4	5/6	0/1	5/7	19/38	50.0	7	10	3	1	1
1	宋晓晨							0/2	0.0						
12	于性哲	4/6	2/7	2/3	1/2	1/4		2/5	12/27	44.4	2				
守门员 合计		4/6	2/7	2/3	1/2	1/4		2/7	12/29	41.4	2				

天津		远射	近射	边射	快攻	突破	任意球	7m球	合计	%	助攻	失误	警告	2'	D+DR
主教练: 杜瑞军															
1	何喜年										1	1			
3	魏雨童													1	
4	刘雪东														
5	王毅	0/7						0/1	0/8	0.0					
6	赵晨阳														
7	张青	2/6	2/2			2/2		4/4	10/14	71.4	3	1	1	1	
8	王晓琪														
9	王子欣		0/1	1/2	1/1				2/4	50.0					
10	苏尧										1		1	1	
11	吴明远														
13	许松			0/1	0/1			0/1	0/3	0.0	1				
14	王维先														
15	周群		2/2						2/2	100					
16	刘宗其														
20	张闻乾														
86	田剑侠	0/7	1/2			1/2		1/1	3/12	25.0	3	5	1		
运动员 合计		2/20	5/7	1/3	1/2	3/4		5/7	17/43	39.5	5	10	2	3	
1	何喜年	3/6	3/4	1/4	2/4	0/5	1/1	2/7	12/31	38.7	1	1			
守门员 合计		3/6	3/4	1/4	2/4	0/5	1/1	2/7	12/31	38.7	1	1			

山东	比赛进程	天津
1st Half		
0	00:45	1 86 田剑侠
31 于亚男	1 01:55	1
1	09:40	2 7 张青
6 李朝鹏	2 10:39	2
2	11:06	3 9 王子欣
19 李语庆	3 13:57	3
3	14:57	4 7 张青
31 于亚男	4 17:58	4
4	21:33	5 15 周群
9 赵元	5 25:34	5
5	27:30	6 7 张青
13 刘晓	6 28:03	6
2nd Half		
31 于亚男	7 00:58	6
7	02:01	7 7 张青
7 林豪文	8 04:08	7
8	06:24	8 9 王子欣
17 王旭东	9 07:05	8
17 王旭东	10 08:36	8
10	10:25	9 7 张青
13 刘晓	11 11:52	9
11	12:16	10 7 张青
11	14:53	11 86 田剑侠
11	20:38	12 7 张青
11 宋朋强	12 21:16	12
12	22:19	13 7 张青
11 宋朋强	13 22:51	13
13	24:03	14 15 周群
31 于亚男	14 25:59	14
19 李语庆	15 27:12	14
15	27:54	15 7 张青
7M		
31 于亚男	16 00:00	15
16	00:00	16 7 张青
10 赵建强	17 00:00	16
17 王旭东	18 00:00	16
18	00:00	17 86 田剑侠
34 王钟彬	19 00:00	17

场上队员: 得分 / 射门

守门员: 救球 / 射门

D	取消资格	DR	取消资格+报告
---	------	----	---------



2019年全国男子手球冠军杯赛

PHMS Pictorial Handball Match Statistics

IHF Official System

个人/全队技术统计表

手球 男子 预赛 轮次 4 组别 B 场次 13 万州体育馆 2019-04-10 13:00

号码	姓名	远射	近射	边射	快攻	突破	任意	七米	合计	%	助攻	失误	警告	2'	取消	时间
山东队(山东)																
(场上队员)																
1	宋晓晨									0.0%						00:00:07
6	李朝鹏	1/1							1/1	100%	3	1		1		00:21:01
7	林豪文			0/1	1/1				1/2	50.0%						00:13:16
8	王炳华	0/1							0/1	0.0%						00:00:00
9	赵元	1/1					0/1		1/2	50.0%	1					00:20:07
10	赵建强							1/2	1/2	50.0%						00:00:05
11	宋朋强	0/1				2/2			2/3	66.7%	1	1				00:45:03
12	于性哲									0.0%	2					00:44:56
13	刘晓	0/1		1/1		1/1			2/3	66.7%						00:18:32
15	张继伟		0/2		0/1				0/3	0.0%	1	1	1			00:45:03
17	王旭东	0/1	1/2	1/1		0/1		1/1	3/6	50.0%	1		1	1		00:42:24
19	李语庆			1/1	1/2				2/3	66.7%		1				00:29:47
21	姜春辉									0.0%						00:00:00
27	胡晋铭									0.0%						00:00:00
31	于亚男	1/4	0/2			2/2		2/3	5/11	45.5%	2	3				00:33:04
34	王钟彬							1/1	1/1	100%						00:01:48
合计		3/10	1/6	3/4	2/4	5/6	0/1	5/7	19/38	50.0%	7	10	3	1	1	
(守门员)																
1	宋晓晨							0/2	0/2	0.0%						00:00:07
12	于性哲	4/6	2/7	2/3	1/2	1/4		2/5	12/27	44.4%	2					00:44:56
合计		4/6	2/7	2/3	1/2	1/4		2/7	12/29	41.4%	2					

场上队员：得分/射门

守门员：救球/射门

全队合计	得分	被救	射失	击柱	封球	合计	%
远射	3	3		1	3	10	30.0%
近射	1	3		2		6	16.7%
边射	3	1				4	75.0%
快攻	2	2				4	50.0%
突破	5		1			6	83.3%
任意		1				1	0.0%
七米	5	2				7	71.4%

## 2019年全国男子手球冠军杯赛

PHMS Pictorial Handball Match Statistics

IHF Official System

### 个人/全队技术统计表

手球 男子 预赛 轮次 4 组别 B 场次 13 万州体育馆 2019-04-10 13:00

号码	姓名	远射	近射	边射	快攻	突破	任意	七米	合计	%	助攻	失误	警告	2'	取消	时间
天津队(天津)																
(场上队员)																
1	何喜年									0.0%	1	1				00:45:03
3	魏雨童									0.0%				1		00:26:45
4	刘雪东									0.0%						00:00:00
5	王毅	0/7						0/1	0/8	0.0%						00:27:12
6	赵晨阳									0.0%						00:00:00
7	张青	2/6	2/2			2/2		4/4	10/14	71.4%		3	1	1		00:45:03
8	王晓琪									0.0%						00:00:00
9	王子欣		0/1	1/2	1/1				2/4	50.0%						00:45:00
10	苏尧									0.0%		1		1		00:06:17
11	吴明远									0.0%						00:00:00
13	许松			0/1	0/1			0/1	0/3	0.0%	1					00:38:46
14	王维先									0.0%						00:00:00
15	周群		2/2						2/2	100%						00:35:38
16	刘宗其									0.0%						00:00:00
20	张闻乾									0.0%						00:00:00
86	田剑侠	0/7	1/2			1/2		1/1	3/12	25.0%	3	5	1			00:45:03
	合计	2/20	5/7	1/3	1/2	3/4		5/7	17/43	39.5%	5	10	2	3		
(守门员)																
1	何喜年	3/6	3/4	1/4	2/4	0/5	1/1	2/7	12/31	38.7%	1	1				00:45:03
	合计	3/6	3/4	1/4	2/4	0/5	1/1	2/7	12/31	38.7%	1	1				

场上队员：得分/射门

守门员：救球/射门

全队合计	得分	被救	射失	击柱	封球	合计	%
远射	2	4	4	1	9	20	10.0%
近射	5	2				7	71.4%
边射	1	2				3	33.3%
快攻	1	1				2	50.0%
突破	3	1				4	75.0%
任意							0.0%
七米	5	2				7	71.4%

图式比赛技术统计表

手球  
男子

预赛  
轮次 4

组别 B  
场次 13

万州体育馆  
2019-04-10 13:00

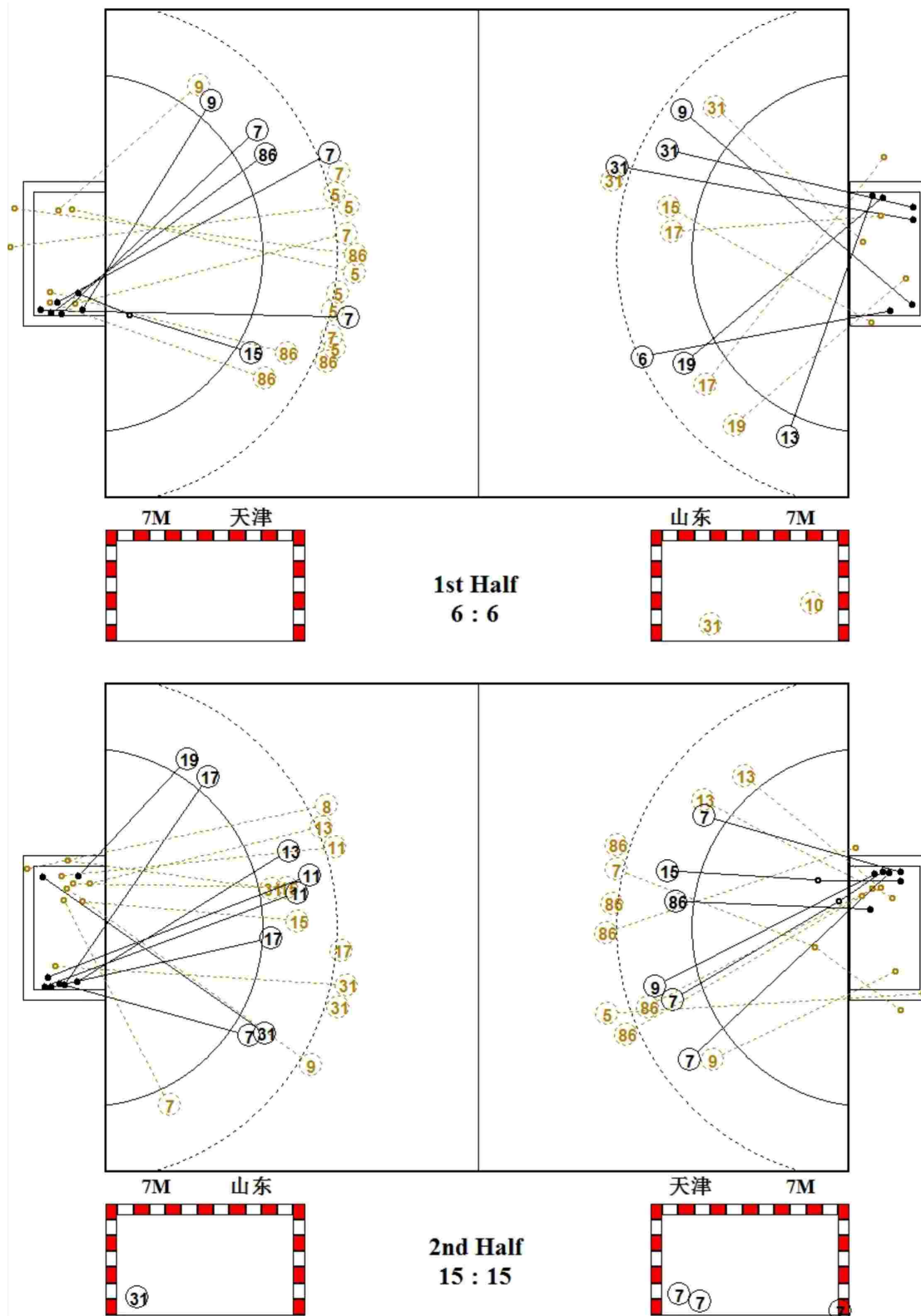

PICTORIAL MATCH STATISTICS

HANDBALL  
男子

预赛  
ROUND 4

GROUP B  
MATCH 13

万州体育馆  
2019-04-10 13:00

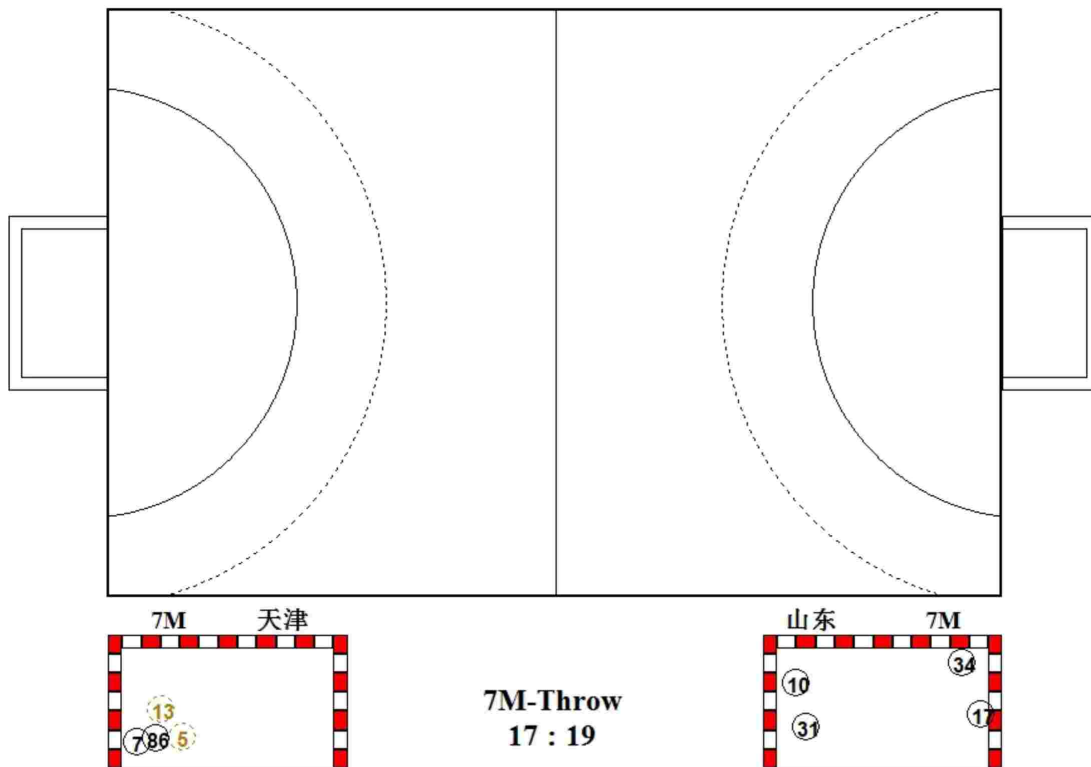

图式射门区域统计

手球  
男子

预赛  
轮次 4

组别 B  
场次 13

万州体育馆  
2019-04-10 13:00

山东队

1 宋晓晨	6 李朝鹏	7 林豪文	8 王炳华	9 赵元	10 赵建强	11 宋朋强	12 于性哲																																																																								
<table border="1"><tr><td></td><td></td><td></td></tr><tr><td></td><td></td><td></td></tr><tr><td></td><td></td><td></td></tr></table>										<table border="1"><tr><td></td><td></td><td></td></tr><tr><td></td><td></td><td>1</td></tr><tr><td></td><td></td><td></td></tr></table>						1				<table border="1"><tr><td></td><td></td><td></td></tr><tr><td>1</td><td></td><td></td></tr><tr><td></td><td></td><td></td></tr></table>				1						<table border="1"><tr><td></td><td></td><td></td></tr><tr><td></td><td></td><td></td></tr><tr><td></td><td></td><td></td></tr></table>										<table border="1"><tr><td></td><td></td><td>1</td></tr><tr><td></td><td></td><td></td></tr><tr><td></td><td></td><td></td></tr></table>			1							<table border="1"><tr><td>1</td><td></td><td></td></tr><tr><td></td><td></td><td></td></tr><tr><td></td><td></td><td></td></tr></table>	1									<table border="1"><tr><td>2</td><td></td><td></td></tr><tr><td></td><td></td><td></td></tr><tr><td></td><td></td><td></td></tr></table>	2									<table border="1"><tr><td></td><td></td><td></td></tr><tr><td></td><td></td><td></td></tr><tr><td></td><td></td><td></td></tr></table>									
		1																																																																													
1																																																																															
		1																																																																													
1																																																																															
2																																																																															
Post - 0 Miss - 0 Block - 0	Post - 0 Miss - 0 Block - 0	Post - 0 Miss - 0 Block - 0	Post - 1 Miss - 0 Block - 0	Post - 0 Miss - 0 Block - 0	Post - 0 Miss - 0 Block - 0	Post - 0 Miss - 0 Block - 0	Post - 0 Miss - 0 Block - 0																																																																								
13 刘晓	15 张继伟	17 王旭东	19 李语庆	21 姜春辉	27 胡晋铭	31 于亚男	34 王钟彬																																																																								
<table border="1"><tr><td>2</td><td></td><td></td></tr><tr><td></td><td></td><td></td></tr><tr><td></td><td></td><td></td></tr></table>	2									<table border="1"><tr><td></td><td></td><td></td></tr><tr><td></td><td></td><td></td></tr><tr><td></td><td></td><td></td></tr></table>										<table border="1"><tr><td>1</td><td></td><td></td></tr><tr><td>1</td><td></td><td>1</td></tr><tr><td></td><td></td><td></td></tr></table>	1			1		1				<table border="1"><tr><td>1</td><td></td><td></td></tr><tr><td></td><td></td><td>1</td></tr><tr><td></td><td></td><td></td></tr></table>	1					1				<table border="1"><tr><td></td><td></td><td></td></tr><tr><td></td><td></td><td></td></tr><tr><td></td><td></td><td></td></tr></table>										<table border="1"><tr><td></td><td></td><td></td></tr><tr><td></td><td></td><td></td></tr><tr><td></td><td></td><td></td></tr></table>										<table border="1"><tr><td>2</td><td></td><td>1</td></tr><tr><td>1</td><td></td><td></td></tr><tr><td>1</td><td></td><td></td></tr></table>	2		1	1			1			<table border="1"><tr><td></td><td></td><td>1</td></tr><tr><td></td><td></td><td></td></tr><tr><td></td><td></td><td></td></tr></table>			1						
2																																																																															
1																																																																															
1		1																																																																													
1																																																																															
		1																																																																													
2		1																																																																													
1																																																																															
1																																																																															
		1																																																																													
Post - 0 Miss - 0 Block - 0	Post - 1 Miss - 0 Block - 0	Post - 0 Miss - 1 Block - 1	Post - 0 Miss - 0 Block - 0	Post - 0 Miss - 0 Block - 0	Post - 0 Miss - 0 Block - 0	Post - 1 Miss - 0 Block - 2	Post - 0 Miss - 0 Block - 0																																																																								

1 宋晓晨

0/2		

12 于性哲

2/7		2/2
5/10		1/1
2/5	0/1	0/1

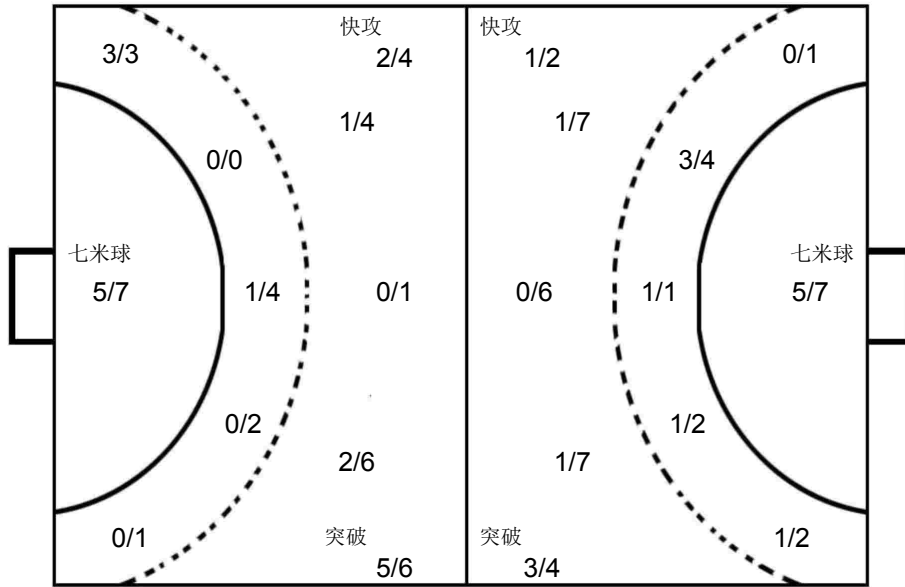

1 何喜年

1/7		1/4
1/7		5/8
1/2	1/1	2/2

天津队

1 何喜年	3 魏雨童	4 刘雪东	5 王毅	6 赵晨阳	7 张青	8 王晓琪	9 王子欣																																																																								
<table border="1"><tr><td></td><td></td><td></td></tr><tr><td></td><td></td><td></td></tr><tr><td></td><td></td><td></td></tr></table>										<table border="1"><tr><td></td><td></td><td></td></tr><tr><td></td><td></td><td></td></tr><tr><td></td><td></td><td></td></tr></table>										<table border="1"><tr><td></td><td></td><td></td></tr><tr><td></td><td></td><td></td></tr><tr><td></td><td></td><td></td></tr></table>										<table border="1"><tr><td></td><td></td><td></td></tr><tr><td></td><td></td><td></td></tr><tr><td></td><td></td><td></td></tr></table>										<table border="1"><tr><td></td><td></td><td></td></tr><tr><td></td><td></td><td></td></tr><tr><td></td><td></td><td></td></tr></table>										<table border="1"><tr><td>3</td><td></td><td></td></tr><tr><td>3</td><td></td><td></td></tr><tr><td>3</td><td></td><td>1</td></tr></table>	3			3			3		1	<table border="1"><tr><td></td><td></td><td></td></tr><tr><td></td><td></td><td></td></tr><tr><td></td><td></td><td></td></tr></table>										<table border="1"><tr><td></td><td></td><td></td></tr><tr><td>1</td><td></td><td></td></tr><tr><td>1</td><td></td><td></td></tr></table>				1			1		
3																																																																															
3																																																																															
3		1																																																																													
1																																																																															
1																																																																															
Post - 0 Miss - 0 Block - 0	Post - 0 Miss - 0 Block - 0	Post - 0 Miss - 0 Block - 0	Post - 1 Miss - 1 Block - 4	Post - 0 Miss - 0 Block - 0	Post - 0 Miss - 1 Block - 2	Post - 0 Miss - 0 Block - 0	Post - 0 Miss - 0 Block - 0																																																																								
10 苏尧	11 吴明远	13 许松	14 王维先	15 周群	16 刘宗其	20 张闻乾	86 田剑侠																																																																								
<table border="1"><tr><td></td><td></td><td></td></tr><tr><td></td><td></td><td></td></tr><tr><td></td><td></td><td></td></tr></table>										<table border="1"><tr><td></td><td></td><td></td></tr><tr><td></td><td></td><td></td></tr><tr><td></td><td></td><td></td></tr></table>										<table border="1"><tr><td></td><td></td><td></td></tr><tr><td></td><td></td><td></td></tr><tr><td></td><td></td><td></td></tr></table>										<table border="1"><tr><td></td><td></td><td></td></tr><tr><td></td><td></td><td></td></tr><tr><td></td><td></td><td></td></tr></table>										<table border="1"><tr><td>1</td><td></td><td></td></tr><tr><td>1</td><td></td><td></td></tr><tr><td></td><td></td><td></td></tr></table>	1			1						<table border="1"><tr><td></td><td></td><td></td></tr><tr><td></td><td></td><td></td></tr><tr><td></td><td></td><td></td></tr></table>										<table border="1"><tr><td></td><td></td><td></td></tr><tr><td></td><td></td><td></td></tr><tr><td></td><td></td><td></td></tr></table>										<table border="1"><tr><td>1</td><td></td><td></td></tr><tr><td></td><td></td><td></td></tr><tr><td>1</td><td>1</td><td></td></tr></table>	1						1	1	
1																																																																															
1																																																																															
1																																																																															
1	1																																																																														
Post - 0 Miss - 0 Block - 0	Post - 0 Miss - 0 Block - 0	Post - 0 Miss - 0 Block - 0	Post - 0 Miss - 0 Block - 0	Post - 0 Miss - 0 Block - 0	Post - 0 Miss - 0 Block - 0	Post - 0 Miss - 0 Block - 0	Post - 0 Miss - 2 Block - 3																																																																								



Team A A 江苏队	Team B B 四川队	Match Number <b>14</b>
-----------------	-----------------	---------------------------

Played in 重庆万州	in the hall 万州体育馆	on 2019-04-10	at 14:30	hours	Spectators
-------------------	----------------------	------------------	-------------	-------	------------

Half-time(30')	A 23	B 11	End of playing time	A 40	B 22	1st extra time	A	B	2nd extra time	A	B	After penalty throws	A	B
----------------	---------	---------	---------------------	---------	---------	----------------	---	---	----------------	---	---	----------------------	---	---

Number of 7 m	A 0/3	Team time-out			Full name of players and officials	Team time-out			B 0/2	Number of 7 m
	1	2	3	1		2	3			

No.	Team A	G	W	2'	D	DR	No.	Team B	G	W	2'	D	DR
1	宋继强						2	张宏运	1	1			
3	周悦骅			1			3	李朗轩	3			1	
4	张家纬						6	董佳辉	7		1		
7	周傲	8					7	曾繁泳	4				
8	谢庆龙	3					8	罗霖泽	2				
11	张天豪	10					9	左典	1				
12	王权						10	李剑琛	1				
16	张帅						11	江成腾					
18	赵楠	5					12	戴景伟					
19	庞连康	5	1				14	洗鹏飞	3				
21	刘江	5		1			17	叶康全					
25	王杰缘												
27	王伟强												
30	吴龙瑞	4											

A	闫威名 (主教练)						A	李中洲					
B	叶强						B	王伟 (主教练)					
C	贾淑君						C	张广建					
E	王建国												

A	Signatures of responsables for the teams (Off.A)	B
---	--	---

TP	Remarks of referees / HF Official	TP
----	-----------------------------------	----

Signatures			
Referees	鲍瑀 (CHN)	刘宇阳 (CHN)	
T.D.	郭剑 (CHN)	张春生 (CHN)	
CHA Off.			

Note: Number of 7m Throws Awarded to Team A and B, Goals (G), Warnings (W), Suspensions (2'), Direct Disqualification (D), Disqualification With Report (DR) and Team Penalty (TP).

Table Officials: 刘明华      张晓虎      Statisticians: 赵悦      谢杨

## 2019年全国男子手球冠军杯赛

PHMS Pictorial Handball Match Statistics

IHF Official System

### 竞赛技术统计

手球 男子      预赛 轮次 4      组别 B 场次 14      万州体育馆  
2019-04-10 14:30

Referees: 鲍瑀 (CHN) / 刘宇阳 (CHN)  
Teams: 江苏队(江苏) VS 四川队(四川)

Result: 40:22(23:11)

江苏		远	近	边	快	突	任意	7m	合计	%	助攻	失误	警告	2'	D+DR
主教练: 闫威名		射	射	射	攻	破	球	球							
1	宋继强														
3	周悦骅							0/2	0/2	0.0		1		1	
4	张家纬														
7	周傲	1/3	2/4		3/5	2/2		0/1	8/15	53.3	4	3			
8	谢庆龙		2/2			1/1			3/3	100	1				
11	张天豪	1/1	4/5	2/4	3/5				10/15	66.7	3	1			
12	王权														
16	张帅										2	1			
18	赵楠	1/1		1/1	3/3				5/5	100		2			
19	庞连康	2/2	2/3			1/1			5/6	83.3	1		1		
21	刘江		4/4		1/2				5/6	83.3	1	2		1	
25	王杰缘														
27	王伟强														
30	吴龙瑞	1/1	0/2		1/1	2/2			4/6	66.7	1	1			
运动员 合计		6/8	14/20	3/5	11/16	6/6		0/3	40/58	69.0	13	11	1	2	
1	宋继强	3/6	0/3	0/2	1/3	0/1			4/15	26.7					
16	张帅	4/7	0/3	1/3	0/1	0/2	1/1		6/17	35.3	2	1			
守门员 合计		7/13	0/6	1/5	1/4	0/3	1/1		10/32	31.3	2	1			

四川		远	近	边	快	突	任意	7m	合计	%	助攻	失误	警告	2'	D+DR
主教练: 王伟		射	射	射	攻	破	球	球							
2	张宏运	0/1	1/1						1/2	50.0		1	1		
3	李朗轩	2/7	1/1					0/2	3/10	30.0		4		1	
6	董佳辉	2/8	3/3		0/1	2/2	0/1		7/15	46.7	1	2		1	
7	曾繁泳			3/5	1/1				4/6	66.7		3			
8	罗霖泽			1/1	1/1				2/2	100		1			
9	左典	1/1	0/1						1/2	50.0		6			
10	李剑琛				1/1				1/1	100		1			
11	江成腾														
12	戴景伟														
14	洗鹏飞	1/4	1/2		0/1	1/1			3/8	37.5	1	8			
17	叶康全														
运动员 合计		6/21	6/8	4/6	3/5	3/3	0/1	0/2	22/46	47.8	2	26	1	1	1
12	戴景伟	1/3	3/13	0/2	2/6	0/5		2/2	8/31	25.8					
17	叶康全	0/4	1/5	0/1	1/8	0/1		1/1	3/20	15.0					
守门员 合计		1/7	4/18	0/3	3/14	0/6		3/3	11/51	21.6					

江苏	比赛 进程	四川
1st Half		
11 张天豪	1 01:40	0
21 刘江	2 02:39	0
21 刘江	3 03:58	0
7 周傲	3 04:46	1 6 董佳辉
7 周傲	4 05:01	1
11 张天豪	5 07:41	1
7 周傲	6 08:28	1
21 刘江	6 09:41	2 6 董佳辉
21 刘江	7 10:56	2
11 张天豪	8 11:36	2
7 周傲	8 12:50	3 8 罗霖泽
21 刘江	9 13:01	3
18 赵楠	9 14:32	4 2 张宏运
18 赵楠	10 14:45	4
30 吴龙瑞	11 15:32	4
11 张天豪	12 16:12	4
30 吴龙瑞	13 17:08	4
	13 17:48	5 3 李朗轩
	13 18:17	6 7 曾繁泳
21 刘江	14 18:39	6
	14 19:09	7 6 董佳辉
19 庞连康	15 20:23	7
7 周傲	16 20:59	7
18 赵楠	17 21:33	7
11 张天豪	18 22:53	7
	18 22:59	8 7 曾繁泳
19 庞连康	19 23:25	8
	19 24:05	9 14 洗鹏飞
	19 25:01	10 14 洗鹏飞
7 周傲	20 25:33	10
7 周傲	21 26:07	10
18 赵楠	22 27:09	10
11 张天豪	23 28:31	10
	23 29:36	11 14 洗鹏飞
2nd Half		
	23 00:33	12 7 曾繁泳
7 周傲	24 01:02	12
11 张天豪	25 02:07	12
	25 02:45	13 6 董佳辉
11 张天豪	26 03:12	13
	26 04:31	14 9 左典
19 庞连康	27 05:01	14
7 周傲	28 05:14	14
19 庞连康	29 06:57	14
	29 07:24	15 6 董佳辉
30 吴龙瑞	30 07:48	15
7 周傲	31 08:57	15
30 吴龙瑞	32 09:58	15
	32 10:12	16 7 曾繁泳
	32 11:11	17 8 罗霖泽
	32 13:56	18 3 李朗轩
	32 14:56	19 6 董佳辉
8 谢庆龙	33 17:00	19
	33 17:41	20 6 董佳辉
19 庞连康	34 17:54	20
11 张天豪	35 18:33	20
	35 21:12	21 10 李剑琛
18 赵楠	36 21:42	21
18 赵楠	37 22:30	21
8 谢庆龙	38 23:44	21
11 张天豪	39 25:22	21
	39 27:07	22 3 李朗轩
8 谢庆龙	40 27:48	22

场上队员: 得分 / 射门

守门员: 救球 / 射门

D	取消资格	DR	取消资格+报告
---	------	----	---------





## 2019年全国男子手球冠军杯赛

PHMS Pictorial Handball Match Statistics

IHF Official System

### 个人/全队技术统计表

手球男子 预赛轮次 4 组别 B 场次 14 万州体育馆  
2019-04-10 14:30

号码	姓名	远射	近射	边射	快攻	突破	任意	七米	合计	%	助攻	失误	警告	2'	取消	时间
<b>江苏队(江苏)</b>																
<b>(场上队员)</b>																
1	宋继强									0.0%						00:30:00
3	周悦骅							0/2	0/2	0.0%		1		1		00:16:26
4	张家纬									0.0%						00:00:00
7	周傲	1/3	2/4		3/5	2/2		0/1	8/15	53.3%	4	3				00:59:44
8	谢庆龙		2/2			1/1			3/3	100%	1					00:13:43
11	张天豪	1/1	4/5	2/4	3/5				10/15	66.7%	3	1				00:59:45
12	王权									0.0%						00:00:00
16	张帅									0.0%	2	1				00:29:45
18	赵楠	1/1		1/1	3/3				5/5	100%		2				00:59:45
19	庞连康	2/2	2/3			1/1			5/6	83.3%	1		1			00:59:45
21	刘江		4/4		1/2				5/6	83.3%	1	2		1		00:46:01
25	王杰缘									0.0%						00:00:00
27	王伟强									0.0%						00:00:00
30	吴龙瑞	1/1	0/2		1/1	2/2			4/6	66.7%	1	1				00:43:19
	<b>合计</b>	<b>6/8</b>	<b>14/20</b>	<b>3/5</b>	<b>11/16</b>	<b>6/6</b>		<b>0/3</b>	<b>40/58</b>	<b>69.0%</b>	<b>13</b>	<b>11</b>	<b>1</b>	<b>2</b>		
<b>(守门员)</b>																
1	宋继强	3/6	0/3	0/2	1/3	0/1			4/15	26.7%						00:30:00
16	张帅	4/7	0/3	1/3	0/1	0/2	1/1		6/17	35.3%	2	1				00:29:45
	<b>合计</b>	<b>7/13</b>	<b>0/6</b>	<b>1/5</b>	<b>1/4</b>	<b>0/3</b>	<b>1/1</b>		<b>10/32</b>	<b>31.3%</b>	<b>2</b>	<b>1</b>				

场上队员：得分/射门

守门员：救球/射门

全队合计	得分	被救	射失	击柱	封球	合计	%
远射	6	1			1	8	75.0%
近射	14	4	2			20	70.0%
边射	3		1	1		5	60.0%
快攻	11	3		2		16	68.8%
突破	6					6	100.0%
任意							0.0%
七米		3				3	0.0%

## 2019年全国男子手球冠军杯赛

PHMS Pictorial Handball Match Statistics

IHF Official System

### 个人/全队技术统计表

手球 男子 预赛 轮次 4 组别 B 场次 14 万州体育馆 2019-04-10 14:30

号码	姓名	远射	近射	边射	快攻	突破	任意	七米	合计	%	助攻	失误	警告	2'	取消	时间
四川队(四川)																
(场上队员)																
2	张宏运	0/1	1/1						1/2	50.0%		1	1			00:54:43
3	李朗轩	2/7	1/1					0/2	3/10	30.0%		4			1	00:34:24
6	董佳辉	2/8	3/3		0/1	2/2	0/1		7/15	46.7%	1	2			1	00:51:42
7	曾繁泳			3/5	1/1				4/6	66.7%		3				00:50:58
8	罗霖泽			1/1	1/1				2/2	100%		1				00:33:59
9	左典	1/1	0/1						1/2	50.0%		6				00:42:07
10	李剑琛				1/1				1/1	100%		1				00:25:03
11	江成腾									0.0%						00:05:34
12	戴景伟									0.0%						00:37:19
14	洗鹏飞	1/4	1/2		0/1	1/1			3/8	37.5%	1	8				00:59:45
17	叶康全									0.0%						00:22:26
	合计	6/21	6/8	4/6	3/5	3/3	0/1	0/2	22/46	47.8%	2	26	1	1	1	
(守门员)																
12	戴景伟	1/3	3/13	0/2	2/6	0/5		2/2	8/31	25.8%						00:37:19
17	叶康全	0/4	1/5	0/1	1/8	0/1		1/1	3/20	15.0%						00:22:26
	合计	1/7	4/18	0/3	3/14	0/6		3/3	11/51	21.6%						

场上队员： 得分/射门

守门员： 救球/射门

全队合计	得分	被救	射失	击柱	封球	合计	%
远射	6	7	3	1	4	21	28.6%
近射	6		1	1		8	75.0%
边射	4	1	1			6	66.7%
快攻	3	1	1			5	60.0%
突破	3					3	100.0%
任意		1				1	0.0%
七米				2		2	0.0%

图式比赛技术统计表

手球  
男子

预赛  
轮次 4

组别 B  
场次 14

万州体育馆  
2019-04-10 14:30

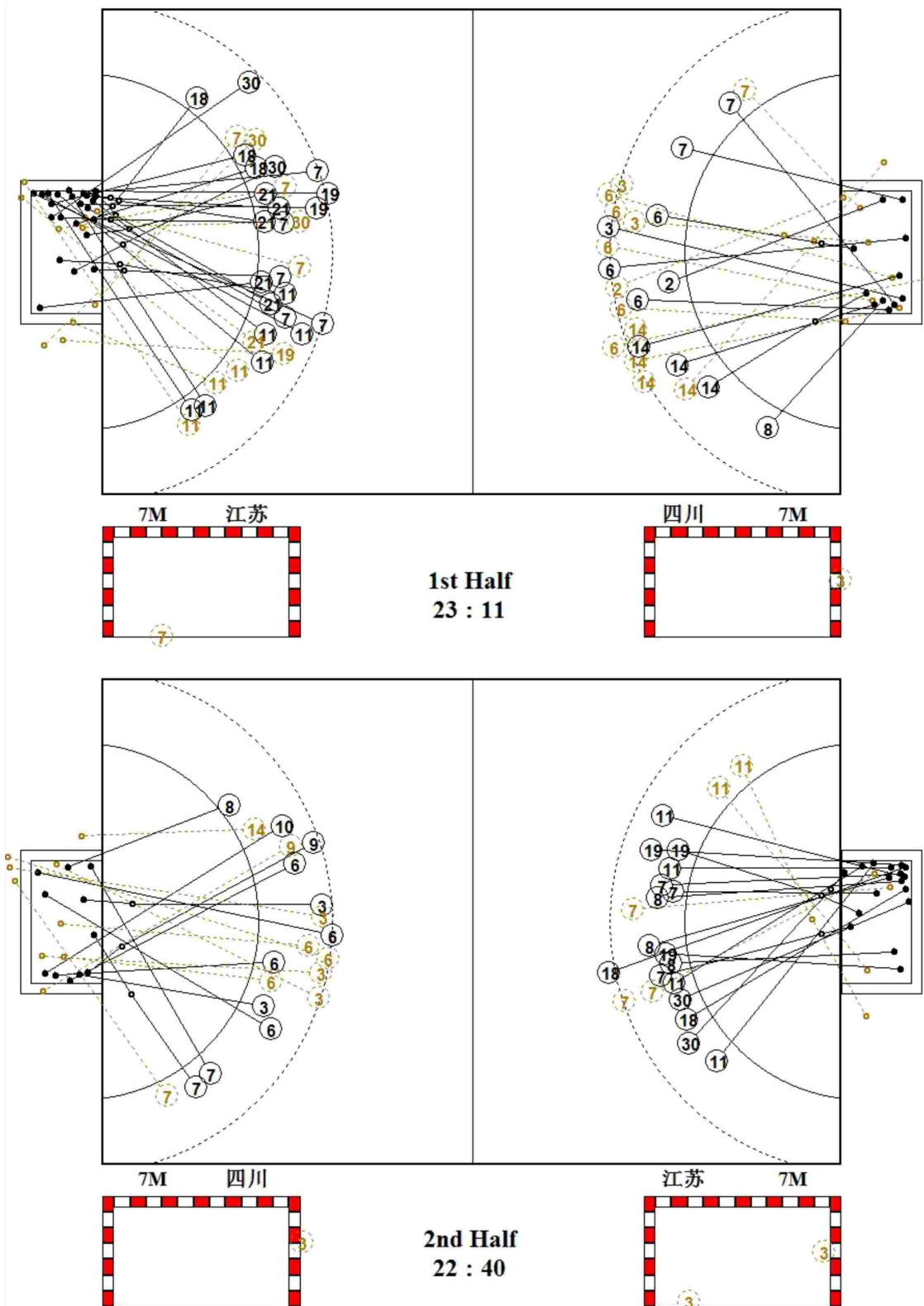

图式射门区域统计

手球  
男子

预赛  
轮次 4

组别 B  
场次 14

万州体育馆  
2019-04-10 14:30

江苏队

1 宋继强	3 周悦骅	4 张家纬	7 周傲	8 谢庆龙	11 张天豪	12 王权	16 张帅																																																																								
<table border="1"><tr><td></td><td></td><td></td></tr><tr><td></td><td></td><td></td></tr><tr><td></td><td></td><td></td></tr></table>										<table border="1"><tr><td></td><td></td><td></td></tr><tr><td></td><td></td><td></td></tr><tr><td></td><td></td><td></td></tr></table>										<table border="1"><tr><td></td><td></td><td></td></tr><tr><td></td><td></td><td></td></tr><tr><td></td><td></td><td></td></tr></table>										<table border="1"><tr><td>1</td><td></td><td>1</td></tr><tr><td>1</td><td></td><td>1</td></tr><tr><td></td><td>2</td><td>2</td></tr></table>	1		1	1		1		2	2	<table border="1"><tr><td>2</td><td></td><td>1</td></tr><tr><td></td><td></td><td></td></tr><tr><td></td><td></td><td></td></tr></table>	2		1							<table border="1"><tr><td>2</td><td></td><td>2</td></tr><tr><td>1</td><td>1</td><td>2</td></tr><tr><td>1</td><td></td><td>1</td></tr></table>	2		2	1	1	2	1		1	<table border="1"><tr><td></td><td></td><td></td></tr><tr><td></td><td></td><td></td></tr><tr><td></td><td></td><td></td></tr></table>										<table border="1"><tr><td></td><td></td><td></td></tr><tr><td></td><td></td><td></td></tr><tr><td></td><td></td><td></td></tr></table>									
1		1																																																																													
1		1																																																																													
	2	2																																																																													
2		1																																																																													
2		2																																																																													
1	1	2																																																																													
1		1																																																																													
Post - 0 Miss - 0 Block - 0	Post - 0 Miss - 0 Block - 0	Post - 0 Miss - 0 Block - 0	Post - 0 Miss - 0 Block - 1	Post - 0 Miss - 0 Block - 0	Post - 3 Miss - 1 Block - 0	Post - 0 Miss - 0 Block - 0	Post - 0 Miss - 0 Block - 0																																																																								
18 赵楠	19 庞连康	21 刘江	25 王杰缘	27 王伟强	30 吴龙瑞																																																																										
<table border="1"><tr><td>2</td><td></td><td>1</td></tr><tr><td></td><td></td><td>1</td></tr><tr><td></td><td></td><td>1</td></tr></table>	2		1			1			1	<table border="1"><tr><td>1</td><td></td><td>1</td></tr><tr><td></td><td></td><td>1</td></tr><tr><td></td><td>1</td><td>1</td></tr></table>	1		1			1		1	1	<table border="1"><tr><td>1</td><td></td><td></td></tr><tr><td></td><td></td><td></td></tr><tr><td></td><td>1</td><td>3</td></tr></table>	1							1	3	<table border="1"><tr><td></td><td></td><td></td></tr><tr><td></td><td></td><td></td></tr><tr><td></td><td></td><td></td></tr></table>										<table border="1"><tr><td></td><td></td><td></td></tr><tr><td></td><td></td><td></td></tr><tr><td></td><td></td><td></td></tr></table>										<table border="1"><tr><td></td><td>1</td><td>1</td></tr><tr><td></td><td>1</td><td></td></tr><tr><td>1</td><td></td><td></td></tr></table>		1	1		1		1																						
2		1																																																																													
		1																																																																													
		1																																																																													
1		1																																																																													
		1																																																																													
	1	1																																																																													
1																																																																															
	1	3																																																																													
	1	1																																																																													
	1																																																																														
1																																																																															
Post - 0 Miss - 0 Block - 0	Post - 0 Miss - 1 Block - 0	Post - 0 Miss - 0 Block - 0	Post - 0 Miss - 0 Block - 0	Post - 0 Miss - 0 Block - 0	Post - 0 Miss - 1 Block - 0																																																																										

1 宋继强		
1/3	0/2	
1/2	1/1	1/2
0/2	0/1	0/2

16 张帅		
0/1	0/1	2/6
0/1	1/1	1/4
2/2	0/1	

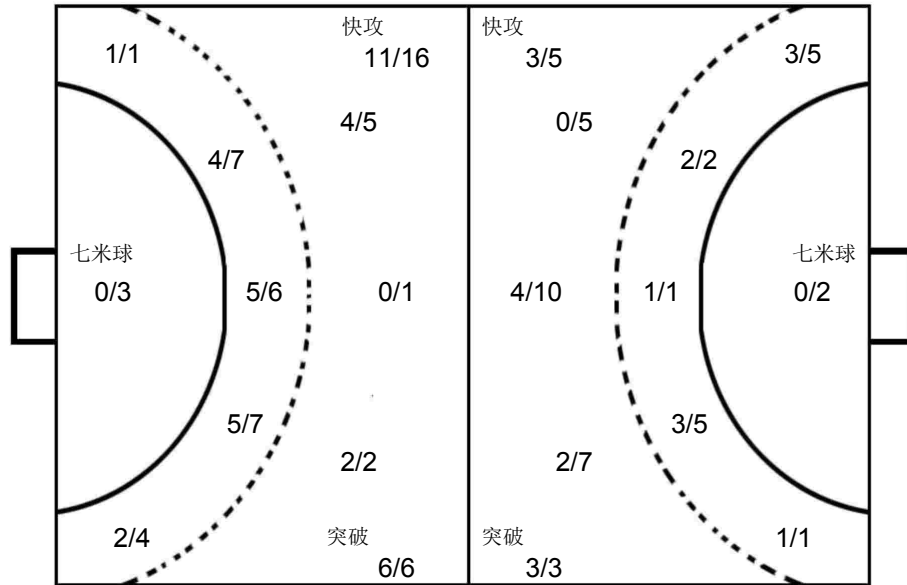

12 戴景伟		
1/9	0/1	0/4
1/3		3/5
1/3	0/2	2/4

17 叶康全		
0/1		0/3
	0/2	0/3
2/2	0/2	1/7

四川队

2 张宏运	3 李朗轩	6 董佳辉	7 曾繁泳	8 罗霖泽	9 左典	10 李剑琛	11 江成腾																																																																								
<table border="1"><tr><td></td><td></td><td></td></tr><tr><td>1</td><td></td><td></td></tr><tr><td></td><td></td><td></td></tr></table>				1						<table border="1"><tr><td></td><td></td><td>1</td></tr><tr><td></td><td></td><td></td></tr><tr><td>1</td><td></td><td>1</td></tr></table>			1				1		1	<table border="1"><tr><td>1</td><td>1</td><td>3</td></tr><tr><td>1</td><td></td><td></td></tr><tr><td></td><td>1</td><td></td></tr></table>	1	1	3	1				1		<table border="1"><tr><td>1</td><td></td><td>1</td></tr><tr><td></td><td></td><td></td></tr><tr><td></td><td>1</td><td>1</td></tr></table>	1		1					1	1	<table border="1"><tr><td></td><td></td><td></td></tr><tr><td></td><td></td><td>2</td></tr><tr><td></td><td></td><td></td></tr></table>						2				<table border="1"><tr><td></td><td></td><td></td></tr><tr><td></td><td></td><td></td></tr><tr><td>1</td><td></td><td></td></tr></table>							1			<table border="1"><tr><td>1</td><td></td><td></td></tr><tr><td></td><td></td><td></td></tr><tr><td></td><td></td><td></td></tr></table>	1									<table border="1"><tr><td></td><td></td><td></td></tr><tr><td></td><td></td><td></td></tr><tr><td></td><td></td><td></td></tr></table>									
1																																																																															
		1																																																																													
1		1																																																																													
1	1	3																																																																													
1																																																																															
	1																																																																														
1		1																																																																													
	1	1																																																																													
		2																																																																													
1																																																																															
1																																																																															
Post - 0 Miss - 0 Block - 0	Post - 2 Miss - 1 Block - 1	Post - 1 Miss - 2 Block - 1	Post - 0 Miss - 1 Block - 0	Post - 0 Miss - 0 Block - 0	Post - 1 Miss - 0 Block - 0	Post - 0 Miss - 0 Block - 0	Post - 0 Miss - 0 Block - 0																																																																								
12 戴景伟	14 洗鹏飞	17 叶康全																																																																													
<table border="1"><tr><td></td><td></td><td></td></tr><tr><td></td><td></td><td></td></tr><tr><td></td><td></td><td></td></tr></table>										<table border="1"><tr><td></td><td></td><td>1</td></tr><tr><td></td><td></td><td>2</td></tr><tr><td></td><td></td><td></td></tr></table>			1			2				<table border="1"><tr><td></td><td></td><td></td></tr><tr><td></td><td></td><td></td></tr><tr><td></td><td></td><td></td></tr></table>																																																											
		1																																																																													
		2																																																																													
Post - 0 Miss - 0 Block - 0	Post - 0 Miss - 2 Block - 2	Post - 0 Miss - 0 Block - 0																																																																													

Team A					Team B					Match Number											
A 广东队					B 山西队					<b>15</b>											
Played in			in the hall			on			at			Spectators									
重庆万州			万州体育馆			2019-04-10			16:00			hours									
Half-time(30')	A	B	End of playing time		A	B	1st extra time		A	B	2nd extra time		A	B	After penalty throws						
	11	10	20 20												24 22						
Number of 7 m	A	Team time-out			Full name of players and officials						Team time-out			B	Number of 7 m						
	4/5	1	2	3							1	2	3	B							
		17:00									29:55	44:23	57:45	2/4							
No.	Team A					G	W	2'	D	DR	No.	Team B					G	W	2'	D	DR
2	孙江山					2					1	鲁世豪									
6	毕晓晨					2					2	张智超					2				
7	王立隆					3					3	龙俊皓									
9	范保坤										4	刘文东									
10	周仲坤					4	1	1			5	王宇恒					1				
11	房友屯										6	盖秀越					2				
12	王雨					3		1			7	任健豪					5	1			
14	王泽润										9	辛浩乐									
15	张建杰					2	1				10	王洋									
18	姚雪岩					1	1				11	吴夏冰					1	1	1		
19	王帅										12	韩乐斌									
21	张昌轲					3		1			13	杜忠浩					1		1		
22	黄培杰					3					14	杨毅					7				
24	高玉杰					1					15	薛瑞寒					3	1			
32	罗柏涵										16	王虹翔									
											18	张禹琛									
A	曲汝洋										A	张栋									
B	刘康伶 (主教练)										B	赵鑫 (主教练)									
C	郭艳辉										C	霖配永									
E	贾章志																				
Signatures of responsables for the teams (Off.A)																					
A																			B		
TP	Remarks of referees / HF Official																		TP		
Signatures																					
Referees	倪震 (CHN)					林子健 (CHN)															
T.D.	吴国忠 (CHN)					张春生 (CHN)															
CHA Off.																					

Note: Number of 7m Throws Awarded to Team A and B, Goals (G), Warnings (W), Suspensions (2'), Direct Disqualification (D), Disqualification With Report (DR) and Team Penalty (TP).

Table Officials: 周胜锋

张智伟

Statisticians: 谢杨

赵悦

2019年全国男子手球冠军杯赛

PHMS Pictorial Handball Match Statistics

IHF Official System

竞赛技术统计

手球 男子 预赛 轮次 4 组别 A 场次 15 万州体育馆 2019-04-10 16:00

Referees: 倪震 (CHN) / 林子健 (CHN) Result: 24:22(11:10)  
Teams: 广东队(广东) VS 山西队(山西)

广东														比赛进程		山西						
主教练: 刘康伶														1st Half								
远射	近射	边射	快攻	突破	任意球	7m球	合计	%	助攻	失误	警告	2'	D+DR	广东	山西							
2	孙江山	1/1				1/1	2/2	100						0	01:44	1	6	盖秀越				
6	毕晓晨	1/3		0/1		1/1	2/5	40.0		2				0	02:27	2	15	薛瑞寒				
7	王立隆			3/3			3/3	100						0	06:26	3	14	杨毅				
9	范保坤													0	08:02	4	6	盖秀越				
10	周仲坤	3/5	1/3	0/1		0/1	4/10	40.0		1	1	1		10	08:30	4						
11	房友屯		0/1				0/1	0.0		2				22	10:48	4						
12	王雨		1/1	1/1	1/1		3/3	100					1	2	11:23	5	7	任健豪				
14	王泽润													10	12:00	5						
15	张建杰	0/5			1/1	1/1	2/7	28.6	1	3	1			3	13:31	6	15	薛瑞寒				
18	姚雪岩		1/1				1/1	100						15	15:41	6						
19	王帅													4	16:07	7	14	杨毅				
21	张昌轲		2/2			1/1	3/3	100		1	1		1	10	17:45	7						
22	黄培杰			1/2	1/2	0/1	1/1	3/6	50.0	1				5	19:42	8	7	任健豪				
24	高玉杰	0/2			0/1	1/1	1/4	25.0						6	20:24	8						
32	罗柏涵													7	21:52	8						
运动员 合计		3/12	7/12	2/4	5/8	3/4	4/5	24/45	53.3	3	13	3	3	7	22:36	9	15	薛瑞寒				
14	王泽润	0/2	2/3		1/1	0/1	0/1	3/8	37.5					15	23:12	9						
19	王帅	2/4	5/11	0/3	0/3	4/6	2/3	13/30	43.3	1	1			7	23:55	9						
守门员 合计		2/6	7/14	0/3	1/4	4/6	0/1	2/4	16/38	42.1	1	1		9	24:30	10	7	任健豪				
														2	孙江山	10	24:57	10				
														7	王立隆	11	29:26	10				
														2nd Half								
														11	00:27	11	14	杨毅				
														24	高玉杰	12	01:58	11				
														12	02:36	12	11	吴夏冰				
														21	张昌轲	13	03:54	12				
														12	王雨	14	05:09	12				
														14	05:51	13	14	杨毅				
														14	10:15	14	14	杨毅				
														10	周仲坤	15	10:48	14				
														7	王立隆	16	12:31	14				
														21	张昌轲	17	14:05	14				
														17	16:51	15	2	张智超				
														17	18:09	16	2	张智超				
														12	王雨	18	21:51	16				
														18	23:11	17	14	杨毅				
														6	毕晓晨	19	24:57	17				
														12	王雨	20	26:57	17				
														20	27:51	18	7	任健豪				
														20	29:31	19	14	杨毅				
														20	29:57	20	7	任健豪				
														7M								
														2	孙江山	21	00:00	20				
														21	00:00	21	5	王宇恒				
														22	00:00	21						
														22	00:00	22	13	杜忠浩				
														6	毕晓晨	23	00:00	22				
														21	张昌轲	24	00:00	22				

场上队员: 得分 / 射门

守门员: 救球 / 射门

D	取消资格	DR	取消资格+报告
---	------	----	---------



2019年全国男子手球冠军杯赛

PHMS Pictorial Handball Match Statistics

IHF Official System

个人/全队技术统计表

手球 预赛 组别 A 万州体育馆  
男子 轮次 4 场次 15 2019-04-10 16:00

号码	姓名	远射	近射	边射	快攻	突破	任意	七米	合计	%	助攻	失误	警告	2'	取消	时间
广东队(广东)																
(场上队员)																
2	孙江山		1/1					1/1	2/2	100%						00:06:02
6	毕晓晨		1/3		0/1			1/1	2/5	40.0%		2				01:00:00
7	王立隆				3/3				3/3	100%						00:33:28
9	范保坤									0.0%						00:02:32
10	周仲坤	3/5	1/3	0/1				0/1	4/10	40.0%		1	1	1		00:50:52
11	房友屯		0/1						0/1	0.0%		2				00:10:09
12	王雨		1/1	1/1		1/1			3/3	100%				1		00:30:00
14	王泽润									0.0%						00:11:40
15	张建杰	0/5			1/1	1/1			2/7	28.6%	1	3	1			00:38:11
18	姚雪岩		1/1						1/1	100%			1			00:39:34
19	王帅									0.0%	1	1				00:48:20
21	张昌轲		2/2					1/1	3/3	100%		1		1		00:23:20
22	黄培杰			1/2	1/2	0/1		1/1	3/6	50.0%	1					00:32:19
24	高玉杰	0/2			0/1	1/1			1/4	25.0%		3				00:33:01
32	罗柏涵									0.0%						00:00:00
合计		3/12	7/12	2/4	5/8	3/4		4/5	24/45	53.3%	3	13	3	3		
(守门员)																
14	王泽润	0/2	2/3		1/1		0/1	0/1	3/8	37.5%						00:11:40
19	王帅	2/4	5/11	0/3	0/3	4/6		2/3	13/30	43.3%	1	1				00:48:20
合计		2/6	7/14	0/3	1/4	4/6	0/1	2/4	16/38	42.1%	1	1				

场上队员：得分/射门

守门员：救球/射门

全队合计	得分	被救	射失	击柱	封球	合计	%
远射	3	1	4	2	2	12	25.0%
近射	7	5				12	58.3%
边射	2	2				4	50.0%
快攻	5	2		1		8	62.5%
突破	3	1				4	75.0%
任意							0.0%
七米	4		1			5	80.0%

## 2019年全国男子手球冠军杯赛

PHMS Pictorial Handball Match Statistics

IHF Official System

### 个人/全队技术统计表

手球男子 预赛轮次 4 组别 A 场次 15 万州体育馆 2019-04-10 16:00

号码	姓名	远射	近射	边射	快攻	突破	任意	七米	合计	%	助攻	失误	警告	2'	取消	时间
山西队(山西)																
(场上队员)																
1	鲁世豪									0.0%						00:00:00
2	张智超			2/2					2/2	100%						00:11:38
3	龙俊皓									0.0%						00:00:00
4	刘文东		0/1						0/1	0.0%						00:24:29
5	王宇恒							1/1	1/1	100%						00:04:11
6	盖秀越		0/1	1/1	1/1				2/3	66.7%	1					00:52:42
7	任健豪	1/2	2/4		1/2	1/2		0/1	5/11	45.5%	2	2	1			00:45:28
9	辛浩乐									0.0%						00:00:00
10	王洋									0.0%		1				00:31:06
11	吴夏冰		1/2						1/2	50.0%		2	1	1		00:53:54
12	韩乐斌									0.0%						01:00:00
13	杜忠浩					0/1		1/1	1/2	50.0%		1		1		00:12:02
14	杨毅	3/5	2/4			1/4	1/1	0/1	7/15	46.7%	3	6				01:00:00
15	薛瑞寒	0/3	2/3		1/1	0/1			3/8	37.5%		3	1			00:44:50
16	王虹翔									0.0%						00:14:23
18	张禹琛									0.0%						00:00:00
合计		4/10	7/15	3/3	3/4	2/8	1/1	2/4	22/45	48.9%	6	15	3	2		

#### (守门员)

1	鲁世豪							0/1	0/1	0.0%						00:00:00
12	韩乐斌	1/4	5/12	2/4	2/7	1/4		0/3	11/34	32.4%						01:00:00
合计		1/4	5/12	2/4	2/7	1/4		0/4	11/35	31.4%						

场上队员：得分/射门

守门员：救球/射门

全队合计	得分	被救	射失	击柱	封球	合计	%
远射	4	2	1		3	10	40.0%
近射	7	7	1			15	46.7%
边射	3					3	100.0%
快攻	3	1				4	75.0%
突破	2	4	2			8	25.0%
任意	1					1	100.0%
七米	2	2				4	50.0%



图式比赛技术统计表

手球  
男子

预赛  
轮次 4

组别 A  
场次 15

万州体育馆  
2019-04-10 16:00

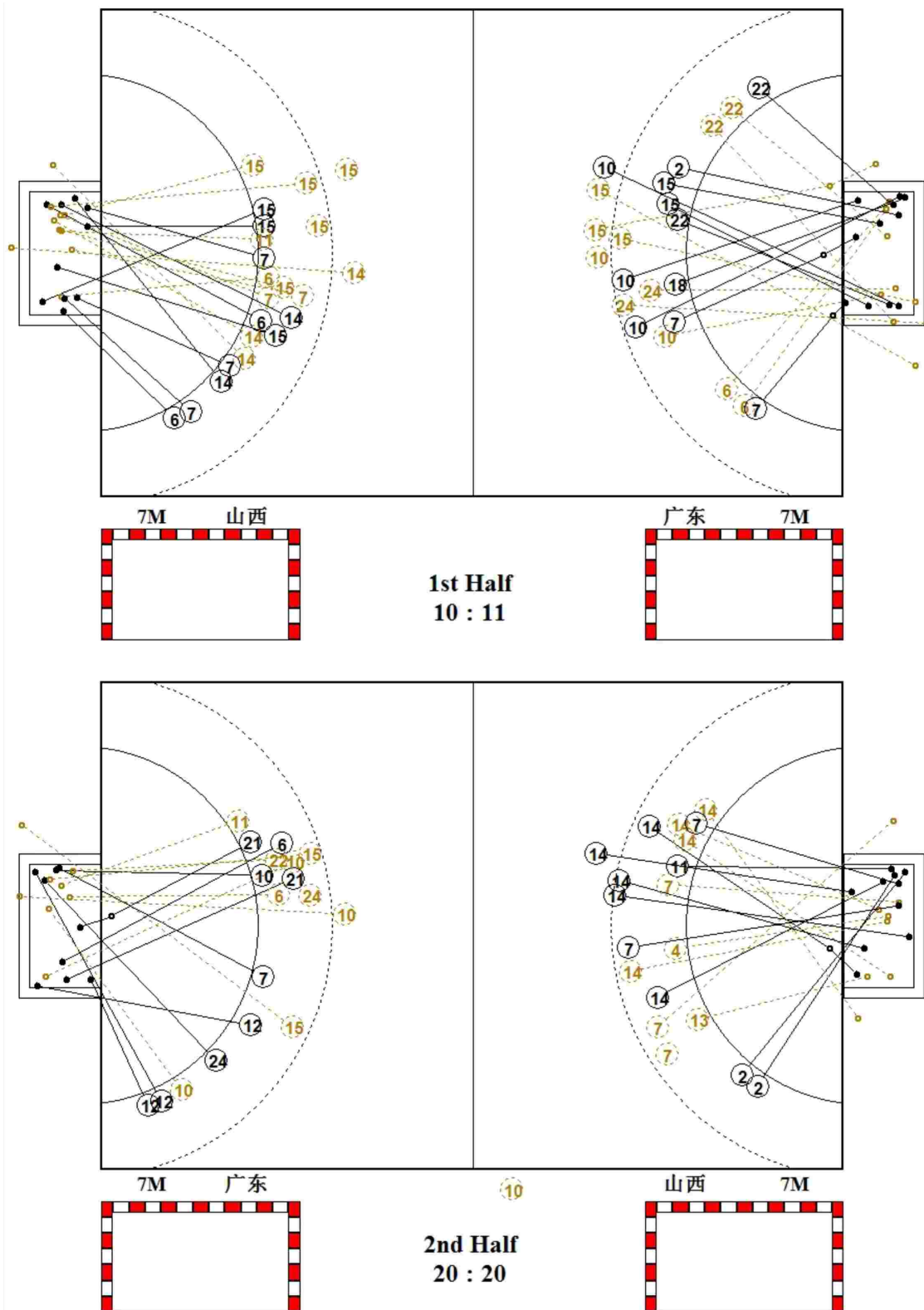

PICTORIAL MATCH STATISTICS

HANDBALL  
男子

预赛  
ROUND 4

GROUP A  
MATCH 15

万州体育馆  
2019-04-10 16:00

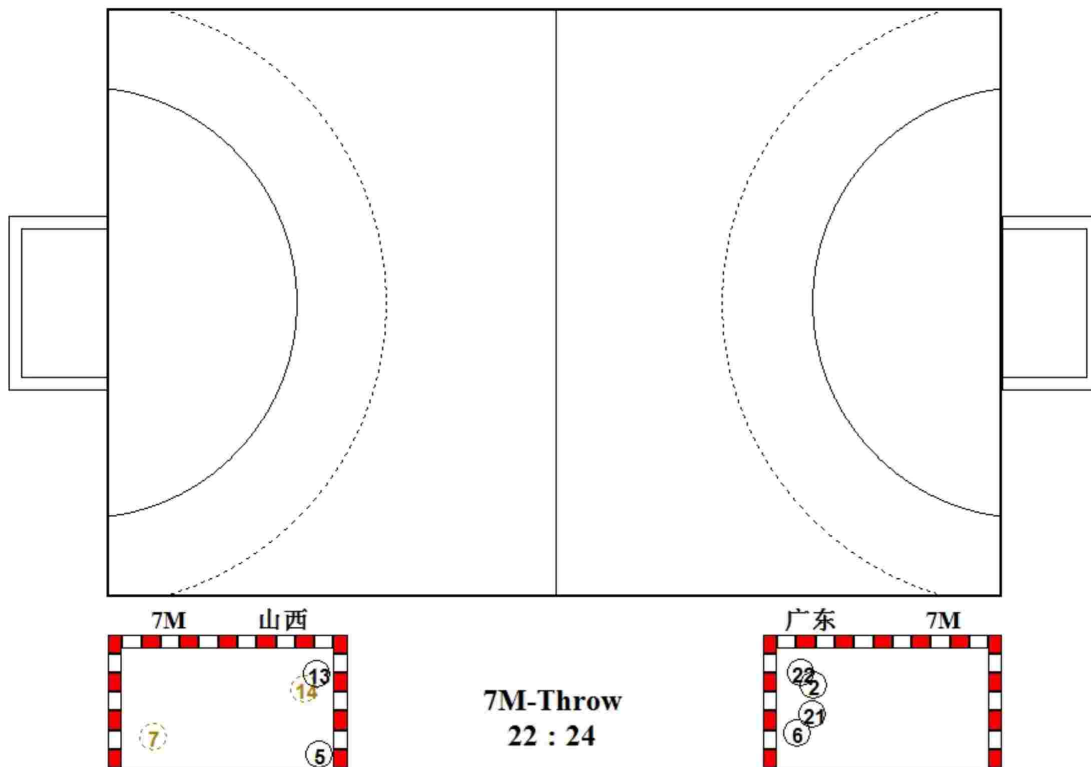

图式射门区域统计

手球  
男子

预赛  
轮次 4

组别 A  
场次 15

万州体育馆  
2019-04-10 16:00

广东队

2 孙江山	6 毕晓晨	7 王立隆	9 范保坤	10 周仲坤	11 房友屯	12 王雨	14 王泽润																																																																								
<table border="1"><tr><td>2</td><td></td><td></td></tr><tr><td></td><td></td><td></td></tr><tr><td></td><td></td><td></td></tr></table>	2									<table border="1"><tr><td></td><td>2</td><td></td></tr><tr><td></td><td></td><td></td></tr><tr><td></td><td></td><td></td></tr></table>		2								<table border="1"><tr><td></td><td></td><td></td></tr><tr><td></td><td></td><td>1</td></tr><tr><td></td><td>1</td><td>1</td></tr></table>						1		1	1	<table border="1"><tr><td></td><td></td><td></td></tr><tr><td></td><td></td><td></td></tr><tr><td></td><td></td><td></td></tr></table>										<table border="1"><tr><td>1</td><td></td><td>1</td></tr><tr><td></td><td></td><td>1</td></tr><tr><td>1</td><td></td><td></td></tr></table>	1		1			1	1			<table border="1"><tr><td></td><td></td><td></td></tr><tr><td></td><td></td><td></td></tr><tr><td></td><td></td><td></td></tr></table>										<table border="1"><tr><td>1</td><td></td><td>1</td></tr><tr><td></td><td></td><td></td></tr><tr><td>1</td><td></td><td></td></tr></table>	1		1				1			<table border="1"><tr><td></td><td></td><td></td></tr><tr><td></td><td></td><td></td></tr><tr><td></td><td></td><td></td></tr></table>									
2																																																																															
	2																																																																														
		1																																																																													
	1	1																																																																													
1		1																																																																													
		1																																																																													
1																																																																															
1		1																																																																													
1																																																																															
Post - 0 Miss - 0 Block - 0	Post - 0 Miss - 0 Block - 0	Post - 0 Miss - 0 Block - 0	Post - 0 Miss - 0 Block - 0	Post - 1 Miss - 1 Block - 1	Post - 0 Miss - 0 Block - 0	Post - 0 Miss - 0 Block - 0	Post - 0 Miss - 0 Block - 0																																																																								
15 张建杰	18 姚雪岩	19 王帅	21 张昌轲	22 黄培杰	24 高玉杰	32 罗柏涵																																																																									
<table border="1"><tr><td></td><td>1</td><td></td></tr><tr><td></td><td></td><td></td></tr><tr><td></td><td></td><td></td></tr></table>		1								<table border="1"><tr><td>1</td><td></td><td></td></tr><tr><td></td><td></td><td></td></tr><tr><td></td><td></td><td></td></tr></table>	1									<table border="1"><tr><td></td><td></td><td></td></tr><tr><td></td><td></td><td></td></tr><tr><td></td><td></td><td></td></tr></table>										<table border="1"><tr><td></td><td>2</td><td></td></tr><tr><td></td><td></td><td></td></tr><tr><td></td><td>1</td><td></td></tr></table>		2						1		<table border="1"><tr><td>2</td><td></td><td>1</td></tr><tr><td></td><td></td><td></td></tr><tr><td></td><td></td><td></td></tr></table>	2		1							<table border="1"><tr><td></td><td></td><td></td></tr><tr><td></td><td></td><td>1</td></tr><tr><td></td><td></td><td></td></tr></table>						1				<table border="1"><tr><td></td><td></td><td></td></tr><tr><td></td><td></td><td></td></tr><tr><td></td><td></td><td></td></tr></table>																			
	1																																																																														
1																																																																															
	2																																																																														
	1																																																																														
2		1																																																																													
		1																																																																													
Post - 1 Miss - 3 Block - 0	Post - 0 Miss - 0 Block - 0	Post - 0 Miss - 0 Block - 0	Post - 0 Miss - 0 Block - 0	Post - 1 Miss - 0 Block - 0	Post - 0 Miss - 1 Block - 1	Post - 0 Miss - 0 Block - 0																																																																									

14 王泽润

1/2	0/2	1/2
	1/1	
0/1		

19 王帅

0/4		3/4
1/5	3/4	5/7
1/1		0/5

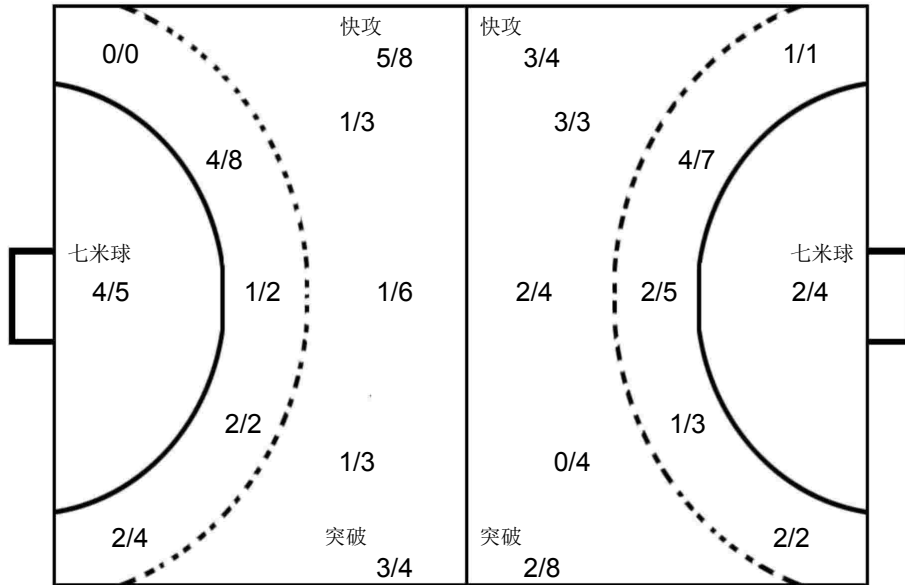

1 鲁世豪

0/1		

12 韩乐斌

2/9	1/1	2/6
1/5	1/1	4/7
0/2	0/2	0/1

山西队

1 鲁世豪	2 张智超	3 龙俊皓	4 刘文东	5 王宇恒	6 盖秀越	7 任健豪	9 辛浩乐																																																																								
<table border="1"><tr><td></td><td></td><td></td></tr><tr><td></td><td></td><td></td></tr><tr><td></td><td></td><td></td></tr></table>										<table border="1"><tr><td>2</td><td></td><td></td></tr><tr><td></td><td></td><td></td></tr><tr><td></td><td></td><td></td></tr></table>	2									<table border="1"><tr><td></td><td></td><td></td></tr><tr><td></td><td></td><td></td></tr><tr><td></td><td></td><td></td></tr></table>										<table border="1"><tr><td></td><td></td><td></td></tr><tr><td></td><td></td><td></td></tr><tr><td></td><td></td><td></td></tr></table>										<table border="1"><tr><td></td><td></td><td></td></tr><tr><td></td><td></td><td>1</td></tr><tr><td></td><td></td><td></td></tr></table>						1				<table border="1"><tr><td></td><td></td><td>1</td></tr><tr><td>1</td><td></td><td></td></tr><tr><td></td><td></td><td></td></tr></table>			1	1						<table border="1"><tr><td>1</td><td>1</td><td></td></tr><tr><td>2</td><td></td><td></td></tr><tr><td></td><td></td><td>1</td></tr></table>	1	1		2					1	<table border="1"><tr><td></td><td></td><td></td></tr><tr><td></td><td></td><td></td></tr><tr><td></td><td></td><td></td></tr></table>									
2																																																																															
		1																																																																													
		1																																																																													
1																																																																															
1	1																																																																														
2																																																																															
		1																																																																													
Post - 0 Miss - 0 Block - 0	Post - 0 Miss - 0 Block - 0	Post - 0 Miss - 0 Block - 0	Post - 0 Miss - 0 Block - 0	Post - 0 Miss - 0 Block - 0	Post - 0 Miss - 0 Block - 0	Post - 0 Miss - 1 Block - 1	Post - 0 Miss - 0 Block - 0																																																																								
10 王洋	11 吴夏冰	12 韩乐斌	13 杜忠浩	14 杨毅	15 薛瑞寒	16 王虹翔	18 张禹琛																																																																								
<table border="1"><tr><td></td><td></td><td></td></tr><tr><td></td><td></td><td></td></tr><tr><td></td><td></td><td></td></tr></table>										<table border="1"><tr><td>1</td><td></td><td></td></tr><tr><td></td><td></td><td></td></tr><tr><td></td><td></td><td></td></tr></table>	1									<table border="1"><tr><td></td><td></td><td></td></tr><tr><td></td><td></td><td></td></tr><tr><td></td><td></td><td></td></tr></table>										<table border="1"><tr><td></td><td></td><td>1</td></tr><tr><td></td><td></td><td></td></tr><tr><td></td><td></td><td></td></tr></table>			1							<table border="1"><tr><td></td><td>1</td><td></td></tr><tr><td>1</td><td></td><td>2</td></tr><tr><td>1</td><td></td><td>2</td></tr></table>		1		1		2	1		2	<table border="1"><tr><td>1</td><td></td><td></td></tr><tr><td></td><td>1</td><td></td></tr><tr><td></td><td></td><td>1</td></tr></table>	1				1				1	<table border="1"><tr><td></td><td></td><td></td></tr><tr><td></td><td></td><td></td></tr><tr><td></td><td></td><td></td></tr></table>										<table border="1"><tr><td></td><td></td><td></td></tr><tr><td></td><td></td><td></td></tr><tr><td></td><td></td><td></td></tr></table>									
1																																																																															
		1																																																																													
	1																																																																														
1		2																																																																													
1		2																																																																													
1																																																																															
	1																																																																														
		1																																																																													
Post - 0 Miss - 0 Block - 0	Post - 0 Miss - 0 Block - 0	Post - 0 Miss - 0 Block - 0	Post - 0 Miss - 0 Block - 0	Post - 0 Miss - 3 Block - 0	Post - 0 Miss - 0 Block - 2	Post - 0 Miss - 0 Block - 0	Post - 0 Miss - 0 Block - 0																																																																								



Team A <b>A 安徽队</b>	Team B <b>B 北京队</b>	Match Number <b>16</b>
------------------------	------------------------	---------------------------

Played in <b>重庆万州</b>	in the hall <b>万州体育馆</b>	on <b>2019-04-10</b>	at <b>17:30</b>	hours	Spectators
--------------------------	-----------------------------	-------------------------	--------------------	-------	------------

Half-time(30')	A <b>10</b>	B <b>9</b>	End of playing time	A <b>19</b>	B <b>19</b>	1st extra time	A	B	2nd extra time	A	B	After penalty throws	A <b>23</b>	B <b>22</b>
----------------	----------------	---------------	---------------------	----------------	----------------	----------------	---	---	----------------	---	---	----------------------	----------------	----------------

Number of 7 m	A <b>4/5</b>	Team time-out			Full name of players and officials	Team time-out			B <b>5/7</b>	Number of 7 m
	1	2	3	1		2	3			

No.	Team A	G	W	2'	D	DR	No.	Team B	G	W	2'	D	DR
1	郭世伟	1					3	逯明松					
4	王巨柱	1					6	解建飞	1	1	1		
5	史小帆						7	马昌震					
6	叶志伟						10	成亚	5				
7	姚雄敏	5					11	赵文宣					
8	董智景	5					12	高云健					
9	金永峰	2					13	王军鸣	2		1		
10	严龙	1					16	刘迈科					
11	黎涛	3					18	傅俊雄					
12	曾献辰						22	王超	1				
18	李双	4	1	2			23	王军程	4				
21	李明						25	王鹏皓					
23	张鹏						26	魏昂					
24	徐安格		1	2			27	闫炳旗	2				
26	饶原源	1					32	蒋维一	2	1			
27	王东昇						33	陈旭	5				
B	Vladimir Stanojevic (主教练)						A	郑永利 (主教练)					
C	黄红						B	孟辉					
D	王来黔						E	陈璇					
E	刘汉杰												

A	Signatures of responsables for the teams (Off.A)	B
---	--	---

TP	Remarks of referees / HF Official	TP
----	-----------------------------------	----

Signatures			
Referees	周云磊 (CHN)	伍豪 (CHN)	
T.D.	李之文 (CHN)	陈少波 (CHN)	
CHA Off.			

Note: Number of 7m Throws Awarded to Team A and B, Goals (G), Warnings (W), Suspensions (2'), Direct Disqualification (D), Disqualification With Report (DR) and Team Penalty (TP).

Table Officials: 刘明华                      张晓虎                      Statisticians: 周亚桥                      谢杨

## 2019年全国男子手球冠军杯赛

PHMS Pictorial Handball Match Statistics

IHF Official System

### 竞赛技术统计

手球 男子      预赛 轮次 4      组别 A 场次 16      万州体育馆 2019-04-10 17:30

Referees: 周云磊 (CHN) / 伍豪 (CHN)      Result: 23:22 (10:9)  
Teams: 安徽队(安徽) VS 北京队(北京)

安徽		远	近	边	快	突	任意	7m	合计	%	助攻	失误	警告	2'	D+DR	安徽		比赛	北京	
主教练: Vladimir Stanojevic		射	射	射	攻	破	球	球								进程	时间	得分		
1	郭世伟	1/3				0/1			1/4	25.0						7	姚雄敏	1	02:26	0
4	王巨柱							1/1	1/1	100						11	黎涛	2	03:07	0
5	史小帆																	2	03:41	1
6	叶志伟																	2	06:01	2
7	姚雄敏	2/3	0/1		3/4	0/1			5/9	55.6		1				9	金永峰	3	07:25	2
8	董智景	0/1		2/2	1/2	1/1		1/1	5/7	71.4	1	1						3	10:01	3
9	金永峰	1/4	0/2			1/1			2/7	28.6		1						3	10:52	4
10	严龙							1/1	1/1	100						8	董智景	4	12:34	4
11	黎涛			1/5	2/2				3/7	42.9						11	黎涛	5	14:13	4
12	曾献辰																	5	16:43	5
18	李双	2/5	0/1		2/2				4/8	50.0	2		1	2		7	姚雄敏	6	18:20	5
21	李明															9	金永峰	7	19:16	5
23	张鹏			0/1					0/1	0.0						7	姚雄敏	8	20:05	5
24	徐安格															8	董智景	8	20:53	6
26	饶源源							1/2	1/2	50.0						8	黎涛	8	23:25	7
27	王东昇															8	李双	8	24:35	8
运动员 合计		6/16	0/4	3/8	8/10	2/4		4/5	23/47	48.9	3	7	2	4		18	李双	9	25:38	8
12	曾献辰							2/2	2/2	100						9	李明	9	26:34	9
21	李明	7/13	4/9	2/4	0/1	0/3		0/5	13/35	37.1						18	李双	10	28:00	9
守门员 合计		7/13	4/9	2/4	0/1	0/3		2/7	15/37	40.5								11	00:45	9
北京		远	近	边	快	突	任意	7m	合计	%	助攻	失误	警告	2'	D+DR	2nd Half				
主教练: 郑永利		射	射	射	攻	破	球	球								11	李双	11	01:45	10
3	透明松																	11	03:52	11
6	解建飞						0/1	1/1	1/2	50.0			1	1		7	姚雄敏	12	05:51	12
7	马昌震		0/1						0/1	0.0		1						12	07:12	13
10	成亚	0/4	1/2			1/1		3/3	5/10	50.0	2	3						12	10:59	14
11	赵文宣																	12	12:18	15
12	高云健															7	姚雄敏	13	13:44	15
13	王军鸣	2/2							2/2	100						18	李双	14	14:38	15
16	刘迈科																	14	15:22	16
18	傅俊雄	0/2						0/1	0/3	0.0		2				11	黎涛	15	17:54	17
22	王超			1/1					1/1	100	1	3						15	18:44	18
23	王军程	3/6						1/1	4/7	57.1		2						15	22:13	19
25	王鹏皓															1	郭世伟	16	23:01	19
26	魏昂			0/2					0/2	0.0						8	董智景	17	25:44	19
27	闫炳旗		1/2	1/2				0/1	2/5	40.0		1				8	董智景	18	27:17	19
32	蒋维一		2/3						2/3	66.7		2	1			8	董智景	19	29:54	19
33	陈旭	1/3	1/1		1/1	2/2			5/7	71.4		4						7M		
运动员 合计		6/17	5/9	2/5	1/1	3/3	0/1	5/7	22/43	51.2	3	18	2	2		8	董智景	20	00:00	20
16	刘迈科	4/10	4/4	4/7	2/10	1/3		0/4	15/38	39.5						10	严龙	21	00:00	21
守门员 合计		4/10	4/4	4/7	2/10	1/3		0/4	15/38	39.5						4	王巨柱	22	00:00	22
																26	饶源源	23	00:00	22

场上队员: 得分 / 射门

守门员: 救球 / 射门

D	取消资格	DR	取消资格+报告
---	------	----	---------



## 2019年全国男子手球冠军杯赛

PHMS Pictorial Handball Match Statistics

IHF Official System

### 个人/全队技术统计表

手球 男子 预赛 轮次 4 组别 A 场次 16 万州体育馆 2019-04-10 17:30

号码	姓名	远射	近射	边射	快攻	突破	任意	七米	合计	%	助攻	失误	警告	2'	取消	时间
<b>安徽队(安徽)</b>																
<b>(场上队员)</b>																
1	郭世伟	1/3				0/1			1/4	25.0%						00:23:17
4	王巨柱							1/1	1/1	100%						00:00:00
5	史小帆									0.0%						00:00:00
6	叶志伟									0.0%						00:00:00
7	姚雄敏	2/3	0/1		3/4	0/1			5/9	55.6%		1				01:00:00
8	董智景	0/1		2/2	1/2	1/1		1/1	5/7	71.4%	1	1				00:58:30
9	金永峰	1/4	0/2			1/1			2/7	28.6%		1				00:38:36
10	严龙							1/1	1/1	100%						00:00:00
11	黎涛			1/5	2/2				3/7	42.9%						00:49:43
12	曾献辰									0.0%						00:00:00
18	李双	2/5	0/1		2/2				4/8	50.0%	2		1	2		00:59:29
21	李明									0.0%						01:00:00
23	张鹏			0/1					0/1	0.0%						00:07:43
24	徐安格									0.0%		4	1	2		01:00:00
26	饶原源							1/2	1/2	50.0%						00:00:19
27	王东昇									0.0%						00:01:25
<b>合计</b>		<b>6/16</b>	<b>0/4</b>	<b>3/8</b>	<b>8/10</b>	<b>2/4</b>		<b>4/5</b>	<b>23/47</b>	<b>48.9%</b>	<b>3</b>	<b>7</b>	<b>2</b>	<b>4</b>		
<b>(守门员)</b>																
12	曾献辰							2/2	2/2	100%						00:00:00
21	李明	7/13	4/9	2/4	0/1	0/3		0/5	13/35	37.1%						01:00:00
<b>合计</b>		<b>7/13</b>	<b>4/9</b>	<b>2/4</b>	<b>0/1</b>	<b>0/3</b>		<b>2/7</b>	<b>15/37</b>	<b>40.5%</b>						

场上队员：得分/射门

守门员：救球/射门

全队合计	得分	被救	射失	击柱	封球	合计	%
远射	6	4	3	2	1	16	37.5%
近射		4				4	0.0%
边射	3	4		1		8	37.5%
快攻	8	2				10	80.0%
突破	2	1		1		4	50.0%
任意							0.0%
七米	4		1			5	80.0%

## 2019年全国男子手球冠军杯赛

PHMS Pictorial Handball Match Statistics

IHF Official System

### 个人/全队技术统计表

手球男子 预赛轮次 4 组别 A 场次 16 万州体育馆 2019-04-10 17:30

号码	姓名	远射	近射	边射	快攻	突破	任意	七米	合计	%	助攻	失误	警告	2'	取消	时间
北京队(北京)																
(场上队员)																
3	逯明松									0.0%						00:00:00
6	解建飞					0/1		1/1	1/2	50.0%			1	1		00:24:56
7	马昌震		0/1						0/1	0.0%		1				00:14:53
10	成亚	0/4	1/2			1/1		3/3	5/10	50.0%	2	3				01:00:00
11	赵文宣									0.0%						00:00:00
12	高云健									0.0%						00:00:00
13	王军鸣	2/2							2/2	100%				1		00:07:49
16	刘迈科									0.0%						01:00:00
18	傅俊雄	0/2						0/1	0/3	0.0%		2				00:18:29
22	王超			1/1					1/1	100%	1	3				00:45:40
23	王军程	3/6						1/1	4/7	57.1%		2				00:35:40
25	王鹏皓									0.0%						00:00:00
26	魏昂			0/2					0/2	0.0%						00:14:18
27	闫炳旗		1/2	1/2				0/1	2/5	40.0%		1				00:57:59
32	蒋维一		2/3						2/3	66.7%		2	1			00:45:54
33	陈旭	1/3	1/1		1/1	2/2			5/7	71.4%		4				00:33:17
	合计	6/17	5/9	2/5	1/1	3/3	0/1	5/7	22/43	51.2%	3	18	2	2		
(守门员)																
16	刘迈科	4/10	4/4	4/7	2/10	1/3		0/4	15/38	39.5%						01:00:00
	合计	4/10	4/4	4/7	2/10	1/3		0/4	15/38	39.5%						

场上队员：得分/射门

守门员：救球/射门

全队合计	得分	被救	射失	击柱	封球	合计	%
远射	6	7			4	17	35.3%
近射	5	4				9	55.6%
边射	2	2		1		5	40.0%
快攻	1					1	100.0%
突破	3					3	100.0%
任意			1			1	0.0%
七米	5	2				7	71.4%

图式比赛技术统计表

手球  
男子

预赛  
轮次 4

组别 A  
场次 16

万州体育馆  
2019-04-10 17:30

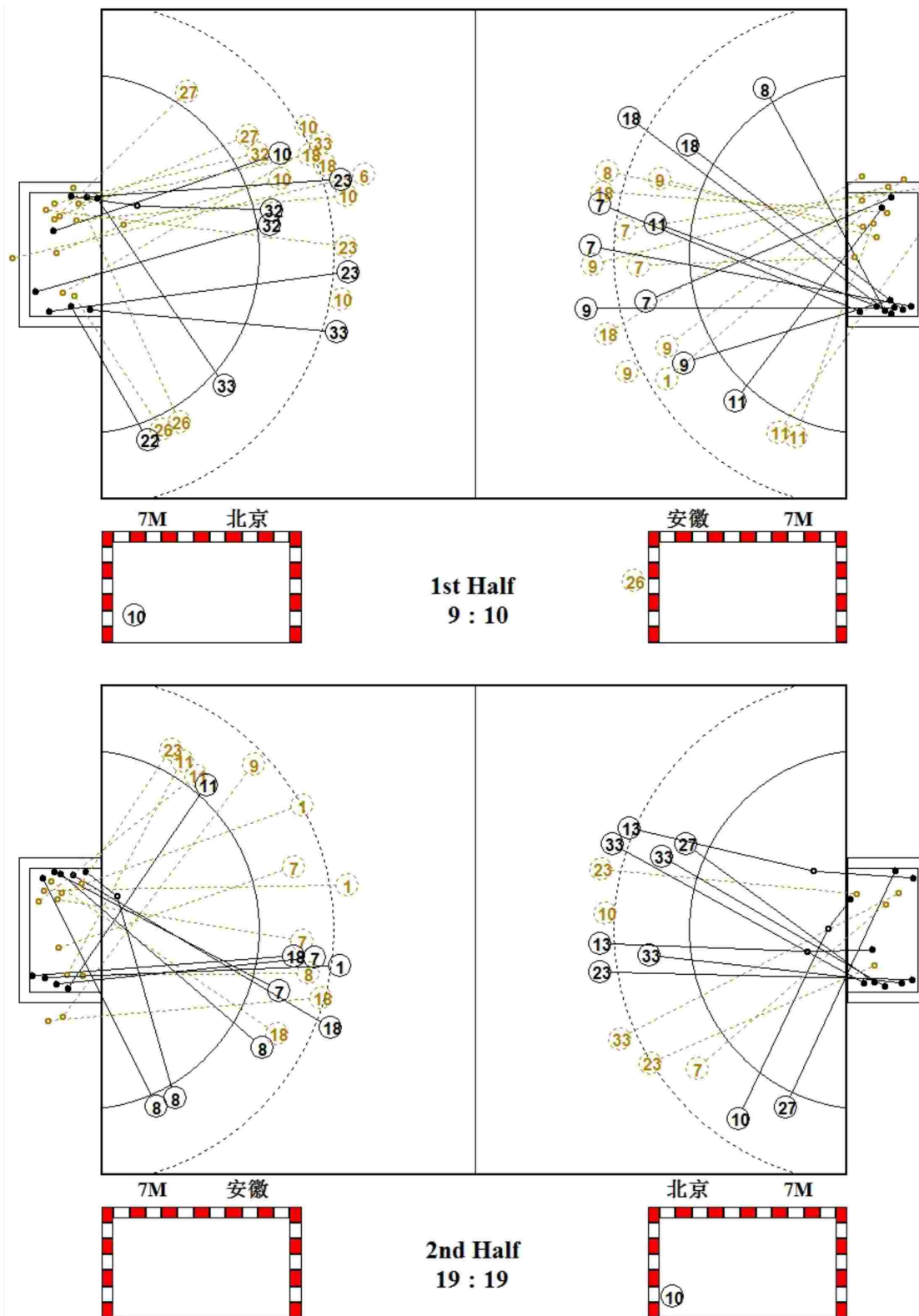



PICTORIAL MATCH STATISTICS

HANDBALL  
男子

预赛  
ROUND 4

GROUP A  
MATCH 16

万州体育馆  
2019-04-10 17:30

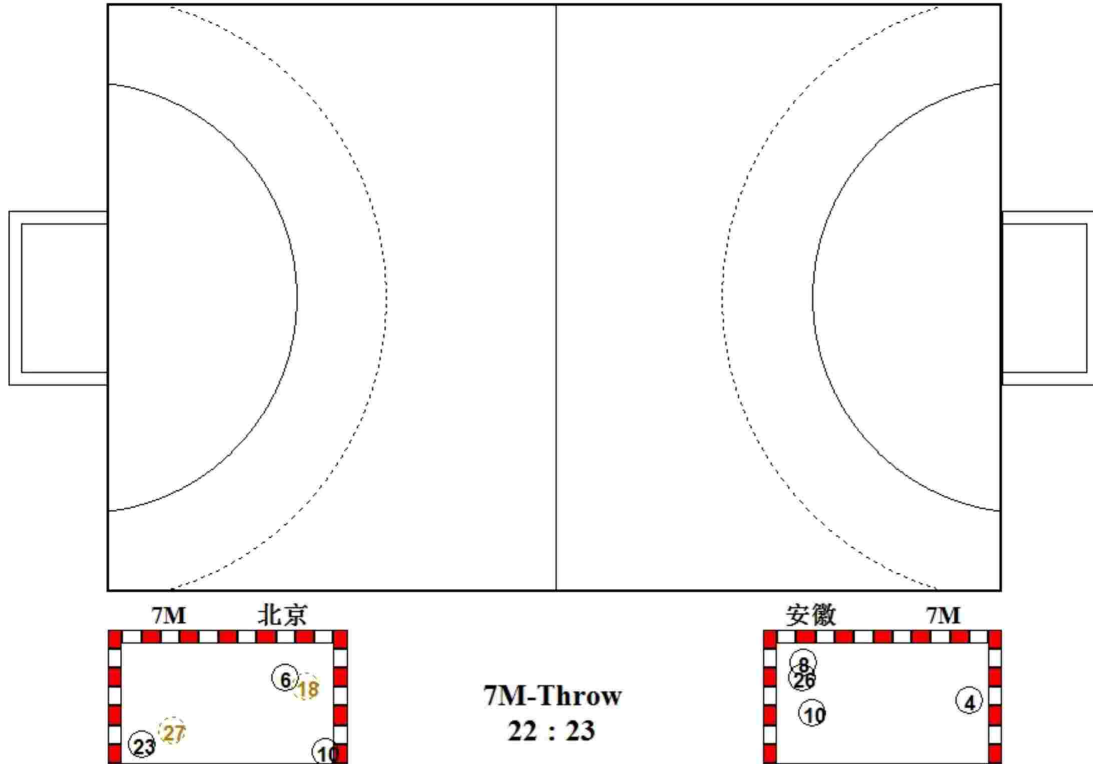

图式射门区域统计

手球  
男子

预赛  
轮次 4

组别 A  
场次 16

万州体育馆  
2019-04-10 17:30

安徽队

1 郭世伟 <table border="1"><tr><td>1</td><td></td><td></td></tr><tr><td></td><td></td><td></td></tr><tr><td></td><td></td><td></td></tr></table> Post - 1 Miss - 0 Block - 0	1									4 王巨柱 <table border="1"><tr><td></td><td></td><td></td></tr><tr><td></td><td></td><td>1</td></tr><tr><td></td><td></td><td></td></tr></table> Post - 0 Miss - 0 Block - 0						1				5 史小帆 <table border="1"><tr><td></td><td></td><td></td></tr><tr><td></td><td></td><td></td></tr><tr><td></td><td></td><td></td></tr></table> Post - 0 Miss - 0 Block - 0										6 叶志伟 <table border="1"><tr><td></td><td></td><td></td></tr><tr><td></td><td></td><td></td></tr><tr><td></td><td></td><td></td></tr></table> Post - 0 Miss - 0 Block - 0										7 姚雄敏 <table border="1"><tr><td></td><td></td><td>2</td></tr><tr><td>2</td><td></td><td></td></tr><tr><td></td><td></td><td>1</td></tr></table> Post - 1 Miss - 0 Block - 0			2	2					1	8 董智景 <table border="1"><tr><td>1</td><td></td><td>1</td></tr><tr><td></td><td></td><td>2</td></tr><tr><td></td><td></td><td>1</td></tr></table> Post - 0 Miss - 0 Block - 0	1		1			2			1	9 金永峰 <table border="1"><tr><td></td><td></td><td>1</td></tr><tr><td></td><td></td><td>1</td></tr><tr><td></td><td></td><td></td></tr></table> Post - 1 Miss - 1 Block - 1			1			1				10 严龙 <table border="1"><tr><td></td><td></td><td></td></tr><tr><td>1</td><td></td><td></td></tr><tr><td></td><td></td><td></td></tr></table> Post - 0 Miss - 0 Block - 0				1					
1																																																																															
		1																																																																													
		2																																																																													
2																																																																															
		1																																																																													
1		1																																																																													
		2																																																																													
		1																																																																													
		1																																																																													
		1																																																																													
1																																																																															
11 黎涛 <table border="1"><tr><td>2</td><td></td><td>1</td></tr><tr><td></td><td></td><td></td></tr><tr><td></td><td></td><td></td></tr></table> Post - 1 Miss - 0 Block - 0	2		1							12 曾献辰 <table border="1"><tr><td></td><td></td><td></td></tr><tr><td></td><td></td><td></td></tr><tr><td></td><td></td><td></td></tr></table> Post - 0 Miss - 0 Block - 0										18 李双 <table border="1"><tr><td>1</td><td></td><td>1</td></tr><tr><td></td><td></td><td>2</td></tr><tr><td></td><td></td><td></td></tr></table> Post - 0 Miss - 2 Block - 0	1		1			2				21 李明 <table border="1"><tr><td></td><td></td><td></td></tr><tr><td></td><td></td><td></td></tr><tr><td></td><td></td><td></td></tr></table> Post - 0 Miss - 0 Block - 0										23 张鹏 <table border="1"><tr><td></td><td></td><td></td></tr><tr><td></td><td></td><td></td></tr><tr><td></td><td></td><td></td></tr></table> Post - 0 Miss - 0 Block - 0										24 徐安格 <table border="1"><tr><td></td><td></td><td></td></tr><tr><td></td><td></td><td></td></tr><tr><td></td><td></td><td></td></tr></table> Post - 0 Miss - 0 Block - 0										26 饶原源 <table border="1"><tr><td>1</td><td></td><td></td></tr><tr><td></td><td></td><td></td></tr><tr><td></td><td></td><td></td></tr></table> Post - 0 Miss - 1 Block - 0	1									27 王东昇 <table border="1"><tr><td></td><td></td><td></td></tr><tr><td></td><td></td><td></td></tr><tr><td></td><td></td><td></td></tr></table> Post - 0 Miss - 0 Block - 0									
2		1																																																																													
1		1																																																																													
		2																																																																													
1																																																																															

12 曾献辰

		1/1
1/1		

21 李明

1/5		3/7
3/5	1/2	3/6
1/5		1/5

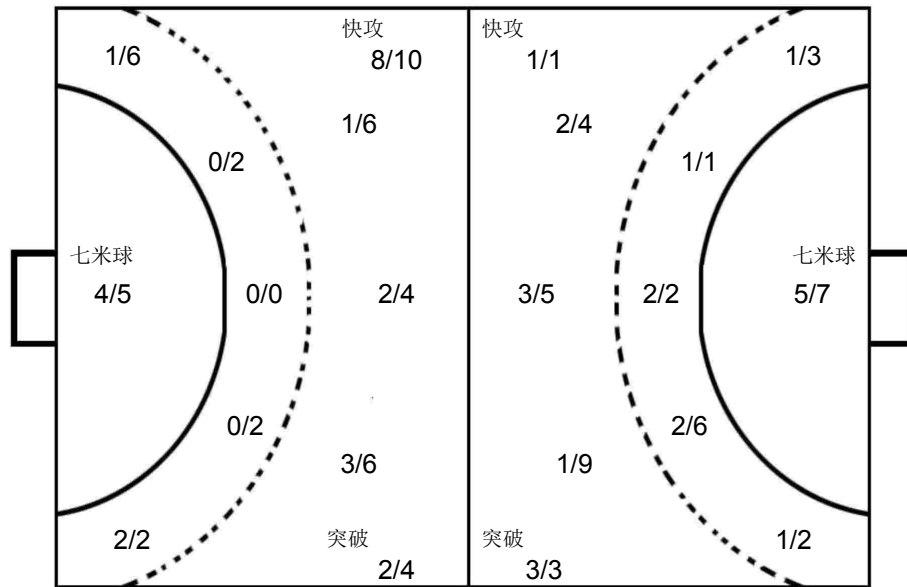

16 刘迈科

0/4		3/8
3/8	2/2	2/9
3/3	1/1	1/3

北京队

3 逯明松 <table border="1"><tr><td></td><td></td><td></td></tr><tr><td></td><td></td><td></td></tr><tr><td></td><td></td><td></td></tr></table> Post - 0 Miss - 0 Block - 0										6 解建飞 <table border="1"><tr><td></td><td></td><td>1</td></tr><tr><td></td><td></td><td></td></tr><tr><td></td><td></td><td></td></tr></table> Post - 0 Miss - 1 Block - 0			1							7 马昌震 <table border="1"><tr><td></td><td></td><td></td></tr><tr><td></td><td></td><td></td></tr><tr><td></td><td></td><td></td></tr></table> Post - 0 Miss - 0 Block - 0										10 成亚 <table border="1"><tr><td></td><td></td><td>1</td></tr><tr><td>1</td><td></td><td></td></tr><tr><td>2</td><td></td><td>1</td></tr></table> Post - 0 Miss - 0 Block - 3			1	1			2		1	11 赵文宣 <table border="1"><tr><td></td><td></td><td></td></tr><tr><td></td><td></td><td></td></tr><tr><td></td><td></td><td></td></tr></table> Post - 0 Miss - 0 Block - 0										12 高云健 <table border="1"><tr><td></td><td></td><td></td></tr><tr><td></td><td></td><td></td></tr><tr><td></td><td></td><td></td></tr></table> Post - 0 Miss - 0 Block - 0										13 王军鸣 <table border="1"><tr><td>1</td><td></td><td></td></tr><tr><td></td><td>1</td><td></td></tr><tr><td></td><td></td><td></td></tr></table> Post - 0 Miss - 0 Block - 0	1				1					16 刘迈科 <table border="1"><tr><td></td><td></td><td></td></tr><tr><td></td><td></td><td></td></tr><tr><td></td><td></td><td></td></tr></table> Post - 0 Miss - 0 Block - 0									
		1																																																																													
		1																																																																													
1																																																																															
2		1																																																																													
1																																																																															
	1																																																																														
18 傅俊雄 <table border="1"><tr><td></td><td></td><td></td></tr><tr><td></td><td></td><td></td></tr><tr><td></td><td></td><td></td></tr></table> Post - 0 Miss - 0 Block - 1										22 王超 <table border="1"><tr><td>1</td><td></td><td></td></tr><tr><td></td><td></td><td></td></tr><tr><td></td><td></td><td></td></tr></table> Post - 0 Miss - 0 Block - 0	1									23 王军程 <table border="1"><tr><td>1</td><td></td><td>1</td></tr><tr><td></td><td></td><td></td></tr><tr><td>1</td><td></td><td>1</td></tr></table> Post - 0 Miss - 0 Block - 0	1		1				1		1	25 王鹏皓 <table border="1"><tr><td></td><td></td><td></td></tr><tr><td></td><td></td><td></td></tr><tr><td></td><td></td><td></td></tr></table> Post - 0 Miss - 0 Block - 0										26 魏昂 <table border="1"><tr><td></td><td></td><td></td></tr><tr><td></td><td></td><td></td></tr><tr><td></td><td></td><td></td></tr></table> Post - 1 Miss - 0 Block - 0										27 闫炳旗 <table border="1"><tr><td>1</td><td></td><td></td></tr><tr><td></td><td></td><td>1</td></tr><tr><td></td><td></td><td></td></tr></table> Post - 0 Miss - 0 Block - 0	1					1				32 蒋维一 <table border="1"><tr><td>1</td><td></td><td></td></tr><tr><td></td><td></td><td>1</td></tr><tr><td></td><td></td><td></td></tr></table> Post - 0 Miss - 0 Block - 0	1					1				33 陈旭 <table border="1"><tr><td></td><td></td><td>1</td></tr><tr><td></td><td></td><td>1</td></tr><tr><td>1</td><td></td><td>2</td></tr></table> Post - 0 Miss - 0 Block - 0			1			1	1		2
1																																																																															
1		1																																																																													
1		1																																																																													
1																																																																															
		1																																																																													
1																																																																															
		1																																																																													
		1																																																																													
		1																																																																													
1		2																																																																													



Team A					Team B					Match Number											
A 山东队					B 上海队					17											
Played in			in the hall			on			at			Spectators									
重庆万州			万州体育馆			2019-04-11			13:00			hours									
Half-time(30')	A	B	End of playing time		A	B	1st extra time		A	B	2nd extra time		A	B	After penalty throws						
	13	6	31 21																		
Number of 7 m	A	Team time-out			Full name of players and officials						Team time-out			B	Number of 7 m						
	4/5	1	2	3							1	2	3	1/1							
			35:54																		
No.	Team A					G	W	2'	D	DR	No.	Team B					G	W	2'	D	DR
1	宋晓晨										1	张峥									
6	李朝鹏					4					4	高天伦					2				
7	林豪文					6					5	贺政					6		1		
8	王炳华										7	周文龙									
9	赵元					1					8	高震东					1		1		
10	赵建强										10	朱世杰					8		1		
11	宋朋强						1				11	蒋慧捷					2				
12	于性哲										13	谢智超									
13	刘晓					2					15	庄旭杰									
15	张继伟					3					16	张逸豪									
17	王旭东										18	董凯									
19	李语庆					5					20	蒋承骅									
21	姜春辉										30	徐俊吉					2				
27	胡晋铭					4		1													
31	于亚男					3															
34	王钟彬					3															
B	王鸿斌 (主教练)										A	吴璟 (主教练)									
C	金京男										B	金迪琦									
D	刘桂妮										C	张勇军									
E	林配永										D	杨时									
A	Signatures of responsables for the teams (Off.A)																		B		
TP	Remarks of referees / HF Official																		TP		

Signatures

Referees	严璐 (CHN)	黄一凡 (CHN)		
T.D.	郭剑 (CHN)	张春生 (CHN)		
CHA Off.				

Note: Number of 7m Throws Awarded to Team A and B, Goals (G), Warnings (W), Suspensions (2'), Direct Disqualification (D), Disqualification With Report (DR) and Team Penalty (TP).

Table Officials: 周云磊 伍豪 Statisticians: 赵悦 周亚桥

2019年全国男子手球冠军杯赛

PHMS Pictorial Handball Match Statistics

IHF Official System

竞赛技术统计

手球  
男子

预赛  
轮次 5

组别 B  
场次 17

万州体育馆  
2019-04-11 13:00

Referees:	严璐 (CHN) / 黄一凡 (CHN)	Result:	31:21 (13:6)
Teams:	山东队(山东) VS 上海队(上海)		

山东		远	近	边	快	突	任意	7m	合计	%	助攻	失误	警告	2'	D+DR
主教练: 王鸿斌		射	射	射	攻	破	球	球							
1	宋晓晨														
6	李朝鹏	1/2			2/2			1/2	4/6	66.7	1	2			
7	林豪文	2/2	2/2	0/1	1/2	1/1			6/8	75.0					
8	王炳华														
9	赵元			1/1					1/1	100	1				
10	赵建强														
11	宋朋强		0/1	0/1					0/2	0.0	1		1		
12	于性哲										2				
13	刘晓	2/3			0/1				2/4	50.0	1	2			
15	张继伟		3/4						3/4	75.0		2			
17	王旭东	0/1	0/1						0/2	0.0	1				
19	李语庆		1/1	1/2	3/3				5/6	83.3		1			
21	姜春辉														
27	胡晋铭		2/2		1/1			1/1	4/4	100	1			1	
31	于亚男	1/3	1/2		1/1				3/6	50.0		1			
34	王钟彬		0/1			1/1		2/2	3/4	75.0	1				
运动员	合计	6/11	9/14	2/5	8/10	2/2		4/5	31/47	66.0	9	8	1	1	
1	宋晓晨	0/6	0/4	0/1		0/1			0/12	0.0					
12	于性哲	2/5	1/3	0/1	1/3		1/1	0/1	5/14	35.7	2				
守门员	合计	2/11	1/7	0/2	1/3	0/1	1/1	0/1	5/26	19.2	2				

上海		远	近	边	快	突	任意	7m	合计	%	助攻	失误	警告	2'	D+DR
主教练: 吴璟		射	射	射	攻	破	球	球							
1	张峥														
4	高天伦		1/1	1/1	0/1				2/3	66.7		1			
5	贺政	4/9	2/4				0/1		6/14	42.9	1	2		1	
7	周文龙														
8	高震东	0/4	1/1		0/1	0/1			1/7	14.3		1		1	
10	朱世杰	5/9	1/2		1/1	1/1			8/13	61.5	1	6		1	
11	蒋慧捷	0/1		1/1	1/1				2/3	66.7		2			
13	谢智超														
15	庄旭杰		0/1						0/1	0.0					
16	张逸豪														
18	董凯														
20	蒋承骅														
30	徐俊吉		1/1					1/1	2/2	100					
运动员	合计	9/23	6/10	2/2	2/4	1/2	0/1	1/1	21/43	48.8	2	12		3	
1	张峥	2/8	5/14	2/4	1/9	0/2		1/5	11/42	26.2					
守门员	合计	2/8	5/14	2/4	1/9	0/2		1/5	11/42	26.2					

山东	比赛进程	上海
1st Half		
19 李语庆	1 01:27 0	
	1 03:15 1 10 朱世杰	
31 于亚男	2 04:31 1	
31 于亚男	3 05:33 1	
	3 06:10 2 30 徐俊吉	
19 李语庆	4 07:00 2	
	4 08:29 3 10 朱世杰	
6 李朝鹏	5 09:55 3	
15 张继伟	6 12:00 3	
	6 12:41 4 5 贺政	
15 张继伟	7 15:52 4	
	7 16:02 5 5 贺政	
19 李语庆	8 18:44 5	
7 林豪文	9 20:14 5	
6 李朝鹏	10 21:04 5	
	10 23:31 6 30 徐俊吉	
7 林豪文	11 24:16 6	
6 李朝鹏	12 24:50 6	
27 胡晋铭	13 27:56 6	
2nd Half		
31 于亚男	14 00:38 6	
6 李朝鹏	15 02:25 6	
	15 03:02 7 4 高天伦	
	15 03:53 8 11 蒋慧捷	
	15 05:48 9 10 朱世杰	
34 王钟彬	16 06:26 9	
	16 07:02 10 4 高天伦	
27 胡晋铭	17 08:02 10	
	17 10:38 11 8 高震东	
	17 11:36 12 10 朱世杰	
7 林豪文	18 12:18 12	
	18 12:54 13 5 贺政	
9 赵元	19 13:23 13	
	19 14:15 14 10 朱世杰	
7 林豪文	20 14:46 14	
	20 15:26 15 5 贺政	
7 林豪文	21 16:09 15	
7 林豪文	22 16:38 15	
19 李语庆	23 17:17 15	
	23 17:58 16 10 朱世杰	
15 张继伟	24 18:07 16	
	24 20:32 17 11 蒋慧捷	
13 刘晓	25 21:12 17	
	25 21:48 18 5 贺政	
	25 22:53 19 10 朱世杰	
19 李语庆	26 23:11 19	
34 王钟彬	27 24:42 19	
	27 25:16 20 10 朱世杰	
27 胡晋铭	28 25:37 20	
34 王钟彬	29 26:50 20	
13 刘晓	30 28:12 20	
	30 29:13 21 5 贺政	
27 胡晋铭	31 29:55 21	

场上队员: 得分 / 射门

守门员: 救球 / 射门

D	取消资格	DR	取消资格+报告
---	------	----	---------

2019年全国男子手球冠军杯赛

PHMS Pictorial Handball Match Statistics

IHF Official System

个人/全队技术统计表

手球 预赛 组别 B 万州体育馆  
男子 轮次 5 场次 17 2019-04-11 13:00

号码	姓名	远射	近射	边射	快攻	突破	任意	七米	合计	%	助攻	失误	警告	2'	取消	时间
山东队(山东)																
(场上队员)																
1	宋晓晨									0.0%						00:24:06
6	李朝鹏	1/2			2/2			1/2	4/6	66.7%	1	2				00:35:54
7	林豪文	2/2	2/2	0/1	1/2	1/1			6/8	75.0%						00:33:58
8	王炳华									0.0%						00:11:05
9	赵元			1/1					1/1	100%	1					00:09:11
10	赵建强									0.0%						00:00:00
11	宋朋强		0/1	0/1					0/2	0.0%	1		1			00:24:37
12	于性哲									0.0%	2					00:35:54
13	刘晓	2/3			0/1				2/4	50.0%	1	2				00:41:41
15	张继伟		3/4						3/4	75.0%		2				00:35:18
17	王旭东	0/1	0/1						0/2	0.0%	1					00:25:28
19	李语庆		1/1	1/2	3/3				5/6	83.3%		1				00:53:25
21	姜春辉									0.0%						00:00:00
27	胡晋铭		2/2		1/1			1/1	4/4	100%	1			1		00:39:19
31	于亚男	1/3	1/2		1/1				3/6	50.0%		1				00:26:01
34	王钟彬		0/1			1/1		2/2	3/4	75.0%	1					00:23:52
	合计	6/11	9/14	2/5	8/10	2/2		4/5	31/47	66.0%	9	8	1	1		
(守门员)																
1	宋晓晨	0/6	0/4	0/1		0/1			0/12	0.0%						00:24:06
12	于性哲	2/5	1/3	0/1	1/3		1/1	0/1	5/14	35.7%	2					00:35:54
	合计	2/11	1/7	0/2	1/3	0/1	1/1	0/1	5/26	19.2%	2					

场上队员：得分/射门

守门员：救球/射门

全队合计	得分	被救	射失	击柱	封球	合计	%
远射	6	2	2	1		11	54.5%
近射	9	5				14	64.3%
边射	2	2	1			5	40.0%
快攻	8	1		1		10	80.0%
突破	2					2	100.0%
任意							0.0%
七米	4	1				5	80.0%

2019年全国男子手球冠军杯赛

PHMS Pictorial Handball Match Statistics

IHF Official System

个人/全队技术统计表

手球 男子 预赛 轮次 5 组别 B 场次 17 万州体育馆 2019-04-11 13:00

号码	姓名	远射	近射	边射	快攻	突破	任意	七米	合计	%	助攻	失误	警告	2'	取消	时间
上海队(上海)																
(场上队员)																
1	张崢									0.0%						01:00:00
4	高天伦		1/1	1/1	0/1				2/3	66.7%		1				00:58:32
5	贺政	4/9	2/4				0/1		6/14	42.9%	1	2		1		01:00:00
7	周文龙									0.0%						00:00:00
8	高震东	0/4	1/1		0/1	0/1			1/7	14.3%		1		1		01:00:00
10	朱世杰	5/9	1/2		1/1	1/1			8/13	61.5%	1	6		1		01:00:00
11	蒋慧捷	0/1		1/1	1/1				2/3	66.7%		2				00:59:59
13	谢智超									0.0%						00:00:00
15	庄旭杰		0/1						0/1	0.0%						00:02:14
16	张逸豪									0.0%						00:00:00
18	董凯									0.0%						00:04:44
20	蒋承骅									0.0%						00:00:00
30	徐俊吉		1/1					1/1	2/2	100%						00:54:26
	合计	9/23	6/10	2/2	2/4	1/2	0/1	1/1	21/43	48.8%	2	12		3		
(守门员)																
1	张崢	2/8	5/14	2/4	1/9	0/2		1/5	11/42	26.2%						01:00:00
	合计	2/8	5/14	2/4	1/9	0/2		1/5	11/42	26.2%						

场上队员： 得分/射门

守门员： 救球/射门

全队合计	得分	被救	射失	击柱	封球	合计	%
远射	9	2	4	3	5	23	39.1%
近射	6	1	1	1	1	10	60.0%
边射	2					2	100.0%
快攻	2	1	1			4	50.0%
突破	1		1			2	50.0%
任意		1				1	0.0%
七米	1					1	100.0%

图式比赛技术统计表

手球  
男子

预赛  
轮次 5

组别 B  
场次 17

万州体育馆  
2019-04-11 13:00

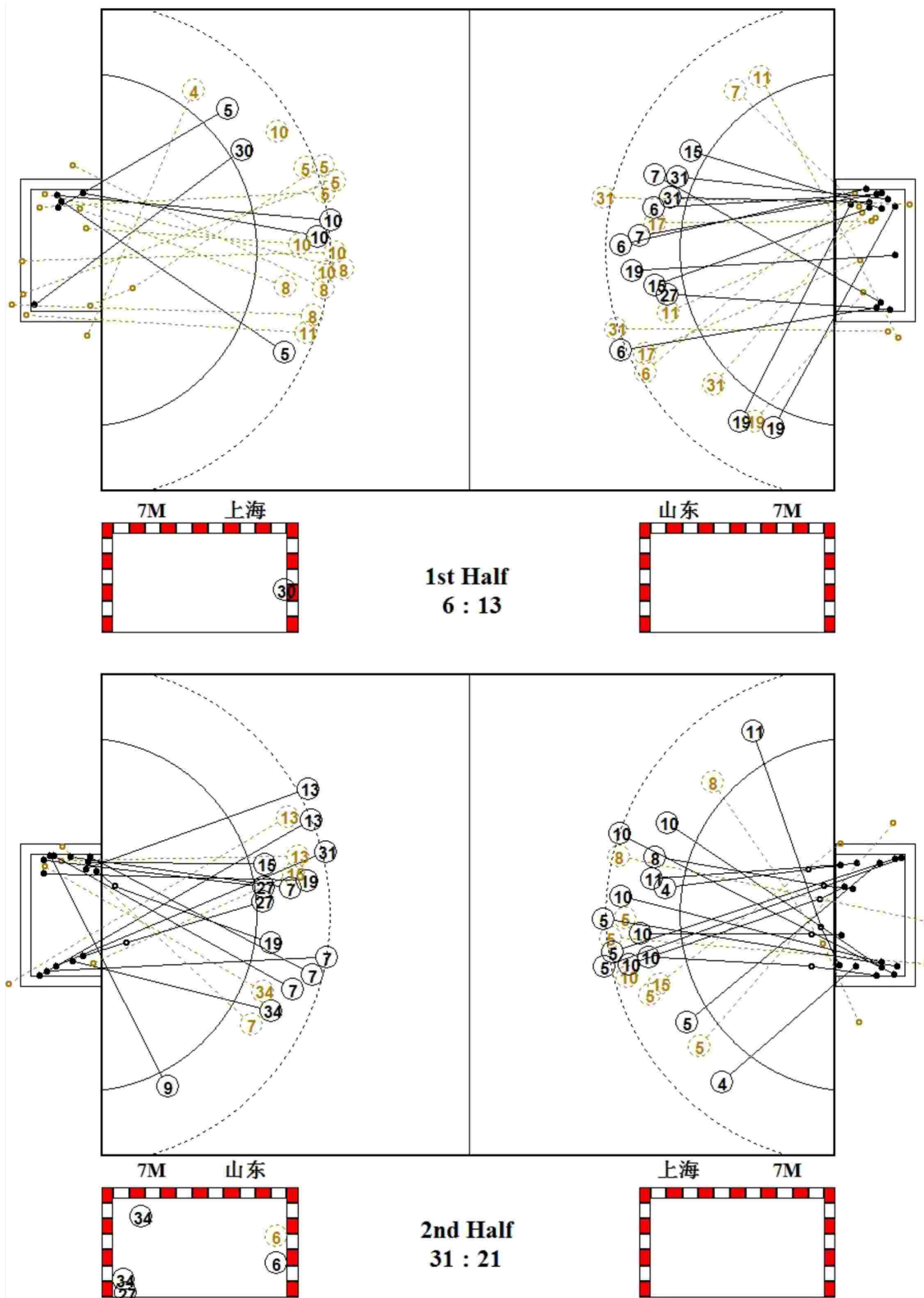

图式射门区域统计

手球  
男子

预赛  
轮次 5

组别 B  
场次 17

万州体育馆  
2019-04-11 13:00

山东队

1 宋晓晨	6 李朝鹏	7 林豪文	8 王炳华	9 赵元	10 赵建强	11 宋朋强	12 于性哲																																																																																																
<table border="1"><tr><td></td><td></td><td></td></tr><tr><td></td><td></td><td></td></tr><tr><td></td><td></td><td></td></tr></table>										<table border="1"><tr><td></td><td></td><td></td></tr><tr><td>2</td><td></td><td>2</td></tr><tr><td></td><td></td><td></td></tr><tr><td></td><td></td><td></td></tr></table>				2		2							<table border="1"><tr><td>2</td><td></td><td>2</td></tr><tr><td></td><td></td><td>1</td></tr><tr><td></td><td></td><td>1</td></tr><tr><td></td><td></td><td></td></tr></table>	2		2			1			1				<table border="1"><tr><td></td><td></td><td></td></tr><tr><td></td><td></td><td></td></tr><tr><td></td><td></td><td></td></tr><tr><td></td><td></td><td></td></tr></table>													<table border="1"><tr><td></td><td></td><td>1</td></tr><tr><td></td><td></td><td></td></tr><tr><td></td><td></td><td></td></tr><tr><td></td><td></td><td></td></tr></table>			1										<table border="1"><tr><td></td><td></td><td></td></tr><tr><td></td><td></td><td></td></tr><tr><td></td><td></td><td></td></tr><tr><td></td><td></td><td></td></tr></table>													<table border="1"><tr><td></td><td></td><td></td></tr><tr><td></td><td></td><td></td></tr><tr><td></td><td></td><td></td></tr><tr><td></td><td></td><td></td></tr></table>													<table border="1"><tr><td></td><td></td><td></td></tr><tr><td></td><td></td><td></td></tr><tr><td></td><td></td><td></td></tr><tr><td></td><td></td><td></td></tr></table>															
2		2																																																																																																					
2		2																																																																																																					
		1																																																																																																					
		1																																																																																																					
		1																																																																																																					
Post - 0 Miss - 0 Block - 0	Post - 0 Miss - 0 Block - 0	Post - 1 Miss - 0 Block - 0	Post - 0 Miss - 0 Block - 0	Post - 0 Miss - 0 Block - 0	Post - 0 Miss - 0 Block - 0	Post - 0 Miss - 1 Block - 0	Post - 0 Miss - 0 Block - 0																																																																																																
13 刘晓	15 张继伟	17 王旭东	19 李语庆	21 姜春辉	27 胡晋铭	31 于亚男	34 王钟彬																																																																																																
<table border="1"><tr><td>1</td><td></td><td></td></tr><tr><td></td><td></td><td></td></tr><tr><td></td><td></td><td>1</td></tr><tr><td></td><td></td><td></td></tr></table>	1								1				<table border="1"><tr><td>1</td><td></td><td></td></tr><tr><td>1</td><td></td><td></td></tr><tr><td></td><td></td><td></td></tr><tr><td></td><td></td><td>1</td></tr></table>	1			1								1	<table border="1"><tr><td></td><td></td><td></td></tr><tr><td></td><td></td><td></td></tr><tr><td></td><td></td><td></td></tr><tr><td></td><td></td><td></td></tr></table>													<table border="1"><tr><td>1</td><td>1</td><td>1</td></tr><tr><td></td><td></td><td></td></tr><tr><td>1</td><td></td><td>1</td></tr><tr><td></td><td></td><td></td></tr></table>	1	1	1				1		1				<table border="1"><tr><td></td><td></td><td></td></tr><tr><td></td><td></td><td></td></tr><tr><td></td><td></td><td></td></tr><tr><td></td><td></td><td></td></tr></table>													<table border="1"><tr><td></td><td></td><td>2</td></tr><tr><td></td><td></td><td></td></tr><tr><td></td><td></td><td></td></tr><tr><td>2</td><td></td><td></td></tr></table>			2							2			<table border="1"><tr><td>1</td><td></td><td></td></tr><tr><td>2</td><td></td><td></td></tr><tr><td></td><td></td><td></td></tr><tr><td></td><td></td><td></td></tr></table>	1			2									<table border="1"><tr><td>1</td><td></td><td></td></tr><tr><td>1</td><td></td><td></td></tr><tr><td></td><td></td><td></td></tr><tr><td>1</td><td></td><td></td></tr></table>	1			1						1		
1																																																																																																							
		1																																																																																																					
1																																																																																																							
1																																																																																																							
		1																																																																																																					
1	1	1																																																																																																					
1		1																																																																																																					
		2																																																																																																					
2																																																																																																							
1																																																																																																							
2																																																																																																							
1																																																																																																							
1																																																																																																							
1																																																																																																							
Post - 0 Miss - 1 Block - 0	Post - 0 Miss - 0 Block - 0	Post - 0 Miss - 0 Block - 0	Post - 0 Miss - 0 Block - 0	Post - 0 Miss - 0 Block - 0	Post - 0 Miss - 0 Block - 0	Post - 1 Miss - 1 Block - 0	Post - 0 Miss - 0 Block - 0																																																																																																

1 宋晓晨

0/2		0/4
0/1		
0/3	0/1	0/1

12 于性哲

0/1		2/2
		0/5
1/2		2/4

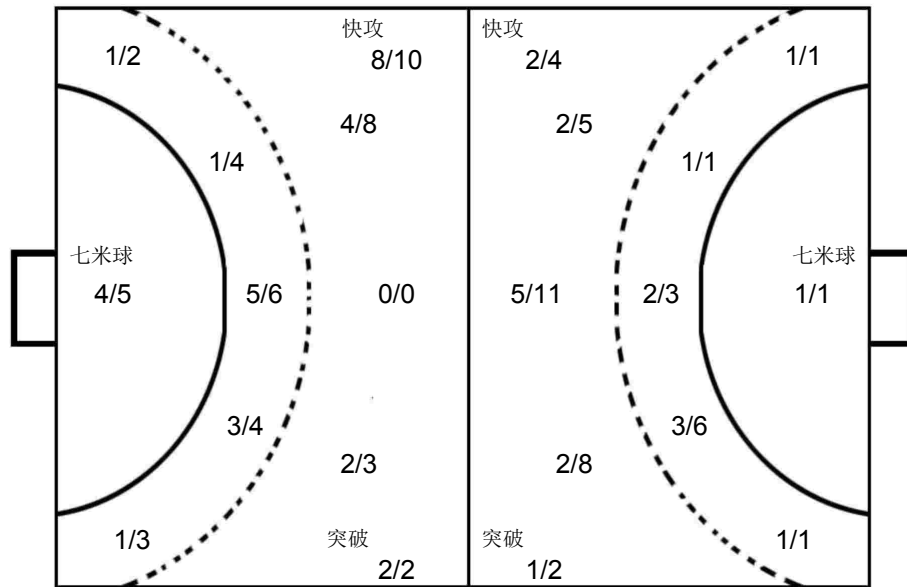

1 张崢

0/7	0/1	2/8
4/10	1/1	2/5
2/6		0/4

上海队

1 张崢	4 高天伦	5 贺政	7 周文龙	8 高震东	10 朱世杰	11 蒋慧捷	13 谢智超																																																																																													
<table border="1"><tr><td></td><td></td><td></td></tr><tr><td></td><td></td><td></td></tr><tr><td></td><td></td><td></td></tr></table>										<table border="1"><tr><td></td><td></td><td></td></tr><tr><td>1</td><td></td><td>1</td></tr><tr><td></td><td></td><td></td></tr><tr><td></td><td></td><td></td></tr></table>				1		1							<table border="1"><tr><td>2</td><td></td><td>1</td></tr><tr><td>1</td><td></td><td>2</td></tr><tr><td></td><td></td><td></td></tr><tr><td></td><td></td><td></td></tr></table>	2		1	1		2							<table border="1"><tr><td></td><td></td><td></td></tr><tr><td></td><td></td><td></td></tr><tr><td></td><td></td><td></td></tr><tr><td></td><td></td><td></td></tr></table>													<table border="1"><tr><td></td><td></td><td></td></tr><tr><td>1</td><td></td><td></td></tr><tr><td></td><td></td><td></td></tr><tr><td></td><td></td><td></td></tr></table>				1									<table border="1"><tr><td></td><td></td><td>3</td></tr><tr><td></td><td></td><td>2</td></tr><tr><td></td><td></td><td></td></tr><tr><td>1</td><td>1</td><td>1</td></tr></table>			3			2				1	1	1	<table border="1"><tr><td></td><td></td><td></td></tr><tr><td></td><td></td><td></td></tr><tr><td></td><td></td><td></td></tr><tr><td>1</td><td></td><td>1</td></tr></table>										1		1	<table border="1"><tr><td></td><td></td><td></td></tr><tr><td></td><td></td><td></td></tr><tr><td></td><td></td><td></td></tr><tr><td></td><td></td><td></td></tr></table>												
1		1																																																																																																		
2		1																																																																																																		
1		2																																																																																																		
1																																																																																																				
		3																																																																																																		
		2																																																																																																		
1	1	1																																																																																																		
1		1																																																																																																		
Post - 0 Miss - 0 Block - 0	Post - 0 Miss - 1 Block - 0	Post - 1 Miss - 2 Block - 3	Post - 0 Miss - 0 Block - 0	Post - 0 Miss - 4 Block - 0	Post - 1 Miss - 0 Block - 3	Post - 1 Miss - 0 Block - 0	Post - 0 Miss - 0 Block - 0																																																																																													
15 庄旭杰	16 张逸豪	18 董凯	20 蒋承骅	30 徐俊吉																																																																																																
<table border="1"><tr><td></td><td></td><td></td></tr><tr><td></td><td></td><td></td></tr><tr><td></td><td></td><td></td></tr><tr><td></td><td></td><td></td></tr></table>													<table border="1"><tr><td></td><td></td><td></td></tr><tr><td></td><td></td><td></td></tr><tr><td></td><td></td><td></td></tr><tr><td></td><td></td><td></td></tr></table>													<table border="1"><tr><td></td><td></td><td></td></tr><tr><td></td><td></td><td></td></tr><tr><td></td><td></td><td></td></tr><tr><td></td><td></td><td></td></tr></table>													<table border="1"><tr><td></td><td></td><td></td></tr><tr><td></td><td></td><td></td></tr><tr><td></td><td></td><td></td></tr><tr><td></td><td></td><td></td></tr></table>													<table border="1"><tr><td>1</td><td></td><td></td></tr><tr><td></td><td></td><td></td></tr><tr><td></td><td></td><td></td></tr><tr><td></td><td></td><td>1</td></tr></table>	1											1																																				
1																																																																																																				
		1																																																																																																		
Post - 1 Miss - 0 Block - 0	Post - 0 Miss - 0 Block - 0	Post - 0 Miss - 0 Block - 0	Post - 0 Miss - 0 Block - 0	Post - 0 Miss - 0 Block - 0																																																																																																



Team A					Team B					Match Number											
A 天津队					B 江苏队					<b>18</b>											
Played in			in the hall			on		at		Spectators											
重庆万州			万州体育馆			2019-04-11		14:30		hours											
Half-time(30')	A	B	End of playing time	A	B	1st extra time	A	B	2nd extra time	A	B	After penalty throws	A	B							
	8	14		22	34																
Number of 7 m	A	Team time-out			Full name of players and officials					Team time-out			B	Number of 7 m							
	1/2	1	2	3						1	2	3	2/4								
		04:57	34:29							52:04											
No.	Team A					G	W	2'	D	DR	No.	Team B					G	W	2'	D	DR
1	何喜年										1	宋继强									
3	魏雨童					4		1			4	张家纬					2	1			
4	刘雪东										6	赵晨					4				
5	王毅					2					7	周傲					1				
6	赵晨阳					1					8	谢庆龙					5				
7	张青					2					11	张天豪					1				
8	王晓琪					2					12	王权									
9	王子欣					5		1			16	张帅									
10	苏尧					2					18	赵楠									
11	吴明远										19	庞连康					1				
13	许松					2					20	顾艳超					4				
14	王维先										21	刘江					4				
15	周群							1	2		25	王杰缘					4				
16	刘宗其										27	王伟强					1				
20	张闻乾										30	吴龙瑞					7				
86	田剑侠					2															
A	贾守信										A	闫威名 (主教练)									
B	杜瑞军 (主教练)										B	叶强									
D	李志成										C	贾淑君									
E	王文龙										E	王建国									
Signatures of responsables for the teams (Off.A)																				B	
TP	Remarks of referees / HF Official																		TP		

Signatures

Referees	倪震 (CHN)	张智伟 (CHN)	
T.D.	郭剑 (CHN)	张春生 (CHN)	
CHA Off.			

Note: Number of 7m Throws Awarded to Team A and B, Goals (G), Warnings (W), Suspensions (2'), Direct Disqualification (D), Disqualification With Report (DR) and Team Penalty (TP).

Table Officials: 张智伟                      周胜锋                      Statisticians: 周亚桥                      谢杨

2019年全国男子手球冠军杯赛

PHMS Pictorial Handball Match Statistics

IHF Official System

竞赛技术统计

手球  
男子

预赛  
轮次 5

组别 B  
场次 18

万州体育馆  
2019-04-11 14:30

Referees:	倪震 (CHN) / 张智伟 (CHN)	Result:	22:34 (8:14)
Teams:	天津队(天津) VS 江苏队(江苏)		

天津		远	近	边	快	突	任意	7m	合计	%	助攻	失误	警告	2'	D+DR
主教练: 杜瑞军		射	射	射	攻	破	球	球							
1	何喜年														
3	魏雨童		3/4			1/1			4/5	80.0		1		1	
4	刘雪东						0/1		0/1	0.0		2			
5	王毅	0/2	1/1					1/1	2/4	50.0		2			
6	赵晨阳				0/1	1/2			1/3	33.3					
7	张青	2/3	0/1					0/1	2/5	40.0	1				
8	王晓琪	1/3		1/1					2/4	50.0		2			
9	王子欣	2/3		1/1	2/2				5/6	83.3	3	2		1	
10	苏尧		1/1	1/1					2/2	100		1			
11	吴明远														
13	许松	0/2		1/2	1/1				2/5	40.0		1			
14	王维先														
15	周群	0/1							0/1	0.0			1	2	
16	刘宗其														
20	张闻乾														
86	田剑侠	0/2	0/1			2/3			2/6	33.3	1	4			
运动员 合计		5/16	5/8	4/5	3/4	4/6	0/1	1/2	22/42	52.4	5	15	1	4	
1	何喜年	0/5	2/9	1/1	0/4	0/3		0/1	3/23	13.0					
16	刘宗其	0/3	0/5	0/1	1/3	1/3		1/2	3/17	17.6					
守门员 合计		0/8	2/14	1/2	1/7	1/6		1/3	6/40	15.0					

天津	比赛 进程	江苏
1st Half		
0	01:12	1 27 王伟强
0	03:58	2 25 王杰缘
0	04:42	3 21 刘江
0	06:18	4 20 顾艳超
13	许松	1 06:49 4
9	王子欣	2 07:24 4
2	09:23	5 25 王杰缘
7	张青	3 09:58 5
3	10:37	6 4 张家纬
7	张青	4 11:45 6
4	12:29	7 8 谢庆龙
4	13:12	8 8 谢庆龙
4	14:04	9 8 谢庆龙
5	王毅	5 16:20 9
5	王毅	6 18:57 9
6	19:31	10 6 赵晨
86	田剑侠	7 21:33 10
7	23:33	11 20 顾艳超
86	田剑侠	8 24:08 11
8	25:14	12 20 顾艳超
8	26:58	13 6 赵晨
8	29:07	14 4 张家纬
2nd Half		
8	00:21	15 20 顾艳超
8	02:43	16 25 王杰缘
8	04:17	17 25 王杰缘
9	王子欣	9 05:59 17
13	许松	10 06:20 17
10	07:13	18 8 谢庆龙
10	08:26	19 21 刘江
3	魏雨童	11 09:02 19
11	09:40	20 30 吴龙瑞
8	王晓琪	12 10:29 20
12	11:15	21 6 赵晨
8	王晓琪	13 11:42 21
3	魏雨童	14 12:31 21
14	12:57	22 6 赵晨
9	王子欣	15 14:10 22
15	14:51	23 30 吴龙瑞
15	15:26	24 21 刘江
6	赵晨阳	16 16:20 24
16	17:48	25 19 庞连康
3	魏雨童	17 18:09 25
17	18:24	26 11 张天豪
17	19:04	27 8 谢庆龙
3	魏雨童	18 19:34 27
18	21:26	28 30 吴龙瑞
9	王子欣	19 21:52 28
19	22:31	29 30 吴龙瑞
10	苏尧	20 22:43 29
20	24:33	30 21 刘江
9	王子欣	21 25:24 30
21	26:26	31 7 周傲
21	27:50	32 30 吴龙瑞
21	29:02	33 30 吴龙瑞
21	29:35	34 30 吴龙瑞
10	苏尧	22 29:44 34

场上队员: 得分 / 射门

守门员: 救球 / 射门

D	取消资格	DR	取消资格+报告
---	------	----	---------



2019年全国男子手球冠军杯赛

PHMS Pictorial Handball Match Statistics

IHF Official System

个人/全队技术统计表

手球 男子 预赛 轮次 5 组别 B 场次 18 万州体育馆 2019-04-11 14:30

号码	姓名	远射	近射	边射	快攻	突破	任意	七米	合计	%	助攻	失误	警告	2'	取消	时间
天津队(天津)																
(场上队员)																
1	何喜年									0.0%						00:40:32
3	魏雨童		3/4			1/1			4/5	80.0%		1		1		00:36:47
4	刘雪东						0/1		0/1	0.0%		2				00:04:27
5	王毅	0/2	1/1					1/1	2/4	50.0%		2				00:37:41
6	赵晨阳				0/1	1/2			1/3	33.3%						00:14:17
7	张青	2/3	0/1					0/1	2/5	40.0%	1					00:34:29
8	王晓琪	1/3		1/1					2/4	50.0%		2				00:25:29
9	王子欣	2/3		1/1	2/2				5/6	83.3%	3	2		1		01:00:00
10	苏尧		1/1	1/1					2/2	100%		1				00:10:48
11	吴明远									0.0%						00:00:00
13	许松	0/2		1/2	1/1				2/5	40.0%		1				00:49:11
14	王维先									0.0%						00:00:00
15	周群	0/1							0/1	0.0%			1	2		00:41:40
16	刘宗其									0.0%						00:19:28
20	张闻乾									0.0%						00:00:00
86	田剑侠	0/2	0/1			2/3			2/6	33.3%	1	4				00:44:16
	合计	5/16	5/8	4/5	3/4	4/6	0/1	1/2	22/42	52.4%	5	15	1	4		
(守门员)																
1	何喜年	0/5	2/9	1/1	0/4	0/3		0/1	3/23	13.0%						00:40:32
16	刘宗其	0/3	0/5	0/1	1/3	1/3		1/2	3/17	17.6%						00:19:28
	合计	0/8	2/14	1/2	1/7	1/6		1/3	6/40	15.0%						

场上队员：得分/射门

守门员：救球/射门

全队合计	得分	被救	射失	击柱	封球	合计	%
远射	5	7	3		1	16	31.3%
近射	5	2	1			8	62.5%
边射	4		1			5	80.0%
快攻	3	1				4	75.0%
突破	4			2		6	66.7%
任意			1			1	0.0%
七米	1		1			2	50.0%

## 2019年全国男子手球冠军杯赛

PHMS Pictorial Handball Match Statistics

IHF Official System

### 个人/全队技术统计表

手球 男子 预赛 轮次 5 组别 B 场次 18 万州体育馆 2019-04-11 14:30

号码	姓名	远射	近射	边射	快攻	突破	任意	七米	合计	%	助攻	失误	警告	2'	取消	时间
江苏队(江苏)																
(场上队员)																
1	宋继强									0.0%						00:00:00
4	张家纬	1/1						1/1	2/2	100%	3	1	1			00:33:25
6	赵晨	3/4	1/1						4/5	80.0%	2	1				00:19:14
7	周傲		1/1						1/1	100%						00:11:31
8	谢庆龙		5/6			0/1			5/7	71.4%						00:52:56
11	张天豪		1/1						1/1	100%		2				00:13:25
12	王权									0.0%	1					00:42:40
16	张帅									0.0%						00:17:20
18	赵楠				0/1				0/1	0.0%						00:26:32
19	庞连康	1/1	0/1						1/2	50.0%						00:14:27
20	顾艳超	2/3				2/2			4/5	80.0%		3				00:36:21
21	刘江		3/3		1/1				4/4	100%	1					00:32:40
25	王杰缘		1/1	1/2	2/2			0/1	4/6	66.7%						00:48:27
27	王伟强		0/1		1/2				1/3	33.3%		1				00:46:30
30	吴龙瑞	1/1			2/2	3/3		1/2	7/8	87.5%	2	2				00:23:31
合计		8/10	12/15	1/2	6/8	5/6		2/4	34/45	75.6%	9	10	1			
(守门员)																
12	王权	4/7	2/4	0/2	0/3	0/3		0/1	6/20	30.0%	1					00:42:40
16	张帅	3/5	0/3	0/2	1/1	0/1			4/12	33.3%						00:17:20
合计		7/12	2/7	0/4	1/4	0/4		0/1	10/32	31.3%	1					

场上队员：得分/射门

守门员：救球/射门

全队合计	得分	被救	射失	击柱	封球	合计	%
远射	8		1	1		10	80.0%
近射	12	2	1			15	80.0%
边射	1	1				2	50.0%
快攻	6	1		1		8	75.0%
突破	5	1				6	83.3%
任意							0.0%
七米	2	1		1		4	50.0%

图式比赛技术统计表

手球  
男子

预赛  
轮次 5

组别 B  
场次 18

万州体育馆  
2019-04-11 14:30

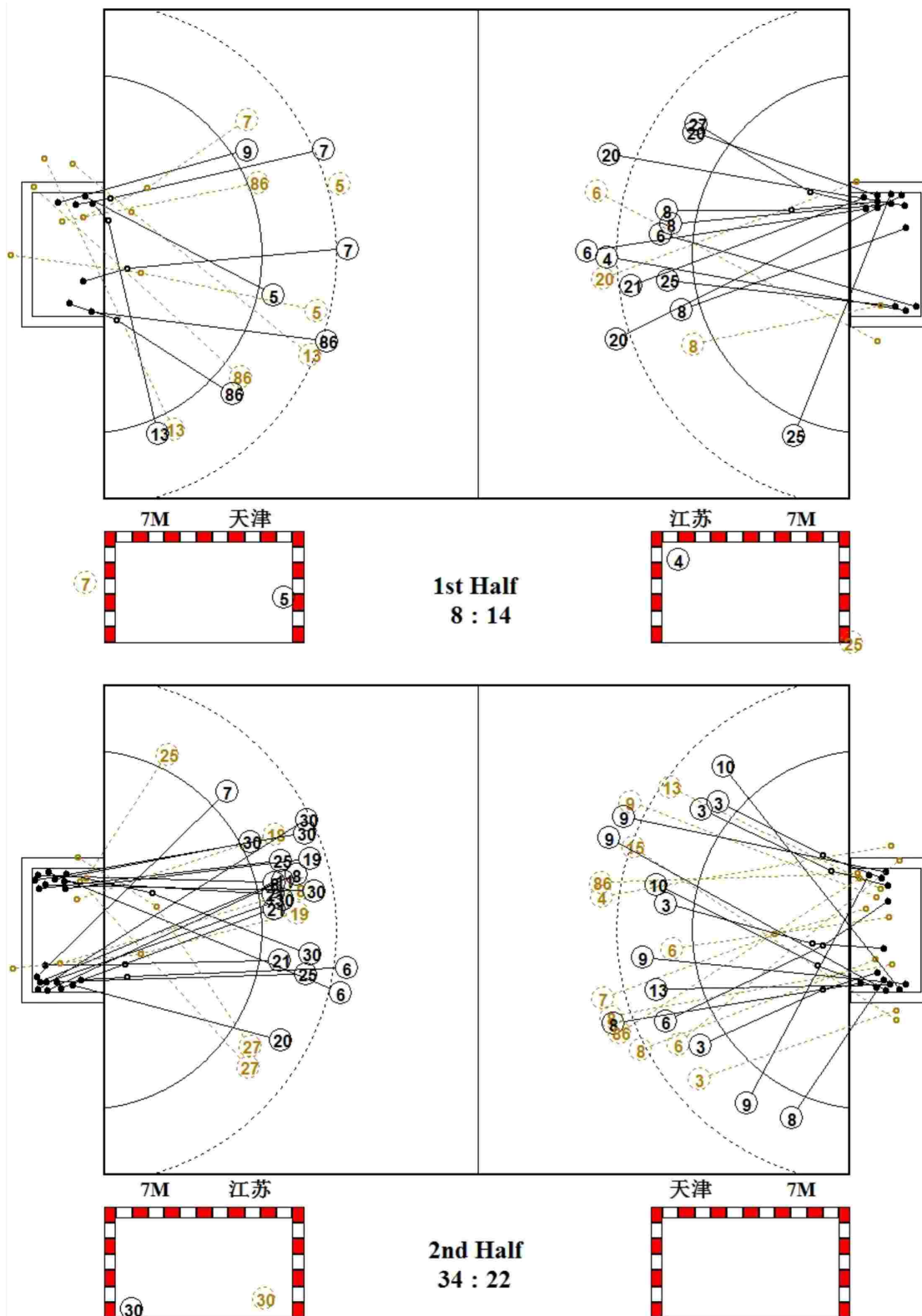

图式射门区域统计

手球  
男子

预赛  
轮次 5

组别 B  
场次 18

万州体育馆  
2019-04-11 14:30

天津队

1 何喜年	3 魏雨童	4 刘雪东	5 王毅	6 赵晨阳	7 张青	8 王晓琪	9 王子欣																																																																								
<table border="1"><tr><td></td><td></td><td></td></tr><tr><td></td><td></td><td></td></tr><tr><td></td><td></td><td></td></tr></table>										<table border="1"><tr><td></td><td></td><td></td></tr><tr><td>2</td><td>1</td><td>1</td></tr><tr><td></td><td></td><td></td></tr></table>				2	1	1				<table border="1"><tr><td></td><td></td><td></td></tr><tr><td></td><td></td><td></td></tr><tr><td></td><td></td><td></td></tr></table>										<table border="1"><tr><td></td><td></td><td></td></tr><tr><td></td><td></td><td>1</td></tr><tr><td></td><td></td><td>1</td></tr></table>						1			1	<table border="1"><tr><td></td><td></td><td></td></tr><tr><td>1</td><td></td><td></td></tr><tr><td></td><td></td><td></td></tr></table>				1						<table border="1"><tr><td></td><td></td><td></td></tr><tr><td></td><td></td><td>1</td></tr><tr><td>1</td><td></td><td></td></tr></table>						1	1			<table border="1"><tr><td></td><td></td><td></td></tr><tr><td></td><td></td><td>1</td></tr><tr><td></td><td></td><td></td></tr></table>						1				<table border="1"><tr><td></td><td></td><td>1</td></tr><tr><td>1</td><td></td><td>2</td></tr><tr><td>1</td><td></td><td></td></tr></table>			1	1		2	1		
2	1	1																																																																													
		1																																																																													
		1																																																																													
1																																																																															
		1																																																																													
1																																																																															
		1																																																																													
		1																																																																													
1		2																																																																													
1																																																																															
Post - 0 Miss - 0 Block - 0	Post - 0 Miss - 1 Block - 0	Post - 0 Miss - 1 Block - 0	Post - 0 Miss - 1 Block - 1	Post - 1 Miss - 0 Block - 0	Post - 0 Miss - 1 Block - 0	Post - 0 Miss - 0 Block - 0	Post - 0 Miss - 0 Block - 0																																																																								
10 苏尧	11 吴明远	13 许松	14 王维先	15 周群	16 刘宗其	20 张闻乾	86 田剑侠																																																																								
<table border="1"><tr><td></td><td></td><td>1</td></tr><tr><td></td><td></td><td>1</td></tr><tr><td></td><td></td><td></td></tr></table>			1			1				<table border="1"><tr><td></td><td></td><td></td></tr><tr><td></td><td></td><td></td></tr><tr><td></td><td></td><td></td></tr></table>										<table border="1"><tr><td></td><td></td><td></td></tr><tr><td></td><td></td><td>1</td></tr><tr><td></td><td></td><td>1</td></tr></table>						1			1	<table border="1"><tr><td></td><td></td><td></td></tr><tr><td></td><td></td><td></td></tr><tr><td></td><td></td><td></td></tr></table>										<table border="1"><tr><td></td><td></td><td></td></tr><tr><td></td><td></td><td></td></tr><tr><td></td><td></td><td></td></tr></table>										<table border="1"><tr><td></td><td></td><td></td></tr><tr><td></td><td></td><td></td></tr><tr><td></td><td></td><td></td></tr></table>										<table border="1"><tr><td></td><td></td><td></td></tr><tr><td></td><td></td><td></td></tr><tr><td></td><td></td><td></td></tr></table>										<table border="1"><tr><td></td><td></td><td></td></tr><tr><td>1</td><td></td><td></td></tr><tr><td>1</td><td></td><td></td></tr></table>				1			1		
		1																																																																													
		1																																																																													
		1																																																																													
		1																																																																													
1																																																																															
1																																																																															
Post - 0 Miss - 0 Block - 0	Post - 0 Miss - 0 Block - 0	Post - 0 Miss - 2 Block - 0	Post - 0 Miss - 0 Block - 0	Post - 0 Miss - 1 Block - 0	Post - 0 Miss - 0 Block - 0	Post - 0 Miss - 0 Block - 0	Post - 1 Miss - 0 Block - 0																																																																								

1 何喜年

0/6		0/4
0/4		2/5
0/3		1/1

16 刘宗其

0/5		0/4
1/4		1/2
0/1		1/1

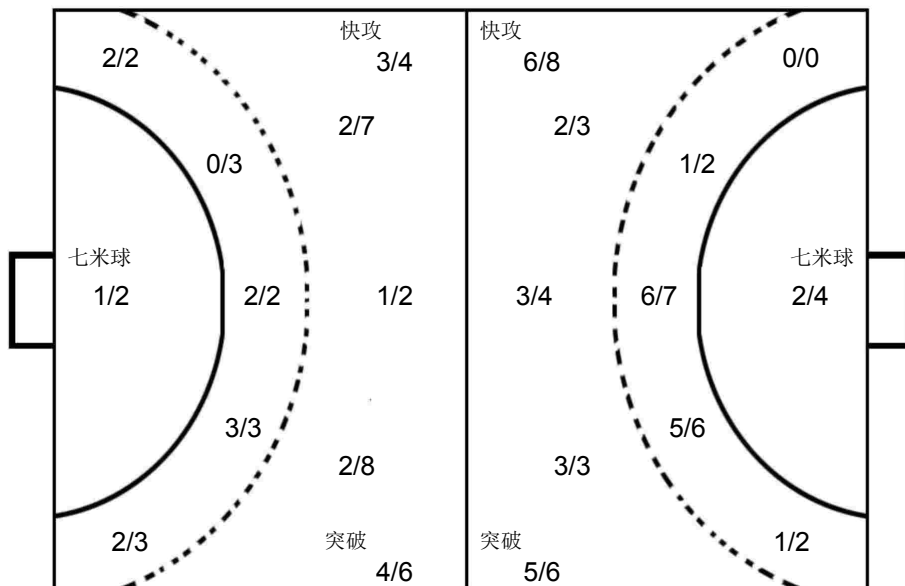

12 王权

		0/1
1/3		2/8
1/3	1/1	1/4

16 张帅

		0/1
1/4	1/2	1/3
1/2		

江苏队

1 宋继强	4 张家纬	6 赵晨	7 周傲	8 谢庆龙	11 张天豪	12 王权	16 张帅																																																																								
<table border="1"><tr><td></td><td></td><td></td></tr><tr><td></td><td></td><td></td></tr><tr><td></td><td></td><td></td></tr></table>										<table border="1"><tr><td></td><td></td><td></td></tr><tr><td>1</td><td></td><td>1</td></tr><tr><td></td><td></td><td></td></tr></table>				1		1				<table border="1"><tr><td></td><td></td><td></td></tr><tr><td></td><td></td><td>2</td></tr><tr><td>2</td><td></td><td></td></tr></table>						2	2			<table border="1"><tr><td></td><td></td><td></td></tr><tr><td>1</td><td></td><td></td></tr><tr><td></td><td></td><td></td></tr></table>				1						<table border="1"><tr><td></td><td></td><td></td></tr><tr><td>2</td><td></td><td>1</td></tr><tr><td>2</td><td></td><td></td></tr></table>				2		1	2			<table border="1"><tr><td></td><td></td><td></td></tr><tr><td>1</td><td></td><td></td></tr><tr><td></td><td></td><td></td></tr></table>				1						<table border="1"><tr><td></td><td></td><td></td></tr><tr><td></td><td></td><td></td></tr><tr><td></td><td></td><td></td></tr></table>										<table border="1"><tr><td></td><td></td><td></td></tr><tr><td></td><td></td><td></td></tr><tr><td></td><td></td><td></td></tr></table>									
1		1																																																																													
		2																																																																													
2																																																																															
1																																																																															
2		1																																																																													
2																																																																															
1																																																																															
Post - 0 Miss - 0 Block - 0	Post - 0 Miss - 0 Block - 0	Post - 0 Miss - 1 Block - 0	Post - 0 Miss - 0 Block - 0	Post - 0 Miss - 0 Block - 0	Post - 0 Miss - 0 Block - 0	Post - 0 Miss - 0 Block - 0	Post - 0 Miss - 0 Block - 0																																																																								
18 赵楠	19 庞连康	20 顾艳超	21 刘江	25 王杰缘	27 王伟强	30 吴龙瑞																																																																									
<table border="1"><tr><td></td><td></td><td></td></tr><tr><td></td><td></td><td></td></tr><tr><td></td><td></td><td></td></tr></table>										<table border="1"><tr><td></td><td></td><td></td></tr><tr><td></td><td></td><td>1</td></tr><tr><td></td><td></td><td></td></tr></table>						1				<table border="1"><tr><td></td><td></td><td></td></tr><tr><td>2</td><td></td><td></td></tr><tr><td>2</td><td></td><td></td></tr></table>				2			2			<table border="1"><tr><td></td><td></td><td></td></tr><tr><td>1</td><td></td><td></td></tr><tr><td>1</td><td></td><td>1</td></tr></table>				1			1		1	<table border="1"><tr><td></td><td></td><td></td></tr><tr><td>1</td><td></td><td>1</td></tr><tr><td>1</td><td></td><td>1</td></tr></table>				1		1	1		1	<table border="1"><tr><td></td><td></td><td></td></tr><tr><td>1</td><td></td><td></td></tr><tr><td></td><td></td><td></td></tr></table>				1						<table border="1"><tr><td></td><td></td><td></td></tr><tr><td>2</td><td></td><td>3</td></tr><tr><td>1</td><td></td><td>1</td></tr></table>				2		3	1		1										
		1																																																																													
2																																																																															
2																																																																															
1																																																																															
1		1																																																																													
1		1																																																																													
1		1																																																																													
1																																																																															
2		3																																																																													
1		1																																																																													
Post - 0 Miss - 0 Block - 0	Post - 0 Miss - 1 Block - 0	Post - 1 Miss - 0 Block - 0	Post - 0 Miss - 0 Block - 0	Post - 1 Miss - 0 Block - 0	Post - 1 Miss - 0 Block - 0	Post - 0 Miss - 0 Block - 0																																																																									



Team A					Team B					Match Number											
A 安徽队					B 陕西队					19											
Played in			in the hall			on			at			Spectators									
重庆万州			万州体育馆			2019-04-11			16:00			hours									
Half-time(30')	A	B	End of playing time	A	B	1st extra time	A	B	2nd extra time	A	B	After penalty throws	A	B							
	16	10	32	16																	
Number of 7 m	A	Team time-out			Full name of players and officials					Team time-out			B	Number of 7 m							
	2/4	1	2	3						1	2	3	0/0								
		26:44									56:09										
No.	Team A					G	W	2'	D	DR	No.	Team B					G	W	2'	D	DR
1	郭世伟										1	陈昊									
4	王巨柱										3	刘赵梁					4				
5	史小帆					4					4	李佳					2	1			
6	叶志伟					1					5	马益奎					2	1	1		
7	姚雄敏					1					6	刘世昌					1				
8	董智景					1					8	季雨					1				
9	金永峰										10	王凯强					3				
10	严龙					3	1				11	张领									
11	黎涛					2					12	赵凯									
12	曾献辰										13	隋家乐									
18	李双					6	1				15	陈冉					3				
21	李明										17	耿畅									
23	张鹏					7					18	刘文星									
24	徐安格					2	1				22	张睿梁									
26	饶原源					5															
27	王东昇							1													
B	Vladimir Stanojevic (主教练)										B	郝可鑫									
C	黄红										C	李安									
D	王来黔																				
E	刘汉杰																				
A	Signatures of responsables for the teams (Off.A)															B					
TP	Remarks of referees / HF Official															TP					

Signatures

Referees	刘明华 (CHN)	张晓虎 (CHN)		
T.D.	李之文 (CHN)	陈少波 (CHN)		
CHA Off.				

Note: Number of 7m Throws Awarded to Team A and B, Goals (G), Warnings (W), Suspensions (2'), Direct Disqualification (D), Disqualification With Report (DR) and Team Penalty (TP).

Table Officials: 周云磊

伍豪

Statisticians: 谢杨

赵悦

## 2019年全国男子手球冠军杯赛

**PHMS** Pictorial Handball Match Statistics

**IHF** Official System

### 竞赛技术统计

手球 男子      预赛 轮次 5      组别 A 场次 19      万州体育馆 2019-04-11 16:00

Referees: 刘明华 (CHN) / 张晓虎 (CHN)      Result: 32:16(16:10)  
Teams: 安徽队(安徽) VS 陕西队(陕西)

安徽		远	近	边	快	突	任意	7m	合计	%	助攻	失误	警告	2'	D+DR
主教练: Vladimir Stanojevic		射	射	射	攻	破	球	球							
1	郭世伟														
4	王巨柱														
5	史小帆	1/1	0/2		2/2	1/1			4/6	66.7					
6	叶志伟		1/1		0/1			0/1	1/3	33.3		1			
7	姚雄敏		0/1			1/1			1/2	50.0					
8	董智景			0/1	1/1	0/1			1/3	33.3					
9	金永峰											2			
10	严龙		0/1	1/3	1/1			1/1	3/6	50.0	1		1		
11	黎涛			1/1	1/1				2/2	100					
12	曾献辰										1	1			
18	李双	3/5	2/2			1/1			6/8	75.0	2	2	1		
21	李明											1			
23	张鹏		4/4	1/3	2/3				7/10	70.0	1	1			
24	徐安格		2/3						2/3	66.7			1		
26	饶原源	0/2			2/2	2/2		1/2	5/8	62.5	2	2			
27	王东昇											1		1	
运动员	合计	4/8	9/14	3/8	9/11	5/6		2/4	32/51	62.7	7	11	3	1	
12	曾献辰	7/10	2/4	1/4	0/1	2/4			12/23	52.2	1	1			
21	李明	0/2		0/3	1/1				1/6	16.7		1			
守门员	合计	7/12	2/4	1/7	1/2	2/4			13/29	44.8	1	2			

陕西		远	近	边	快	突	任意	7m	合计	%	助攻	失误	警告	2'	D+DR
主教练: 王建国		射	射	射	攻	破	球	球							
1	陈昊														
3	刘赵梁	2/4				2/3			4/7	57.1	1	7			
4	李佳	0/2		2/3					2/5	40.0	1	1	1		
5	马益奎		1/3	1/1					2/4	50.0			1	1	
6	刘世昌			1/1					1/1	100					
8	季雨	1/3							1/3	33.3		6			
10	王凯强	2/9	1/1						3/10	30.0	1	4			
11	张领	0/3	0/1			0/1			0/5	0.0		3			
12	赵凯														
13	隋家乐														
15	陈冉			2/3	1/2				3/5	60.0		2			
17	耿畅														
18	刘文星														
22	张睿梁														
运动员	合计	5/21	2/5	6/8	1/2	2/4			16/40	40.0	3	23	2	1	
1	陈昊	0/2	1/1		0/2				1/5	20.0					
22	张睿梁	2/4	2/11	3/6	2/9	0/5		0/2	9/37	24.3					
守门员	合计	2/6	3/12	3/6	2/11	0/5		0/2	10/42	23.8					

安徽	比赛进程	陕西
1st Half		
24 徐安格	1 02:04	0
8 董智景	2 02:48	0
	2 03:14	1 15 陈冉
18 李双	3 03:42	1
	3 04:13	2 5 马益奎
11 黎涛	4 04:24	2
	4 05:11	3 8 季雨
26 饶原源	5 06:12	3
	5 07:22	4 3 刘赵梁
7 姚雄敏	6 07:30	4
11 黎涛	7 08:15	4
	7 08:54	5 15 陈冉
23 张鹏	8 09:35	5
10 严龙	9 11:34	5
	9 12:23	6 5 马益奎
18 李双	10 13:44	6
23 张鹏	11 15:52	6
	11 16:52	7 6 刘世昌
18 李双	12 17:32	7
	12 19:53	8 15 陈冉
	12 21:17	9 3 刘赵梁
18 李双	13 21:28	9
26 饶原源	14 23:55	9
	14 24:27	10 10 王凯强
23 张鹏	15 26:53	10
18 李双	16 28:29	10
2nd Half		
	16 00:43	11 4 李佳
	16 02:12	12 10 王凯强
26 饶原源	17 02:31	12
	17 03:31	13 3 刘赵梁
24 徐安格	18 04:24	13
18 李双	19 09:35	13
10 严龙	20 10:42	13
5 史小帆	21 11:29	13
5 史小帆	22 13:34	13
23 张鹏	23 15:10	13
10 严龙	24 16:31	13
23 张鹏	25 18:21	13
23 张鹏	26 20:39	13
5 史小帆	27 22:05	13
	27 22:13	14 10 王凯强
26 饶原源	28 23:28	14
5 史小帆	29 24:28	14
	29 25:05	15 3 刘赵梁
23 张鹏	30 26:04	15
6 叶志伟	31 26:40	15
26 饶原源	32 29:21	15
	32 29:45	16 4 李佳

场上队员: 得分 / 射门

守门员: 救球 / 射门

D	取消资格	DR	取消资格+报告
---	------	----	---------





## 2019年全国男子手球冠军杯赛

PHMS Pictorial Handball Match Statistics

IHF Official System

### 个人/全队技术统计表

手球 男子 预赛 轮次 5 组别 A 场次 19 万州体育馆 2019-04-11 16:00

号码	姓名	远射	近射	边射	快攻	突破	任意	七米	合计	%	助攻	失误	警告	2'	取消	时间
<b>安徽队(安徽)</b>																
<b>(场上队员)</b>																
1	郭世伟									0.0%						00:07:08
4	王巨柱									0.0%						00:00:00
5	史小帆	1/1	0/2		2/2	1/1			4/6	66.7%						00:29:04
6	叶志伟		1/1		0/1			0/1	1/3	33.3%		1				00:14:22
7	姚雄敏		0/1			1/1			1/2	50.0%						00:17:02
8	董智景			0/1	1/1	0/1			1/3	33.3%						00:11:27
9	金永峰									0.0%		2				00:41:11
10	严龙		0/1	1/3	1/1			1/1	3/6	50.0%	1		1			00:44:51
11	黎涛			1/1	1/1				2/2	100%						00:08:48
12	曾献辰									0.0%	1	1				00:50:04
18	李双	3/5	2/2			1/1			6/8	75.0%	2	2	1			00:47:14
21	李明									0.0%		1				00:09:56
23	张鹏		4/4	1/3	2/3				7/10	70.0%	1	1				00:50:54
24	徐安格		2/3						2/3	66.7%			1			00:51:13
26	饶源源	0/2			2/2	2/2		1/2	5/8	62.5%	2	2				00:26:26
27	王东昇									0.0%		1		1		00:09:21
	<b>合计</b>	<b>4/8</b>	<b>9/14</b>	<b>3/8</b>	<b>9/11</b>	<b>5/6</b>		<b>2/4</b>	<b>32/51</b>	<b>62.7%</b>	<b>7</b>	<b>11</b>	<b>3</b>	<b>1</b>		
<b>(守门员)</b>																
12	曾献辰	7/10	2/4	1/4	0/1	2/4			12/23	52.2%	1	1				00:50:04
21	李明	0/2		0/3	1/1				1/6	16.7%		1				00:09:56
	<b>合计</b>	<b>7/12</b>	<b>2/4</b>	<b>1/7</b>	<b>1/2</b>	<b>2/4</b>			<b>13/29</b>	<b>44.8%</b>	<b>1</b>	<b>2</b>				

场上队员：得分/射门

守门员：救球/射门

全队合计	得分	被救	射失	击柱	封球	合计	%
远射	4	2		1	1	8	50.0%
近射	9	3		2		14	64.3%
边射	3	3		2		8	37.5%
快攻	9	2				11	81.8%
突破	5		1			6	83.3%
任意							0.0%
七米	2			2		4	50.0%

2019年全国男子手球冠军杯赛

PHMS Pictorial Handball Match Statistics

IHF Official System

个人/全队技术统计表

手球 男子 预赛 轮次 5 组别 A 场次 19 万州体育馆 2019-04-11 16:00

号码	姓名	远射	近射	边射	快攻	突破	任意	七米	合计	%	助攻	失误	警告	2'	取消	时间
陕西队(陕西)																
(场上队员)																
1	陈昊									0.0%						00:07:53
3	刘赵梁	2/4				2/3			4/7	57.1%	1	7				00:34:58
4	李佳	0/2		2/3					2/5	40.0%	1	1	1			00:43:17
5	马益奎		1/3	1/1					2/4	50.0%			1	1		01:00:00
6	刘世昌			1/1					1/1	100%						00:20:14
8	季雨	1/3							1/3	33.3%		6				00:29:31
10	王凯强	2/9	1/1						3/10	30.0%	1	4				01:00:00
11	张领	0/3	0/1			0/1			0/5	0.0%		3				00:51:29
12	赵凯									0.0%						00:00:00
13	隋家乐									0.0%						00:00:00
15	陈冉			2/3	1/2				3/5	60.0%		2				01:00:00
17	耿畅									0.0%						00:00:00
18	刘文星									0.0%						00:00:00
22	张睿梁									0.0%						00:52:07
合计		5/21	2/5	6/8	1/2	2/4			16/40	40.0%	3	23	2	1		
(守门员)																
1	陈昊	0/2	1/1		0/2				1/5	20.0%						00:07:53
22	张睿梁	2/4	2/11	3/6	2/9	0/5		0/2	9/37	24.3%						00:52:07
合计		2/6	3/12	3/6	2/11	0/5		0/2	10/42	23.8%						

场上队员：得分/射门

守门员：救球/射门

全队合计	得分	被救	射失	击柱	封球	合计	%
远射	5	7	3	2	4	21	23.8%
近射	2	2	1			5	40.0%
边射	6	1	1			8	75.0%
快攻	1	1				2	50.0%
突破	2	2				4	50.0%
任意							0.0%
七米							0.0%

图式比赛技术统计表

手球  
男子

预赛  
轮次 5

组别 A  
场次 19

万州体育馆  
2019-04-11 16:00

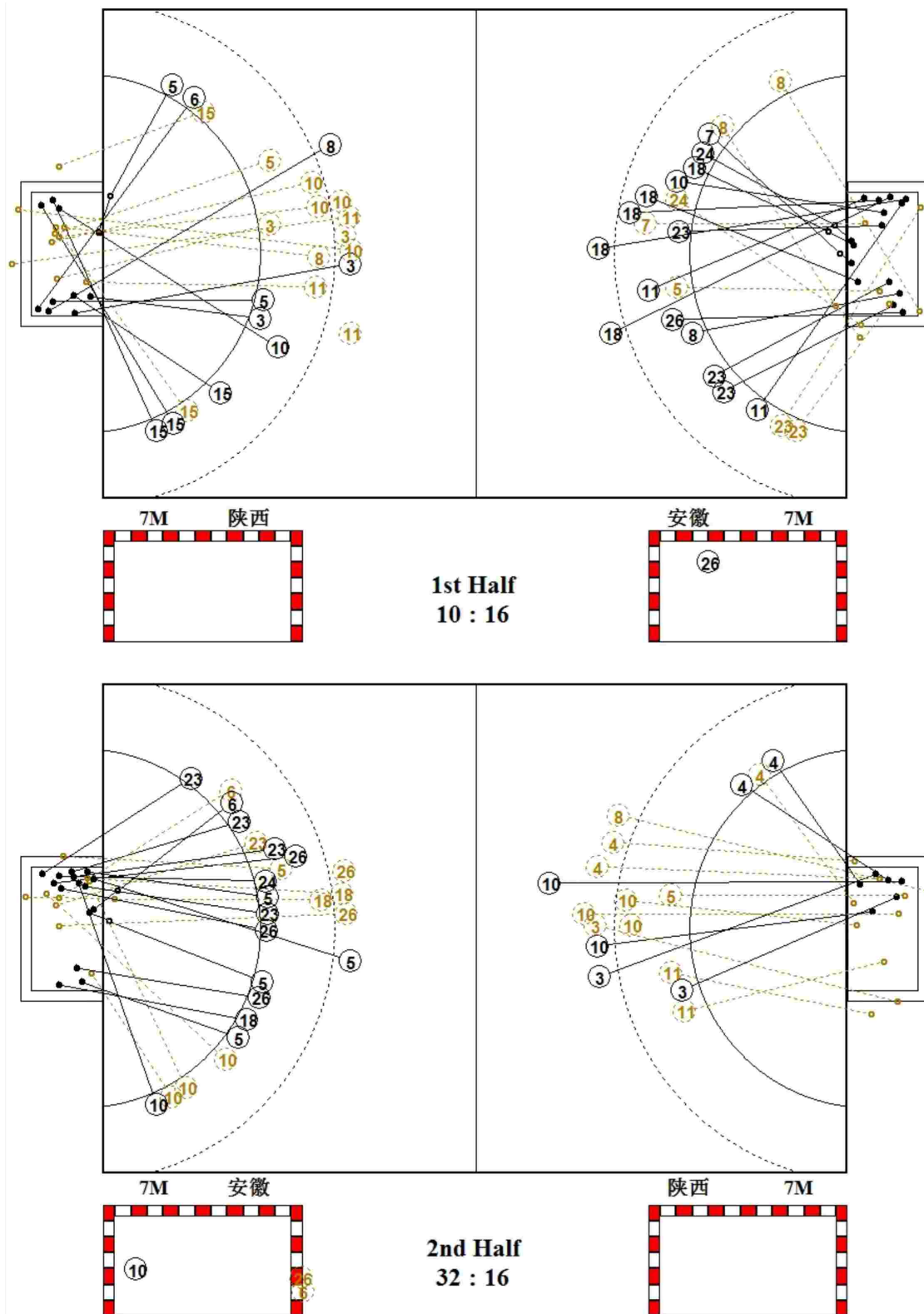

图式射门区域统计

手球  
男子

预赛  
轮次 5

组别 A  
场次 19

万州体育馆  
2019-04-11 16:00

安徽队

1 郭世伟 <table border="1"><tr><td></td><td></td><td></td></tr><tr><td></td><td></td><td></td></tr><tr><td></td><td></td><td></td></tr></table> Post - 0 Miss - 0 Block - 0										4 王巨柱 <table border="1"><tr><td></td><td></td><td></td></tr><tr><td></td><td></td><td></td></tr><tr><td></td><td></td><td></td></tr></table> Post - 0 Miss - 0 Block - 0										5 史小帆 <table border="1"><tr><td></td><td></td><td></td></tr><tr><td>1</td><td>1</td><td>2</td></tr><tr><td></td><td></td><td></td></tr></table> Post - 1 Miss - 0 Block - 0				1	1	2				6 叶志伟 <table border="1"><tr><td></td><td></td><td></td></tr><tr><td></td><td>1</td><td></td></tr><tr><td></td><td></td><td></td></tr></table> Post - 1 Miss - 0 Block - 0					1					7 姚雄敏 <table border="1"><tr><td></td><td></td><td></td></tr><tr><td></td><td>1</td><td></td></tr><tr><td></td><td></td><td></td></tr></table> Post - 0 Miss - 0 Block - 0					1					8 董智景 <table border="1"><tr><td></td><td></td><td>1</td></tr><tr><td></td><td></td><td></td></tr><tr><td></td><td></td><td></td></tr></table> Post - 1 Miss - 1 Block - 0			1							9 金永峰 <table border="1"><tr><td></td><td></td><td></td></tr><tr><td></td><td></td><td></td></tr><tr><td></td><td></td><td></td></tr></table> Post - 0 Miss - 0 Block - 0										10 严龙 <table border="1"><tr><td></td><td></td><td></td></tr><tr><td>2</td><td></td><td>1</td></tr><tr><td></td><td></td><td></td></tr></table> Post - 0 Miss - 0 Block - 0				2		1			
1	1	2																																																																													
	1																																																																														
	1																																																																														
		1																																																																													
2		1																																																																													
11 黎涛 <table border="1"><tr><td>1</td><td></td><td></td></tr><tr><td></td><td></td><td></td></tr><tr><td>1</td><td></td><td></td></tr></table> Post - 0 Miss - 0 Block - 0	1						1			12 曾献辰 <table border="1"><tr><td></td><td></td><td></td></tr><tr><td></td><td></td><td></td></tr><tr><td></td><td></td><td></td></tr></table> Post - 0 Miss - 0 Block - 0										18 李双 <table border="1"><tr><td>1</td><td></td><td></td></tr><tr><td>3</td><td></td><td></td></tr><tr><td></td><td>1</td><td>1</td></tr></table> Post - 1 Miss - 0 Block - 0	1			3				1	1	21 李明 <table border="1"><tr><td></td><td></td><td></td></tr><tr><td></td><td></td><td></td></tr><tr><td></td><td></td><td></td></tr></table> Post - 0 Miss - 0 Block - 0										23 张鹏 <table border="1"><tr><td></td><td></td><td>2</td></tr><tr><td>1</td><td></td><td>3</td></tr><tr><td></td><td></td><td>1</td></tr></table> Post - 1 Miss - 0 Block - 0			2	1		3			1	24 徐安格 <table border="1"><tr><td></td><td></td><td></td></tr><tr><td></td><td></td><td>1</td></tr><tr><td></td><td>1</td><td></td></tr></table> Post - 1 Miss - 0 Block - 0						1		1		26 饶原源 <table border="1"><tr><td>1</td><td></td><td>2</td></tr><tr><td>1</td><td></td><td>1</td></tr><tr><td></td><td></td><td></td></tr></table> Post - 1 Miss - 0 Block - 1	1		2	1		1				27 王东昇 <table border="1"><tr><td></td><td></td><td></td></tr><tr><td></td><td></td><td></td></tr><tr><td></td><td></td><td></td></tr></table> Post - 0 Miss - 0 Block - 0									
1																																																																															
1																																																																															
1																																																																															
3																																																																															
	1	1																																																																													
		2																																																																													
1		3																																																																													
		1																																																																													
		1																																																																													
	1																																																																														
1		2																																																																													
1		1																																																																													

12 曾献辰

1/5	3/3	
2/5	1/2	2/3
2/4	1/1	

21 李明

0/1		1/3
0/1		
	0/1	

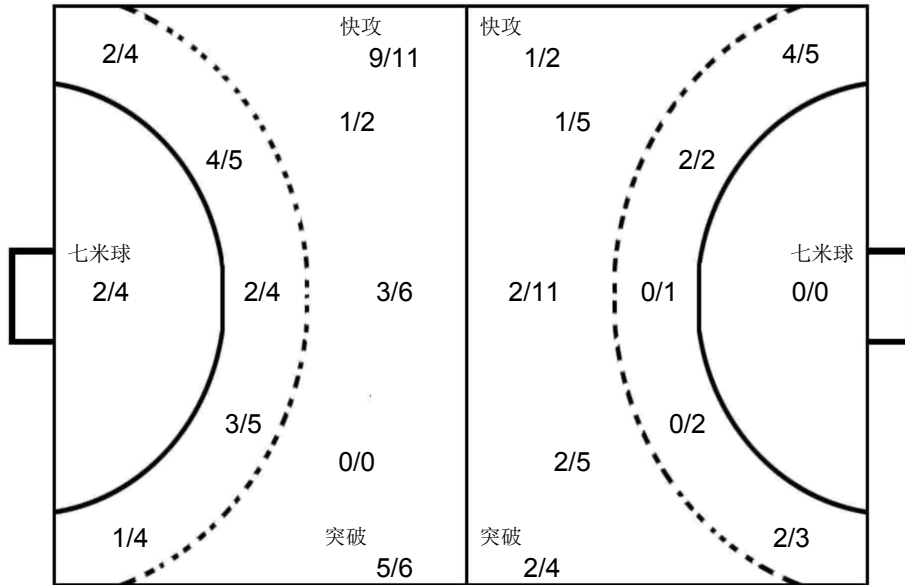

1 陈昊

		0/1
0/3		
1/1		

22 张睿梁

0/3		2/6
0/4	1/1	3/9
1/3	0/5	2/6

陕西队

1 陈昊 <table border="1"><tr><td></td><td></td><td></td></tr><tr><td></td><td></td><td></td></tr><tr><td></td><td></td><td></td></tr></table> Post - 0 Miss - 0 Block - 0										3 刘赵梁 <table border="1"><tr><td>1</td><td></td><td></td></tr><tr><td>2</td><td></td><td></td></tr><tr><td>1</td><td></td><td></td></tr></table> Post - 1 Miss - 0 Block - 1	1			2			1			4 李佳 <table border="1"><tr><td></td><td></td><td></td></tr><tr><td>1</td><td></td><td></td></tr><tr><td>1</td><td></td><td></td></tr></table> Post - 1 Miss - 0 Block - 0				1			1			5 马益奎 <table border="1"><tr><td>1</td><td></td><td></td></tr><tr><td></td><td></td><td></td></tr><tr><td></td><td>1</td><td></td></tr></table> Post - 0 Miss - 0 Block - 0	1							1		6 刘世昌 <table border="1"><tr><td>1</td><td></td><td></td></tr><tr><td></td><td></td><td></td></tr><tr><td></td><td></td><td></td></tr></table> Post - 0 Miss - 0 Block - 0	1									8 季雨 <table border="1"><tr><td>1</td><td></td><td></td></tr><tr><td></td><td></td><td></td></tr><tr><td></td><td></td><td></td></tr></table> Post - 0 Miss - 1 Block - 0	1									10 王凯强 <table border="1"><tr><td>1</td><td></td><td></td></tr><tr><td></td><td>1</td><td>1</td></tr><tr><td></td><td></td><td></td></tr></table> Post - 0 Miss - 1 Block - 2	1				1	1				11 张颖 <table border="1"><tr><td></td><td></td><td></td></tr><tr><td></td><td></td><td></td></tr><tr><td></td><td></td><td></td></tr></table> Post - 0 Miss - 2 Block - 1									
1																																																																															
2																																																																															
1																																																																															
1																																																																															
1																																																																															
1																																																																															
	1																																																																														
1																																																																															
1																																																																															
1																																																																															
	1	1																																																																													
12 赵凯 <table border="1"><tr><td></td><td></td><td></td></tr><tr><td></td><td></td><td></td></tr><tr><td></td><td></td><td></td></tr></table> Post - 0 Miss - 0 Block - 0										13 隋家乐 <table border="1"><tr><td></td><td></td><td></td></tr><tr><td></td><td></td><td></td></tr><tr><td></td><td></td><td></td></tr></table> Post - 0 Miss - 0 Block - 0										15 陈冉 <table border="1"><tr><td></td><td></td><td>2</td></tr><tr><td>1</td><td></td><td></td></tr><tr><td></td><td></td><td></td></tr></table> Post - 0 Miss - 1 Block - 0			2	1						17 耿畅 <table border="1"><tr><td></td><td></td><td></td></tr><tr><td></td><td></td><td></td></tr><tr><td></td><td></td><td></td></tr></table> Post - 0 Miss - 0 Block - 0										18 刘文星 <table border="1"><tr><td></td><td></td><td></td></tr><tr><td></td><td></td><td></td></tr><tr><td></td><td></td><td></td></tr></table> Post - 0 Miss - 0 Block - 0										22 张睿梁 <table border="1"><tr><td></td><td></td><td></td></tr><tr><td></td><td></td><td></td></tr><tr><td></td><td></td><td></td></tr></table> Post - 0 Miss - 0 Block - 0																													
		2																																																																													
1																																																																															



Team A					Team B					Match Number											
A 北京队					B 广东队					20											
Played in			in the hall			on			at			Spectators									
重庆万州			万州体育馆			2019-04-11			17:30			hours									
Half-time(30')	A	B	End of playing time	A	B	1st extra time	A	B	2nd extra time	A	B	After penalty throws	A	B							
	10	13		20	21																
Number of 7 m	A	Team time-out			Full name of players and officials					Team time-out			B	Number of 7 m							
	1/1	1	2	3						1	2	3	B								
		24:03	52:04							41:13	56:25	0/0									
No.	Team A					G	W	2'	D	DR	No.	Team B					G	W	2'	D	DR
3	逯明松					4					2	孙江山									
6	解建飞										6	毕晓晨					5		1		
7	马昌震					1					7	王立隆					1				
10	成亚					1					9	范保坤									
11	赵文宣					1					10	周仲坤					1				
12	高云健										11	房友屯							1		
13	王军鸣					2					12	王雨					2				
16	刘迈科										14	王泽润									
18	傅俊雄					2	1				15	张建杰					4				
22	王超										18	姚雪岩									
23	王军程					2					19	王帅									
25	王鹏皓										21	张昌轲									
26	魏昂					4	1				22	黄培杰					8				
27	闫炳旗					1					24	高玉杰									
32	蒋维一					1					32	罗柏涵									
33	陈旭					1															
A	郑永利 (主教练)										A	曲汝洋									
B	孟辉										B	刘康伶 (主教练)									
E	陈璇										C	郭艳辉									
											E	贾章志									
A	Signatures of responsables for the teams (Off.A)															B					
TP	Remarks of referees / HF Official															TP					

Signatures

Referees	张之伟 (CHN)	王雨洋 (CHN)		
T.D.	吴国忠 (CHN)	倪震 (CHN)		
CHA Off.				

Note: Number of 7m Throws Awarded to Team A and B, Goals (G), Warnings (W), Suspensions (2'), Direct Disqualification (D), Disqualification With Report (DR) and Team Penalty (TP).

Table Officials: 张智伟 周胜锋 Statisticians: 赵悦 周亚桥

2019年全国男子手球冠军杯赛

PHMS Pictorial Handball Match Statistics

IHF Official System

竞赛技术统计

手球  
男子

预赛  
轮次 5

组别 A  
场次 20

万州体育馆  
2019-04-11 17:30

Referees:	张之伟 (CHN) / 王雨洋 (CHN)	Result:	20:21(10:13)
Teams:	北京队(北京) VS 广东队(广东)		

北京														北京		比赛 进程		广东	
主教练: 郑永利	远射	近射	边射	快攻	突破	任意球	7m球	合计	%	助攻	失误	警告	2'	D+DR					
3 逯明松		1/1	1/2	2/2				4/5	80.0										
6 解建飞																			
7 马昌震		1/1						1/1	100		2								
10 成亚	0/3				1/1	0/1		1/5	20.0	1	3								
11 赵文宣				1/1				1/1	100										
12 高云健																			
13 王军鸣	0/2	0/1		1/1		1/1		2/5	40.0	1	3								
16 刘迈科										1									
18 傅俊雄	1/2	1/1						2/3	66.7	1	2	1							
22 王超																			
23 王军程	1/3	0/1	0/1				1/1	2/6	33.3	2	2								
25 王鹏皓																			
26 魏昂				3/3	1/1			4/4	100		4	1							
27 闫炳旗		1/1						1/1	100										
32 蒋维一	0/1	0/1			1/1			1/3	33.3		2								
33 陈旭	0/1				1/1			1/2	50.0		1								
运动员 合计	2/12	4/7	1/3	7/7	4/4	1/2	1/1	20/36	55.6	6	19	2							
16 刘迈科	7/12	3/8	2/3	3/8	1/6			16/37	43.2	1									
守门员 合计	7/12	3/8	2/3	3/8	1/6			16/37	43.2	1									
广东														北京		比赛 进程		广东	
主教练: 刘康伶	远射	近射	边射	快攻	突破	任意球	7m球	合计	%	助攻	失误	警告	2'	D+DR					
2 孙江山																			
6 毕晓晨	2/6	0/1		2/3	1/1			5/11	45.5		1		1						
7 王立隆				1/1				1/1	100										
9 范保坤																			
10 周仲坤	0/1	1/2	0/1					1/4	25.0		1								
11 房友屯	0/1		0/1					0/2	0.0		1		1						
12 王雨	0/1		1/1	1/1				2/3	66.7		2								
14 王泽润																			
15 张建杰	2/9	2/4						4/13	30.8	1									
18 姚雪岩																			
19 王帅																			
21 张昌轲	0/1							0/1	0.0										
22 黄培杰	1/2	2/3		1/1	4/5			8/11	72.7	1	2								
24 高玉杰				0/2				0/2	0.0										
32 罗柏涵																			
运动员 合计	5/21	5/10	1/3	5/8	5/6			21/48	43.8	2	7		2						
14 王泽润	4/6	2/6	1/2	0/7	0/4	1/2	0/1	8/28	28.6										
守门员 合计	4/6	2/6	1/2	0/7	0/4	1/2	0/1	8/28	28.6										

场上队员: 得分 / 射门

守门员: 救球 / 射门

D	取消资格	DR	取消资格+报告
---	------	----	---------



## 2019年全国男子手球冠军杯赛

PHMS Pictorial Handball Match Statistics

IHF Official System

### 个人/全队技术统计表

手球男子 预赛轮次 5 组别 A 场次 20 万州体育馆 2019-04-11 17:30

号码	姓名	远射	近射	边射	快攻	突破	任意	七米	合计	%	助攻	失误	警告	2'	取消	时间
北京队(北京)																
(场上队员)																
3	逯明松		1/1	1/2	2/2				4/5	80.0%						00:43:25
6	解建飞									0.0%						00:13:03
7	马昌震		1/1						1/1	100%		2				00:24:14
10	成亚	0/3				1/1	0/1		1/5	20.0%	1	3				00:57:16
11	赵文宣				1/1				1/1	100%						00:04:32
12	高云健									0.0%						00:00:00
13	王军鸣	0/2	0/1		1/1		1/1		2/5	40.0%	1	3				00:25:44
16	刘迈科									0.0%	1					01:00:00
18	傅俊雄	1/2	1/1						2/3	66.7%	1	2	1			00:16:07
22	王超									0.0%						00:06:53
23	王军程	1/3	0/1	0/1				1/1	2/6	33.3%	2	2				00:38:17
25	王鹏皓									0.0%						00:00:00
26	魏昂				3/3	1/1			4/4	100%		4	1			00:52:11
27	闫炳旗		1/1						1/1	100%						00:19:14
32	蒋维一	0/1	0/1			1/1			1/3	33.3%		2				00:31:02
33	陈旭	0/1				1/1			1/2	50.0%		1				00:26:38
合计		2/12	4/7	1/3	7/7	4/4	1/2	1/1	20/36	55.6%	6	19	2			
(守门员)																
16	刘迈科	7/12	3/8	2/3	3/8	1/6			16/37	43.2%	1					01:00:00
合计		7/12	3/8	2/3	3/8	1/6			16/37	43.2%	1					

场上队员：得分/射门

守门员：救球/射门

全队合计	得分	被救	射失	击柱	封球	合计	%
远射	2	4	2	1	3	12	16.7%
近射	4	2	1			7	57.1%
边射	1	1		1		3	33.3%
快攻	7					7	100.0%
突破	4					4	100.0%
任意	1	1				2	50.0%
七米	1					1	100.0%

2019年全国男子手球冠军杯赛

PHMS Pictorial Handball Match Statistics

IHF Official System

个人/全队技术统计表

手球 男子 预赛 轮次 5 组别 A 场次 20 万州体育馆 2019-04-11 17:30

号码	姓名	远射	近射	边射	快攻	突破	任意	七米	合计	%	助攻	失误	警告	2'	取消	时间
广东队(广东)																
(场上队员)																
2	孙江山									0.0%						00:00:00
6	毕晓晨	2/6	0/1		2/3	1/1			5/11	45.5%		1		1		00:48:54
7	王立隆				1/1				1/1	100%						00:30:00
9	范保坤									0.0%						00:00:00
10	周仲坤	0/1	1/2	0/1					1/4	25.0%		1				01:00:00
11	房友屯	0/1		0/1					0/2	0.0%		1		1		00:39:02
12	王雨	0/1		1/1	1/1				2/3	66.7%		2				01:00:00
14	王泽润									0.0%						01:00:00
15	张建杰	2/9	2/4						4/13	30.8%	1					00:43:23
18	姚雪岩									0.0%						00:00:00
19	王帅									0.0%						00:00:00
21	张昌轲	0/1							0/1	0.0%						00:11:39
22	黄培杰	1/2	2/3		1/1	4/5			8/11	72.7%	1	2				00:36:10
24	高玉杰				0/2				0/2	0.0%						00:28:04
32	罗柏涵									0.0%						00:00:00
合计		5/21	5/10	1/3	5/8	5/6			21/48	43.8%	2	7		2		
(守门员)																
14	王泽润	4/6	2/6	1/2	0/7	0/4	1/2	0/1	8/28	28.6%						01:00:00
合计		4/6	2/6	1/2	0/7	0/4	1/2	0/1	8/28	28.6%						

场上队员：得分/射门

守门员：救球/射门

全队合计	得分	被救	射失	击柱	封球	合计	%
远射	5	7	5		4	21	23.8%
近射	5	3	1	1		10	50.0%
边射	1	2				3	33.3%
快攻	5	3				8	62.5%
突破	5	1				6	83.3%
任意							0.0%
七米							0.0%



图式比赛技术统计表

手球  
男子

预赛  
轮次 5

组别 A  
场次 20

万州体育馆  
2019-04-11 17:30

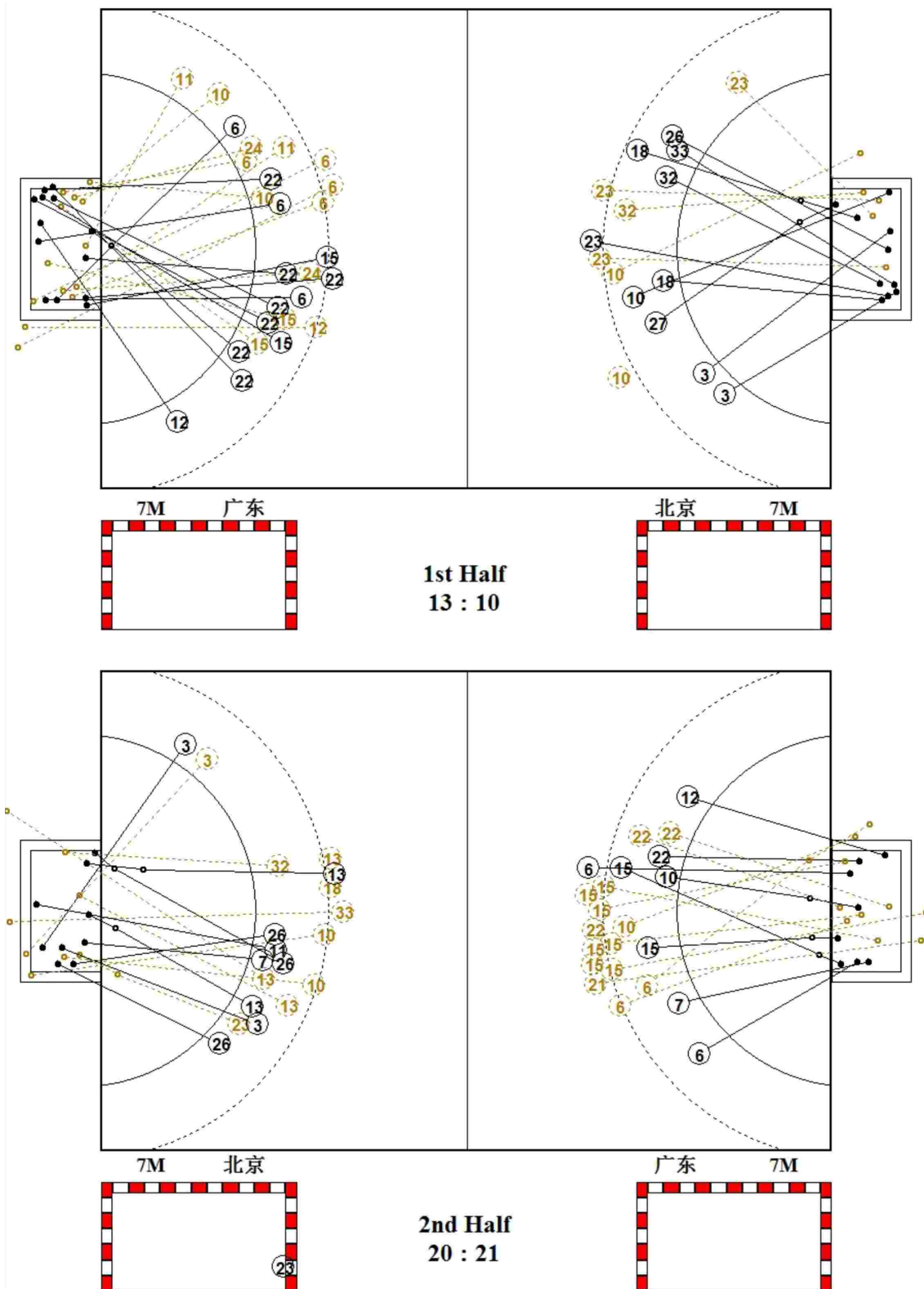

图式射门区域统计

手球  
男子

预赛  
轮次 5

组别 A  
场次 20

万州体育馆  
2019-04-11 17:30

北京队

3 透明松	6 解建飞	7 马昌震	10 成亚	11 赵文宣	12 高云健	13 王军鸣	16 刘迈科																																																																								
<table border="1"><tr><td>1</td><td>1</td><td>1</td></tr><tr><td>1</td><td></td><td></td></tr><tr><td></td><td></td><td></td></tr></table>	1	1	1	1						<table border="1"><tr><td></td><td></td><td></td></tr><tr><td></td><td></td><td></td></tr><tr><td></td><td></td><td></td></tr></table>										<table border="1"><tr><td></td><td></td><td></td></tr><tr><td></td><td></td><td></td></tr><tr><td>1</td><td></td><td></td></tr></table>							1			<table border="1"><tr><td>1</td><td></td><td></td></tr><tr><td></td><td></td><td></td></tr><tr><td></td><td></td><td></td></tr></table>	1									<table border="1"><tr><td></td><td>1</td><td></td></tr><tr><td></td><td></td><td></td></tr><tr><td></td><td></td><td></td></tr></table>		1								<table border="1"><tr><td></td><td></td><td></td></tr><tr><td></td><td></td><td></td></tr><tr><td></td><td></td><td></td></tr></table>										<table border="1"><tr><td></td><td></td><td></td></tr><tr><td></td><td>1</td><td>1</td></tr><tr><td></td><td></td><td></td></tr></table>					1	1				<table border="1"><tr><td></td><td></td><td></td></tr><tr><td></td><td></td><td></td></tr><tr><td></td><td></td><td></td></tr></table>									
1	1	1																																																																													
1																																																																															
1																																																																															
1																																																																															
	1																																																																														
	1	1																																																																													
Post - 1 Miss - 0 Block - 0	Post - 0 Miss - 0 Block - 0	Post - 0 Miss - 0 Block - 0	Post - 1 Miss - 1 Block - 1	Post - 0 Miss - 0 Block - 0	Post - 0 Miss - 0 Block - 0	Post - 0 Miss - 1 Block - 1	Post - 0 Miss - 0 Block - 0																																																																								
18 傅俊雄	22 王超	23 王军程	25 王鹏皓	26 魏昂	27 闫炳旗	32 蒋维一	33 陈旭																																																																								
<table border="1"><tr><td></td><td></td><td>1</td></tr><tr><td>1</td><td></td><td></td></tr><tr><td></td><td></td><td></td></tr></table>			1	1						<table border="1"><tr><td></td><td></td><td></td></tr><tr><td></td><td></td><td></td></tr><tr><td></td><td></td><td></td></tr></table>										<table border="1"><tr><td></td><td></td><td>1</td></tr><tr><td></td><td></td><td></td></tr><tr><td></td><td></td><td>1</td></tr></table>			1						1	<table border="1"><tr><td></td><td></td><td></td></tr><tr><td></td><td></td><td></td></tr><tr><td></td><td></td><td></td></tr></table>										<table border="1"><tr><td></td><td>1</td><td></td></tr><tr><td>2</td><td></td><td></td></tr><tr><td></td><td></td><td>1</td></tr></table>		1		2					1	<table border="1"><tr><td></td><td></td><td></td></tr><tr><td></td><td></td><td></td></tr><tr><td>1</td><td></td><td></td></tr></table>							1			<table border="1"><tr><td></td><td></td><td>1</td></tr><tr><td></td><td></td><td></td></tr><tr><td></td><td></td><td></td></tr></table>			1							<table border="1"><tr><td></td><td></td><td>1</td></tr><tr><td></td><td></td><td></td></tr><tr><td></td><td></td><td></td></tr></table>			1						
		1																																																																													
1																																																																															
		1																																																																													
		1																																																																													
	1																																																																														
2																																																																															
		1																																																																													
1																																																																															
		1																																																																													
		1																																																																													
Post - 0 Miss - 0 Block - 1	Post - 0 Miss - 0 Block - 0	Post - 0 Miss - 0 Block - 0	Post - 0 Miss - 0 Block - 0	Post - 0 Miss - 0 Block - 0	Post - 0 Miss - 0 Block - 0	Post - 0 Miss - 0 Block - 0	Post - 0 Miss - 1 Block - 0																																																																								

16 刘迈科

1/3	2/3	1/7
3/5	1/2	3/5
1/4	3/5	1/3

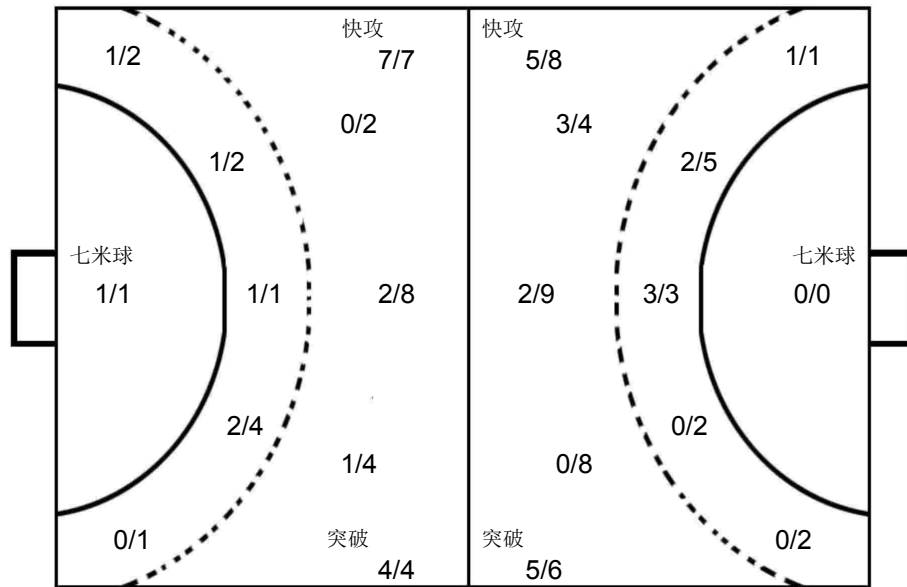

14 王泽润

1/3	1/4	0/5
3/7		1/1
1/3	1/2	0/3

广东队

2 孙江山	6 毕晓晨	7 王立隆	9 范保坤	10 周仲坤	11 房友屯	12 王雨	14 王泽润																																																																								
<table border="1"><tr><td></td><td></td><td></td></tr><tr><td></td><td></td><td></td></tr><tr><td></td><td></td><td></td></tr></table>										<table border="1"><tr><td>1</td><td>1</td><td></td></tr><tr><td>1</td><td></td><td>1</td></tr><tr><td>1</td><td></td><td></td></tr></table>	1	1		1		1	1			<table border="1"><tr><td></td><td></td><td></td></tr><tr><td></td><td></td><td>1</td></tr><tr><td></td><td></td><td></td></tr></table>						1				<table border="1"><tr><td></td><td></td><td></td></tr><tr><td></td><td></td><td></td></tr><tr><td></td><td></td><td></td></tr></table>										<table border="1"><tr><td></td><td></td><td></td></tr><tr><td></td><td>1</td><td></td></tr><tr><td></td><td></td><td></td></tr></table>					1					<table border="1"><tr><td></td><td></td><td></td></tr><tr><td></td><td></td><td></td></tr><tr><td></td><td></td><td></td></tr></table>										<table border="1"><tr><td></td><td>1</td><td></td></tr><tr><td></td><td></td><td>1</td></tr><tr><td></td><td></td><td></td></tr></table>		1				1				<table border="1"><tr><td></td><td></td><td></td></tr><tr><td></td><td></td><td></td></tr><tr><td></td><td></td><td></td></tr></table>									
1	1																																																																														
1		1																																																																													
1																																																																															
		1																																																																													
	1																																																																														
	1																																																																														
		1																																																																													
Post - 0 Miss - 0 Block - 0	Post - 0 Miss - 2 Block - 0	Post - 0 Miss - 0 Block - 0	Post - 0 Miss - 0 Block - 0	Post - 1 Miss - 1 Block - 0	Post - 0 Miss - 0 Block - 0	Post - 0 Miss - 1 Block - 0	Post - 0 Miss - 0 Block - 0																																																																								
15 张建杰	18 姚雪岩	19 王帅	21 张昌轲	22 黄培杰	24 高玉杰	32 罗柏涵																																																																									
<table border="1"><tr><td></td><td></td><td>1</td></tr><tr><td>1</td><td></td><td>2</td></tr><tr><td></td><td></td><td></td></tr></table>			1	1		2				<table border="1"><tr><td></td><td></td><td></td></tr><tr><td></td><td></td><td></td></tr><tr><td></td><td></td><td></td></tr></table>										<table border="1"><tr><td></td><td></td><td></td></tr><tr><td></td><td></td><td></td></tr><tr><td></td><td></td><td></td></tr></table>										<table border="1"><tr><td></td><td></td><td></td></tr><tr><td></td><td></td><td></td></tr><tr><td></td><td></td><td></td></tr></table>										<table border="1"><tr><td></td><td></td><td>4</td></tr><tr><td>1</td><td></td><td></td></tr><tr><td>1</td><td>2</td><td></td></tr></table>			4	1			1	2		<table border="1"><tr><td></td><td></td><td></td></tr><tr><td></td><td></td><td></td></tr><tr><td></td><td></td><td></td></tr></table>										<table border="1"><tr><td></td><td></td><td></td></tr><tr><td></td><td></td><td></td></tr><tr><td></td><td></td><td></td></tr></table>																			
		1																																																																													
1		2																																																																													
		4																																																																													
1																																																																															
1	2																																																																														
Post - 0 Miss - 1 Block - 3	Post - 0 Miss - 0 Block - 0	Post - 0 Miss - 0 Block - 0	Post - 0 Miss - 1 Block - 0	Post - 0 Miss - 0 Block - 1	Post - 0 Miss - 0 Block - 0	Post - 0 Miss - 0 Block - 0																																																																									

Team A					Team B					Match Number											
A 安徽队					B 上海队					21											
Played in			in the hall			on			at			Spectators									
重庆万州			万州体育馆			2019-04-13			13:00			hours									
Half-time(30')	A	B	End of playing time		A	B	1st extra time		A	B	2nd extra time		A	B	After penalty throws						
	12	11	25 24																		
Number of 7 m	A	Team time-out			Full name of players and officials						Team time-out			B	Number of 7 m						
	1/2	1	2	3							1	2	3	B							
		28:33	48:27	59:32							20:25	49:18	58:15	4/6							
No.	Team A					G	W	2'	D	DR	No.	Team B					G	W	2'	D	DR
1	郭世伟					3					1	张峥									
4	王巨柱					2					3	张立成									
5	史小帆										4	高天伦									
6	叶志伟										5	贺政					5				
7	姚雄敏					3					7	周文龙									
8	董智景					9					8	高震东					2		1		
9	金永峰					1	1				10	朱世杰					5		1		
10	严龙					1					11	蒋慧捷					4				
11	黎涛					1	1				12	周哲韬									
12	曾献辰										13	谢智超									
18	李双					4		2			15	庄旭杰									
21	李明										18	董凯									
23	张鹏					1					20	蒋承骅									
24	徐安格						1	3			23	吴双					1	1		1	
26	饶原源										30	徐俊吉					7				
27	王东昇																				
A	吴翔										A	吴璟 (主教练)									
B	Vladimir Stanojevic (主教练)										B	金迪琦									
C	黄红										C	张勇军									
E	刘汉杰										D	杨时									
A	Signatures of responsables for the teams (Off.A)															B					
TP	Remarks of referees / HF Official															TP					

Signatures

Referees	周云磊 (CHN)	张之伟 (CHN)		
T.D.	李之文 (CHN)	陈少波 (CHN)		
CHA Off.				

Note: Number of 7m Throws Awarded to Team A and B, Goals (G), Warnings (W), Suspensions (2'), Direct Disqualification (D), Disqualification With Report (DR) and Team Penalty (TP).

Table Officials: 陈常增

林子建

Statisticians: 谢杨

周亚桥

2019年全国男子手球冠军杯赛

PHMS Pictorial Handball Match Statistics

IHF Official System

竞赛技术统计

手球  
男子

四分之一决赛  
轮次 6

组别 X  
场次 21

万州体育馆  
2019-04-13 13:00

Referees:	周云磊 (CHN) / 张之伟 (CHN)	Result:	25:24(12:11)
Teams:	安徽队(安徽) VS 上海队(上海)		

安徽		远	近	边	快	突	任意	7m	合计	%	助攻	失误	警告	2'	D+DR
主教练: Vladimir Stanojevic		射	射	射	攻	破	球	球							
1	郭世伟		1/2		1/1	1/1			3/4	75.0		1			
4	王巨柱		1/3			0/1	1/1		2/5	40.0					
5	史小帆														
6	叶志伟														
7	姚雄敏	0/1	1/1			2/3			3/5	60.0	4				
8	董智景		0/1	3/5	4/4	1/1		1/1	9/12	75.0	1				
9	金永峰		0/2			1/2			1/4	25.0		1			
10	严龙		1/1						1/1	100					
11	黎涛			1/3					1/3	33.3	3	1			
12	曾献辰														
18	李双	1/3	1/1		1/1	1/1			4/6	66.7	2	2		2	
21	李明										1				
23	张鹏			1/1					1/1	100					
24	徐安格											1		3	
26	饶源源							0/1	0/1	0.0					
27	王东昇														
运动员	合计	1/4	5/11	5/9	6/6	6/9	1/1	1/2	25/42	59.5	3	11	3	5	
12	曾献辰							0/1	0/1	0.0					
21	李明	1/1	0/8	2/5	0/4	1/6		2/5	6/29	20.7	1				
守门员	合计	1/1	0/8	2/5	0/4	1/6		2/6	6/30	20.0	1				

安徽	比赛 进程	上海
1st Half		
	0 01:46	1 5 贺政
18 李双	1 03:20	1
	1 03:42	2 30 徐俊吉
	1 04:55	3 10 朱世杰
8 董智景	2 05:07	3
9 金永峰	3 05:48	3
	3 06:20	4 10 朱世杰
8 董智景	4 08:06	4
	4 09:36	5 5 贺政
7 姚雄敏	5 10:33	5
8 董智景	6 11:12	5
	6 13:13	6 11 蒋慧捷
18 李双	7 14:55	6
1 郭世伟	8 15:46	6
	8 16:15	7 30 徐俊吉
18 李双	9 20:08	7
8 董智景	10 21:22	7
8 董智景	11 22:03	7
	11 22:47	8 30 徐俊吉
8 董智景	12 23:04	8
	12 24:39	9 10 朱世杰
	12 25:40	10 5 贺政
	12 27:58	11 8 高震东
2nd Half		
	12 00:37	12 10 朱世杰
	12 02:41	13 5 贺政
1 郭世伟	13 03:28	13
	14 04:29	13
	14 05:26	14 11 蒋慧捷
7 姚雄敏	15 06:11	14
11 黎涛	16 08:40	14
8 董智景	17 09:22	14
	17 12:36	15 11 蒋慧捷
	17 13:29	16 30 徐俊吉
4 王巨柱	18 14:06	16
	18 14:24	17 5 贺政
8 董智景	19 16:14	17
	19 17:00	18 30 徐俊吉
	19 17:51	19 23 吴双
18 李双	20 19:45	19
	20 20:23	20 30 徐俊吉
	20 21:11	21 8 高震东
4 王巨柱	21 23:25	21
	21 24:08	22 10 朱世杰
23 张鹏	22 24:41	22
	22 25:53	23 30 徐俊吉
8 董智景	23 26:43	23
	23 27:14	24 11 蒋慧捷
10 严龙	24 28:40	24
7 姚雄敏	25 29:45	24

场上队员: 得分 / 射门

守门员: 救球 / 射门

D	取消资格	DR	取消资格+报告
---	------	----	---------



2019年全国男子手球冠军杯赛

PHMS Pictorial Handball Match Statistics

IHF Official System

个人/全队技术统计表

手球 四分之一决赛 组别 X 万州体育馆  
男子 轮次 6 场次 21 2019-04-13 13:00

号码	姓名	远射	近射	边射	快攻	突破	任意	七米	合计	%	助攻	失误	警告	2'	取消	时间
安徽队(安徽)																
(场上队员)																
1	郭世伟		1/2		1/1	1/1			3/4	75.0%		1				00:28:14
4	王巨柱		1/3			0/1	1/1		2/5	40.0%						00:09:03
5	史小帆									0.0%						00:00:00
6	叶志伟									0.0%						00:00:00
7	姚雄敏	0/1	1/1			2/3			3/5	60.0%		4				00:45:01
8	董智景		0/1	3/5	4/4	1/1		1/1	9/12	75.0%		1				00:59:45
9	金永峰		0/2			1/2			1/4	25.0%			1			00:40:03
10	严龙		1/1						1/1	100%						00:01:26
11	黎涛			1/3					1/3	33.3%		3	1			00:51:39
12	曾献辰									0.0%						00:00:28
18	李双	1/3	1/1		1/1	1/1			4/6	66.7%	2	2		2		00:59:37
21	李明									0.0%	1					00:59:32
23	张鹏			1/1					1/1	100%						00:06:34
24	徐安格									0.0%			1	3		00:52:16
26	饶原源							0/1	0/1	0.0%						00:00:16
27	王东昇									0.0%						00:01:22
合计		1/4	5/11	5/9	6/6	6/9	1/1	1/2	25/42	59.5%	3	11	3	5		
(守门员)																
12	曾献辰							0/1	0/1	0.0%						00:00:28
21	李明	1/1	0/8	2/5	0/4	1/6		2/5	6/29	20.7%	1					00:59:32
合计		1/1	0/8	2/5	0/4	1/6		2/6	6/30	20.0%	1					

场上队员：得分/射门

守门员：救球/射门

全队合计	得分	被救	射失	击柱	封球	合计	%
远射	1	3				4	25.0%
近射	5	6				11	45.5%
边射	5	1	2	1		9	55.6%
快攻	6					6	100.0%
突破	6	2	1			9	66.7%
任意	1					1	100.0%
七米	1		1			2	50.0%

## 2019年全国男子手球冠军杯赛

PHMS Pictorial Handball Match Statistics

IHF Official System

### 个人/全队技术统计表

手球 四分之一决赛 组别 X 万州体育馆  
男子 轮次 6 场次 21 2019-04-13 13:00

号码	姓名	远射	近射	边射	快攻	突破	任意	七米	合计	%	助攻	失误	警告	2'	取消	时间
上海队(上海)																
(场上队员)																
1	张崢									0.0%						00:23:35
3	张立成									0.0%						00:00:00
4	高天伦									0.0%						00:00:00
5	贺政		1/1		1/1	1/1	0/3	2/2	5/8	62.5%	2	5				00:39:00
7	周文龙	0/2		0/1					0/3	0.0%		3				00:21:39
8	高震东			1/1	1/1	0/1			2/3	66.7%		2		1		00:38:44
10	朱世杰					4/4		1/2	5/6	83.3%	3	3		1		01:00:00
11	蒋慧捷		2/2	2/3					4/5	80.0%						01:00:00
12	周哲韬									0.0%						00:36:25
13	谢智超									0.0%						00:00:00
15	庄旭杰									0.0%						00:00:00
18	董凯									0.0%		1				00:12:14
20	蒋承骅									0.0%						00:31:10
23	吴双				1/1				1/1	100%		1	1		1	00:35:33
30	徐俊吉		5/5		1/1			1/2	7/8	87.5%		3				01:02:02
合计		0/2	8/8	3/5	4/4	5/6	0/3	4/6	24/34	70.6%	5	18	1	2	1	
(守门员)																
1	张崢	2/3	1/1	0/2	0/4	0/5		0/1	3/16	18.8%						00:23:35
12	周哲韬	1/1	5/10	1/4	0/2	2/3	0/1		9/21	42.9%						00:36:25
合计		3/4	6/11	1/6	0/6	2/8	0/1	0/1	12/37	32.4%						

场上队员：得分/射门

守门员：救球/射门

全队合计	得分	被救	射失	击柱	封球	合计	%
远射		1			1	2	0.0%
近射	8					8	100.0%
边射	3	2				5	60.0%
快攻	4					4	100.0%
突破	5	1				6	83.3%
任意			3			3	0.0%
七米	4	2				6	66.7%

图式比赛技术统计表

手球  
男子

四分之一决赛  
轮次 6

组别 X  
场次 21

万州体育馆  
2019-04-13 13:00

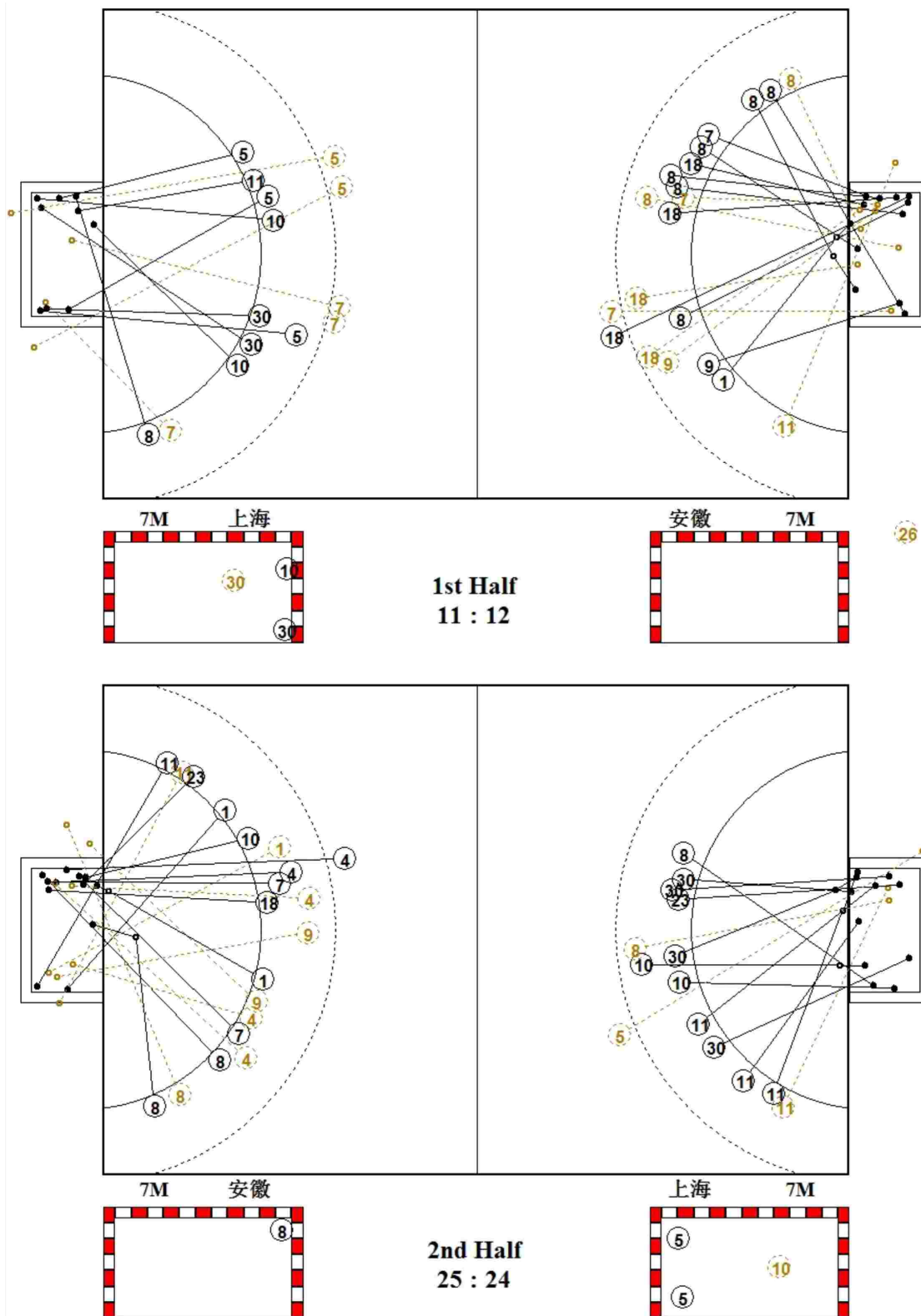

图式射门区域统计

手球  
男子

四分之一决赛  
轮次 6

组别 X  
场次 21

万州体育馆  
2019-04-13 13:00

安徽队

1 郭世伟 <table border="1"><tr><td></td><td></td><td></td></tr><tr><td>1</td><td></td><td></td></tr><tr><td>1</td><td></td><td>1</td></tr></table> Post - 0 Miss - 0 Block - 0				1			1		1	4 王巨柱 <table border="1"><tr><td></td><td></td><td>1</td></tr><tr><td></td><td></td><td>1</td></tr><tr><td></td><td></td><td></td></tr></table> Post - 0 Miss - 0 Block - 0			1			1				5 史小帆 <table border="1"><tr><td></td><td></td><td></td></tr><tr><td></td><td></td><td></td></tr><tr><td></td><td></td><td></td></tr></table> Post - 0 Miss - 0 Block - 0										6 叶志伟 <table border="1"><tr><td></td><td></td><td></td></tr><tr><td></td><td></td><td></td></tr><tr><td></td><td></td><td></td></tr></table> Post - 0 Miss - 0 Block - 0										7 姚雄敏 <table border="1"><tr><td></td><td></td><td>1</td></tr><tr><td></td><td></td><td>1</td></tr><tr><td>1</td><td></td><td></td></tr></table> Post - 0 Miss - 0 Block - 0			1			1	1			8 董智景 <table border="1"><tr><td>2</td><td></td><td>3</td></tr><tr><td>1</td><td></td><td></td></tr><tr><td></td><td>2</td><td>1</td></tr></table> Post - 0 Miss - 1 Block - 0	2		3	1				2	1	9 金永峰 <table border="1"><tr><td></td><td></td><td>1</td></tr><tr><td></td><td></td><td></td></tr><tr><td></td><td></td><td></td></tr></table> Post - 0 Miss - 1 Block - 0			1							10 严龙 <table border="1"><tr><td></td><td></td><td></td></tr><tr><td></td><td></td><td></td></tr><tr><td></td><td></td><td>1</td></tr></table> Post - 0 Miss - 0 Block - 0									1
1																																																																															
1		1																																																																													
		1																																																																													
		1																																																																													
		1																																																																													
		1																																																																													
1																																																																															
2		3																																																																													
1																																																																															
	2	1																																																																													
		1																																																																													
		1																																																																													
11 黎涛 <table border="1"><tr><td>1</td><td></td><td></td></tr><tr><td></td><td></td><td></td></tr><tr><td></td><td></td><td></td></tr></table> Post - 1 Miss - 1 Block - 0	1									12 曾献辰 <table border="1"><tr><td></td><td></td><td></td></tr><tr><td></td><td></td><td></td></tr><tr><td></td><td></td><td></td></tr></table> Post - 0 Miss - 0 Block - 0										18 李双 <table border="1"><tr><td>2</td><td></td><td>1</td></tr><tr><td></td><td></td><td></td></tr><tr><td>1</td><td></td><td></td></tr></table> Post - 0 Miss - 0 Block - 0	2		1				1			21 李明 <table border="1"><tr><td></td><td></td><td></td></tr><tr><td></td><td></td><td></td></tr><tr><td></td><td></td><td></td></tr></table> Post - 0 Miss - 0 Block - 0										23 张鹏 <table border="1"><tr><td></td><td></td><td></td></tr><tr><td></td><td></td><td></td></tr><tr><td></td><td></td><td>1</td></tr></table> Post - 0 Miss - 0 Block - 0									1	24 徐安格 <table border="1"><tr><td></td><td></td><td></td></tr><tr><td></td><td></td><td></td></tr><tr><td></td><td></td><td></td></tr></table> Post - 0 Miss - 0 Block - 0										26 饶原源 <table border="1"><tr><td></td><td></td><td></td></tr><tr><td></td><td></td><td></td></tr><tr><td></td><td></td><td></td></tr></table> Post - 0 Miss - 1 Block - 0										27 王东昇 <table border="1"><tr><td></td><td></td><td></td></tr><tr><td></td><td></td><td></td></tr><tr><td></td><td></td><td></td></tr></table> Post - 0 Miss - 0 Block - 0									
1																																																																															
2		1																																																																													
1																																																																															
		1																																																																													

12 曾献辰

		0/1

21 李明

1/5	1/1	0/3
2/5	2/2	0/5
0/4	0/1	0/3

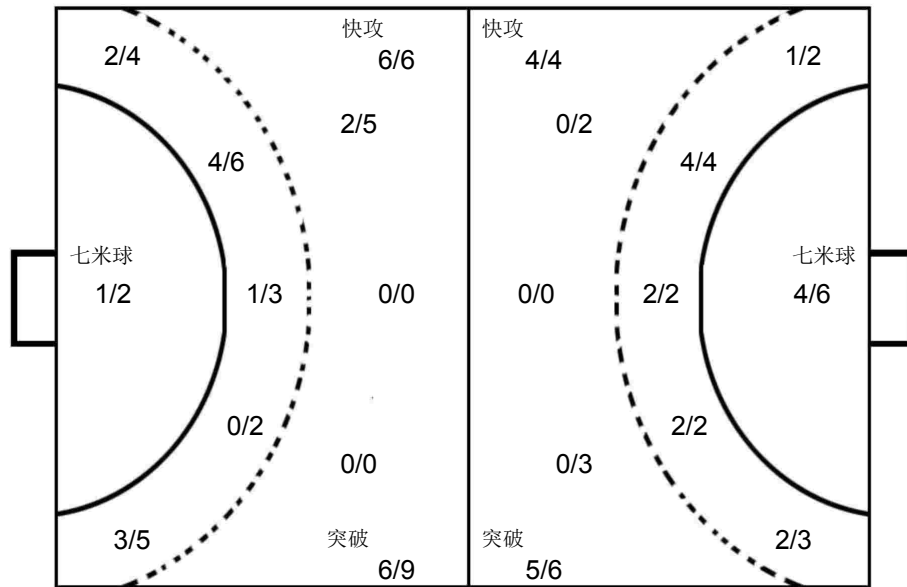

1 张峥

0/4	1/1	0/3
0/1		1/1
0/3	1/2	0/1

12 周哲韬

1/2		1/5
4/5		1/3
2/2	0/1	0/3

上海队

1 张峥 <table border="1"><tr><td></td><td></td><td></td></tr><tr><td></td><td></td><td></td></tr><tr><td></td><td></td><td></td></tr></table> Post - 0 Miss - 0 Block - 0										3 张立成 <table border="1"><tr><td></td><td></td><td></td></tr><tr><td></td><td></td><td></td></tr><tr><td></td><td></td><td></td></tr></table> Post - 0 Miss - 0 Block - 0										4 高天伦 <table border="1"><tr><td></td><td></td><td></td></tr><tr><td></td><td></td><td></td></tr><tr><td></td><td></td><td></td></tr></table> Post - 0 Miss - 0 Block - 0										5 贺政 <table border="1"><tr><td>2</td><td></td><td></td></tr><tr><td>1</td><td></td><td>1</td></tr><tr><td>1</td><td></td><td></td></tr></table> Post - 0 Miss - 3 Block - 0	2			1		1	1			7 周文龙 <table border="1"><tr><td></td><td></td><td></td></tr><tr><td></td><td></td><td></td></tr><tr><td></td><td></td><td></td></tr></table> Post - 0 Miss - 0 Block - 1										8 高震东 <table border="1"><tr><td></td><td></td><td></td></tr><tr><td></td><td></td><td>2</td></tr><tr><td></td><td></td><td></td></tr></table> Post - 0 Miss - 0 Block - 0						2				10 朱世杰 <table border="1"><tr><td></td><td></td><td>2</td></tr><tr><td></td><td></td><td>1</td></tr><tr><td></td><td></td><td>2</td></tr></table> Post - 0 Miss - 0 Block - 0			2			1			2	11 蒋慧捷 <table border="1"><tr><td></td><td></td><td></td></tr><tr><td>1</td><td></td><td>1</td></tr><tr><td>1</td><td>1</td><td></td></tr></table> Post - 0 Miss - 0 Block - 0				1		1	1	1	
2																																																																															
1		1																																																																													
1																																																																															
		2																																																																													
		2																																																																													
		1																																																																													
		2																																																																													
1		1																																																																													
1	1																																																																														
12 周哲韬 <table border="1"><tr><td></td><td></td><td></td></tr><tr><td></td><td></td><td></td></tr><tr><td></td><td></td><td></td></tr></table> Post - 0 Miss - 0 Block - 0										13 谢智超 <table border="1"><tr><td></td><td></td><td></td></tr><tr><td></td><td></td><td></td></tr><tr><td></td><td></td><td></td></tr></table> Post - 0 Miss - 0 Block - 0										15 庄旭杰 <table border="1"><tr><td></td><td></td><td></td></tr><tr><td></td><td></td><td></td></tr><tr><td></td><td></td><td></td></tr></table> Post - 0 Miss - 0 Block - 0										18 董凯 <table border="1"><tr><td></td><td></td><td></td></tr><tr><td></td><td></td><td></td></tr><tr><td></td><td></td><td></td></tr></table> Post - 0 Miss - 0 Block - 0										20 蒋承骅 <table border="1"><tr><td></td><td></td><td></td></tr><tr><td></td><td></td><td></td></tr><tr><td></td><td></td><td></td></tr></table> Post - 0 Miss - 0 Block - 0										23 吴双 <table border="1"><tr><td>1</td><td></td><td></td></tr><tr><td></td><td></td><td></td></tr><tr><td></td><td></td><td></td></tr></table> Post - 0 Miss - 0 Block - 0	1									30 徐俊吉 <table border="1"><tr><td>1</td><td></td><td>2</td></tr><tr><td>1</td><td></td><td></td></tr><tr><td>2</td><td></td><td>1</td></tr></table> Post - 0 Miss - 0 Block - 0	1		2	1			2		1										
1																																																																															
1		2																																																																													
1																																																																															
2		1																																																																													





Team A	Team B	Match Number
A 山东队	B 北京队	22

Played in	in the hall	on	at	Spepectors
重庆万州	万州体育馆	2019-04-13	14:30	hours

Half-time(30')	A	B	End of playing time	A	B	1st extra time	A	B	2nd extra time	A	B	After penalty throws	A	B
	11	12	20	22										

Number of 7 m	A	Team time-out			Full name of players and officials	Team time-out			B	Number of 7 m
	2/2	1	2	3		1	2	3	5/7	
		12:29	47:30	59:21		17:57	45:12			

No.	Team A	G	W	2'	D	DR	No.	Team B	G	W	2'	D	DR
1	宋晓晨						3	逯明松					
6	李朝鹏	6					6	解建飞	3	1			
7	林豪文	2		1			7	马昌震	3	1			
8	王炳华			1			10	成亚	6				
9	赵元						11	赵文宣					
10	赵建强						12	高云健					
11	宋朋强	3					13	王军鸣	4		1		
12	于性哲						16	刘迈科					
13	刘晓	2	1				18	傅俊雄					
15	张继伟	2	1	1			22	王超	1		1		
17	王旭东						23	王军程	1				
19	李语庆	1					25	王鹏皓					
21	姜春辉						26	魏昂					
27	胡晋铭	1		1			27	闫炳旗	1				
31	于亚男	3					32	蒋维一		1			
34	王钟彬						33	陈旭	3				
B	王鸿斌 (主教练)						A	郑永利 (主教练)					
C	金京男						B	孟辉					
D	刘桂妮						E	陈璇					
E	林配永												

A	Signatures of responsables for the teams (Off.A)	B
---	--	---

TP	Remarks of referees / HF Official	TP
----	-----------------------------------	----

Signatures			
Referees	倪震 (CHN)	严璐 (CHN)	
T.D.	李之文 (CHN)	陈少波 (CHN)	
CHA Off.			

Note: Number of 7m Throws Awarded to Team A and B, Goals (G), Warnings (W), Suspensions (2'), Direct Disqualification (D), Disqualification With Report (DR) and Team Penalty (TP).

Table Officials: 鲍瑀                      刘宇阳                      Statisticians: 赵悦                      谢杨

2019年全国男子手球冠军杯赛

PHMS Pictorial Handball Match Statistics

IHF Official System

竞赛技术统计

手球  
男子

四分之一决赛  
轮次 6

组别 X  
场次 22

万州体育馆  
2019-04-13 14:30

Referees:	倪震 (CHN) / 严璐 (CHN)	Result:	20:22(11:12)
Teams:	山东队(山东) VS 北京队(北京)		

山东		远	近	边	快	突	任意	7m	合计	%	助攻	失误	警告	2'	D+DR
主教练: 王鸿斌		射	射	射	攻	破	球	球							
1	宋晓晨														
6	李朝鹏	1/3	2/3			3/3			6/9	66.7	1	1			
7	林豪文	0/1	1/1	1/1			0/1		2/4	50.0		2		1	
8	王炳华	0/1							0/1	0.0	1			1	
9	赵元														
10	赵建强														
11	宋朋强	1/3	1/1			1/1			3/5	60.0					
12	于性哲														
13	刘晓	1/5	1/2						2/7	28.6		2	1		
15	张继伟		1/1		1/1				2/2	100		1	1	1	
17	王旭东			0/1					0/1	0.0		1			
19	李语庆			1/2	0/1				1/3	33.3					
21	姜春辉														
27	胡晋铭		1/1						1/1	100				1	
31	于亚男	1/3		0/1			0/1	2/2	3/7	42.9					
34	王钟彬														
运动员 合计		4/16	7/9	2/5	1/2	4/4	0/2	2/2	20/40	50.0	2	7	2	4	
1	宋晓晨		0/2			0/1			0/3	0.0					
12	于性哲	4/7	2/5	1/3	1/5	2/4		0/5	10/29	34.5					
守门员 合计		4/7	2/7	1/3	1/5	2/5		0/5	10/32	31.3					

山东	比赛 进程	北京
1st Half		
0	01:01	1 33 陈旭
0	01:54	2 10 成亚
6	李朝鹏	1 05:01 2
7	林豪文	2 08:47 2
2	09:59	3 10 成亚
6	李朝鹏	3 13:10 3
7	林豪文	4 14:42 3
15	张继伟	5 16:41 3
5	18:29	4 7 马昌震
19	李语庆	6 19:01 4
15	张继伟	7 19:42 4
7	20:13	5 13 王军鸣
7	20:52	6 7 马昌震
6	李朝鹏	8 21:29 6
8	21:40	7 22 王超
27	胡晋铭	9 22:09 7
9	22:16	8 7 马昌震
6	李朝鹏	10 24:21 8
10	24:54	9 13 王军鸣
6	李朝鹏	11 25:22 9
11	25:54	10 33 陈旭
11	28:03	11 10 成亚
11	29:14	12 23 王军程
2nd Half		
11	00:20	13 10 成亚
31	于亚男	12 00:54 13
12	01:31	14 10 成亚
11	宋朋强	13 04:53 14
31	于亚男	14 08:03 14
6	李朝鹏	15 09:15 14
15	09:43	15 13 王军鸣
15	10:53	16 27 闫炳旗
15	12:01	17 6 解建飞
13	刘晓	16 14:32 17
16	16:09	18 10 成亚
16	17:22	19 6 解建飞
11	宋朋强	17 22:14 19
11	宋朋强	18 25:53 19
18	26:20	20 13 王军鸣
13	刘晓	19 26:33 20
19	27:55	21 6 解建飞
31	于亚男	20 28:28 21
20	29:02	22 33 陈旭

场上队员: 得分 / 射门

守门员: 救球 / 射门

D	取消资格	DR	取消资格+报告
---	------	----	---------



2019年全国男子手球冠军杯赛

PHMS Pictorial Handball Match Statistics

IHF Official System

个人/全队技术统计表

手球 四分之一决赛 组别 X 万州体育馆  
男子 轮次 6 场次 22 2019-04-13 14:30

号码	姓名	远射	近射	边射	快攻	突破	任意	七米	合计	%	助攻	失误	警告	2'	取消	时间
山东队(山东)																
(场上队员)																
1	宋晓晨									0.0%						00:06:49
6	李朝鹏	1/3	2/3			3/3			6/9	66.7%	1	1				00:58:24
7	林豪文	0/1	1/1	1/1			0/1		2/4	50.0%		2		1		00:32:27
8	王炳华	0/1							0/1	0.0%	1			1		00:37:03
9	赵元									0.0%						00:01:34
10	赵建强									0.0%						00:00:00
11	宋朋强	1/3	1/1			1/1			3/5	60.0%						00:30:00
12	于性哲									0.0%						00:53:51
13	刘晓	1/5	1/2						2/7	28.6%		2	1			01:00:00
15	张继伟		1/1		1/1				2/2	100%		1	1	1		00:40:57
17	王旭东			0/1					0/1	0.0%		1				00:09:09
19	李语庆			1/2	0/1				1/3	33.3%						00:47:04
21	姜春辉									0.0%						00:00:00
27	胡晋铭		1/1						1/1	100%				1		00:21:36
31	于亚男	1/3		0/1		0/1	2/2		3/7	42.9%						00:20:21
34	王钟彬									0.0%						00:01:16
合计		4/16	7/9	2/5	1/2	4/4	0/2	2/2	20/40	50.0%	2	7	2	4		
(守门员)																
1	宋晓晨		0/2			0/1			0/3	0.0%						00:06:49
12	于性哲	4/7	2/5	1/3	1/5	2/4		0/5	10/29	34.5%						00:53:51
合计		4/7	2/7	1/3	1/5	2/5		0/5	10/32	31.3%						

场上队员：得分/射门

守门员：救球/射门

全队合计	得分	被救	射失	击柱	封球	合计	%
远射	4	5	4	2	1	16	25.0%
近射	7	2				9	77.8%
边射	2	3				5	40.0%
快攻	1	1				2	50.0%
突破	4					4	100.0%
任意		2				2	0.0%
七米	2					2	100.0%

## 2019年全国男子手球冠军杯赛

PHMS Pictorial Handball Match Statistics

IHF Official System

### 个人/全队技术统计表

手球 四分之一决赛 组别 X 万州体育馆  
男子 轮次 6 场次 22 2019-04-13 14:30

号码	姓名	远射	近射	边射	快攻	突破	任意	七米	合计	%	助攻	失误	警告	2'	取消	时间
北京队(北京)																
(场上队员)																
3	逯明松									0.0%						00:00:00
6	解建飞							3/3	3/3	100%			1			00:27:10
7	马昌震		2/2		1/1				3/3	100%			1			00:21:50
10	成亚	0/4	1/1		2/3	1/1		2/4	6/13	46.2%	1					00:57:07
11	赵文宣									0.0%						00:00:00
12	高云健									0.0%						00:00:00
13	王军鸣	3/3				1/1			4/4	100%	1	1		1		00:24:26
16	刘迈科									0.0%						01:00:00
18	傅俊雄									0.0%						00:00:00
22	王超			1/1					1/1	100%		1		1		00:54:07
23	王军程	0/3	1/2			0/1			1/6	16.7%		2				00:28:12
25	王鹏皓									0.0%						00:00:00
26	魏昂									0.0%		1				00:14:48
27	闫炳旗		0/1	1/2					1/3	33.3%		1				00:59:47
32	蒋维一		0/1						0/1	0.0%		2	1			00:44:09
33	陈旭	0/2	1/2		1/1	1/2			3/7	42.9%		2				00:36:06
	合计	3/12	5/9	2/3	4/5	3/5		5/7	22/41	53.7%	2	10	3	2		
(守门员)																
16	刘迈科	5/9	2/9	3/5	1/2	0/4	2/2	0/2	13/33	39.4%						01:00:00
	合计	5/9	2/9	3/5	1/2	0/4	2/2	0/2	13/33	39.4%						

场上队员：得分/射门

守门员：救球/射门

全队合计	得分	被救	射失	击柱	封球	合计	%
远射	3	4	3	1	1	12	25.0%
近射	5	2		2		9	55.6%
边射	2	1				3	66.7%
快攻	4	1				5	80.0%
突破	3	2				5	60.0%
任意							0.0%
七米	5		1	1		7	71.4%

图式比赛技术统计表

手球  
男子

四分之一决赛  
轮次 6

组别 X  
场次 22

万州体育馆  
2019-04-13 14:30

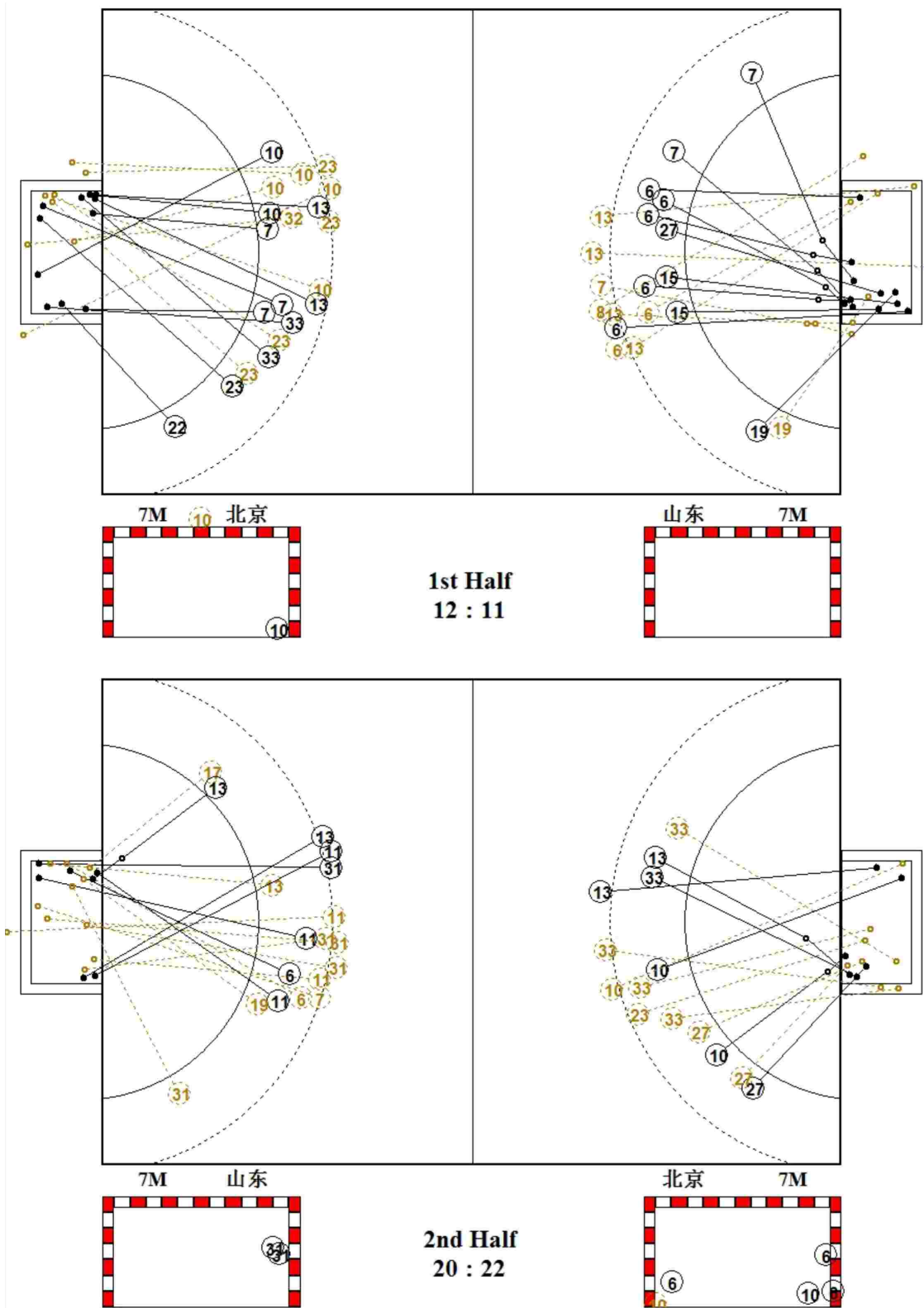

图式射门区域统计

手球  
男子

四分之一决赛  
轮次 6

组别 X  
场次 22

万州体育馆  
2019-04-13 14:30

山东队

1 宋晓晨	6 李朝鹏	7 林豪文	8 王炳华	9 赵元	10 赵建强	11 宋朋强	12 于性哲																																																																								
<table border="1"><tr><td></td><td></td><td></td></tr><tr><td></td><td></td><td></td></tr><tr><td></td><td></td><td></td></tr></table>										<table border="1"><tr><td></td><td></td><td>1</td></tr><tr><td></td><td></td><td>1</td></tr><tr><td>1</td><td>1</td><td>2</td></tr></table>			1			1	1	1	2	<table border="1"><tr><td></td><td></td><td></td></tr><tr><td></td><td></td><td></td></tr><tr><td></td><td></td><td>2</td></tr></table>									2	<table border="1"><tr><td></td><td></td><td></td></tr><tr><td></td><td></td><td></td></tr><tr><td></td><td></td><td></td></tr></table>										<table border="1"><tr><td></td><td></td><td></td></tr><tr><td></td><td></td><td></td></tr><tr><td></td><td></td><td></td></tr></table>										<table border="1"><tr><td></td><td></td><td></td></tr><tr><td></td><td></td><td></td></tr><tr><td></td><td></td><td></td></tr></table>										<table border="1"><tr><td></td><td></td><td>1</td></tr><tr><td></td><td></td><td></td></tr><tr><td>1</td><td></td><td>1</td></tr></table>			1				1		1	<table border="1"><tr><td></td><td></td><td></td></tr><tr><td></td><td></td><td></td></tr><tr><td></td><td></td><td></td></tr></table>									
		1																																																																													
		1																																																																													
1	1	2																																																																													
		2																																																																													
		1																																																																													
1		1																																																																													
Post - 0 Miss - 0 Block - 0	Post - 0 Miss - 0 Block - 1	Post - 0 Miss - 1 Block - 0	Post - 0 Miss - 1 Block - 0	Post - 0 Miss - 0 Block - 0	Post - 0 Miss - 0 Block - 0	Post - 0 Miss - 1 Block - 0	Post - 0 Miss - 0 Block - 0																																																																								
13 刘晓	15 张继伟	17 王旭东	19 李语庆	21 姜春辉	27 胡晋铭	31 于亚男	34 王钟彬																																																																								
<table border="1"><tr><td></td><td></td><td></td></tr><tr><td></td><td></td><td></td></tr><tr><td>1</td><td></td><td>1</td></tr></table>							1		1	<table border="1"><tr><td></td><td></td><td>1</td></tr><tr><td></td><td></td><td>1</td></tr><tr><td></td><td></td><td></td></tr></table>			1			1				<table border="1"><tr><td></td><td></td><td></td></tr><tr><td></td><td></td><td></td></tr><tr><td></td><td></td><td></td></tr></table>										<table border="1"><tr><td></td><td></td><td>1</td></tr><tr><td></td><td></td><td></td></tr><tr><td></td><td></td><td></td></tr></table>			1							<table border="1"><tr><td></td><td></td><td></td></tr><tr><td></td><td></td><td></td></tr><tr><td></td><td></td><td></td></tr></table>										<table border="1"><tr><td></td><td></td><td></td></tr><tr><td></td><td></td><td></td></tr><tr><td></td><td></td><td>1</td></tr></table>									1	<table border="1"><tr><td></td><td></td><td>1</td></tr><tr><td></td><td></td><td>2</td></tr><tr><td></td><td></td><td></td></tr></table>			1			2				<table border="1"><tr><td></td><td></td><td></td></tr><tr><td></td><td></td><td></td></tr><tr><td></td><td></td><td></td></tr></table>									
1		1																																																																													
		1																																																																													
		1																																																																													
		1																																																																													
		1																																																																													
		1																																																																													
		2																																																																													
Post - 2 Miss - 1 Block - 0	Post - 0 Miss - 0 Block - 0	Post - 0 Miss - 0 Block - 0	Post - 0 Miss - 0 Block - 0	Post - 0 Miss - 0 Block - 0	Post - 0 Miss - 0 Block - 0	Post - 0 Miss - 0 Block - 0	Post - 0 Miss - 0 Block - 0																																																																								

1 宋晓晨									
<table border="1"><tr><td>0/2</td><td></td><td>0/1</td></tr><tr><td></td><td></td><td></td></tr><tr><td></td><td></td><td></td></tr></table>	0/2		0/1						
0/2		0/1							

12 于性哲									
<table border="1"><tr><td>1/2</td><td></td><td>4/5</td></tr><tr><td>0/2</td><td>3/3</td><td>0/2</td></tr><tr><td>0/2</td><td></td><td>2/13</td></tr></table>	1/2		4/5	0/2	3/3	0/2	0/2		2/13
1/2		4/5							
0/2	3/3	0/2							
0/2		2/13							

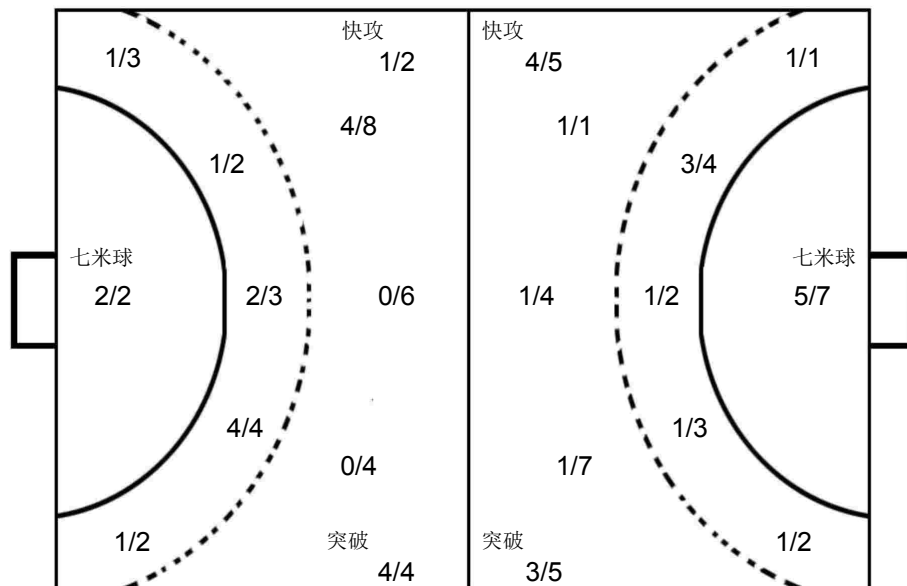

16 刘迈科									
<table border="1"><tr><td></td><td>2/2</td><td>1/6</td></tr><tr><td>1/1</td><td></td><td>3/8</td></tr><tr><td>3/6</td><td>1/2</td><td>2/8</td></tr></table>		2/2	1/6	1/1		3/8	3/6	1/2	2/8
	2/2	1/6							
1/1		3/8							
3/6	1/2	2/8							

北京队

3 逯明松	6 解建飞	7 马昌震	10 成亚	11 赵文宣	12 高云健	13 王军鸣	16 刘迈科																																																																								
<table border="1"><tr><td></td><td></td><td></td></tr><tr><td></td><td></td><td></td></tr><tr><td></td><td></td><td></td></tr></table>										<table border="1"><tr><td></td><td></td><td>1</td></tr><tr><td></td><td></td><td>1</td></tr><tr><td>1</td><td></td><td>1</td></tr></table>			1			1	1		1	<table border="1"><tr><td></td><td></td><td>1</td></tr><tr><td></td><td></td><td>1</td></tr><tr><td>1</td><td></td><td>1</td></tr></table>			1			1	1		1	<table border="1"><tr><td>2</td><td></td><td></td></tr><tr><td></td><td></td><td></td></tr><tr><td></td><td></td><td>4</td></tr></table>	2								4	<table border="1"><tr><td></td><td></td><td></td></tr><tr><td></td><td></td><td></td></tr><tr><td></td><td></td><td></td></tr></table>										<table border="1"><tr><td></td><td></td><td></td></tr><tr><td></td><td></td><td></td></tr><tr><td></td><td></td><td></td></tr></table>										<table border="1"><tr><td></td><td></td><td></td></tr><tr><td></td><td></td><td></td></tr><tr><td>1</td><td></td><td>3</td></tr></table>							1		3	<table border="1"><tr><td></td><td></td><td></td></tr><tr><td></td><td></td><td></td></tr><tr><td></td><td></td><td></td></tr></table>									
		1																																																																													
		1																																																																													
1		1																																																																													
		1																																																																													
		1																																																																													
1		1																																																																													
2																																																																															
		4																																																																													
1		3																																																																													
Post - 0 Miss - 0 Block - 0	Post - 0 Miss - 0 Block - 0	Post - 0 Miss - 0 Block - 0	Post - 1 Miss - 3 Block - 0	Post - 0 Miss - 0 Block - 0	Post - 0 Miss - 0 Block - 0	Post - 0 Miss - 0 Block - 0	Post - 0 Miss - 0 Block - 0																																																																								
18 傅俊雄	22 王超	23 王军程	25 王鹏皓	26 魏昂	27 闫炳旗	32 蒋维一	33 陈旭																																																																								
<table border="1"><tr><td></td><td></td><td></td></tr><tr><td></td><td></td><td></td></tr><tr><td></td><td></td><td></td></tr></table>										<table border="1"><tr><td></td><td></td><td></td></tr><tr><td></td><td></td><td></td></tr><tr><td>1</td><td></td><td></td></tr></table>							1			<table border="1"><tr><td></td><td></td><td>1</td></tr><tr><td></td><td></td><td></td></tr><tr><td></td><td></td><td></td></tr></table>			1							<table border="1"><tr><td></td><td></td><td></td></tr><tr><td></td><td></td><td></td></tr><tr><td></td><td></td><td></td></tr></table>										<table border="1"><tr><td></td><td></td><td></td></tr><tr><td></td><td></td><td></td></tr><tr><td></td><td></td><td></td></tr></table>										<table border="1"><tr><td></td><td></td><td></td></tr><tr><td></td><td></td><td></td></tr><tr><td></td><td></td><td>1</td></tr></table>									1	<table border="1"><tr><td></td><td></td><td></td></tr><tr><td></td><td></td><td></td></tr><tr><td></td><td></td><td></td></tr></table>										<table border="1"><tr><td></td><td></td><td>1</td></tr><tr><td></td><td></td><td></td></tr><tr><td></td><td></td><td>2</td></tr></table>			1						2
1																																																																															
		1																																																																													
		1																																																																													
		1																																																																													
		2																																																																													
Post - 0 Miss - 0 Block - 0	Post - 0 Miss - 0 Block - 0	Post - 0 Miss - 1 Block - 1	Post - 0 Miss - 0 Block - 0	Post - 0 Miss - 0 Block - 0	Post - 0 Miss - 0 Block - 0	Post - 1 Miss - 0 Block - 0	Post - 2 Miss - 0 Block - 0																																																																								



Team A					Team B					Match Number											
A 广东队					B 天津队					23											
Played in			in the hall			on			at			Spectators									
重庆万州			万州体育馆			2019-04-13			16:00			hours									
Half-time(30')	A	B	End of playing time		A	B	1st extra time		A	B	2nd extra time		A	B	After penalty throws						
	8	12	23		26																
Number of 7 m	A	Team time-out			Full name of players and officials						Team time-out			B	Number of 7 m						
	0/3	1	2	3							1	2	3	B							
		18:07	48:38						28:22	39:48	59:13		2/3								
No.	Team A					G	W	2'	D	DR	No.	Team B					G	W	2'	D	DR
2	孙江山										1	何喜年									
6	毕晓晨					3	1	1			3	魏雨童							2		
7	王立隆					2					4	刘雪东									
9	范保坤										5	王毅					4		1		
10	周仲坤					3					6	赵晨阳									
11	房友屯						1				7	张青					4				
12	王雨					4					8	王晓琪									
14	王泽润										9	王子欣					3				
15	张建杰					6					10	苏尧									
18	姚雪岩					1					11	吴明远									
19	王帅										13	许松					5				
21	张昌轲					1		1			14	王维先									
22	黄培杰					3		1			15	周群					3	1			
24	高玉杰							1			16	刘宗其									
											20	张闻乾									
											86	田剑侠					7		2		
A	曲汝洋										A	贾守信									
B	刘康伶 (主教练)					1					B	杜瑞军 (主教练)									
C	郭艳辉										D	李志成									
E	贾章志										E	王文龙									
Signatures of responsables for the teams (Off.A)																				B	
TP	Remarks of referees / HF Official																		TP		

Signatures

Referees	王雨洋 (CHN)	伍豪 (CHN)		
T.D.	吴国忠 (CHN)	张春生 (CHN)		
CHA Off.				

Note: Number of 7m Throws Awarded to Team A and B, Goals (G), Warnings (W), Suspensions (2'), Direct Disqualification (D), Disqualification With Report (DR) and Team Penalty (TP).

Table Officials: 陈常增

林子建

Statisticians: 周亚桥

赵悦

## 2019年全国男子手球冠军杯赛

PHMS Pictorial Handball Match Statistics

IHF Official System

### 竞赛技术统计

手球  
男子

四分之一决赛  
轮次 6

组别 X  
场次 23

万州体育馆  
2019-04-13 16:00

Referees:	王雨洋 (CHN) / 伍豪 (CHN)	Result:	23:26 (8:12)
Teams:	广东队(广东) VS 天津队(天津)		

广东		远	近	边	快	突	任意	7m	合计	%	助攻	失误	警告	2'	D+DR
主教练: 刘康伶		射	射	射	攻	破	球	球							
2	孙江山														
6	毕晓晨	0/2	1/1		0/1	2/2		0/1	3/7	42.9		2	1	1	
7	王立隆					2/2			2/2	100		1			
9	范保坤														
10	周仲坤		1/1		2/2			0/1	3/4	75.0		2			
11	房友屯												1		
12	王雨		1/1	0/2	2/2	1/1			4/6	66.7		2			
14	王泽润														
15	张建杰	1/5	1/1			4/4	0/1		6/11	54.5	1				
18	姚雪岩						1/1		1/1	100		1			
19	王帅														
21	张昌轲				1/1				1/1	100				1	
22	黄培杰	0/3	0/1			3/5		0/1	3/10	30.0	2	2		1	
24	高玉杰										1	1		1	
运动员 合计		1/10	4/5	0/2	5/6	12/14	1/2	0/3	23/42	54.8	4	11	2	4	
14	王泽润	0/1	3/8	1/2	3/5	1/7			8/23	34.8					
19	王帅	1/2	1/3	1/1	0/2	0/4		1/3	4/15	26.7					
守门员 合计		1/3	4/11	2/3	3/7	1/11		1/3	12/38	31.6					

天津		远	近	边	快	突	任意	7m	合计	%	助攻	失误	警告	2'	D+DR
主教练: 杜瑞军		射	射	射	攻	破	球	球							
1	何喜年														
3	魏雨童				0/1				0/1	0.0				2	
4	刘雪东														
5	王毅		2/3		1/1			1/1	4/5	80.0		2		1	
6	赵晨阳														
7	张青	1/1	1/3		1/1			1/2	4/7	57.1	1	4			
8	王晓琪														
9	王子欣			1/2	1/2	1/1			3/5	60.0	1	2			
10	苏尧														
11	吴明远														
13	许松	0/1	1/2	0/1	1/2	3/3			5/9	55.6	3	3			
14	王维先														
15	周群		3/5						3/5	60.0		2	1		
16	刘宗其											1			
20	张闻乾														
86	田剑侠	1/1				6/7			7/8	87.5	1	1		2	
运动员 合计		2/3	7/13	1/3	4/7	10/11		2/3	26/40	65.0	7	14	1	5	
1	何喜年	5/6	0/3		1/3	1/10	0/1		7/23	30.4					
16	刘宗其	1/1	0/1	2/2	0/3	0/3		3/3	6/13	46.2	1				
守门员 合计		6/7	0/4	2/2	1/6	1/13	0/1	3/3	13/36	36.1	1				

广东	比赛进程	天津
1st Half		
22	黄培杰 0 04:31	1 13 许松
	1 05:22	1
	1 06:00	2 86 田剑侠
	1 07:29	3 15 周群
	1 07:48	4 13 许松
6	毕晓晨 2 08:23	4
	2 11:20	5 7 张青
15	张建杰 3 12:17	5
10	周仲坤 4 14:26	5
	4 15:52	6 5 王毅
	4 16:52	7 15 周群
22	黄培杰 5 17:19	7
	5 17:53	8 13 许松
10	周仲坤 6 19:17	8
	6 19:50	9 86 田剑侠
	6 21:53	10 7 张青
22	黄培杰 7 22:14	10
	7 24:14	11 86 田剑侠
	7 29:30	12 9 王子欣
18	姚雪岩 8 30:00	12
2nd Half		
7	王立隆 8 01:24	13 5 王毅
	9 02:06	13
15	张建杰 9 04:27	14 7 张青
	10 05:16	14
	10 06:03	15 86 田剑侠
15	张建杰 11 07:02	15
	11 08:11	16 5 王毅
7	王立隆 12 08:56	16
21	张昌轲 13 09:40	16
	13 10:40	17 86 田剑侠
6	毕晓晨 14 10:54	17
	14 12:49	18 9 王子欣
	14 13:49	19 13 许松
6	毕晓晨 15 16:26	19
10	周仲坤 16 19:30	19
	16 19:58	20 13 许松
12	王雨 17 21:23	20
	17 22:17	21 9 王子欣
15	张建杰 18 24:03	21
	18 25:01	22 7 张青
15	张建杰 19 25:16	22
	19 25:31	23 15 周群
12	王雨 20 25:45	23
	20 26:09	24 86 田剑侠
	20 26:50	25 5 王毅
	20 27:59	26 86 田剑侠
15	张建杰 21 28:17	26
12	王雨 22 28:59	26
12	王雨 23 29:33	26

场上队员: 得分 / 射门

守门员: 救球 / 射门

D	取消资格	DR	取消资格+报告
---	------	----	---------



2019年全国男子手球冠军杯赛

PHMS Pictorial Handball Match Statistics

IHF Official System

个人/全队技术统计表

手球 四分之一决赛 组别 X 万州体育馆  
男子 轮次 6 场次 23 2019-04-13 16:00

号码	姓名	远射	近射	边射	快攻	突破	任意	七米	合计	%	助攻	失误	警告	2'	取消	时间
广东队(广东)																
(场上队员)																
2	孙江山									0.0%						00:00:00
6	毕晓晨	0/2	1/1		0/1	2/2		0/1	3/7	42.9%		2	1	1		00:41:40
7	王立隆					2/2			2/2	100%		1				00:39:47
9	范保坤									0.0%						00:00:00
10	周仲坤		1/1		2/2			0/1	3/4	75.0%		2				00:42:33
11	房友屯									0.0%			1			00:20:12
12	王雨		1/1	0/2	2/2	1/1			4/6	66.7%		2				01:00:00
14	王泽润									0.0%						00:35:18
15	张建杰	1/5	1/1			4/4	0/1		6/11	54.5%	1					00:48:42
18	姚雪岩						1/1		1/1	100%		1				00:17:25
19	王帅									0.0%						00:24:42
21	张昌轲				1/1				1/1	100%				1		00:25:58
22	黄培杰	0/3	0/1			3/5		0/1	3/10	30.0%	2	2		1		00:32:28
24	高玉杰									0.0%	1	1		1		00:28:28
合计		1/10	4/5	0/2	5/6	12/14	1/2	0/3	23/42	54.8%	4	11	2	4		
(守门员)																
14	王泽润	0/1	3/8	1/2	3/5	1/7			8/23	34.8%						00:35:18
19	王帅	1/2	1/3	1/1	0/2	0/4		1/3	4/15	26.7%						00:24:42
合计		1/3	4/11	2/3	3/7	1/11		1/3	12/38	31.6%						

场上队员：得分/射门

守门员：救球/射门

全队合计	得分	被救	射失	击柱	封球	合计	%
远射	1	6	1	1	1	10	10.0%
近射	4		1			5	80.0%
边射		2				2	0.0%
快攻	5	1				6	83.3%
突破	12	1	1			14	85.7%
任意	1			1		2	50.0%
七米		3				3	0.0%

2019年全国男子手球冠军杯赛

PHMS Pictorial Handball Match Statistics

IHF Official System

个人/全队技术统计表

手球 四分之一决赛 组别 X 万州体育馆  
男子 轮次 6 场次 23 2019-04-13 16:00

号码	姓名	远射	近射	边射	快攻	突破	任意	七米	合计	%	助攻	失误	警告	2'	取消	时间
天津队(天津)																
(场上队员)																
1	何喜年									0.0%						00:43:04
3	魏雨童				0/1				0/1	0.0%				2		00:27:01
4	刘雪东									0.0%						00:00:00
5	王毅		2/3		1/1			1/1	4/5	80.0%		2		1		00:43:23
6	赵晨阳									0.0%						00:00:00
7	张青	1/1	1/3		1/1			1/2	4/7	57.1%	1	4				00:56:30
8	王晓琪									0.0%						00:00:00
9	王子欣			1/2	1/2	1/1			3/5	60.0%	1	2				01:00:00
10	苏尧									0.0%						00:00:00
11	吴明远									0.0%						00:00:00
13	许松	0/1	1/2	0/1	1/2	3/3			5/9	55.6%	3	3				01:00:00
14	王维先									0.0%						00:00:00
15	周群		3/5						3/5	60.0%		2	1			00:59:55
16	刘宗其									0.0%	1					00:16:56
20	张闻乾									0.0%						00:00:00
86	田剑侠	1/1				6/7			7/8	87.5%	1	1		2		00:53:44
合计		2/3	7/13	1/3	4/7	10/11		2/3	26/40	65.0%	7	14	1	5		
(守门员)																
1	何喜年	5/6	0/3		1/3	1/10	0/1		7/23	30.4%						00:43:04
16	刘宗其	1/1	0/1	2/2	0/3	0/3		3/3	6/13	46.2%	1					00:16:56
合计		6/7	0/4	2/2	1/6	1/13	0/1	3/3	13/36	36.1%	1					

场上队员：得分/射门

守门员：救球/射门

全队合计	得分	被救	射失	击柱	封球	合计	%
远射	2	1				3	66.7%
近射	7	4	1	1		13	53.8%
边射	1	2				3	33.3%
快攻	4	3				7	57.1%
突破	10	1				11	90.9%
任意							0.0%
七米	2	1				3	66.7%

图式比赛技术统计表

手球  
男子

四分之一决赛  
轮次 6

组别 X  
场次 23

万州体育馆  
2019-04-13 16:00

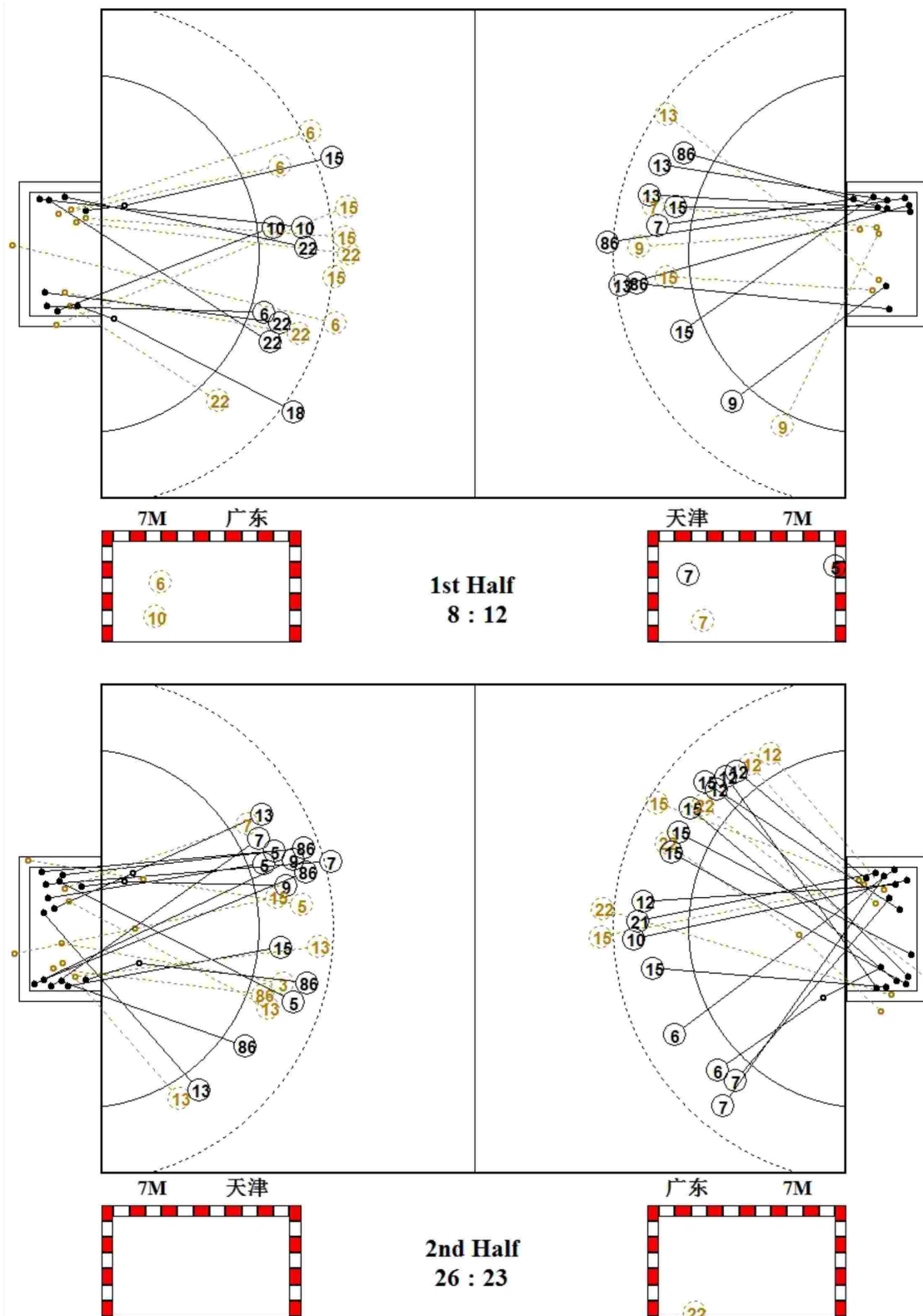

图式射门区域统计

手球  
男子

四分之一决赛  
轮次 6

组别 X  
场次 23

万州体育馆  
2019-04-13 16:00

广东队

2 孙江山	6 毕晓晨	7 王立隆	9 范保坤	10 周仲坤	11 房友屯	12 王雨	14 王泽润																																																																								
<table border="1"><tr><td></td><td></td><td></td></tr><tr><td></td><td></td><td></td></tr><tr><td></td><td></td><td></td></tr></table>										<table border="1"><tr><td>2</td><td></td><td></td></tr><tr><td></td><td></td><td>1</td></tr><tr><td></td><td></td><td></td></tr></table>	2					1				<table border="1"><tr><td></td><td></td><td></td></tr><tr><td>2</td><td></td><td></td></tr><tr><td></td><td></td><td></td></tr></table>				2						<table border="1"><tr><td></td><td></td><td></td></tr><tr><td></td><td></td><td></td></tr><tr><td></td><td></td><td></td></tr></table>										<table border="1"><tr><td>1</td><td></td><td>1</td></tr><tr><td>1</td><td></td><td></td></tr><tr><td></td><td></td><td></td></tr></table>	1		1	1						<table border="1"><tr><td></td><td></td><td></td></tr><tr><td></td><td></td><td></td></tr><tr><td></td><td></td><td></td></tr></table>										<table border="1"><tr><td>1</td><td></td><td>1</td></tr><tr><td></td><td></td><td>1</td></tr><tr><td>1</td><td></td><td></td></tr></table>	1		1			1	1			<table border="1"><tr><td></td><td></td><td></td></tr><tr><td></td><td></td><td></td></tr><tr><td></td><td></td><td></td></tr></table>									
2																																																																															
		1																																																																													
2																																																																															
1		1																																																																													
1																																																																															
1		1																																																																													
		1																																																																													
1																																																																															
Post - 0 Miss - 0 Block - 0	Post - 0 Miss - 1 Block - 0	Post - 0 Miss - 0 Block - 0	Post - 0 Miss - 0 Block - 0	Post - 0 Miss - 0 Block - 0	Post - 0 Miss - 0 Block - 0	Post - 0 Miss - 0 Block - 0	Post - 0 Miss - 0 Block - 0																																																																								
15 张建杰	18 姚雪岩	19 王帅	21 张昌轲	22 黄培杰	24 高玉杰																																																																										
<table border="1"><tr><td></td><td>1</td><td>3</td></tr><tr><td></td><td></td><td>1</td></tr><tr><td></td><td></td><td>1</td></tr></table>		1	3			1			1	<table border="1"><tr><td>1</td><td></td><td></td></tr><tr><td></td><td></td><td></td></tr><tr><td></td><td></td><td></td></tr></table>	1									<table border="1"><tr><td></td><td></td><td></td></tr><tr><td></td><td></td><td></td></tr><tr><td></td><td></td><td></td></tr></table>										<table border="1"><tr><td></td><td></td><td></td></tr><tr><td>1</td><td></td><td></td></tr><tr><td></td><td></td><td></td></tr></table>				1						<table border="1"><tr><td>1</td><td></td><td>1</td></tr><tr><td></td><td></td><td>1</td></tr><tr><td></td><td></td><td></td></tr></table>	1		1			1				<table border="1"><tr><td></td><td></td><td></td></tr><tr><td></td><td></td><td></td></tr><tr><td></td><td></td><td></td></tr></table>																													
	1	3																																																																													
		1																																																																													
		1																																																																													
1																																																																															
1																																																																															
1		1																																																																													
		1																																																																													
Post - 1 Miss - 0 Block - 1	Post - 0 Miss - 0 Block - 0	Post - 0 Miss - 0 Block - 0	Post - 0 Miss - 0 Block - 0	Post - 1 Miss - 2 Block - 0	Post - 0 Miss - 0 Block - 0																																																																										

14 王泽润

1/4	0/2	0/3
3/5	1/1	2/5
1/2		0/1

19 王帅

0/4		0/1
0/4	1/1	2/3
1/2		

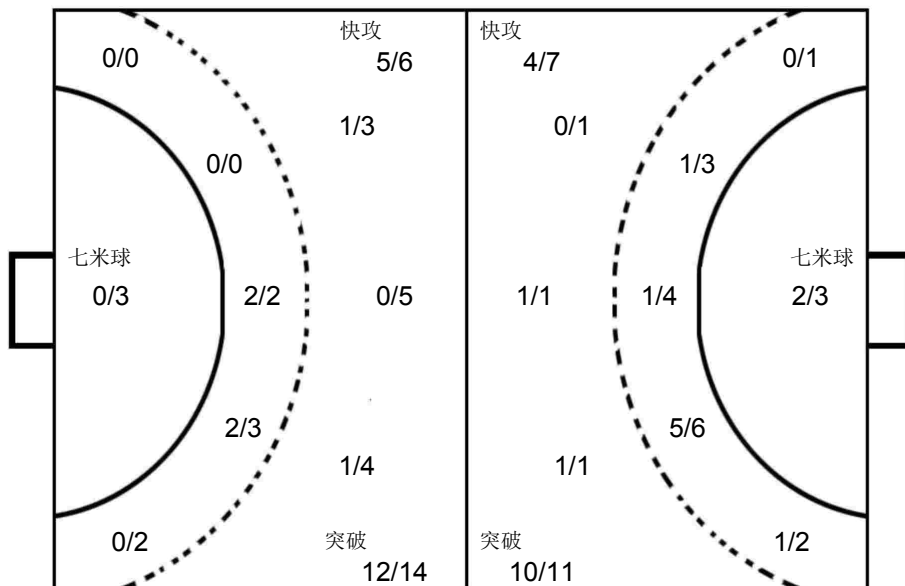

1 何喜年

0/3	0/1	0/5
2/6		3/5
1/1		1/2

16 刘宗其

0/2		0/1
3/4		0/2
3/4		

天津队

1 何喜年	3 魏雨童	4 刘雪东	5 王毅	6 赵晨阳	7 张青	8 王晓琪	9 王子欣																																																																								
<table border="1"><tr><td></td><td></td><td></td></tr><tr><td></td><td></td><td></td></tr><tr><td></td><td></td><td></td></tr></table>										<table border="1"><tr><td></td><td></td><td></td></tr><tr><td></td><td></td><td></td></tr><tr><td></td><td></td><td></td></tr></table>										<table border="1"><tr><td></td><td></td><td></td></tr><tr><td></td><td></td><td></td></tr><tr><td></td><td></td><td></td></tr></table>										<table border="1"><tr><td></td><td></td><td>2</td></tr><tr><td></td><td></td><td>2</td></tr><tr><td></td><td></td><td></td></tr></table>			2			2				<table border="1"><tr><td></td><td></td><td></td></tr><tr><td></td><td></td><td></td></tr><tr><td></td><td></td><td></td></tr></table>										<table border="1"><tr><td>2</td><td></td><td>1</td></tr><tr><td></td><td></td><td></td></tr><tr><td>1</td><td></td><td></td></tr></table>	2		1				1			<table border="1"><tr><td></td><td></td><td></td></tr><tr><td></td><td></td><td></td></tr><tr><td></td><td></td><td></td></tr></table>										<table border="1"><tr><td>1</td><td></td><td></td></tr><tr><td></td><td></td><td>1</td></tr><tr><td></td><td></td><td>1</td></tr></table>	1					1			1
		2																																																																													
		2																																																																													
2		1																																																																													
1																																																																															
1																																																																															
		1																																																																													
		1																																																																													
Post - 0 Miss - 0 Block - 0	Post - 0 Miss - 0 Block - 0	Post - 0 Miss - 0 Block - 0	Post - 1 Miss - 0 Block - 0	Post - 0 Miss - 0 Block - 0	Post - 0 Miss - 0 Block - 0	Post - 0 Miss - 0 Block - 0	Post - 0 Miss - 0 Block - 0																																																																								
10 苏尧	11 吴明远	13 许松	14 王维先	15 周群	16 刘宗其	20 张闻乾	86 田剑侠																																																																								
<table border="1"><tr><td></td><td></td><td></td></tr><tr><td></td><td></td><td></td></tr><tr><td></td><td></td><td></td></tr></table>										<table border="1"><tr><td></td><td></td><td></td></tr><tr><td></td><td></td><td></td></tr><tr><td></td><td></td><td></td></tr></table>										<table border="1"><tr><td>1</td><td>2</td><td></td></tr><tr><td>2</td><td></td><td></td></tr><tr><td></td><td></td><td></td></tr></table>	1	2		2						<table border="1"><tr><td></td><td></td><td></td></tr><tr><td></td><td></td><td></td></tr><tr><td></td><td></td><td></td></tr></table>										<table border="1"><tr><td>1</td><td></td><td></td></tr><tr><td>2</td><td></td><td></td></tr><tr><td></td><td></td><td></td></tr></table>	1			2						<table border="1"><tr><td></td><td></td><td></td></tr><tr><td></td><td></td><td></td></tr><tr><td></td><td></td><td></td></tr></table>										<table border="1"><tr><td></td><td></td><td></td></tr><tr><td></td><td></td><td></td></tr><tr><td></td><td></td><td></td></tr></table>										<table border="1"><tr><td>2</td><td></td><td>1</td></tr><tr><td>2</td><td></td><td>1</td></tr><tr><td>1</td><td></td><td></td></tr></table>	2		1	2		1	1		
1	2																																																																														
2																																																																															
1																																																																															
2																																																																															
2		1																																																																													
2		1																																																																													
1																																																																															
Post - 0 Miss - 0 Block - 0	Post - 0 Miss - 0 Block - 0	Post - 0 Miss - 0 Block - 0	Post - 0 Miss - 0 Block - 0	Post - 0 Miss - 1 Block - 0	Post - 0 Miss - 0 Block - 0	Post - 0 Miss - 0 Block - 0	Post - 0 Miss - 0 Block - 0																																																																								



Team A	Team B	Match Number
A 江苏队	B 山西队	24

Played in	in the hall	on	at	Spepectors
重庆万州	万州体育馆	2019-04-13	17:30	hours

Half-time(30')	A	B	End of playing time	A	B	1st extra time	A	B	2nd extra time	A	B	After penalty throws	A	B
	15	15	34	23										

Number of 7 m	A	Team time-out			Full name of players and officials	Team time-out			B	Number of 7 m	
	2/3	1	2	3		1	2	3	1/1		
		17:04	48:44					53:45	59:14		

No.	Team A	G	W	2'	D	DR	No.	Team B	G	W	2'	D	DR
1	宋继强						1	鲁世豪					
4	张家纬	2					2	张智超					
6	赵晨	6					3	龙俊皓					
7	周傲	5					4	刘文东	3	1			
8	谢庆龙	2					5	王宇恒	1				
11	张天豪	4					6	盖秀越	4				
12	王权						7	任健豪	1				
16	张帅						9	辛浩乐					
18	赵楠	3					10	王洋					
19	庞连康	3					11	吴夏冰	2	1	1		
20	顾艳超	2					12	韩乐斌					
21	刘江						13	杜忠浩	1				
25	王杰缘	5					14	杨毅	7				
27	王伟强	1					15	薛瑞寒	4				
30	吴龙瑞	1					16	王虹翔					
							18	张禹琛					
A	闫威名 (主教练)						A	张栋					
B	叶强						B	赵鑫 (主教练)					
C	贾淑君						C	霖配永					
E	王建国												

A	Signatures of responsables for the teams (Off.A)	B
---	--	---

TP	Remarks of referees / HF Official	TP
----	-----------------------------------	----

Signatures			
Referees	周胜锋 (CHN)	黄一凡 (CHN)	
T.D.	吴国忠 (CHN)	张春生 (CHN)	
CHA Off.			

Note: Number of 7m Throws Awarded to Team A and B, Goals (G), Warnings (W), Suspensions (2'), Direct Disqualification (D), Disqualification With Report (DR) and Team Penalty (TP).

Table Officials: 鲍瑀                      刘宇阳                      Statisticians: 谢杨                      赵悦

## 2019年全国男子手球冠军杯赛

PHMS Pictorial Handball Match Statistics

IHF Official System

### 竞赛技术统计

手球  
男子

四分之一决赛  
轮次 6

组别 X  
场次 24

万州体育馆  
2019-04-13 17:30

Referees: 周胜锋 (CHN) / 黄一凡 (CHN)

Result: 34:23(15:15)

Teams: 江苏队(江苏) VS 山西队(山西)

江苏													比赛进程		山西			
主教练: 闫威名													1st Half					
	远射	近射	边射	快攻	突破	任意球	7m球	合计	%	助攻	失误	警告	2'	D+DR				
1	宋继强																	
4	张家纬		2/3					2/3	66.7									
6	赵晨	3/3	2/2			1/1	0/1	6/7	85.7	4								
7	周傲	0/1	2/3			2/2		5/7	71.4	1								
8	谢庆龙		0/1		2/2			2/3	66.7									
11	张天豪		1/1	2/3	1/1			4/5	80.0									
12	王权									1								
16	张帅									1								
18	赵楠		2/5			1/1		3/6	50.0		2							
19	庞连康	0/1	1/2			2/3		3/6	50.0	1	4							
20	顾艳超	1/2	0/1		1/1			2/4	50.0	1								
21	刘江				0/2			0/2	0.0									
25	王杰缘		0/1	3/3	1/1		1/2	5/7	71.4									
27	王伟强			0/1	1/1			1/2	50.0									
30	吴龙瑞		1/1			0/1		1/2	50.0									
运动员 合计		4/7	11/20	5/7	6/8	6/8	0/1	2/3	34/54	63.0	9	6						
1	宋继强	1/2	1/4			0/2		2/8	25.0									
12	王权	3/3	5/9					8/12	66.7	1								
16	张帅	5/7	3/7	0/2	0/2	0/1	0/1	8/21	38.1	1								
守门员 合计		9/12	9/20	0/2	0/2	0/3	0/1	0/1	18/41	43.9	2							
山西													2nd Half					
主教练: 赵鑫																		
	远射	近射	边射	快攻	突破	任意球	7m球	合计	%	助攻	失误	警告	2'	D+DR				
1	鲁世豪																	
2	张智超		0/1					0/1	0.0									
3	龙俊皓																	
4	刘文东		3/3					3/3	100		1	1						
5	王宇恒	0/2	1/2					1/4	25.0		1							
6	盖秀越		1/1	2/2	1/1			4/4	100									
7	任健豪		1/3					1/3	33.3	2	2							
9	辛浩乐																	
10	王洋																	
11	吴夏冰		1/1		1/1			2/2	100		1	1	1					
12	韩乐斌									1								
13	杜忠浩	0/4					1/1	1/5	20.0		3							
14	杨毅	3/9	2/5			1/1	1/1	7/16	43.8	1	5							
15	薛瑞寒	0/4	2/5			2/2		4/11	36.4		1							
16	王虹翔																	
18	张禹琛																	
运动员 合计		3/19	11/21	2/2	2/2	3/3	1/1	1/1	23/49	46.9	4	14	2	1				
1	鲁世豪	1/2	5/8	1/3	0/4	0/1		0/2	7/20	35.0								
12	韩乐斌	1/4	0/8	0/3	1/3	0/5		2/23	8.7	1								
16	王虹翔																	
守门员 合计		2/6	5/16	1/6	1/7	0/6		0/2	9/43	20.9	1							
19	庞连康	1	05:14	2														
7	周傲	2	06:44	3														
7	周傲	3	11:05	3														
11	张天豪	4	13:53	4														
4	张天豪	4	14:32	5	14	杨毅												
4	张天豪	4	15:25	6	11	吴夏冰												
7	周傲	5	15:56	6														
5	张天豪	5	16:47	7	14	杨毅												
5	张天豪	5	17:27	8	6	盖秀越												
19	庞连康	6	19:11	8														
6	赵晨	6	19:57	9	6	盖秀越												
7	周傲	7	20:25	9														
7	周傲	7	20:59	10	15	薛瑞寒												
18	赵楠	8	21:50	10														
11	张天豪	8	22:36	11	15	薛瑞寒												
25	王杰缘	9	23:07	11														
25	王杰缘	10	23:26	11														
10	张天豪	10	24:05	12	14	杨毅												
10	张天豪	10	25:43	13	6	盖秀越												
18	赵楠	11	26:08	13														
25	王杰缘	12	26:49	13														
12	王权	12	27:12	14	14	杨毅												
18	赵楠	13	27:48	14														
6	赵晨	14	28:47	14														
14	赵晨	14	29:25	15	14	杨毅												
6	赵晨	15	29:59	15														
6	赵晨	16	00:24	15														
16	赵晨	16	01:38	16	14	杨毅												
20	顾艳超	17	02:05	16														
17	顾艳超	17	02:50	17	15	薛瑞寒												
6	赵晨	18	02:59	17														
4	张家纬	19	03:51	17														
19	庞连康	19	05:01	18	13	杜忠浩												
27	王伟强	20	06:09	18														
6	赵晨	21	07:22	18														
25	王杰缘	22	08:22	18														
22	王杰缘	22	09:44	19	5	王宇恒												
22	王杰缘	22	10:48	20	4	刘文东												
25	王杰缘	23	11:19	20														
23	王杰缘	23	12:14	21	14	杨毅												
4	张家纬	24	12:20	21														
8	谢庆龙	25	13:51	21														
20	顾艳超	26	17:07	21														
6	赵晨	27	21:25	21														
8	谢庆龙	28	22:09	21														
28	谢庆龙	28	22:48	22	4	刘文东												
25	王杰缘	29	23:33	22														
7	周傲	30	24:34	22														
19	庞连康	31	25:33	22														
31	庞连康	31	26:10	23	4	刘文东												
11	张天豪	32	26:37	23														
11	张天豪	33	27:21	23														
30	吴龙瑞	34	28:26	23														

场上队员: 得分 / 射门

守门员: 救球 / 射门

D	取消资格	DR	取消资格+报告
---	------	----	---------



2019年全国男子手球冠军杯赛

PHMS Pictorial Handball Match Statistics

IHF Official System

个人/全队技术统计表

手球 四分之一决赛 组别 X 万州体育馆  
男子 轮次 6 场次 24 2019-04-13 17:30

号码	姓名	远射	近射	边射	快攻	突破	任意	七米	合计	%	助攻	失误	警告	2'	取消	时间
江苏队(江苏)																
(场上队员)																
1	宋继强									0.0%						00:09:47
4	张家纬		2/3						2/3	66.7%						00:18:16
6	赵晨	3/3	2/2			1/1	0/1		6/7	85.7%	4					00:33:53
7	周傲	0/1	2/3			2/2		1/1	5/7	71.4%	1					00:27:56
8	谢庆龙		0/1		2/2				2/3	66.7%						00:24:35
11	张天豪		1/1	2/3	1/1				4/5	80.0%						00:35:34
12	王权									0.0%	1					00:19:01
16	张帅									0.0%	1					00:31:12
18	赵楠		2/5			1/1			3/6	50.0%		2				00:56:44
19	庞连康	0/1	1/2			2/3			3/6	50.0%	1	4				00:32:37
20	顾艳超	1/2	0/1		1/1				2/4	50.0%	1					00:26:35
21	刘江				0/2				0/2	0.0%						00:35:00
25	王杰缘		0/1	3/3	1/1			1/2	5/7	71.4%						00:32:51
27	王伟强			0/1	1/1				1/2	50.0%						00:24:42
30	吴龙瑞		1/1			0/1			1/2	50.0%						00:27:59
合计		4/7	11/20	5/7	6/8	6/8	0/1	2/3	34/54	63.0%	9	6				
(守门员)																
1	宋继强	1/2	1/4			0/2			2/8	25.0%						00:09:47
12	王权	3/3	5/9						8/12	66.7%	1					00:19:01
16	张帅	5/7	3/7	0/2	0/2	0/1	0/1	0/1	8/21	38.1%	1					00:31:12
合计		9/12	9/20	0/2	0/2	0/3	0/1	0/1	18/41	43.9%	2					

场上队员：得分/射门

守门员：救球/射门

全队合计	得分	被救	射失	击柱	封球	合计	%
远射	4	2		1		7	57.1%
近射	11	5	1	2	1	20	55.0%
边射	5	1	1			7	71.4%
快攻	6	1	1			8	75.0%
突破	6		1	1		8	75.0%
任意			1			1	0.0%
七米	2			1		3	66.7%

## 2019年全国男子手球冠军杯赛

PHMS Pictorial Handball Match Statistics

IHF Official System

### 个人/全队技术统计表

手球 四分之一决赛 组别 X 万州体育馆  
男子 轮次 6 场次 24 2019-04-13 17:30

号码	姓名	远射	近射	边射	快攻	突破	任意	七米	合计	%	助攻	失误	警告	2'	取消	时间
山西队(山西)																
(场上队员)																
1	鲁世豪									0.0%						00:21:13
2	张智超		0/1						0/1	0.0%						00:24:30
3	龙俊皓									0.0%						00:00:00
4	刘文东		3/3						3/3	100%		1	1			00:30:30
5	王宇恒	0/2	1/2						1/4	25.0%		1				00:23:19
6	盖秀越		1/1	2/2	1/1				4/4	100%						00:47:13
7	任健豪		1/3						1/3	33.3%	2	2				00:30:13
9	辛浩乐									0.0%						00:00:00
10	王洋									0.0%						00:35:29
11	吴夏冰		1/1		1/1				2/2	100%		1	1	1		00:50:43
12	韩乐斌									0.0%	1					00:38:01
13	杜忠浩	0/4				1/1			1/5	20.0%		3				00:20:17
14	杨毅	3/9	2/5			1/1		1/1	7/16	43.8%	1	5				00:40:03
15	薛瑞寒	0/4	2/5			2/2			4/11	36.4%		1				00:56:49
16	王虹翔									0.0%						00:00:46
18	张禹琛									0.0%						00:00:00
	合计	3/19	11/21	2/2	2/2	3/3	1/1	1/1	23/49	46.9%	4	14	2	1		

#### (守门员)

1	鲁世豪	1/2	5/8	1/3	0/4	0/1		0/2	7/20	35.0%						00:21:13
12	韩乐斌	1/4	0/8	0/3	1/3	0/5			2/23	8.7%	1					00:38:01
16	王虹翔									0.0%						00:00:46
	合计	2/6	5/16	1/6	1/7	0/6		0/2	9/43	20.9%	1					

场上队员：得分/射门

守门员：救球/射门

全队合计	得分	被救	射失	击柱	封球	合计	%
远射	3	9	1	1	5	19	15.8%
近射	11	9	1			21	52.4%
边射	2					2	100.0%
快攻	2					2	100.0%
突破	3					3	100.0%
任意	1					1	100.0%
七米	1					1	100.0%





图式比赛技术统计表

手球  
男子

四分之一决赛  
轮次 6

组别 X  
场次 24

万州体育馆  
2019-04-13 17:30

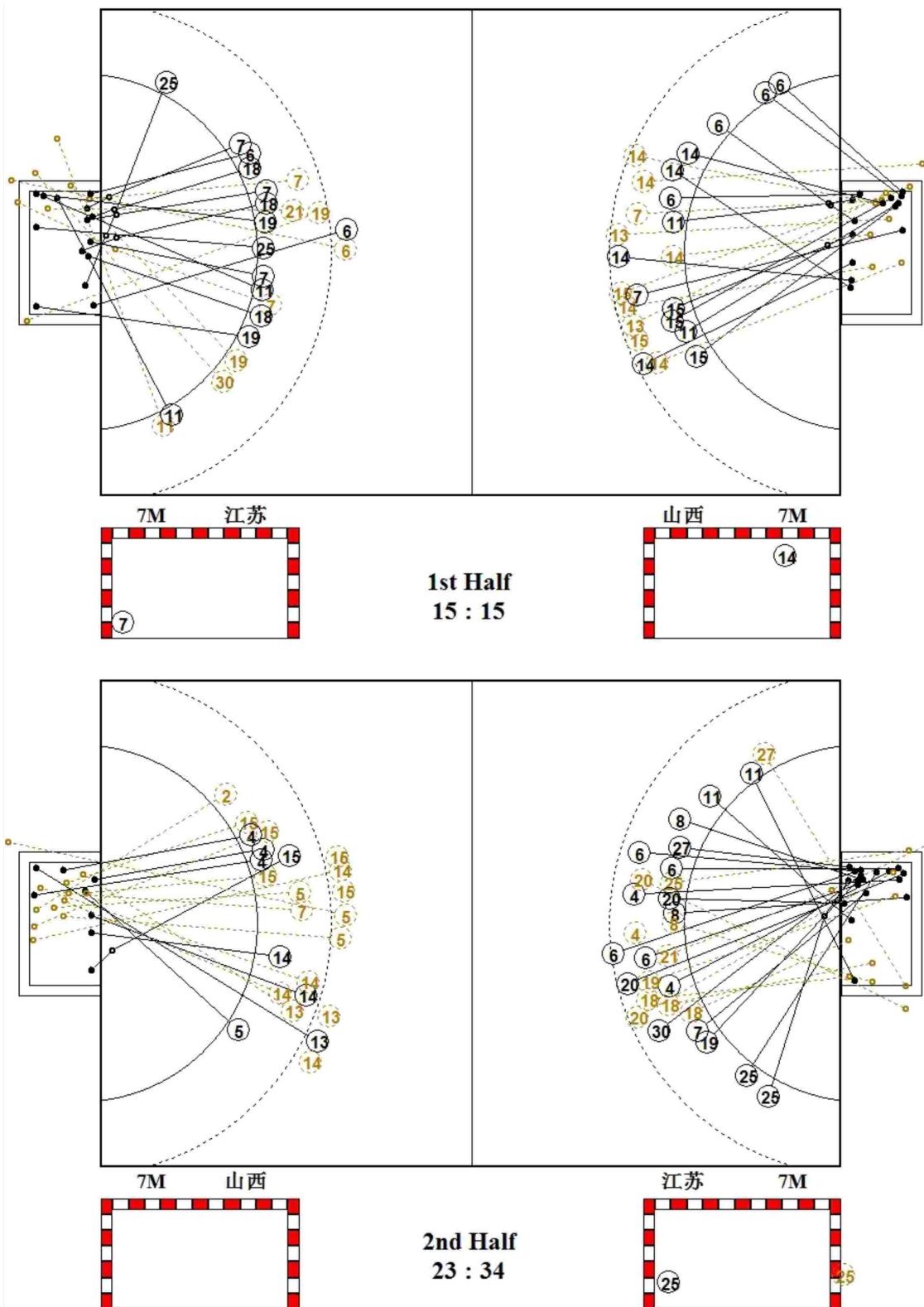

图式射门区域统计

手球  
男子

四分之一决赛  
轮次 6

组别 X  
场次 24

万州体育馆  
2019-04-13 17:30

江苏队

1 宋继强	4 张家纬	6 赵晨	7 周傲	8 谢庆龙	11 张天豪	12 王权	16 张帅																																																																								
<table border="1"><tr><td></td><td></td><td></td></tr><tr><td></td><td></td><td></td></tr><tr><td></td><td></td><td></td></tr></table>										<table border="1"><tr><td>2</td><td></td><td></td></tr><tr><td></td><td></td><td></td></tr><tr><td></td><td></td><td></td></tr></table>	2									<table border="1"><tr><td>1</td><td></td><td></td></tr><tr><td></td><td></td><td></td></tr><tr><td>4</td><td></td><td>1</td></tr></table>	1						4		1	<table border="1"><tr><td></td><td></td><td></td></tr><tr><td>1</td><td></td><td></td></tr><tr><td>1</td><td>1</td><td>2</td></tr></table>				1			1	1	2	<table border="1"><tr><td>1</td><td></td><td></td></tr><tr><td></td><td></td><td></td></tr><tr><td>1</td><td></td><td></td></tr></table>	1						1			<table border="1"><tr><td></td><td></td><td>1</td></tr><tr><td></td><td></td><td>1</td></tr><tr><td></td><td>1</td><td>1</td></tr></table>			1			1		1	1	<table border="1"><tr><td></td><td></td><td></td></tr><tr><td></td><td></td><td></td></tr><tr><td></td><td></td><td></td></tr></table>										<table border="1"><tr><td></td><td></td><td></td></tr><tr><td></td><td></td><td></td></tr><tr><td></td><td></td><td></td></tr></table>									
2																																																																															
1																																																																															
4		1																																																																													
1																																																																															
1	1	2																																																																													
1																																																																															
1																																																																															
		1																																																																													
		1																																																																													
	1	1																																																																													
18 赵楠	19 庞连康	20 顾艳超	21 刘江	25 王杰缘	27 王伟强	30 吴龙瑞																																																																									
<table border="1"><tr><td></td><td></td><td></td></tr><tr><td></td><td></td><td></td></tr><tr><td>2</td><td>1</td><td></td></tr></table>							2	1		<table border="1"><tr><td>1</td><td></td><td>1</td></tr><tr><td></td><td></td><td></td></tr><tr><td>1</td><td></td><td></td></tr></table>	1		1				1			<table border="1"><tr><td>1</td><td></td><td></td></tr><tr><td></td><td></td><td></td></tr><tr><td></td><td>1</td><td></td></tr></table>	1							1		<table border="1"><tr><td></td><td></td><td></td></tr><tr><td></td><td></td><td></td></tr><tr><td></td><td></td><td></td></tr></table>										<table border="1"><tr><td></td><td></td><td>1</td></tr><tr><td>1</td><td></td><td></td></tr><tr><td>3</td><td></td><td></td></tr></table>			1	1			3			<table border="1"><tr><td></td><td></td><td></td></tr><tr><td>1</td><td></td><td></td></tr><tr><td></td><td></td><td></td></tr></table>				1						<table border="1"><tr><td></td><td></td><td></td></tr><tr><td></td><td></td><td></td></tr><tr><td>1</td><td></td><td></td></tr></table>							1												
2	1																																																																														
1		1																																																																													
1																																																																															
1																																																																															
	1																																																																														
		1																																																																													
1																																																																															
3																																																																															
1																																																																															
1																																																																															
Post - 0 Miss - 0 Block - 0	Post - 0 Miss - 0 Block - 1	Post - 0 Miss - 1 Block - 0	Post - 1 Miss - 0 Block - 0	Post - 0 Miss - 0 Block - 0	Post - 0 Miss - 1 Block - 0	Post - 0 Miss - 0 Block - 0	Post - 0 Miss - 0 Block - 0																																																																								

1 宋继强
0/1 1/1
0/1 1/1
0/1 0/1 0/2

12 王权
3/3
1/1 2/3
0/1 2/4

16 张帅
1/6 1/1 1/4
3/3 1/1 1/1
0/3 0/2

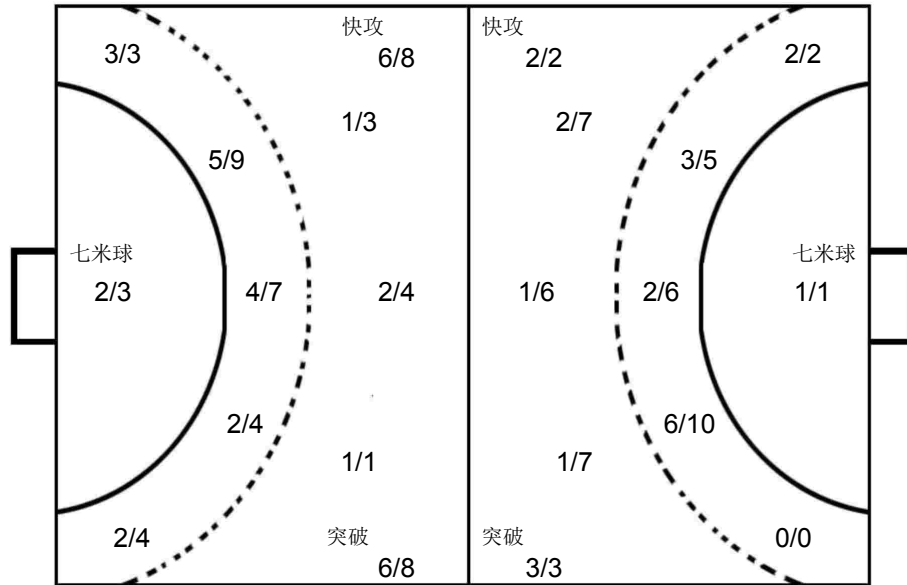

1 鲁世豪
2/4 1/1
0/2 2/2
0/6 1/3 1/2

12 韩乐斌
0/4 1/4
0/1
0/6 0/3 1/5

16 王虹翔

山西队

1 鲁世豪	2 张智超	3 龙俊皓	4 刘文东	5 王宇恒	6 盖秀越	7 任健豪	9 辛浩乐																																																																								
<table border="1"><tr><td></td><td></td><td></td></tr><tr><td></td><td></td><td></td></tr><tr><td></td><td></td><td></td></tr></table>										<table border="1"><tr><td></td><td></td><td></td></tr><tr><td></td><td></td><td></td></tr><tr><td></td><td></td><td></td></tr></table>										<table border="1"><tr><td></td><td></td><td></td></tr><tr><td></td><td></td><td></td></tr><tr><td></td><td></td><td></td></tr></table>										<table border="1"><tr><td></td><td></td><td>1</td></tr><tr><td></td><td></td><td>1</td></tr><tr><td></td><td></td><td>1</td></tr></table>			1			1			1	<table border="1"><tr><td></td><td></td><td></td></tr><tr><td></td><td></td><td></td></tr><tr><td></td><td></td><td>1</td></tr></table>									1	<table border="1"><tr><td>2</td><td></td><td></td></tr><tr><td></td><td></td><td></td></tr><tr><td>2</td><td></td><td></td></tr></table>	2						2			<table border="1"><tr><td>1</td><td></td><td></td></tr><tr><td></td><td></td><td></td></tr><tr><td></td><td></td><td></td></tr></table>	1									<table border="1"><tr><td></td><td></td><td></td></tr><tr><td></td><td></td><td></td></tr><tr><td></td><td></td><td></td></tr></table>									
		1																																																																													
		1																																																																													
		1																																																																													
		1																																																																													
2																																																																															
2																																																																															
1																																																																															
10 王洋	11 吴夏冰	12 韩乐斌	13 杜忠浩	14 杨毅	15 薛瑞寒	16 王虹翔	18 张禹琛																																																																								
<table border="1"><tr><td></td><td></td><td></td></tr><tr><td></td><td></td><td></td></tr><tr><td></td><td></td><td></td></tr></table>										<table border="1"><tr><td>1</td><td></td><td></td></tr><tr><td></td><td></td><td></td></tr><tr><td>1</td><td></td><td></td></tr></table>	1						1			<table border="1"><tr><td></td><td></td><td></td></tr><tr><td></td><td></td><td></td></tr><tr><td></td><td></td><td></td></tr></table>										<table border="1"><tr><td></td><td></td><td>1</td></tr><tr><td></td><td></td><td></td></tr><tr><td></td><td></td><td></td></tr></table>			1							<table border="1"><tr><td></td><td></td><td>1</td></tr><tr><td>1</td><td></td><td></td></tr><tr><td>3</td><td>2</td><td></td></tr></table>			1	1			3	2		<table border="1"><tr><td>2</td><td></td><td></td></tr><tr><td></td><td></td><td></td></tr><tr><td>1</td><td>1</td><td></td></tr></table>	2						1	1		<table border="1"><tr><td></td><td></td><td></td></tr><tr><td></td><td></td><td></td></tr><tr><td></td><td></td><td></td></tr></table>										<table border="1"><tr><td></td><td></td><td></td></tr><tr><td></td><td></td><td></td></tr><tr><td></td><td></td><td></td></tr></table>									
1																																																																															
1																																																																															
		1																																																																													
		1																																																																													
1																																																																															
3	2																																																																														
2																																																																															
1	1																																																																														
Post - 0 Miss - 0 Block - 0	Post - 0 Miss - 0 Block - 0	Post - 0 Miss - 0 Block - 0	Post - 0 Miss - 0 Block - 0	Post - 0 Miss - 1 Block - 0	Post - 0 Miss - 0 Block - 0	Post - 0 Miss - 0 Block - 0	Post - 0 Miss - 0 Block - 0																																																																								



Team A					Team B					Match Number											
A 上海队					B 山东队					26											
Played in			in the hall			on			at			Spectators									
重庆万州			万州体育馆			2019-04-14			13:00			hours									
Half-time(30')	A	B	End of playing time		A	B	1st extra time		A	B	2nd extra time		A	B	After penalty throws						
	12	12	23		21																
Number of 7 m	A	Team time-out			Full name of players and officials						Team time-out			B	Number of 7 m						
	1/1	1	2	3							1	2	3	0/0							
		14:37	59:07									35:51									
No.	Team A					G	W	2'	D	DR	No.	Team B					G	W	2'	D	DR
1	张峥										1	宋晓晨									
3	张立成										6	李朝鹏					3				
4	高天伦					1					7	林豪文					3				
5	贺政					9					8	王炳华					1				
7	周文龙										9	赵元									
8	高震东					1		1			10	赵建强					4				
10	朱世杰					6					11	宋朋强					2		1		
11	蒋慧捷										12	于性哲									
12	周哲韬										13	刘晓									
13	谢智超					2					15	张继伟									
15	庄旭杰										17	王旭东									
18	董凯										19	李语庆									
20	蒋承骅										21	姜春辉					1				
23	吴双					4					27	胡晋铭					1				
30	徐俊吉							1			31	于亚男					3				
											34	王钟彬					3		1		
A	吴璟 (主教练)										B	王鸿斌 (主教练)									
B	金迪琦										C	金京男									
C	张勇军										D	刘桂妮									
D	杨时										E	林配永									
A	Signatures of responsables for the teams (Off.A)																			B	
TP	Remarks of referees / HF Official																			TP	

Signatures

Referees	王雨洋 (CHN)	伍豪 (CHN)		
T.D.	郭剑 (CHN)	张春生 (CHN)		
CHA Off.				

Note: Number of 7m Throws Awarded to Team A and B, Goals (G), Warnings (W), Suspensions (2'), Direct Disqualification (D), Disqualification With Report (DR) and Team Penalty (TP).

Table Officials: 刘明华

张晓虎

Statisticians: 赵悦

谢杨

2019年全国男子手球冠军杯赛

PHMS Pictorial Handball Match Statistics

IHF Official System

竞赛技术统计

手球 男子 5-8名 轮次 7 组别 X 场次 26 万州体育馆 2019-04-14 13:00

Referees: 王雨洋 (CHN) / 伍豪 (CHN) Result: 23:21(12:12)  
Teams: 上海队(上海) VS 山东队(山东)

上海		远	近	边	快	突	任意	7m	合计	%	助攻	失误	警告	2'	D+DR
主教练: 吴璟		射	射	射	攻	破	球	球							
1	张峥										1	1			
3	张立成			0/1					0/1	0.0		1			
4	高天伦			1/1					1/1	100					
5	贺政	2/6	2/2	1/2	2/2	1/1		1/1	9/14	64.3		2			
7	周文龙														
8	高震东		1/1	0/1		0/1			1/3	33.3		4		1	
10	朱世杰	3/7	0/1	1/1	0/1	1/1	1/1		6/12	50.0	1	3			
11	蒋慧捷														
12	周哲韬														
13	谢智超			2/6					2/6	33.3	1	1			
15	庄旭杰														
18	董凯											1			
20	蒋承骅														
23	吴双		2/3	0/1	2/3				4/7	57.1		2			
30	徐俊吉											4	1		
运动员 合计		5/13	5/7	5/13	4/6	2/3	1/1	1/1	23/44	52.3	3	19	1	1	
1	张峥	4/7	3/5	2/6	0/7	1/6			10/31	32.3	1	1			
守门员 合计		4/7	3/5	2/6	0/7	1/6			10/31	32.3	1	1			

山东		远	近	边	快	突	任意	7m	合计	%	助攻	失误	警告	2'	D+DR
主教练: 王鸿斌		射	射	射	攻	破	球	球							
1	宋晓晨										1				
6	李朝鹏			1/2	1/1	1/1			3/4	75.0		2			
7	林豪文	0/2	1/4			2/2			3/8	37.5		1			
8	王炳华		1/1						1/1	100					
9	赵元			0/2					0/2	0.0					
10	赵建强			1/2	3/4				4/6	66.7		1			
11	宋朋强	2/2				0/1			2/3	66.7				1	
12	于性哲														
13	刘晓	0/1				0/1			0/2	0.0		3			
15	张继伟		0/1		0/1				0/2	0.0					
17	王旭东											3			
19	李语庆														
21	姜春辉			1/2					1/2	50.0					
27	胡晋铭		0/1		1/1				1/2	50.0					
31	于亚男	1/3			1/1	1/1			3/5	60.0		1			
34	王钟彬	0/1		1/1	1/1	1/1			3/4	75.0		2		1	
运动员 合计		3/9	2/7	4/9	7/9	5/7			21/41	51.2	2	13		2	
1	宋晓晨		0/2	1/3	0/2			0/1	1/8	12.5	1				
12	于性哲	5/10	1/4	4/7	1/3	1/3	0/1		12/28	42.9	1				
守门员 合计		5/10	1/6	5/10	1/5	1/3	0/1	0/1	13/36	36.1	2				

上海	比赛进程	山东
1st Half		
10 朱世杰	1 00:45 0	
5 贺政	2 02:37 0	
	2 03:57 1 31 于亚男	
	2 04:56 2 27 胡晋铭	
4 高天伦	3 05:55 2	
5 贺政	4 06:44 2	
5 贺政	5 07:39 2	
5 贺政	6 08:47 2	
	6 09:13 3 31 于亚男	
	6 10:40 4 6 李朝鹏	
	6 12:07 5 10 赵建强	
	6 13:40 6 10 赵建强	
	6 14:25 7 6 李朝鹏	
10 朱世杰	7 15:02 7	
	7 17:26 8 11 宋朋强	
5 贺政	8 20:31 8	
	8 21:20 9 6 李朝鹏	
5 贺政	9 21:45 9	
	9 23:20 10 10 赵建强	
	9 24:11 11 31 于亚男	
10 朱世杰	10 24:57 11	
8 高震东	11 28:13 11	
	11 28:51 12 11 宋朋强	
10 朱世杰	12 29:58 12	
2nd Half		
	12 02:35 13 34 王钟彬	
5 贺政	13 08:28 13	
23 吴双	14 09:07 13	
	14 09:55 14 7 林豪文	
13 谢智超	15 10:34 14	
5 贺政	16 11:46 14	
	16 13:11 15 10 赵建强	
5 贺政	17 13:35 15	
	17 14:14 16 21 姜春辉	
13 谢智超	18 14:59 16	
23 吴双	19 15:55 16	
10 朱世杰	20 17:36 16	
	20 22:03 17 7 林豪文	
23 吴双	21 22:42 17	
	21 23:33 18 34 王钟彬	
10 朱世杰	22 24:54 18	
	22 25:56 19 34 王钟彬	
23 吴双	23 27:26 19	
	23 27:50 20 7 林豪文	
	23 28:46 21 8 王炳华	

场上队员: 得分 / 射门

守门员: 救球 / 射门

D	取消资格	DR	取消资格+报告
---	------	----	---------



2019年全国男子手球冠军杯赛

PHMS Pictorial Handball Match Statistics

IHF Official System

个人/全队技术统计表

手球 男子 5-8名 轮次 7 组别 X 场次 26 万州体育馆 2019-04-14 13:00

号码	姓名	远射	近射	边射	快攻	突破	任意	七米	合计	%	助攻	失误	警告	2'	取消	时间
上海队(上海)																
(场上队员)																
1	张崢									0.0%	1	1				01:00:00
3	张立成			0/1					0/1	0.0%		1				00:18:58
4	高天伦			1/1					1/1	100%						00:23:28
5	贺政	2/6	2/2	1/2	2/2	1/1		1/1	9/14	64.3%		2				00:59:33
7	周文龙									0.0%						00:00:00
8	高震东		1/1	0/1		0/1			1/3	33.3%		4		1		00:48:29
10	朱世杰	3/7	0/1	1/1	0/1	1/1	1/1		6/12	50.0%	1	3				01:00:00
11	蒋慧捷									0.0%						00:00:00
12	周哲韬									0.0%						00:00:00
13	谢智超			2/6					2/6	33.3%	1	1				00:27:48
15	庄旭杰									0.0%						00:00:00
18	董凯									0.0%		1				00:22:03
20	蒋承骅									0.0%						00:18:09
23	吴双		2/3	0/1	2/3				4/7	57.1%		2				00:41:18
30	徐俊吉									0.0%		4	1			00:39:05
合计		5/13	5/7	5/13	4/6	2/3	1/1	1/1	23/44	52.3%	3	19	1	1		
(守门员)																
1	张崢	4/7	3/5	2/6	0/7	1/6			10/31	32.3%	1	1				01:00:00
合计		4/7	3/5	2/6	0/7	1/6			10/31	32.3%	1	1				

场上队员： 得分/射门

守门员： 救球/射门

全队合计	得分	被救	射失	击柱	封球	合计	%
远射	5	5			3	13	38.5%
近射	5	1	1			7	71.4%
边射	5	5	3			13	38.5%
快攻	4	1		1		6	66.7%
突破	2	1				3	66.7%
任意	1					1	100.0%
七米	1					1	100.0%

2019年全国男子手球冠军杯赛

PHMS Pictorial Handball Match Statistics

IHF Official System

个人/全队技术统计表

手球 男子 5-8名 轮次 7 组别 X 场次 26 万州体育馆 2019-04-14 13:00

号码	姓名	远射	近射	边射	快攻	突破	任意	七米	合计	%	助攻	失误	警告	2'	取消	时间
山东队(山东)																
(场上队员)																
1	宋晓晨									0.0%	1					00:15:37
6	李朝鹏			1/2	1/1	1/1			3/4	75.0%		2				00:30:00
7	林豪文	0/2	1/4			2/2			3/8	37.5%		1				00:13:22
8	王炳华		1/1						1/1	100%						00:17:29
9	赵元			0/2					0/2	0.0%						00:05:51
10	赵建强			1/2	3/4				4/6	66.7%		1				01:00:00
11	宋朋强	2/2				0/1			2/3	66.7%				1		00:30:00
12	于性哲									0.0%	1					00:44:23
13	刘晓	0/1				0/1			0/2	0.0%		3				00:29:45
15	张继伟		0/1		0/1				0/2	0.0%						00:28:52
17	王旭东									0.0%		3				00:30:00
19	李语庆									0.0%						00:00:00
21	姜春辉			1/2					1/2	50.0%						00:24:02
27	胡晋铭		0/1		1/1				1/2	50.0%						00:31:08
31	于亚男	1/3			1/1	1/1			3/5	60.0%		1				00:30:00
34	王钟彬	0/1		1/1	1/1	1/1			3/4	75.0%		2		1		00:28:46
合计		3/9	2/7	4/9	7/9	5/7			21/41	51.2%	2	13		2		
(守门员)																
1	宋晓晨		0/2	1/3	0/2			0/1	1/8	12.5%	1					00:15:37
12	于性哲	5/10	1/4	4/7	1/3	1/3	0/1		12/28	42.9%	1					00:44:23
合计		5/10	1/6	5/10	1/5	1/3	0/1	0/1	13/36	36.1%	2					

场上队员：得分/射门

守门员：救球/射门

全队合计	得分	被救	射失	击柱	封球	合计	%
远射	3	4	1		1	9	33.3%
近射	2	3	1	1		7	28.6%
边射	4	2	1	2		9	44.4%
快攻	7		2			9	77.8%
突破	5	1		1		7	71.4%
任意							0.0%
七米							0.0%

图式比赛技术统计表

手球  
男子

5-8名  
轮次 7

组别 X  
场次 26

万州体育馆  
2019-04-14 13:00

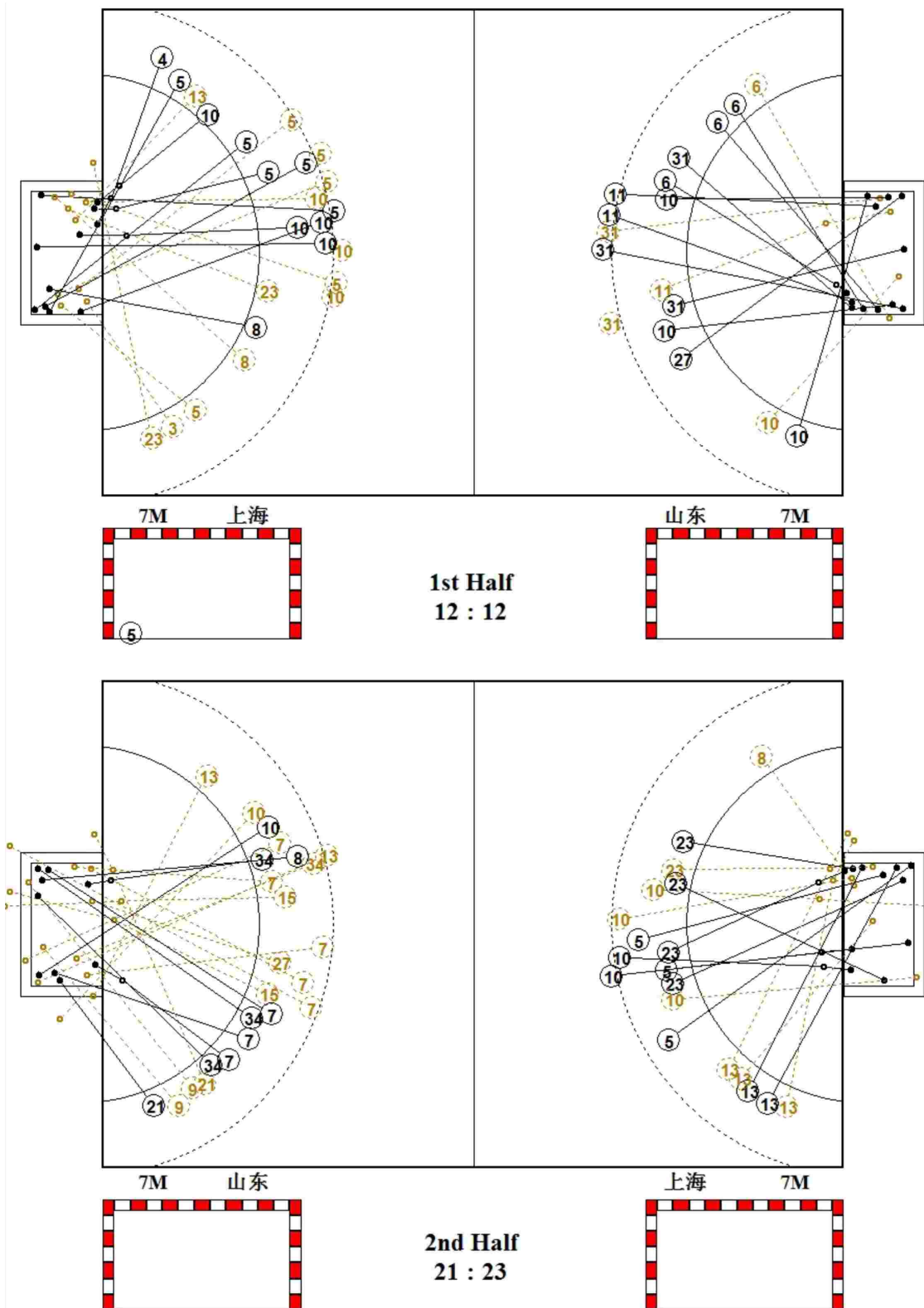

图式射门区域统计

手球  
男子

5-8名  
轮次 7

组别 X  
场次 26

万州体育馆  
2019-04-14 13:00

上海队

1 张峥	3 张立成	4 高天伦	5 贺政	7 周文龙	8 高震东	10 朱世杰	11 蒋慧捷																																																																								
<table border="1"><tr><td></td><td></td><td></td></tr><tr><td></td><td></td><td></td></tr><tr><td></td><td></td><td></td></tr></table>										<table border="1"><tr><td></td><td></td><td></td></tr><tr><td></td><td></td><td></td></tr><tr><td></td><td></td><td></td></tr></table>										<table border="1"><tr><td></td><td></td><td></td></tr><tr><td></td><td></td><td></td></tr><tr><td></td><td></td><td>1</td></tr></table>									1	<table border="1"><tr><td>4</td><td>1</td><td>1</td></tr><tr><td>1</td><td></td><td></td></tr><tr><td>1</td><td></td><td>1</td></tr></table>	4	1	1	1			1		1	<table border="1"><tr><td></td><td></td><td></td></tr><tr><td></td><td></td><td></td></tr><tr><td></td><td></td><td></td></tr></table>										<table border="1"><tr><td>1</td><td></td><td></td></tr><tr><td></td><td></td><td></td></tr><tr><td></td><td></td><td></td></tr></table>	1									<table border="1"><tr><td></td><td>1</td><td></td></tr><tr><td></td><td></td><td></td></tr><tr><td>1</td><td>1</td><td>3</td></tr></table>		1					1	1	3	<table border="1"><tr><td></td><td></td><td></td></tr><tr><td></td><td></td><td></td></tr><tr><td></td><td></td><td></td></tr></table>									
		1																																																																													
4	1	1																																																																													
1																																																																															
1		1																																																																													
1																																																																															
	1																																																																														
1	1	3																																																																													
Post - 0 Miss - 0 Block - 0	Post - 0 Miss - 0 Block - 0	Post - 0 Miss - 0 Block - 0	Post - 0 Miss - 0 Block - 1	Post - 0 Miss - 0 Block - 0	Post - 0 Miss - 0 Block - 0	Post - 1 Miss - 1 Block - 2	Post - 0 Miss - 0 Block - 0																																																																								
12 周哲韬	13 谢智超	15 庄旭杰	18 董凯	20 蒋承骅	23 吴双	30 徐俊吉																																																																									
<table border="1"><tr><td></td><td></td><td></td></tr><tr><td></td><td></td><td></td></tr><tr><td></td><td></td><td></td></tr></table>										<table border="1"><tr><td>1</td><td></td><td></td></tr><tr><td></td><td></td><td></td></tr><tr><td>1</td><td></td><td></td></tr></table>	1						1			<table border="1"><tr><td></td><td></td><td></td></tr><tr><td></td><td></td><td></td></tr><tr><td></td><td></td><td></td></tr></table>										<table border="1"><tr><td></td><td></td><td></td></tr><tr><td></td><td></td><td></td></tr><tr><td></td><td></td><td></td></tr></table>										<table border="1"><tr><td></td><td></td><td></td></tr><tr><td></td><td></td><td></td></tr><tr><td></td><td></td><td></td></tr></table>										<table border="1"><tr><td>1</td><td></td><td></td></tr><tr><td></td><td></td><td>1</td></tr><tr><td>2</td><td></td><td></td></tr></table>	1					1	2			<table border="1"><tr><td></td><td></td><td></td></tr><tr><td></td><td></td><td></td></tr><tr><td></td><td></td><td></td></tr></table>																			
1																																																																															
1																																																																															
1																																																																															
		1																																																																													
2																																																																															
Post - 0 Miss - 0 Block - 0	Post - 0 Miss - 2 Block - 0	Post - 0 Miss - 0 Block - 0	Post - 0 Miss - 0 Block - 0	Post - 0 Miss - 0 Block - 0	Post - 0 Miss - 1 Block - 0	Post - 0 Miss - 0 Block - 0																																																																									

1 张峥

3/6	0/1	1/7
2/6		1/2
1/2		2/7

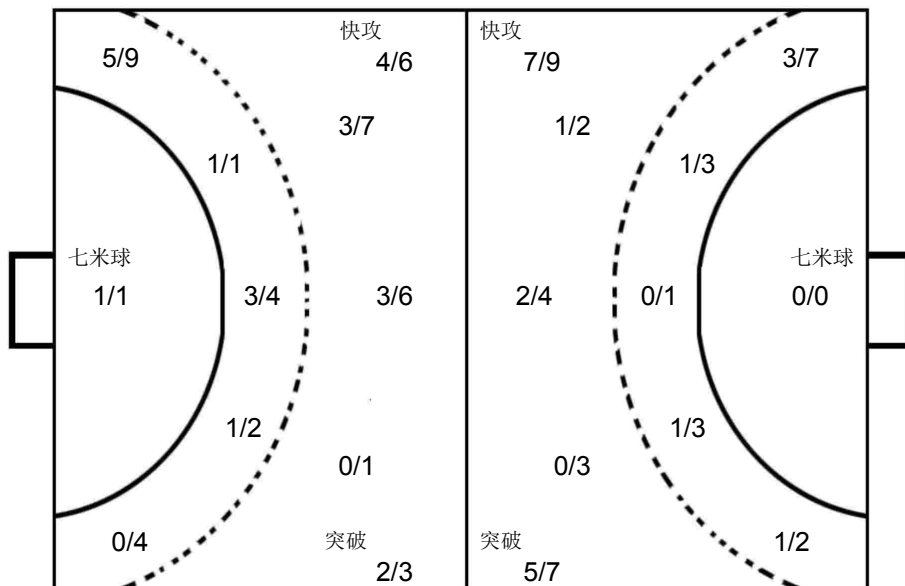

1 宋晓晨

0/2	0/1	
0/1		
1/4		

12 于性哲

0/5	0/1	1/2
4/4	1/1	3/4
2/4	0/1	1/6

山东队

1 宋晓晨	6 李朝鹏	7 林豪文	8 王炳华	9 赵元	10 赵建强	11 宋朋强	12 于性哲																																																																								
<table border="1"><tr><td></td><td></td><td></td></tr><tr><td></td><td></td><td></td></tr><tr><td></td><td></td><td></td></tr></table>										<table border="1"><tr><td></td><td></td><td>1</td></tr><tr><td></td><td></td><td>2</td></tr><tr><td></td><td></td><td></td></tr></table>			1			2				<table border="1"><tr><td>1</td><td></td><td>1</td></tr><tr><td></td><td></td><td></td></tr><tr><td>1</td><td></td><td></td></tr></table>	1		1				1			<table border="1"><tr><td></td><td></td><td>1</td></tr><tr><td></td><td></td><td></td></tr><tr><td></td><td></td><td></td></tr></table>			1							<table border="1"><tr><td></td><td></td><td></td></tr><tr><td></td><td></td><td></td></tr><tr><td></td><td></td><td></td></tr></table>										<table border="1"><tr><td>1</td><td></td><td>1</td></tr><tr><td>2</td><td></td><td></td></tr><tr><td></td><td></td><td></td></tr></table>	1		1	2						<table border="1"><tr><td></td><td></td><td></td></tr><tr><td>1</td><td></td><td></td></tr><tr><td></td><td></td><td>1</td></tr></table>				1					1	<table border="1"><tr><td></td><td></td><td></td></tr><tr><td></td><td></td><td></td></tr><tr><td></td><td></td><td></td></tr></table>									
		1																																																																													
		2																																																																													
1		1																																																																													
1																																																																															
		1																																																																													
1		1																																																																													
2																																																																															
1																																																																															
		1																																																																													
Post - 0 Miss - 0 Block - 0	Post - 1 Miss - 0 Block - 0	Post - 1 Miss - 1 Block - 0	Post - 0 Miss - 0 Block - 0	Post - 1 Miss - 0 Block - 0	Post - 0 Miss - 1 Block - 0	Post - 0 Miss - 0 Block - 0	Post - 0 Miss - 0 Block - 0																																																																								
13 刘晓	15 张继伟	17 王旭东	19 李语庆	21 姜春辉	27 胡晋铭	31 于亚男	34 王钟彬																																																																								
<table border="1"><tr><td></td><td></td><td></td></tr><tr><td></td><td></td><td></td></tr><tr><td></td><td></td><td></td></tr></table>										<table border="1"><tr><td></td><td></td><td></td></tr><tr><td></td><td></td><td></td></tr><tr><td></td><td></td><td></td></tr></table>										<table border="1"><tr><td></td><td></td><td></td></tr><tr><td></td><td></td><td></td></tr><tr><td></td><td></td><td></td></tr></table>										<table border="1"><tr><td></td><td></td><td></td></tr><tr><td></td><td></td><td></td></tr><tr><td></td><td></td><td></td></tr></table>										<table border="1"><tr><td></td><td></td><td></td></tr><tr><td>1</td><td></td><td></td></tr><tr><td></td><td></td><td></td></tr></table>				1						<table border="1"><tr><td>1</td><td></td><td></td></tr><tr><td></td><td></td><td></td></tr><tr><td></td><td></td><td></td></tr></table>	1									<table border="1"><tr><td></td><td>1</td><td>1</td></tr><tr><td></td><td></td><td></td></tr><tr><td></td><td></td><td>1</td></tr></table>		1	1						1	<table border="1"><tr><td></td><td></td><td>2</td></tr><tr><td></td><td></td><td></td></tr><tr><td></td><td></td><td>1</td></tr></table>			2						1
1																																																																															
1																																																																															
	1	1																																																																													
		1																																																																													
		2																																																																													
		1																																																																													
Post - 1 Miss - 0 Block - 0	Post - 0 Miss - 2 Block - 0	Post - 0 Miss - 0 Block - 0	Post - 0 Miss - 0 Block - 0	Post - 0 Miss - 1 Block - 0	Post - 0 Miss - 0 Block - 0	Post - 0 Miss - 0 Block - 1	Post - 0 Miss - 0 Block - 0																																																																								





**PHMS** Pictorial Handball Match Statistics **IHF** Official System

Team A	Team B	Match Number
A 广东队	B 山西队	27

Played in	in the hall	on	at	Spepectors
重庆万州	万州体育馆	2019-04-14	14:30	hours

Half-time(30')	A	B	End of playing time	A	B	1st extra time	A	B	2nd extra time	A	B	After penalty throws	A	B
	15	8	27	21										

Number of 7 m	A	Team time-out			Full name of players and officials	Team time-out			B	Number of 7 m
	2/3	1	2	3		1	2	3	1/3	
		27:26	49:26			17:45	25:00	58:16		

No.	Team A	G	W	2'	D	DR	No.	Team B	G	W	2'	D	DR
2	孙江山						1	鲁世豪					
6	毕晓晨	7					2	张智超					
7	王立隆	5					3	龙俊皓					
9	范保坤						4	刘文东	1		1		
10	周仲坤	4					5	王宇恒			1		
11	房友屯						6	盖秀越	5	1			
12	王雨	1		1			7	任健豪	3				
14	王泽润						9	辛浩乐					
15	张建杰	5		1			10	王洋		1			
18	姚雪岩						11	吴夏冰					
19	王帅						12	韩乐斌					
21	张昌轲						13	杜忠浩					
22	黄培杰	3					14	杨毅	11				
24	高玉杰	2	1				15	薛瑞寒	1				
							16	王虹翔					
							18	张禹琛					
A	曲汝洋						A	张栋					
B	刘康伶 (主教练)						B	赵鑫 (主教练)	1				
C	郭艳辉						C	霖配永					
E	贾章志												

A	Signatures of responsables for the teams (Off.A)	B
---	--	---

TP	Remarks of referees / HF Official	TP
----	-----------------------------------	----

Signatures			
Referees	周云磊 (CHN)	陈常增 (CHN)	
T.D.	郭剑 (CHN)	张春生 (CHN)	
CHA Off.			

Note: Number of 7m Throws Awarded to Team A and B, Goals (G), Warnings (W), Suspensions (2'), Direct Disqualification (D), Disqualification With Report (DR) and Team Penalty (TP).

Table Officials: 严璐                      周胜锋                      Statisticians: 谢杨                      周亚桥



2019年全国男子手球冠军杯赛

PHMS Pictorial Handball Match Statistics

IHF Official System

个人/全队技术统计表

手球 男子 5-8名 轮次 7 组别 X 场次 27 万州体育馆 2019-04-14 14:30

号码	姓名	远射	近射	边射	快攻	突破	任意	七米	合计	%	助攻	失误	警告	2'	取消	时间
广东队(广东)																
(场上队员)																
2	孙江山									0.0%						00:00:00
6	毕晓晨	3/4	1/3	2/2	1/1				7/10	70.0%		2				00:54:48
7	王立隆			3/4	2/3				5/7	71.4%		2				01:00:00
9	范保坤									0.0%						00:00:00
10	周仲坤	1/1	1/2					2/3	4/6	66.7%						00:52:28
11	房友屯									0.0%						00:04:32
12	王雨	0/1		1/2					1/3	33.3%		1		1		01:00:00
14	王泽润									0.0%						00:37:04
15	张建杰	5/7	0/1		0/1	0/1			5/10	50.0%	1	1		1		00:52:35
18	姚雪岩									0.0%	1					00:14:50
19	王帅									0.0%		2				00:22:56
21	张昌轲									0.0%						00:00:00
22	黄培杰	0/2	0/1	1/1		2/3			3/7	42.9%	2	2				00:25:26
24	高玉杰		1/1		1/1				2/2	100%				1		00:34:00
	合计	9/15	3/8	7/9	4/6	2/4		2/3	27/45	60.0%	4	10	1	2		
(守门员)																
14	王泽润	3/8	4/5	1/3	0/1	1/3			9/20	45.0%						00:37:04
19	王帅	1/3	2/4	0/1	1/2	0/3		2/3	6/16	37.5%		2				00:22:56
	合计	4/11	6/9	1/4	1/3	1/6		2/3	15/36	41.7%		2				

场上队员：得分/射门

守门员：救球/射门

全队合计	得分	被救	射失	击柱	封球	合计	%
远射	9	3	2		1	15	60.0%
近射	3	3	1	1		8	37.5%
边射	7	2				9	77.8%
快攻	4	2				6	66.7%
突破	2	1	1			4	50.0%
任意							0.0%
七米	2	1				3	66.7%

2019年全国男子手球冠军杯赛

PHMS Pictorial Handball Match Statistics

IHF Official System

个人/全队技术统计表

手球 男子 5-8名 轮次 7 组别 X 场次 27 万州体育馆 2019-04-14 14:30

号码	姓名	远射	近射	边射	快攻	突破	任意	七米	合计	%	助攻	失误	警告	2'	取消	时间
山西队(山西)																
(场上队员)																
1	鲁世豪									0.0%						00:01:41
2	张智超									0.0%	2					00:16:49
3	龙俊皓									0.0%						00:00:00
4	刘文东				1/1				1/1	100%				1		00:24:56
5	王宇恒	0/1							0/1	0.0%		1		1		00:30:03
6	盖秀越			3/3	1/1	1/1		0/1	5/6	83.3%		1	1			00:55:46
7	任健豪	0/2	1/3		0/1	2/3			3/9	33.3%	1	4				00:45:27
9	辛浩乐									0.0%						00:00:00
10	王洋			0/1					0/1	0.0%				1		00:43:27
11	吴夏冰		0/2						0/2	0.0%						00:57:23
12	韩乐斌									0.0%						00:58:19
13	杜忠浩									0.0%						00:00:00
14	杨毅	7/15	1/3	0/1		2/4		1/2	11/25	44.0%		4				00:49:59
15	薛瑞寒		1/5						1/5	20.0%		2				00:36:37
16	王虹翔									0.0%						00:00:00
18	张禹琛									0.0%						00:00:00
	合计	7/18	3/13	3/5	2/3	5/8		1/3	21/50	42.0%	3	12	2	2		
(守门员)																
1	鲁世豪	0/1						0/1	0/2	0.0%						00:01:41
12	韩乐斌	3/11	3/6	2/9	2/6	1/3		1/2	12/37	32.4%						00:58:19
	合计	3/12	3/6	2/9	2/6	1/3		1/3	12/39	30.8%						

场上队员：得分/射门

守门员：救球/射门

全队合计	得分	被救	射失	击柱	封球	合计	%
远射	7	4	3		4	18	38.9%
近射	3	6	2		2	13	23.1%
边射	3	1	1			5	60.0%
快攻	2	1				3	66.7%
突破	5	1	2			8	62.5%
任意							0.0%
七米	1	2				3	33.3%

图式比赛技术统计表

手球  
男子

5-8名  
轮次 7

组别 X  
场次 27

万州体育馆  
2019-04-14 14:30

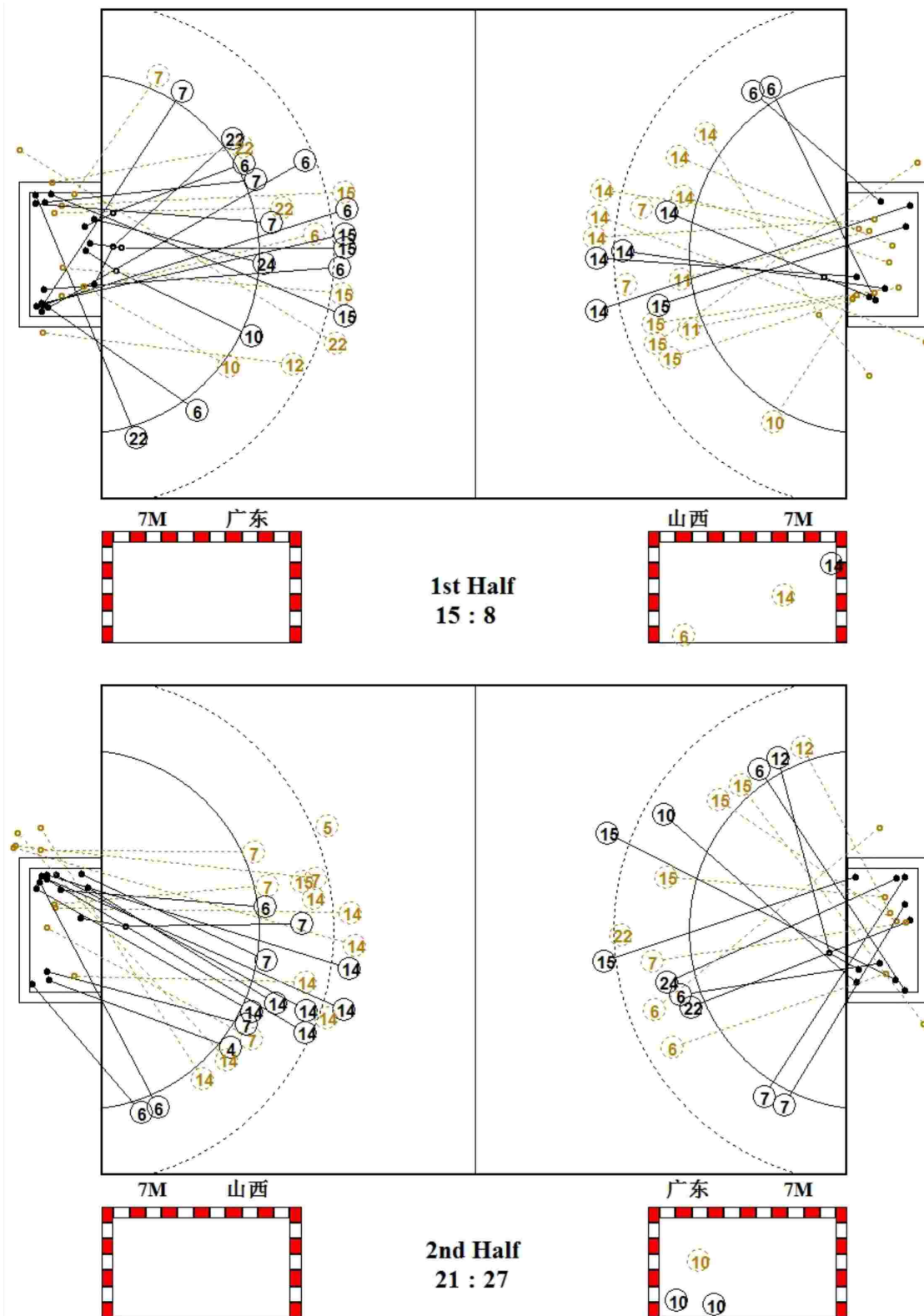

图式射门区域统计

手球  
男子

5-8名  
轮次 7

组别 X  
场次 27

万州体育馆  
2019-04-14 14:30

广东队

2 孙江山	6 毕晓晨	7 王立隆	9 范保坤	10 周仲坤	11 房友屯	12 王雨	14 王泽润																																																																								
<table border="1"><tr><td></td><td></td><td></td></tr><tr><td></td><td></td><td></td></tr><tr><td></td><td></td><td></td></tr></table>										<table border="1"><tr><td>4</td><td></td><td>1</td></tr><tr><td></td><td></td><td>1</td></tr><tr><td></td><td></td><td>1</td></tr></table>	4		1			1			1	<table border="1"><tr><td>3</td><td></td><td>2</td></tr><tr><td></td><td></td><td></td></tr><tr><td></td><td></td><td></td></tr></table>	3		2							<table border="1"><tr><td></td><td></td><td></td></tr><tr><td></td><td></td><td></td></tr><tr><td></td><td></td><td></td></tr></table>										<table border="1"><tr><td></td><td></td><td></td></tr><tr><td></td><td></td><td></td></tr><tr><td>2</td><td>1</td><td>1</td></tr></table>							2	1	1	<table border="1"><tr><td></td><td></td><td></td></tr><tr><td></td><td></td><td></td></tr><tr><td></td><td></td><td></td></tr></table>										<table border="1"><tr><td></td><td></td><td></td></tr><tr><td></td><td></td><td></td></tr><tr><td></td><td></td><td>1</td></tr></table>									1	<table border="1"><tr><td></td><td></td><td></td></tr><tr><td></td><td></td><td></td></tr><tr><td></td><td></td><td></td></tr></table>									
4		1																																																																													
		1																																																																													
		1																																																																													
3		2																																																																													
2	1	1																																																																													
		1																																																																													
Post - 0 Miss - 0 Block - 0	Post - 0 Miss - 1 Block - 0	Post - 0 Miss - 0 Block - 0	Post - 0 Miss - 0 Block - 0	Post - 0 Miss - 0 Block - 0	Post - 0 Miss - 0 Block - 0	Post - 0 Miss - 1 Block - 0	Post - 0 Miss - 0 Block - 0																																																																								
15 张建杰	18 姚雪岩	19 王帅	21 张昌轲	22 黄培杰	24 高玉杰																																																																										
<table border="1"><tr><td>1</td><td></td><td>2</td></tr><tr><td></td><td></td><td></td></tr><tr><td>1</td><td>1</td><td></td></tr></table>	1		2				1	1		<table border="1"><tr><td></td><td></td><td></td></tr><tr><td></td><td></td><td></td></tr><tr><td></td><td></td><td></td></tr></table>										<table border="1"><tr><td></td><td></td><td></td></tr><tr><td></td><td></td><td></td></tr><tr><td></td><td></td><td></td></tr></table>										<table border="1"><tr><td></td><td></td><td></td></tr><tr><td></td><td></td><td></td></tr><tr><td></td><td></td><td></td></tr></table>										<table border="1"><tr><td></td><td>1</td><td>1</td></tr><tr><td></td><td></td><td></td></tr><tr><td>1</td><td></td><td></td></tr></table>		1	1				1			<table border="1"><tr><td>1</td><td></td><td></td></tr><tr><td></td><td></td><td></td></tr><tr><td></td><td></td><td>1</td></tr></table>	1								1																				
1		2																																																																													
1	1																																																																														
	1	1																																																																													
1																																																																															
1																																																																															
		1																																																																													
Post - 0 Miss - 1 Block - 0	Post - 0 Miss - 0 Block - 0	Post - 0 Miss - 0 Block - 0	Post - 0 Miss - 0 Block - 0	Post - 1 Miss - 1 Block - 1	Post - 0 Miss - 0 Block - 0																																																																										

14 王泽润

0/2		1/5
2/3	1/1	1/3
2/2		2/4

19 王帅

0/3	1/1	1/3
	2/2	1/3
1/1	0/1	0/2

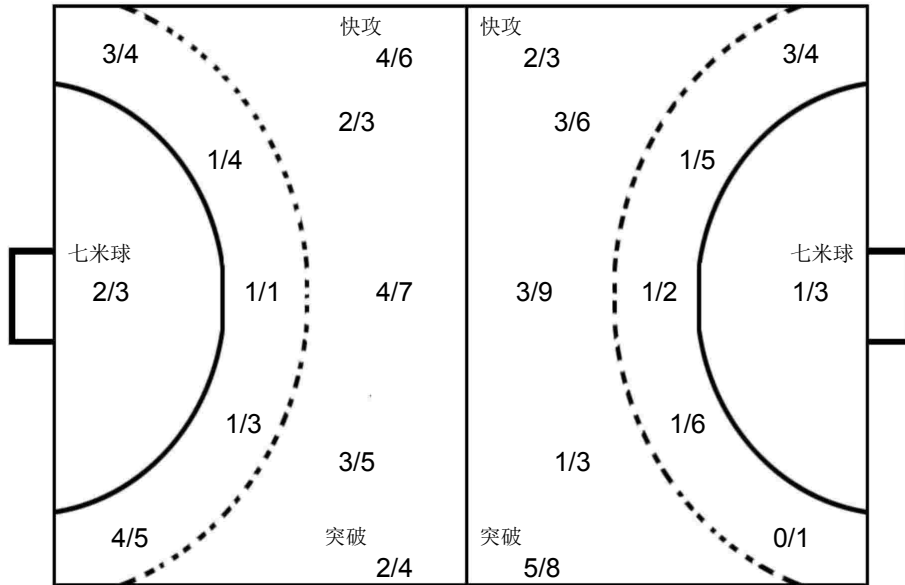

1 鲁世豪

0/1	0/1	

12 韩乐斌

0/9	2/3	1/7
3/3	2/2	3/4
1/4	0/1	0/4

山西队

1 鲁世豪	2 张智超	3 龙俊皓	4 刘文东	5 王宇恒	6 盖秀越	7 任健豪	9 辛浩乐																																																																								
<table border="1"><tr><td></td><td></td><td></td></tr><tr><td></td><td></td><td></td></tr><tr><td></td><td></td><td></td></tr></table>										<table border="1"><tr><td></td><td></td><td></td></tr><tr><td></td><td></td><td></td></tr><tr><td></td><td></td><td></td></tr></table>										<table border="1"><tr><td></td><td></td><td></td></tr><tr><td></td><td></td><td></td></tr><tr><td></td><td></td><td></td></tr></table>										<table border="1"><tr><td>1</td><td></td><td></td></tr><tr><td></td><td></td><td></td></tr><tr><td></td><td></td><td></td></tr></table>	1									<table border="1"><tr><td></td><td></td><td></td></tr><tr><td></td><td></td><td></td></tr><tr><td></td><td></td><td></td></tr></table>										<table border="1"><tr><td>1</td><td></td><td>1</td></tr><tr><td>1</td><td></td><td>2</td></tr><tr><td></td><td></td><td></td></tr></table>	1		1	1		2				<table border="1"><tr><td>1</td><td></td><td></td></tr><tr><td></td><td></td><td></td></tr><tr><td></td><td>1</td><td>1</td></tr></table>	1							1	1	<table border="1"><tr><td></td><td></td><td></td></tr><tr><td></td><td></td><td></td></tr><tr><td></td><td></td><td></td></tr></table>									
1																																																																															
1		1																																																																													
1		2																																																																													
1																																																																															
	1	1																																																																													
Post - 0 Miss - 0 Block - 0	Post - 0 Miss - 0 Block - 0	Post - 0 Miss - 0 Block - 0	Post - 0 Miss - 0 Block - 0	Post - 0 Miss - 0 Block - 1	Post - 0 Miss - 0 Block - 0	Post - 0 Miss - 2 Block - 2	Post - 0 Miss - 0 Block - 0																																																																								
10 王洋	11 吴夏冰	12 韩乐斌	13 杜忠浩	14 杨毅	15 薛瑞寒	16 王虹翔	18 张禹琛																																																																								
<table border="1"><tr><td></td><td></td><td></td></tr><tr><td></td><td></td><td></td></tr><tr><td></td><td></td><td></td></tr></table>										<table border="1"><tr><td></td><td></td><td></td></tr><tr><td></td><td></td><td></td></tr><tr><td></td><td></td><td></td></tr></table>										<table border="1"><tr><td></td><td></td><td></td></tr><tr><td></td><td></td><td></td></tr><tr><td></td><td></td><td></td></tr></table>										<table border="1"><tr><td></td><td></td><td></td></tr><tr><td></td><td></td><td></td></tr><tr><td></td><td></td><td></td></tr></table>										<table border="1"><tr><td>1</td><td></td><td>5</td></tr><tr><td></td><td></td><td>2</td></tr><tr><td></td><td></td><td>3</td></tr></table>	1		5			2			3	<table border="1"><tr><td>1</td><td></td><td></td></tr><tr><td></td><td></td><td></td></tr><tr><td></td><td></td><td></td></tr></table>	1									<table border="1"><tr><td></td><td></td><td></td></tr><tr><td></td><td></td><td></td></tr><tr><td></td><td></td><td></td></tr></table>										<table border="1"><tr><td></td><td></td><td></td></tr><tr><td></td><td></td><td></td></tr><tr><td></td><td></td><td></td></tr></table>									
1		5																																																																													
		2																																																																													
		3																																																																													
1																																																																															
Post - 0 Miss - 0 Block - 0	Post - 0 Miss - 0 Block - 0	Post - 0 Miss - 0 Block - 0	Post - 0 Miss - 0 Block - 0	Post - 0 Miss - 5 Block - 2	Post - 0 Miss - 1 Block - 1	Post - 0 Miss - 0 Block - 0	Post - 0 Miss - 0 Block - 0																																																																								



Team A					Team B					Match Number											
A 安徽队					B 北京队					28											
Played in			in the hall			on			at			Spectators									
重庆万州			万州体育馆			2019-04-14			16:00			hours									
Half-time(30')	A	B	End of playing time		A	B	1st extra time		A	B	2nd extra time		A	B	After penalty throws						
	12	14	19		23																
Number of 7 m	A	Team time-out			Full name of players and officials						Team time-out			B	Number of 7 m						
	1/4	1	2	3							1	2	3	B							
		10:49	54:02								22:05	50:46		3/3							
No.	Team A					G	W	2'	D	DR	No.	Team B					G	W	2'	D	DR
1	郭世伟					5					3	逯明松									
4	王巨柱										6	解建飞							2		
5	史小帆					6					7	马昌震									
6	叶志伟										10	成亚					6	1	1		
7	姚雄敏										11	赵文宣									
8	董智景										12	高云健									
9	金永峰						1	1			13	王军鸣									
10	严龙					3					16	刘迈科									
11	黎涛					3					18	傅俊雄									
12	曾献辰										22	王超					3		1		
18	李双					1					23	王军程					3				
21	李明										25	王鹏皓									
23	张鹏										26	魏昂					2				
24	徐安格					1					27	闫炳旗					2				
26	饶原源										32	蒋维一					1				
27	王东昇										33	陈旭					6	1			
A	吴翔										A	郑永利 (主教练)									
B	Vladimir Stanojevic (主教练)										B	孟辉									
C	黄红										E	陈璇									
E	刘汉杰																				
A	Signatures of responsables for the teams (Off.A)										B										
TP	Remarks of referees / HF Official										TP										

Signatures

Referees	倪震 (CHN)	张智伟 (CHN)		
T.D.	吴国忠 (CHN)	陈少波 (CHN)		
CHA Off.				

Note: Number of 7m Throws Awarded to Team A and B, Goals (G), Warnings (W), Suspensions (2'), Direct Disqualification (D), Disqualification With Report (DR) and Team Penalty (TP).

Table Officials: 刘明华

张晓虎

Statisticians: 周亚桥

赵悦

2019年全国男子手球冠军杯赛

PHMS Pictorial Handball Match Statistics

IHF Official System

竞赛技术统计

手球 男子 半决赛 轮次 7 组别 X 场次 28 万州体育馆 2019-04-14 16:00

Referees: 倪震 (CHN) / 张智伟 (CHN) Result: 19:23(12:14)  
Teams: 安徽队(安徽) VS 北京队(北京)

安徽		远	近	边	快	突	任意	7m	合计	%	助攻	失误	警告	2'	D+DR
主教练: Vladimir Stanojevic		射	射	射	攻	破	球	球							
1	郭世伟	2/5	2/2			1/1		0/2	5/10	50.0					
4	王巨柱														
5	史小帆	1/3	1/1			4/6			6/10	60.0		1			
6	叶志伟														
7	姚雄敏														
8	董智景														
9	金永峰	0/3				0/1			0/4	0.0		1	1	1	
10	严龙			2/3				1/2	3/5	60.0		1			
11	黎涛	0/1	1/1	2/2					3/4	75.0		2			
12	曾献辰														
18	李双	1/7	0/1						1/8	12.5	1	3			
21	李明														
23	张鹏			0/1					0/1	0.0					
24	徐安格		1/2						1/2	50.0		2			
26	饶源源														
27	王东昇														
运动员 合计		4/19	5/7	4/6		5/8		1/4	19/44	43.2	1	10	1	1	
12	曾献辰	2/6	0/4	0/1	0/2	0/3	1/1	0/1	3/18	16.7					
21	李明	0/1	0/1	0/2	1/1	0/1	1/2	0/2	2/10	20.0					
守门员 合计		2/7	0/5	0/3	1/3	0/4	2/3	0/3	5/28	17.9					

北京		远	近	边	快	突	任意	7m	合计	%	助攻	失误	警告	2'	D+DR
主教练: 郑永利		射	射	射	攻	破	球	球							
3	逯明松											1			
6	解建飞													2	
7	马昌震											1			
10	成亚	1/3				2/2		3/3	6/8	75.0	2	2	1	1	
11	赵文宣														
12	高云健														
13	王军鸣	0/1							0/1	0.0		1			
16	刘迈科														
18	傅俊雄														
22	王超		2/2		1/2				3/4	75.0		1		1	
23	王军程	1/3				1/1	1/3		3/7	42.9	1	4			
25	王鹏皓														
26	魏昂			2/2					2/2	100					
27	闫炳旗	1/1		1/2					2/3	66.7	1				
32	蒋维一		1/1						1/1	100	1	1			
33	陈旭	2/4	2/3		1/1	1/1			6/9	66.7		6	1		
运动员 合计		5/12	5/6	3/4	2/3	4/4	1/3	3/3	23/35	65.7	5	17	2	4	
12	高云健		0/1			1/1			1/2	50.0					
16	刘迈科	6/10	2/6	2/6		2/7		1/2	13/31	41.9					
守门员 合计		6/10	2/7	2/6		3/8		1/2	14/33	42.4					

安徽	比赛进程	北京
1st Half		
	0 00:35	1 23 王军程
	0 02:14	2 23 王军程
1 郭世伟	1 04:57	2
	1 08:19	3 27 闫炳旗
	1 09:10	4 23 王军程
11 黎涛	2 09:44	4
	2 10:24	5 33 陈旭
	2 10:41	6 33 陈旭
	2 11:50	7 33 陈旭
1 郭世伟	3 13:58	7
	3 14:47	8 32 蒋维一
10 严龙	4 15:02	8
5 史小帆	5 16:28	8
5 史小帆	6 17:07	8
18 李双	7 17:58	8
11 黎涛	8 19:22	8
	8 20:13	9 10 成亚
	8 22:34	10 10 成亚
	8 24:05	11 10 成亚
24 徐安格	9 24:54	11
	9 26:26	12 22 王超
11 黎涛	10 26:35	12
	10 27:47	13 22 王超
5 史小帆	11 28:10	13
5 史小帆	12 29:28	13
	12 29:58	14 27 闫炳旗
2nd Half		
	12 01:52	15 33 陈旭
5 史小帆	13 02:01	15
5 史小帆	14 03:10	15
	14 06:17	16 33 陈旭
1 郭世伟	15 07:03	16
	15 07:36	17 22 王超
	15 09:07	18 10 成亚
1 郭世伟	16 09:49	18
	16 10:31	19 10 成亚
10 严龙	17 12:55	19
	17 14:25	20 10 成亚
10 严龙	18 17:21	20
	18 19:30	21 26 魏昂
	18 21:12	22 33 陈旭
	18 23:53	23 26 魏昂
1 郭世伟	19 29:11	23

场上队员: 得分 / 射门

守门员: 救球 / 射门

D	取消资格	DR	取消资格+报告
---	------	----	---------





2019年全国男子手球冠军杯赛

PHMS Pictorial Handball Match Statistics

IHF Official System

个人/全队技术统计表

手球 半决赛 组别 X 万州体育馆  
男子 轮次 7 场次 28 2019-04-14 16:00

号码	姓名	远射	近射	边射	快攻	突破	任意	七米	合计	%	助攻	失误	警告	2'	取消	时间
<b>安徽队(安徽)</b>																
<b>(场上队员)</b>																
1	郭世伟	2/5	2/2			1/1		0/2	5/10	50.0%						00:33:04
4	王巨柱									0.0%						00:00:00
5	史小帆	1/3	1/1			4/6			6/10	60.0%		1				00:42:22
6	叶志伟									0.0%						00:00:00
7	姚雄敏									0.0%						00:00:00
8	董智景									0.0%						00:00:00
9	金永峰	0/3				0/1			0/4	0.0%		1	1	1		00:41:20
10	严龙			2/3				1/2	3/5	60.0%		1				00:59:16
11	黎涛	0/1	1/1	2/2					3/4	75.0%		2				00:39:15
12	曾献辰									0.0%						00:39:42
18	李双	1/7	0/1						1/8	12.5%	1	3				01:00:00
21	李明									0.0%						00:20:18
23	张鹏			0/1					0/1	0.0%						00:23:22
24	徐安格		1/2						1/2	50.0%		2				01:00:00
26	饶原源									0.0%						00:00:00
27	王东昇									0.0%						00:00:00
	<b>合计</b>	<b>4/19</b>	<b>5/7</b>	<b>4/6</b>		<b>5/8</b>		<b>1/4</b>	<b>19/44</b>	<b>43.2%</b>	<b>1</b>	<b>10</b>	<b>1</b>	<b>1</b>		
<b>(守门员)</b>																
12	曾献辰	2/6	0/4	0/1	0/2	0/3	1/1	0/1	3/18	16.7%						00:39:42
21	李明	0/1	0/1	0/2	1/1	0/1	1/2	0/2	2/10	20.0%						00:20:18
	<b>合计</b>	<b>2/7</b>	<b>0/5</b>	<b>0/3</b>	<b>1/3</b>	<b>0/4</b>	<b>2/3</b>	<b>0/3</b>	<b>5/28</b>	<b>17.9%</b>						

场上队员：得分/射门

守门员：救球/射门

全队合计	得分	被救	射失	击柱	封球	合计	%
远射	4	6	3	2	4	19	21.1%
近射	5	2				7	71.4%
边射	4	2				6	66.7%
快攻							0.0%
突破	5	3				8	62.5%
任意							0.0%
七米	1	1	2			4	25.0%

2019年全国男子手球冠军杯赛

PHMS Pictorial Handball Match Statistics

IHF Official System

个人/全队技术统计表

手球 半决赛 组别 X 万州体育馆  
男子 轮次 7 场次 28 2019-04-14 16:00

号码	姓名	远射	近射	边射	快攻	突破	任意	七米	合计	%	助攻	失误	警告	2'	取消	时间
北京队(北京)																
(场上队员)																
3	逯明松									0.0%		1				00:04:12
6	解建飞									0.0%				2		00:24:11
7	马昌震									0.0%		1				00:13:17
10	成亚	1/3				2/2		3/3	6/8	75.0%	2	2	1	1		00:55:08
11	赵文宣									0.0%						00:00:00
12	高云健									0.0%						00:05:10
13	王军鸣	0/1							0/1	0.0%		1				00:07:13
16	刘迈科									0.0%						00:54:50
18	傅俊雄									0.0%						00:00:00
22	王超		2/2		1/2				3/4	75.0%		1		1		00:47:38
23	王军程	1/3				1/1	1/3		3/7	42.9%	1	4				00:43:45
25	王鹏皓									0.0%						00:00:00
26	魏昂			2/2					2/2	100%						00:13:15
27	闫炳旗	1/1		1/2					2/3	66.7%	1					00:55:20
32	蒋维一		1/1						1/1	100%	1	1				00:49:58
33	陈旭	2/4	2/3		1/1	1/1			6/9	66.7%		6	1			00:44:02
	合计	5/12	5/6	3/4	2/3	4/4	1/3	3/3	23/35	65.7%	5	17	2	4		
(守门员)																
12	高云健		0/1			1/1			1/2	50.0%						00:05:10
16	刘迈科	6/10	2/6	2/6		2/7		1/2	13/31	41.9%						00:54:50
	合计	6/10	2/7	2/6		3/8		1/2	14/33	42.4%						

场上队员：得分/射门

守门员：救球/射门

全队合计	得分	被救	射失	击柱	封球	合计	%
远射	5	2	2	1	2	12	41.7%
近射	5			1		6	83.3%
边射	3			1		4	75.0%
快攻	2	1				3	66.7%
突破	4					4	100.0%
任意	1	2				3	33.3%
七米	3					3	100.0%

图式比赛技术统计表

手球  
男子

半决赛  
轮次 7

组别 X  
场次 28

万州体育馆  
2019-04-14 16:00

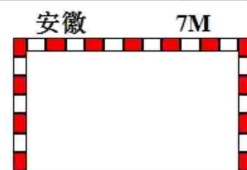
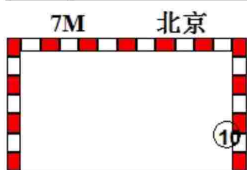
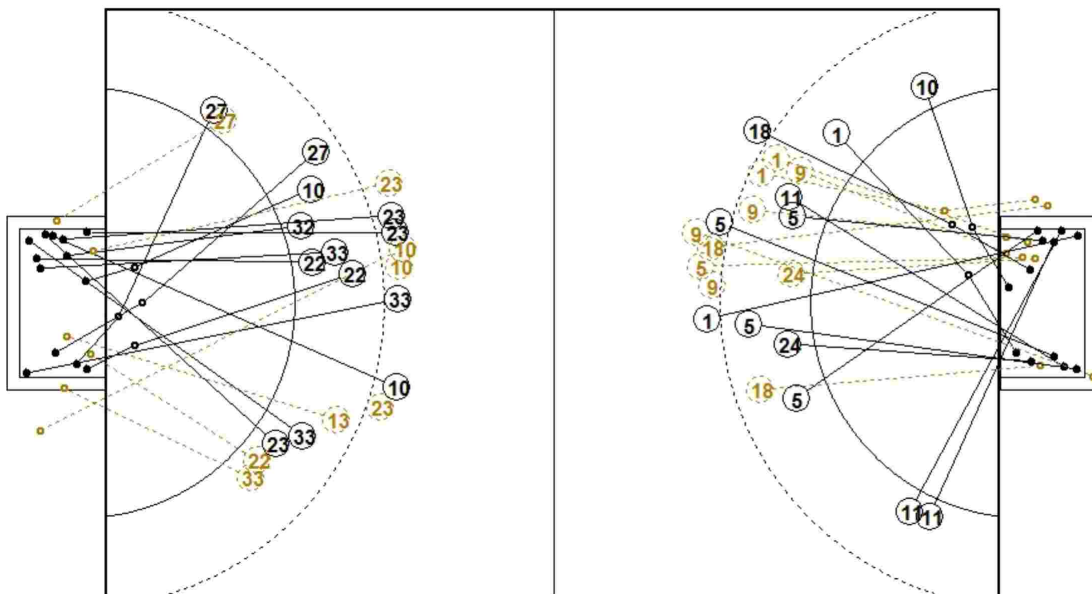

1st Half  
14 : 12

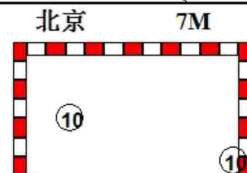
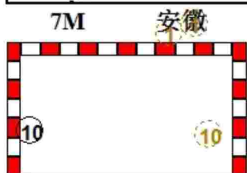
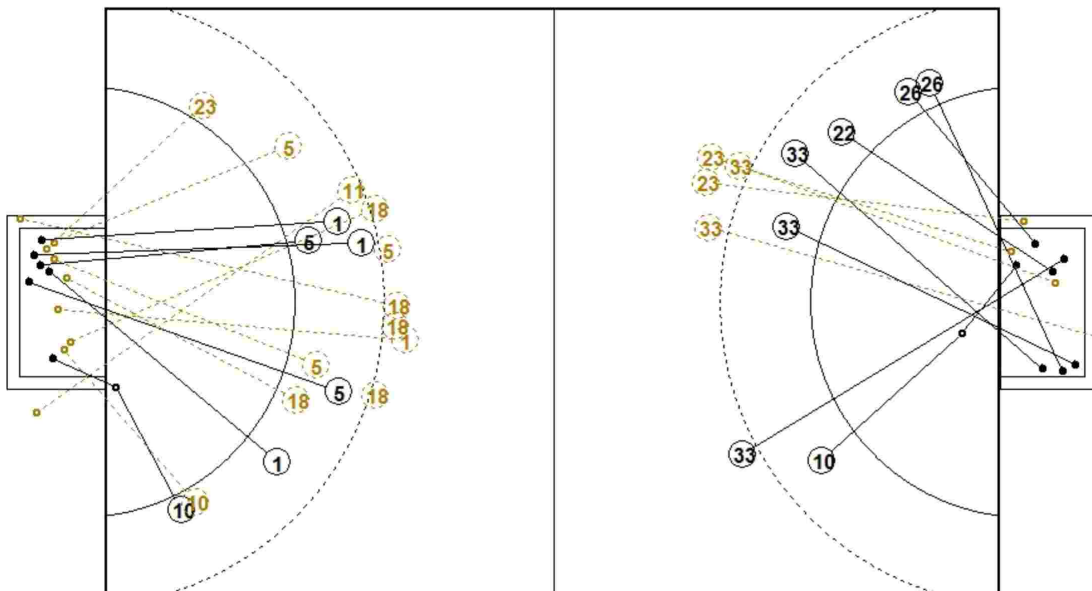

2nd Half  
19 : 23

图式射门区域统计

手球  
男子

半决赛  
轮次 7

组别 X  
场次 28

万州体育馆  
2019-04-14 16:00

安徽队

1 郭世伟 1 3 1 Post - 0 Miss - 3 Block - 0	4 王巨柱 Post - 0 Miss - 0 Block - 0	5 史小帆 1 2 2 1 Post - 0 Miss - 0 Block - 1	6 叶志伟 Post - 0 Miss - 0 Block - 0	7 姚雄敏 Post - 0 Miss - 0 Block - 0	8 董智景 Post - 0 Miss - 0 Block - 0	9 金永峰 Post - 1 Miss - 0 Block - 1	10 严龙 2 1 Post - 0 Miss - 0 Block - 0
11 黎涛 1 1 1 Post - 0 Miss - 1 Block - 0	12 曾献辰 Post - 0 Miss - 0 Block - 0	18 李双 1 Post - 1 Miss - 1 Block - 2	21 李明 Post - 0 Miss - 0 Block - 0	23 张鹏 Post - 0 Miss - 0 Block - 0	24 徐安格 1 Post - 0 Miss - 0 Block - 0	26 饶原源 Post - 0 Miss - 0 Block - 0	27 王东昇 Post - 0 Miss - 0 Block - 0

12 曾献辰
0/2 1/1 0/4
1/4 0/1 0/3
0/2 0/1 1/1

21 李明
0/2 0/2
2/2 0/2

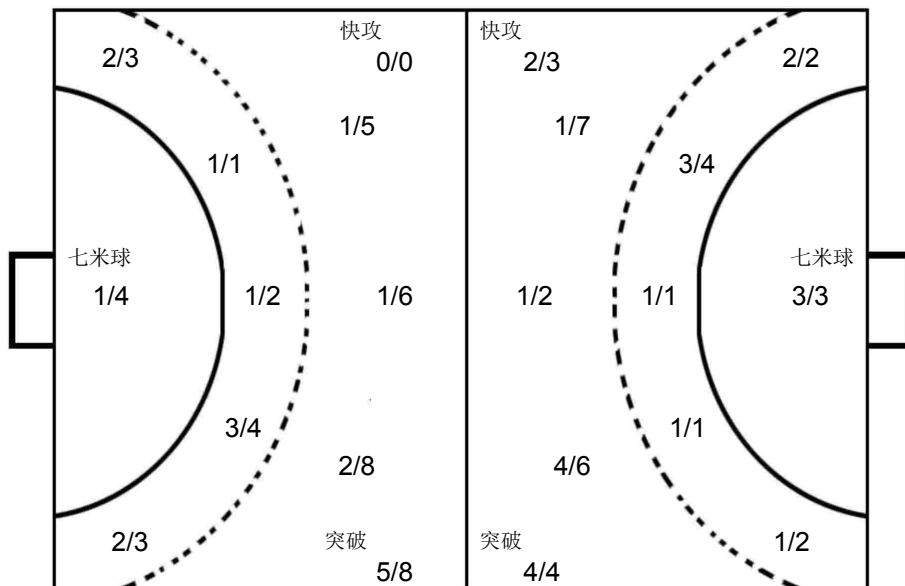

12 高云健
0/1 1/1

16 刘迈科
0/2 0/1 1/6
4/10 2/2 3/5
3/3 0/1 0/1

北京队

3 逯明松 Post - 0 Miss - 0 Block - 0	6 解建飞 Post - 0 Miss - 0 Block - 0	7 马昌震 Post - 0 Miss - 0 Block - 0	10 成亚 1 2 1 1 1 Post - 0 Miss - 1 Block - 1	11 赵文宣 Post - 0 Miss - 0 Block - 0	12 高云健 Post - 0 Miss - 0 Block - 0	13 王军鸣 Post - 0 Miss - 0 Block - 0	16 刘迈科 Post - 0 Miss - 0 Block - 0
18 傅俊雄 Post - 0 Miss - 0 Block - 0	22 王超 1 1 1 Post - 0 Miss - 0 Block - 0	23 王军程 1 1 1 Post - 1 Miss - 0 Block - 1	25 王鹏皓 Post - 0 Miss - 0 Block - 0	26 魏昂 1 1 Post - 0 Miss - 0 Block - 0	27 闫炳旗 2 Post - 1 Miss - 0 Block - 0	32 蒋维一 1 Post - 0 Miss - 0 Block - 0	33 陈旭 2 3 1 Post - 1 Miss - 1 Block - 0



## 2019年全国男子手球冠军杯赛

PHMS Pictorial Handball Match Statistics

IHF Official System

### 比赛进程表

手球 半决赛 组别 X 万州体育馆  
男子 轮次 7 场次 28 2019-04-14 16:00

时间	队员	动作	比分	队员	动作
安徽队			北京队		
上半时					
00:35	21 李明	被射入	0-1	23 王军程	右远射 得分
01:18	9 金永峰	中远射 被封		32 蒋维一	封球
01:22	18 李双	右远射 被救		16 刘迈科	挡住球
01:31	24 徐安格	近射 被救		16 刘迈科	挡住球
02:14	21 李明	被射入	0-2	23 王军程	任意球 得分
02:23	9 金永峰	左远射 被救		16 刘迈科	挡住球
02:51				32 蒋维一	侵区
02:52		裁判暂停			
03:19	1 郭世伟	左远射 射失			
03:29				33 陈旭	传球失误
04:10	9 金永峰	突破 被救		16 刘迈科	挡住球
04:18	1 郭世伟	造犯规		10 成亚	进攻犯规
04:57	1 郭世伟	突破 得分	1-2	16 刘迈科	被射入
05:38		裁判暂停			
06:09	9 金永峰	警告			
06:27	24 徐安格	封球		23 王军程	左远射 被封
06:37				10 成亚	警告
07:12	24 徐安格	接球失误		23 王军程	抢球
07:24	21 李明	挡住球		22 王超	短传快攻 被救
08:19	21 李明	被射入	1-3	27 闫炳旗	右边射 得分
08:57	1 郭世伟	左远射 被救		16 刘迈科	挡住球
09:10	21 李明	被射入	1-4	23 王军程	突破 得分
09:44	11 黎涛	近射 得分	2-4	16 刘迈科	被射入
10:24	12 曾献辰	被射入	2-5	33 陈旭	中远射 得分
10:37	9 金永峰	左远射 击柱			
10:41	12 曾献辰	被射入	2-6	33 陈旭	短传快攻 得分
10:49		球队暂停			
11:15	9 金永峰	运球失误			
11:50	12 曾献辰	被射入	2-7	33 陈旭	近射 得分
11:52				10 成亚	助攻
12:02				33 陈旭	警告
12:44	5 史小帆	中远射 被救		16 刘迈科	挡住球
12:52				10 成亚	传球失误
13:58	1 郭世伟	中远射 得分	3-7	16 刘迈科	被射入
14:47	12 曾献辰	被射入	3-8	32 蒋维一	近射 得分
14:49				10 成亚	助攻
15:02	10 严龙	左边射 得分	4-8	16 刘迈科	被射入
15:48				22 王超	接球失误
16:28	5 史小帆	左远射 得分	5-8	16 刘迈科	被射入
16:52				27 闫炳旗	右边射 击柱
17:07	5 史小帆	突破 得分	6-8	16 刘迈科	被射入



## 2019年全国男子手球冠军杯赛

PHMS Pictorial Handball Match Statistics

IHF Official System

### 比赛进程表

手球 半决赛 组别 X 万州体育馆  
男子 轮次 7 场次 28 2019-04-14 16:00

时间	队员	动作	比分	队员	动作			
安徽队			上半时			北京队		
17:48			6-8	33 陈旭	近射 击柱			
17:58	18 李双	左远射 得分	7-8	16 刘迈科	被射入			
18:37				10 成亚	右远射 射失			
19:22	11 黎涛	右边射 得分	8-8	16 刘迈科	被射入			
19:54				33 陈旭	传球失误			
20:04	18 李双	左远射 射失						
20:13	12 曾献辰	被射入	8-9	10 成亚	突破 得分			
20:23	24 徐安格	传球失误		10 成亚	断球			
21:43	5 史小帆	封球		10 成亚	中远射 被封			
21:52	10 严龙	侵入						
22:05					球队暂停			
22:34	12 曾献辰	被射入	8-10	10 成亚	左远射 得分			
23:27	18 李双	四步						
23:48	11 黎涛	使被罚7M球		23 王军程	造7M			
24:01		裁判暂停						
24:05	21 李明	被射入	8-11	10 成亚	7M球 得分			
24:54	24 徐安格	近射 得分	9-11	16 刘迈科	被射入			
24:56	18 李双	助攻						
25:41	5 史小帆	造犯规		13 王军鸣	进攻犯规			
26:21	11 黎涛	传球失误		32 蒋维一	断球			
26:26	12 曾献辰	被射入	9-12	22 王超	一传快攻 得分			
26:27				32 蒋维一	助攻			
26:35	11 黎涛	右边射 得分	10-12	16 刘迈科	被射入			
27:47	12 曾献辰	被射入	10-13	22 王超	近射 得分			
27:49				27 闫炳旗	助攻			
27:55		裁判暂停						
27:55				6 解建飞	罚出场2分钟			
28:10	5 史小帆	突破 得分	11-13	16 刘迈科	被射入			
28:20		裁判暂停						
28:23		裁判暂停						
29:20	12 曾献辰	挡住球		23 王军程	任意球 被救			
29:28	5 史小帆	突破 得分	12-13	16 刘迈科	被射入			
29:55	12 曾献辰	挡住球		13 王军鸣	左远射 被救			
29:58	12 曾献辰	被射入	12-14	27 闫炳旗	右远射 得分			

## 2019年全国男子手球冠军杯赛

PHMS Pictorial Handball Match Statistics

IHF Official System

### 比赛进程表

手球 半决赛 组别 X 万州体育馆  
男子 轮次 7 场次 28 2019-04-14 16:00

时间	队员	动作	比分	队员	动作
安徽队			北京队		
00:33			12-14	6 解建飞	断球
00:33	5 史小帆	传球失误		33 陈旭	快攻 侵入
00:39					
00:47	11 黎涛	侵入			
01:52	12 曾献辰	被射入	12-15	33 陈旭	右远射 得分
02:01	5 史小帆	突破 得分	13-15	16 刘迈科	被射入
02:32				23 王军程	传球失误
03:10	5 史小帆	近射 得分	14-15	16 刘迈科	被射入
03:46				33 陈旭	左远射 射失
04:37	5 史小帆	突破 被救		12 高云健	挡住球
04:46	11 黎涛	造犯规		33 陈旭	进攻犯规
05:32	11 黎涛	右远射 射失			
06:09		裁判暂停			
06:09	18 李双	选位 成功			
06:17	12 曾献辰	被射入	14-16	33 陈旭	突破 得分
06:20	5 史小帆	顶贴 失误			
07:03	1 郭世伟	近射 得分	15-16	12 高云健	被射入
07:12		裁判暂停			
07:12	9 金永峰	罚出场2分钟			
07:36	12 曾献辰	被射入	15-17	22 王超	近射 得分
08:19	5 史小帆	右远射 被封		32 蒋维一	封球
08:35	18 李双	进攻犯规		27 闫炳旗	造犯规
08:39		裁判暂停			
09:07	12 曾献辰	被射入	15-18	10 成亚	突破 得分
09:49	1 郭世伟	右远射 得分	16-18	16 刘迈科	被射入
10:03	5 史小帆	使被罚7M球		32 蒋维一	造7M
10:31	21 李明	被射入	16-19	10 成亚	7M球 得分
11:10	18 李双	右远射 被救		16 刘迈科	挡住球
11:16				3 逯明松	快攻 运球失误
11:25		裁判暂停			
11:51	18 李双	左远射 被封		6 解建飞	封球
12:45	12 曾献辰	挡住球		33 陈旭	左远射 被救
12:55	10 严龙	左边射 得分	17-19	16 刘迈科	被射入
13:55	18 李双	使被罚7M球		27 闫炳旗	造7M
14:19		裁判暂停			
14:25	12 曾献辰	被射入	17-20	10 成亚	7M球 得分
15:04		裁判暂停			
15:04	23 张鹏	造7M		22 王超	使被罚7M球
15:04				22 王超	罚出场2分钟
15:09	1 郭世伟	7M球 射失			
15:49				33 陈旭	四步
15:52		裁判暂停			

## 2019年全国男子手球冠军杯赛

PHMS Pictorial Handball Match Statistics

IHF Official System

### 比赛进程表

手球 半决赛 组别 X 万州体育馆  
男子 轮次 7 场次 28 2019-04-14 16:00

时间	队员	动作	比分	队员	动作
安徽队			北京队		
15:52			17-20	10 成亚	罚出场2分钟
16:05	10 严龙	左边射 被救		16 刘迈科	挡住球
16:54				23 王军程	四步
17:08	5 史小帆	快攻 造7M		7 马昌震	使被罚7M球
17:21	10 严龙	7M球 得分	18-20	16 刘迈科	被射入
17:59				23 王军程	传球失误
18:38	5 史小帆	突破 被救		16 刘迈科	挡住球
18:43	18 李双	造犯规		33 陈旭	进攻犯规
18:45		裁判暂停			
19:16	1 郭世伟	中远射 被救		16 刘迈科	挡住球
19:30	12 曾献辰	被射入	18-21	26 魏昂	左边射 得分
20:08	18 李双	中远射 击柱			
20:46					球队暂停
21:12	21 李明	被射入	18-22	33 陈旭	近射 得分
21:16				23 王军程	助攻
22:01		裁判暂停			
22:20	9 金永峰	造7M		26 魏昂	使被罚7M球
22:36	10 严龙	7M球 被救		16 刘迈科	挡住球
23:17	18 李双	运球失误			
23:53	21 李明	被射入	18-23	26 魏昂	左边射 得分
24:01		裁判暂停			
24:01				6 解建飞	罚出场2分钟
24:02		球队暂停			
24:26	18 李双	近射 被救		16 刘迈科	挡住球
25:44	21 李明	挡住球		23 王军程	任意球 被救
26:01	5 史小帆	造7M		6 解建飞	使被罚7M球
26:04	1 郭世伟	7M球 射失			
26:30				23 王军程	其它失误
27:09	18 李双	中远射 被封		33 陈旭	封球
27:25	23 张鹏	右边射 被救		16 刘迈科	挡住球
27:54				23 王军程	左远射 击柱
29:11	1 郭世伟	近射 得分	19-23	16 刘迈科	被射入
29:47				7 马昌震	运球失误



Team A					Team B					Match Number											
A 天津队					B 江苏队					29											
Played in			in the hall			on			at			Spectators									
重庆万州			万州体育馆			2019-04-14			17:30			hours									
Half-time(30')	A	B	End of playing time	A	B	1st extra time	A	B	2nd extra time	A	B	After penalty throws	A	B							
	5	13		16	23																
Number of 7 m	A	Team time-out			Full name of players and officials					Team time-out			B	Number of 7 m							
	1/3	1	2	3						1	2	3	B								
		07:19							26:10	33:35	52:01	0/2									
No.	Team A					G	W	2'	D	DR	No.	Team B					G	W	2'	D	DR
1	何喜年										1	宋继强									
3	魏雨童						1				4	张家纬					3	1	1		
4	刘雪东										6	赵晨					4				
5	王毅					2					7	周傲									
6	赵晨阳					2					8	谢庆龙					2	1			
7	张青										11	张天豪					1				
8	王晓琪					5		1			12	王权									
9	王子欣					3					16	张帅									
10	苏尧					1					18	赵楠									
11	吴明远										19	庞连康					1		1		
13	许松					2					20	顾艳超					4				
14	王维先										21	刘江						1			
15	周群										25	王杰缘					6				
16	刘宗其										27	王伟强					2		1		
20	张闻乾										30	吴龙瑞									
86	田剑侠					1		1													
A	贾守信										A	闫威名 (主教练)									
B	杜瑞军 (主教练)										B	叶强									
D	李志成										C	贾淑君									
E	王文龙										E	王建国									
A	Signatures of responsables for the teams (Off.A)										B										
TP	Remarks of referees / HF Official										TP										

Signatures

Referees	张之伟 (CHN)	康曦 (CHN)		
T.D.	吴国忠 (CHN)	陈少波 (CHN)		
CHA Off.				

Note: Number of 7m Throws Awarded to Team A and B, Goals (G), Warnings (W), Suspensions (2'), Direct Disqualification (D), Disqualification With Report (DR) and Team Penalty (TP).

Table Officials: 严璐 周胜锋 Statisticians: 赵悦 周亚桥

2019年全国男子手球冠军杯赛

PHMS Pictorial Handball Match Statistics

IHF Official System

竞赛技术统计

手球 男子 半决赛 轮次 7 组别 X 场次 29 万州体育馆 2019-04-14 17:30

Referees: 张之伟 (CHN) / 康曦 (CHN) Result: 16:23 (5:13)  
Teams: 天津队(天津) VS 江苏队(江苏)

天津		远	近	边	快	突	任意	7m	合计	%	助攻	失误	警告	2'	D+DR	天津	比赛	江苏
主教练: 杜瑞军		射	射	射	攻	破	球	球								进程		
1	何喜年															0	00:58	1 4 张家伟
3	魏雨童											1	1			0	04:23	2 20 顾艳超
4	刘雪东	0/2							0/2	0.0						0	06:06	3 20 顾艳超
5	王毅	1/5	1/2				0/1	0/1	2/9	22.2		1				0	07:03	4 6 赵晨
6	赵晨阳	2/2	0/1	0/1		0/1			2/5	40.0						9	09:51	4 4 张家伟
7	张青	0/3			0/1				0/4	0.0		1				8	13:41	5 4 张家伟
8	王晓琪	2/3	1/2		1/1	0/1		1/1	5/8	62.5	2	4		1		2	15:30	5 6 赵晨
9	王子欣		0/1	3/4					3/5	60.0		1				5	16:41	6 6 赵晨
10	苏尧	1/1	0/1						1/2	50.0						3	18:46	6 6 赵晨
11	吴明远															3	19:19	7 25 王杰缘
13	许松	0/2		1/2	1/1			0/1	2/6	33.3	1	2				3	19:57	8 27 王伟强
14	王维先															3	22:39	9 25 王杰缘
15	周群		0/1						0/1	0.0						3	25:02	10 25 王杰缘
16	刘宗其															3	26:51	11 25 王杰缘
20	张闻乾															3	28:23	12 25 王杰缘
86	田剑侠	0/1			1/1				1/2	50.0		4		1		9	29:10	12 12 王子欣
运动员 合计		6/19	2/8	4/7	3/4	0/2	0/1	1/3	16/44	36.4	3	14	1	2		86	29:45	12 12 田剑侠
1	何喜年	2/6	5/13	0/3	3/8	0/2	0/1	1/1	11/34	32.4						5	29:53	13 6 赵晨
16	刘宗其																	
守门员 合计		2/6	5/13	0/3	3/8	0/2	0/1	1/1	11/34	32.4								
江苏		远	近	边	快	突	任意	7m	合计	%	助攻	失误	警告	2'	D+DR			
主教练: 闫威名		射	射	射	攻	破	球	球										
1	宋继强															13	01:11	13
4	张家伟	1/2	1/1		0/2	1/1			3/6	50.0		1	1	1		13	01:37	13
6	赵晨	2/5	1/1				1/1		4/7	57.1	2					7	04:26	14 25 王杰缘
7	周傲															8	05:26	14
8	谢庆龙	0/1	2/4		0/1				2/6	33.3		1	1			8	05:54	15 20 顾艳超
11	张天豪			0/1	1/1				1/2	50.0						8	07:34	16 4 张家伟
12	王权										2					8	09:15	17 8 谢庆龙
16	张帅															8	10:15	18 20 顾艳超
18	赵楠										1	1				8	13:26	18
19	庞连康	0/2	1/1						1/3	33.3				1		6	15:05	18
20	顾艳超	1/2	2/5		0/1	1/1			4/9	44.4	2	3				9	17:40	19 11 张天豪
21	刘江												1			9	18:04	19
25	王杰缘			3/4	3/3			0/1	6/8	75.0		1				8	18:50	19
27	王伟强		1/1		1/2				2/3	66.7		3		1		6	23:53	20 27 王伟强
30	吴龙瑞							0/1	0/1	0.0		1				6	24:24	20
运动员 合计		4/12	8/13	3/5	5/10	2/2	1/1	0/2	23/45	51.1	7	14	3	3		13	26:12	21 6 赵晨
12	王权	6/8	1/2	1/4	0/2				8/16	50.0	2					5	26:53	21
16	张帅	0/4	2/3	0/1	0/1	2/2		2/3	6/14	42.9						14	27:42	22 19 庞连康
守门员 合计		6/12	3/5	1/5	0/3	2/2		2/3	14/30	46.7	2					8	28:24	22
10	苏尧															10	29:03	23 8 谢庆龙
																16	29:34	23

场上队员: 得分 / 射门

守门员: 救球 / 射门

D	取消资格	DR	取消资格+报告
---	------	----	---------



## 2019年全国男子手球冠军杯赛

PHMS Pictorial Handball Match Statistics

IHF Official System

## 个人/全队技术统计表

 手球 半决赛 组别 X 万州体育馆  
 男子 轮次 7 场次 29 2019-04-14 17:30

号码	姓名	远射	近射	边射	快攻	突破	任意	七米	合计	%	助攻	失误	警告	2'	取消	时间
天津队(天津)																
(场上队员)																
1	何喜年									0.0%						00:59:44
3	魏雨童									0.0%		1	1			00:53:54
4	刘雪东	0/2							0/2	0.0%						00:05:21
5	王毅	1/5	1/2				0/1	0/1	2/9	22.2%		1				00:49:38
6	赵晨阳	2/2	0/1	0/1		0/1			2/5	40.0%						00:16:53
7	张青	0/3			0/1				0/4	0.0%		1				00:20:35
8	王晓琪	2/3	1/2		1/1	0/1		1/1	5/8	62.5%	2	4		1		00:42:23
9	王子欣		0/1	3/4					3/5	60.0%		1				00:59:06
10	苏尧	1/1	0/1						1/2	50.0%						00:36:15
11	吴明远									0.0%						00:00:00
13	许松	0/2		1/2	1/1			0/1	2/6	33.3%	1	2				00:30:42
14	王维先									0.0%						00:00:00
15	周群		0/1						0/1	0.0%						00:14:30
16	刘宗其									0.0%						00:00:16
20	张闻乾									0.0%						00:00:00
86	田剑侠	0/1			1/1				1/2	50.0%		4		1		00:30:09
	合计	6/19	2/8	4/7	3/4	0/2	0/1	1/3	16/44	36.4%	3	14	1	2		
(守门员)																
1	何喜年	2/6	5/13	0/3	3/8	0/2	0/1	1/1	11/34	32.4%						00:59:44
16	刘宗其									0.0%						00:00:16
	合计	2/6	5/13	0/3	3/8	0/2	0/1	1/1	11/34	32.4%						

场上队员：得分/射门

守门员：救球/射门

全队合计	得分	被救	射失	击柱	封球	合计	%
远射	6	6	3		4	19	31.6%
近射	2	3	1	1	1	8	25.0%
边射	4	1	1	1		7	57.1%
快攻	3		1			4	75.0%
突破		2				2	0.0%
任意				1		1	0.0%
七米	1	2				3	33.3%

## 2019年全国男子手球冠军杯赛

PHMS Pictorial Handball Match Statistics

IHF Official System

### 个人/全队技术统计表

手球男子 半决赛 轮次 7 组别 X 场次 29 万州体育馆 2019-04-14 17:30

号码	姓名	远射	近射	边射	快攻	突破	任意	七米	合计	%	助攻	失误	警告	2'	取消	时间
江苏队(江苏)																
(场上队员)																
1	宋继强									0.0%						00:00:00
4	张家纬	1/2	1/1		0/2	1/1			3/6	50.0%		1	1	1		00:45:31
6	赵晨	2/5	1/1				1/1		4/7	57.1%	2					00:33:07
7	周傲									0.0%		1				00:02:26
8	谢庆龙	0/1	2/4		0/1				2/6	33.3%		2	1			00:42:22
11	张天豪			0/1	1/1				1/2	50.0%						00:08:23
12	王权									0.0%	2					00:39:50
16	张帅									0.0%						00:20:10
18	赵楠									0.0%	1	1				00:13:58
19	庞连康	0/2	1/1						1/3	33.3%		1		1		00:11:56
20	顾艳超	1/2	2/5		0/1	1/1			4/9	44.4%	2	3				00:51:34
21	刘江									0.0%			1			00:30:59
25	王杰缘			3/4	3/3			0/1	6/8	75.0%		1				00:58:46
27	王伟强		1/1		1/2				2/3	66.7%		3		1		00:51:36
30	吴龙瑞							0/1	0/1	0.0%		1				00:08:25
合计		4/12	8/13	3/5	5/10	2/2	1/1	0/2	23/45	51.1%	7	14	3	3		
(守门员)																
12	王权	6/8	1/2	1/4	0/2				8/16	50.0%	2					00:39:50
16	张帅	0/4	2/3	0/1	0/1	2/2		2/3	6/14	42.9%						00:20:10
合计		6/12	3/5	1/5	0/3	2/2		2/3	14/30	46.7%	2					

场上队员：得分/射门

守门员：救球/射门

全队合计	得分	被救	射失	击柱	封球	合计	%
远射	4	2	5	1		12	33.3%
近射	8	5				13	61.5%
边射	3		1	1		5	60.0%
快攻	5	3	1	1		10	50.0%
突破	2					2	100.0%
任意	1					1	100.0%
七米		1	1			2	0.0%

图式比赛技术统计表

手球  
男子

半决赛  
轮次 7

组别 X  
场次 29

万州体育馆  
2019-04-14 17:30

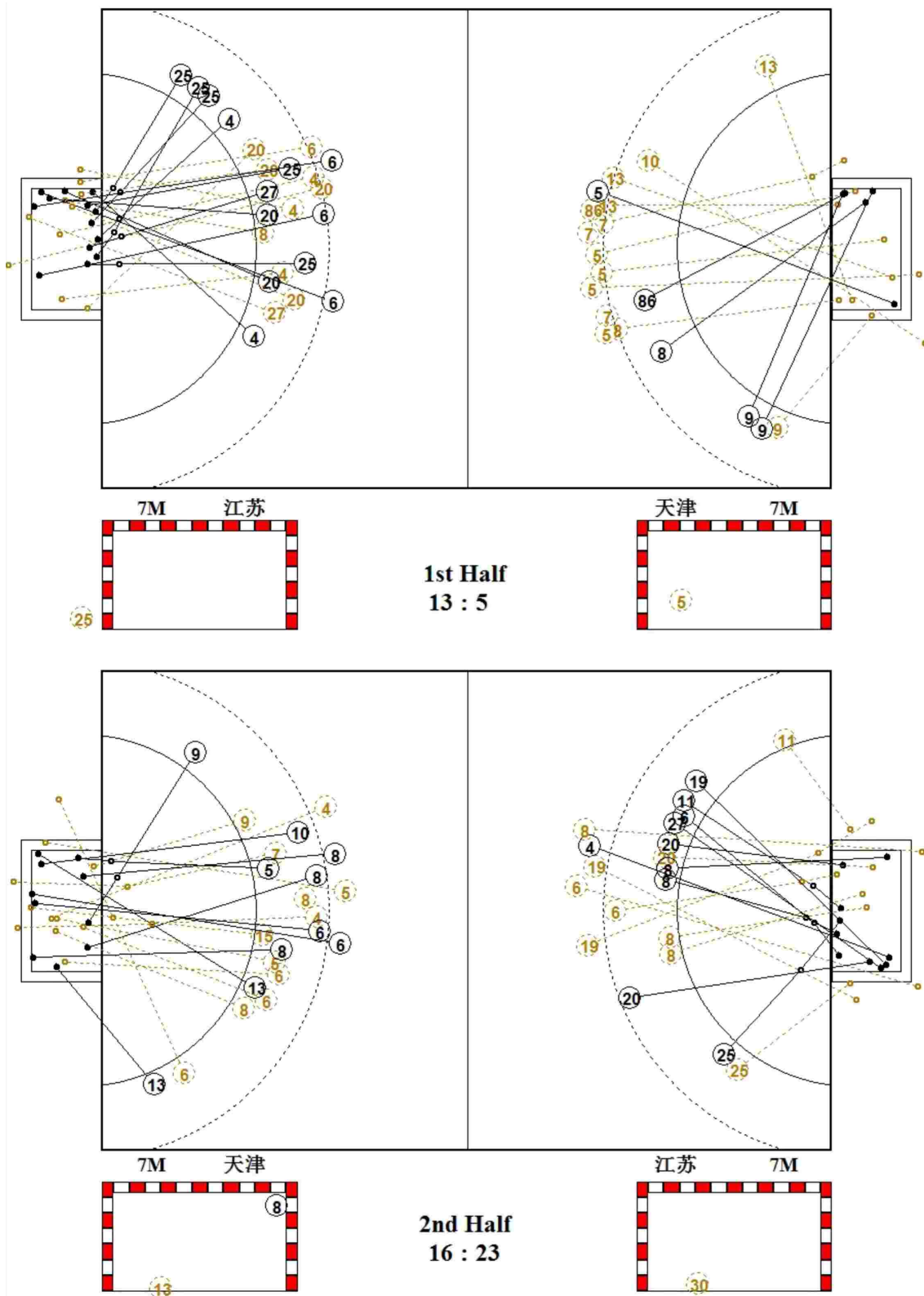

图式射门区域统计

手球  
男子

半决赛  
轮次 7

组别 X  
场次 29

万州体育馆  
2019-04-14 17:30

天津队

1 何喜年 <table border="1"><tr><td></td><td></td><td></td></tr><tr><td></td><td></td><td></td></tr><tr><td></td><td></td><td></td></tr></table> Post - 0 Miss - 0 Block - 0										3 魏雨童 <table border="1"><tr><td></td><td></td><td></td></tr><tr><td></td><td></td><td></td></tr><tr><td></td><td></td><td></td></tr></table> Post - 0 Miss - 0 Block - 0										4 刘雪东 <table border="1"><tr><td></td><td></td><td></td></tr><tr><td></td><td></td><td></td></tr><tr><td></td><td></td><td></td></tr></table> Post - 0 Miss - 1 Block - 0										5 王毅 <table border="1"><tr><td></td><td></td><td>1</td></tr><tr><td></td><td></td><td>1</td></tr><tr><td></td><td></td><td></td></tr></table> Post - 1 Miss - 1 Block - 1			1			1				6 赵晨阳 <table border="1"><tr><td></td><td>2</td><td></td></tr><tr><td></td><td></td><td></td></tr><tr><td></td><td></td><td></td></tr></table> Post - 0 Miss - 1 Block - 0		2								7 张青 <table border="1"><tr><td></td><td></td><td></td></tr><tr><td></td><td></td><td></td></tr><tr><td></td><td></td><td></td></tr></table> Post - 0 Miss - 2 Block - 2										8 王晓琪 <table border="1"><tr><td>1</td><td></td><td>1</td></tr><tr><td>1</td><td></td><td></td></tr><tr><td>1</td><td></td><td>1</td></tr></table> Post - 0 Miss - 0 Block - 1	1		1	1			1		1	9 王子欣 <table border="1"><tr><td></td><td></td><td></td></tr><tr><td>1</td><td></td><td></td></tr><tr><td>1</td><td>1</td><td></td></tr></table> Post - 1 Miss - 0 Block - 0				1			1	1	
		1																																																																													
		1																																																																													
	2																																																																														
1		1																																																																													
1																																																																															
1		1																																																																													
1																																																																															
1	1																																																																														
10 苏尧 <table border="1"><tr><td></td><td></td><td>1</td></tr><tr><td></td><td></td><td></td></tr><tr><td></td><td></td><td></td></tr></table> Post - 0 Miss - 1 Block - 0			1							11 吴明远 <table border="1"><tr><td></td><td></td><td></td></tr><tr><td></td><td></td><td></td></tr><tr><td></td><td></td><td></td></tr></table> Post - 0 Miss - 0 Block - 0										13 许松 <table border="1"><tr><td></td><td></td><td>1</td></tr><tr><td>1</td><td></td><td></td></tr><tr><td></td><td></td><td></td></tr></table> Post - 0 Miss - 0 Block - 0			1	1						14 王维先 <table border="1"><tr><td></td><td></td><td></td></tr><tr><td></td><td></td><td></td></tr><tr><td></td><td></td><td></td></tr></table> Post - 0 Miss - 0 Block - 0										15 周群 <table border="1"><tr><td></td><td></td><td></td></tr><tr><td></td><td></td><td></td></tr><tr><td></td><td></td><td></td></tr></table> Post - 1 Miss - 0 Block - 0										16 刘宗其 <table border="1"><tr><td></td><td></td><td></td></tr><tr><td></td><td></td><td></td></tr><tr><td></td><td></td><td></td></tr></table> Post - 0 Miss - 0 Block - 0										20 张闻乾 <table border="1"><tr><td></td><td></td><td></td></tr><tr><td></td><td></td><td></td></tr><tr><td></td><td></td><td></td></tr></table> Post - 0 Miss - 0 Block - 0										86 田剑侠 <table border="1"><tr><td></td><td></td><td></td></tr><tr><td></td><td></td><td></td></tr><tr><td>1</td><td></td><td></td></tr></table> Post - 0 Miss - 0 Block - 1							1		
		1																																																																													
		1																																																																													
1																																																																															
1																																																																															

1 何喜年

0/2	0/6	
2/2	3/3	2/4
3/4	0/6	1/7

16 刘宗其

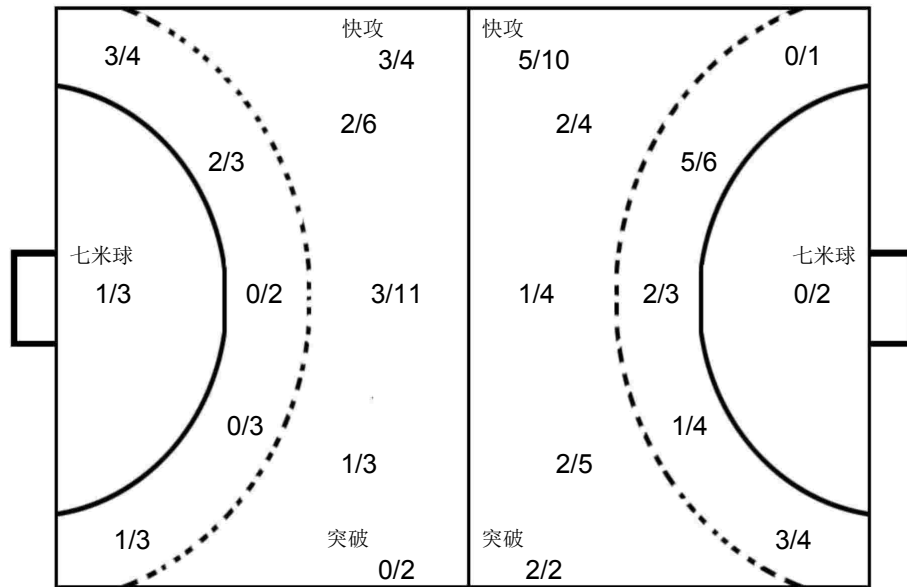
12 王权

	2/2	1/3
1/4	1/1	
1/4		2/2

16 张帅

0/1	1/3	0/2
2/2		0/1
1/1	1/2	1/2

江苏队

1 宋继强 <table border="1"><tr><td></td><td></td><td></td></tr><tr><td></td><td></td><td></td></tr><tr><td></td><td></td><td></td></tr></table> Post - 0 Miss - 0 Block - 0										4 张家纬 <table border="1"><tr><td></td><td></td><td>1</td></tr><tr><td></td><td></td><td></td></tr><tr><td>1</td><td>1</td><td></td></tr></table> Post - 0 Miss - 1 Block - 0			1				1	1		6 赵晨 <table border="1"><tr><td>1</td><td></td><td>2</td></tr><tr><td></td><td></td><td></td></tr><tr><td></td><td></td><td>1</td></tr></table> Post - 1 Miss - 1 Block - 0	1		2						1	7 周傲 <table border="1"><tr><td></td><td></td><td></td></tr><tr><td></td><td></td><td></td></tr><tr><td></td><td></td><td></td></tr></table> Post - 0 Miss - 0 Block - 0										8 谢庆龙 <table border="1"><tr><td>1</td><td></td><td></td></tr><tr><td></td><td></td><td></td></tr><tr><td></td><td></td><td>1</td></tr></table> Post - 0 Miss - 1 Block - 0	1								1	11 张天豪 <table border="1"><tr><td></td><td></td><td></td></tr><tr><td></td><td></td><td></td></tr><tr><td></td><td></td><td>1</td></tr></table> Post - 0 Miss - 1 Block - 0									1	12 王权 <table border="1"><tr><td></td><td></td><td></td></tr><tr><td></td><td></td><td></td></tr><tr><td></td><td></td><td></td></tr></table> Post - 0 Miss - 0 Block - 0										16 张帅 <table border="1"><tr><td></td><td></td><td></td></tr><tr><td></td><td></td><td></td></tr><tr><td></td><td></td><td></td></tr></table> Post - 0 Miss - 0 Block - 0									
		1																																																																													
1	1																																																																														
1		2																																																																													
		1																																																																													
1																																																																															
		1																																																																													
		1																																																																													
18 赵楠 <table border="1"><tr><td></td><td></td><td></td></tr><tr><td></td><td></td><td></td></tr><tr><td></td><td></td><td></td></tr></table> Post - 0 Miss - 0 Block - 0										19 庞连康 <table border="1"><tr><td></td><td></td><td>1</td></tr><tr><td></td><td></td><td></td></tr><tr><td></td><td></td><td></td></tr></table> Post - 0 Miss - 2 Block - 0			1							20 顾艳超 <table border="1"><tr><td></td><td></td><td>1</td></tr><tr><td></td><td></td><td>2</td></tr><tr><td>1</td><td></td><td></td></tr></table> Post - 0 Miss - 1 Block - 0			1			2	1			21 刘江 <table border="1"><tr><td></td><td></td><td></td></tr><tr><td></td><td></td><td></td></tr><tr><td></td><td></td><td></td></tr></table> Post - 0 Miss - 0 Block - 0										25 王杰缘 <table border="1"><tr><td></td><td></td><td></td></tr><tr><td></td><td></td><td></td></tr><tr><td>3</td><td>3</td><td></td></tr></table> Post - 1 Miss - 1 Block - 0							3	3		27 王伟强 <table border="1"><tr><td></td><td></td><td>1</td></tr><tr><td></td><td></td><td></td></tr><tr><td></td><td></td><td>1</td></tr></table> Post - 1 Miss - 0 Block - 0			1						1	30 吴龙瑞 <table border="1"><tr><td></td><td></td><td></td></tr><tr><td></td><td></td><td></td></tr><tr><td></td><td></td><td></td></tr></table> Post - 0 Miss - 0 Block - 0																			
		1																																																																													
		1																																																																													
		2																																																																													
1																																																																															
3	3																																																																														
		1																																																																													
		1																																																																													

## 2019年全国男子手球冠军杯赛

PHMS Pictorial Handball Match Statistics

IHF Official System

### 比赛进程表

手球 半决赛 组别 X 万州体育馆  
男子 轮次 7 场次 29 2019-04-14 17:30

时间	队员	动作	比分	队员	动作
天津队			江苏队		
上半时			上半时		
00:58	1 何喜年	被射入	0-1	4 张家纬	突破 得分
02:22	86 田剑侠	中远射 被封		21 刘江	封球
02:54	1 何喜年	挡住球		4 张家纬	右远射 被救
03:43	7 张青	中远射 被封		20 顾艳超	封球
03:47	86 田剑侠	传球失误		8 谢庆龙	断球
04:23	1 何喜年	被射入	0-2	20 顾艳超	突破 得分
05:04				21 刘江	警告
05:28	7 张青	右远射 被封		20 顾艳超	封球
05:54	7 张青	传球失误		21 刘江	断球
06:01				27 王伟强	一传快攻 击柱
06:06	1 何喜年	被射入	0-3	20 顾艳超	近射 得分
06:39	86 田剑侠	进攻犯规		25 王杰缘	造犯规
07:03	1 何喜年	被射入	0-4	6 赵晨	中远射 得分
07:19		球队暂停			
07:42	5 王毅	运球失误		8 谢庆龙	造失误
07:48	1 何喜年	挡住球		4 张家纬	短传快攻 被救
08:08	13 许松	进攻犯规		25 王杰缘	造犯规
08:42				20 顾艳超	右远射 射失
08:57				4 张家纬	警告
09:51	9 王子欣	右边射 得分	1-4	12 王权	被射入
10:31	15 周群	造犯规		8 谢庆龙	进攻犯规
11:21				8 谢庆龙	警告
11:48	9 王子欣	右边射 击柱			
11:54				27 王伟强	快攻 侵区
12:45	5 王毅	右远射 被封		8 谢庆龙	封球
13:10	5 王毅	中远射 被救		12 王权	挡住球
13:22	1 何喜年	挡住球		8 谢庆龙	短传快攻 被救
13:32	7 张青	中远射 射失			
13:41	1 何喜年	被射入	1-5	4 张家纬	近射 得分
14:19	13 许松	左边射 被救		12 王权	挡住球
14:25	7 张青	使被罚7M球		25 王杰缘	快攻 造7M
14:33		裁判暂停			
14:38				25 王杰缘	7M球 射失
15:16		裁判暂停			
15:16				27 王伟强	罚出场2分钟
15:30	8 王晓琪	近射 得分	2-5	12 王权	被射入
16:41	1 何喜年	被射入	2-6	6 赵晨	任意球 得分
17:00	86 田剑侠	进攻犯规		25 王杰缘	造犯规
17:38	3 魏雨童	警告			
17:41		裁判暂停			
17:54				27 王伟强	接球失误



## 2019年全国男子手球冠军杯赛

PHMS Pictorial Handball Match Statistics

IHF Official System

### 比赛进程表

手球 男子 半决赛 轮次 7 组别 X 场次 29 万州体育馆 2019-04-14 17:30

时间	队员	动作	比分	队员	动作			
天津队			上半时			江苏队		
18:46	5 王毅	左远射 得分	3-6	12 王权	被射入			
18:58	1 何喜年	挡住球		20 顾艳超	近射 被救			
19:03	1 何喜年	挡住球		20 顾艳超	近射 被救			
19:08	3 魏雨童	接球失误						
19:19	1 何喜年	被射入	3-7	25 王杰缘	右边射 得分			
19:47	8 王晓琪	右远射 被救		12 王权	挡住球			
19:57	1 何喜年	被射入	3-8	27 王伟强	近射 得分			
20:25	13 许松	左远射 被救		12 王权	挡住球			
20:33	1 何喜年	挡住球		20 顾艳超	近射 被救			
21:25	5 王毅	中远射 被救		12 王权	挡住球			
21:56	8 王晓琪	传球失误		27 王伟强	断球			
22:01				27 王伟强	快攻 侵入			
22:33	13 许松	运球失误						
22:39	1 何喜年	被射入	3-9	25 王杰缘	短传快攻 得分			
23:14	13 许松	左远射 被救		12 王权	挡住球			
23:46				6 赵晨	右远射 击柱			
24:04				4 张家纬	一传快攻 射失			
24:39		裁判暂停						
24:39				4 张家纬	罚出场2分钟			
24:54	5 王毅	中远射 射失						
25:02	1 何喜年	被射入	3-10	25 王杰缘	一传快攻 得分			
25:04				12 王权	助攻			
25:29	10 苏尧	造7M		21 刘江	使被罚7M球			
25:52	5 王毅	7M球 被救		16 张帅	挡住球			
26:10					球队暂停			
26:36		裁判暂停						
26:36	86 田剑侠	罚出场2分钟						
26:51	1 何喜年	被射入	3-11	25 王杰缘	右边射 得分			
27:59	10 苏尧	近射 射失						
28:23	1 何喜年	被射入	3-12	25 王杰缘	右边射 得分			
29:10	9 王子欣	右边射 得分	4-12	12 王权	被射入			
29:40	86 田剑侠	断球		20 顾艳超	传球失误			
29:45	86 田剑侠	一传快攻 得分	5-12	12 王权	被射入			
29:53	1 何喜年	被射入	5-13	6 赵晨	右远射 得分			



## 2019年全国男子手球冠军杯赛

PHMS Pictorial Handball Match Statistics

IHF Official System

### 比赛进程表

手球 半决赛 组别 X 万州体育馆  
男子 轮次 7 场次 29 2019-04-14 17:30

时间	队员	动作	比分	队员	动作
天津队			江苏队		
下半场			下半场		
00:24	86 田剑侠	运球失误	5-13		
01:03				6 赵晨	中远射 射失
01:11	13 许松	左边射 得分	6-13	12 王权	被射入
01:30	13 许松	断球		20 顾艳超	传球失误
01:37	13 许松	一传快攻 得分	7-13	12 王权	被射入
02:05				4 张家纬	传球失误
02:20	7 张青	造7M		4 张家纬	使被罚7M球
02:48	13 许松	7M球 被救		16 张帅	挡住球
03:21	13 许松	造失误		20 顾艳超	运球失误
03:28	7 张青	一传快攻 射失			
03:30	13 许松	助攻			
03:35					球队暂停
04:00				8 谢庆龙	侵区
04:18	5 王毅	近射 被救		12 王权	挡住球
04:26	1 何喜年	被射入	7-14	25 王杰缘	一传快攻 得分
04:28				12 王权	助攻
05:26	8 王晓琪	中远射 得分	8-14	12 王权	被射入
05:54	1 何喜年	被射入	8-15	20 顾艳超	近射 得分
05:56				6 赵晨	助攻
06:45	15 周群	近射 击柱			
06:48	8 王晓琪	助攻			
06:55	10 苏尧	抢球		25 王杰缘	接球失误
07:01	9 王子欣	快攻 传球失误			
07:34	1 何喜年	被射入	8-16	4 张家纬	左远射 得分
08:34	4 刘雪东	中远射 射失			
09:15	1 何喜年	被射入	8-17	8 谢庆龙	近射 得分
09:17				6 赵晨	助攻
09:47	4 刘雪东	右远射 被救		12 王权	挡住球
10:15	1 何喜年	被射入	8-18	20 顾艳超	右远射 得分
11:15		裁判暂停			
11:40	5 王毅	任意球 击柱			
12:13				18 赵楠	四步
12:29	8 王晓琪	突破 被救		16 张帅	挡住球
13:26	8 王晓琪	右远射 得分	9-18	16 张帅	被射入
14:03				30 吴龙瑞	接球失误
14:12	8 王晓琪	传球失误			
14:54				25 王杰缘	右边射 击柱
15:05	6 赵晨阳	中远射 得分	10-18	16 张帅	被射入
15:30				11 张天豪	左边射 射失
16:02	8 王晓琪	传球失误		18 赵楠	断球
16:15		裁判暂停			



## 2019年全国男子手球冠军杯赛

PHMS Pictorial Handball Match Statistics

IHF Official System

### 比赛进程表

手球 半决赛 组别 X 万州体育馆  
男子 轮次 7 场次 29 2019-04-14 17:30

时间	队员	动作	比分	队员	动作
天津队			江苏队		
上半场			下半场		
16:14	8 王晓琪	使被罚7M球	10-18	11 张天豪	快攻 造7M
16:12	8 王晓琪	罚出场2分钟			
16:17	1 何喜年	挡住球		30 吴龙瑞	7M球 被救
16:50				19 庞连康	中远射 射失
17:40	1 何喜年	被射入	10-19	11 张天豪	一传快攻 得分
17:42				18 赵楠	助攻
18:04	9 王子欣	右边射 得分	11-19	16 张帅	被射入
18:43				19 庞连康	传球失误
18:50	8 王晓琪	短传快攻 得分	12-19	16 张帅	被射入
19:29				19 庞连康	左远射 射失
20:15	6 赵晨阳	左边射 射失			
20:57	3 魏雨童	断球		7 周傲	传球失误
21:45	6 赵晨阳	近射 被救		16 张帅	挡住球
22:01					球队暂停
22:22	1 何喜年	挡住球		8 谢庆龙	近射 被救
22:23				20 顾艳超	助攻
22:36	6 赵晨阳	突破 被救		16 张帅	挡住球
23:01	1 何喜年	挡住球		8 谢庆龙	近射 被救
23:47	8 王晓琪	近射 被封		6 赵晨	封球
23:53	1 何喜年	被射入	12-20	27 王伟强	一传快攻 得分
24:24	6 赵晨阳	中远射 得分	13-20	16 张帅	被射入
24:33		裁判暂停			
24:52	1 何喜年	挡住球		6 赵晨	中远射 被救
25:22	9 王子欣	近射 被救		16 张帅	挡住球
25:30	1 何喜年	挡住球		20 顾艳超	短传快攻 被救
25:54	8 王晓琪	传球失误		20 顾艳超	断球
26:12	1 何喜年	被射入	13-21	6 赵晨	近射 得分
26:14				20 顾艳超	助攻
26:53	5 王毅	近射 得分	14-21	16 张帅	被射入
26:56	8 王晓琪	助攻			
27:42	1 何喜年	被射入	14-22	19 庞连康	近射 得分
28:20		裁判暂停			
28:20	3 魏雨童	造7M		19 庞连康	使被罚7M球
28:20				19 庞连康	罚出场2分钟
28:24	8 王晓琪	7M球 得分	15-22	16 张帅	被射入
29:03	1 何喜年	被射入	15-23	8 谢庆龙	近射 得分
29:34	10 苏尧	右远射 得分	16-23	16 张帅	被射入
29:50				8 谢庆龙	左远射 射失

**PHMS** Pictorial Handball Match Statistics **IHF** Official System

Team A <b>A 山东队</b>	Team B <b>B 山西队</b>	Match Number <b>30</b>
------------------------	------------------------	---------------------------

Played in <b>重庆万州</b>	in the hall <b>万州体育馆</b>	on <b>2019-04-16</b>	at <b>09:30</b>	hours	Spectators
--------------------------	-----------------------------	-------------------------	--------------------	-------	------------

Half-time(30')	A <b>10</b>	B <b>10</b>	End of playing time	A <b>24</b>	B <b>17</b>	1st extra time	A	B	2nd extra time	A	B	After penalty throws	A	B
----------------	----------------	----------------	---------------------	----------------	----------------	----------------	---	---	----------------	---	---	----------------------	---	---

Number of 7 m	A <b>0/0</b>	Team time-out			Full name of players and officials	Team time-out			B <b>2/2</b>	Number of 7 m
	1	2	3	1		2	3			

No.	Team A	G	W	2'	D	DR	No.	Team B	G	W	2'	D	DR
1	宋晓晨						1	鲁世豪					
6	李朝鹏						2	张智超	1				
7	林豪文	4		1			3	龙俊皓					
8	王炳华	5					4	刘文东			1		
9	赵元						5	王宇恒	3				
10	赵建强						6	盖秀越	1				
11	宋朋强						7	任健豪	4				
12	于性哲						9	辛浩乐					
13	刘晓	1					10	王洋	1				
15	张继伟	11	1				11	吴夏冰					
17	王旭东						12	韩乐斌					
19	李语庆	1					13	杜忠浩					
21	姜春辉	2					14	杨毅	6				
27	胡晋铭						15	薛瑞寒	1				
31	于亚男						16	王虹翔					
34	王钟彬						18	张禹琛					
B	王鸿斌 (主教练)						A	张栋					
C	金京男						B	赵鑫 (主教练)					
D	刘桂妮												
E	林配永												

A	Signatures of responsables for the teams (Off.A)	B
---	--	---

TP	Remarks of referees / HF Official	TP
----	-----------------------------------	----

Signatures			
Referees	鲍瑀 (CHN)	刘宇阳 (CHN)	
T.D.	郭剑 (CHN)	张春生 (CHN)	
CHA Off.			

Note: Number of 7m Throws Awarded to Team A and B, Goals (G), Warnings (W), Suspensions (2'), Direct Disqualification (D), Disqualification With Report (DR) and Team Penalty (TP).

Table Officials: 周胜锋 陈常增 Statisticians: 谢杨 赵悦

2019年全国男子手球冠军杯赛

PHMS Pictorial Handball Match Statistics

IHF Official System

竞赛技术统计

手球 男子 7-8名 轮次 8 组别 X 场次 30 万州体育馆 2019-04-16 09:30

Referees: 鲍瑀 (CHN) / 刘宇阳 (CHN) Result: 24:17(10:10)  
Teams: 山东队(山东) VS 山西队(山西)

山东		远	近	边	快	突	任意	7m	合计	%	助攻	失误	警告	2'	D+DR
主教练: 王鸿斌		射	射	射	攻	破	球	球							
1	宋晓晨														
6	李朝鹏														
7	林豪文	3/4	1/2						4/6	66.7	3	1		1	
8	王炳华	0/3	3/4		1/1	1/1			5/9	55.6	1	1			
9	赵元		0/1						0/1	0.0	1	3			
10	赵建强										3	1			
11	宋朋强														
12	于性哲														
13	刘晓	1/4				0/1			1/5	20.0	3	3			
15	张继伟		10/12		0/1	1/1	0/1		11/15	73.3		2	1		
17	王旭东														
19	李语庆		1/1	0/1					1/2	50.0					
21	姜春辉			0/2	2/2				2/4	50.0		1			
27	胡晋铭														
31	于亚男														
34	王钟彬										1	1			
运动员	合计	4/11	15/20	0/3	3/4	2/3	0/1		24/42	57.1	12	13	1	1	
1	宋晓晨	5/9	3/7	2/3	2/7	0/1		0/2	12/29	41.4					
守门员	合计	5/9	3/7	2/3	2/7	0/1		0/2	12/29	41.4					

山东	比赛进程	山西
1st Half		
0	01:14	1 7 任健豪
8 王炳华	1 03:46	1
	1 04:39	2 10 王洋
15 张继伟	2 05:18	2
15 张继伟	3 06:00	2
	3 07:15	3 14 杨毅
	3 07:51	4 14 杨毅
15 张继伟	4 08:24	4
21 姜春辉	5 09:38	4
	5 10:45	5 7 任健豪
	5 12:07	6 14 杨毅
8 王炳华	6 12:39	6
	6 13:08	7 14 杨毅
19 李语庆	7 16:36	7
	7 20:36	8 14 杨毅
15 张继伟	8 21:12	8
8 王炳华	9 24:16	8
	9 24:57	9 14 杨毅
15 张继伟	10 26:09	9
	10 29:24	10 7 任健豪
2nd Half		
15 张继伟	11 01:53	10
21 姜春辉	12 03:11	10
7 林豪文	13 04:24	10
	13 05:14	11 7 任健豪
7 林豪文	14 05:53	11
	14 07:20	12 5 王宇恒
	14 09:26	13 5 王宇恒
15 张继伟	15 10:39	13
	15 11:25	14 2 张智超
13 刘晓	16 12:07	14
7 林豪文	17 13:40	14
15 张继伟	18 17:38	14
8 王炳华	19 20:47	14
	19 22:04	15 6 盖秀越
7 林豪文	20 22:46	15
15 张继伟	21 24:18	15
15 张继伟	22 25:45	15
	22 26:32	16 5 王宇恒
15 张继伟	23 27:14	16
8 王炳华	24 29:17	16
	24 29:56	17 15 薛瑞寒

场上队员: 得分 / 射门

守门员: 救球 / 射门

D	取消资格	DR	取消资格+报告
---	------	----	---------



2019年全国男子手球冠军杯赛

PHMS Pictorial Handball Match Statistics

IHF Official System

个人/全队技术统计表

手球 男子 7-8名 轮次 8 组别 X 场次 30 万州体育馆 2019-04-16 09:30

号码	姓名	远射	近射	边射	快攻	突破	任意	七米	合计	%	助攻	失误	警告	2'	取消	时间
山东队(山东)																
(场上队员)																
1	宋晓晨									0.0%						01:00:00
6	李朝鹏									0.0%						00:00:00
7	林豪文	3/4	1/2						4/6	66.7%	3	1		1		00:30:00
8	王炳华	0/3	3/4		1/1	1/1			5/9	55.6%	1	1				00:45:23
9	赵元		0/1						0/1	0.0%	1	3				00:42:54
10	赵建强									0.0%	3	1				00:30:00
11	宋朋强									0.0%						00:00:00
12	于性哲									0.0%						00:00:00
13	刘晓	1/4				0/1			1/5	20.0%	3	3				00:44:36
15	张继伟		10/12		0/1	1/1	0/1		11/15	73.3%		2	1			01:00:00
17	王旭东									0.0%						00:00:00
19	李语庆		1/1	0/1					1/2	50.0%						00:30:00
21	姜春辉			0/2	2/2				2/4	50.0%		1				01:00:00
27	胡晋铭									0.0%						00:00:00
31	于亚男									0.0%						00:00:00
34	王钟彬									0.0%	1	1				00:17:05
合计		4/11	15/20	0/3	3/4	2/3	0/1		24/42	57.1%	12	13	1	1		
(守门员)																
1	宋晓晨	5/9	3/7	2/3	2/7	0/1		0/2	12/29	41.4%						01:00:00
合计		5/9	3/7	2/3	2/7	0/1		0/2	12/29	41.4%						

场上队员：得分/射门

守门员：救球/射门

全队合计	得分	被救	射失	击柱	封球	合计	%
远射	4	4	1	1	1	11	36.4%
近射	15	5				20	75.0%
边射		2		1		3	0.0%
快攻	3	1				4	75.0%
突破	2			1		3	66.7%
任意		1				1	0.0%
七米							0.0%

## 2019年全国男子手球冠军杯赛

PHMS Pictorial Handball Match Statistics

IHF Official System

### 个人/全队技术统计表

手球 男子 7-8名 轮次 8 组别 X 场次 30 万州体育馆 2019-04-16 09:30

号码	姓名	远射	近射	边射	快攻	突破	任意	七米	合计	%	助攻	失误	警告	2'	取消	时间
山西队(山西)																
(场上队员)																
1	鲁世豪									0.0%						00:30:00
2	张智超		0/1	1/2					1/3	33.3%		1				00:37:18
3	龙俊皓									0.0%						00:00:00
4	刘文东		0/1						0/1	0.0%	1	1		1		00:38:10
5	王宇恒	1/1	2/2						3/3	100%						00:32:07
6	盖秀越			0/3	1/1				1/4	25.0%	1	1				01:00:00
7	任健豪	1/3	0/1		2/3	1/1			4/8	50.0%	1	2				00:46:01
9	辛浩乐									0.0%						00:00:00
10	王洋	0/1			1/1				1/2	50.0%						00:22:41
11	吴夏冰									0.0%						00:35:37
12	韩乐斌									0.0%		1				00:30:00
13	杜忠浩									0.0%						00:00:00
14	杨毅	2/9	1/3		1/1		0/1	2/2	6/16	37.5%	1	6				00:45:35
15	薛瑞寒	0/3	1/1		0/2				1/6	16.7%		1				00:41:39
16	王虹翔									0.0%						00:00:00
18	张禹琛									0.0%						00:00:00
	合计	4/17	4/9	1/5	5/8	1/1	0/1	2/2	17/43	39.5%	4	13		1		
(守门员)																
1	鲁世豪	1/5	3/12		1/2				5/19	26.3%						00:30:00
12	韩乐斌	3/3	2/8	2/2	0/2	0/2	1/1		8/18	44.4%		1				00:30:00
	合计	4/8	5/20	2/2	1/4	0/2	1/1		13/37	35.1%		1				

场上队员：得分/射门

守门员：救球/射门

全队合计	得分	被救	射失	击柱	封球	合计	%
远射	4	5	2	2	4	17	23.5%
近射	4	3	1	1		9	44.4%
边射	1	2	1	1		5	20.0%
快攻	5	2		1		8	62.5%
突破	1					1	100.0%
任意			1			1	0.0%
七米	2					2	100.0%

图式比赛技术统计表

手球  
男子

7-8名  
轮次 8

组别 X  
场次 30

万州体育馆  
2019-04-16 09:30

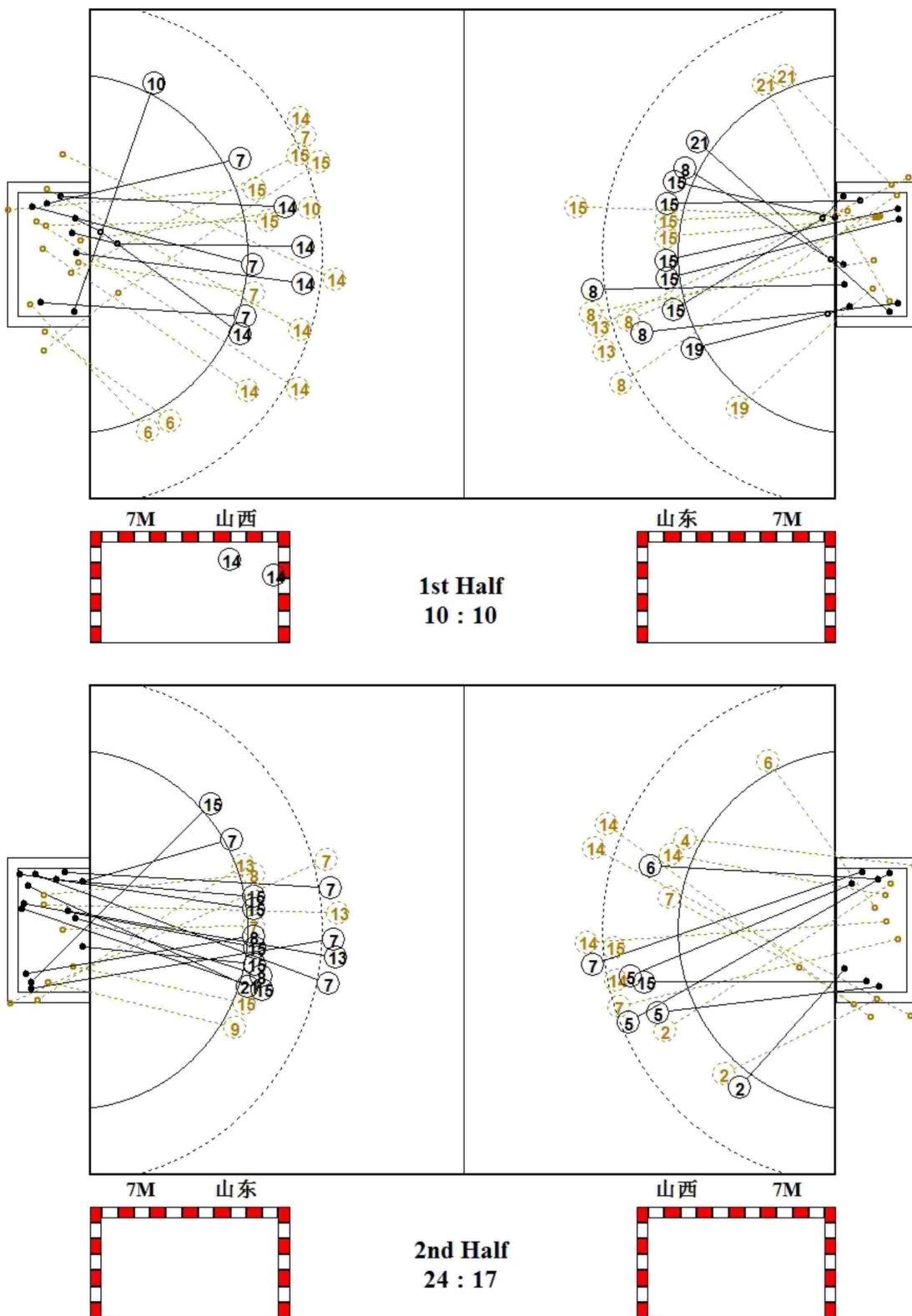

图式射门区域统计

手球  
男子

7-8名  
轮次 8

组别 X  
场次 30

万州体育馆  
2019-04-16 09:30

山东队

1 宋晓晨	6 李朝鹏	7 林豪文	8 王炳华	9 赵元	10 赵建强	11 宋朋强	12 于性哲																																																																								
<table border="1"><tr><td></td><td></td><td></td></tr><tr><td></td><td></td><td></td></tr><tr><td></td><td></td><td></td></tr></table>										<table border="1"><tr><td></td><td></td><td></td></tr><tr><td></td><td></td><td></td></tr><tr><td></td><td></td><td></td></tr></table>										<table border="1"><tr><td>1</td><td></td><td>1</td></tr><tr><td></td><td></td><td>1</td></tr><tr><td></td><td></td><td>1</td></tr></table>	1		1			1			1	<table border="1"><tr><td>1</td><td></td><td>1</td></tr><tr><td></td><td></td><td></td></tr><tr><td></td><td>2</td><td>1</td></tr></table>	1		1					2	1	<table border="1"><tr><td></td><td></td><td></td></tr><tr><td></td><td></td><td></td></tr><tr><td></td><td></td><td></td></tr></table>										<table border="1"><tr><td></td><td></td><td></td></tr><tr><td></td><td></td><td></td></tr><tr><td></td><td></td><td></td></tr></table>										<table border="1"><tr><td></td><td></td><td></td></tr><tr><td></td><td></td><td></td></tr><tr><td></td><td></td><td></td></tr></table>										<table border="1"><tr><td></td><td></td><td></td></tr><tr><td></td><td></td><td></td></tr><tr><td></td><td></td><td></td></tr></table>									
1		1																																																																													
		1																																																																													
		1																																																																													
1		1																																																																													
	2	1																																																																													
Post - 0 Miss - 0 Block - 0	Post - 0 Miss - 0 Block - 0	Post - 1 Miss - 0 Block - 0	Post - 0 Miss - 0 Block - 0	Post - 0 Miss - 0 Block - 0	Post - 0 Miss - 0 Block - 0	Post - 0 Miss - 0 Block - 0	Post - 0 Miss - 0 Block - 0																																																																								
13 刘晓	15 张继伟	17 王旭东	19 李语庆	21 姜春辉	27 胡晋铭	31 于亚男	34 王钟彬																																																																								
<table border="1"><tr><td></td><td></td><td></td></tr><tr><td></td><td></td><td></td></tr><tr><td></td><td>1</td><td></td></tr></table>								1		<table border="1"><tr><td>3</td><td>1</td><td>2</td></tr><tr><td>1</td><td></td><td>1</td></tr><tr><td>2</td><td>1</td><td></td></tr></table>	3	1	2	1		1	2	1		<table border="1"><tr><td></td><td></td><td></td></tr><tr><td></td><td></td><td></td></tr><tr><td></td><td></td><td></td></tr></table>										<table border="1"><tr><td></td><td></td><td></td></tr><tr><td></td><td></td><td></td></tr><tr><td></td><td></td><td>1</td></tr></table>									1	<table border="1"><tr><td></td><td></td><td>2</td></tr><tr><td></td><td></td><td></td></tr><tr><td></td><td></td><td></td></tr></table>			2							<table border="1"><tr><td></td><td></td><td></td></tr><tr><td></td><td></td><td></td></tr><tr><td></td><td></td><td></td></tr></table>										<table border="1"><tr><td></td><td></td><td></td></tr><tr><td></td><td></td><td></td></tr><tr><td></td><td></td><td></td></tr></table>										<table border="1"><tr><td></td><td></td><td></td></tr><tr><td></td><td></td><td></td></tr><tr><td></td><td></td><td></td></tr></table>									
	1																																																																														
3	1	2																																																																													
1		1																																																																													
2	1																																																																														
		1																																																																													
		2																																																																													
Post - 1 Miss - 1 Block - 1	Post - 0 Miss - 0 Block - 0	Post - 0 Miss - 0 Block - 0	Post - 0 Miss - 0 Block - 0	Post - 1 Miss - 0 Block - 0	Post - 0 Miss - 0 Block - 0	Post - 0 Miss - 0 Block - 0	Post - 0 Miss - 0 Block - 0																																																																								

1 宋晓晨

3/5	3/3	1/4
1/3		1/5
0/2	3/5	0/2

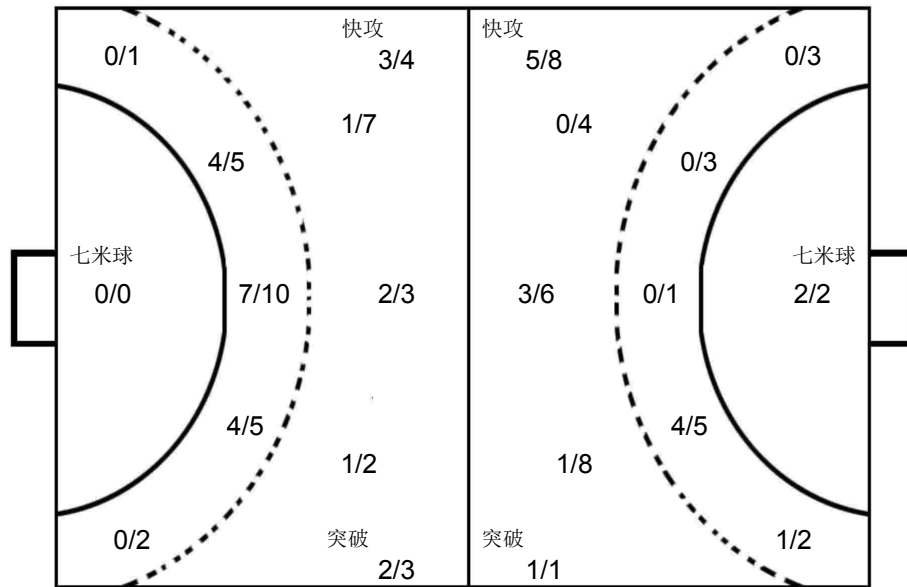

1 鲁世豪

0/3	0/1	0/4
1/1	1/1	2/4
1/1	0/3	0/1

12 韩乐斌

1/3		1/3
3/4	1/1	1/1
1/3	0/1	0/2

山西队

1 鲁世豪	2 张智超	3 龙俊皓	4 刘文东	5 王宇恒	6 盖秀越	7 任健豪	9 辛浩乐																																																																								
<table border="1"><tr><td></td><td></td><td></td></tr><tr><td></td><td></td><td></td></tr><tr><td></td><td></td><td></td></tr></table>										<table border="1"><tr><td></td><td></td><td></td></tr><tr><td></td><td></td><td>1</td></tr><tr><td></td><td></td><td></td></tr></table>						1				<table border="1"><tr><td></td><td></td><td></td></tr><tr><td></td><td></td><td></td></tr><tr><td></td><td></td><td></td></tr></table>										<table border="1"><tr><td></td><td></td><td></td></tr><tr><td></td><td></td><td></td></tr><tr><td></td><td></td><td></td></tr></table>										<table border="1"><tr><td>1</td><td></td><td></td></tr><tr><td></td><td></td><td>1</td></tr><tr><td>1</td><td></td><td></td></tr></table>	1					1	1			<table border="1"><tr><td></td><td></td><td></td></tr><tr><td>1</td><td></td><td></td></tr><tr><td></td><td></td><td></td></tr></table>				1						<table border="1"><tr><td>1</td><td></td><td>1</td></tr><tr><td>1</td><td></td><td>1</td></tr><tr><td></td><td></td><td></td></tr></table>	1		1	1		1				<table border="1"><tr><td></td><td></td><td></td></tr><tr><td></td><td></td><td></td></tr><tr><td></td><td></td><td></td></tr></table>									
		1																																																																													
1																																																																															
		1																																																																													
1																																																																															
1																																																																															
1		1																																																																													
1		1																																																																													
Post - 0 Miss - 0 Block - 0	Post - 1 Miss - 0 Block - 0	Post - 0 Miss - 0 Block - 0	Post - 1 Miss - 0 Block - 0	Post - 0 Miss - 0 Block - 0	Post - 0 Miss - 1 Block - 0	Post - 0 Miss - 1 Block - 1	Post - 0 Miss - 0 Block - 0																																																																								
10 王洋	11 吴夏冰	12 韩乐斌	13 杜忠浩	14 杨毅	15 薛瑞寒	16 王虹翔	18 张禹琛																																																																								
<table border="1"><tr><td></td><td></td><td></td></tr><tr><td></td><td></td><td></td></tr><tr><td>1</td><td></td><td></td></tr></table>							1			<table border="1"><tr><td></td><td></td><td></td></tr><tr><td></td><td></td><td></td></tr><tr><td></td><td></td><td></td></tr></table>										<table border="1"><tr><td></td><td></td><td></td></tr><tr><td></td><td></td><td></td></tr><tr><td></td><td></td><td></td></tr></table>										<table border="1"><tr><td></td><td></td><td></td></tr><tr><td></td><td></td><td></td></tr><tr><td></td><td></td><td></td></tr></table>										<table border="1"><tr><td></td><td></td><td>2</td></tr><tr><td></td><td></td><td>1</td></tr><tr><td>2</td><td></td><td>1</td></tr></table>			2			1	2		1	<table border="1"><tr><td></td><td></td><td></td></tr><tr><td></td><td></td><td>1</td></tr><tr><td></td><td></td><td></td></tr></table>						1				<table border="1"><tr><td></td><td></td><td></td></tr><tr><td></td><td></td><td></td></tr><tr><td></td><td></td><td></td></tr></table>										<table border="1"><tr><td></td><td></td><td></td></tr><tr><td></td><td></td><td></td></tr><tr><td></td><td></td><td></td></tr></table>									
1																																																																															
		2																																																																													
		1																																																																													
2		1																																																																													
		1																																																																													
Post - 0 Miss - 0 Block - 0	Post - 0 Miss - 0 Block - 0	Post - 0 Miss - 0 Block - 0	Post - 0 Miss - 0 Block - 0	Post - 2 Miss - 2 Block - 2	Post - 1 Miss - 1 Block - 1	Post - 0 Miss - 0 Block - 0	Post - 0 Miss - 0 Block - 0																																																																								





Team A	Team B	Match Number
A 上海队	B 广东队	31

Played in	in the hall	on	at	Spepectors
重庆万州	万州体育馆	2019-04-16	13:00	hours

Half-time(30')	A	B	End of playing time	A	B	1st extra time	A	B	2nd extra time	A	B	After penalty throws	A	B
	11	14	22	27										

Number of 7 m	A	Team time-out			Full name of players and officials	Team time-out			B	Number of 7 m
	3/6	1	2	3		1	2	3	1/1	
		15:34	37:37	47:04		24:14	54:54			

No.	Team A	G	W	2'	D	DR	No.	Team B	G	W	2'	D	DR
1	张峥						2	孙江山					
3	张立成	1					6	毕晓晨	2		1		
4	高天伦	1		2			7	王立隆	7				
5	贺政						9	范保坤					
7	周文龙						10	周仲坤	3		1		
8	高震东	10	1				11	房友屯	1				
10	朱世杰	2		1			12	王雨	4	1			
11	蒋慧捷						14	王泽润					
12	周哲韬						15	张建杰	3				
13	谢智超						18	姚雪岩	1				
15	庄旭杰						19	王帅					
18	董凯	2					21	张昌轲					
20	蒋承骅						22	黄培杰	5				
23	吴双	3					24	高玉杰	1		3		
30	徐俊吉	3	1										

A	吴璟 (主教练)						A	曲汝洋					
B	金迪琦						B	刘康伶 (主教练)					
C	张勇军						C	郭艳辉					
D	杨时						E	贾章志					

	Signatures of responsables for the teams (Off.A)	
--	--	--

A			B
TP	Remarks of referees / HF Official		TP

Signatures			
Referees	康曦 (CHN)	张智伟 (CHN)	
T.D.	郭剑 (CHN)	倪震 (CHN)	
CHA Off.			

Note: Number of 7m Throws Awarded to Team A and B, Goals (G), Warnings (W), Suspensions (2'), Direct Disqualification (D), Disqualification With Report (DR) and Team Penalty (TP).

Table Officials: 张晓虎                      黄一凡                      Statisticians: 赵悦                      周亚桥

2019年全国男子手球冠军杯赛

PHMS Pictorial Handball Match Statistics

IHF Official System

竞赛技术统计

手球 男子 5-6名 轮次 8 组别 X 场次 31 万州体育馆 2019-04-16 13:00

Referees: 康曦 (CHN) / 张智伟 (CHN) Result: 22:27(11:14)  
Teams: 上海队(上海) VS 广东队(广东)

上海		远射	近射	边射	快攻	突破	任意球	7m球	合计	%	助攻	失误	警告	2'	D+DR
主教练:	吴璟														
1	张峥														
3	张立成				1/1	0/2			1/3	33.3		2			
4	高天伦	0/1	1/2	0/2					1/5	20.0		1		2	
5	贺政														
7	周文龙	0/1							0/1	0.0					
8	高震东	0/2	2/5	3/3	1/1	2/2		2/2	10/15	66.7	2	3	1		
10	朱世杰	0/3	0/1			1/2		1/2	2/8	25.0	3	6		1	
11	蒋慧捷														
12	周哲韬														
13	谢智超														
15	庄旭杰			0/1					0/1	0.0					
18	董凯		2/3					0/1	2/4	50.0		1			
20	蒋承骅											1			
23	吴双	1/1			2/3				3/4	75.0		3			
30	徐俊吉		3/4	0/1				0/1	3/6	50.0		2	1		
运动员	合计	1/8	8/15	3/7	4/5	3/6		3/6	22/47	46.8	5	19	2	3	
1	张峥	3/3	2/5	0/2	0/3	2/7		0/1	7/21	33.3					
12	周哲韬	3/3	2/6	1/3	1/4	0/4			7/20	35.0					
守门员	合计	6/6	4/11	1/5	1/7	2/11		0/1	14/41	34.1					

广东		远射	近射	边射	快攻	突破	任意球	7m球	合计	%	助攻	失误	警告	2'	D+DR
主教练:	刘康伶														
2	孙江山														
6	毕晓晨	0/2	1/3			1/3			2/8	25.0		2		1	
7	王立隆			3/3	2/4	2/2			7/9	77.8		3			
9	范保坤														
10	周仲坤		1/2			1/1		1/1	3/4	75.0	1	2		1	
11	房友屯				1/1				1/1	100		2			
12	王雨			1/2	2/3	1/1			4/6	66.7	1	1	1		
14	王泽润														
15	张建杰	0/3	2/3		0/1	1/1			3/8	37.5		2			
18	姚雪岩	0/1	1/2						1/3	33.3	1				
19	王帅														
21	张昌轲														
22	黄培杰	0/1	2/2	0/1		3/4			5/8	62.5	2	2			
24	高玉杰				1/1				1/1	100					
运动员	合计	0/7	7/12	4/6	6/10	9/12		1/1	27/48	56.3	5	14	1	5	
14	王泽润	0/1	3/7	1/3	0/3	1/4		1/2	6/20	30.0					
19	王帅	1/1	2/6	2/3	1/2	1/1		0/2	7/15	46.7					
守门员	合计	1/2	5/13	3/6	1/5	2/5		1/4	13/35	37.1					

上海	比赛进程	广东
	1st Half	
	0 02:01	1 22 黄培杰
	0 05:11	2 10 周仲坤
30 徐俊吉	1 06:07	2
	1 06:37	3 6 毕晓晨
8 高震东	2 07:32	3
	2 07:42	4 12 王雨
	2 08:33	5 7 王立隆
8 高震东	3 10:09	5
23 吴双	4 10:52	5
	4 12:06	6 10 周仲坤
	4 14:46	7 15 张建杰
	4 15:26	8 7 王立隆
30 徐俊吉	5 16:20	8
18 董凯	6 17:35	8
	6 18:12	9 12 王雨
	6 19:32	10 7 王立隆
	6 20:31	11 7 王立隆
8 高震东	7 21:02	11
	7 21:55	12 6 毕晓晨
	7 24:33	13 22 黄培杰
10 朱世杰	8 25:29	13
	8 26:37	14 7 王立隆
18 董凯	9 27:38	14
23 吴双	10 28:20	14
23 吴双	11 29:43	14
	2nd Half	
8 高震东	12 00:57	14
8 高震东	13 02:43	14
10 朱世杰	14 04:07	14
	14 04:16	15 22 黄培杰
	14 05:07	16 15 张建杰
	14 06:03	17 15 张建杰
	14 07:27	18 12 王雨
	14 08:25	19 12 王雨
8 高震东	15 09:43	19
	15 13:02	20 7 王立隆
	15 14:28	21 7 王立隆
	15 16:43	22 18 姚雪岩
	15 17:27	23 24 高玉杰
	15 18:29	24 11 房友屯
3 张立成	16 19:44	24
8 高震东	17 21:44	24
	17 22:46	25 22 黄培杰
	17 23:36	26 10 周仲坤
8 高震东	18 24:12	26
4 高天伦	19 26:29	26
30 徐俊吉	20 27:54	26
	20 28:34	27 22 黄培杰
8 高震东	21 28:59	27
8 高震东	22 29:58	27

场上队员: 得分 / 射门

守门员: 救球 / 射门

D	取消资格	DR	取消资格+报告
---	------	----	---------



## 2019年全国男子手球冠军杯赛

PHMS Pictorial Handball Match Statistics

IHF Official System

### 个人/全队技术统计表

手球 男子 5-6名 轮次 8 组别 X 场次 31 万州体育馆 2019-04-16 13:00

号码	姓名	远射	近射	边射	快攻	突破	任意	七米	合计	%	助攻	失误	警告	2'	取消	时间
上海队(上海)																
(场上队员)																
1	张崢									0.0%						00:26:50
3	张立成				1/1	0/2			1/3	33.3%		2				00:27:35
4	高天伦	0/1	1/2	0/2					1/5	20.0%		1		2		00:50:36
5	贺政									0.0%						00:00:00
7	周文龙	0/1							0/1	0.0%						00:03:49
8	高震东	0/2	2/5	3/3	1/1	2/2		2/2	10/15	66.7%	2	3	1			01:00:00
10	朱世杰	0/3	0/1			1/2		1/2	2/8	25.0%	3	6		1		01:00:00
11	蒋慧捷									0.0%						00:00:00
12	周哲韬									0.0%						00:33:10
13	谢智超									0.0%						00:00:00
15	庄旭杰			0/1					0/1	0.0%						00:08:28
18	董凯		2/3					0/1	2/4	50.0%		1				00:18:54
20	蒋承骅									0.0%		1				00:19:11
23	吴双	1/1			2/3				3/4	75.0%		3				00:51:19
30	徐俊吉		3/4	0/1				0/1	3/6	50.0%		2	1			00:59:16
合计		1/8	8/15	3/7	4/5	3/6		3/6	22/47	46.8%	5	19	2	3		
(守门员)																
1	张崢	3/3	2/5	0/2	0/3	2/7		0/1	7/21	33.3%						00:26:50
12	周哲韬	3/3	2/6	1/3	1/4	0/4			7/20	35.0%						00:33:10
合计		6/6	4/11	1/5	1/7	2/11		0/1	14/41	34.1%						

场上队员：得分/射门

守门员：救球/射门

全队合计	得分	被救	射失	击柱	封球	合计	%
远射	1	1	3		3	8	12.5%
近射	8	5	1	1		15	53.3%
边射	3	3	1			7	42.9%
快攻	4	1				5	80.0%
突破	3	2		1		6	50.0%
任意							0.0%
七米	3	1		2		6	50.0%

2019年全国男子手球冠军杯赛

PHMS Pictorial Handball Match Statistics

IHF Official System

个人/全队技术统计表

手球 男子 5-6名 轮次 8 组别 X 场次 31 万州体育馆 2019-04-16 13:00

号码	姓名	远射	近射	边射	快攻	突破	任意	七米	合计	%	助攻	失误	警告	2'	取消	时间
广东队(广东)																
(场上队员)																
2	孙江山									0.0%						00:00:00
6	毕晓晨	0/2	1/3			1/3			2/8	25.0%		2		1		00:49:47
7	王立隆			3/3	2/4	2/2			7/9	77.8%		3				00:46:14
9	范保坤									0.0%						00:00:00
10	周仲坤		1/2			1/1		1/1	3/4	75.0%	1	2		1		00:42:38
11	房友屯				1/1				1/1	100%		2				00:19:01
12	王雨			1/2	2/3	1/1			4/6	66.7%	1	1	1			01:00:00
14	王泽润									0.0%						00:35:14
15	张建杰	0/3	2/3		0/1	1/1			3/8	37.5%		2				00:55:57
18	姚雪岩	0/1	1/2						1/3	33.3%	1					00:23:55
19	王帅									0.0%						00:24:46
21	张昌轲									0.0%						00:00:00
22	黄培杰	0/1	2/2	0/1		3/4			5/8	62.5%	2	2				00:28:29
24	高玉杰				1/1				1/1	100%				3		00:30:41
合计		0/7	7/12	4/6	6/10	9/12		1/1	27/48	56.3%	5	14	1	5		
(守门员)																
14	王泽润	0/1	3/7	1/3	0/3	1/4		1/2	6/20	30.0%						00:35:14
19	王帅	1/1	2/6	2/3	1/2	1/1		0/2	7/15	46.7%						00:24:46
合计		1/2	5/13	3/6	1/5	2/5		1/4	13/35	37.1%						

场上队员：得分/射门

守门员：救球/射门

全队合计	得分	被救	射失	击柱	封球	合计	%
远射		6	1			7	0.0%
近射	7	4	1			12	58.3%
边射	4	1		1		6	66.7%
快攻	6	1	1	2		10	60.0%
突破	9	2		1		12	75.0%
任意							0.0%
七米	1					1	100.0%

图式比赛技术统计表

手球  
男子

5-6名  
轮次 8

组别 X  
场次 31

万州体育馆  
2019-04-16 13:00

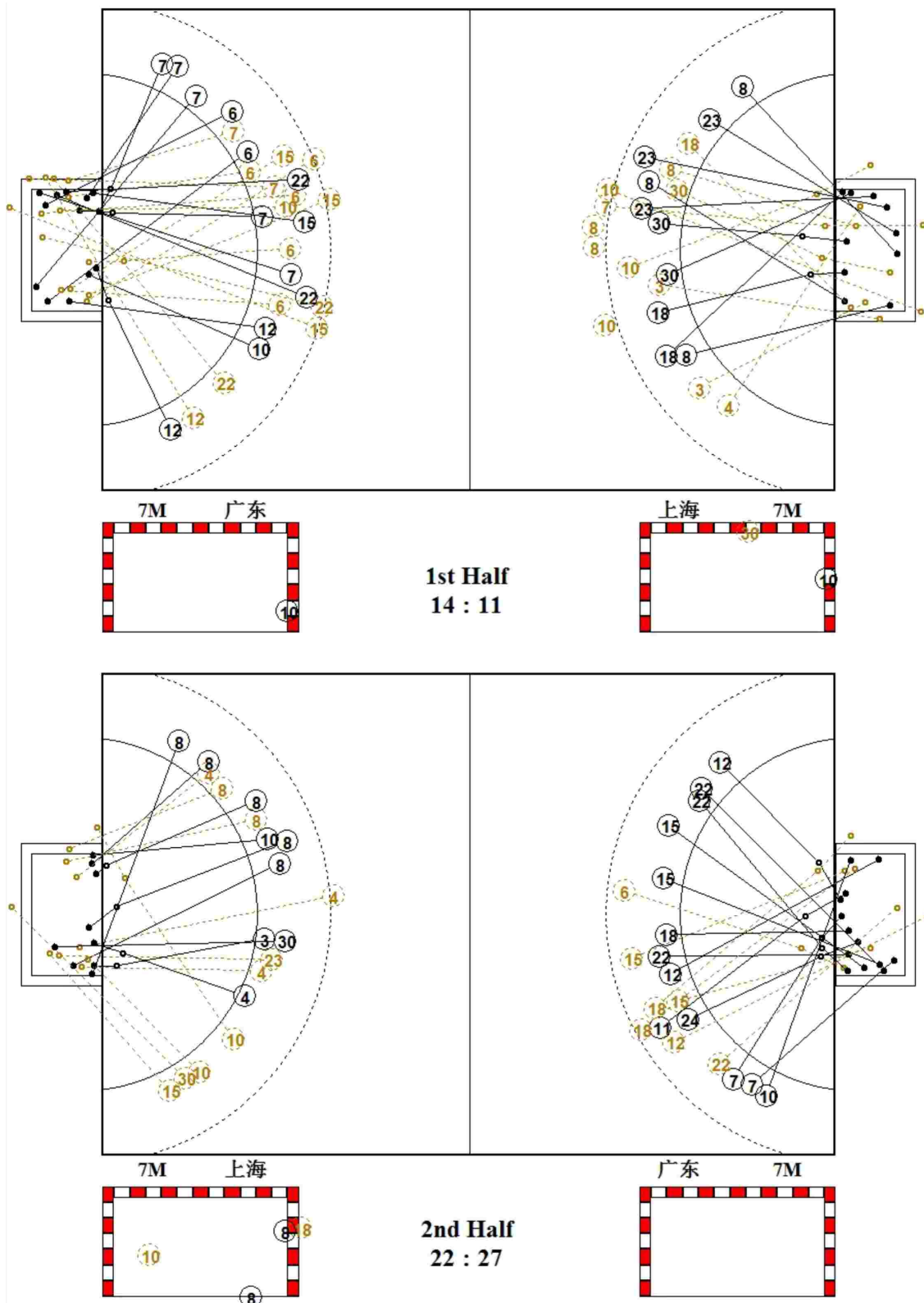

图式射门区域统计

手球  
男子

5-6名  
轮次 8

组别 X  
场次 31

万州体育馆  
2019-04-16 13:00

上海队

1 张峥	3 张立成	4 高天伦	5 贺政	7 周文龙	8 高震东	10 朱世杰	11 蒋慧捷																																																																								
<table border="1"><tr><td></td><td></td><td></td></tr><tr><td></td><td></td><td></td></tr><tr><td></td><td></td><td></td></tr></table>										<table border="1"><tr><td></td><td></td><td></td></tr><tr><td>1</td><td></td><td></td></tr><tr><td></td><td></td><td></td></tr></table>				1						<table border="1"><tr><td></td><td></td><td></td></tr><tr><td>1</td><td></td><td></td></tr><tr><td></td><td></td><td></td></tr></table>				1						<table border="1"><tr><td></td><td></td><td></td></tr><tr><td></td><td></td><td></td></tr><tr><td></td><td></td><td></td></tr></table>										<table border="1"><tr><td></td><td></td><td></td></tr><tr><td></td><td></td><td></td></tr><tr><td></td><td></td><td></td></tr></table>										<table border="1"><tr><td></td><td>1</td><td>2</td></tr><tr><td>1</td><td></td><td></td></tr><tr><td>1</td><td>1</td><td>4</td></tr></table>		1	2	1			1	1	4	<table border="1"><tr><td></td><td></td><td></td></tr><tr><td></td><td></td><td>1</td></tr><tr><td></td><td></td><td>1</td></tr></table>						1			1	<table border="1"><tr><td></td><td></td><td></td></tr><tr><td></td><td></td><td></td></tr><tr><td></td><td></td><td></td></tr></table>									
1																																																																															
1																																																																															
	1	2																																																																													
1																																																																															
1	1	4																																																																													
		1																																																																													
		1																																																																													
Post - 0 Miss - 0 Block - 0	Post - 1 Miss - 0 Block - 0	Post - 0 Miss - 0 Block - 0	Post - 0 Miss - 0 Block - 0	Post - 0 Miss - 1 Block - 0	Post - 1 Miss - 0 Block - 2	Post - 0 Miss - 3 Block - 1	Post - 0 Miss - 0 Block - 0																																																																								
12 周哲韬	13 谢智超	15 庄旭杰	18 董凯	20 蒋承骅	23 吴双	30 徐俊吉																																																																									
<table border="1"><tr><td></td><td></td><td></td></tr><tr><td></td><td></td><td></td></tr><tr><td></td><td></td><td></td></tr></table>										<table border="1"><tr><td></td><td></td><td></td></tr><tr><td></td><td></td><td></td></tr><tr><td></td><td></td><td></td></tr></table>										<table border="1"><tr><td></td><td></td><td></td></tr><tr><td></td><td></td><td></td></tr><tr><td></td><td></td><td></td></tr></table>										<table border="1"><tr><td></td><td></td><td></td></tr><tr><td>1</td><td></td><td>1</td></tr><tr><td></td><td></td><td></td></tr></table>				1		1				<table border="1"><tr><td></td><td></td><td></td></tr><tr><td></td><td></td><td></td></tr><tr><td></td><td></td><td></td></tr></table>										<table border="1"><tr><td>1</td><td>1</td><td></td></tr><tr><td>1</td><td></td><td></td></tr><tr><td></td><td></td><td></td></tr></table>	1	1		1						<table border="1"><tr><td>1</td><td></td><td></td></tr><tr><td></td><td></td><td></td></tr><tr><td>1</td><td>1</td><td></td></tr></table>	1						1	1											
1		1																																																																													
1	1																																																																														
1																																																																															
1																																																																															
1	1																																																																														
Post - 0 Miss - 0 Block - 0	Post - 0 Miss - 0 Block - 0	Post - 0 Miss - 0 Block - 0	Post - 1 Miss - 0 Block - 0	Post - 0 Miss - 0 Block - 0	Post - 0 Miss - 0 Block - 0	Post - 1 Miss - 1 Block - 0																																																																									

1 张峥

0/2	1/1	1/3
1/2		1/3
2/3	1/2	0/5

12 周哲韬

	1/1	0/2
1/2		2/5
2/3	0/4	1/3

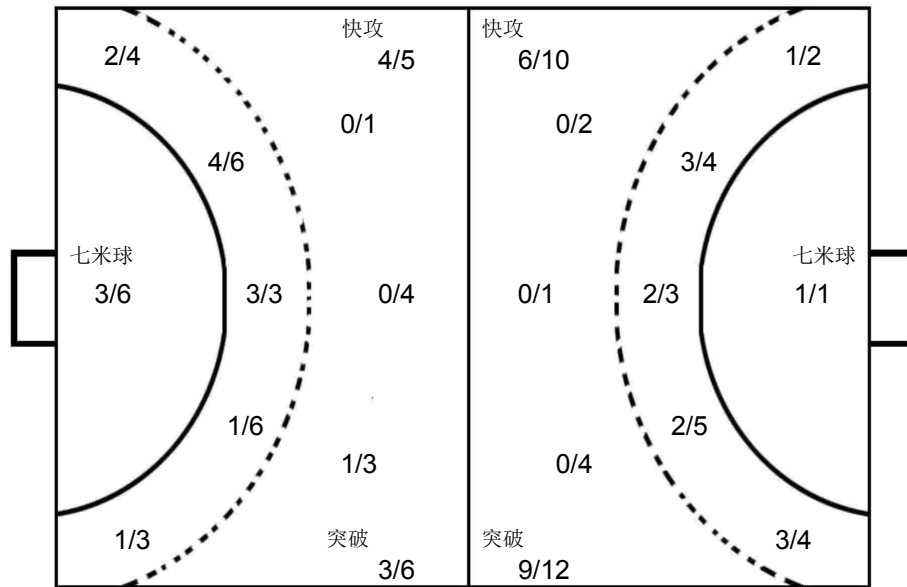

14 王泽润

0/1	0/2	1/3
2/4		1/1
1/3	0/1	1/5

19 王帅

1/2		
1/1		2/3
3/6	0/1	0/2

广东队

2 孙江山	6 毕晓晨	7 王立隆	9 范保坤	10 周仲坤	11 房友屯	12 王雨	14 王泽润																																																																								
<table border="1"><tr><td></td><td></td><td></td></tr><tr><td></td><td></td><td></td></tr><tr><td></td><td></td><td></td></tr></table>										<table border="1"><tr><td>1</td><td></td><td>1</td></tr><tr><td></td><td></td><td></td></tr><tr><td></td><td></td><td></td></tr></table>	1		1							<table border="1"><tr><td>1</td><td></td><td>2</td></tr><tr><td></td><td></td><td></td></tr><tr><td></td><td>1</td><td>3</td></tr></table>	1		2					1	3	<table border="1"><tr><td></td><td></td><td></td></tr><tr><td></td><td></td><td></td></tr><tr><td></td><td></td><td></td></tr></table>										<table border="1"><tr><td></td><td></td><td></td></tr><tr><td>2</td><td></td><td>1</td></tr><tr><td></td><td></td><td></td></tr></table>				2		1				<table border="1"><tr><td></td><td></td><td></td></tr><tr><td></td><td></td><td></td></tr><tr><td></td><td>1</td><td></td></tr></table>								1		<table border="1"><tr><td></td><td></td><td></td></tr><tr><td>2</td><td></td><td></td></tr><tr><td></td><td>2</td><td></td></tr></table>				2				2		<table border="1"><tr><td></td><td></td><td></td></tr><tr><td></td><td></td><td></td></tr><tr><td></td><td></td><td></td></tr></table>									
1		1																																																																													
1		2																																																																													
	1	3																																																																													
2		1																																																																													
	1																																																																														
2																																																																															
	2																																																																														
Post - 0 Miss - 0 Block - 0	Post - 0 Miss - 0 Block - 0	Post - 2 Miss - 0 Block - 0	Post - 0 Miss - 0 Block - 0	Post - 0 Miss - 0 Block - 0	Post - 0 Miss - 0 Block - 0	Post - 1 Miss - 1 Block - 0	Post - 0 Miss - 0 Block - 0																																																																								
15 张建杰	18 姚雪岩	19 王帅	21 张昌轲	22 黄培杰	24 高玉杰																																																																										
<table border="1"><tr><td></td><td></td><td></td></tr><tr><td></td><td></td><td>2</td></tr><tr><td></td><td></td><td>1</td></tr></table>						2			1	<table border="1"><tr><td></td><td></td><td></td></tr><tr><td></td><td></td><td></td></tr><tr><td></td><td>1</td><td></td></tr></table>								1		<table border="1"><tr><td></td><td></td><td></td></tr><tr><td></td><td></td><td></td></tr><tr><td></td><td></td><td></td></tr></table>										<table border="1"><tr><td></td><td></td><td></td></tr><tr><td></td><td></td><td></td></tr><tr><td></td><td></td><td></td></tr></table>										<table border="1"><tr><td></td><td></td><td>1</td></tr><tr><td></td><td></td><td>2</td></tr><tr><td></td><td></td><td>2</td></tr></table>			1			2			2	<table border="1"><tr><td></td><td></td><td></td></tr><tr><td></td><td></td><td>1</td></tr><tr><td></td><td></td><td></td></tr></table>						1																							
		2																																																																													
		1																																																																													
	1																																																																														
		1																																																																													
		2																																																																													
		2																																																																													
		1																																																																													
Post - 0 Miss - 1 Block - 0	Post - 0 Miss - 1 Block - 0	Post - 0 Miss - 0 Block - 0	Post - 0 Miss - 0 Block - 0	Post - 1 Miss - 0 Block - 0	Post - 0 Miss - 0 Block - 0																																																																										



Team A <b>A 安徽队</b>	Team B <b>B 天津队</b>	Match Number <b>32</b>
------------------------	------------------------	---------------------------

Played in <b>重庆万州</b>	in the hall <b>万州体育馆</b>	on <b>2019-04-16</b>	at <b>14:30</b>	hours	Spectators
--------------------------	-----------------------------	-------------------------	--------------------	-------	------------

Half-time(30')	A <b>14</b>	B <b>13</b>	End of playing time	A <b>27</b>	B <b>27</b>	1st extra time	A <b>32</b>	B <b>33</b>	2nd extra time	A	B	After penalty throws	A	B
----------------	----------------	----------------	---------------------	----------------	----------------	----------------	----------------	----------------	----------------	---	---	----------------------	---	---

Number of 7 m	A <b>2/2</b>	Team time-out			Full name of players and officials	Team time-out			B <b>5/5</b>	Number of 7 m
	1 <b>16:36</b>	2 <b>48:20</b>	3 <b>59:12</b>	1 <b>23:00</b>		2 <b>43:24</b>	3 <b>59:26</b>			

No.	Team A	G	W	2'	D	DR	No.	Team B	G	W	2'	D	DR
1	郭世伟	4					1	何喜年					
4	王巨柱	5					3	魏雨童			2		
5	史小帆		1				4	刘雪东					
6	叶志伟						5	王毅	1				
7	姚雄敏	3					6	赵晨阳					
8	董智景	5					7	张青	12		1		
9	金永峰			1			8	王晓琪	3				
10	严龙	1					9	王子欣	5				
11	黎涛	1					10	苏尧					
12	曾献辰						11	吴明远					
18	李双	7		1			13	许松	5				
21	李明						14	王维先					
23	张鹏	1					15	周群	3				
24	徐安格	5		1			16	刘宗其					
26	饶原源						20	张闻乾					
27	王东昇						86	田剑侠	4				
B	Vladimir Stanojevic (主教练)	1					A	贾守信					
C	黄红						B	杜瑞军 (主教练)					
D	王来黔						D	李志成					
E	刘汉杰						E	王文龙					

A	Signatures of responsables for the teams (Off.A)	B
---	--	---

TP	Remarks of referees / HF Official	TP
----	-----------------------------------	----

Signatures			
Referees	周云磊 (CHN)	伍豪 (CHN)	
T.D.	吴国忠 (CHN)	倪震 (CHN)	
CHA Off.			

Note: Number of 7m Throws Awarded to Team A and B, Goals (G), Warnings (W), Suspensions (2'), Direct Disqualification (D), Disqualification With Report (DR) and Team Penalty (TP).

Table Officials: 周胜锋                      陈常增                      Statisticians: 周亚桥                      谢杨

2019年全国男子手球冠军杯赛

PHMS Pictorial Handball Match Statistics

IHF Official System

竞赛技术统计

手球 男子 3-4名 轮次 8 组别 X 场次 32 万州体育馆 2019-04-16 14:30

Referees: 周云磊 (CHN) / 伍豪 (CHN) Result: 32:33(14:13)  
Teams: 安徽队(安徽) VS 天津队(天津)

安徽														比赛进程		天津			
主教练: Vladimir Stanojevic														1st Half					
	远射	近射	边射	快攻	突破	任意球	7m球	合计	%	助攻	失误	警告	2'	D+DR					
1 郭世伟	3/4	0/1			1/2			4/7	57.1	1	4				24 徐安格	1 01:47	0		
4 王巨柱	5/8				0/1			5/9	55.6		1				1 郭世伟	1 02:50	1	7 张青	
5 史小帆												1			2 郭世伟	2 03:33	1	86 田剑侠	
6 叶志伟															24 徐安格	3 06:31	2		
7 姚雄敏	1/1				2/2		3/3	100		3					3 徐安格	3 07:24	3	7 张青	
8 董智景	0/1		1/2	1/1	1/1		2/2	5/7	71.4		1				3 姚雄敏	3 08:42	4	9 王子欣	
9 金永峰													1		3 董智景	3 10:49	5	7 张青	
10 严龙				1/1			1/1	100							24 徐安格	4 12:04	6	86 田剑侠	
11 黎涛			1/2				1/2	50.0		1	2				18 李双	5 13:43	6		
12 曾献辰															4 徐安格	5 14:57	7	86 田剑侠	
18 李双	4/4	1/2		2/2	0/2		7/10	70.0		1	4		1		5 李双	5 15:16	8	13 许松	
21 李明															5 徐安格	5 16:30	9	13 许松	
23 张鹏		0/1	1/2	0/1			1/4	25.0							24 徐安格	6 17:05	9		
24 徐安格		2/2	1/1	2/2			5/5	100			2		1		18 李双	7 17:58	9		
26 饶源源															4 王巨柱	8 19:17	9		
27 王东昇															8 王巨柱	8 21:16	10	5 王毅	
运动员 合计	13/18	3/6	4/7	6/7	4/8		2/2	32/48	66.7	3	17	1	3		4 王巨柱	9 22:08	10		
1 郭世伟											1				18 李双	10 22:48	10		
12 曾献辰							0/1	0/1	0.0						10 李双	10 23:24	11	7 张青	
21 李明	5/10	0/10	2/7	1/5	1/4	1/2	0/4	10/42	23.8						4 王巨柱	11 24:31	11		
守门员 合计	5/10	0/10	2/7	1/5	1/4	1/2	0/5	10/43	23.3		1				11 王巨柱	11 25:16	12	9 王子欣	
														2nd Half					
天津														14 王巨柱		12 25:59		12	
主教练: 杜瑞军														18 李双		13 27:10		12	
1 何喜年															11 黎涛	14 28:41	12		
3 魏雨童															24 徐安格	14 29:49	13	7 张青	
4 刘雪东															8 董智景	15 00:27	14	7 张青	
5 王毅	0/1	1/1				0/1	1/3	33.3			2				8 董智景	16 03:37	14		
6 赵晨阳															16 徐安格	16 04:48	15	13 许松	
7 张青	3/6	3/3		1/1			5/5	12/15	80.0		2		1		17 徐安格	17 05:32	15		
8 王晓琪		1/1	2/2				3/3	100							17 徐安格	17 05:52	16	9 王子欣	
9 王子欣	2/4	1/1	1/2	0/1		1/1	5/9	55.6		1	3				17 徐安格	17 07:02	17	8 王晓琪	
10 苏尧															18 郭世伟	18 08:11	17		
11 吴明远															18 郭世伟	18 09:15	18	8 王晓琪	
13 许松			2/4	3/3	0/1		5/8	62.5			2				18 郭世伟	18 09:55	19	9 王子欣	
14 王维先															7 姚雄敏	19 10:37	19		
15 周群		3/3					3/3	100							8 董智景	20 12:04	19		
16 刘宗其															23 张鹏	21 13:02	19		
20 张闻乾															1 郭世伟	22 14:34	19		
86 田剑侠	0/2	1/1			3/4	0/1	4/8	50.0		3	3				1 郭世伟	22 15:22	20	7 张青	
运动员 合计	5/13	10/10	5/8	4/5	3/5	1/3	5/5	33/49	67.3	4	15		3		22 徐安格	22 16:44	21	15 周群	
1 何喜年	2/13	3/4	0/2	1/6	3/7		9/32	28.1			1				22 徐安格	22 17:27	22	7 张青	
16 刘宗其	1/3	0/2	0/2	0/1			0/2	1/10	10.0						22 徐安格	22 18:14	23	13 许松	
守门员 合计	3/16	3/6	0/4	1/7	3/7		0/2	10/42	23.8		1				8 董智景	23 18:48	23		
														Ext. 1-1					
														28 王巨柱		24 20:03		24	
														24 王巨柱		24 20:47		25	
														18 李双		24 21:35		26	
														7 姚雄敏		25 26:16		26	
														1 郭世伟		25 27:15		27	
														7 姚雄敏		26 27:25		27	
														Ext. 1-2					
														27 郭世伟		27 29:22		27	
														7 姚雄敏		28 01:42		27	
														8 董智景		28 03:28		28	
														8 董智景		28 04:09		29	
														10 严龙		29 04:44		29	
														18 李双		29 05:00		30	
														30 李双		30 00:33		30	
														30 李双		30 01:11		31	
														30 李双		30 02:46		32	
														10 严龙		30 03:04		33	
														18 李双		31 04:11		33	
														18 李双		32 04:39		33	

场上队员: 得分 / 射门

守门员: 救球 / 射门

D	取消资格	DR	取消资格+报告
---	------	----	---------





## 2019年全国男子手球冠军杯赛

PHMS Pictorial Handball Match Statistics

IHF Official System

### 个人/全队技术统计表

手球 男子 3-4名 轮次 8 组别 X 场次 32 万州体育馆 2019-04-16 14:30

号码	姓名	远射	近射	边射	快攻	突破	任意	七米	合计	%	助攻	失误	警告	2'	取消	时间
安徽队(安徽)																
(场上队员)																
1	郭世伟	3/4	0/1			1/2			4/7	57.1%	1	4				00:27:27
4	王巨柱	5/8				0/1			5/9	55.6%		1				00:27:38
5	史小帆									0.0%			1			00:12:18
6	叶志伟									0.0%						00:00:00
7	姚雄敏	1/1				2/2			3/3	100%		3				00:51:57
8	董智景	0/1		1/2	1/1	1/1		2/2	5/7	71.4%		1				01:10:00
9	金永峰									0.0%				1		00:20:18
10	严龙				1/1				1/1	100%						00:15:27
11	黎涛			1/2					1/2	50.0%	1	2				00:39:20
12	曾献辰									0.0%						00:00:16
18	李双	4/4	1/2		2/2	0/2			7/10	70.0%	1	4		1		01:09:57
21	李明									0.0%						01:09:44
23	张鹏		0/1	1/2	0/1				1/4	25.0%						00:14:44
24	徐安格		2/2	1/1	2/2				5/5	100%		2		1		01:08:50
26	饶原源									0.0%						00:00:00
27	王东昇									0.0%						00:00:00
合计		13/18	3/6	4/7	6/7	4/8		2/2	32/48	66.7%	3	17	1	3		

#### (守门员)

1	郭世伟									0.0%		1				00:27:27
12	曾献辰							0/1	0/1	0.0%						00:00:16
21	李明	5/10	0/10	2/7	1/5	1/4	1/2	0/4	10/42	23.8%						01:09:44
合计		5/10	0/10	2/7	1/5	1/4	1/2	0/5	10/43	23.3%		1				

场上队员：得分/射门

守门员：救球/射门

全队合计	得分	被救	射失	击柱	封球	合计	%
远射	13	3			2	18	72.2%
近射	3	3				6	50.0%
边射	4		2	1		7	57.1%
快攻	6	1				7	85.7%
突破	4	3		1		8	50.0%
任意							0.0%
七米	2					2	100.0%

## 2019年全国男子手球冠军杯赛

PHMS Pictorial Handball Match Statistics

IHF Official System

### 个人/全队技术统计表

手球 男子 3-4名 轮次 8 组别 X 场次 32 万州体育馆 2019-04-16 14:30

号码	姓名	远射	近射	边射	快攻	突破	任意	七米	合计	%	助攻	失误	警告	2'	取消	时间
天津队(天津)																
(场上队员)																
1	何喜年									0.0%		1				00:50:51
3	魏雨童									0.0%				2		00:39:07
4	刘雪东									0.0%						00:00:00
5	王毅	0/1	1/1				0/1		1/3	33.3%		2				00:17:14
6	赵晨阳									0.0%						00:02:31
7	张青	3/6	3/3		1/1			5/5	12/15	80.0%		2		1		01:09:55
8	王晓琪		1/1	2/2					3/3	100%						00:47:44
9	王子欣	2/4	1/1	1/2	0/1		1/1		5/9	55.6%	1	3				01:04:26
10	苏尧									0.0%						00:00:00
11	吴明远									0.0%						00:00:00
13	许松			2/4	3/3	0/1			5/8	62.5%		2				01:10:00
14	王维先									0.0%						00:00:00
15	周群		3/3						3/3	100%		2				00:43:05
16	刘宗其									0.0%						00:19:00
20	张闻乾									0.0%						00:00:00
86	田剑侠	0/2	1/1			3/4	0/1		4/8	50.0%	3	3				01:04:48
	合计	5/13	10/10	5/8	4/5	3/5	1/3	5/5	33/49	67.3%	4	15		3		
(守门员)																
1	何喜年	2/13	3/4	0/2	1/6	3/7			9/32	28.1%		1				00:50:51
16	刘宗其	1/3	0/2	0/2	0/1			0/2	1/10	10.0%						00:19:00
	合计	3/16	3/6	0/4	1/7	3/7		0/2	10/42	23.8%		1				

场上队员：得分/射门

守门员：救球/射门

全队合计	得分	被救	射失	击柱	封球	合计	%
远射	5	5	1	2		13	38.5%
近射	10					10	100.0%
边射	5	2		1		8	62.5%
快攻	4	1				5	80.0%
突破	3	1		1		5	60.0%
任意	1	1	1			3	33.3%
七米	5					5	100.0%

图式比赛技术统计表

手球  
男子

3-4名  
轮次 8

组别 X  
场次 32

万州体育馆  
2019-04-16 14:30

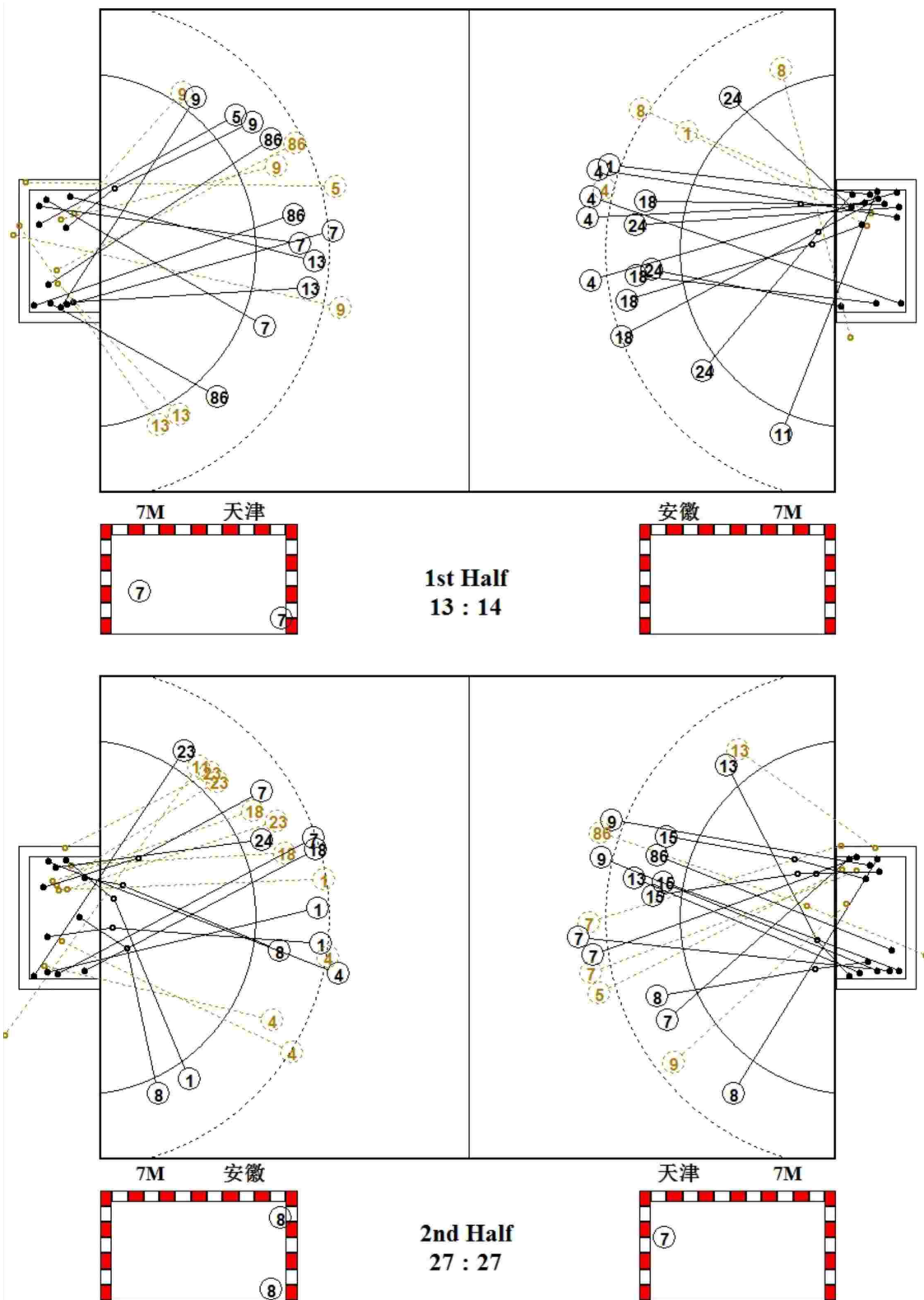

PICTORIAL MATCH STATISTICS

HANDBALL  
男子

3-4名  
ROUND 8

GROUP X  
MATCH 32

万州体育馆  
2019-04-16 14:30

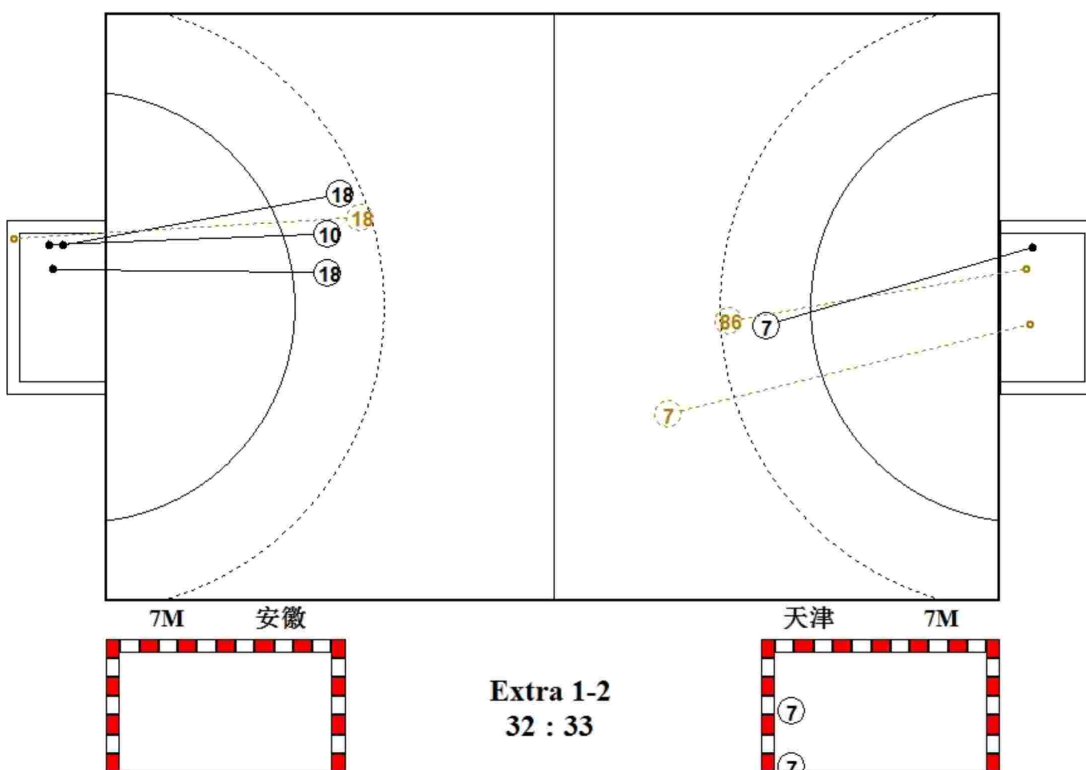
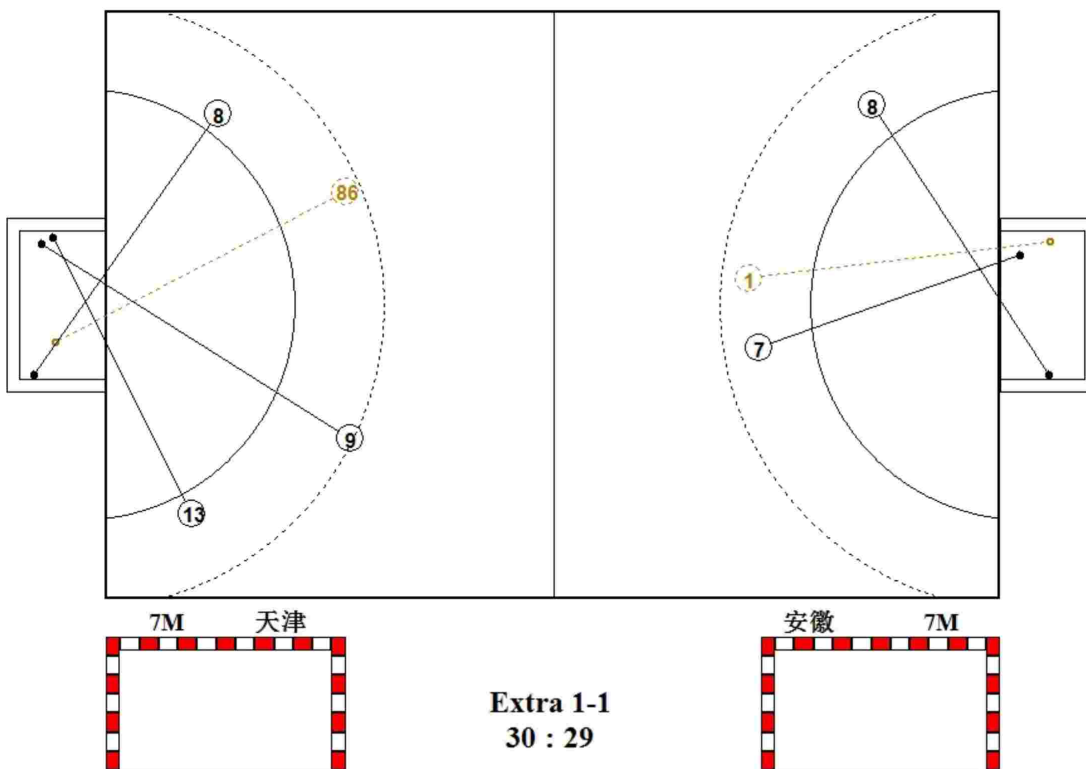

图式射门区域统计

手球  
男子

3-4名  
轮次 8

组别 X  
场次 32

万州体育馆  
2019-04-16 14:30

安徽队

1 郭世伟 <table border="1"><tr><td>1</td><td>1</td><td></td></tr><tr><td>1</td><td></td><td>1</td></tr><tr><td></td><td></td><td></td></tr></table> Post - 0 Miss - 0 Block - 0	1	1		1		1				4 王巨柱 <table border="1"><tr><td>2</td><td></td><td>2</td></tr><tr><td>1</td><td></td><td></td></tr><tr><td></td><td></td><td></td></tr></table> Post - 0 Miss - 0 Block - 2	2		2	1						5 史小帆 <table border="1"><tr><td></td><td></td><td></td></tr><tr><td></td><td></td><td></td></tr><tr><td></td><td></td><td></td></tr></table> Post - 0 Miss - 0 Block - 0										6 叶志伟 <table border="1"><tr><td></td><td></td><td></td></tr><tr><td></td><td></td><td></td></tr><tr><td></td><td></td><td></td></tr></table> Post - 0 Miss - 0 Block - 0										7 姚雄敏 <table border="1"><tr><td></td><td></td><td>1</td></tr><tr><td>1</td><td></td><td></td></tr><tr><td>1</td><td></td><td></td></tr></table> Post - 0 Miss - 0 Block - 0			1	1			1			8 董智景 <table border="1"><tr><td></td><td></td><td>1</td></tr><tr><td></td><td></td><td>1</td></tr><tr><td></td><td>1</td><td>2</td></tr></table> Post - 0 Miss - 1 Block - 0			1			1		1	2	9 金永峰 <table border="1"><tr><td></td><td></td><td></td></tr><tr><td></td><td></td><td></td></tr><tr><td></td><td></td><td></td></tr></table> Post - 0 Miss - 0 Block - 0										10 严龙 <table border="1"><tr><td></td><td></td><td>1</td></tr><tr><td></td><td></td><td></td></tr><tr><td></td><td></td><td></td></tr></table> Post - 0 Miss - 0 Block - 0			1						
1	1																																																																														
1		1																																																																													
2		2																																																																													
1																																																																															
		1																																																																													
1																																																																															
1																																																																															
		1																																																																													
		1																																																																													
	1	2																																																																													
		1																																																																													
11 黎涛 <table border="1"><tr><td>1</td><td></td><td></td></tr><tr><td></td><td></td><td></td></tr><tr><td></td><td></td><td></td></tr></table> Post - 0 Miss - 1 Block - 0	1									12 曾献辰 <table border="1"><tr><td></td><td></td><td></td></tr><tr><td></td><td></td><td></td></tr><tr><td></td><td></td><td></td></tr></table> Post - 0 Miss - 0 Block - 0										18 李双 <table border="1"><tr><td>1</td><td></td><td></td></tr><tr><td>2</td><td></td><td>3</td></tr><tr><td>1</td><td></td><td></td></tr></table> Post - 1 Miss - 0 Block - 0	1			2		3	1			21 李明 <table border="1"><tr><td></td><td></td><td></td></tr><tr><td></td><td></td><td></td></tr><tr><td></td><td></td><td></td></tr></table> Post - 0 Miss - 0 Block - 0										23 张鹏 <table border="1"><tr><td>1</td><td></td><td></td></tr><tr><td></td><td></td><td></td></tr><tr><td></td><td></td><td></td></tr></table> Post - 1 Miss - 0 Block - 0	1									24 徐安格 <table border="1"><tr><td>1</td><td></td><td></td></tr><tr><td></td><td></td><td>1</td></tr><tr><td>2</td><td></td><td>1</td></tr></table> Post - 0 Miss - 0 Block - 0	1					1	2		1	26 饶原源 <table border="1"><tr><td></td><td></td><td></td></tr><tr><td></td><td></td><td></td></tr><tr><td></td><td></td><td></td></tr></table> Post - 0 Miss - 0 Block - 0										27 王东昇 <table border="1"><tr><td></td><td></td><td></td></tr><tr><td></td><td></td><td></td></tr><tr><td></td><td></td><td></td></tr></table> Post - 0 Miss - 0 Block - 0									
1																																																																															
1																																																																															
2		3																																																																													
1																																																																															
1																																																																															
1																																																																															
		1																																																																													
2		1																																																																													

1 郭世伟

12 曾献辰
0/1

21 李明
0/5
2/12 2/2 2/8
3/6 1/1 0/1

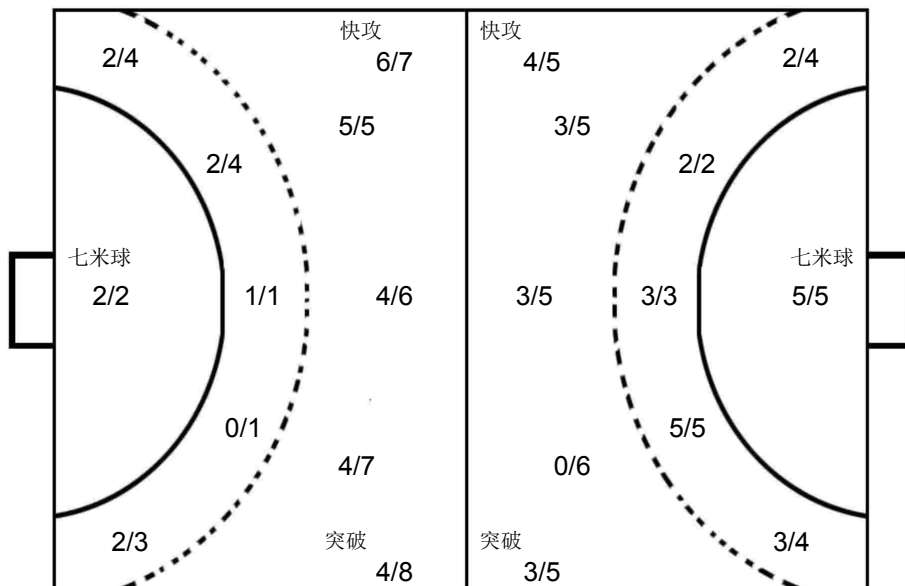

1 何喜年
1/6 0/1 1/5
3/6 4/9
0/2 0/1 0/2

16 刘宗其
0/1 0/1
1/4 0/1
0/2 0/1

天津队

1 何喜年 <table border="1"><tr><td></td><td></td><td></td></tr><tr><td></td><td></td><td></td></tr><tr><td></td><td></td><td></td></tr></table> Post - 0 Miss - 0 Block - 0										3 魏雨童 <table border="1"><tr><td></td><td></td><td></td></tr><tr><td></td><td></td><td></td></tr><tr><td></td><td></td><td></td></tr></table> Post - 0 Miss - 0 Block - 0										4 刘雪东 <table border="1"><tr><td></td><td></td><td></td></tr><tr><td></td><td></td><td></td></tr><tr><td></td><td></td><td></td></tr></table> Post - 0 Miss - 0 Block - 0										5 王毅 <table border="1"><tr><td></td><td></td><td>1</td></tr><tr><td></td><td></td><td></td></tr><tr><td></td><td></td><td></td></tr></table> Post - 1 Miss - 0 Block - 0			1							6 赵晨阳 <table border="1"><tr><td></td><td></td><td></td></tr><tr><td></td><td></td><td></td></tr><tr><td></td><td></td><td></td></tr></table> Post - 0 Miss - 0 Block - 0										7 张青 <table border="1"><tr><td>1</td><td></td><td>3</td></tr><tr><td>4</td><td></td><td></td></tr><tr><td>3</td><td></td><td>1</td></tr></table> Post - 1 Miss - 0 Block - 0	1		3	4			3		1	8 王晓琪 <table border="1"><tr><td>1</td><td></td><td></td></tr><tr><td>1</td><td></td><td>1</td></tr><tr><td></td><td></td><td></td></tr></table> Post - 0 Miss - 0 Block - 0	1			1		1				9 王子欣 <table border="1"><tr><td></td><td></td><td>1</td></tr><tr><td>2</td><td></td><td>2</td></tr><tr><td></td><td></td><td></td></tr></table> Post - 0 Miss - 1 Block - 0			1	2		2			
		1																																																																													
1		3																																																																													
4																																																																															
3		1																																																																													
1																																																																															
1		1																																																																													
		1																																																																													
2		2																																																																													
10 苏尧 <table border="1"><tr><td></td><td></td><td></td></tr><tr><td></td><td></td><td></td></tr><tr><td></td><td></td><td></td></tr></table> Post - 0 Miss - 0 Block - 0										11 吴明远 <table border="1"><tr><td></td><td></td><td></td></tr><tr><td></td><td></td><td></td></tr><tr><td></td><td></td><td></td></tr></table> Post - 0 Miss - 0 Block - 0										13 许松 <table border="1"><tr><td>1</td><td></td><td>3</td></tr><tr><td></td><td></td><td>1</td></tr><tr><td></td><td></td><td></td></tr></table> Post - 2 Miss - 0 Block - 0	1		3			1				14 王维先 <table border="1"><tr><td></td><td></td><td></td></tr><tr><td></td><td></td><td></td></tr><tr><td></td><td></td><td></td></tr></table> Post - 0 Miss - 0 Block - 0										15 周群 <table border="1"><tr><td></td><td></td><td>1</td></tr><tr><td>2</td><td></td><td></td></tr><tr><td></td><td></td><td></td></tr></table> Post - 0 Miss - 0 Block - 0			1	2						16 刘宗其 <table border="1"><tr><td></td><td></td><td></td></tr><tr><td></td><td></td><td></td></tr><tr><td></td><td></td><td></td></tr></table> Post - 0 Miss - 0 Block - 0										20 张闻乾 <table border="1"><tr><td></td><td></td><td></td></tr><tr><td></td><td></td><td></td></tr><tr><td></td><td></td><td></td></tr></table> Post - 0 Miss - 0 Block - 0										86 田剑侠 <table border="1"><tr><td>3</td><td></td><td>1</td></tr><tr><td></td><td></td><td></td></tr><tr><td></td><td></td><td></td></tr></table> Post - 0 Miss - 1 Block - 0	3		1						
1		3																																																																													
		1																																																																													
		1																																																																													
2																																																																															
3		1																																																																													



## 2019年全国男子手球冠军杯赛

PHMS Pictorial Handball Match Statistics

IHF Official System

### 比赛进程表

手球 男子 3-4名 轮次 8 组别 X 场次 32 万州体育馆 2019-04-16 14:30

时间	队员	动作	比分	队员	动作
安徽队			上半时		
00:57	1 郭世伟	接球失误	0-0		
01:42	21 李明	挡住球		9 王子欣	右边射 被救
01:47	24 徐安格	短传快攻 得分	1-0	1 何喜年	被射入
01:50	1 郭世伟	助攻			
02:32				15 周群	接球失误
02:43	1 郭世伟	近射 被救		1 何喜年	挡住球
02:50	21 李明	被射入	1-1	7 张青	近射 得分
03:33	1 郭世伟	左远射 得分	2-1	1 何喜年	被射入
04:12				5 王毅	接球失误
04:21	11 黎涛	侵入			
04:49	21 李明	被射入	2-2	86 田剑侠	突破 得分
05:00	8 董智景	左远射 被救		16 刘宗其	挡住球
05:12	24 徐安格	造犯规		15 周群	进攻犯规
05:51	11 黎涛	接球失误			
06:26				5 王毅	右远射 击柱
06:31	24 徐安格	短传快攻 得分	3-2	16 刘宗其	被射入
07:05	11 黎涛	使被罚7M球		15 周群	造7M
07:24	21 李明	被射入	3-3	7 张青	7M球 得分
08:27	1 郭世伟	传球失误		13 许松	断球
08:42	21 李明	被射入	3-4	9 王子欣	右边射 得分
08:50	18 李双	接球失误		3 魏雨童	抢球
08:54	21 李明	挡住球		9 王子欣	短传快攻 被救
09:35	18 李双	传球失误			
10:49	21 李明	被射入	3-5	7 张青	近射 得分
11:00	24 徐安格	接球失误			
11:09	5 史小帆	警告			
11:50	21 李明	被射入	3-6	86 田剑侠	近射 得分
12:04	24 徐安格	左边射 得分	4-6	16 刘宗其	被射入
12:47				9 王子欣	左远射 射失
13:07	4 王巨柱	左远射 被封		7 张青	封球
13:43	18 李双	近射 得分	5-6	16 刘宗其	被射入
14:57	21 李明	被射入	5-7	86 田剑侠	突破 得分
15:11	4 王巨柱	接球失误		8 王晓琪	抢球
15:16	21 李明	被射入	5-8	13 许松	短传快攻 得分
16:25	7 姚雄敏	运球失误			
16:30	21 李明	被射入	5-9	13 许松	一传快攻 得分
16:32				86 田剑侠	助攻
16:36		球队暂停			
17:05	24 徐安格	近射 得分	6-9	16 刘宗其	被射入
17:10	18 李双	助攻			
17:50	21 李明	挡住球		86 田剑侠	右远射 被救



## 2019年全国男子手球冠军杯赛

PHMS Pictorial Handball Match Statistics

IHF Official System

### 比赛进程表

手球 男子 3-4名 轮次 8 组别 X 场次 32 万州体育馆 2019-04-16 14:30

时间	队员	动作	比分	队员	动作			
安徽队			上半时			天津队		
17:58	18 李双	右远射 得分	7-9	16 刘宗其	被射入			
18:36		裁判暂停						
18:36	18 李双	罚出场2分钟						
18:44	21 李明	挡住球		13 许松	左边射 被救			
19:17	4 王巨柱	中远射 得分	8-9	1 何喜年	被射入			
19:49				9 王子欣	传球失误			
20:37	8 董智景	左边射 射失						
21:16	21 李明	被射入	8-10	5 王毅	近射 得分			
22:08	4 王巨柱	左远射 得分	9-10	1 何喜年	被射入			
22:40	18 李双	断球		7 张青	传球失误			
22:48	18 李双	一传快攻 得分	10-10	1 何喜年	被射入			
23:00					球队暂停			
23:24	21 李明	被射入	10-11	7 张青	中远射 得分			
24:31	4 王巨柱	左远射 得分	11-11	1 何喜年	被射入			
25:13				13 许松	左边射 击柱			
25:16	21 李明	被射入	11-12	9 王子欣	近射 得分			
25:23		裁判暂停						
25:23				3 魏雨童	罚出场2分钟			
25:59	4 王巨柱	中远射 得分	12-12	1 何喜年	被射入			
27:01				13 许松	侵区			
27:10	18 李双	右远射 得分	13-12	16 刘宗其	被射入			
27:55	8 董智景	造犯规		86 田剑侠	进攻犯规			
28:41	11 黎涛	右边射 得分	14-12	16 刘宗其	被射入			
29:42	24 徐安格	使被罚7M球		15 周群	造7M			
29:44		裁判暂停						
29:49	12 曾献辰	被射入	14-13	7 张青	7M球 得分			

## 2019年全国男子手球冠军杯赛

PHMS Pictorial Handball Match Statistics

IHF Official System

### 比赛进程表

手球 3-4名 组别 X 万州体育馆  
男子 轮次 8 场次 32 2019-04-16 14:30

时间	队员	动作	比分	队员	动作
安徽队			天津队		
下半场					
00:27	21 李明	被射入	14-14	7 张青	中远射 得分
00:36	4 王巨柱	突破 被救		1 何喜年	挡住球
01:32		裁判暂停			
02:01				5 王毅	接球失误
02:04	8 董智景	短传快攻 得分	15-14	1 何喜年	被射入
02:57	21 李明	挡住球		5 王毅	任意球 被救
03:07	18 李双	近射 被救		1 何喜年	挡住球
03:10	24 徐安格	造7M		5 王毅	使被罚7M球
03:37	8 董智景	7M球 得分	16-14	16 刘宗其	被射入
04:05		裁判暂停			
04:05	9 金永峰	罚出场2分钟			
04:48	21 李明	被射入	16-15	13 许松	左边射 得分
05:32	24 徐安格	近射 得分	17-15	1 何喜年	被射入
05:34	11 黎涛	助攻			
05:52	21 李明	被射入	17-16	9 王子欣	左远射 得分
06:28	7 姚雄敏	传球失误		8 王晓琪	断球
07:02	21 李明	被射入	17-17	8 王晓琪	近射 得分
07:16	11 黎涛	右边射 射失			
08:02				13 许松	突破 击柱
08:11	1 郭世伟	中远射 得分	18-17	1 何喜年	被射入
09:09				7 张青	中远射 击柱
09:09				9 王子欣	助攻
09:15	21 李明	被射入	18-18	8 王晓琪	右边射 得分
09:44	7 姚雄敏	传球失误		9 王子欣	断球
09:55	21 李明	被射入	18-19	9 王子欣	左远射 得分
10:37	7 姚雄敏	右远射 得分	19-19	1 何喜年	被射入
11:11	21 李明	挡住球		7 张青	右远射 被救
11:59		裁判暂停			
11:59	1 郭世伟	造7M		7 张青	使被罚7M球
11:59				7 张青	罚出场2分钟
12:04	8 董智景	7M球 得分	20-19	16 刘宗其	被射入
12:46	21 李明	挡住球		9 王子欣	右远射 被救
13:02	23 张鹏	右边射 得分	21-19	1 何喜年	被射入
13:24					球队暂停
14:25				86 田剑侠	任意球 射失
14:34	1 郭世伟	中远射 得分	22-19	1 何喜年	被射入
15:22	21 李明	被射入	22-20	7 张青	近射 得分
15:58		裁判暂停			
16:31	24 徐安格	进攻犯规		13 许松	造犯规
16:44	21 李明	被射入	22-21	15 周群	近射 得分
16:46				86 田剑侠	助攻



## 2019年全国男子手球冠军杯赛

PHMS Pictorial Handball Match Statistics

IHF Official System

### 比赛进程表

手球 男子 3-4名 轮次 8 组别 X 场次 32 万州体育馆 2019-04-16 14:30

时间	队员	动作	比分	队员	动作
安徽队			天津队		
下半场					
16:55	18 李双	突破 被救	22-21	1 何喜年	挡住球
17:27	21 李明	被射入	22-22	7 张青	中远射 得分
18:05	23 张鹏	右边射 击柱			
18:14	21 李明	被射入	22-23	13 许松	短传快攻 得分
18:20		球队暂停			
18:48	8 董智景	突破 得分	23-23	1 何喜年	被射入
19:24	21 李明	被射入	23-24	15 周群	近射 得分
20:03	4 王巨柱	左远射 得分	24-24	1 何喜年	被射入
20:47	21 李明	被射入	24-25	15 周群	近射 得分
20:49				86 田剑侠	助攻
20:57	1 郭世伟	四步			
21:35	21 李明	被射入	24-26	86 田剑侠	突破 得分
21:52	23 张鹏	近射 被救		1 何喜年	挡住球
22:34	4 王巨柱	中远射 被封		8 王晓琪	封球
23:00	4 王巨柱	左远射 被救		1 何喜年	挡住球
23:10		裁判暂停			
23:56				86 田剑侠	接球失误
24:00	23 张鹏	一传快攻 被救		1 何喜年	挡住球
24:36		裁判暂停			
24:59	1 郭世伟	中远射 被救		1 何喜年	挡住球
26:09	18 李双	断球		86 田剑侠	传球失误
26:16	18 李双	右远射 得分	25-26	1 何喜年	被射入
27:08	24 徐安格	使被罚7M球		9 王子欣	造7M
27:10		裁判暂停			
27:15	21 李明	被射入	25-27	7 张青	7M球 得分
27:25	7 姚雄敏	突破 得分	26-27	1 何喜年	被射入
28:13	18 李双	造失误		9 王子欣	运球失误
29:12		球队暂停			
29:22	1 郭世伟	突破 得分	27-27	1 何喜年	被射入
29:26					球队暂停
29:48				13 许松	接球失误
29:58	18 李双	快攻 传球失误			

## 2019年全国男子手球冠军杯赛

PHMS Pictorial Handball Match Statistics

IHF Official System

### 比赛进程表

手球 男子 3-4名 轮次 8 组别 X 场次 32 万州体育馆 2019-04-16 14:30

时间	队员	动作	比分	队员	动作
安徽队			天津队		
			决胜期 1-1		
00:26			27-27	9 王子欣	传球失误
01:42	7 姚雄敏	突破 得分	28-27	1 何喜年	被射入
02:21	21 李明	挡住球		86 田剑侠	突破 被救
02:31		裁判暂停			
02:52	1 郭世伟	突破 被救		1 何喜年	挡住球
03:03				1 何喜年	快攻 传球失误
03:05		裁判暂停			
03:28	21 李明	被射入	28-28	8 王晓琪	右边射 得分
03:39	1 郭世伟	其它失误			
03:53		裁判暂停			
03:53	24 徐安格	罚出场2分钟			
04:09	21 李明	被射入	28-29	13 许松	左边射 得分
04:44	8 董智景	左边射 得分	29-29	1 何喜年	被射入
05:00	21 李明	被射入	29-30	9 王子欣	任意球 得分

## 2019年全国男子手球冠军杯赛

PHMS Pictorial Handball Match Statistics

IHF Official System

### 比赛进程表

手球 男子 3-4名 轮次 8 组别 X 场次 32 万州体育馆 2019-04-16 14:30

时间	队员	动作	比分	队员	动作			
安徽队			决胜期 1-2			天津队		
00:00	B Vladimir Stanojevic	警告	29-30					
00:33	18 李双	右远射 得分	30-30	1 何喜年	被射入			
01:01	9 金永峰	使被罚7M球		86 田剑侠	造7M			
01:06		裁判暂停						
01:11	21 李明	被射入	30-31	7 张青	7M球 得分			
01:48	8 董智景	进攻犯规		8 王晓琪	造犯规			
02:23	10 严龙	使被罚7M球		9 王子欣	造7M			
02:46	21 李明	被射入	30-32	7 张青	7M球 得分			
02:59	18 李双	传球失误		8 王晓琪	断球			
03:04	21 李明	被射入	30-33	7 张青	短传快攻 得分			
03:11		裁判暂停						
03:11				3 魏雨童	罚出场2分钟			
03:33	18 李双	突破 击柱						
04:05	21 李明	挡住球		86 田剑侠	中远射 被救			
04:11	10 严龙	短传快攻 得分	31-33	1 何喜年	被射入			
04:32				7 张青	四步			
04:39	18 李双	短传快攻 得分	32-33	1 何喜年	被射入			
04:59	21 李明	挡住球		7 张青	右远射 被救			

Team A					Team B					Match Number											
A 北京队					B 江苏队					33											
Played in			in the hall			on			at			Spectators									
重庆万州			万州体育馆			2019-04-16			16:00			hours									
Half-time(30')	A	B	End of playing time		A	B	1st extra time		A	B	2nd extra time		A	B	After penalty throws						
	9	12	17		23																
Number of 7 m	A	Team time-out			Full name of players and officials						Team time-out			B	Number of 7 m						
	3/4	1	2	3							1	2	3	B							
		12:52	40:53								23:40			1/3							
No.	Team A					G	W	2'	D	DR	No.	Team B					G	W	2'	D	DR
3	逯明松										1	宋继强									
6	解建飞					2					3	周悦骅									
7	马昌震					2	1		1		4	张家纬					2				
10	成亚					4					6	赵晨					3		1		
11	赵文宣										7	周傲					1				
12	高云健										8	谢庆龙					4	1			
13	王军鸣					2					11	张天豪					1				
16	刘迈科										12	王权									
18	傅俊雄										16	张帅									
22	王超										18	赵楠									
23	王军程						1				19	庞连康									
25	王鹏皓										20	顾艳超					4	1			
26	魏昂					1					21	刘江									
27	闫炳旗					3		1			25	王杰缘					5				
32	蒋维一					3	1				27	王伟强					3	1			
33	陈旭							1													
A	郑永利 (主教练)										A	闫威名 (主教练)									
B	孟辉										B	叶强									
E	陈璇										C	贾淑君									
											E	王建国									
A	Signatures of responsables for the teams (Off.A)															B					
TP	Remarks of referees / HF Official															TP					

Signatures

Referees	严璐 (CHN)	王雨洋 (CHN)		
T.D.	李之文 (CHN)	张春生 (CHN)		
CHA Off.				

Note: Number of 7m Throws Awarded to Team A and B, Goals (G), Warnings (W), Suspensions (2'), Direct Disqualification (D), Disqualification With Report (DR) and Team Penalty (TP).

Table Officials: 张晓虎

黄一凡

Statisticians: 谢杨

赵悦

2019年全国男子手球冠军杯赛

PHMS Pictorial Handball Match Statistics

IHF Official System

竞赛技术统计

手球 男子 决赛 轮次 8 组别 X 场次 33 万州体育馆 2019-04-16 16:00

Referees: 严璐 (CHN) / 王雨洋 (CHN) Result: 17:23 (9:12)  
Teams: 北京队(北京) VS 江苏队(江苏)

北京		远	近	边	快	突	任意	7m	合计	%	助攻	失误	警告	2'	D+DR
主教练: 郑永利		射	射	射	攻	破	球	球							
3	透明松														
6	解建飞							2/2	2/2	100					
7	马昌震		1/1	1/2					2/3	66.7			1		1
10	成亚		1/3	0/1	2/2			1/1	4/7	57.1	1	2			
11	赵文宣														
12	高云健														
13	王军鸣	1/3	1/2					0/1	2/6	33.3	1	1			
16	刘迈科														
18	傅俊雄	0/1				0/1			0/2	0.0		1			
22	王超										1				
23	王军程	0/6	0/2						0/8	0.0		1	1		
25	王鹏皓														
26	魏昂		1/2					1/2	1/2	50.0		1			
27	闫炳旗		1/1	2/2				3/3	3/3	100				1	
32	蒋维一		2/2		1/1		0/1	3/4	3/4	75.0			1		
33	陈旭	0/7	0/1					0/8	0/8	0.0				1	
运动员	合计	1/17	7/14	3/5	3/3	0/1	0/1	3/4	17/45	37.8	3	6	3	2	1
12	高云健	1/1			1/4			2/5	2/5	40.0					
16	刘迈科	4/6	5/16	1/2	0/3	1/3		2/3	13/33	39.4					
守门员	合计	5/7	5/16	1/2	1/7	1/3		2/3	15/38	39.5					

北京	比赛 进程	江苏
1st Half		
10 成亚	1 01:07	0
	1 01:33	1 20 顾艳超
	1 03:29	2 4 张家纬
7 马昌震	2 04:04	2
	2 05:03	3 8 谢庆龙
7 马昌震	3 06:17	3
	3 06:53	4 8 谢庆龙
	3 08:47	5 6 赵晨
	3 11:48	6 25 王杰缘
32 蒋维一	4 13:25	6
	4 15:39	7 20 顾艳超
10 成亚	5 16:59	7
13 王军鸣	6 19:04	7
	6 19:31	8 8 谢庆龙
27 闫炳旗	7 21:36	8
	7 22:07	9 4 张家纬
	7 22:50	10 8 谢庆龙
27 闫炳旗	8 23:27	10
	8 25:14	11 27 王伟强
10 成亚	9 26:51	11
	9 28:59	12 20 顾艳超
2nd Half		
6 解建飞	10 00:59	12
	10 01:42	13 6 赵晨
10 成亚	11 05:16	13
	11 07:10	14 27 王伟强
	11 10:40	15 6 赵晨
	11 11:36	16 20 顾艳超
26 魏昂	12 11:40	16
	12 11:50	17 25 王杰缘
13 王军鸣	13 14:33	17
	13 15:34	18 25 王杰缘
	13 16:06	19 25 王杰缘
	13 18:22	20 27 王伟强
6 解建飞	14 22:29	20
32 蒋维一	15 23:29	20
	15 24:25	21 11 张天豪
	15 25:33	22 7 周傲
	15 26:54	23 25 王杰缘
27 闫炳旗	16 27:48	23
32 蒋维一	17 28:58	23

场上队员: 得分 / 射门

守门员: 救球 / 射门

D	取消资格	DR	取消资格+报告
---	------	----	---------



## 2019年全国男子手球冠军杯赛

PHMS Pictorial Handball Match Statistics

IHF Official System

### 个人/全队技术统计表

手球 男子 决赛 轮次 8 组别 X 场次 33 万州体育馆 2019-04-16 16:00

号码	姓名	远射	近射	边射	快攻	突破	任意	七米	合计	%	助攻	失误	警告	2'	取消	时间
北京队(北京)																
(场上队员)																
3	逯明松									0.0%						00:00:00
6	解建飞							2/2	2/2	100%						00:21:08
7	马昌震		1/1	1/2					2/3	66.7%			1		1	00:24:46
10	成亚		1/3	0/1	2/2			1/1	4/7	57.1%	1	2				01:00:00
11	赵文宣									0.0%						00:04:00
12	高云健									0.0%						00:11:36
13	王军鸣	1/3	1/2					0/1	2/6	33.3%	1	1				00:20:00
16	刘迈科									0.0%						00:48:24
18	傅俊雄	0/1				0/1			0/2	0.0%		1				00:08:25
22	王超									0.0%	1					00:34:01
23	王军程	0/6	0/2						0/8	0.0%		1	1			00:34:22
25	王鹏皓									0.0%						00:08:10
26	魏昂		1/2						1/2	50.0%		1				00:21:13
27	闫炳旗		1/1	2/2					3/3	100%				1		00:33:22
32	蒋维一		2/2		1/1		0/1		3/4	75.0%			1			00:47:34
33	陈旭	0/7	0/1						0/8	0.0%				1		00:55:00
合计		1/17	7/14	3/5	3/3	0/1	0/1	3/4	17/45	37.8%	3	6	3	2	1	
(守门员)																
12	高云健	1/1			1/4				2/5	40.0%						00:11:36
16	刘迈科	4/6	5/16	1/2	0/3	1/3		2/3	13/33	39.4%						00:48:24
合计		5/7	5/16	1/2	1/7	1/3		2/3	15/38	39.5%						

场上队员：得分/射门

守门员：救球/射门

全队合计	得分	被救	射失	击柱	封球	合计	%
远射	1	5	5		6	17	5.9%
近射	7	3	1	2	1	14	50.0%
边射	3	1	1			5	60.0%
快攻	3					3	100.0%
突破		1				1	0.0%
任意		1				1	0.0%
七米	3	1				4	75.0%

2019年全国男子手球冠军杯赛

PHMS Pictorial Handball Match Statistics

IHF Official System

个人/全队技术统计表

手球 男子 决赛 轮次 8 组别 X 场次 33 万州体育馆 2019-04-16 16:00

号码	姓名	远射	近射	边射	快攻	突破	任意	七米	合计	%	助攻	失误	警告	2'	取消	时间
江苏队(江苏)																
(场上队员)																
1	宋继强									0.0%						00:00:00
3	周悦骅									0.0%						00:00:00
4	张家纬	0/2	1/1			1/2			2/5	40.0%	1	1				00:49:04
6	赵晨	2/5	1/1				0/1	0/1	3/8	37.5%	2			1		00:33:15
7	周傲	0/1			1/1				1/2	50.0%						00:11:04
8	谢庆龙		4/6						4/6	66.7%		1	1			00:58:42
11	张天豪				1/2				1/2	50.0%		1				00:10:36
12	王权									0.0%	1					00:49:01
16	张帅									0.0%						00:10:59
18	赵楠	0/1							0/1	0.0%		1				00:10:55
19	庞连康			0/1					0/1	0.0%						00:13:05
20	顾艳超	0/1	3/7			1/1			4/9	44.4%	1	2	1			00:48:56
21	刘江									0.0%						00:14:20
25	王杰缘		1/1		3/3			1/2	5/6	83.3%						01:00:00
27	王伟强		1/1	1/2	1/1				3/4	75.0%				1		00:49:23
合计		2/10	11/17	1/3	6/7	2/3	0/1	1/3	23/44	52.3%	5	6	3	1		
(守门员)																
12	王权	5/6	2/7	1/4	0/2		1/1	1/3	10/23	43.5%	1					00:49:01
16	张帅		1/3		0/1	1/1		0/1	2/6	33.3%						00:10:59
合计		5/6	3/10	1/4	0/3	1/1	1/1	1/4	12/29	41.4%	1					

场上队员：得分/射门

守门员：救球/射门

全队合计	得分	被救	射失	击柱	封球	合计	%
远射	2	5		2	1	10	20.0%
近射	11	5			1	17	64.7%
边射	1	1		1		3	33.3%
快攻	6	1				7	85.7%
突破	2	1				3	66.7%
任意			1			1	0.0%
七米	1	2				3	33.3%

图式比赛技术统计表

手球  
男子

决赛  
轮次 8

组别 X  
场次 33

万州体育馆  
2019-04-16 16:00

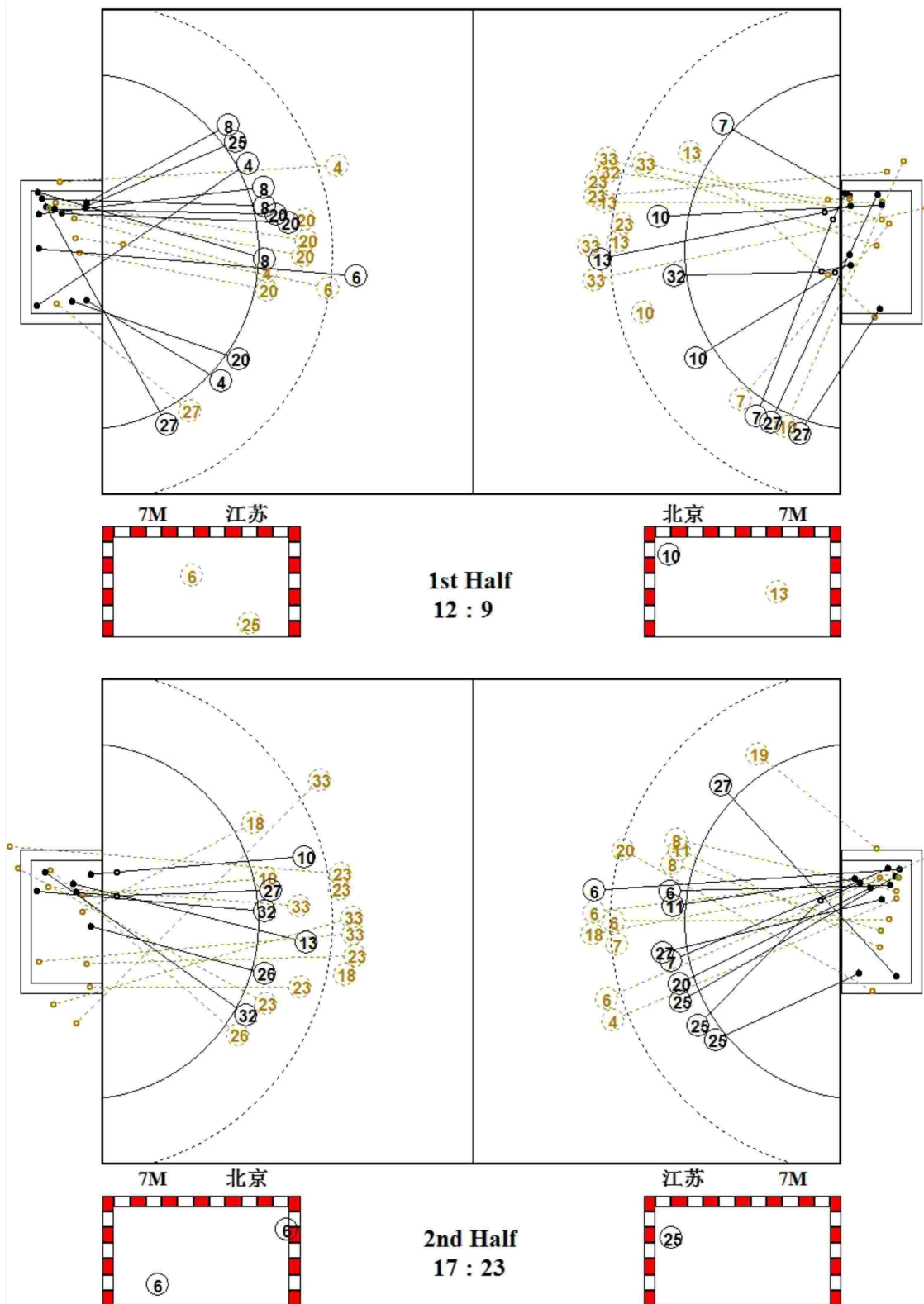



图式射门区域统计

手球  
男子

决赛  
轮次 8

组别 X  
场次 33

万州体育馆  
2019-04-16 16:00

北京队

3 逯明松	6 解建飞	7 马昌震	10 成亚	11 赵文宣	12 高云健	13 王军鸣	16 刘迈科																																																																								
<table border="1"><tr><td></td><td></td><td></td></tr><tr><td></td><td></td><td></td></tr><tr><td></td><td></td><td></td></tr></table>										<table border="1"><tr><td></td><td></td><td>1</td></tr><tr><td></td><td></td><td></td></tr><tr><td>1</td><td></td><td></td></tr></table>			1				1			<table border="1"><tr><td></td><td></td><td></td></tr><tr><td></td><td></td><td></td></tr><tr><td>2</td><td></td><td></td></tr></table>							2			<table border="1"><tr><td>1</td><td></td><td></td></tr><tr><td>1</td><td></td><td></td></tr><tr><td></td><td>1</td><td>1</td></tr></table>	1			1				1	1	<table border="1"><tr><td></td><td></td><td></td></tr><tr><td></td><td></td><td></td></tr><tr><td></td><td></td><td></td></tr></table>										<table border="1"><tr><td></td><td></td><td></td></tr><tr><td></td><td></td><td></td></tr><tr><td></td><td></td><td></td></tr></table>										<table border="1"><tr><td></td><td></td><td></td></tr><tr><td></td><td></td><td>1</td></tr><tr><td>1</td><td></td><td></td></tr></table>						1	1			<table border="1"><tr><td></td><td></td><td></td></tr><tr><td></td><td></td><td></td></tr><tr><td></td><td></td><td></td></tr></table>									
		1																																																																													
1																																																																															
2																																																																															
1																																																																															
1																																																																															
	1	1																																																																													
		1																																																																													
1																																																																															
Post - 0 Miss - 0 Block - 0	Post - 0 Miss - 0 Block - 0	Post - 0 Miss - 0 Block - 0	Post - 0 Miss - 1 Block - 1	Post - 0 Miss - 0 Block - 0	Post - 0 Miss - 0 Block - 0	Post - 1 Miss - 0 Block - 1	Post - 0 Miss - 0 Block - 0																																																																								
18 傅俊雄	22 王超	23 王军程	25 王鹏皓	26 魏昂	27 闫炳旗	32 蒋维一	33 陈旭																																																																								
<table border="1"><tr><td></td><td></td><td></td></tr><tr><td></td><td></td><td></td></tr><tr><td></td><td></td><td></td></tr></table>										<table border="1"><tr><td></td><td></td><td></td></tr><tr><td></td><td></td><td></td></tr><tr><td></td><td></td><td></td></tr></table>										<table border="1"><tr><td></td><td></td><td></td></tr><tr><td></td><td></td><td></td></tr><tr><td></td><td></td><td></td></tr></table>										<table border="1"><tr><td></td><td></td><td></td></tr><tr><td></td><td></td><td></td></tr><tr><td></td><td></td><td></td></tr></table>										<table border="1"><tr><td></td><td></td><td></td></tr><tr><td></td><td></td><td></td></tr><tr><td></td><td>1</td><td></td></tr></table>								1		<table border="1"><tr><td></td><td></td><td>2</td></tr><tr><td></td><td></td><td></td></tr><tr><td></td><td>1</td><td></td></tr></table>			2					1		<table border="1"><tr><td></td><td></td><td></td></tr><tr><td></td><td></td><td></td></tr><tr><td></td><td></td><td></td></tr></table>										<table border="1"><tr><td></td><td></td><td></td></tr><tr><td></td><td></td><td></td></tr><tr><td></td><td></td><td></td></tr></table>									
	1																																																																														
		2																																																																													
	1																																																																														
Post - 0 Miss - 0 Block - 1	Post - 0 Miss - 0 Block - 0	Post - 1 Miss - 3 Block - 3	Post - 0 Miss - 0 Block - 0	Post - 0 Miss - 0 Block - 0	Post - 0 Miss - 0 Block - 0	Post - 0 Miss - 0 Block - 0	Post - 0 Miss - 3 Block - 1																																																																								

12 高云健

1/2		
		1/1
0/2		

16 刘迈科

2/7	2/3	2/8
2/5	2/2	1/2
0/1	1/1	1/4

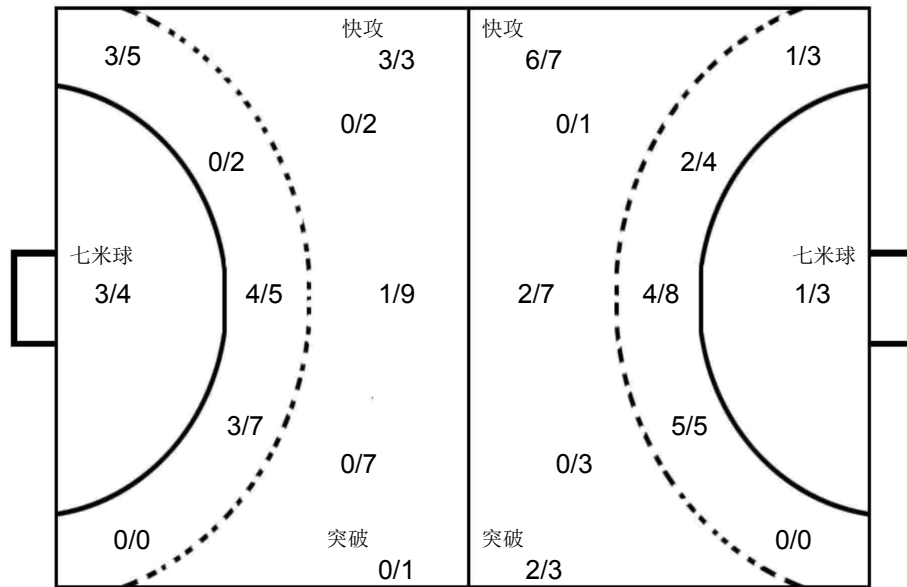

12 王权

2/3		2/2
2/4	2/2	0/2
2/6	0/3	0/1

16 张帅

		0/3
		0/1
	1/1	1/1

江苏队

1 宋继强	3 周悦骅	4 张家纬	6 赵晨	7 周傲	8 谢庆龙	11 张天豪	12 王权																																																																								
<table border="1"><tr><td></td><td></td><td></td></tr><tr><td></td><td></td><td></td></tr><tr><td></td><td></td><td></td></tr></table>										<table border="1"><tr><td></td><td></td><td></td></tr><tr><td></td><td></td><td></td></tr><tr><td></td><td></td><td></td></tr></table>										<table border="1"><tr><td>1</td><td></td><td></td></tr><tr><td></td><td></td><td></td></tr><tr><td>1</td><td></td><td></td></tr></table>	1						1			<table border="1"><tr><td>2</td><td>1</td><td></td></tr><tr><td></td><td></td><td></td></tr><tr><td></td><td></td><td></td></tr></table>	2	1								<table border="1"><tr><td>1</td><td></td><td></td></tr><tr><td></td><td></td><td></td></tr><tr><td></td><td></td><td></td></tr></table>	1									<table border="1"><tr><td></td><td></td><td>3</td></tr><tr><td></td><td></td><td></td></tr><tr><td></td><td></td><td>1</td></tr></table>			3						1	<table border="1"><tr><td></td><td></td><td></td></tr><tr><td></td><td></td><td></td></tr><tr><td>1</td><td></td><td></td></tr></table>							1			<table border="1"><tr><td></td><td></td><td></td></tr><tr><td></td><td></td><td></td></tr><tr><td></td><td></td><td></td></tr></table>									
1																																																																															
1																																																																															
2	1																																																																														
1																																																																															
		3																																																																													
		1																																																																													
1																																																																															
Post - 0 Miss - 0 Block - 0	Post - 0 Miss - 0 Block - 0	Post - 1 Miss - 0 Block - 0	Post - 0 Miss - 1 Block - 0	Post - 0 Miss - 0 Block - 1	Post - 0 Miss - 0 Block - 0	Post - 0 Miss - 0 Block - 0	Post - 0 Miss - 0 Block - 0																																																																								
16 张帅	18 赵楠	19 庞连康	20 顾艳超	21 刘江	25 王杰缘	27 王伟强																																																																									
<table border="1"><tr><td></td><td></td><td></td></tr><tr><td></td><td></td><td></td></tr><tr><td></td><td></td><td></td></tr></table>										<table border="1"><tr><td></td><td></td><td></td></tr><tr><td></td><td></td><td></td></tr><tr><td></td><td></td><td></td></tr></table>										<table border="1"><tr><td></td><td></td><td></td></tr><tr><td></td><td></td><td></td></tr><tr><td></td><td></td><td></td></tr></table>										<table border="1"><tr><td></td><td></td><td>1</td></tr><tr><td>2</td><td></td><td>1</td></tr><tr><td></td><td></td><td></td></tr></table>			1	2		1				<table border="1"><tr><td></td><td></td><td></td></tr><tr><td></td><td></td><td></td></tr><tr><td></td><td></td><td></td></tr></table>										<table border="1"><tr><td>2</td><td></td><td></td></tr><tr><td></td><td></td><td></td></tr><tr><td>1</td><td></td><td>2</td></tr></table>	2						1		2	<table border="1"><tr><td></td><td></td><td>2</td></tr><tr><td></td><td></td><td></td></tr><tr><td>1</td><td></td><td></td></tr></table>			2				1												
		1																																																																													
2		1																																																																													
2																																																																															
1		2																																																																													
		2																																																																													
1																																																																															
Post - 0 Miss - 0 Block - 0	Post - 0 Miss - 0 Block - 0	Post - 1 Miss - 0 Block - 0	Post - 1 Miss - 0 Block - 1	Post - 0 Miss - 0 Block - 0	Post - 0 Miss - 0 Block - 0	Post - 0 Miss - 0 Block - 0																																																																									



## 2019年全国男子手球冠军杯赛

PHMS Pictorial Handball Match Statistics

IHF Official System

### 比赛进程表

手球 男子 决赛 轮次 8 组别 X 场次 33 万州体育馆 2019-04-16 16:00

时间	队员	动作	比分	队员	动作
北京队			上半时		
江苏队					
00:50	6 解建飞	封球	0-0	20 顾艳超	近射 被封
00:55	16 刘迈科	挡住球		20 顾艳超	近射 被救
01:07	10 成亚	短传快攻 得分	1-0	12 王权	被射入
01:33	16 刘迈科	被射入	1-1	20 顾艳超	突破 得分
02:45	23 王军程	中远射 被封		21 刘江	封球
02:58	33 陈旭	左远射 被救		12 王权	挡住球
03:29	16 刘迈科	被射入	1-2	4 张家纬	近射 得分
04:04	7 马昌震	近射 得分	2-2	12 王权	被射入
04:08	22 王超	助攻			
04:39	7 马昌震	警告			
04:59	16 刘迈科	挡住球		20 顾艳超	近射 被救
05:03	16 刘迈科	被射入	2-3	8 谢庆龙	近射 得分
05:47	33 陈旭	左远射 被救		12 王权	挡住球
06:05	10 成亚	造犯规		20 顾艳超	进攻犯规
06:17	7 马昌震	右边射 得分	3-3	12 王权	被射入
06:53	16 刘迈科	被射入	3-4	8 谢庆龙	近射 得分
06:55				4 张家纬	助攻
07:16	23 王军程	左远射 被封		20 顾艳超	封球
07:40				27 王伟强	警告
08:21	10 成亚	近射 被封		21 刘江	封球
08:47	16 刘迈科	被射入	3-5	6 赵晨	中远射 得分
09:30	7 马昌震	右边射 被救		12 王权	挡住球
10:11	23 王军程	使被罚7M球		4 张家纬	造7M
10:16	23 王军程	警告			
10:20	16 刘迈科	挡住球		25 王杰缘	7M球 被救
10:52				8 谢庆龙	警告
11:39	23 王军程	左远射 射失			
11:48	16 刘迈科	被射入	3-6	25 王杰缘	一传快攻 得分
11:50				12 王权	助攻
12:52		球队暂停			
13:25	32 蒋维一	近射 得分	4-6	12 王权	被射入
13:28	10 成亚	助攻			
13:41	33 陈旭	造犯规		4 张家纬	进攻犯规
14:24	10 成亚	右边射 射失			
14:59	32 蒋维一	使被罚7M球		4 张家纬	造7M
15:01	32 蒋维一	警告			
15:19	16 刘迈科	挡住球		6 赵晨	7M球 被救
15:39	16 刘迈科	被射入	4-7	20 顾艳超	近射 得分
16:18	33 陈旭	中远射 被封		21 刘江	封球
16:41	7 马昌震	造7M		27 王伟强	使被罚7M球
16:59	10 成亚	7M球 得分	5-7	12 王权	被射入

## 2019年全国男子手球冠军杯赛

PHMS Pictorial Handball Match Statistics

IHF Official System

### 比赛进程表

手球 男子 决赛 轮次 8 组别 X 场次 33 万州体育馆 2019-04-16 16:00

时间	队员	动作	比分	队员	动作			
北京队			上半时			江苏队		
17:32		裁判暂停	5-7					
17:32	33 陈旭	罚出场2分钟						
17:44				4 张家纬	右远射 击柱			
18:31				20 顾艳超	警告			
19:04	13 王军鸣	中远射 得分	6-7	12 王权	被射入			
19:21		裁判暂停						
19:31	16 刘迈科	被射入	6-8	8 谢庆龙	近射 得分			
19:33				20 顾艳超	助攻			
20:37	13 王军鸣	左远射 被救		12 王权	挡住球			
20:40		裁判暂停						
21:36	27 闫炳旗	右边射 得分	7-8	12 王权	被射入			
22:07	16 刘迈科	被射入	7-9	4 张家纬	突破 得分			
22:22	13 王军鸣	近射 击柱						
22:50	16 刘迈科	被射入	7-10	8 谢庆龙	近射 得分			
22:52				6 赵晨	助攻			
23:27	27 闫炳旗	右边射 得分	8-10	12 王权	被射入			
23:40					球队暂停			
23:57				20 顾艳超	传球失误			
24:09	10 成亚	造7M		20 顾艳超	使被罚7M球			
24:28	13 王军鸣	7M球 被救		12 王权	挡住球			
25:08	16 刘迈科	挡住球		4 张家纬	突破 被救			
25:14	16 刘迈科	被射入	8-11	27 王伟强	左边射 得分			
25:59	13 王军鸣	中远射 被封		6 赵晨	封球			
26:21	16 刘迈科	挡住球		6 赵晨	中远射 被救			
26:34		裁判暂停						
26:34				6 赵晨	罚出场2分钟			
26:51	10 成亚	近射 得分	9-11	12 王权	被射入			
27:47	16 刘迈科	挡住球		20 顾艳超	近射 被救			
27:50	16 刘迈科	挡住球		27 王伟强	左边射 被救			
28:25	33 陈旭	中远射 射失						
28:47		裁判暂停						
28:47	7 马昌震	取消比赛资格						
28:59	16 刘迈科	被射入	9-12	20 顾艳超	近射 得分			
29:55	32 蒋维一	任意球 被救		12 王权	挡住球			

## 2019年全国男子手球冠军杯赛

PHMS Pictorial Handball Match Statistics

IHF Official System

### 比赛进程表

手球 男子 决赛 轮次 8 组别 X 场次 33 万州体育馆 2019-04-16 16:00

时间	队员	动作	比分	队员	动作
北京队			江苏队		
00:45	32 蒋维一	造7M	9-12	21 刘江	使被罚7M球
00:53		裁判暂停			
00:59	6 解建飞	7M球 得分	10-12	12 王权	被射入
01:42	16 刘迈科	被射入	10-13	6 赵晨	中远射 得分
02:26	33 陈旭	右远射 射失			
03:18	16 刘迈科	挡住球		6 赵晨	中远射 被救
04:09	23 王军程	中远射 被救		12 王权	挡住球
04:58	16 刘迈科	挡住球		6 赵晨	中远射 被救
05:16	10 成亚	短传快攻 得分	11-13	12 王权	被射入
05:58				6 赵晨	任意球 射失
06:44	10 成亚	传球失误			
06:50	27 闫炳旗	罚出场2分钟			
07:10	16 刘迈科	被射入	11-14	27 王伟强	近射 得分
08:49	23 王军程	近射 射失			
09:23	16 刘迈科	挡住球		8 谢庆龙	近射 被救
09:29	23 王军程	右远射 射失			
09:40	16 刘迈科	挡住球		8 谢庆龙	近射 被救
10:23	10 成亚	进攻犯规		20 顾艳超	造犯规
10:40	16 刘迈科	被射入	11-15	6 赵晨	近射 得分
10:53		球队暂停			
11:26	23 王军程	中远射 被封		6 赵晨	封球
11:36	16 刘迈科	被射入	11-16	20 顾艳超	近射 得分
11:40	26 魏昂	近射 得分	12-16	12 王权	被射入
11:50	16 刘迈科	被射入	12-17	25 王杰缘	近射 得分
12:41	33 陈旭	中远射 射失			
13:13	16 刘迈科	挡住球		4 张家纬	右远射 被救
14:33	13 王军鸣	近射 得分	13-17	12 王权	被射入
14:49		裁判暂停			
15:28	27 闫炳旗	使被罚7M球		27 王伟强	造7M
15:34	16 刘迈科	被射入	13-18	25 王杰缘	7M球 得分
16:02	33 陈旭	近射 被救		12 王权	挡住球
16:06	16 刘迈科	被射入	13-19	25 王杰缘	一传快攻 得分
16:13				6 赵晨	助攻
16:50	33 陈旭	中远射 被救		12 王权	挡住球
17:32				20 顾艳超	左远射 击柱
18:13	13 王军鸣	传球失误		19 庞连康	断球
18:22	16 刘迈科	被射入	13-20	27 王伟强	一传快攻 得分
18:24		裁判暂停			
18:46	26 魏昂	近射 被救		12 王权	挡住球
19:59	27 闫炳旗	抢球		11 张天豪	接球失误
20:53	26 魏昂	传球失误			

2019年全国男子手球冠军杯赛

PHMS Pictorial Handball Match Statistics

IHF Official System

比赛进程表

手球 男子 决赛 轮次 8 组别 X 场次 33 万州体育馆 2019-04-16 16:00

时间	队员	动作	比分	队员	动作
北京队			江苏队		
上半场			下半场		
21:41	6 解建飞	封球	13-20	7 周傲	中远射 被封
21:57	18 傅俊雄	造7M		18 赵楠	使被罚7M球
22:29	6 解建飞	7M球 得分	14-20	16 张帅	被射入
23:01	12 高云健	挡住球		18 赵楠	中远射 被救
23:13	18 傅俊雄	传球失误		25 王杰缘	断球
23:20	12 高云健	挡住球		11 张天豪	短传快攻 被救
23:29	32 蒋维一	短传快攻 得分	15-20	16 张帅	被射入
24:09				18 赵楠	运球失误
24:14	10 成亚	近射 被救		16 张帅	挡住球
24:25	12 高云健	被射入	15-21	11 张天豪	短传快攻 得分
24:57	18 傅俊雄	突破 被救		16 张帅	挡住球
25:28	18 傅俊雄	左远射 被封		7 周傲	封球
25:33	12 高云健	被射入	15-22	7 周傲	一传快攻 得分
26:10		裁判暂停			
26:48	23 王军程	运球失误		25 王杰缘	造失误
26:54	12 高云健	被射入	15-23	25 王杰缘	一传快攻 得分
27:48	27 闫炳旗	近射 得分	16-23	16 张帅	被射入
27:51	13 王军鸣	助攻			
28:25				19 庞连康	左边射 击柱
28:58	32 蒋维一	近射 得分	17-23	16 张帅	被射入
29:28				8 谢庆龙	侵区
29:38	23 王军程	近射 击柱			