

第二届全国青年运动会男子手球 乙组决赛体校组(U16)

成绩与技术统计数据册



中国手球协会
CHINESE HANDBALL ASSOCIATION



数据由PHMS收集生成



PHMS 国际手球联合会官方技术统计系统

成绩与技术统计数据册目录

- 1 比赛结果
 - 1) 名次
 - 2) 获奖队员名单
 - 3) 场次成绩
 - 4) 分组成绩
- 2 运动员排名
 - 1) 得分
 - 2) 助攻
 - 3) 封球
 - 4) 防守
 - 5) 失误
 - 6) 受罚
- 3 守门员排名
 - 1) 救球
 - 2) 救7M球
- 4 球队总体比较
- 5 球队受罚表
- 6 球队累计
 - 1) 球队名单
 - 2) 个人/全队技术累计表
 - 3) 图式射门区域累计
- 7 每场比赛统计
 - 1) 比赛报告表
 - 2) 竞赛技术统计表
 - 3) 个人/全队技术统计表
 - 4) 图式比赛技术统计
 - 5) 图式射门区域统计
 - 6) 比赛进程表(决赛场次)

注：如需更多比赛统计数据，请通过以下电邮联络：handball@126.com

大赛名次

手球
青年男子

截止至第42场

安徽滁州
2019-06-05

| 奖牌 | 名次 | 缩写 | 队名 |
|--------|----|----|-------|
| Gold | 1 | 安徽 | 安徽省体校 |
| Silver | 2 | 香港 | 中国香港 |
| Bronze | 3 | 苏州 | 江苏苏州 |
| | 4 | 宝山 | 上海宝山 |
| | 5 | 龙岩 | 福建龙岩 |
| | 6 | 抚顺 | 辽宁抚顺 |
| | 7 | 淮南 | 安徽淮南 |
| | 8 | 济南 | 山东济南 |

获奖队员名单

手球
青年男子

安徽滁州
2019-06-05

| 金牌 | 银牌 | 铜牌 |
|----------|---------|---------|
| 安徽-安徽省体校 | 香港-中国香港 | 苏州-江苏苏州 |
| 52 花驰 | 1 江力为 | 1 邹明轩 |
| 53 叶天赐 | 2 梁凯乔 | 2 马力 |
| 54 姚幸运 | 3 陈嘉熙 | 4 孙钊 |
| 55 苏凯 | 10 叶滋权 | 5 马奔 |
| 56 王健鹏 | 15 梁栢朗 | 6 潘超群 |
| 57 朱正翔 | 16 冯智聪 | 8 王震 |
| 58 蔡博飞 | 22 吴泽斌 | 9 李文俊 |
| 59 毛饶翔 | 23 石铭泽 | 10 朱红雨 |
| 60 朱超 | 27 巫迪涛 | 11 许多 |
| 61 钮伟豪 | 28 关健辉 | 12 周文贤 |
| 62 赵俊阳 | 30 陈永曦 | 13 蒋超 |
| 64 章道胜 | 41 莫敬朗 | 14 刘亚力 |
| 65 韩伟伦 | 47 薛浩锋 | 15 刘成果 |
| 66 刘家豪 | 73 黄塍鎏 | 18 何志伟 |
| 67 江文 | 79 吴坤霖 | 19 夏思毅 |
| 68 黄天源 | 99 苏俊轩 | 23 张铮洋 |

场次成绩

手球
青年男子

截止至第42场

安徽滁州
2019-06-05

| 日期 | 时间 | 场次 | 体育馆 | 组别 | 球队 | 成绩 (半时) | 阶段 |
|----------|-------|----|---------|----|-------|--------------|--------|
| 02/06/19 | 17:00 | 25 | 滁州国际手球馆 | X | 安徽-济南 | 18-10 (7-6) | 四分之一决赛 |
| | 18:00 | 26 | 滁州国际手球馆 | X | 宝山-抚顺 | 21-19 (7-8) | 四分之一决赛 |
| | 19:00 | 27 | 滁州国际手球馆 | X | 淮南-香港 | 9-14 (3-8) | 四分之一决赛 |
| | 20:00 | 28 | 滁州国际手球馆 | X | 苏州-龙岩 | 21-9 (10-3) | 四分之一决赛 |
| 04/06/19 | 14:00 | 32 | 滁州国际手球馆 | X | 济南-抚顺 | 7-21 (3-10) | 5-8名 |
| | 15:00 | 33 | 滁州国际手球馆 | X | 淮南-龙岩 | 13-15 (6-6) | 5-8名 |
| | 16:00 | 34 | 滁州国际手球馆 | X | 安徽-宝山 | 17-11 (8-6) | 半决赛 |
| | 17:00 | 35 | 滁州国际手球馆 | X | 香港-苏州 | 13-11 (5-5) | 半决赛 |
| 05/06/19 | 08:30 | 36 | 滁州国际手球馆 | X | 济南-淮南 | 14-23 (9-14) | 7-8名 |
| | 09:30 | 37 | 滁州国际手球馆 | X | 抚顺-龙岩 | 13-16 (6-8) | 5-6名 |
| | 16:00 | 41 | 滁州国际手球馆 | X | 宝山-苏州 | 12-13 (6-7) | 3-4名 |
| | 17:00 | 42 | 滁州国际手球馆 | X | 安徽-香港 | 15-10 (9-2) | 决赛 |

分组成绩

手球
青年男子

截止至第42场

安徽滁州
2019-06-05

组别: A 预赛

| 名次 | 球队 | 积 | 场 | 胜 | 平 | 负 | 得分 | 失分 | 净胜 |
|----|----|---|---|---|---|---|----|----|-----|
| 1 | 安徽 | 6 | 3 | 3 | 0 | 0 | 64 | 38 | 26 |
| 2 | 淮南 | 2 | 3 | 1 | 0 | 2 | 56 | 70 | -14 |
| 2 | 抚顺 | 2 | 3 | 1 | 0 | 2 | 48 | 53 | -5 |
| 4 | 龙岩 | 2 | 3 | 1 | 0 | 2 | 44 | 51 | -7 |

| 球队 | 安徽 | 淮南 | 抚顺 | 龙岩 |
|----|-------|-------|-------|-------|
| 安徽 | | 26-15 | 15-10 | 23-13 |
| 淮南 | 15-26 | | 26-25 | 15-19 |
| 抚顺 | 10-15 | 25-26 | | 13-12 |
| 龙岩 | 13-23 | 19-15 | 12-13 | |

组别: B 预赛

| 名次 | 球队 | 积 | 场 | 胜 | 平 | 负 | 得分 | 失分 | 净胜 |
|----|----|---|---|---|---|---|----|----|----|
| 1 | 苏州 | 4 | 3 | 2 | 0 | 1 | 46 | 34 | 12 |
| 2 | 宝山 | 4 | 3 | 2 | 0 | 1 | 48 | 48 | 0 |
| 3 | 香港 | 2 | 3 | 1 | 0 | 2 | 42 | 46 | -4 |
| 4 | 济南 | 2 | 3 | 1 | 0 | 2 | 36 | 44 | -8 |

| 球队 | 苏州 | 宝山 | 香港 | 济南 |
|----|-------|-------|-------|-------|
| 苏州 | | 20-12 | 15-10 | 11-12 |
| 宝山 | 12-20 | | 18-17 | 18-11 |
| 香港 | 10-15 | 17-18 | | 15-13 |
| 济南 | 12-11 | 11-18 | 13-15 | |

Legend:

| | | | | | | | |
|---|----|---|-------|----|------|----|-----|
| 积 | 积分 | ■ | 已比赛场次 | 胜 | 胜场 | 平 | 平场 |
| 负 | 负场 | ■ | 得分累计 | 失分 | 失分累计 | 净胜 | 净胜分 |

得分排名表(场上队员)

手球
青年男子

截止至第42场
按总得分排序

安徽滁州
2019-06-05

| 排序 | 号码 | 姓名 | 球队 | 远射 | 近射 | 边射 | 快攻 | 突破 | 任意 | 七米 | 合计 | % | 助攻 | 场数 |
|----|----|-----|----|-------|-------|-------|-------|-----|------|-------|-------|------|----|----|
| 1 | 13 | 高鑫 | 抚顺 | 7-13 | 10-12 | 0-3 | 1-1 | 5-9 | 1-2 | 9-12 | 33-52 | 63.5 | 2 | 6 |
| 2 | 5 | 郭雨强 | 龙岩 | 23-45 | 2-2 | 0-1 | 3-4 | 2-2 | 2-5 | 1-3 | 33-62 | 53.2 | 5 | 6 |
| 3 | 10 | 孙飞扬 | 淮南 | 8-16 | 7-9 | 1-1 | 1-2 | 3-3 | 6-11 | 3-4 | 29-46 | 63.0 | 3 | 6 |
| 4 | 9 | 杨金龙 | 淮南 | 8-20 | 5-9 | 0-0 | 2-2 | 4-4 | 0-1 | 10-13 | 29-49 | 59.2 | 3 | 6 |
| 5 | 17 | 杨宇 | 抚顺 | 11-30 | 6-9 | 0-0 | 5-6 | 4-5 | 1-4 | 0-2 | 27-56 | 48.2 | 5 | 6 |
| 6 | 21 | 曾新宇 | 宝山 | 10-31 | 7-10 | 1-1 | 6-9 | 2-4 | 0-0 | 0-0 | 26-55 | 47.3 | 3 | 6 |
| 7 | 35 | 刘子杰 | 宝山 | 3-7 | 10-14 | 0-0 | 1-3 | 0-2 | 0-2 | 7-8 | 21-36 | 58.3 | 0 | 6 |
| 8 | 6 | 潘超群 | 苏州 | 16-30 | 0-1 | 0-0 | 0-0 | 1-1 | 1-2 | 3-5 | 21-39 | 53.8 | 7 | 6 |
| 9 | 8 | 陈子涵 | 淮南 | 5-12 | 6-9 | 2-3 | 4-4 | 2-2 | 0-1 | 1-2 | 20-33 | 60.6 | 2 | 6 |
| 10 | 27 | 巫迪涛 | 香港 | 6-15 | 2-6 | 1-1 | 0-0 | 7-8 | 0-5 | 4-7 | 20-42 | 47.6 | 0 | 6 |
| 11 | 56 | 王健鹏 | 安徽 | 7-16 | 9-9 | 0-0 | 1-3 | 2-3 | 0-0 | 0-0 | 19-31 | 61.3 | 7 | 6 |
| 12 | 6 | 刘尊哲 | 济南 | 7-22 | 1-4 | 2-4 | 1-1 | 4-4 | 0-1 | 3-3 | 18-39 | 46.2 | 7 | 6 |
| 13 | 13 | 刘振宇 | 济南 | 12-36 | 2-3 | 0-0 | 0-0 | 1-1 | 3-5 | 0-0 | 18-45 | 40.0 | 2 | 6 |
| 14 | 64 | 章道胜 | 安徽 | 0-1 | 5-6 | 1-2 | 11-12 | 0-0 | 0-0 | 0-0 | 17-21 | 81.0 | 0 | 6 |
| 15 | 13 | 刘启群 | 宝山 | 1-4 | 2-3 | 11-16 | 1-1 | 2-2 | 0-0 | 0-0 | 17-26 | 65.4 | 1 | 6 |
| 16 | 10 | 赵一 | 龙岩 | 4-11 | 3-5 | 0-0 | 1-3 | 6-7 | 1-1 | 2-2 | 17-29 | 58.6 | 10 | 6 |
| 17 | 60 | 朱超 | 安徽 | 1-1 | 6-8 | 5-9 | 3-3 | 1-1 | 0-0 | 0-0 | 16-22 | 72.7 | 1 | 6 |
| 18 | 4 | 孙钊 | 苏州 | 10-17 | 3-6 | 1-2 | 0-0 | 2-5 | 0-2 | 0-0 | 16-32 | 50.0 | 3 | 6 |
| 19 | 28 | 靳皓添 | 抚顺 | 1-1 | 12-18 | 0-0 | 0-0 | 0-0 | 0-0 | 2-2 | 15-21 | 71.4 | 0 | 6 |
| 20 | 47 | 薛浩锋 | 香港 | 4-6 | 4-6 | 4-7 | 0-1 | 3-5 | 0-0 | 0-1 | 15-26 | 57.7 | 2 | 6 |
| 21 | 58 | 蔡博飞 | 安徽 | 3-5 | 7-9 | 0-0 | 3-4 | 0-1 | 0-0 | 1-1 | 14-20 | 70.0 | 8 | 6 |
| 22 | 10 | 叶滋权 | 香港 | 5-14 | 2-3 | 0-1 | 0-0 | 5-6 | 1-1 | 1-1 | 14-26 | 53.8 | 2 | 6 |
| 23 | 59 | 毛饶翔 | 安徽 | 4-13 | 2-4 | 0-0 | 5-5 | 2-3 | 0-2 | 1-1 | 14-28 | 50.0 | 10 | 6 |
| 24 | 22 | 马浩东 | 宝山 | 4-11 | 1-1 | 2-5 | 2-3 | 4-4 | 0-0 | 0-0 | 13-24 | 54.2 | 1 | 6 |
| 25 | 55 | 苏凯 | 安徽 | 0-0 | 3-3 | 6-7 | 2-6 | 0-0 | 0-0 | 1-1 | 12-17 | 70.6 | 0 | 6 |
| 26 | 18 | 何志伟 | 苏州 | 1-2 | 3-5 | 2-6 | 6-6 | 0-0 | 0-0 | 0-0 | 12-19 | 63.2 | 4 | 6 |
| 27 | 15 | 刘家良 | 龙岩 | 4-12 | 4-8 | 0-0 | 1-1 | 2-4 | 0-0 | 1-1 | 12-26 | 46.2 | 2 | 6 |
| 28 | 10 | 颜同霖 | 济南 | 2-9 | 1-3 | 0-2 | 2-2 | 4-4 | 2-5 | 0-0 | 11-25 | 44.0 | 1 | 6 |
| 29 | 54 | 姚幸运 | 安徽 | 0-0 | 2-3 | 2-3 | 5-6 | 1-1 | 0-0 | 0-0 | 10-13 | 76.9 | 3 | 6 |
| 30 | 5 | 马奔 | 苏州 | 0-0 | 8-11 | 0-0 | 2-3 | 0-0 | 0-0 | 0-0 | 10-14 | 71.4 | 2 | 6 |
| 31 | 28 | 关健辉 | 香港 | 0-0 | 1-2 | 9-13 | 0-1 | 0-0 | 0-0 | 0-0 | 10-16 | 62.5 | 0 | 6 |
| 32 | 19 | 靳皓童 | 抚顺 | 1-4 | 4-6 | 0-0 | 1-1 | 2-2 | 0-1 | 2-3 | 10-17 | 58.8 | 10 | 6 |
| 33 | 9 | 隋博 | 抚顺 | 0-0 | 2-2 | 7-12 | 0-0 | 0-0 | 0-0 | 0-0 | 9-14 | 64.3 | 0 | 6 |
| 34 | 8 | 王震 | 苏州 | 8-18 | 0-0 | 0-2 | 0-0 | 1-1 | 0-2 | 0-0 | 9-23 | 39.1 | 1 | 6 |
| 35 | 18 | 奚尧 | 龙岩 | 0-1 | 2-3 | 5-6 | 1-2 | 0-0 | 0-0 | 0-0 | 8-12 | 66.7 | 0 | 6 |
| 36 | 11 | 李延舒 | 济南 | 0-0 | 5-7 | 1-1 | 1-1 | 0-0 | 0-0 | 0-0 | 7-9 | 77.8 | 0 | 6 |
| 37 | 6 | 童浩宇 | 淮南 | 0-0 | 1-2 | 5-9 | 0-0 | 0-0 | 0-0 | 1-2 | 7-13 | 53.8 | 0 | 6 |
| 38 | 7 | 王帅 | 济南 | 0-4 | 2-7 | 1-2 | 3-3 | 0-0 | 1-1 | 0-0 | 7-17 | 41.2 | 0 | 6 |
| 39 | 57 | 朱正翔 | 安徽 | 1-5 | 1-1 | 2-2 | 0-0 | 1-1 | 1-1 | 0-0 | 6-10 | 60.0 | 2 | 6 |
| 40 | 10 | 朱红雨 | 苏州 | 0-0 | 1-2 | 3-3 | 1-2 | 0-0 | 0-0 | 0-0 | 5-7 | 71.4 | 0 | 6 |

得分排名表(场上队员)

手球
青年男子

截止至第42场
按助攻次数排序

安徽滁州
2019-06-05

| 排序 | 号码 | 姓名 | 球队 | 远射 | 近射 | 边射 | 快攻 | 突破 | 任意 | 七米 | 合计 | % | 助攻 | 场数 |
|----|----|-----|----|-------|-------|-------|-----|-----|------|-------|-------|-------|----|----|
| 1 | 10 | 赵一 | 龙岩 | 4-11 | 3-5 | 0-0 | 1-3 | 6-7 | 1-1 | 2-2 | 17-29 | 58.6 | 10 | 6 |
| 2 | 59 | 毛饶翔 | 安徽 | 4-13 | 2-4 | 0-0 | 5-5 | 2-3 | 0-2 | 1-1 | 14-28 | 50.0 | 10 | 6 |
| 3 | 19 | 靳皓童 | 抚顺 | 1-4 | 4-6 | 0-0 | 1-1 | 2-2 | 0-1 | 2-3 | 10-17 | 58.8 | 10 | 6 |
| 4 | 58 | 蔡博飞 | 安徽 | 3-5 | 7-9 | 0-0 | 3-4 | 0-1 | 0-0 | 1-1 | 14-20 | 70.0 | 8 | 6 |
| 5 | 6 | 潘超群 | 苏州 | 16-30 | 0-1 | 0-0 | 0-0 | 1-1 | 1-2 | 3-5 | 21-39 | 53.8 | 7 | 6 |
| 6 | 56 | 王健鹏 | 安徽 | 7-16 | 9-9 | 0-0 | 1-3 | 2-3 | 0-0 | 0-0 | 19-31 | 61.3 | 7 | 6 |
| 7 | 6 | 刘尊哲 | 济南 | 7-22 | 1-4 | 2-4 | 1-1 | 4-4 | 0-1 | 3-3 | 18-39 | 46.2 | 7 | 6 |
| 8 | 5 | 郭雨强 | 龙岩 | 23-45 | 2-2 | 0-1 | 3-4 | 2-2 | 2-5 | 1-3 | 33-62 | 53.2 | 5 | 6 |
| 9 | 17 | 杨宇 | 抚顺 | 11-30 | 6-9 | 0-0 | 5-6 | 4-5 | 1-4 | 0-2 | 27-56 | 48.2 | 5 | 6 |
| 10 | 18 | 何志伟 | 苏州 | 1-2 | 3-5 | 2-6 | 6-6 | 0-0 | 0-0 | 0-0 | 12-19 | 63.2 | 4 | 6 |
| 11 | 10 | 孙飞扬 | 淮南 | 8-16 | 7-9 | 1-1 | 1-2 | 3-3 | 6-11 | 3-4 | 29-46 | 63.0 | 3 | 6 |
| 12 | 9 | 杨金龙 | 淮南 | 8-20 | 5-9 | 0-0 | 2-2 | 4-4 | 0-1 | 10-13 | 29-49 | 59.2 | 3 | 6 |
| 13 | 21 | 曾新宇 | 宝山 | 10-31 | 7-10 | 1-1 | 6-9 | 2-4 | 0-0 | 0-0 | 26-55 | 47.3 | 3 | 6 |
| 14 | 4 | 孙钊 | 苏州 | 10-17 | 3-6 | 1-2 | 0-0 | 2-5 | 0-2 | 0-0 | 16-32 | 50.0 | 3 | 6 |
| 15 | 54 | 姚幸运 | 安徽 | 0-0 | 2-3 | 2-3 | 5-6 | 1-1 | 0-0 | 0-0 | 10-13 | 76.9 | 3 | 6 |
| 16 | 10 | 马涛 | 宝山 | 1-5 | 2-4 | 0-1 | 0-0 | 1-1 | 0-0 | 0-0 | 4-11 | 36.4 | 3 | 6 |
| 17 | 13 | 高鑫 | 抚顺 | 7-13 | 10-12 | 0-3 | 1-1 | 5-9 | 1-2 | 9-12 | 33-52 | 63.5 | 2 | 6 |
| 18 | 8 | 陈子涵 | 淮南 | 5-12 | 6-9 | 2-3 | 4-4 | 2-2 | 0-1 | 1-2 | 20-33 | 60.6 | 2 | 6 |
| 19 | 13 | 刘振宇 | 济南 | 12-36 | 2-3 | 0-0 | 0-0 | 1-1 | 3-5 | 0-0 | 18-45 | 40.0 | 2 | 6 |
| 20 | 47 | 薛浩锋 | 香港 | 4-6 | 4-6 | 4-7 | 0-1 | 3-5 | 0-0 | 0-1 | 15-26 | 57.7 | 2 | 6 |
| 21 | 10 | 叶滋权 | 香港 | 5-14 | 2-3 | 0-1 | 0-0 | 5-6 | 1-1 | 1-1 | 14-26 | 53.8 | 2 | 6 |
| 22 | 15 | 刘家良 | 龙岩 | 4-12 | 4-8 | 0-0 | 1-1 | 2-4 | 0-0 | 1-1 | 12-26 | 46.2 | 2 | 6 |
| 23 | 5 | 马奔 | 苏州 | 0-0 | 8-11 | 0-0 | 2-3 | 0-0 | 0-0 | 0-0 | 10-14 | 71.4 | 2 | 6 |
| 24 | 57 | 朱正翔 | 安徽 | 1-5 | 1-1 | 2-2 | 0-0 | 1-1 | 1-1 | 0-0 | 6-10 | 60.0 | 2 | 6 |
| 25 | 23 | 石铭泽 | 香港 | 0-1 | 2-4 | 1-3 | 1-1 | 0-0 | 0-0 | 0-0 | 4-9 | 44.4 | 2 | 6 |
| 26 | 11 | 许多 | 苏州 | 0-3 | 0-0 | 0-0 | 0-0 | 2-3 | 0-1 | 0-1 | 2-8 | 25.0 | 2 | 6 |
| 27 | 3 | 陈嘉熙 | 香港 | 0-0 | 1-1 | 0-0 | 0-1 | 0-0 | 0-0 | 0-0 | 1-2 | 50.0 | 2 | 6 |
| 28 | 52 | 花驰 | 安徽 | 0-0 | 0-0 | 0-0 | 0-0 | 0-0 | 0-0 | 0-0 | 0-0 | 0 | 2 | 6 |
| 29 | 13 | 刘启群 | 宝山 | 1-4 | 2-3 | 11-16 | 1-1 | 2-2 | 0-0 | 0-0 | 17-26 | 65.4 | 1 | 6 |
| 30 | 60 | 朱超 | 安徽 | 1-1 | 6-8 | 5-9 | 3-3 | 1-1 | 0-0 | 0-0 | 16-22 | 72.7 | 1 | 6 |
| 31 | 22 | 马浩东 | 宝山 | 4-11 | 1-1 | 2-5 | 2-3 | 4-4 | 0-0 | 0-0 | 13-24 | 54.2 | 1 | 6 |
| 32 | 10 | 颜同霖 | 济南 | 2-9 | 1-3 | 0-2 | 2-2 | 4-4 | 2-5 | 0-0 | 11-25 | 44.0 | 1 | 6 |
| 33 | 8 | 王震 | 苏州 | 8-18 | 0-0 | 0-2 | 0-0 | 1-1 | 0-2 | 0-0 | 9-23 | 39.1 | 1 | 6 |
| 34 | 13 | 蒋超 | 苏州 | 0-0 | 1-1 | 0-1 | 3-5 | 0-0 | 0-0 | 0-0 | 4-7 | 57.1 | 1 | 6 |
| 35 | 15 | 梁栢朗 | 香港 | 0-0 | 1-1 | 0-0 | 2-3 | 0-0 | 0-0 | 0-0 | 3-4 | 75.0 | 1 | 6 |
| 36 | 23 | 张铮洋 | 苏州 | 0-4 | 1-2 | 0-0 | 2-3 | 0-0 | 0-0 | 0-1 | 3-10 | 30.0 | 1 | 6 |
| 37 | 79 | 吴坤霖 | 香港 | 0-0 | 1-1 | 0-0 | 1-1 | 0-0 | 0-0 | 0-0 | 2-2 | 100.0 | 1 | 6 |
| 38 | 9 | 荆胤丞 | 龙岩 | 0-0 | 2-3 | 0-0 | 0-0 | 0-0 | 0-0 | 0-0 | 2-3 | 66.7 | 1 | 6 |
| 39 | 7 | 王晨旭 | 龙岩 | 0-0 | 2-3 | 0-1 | 0-0 | 0-0 | 0-0 | 0-0 | 2-4 | 50.0 | 1 | 6 |
| 40 | 8 | 金正凯 | 济南 | 0-0 | 1-2 | 1-3 | 0-0 | 0-0 | 0-0 | 0-0 | 2-5 | 40.0 | 1 | 6 |

得分排名表(场上队员)

 手球
 青年男子

 截止至第42场
 按封球次数排序

 安徽滁州
 2019-06-05

| 名次 | 号码 | 姓名 | 球队 | 抢球 | 断球 | 造失误 | 造犯规 | 合计 | 封球 | 场数 |
|----|----|-----|----|----|----|-----|-----|----|----|----|
| 1 | 23 | 张铮洋 | 苏州 | 0 | 3 | 0 | 0 | 3 | 8 | 6 |
| 2 | 6 | 潘超群 | 苏州 | 1 | 3 | 0 | 0 | 4 | 7 | 6 |
| 3 | 35 | 刘子杰 | 宝山 | 0 | 0 | 0 | 0 | 0 | 5 | 6 |
| 4 | 56 | 王健鹏 | 安徽 | 1 | 6 | 0 | 0 | 7 | 4 | 6 |
| 5 | 23 | 石铭泽 | 香港 | 0 | 5 | 0 | 1 | 6 | 4 | 6 |
| 6 | 28 | 靳皓添 | 抚顺 | 0 | 1 | 0 | 1 | 2 | 3 | 6 |
| 7 | 64 | 章道胜 | 安徽 | 2 | 2 | 1 | 0 | 5 | 3 | 6 |
| 8 | 15 | 梁栢朗 | 香港 | 2 | 4 | 1 | 0 | 7 | 3 | 6 |
| 9 | 9 | 荆胤丞 | 龙岩 | 0 | 1 | 0 | 0 | 1 | 2 | 6 |
| 10 | 19 | 靳皓童 | 抚顺 | 1 | 1 | 2 | 0 | 4 | 2 | 6 |
| 11 | 57 | 朱正翔 | 安徽 | 1 | 7 | 0 | 0 | 8 | 2 | 6 |
| 12 | 47 | 薛浩锋 | 香港 | 0 | 4 | 1 | 1 | 6 | 2 | 6 |
| 13 | 13 | 高鑫 | 抚顺 | 0 | 2 | 0 | 1 | 3 | 2 | 6 |
| 14 | 11 | 李延舒 | 济南 | 2 | 0 | 0 | 1 | 3 | 2 | 6 |
| 15 | 30 | 戴泽昊 | 宝山 | 0 | 0 | 0 | 0 | 0 | 1 | 4 |
| 16 | 8 | 王震 | 苏州 | 0 | 2 | 0 | 0 | 2 | 1 | 6 |
| 17 | 60 | 朱超 | 安徽 | 2 | 1 | 0 | 0 | 3 | 1 | 6 |
| 18 | 22 | 马浩东 | 宝山 | 5 | 8 | 0 | 2 | 15 | 1 | 6 |
| 19 | 23 | 朱天一 | 龙岩 | 0 | 3 | 0 | 0 | 3 | 1 | 6 |
| 20 | 79 | 吴坤霖 | 香港 | 1 | 0 | 0 | 0 | 1 | 1 | 6 |
| 21 | 5 | 郭雨强 | 龙岩 | 1 | 2 | 0 | 0 | 3 | 1 | 6 |
| 22 | 17 | 徐鹏辉 | 淮南 | 0 | 0 | 0 | 0 | 0 | 1 | 6 |
| 23 | 13 | 刘振宇 | 济南 | 0 | 2 | 0 | 0 | 2 | 1 | 6 |
| 24 | 18 | 奚尧 | 龙岩 | 1 | 1 | 0 | 1 | 3 | 1 | 6 |
| 25 | 17 | 杨宇 | 抚顺 | 1 | 4 | 0 | 1 | 6 | 1 | 6 |
| 26 | 10 | 马涛 | 宝山 | 1 | 3 | 1 | 1 | 6 | 1 | 6 |
| 27 | 27 | 巫迪涛 | 香港 | 0 | 0 | 0 | 0 | 0 | 1 | 6 |
| 28 | 12 | 薛凯 | 宝山 | 0 | 0 | 0 | 0 | 0 | 0 | 2 |
| 29 | 67 | 江文 | 安徽 | 0 | 0 | 0 | 0 | 0 | 0 | 4 |
| 30 | 19 | 夏思毅 | 苏州 | 0 | 0 | 0 | 0 | 0 | 0 | 4 |
| 31 | 19 | 张申杰 | 宝山 | 0 | 1 | 0 | 0 | 1 | 0 | 4 |
| 32 | 88 | 王麒翔 | 济南 | 0 | 0 | 0 | 0 | 0 | 0 | 5 |
| 33 | 5 | 吴修民 | 淮南 | 0 | 0 | 0 | 0 | 0 | 0 | 6 |
| 34 | 13 | 张昊燃 | 淮南 | 0 | 0 | 0 | 0 | 0 | 0 | 6 |
| 35 | 14 | 单中宝 | 淮南 | 0 | 0 | 0 | 0 | 0 | 0 | 6 |
| 36 | 15 | 刘淇 | 淮南 | 0 | 1 | 0 | 0 | 1 | 0 | 6 |
| 37 | 16 | 胡文柯 | 淮南 | 0 | 0 | 0 | 0 | 0 | 0 | 6 |
| 38 | 3 | 陈嘉熙 | 香港 | 0 | 1 | 0 | 0 | 1 | 0 | 6 |
| 39 | 6 | 刘尊哲 | 济南 | 0 | 1 | 0 | 0 | 1 | 0 | 6 |
| 40 | 10 | 颜同霖 | 济南 | 1 | 1 | 0 | 1 | 3 | 0 | 6 |

得分排名表(场上队员)

手球
青年男子

截止至第42场
按防守成功总数排序

安徽滁州
2019-06-05

| 名次 | 号码 | 姓名 | 球队 | 抢球 | 断球 | 造失误 | 造犯规 | 合计 | 封球 | 场数 |
|----|----|------|----|----|----|-----|-----|----|----|----|
| 1 | 22 | 马浩东 | 宝山 | 5 | 8 | 0 | 2 | 15 | 1 | 6 |
| 2 | 21 | 曾新宇 | 宝山 | 2 | 9 | 1 | 1 | 13 | 0 | 6 |
| 3 | 59 | 毛饶翔 | 安徽 | 2 | 7 | 1 | 0 | 10 | 0 | 6 |
| 4 | 57 | 朱正翔 | 安徽 | 1 | 7 | 0 | 0 | 8 | 2 | 6 |
| 5 | 10 | 孙飞扬 | 淮南 | 2 | 3 | 2 | 0 | 7 | 0 | 6 |
| 6 | 15 | 梁栢朗 | 香港 | 2 | 4 | 1 | 0 | 7 | 3 | 6 |
| 7 | 56 | 王健鹏 | 安徽 | 1 | 6 | 0 | 0 | 7 | 4 | 6 |
| 8 | 17 | 杨宇 | 抚顺 | 1 | 4 | 0 | 1 | 6 | 1 | 6 |
| 9 | 23 | 石铭泽 | 香港 | 0 | 5 | 0 | 1 | 6 | 4 | 6 |
| 10 | 47 | 薛浩锋 | 香港 | 0 | 4 | 1 | 1 | 6 | 2 | 6 |
| 11 | 54 | 姚幸运 | 安徽 | 0 | 4 | 2 | 0 | 6 | 0 | 6 |
| 12 | 10 | 马涛 | 宝山 | 1 | 3 | 1 | 1 | 6 | 1 | 6 |
| 13 | 8 | 陈子涵 | 淮南 | 1 | 3 | 1 | 1 | 6 | 0 | 6 |
| 14 | 64 | 章道胜 | 安徽 | 2 | 2 | 1 | 0 | 5 | 3 | 6 |
| 15 | 18 | 何志伟 | 苏州 | 1 | 4 | 0 | 0 | 5 | 0 | 6 |
| 16 | 7 | 张羽虹冰 | 抚顺 | 3 | 0 | 2 | 0 | 5 | 0 | 6 |
| 17 | 6 | 潘超群 | 苏州 | 1 | 3 | 0 | 0 | 4 | 7 | 6 |
| 18 | 58 | 蔡博飞 | 安徽 | 1 | 3 | 0 | 0 | 4 | 0 | 6 |
| 19 | 10 | 赵一 | 龙岩 | 0 | 4 | 0 | 0 | 4 | 0 | 6 |
| 20 | 19 | 靳皓童 | 抚顺 | 1 | 1 | 2 | 0 | 4 | 2 | 6 |
| 21 | 23 | 朱天一 | 龙岩 | 0 | 3 | 0 | 0 | 3 | 1 | 6 |
| 22 | 5 | 郭雨强 | 龙岩 | 1 | 2 | 0 | 0 | 3 | 1 | 6 |
| 23 | 13 | 高鑫 | 抚顺 | 0 | 2 | 0 | 1 | 3 | 2 | 6 |
| 24 | 23 | 张铮洋 | 苏州 | 0 | 3 | 0 | 0 | 3 | 8 | 6 |
| 25 | 10 | 颜同霖 | 济南 | 1 | 1 | 0 | 1 | 3 | 0 | 6 |
| 26 | 18 | 奚尧 | 龙岩 | 1 | 1 | 0 | 1 | 3 | 1 | 6 |
| 27 | 11 | 刘新然 | 淮南 | 1 | 2 | 0 | 0 | 3 | 0 | 6 |
| 28 | 60 | 朱超 | 安徽 | 2 | 1 | 0 | 0 | 3 | 1 | 6 |
| 29 | 11 | 李延舒 | 济南 | 2 | 0 | 0 | 1 | 3 | 2 | 6 |
| 30 | 25 | 江锦 | 宝山 | 1 | 0 | 1 | 0 | 2 | 0 | 6 |
| 31 | 28 | 关健辉 | 香港 | 0 | 2 | 0 | 0 | 2 | 0 | 6 |
| 32 | 27 | 邓可钊 | 龙岩 | 1 | 0 | 0 | 1 | 2 | 0 | 6 |
| 33 | 62 | 赵俊阳 | 安徽 | 0 | 1 | 1 | 0 | 2 | 0 | 6 |
| 34 | 28 | 靳皓添 | 抚顺 | 0 | 1 | 0 | 1 | 2 | 3 | 6 |
| 35 | 4 | 张广一 | 济南 | 1 | 1 | 0 | 0 | 2 | 0 | 6 |
| 36 | 55 | 苏凯 | 安徽 | 1 | 1 | 0 | 0 | 2 | 0 | 6 |
| 37 | 13 | 刘振宇 | 济南 | 0 | 2 | 0 | 0 | 2 | 1 | 6 |
| 38 | 10 | 朱红雨 | 苏州 | 1 | 0 | 0 | 1 | 2 | 0 | 6 |
| 39 | 8 | 王震 | 苏州 | 0 | 2 | 0 | 0 | 2 | 1 | 6 |
| 40 | 6 | 刘尊哲 | 济南 | 0 | 1 | 0 | 0 | 1 | 0 | 6 |

得分排名表(场上队员)

手球
青年男子

截止至第42场
按失误总数排序

安徽滁州
2019-06-05

| 排序 | 号码 | 姓名 | 球队 | 传失 | 接失 | 两次 | 四步 | 侵区 | 进犯 | 其它 | 合计 | 场数 |
|----|----|-----|----|----|----|----|----|----|----|----|----|----|
| 1 | 17 | 杨宇 | 抚顺 | 8 | 5 | 3 | 4 | 2 | 2 | 0 | 24 | 6 |
| 2 | 19 | 靳皓童 | 抚顺 | 7 | 6 | 3 | 3 | 0 | 1 | 0 | 20 | 6 |
| 3 | 6 | 刘尊哲 | 济南 | 15 | 3 | 1 | 0 | 1 | 0 | 0 | 20 | 6 |
| 4 | 8 | 陈子涵 | 淮南 | 9 | 2 | 2 | 3 | 0 | 2 | 0 | 18 | 6 |
| 5 | 13 | 刘振宇 | 济南 | 6 | 1 | 3 | 5 | 0 | 0 | 0 | 15 | 6 |
| 6 | 9 | 杨金龙 | 淮南 | 8 | 3 | 1 | 2 | 0 | 1 | 0 | 15 | 6 |
| 7 | 13 | 高鑫 | 抚顺 | 8 | 0 | 2 | 3 | 0 | 1 | 0 | 14 | 6 |
| 8 | 10 | 颜同霖 | 济南 | 6 | 3 | 0 | 3 | 0 | 1 | 0 | 13 | 6 |
| 9 | 10 | 孙飞扬 | 淮南 | 7 | 3 | 0 | 1 | 0 | 0 | 1 | 12 | 6 |
| 10 | 15 | 刘家良 | 龙岩 | 6 | 3 | 1 | 2 | 0 | 0 | 0 | 12 | 6 |
| 11 | 21 | 曾新宇 | 宝山 | 8 | 1 | 1 | 0 | 0 | 1 | 0 | 11 | 6 |
| 12 | 6 | 潘超群 | 苏州 | 8 | 2 | 0 | 1 | 0 | 0 | 0 | 11 | 6 |
| 13 | 13 | 刘启群 | 宝山 | 3 | 1 | 0 | 3 | 3 | 0 | 0 | 10 | 6 |
| 14 | 22 | 马浩东 | 宝山 | 5 | 0 | 2 | 1 | 1 | 1 | 0 | 10 | 6 |
| 15 | 27 | 巫迪涛 | 香港 | 3 | 2 | 1 | 3 | 0 | 0 | 1 | 10 | 6 |
| 16 | 64 | 章道胜 | 安徽 | 1 | 2 | 0 | 0 | 7 | 0 | 0 | 10 | 6 |
| 17 | 5 | 郭雨强 | 龙岩 | 4 | 3 | 1 | 1 | 0 | 0 | 0 | 9 | 6 |
| 18 | 10 | 赵一 | 龙岩 | 2 | 3 | 0 | 2 | 1 | 0 | 0 | 8 | 6 |
| 19 | 27 | 邓可钊 | 龙岩 | 4 | 1 | 2 | 1 | 0 | 0 | 0 | 8 | 6 |
| 20 | 59 | 毛饶翔 | 安徽 | 5 | 0 | 2 | 1 | 0 | 0 | 0 | 8 | 6 |
| 21 | 28 | 靳皓添 | 抚顺 | 2 | 2 | 0 | 0 | 4 | 0 | 0 | 8 | 6 |
| 22 | 35 | 刘子杰 | 宝山 | 0 | 3 | 1 | 0 | 0 | 2 | 2 | 8 | 6 |
| 23 | 15 | 刘淇 | 淮南 | 0 | 2 | 2 | 3 | 1 | 0 | 0 | 8 | 6 |
| 24 | 56 | 王健鹏 | 安徽 | 6 | 0 | 1 | 0 | 1 | 0 | 0 | 8 | 6 |
| 25 | 58 | 蔡博飞 | 安徽 | 3 | 1 | 0 | 2 | 0 | 0 | 2 | 8 | 6 |
| 26 | 3 | 陈嘉熙 | 香港 | 6 | 0 | 1 | 0 | 0 | 1 | 0 | 8 | 6 |
| 27 | 47 | 薛浩锋 | 香港 | 4 | 2 | 0 | 1 | 0 | 0 | 0 | 7 | 6 |
| 28 | 10 | 马涛 | 宝山 | 3 | 3 | 1 | 0 | 0 | 0 | 0 | 7 | 6 |
| 29 | 11 | 李延舒 | 济南 | 1 | 1 | 1 | 1 | 2 | 0 | 0 | 6 | 6 |
| 30 | 5 | 马奔 | 苏州 | 0 | 2 | 0 | 1 | 3 | 0 | 0 | 6 | 6 |
| 31 | 57 | 朱正翔 | 安徽 | 1 | 2 | 1 | 1 | 0 | 1 | 0 | 6 | 6 |
| 32 | 18 | 奚尧 | 龙岩 | 2 | 2 | 0 | 0 | 0 | 0 | 1 | 5 | 6 |
| 33 | 23 | 朱天一 | 龙岩 | 2 | 1 | 0 | 0 | 1 | 0 | 1 | 5 | 6 |
| 34 | 17 | 徐鹏辉 | 淮南 | 0 | 1 | 0 | 0 | 1 | 2 | 1 | 5 | 6 |
| 35 | 11 | 刘新然 | 淮南 | 1 | 0 | 1 | 0 | 2 | 0 | 1 | 5 | 6 |
| 36 | 55 | 苏凯 | 安徽 | 0 | 3 | 0 | 0 | 2 | 0 | 0 | 5 | 6 |
| 37 | 8 | 王震 | 苏州 | 2 | 2 | 0 | 0 | 1 | 0 | 0 | 5 | 6 |
| 38 | 30 | 陈永曦 | 香港 | 4 | 1 | 0 | 0 | 0 | 0 | 0 | 5 | 6 |
| 39 | 6 | 童浩宇 | 淮南 | 1 | 2 | 0 | 0 | 1 | 0 | 0 | 4 | 6 |
| 40 | 41 | 莫敬朗 | 香港 | 1 | 2 | 1 | 0 | 0 | 0 | 0 | 4 | 6 |

得分排名表(场上队员)

手球
青年男子

截止至第42场
接受罚次数排序

安徽滁州
2019-06-05

| 排序 | 号码 | 姓名 | 球队 | 警告 | 罚2分钟 | D | DR | 场数 |
|----|----|-----|----|----|------|---|----|----|
| 1 | 35 | 刘子杰 | 宝山 | 0 | 2 | 1 | 0 | 6 |
| 2 | 10 | 颜同霖 | 济南 | 1 | 4 | 0 | 0 | 6 |
| 3 | 5 | 郭雨强 | 龙岩 | 2 | 3 | 0 | 0 | 6 |
| 4 | 57 | 朱正翔 | 安徽 | 0 | 3 | 0 | 0 | 6 |
| 5 | 10 | 孙飞扬 | 淮南 | 0 | 3 | 0 | 0 | 6 |
| 6 | 13 | 刘启群 | 宝山 | 2 | 2 | 0 | 0 | 6 |
| 7 | 18 | 奚尧 | 龙岩 | 1 | 2 | 0 | 0 | 6 |
| 8 | 19 | 靳皓童 | 抚顺 | 0 | 2 | 0 | 0 | 6 |
| 9 | 28 | 靳皓添 | 抚顺 | 0 | 2 | 0 | 0 | 6 |
| 10 | 59 | 毛饶翔 | 安徽 | 0 | 2 | 0 | 0 | 6 |
| 11 | 15 | 梁栢朗 | 香港 | 2 | 1 | 0 | 0 | 6 |
| 12 | 8 | 陈子涵 | 淮南 | 2 | 1 | 0 | 0 | 6 |
| 13 | 13 | 刘振宇 | 济南 | 2 | 1 | 0 | 0 | 6 |
| 14 | 8 | 王震 | 苏州 | 2 | 1 | 0 | 0 | 6 |
| 15 | 6 | 刘阳 | 龙岩 | 1 | 1 | 0 | 0 | 6 |
| 16 | 17 | 杨宇 | 抚顺 | 1 | 1 | 0 | 0 | 6 |
| 17 | 22 | 马浩东 | 宝山 | 1 | 1 | 0 | 0 | 6 |
| 18 | 23 | 张铮洋 | 苏州 | 0 | 1 | 0 | 0 | 6 |
| 19 | 11 | 刘新然 | 淮南 | 0 | 1 | 0 | 0 | 6 |
| 20 | 23 | 石铭泽 | 香港 | 0 | 1 | 0 | 0 | 6 |
| 21 | 79 | 吴坤霖 | 香港 | 0 | 1 | 0 | 0 | 6 |
| 22 | 21 | 杨明毅 | 济南 | 0 | 1 | 0 | 0 | 6 |
| 23 | 13 | 高鑫 | 抚顺 | 0 | 1 | 0 | 0 | 6 |
| 24 | 10 | 马涛 | 宝山 | 0 | 1 | 0 | 0 | 6 |
| 25 | 17 | 徐鹏辉 | 淮南 | 0 | 1 | 0 | 0 | 6 |
| 26 | 47 | 薛浩锋 | 香港 | 0 | 1 | 0 | 0 | 6 |
| 27 | 24 | 钟盛发 | 龙岩 | 0 | 1 | 0 | 0 | 6 |
| 28 | 7 | 王帅 | 济南 | 0 | 1 | 0 | 0 | 6 |
| 29 | 7 | 王晨旭 | 龙岩 | 0 | 1 | 0 | 0 | 6 |
| 30 | 68 | 黄天源 | 安徽 | 0 | 1 | 0 | 0 | 6 |
| 31 | 13 | 蒋超 | 苏州 | 0 | 1 | 0 | 0 | 6 |
| 32 | 9 | 隋博 | 抚顺 | 0 | 1 | 0 | 0 | 6 |
| 33 | 62 | 赵俊阳 | 安徽 | 0 | 1 | 0 | 0 | 6 |
| 34 | 60 | 朱超 | 安徽 | 0 | 1 | 0 | 0 | 6 |
| 35 | 11 | 李延舒 | 济南 | 3 | 0 | 0 | 0 | 6 |
| 36 | 10 | 赵一 | 龙岩 | 3 | 0 | 0 | 0 | 6 |
| 37 | 15 | 刘家良 | 龙岩 | 1 | 0 | 0 | 0 | 6 |
| 38 | 56 | 王健鹏 | 安徽 | 1 | 0 | 0 | 0 | 6 |
| 39 | 6 | 刘尊哲 | 济南 | 1 | 0 | 0 | 0 | 6 |
| 40 | 58 | 蔡博飞 | 安徽 | 1 | 0 | 0 | 0 | 6 |

排名表(守门员)

手球
青年男子

截止至第42场
按总救球数排序

安徽滁州
2019-06-05

| 排序 | 号码 | 姓名 | 球队 | 远射 | 近射 | 边射 | 快攻 | 突破 | 任意 | 七米 | 得分 | % | 助攻 | 场数 |
|----|----|-----|----|-------|-------|-------|------|------|-----|------|--------|------|----|----|
| 1 | 2 | 赫天铭 | 抚顺 | 15-40 | 9-29 | 12-24 | 2-17 | 1-11 | 3-5 | 4-15 | 46-141 | 32.6 | 0 | 6 |
| 2 | 52 | 花驰 | 安徽 | 19-35 | 8-25 | 9-14 | 1-3 | 4-10 | 3-5 | 1-7 | 45-99 | 45.5 | 2 | 6 |
| 3 | 1 | 刘在攀 | 济南 | 9-31 | 13-53 | 5-20 | 3-16 | 4-11 | 0-2 | 4-9 | 38-142 | 26.8 | 1 | 6 |
| 4 | 1 | 刘子豪 | 龙岩 | 16-46 | 5-30 | 7-17 | 2-13 | 3-12 | 2-8 | 0-7 | 35-133 | 26.3 | 0 | 6 |
| 5 | 12 | 周文贤 | 苏州 | 7-20 | 2-9 | 11-18 | 2-5 | 0-4 | 1-1 | 1-5 | 24-62 | 38.7 | 0 | 6 |
| 6 | 66 | 黄嘉遥 | 宝山 | 15-31 | 4-25 | 2-12 | 0-11 | 2-13 | 0-2 | 1-3 | 24-97 | 24.7 | 0 | 6 |
| 7 | 1 | 苟嘉毅 | 淮南 | 3-15 | 7-29 | 2-18 | 6-20 | 1-18 | 2-6 | 1-9 | 22-115 | 19.1 | 0 | 6 |
| 8 | 1 | 邹明轩 | 苏州 | 10-24 | 6-11 | 1-4 | 1-2 | 1-5 | 2-4 | 0-1 | 21-51 | 41.2 | 1 | 6 |
| 9 | 22 | 吴泽斌 | 香港 | 7-16 | 0-3 | 3-6 | 3-9 | 0-6 | 3-3 | 0-1 | 16-44 | 36.4 | 0 | 6 |
| 10 | 1 | 江力为 | 香港 | 8-20 | 2-14 | 2-8 | 1-7 | 0-0 | 0-0 | 0-0 | 13-49 | 26.5 | 0 | 6 |
| 11 | 12 | 薛凯 | 宝山 | 3-8 | 1-7 | 2-5 | 0-2 | 0-3 | 1-2 | 1-3 | 8-30 | 26.7 | 0 | 2 |
| 12 | 16 | 胡文柯 | 淮南 | 1-2 | 2-7 | 1-1 | 0-3 | 0-5 | 0-0 | 2-8 | 6-26 | 23.1 | 0 | 6 |
| 13 | 99 | 苏俊轩 | 香港 | 1-5 | 4-12 | 0-2 | 0-1 | 0-0 | 0-1 | 0-1 | 5-22 | 22.7 | 0 | 6 |
| 14 | 67 | 江文 | 安徽 | 2-4 | 0-1 | 0-1 | 0-2 | 0-0 | 0-0 | 0-1 | 2-9 | 22.2 | 0 | 4 |
| 15 | 32 | 袁梓赫 | 抚顺 | 0-0 | 0-0 | 0-0 | 1-2 | 0-0 | 0-0 | 0-1 | 1-3 | 33.3 | 0 | 6 |
| 16 | 53 | 叶天赐 | 安徽 | 1-3 | 0-3 | 0-1 | 0-1 | 0-1 | 0-0 | 0-0 | 1-9 | 11.1 | 1 | 6 |
| 17 | 35 | 刘子杰 | 宝山 | 0-0 | 0-0 | 0-0 | 0-1 | 0-0 | 0-0 | 0-1 | 0-2 | 0.0 | 0 | 6 |
| 18 | 16 | 高宇轩 | 济南 | 0-0 | 0-1 | 0-0 | 0-1 | 0-0 | 0-0 | 0-0 | 0-2 | 0.0 | 0 | 6 |

排名表(守门员)

手球
青年男子

截止至第42场
按救七米球数排序

安徽滁州
2019-06-05

| 排序 | 号码 | 姓名 | 球队 | 远射 | 近射 | 边射 | 快攻 | 突破 | 任意 | 七米 | 得分 | % | 助攻 | 场数 |
|----|----|-----|----|-------|-------|-------|------|------|-----|------|--------|------|----|----|
| 1 | 1 | 刘在攀 | 济南 | 9-31 | 13-53 | 5-20 | 3-16 | 4-11 | 0-2 | 4-9 | 38-142 | 44.4 | 1 | 6 |
| 2 | 2 | 赫天铭 | 抚顺 | 15-40 | 9-29 | 12-24 | 2-17 | 1-11 | 3-5 | 4-15 | 46-141 | 26.7 | 0 | 6 |
| 3 | 16 | 胡文柯 | 淮南 | 1-2 | 2-7 | 1-1 | 0-3 | 0-5 | 0-0 | 2-8 | 6-26 | 25.0 | 0 | 6 |
| 4 | 66 | 黄嘉遥 | 宝山 | 15-31 | 4-25 | 2-12 | 0-11 | 2-13 | 0-2 | 1-3 | 24-97 | 33.3 | 0 | 6 |
| 5 | 12 | 薛凯 | 宝山 | 3-8 | 1-7 | 2-5 | 0-2 | 0-3 | 1-2 | 1-3 | 8-30 | 33.3 | 0 | 2 |
| 6 | 12 | 周文贤 | 苏州 | 7-20 | 2-9 | 11-18 | 2-5 | 0-4 | 1-1 | 1-5 | 24-62 | 20.0 | 0 | 6 |
| 7 | 52 | 花驰 | 安徽 | 19-35 | 8-25 | 9-14 | 1-3 | 4-10 | 3-5 | 1-7 | 45-99 | 14.3 | 2 | 6 |
| 8 | 1 | 苟嘉毅 | 淮南 | 3-15 | 7-29 | 2-18 | 6-20 | 1-18 | 2-6 | 1-9 | 22-115 | 11.1 | 0 | 6 |
| 9 | 1 | 江力为 | 香港 | 8-20 | 2-14 | 2-8 | 1-7 | 0-0 | 0-0 | 0-0 | 13-49 | 0 | 0 | 6 |
| 10 | 53 | 叶天赐 | 安徽 | 1-3 | 0-3 | 0-1 | 0-1 | 0-1 | 0-0 | 0-0 | 1-9 | 0 | 1 | 6 |
| 11 | 16 | 高宇轩 | 济南 | 0-0 | 0-1 | 0-0 | 0-1 | 0-0 | 0-0 | 0-0 | 0-2 | 0 | 0 | 6 |
| 12 | 1 | 邹明轩 | 苏州 | 10-24 | 6-11 | 1-4 | 1-2 | 1-5 | 2-4 | 0-1 | 21-51 | 0.0 | 1 | 6 |
| 13 | 22 | 吴泽斌 | 香港 | 7-16 | 0-3 | 3-6 | 3-9 | 0-6 | 3-3 | 0-1 | 16-44 | 0.0 | 0 | 6 |
| 14 | 99 | 苏俊轩 | 香港 | 1-5 | 4-12 | 0-2 | 0-1 | 0-0 | 0-1 | 0-1 | 5-22 | 0.0 | 0 | 6 |
| 15 | 67 | 江文 | 安徽 | 2-4 | 0-1 | 0-1 | 0-2 | 0-0 | 0-0 | 0-1 | 2-9 | 0.0 | 0 | 4 |
| 16 | 32 | 袁梓赫 | 抚顺 | 0-0 | 0-0 | 0-0 | 1-2 | 0-0 | 0-0 | 0-1 | 1-3 | 0.0 | 0 | 6 |
| 17 | 35 | 刘子杰 | 宝山 | 0-0 | 0-0 | 0-0 | 0-1 | 0-0 | 0-0 | 0-1 | 0-2 | 0.0 | 0 | 6 |
| 18 | 1 | 刘子豪 | 龙岩 | 16-46 | 5-30 | 7-17 | 2-13 | 3-12 | 2-8 | 0-7 | 35-133 | 0.0 | 0 | 6 |

第二届全国青年运动会男子手球乙组决赛 体校组(U16)

PHMS Pictorial Handball Match Statistics

IHF Official System

攻防成功率统计总表

手球
青年男子

截止至第42场

安徽滁州
2019-06-05

| 序号 | 球队 | 比分 | 进攻成功率 | | | | | | | | | | | | | | | 助攻 | 防守成功率 | | | | | | | | |
|----|----|---------|-------|-----|------|------|----|-------|------|----|------|-----|-----|------|-----|----|-------|----|-------|-------|----|------|-----|------|------|-----|------|
| | | | 阵地进攻 | | | 一传快攻 | | | 短传快攻 | | | 合计 | | | 多打少 | | | | 少打多 | | | 封打抢断 | 守门员 | 对方射失 | 对方失误 | 合计 | % |
| | | | 得分 | 进攻 | % | 得分 | 进攻 | % | 得分 | 进攻 | % | 得分 | 进攻 | % | 得分 | 进攻 | % | | 得分 | 进攻 | % | | | | | | |
| 1 | 安徽 | 114:69 | 82 | 171 | 48.0 | 22 | 30 | 73.3 | 10 | 33 | 30.3 | 114 | 234 | 48.7 | 6 | 6 | 100.0 | 8 | 13 | 61.5 | 35 | 57 | 48 | 29 | 40 | 174 | 71.6 |
| 2 | 淮南 | 101:113 | 92 | 222 | 41.4 | 5 | 7 | 71.4 | 4 | 8 | 50.0 | 101 | 237 | 42.6 | 16 | 30 | 53.3 | 2 | 2 | 100.0 | 8 | 19 | 28 | 27 | 35 | 109 | 49.1 |
| 3 | 济南 | 67:106 | 60 | 212 | 28.3 | 3 | 3 | 100.0 | 4 | 8 | 50.0 | 67 | 223 | 30.0 | 3 | 5 | 60.0 | 2 | 9 | 22.2 | 12 | 16 | 38 | 29 | 36 | 119 | 52.9 |
| 4 | 抚顺 | 101:97 | 93 | 236 | 39.4 | 4 | 5 | 80.0 | 4 | 11 | 36.4 | 101 | 252 | 40.1 | 9 | 17 | 52.9 | 3 | 7 | 42.9 | 17 | 29 | 47 | 36 | 43 | 155 | 61.5 |
| 5 | 龙岩 | 84:98 | 77 | 197 | 39.1 | 3 | 6 | 50.0 | 4 | 12 | 33.3 | 84 | 215 | 39.1 | 10 | 15 | 66.7 | 10 | 13 | 76.9 | 19 | 23 | 35 | 29 | 36 | 123 | 55.7 |
| 6 | 宝山 | 92:97 | 82 | 212 | 38.7 | 5 | 8 | 62.5 | 5 | 13 | 38.5 | 92 | 233 | 39.5 | 7 | 12 | 58.3 | 2 | 9 | 22.2 | 8 | 45 | 32 | 21 | 29 | 127 | 56.7 |
| 7 | 苏州 | 91:68 | 75 | 186 | 40.3 | 12 | 14 | 85.7 | 4 | 12 | 33.3 | 91 | 212 | 42.9 | 3 | 5 | 60.0 | 3 | 3 | 100.0 | 22 | 33 | 45 | 28 | 36 | 142 | 67.6 |
| 8 | 香港 | 79:81 | 74 | 177 | 41.8 | 3 | 7 | 42.9 | 2 | 9 | 22.2 | 79 | 193 | 40.9 | 6 | 12 | 50.0 | 2 | 3 | 66.7 | 10 | 36 | 34 | 19 | 32 | 121 | 59.9 |

注释:

| | | | | | |
|----|------------------|------|------------------|--------|-----------------|
| 进攻 | 进攻次数 (射门 + 进攻失误) | 对方射失 | 对方射门失误 (射失 + 击柱) | 防守成功率% | 本方防守合计 / 对方进攻合计 |
|----|------------------|------|------------------|--------|-----------------|

第二届全国青年运动会男子手球乙组决赛 体校组(U16)

PHMS Pictorial Handball Match Statistics

IHF Official System

防守技术统计总表

手球
青年男子

截止至第42场

安徽滁州
2019-06-05

| 序号 | 球队 | 比分 | 防守成功 | | | | | | 防守(成功:失误) | | | | | | | 处罚 | | | | | 守门员 | | | |
|----|----|---------|------|----|----|----|----|----|-----------|-----|-----|-----|-----|-----|-----|-----|----|----|----|----|-----|----|-----|------|
| | | | 封球 | 抢球 | 断球 | 造失 | 造犯 | 合计 | 选位 | 顶贴 | 观察 | 移动 | 换防 | 其他 | 合计 | 警告 | 2' | 取消 | DR | 合计 | 救球 | 射门 | % | |
| 1 | 安徽 | 114:69 | 10 | 10 | 32 | 5 | 0 | 57 | 0:0 | 0:0 | 0:0 | 0:0 | 0:0 | 0:0 | 0:0 | 0:0 | 3 | 8 | 0 | 0 | 11 | 48 | 117 | 41.0 |
| 2 | 淮南 | 101:113 | 1 | 4 | 10 | 3 | 1 | 19 | 0:0 | 0:0 | 0:0 | 0:0 | 0:0 | 0:0 | 0:0 | 0:0 | 2 | 6 | 0 | 0 | 8 | 28 | 141 | 19.9 |
| 3 | 济南 | 67:106 | 3 | 4 | 6 | 1 | 2 | 16 | 0:0 | 0:0 | 0:0 | 0:0 | 0:0 | 0:0 | 0:0 | 0:0 | 7 | 7 | 0 | 0 | 14 | 38 | 144 | 26.4 |
| 4 | 抚顺 | 101:97 | 8 | 5 | 9 | 4 | 3 | 29 | 0:0 | 0:0 | 0:0 | 0:0 | 0:0 | 0:0 | 0:0 | 0:0 | 2 | 7 | 0 | 0 | 9 | 47 | 144 | 32.6 |
| 5 | 龙岩 | 84:98 | 5 | 3 | 11 | 1 | 3 | 23 | 0:0 | 0:0 | 0:0 | 0:0 | 0:0 | 0:0 | 0:0 | 0:0 | 9 | 8 | 0 | 0 | 17 | 35 | 133 | 26.3 |
| 6 | 宝山 | 92:97 | 8 | 9 | 21 | 3 | 4 | 45 | 0:0 | 0:0 | 0:0 | 0:0 | 0:0 | 0:0 | 0:0 | 0:0 | 3 | 6 | 1 | 0 | 10 | 32 | 129 | 24.8 |
| 7 | 苏州 | 91:68 | 16 | 4 | 12 | 0 | 1 | 33 | 0:0 | 0:0 | 0:0 | 0:0 | 0:0 | 0:0 | 0:0 | 0:0 | 4 | 3 | 0 | 0 | 7 | 45 | 113 | 39.8 |
| 8 | 香港 | 79:81 | 11 | 3 | 17 | 2 | 3 | 36 | 0:0 | 0:0 | 0:0 | 0:0 | 0:0 | 0:0 | 0:0 | 0:0 | 2 | 4 | 0 | 0 | 6 | 34 | 115 | 29.6 |

注释:

| | | | | | |
|----|-------|----|-------|----|---------|
| 造失 | 造对方失误 | 造犯 | 造对方犯规 | DR | 取消资格+报告 |
|----|-------|----|-------|----|---------|

第二届全国青年运动会男子手球乙组决赛 体校组(U16)

PHMS Pictorial Handball Match Statistics

IHF Official System

球队名单

安徽滁州

安徽省体校

2019-05-27

| 号码 | 姓名 | 位置 | 生日 | 年龄 | 俱乐部 | 身高 (CM) | 体重 (KG) | 国际场次 | 国际进球 |
|----|-----|-----|------------|------|-----|------------|------------|------|------|
| 52 | 花驰 | 守门员 | 27/03/2003 | 16 | | 187 | 74 | | |
| 53 | 叶天赐 | 守门员 | 22/04/2003 | 16 | | 189 | 70 | | |
| 54 | 姚幸运 | 右边锋 | 27/01/2004 | 15 | | 175 | 58 | | |
| 55 | 苏凯 | 右边锋 | 19/01/2003 | 16 | | 184 | 71 | | |
| 56 | 王健鹏 | 左后卫 | 22/10/2003 | 15 | | 181 | 65 | | |
| 57 | 朱正翔 | 左边锋 | 27/12/2003 | 15 | | 189 | 75 | | |
| 58 | 蔡博飞 | 中后卫 | 07/02/2003 | 16 | | 173 | 76 | | |
| 59 | 毛饶翔 | 左后卫 | 09/09/2003 | 15 | | 188 | 77 | | |
| 60 | 朱超 | 右后卫 | 08/04/2004 | 15 | | 183 | 76 | | |
| 61 | 钮伟豪 | 右后卫 | 14/03/2003 | 16 | | 186 | 72 | | |
| 62 | 赵俊阳 | 左边锋 | 19/02/2004 | 15 | | 182 | 82 | | |
| 64 | 章道胜 | 底线 | 23/10/2003 | 15 | | 180 | 64 | | |
| 65 | 韩伟伦 | 右后卫 | 28/05/2003 | 15 | | 188 | 72 | | |
| 66 | 刘家豪 | 左边锋 | 28/02/2004 | 15 | | 177 | 65 | | |
| 67 | 江文 | 守门员 | 01/12/2003 | 15 | | 181 | 67 | | |
| 68 | 黄天源 | 底线 | 01/10/2003 | 15 | | 186 | 75 | | |
| | 平均 | | | 15.3 | | 183.1 | 71.2 | | |

| 编码 | 姓名 | 职务 |
|----|-----|-----|
| A | 赵前军 | 领队 |
| C | 吕串 | 教练 |
| D | 沈强 | 教练 |
| E | 李煜 | 医生 |
| B | 张林 | 主教练 |

手球
青年男子

个人/全队技术累计表

安徽滁州
2019-06-05

截止至第42场

| 号码 | 姓名 | 远射 | 近射 | 边射 | 快攻 | 突破 | 任意 | 七米 | 合计 | % | 助攻 | 失误 | 警告 | 2' | 取消 | 场次 | 时间 |
|---------------|-----|--------------|--------------|--------------|--------------|-------------|------------|------------|----------------|--------------|-----------|-----------|----------|----------|----|-----------|----------|
| 安徽省体校 | | | | | | | | | | | | | | | | | |
| (场上队员) | | | | | | | | | | | | | | | | | |
| 52 | 花驰 | | | | | | | | | | 2 | 2 | | | | 6 | 02:34:12 |
| 53 | 叶天赐 | | | | | | | | | | 1 | 1 | | | | 6 | 00:13:55 |
| 54 | 姚幸运 | | 2/3 | 2/3 | 5/6 | 1/1 | | | 10/13 | 76.9% | 3 | 2 | | | | 6 | 01:08:41 |
| 55 | 苏凯 | | 3/3 | 6/7 | 2/6 | | | 1/1 | 12/17 | 70.6% | | 5 | | | | 6 | 01:53:39 |
| 56 | 王健鹏 | 7/16 | 9/9 | | 1/3 | 2/3 | | | 19/31 | 61.3% | 7 | 8 | 1 | | | 6 | 02:10:39 |
| 57 | 朱正翔 | 1/5 | 1/1 | 2/2 | | 1/1 | 1/1 | | 6/10 | 60.0% | 2 | 6 | | 3 | | 6 | 01:54:55 |
| 58 | 蔡博飞 | 3/5 | 7/9 | | 3/4 | 0/1 | | 1/1 | 14/20 | 70.0% | 8 | 8 | 1 | | | 6 | 01:19:56 |
| 59 | 毛饶翔 | 4/13 | 2/4 | | 5/5 | 2/3 | 0/2 | 1/1 | 14/28 | 50.0% | 10 | 8 | | 2 | | 6 | 02:32:07 |
| 60 | 朱超 | 1/1 | 6/8 | 5/9 | 3/3 | 1/1 | | | 16/22 | 72.7% | 1 | 3 | | 1 | | 6 | 02:44:25 |
| 61 | 钮伟豪 | | | | | | | | | | | | | | | 6 | 00:02:01 |
| 62 | 赵俊阳 | | 1/1 | 1/1 | 1/3 | | | | 3/5 | 60.0% | | 4 | | 1 | | 6 | 01:02:51 |
| 64 | 章道胜 | 0/1 | 5/6 | 1/2 | 11/12 | | | | 17/21 | 81.0% | | 10 | 1 | | | 6 | 02:15:00 |
| 65 | 韩伟伦 | | 1/1 | | 1/1 | | | | 2/2 | 100% | | | | | | 6 | 00:07:14 |
| 66 | 刘家豪 | 0/1 | | | | | | | 0/1 | 0.0% | 1 | 2 | | | | 6 | 00:09:38 |
| 67 | 江文 | | | | | | | | | | | | | | | 4 | 00:11:53 |
| 68 | 黄天源 | | 1/2 | | | | | | 1/2 | 50.0% | | 3 | | 1 | | 6 | 00:37:05 |
| 合计 | | 16/42 | 38/47 | 17/24 | 32/43 | 7/10 | 1/3 | 3/3 | 114/172 | 66.3% | 35 | 62 | 3 | 8 | | 94 | |
| (守门员) | | | | | | | | | | | | | | | | | |
| 52 | 花驰 | 19/35 | 8/25 | 9/14 | 1/3 | 4/10 | 3/5 | 1/7 | 45/99 | 45.5% | 2 | 2 | | | | 6 | 02:34:12 |
| 53 | 叶天赐 | 1/3 | 0/3 | 0/1 | 0/1 | 0/1 | | | 1/9 | 11.1% | 1 | 1 | | | | 6 | 00:13:55 |
| 67 | 江文 | 2/4 | 0/1 | 0/1 | 0/2 | | | 0/1 | 2/9 | 22.2% | | | | | | 4 | 00:11:53 |
| 合计 | | 22/42 | 8/29 | 9/16 | 1/6 | 4/11 | 3/5 | 1/8 | 48/117 | 41.0% | 3 | 3 | | | | 16 | |

场上队员：得分/射门

守门员：救球/射门

已打比赛

| 全队合计 | 进球 | 被救 | 射失 | 击柱 | 封球 | 合计 | % | 阶段 | 场次 | 对手 | 比分 |
|------|----|----|----|----|----|----|--------|--------|----|----|--------------|
| 远射 | 16 | 9 | 5 | 5 | 7 | 42 | 38.1% | 预赛 | 4 | 淮南 | 26:15 (16:5) |
| 近射 | 38 | 3 | 2 | 4 | | 47 | 80.9% | 预赛 | 13 | 抚顺 | 15:10 (5:4) |
| 边射 | 17 | 6 | 1 | | | 24 | 70.8% | 预赛 | 19 | 龙岩 | 23:13 (11:6) |
| 快攻 | 32 | 5 | 4 | 2 | | 43 | 74.4% | 四分之一决赛 | 25 | 济南 | 18:10 (7:6) |
| 突破 | 7 | 1 | | 2 | | 10 | 70.0% | 半决赛 | 34 | 宝山 | 17:11 (8:6) |
| 任意 | 1 | | 1 | 1 | | 3 | 33.3% | 决赛 | 42 | 香港 | 15:10 (9:2) |
| 七米 | 3 | | | | | 3 | 100.0% | | | | |

图式射门区域累计

手球
青年男子

截止至第42场

安徽滁州
2019-06-05

安徽省体校

| | | | | | | | |
|---|--|--|--|--|--|--|--|
| 52 花驰 [Table with 3 columns, 2 rows of stats] Post - 0 Miss - 0 Block - 0 | 53 叶天赐 [Table with 3 columns, 2 rows of stats] Post - 0 Miss - 0 Block - 0 | 54 姚幸运 [Table with 3 columns, 2 rows of stats] Post - 0 Miss - 1 Block - 0 | 55 苏凯 [Table with 3 columns, 2 rows of stats] Post - 1 Miss - 2 Block - 0 | 56 王健鹏 [Table with 3 columns, 2 rows of stats] Post - 2 Miss - 2 Block - 3 | 57 朱正翔 [Table with 3 columns, 2 rows of stats] Post - 2 Miss - 1 Block - 1 | 58 蔡博飞 [Table with 3 columns, 2 rows of stats] Post - 0 Miss - 3 Block - 0 | 59 毛饶翔 [Table with 3 columns, 2 rows of stats] Post - 5 Miss - 3 Block - 3 |
| 60 朱超 [Table with 3 columns, 2 rows of stats] Post - 1 Miss - 1 Block - 0 | 61 钮伟豪 [Table with 3 columns, 2 rows of stats] Post - 0 Miss - 0 Block - 0 | 62 赵俊阳 [Table with 3 columns, 2 rows of stats] Post - 0 Miss - 0 Block - 0 | 64 章道胜 [Table with 3 columns, 2 rows of stats] Post - 3 Miss - 0 Block - 0 | 65 韩伟伦 [Table with 3 columns, 2 rows of stats] Post - 0 Miss - 0 Block - 0 | 66 刘家豪 [Table with 3 columns, 2 rows of stats] Post - 0 Miss - 0 Block - 0 | 67 江文 [Table with 3 columns, 2 rows of stats] Post - 0 Miss - 0 Block - 0 | 68 黄天源 [Table with 3 columns, 2 rows of stats] Post - 0 Miss - 0 Block - 0 |

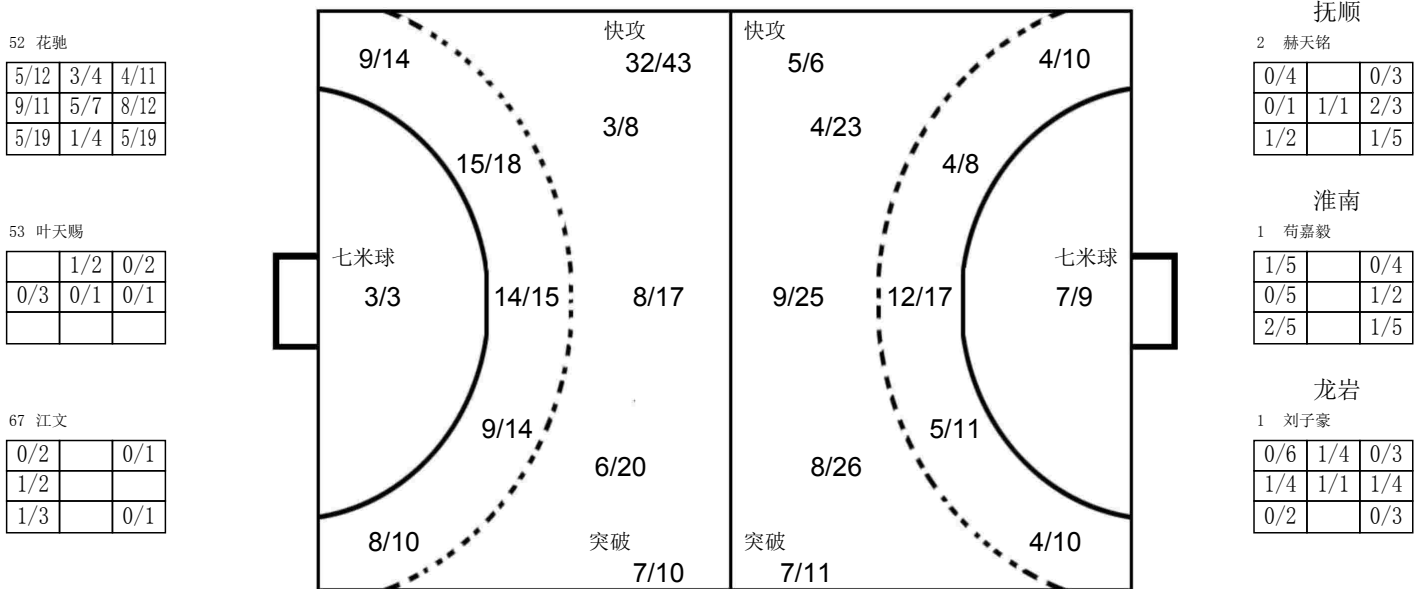

OPPONENT

| | | | | | | | |
|---|--|---|---|--|---|---|---|
| 淮南 10 孙飞扬 [Table with 3 columns, 2 rows of stats] Post - 0 Miss - 1 Block - 0 | 龙岩 5 郭雨强 [Table with 3 columns, 2 rows of stats] Post - 1 Miss - 0 Block - 1 | 抚顺 17 杨宇 [Table with 3 columns, 2 rows of stats] Post - 0 Miss - 1 Block - 3 | 香港 10 叶滋权 [Table with 3 columns, 2 rows of stats] Post - 0 Miss - 1 Block - 0 | 抚顺 13 高鑫 [Table with 3 columns, 2 rows of stats] Post - 0 Miss - 1 Block - 0 | 淮南 9 杨金龙 [Table with 3 columns, 2 rows of stats] Post - 2 Miss - 2 Block - 0 | 济南 13 刘振宇 [Table with 3 columns, 2 rows of stats] Post - 2 Miss - 2 Block - 0 | 宝山 35 刘子杰 [Table with 3 columns, 2 rows of stats] Post - 2 Miss - 0 Block - 1 |
| 淮南 8 陈子涵 [Table with 3 columns, 2 rows of stats] Post - 0 Miss - 1 Block - 1 | 济南 6 刘尊哲 [Table with 3 columns, 2 rows of stats] Post - 0 Miss - 1 Block - 1 | 济南 10 颜同霖 [Table with 3 columns, 2 rows of stats] Post - 0 Miss - 1 Block - 1 | 济南 11 李延舒 [Table with 3 columns, 2 rows of stats] Post - 0 Miss - 0 Block - 0 | 龙岩 10 赵一 [Table with 3 columns, 2 rows of stats] Post - 0 Miss - 0 Block - 0 | 龙岩 23 朱天一 [Table with 3 columns, 2 rows of stats] Post - 0 Miss - 0 Block - 0 | 宝山 10 马涛 [Table with 3 columns, 2 rows of stats] Post - 1 Miss - 0 Block - 1 | 香港 47 薛浩锋 [Table with 3 columns, 2 rows of stats] Post - 0 Miss - 1 Block - 0 |



第二届全国青年运动会男子手球乙组决赛 体校组(U16)

PHMS Pictorial Handball Match Statistics

IHF Official System

球队名单

安徽滁州

中国香港

2019-05-27

| 号码 | 姓名 | 位置 | 生日 | 年龄 | 俱乐部 | 身高 (CM) | 体重 (KG) | 国际场次 | 国际进球 |
|----|-----|-----|------------|------|-----|------------|------------|------|------|
| 1 | 江力为 | 守门员 | 21/12/2003 | 15 | | 181 | 88 | | |
| 2 | 梁凯乔 | 右后卫 | 01/09/2003 | 15 | | 171 | 62 | | |
| 3 | 陈嘉熙 | 左边锋 | 19/03/2003 | 16 | | 175 | 55 | | |
| 10 | 叶滋权 | 右后卫 | 02/08/2003 | 15 | | 183 | 98 | | |
| 15 | 梁栢朗 | 左边锋 | 01/06/2003 | 15 | | 172 | 70 | | |
| 16 | 冯智聪 | 右后卫 | 10/02/2004 | 15 | | 172 | 60 | | |
| 22 | 吴泽斌 | 守门员 | 22/04/2003 | 16 | | 177 | 78 | | |
| 23 | 石铭泽 | 左边锋 | 27/04/2003 | 16 | | 180 | 73 | | |
| 27 | 巫迪涛 | 左后卫 | 07/09/2003 | 15 | | 178 | 62 | | |
| 28 | 关健辉 | 右边锋 | 05/10/2003 | 15 | | 172 | 58 | | |
| 30 | 陈永曦 | 左后卫 | 28/01/2004 | 15 | | 179 | 71 | | |
| 41 | 莫敬朗 | 右边锋 | 30/03/2003 | 16 | | 170 | 52 | | |
| 47 | 薛浩锋 | 中后卫 | 02/03/2003 | 16 | | 177 | 68 | | |
| 73 | 黄塋鏊 | 底线 | 07/06/2003 | 15 | | 182 | 72 | | |
| 79 | 吴坤霖 | 底线 | 27/06/2003 | 15 | | 175 | 70 | | |
| 99 | 苏俊轩 | 守门员 | 08/07/2003 | 15 | | 180 | 76 | | |
| | 平均 | | | 15.3 | | 176.5 | 69.6 | | |

| 编码 | 姓名 | 职务 |
|----|-----|-----|
| B | 练明辉 | 主教练 |
| C | 钟昫延 | 教练 |

个人/全队技术累计表

手球 青年男子 截止至第42场 安徽滁州 2019-06-05

| 号码 | 姓名 | 远射 | 近射 | 边射 | 快攻 | 突破 | 任意 | 七米 | 合计 | % | 助攻 | 失误 | 警告 | 2' | 取消 | 场次 | 时间 |
|--------|-----|-------|-------|-------|------|-------|-----|-----|--------|-------|----|----|----|----|----|----|----------|
| 中国香港 | | | | | | | | | | | | | | | | | |
| (场上队员) | | | | | | | | | | | | | | | | | |
| 1 | 江力为 | | | | | | | | | | | 1 | | | | 6 | 01:22:41 |
| 2 | 梁凯乔 | | 1/2 | | | | | | 1/2 | 50.0% | | 2 | | | | 6 | 00:54:30 |
| 3 | 陈嘉熙 | | 1/1 | | 0/1 | | | | 1/2 | 50.0% | 2 | 8 | | | | 6 | 01:00:52 |
| 10 | 叶滋权 | 5/14 | 2/3 | 0/1 | | 5/6 | 1/1 | 1/1 | 14/26 | 53.8% | 2 | 3 | | | | 6 | 01:31:24 |
| 15 | 梁栢朗 | | 1/1 | | 2/3 | | | | 3/4 | 75.0% | 1 | | 2 | 1 | | 6 | 01:12:20 |
| 16 | 冯智聪 | | 1/1 | 0/1 | | 1/1 | | | 2/3 | 66.7% | | 2 | | | | 6 | 00:17:35 |
| 22 | 吴泽斌 | | | | | | | | | | | | | | | 6 | 01:04:10 |
| 23 | 石铭泽 | 0/1 | 2/4 | 1/3 | 1/1 | | | | 4/9 | 44.4% | 2 | 3 | | 1 | | 6 | 01:48:55 |
| 27 | 巫迪涛 | 6/15 | 2/6 | 1/1 | | 7/8 | 0/5 | 4/7 | 20/42 | 47.6% | | 10 | | | | 6 | 01:56:34 |
| 28 | 关键辉 | | 1/2 | 9/13 | 0/1 | | | | 10/16 | 62.5% | | | | | | 6 | 02:14:13 |
| 30 | 陈永曦 | | 1/1 | | | 0/1 | | | 1/2 | 50.0% | | 5 | | | | 6 | 00:52:13 |
| 41 | 莫敬朗 | | 1/1 | 3/6 | | | 1/1 | | 5/8 | 62.5% | | 4 | | | | 6 | 00:50:42 |
| 47 | 薛浩锋 | 4/6 | 4/6 | 4/7 | 0/1 | 3/5 | | 0/1 | 15/26 | 57.7% | 2 | 7 | | 1 | | 6 | 02:17:02 |
| 73 | 黄塍鎏 | | 0/1 | | 1/2 | | | | 1/3 | 33.3% | | 1 | | | | 6 | 00:53:45 |
| 79 | 吴坤霖 | | 1/1 | | 1/1 | | | | 2/2 | 100% | 1 | 2 | | 1 | | 6 | 02:03:57 |
| 99 | 苏俊轩 | | | | | | | | | | | | | | | 6 | 00:33:19 |
| 合计 | | 15/36 | 18/30 | 18/32 | 5/10 | 16/21 | 2/7 | 5/9 | 79/145 | 54.5% | 10 | 48 | 2 | 4 | | 96 | |

| | | | | | | | | | | | | | | | | | |
|-------|-----|-------|------|------|------|-----|-----|-----|--------|-------|--|---|--|--|--|----|----------|
| (守门员) | | | | | | | | | | | | | | | | | |
| 1 | 江力为 | 8/20 | 2/14 | 2/8 | 1/7 | | | | 13/49 | 26.5% | | 1 | | | | 6 | 01:22:41 |
| 22 | 吴泽斌 | 7/16 | 0/3 | 3/6 | 3/9 | 0/6 | 3/3 | 0/1 | 16/44 | 36.4% | | | | | | 6 | 01:04:10 |
| 99 | 苏俊轩 | 1/5 | 4/12 | 0/2 | 0/1 | | 0/1 | 0/1 | 5/22 | 22.7% | | | | | | 6 | 00:33:19 |
| 合计 | | 16/41 | 6/29 | 5/16 | 4/17 | 0/6 | 3/4 | 0/2 | 34/115 | 29.6% | | 1 | | | | 18 | |

场上队员：得分/射门

守门员：救球/射门

已打比赛

| 全队合计 | 进球 | 被救 | 射失 | 击柱 | 封球 | 合计 | % | 阶段 | 场次 | 对手 | 比分 |
|------|----|----|----|----|----|----|-------|--------|----|----|-------------|
| 远射 | 15 | 7 | 8 | 1 | 5 | 36 | 41.7% | 预赛 | 7 | 济南 | 15:13 (7:7) |
| 近射 | 18 | 6 | 4 | 2 | | 30 | 60.0% | 预赛 | 12 | 宝山 | 17:18 (9:7) |
| 边射 | 18 | 7 | 2 | 5 | | 32 | 56.3% | 预赛 | 21 | 苏州 | 10:15 (3:7) |
| 快攻 | 5 | 3 | 1 | 1 | | 10 | 50.0% | 四分之一决赛 | 27 | 淮南 | 14:9 (8:3) |
| 突破 | 16 | 4 | | 1 | | 21 | 76.2% | 半决赛 | 35 | 苏州 | 13:11 (5:5) |
| 任意 | 2 | 2 | 3 | | | 7 | 28.6% | 决赛 | 42 | 安徽 | 10:15 (2:9) |
| 七米 | 5 | 3 | | 1 | | 9 | 55.6% | | | | |

图式射门区域累计

手球
青年男子

截止至第42场

安徽滁州
2019-06-05

中国香港

| | | | | | | | |
|---------------------------------------|---------------------------------------|---------------------------------------|---------------------------------------|---------------------------------------|---------------------------------------|---------------------------------------|---------------------------------------|
| 1 江力为 Post - 0 Miss - 0 Block - 0 | 2 梁凯乔 Post - 0 Miss - 1 Block - 0 | 3 陈嘉熙 Post - 0 Miss - 0 Block - 0 | 10 叶溢权 Post - 1 Miss - 2 Block - 2 | 15 梁栢朗 Post - 0 Miss - 0 Block - 0 | 16 冯智聪 Post - 0 Miss - 0 Block - 0 | 22 吴泽斌 Post - 0 Miss - 0 Block - 0 | 23 石铭泽 Post - 1 Miss - 1 Block - 0 |
| 27 巫迪涛 Post - 3 Miss - 9 Block - 3 | 28 关键辉 Post - 2 Miss - 2 Block - 0 | 30 陈永曦 Post - 1 Miss - 0 Block - 0 | 41 莫敬明 Post - 2 Miss - 0 Block - 0 | 47 薛浩锋 Post - 1 Miss - 1 Block - 0 | 73 黄望鏊 Post - 0 Miss - 2 Block - 0 | 79 吴坤霖 Post - 0 Miss - 0 Block - 0 | 99 苏俊轩 Post - 0 Miss - 0 Block - 0 |

| |
|--------------|
| 1 江力为 |
| 2/7 1/3 2/7 |
| 1/4 3/5 1/8 |
| 1/3 1/1 1/11 |

| |
|-------------|
| 22 吴泽斌 |
| 1/5 2/8 |
| 2/4 1/1 2/7 |
| 3/7 1/3 4/9 |

| |
|-------------|
| 99 苏俊轩 |
| 1/4 0/3 |
| 1/2 2/2 1/3 |
| 0/1 0/1 0/6 |

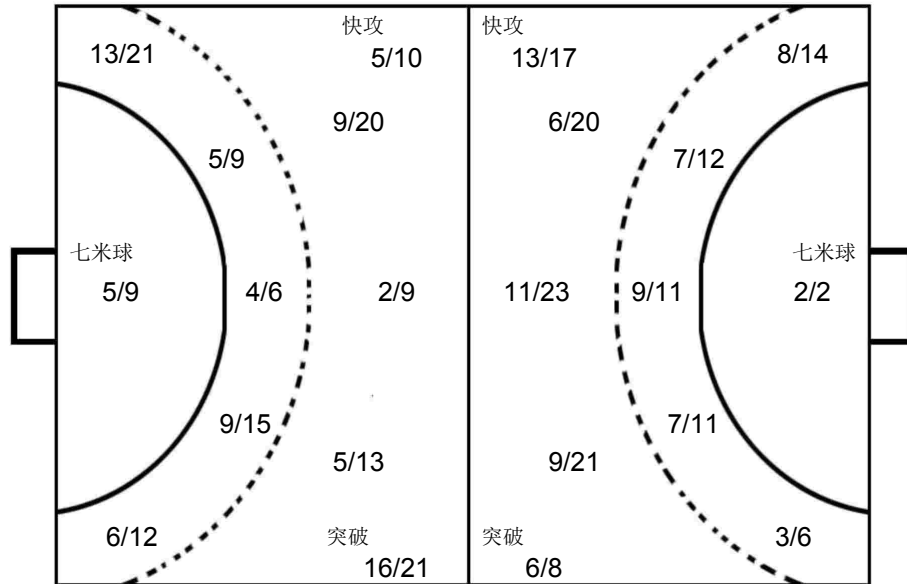

| |
|-------------|
| 安徽 |
| 52 花驰 |
| 2/3 1/1 0/1 |
| 2/3 2/3 3/4 |
| 0/1 0/4 |

| |
|---------|
| 济南 |
| 1 刘在攀 |
| 1/7 1/1 |
| 1/2 3/4 |
| 0/5 2/4 |

| |
|-------------|
| 苏州 |
| 1 邹明轩 |
| 0/1 0/1 |
| 2/4 1/3 3/6 |
| 0/1 1/6 |

OPPONENT

| | | | | | | | |
|------------|-------------|-------------|-------------|-------------|-------------|-------------|-------------|
| 6 潘超群 (苏州) | 13 刘振宇 (济南) | 21 曾新宇 (宝山) | 8 陈子涵 (淮南) | 18 何志伟 (苏州) | 56 王健鹏 (安徽) | 59 毛饶翔 (安徽) | 13 刘启群 (宝山) |
| 5 马奔 (苏州) | 8 王震 (苏州) | 57 朱正翔 (安徽) | 22 马浩东 (宝山) | 35 刘子杰 (宝山) | 55 苏凯 (安徽) | 6 刘尊哲 (济南) | 7 王帅 (济南) |



第二届全国青年运动会男子手球乙组决赛 体校组(U16)

PHMS Pictorial Handball Match Statistics

IHF Official System

球队名单

安徽滁州

江苏苏州

2019-05-27

| 号码 | 姓名 | 位置 | 生日 | 年龄 | 俱乐部 | 身高 (CM) | 体重 (KG) | 国际场次 | 国际进球 |
|----|-----|-----|------------|------|-----|------------|------------|------|------|
| 1 | 邹明轩 | 守门员 | 16/03/2003 | 16 | | 176 | 74 | | |
| 2 | 马力 | 左后卫 | 21/01/2003 | 16 | | 188 | 85 | | |
| 4 | 孙钊 | 左后卫 | 31/05/2003 | 15 | | 183 | 70 | | |
| 5 | 马奔 | 左后卫 | 13/06/2003 | 15 | | 180 | 70 | | |
| 6 | 潘超群 | 左后卫 | 27/10/2003 | 15 | | 185 | 65 | | |
| 8 | 王震 | 右后卫 | 10/02/2003 | 16 | | 185 | 60 | | |
| 9 | 李文俊 | 边锋 | 25/04/2004 | 15 | | 177 | 65 | | |
| 10 | 朱红雨 | 边锋 | 28/12/2003 | 15 | | 175 | 62 | | |
| 11 | 许多 | 右后卫 | 17/08/2003 | 15 | | 185 | 72 | | |
| 12 | 周文贤 | 守门员 | 28/07/2004 | 14 | | 183 | 75 | | |
| 13 | 蒋超 | 边锋 | 27/12/2004 | 14 | | 176 | 60 | | |
| 14 | 刘亚力 | 中后卫 | 24/06/2003 | 15 | | | | | |
| 15 | 刘成果 | 后卫 | 25/03/2003 | 16 | | 175 | 61 | | |
| 18 | 何志伟 | 边锋 | 21/03/2003 | 16 | | 177 | 63 | | |
| 19 | 夏思毅 | 边锋 | 12/07/2004 | 14 | | 172 | 57 | | |
| 23 | 张铮洋 | 底线 | 20/03/2004 | 15 | | 185 | 71 | | |
| | 平均 | | | 15.1 | | 180.1 | 67.3 | | |

| 编码 | 姓名 | 职务 |
|----|-----|----|
| A | 周清 | 领队 |
| C | 郝可鑫 | 教练 |
| D | 陈冬冬 | 教练 |
| E | 陈伟 | 医生 |

手球
青年男子

个人/全队技术累计表

安徽滁州
2019-06-05

截止至第42场

| 号码 | 姓名 | 远射 | 近射 | 边射 | 快攻 | 突破 | 任意 | 七米 | 合计 | % | 助攻 | 失误 | 警告 | 2' | 取消 | 场次 | 时间 |
|--------|-----|-------|-------|-------|-------|------|-----|-----|--------|-------|----|----|----|----|----|----|----------|
| 江苏苏州 | | | | | | | | | | | | | | | | | |
| (场上队员) | | | | | | | | | | | | | | | | | |
| 1 | 邹明轩 | | | | | | | | | | 1 | | | | | 6 | 01:22:26 |
| 2 | 马力 | | 0/1 | | | | | 1/1 | 1/2 | 50.0% | | 1 | | | | 6 | 00:22:44 |
| 4 | 孙钊 | 10/17 | 3/6 | 1/2 | | 2/5 | 0/2 | | 16/32 | 50.0% | 3 | 4 | | | | 6 | 00:51:28 |
| 5 | 马奔 | | 8/11 | | 2/3 | | | | 10/14 | 71.4% | 2 | 6 | | | | 6 | 02:38:42 |
| 6 | 潘超群 | 16/30 | 0/1 | | | 1/1 | 1/2 | 3/5 | 21/39 | 53.8% | 7 | 11 | | | | 6 | 02:37:24 |
| 8 | 王震 | 8/18 | | 0/2 | | 1/1 | 0/2 | | 9/23 | 39.1% | 1 | 5 | 2 | 1 | | 6 | 02:38:21 |
| 9 | 李文俊 | | | 1/1 | 2/2 | | | | 3/3 | 100% | | 2 | 1 | | | 6 | 00:21:16 |
| 10 | 朱红雨 | | 1/2 | 3/3 | 1/2 | | | | 5/7 | 71.4% | | 1 | | | | 6 | 00:51:15 |
| 11 | 许多 | 0/3 | | | | 2/3 | 0/1 | 0/1 | 2/8 | 25.0% | 2 | 1 | | | | 6 | 00:21:18 |
| 12 | 周文贤 | | | | | | | | | | | 1 | | | | 6 | 01:37:34 |
| 13 | 蒋超 | | 1/1 | 0/1 | 3/5 | | | | 4/7 | 57.1% | 1 | 1 | | 1 | | 6 | 02:08:22 |
| 14 | 刘亚力 | 1/2 | 1/1 | | | 1/1 | | | 3/4 | 75.0% | | | | | | 6 | 00:19:12 |
| 15 | 刘成果 | 1/1 | 1/2 | | | | | | 2/3 | 66.7% | | 1 | | | | 6 | 00:26:17 |
| 18 | 何志伟 | 1/2 | 3/5 | 2/6 | 6/6 | | | | 12/19 | 63.2% | 4 | 4 | 1 | | | 6 | 02:38:38 |
| 19 | 夏思毅 | | | | | | | | | | | | | | | 4 | 00:00:00 |
| 23 | 张铮洋 | 0/4 | 1/2 | | 2/3 | | | 0/1 | 3/10 | 30.0% | 1 | 3 | | 1 | | 6 | 01:41:57 |
| | 合计 | 37/77 | 19/32 | 7/15 | 16/21 | 7/11 | 1/7 | 4/8 | 91/171 | 53.2% | 22 | 41 | 4 | 3 | | 94 | |
| (守门员) | | | | | | | | | | | | | | | | | |
| 1 | 邹明轩 | 10/24 | 6/11 | 1/4 | 1/2 | 1/5 | 2/4 | 0/1 | 21/51 | 41.2% | 1 | | | | | 6 | 01:22:26 |
| 12 | 周文贤 | 7/20 | 2/9 | 11/18 | 2/5 | 0/4 | 1/1 | 1/5 | 24/62 | 38.7% | | 1 | | | | 6 | 01:37:34 |
| | 合计 | 17/44 | 8/20 | 12/22 | 3/7 | 1/9 | 3/5 | 1/6 | 45/113 | 39.8% | 1 | 1 | | | | 12 | |

场上队员：得分/射门

守门员：救球/射门

已打比赛

| 全队合计 | 进球 | 被救 | 射失 | 击柱 | 封球 | 合计 | % | 阶段 | 场次 | 对手 | 比分 |
|------|----|----|----|----|----|----|-------|--------|----|----|--------------|
| 远射 | 37 | 24 | 6 | 4 | 6 | 77 | 48.1% | 预赛 | 6 | 宝山 | 20:12 (11:3) |
| 近射 | 19 | 8 | 4 | 1 | | 32 | 59.4% | 预赛 | 11 | 济南 | 11:12 (6:7) |
| 边射 | 7 | 6 | 1 | 1 | | 15 | 46.7% | 预赛 | 21 | 香港 | 15:10 (7:3) |
| 快攻 | 16 | 4 | 1 | | | 21 | 76.2% | 四分之一决赛 | 28 | 龙岩 | 21:9 (10:3) |
| 突破 | 7 | 3 | 1 | | | 11 | 63.6% | 半决赛 | 35 | 香港 | 11:13 (5:5) |
| 任意 | 1 | 2 | 3 | 1 | | 7 | 14.3% | 3-4名 | 41 | 宝山 | 13:12 (7:6) |
| 七米 | 4 | 3 | | 1 | | 8 | 50.0% | | | | |

图式射门区域累计

手球
青年男子

截止至第42场

安徽滁州
2019-06-05

江苏苏州

| | | | | | | | |
|--------------------------------------|---------------------------------------|--------------------------------------|---------------------------------------|---------------------------------------|---------------------------------------|---------------------------------------|---------------------------------------|
| 1 邹明轩 Post - 0 Miss - 0 Block - 0 | 2 马力 Post - 0 Miss - 1 Block - 0 | 4 孙剡 Post - 1 Miss - 5 Block - 0 | 5 马奔 Post - 1 Miss - 1 Block - 0 | 6 潘超群 Post - 2 Miss - 1 Block - 5 | 8 王震 Post - 3 Miss - 4 Block - 1 | 9 李文俊 Post - 0 Miss - 0 Block - 0 | 10 朱红雨 Post - 0 Miss - 0 Block - 0 |
| 11 许多 Post - 0 Miss - 1 Block - 0 | 12 周文贤 Post - 0 Miss - 0 Block - 0 | 13 蒋超 Post - 0 Miss - 0 Block - 0 | 14 刘亚力 Post - 0 Miss - 0 Block - 0 | 15 刘成果 Post - 0 Miss - 1 Block - 0 | 18 何志伟 Post - 1 Miss - 1 Block - 0 | 19 夏思毅 Post - 0 Miss - 0 Block - 0 | 23 张铮洋 Post - 0 Miss - 1 Block - 0 |

| | | |
|-----|-----|------|
| 0/3 | 0/1 | 1/6 |
| 4/7 | 1/4 | 9/14 |
| 1/5 | | 5/11 |

| | | |
|-----|-----|------|
| 2/7 | 3/5 | 2/10 |
| 3/7 | 4/4 | 2/7 |
| 3/9 | 2/3 | 3/10 |

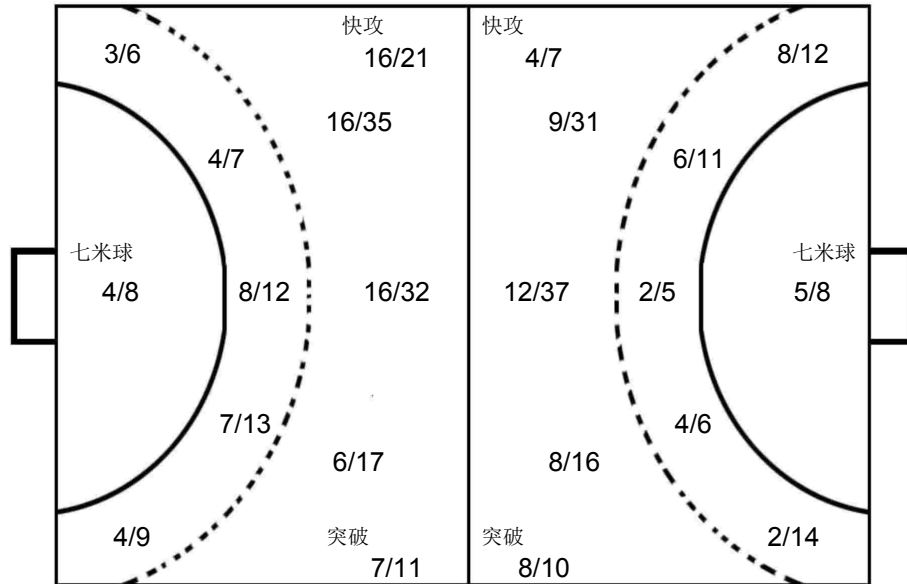

龙岩

| | | |
|-------|-----|-----|
| 1 刘子豪 | 1/7 | 0/2 |
| | 1/4 | 3/7 |
| | 2/5 | 0/1 |
| | | 4/6 |

济南

| | | | |
|-------|-----|-----|-----|
| 1 刘在攀 | 1/2 | 1/1 | 0/2 |
| | 3/3 | | 2/2 |
| | 2/4 | | 2/8 |

香港

| | | |
|--------|-----|-----|
| 22 吴泽斌 | 0/2 | 0/1 |
| | 2/3 | 1/3 |
| | 2/4 | 1/2 |
| | | 2/4 |

OPPONENT

| | | | | | | | |
|---|---|--|---|---|---|---|---|
| 香港 27 巫迪涛 Post - 2 Miss - 2 Block - 2 | 宝山 13 刘启群 Post - 0 Miss - 0 Block - 1 | 济南 6 刘尊哲 Post - 0 Miss - 1 Block - 1 | 宝山 35 刘子杰 Post - 0 Miss - 2 Block - 0 | 香港 47 薛浩锋 Post - 0 Miss - 0 Block - 0 | 宝山 21 曾新宇 Post - 2 Miss - 5 Block - 4 | 龙岩 5 郭雨强 Post - 0 Miss - 1 Block - 2 | 济南 10 颜同霖 Post - 1 Miss - 0 Block - 1 |
| 香港 28 关键辉 Post - 1 Miss - 1 Block - 0 | 龙岩 7 王晨旭 Post - 0 Miss - 0 Block - 0 | 宝山 10 马涛 Post - 0 Miss - 0 Block - 1 | 香港 10 叶滋权 Post - 0 Miss - 0 Block - 1 | 济南 11 李延舒 Post - 0 Miss - 0 Block - 0 | 济南 13 刘振宇 Post - 1 Miss - 1 Block - 1 | 龙岩 15 刘家良 Post - 1 Miss - 1 Block - 0 | 龙岩 18 奚尧 Post - 0 Miss - 0 Block - 0 |



第二届全国青年运动会男子手球乙组决赛 体校组(U16)

PHMS Pictorial Handball Match Statistics

IHF Official System

球队名单

安徽滁州

上海宝山

2019-05-27

| 号码 | 姓名 | 位置 | 生日 | 年龄 | 俱乐部 | 身高 (CM) | 体重 (KG) | 国际场次 | 国际进球 |
|----|-----|-----|------------|------|-----|------------|------------|------|------|
| 3 | 侯俊杰 | 边锋 | 23/11/2005 | 13 | | 172 | 70 | | |
| 5 | 范斯哲 | 底线 | 03/02/2005 | 14 | | 170 | 90 | | |
| 6 | 吴梓涵 | 右后卫 | 10/10/2004 | 14 | | 177 | 55 | | |
| 7 | 彭意焱 | 边锋 | 26/11/2004 | 14 | | 172 | 55 | | |
| 10 | 马涛 | 右后卫 | 16/12/2003 | 15 | | 185 | 78 | | |
| 12 | 薛凯 | 守门员 | 30/12/2003 | 15 | | 188 | 83 | | |
| 13 | 刘启群 | 左边锋 | 09/06/2004 | 14 | | 180 | 7 | | |
| 19 | 张申杰 | 右后卫 | 30/01/2004 | 15 | | 183 | 70 | | |
| 21 | 曾新宇 | 左后卫 | 05/01/2004 | 15 | | 185 | 77 | | |
| 22 | 马浩东 | 右后卫 | 04/11/2004 | 14 | | 170 | 60 | | |
| 25 | 江锦 | 边锋 | 16/12/2005 | 13 | | 175 | 73 | | |
| 30 | 戴泽昊 | 后卫 | 14/02/2004 | 15 | | 200 | 90 | | |
| 35 | 刘子杰 | 底线 | 10/09/2003 | 15 | | 195 | 93 | | |
| 39 | 陆毅泽 | 后卫 | 02/06/2005 | 13 | | 178 | 63 | | |
| 66 | 黄嘉遥 | 守门员 | 10/06/2004 | 14 | | 185 | 80 | | |
| 68 | 陈沁磊 | 守门员 | 20/07/2005 | 13 | | 188 | 100 | | |
| | 平均 | | | 14.1 | | 181.4 | 71.5 | | |

| 编码 | 姓名 | 职务 |
|----|-----|-----|
| B | 徐聪豪 | 主教练 |
| D | 赵时俊 | 教练 |
| A | 马革 | 领队 |
| C | 吴欣 | 教练 |
| E | 刘春英 | 医生 |

手球
青年男子

个人/全队技术累计表

安徽滁州
2019-06-05

截止至第42场

| 号码 | 姓名 | 远射 | 近射 | 边射 | 快攻 | 突破 | 任意 | 七米 | 合计 | % | 助攻 | 失误 | 警告 | 2' | 取消 | 场次 | 时间 |
|--------|-----|-------|-------|-------|-------|------|-----|-----|--------|-------|----|----|----|----|----|----|----------|
| 上海宝山 | | | | | | | | | | | | | | | | | |
| (场上队员) | | | | | | | | | | | | | | | | | |
| 3 | 侯俊杰 | | | 2/3 | | | | | 2/3 | 66.7% | | 3 | | | | 6 | 01:00:18 |
| 5 | 范斯哲 | | 1/1 | | | | | 1/1 | 2/2 | 100% | | | | | | 6 | 00:52:07 |
| 6 | 吴梓涵 | | | | | | | | | | | 2 | | | | 6 | 00:06:24 |
| 7 | 彭意焱 | 1/1 | | | | | 1/1 | | 2/2 | 100% | | | | | | 6 | 00:08:47 |
| 10 | 马涛 | 1/5 | 2/4 | 0/1 | | 1/1 | | | 4/11 | 36.4% | 3 | 7 | | 1 | | 6 | 02:44:27 |
| 12 | 薛凯 | | | | | | | | | | | | | | | 2 | 00:49:57 |
| 13 | 刘启群 | 1/4 | 2/3 | 11/16 | 1/1 | 2/2 | | | 17/26 | 65.4% | 1 | 10 | 2 | 2 | | 6 | 02:28:59 |
| 19 | 张申杰 | | 0/1 | 3/8 | | | | | 3/9 | 33.3% | | 3 | | | | 4 | 02:10:00 |
| 21 | 曾新宇 | 10/31 | 7/10 | 1/1 | 6/9 | 2/4 | | | 26/55 | 47.3% | 3 | 11 | | | | 6 | 02:47:23 |
| 22 | 马浩东 | 4/11 | 1/1 | 2/5 | 2/3 | 4/4 | | | 13/24 | 54.2% | 1 | 10 | 1 | 1 | | 6 | 02:53:02 |
| 25 | 江锦 | | 0/1 | 1/3 | | | | | 1/4 | 25.0% | | 1 | | | | 6 | 00:46:07 |
| 30 | 戴泽昊 | 0/1 | 1/2 | | | | 0/1 | | 1/4 | 25.0% | | | | | | 4 | 00:29:35 |
| 35 | 刘子杰 | 3/7 | 10/14 | | 1/3 | 0/2 | 0/2 | 7/8 | 21/36 | 58.3% | | 8 | | 2 | 1 | 6 | 02:31:39 |
| 39 | 陆毅泽 | 0/1 | | 0/1 | | | | | 0/2 | 0.0% | | | | | | 6 | 00:04:22 |
| 66 | 黄嘉遥 | | | | | | | | | | | | | | | 6 | 02:15:59 |
| 68 | 陈沁磊 | | | | | | | | | | | | | | | 6 | 00:00:00 |
| 合计 | | 20/61 | 24/37 | 20/38 | 10/16 | 9/13 | 1/4 | 8/9 | 92/178 | 51.7% | 8 | 55 | 3 | 6 | 1 | 88 | |
| (守门员) | | | | | | | | | | | | | | | | | |
| 12 | 薛凯 | 3/8 | 1/7 | 2/5 | 0/2 | 0/3 | 1/2 | 1/3 | 8/30 | 26.7% | | | | | | 2 | 00:49:57 |
| 35 | 刘子杰 | | | | 0/1 | | | 0/1 | 0/2 | 0.0% | | | | | | 6 | 00:27:38 |
| 66 | 黄嘉遥 | 15/31 | 4/25 | 2/12 | 0/11 | 2/13 | 0/2 | 1/3 | 24/97 | 24.7% | | | | | | 6 | 02:15:59 |
| 合计 | | 18/39 | 5/32 | 4/17 | 0/14 | 2/16 | 1/4 | 2/7 | 32/129 | 24.8% | | | | | | 14 | |

场上队员：得分/射门

守门员：救球/射门

已打比赛

| 全队合计 | 进球 | 被救 | 射失 | 击柱 | 封球 | 合计 | % | 阶段 | 场次 | 对手 | 比分 |
|------|----|----|----|----|----|----|-------|--------|----|----|--------------|
| 远射 | 20 | 18 | 8 | 3 | 12 | 61 | 32.8% | 预赛 | 6 | 苏州 | 12:20 (3:11) |
| 近射 | 24 | 6 | 4 | 3 | | 37 | 64.9% | 预赛 | 12 | 香港 | 18:17 (7:9) |
| 边射 | 20 | 12 | 4 | 2 | | 38 | 52.6% | 预赛 | 20 | 济南 | 18:11 (10:6) |
| 快攻 | 10 | 4 | 1 | 1 | | 16 | 62.5% | 四分之一决赛 | 26 | 抚顺 | 21:19 (7:8) |
| 突破 | 9 | 3 | 1 | | | 13 | 69.2% | 半决赛 | 34 | 安徽 | 11:17 (6:8) |
| 任意 | 1 | 2 | | 1 | | 4 | 25.0% | 3-4名 | 41 | 苏州 | 12:13 (6:7) |
| 七米 | 8 | | 1 | | | 9 | 88.9% | | | | |

图式射门区域累计

手球
青年男子

截止至第42场

安徽滁州
2019-06-05

上海宝山

| | | | | | | | |
|-----------------------------|-----------------------------|-----------------------------|-----------------------------|---------------------------------|-----------------------------|---------------------------------|-----------------------------|
| 3 侯俊杰 2 | 5 范斯哲 1 | 6 吴梓涵 | 7 彭意焱 1 | 10 马涛 3 | 12 薛凯 | 13 刘启群 2 1 6 1 2 3 1 1 | 19 张申杰 1 2 |
| Post - 0 Miss - 0 Block - 0 | Post - 0 Miss - 0 Block - 0 | Post - 0 Miss - 0 Block - 0 | Post - 0 Miss - 0 Block - 0 | Post - 2 Miss - 0 Block - 2 | Post - 0 Miss - 0 Block - 0 | Post - 0 Miss - 2 Block - 1 | Post - 1 Miss - 3 Block - 0 |
| 21 曾新宇 1 1 4 5 1 12 | 22 马浩东 2 2 4 | 25 江锦 1 | 30 戴泽昊 1 | 35 刘子杰 4 1 5 1 3 4 1 2 | 39 陆毅泽 | 66 黄嘉遥 | 68 陈沁磊 |
| Post - 4 Miss - 7 Block - 5 | Post - 1 Miss - 2 Block - 1 | Post - 0 Miss - 0 Block - 0 | Post - 0 Miss - 1 Block - 0 | Post - 2 Miss - 4 Block - 2 | Post - 0 Miss - 0 Block - 1 | Post - 0 Miss - 0 Block - 0 | Post - 0 Miss - 0 Block - 0 |

| | | |
|----------------------|-------------|-------------|
| 12 薛凯 0/3 0/3 1/7 | 0/1 2/2 1/1 | 0/1 2/6 2/7 |
|----------------------|-------------|-------------|

| |
|---------------|
| 35 刘子杰 0/2 |
|---------------|

| | | |
|-------------------------|-------------|----------------|
| 66 黄嘉遥 0/13 4/8 5/18 | 1/5 2/3 3/7 | 1/13 6/13 2/17 |
|-------------------------|-------------|----------------|

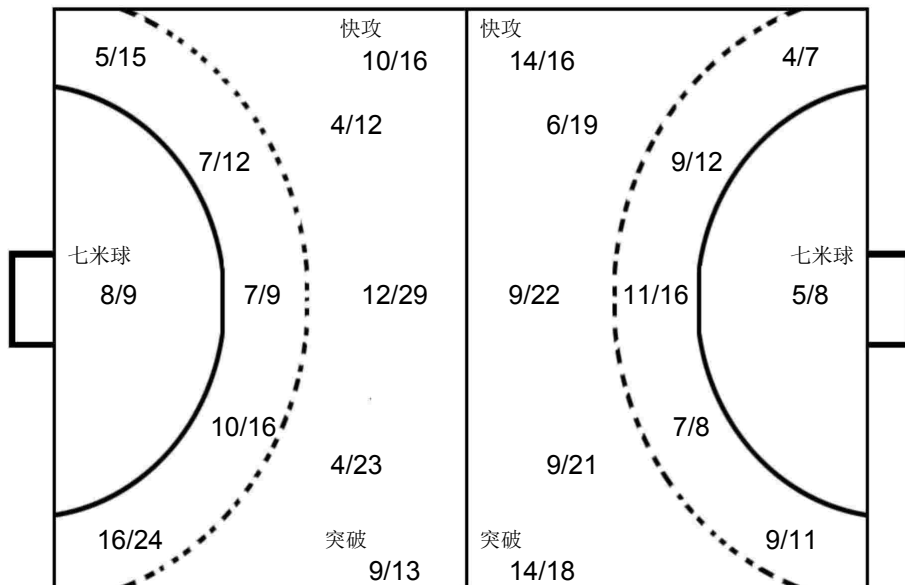

| | |
|-----------------------------|-------------|
| 苏州 12 周文贤 3/5 0/3 2/6 | 2/7 0/4 1/4 |
|-----------------------------|-------------|

| | | |
|------------------------|-------------|-----|
| 抚顺 2 赫天铭 1/2 3/9 | 2/3 2/7 0/2 | 2/8 |
|------------------------|-------------|-----|

| | | |
|----------------------------|-------------|-------------|
| 济南 1 刘在攀 0/3 0/1 0/6 | 1/1 2/2 1/3 | 0/3 2/2 2/5 |
|----------------------------|-------------|-------------|

OPPONENT

| | | | | | | | |
|-----------------------------|-----------------------------|-----------------------------|-----------------------------|-----------------------------|-----------------------------|-----------------------------|-----------------------------|
| 抚顺 13 高鑫 2 | 苏州 6 潘超群 1 2 2 | 苏州 18 何志伟 2 | 香港 27 巫迪涛 2 1 2 | 抚顺 19 靳皓童 1 2 1 | 安徽 56 王健鹏 1 2 | 安徽 58 蔡博飞 1 2 | 安徽 60 朱超 2 1 |
| Post - 0 Miss - 0 Block - 1 | Post - 1 Miss - 0 Block - 2 | Post - 0 Miss - 0 Block - 0 | Post - 0 Miss - 1 Block - 0 | Post - 0 Miss - 0 Block - 0 | Post - 1 Miss - 1 Block - 1 | Post - 0 Miss - 0 Block - 0 | Post - 0 Miss - 1 Block - 0 |
| 安徽 64 章道胜 2 1 | 济南 11 李延舒 1 1 | 抚顺 17 杨宇 1 1 | 苏州 4 孙钊 1 1 | 苏州 5 马奔 2 | 苏州 8 王震 1 1 | 苏州 10 朱红雨 1 1 | 苏州 13 蒋超 1 1 |
| Post - 0 Miss - 0 Block - 0 | Post - 0 Miss - 0 Block - 0 | Post - 0 Miss - 2 Block - 1 | Post - 1 Miss - 1 Block - 0 | Post - 0 Miss - 1 Block - 0 | Post - 1 Miss - 1 Block - 1 | Post - 0 Miss - 0 Block - 0 | Post - 0 Miss - 0 Block - 0 |



第二届全国青年运动会男子手球乙组决赛 体校组(U16)

球队名单

安徽滁州

福建龙岩

2019-05-27

| 号码 | 姓名 | 位置 | 生日 | 年龄 | 俱乐部 | 身高 (CM) | 体重 (KG) | 国际场次 | 国际进球 |
|----|-----|-----|------------|------|-----|------------|------------|------|------|
| 1 | 刘子豪 | 守门员 | 07/02/2003 | 16 | | 184 | 64 | | |
| 5 | 郭雨强 | 右后卫 | 12/02/2003 | 16 | | 183 | 72 | | |
| 6 | 刘阳 | 右边锋 | 27/01/2003 | 16 | | 176 | 60 | | |
| 7 | 王晨旭 | 左后卫 | 09/04/2004 | 15 | | 193 | 63 | | |
| 8 | 杨鑫祥 | 左边锋 | 11/02/2003 | 16 | | 181 | 76 | | |
| 9 | 荆胤丞 | 底线 | 14/11/2003 | 15 | | 186 | 78 | | |
| 10 | 赵一 | 中后卫 | 05/01/2003 | 16 | | 180 | 76 | | |
| 15 | 刘家良 | 中后卫 | 09/06/2003 | 15 | | 181 | 76 | | |
| 16 | 李凯锋 | 守门员 | 19/01/2003 | 16 | | 175 | 68 | | |
| 17 | 陈锐涛 | 左边锋 | 13/06/2003 | 15 | | 175 | 74 | | |
| 18 | 奚尧 | 左后卫 | 21/12/2003 | 15 | | 187 | 70 | | |
| 21 | 刘晓青 | 底线 | 18/06/2004 | 14 | | 178 | 66 | | |
| 23 | 朱天一 | 底线 | 18/04/2003 | 16 | | 181 | 75 | | |
| 24 | 钟盛发 | 右后卫 | 07/07/2004 | 14 | | 177 | 64 | | |
| 27 | 邓可飏 | 边锋 | 30/04/2004 | 15 | | 179 | 65 | | |
| 36 | 陈泽锟 | 底线 | 18/02/2003 | 16 | | 183 | 80 | | |
| | 平均 | | | 15.4 | | 181.2 | 70.4 | | |

| 编码 | 姓名 | 职务 |
|----|-----|----|
| B | 杜长义 | 教练 |
| C | 饶开发 | 教练 |
| D | 李绍南 | 教练 |
| A | 舒健 | 领队 |
| E | 何榕华 | 医生 |

手球 青年男子 个人/全队技术累计表 截止至第42场 安徽滁州 2019-06-05

| 号码 | 姓名 | 远射 | 近射 | 边射 | 快攻 | 突破 | 任意 | 七米 | 合计 | % | 助攻 | 失误 | 警告 | 2' | 取消 | 场次 | 时间 |
|--------|-----|-------|-------|------|------|-------|-----|-----|--------|-------|----|----|----|----|----|----|----------|
| 福建龙岩 | | | | | | | | | | | | | | | | | |
| (场上队员) | | | | | | | | | | | | | | | | | |
| 1 | 刘子豪 | | | | | | | | | | | | | | | 6 | 03:00:00 |
| 5 | 郭雨强 | 23/45 | 2/2 | 0/1 | 3/4 | 2/2 | 2/5 | 1/3 | 33/62 | 53.2% | 5 | 9 | 2 | 3 | | 6 | 02:46:34 |
| 6 | 刘阳 | | 0/1 | 2/7 | | 1/1 | | | 3/9 | 33.3% | | 2 | 1 | 1 | | 6 | 01:44:31 |
| 7 | 王晨旭 | | 2/3 | 0/1 | | | | | 2/4 | 50.0% | 1 | 4 | | 1 | | 6 | 00:50:58 |
| 8 | 杨鑫祥 | | | | | | | | | | | | | | | 6 | 00:00:00 |
| 9 | 荆胤丞 | | 2/3 | | | | | | 2/3 | 66.7% | 1 | 1 | 1 | | | 6 | 00:43:14 |
| 10 | 赵一 | 4/11 | 3/5 | | 1/3 | 6/7 | 1/1 | 2/2 | 17/29 | 58.6% | 10 | 8 | 3 | | | 6 | 02:51:15 |
| 15 | 刘家良 | 4/12 | 4/8 | | 1/1 | 2/4 | | 1/1 | 12/26 | 46.2% | 2 | 12 | 1 | | | 6 | 02:31:26 |
| 16 | 李凯锋 | | | | | | | | | | | | | | | 6 | 00:00:00 |
| 17 | 陈锐涛 | | | | | | | | | | | | | | | 6 | 00:00:00 |
| 18 | 奚尧 | 0/1 | 2/3 | 5/6 | 1/2 | | | | 8/12 | 66.7% | | 5 | 1 | 2 | | 6 | 02:52:31 |
| 21 | 刘晓青 | | | | | | | | | | | | | | | 6 | 00:00:00 |
| 23 | 朱天一 | | 4/8 | 1/1 | | | | | 5/9 | 55.6% | | 5 | | | | 6 | 02:23:53 |
| 24 | 钟盛发 | | | | | | | | | | | 1 | | 1 | | 6 | 00:05:04 |
| 27 | 邓可钊 | 0/1 | | 1/2 | 1/2 | | | | 2/5 | 40.0% | | 8 | | | | 6 | 01:08:51 |
| 36 | 陈泽锟 | | | | | | | | | | | 1 | | | | 6 | 00:00:41 |
| 合计 | | 31/70 | 19/33 | 9/18 | 7/12 | 11/14 | 3/6 | 4/6 | 84/159 | 52.8% | 19 | 56 | 9 | 8 | | 96 | |
| (守门员) | | | | | | | | | | | | | | | | | |
| 1 | 刘子豪 | 16/46 | 5/30 | 7/17 | 2/13 | 3/12 | 2/8 | 0/7 | 35/133 | 26.3% | | | | | | 6 | 03:00:00 |
| 合计 | | 16/46 | 5/30 | 7/17 | 2/13 | 3/12 | 2/8 | 0/7 | 35/133 | 26.3% | | | | | | 6 | |

场上队员：得分/射门

守门员：救球/射门

已打比赛

| 全队合计 | 进球 | 被救 | 射失 | 击柱 | 封球 | 合计 | % | 阶段 | 场次 | 对手 | 比分 |
|------|----|----|----|----|----|----|-------|--------|----|----|--------------|
| 远射 | 31 | 17 | 10 | 6 | 6 | 70 | 44.3% | 预赛 | 5 | 抚顺 | 12:13 (5:7) |
| 近射 | 19 | 11 | 2 | 1 | | 33 | 57.6% | 预赛 | 14 | 淮南 | 19:15 (9:9) |
| 边射 | 9 | 8 | | 1 | | 18 | 50.0% | 预赛 | 19 | 安徽 | 13:23 (6:11) |
| 快攻 | 7 | 4 | | 1 | | 12 | 58.3% | 四分之一决赛 | 28 | 苏州 | 9:21 (3:10) |
| 突破 | 11 | | 3 | | | 14 | 78.6% | 5-8名 | 33 | 淮南 | 15:13 (6:6) |
| 任意 | 3 | 3 | | | | 6 | 50.0% | 5-6名 | 37 | 抚顺 | 16:13 (8:6) |
| 七米 | 4 | 1 | | 1 | | 6 | 66.7% | | | | |

图式射门区域累计

手球
青年男子

截止至第42场

安徽滁州
2019-06-05

福建龙岩

| | | | | | | | | | | | | | | | | | | | | | | | | | | | | | | | | | | | | | | | | | | | | | | | | | | | | | | | | | | | | | | | | | | | | | | | | | | | | | | | |
|--|-----------------------------|-----------------------------|-----------------------------|-----------------------------|-----------------------------|-----------------------------|-----------------------------|--|--|---|---|--|----|---|---|---|---|---|---|---|---|--|---|--|--|---|--|--|--|---|--|--|--|--|--|--|--|--|---|--|---|--|--|---|---|--|---|--|--|---|--|--|--|--|--|--|--|--|---|--|---|---|---|---|--|--|---|--|---|--|---|---|--|---|--|--|---|--|--|
| 1 刘子豪 | 5 郭雨强 | 6 刘阳 | 7 王晨旭 | 8 杨鑫祥 | 9 荆胤丞 | 10 赵一 | 15 刘家良 | | | | | | | | | | | | | | | | | | | | | | | | | | | | | | | | | | | | | | | | | | | | | | | | | | | | | | | | | | | | | | | | | | | | | | | | |
| <table border="1"><tr><td></td><td></td><td></td></tr><tr><td></td><td></td><td></td></tr><tr><td></td><td></td><td></td></tr></table> | | | | | | | | | | <table border="1"><tr><td>2</td><td></td><td>11</td></tr><tr><td>1</td><td>1</td><td>3</td></tr><tr><td>6</td><td>1</td><td>8</td></tr></table> | 2 | | 11 | 1 | 1 | 3 | 6 | 1 | 8 | <table border="1"><tr><td>1</td><td></td><td>1</td></tr><tr><td></td><td></td><td>1</td></tr><tr><td></td><td></td><td></td></tr></table> | 1 | | 1 | | | 1 | | | | <table border="1"><tr><td></td><td></td><td></td></tr><tr><td></td><td></td><td></td></tr><tr><td></td><td></td><td>2</td></tr></table> | | | | | | | | | 2 | <table border="1"><tr><td></td><td></td><td></td></tr><tr><td></td><td></td><td></td></tr><tr><td></td><td></td><td></td></tr></table> | | | | | | | | | | <table border="1"><tr><td></td><td></td><td></td></tr><tr><td></td><td></td><td></td></tr><tr><td></td><td></td><td>2</td></tr></table> | | | | | | | | | 2 | <table border="1"><tr><td>2</td><td>3</td><td>2</td></tr><tr><td>1</td><td></td><td></td></tr><tr><td>5</td><td></td><td>4</td></tr></table> | 2 | 3 | 2 | 1 | | | 5 | | 4 | <table border="1"><tr><td>4</td><td>2</td><td></td></tr><tr><td>3</td><td></td><td></td></tr><tr><td>3</td><td></td><td></td></tr></table> | 4 | 2 | | 3 | | | 3 | | |
| | | | | | | | | | | | | | | | | | | | | | | | | | | | | | | | | | | | | | | | | | | | | | | | | | | | | | | | | | | | | | | | | | | | | | | | | | | | | | | | |
| | | | | | | | | | | | | | | | | | | | | | | | | | | | | | | | | | | | | | | | | | | | | | | | | | | | | | | | | | | | | | | | | | | | | | | | | | | | | | | | |
| | | | | | | | | | | | | | | | | | | | | | | | | | | | | | | | | | | | | | | | | | | | | | | | | | | | | | | | | | | | | | | | | | | | | | | | | | | | | | | | |
| 2 | | 11 | | | | | | | | | | | | | | | | | | | | | | | | | | | | | | | | | | | | | | | | | | | | | | | | | | | | | | | | | | | | | | | | | | | | | | | | | | | | | |
| 1 | 1 | 3 | | | | | | | | | | | | | | | | | | | | | | | | | | | | | | | | | | | | | | | | | | | | | | | | | | | | | | | | | | | | | | | | | | | | | | | | | | | | | |
| 6 | 1 | 8 | | | | | | | | | | | | | | | | | | | | | | | | | | | | | | | | | | | | | | | | | | | | | | | | | | | | | | | | | | | | | | | | | | | | | | | | | | | | | |
| 1 | | 1 | | | | | | | | | | | | | | | | | | | | | | | | | | | | | | | | | | | | | | | | | | | | | | | | | | | | | | | | | | | | | | | | | | | | | | | | | | | | | |
| | | 1 | | | | | | | | | | | | | | | | | | | | | | | | | | | | | | | | | | | | | | | | | | | | | | | | | | | | | | | | | | | | | | | | | | | | | | | | | | | | | |
| | | | | | | | | | | | | | | | | | | | | | | | | | | | | | | | | | | | | | | | | | | | | | | | | | | | | | | | | | | | | | | | | | | | | | | | | | | | | | | | |
| | | | | | | | | | | | | | | | | | | | | | | | | | | | | | | | | | | | | | | | | | | | | | | | | | | | | | | | | | | | | | | | | | | | | | | | | | | | | | | | |
| | | | | | | | | | | | | | | | | | | | | | | | | | | | | | | | | | | | | | | | | | | | | | | | | | | | | | | | | | | | | | | | | | | | | | | | | | | | | | | | |
| | | 2 | | | | | | | | | | | | | | | | | | | | | | | | | | | | | | | | | | | | | | | | | | | | | | | | | | | | | | | | | | | | | | | | | | | | | | | | | | | | | |
| | | | | | | | | | | | | | | | | | | | | | | | | | | | | | | | | | | | | | | | | | | | | | | | | | | | | | | | | | | | | | | | | | | | | | | | | | | | | | | | |
| | | | | | | | | | | | | | | | | | | | | | | | | | | | | | | | | | | | | | | | | | | | | | | | | | | | | | | | | | | | | | | | | | | | | | | | | | | | | | | | |
| | | | | | | | | | | | | | | | | | | | | | | | | | | | | | | | | | | | | | | | | | | | | | | | | | | | | | | | | | | | | | | | | | | | | | | | | | | | | | | | |
| | | | | | | | | | | | | | | | | | | | | | | | | | | | | | | | | | | | | | | | | | | | | | | | | | | | | | | | | | | | | | | | | | | | | | | | | | | | | | | | |
| | | | | | | | | | | | | | | | | | | | | | | | | | | | | | | | | | | | | | | | | | | | | | | | | | | | | | | | | | | | | | | | | | | | | | | | | | | | | | | | |
| | | 2 | | | | | | | | | | | | | | | | | | | | | | | | | | | | | | | | | | | | | | | | | | | | | | | | | | | | | | | | | | | | | | | | | | | | | | | | | | | | | |
| 2 | 3 | 2 | | | | | | | | | | | | | | | | | | | | | | | | | | | | | | | | | | | | | | | | | | | | | | | | | | | | | | | | | | | | | | | | | | | | | | | | | | | | | |
| 1 | | | | | | | | | | | | | | | | | | | | | | | | | | | | | | | | | | | | | | | | | | | | | | | | | | | | | | | | | | | | | | | | | | | | | | | | | | | | | | | |
| 5 | | 4 | | | | | | | | | | | | | | | | | | | | | | | | | | | | | | | | | | | | | | | | | | | | | | | | | | | | | | | | | | | | | | | | | | | | | | | | | | | | | |
| 4 | 2 | | | | | | | | | | | | | | | | | | | | | | | | | | | | | | | | | | | | | | | | | | | | | | | | | | | | | | | | | | | | | | | | | | | | | | | | | | | | | | |
| 3 | | | | | | | | | | | | | | | | | | | | | | | | | | | | | | | | | | | | | | | | | | | | | | | | | | | | | | | | | | | | | | | | | | | | | | | | | | | | | | | |
| 3 | | | | | | | | | | | | | | | | | | | | | | | | | | | | | | | | | | | | | | | | | | | | | | | | | | | | | | | | | | | | | | | | | | | | | | | | | | | | | | | |
| Post - 0 Miss - 0 Block - 0 | Post - 5 Miss - 6 Block - 5 | Post - 1 Miss - 0 Block - 0 | Post - 0 Miss - 0 Block - 0 | Post - 0 Miss - 0 Block - 0 | Post - 0 Miss - 0 Block - 0 | Post - 1 Miss - 3 Block - 0 | Post - 2 Miss - 5 Block - 1 | | | | | | | | | | | | | | | | | | | | | | | | | | | | | | | | | | | | | | | | | | | | | | | | | | | | | | | | | | | | | | | | | | | | | | | | |
| 16 李凯锋 | 17 陈锐涛 | 18 奚尧 | 21 刘晓青 | 23 朱天一 | 24 钟盛发 | 27 邓可帆 | 36 陈泽银 | | | | | | | | | | | | | | | | | | | | | | | | | | | | | | | | | | | | | | | | | | | | | | | | | | | | | | | | | | | | | | | | | | | | | | | | |
| <table border="1"><tr><td></td><td></td><td></td></tr><tr><td></td><td></td><td></td></tr><tr><td></td><td></td><td></td></tr></table> | | | | | | | | | | <table border="1"><tr><td></td><td></td><td></td></tr><tr><td></td><td></td><td></td></tr><tr><td></td><td></td><td></td></tr></table> | | | | | | | | | | <table border="1"><tr><td>5</td><td></td><td>2</td></tr><tr><td></td><td></td><td>1</td></tr><tr><td></td><td></td><td></td></tr></table> | 5 | | 2 | | | 1 | | | | <table border="1"><tr><td></td><td></td><td></td></tr><tr><td></td><td></td><td></td></tr><tr><td></td><td></td><td></td></tr></table> | | | | | | | | | | <table border="1"><tr><td>1</td><td></td><td></td></tr><tr><td>1</td><td>1</td><td></td></tr><tr><td>2</td><td></td><td></td></tr></table> | 1 | | | 1 | 1 | | 2 | | | <table border="1"><tr><td></td><td></td><td></td></tr><tr><td></td><td></td><td></td></tr><tr><td></td><td></td><td></td></tr></table> | | | | | | | | | | <table border="1"><tr><td>1</td><td></td><td></td></tr><tr><td>1</td><td></td><td></td></tr><tr><td></td><td></td><td></td></tr></table> | 1 | | | 1 | | | | | | <table border="1"><tr><td></td><td></td><td></td></tr><tr><td></td><td></td><td></td></tr><tr><td></td><td></td><td></td></tr></table> | | | | | | | | | |
| | | | | | | | | | | | | | | | | | | | | | | | | | | | | | | | | | | | | | | | | | | | | | | | | | | | | | | | | | | | | | | | | | | | | | | | | | | | | | | | |
| | | | | | | | | | | | | | | | | | | | | | | | | | | | | | | | | | | | | | | | | | | | | | | | | | | | | | | | | | | | | | | | | | | | | | | | | | | | | | | | |
| | | | | | | | | | | | | | | | | | | | | | | | | | | | | | | | | | | | | | | | | | | | | | | | | | | | | | | | | | | | | | | | | | | | | | | | | | | | | | | | |
| | | | | | | | | | | | | | | | | | | | | | | | | | | | | | | | | | | | | | | | | | | | | | | | | | | | | | | | | | | | | | | | | | | | | | | | | | | | | | | | |
| | | | | | | | | | | | | | | | | | | | | | | | | | | | | | | | | | | | | | | | | | | | | | | | | | | | | | | | | | | | | | | | | | | | | | | | | | | | | | | | |
| | | | | | | | | | | | | | | | | | | | | | | | | | | | | | | | | | | | | | | | | | | | | | | | | | | | | | | | | | | | | | | | | | | | | | | | | | | | | | | | |
| 5 | | 2 | | | | | | | | | | | | | | | | | | | | | | | | | | | | | | | | | | | | | | | | | | | | | | | | | | | | | | | | | | | | | | | | | | | | | | | | | | | | | |
| | | 1 | | | | | | | | | | | | | | | | | | | | | | | | | | | | | | | | | | | | | | | | | | | | | | | | | | | | | | | | | | | | | | | | | | | | | | | | | | | | | |
| | | | | | | | | | | | | | | | | | | | | | | | | | | | | | | | | | | | | | | | | | | | | | | | | | | | | | | | | | | | | | | | | | | | | | | | | | | | | | | | |
| | | | | | | | | | | | | | | | | | | | | | | | | | | | | | | | | | | | | | | | | | | | | | | | | | | | | | | | | | | | | | | | | | | | | | | | | | | | | | | | |
| | | | | | | | | | | | | | | | | | | | | | | | | | | | | | | | | | | | | | | | | | | | | | | | | | | | | | | | | | | | | | | | | | | | | | | | | | | | | | | | |
| | | | | | | | | | | | | | | | | | | | | | | | | | | | | | | | | | | | | | | | | | | | | | | | | | | | | | | | | | | | | | | | | | | | | | | | | | | | | | | | |
| 1 | | | | | | | | | | | | | | | | | | | | | | | | | | | | | | | | | | | | | | | | | | | | | | | | | | | | | | | | | | | | | | | | | | | | | | | | | | | | | | | |
| 1 | 1 | | | | | | | | | | | | | | | | | | | | | | | | | | | | | | | | | | | | | | | | | | | | | | | | | | | | | | | | | | | | | | | | | | | | | | | | | | | | | | |
| 2 | | | | | | | | | | | | | | | | | | | | | | | | | | | | | | | | | | | | | | | | | | | | | | | | | | | | | | | | | | | | | | | | | | | | | | | | | | | | | | | |
| | | | | | | | | | | | | | | | | | | | | | | | | | | | | | | | | | | | | | | | | | | | | | | | | | | | | | | | | | | | | | | | | | | | | | | | | | | | | | | | |
| | | | | | | | | | | | | | | | | | | | | | | | | | | | | | | | | | | | | | | | | | | | | | | | | | | | | | | | | | | | | | | | | | | | | | | | | | | | | | | | |
| | | | | | | | | | | | | | | | | | | | | | | | | | | | | | | | | | | | | | | | | | | | | | | | | | | | | | | | | | | | | | | | | | | | | | | | | | | | | | | | |
| 1 | | | | | | | | | | | | | | | | | | | | | | | | | | | | | | | | | | | | | | | | | | | | | | | | | | | | | | | | | | | | | | | | | | | | | | | | | | | | | | | |
| 1 | | | | | | | | | | | | | | | | | | | | | | | | | | | | | | | | | | | | | | | | | | | | | | | | | | | | | | | | | | | | | | | | | | | | | | | | | | | | | | | |
| | | | | | | | | | | | | | | | | | | | | | | | | | | | | | | | | | | | | | | | | | | | | | | | | | | | | | | | | | | | | | | | | | | | | | | | | | | | | | | | |
| | | | | | | | | | | | | | | | | | | | | | | | | | | | | | | | | | | | | | | | | | | | | | | | | | | | | | | | | | | | | | | | | | | | | | | | | | | | | | | | |
| | | | | | | | | | | | | | | | | | | | | | | | | | | | | | | | | | | | | | | | | | | | | | | | | | | | | | | | | | | | | | | | | | | | | | | | | | | | | | | | |
| | | | | | | | | | | | | | | | | | | | | | | | | | | | | | | | | | | | | | | | | | | | | | | | | | | | | | | | | | | | | | | | | | | | | | | | | | | | | | | | |
| Post - 0 Miss - 0 Block - 0 | Post - 0 Miss - 0 Block - 0 | Post - 1 Miss - 0 Block - 0 | Post - 0 Miss - 0 Block - 0 | Post - 0 Miss - 1 Block - 0 | Post - 0 Miss - 0 Block - 0 | Post - 0 Miss - 0 Block - 0 | Post - 0 Miss - 0 Block - 0 | | | | | | | | | | | | | | | | | | | | | | | | | | | | | | | | | | | | | | | | | | | | | | | | | | | | | | | | | | | | | | | | | | | | | | | | |

1 刘子豪

| | | |
|------|-----|-------|
| 2/19 | 2/6 | 0/11 |
| 3/16 | 2/2 | 10/22 |
| 6/27 | 2/6 | 8/24 |

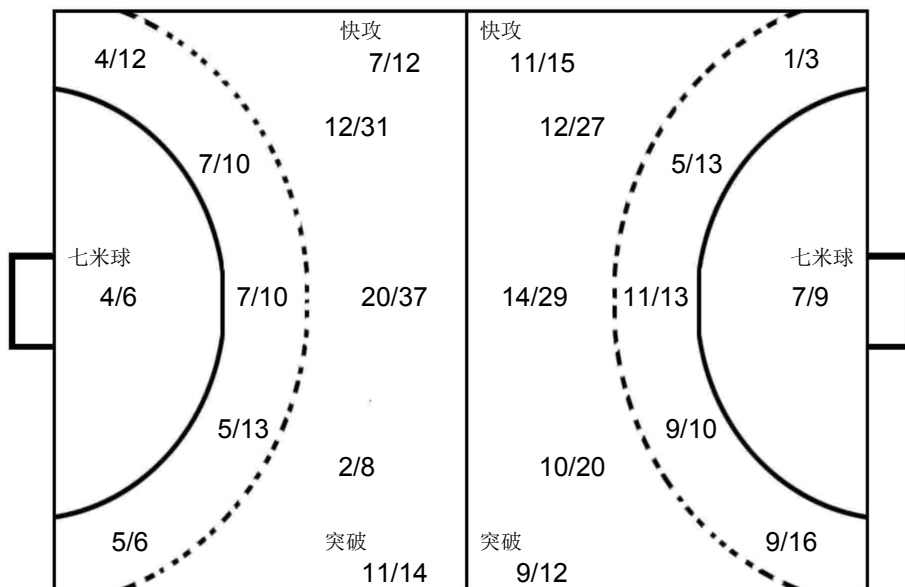

抚顺

2 赫天铭

| | | |
|-----|-----|-----|
| 0/3 | 1/1 | 2/6 |
| 2/4 | 2/3 | 3/6 |
| 1/6 | 2/4 | 1/9 |

苏州

12 周文贤

| | | |
|-----|--|-----|
| 2/4 | | 0/2 |
| 3/3 | | 2/3 |
| 1/2 | | 2/5 |

淮南

1 苟嘉毅

| | | |
|------|-----|-----|
| 0/10 | 1/5 | 1/6 |
| 4/8 | | 1/1 |
| 1/10 | | 2/4 |

OPPONENT

| | | | | | | | | | | | | | | | | | | | | | | | | | | | | | | | | | | | | | | | | | | | | | | | | | | | | | | | | | | | | | | | | | | | | | | | | | | | | | | | |
|--|-----------------------------|-----------------------------|-----------------------------|-----------------------------|-----------------------------|-----------------------------|-----------------------------|--|---|--|---|--|---|---|--|---|---|---|---|--|---|---|---|---|--|--|---|--|--|---|--|--|---|---|--|---|---|--|---|---|---|--|--|--|--|---|---|---|---|---|---|---|---|---|--|---|---|--|---|---|---|--|--|---|--|---|---|--|---|--|---|--|--|---|--|---|---|---|---|
| 淮南 | 淮南 | 抚顺 | 抚顺 | 抚顺 | 安徽 | 苏州 | 安徽 | | | | | | | | | | | | | | | | | | | | | | | | | | | | | | | | | | | | | | | | | | | | | | | | | | | | | | | | | | | | | | | | | | | | | | | | |
| 9 杨金龙 | 10 孙飞扬 | 17 杨宇 | 28 靳皓添 | 13 高鑫 | 59 毛饶翔 | 4 孙钊 | 58 蔡博飞 | | | | | | | | | | | | | | | | | | | | | | | | | | | | | | | | | | | | | | | | | | | | | | | | | | | | | | | | | | | | | | | | | | | | | | | | |
| <table border="1"><tr><td>1</td><td></td><td>4</td></tr><tr><td>2</td><td></td><td>1</td></tr><tr><td>1</td><td></td><td>1</td></tr></table> | 1 | | 4 | 2 | | 1 | 1 | | 1 | <table border="1"><tr><td>1</td><td></td><td>1</td></tr><tr><td></td><td></td><td>2</td></tr><tr><td>2</td><td>2</td><td>2</td></tr></table> | 1 | | 1 | | | 2 | 2 | 2 | 2 | <table border="1"><tr><td>1</td><td>1</td><td></td></tr><tr><td>2</td><td></td><td></td></tr><tr><td>4</td><td></td><td></td></tr></table> | 1 | 1 | | 2 | | | 4 | | | <table border="1"><tr><td></td><td></td><td></td></tr><tr><td>1</td><td></td><td></td></tr><tr><td>3</td><td></td><td>3</td></tr></table> | | | | 1 | | | 3 | | 3 | <table border="1"><tr><td>1</td><td></td><td></td></tr><tr><td></td><td></td><td>1</td></tr><tr><td>1</td><td>1</td><td>2</td></tr></table> | 1 | | | | | 1 | 1 | 1 | 2 | <table border="1"><tr><td>1</td><td>1</td><td>1</td></tr><tr><td></td><td></td><td>1</td></tr><tr><td></td><td></td><td>1</td></tr></table> | 1 | 1 | 1 | | | 1 | | | 1 | <table border="1"><tr><td>3</td><td></td><td></td></tr><tr><td></td><td></td><td>1</td></tr><tr><td></td><td></td><td>1</td></tr></table> | 3 | | | | | 1 | | | 1 | <table border="1"><tr><td>1</td><td></td><td></td></tr><tr><td>1</td><td></td><td>1</td></tr><tr><td>1</td><td></td><td></td></tr></table> | 1 | | | 1 | | 1 | 1 | | |
| 1 | | 4 | | | | | | | | | | | | | | | | | | | | | | | | | | | | | | | | | | | | | | | | | | | | | | | | | | | | | | | | | | | | | | | | | | | | | | | | | | | | | |
| 2 | | 1 | | | | | | | | | | | | | | | | | | | | | | | | | | | | | | | | | | | | | | | | | | | | | | | | | | | | | | | | | | | | | | | | | | | | | | | | | | | | | |
| 1 | | 1 | | | | | | | | | | | | | | | | | | | | | | | | | | | | | | | | | | | | | | | | | | | | | | | | | | | | | | | | | | | | | | | | | | | | | | | | | | | | | |
| 1 | | 1 | | | | | | | | | | | | | | | | | | | | | | | | | | | | | | | | | | | | | | | | | | | | | | | | | | | | | | | | | | | | | | | | | | | | | | | | | | | | | |
| | | 2 | | | | | | | | | | | | | | | | | | | | | | | | | | | | | | | | | | | | | | | | | | | | | | | | | | | | | | | | | | | | | | | | | | | | | | | | | | | | | |
| 2 | 2 | 2 | | | | | | | | | | | | | | | | | | | | | | | | | | | | | | | | | | | | | | | | | | | | | | | | | | | | | | | | | | | | | | | | | | | | | | | | | | | | | |
| 1 | 1 | | | | | | | | | | | | | | | | | | | | | | | | | | | | | | | | | | | | | | | | | | | | | | | | | | | | | | | | | | | | | | | | | | | | | | | | | | | | | | |
| 2 | | | | | | | | | | | | | | | | | | | | | | | | | | | | | | | | | | | | | | | | | | | | | | | | | | | | | | | | | | | | | | | | | | | | | | | | | | | | | | | |
| 4 | | | | | | | | | | | | | | | | | | | | | | | | | | | | | | | | | | | | | | | | | | | | | | | | | | | | | | | | | | | | | | | | | | | | | | | | | | | | | | | |
| | | | | | | | | | | | | | | | | | | | | | | | | | | | | | | | | | | | | | | | | | | | | | | | | | | | | | | | | | | | | | | | | | | | | | | | | | | | | | | | |
| 1 | | | | | | | | | | | | | | | | | | | | | | | | | | | | | | | | | | | | | | | | | | | | | | | | | | | | | | | | | | | | | | | | | | | | | | | | | | | | | | | |
| 3 | | 3 | | | | | | | | | | | | | | | | | | | | | | | | | | | | | | | | | | | | | | | | | | | | | | | | | | | | | | | | | | | | | | | | | | | | | | | | | | | | | |
| 1 | | | | | | | | | | | | | | | | | | | | | | | | | | | | | | | | | | | | | | | | | | | | | | | | | | | | | | | | | | | | | | | | | | | | | | | | | | | | | | | |
| | | 1 | | | | | | | | | | | | | | | | | | | | | | | | | | | | | | | | | | | | | | | | | | | | | | | | | | | | | | | | | | | | | | | | | | | | | | | | | | | | | |
| 1 | 1 | 2 | | | | | | | | | | | | | | | | | | | | | | | | | | | | | | | | | | | | | | | | | | | | | | | | | | | | | | | | | | | | | | | | | | | | | | | | | | | | | |
| 1 | 1 | 1 | | | | | | | | | | | | | | | | | | | | | | | | | | | | | | | | | | | | | | | | | | | | | | | | | | | | | | | | | | | | | | | | | | | | | | | | | | | | | |
| | | 1 | | | | | | | | | | | | | | | | | | | | | | | | | | | | | | | | | | | | | | | | | | | | | | | | | | | | | | | | | | | | | | | | | | | | | | | | | | | | | |
| | | 1 | | | | | | | | | | | | | | | | | | | | | | | | | | | | | | | | | | | | | | | | | | | | | | | | | | | | | | | | | | | | | | | | | | | | | | | | | | | | | |
| 3 | | | | | | | | | | | | | | | | | | | | | | | | | | | | | | | | | | | | | | | | | | | | | | | | | | | | | | | | | | | | | | | | | | | | | | | | | | | | | | | |
| | | 1 | | | | | | | | | | | | | | | | | | | | | | | | | | | | | | | | | | | | | | | | | | | | | | | | | | | | | | | | | | | | | | | | | | | | | | | | | | | | | |
| | | 1 | | | | | | | | | | | | | | | | | | | | | | | | | | | | | | | | | | | | | | | | | | | | | | | | | | | | | | | | | | | | | | | | | | | | | | | | | | | | | |
| 1 | | | | | | | | | | | | | | | | | | | | | | | | | | | | | | | | | | | | | | | | | | | | | | | | | | | | | | | | | | | | | | | | | | | | | | | | | | | | | | | |
| 1 | | 1 | | | | | | | | | | | | | | | | | | | | | | | | | | | | | | | | | | | | | | | | | | | | | | | | | | | | | | | | | | | | | | | | | | | | | | | | | | | | | |
| 1 | | | | | | | | | | | | | | | | | | | | | | | | | | | | | | | | | | | | | | | | | | | | | | | | | | | | | | | | | | | | | | | | | | | | | | | | | | | | | | | |
| Post - 1 Miss - 2 Block - 0 | Post - 1 Miss - 2 Block - 2 | Post - 2 Miss - 5 Block - 1 | Post - 0 Miss - 1 Block - 0 | Post - 0 Miss - 1 Block - 1 | Post - 0 Miss - 2 Block - 0 | Post - 0 Miss - 1 Block - 0 | Post - 0 Miss - 1 Block - 0 | | | | | | | | | | | | | | | | | | | | | | | | | | | | | | | | | | | | | | | | | | | | | | | | | | | | | | | | | | | | | | | | | | | | | | | | |
| 安徽 | 安徽 | 苏州 | 安徽 | 淮南 | 淮南 | 抚顺 | 苏州 | | | | | | | | | | | | | | | | | | | | | | | | | | | | | | | | | | | | | | | | | | | | | | | | | | | | | | | | | | | | | | | | | | | | | | | | |
| 60 朱超 | 64 章道胜 | 6 潘超群 | 56 王健鹏 | 8 陈子涵 | 15 刘淇 | 9 隋博 | 9 李文俊 | | | | | | | | | | | | | | | | | | | | | | | | | | | | | | | | | | | | | | | | | | | | | | | | | | | | | | | | | | | | | | | | | | | | | | | | |
| <table border="1"><tr><td>1</td><td>1</td><td></td></tr><tr><td>1</td><td></td><td>1</td></tr><tr><td></td><td></td><td></td></tr></table> | 1 | 1 | | 1 | | 1 | | | | <table border="1"><tr><td>2</td><td></td><td></td></tr><tr><td>1</td><td></td><td></td></tr><tr><td>1</td><td></td><td></td></tr></table> | 2 | | | 1 | | | 1 | | | <table border="1"><tr><td></td><td></td><td>2</td></tr><tr><td>1</td><td></td><td></td></tr><tr><td>1</td><td></td><td></td></tr></table> | | | 2 | 1 | | | 1 | | | <table border="1"><tr><td></td><td></td><td>1</td></tr><tr><td></td><td></td><td>2</td></tr><tr><td></td><td></td><td></td></tr></table> | | | 1 | | | 2 | | | | <table border="1"><tr><td></td><td></td><td></td></tr><tr><td></td><td></td><td>1</td></tr><tr><td>1</td><td></td><td>1</td></tr></table> | | | | | | 1 | 1 | | 1 | <table border="1"><tr><td></td><td></td><td></td></tr><tr><td>1</td><td></td><td></td></tr><tr><td>1</td><td></td><td>1</td></tr></table> | | | | 1 | | | 1 | | 1 | <table border="1"><tr><td></td><td></td><td></td></tr><tr><td>1</td><td></td><td></td></tr><tr><td>2</td><td></td><td></td></tr></table> | | | | 1 | | | 2 | | | <table border="1"><tr><td></td><td></td><td></td></tr><tr><td></td><td></td><td>1</td></tr><tr><td></td><td>1</td><td>1</td></tr></table> | | | | | | 1 | | 1 | 1 |
| 1 | 1 | | | | | | | | | | | | | | | | | | | | | | | | | | | | | | | | | | | | | | | | | | | | | | | | | | | | | | | | | | | | | | | | | | | | | | | | | | | | | | |
| 1 | | 1 | | | | | | | | | | | | | | | | | | | | | | | | | | | | | | | | | | | | | | | | | | | | | | | | | | | | | | | | | | | | | | | | | | | | | | | | | | | | | |
| | | | | | | | | | | | | | | | | | | | | | | | | | | | | | | | | | | | | | | | | | | | | | | | | | | | | | | | | | | | | | | | | | | | | | | | | | | | | | | | |
| 2 | | | | | | | | | | | | | | | | | | | | | | | | | | | | | | | | | | | | | | | | | | | | | | | | | | | | | | | | | | | | | | | | | | | | | | | | | | | | | | | |
| 1 | | | | | | | | | | | | | | | | | | | | | | | | | | | | | | | | | | | | | | | | | | | | | | | | | | | | | | | | | | | | | | | | | | | | | | | | | | | | | | | |
| 1 | | | | | | | | | | | | | | | | | | | | | | | | | | | | | | | | | | | | | | | | | | | | | | | | | | | | | | | | | | | | | | | | | | | | | | | | | | | | | | | |
| | | 2 | | | | | | | | | | | | | | | | | | | | | | | | | | | | | | | | | | | | | | | | | | | | | | | | | | | | | | | | | | | | | | | | | | | | | | | | | | | | | |
| 1 | | | | | | | | | | | | | | | | | | | | | | | | | | | | | | | | | | | | | | | | | | | | | | | | | | | | | | | | | | | | | | | | | | | | | | | | | | | | | | | |
| 1 | | | | | | | | | | | | | | | | | | | | | | | | | | | | | | | | | | | | | | | | | | | | | | | | | | | | | | | | | | | | | | | | | | | | | | | | | | | | | | | |
| | | 1 | | | | | | | | | | | | | | | | | | | | | | | | | | | | | | | | | | | | | | | | | | | | | | | | | | | | | | | | | | | | | | | | | | | | | | | | | | | | | |
| | | 2 | | | | | | | | | | | | | | | | | | | | | | | | | | | | | | | | | | | | | | | | | | | | | | | | | | | | | | | | | | | | | | | | | | | | | | | | | | | | | |
| | | | | | | | | | | | | | | | | | | | | | | | | | | | | | | | | | | | | | | | | | | | | | | | | | | | | | | | | | | | | | | | | | | | | | | | | | | | | | | | |
| | | | | | | | | | | | | | | | | | | | | | | | | | | | | | | | | | | | | | | | | | | | | | | | | | | | | | | | | | | | | | | | | | | | | | | | | | | | | | | | |
| | | 1 | | | | | | | | | | | | | | | | | | | | | | | | | | | | | | | | | | | | | | | | | | | | | | | | | | | | | | | | | | | | | | | | | | | | | | | | | | | | | |
| 1 | | 1 | | | | | | | | | | | | | | | | | | | | | | | | | | | | | | | | | | | | | | | | | | | | | | | | | | | | | | | | | | | | | | | | | | | | | | | | | | | | | |
| | | | | | | | | | | | | | | | | | | | | | | | | | | | | | | | | | | | | | | | | | | | | | | | | | | | | | | | | | | | | | | | | | | | | | | | | | | | | | | | |
| 1 | | | | | | | | | | | | | | | | | | | | | | | | | | | | | | | | | | | | | | | | | | | | | | | | | | | | | | | | | | | | | | | | | | | | | | | | | | | | | | | |
| 1 | | 1 | | | | | | | | | | | | | | | | | | | | | | | | | | | | | | | | | | | | | | | | | | | | | | | | | | | | | | | | | | | | | | | | | | | | | | | | | | | | | |
| | | | | | | | | | | | | | | | | | | | | | | | | | | | | | | | | | | | | | | | | | | | | | | | | | | | | | | | | | | | | | | | | | | | | | | | | | | | | | | | |
| 1 | | | | | | | | | | | | | | | | | | | | | | | | | | | | | | | | | | | | | | | | | | | | | | | | | | | | | | | | | | | | | | | | | | | | | | | | | | | | | | | |
| 2 | | | | | | | | | | | | | | | | | | | | | | | | | | | | | | | | | | | | | | | | | | | | | | | | | | | | | | | | | | | | | | | | | | | | | | | | | | | | | | | |
| | | | | | | | | | | | | | | | | | | | | | | | | | | | | | | | | | | | | | | | | | | | | | | | | | | | | | | | | | | | | | | | | | | | | | | | | | | | | | | | |
| | | 1 | | | | | | | | | | | | | | | | | | | | | | | | | | | | | | | | | | | | | | | | | | | | | | | | | | | | | | | | | | | | | | | | | | | | | | | | | | | | | |
| | 1 | 1 | | | | | | | | | | | | | | | | | | | | | | | | | | | | | | | | | | | | | | | | | | | | | | | | | | | | | | | | | | | | | | | | | | | | | | | | | | | | | |
| Post - 1 Miss - 0 Block - 0 | Post - 0 Miss - 0 Block - 0 | Post - 1 Miss - 0 Block - 0 | Post - 1 Miss - 0 Block - 0 | Post - 0 Miss - 0 Block - 0 | Post - 0 Miss - 0 Block - 0 | Post - 1 Miss - 1 Block - 0 | Post - 0 Miss - 0 Block - 0 | | | | | | | | | | | | | | | | | | | | | | | | | | | | | | | | | | | | | | | | | | | | | | | | | | | | | | | | | | | | | | | | | | | | | | | | |



第二届全国青年运动会男子手球乙组决赛 体校组(U16)

PHMS Pictorial Handball Match Statistics

IHF Official System

球队名单

安徽滁州

辽宁抚顺

2019-05-27

| 号码 | 姓名 | 位置 | 生日 | 年龄 | 俱乐部 | 身高 (CM) | 体重 (KG) | 国际场次 | 国际进球 |
|----|------|-----|------------|------|-----|------------|------------|------|------|
| 2 | 赫天铭 | 守门员 | 13/01/2003 | 16 | | 192 | 90 | | |
| 5 | 王梓翺 | 底线 | 24/03/2003 | 16 | | 182 | 80 | | |
| 6 | 尚禹辰 | 右边锋 | 07/01/2005 | 14 | | 175 | 65 | | |
| 7 | 张羽虹冰 | 右后卫 | 12/11/2003 | 15 | | 180 | 70 | | |
| 9 | 隋博 | 右边锋 | 20/01/2003 | 16 | | 184 | 75 | | |
| 11 | 陈思 | 底线 | 08/05/2003 | 16 | | 182 | 70 | | |
| 13 | 高鑫 | 右后卫 | 20/03/2003 | 16 | | 183 | 65 | | |
| 17 | 杨宇 | 左后卫 | 27/04/2003 | 16 | | 188 | 68 | | |
| 19 | 靳皓童 | 左后卫 | 13/04/2003 | 16 | | 188 | 68 | | |
| 22 | 杨辰 | 中后卫 | 25/08/2003 | 15 | | 185 | 75 | | |
| 28 | 靳皓添 | 底线 | 13/04/2003 | 16 | | 180 | 60 | | |
| 32 | 袁梓赫 | 守门员 | 28/05/2003 | 15 | | 193 | 95 | | |
| | 平均 | | | 15.6 | | 184.3 | 73.4 | | |

| 编码 | 姓名 | 职务 |
|----|-----|-----|
| C | 刘启迪 | 教练 |
| B | 徐毅 | 主教练 |

手球 个人/全队技术累计表 安徽滁州 2019-06-05
青年男子 截止至第42场

| 号码 | 姓名 | 远射 | 近射 | 边射 | 快攻 | 突破 | 任意 | 七米 | 合计 | % | 助攻 | 失误 | 警告 | 2' | 取消 | 场次 | 时间 |
|---------------|------|--------------|--------------|--------------|-------------|--------------|------------|--------------|----------------|--------------|-----------|-----------|----------|----------|----|-----------|----------|
| 辽宁抚顺 | | | | | | | | | | | | | | | | | |
| (场上队员) | | | | | | | | | | | | | | | | | |
| 2 | 赫天铭 | | 1/1 | | | | | | 1/1 | 100% | | 1 | | | | 6 | 03:36:17 |
| 5 | 王梓翹 | | | | 1/1 | | | | 1/1 | 100% | 2 | | | | | 6 | 00:09:43 |
| 6 | 尚禹辰 | 2/4 | | 1/2 | | | | 1/2 | 4/8 | 50.0% | 4 | | | | | 6 | 01:55:23 |
| 7 | 张羽虹冰 | | | 1/3 | | | | | 1/3 | 33.3% | 2 | 1 | | | | 6 | 02:04:36 |
| 9 | 隋博 | | 2/2 | 7/12 | | | | | 9/14 | 64.3% | 4 | | 1 | | | 6 | 02:19:02 |
| 11 | 陈思 | | | | | | | | | | | | | | | 6 | 00:02:29 |
| 13 | 高鑫 | 7/13 | 10/12 | 0/3 | 1/1 | 5/9 | 1/2 | 9/12 | 33/52 | 63.5% | 2 | 14 | | 1 | | 6 | 03:10:00 |
| 17 | 杨宇 | 11/30 | 6/9 | | 5/6 | 4/5 | 1/4 | 0/2 | 27/56 | 48.2% | 5 | 24 | 1 | 1 | | 6 | 03:09:58 |
| 19 | 靳皓童 | 1/4 | 4/6 | | 1/1 | 2/2 | 0/1 | 2/3 | 10/17 | 58.8% | 10 | 20 | | 2 | | 6 | 03:38:55 |
| 22 | 杨辰 | | | | | | | | | | | | | | | 6 | 00:00:00 |
| 28 | 靳皓添 | 1/1 | 12/18 | | | | | 2/2 | 15/21 | 71.4% | | 8 | | 2 | | 6 | 02:59:25 |
| 32 | 袁梓赫 | | | | | | | | | | | | | | | 6 | 00:03:40 |
| 合计 | | 20/48 | 37/52 | 9/20 | 8/9 | 11/16 | 2/7 | 14/21 | 101/173 | 58.4% | 17 | 79 | 2 | 7 | | 72 | |
| (守门员) | | | | | | | | | | | | | | | | | |
| 2 | 赫天铭 | 15/40 | 9/29 | 12/24 | 2/17 | 1/11 | 3/5 | 4/15 | 46/141 | 32.6% | | 1 | | | | 6 | 03:36:17 |
| 32 | 袁梓赫 | | | | 1/2 | | | 0/1 | 1/3 | 33.3% | | | | | | 6 | 00:03:40 |
| 合计 | | 15/40 | 9/29 | 12/24 | 3/19 | 1/11 | 3/5 | 4/16 | 47/144 | 32.6% | | 1 | | | | 12 | |

场上队员：得分/射门

守门员：救球/射门

已打比赛

| 全队合计 | 进球 | 被救 | 射失 | 击柱 | 封球 | 合计 | % | 阶段 | 场次 | 对手 | 比分 |
|------|----|----|----|----|----|----|-------|--------|----|----|--------------|
| 远射 | 20 | 8 | 8 | 3 | 9 | 48 | 41.7% | 预赛 | 5 | 龙岩 | 13:12 (7:5) |
| 近射 | 37 | 8 | 6 | 1 | | 52 | 71.2% | 预赛 | 13 | 安徽 | 10:15 (4:5) |
| 边射 | 9 | 6 | 2 | 3 | | 20 | 45.0% | 预赛 | 18 | 淮南 | 25:26 (10:8) |
| 快攻 | 8 | 1 | | | | 9 | 88.9% | 四分之一决赛 | 26 | 宝山 | 19:21 (8:7) |
| 突破 | 11 | 5 | | | | 16 | 68.8% | 5-8名 | 32 | 济南 | 21:7 (10:3) |
| 任意 | 2 | 2 | 3 | | | 7 | 28.6% | 5-6名 | 37 | 龙岩 | 13:16 (6:8) |
| 七米 | 14 | 5 | 2 | | | 21 | 66.7% | | | | |

图式射门区域累计

手球
青年男子

截止至第42场

安徽滁州
2019-06-05

辽宁抚顺

| | | | | | | | |
|---|---|---|--|--|--------------------------------------|---|---|
| 2 赫天铭 1 Post - 0 Miss - 0 Block - 0 | 5 王梓翹 1 Post - 0 Miss - 0 Block - 0 | 6 尚禹辰 1 1 1 Post - 1 Miss - 1 Block - 0 | 7 张羽虹冰 1 Post - 1 Miss - 1 Block - 0 | 9 隋博 2 3 3 Post - 1 Miss - 1 Block - 0 | 11 陈思 Post - 0 Miss - 0 Block - 0 | 13 高鑫 3 3 3 3 3 6 6 2 7 Post - 0 Miss - 3 Block - 2 | 17 杨宇 2 1 1 5 1 2 10 2 3 Post - 3 Miss - 10 Block - 6 |
| 19 靳皓童 2 1 1 1 2 4 Post - 0 Miss - 2 Block - 1 | 22 杨辰 Post - 0 Miss - 0 Block - 0 | 28 靳皓添 2 2 1 1 4 5 Post - 1 Miss - 3 Block - 0 | 32 袁梓赫 Post - 0 Miss - 0 Block - 0 | | | | |

| | | | |
|-------|------|-----|-------|
| 2 赫天铭 | 2/14 | 2/3 | 7/19 |
| | 5/18 | 5/6 | 10/22 |
| | 7/24 | 3/8 | 5/27 |

| | | |
|--------|-----|-----|
| 32 袁梓赫 | 0/1 | |
| | 1/1 | 0/1 |

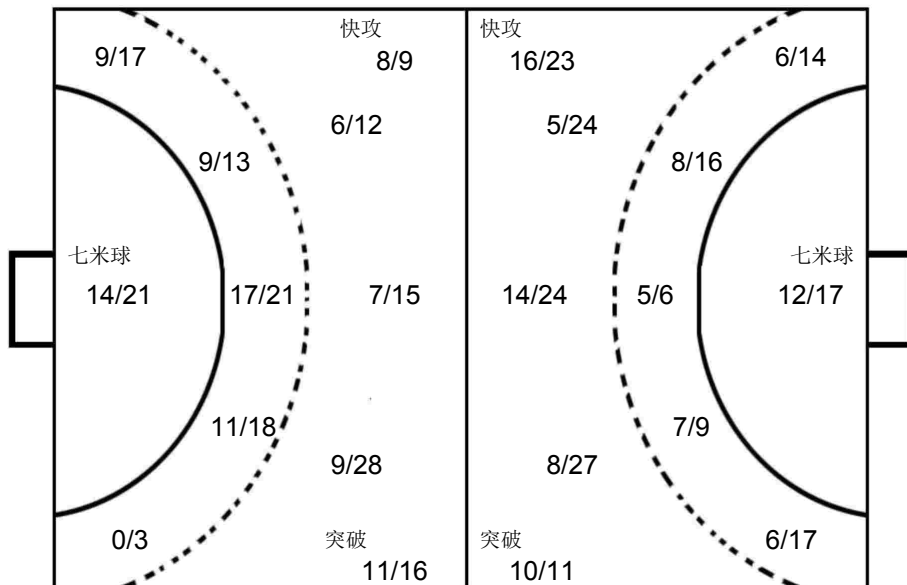

龙岩

| | | | |
|-------|------|-----|-----|
| 1 刘子豪 | 0/2 | 0/1 | 0/1 |
| | 1/5 | 1/1 | 4/5 |
| | 4/14 | 1/2 | 0/6 |

宝山

| | | | |
|--------|-----|-----|-----|
| 66 黄嘉遥 | 0/1 | 0/2 | 0/2 |
| | 1/3 | | 4/5 |
| | 2/5 | 0/2 | 0/6 |

济南

| | | | |
|-------|-----|-----|-----|
| 1 刘在攀 | 0/2 | 0/2 | 0/2 |
| | 3/8 | 0/1 | 1/3 |
| | 2/6 | | 0/3 |

OPPONENT

| | | | | | | | |
|-----------------------------|-----------------------------|-----------------------------|-----------------------------|-----------------------------|-----------------------------|-----------------------------|-----------------------------|
| 5 郭雨强 (龙岩) | 9 杨金龙 (淮南) | 21 曾新宇 (宝山) | 10 孙飞扬 (淮南) | 10 赵一 (龙岩) | 22 马浩东 (宝山) | 8 陈子涵 (淮南) | 64 章道胜 (安徽) |
| 1 3 | 1 1 | 1 5 | 2 1 | 1 1 | 2 1 | 1 2 | 2 2 |
| Post - 3 Miss - 5 Block - 2 | Post - 0 Miss - 0 Block - 0 | Post - 0 Miss - 0 Block - 0 | Post - 0 Miss - 1 Block - 0 | Post - 1 Miss - 0 Block - 0 | Post - 0 Miss - 0 Block - 0 | Post - 1 Miss - 0 Block - 0 | Post - 1 Miss - 0 Block - 0 |
| 6 童浩宇 (淮南) | 35 刘子杰 (宝山) | 56 王健鹏 (安徽) | 18 奚尧 (龙岩) | 55 苏凯 (安徽) | 58 蔡博飞 (安徽) | 11 刘新然 (淮南) | 17 徐鹏辉 (淮南) |
| 1 1 | 1 2 | 3 | 1 1 | 1 1 | 1 1 | 1 1 | 1 1 |
| Post - 1 Miss - 1 Block - 0 | Post - 0 Miss - 1 Block - 1 | Post - 0 Miss - 1 Block - 1 | Post - 1 Miss - 0 Block - 0 | Post - 0 Miss - 1 Block - 0 | Post - 0 Miss - 0 Block - 0 | Post - 1 Miss - 0 Block - 0 | Post - 0 Miss - 0 Block - 0 |



第二届全国青年运动会男子手球乙组决赛 体校组(U16)

PHMS Pictorial Handball Match Statistics

IHF Official System

球队名单

安徽淮南

安徽滁州

2019-05-27

| 号码 | 姓名 | 位置 | 生日 | 年龄 | 俱乐部 | 身高 (CM) | 体重 (KG) | 国际场次 | 国际进球 |
|----|-----|-----|------------|------|-----|------------|------------|------|------|
| 1 | 苟嘉毅 | 守门员 | 28/07/2003 | 15 | | 180 | 65 | | |
| 2 | 邹俊洁 | 左边锋 | 27/03/2003 | 16 | | 177 | 60 | | |
| 3 | 童守宣 | 左边锋 | 16/07/2003 | 15 | | 173 | 55 | | |
| 4 | 李攀 | 右边锋 | 31/03/2003 | 16 | | 178 | 74 | | |
| 5 | 吴修民 | 右后卫 | 19/12/2003 | 15 | | 182 | 70 | | |
| 6 | 童浩宇 | 底线 | 18/06/2003 | 15 | | 175 | 82 | | |
| 7 | 赵琨鹏 | 左后卫 | 11/01/2005 | 14 | | 193 | 100 | | |
| 8 | 陈子涵 | 左后卫 | 15/03/2003 | 16 | | 182 | 70 | | |
| 9 | 杨金龙 | 中后卫 | 27/07/2003 | 15 | | 180 | 65 | | |
| 10 | 孙飞扬 | 右后卫 | 29/03/2003 | 16 | | 188 | 88 | | |
| 11 | 刘新然 | 右边锋 | 12/06/2003 | 15 | | 183 | 70 | | |
| 13 | 张昊燃 | 左边锋 | 25/10/2003 | 15 | | 185 | 100 | | |
| 14 | 单中宝 | 底线 | 02/07/2003 | 15 | | 172 | 67 | | |
| 15 | 刘淇 | 左边锋 | 06/01/2003 | 16 | | 180 | 72 | | |
| 16 | 胡文柯 | 右边锋 | 02/11/2003 | 15 | | 186 | 78 | | |
| 17 | 徐鹏辉 | 右后卫 | 08/07/2003 | 15 | | 185 | 90 | | |
| | 平均 | | | 15.3 | | 181.2 | 75.4 | | |

| 编码 | 姓名 | 职务 |
|----|-----|-----|
| A | 常洪飞 | 领队 |
| B | 阮圣杰 | 主教练 |

手球
青年男子

个人/全队技术累计表

安徽滁州
2019-06-05

截止至第42场

| 号码 | 姓名 | 远射 | 近射 | 边射 | 快攻 | 突破 | 任意 | 七米 | 合计 | % | 助攻 | 失误 | 警告 | 2' | 取消 | 场次 | 时间 |
|---------------|-----------|--------------|--------------|-------------|-------------|--------------|-------------|--------------|----------------|--------------|----------|-----------|----------|----------|----|-----------|----------|
| 安徽淮南 | | | | | | | | | | | | | | | | | |
| (场上队员) | | | | | | | | | | | | | | | | | |
| 1 | 苟嘉毅 | | | | | | | | | | | 1 | | | | 6 | 03:10:14 |
| 2 | 邹俊洁 | | 1/1 | 0/1 | | | | | 1/2 | 50.0% | | | | | | 6 | 00:13:33 |
| 3 | 童守宣 | | | | 1/1 | | | | 1/1 | 100% | | 2 | | | | 6 | 00:15:00 |
| 4 | 李攀 | | | | | | | | | | | 1 | | | | 6 | 00:12:37 |
| 5 | 吴修民 | | | | | | | | | | | | | | | 6 | 00:00:00 |
| 6 | 童浩宇 | | 1/2 | 5/9 | | | | 1/2 | 7/13 | 53.8% | | 4 | | | | 6 | 02:31:20 |
| 7 | 赵琨鹏 | | 2/2 | | | | | | 2/2 | 100% | | | | | | 6 | 00:14:36 |
| 8 | 陈子涵 | 5/12 | 6/9 | 2/3 | 4/4 | 2/2 | 0/1 | 1/2 | 20/33 | 60.6% | 2 | 18 | 2 | 1 | | 6 | 02:53:50 |
| 9 | 杨金龙 | 8/20 | 5/9 | | 2/2 | 4/4 | 0/1 | 10/13 | 29/49 | 59.2% | 3 | 15 | | | | 6 | 03:00:00 |
| 10 | 孙飞扬 | 8/16 | 7/9 | 1/1 | 1/2 | 3/3 | 6/11 | 3/4 | 29/46 | 63.0% | 3 | 12 | | 3 | | 6 | 03:26:26 |
| 11 | 刘新然 | 0/1 | 2/2 | 1/1 | 0/1 | | | 1/2 | 4/7 | 57.1% | | 5 | | 1 | | 6 | 02:22:51 |
| 13 | 张昊燃 | | 1/1 | | | | | | 1/1 | 100% | | 1 | | | | 6 | 00:16:14 |
| 14 | 单中宝 | | | | | | | | | | | | | | | 6 | 00:00:00 |
| 15 | 刘淇 | | 0/1 | 0/2 | | 3/3 | | | 3/6 | 50.0% | | 8 | | | | 6 | 01:37:36 |
| 16 | 胡文柯 | | | | | | | | | | | | | | | 6 | 00:19:46 |
| 17 | 徐鹏辉 | | 3/4 | | 1/1 | | | | 4/5 | 80.0% | | 5 | | 1 | | 6 | 01:25:15 |
| | 合计 | 21/49 | 28/40 | 9/17 | 9/11 | 12/12 | 6/13 | 16/23 | 101/165 | 61.2% | 8 | 72 | 2 | 6 | | 96 | |
| (守门员) | | | | | | | | | | | | | | | | | |
| 1 | 苟嘉毅 | 3/15 | 7/29 | 2/18 | 6/20 | 1/18 | 2/6 | 1/9 | 22/115 | 19.1% | | 1 | | | | 6 | 03:10:14 |
| 16 | 胡文柯 | 1/2 | 2/7 | 1/1 | 0/3 | 0/5 | | 2/8 | 6/26 | 23.1% | | | | | | 6 | 00:19:46 |
| | 合计 | 4/17 | 9/36 | 3/19 | 6/23 | 1/23 | 2/6 | 3/17 | 28/141 | 19.9% | | 1 | | | | 12 | |

场上队员：得分/射门

守门员：救球/射门

已打比赛

| 全队合计 | 进球 | 被救 | 射失 | 击柱 | 封球 | 合计 | % | 阶段 | 场次 | 对手 | 比分 |
|------|----|----|----|----|----|----|--------|--------|----|----|--------------|
| 远射 | 21 | 15 | 5 | 2 | 6 | 49 | 42.9% | 预赛 | 4 | 安徽 | 15:26 (5:16) |
| 近射 | 28 | 6 | 2 | 4 | | 40 | 70.0% | 预赛 | 14 | 龙岩 | 15:19 (9:9) |
| 边射 | 9 | 5 | 1 | 2 | | 17 | 52.9% | 预赛 | 18 | 抚顺 | 26:25 (8:10) |
| 快攻 | 9 | 1 | | 1 | | 11 | 81.8% | 四分之一决赛 | 27 | 香港 | 9:14 (3:8) |
| 突破 | 12 | | | | | 12 | 100.0% | 5-8名 | 33 | 龙岩 | 13:15 (6:6) |
| 任意 | 6 | 3 | 3 | 1 | | 13 | 46.2% | 7-8名 | 36 | 济南 | 23:14 (14:9) |
| 七米 | 16 | 3 | 2 | 2 | | 23 | 69.6% | | | | |

图式射门区域累计

手球
青年男子

截止至第42场

安徽滁州
2019-06-05

安徽淮南

| | | | | | | | |
|--------------------------------------|---------------------------------------|---------------------------------------|---------------------------------------|---------------------------------------|--------------------------------------|---------------------------------------|---------------------------------------|
| 1 苟嘉毅 Post - 0 Miss - 0 Block - 0 | 2 邹俊洁 Post - 0 Miss - 0 Block - 0 | 3 童守宣 Post - 0 Miss - 0 Block - 0 | 4 李攀 Post - 0 Miss - 0 Block - 0 | 5 吴修民 Post - 0 Miss - 0 Block - 0 | 6 童浩宇 Post - 1 Miss - 1 Block - 0 | 7 赵琨鹏 Post - 0 Miss - 0 Block - 0 | 8 陈子涵 Post - 3 Miss - 1 Block - 1 |
| 9 杨金龙 Post - 5 Miss - 6 Block - 0 | 10 孙飞扬 Post - 1 Miss - 4 Block - 5 | 11 刘新然 Post - 1 Miss - 0 Block - 0 | 13 张昊燃 Post - 0 Miss - 0 Block - 0 | 14 单中宝 Post - 0 Miss - 0 Block - 0 | 15 刘淇 Post - 1 Miss - 0 Block - 0 | 16 胡文柯 Post - 0 Miss - 0 Block - 0 | 17 徐鹏辉 Post - 0 Miss - 1 Block - 0 |

1 苟嘉毅

| | | |
|------|------|------|
| 2/23 | 4/10 | 1/16 |
| 5/20 | 0/1 | 2/8 |
| 5/24 | | 3/13 |

16 胡文柯

| | | |
|-----|-----|-----|
| 1/4 | | 0/2 |
| 2/5 | 0/1 | 1/3 |
| 1/5 | 1/1 | 0/5 |

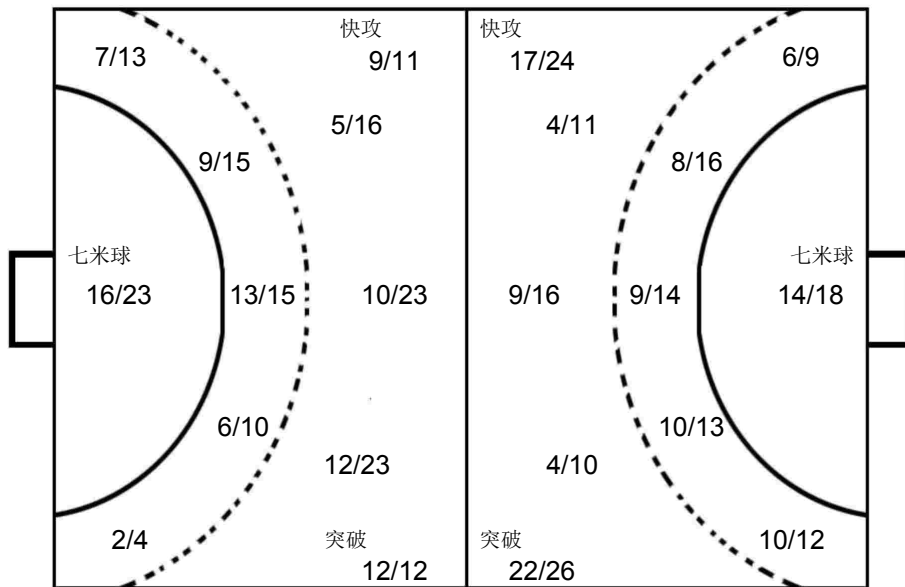

龙岩

1 刘子豪

| | | |
|-----|-----|-----|
| 1/4 | 1/1 | 0/5 |
| 0/3 | | 2/6 |
| 0/6 | 1/3 | 4/9 |

抚顺

2 赫天铭

| | | |
|-----|-----|-----|
| 0/4 | 1/2 | 1/5 |
| 2/8 | 1/1 | 2/5 |
| 1/3 | 1/2 | 0/4 |

安徽

52 花驰

| | | |
|-----|--|-----|
| 1/1 | | |
| 2/2 | | 0/1 |
| 1/3 | | 2/4 |

OPPONENT

| | | | | | | | |
|---|--|---|---|--|---|---|---|
| 龙岩 10 赵一 Post - 0 Miss - 0 Block - 0 | 抚顺 13 高鑫 Post - 0 Miss - 0 Block - 0 | 龙岩 5 郭雨强 Post - 1 Miss - 0 Block - 0 | 龙岩 15 刘家良 Post - 1 Miss - 4 Block - 0 | 安徽 60 朱超 Post - 0 Miss - 0 Block - 0 | 抚顺 17 杨宇 Post - 1 Miss - 2 Block - 1 | 济南 13 刘振宇 Post - 0 Miss - 3 Block - 0 | 安徽 54 姚幸运 Post - 0 Miss - 0 Block - 0 |
| 安徽 56 王健鹏 Post - 0 Miss - 0 Block - 0 | 济南 6 刘尊哲 Post - 0 Miss - 0 Block - 0 | 抚顺 19 靳皓童 Post - 0 Miss - 0 Block - 0 | 龙岩 18 奚尧 Post - 0 Miss - 0 Block - 0 | 安徽 55 苏凯 Post - 0 Miss - 0 Block - 0 | 安徽 58 蔡博飞 Post - 0 Miss - 0 Block - 0 | 安徽 64 章道胜 Post - 0 Miss - 0 Block - 0 | 抚顺 9 隋博 Post - 0 Miss - 0 Block - 0 |

第二届全国青年运动会男子手球乙组决赛 体校组(U16)

PHMS Pictorial Handball Match Statistics

IHF Official System

球队名单

安徽滁州

山东济南

2019-05-27

| 号码 | 姓名 | 位置 | 生日 | 年龄 | 俱乐部 | 身高 (CM) | 体重 (KG) | 国际场次 | 国际进球 |
|----|-----|-----|------------|------|-----|------------|------------|------|------|
| 1 | 刘在攀 | 左边锋 | 27/01/2004 | 15 | | 195 | 85 | | |
| 4 | 张广一 | 左边锋 | 30/03/2004 | 15 | | 177 | 75 | | |
| 6 | 刘尊哲 | 后卫 | 12/02/2004 | 15 | | 173 | 70 | | |
| 7 | 王帅 | 左边锋 | 15/01/2004 | 15 | | 180 | 60 | | |
| 8 | 金正凯 | 右边锋 | 12/09/2003 | 15 | | 173 | 68 | | |
| 9 | 张嘉树 | 后卫 | 24/02/2005 | 14 | | 173 | 60 | | |
| 10 | 颜同霖 | 左后卫 | 20/10/2003 | 15 | | 188 | 80 | | |
| 11 | 李延舒 | 底线 | 01/11/2004 | 14 | | 185 | 80 | | |
| 13 | 刘振宇 | 左边锋 | 07/06/2004 | 14 | | 188 | 80 | | |
| 16 | 高宇轩 | 守门员 | 24/07/2005 | 13 | | 185 | 80 | | |
| 17 | 张昊 | 右边锋 | 09/03/2004 | 15 | | 180 | 75 | | |
| 21 | 杨明毅 | 左边锋 | 26/05/2004 | 15 | | 180 | 75 | | |
| 24 | 于昊 | 右后卫 | 25/05/2004 | 15 | | 177 | 70 | | |
| 26 | 曹立志 | 右边锋 | 13/12/2004 | 14 | | 180 | 75 | | |
| 40 | 鹿智豪 | 底线 | 19/12/2003 | 15 | | 200 | 100 | | |
| 88 | 王麒翔 | 左边锋 | 23/10/2005 | 13 | | 185 | 67 | | |
| | 平均 | | | 14.5 | | 182.4 | 75.0 | | |

| 编码 | 姓名 | 职务 |
|----|-----|-----|
| A | 李楠 | 领队 |
| B | 陈鹏波 | 主教练 |
| C | 陶丛龙 | 教练 |
| E | 郭军旗 | 医生 |

手球 个人/全队技术累计表 安徽滁州 2019-06-05
青年男子 截止至第42场

| 号码 | 姓名 | 远射 | 近射 | 边射 | 快攻 | 突破 | 任意 | 七米 | 合计 | % | 助攻 | 失误 | 警告 | 2' | 取消 | 场次 | 时间 |
|---------------|-----|--------------|--------------|-------------|-------------|--------------|-------------|------------|---------------|--------------|-----------|-----------|----------|----------|----|-----------|----------|
| 山东济南 | | | | | | | | | | | | | | | | | |
| (场上队员) | | | | | | | | | | | | | | | | | |
| 1 | 刘在攀 | | | | | | | | | | 1 | | | | | 6 | 02:56:09 |
| 4 | 张广一 | 0/1 | 0/2 | 0/2 | | | | | 0/5 | 0.0% | | 1 | | | | 6 | 00:22:46 |
| 6 | 刘尊哲 | 7/22 | 1/4 | 2/4 | 1/1 | 4/4 | 0/1 | 3/3 | 18/39 | 46.2% | 7 | 20 | 1 | | | 6 | 02:44:00 |
| 7 | 王帅 | 0/4 | 2/7 | 1/2 | 3/3 | | 1/1 | | 7/17 | 41.2% | | 3 | | 1 | | 6 | 02:54:20 |
| 8 | 金正凯 | | 1/2 | 1/3 | | | | | 2/5 | 40.0% | 1 | 4 | | | | 6 | 02:04:57 |
| 9 | 张嘉树 | 1/4 | 0/1 | | | 1/1 | | | 2/6 | 33.3% | | 3 | | | | 6 | 00:37:41 |
| 10 | 颜同霖 | 2/9 | 1/3 | 0/2 | 2/2 | 4/4 | 2/5 | | 11/25 | 44.0% | 1 | 13 | 1 | 4 | | 6 | 02:26:46 |
| 11 | 李延舒 | | 5/7 | 1/1 | 1/1 | | | | 7/9 | 77.8% | | 6 | 3 | | | 6 | 02:44:07 |
| 13 | 刘振宇 | 12/36 | 2/3 | | | 1/1 | 3/5 | | 18/45 | 40.0% | 2 | 15 | 2 | 1 | | 6 | 02:40:34 |
| 16 | 高宇轩 | | | | | | | | | | | | | | | 6 | 00:03:41 |
| 17 | 张昊 | | | | | | | | | | | | | | | 6 | 00:00:00 |
| 21 | 杨明毅 | 1/1 | 1/1 | | | | | | 2/2 | 100% | | 3 | | 1 | | 6 | 00:15:00 |
| 24 | 于昊 | | | | | | | | | | | 1 | | | | 6 | 00:17:38 |
| 26 | 曹立志 | | | | | | | | | | | 1 | | | | 6 | 00:50:27 |
| 40 | 鹿智豪 | | | | | | | | | | | | | | | 6 | 00:00:00 |
| 88 | 王麒麟 | | | | | | | | | | | | | | | 5 | 00:00:00 |
| 合计 | | 23/77 | 13/30 | 5/14 | 7/7 | 10/10 | 6/12 | 3/3 | 67/153 | 43.8% | 12 | 70 | 7 | 7 | | 95 | |
| (守门员) | | | | | | | | | | | | | | | | | |
| 1 | 刘在攀 | 9/31 | 13/53 | 5/20 | 3/16 | 4/11 | 0/2 | 4/9 | 38/142 | 26.8% | 1 | | | | | 6 | 02:56:09 |
| 16 | 高宇轩 | | 0/1 | | 0/1 | | | | 0/2 | 0.0% | | | | | | 6 | 00:03:41 |
| 合计 | | 9/31 | 13/54 | 5/20 | 3/17 | 4/11 | 0/2 | 4/9 | 38/144 | 26.4% | 1 | | | | | 12 | |

场上队员：得分/射门

守门员：救球/射门

已打比赛

| 全队合计 | 进球 | 被救 | 射失 | 击柱 | 封球 | 合计 | % | 阶段 | 场次 | 对手 | 比分 |
|------|----|----|----|----|----|----|--------|--------|----|----|--------------|
| 远射 | 23 | 19 | 18 | 6 | 11 | 77 | 29.9% | 预赛 | 7 | 香港 | 13:15 (7:7) |
| 近射 | 13 | 15 | 2 | | | 30 | 43.3% | 预赛 | 11 | 苏州 | 12:11 (7:6) |
| 边射 | 5 | 7 | 1 | 1 | | 14 | 35.7% | 预赛 | 20 | 宝山 | 11:18 (6:10) |
| 快攻 | 7 | | | | | 7 | 100.0% | 四分之一决赛 | 25 | 安徽 | 10:18 (6:7) |
| 突破 | 10 | | | | | 10 | 100.0% | 5-8名 | 32 | 抚顺 | 7:21 (3:10) |
| 任意 | 6 | 3 | 1 | 2 | | 12 | 50.0% | 7-8名 | 36 | 淮南 | 14:23 (9:14) |
| 七米 | 3 | | | | | 3 | 100.0% | | | | |

图式射门区域累计

手球
青年男子

截止至第42场

安徽滁州
2019-06-05

山东济南

| | | | | | | | |
|--|---------------------------------------|--------------------------------------|---------------------------------------|--------------------------------------|---------------------------------------|---------------------------------------|---------------------------------------|
| 1 刘在攀 Post - 0 Miss - 0 Block - 0 | 4 张广一 Post - 0 Miss - 1 Block - 1 | 6 刘尊哲 Post - 3 Miss - 5 Block - 3 | 7 王帅 Post - 0 Miss - 4 Block - 0 | 8 金正凯 Post - 0 Miss - 0 Block - 0 | 9 张嘉树 Post - 0 Miss - 1 Block - 0 | 10 颜同霖 Post - 3 Miss - 1 Block - 2 | 11 李延舒 Post - 0 Miss - 0 Block - 0 |
| 13 刘振宇 Post - 3 Miss - 10 Block - 5 | 16 高宇轩 Post - 0 Miss - 0 Block - 0 | 17 张昊 Post - 0 Miss - 0 Block - 0 | 21 杨明毅 Post - 0 Miss - 0 Block - 0 | 24 于昊 Post - 0 Miss - 0 Block - 0 | 26 曹立志 Post - 0 Miss - 0 Block - 0 | 40 鹿智豪 Post - 0 Miss - 0 Block - 0 | 88 王麒翔 Post - 0 Miss - 0 Block - 0 |

1 刘在攀

| | | |
|------|-----|------|
| 2/21 | 2/5 | 2/16 |
| 7/17 | 2/3 | 8/16 |
| 5/32 | 2/4 | 8/28 |

16 高宇轩

| | | |
|-----|--|-----|
| 0/1 | | 0/1 |
| | | |
| | | |

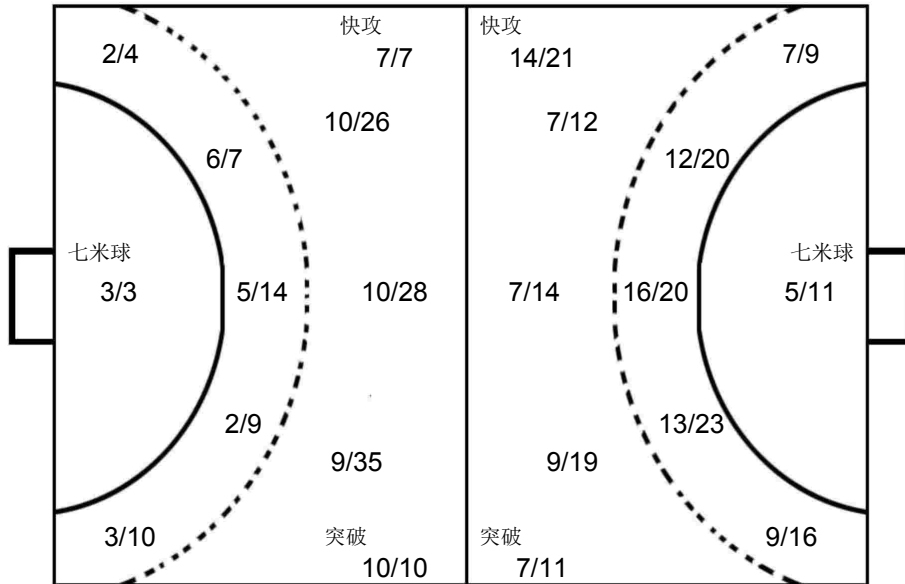

苏州

1 邹明轩

| | | |
|-----|--|-----|
| 0/2 | | 1/5 |
| 1/2 | | 4/5 |
| 0/3 | | 3/4 |

抚顺

2 赫天铭

| | | |
|-----|-----|-----|
| 1/1 | | 2/2 |
| 1/5 | 1/1 | 1/1 |
| 1/4 | | 1/1 |

宝山

66 黄嘉遥

| | | |
|-----|-----|-----|
| 0/3 | 0/1 | 0/2 |
| 1/1 | 1/1 | 0/1 |
| 2/3 | 2/3 | 1/3 |

OPPONENT

| | | | | | | | |
|--|---|---|---|--|---|---|---|
| 淮南 9 杨金龙 Post - 2 Miss - 0 Block - 0 | 抚顺 13 高鑫 Post - 0 Miss - 1 Block - 0 | 宝山 21 曾新宇 Post - 1 Miss - 1 Block - 0 | 苏州 4 孙钊 Post - 0 Miss - 1 Block - 0 | 淮南 8 陈子涵 Post - 0 Miss - 0 Block - 0 | 淮南 10 孙飞扬 Post - 0 Miss - 0 Block - 3 | 宝山 35 刘子杰 Post - 0 Miss - 1 Block - 0 | 安徽 54 姚幸运 Post - 0 Miss - 0 Block - 0 |
| 抚顺 17 杨宇 Post - 0 Miss - 0 Block - 0 | 香港 10 叶滋权 Post - 1 Miss - 0 Block - 0 | 安徽 55 苏凯 Post - 0 Miss - 1 Block - 0 | 安徽 59 毛饶翔 Post - 0 Miss - 0 Block - 0 | 抚顺 9 隋博 Post - 0 Miss - 0 Block - 0 | 抚顺 28 靳皓添 Post - 1 Miss - 0 Block - 0 | 宝山 13 刘启群 Post - 0 Miss - 1 Block - 0 | 香港 27 巫迪涛 Post - 1 Miss - 2 Block - 0 |



| | | |
|-------------------------|--------------------------|--------------------------|
| Team A A 安徽淮南 | Team B B 安徽省体校 | Match Number 4 |
|-------------------------|--------------------------|--------------------------|

| | | | | | |
|--------------------------|-------------------------------|-------------------------|--------------------|-------|------------|
| Played in 安徽滁州 | in the hall 滁州国际手球馆 | on 2019-05-27 | at 17:00 | hours | Spectators |
|--------------------------|-------------------------------|-------------------------|--------------------|-------|------------|

| | | | | | | | | | | | | | | |
|----------------|---------------|----------------|---------------------|----------------|----------------|----------------|---|---|----------------|---|---|----------------------|---|---|
| Half-time(30') | A 5 | B 16 | End of playing time | A 15 | B 26 | 1st extra time | A | B | 2nd extra time | A | B | After penalty throws | A | B |
|----------------|---------------|----------------|---------------------|----------------|----------------|----------------|---|---|----------------|---|---|----------------------|---|---|

| | | | | | | | | | | |
|---------------|-----------------|---------------|---|---|------------------------------------|---------------|---|--|-----------------|---------------|
| Number of 7 m | A 1/2 | Team time-out | | | Full name of players and officials | Team time-out | | | B 1/1 | Number of 7 m |
| | 1 | 2 | 3 | 1 | | 2 | 3 | | | |

| No. | Team A | G | W | 2' | D | DR | No. | Team B | G | W | 2' | D | DR |
|-----|-----------|---|---|----|---|----|-----|--------|---|---|----|---|----|
| 1 | 苟嘉毅 | | | | | | 52 | 花驰 | | | | | |
| 2 | 邹俊洁 | | | | | | 53 | 叶天赐 | | | | | |
| 3 | 童守宣 | 1 | | | | | 54 | 姚幸运 | 4 | | | | |
| 4 | 李攀 | | | | | | 55 | 苏凯 | 3 | | | | |
| 5 | 吴修民 | | | | | | 56 | 王健鹏 | 4 | | | | |
| 6 | 童浩宇 | | | | | | 57 | 朱正翔 | 1 | | 2 | | |
| 7 | 赵琨鹏 | 1 | | | | | 58 | 蔡博飞 | 3 | | | | |
| 8 | 陈子涵 | 2 | | | | | 59 | 毛饶翔 | 1 | | | | |
| 9 | 杨金龙 | 3 | | | | | 60 | 朱超 | 6 | | 1 | | |
| 10 | 孙飞扬 | 7 | | | | | 61 | 钮伟豪 | | | | | |
| 11 | 刘新然 | | | | | | 62 | 赵俊阳 | | | 1 | | |
| 13 | 张昊燃 | 1 | | | | | 64 | 章道胜 | 3 | 1 | | | |
| 14 | 单中宝 | | | | | | 65 | 韩伟伦 | 1 | | | | |
| 15 | 刘淇 | | | | | | 66 | 刘家豪 | | | | | |
| 16 | 胡文柯 | | | | | | 67 | 江文 | | | | | |
| 17 | 徐鹏辉 | | | 1 | | | 68 | 黄天源 | | | 1 | | |
| A | 常洪飞 | | | | | | A | 赵前军 | | | | | |
| B | 阮圣杰 (主教练) | | | | | | C | 吕串 | | | | | |
| | | | | | | | D | 沈强 | | | | | |
| | | | | | | | E | 李煜 | | | | | |

| | | |
|---|--|---|
| A | Signatures of responsables for the teams (Off.A) | B |
|---|--|---|

| | | |
|----|-----------------------------------|----|
| TP | Remarks of referees / HF Official | TP |
|----|-----------------------------------|----|

| | | | |
|------------|-----------|-----------|--|
| Signatures | | | |
| Referees | 王洋 (CHN) | 刘晓辉 (CHN) | |
| T.D. | 吴瑞亭 (CHN) | 徐健 (CHN) | |
| CHA Off. | | | |

Note: Number of 7m Throws Awarded to Team A and B, Goals (G), Warnings (W), Suspensions (2'), Direct Disqualification (D), Disqualification With Report (DR) and Team Penalty (TP).

Table Officials: 刘洋洋 许修凯 Statisticians: 张格 童佩瑶

第二届全国青年运动会男子手球乙组决赛 体校组 (U16)

PHMS Pictorial Handball Match Statistics

IHF Official System

竞赛技术统计

手球
青年男子

预赛
轮次 1

组别 A
场次 4

滁州国际手球馆
2019-05-27 17:00

Referees: 王洋 (CHN) / 刘晓辉 (CHN)
Teams: 安徽淮南(淮南) VS 安徽省体校(安徽)

Result: 15:26 (5:16)

| 淮南 | | 远 | 近 | 边 | 快 | 突 | 任意 | 7m | 合计 | % | 助攻 | 失误 | 警告 | 2' | D+DR |
|----------|-----|------|------|-----|------|-----|----|-----|-------|------|----|----|----|----|------|
| 主教练: 阮圣杰 | | 射 | 射 | 射 | 攻 | 破 | 球 | 球 | | | | | | | |
| 1 | 苟嘉毅 | | | | | | | | | | | 1 | | | |
| 2 | 邹俊洁 | | | 0/1 | | | | | 0/1 | 0.0 | | | | | |
| 3 | 童守宣 | | | | 1/1 | | | | 1/1 | 100 | | 2 | | | |
| 4 | 李攀 | | | | | | | | | | 1 | | | | |
| 5 | 吴修民 | | | | | | | | | | | | | | |
| 6 | 童浩宇 | | | | | | | | | | | | | | |
| 7 | 赵琨鹏 | | 1/1 | | | | | | 1/1 | 100 | | | | | |
| 8 | 陈子涵 | 0/2 | 1/2 | | 1/1 | | | | 2/5 | 40.0 | 1 | 1 | | | |
| 9 | 杨金龙 | 1/7 | 1/3 | | | | | 1/2 | 3/12 | 25.0 | | 5 | | | |
| 10 | 孙飞扬 | 2/4 | 4/4 | 1/1 | | | | | 7/9 | 77.8 | | 3 | | | |
| 11 | 刘新然 | | | | | | | | | | | | | | |
| 13 | 张昊燃 | | 1/1 | | | | | | 1/1 | 100 | | | | | |
| 14 | 单中宝 | | | | | | | | | | | | | | |
| 15 | 刘淇 | | | | | | | | | | | 1 | | | |
| 16 | 胡文柯 | | | | | | | | | | | | | | |
| 17 | 徐鹏辉 | | | | | | | | | | | 1 | | 1 | |
| 运动员 合计 | | 3/13 | 8/11 | 1/2 | 2/2 | | | 1/2 | 15/30 | 50.0 | 1 | 15 | | 1 | |
| 1 | 苟嘉毅 | 0/1 | 1/9 | 1/3 | 2/9 | 1/3 | | 0/1 | 5/26 | 19.2 | | 1 | | | |
| 16 | 胡文柯 | 1/1 | 0/2 | | 0/2 | 0/1 | | | 1/6 | 16.7 | | | | | |
| 守门员 合计 | | 1/2 | 1/11 | 1/3 | 2/11 | 1/4 | | 0/1 | 6/32 | 18.8 | | 1 | | | |

| 安徽 | | 远 | 近 | 边 | 快 | 突 | 任意 | 7m | 合计 | % | 助攻 | 失误 | 警告 | 2' | D+DR |
|---------|-----|-----|-------|-----|------|-----|----|-----|-------|------|----|----|----|----|------|
| 主教练: 张林 | | 射 | 射 | 射 | 攻 | 破 | 球 | 球 | | | | | | | |
| 52 | 花驰 | | | | | | | | | | | | | | |
| 53 | 叶天赐 | | | | | | | | | | | | | | |
| 54 | 姚幸运 | | 1/1 | 1/1 | 1/2 | 1/1 | | | 4/5 | 80.0 | | | | | |
| 55 | 苏凯 | | 2/2 | 0/1 | 1/1 | | | | 3/4 | 75.0 | | | | | |
| 56 | 王健鹏 | | 2/2 | | 1/1 | 1/1 | | | 4/4 | 100 | | | | | |
| 57 | 朱正翔 | 0/2 | | 1/1 | | | | | 1/3 | 33.3 | | 1 | | 2 | |
| 58 | 蔡博飞 | 1/1 | 1/1 | | 1/1 | 0/1 | | | 3/4 | 75.0 | | 1 | | | |
| 59 | 毛饶翔 | 0/1 | | | | | | 1/1 | 1/2 | 50.0 | 1 | | | | |
| 60 | 朱超 | | 4/4 | | 1/1 | 1/1 | | | 6/6 | 100 | | 1 | | 1 | |
| 61 | 钮伟豪 | | | | | | | | | | | | | | |
| 62 | 赵俊阳 | | | | 0/1 | | | | 0/1 | 0.0 | | 1 | | 1 | |
| 64 | 章道胜 | | | | 3/3 | | | | 3/3 | 100 | | | 1 | | |
| 65 | 韩伟伦 | | | | 1/1 | | | | 1/1 | 100 | | | | | |
| 66 | 刘家豪 | 0/1 | | | | | | | 0/1 | 0.0 | 1 | 1 | | | |
| 67 | 江文 | | | | | | | | | | | | | | |
| 68 | 黄天源 | | 0/1 | | | | | | 0/1 | 0.0 | | 1 | | 1 | |
| 运动员 合计 | | 1/5 | 10/11 | 2/3 | 9/11 | 3/4 | | 1/1 | 26/35 | 74.3 | 2 | 6 | 1 | 5 | |
| 52 | 花驰 | 4/5 | 1/5 | 1/1 | | | | | 6/11 | 54.5 | | | | | |
| 53 | 叶天赐 | | 0/3 | | | | | | 0/3 | 0.0 | | | | | |
| 67 | 江文 | 2/4 | 0/1 | 0/1 | 0/2 | | | 0/1 | 2/9 | 22.2 | | | | | |
| 守门员 合计 | | 6/9 | 1/9 | 1/2 | 0/2 | | | 0/1 | 8/23 | 34.8 | | | | | |

| 淮南 | 比赛 进程 | 安徽 |
|----------|----------|-----------|
| 1st Half | | |
| | 0 00:31 | 1 54 姚幸运 |
| | 0 01:13 | 2 55 苏凯 |
| | 0 01:46 | 3 56 王健鹏 |
| 10 孙飞扬 | 1 02:17 | 3 |
| | 1 02:37 | 4 57 朱正翔 |
| | 1 04:47 | 5 64 章道胜 |
| | 1 05:32 | 6 59 毛饶翔 |
| | 1 06:11 | 7 64 章道胜 |
| | 1 06:57 | 8 56 王健鹏 |
| | 1 07:34 | 9 60 朱超 |
| 8 陈子涵 | 2 07:44 | 9 |
| | 2 08:24 | 10 60 朱超 |
| | 2 08:51 | 11 64 章道胜 |
| | 2 09:18 | 12 55 苏凯 |
| | 2 09:57 | 13 58 蔡博飞 |
| 10 孙飞扬 | 3 10:33 | 13 |
| | 3 11:09 | 14 55 苏凯 |
| 10 孙飞扬 | 4 11:38 | 14 |
| 10 孙飞扬 | 5 13:18 | 14 |
| | 5 13:35 | 15 56 王健鹏 |
| | 5 14:38 | 16 56 王健鹏 |
| 2nd Half | | |
| 10 孙飞扬 | 6 00:32 | 16 |
| | 6 00:54 | 17 58 蔡博飞 |
| 10 孙飞扬 | 7 01:16 | 17 |
| 8 陈子涵 | 8 02:04 | 17 |
| | 8 02:27 | 18 58 蔡博飞 |
| | 8 03:34 | 19 54 姚幸运 |
| | 8 06:57 | 20 54 姚幸运 |
| 9 杨金龙 | 9 07:20 | 20 |
| 3 童守宣 | 10 07:53 | 20 |
| | 10 08:04 | 21 60 朱超 |
| 10 孙飞扬 | 11 08:20 | 21 |
| | 11 09:54 | 22 60 朱超 |
| | 11 10:07 | 23 60 朱超 |
| 9 杨金龙 | 12 10:31 | 23 |
| | 12 12:07 | 24 54 姚幸运 |
| 13 张昊燃 | 13 12:23 | 24 |
| 7 赵琨鹏 | 14 13:17 | 24 |
| | 14 13:43 | 25 60 朱超 |
| 9 杨金龙 | 15 13:53 | 25 |
| | 15 14:51 | 26 65 韩伟伦 |

场上队员: 得分 / 射门

守门员: 救球 / 射门

| | | | |
|---|------|----|---------|
| D | 取消资格 | DR | 取消资格+报告 |
|---|------|----|---------|



个人/全队技术统计表

手球 预赛 组别 A 滁州国际手球馆
青年男子 轮次 1 场次 4 2019-05-27 17:00

| 号码 | 姓名 | 远射 | 近射 | 边射 | 快攻 | 突破 | 任意 | 七米 | 合计 | % | 助攻 | 失误 | 警告 | 2' | 取消 | 时间 |
|-----------------|-----------|-------------|-------------|------------|-------------|------------|----|------------|--------------|--------------|----------|-----------|----|----------|----|----------|
| 安徽淮南(淮南) | | | | | | | | | | | | | | | | |
| (场上队员) | | | | | | | | | | | | | | | | |
| 1 | 苟嘉毅 | | | | | | | | | 0.0% | | 1 | | | | 00:24:03 |
| 2 | 邹俊洁 | | | 0/1 | | | | | 0/1 | 0.0% | | | | | | 00:11:08 |
| 3 | 童守宣 | | | | 1/1 | | | | 1/1 | 100% | | 2 | | | | 00:15:00 |
| 4 | 李攀 | | | | | | | | | 0.0% | | 1 | | | | 00:12:37 |
| 5 | 吴修民 | | | | | | | | | 0.0% | | | | | | 00:00:00 |
| 6 | 童浩宇 | | | | | | | | | 0.0% | | | | | | 00:03:50 |
| 7 | 赵琨鹏 | | 1/1 | | | | | | 1/1 | 100% | | | | | | 00:04:24 |
| 8 | 陈子涵 | 0/2 | 1/2 | | 1/1 | | | | 2/5 | 40.0% | 1 | 1 | | | | 00:25:35 |
| 9 | 杨金龙 | 1/7 | 1/3 | | | | | 1/2 | 3/12 | 25.0% | | 5 | | | | 00:30:00 |
| 10 | 孙飞扬 | 2/4 | 4/4 | 1/1 | | | | | 7/9 | 77.8% | | 3 | | | | 00:26:26 |
| 11 | 刘新然 | | | | | | | | | 0.0% | | | | | | 00:03:32 |
| 13 | 张昊燃 | | 1/1 | | | | | | 1/1 | 100% | | | | | | 00:13:41 |
| 14 | 单中宝 | | | | | | | | | 0.0% | | | | | | 00:00:00 |
| 15 | 刘淇 | | | | | | | | | 0.0% | | 1 | | | | 00:15:00 |
| 16 | 胡文柯 | | | | | | | | | 0.0% | | | | | | 00:05:57 |
| 17 | 徐鹏辉 | | | | | | | | | 0.0% | | 1 | | 1 | | 00:18:39 |
| | 合计 | 3/13 | 8/11 | 1/2 | 2/2 | | | 1/2 | 15/30 | 50.0% | 1 | 15 | | 1 | | |
| (守门员) | | | | | | | | | | | | | | | | |
| 1 | 苟嘉毅 | 0/1 | 1/9 | 1/3 | 2/9 | 1/3 | | 0/1 | 5/26 | 19.2% | | 1 | | | | 00:24:03 |
| 16 | 胡文柯 | 1/1 | 0/2 | | 0/2 | 0/1 | | | 1/6 | 16.7% | | | | | | 00:05:57 |
| | 合计 | 1/2 | 1/11 | 1/3 | 2/11 | 1/4 | | 0/1 | 6/32 | 18.8% | | 1 | | | | |

场上队员：得分/射门

守门员：救球/射门

| 全队合计 | 得分 | 被救 | 射失 | 击柱 | 封球 | 合计 | % |
|------|----|----|----|----|----|----|--------|
| 远射 | 3 | 6 | 3 | | 1 | 13 | 23.1% |
| 近射 | 8 | 1 | | 2 | | 11 | 72.7% |
| 边射 | 1 | 1 | | | | 2 | 50.0% |
| 快攻 | 2 | | | | | 2 | 100.0% |
| 突破 | | | | | | | 0.0% |
| 任意 | | | | | | | 0.0% |
| 七米 | 1 | | 1 | | | 2 | 50.0% |

个人/全队技术统计表

手球 青年男子 预赛 轮次 1 组别 A 场次 4 滁州国际手球馆 2019-05-27 17:00

| 号码 | 姓名 | 远射 | 近射 | 边射 | 快攻 | 突破 | 任意 | 七米 | 合计 | % | 助攻 | 失误 | 警告 | 2' | 取消 | 时间 |
|-----------|-----|-----|-------|-----|------|-----|----|-----|-------|-------|----|----|----|----|----|----------|
| 安徽省体校(安徽) | | | | | | | | | | | | | | | | |
| (场上队员) | | | | | | | | | | | | | | | | |
| 52 | 花驰 | | | | | | | | 4/5 | 80.0% | | | | | | 00:15:00 |
| 53 | 叶天赐 | | | | | | | | 3/4 | 75.0% | | | | | | 00:03:07 |
| 54 | 姚幸运 | | 1/1 | 1/1 | 1/2 | 1/1 | | | 4/4 | 100% | | | | | | 00:19:41 |
| 55 | 苏凯 | | 2/2 | 0/1 | 1/1 | | | | 4/4 | 100% | | | | | | 00:15:00 |
| 56 | 王健鹏 | | 2/2 | | 1/1 | 1/1 | | | 4/4 | 100% | | | | | | 00:15:00 |
| 57 | 朱正翔 | 0/2 | | 1/1 | | | | | 1/3 | 33.3% | | 1 | | 2 | | 00:19:48 |
| 58 | 蔡博飞 | 1/1 | 1/1 | | 1/1 | 0/1 | | | 3/4 | 75.0% | | 1 | | | | 00:12:01 |
| 59 | 毛饶翔 | 0/1 | | | | | | 1/1 | 1/2 | 50.0% | 1 | | | | | 00:18:04 |
| 60 | 朱超 | | 4/4 | | 1/1 | 1/1 | | | 6/6 | 100% | | 1 | | 1 | | 00:29:55 |
| 61 | 钮伟豪 | | | | | | | | | 0.0% | | | | | | 00:02:01 |
| 62 | 赵俊阳 | | | | 0/1 | | | | 0/1 | 0.0% | | 1 | | 1 | | 00:14:58 |
| 64 | 章道胜 | | | | 3/3 | | | | 3/3 | 100% | | | 1 | | | 00:05:08 |
| 65 | 韩伟伦 | | | | 1/1 | | | | 1/1 | 100% | | | | | | 00:01:54 |
| 66 | 刘家豪 | 0/1 | | | | | | | 0/1 | 0.0% | 1 | 1 | | | | 00:07:28 |
| 67 | 江文 | | | | | | | | | 0.0% | | | | | | 00:11:53 |
| 68 | 黄天源 | | 0/1 | | | | | | 0/1 | 0.0% | | 1 | | 1 | | 00:19:41 |
| 合计 | | 1/5 | 10/11 | 2/3 | 9/11 | 3/4 | | 1/1 | 26/35 | 74.3% | 2 | 6 | 1 | 5 | | |

(守门员)

| | | | | | | | | | | | | | | | | |
|----|-----|-----|-----|-----|-----|--|--|-----|------|-------|--|--|--|--|--|----------|
| 52 | 花驰 | 4/5 | 1/5 | 1/1 | | | | | 6/11 | 54.5% | | | | | | 00:15:00 |
| 53 | 叶天赐 | | 0/3 | | | | | | 0/3 | 0.0% | | | | | | 00:03:07 |
| 67 | 江文 | 2/4 | 0/1 | 0/1 | 0/2 | | | 0/1 | 2/9 | 22.2% | | | | | | 00:11:53 |
| 合计 | | 6/9 | 1/9 | 1/2 | 0/2 | | | 0/1 | 8/23 | 34.8% | | | | | | |

场上队员：得分/射门

守门员：救球/射门

| 全队合计 | 得分 | 被救 | 射失 | 击柱 | 封球 | 合计 | % |
|------|----|----|----|----|----|----|--------|
| 远射 | 1 | 1 | 1 | 2 | | 5 | 20.0% |
| 近射 | 10 | 1 | | | | 11 | 90.9% |
| 边射 | 2 | 1 | | | | 3 | 66.7% |
| 快攻 | 9 | 2 | | | | 11 | 81.8% |
| 突破 | 3 | 1 | | | | 4 | 75.0% |
| 任意 | | | | | | | 0.0% |
| 七米 | 1 | | | | | 1 | 100.0% |

图式比赛技术统计表

手球
青年男子

预赛
轮次 1

组别 A
场次 4

滁州国际手球馆
2019-05-27 17:00

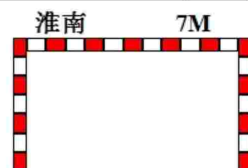
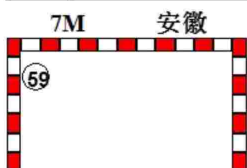
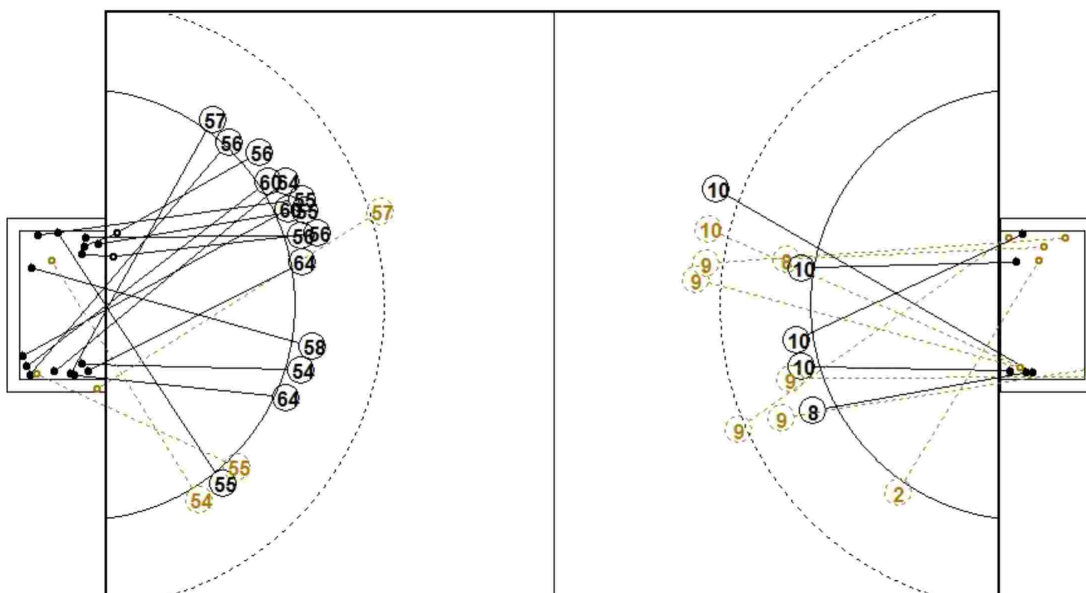

1st Half
16 : 5

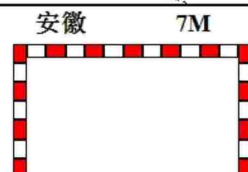
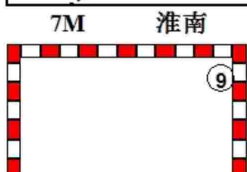
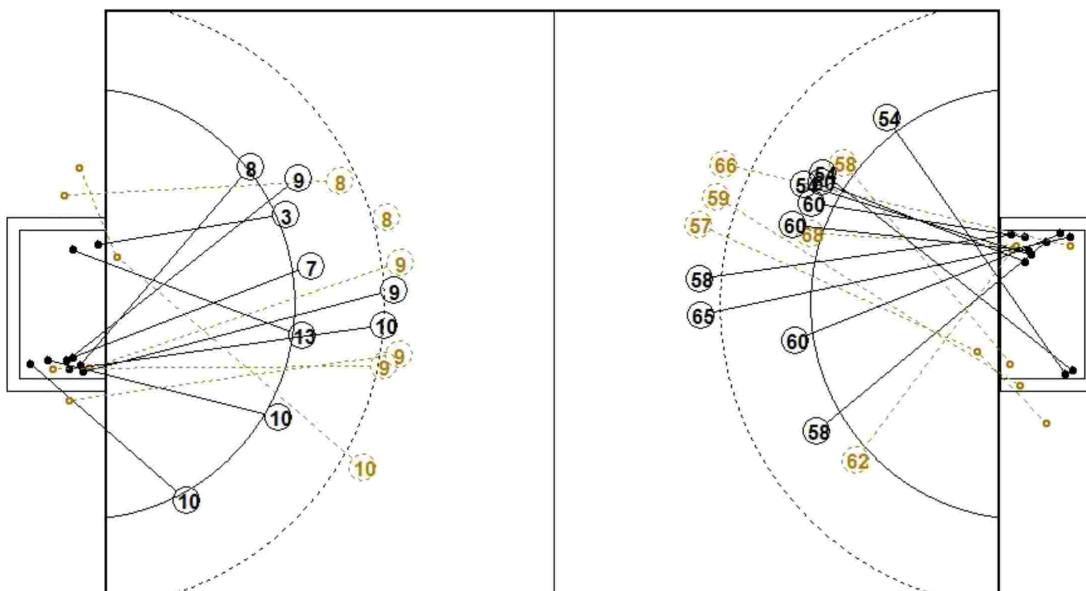

2nd Half
15 : 26

图式射门区域统计

手球
青年男子

预赛
轮次 1

组别 A
场次 4

滁州国际手球馆
2019-05-27 17:00

安徽淮南

| | | | | | | | | | | | | | | | | | | | | | | | | | | | | | | | | | | | | | | | | | | | | | | | | | | | | | | | | | | | | | | | | | | | | | | | | | | | | | | | |
|---|-----------------------------|-----------------------------|-----------------------------|-----------------------------|-----------------------------|-----------------------------|-----------------------------|--|--|---|---|--|--|---|--|---|---|--|---|---|--|--|--|--|--|--|--|--|---|---|--|--|--|--|--|---|--|--|--|--|--|--|--|--|--|--|--|--|--|--|--|--|--|--|--|--|--|--|--|---|--|--|--|---|--|--|--|--|--|--|--|--|--|--|--|--|---|--|---|
| 1 苟嘉毅 | 2 邹俊洁 | 3 童守宣 | 4 李攀 | 5 吴修民 | 6 童浩宇 | 7 赵琨鹏 | 8 陈子涵 | | | | | | | | | | | | | | | | | | | | | | | | | | | | | | | | | | | | | | | | | | | | | | | | | | | | | | | | | | | | | | | | | | | | | | | | |
| <table border="1"><tr><td></td><td></td><td></td></tr><tr><td></td><td></td><td></td></tr><tr><td></td><td></td><td></td></tr></table> | | | | | | | | | | <table border="1"><tr><td></td><td></td><td></td></tr><tr><td></td><td></td><td></td></tr><tr><td></td><td></td><td></td></tr></table> | | | | | | | | | | <table border="1"><tr><td></td><td></td><td></td></tr><tr><td></td><td></td><td></td></tr><tr><td></td><td></td><td>1</td></tr></table> | | | | | | | | | 1 | <table border="1"><tr><td></td><td></td><td></td></tr><tr><td></td><td></td><td></td></tr><tr><td></td><td></td><td></td></tr></table> | | | | | | | | | | <table border="1"><tr><td></td><td></td><td></td></tr><tr><td></td><td></td><td></td></tr><tr><td></td><td></td><td></td></tr></table> | | | | | | | | | | <table border="1"><tr><td></td><td></td><td></td></tr><tr><td></td><td></td><td></td></tr><tr><td></td><td></td><td></td></tr></table> | | | | | | | | | | <table border="1"><tr><td></td><td></td><td></td></tr><tr><td>1</td><td></td><td></td></tr><tr><td></td><td></td><td></td></tr></table> | | | | 1 | | | | | | <table border="1"><tr><td></td><td></td><td></td></tr><tr><td></td><td></td><td></td></tr><tr><td>1</td><td></td><td>1</td></tr></table> | | | | | | | 1 | | 1 |
| | | | | | | | | | | | | | | | | | | | | | | | | | | | | | | | | | | | | | | | | | | | | | | | | | | | | | | | | | | | | | | | | | | | | | | | | | | | | | | | |
| | | | | | | | | | | | | | | | | | | | | | | | | | | | | | | | | | | | | | | | | | | | | | | | | | | | | | | | | | | | | | | | | | | | | | | | | | | | | | | | |
| | | | | | | | | | | | | | | | | | | | | | | | | | | | | | | | | | | | | | | | | | | | | | | | | | | | | | | | | | | | | | | | | | | | | | | | | | | | | | | | |
| | | | | | | | | | | | | | | | | | | | | | | | | | | | | | | | | | | | | | | | | | | | | | | | | | | | | | | | | | | | | | | | | | | | | | | | | | | | | | | | |
| | | | | | | | | | | | | | | | | | | | | | | | | | | | | | | | | | | | | | | | | | | | | | | | | | | | | | | | | | | | | | | | | | | | | | | | | | | | | | | | |
| | | | | | | | | | | | | | | | | | | | | | | | | | | | | | | | | | | | | | | | | | | | | | | | | | | | | | | | | | | | | | | | | | | | | | | | | | | | | | | | |
| | | | | | | | | | | | | | | | | | | | | | | | | | | | | | | | | | | | | | | | | | | | | | | | | | | | | | | | | | | | | | | | | | | | | | | | | | | | | | | | |
| | | | | | | | | | | | | | | | | | | | | | | | | | | | | | | | | | | | | | | | | | | | | | | | | | | | | | | | | | | | | | | | | | | | | | | | | | | | | | | | |
| | | 1 | | | | | | | | | | | | | | | | | | | | | | | | | | | | | | | | | | | | | | | | | | | | | | | | | | | | | | | | | | | | | | | | | | | | | | | | | | | | | |
| | | | | | | | | | | | | | | | | | | | | | | | | | | | | | | | | | | | | | | | | | | | | | | | | | | | | | | | | | | | | | | | | | | | | | | | | | | | | | | | |
| | | | | | | | | | | | | | | | | | | | | | | | | | | | | | | | | | | | | | | | | | | | | | | | | | | | | | | | | | | | | | | | | | | | | | | | | | | | | | | | |
| | | | | | | | | | | | | | | | | | | | | | | | | | | | | | | | | | | | | | | | | | | | | | | | | | | | | | | | | | | | | | | | | | | | | | | | | | | | | | | | |
| | | | | | | | | | | | | | | | | | | | | | | | | | | | | | | | | | | | | | | | | | | | | | | | | | | | | | | | | | | | | | | | | | | | | | | | | | | | | | | | |
| | | | | | | | | | | | | | | | | | | | | | | | | | | | | | | | | | | | | | | | | | | | | | | | | | | | | | | | | | | | | | | | | | | | | | | | | | | | | | | | |
| | | | | | | | | | | | | | | | | | | | | | | | | | | | | | | | | | | | | | | | | | | | | | | | | | | | | | | | | | | | | | | | | | | | | | | | | | | | | | | | |
| | | | | | | | | | | | | | | | | | | | | | | | | | | | | | | | | | | | | | | | | | | | | | | | | | | | | | | | | | | | | | | | | | | | | | | | | | | | | | | | |
| | | | | | | | | | | | | | | | | | | | | | | | | | | | | | | | | | | | | | | | | | | | | | | | | | | | | | | | | | | | | | | | | | | | | | | | | | | | | | | | |
| | | | | | | | | | | | | | | | | | | | | | | | | | | | | | | | | | | | | | | | | | | | | | | | | | | | | | | | | | | | | | | | | | | | | | | | | | | | | | | | |
| | | | | | | | | | | | | | | | | | | | | | | | | | | | | | | | | | | | | | | | | | | | | | | | | | | | | | | | | | | | | | | | | | | | | | | | | | | | | | | | |
| 1 | | | | | | | | | | | | | | | | | | | | | | | | | | | | | | | | | | | | | | | | | | | | | | | | | | | | | | | | | | | | | | | | | | | | | | | | | | | | | | | |
| | | | | | | | | | | | | | | | | | | | | | | | | | | | | | | | | | | | | | | | | | | | | | | | | | | | | | | | | | | | | | | | | | | | | | | | | | | | | | | | |
| | | | | | | | | | | | | | | | | | | | | | | | | | | | | | | | | | | | | | | | | | | | | | | | | | | | | | | | | | | | | | | | | | | | | | | | | | | | | | | | |
| | | | | | | | | | | | | | | | | | | | | | | | | | | | | | | | | | | | | | | | | | | | | | | | | | | | | | | | | | | | | | | | | | | | | | | | | | | | | | | | |
| 1 | | 1 | | | | | | | | | | | | | | | | | | | | | | | | | | | | | | | | | | | | | | | | | | | | | | | | | | | | | | | | | | | | | | | | | | | | | | | | | | | | | |
| Post - 0 Miss - 0 Block - 0 | Post - 0 Miss - 0 Block - 0 | Post - 0 Miss - 0 Block - 0 | Post - 0 Miss - 0 Block - 0 | Post - 0 Miss - 0 Block - 0 | Post - 0 Miss - 0 Block - 0 | Post - 0 Miss - 0 Block - 0 | Post - 0 Miss - 0 Block - 0 | | | | | | | | | | | | | | | | | | | | | | | | | | | | | | | | | | | | | | | | | | | | | | | | | | | | | | | | | | | | | | | | | | | | | | | | |
| 9 杨金龙 | 10 孙飞扬 | 11 刘新然 | 13 张昊燃 | 14 单中宝 | 15 刘淇 | 16 胡文柯 | 17 徐鹏辉 | | | | | | | | | | | | | | | | | | | | | | | | | | | | | | | | | | | | | | | | | | | | | | | | | | | | | | | | | | | | | | | | | | | | | | | | |
| <table border="1"><tr><td></td><td></td><td>1</td></tr><tr><td>1</td><td></td><td></td></tr><tr><td>1</td><td></td><td></td></tr></table> | | | 1 | 1 | | | 1 | | | <table border="1"><tr><td>2</td><td></td><td></td></tr><tr><td>1</td><td></td><td>1</td></tr><tr><td>2</td><td></td><td>1</td></tr></table> | 2 | | | 1 | | 1 | 2 | | 1 | <table border="1"><tr><td></td><td></td><td></td></tr><tr><td></td><td></td><td></td></tr><tr><td></td><td></td><td></td></tr></table> | | | | | | | | | | <table border="1"><tr><td></td><td></td><td></td></tr><tr><td></td><td></td><td>1</td></tr><tr><td></td><td></td><td></td></tr></table> | | | | | | 1 | | | | <table border="1"><tr><td></td><td></td><td></td></tr><tr><td></td><td></td><td></td></tr><tr><td></td><td></td><td></td></tr></table> | | | | | | | | | | <table border="1"><tr><td></td><td></td><td></td></tr><tr><td></td><td></td><td></td></tr><tr><td></td><td></td><td></td></tr></table> | | | | | | | | | | <table border="1"><tr><td></td><td></td><td></td></tr><tr><td></td><td></td><td></td></tr><tr><td></td><td></td><td></td></tr></table> | | | | | | | | | | <table border="1"><tr><td></td><td></td><td></td></tr><tr><td></td><td></td><td></td></tr><tr><td></td><td></td><td></td></tr></table> | | | | | | | | | |
| | | 1 | | | | | | | | | | | | | | | | | | | | | | | | | | | | | | | | | | | | | | | | | | | | | | | | | | | | | | | | | | | | | | | | | | | | | | | | | | | | | |
| 1 | | | | | | | | | | | | | | | | | | | | | | | | | | | | | | | | | | | | | | | | | | | | | | | | | | | | | | | | | | | | | | | | | | | | | | | | | | | | | | | |
| 1 | | | | | | | | | | | | | | | | | | | | | | | | | | | | | | | | | | | | | | | | | | | | | | | | | | | | | | | | | | | | | | | | | | | | | | | | | | | | | | | |
| 2 | | | | | | | | | | | | | | | | | | | | | | | | | | | | | | | | | | | | | | | | | | | | | | | | | | | | | | | | | | | | | | | | | | | | | | | | | | | | | | | |
| 1 | | 1 | | | | | | | | | | | | | | | | | | | | | | | | | | | | | | | | | | | | | | | | | | | | | | | | | | | | | | | | | | | | | | | | | | | | | | | | | | | | | |
| 2 | | 1 | | | | | | | | | | | | | | | | | | | | | | | | | | | | | | | | | | | | | | | | | | | | | | | | | | | | | | | | | | | | | | | | | | | | | | | | | | | | | |
| | | | | | | | | | | | | | | | | | | | | | | | | | | | | | | | | | | | | | | | | | | | | | | | | | | | | | | | | | | | | | | | | | | | | | | | | | | | | | | | |
| | | | | | | | | | | | | | | | | | | | | | | | | | | | | | | | | | | | | | | | | | | | | | | | | | | | | | | | | | | | | | | | | | | | | | | | | | | | | | | | |
| | | | | | | | | | | | | | | | | | | | | | | | | | | | | | | | | | | | | | | | | | | | | | | | | | | | | | | | | | | | | | | | | | | | | | | | | | | | | | | | |
| | | | | | | | | | | | | | | | | | | | | | | | | | | | | | | | | | | | | | | | | | | | | | | | | | | | | | | | | | | | | | | | | | | | | | | | | | | | | | | | |
| | | 1 | | | | | | | | | | | | | | | | | | | | | | | | | | | | | | | | | | | | | | | | | | | | | | | | | | | | | | | | | | | | | | | | | | | | | | | | | | | | | |
| | | | | | | | | | | | | | | | | | | | | | | | | | | | | | | | | | | | | | | | | | | | | | | | | | | | | | | | | | | | | | | | | | | | | | | | | | | | | | | | |
| | | | | | | | | | | | | | | | | | | | | | | | | | | | | | | | | | | | | | | | | | | | | | | | | | | | | | | | | | | | | | | | | | | | | | | | | | | | | | | | |
| | | | | | | | | | | | | | | | | | | | | | | | | | | | | | | | | | | | | | | | | | | | | | | | | | | | | | | | | | | | | | | | | | | | | | | | | | | | | | | | |
| | | | | | | | | | | | | | | | | | | | | | | | | | | | | | | | | | | | | | | | | | | | | | | | | | | | | | | | | | | | | | | | | | | | | | | | | | | | | | | | |
| | | | | | | | | | | | | | | | | | | | | | | | | | | | | | | | | | | | | | | | | | | | | | | | | | | | | | | | | | | | | | | | | | | | | | | | | | | | | | | | |
| | | | | | | | | | | | | | | | | | | | | | | | | | | | | | | | | | | | | | | | | | | | | | | | | | | | | | | | | | | | | | | | | | | | | | | | | | | | | | | | |
| | | | | | | | | | | | | | | | | | | | | | | | | | | | | | | | | | | | | | | | | | | | | | | | | | | | | | | | | | | | | | | | | | | | | | | | | | | | | | | | |
| | | | | | | | | | | | | | | | | | | | | | | | | | | | | | | | | | | | | | | | | | | | | | | | | | | | | | | | | | | | | | | | | | | | | | | | | | | | | | | | |
| | | | | | | | | | | | | | | | | | | | | | | | | | | | | | | | | | | | | | | | | | | | | | | | | | | | | | | | | | | | | | | | | | | | | | | | | | | | | | | | |
| | | | | | | | | | | | | | | | | | | | | | | | | | | | | | | | | | | | | | | | | | | | | | | | | | | | | | | | | | | | | | | | | | | | | | | | | | | | | | | | |
| | | | | | | | | | | | | | | | | | | | | | | | | | | | | | | | | | | | | | | | | | | | | | | | | | | | | | | | | | | | | | | | | | | | | | | | | | | | | | | | |
| | | | | | | | | | | | | | | | | | | | | | | | | | | | | | | | | | | | | | | | | | | | | | | | | | | | | | | | | | | | | | | | | | | | | | | | | | | | | | | | |
| | | | | | | | | | | | | | | | | | | | | | | | | | | | | | | | | | | | | | | | | | | | | | | | | | | | | | | | | | | | | | | | | | | | | | | | | | | | | | | | |
| Post - 2 Miss - 2 Block - 0 | Post - 0 Miss - 1 Block - 0 | Post - 0 Miss - 0 Block - 0 | Post - 0 Miss - 0 Block - 0 | Post - 0 Miss - 0 Block - 0 | Post - 0 Miss - 0 Block - 0 | Post - 0 Miss - 0 Block - 0 | Post - 0 Miss - 0 Block - 0 | | | | | | | | | | | | | | | | | | | | | | | | | | | | | | | | | | | | | | | | | | | | | | | | | | | | | | | | | | | | | | | | | | | | | | | | |

1 苟嘉毅

| | | |
|-----|--|-----|
| 1/5 | | 0/4 |
| 0/5 | | 1/2 |
| 2/5 | | 1/5 |

16 胡文柯

| | | |
|-----|--|--|
| 1/3 | | |
| 0/1 | | |
| 0/2 | | |

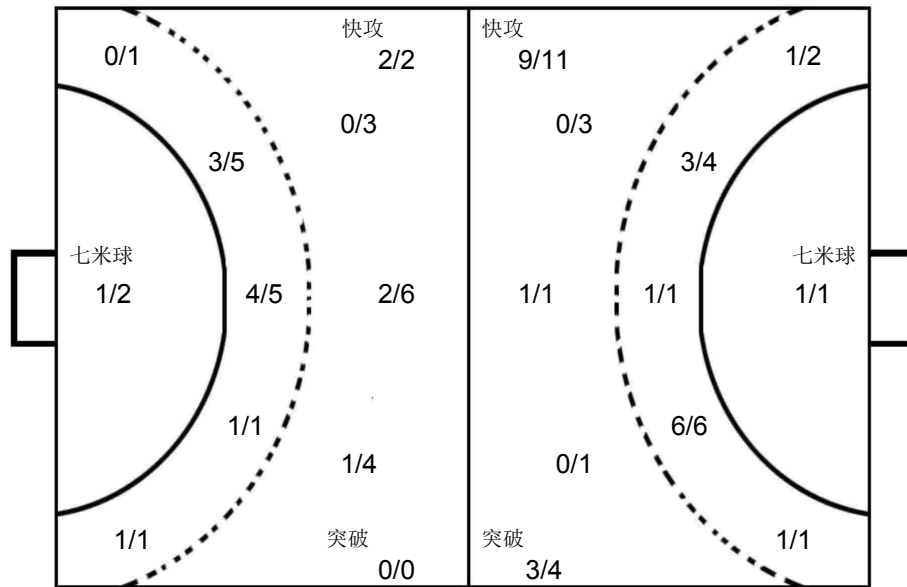

52 花驰

| | | |
|-----|--|-----|
| 1/1 | | |
| 2/2 | | 0/1 |
| 1/3 | | 2/4 |

53 叶天赐

| | | |
|-----|--|-----|
| | | |
| 0/2 | | 0/1 |
| | | |

67 江文

| | | |
|-----|--|-----|
| 0/2 | | 0/1 |
| 1/2 | | |
| 1/3 | | 0/1 |

安徽省体校

| | | | | | | | | | | | | | | | | | | | | | | | | | | | | | | | | | | | | | | | | | | | | | | | | | | | | | | | | | | | | | | | | | | | | | | | | | | | | | | | |
|---|-----------------------------|-----------------------------|-----------------------------|-----------------------------|-----------------------------|-----------------------------|-----------------------------|--|--|--|--|--|--|--|--|--|--|--|--|---|--|--|---|---|--|--|---|--|--|---|--|--|---|---|--|---|---|--|---|--|---|--|--|--|--|--|--|--|---|---|--|--|--|---|--|--|--|--|--|---|--|--|---|---|--|--|---|--|--|---|---|--|--|--|--|--|--|--|--|
| 52 花驰 | 53 叶天赐 | 54 姚幸运 | 55 苏凯 | 56 王健鹏 | 57 朱正翔 | 58 蔡博飞 | 59 毛饶翔 | | | | | | | | | | | | | | | | | | | | | | | | | | | | | | | | | | | | | | | | | | | | | | | | | | | | | | | | | | | | | | | | | | | | | | | | |
| <table border="1"><tr><td></td><td></td><td></td></tr><tr><td></td><td></td><td></td></tr><tr><td></td><td></td><td></td></tr></table> | | | | | | | | | | <table border="1"><tr><td></td><td></td><td></td></tr><tr><td></td><td></td><td></td></tr><tr><td></td><td></td><td></td></tr></table> | | | | | | | | | | <table border="1"><tr><td></td><td></td><td>2</td></tr><tr><td>1</td><td></td><td></td></tr><tr><td>1</td><td></td><td></td></tr></table> | | | 2 | 1 | | | 1 | | | <table border="1"><tr><td></td><td></td><td>1</td></tr><tr><td></td><td></td><td>1</td></tr><tr><td></td><td></td><td>1</td></tr></table> | | | 1 | | | 1 | | | 1 | <table border="1"><tr><td>1</td><td></td><td></td></tr><tr><td></td><td></td><td></td></tr><tr><td></td><td></td><td>3</td></tr></table> | 1 | | | | | | | | 3 | <table border="1"><tr><td></td><td></td><td></td></tr><tr><td>1</td><td></td><td></td></tr><tr><td></td><td></td><td></td></tr></table> | | | | 1 | | | | | | <table border="1"><tr><td></td><td></td><td>1</td></tr><tr><td>1</td><td></td><td></td></tr><tr><td>1</td><td></td><td></td></tr></table> | | | 1 | 1 | | | 1 | | | <table border="1"><tr><td>1</td><td></td><td></td></tr><tr><td></td><td></td><td></td></tr><tr><td></td><td></td><td></td></tr></table> | 1 | | | | | | | | |
| | | | | | | | | | | | | | | | | | | | | | | | | | | | | | | | | | | | | | | | | | | | | | | | | | | | | | | | | | | | | | | | | | | | | | | | | | | | | | | | |
| | | | | | | | | | | | | | | | | | | | | | | | | | | | | | | | | | | | | | | | | | | | | | | | | | | | | | | | | | | | | | | | | | | | | | | | | | | | | | | | |
| | | | | | | | | | | | | | | | | | | | | | | | | | | | | | | | | | | | | | | | | | | | | | | | | | | | | | | | | | | | | | | | | | | | | | | | | | | | | | | | |
| | | | | | | | | | | | | | | | | | | | | | | | | | | | | | | | | | | | | | | | | | | | | | | | | | | | | | | | | | | | | | | | | | | | | | | | | | | | | | | | |
| | | | | | | | | | | | | | | | | | | | | | | | | | | | | | | | | | | | | | | | | | | | | | | | | | | | | | | | | | | | | | | | | | | | | | | | | | | | | | | | |
| | | | | | | | | | | | | | | | | | | | | | | | | | | | | | | | | | | | | | | | | | | | | | | | | | | | | | | | | | | | | | | | | | | | | | | | | | | | | | | | |
| | | 2 | | | | | | | | | | | | | | | | | | | | | | | | | | | | | | | | | | | | | | | | | | | | | | | | | | | | | | | | | | | | | | | | | | | | | | | | | | | | | |
| 1 | | | | | | | | | | | | | | | | | | | | | | | | | | | | | | | | | | | | | | | | | | | | | | | | | | | | | | | | | | | | | | | | | | | | | | | | | | | | | | | |
| 1 | | | | | | | | | | | | | | | | | | | | | | | | | | | | | | | | | | | | | | | | | | | | | | | | | | | | | | | | | | | | | | | | | | | | | | | | | | | | | | | |
| | | 1 | | | | | | | | | | | | | | | | | | | | | | | | | | | | | | | | | | | | | | | | | | | | | | | | | | | | | | | | | | | | | | | | | | | | | | | | | | | | | |
| | | 1 | | | | | | | | | | | | | | | | | | | | | | | | | | | | | | | | | | | | | | | | | | | | | | | | | | | | | | | | | | | | | | | | | | | | | | | | | | | | | |
| | | 1 | | | | | | | | | | | | | | | | | | | | | | | | | | | | | | | | | | | | | | | | | | | | | | | | | | | | | | | | | | | | | | | | | | | | | | | | | | | | | |
| 1 | | | | | | | | | | | | | | | | | | | | | | | | | | | | | | | | | | | | | | | | | | | | | | | | | | | | | | | | | | | | | | | | | | | | | | | | | | | | | | | |
| | | | | | | | | | | | | | | | | | | | | | | | | | | | | | | | | | | | | | | | | | | | | | | | | | | | | | | | | | | | | | | | | | | | | | | | | | | | | | | | |
| | | 3 | | | | | | | | | | | | | | | | | | | | | | | | | | | | | | | | | | | | | | | | | | | | | | | | | | | | | | | | | | | | | | | | | | | | | | | | | | | | | |
| | | | | | | | | | | | | | | | | | | | | | | | | | | | | | | | | | | | | | | | | | | | | | | | | | | | | | | | | | | | | | | | | | | | | | | | | | | | | | | | |
| 1 | | | | | | | | | | | | | | | | | | | | | | | | | | | | | | | | | | | | | | | | | | | | | | | | | | | | | | | | | | | | | | | | | | | | | | | | | | | | | | | |
| | | | | | | | | | | | | | | | | | | | | | | | | | | | | | | | | | | | | | | | | | | | | | | | | | | | | | | | | | | | | | | | | | | | | | | | | | | | | | | | |
| | | 1 | | | | | | | | | | | | | | | | | | | | | | | | | | | | | | | | | | | | | | | | | | | | | | | | | | | | | | | | | | | | | | | | | | | | | | | | | | | | | |
| 1 | | | | | | | | | | | | | | | | | | | | | | | | | | | | | | | | | | | | | | | | | | | | | | | | | | | | | | | | | | | | | | | | | | | | | | | | | | | | | | | |
| 1 | | | | | | | | | | | | | | | | | | | | | | | | | | | | | | | | | | | | | | | | | | | | | | | | | | | | | | | | | | | | | | | | | | | | | | | | | | | | | | | |
| 1 | | | | | | | | | | | | | | | | | | | | | | | | | | | | | | | | | | | | | | | | | | | | | | | | | | | | | | | | | | | | | | | | | | | | | | | | | | | | | | | |
| | | | | | | | | | | | | | | | | | | | | | | | | | | | | | | | | | | | | | | | | | | | | | | | | | | | | | | | | | | | | | | | | | | | | | | | | | | | | | | | |
| | | | | | | | | | | | | | | | | | | | | | | | | | | | | | | | | | | | | | | | | | | | | | | | | | | | | | | | | | | | | | | | | | | | | | | | | | | | | | | | |
| Post - 0 Miss - 0 Block - 0 | Post - 0 Miss - 0 Block - 0 | Post - 0 Miss - 0 Block - 0 | Post - 0 Miss - 0 Block - 0 | Post - 0 Miss - 0 Block - 0 | Post - 1 Miss - 1 Block - 0 | Post - 0 Miss - 0 Block - 0 | Post - 1 Miss - 0 Block - 0 | | | | | | | | | | | | | | | | | | | | | | | | | | | | | | | | | | | | | | | | | | | | | | | | | | | | | | | | | | | | | | | | | | | | | | | | |
| 60 朱超 | 61 钮伟豪 | 62 赵俊阳 | 64 章道胜 | 65 韩伟伦 | 66 刘家豪 | 67 江文 | 68 黄天源 | | | | | | | | | | | | | | | | | | | | | | | | | | | | | | | | | | | | | | | | | | | | | | | | | | | | | | | | | | | | | | | | | | | | | | | | |
| <table border="1"><tr><td>3</td><td></td><td></td></tr><tr><td>1</td><td></td><td></td></tr><tr><td>2</td><td></td><td></td></tr></table> | 3 | | | 1 | | | 2 | | | <table border="1"><tr><td></td><td></td><td></td></tr><tr><td></td><td></td><td></td></tr><tr><td></td><td></td><td></td></tr></table> | | | | | | | | | | <table border="1"><tr><td></td><td></td><td></td></tr><tr><td></td><td></td><td></td></tr><tr><td></td><td></td><td></td></tr></table> | | | | | | | | | | <table border="1"><tr><td></td><td></td><td></td></tr><tr><td>2</td><td></td><td></td></tr><tr><td>1</td><td></td><td></td></tr></table> | | | | 2 | | | 1 | | | <table border="1"><tr><td>1</td><td></td><td></td></tr><tr><td></td><td></td><td></td></tr><tr><td></td><td></td><td></td></tr></table> | 1 | | | | | | | | | <table border="1"><tr><td></td><td></td><td></td></tr><tr><td></td><td></td><td></td></tr><tr><td></td><td></td><td></td></tr></table> | | | | | | | | | | <table border="1"><tr><td></td><td></td><td></td></tr><tr><td></td><td></td><td></td></tr><tr><td></td><td></td><td></td></tr></table> | | | | | | | | | | <table border="1"><tr><td></td><td></td><td></td></tr><tr><td></td><td></td><td></td></tr><tr><td></td><td></td><td></td></tr></table> | | | | | | | | | |
| 3 | | | | | | | | | | | | | | | | | | | | | | | | | | | | | | | | | | | | | | | | | | | | | | | | | | | | | | | | | | | | | | | | | | | | | | | | | | | | | | | |
| 1 | | | | | | | | | | | | | | | | | | | | | | | | | | | | | | | | | | | | | | | | | | | | | | | | | | | | | | | | | | | | | | | | | | | | | | | | | | | | | | | |
| 2 | | | | | | | | | | | | | | | | | | | | | | | | | | | | | | | | | | | | | | | | | | | | | | | | | | | | | | | | | | | | | | | | | | | | | | | | | | | | | | | |
| | | | | | | | | | | | | | | | | | | | | | | | | | | | | | | | | | | | | | | | | | | | | | | | | | | | | | | | | | | | | | | | | | | | | | | | | | | | | | | | |
| | | | | | | | | | | | | | | | | | | | | | | | | | | | | | | | | | | | | | | | | | | | | | | | | | | | | | | | | | | | | | | | | | | | | | | | | | | | | | | | |
| | | | | | | | | | | | | | | | | | | | | | | | | | | | | | | | | | | | | | | | | | | | | | | | | | | | | | | | | | | | | | | | | | | | | | | | | | | | | | | | |
| | | | | | | | | | | | | | | | | | | | | | | | | | | | | | | | | | | | | | | | | | | | | | | | | | | | | | | | | | | | | | | | | | | | | | | | | | | | | | | | |
| | | | | | | | | | | | | | | | | | | | | | | | | | | | | | | | | | | | | | | | | | | | | | | | | | | | | | | | | | | | | | | | | | | | | | | | | | | | | | | | |
| | | | | | | | | | | | | | | | | | | | | | | | | | | | | | | | | | | | | | | | | | | | | | | | | | | | | | | | | | | | | | | | | | | | | | | | | | | | | | | | |
| | | | | | | | | | | | | | | | | | | | | | | | | | | | | | | | | | | | | | | | | | | | | | | | | | | | | | | | | | | | | | | | | | | | | | | | | | | | | | | | |
| 2 | | | | | | | | | | | | | | | | | | | | | | | | | | | | | | | | | | | | | | | | | | | | | | | | | | | | | | | | | | | | | | | | | | | | | | | | | | | | | | | |
| 1 | | | | | | | | | | | | | | | | | | | | | | | | | | | | | | | | | | | | | | | | | | | | | | | | | | | | | | | | | | | | | | | | | | | | | | | | | | | | | | | |
| 1 | | | | | | | | | | | | | | | | | | | | | | | | | | | | | | | | | | | | | | | | | | | | | | | | | | | | | | | | | | | | | | | | | | | | | | | | | | | | | | | |
| | | | | | | | | | | | | | | | | | | | | | | | | | | | | | | | | | | | | | | | | | | | | | | | | | | | | | | | | | | | | | | | | | | | | | | | | | | | | | | | |
| | | | | | | | | | | | | | | | | | | | | | | | | | | | | | | | | | | | | | | | | | | | | | | | | | | | | | | | | | | | | | | | | | | | | | | | | | | | | | | | |
| | | | | | | | | | | | | | | | | | | | | | | | | | | | | | | | | | | | | | | | | | | | | | | | | | | | | | | | | | | | | | | | | | | | | | | | | | | | | | | | |
| | | | | | | | | | | | | | | | | | | | | | | | | | | | | | | | | | | | | | | | | | | | | | | | | | | | | | | | | | | | | | | | | | | | | | | | | | | | | | | | |
| | | | | | | | | | | | | | | | | | | | | | | | | | | | | | | | | | | | | | | | | | | | | | | | | | | | | | | | | | | | | | | | | | | | | | | | | | | | | | | | |
| | | | | | | | | | | | | | | | | | | | | | | | | | | | | | | | | | | | | | | | | | | | | | | | | | | | | | | | | | | | | | | | | | | | | | | | | | | | | | | | |
| | | | | | | | | | | | | | | | | | | | | | | | | | | | | | | | | | | | | | | | | | | | | | | | | | | | | | | | | | | | | | | | | | | | | | | | | | | | | | | | |
| | | | | | | | | | | | | | | | | | | | | | | | | | | | | | | | | | | | | | | | | | | | | | | | | | | | | | | | | | | | | | | | | | | | | | | | | | | | | | | | |
| | | | | | | | | | | | | | | | | | | | | | | | | | | | | | | | | | | | | | | | | | | | | | | | | | | | | | | | | | | | | | | | | | | | | | | | | | | | | | | | |
| | | | | | | | | | | | | | | | | | | | | | | | | | | | | | | | | | | | | | | | | | | | | | | | | | | | | | | | | | | | | | | | | | | | | | | | | | | | | | | | |
| | | | | | | | | | | | | | | | | | | | | | | | | | | | | | | | | | | | | | | | | | | | | | | | | | | | | | | | | | | | | | | | | | | | | | | | | | | | | | | | |
| Post - 0 Miss - 0 Block - 0 | Post - 0 Miss - 0 Block - 0 | Post - 0 Miss - 0 Block - 0 | Post - 0 Miss - 0 Block - 0 | Post - 0 Miss - 0 Block - 0 | Post - 0 Miss - 0 Block - 0 | Post - 0 Miss - 0 Block - 0 | Post - 0 Miss - 0 Block - 0 | | | | | | | | | | | | | | | | | | | | | | | | | | | | | | | | | | | | | | | | | | | | | | | | | | | | | | | | | | | | | | | | | | | | | | | | |

PHMS Pictorial Handball Match Statistics **IHF** Official System

| | | | | | | | | | | | |
|------------------|--|--|--|------------------|--|--|--|--------------------------|--|--|--|
| Team A A 辽宁抚顺 | | | | Team B B 福建龙岩 | | | | Match Number 5 | | | |
|------------------|--|--|--|------------------|--|--|--|--------------------------|--|--|--|

| | | | | | |
|-------------------|------------------------|------------------|-------------|-------|----------|
| Played in 安徽滁州 | in the hall 滁州国际手球馆 | on 2019-05-27 | at 18:00 | hours | Speakers |
|-------------------|------------------------|------------------|-------------|-------|----------|

| | | | | | | | | | | | | | | |
|----------------|--------|--------|---------------------|---------|---------|----------------|---|---|----------------|---|---|----------------------|---|---|
| Half-time(30') | A 7 | B 5 | End of playing time | A 13 | B 12 | 1st extra time | A | B | 2nd extra time | A | B | After penalty throws | A | B |
|----------------|--------|--------|---------------------|---------|---------|----------------|---|---|----------------|---|---|----------------------|---|---|

| | | | | | | | | | |
|----------------------|---------------|---|---|------------------------------------|---------------|-------|---|----------|---------------|
| Number of 7 m 0/0 | Team time-out | | | Full name of players and officials | Team time-out | | | B 0/1 | Number of 7 m |
| | 1 | 2 | 3 | | 1 | 2 | 3 | | |
| | | | | | 06:46 | 44:40 | | | |

| No. | Team A | G | W | 2' | D | DR | No. | Team B | G | W | 2' | D | DR |
|-----|--------|---|---|----|---|----|-----|--------|---|---|----|---|----|
| 2 | 赫天铭 | | | | | | 1 | 刘子豪 | | | | | |
| 5 | 王梓翺 | | | | | | 5 | 郭雨强 | 5 | | 1 | | |
| 6 | 尚禹辰 | | | | | | 6 | 刘阳 | | | | | |
| 7 | 张羽虹冰 | | | | | | 7 | 王晨旭 | | | | | |
| 9 | 隋博 | 1 | | | | | 8 | 杨鑫祥 | | | | | |
| 11 | 陈思 | | | | | | 9 | 荆胤丞 | | 1 | | | |
| 13 | 高鑫 | 4 | | 1 | | | 10 | 赵一 | 5 | 1 | | | |
| 17 | 杨宇 | 2 | | | | | 15 | 刘家良 | | | | | |
| 19 | 靳皓童 | 1 | | 1 | | | 16 | 李凯锋 | | | | | |
| 22 | 杨辰 | | | | | | 17 | 陈锐涛 | | | | | |
| 28 | 靳皓添 | 5 | | 1 | | | 18 | 奚尧 | 2 | | | | |
| 32 | 袁梓赫 | | | | | | 21 | 刘晓青 | | | | | |
| | | | | | | | 23 | 朱天一 | | | | | |
| | | | | | | | 24 | 钟盛发 | | | | | |
| | | | | | | | 27 | 邓可钊 | | | | | |
| | | | | | | | 36 | 陈泽锟 | | | | | |
| C | 刘启迪 | | | | | | B | 杜长义 | | | | | |
| | | | | | | | C | 饶开发 | | | | | |
| | | | | | | | D | 李绍南 | | | | | |

| | | | | | | | | | | | | | |
|---|--|--|--|--|--|--|--|--|--|--|--|--|---|
| A | Signatures of responsables for the teams (Off.A) | | | | | | | | | | | | B |
|---|--|--|--|--|--|--|--|--|--|--|--|--|---|

| | | | | | | | | | | | | | | |
|----|-----------------------------------|--|--|--|--|--|--|--|--|--|--|--|--|----|
| TP | Remarks of referees / HF Official | | | | | | | | | | | | | TP |
|----|-----------------------------------|--|--|--|--|--|--|--|--|--|--|--|--|----|

| | | | | |
|----------|-----------|-----------|--|--|
| Referees | 王雨洋 (CHN) | 严璐 (CHN) | | |
| T.D. | 徐健 (CHN) | 李兆蒙 (CHN) | | |
| CHA Off. | | | | |

Note: Number of 7m Throws Awarded to Team A and B, Goals (G), Warnings (W), Suspensions (2'), Direct Disqualification (D), Disqualification With Report (DR) and Team Penalty (TP).

Table Officials: 刘洋洋 许修凯 Statisticians: 马安兴 沈家洛

第二届全国青年运动会男子手球乙组决赛 体校组 (U16)

PHMS Pictorial Handball Match Statistics

IHF Official System

竞赛技术统计

手球
青年男子

预赛
轮次 1

组别 A
场次 5

滁州国际手球馆
2019-05-27 18:00

| | | | |
|-----------|----------------------|---------|------------|
| Referees: | 王雨洋 (CHN) / 严璐 (CHN) | Result: | 13:12(7:5) |
| Teams: | 辽宁抚顺(抚顺) VS 福建龙岩(龙岩) | | |

| 抚顺 | | 远 | 近 | 边 | 快 | 突 | 任意 | 7m | 合计 | % | 助攻 | 失误 | 警告 | 2' | D+DR |
|---------|------|------|------|-----|-----|-----|-----|-----|-------|------|----|----|----|----|------|
| 主教练: 徐毅 | | 射 | 射 | 射 | 攻 | 破 | 球 | 球 | | | | | | | |
| 2 | 赫天铭 | | | | | | | | | | | | | | |
| 5 | 王梓翊 | | | | | | | | | | | | | | |
| 6 | 尚禹辰 | | | | | | | | | | | | | | |
| 7 | 张羽虹冰 | | | | | | | | | | | | | | |
| 9 | 隋博 | | | 1/4 | | | | | 1/4 | 25.0 | | | | | |
| 11 | 陈思 | | | | | | | | | | | | | | |
| 13 | 高鑫 | 1/2 | 2/3 | | | 1/1 | | | 4/6 | 66.7 | | 2 | | 1 | |
| 17 | 杨宇 | 1/5 | 1/3 | | | | 0/1 | | 2/9 | 22.2 | 2 | 6 | | | |
| 19 | 靳皓童 | 1/3 | | | | | | | 1/3 | 33.3 | | 2 | | 1 | |
| 22 | 杨辰 | | | | | | | | | | | | | | |
| 28 | 靳皓添 | 1/1 | 4/4 | | | | | | 5/5 | 100 | | 1 | | 1 | |
| 32 | 袁梓赫 | | | | | | | | | | | | | | |
| 运动员 合计 | | 4/11 | 7/10 | 1/4 | | 1/1 | 0/1 | | 13/27 | 48.1 | 2 | 11 | | 3 | |
| 2 | 赫天铭 | 4/8 | 3/6 | 1/2 | 0/1 | 0/2 | 1/2 | 1/1 | 10/22 | 45.5 | | | | | |
| 守门员 合计 | | 4/8 | 3/6 | 1/2 | 0/1 | 0/2 | 1/2 | 1/1 | 10/22 | 45.5 | | | | | |

| 抚顺 | 比赛进程 | 龙岩 |
|----------|----------|----------|
| 1st Half | | |
| 28 靳皓添 | 1 00:50 | 0 |
| 13 高鑫 | 2 01:26 | 0 |
| | 2 02:02 | 1 5 郭雨强 |
| | 2 03:13 | 2 18 奚尧 |
| 13 高鑫 | 3 04:12 | 2 |
| | 3 06:53 | 3 5 郭雨强 |
| 17 杨宇 | 4 07:19 | 3 |
| | 4 09:23 | 4 10 赵一 |
| 28 靳皓添 | 5 09:44 | 4 |
| | 5 10:23 | 5 10 赵一 |
| 17 杨宇 | 6 11:16 | 5 |
| 19 靳皓童 | 7 12:32 | 5 |
| 2nd Half | | |
| 28 靳皓添 | 8 01:10 | 5 |
| | 8 01:57 | 6 10 赵一 |
| 28 靳皓添 | 9 02:33 | 6 |
| | 9 03:03 | 7 10 赵一 |
| 28 靳皓添 | 10 04:00 | 7 |
| | 10 04:25 | 8 5 郭雨强 |
| | 10 04:53 | 9 5 郭雨强 |
| 9 隋博 | 11 07:38 | 9 |
| | 11 07:59 | 10 18 奚尧 |
| 13 高鑫 | 12 08:15 | 10 |
| 13 高鑫 | 13 09:20 | 10 |
| | 13 11:00 | 11 5 郭雨强 |
| | 13 14:04 | 12 10 赵一 |

| 龙岩 | | 远 | 近 | 边 | 快 | 突 | 任意 | 7m | 合计 | % | 助攻 | 失误 | 警告 | 2' | D+DR |
|----------|-----|------|-----|-----|-----|-----|-----|-----|-------|------|----|----|----|----|------|
| 主教练: 李绍南 | | 射 | 射 | 射 | 攻 | 破 | 球 | 球 | | | | | | | |
| 1 | 刘子豪 | | | | | | | | | | | | | | |
| 5 | 郭雨强 | 3/12 | 1/1 | | 1/1 | | 0/1 | 0/1 | 5/16 | 31.3 | | 1 | | 1 | |
| 6 | 刘阳 | | 0/1 | 0/2 | | | | | 0/3 | 0.0 | | | | | |
| 7 | 王晨旭 | | | | | | | | | | | | | | |
| 8 | 杨鑫祥 | | | | | | | | | | | | | | |
| 9 | 荆胤丞 | | | | | | | | | | | | 1 | | |
| 10 | 赵一 | 1/1 | 1/1 | | | 2/2 | 1/1 | | 5/5 | 100 | 3 | 3 | 1 | | |
| 15 | 刘家良 | 0/1 | | | | | | | 0/1 | 0.0 | | | | | |
| 16 | 李凯锋 | | | | | | | | | | | | | | |
| 17 | 陈锐涛 | | | | | | | | | | | | | | |
| 18 | 奚尧 | | 1/2 | 1/1 | 0/1 | | | | 2/4 | 50.0 | | | | | |
| 21 | 刘晓青 | | | | | | | | | | | | | | |
| 23 | 朱天一 | | 0/1 | | | | | | 0/1 | 0.0 | | | | | |
| 24 | 钟盛发 | | | | | | | | | | | | | | |
| 27 | 邓可钊 | 0/1 | | | | | | | 0/1 | 0.0 | | 5 | | | |
| 36 | 陈泽锟 | | | | | | | | | | | | | | |
| 运动员 合计 | | 4/15 | 3/6 | 1/3 | 1/2 | 2/2 | 1/2 | 0/1 | 12/31 | 38.7 | 3 | 9 | 2 | 1 | |
| 1 | 刘子豪 | 1/5 | 2/9 | 1/2 | | 0/1 | 1/1 | | 5/18 | 27.8 | | | | | |
| 守门员 合计 | | 1/5 | 2/9 | 1/2 | | 0/1 | 1/1 | | 5/18 | 27.8 | | | | | |

场上队员: 得分 / 射门

守门员: 救球 / 射门

| | | | |
|---|------|----|---------|
| D | 取消资格 | DR | 取消资格+报告 |
|---|------|----|---------|



个人/全队技术统计表

手球 预赛 组别 A 滁州国际手球馆
青年男子 轮次 1 场次 5 2019-05-27 18:00

| 号码 | 姓名 | 远射 | 近射 | 边射 | 快攻 | 突破 | 任意 | 七米 | 合计 | % | 助攻 | 失误 | 警告 | 2' | 取消 | 时间 |
|-----------------|------|-------------|-------------|------------|------------|------------|------------|------------|--------------|--------------|----------|-----------|----|----------|----|----------|
| 辽宁抚顺(抚顺) | | | | | | | | | | | | | | | | |
| (场上队员) | | | | | | | | | | | | | | | | |
| 2 | 赫天铭 | | | | | | | | | 0.0% | | | | | | 00:29:57 |
| 5 | 王梓翹 | | | | | | | | | 0.0% | | | | | | 00:00:00 |
| 6 | 尚禹辰 | | | | | | | | | 0.0% | | | | | | 00:15:00 |
| 7 | 张羽虹冰 | | | | | | | | | 0.0% | | | | | | 00:15:00 |
| 9 | 隋博 | | | 1/4 | | | | | 1/4 | 25.0% | | | | | | 00:29:57 |
| 11 | 陈思 | | | | | | | | | 0.0% | | | | | | 00:00:00 |
| 13 | 高鑫 | 1/2 | 2/3 | | | 1/1 | | | 4/6 | 66.7% | 2 | | | 1 | | 00:30:00 |
| 17 | 杨宇 | 1/5 | 1/3 | | | | 0/1 | | 2/9 | 22.2% | 2 | 6 | | | | 00:29:58 |
| 19 | 靳皓童 | 1/3 | | | | | | | 1/3 | 33.3% | 2 | | | 1 | | 00:29:59 |
| 22 | 杨辰 | | | | | | | | | 0.0% | | | | | | 00:00:00 |
| 28 | 靳皓添 | 1/1 | 4/4 | | | | | | 5/5 | 100% | 1 | | | 1 | | 00:29:51 |
| 32 | 袁梓赫 | | | | | | | | | 0.0% | | | | | | 00:00:00 |
| 合计 | | 4/11 | 7/10 | 1/4 | | 1/1 | 0/1 | | 13/27 | 48.1% | 2 | 11 | | 3 | | |
| (守门员) | | | | | | | | | | | | | | | | |
| 2 | 赫天铭 | 4/8 | 3/6 | 1/2 | 0/1 | 0/2 | 1/2 | 1/1 | 10/22 | 45.5% | | | | | | 00:29:57 |
| 合计 | | 4/8 | 3/6 | 1/2 | 0/1 | 0/2 | 1/2 | 1/1 | 10/22 | 45.5% | | | | | | |

场上队员： 得分/射门

守门员： 救球/射门

| 全队合计 | 得分 | 被救 | 射失 | 击柱 | 封球 | 合计 | % |
|------|----|----|----|----|----|----|--------|
| 远射 | 4 | 1 | 4 | | 2 | 11 | 36.4% |
| 近射 | 7 | 2 | 1 | | | 10 | 70.0% |
| 边射 | 1 | 1 | 1 | 1 | | 4 | 25.0% |
| 快攻 | | | | | | | 0.0% |
| 突破 | 1 | | | | | 1 | 100.0% |
| 任意 | | 1 | | | | 1 | 0.0% |
| 七米 | | | | | | | 0.0% |

个人/全队技术统计表

手球 预赛 组别 A 滁州国际手球馆
青年男子 轮次 1 场次 5 2019-05-27 18:00

| 号码 | 姓名 | 远射 | 近射 | 边射 | 快攻 | 突破 | 任意 | 七米 | 合计 | % | 助攻 | 失误 | 警告 | 2' | 取消 | 时间 |
|-----------------|-----------|-------------|------------|------------|------------|------------|------------|------------|--------------|--------------|----------|----------|----------|----------|----|----------|
| 福建龙岩(龙岩) | | | | | | | | | | | | | | | | |
| (场上队员) | | | | | | | | | | | | | | | | |
| 1 | 刘子豪 | | | | | | | | | 0.0% | | | | | | 00:30:00 |
| 5 | 郭雨强 | 3/12 | 1/1 | | 1/1 | | 0/1 | 0/1 | 5/16 | 31.3% | | 1 | | 1 | | 00:30:00 |
| 6 | 刘阳 | | 0/1 | 0/2 | | | | | 0/3 | 0.0% | | | | | | 00:30:00 |
| 7 | 王晨旭 | | | | | | | | | 0.0% | | | | | | 00:00:00 |
| 8 | 杨鑫祥 | | | | | | | | | 0.0% | | | | | | 00:00:00 |
| 9 | 荆胤丞 | | | | | | | | | 0.0% | | | 1 | | | 00:17:43 |
| 10 | 赵一 | 1/1 | 1/1 | | | 2/2 | 1/1 | | 5/5 | 100% | 3 | 3 | 1 | | | 00:30:00 |
| 15 | 刘家良 | 0/1 | | | | | | | 0/1 | 0.0% | | | | | | 00:08:14 |
| 16 | 李凯锋 | | | | | | | | | 0.0% | | | | | | 00:00:00 |
| 17 | 陈锐涛 | | | | | | | | | 0.0% | | | | | | 00:00:00 |
| 18 | 奚尧 | | 1/2 | 1/1 | 0/1 | | | | 2/4 | 50.0% | | | | | | 00:26:38 |
| 21 | 刘晓青 | | | | | | | | | 0.0% | | | | | | 00:00:00 |
| 23 | 朱天一 | | 0/1 | | | | | | 0/1 | 0.0% | | | | | | 00:12:15 |
| 24 | 钟盛发 | | | | | | | | | 0.0% | | | | | | 00:00:00 |
| 27 | 邓可钊 | 0/1 | | | | | | | 0/1 | 0.0% | | 5 | | | | 00:24:38 |
| 36 | 陈泽银 | | | | | | | | | 0.0% | | | | | | 00:00:00 |
| | 合计 | 4/15 | 3/6 | 1/3 | 1/2 | 2/2 | 1/2 | 0/1 | 12/31 | 38.7% | 3 | 9 | 2 | 1 | | |
| (守门员) | | | | | | | | | | | | | | | | |
| 1 | 刘子豪 | 1/5 | 2/9 | 1/2 | | 0/1 | 1/1 | | 5/18 | 27.8% | | | | | | 00:30:00 |
| | 合计 | 1/5 | 2/9 | 1/2 | | 0/1 | 1/1 | | 5/18 | 27.8% | | | | | | |

场上队员：得分/射门

守门员：救球/射门

| 全队合计 | 得分 | 被救 | 射失 | 击柱 | 封球 | 合计 | % |
|------|----|----|----|----|----|----|--------|
| 远射 | 4 | 4 | 4 | | 3 | 15 | 26.7% |
| 近射 | 3 | 3 | | | | 6 | 50.0% |
| 边射 | 1 | 1 | | 1 | | 3 | 33.3% |
| 快攻 | 1 | | | 1 | | 2 | 50.0% |
| 突破 | 2 | | | | | 2 | 100.0% |
| 任意 | 1 | 1 | | | | 2 | 50.0% |
| 七米 | | 1 | | | | 1 | 0.0% |

图式比赛技术统计表

手球
青年男子

预赛
轮次 1

组别 A
场次 5

滁州国际手球馆
2019-05-27 18:00

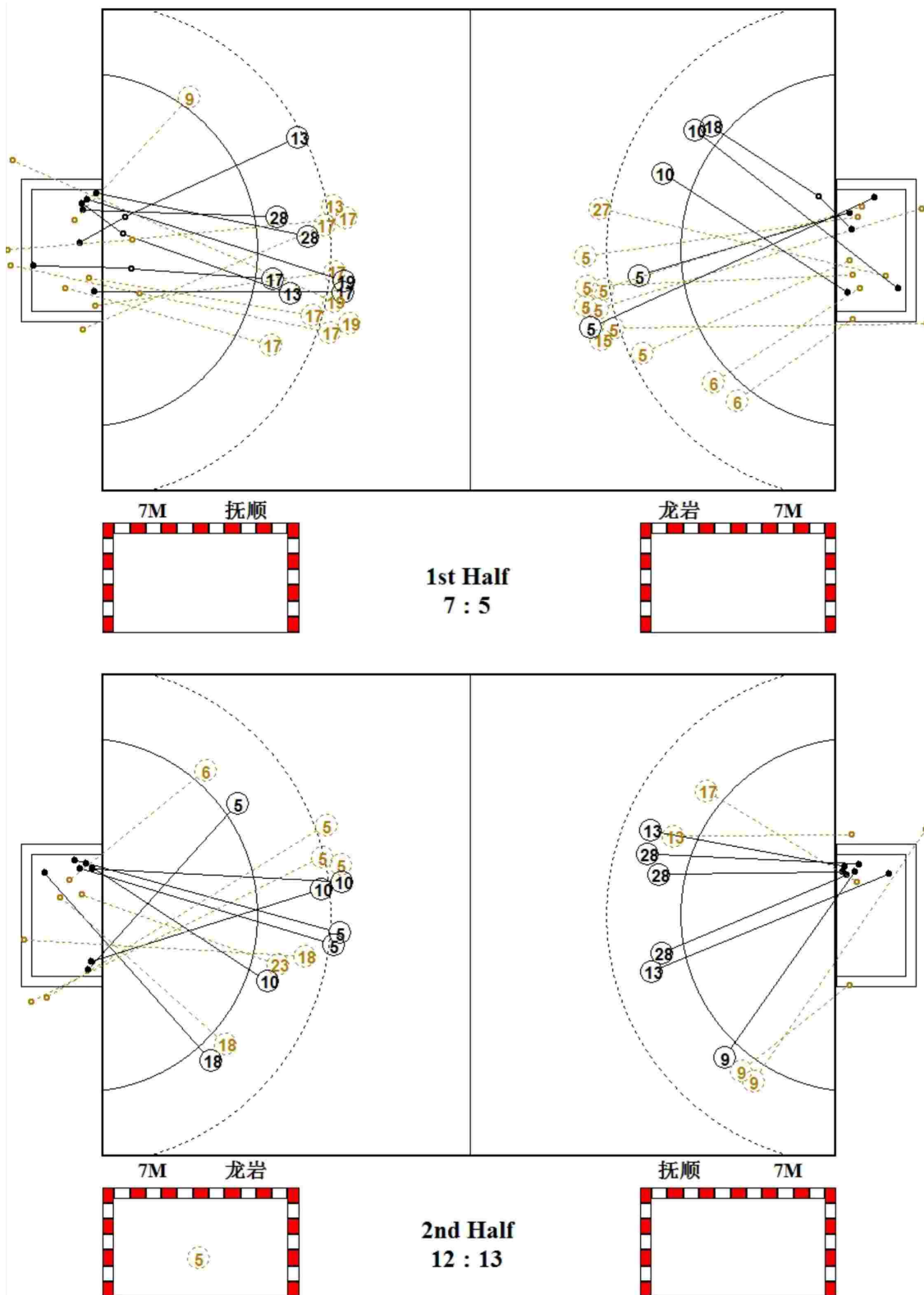

图式射门区域统计

手球
青年男子

预赛
轮次 1

组别 A
场次 5

滁州国际手球馆
2019-05-27 18:00

辽宁抚顺

| | | | | | | | | | | | | | | | | | | | | | | | | | | | | | | | | | | | | | | | | | | | | | | | | | | | | | | | | | | | | | | | | | | | | | | | | | | | | | | | |
|--|-----|-----|--|--|--|--|--|--|---|--|--|--|--|--|--|--|--|--|--|--|--|--|--|---|--|--|---|--|---|---|--|--|--|--|--|--|--|--|--|--|--|--|--|--|--|--|-----|-----|-----|--|-----|-----|-----|--|--|--|--|--|--|--|---|--|--|--|--|--|---|---|---|--|--|---|--|--|--|--|---|--|--|
| 2 赫天铭 <table border="1"><tr><td></td><td></td><td></td></tr><tr><td></td><td></td><td></td></tr><tr><td></td><td></td><td></td></tr></table> Post - 0 Miss - 0 Block - 0 | | | | | | | | | | 5 王梓翹 <table border="1"><tr><td></td><td></td><td></td></tr><tr><td></td><td></td><td></td></tr><tr><td></td><td></td><td></td></tr></table> Post - 0 Miss - 0 Block - 0 | | | | | | | | | | 6 尚禹辰 <table border="1"><tr><td></td><td></td><td></td></tr><tr><td></td><td></td><td></td></tr><tr><td></td><td></td><td></td></tr></table> Post - 0 Miss - 0 Block - 0 | | | | | | | | | | 7 张羽虹冰 <table border="1"><tr><td></td><td></td><td></td></tr><tr><td></td><td></td><td></td></tr><tr><td></td><td></td><td></td></tr></table> Post - 0 Miss - 0 Block - 0 | | | | | | | | | | 9 隋博 <table border="1"><tr><td></td><td></td><td></td></tr><tr><td></td><td></td><td></td></tr><tr><td>1</td><td></td><td></td></tr></table> Post - 1 Miss - 1 Block - 0 | | | | | | | 1 | | | 11 陈思 <table border="1"><tr><td></td><td></td><td></td></tr><tr><td></td><td></td><td></td></tr><tr><td></td><td></td><td></td></tr></table> Post - 0 Miss - 0 Block - 0 | | | | | | | | | | 13 高鑫 <table border="1"><tr><td>1</td><td></td><td></td></tr><tr><td></td><td></td><td></td></tr><tr><td>1</td><td>1</td><td>1</td></tr></table> Post - 0 Miss - 1 Block - 1 | 1 | | | | | | 1 | 1 | 1 | 17 杨宇 <table border="1"><tr><td></td><td>1</td><td></td></tr><tr><td></td><td></td><td></td></tr><tr><td>1</td><td></td><td></td></tr></table> Post - 0 Miss - 3 Block - 0 | | 1 | | | | | 1 | | |
| | | | | | | | | | | | | | | | | | | | | | | | | | | | | | | | | | | | | | | | | | | | | | | | | | | | | | | | | | | | | | | | | | | | | | | | | | | | | | | | |
| | | | | | | | | | | | | | | | | | | | | | | | | | | | | | | | | | | | | | | | | | | | | | | | | | | | | | | | | | | | | | | | | | | | | | | | | | | | | | | | |
| | | | | | | | | | | | | | | | | | | | | | | | | | | | | | | | | | | | | | | | | | | | | | | | | | | | | | | | | | | | | | | | | | | | | | | | | | | | | | | | |
| | | | | | | | | | | | | | | | | | | | | | | | | | | | | | | | | | | | | | | | | | | | | | | | | | | | | | | | | | | | | | | | | | | | | | | | | | | | | | | | |
| | | | | | | | | | | | | | | | | | | | | | | | | | | | | | | | | | | | | | | | | | | | | | | | | | | | | | | | | | | | | | | | | | | | | | | | | | | | | | | | |
| | | | | | | | | | | | | | | | | | | | | | | | | | | | | | | | | | | | | | | | | | | | | | | | | | | | | | | | | | | | | | | | | | | | | | | | | | | | | | | | |
| | | | | | | | | | | | | | | | | | | | | | | | | | | | | | | | | | | | | | | | | | | | | | | | | | | | | | | | | | | | | | | | | | | | | | | | | | | | | | | | |
| | | | | | | | | | | | | | | | | | | | | | | | | | | | | | | | | | | | | | | | | | | | | | | | | | | | | | | | | | | | | | | | | | | | | | | | | | | | | | | | |
| | | | | | | | | | | | | | | | | | | | | | | | | | | | | | | | | | | | | | | | | | | | | | | | | | | | | | | | | | | | | | | | | | | | | | | | | | | | | | | | |
| | | | | | | | | | | | | | | | | | | | | | | | | | | | | | | | | | | | | | | | | | | | | | | | | | | | | | | | | | | | | | | | | | | | | | | | | | | | | | | | |
| | | | | | | | | | | | | | | | | | | | | | | | | | | | | | | | | | | | | | | | | | | | | | | | | | | | | | | | | | | | | | | | | | | | | | | | | | | | | | | | |
| | | | | | | | | | | | | | | | | | | | | | | | | | | | | | | | | | | | | | | | | | | | | | | | | | | | | | | | | | | | | | | | | | | | | | | | | | | | | | | | |
| | | | | | | | | | | | | | | | | | | | | | | | | | | | | | | | | | | | | | | | | | | | | | | | | | | | | | | | | | | | | | | | | | | | | | | | | | | | | | | | |
| | | | | | | | | | | | | | | | | | | | | | | | | | | | | | | | | | | | | | | | | | | | | | | | | | | | | | | | | | | | | | | | | | | | | | | | | | | | | | | | |
| 1 | | | | | | | | | | | | | | | | | | | | | | | | | | | | | | | | | | | | | | | | | | | | | | | | | | | | | | | | | | | | | | | | | | | | | | | | | | | | | | | |
| | | | | | | | | | | | | | | | | | | | | | | | | | | | | | | | | | | | | | | | | | | | | | | | | | | | | | | | | | | | | | | | | | | | | | | | | | | | | | | | |
| | | | | | | | | | | | | | | | | | | | | | | | | | | | | | | | | | | | | | | | | | | | | | | | | | | | | | | | | | | | | | | | | | | | | | | | | | | | | | | | |
| | | | | | | | | | | | | | | | | | | | | | | | | | | | | | | | | | | | | | | | | | | | | | | | | | | | | | | | | | | | | | | | | | | | | | | | | | | | | | | | |
| 1 | | | | | | | | | | | | | | | | | | | | | | | | | | | | | | | | | | | | | | | | | | | | | | | | | | | | | | | | | | | | | | | | | | | | | | | | | | | | | | | |
| | | | | | | | | | | | | | | | | | | | | | | | | | | | | | | | | | | | | | | | | | | | | | | | | | | | | | | | | | | | | | | | | | | | | | | | | | | | | | | | |
| 1 | 1 | 1 | | | | | | | | | | | | | | | | | | | | | | | | | | | | | | | | | | | | | | | | | | | | | | | | | | | | | | | | | | | | | | | | | | | | | | | | | | | | | |
| | 1 | | | | | | | | | | | | | | | | | | | | | | | | | | | | | | | | | | | | | | | | | | | | | | | | | | | | | | | | | | | | | | | | | | | | | | | | | | | | | | |
| | | | | | | | | | | | | | | | | | | | | | | | | | | | | | | | | | | | | | | | | | | | | | | | | | | | | | | | | | | | | | | | | | | | | | | | | | | | | | | | |
| 1 | | | | | | | | | | | | | | | | | | | | | | | | | | | | | | | | | | | | | | | | | | | | | | | | | | | | | | | | | | | | | | | | | | | | | | | | | | | | | | | |
| 19 靳皓童 <table border="1"><tr><td></td><td></td><td></td></tr><tr><td></td><td></td><td></td></tr><tr><td></td><td></td><td>1</td></tr></table> Post - 0 Miss - 1 Block - 1 | | | | | | | | | 1 | 22 杨辰 <table border="1"><tr><td></td><td></td><td></td></tr><tr><td></td><td></td><td></td></tr><tr><td></td><td></td><td></td></tr></table> Post - 0 Miss - 0 Block - 0 | | | | | | | | | | 28 靳皓添 <table border="1"><tr><td></td><td></td><td></td></tr><tr><td>1</td><td></td><td></td></tr><tr><td>2</td><td></td><td>2</td></tr></table> Post - 0 Miss - 0 Block - 0 | | | | 1 | | | 2 | | 2 | 32 袁梓赫 <table border="1"><tr><td></td><td></td><td></td></tr><tr><td></td><td></td><td></td></tr><tr><td></td><td></td><td></td></tr></table> Post - 0 Miss - 0 Block - 0 | | | | | | | | | | | | | | 2 赫天铭 <table border="1"><tr><td></td><td></td><td>1/3</td></tr><tr><td>1/2</td><td>2/2</td><td>2/3</td></tr><tr><td>1/4</td><td>2/3</td><td>1/5</td></tr></table> | | | 1/3 | 1/2 | 2/2 | 2/3 | 1/4 | 2/3 | 1/5 | | | | | | | | | | | | | | | | | | | | | | | | | | |
| | | | | | | | | | | | | | | | | | | | | | | | | | | | | | | | | | | | | | | | | | | | | | | | | | | | | | | | | | | | | | | | | | | | | | | | | | | | | | | | |
| | | | | | | | | | | | | | | | | | | | | | | | | | | | | | | | | | | | | | | | | | | | | | | | | | | | | | | | | | | | | | | | | | | | | | | | | | | | | | | | |
| | | 1 | | | | | | | | | | | | | | | | | | | | | | | | | | | | | | | | | | | | | | | | | | | | | | | | | | | | | | | | | | | | | | | | | | | | | | | | | | | | | |
| | | | | | | | | | | | | | | | | | | | | | | | | | | | | | | | | | | | | | | | | | | | | | | | | | | | | | | | | | | | | | | | | | | | | | | | | | | | | | | | |
| | | | | | | | | | | | | | | | | | | | | | | | | | | | | | | | | | | | | | | | | | | | | | | | | | | | | | | | | | | | | | | | | | | | | | | | | | | | | | | | |
| | | | | | | | | | | | | | | | | | | | | | | | | | | | | | | | | | | | | | | | | | | | | | | | | | | | | | | | | | | | | | | | | | | | | | | | | | | | | | | | |
| | | | | | | | | | | | | | | | | | | | | | | | | | | | | | | | | | | | | | | | | | | | | | | | | | | | | | | | | | | | | | | | | | | | | | | | | | | | | | | | |
| 1 | | | | | | | | | | | | | | | | | | | | | | | | | | | | | | | | | | | | | | | | | | | | | | | | | | | | | | | | | | | | | | | | | | | | | | | | | | | | | | | |
| 2 | | 2 | | | | | | | | | | | | | | | | | | | | | | | | | | | | | | | | | | | | | | | | | | | | | | | | | | | | | | | | | | | | | | | | | | | | | | | | | | | | | |
| | | | | | | | | | | | | | | | | | | | | | | | | | | | | | | | | | | | | | | | | | | | | | | | | | | | | | | | | | | | | | | | | | | | | | | | | | | | | | | | |
| | | | | | | | | | | | | | | | | | | | | | | | | | | | | | | | | | | | | | | | | | | | | | | | | | | | | | | | | | | | | | | | | | | | | | | | | | | | | | | | |
| | | | | | | | | | | | | | | | | | | | | | | | | | | | | | | | | | | | | | | | | | | | | | | | | | | | | | | | | | | | | | | | | | | | | | | | | | | | | | | | |
| | | 1/3 | | | | | | | | | | | | | | | | | | | | | | | | | | | | | | | | | | | | | | | | | | | | | | | | | | | | | | | | | | | | | | | | | | | | | | | | | | | | | |
| 1/2 | 2/2 | 2/3 | | | | | | | | | | | | | | | | | | | | | | | | | | | | | | | | | | | | | | | | | | | | | | | | | | | | | | | | | | | | | | | | | | | | | | | | | | | | | |
| 1/4 | 2/3 | 1/5 | | | | | | | | | | | | | | | | | | | | | | | | | | | | | | | | | | | | | | | | | | | | | | | | | | | | | | | | | | | | | | | | | | | | | | | | | | | | | |

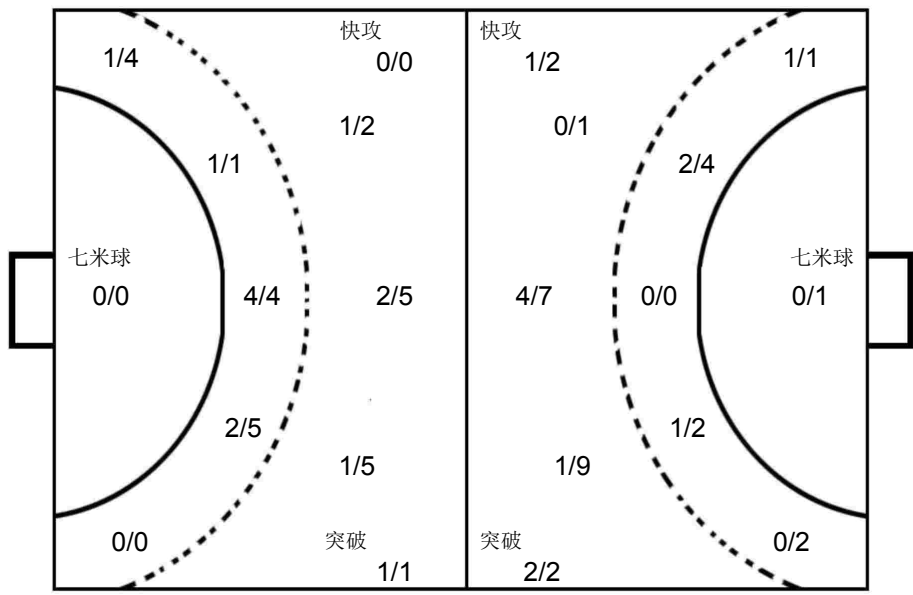

1 刘子豪

| | | |
|-----|-----|-----|
| 0/1 | 0/1 | |
| 1/2 | | 1/1 |
| 3/8 | 0/1 | 0/4 |

福建龙岩

| | | | | | | | | | | | | | | | | | | | | | | | | | | | | | | | | | | | | | | | | | | | | | | | | | | | | | | | | | | | | | | | | | | | | | | | | | | | | | | | |
|---|---|---|--|--|--|--|--|--|--|--|--|--|--|---|--|---|---|--|---|--|--|--|---|--|--|--|--|---|--|---|--|--|--|--|--|--|--|--|--|---|--|--|--|--|--|--|--|--|--|---|--|--|--|--|--|--|--|--|--|---|--|--|---|--|--|--|---|--|---|---|--|--|--|--|--|--|--|--|--|
| 1 刘子豪 <table border="1"><tr><td></td><td></td><td></td></tr><tr><td></td><td></td><td></td></tr><tr><td></td><td></td><td></td></tr></table> Post - 0 Miss - 0 Block - 0 | | | | | | | | | | 5 郭雨强 <table border="1"><tr><td></td><td></td><td></td></tr><tr><td>1</td><td></td><td>1</td></tr><tr><td>2</td><td></td><td>1</td></tr></table> Post - 0 Miss - 4 Block - 2 | | | | 1 | | 1 | 2 | | 1 | 6 刘阳 <table border="1"><tr><td></td><td></td><td></td></tr><tr><td></td><td></td><td></td></tr><tr><td></td><td></td><td></td></tr></table> Post - 1 Miss - 0 Block - 0 | | | | | | | | | | 7 王晨旭 <table border="1"><tr><td></td><td></td><td></td></tr><tr><td></td><td></td><td></td></tr><tr><td></td><td></td><td></td></tr></table> Post - 0 Miss - 0 Block - 0 | | | | | | | | | | 8 杨鑫祥 <table border="1"><tr><td></td><td></td><td></td></tr><tr><td></td><td></td><td></td></tr><tr><td></td><td></td><td></td></tr></table> Post - 0 Miss - 0 Block - 0 | | | | | | | | | | 9 荆胤丞 <table border="1"><tr><td></td><td></td><td></td></tr><tr><td></td><td></td><td></td></tr><tr><td></td><td></td><td></td></tr></table> Post - 0 Miss - 0 Block - 0 | | | | | | | | | | 10 赵一 <table border="1"><tr><td></td><td></td><td>1</td></tr><tr><td></td><td></td><td></td></tr><tr><td>1</td><td></td><td>3</td></tr></table> Post - 0 Miss - 0 Block - 0 | | | 1 | | | | 1 | | 3 | 15 刘家良 <table border="1"><tr><td></td><td></td><td></td></tr><tr><td></td><td></td><td></td></tr><tr><td></td><td></td><td></td></tr></table> Post - 0 Miss - 0 Block - 1 | | | | | | | | | |
| | | | | | | | | | | | | | | | | | | | | | | | | | | | | | | | | | | | | | | | | | | | | | | | | | | | | | | | | | | | | | | | | | | | | | | | | | | | | | | | |
| | | | | | | | | | | | | | | | | | | | | | | | | | | | | | | | | | | | | | | | | | | | | | | | | | | | | | | | | | | | | | | | | | | | | | | | | | | | | | | | |
| | | | | | | | | | | | | | | | | | | | | | | | | | | | | | | | | | | | | | | | | | | | | | | | | | | | | | | | | | | | | | | | | | | | | | | | | | | | | | | | |
| | | | | | | | | | | | | | | | | | | | | | | | | | | | | | | | | | | | | | | | | | | | | | | | | | | | | | | | | | | | | | | | | | | | | | | | | | | | | | | | |
| 1 | | 1 | | | | | | | | | | | | | | | | | | | | | | | | | | | | | | | | | | | | | | | | | | | | | | | | | | | | | | | | | | | | | | | | | | | | | | | | | | | | | |
| 2 | | 1 | | | | | | | | | | | | | | | | | | | | | | | | | | | | | | | | | | | | | | | | | | | | | | | | | | | | | | | | | | | | | | | | | | | | | | | | | | | | | |
| | | | | | | | | | | | | | | | | | | | | | | | | | | | | | | | | | | | | | | | | | | | | | | | | | | | | | | | | | | | | | | | | | | | | | | | | | | | | | | | |
| | | | | | | | | | | | | | | | | | | | | | | | | | | | | | | | | | | | | | | | | | | | | | | | | | | | | | | | | | | | | | | | | | | | | | | | | | | | | | | | |
| | | | | | | | | | | | | | | | | | | | | | | | | | | | | | | | | | | | | | | | | | | | | | | | | | | | | | | | | | | | | | | | | | | | | | | | | | | | | | | | |
| | | | | | | | | | | | | | | | | | | | | | | | | | | | | | | | | | | | | | | | | | | | | | | | | | | | | | | | | | | | | | | | | | | | | | | | | | | | | | | | |
| | | | | | | | | | | | | | | | | | | | | | | | | | | | | | | | | | | | | | | | | | | | | | | | | | | | | | | | | | | | | | | | | | | | | | | | | | | | | | | | |
| | | | | | | | | | | | | | | | | | | | | | | | | | | | | | | | | | | | | | | | | | | | | | | | | | | | | | | | | | | | | | | | | | | | | | | | | | | | | | | | |
| | | | | | | | | | | | | | | | | | | | | | | | | | | | | | | | | | | | | | | | | | | | | | | | | | | | | | | | | | | | | | | | | | | | | | | | | | | | | | | | |
| | | | | | | | | | | | | | | | | | | | | | | | | | | | | | | | | | | | | | | | | | | | | | | | | | | | | | | | | | | | | | | | | | | | | | | | | | | | | | | | |
| | | | | | | | | | | | | | | | | | | | | | | | | | | | | | | | | | | | | | | | | | | | | | | | | | | | | | | | | | | | | | | | | | | | | | | | | | | | | | | | |
| | | | | | | | | | | | | | | | | | | | | | | | | | | | | | | | | | | | | | | | | | | | | | | | | | | | | | | | | | | | | | | | | | | | | | | | | | | | | | | | |
| | | | | | | | | | | | | | | | | | | | | | | | | | | | | | | | | | | | | | | | | | | | | | | | | | | | | | | | | | | | | | | | | | | | | | | | | | | | | | | | |
| | | | | | | | | | | | | | | | | | | | | | | | | | | | | | | | | | | | | | | | | | | | | | | | | | | | | | | | | | | | | | | | | | | | | | | | | | | | | | | | |
| | | 1 | | | | | | | | | | | | | | | | | | | | | | | | | | | | | | | | | | | | | | | | | | | | | | | | | | | | | | | | | | | | | | | | | | | | | | | | | | | | | |
| | | | | | | | | | | | | | | | | | | | | | | | | | | | | | | | | | | | | | | | | | | | | | | | | | | | | | | | | | | | | | | | | | | | | | | | | | | | | | | | |
| 1 | | 3 | | | | | | | | | | | | | | | | | | | | | | | | | | | | | | | | | | | | | | | | | | | | | | | | | | | | | | | | | | | | | | | | | | | | | | | | | | | | | |
| | | | | | | | | | | | | | | | | | | | | | | | | | | | | | | | | | | | | | | | | | | | | | | | | | | | | | | | | | | | | | | | | | | | | | | | | | | | | | | | |
| | | | | | | | | | | | | | | | | | | | | | | | | | | | | | | | | | | | | | | | | | | | | | | | | | | | | | | | | | | | | | | | | | | | | | | | | | | | | | | | |
| | | | | | | | | | | | | | | | | | | | | | | | | | | | | | | | | | | | | | | | | | | | | | | | | | | | | | | | | | | | | | | | | | | | | | | | | | | | | | | | |
| 16 李凯锋 <table border="1"><tr><td></td><td></td><td></td></tr><tr><td></td><td></td><td></td></tr><tr><td></td><td></td><td></td></tr></table> Post - 0 Miss - 0 Block - 0 | | | | | | | | | | 17 陈锐涛 <table border="1"><tr><td></td><td></td><td></td></tr><tr><td></td><td></td><td></td></tr><tr><td></td><td></td><td></td></tr></table> Post - 0 Miss - 0 Block - 0 | | | | | | | | | | 18 奚尧 <table border="1"><tr><td></td><td></td><td>1</td></tr><tr><td></td><td></td><td></td></tr><tr><td></td><td>1</td><td></td></tr></table> Post - 1 Miss - 0 Block - 0 | | | 1 | | | | | 1 | | 21 刘晓青 <table border="1"><tr><td></td><td></td><td></td></tr><tr><td></td><td></td><td></td></tr><tr><td></td><td></td><td></td></tr></table> Post - 0 Miss - 0 Block - 0 | | | | | | | | | | 23 朱天一 <table border="1"><tr><td></td><td></td><td></td></tr><tr><td></td><td></td><td></td></tr><tr><td></td><td></td><td></td></tr></table> Post - 0 Miss - 0 Block - 0 | | | | | | | | | | 24 钟盛发 <table border="1"><tr><td></td><td></td><td></td></tr><tr><td></td><td></td><td></td></tr><tr><td></td><td></td><td></td></tr></table> Post - 0 Miss - 0 Block - 0 | | | | | | | | | | 27 邓可钊 <table border="1"><tr><td></td><td></td><td></td></tr><tr><td></td><td></td><td></td></tr><tr><td></td><td></td><td></td></tr></table> Post - 0 Miss - 0 Block - 0 | | | | | | | | | | 36 陈泽锟 <table border="1"><tr><td></td><td></td><td></td></tr><tr><td></td><td></td><td></td></tr><tr><td></td><td></td><td></td></tr></table> Post - 0 Miss - 0 Block - 0 | | | | | | | | | |
| | | | | | | | | | | | | | | | | | | | | | | | | | | | | | | | | | | | | | | | | | | | | | | | | | | | | | | | | | | | | | | | | | | | | | | | | | | | | | | | |
| | | | | | | | | | | | | | | | | | | | | | | | | | | | | | | | | | | | | | | | | | | | | | | | | | | | | | | | | | | | | | | | | | | | | | | | | | | | | | | | |
| | | | | | | | | | | | | | | | | | | | | | | | | | | | | | | | | | | | | | | | | | | | | | | | | | | | | | | | | | | | | | | | | | | | | | | | | | | | | | | | |
| | | | | | | | | | | | | | | | | | | | | | | | | | | | | | | | | | | | | | | | | | | | | | | | | | | | | | | | | | | | | | | | | | | | | | | | | | | | | | | | |
| | | | | | | | | | | | | | | | | | | | | | | | | | | | | | | | | | | | | | | | | | | | | | | | | | | | | | | | | | | | | | | | | | | | | | | | | | | | | | | | |
| | | | | | | | | | | | | | | | | | | | | | | | | | | | | | | | | | | | | | | | | | | | | | | | | | | | | | | | | | | | | | | | | | | | | | | | | | | | | | | | |
| | | 1 | | | | | | | | | | | | | | | | | | | | | | | | | | | | | | | | | | | | | | | | | | | | | | | | | | | | | | | | | | | | | | | | | | | | | | | | | | | | | |
| | | | | | | | | | | | | | | | | | | | | | | | | | | | | | | | | | | | | | | | | | | | | | | | | | | | | | | | | | | | | | | | | | | | | | | | | | | | | | | | |
| | 1 | | | | | | | | | | | | | | | | | | | | | | | | | | | | | | | | | | | | | | | | | | | | | | | | | | | | | | | | | | | | | | | | | | | | | | | | | | | | | | |
| | | | | | | | | | | | | | | | | | | | | | | | | | | | | | | | | | | | | | | | | | | | | | | | | | | | | | | | | | | | | | | | | | | | | | | | | | | | | | | | |
| | | | | | | | | | | | | | | | | | | | | | | | | | | | | | | | | | | | | | | | | | | | | | | | | | | | | | | | | | | | | | | | | | | | | | | | | | | | | | | | |
| | | | | | | | | | | | | | | | | | | | | | | | | | | | | | | | | | | | | | | | | | | | | | | | | | | | | | | | | | | | | | | | | | | | | | | | | | | | | | | | |
| | | | | | | | | | | | | | | | | | | | | | | | | | | | | | | | | | | | | | | | | | | | | | | | | | | | | | | | | | | | | | | | | | | | | | | | | | | | | | | | |
| | | | | | | | | | | | | | | | | | | | | | | | | | | | | | | | | | | | | | | | | | | | | | | | | | | | | | | | | | | | | | | | | | | | | | | | | | | | | | | | |
| | | | | | | | | | | | | | | | | | | | | | | | | | | | | | | | | | | | | | | | | | | | | | | | | | | | | | | | | | | | | | | | | | | | | | | | | | | | | | | | |
| | | | | | | | | | | | | | | | | | | | | | | | | | | | | | | | | | | | | | | | | | | | | | | | | | | | | | | | | | | | | | | | | | | | | | | | | | | | | | | | |
| | | | | | | | | | | | | | | | | | | | | | | | | | | | | | | | | | | | | | | | | | | | | | | | | | | | | | | | | | | | | | | | | | | | | | | | | | | | | | | | |
| | | | | | | | | | | | | | | | | | | | | | | | | | | | | | | | | | | | | | | | | | | | | | | | | | | | | | | | | | | | | | | | | | | | | | | | | | | | | | | | |
| | | | | | | | | | | | | | | | | | | | | | | | | | | | | | | | | | | | | | | | | | | | | | | | | | | | | | | | | | | | | | | | | | | | | | | | | | | | | | | | |
| | | | | | | | | | | | | | | | | | | | | | | | | | | | | | | | | | | | | | | | | | | | | | | | | | | | | | | | | | | | | | | | | | | | | | | | | | | | | | | | |
| | | | | | | | | | | | | | | | | | | | | | | | | | | | | | | | | | | | | | | | | | | | | | | | | | | | | | | | | | | | | | | | | | | | | | | | | | | | | | | | |
| | | | | | | | | | | | | | | | | | | | | | | | | | | | | | | | | | | | | | | | | | | | | | | | | | | | | | | | | | | | | | | | | | | | | | | | | | | | | | | | |
| | | | | | | | | | | | | | | | | | | | | | | | | | | | | | | | | | | | | | | | | | | | | | | | | | | | | | | | | | | | | | | | | | | | | | | | | | | | | | | | |
| | | | | | | | | | | | | | | | | | | | | | | | | | | | | | | | | | | | | | | | | | | | | | | | | | | | | | | | | | | | | | | | | | | | | | | | | | | | | | | | |

PHMS Pictorial Handball Match Statistics **IHF** Official System

| | | | | | | | | | | | |
|------------------|--|--|--|------------------|--|--|--|--------------------------|--|--|--|
| Team A A 江苏苏州 | | | | Team B B 上海宝山 | | | | Match Number 6 | | | |
|------------------|--|--|--|------------------|--|--|--|--------------------------|--|--|--|

| | | | | | |
|-------------------|------------------------|------------------|-------------|-------|----------|
| Played in 安徽滁州 | in the hall 滁州国际手球馆 | on 2019-05-27 | at 19:00 | hours | Speakers |
|-------------------|------------------------|------------------|-------------|-------|----------|

| | | | | | | | | | | | | | | |
|----------------|---------|--------|---------------------|---------|---------|----------------|---|---|----------------|---|---|----------------------|---|---|
| Half-time(30') | A 11 | B 3 | End of playing time | A 20 | B 12 | 1st extra time | A | B | 2nd extra time | A | B | After penalty throws | A | B |
|----------------|---------|--------|---------------------|---------|---------|----------------|---|---|----------------|---|---|----------------------|---|---|

| | | | | | | | | | |
|----------------------|---------------|---|---|------------------------------------|---------------|---|---|----------|---------------|
| Number of 7 m 0/1 | Team time-out | | | Full name of players and officials | Team time-out | | | B 1/2 | Number of 7 m |
| | 1 | 2 | 3 | | 1 | 2 | 3 | | |

| No. | Team A | G | W | 2' | D | DR | No. | Team B | G | W | 2' | D | DR |
|-----|--------|---|---|----|---|----|-----|-----------|---|---|----|---|----|
| 1 | 邹明轩 | | | | | | 3 | 侯俊杰 | | | | | |
| 2 | 马力 | | | | | | 5 | 范斯哲 | 1 | | | | |
| 4 | 孙钊 | 3 | | | | | 6 | 吴梓涵 | | | | | |
| 5 | 马奔 | 1 | | | | | 7 | 彭意焱 | 1 | | | | |
| 6 | 潘超群 | 4 | | | | | 10 | 马涛 | 1 | | | | |
| 8 | 王震 | 1 | 1 | | | | 13 | 刘启群 | 5 | | | | |
| 9 | 李文俊 | | | | | | 21 | 曾新宇 | 3 | | | | |
| 10 | 朱红雨 | 3 | | | | | 22 | 马浩东 | | | | | |
| 11 | 许多 | | | | | | 25 | 江锦 | | | | | |
| 12 | 周文贤 | | | | | | 35 | 刘子杰 | 1 | | | | |
| 13 | 蒋超 | 3 | | | | | 39 | 陆毅泽 | | | | | |
| 14 | 刘亚力 | 3 | | | | | 66 | 黄嘉遥 | | | | | |
| 15 | 刘成果 | 1 | | | | | 68 | 陈沁磊 | | | | | |
| 18 | 何志伟 | 1 | | | | | | | | | | | |
| 23 | 张铮洋 | | | | | | | | | | | | |
| A | 周清 | | | | | | A | 马革 | | | | | |
| C | 郝可鑫 | | | | | | B | 徐聪豪 (主教练) | | | | | |
| D | 陈冬冬 | | | | | | D | 赵时俊 | | | | | |
| E | 陈伟 | | | | | | | | | | | | |

| | | | | | | | | | | | | | |
|---|--|--|--|--|--|--|--|--|--|--|--|--|---|
| A | Signatures of responsables for the teams (Off.A) | | | | | | | | | | | | B |
|---|--|--|--|--|--|--|--|--|--|--|--|--|---|

| | | | | | | | | | | | | | | |
|----|-----------------------------------|--|--|--|--|--|--|--|--|--|--|--|--|----|
| TP | Remarks of referees / HF Official | | | | | | | | | | | | | TP |
|----|-----------------------------------|--|--|--|--|--|--|--|--|--|--|--|--|----|

| | | | | |
|----------|-----------|-----------|--|--|
| Referees | 刘禹 (CHN) | 许翔 (CHN) | | |
| T.D. | 吴瑞亭 (CHN) | 许宜扬 (CHN) | | |
| CHA Off. | | | | |

Note: Number of 7m Throws Awarded to Team A and B, Goals (G), Warnings (W), Suspensions (2'), Direct Disqualification (D), Disqualification With Report (DR) and Team Penalty (TP).

Table Officials: 刘洋洋 许修凯 Statisticians: 沈家洛 马安兴

竞赛技术统计

手球
青年男子

预赛
轮次 1

组别 B
场次 6

滁州国际手球馆
2019-05-27 19:00

| | | | |
|-----------|------------------------|---------|--------------|
| Referees: | 刘禹 (CHN) / 许翔 (CHN) | Result: | 20:12 (11:3) |
| Teams: | 江苏苏州 (苏州) VS 上海宝山 (宝山) | | |

| 苏州 | | 远射 | 近射 | 边射 | 快攻 | 突破 | 任意球 | 7m球 | 合计 | % | 助攻 | 失误 | 警告 | 2' | D+DR |
|----------|-----|------|-----|-----|-----|-----|-----|-----|-------|------|----|----|----|----|------|
| 主教练: 陈冬冬 | | | | | | | | | | | | | | | |
| 1 | 邹明轩 | | | | | | | | | | | | | | |
| 2 | 马力 | | 0/1 | | | | | 0/1 | 0.0 | | | | | | |
| 4 | 孙钊 | 2/3 | | | | 1/1 | 0/1 | 3/5 | 60.0 | | | | | | |
| 5 | 马奔 | | | | 1/1 | | | 1/1 | 100 | 1 | 1 | | | | |
| 6 | 潘超群 | 3/5 | | | | | 1/1 | 4/6 | 66.7 | 1 | 1 | | | | |
| 8 | 王震 | 0/1 | | | | 1/1 | | 1/2 | 50.0 | 1 | | 1 | | | |
| 9 | 李文俊 | | | | | | | | | | | 1 | | | |
| 10 | 朱红雨 | | 1/1 | 2/2 | | | | 3/3 | 100 | | | 1 | | | |
| 11 | 许多 | 0/1 | | | | | | 0/1 | 0.0 | 2 | | | | | |
| 12 | 周文贤 | | | | | | | | | | | | | | |
| 13 | 蒋超 | | | | 3/3 | | | 3/3 | 100 | | | | | | |
| 14 | 刘亚力 | 1/2 | 1/1 | | | 1/1 | | 3/4 | 75.0 | | | | | | |
| 15 | 刘成果 | | 1/1 | | | | | 1/1 | 100 | | | 1 | | | |
| 18 | 何志伟 | 0/1 | 1/1 | | | | | 1/2 | 50.0 | 1 | | | | | |
| 23 | 张铮洋 | | | | | | | | | | | | | | |
| 运动员 | 合计 | 6/13 | 4/5 | 2/2 | 4/4 | 3/3 | 1/2 | 0/1 | 20/30 | 66.7 | 6 | 5 | 1 | | |
| 1 | 邹明轩 | 4/4 | 1/1 | 0/1 | 0/1 | 0/1 | | 5/8 | 62.5 | | | | | | |
| 12 | 周文贤 | 1/3 | 0/2 | 3/4 | 0/1 | 0/2 | | 0/1 | 4/13 | 30.8 | | | | | |
| 守门员 | 合计 | 5/7 | 1/3 | 3/5 | 0/2 | 0/3 | | 0/1 | 9/21 | 42.9 | | | | | |

| 苏州 | 比赛进程 | 宝山 |
|----------|----------|-----------|
| 1st Half | | |
| 6 潘超群 | 1 01:57 | 0 |
| 4 孙钊 | 2 02:55 | 0 |
| 4 孙钊 | 3 03:48 | 0 |
| 13 蒋超 | 4 04:28 | 0 |
| 5 马奔 | 5 05:28 | 0 |
| 4 孙钊 | 6 07:05 | 0 |
| 6 潘超群 | 6 07:29 | 1 13 刘启群 |
| 6 潘超群 | 6 08:11 | 2 21 曾新宇 |
| 6 潘超群 | 7 08:35 | 2 |
| 13 蒋超 | 8 09:05 | 2 |
| 13 蒋超 | 9 09:31 | 2 |
| 9 李文俊 | 9 10:25 | 3 21 曾新宇 |
| 18 何志伟 | 10 12:31 | 3 |
| 8 王震 | 11 14:41 | 3 |
| 2nd Half | | |
| 11 王震 | 11 00:48 | 4 5 范斯哲 |
| 6 潘超群 | 12 01:29 | 4 |
| 12 周文贤 | 12 01:53 | 5 35 刘子杰 |
| 10 朱红雨 | 13 02:43 | 5 |
| 6 潘超群 | 14 03:25 | 5 |
| 14 刘亚力 | 14 03:47 | 6 13 刘启群 |
| 10 朱红雨 | 15 04:21 | 6 |
| 14 刘亚力 | 16 05:35 | 6 |
| 14 刘亚力 | 16 05:53 | 7 13 刘启群 |
| 14 刘亚力 | 17 06:05 | 7 |
| 17 王震 | 17 06:28 | 8 13 刘启群 |
| 17 王震 | 17 07:49 | 9 13 刘启群 |
| 15 刘成果 | 18 08:04 | 9 |
| 18 何志伟 | 18 08:27 | 10 10 马涛 |
| 18 何志伟 | 18 10:34 | 11 21 曾新宇 |
| 10 朱红雨 | 19 13:04 | 11 |
| 19 李文俊 | 19 13:30 | 12 7 彭意焱 |
| 14 刘亚力 | 20 13:43 | 12 |

| 宝山 | | 远射 | 近射 | 边射 | 快攻 | 突破 | 任意球 | 7m球 | 合计 | % | 助攻 | 失误 | 警告 | 2' | D+DR |
|----------|-----|------|-----|-----|-----|-----|-----|------|-------|------|----|----|----|----|------|
| 主教练: 徐聪豪 | | | | | | | | | | | | | | | |
| 3 | 侯俊杰 | | | 0/1 | | | | | 0/1 | 0.0 | | 1 | | | |
| 5 | 范斯哲 | | 1/1 | | | | | 1/1 | 100 | | | | | | |
| 6 | 吴梓涵 | | | | | | | | | | | | | | |
| 7 | 彭意焱 | 1/1 | | | | | | 1/1 | 100 | | | | | | |
| 10 | 马涛 | | 1/1 | | | | | 1/1 | 100 | 1 | 1 | | | | |
| 13 | 刘启群 | 1/3 | | 2/2 | | 2/2 | | 5/7 | 71.4 | | 3 | | | | |
| 21 | 曾新宇 | 0/11 | 0/1 | | 2/2 | 1/1 | | 3/15 | 20.0 | | | | | | |
| 22 | 马浩东 | 0/1 | | | | | | 0/1 | 0.0 | 1 | 2 | | | | |
| 25 | 江锦 | | | 0/2 | | | | 0/2 | 0.0 | | 1 | | | | |
| 35 | 刘子杰 | | | | | | | 1/2 | 50.0 | | | | | | |
| 39 | 陆毅洋 | 0/1 | | | | | | 0/1 | 0.0 | | | | | | |
| 66 | 黄嘉遥 | | | | | | | | | | | | | | |
| 68 | 陈沁磊 | | | | | | | | | | | | | | |
| 运动员 | 合计 | 2/17 | 2/3 | 2/5 | 2/2 | 3/3 | | 1/2 | 12/32 | 37.5 | 2 | 8 | | | |
| 66 | 黄嘉遥 | 6/12 | 0/4 | 0/2 | 0/4 | 0/3 | 0/1 | 1/1 | 7/27 | 25.9 | | | | | |
| 守门员 | 合计 | 6/12 | 0/4 | 0/2 | 0/4 | 0/3 | 0/1 | 1/1 | 7/27 | 25.9 | | | | | |

场上队员: 得分 / 射门

守门员: 救球 / 射门

| | | | |
|---|------|----|---------|
| D | 取消资格 | DR | 取消资格+报告 |
|---|------|----|---------|

个人/全队技术统计表

手球 青年男子 预赛 轮次 1 组别 B 场次 6 滁州国际手球馆 2019-05-27 19:00

| 号码 | 姓名 | 远射 | 近射 | 边射 | 快攻 | 突破 | 任意 | 七米 | 合计 | % | 助攻 | 失误 | 警告 | 2' | 取消 | 时间 |
|----------|-----|------|-----|-----|-----|-----|-----|-----|-------|-------|----|----|----|----|----|----------|
| 江苏苏州(苏州) | | | | | | | | | | | | | | | | |
| (场上队员) | | | | | | | | | | | | | | | | |
| 1 | 邹明轩 | | | | | | | | | 0.0% | | | | | | 00:15:00 |
| 2 | 马力 | | 0/1 | | | | | | 0/1 | 0.0% | | | | | | 00:10:01 |
| 4 | 孙钊 | 2/3 | | | | 1/1 | 0/1 | | 3/5 | 60.0% | | | | | | 00:07:22 |
| 5 | 马奔 | | | | 1/1 | | | | 1/1 | 100% | 1 | 1 | | | | 00:15:00 |
| 6 | 潘超群 | 3/5 | | | | | 1/1 | | 4/6 | 66.7% | 1 | 1 | | | | 00:18:48 |
| 8 | 王震 | 0/1 | | | | 1/1 | | | 1/2 | 50.0% | 1 | | 1 | | | 00:15:00 |
| 9 | 李文俊 | | | | | | | | | 0.0% | | 1 | | | | 00:15:00 |
| 10 | 朱红雨 | | 1/1 | 2/2 | | | | | 3/3 | 100% | | 1 | | | | 00:15:00 |
| 11 | 许多 | 0/1 | | | | | | 0/1 | 0/2 | 0.0% | 2 | | | | | 00:08:39 |
| 12 | 周文贤 | | | | | | | | | 0.0% | | | | | | 00:15:00 |
| 13 | 蒋超 | | | | 3/3 | | | | 3/3 | 100% | | | | | | 00:15:00 |
| 14 | 刘亚力 | 1/2 | 1/1 | | | 1/1 | | | 3/4 | 75.0% | | | | | | 00:15:00 |
| 15 | 刘成果 | | 1/1 | | | | | | 1/1 | 100% | | 1 | | | | 00:15:00 |
| 18 | 何志伟 | 0/1 | 1/1 | | | | | | 1/2 | 50.0% | 1 | | | | | 00:15:00 |
| 23 | 张铮洋 | | | | | | | | | 0.0% | | | | | | 00:14:54 |
| 合计 | | 6/13 | 4/5 | 2/2 | 4/4 | 3/3 | 1/2 | 0/1 | 20/30 | 66.7% | 6 | 5 | 1 | | | |
| (守门员) | | | | | | | | | | | | | | | | |
| 1 | 邹明轩 | 4/4 | 1/1 | 0/1 | 0/1 | 0/1 | | | 5/8 | 62.5% | | | | | | 00:15:00 |
| 12 | 周文贤 | 1/3 | 0/2 | 3/4 | 0/1 | 0/2 | | 0/1 | 4/13 | 30.8% | | | | | | 00:15:00 |
| 合计 | | 5/7 | 1/3 | 3/5 | 0/2 | 0/3 | | 0/1 | 9/21 | 42.9% | | | | | | |

场上队员：得分/射门

守门员：救球/射门

| 全队合计 | 得分 | 被救 | 射失 | 击柱 | 封球 | 合计 | % |
|------|----|----|----|----|----|----|--------|
| 远射 | 6 | 6 | | 1 | | 13 | 46.2% |
| 近射 | 4 | | 1 | | | 5 | 80.0% |
| 边射 | 2 | | | | | 2 | 100.0% |
| 快攻 | 4 | | | | | 4 | 100.0% |
| 突破 | 3 | | | | | 3 | 100.0% |
| 任意 | 1 | | 1 | | | 2 | 50.0% |
| 七米 | | 1 | | | | 1 | 0.0% |

个人/全队技术统计表

手球 预赛 组别 B 滁州国际手球馆
青年男子 轮次 1 场次 6 2019-05-27 19:00

| 号码 | 姓名 | 远射 | 近射 | 边射 | 快攻 | 突破 | 任意 | 七米 | 合计 | % | 助攻 | 失误 | 警告 | 2' | 取消 | 时间 |
|----------|-----|------|-----|-----|-----|-----|-----|-----|-------|-------|----|----|----|----|----|----------|
| 上海宝山(宝山) | | | | | | | | | | | | | | | | |
| (场上队员) | | | | | | | | | | | | | | | | |
| 3 | 侯俊杰 | | | 0/1 | | | | | 0/1 | 0.0% | | 1 | | | | 00:24:22 |
| 5 | 范斯哲 | | 1/1 | | | | | | 1/1 | 100% | | | | | | 00:30:00 |
| 6 | 吴梓涵 | | | | | | | | | 0.0% | | | | | | 00:00:00 |
| 7 | 彭意焱 | 1/1 | | | | | | | 1/1 | 100% | | | | | | 00:02:23 |
| 10 | 马涛 | | 1/1 | | | | | | 1/1 | 100% | 1 | 1 | | | | 00:27:18 |
| 13 | 刘启群 | 1/3 | | 2/2 | | 2/2 | | | 5/7 | 71.4% | | 3 | | | | 00:30:00 |
| 21 | 曾新宇 | 0/11 | 0/1 | | 2/2 | 1/1 | | | 3/15 | 20.0% | | | | | | 00:27:36 |
| 22 | 马浩东 | 0/1 | | | | | | | 0/1 | 0.0% | 1 | 2 | | | | 00:19:25 |
| 25 | 江锦 | | | 0/2 | | | | | 0/2 | 0.0% | | 1 | | | | 00:16:07 |
| 35 | 刘子杰 | | | | | | | 1/2 | 1/2 | 50.0% | | | | | | 00:00:29 |
| 39 | 陆毅泽 | 0/1 | | | | | | | 0/1 | 0.0% | | | | | | 00:02:07 |
| 66 | 黄嘉遥 | | | | | | | | | 0.0% | | | | | | 00:30:00 |
| 68 | 陈沁磊 | | | | | | | | | 0.0% | | | | | | 00:00:00 |
| 合计 | | 2/17 | 2/3 | 2/5 | 2/2 | 3/3 | | 1/2 | 12/32 | 37.5% | 2 | 8 | | | | |
| (守门员) | | | | | | | | | | | | | | | | |
| 66 | 黄嘉遥 | 6/12 | 0/4 | 0/2 | 0/4 | 0/3 | 0/1 | 1/1 | 7/27 | 25.9% | | | | | | 00:30:00 |
| 合计 | | 6/12 | 0/4 | 0/2 | 0/4 | 0/3 | 0/1 | 1/1 | 7/27 | 25.9% | | | | | | |

场上队员： 得分/射门

守门员： 救球/射门

| 全队合计 | 得分 | 被救 | 射失 | 击柱 | 封球 | 合计 | % |
|------|----|----|----|----|----|----|--------|
| 远射 | 2 | 5 | 3 | 1 | 6 | 17 | 11.8% |
| 近射 | 2 | 1 | | | | 3 | 66.7% |
| 边射 | 2 | 3 | | | | 5 | 40.0% |
| 快攻 | 2 | | | | | 2 | 100.0% |
| 突破 | 3 | | | | | 3 | 100.0% |
| 任意 | | | | | | | 0.0% |
| 七米 | 1 | | 1 | | | 2 | 50.0% |

图式比赛技术统计表

手球
青年男子

预赛
轮次 1

组别 B
场次 6

滁州国际手球馆
2019-05-27 19:00

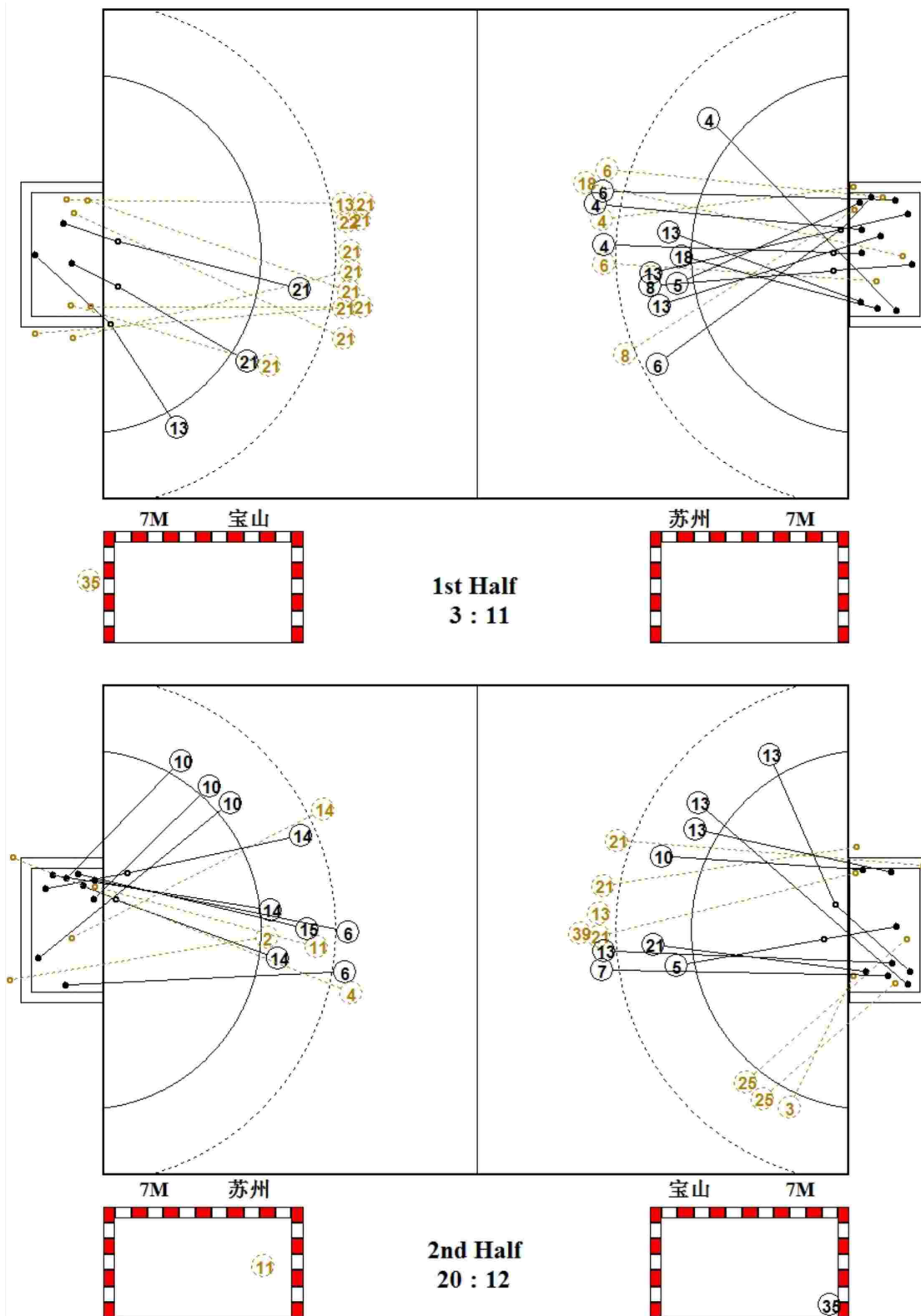

图式射门区域统计

手球
青年男子

预赛
轮次 1

组别 B
场次 6

滁州国际手球馆
2019-05-27 19:00

江苏苏州

| | | | | | | | | | | | | | | | | | | | | | | | | | | | | | | | | | | | | | | | | | | | | | | | | | | | | | | | | | | | | | | | | | | | | | | | | | | | | | | | |
|--|-----------------------------|-----------------------------|-----------------------------|-----------------------------|-----------------------------|-----------------------------|-----------------------------|--|--|--|--|--|--|--|--|--|--|--|--|---|---|--|---|---|---|--|--|--|---|--|--|--|---|---|--|--|--|--|---|--|---|--|--|---|--|---|---|---|--|---|--|---|--|--|--|---|--|--|--|--|--|--|--|--|--|--|--|--|--|---|---|--|--|--|--|---|--|--|---|
| 1 邹明轩 | 2 马力 | 4 孙判 | 5 马奔 | 6 潘超群 | 8 王震 | 9 李文俊 | 10 朱红雨 | | | | | | | | | | | | | | | | | | | | | | | | | | | | | | | | | | | | | | | | | | | | | | | | | | | | | | | | | | | | | | | | | | | | | | | | |
| <table border="1"><tr><td></td><td></td><td></td></tr><tr><td></td><td></td><td></td></tr><tr><td></td><td></td><td></td></tr></table> | | | | | | | | | | <table border="1"><tr><td></td><td></td><td></td></tr><tr><td></td><td></td><td></td></tr><tr><td></td><td></td><td></td></tr></table> | | | | | | | | | | <table border="1"><tr><td></td><td></td><td>1</td></tr><tr><td>1</td><td>1</td><td></td></tr><tr><td></td><td></td><td></td></tr></table> | | | 1 | 1 | 1 | | | | | <table border="1"><tr><td></td><td></td><td></td></tr><tr><td>1</td><td></td><td></td></tr><tr><td></td><td></td><td></td></tr></table> | | | | 1 | | | | | | <table border="1"><tr><td>1</td><td></td><td></td></tr><tr><td>1</td><td></td><td></td></tr><tr><td>1</td><td>1</td><td></td></tr></table> | 1 | | | 1 | | | 1 | 1 | | <table border="1"><tr><td></td><td>1</td><td></td></tr><tr><td></td><td></td><td></td></tr><tr><td></td><td></td><td></td></tr></table> | | 1 | | | | | | | | <table border="1"><tr><td></td><td></td><td></td></tr><tr><td></td><td></td><td></td></tr><tr><td></td><td></td><td></td></tr></table> | | | | | | | | | | <table border="1"><tr><td>1</td><td></td><td></td></tr><tr><td></td><td></td><td>1</td></tr><tr><td></td><td></td><td>1</td></tr></table> | 1 | | | | | 1 | | | 1 |
| | | | | | | | | | | | | | | | | | | | | | | | | | | | | | | | | | | | | | | | | | | | | | | | | | | | | | | | | | | | | | | | | | | | | | | | | | | | | | | | |
| | | | | | | | | | | | | | | | | | | | | | | | | | | | | | | | | | | | | | | | | | | | | | | | | | | | | | | | | | | | | | | | | | | | | | | | | | | | | | | | |
| | | | | | | | | | | | | | | | | | | | | | | | | | | | | | | | | | | | | | | | | | | | | | | | | | | | | | | | | | | | | | | | | | | | | | | | | | | | | | | | |
| | | | | | | | | | | | | | | | | | | | | | | | | | | | | | | | | | | | | | | | | | | | | | | | | | | | | | | | | | | | | | | | | | | | | | | | | | | | | | | | |
| | | | | | | | | | | | | | | | | | | | | | | | | | | | | | | | | | | | | | | | | | | | | | | | | | | | | | | | | | | | | | | | | | | | | | | | | | | | | | | | |
| | | | | | | | | | | | | | | | | | | | | | | | | | | | | | | | | | | | | | | | | | | | | | | | | | | | | | | | | | | | | | | | | | | | | | | | | | | | | | | | |
| | | 1 | | | | | | | | | | | | | | | | | | | | | | | | | | | | | | | | | | | | | | | | | | | | | | | | | | | | | | | | | | | | | | | | | | | | | | | | | | | | | |
| 1 | 1 | | | | | | | | | | | | | | | | | | | | | | | | | | | | | | | | | | | | | | | | | | | | | | | | | | | | | | | | | | | | | | | | | | | | | | | | | | | | | | |
| | | | | | | | | | | | | | | | | | | | | | | | | | | | | | | | | | | | | | | | | | | | | | | | | | | | | | | | | | | | | | | | | | | | | | | | | | | | | | | | |
| | | | | | | | | | | | | | | | | | | | | | | | | | | | | | | | | | | | | | | | | | | | | | | | | | | | | | | | | | | | | | | | | | | | | | | | | | | | | | | | |
| 1 | | | | | | | | | | | | | | | | | | | | | | | | | | | | | | | | | | | | | | | | | | | | | | | | | | | | | | | | | | | | | | | | | | | | | | | | | | | | | | | |
| | | | | | | | | | | | | | | | | | | | | | | | | | | | | | | | | | | | | | | | | | | | | | | | | | | | | | | | | | | | | | | | | | | | | | | | | | | | | | | | |
| 1 | | | | | | | | | | | | | | | | | | | | | | | | | | | | | | | | | | | | | | | | | | | | | | | | | | | | | | | | | | | | | | | | | | | | | | | | | | | | | | | |
| 1 | | | | | | | | | | | | | | | | | | | | | | | | | | | | | | | | | | | | | | | | | | | | | | | | | | | | | | | | | | | | | | | | | | | | | | | | | | | | | | | |
| 1 | 1 | | | | | | | | | | | | | | | | | | | | | | | | | | | | | | | | | | | | | | | | | | | | | | | | | | | | | | | | | | | | | | | | | | | | | | | | | | | | | | |
| | 1 | | | | | | | | | | | | | | | | | | | | | | | | | | | | | | | | | | | | | | | | | | | | | | | | | | | | | | | | | | | | | | | | | | | | | | | | | | | | | | |
| | | | | | | | | | | | | | | | | | | | | | | | | | | | | | | | | | | | | | | | | | | | | | | | | | | | | | | | | | | | | | | | | | | | | | | | | | | | | | | | |
| | | | | | | | | | | | | | | | | | | | | | | | | | | | | | | | | | | | | | | | | | | | | | | | | | | | | | | | | | | | | | | | | | | | | | | | | | | | | | | | |
| | | | | | | | | | | | | | | | | | | | | | | | | | | | | | | | | | | | | | | | | | | | | | | | | | | | | | | | | | | | | | | | | | | | | | | | | | | | | | | | |
| | | | | | | | | | | | | | | | | | | | | | | | | | | | | | | | | | | | | | | | | | | | | | | | | | | | | | | | | | | | | | | | | | | | | | | | | | | | | | | | |
| | | | | | | | | | | | | | | | | | | | | | | | | | | | | | | | | | | | | | | | | | | | | | | | | | | | | | | | | | | | | | | | | | | | | | | | | | | | | | | | |
| 1 | | | | | | | | | | | | | | | | | | | | | | | | | | | | | | | | | | | | | | | | | | | | | | | | | | | | | | | | | | | | | | | | | | | | | | | | | | | | | | | |
| | | 1 | | | | | | | | | | | | | | | | | | | | | | | | | | | | | | | | | | | | | | | | | | | | | | | | | | | | | | | | | | | | | | | | | | | | | | | | | | | | | |
| | | 1 | | | | | | | | | | | | | | | | | | | | | | | | | | | | | | | | | | | | | | | | | | | | | | | | | | | | | | | | | | | | | | | | | | | | | | | | | | | | | |
| Post - 0 Miss - 0 Block - 0 | Post - 0 Miss - 1 Block - 0 | Post - 1 Miss - 1 Block - 0 | Post - 0 Miss - 0 Block - 0 | Post - 0 Miss - 0 Block - 0 | Post - 0 Miss - 0 Block - 0 | Post - 0 Miss - 0 Block - 0 | Post - 0 Miss - 0 Block - 0 | | | | | | | | | | | | | | | | | | | | | | | | | | | | | | | | | | | | | | | | | | | | | | | | | | | | | | | | | | | | | | | | | | | | | | | | |
| 11 许多 | 12 周文贤 | 13 蒋超 | 14 刘亚力 | 15 刘成果 | 18 何志伟 | 23 张铮洋 | | | | | | | | | | | | | | | | | | | | | | | | | | | | | | | | | | | | | | | | | | | | | | | | | | | | | | | | | | | | | | | | | | | | | | | | | |
| <table border="1"><tr><td></td><td></td><td></td></tr><tr><td></td><td></td><td></td></tr><tr><td></td><td></td><td></td></tr></table> | | | | | | | | | | <table border="1"><tr><td></td><td></td><td></td></tr><tr><td></td><td></td><td></td></tr><tr><td></td><td></td><td></td></tr></table> | | | | | | | | | | <table border="1"><tr><td>1</td><td></td><td></td></tr><tr><td></td><td>1</td><td></td></tr><tr><td></td><td></td><td>1</td></tr></table> | 1 | | | | 1 | | | | 1 | <table border="1"><tr><td></td><td></td><td>2</td></tr><tr><td></td><td></td><td></td></tr><tr><td></td><td></td><td>1</td></tr></table> | | | 2 | | | | | | 1 | <table border="1"><tr><td></td><td></td><td></td></tr><tr><td></td><td></td><td>1</td></tr><tr><td></td><td></td><td></td></tr></table> | | | | | | 1 | | | | <table border="1"><tr><td></td><td></td><td></td></tr><tr><td></td><td></td><td>1</td></tr><tr><td></td><td></td><td></td></tr></table> | | | | | | 1 | | | | <table border="1"><tr><td></td><td></td><td></td></tr><tr><td></td><td></td><td></td></tr><tr><td></td><td></td><td></td></tr></table> | | | | | | | | | | | | | | | | | | | |
| | | | | | | | | | | | | | | | | | | | | | | | | | | | | | | | | | | | | | | | | | | | | | | | | | | | | | | | | | | | | | | | | | | | | | | | | | | | | | | | |
| | | | | | | | | | | | | | | | | | | | | | | | | | | | | | | | | | | | | | | | | | | | | | | | | | | | | | | | | | | | | | | | | | | | | | | | | | | | | | | | |
| | | | | | | | | | | | | | | | | | | | | | | | | | | | | | | | | | | | | | | | | | | | | | | | | | | | | | | | | | | | | | | | | | | | | | | | | | | | | | | | |
| | | | | | | | | | | | | | | | | | | | | | | | | | | | | | | | | | | | | | | | | | | | | | | | | | | | | | | | | | | | | | | | | | | | | | | | | | | | | | | | |
| | | | | | | | | | | | | | | | | | | | | | | | | | | | | | | | | | | | | | | | | | | | | | | | | | | | | | | | | | | | | | | | | | | | | | | | | | | | | | | | |
| | | | | | | | | | | | | | | | | | | | | | | | | | | | | | | | | | | | | | | | | | | | | | | | | | | | | | | | | | | | | | | | | | | | | | | | | | | | | | | | |
| 1 | | | | | | | | | | | | | | | | | | | | | | | | | | | | | | | | | | | | | | | | | | | | | | | | | | | | | | | | | | | | | | | | | | | | | | | | | | | | | | | |
| | 1 | | | | | | | | | | | | | | | | | | | | | | | | | | | | | | | | | | | | | | | | | | | | | | | | | | | | | | | | | | | | | | | | | | | | | | | | | | | | | | |
| | | 1 | | | | | | | | | | | | | | | | | | | | | | | | | | | | | | | | | | | | | | | | | | | | | | | | | | | | | | | | | | | | | | | | | | | | | | | | | | | | | |
| | | 2 | | | | | | | | | | | | | | | | | | | | | | | | | | | | | | | | | | | | | | | | | | | | | | | | | | | | | | | | | | | | | | | | | | | | | | | | | | | | | |
| | | | | | | | | | | | | | | | | | | | | | | | | | | | | | | | | | | | | | | | | | | | | | | | | | | | | | | | | | | | | | | | | | | | | | | | | | | | | | | | |
| | | 1 | | | | | | | | | | | | | | | | | | | | | | | | | | | | | | | | | | | | | | | | | | | | | | | | | | | | | | | | | | | | | | | | | | | | | | | | | | | | | |
| | | | | | | | | | | | | | | | | | | | | | | | | | | | | | | | | | | | | | | | | | | | | | | | | | | | | | | | | | | | | | | | | | | | | | | | | | | | | | | | |
| | | 1 | | | | | | | | | | | | | | | | | | | | | | | | | | | | | | | | | | | | | | | | | | | | | | | | | | | | | | | | | | | | | | | | | | | | | | | | | | | | | |
| | | | | | | | | | | | | | | | | | | | | | | | | | | | | | | | | | | | | | | | | | | | | | | | | | | | | | | | | | | | | | | | | | | | | | | | | | | | | | | | |
| | | | | | | | | | | | | | | | | | | | | | | | | | | | | | | | | | | | | | | | | | | | | | | | | | | | | | | | | | | | | | | | | | | | | | | | | | | | | | | | |
| | | 1 | | | | | | | | | | | | | | | | | | | | | | | | | | | | | | | | | | | | | | | | | | | | | | | | | | | | | | | | | | | | | | | | | | | | | | | | | | | | | |
| | | | | | | | | | | | | | | | | | | | | | | | | | | | | | | | | | | | | | | | | | | | | | | | | | | | | | | | | | | | | | | | | | | | | | | | | | | | | | | | |
| | | | | | | | | | | | | | | | | | | | | | | | | | | | | | | | | | | | | | | | | | | | | | | | | | | | | | | | | | | | | | | | | | | | | | | | | | | | | | | | |
| | | | | | | | | | | | | | | | | | | | | | | | | | | | | | | | | | | | | | | | | | | | | | | | | | | | | | | | | | | | | | | | | | | | | | | | | | | | | | | | |
| | | | | | | | | | | | | | | | | | | | | | | | | | | | | | | | | | | | | | | | | | | | | | | | | | | | | | | | | | | | | | | | | | | | | | | | | | | | | | | | |
| Post - 0 Miss - 0 Block - 0 | Post - 0 Miss - 0 Block - 0 | Post - 0 Miss - 0 Block - 0 | Post - 0 Miss - 0 Block - 0 | Post - 0 Miss - 0 Block - 0 | Post - 0 Miss - 0 Block - 0 | Post - 0 Miss - 0 Block - 0 | | | | | | | | | | | | | | | | | | | | | | | | | | | | | | | | | | | | | | | | | | | | | | | | | | | | | | | | | | | | | | | | | | | | | | | | | |

1 邹明轩

| | | |
|-----|-----|-----|
| | 0/1 | |
| 1/1 | 0/1 | 2/3 |
| 1/1 | | 1/1 |

12 周文贤

| | | |
|-----|-----|-----|
| | 1/2 | 1/3 |
| 0/1 | | 0/2 |
| 1/2 | | 1/3 |

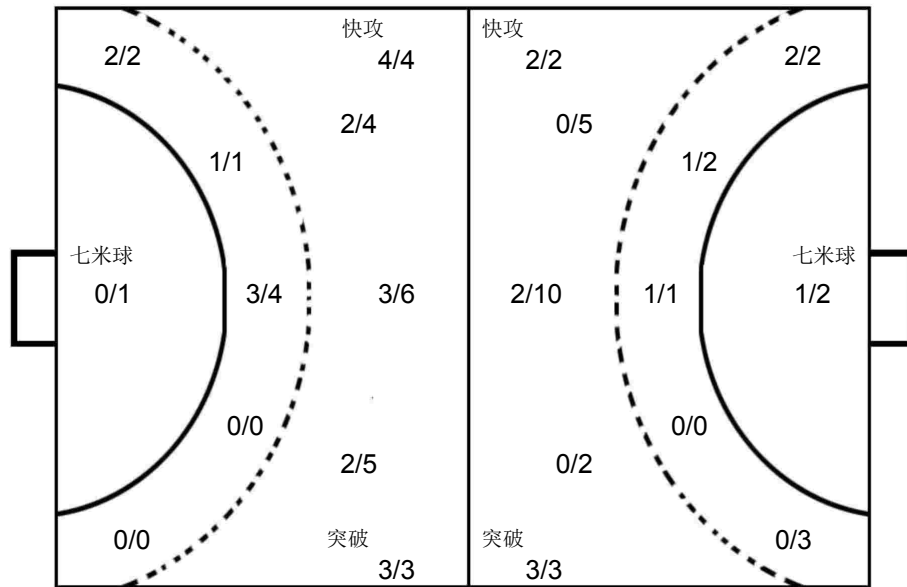

66 黄嘉遥

| | | |
|-----|-----|-----|
| 0/3 | 1/2 | 0/3 |
| 1/2 | 1/2 | 2/5 |
| 1/4 | 0/1 | 1/5 |

上海宝山

| | | | | | | | | | | | | | | | | | | | | | | | | | | | | | | | | | | | | | | | | | | | | | | | | | | | | | | | | | | | | | | | | | | | | | | | | | | | | | | | |
|--|-----------------------------|-----------------------------|-----------------------------|-----------------------------|-----------------------------|-----------------------------|-----------------------------|--|--|---|--|---|--|--|--|---|--|--|--|--|--|--|--|--|--|--|--|--|--|---|--|--|--|--|--|---|--|--|--|---|--|--|--|--|--|--|---|--|--|--|--|---|---|---|--|---|--|--|--|---|--|--|--|--|---|---|--|--|---|--|--|--|--|--|--|--|--|--|--|
| 3 侯俊杰 | 5 范斯哲 | 6 吴梓涵 | 7 彭意焱 | 10 马涛 | 13 刘启群 | 21 曾新宇 | 22 马浩东 | | | | | | | | | | | | | | | | | | | | | | | | | | | | | | | | | | | | | | | | | | | | | | | | | | | | | | | | | | | | | | | | | | | | | | | | |
| <table border="1"><tr><td></td><td></td><td></td></tr><tr><td></td><td></td><td></td></tr><tr><td></td><td></td><td></td></tr></table> | | | | | | | | | | <table border="1"><tr><td></td><td>1</td><td></td></tr><tr><td></td><td></td><td></td></tr><tr><td></td><td></td><td></td></tr></table> | | 1 | | | | | | | | <table border="1"><tr><td></td><td></td><td></td></tr><tr><td></td><td></td><td></td></tr><tr><td></td><td></td><td></td></tr></table> | | | | | | | | | | <table border="1"><tr><td></td><td></td><td></td></tr><tr><td></td><td></td><td>1</td></tr><tr><td></td><td></td><td></td></tr></table> | | | | | | 1 | | | | <table border="1"><tr><td></td><td></td><td></td></tr><tr><td></td><td></td><td></td></tr><tr><td>1</td><td></td><td></td></tr></table> | | | | | | | 1 | | | <table border="1"><tr><td></td><td>1</td><td>2</td></tr><tr><td>1</td><td></td><td>1</td></tr><tr><td></td><td></td><td></td></tr></table> | | 1 | 2 | 1 | | 1 | | | | <table border="1"><tr><td></td><td></td><td></td></tr><tr><td></td><td>1</td><td>1</td></tr><tr><td></td><td></td><td>1</td></tr></table> | | | | | 1 | 1 | | | 1 | <table border="1"><tr><td></td><td></td><td></td></tr><tr><td></td><td></td><td></td></tr><tr><td></td><td></td><td></td></tr></table> | | | | | | | | | |
| | | | | | | | | | | | | | | | | | | | | | | | | | | | | | | | | | | | | | | | | | | | | | | | | | | | | | | | | | | | | | | | | | | | | | | | | | | | | | | | |
| | | | | | | | | | | | | | | | | | | | | | | | | | | | | | | | | | | | | | | | | | | | | | | | | | | | | | | | | | | | | | | | | | | | | | | | | | | | | | | | |
| | | | | | | | | | | | | | | | | | | | | | | | | | | | | | | | | | | | | | | | | | | | | | | | | | | | | | | | | | | | | | | | | | | | | | | | | | | | | | | | |
| | 1 | | | | | | | | | | | | | | | | | | | | | | | | | | | | | | | | | | | | | | | | | | | | | | | | | | | | | | | | | | | | | | | | | | | | | | | | | | | | | | |
| | | | | | | | | | | | | | | | | | | | | | | | | | | | | | | | | | | | | | | | | | | | | | | | | | | | | | | | | | | | | | | | | | | | | | | | | | | | | | | | |
| | | | | | | | | | | | | | | | | | | | | | | | | | | | | | | | | | | | | | | | | | | | | | | | | | | | | | | | | | | | | | | | | | | | | | | | | | | | | | | | |
| | | | | | | | | | | | | | | | | | | | | | | | | | | | | | | | | | | | | | | | | | | | | | | | | | | | | | | | | | | | | | | | | | | | | | | | | | | | | | | | |
| | | | | | | | | | | | | | | | | | | | | | | | | | | | | | | | | | | | | | | | | | | | | | | | | | | | | | | | | | | | | | | | | | | | | | | | | | | | | | | | |
| | | | | | | | | | | | | | | | | | | | | | | | | | | | | | | | | | | | | | | | | | | | | | | | | | | | | | | | | | | | | | | | | | | | | | | | | | | | | | | | |
| | | | | | | | | | | | | | | | | | | | | | | | | | | | | | | | | | | | | | | | | | | | | | | | | | | | | | | | | | | | | | | | | | | | | | | | | | | | | | | | |
| | | 1 | | | | | | | | | | | | | | | | | | | | | | | | | | | | | | | | | | | | | | | | | | | | | | | | | | | | | | | | | | | | | | | | | | | | | | | | | | | | | |
| | | | | | | | | | | | | | | | | | | | | | | | | | | | | | | | | | | | | | | | | | | | | | | | | | | | | | | | | | | | | | | | | | | | | | | | | | | | | | | | |
| | | | | | | | | | | | | | | | | | | | | | | | | | | | | | | | | | | | | | | | | | | | | | | | | | | | | | | | | | | | | | | | | | | | | | | | | | | | | | | | |
| | | | | | | | | | | | | | | | | | | | | | | | | | | | | | | | | | | | | | | | | | | | | | | | | | | | | | | | | | | | | | | | | | | | | | | | | | | | | | | | |
| 1 | | | | | | | | | | | | | | | | | | | | | | | | | | | | | | | | | | | | | | | | | | | | | | | | | | | | | | | | | | | | | | | | | | | | | | | | | | | | | | | |
| | 1 | 2 | | | | | | | | | | | | | | | | | | | | | | | | | | | | | | | | | | | | | | | | | | | | | | | | | | | | | | | | | | | | | | | | | | | | | | | | | | | | | |
| 1 | | 1 | | | | | | | | | | | | | | | | | | | | | | | | | | | | | | | | | | | | | | | | | | | | | | | | | | | | | | | | | | | | | | | | | | | | | | | | | | | | | |
| | | | | | | | | | | | | | | | | | | | | | | | | | | | | | | | | | | | | | | | | | | | | | | | | | | | | | | | | | | | | | | | | | | | | | | | | | | | | | | | |
| | | | | | | | | | | | | | | | | | | | | | | | | | | | | | | | | | | | | | | | | | | | | | | | | | | | | | | | | | | | | | | | | | | | | | | | | | | | | | | | |
| | 1 | 1 | | | | | | | | | | | | | | | | | | | | | | | | | | | | | | | | | | | | | | | | | | | | | | | | | | | | | | | | | | | | | | | | | | | | | | | | | | | | | |
| | | 1 | | | | | | | | | | | | | | | | | | | | | | | | | | | | | | | | | | | | | | | | | | | | | | | | | | | | | | | | | | | | | | | | | | | | | | | | | | | | | |
| | | | | | | | | | | | | | | | | | | | | | | | | | | | | | | | | | | | | | | | | | | | | | | | | | | | | | | | | | | | | | | | | | | | | | | | | | | | | | | | |
| | | | | | | | | | | | | | | | | | | | | | | | | | | | | | | | | | | | | | | | | | | | | | | | | | | | | | | | | | | | | | | | | | | | | | | | | | | | | | | | |
| | | | | | | | | | | | | | | | | | | | | | | | | | | | | | | | | | | | | | | | | | | | | | | | | | | | | | | | | | | | | | | | | | | | | | | | | | | | | | | | |
| Post - 0 Miss - 0 Block - 0 | Post - 0 Miss - 0 Block - 0 | Post - 0 Miss - 0 Block - 0 | Post - 0 Miss - 0 Block - 0 | Post - 0 Miss - 0 Block - 0 | Post - 0 Miss - 0 Block - 1 | Post - 1 Miss - 3 Block - 3 | Post - 0 Miss - 0 Block - 1 | | | | | | | | | | | | | | | | | | | | | | | | | | | | | | | | | | | | | | | | | | | | | | | | | | | | | | | | | | | | | | | | | | | | | | | | |
| 25 江锦 | 35 刘子杰 | 39 陆毅洋 | 66 黄嘉遥 | 68 陈沁磊 | | | | | | | | | | | | | | | | | | | | | | | | | | | | | | | | | | | | | | | | | | | | | | | | | | | | | | | | | | | | | | | | | | | | | | | | | | | |
| <table border="1"><tr><td></td><td></td><td></td></tr><tr><td></td><td></td><td></td></tr><tr><td></td><td></td><td></td></tr></table> | | | | | | | | | | <table border="1"><tr><td></td><td></td><td></td></tr><tr><td></td><td></td><td>1</td></tr><tr><td></td><td></td><td></td></tr></table> | | | | | | 1 | | | | <table border="1"><tr><td></td><td></td><td></td></tr><tr><td></td><td></td><td></td></tr><tr><td></td><td></td><td></td></tr></table> | | | | | | | | | | <table border="1"><tr><td></td><td></td><td></td></tr><tr><td></td><td></td><td></td></tr><tr><td></td><td></td><td></td></tr></table> | | | | | | | | | | <table border="1"><tr><td></td><td></td><td></td></tr><tr><td></td><td></td><td></td></tr><tr><td></td><td></td><td></td></tr></table> | | | | | | | | | | | | | | | | | | | | | | | | | | | | | | | | | | | | | | | |
| | | | | | | | | | | | | | | | | | | | | | | | | | | | | | | | | | | | | | | | | | | | | | | | | | | | | | | | | | | | | | | | | | | | | | | | | | | | | | | | |
| | | | | | | | | | | | | | | | | | | | | | | | | | | | | | | | | | | | | | | | | | | | | | | | | | | | | | | | | | | | | | | | | | | | | | | | | | | | | | | | |
| | | | | | | | | | | | | | | | | | | | | | | | | | | | | | | | | | | | | | | | | | | | | | | | | | | | | | | | | | | | | | | | | | | | | | | | | | | | | | | | |
| | | | | | | | | | | | | | | | | | | | | | | | | | | | | | | | | | | | | | | | | | | | | | | | | | | | | | | | | | | | | | | | | | | | | | | | | | | | | | | | |
| | | 1 | | | | | | | | | | | | | | | | | | | | | | | | | | | | | | | | | | | | | | | | | | | | | | | | | | | | | | | | | | | | | | | | | | | | | | | | | | | | | |
| | | | | | | | | | | | | | | | | | | | | | | | | | | | | | | | | | | | | | | | | | | | | | | | | | | | | | | | | | | | | | | | | | | | | | | | | | | | | | | | |
| | | | | | | | | | | | | | | | | | | | | | | | | | | | | | | | | | | | | | | | | | | | | | | | | | | | | | | | | | | | | | | | | | | | | | | | | | | | | | | | |
| | | | | | | | | | | | | | | | | | | | | | | | | | | | | | | | | | | | | | | | | | | | | | | | | | | | | | | | | | | | | | | | | | | | | | | | | | | | | | | | |
| | | | | | | | | | | | | | | | | | | | | | | | | | | | | | | | | | | | | | | | | | | | | | | | | | | | | | | | | | | | | | | | | | | | | | | | | | | | | | | | |
| | | | | | | | | | | | | | | | | | | | | | | | | | | | | | | | | | | | | | | | | | | | | | | | | | | | | | | | | | | | | | | | | | | | | | | | | | | | | | | | |
| | | | | | | | | | | | | | | | | | | | | | | | | | | | | | | | | | | | | | | | | | | | | | | | | | | | | | | | | | | | | | | | | | | | | | | | | | | | | | | | |
| | | | | | | | | | | | | | | | | | | | | | | | | | | | | | | | | | | | | | | | | | | | | | | | | | | | | | | | | | | | | | | | | | | | | | | | | | | | | | | | |
| | | | | | | | | | | | | | | | | | | | | | | | | | | | | | | | | | | | | | | | | | | | | | | | | | | | | | | | | | | | | | | | | | | | | | | | | | | | | | | | |
| | | | | | | | | | | | | | | | | | | | | | | | | | | | | | | | | | | | | | | | | | | | | | | | | | | | | | | | | | | | | | | | | | | | | | | | | | | | | | | | |
| | | | | | | | | | | | | | | | | | | | | | | | | | | | | | | | | | | | | | | | | | | | | | | | | | | | | | | | | | | | | | | | | | | | | | | | | | | | | | | | |
| Post - 0 Miss - 0 Block - 0 | Post - 0 Miss - 1 Block - 0 | Post - 0 Miss - 0 Block - 1 | Post - 0 Miss - 0 Block - 0 | Post - 0 Miss - 0 Block - 0 | | | | | | | | | | | | | | | | | | | | | | | | | | | | | | | | | | | | | | | | | | | | | | | | | | | | | | | | | | | | | | | | | | | | | | | | | | | |

PHMS Pictorial Handball Match Statistics **IHF** Official System

| | | |
|--------|--------|--------------|
| Team A | Team B | Match Number |
| A 中国香港 | B 山东济南 | 7 |

| | | | | |
|-----------|-------------|------------|-------|------------|
| Played in | in the hall | on | at | Spepectors |
| 安徽滁州 | 滁州国际手球馆 | 2019-05-27 | 20:00 | hours |

| | | | | | | | | | | | | | | |
|----------------|---|---|---------------------|----|---|----------------|---|---|----------------|---|---|----------------------|---|---|
| Half-time(30') | A | B | End of playing time | A | B | 1st extra time | A | B | 2nd extra time | A | B | After penalty throws | A | B |
| | 7 | 7 | 15 | 13 | | | | | | | | | | |

| | | | | | | | | | | |
|---------------|-----|---------------|---|---|------------------------------------|---------------|-------|---|-----|---------------|
| Number of 7 m | A | Team time-out | | | Full name of players and officials | Team time-out | | | B | Number of 7 m |
| | 0/1 | 1 | 2 | 3 | | 1 | 2 | 3 | 0/0 | |
| | | 11:58 | | | | 09:27 | 40:51 | | | |

| No. | Team A | G | W | 2' | D | DR | No. | Team B | G | W | 2' | D | DR |
|-----|-----------|---|---|----|---|----|-----|-----------|---|---|----|---|----|
| 1 | 江力为 | | | | | | 1 | 刘在攀 | | | | | |
| 2 | 梁凯乔 | 1 | | | | | 4 | 张广一 | | | | | |
| 3 | 陈嘉熙 | | | | | | 6 | 刘尊哲 | 2 | | | | |
| 10 | 叶滋权 | 4 | | | | | 7 | 王帅 | 2 | | | | |
| 15 | 梁栢朗 | | 1 | | | | 8 | 金正凯 | 1 | | | | |
| 16 | 冯智聪 | | | | | | 9 | 张嘉树 | | | | | |
| 22 | 吴泽斌 | | | | | | 10 | 颜同霖 | 2 | | 2 | | |
| 23 | 石铭泽 | 1 | | | | | 11 | 李延舒 | | | | | |
| 27 | 巫迪涛 | 3 | | | | | 13 | 刘振宇 | 6 | | | | |
| 28 | 关健辉 | 1 | | | | | 16 | 高宇轩 | | | | | |
| 30 | 陈永曦 | 1 | | | | | 17 | 张昊 | | | | | |
| 41 | 莫敬朗 | 2 | | | | | 21 | 杨明毅 | | | | | |
| 47 | 薛浩锋 | 2 | | | | | 24 | 于昊 | | | | | |
| 73 | 黄塋鎏 | | | | | | 26 | 曹立志 | | | | | |
| 79 | 吴坤霖 | | | | | | 40 | 鹿智豪 | | | | | |
| 99 | 苏俊轩 | | | | | | 88 | 王麒翔 | | | | | |
| B | 练明辉 (主教练) | | | | | | A | 李楠 | | | | | |
| | | | | | | | B | 陈鹏波 (主教练) | | | | | |
| | | | | | | | C | 陶丛龙 | | | | | |
| | | | | | | | E | 郭军旗 | | | | | |

| | | |
|---|--|---|
| A | Signatures of responsables for the teams (Off.A) | B |
|---|--|---|

| | | |
|----|-----------------------------------|----|
| TP | Remarks of referees / HF Official | TP |
| | | |
| | | |
| | | |

| | | | |
|------------|-----------|-----------|--|
| Signatures | | | |
| Referees | 尹静阳 (CHN) | 马晓晔 (CHN) | |
| T.D. | 吴国忠 (CHN) | 李兆蒙 (CHN) | |
| CHA Off. | | | |

Note: Number of 7m Throws Awarded to Team A and B, Goals (G), Warnings (W), Suspensions (2'), Direct Disqualification (D), Disqualification With Report (DR) and Team Penalty (TP).

Table Officials: 李莉君 吴荣 Statisticians: 王梓衡 童佩瑶

第二届全国青年运动会男子手球乙组决赛 体校组 (U16)

PHMS Pictorial Handball Match Statistics

IHF Official System

竞赛技术统计

手球
青年男子

预赛
轮次 1

组别 B
场次 7

滁州国际手球馆
2019-05-27 20:00

Referees: 尹静阳 (CHN) / 马晓晔 (CHN)

Result: 15:13(7:7)

Teams: 中国香港(香港) VS 山东济南(济南)

| 香港 | | 远 | 近 | 边 | 快 | 突 | 任意 | 7m | 合计 | % | 助攻 | 失误 | 警告 | 2' | D+DR |
|----------|-----|------|-----|-----|-----|-----|-----|-----|-------|------|----|----|----|----|------|
| 主教练: 练明辉 | | 射 | 射 | 射 | 攻 | 破 | 球 | 球 | | | | | | | |
| 1 | 江力为 | | | | | | | | | | | 1 | | | |
| 2 | 梁凯乔 | | 1/1 | | | | | | 1/1 | 100 | | | | | |
| 3 | 陈嘉熙 | | | | | | | | | | | 1 | | | |
| 10 | 叶滋权 | 2/5 | 1/1 | 0/1 | | 1/1 | | | 4/8 | 50.0 | 1 | | | | |
| 15 | 梁栢朗 | | | | | | | | | | | | 1 | | |
| 16 | 冯智聪 | | | | | | | | | | | | | | |
| 22 | 吴泽斌 | | | | | | | | | | | | | | |
| 23 | 石铭泽 | | | 0/1 | 1/1 | | | | 1/2 | 50.0 | | 1 | | | |
| 27 | 巫迪涛 | 1/2 | 0/2 | 1/1 | | 1/2 | 0/1 | 0/1 | 3/9 | 33.3 | | 1 | | | |
| 28 | 关键辉 | | | 1/2 | | | | | 1/2 | 50.0 | | | | | |
| 30 | 陈永曦 | | 1/1 | | | | | | 1/1 | 100 | | | | | |
| 41 | 莫敬朗 | | | 1/2 | | | 1/1 | | 2/3 | 66.7 | | 1 | | | |
| 47 | 薛浩锋 | | 2/3 | | | | | | 2/3 | 66.7 | | 1 | | | |
| 73 | 黄塍臻 | | 0/1 | | | | | | 0/1 | 0.0 | | | | | |
| 79 | 吴坤霖 | | | | | | | | | | | | | | |
| 99 | 苏俊轩 | | | | | | | | | | | | | | |
| 运动员 合计 | | 3/7 | 5/9 | 3/7 | 1/1 | 2/3 | 1/2 | 0/1 | 15/30 | 50.0 | 2 | 6 | 1 | | |
| 1 | 江力为 | 3/6 | 0/1 | 1/2 | 0/2 | | | | 4/11 | 36.4 | | 1 | | | |
| 22 | 吴泽斌 | 1/2 | 0/1 | 1/1 | | | 1/1 | | 3/5 | 60.0 | | | | | |
| 99 | 苏俊轩 | 0/3 | 3/3 | | 0/1 | | | | 3/7 | 42.9 | | | | | |
| 守门员 合计 | | 4/11 | 3/5 | 2/3 | 0/3 | | 1/1 | | 10/23 | 43.5 | | 1 | | | |

| 香港 | 比赛进程 | 济南 |
|----------|-------|--------------------|
| 1st Half | | |
| 0 | 01:38 | 1 10 颜同霖 |
| 0 | 02:19 | 2 10 颜同霖 |
| 0 | 03:07 | 3 7 王帅 |
| 10 | 叶滋权 | 1 03:55 3 |
| 27 | 巫迪涛 | 2 04:23 3 |
| | | 2 06:20 4 6 刘尊哲 |
| 47 | 薛浩锋 | 3 06:50 4 |
| 10 | 叶滋权 | 4 10:00 4 |
| | | 4 10:12 5 13 刘振宇 |
| 23 | 石铭泽 | 5 11:15 5 |
| 27 | 巫迪涛 | 6 13:50 5 |
| | | 6 14:04 6 13 刘振宇 |
| 28 | 关键辉 | 7 14:43 6 |
| | | 7 14:54 7 6 刘尊哲 |
| 2nd Half | | |
| | | 7 00:24 8 13 刘振宇 |
| 47 | 薛浩锋 | 8 00:58 8 |
| | | 8 01:38 9 7 王帅 |
| 41 | 莫敬朗 | 9 02:10 9 |
| | | 9 02:25 10 13 刘振宇 |
| 10 | 叶滋权 | 10 03:33 10 |
| 10 | 叶滋权 | 11 06:00 10 |
| | | 11 06:15 11 13 刘振宇 |
| 2 | 梁凯乔 | 12 06:47 11 |
| | | 12 07:33 12 13 刘振宇 |
| 41 | 莫敬朗 | 13 08:44 12 |
| 27 | 巫迪涛 | 14 12:26 12 |
| | | 14 12:52 13 8 金正凯 |
| 30 | 陈永曦 | 15 14:29 13 |

| 济南 | | 远 | 近 | 边 | 快 | 突 | 任意 | 7m | 合计 | % | 助攻 | 失误 | 警告 | 2' | D+DR |
|----------|-----|------|-----|-----|-----|-----|-----|-----|-------|------|----|----|----|----|------|
| 主教练: 陈鹏波 | | 射 | 射 | 射 | 攻 | 破 | 球 | 球 | | | | | | | |
| 1 | 刘在攀 | | | | | | | | | | 1 | | | | |
| 4 | 张广一 | | | | | | | | | | | | | | |
| 6 | 刘尊哲 | 1/1 | | 1/2 | | | 0/1 | | 2/4 | 50.0 | 3 | 4 | | | |
| 7 | 王帅 | 0/1 | 0/1 | | 2/2 | | | | 2/4 | 50.0 | | | | | |
| 8 | 金正凯 | | 1/1 | | | | | | 1/1 | 100 | | 1 | | | |
| 9 | 张嘉树 | | | | | | | | | | | 1 | | | |
| 10 | 颜同霖 | | 1/2 | 0/1 | 1/1 | | | | 2/4 | 50.0 | | 2 | | 2 | |
| 11 | 李延舒 | | 0/1 | | | | | | 0/1 | 0.0 | | 1 | | | |
| 13 | 刘振宇 | 6/12 | | | | | | | 6/12 | 50.0 | 1 | 2 | | | |
| 16 | 高宇轩 | | | | | | | | | | | | | | |
| 17 | 张昊 | | | | | | | | | | | | | | |
| 21 | 杨明毅 | | | | | | | | | | | | | | |
| 24 | 于昊 | | | | | | | | | | | | | | |
| 26 | 曹立志 | | | | | | | | | | | | | | |
| 40 | 鹿智豪 | | | | | | | | | | | | | | |
| 88 | 王麒翔 | | | | | | | | | | | | | | |
| 运动员 合计 | | 7/14 | 2/5 | 1/3 | 3/3 | | 0/1 | | 13/26 | 50.0 | 5 | 11 | | 2 | |
| 1 | 刘在攀 | 2/5 | 2/7 | 2/5 | 0/1 | 1/3 | 0/1 | 1/1 | 8/23 | 34.8 | 1 | | | | |
| 守门员 合计 | | 2/5 | 2/7 | 2/5 | 0/1 | 1/3 | 0/1 | 1/1 | 8/23 | 34.8 | 1 | | | | |

场上队员: 得分 / 射门

守门员: 救球 / 射门

| | | | |
|---|------|----|---------|
| D | 取消资格 | DR | 取消资格+报告 |
|---|------|----|---------|



个人/全队技术统计表

手球 预赛 组别 B 滁州国际手球馆
青年男子 轮次 1 场次 7 2019-05-27 20:00

| 号码 | 姓名 | 远射 | 近射 | 边射 | 快攻 | 突破 | 任意 | 七米 | 合计 | % | 助攻 | 失误 | 警告 | 2' | 取消 | 时间 |
|----------|-----|-----|-----|-----|-----|-----|-----|-----|-------|-------|----|----|----|----|----|----------|
| 中国香港(香港) | | | | | | | | | | | | | | | | |
| (场上队员) | | | | | | | | | | | | | | | | |
| 1 | 江力为 | | | | | | | | | 0.0% | | 1 | | | | 00:15:00 |
| 2 | 梁凯乔 | | 1/1 | | | | | | 1/1 | 100% | | | | | | 00:14:46 |
| 3 | 陈嘉熙 | | | | | | | | | 0.0% | | 1 | | | | 00:03:12 |
| 10 | 叶滋权 | 2/5 | 1/1 | 0/1 | | 1/1 | | | 4/8 | 50.0% | 1 | | | | | 00:24:30 |
| 15 | 梁栢朗 | | | | | | | | | 0.0% | | | 1 | | | 00:09:53 |
| 16 | 冯智聪 | | | | | | | | | 0.0% | | | | | | 00:00:00 |
| 22 | 吴泽斌 | | | | | | | | | 0.0% | | | | | | 00:08:40 |
| 23 | 石铭泽 | | | 0/1 | 1/1 | | | | 1/2 | 50.0% | | 1 | | | | 00:15:00 |
| 27 | 巫迪涛 | 1/2 | 0/2 | 1/1 | | 1/2 | 0/1 | 0/1 | 3/9 | 33.3% | | 1 | | | | 00:24:50 |
| 28 | 关健辉 | | | 1/2 | | | | | 1/2 | 50.0% | | | | | | 00:18:37 |
| 30 | 陈永曦 | | 1/1 | | | | | | 1/1 | 100% | | | | | | 00:00:09 |
| 41 | 莫敬朗 | | | 1/2 | | | 1/1 | | 2/3 | 66.7% | | 1 | | | | 00:11:32 |
| 47 | 薛浩锋 | | 2/3 | | | | | | 2/3 | 66.7% | | 1 | | | | 00:26:55 |
| 73 | 黄望婆 | | 0/1 | | | | | | 0/1 | 0.0% | | | | | | 00:06:28 |
| 79 | 吴坤霖 | | | | | | | | | 0.0% | 1 | | | | | 00:23:55 |
| 99 | 苏俊轩 | | | | | | | | | 0.0% | | | | | | 00:06:30 |
| | 合计 | 3/7 | 5/9 | 3/7 | 1/1 | 2/3 | 1/2 | 0/1 | 15/30 | 50.0% | 2 | 6 | 1 | | | |

(守门员)

| | | | | | | | | | | | | | | | | |
|----|-----|------|-----|-----|-----|--|-----|--|-------|-------|--|---|--|--|--|----------|
| 1 | 江力为 | 3/6 | 0/1 | 1/2 | 0/2 | | | | 4/11 | 36.4% | | 1 | | | | 00:15:00 |
| 22 | 吴泽斌 | 1/2 | 0/1 | 1/1 | | | 1/1 | | 3/5 | 60.0% | | | | | | 00:08:40 |
| 99 | 苏俊轩 | 0/3 | 3/3 | | 0/1 | | | | 3/7 | 42.9% | | | | | | 00:06:30 |
| | 合计 | 4/11 | 3/5 | 2/3 | 0/3 | | 1/1 | | 10/23 | 43.5% | | 1 | | | | |

场上队员：得分/射门

守门员：救球/射门

| 全队合计 | 得分 | 被救 | 射失 | 击柱 | 封球 | 合计 | % |
|------|----|----|----|----|----|----|--------|
| 远射 | 3 | 2 | 1 | 1 | | 7 | 42.9% |
| 近射 | 5 | 2 | 1 | 1 | | 9 | 55.6% |
| 边射 | 3 | 2 | | 2 | | 7 | 42.9% |
| 快攻 | 1 | | | | | 1 | 100.0% |
| 突破 | 2 | 1 | | | | 3 | 66.7% |
| 任意 | 1 | | 1 | | | 2 | 50.0% |
| 七米 | | 1 | | | | 1 | 0.0% |

个人/全队技术统计表

手球 预赛 组别 B 滁州国际手球馆
青年男子 轮次 1 场次 7 2019-05-27 20:00

| 号码 | 姓名 | 远射 | 近射 | 边射 | 快攻 | 突破 | 任意 | 七米 | 合计 | % | 助攻 | 失误 | 警告 | 2' | 取消 | 时间 |
|----------|-----|------|-----|-----|-----|-----|-----|-----|-------|-------|----|----|----|----|----|----------|
| 山东济南(济南) | | | | | | | | | | | | | | | | |
| (场上队员) | | | | | | | | | | | | | | | | |
| 1 | 刘在攀 | | | | | | | | | 0.0% | 1 | | | | | 00:30:00 |
| 4 | 张广一 | | | | | | | | | 0.0% | | | | | | 00:00:00 |
| 6 | 刘尊哲 | 1/1 | | 1/2 | | | 0/1 | | 2/4 | 50.0% | 3 | 4 | | | | 00:30:00 |
| 7 | 王帅 | 0/1 | 0/1 | | 2/2 | | | | 2/4 | 50.0% | | | | | | 00:30:00 |
| 8 | 金正凯 | | 1/1 | | | | | | 1/1 | 100% | | 1 | | | | 00:10:22 |
| 9 | 张嘉树 | | | | | | | | | 0.0% | | 1 | | | | 00:02:33 |
| 10 | 颜同霖 | | 1/2 | 0/1 | 1/1 | | | | 2/4 | 50.0% | | 2 | | 2 | | 00:27:35 |
| 11 | 李延舒 | | 0/1 | | | | | | 0/1 | 0.0% | | 1 | | | | 00:30:00 |
| 13 | 刘振宇 | 6/12 | | | | | | | 6/12 | 50.0% | 1 | 2 | | | | 00:30:00 |
| 16 | 高宇轩 | | | | | | | | | 0.0% | | | | | | 00:00:00 |
| 17 | 张昊 | | | | | | | | | 0.0% | | | | | | 00:00:00 |
| 21 | 杨明毅 | | | | | | | | | 0.0% | | | | | | 00:00:00 |
| 24 | 于昊 | | | | | | | | | 0.0% | | | | | | 00:00:00 |
| 26 | 曹立志 | | | | | | | | | 0.0% | | | | | | 00:19:29 |
| 40 | 鹿智豪 | | | | | | | | | 0.0% | | | | | | 00:00:00 |
| 88 | 王麒翔 | | | | | | | | | 0.0% | | | | | | 00:00:00 |
| | 合计 | 7/14 | 2/5 | 1/3 | 3/3 | | 0/1 | | 13/26 | 50.0% | 5 | 11 | | 2 | | |
| (守门员) | | | | | | | | | | | | | | | | |
| 1 | 刘在攀 | 2/5 | 2/7 | 2/5 | 0/1 | 1/3 | 0/1 | 1/1 | 8/23 | 34.8% | 1 | | | | | 00:30:00 |
| | 合计 | 2/5 | 2/7 | 2/5 | 0/1 | 1/3 | 0/1 | 1/1 | 8/23 | 34.8% | 1 | | | | | |

场上队员：得分/射门

守门员：救球/射门

| 全队合计 | 得分 | 被救 | 射失 | 击柱 | 封球 | 合计 | % |
|------|----|----|----|----|----|----|--------|
| 远射 | 7 | 4 | | | 3 | 14 | 50.0% |
| 近射 | 2 | 3 | | | | 5 | 40.0% |
| 边射 | 1 | 2 | | | | 3 | 33.3% |
| 快攻 | 3 | | | | | 3 | 100.0% |
| 突破 | | | | | | | 0.0% |
| 任意 | | 1 | | | | 1 | 0.0% |
| 七米 | | | | | | | 0.0% |

图式比赛技术统计表

手球
青年男子

预赛
轮次 1

组别 B
场次 7

滁州国际手球馆
2019-05-27 20:00

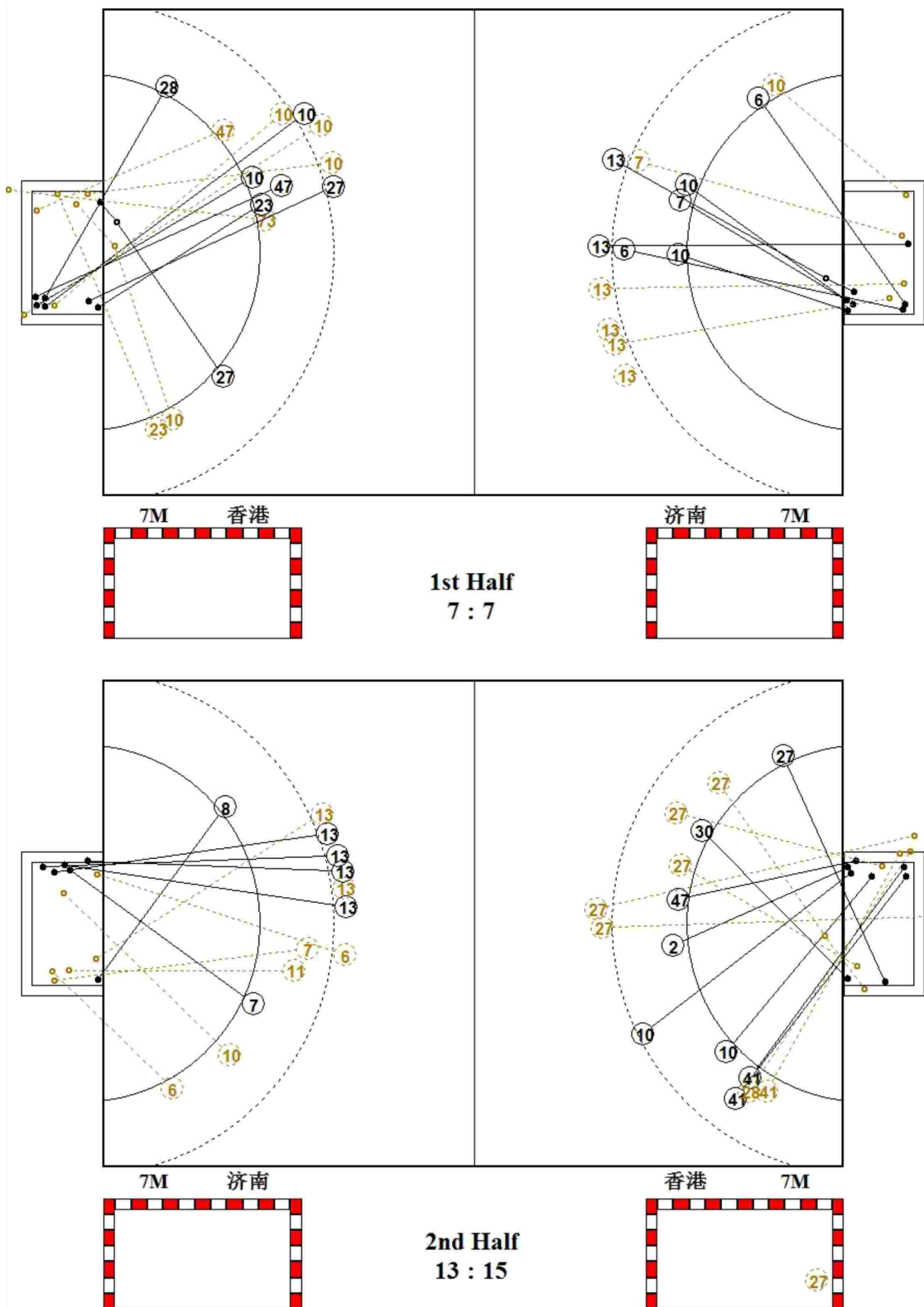

图式射门区域统计

手球
青年男子

预赛
轮次 1

组别 B
场次 7

滁州国际手球馆
2019-05-27 20:00

中国香港

| | | | | | | | | | | | | | | | | | | | | | | | | | | | | | | | | | | | | | | | | | | | | | | | | | | | | | | | | | | | | | | | | | | | | | | | | | | | | | | | |
|---|-----------------------------|-----------------------------|-----------------------------|-----------------------------|-----------------------------|-----------------------------|-----------------------------|--|---|---|---|--|--|--|--|--|---|--|--|---|--|--|--|--|--|--|--|--|---|---|---|--|--|---|--|--|---|--|--|--|---|--|--|--|--|--|---|--|--|--|--|--|--|--|--|--|--|--|--|--|--|--|--|--|--|--|--|--|--|---|--|--|--|--|--|--|---|--|--|
| 1 江力为 | 2 梁凯乔 | 3 陈嘉熙 | 10 叶澁权 | 15 梁栢朗 | 16 冯智聪 | 22 吴泽斌 | 23 石铭泽 | | | | | | | | | | | | | | | | | | | | | | | | | | | | | | | | | | | | | | | | | | | | | | | | | | | | | | | | | | | | | | | | | | | | | | | | |
| <table border="1"><tr><td></td><td></td><td></td></tr><tr><td></td><td></td><td></td></tr><tr><td></td><td></td><td></td></tr></table> | | | | | | | | | | <table border="1"><tr><td></td><td></td><td></td></tr><tr><td></td><td></td><td></td></tr><tr><td>1</td><td></td><td></td></tr></table> | | | | | | | 1 | | | <table border="1"><tr><td></td><td></td><td></td></tr><tr><td></td><td></td><td></td></tr><tr><td></td><td></td><td></td></tr></table> | | | | | | | | | | <table border="1"><tr><td>2</td><td></td><td></td></tr><tr><td>1</td><td></td><td></td></tr><tr><td>1</td><td></td><td></td></tr></table> | 2 | | | 1 | | | 1 | | | <table border="1"><tr><td></td><td></td><td></td></tr><tr><td></td><td></td><td></td></tr><tr><td></td><td></td><td></td></tr></table> | | | | | | | | | | <table border="1"><tr><td></td><td></td><td></td></tr><tr><td></td><td></td><td></td></tr><tr><td></td><td></td><td></td></tr></table> | | | | | | | | | | <table border="1"><tr><td></td><td></td><td></td></tr><tr><td></td><td></td><td></td></tr><tr><td></td><td></td><td></td></tr></table> | | | | | | | | | | <table border="1"><tr><td></td><td></td><td></td></tr><tr><td></td><td></td><td></td></tr><tr><td>1</td><td></td><td></td></tr></table> | | | | | | | 1 | | |
| | | | | | | | | | | | | | | | | | | | | | | | | | | | | | | | | | | | | | | | | | | | | | | | | | | | | | | | | | | | | | | | | | | | | | | | | | | | | | | | |
| | | | | | | | | | | | | | | | | | | | | | | | | | | | | | | | | | | | | | | | | | | | | | | | | | | | | | | | | | | | | | | | | | | | | | | | | | | | | | | | |
| | | | | | | | | | | | | | | | | | | | | | | | | | | | | | | | | | | | | | | | | | | | | | | | | | | | | | | | | | | | | | | | | | | | | | | | | | | | | | | | |
| | | | | | | | | | | | | | | | | | | | | | | | | | | | | | | | | | | | | | | | | | | | | | | | | | | | | | | | | | | | | | | | | | | | | | | | | | | | | | | | |
| | | | | | | | | | | | | | | | | | | | | | | | | | | | | | | | | | | | | | | | | | | | | | | | | | | | | | | | | | | | | | | | | | | | | | | | | | | | | | | | |
| 1 | | | | | | | | | | | | | | | | | | | | | | | | | | | | | | | | | | | | | | | | | | | | | | | | | | | | | | | | | | | | | | | | | | | | | | | | | | | | | | | |
| | | | | | | | | | | | | | | | | | | | | | | | | | | | | | | | | | | | | | | | | | | | | | | | | | | | | | | | | | | | | | | | | | | | | | | | | | | | | | | | |
| | | | | | | | | | | | | | | | | | | | | | | | | | | | | | | | | | | | | | | | | | | | | | | | | | | | | | | | | | | | | | | | | | | | | | | | | | | | | | | | |
| | | | | | | | | | | | | | | | | | | | | | | | | | | | | | | | | | | | | | | | | | | | | | | | | | | | | | | | | | | | | | | | | | | | | | | | | | | | | | | | |
| 2 | | | | | | | | | | | | | | | | | | | | | | | | | | | | | | | | | | | | | | | | | | | | | | | | | | | | | | | | | | | | | | | | | | | | | | | | | | | | | | | |
| 1 | | | | | | | | | | | | | | | | | | | | | | | | | | | | | | | | | | | | | | | | | | | | | | | | | | | | | | | | | | | | | | | | | | | | | | | | | | | | | | | |
| 1 | | | | | | | | | | | | | | | | | | | | | | | | | | | | | | | | | | | | | | | | | | | | | | | | | | | | | | | | | | | | | | | | | | | | | | | | | | | | | | | |
| | | | | | | | | | | | | | | | | | | | | | | | | | | | | | | | | | | | | | | | | | | | | | | | | | | | | | | | | | | | | | | | | | | | | | | | | | | | | | | | |
| | | | | | | | | | | | | | | | | | | | | | | | | | | | | | | | | | | | | | | | | | | | | | | | | | | | | | | | | | | | | | | | | | | | | | | | | | | | | | | | |
| | | | | | | | | | | | | | | | | | | | | | | | | | | | | | | | | | | | | | | | | | | | | | | | | | | | | | | | | | | | | | | | | | | | | | | | | | | | | | | | |
| | | | | | | | | | | | | | | | | | | | | | | | | | | | | | | | | | | | | | | | | | | | | | | | | | | | | | | | | | | | | | | | | | | | | | | | | | | | | | | | |
| | | | | | | | | | | | | | | | | | | | | | | | | | | | | | | | | | | | | | | | | | | | | | | | | | | | | | | | | | | | | | | | | | | | | | | | | | | | | | | | |
| | | | | | | | | | | | | | | | | | | | | | | | | | | | | | | | | | | | | | | | | | | | | | | | | | | | | | | | | | | | | | | | | | | | | | | | | | | | | | | | |
| | | | | | | | | | | | | | | | | | | | | | | | | | | | | | | | | | | | | | | | | | | | | | | | | | | | | | | | | | | | | | | | | | | | | | | | | | | | | | | | |
| | | | | | | | | | | | | | | | | | | | | | | | | | | | | | | | | | | | | | | | | | | | | | | | | | | | | | | | | | | | | | | | | | | | | | | | | | | | | | | | |
| | | | | | | | | | | | | | | | | | | | | | | | | | | | | | | | | | | | | | | | | | | | | | | | | | | | | | | | | | | | | | | | | | | | | | | | | | | | | | | | |
| | | | | | | | | | | | | | | | | | | | | | | | | | | | | | | | | | | | | | | | | | | | | | | | | | | | | | | | | | | | | | | | | | | | | | | | | | | | | | | | |
| | | | | | | | | | | | | | | | | | | | | | | | | | | | | | | | | | | | | | | | | | | | | | | | | | | | | | | | | | | | | | | | | | | | | | | | | | | | | | | | |
| 1 | | | | | | | | | | | | | | | | | | | | | | | | | | | | | | | | | | | | | | | | | | | | | | | | | | | | | | | | | | | | | | | | | | | | | | | | | | | | | | | |
| Post - 0 Miss - 0 Block - 0 | Post - 0 Miss - 0 Block - 0 | Post - 0 Miss - 0 Block - 0 | Post - 1 Miss - 0 Block - 0 | Post - 0 Miss - 0 Block - 0 | Post - 0 Miss - 0 Block - 0 | Post - 0 Miss - 0 Block - 0 | Post - 0 Miss - 0 Block - 0 | | | | | | | | | | | | | | | | | | | | | | | | | | | | | | | | | | | | | | | | | | | | | | | | | | | | | | | | | | | | | | | | | | | | | | | | |
| 27 巫迪涛 | 28 关健辉 | 30 陈永曦 | 41 莫敬朗 | 47 薛浩锋 | 73 黄望鏊 | 79 吴坤霖 | 99 苏俊轩 | | | | | | | | | | | | | | | | | | | | | | | | | | | | | | | | | | | | | | | | | | | | | | | | | | | | | | | | | | | | | | | | | | | | | | | | |
| <table border="1"><tr><td></td><td></td><td></td></tr><tr><td></td><td></td><td>1</td></tr><tr><td>1</td><td></td><td>1</td></tr></table> | | | | | | 1 | 1 | | 1 | <table border="1"><tr><td>1</td><td></td><td></td></tr><tr><td></td><td></td><td></td></tr><tr><td></td><td></td><td></td></tr></table> | 1 | | | | | | | | | <table border="1"><tr><td></td><td></td><td></td></tr><tr><td></td><td></td><td></td></tr><tr><td></td><td></td><td>1</td></tr></table> | | | | | | | | | 1 | <table border="1"><tr><td>2</td><td></td><td></td></tr><tr><td></td><td></td><td></td></tr><tr><td></td><td></td><td></td></tr></table> | 2 | | | | | | | | | <table border="1"><tr><td>1</td><td></td><td></td></tr><tr><td></td><td></td><td></td></tr><tr><td>1</td><td></td><td></td></tr></table> | 1 | | | | | | 1 | | | <table border="1"><tr><td></td><td></td><td></td></tr><tr><td></td><td></td><td></td></tr><tr><td></td><td></td><td></td></tr></table> | | | | | | | | | | <table border="1"><tr><td></td><td></td><td></td></tr><tr><td></td><td></td><td></td></tr><tr><td></td><td></td><td></td></tr></table> | | | | | | | | | | <table border="1"><tr><td></td><td></td><td></td></tr><tr><td></td><td></td><td></td></tr><tr><td></td><td></td><td></td></tr></table> | | | | | | | | | |
| | | | | | | | | | | | | | | | | | | | | | | | | | | | | | | | | | | | | | | | | | | | | | | | | | | | | | | | | | | | | | | | | | | | | | | | | | | | | | | | |
| | | 1 | | | | | | | | | | | | | | | | | | | | | | | | | | | | | | | | | | | | | | | | | | | | | | | | | | | | | | | | | | | | | | | | | | | | | | | | | | | | | |
| 1 | | 1 | | | | | | | | | | | | | | | | | | | | | | | | | | | | | | | | | | | | | | | | | | | | | | | | | | | | | | | | | | | | | | | | | | | | | | | | | | | | | |
| 1 | | | | | | | | | | | | | | | | | | | | | | | | | | | | | | | | | | | | | | | | | | | | | | | | | | | | | | | | | | | | | | | | | | | | | | | | | | | | | | | |
| | | | | | | | | | | | | | | | | | | | | | | | | | | | | | | | | | | | | | | | | | | | | | | | | | | | | | | | | | | | | | | | | | | | | | | | | | | | | | | | |
| | | | | | | | | | | | | | | | | | | | | | | | | | | | | | | | | | | | | | | | | | | | | | | | | | | | | | | | | | | | | | | | | | | | | | | | | | | | | | | | |
| | | | | | | | | | | | | | | | | | | | | | | | | | | | | | | | | | | | | | | | | | | | | | | | | | | | | | | | | | | | | | | | | | | | | | | | | | | | | | | | |
| | | | | | | | | | | | | | | | | | | | | | | | | | | | | | | | | | | | | | | | | | | | | | | | | | | | | | | | | | | | | | | | | | | | | | | | | | | | | | | | |
| | | 1 | | | | | | | | | | | | | | | | | | | | | | | | | | | | | | | | | | | | | | | | | | | | | | | | | | | | | | | | | | | | | | | | | | | | | | | | | | | | | |
| 2 | | | | | | | | | | | | | | | | | | | | | | | | | | | | | | | | | | | | | | | | | | | | | | | | | | | | | | | | | | | | | | | | | | | | | | | | | | | | | | | |
| | | | | | | | | | | | | | | | | | | | | | | | | | | | | | | | | | | | | | | | | | | | | | | | | | | | | | | | | | | | | | | | | | | | | | | | | | | | | | | | |
| | | | | | | | | | | | | | | | | | | | | | | | | | | | | | | | | | | | | | | | | | | | | | | | | | | | | | | | | | | | | | | | | | | | | | | | | | | | | | | | |
| 1 | | | | | | | | | | | | | | | | | | | | | | | | | | | | | | | | | | | | | | | | | | | | | | | | | | | | | | | | | | | | | | | | | | | | | | | | | | | | | | | |
| | | | | | | | | | | | | | | | | | | | | | | | | | | | | | | | | | | | | | | | | | | | | | | | | | | | | | | | | | | | | | | | | | | | | | | | | | | | | | | | |
| 1 | | | | | | | | | | | | | | | | | | | | | | | | | | | | | | | | | | | | | | | | | | | | | | | | | | | | | | | | | | | | | | | | | | | | | | | | | | | | | | | |
| | | | | | | | | | | | | | | | | | | | | | | | | | | | | | | | | | | | | | | | | | | | | | | | | | | | | | | | | | | | | | | | | | | | | | | | | | | | | | | | |
| | | | | | | | | | | | | | | | | | | | | | | | | | | | | | | | | | | | | | | | | | | | | | | | | | | | | | | | | | | | | | | | | | | | | | | | | | | | | | | | |
| | | | | | | | | | | | | | | | | | | | | | | | | | | | | | | | | | | | | | | | | | | | | | | | | | | | | | | | | | | | | | | | | | | | | | | | | | | | | | | | |
| | | | | | | | | | | | | | | | | | | | | | | | | | | | | | | | | | | | | | | | | | | | | | | | | | | | | | | | | | | | | | | | | | | | | | | | | | | | | | | | |
| | | | | | | | | | | | | | | | | | | | | | | | | | | | | | | | | | | | | | | | | | | | | | | | | | | | | | | | | | | | | | | | | | | | | | | | | | | | | | | | |
| | | | | | | | | | | | | | | | | | | | | | | | | | | | | | | | | | | | | | | | | | | | | | | | | | | | | | | | | | | | | | | | | | | | | | | | | | | | | | | | |
| | | | | | | | | | | | | | | | | | | | | | | | | | | | | | | | | | | | | | | | | | | | | | | | | | | | | | | | | | | | | | | | | | | | | | | | | | | | | | | | |
| | | | | | | | | | | | | | | | | | | | | | | | | | | | | | | | | | | | | | | | | | | | | | | | | | | | | | | | | | | | | | | | | | | | | | | | | | | | | | | | |
| | | | | | | | | | | | | | | | | | | | | | | | | | | | | | | | | | | | | | | | | | | | | | | | | | | | | | | | | | | | | | | | | | | | | | | | | | | | | | | | |
| Post - 1 Miss - 2 Block - 0 | Post - 1 Miss - 0 Block - 0 | Post - 0 Miss - 0 Block - 0 | Post - 1 Miss - 0 Block - 0 | Post - 0 Miss - 0 Block - 0 | Post - 0 Miss - 1 Block - 0 | Post - 0 Miss - 0 Block - 0 | Post - 0 Miss - 0 Block - 0 | | | | | | | | | | | | | | | | | | | | | | | | | | | | | | | | | | | | | | | | | | | | | | | | | | | | | | | | | | | | | | | | | | | | | | | | |

1 江力为

| | | |
|-----|-----|-----|
| 1/1 | 1/2 | 2/4 |
| | | 0/4 |

22 吴泽斌

| | | |
|-----|--|-----|
| 1/1 | | 0/1 |
| 1/2 | | 1/1 |

99 苏俊轩

| | | |
|-----|--|-----|
| 1/1 | | 0/1 |
| 1/1 | | 1/3 |
| | | 0/1 |

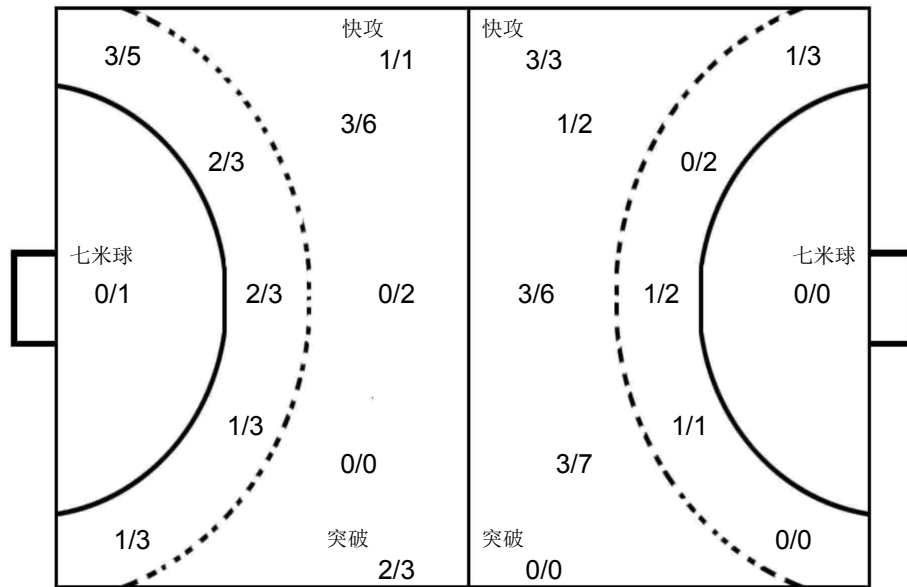

1 刘在攀

| | | |
|-----|--|-----|
| 1/7 | | 1/1 |
| 1/2 | | 3/4 |
| 0/5 | | 2/4 |

山东济南

| | | | | | | | | | | | | | | | | | | | | | | | | | | | | | | | | | | | | | | | | | | | | | | | | | | | | | | | | | | | | | | | | | | | | | | | | | | | | | | | |
|--|-----------------------------|-----------------------------|-----------------------------|-----------------------------|-----------------------------|-----------------------------|-----------------------------|--|---|--|--|--|--|--|--|--|--|--|--|---|--|--|---|--|--|--|--|--|--|--|--|--|--|--|--|---|--|--|---|---|--|--|--|--|--|--|---|--|--|--|--|--|--|--|--|--|--|--|--|---|--|--|--|--|--|--|--|--|---|--|--|--|--|--|--|--|--|--|--|
| 1 刘在攀 | 4 张广一 | 6 刘尊哲 | 7 王帅 | 8 金正凯 | 9 张嘉树 | 10 颜同霖 | 11 李延舒 | | | | | | | | | | | | | | | | | | | | | | | | | | | | | | | | | | | | | | | | | | | | | | | | | | | | | | | | | | | | | | | | | | | | | | | | |
| <table border="1"><tr><td></td><td></td><td></td></tr><tr><td></td><td></td><td></td></tr><tr><td></td><td></td><td></td></tr></table> | | | | | | | | | | <table border="1"><tr><td></td><td></td><td></td></tr><tr><td></td><td></td><td></td></tr><tr><td></td><td></td><td></td></tr></table> | | | | | | | | | | <table border="1"><tr><td></td><td></td><td>2</td></tr><tr><td></td><td></td><td></td></tr><tr><td></td><td></td><td></td></tr></table> | | | 2 | | | | | | | <table border="1"><tr><td></td><td></td><td></td></tr><tr><td></td><td></td><td>1</td></tr><tr><td></td><td></td><td>1</td></tr></table> | | | | | | 1 | | | 1 | <table border="1"><tr><td></td><td></td><td></td></tr><tr><td></td><td></td><td></td></tr><tr><td>1</td><td></td><td></td></tr></table> | | | | | | | 1 | | | <table border="1"><tr><td></td><td></td><td></td></tr><tr><td></td><td></td><td></td></tr><tr><td></td><td></td><td></td></tr></table> | | | | | | | | | | <table border="1"><tr><td></td><td></td><td></td></tr><tr><td></td><td></td><td></td></tr><tr><td></td><td></td><td>2</td></tr></table> | | | | | | | | | 2 | <table border="1"><tr><td></td><td></td><td></td></tr><tr><td></td><td></td><td></td></tr><tr><td></td><td></td><td></td></tr></table> | | | | | | | | | |
| | | | | | | | | | | | | | | | | | | | | | | | | | | | | | | | | | | | | | | | | | | | | | | | | | | | | | | | | | | | | | | | | | | | | | | | | | | | | | | | |
| | | | | | | | | | | | | | | | | | | | | | | | | | | | | | | | | | | | | | | | | | | | | | | | | | | | | | | | | | | | | | | | | | | | | | | | | | | | | | | | |
| | | | | | | | | | | | | | | | | | | | | | | | | | | | | | | | | | | | | | | | | | | | | | | | | | | | | | | | | | | | | | | | | | | | | | | | | | | | | | | | |
| | | | | | | | | | | | | | | | | | | | | | | | | | | | | | | | | | | | | | | | | | | | | | | | | | | | | | | | | | | | | | | | | | | | | | | | | | | | | | | | |
| | | | | | | | | | | | | | | | | | | | | | | | | | | | | | | | | | | | | | | | | | | | | | | | | | | | | | | | | | | | | | | | | | | | | | | | | | | | | | | | |
| | | | | | | | | | | | | | | | | | | | | | | | | | | | | | | | | | | | | | | | | | | | | | | | | | | | | | | | | | | | | | | | | | | | | | | | | | | | | | | | |
| | | 2 | | | | | | | | | | | | | | | | | | | | | | | | | | | | | | | | | | | | | | | | | | | | | | | | | | | | | | | | | | | | | | | | | | | | | | | | | | | | | |
| | | | | | | | | | | | | | | | | | | | | | | | | | | | | | | | | | | | | | | | | | | | | | | | | | | | | | | | | | | | | | | | | | | | | | | | | | | | | | | | |
| | | | | | | | | | | | | | | | | | | | | | | | | | | | | | | | | | | | | | | | | | | | | | | | | | | | | | | | | | | | | | | | | | | | | | | | | | | | | | | | |
| | | | | | | | | | | | | | | | | | | | | | | | | | | | | | | | | | | | | | | | | | | | | | | | | | | | | | | | | | | | | | | | | | | | | | | | | | | | | | | | |
| | | 1 | | | | | | | | | | | | | | | | | | | | | | | | | | | | | | | | | | | | | | | | | | | | | | | | | | | | | | | | | | | | | | | | | | | | | | | | | | | | | |
| | | 1 | | | | | | | | | | | | | | | | | | | | | | | | | | | | | | | | | | | | | | | | | | | | | | | | | | | | | | | | | | | | | | | | | | | | | | | | | | | | | |
| | | | | | | | | | | | | | | | | | | | | | | | | | | | | | | | | | | | | | | | | | | | | | | | | | | | | | | | | | | | | | | | | | | | | | | | | | | | | | | | |
| | | | | | | | | | | | | | | | | | | | | | | | | | | | | | | | | | | | | | | | | | | | | | | | | | | | | | | | | | | | | | | | | | | | | | | | | | | | | | | | |
| 1 | | | | | | | | | | | | | | | | | | | | | | | | | | | | | | | | | | | | | | | | | | | | | | | | | | | | | | | | | | | | | | | | | | | | | | | | | | | | | | | |
| | | | | | | | | | | | | | | | | | | | | | | | | | | | | | | | | | | | | | | | | | | | | | | | | | | | | | | | | | | | | | | | | | | | | | | | | | | | | | | | |
| | | | | | | | | | | | | | | | | | | | | | | | | | | | | | | | | | | | | | | | | | | | | | | | | | | | | | | | | | | | | | | | | | | | | | | | | | | | | | | | |
| | | | | | | | | | | | | | | | | | | | | | | | | | | | | | | | | | | | | | | | | | | | | | | | | | | | | | | | | | | | | | | | | | | | | | | | | | | | | | | | |
| | | | | | | | | | | | | | | | | | | | | | | | | | | | | | | | | | | | | | | | | | | | | | | | | | | | | | | | | | | | | | | | | | | | | | | | | | | | | | | | |
| | | | | | | | | | | | | | | | | | | | | | | | | | | | | | | | | | | | | | | | | | | | | | | | | | | | | | | | | | | | | | | | | | | | | | | | | | | | | | | | |
| | | 2 | | | | | | | | | | | | | | | | | | | | | | | | | | | | | | | | | | | | | | | | | | | | | | | | | | | | | | | | | | | | | | | | | | | | | | | | | | | | | |
| | | | | | | | | | | | | | | | | | | | | | | | | | | | | | | | | | | | | | | | | | | | | | | | | | | | | | | | | | | | | | | | | | | | | | | | | | | | | | | | |
| | | | | | | | | | | | | | | | | | | | | | | | | | | | | | | | | | | | | | | | | | | | | | | | | | | | | | | | | | | | | | | | | | | | | | | | | | | | | | | | |
| | | | | | | | | | | | | | | | | | | | | | | | | | | | | | | | | | | | | | | | | | | | | | | | | | | | | | | | | | | | | | | | | | | | | | | | | | | | | | | | |
| Post - 0 Miss - 0 Block - 0 | Post - 0 Miss - 0 Block - 0 | Post - 0 Miss - 0 Block - 0 | Post - 0 Miss - 0 Block - 0 | Post - 0 Miss - 0 Block - 0 | Post - 0 Miss - 0 Block - 0 | Post - 0 Miss - 0 Block - 0 | Post - 0 Miss - 0 Block - 0 | | | | | | | | | | | | | | | | | | | | | | | | | | | | | | | | | | | | | | | | | | | | | | | | | | | | | | | | | | | | | | | | | | | | | | | | |
| 13 刘振宇 | 16 高宇轩 | 17 张昊 | 21 杨明毅 | 24 于昊 | 26 曹立志 | 40 鹿智豪 | 88 王麒翔 | | | | | | | | | | | | | | | | | | | | | | | | | | | | | | | | | | | | | | | | | | | | | | | | | | | | | | | | | | | | | | | | | | | | | | | | |
| <table border="1"><tr><td></td><td>1</td><td>2</td></tr><tr><td></td><td></td><td>1</td></tr><tr><td></td><td></td><td>2</td></tr></table> | | 1 | 2 | | | 1 | | | 2 | <table border="1"><tr><td></td><td></td><td></td></tr><tr><td></td><td></td><td></td></tr><tr><td></td><td></td><td></td></tr></table> | | | | | | | | | | <table border="1"><tr><td></td><td></td><td></td></tr><tr><td></td><td></td><td></td></tr><tr><td></td><td></td><td></td></tr></table> | | | | | | | | | | <table border="1"><tr><td></td><td></td><td></td></tr><tr><td></td><td></td><td></td></tr><tr><td></td><td></td><td></td></tr></table> | | | | | | | | | | <table border="1"><tr><td></td><td></td><td></td></tr><tr><td></td><td></td><td></td></tr><tr><td></td><td></td><td></td></tr></table> | | | | | | | | | | <table border="1"><tr><td></td><td></td><td></td></tr><tr><td></td><td></td><td></td></tr><tr><td></td><td></td><td></td></tr></table> | | | | | | | | | | <table border="1"><tr><td></td><td></td><td></td></tr><tr><td></td><td></td><td></td></tr><tr><td></td><td></td><td></td></tr></table> | | | | | | | | | | <table border="1"><tr><td></td><td></td><td></td></tr><tr><td></td><td></td><td></td></tr><tr><td></td><td></td><td></td></tr></table> | | | | | | | | | |
| | 1 | 2 | | | | | | | | | | | | | | | | | | | | | | | | | | | | | | | | | | | | | | | | | | | | | | | | | | | | | | | | | | | | | | | | | | | | | | | | | | | | | |
| | | 1 | | | | | | | | | | | | | | | | | | | | | | | | | | | | | | | | | | | | | | | | | | | | | | | | | | | | | | | | | | | | | | | | | | | | | | | | | | | | | |
| | | 2 | | | | | | | | | | | | | | | | | | | | | | | | | | | | | | | | | | | | | | | | | | | | | | | | | | | | | | | | | | | | | | | | | | | | | | | | | | | | | |
| | | | | | | | | | | | | | | | | | | | | | | | | | | | | | | | | | | | | | | | | | | | | | | | | | | | | | | | | | | | | | | | | | | | | | | | | | | | | | | | |
| | | | | | | | | | | | | | | | | | | | | | | | | | | | | | | | | | | | | | | | | | | | | | | | | | | | | | | | | | | | | | | | | | | | | | | | | | | | | | | | |
| | | | | | | | | | | | | | | | | | | | | | | | | | | | | | | | | | | | | | | | | | | | | | | | | | | | | | | | | | | | | | | | | | | | | | | | | | | | | | | | |
| | | | | | | | | | | | | | | | | | | | | | | | | | | | | | | | | | | | | | | | | | | | | | | | | | | | | | | | | | | | | | | | | | | | | | | | | | | | | | | | |
| | | | | | | | | | | | | | | | | | | | | | | | | | | | | | | | | | | | | | | | | | | | | | | | | | | | | | | | | | | | | | | | | | | | | | | | | | | | | | | | |
| | | | | | | | | | | | | | | | | | | | | | | | | | | | | | | | | | | | | | | | | | | | | | | | | | | | | | | | | | | | | | | | | | | | | | | | | | | | | | | | |
| | | | | | | | | | | | | | | | | | | | | | | | | | | | | | | | | | | | | | | | | | | | | | | | | | | | | | | | | | | | | | | | | | | | | | | | | | | | | | | | |
| | | | | | | | | | | | | | | | | | | | | | | | | | | | | | | | | | | | | | | | | | | | | | | | | | | | | | | | | | | | | | | | | | | | | | | | | | | | | | | | |
| | | | | | | | | | | | | | | | | | | | | | | | | | | | | | | | | | | | | | | | | | | | | | | | | | | | | | | | | | | | | | | | | | | | | | | | | | | | | | | | |
| | | | | | | | | | | | | | | | | | | | | | | | | | | | | | | | | | | | | | | | | | | | | | | | | | | | | | | | | | | | | | | | | | | | | | | | | | | | | | | | |
| | | | | | | | | | | | | | | | | | | | | | | | | | | | | | | | | | | | | | | | | | | | | | | | | | | | | | | | | | | | | | | | | | | | | | | | | | | | | | | | |
| | | | | | | | | | | | | | | | | | | | | | | | | | | | | | | | | | | | | | | | | | | | | | | | | | | | | | | | | | | | | | | | | | | | | | | | | | | | | | | | |
| | | | | | | | | | | | | | | | | | | | | | | | | | | | | | | | | | | | | | | | | | | | | | | | | | | | | | | | | | | | | | | | | | | | | | | | | | | | | | | | |
| | | | | | | | | | | | | | | | | | | | | | | | | | | | | | | | | | | | | | | | | | | | | | | | | | | | | | | | | | | | | | | | | | | | | | | | | | | | | | | | |
| | | | | | | | | | | | | | | | | | | | | | | | | | | | | | | | | | | | | | | | | | | | | | | | | | | | | | | | | | | | | | | | | | | | | | | | | | | | | | | | |
| | | | | | | | | | | | | | | | | | | | | | | | | | | | | | | | | | | | | | | | | | | | | | | | | | | | | | | | | | | | | | | | | | | | | | | | | | | | | | | | |
| | | | | | | | | | | | | | | | | | | | | | | | | | | | | | | | | | | | | | | | | | | | | | | | | | | | | | | | | | | | | | | | | | | | | | | | | | | | | | | | |
| | | | | | | | | | | | | | | | | | | | | | | | | | | | | | | | | | | | | | | | | | | | | | | | | | | | | | | | | | | | | | | | | | | | | | | | | | | | | | | | |
| | | | | | | | | | | | | | | | | | | | | | | | | | | | | | | | | | | | | | | | | | | | | | | | | | | | | | | | | | | | | | | | | | | | | | | | | | | | | | | | |
| | | | | | | | | | | | | | | | | | | | | | | | | | | | | | | | | | | | | | | | | | | | | | | | | | | | | | | | | | | | | | | | | | | | | | | | | | | | | | | | |
| | | | | | | | | | | | | | | | | | | | | | | | | | | | | | | | | | | | | | | | | | | | | | | | | | | | | | | | | | | | | | | | | | | | | | | | | | | | | | | | |
| Post - 0 Miss - 0 Block - 3 | Post - 0 Miss - 0 Block - 0 | Post - 0 Miss - 0 Block - 0 | Post - 0 Miss - 0 Block - 0 | Post - 0 Miss - 0 Block - 0 | Post - 0 Miss - 0 Block - 0 | Post - 0 Miss - 0 Block - 0 | Post - 0 Miss - 0 Block - 0 | | | | | | | | | | | | | | | | | | | | | | | | | | | | | | | | | | | | | | | | | | | | | | | | | | | | | | | | | | | | | | | | | | | | | | | | |



| | | |
|-------------------------|-------------------------|---------------------------|
| Team A A 山东济南 | Team B B 江苏苏州 | Match Number 11 |
|-------------------------|-------------------------|---------------------------|

| | | | | | |
|-------------------|------------------------|------------------|-------------|-------|------------|
| Played in 安徽滁州 | in the hall 滁州国际手球馆 | on 2019-05-29 | at 14:00 | hours | Spectators |
|-------------------|------------------------|------------------|-------------|-------|------------|

| | | | | | | | | | | | | | | |
|----------------|--------|--------|---------------------|---------|---------|----------------|---|---|----------------|---|---|----------------------|---|---|
| Half-time(30') | A 7 | B 6 | End of playing time | A 12 | B 11 | 1st extra time | A | B | 2nd extra time | A | B | After penalty throws | A | B |
|----------------|--------|--------|---------------------|---------|---------|----------------|---|---|----------------|---|---|----------------------|---|---|

| | | | | | | | | | | |
|---------------|------------|---------------|------------|------------|------------------------------------|---------------|---|--|----------|---------------|
| Number of 7 m | A 0/0 | Team time-out | | | Full name of players and officials | Team time-out | | | B 0/1 | Number of 7 m |
| | 1 14:23 | 2 36:07 | 3 44:54 | 1 12:16 | | 2 | 3 | | | |

| No. | Team A | G | W | 2' | D | DR | No. | Team B | G | W | 2' | D | DR |
|-----|-----------|---|---|----|---|----|-----|--------|---|---|----|---|----|
| 1 | 刘在攀 | | | | | | 1 | 邹明轩 | | | | | |
| 4 | 张广一 | | | | | | 2 | 马力 | | | | | |
| 6 | 刘尊哲 | 7 | | | | | 4 | 孙钊 | 6 | | | | |
| 7 | 王帅 | | | | | | 5 | 马奔 | 1 | | | | |
| 8 | 金正凯 | | | | | | 6 | 潘超群 | 1 | | | | |
| 9 | 张嘉树 | | | | | | 8 | 王震 | | | | | |
| 10 | 颜同霖 | 3 | 1 | | | | 9 | 李文俊 | | | | | |
| 11 | 李延舒 | 1 | | | | | 10 | 朱红雨 | 1 | | | | |
| 13 | 刘振宇 | 1 | | | | | 11 | 许多 | | | | | |
| 16 | 高宇轩 | | | | | | 12 | 周文贤 | | | | | |
| 17 | 张昊 | | | | | | 13 | 蒋超 | 1 | | | | |
| 21 | 杨明毅 | | | | | | 14 | 刘亚力 | | | | | |
| 24 | 于昊 | | | | | | 15 | 刘成果 | | | | | |
| 26 | 曹立志 | | | | | | 18 | 何志伟 | 1 | | | | |
| 40 | 鹿智豪 | | | | | | 19 | 夏思毅 | | | | | |
| | | | | | | | 23 | 张铮洋 | | | 1 | | |
| A | 李楠 | | | | | | A | 周清 | | | | | |
| B | 陈鹏波 (主教练) | | | | | | C | 郝可鑫 | | | | | |
| C | 陶丛龙 | | | | | | D | 陈冬冬 | | | | | |
| E | 郭军旗 | | | | | | E | 陈伟 | | | | | |

| | | |
|---|--|---|
| A | Signatures of responsables for the teams (Off.A) | B |
|---|--|---|

| | | |
|----|-----------------------------------|----|
| TP | Remarks of referees / HF Official | TP |
|----|-----------------------------------|----|

| | | | |
|------------|-----------|-----------|--|
| Signatures | | | |
| Referees | 严璐 (CHN) | 王雨洋 (CHN) | |
| T.D. | 吴国忠 (CHN) | 王洋 (CHN) | |
| CHA Off. | | | |

Note: Number of 7m Throws Awarded to Team A and B, Goals (G), Warnings (W), Suspensions (2'), Direct Disqualification (D), Disqualification With Report (DR) and Team Penalty (TP).

Table Officials: 李莉君 吴荣 Statisticians: 童佩瑶 马安兴

竞赛技术统计

手球
青年男子

预赛
轮次 3

组别 B
场次 11

滁州国际手球馆
2019-05-29 14:00

| | | | |
|-----------|----------------------|---------|------------|
| Referees: | 严璐 (CHN) / 王雨洋 (CHN) | Result: | 12:11(7:6) |
| Teams: | 山东济南(济南) VS 江苏苏州(苏州) | | |

| 济南 | | 远射 | 近射 | 边射 | 快攻 | 突破 | 任意球 | 7m球 | 合计 | % | 助攻 | 失误 | 警告 | 2' | D+DR |
|----------|-----|------|-----|-----|-----|-----|-----|-----|-------|------|----|----|----|----|------|
| 主教练: 陈鹏波 | | | | | | | | | | | | | | | |
| 1 | 刘在攀 | | | | | | | | | | | | | | |
| 4 | 张广一 | | | | | | | | | | | | | | |
| 6 | 刘尊哲 | 5/9 | 1/2 | 1/1 | | | | | 7/12 | 58.3 | | | | | |
| 7 | 王帅 | | | | | | | | | | | | | | |
| 8 | 金正凯 | | | | | | | | | | | | | | |
| 9 | 张嘉树 | | | | | | | | | | | | | | |
| 10 | 颜同霖 | 1/3 | 0/1 | | | | 2/3 | | 3/7 | 42.9 | | 1 | 1 | | |
| 11 | 李延舒 | | 1/1 | | | | | | 1/1 | 100 | | | | | |
| 13 | 刘振宇 | 1/6 | 0/1 | | | | 0/1 | | 1/8 | 12.5 | | 1 | | | |
| 16 | 高宇轩 | | | | | | | | | | | | | | |
| 17 | 张昊 | | | | | | | | | | | | | | |
| 21 | 杨明毅 | | | | | | | | | | | | | | |
| 24 | 于昊 | | | | | | | | | | | | | | |
| 26 | 曹立志 | | | | | | | | | | | | | | |
| 40 | 鹿智豪 | | | | | | | | | | | | | | |
| 运动员 | 合计 | 7/18 | 2/5 | 1/1 | | | 2/4 | | 12/28 | 42.9 | | 2 | 1 | | |
| 1 | 刘在攀 | 0/5 | 5/8 | 2/2 | 1/3 | 2/3 | | 1/1 | 11/22 | 50.0 | | | | | |
| 16 | 高宇轩 | | | | | | | | | | | | | | |
| 守门员 | 合计 | 0/5 | 5/8 | 2/2 | 1/3 | 2/3 | | 1/1 | 11/22 | 50.0 | | | | | |

| 济南 | 比赛进程 | 苏州 |
|----------|----------|----------|
| 1st Half | | |
| 6 刘尊哲 | 1 01:05 | 0 |
| | 1 01:30 | 1 4 孙钊 |
| 6 刘尊哲 | 2 02:09 | 1 |
| | 2 02:34 | 2 6 潘超群 |
| | 2 05:29 | 3 4 孙钊 |
| | 2 07:08 | 4 18 何志伟 |
| 6 刘尊哲 | 3 07:18 | 4 |
| 11 李延舒 | 4 08:11 | 4 |
| | 4 08:39 | 5 13 蒋超 |
| 10 颜同霖 | 5 09:23 | 5 |
| 10 颜同霖 | 6 11:15 | 5 |
| 6 刘尊哲 | 7 11:48 | 5 |
| | 7 12:38 | 6 4 孙钊 |
| 2nd Half | | |
| | 7 00:28 | 7 10 朱红雨 |
| 6 刘尊哲 | 8 00:57 | 7 |
| | 8 02:11 | 8 4 孙钊 |
| 6 刘尊哲 | 9 03:03 | 8 |
| | 9 03:28 | 9 4 孙钊 |
| 6 刘尊哲 | 10 06:57 | 9 |
| 13 刘振宇 | 11 09:30 | 9 |
| | 11 11:45 | 10 4 孙钊 |
| 10 颜同霖 | 12 13:40 | 10 |
| | 12 14:43 | 11 5 马奔 |

| 苏州 | | 远射 | 近射 | 边射 | 快攻 | 突破 | 任意球 | 7m球 | 合计 | % | 助攻 | 失误 | 警告 | 2' | D+DR |
|----------|-----|------|-----|-----|-----|-----|-----|-----|-------|------|----|----|----|----|------|
| 主教练: 陈冬冬 | | | | | | | | | | | | | | | |
| 1 | 邹明轩 | | | | | | | | | | 1 | | | | |
| 2 | 马力 | | | | | | | | | | | | | | |
| 4 | 孙钊 | 4/4 | 1/3 | | | 1/3 | 0/1 | | 6/11 | 54.5 | | 1 | | | |
| 5 | 马奔 | | 1/1 | | | | | | 1/1 | 100 | | 2 | | | |
| 6 | 潘超群 | 1/1 | 0/1 | | | | | | 1/2 | 50.0 | | 2 | | | |
| 8 | 王震 | 0/2 | | 0/2 | | | | | 0/4 | 0.0 | | | | | |
| 9 | 李文俊 | | | | | | | | | | | | | | |
| 10 | 朱红雨 | | 0/1 | | 1/2 | | | | 1/3 | 33.3 | | | | | |
| 11 | 许多 | | | | | | | | | | | | | | |
| 12 | 周文贤 | | | | | | | | | | | | | | |
| 13 | 蒋超 | | 1/1 | | | | | | 1/1 | 100 | | | | | |
| 14 | 刘亚力 | | | | | | | | | | | | | | |
| 15 | 刘成果 | | | | | | | | | | | | | | |
| 18 | 何志伟 | | | | 1/1 | | | | 1/1 | 100 | 1 | | | | |
| 19 | 夏思毅 | | | | | | | | | | | | | | |
| 23 | 张铮洋 | | 0/1 | | | | | 0/1 | 0/2 | 0.0 | | | | 1 | |
| 运动员 | 合计 | 5/7 | 3/8 | 0/2 | 2/3 | 1/3 | 0/1 | 0/1 | 11/25 | 44.0 | 2 | 5 | | 1 | |
| 1 | 邹明轩 | 5/12 | 3/5 | 0/1 | | | 1/3 | | 9/21 | 42.9 | 1 | | | | |
| 守门员 | 合计 | 5/12 | 3/5 | 0/1 | | | 1/3 | | 9/21 | 42.9 | 1 | | | | |

场上队员: 得分 / 射门

守门员: 救球 / 射门

| | | | |
|---|------|----|---------|
| D | 取消资格 | DR | 取消资格+报告 |
|---|------|----|---------|

个人/全队技术统计表

手球 预赛 组别 B 滁州国际手球馆
青年男子 轮次 3 场次 11 2019-05-29 14:00

| 号码 | 姓名 | 远射 | 近射 | 边射 | 快攻 | 突破 | 任意 | 七米 | 合计 | % | 助攻 | 失误 | 警告 | 2' | 取消 | 时间 |
|----------|-----|------|-----|-----|-----|-----|-----|-----|-------|-------|----|----|----|----|----|----------|
| 山东济南(济南) | | | | | | | | | | | | | | | | |
| (场上队员) | | | | | | | | | | | | | | | | |
| 1 | 刘在攀 | | | | | | | | | 0.0% | | | | | | 00:29:31 |
| 4 | 张广一 | | | | | | | | | 0.0% | | | | | | 00:00:00 |
| 6 | 刘尊哲 | 5/9 | 1/2 | 1/1 | | | | | 7/12 | 58.3% | | | | | | 00:30:00 |
| 7 | 王帅 | | | | | | | | | 0.0% | | | | | | 00:30:00 |
| 8 | 金正凯 | | | | | | | | | 0.0% | | | | | | 00:30:00 |
| 9 | 张嘉树 | | | | | | | | | 0.0% | | | | | | 00:00:00 |
| 10 | 颜同霖 | 1/3 | 0/1 | | | | 2/3 | | 3/7 | 42.9% | 1 | | 1 | | | 00:30:00 |
| 11 | 李延舒 | | 1/1 | | | | | | 1/1 | 100% | | | | | | 00:30:00 |
| 13 | 刘振宇 | 1/6 | 0/1 | | | | 0/1 | | 1/8 | 12.5% | 1 | | | | | 00:30:00 |
| 16 | 高宇轩 | | | | | | | | | 0.0% | | | | | | 00:00:29 |
| 17 | 张昊 | | | | | | | | | 0.0% | | | | | | 00:00:00 |
| 21 | 杨明毅 | | | | | | | | | 0.0% | | | | | | 00:00:00 |
| 24 | 于昊 | | | | | | | | | 0.0% | | | | | | 00:00:00 |
| 26 | 曹立志 | | | | | | | | | 0.0% | | | | | | 00:00:00 |
| 40 | 鹿智豪 | | | | | | | | | 0.0% | | | | | | 00:00:00 |
| 合计 | | 7/18 | 2/5 | 1/1 | | | 2/4 | | 12/28 | 42.9% | 2 | | 1 | | | |
| (守门员) | | | | | | | | | | | | | | | | |
| 1 | 刘在攀 | 0/5 | 5/8 | 2/2 | 1/3 | 2/3 | | 1/1 | 11/22 | 50.0% | | | | | | 00:29:31 |
| 16 | 高宇轩 | | | | | | | | | 0.0% | | | | | | 00:00:29 |
| 合计 | | 0/5 | 5/8 | 2/2 | 1/3 | 2/3 | | 1/1 | 11/22 | 50.0% | | | | | | |

场上队员：得分/射门

守门员：救球/射门

| 全队合计 | 得分 | 被救 | 射失 | 击柱 | 封球 | 合计 | % |
|------|----|----|----|----|----|----|--------|
| 远射 | 7 | 5 | 2 | 1 | 3 | 18 | 38.9% |
| 近射 | 2 | 3 | | | | 5 | 40.0% |
| 边射 | 1 | | | | | 1 | 100.0% |
| 快攻 | | | | | | | 0.0% |
| 突破 | | | | | | | 0.0% |
| 任意 | 2 | 1 | | 1 | | 4 | 50.0% |
| 七米 | | | | | | | 0.0% |

个人/全队技术统计表

手球 预赛 组别 B 滁州国际手球馆
青年男子 轮次 3 场次 11 2019-05-29 14:00

| 号码 | 姓名 | 远射 | 近射 | 边射 | 快攻 | 突破 | 任意 | 七米 | 合计 | % | 助攻 | 失误 | 警告 | 2' | 取消 | 时间 |
|----------|-----|------|-----|-----|-----|-----|-----|-----|-------|-------|----|----|----|----|----|----------|
| 江苏苏州(苏州) | | | | | | | | | | | | | | | | |
| (场上队员) | | | | | | | | | | | | | | | | |
| 1 | 邹明轩 | | | | | | | | | 0.0% | 1 | | | | | 00:30:00 |
| 2 | 马力 | | | | | | | | | 0.0% | | | | | | 00:00:00 |
| 4 | 孙钊 | 4/4 | 1/3 | | | 1/3 | 0/1 | | 6/11 | 54.5% | | 1 | | | | 00:12:09 |
| 5 | 马奔 | | 1/1 | | | | | | 1/1 | 100% | | 2 | | | | 00:30:00 |
| 6 | 潘超群 | 1/1 | 0/1 | | | | | | 1/2 | 50.0% | | 2 | | | | 00:26:09 |
| 8 | 王震 | 0/2 | | 0/2 | | | | | 0/4 | 0.0% | | | | | | 00:29:41 |
| 9 | 李文俊 | | | | | | | | | 0.0% | | | | | | 00:00:00 |
| 10 | 朱红雨 | | 0/1 | | 1/2 | | | | 1/3 | 33.3% | | | | | | 00:15:00 |
| 11 | 许多 | | | | | | | | | 0.0% | | | | | | 00:00:00 |
| 12 | 周文贤 | | | | | | | | | 0.0% | | | | | | 00:00:00 |
| 13 | 蒋超 | | 1/1 | | | | | | 1/1 | 100% | | | | | | 00:14:43 |
| 14 | 刘亚力 | | | | | | | | | 0.0% | | | | | | 00:00:00 |
| 15 | 刘成果 | | | | | | | | | 0.0% | | | | | | 00:03:48 |
| 18 | 何志伟 | | | | 1/1 | | | | 1/1 | 100% | 1 | | | | | 00:30:00 |
| 19 | 夏思毅 | | | | | | | | | 0.0% | | | | | | 00:00:00 |
| 23 | 张铮洋 | | 0/1 | | | | | 0/1 | 0/2 | 0.0% | | | | 1 | | 00:17:13 |
| | 合计 | 5/7 | 3/8 | 0/2 | 2/3 | 1/3 | 0/1 | 0/1 | 11/25 | 44.0% | 2 | 5 | | 1 | | |
| (守门员) | | | | | | | | | | | | | | | | |
| 1 | 邹明轩 | 5/12 | 3/5 | 0/1 | | | 1/3 | | 9/21 | 42.9% | 1 | | | | | 00:30:00 |
| | 合计 | 5/12 | 3/5 | 0/1 | | | 1/3 | | 9/21 | 42.9% | 1 | | | | | |

场上队员：得分/射门

守门员：救球/射门

| 全队合计 | 得分 | 被救 | 射失 | 击柱 | 封球 | 合计 | % |
|------|----|----|----|----|----|----|-------|
| 远射 | 5 | | | 2 | | 7 | 71.4% |
| 近射 | 3 | 5 | | | | 8 | 37.5% |
| 边射 | | 2 | | | | 2 | 0.0% |
| 快攻 | 2 | 1 | | | | 3 | 66.7% |
| 突破 | 1 | 2 | | | | 3 | 33.3% |
| 任意 | | | 1 | | | 1 | 0.0% |
| 七米 | | 1 | | | | 1 | 0.0% |

图式比赛技术统计表

手球
青年男子

预赛
轮次 3

组别 B
场次 11

滁州国际手球馆
2019-05-29 14:00

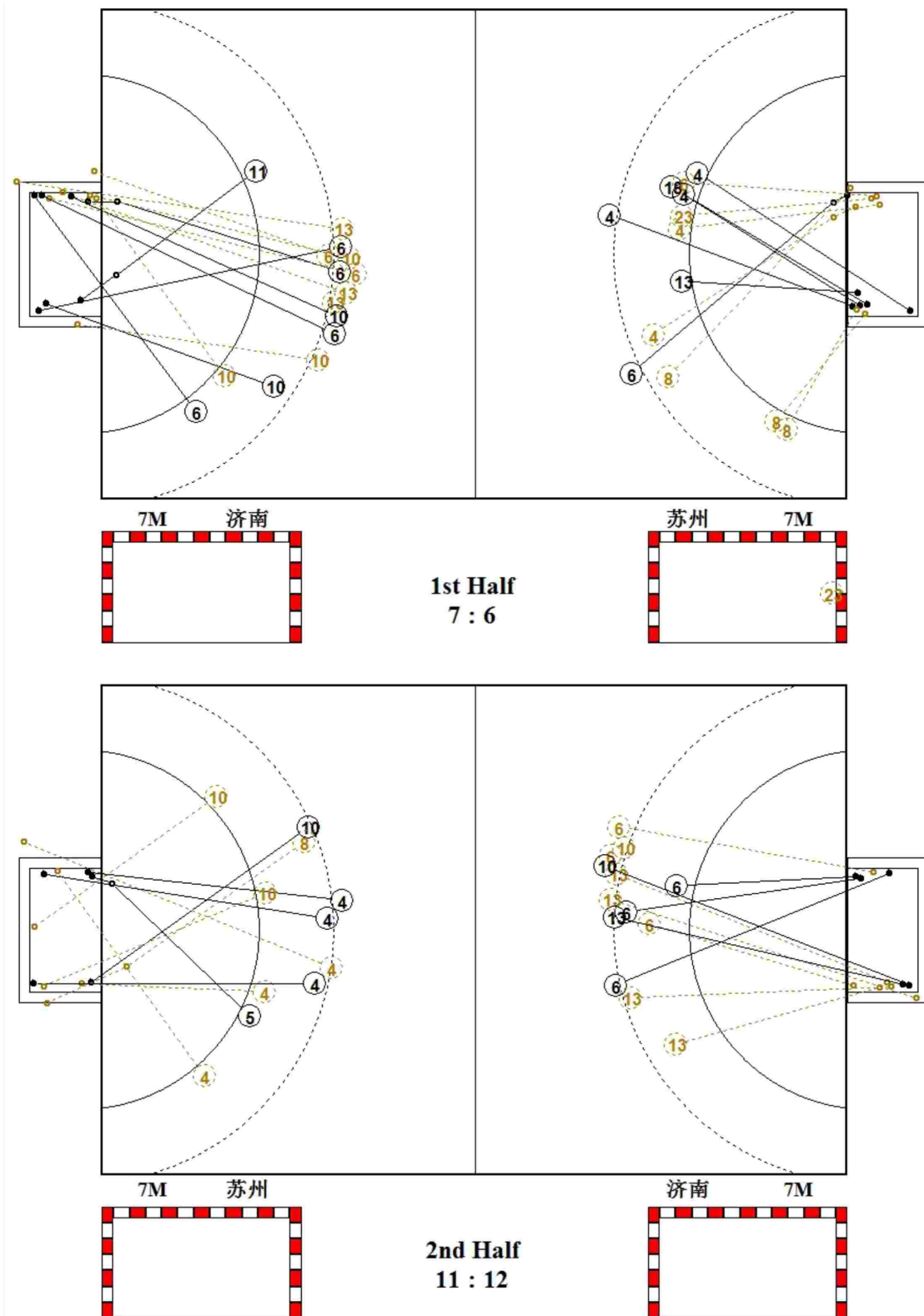

图式射门区域统计

手球
青年男子

预赛
轮次 3

组别 B
场次 11

滁州国际手球馆
2019-05-29 14:00

山东济南

| | | | | | | | | | | | | | | | | | | | | | | | | | | | | | | | | | | | | | | | | | | | | | | | | | | | | | | | | | | | | | | | | | | | | | | | | | | | | | | | |
|---|-----------------------------|-----------------------------|-----------------------------|-----------------------------|-----------------------------|-----------------------------|-----------------------------|--|--|--|--|--|--|--|--|--|--|--|--|---|---|--|---|---|--|--|---|--|---|--|--|--|--|--|--|--|--|--|--|--|--|--|--|--|--|--|--|--|--|--|--|--|--|--|--|--|--|--|--|---|---|--|---|--|--|---|--|--|--|---|--|--|--|--|--|--|---|--|--|
| 1 刘在攀 | 4 张广一 | 6 刘尊哲 | 7 王帅 | 8 金正凯 | 9 张嘉树 | 10 颜同霖 | 11 李延舒 | | | | | | | | | | | | | | | | | | | | | | | | | | | | | | | | | | | | | | | | | | | | | | | | | | | | | | | | | | | | | | | | | | | | | | | | |
| <table border="1"><tr><td></td><td></td><td></td></tr><tr><td></td><td></td><td></td></tr><tr><td></td><td></td><td></td></tr></table> | | | | | | | | | | <table border="1"><tr><td></td><td></td><td></td></tr><tr><td></td><td></td><td></td></tr><tr><td></td><td></td><td></td></tr></table> | | | | | | | | | | <table border="1"><tr><td>1</td><td></td><td>2</td></tr><tr><td>1</td><td></td><td></td></tr><tr><td>2</td><td></td><td>1</td></tr></table> | 1 | | 2 | 1 | | | 2 | | 1 | <table border="1"><tr><td></td><td></td><td></td></tr><tr><td></td><td></td><td></td></tr><tr><td></td><td></td><td></td></tr></table> | | | | | | | | | | <table border="1"><tr><td></td><td></td><td></td></tr><tr><td></td><td></td><td></td></tr><tr><td></td><td></td><td></td></tr></table> | | | | | | | | | | <table border="1"><tr><td></td><td></td><td></td></tr><tr><td></td><td></td><td></td></tr><tr><td></td><td></td><td></td></tr></table> | | | | | | | | | | <table border="1"><tr><td>1</td><td></td><td>1</td></tr><tr><td></td><td></td><td>1</td></tr><tr><td></td><td></td><td></td></tr></table> | 1 | | 1 | | | 1 | | | | <table border="1"><tr><td></td><td></td><td></td></tr><tr><td></td><td></td><td></td></tr><tr><td>1</td><td></td><td></td></tr></table> | | | | | | | 1 | | |
| | | | | | | | | | | | | | | | | | | | | | | | | | | | | | | | | | | | | | | | | | | | | | | | | | | | | | | | | | | | | | | | | | | | | | | | | | | | | | | | |
| | | | | | | | | | | | | | | | | | | | | | | | | | | | | | | | | | | | | | | | | | | | | | | | | | | | | | | | | | | | | | | | | | | | | | | | | | | | | | | | |
| | | | | | | | | | | | | | | | | | | | | | | | | | | | | | | | | | | | | | | | | | | | | | | | | | | | | | | | | | | | | | | | | | | | | | | | | | | | | | | | |
| | | | | | | | | | | | | | | | | | | | | | | | | | | | | | | | | | | | | | | | | | | | | | | | | | | | | | | | | | | | | | | | | | | | | | | | | | | | | | | | |
| | | | | | | | | | | | | | | | | | | | | | | | | | | | | | | | | | | | | | | | | | | | | | | | | | | | | | | | | | | | | | | | | | | | | | | | | | | | | | | | |
| | | | | | | | | | | | | | | | | | | | | | | | | | | | | | | | | | | | | | | | | | | | | | | | | | | | | | | | | | | | | | | | | | | | | | | | | | | | | | | | |
| 1 | | 2 | | | | | | | | | | | | | | | | | | | | | | | | | | | | | | | | | | | | | | | | | | | | | | | | | | | | | | | | | | | | | | | | | | | | | | | | | | | | | |
| 1 | | | | | | | | | | | | | | | | | | | | | | | | | | | | | | | | | | | | | | | | | | | | | | | | | | | | | | | | | | | | | | | | | | | | | | | | | | | | | | | |
| 2 | | 1 | | | | | | | | | | | | | | | | | | | | | | | | | | | | | | | | | | | | | | | | | | | | | | | | | | | | | | | | | | | | | | | | | | | | | | | | | | | | | |
| | | | | | | | | | | | | | | | | | | | | | | | | | | | | | | | | | | | | | | | | | | | | | | | | | | | | | | | | | | | | | | | | | | | | | | | | | | | | | | | |
| | | | | | | | | | | | | | | | | | | | | | | | | | | | | | | | | | | | | | | | | | | | | | | | | | | | | | | | | | | | | | | | | | | | | | | | | | | | | | | | |
| | | | | | | | | | | | | | | | | | | | | | | | | | | | | | | | | | | | | | | | | | | | | | | | | | | | | | | | | | | | | | | | | | | | | | | | | | | | | | | | |
| | | | | | | | | | | | | | | | | | | | | | | | | | | | | | | | | | | | | | | | | | | | | | | | | | | | | | | | | | | | | | | | | | | | | | | | | | | | | | | | |
| | | | | | | | | | | | | | | | | | | | | | | | | | | | | | | | | | | | | | | | | | | | | | | | | | | | | | | | | | | | | | | | | | | | | | | | | | | | | | | | |
| | | | | | | | | | | | | | | | | | | | | | | | | | | | | | | | | | | | | | | | | | | | | | | | | | | | | | | | | | | | | | | | | | | | | | | | | | | | | | | | |
| | | | | | | | | | | | | | | | | | | | | | | | | | | | | | | | | | | | | | | | | | | | | | | | | | | | | | | | | | | | | | | | | | | | | | | | | | | | | | | | |
| | | | | | | | | | | | | | | | | | | | | | | | | | | | | | | | | | | | | | | | | | | | | | | | | | | | | | | | | | | | | | | | | | | | | | | | | | | | | | | | |
| | | | | | | | | | | | | | | | | | | | | | | | | | | | | | | | | | | | | | | | | | | | | | | | | | | | | | | | | | | | | | | | | | | | | | | | | | | | | | | | |
| 1 | | 1 | | | | | | | | | | | | | | | | | | | | | | | | | | | | | | | | | | | | | | | | | | | | | | | | | | | | | | | | | | | | | | | | | | | | | | | | | | | | | |
| | | 1 | | | | | | | | | | | | | | | | | | | | | | | | | | | | | | | | | | | | | | | | | | | | | | | | | | | | | | | | | | | | | | | | | | | | | | | | | | | | | |
| | | | | | | | | | | | | | | | | | | | | | | | | | | | | | | | | | | | | | | | | | | | | | | | | | | | | | | | | | | | | | | | | | | | | | | | | | | | | | | | |
| | | | | | | | | | | | | | | | | | | | | | | | | | | | | | | | | | | | | | | | | | | | | | | | | | | | | | | | | | | | | | | | | | | | | | | | | | | | | | | | |
| | | | | | | | | | | | | | | | | | | | | | | | | | | | | | | | | | | | | | | | | | | | | | | | | | | | | | | | | | | | | | | | | | | | | | | | | | | | | | | | |
| 1 | | | | | | | | | | | | | | | | | | | | | | | | | | | | | | | | | | | | | | | | | | | | | | | | | | | | | | | | | | | | | | | | | | | | | | | | | | | | | | | |
| Post - 0 Miss - 0 Block - 0 | Post - 0 Miss - 0 Block - 0 | Post - 0 Miss - 1 Block - 1 | Post - 0 Miss - 0 Block - 0 | Post - 0 Miss - 0 Block - 0 | Post - 0 Miss - 0 Block - 0 | Post - 1 Miss - 0 Block - 1 | Post - 0 Miss - 0 Block - 0 | | | | | | | | | | | | | | | | | | | | | | | | | | | | | | | | | | | | | | | | | | | | | | | | | | | | | | | | | | | | | | | | | | | | | | | | |
| 13 刘振宇 | 16 高宇轩 | 17 张昊 | 21 杨明毅 | 24 于昊 | 26 曹立志 | 40 鹿智豪 | | | | | | | | | | | | | | | | | | | | | | | | | | | | | | | | | | | | | | | | | | | | | | | | | | | | | | | | | | | | | | | | | | | | | | | | | |
| <table border="1"><tr><td></td><td></td><td>1</td></tr><tr><td></td><td></td><td></td></tr><tr><td></td><td></td><td></td></tr></table> | | | 1 | | | | | | | <table border="1"><tr><td></td><td></td><td></td></tr><tr><td></td><td></td><td></td></tr><tr><td></td><td></td><td></td></tr></table> | | | | | | | | | | <table border="1"><tr><td></td><td></td><td></td></tr><tr><td></td><td></td><td></td></tr><tr><td></td><td></td><td></td></tr></table> | | | | | | | | | | <table border="1"><tr><td></td><td></td><td></td></tr><tr><td></td><td></td><td></td></tr><tr><td></td><td></td><td></td></tr></table> | | | | | | | | | | <table border="1"><tr><td></td><td></td><td></td></tr><tr><td></td><td></td><td></td></tr><tr><td></td><td></td><td></td></tr></table> | | | | | | | | | | <table border="1"><tr><td></td><td></td><td></td></tr><tr><td></td><td></td><td></td></tr><tr><td></td><td></td><td></td></tr></table> | | | | | | | | | | <table border="1"><tr><td></td><td></td><td></td></tr><tr><td></td><td></td><td></td></tr><tr><td></td><td></td><td></td></tr></table> | | | | | | | | | | | | | | | | | | | |
| | | 1 | | | | | | | | | | | | | | | | | | | | | | | | | | | | | | | | | | | | | | | | | | | | | | | | | | | | | | | | | | | | | | | | | | | | | | | | | | | | | |
| | | | | | | | | | | | | | | | | | | | | | | | | | | | | | | | | | | | | | | | | | | | | | | | | | | | | | | | | | | | | | | | | | | | | | | | | | | | | | | | |
| | | | | | | | | | | | | | | | | | | | | | | | | | | | | | | | | | | | | | | | | | | | | | | | | | | | | | | | | | | | | | | | | | | | | | | | | | | | | | | | |
| | | | | | | | | | | | | | | | | | | | | | | | | | | | | | | | | | | | | | | | | | | | | | | | | | | | | | | | | | | | | | | | | | | | | | | | | | | | | | | | |
| | | | | | | | | | | | | | | | | | | | | | | | | | | | | | | | | | | | | | | | | | | | | | | | | | | | | | | | | | | | | | | | | | | | | | | | | | | | | | | | |
| | | | | | | | | | | | | | | | | | | | | | | | | | | | | | | | | | | | | | | | | | | | | | | | | | | | | | | | | | | | | | | | | | | | | | | | | | | | | | | | |
| | | | | | | | | | | | | | | | | | | | | | | | | | | | | | | | | | | | | | | | | | | | | | | | | | | | | | | | | | | | | | | | | | | | | | | | | | | | | | | | |
| | | | | | | | | | | | | | | | | | | | | | | | | | | | | | | | | | | | | | | | | | | | | | | | | | | | | | | | | | | | | | | | | | | | | | | | | | | | | | | | |
| | | | | | | | | | | | | | | | | | | | | | | | | | | | | | | | | | | | | | | | | | | | | | | | | | | | | | | | | | | | | | | | | | | | | | | | | | | | | | | | |
| | | | | | | | | | | | | | | | | | | | | | | | | | | | | | | | | | | | | | | | | | | | | | | | | | | | | | | | | | | | | | | | | | | | | | | | | | | | | | | | |
| | | | | | | | | | | | | | | | | | | | | | | | | | | | | | | | | | | | | | | | | | | | | | | | | | | | | | | | | | | | | | | | | | | | | | | | | | | | | | | | |
| | | | | | | | | | | | | | | | | | | | | | | | | | | | | | | | | | | | | | | | | | | | | | | | | | | | | | | | | | | | | | | | | | | | | | | | | | | | | | | | |
| | | | | | | | | | | | | | | | | | | | | | | | | | | | | | | | | | | | | | | | | | | | | | | | | | | | | | | | | | | | | | | | | | | | | | | | | | | | | | | | |
| | | | | | | | | | | | | | | | | | | | | | | | | | | | | | | | | | | | | | | | | | | | | | | | | | | | | | | | | | | | | | | | | | | | | | | | | | | | | | | | |
| | | | | | | | | | | | | | | | | | | | | | | | | | | | | | | | | | | | | | | | | | | | | | | | | | | | | | | | | | | | | | | | | | | | | | | | | | | | | | | | |
| | | | | | | | | | | | | | | | | | | | | | | | | | | | | | | | | | | | | | | | | | | | | | | | | | | | | | | | | | | | | | | | | | | | | | | | | | | | | | | | |
| | | | | | | | | | | | | | | | | | | | | | | | | | | | | | | | | | | | | | | | | | | | | | | | | | | | | | | | | | | | | | | | | | | | | | | | | | | | | | | | |
| | | | | | | | | | | | | | | | | | | | | | | | | | | | | | | | | | | | | | | | | | | | | | | | | | | | | | | | | | | | | | | | | | | | | | | | | | | | | | | | |
| | | | | | | | | | | | | | | | | | | | | | | | | | | | | | | | | | | | | | | | | | | | | | | | | | | | | | | | | | | | | | | | | | | | | | | | | | | | | | | | |
| | | | | | | | | | | | | | | | | | | | | | | | | | | | | | | | | | | | | | | | | | | | | | | | | | | | | | | | | | | | | | | | | | | | | | | | | | | | | | | | |
| | | | | | | | | | | | | | | | | | | | | | | | | | | | | | | | | | | | | | | | | | | | | | | | | | | | | | | | | | | | | | | | | | | | | | | | | | | | | | | | |
| Post - 1 Miss - 1 Block - 1 | Post - 0 Miss - 0 Block - 0 | Post - 0 Miss - 0 Block - 0 | Post - 0 Miss - 0 Block - 0 | Post - 0 Miss - 0 Block - 0 | Post - 0 Miss - 0 Block - 0 | Post - 0 Miss - 0 Block - 0 | | | | | | | | | | | | | | | | | | | | | | | | | | | | | | | | | | | | | | | | | | | | | | | | | | | | | | | | | | | | | | | | | | | | | | | | | |

1 刘在攀

| | | |
|-----|-----|-----|
| 1/2 | 1/1 | 0/2 |
| 3/3 | | 2/2 |
| 2/4 | | 2/8 |

16 高宇轩

| | | |
|--|--|--|
| | | |
| | | |
| | | |

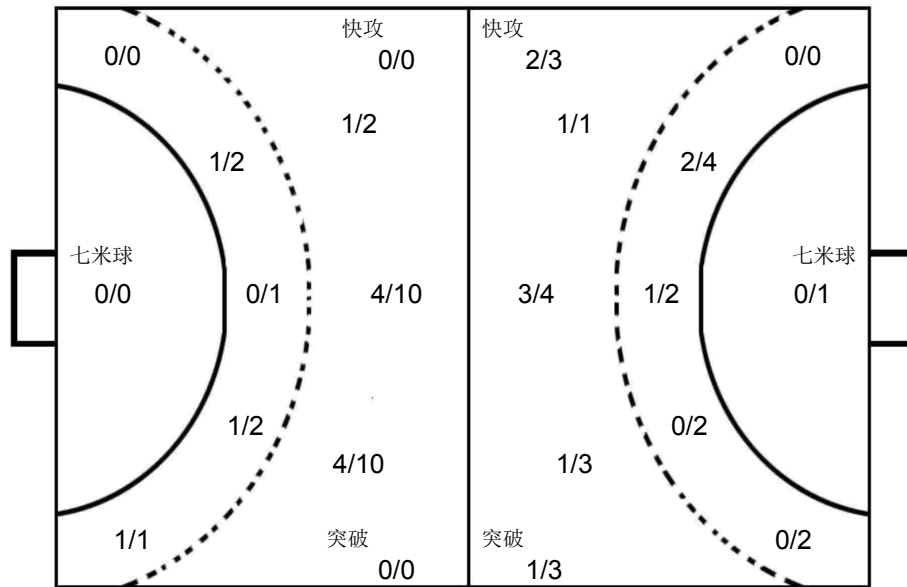

1 邹明轩

| | | |
|-----|--|-----|
| 0/2 | | 1/5 |
| 1/2 | | 4/5 |
| 0/3 | | 3/4 |

江苏苏州

| | | | | | | | | | | | | | | | | | | | | | | | | | | | | | | | | | | | | | | | | | | | | | | | | | | | | | | | | | | | | | | | | | | | | | | | | | | | | | | | |
|--|-----------------------------|-----------------------------|-----------------------------|-----------------------------|-----------------------------|-----------------------------|-----------------------------|--|--|--|--|--|--|--|--|--|--|--|--|---|---|--|---|--|--|---|--|--|--|--|--|--|--|--|--|--|--|--|--|--|--|--|--|--|--|--|--|--|--|--|--|--|--|--|--|--|--|--|--|--|--|--|--|--|--|--|--|--|--|--|--|--|--|--|--|--|--|--|--|
| 1 邹明轩 | 2 马力 | 4 孙钊 | 5 马奔 | 6 潘超群 | 8 王震 | 9 李文俊 | 10 朱红雨 | | | | | | | | | | | | | | | | | | | | | | | | | | | | | | | | | | | | | | | | | | | | | | | | | | | | | | | | | | | | | | | | | | | | | | | | |
| <table border="1"><tr><td></td><td></td><td></td></tr><tr><td></td><td></td><td></td></tr><tr><td></td><td></td><td></td></tr></table> | | | | | | | | | | <table border="1"><tr><td></td><td></td><td></td></tr><tr><td></td><td></td><td></td></tr><tr><td></td><td></td><td></td></tr></table> | | | | | | | | | | <table border="1"><tr><td>1</td><td></td><td>2</td></tr><tr><td></td><td></td><td>3</td></tr><tr><td></td><td></td><td></td></tr></table> | 1 | | 2 | | | 3 | | | | <table border="1"><tr><td></td><td></td><td></td></tr><tr><td></td><td></td><td></td></tr><tr><td></td><td></td><td></td></tr></table> | | | | | | | | | | <table border="1"><tr><td></td><td></td><td></td></tr><tr><td></td><td></td><td></td></tr><tr><td></td><td></td><td></td></tr></table> | | | | | | | | | | <table border="1"><tr><td></td><td></td><td></td></tr><tr><td></td><td></td><td></td></tr><tr><td></td><td></td><td></td></tr></table> | | | | | | | | | | <table border="1"><tr><td></td><td></td><td></td></tr><tr><td></td><td></td><td></td></tr><tr><td></td><td></td><td></td></tr></table> | | | | | | | | | | <table border="1"><tr><td></td><td></td><td></td></tr><tr><td></td><td></td><td></td></tr><tr><td></td><td></td><td></td></tr></table> | | | | | | | | | |
| | | | | | | | | | | | | | | | | | | | | | | | | | | | | | | | | | | | | | | | | | | | | | | | | | | | | | | | | | | | | | | | | | | | | | | | | | | | | | | | |
| | | | | | | | | | | | | | | | | | | | | | | | | | | | | | | | | | | | | | | | | | | | | | | | | | | | | | | | | | | | | | | | | | | | | | | | | | | | | | | | |
| | | | | | | | | | | | | | | | | | | | | | | | | | | | | | | | | | | | | | | | | | | | | | | | | | | | | | | | | | | | | | | | | | | | | | | | | | | | | | | | |
| | | | | | | | | | | | | | | | | | | | | | | | | | | | | | | | | | | | | | | | | | | | | | | | | | | | | | | | | | | | | | | | | | | | | | | | | | | | | | | | |
| | | | | | | | | | | | | | | | | | | | | | | | | | | | | | | | | | | | | | | | | | | | | | | | | | | | | | | | | | | | | | | | | | | | | | | | | | | | | | | | |
| | | | | | | | | | | | | | | | | | | | | | | | | | | | | | | | | | | | | | | | | | | | | | | | | | | | | | | | | | | | | | | | | | | | | | | | | | | | | | | | |
| 1 | | 2 | | | | | | | | | | | | | | | | | | | | | | | | | | | | | | | | | | | | | | | | | | | | | | | | | | | | | | | | | | | | | | | | | | | | | | | | | | | | | |
| | | 3 | | | | | | | | | | | | | | | | | | | | | | | | | | | | | | | | | | | | | | | | | | | | | | | | | | | | | | | | | | | | | | | | | | | | | | | | | | | | | |
| | | | | | | | | | | | | | | | | | | | | | | | | | | | | | | | | | | | | | | | | | | | | | | | | | | | | | | | | | | | | | | | | | | | | | | | | | | | | | | | |
| | | | | | | | | | | | | | | | | | | | | | | | | | | | | | | | | | | | | | | | | | | | | | | | | | | | | | | | | | | | | | | | | | | | | | | | | | | | | | | | |
| | | | | | | | | | | | | | | | | | | | | | | | | | | | | | | | | | | | | | | | | | | | | | | | | | | | | | | | | | | | | | | | | | | | | | | | | | | | | | | | |
| | | | | | | | | | | | | | | | | | | | | | | | | | | | | | | | | | | | | | | | | | | | | | | | | | | | | | | | | | | | | | | | | | | | | | | | | | | | | | | | |
| | | | | | | | | | | | | | | | | | | | | | | | | | | | | | | | | | | | | | | | | | | | | | | | | | | | | | | | | | | | | | | | | | | | | | | | | | | | | | | | |
| | | | | | | | | | | | | | | | | | | | | | | | | | | | | | | | | | | | | | | | | | | | | | | | | | | | | | | | | | | | | | | | | | | | | | | | | | | | | | | | |
| | | | | | | | | | | | | | | | | | | | | | | | | | | | | | | | | | | | | | | | | | | | | | | | | | | | | | | | | | | | | | | | | | | | | | | | | | | | | | | | |
| | | | | | | | | | | | | | | | | | | | | | | | | | | | | | | | | | | | | | | | | | | | | | | | | | | | | | | | | | | | | | | | | | | | | | | | | | | | | | | | |
| | | | | | | | | | | | | | | | | | | | | | | | | | | | | | | | | | | | | | | | | | | | | | | | | | | | | | | | | | | | | | | | | | | | | | | | | | | | | | | | |
| | | | | | | | | | | | | | | | | | | | | | | | | | | | | | | | | | | | | | | | | | | | | | | | | | | | | | | | | | | | | | | | | | | | | | | | | | | | | | | | |
| | | | | | | | | | | | | | | | | | | | | | | | | | | | | | | | | | | | | | | | | | | | | | | | | | | | | | | | | | | | | | | | | | | | | | | | | | | | | | | | |
| | | | | | | | | | | | | | | | | | | | | | | | | | | | | | | | | | | | | | | | | | | | | | | | | | | | | | | | | | | | | | | | | | | | | | | | | | | | | | | | |
| | | | | | | | | | | | | | | | | | | | | | | | | | | | | | | | | | | | | | | | | | | | | | | | | | | | | | | | | | | | | | | | | | | | | | | | | | | | | | | | |
| | | | | | | | | | | | | | | | | | | | | | | | | | | | | | | | | | | | | | | | | | | | | | | | | | | | | | | | | | | | | | | | | | | | | | | | | | | | | | | | |
| | | | | | | | | | | | | | | | | | | | | | | | | | | | | | | | | | | | | | | | | | | | | | | | | | | | | | | | | | | | | | | | | | | | | | | | | | | | | | | | |
| | | | | | | | | | | | | | | | | | | | | | | | | | | | | | | | | | | | | | | | | | | | | | | | | | | | | | | | | | | | | | | | | | | | | | | | | | | | | | | | |
| Post - 0 Miss - 0 Block - 0 | Post - 0 Miss - 0 Block - 0 | Post - 0 Miss - 1 Block - 0 | Post - 0 Miss - 0 Block - 0 | Post - 0 Miss - 0 Block - 0 | Post - 2 Miss - 0 Block - 0 | Post - 0 Miss - 0 Block - 0 | Post - 0 Miss - 0 Block - 0 | | | | | | | | | | | | | | | | | | | | | | | | | | | | | | | | | | | | | | | | | | | | | | | | | | | | | | | | | | | | | | | | | | | | | | | | |
| 11 许多 | 12 周文贤 | 13 蒋超 | 14 刘亚力 | 15 刘成果 | 18 何志伟 | 19 夏思毅 | 23 张铮洋 | | | | | | | | | | | | | | | | | | | | | | | | | | | | | | | | | | | | | | | | | | | | | | | | | | | | | | | | | | | | | | | | | | | | | | | | |
| <table border="1"><tr><td></td><td></td><td></td></tr><tr><td></td><td></td><td></td></tr><tr><td></td><td></td><td></td></tr></table> | | | | | | | | | | <table border="1"><tr><td></td><td></td><td></td></tr><tr><td></td><td></td><td></td></tr><tr><td></td><td></td><td></td></tr></table> | | | | | | | | | | <table border="1"><tr><td></td><td></td><td></td></tr><tr><td></td><td></td><td></td></tr><tr><td></td><td></td><td></td></tr></table> | | | | | | | | | | <table border="1"><tr><td></td><td></td><td></td></tr><tr><td></td><td></td><td></td></tr><tr><td></td><td></td><td></td></tr></table> | | | | | | | | | | <table border="1"><tr><td></td><td></td><td></td></tr><tr><td></td><td></td><td></td></tr><tr><td></td><td></td><td></td></tr></table> | | | | | | | | | | <table border="1"><tr><td></td><td></td><td></td></tr><tr><td></td><td></td><td></td></tr><tr><td></td><td></td><td></td></tr></table> | | | | | | | | | | <table border="1"><tr><td></td><td></td><td></td></tr><tr><td></td><td></td><td></td></tr><tr><td></td><td></td><td></td></tr></table> | | | | | | | | | | <table border="1"><tr><td></td><td></td><td></td></tr><tr><td></td><td></td><td></td></tr><tr><td></td><td></td><td></td></tr></table> | | | | | | | | | |
| | | | | | | | | | | | | | | | | | | | | | | | | | | | | | | | | | | | | | | | | | | | | | | | | | | | | | | | | | | | | | | | | | | | | | | | | | | | | | | | |
| | | | | | | | | | | | | | | | | | | | | | | | | | | | | | | | | | | | | | | | | | | | | | | | | | | | | | | | | | | | | | | | | | | | | | | | | | | | | | | | |
| | | | | | | | | | | | | | | | | | | | | | | | | | | | | | | | | | | | | | | | | | | | | | | | | | | | | | | | | | | | | | | | | | | | | | | | | | | | | | | | |
| | | | | | | | | | | | | | | | | | | | | | | | | | | | | | | | | | | | | | | | | | | | | | | | | | | | | | | | | | | | | | | | | | | | | | | | | | | | | | | | |
| | | | | | | | | | | | | | | | | | | | | | | | | | | | | | | | | | | | | | | | | | | | | | | | | | | | | | | | | | | | | | | | | | | | | | | | | | | | | | | | |
| | | | | | | | | | | | | | | | | | | | | | | | | | | | | | | | | | | | | | | | | | | | | | | | | | | | | | | | | | | | | | | | | | | | | | | | | | | | | | | | |
| | | | | | | | | | | | | | | | | | | | | | | | | | | | | | | | | | | | | | | | | | | | | | | | | | | | | | | | | | | | | | | | | | | | | | | | | | | | | | | | |
| | | | | | | | | | | | | | | | | | | | | | | | | | | | | | | | | | | | | | | | | | | | | | | | | | | | | | | | | | | | | | | | | | | | | | | | | | | | | | | | |
| | | | | | | | | | | | | | | | | | | | | | | | | | | | | | | | | | | | | | | | | | | | | | | | | | | | | | | | | | | | | | | | | | | | | | | | | | | | | | | | |
| | | | | | | | | | | | | | | | | | | | | | | | | | | | | | | | | | | | | | | | | | | | | | | | | | | | | | | | | | | | | | | | | | | | | | | | | | | | | | | | |
| | | | | | | | | | | | | | | | | | | | | | | | | | | | | | | | | | | | | | | | | | | | | | | | | | | | | | | | | | | | | | | | | | | | | | | | | | | | | | | | |
| | | | | | | | | | | | | | | | | | | | | | | | | | | | | | | | | | | | | | | | | | | | | | | | | | | | | | | | | | | | | | | | | | | | | | | | | | | | | | | | |
| | | | | | | | | | | | | | | | | | | | | | | | | | | | | | | | | | | | | | | | | | | | | | | | | | | | | | | | | | | | | | | | | | | | | | | | | | | | | | | | |
| | | | | | | | | | | | | | | | | | | | | | | | | | | | | | | | | | | | | | | | | | | | | | | | | | | | | | | | | | | | | | | | | | | | | | | | | | | | | | | | |
| | | | | | | | | | | | | | | | | | | | | | | | | | | | | | | | | | | | | | | | | | | | | | | | | | | | | | | | | | | | | | | | | | | | | | | | | | | | | | | | |
| | | | | | | | | | | | | | | | | | | | | | | | | | | | | | | | | | | | | | | | | | | | | | | | | | | | | | | | | | | | | | | | | | | | | | | | | | | | | | | | |
| | | | | | | | | | | | | | | | | | | | | | | | | | | | | | | | | | | | | | | | | | | | | | | | | | | | | | | | | | | | | | | | | | | | | | | | | | | | | | | | |
| | | | | | | | | | | | | | | | | | | | | | | | | | | | | | | | | | | | | | | | | | | | | | | | | | | | | | | | | | | | | | | | | | | | | | | | | | | | | | | | |
| | | | | | | | | | | | | | | | | | | | | | | | | | | | | | | | | | | | | | | | | | | | | | | | | | | | | | | | | | | | | | | | | | | | | | | | | | | | | | | | |
| | | | | | | | | | | | | | | | | | | | | | | | | | | | | | | | | | | | | | | | | | | | | | | | | | | | | | | | | | | | | | | | | | | | | | | | | | | | | | | | |
| | | | | | | | | | | | | | | | | | | | | | | | | | | | | | | | | | | | | | | | | | | | | | | | | | | | | | | | | | | | | | | | | | | | | | | | | | | | | | | | |
| | | | | | | | | | | | | | | | | | | | | | | | | | | | | | | | | | | | | | | | | | | | | | | | | | | | | | | | | | | | | | | | | | | | | | | | | | | | | | | | |
| | | | | | | | | | | | | | | | | | | | | | | | | | | | | | | | | | | | | | | | | | | | | | | | | | | | | | | | | | | | | | | | | | | | | | | | | | | | | | | | |
| | | | | | | | | | | | | | | | | | | | | | | | | | | | | | | | | | | | | | | | | | | | | | | | | | | | | | | | | | | | | | | | | | | | | | | | | | | | | | | | |
| Post - 0 Miss - 0 Block - 0 | Post - 0 Miss - 0 Block - 0 | Post - 0 Miss - 0 Block - 0 | Post - 0 Miss - 0 Block - 0 | Post - 0 Miss - 0 Block - 0 | Post - 0 Miss - 0 Block - 0 | Post - 0 Miss - 0 Block - 0 | Post - 0 Miss - 0 Block - 0 | | | | | | | | | | | | | | | | | | | | | | | | | | | | | | | | | | | | | | | | | | | | | | | | | | | | | | | | | | | | | | | | | | | | | | | | |



| | | |
|--------|--------|--------------|
| Team A | Team B | Match Number |
| A 上海宝山 | B 中国香港 | 12 |

| | | | | |
|-----------|-------------|------------|-------|------------|
| Played in | in the hall | on | at | Spectators |
| 安徽滁州 | 滁州国际手球馆 | 2019-05-29 | 15:00 | hours |

| | | | | | | | | | | | | | | |
|----------------|---|---|---------------------|----|---|----------------|---|---|----------------|---|---|----------------------|---|---|
| Half-time(30') | A | B | End of playing time | A | B | 1st extra time | A | B | 2nd extra time | A | B | After penalty throws | A | B |
| | 7 | 9 | 18 | 17 | | | | | | | | | | |

| | | | | | | | | | | |
|---------------|-----|---------------|---|---|------------------------------------|---------------|-------|---|-----|---------------|
| Number of 7 m | A | Team time-out | | | Full name of players and officials | Team time-out | | | B | Number of 7 m |
| | 0/0 | 1 | 2 | 3 | | 1 | 2 | 3 | 1/1 | |
| | | 13:36 | | | | 14:32 | 44:10 | | | |

| No. | Team A | G | W | 2' | D | DR | No. | Team B | G | W | 2' | D | DR |
|-----|-----------|---|---|----|---|----|-----|-----------|---|---|----|---|----|
| 3 | 侯俊杰 | | | | | | 1 | 江力为 | | | | | |
| 5 | 范斯哲 | | | | | | 2 | 梁凯乔 | | | | | |
| 6 | 吴梓涵 | | | | | | 3 | 陈嘉熙 | 1 | | | | |
| 7 | 彭意焱 | | | | | | 10 | 叶滋权 | 3 | | | | |
| 10 | 马涛 | | | | | | 15 | 梁栢朗 | | | | | |
| 12 | 薛凯 | | | | | | 16 | 冯智聪 | | | | | |
| 13 | 刘启群 | 4 | 1 | | | | 22 | 吴泽斌 | | | | | |
| 19 | 张申杰 | 2 | | | | | 23 | 石铭泽 | 2 | | | | |
| 21 | 曾新宇 | 6 | | | | | 27 | 巫迪涛 | 5 | | | | |
| 22 | 马浩东 | 3 | | | | | 28 | 关健辉 | 2 | | | | |
| 25 | 江锦 | | | | | | 30 | 陈永曦 | | | | | |
| 30 | 戴泽昊 | | | | | | 41 | 莫敬朗 | 2 | | | | |
| 35 | 刘子杰 | 3 | | | | | 47 | 薛浩锋 | 2 | | 1 | | |
| 39 | 陆毅泽 | | | | | | 73 | 黄望鎏 | | | | | |
| 66 | 黄嘉遥 | | | | | | 79 | 吴坤霖 | | | 1 | | |
| 68 | 陈沁磊 | | | | | | 99 | 苏俊轩 | | | | | |
| A | 马革 | | | | | | B | 练明辉 (主教练) | | | | | |
| B | 徐聪豪 (主教练) | | | | | | C | 钟昀延 | | | | | |
| D | 赵时俊 | | | | | | | | | | | | |
| | | | | | | | | | | | | | |
| | | | | | | | | | | | | | |
| | | | | | | | | | | | | | |
| | | | | | | | | | | | | | |
| | | | | | | | | | | | | | |

| | | |
|---|--|---|
| A | Signatures of responsables for the teams (Off.A) | B |
|---|--|---|

| | | |
|----|-----------------------------------|----|
| TP | Remarks of referees / HF Official | TP |
| | | |
| | | |
| | | |

| | | | |
|------------|-----------|-----------|--|
| Signatures | | | |
| Referees | 尹静阳 (CHN) | 刘禹 (CHN) | |
| T.D. | 许宜扬 (CHN) | 李兆蒙 (CHN) | |
| CHA Off. | | | |

Note: Number of 7m Throws Awarded to Team A and B, Goals (G), Warnings (W), Suspensions (2'), Direct Disqualification (D), Disqualification With Report (DR) and Team Penalty (TP).

Table Officials: 刘洋洋 许修凯 Statisticians: 马安兴 王梓衡

第二届全国青年运动会男子手球乙组决赛 体校组 (U16)

PHMS Pictorial Handball Match Statistics

IHF Official System

竞赛技术统计

手球
青年男子

预赛
轮次 3

组别 B
场次 12

滁州国际手球馆
2019-05-29 15:00

| | | | |
|-----------|----------------------|---------|------------|
| Referees: | 尹静阳 (CHN) / 刘禹 (CHN) | Result: | 18:17(7:9) |
| Teams: | 上海宝山(宝山) VS 中国香港(香港) | | |

| 宝山 | | | | | | | | | | | | | | 宝山 | | 比赛进程 | | 香港 | |
|----------|-----|-----|-----|-----|-----|-----|-----|-------|------|----|----|----|----|------|---|------|--|----|--|
| 主教练: 徐聪豪 | | | | | | | | | | | | | | | | | | | |
| | 远射 | 近射 | 边射 | 快攻 | 突破 | 任意球 | 7m球 | 合计 | % | 助攻 | 失误 | 警告 | 2' | D+DR | | | | | |
| 3 侯俊杰 | | | | | | | | | | | | | | | | | | | |
| 5 范斯哲 | | | | | | | | | | | | | | | | | | | |
| 6 吴梓涵 | | | | | | | | | | | | | | | | | | | |
| 7 彭意焱 | | | | | | | | | | | | | | | | | | | |
| 10 马涛 | | 0/1 | | | | | | 0/1 | 0.0 | | 1 | | | | | | | | |
| 12 薛凯 | | | | | | | | | | | | | | | | | | | |
| 13 刘启群 | | 1/1 | 2/3 | 1/1 | | | | 4/5 | 80.0 | | 2 | 1 | | | | | | | |
| 19 张申杰 | | | 2/3 | | | | | 2/3 | 66.7 | | 1 | | | | | | | | |
| 21 曾新宇 | 2/3 | 3/4 | 1/1 | | 0/1 | | | 6/9 | 66.7 | | 2 | | | | | | | | |
| 22 马浩东 | | | 1/1 | | 2/2 | | | 3/3 | 100 | | 1 | | | | | | | | |
| 25 江锦 | | | | | | | | | | | | | | | | | | | |
| 30 戴泽昊 | | | | | | | | | | | | | | | | | | | |
| 35 刘子杰 | | 2/2 | | 1/2 | | | | 3/4 | 75.0 | | | | | | | | | | |
| 39 陆毅泽 | | | | | | | | | | | | | | | | | | | |
| 66 黄嘉遥 | | | | | | | | | | | | | | | | | | | |
| 68 陈沁磊 | | | | | | | | | | | | | | | | | | | |
| 运动员 合计 | 2/3 | 6/8 | 6/8 | 2/3 | 2/3 | | | 18/25 | 72.0 | | 7 | 1 | | | | | | | |
| 12 薛凯 | 0/1 | 0/3 | 0/2 | | 0/3 | 0/1 | 0/1 | 0/11 | 0.0 | | | | | | | | | | |
| 66 黄嘉遥 | 1/3 | 0/2 | 1/3 | | | | | 2/8 | 25.0 | | | | | | | | | | |
| 守门员 合计 | 1/4 | 0/5 | 1/5 | | 0/3 | 0/1 | 0/1 | 2/19 | 10.5 | | | | | | | | | | |
| 香港 | | | | | | | | | | | | | | 香港 | | 比赛进程 | | 宝山 | |
| 主教练: 练明辉 | | | | | | | | | | | | | | | | | | | |
| | 远射 | 近射 | 边射 | 快攻 | 突破 | 任意球 | 7m球 | 合计 | % | 助攻 | 失误 | 警告 | 2' | D+DR | | | | | |
| 1 江力为 | | | | | | | | | | | | | | | | | | | |
| 2 梁凯乔 | | | | | | | | | | | | | | | | | | | |
| 3 陈嘉熙 | | 1/1 | | | | | | 1/1 | 100 | 1 | 1 | | | | | | | | |
| 10 叶滋权 | 1/3 | | | | 1/1 | 1/1 | | 3/5 | 60.0 | 1 | 1 | | | | | | | | |
| 15 梁栢朗 | | | | | | | | | | | | | | | | | | | |
| 16 冯智聪 | | | | | | | | | | | | | | | | | | | |
| 22 吴泽斌 | | | | | | | | | | | | | | | | | | | |
| 23 石铭泽 | 0/1 | 2/2 | | | | | | 2/3 | 66.7 | | | | | | | | | | |
| 27 巫迪涛 | 2/3 | 1/1 | | | 1/1 | | 1/1 | 5/6 | 83.3 | | 4 | | | | | | | | |
| 28 关健辉 | | | 2/2 | | | | | 2/2 | 100 | | | | | | | | | | |
| 30 陈永曦 | | | | | | | | | | | | | | | | | | | |
| 41 莫敬朗 | | 1/1 | 1/1 | | | | | 2/2 | 100 | | | | | | | | | | |
| 47 薛浩锋 | | | 1/2 | | 1/1 | | | 2/3 | 66.7 | | | | | | 1 | | | | |
| 73 黄塍臻 | | | | 0/1 | | | | 0/1 | 0.0 | | | | | | | | | | |
| 79 吴坤霖 | | | | | | | | | | | | | | | 1 | | | | |
| 99 苏俊轩 | | | | | | | | | | | | | | | | | | | |
| 运动员 合计 | 3/7 | 5/5 | 4/5 | 0/1 | 3/3 | 1/1 | 1/1 | 17/23 | 73.9 | 2 | 7 | | | | 2 | | | | |
| 1 江力为 | 0/1 | 0/3 | 1/4 | 0/2 | | | | 1/10 | 10.0 | | | | | | | | | | |
| 22 吴泽斌 | 0/1 | 0/2 | 0/2 | 1/1 | 0/2 | | | 1/8 | 12.5 | | | | | | | | | | |
| 99 苏俊轩 | | 0/1 | 0/1 | | | | | 0/2 | 0.0 | | | | | | | | | | |
| 守门员 合计 | 0/2 | 0/6 | 1/7 | 1/3 | 0/2 | | | 2/20 | 10.0 | | | | | | | | | | |

场上队员: 得分 / 射门

守门员: 救球 / 射门

| | | | |
|---|------|----|---------|
| D | 取消资格 | DR | 取消资格+报告 |
|---|------|----|---------|



个人/全队技术统计表

手球 青年男子 预赛 轮次 3 组别 B 场次 12 滁州国际手球馆 2019-05-29 15:00

| 号码 | 姓名 | 远射 | 近射 | 边射 | 快攻 | 突破 | 任意 | 七米 | 合计 | % | 助攻 | 失误 | 警告 | 2' | 取消 | 时间 |
|----------|-----|-----|-----|-----|-----|-----|-----|-----|-------|-------|----|----|----|----|----|----------|
| 上海宝山(宝山) | | | | | | | | | | | | | | | | |
| (场上队员) | | | | | | | | | | | | | | | | |
| 3 | 侯俊杰 | | | | | | | | | 0.0% | | | | | | 00:00:00 |
| 5 | 范斯哲 | | | | | | | | | 0.0% | | | | | | 00:00:00 |
| 6 | 吴梓涵 | | | | | | | | | 0.0% | | | | | | 00:00:00 |
| 7 | 彭意焱 | | | | | | | | | 0.0% | | | | | | 00:00:00 |
| 10 | 马涛 | | 0/1 | | | | | | 0/1 | 0.0% | 1 | | | | | 00:30:00 |
| 12 | 薛凯 | | | | | | | | | 0.0% | | | | | | 00:22:10 |
| 13 | 刘启群 | | 1/1 | 2/3 | 1/1 | | | | 4/5 | 80.0% | 2 | 1 | | | | 00:30:00 |
| 19 | 张申杰 | | | 2/3 | | | | | 2/3 | 66.7% | 1 | | | | | 00:30:00 |
| 21 | 曾新宇 | 2/3 | 3/4 | 1/1 | | 0/1 | | | 6/9 | 66.7% | 2 | | | | | 00:30:00 |
| 22 | 马浩东 | | | 1/1 | | 2/2 | | | 3/3 | 100% | 1 | | | | | 00:30:00 |
| 25 | 江锦 | | | | | | | | | 0.0% | | | | | | 00:00:00 |
| 30 | 戴泽昊 | | | | | | | | | 0.0% | | | | | | 00:02:34 |
| 35 | 刘子杰 | | 2/2 | | 1/2 | | | | 3/4 | 75.0% | | | | | | 00:27:20 |
| 39 | 陆毅泽 | | | | | | | | | 0.0% | | | | | | 00:00:00 |
| 66 | 黄嘉遥 | | | | | | | | | 0.0% | | | | | | 00:07:50 |
| 68 | 陈沁磊 | | | | | | | | | 0.0% | | | | | | 00:00:00 |
| 合计 | | 2/3 | 6/8 | 6/8 | 2/3 | 2/3 | | | 18/25 | 72.0% | 7 | 1 | | | | |
| (守门员) | | | | | | | | | | | | | | | | |
| 12 | 薛凯 | 0/1 | 0/3 | 0/2 | | 0/3 | 0/1 | 0/1 | 0/11 | 0.0% | | | | | | 00:22:10 |
| 66 | 黄嘉遥 | 1/3 | 0/2 | 1/3 | | | | | 2/8 | 25.0% | | | | | | 00:07:50 |
| 合计 | | 1/4 | 0/5 | 1/5 | | 0/3 | 0/1 | 0/1 | 2/19 | 10.5% | | | | | | |

场上队员：得分/射门

守门员：救球/射门

| 全队合计 | 得分 | 被救 | 射失 | 击柱 | 封球 | 合计 | % |
|------|----|----|----|----|----|----|-------|
| 远射 | 2 | | | | 1 | 3 | 66.7% |
| 近射 | 6 | | | 2 | | 8 | 75.0% |
| 边射 | 6 | 1 | | 1 | | 8 | 75.0% |
| 快攻 | 2 | 1 | | | | 3 | 66.7% |
| 突破 | 2 | | 1 | | | 3 | 66.7% |
| 任意 | | | | | | | 0.0% |
| 七米 | | | | | | | 0.0% |

个人/全队技术统计表

手球 青年男子 预赛 轮次 3 组别 B 场次 12 滁州国际手球馆 2019-05-29 15:00

| 号码 | 姓名 | 远射 | 近射 | 边射 | 快攻 | 突破 | 任意 | 七米 | 合计 | % | 助攻 | 失误 | 警告 | 2' | 取消 | 时间 |
|----------|-----|-----|-----|-----|-----|-----|-----|-----|-------|-------|----|----|----|----|----|----------|
| 中国香港(香港) | | | | | | | | | | | | | | | | |
| (场上队员) | | | | | | | | | | | | | | | | |
| 1 | 江力为 | | | | | | | | | 0.0% | | | | | | 00:20:02 |
| 2 | 梁凯乔 | | | | | | | | | 0.0% | | 1 | | | | 00:04:13 |
| 3 | 陈嘉熙 | | 1/1 | | | | | | 1/1 | 100% | 1 | 1 | | | | 00:18:06 |
| 10 | 叶滋权 | 1/3 | | | | 1/1 | 1/1 | | 3/5 | 60.0% | 1 | 1 | | | | 00:15:45 |
| 15 | 梁栢朗 | | | | | | | | | 0.0% | | | | | | 00:13:05 |
| 16 | 冯智聪 | | | | | | | | | 0.0% | | | | | | 00:00:00 |
| 22 | 吴泽斌 | | | | | | | | | 0.0% | | | | | | 00:07:08 |
| 23 | 石铭泽 | 0/1 | 2/2 | | | | | | 2/3 | 66.7% | | | | | | 00:22:48 |
| 27 | 巫迪涛 | 2/3 | 1/1 | | | 1/1 | | 1/1 | 5/6 | 83.3% | | 4 | | | | 00:22:27 |
| 28 | 关健辉 | | | 2/2 | | | | | 2/2 | 100% | | | | | | 00:19:58 |
| 30 | 陈永曦 | | | | | | | | | 0.0% | | | | | | 00:04:09 |
| 41 | 莫敬朗 | | 1/1 | 1/1 | | | | | 2/2 | 100% | | | | | | 00:10:01 |
| 47 | 薛浩锋 | | | 1/2 | | 1/1 | | | 2/3 | 66.7% | | | | 1 | | 00:17:33 |
| 73 | 黄望婆 | | | | 0/1 | | | | 0/1 | 0.0% | | | | | | 00:03:51 |
| 79 | 吴坤霖 | | | | | | | | | 0.0% | | | | 1 | | 00:25:02 |
| 99 | 苏俊轩 | | | | | | | | | 0.0% | | | | | | 00:02:50 |
| | 合计 | 3/7 | 5/5 | 4/5 | 0/1 | 3/3 | 1/1 | 1/1 | 17/23 | 73.9% | 2 | 7 | | 2 | | |

(守门员)

| | | | | | | | | | | | | | | | | |
|----|-----|-----|-----|-----|-----|-----|--|--|------|-------|--|--|--|--|--|----------|
| 1 | 江力为 | 0/1 | 0/3 | 1/4 | 0/2 | | | | 1/10 | 10.0% | | | | | | 00:20:02 |
| 22 | 吴泽斌 | 0/1 | 0/2 | 0/2 | 1/1 | 0/2 | | | 1/8 | 12.5% | | | | | | 00:07:08 |
| 99 | 苏俊轩 | | 0/1 | 0/1 | | | | | 0/2 | 0.0% | | | | | | 00:02:50 |
| | 合计 | 0/2 | 0/6 | 1/7 | 1/3 | 0/2 | | | 2/20 | 10.0% | | | | | | |

场上队员：得分/射门

守门员：救球/射门

| 全队合计 | 得分 | 被救 | 射失 | 击柱 | 封球 | 合计 | % |
|------|----|----|----|----|----|----|--------|
| 远射 | 3 | 1 | 2 | | 1 | 7 | 42.9% |
| 近射 | 5 | | | | | 5 | 100.0% |
| 边射 | 4 | 1 | | | | 5 | 80.0% |
| 快攻 | | | 1 | | | 1 | 0.0% |
| 突破 | 3 | | | | | 3 | 100.0% |
| 任意 | 1 | | | | | 1 | 100.0% |
| 七米 | 1 | | | | | 1 | 100.0% |

图式比赛技术统计表

手球
青年男子

预赛
轮次 3

组别 B
场次 12

滁州国际手球馆
2019-05-29 15:00

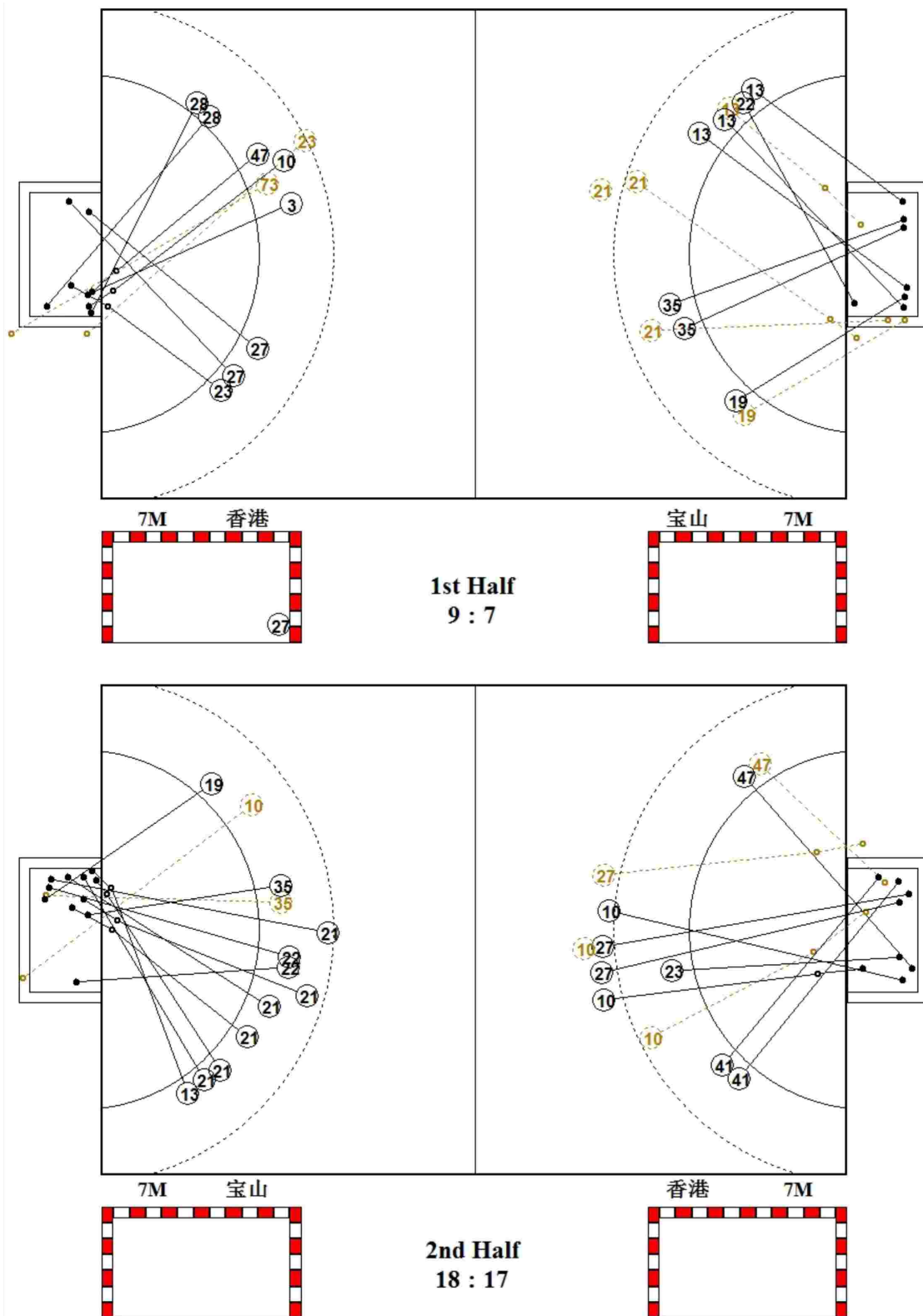

图式射门区域统计

手球
青年男子

预赛
轮次 3

组别 B
场次 12

滁州国际手球馆
2019-05-29 15:00

上海宝山

| | | | | | | | |
|---------------------------------------|---------------------------------------|--------------------------------------|---------------------------------------|---------------------------------------|---------------------------------------|---------------------------------------|---------------------------------------|
| 3 侯俊杰 Post - 0 Miss - 0 Block - 0 | 5 范斯哲 Post - 0 Miss - 0 Block - 0 | 6 吴梓涵 Post - 0 Miss - 0 Block - 0 | 7 彭意焱 Post - 0 Miss - 0 Block - 0 | 10 马涛 Post - 1 Miss - 0 Block - 0 | 12 薛凯 Post - 0 Miss - 0 Block - 0 | 13 刘启群 Post - 0 Miss - 0 Block - 0 | 19 张申杰 Post - 1 Miss - 0 Block - 0 |
| 21 曾新宇 Post - 1 Miss - 1 Block - 1 | 22 马浩东 Post - 0 Miss - 0 Block - 0 | 25 江锦 Post - 0 Miss - 0 Block - 0 | 30 戴泽昊 Post - 0 Miss - 0 Block - 0 | 35 刘子杰 Post - 0 Miss - 0 Block - 0 | 39 陆毅泽 Post - 0 Miss - 0 Block - 0 | 66 黄嘉遥 Post - 0 Miss - 0 Block - 0 | 68 陈沁磊 Post - 0 Miss - 0 Block - 0 |

| | | |
|--------------|-----|-----|
| 12 薛凯 0/2 | 0/1 | 0/1 |
| 0/4 | | 0/3 |

| | |
|---------------|-----|
| 66 黄嘉遥 0/2 | 0/3 |
| 1/2 | |
| | 1/1 |

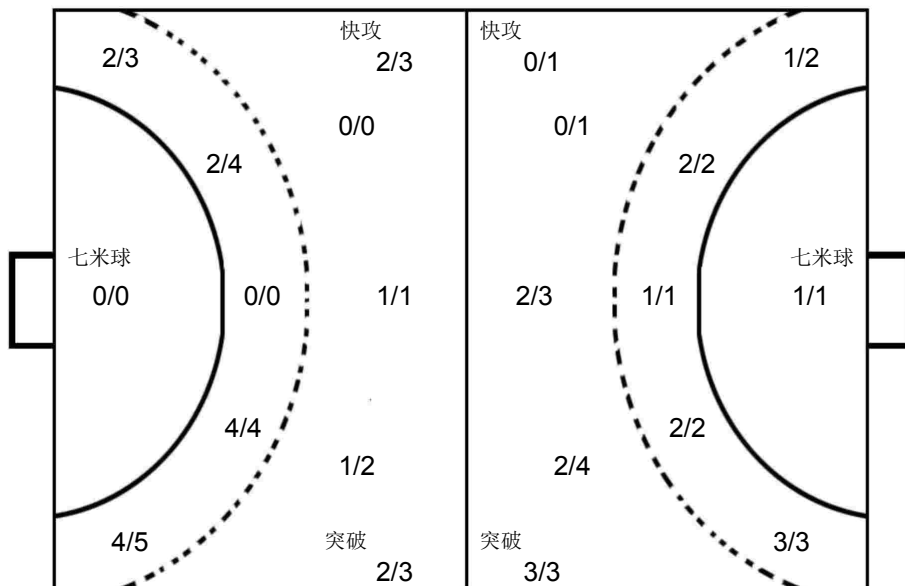

| | |
|--------------|-----|
| 1 江力为 0/3 | 0/3 |
| 1/1 | 0/2 |

| | |
|---------------|-----|
| 22 吴泽斌 0/1 | 1/4 |
| 0/1 | 0/1 |
| 0/1 | 0/1 |

| |
|---------------|
| 99 苏俊轩 0/2 |
|---------------|

中国香港

| | | | | | | | |
|---------------------------------------|---------------------------------------|---------------------------------------|---------------------------------------|---------------------------------------|---------------------------------------|---------------------------------------|---------------------------------------|
| 1 江力为 Post - 0 Miss - 0 Block - 0 | 2 梁凯乔 Post - 0 Miss - 0 Block - 0 | 3 陈嘉熙 Post - 0 Miss - 0 Block - 0 | 10 叶滋权 Post - 0 Miss - 0 Block - 1 | 15 梁栢朗 Post - 0 Miss - 0 Block - 0 | 16 冯智聪 Post - 0 Miss - 0 Block - 0 | 22 吴泽斌 Post - 0 Miss - 0 Block - 0 | 23 石铭泽 Post - 0 Miss - 1 Block - 0 |
| 27 巫迪涛 Post - 0 Miss - 1 Block - 0 | 28 关键辉 Post - 0 Miss - 0 Block - 0 | 30 陈永曦 Post - 0 Miss - 0 Block - 0 | 41 莫敬朗 Post - 0 Miss - 0 Block - 0 | 47 薛浩锋 Post - 0 Miss - 0 Block - 0 | 73 黄望臻 Post - 0 Miss - 1 Block - 0 | 79 吴坤霖 Post - 0 Miss - 0 Block - 0 | 99 苏俊轩 Post - 0 Miss - 0 Block - 0 |



| | | | | | | | | | | | |
|-------------------|--|--|--|------------------|--|--|--|---------------------------|--|--|--|
| Team A A 安徽省体校 | | | | Team B B 辽宁抚顺 | | | | Match Number 13 | | | |
|-------------------|--|--|--|------------------|--|--|--|---------------------------|--|--|--|

| | | | | | |
|-------------------|------------------------|------------------|-------------|-------|----------|
| Played in 安徽滁州 | in the hall 滁州国际手球馆 | on 2019-05-29 | at 16:00 | hours | Speakers |
|-------------------|------------------------|------------------|-------------|-------|----------|

| | | | | | | | | | | | | | | |
|----------------|--------|--------|---------------------|---------|---------|----------------|---|---|----------------|---|---|----------------------|---|---|
| Half-time(30') | A 5 | B 4 | End of playing time | A 15 | B 10 | 1st extra time | A | B | 2nd extra time | A | B | After penalty throws | A | B |
|----------------|--------|--------|---------------------|---------|---------|----------------|---|---|----------------|---|---|----------------------|---|---|

| | | | | | | | | | |
|----------------------|---------------|---|---|------------------------------------|---------------|-------|---|----------|---------------|
| Number of 7 m 0/0 | Team time-out | | | Full name of players and officials | Team time-out | | | B 1/1 | Number of 7 m |
| | 1 | 2 | 3 | | 1 | 2 | 3 | | |
| | | | | | 06:59 | 36:14 | | | |

| No. | Team A | G | W | 2' | D | DR | No. | Team B | G | W | 2' | D | DR |
|-----|--------|---|---|----|---|----|-----|--------|---|---|----|---|----|
| 52 | 花驰 | | | | | | 2 | 赫天铭 | | | | | |
| 53 | 叶天赐 | | | | | | 5 | 王梓翹 | | | | | |
| 54 | 姚幸运 | 1 | | | | | 6 | 尚禹辰 | | | | | |
| 55 | 苏凯 | 2 | | | | | 7 | 张羽虹冰 | | | | | |
| 56 | 王健鹏 | 3 | | | | | 9 | 隋博 | | | | | |
| 57 | 朱正翔 | | | | | | 11 | 陈思 | | | | | |
| 58 | 蔡博飞 | 2 | 1 | | | | 13 | 高鑫 | 4 | | | | |
| 59 | 毛饶翔 | 1 | | | | | 17 | 杨宇 | 6 | | | | |
| 60 | 朱超 | 1 | | | | | 19 | 靳皓童 | | | 1 | | |
| 61 | 钮伟豪 | | | | | | 22 | 杨辰 | | | | | |
| 62 | 赵俊阳 | | | | | | 28 | 靳皓添 | | | | | |
| 64 | 章道胜 | 4 | | | | | 32 | 袁梓赫 | | | | | |
| 65 | 韩伟伦 | | | | | | | | | | | | |
| 66 | 刘家豪 | | | | | | | | | | | | |
| 67 | 江文 | | | | | | | | | | | | |
| 68 | 黄天源 | 1 | | | | | | | | | | | |
| A | 赵前军 | | | | | | C | 刘启迪 | | | | | |
| C | 吕串 | | | | | | | | | | | | |
| D | 沈强 | | | | | | | | | | | | |
| E | 李煜 | | | | | | | | | | | | |

| | | | | | | | | | | | | | |
|---|--|--|--|--|--|--|--|--|--|--|--|--|---|
| A | Signatures of responsables for the teams (Off.A) | | | | | | | | | | | | B |
|---|--|--|--|--|--|--|--|--|--|--|--|--|---|

| | | | | | | | | | | | | | | |
|----|-----------------------------------|--|--|--|--|--|--|--|--|--|--|--|--|----|
| TP | Remarks of referees / HF Official | | | | | | | | | | | | | TP |
|----|-----------------------------------|--|--|--|--|--|--|--|--|--|--|--|--|----|

| | | | | |
|----------|-----------|-----------|--|--|
| Referees | 徐健 (CHN) | 康曦 (CHN) | | |
| T.D. | 吴瑞亭 (CHN) | 龙佩莉 (CHN) | | |
| CHA Off. | | | | |

Note: Number of 7m Throws Awarded to Team A and B, Goals (G), Warnings (W), Suspensions (2'), Direct Disqualification (D), Disqualification With Report (DR) and Team Penalty (TP).

Table Officials: 吴荣 李莉君 Statisticians: 马安兴 童佩瑶

竞赛技术统计

手球
青年男子

预赛
轮次 3

组别 A
场次 13

滁州国际手球馆
2019-05-29 16:00

| | | | |
|-----------|-----------------------|---------|------------|
| Referees: | 徐健 (CHN) / 康曦 (CHN) | Result: | 15:10(5:4) |
| Teams: | 安徽省体校(安徽) VS 辽宁抚顺(抚顺) | | |

| 安徽 | | 远射 | 近射 | 边射 | 快攻 | 突破 | 任意球 | 7m球 | 合计 | % | 助攻 | 失误 | 警告 | 2' | D+DR |
|---------|-----|------|-----|-----|-----|-----|-----|-----|-------|------|----|----|----|----|------|
| 主教练: 张林 | | | | | | | | | | | | | | | |
| 52 | 花驰 | | | | | | | | | | | | | | |
| 53 | 叶天赐 | | | | | | | | | | | | | | |
| 54 | 姚幸运 | | | 0/1 | 1/1 | | | | 1/2 | 50.0 | | | | | |
| 55 | 苏凯 | | | 1/1 | 1/2 | | | | 2/3 | 66.7 | | 1 | | | |
| 56 | 王健鹏 | 2/5 | 1/1 | | | | | | 3/6 | 50.0 | 1 | 2 | | | |
| 57 | 朱正翔 | | | | | | | | | | 1 | 3 | | | |
| 58 | 蔡鹏飞 | 1/2 | | | 1/1 | | | | 2/3 | 66.7 | 3 | 1 | 1 | | |
| 59 | 毛饶翔 | 0/3 | 0/1 | | | 1/1 | | | 1/5 | 20.0 | 3 | 1 | | | |
| 60 | 朱超 | | | 1/3 | | | | | 1/3 | 33.3 | | | | | |
| 61 | 钮伟豪 | | | | | | | | | | | | | | |
| 62 | 赵俊阳 | | | | 0/1 | | | | 0/1 | 0.0 | | | | | |
| 64 | 章道胜 | | 0/1 | | 4/4 | | | | 4/5 | 80.0 | | 5 | | | |
| 65 | 韩伟伦 | | | | | | | | | | | | | | |
| 66 | 刘家豪 | | | | | | | | | | | | | | |
| 67 | 江文 | | | | | | | | | | | | | | |
| 68 | 黄天源 | | 1/1 | | | | | | 1/1 | 100 | | | | | |
| 运动员 合计 | | 3/10 | 2/4 | 2/5 | 7/9 | 1/1 | | | 15/29 | 51.7 | 8 | 13 | 1 | | |
| 52 | 花驰 | 1/4 | 1/5 | 1/1 | 0/1 | 1/1 | 1/2 | 0/1 | 5/15 | 33.3 | | | | | |
| 守门员 合计 | | 1/4 | 1/5 | 1/1 | 0/1 | 1/1 | 1/2 | 0/1 | 5/15 | 33.3 | | | | | |

| 安徽 | 比赛进程 | 抚顺 |
|----------|----------|----------|
| 1st Half | | |
| | 0 00:28 | 1 17 杨宇 |
| 64 章道胜 | 1 01:51 | 1 |
| | 1 03:38 | 2 13 高鑫 |
| 55 苏凯 | 2 05:07 | 2 |
| 64 章道胜 | 3 06:50 | 2 |
| | 3 08:19 | 3 17 杨宇 |
| 58 蔡鹏飞 | 4 08:47 | 3 |
| 58 蔡鹏飞 | 5 11:23 | 3 |
| | 5 15:00 | 4 13 高鑫 |
| 2nd Half | | |
| 64 章道胜 | 6 01:13 | 4 |
| 64 章道胜 | 7 01:37 | 4 |
| | 7 02:08 | 5 17 杨宇 |
| 60 朱超 | 8 02:40 | 5 |
| | 8 03:05 | 6 13 高鑫 |
| 56 王健鹏 | 9 04:37 | 6 |
| 55 苏凯 | 10 04:52 | 6 |
| 59 毛饶翔 | 11 05:59 | 6 |
| | 11 07:57 | 7 17 杨宇 |
| 68 黄天源 | 12 09:14 | 7 |
| 56 王健鹏 | 13 09:48 | 7 |
| | 13 10:23 | 8 13 高鑫 |
| 56 王健鹏 | 14 10:53 | 8 |
| | 14 11:30 | 9 17 杨宇 |
| 54 姚幸运 | 15 12:57 | 9 |
| | 15 14:15 | 10 17 杨宇 |

| 抚顺 | | 远射 | 近射 | 边射 | 快攻 | 突破 | 任意球 | 7m球 | 合计 | % | 助攻 | 失误 | 警告 | 2' | D+DR |
|---------|------|-----|-----|-----|-----|-----|-----|-----|-------|------|----|----|----|----|------|
| 主教练: 徐毅 | | | | | | | | | | | | | | | |
| 2 | 赫天铭 | | | | | | | | | | | | | | |
| 5 | 王梓翊 | | | | | | | | | | | 1 | | | |
| 6 | 尚禹辰 | | 0/1 | 0/1 | | | | | 0/2 | 0.0 | | 1 | | | |
| 7 | 张羽虹冰 | | | 0/1 | | | | | 0/1 | 0.0 | | | | | |
| 9 | 隋博 | | | | | | | | | | | | | | |
| 11 | 陈思 | | | | | | | | | | | | | | |
| 13 | 高鑫 | 1/2 | 1/1 | 0/1 | | 0/1 | 1/2 | 1/1 | 4/8 | 50.0 | | 4 | | | |
| 17 | 杨宇 | 2/6 | 3/3 | | 1/1 | | | | 6/10 | 60.0 | | 6 | | | |
| 19 | 靳皓童 | 0/1 | | | | | | | 0/1 | 0.0 | 2 | 4 | | 1 | |
| 22 | 杨辰 | | | | | | | | | | | | | | |
| 28 | 靳皓添 | | 0/3 | | | | | | 0/3 | 0.0 | | 1 | | | |
| 32 | 袁梓赫 | | | | | | | | | | | | | | |
| 运动员 合计 | | 3/9 | 4/8 | 0/3 | 1/1 | 0/1 | 1/2 | 1/1 | 10/25 | 40.0 | 2 | 17 | | 1 | |
| 2 | 赫天铭 | 3/6 | 0/2 | 2/4 | 0/6 | 0/1 | | | 5/19 | 26.3 | | | | | |
| 32 | 袁梓赫 | | | 1/2 | | | | | 1/2 | 50.0 | | | | | |
| 守门员 合计 | | 3/6 | 0/2 | 2/4 | 1/8 | 0/1 | | | 6/21 | 28.6 | | | | | |

场上队员: 得分 / 射门

守门员: 救球 / 射门

| | | | |
|---|------|----|---------|
| D | 取消资格 | DR | 取消资格+报告 |
|---|------|----|---------|

个人/全队技术统计表

手球 预赛 组别 A 滁州国际手球馆
青年男子 轮次 3 场次 13 2019-05-29 16:00

| 号码 | 姓名 | 远射 | 近射 | 边射 | 快攻 | 突破 | 任意 | 七米 | 合计 | % | 助攻 | 失误 | 警告 | 2' | 取消 | 时间 |
|------------------|-----------|-------------|------------|------------|------------|------------|------------|------------|--------------|--------------|----------|-----------|----------|----|----|----------|
| 安徽省体校(安徽) | | | | | | | | | | | | | | | | |
| (场上队员) | | | | | | | | | | | | | | | | |
| 52 | 花驰 | | | | | | | | | 0.0% | | | | | | 00:30:00 |
| 53 | 叶天赐 | | | | | | | | | 0.0% | | | | | | 00:00:00 |
| 54 | 姚幸运 | | | 0/1 | 1/1 | | | | 1/2 | 50.0% | | | | | | 00:04:00 |
| 55 | 苏凯 | | | 1/1 | 1/2 | | | | 2/3 | 66.7% | | 1 | | | | 00:25:57 |
| 56 | 王健鹏 | 2/5 | 1/1 | | | | | | 3/6 | 50.0% | 1 | 2 | | | | 00:19:20 |
| 57 | 朱正翔 | | | | | | | | | 0.0% | 1 | 3 | | | | 00:30:00 |
| 58 | 蔡博飞 | 1/2 | | | 1/1 | | | | 2/3 | 66.7% | 3 | 1 | 1 | | | 00:10:35 |
| 59 | 毛饶翔 | 0/3 | 0/1 | | | 1/1 | | | 1/5 | 20.0% | 3 | 1 | | | | 00:28:07 |
| 60 | 朱超 | | | 1/3 | | | | | 1/3 | 33.3% | | | | | | 00:30:00 |
| 61 | 钮伟豪 | | | | | | | | | 0.0% | | | | | | 00:00:00 |
| 62 | 赵俊阳 | | | | 0/1 | | | | 0/1 | 0.0% | | | | | | 00:01:53 |
| 64 | 章道胜 | | 0/1 | | 4/4 | | | | 4/5 | 80.0% | | 5 | | | | 00:23:49 |
| 65 | 韩伟伦 | | | | | | | | | 0.0% | | | | | | 00:00:00 |
| 66 | 刘家豪 | | | | | | | | | 0.0% | | | | | | 00:00:00 |
| 67 | 江文 | | | | | | | | | 0.0% | | | | | | 00:00:00 |
| 68 | 黄天源 | | 1/1 | | | | | | 1/1 | 100% | | | | | | 00:06:11 |
| | 合计 | 3/10 | 2/4 | 2/5 | 7/9 | 1/1 | | | 15/29 | 51.7% | 8 | 13 | 1 | | | |
| (守门员) | | | | | | | | | | | | | | | | |
| 52 | 花驰 | 1/4 | 1/5 | 1/1 | 0/1 | 1/1 | 1/2 | 0/1 | 5/15 | 33.3% | | | | | | 00:30:00 |
| | 合计 | 1/4 | 1/5 | 1/1 | 0/1 | 1/1 | 1/2 | 0/1 | 5/15 | 33.3% | | | | | | |

场上队员：得分/射门

守门员：救球/射门

| 全队合计 | 得分 | 被救 | 射失 | 击柱 | 封球 | 合计 | % |
|------|----|----|----|----|----|----|--------|
| 远射 | 3 | 3 | 2 | | 2 | 10 | 30.0% |
| 近射 | 2 | | | 2 | | 4 | 50.0% |
| 边射 | 2 | 2 | 1 | | | 5 | 40.0% |
| 快攻 | 7 | 1 | 1 | | | 9 | 77.8% |
| 突破 | 1 | | | | | 1 | 100.0% |
| 任意 | | | | | | | 0.0% |
| 七米 | | | | | | | 0.0% |

个人/全队技术统计表

手球 预赛 组别 A 滁州国际手球馆
青年男子 轮次 3 场次 13 2019-05-29 16:00

| 号码 | 姓名 | 远射 | 近射 | 边射 | 快攻 | 突破 | 任意 | 七米 | 合计 | % | 助攻 | 失误 | 警告 | 2' | 取消 | 时间 |
|----------|------|-----|-----|-----|-----|-----|-----|-----|-------|-------|----|----|----|----|----|----------|
| 辽宁抚顺(抚顺) | | | | | | | | | | | | | | | | |
| (场上队员) | | | | | | | | | | | | | | | | |
| 2 | 赫天铭 | | | | | | | | | 0.0% | | | | | | 00:27:31 |
| 5 | 王梓翹 | | | | | | | | | 0.0% | | 1 | | | | 00:03:02 |
| 6 | 尚禹辰 | | 0/1 | 0/1 | | | | | 0/2 | 0.0% | | 1 | | | | 00:30:00 |
| 7 | 张羽虹冰 | | | 0/1 | | | | | 0/1 | 0.0% | | | | | | 00:25:27 |
| 9 | 隋博 | | | | | | | | | 0.0% | | | | | | 00:04:30 |
| 11 | 陈思 | | | | | | | | | 0.0% | | | | | | 00:00:00 |
| 13 | 高鑫 | 1/2 | 1/1 | 0/1 | | 0/1 | 1/2 | 1/1 | 4/8 | 50.0% | | 4 | | | | 00:30:00 |
| 17 | 杨宇 | 2/6 | 3/3 | | 1/1 | | | | 6/10 | 60.0% | | 6 | | | | 00:30:00 |
| 19 | 靳皓童 | 0/1 | | | | | | | 0/1 | 0.0% | 2 | 4 | | 1 | | 00:30:00 |
| 22 | 杨辰 | | | | | | | | | 0.0% | | | | | | 00:00:00 |
| 28 | 靳皓添 | | 0/3 | | | | | | 0/3 | 0.0% | | 1 | | | | 00:26:58 |
| 32 | 袁梓赫 | | | | | | | | | 0.0% | | | | | | 00:02:29 |
| 合计 | | 3/9 | 4/8 | 0/3 | 1/1 | 0/1 | 1/2 | 1/1 | 10/25 | 40.0% | 2 | 17 | | 1 | | |
| (守门员) | | | | | | | | | | | | | | | | |
| 2 | 赫天铭 | 3/6 | 0/2 | 2/4 | 0/6 | 0/1 | | | 5/19 | 26.3% | | | | | | 00:27:31 |
| 32 | 袁梓赫 | | | | 1/2 | | | | 1/2 | 50.0% | | | | | | 00:02:29 |
| 合计 | | 3/6 | 0/2 | 2/4 | 1/8 | 0/1 | | | 6/21 | 28.6% | | | | | | |

场上队员：得分/射门

守门员：救球/射门

| 全队合计 | 得分 | 被救 | 射失 | 击柱 | 封球 | 合计 | % |
|------|----|----|----|----|----|----|--------|
| 远射 | 3 | 1 | 2 | | 3 | 9 | 33.3% |
| 近射 | 4 | 1 | 3 | | | 8 | 50.0% |
| 边射 | | 1 | 1 | 1 | | 3 | 0.0% |
| 快攻 | 1 | | | | | 1 | 100.0% |
| 突破 | | 1 | | | | 1 | 0.0% |
| 任意 | 1 | 1 | | | | 2 | 50.0% |
| 七米 | 1 | | | | | 1 | 100.0% |

图式比赛技术统计表

手球
青年男子

预赛
轮次 3

组别 A
场次 13

滁州国际手球馆
2019-05-29 16:00

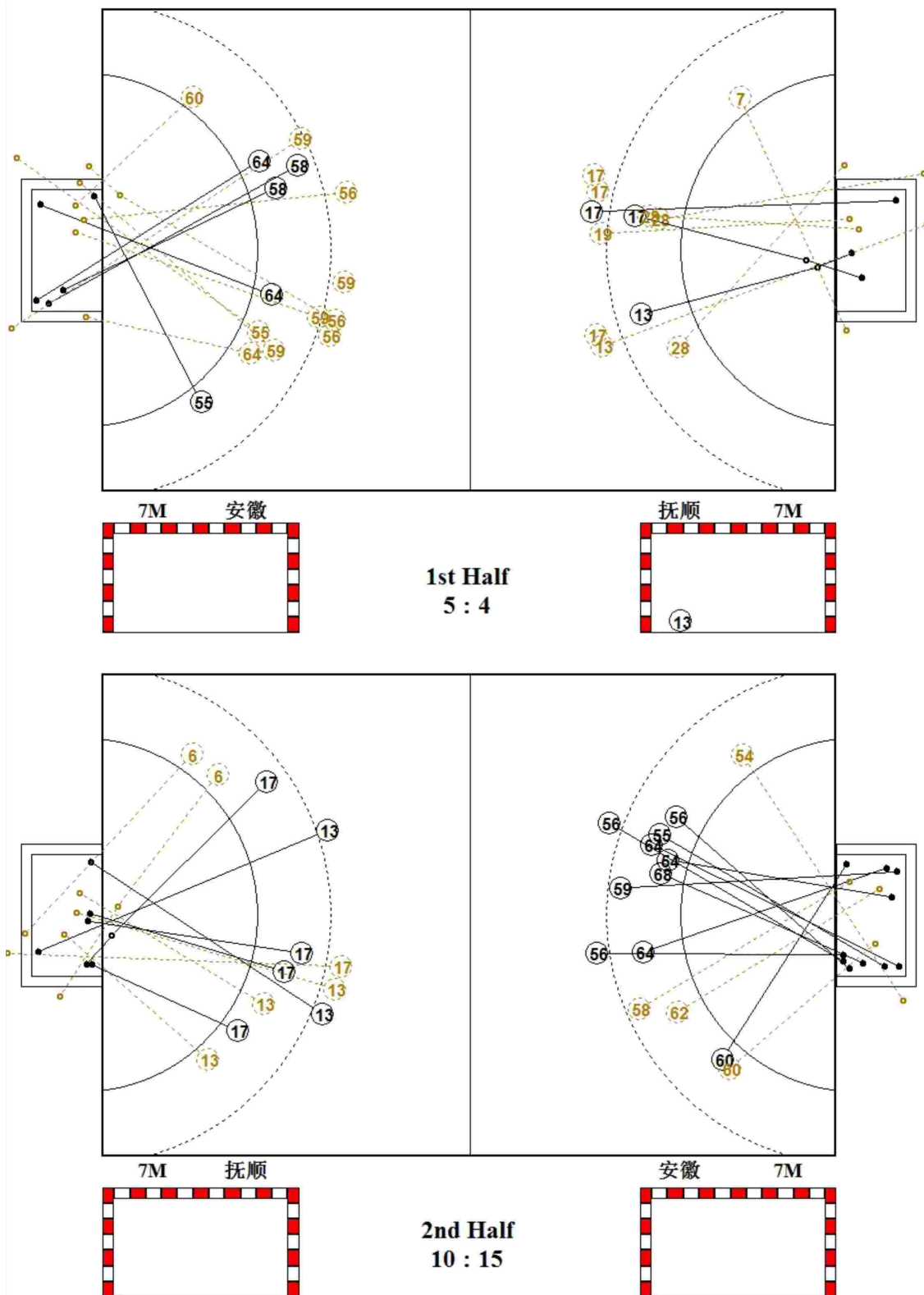

图式射门区域统计

手球
青年男子

预赛
轮次 3

组别 A
场次 13

滁州国际手球馆
2019-05-29 16:00

安徽省体校

| | | | | | | | | | | | | | | | | | | | | | | | | | | | | | | | | | | | | | | | | | | | | | | | | | | | | | | | | | | | | | | | | | | | | | | | | | | | | | | | |
|---|-----------------------------|-----------------------------|-----------------------------|-----------------------------|-----------------------------|-----------------------------|-----------------------------|--|--|--|--|--|--|--|--|--|--|--|--|---|--|---|--|--|--|--|--|--|--|--|---|--|---|--|--|--|--|--|---|---|--|--|--|--|--|--|--|--|---|--|--|--|--|--|--|--|--|--|--|--|---|--|--|---|--|--|--|--|--|---|---|--|---|--|--|--|--|--|--|
| 52 花驰 | 53 叶天赐 | 54 姚幸运 | 55 苏凯 | 56 王健鹏 | 57 朱正翔 | 58 蔡博飞 | 59 毛饶翔 | | | | | | | | | | | | | | | | | | | | | | | | | | | | | | | | | | | | | | | | | | | | | | | | | | | | | | | | | | | | | | | | | | | | | | | | |
| <table border="1"><tr><td></td><td></td><td></td></tr><tr><td></td><td></td><td></td></tr><tr><td></td><td></td><td></td></tr></table> | | | | | | | | | | <table border="1"><tr><td></td><td></td><td></td></tr><tr><td></td><td></td><td></td></tr><tr><td></td><td></td><td></td></tr></table> | | | | | | | | | | <table border="1"><tr><td></td><td>1</td><td></td></tr><tr><td></td><td></td><td></td></tr><tr><td></td><td></td><td></td></tr></table> | | 1 | | | | | | | | <table border="1"><tr><td></td><td></td><td>1</td></tr><tr><td></td><td></td><td></td></tr><tr><td></td><td></td><td>1</td></tr></table> | | | 1 | | | | | | 1 | <table border="1"><tr><td></td><td></td><td></td></tr><tr><td></td><td></td><td></td></tr><tr><td></td><td></td><td>3</td></tr></table> | | | | | | | | | 3 | <table border="1"><tr><td></td><td></td><td></td></tr><tr><td></td><td></td><td></td></tr><tr><td></td><td></td><td></td></tr></table> | | | | | | | | | | <table border="1"><tr><td>1</td><td></td><td></td></tr><tr><td>1</td><td></td><td></td></tr><tr><td></td><td></td><td></td></tr></table> | 1 | | | 1 | | | | | | <table border="1"><tr><td>1</td><td></td><td></td></tr><tr><td></td><td></td><td></td></tr><tr><td></td><td></td><td></td></tr></table> | 1 | | | | | | | | |
| | | | | | | | | | | | | | | | | | | | | | | | | | | | | | | | | | | | | | | | | | | | | | | | | | | | | | | | | | | | | | | | | | | | | | | | | | | | | | | | |
| | | | | | | | | | | | | | | | | | | | | | | | | | | | | | | | | | | | | | | | | | | | | | | | | | | | | | | | | | | | | | | | | | | | | | | | | | | | | | | | |
| | | | | | | | | | | | | | | | | | | | | | | | | | | | | | | | | | | | | | | | | | | | | | | | | | | | | | | | | | | | | | | | | | | | | | | | | | | | | | | | |
| | | | | | | | | | | | | | | | | | | | | | | | | | | | | | | | | | | | | | | | | | | | | | | | | | | | | | | | | | | | | | | | | | | | | | | | | | | | | | | | |
| | | | | | | | | | | | | | | | | | | | | | | | | | | | | | | | | | | | | | | | | | | | | | | | | | | | | | | | | | | | | | | | | | | | | | | | | | | | | | | | |
| | | | | | | | | | | | | | | | | | | | | | | | | | | | | | | | | | | | | | | | | | | | | | | | | | | | | | | | | | | | | | | | | | | | | | | | | | | | | | | | |
| | 1 | | | | | | | | | | | | | | | | | | | | | | | | | | | | | | | | | | | | | | | | | | | | | | | | | | | | | | | | | | | | | | | | | | | | | | | | | | | | | | |
| | | | | | | | | | | | | | | | | | | | | | | | | | | | | | | | | | | | | | | | | | | | | | | | | | | | | | | | | | | | | | | | | | | | | | | | | | | | | | | | |
| | | | | | | | | | | | | | | | | | | | | | | | | | | | | | | | | | | | | | | | | | | | | | | | | | | | | | | | | | | | | | | | | | | | | | | | | | | | | | | | |
| | | 1 | | | | | | | | | | | | | | | | | | | | | | | | | | | | | | | | | | | | | | | | | | | | | | | | | | | | | | | | | | | | | | | | | | | | | | | | | | | | | |
| | | | | | | | | | | | | | | | | | | | | | | | | | | | | | | | | | | | | | | | | | | | | | | | | | | | | | | | | | | | | | | | | | | | | | | | | | | | | | | | |
| | | 1 | | | | | | | | | | | | | | | | | | | | | | | | | | | | | | | | | | | | | | | | | | | | | | | | | | | | | | | | | | | | | | | | | | | | | | | | | | | | | |
| | | | | | | | | | | | | | | | | | | | | | | | | | | | | | | | | | | | | | | | | | | | | | | | | | | | | | | | | | | | | | | | | | | | | | | | | | | | | | | | |
| | | | | | | | | | | | | | | | | | | | | | | | | | | | | | | | | | | | | | | | | | | | | | | | | | | | | | | | | | | | | | | | | | | | | | | | | | | | | | | | |
| | | 3 | | | | | | | | | | | | | | | | | | | | | | | | | | | | | | | | | | | | | | | | | | | | | | | | | | | | | | | | | | | | | | | | | | | | | | | | | | | | | |
| | | | | | | | | | | | | | | | | | | | | | | | | | | | | | | | | | | | | | | | | | | | | | | | | | | | | | | | | | | | | | | | | | | | | | | | | | | | | | | | |
| | | | | | | | | | | | | | | | | | | | | | | | | | | | | | | | | | | | | | | | | | | | | | | | | | | | | | | | | | | | | | | | | | | | | | | | | | | | | | | | |
| | | | | | | | | | | | | | | | | | | | | | | | | | | | | | | | | | | | | | | | | | | | | | | | | | | | | | | | | | | | | | | | | | | | | | | | | | | | | | | | |
| 1 | | | | | | | | | | | | | | | | | | | | | | | | | | | | | | | | | | | | | | | | | | | | | | | | | | | | | | | | | | | | | | | | | | | | | | | | | | | | | | | |
| 1 | | | | | | | | | | | | | | | | | | | | | | | | | | | | | | | | | | | | | | | | | | | | | | | | | | | | | | | | | | | | | | | | | | | | | | | | | | | | | | | |
| | | | | | | | | | | | | | | | | | | | | | | | | | | | | | | | | | | | | | | | | | | | | | | | | | | | | | | | | | | | | | | | | | | | | | | | | | | | | | | | |
| 1 | | | | | | | | | | | | | | | | | | | | | | | | | | | | | | | | | | | | | | | | | | | | | | | | | | | | | | | | | | | | | | | | | | | | | | | | | | | | | | | |
| | | | | | | | | | | | | | | | | | | | | | | | | | | | | | | | | | | | | | | | | | | | | | | | | | | | | | | | | | | | | | | | | | | | | | | | | | | | | | | | |
| | | | | | | | | | | | | | | | | | | | | | | | | | | | | | | | | | | | | | | | | | | | | | | | | | | | | | | | | | | | | | | | | | | | | | | | | | | | | | | | |
| Post - 0 Miss - 0 Block - 0 | Post - 0 Miss - 0 Block - 0 | Post - 0 Miss - 1 Block - 0 | Post - 0 Miss - 1 Block - 0 | Post - 0 Miss - 1 Block - 1 | Post - 0 Miss - 0 Block - 0 | Post - 0 Miss - 0 Block - 0 | Post - 1 Miss - 1 Block - 1 | | | | | | | | | | | | | | | | | | | | | | | | | | | | | | | | | | | | | | | | | | | | | | | | | | | | | | | | | | | | | | | | | | | | | | | | |
| 60 朱超 | 61 钮伟豪 | 62 赵俊阳 | 64 章道胜 | 65 韩伟伦 | 66 刘家豪 | 67 江文 | 68 黄天源 | | | | | | | | | | | | | | | | | | | | | | | | | | | | | | | | | | | | | | | | | | | | | | | | | | | | | | | | | | | | | | | | | | | | | | | | |
| <table border="1"><tr><td>1</td><td></td><td></td></tr><tr><td></td><td></td><td></td></tr><tr><td></td><td></td><td></td></tr></table> | 1 | | | | | | | | | <table border="1"><tr><td></td><td></td><td></td></tr><tr><td></td><td></td><td></td></tr><tr><td></td><td></td><td></td></tr></table> | | | | | | | | | | <table border="1"><tr><td></td><td></td><td></td></tr><tr><td></td><td></td><td></td></tr><tr><td></td><td></td><td></td></tr></table> | | | | | | | | | | <table border="1"><tr><td>2</td><td></td><td>2</td></tr><tr><td></td><td></td><td></td></tr><tr><td></td><td></td><td></td></tr></table> | 2 | | 2 | | | | | | | <table border="1"><tr><td></td><td></td><td></td></tr><tr><td></td><td></td><td></td></tr><tr><td></td><td></td><td></td></tr></table> | | | | | | | | | | <table border="1"><tr><td></td><td></td><td></td></tr><tr><td></td><td></td><td></td></tr><tr><td></td><td></td><td></td></tr></table> | | | | | | | | | | <table border="1"><tr><td></td><td></td><td></td></tr><tr><td></td><td></td><td></td></tr><tr><td></td><td></td><td></td></tr></table> | | | | | | | | | | <table border="1"><tr><td></td><td></td><td>1</td></tr><tr><td></td><td></td><td></td></tr><tr><td></td><td></td><td></td></tr></table> | | | 1 | | | | | | |
| 1 | | | | | | | | | | | | | | | | | | | | | | | | | | | | | | | | | | | | | | | | | | | | | | | | | | | | | | | | | | | | | | | | | | | | | | | | | | | | | | | |
| | | | | | | | | | | | | | | | | | | | | | | | | | | | | | | | | | | | | | | | | | | | | | | | | | | | | | | | | | | | | | | | | | | | | | | | | | | | | | | | |
| | | | | | | | | | | | | | | | | | | | | | | | | | | | | | | | | | | | | | | | | | | | | | | | | | | | | | | | | | | | | | | | | | | | | | | | | | | | | | | | |
| | | | | | | | | | | | | | | | | | | | | | | | | | | | | | | | | | | | | | | | | | | | | | | | | | | | | | | | | | | | | | | | | | | | | | | | | | | | | | | | |
| | | | | | | | | | | | | | | | | | | | | | | | | | | | | | | | | | | | | | | | | | | | | | | | | | | | | | | | | | | | | | | | | | | | | | | | | | | | | | | | |
| | | | | | | | | | | | | | | | | | | | | | | | | | | | | | | | | | | | | | | | | | | | | | | | | | | | | | | | | | | | | | | | | | | | | | | | | | | | | | | | |
| | | | | | | | | | | | | | | | | | | | | | | | | | | | | | | | | | | | | | | | | | | | | | | | | | | | | | | | | | | | | | | | | | | | | | | | | | | | | | | | |
| | | | | | | | | | | | | | | | | | | | | | | | | | | | | | | | | | | | | | | | | | | | | | | | | | | | | | | | | | | | | | | | | | | | | | | | | | | | | | | | |
| | | | | | | | | | | | | | | | | | | | | | | | | | | | | | | | | | | | | | | | | | | | | | | | | | | | | | | | | | | | | | | | | | | | | | | | | | | | | | | | |
| 2 | | 2 | | | | | | | | | | | | | | | | | | | | | | | | | | | | | | | | | | | | | | | | | | | | | | | | | | | | | | | | | | | | | | | | | | | | | | | | | | | | | |
| | | | | | | | | | | | | | | | | | | | | | | | | | | | | | | | | | | | | | | | | | | | | | | | | | | | | | | | | | | | | | | | | | | | | | | | | | | | | | | | |
| | | | | | | | | | | | | | | | | | | | | | | | | | | | | | | | | | | | | | | | | | | | | | | | | | | | | | | | | | | | | | | | | | | | | | | | | | | | | | | | |
| | | | | | | | | | | | | | | | | | | | | | | | | | | | | | | | | | | | | | | | | | | | | | | | | | | | | | | | | | | | | | | | | | | | | | | | | | | | | | | | |
| | | | | | | | | | | | | | | | | | | | | | | | | | | | | | | | | | | | | | | | | | | | | | | | | | | | | | | | | | | | | | | | | | | | | | | | | | | | | | | | |
| | | | | | | | | | | | | | | | | | | | | | | | | | | | | | | | | | | | | | | | | | | | | | | | | | | | | | | | | | | | | | | | | | | | | | | | | | | | | | | | |
| | | | | | | | | | | | | | | | | | | | | | | | | | | | | | | | | | | | | | | | | | | | | | | | | | | | | | | | | | | | | | | | | | | | | | | | | | | | | | | | |
| | | | | | | | | | | | | | | | | | | | | | | | | | | | | | | | | | | | | | | | | | | | | | | | | | | | | | | | | | | | | | | | | | | | | | | | | | | | | | | | |
| | | | | | | | | | | | | | | | | | | | | | | | | | | | | | | | | | | | | | | | | | | | | | | | | | | | | | | | | | | | | | | | | | | | | | | | | | | | | | | | |
| | | | | | | | | | | | | | | | | | | | | | | | | | | | | | | | | | | | | | | | | | | | | | | | | | | | | | | | | | | | | | | | | | | | | | | | | | | | | | | | |
| | | | | | | | | | | | | | | | | | | | | | | | | | | | | | | | | | | | | | | | | | | | | | | | | | | | | | | | | | | | | | | | | | | | | | | | | | | | | | | | |
| | | | | | | | | | | | | | | | | | | | | | | | | | | | | | | | | | | | | | | | | | | | | | | | | | | | | | | | | | | | | | | | | | | | | | | | | | | | | | | | |
| | | 1 | | | | | | | | | | | | | | | | | | | | | | | | | | | | | | | | | | | | | | | | | | | | | | | | | | | | | | | | | | | | | | | | | | | | | | | | | | | | | |
| | | | | | | | | | | | | | | | | | | | | | | | | | | | | | | | | | | | | | | | | | | | | | | | | | | | | | | | | | | | | | | | | | | | | | | | | | | | | | | | |
| | | | | | | | | | | | | | | | | | | | | | | | | | | | | | | | | | | | | | | | | | | | | | | | | | | | | | | | | | | | | | | | | | | | | | | | | | | | | | | | |
| Post - 0 Miss - 0 Block - 0 | Post - 0 Miss - 0 Block - 0 | Post - 0 Miss - 0 Block - 0 | Post - 1 Miss - 0 Block - 0 | Post - 0 Miss - 0 Block - 0 | Post - 0 Miss - 0 Block - 0 | Post - 0 Miss - 0 Block - 0 | Post - 0 Miss - 0 Block - 0 | | | | | | | | | | | | | | | | | | | | | | | | | | | | | | | | | | | | | | | | | | | | | | | | | | | | | | | | | | | | | | | | | | | | | | | | |

52 花驰

| | | |
|-----|-----|-----|
| 0/2 | | |
| | 3/3 | 0/1 |
| 1/4 | 0/3 | 1/2 |

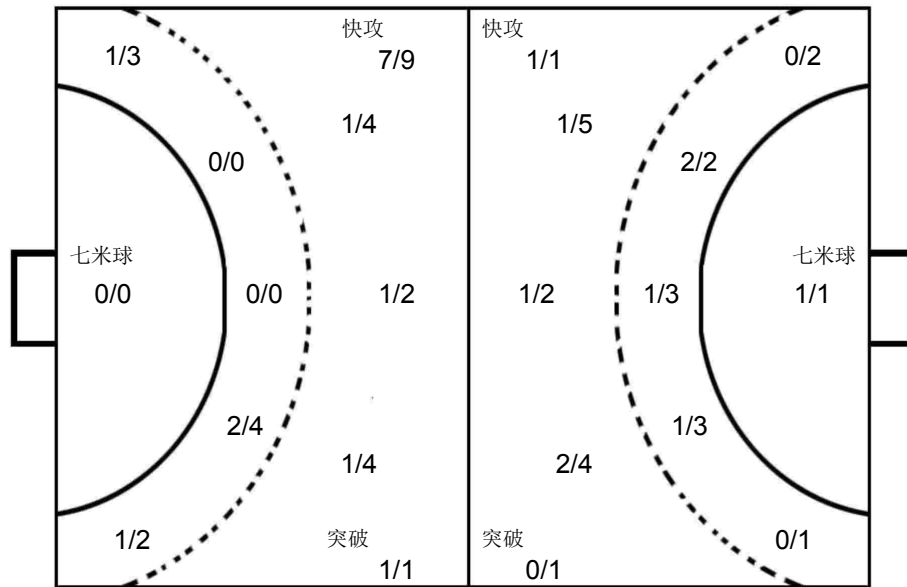

2 赫天铭

| | | |
|-----|-----|-----|
| 0/4 | | 0/3 |
| 0/1 | 1/1 | 2/3 |
| 1/2 | | 1/5 |

32 袁梓赫

| | | |
|-----|-----|--|
| | 0/1 | |
| 1/1 | | |
| | | |

辽宁抚顺

| | | | | | | | | | | | | | | | | | | | | | | | | | | | | | | | | | | | | | | | | | | | | | | | | | | | | | | | | | | | | | | | | | | | | | | | | | | | | | | | |
|--|-----------------------------|-----------------------------|-----------------------------|-----------------------------|-----------------------------|-----------------------------|-----------------------------|--|--|--|--|--|--|--|--|--|--|--|--|--|--|--|--|--|--|--|--|--|--|--|--|--|--|--|--|--|--|--|--|--|--|--|--|--|--|--|--|--|--|--|--|--|--|--|--|--|--|--|--|--|---|--|--|--|--|--|---|---|---|--|---|--|--|--|--|---|---|---|--|
| 2 赫天铭 | 5 王梓翾 | 6 尚禹辰 | 7 张羽虹冰 | 9 隋博 | 11 陈思 | 13 高鑫 | 17 杨宇 | | | | | | | | | | | | | | | | | | | | | | | | | | | | | | | | | | | | | | | | | | | | | | | | | | | | | | | | | | | | | | | | | | | | | | | | |
| <table border="1"><tr><td></td><td></td><td></td></tr><tr><td></td><td></td><td></td></tr><tr><td></td><td></td><td></td></tr></table> | | | | | | | | | | <table border="1"><tr><td></td><td></td><td></td></tr><tr><td></td><td></td><td></td></tr><tr><td></td><td></td><td></td></tr></table> | | | | | | | | | | <table border="1"><tr><td></td><td></td><td></td></tr><tr><td></td><td></td><td></td></tr><tr><td></td><td></td><td></td></tr></table> | | | | | | | | | | <table border="1"><tr><td></td><td></td><td></td></tr><tr><td></td><td></td><td></td></tr><tr><td></td><td></td><td></td></tr></table> | | | | | | | | | | <table border="1"><tr><td></td><td></td><td></td></tr><tr><td></td><td></td><td></td></tr><tr><td></td><td></td><td></td></tr></table> | | | | | | | | | | <table border="1"><tr><td></td><td></td><td></td></tr><tr><td></td><td></td><td></td></tr><tr><td></td><td></td><td></td></tr></table> | | | | | | | | | | <table border="1"><tr><td>1</td><td></td><td></td></tr><tr><td></td><td></td><td></td></tr><tr><td>1</td><td>1</td><td>1</td></tr></table> | 1 | | | | | | 1 | 1 | 1 | <table border="1"><tr><td>1</td><td></td><td></td></tr><tr><td></td><td></td><td>1</td></tr><tr><td>2</td><td>2</td><td></td></tr></table> | 1 | | | | | 1 | 2 | 2 | |
| | | | | | | | | | | | | | | | | | | | | | | | | | | | | | | | | | | | | | | | | | | | | | | | | | | | | | | | | | | | | | | | | | | | | | | | | | | | | | | | |
| | | | | | | | | | | | | | | | | | | | | | | | | | | | | | | | | | | | | | | | | | | | | | | | | | | | | | | | | | | | | | | | | | | | | | | | | | | | | | | | |
| | | | | | | | | | | | | | | | | | | | | | | | | | | | | | | | | | | | | | | | | | | | | | | | | | | | | | | | | | | | | | | | | | | | | | | | | | | | | | | | |
| | | | | | | | | | | | | | | | | | | | | | | | | | | | | | | | | | | | | | | | | | | | | | | | | | | | | | | | | | | | | | | | | | | | | | | | | | | | | | | | |
| | | | | | | | | | | | | | | | | | | | | | | | | | | | | | | | | | | | | | | | | | | | | | | | | | | | | | | | | | | | | | | | | | | | | | | | | | | | | | | | |
| | | | | | | | | | | | | | | | | | | | | | | | | | | | | | | | | | | | | | | | | | | | | | | | | | | | | | | | | | | | | | | | | | | | | | | | | | | | | | | | |
| | | | | | | | | | | | | | | | | | | | | | | | | | | | | | | | | | | | | | | | | | | | | | | | | | | | | | | | | | | | | | | | | | | | | | | | | | | | | | | | |
| | | | | | | | | | | | | | | | | | | | | | | | | | | | | | | | | | | | | | | | | | | | | | | | | | | | | | | | | | | | | | | | | | | | | | | | | | | | | | | | |
| | | | | | | | | | | | | | | | | | | | | | | | | | | | | | | | | | | | | | | | | | | | | | | | | | | | | | | | | | | | | | | | | | | | | | | | | | | | | | | | |
| | | | | | | | | | | | | | | | | | | | | | | | | | | | | | | | | | | | | | | | | | | | | | | | | | | | | | | | | | | | | | | | | | | | | | | | | | | | | | | | |
| | | | | | | | | | | | | | | | | | | | | | | | | | | | | | | | | | | | | | | | | | | | | | | | | | | | | | | | | | | | | | | | | | | | | | | | | | | | | | | | |
| | | | | | | | | | | | | | | | | | | | | | | | | | | | | | | | | | | | | | | | | | | | | | | | | | | | | | | | | | | | | | | | | | | | | | | | | | | | | | | | |
| | | | | | | | | | | | | | | | | | | | | | | | | | | | | | | | | | | | | | | | | | | | | | | | | | | | | | | | | | | | | | | | | | | | | | | | | | | | | | | | |
| | | | | | | | | | | | | | | | | | | | | | | | | | | | | | | | | | | | | | | | | | | | | | | | | | | | | | | | | | | | | | | | | | | | | | | | | | | | | | | | |
| | | | | | | | | | | | | | | | | | | | | | | | | | | | | | | | | | | | | | | | | | | | | | | | | | | | | | | | | | | | | | | | | | | | | | | | | | | | | | | | |
| | | | | | | | | | | | | | | | | | | | | | | | | | | | | | | | | | | | | | | | | | | | | | | | | | | | | | | | | | | | | | | | | | | | | | | | | | | | | | | | |
| | | | | | | | | | | | | | | | | | | | | | | | | | | | | | | | | | | | | | | | | | | | | | | | | | | | | | | | | | | | | | | | | | | | | | | | | | | | | | | | |
| | | | | | | | | | | | | | | | | | | | | | | | | | | | | | | | | | | | | | | | | | | | | | | | | | | | | | | | | | | | | | | | | | | | | | | | | | | | | | | | |
| 1 | | | | | | | | | | | | | | | | | | | | | | | | | | | | | | | | | | | | | | | | | | | | | | | | | | | | | | | | | | | | | | | | | | | | | | | | | | | | | | | |
| | | | | | | | | | | | | | | | | | | | | | | | | | | | | | | | | | | | | | | | | | | | | | | | | | | | | | | | | | | | | | | | | | | | | | | | | | | | | | | | |
| 1 | 1 | 1 | | | | | | | | | | | | | | | | | | | | | | | | | | | | | | | | | | | | | | | | | | | | | | | | | | | | | | | | | | | | | | | | | | | | | | | | | | | | | |
| 1 | | | | | | | | | | | | | | | | | | | | | | | | | | | | | | | | | | | | | | | | | | | | | | | | | | | | | | | | | | | | | | | | | | | | | | | | | | | | | | | |
| | | 1 | | | | | | | | | | | | | | | | | | | | | | | | | | | | | | | | | | | | | | | | | | | | | | | | | | | | | | | | | | | | | | | | | | | | | | | | | | | | | |
| 2 | 2 | | | | | | | | | | | | | | | | | | | | | | | | | | | | | | | | | | | | | | | | | | | | | | | | | | | | | | | | | | | | | | | | | | | | | | | | | | | | | | |
| Post - 0 Miss - 0 Block - 0 | Post - 0 Miss - 0 Block - 0 | Post - 1 Miss - 1 Block - 0 | Post - 0 Miss - 1 Block - 0 | Post - 0 Miss - 0 Block - 0 | Post - 0 Miss - 0 Block - 0 | Post - 0 Miss - 1 Block - 0 | Post - 0 Miss - 1 Block - 3 | | | | | | | | | | | | | | | | | | | | | | | | | | | | | | | | | | | | | | | | | | | | | | | | | | | | | | | | | | | | | | | | | | | | | | | | |
| 19 靳皓童 | 22 杨辰 | 28 靳皓添 | 32 袁梓赫 | | | | | | | | | | | | | | | | | | | | | | | | | | | | | | | | | | | | | | | | | | | | | | | | | | | | | | | | | | | | | | | | | | | | | | | | | | | | |
| <table border="1"><tr><td></td><td></td><td></td></tr><tr><td></td><td></td><td></td></tr><tr><td></td><td></td><td></td></tr></table> | | | | | | | | | | <table border="1"><tr><td></td><td></td><td></td></tr><tr><td></td><td></td><td></td></tr><tr><td></td><td></td><td></td></tr></table> | | | | | | | | | | <table border="1"><tr><td></td><td></td><td></td></tr><tr><td></td><td></td><td></td></tr><tr><td></td><td></td><td></td></tr></table> | | | | | | | | | | <table border="1"><tr><td></td><td></td><td></td></tr><tr><td></td><td></td><td></td></tr><tr><td></td><td></td><td></td></tr></table> | | | | | | | | | | | | | | | | | | | | | | | | | | | | | | | | | | | | | | | | | | | | | | | | | |
| | | | | | | | | | | | | | | | | | | | | | | | | | | | | | | | | | | | | | | | | | | | | | | | | | | | | | | | | | | | | | | | | | | | | | | | | | | | | | | | |
| | | | | | | | | | | | | | | | | | | | | | | | | | | | | | | | | | | | | | | | | | | | | | | | | | | | | | | | | | | | | | | | | | | | | | | | | | | | | | | | |
| | | | | | | | | | | | | | | | | | | | | | | | | | | | | | | | | | | | | | | | | | | | | | | | | | | | | | | | | | | | | | | | | | | | | | | | | | | | | | | | |
| | | | | | | | | | | | | | | | | | | | | | | | | | | | | | | | | | | | | | | | | | | | | | | | | | | | | | | | | | | | | | | | | | | | | | | | | | | | | | | | |
| | | | | | | | | | | | | | | | | | | | | | | | | | | | | | | | | | | | | | | | | | | | | | | | | | | | | | | | | | | | | | | | | | | | | | | | | | | | | | | | |
| | | | | | | | | | | | | | | | | | | | | | | | | | | | | | | | | | | | | | | | | | | | | | | | | | | | | | | | | | | | | | | | | | | | | | | | | | | | | | | | |
| | | | | | | | | | | | | | | | | | | | | | | | | | | | | | | | | | | | | | | | | | | | | | | | | | | | | | | | | | | | | | | | | | | | | | | | | | | | | | | | |
| | | | | | | | | | | | | | | | | | | | | | | | | | | | | | | | | | | | | | | | | | | | | | | | | | | | | | | | | | | | | | | | | | | | | | | | | | | | | | | | |
| | | | | | | | | | | | | | | | | | | | | | | | | | | | | | | | | | | | | | | | | | | | | | | | | | | | | | | | | | | | | | | | | | | | | | | | | | | | | | | | |
| | | | | | | | | | | | | | | | | | | | | | | | | | | | | | | | | | | | | | | | | | | | | | | | | | | | | | | | | | | | | | | | | | | | | | | | | | | | | | | | |
| | | | | | | | | | | | | | | | | | | | | | | | | | | | | | | | | | | | | | | | | | | | | | | | | | | | | | | | | | | | | | | | | | | | | | | | | | | | | | | | |
| | | | | | | | | | | | | | | | | | | | | | | | | | | | | | | | | | | | | | | | | | | | | | | | | | | | | | | | | | | | | | | | | | | | | | | | | | | | | | | | |
| Post - 0 Miss - 0 Block - 0 | Post - 0 Miss - 0 Block - 0 | Post - 0 Miss - 2 Block - 0 | Post - 0 Miss - 0 Block - 0 | | | | | | | | | | | | | | | | | | | | | | | | | | | | | | | | | | | | | | | | | | | | | | | | | | | | | | | | | | | | | | | | | | | | | | | | | | | | |



| Team A | | | | | Team B | | | | | Match Number | | | | | | | | | | | | | | |
|----------------|-----------------------------------|---------------|---------------------|-------|------------------------------------|------------|----------------|----|-------|--------------|--|------------|---|-----|----------------------|--|---|---|----|---|----|--|--|--|
| A 福建龙岩 | | | | | B 安徽淮南 | | | | | 14 | | | | | | | | | | | | | | |
| Played in | | | in the hall | | | on | | | at | | | Spectators | | | | | | | | | | | | |
| 安徽滁州 | | | 滁州国际手球馆 | | | 2019-05-29 | | | 17:00 | | | hours | | | | | | | | | | | | |
| Half-time(30') | A | B | End of playing time | | A | B | 1st extra time | | A | B | 2nd extra time | | A | B | After penalty throws | | A | B | | | | | | |
| | 9 | 9 | 19 | | 15 | | | | | | | | | | | | | | | | | | | |
| Number of 7 m | A | Team time-out | | | Full name of players and officials | | | | | | Team time-out | | | B | Number of 7 m | | | | | | | | | |
| | 1/1 | 1 | 2 | 3 | | | | | | | 1 | 2 | 3 | B | | | | | | | | | | |
| | | 06:40 | 35:43 | 43:01 | | | | | | | 04:17 | | | 1/3 | | | | | | | | | | |
| No. | Team A | | | | | G | W | 2' | D | DR | No. | Team B | | | | | G | W | 2' | D | DR | | | |
| 1 | 刘子豪 | | | | | | | | | | 1 | 苟嘉毅 | | | | | | | | | | | | |
| 5 | 郭雨强 | | | | | 4 | 1 | 2 | | | 2 | 邹俊洁 | | | | | | | | | | | | |
| 6 | 刘阳 | | | | | | 1 | 1 | | | 3 | 童守宣 | | | | | | | | | | | | |
| 7 | 王晨旭 | | | | | | | 1 | | | 4 | 李攀 | | | | | | | | | | | | |
| 8 | 杨鑫祥 | | | | | | | | | | 5 | 吴修民 | | | | | | | | | | | | |
| 9 | 荆胤丞 | | | | | | | | | | 6 | 童浩宇 | | | | | 2 | | | | | | | |
| 10 | 赵一 | | | | | 6 | | | | | 7 | 赵琨鹏 | | | | | | | | | | | | |
| 15 | 刘家良 | | | | | 4 | | | | | 8 | 陈子涵 | | | | | 1 | | | | | | | |
| 16 | 李凯锋 | | | | | | | | | | 9 | 杨金龙 | | | | | 3 | | | | | | | |
| 17 | 陈锐涛 | | | | | | | | | | 10 | 孙飞扬 | | | | | 6 | | 1 | | | | | |
| 18 | 奚尧 | | | | | 3 | | | | | 11 | 刘新然 | | | | | | | | | | | | |
| 21 | 刘晓青 | | | | | | | | | | 13 | 张昊燃 | | | | | | | | | | | | |
| 23 | 朱天一 | | | | | 2 | | | | | 14 | 单中宝 | | | | | | | | | | | | |
| 24 | 钟盛发 | | | | | | | | | | 15 | 刘淇 | | | | | 3 | | | | | | | |
| 27 | 邓可钊 | | | | | | | | | | 16 | 胡文柯 | | | | | | | | | | | | |
| 36 | 陈泽锟 | | | | | | | | | | 17 | 徐鹏辉 | | | | | | | | | | | | |
| B | 杜长义 | | | | | | | | | | A | 常洪飞 | | | | | | | | | | | | |
| C | 饶开发 | | | | | | | | | | B | 阮圣杰 (主教练) | | | | | | | | | | | | |
| D | 李绍南 | | | | | | | | | | | | | | | | | | | | | | | |
| | | | | | | | | | | | | | | | | | | | | | | | | |
| A | | | | | | | | | | | Signatures of responsables for the teams (Off.A) | | | | | | | | | | B | | | |
| TP | Remarks of referees / HF Official | | | | | | | | | | | | | | | | | | | | TP | | | |
| | | | | | | | | | | | | | | | | | | | | | | | | |

Signatures

| | | | | |
|----------|-----------|-----------|--|--|
| Referees | 李兆蒙 (CHN) | 马晓晔 (CHN) | | |
| T.D. | 王洋 (CHN) | 龙佩莉 (CHN) | | |
| CHA Off. | | | | |

Note: Number of 7m Throws Awarded to Team A and B, Goals (G), Warnings (W), Suspensions (2'), Direct Disqualification (D), Disqualification With Report (DR) and Team Penalty (TP).

Table Officials: 刘洋洋

许修凯

Statisticians: 王梓衡

童佩瑶

第二届全国青年运动会男子手球乙组决赛 体校组 (U16)

PHMS Pictorial Handball Match Statistics

IHF Official System

竞赛技术统计

手球
青年男子

预赛
轮次 3

组别 A
场次 14

滁州国际手球馆
2019-05-29 17:00

| | | | |
|-----------|-----------------------|---------|------------|
| Referees: | 李兆蒙 (CHN) / 马晓晔 (CHN) | Result: | 19:15(9:9) |
| Teams: | 福建龙岩(龙岩) VS 安徽淮南(淮南) | | |

| 龙岩 | | | | | | | | | | | | | | 比赛进程 | | 淮南 | | | |
|----------|-----|-----|-----|-----|-----|-----|-----|-------|------|----|----|----|----|------|----------|----------|--------|-------|--|
| 主教练: 李绍南 | 远射 | 近射 | 边射 | 快攻 | 突破 | 任意球 | 7m球 | 合计 | % | 助攻 | 失误 | 警告 | 2' | D+DR | 龙岩 | 淮南 | | | |
| 1 刘子豪 | | | | | | | | | | | | | | | | | | | |
| 5 郭雨强 | 2/4 | | | 1/2 | | 1/1 | | 4/7 | 57.1 | 3 | 1 | 1 | 2 | | 5 郭雨强 | 1 01:04 | 0 | | |
| 6 刘阳 | | | | | | | | | | | | 1 | 1 | | 10 赵一 | 2 02:02 | 1 | | |
| 7 王晨旭 | | | | | | | | | | 1 | | | | | 2 03:45 | 2 | 10 孙飞扬 | | |
| 8 杨鑫祥 | | | | | | | | | | | | | | | 2 04:50 | 3 | 15 刘淇 | | |
| 9 荆胤丞 | | | | | | | | | | | | | | | 5 郭雨强 | 3 05:02 | 3 | | |
| 10 赵一 | 1/1 | 1/3 | | | 3/3 | | 1/1 | 6/8 | 75.0 | 1 | | | | | 3 05:36 | 4 | 10 孙飞扬 | | |
| 15 刘家良 | 1/1 | 2/3 | | | 1/2 | | | 4/6 | 66.7 | 1 | 2 | | | | 4 06:06 | 4 | | | |
| 16 李凯锋 | | | | | | | | | | | | | | | 4 06:32 | 5 | 9 杨金龙 | | |
| 17 陈锐涛 | | | | | | | | | | | | | | | 23 朱天一 | 5 07:08 | 5 | | |
| 18 奚尧 | | | 2/2 | 1/1 | | | | 3/3 | 100 | | | | | | 10 赵一 | 6 07:51 | 5 | | |
| 21 刘晓青 | | | | | | | | | | | | | | | 10 赵一 | 7 09:00 | 5 | | |
| 23 朱天一 | | 2/3 | | | | | | 2/3 | 66.7 | | 2 | | | | 18 奚尧 | 8 09:46 | 5 | | |
| 24 钟盛发 | | | | | | | | | | | | | | | 8 10:30 | 6 | 10 孙飞扬 | | |
| 27 邓可帆 | | | | | | | | | | | | | | | 8 12:26 | 7 | 9 杨金龙 | | |
| 36 陈泽锟 | | | | | | | | | | | | | | | 8 14:01 | 8 | 6 童浩宇 | | |
| 运动员 合计 | 4/6 | 5/9 | 2/2 | 2/3 | 4/5 | 1/1 | 1/1 | 19/27 | 70.4 | 6 | 5 | 2 | 4 | | 15 刘家良 | 9 14:38 | 8 | | |
| 1 刘子豪 | 2/6 | 1/1 | 1/3 | 0/1 | 0/4 | 1/4 | 0/1 | 5/20 | 25.0 | | | | | | 9 14:55 | 9 | 10 孙飞扬 | | |
| 守门员 合计 | 2/6 | 1/1 | 1/3 | 0/1 | 0/4 | 1/4 | 0/1 | 5/20 | 25.0 | | | | | | 2nd Half | | | | |
| | | | | | | | | | | | | | | | 15 刘家良 | 10 00:54 | 9 | | |
| | | | | | | | | | | | | | | | 10 赵一 | 10 01:15 | 10 | 15 刘淇 | |
| | | | | | | | | | | | | | | | 18 奚尧 | 11 01:38 | 10 | | |
| | | | | | | | | | | | | | | | 10 赵一 | 12 02:48 | 10 | | |
| | | | | | | | | | | | | | | | 5 郭雨强 | 13 04:23 | 10 | | |
| | | | | | | | | | | | | | | | 23 朱天一 | 14 06:02 | 10 | | |
| | | | | | | | | | | | | | | | 14 07:10 | 11 | 10 孙飞扬 | | |
| | | | | | | | | | | | | | | | 10 赵一 | 15 07:32 | 11 | | |
| | | | | | | | | | | | | | | | 15 07:52 | 12 | 15 刘淇 | | |
| | | | | | | | | | | | | | | | 10 赵一 | 16 09:12 | 12 | | |
| | | | | | | | | | | | | | | | 15 刘家良 | 17 12:25 | 12 | | |
| | | | | | | | | | | | | | | | 17 12:52 | 13 | 6 童浩宇 | | |
| | | | | | | | | | | | | | | | 5 郭雨强 | 18 13:39 | 13 | | |
| | | | | | | | | | | | | | | | 18 13:48 | 14 | 9 杨金龙 | | |
| | | | | | | | | | | | | | | | 18 14:39 | 15 | 8 陈子涵 | | |
| | | | | | | | | | | | | | | | 18 奚尧 | 19 14:52 | 15 | | |

场上队员: 得分 / 射门

守门员: 救球 / 射门

| | | | |
|---|------|----|---------|
| D | 取消资格 | DR | 取消资格+报告 |
|---|------|----|---------|



个人/全队技术统计表

手球 预赛 组别 A 滁州国际手球馆
青年男子 轮次 3 场次 14 2019-05-29 17:00

| 号码 | 姓名 | 远射 | 近射 | 边射 | 快攻 | 突破 | 任意 | 七米 | 合计 | % | 助攻 | 失误 | 警告 | 2' | 取消 | 时间 |
|----------|-----|-----|-----|-----|-----|-----|-----|-----|-------|-------|----|----|----|----|----|----------|
| 福建龙岩(龙岩) | | | | | | | | | | | | | | | | |
| (场上队员) | | | | | | | | | | | | | | | | |
| 1 | 刘子豪 | | | | | | | | | 0.0% | | | | | | 00:30:00 |
| 5 | 郭雨强 | 2/4 | | | 1/2 | | 1/1 | | 4/7 | 57.1% | 3 | 1 | 1 | 2 | | 00:28:28 |
| 6 | 刘阳 | | | | | | | | | 0.0% | | | 1 | 1 | | 00:20:44 |
| 7 | 王晨旭 | | | | | | | | | 0.0% | 1 | | | 1 | | 00:14:46 |
| 8 | 杨鑫祥 | | | | | | | | | 0.0% | | | | | | 00:00:00 |
| 9 | 荆胤丞 | | | | | | | | | 0.0% | | | | | | 00:00:00 |
| 10 | 赵一 | 1/1 | 1/3 | | | 3/3 | | 1/1 | 6/8 | 75.0% | 1 | | | | | 00:30:00 |
| 15 | 刘家良 | 1/1 | 2/3 | | | 1/2 | | | 4/6 | 66.7% | 1 | 2 | | | | 00:30:00 |
| 16 | 李凯锋 | | | | | | | | | 0.0% | | | | | | 00:00:00 |
| 17 | 陈锐涛 | | | | | | | | | 0.0% | | | | | | 00:00:00 |
| 18 | 奚尧 | | | 2/2 | 1/1 | | | | 3/3 | 100% | | | | | | 00:25:53 |
| 21 | 刘晓青 | | | | | | | | | 0.0% | | | | | | 00:00:00 |
| 23 | 朱天一 | | 2/3 | | | | | | 2/3 | 66.7% | | 2 | | | | 00:30:00 |
| 24 | 钟盛发 | | | | | | | | | 0.0% | | | | | | 00:00:00 |
| 27 | 邓可钊 | | | | | | | | | 0.0% | | | | | | 00:00:00 |
| 36 | 陈泽锟 | | | | | | | | | 0.0% | | | | | | 00:00:00 |
| 合计 | | 4/6 | 5/9 | 2/2 | 2/3 | 4/5 | 1/1 | 1/1 | 19/27 | 70.4% | 6 | 5 | 2 | 4 | | |
| (守门员) | | | | | | | | | | | | | | | | |
| 1 | 刘子豪 | 2/6 | 1/1 | 1/3 | 0/1 | 0/4 | 1/4 | 0/1 | 5/20 | 25.0% | | | | | | 00:30:00 |
| 合计 | | 2/6 | 1/1 | 1/3 | 0/1 | 0/4 | 1/4 | 0/1 | 5/20 | 25.0% | | | | | | |

场上队员：得分/射门

守门员：救球/射门

| 全队合计 | 得分 | 被救 | 射失 | 击柱 | 封球 | 合计 | % |
|------|----|----|----|----|----|----|--------|
| 远射 | 4 | 1 | | 1 | | 6 | 66.7% |
| 近射 | 5 | 2 | 1 | 1 | | 9 | 55.6% |
| 边射 | 2 | | | | | 2 | 100.0% |
| 快攻 | 2 | 1 | | | | 3 | 66.7% |
| 突破 | 4 | | 1 | | | 5 | 80.0% |
| 任意 | 1 | | | | | 1 | 100.0% |
| 七米 | 1 | | | | | 1 | 100.0% |

个人/全队技术统计表

手球 预赛 组别 A 滁州国际手球馆
青年男子 轮次 3 场次 14 2019-05-29 17:00

| 号码 | 姓名 | 远射 | 近射 | 边射 | 快攻 | 突破 | 任意 | 七米 | 合计 | % | 助攻 | 失误 | 警告 | 2' | 取消 | 时间 |
|----------|-----|-----|-----|-----|-----|-----|-----|-----|-------|-------|----|----|----|----|----|----------|
| 安徽淮南(淮南) | | | | | | | | | | | | | | | | |
| (场上队员) | | | | | | | | | | | | | | | | |
| 1 | 苟嘉毅 | | | | | | | | | 0.0% | | | | | | 00:30:00 |
| 2 | 邹俊洁 | | | | | | | | | 0.0% | | | | | | 00:00:00 |
| 3 | 童守宣 | | | | | | | | | 0.0% | | | | | | 00:00:00 |
| 4 | 李攀 | | | | | | | | | 0.0% | | | | | | 00:00:00 |
| 5 | 吴修民 | | | | | | | | | 0.0% | | | | | | 00:00:00 |
| 6 | 童浩宇 | | | 2/2 | | | | | 2/2 | 100% | | | | | | 00:30:00 |
| 7 | 赵琨鹏 | | | | | | | | | 0.0% | | | | | | 00:00:00 |
| 8 | 陈子涵 | 0/1 | | | 1/1 | | | | 1/2 | 50.0% | | 3 | | | | 00:30:00 |
| 9 | 杨金龙 | 2/4 | | | | | | 1/2 | 3/6 | 50.0% | | 2 | | | | 00:30:00 |
| 10 | 孙飞扬 | 2/2 | 0/1 | | | 1/1 | 3/4 | 0/1 | 6/9 | 66.7% | 1 | 1 | | 1 | | 00:30:00 |
| 11 | 刘新然 | | | | | | | | | 0.0% | | 2 | | | | 00:26:41 |
| 13 | 张昊燃 | | | | | | | | | 0.0% | | | | | | 00:00:00 |
| 14 | 单中宝 | | | | | | | | | 0.0% | | | | | | 00:00:00 |
| 15 | 刘淇 | | | 0/1 | | 3/3 | | | 3/4 | 75.0% | | 1 | | | | 00:30:00 |
| 16 | 胡文柯 | | | | | | | | | 0.0% | | | | | | 00:00:00 |
| 17 | 徐鹏辉 | | | | | | | | | 0.0% | | | | | | 00:03:19 |
| 合计 | | 4/7 | 0/1 | 2/3 | 1/1 | 4/4 | 3/4 | 1/3 | 15/23 | 65.2% | 1 | 9 | | 1 | | |
| (守门员) | | | | | | | | | | | | | | | | |
| 1 | 苟嘉毅 | 1/5 | 2/7 | 0/2 | 1/3 | 0/4 | 0/1 | 0/1 | 4/23 | 17.4% | | | | | | 00:30:00 |
| 合计 | | 1/5 | 2/7 | 0/2 | 1/3 | 0/4 | 0/1 | 0/1 | 4/23 | 17.4% | | | | | | |

场上队员：得分/射门

守门员：救球/射门

| 全队合计 | 得分 | 被救 | 射失 | 击柱 | 封球 | 合计 | % |
|------|----|----|----|----|----|----|--------|
| 远射 | 4 | 2 | 1 | | | 7 | 57.1% |
| 近射 | | 1 | | | | 1 | 0.0% |
| 边射 | 2 | 1 | | | | 3 | 66.7% |
| 快攻 | 1 | | | | | 1 | 100.0% |
| 突破 | 4 | | | | | 4 | 100.0% |
| 任意 | 3 | 1 | | | | 4 | 75.0% |
| 七米 | 1 | | 1 | 1 | | 3 | 33.3% |

图式比赛技术统计表

手球
青年男子

预赛
轮次 3

组别 A
场次 14

滁州国际手球馆
2019-05-29 17:00

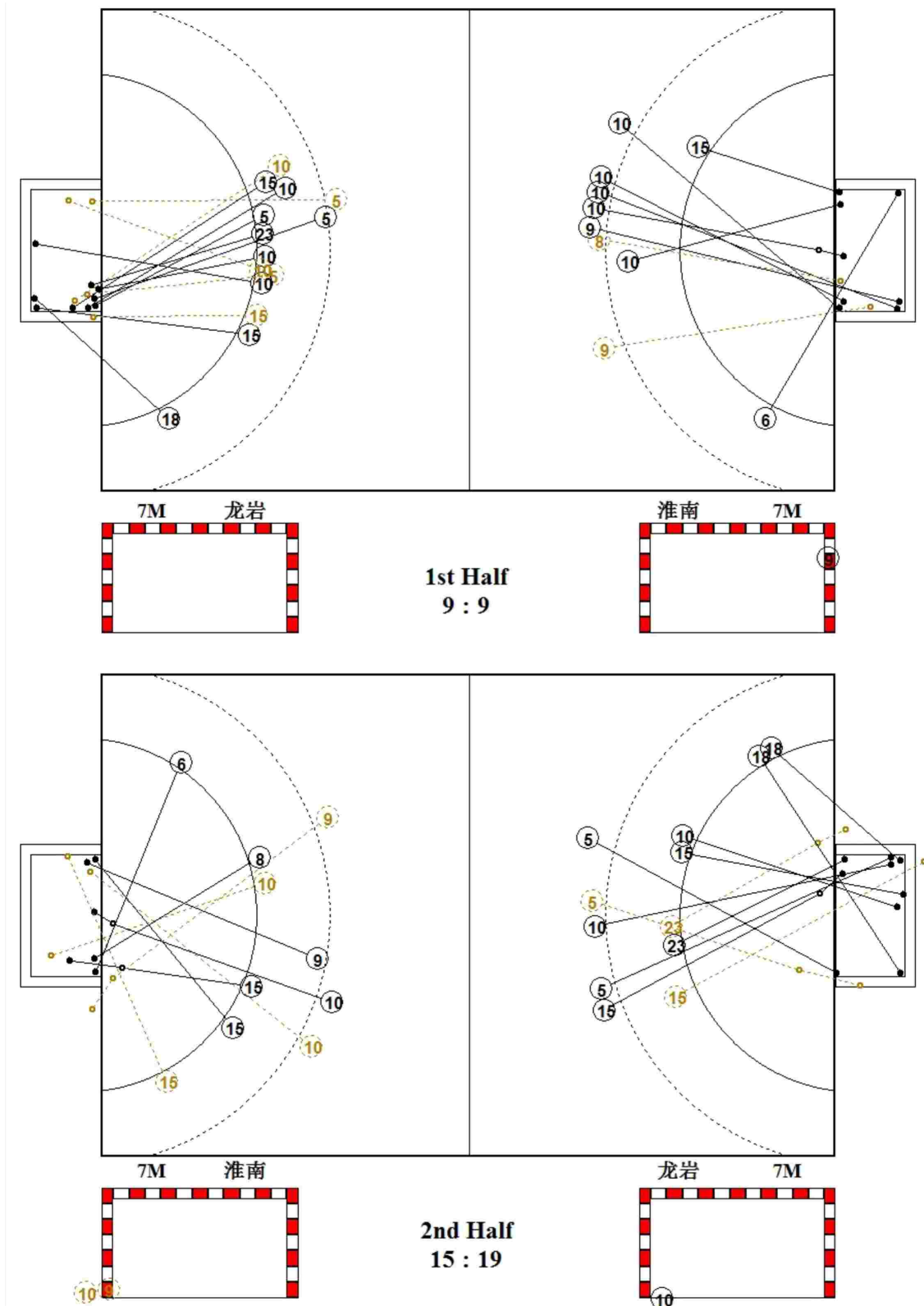

图式射门区域统计

手球
青年男子

预赛
轮次 3

组别 A
场次 14

滁州国际手球馆
2019-05-29 17:00

福建龙岩

| | | | | | | | | | | | | | | | | | | | | | | | | | | | | | | | | | | | | | | | | | | | | | | | | | | | | | | | | | | | | | | | | | | | | | | | | | | | | | | | |
|--|-----------------------------|-----------------------------|-----------------------------|-----------------------------|-----------------------------|-----------------------------|-----------------------------|--|--|---|---|--|--|---|--|---|--|--|--|--|---|--|---|--|--|--|--|--|--|--|--|--|--|--|--|--|--|--|--|---|--|--|--|--|--|--|---|--|--|--|--|--|--|--|--|--|--|--|--|---|---|---|--|---|--|--|--|--|--|--|---|---|--|---|--|--|---|--|--|
| 1 刘子豪 | 5 郭雨强 | 6 刘阳 | 7 王晨旭 | 8 杨鑫祥 | 9 荆胤丞 | 10 赵一 | 15 刘家良 | | | | | | | | | | | | | | | | | | | | | | | | | | | | | | | | | | | | | | | | | | | | | | | | | | | | | | | | | | | | | | | | | | | | | | | | |
| <table border="1"><tr><td></td><td></td><td></td></tr><tr><td></td><td></td><td></td></tr><tr><td></td><td></td><td></td></tr></table> | | | | | | | | | | <table border="1"><tr><td>1</td><td></td><td></td></tr><tr><td>2</td><td></td><td>1</td></tr><tr><td></td><td></td><td></td></tr></table> | 1 | | | 2 | | 1 | | | | <table border="1"><tr><td></td><td></td><td></td></tr><tr><td></td><td></td><td></td></tr><tr><td></td><td></td><td></td></tr></table> | | | | | | | | | | <table border="1"><tr><td></td><td></td><td></td></tr><tr><td></td><td></td><td></td></tr><tr><td></td><td></td><td></td></tr></table> | | | | | | | | | | <table border="1"><tr><td></td><td></td><td></td></tr><tr><td></td><td></td><td></td></tr><tr><td></td><td></td><td></td></tr></table> | | | | | | | | | | <table border="1"><tr><td></td><td></td><td></td></tr><tr><td></td><td></td><td></td></tr><tr><td></td><td></td><td></td></tr></table> | | | | | | | | | | <table border="1"><tr><td>1</td><td>2</td><td></td></tr><tr><td>3</td><td></td><td></td></tr><tr><td></td><td></td><td></td></tr></table> | 1 | 2 | | 3 | | | | | | <table border="1"><tr><td>1</td><td>1</td><td></td></tr><tr><td>1</td><td></td><td></td></tr><tr><td>1</td><td></td><td></td></tr></table> | 1 | 1 | | 1 | | | 1 | | |
| | | | | | | | | | | | | | | | | | | | | | | | | | | | | | | | | | | | | | | | | | | | | | | | | | | | | | | | | | | | | | | | | | | | | | | | | | | | | | | | |
| | | | | | | | | | | | | | | | | | | | | | | | | | | | | | | | | | | | | | | | | | | | | | | | | | | | | | | | | | | | | | | | | | | | | | | | | | | | | | | | |
| | | | | | | | | | | | | | | | | | | | | | | | | | | | | | | | | | | | | | | | | | | | | | | | | | | | | | | | | | | | | | | | | | | | | | | | | | | | | | | | |
| 1 | | | | | | | | | | | | | | | | | | | | | | | | | | | | | | | | | | | | | | | | | | | | | | | | | | | | | | | | | | | | | | | | | | | | | | | | | | | | | | | |
| 2 | | 1 | | | | | | | | | | | | | | | | | | | | | | | | | | | | | | | | | | | | | | | | | | | | | | | | | | | | | | | | | | | | | | | | | | | | | | | | | | | | | |
| | | | | | | | | | | | | | | | | | | | | | | | | | | | | | | | | | | | | | | | | | | | | | | | | | | | | | | | | | | | | | | | | | | | | | | | | | | | | | | | |
| | | | | | | | | | | | | | | | | | | | | | | | | | | | | | | | | | | | | | | | | | | | | | | | | | | | | | | | | | | | | | | | | | | | | | | | | | | | | | | | |
| | | | | | | | | | | | | | | | | | | | | | | | | | | | | | | | | | | | | | | | | | | | | | | | | | | | | | | | | | | | | | | | | | | | | | | | | | | | | | | | |
| | | | | | | | | | | | | | | | | | | | | | | | | | | | | | | | | | | | | | | | | | | | | | | | | | | | | | | | | | | | | | | | | | | | | | | | | | | | | | | | |
| | | | | | | | | | | | | | | | | | | | | | | | | | | | | | | | | | | | | | | | | | | | | | | | | | | | | | | | | | | | | | | | | | | | | | | | | | | | | | | | |
| | | | | | | | | | | | | | | | | | | | | | | | | | | | | | | | | | | | | | | | | | | | | | | | | | | | | | | | | | | | | | | | | | | | | | | | | | | | | | | | |
| | | | | | | | | | | | | | | | | | | | | | | | | | | | | | | | | | | | | | | | | | | | | | | | | | | | | | | | | | | | | | | | | | | | | | | | | | | | | | | | |
| | | | | | | | | | | | | | | | | | | | | | | | | | | | | | | | | | | | | | | | | | | | | | | | | | | | | | | | | | | | | | | | | | | | | | | | | | | | | | | | |
| | | | | | | | | | | | | | | | | | | | | | | | | | | | | | | | | | | | | | | | | | | | | | | | | | | | | | | | | | | | | | | | | | | | | | | | | | | | | | | | |
| | | | | | | | | | | | | | | | | | | | | | | | | | | | | | | | | | | | | | | | | | | | | | | | | | | | | | | | | | | | | | | | | | | | | | | | | | | | | | | | |
| | | | | | | | | | | | | | | | | | | | | | | | | | | | | | | | | | | | | | | | | | | | | | | | | | | | | | | | | | | | | | | | | | | | | | | | | | | | | | | | |
| | | | | | | | | | | | | | | | | | | | | | | | | | | | | | | | | | | | | | | | | | | | | | | | | | | | | | | | | | | | | | | | | | | | | | | | | | | | | | | | |
| | | | | | | | | | | | | | | | | | | | | | | | | | | | | | | | | | | | | | | | | | | | | | | | | | | | | | | | | | | | | | | | | | | | | | | | | | | | | | | | |
| 1 | 2 | | | | | | | | | | | | | | | | | | | | | | | | | | | | | | | | | | | | | | | | | | | | | | | | | | | | | | | | | | | | | | | | | | | | | | | | | | | | | | |
| 3 | | | | | | | | | | | | | | | | | | | | | | | | | | | | | | | | | | | | | | | | | | | | | | | | | | | | | | | | | | | | | | | | | | | | | | | | | | | | | | | |
| | | | | | | | | | | | | | | | | | | | | | | | | | | | | | | | | | | | | | | | | | | | | | | | | | | | | | | | | | | | | | | | | | | | | | | | | | | | | | | | |
| 1 | 1 | | | | | | | | | | | | | | | | | | | | | | | | | | | | | | | | | | | | | | | | | | | | | | | | | | | | | | | | | | | | | | | | | | | | | | | | | | | | | | |
| 1 | | | | | | | | | | | | | | | | | | | | | | | | | | | | | | | | | | | | | | | | | | | | | | | | | | | | | | | | | | | | | | | | | | | | | | | | | | | | | | | |
| 1 | | | | | | | | | | | | | | | | | | | | | | | | | | | | | | | | | | | | | | | | | | | | | | | | | | | | | | | | | | | | | | | | | | | | | | | | | | | | | | | |
| Post - 0 Miss - 0 Block - 0 | Post - 1 Miss - 0 Block - 0 | Post - 0 Miss - 0 Block - 0 | Post - 0 Miss - 0 Block - 0 | Post - 0 Miss - 0 Block - 0 | Post - 0 Miss - 0 Block - 0 | Post - 0 Miss - 0 Block - 0 | Post - 1 Miss - 1 Block - 0 | | | | | | | | | | | | | | | | | | | | | | | | | | | | | | | | | | | | | | | | | | | | | | | | | | | | | | | | | | | | | | | | | | | | | | | | |
| 16 李凯锋 | 17 陈锐涛 | 18 奚尧 | 21 刘晓青 | 23 朱天一 | 24 钟盛发 | 27 邓可帆 | 36 陈泽银 | | | | | | | | | | | | | | | | | | | | | | | | | | | | | | | | | | | | | | | | | | | | | | | | | | | | | | | | | | | | | | | | | | | | | | | | |
| <table border="1"><tr><td></td><td></td><td></td></tr><tr><td></td><td></td><td></td></tr><tr><td></td><td></td><td></td></tr></table> | | | | | | | | | | <table border="1"><tr><td></td><td></td><td></td></tr><tr><td></td><td></td><td></td></tr><tr><td></td><td></td><td></td></tr></table> | | | | | | | | | | <table border="1"><tr><td>2</td><td></td><td>1</td></tr><tr><td></td><td></td><td></td></tr><tr><td></td><td></td><td></td></tr></table> | 2 | | 1 | | | | | | | <table border="1"><tr><td></td><td></td><td></td></tr><tr><td></td><td></td><td></td></tr><tr><td></td><td></td><td></td></tr></table> | | | | | | | | | | <table border="1"><tr><td></td><td></td><td></td></tr><tr><td></td><td></td><td></td></tr><tr><td>2</td><td></td><td></td></tr></table> | | | | | | | 2 | | | <table border="1"><tr><td></td><td></td><td></td></tr><tr><td></td><td></td><td></td></tr><tr><td></td><td></td><td></td></tr></table> | | | | | | | | | | <table border="1"><tr><td></td><td></td><td></td></tr><tr><td></td><td></td><td></td></tr><tr><td></td><td></td><td></td></tr></table> | | | | | | | | | | <table border="1"><tr><td></td><td></td><td></td></tr><tr><td></td><td></td><td></td></tr><tr><td></td><td></td><td></td></tr></table> | | | | | | | | | |
| | | | | | | | | | | | | | | | | | | | | | | | | | | | | | | | | | | | | | | | | | | | | | | | | | | | | | | | | | | | | | | | | | | | | | | | | | | | | | | | |
| | | | | | | | | | | | | | | | | | | | | | | | | | | | | | | | | | | | | | | | | | | | | | | | | | | | | | | | | | | | | | | | | | | | | | | | | | | | | | | | |
| | | | | | | | | | | | | | | | | | | | | | | | | | | | | | | | | | | | | | | | | | | | | | | | | | | | | | | | | | | | | | | | | | | | | | | | | | | | | | | | |
| | | | | | | | | | | | | | | | | | | | | | | | | | | | | | | | | | | | | | | | | | | | | | | | | | | | | | | | | | | | | | | | | | | | | | | | | | | | | | | | |
| | | | | | | | | | | | | | | | | | | | | | | | | | | | | | | | | | | | | | | | | | | | | | | | | | | | | | | | | | | | | | | | | | | | | | | | | | | | | | | | |
| | | | | | | | | | | | | | | | | | | | | | | | | | | | | | | | | | | | | | | | | | | | | | | | | | | | | | | | | | | | | | | | | | | | | | | | | | | | | | | | |
| 2 | | 1 | | | | | | | | | | | | | | | | | | | | | | | | | | | | | | | | | | | | | | | | | | | | | | | | | | | | | | | | | | | | | | | | | | | | | | | | | | | | | |
| | | | | | | | | | | | | | | | | | | | | | | | | | | | | | | | | | | | | | | | | | | | | | | | | | | | | | | | | | | | | | | | | | | | | | | | | | | | | | | | |
| | | | | | | | | | | | | | | | | | | | | | | | | | | | | | | | | | | | | | | | | | | | | | | | | | | | | | | | | | | | | | | | | | | | | | | | | | | | | | | | |
| | | | | | | | | | | | | | | | | | | | | | | | | | | | | | | | | | | | | | | | | | | | | | | | | | | | | | | | | | | | | | | | | | | | | | | | | | | | | | | | |
| | | | | | | | | | | | | | | | | | | | | | | | | | | | | | | | | | | | | | | | | | | | | | | | | | | | | | | | | | | | | | | | | | | | | | | | | | | | | | | | |
| | | | | | | | | | | | | | | | | | | | | | | | | | | | | | | | | | | | | | | | | | | | | | | | | | | | | | | | | | | | | | | | | | | | | | | | | | | | | | | | |
| | | | | | | | | | | | | | | | | | | | | | | | | | | | | | | | | | | | | | | | | | | | | | | | | | | | | | | | | | | | | | | | | | | | | | | | | | | | | | | | |
| | | | | | | | | | | | | | | | | | | | | | | | | | | | | | | | | | | | | | | | | | | | | | | | | | | | | | | | | | | | | | | | | | | | | | | | | | | | | | | | |
| 2 | | | | | | | | | | | | | | | | | | | | | | | | | | | | | | | | | | | | | | | | | | | | | | | | | | | | | | | | | | | | | | | | | | | | | | | | | | | | | | | |
| | | | | | | | | | | | | | | | | | | | | | | | | | | | | | | | | | | | | | | | | | | | | | | | | | | | | | | | | | | | | | | | | | | | | | | | | | | | | | | | |
| | | | | | | | | | | | | | | | | | | | | | | | | | | | | | | | | | | | | | | | | | | | | | | | | | | | | | | | | | | | | | | | | | | | | | | | | | | | | | | | |
| | | | | | | | | | | | | | | | | | | | | | | | | | | | | | | | | | | | | | | | | | | | | | | | | | | | | | | | | | | | | | | | | | | | | | | | | | | | | | | | |
| | | | | | | | | | | | | | | | | | | | | | | | | | | | | | | | | | | | | | | | | | | | | | | | | | | | | | | | | | | | | | | | | | | | | | | | | | | | | | | | |
| | | | | | | | | | | | | | | | | | | | | | | | | | | | | | | | | | | | | | | | | | | | | | | | | | | | | | | | | | | | | | | | | | | | | | | | | | | | | | | | |
| | | | | | | | | | | | | | | | | | | | | | | | | | | | | | | | | | | | | | | | | | | | | | | | | | | | | | | | | | | | | | | | | | | | | | | | | | | | | | | | |
| | | | | | | | | | | | | | | | | | | | | | | | | | | | | | | | | | | | | | | | | | | | | | | | | | | | | | | | | | | | | | | | | | | | | | | | | | | | | | | | |
| | | | | | | | | | | | | | | | | | | | | | | | | | | | | | | | | | | | | | | | | | | | | | | | | | | | | | | | | | | | | | | | | | | | | | | | | | | | | | | | |
| | | | | | | | | | | | | | | | | | | | | | | | | | | | | | | | | | | | | | | | | | | | | | | | | | | | | | | | | | | | | | | | | | | | | | | | | | | | | | | | |
| Post - 0 Miss - 0 Block - 0 | Post - 0 Miss - 0 Block - 0 | Post - 0 Miss - 0 Block - 0 | Post - 0 Miss - 0 Block - 0 | Post - 0 Miss - 1 Block - 0 | Post - 0 Miss - 0 Block - 0 | Post - 0 Miss - 0 Block - 0 | Post - 0 Miss - 0 Block - 0 | | | | | | | | | | | | | | | | | | | | | | | | | | | | | | | | | | | | | | | | | | | | | | | | | | | | | | | | | | | | | | | | | | | | | | | | |

1 刘子豪

| | | |
|-----|-----|-----|
| 1/2 | | 0/3 |
| 0/1 | | 2/2 |
| 0/4 | 0/2 | 2/6 |

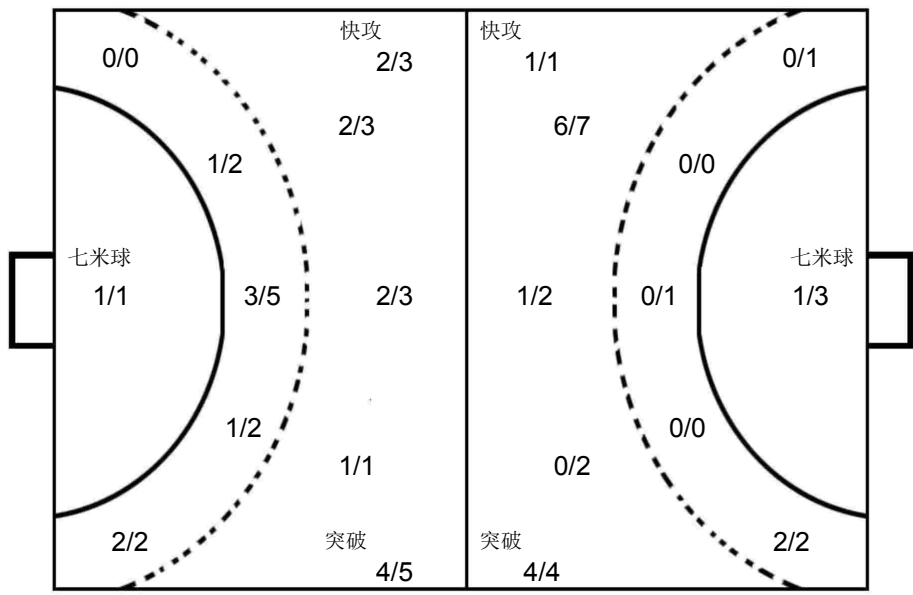

1 苟嘉毅

| | | |
|-----|-----|-----|
| 0/5 | 0/3 | 0/1 |
| 1/2 | | 1/1 |
| 1/9 | | 1/2 |

安徽淮南

| | | | | | | | | | | | | | | | | | | | | | | | | | | | | | | | | | | | | | | | | | | | | | | | | | | | | | | | | | | | | | | | | | | | | | | | | | | | | | | | |
|--|-----------------------------|-----------------------------|-----------------------------|-----------------------------|-----------------------------|-----------------------------|-----------------------------|--|--|--|--|--|---|---|---|---|--|--|--|--|--|--|--|--|--|--|--|--|--|--|--|--|--|--|--|--|--|--|--|--|--|--|--|--|--|--|--|--|--|---|---|--|--|---|--|--|---|--|---|--|--|--|--|--|--|--|--|--|--|--|--|--|--|--|--|--|--|--|--|
| 1 苟嘉毅 | 2 邹俊洁 | 3 童守宣 | 4 李攀 | 5 吴修民 | 6 童浩宇 | 7 赵琨鹏 | 8 陈子涵 | | | | | | | | | | | | | | | | | | | | | | | | | | | | | | | | | | | | | | | | | | | | | | | | | | | | | | | | | | | | | | | | | | | | | | | | |
| <table border="1"><tr><td></td><td></td><td></td></tr><tr><td></td><td></td><td></td></tr><tr><td></td><td></td><td></td></tr></table> | | | | | | | | | | <table border="1"><tr><td></td><td></td><td></td></tr><tr><td></td><td></td><td></td></tr><tr><td></td><td></td><td></td></tr></table> | | | | | | | | | | <table border="1"><tr><td></td><td></td><td></td></tr><tr><td></td><td></td><td></td></tr><tr><td></td><td></td><td></td></tr></table> | | | | | | | | | | <table border="1"><tr><td></td><td></td><td></td></tr><tr><td></td><td></td><td></td></tr><tr><td></td><td></td><td></td></tr></table> | | | | | | | | | | <table border="1"><tr><td></td><td></td><td></td></tr><tr><td></td><td></td><td></td></tr><tr><td></td><td></td><td></td></tr></table> | | | | | | | | | | <table border="1"><tr><td>1</td><td></td><td></td></tr><tr><td>1</td><td></td><td></td></tr><tr><td></td><td></td><td></td></tr></table> | 1 | | | 1 | | | | | | <table border="1"><tr><td></td><td></td><td></td></tr><tr><td></td><td></td><td></td></tr><tr><td></td><td></td><td></td></tr></table> | | | | | | | | | | <table border="1"><tr><td></td><td></td><td></td></tr><tr><td></td><td></td><td></td></tr><tr><td></td><td></td><td></td></tr></table> | | | | | | | | | |
| | | | | | | | | | | | | | | | | | | | | | | | | | | | | | | | | | | | | | | | | | | | | | | | | | | | | | | | | | | | | | | | | | | | | | | | | | | | | | | | |
| | | | | | | | | | | | | | | | | | | | | | | | | | | | | | | | | | | | | | | | | | | | | | | | | | | | | | | | | | | | | | | | | | | | | | | | | | | | | | | | |
| | | | | | | | | | | | | | | | | | | | | | | | | | | | | | | | | | | | | | | | | | | | | | | | | | | | | | | | | | | | | | | | | | | | | | | | | | | | | | | | |
| | | | | | | | | | | | | | | | | | | | | | | | | | | | | | | | | | | | | | | | | | | | | | | | | | | | | | | | | | | | | | | | | | | | | | | | | | | | | | | | |
| | | | | | | | | | | | | | | | | | | | | | | | | | | | | | | | | | | | | | | | | | | | | | | | | | | | | | | | | | | | | | | | | | | | | | | | | | | | | | | | |
| | | | | | | | | | | | | | | | | | | | | | | | | | | | | | | | | | | | | | | | | | | | | | | | | | | | | | | | | | | | | | | | | | | | | | | | | | | | | | | | |
| | | | | | | | | | | | | | | | | | | | | | | | | | | | | | | | | | | | | | | | | | | | | | | | | | | | | | | | | | | | | | | | | | | | | | | | | | | | | | | | |
| | | | | | | | | | | | | | | | | | | | | | | | | | | | | | | | | | | | | | | | | | | | | | | | | | | | | | | | | | | | | | | | | | | | | | | | | | | | | | | | |
| | | | | | | | | | | | | | | | | | | | | | | | | | | | | | | | | | | | | | | | | | | | | | | | | | | | | | | | | | | | | | | | | | | | | | | | | | | | | | | | |
| | | | | | | | | | | | | | | | | | | | | | | | | | | | | | | | | | | | | | | | | | | | | | | | | | | | | | | | | | | | | | | | | | | | | | | | | | | | | | | | |
| | | | | | | | | | | | | | | | | | | | | | | | | | | | | | | | | | | | | | | | | | | | | | | | | | | | | | | | | | | | | | | | | | | | | | | | | | | | | | | | |
| | | | | | | | | | | | | | | | | | | | | | | | | | | | | | | | | | | | | | | | | | | | | | | | | | | | | | | | | | | | | | | | | | | | | | | | | | | | | | | | |
| | | | | | | | | | | | | | | | | | | | | | | | | | | | | | | | | | | | | | | | | | | | | | | | | | | | | | | | | | | | | | | | | | | | | | | | | | | | | | | | |
| | | | | | | | | | | | | | | | | | | | | | | | | | | | | | | | | | | | | | | | | | | | | | | | | | | | | | | | | | | | | | | | | | | | | | | | | | | | | | | | |
| | | | | | | | | | | | | | | | | | | | | | | | | | | | | | | | | | | | | | | | | | | | | | | | | | | | | | | | | | | | | | | | | | | | | | | | | | | | | | | | |
| 1 | | | | | | | | | | | | | | | | | | | | | | | | | | | | | | | | | | | | | | | | | | | | | | | | | | | | | | | | | | | | | | | | | | | | | | | | | | | | | | | |
| 1 | | | | | | | | | | | | | | | | | | | | | | | | | | | | | | | | | | | | | | | | | | | | | | | | | | | | | | | | | | | | | | | | | | | | | | | | | | | | | | | |
| | | | | | | | | | | | | | | | | | | | | | | | | | | | | | | | | | | | | | | | | | | | | | | | | | | | | | | | | | | | | | | | | | | | | | | | | | | | | | | | |
| | | | | | | | | | | | | | | | | | | | | | | | | | | | | | | | | | | | | | | | | | | | | | | | | | | | | | | | | | | | | | | | | | | | | | | | | | | | | | | | |
| | | | | | | | | | | | | | | | | | | | | | | | | | | | | | | | | | | | | | | | | | | | | | | | | | | | | | | | | | | | | | | | | | | | | | | | | | | | | | | | |
| | | | | | | | | | | | | | | | | | | | | | | | | | | | | | | | | | | | | | | | | | | | | | | | | | | | | | | | | | | | | | | | | | | | | | | | | | | | | | | | |
| | | | | | | | | | | | | | | | | | | | | | | | | | | | | | | | | | | | | | | | | | | | | | | | | | | | | | | | | | | | | | | | | | | | | | | | | | | | | | | | |
| | | | | | | | | | | | | | | | | | | | | | | | | | | | | | | | | | | | | | | | | | | | | | | | | | | | | | | | | | | | | | | | | | | | | | | | | | | | | | | | |
| | | | | | | | | | | | | | | | | | | | | | | | | | | | | | | | | | | | | | | | | | | | | | | | | | | | | | | | | | | | | | | | | | | | | | | | | | | | | | | | |
| Post - 0 Miss - 0 Block - 0 | Post - 0 Miss - 0 Block - 0 | Post - 0 Miss - 0 Block - 0 | Post - 0 Miss - 0 Block - 0 | Post - 0 Miss - 0 Block - 0 | Post - 0 Miss - 0 Block - 0 | Post - 0 Miss - 0 Block - 0 | Post - 0 Miss - 0 Block - 0 | | | | | | | | | | | | | | | | | | | | | | | | | | | | | | | | | | | | | | | | | | | | | | | | | | | | | | | | | | | | | | | | | | | | | | | | |
| 9 杨金龙 | 10 孙飞扬 | 11 刘新然 | 13 张昊燃 | 14 单中宝 | 15 刘淇 | 16 胡文柯 | 17 徐鹏辉 | | | | | | | | | | | | | | | | | | | | | | | | | | | | | | | | | | | | | | | | | | | | | | | | | | | | | | | | | | | | | | | | | | | | | | | | |
| <table border="1"><tr><td></td><td></td><td>2</td></tr><tr><td></td><td></td><td>1</td></tr><tr><td></td><td></td><td></td></tr></table> | | | 2 | | | 1 | | | | <table border="1"><tr><td></td><td></td><td>1</td></tr><tr><td>1</td><td>2</td><td>2</td></tr><tr><td></td><td></td><td></td></tr></table> | | | 1 | 1 | 2 | 2 | | | | <table border="1"><tr><td></td><td></td><td></td></tr><tr><td></td><td></td><td></td></tr><tr><td></td><td></td><td></td></tr></table> | | | | | | | | | | <table border="1"><tr><td></td><td></td><td></td></tr><tr><td></td><td></td><td></td></tr><tr><td></td><td></td><td></td></tr></table> | | | | | | | | | | <table border="1"><tr><td></td><td></td><td></td></tr><tr><td></td><td></td><td></td></tr><tr><td></td><td></td><td></td></tr></table> | | | | | | | | | | <table border="1"><tr><td></td><td></td><td></td></tr><tr><td>1</td><td></td><td></td></tr><tr><td>1</td><td></td><td>1</td></tr></table> | | | | 1 | | | 1 | | 1 | <table border="1"><tr><td></td><td></td><td></td></tr><tr><td></td><td></td><td></td></tr><tr><td></td><td></td><td></td></tr></table> | | | | | | | | | | <table border="1"><tr><td></td><td></td><td></td></tr><tr><td></td><td></td><td></td></tr><tr><td></td><td></td><td></td></tr></table> | | | | | | | | | |
| | | 2 | | | | | | | | | | | | | | | | | | | | | | | | | | | | | | | | | | | | | | | | | | | | | | | | | | | | | | | | | | | | | | | | | | | | | | | | | | | | | |
| | | 1 | | | | | | | | | | | | | | | | | | | | | | | | | | | | | | | | | | | | | | | | | | | | | | | | | | | | | | | | | | | | | | | | | | | | | | | | | | | | | |
| | | | | | | | | | | | | | | | | | | | | | | | | | | | | | | | | | | | | | | | | | | | | | | | | | | | | | | | | | | | | | | | | | | | | | | | | | | | | | | | |
| | | 1 | | | | | | | | | | | | | | | | | | | | | | | | | | | | | | | | | | | | | | | | | | | | | | | | | | | | | | | | | | | | | | | | | | | | | | | | | | | | | |
| 1 | 2 | 2 | | | | | | | | | | | | | | | | | | | | | | | | | | | | | | | | | | | | | | | | | | | | | | | | | | | | | | | | | | | | | | | | | | | | | | | | | | | | | |
| | | | | | | | | | | | | | | | | | | | | | | | | | | | | | | | | | | | | | | | | | | | | | | | | | | | | | | | | | | | | | | | | | | | | | | | | | | | | | | | |
| | | | | | | | | | | | | | | | | | | | | | | | | | | | | | | | | | | | | | | | | | | | | | | | | | | | | | | | | | | | | | | | | | | | | | | | | | | | | | | | |
| | | | | | | | | | | | | | | | | | | | | | | | | | | | | | | | | | | | | | | | | | | | | | | | | | | | | | | | | | | | | | | | | | | | | | | | | | | | | | | | |
| | | | | | | | | | | | | | | | | | | | | | | | | | | | | | | | | | | | | | | | | | | | | | | | | | | | | | | | | | | | | | | | | | | | | | | | | | | | | | | | |
| | | | | | | | | | | | | | | | | | | | | | | | | | | | | | | | | | | | | | | | | | | | | | | | | | | | | | | | | | | | | | | | | | | | | | | | | | | | | | | | |
| | | | | | | | | | | | | | | | | | | | | | | | | | | | | | | | | | | | | | | | | | | | | | | | | | | | | | | | | | | | | | | | | | | | | | | | | | | | | | | | |
| | | | | | | | | | | | | | | | | | | | | | | | | | | | | | | | | | | | | | | | | | | | | | | | | | | | | | | | | | | | | | | | | | | | | | | | | | | | | | | | |
| | | | | | | | | | | | | | | | | | | | | | | | | | | | | | | | | | | | | | | | | | | | | | | | | | | | | | | | | | | | | | | | | | | | | | | | | | | | | | | | |
| | | | | | | | | | | | | | | | | | | | | | | | | | | | | | | | | | | | | | | | | | | | | | | | | | | | | | | | | | | | | | | | | | | | | | | | | | | | | | | | |
| | | | | | | | | | | | | | | | | | | | | | | | | | | | | | | | | | | | | | | | | | | | | | | | | | | | | | | | | | | | | | | | | | | | | | | | | | | | | | | | |
| | | | | | | | | | | | | | | | | | | | | | | | | | | | | | | | | | | | | | | | | | | | | | | | | | | | | | | | | | | | | | | | | | | | | | | | | | | | | | | | |
| 1 | | | | | | | | | | | | | | | | | | | | | | | | | | | | | | | | | | | | | | | | | | | | | | | | | | | | | | | | | | | | | | | | | | | | | | | | | | | | | | | |
| 1 | | 1 | | | | | | | | | | | | | | | | | | | | | | | | | | | | | | | | | | | | | | | | | | | | | | | | | | | | | | | | | | | | | | | | | | | | | | | | | | | | | |
| | | | | | | | | | | | | | | | | | | | | | | | | | | | | | | | | | | | | | | | | | | | | | | | | | | | | | | | | | | | | | | | | | | | | | | | | | | | | | | | |
| | | | | | | | | | | | | | | | | | | | | | | | | | | | | | | | | | | | | | | | | | | | | | | | | | | | | | | | | | | | | | | | | | | | | | | | | | | | | | | | |
| | | | | | | | | | | | | | | | | | | | | | | | | | | | | | | | | | | | | | | | | | | | | | | | | | | | | | | | | | | | | | | | | | | | | | | | | | | | | | | | |
| | | | | | | | | | | | | | | | | | | | | | | | | | | | | | | | | | | | | | | | | | | | | | | | | | | | | | | | | | | | | | | | | | | | | | | | | | | | | | | | |
| | | | | | | | | | | | | | | | | | | | | | | | | | | | | | | | | | | | | | | | | | | | | | | | | | | | | | | | | | | | | | | | | | | | | | | | | | | | | | | | |
| | | | | | | | | | | | | | | | | | | | | | | | | | | | | | | | | | | | | | | | | | | | | | | | | | | | | | | | | | | | | | | | | | | | | | | | | | | | | | | | |
| Post - 1 Miss - 1 Block - 0 | Post - 0 Miss - 1 Block - 0 | Post - 0 Miss - 0 Block - 0 | Post - 0 Miss - 0 Block - 0 | Post - 0 Miss - 0 Block - 0 | Post - 0 Miss - 0 Block - 0 | Post - 0 Miss - 0 Block - 0 | Post - 0 Miss - 0 Block - 0 | | | | | | | | | | | | | | | | | | | | | | | | | | | | | | | | | | | | | | | | | | | | | | | | | | | | | | | | | | | | | | | | | | | | | | | | |



PHMS Pictorial Handball Match Statistics **IHF** Official System

| | | |
|-------------------------|-------------------------|---------------------------|
| Team A A 辽宁抚顺 | Team B B 安徽淮南 | Match Number 18 |
|-------------------------|-------------------------|---------------------------|

| | | | | | |
|-------------------|------------------------|------------------|-------------|-------|------------|
| Played in 安徽滁州 | in the hall 滁州国际手球馆 | on 2019-05-31 | at 14:00 | hours | Spectators |
|-------------------|------------------------|------------------|-------------|-------|------------|

| | | | | | | | | | | | | | | |
|----------------|---------|--------|---------------------|---------|---------|----------------|---|---|----------------|---|---|----------------------|---------|---------|
| Half-time(30') | A 10 | B 8 | End of playing time | A 17 | B 17 | 1st extra time | A | B | 2nd extra time | A | B | After penalty throws | A 25 | B 26 |
|----------------|---------|--------|---------------------|---------|---------|----------------|---|---|----------------|---|---|----------------------|---------|---------|

| | | | | | | | | | | |
|---------------|------------|---------------|---|------------|------------------------------------|---------------|---|--|-----------|---------------|
| Number of 7 m | A 9/13 | Team time-out | | | Full name of players and officials | Team time-out | | | B 9/12 | Number of 7 m |
| | 1 09:36 | 2 38:12 | 3 | 1 07:14 | | 2 44:21 | 3 | | | |

| No. | Team A | G | W | 2' | D | DR | No. | Team B | G | W | 2' | D | DR |
|-----|--------|---|---|----|---|----|-----|-----------|---|---|----|---|----|
| 2 | 赫天铭 | | | | | | 1 | 苟嘉毅 | | | | | |
| 5 | 王梓翺 | | | | | | 2 | 邹俊洁 | | | | | |
| 6 | 尚禹辰 | 1 | | | | | 3 | 童守宣 | | | | | |
| 7 | 张羽虹冰 | | | | | | 4 | 李攀 | | | | | |
| 9 | 隋博 | 3 | | | | | 5 | 吴修民 | | | | | |
| 11 | 陈思 | | | | | | 6 | 童浩宇 | 4 | | | | |
| 13 | 高鑫 | 8 | | | | | 7 | 赵琨鹏 | | | | | |
| 17 | 杨宇 | 6 | 1 | | | | 8 | 陈子涵 | 5 | 1 | | | |
| 19 | 靳皓童 | 4 | | | | | 9 | 杨金龙 | 7 | | | | |
| 22 | 杨辰 | | | | | | 10 | 孙飞扬 | 6 | | 1 | | |
| 28 | 靳皓添 | 3 | | | | | 11 | 刘新然 | 2 | | | | |
| 32 | 袁梓赫 | | | | | | 13 | 张昊燃 | | | | | |
| | | | | | | | 14 | 单中宝 | | | | | |
| | | | | | | | 15 | 刘淇 | | | | | |
| | | | | | | | 16 | 胡文柯 | | | | | |
| | | | | | | | 17 | 徐鹏辉 | 2 | | | | |
| C | 刘启迪 | | | | | | A | 常洪飞 | | | | | |
| | | | | | | | B | 阮圣杰 (主教练) | | | | | |

| | | |
|---|--|---|
| A | Signatures of responsables for the teams (Off.A) | B |
|---|--|---|

| | | |
|----|-----------------------------------|----|
| TP | Remarks of referees / HF Official | TP |
|----|-----------------------------------|----|

| | | | |
|------------|-----------|-----------|--|
| Signatures | | | |
| Referees | 徐健 (CHN) | 康曦 (CHN) | |
| T.D. | 吴国忠 (CHN) | 龙佩莉 (CHN) | |
| CHA Off. | | | |

Note: Number of 7m Throws Awarded to Team A and B, Goals (G), Warnings (W), Suspensions (2'), Direct Disqualification (D), Disqualification With Report (DR) and Team Penalty (TP).

Table Officials: 李莉君 吴荣 统计人员: 沈家洛 马安兴

竞赛技术统计

手球
青年男子

预赛
轮次 3

组别 A
场次 18

滁州国际手球馆
2019-05-31 14:00

| | | | |
|-----------|------------------------|---------|--------------|
| Referees: | 徐健 (CHN) / 康曦 (CHN) | Result: | 25:26 (10:8) |
| Teams: | 辽宁抚顺 (抚顺) VS 安徽淮南 (淮南) | | |

| 抚顺 | | 远射 | 近射 | 边射 | 快攻 | 突破 | 任意球 | 7m球 | 合计 | % | 助攻 | 失误 | 警告 | 2' | D+DR |
|---------|------|-----|-----|-----|-----|-----|-----|------|-------|------|----|----|----|----|------|
| 主教练: 徐毅 | | | | | | | | | | | | | | | |
| 2 | 赫天铭 | | | | | | | | | | | 1 | | | |
| 5 | 王梓翹 | | | | | | | | | | | | | | |
| 6 | 尚禹辰 | | | | | | | 1/2 | 1/2 | 50.0 | | | | | |
| 7 | 张羽虹冰 | | | 0/1 | | | | 0/1 | 0/1 | 0.0 | | 2 | | | |
| 9 | 隋博 | | 1/1 | 2/3 | | | | 3/4 | 3/4 | 75.0 | | 1 | | | |
| 11 | 陈思 | | | | | | | | | | | | | | |
| 13 | 高鑫 | | 2/2 | | | 2/2 | | 4/4 | 8/8 | 100 | | 2 | | | |
| 17 | 杨宇 | 2/4 | | | 1/2 | 3/3 | 0/1 | 0/2 | 6/12 | 50.0 | | 5 | 1 | | |
| 19 | 靳皓童 | | 1/1 | | 1/1 | | | 2/3 | 4/5 | 80.0 | 3 | 3 | | | |
| 22 | 杨辰 | | | | | | | | | | | | | | |
| 28 | 靳皓添 | | 1/2 | | | | | 2/2 | 3/4 | 75.0 | | 2 | | | |
| 32 | 袁梓赫 | | | | | | | | | | | | | | |
| 运动员 | 合计 | 2/4 | 5/6 | 2/4 | 2/3 | 5/5 | 0/1 | 9/13 | 25/36 | 69.4 | 3 | 16 | 1 | | |
| 2 | 赫天铭 | 1/6 | 1/4 | 2/6 | 1/4 | 0/2 | 1/1 | 3/11 | 9/34 | 26.5 | | 1 | | | |
| 32 | 袁梓赫 | | | | | | | 0/1 | 0/1 | 0.0 | | | | | |
| 守门员 | 合计 | 1/6 | 1/4 | 2/6 | 1/4 | 0/2 | 1/1 | 3/12 | 9/35 | 25.7 | | 1 | | | |

| 淮南 | | 远射 | 近射 | 边射 | 快攻 | 突破 | 任意球 | 7m球 | 合计 | % | 助攻 | 失误 | 警告 | 2' | D+DR |
|----------|-----|-----|-----|-----|-----|-----|-----|------|-------|------|----|----|----|----|------|
| 主教练: 阮圣杰 | | | | | | | | | | | | | | | |
| 1 | 苟嘉毅 | | | | | | | | | | | | | | |
| 2 | 邹俊洁 | | | | | | | | | | | | | | |
| 3 | 童守宣 | | | | | | | | | | | | | | |
| 4 | 李攀 | | | | | | | | | | | | | | |
| 5 | 吴修民 | | | | | | | | | | | | | | |
| 6 | 童浩宇 | | | 3/6 | | | | 1/2 | 4/8 | 50.0 | | 1 | | | |
| 7 | 赵琨鹏 | | | | | | | | | | | | | | |
| 8 | 陈子涵 | 3/4 | 0/1 | 1/1 | | | | 1/2 | 5/8 | 62.5 | 1 | 8 | 1 | | |
| 9 | 杨金龙 | 1/2 | | | 1/1 | 2/2 | | 3/3 | 7/8 | 87.5 | 1 | | | | |
| 10 | 孙飞扬 | 1/1 | 1/1 | | 1/2 | | 0/2 | 3/3 | 6/9 | 66.7 | 1 | 1 | | 1 | |
| 11 | 刘新然 | | 1/1 | | 0/1 | | | 1/2 | 2/4 | 50.0 | | 1 | | | |
| 13 | 张昊燃 | | | | | | | | | | | | | | |
| 14 | 单中宝 | | | | | | | | | | | | | | |
| 15 | 刘淇 | | | 0/1 | | | | 0/1 | 0/1 | 0.0 | | 1 | | | |
| 16 | 胡文柯 | | | | | | | | | | | | | | |
| 17 | 徐鹏辉 | | 1/1 | | 1/1 | | | 2/2 | 2/2 | 100 | | 2 | | | |
| 运动员 | 合计 | 5/7 | 3/4 | 4/8 | 3/5 | 2/2 | 0/2 | 9/12 | 26/40 | 65.0 | 3 | 14 | 1 | 1 | |
| 1 | 苟嘉毅 | 0/1 | 0/3 | 0/2 | 1/2 | 0/4 | | 1/4 | 2/16 | 12.5 | | | | | |
| 16 | 胡文柯 | 0/1 | 1/3 | 1/1 | 0/1 | 0/1 | | 2/8 | 4/15 | 26.7 | | | | | |
| 守门员 | 合计 | 0/2 | 1/6 | 1/3 | 1/3 | 0/5 | | 3/12 | 6/31 | 19.4 | | | | | |

| 抚顺 | 比赛进程 | 淮南 |
|----------|----------|-----------|
| 1st Half | | |
| 9 隋博 | 1 02:01 | 0 |
| | 1 02:19 | 1 10 孙飞扬 |
| 19 靳皓童 | 2 03:17 | 1 |
| | 2 03:32 | 2 8 陈子涵 |
| 13 高鑫 | 3 04:13 | 2 |
| | 3 04:50 | 3 6 童浩宇 |
| 13 高鑫 | 4 05:35 | 3 |
| 17 杨宇 | 5 06:06 | 3 |
| 9 隋博 | 6 07:01 | 3 |
| | 6 07:37 | 4 6 童浩宇 |
| | 6 08:36 | 5 10 孙飞扬 |
| | 6 09:02 | 6 11 刘新然 |
| | 6 09:25 | 7 8 陈子涵 |
| 19 靳皓童 | 7 09:53 | 7 |
| 28 靳皓添 | 8 10:35 | 7 |
| 17 杨宇 | 9 11:40 | 7 |
| | 9 12:24 | 8 9 杨金龙 |
| 17 杨宇 | 10 14:06 | 8 |
| 2nd Half | | |
| 17 杨宇 | 11 00:32 | 8 |
| 13 高鑫 | 12 01:18 | 8 |
| | 12 01:39 | 9 8 陈子涵 |
| 9 隋博 | 13 02:08 | 9 |
| 17 杨宇 | 14 03:36 | 9 |
| | 14 04:14 | 10 9 杨金龙 |
| | 14 05:32 | 11 17 徐鹏辉 |
| | 14 06:54 | 12 9 杨金龙 |
| | 14 07:58 | 13 17 徐鹏辉 |
| | 14 08:53 | 14 8 陈子涵 |
| | 14 09:37 | 15 9 杨金龙 |
| 13 高鑫 | 15 09:53 | 15 |
| | 15 10:39 | 16 6 童浩宇 |
| 17 杨宇 | 16 10:55 | 16 |
| | 16 12:17 | 17 10 孙飞扬 |
| 13 高鑫 | 17 14:00 | 17 |
| 7M | | |
| 13 高鑫 | 18 00:00 | 17 |
| | 18 00:00 | 18 9 杨金龙 |
| | 18 00:00 | 19 8 陈子涵 |
| 19 靳皓童 | 19 00:00 | 19 |
| 28 靳皓添 | 20 00:00 | 19 |
| | 20 00:00 | 20 10 孙飞扬 |
| | 20 00:00 | 21 9 杨金龙 |
| 13 高鑫 | 21 00:00 | 21 |
| | 21 00:00 | 22 10 孙飞扬 |
| 19 靳皓童 | 22 00:00 | 22 |
| | 22 00:00 | 23 6 童浩宇 |
| 28 靳皓添 | 23 00:00 | 23 |
| | 23 00:00 | 24 11 刘新然 |
| 6 尚禹辰 | 24 00:00 | 24 |
| 13 高鑫 | 25 00:00 | 24 |
| | 25 00:00 | 25 9 杨金龙 |
| | 25 00:00 | 26 10 孙飞扬 |

场上队员: 得分 / 射门

守门员: 救球 / 射门

| | | | |
|---|------|----|---------|
| D | 取消资格 | DR | 取消资格+报告 |
|---|------|----|---------|

个人/全队技术统计表

手球 预赛 组别 A 滁州国际手球馆
青年男子 轮次 3 场次 18 2019-05-31 14:00

| 号码 | 姓名 | 远射 | 近射 | 边射 | 快攻 | 突破 | 任意 | 七米 | 合计 | % | 助攻 | 失误 | 警告 | 2' | 取消 | 时间 |
|----------|------|-----|-----|-----|-----|-----|-----|------|-------|-------|----|----|----|----|----|----------|
| 辽宁抚顺(抚顺) | | | | | | | | | | | | | | | | |
| (场上队员) | | | | | | | | | | | | | | | | |
| 2 | 赫天铭 | | | | | | | | | 0.0% | | 1 | | | | 01:00:00 |
| 5 | 王梓翹 | | | | | | | | | 0.0% | | | | | | 00:00:00 |
| 6 | 尚禹辰 | | | | | | | 1/2 | 1/2 | 50.0% | | | | | | 00:01:02 |
| 7 | 张羽虹冰 | | | 0/1 | | | | | 0/1 | 0.0% | | 2 | | | | 00:30:00 |
| 9 | 隋博 | | 1/1 | 2/3 | | | | | 3/4 | 75.0% | | 1 | | | | 00:30:00 |
| 11 | 陈思 | | | | | | | | | 0.0% | | | | | | 00:00:00 |
| 13 | 高鑫 | | 2/2 | | | 2/2 | | 4/4 | 8/8 | 100% | | 2 | | | | 00:30:00 |
| 17 | 杨宇 | 2/4 | | | 1/2 | 3/3 | 0/1 | 0/2 | 6/12 | 50.0% | | 5 | 1 | | | 00:30:00 |
| 19 | 靳皓童 | | 1/1 | | 1/1 | | | 2/3 | 4/5 | 80.0% | 3 | 3 | | | | 00:58:56 |
| 22 | 杨辰 | | | | | | | | | 0.0% | | | | | | 00:00:00 |
| 28 | 靳皓添 | | 1/2 | | | | | 2/2 | 3/4 | 75.0% | | 2 | | | | 00:30:00 |
| 32 | 袁梓赫 | | | | | | | | | 0.0% | | | | | | 00:00:00 |
| 合计 | | 2/4 | 5/6 | 2/4 | 2/3 | 5/5 | 0/1 | 9/13 | 25/36 | 69.4% | 3 | 16 | 1 | | | |
| (守门员) | | | | | | | | | | | | | | | | |
| 2 | 赫天铭 | 1/6 | 1/4 | 2/6 | 1/4 | 0/2 | 1/1 | 3/11 | 9/34 | 26.5% | | 1 | | | | 01:00:00 |
| 32 | 袁梓赫 | | | | | | | 0/1 | 0/1 | 0.0% | | | | | | 00:00:00 |
| 合计 | | 1/6 | 1/4 | 2/6 | 1/4 | 0/2 | 1/1 | 3/12 | 9/35 | 25.7% | | 1 | | | | |

场上队员：得分/射门

守门员：救球/射门

| 全队合计 | 得分 | 被救 | 射失 | 击柱 | 封球 | 合计 | % |
|------|----|----|----|----|----|----|--------|
| 远射 | 2 | | | 1 | 1 | 4 | 50.0% |
| 近射 | 5 | 1 | | | | 6 | 83.3% |
| 边射 | 2 | 1 | | 1 | | 4 | 50.0% |
| 快攻 | 2 | 1 | | | | 3 | 66.7% |
| 突破 | 5 | | | | | 5 | 100.0% |
| 任意 | | | 1 | | | 1 | 0.0% |
| 七米 | 9 | 3 | 1 | | | 13 | 69.2% |

个人/全队技术统计表

手球 预赛 组别 A 滁州国际手球馆
青年男子 轮次 3 场次 18 2019-05-31 14:00

| 号码 | 姓名 | 远射 | 近射 | 边射 | 快攻 | 突破 | 任意 | 七米 | 合计 | % | 助攻 | 失误 | 警告 | 2' | 取消 | 时间 |
|----------|-----|-----|-----|-----|-----|-----|-----|------|-------|-------|----|----|----|----|----|----------|
| 安徽淮南(淮南) | | | | | | | | | | | | | | | | |
| (场上队员) | | | | | | | | | | | | | | | | |
| 1 | 苟嘉毅 | | | | | | | | | 0.0% | | | | | | 00:51:26 |
| 2 | 邹俊洁 | | | | | | | | | 0.0% | | | | | | 00:00:00 |
| 3 | 童守宣 | | | | | | | | | 0.0% | | | | | | 00:00:00 |
| 4 | 李攀 | | | | | | | | | 0.0% | | | | | | 00:00:00 |
| 5 | 吴修民 | | | | | | | | | 0.0% | | | | | | 00:00:00 |
| 6 | 童浩宇 | | | 3/6 | | | | 1/2 | 4/8 | 50.0% | | 1 | | | | 00:30:00 |
| 7 | 赵琨鹏 | | | | | | | | | 0.0% | | | | | | 00:01:52 |
| 8 | 陈子涵 | 3/4 | 0/1 | 1/1 | | | | 1/2 | 5/8 | 62.5% | 1 | 8 | 1 | | | 00:30:00 |
| 9 | 杨金龙 | 1/2 | | | 1/1 | 2/2 | | 3/3 | 7/8 | 87.5% | 1 | | | | | 00:30:00 |
| 10 | 孙飞扬 | 1/1 | 1/1 | | 1/2 | | 0/2 | 3/3 | 6/9 | 66.7% | 1 | 1 | | 1 | | 01:00:00 |
| 11 | 刘新然 | | 1/1 | | 0/1 | | | 1/2 | 2/4 | 50.0% | | 1 | | | | 00:25:53 |
| 13 | 张昊燃 | | | | | | | | | 0.0% | | | | | | 00:00:00 |
| 14 | 单中宝 | | | | | | | | | 0.0% | | | | | | 00:00:00 |
| 15 | 刘淇 | | | 0/1 | | | | | 0/1 | 0.0% | | 1 | | | | 00:05:54 |
| 16 | 胡文柯 | | | | | | | | | 0.0% | | | | | | 00:08:34 |
| 17 | 徐鹏辉 | | 1/1 | | 1/1 | | | | 2/2 | 100% | | 2 | | | | 00:26:19 |
| | 合计 | 5/7 | 3/4 | 4/8 | 3/5 | 2/2 | 0/2 | 9/12 | 26/40 | 65.0% | 3 | 14 | 1 | 1 | | |
| (守门员) | | | | | | | | | | | | | | | | |
| 1 | 苟嘉毅 | 0/1 | 0/3 | 0/2 | 1/2 | 0/4 | | 1/4 | 2/16 | 12.5% | | | | | | 00:51:26 |
| 16 | 胡文柯 | 0/1 | 1/3 | 1/1 | 0/1 | 0/1 | | 2/8 | 4/15 | 26.7% | | | | | | 00:08:34 |
| | 合计 | 0/2 | 1/6 | 1/3 | 1/3 | 0/5 | | 3/12 | 6/31 | 19.4% | | | | | | |

场上队员：得分/射门

守门员：救球/射门

| 全队合计 | 得分 | 被救 | 射失 | 击柱 | 封球 | 合计 | % |
|------|----|----|----|----|----|----|--------|
| 远射 | 5 | 1 | | 1 | | 7 | 71.4% |
| 近射 | 3 | 1 | | | | 4 | 75.0% |
| 边射 | 4 | 2 | 1 | 1 | | 8 | 50.0% |
| 快攻 | 3 | 1 | | 1 | | 5 | 60.0% |
| 突破 | 2 | | | | | 2 | 100.0% |
| 任意 | | 1 | 1 | | | 2 | 0.0% |
| 七米 | 9 | 3 | | | | 12 | 75.0% |

图式比赛技术统计表

手球
青年男子

预赛
轮次 3

组别 A
场次 18

滁州国际手球馆
2019-05-31 14:00

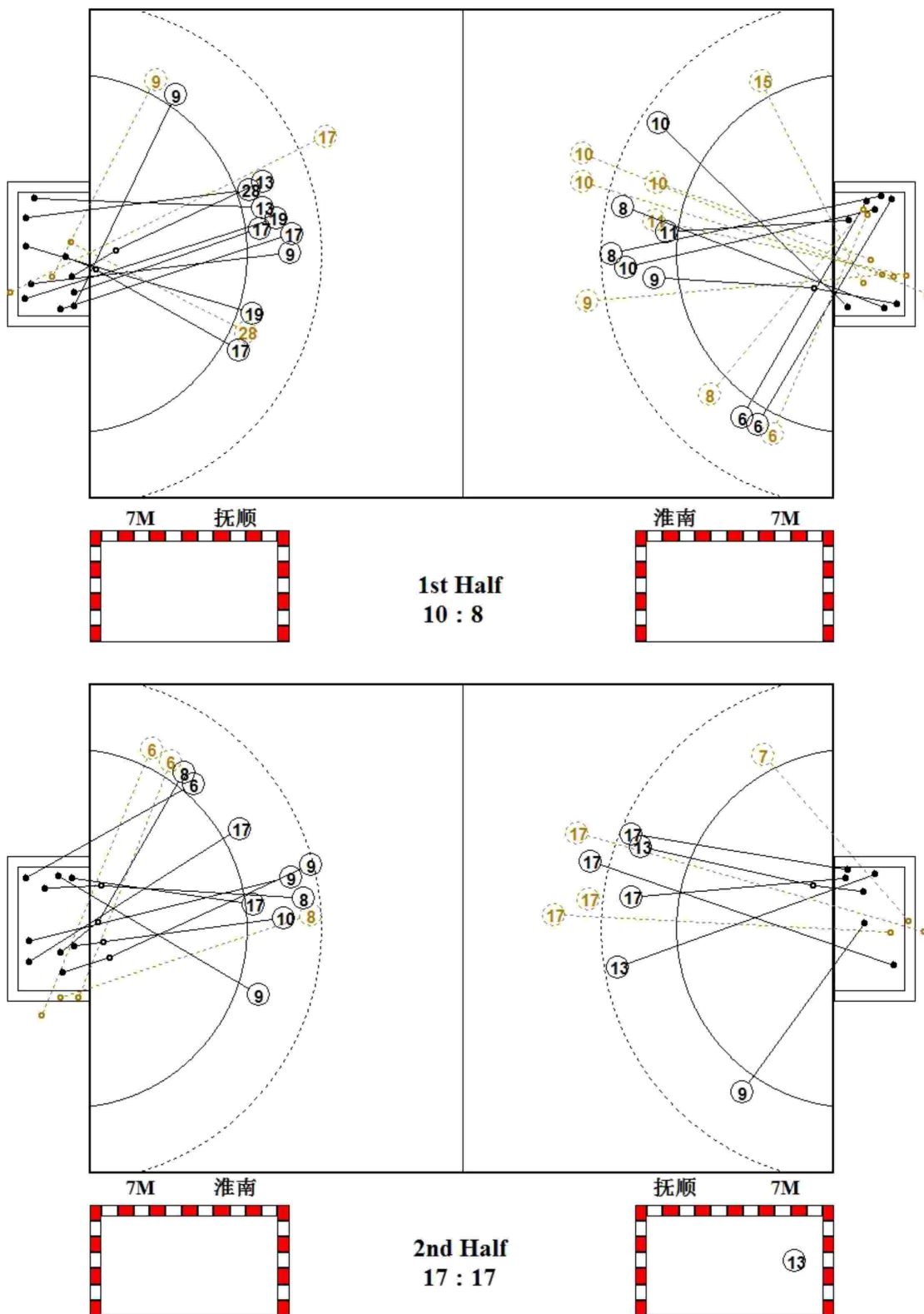

PICTORIAL MATCH STATISTICS

HANDBALL
青年男子

预赛
ROUND 3

GROUP A
MATCH 18

滁州国际手球馆
2019-05-31 14:00

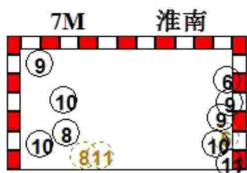
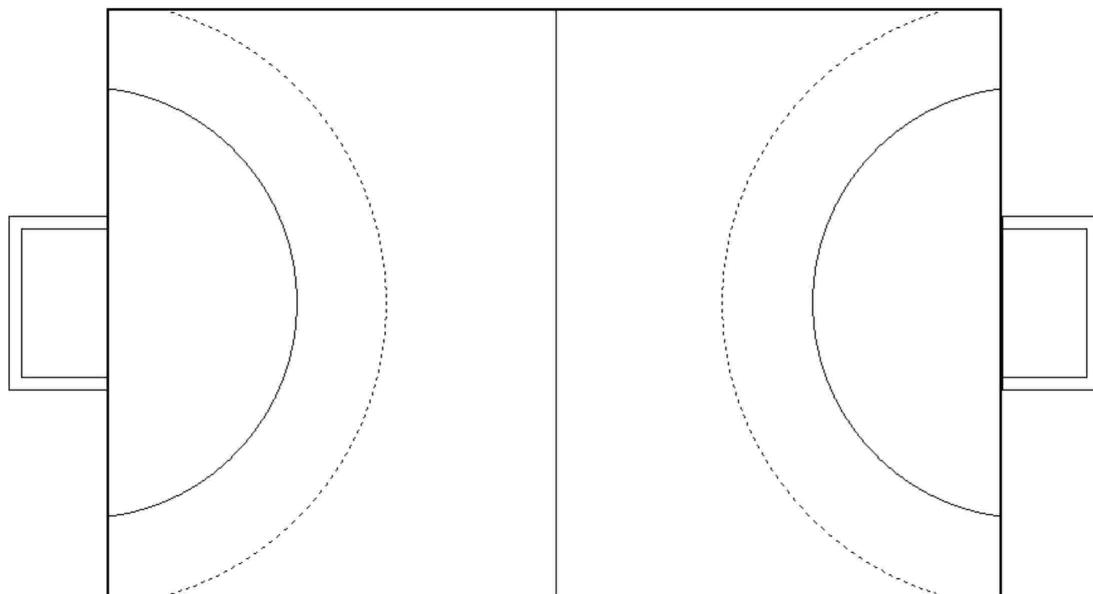

7M-Throw
26 : 25

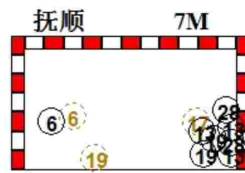

图式射门区域统计

手球
青年男子

预赛
轮次 3

组别 A
场次 18

滁州国际手球馆
2019-05-31 14:00

辽宁抚顺

| | | | | | | | | | | | | | | | | | | | | | | | | | | | | | | | | | | | | | | | | | | | | | | | | | | | | | | | | | | | | | | | | | | | | | | | | | | | | | | | |
|---|-------|--------|--------|------|-------|-------|--------|-----|-----|--|--|--|--|--|--|---|-----|-----|-----|---|-----|-----|-----|-----|-----|---|--|--|---|--|--|--|--|--|--|--|--|--|--|---|---|--|--|--|---|--|---|--|--|--|--|--|--|--|--|--|--|--|--|---|--|--|---|---|--|---|---|--|---|--|--|--|---|---|---|--|---|--|--|
| 2 赫天铭 | 5 王梓翊 | 6 尚禹辰 | 7 张羽虹冰 | 9 隋博 | 11 陈思 | 13 高鑫 | 17 杨宇 | | | | | | | | | | | | | | | | | | | | | | | | | | | | | | | | | | | | | | | | | | | | | | | | | | | | | | | | | | | | | | | | | | | | | | | | |
| <table border="1"><tr><td></td><td></td><td></td></tr><tr><td></td><td></td><td></td></tr><tr><td></td><td></td><td></td></tr></table> | | | | | | | | | | <table border="1"><tr><td></td><td></td><td></td></tr><tr><td></td><td></td><td></td></tr><tr><td></td><td></td><td></td></tr></table> | | | | | | | | | | <table border="1"><tr><td></td><td></td><td></td></tr><tr><td>1</td><td></td><td></td></tr><tr><td></td><td></td><td></td></tr></table> | | | | 1 | | | | | | <table border="1"><tr><td></td><td></td><td></td></tr><tr><td></td><td></td><td></td></tr><tr><td></td><td></td><td></td></tr></table> | | | | | | | | | | <table border="1"><tr><td>1</td><td></td><td></td></tr><tr><td></td><td>1</td><td></td></tr><tr><td>1</td><td></td><td></td></tr></table> | 1 | | | | 1 | | 1 | | | <table border="1"><tr><td></td><td></td><td></td></tr><tr><td></td><td></td><td></td></tr><tr><td></td><td></td><td></td></tr></table> | | | | | | | | | | <table border="1"><tr><td></td><td></td><td>1</td></tr><tr><td>2</td><td></td><td>3</td></tr><tr><td>1</td><td></td><td>1</td></tr></table> | | | 1 | 2 | | 3 | 1 | | 1 | <table border="1"><tr><td></td><td></td><td>1</td></tr><tr><td>1</td><td>1</td><td></td></tr><tr><td>3</td><td></td><td></td></tr></table> | | | 1 | 1 | 1 | | 3 | | |
| | | | | | | | | | | | | | | | | | | | | | | | | | | | | | | | | | | | | | | | | | | | | | | | | | | | | | | | | | | | | | | | | | | | | | | | | | | | | | | | |
| | | | | | | | | | | | | | | | | | | | | | | | | | | | | | | | | | | | | | | | | | | | | | | | | | | | | | | | | | | | | | | | | | | | | | | | | | | | | | | | |
| | | | | | | | | | | | | | | | | | | | | | | | | | | | | | | | | | | | | | | | | | | | | | | | | | | | | | | | | | | | | | | | | | | | | | | | | | | | | | | | |
| | | | | | | | | | | | | | | | | | | | | | | | | | | | | | | | | | | | | | | | | | | | | | | | | | | | | | | | | | | | | | | | | | | | | | | | | | | | | | | | |
| | | | | | | | | | | | | | | | | | | | | | | | | | | | | | | | | | | | | | | | | | | | | | | | | | | | | | | | | | | | | | | | | | | | | | | | | | | | | | | | |
| | | | | | | | | | | | | | | | | | | | | | | | | | | | | | | | | | | | | | | | | | | | | | | | | | | | | | | | | | | | | | | | | | | | | | | | | | | | | | | | |
| | | | | | | | | | | | | | | | | | | | | | | | | | | | | | | | | | | | | | | | | | | | | | | | | | | | | | | | | | | | | | | | | | | | | | | | | | | | | | | | |
| 1 | | | | | | | | | | | | | | | | | | | | | | | | | | | | | | | | | | | | | | | | | | | | | | | | | | | | | | | | | | | | | | | | | | | | | | | | | | | | | | | |
| | | | | | | | | | | | | | | | | | | | | | | | | | | | | | | | | | | | | | | | | | | | | | | | | | | | | | | | | | | | | | | | | | | | | | | | | | | | | | | | |
| | | | | | | | | | | | | | | | | | | | | | | | | | | | | | | | | | | | | | | | | | | | | | | | | | | | | | | | | | | | | | | | | | | | | | | | | | | | | | | | |
| | | | | | | | | | | | | | | | | | | | | | | | | | | | | | | | | | | | | | | | | | | | | | | | | | | | | | | | | | | | | | | | | | | | | | | | | | | | | | | | |
| | | | | | | | | | | | | | | | | | | | | | | | | | | | | | | | | | | | | | | | | | | | | | | | | | | | | | | | | | | | | | | | | | | | | | | | | | | | | | | | |
| 1 | | | | | | | | | | | | | | | | | | | | | | | | | | | | | | | | | | | | | | | | | | | | | | | | | | | | | | | | | | | | | | | | | | | | | | | | | | | | | | | |
| | 1 | | | | | | | | | | | | | | | | | | | | | | | | | | | | | | | | | | | | | | | | | | | | | | | | | | | | | | | | | | | | | | | | | | | | | | | | | | | | | | |
| 1 | | | | | | | | | | | | | | | | | | | | | | | | | | | | | | | | | | | | | | | | | | | | | | | | | | | | | | | | | | | | | | | | | | | | | | | | | | | | | | | |
| | | | | | | | | | | | | | | | | | | | | | | | | | | | | | | | | | | | | | | | | | | | | | | | | | | | | | | | | | | | | | | | | | | | | | | | | | | | | | | | |
| | | | | | | | | | | | | | | | | | | | | | | | | | | | | | | | | | | | | | | | | | | | | | | | | | | | | | | | | | | | | | | | | | | | | | | | | | | | | | | | |
| | | | | | | | | | | | | | | | | | | | | | | | | | | | | | | | | | | | | | | | | | | | | | | | | | | | | | | | | | | | | | | | | | | | | | | | | | | | | | | | |
| | | 1 | | | | | | | | | | | | | | | | | | | | | | | | | | | | | | | | | | | | | | | | | | | | | | | | | | | | | | | | | | | | | | | | | | | | | | | | | | | | | |
| 2 | | 3 | | | | | | | | | | | | | | | | | | | | | | | | | | | | | | | | | | | | | | | | | | | | | | | | | | | | | | | | | | | | | | | | | | | | | | | | | | | | | |
| 1 | | 1 | | | | | | | | | | | | | | | | | | | | | | | | | | | | | | | | | | | | | | | | | | | | | | | | | | | | | | | | | | | | | | | | | | | | | | | | | | | | | |
| | | 1 | | | | | | | | | | | | | | | | | | | | | | | | | | | | | | | | | | | | | | | | | | | | | | | | | | | | | | | | | | | | | | | | | | | | | | | | | | | | | |
| 1 | 1 | | | | | | | | | | | | | | | | | | | | | | | | | | | | | | | | | | | | | | | | | | | | | | | | | | | | | | | | | | | | | | | | | | | | | | | | | | | | | | |
| 3 | | | | | | | | | | | | | | | | | | | | | | | | | | | | | | | | | | | | | | | | | | | | | | | | | | | | | | | | | | | | | | | | | | | | | | | | | | | | | | | |
| 19 靳皓童 | 22 杨辰 | 28 靳皓添 | 32 袁梓赫 | | | | | | | | | | | | | | | | | | | | | | | | | | | | | | | | | | | | | | | | | | | | | | | | | | | | | | | | | | | | | | | | | | | | | | | | | | | | |
| <table border="1"><tr><td>1</td><td>1</td><td></td></tr><tr><td></td><td></td><td></td></tr><tr><td></td><td></td><td>2</td></tr></table> | 1 | 1 | | | | | | | 2 | <table border="1"><tr><td></td><td></td><td></td></tr><tr><td></td><td></td><td></td></tr><tr><td></td><td></td><td></td></tr></table> | | | | | | | | | | <table border="1"><tr><td></td><td></td><td>1</td></tr><tr><td></td><td></td><td>1</td></tr><tr><td></td><td></td><td>1</td></tr></table> | | | 1 | | | 1 | | | 1 | <table border="1"><tr><td></td><td></td><td></td></tr><tr><td></td><td></td><td></td></tr><tr><td></td><td></td><td></td></tr></table> | | | | | | | | | | | | | | | | | | | | | | | | | | | | | | | | | | | | | | | | | | | | | | | | | |
| 1 | 1 | | | | | | | | | | | | | | | | | | | | | | | | | | | | | | | | | | | | | | | | | | | | | | | | | | | | | | | | | | | | | | | | | | | | | | | | | | | | | | |
| | | | | | | | | | | | | | | | | | | | | | | | | | | | | | | | | | | | | | | | | | | | | | | | | | | | | | | | | | | | | | | | | | | | | | | | | | | | | | | | |
| | | 2 | | | | | | | | | | | | | | | | | | | | | | | | | | | | | | | | | | | | | | | | | | | | | | | | | | | | | | | | | | | | | | | | | | | | | | | | | | | | | |
| | | | | | | | | | | | | | | | | | | | | | | | | | | | | | | | | | | | | | | | | | | | | | | | | | | | | | | | | | | | | | | | | | | | | | | | | | | | | | | | |
| | | | | | | | | | | | | | | | | | | | | | | | | | | | | | | | | | | | | | | | | | | | | | | | | | | | | | | | | | | | | | | | | | | | | | | | | | | | | | | | |
| | | | | | | | | | | | | | | | | | | | | | | | | | | | | | | | | | | | | | | | | | | | | | | | | | | | | | | | | | | | | | | | | | | | | | | | | | | | | | | | |
| | | 1 | | | | | | | | | | | | | | | | | | | | | | | | | | | | | | | | | | | | | | | | | | | | | | | | | | | | | | | | | | | | | | | | | | | | | | | | | | | | | |
| | | 1 | | | | | | | | | | | | | | | | | | | | | | | | | | | | | | | | | | | | | | | | | | | | | | | | | | | | | | | | | | | | | | | | | | | | | | | | | | | | | |
| | | 1 | | | | | | | | | | | | | | | | | | | | | | | | | | | | | | | | | | | | | | | | | | | | | | | | | | | | | | | | | | | | | | | | | | | | | | | | | | | | | |
| | | | | | | | | | | | | | | | | | | | | | | | | | | | | | | | | | | | | | | | | | | | | | | | | | | | | | | | | | | | | | | | | | | | | | | | | | | | | | | | |
| | | | | | | | | | | | | | | | | | | | | | | | | | | | | | | | | | | | | | | | | | | | | | | | | | | | | | | | | | | | | | | | | | | | | | | | | | | | | | | | |
| | | | | | | | | | | | | | | | | | | | | | | | | | | | | | | | | | | | | | | | | | | | | | | | | | | | | | | | | | | | | | | | | | | | | | | | | | | | | | | | |
| 2 赫天铭 | | | | | | | 17 杨宇 | | | | | | | | | | | | | | | | | | | | | | | | | | | | | | | | | | | | | | | | | | | | | | | | | | | | | | | | | | | | | | | | | | | | | | | | |
| <table border="1"><tr><td>0/4</td><td>1/2</td><td>1/5</td></tr><tr><td>2/8</td><td>1/1</td><td>2/5</td></tr><tr><td>1/3</td><td>1/2</td><td>0/4</td></tr></table> | 0/4 | 1/2 | 1/5 | 2/8 | 1/1 | 2/5 | 1/3 | 1/2 | 0/4 | | | | | | | <table border="1"><tr><td>0/1</td><td>1/2</td><td>0/1</td></tr><tr><td>0/2</td><td>0/1</td><td>0/3</td></tr><tr><td>1/6</td><td></td><td></td></tr></table> | 0/1 | 1/2 | 0/1 | 0/2 | 0/1 | 0/3 | 1/6 | | | | | | | | | | | | | | | | | | | | | | | | | | | | | | | | | | | | | | | | | | | | | | | | | | | | | | | | |
| 0/4 | 1/2 | 1/5 | | | | | | | | | | | | | | | | | | | | | | | | | | | | | | | | | | | | | | | | | | | | | | | | | | | | | | | | | | | | | | | | | | | | | | | | | | | | | |
| 2/8 | 1/1 | 2/5 | | | | | | | | | | | | | | | | | | | | | | | | | | | | | | | | | | | | | | | | | | | | | | | | | | | | | | | | | | | | | | | | | | | | | | | | | | | | | |
| 1/3 | 1/2 | 0/4 | | | | | | | | | | | | | | | | | | | | | | | | | | | | | | | | | | | | | | | | | | | | | | | | | | | | | | | | | | | | | | | | | | | | | | | | | | | | | |
| 0/1 | 1/2 | 0/1 | | | | | | | | | | | | | | | | | | | | | | | | | | | | | | | | | | | | | | | | | | | | | | | | | | | | | | | | | | | | | | | | | | | | | | | | | | | | | |
| 0/2 | 0/1 | 0/3 | | | | | | | | | | | | | | | | | | | | | | | | | | | | | | | | | | | | | | | | | | | | | | | | | | | | | | | | | | | | | | | | | | | | | | | | | | | | | |
| 1/6 | | | | | | | | | | | | | | | | | | | | | | | | | | | | | | | | | | | | | | | | | | | | | | | | | | | | | | | | | | | | | | | | | | | | | | | | | | | | | | | |
| 32 袁梓赫 | | | | | | | 16 胡文柯 | | | | | | | | | | | | | | | | | | | | | | | | | | | | | | | | | | | | | | | | | | | | | | | | | | | | | | | | | | | | | | | | | | | | | | | | |
| <table border="1"><tr><td></td><td></td><td>0/1</td></tr><tr><td></td><td></td><td></td></tr><tr><td></td><td></td><td></td></tr></table> | | | 0/1 | | | | | | | | | | | | | <table border="1"><tr><td>0/1</td><td></td><td>0/2</td></tr><tr><td>2/4</td><td>0/1</td><td>1/2</td></tr><tr><td></td><td>1/1</td><td>0/4</td></tr></table> | 0/1 | | 0/2 | 2/4 | 0/1 | 1/2 | | 1/1 | 0/4 | | | | | | | | | | | | | | | | | | | | | | | | | | | | | | | | | | | | | | | | | | | | | | | | | | | | | | |
| | | 0/1 | | | | | | | | | | | | | | | | | | | | | | | | | | | | | | | | | | | | | | | | | | | | | | | | | | | | | | | | | | | | | | | | | | | | | | | | | | | | | |
| | | | | | | | | | | | | | | | | | | | | | | | | | | | | | | | | | | | | | | | | | | | | | | | | | | | | | | | | | | | | | | | | | | | | | | | | | | | | | | | |
| | | | | | | | | | | | | | | | | | | | | | | | | | | | | | | | | | | | | | | | | | | | | | | | | | | | | | | | | | | | | | | | | | | | | | | | | | | | | | | | |
| 0/1 | | 0/2 | | | | | | | | | | | | | | | | | | | | | | | | | | | | | | | | | | | | | | | | | | | | | | | | | | | | | | | | | | | | | | | | | | | | | | | | | | | | | |
| 2/4 | 0/1 | 1/2 | | | | | | | | | | | | | | | | | | | | | | | | | | | | | | | | | | | | | | | | | | | | | | | | | | | | | | | | | | | | | | | | | | | | | | | | | | | | | |
| | 1/1 | 0/4 | | | | | | | | | | | | | | | | | | | | | | | | | | | | | | | | | | | | | | | | | | | | | | | | | | | | | | | | | | | | | | | | | | | | | | | | | | | | | |

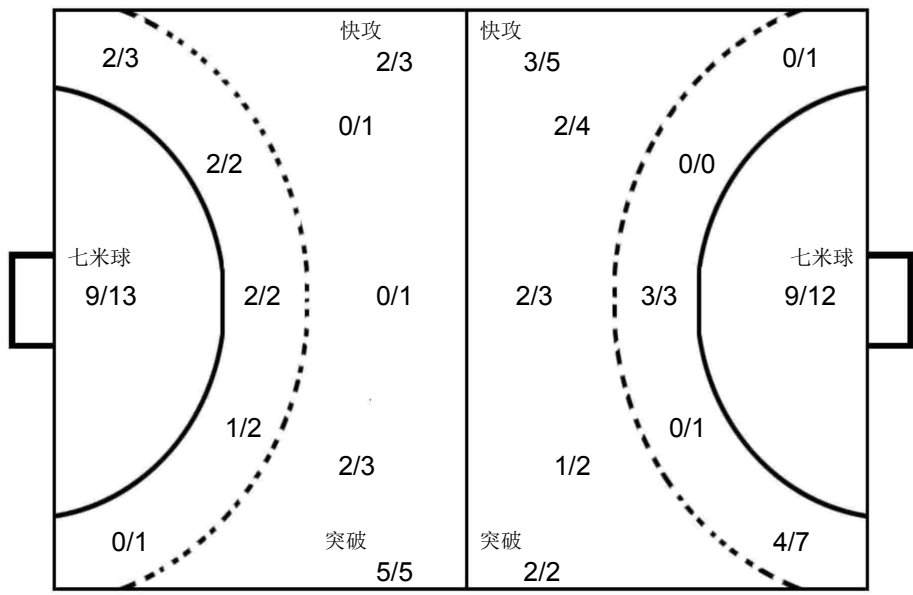

安徽淮南

| | | | | | | | | | | | | | | | | | | | | | | | | | | | | | | | | | | | | | | | | | | | | | | | | | | | | | | | | | | | | | | | | | | | | | | | | | | | | | | | |
|---|-----------------------------|-----------------------------|-----------------------------|-----------------------------|-----------------------------|-----------------------------|-----------------------------|--|--|--|---|--|--|---|---|---|--|--|--|--|--|--|--|---|--|---|--|--|--|--|--|--|--|--|--|--|--|--|--|--|--|--|--|--|--|--|--|--|--|---|---|--|---|---|--|--|--|--|--|--|--|--|--|--|--|--|--|--|--|--|---|--|---|---|--|---|--|--|---|
| 1 苟嘉毅 | 2 邹俊洁 | 3 童守宣 | 4 李攀 | 5 吴修民 | 6 童浩宇 | 7 赵琨鹏 | 8 陈子涵 | | | | | | | | | | | | | | | | | | | | | | | | | | | | | | | | | | | | | | | | | | | | | | | | | | | | | | | | | | | | | | | | | | | | | | | | |
| <table border="1"><tr><td></td><td></td><td></td></tr><tr><td></td><td></td><td></td></tr><tr><td></td><td></td><td></td></tr></table> | | | | | | | | | | <table border="1"><tr><td></td><td></td><td></td></tr><tr><td></td><td></td><td></td></tr><tr><td></td><td></td><td></td></tr></table> | | | | | | | | | | <table border="1"><tr><td></td><td></td><td></td></tr><tr><td></td><td></td><td></td></tr><tr><td></td><td></td><td></td></tr></table> | | | | | | | | | | <table border="1"><tr><td></td><td></td><td></td></tr><tr><td></td><td></td><td></td></tr><tr><td></td><td></td><td></td></tr></table> | | | | | | | | | | <table border="1"><tr><td></td><td></td><td></td></tr><tr><td></td><td></td><td></td></tr><tr><td></td><td></td><td></td></tr></table> | | | | | | | | | | <table border="1"><tr><td>1</td><td></td><td>2</td></tr><tr><td>1</td><td></td><td></td></tr><tr><td></td><td></td><td></td></tr></table> | 1 | | 2 | 1 | | | | | | <table border="1"><tr><td></td><td></td><td></td></tr><tr><td></td><td></td><td></td></tr><tr><td></td><td></td><td></td></tr></table> | | | | | | | | | | <table border="1"><tr><td>1</td><td></td><td>1</td></tr><tr><td>2</td><td></td><td>1</td></tr><tr><td></td><td></td><td></td></tr></table> | 1 | | 1 | 2 | | 1 | | | |
| | | | | | | | | | | | | | | | | | | | | | | | | | | | | | | | | | | | | | | | | | | | | | | | | | | | | | | | | | | | | | | | | | | | | | | | | | | | | | | | |
| | | | | | | | | | | | | | | | | | | | | | | | | | | | | | | | | | | | | | | | | | | | | | | | | | | | | | | | | | | | | | | | | | | | | | | | | | | | | | | | |
| | | | | | | | | | | | | | | | | | | | | | | | | | | | | | | | | | | | | | | | | | | | | | | | | | | | | | | | | | | | | | | | | | | | | | | | | | | | | | | | |
| | | | | | | | | | | | | | | | | | | | | | | | | | | | | | | | | | | | | | | | | | | | | | | | | | | | | | | | | | | | | | | | | | | | | | | | | | | | | | | | |
| | | | | | | | | | | | | | | | | | | | | | | | | | | | | | | | | | | | | | | | | | | | | | | | | | | | | | | | | | | | | | | | | | | | | | | | | | | | | | | | |
| | | | | | | | | | | | | | | | | | | | | | | | | | | | | | | | | | | | | | | | | | | | | | | | | | | | | | | | | | | | | | | | | | | | | | | | | | | | | | | | |
| | | | | | | | | | | | | | | | | | | | | | | | | | | | | | | | | | | | | | | | | | | | | | | | | | | | | | | | | | | | | | | | | | | | | | | | | | | | | | | | |
| | | | | | | | | | | | | | | | | | | | | | | | | | | | | | | | | | | | | | | | | | | | | | | | | | | | | | | | | | | | | | | | | | | | | | | | | | | | | | | | |
| | | | | | | | | | | | | | | | | | | | | | | | | | | | | | | | | | | | | | | | | | | | | | | | | | | | | | | | | | | | | | | | | | | | | | | | | | | | | | | | |
| | | | | | | | | | | | | | | | | | | | | | | | | | | | | | | | | | | | | | | | | | | | | | | | | | | | | | | | | | | | | | | | | | | | | | | | | | | | | | | | |
| | | | | | | | | | | | | | | | | | | | | | | | | | | | | | | | | | | | | | | | | | | | | | | | | | | | | | | | | | | | | | | | | | | | | | | | | | | | | | | | |
| | | | | | | | | | | | | | | | | | | | | | | | | | | | | | | | | | | | | | | | | | | | | | | | | | | | | | | | | | | | | | | | | | | | | | | | | | | | | | | | |
| | | | | | | | | | | | | | | | | | | | | | | | | | | | | | | | | | | | | | | | | | | | | | | | | | | | | | | | | | | | | | | | | | | | | | | | | | | | | | | | |
| | | | | | | | | | | | | | | | | | | | | | | | | | | | | | | | | | | | | | | | | | | | | | | | | | | | | | | | | | | | | | | | | | | | | | | | | | | | | | | | |
| | | | | | | | | | | | | | | | | | | | | | | | | | | | | | | | | | | | | | | | | | | | | | | | | | | | | | | | | | | | | | | | | | | | | | | | | | | | | | | | |
| 1 | | 2 | | | | | | | | | | | | | | | | | | | | | | | | | | | | | | | | | | | | | | | | | | | | | | | | | | | | | | | | | | | | | | | | | | | | | | | | | | | | | |
| 1 | | | | | | | | | | | | | | | | | | | | | | | | | | | | | | | | | | | | | | | | | | | | | | | | | | | | | | | | | | | | | | | | | | | | | | | | | | | | | | | |
| | | | | | | | | | | | | | | | | | | | | | | | | | | | | | | | | | | | | | | | | | | | | | | | | | | | | | | | | | | | | | | | | | | | | | | | | | | | | | | | |
| | | | | | | | | | | | | | | | | | | | | | | | | | | | | | | | | | | | | | | | | | | | | | | | | | | | | | | | | | | | | | | | | | | | | | | | | | | | | | | | |
| | | | | | | | | | | | | | | | | | | | | | | | | | | | | | | | | | | | | | | | | | | | | | | | | | | | | | | | | | | | | | | | | | | | | | | | | | | | | | | | |
| | | | | | | | | | | | | | | | | | | | | | | | | | | | | | | | | | | | | | | | | | | | | | | | | | | | | | | | | | | | | | | | | | | | | | | | | | | | | | | | |
| 1 | | 1 | | | | | | | | | | | | | | | | | | | | | | | | | | | | | | | | | | | | | | | | | | | | | | | | | | | | | | | | | | | | | | | | | | | | | | | | | | | | | |
| 2 | | 1 | | | | | | | | | | | | | | | | | | | | | | | | | | | | | | | | | | | | | | | | | | | | | | | | | | | | | | | | | | | | | | | | | | | | | | | | | | | | | |
| | | | | | | | | | | | | | | | | | | | | | | | | | | | | | | | | | | | | | | | | | | | | | | | | | | | | | | | | | | | | | | | | | | | | | | | | | | | | | | | |
| 9 杨金龙 | 10 孙飞扬 | 11 刘新然 | 13 张昊燃 | 14 单中宝 | 15 刘淇 | 16 胡文柯 | 17 徐鹏辉 | | | | | | | | | | | | | | | | | | | | | | | | | | | | | | | | | | | | | | | | | | | | | | | | | | | | | | | | | | | | | | | | | | | | | | | | |
| <table border="1"><tr><td>1</td><td>1</td><td>1</td></tr><tr><td>1</td><td></td><td>3</td></tr><tr><td></td><td></td><td></td></tr></table> | 1 | 1 | 1 | 1 | | 3 | | | | <table border="1"><tr><td>2</td><td></td><td></td></tr><tr><td>1</td><td>1</td><td>2</td></tr><tr><td></td><td></td><td></td></tr></table> | 2 | | | 1 | 1 | 2 | | | | <table border="1"><tr><td></td><td></td><td></td></tr><tr><td>1</td><td></td><td>1</td></tr><tr><td></td><td></td><td></td></tr></table> | | | | 1 | | 1 | | | | <table border="1"><tr><td></td><td></td><td></td></tr><tr><td></td><td></td><td></td></tr><tr><td></td><td></td><td></td></tr></table> | | | | | | | | | | <table border="1"><tr><td></td><td></td><td></td></tr><tr><td></td><td></td><td></td></tr><tr><td></td><td></td><td></td></tr></table> | | | | | | | | | | <table border="1"><tr><td></td><td></td><td></td></tr><tr><td></td><td></td><td></td></tr><tr><td></td><td></td><td></td></tr></table> | | | | | | | | | | <table border="1"><tr><td></td><td></td><td></td></tr><tr><td></td><td></td><td></td></tr><tr><td></td><td></td><td></td></tr></table> | | | | | | | | | | <table border="1"><tr><td>1</td><td></td><td></td></tr><tr><td></td><td></td><td></td></tr><tr><td></td><td></td><td>1</td></tr></table> | 1 | | | | | | | | 1 |
| 1 | 1 | 1 | | | | | | | | | | | | | | | | | | | | | | | | | | | | | | | | | | | | | | | | | | | | | | | | | | | | | | | | | | | | | | | | | | | | | | | | | | | | | |
| 1 | | 3 | | | | | | | | | | | | | | | | | | | | | | | | | | | | | | | | | | | | | | | | | | | | | | | | | | | | | | | | | | | | | | | | | | | | | | | | | | | | | |
| | | | | | | | | | | | | | | | | | | | | | | | | | | | | | | | | | | | | | | | | | | | | | | | | | | | | | | | | | | | | | | | | | | | | | | | | | | | | | | | |
| 2 | | | | | | | | | | | | | | | | | | | | | | | | | | | | | | | | | | | | | | | | | | | | | | | | | | | | | | | | | | | | | | | | | | | | | | | | | | | | | | | |
| 1 | 1 | 2 | | | | | | | | | | | | | | | | | | | | | | | | | | | | | | | | | | | | | | | | | | | | | | | | | | | | | | | | | | | | | | | | | | | | | | | | | | | | | |
| | | | | | | | | | | | | | | | | | | | | | | | | | | | | | | | | | | | | | | | | | | | | | | | | | | | | | | | | | | | | | | | | | | | | | | | | | | | | | | | |
| | | | | | | | | | | | | | | | | | | | | | | | | | | | | | | | | | | | | | | | | | | | | | | | | | | | | | | | | | | | | | | | | | | | | | | | | | | | | | | | |
| 1 | | 1 | | | | | | | | | | | | | | | | | | | | | | | | | | | | | | | | | | | | | | | | | | | | | | | | | | | | | | | | | | | | | | | | | | | | | | | | | | | | | |
| | | | | | | | | | | | | | | | | | | | | | | | | | | | | | | | | | | | | | | | | | | | | | | | | | | | | | | | | | | | | | | | | | | | | | | | | | | | | | | | |
| | | | | | | | | | | | | | | | | | | | | | | | | | | | | | | | | | | | | | | | | | | | | | | | | | | | | | | | | | | | | | | | | | | | | | | | | | | | | | | | |
| | | | | | | | | | | | | | | | | | | | | | | | | | | | | | | | | | | | | | | | | | | | | | | | | | | | | | | | | | | | | | | | | | | | | | | | | | | | | | | | |
| | | | | | | | | | | | | | | | | | | | | | | | | | | | | | | | | | | | | | | | | | | | | | | | | | | | | | | | | | | | | | | | | | | | | | | | | | | | | | | | |
| | | | | | | | | | | | | | | | | | | | | | | | | | | | | | | | | | | | | | | | | | | | | | | | | | | | | | | | | | | | | | | | | | | | | | | | | | | | | | | | |
| | | | | | | | | | | | | | | | | | | | | | | | | | | | | | | | | | | | | | | | | | | | | | | | | | | | | | | | | | | | | | | | | | | | | | | | | | | | | | | | |
| | | | | | | | | | | | | | | | | | | | | | | | | | | | | | | | | | | | | | | | | | | | | | | | | | | | | | | | | | | | | | | | | | | | | | | | | | | | | | | | |
| | | | | | | | | | | | | | | | | | | | | | | | | | | | | | | | | | | | | | | | | | | | | | | | | | | | | | | | | | | | | | | | | | | | | | | | | | | | | | | | |
| | | | | | | | | | | | | | | | | | | | | | | | | | | | | | | | | | | | | | | | | | | | | | | | | | | | | | | | | | | | | | | | | | | | | | | | | | | | | | | | |
| | | | | | | | | | | | | | | | | | | | | | | | | | | | | | | | | | | | | | | | | | | | | | | | | | | | | | | | | | | | | | | | | | | | | | | | | | | | | | | | |
| | | | | | | | | | | | | | | | | | | | | | | | | | | | | | | | | | | | | | | | | | | | | | | | | | | | | | | | | | | | | | | | | | | | | | | | | | | | | | | | |
| | | | | | | | | | | | | | | | | | | | | | | | | | | | | | | | | | | | | | | | | | | | | | | | | | | | | | | | | | | | | | | | | | | | | | | | | | | | | | | | |
| | | | | | | | | | | | | | | | | | | | | | | | | | | | | | | | | | | | | | | | | | | | | | | | | | | | | | | | | | | | | | | | | | | | | | | | | | | | | | | | |
| 1 | | | | | | | | | | | | | | | | | | | | | | | | | | | | | | | | | | | | | | | | | | | | | | | | | | | | | | | | | | | | | | | | | | | | | | | | | | | | | | | |
| | | | | | | | | | | | | | | | | | | | | | | | | | | | | | | | | | | | | | | | | | | | | | | | | | | | | | | | | | | | | | | | | | | | | | | | | | | | | | | | |
| | | 1 | | | | | | | | | | | | | | | | | | | | | | | | | | | | | | | | | | | | | | | | | | | | | | | | | | | | | | | | | | | | | | | | | | | | | | | | | | | | | |
| Post - 0 Miss - 0 Block - 0 | Post - 0 Miss - 0 Block - 0 | Post - 0 Miss - 0 Block - 0 | Post - 0 Miss - 0 Block - 0 | Post - 0 Miss - 0 Block - 0 | Post - 1 Miss - 1 Block - 0 | Post - 0 Miss - 0 Block - 0 | Post - 1 Miss - 0 Block - 0 | | | | | | | | | | | | | | | | | | | | | | | | | | | | | | | | | | | | | | | | | | | | | | | | | | | | | | | | | | | | | | | | | | | | | | | | |
| Post - 0 Miss - 0 Block - 0 | Post - 0 Miss - 1 Block - 0 | Post - 1 Miss - 0 Block - 0 | Post - 0 Miss - 0 Block - 0 | Post - 0 Miss - 0 Block - 0 | Post - 0 Miss - 0 Block - 0 | Post - 0 Miss - 0 Block - 0 | Post - 0 Miss - 0 Block - 0 | | | | | | | | | | | | | | | | | | | | | | | | | | | | | | | | | | | | | | | | | | | | | | | | | | | | | | | | | | | | | | | | | | | | | | | | |



| | | |
|---------|--------|--------------|
| Team A | Team B | Match Number |
| A 安徽省体校 | B 福建龙岩 | 19 |

| | | | | |
|-----------|-------------|------------|-------|------------|
| Played in | in the hall | on | at | Spepectors |
| 安徽滁州 | 滁州国际手球馆 | 2019-05-31 | 15:00 | hours |

| | | | | | | | | | | | | | | |
|----------------|----|---|---------------------|----|---|----------------|---|---|----------------|---|---|----------------------|---|---|
| Half-time(30') | A | B | End of playing time | A | B | 1st extra time | A | B | 2nd extra time | A | B | After penalty throws | A | B |
| | 11 | 6 | 23 | 13 | | | | | | | | | | |

| | | | | | | | | | | |
|---------------|-----|---------------|-------|---|------------------------------------|---------------|-------|---|-----|---------------|
| Number of 7 m | A | Team time-out | | | Full name of players and officials | Team time-out | | | B | Number of 7 m |
| | 0/0 | 1 | 2 | 3 | | 1 | 2 | 3 | 1/1 | |
| | | 11:57 | 41:33 | | | 02:33 | 33:30 | | | |

| No. | Team A | G | W | 2' | D | DR | No. | Team B | G | W | 2' | D | DR |
|-----|--------|---|---|----|---|----|-----|--------|---|---|----|---|----|
| 52 | 花驰 | | | | | | 1 | 刘子豪 | | | | | |
| 53 | 叶天赐 | | | | | | 5 | 郭雨强 | 7 | | | | |
| 54 | 姚幸运 | | | | | | 6 | 刘阳 | | | | | |
| 55 | 苏凯 | | | | | | 7 | 王晨旭 | | | | | |
| 56 | 王健鹏 | 3 | | | | | 8 | 杨鑫祥 | | | | | |
| 57 | 朱正翔 | 2 | | | | | 9 | 荆胤丞 | 1 | | | | |
| 58 | 蔡博飞 | 4 | | | | | 10 | 赵一 | 2 | | | | |
| 59 | 毛饶翔 | 5 | | | | | 15 | 刘家良 | 1 | | | | |
| 60 | 朱超 | 4 | | | | | 16 | 李凯锋 | | | | | |
| 61 | 钮伟豪 | | | | | | 17 | 陈锐涛 | | | | | |
| 62 | 赵俊阳 | | | | | | 18 | 奚尧 | | | | | |
| 64 | 章道胜 | 4 | | | | | 21 | 刘晓青 | | | | | |
| 65 | 韩伟伦 | 1 | | | | | 23 | 朱天一 | 2 | | | | |
| 66 | 刘家豪 | | | | | | 24 | 钟盛发 | | | | | |
| 67 | 江文 | | | | | | 27 | 邓可钊 | | | | | |
| 68 | 黄天源 | | | | | | 36 | 陈泽锟 | | | | | |
| A | 赵前军 | | | | | | B | 杜长义 | | | | | |
| C | 吕串 | | | | | | C | 饶开发 | | | | | |
| D | 沈强 | | | | | | D | 李绍南 | | | | | |
| E | 李煜 | | | | | | | | | | | | |

| | | |
|---|--|---|
| A | Signatures of responsables for the teams (Off.A) | B |
|---|--|---|

| | | |
|----|-----------------------------------|----|
| TP | Remarks of referees / HF Official | TP |
|----|-----------------------------------|----|

| | | | |
|------------|-----------|-----------|--|
| Signatures | | | |
| Referees | 李兆蒙 (CHN) | 马晓晔 (CHN) | |
| T.D. | 吴国忠 (CHN) | 王洋 (CHN) | |
| CHA Off. | | | |

Note: Number of 7m Throws Awarded to Team A and B, Goals (G), Warnings (W), Suspensions (2'), Direct Disqualification (D), Disqualification With Report (DR) and Team Penalty (TP).

Table Officials: 许修凯 刘洋洋 Statisticians: 马安兴 沈家洛

第二届全国青年运动会男子手球乙组决赛 体校组 (U16)

PHMS Pictorial Handball Match Statistics

IHF Official System

竞赛技术统计

手球
青年男子

预赛
轮次 3

组别 A
场次 19

滁州国际手球馆
2019-05-31 15:00

| | | | |
|-----------|-----------------------|---------|--------------|
| Referees: | 李兆蒙 (CHN) / 马晓晔 (CHN) | Result: | 23:13 (11:6) |
| Teams: | 安徽省体校(安徽) VS 福建龙岩(龙岩) | | |

| 安徽 | | 远射 | 近射 | 边射 | 快攻 | 突破 | 任意球 | 7m球 | 合计 | % | 助攻 | 失误 | 警告 | 2' | D+DR | 安徽 | 比赛进程 | 龙岩 |
|----------|-----|------|------|-----|-----|-----|-----|-------|-------|------|----|----|----|----|------|----|----------|--------------------|
| 主教练: 张林 | | | | | | | | | | | | | | | | | 1st Half | |
| 52 | 花驰 | | | | | | | | | | 1 | | | | | 56 | 王健鹏 | 1 00:26 0 |
| 53 | 叶天赐 | | | | | | | | | | | | | | | | 1 00:53 | 1 10 赵一 |
| 54 | 姚幸运 | | 0/1 | | | | | 0/1 | 0.0 | 2 | | | | | | 59 | 毛饶翔 | 2 02:23 1 |
| 55 | 苏凯 | | | | 0/1 | | | 0/1 | 0.0 | | | | | | | 56 | 王健鹏 | 3 03:08 1 |
| 56 | 王健鹏 | 2/4 | 1/1 | | 0/1 | | | 3/6 | 50.0 | | 2 | | | | | | 3 04:02 | 2 5 郭雨强 |
| 57 | 朱正翔 | | | | | 1/1 | 1/1 | 2/2 | 100 | | 2 | | | | | | 4 04:31 | 2 |
| 58 | 蔡博飞 | 1/2 | 3/3 | | | | | 4/5 | 80.0 | 2 | 2 | | | | | | 4 04:51 | 3 5 郭雨强 |
| 59 | 毛饶翔 | 1/2 | 2/2 | | 2/2 | | 0/1 | 5/7 | 71.4 | 2 | 3 | | | | | | 4 05:33 | 4 5 郭雨强 |
| 60 | 朱超 | | 0/1 | 3/4 | 1/1 | | | 4/6 | 66.7 | | | | | | | 60 | 朱超 | 5 06:08 4 |
| 61 | 钮伟豪 | | | | | | | | | | | | | | | 64 | 章道胜 | 6 06:59 4 |
| 62 | 赵俊阳 | | | | | | | | | | | | | | | 59 | 毛饶翔 | 7 09:15 4 |
| 64 | 章道胜 | | 1/1 | 1/1 | 2/2 | | | 4/4 | 100 | | 1 | | | | | | 7 09:40 | 5 10 赵一 |
| 65 | 韩伟伦 | | 1/1 | | | | | 1/1 | 100 | | | | | | | 64 | 章道胜 | 8 10:46 5 |
| 66 | 刘家豪 | | | | | | | | | | | | | | | 59 | 毛饶翔 | 9 12:58 5 |
| 67 | 江文 | | | | | | | | | | | | | | | | 9 13:14 | 6 5 郭雨强 |
| 68 | 黄天源 | | | | | | | | | | | | | | | 64 | 章道胜 | 10 14:08 6 |
| 运动员 合计 | | 4/8 | 8/10 | 4/5 | 5/7 | 1/1 | 1/2 | 23/33 | 69.7 | 7 | 11 | | | | | 59 | 毛饶翔 | 11 14:47 6 |
| 52 花驰 | | 6/14 | 1/4 | 2/3 | 1/1 | | | 0/1 | 10/23 | 43.5 | 1 | | | | | | 2nd Half | |
| 守门员 合计 | | 6/14 | 1/4 | 2/3 | 1/1 | | | 0/1 | 10/23 | 43.5 | 1 | | | | | 58 | 蔡博飞 | 12 00:28 6 |
| 主教练: 李绍南 | | | | | | | | | | | | | | | | | 12 02:24 | 7 5 郭雨强 |
| 1 | 刘子豪 | | | | | | | | | | | | | | | 58 | 蔡博飞 | 13 03:13 7 |
| 5 | 郭雨强 | 7/10 | | 0/1 | | | | 7/11 | 63.6 | 2 | 3 | | | | | 60 | 朱超 | 14 03:58 7 |
| 6 | 刘阳 | | | | | | | | | | | | | | | 60 | 朱超 | 15 04:23 7 |
| 7 | 王晨旭 | | 0/1 | | | | | 0/1 | 0.0 | | 3 | | | | | 58 | 蔡博飞 | 15 04:43 8 9 荆胤丞 |
| 8 | 杨鑫祥 | | | | | | | | | | | | | | | 58 | 蔡博飞 | 16 04:56 8 |
| 9 | 荆胤丞 | | 1/1 | | | | | 1/1 | 100 | | | | | | | 16 | 05:39 | 9 15 刘家良 |
| 10 | 赵一 | 1/4 | 1/1 | | 0/1 | | | 2/6 | 33.3 | 2 | 1 | | | | | 60 | 朱超 | 17 06:03 9 |
| 15 | 刘家良 | 0/2 | | | | | | 1/1 | 1/3 | 33.3 | 1 | 6 | | | | 59 | 毛饶翔 | 18 06:49 9 |
| 16 | 李凯锋 | | | | | | | | | | | | | | | 64 | 章道胜 | 19 07:13 9 |
| 17 | 陈锐涛 | | | | | | | | | | | | | | | 58 | 蔡博飞 | 19 08:57 10 23 朱天一 |
| 18 | 奚尧 | | | | | | | | | | | | | | | 57 | 朱正翔 | 20 09:31 10 |
| 21 | 刘晓青 | | | | | | | | | | | | | | | | 21 10:31 | 10 |
| 23 | 朱天一 | | 1/1 | 1/1 | | | | 2/2 | 100 | | 1 | | | | | | 21 11:30 | 11 23 朱天一 |
| 24 | 钟盛发 | | | | | | | | | | | | | | | | 21 12:00 | 12 5 郭雨强 |
| 27 | 邓可钊 | | | 0/1 | | | | 0/1 | 0.0 | | 3 | | | | | 57 | 朱正翔 | 22 12:26 12 |
| 36 | 陈泽锟 | | | | | | | | | | | | | | | 65 | 韩伟伦 | 23 13:40 12 |
| 运动员 合计 | | 8/16 | 3/4 | 1/3 | 0/1 | | | 1/1 | 13/25 | 52.0 | 5 | 20 | | | | | 23 14:28 | 13 5 郭雨强 |
| 1 刘子豪 | | 1/5 | 1/9 | 1/5 | 1/6 | 0/1 | 0/1 | 4/27 | 14.8 | | | | | | | | | |
| 守门员 合计 | | 1/5 | 1/9 | 1/5 | 1/6 | 0/1 | 0/1 | 4/27 | 14.8 | | | | | | | | | |

场上队员: 得分 / 射门

守门员: 救球 / 射门

| | | | |
|---|------|----|---------|
| D | 取消资格 | DR | 取消资格+报告 |
|---|------|----|---------|



个人/全队技术统计表

手球 预赛 组别 A 滁州国际手球馆
青年男子 轮次 3 场次 19 2019-05-31 15:00

| 号码 | 姓名 | 远射 | 近射 | 边射 | 快攻 | 突破 | 任意 | 七米 | 合计 | % | 助攻 | 失误 | 警告 | 2' | 取消 | 时间 |
|-----------|-----|------|------|-----|-----|-----|-----|-----|-------|-------|----|----|----|----|----|----------|
| 安徽省体校(安徽) | | | | | | | | | | | | | | | | |
| (场上队员) | | | | | | | | | | | | | | | | |
| 52 | 花驰 | | | | | | | | | 0.0% | 1 | | | | | 00:30:00 |
| 53 | 叶天赐 | | | | | | | | | 0.0% | | | | | | 00:00:00 |
| 54 | 姚幸运 | | 0/1 | | | | | | 0/1 | 0.0% | 2 | | | | | 00:15:00 |
| 55 | 苏凯 | | | | 0/1 | | | | 0/1 | 0.0% | | | | | | 00:15:00 |
| 56 | 王健鹏 | 2/4 | 1/1 | | 0/1 | | | | 3/6 | 50.0% | | 2 | | | | 00:25:16 |
| 57 | 朱正翔 | | | | | 1/1 | 1/1 | | 2/2 | 100% | | 2 | | | | 00:20:10 |
| 58 | 蔡博飞 | 1/2 | 3/3 | | | | | | 4/5 | 80.0% | 2 | 2 | | | | 00:16:35 |
| 59 | 毛饶翔 | 1/2 | 2/2 | | 2/2 | | 0/1 | | 5/7 | 71.4% | 2 | 3 | | | | 00:22:39 |
| 60 | 朱超 | | 0/1 | 3/4 | 1/1 | | | | 4/6 | 66.7% | | | | | | 00:30:00 |
| 61 | 钮伟豪 | | | | | | | | | 0.0% | | | | | | 00:00:00 |
| 62 | 赵俊阳 | | | | | | | | | 0.0% | | | | | | 00:00:00 |
| 64 | 章道胜 | | 1/1 | 1/1 | 2/2 | | | | 4/4 | 100% | | 1 | | | | 00:24:08 |
| 65 | 韩伟伦 | | 1/1 | | | | | | 1/1 | 100% | | | | | | 00:04:42 |
| 66 | 刘家豪 | | | | | | | | | 0.0% | | | | | | 00:00:30 |
| 67 | 江文 | | | | | | | | | 0.0% | | | | | | 00:00:00 |
| 68 | 黄天源 | | | | | | | | | 0.0% | | 1 | | | | 00:05:50 |
| 合计 | | 4/8 | 8/10 | 4/5 | 5/7 | 1/1 | 1/2 | | 23/33 | 69.7% | 7 | 11 | | | | |
| (守门员) | | | | | | | | | | | | | | | | |
| 52 | 花驰 | 6/14 | 1/4 | 2/3 | 1/1 | | | 0/1 | 10/23 | 43.5% | 1 | | | | | 00:30:00 |
| 合计 | | 6/14 | 1/4 | 2/3 | 1/1 | | | 0/1 | 10/23 | 43.5% | 1 | | | | | |

场上队员：得分/射门

守门员：救球/射门

| 全队合计 | 得分 | 被救 | 射失 | 击柱 | 封球 | 合计 | % |
|------|----|----|----|----|----|----|--------|
| 远射 | 4 | 1 | 2 | 1 | | 8 | 50.0% |
| 近射 | 8 | 1 | | 1 | | 10 | 80.0% |
| 边射 | 4 | 1 | | | | 5 | 80.0% |
| 快攻 | 5 | 1 | | 1 | | 7 | 71.4% |
| 突破 | 1 | | | | | 1 | 100.0% |
| 任意 | 1 | | 1 | | | 2 | 50.0% |
| 七米 | | | | | | | 0.0% |

个人/全队技术统计表

手球 预赛 组别 A 滁州国际手球馆
青年男子 轮次 3 场次 19 2019-05-31 15:00

| 号码 | 姓名 | 远射 | 近射 | 边射 | 快攻 | 突破 | 任意 | 七米 | 合计 | % | 助攻 | 失误 | 警告 | 2' | 取消 | 时间 |
|----------|-----|------|-----|-----|-----|-----|-----|-----|-------|-------|----|----|----|----|----|----------|
| 福建龙岩(龙岩) | | | | | | | | | | | | | | | | |
| (场上队员) | | | | | | | | | | | | | | | | |
| 1 | 刘子豪 | | | | | | | | | 0.0% | | | | | | 00:30:00 |
| 5 | 郭雨强 | 7/10 | | 0/1 | | | | | 7/11 | 63.6% | 2 | 3 | | | | 00:23:45 |
| 6 | 刘阳 | | | | | | | | | 0.0% | | | | | | 00:01:59 |
| 7 | 王晨旭 | | 0/1 | | | | | | 0/1 | 0.0% | | 3 | | | | 00:15:00 |
| 8 | 杨鑫祥 | | | | | | | | | 0.0% | | | | | | 00:00:00 |
| 9 | 荆胤丞 | | 1/1 | | | | | | 1/1 | 100% | | | | | | 00:06:12 |
| 10 | 赵一 | 1/4 | 1/1 | | 0/1 | | | | 2/6 | 33.3% | 2 | 1 | | | | 00:23:53 |
| 15 | 刘家良 | 0/2 | | | | | | 1/1 | 1/3 | 33.3% | 1 | 6 | | | | 00:30:00 |
| 16 | 李凯锋 | | | | | | | | | 0.0% | | | | | | 00:00:00 |
| 17 | 陈锐涛 | | | | | | | | | 0.0% | | | | | | 00:00:00 |
| 18 | 奚尧 | | | | | | | | | 0.0% | | 3 | | | | 00:30:00 |
| 21 | 刘晓青 | | | | | | | | | 0.0% | | | | | | 00:00:00 |
| 23 | 朱天一 | | 1/1 | 1/1 | | | | | 2/2 | 100% | | 1 | | | | 00:30:00 |
| 24 | 钟盛发 | | | | | | | | | 0.0% | | | | | | 00:00:00 |
| 27 | 邓可钊 | | | 0/1 | | | | | 0/1 | 0.0% | | 3 | | | | 00:19:06 |
| 36 | 陈泽锟 | | | | | | | | | 0.0% | | | | | | 00:00:00 |
| | 合计 | 8/16 | 3/4 | 1/3 | 0/1 | | | 1/1 | 13/25 | 52.0% | 5 | 20 | | | | |
| (守门员) | | | | | | | | | | | | | | | | |
| 1 | 刘子豪 | 1/5 | 1/9 | 1/5 | 1/6 | 0/1 | 0/1 | | 4/27 | 14.8% | | | | | | 00:30:00 |
| | 合计 | 1/5 | 1/9 | 1/5 | 1/6 | 0/1 | 0/1 | | 4/27 | 14.8% | | | | | | |

场上队员：得分/射门

守门员：救球/射门

| 全队合计 | 得分 | 被救 | 射失 | 击柱 | 封球 | 合计 | % |
|------|----|----|----|----|----|----|--------|
| 远射 | 8 | 6 | | 1 | 1 | 16 | 50.0% |
| 近射 | 3 | 1 | | | | 4 | 75.0% |
| 边射 | 1 | 2 | | | | 3 | 33.3% |
| 快攻 | | 1 | | | | 1 | 0.0% |
| 突破 | | | | | | | 0.0% |
| 任意 | | | | | | | 0.0% |
| 七米 | 1 | | | | | 1 | 100.0% |

图式比赛技术统计表

手球
青年男子

预赛
轮次 3

组别 A
场次 19

滁州国际手球馆
2019-05-31 15:00

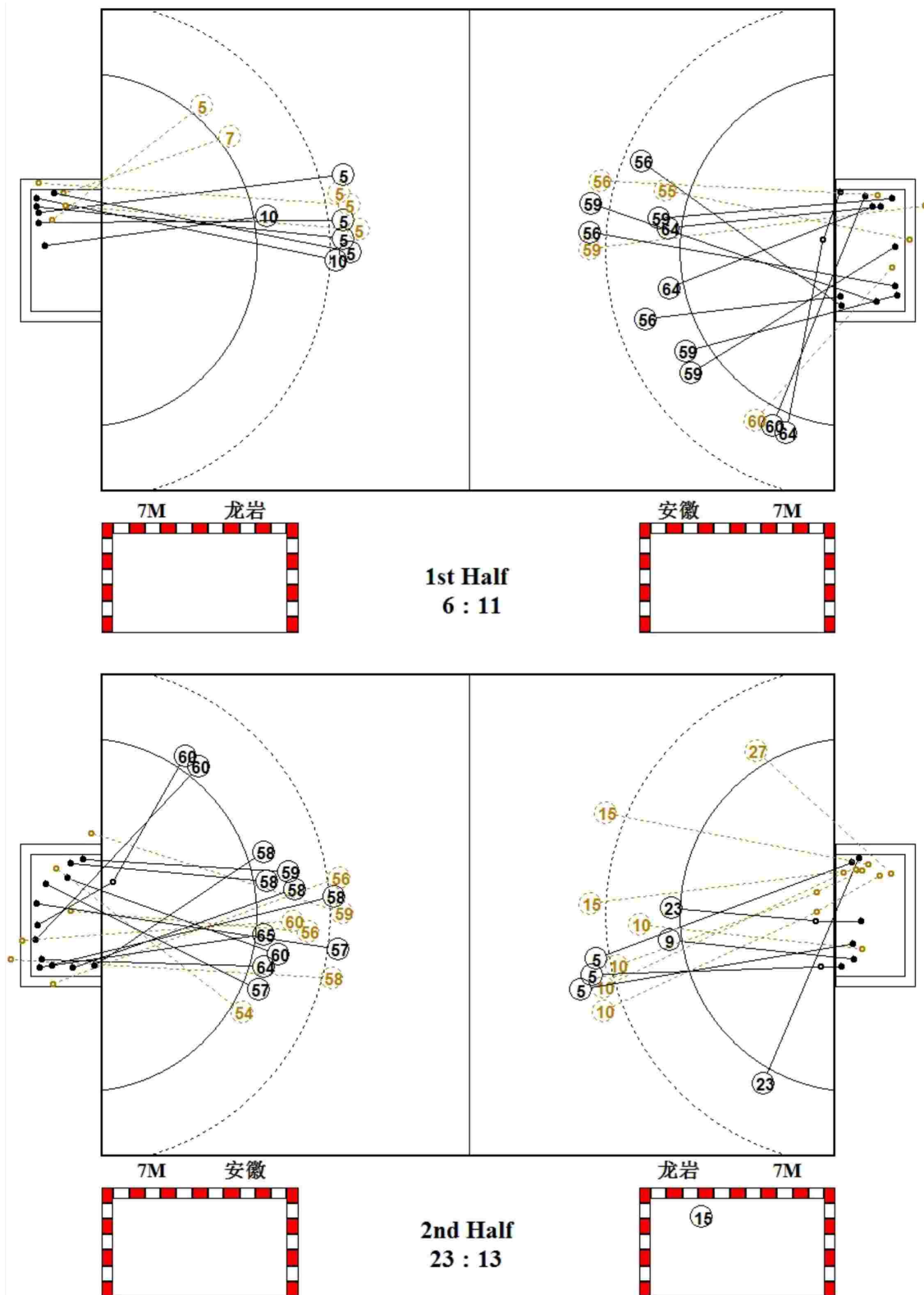

图式射门区域统计

手球
青年男子

预赛
轮次 3

组别 A
场次 19

滁州国际手球馆
2019-05-31 15:00

安徽省体校

| | | | | | | | | | | | | | | | | | | | | | | | | | | | | | | | | | | | | | | | | | | | | | | | | | | | | | | | | | | | | | | | | | | | | | | | | | | | | | | | |
|--|---|---|--|---|--|---|--|--|--|---|--|--|--|--|--|--|--|--|--|---|--|--|--|--|--|--|--|--|--|--|---|--|--|---|--|--|---|--|--|---|---|--|---|--|--|--|--|--|---|---|--|---|---|--|--|--|--|--|--|---|---|--|--|---|--|---|---|--|--|--|---|---|---|--|--|---|--|--|---|
| 52 花驰 <table border="1"><tr><td></td><td></td><td></td></tr><tr><td></td><td></td><td></td></tr><tr><td></td><td></td><td></td></tr></table> Post - 0 Miss - 0 Block - 0 | | | | | | | | | | 53 叶天赐 <table border="1"><tr><td></td><td></td><td></td></tr><tr><td></td><td></td><td></td></tr><tr><td></td><td></td><td></td></tr></table> Post - 0 Miss - 0 Block - 0 | | | | | | | | | | 54 姚幸运 <table border="1"><tr><td></td><td></td><td></td></tr><tr><td></td><td></td><td></td></tr><tr><td></td><td></td><td></td></tr></table> Post - 0 Miss - 0 Block - 0 | | | | | | | | | | 55 苏凯 <table border="1"><tr><td></td><td></td><td></td></tr><tr><td></td><td></td><td></td></tr><tr><td></td><td></td><td></td></tr></table> Post - 1 Miss - 0 Block - 0 | | | | | | | | | | 56 王健鹏 <table border="1"><tr><td></td><td></td><td>1</td></tr><tr><td></td><td></td><td></td></tr><tr><td></td><td></td><td>2</td></tr></table> Post - 1 Miss - 0 Block - 0 | | | 1 | | | | | | 2 | 57 朱正翔 <table border="1"><tr><td></td><td>1</td><td>1</td></tr><tr><td></td><td></td><td></td></tr><tr><td></td><td></td><td></td></tr></table> Post - 0 Miss - 0 Block - 0 | | 1 | 1 | | | | | | | 58 蔡博飞 <table border="1"><tr><td>1</td><td></td><td></td></tr><tr><td>1</td><td></td><td>1</td></tr><tr><td>1</td><td></td><td></td></tr></table> Post - 0 Miss - 1 Block - 0 | 1 | | | 1 | | 1 | 1 | | | 59 毛饶翔 <table border="1"><tr><td>1</td><td>1</td><td>1</td></tr><tr><td></td><td></td><td>1</td></tr><tr><td></td><td></td><td>1</td></tr></table> Post - 0 Miss - 2 Block - 0 | 1 | 1 | 1 | | | 1 | | | 1 |
| | | | | | | | | | | | | | | | | | | | | | | | | | | | | | | | | | | | | | | | | | | | | | | | | | | | | | | | | | | | | | | | | | | | | | | | | | | | | | | | |
| | | | | | | | | | | | | | | | | | | | | | | | | | | | | | | | | | | | | | | | | | | | | | | | | | | | | | | | | | | | | | | | | | | | | | | | | | | | | | | | |
| | | | | | | | | | | | | | | | | | | | | | | | | | | | | | | | | | | | | | | | | | | | | | | | | | | | | | | | | | | | | | | | | | | | | | | | | | | | | | | | |
| | | | | | | | | | | | | | | | | | | | | | | | | | | | | | | | | | | | | | | | | | | | | | | | | | | | | | | | | | | | | | | | | | | | | | | | | | | | | | | | |
| | | | | | | | | | | | | | | | | | | | | | | | | | | | | | | | | | | | | | | | | | | | | | | | | | | | | | | | | | | | | | | | | | | | | | | | | | | | | | | | |
| | | | | | | | | | | | | | | | | | | | | | | | | | | | | | | | | | | | | | | | | | | | | | | | | | | | | | | | | | | | | | | | | | | | | | | | | | | | | | | | |
| | | | | | | | | | | | | | | | | | | | | | | | | | | | | | | | | | | | | | | | | | | | | | | | | | | | | | | | | | | | | | | | | | | | | | | | | | | | | | | | |
| | | | | | | | | | | | | | | | | | | | | | | | | | | | | | | | | | | | | | | | | | | | | | | | | | | | | | | | | | | | | | | | | | | | | | | | | | | | | | | | |
| | | | | | | | | | | | | | | | | | | | | | | | | | | | | | | | | | | | | | | | | | | | | | | | | | | | | | | | | | | | | | | | | | | | | | | | | | | | | | | | |
| | | | | | | | | | | | | | | | | | | | | | | | | | | | | | | | | | | | | | | | | | | | | | | | | | | | | | | | | | | | | | | | | | | | | | | | | | | | | | | | |
| | | | | | | | | | | | | | | | | | | | | | | | | | | | | | | | | | | | | | | | | | | | | | | | | | | | | | | | | | | | | | | | | | | | | | | | | | | | | | | | |
| | | | | | | | | | | | | | | | | | | | | | | | | | | | | | | | | | | | | | | | | | | | | | | | | | | | | | | | | | | | | | | | | | | | | | | | | | | | | | | | |
| | | 1 | | | | | | | | | | | | | | | | | | | | | | | | | | | | | | | | | | | | | | | | | | | | | | | | | | | | | | | | | | | | | | | | | | | | | | | | | | | | | |
| | | | | | | | | | | | | | | | | | | | | | | | | | | | | | | | | | | | | | | | | | | | | | | | | | | | | | | | | | | | | | | | | | | | | | | | | | | | | | | | |
| | | 2 | | | | | | | | | | | | | | | | | | | | | | | | | | | | | | | | | | | | | | | | | | | | | | | | | | | | | | | | | | | | | | | | | | | | | | | | | | | | | |
| | 1 | 1 | | | | | | | | | | | | | | | | | | | | | | | | | | | | | | | | | | | | | | | | | | | | | | | | | | | | | | | | | | | | | | | | | | | | | | | | | | | | | |
| | | | | | | | | | | | | | | | | | | | | | | | | | | | | | | | | | | | | | | | | | | | | | | | | | | | | | | | | | | | | | | | | | | | | | | | | | | | | | | | |
| | | | | | | | | | | | | | | | | | | | | | | | | | | | | | | | | | | | | | | | | | | | | | | | | | | | | | | | | | | | | | | | | | | | | | | | | | | | | | | | |
| 1 | | | | | | | | | | | | | | | | | | | | | | | | | | | | | | | | | | | | | | | | | | | | | | | | | | | | | | | | | | | | | | | | | | | | | | | | | | | | | | | |
| 1 | | 1 | | | | | | | | | | | | | | | | | | | | | | | | | | | | | | | | | | | | | | | | | | | | | | | | | | | | | | | | | | | | | | | | | | | | | | | | | | | | | |
| 1 | | | | | | | | | | | | | | | | | | | | | | | | | | | | | | | | | | | | | | | | | | | | | | | | | | | | | | | | | | | | | | | | | | | | | | | | | | | | | | | |
| 1 | 1 | 1 | | | | | | | | | | | | | | | | | | | | | | | | | | | | | | | | | | | | | | | | | | | | | | | | | | | | | | | | | | | | | | | | | | | | | | | | | | | | | |
| | | 1 | | | | | | | | | | | | | | | | | | | | | | | | | | | | | | | | | | | | | | | | | | | | | | | | | | | | | | | | | | | | | | | | | | | | | | | | | | | | | |
| | | 1 | | | | | | | | | | | | | | | | | | | | | | | | | | | | | | | | | | | | | | | | | | | | | | | | | | | | | | | | | | | | | | | | | | | | | | | | | | | | | |
| 60 朱超 <table border="1"><tr><td>1</td><td>1</td><td></td></tr><tr><td>1</td><td></td><td>1</td></tr><tr><td></td><td></td><td></td></tr></table> Post - 1 Miss - 0 Block - 0 | 1 | 1 | | 1 | | 1 | | | | 61 钮伟豪 <table border="1"><tr><td></td><td></td><td></td></tr><tr><td></td><td></td><td></td></tr><tr><td></td><td></td><td></td></tr></table> Post - 0 Miss - 0 Block - 0 | | | | | | | | | | 62 赵俊阳 <table border="1"><tr><td></td><td></td><td></td></tr><tr><td></td><td></td><td></td></tr><tr><td></td><td></td><td></td></tr></table> Post - 0 Miss - 0 Block - 0 | | | | | | | | | | 64 章道胜 <table border="1"><tr><td>2</td><td></td><td></td></tr><tr><td>1</td><td></td><td></td></tr><tr><td>1</td><td></td><td></td></tr></table> Post - 0 Miss - 0 Block - 0 | 2 | | | 1 | | | 1 | | | 65 韩伟伦 <table border="1"><tr><td>1</td><td></td><td></td></tr><tr><td></td><td></td><td></td></tr><tr><td></td><td></td><td></td></tr></table> Post - 0 Miss - 0 Block - 0 | 1 | | | | | | | | | 66 刘家豪 <table border="1"><tr><td></td><td></td><td></td></tr><tr><td></td><td></td><td></td></tr><tr><td></td><td></td><td></td></tr></table> Post - 0 Miss - 0 Block - 0 | | | | | | | | | | 67 江文 <table border="1"><tr><td></td><td></td><td></td></tr><tr><td></td><td></td><td></td></tr><tr><td></td><td></td><td></td></tr></table> Post - 0 Miss - 0 Block - 0 | | | | | | | | | | 68 黄天源 <table border="1"><tr><td></td><td></td><td></td></tr><tr><td></td><td></td><td></td></tr><tr><td></td><td></td><td></td></tr></table> Post - 0 Miss - 0 Block - 0 | | | | | | | | | |
| 1 | 1 | | | | | | | | | | | | | | | | | | | | | | | | | | | | | | | | | | | | | | | | | | | | | | | | | | | | | | | | | | | | | | | | | | | | | | | | | | | | | | |
| 1 | | 1 | | | | | | | | | | | | | | | | | | | | | | | | | | | | | | | | | | | | | | | | | | | | | | | | | | | | | | | | | | | | | | | | | | | | | | | | | | | | | |
| | | | | | | | | | | | | | | | | | | | | | | | | | | | | | | | | | | | | | | | | | | | | | | | | | | | | | | | | | | | | | | | | | | | | | | | | | | | | | | | |
| | | | | | | | | | | | | | | | | | | | | | | | | | | | | | | | | | | | | | | | | | | | | | | | | | | | | | | | | | | | | | | | | | | | | | | | | | | | | | | | |
| | | | | | | | | | | | | | | | | | | | | | | | | | | | | | | | | | | | | | | | | | | | | | | | | | | | | | | | | | | | | | | | | | | | | | | | | | | | | | | | |
| | | | | | | | | | | | | | | | | | | | | | | | | | | | | | | | | | | | | | | | | | | | | | | | | | | | | | | | | | | | | | | | | | | | | | | | | | | | | | | | |
| | | | | | | | | | | | | | | | | | | | | | | | | | | | | | | | | | | | | | | | | | | | | | | | | | | | | | | | | | | | | | | | | | | | | | | | | | | | | | | | |
| | | | | | | | | | | | | | | | | | | | | | | | | | | | | | | | | | | | | | | | | | | | | | | | | | | | | | | | | | | | | | | | | | | | | | | | | | | | | | | | |
| | | | | | | | | | | | | | | | | | | | | | | | | | | | | | | | | | | | | | | | | | | | | | | | | | | | | | | | | | | | | | | | | | | | | | | | | | | | | | | | |
| 2 | | | | | | | | | | | | | | | | | | | | | | | | | | | | | | | | | | | | | | | | | | | | | | | | | | | | | | | | | | | | | | | | | | | | | | | | | | | | | | | |
| 1 | | | | | | | | | | | | | | | | | | | | | | | | | | | | | | | | | | | | | | | | | | | | | | | | | | | | | | | | | | | | | | | | | | | | | | | | | | | | | | | |
| 1 | | | | | | | | | | | | | | | | | | | | | | | | | | | | | | | | | | | | | | | | | | | | | | | | | | | | | | | | | | | | | | | | | | | | | | | | | | | | | | | |
| 1 | | | | | | | | | | | | | | | | | | | | | | | | | | | | | | | | | | | | | | | | | | | | | | | | | | | | | | | | | | | | | | | | | | | | | | | | | | | | | | | |
| | | | | | | | | | | | | | | | | | | | | | | | | | | | | | | | | | | | | | | | | | | | | | | | | | | | | | | | | | | | | | | | | | | | | | | | | | | | | | | | |
| | | | | | | | | | | | | | | | | | | | | | | | | | | | | | | | | | | | | | | | | | | | | | | | | | | | | | | | | | | | | | | | | | | | | | | | | | | | | | | | |
| | | | | | | | | | | | | | | | | | | | | | | | | | | | | | | | | | | | | | | | | | | | | | | | | | | | | | | | | | | | | | | | | | | | | | | | | | | | | | | | |
| | | | | | | | | | | | | | | | | | | | | | | | | | | | | | | | | | | | | | | | | | | | | | | | | | | | | | | | | | | | | | | | | | | | | | | | | | | | | | | | |
| | | | | | | | | | | | | | | | | | | | | | | | | | | | | | | | | | | | | | | | | | | | | | | | | | | | | | | | | | | | | | | | | | | | | | | | | | | | | | | | |
| | | | | | | | | | | | | | | | | | | | | | | | | | | | | | | | | | | | | | | | | | | | | | | | | | | | | | | | | | | | | | | | | | | | | | | | | | | | | | | | |
| | | | | | | | | | | | | | | | | | | | | | | | | | | | | | | | | | | | | | | | | | | | | | | | | | | | | | | | | | | | | | | | | | | | | | | | | | | | | | | | |
| | | | | | | | | | | | | | | | | | | | | | | | | | | | | | | | | | | | | | | | | | | | | | | | | | | | | | | | | | | | | | | | | | | | | | | | | | | | | | | | |
| | | | | | | | | | | | | | | | | | | | | | | | | | | | | | | | | | | | | | | | | | | | | | | | | | | | | | | | | | | | | | | | | | | | | | | | | | | | | | | | |
| | | | | | | | | | | | | | | | | | | | | | | | | | | | | | | | | | | | | | | | | | | | | | | | | | | | | | | | | | | | | | | | | | | | | | | | | | | | | | | | |
| | | | | | | | | | | | | | | | | | | | | | | | | | | | | | | | | | | | | | | | | | | | | | | | | | | | | | | | | | | | | | | | | | | | | | | | | | | | | | | | |

52 花驰

| | | |
|-----|-----|-----|
| 1/2 | 0/1 | 1/6 |
| 3/4 | 0/1 | 3/3 |
| 2/3 | | 0/3 |

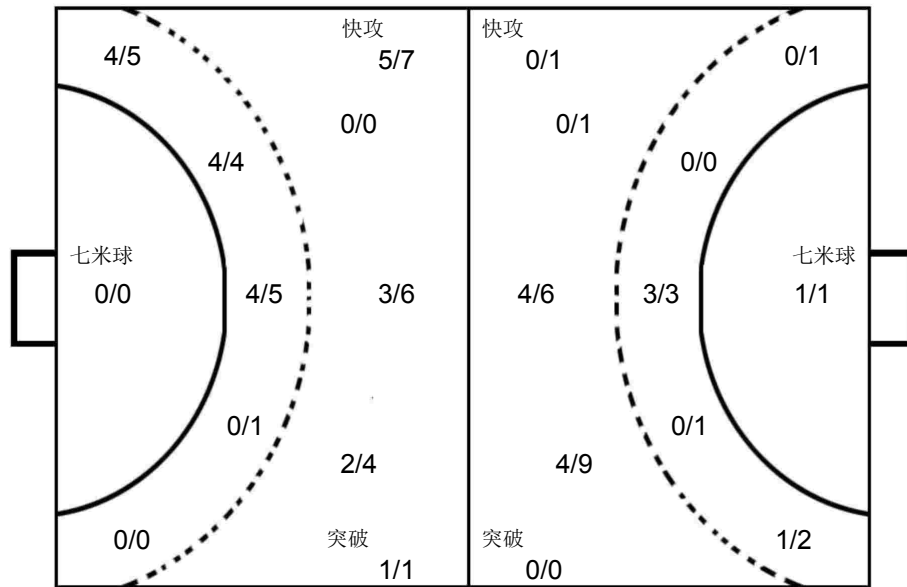

1 刘子豪

| | | |
|-----|-----|-----|
| 0/6 | 1/4 | 0/3 |
| 1/4 | 1/1 | 1/4 |
| 0/2 | | 0/3 |

福建龙岩

| | | | | | | | | | | | | | | | | | | | | | | | | | | | | | | | | | | | | | | | | | | | | | | | | | | | | | | | | | | | | | | | | | | | | | | | | | | | | | | | |
|---|---|---|--|--|--|--|--|--|--|---|--|--|---|--|--|--|---|--|---|--|--|--|--|--|--|--|--|--|--|---|--|--|--|--|--|--|--|--|--|---|--|---|---|--|--|--|--|--|--|---|--|--|--|--|--|--|--|--|---|--|--|---|---|--|--|--|--|--|--|--|---|--|--|--|--|--|--|--|--|
| 1 刘子豪 <table border="1"><tr><td></td><td></td><td></td></tr><tr><td></td><td></td><td></td></tr><tr><td></td><td></td><td></td></tr></table> Post - 0 Miss - 0 Block - 0 | | | | | | | | | | 5 郭雨强 <table border="1"><tr><td></td><td></td><td>4</td></tr><tr><td></td><td></td><td></td></tr><tr><td>1</td><td></td><td>2</td></tr></table> Post - 1 Miss - 0 Block - 1 | | | 4 | | | | 1 | | 2 | 6 刘阳 <table border="1"><tr><td></td><td></td><td></td></tr><tr><td></td><td></td><td></td></tr><tr><td></td><td></td><td></td></tr></table> Post - 0 Miss - 0 Block - 0 | | | | | | | | | | 7 王晨旭 <table border="1"><tr><td></td><td></td><td></td></tr><tr><td></td><td></td><td></td></tr><tr><td></td><td></td><td></td></tr></table> Post - 0 Miss - 0 Block - 0 | | | | | | | | | | 8 杨鑫祥 <table border="1"><tr><td></td><td></td><td></td></tr><tr><td></td><td></td><td></td></tr><tr><td></td><td></td><td></td></tr></table> Post - 0 Miss - 0 Block - 0 | | | | | | | | | | 9 荆胤丞 <table border="1"><tr><td></td><td></td><td></td></tr><tr><td></td><td></td><td></td></tr><tr><td></td><td></td><td>1</td></tr></table> Post - 0 Miss - 0 Block - 0 | | | | | | | | | 1 | 10 赵一 <table border="1"><tr><td></td><td>1</td><td>1</td></tr><tr><td></td><td></td><td></td></tr><tr><td></td><td></td><td></td></tr></table> Post - 0 Miss - 0 Block - 0 | | 1 | 1 | | | | | | | 15 刘家良 <table border="1"><tr><td>1</td><td></td><td></td></tr><tr><td></td><td></td><td></td></tr><tr><td></td><td></td><td></td></tr></table> Post - 0 Miss - 0 Block - 0 | 1 | | | | | | | | |
| | | | | | | | | | | | | | | | | | | | | | | | | | | | | | | | | | | | | | | | | | | | | | | | | | | | | | | | | | | | | | | | | | | | | | | | | | | | | | | | |
| | | | | | | | | | | | | | | | | | | | | | | | | | | | | | | | | | | | | | | | | | | | | | | | | | | | | | | | | | | | | | | | | | | | | | | | | | | | | | | | |
| | | | | | | | | | | | | | | | | | | | | | | | | | | | | | | | | | | | | | | | | | | | | | | | | | | | | | | | | | | | | | | | | | | | | | | | | | | | | | | | |
| | | 4 | | | | | | | | | | | | | | | | | | | | | | | | | | | | | | | | | | | | | | | | | | | | | | | | | | | | | | | | | | | | | | | | | | | | | | | | | | | | | |
| | | | | | | | | | | | | | | | | | | | | | | | | | | | | | | | | | | | | | | | | | | | | | | | | | | | | | | | | | | | | | | | | | | | | | | | | | | | | | | | |
| 1 | | 2 | | | | | | | | | | | | | | | | | | | | | | | | | | | | | | | | | | | | | | | | | | | | | | | | | | | | | | | | | | | | | | | | | | | | | | | | | | | | | |
| | | | | | | | | | | | | | | | | | | | | | | | | | | | | | | | | | | | | | | | | | | | | | | | | | | | | | | | | | | | | | | | | | | | | | | | | | | | | | | | |
| | | | | | | | | | | | | | | | | | | | | | | | | | | | | | | | | | | | | | | | | | | | | | | | | | | | | | | | | | | | | | | | | | | | | | | | | | | | | | | | |
| | | | | | | | | | | | | | | | | | | | | | | | | | | | | | | | | | | | | | | | | | | | | | | | | | | | | | | | | | | | | | | | | | | | | | | | | | | | | | | | |
| | | | | | | | | | | | | | | | | | | | | | | | | | | | | | | | | | | | | | | | | | | | | | | | | | | | | | | | | | | | | | | | | | | | | | | | | | | | | | | | |
| | | | | | | | | | | | | | | | | | | | | | | | | | | | | | | | | | | | | | | | | | | | | | | | | | | | | | | | | | | | | | | | | | | | | | | | | | | | | | | | |
| | | | | | | | | | | | | | | | | | | | | | | | | | | | | | | | | | | | | | | | | | | | | | | | | | | | | | | | | | | | | | | | | | | | | | | | | | | | | | | | |
| | | | | | | | | | | | | | | | | | | | | | | | | | | | | | | | | | | | | | | | | | | | | | | | | | | | | | | | | | | | | | | | | | | | | | | | | | | | | | | | |
| | | | | | | | | | | | | | | | | | | | | | | | | | | | | | | | | | | | | | | | | | | | | | | | | | | | | | | | | | | | | | | | | | | | | | | | | | | | | | | | |
| | | | | | | | | | | | | | | | | | | | | | | | | | | | | | | | | | | | | | | | | | | | | | | | | | | | | | | | | | | | | | | | | | | | | | | | | | | | | | | | |
| | | | | | | | | | | | | | | | | | | | | | | | | | | | | | | | | | | | | | | | | | | | | | | | | | | | | | | | | | | | | | | | | | | | | | | | | | | | | | | | |
| | | | | | | | | | | | | | | | | | | | | | | | | | | | | | | | | | | | | | | | | | | | | | | | | | | | | | | | | | | | | | | | | | | | | | | | | | | | | | | | |
| | | 1 | | | | | | | | | | | | | | | | | | | | | | | | | | | | | | | | | | | | | | | | | | | | | | | | | | | | | | | | | | | | | | | | | | | | | | | | | | | | | |
| | 1 | 1 | | | | | | | | | | | | | | | | | | | | | | | | | | | | | | | | | | | | | | | | | | | | | | | | | | | | | | | | | | | | | | | | | | | | | | | | | | | | | |
| | | | | | | | | | | | | | | | | | | | | | | | | | | | | | | | | | | | | | | | | | | | | | | | | | | | | | | | | | | | | | | | | | | | | | | | | | | | | | | | |
| | | | | | | | | | | | | | | | | | | | | | | | | | | | | | | | | | | | | | | | | | | | | | | | | | | | | | | | | | | | | | | | | | | | | | | | | | | | | | | | |
| 1 | | | | | | | | | | | | | | | | | | | | | | | | | | | | | | | | | | | | | | | | | | | | | | | | | | | | | | | | | | | | | | | | | | | | | | | | | | | | | | | |
| | | | | | | | | | | | | | | | | | | | | | | | | | | | | | | | | | | | | | | | | | | | | | | | | | | | | | | | | | | | | | | | | | | | | | | | | | | | | | | | |
| | | | | | | | | | | | | | | | | | | | | | | | | | | | | | | | | | | | | | | | | | | | | | | | | | | | | | | | | | | | | | | | | | | | | | | | | | | | | | | | |
| 16 李凯锋 <table border="1"><tr><td></td><td></td><td></td></tr><tr><td></td><td></td><td></td></tr><tr><td></td><td></td><td></td></tr></table> Post - 0 Miss - 0 Block - 0 | | | | | | | | | | 17 陈锐涛 <table border="1"><tr><td></td><td></td><td></td></tr><tr><td></td><td></td><td></td></tr><tr><td></td><td></td><td></td></tr></table> Post - 0 Miss - 0 Block - 0 | | | | | | | | | | 18 奚尧 <table border="1"><tr><td></td><td></td><td></td></tr><tr><td></td><td></td><td></td></tr><tr><td></td><td></td><td></td></tr></table> Post - 0 Miss - 0 Block - 0 | | | | | | | | | | 21 刘晓青 <table border="1"><tr><td></td><td></td><td></td></tr><tr><td></td><td></td><td></td></tr><tr><td></td><td></td><td></td></tr></table> Post - 0 Miss - 0 Block - 0 | | | | | | | | | | 23 朱天一 <table border="1"><tr><td></td><td>1</td><td>1</td></tr><tr><td></td><td></td><td></td></tr><tr><td></td><td></td><td></td></tr></table> Post - 0 Miss - 0 Block - 0 | | 1 | 1 | | | | | | | 24 钟盛发 <table border="1"><tr><td></td><td></td><td></td></tr><tr><td></td><td></td><td></td></tr><tr><td></td><td></td><td></td></tr></table> Post - 0 Miss - 0 Block - 0 | | | | | | | | | | 27 邓可钊 <table border="1"><tr><td></td><td></td><td></td></tr><tr><td></td><td></td><td></td></tr><tr><td></td><td></td><td></td></tr></table> Post - 0 Miss - 0 Block - 0 | | | | | | | | | | 36 陈泽锟 <table border="1"><tr><td></td><td></td><td></td></tr><tr><td></td><td></td><td></td></tr><tr><td></td><td></td><td></td></tr></table> Post - 0 Miss - 0 Block - 0 | | | | | | | | | |
| | | | | | | | | | | | | | | | | | | | | | | | | | | | | | | | | | | | | | | | | | | | | | | | | | | | | | | | | | | | | | | | | | | | | | | | | | | | | | | | |
| | | | | | | | | | | | | | | | | | | | | | | | | | | | | | | | | | | | | | | | | | | | | | | | | | | | | | | | | | | | | | | | | | | | | | | | | | | | | | | | |
| | | | | | | | | | | | | | | | | | | | | | | | | | | | | | | | | | | | | | | | | | | | | | | | | | | | | | | | | | | | | | | | | | | | | | | | | | | | | | | | |
| | | | | | | | | | | | | | | | | | | | | | | | | | | | | | | | | | | | | | | | | | | | | | | | | | | | | | | | | | | | | | | | | | | | | | | | | | | | | | | | |
| | | | | | | | | | | | | | | | | | | | | | | | | | | | | | | | | | | | | | | | | | | | | | | | | | | | | | | | | | | | | | | | | | | | | | | | | | | | | | | | |
| | | | | | | | | | | | | | | | | | | | | | | | | | | | | | | | | | | | | | | | | | | | | | | | | | | | | | | | | | | | | | | | | | | | | | | | | | | | | | | | |
| | | | | | | | | | | | | | | | | | | | | | | | | | | | | | | | | | | | | | | | | | | | | | | | | | | | | | | | | | | | | | | | | | | | | | | | | | | | | | | | |
| | | | | | | | | | | | | | | | | | | | | | | | | | | | | | | | | | | | | | | | | | | | | | | | | | | | | | | | | | | | | | | | | | | | | | | | | | | | | | | | |
| | | | | | | | | | | | | | | | | | | | | | | | | | | | | | | | | | | | | | | | | | | | | | | | | | | | | | | | | | | | | | | | | | | | | | | | | | | | | | | | |
| | | | | | | | | | | | | | | | | | | | | | | | | | | | | | | | | | | | | | | | | | | | | | | | | | | | | | | | | | | | | | | | | | | | | | | | | | | | | | | | |
| | | | | | | | | | | | | | | | | | | | | | | | | | | | | | | | | | | | | | | | | | | | | | | | | | | | | | | | | | | | | | | | | | | | | | | | | | | | | | | | |
| | | | | | | | | | | | | | | | | | | | | | | | | | | | | | | | | | | | | | | | | | | | | | | | | | | | | | | | | | | | | | | | | | | | | | | | | | | | | | | | |
| | 1 | 1 | | | | | | | | | | | | | | | | | | | | | | | | | | | | | | | | | | | | | | | | | | | | | | | | | | | | | | | | | | | | | | | | | | | | | | | | | | | | | |
| | | | | | | | | | | | | | | | | | | | | | | | | | | | | | | | | | | | | | | | | | | | | | | | | | | | | | | | | | | | | | | | | | | | | | | | | | | | | | | | |
| | | | | | | | | | | | | | | | | | | | | | | | | | | | | | | | | | | | | | | | | | | | | | | | | | | | | | | | | | | | | | | | | | | | | | | | | | | | | | | | |
| | | | | | | | | | | | | | | | | | | | | | | | | | | | | | | | | | | | | | | | | | | | | | | | | | | | | | | | | | | | | | | | | | | | | | | | | | | | | | | | |
| | | | | | | | | | | | | | | | | | | | | | | | | | | | | | | | | | | | | | | | | | | | | | | | | | | | | | | | | | | | | | | | | | | | | | | | | | | | | | | | |
| | | | | | | | | | | | | | | | | | | | | | | | | | | | | | | | | | | | | | | | | | | | | | | | | | | | | | | | | | | | | | | | | | | | | | | | | | | | | | | | |
| | | | | | | | | | | | | | | | | | | | | | | | | | | | | | | | | | | | | | | | | | | | | | | | | | | | | | | | | | | | | | | | | | | | | | | | | | | | | | | | |
| | | | | | | | | | | | | | | | | | | | | | | | | | | | | | | | | | | | | | | | | | | | | | | | | | | | | | | | | | | | | | | | | | | | | | | | | | | | | | | | |
| | | | | | | | | | | | | | | | | | | | | | | | | | | | | | | | | | | | | | | | | | | | | | | | | | | | | | | | | | | | | | | | | | | | | | | | | | | | | | | | |
| | | | | | | | | | | | | | | | | | | | | | | | | | | | | | | | | | | | | | | | | | | | | | | | | | | | | | | | | | | | | | | | | | | | | | | | | | | | | | | | |
| | | | | | | | | | | | | | | | | | | | | | | | | | | | | | | | | | | | | | | | | | | | | | | | | | | | | | | | | | | | | | | | | | | | | | | | | | | | | | | | |
| | | | | | | | | | | | | | | | | | | | | | | | | | | | | | | | | | | | | | | | | | | | | | | | | | | | | | | | | | | | | | | | | | | | | | | | | | | | | | | | |

| | | |
|-------------------------|-------------------------|---------------------------|
| Team A A 上海宝山 | Team B B 山东济南 | Match Number 20 |
|-------------------------|-------------------------|---------------------------|

| | | | | | |
|--------------------------|-------------------------------|-------------------------|--------------------|-------|------------|
| Played in 安徽滁州 | in the hall 滁州国际手球馆 | on 2019-05-31 | at 16:00 | hours | Spectators |
|--------------------------|-------------------------------|-------------------------|--------------------|-------|------------|

| | | | | | | | | | | | | | | |
|----------------|----------------|---------------|---------------------|----------------|----------------|----------------|---|---|----------------|---|---|----------------------|---|---|
| Half-time(30') | A 10 | B 6 | End of playing time | A 18 | B 11 | 1st extra time | A | B | 2nd extra time | A | B | After penalty throws | A | B |
|----------------|----------------|---------------|---------------------|----------------|----------------|----------------|---|---|----------------|---|---|----------------------|---|---|

| | | | | | | | | | | |
|---------------|-----------------|---------------|---|---|------------------------------------|---------------|---|--|-----------------|---------------|
| Number of 7 m | A 2/2 | Team time-out | | | Full name of players and officials | Team time-out | | | B 0/0 | Number of 7 m |
| | 1 | 2 | 3 | 1 | | 2 | 3 | | | |

| No. | Team A | G | W | 2' | D | DR | No. | Team B | G | W | 2' | D | DR |
|-----|-----------|---|---|----|---|----|-----|-----------|---|---|----|---|----|
| 3 | 侯俊杰 | | | | | | 1 | 刘在攀 | | | | | |
| 5 | 范斯哲 | | | | | | 4 | 张广一 | | | | | |
| 6 | 吴梓涵 | | | | | | 6 | 刘尊哲 | 1 | | | | |
| 7 | 彭意焱 | | | | | | 7 | 王帅 | 2 | | | | |
| 10 | 马涛 | | | | | | 8 | 金正凯 | 1 | | | | |
| 13 | 刘启群 | 3 | | | | | 9 | 张嘉树 | | | | | |
| 19 | 张申杰 | | | | | | 10 | 颜同霖 | 2 | | | | |
| 21 | 曾新宇 | 7 | | | | | 11 | 李延舒 | 3 | 1 | | | |
| 22 | 马浩东 | 2 | | | | | 13 | 刘振宇 | 2 | | | | |
| 25 | 江锦 | | | | | | 16 | 高宇轩 | | | | | |
| 30 | 戴泽昊 | 1 | | | | | 17 | 张昊 | | | | | |
| 35 | 刘子杰 | 5 | | | | | 21 | 杨明毅 | | | | | |
| 39 | 陆毅泽 | | | | | | 24 | 于昊 | | | | | |
| 66 | 黄嘉遥 | | | | | | 26 | 曹立志 | | | | | |
| 68 | 陈沁磊 | | | | | | 40 | 鹿智豪 | | | | | |
| | | | | | | | 88 | 王麒翔 | | | | | |
| A | 马革 | | | | | | A | 李楠 | | | | | |
| B | 徐聪豪 (主教练) | | | | | | B | 陈鹏波 (主教练) | | | | | |
| D | 赵时俊 | | | | | | C | 陶丛龙 | | | | | |
| | | | | | | | E | 郭军旗 | | | | | |

| | | |
|---|--|---|
| A | Signatures of responsables for the teams (Off.A) | B |
|---|--|---|

| | | |
|----|-----------------------------------|----|
| TP | Remarks of referees / HF Official | TP |
|----|-----------------------------------|----|

| | | | |
|------------|-----------|-----------|--|
| Signatures | | | |
| Referees | 尹静阳 (CHN) | 李兆蒙 (CHN) | |
| T.D. | 许宜扬 (CHN) | 徐健 (CHN) | |
| CHA Off. | | | |

Note: Number of 7m Throws Awarded to Team A and B, Goals (G), Warnings (W), Suspensions (2'), Direct Disqualification (D), Disqualification With Report (DR) and Team Penalty (TP).

Table Officials: 李莉君 吴荣 Statisticians: 马安兴 沈家洛

第二届全国青年运动会男子手球乙组决赛 体校组 (U16)

PHMS Pictorial Handball Match Statistics

IHF Official System

竞赛技术统计

手球
青年男子

预赛
轮次 3

组别 B
场次 20

滁州国际手球馆
2019-05-31 16:00

Referees: 尹静阳 (CHN) / 李兆蒙 (CHN)

Result: 18:11 (10:6)

Teams: 上海宝山 (宝山) VS 山东济南 (济南)

| 宝山 | | 远 | 近 | 边 | 快 | 突 | 任意 | 7m | 合计 | % | 助攻 | 失误 | 警告 | 2' | D+DR |
|----------|-----|-----|------|-----|-----|-----|-----|-----|-------|------|----|----|----|----|------|
| 主教练: 徐聪豪 | | 射 | 射 | 射 | 攻 | 破 | 球 | 球 | | | | | | | |
| 3 | 侯俊杰 | | | | | | | | | | | | | | |
| 5 | 范斯哲 | | | | | | | | | | | | | | |
| 6 | 吴梓涵 | | | | | | | | | | | | | | |
| 7 | 彭意焱 | | | | | | | | | | | | | | |
| 10 | 马涛 | 0/1 | | | | | | | 0/1 | 0.0 | 1 | 2 | | | |
| 13 | 刘启群 | | 1/2 | 2/2 | | | | | 3/4 | 75.0 | | 1 | | | |
| 19 | 张申杰 | | 0/1 | 0/2 | | | | | 0/3 | 0.0 | | | | | |
| 21 | 曾新宇 | 3/5 | 1/1 | | 3/5 | 0/1 | | | 7/12 | 58.3 | 1 | 1 | | | |
| 22 | 马浩东 | 1/3 | | | 0/1 | 1/1 | | | 2/5 | 40.0 | | 2 | | | |
| 25 | 江锦 | | | | | | | | | | | | | | |
| 30 | 戴泽昊 | | 1/2 | | | | | | 1/2 | 50.0 | | | | | |
| 35 | 刘子杰 | | 3/4 | | | | | 2/2 | 5/6 | 83.3 | | 1 | | | |
| 39 | 陆毅泽 | | | | | | | | | | | | | | |
| 66 | 黄嘉遥 | | | | | | | | | | | | | | |
| 68 | 陈沁磊 | | | | | | | | | | | | | | |
| 运动员 | 合计 | 4/9 | 6/10 | 2/4 | 3/6 | 1/2 | | 2/2 | 18/33 | 54.5 | 2 | 7 | | | |
| 66 | 黄嘉遥 | 4/6 | 3/5 | 0/2 | 0/2 | 0/2 | 0/1 | | 7/18 | 38.9 | | | | | |
| 守门员 | 合计 | 4/6 | 3/5 | 0/2 | 0/2 | 0/2 | 0/1 | | 7/18 | 38.9 | | | | | |

| 济南 | | 远 | 近 | 边 | 快 | 突 | 任意 | 7m | 合计 | % | 助攻 | 失误 | 警告 | 2' | D+DR |
|----------|-----|------|-----|-----|-----|-----|-----|-----|-------|------|----|----|----|----|------|
| 主教练: 陈鹏波 | | 射 | 射 | 射 | 攻 | 破 | 球 | 球 | | | | | | | |
| 1 | 刘在攀 | | | | | | | | | | | | | | |
| 4 | 张广一 | | | | | | | | | | | | | | |
| 6 | 刘尊哲 | 0/3 | | 0/1 | | 1/1 | | | 1/5 | 20.0 | 2 | 6 | | | |
| 7 | 王帅 | | 0/1 | | 1/1 | | 1/1 | | 2/3 | 66.7 | | | | | |
| 8 | 金正凯 | | 0/1 | 1/1 | | | | | 1/2 | 50.0 | | 1 | | | |
| 9 | 张嘉树 | 0/2 | | | | | | | 0/2 | 0.0 | | | | | |
| 10 | 颜同霖 | | | | 1/1 | 1/1 | | | 2/2 | 100 | | 5 | | | |
| 11 | 李延舒 | | 2/3 | 1/1 | | | | | 3/4 | 75.0 | | 2 | 1 | | |
| 13 | 刘振宇 | 2/5 | | | | | | | 2/5 | 40.0 | | 1 | | | |
| 16 | 高宇轩 | | | | | | | | | | | | | | |
| 17 | 张昊 | | | | | | | | | | | | | | |
| 21 | 杨明毅 | | | | | | | | | | | | | | |
| 24 | 于昊 | | | | | | | | | | | | | | |
| 26 | 曹立志 | | | | | | | | | | | | | | |
| 40 | 鹿智豪 | | | | | | | | | | | | | | |
| 88 | 王麒麟 | | | | | | | | | | | | | | |
| 运动员 | 合计 | 2/10 | 2/5 | 2/3 | 2/2 | 2/2 | 1/1 | | 11/23 | 47.8 | 2 | 15 | 1 | | |
| 1 | 刘在攀 | 4/8 | 1/7 | 0/2 | 2/5 | 1/2 | | 0/2 | 8/26 | 30.8 | | | | | |
| 守门员 | 合计 | 4/8 | 1/7 | 0/2 | 2/5 | 1/2 | | 0/2 | 8/26 | 30.8 | | | | | |

| 宝山 | 比赛进程 | 济南 |
|----------|----------|-----------|
| 1st Half | | |
| 35 刘子杰 | 1 00:55 | 0 |
| 21 曾新宇 | 2 01:17 | 0 |
| 35 刘子杰 | 3 03:35 | 0 |
| | 3 04:02 | 1 7 王帅 |
| 13 刘启群 | 4 06:06 | 1 |
| | 4 06:25 | 2 10 颜同霖 |
| | 4 06:51 | 3 10 颜同霖 |
| 13 刘启群 | 5 07:16 | 3 |
| | 5 08:13 | 4 7 王帅 |
| 30 戴泽昊 | 6 08:41 | 4 |
| | 6 10:54 | 5 8 金正凯 |
| 21 曾新宇 | 7 11:15 | 5 |
| | 7 11:58 | 6 6 刘尊哲 |
| 35 刘子杰 | 8 12:22 | 6 |
| 21 曾新宇 | 9 13:02 | 6 |
| 21 曾新宇 | 10 14:09 | 6 |
| 2nd Half | | |
| 21 曾新宇 | 11 00:15 | 6 |
| 13 刘启群 | 12 00:49 | 6 |
| | 12 01:11 | 7 11 李延舒 |
| | 12 02:10 | 8 13 刘振宇 |
| 21 曾新宇 | 13 03:56 | 8 |
| | 13 04:26 | 9 11 李延舒 |
| | 13 05:41 | 10 13 刘振宇 |
| 35 刘子杰 | 14 09:59 | 10 |
| 22 马浩东 | 15 10:43 | 10 |
| 22 马浩东 | 16 11:26 | 10 |
| 21 曾新宇 | 17 12:39 | 10 |
| 35 刘子杰 | 18 14:09 | 10 |
| | 18 14:42 | 11 11 李延舒 |

场上队员: 得分 / 射门

守门员: 救球 / 射门

| | | | |
|---|------|----|---------|
| D | 取消资格 | DR | 取消资格+报告 |
|---|------|----|---------|

个人/全队技术统计表

手球 青年男子 预赛 轮次 3 组别 B 场次 20 滁州国际手球馆 2019-05-31 16:00

| 号码 | 姓名 | 远射 | 近射 | 边射 | 快攻 | 突破 | 任意 | 七米 | 合计 | % | 助攻 | 失误 | 警告 | 2' | 取消 | 时间 |
|----------|-----|-----|------|-----|-----|-----|-----|-----|-------|-------|----|----|----|----|----|----------|
| 上海宝山(宝山) | | | | | | | | | | | | | | | | |
| (场上队员) | | | | | | | | | | | | | | | | |
| 3 | 侯俊杰 | | | | | | | | | 0.0% | | | | | | 00:00:00 |
| 5 | 范斯哲 | | | | | | | | | 0.0% | | | | | | 00:00:00 |
| 6 | 吴梓涵 | | | | | | | | | 0.0% | | | | | | 00:00:00 |
| 7 | 彭意焱 | | | | | | | | | 0.0% | | | | | | 00:00:00 |
| 10 | 马涛 | 0/1 | | | | | | | 0/1 | 0.0% | 1 | 2 | | | | 00:21:21 |
| 13 | 刘启群 | | 1/2 | 2/2 | | | | | 3/4 | 75.0% | | 1 | | | | 00:30:00 |
| 19 | 张申杰 | | 0/1 | 0/2 | | | | | 0/3 | 0.0% | | | | | | 00:30:00 |
| 21 | 曾新宇 | 3/5 | 1/1 | | 3/5 | 0/1 | | | 7/12 | 58.3% | 1 | 1 | | | | 00:30:00 |
| 22 | 马浩东 | 1/3 | | | 0/1 | 1/1 | | | 2/5 | 40.0% | | 2 | | | | 00:29:58 |
| 25 | 江锦 | | | | | | | | | 0.0% | | | | | | 00:00:00 |
| 30 | 戴泽昊 | | 1/2 | | | | | | 1/2 | 50.0% | | | | | | 00:12:13 |
| 35 | 刘子杰 | | 3/4 | | | | | 2/2 | 5/6 | 83.3% | | 1 | | | | 00:26:12 |
| 39 | 陆毅泽 | | | | | | | | | 0.0% | | | | | | 00:00:00 |
| 66 | 黄嘉遥 | | | | | | | | | 0.0% | | | | | | 00:30:00 |
| 68 | 陈沁磊 | | | | | | | | | 0.0% | | | | | | 00:00:00 |
| 合计 | | 4/9 | 6/10 | 2/4 | 3/6 | 1/2 | | 2/2 | 18/33 | 54.5% | 2 | 7 | | | | |
| (守门员) | | | | | | | | | | | | | | | | |
| 66 | 黄嘉遥 | 4/6 | 3/5 | 0/2 | 0/2 | 0/2 | 0/1 | | 7/18 | 38.9% | | | | | | 00:30:00 |
| 合计 | | 4/6 | 3/5 | 0/2 | 0/2 | 0/2 | 0/1 | | 7/18 | 38.9% | | | | | | |

场上队员：得分/射门

守门员：救球/射门

| 全队合计 | 得分 | 被救 | 射失 | 击柱 | 封球 | 合计 | % |
|------|----|----|----|----|----|----|--------|
| 远射 | 4 | 4 | 1 | | | 9 | 44.4% |
| 近射 | 6 | 1 | 3 | | | 10 | 60.0% |
| 边射 | 2 | | 2 | | | 4 | 50.0% |
| 快攻 | 3 | 2 | | 1 | | 6 | 50.0% |
| 突破 | 1 | 1 | | | | 2 | 50.0% |
| 任意 | | | | | | | 0.0% |
| 七米 | 2 | | | | | 2 | 100.0% |

个人/全队技术统计表

手球 预赛 组别 B 滁州国际手球馆
青年男子 轮次 3 场次 20 2019-05-31 16:00

| 号码 | 姓名 | 远射 | 近射 | 边射 | 快攻 | 突破 | 任意 | 七米 | 合计 | % | 助攻 | 失误 | 警告 | 2' | 取消 | 时间 |
|----------|-----|------|-----|-----|-----|-----|-----|-----|-------|-------|----|----|----|----|----|----------|
| 山东济南(济南) | | | | | | | | | | | | | | | | |
| (场上队员) | | | | | | | | | | | | | | | | |
| 1 | 刘在攀 | | | | | | | | | 0.0% | | | | | | 00:29:50 |
| 4 | 张广一 | | | | | | | | | 0.0% | | | | | | 00:02:33 |
| 6 | 刘尊哲 | 0/3 | | 0/1 | | 1/1 | | | 1/5 | 20.0% | 2 | 6 | | | | 00:29:03 |
| 7 | 王帅 | | 0/1 | | 1/1 | | 1/1 | | 2/3 | 66.7% | | | | | | 00:29:59 |
| 8 | 金正凯 | | 0/1 | 1/1 | | | | | 1/2 | 50.0% | | 1 | | | | 00:29:39 |
| 9 | 张嘉树 | 0/2 | | | | | | | 0/2 | 0.0% | | | | | | 00:06:57 |
| 10 | 颜同霖 | | | | 1/1 | 1/1 | | | 2/2 | 100% | | 5 | | | | 00:21:16 |
| 11 | 李延舒 | | 2/3 | 1/1 | | | | | 3/4 | 75.0% | | 2 | 1 | | | 00:29:38 |
| 13 | 刘振宇 | 2/5 | | | | | | | 2/5 | 40.0% | | 1 | | | | 00:29:57 |
| 16 | 高宇轩 | | | | | | | | | 0.0% | | | | | | 00:00:00 |
| 17 | 张昊 | | | | | | | | | 0.0% | | | | | | 00:00:00 |
| 21 | 杨明毅 | | | | | | | | | 0.0% | | | | | | 00:00:00 |
| 24 | 于昊 | | | | | | | | | 0.0% | | | | | | 00:00:00 |
| 26 | 曹立志 | | | | | | | | | 0.0% | | | | | | 00:00:00 |
| 40 | 鹿智豪 | | | | | | | | | 0.0% | | | | | | 00:00:00 |
| 88 | 王麒翔 | | | | | | | | | 0.0% | | | | | | 00:00:00 |
| | 合计 | 2/10 | 2/5 | 2/3 | 2/2 | 2/2 | 1/1 | | 11/23 | 47.8% | 2 | 15 | 1 | | | |
| (守门员) | | | | | | | | | | | | | | | | |
| 1 | 刘在攀 | 4/8 | 1/7 | 0/2 | 2/5 | 1/2 | | 0/2 | 8/26 | 30.8% | | | | | | 00:29:50 |
| | 合计 | 4/8 | 1/7 | 0/2 | 2/5 | 1/2 | | 0/2 | 8/26 | 30.8% | | | | | | |

场上队员：得分/射门

守门员：救球/射门

| 全队合计 | 得分 | 被救 | 射失 | 击柱 | 封球 | 合计 | % |
|------|----|----|----|----|----|----|--------|
| 远射 | 2 | 4 | 3 | | 1 | 10 | 20.0% |
| 近射 | 2 | 3 | | | | 5 | 40.0% |
| 边射 | 2 | | | 1 | | 3 | 66.7% |
| 快攻 | 2 | | | | | 2 | 100.0% |
| 突破 | 2 | | | | | 2 | 100.0% |
| 任意 | 1 | | | | | 1 | 100.0% |
| 七米 | | | | | | | 0.0% |

图式比赛技术统计表

手球
青年男子

预赛
轮次 3

组别 B
场次 20

滁州国际手球馆
2019-05-31 16:00

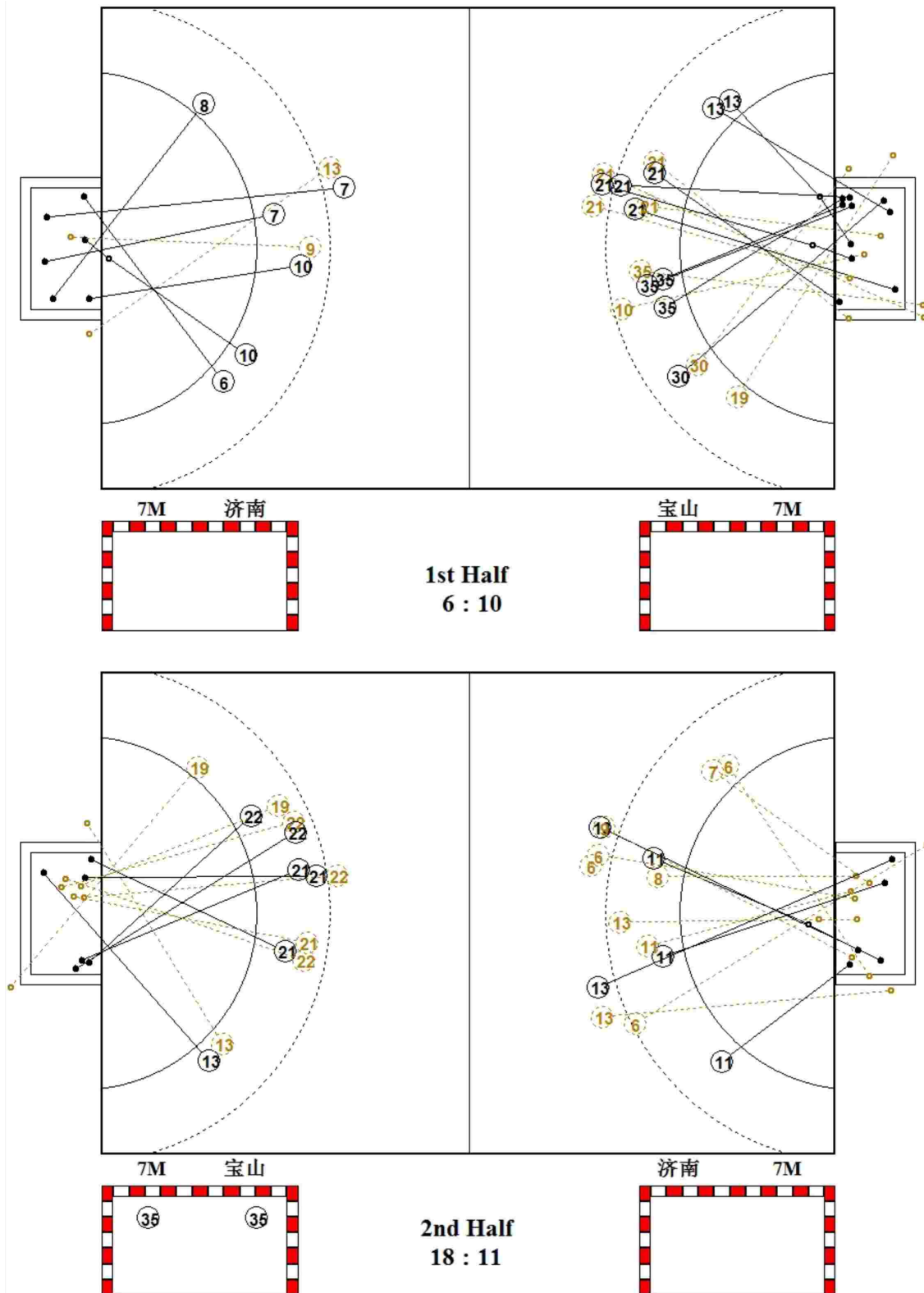

图式射门区域统计

手球
青年男子

预赛
轮次 3

组别 B
场次 20

滁州国际手球馆
2019-05-31 16:00

上海宝山

| | | | | | | | | | | | | | | | | | | | | | | | | | | | | | | | | | | | | | | | | | | | | | | | | | | | | | | | | | | | | | | | | | | | | | | | | | | | | | | | |
|--|-----------------------------|-----------------------------|-----------------------------|-----------------------------|-----------------------------|-----------------------------|-----------------------------|--|--|--|--|--|--|--|--|--|--|--|--|---|---|--|--|--|--|--|--|--|--|---|---|--|---|--|--|--|---|--|--|--|--|--|--|--|--|--|--|--|--|---|---|--|---|--|--|--|--|---|--|--|--|--|--|--|--|--|--|--|--|--|--|--|---|--|--|--|---|---|---|
| 3 侯俊杰 | 5 范斯哲 | 6 吴梓涵 | 7 彭意焱 | 10 马涛 | 13 刘启群 | 19 张申杰 | 21 曾新宇 | | | | | | | | | | | | | | | | | | | | | | | | | | | | | | | | | | | | | | | | | | | | | | | | | | | | | | | | | | | | | | | | | | | | | | | | |
| <table border="1"><tr><td></td><td></td><td></td></tr><tr><td></td><td></td><td></td></tr><tr><td></td><td></td><td></td></tr></table> | | | | | | | | | | <table border="1"><tr><td></td><td></td><td></td></tr><tr><td></td><td></td><td></td></tr><tr><td></td><td></td><td></td></tr></table> | | | | | | | | | | <table border="1"><tr><td></td><td></td><td></td></tr><tr><td></td><td></td><td></td></tr><tr><td></td><td></td><td></td></tr></table> | | | | | | | | | | <table border="1"><tr><td></td><td></td><td></td></tr><tr><td></td><td></td><td></td></tr><tr><td></td><td></td><td></td></tr></table> | | | | | | | | | | <table border="1"><tr><td></td><td></td><td></td></tr><tr><td></td><td></td><td></td></tr><tr><td></td><td></td><td></td></tr></table> | | | | | | | | | | <table border="1"><tr><td>1</td><td></td><td>1</td></tr><tr><td></td><td></td><td></td></tr><tr><td></td><td>1</td><td></td></tr></table> | 1 | | 1 | | | | | 1 | | <table border="1"><tr><td></td><td></td><td></td></tr><tr><td></td><td></td><td></td></tr><tr><td></td><td></td><td></td></tr></table> | | | | | | | | | | <table border="1"><tr><td></td><td></td><td>1</td></tr><tr><td></td><td></td><td></td></tr><tr><td>2</td><td>1</td><td>3</td></tr></table> | | | 1 | | | | 2 | 1 | 3 |
| | | | | | | | | | | | | | | | | | | | | | | | | | | | | | | | | | | | | | | | | | | | | | | | | | | | | | | | | | | | | | | | | | | | | | | | | | | | | | | | |
| | | | | | | | | | | | | | | | | | | | | | | | | | | | | | | | | | | | | | | | | | | | | | | | | | | | | | | | | | | | | | | | | | | | | | | | | | | | | | | | |
| | | | | | | | | | | | | | | | | | | | | | | | | | | | | | | | | | | | | | | | | | | | | | | | | | | | | | | | | | | | | | | | | | | | | | | | | | | | | | | | |
| | | | | | | | | | | | | | | | | | | | | | | | | | | | | | | | | | | | | | | | | | | | | | | | | | | | | | | | | | | | | | | | | | | | | | | | | | | | | | | | |
| | | | | | | | | | | | | | | | | | | | | | | | | | | | | | | | | | | | | | | | | | | | | | | | | | | | | | | | | | | | | | | | | | | | | | | | | | | | | | | | |
| | | | | | | | | | | | | | | | | | | | | | | | | | | | | | | | | | | | | | | | | | | | | | | | | | | | | | | | | | | | | | | | | | | | | | | | | | | | | | | | |
| | | | | | | | | | | | | | | | | | | | | | | | | | | | | | | | | | | | | | | | | | | | | | | | | | | | | | | | | | | | | | | | | | | | | | | | | | | | | | | | |
| | | | | | | | | | | | | | | | | | | | | | | | | | | | | | | | | | | | | | | | | | | | | | | | | | | | | | | | | | | | | | | | | | | | | | | | | | | | | | | | |
| | | | | | | | | | | | | | | | | | | | | | | | | | | | | | | | | | | | | | | | | | | | | | | | | | | | | | | | | | | | | | | | | | | | | | | | | | | | | | | | |
| | | | | | | | | | | | | | | | | | | | | | | | | | | | | | | | | | | | | | | | | | | | | | | | | | | | | | | | | | | | | | | | | | | | | | | | | | | | | | | | |
| | | | | | | | | | | | | | | | | | | | | | | | | | | | | | | | | | | | | | | | | | | | | | | | | | | | | | | | | | | | | | | | | | | | | | | | | | | | | | | | |
| | | | | | | | | | | | | | | | | | | | | | | | | | | | | | | | | | | | | | | | | | | | | | | | | | | | | | | | | | | | | | | | | | | | | | | | | | | | | | | | |
| | | | | | | | | | | | | | | | | | | | | | | | | | | | | | | | | | | | | | | | | | | | | | | | | | | | | | | | | | | | | | | | | | | | | | | | | | | | | | | | |
| | | | | | | | | | | | | | | | | | | | | | | | | | | | | | | | | | | | | | | | | | | | | | | | | | | | | | | | | | | | | | | | | | | | | | | | | | | | | | | | |
| | | | | | | | | | | | | | | | | | | | | | | | | | | | | | | | | | | | | | | | | | | | | | | | | | | | | | | | | | | | | | | | | | | | | | | | | | | | | | | | |
| 1 | | 1 | | | | | | | | | | | | | | | | | | | | | | | | | | | | | | | | | | | | | | | | | | | | | | | | | | | | | | | | | | | | | | | | | | | | | | | | | | | | | |
| | | | | | | | | | | | | | | | | | | | | | | | | | | | | | | | | | | | | | | | | | | | | | | | | | | | | | | | | | | | | | | | | | | | | | | | | | | | | | | | |
| | 1 | | | | | | | | | | | | | | | | | | | | | | | | | | | | | | | | | | | | | | | | | | | | | | | | | | | | | | | | | | | | | | | | | | | | | | | | | | | | | | |
| | | | | | | | | | | | | | | | | | | | | | | | | | | | | | | | | | | | | | | | | | | | | | | | | | | | | | | | | | | | | | | | | | | | | | | | | | | | | | | | |
| | | | | | | | | | | | | | | | | | | | | | | | | | | | | | | | | | | | | | | | | | | | | | | | | | | | | | | | | | | | | | | | | | | | | | | | | | | | | | | | |
| | | | | | | | | | | | | | | | | | | | | | | | | | | | | | | | | | | | | | | | | | | | | | | | | | | | | | | | | | | | | | | | | | | | | | | | | | | | | | | | |
| | | 1 | | | | | | | | | | | | | | | | | | | | | | | | | | | | | | | | | | | | | | | | | | | | | | | | | | | | | | | | | | | | | | | | | | | | | | | | | | | | | |
| | | | | | | | | | | | | | | | | | | | | | | | | | | | | | | | | | | | | | | | | | | | | | | | | | | | | | | | | | | | | | | | | | | | | | | | | | | | | | | | |
| 2 | 1 | 3 | | | | | | | | | | | | | | | | | | | | | | | | | | | | | | | | | | | | | | | | | | | | | | | | | | | | | | | | | | | | | | | | | | | | | | | | | | | | | |
| Post - 0 Miss - 0 Block - 0 | Post - 0 Miss - 0 Block - 0 | Post - 0 Miss - 0 Block - 0 | Post - 0 Miss - 0 Block - 0 | Post - 0 Miss - 0 Block - 0 | Post - 0 Miss - 1 Block - 0 | Post - 0 Miss - 2 Block - 0 | Post - 1 Miss - 1 Block - 0 | | | | | | | | | | | | | | | | | | | | | | | | | | | | | | | | | | | | | | | | | | | | | | | | | | | | | | | | | | | | | | | | | | | | | | | | |
| 22 马浩东 | 25 江锦 | 30 戴泽昊 | 35 刘子杰 | 39 陆毅译 | 66 黄嘉遥 | 68 陈沁磊 | | | | | | | | | | | | | | | | | | | | | | | | | | | | | | | | | | | | | | | | | | | | | | | | | | | | | | | | | | | | | | | | | | | | | | | | | |
| <table border="1"><tr><td>1</td><td></td><td></td></tr><tr><td>1</td><td></td><td></td></tr><tr><td></td><td></td><td></td></tr></table> | 1 | | | 1 | | | | | | <table border="1"><tr><td></td><td></td><td></td></tr><tr><td></td><td></td><td></td></tr><tr><td></td><td></td><td></td></tr></table> | | | | | | | | | | <table border="1"><tr><td>1</td><td></td><td></td></tr><tr><td></td><td></td><td></td></tr><tr><td></td><td></td><td></td></tr></table> | 1 | | | | | | | | | <table border="1"><tr><td>1</td><td></td><td>1</td></tr><tr><td></td><td></td><td></td></tr><tr><td>3</td><td></td><td></td></tr></table> | 1 | | 1 | | | | 3 | | | <table border="1"><tr><td></td><td></td><td></td></tr><tr><td></td><td></td><td></td></tr><tr><td></td><td></td><td></td></tr></table> | | | | | | | | | | <table border="1"><tr><td></td><td></td><td></td></tr><tr><td></td><td></td><td></td></tr><tr><td></td><td></td><td></td></tr></table> | | | | | | | | | | <table border="1"><tr><td></td><td></td><td></td></tr><tr><td></td><td></td><td></td></tr><tr><td></td><td></td><td></td></tr></table> | | | | | | | | | | | | | | | | | | | |
| 1 | | | | | | | | | | | | | | | | | | | | | | | | | | | | | | | | | | | | | | | | | | | | | | | | | | | | | | | | | | | | | | | | | | | | | | | | | | | | | | | |
| 1 | | | | | | | | | | | | | | | | | | | | | | | | | | | | | | | | | | | | | | | | | | | | | | | | | | | | | | | | | | | | | | | | | | | | | | | | | | | | | | | |
| | | | | | | | | | | | | | | | | | | | | | | | | | | | | | | | | | | | | | | | | | | | | | | | | | | | | | | | | | | | | | | | | | | | | | | | | | | | | | | | |
| | | | | | | | | | | | | | | | | | | | | | | | | | | | | | | | | | | | | | | | | | | | | | | | | | | | | | | | | | | | | | | | | | | | | | | | | | | | | | | | |
| | | | | | | | | | | | | | | | | | | | | | | | | | | | | | | | | | | | | | | | | | | | | | | | | | | | | | | | | | | | | | | | | | | | | | | | | | | | | | | | |
| | | | | | | | | | | | | | | | | | | | | | | | | | | | | | | | | | | | | | | | | | | | | | | | | | | | | | | | | | | | | | | | | | | | | | | | | | | | | | | | |
| 1 | | | | | | | | | | | | | | | | | | | | | | | | | | | | | | | | | | | | | | | | | | | | | | | | | | | | | | | | | | | | | | | | | | | | | | | | | | | | | | | |
| | | | | | | | | | | | | | | | | | | | | | | | | | | | | | | | | | | | | | | | | | | | | | | | | | | | | | | | | | | | | | | | | | | | | | | | | | | | | | | | |
| | | | | | | | | | | | | | | | | | | | | | | | | | | | | | | | | | | | | | | | | | | | | | | | | | | | | | | | | | | | | | | | | | | | | | | | | | | | | | | | |
| 1 | | 1 | | | | | | | | | | | | | | | | | | | | | | | | | | | | | | | | | | | | | | | | | | | | | | | | | | | | | | | | | | | | | | | | | | | | | | | | | | | | | |
| | | | | | | | | | | | | | | | | | | | | | | | | | | | | | | | | | | | | | | | | | | | | | | | | | | | | | | | | | | | | | | | | | | | | | | | | | | | | | | | |
| 3 | | | | | | | | | | | | | | | | | | | | | | | | | | | | | | | | | | | | | | | | | | | | | | | | | | | | | | | | | | | | | | | | | | | | | | | | | | | | | | | |
| | | | | | | | | | | | | | | | | | | | | | | | | | | | | | | | | | | | | | | | | | | | | | | | | | | | | | | | | | | | | | | | | | | | | | | | | | | | | | | | |
| | | | | | | | | | | | | | | | | | | | | | | | | | | | | | | | | | | | | | | | | | | | | | | | | | | | | | | | | | | | | | | | | | | | | | | | | | | | | | | | |
| | | | | | | | | | | | | | | | | | | | | | | | | | | | | | | | | | | | | | | | | | | | | | | | | | | | | | | | | | | | | | | | | | | | | | | | | | | | | | | | |
| | | | | | | | | | | | | | | | | | | | | | | | | | | | | | | | | | | | | | | | | | | | | | | | | | | | | | | | | | | | | | | | | | | | | | | | | | | | | | | | |
| | | | | | | | | | | | | | | | | | | | | | | | | | | | | | | | | | | | | | | | | | | | | | | | | | | | | | | | | | | | | | | | | | | | | | | | | | | | | | | | |
| | | | | | | | | | | | | | | | | | | | | | | | | | | | | | | | | | | | | | | | | | | | | | | | | | | | | | | | | | | | | | | | | | | | | | | | | | | | | | | | |
| | | | | | | | | | | | | | | | | | | | | | | | | | | | | | | | | | | | | | | | | | | | | | | | | | | | | | | | | | | | | | | | | | | | | | | | | | | | | | | | |
| | | | | | | | | | | | | | | | | | | | | | | | | | | | | | | | | | | | | | | | | | | | | | | | | | | | | | | | | | | | | | | | | | | | | | | | | | | | | | | | |
| | | | | | | | | | | | | | | | | | | | | | | | | | | | | | | | | | | | | | | | | | | | | | | | | | | | | | | | | | | | | | | | | | | | | | | | | | | | | | | | |
| Post - 0 Miss - 0 Block - 0 | Post - 0 Miss - 0 Block - 0 | Post - 0 Miss - 1 Block - 0 | Post - 0 Miss - 1 Block - 0 | Post - 0 Miss - 0 Block - 0 | Post - 0 Miss - 0 Block - 0 | Post - 0 Miss - 0 Block - 0 | | | | | | | | | | | | | | | | | | | | | | | | | | | | | | | | | | | | | | | | | | | | | | | | | | | | | | | | | | | | | | | | | | | | | | | | | |

66 黄嘉遥

| | | |
|-----|-----|-----|
| 0/3 | 0/1 | 0/2 |
| 1/1 | 1/1 | 0/1 |
| 2/3 | 2/3 | 1/3 |

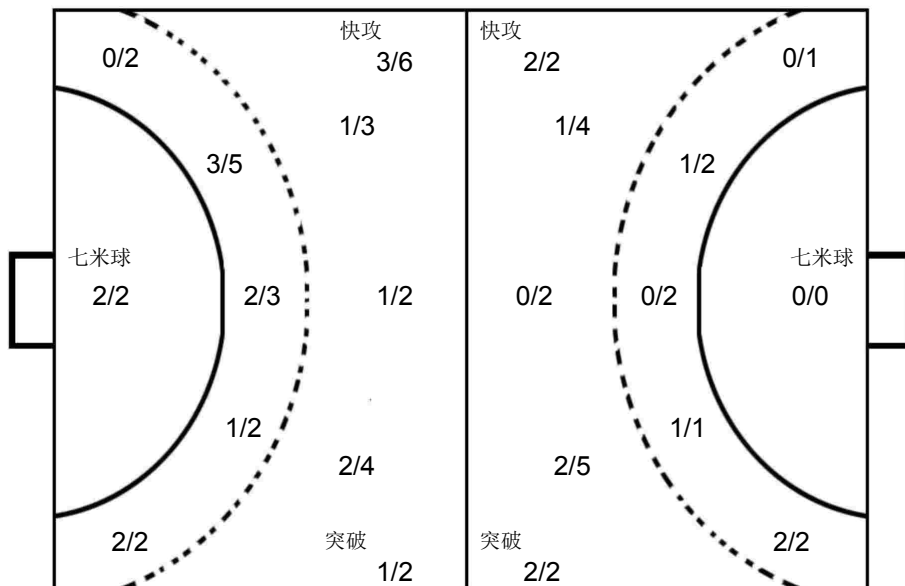

1 刘在攀

| | | |
|-----|-----|-----|
| 0/3 | 1/1 | 0/3 |
| 0/1 | 2/2 | 2/2 |
| 0/6 | 1/3 | 2/5 |

山东济南

| | | | | | | | | | | | | | | | | | | | | | | | | | | | | | | | | | | | | | | | | | | | | | | | | | | | | | | | | | | | | | | | | | | | | | | | | | | | | | | | |
|--|-----------------------------|-----------------------------|-----------------------------|-----------------------------|-----------------------------|-----------------------------|-----------------------------|--|--|--|--|--|--|--|--|--|--|--|--|---|--|--|--|--|--|--|--|--|---|--|--|---|---|--|--|--|--|--|--|---|---|--|--|--|--|--|--|--|--|--|--|--|--|--|--|--|--|--|--|--|--|--|--|--|--|--|---|---|--|---|---|--|--|--|--|---|--|--|---|
| 1 刘在攀 | 4 张广一 | 6 刘尊哲 | 7 王帅 | 8 金正凯 | 9 张嘉树 | 10 颜同霖 | 11 李延舒 | | | | | | | | | | | | | | | | | | | | | | | | | | | | | | | | | | | | | | | | | | | | | | | | | | | | | | | | | | | | | | | | | | | | | | | | |
| <table border="1"><tr><td></td><td></td><td></td></tr><tr><td></td><td></td><td></td></tr><tr><td></td><td></td><td></td></tr></table> | | | | | | | | | | <table border="1"><tr><td></td><td></td><td></td></tr><tr><td></td><td></td><td></td></tr><tr><td></td><td></td><td></td></tr></table> | | | | | | | | | | <table border="1"><tr><td></td><td></td><td></td></tr><tr><td></td><td></td><td></td></tr><tr><td></td><td></td><td>1</td></tr></table> | | | | | | | | | 1 | <table border="1"><tr><td></td><td>1</td><td>1</td></tr><tr><td></td><td></td><td></td></tr><tr><td></td><td></td><td></td></tr></table> | | 1 | 1 | | | | | | | <table border="1"><tr><td>1</td><td></td><td></td></tr><tr><td></td><td></td><td></td></tr><tr><td></td><td></td><td></td></tr></table> | 1 | | | | | | | | | <table border="1"><tr><td></td><td></td><td></td></tr><tr><td></td><td></td><td></td></tr><tr><td></td><td></td><td></td></tr></table> | | | | | | | | | | <table border="1"><tr><td></td><td></td><td></td></tr><tr><td></td><td></td><td></td></tr><tr><td>1</td><td>1</td><td></td></tr></table> | | | | | | | 1 | 1 | | <table border="1"><tr><td>1</td><td></td><td></td></tr><tr><td></td><td></td><td>1</td></tr><tr><td></td><td></td><td>1</td></tr></table> | 1 | | | | | 1 | | | 1 |
| | | | | | | | | | | | | | | | | | | | | | | | | | | | | | | | | | | | | | | | | | | | | | | | | | | | | | | | | | | | | | | | | | | | | | | | | | | | | | | | |
| | | | | | | | | | | | | | | | | | | | | | | | | | | | | | | | | | | | | | | | | | | | | | | | | | | | | | | | | | | | | | | | | | | | | | | | | | | | | | | | |
| | | | | | | | | | | | | | | | | | | | | | | | | | | | | | | | | | | | | | | | | | | | | | | | | | | | | | | | | | | | | | | | | | | | | | | | | | | | | | | | |
| | | | | | | | | | | | | | | | | | | | | | | | | | | | | | | | | | | | | | | | | | | | | | | | | | | | | | | | | | | | | | | | | | | | | | | | | | | | | | | | |
| | | | | | | | | | | | | | | | | | | | | | | | | | | | | | | | | | | | | | | | | | | | | | | | | | | | | | | | | | | | | | | | | | | | | | | | | | | | | | | | |
| | | | | | | | | | | | | | | | | | | | | | | | | | | | | | | | | | | | | | | | | | | | | | | | | | | | | | | | | | | | | | | | | | | | | | | | | | | | | | | | |
| | | | | | | | | | | | | | | | | | | | | | | | | | | | | | | | | | | | | | | | | | | | | | | | | | | | | | | | | | | | | | | | | | | | | | | | | | | | | | | | |
| | | | | | | | | | | | | | | | | | | | | | | | | | | | | | | | | | | | | | | | | | | | | | | | | | | | | | | | | | | | | | | | | | | | | | | | | | | | | | | | |
| | | 1 | | | | | | | | | | | | | | | | | | | | | | | | | | | | | | | | | | | | | | | | | | | | | | | | | | | | | | | | | | | | | | | | | | | | | | | | | | | | | |
| | 1 | 1 | | | | | | | | | | | | | | | | | | | | | | | | | | | | | | | | | | | | | | | | | | | | | | | | | | | | | | | | | | | | | | | | | | | | | | | | | | | | | |
| | | | | | | | | | | | | | | | | | | | | | | | | | | | | | | | | | | | | | | | | | | | | | | | | | | | | | | | | | | | | | | | | | | | | | | | | | | | | | | | |
| | | | | | | | | | | | | | | | | | | | | | | | | | | | | | | | | | | | | | | | | | | | | | | | | | | | | | | | | | | | | | | | | | | | | | | | | | | | | | | | |
| 1 | | | | | | | | | | | | | | | | | | | | | | | | | | | | | | | | | | | | | | | | | | | | | | | | | | | | | | | | | | | | | | | | | | | | | | | | | | | | | | | |
| | | | | | | | | | | | | | | | | | | | | | | | | | | | | | | | | | | | | | | | | | | | | | | | | | | | | | | | | | | | | | | | | | | | | | | | | | | | | | | | |
| | | | | | | | | | | | | | | | | | | | | | | | | | | | | | | | | | | | | | | | | | | | | | | | | | | | | | | | | | | | | | | | | | | | | | | | | | | | | | | | |
| | | | | | | | | | | | | | | | | | | | | | | | | | | | | | | | | | | | | | | | | | | | | | | | | | | | | | | | | | | | | | | | | | | | | | | | | | | | | | | | |
| | | | | | | | | | | | | | | | | | | | | | | | | | | | | | | | | | | | | | | | | | | | | | | | | | | | | | | | | | | | | | | | | | | | | | | | | | | | | | | | |
| | | | | | | | | | | | | | | | | | | | | | | | | | | | | | | | | | | | | | | | | | | | | | | | | | | | | | | | | | | | | | | | | | | | | | | | | | | | | | | | |
| | | | | | | | | | | | | | | | | | | | | | | | | | | | | | | | | | | | | | | | | | | | | | | | | | | | | | | | | | | | | | | | | | | | | | | | | | | | | | | | |
| | | | | | | | | | | | | | | | | | | | | | | | | | | | | | | | | | | | | | | | | | | | | | | | | | | | | | | | | | | | | | | | | | | | | | | | | | | | | | | | |
| 1 | 1 | | | | | | | | | | | | | | | | | | | | | | | | | | | | | | | | | | | | | | | | | | | | | | | | | | | | | | | | | | | | | | | | | | | | | | | | | | | | | | |
| 1 | | | | | | | | | | | | | | | | | | | | | | | | | | | | | | | | | | | | | | | | | | | | | | | | | | | | | | | | | | | | | | | | | | | | | | | | | | | | | | | |
| | | 1 | | | | | | | | | | | | | | | | | | | | | | | | | | | | | | | | | | | | | | | | | | | | | | | | | | | | | | | | | | | | | | | | | | | | | | | | | | | | | |
| | | 1 | | | | | | | | | | | | | | | | | | | | | | | | | | | | | | | | | | | | | | | | | | | | | | | | | | | | | | | | | | | | | | | | | | | | | | | | | | | | | |
| Post - 0 Miss - 0 Block - 0 | Post - 0 Miss - 0 Block - 0 | Post - 1 Miss - 1 Block - 1 | Post - 0 Miss - 0 Block - 0 | Post - 0 Miss - 0 Block - 0 | Post - 0 Miss - 0 Block - 0 | Post - 0 Miss - 0 Block - 0 | Post - 0 Miss - 0 Block - 0 | | | | | | | | | | | | | | | | | | | | | | | | | | | | | | | | | | | | | | | | | | | | | | | | | | | | | | | | | | | | | | | | | | | | | | | | |
| 13 刘振宇 | 16 高宇轩 | 17 张昊 | 21 杨明毅 | 24 于昊 | 26 曹立志 | 40 鹿智豪 | 88 王麒麟 | | | | | | | | | | | | | | | | | | | | | | | | | | | | | | | | | | | | | | | | | | | | | | | | | | | | | | | | | | | | | | | | | | | | | | | | |
| <table border="1"><tr><td>1</td><td></td><td>1</td></tr><tr><td></td><td></td><td></td></tr><tr><td></td><td></td><td></td></tr></table> | 1 | | 1 | | | | | | | <table border="1"><tr><td></td><td></td><td></td></tr><tr><td></td><td></td><td></td></tr><tr><td></td><td></td><td></td></tr></table> | | | | | | | | | | <table border="1"><tr><td></td><td></td><td></td></tr><tr><td></td><td></td><td></td></tr><tr><td></td><td></td><td></td></tr></table> | | | | | | | | | | <table border="1"><tr><td></td><td></td><td></td></tr><tr><td></td><td></td><td></td></tr><tr><td></td><td></td><td></td></tr></table> | | | | | | | | | | <table border="1"><tr><td></td><td></td><td></td></tr><tr><td></td><td></td><td></td></tr><tr><td></td><td></td><td></td></tr></table> | | | | | | | | | | <table border="1"><tr><td></td><td></td><td></td></tr><tr><td></td><td></td><td></td></tr><tr><td></td><td></td><td></td></tr></table> | | | | | | | | | | <table border="1"><tr><td></td><td></td><td></td></tr><tr><td></td><td></td><td></td></tr><tr><td></td><td></td><td></td></tr></table> | | | | | | | | | | <table border="1"><tr><td></td><td></td><td></td></tr><tr><td></td><td></td><td></td></tr><tr><td></td><td></td><td></td></tr></table> | | | | | | | | | |
| 1 | | 1 | | | | | | | | | | | | | | | | | | | | | | | | | | | | | | | | | | | | | | | | | | | | | | | | | | | | | | | | | | | | | | | | | | | | | | | | | | | | | |
| | | | | | | | | | | | | | | | | | | | | | | | | | | | | | | | | | | | | | | | | | | | | | | | | | | | | | | | | | | | | | | | | | | | | | | | | | | | | | | | |
| | | | | | | | | | | | | | | | | | | | | | | | | | | | | | | | | | | | | | | | | | | | | | | | | | | | | | | | | | | | | | | | | | | | | | | | | | | | | | | | |
| | | | | | | | | | | | | | | | | | | | | | | | | | | | | | | | | | | | | | | | | | | | | | | | | | | | | | | | | | | | | | | | | | | | | | | | | | | | | | | | |
| | | | | | | | | | | | | | | | | | | | | | | | | | | | | | | | | | | | | | | | | | | | | | | | | | | | | | | | | | | | | | | | | | | | | | | | | | | | | | | | |
| | | | | | | | | | | | | | | | | | | | | | | | | | | | | | | | | | | | | | | | | | | | | | | | | | | | | | | | | | | | | | | | | | | | | | | | | | | | | | | | |
| | | | | | | | | | | | | | | | | | | | | | | | | | | | | | | | | | | | | | | | | | | | | | | | | | | | | | | | | | | | | | | | | | | | | | | | | | | | | | | | |
| | | | | | | | | | | | | | | | | | | | | | | | | | | | | | | | | | | | | | | | | | | | | | | | | | | | | | | | | | | | | | | | | | | | | | | | | | | | | | | | |
| | | | | | | | | | | | | | | | | | | | | | | | | | | | | | | | | | | | | | | | | | | | | | | | | | | | | | | | | | | | | | | | | | | | | | | | | | | | | | | | |
| | | | | | | | | | | | | | | | | | | | | | | | | | | | | | | | | | | | | | | | | | | | | | | | | | | | | | | | | | | | | | | | | | | | | | | | | | | | | | | | |
| | | | | | | | | | | | | | | | | | | | | | | | | | | | | | | | | | | | | | | | | | | | | | | | | | | | | | | | | | | | | | | | | | | | | | | | | | | | | | | | |
| | | | | | | | | | | | | | | | | | | | | | | | | | | | | | | | | | | | | | | | | | | | | | | | | | | | | | | | | | | | | | | | | | | | | | | | | | | | | | | | |
| | | | | | | | | | | | | | | | | | | | | | | | | | | | | | | | | | | | | | | | | | | | | | | | | | | | | | | | | | | | | | | | | | | | | | | | | | | | | | | | |
| | | | | | | | | | | | | | | | | | | | | | | | | | | | | | | | | | | | | | | | | | | | | | | | | | | | | | | | | | | | | | | | | | | | | | | | | | | | | | | | |
| | | | | | | | | | | | | | | | | | | | | | | | | | | | | | | | | | | | | | | | | | | | | | | | | | | | | | | | | | | | | | | | | | | | | | | | | | | | | | | | |
| | | | | | | | | | | | | | | | | | | | | | | | | | | | | | | | | | | | | | | | | | | | | | | | | | | | | | | | | | | | | | | | | | | | | | | | | | | | | | | | |
| | | | | | | | | | | | | | | | | | | | | | | | | | | | | | | | | | | | | | | | | | | | | | | | | | | | | | | | | | | | | | | | | | | | | | | | | | | | | | | | |
| | | | | | | | | | | | | | | | | | | | | | | | | | | | | | | | | | | | | | | | | | | | | | | | | | | | | | | | | | | | | | | | | | | | | | | | | | | | | | | | |
| | | | | | | | | | | | | | | | | | | | | | | | | | | | | | | | | | | | | | | | | | | | | | | | | | | | | | | | | | | | | | | | | | | | | | | | | | | | | | | | |
| | | | | | | | | | | | | | | | | | | | | | | | | | | | | | | | | | | | | | | | | | | | | | | | | | | | | | | | | | | | | | | | | | | | | | | | | | | | | | | | |
| | | | | | | | | | | | | | | | | | | | | | | | | | | | | | | | | | | | | | | | | | | | | | | | | | | | | | | | | | | | | | | | | | | | | | | | | | | | | | | | |
| | | | | | | | | | | | | | | | | | | | | | | | | | | | | | | | | | | | | | | | | | | | | | | | | | | | | | | | | | | | | | | | | | | | | | | | | | | | | | | | |
| | | | | | | | | | | | | | | | | | | | | | | | | | | | | | | | | | | | | | | | | | | | | | | | | | | | | | | | | | | | | | | | | | | | | | | | | | | | | | | | |
| | | | | | | | | | | | | | | | | | | | | | | | | | | | | | | | | | | | | | | | | | | | | | | | | | | | | | | | | | | | | | | | | | | | | | | | | | | | | | | | |
| Post - 0 Miss - 2 Block - 0 | Post - 0 Miss - 0 Block - 0 | Post - 0 Miss - 0 Block - 0 | Post - 0 Miss - 0 Block - 0 | Post - 0 Miss - 0 Block - 0 | Post - 0 Miss - 0 Block - 0 | Post - 0 Miss - 0 Block - 0 | Post - 0 Miss - 0 Block - 0 | | | | | | | | | | | | | | | | | | | | | | | | | | | | | | | | | | | | | | | | | | | | | | | | | | | | | | | | | | | | | | | | | | | | | | | | |



| | | | | | | | | | | | | | | |
|----------------|-----|---------------|---------------------|------------|------------------------------------|----------------|-------|---------------|----------------|---|-----|----------------------|---|---|
| Team A | | | | Team B | | | | Match Number | | | | | | |
| A 江苏苏州 | | | | B 中国香港 | | | | 21 | | | | | | |
| Played in | | in the hall | | on | | at | | Spectators | | | | | | |
| 安徽滁州 | | 滁州国际手球馆 | | 2019-05-31 | | 17:00 | | hours | | | | | | |
| Half-time(30') | A | B | End of playing time | A | B | 1st extra time | A | B | 2nd extra time | A | B | After penalty throws | A | B |
| | 7 | 3 | 15 | 10 | | | | | | | | | | |
| Number of 7 m | A | Team time-out | | | Full name of players and officials | | | Team time-out | | | B | Number of 7 m | | |
| | 1/1 | 1 | 2 | 3 | | | | 1 | 2 | 3 | 0/2 | | | |
| | | | | | | | 09:22 | 38:41 | | | | | | |

| No. | Team A | G | W | 2' | D | DR | No. | Team B | G | W | 2' | D | DR |
|-----|-----------------------------------|--|---|----|---|----|-----|-----------|---|---|----|---|----|
| 1 | 邹明轩 | | | | | | 1 | 江力为 | | | | | |
| 2 | 马力 | | | | | | 2 | 梁凯乔 | | | | | |
| 4 | 孙钊 | 1 | | | | | 3 | 陈嘉熙 | | | | | |
| 5 | 马奔 | 4 | | | | | 10 | 叶滋权 | 1 | | | | |
| 6 | 潘超群 | 4 | | | | | 15 | 梁栢朗 | | 1 | 1 | | |
| 8 | 王震 | 3 | 1 | | | | 16 | 冯智聪 | | | | | |
| 9 | 李文俊 | | | | | | 22 | 吴泽斌 | | | | | |
| 10 | 朱红雨 | | | | | | 23 | 石铭泽 | | | | | |
| 11 | 许多 | | | | | | 27 | 巫迪涛 | 5 | | | | |
| 12 | 周文贤 | | | | | | 28 | 关健辉 | 1 | | | | |
| 13 | 蒋超 | | | | | | 30 | 陈永曦 | | | | | |
| 14 | 刘亚力 | | | | | | 41 | 莫敬朗 | | | | | |
| 15 | 刘成果 | | | | | | 47 | 薛浩锋 | 3 | | | | |
| 18 | 何志伟 | 3 | | | | | 73 | 黄堃鎏 | | | | | |
| 19 | 夏思毅 | | | | | | 79 | 吴坤霖 | | | | | |
| 23 | 张铮洋 | | | | | | 99 | 苏俊轩 | | | | | |
| A | 周清 | | | | | | B | 练明辉 (主教练) | | | | | |
| C | 郝可鑫 | | | | | | C | 钟昀延 | | | | | |
| D | 陈冬冬 | | | | | | | | | | | | |
| E | 陈伟 | | | | | | | | | | | | |
| | | | | | | | | | | | | | |
| | | | | | | | | | | | | | |
| | | | | | | | | | | | | | |
| A | | Signatures of responsables for the teams (Off.A) | | | | | | | | | | | B |
| TP | Remarks of referees / HF Official | | | | | | | | | | | | TP |

Signatures

| | | | |
|----------|-----------|-----------|--|
| Referees | 许翔 (CHN) | 刘禹 (CHN) | |
| T.D. | 吴瑞亭 (CHN) | 许宜扬 (CHN) | |
| CHA Off. | | | |

Note: Number of 7m Throws Awarded to Team A and B, Goals (G), Warnings (W), Suspensions (2'), Direct Disqualification (D), Disqualification With Report (DR) and Team Penalty (TP).

Table Officials: 刘洋洋 许修凯 Statisticians: 马安兴 沈家洛

第二届全国青年运动会男子手球乙组决赛 体校组 (U16)

PHMS Pictorial Handball Match Statistics

IHF Official System

竞赛技术统计

手球
青年男子

预赛
轮次 3

组别 B
场次 21

滁州国际手球馆
2019-05-31 17:00

Referees: 许翔 (CHN) / 刘禹 (CHN) Result: 15:10(7:3)
Teams: 江苏苏州(苏州) VS 中国香港(香港)

| 苏州 | | 远 | 近 | 边 | 快 | 突 | 任意 | 7m | 合计 | % | 助攻 | 失误 | 警告 | 2' | D+DR |
|----------|-----|------|-----|-----|-----|-----|-----|-----|-------|------|----|----|----|----|------|
| 主教练: 陈冬冬 | | 射 | 射 | 射 | 攻 | 破 | 球 | 球 | | | | | | | |
| 1 | 邹明轩 | | | | | | | | | | | | | | |
| 2 | 马力 | | | | | | | | | | | | | | |
| 4 | 孙钊 | 0/2 | 0/1 | 1/1 | | | | | 1/4 | 25.0 | 1 | 1 | | | |
| 5 | 马奔 | | 3/4 | | 1/2 | | | | 4/6 | 66.7 | | | | | |
| 6 | 潘超群 | 3/5 | | | | | | 1/1 | 4/6 | 66.7 | 3 | 1 | | | |
| 8 | 王震 | 3/4 | | | | | | | 3/4 | 75.0 | | 1 | 1 | | |
| 9 | 李文俊 | | | | | | | | | | | | | | |
| 10 | 朱红雨 | | | | | | | | | | | | | | |
| 11 | 许多 | | | | | | 0/1 | | 0/1 | 0.0 | | | | | |
| 12 | 周文贤 | | | | | | | | | | | | | | |
| 13 | 蒋超 | | | | | | | | | | 1 | 1 | | | |
| 14 | 刘亚力 | | | | | | | | | | | | | | |
| 15 | 刘成果 | | 0/1 | | | | | | 0/1 | 0.0 | | | | | |
| 18 | 何志伟 | 1/1 | 1/2 | | 1/1 | | | | 3/4 | 75.0 | | 2 | | | |
| 19 | 夏思毅 | | | | | | | | | | | | | | |
| 23 | 张铮洋 | | | | | | | | | | | | | | |
| 运动员 合计 | | 7/12 | 4/8 | 1/1 | 2/3 | | 0/1 | 1/1 | 15/26 | 57.7 | 5 | 6 | 1 | | |
| 1 | 邹明轩 | 1/4 | 2/4 | 1/2 | 1/1 | 0/1 | | | 5/12 | 41.7 | | | | | |
| 12 | 周文贤 | 1/2 | 0/1 | | | 0/1 | | 1/1 | 2/5 | 40.0 | | | | | |
| 守门员 合计 | | 2/6 | 2/5 | 1/2 | 1/1 | 0/2 | | 1/1 | 7/17 | 41.2 | | | | | |

| 苏州 | 比赛 进程 | 香港 |
|----------|----------|-----------|
| 1st Half | | |
| 18 何志伟 | 1 02:29 | 0 |
| | 1 04:09 | 1 27 巫迪涛 |
| 8 王震 | 2 04:36 | 1 |
| 5 马奔 | 3 05:52 | 1 |
| 5 马奔 | 4 08:52 | 1 |
| | 4 11:15 | 2 10 叶滋权 |
| 5 马奔 | 5 11:49 | 2 |
| | 5 12:15 | 3 47 薛浩锋 |
| 18 何志伟 | 6 14:08 | 3 |
| 5 马奔 | 7 14:37 | 3 |
| 2nd Half | | |
| 6 潘超群 | 8 00:48 | 3 |
| | 8 01:16 | 4 47 薛浩锋 |
| | 8 02:08 | 5 27 巫迪涛 |
| 4 孙钊 | 9 02:33 | 5 |
| | 9 03:16 | 6 47 薛浩锋 |
| | 9 04:30 | 7 27 巫迪涛 |
| 18 何志伟 | 10 04:44 | 7 |
| 6 潘超群 | 11 06:46 | 7 |
| 6 潘超群 | 12 08:28 | 7 |
| 8 王震 | 13 10:26 | 7 |
| 6 潘超群 | 14 12:14 | 7 |
| | 14 13:34 | 8 27 巫迪涛 |
| | 14 13:55 | 9 27 巫迪涛 |
| 8 王震 | 15 14:03 | 9 |
| | 15 14:29 | 10 28 关健辉 |

| 香港 | | 远 | 近 | 边 | 快 | 突 | 任意 | 7m | 合计 | % | 助攻 | 失误 | 警告 | 2' | D+DR |
|----------|-----|------|-----|-----|-----|-----|-----|-----|-------|------|----|----|----|----|------|
| 主教练: 练明辉 | | 射 | 射 | 射 | 攻 | 破 | 球 | 球 | | | | | | | |
| 1 | 江力为 | | | | | | | | | | | | | | |
| 2 | 梁凯乔 | | | | | | | | | | | | | | |
| 3 | 陈嘉熙 | | | | | | | | | | | | | | |
| 10 | 叶滋权 | 1/3 | | | | | | | 1/3 | 33.3 | | 1 | | | |
| 15 | 梁栢朗 | | | | | | | | | | | | 1 | 1 | |
| 16 | 冯智聪 | | | | | | | | | | | 1 | | | |
| 22 | 吴泽斌 | | | | | | | | | | | | | | |
| 23 | 石铭泽 | | 0/1 | 0/1 | | | | | 0/2 | 0.0 | 1 | 1 | | | |
| 27 | 巫迪涛 | 2/7 | 1/2 | | | 2/2 | | 0/2 | 5/13 | 38.5 | | | | | |
| 28 | 关健辉 | | 1/2 | 0/1 | 0/1 | | | | 1/4 | 25.0 | | | | | |
| 30 | 陈永曦 | | | | | | | | | | | 1 | | | |
| 41 | 莫敬朗 | | | 0/1 | | | | | 0/1 | 0.0 | | | | | |
| 47 | 薛浩锋 | 1/1 | 1/1 | 1/2 | | | | | 3/4 | 75.0 | | 1 | | | |
| 73 | 黄堃臻 | | | | | | | | | | | | | | |
| 79 | 吴坤霖 | | | | | | | | | | | | 2 | | |
| 99 | 苏俊轩 | | | | | | | | | | | | | | |
| 运动员 合计 | | 4/11 | 3/6 | 1/5 | 0/1 | 2/2 | | 0/2 | 10/27 | 37.0 | 1 | 7 | 1 | 1 | |
| 1 | 江力为 | 2/4 | 2/5 | | 1/3 | | | | 5/12 | 41.7 | | | | | |
| 22 | 吴泽斌 | 1/5 | | | | | 1/1 | | 2/6 | 33.3 | | | | | |
| 99 | 苏俊轩 | 0/1 | 0/1 | 0/1 | | | | 0/1 | 0/4 | 0.0 | | | | | |
| 守门员 合计 | | 3/10 | 2/6 | 0/1 | 1/3 | | 1/1 | 0/1 | 7/22 | 31.8 | | | | | |

场上队员: 得分 / 射门

守门员: 救球 / 射门

| | | | |
|---|------|----|---------|
| D | 取消资格 | DR | 取消资格+报告 |
|---|------|----|---------|

个人/全队技术统计表

手球 预赛 组别 B 滁州国际手球馆
青年男子 轮次 3 场次 21 2019-05-31 17:00

| 号码 | 姓名 | 远射 | 近射 | 边射 | 快攻 | 突破 | 任意 | 七米 | 合计 | % | 助攻 | 失误 | 警告 | 2' | 取消 | 时间 |
|----------|-----|------|-----|-----|-----|-----|-----|-----|-------|-------|----|----|----|----|----|----------|
| 江苏苏州(苏州) | | | | | | | | | | | | | | | | |
| (场上队员) | | | | | | | | | | | | | | | | |
| 1 | 邹明轩 | | | | | | | | | 0.0% | | | | | | 00:21:04 |
| 2 | 马力 | | | | | | | | | 0.0% | | | | | | 00:06:26 |
| 4 | 孙钊 | 0/2 | 0/1 | 1/1 | | | | | 1/4 | 25.0% | 1 | 1 | | | | 00:09:35 |
| 5 | 马奔 | | 3/4 | | 1/2 | | | | 4/6 | 66.7% | | | | | | 00:30:00 |
| 6 | 潘超群 | 3/5 | | | | | | 1/1 | 4/6 | 66.7% | 3 | 1 | | | | 00:27:42 |
| 8 | 王震 | 3/4 | | | | | | | 3/4 | 75.0% | | 1 | 1 | | | 00:30:00 |
| 9 | 李文俊 | | | | | | | | | 0.0% | | | | | | 00:00:00 |
| 10 | 朱红雨 | | | | | | | | | 0.0% | | | | | | 00:00:00 |
| 11 | 许多 | | | | | | 0/1 | | 0/1 | 0.0% | | | | | | 00:02:38 |
| 12 | 周文贤 | | | | | | | | | 0.0% | | | | | | 00:08:56 |
| 13 | 蒋超 | | | | | | | | | 0.0% | 1 | 1 | | | | 00:30:00 |
| 14 | 刘亚力 | | | | | | | | | 0.0% | | | | | | 00:00:00 |
| 15 | 刘成果 | | 0/1 | | | | | | 0/1 | 0.0% | | | | | | 00:02:16 |
| 18 | 何志伟 | 1/1 | 1/2 | | 1/1 | | | | 3/4 | 75.0% | | 2 | | | | 00:30:00 |
| 19 | 夏思毅 | | | | | | | | | 0.0% | | | | | | 00:00:00 |
| 23 | 张铮洋 | | | | | | | | | 0.0% | | | | | | 00:10:36 |
| | 合计 | 7/12 | 4/8 | 1/1 | 2/3 | | 0/1 | 1/1 | 15/26 | 57.7% | 5 | 6 | 1 | | | |
| (守门员) | | | | | | | | | | | | | | | | |
| 1 | 邹明轩 | 1/4 | 2/4 | 1/2 | 1/1 | 0/1 | | | 5/12 | 41.7% | | | | | | 00:21:04 |
| 12 | 周文贤 | 1/2 | 0/1 | | | 0/1 | | 1/1 | 2/5 | 40.0% | | | | | | 00:08:56 |
| | 合计 | 2/6 | 2/5 | 1/2 | 1/1 | 0/2 | | 1/1 | 7/17 | 41.2% | | | | | | |

场上队员：得分/射门

守门员：救球/射门

| 全队合计 | 得分 | 被救 | 射失 | 击柱 | 封球 | 合计 | % |
|------|----|----|----|----|----|----|--------|
| 远射 | 7 | 3 | 2 | | | 12 | 58.3% |
| 近射 | 4 | 2 | 2 | | | 8 | 50.0% |
| 边射 | 1 | | | | | 1 | 100.0% |
| 快攻 | 2 | 1 | | | | 3 | 66.7% |
| 突破 | | | | | | | 0.0% |
| 任意 | | 1 | | | | 1 | 0.0% |
| 七米 | 1 | | | | | 1 | 100.0% |

个人/全队技术统计表

手球 青年男子 预赛 轮次 3 组别 B 场次 21 滁州国际手球馆 2019-05-31 17:00

| 号码 | 姓名 | 远射 | 近射 | 边射 | 快攻 | 突破 | 任意 | 七米 | 合计 | % | 助攻 | 失误 | 警告 | 2' | 取消 | 时间 |
|----------|-----|------|-----|-----|-----|-----|----|-----|-------|-------|----|----|----|----|----|----------|
| 中国香港(香港) | | | | | | | | | | | | | | | | |
| (场上队员) | | | | | | | | | | | | | | | | |
| 1 | 江力为 | | | | | | | | | 0.0% | | | | | | 00:15:00 |
| 2 | 梁凯乔 | | | | | | | | | 0.0% | | | | | | 00:08:53 |
| 3 | 陈嘉熙 | | | | | | | | | 0.0% | | | | | | 00:07:13 |
| 10 | 叶滋权 | 1/3 | | | | | | | 1/3 | 33.3% | 1 | | | | | 00:15:18 |
| 15 | 梁栢朗 | | | | | | | | | 0.0% | | | 1 | 1 | | 00:09:49 |
| 16 | 冯智聪 | | | | | | | | | 0.0% | 1 | | | | | 00:06:12 |
| 22 | 吴泽斌 | | | | | | | | | 0.0% | | | | | | 00:08:03 |
| 23 | 石铭泽 | | 0/1 | 0/1 | | | | | 0/2 | 0.0% | 1 | 1 | | | | 00:15:00 |
| 27 | 巫迪涛 | 2/7 | 1/2 | | | 2/2 | | 0/2 | 5/13 | 38.5% | | | | | | 00:20:50 |
| 28 | 关键辉 | | 1/2 | 0/1 | 0/1 | | | | 1/4 | 25.0% | | | | | | 00:21:06 |
| 30 | 陈永曦 | | | | | | | | | 0.0% | | 1 | | | | 00:15:00 |
| 41 | 莫敬朗 | | | 0/1 | | | | | 0/1 | 0.0% | | | | | | 00:07:53 |
| 47 | 薛浩锋 | 1/1 | 1/1 | 1/2 | | | | | 3/4 | 75.0% | | 1 | | | | 00:22:48 |
| 73 | 黄望婆 | | | | | | | | | 0.0% | | | | | | 00:13:51 |
| 79 | 吴坤霖 | | | | | | | | | 0.0% | | 2 | | | | 00:15:00 |
| 99 | 苏俊轩 | | | | | | | | | 0.0% | | | | | | 00:06:57 |
| | 合计 | 4/11 | 3/6 | 1/5 | 0/1 | 2/2 | | 0/2 | 10/27 | 37.0% | 1 | 7 | 1 | 1 | | |

(守门员)

| | | | | | | | | | | | | | | | | |
|----|-----|------|-----|-----|-----|--|-----|-----|------|-------|--|--|--|--|--|----------|
| 1 | 江力为 | 2/4 | 2/5 | | 1/3 | | | | 5/12 | 41.7% | | | | | | 00:15:00 |
| 22 | 吴泽斌 | 1/5 | | | | | 1/1 | | 2/6 | 33.3% | | | | | | 00:08:03 |
| 99 | 苏俊轩 | 0/1 | 0/1 | 0/1 | | | | 0/1 | 0/4 | 0.0% | | | | | | 00:06:57 |
| | 合计 | 3/10 | 2/6 | 0/1 | 1/3 | | 1/1 | 0/1 | 7/22 | 31.8% | | | | | | |

场上队员：得分/射门

守门员：救球/射门

| 全队合计 | 得分 | 被救 | 射失 | 击柱 | 封球 | 合计 | % |
|------|----|----|----|----|----|----|--------|
| 远射 | 4 | 2 | 2 | | 3 | 11 | 36.4% |
| 近射 | 3 | 2 | | 1 | | 6 | 50.0% |
| 边射 | 1 | 1 | 1 | 2 | | 5 | 20.0% |
| 快攻 | | 1 | | | | 1 | 0.0% |
| 突破 | 2 | | | | | 2 | 100.0% |
| 任意 | | | | | | | 0.0% |
| 七米 | | 1 | | 1 | | 2 | 0.0% |

图式比赛技术统计表

手球
青年男子

预赛
轮次 3

组别 B
场次 21

滁州国际手球馆
2019-05-31 17:00

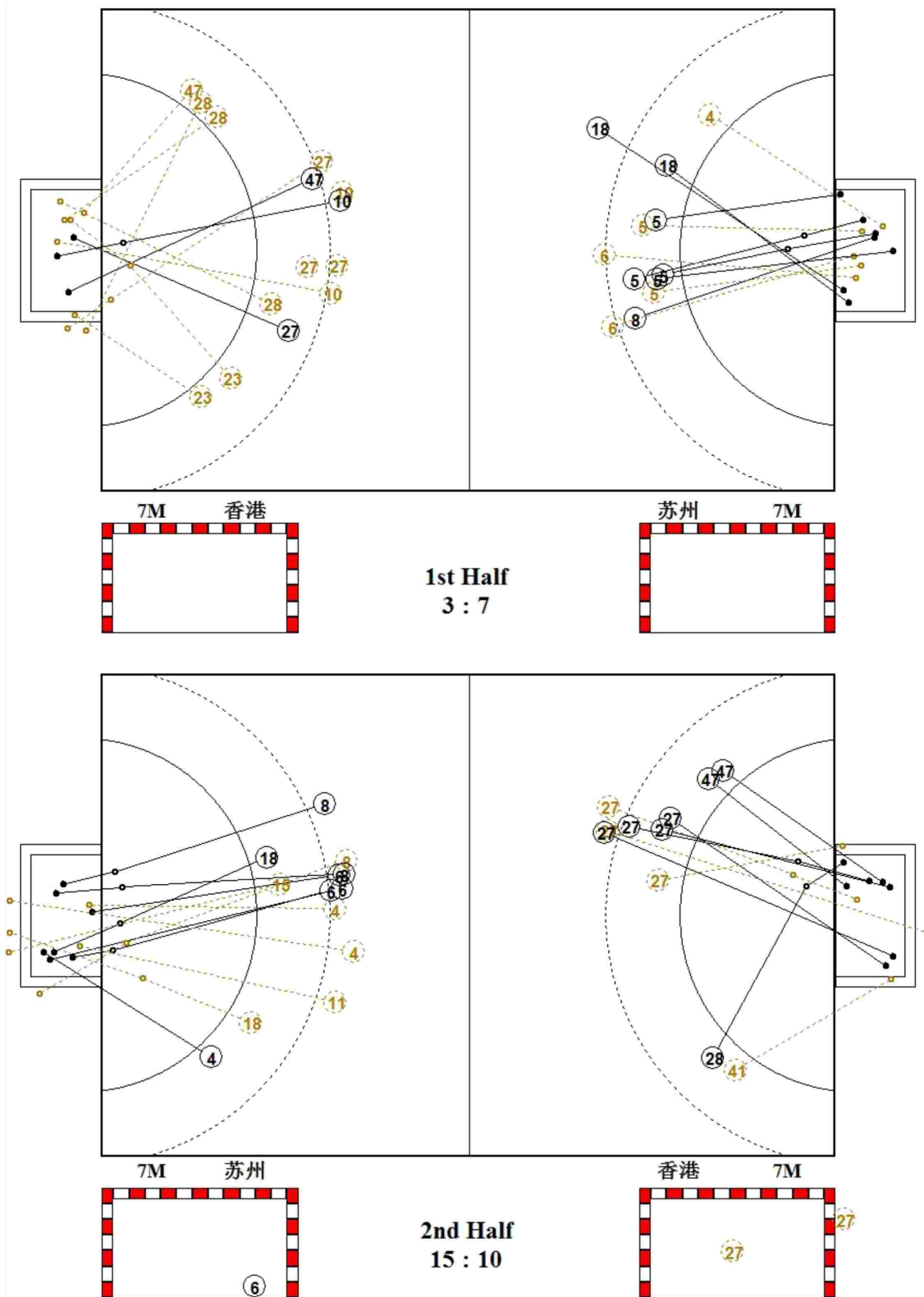

图式射门区域统计

手球
青年男子

预赛
轮次 3

组别 B
场次 21

滁州国际手球馆
2019-05-31 17:00

江苏苏州

| | | | | | | | | | | | | | | | | | | | | | | | | | | | | | | | | | | | | | | | | | | | | | | | | | | | | | | | | | | | | | | | | | | | | | | | | | | | | | | | |
|--|---|---|--|--|--|--|--|--|--|---|--|--|--|--|--|--|--|--|--|--|---|--|--|--|--|--|--|--|--|---|--|---|--|---|---|--|---|--|--|--|---|--|--|---|--|--|--|---|---|---|---|--|--|--|---|---|--|---|--|---|--|--|--|--|--|--|--|--|--|---|--|--|--|--|--|--|--|--|--|
| 1 邹明轩 <table border="1"><tr><td></td><td></td><td></td></tr><tr><td></td><td></td><td></td></tr><tr><td></td><td></td><td></td></tr></table> Post - 0 Miss - 0 Block - 0 | | | | | | | | | | 2 马力 <table border="1"><tr><td></td><td></td><td></td></tr><tr><td></td><td></td><td></td></tr><tr><td></td><td></td><td></td></tr></table> Post - 0 Miss - 0 Block - 0 | | | | | | | | | | 4 孙判 <table border="1"><tr><td>1</td><td></td><td></td></tr><tr><td></td><td></td><td></td></tr><tr><td></td><td></td><td></td></tr></table> Post - 0 Miss - 1 Block - 0 | 1 | | | | | | | | | 5 马奔 <table border="1"><tr><td></td><td>1</td><td></td></tr><tr><td>1</td><td>1</td><td></td></tr><tr><td>1</td><td></td><td></td></tr></table> Post - 0 Miss - 0 Block - 0 | | 1 | | 1 | 1 | | 1 | | | 6 潘超群 <table border="1"><tr><td>1</td><td></td><td></td></tr><tr><td>1</td><td></td><td></td></tr><tr><td></td><td>1</td><td>1</td></tr></table> Post - 0 Miss - 0 Block - 0 | 1 | | | 1 | | | | 1 | 1 | 8 王震 <table border="1"><tr><td></td><td></td><td></td></tr><tr><td></td><td>1</td><td>2</td></tr><tr><td></td><td></td><td></td></tr></table> Post - 0 Miss - 1 Block - 0 | | | | | 1 | 2 | | | | 9 李文俊 <table border="1"><tr><td></td><td></td><td></td></tr><tr><td></td><td></td><td></td></tr><tr><td></td><td></td><td></td></tr></table> Post - 0 Miss - 0 Block - 0 | | | | | | | | | | 10 朱红雨 <table border="1"><tr><td></td><td></td><td></td></tr><tr><td></td><td></td><td></td></tr><tr><td></td><td></td><td></td></tr></table> Post - 0 Miss - 0 Block - 0 | | | | | | | | | |
| | | | | | | | | | | | | | | | | | | | | | | | | | | | | | | | | | | | | | | | | | | | | | | | | | | | | | | | | | | | | | | | | | | | | | | | | | | | | | | | |
| | | | | | | | | | | | | | | | | | | | | | | | | | | | | | | | | | | | | | | | | | | | | | | | | | | | | | | | | | | | | | | | | | | | | | | | | | | | | | | | |
| | | | | | | | | | | | | | | | | | | | | | | | | | | | | | | | | | | | | | | | | | | | | | | | | | | | | | | | | | | | | | | | | | | | | | | | | | | | | | | | |
| | | | | | | | | | | | | | | | | | | | | | | | | | | | | | | | | | | | | | | | | | | | | | | | | | | | | | | | | | | | | | | | | | | | | | | | | | | | | | | | |
| | | | | | | | | | | | | | | | | | | | | | | | | | | | | | | | | | | | | | | | | | | | | | | | | | | | | | | | | | | | | | | | | | | | | | | | | | | | | | | | |
| | | | | | | | | | | | | | | | | | | | | | | | | | | | | | | | | | | | | | | | | | | | | | | | | | | | | | | | | | | | | | | | | | | | | | | | | | | | | | | | |
| 1 | | | | | | | | | | | | | | | | | | | | | | | | | | | | | | | | | | | | | | | | | | | | | | | | | | | | | | | | | | | | | | | | | | | | | | | | | | | | | | | |
| | | | | | | | | | | | | | | | | | | | | | | | | | | | | | | | | | | | | | | | | | | | | | | | | | | | | | | | | | | | | | | | | | | | | | | | | | | | | | | | |
| | | | | | | | | | | | | | | | | | | | | | | | | | | | | | | | | | | | | | | | | | | | | | | | | | | | | | | | | | | | | | | | | | | | | | | | | | | | | | | | |
| | 1 | | | | | | | | | | | | | | | | | | | | | | | | | | | | | | | | | | | | | | | | | | | | | | | | | | | | | | | | | | | | | | | | | | | | | | | | | | | | | | |
| 1 | 1 | | | | | | | | | | | | | | | | | | | | | | | | | | | | | | | | | | | | | | | | | | | | | | | | | | | | | | | | | | | | | | | | | | | | | | | | | | | | | | |
| 1 | | | | | | | | | | | | | | | | | | | | | | | | | | | | | | | | | | | | | | | | | | | | | | | | | | | | | | | | | | | | | | | | | | | | | | | | | | | | | | | |
| 1 | | | | | | | | | | | | | | | | | | | | | | | | | | | | | | | | | | | | | | | | | | | | | | | | | | | | | | | | | | | | | | | | | | | | | | | | | | | | | | | |
| 1 | | | | | | | | | | | | | | | | | | | | | | | | | | | | | | | | | | | | | | | | | | | | | | | | | | | | | | | | | | | | | | | | | | | | | | | | | | | | | | | |
| | 1 | 1 | | | | | | | | | | | | | | | | | | | | | | | | | | | | | | | | | | | | | | | | | | | | | | | | | | | | | | | | | | | | | | | | | | | | | | | | | | | | | |
| | | | | | | | | | | | | | | | | | | | | | | | | | | | | | | | | | | | | | | | | | | | | | | | | | | | | | | | | | | | | | | | | | | | | | | | | | | | | | | | |
| | 1 | 2 | | | | | | | | | | | | | | | | | | | | | | | | | | | | | | | | | | | | | | | | | | | | | | | | | | | | | | | | | | | | | | | | | | | | | | | | | | | | | |
| | | | | | | | | | | | | | | | | | | | | | | | | | | | | | | | | | | | | | | | | | | | | | | | | | | | | | | | | | | | | | | | | | | | | | | | | | | | | | | | |
| | | | | | | | | | | | | | | | | | | | | | | | | | | | | | | | | | | | | | | | | | | | | | | | | | | | | | | | | | | | | | | | | | | | | | | | | | | | | | | | |
| | | | | | | | | | | | | | | | | | | | | | | | | | | | | | | | | | | | | | | | | | | | | | | | | | | | | | | | | | | | | | | | | | | | | | | | | | | | | | | | |
| | | | | | | | | | | | | | | | | | | | | | | | | | | | | | | | | | | | | | | | | | | | | | | | | | | | | | | | | | | | | | | | | | | | | | | | | | | | | | | | |
| | | | | | | | | | | | | | | | | | | | | | | | | | | | | | | | | | | | | | | | | | | | | | | | | | | | | | | | | | | | | | | | | | | | | | | | | | | | | | | | |
| | | | | | | | | | | | | | | | | | | | | | | | | | | | | | | | | | | | | | | | | | | | | | | | | | | | | | | | | | | | | | | | | | | | | | | | | | | | | | | | |
| | | | | | | | | | | | | | | | | | | | | | | | | | | | | | | | | | | | | | | | | | | | | | | | | | | | | | | | | | | | | | | | | | | | | | | | | | | | | | | | |
| 11 许多 <table border="1"><tr><td></td><td></td><td></td></tr><tr><td></td><td></td><td></td></tr><tr><td></td><td></td><td></td></tr></table> Post - 0 Miss - 0 Block - 0 | | | | | | | | | | 12 周文贤 <table border="1"><tr><td></td><td></td><td></td></tr><tr><td></td><td></td><td></td></tr><tr><td></td><td></td><td></td></tr></table> Post - 0 Miss - 0 Block - 0 | | | | | | | | | | 13 蒋超 <table border="1"><tr><td></td><td></td><td></td></tr><tr><td></td><td></td><td></td></tr><tr><td></td><td></td><td></td></tr></table> Post - 0 Miss - 0 Block - 0 | | | | | | | | | | 14 刘亚力 <table border="1"><tr><td></td><td></td><td></td></tr><tr><td></td><td></td><td></td></tr><tr><td></td><td></td><td></td></tr></table> Post - 0 Miss - 0 Block - 0 | | | | | | | | | | 15 刘成果 <table border="1"><tr><td></td><td></td><td></td></tr><tr><td></td><td></td><td></td></tr><tr><td></td><td></td><td></td></tr></table> Post - 0 Miss - 1 Block - 0 | | | | | | | | | | 18 何志伟 <table border="1"><tr><td>1</td><td></td><td></td></tr><tr><td></td><td></td><td></td></tr><tr><td></td><td>2</td><td></td></tr></table> Post - 0 Miss - 1 Block - 0 | 1 | | | | | | | 2 | | 19 夏思毅 <table border="1"><tr><td></td><td></td><td></td></tr><tr><td></td><td></td><td></td></tr><tr><td></td><td></td><td></td></tr></table> Post - 0 Miss - 0 Block - 0 | | | | | | | | | | 23 张铮洋 <table border="1"><tr><td></td><td></td><td></td></tr><tr><td></td><td></td><td></td></tr><tr><td></td><td></td><td></td></tr></table> Post - 0 Miss - 0 Block - 0 | | | | | | | | | |
| | | | | | | | | | | | | | | | | | | | | | | | | | | | | | | | | | | | | | | | | | | | | | | | | | | | | | | | | | | | | | | | | | | | | | | | | | | | | | | | |
| | | | | | | | | | | | | | | | | | | | | | | | | | | | | | | | | | | | | | | | | | | | | | | | | | | | | | | | | | | | | | | | | | | | | | | | | | | | | | | | |
| | | | | | | | | | | | | | | | | | | | | | | | | | | | | | | | | | | | | | | | | | | | | | | | | | | | | | | | | | | | | | | | | | | | | | | | | | | | | | | | |
| | | | | | | | | | | | | | | | | | | | | | | | | | | | | | | | | | | | | | | | | | | | | | | | | | | | | | | | | | | | | | | | | | | | | | | | | | | | | | | | |
| | | | | | | | | | | | | | | | | | | | | | | | | | | | | | | | | | | | | | | | | | | | | | | | | | | | | | | | | | | | | | | | | | | | | | | | | | | | | | | | |
| | | | | | | | | | | | | | | | | | | | | | | | | | | | | | | | | | | | | | | | | | | | | | | | | | | | | | | | | | | | | | | | | | | | | | | | | | | | | | | | |
| | | | | | | | | | | | | | | | | | | | | | | | | | | | | | | | | | | | | | | | | | | | | | | | | | | | | | | | | | | | | | | | | | | | | | | | | | | | | | | | |
| | | | | | | | | | | | | | | | | | | | | | | | | | | | | | | | | | | | | | | | | | | | | | | | | | | | | | | | | | | | | | | | | | | | | | | | | | | | | | | | |
| | | | | | | | | | | | | | | | | | | | | | | | | | | | | | | | | | | | | | | | | | | | | | | | | | | | | | | | | | | | | | | | | | | | | | | | | | | | | | | | |
| | | | | | | | | | | | | | | | | | | | | | | | | | | | | | | | | | | | | | | | | | | | | | | | | | | | | | | | | | | | | | | | | | | | | | | | | | | | | | | | |
| | | | | | | | | | | | | | | | | | | | | | | | | | | | | | | | | | | | | | | | | | | | | | | | | | | | | | | | | | | | | | | | | | | | | | | | | | | | | | | | |
| | | | | | | | | | | | | | | | | | | | | | | | | | | | | | | | | | | | | | | | | | | | | | | | | | | | | | | | | | | | | | | | | | | | | | | | | | | | | | | | |
| | | | | | | | | | | | | | | | | | | | | | | | | | | | | | | | | | | | | | | | | | | | | | | | | | | | | | | | | | | | | | | | | | | | | | | | | | | | | | | | |
| | | | | | | | | | | | | | | | | | | | | | | | | | | | | | | | | | | | | | | | | | | | | | | | | | | | | | | | | | | | | | | | | | | | | | | | | | | | | | | | |
| | | | | | | | | | | | | | | | | | | | | | | | | | | | | | | | | | | | | | | | | | | | | | | | | | | | | | | | | | | | | | | | | | | | | | | | | | | | | | | | |
| 1 | | | | | | | | | | | | | | | | | | | | | | | | | | | | | | | | | | | | | | | | | | | | | | | | | | | | | | | | | | | | | | | | | | | | | | | | | | | | | | | |
| | | | | | | | | | | | | | | | | | | | | | | | | | | | | | | | | | | | | | | | | | | | | | | | | | | | | | | | | | | | | | | | | | | | | | | | | | | | | | | | |
| | 2 | | | | | | | | | | | | | | | | | | | | | | | | | | | | | | | | | | | | | | | | | | | | | | | | | | | | | | | | | | | | | | | | | | | | | | | | | | | | | | |
| | | | | | | | | | | | | | | | | | | | | | | | | | | | | | | | | | | | | | | | | | | | | | | | | | | | | | | | | | | | | | | | | | | | | | | | | | | | | | | | |
| | | | | | | | | | | | | | | | | | | | | | | | | | | | | | | | | | | | | | | | | | | | | | | | | | | | | | | | | | | | | | | | | | | | | | | | | | | | | | | | |
| | | | | | | | | | | | | | | | | | | | | | | | | | | | | | | | | | | | | | | | | | | | | | | | | | | | | | | | | | | | | | | | | | | | | | | | | | | | | | | | |
| | | | | | | | | | | | | | | | | | | | | | | | | | | | | | | | | | | | | | | | | | | | | | | | | | | | | | | | | | | | | | | | | | | | | | | | | | | | | | | | |
| | | | | | | | | | | | | | | | | | | | | | | | | | | | | | | | | | | | | | | | | | | | | | | | | | | | | | | | | | | | | | | | | | | | | | | | | | | | | | | | |
| | | | | | | | | | | | | | | | | | | | | | | | | | | | | | | | | | | | | | | | | | | | | | | | | | | | | | | | | | | | | | | | | | | | | | | | | | | | | | | | |

1 邹明轩

| | | |
|-----|-----|-----|
| 0/1 | | 0/1 |
| 0/2 | 1/3 | 3/3 |
| 0/1 | | 1/1 |

12 周文贤

| | | |
|-----|-----|-----|
| 0/1 | | 0/1 |
| | 1/1 | |
| 0/1 | 1/1 | |

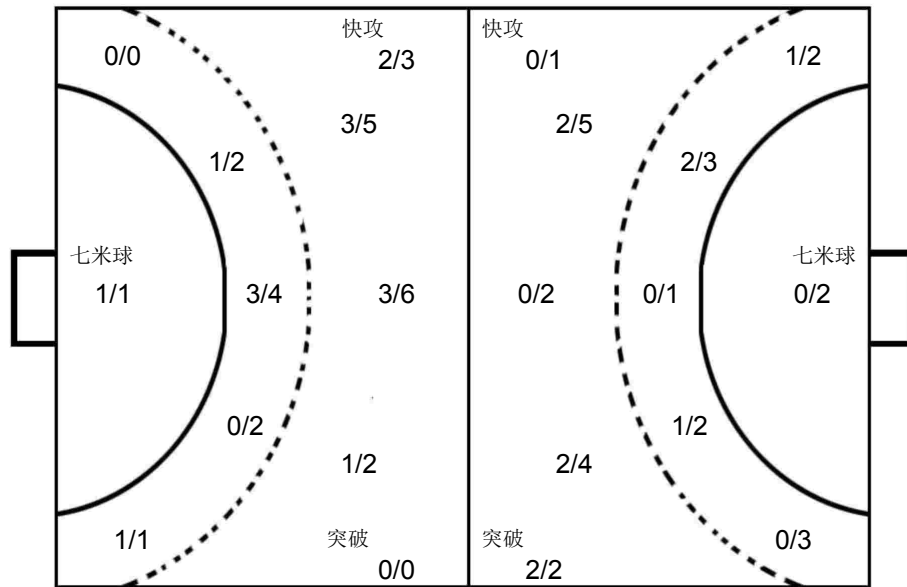

1 江力为

| | | |
|-----|-----|-----|
| 1/1 | 0/1 | |
| 0/1 | 2/4 | |
| 0/1 | 1/1 | 1/3 |

22 吴泽斌

| | | |
|-----|-----|-----|
| 0/1 | | |
| | | 0/2 |
| 1/1 | 1/2 | |

99 苏俊轩

| | | |
|-----|--|-----|
| 0/2 | | |
| 0/1 | | |
| | | 0/1 |

中国香港

| | | | | | | | | | | | | | | | | | | | | | | | | | | | | | | | | | | | | | | | | | | | | | | | | | | | | | | | | | | | | | | | | | | | | | | | | | | | | | | | |
|---|---|---|---|---|---|--|--|--|--|--|--|--|--|--|--|--|---|--|--|---|--|--|--|--|--|--|--|--|--|--|--|---|--|--|--|--|--|--|--|--|---|--|--|---|--|--|---|--|--|---|--|--|--|--|--|--|--|--|--|---|--|--|--|--|--|--|--|--|--|---|--|--|--|--|--|--|--|--|--|
| 1 江力为 <table border="1"><tr><td></td><td></td><td></td></tr><tr><td></td><td></td><td></td></tr><tr><td></td><td></td><td></td></tr></table> Post - 0 Miss - 0 Block - 0 | | | | | | | | | | 2 梁凯乔 <table border="1"><tr><td></td><td></td><td></td></tr><tr><td></td><td></td><td></td></tr><tr><td></td><td></td><td></td></tr></table> Post - 0 Miss - 0 Block - 0 | | | | | | | | | | 3 陈嘉熙 <table border="1"><tr><td></td><td></td><td></td></tr><tr><td></td><td></td><td></td></tr><tr><td></td><td></td><td></td></tr></table> Post - 0 Miss - 0 Block - 0 | | | | | | | | | | 10 叶滋权 <table border="1"><tr><td></td><td>1</td><td></td></tr><tr><td></td><td></td><td></td></tr><tr><td></td><td></td><td></td></tr></table> Post - 0 Miss - 0 Block - 1 | | 1 | | | | | | | | 15 梁栢朗 <table border="1"><tr><td></td><td></td><td></td></tr><tr><td></td><td></td><td></td></tr><tr><td></td><td></td><td></td></tr></table> Post - 0 Miss - 0 Block - 0 | | | | | | | | | | 16 冯智聪 <table border="1"><tr><td></td><td></td><td></td></tr><tr><td></td><td></td><td></td></tr><tr><td></td><td></td><td></td></tr></table> Post - 0 Miss - 0 Block - 0 | | | | | | | | | | 22 吴泽斌 <table border="1"><tr><td></td><td></td><td></td></tr><tr><td></td><td></td><td></td></tr><tr><td></td><td></td><td></td></tr></table> Post - 0 Miss - 0 Block - 0 | | | | | | | | | | 23 石铭泽 <table border="1"><tr><td></td><td></td><td></td></tr><tr><td></td><td></td><td></td></tr><tr><td></td><td></td><td></td></tr></table> Post - 1 Miss - 0 Block - 0 | | | | | | | | | |
| | | | | | | | | | | | | | | | | | | | | | | | | | | | | | | | | | | | | | | | | | | | | | | | | | | | | | | | | | | | | | | | | | | | | | | | | | | | | | | | |
| | | | | | | | | | | | | | | | | | | | | | | | | | | | | | | | | | | | | | | | | | | | | | | | | | | | | | | | | | | | | | | | | | | | | | | | | | | | | | | | |
| | | | | | | | | | | | | | | | | | | | | | | | | | | | | | | | | | | | | | | | | | | | | | | | | | | | | | | | | | | | | | | | | | | | | | | | | | | | | | | | |
| | | | | | | | | | | | | | | | | | | | | | | | | | | | | | | | | | | | | | | | | | | | | | | | | | | | | | | | | | | | | | | | | | | | | | | | | | | | | | | | |
| | | | | | | | | | | | | | | | | | | | | | | | | | | | | | | | | | | | | | | | | | | | | | | | | | | | | | | | | | | | | | | | | | | | | | | | | | | | | | | | |
| | | | | | | | | | | | | | | | | | | | | | | | | | | | | | | | | | | | | | | | | | | | | | | | | | | | | | | | | | | | | | | | | | | | | | | | | | | | | | | | |
| | | | | | | | | | | | | | | | | | | | | | | | | | | | | | | | | | | | | | | | | | | | | | | | | | | | | | | | | | | | | | | | | | | | | | | | | | | | | | | | |
| | | | | | | | | | | | | | | | | | | | | | | | | | | | | | | | | | | | | | | | | | | | | | | | | | | | | | | | | | | | | | | | | | | | | | | | | | | | | | | | |
| | | | | | | | | | | | | | | | | | | | | | | | | | | | | | | | | | | | | | | | | | | | | | | | | | | | | | | | | | | | | | | | | | | | | | | | | | | | | | | | |
| | 1 | | | | | | | | | | | | | | | | | | | | | | | | | | | | | | | | | | | | | | | | | | | | | | | | | | | | | | | | | | | | | | | | | | | | | | | | | | | | | | |
| | | | | | | | | | | | | | | | | | | | | | | | | | | | | | | | | | | | | | | | | | | | | | | | | | | | | | | | | | | | | | | | | | | | | | | | | | | | | | | | |
| | | | | | | | | | | | | | | | | | | | | | | | | | | | | | | | | | | | | | | | | | | | | | | | | | | | | | | | | | | | | | | | | | | | | | | | | | | | | | | | |
| | | | | | | | | | | | | | | | | | | | | | | | | | | | | | | | | | | | | | | | | | | | | | | | | | | | | | | | | | | | | | | | | | | | | | | | | | | | | | | | |
| | | | | | | | | | | | | | | | | | | | | | | | | | | | | | | | | | | | | | | | | | | | | | | | | | | | | | | | | | | | | | | | | | | | | | | | | | | | | | | | |
| | | | | | | | | | | | | | | | | | | | | | | | | | | | | | | | | | | | | | | | | | | | | | | | | | | | | | | | | | | | | | | | | | | | | | | | | | | | | | | | |
| | | | | | | | | | | | | | | | | | | | | | | | | | | | | | | | | | | | | | | | | | | | | | | | | | | | | | | | | | | | | | | | | | | | | | | | | | | | | | | | |
| | | | | | | | | | | | | | | | | | | | | | | | | | | | | | | | | | | | | | | | | | | | | | | | | | | | | | | | | | | | | | | | | | | | | | | | | | | | | | | | |
| | | | | | | | | | | | | | | | | | | | | | | | | | | | | | | | | | | | | | | | | | | | | | | | | | | | | | | | | | | | | | | | | | | | | | | | | | | | | | | | |
| | | | | | | | | | | | | | | | | | | | | | | | | | | | | | | | | | | | | | | | | | | | | | | | | | | | | | | | | | | | | | | | | | | | | | | | | | | | | | | | |
| | | | | | | | | | | | | | | | | | | | | | | | | | | | | | | | | | | | | | | | | | | | | | | | | | | | | | | | | | | | | | | | | | | | | | | | | | | | | | | | |
| | | | | | | | | | | | | | | | | | | | | | | | | | | | | | | | | | | | | | | | | | | | | | | | | | | | | | | | | | | | | | | | | | | | | | | | | | | | | | | | |
| | | | | | | | | | | | | | | | | | | | | | | | | | | | | | | | | | | | | | | | | | | | | | | | | | | | | | | | | | | | | | | | | | | | | | | | | | | | | | | | |
| | | | | | | | | | | | | | | | | | | | | | | | | | | | | | | | | | | | | | | | | | | | | | | | | | | | | | | | | | | | | | | | | | | | | | | | | | | | | | | | |
| | | | | | | | | | | | | | | | | | | | | | | | | | | | | | | | | | | | | | | | | | | | | | | | | | | | | | | | | | | | | | | | | | | | | | | | | | | | | | | | |
| 27 巫迪涛 <table border="1"><tr><td>1</td><td></td><td>2</td></tr><tr><td>1</td><td>1</td><td></td></tr><tr><td></td><td></td><td></td></tr></table> Post - 2 Miss - 2 Block - 2 | 1 | | 2 | 1 | 1 | | | | | 28 关键辉 <table border="1"><tr><td></td><td></td><td></td></tr><tr><td></td><td></td><td></td></tr><tr><td>1</td><td></td><td></td></tr></table> Post - 0 Miss - 1 Block - 0 | | | | | | | 1 | | | 30 陈永曦 <table border="1"><tr><td></td><td></td><td></td></tr><tr><td></td><td></td><td></td></tr><tr><td></td><td></td><td></td></tr></table> Post - 0 Miss - 0 Block - 0 | | | | | | | | | | 41 莫敬朗 <table border="1"><tr><td></td><td></td><td></td></tr><tr><td></td><td></td><td></td></tr><tr><td></td><td></td><td></td></tr></table> Post - 1 Miss - 0 Block - 0 | | | | | | | | | | 47 薛浩锋 <table border="1"><tr><td>1</td><td></td><td></td></tr><tr><td>1</td><td></td><td></td></tr><tr><td>1</td><td></td><td></td></tr></table> Post - 0 Miss - 0 Block - 0 | 1 | | | 1 | | | 1 | | | 73 黄望臻 <table border="1"><tr><td></td><td></td><td></td></tr><tr><td></td><td></td><td></td></tr><tr><td></td><td></td><td></td></tr></table> Post - 0 Miss - 0 Block - 0 | | | | | | | | | | 79 吴坤霖 <table border="1"><tr><td></td><td></td><td></td></tr><tr><td></td><td></td><td></td></tr><tr><td></td><td></td><td></td></tr></table> Post - 0 Miss - 0 Block - 0 | | | | | | | | | | 99 苏俊轩 <table border="1"><tr><td></td><td></td><td></td></tr><tr><td></td><td></td><td></td></tr><tr><td></td><td></td><td></td></tr></table> Post - 0 Miss - 0 Block - 0 | | | | | | | | | |
| 1 | | 2 | | | | | | | | | | | | | | | | | | | | | | | | | | | | | | | | | | | | | | | | | | | | | | | | | | | | | | | | | | | | | | | | | | | | | | | | | | | | | |
| 1 | 1 | | | | | | | | | | | | | | | | | | | | | | | | | | | | | | | | | | | | | | | | | | | | | | | | | | | | | | | | | | | | | | | | | | | | | | | | | | | | | | |
| | | | | | | | | | | | | | | | | | | | | | | | | | | | | | | | | | | | | | | | | | | | | | | | | | | | | | | | | | | | | | | | | | | | | | | | | | | | | | | | |
| | | | | | | | | | | | | | | | | | | | | | | | | | | | | | | | | | | | | | | | | | | | | | | | | | | | | | | | | | | | | | | | | | | | | | | | | | | | | | | | |
| | | | | | | | | | | | | | | | | | | | | | | | | | | | | | | | | | | | | | | | | | | | | | | | | | | | | | | | | | | | | | | | | | | | | | | | | | | | | | | | |
| 1 | | | | | | | | | | | | | | | | | | | | | | | | | | | | | | | | | | | | | | | | | | | | | | | | | | | | | | | | | | | | | | | | | | | | | | | | | | | | | | | |
| | | | | | | | | | | | | | | | | | | | | | | | | | | | | | | | | | | | | | | | | | | | | | | | | | | | | | | | | | | | | | | | | | | | | | | | | | | | | | | | |
| | | | | | | | | | | | | | | | | | | | | | | | | | | | | | | | | | | | | | | | | | | | | | | | | | | | | | | | | | | | | | | | | | | | | | | | | | | | | | | | |
| | | | | | | | | | | | | | | | | | | | | | | | | | | | | | | | | | | | | | | | | | | | | | | | | | | | | | | | | | | | | | | | | | | | | | | | | | | | | | | | |
| | | | | | | | | | | | | | | | | | | | | | | | | | | | | | | | | | | | | | | | | | | | | | | | | | | | | | | | | | | | | | | | | | | | | | | | | | | | | | | | |
| | | | | | | | | | | | | | | | | | | | | | | | | | | | | | | | | | | | | | | | | | | | | | | | | | | | | | | | | | | | | | | | | | | | | | | | | | | | | | | | |
| | | | | | | | | | | | | | | | | | | | | | | | | | | | | | | | | | | | | | | | | | | | | | | | | | | | | | | | | | | | | | | | | | | | | | | | | | | | | | | | |
| 1 | | | | | | | | | | | | | | | | | | | | | | | | | | | | | | | | | | | | | | | | | | | | | | | | | | | | | | | | | | | | | | | | | | | | | | | | | | | | | | | |
| 1 | | | | | | | | | | | | | | | | | | | | | | | | | | | | | | | | | | | | | | | | | | | | | | | | | | | | | | | | | | | | | | | | | | | | | | | | | | | | | | | |
| 1 | | | | | | | | | | | | | | | | | | | | | | | | | | | | | | | | | | | | | | | | | | | | | | | | | | | | | | | | | | | | | | | | | | | | | | | | | | | | | | | |
| | | | | | | | | | | | | | | | | | | | | | | | | | | | | | | | | | | | | | | | | | | | | | | | | | | | | | | | | | | | | | | | | | | | | | | | | | | | | | | | |
| | | | | | | | | | | | | | | | | | | | | | | | | | | | | | | | | | | | | | | | | | | | | | | | | | | | | | | | | | | | | | | | | | | | | | | | | | | | | | | | |
| | | | | | | | | | | | | | | | | | | | | | | | | | | | | | | | | | | | | | | | | | | | | | | | | | | | | | | | | | | | | | | | | | | | | | | | | | | | | | | | |
| | | | | | | | | | | | | | | | | | | | | | | | | | | | | | | | | | | | | | | | | | | | | | | | | | | | | | | | | | | | | | | | | | | | | | | | | | | | | | | | |
| | | | | | | | | | | | | | | | | | | | | | | | | | | | | | | | | | | | | | | | | | | | | | | | | | | | | | | | | | | | | | | | | | | | | | | | | | | | | | | | |
| | | | | | | | | | | | | | | | | | | | | | | | | | | | | | | | | | | | | | | | | | | | | | | | | | | | | | | | | | | | | | | | | | | | | | | | | | | | | | | | |
| | | | | | | | | | | | | | | | | | | | | | | | | | | | | | | | | | | | | | | | | | | | | | | | | | | | | | | | | | | | | | | | | | | | | | | | | | | | | | | | |
| | | | | | | | | | | | | | | | | | | | | | | | | | | | | | | | | | | | | | | | | | | | | | | | | | | | | | | | | | | | | | | | | | | | | | | | | | | | | | | | |
| | | | | | | | | | | | | | | | | | | | | | | | | | | | | | | | | | | | | | | | | | | | | | | | | | | | | | | | | | | | | | | | | | | | | | | | | | | | | | | | |

| | | | | | | | | | | | | | | | | | | | | | |
|--|-----------------------------------|---------------|---------------------|---|------------------------------------|------------|----------------|----|-------|--------------|----------------|------------|---|-----|----------------------|--|---|---|----|---|----|
| Team A | | | | | Team B | | | | | Match Number | | | | | | | | | | | |
| A 安徽省体校 | | | | | B 山东济南 | | | | | 25 | | | | | | | | | | | |
| Played in | | | in the hall | | | on | | | at | | | Spectators | | | | | | | | | |
| 安徽滁州 | | | 滁州国际手球馆 | | | 2019-06-02 | | | 17:00 | | | hours | | | | | | | | | |
| Half-time(30') | A | B | End of playing time | | A | B | 1st extra time | | A | B | 2nd extra time | | A | B | After penalty throws | | A | B | | | |
| | 7 | 6 | 18 | | 10 | | | | | | | | | | | | | | | | |
| Number of 7 m | A | Team time-out | | | Full name of players and officials | | | | | | Team time-out | | | B | Number of 7 m | | | | | | |
| | 1/1 | 1 | 2 | 3 | | | | | | | 1 | 2 | 3 | B | | | | | | | |
| | | | | | | | | | | | | | | 1/1 | | | | | | | |
| No. | Team A | | | | | G | W | 2' | D | DR | No. | Team B | | | | | G | W | 2' | D | DR |
| 52 | 花驰 | | | | | | | | | | 1 | 刘在攀 | | | | | | | | | |
| 53 | 叶天赐 | | | | | | | | | | 4 | 张广一 | | | | | | | | | |
| 54 | 姚幸运 | | | | | 4 | | | | | 6 | 刘尊哲 | | | | | 2 | | | | |
| 55 | 苏凯 | | | | | 3 | | | | | 7 | 王帅 | | | | | 1 | | | | |
| 56 | 王健鹏 | | | | | 2 | | | | | 8 | 金正凯 | | | | | | | | | |
| 57 | 朱正翔 | | | | | | | | | | 9 | 张嘉树 | | | | | | | | | |
| 58 | 蔡博飞 | | | | | 2 | | | | | 10 | 颜同霖 | | | | | 2 | | | | |
| 59 | 毛饶翔 | | | | | 3 | | 1 | | | 11 | 李延舒 | | | | | 2 | | | | |
| 60 | 朱超 | | | | | 2 | | | | | 13 | 刘振宇 | | | | | 3 | 1 | | | |
| 61 | 钮伟豪 | | | | | | | | | | 16 | 高宇轩 | | | | | | | | | |
| 62 | 赵俊阳 | | | | | | | | | | 17 | 张昊 | | | | | | | | | |
| 64 | 章道胜 | | | | | 2 | | | | | 21 | 杨明毅 | | | | | | | | | |
| 65 | 韩伟伦 | | | | | | | | | | 24 | 于昊 | | | | | | | | | |
| 66 | 刘家豪 | | | | | | | | | | 26 | 曹立志 | | | | | | | | | |
| 68 | 黄天源 | | | | | | | | | | 40 | 鹿智豪 | | | | | | | | | |
| | | | | | | | | | | | 88 | 王麒翔 | | | | | | | | | |
| A | 赵前军 | | | | | | | | | | A | 李楠 | | | | | | | | | |
| C | 吕串 | | | | | | | | | | B | 陈鹏波 (主教练) | | | | | | | | | |
| D | 沈强 | | | | | | | | | | C | 陶丛龙 | | | | | | | | | |
| E | 李煜 | | | | | | | | | | E | 郭军旗 | | | | | | | | | |
| Signatures of responsables for the teams (Off.A) | | | | | | | | | | | | | | | | | | | | | |
| A | | | | | | | | | | | | | | | | | | | B | | |
| TP | Remarks of referees / HF Official | | | | | | | | | | | | | | | | | | TP | | |

Signatures

| | | | | |
|----------|-----------|-----------|--|--|
| Referees | 王洋 (CHN) | 马晓晔 (CHN) | | |
| T.D. | 吴瑞亭 (CHN) | 徐健 (CHN) | | |
| CHA Off. | | | | |

Note: Number of 7m Throws Awarded to Team A and B, Goals (G), Warnings (W), Suspensions (2'), Direct Disqualification (D), Disqualification With Report (DR) and Team Penalty (TP).

Table Officials: 李莉君 吴荣 Statisticians: 沈家洛 马安兴

第二届全国青年运动会男子手球乙组决赛 体校组 (U16)

PHMS Pictorial Handball Match Statistics

IHF Official System

竞赛技术统计

手球
青年男子

四分之一决赛
轮次 4

组别 X
场次 25

滁州国际手球馆
2019-06-02 17:00

Referees: 王洋 (CHN) / 马晓晔 (CHN)

Result: 18:10(7:6)

Teams: 安徽省体校(安徽) VS 山东济南(济南)

| 安徽 | | 远 | 近 | 边 | 快 | 突 | 任意 | 7m | 合计 | % | 助攻 | 失误 | 警告 | 2' | D+DR |
|---------|-----|-----|-----|-----|-----|-----|----|-----|-------|------|----|----|----|----|------|
| 主教练: 张林 | | 射 | 射 | 射 | 攻 | 破 | 球 | 球 | | | | | | | |
| 52 | 花驰 | | | | | | | | | | | | | | |
| 53 | 叶天赐 | | | | | | | | | | 1 | 1 | | | |
| 54 | 姚幸运 | | | 1/1 | 3/3 | | | | 4/4 | 100 | 1 | 1 | | | |
| 55 | 苏凯 | | | 2/2 | 0/1 | | | 1/1 | 3/4 | 75.0 | | | | | |
| 56 | 王健鹏 | 1/2 | 1/1 | | | | | | 2/3 | 66.7 | 4 | 4 | | | |
| 57 | 朱正翔 | | | | | | | | | | 1 | | | | |
| 58 | 蔡博飞 | | 2/3 | | 0/1 | | | | 2/4 | 50.0 | 2 | 2 | | | |
| 59 | 毛饶翔 | 2/2 | | | 1/1 | | | | 3/3 | 100 | 2 | 1 | | 1 | |
| 60 | 朱超 | | | 1/1 | 1/1 | | | | 2/2 | 100 | | 2 | | | |
| 61 | 钮伟豪 | | | | | | | | | | | | | | |
| 62 | 赵俊阳 | | | | | | | | | | | | | | |
| 64 | 章道胜 | 0/1 | 2/2 | 0/1 | 0/1 | | | | 2/5 | 40.0 | | 2 | | | |
| 65 | 韩伟伦 | | | | | | | | | | | | | | |
| 66 | 刘家豪 | | | | | | | | | | | 1 | | | |
| 68 | 黄天源 | | | | | | | | | | | 1 | | | |
| 运动员 | 合计 | 3/5 | 5/6 | 4/5 | 5/8 | | | 1/1 | 18/25 | 72.0 | 11 | 15 | | 1 | |
| 52 | 花驰 | 2/4 | 2/3 | 2/2 | | 0/1 | | 0/1 | 6/11 | 54.5 | | | | | |
| 53 | 叶天赐 | 1/3 | | 0/1 | 0/1 | 0/1 | | | 1/6 | 16.7 | 1 | 1 | | | |
| 守门员 | 合计 | 3/7 | 2/3 | 2/3 | 0/1 | 0/2 | | 0/1 | 7/17 | 41.2 | 1 | 1 | | | |

| 济南 | | 远 | 近 | 边 | 快 | 突 | 任意 | 7m | 合计 | % | 助攻 | 失误 | 警告 | 2' | D+DR |
|----------|-----|------|-----|-----|-----|-----|----|-----|-------|------|----|----|----|----|------|
| 主教练: 陈鹏波 | | 射 | 射 | 射 | 攻 | 破 | 球 | 球 | | | | | | | |
| 1 | 刘在攀 | | | | | | | | | | | | | | |
| 4 | 张广一 | | | | | | | | | | | | | | |
| 6 | 刘尊哲 | 1/5 | | | | | | 1/1 | 2/6 | 33.3 | 1 | 4 | | | |
| 7 | 王帅 | | 0/1 | 1/1 | | | | | 1/2 | 50.0 | | | | | |
| 8 | 金正凯 | | | 0/1 | | | | | 0/1 | 0.0 | 1 | 1 | | | |
| 9 | 张嘉树 | | 0/1 | | | | | | 0/1 | 0.0 | | 2 | | | |
| 10 | 颜同霖 | 1/4 | | 0/1 | | 1/1 | | | 2/6 | 33.3 | | 2 | | | |
| 11 | 李延舒 | | 1/1 | | 1/1 | | | | 2/2 | 100 | | 3 | | | |
| 13 | 刘振宇 | 2/6 | | | | 1/1 | | | 3/7 | 42.9 | | 7 | 1 | | |
| 16 | 高宇轩 | | | | | | | | | | | | | | |
| 17 | 张昊 | | | | | | | | | | | | | | |
| 21 | 杨明毅 | | | | | | | | | | | | | | |
| 24 | 于昊 | | | | | | | | | | | | | | |
| 26 | 曹立志 | | | | | | | | | | | 1 | | | |
| 40 | 鹿智豪 | | | | | | | | | | | | | | |
| 88 | 王麒麟 | | | | | | | | | | | | | | |
| 运动员 | 合计 | 4/15 | 1/3 | 1/3 | 1/1 | 2/2 | | 1/1 | 10/25 | 40.0 | 2 | 20 | 1 | | |
| 1 | 刘在攀 | 1/4 | 0/4 | 1/5 | 0/4 | | | 0/1 | 2/18 | 11.1 | | | | | |
| 16 | 高宇轩 | | 0/1 | | 0/1 | | | | 0/2 | 0.0 | | | | | |
| 守门员 | 合计 | 1/4 | 0/5 | 1/5 | 0/5 | | | 0/1 | 2/20 | 10.0 | | | | | |

| 安徽 | 比赛进程 | 济南 |
|----------|--------------------|----|
| 1st Half | | |
| 64 章道胜 | 1 01:57 0 | |
| | 1 03:57 1 10 颜同霖 | |
| 59 毛饶翔 | 2 04:38 1 | |
| | 2 05:01 2 13 刘振宇 | |
| 56 王健鹏 | 3 06:06 2 | |
| 55 苏凯 | 4 07:47 2 | |
| | 4 08:31 3 10 颜同霖 | |
| 64 章道胜 | 5 09:23 3 | |
| 55 苏凯 | 6 10:47 3 | |
| | 6 11:44 4 13 刘振宇 | |
| 55 苏凯 | 7 12:08 4 | |
| | 7 13:11 5 11 李延舒 | |
| | 7 14:48 6 7 王帅 | |
| 2nd Half | | |
| 58 蔡博飞 | 8 00:51 6 | |
| | 8 01:16 7 11 李延舒 | |
| 56 王健鹏 | 9 01:39 7 | |
| 54 姚幸运 | 10 03:46 7 | |
| 60 朱超 | 11 04:36 7 | |
| | 11 05:36 8 6 刘尊哲 | |
| 54 姚幸运 | 12 05:59 8 | |
| 60 朱超 | 13 06:55 8 | |
| | 13 07:56 9 6 刘尊哲 | |
| 59 毛饶翔 | 14 08:25 9 | |
| 59 毛饶翔 | 15 10:41 9 | |
| 54 姚幸运 | 16 11:33 9 | |
| 58 蔡博飞 | 17 12:42 9 | |
| 54 姚幸运 | 18 13:12 9 | |
| | 18 14:24 10 13 刘振宇 | |

场上队员: 得分 / 射门

守门员: 救球 / 射门

| | | | |
|---|------|----|---------|
| D | 取消资格 | DR | 取消资格+报告 |
|---|------|----|---------|



个人/全队技术统计表

手球 四分之一决赛 组别 X
青年男子 轮次 4 场次 25
滁州国际手球馆
2019-06-02 17:00

| 号码 | 姓名 | 远射 | 近射 | 边射 | 快攻 | 突破 | 任意 | 七米 | 合计 | % | 助攻 | 失误 | 警告 | 2' | 取消 | 时间 |
|------------------|-----|------------|------------|------------|------------|------------|----|------------|--------------|--------------|-----------|-----------|----|----------|----|----------|
| 安徽省体校(安徽) | | | | | | | | | | | | | | | | |
| (场上队员) | | | | | | | | | | | | | | | | |
| 52 | 花驰 | | | | | | | | | 0.0% | | | | | | 00:19:12 |
| 53 | 叶天赐 | | | | | | | | | 0.0% | 1 | 1 | | | | 00:10:48 |
| 54 | 姚幸运 | | | 1/1 | 3/3 | | | | 4/4 | 100% | 1 | 1 | | | | 00:15:00 |
| 55 | 苏凯 | | | 2/2 | 0/1 | | | 1/1 | 3/4 | 75.0% | | | | | | 00:15:00 |
| 56 | 王健鹏 | 1/2 | 1/1 | | | | | | 2/3 | 66.7% | 4 | 4 | | | | 00:26:39 |
| 57 | 朱正翔 | | | | | | | | | 0.0% | 1 | | | | | 00:15:07 |
| 58 | 蔡博飞 | | 2/3 | | 0/1 | | | | 2/4 | 50.0% | 2 | 2 | | | | 00:18:13 |
| 59 | 毛饶翔 | 2/2 | | | 1/1 | | | | 3/3 | 100% | 2 | 1 | | 1 | | 00:28:15 |
| 60 | 朱超 | | | 1/1 | 1/1 | | | | 2/2 | 100% | | 2 | | | | 00:23:02 |
| 61 | 钮伟豪 | | | | | | | | | 0.0% | | | | | | 00:00:00 |
| 62 | 赵俊阳 | | | | | | | | | 0.0% | | | | | | 00:06:53 |
| 64 | 章道胜 | 0/1 | 2/2 | 0/1 | 0/1 | | | | 2/5 | 40.0% | | 2 | | | | 00:25:45 |
| 65 | 韩伟伦 | | | | | | | | | 0.0% | | | | | | 00:00:00 |
| 66 | 刘家豪 | | | | | | | | | 0.0% | | 1 | | | | 00:01:40 |
| 68 | 黄天源 | | | | | | | | | 0.0% | | 1 | | | | 00:04:14 |
| 合计 | | 3/5 | 5/6 | 4/5 | 5/8 | | | 1/1 | 18/25 | 72.0% | 11 | 15 | | 1 | | |
| (守门员) | | | | | | | | | | | | | | | | |
| 52 | 花驰 | 2/4 | 2/3 | 2/2 | | 0/1 | | 0/1 | 6/11 | 54.5% | | | | | | 00:19:12 |
| 53 | 叶天赐 | 1/3 | | 0/1 | 0/1 | 0/1 | | | 1/6 | 16.7% | 1 | 1 | | | | 00:10:48 |
| 合计 | | 3/7 | 2/3 | 2/3 | 0/1 | 0/2 | | 0/1 | 7/17 | 41.2% | 1 | 1 | | | | |

场上队员：得分/射门

守门员：救球/射门

| 全队合计 | 得分 | 被救 | 射失 | 击柱 | 封球 | 合计 | % |
|------|----|----|----|----|----|----|--------|
| 远射 | 3 | 1 | | 1 | | 5 | 60.0% |
| 近射 | 5 | | 1 | | | 6 | 83.3% |
| 边射 | 4 | 1 | | | | 5 | 80.0% |
| 快攻 | 5 | | 2 | 1 | | 8 | 62.5% |
| 突破 | | | | | | | 0.0% |
| 任意 | | | | | | | 0.0% |
| 七米 | 1 | | | | | 1 | 100.0% |

个人/全队技术统计表

手球 四分之一决赛 组别 X
青年男子 轮次 4 场次 25
滁州国际手球馆
2019-06-02 17:00

| 号码 | 姓名 | 远射 | 近射 | 边射 | 快攻 | 突破 | 任意 | 七米 | 合计 | % | 助攻 | 失误 | 警告 | 2' | 取消 | 时间 |
|----------|-----|------|-----|-----|-----|-----|----|-----|-------|-------|----|----|----|----|----|----------|
| 山东济南(济南) | | | | | | | | | | | | | | | | |
| (场上队员) | | | | | | | | | | | | | | | | |
| 1 | 刘在攀 | | | | | | | | | 0.0% | | | | | | 00:26:48 |
| 4 | 张广一 | | | | | | | | | 0.0% | | | | | | 00:04:05 |
| 6 | 刘尊哲 | 1/5 | | | | | | 1/1 | 2/6 | 33.3% | 1 | 4 | | | | 00:30:00 |
| 7 | 王帅 | | 0/1 | 1/1 | | | | | 1/2 | 50.0% | | | | | | 00:30:00 |
| 8 | 金正凯 | | | 0/1 | | | | | 0/1 | 0.0% | 1 | 1 | | | | 00:21:25 |
| 9 | 张嘉树 | | 0/1 | | | | | | 0/1 | 0.0% | | 2 | | | | 00:10:53 |
| 10 | 颜同霖 | 1/4 | | 0/1 | | 1/1 | | | 2/6 | 33.3% | | 2 | | | | 00:25:14 |
| 11 | 李延舒 | | 1/1 | | 1/1 | | | | 2/2 | 100% | | 3 | | | | 00:29:29 |
| 13 | 刘振宇 | 2/6 | | | | 1/1 | | | 3/7 | 42.9% | | 7 | 1 | | | 00:23:41 |
| 16 | 高宇轩 | | | | | | | | | 0.0% | | | | | | 00:03:12 |
| 17 | 张昊 | | | | | | | | | 0.0% | | | | | | 00:00:00 |
| 21 | 杨明毅 | | | | | | | | | 0.0% | | | | | | 00:00:00 |
| 24 | 于昊 | | | | | | | | | 0.0% | | | | | | 00:00:30 |
| 26 | 曹立志 | | | | | | | | | 0.0% | | 1 | | | | 00:04:37 |
| 40 | 鹿智豪 | | | | | | | | | 0.0% | | | | | | 00:00:00 |
| 88 | 王麒翔 | | | | | | | | | 0.0% | | | | | | 00:00:00 |
| | 合计 | 4/15 | 1/3 | 1/3 | 1/1 | 2/2 | | 1/1 | 10/25 | 40.0% | 2 | 20 | 1 | | | |
| (守门员) | | | | | | | | | | | | | | | | |
| 1 | 刘在攀 | 1/4 | 0/4 | 1/5 | 0/4 | | | 0/1 | 2/18 | 11.1% | | | | | | 00:26:48 |
| 16 | 高宇轩 | | 0/1 | | 0/1 | | | | 0/2 | 0.0% | | | | | | 00:03:12 |
| | 合计 | 1/4 | 0/5 | 1/5 | 0/5 | | | 0/1 | 2/20 | 10.0% | | | | | | |

场上队员：得分/射门

守门员：救球/射门

| 全队合计 | 得分 | 被救 | 射失 | 击柱 | 封球 | 合计 | % |
|------|----|----|----|----|----|----|--------|
| 远射 | 4 | 3 | 4 | 2 | 2 | 15 | 26.7% |
| 近射 | 1 | 2 | | | | 3 | 33.3% |
| 边射 | 1 | 2 | | | | 3 | 33.3% |
| 快攻 | 1 | | | | | 1 | 100.0% |
| 突破 | 2 | | | | | 2 | 100.0% |
| 任意 | | | | | | | 0.0% |
| 七米 | 1 | | | | | 1 | 100.0% |

图式比赛技术统计表

手球
青年男子

四分之一决赛
轮次 4

组别 X
场次 25

滁州国际手球馆
2019-06-02 17:00

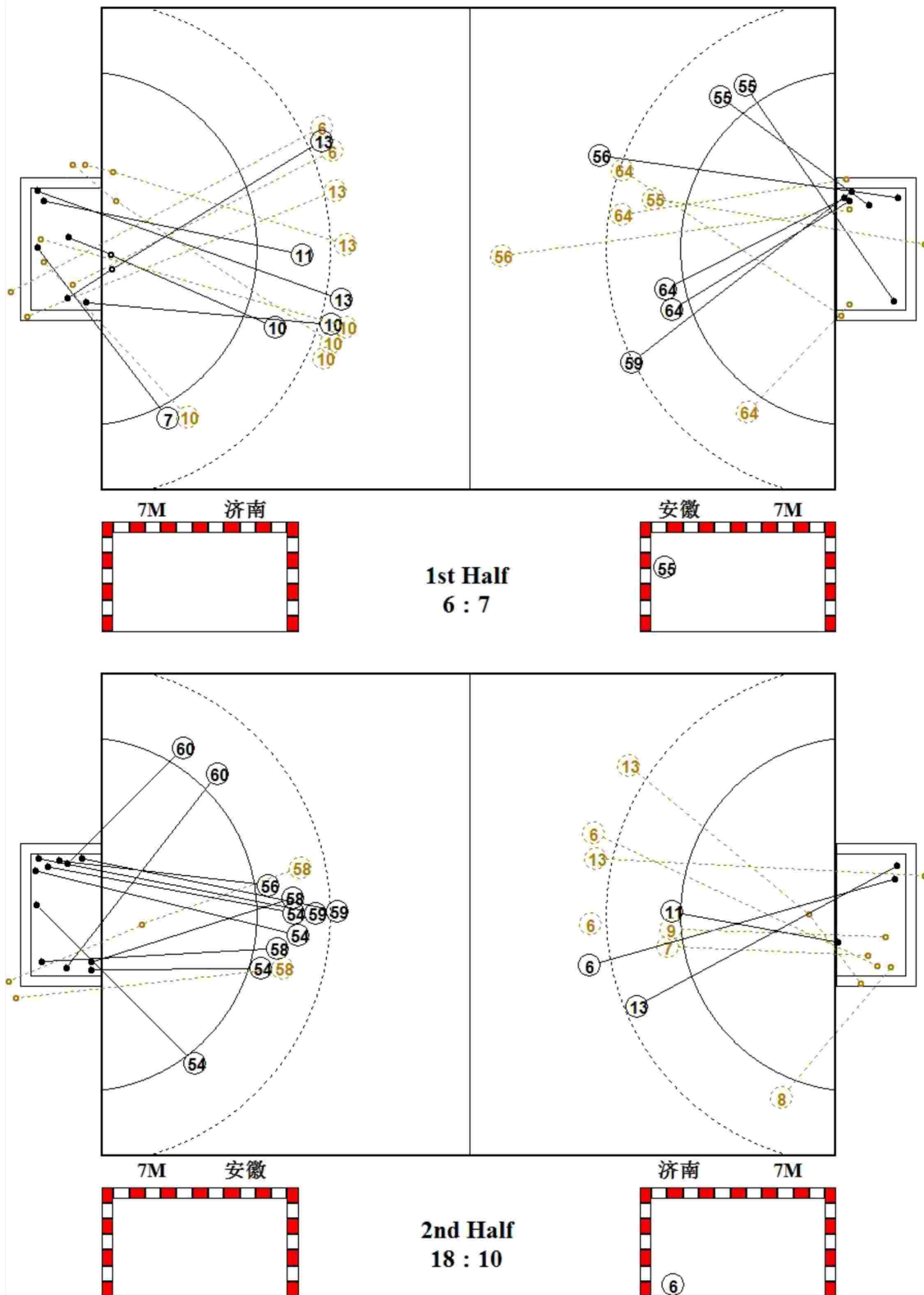

图式射门区域统计

手球
青年男子

四分之一决赛
轮次 4

组别 X
场次 25

滁州国际手球馆
2019-06-02 17:00

安徽省体校

| | | | | | | | | | | | | | | | | | | | | | | | | | | | | | | | | | | | | | | | | | | | | | | | | | | | | | | | | | | | | | | | | | | | | | | | | | | | | | | | |
|--|-----------------------------|-----------------------------|-----------------------------|-----------------------------|-----------------------------|-----------------------------|-----------------------------|--|--|--|--|--|--|--|--|--|--|--|--|---|--|---|---|--|--|--|---|--|--|---|---|--|---|---|--|--|--|--|--|--|---|--|--|--|--|---|--|--|--|--|--|--|--|--|--|--|--|--|--|--|---|--|--|--|--|--|---|--|--|---|--|--|---|--|--|--|---|--|---|
| 52 花驰 | 53 叶天赐 | 54 姚幸运 | 55 苏凯 | 56 王健鹏 | 57 朱正翔 | 58 蔡博飞 | 59 毛饶翔 | | | | | | | | | | | | | | | | | | | | | | | | | | | | | | | | | | | | | | | | | | | | | | | | | | | | | | | | | | | | | | | | | | | | | | | | |
| <table border="1"><tr><td></td><td></td><td></td></tr><tr><td></td><td></td><td></td></tr><tr><td></td><td></td><td></td></tr></table> | | | | | | | | | | <table border="1"><tr><td></td><td></td><td></td></tr><tr><td></td><td></td><td></td></tr><tr><td></td><td></td><td></td></tr></table> | | | | | | | | | | <table border="1"><tr><td></td><td>1</td><td>2</td></tr><tr><td></td><td></td><td></td></tr><tr><td>1</td><td></td><td></td></tr></table> | | 1 | 2 | | | | 1 | | | <table border="1"><tr><td>1</td><td></td><td>1</td></tr><tr><td>1</td><td></td><td></td></tr><tr><td></td><td></td><td></td></tr></table> | 1 | | 1 | 1 | | | | | | <table border="1"><tr><td>1</td><td></td><td></td></tr><tr><td></td><td></td><td>1</td></tr><tr><td></td><td></td><td></td></tr></table> | 1 | | | | | 1 | | | | <table border="1"><tr><td></td><td></td><td></td></tr><tr><td></td><td></td><td></td></tr><tr><td></td><td></td><td></td></tr></table> | | | | | | | | | | <table border="1"><tr><td>1</td><td></td><td></td></tr><tr><td></td><td></td><td></td></tr><tr><td>1</td><td></td><td></td></tr></table> | 1 | | | | | | 1 | | | <table border="1"><tr><td></td><td></td><td>1</td></tr><tr><td></td><td></td><td></td></tr><tr><td>1</td><td></td><td>1</td></tr></table> | | | 1 | | | | 1 | | 1 |
| | | | | | | | | | | | | | | | | | | | | | | | | | | | | | | | | | | | | | | | | | | | | | | | | | | | | | | | | | | | | | | | | | | | | | | | | | | | | | | | |
| | | | | | | | | | | | | | | | | | | | | | | | | | | | | | | | | | | | | | | | | | | | | | | | | | | | | | | | | | | | | | | | | | | | | | | | | | | | | | | | |
| | | | | | | | | | | | | | | | | | | | | | | | | | | | | | | | | | | | | | | | | | | | | | | | | | | | | | | | | | | | | | | | | | | | | | | | | | | | | | | | |
| | | | | | | | | | | | | | | | | | | | | | | | | | | | | | | | | | | | | | | | | | | | | | | | | | | | | | | | | | | | | | | | | | | | | | | | | | | | | | | | |
| | | | | | | | | | | | | | | | | | | | | | | | | | | | | | | | | | | | | | | | | | | | | | | | | | | | | | | | | | | | | | | | | | | | | | | | | | | | | | | | |
| | | | | | | | | | | | | | | | | | | | | | | | | | | | | | | | | | | | | | | | | | | | | | | | | | | | | | | | | | | | | | | | | | | | | | | | | | | | | | | | |
| | 1 | 2 | | | | | | | | | | | | | | | | | | | | | | | | | | | | | | | | | | | | | | | | | | | | | | | | | | | | | | | | | | | | | | | | | | | | | | | | | | | | | |
| | | | | | | | | | | | | | | | | | | | | | | | | | | | | | | | | | | | | | | | | | | | | | | | | | | | | | | | | | | | | | | | | | | | | | | | | | | | | | | | |
| 1 | | | | | | | | | | | | | | | | | | | | | | | | | | | | | | | | | | | | | | | | | | | | | | | | | | | | | | | | | | | | | | | | | | | | | | | | | | | | | | | |
| 1 | | 1 | | | | | | | | | | | | | | | | | | | | | | | | | | | | | | | | | | | | | | | | | | | | | | | | | | | | | | | | | | | | | | | | | | | | | | | | | | | | | |
| 1 | | | | | | | | | | | | | | | | | | | | | | | | | | | | | | | | | | | | | | | | | | | | | | | | | | | | | | | | | | | | | | | | | | | | | | | | | | | | | | | |
| | | | | | | | | | | | | | | | | | | | | | | | | | | | | | | | | | | | | | | | | | | | | | | | | | | | | | | | | | | | | | | | | | | | | | | | | | | | | | | | |
| 1 | | | | | | | | | | | | | | | | | | | | | | | | | | | | | | | | | | | | | | | | | | | | | | | | | | | | | | | | | | | | | | | | | | | | | | | | | | | | | | | |
| | | 1 | | | | | | | | | | | | | | | | | | | | | | | | | | | | | | | | | | | | | | | | | | | | | | | | | | | | | | | | | | | | | | | | | | | | | | | | | | | | | |
| | | | | | | | | | | | | | | | | | | | | | | | | | | | | | | | | | | | | | | | | | | | | | | | | | | | | | | | | | | | | | | | | | | | | | | | | | | | | | | | |
| | | | | | | | | | | | | | | | | | | | | | | | | | | | | | | | | | | | | | | | | | | | | | | | | | | | | | | | | | | | | | | | | | | | | | | | | | | | | | | | |
| | | | | | | | | | | | | | | | | | | | | | | | | | | | | | | | | | | | | | | | | | | | | | | | | | | | | | | | | | | | | | | | | | | | | | | | | | | | | | | | |
| | | | | | | | | | | | | | | | | | | | | | | | | | | | | | | | | | | | | | | | | | | | | | | | | | | | | | | | | | | | | | | | | | | | | | | | | | | | | | | | |
| 1 | | | | | | | | | | | | | | | | | | | | | | | | | | | | | | | | | | | | | | | | | | | | | | | | | | | | | | | | | | | | | | | | | | | | | | | | | | | | | | | |
| | | | | | | | | | | | | | | | | | | | | | | | | | | | | | | | | | | | | | | | | | | | | | | | | | | | | | | | | | | | | | | | | | | | | | | | | | | | | | | | |
| 1 | | | | | | | | | | | | | | | | | | | | | | | | | | | | | | | | | | | | | | | | | | | | | | | | | | | | | | | | | | | | | | | | | | | | | | | | | | | | | | | |
| | | 1 | | | | | | | | | | | | | | | | | | | | | | | | | | | | | | | | | | | | | | | | | | | | | | | | | | | | | | | | | | | | | | | | | | | | | | | | | | | | | |
| | | | | | | | | | | | | | | | | | | | | | | | | | | | | | | | | | | | | | | | | | | | | | | | | | | | | | | | | | | | | | | | | | | | | | | | | | | | | | | | |
| 1 | | 1 | | | | | | | | | | | | | | | | | | | | | | | | | | | | | | | | | | | | | | | | | | | | | | | | | | | | | | | | | | | | | | | | | | | | | | | | | | | | | |
| Post - 0 Miss - 0 Block - 0 | Post - 0 Miss - 0 Block - 0 | Post - 0 Miss - 0 Block - 0 | Post - 0 Miss - 1 Block - 0 | Post - 0 Miss - 0 Block - 0 | Post - 0 Miss - 0 Block - 0 | Post - 0 Miss - 2 Block - 0 | Post - 0 Miss - 0 Block - 0 | | | | | | | | | | | | | | | | | | | | | | | | | | | | | | | | | | | | | | | | | | | | | | | | | | | | | | | | | | | | | | | | | | | | | | | | |
| 60 朱超 | 61 钮伟豪 | 62 赵俊阳 | 64 章道胜 | 65 韩伟伦 | 66 刘家豪 | 68 黄天源 | | | | | | | | | | | | | | | | | | | | | | | | | | | | | | | | | | | | | | | | | | | | | | | | | | | | | | | | | | | | | | | | | | | | | | | | | |
| <table border="1"><tr><td>1</td><td></td><td>1</td></tr><tr><td></td><td></td><td></td></tr><tr><td></td><td></td><td></td></tr></table> | 1 | | 1 | | | | | | | <table border="1"><tr><td></td><td></td><td></td></tr><tr><td></td><td></td><td></td></tr><tr><td></td><td></td><td></td></tr></table> | | | | | | | | | | <table border="1"><tr><td></td><td></td><td></td></tr><tr><td></td><td></td><td></td></tr><tr><td></td><td></td><td></td></tr></table> | | | | | | | | | | <table border="1"><tr><td></td><td></td><td></td></tr><tr><td>2</td><td></td><td></td></tr><tr><td></td><td></td><td></td></tr></table> | | | | 2 | | | | | | <table border="1"><tr><td></td><td></td><td></td></tr><tr><td></td><td></td><td></td></tr><tr><td></td><td></td><td></td></tr></table> | | | | | | | | | | <table border="1"><tr><td></td><td></td><td></td></tr><tr><td></td><td></td><td></td></tr><tr><td></td><td></td><td></td></tr></table> | | | | | | | | | | <table border="1"><tr><td></td><td></td><td></td></tr><tr><td></td><td></td><td></td></tr><tr><td></td><td></td><td></td></tr></table> | | | | | | | | | | | | | | | | | | | |
| 1 | | 1 | | | | | | | | | | | | | | | | | | | | | | | | | | | | | | | | | | | | | | | | | | | | | | | | | | | | | | | | | | | | | | | | | | | | | | | | | | | | | |
| | | | | | | | | | | | | | | | | | | | | | | | | | | | | | | | | | | | | | | | | | | | | | | | | | | | | | | | | | | | | | | | | | | | | | | | | | | | | | | | |
| | | | | | | | | | | | | | | | | | | | | | | | | | | | | | | | | | | | | | | | | | | | | | | | | | | | | | | | | | | | | | | | | | | | | | | | | | | | | | | | |
| | | | | | | | | | | | | | | | | | | | | | | | | | | | | | | | | | | | | | | | | | | | | | | | | | | | | | | | | | | | | | | | | | | | | | | | | | | | | | | | |
| | | | | | | | | | | | | | | | | | | | | | | | | | | | | | | | | | | | | | | | | | | | | | | | | | | | | | | | | | | | | | | | | | | | | | | | | | | | | | | | |
| | | | | | | | | | | | | | | | | | | | | | | | | | | | | | | | | | | | | | | | | | | | | | | | | | | | | | | | | | | | | | | | | | | | | | | | | | | | | | | | |
| | | | | | | | | | | | | | | | | | | | | | | | | | | | | | | | | | | | | | | | | | | | | | | | | | | | | | | | | | | | | | | | | | | | | | | | | | | | | | | | |
| | | | | | | | | | | | | | | | | | | | | | | | | | | | | | | | | | | | | | | | | | | | | | | | | | | | | | | | | | | | | | | | | | | | | | | | | | | | | | | | |
| | | | | | | | | | | | | | | | | | | | | | | | | | | | | | | | | | | | | | | | | | | | | | | | | | | | | | | | | | | | | | | | | | | | | | | | | | | | | | | | |
| | | | | | | | | | | | | | | | | | | | | | | | | | | | | | | | | | | | | | | | | | | | | | | | | | | | | | | | | | | | | | | | | | | | | | | | | | | | | | | | |
| 2 | | | | | | | | | | | | | | | | | | | | | | | | | | | | | | | | | | | | | | | | | | | | | | | | | | | | | | | | | | | | | | | | | | | | | | | | | | | | | | | |
| | | | | | | | | | | | | | | | | | | | | | | | | | | | | | | | | | | | | | | | | | | | | | | | | | | | | | | | | | | | | | | | | | | | | | | | | | | | | | | | |
| | | | | | | | | | | | | | | | | | | | | | | | | | | | | | | | | | | | | | | | | | | | | | | | | | | | | | | | | | | | | | | | | | | | | | | | | | | | | | | | |
| | | | | | | | | | | | | | | | | | | | | | | | | | | | | | | | | | | | | | | | | | | | | | | | | | | | | | | | | | | | | | | | | | | | | | | | | | | | | | | | |
| | | | | | | | | | | | | | | | | | | | | | | | | | | | | | | | | | | | | | | | | | | | | | | | | | | | | | | | | | | | | | | | | | | | | | | | | | | | | | | | |
| | | | | | | | | | | | | | | | | | | | | | | | | | | | | | | | | | | | | | | | | | | | | | | | | | | | | | | | | | | | | | | | | | | | | | | | | | | | | | | | |
| | | | | | | | | | | | | | | | | | | | | | | | | | | | | | | | | | | | | | | | | | | | | | | | | | | | | | | | | | | | | | | | | | | | | | | | | | | | | | | | |
| | | | | | | | | | | | | | | | | | | | | | | | | | | | | | | | | | | | | | | | | | | | | | | | | | | | | | | | | | | | | | | | | | | | | | | | | | | | | | | | |
| | | | | | | | | | | | | | | | | | | | | | | | | | | | | | | | | | | | | | | | | | | | | | | | | | | | | | | | | | | | | | | | | | | | | | | | | | | | | | | | |
| | | | | | | | | | | | | | | | | | | | | | | | | | | | | | | | | | | | | | | | | | | | | | | | | | | | | | | | | | | | | | | | | | | | | | | | | | | | | | | | |
| | | | | | | | | | | | | | | | | | | | | | | | | | | | | | | | | | | | | | | | | | | | | | | | | | | | | | | | | | | | | | | | | | | | | | | | | | | | | | | | |
| Post - 0 Miss - 0 Block - 0 | Post - 0 Miss - 0 Block - 0 | Post - 0 Miss - 0 Block - 0 | Post - 2 Miss - 0 Block - 0 | Post - 0 Miss - 0 Block - 0 | Post - 0 Miss - 0 Block - 0 | Post - 0 Miss - 0 Block - 0 | | | | | | | | | | | | | | | | | | | | | | | | | | | | | | | | | | | | | | | | | | | | | | | | | | | | | | | | | | | | | | | | | | | | | | | | | |

52 花驰

| | | |
|-----|-----|-----|
| 0/2 | 1/1 | 2/2 |
| 1/1 | | 2/2 |
| 0/2 | | 0/1 |

53 叶天赐

| | | |
|-----|-----|-----|
| | 1/2 | 0/2 |
| 0/1 | 0/1 | |
| | | |

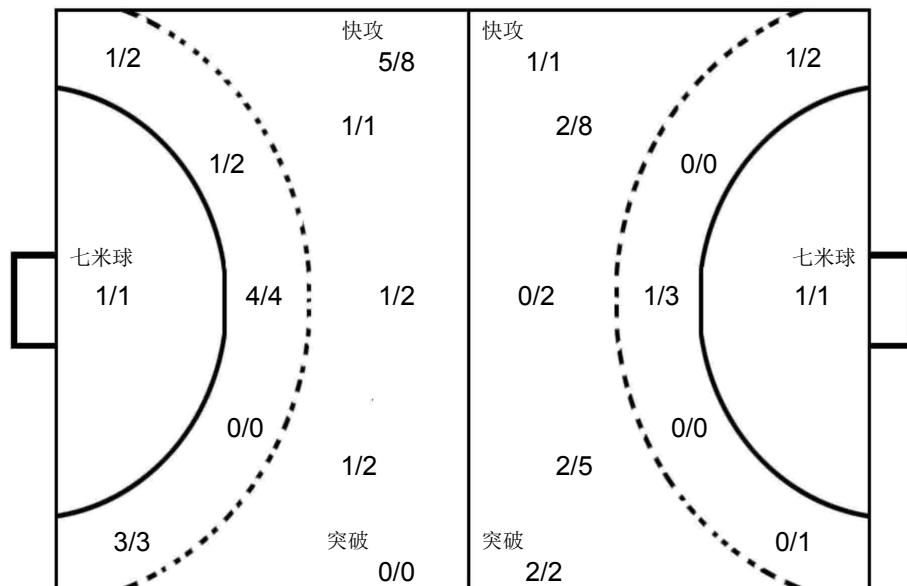

1 刘在攀

| | | |
|-----|-----|-----|
| 0/2 | 0/1 | 0/3 |
| 0/2 | | 0/2 |
| 1/6 | | 1/2 |

16 高宇轩

| | | |
|-----|--|-----|
| 0/1 | | 0/1 |
| | | |
| | | |

山东济南

| | | | | | | | | | | | | | | | | | | | | | | | | | | | | | | | | | | | | | | | | | | | | | | | | | | | | | | | | | | | | | | | | | | | | | | | | | | | | | | | |
|---|-----------------------------|-----------------------------|-----------------------------|-----------------------------|-----------------------------|-----------------------------|-----------------------------|--|--|--|--|--|--|--|--|--|--|--|--|--|---|--|--|--|--|--|---|--|--|---|--|---|--|--|--|--|--|--|--|--|--|--|--|--|--|--|--|--|--|--|--|--|--|--|--|--|--|--|--|--|--|--|--|--|---|--|---|--|--|--|--|--|---|--|--|--|--|--|---|
| 1 刘在攀 | 4 张广一 | 6 刘尊哲 | 7 王帅 | 8 金正凯 | 9 张嘉树 | 10 颜同霖 | 11 李延舒 | | | | | | | | | | | | | | | | | | | | | | | | | | | | | | | | | | | | | | | | | | | | | | | | | | | | | | | | | | | | | | | | | | | | | | | | |
| <table border="1"><tr><td></td><td></td><td></td></tr><tr><td></td><td></td><td></td></tr><tr><td></td><td></td><td></td></tr></table> | | | | | | | | | | <table border="1"><tr><td></td><td></td><td></td></tr><tr><td></td><td></td><td></td></tr><tr><td></td><td></td><td></td></tr></table> | | | | | | | | | | <table border="1"><tr><td>1</td><td></td><td></td></tr><tr><td></td><td></td><td></td></tr><tr><td>1</td><td></td><td></td></tr></table> | 1 | | | | | | 1 | | | <table border="1"><tr><td></td><td>1</td><td></td></tr><tr><td></td><td></td><td></td></tr><tr><td></td><td></td><td></td></tr></table> | | 1 | | | | | | | | <table border="1"><tr><td></td><td></td><td></td></tr><tr><td></td><td></td><td></td></tr><tr><td></td><td></td><td></td></tr></table> | | | | | | | | | | <table border="1"><tr><td></td><td></td><td></td></tr><tr><td></td><td></td><td></td></tr><tr><td></td><td></td><td></td></tr></table> | | | | | | | | | | <table border="1"><tr><td></td><td></td><td></td></tr><tr><td></td><td>1</td><td></td></tr><tr><td>1</td><td></td><td></td></tr></table> | | | | | 1 | | 1 | | | <table border="1"><tr><td></td><td></td><td>1</td></tr><tr><td></td><td></td><td></td></tr><tr><td></td><td></td><td>1</td></tr></table> | | | 1 | | | | | | 1 |
| | | | | | | | | | | | | | | | | | | | | | | | | | | | | | | | | | | | | | | | | | | | | | | | | | | | | | | | | | | | | | | | | | | | | | | | | | | | | | | | |
| | | | | | | | | | | | | | | | | | | | | | | | | | | | | | | | | | | | | | | | | | | | | | | | | | | | | | | | | | | | | | | | | | | | | | | | | | | | | | | | |
| | | | | | | | | | | | | | | | | | | | | | | | | | | | | | | | | | | | | | | | | | | | | | | | | | | | | | | | | | | | | | | | | | | | | | | | | | | | | | | | |
| | | | | | | | | | | | | | | | | | | | | | | | | | | | | | | | | | | | | | | | | | | | | | | | | | | | | | | | | | | | | | | | | | | | | | | | | | | | | | | | |
| | | | | | | | | | | | | | | | | | | | | | | | | | | | | | | | | | | | | | | | | | | | | | | | | | | | | | | | | | | | | | | | | | | | | | | | | | | | | | | | |
| | | | | | | | | | | | | | | | | | | | | | | | | | | | | | | | | | | | | | | | | | | | | | | | | | | | | | | | | | | | | | | | | | | | | | | | | | | | | | | | |
| 1 | | | | | | | | | | | | | | | | | | | | | | | | | | | | | | | | | | | | | | | | | | | | | | | | | | | | | | | | | | | | | | | | | | | | | | | | | | | | | | | |
| | | | | | | | | | | | | | | | | | | | | | | | | | | | | | | | | | | | | | | | | | | | | | | | | | | | | | | | | | | | | | | | | | | | | | | | | | | | | | | | |
| 1 | | | | | | | | | | | | | | | | | | | | | | | | | | | | | | | | | | | | | | | | | | | | | | | | | | | | | | | | | | | | | | | | | | | | | | | | | | | | | | | |
| | 1 | | | | | | | | | | | | | | | | | | | | | | | | | | | | | | | | | | | | | | | | | | | | | | | | | | | | | | | | | | | | | | | | | | | | | | | | | | | | | | |
| | | | | | | | | | | | | | | | | | | | | | | | | | | | | | | | | | | | | | | | | | | | | | | | | | | | | | | | | | | | | | | | | | | | | | | | | | | | | | | | |
| | | | | | | | | | | | | | | | | | | | | | | | | | | | | | | | | | | | | | | | | | | | | | | | | | | | | | | | | | | | | | | | | | | | | | | | | | | | | | | | |
| | | | | | | | | | | | | | | | | | | | | | | | | | | | | | | | | | | | | | | | | | | | | | | | | | | | | | | | | | | | | | | | | | | | | | | | | | | | | | | | |
| | | | | | | | | | | | | | | | | | | | | | | | | | | | | | | | | | | | | | | | | | | | | | | | | | | | | | | | | | | | | | | | | | | | | | | | | | | | | | | | |
| | | | | | | | | | | | | | | | | | | | | | | | | | | | | | | | | | | | | | | | | | | | | | | | | | | | | | | | | | | | | | | | | | | | | | | | | | | | | | | | |
| | | | | | | | | | | | | | | | | | | | | | | | | | | | | | | | | | | | | | | | | | | | | | | | | | | | | | | | | | | | | | | | | | | | | | | | | | | | | | | | |
| | | | | | | | | | | | | | | | | | | | | | | | | | | | | | | | | | | | | | | | | | | | | | | | | | | | | | | | | | | | | | | | | | | | | | | | | | | | | | | | |
| | | | | | | | | | | | | | | | | | | | | | | | | | | | | | | | | | | | | | | | | | | | | | | | | | | | | | | | | | | | | | | | | | | | | | | | | | | | | | | | |
| | | | | | | | | | | | | | | | | | | | | | | | | | | | | | | | | | | | | | | | | | | | | | | | | | | | | | | | | | | | | | | | | | | | | | | | | | | | | | | | |
| | 1 | | | | | | | | | | | | | | | | | | | | | | | | | | | | | | | | | | | | | | | | | | | | | | | | | | | | | | | | | | | | | | | | | | | | | | | | | | | | | | |
| 1 | | | | | | | | | | | | | | | | | | | | | | | | | | | | | | | | | | | | | | | | | | | | | | | | | | | | | | | | | | | | | | | | | | | | | | | | | | | | | | | |
| | | 1 | | | | | | | | | | | | | | | | | | | | | | | | | | | | | | | | | | | | | | | | | | | | | | | | | | | | | | | | | | | | | | | | | | | | | | | | | | | | | |
| | | | | | | | | | | | | | | | | | | | | | | | | | | | | | | | | | | | | | | | | | | | | | | | | | | | | | | | | | | | | | | | | | | | | | | | | | | | | | | | |
| | | 1 | | | | | | | | | | | | | | | | | | | | | | | | | | | | | | | | | | | | | | | | | | | | | | | | | | | | | | | | | | | | | | | | | | | | | | | | | | | | | |
| Post - 0 Miss - 0 Block - 0 | Post - 0 Miss - 0 Block - 0 | Post - 0 Miss - 1 Block - 1 | Post - 0 Miss - 0 Block - 0 | Post - 0 Miss - 0 Block - 0 | Post - 0 Miss - 0 Block - 0 | Post - 0 Miss - 1 Block - 1 | Post - 0 Miss - 0 Block - 0 | | | | | | | | | | | | | | | | | | | | | | | | | | | | | | | | | | | | | | | | | | | | | | | | | | | | | | | | | | | | | | | | | | | | | | | | |
| 13 刘振宇 | 16 高宇轩 | 17 张昊 | 21 杨明毅 | 24 于昊 | 26 曹立志 | 40 鹿智豪 | 88 王麒翔 | | | | | | | | | | | | | | | | | | | | | | | | | | | | | | | | | | | | | | | | | | | | | | | | | | | | | | | | | | | | | | | | | | | | | | | | |
| <table border="1"><tr><td>1</td><td></td><td>1</td></tr><tr><td>1</td><td></td><td></td></tr><tr><td></td><td></td><td></td></tr></table> | 1 | | 1 | 1 | | | | | | <table border="1"><tr><td></td><td></td><td></td></tr><tr><td></td><td></td><td></td></tr><tr><td></td><td></td><td></td></tr></table> | | | | | | | | | | <table border="1"><tr><td></td><td></td><td></td></tr><tr><td></td><td></td><td></td></tr><tr><td></td><td></td><td></td></tr></table> | | | | | | | | | | <table border="1"><tr><td></td><td></td><td></td></tr><tr><td></td><td></td><td></td></tr><tr><td></td><td></td><td></td></tr></table> | | | | | | | | | | <table border="1"><tr><td></td><td></td><td></td></tr><tr><td></td><td></td><td></td></tr><tr><td></td><td></td><td></td></tr></table> | | | | | | | | | | <table border="1"><tr><td></td><td></td><td></td></tr><tr><td></td><td></td><td></td></tr><tr><td></td><td></td><td></td></tr></table> | | | | | | | | | | <table border="1"><tr><td></td><td></td><td></td></tr><tr><td></td><td></td><td></td></tr><tr><td></td><td></td><td></td></tr></table> | | | | | | | | | | <table border="1"><tr><td></td><td></td><td></td></tr><tr><td></td><td></td><td></td></tr><tr><td></td><td></td><td></td></tr></table> | | | | | | | | | |
| 1 | | 1 | | | | | | | | | | | | | | | | | | | | | | | | | | | | | | | | | | | | | | | | | | | | | | | | | | | | | | | | | | | | | | | | | | | | | | | | | | | | | |
| 1 | | | | | | | | | | | | | | | | | | | | | | | | | | | | | | | | | | | | | | | | | | | | | | | | | | | | | | | | | | | | | | | | | | | | | | | | | | | | | | | |
| | | | | | | | | | | | | | | | | | | | | | | | | | | | | | | | | | | | | | | | | | | | | | | | | | | | | | | | | | | | | | | | | | | | | | | | | | | | | | | | |
| | | | | | | | | | | | | | | | | | | | | | | | | | | | | | | | | | | | | | | | | | | | | | | | | | | | | | | | | | | | | | | | | | | | | | | | | | | | | | | | |
| | | | | | | | | | | | | | | | | | | | | | | | | | | | | | | | | | | | | | | | | | | | | | | | | | | | | | | | | | | | | | | | | | | | | | | | | | | | | | | | |
| | | | | | | | | | | | | | | | | | | | | | | | | | | | | | | | | | | | | | | | | | | | | | | | | | | | | | | | | | | | | | | | | | | | | | | | | | | | | | | | |
| | | | | | | | | | | | | | | | | | | | | | | | | | | | | | | | | | | | | | | | | | | | | | | | | | | | | | | | | | | | | | | | | | | | | | | | | | | | | | | | |
| | | | | | | | | | | | | | | | | | | | | | | | | | | | | | | | | | | | | | | | | | | | | | | | | | | | | | | | | | | | | | | | | | | | | | | | | | | | | | | | |
| | | | | | | | | | | | | | | | | | | | | | | | | | | | | | | | | | | | | | | | | | | | | | | | | | | | | | | | | | | | | | | | | | | | | | | | | | | | | | | | |
| | | | | | | | | | | | | | | | | | | | | | | | | | | | | | | | | | | | | | | | | | | | | | | | | | | | | | | | | | | | | | | | | | | | | | | | | | | | | | | | |
| | | | | | | | | | | | | | | | | | | | | | | | | | | | | | | | | | | | | | | | | | | | | | | | | | | | | | | | | | | | | | | | | | | | | | | | | | | | | | | | |
| | | | | | | | | | | | | | | | | | | | | | | | | | | | | | | | | | | | | | | | | | | | | | | | | | | | | | | | | | | | | | | | | | | | | | | | | | | | | | | | |
| | | | | | | | | | | | | | | | | | | | | | | | | | | | | | | | | | | | | | | | | | | | | | | | | | | | | | | | | | | | | | | | | | | | | | | | | | | | | | | | |
| | | | | | | | | | | | | | | | | | | | | | | | | | | | | | | | | | | | | | | | | | | | | | | | | | | | | | | | | | | | | | | | | | | | | | | | | | | | | | | | |
| | | | | | | | | | | | | | | | | | | | | | | | | | | | | | | | | | | | | | | | | | | | | | | | | | | | | | | | | | | | | | | | | | | | | | | | | | | | | | | | |
| | | | | | | | | | | | | | | | | | | | | | | | | | | | | | | | | | | | | | | | | | | | | | | | | | | | | | | | | | | | | | | | | | | | | | | | | | | | | | | | |
| | | | | | | | | | | | | | | | | | | | | | | | | | | | | | | | | | | | | | | | | | | | | | | | | | | | | | | | | | | | | | | | | | | | | | | | | | | | | | | | |
| | | | | | | | | | | | | | | | | | | | | | | | | | | | | | | | | | | | | | | | | | | | | | | | | | | | | | | | | | | | | | | | | | | | | | | | | | | | | | | | |
| | | | | | | | | | | | | | | | | | | | | | | | | | | | | | | | | | | | | | | | | | | | | | | | | | | | | | | | | | | | | | | | | | | | | | | | | | | | | | | | |
| | | | | | | | | | | | | | | | | | | | | | | | | | | | | | | | | | | | | | | | | | | | | | | | | | | | | | | | | | | | | | | | | | | | | | | | | | | | | | | | |
| | | | | | | | | | | | | | | | | | | | | | | | | | | | | | | | | | | | | | | | | | | | | | | | | | | | | | | | | | | | | | | | | | | | | | | | | | | | | | | | |
| | | | | | | | | | | | | | | | | | | | | | | | | | | | | | | | | | | | | | | | | | | | | | | | | | | | | | | | | | | | | | | | | | | | | | | | | | | | | | | | |
| | | | | | | | | | | | | | | | | | | | | | | | | | | | | | | | | | | | | | | | | | | | | | | | | | | | | | | | | | | | | | | | | | | | | | | | | | | | | | | | |
| | | | | | | | | | | | | | | | | | | | | | | | | | | | | | | | | | | | | | | | | | | | | | | | | | | | | | | | | | | | | | | | | | | | | | | | | | | | | | | | |
| Post - 2 Miss - 2 Block - 0 | Post - 0 Miss - 0 Block - 0 | Post - 0 Miss - 0 Block - 0 | Post - 0 Miss - 0 Block - 0 | Post - 0 Miss - 0 Block - 0 | Post - 0 Miss - 0 Block - 0 | Post - 0 Miss - 0 Block - 0 | Post - 0 Miss - 0 Block - 0 | | | | | | | | | | | | | | | | | | | | | | | | | | | | | | | | | | | | | | | | | | | | | | | | | | | | | | | | | | | | | | | | | | | | | | | | |



| | | | | | | | | | | | |
|------------------|--|--|--|------------------|--|--|--|---------------------------|--|--|--|
| Team A A 上海宝山 | | | | Team B B 辽宁抚顺 | | | | Match Number 26 | | | |
|------------------|--|--|--|------------------|--|--|--|---------------------------|--|--|--|

| | | | | | |
|-------------------|------------------------|------------------|-------------|-------|----------|
| Played in 安徽滁州 | in the hall 滁州国际手球馆 | on 2019-06-02 | at 18:00 | hours | Speakers |
|-------------------|------------------------|------------------|-------------|-------|----------|

| | | | | | | | | | | | | | | |
|----------------|--------|--------|---------------------|---------|---------|----------------|---------|---------|----------------|---|---|----------------------|---|---|
| Half-time(30') | A 7 | B 8 | End of playing time | A 15 | B 15 | 1st extra time | A 21 | B 19 | 2nd extra time | A | B | After penalty throws | A | B |
|----------------|--------|--------|---------------------|---------|---------|----------------|---------|---------|----------------|---|---|----------------------|---|---|

| | | | | | | | | | | |
|---------------|----------|---------------|---|---|------------------------------------|---------------|---|--|----------|---------------|
| Number of 7 m | A 1/1 | Team time-out | | | Full name of players and officials | Team time-out | | | B 2/2 | Number of 7 m |
| | 1 | 2 | 3 | 1 | | 2 | 3 | | | |

| No. | Team A | G | W | 2' | D | DR | No. | Team B | G | W | 2' | D | DR |
|-----|-----------|---|---|----|---|----|-----|--------|---|---|----|---|----|
| 3 | 侯俊杰 | 1 | | | | | 2 | 赫天铭 | | | | | |
| 5 | 范斯哲 | | | | | | 5 | 王梓翹 | 1 | | | | |
| 6 | 吴梓涵 | | | | | | 6 | 尚禹辰 | 1 | | | | |
| 7 | 彭意焱 | | | | | | 7 | 张羽虹冰 | | 1 | | | |
| 10 | 马涛 | | | 1 | | | 9 | 隋博 | | | | | |
| 13 | 刘启群 | 2 | 1 | | | | 11 | 陈思 | | | | | |
| 19 | 张申杰 | 1 | | | | | 13 | 高鑫 | 8 | | | | |
| 21 | 曾新宇 | 7 | | | | | 17 | 杨宇 | 3 | | 1 | | |
| 22 | 马浩东 | 6 | | 1 | | | 19 | 靳皓童 | 4 | | | | |
| 25 | 江锦 | | | | | | 22 | 杨辰 | | | | | |
| 30 | 戴泽昊 | | | | | | 28 | 靳皓添 | 2 | | 1 | | |
| 35 | 刘子杰 | 4 | | 2 | 1 | | 32 | 袁梓赫 | | | | | |
| 39 | 陆毅泽 | | | | | | | | | | | | |
| 66 | 黄嘉遥 | | | | | | | | | | | | |
| 68 | 陈沁磊 | | | | | | | | | | | | |
| A | 马革 | | | | | | C | 刘启迪 | | | | | |
| B | 徐聪豪 (主教练) | | | | | | | | | | | | |
| D | 赵时俊 | | | | | | | | | | | | |

| | | | | | | | | | | | | | |
|---|--|--|--|--|--|--|--|--|--|--|--|--|---|
| A | Signatures of responsables for the teams (Off.A) | | | | | | | | | | | | B |
|---|--|--|--|--|--|--|--|--|--|--|--|--|---|

| | | | | | | | | | | | | | | |
|----|-----------------------------------|--|--|--|--|--|--|--|--|--|--|--|--|----|
| TP | Remarks of referees / HF Official | | | | | | | | | | | | | TP |
|----|-----------------------------------|--|--|--|--|--|--|--|--|--|--|--|--|----|

| | | | | |
|----------|-----------|-----------|--|--|
| Referees | 许翔 (CHN) | 刘禹 (CHN) | | |
| T.D. | 许宜扬 (CHN) | 尹静阳 (CHN) | | |
| CHA Off. | | | | |

Note: Number of 7m Throws Awarded to Team A and B, Goals (G), Warnings (W), Suspensions (2'), Direct Disqualification (D), Disqualification With Report (DR) and Team Penalty (TP).

Table Officials: 刘洋洋 许修凯 Statisticians: 童佩瑶 王梓衡

第二届全国青年运动会男子手球乙组决赛 体校组 (U16)

PHMS Pictorial Handball Match Statistics

IHF Official System

竞赛技术统计

手球
青年男子

四分之一决赛
轮次 4

组别 X
场次 26

滁州国际手球馆
2019-06-02 18:00

| | | | |
|-----------|------------------------|---------|-------------|
| Referees: | 许翔 (CHN) / 刘禹 (CHN) | Result: | 21:19 (7:8) |
| Teams: | 上海宝山 (宝山) VS 辽宁抚顺 (抚顺) | | |

| 宝山 | | 远射 | 近射 | 边射 | 快攻 | 突破 | 任意球 | 7m球 | 合计 | % | 助攻 | 失误 | 警告 | 2' | D+DR |
|------|-----|------|-----|-----|-----|-----|-----|-----|-------|------|----|----|----|----|------|
| 主教练: | 徐聪豪 | | | | | | | | | | | | | | |
| 3 | 侯俊杰 | | | 1/1 | | | | | 1/1 | 100 | | | | | |
| 5 | 范斯哲 | | | | | | | | | | | | | | |
| 6 | 吴梓涵 | | | | | | | | | | | | | | |
| 7 | 彭意焱 | | | | | | | | | | | | | | |
| 10 | 马涛 | | | | | | | | | | 1 | 1 | | 1 | |
| 13 | 刘启群 | | | 2/4 | | | | | 2/4 | 50.0 | 1 | 1 | 1 | | |
| 19 | 张申杰 | | | 1/2 | | | | | 1/2 | 50.0 | | | | | |
| 21 | 曾新宇 | 3/5 | 3/4 | | 0/1 | 1/1 | | | 7/11 | 63.6 | | 3 | | | |
| 22 | 马浩东 | 2/2 | 1/1 | 1/2 | 2/2 | | | | 6/7 | 85.7 | | 2 | | 1 | |
| 25 | 江锦 | | | | | | | | | | | | | | |
| 30 | 戴泽昊 | 0/1 | | | | | 0/1 | | 0/2 | 0.0 | | | | | |
| 35 | 刘子杰 | 1/2 | 2/3 | | 0/1 | 0/1 | | 1/1 | 4/8 | 50.0 | | 5 | | 2 | 1 |
| 39 | 陆毅泽 | | | | | | | | | | | | | | |
| 66 | 黄嘉遥 | | | | | | | | | | | | | | |
| 68 | 陈沁磊 | | | | | | | | | | | | | | |
| 运动员 | 合计 | 6/10 | 6/8 | 5/9 | 2/4 | 1/2 | 0/1 | 1/1 | 21/35 | 60.0 | 2 | 12 | 1 | 4 | 1 |
| 66 | 黄嘉遥 | 3/7 | 1/7 | 1/2 | 0/2 | 2/6 | | 0/2 | 7/26 | 26.9 | | | | | |
| 守门员 | 合计 | 3/7 | 1/7 | 1/2 | 0/2 | 2/6 | | 0/2 | 7/26 | 26.9 | | | | | |

| 抚顺 | | 远射 | 近射 | 边射 | 快攻 | 突破 | 任意球 | 7m球 | 合计 | % | 助攻 | 失误 | 警告 | 2' | D+DR |
|------|------|------|-----|-----|-----|-----|-----|-----|-------|------|----|----|----|----|------|
| 主教练: | 徐毅 | | | | | | | | | | | | | | |
| 2 | 赫天铭 | | | | | | | | | | | | | | |
| 5 | 王梓翀 | | | | 1/1 | | | | 1/1 | 100 | | 1 | | | |
| 6 | 尚禹辰 | | 0/1 | 1/1 | | | | | 1/2 | 50.0 | | 2 | | | |
| 7 | 张羽虹冰 | | | | | | | | | | | | 1 | | |
| 9 | 隋博 | | | | | | | | | | | 1 | | | |
| 11 | 陈思 | | | | | | | | | | | | | | |
| 13 | 高鑫 | 3/6 | 1/1 | 0/1 | | 2/3 | | 2/2 | 8/13 | 61.5 | | 5 | | | |
| 17 | 杨宇 | 1/4 | 1/1 | | 1/1 | 0/1 | 0/1 | | 3/8 | 37.5 | | 2 | | 1 | |
| 19 | 靳皓童 | | 2/2 | | | 2/2 | | | 4/4 | 100 | 2 | 6 | | | |
| 22 | 杨辰 | | | | | | | | | | | | | | |
| 28 | 靳皓添 | | 2/2 | | | | | | 2/2 | 100 | | 1 | | 1 | |
| 32 | 袁梓赫 | | | | | | | | | | | | | | |
| 运动员 | 合计 | 4/10 | 6/7 | 1/2 | 2/2 | 4/6 | 0/1 | 2/2 | 19/30 | 63.3 | 2 | 18 | 1 | 2 | |
| 2 | 赫天铭 | 3/9 | 2/8 | 2/7 | 1/3 | 1/2 | 1/1 | 0/1 | 10/31 | 32.3 | | | | | |
| 守门员 | 合计 | 3/9 | 2/8 | 2/7 | 1/3 | 1/2 | 1/1 | 0/1 | 10/31 | 32.3 | | | | | |

| 宝山 | 比赛进程 | 抚顺 |
|----------|--------------------|----|
| 1st Half | | |
| 22 马浩东 | 1 01:18 0 | |
| | 1 02:06 1 13 高鑫 | |
| 13 刘启群 | 2 02:39 1 | |
| | 2 03:32 2 28 靳皓添 | |
| 21 曾新宇 | 3 04:49 2 | |
| | 3 05:13 3 17 杨宇 | |
| 13 刘启群 | 4 06:45 3 | |
| | 4 07:40 4 28 靳皓添 | |
| 21 曾新宇 | 5 08:16 4 | |
| | 5 09:21 5 13 高鑫 | |
| 3 侯俊杰 | 6 09:46 5 | |
| | 6 10:09 6 13 高鑫 | |
| 21 曾新宇 | 7 10:30 6 | |
| | 7 13:01 7 17 杨宇 | |
| | 7 14:32 8 13 高鑫 | |
| 2nd Half | | |
| 35 刘子杰 | 8 00:11 8 | |
| | 8 00:26 9 13 高鑫 | |
| 35 刘子杰 | 9 00:42 9 | |
| 22 马浩东 | 10 02:22 9 | |
| 22 马浩东 | 11 03:54 9 | |
| 35 刘子杰 | 12 05:12 9 | |
| | 12 05:45 10 13 高鑫 | |
| 22 马浩东 | 13 06:17 10 | |
| | 13 06:55 11 13 高鑫 | |
| 22 马浩东 | 14 07:21 11 | |
| | 14 09:34 12 13 高鑫 | |
| 22 马浩东 | 15 12:09 12 | |
| | 15 12:53 13 19 靳皓童 | |
| | 15 14:09 14 17 杨宇 | |
| | 15 14:30 15 6 尚禹辰 | |
| Ext. 1-1 | | |
| 21 曾新宇 | 16 02:40 15 | |
| | 16 03:43 16 19 靳皓童 | |
| 19 张申杰 | 17 03:59 16 | |
| | 17 04:15 17 19 靳皓童 | |
| 21 曾新宇 | 18 04:44 17 | |
| Ext. 1-2 | | |
| 35 刘子杰 | 19 00:26 17 | |
| 21 曾新宇 | 20 01:00 17 | |
| | 20 02:39 18 19 靳皓童 | |
| | 20 03:24 19 5 王梓翀 | |
| 21 曾新宇 | 21 04:27 19 | |

场上队员: 得分 / 射门

守门员: 救球 / 射门

| | | | |
|---|------|----|---------|
| D | 取消资格 | DR | 取消资格+报告 |
|---|------|----|---------|



个人/全队技术统计表

手球 四分之一决赛 组别 X
青年男子 轮次 4 场次 26 滁州国际手球馆
2019-06-02 18:00

| 号码 | 姓名 | 远射 | 近射 | 边射 | 快攻 | 突破 | 任意 | 七米 | 合计 | % | 助攻 | 失误 | 警告 | 2' | 取消 | 时间 |
|----------|-----|------|-----|-----|-----|-----|-----|-----|-------|-------|----|----|----|----|----|----------|
| 上海宝山(宝山) | | | | | | | | | | | | | | | | |
| (场上队员) | | | | | | | | | | | | | | | | |
| 3 | 侯俊杰 | | | 1/1 | | | | | 1/1 | 100% | | | | | | 00:05:56 |
| 5 | 范斯哲 | | | | | | | | | 0.0% | | | | | | 00:00:00 |
| 6 | 吴梓涵 | | | | | | | | | 0.0% | | | | | | 00:00:00 |
| 7 | 彭意焱 | | | | | | | | | 0.0% | | | | | | 00:00:00 |
| 10 | 马涛 | | | | | | | | | 0.0% | 1 | 1 | | 1 | | 00:36:54 |
| 13 | 刘启群 | | | 2/4 | | | | | 2/4 | 50.0% | 1 | 1 | 1 | | | 00:26:55 |
| 19 | 张申杰 | | | 1/2 | | | | | 1/2 | 50.0% | | | | | | 00:40:00 |
| 21 | 曾新宇 | 3/5 | 3/4 | | 0/1 | 1/1 | | | 7/11 | 63.6% | | 3 | | | | 00:40:00 |
| 22 | 马浩东 | 2/2 | 1/1 | 1/2 | 2/2 | | | | 6/7 | 85.7% | | 2 | | 1 | | 00:40:00 |
| 25 | 江锦 | | | | | | | | | 0.0% | | | | | | 00:00:00 |
| 30 | 戴泽昊 | 0/1 | | | | | 0/1 | | 0/2 | 0.0% | | | | | | 00:10:09 |
| 35 | 刘子杰 | 1/2 | 2/3 | | 0/1 | 0/1 | | 1/1 | 4/8 | 50.0% | | 5 | | 2 | 1 | 00:40:00 |
| 39 | 陆毅泽 | | | | | | | | | 0.0% | | | | | | 00:00:00 |
| 66 | 黄嘉遥 | | | | | | | | | 0.0% | | | | | | 00:40:00 |
| 68 | 陈沁磊 | | | | | | | | | 0.0% | | | | | | 00:00:00 |
| 合计 | | 6/10 | 6/8 | 5/9 | 2/4 | 1/2 | 0/1 | 1/1 | 21/35 | 60.0% | 2 | 12 | 1 | 4 | 1 | |
| (守门员) | | | | | | | | | | | | | | | | |
| 66 | 黄嘉遥 | 3/7 | 1/7 | 1/2 | 0/2 | 2/6 | | 0/2 | 7/26 | 26.9% | | | | | | 00:40:00 |
| 合计 | | 3/7 | 1/7 | 1/2 | 0/2 | 2/6 | | 0/2 | 7/26 | 26.9% | | | | | | |

场上队员：得分/射门

守门员：救球/射门

| 全队合计 | 得分 | 被救 | 射失 | 击柱 | 封球 | 合计 | % |
|------|----|----|----|----|----|----|--------|
| 远射 | 6 | 3 | | | 1 | 10 | 60.0% |
| 近射 | 6 | 2 | | | | 8 | 75.0% |
| 边射 | 5 | 2 | 2 | | | 9 | 55.6% |
| 快攻 | 2 | 1 | 1 | | | 4 | 50.0% |
| 突破 | 1 | 1 | | | | 2 | 50.0% |
| 任意 | | 1 | | | | 1 | 0.0% |
| 七米 | 1 | | | | | 1 | 100.0% |

个人/全队技术统计表

手球 四分之一决赛 组别 X
青年男子 轮次 4 场次 26
滁州国际手球馆
2019-06-02 18:00

| 号码 | 姓名 | 远射 | 近射 | 边射 | 快攻 | 突破 | 任意 | 七米 | 合计 | % | 助攻 | 失误 | 警告 | 2' | 取消 | 时间 |
|----------|------|------|-----|-----|-----|-----|-----|-----|-------|-------|----|----|----|----|----|----------|
| 辽宁抚顺(抚顺) | | | | | | | | | | | | | | | | |
| (场上队员) | | | | | | | | | | | | | | | | |
| 2 | 赫天铭 | | | | | | | | | 0.0% | | | | | | 00:40:00 |
| 5 | 王梓翹 | | | | 1/1 | | | | 1/1 | 100% | 1 | | | | | 00:01:18 |
| 6 | 尚禹辰 | | 0/1 | 1/1 | | | | | 1/2 | 50.0% | 2 | | | | | 00:26:51 |
| 7 | 张羽虹冰 | | | | | | | | | 0.0% | | | 1 | | | 00:30:00 |
| 9 | 隋博 | | | | | | | | | 0.0% | 1 | | | | | 00:23:45 |
| 11 | 陈思 | | | | | | | | | 0.0% | | | | | | 00:00:00 |
| 13 | 高鑫 | 3/6 | 1/1 | 0/1 | | 2/3 | | 2/2 | 8/13 | 61.5% | 5 | | | | | 00:40:00 |
| 17 | 杨宇 | 1/4 | 1/1 | | 1/1 | 0/1 | 0/1 | | 3/8 | 37.5% | 2 | | | 1 | | 00:40:00 |
| 19 | 靳皓童 | | 2/2 | | | 2/2 | | | 4/4 | 100% | 2 | 6 | | | | 00:40:00 |
| 22 | 杨辰 | | | | | | | | | 0.0% | | | | | | 00:00:00 |
| 28 | 靳皓添 | | 2/2 | | | | | | 2/2 | 100% | 1 | | | 1 | | 00:38:01 |
| 32 | 袁梓赫 | | | | | | | | | 0.0% | | | | | | 00:00:00 |
| 合计 | | 4/10 | 6/7 | 1/2 | 2/2 | 4/6 | 0/1 | 2/2 | 19/30 | 63.3% | 2 | 18 | 1 | 2 | | |

| | | | | | | | | | | | | | | | | |
|-------|-----|-----|-----|-----|-----|-----|-----|-----|-------|-------|--|--|--|--|--|----------|
| (守门员) | | | | | | | | | | | | | | | | |
| 2 | 赫天铭 | 3/9 | 2/8 | 2/7 | 1/3 | 1/2 | 1/1 | 0/1 | 10/31 | 32.3% | | | | | | 00:40:00 |
| 合计 | | 3/9 | 2/8 | 2/7 | 1/3 | 1/2 | 1/1 | 0/1 | 10/31 | 32.3% | | | | | | |

场上队员：得分/射门

守门员：救球/射门

| 全队合计 | 得分 | 被救 | 射失 | 击柱 | 封球 | 合计 | % |
|------|----|----|----|----|----|----|--------|
| 远射 | 4 | 3 | 1 | | 2 | 10 | 40.0% |
| 近射 | 6 | 1 | | | | 7 | 85.7% |
| 边射 | 1 | 1 | | | | 2 | 50.0% |
| 快攻 | 2 | | | | | 2 | 100.0% |
| 突破 | 4 | 2 | | | | 6 | 66.7% |
| 任意 | | | 1 | | | 1 | 0.0% |
| 七米 | 2 | | | | | 2 | 100.0% |

图式比赛技术统计表

手球
青年男子

四分之一决赛
轮次 4

组别 X
场次 26

滁州国际手球馆
2019-06-02 18:00

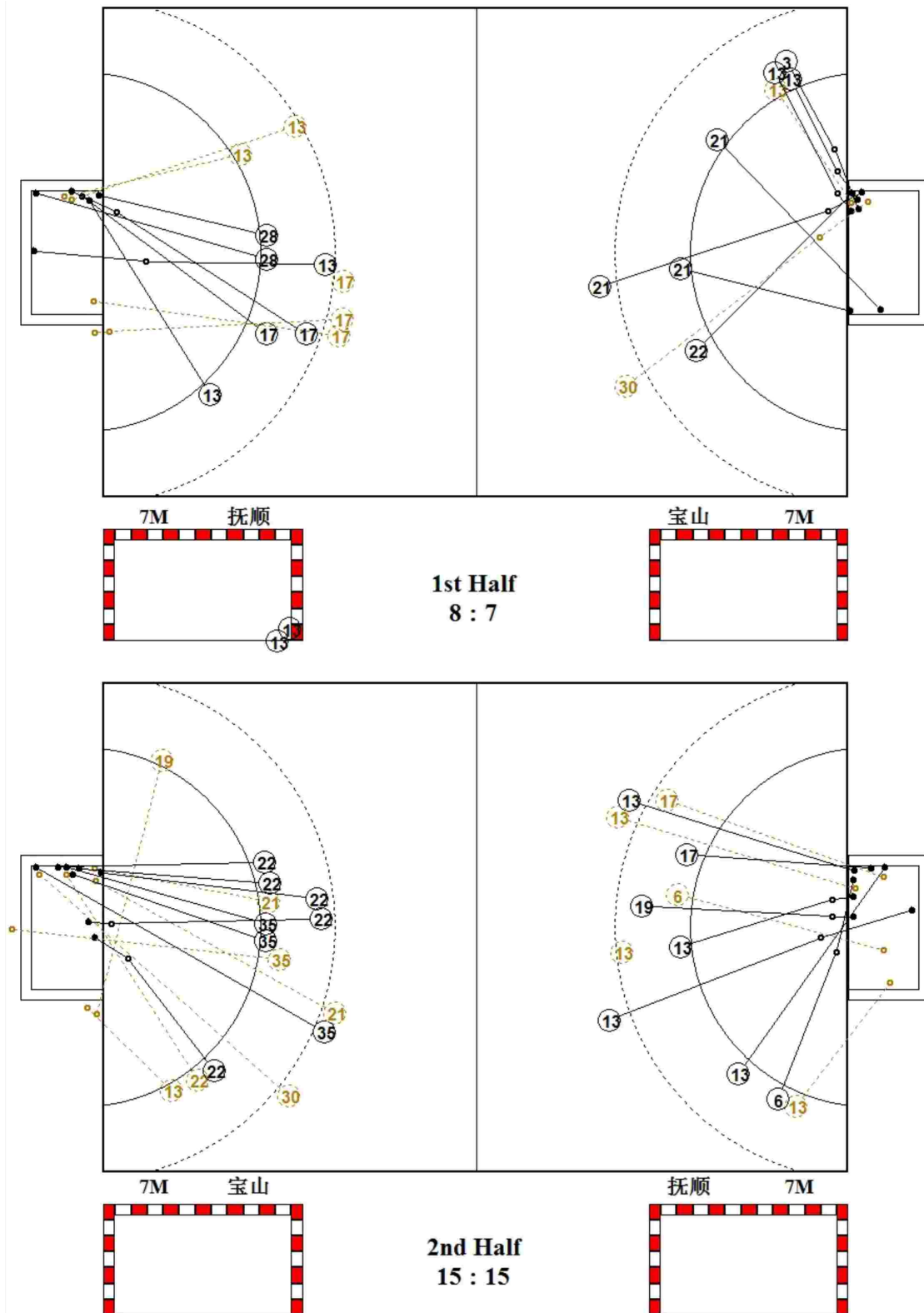

PICTORIAL MATCH STATISTICS

HANDBALL
青年男子

四分之一决赛
ROUND 4

GROUP X
MATCH 26

滁州国际手球馆
2019-06-02 18:00

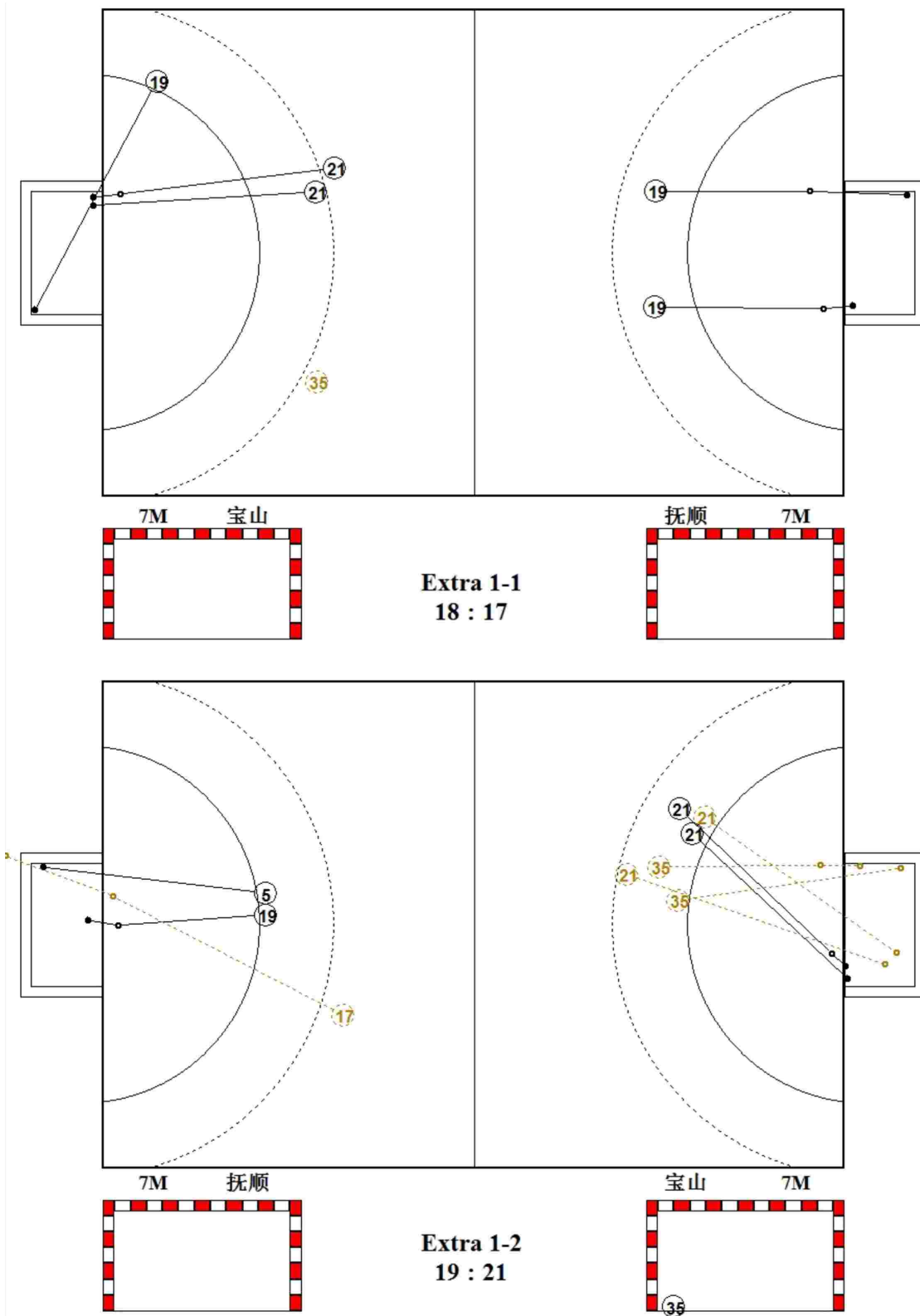

图式射门区域统计

手球
青年男子

四分之一决赛
轮次 4

组别 X
场次 26

滁州国际手球馆
2019-06-02 18:00

上海宝山

| | | | | | | | | | | | | | | | | | | | | | | | | | | | | | | | | | | | | | | | | | | | | | | | | | | | | | | | | | | | | | | | | | | | | | | | | | | | | | | | |
|--|-----------------------------|-----------------------------|-----------------------------|-----------------------------|-----------------------------|-----------------------------|-----------------------------|---|---|--|--|--|--|--|--|--|--|--|--|--|--|--|--|--|--|--|--|--|--|---|--|--|---|--|--|---|---|--|--|--|--|--|--|--|--|--|--|--|--|---|--|--|--|---|--|--|--|--|--|---|---|--|--|--|--|--|--|--|--|---|--|--|--|--|--|---|---|--|---|
| 3 侯俊杰 | 5 范斯哲 | 6 吴梓涵 | 7 彭意焱 | 10 马涛 | 13 刘启群 | 19 张申杰 | 21 曾新宇 | | | | | | | | | | | | | | | | | | | | | | | | | | | | | | | | | | | | | | | | | | | | | | | | | | | | | | | | | | | | | | | | | | | | | | | | |
| <table border="1"><tr><td></td><td></td><td></td></tr><tr><td>1</td><td></td><td></td></tr><tr><td></td><td></td><td></td></tr></table> | | | | 1 | | | | | | <table border="1"><tr><td></td><td></td><td></td></tr><tr><td></td><td></td><td></td></tr><tr><td></td><td></td><td></td></tr></table> | | | | | | | | | | <table border="1"><tr><td></td><td></td><td></td></tr><tr><td></td><td></td><td></td></tr><tr><td></td><td></td><td></td></tr></table> | | | | | | | | | | <table border="1"><tr><td></td><td></td><td></td></tr><tr><td></td><td></td><td></td></tr><tr><td></td><td></td><td></td></tr></table> | | | | | | | | | | <table border="1"><tr><td></td><td></td><td></td></tr><tr><td></td><td></td><td></td></tr><tr><td></td><td></td><td></td></tr></table> | | | | | | | | | | <table border="1"><tr><td></td><td></td><td></td></tr><tr><td>2</td><td></td><td></td></tr><tr><td></td><td></td><td></td></tr></table> | | | | 2 | | | | | | <table border="1"><tr><td>1</td><td></td><td></td></tr><tr><td></td><td></td><td></td></tr><tr><td></td><td></td><td></td></tr></table> | 1 | | | | | | | | | <table border="1"><tr><td></td><td></td><td></td></tr><tr><td></td><td></td><td>1</td></tr><tr><td>1</td><td></td><td>5</td></tr></table> | | | | | | 1 | 1 | | 5 |
| | | | | | | | | | | | | | | | | | | | | | | | | | | | | | | | | | | | | | | | | | | | | | | | | | | | | | | | | | | | | | | | | | | | | | | | | | | | | | | | |
| 1 | | | | | | | | | | | | | | | | | | | | | | | | | | | | | | | | | | | | | | | | | | | | | | | | | | | | | | | | | | | | | | | | | | | | | | | | | | | | | | | |
| | | | | | | | | | | | | | | | | | | | | | | | | | | | | | | | | | | | | | | | | | | | | | | | | | | | | | | | | | | | | | | | | | | | | | | | | | | | | | | | |
| | | | | | | | | | | | | | | | | | | | | | | | | | | | | | | | | | | | | | | | | | | | | | | | | | | | | | | | | | | | | | | | | | | | | | | | | | | | | | | | |
| | | | | | | | | | | | | | | | | | | | | | | | | | | | | | | | | | | | | | | | | | | | | | | | | | | | | | | | | | | | | | | | | | | | | | | | | | | | | | | | |
| | | | | | | | | | | | | | | | | | | | | | | | | | | | | | | | | | | | | | | | | | | | | | | | | | | | | | | | | | | | | | | | | | | | | | | | | | | | | | | | |
| | | | | | | | | | | | | | | | | | | | | | | | | | | | | | | | | | | | | | | | | | | | | | | | | | | | | | | | | | | | | | | | | | | | | | | | | | | | | | | | |
| | | | | | | | | | | | | | | | | | | | | | | | | | | | | | | | | | | | | | | | | | | | | | | | | | | | | | | | | | | | | | | | | | | | | | | | | | | | | | | | |
| | | | | | | | | | | | | | | | | | | | | | | | | | | | | | | | | | | | | | | | | | | | | | | | | | | | | | | | | | | | | | | | | | | | | | | | | | | | | | | | |
| | | | | | | | | | | | | | | | | | | | | | | | | | | | | | | | | | | | | | | | | | | | | | | | | | | | | | | | | | | | | | | | | | | | | | | | | | | | | | | | |
| | | | | | | | | | | | | | | | | | | | | | | | | | | | | | | | | | | | | | | | | | | | | | | | | | | | | | | | | | | | | | | | | | | | | | | | | | | | | | | | |
| | | | | | | | | | | | | | | | | | | | | | | | | | | | | | | | | | | | | | | | | | | | | | | | | | | | | | | | | | | | | | | | | | | | | | | | | | | | | | | | |
| | | | | | | | | | | | | | | | | | | | | | | | | | | | | | | | | | | | | | | | | | | | | | | | | | | | | | | | | | | | | | | | | | | | | | | | | | | | | | | | |
| | | | | | | | | | | | | | | | | | | | | | | | | | | | | | | | | | | | | | | | | | | | | | | | | | | | | | | | | | | | | | | | | | | | | | | | | | | | | | | | |
| | | | | | | | | | | | | | | | | | | | | | | | | | | | | | | | | | | | | | | | | | | | | | | | | | | | | | | | | | | | | | | | | | | | | | | | | | | | | | | | |
| | | | | | | | | | | | | | | | | | | | | | | | | | | | | | | | | | | | | | | | | | | | | | | | | | | | | | | | | | | | | | | | | | | | | | | | | | | | | | | | |
| 2 | | | | | | | | | | | | | | | | | | | | | | | | | | | | | | | | | | | | | | | | | | | | | | | | | | | | | | | | | | | | | | | | | | | | | | | | | | | | | | | |
| | | | | | | | | | | | | | | | | | | | | | | | | | | | | | | | | | | | | | | | | | | | | | | | | | | | | | | | | | | | | | | | | | | | | | | | | | | | | | | | |
| 1 | | | | | | | | | | | | | | | | | | | | | | | | | | | | | | | | | | | | | | | | | | | | | | | | | | | | | | | | | | | | | | | | | | | | | | | | | | | | | | | |
| | | | | | | | | | | | | | | | | | | | | | | | | | | | | | | | | | | | | | | | | | | | | | | | | | | | | | | | | | | | | | | | | | | | | | | | | | | | | | | | |
| | | | | | | | | | | | | | | | | | | | | | | | | | | | | | | | | | | | | | | | | | | | | | | | | | | | | | | | | | | | | | | | | | | | | | | | | | | | | | | | |
| | | | | | | | | | | | | | | | | | | | | | | | | | | | | | | | | | | | | | | | | | | | | | | | | | | | | | | | | | | | | | | | | | | | | | | | | | | | | | | | |
| | | 1 | | | | | | | | | | | | | | | | | | | | | | | | | | | | | | | | | | | | | | | | | | | | | | | | | | | | | | | | | | | | | | | | | | | | | | | | | | | | | |
| 1 | | 5 | | | | | | | | | | | | | | | | | | | | | | | | | | | | | | | | | | | | | | | | | | | | | | | | | | | | | | | | | | | | | | | | | | | | | | | | | | | | | |
| Post - 0 Miss - 0 Block - 0 | Post - 0 Miss - 0 Block - 0 | Post - 0 Miss - 0 Block - 0 | Post - 0 Miss - 0 Block - 0 | Post - 0 Miss - 0 Block - 0 | Post - 0 Miss - 1 Block - 0 | Post - 0 Miss - 1 Block - 0 | Post - 0 Miss - 0 Block - 0 | | | | | | | | | | | | | | | | | | | | | | | | | | | | | | | | | | | | | | | | | | | | | | | | | | | | | | | | | | | | | | | | | | | | | | | | |
| 22 马浩东 | 25 江锦 | 30 戴泽昊 | 35 刘子杰 | 39 陆毅译 | 66 黄嘉遥 | 68 陈沁磊 | | | | | | | | | | | | | | | | | | | | | | | | | | | | | | | | | | | | | | | | | | | | | | | | | | | | | | | | | | | | | | | | | | | | | | | | | |
| <table border="1"><tr><td></td><td></td><td></td></tr><tr><td></td><td></td><td>2</td></tr><tr><td>1</td><td>2</td><td>1</td></tr></table> | | | | | | 2 | 1 | 2 | 1 | <table border="1"><tr><td></td><td></td><td></td></tr><tr><td></td><td></td><td></td></tr><tr><td></td><td></td><td></td></tr></table> | | | | | | | | | | <table border="1"><tr><td></td><td></td><td></td></tr><tr><td></td><td></td><td></td></tr><tr><td></td><td></td><td></td></tr></table> | | | | | | | | | | <table border="1"><tr><td></td><td></td><td>1</td></tr><tr><td></td><td></td><td>2</td></tr><tr><td>1</td><td></td><td></td></tr></table> | | | 1 | | | 2 | 1 | | | <table border="1"><tr><td></td><td></td><td></td></tr><tr><td></td><td></td><td></td></tr><tr><td></td><td></td><td></td></tr></table> | | | | | | | | | | <table border="1"><tr><td></td><td></td><td></td></tr><tr><td></td><td></td><td></td></tr><tr><td></td><td></td><td></td></tr></table> | | | | | | | | | | <table border="1"><tr><td></td><td></td><td></td></tr><tr><td></td><td></td><td></td></tr><tr><td></td><td></td><td></td></tr></table> | | | | | | | | | | | | | | | | | | | |
| | | | | | | | | | | | | | | | | | | | | | | | | | | | | | | | | | | | | | | | | | | | | | | | | | | | | | | | | | | | | | | | | | | | | | | | | | | | | | | | |
| | | 2 | | | | | | | | | | | | | | | | | | | | | | | | | | | | | | | | | | | | | | | | | | | | | | | | | | | | | | | | | | | | | | | | | | | | | | | | | | | | | |
| 1 | 2 | 1 | | | | | | | | | | | | | | | | | | | | | | | | | | | | | | | | | | | | | | | | | | | | | | | | | | | | | | | | | | | | | | | | | | | | | | | | | | | | | |
| | | | | | | | | | | | | | | | | | | | | | | | | | | | | | | | | | | | | | | | | | | | | | | | | | | | | | | | | | | | | | | | | | | | | | | | | | | | | | | | |
| | | | | | | | | | | | | | | | | | | | | | | | | | | | | | | | | | | | | | | | | | | | | | | | | | | | | | | | | | | | | | | | | | | | | | | | | | | | | | | | |
| | | | | | | | | | | | | | | | | | | | | | | | | | | | | | | | | | | | | | | | | | | | | | | | | | | | | | | | | | | | | | | | | | | | | | | | | | | | | | | | |
| | | | | | | | | | | | | | | | | | | | | | | | | | | | | | | | | | | | | | | | | | | | | | | | | | | | | | | | | | | | | | | | | | | | | | | | | | | | | | | | |
| | | | | | | | | | | | | | | | | | | | | | | | | | | | | | | | | | | | | | | | | | | | | | | | | | | | | | | | | | | | | | | | | | | | | | | | | | | | | | | | |
| | | | | | | | | | | | | | | | | | | | | | | | | | | | | | | | | | | | | | | | | | | | | | | | | | | | | | | | | | | | | | | | | | | | | | | | | | | | | | | | |
| | | 1 | | | | | | | | | | | | | | | | | | | | | | | | | | | | | | | | | | | | | | | | | | | | | | | | | | | | | | | | | | | | | | | | | | | | | | | | | | | | | |
| | | 2 | | | | | | | | | | | | | | | | | | | | | | | | | | | | | | | | | | | | | | | | | | | | | | | | | | | | | | | | | | | | | | | | | | | | | | | | | | | | | |
| 1 | | | | | | | | | | | | | | | | | | | | | | | | | | | | | | | | | | | | | | | | | | | | | | | | | | | | | | | | | | | | | | | | | | | | | | | | | | | | | | | |
| | | | | | | | | | | | | | | | | | | | | | | | | | | | | | | | | | | | | | | | | | | | | | | | | | | | | | | | | | | | | | | | | | | | | | | | | | | | | | | | |
| | | | | | | | | | | | | | | | | | | | | | | | | | | | | | | | | | | | | | | | | | | | | | | | | | | | | | | | | | | | | | | | | | | | | | | | | | | | | | | | |
| | | | | | | | | | | | | | | | | | | | | | | | | | | | | | | | | | | | | | | | | | | | | | | | | | | | | | | | | | | | | | | | | | | | | | | | | | | | | | | | |
| | | | | | | | | | | | | | | | | | | | | | | | | | | | | | | | | | | | | | | | | | | | | | | | | | | | | | | | | | | | | | | | | | | | | | | | | | | | | | | | |
| | | | | | | | | | | | | | | | | | | | | | | | | | | | | | | | | | | | | | | | | | | | | | | | | | | | | | | | | | | | | | | | | | | | | | | | | | | | | | | | |
| | | | | | | | | | | | | | | | | | | | | | | | | | | | | | | | | | | | | | | | | | | | | | | | | | | | | | | | | | | | | | | | | | | | | | | | | | | | | | | | |
| | | | | | | | | | | | | | | | | | | | | | | | | | | | | | | | | | | | | | | | | | | | | | | | | | | | | | | | | | | | | | | | | | | | | | | | | | | | | | | | |
| | | | | | | | | | | | | | | | | | | | | | | | | | | | | | | | | | | | | | | | | | | | | | | | | | | | | | | | | | | | | | | | | | | | | | | | | | | | | | | | |
| | | | | | | | | | | | | | | | | | | | | | | | | | | | | | | | | | | | | | | | | | | | | | | | | | | | | | | | | | | | | | | | | | | | | | | | | | | | | | | | |
| Post - 0 Miss - 0 Block - 0 | Post - 0 Miss - 0 Block - 0 | Post - 0 Miss - 0 Block - 0 | Post - 0 Miss - 1 Block - 1 | Post - 0 Miss - 0 Block - 0 | Post - 0 Miss - 0 Block - 0 | Post - 0 Miss - 0 Block - 0 | | | | | | | | | | | | | | | | | | | | | | | | | | | | | | | | | | | | | | | | | | | | | | | | | | | | | | | | | | | | | | | | | | | | | | | | | |

66 黄嘉遥

| | | |
|-----|-----|-----|
| 0/1 | 0/2 | 0/2 |
| 1/3 | | 4/5 |
| 2/5 | 0/2 | 0/6 |

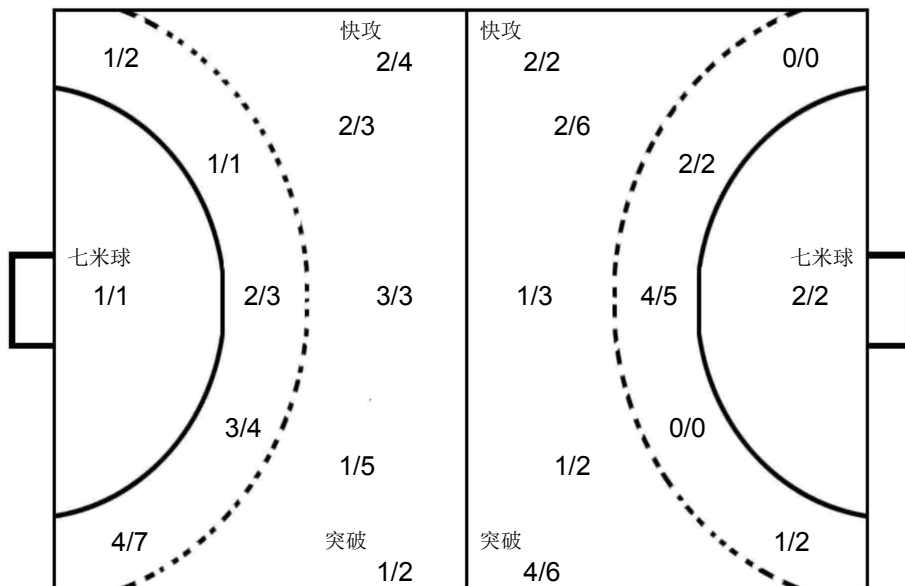

2 赫天铭

| | | |
|-----|-----|-----|
| 1/2 | | 2/3 |
| | | 2/7 |
| 3/9 | 0/2 | 2/8 |

辽宁抚顺

| | | | | | | | | | | | | | | | | | | | | | | | | | | | | | | | | | | | | | | | | | | | | | | | | | | | | | | | | | | | | | | | | | | | | | | | | | | | | | | | |
|---|-----------------------------|-----------------------------|-----------------------------|-----------------------------|-----------------------------|-----------------------------|-----------------------------|---|---|---|--|--|---|--|--|--|--|--|--|--|--|--|---|---|--|--|--|--|---|--|--|--|--|--|--|--|--|--|--|--|--|--|--|--|--|--|--|--|--|--|--|--|--|--|--|--|--|--|--|--|--|---|--|---|--|--|---|--|---|---|--|--|--|---|--|---|--|--|---|
| 2 赫天铭 | 5 王梓翾 | 6 尚禹辰 | 7 张羽虹冰 | 9 隋博 | 11 陈思 | 13 高鑫 | 17 杨宇 | | | | | | | | | | | | | | | | | | | | | | | | | | | | | | | | | | | | | | | | | | | | | | | | | | | | | | | | | | | | | | | | | | | | | | | | |
| <table border="1"><tr><td></td><td></td><td></td></tr><tr><td></td><td></td><td></td></tr><tr><td></td><td></td><td></td></tr></table> | | | | | | | | | | <table border="1"><tr><td></td><td></td><td>1</td></tr><tr><td></td><td></td><td></td></tr><tr><td></td><td></td><td></td></tr></table> | | | 1 | | | | | | | <table border="1"><tr><td></td><td></td><td></td></tr><tr><td>1</td><td></td><td></td></tr><tr><td></td><td></td><td></td></tr></table> | | | | 1 | | | | | | <table border="1"><tr><td></td><td></td><td></td></tr><tr><td></td><td></td><td></td></tr><tr><td></td><td></td><td></td></tr></table> | | | | | | | | | | <table border="1"><tr><td></td><td></td><td></td></tr><tr><td></td><td></td><td></td></tr><tr><td></td><td></td><td></td></tr></table> | | | | | | | | | | <table border="1"><tr><td></td><td></td><td></td></tr><tr><td></td><td></td><td></td></tr><tr><td></td><td></td><td></td></tr></table> | | | | | | | | | | <table border="1"><tr><td></td><td>2</td><td></td></tr><tr><td>1</td><td></td><td></td></tr><tr><td>2</td><td></td><td>3</td></tr></table> | | 2 | | 1 | | | 2 | | 3 | <table border="1"><tr><td></td><td></td><td></td></tr><tr><td>1</td><td></td><td>1</td></tr><tr><td></td><td></td><td>1</td></tr></table> | | | | 1 | | 1 | | | 1 |
| | | | | | | | | | | | | | | | | | | | | | | | | | | | | | | | | | | | | | | | | | | | | | | | | | | | | | | | | | | | | | | | | | | | | | | | | | | | | | | | |
| | | | | | | | | | | | | | | | | | | | | | | | | | | | | | | | | | | | | | | | | | | | | | | | | | | | | | | | | | | | | | | | | | | | | | | | | | | | | | | | |
| | | | | | | | | | | | | | | | | | | | | | | | | | | | | | | | | | | | | | | | | | | | | | | | | | | | | | | | | | | | | | | | | | | | | | | | | | | | | | | | |
| | | 1 | | | | | | | | | | | | | | | | | | | | | | | | | | | | | | | | | | | | | | | | | | | | | | | | | | | | | | | | | | | | | | | | | | | | | | | | | | | | | |
| | | | | | | | | | | | | | | | | | | | | | | | | | | | | | | | | | | | | | | | | | | | | | | | | | | | | | | | | | | | | | | | | | | | | | | | | | | | | | | | |
| | | | | | | | | | | | | | | | | | | | | | | | | | | | | | | | | | | | | | | | | | | | | | | | | | | | | | | | | | | | | | | | | | | | | | | | | | | | | | | | |
| | | | | | | | | | | | | | | | | | | | | | | | | | | | | | | | | | | | | | | | | | | | | | | | | | | | | | | | | | | | | | | | | | | | | | | | | | | | | | | | |
| 1 | | | | | | | | | | | | | | | | | | | | | | | | | | | | | | | | | | | | | | | | | | | | | | | | | | | | | | | | | | | | | | | | | | | | | | | | | | | | | | | |
| | | | | | | | | | | | | | | | | | | | | | | | | | | | | | | | | | | | | | | | | | | | | | | | | | | | | | | | | | | | | | | | | | | | | | | | | | | | | | | | |
| | | | | | | | | | | | | | | | | | | | | | | | | | | | | | | | | | | | | | | | | | | | | | | | | | | | | | | | | | | | | | | | | | | | | | | | | | | | | | | | |
| | | | | | | | | | | | | | | | | | | | | | | | | | | | | | | | | | | | | | | | | | | | | | | | | | | | | | | | | | | | | | | | | | | | | | | | | | | | | | | | |
| | | | | | | | | | | | | | | | | | | | | | | | | | | | | | | | | | | | | | | | | | | | | | | | | | | | | | | | | | | | | | | | | | | | | | | | | | | | | | | | |
| | | | | | | | | | | | | | | | | | | | | | | | | | | | | | | | | | | | | | | | | | | | | | | | | | | | | | | | | | | | | | | | | | | | | | | | | | | | | | | | |
| | | | | | | | | | | | | | | | | | | | | | | | | | | | | | | | | | | | | | | | | | | | | | | | | | | | | | | | | | | | | | | | | | | | | | | | | | | | | | | | |
| | | | | | | | | | | | | | | | | | | | | | | | | | | | | | | | | | | | | | | | | | | | | | | | | | | | | | | | | | | | | | | | | | | | | | | | | | | | | | | | |
| | | | | | | | | | | | | | | | | | | | | | | | | | | | | | | | | | | | | | | | | | | | | | | | | | | | | | | | | | | | | | | | | | | | | | | | | | | | | | | | |
| | | | | | | | | | | | | | | | | | | | | | | | | | | | | | | | | | | | | | | | | | | | | | | | | | | | | | | | | | | | | | | | | | | | | | | | | | | | | | | | |
| | | | | | | | | | | | | | | | | | | | | | | | | | | | | | | | | | | | | | | | | | | | | | | | | | | | | | | | | | | | | | | | | | | | | | | | | | | | | | | | |
| | 2 | | | | | | | | | | | | | | | | | | | | | | | | | | | | | | | | | | | | | | | | | | | | | | | | | | | | | | | | | | | | | | | | | | | | | | | | | | | | | | |
| 1 | | | | | | | | | | | | | | | | | | | | | | | | | | | | | | | | | | | | | | | | | | | | | | | | | | | | | | | | | | | | | | | | | | | | | | | | | | | | | | | |
| 2 | | 3 | | | | | | | | | | | | | | | | | | | | | | | | | | | | | | | | | | | | | | | | | | | | | | | | | | | | | | | | | | | | | | | | | | | | | | | | | | | | | |
| | | | | | | | | | | | | | | | | | | | | | | | | | | | | | | | | | | | | | | | | | | | | | | | | | | | | | | | | | | | | | | | | | | | | | | | | | | | | | | | |
| 1 | | 1 | | | | | | | | | | | | | | | | | | | | | | | | | | | | | | | | | | | | | | | | | | | | | | | | | | | | | | | | | | | | | | | | | | | | | | | | | | | | | |
| | | 1 | | | | | | | | | | | | | | | | | | | | | | | | | | | | | | | | | | | | | | | | | | | | | | | | | | | | | | | | | | | | | | | | | | | | | | | | | | | | | |
| Post - 0 Miss - 0 Block - 0 | Post - 0 Miss - 0 Block - 0 | Post - 0 Miss - 0 Block - 0 | Post - 0 Miss - 0 Block - 0 | Post - 0 Miss - 0 Block - 0 | Post - 0 Miss - 0 Block - 0 | Post - 0 Miss - 0 Block - 1 | Post - 0 Miss - 2 Block - 1 | | | | | | | | | | | | | | | | | | | | | | | | | | | | | | | | | | | | | | | | | | | | | | | | | | | | | | | | | | | | | | | | | | | | | | | | |
| 19 靳皓童 | 22 杨辰 | 28 靳皓添 | 32 袁梓赫 | | | | | | | | | | | | | | | | | | | | | | | | | | | | | | | | | | | | | | | | | | | | | | | | | | | | | | | | | | | | | | | | | | | | | | | | | | | | |
| <table border="1"><tr><td>1</td><td></td><td></td></tr><tr><td></td><td></td><td></td></tr><tr><td></td><td>2</td><td>1</td></tr></table> | 1 | | | | | | | 2 | 1 | <table border="1"><tr><td></td><td></td><td></td></tr><tr><td></td><td></td><td></td></tr><tr><td></td><td></td><td></td></tr></table> | | | | | | | | | | <table border="1"><tr><td></td><td></td><td>1</td></tr><tr><td></td><td></td><td></td></tr><tr><td></td><td></td><td>1</td></tr></table> | | | 1 | | | | | | 1 | <table border="1"><tr><td></td><td></td><td></td></tr><tr><td></td><td></td><td></td></tr><tr><td></td><td></td><td></td></tr></table> | | | | | | | | | | | | | | | | | | | | | | | | | | | | | | | | | | | | | | | | | | | | | | | | | |
| 1 | | | | | | | | | | | | | | | | | | | | | | | | | | | | | | | | | | | | | | | | | | | | | | | | | | | | | | | | | | | | | | | | | | | | | | | | | | | | | | | |
| | | | | | | | | | | | | | | | | | | | | | | | | | | | | | | | | | | | | | | | | | | | | | | | | | | | | | | | | | | | | | | | | | | | | | | | | | | | | | | | |
| | 2 | 1 | | | | | | | | | | | | | | | | | | | | | | | | | | | | | | | | | | | | | | | | | | | | | | | | | | | | | | | | | | | | | | | | | | | | | | | | | | | | | |
| | | | | | | | | | | | | | | | | | | | | | | | | | | | | | | | | | | | | | | | | | | | | | | | | | | | | | | | | | | | | | | | | | | | | | | | | | | | | | | | |
| | | | | | | | | | | | | | | | | | | | | | | | | | | | | | | | | | | | | | | | | | | | | | | | | | | | | | | | | | | | | | | | | | | | | | | | | | | | | | | | |
| | | | | | | | | | | | | | | | | | | | | | | | | | | | | | | | | | | | | | | | | | | | | | | | | | | | | | | | | | | | | | | | | | | | | | | | | | | | | | | | |
| | | 1 | | | | | | | | | | | | | | | | | | | | | | | | | | | | | | | | | | | | | | | | | | | | | | | | | | | | | | | | | | | | | | | | | | | | | | | | | | | | | |
| | | | | | | | | | | | | | | | | | | | | | | | | | | | | | | | | | | | | | | | | | | | | | | | | | | | | | | | | | | | | | | | | | | | | | | | | | | | | | | | |
| | | 1 | | | | | | | | | | | | | | | | | | | | | | | | | | | | | | | | | | | | | | | | | | | | | | | | | | | | | | | | | | | | | | | | | | | | | | | | | | | | | |
| | | | | | | | | | | | | | | | | | | | | | | | | | | | | | | | | | | | | | | | | | | | | | | | | | | | | | | | | | | | | | | | | | | | | | | | | | | | | | | | |
| | | | | | | | | | | | | | | | | | | | | | | | | | | | | | | | | | | | | | | | | | | | | | | | | | | | | | | | | | | | | | | | | | | | | | | | | | | | | | | | |
| | | | | | | | | | | | | | | | | | | | | | | | | | | | | | | | | | | | | | | | | | | | | | | | | | | | | | | | | | | | | | | | | | | | | | | | | | | | | | | | |
| Post - 0 Miss - 0 Block - 0 | Post - 0 Miss - 0 Block - 0 | Post - 0 Miss - 0 Block - 0 | Post - 0 Miss - 0 Block - 0 | | | | | | | | | | | | | | | | | | | | | | | | | | | | | | | | | | | | | | | | | | | | | | | | | | | | | | | | | | | | | | | | | | | | | | | | | | | | |



| | | | | | | | | | | | | | | | | | | | | | |
|----------------|--|---------------|---------------------|------------|------------------------------------|----------------|---|---------------|----------------|----|-------|----------------------|-----|---|--|--|---|---|----|---|----|
| Team A | | | | Team B | | | | Match Number | | | | | | | | | | | | | |
| A 安徽淮南 | | | | B 中国香港 | | | | 27 | | | | | | | | | | | | | |
| Played in | | in the hall | | on | | at | | Spectators | | | | | | | | | | | | | |
| 安徽滁州 | | 滁州国际手球馆 | | 2019-06-02 | | 19:00 | | hours | | | | | | | | | | | | | |
| Half-time(30') | A | B | End of playing time | A | B | 1st extra time | A | B | 2nd extra time | A | B | After penalty throws | A | B | | | | | | | |
| | 3 | 8 | 9 | 14 | | | | | | | | | | | | | | | | | |
| Number of 7 m | A | Team time-out | | | Full name of players and officials | | | Team time-out | | | B | Number of 7 m | | | | | | | | | |
| | 0/0 | 1 | 2 | 3 | | | | 1 | 2 | 3 | 40:08 | | 1/1 | | | | | | | | |
| No. | Team A | | | | | G | W | 2' | D | DR | No. | Team B | | | | | G | W | 2' | D | DR |
| 1 | 苟嘉毅 | | | | | | | | | | 1 | 江力为 | | | | | | | | | |
| 2 | 邹俊洁 | | | | | | | | | | 2 | 梁凯乔 | | | | | | | | | |
| 3 | 童守宣 | | | | | | | | | | 3 | 陈嘉熙 | | | | | | | | | |
| 4 | 李攀 | | | | | | | | | | 10 | 叶滋权 | | | | | | | | | |
| 5 | 吴修民 | | | | | | | | | | 15 | 梁栢朗 | | | | | 2 | | | | |
| 6 | 童浩宇 | | | | | 1 | | | | | 16 | 冯智聪 | | | | | 2 | | | | |
| 7 | 赵琨鹏 | | | | | 1 | | | | | 22 | 吴泽斌 | | | | | | | | | |
| 8 | 陈子涵 | | | | | 5 | | | | | 23 | 石铭泽 | | | | | 1 | | | | |
| 9 | 杨金龙 | | | | | 1 | | | | | 27 | 巫迪涛 | | | | | 1 | | | | |
| 10 | 孙飞扬 | | | | | 1 | | | | | 28 | 关健辉 | | | | | 3 | | | | |
| 11 | 刘新然 | | | | | | | 1 | | | 30 | 陈永曦 | | | | | | | | | |
| 13 | 张昊燃 | | | | | | | | | | 41 | 莫敬朗 | | | | | 1 | | | | |
| 14 | 单中宝 | | | | | | | | | | 47 | 薛浩锋 | | | | | 3 | | | | |
| 15 | 刘淇 | | | | | | | | | | 73 | 黄望鎏 | | | | | | | | | |
| 16 | 胡文柯 | | | | | | | | | | 79 | 吴坤霖 | | | | | 1 | | | | |
| 17 | 徐鹏辉 | | | | | | | | | | 99 | 苏俊轩 | | | | | | | | | |
| A | 常洪飞 | | | | | | | | | | B | 练明辉 (主教练) | | | | | | | | | |
| B | 阮圣杰 (主教练) | | | | | | | | | | C | 钟昀延 | | | | | | | | | |
| A | Signatures of responsables for the teams (Off.A) | | | | | | | | | | B | | | | | | | | | | |
| TP | Remarks of referees / HF Official | | | | | | | | | | TP | | | | | | | | | | |

Signatures

| | | | | |
|----------|-----------|-----------|--|--|
| Referees | 徐健 (CHN) | 康曦 (CHN) | | |
| T.D. | 吴国忠 (CHN) | 李兆蒙 (CHN) | | |
| CHA Off. | | | | |

Note: Number of 7m Throws Awarded to Team A and B, Goals (G), Warnings (W), Suspensions (2'), Direct Disqualification (D), Disqualification With Report (DR) and Team Penalty (TP).

Table Officials: 李莉君 吴荣 Statisticians: 王梓衡 童佩瑶



第二届全国青年运动会男子手球乙组决赛 体校组 (U16)

PHMS Pictorial Handball Match Statistics

IHF Official System

竞赛技术统计

手球
青年男子

四分之一决赛
轮次 4

组别 X
场次 27

滁州国际手球馆
2019-06-02 19:00

| | | | |
|-----------|----------------------|---------|------------|
| Referees: | 徐健 (CHN) / 康曦 (CHN) | Result: | 9:14 (3:8) |
| Teams: | 安徽淮南(淮南) VS 中国香港(香港) | | |

| 淮南 | | 远射 | 近射 | 边射 | 快攻 | 突破 | 任意球 | 7m球 | 合计 | % | 助攻 | 失误 | 警告 | 2' | D+DR |
|----------|-----|-----|-----|-----|-----|-----|-----|------|------|------|----|----|----|----|------|
| 主教练: 阮圣杰 | | | | | | | | | | | | | | | |
| 1 | 苟嘉毅 | | | | | | | | | | | | | | |
| 2 | 邹俊洁 | | | | | | | | | | | | | | |
| 3 | 童守宣 | | | | | | | | | | | | | | |
| 4 | 李攀 | | | | | | | | | | | | | | |
| 5 | 吴修民 | | | | | | | | | | | | | | |
| 6 | 童浩宇 | | 1/1 | | | | | 1/1 | 100 | | 2 | | | | |
| 7 | 赵琨鹏 | | 1/1 | | | | | 1/1 | 100 | | | | | | |
| 8 | 陈子涵 | 1/3 | 2/2 | 0/1 | 2/2 | | 0/1 | 5/9 | 55.6 | | 4 | | | | |
| 9 | 杨金龙 | 0/1 | 0/1 | | | 1/1 | | 1/3 | 33.3 | | 5 | | | | |
| 10 | 孙飞扬 | 0/1 | | | | | 1/2 | 1/3 | 33.3 | | 4 | | | | |
| 11 | 刘新然 | | | | | | | | | | | | | 1 | |
| 13 | 张昊燃 | | | | | | | | | | 1 | | | | |
| 14 | 单中宝 | | | | | | | | | | | | | | |
| 15 | 刘淇 | | | | | | | | | | 2 | | | | |
| 16 | 胡文柯 | | | | | | | | | | | | | | |
| 17 | 徐鹏辉 | | | | | | | | | | | | | | |
| 运动员 | 合计 | 1/5 | 4/5 | 0/1 | 2/2 | 1/1 | 1/3 | 9/17 | 52.9 | | 18 | | | 1 | |
| 1 | 苟嘉毅 | | 0/2 | 1/7 | 2/4 | 0/3 | | 0/1 | 3/17 | 17.6 | | | | | |
| 守门员 | 合计 | | 0/2 | 1/7 | 2/4 | 0/3 | | 0/1 | 3/17 | 17.6 | | | | | |

| 淮南 | 比赛进程 | 香港 |
|----------|---------|-----------|
| 1st Half | | |
| 8 陈子涵 | 1 02:33 | 0 |
| | 1 02:59 | 1 28 关键辉 |
| | 1 04:14 | 2 23 石铭泽 |
| 6 童浩宇 | 2 04:30 | 2 |
| | 2 04:45 | 3 28 关键辉 |
| | 2 06:06 | 4 28 关键辉 |
| 8 陈子涵 | 3 07:10 | 4 |
| | 3 08:17 | 5 15 梁栢朗 |
| | 3 09:39 | 6 27 巫迪涛 |
| | 3 10:43 | 7 15 梁栢朗 |
| | 3 12:02 | 8 79 吴坤霖 |
| 2nd Half | | |
| 8 陈子涵 | 3 00:52 | 9 16 冯智聪 |
| | 4 02:00 | 9 |
| | 4 02:29 | 10 41 莫敬朗 |
| 8 陈子涵 | 5 03:32 | 10 |
| | 5 04:58 | 11 16 冯智聪 |
| 9 杨金龙 | 6 05:50 | 11 |
| | 6 10:36 | 12 47 薛浩锋 |
| | 6 11:35 | 13 47 薛浩锋 |
| 10 孙飞扬 | 7 12:30 | 13 |
| 7 赵琨鹏 | 8 13:35 | 13 |
| | 8 13:54 | 14 47 薛浩锋 |
| 8 陈子涵 | 9 14:16 | 14 |

| 香港 | | 远射 | 近射 | 边射 | 快攻 | 突破 | 任意球 | 7m球 | 合计 | % | 助攻 | 失误 | 警告 | 2' | D+DR |
|----------|-----|-----|-----|-----|-----|-----|-----|------|-------|------|----|----|----|----|------|
| 主教练: 练明辉 | | | | | | | | | | | | | | | |
| 1 | 江力为 | | | | | | | | | | | | | | |
| 2 | 梁凯乔 | | 0/1 | | | | | 0/1 | 0.0 | | | | | | |
| 3 | 陈嘉熙 | | | | 0/1 | | | 0/1 | 0.0 | | 4 | | | | |
| 10 | 叶滋权 | | 0/1 | | | | | 0/1 | 0.0 | | | | | | |
| 15 | 梁栢朗 | | 1/1 | | 1/2 | | | 2/3 | 66.7 | | 1 | | | | |
| 16 | 冯智聪 | | 1/1 | 0/1 | | 1/1 | | 2/3 | 66.7 | | 1 | | | | |
| 22 | 吴泽斌 | | | | | | | | | | | | | | |
| 23 | 石铭泽 | | | 1/1 | | | | 1/1 | 100 | | 1 | 1 | | | |
| 27 | 巫迪涛 | 0/1 | | | | | 0/1 | 1/1 | 33.3 | | | | | | |
| 28 | 关键辉 | | | 3/4 | | | | 3/4 | 75.0 | | | | | | |
| 30 | 陈永曦 | | | | | 0/1 | | 0/1 | 0.0 | | 1 | | | | |
| 41 | 莫敬朗 | | | 1/1 | | | | 1/1 | 100 | | 2 | | | | |
| 47 | 薛浩锋 | | | 1/1 | 0/1 | 2/2 | | 3/4 | 75.0 | | 1 | 1 | | | |
| 73 | 黄望鏊 | | | | | | | | | | 1 | | | | |
| 79 | 吴坤霖 | | | | 1/1 | | | 1/1 | 100 | | | | | | |
| 99 | 苏俊轩 | | | | | | | | | | | | | | |
| 运动员 | 合计 | 0/1 | 2/4 | 6/8 | 2/5 | 3/4 | 0/1 | 1/1 | 14/24 | 58.3 | 3 | 11 | | | |
| 1 | 江力为 | 3/4 | 0/2 | | | | | 3/6 | 50.0 | | | | | | |
| 22 | 吴泽斌 | | | | 0/2 | 0/1 | 1/1 | 1/4 | 25.0 | | | | | | |
| 99 | 苏俊轩 | | 0/2 | | | | 0/1 | 0/3 | 0.0 | | | | | | |
| 守门员 | 合计 | 3/4 | 0/4 | | 0/2 | 0/1 | 1/2 | 4/13 | 30.8 | | | | | | |

场上队员: 得分 / 射门

守门员: 救球 / 射门

| | | | |
|---|------|----|---------|
| D | 取消资格 | DR | 取消资格+报告 |
|---|------|----|---------|



个人/全队技术统计表

手球 四分之一决赛 组别 X
青年男子 轮次 4 场次 27
滁州国际手球馆
2019-06-02 19:00

| 号码 | 姓名 | 远射 | 近射 | 边射 | 快攻 | 突破 | 任意 | 七米 | 合计 | % | 助攻 | 失误 | 警告 | 2' | 取消 | 时间 |
|----------|-----|-----|-----|-----|-----|-----|-----|----|------|-------|----|----|----|----|----|----------|
| 安徽淮南(淮南) | | | | | | | | | | | | | | | | |
| (场上队员) | | | | | | | | | | | | | | | | |
| 1 | 苟嘉毅 | | | | | | | | | 0.0% | | | | | | 00:30:00 |
| 2 | 邹俊洁 | | | | | | | | | 0.0% | | | | | | 00:00:00 |
| 3 | 童守宣 | | | | | | | | | 0.0% | | | | | | 00:00:00 |
| 4 | 李攀 | | | | | | | | | 0.0% | | | | | | 00:00:00 |
| 5 | 吴修民 | | | | | | | | | 0.0% | | | | | | 00:00:00 |
| 6 | 童浩宇 | | 1/1 | | | | | | 1/1 | 100% | | 2 | | | | 00:30:00 |
| 7 | 赵琨鹏 | | 1/1 | | | | | | 1/1 | 100% | | | | | | 00:01:13 |
| 8 | 陈子涵 | 1/3 | 2/2 | 0/1 | 2/2 | | 0/1 | | 5/9 | 55.6% | | 4 | | | | 00:30:00 |
| 9 | 杨金龙 | 0/1 | 0/1 | | | 1/1 | | | 1/3 | 33.3% | | 5 | | | | 00:30:00 |
| 10 | 孙飞扬 | 0/1 | | | | | 1/2 | | 1/3 | 33.3% | | 4 | | | | 00:30:00 |
| 11 | 刘新然 | | | | | | | | | 0.0% | | | | 1 | | 00:30:00 |
| 13 | 张昊燃 | | | | | | | | | 0.0% | | 1 | | | | 00:02:33 |
| 14 | 单中宝 | | | | | | | | | 0.0% | | | | | | 00:00:00 |
| 15 | 刘淇 | | | | | | | | | 0.0% | | 2 | | | | 00:13:45 |
| 16 | 胡文柯 | | | | | | | | | 0.0% | | | | | | 00:00:00 |
| 17 | 徐鹏辉 | | | | | | | | | 0.0% | | | | | | 00:12:26 |
| 合计 | | 1/5 | 4/5 | 0/1 | 2/2 | 1/1 | 1/3 | | 9/17 | 52.9% | | 18 | | 1 | | |

(守门员)

| | | | | | | | | | | | | | | | | |
|----|-----|-----|-----|-----|-----|--|-----|------|-------|--|--|--|--|--|--|----------|
| 1 | 苟嘉毅 | 0/2 | 1/7 | 2/4 | 0/3 | | 0/1 | 3/17 | 17.6% | | | | | | | 00:30:00 |
| 合计 | | 0/2 | 1/7 | 2/4 | 0/3 | | 0/1 | 3/17 | 17.6% | | | | | | | |

场上队员：得分/射门

守门员：救球/射门

| 全队合计 | 得分 | 被救 | 射失 | 击柱 | 封球 | 合计 | % |
|------|----|----|----|----|----|----|--------|
| 远射 | 1 | 3 | 1 | | | 5 | 20.0% |
| 近射 | 4 | | 1 | | | 5 | 80.0% |
| 边射 | | | | 1 | | 1 | 0.0% |
| 快攻 | 2 | | | | | 2 | 100.0% |
| 突破 | 1 | | | | | 1 | 100.0% |
| 任意 | 1 | 1 | | 1 | | 3 | 33.3% |
| 七米 | | | | | | | 0.0% |

个人/全队技术统计表

手球 四分之一决赛 组别 X
青年男子 轮次 4 场次 27 滁州国际手球馆
2019-06-02 19:00

| 号码 | 姓名 | 远射 | 近射 | 边射 | 快攻 | 突破 | 任意 | 七米 | 合计 | % | 助攻 | 失误 | 警告 | 2' | 取消 | 时间 |
|----------|-----|-----|-----|-----|-----|-----|-----|-----|-------|-------|----|----|----|----|----|----------|
| 中国香港(香港) | | | | | | | | | | | | | | | | |
| (场上队员) | | | | | | | | | | | | | | | | |
| 1 | 江力为 | | | | | | | | | 0.0% | | | | | | 00:15:00 |
| 2 | 梁凯乔 | | 0/1 | | | | | | 0/1 | 0.0% | | | | | | 00:15:41 |
| 3 | 陈嘉熙 | | | | 0/1 | | | | 0/1 | 0.0% | | 4 | | | | 00:12:00 |
| 10 | 叶滋权 | | 0/1 | | | | | | 0/1 | 0.0% | | | | | | 00:03:15 |
| 15 | 梁栢朗 | | 1/1 | | 1/2 | | | | 2/3 | 66.7% | 1 | | | | | 00:14:01 |
| 16 | 冯智聪 | | 1/1 | 0/1 | | 1/1 | | | 2/3 | 66.7% | | 1 | | | | 00:11:23 |
| 22 | 吴泽斌 | | | | | | | | | 0.0% | | | | | | 00:10:08 |
| 23 | 石铭泽 | | | 1/1 | | | | | 1/1 | 100% | 1 | 1 | | | | 00:15:00 |
| 27 | 巫迪涛 | 0/1 | | | | | 0/1 | 1/1 | 1/3 | 33.3% | | | | | | 00:09:43 |
| 28 | 关键辉 | | | 3/4 | | | | | 3/4 | 75.0% | | | | | | 00:30:00 |
| 30 | 陈永曦 | | | | | 0/1 | | | 0/1 | 0.0% | | 1 | | | | 00:11:49 |
| 41 | 莫敬朗 | | | 1/1 | | | | | 1/1 | 100% | | 2 | | | | 00:09:26 |
| 47 | 薛浩锋 | | | 1/1 | 0/1 | 2/2 | | | 3/4 | 75.0% | 1 | 1 | | | | 00:17:17 |
| 73 | 黄望婆 | | | | | | | | | 0.0% | | 1 | | | | 00:15:00 |
| 79 | 吴坤霖 | | | | 1/1 | | | | 1/1 | 100% | | | | | | 00:15:00 |
| 99 | 苏俊轩 | | | | | | | | | 0.0% | | | | | | 00:04:52 |
| | 合计 | 0/1 | 2/4 | 6/8 | 2/5 | 3/4 | 0/1 | 1/1 | 14/24 | 58.3% | 3 | 11 | | | | |

(守门员)

| | | | | | | | | | | | | | | | | |
|----|-----|-----|-----|--|-----|-----|-----|--|------|-------|--|--|--|--|--|----------|
| 1 | 江力为 | 3/4 | 0/2 | | | | | | 3/6 | 50.0% | | | | | | 00:15:00 |
| 22 | 吴泽斌 | | | | 0/2 | 0/1 | 1/1 | | 1/4 | 25.0% | | | | | | 00:10:08 |
| 99 | 苏俊轩 | | 0/2 | | | | 0/1 | | 0/3 | 0.0% | | | | | | 00:04:52 |
| | 合计 | 3/4 | 0/4 | | 0/2 | 0/1 | 1/2 | | 4/13 | 30.8% | | | | | | |

场上队员：得分/射门

守门员：救球/射门

| 全队合计 | 得分 | 被救 | 射失 | 击柱 | 封球 | 合计 | % |
|------|----|----|----|----|----|----|--------|
| 远射 | | | 1 | | | 1 | 0.0% |
| 近射 | 2 | | 2 | | | 4 | 50.0% |
| 边射 | 6 | 1 | 1 | | | 8 | 75.0% |
| 快攻 | 2 | 2 | | 1 | | 5 | 40.0% |
| 突破 | 3 | | | 1 | | 4 | 75.0% |
| 任意 | | | 1 | | | 1 | 0.0% |
| 七米 | 1 | | | | | 1 | 100.0% |

图式比赛技术统计表

手球
青年男子

四分之一决赛
轮次 4

组别 X
场次 27

滁州国际手球馆
2019-06-02 19:00

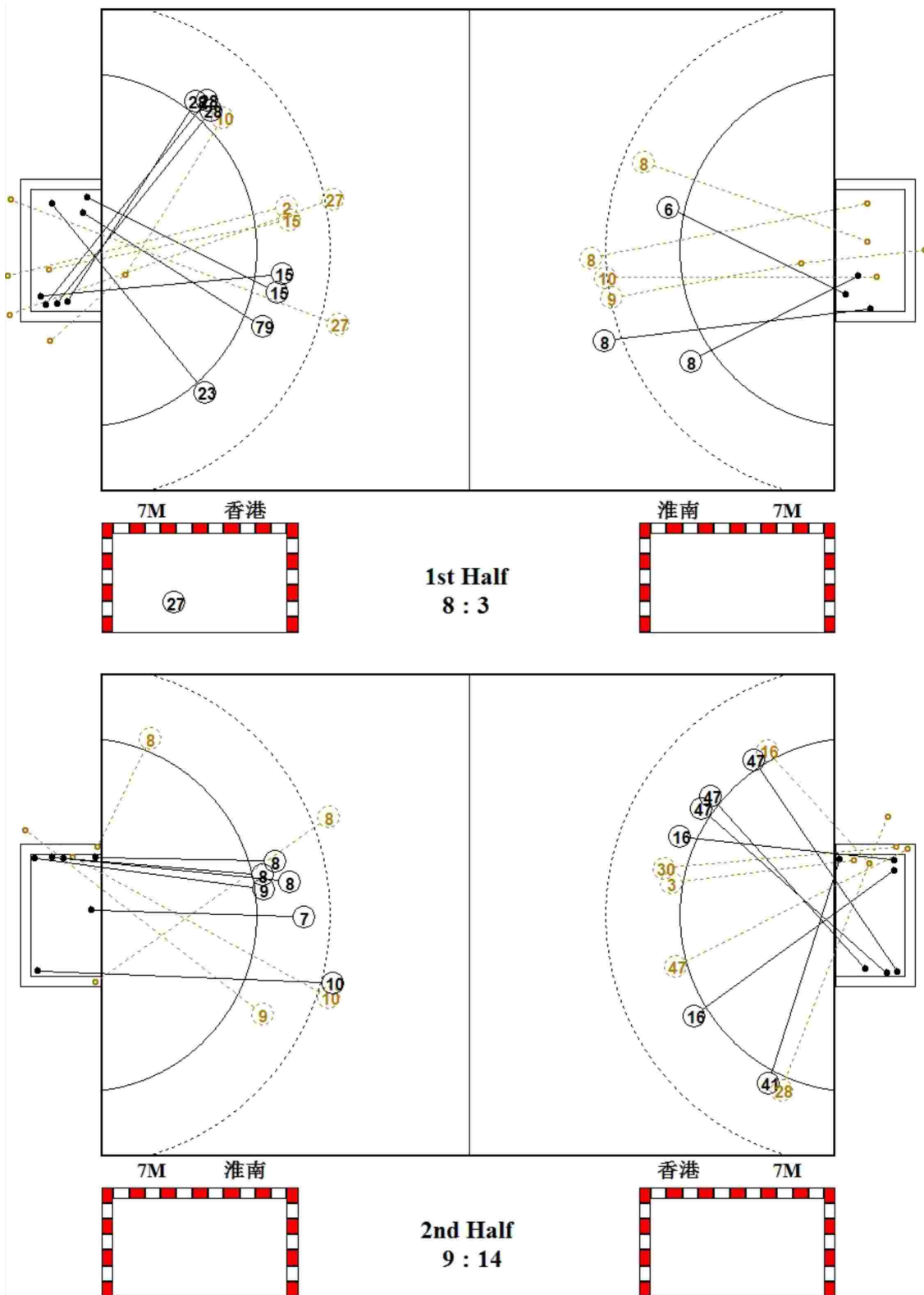

图式射门区域统计

手球
青年男子

四分之一决赛
轮次 4

组别 X
场次 27

滁州国际手球馆
2019-06-02 19:00

安徽淮南

| | | | | | | | | | | | | | | | | | | | | | | | | | | | | | | | | | | | | | | | | | | | | | | | | | | | | | | | | | | | | | | | | | | | | | | | | | | | | | | | |
|---|-----------------------------|-----------------------------|-----------------------------|-----------------------------|-----------------------------|-----------------------------|-----------------------------|--|--|---|---|--|--|--|--|--|--|--|--|--|--|--|--|--|--|--|--|--|--|--|--|--|--|--|--|--|--|--|--|--|--|--|--|--|--|--|--|--|--|---|--|--|---|--|--|--|--|--|--|--|--|--|--|--|--|--|--|--|--|---|--|--|---|--|--|--|--|--|--|
| 1 苟嘉毅 | 2 邹俊洁 | 3 童守宣 | 4 李攀 | 5 吴修民 | 6 童浩宇 | 7 赵琨鹏 | 8 陈子涵 | | | | | | | | | | | | | | | | | | | | | | | | | | | | | | | | | | | | | | | | | | | | | | | | | | | | | | | | | | | | | | | | | | | | | | | | |
| <table border="1"><tr><td></td><td></td><td></td></tr><tr><td></td><td></td><td></td></tr><tr><td></td><td></td><td></td></tr></table> | | | | | | | | | | <table border="1"><tr><td></td><td></td><td></td></tr><tr><td></td><td></td><td></td></tr><tr><td></td><td></td><td></td></tr></table> | | | | | | | | | | <table border="1"><tr><td></td><td></td><td></td></tr><tr><td></td><td></td><td></td></tr><tr><td></td><td></td><td></td></tr></table> | | | | | | | | | | <table border="1"><tr><td></td><td></td><td></td></tr><tr><td></td><td></td><td></td></tr><tr><td></td><td></td><td></td></tr></table> | | | | | | | | | | <table border="1"><tr><td></td><td></td><td></td></tr><tr><td></td><td></td><td></td></tr><tr><td></td><td></td><td></td></tr></table> | | | | | | | | | | <table border="1"><tr><td></td><td></td><td>1</td></tr><tr><td></td><td></td><td></td></tr><tr><td></td><td></td><td></td></tr></table> | | | 1 | | | | | | | <table border="1"><tr><td></td><td></td><td></td></tr><tr><td></td><td></td><td></td></tr><tr><td></td><td></td><td></td></tr></table> | | | | | | | | | | <table border="1"><tr><td></td><td></td><td>1</td></tr><tr><td></td><td></td><td></td></tr><tr><td></td><td></td><td></td></tr></table> | | | 1 | | | | | | |
| | | | | | | | | | | | | | | | | | | | | | | | | | | | | | | | | | | | | | | | | | | | | | | | | | | | | | | | | | | | | | | | | | | | | | | | | | | | | | | | |
| | | | | | | | | | | | | | | | | | | | | | | | | | | | | | | | | | | | | | | | | | | | | | | | | | | | | | | | | | | | | | | | | | | | | | | | | | | | | | | | |
| | | | | | | | | | | | | | | | | | | | | | | | | | | | | | | | | | | | | | | | | | | | | | | | | | | | | | | | | | | | | | | | | | | | | | | | | | | | | | | | |
| | | | | | | | | | | | | | | | | | | | | | | | | | | | | | | | | | | | | | | | | | | | | | | | | | | | | | | | | | | | | | | | | | | | | | | | | | | | | | | | |
| | | | | | | | | | | | | | | | | | | | | | | | | | | | | | | | | | | | | | | | | | | | | | | | | | | | | | | | | | | | | | | | | | | | | | | | | | | | | | | | |
| | | | | | | | | | | | | | | | | | | | | | | | | | | | | | | | | | | | | | | | | | | | | | | | | | | | | | | | | | | | | | | | | | | | | | | | | | | | | | | | |
| | | | | | | | | | | | | | | | | | | | | | | | | | | | | | | | | | | | | | | | | | | | | | | | | | | | | | | | | | | | | | | | | | | | | | | | | | | | | | | | |
| | | | | | | | | | | | | | | | | | | | | | | | | | | | | | | | | | | | | | | | | | | | | | | | | | | | | | | | | | | | | | | | | | | | | | | | | | | | | | | | |
| | | | | | | | | | | | | | | | | | | | | | | | | | | | | | | | | | | | | | | | | | | | | | | | | | | | | | | | | | | | | | | | | | | | | | | | | | | | | | | | |
| | | | | | | | | | | | | | | | | | | | | | | | | | | | | | | | | | | | | | | | | | | | | | | | | | | | | | | | | | | | | | | | | | | | | | | | | | | | | | | | |
| | | | | | | | | | | | | | | | | | | | | | | | | | | | | | | | | | | | | | | | | | | | | | | | | | | | | | | | | | | | | | | | | | | | | | | | | | | | | | | | |
| | | | | | | | | | | | | | | | | | | | | | | | | | | | | | | | | | | | | | | | | | | | | | | | | | | | | | | | | | | | | | | | | | | | | | | | | | | | | | | | |
| | | | | | | | | | | | | | | | | | | | | | | | | | | | | | | | | | | | | | | | | | | | | | | | | | | | | | | | | | | | | | | | | | | | | | | | | | | | | | | | |
| | | | | | | | | | | | | | | | | | | | | | | | | | | | | | | | | | | | | | | | | | | | | | | | | | | | | | | | | | | | | | | | | | | | | | | | | | | | | | | | |
| | | | | | | | | | | | | | | | | | | | | | | | | | | | | | | | | | | | | | | | | | | | | | | | | | | | | | | | | | | | | | | | | | | | | | | | | | | | | | | | |
| | | 1 | | | | | | | | | | | | | | | | | | | | | | | | | | | | | | | | | | | | | | | | | | | | | | | | | | | | | | | | | | | | | | | | | | | | | | | | | | | | | |
| | | | | | | | | | | | | | | | | | | | | | | | | | | | | | | | | | | | | | | | | | | | | | | | | | | | | | | | | | | | | | | | | | | | | | | | | | | | | | | | |
| | | | | | | | | | | | | | | | | | | | | | | | | | | | | | | | | | | | | | | | | | | | | | | | | | | | | | | | | | | | | | | | | | | | | | | | | | | | | | | | |
| | | | | | | | | | | | | | | | | | | | | | | | | | | | | | | | | | | | | | | | | | | | | | | | | | | | | | | | | | | | | | | | | | | | | | | | | | | | | | | | |
| | | | | | | | | | | | | | | | | | | | | | | | | | | | | | | | | | | | | | | | | | | | | | | | | | | | | | | | | | | | | | | | | | | | | | | | | | | | | | | | |
| | | | | | | | | | | | | | | | | | | | | | | | | | | | | | | | | | | | | | | | | | | | | | | | | | | | | | | | | | | | | | | | | | | | | | | | | | | | | | | | |
| | | 1 | | | | | | | | | | | | | | | | | | | | | | | | | | | | | | | | | | | | | | | | | | | | | | | | | | | | | | | | | | | | | | | | | | | | | | | | | | | | | |
| | | | | | | | | | | | | | | | | | | | | | | | | | | | | | | | | | | | | | | | | | | | | | | | | | | | | | | | | | | | | | | | | | | | | | | | | | | | | | | | |
| | | | | | | | | | | | | | | | | | | | | | | | | | | | | | | | | | | | | | | | | | | | | | | | | | | | | | | | | | | | | | | | | | | | | | | | | | | | | | | | |
| Post - 0 Miss - 0 Block - 0 | Post - 0 Miss - 0 Block - 0 | Post - 0 Miss - 0 Block - 0 | Post - 0 Miss - 0 Block - 0 | Post - 0 Miss - 0 Block - 0 | Post - 0 Miss - 0 Block - 0 | Post - 0 Miss - 0 Block - 0 | Post - 2 Miss - 0 Block - 0 | | | | | | | | | | | | | | | | | | | | | | | | | | | | | | | | | | | | | | | | | | | | | | | | | | | | | | | | | | | | | | | | | | | | | | | | |
| 9 杨金龙 | 10 孙飞扬 | 11 刘新然 | 13 张昊燃 | 14 单中宝 | 15 刘淇 | 16 胡文柯 | 17 徐鹏辉 | | | | | | | | | | | | | | | | | | | | | | | | | | | | | | | | | | | | | | | | | | | | | | | | | | | | | | | | | | | | | | | | | | | | | | | | |
| <table border="1"><tr><td></td><td></td><td>1</td></tr><tr><td></td><td></td><td></td></tr><tr><td></td><td></td><td></td></tr></table> | | | 1 | | | | | | | <table border="1"><tr><td>1</td><td></td><td></td></tr><tr><td></td><td></td><td></td></tr><tr><td></td><td></td><td></td></tr></table> | 1 | | | | | | | | | <table border="1"><tr><td></td><td></td><td></td></tr><tr><td></td><td></td><td></td></tr><tr><td></td><td></td><td></td></tr></table> | | | | | | | | | | <table border="1"><tr><td></td><td></td><td></td></tr><tr><td></td><td></td><td></td></tr><tr><td></td><td></td><td></td></tr></table> | | | | | | | | | | <table border="1"><tr><td></td><td></td><td></td></tr><tr><td></td><td></td><td></td></tr><tr><td></td><td></td><td></td></tr></table> | | | | | | | | | | <table border="1"><tr><td></td><td></td><td></td></tr><tr><td></td><td></td><td></td></tr><tr><td></td><td></td><td></td></tr></table> | | | | | | | | | | <table border="1"><tr><td></td><td></td><td></td></tr><tr><td></td><td></td><td></td></tr><tr><td></td><td></td><td></td></tr></table> | | | | | | | | | | <table border="1"><tr><td></td><td></td><td></td></tr><tr><td></td><td></td><td></td></tr><tr><td></td><td></td><td></td></tr></table> | | | | | | | | | |
| | | 1 | | | | | | | | | | | | | | | | | | | | | | | | | | | | | | | | | | | | | | | | | | | | | | | | | | | | | | | | | | | | | | | | | | | | | | | | | | | | | |
| | | | | | | | | | | | | | | | | | | | | | | | | | | | | | | | | | | | | | | | | | | | | | | | | | | | | | | | | | | | | | | | | | | | | | | | | | | | | | | | |
| | | | | | | | | | | | | | | | | | | | | | | | | | | | | | | | | | | | | | | | | | | | | | | | | | | | | | | | | | | | | | | | | | | | | | | | | | | | | | | | |
| 1 | | | | | | | | | | | | | | | | | | | | | | | | | | | | | | | | | | | | | | | | | | | | | | | | | | | | | | | | | | | | | | | | | | | | | | | | | | | | | | | |
| | | | | | | | | | | | | | | | | | | | | | | | | | | | | | | | | | | | | | | | | | | | | | | | | | | | | | | | | | | | | | | | | | | | | | | | | | | | | | | | |
| | | | | | | | | | | | | | | | | | | | | | | | | | | | | | | | | | | | | | | | | | | | | | | | | | | | | | | | | | | | | | | | | | | | | | | | | | | | | | | | |
| | | | | | | | | | | | | | | | | | | | | | | | | | | | | | | | | | | | | | | | | | | | | | | | | | | | | | | | | | | | | | | | | | | | | | | | | | | | | | | | |
| | | | | | | | | | | | | | | | | | | | | | | | | | | | | | | | | | | | | | | | | | | | | | | | | | | | | | | | | | | | | | | | | | | | | | | | | | | | | | | | |
| | | | | | | | | | | | | | | | | | | | | | | | | | | | | | | | | | | | | | | | | | | | | | | | | | | | | | | | | | | | | | | | | | | | | | | | | | | | | | | | |
| | | | | | | | | | | | | | | | | | | | | | | | | | | | | | | | | | | | | | | | | | | | | | | | | | | | | | | | | | | | | | | | | | | | | | | | | | | | | | | | |
| | | | | | | | | | | | | | | | | | | | | | | | | | | | | | | | | | | | | | | | | | | | | | | | | | | | | | | | | | | | | | | | | | | | | | | | | | | | | | | | |
| | | | | | | | | | | | | | | | | | | | | | | | | | | | | | | | | | | | | | | | | | | | | | | | | | | | | | | | | | | | | | | | | | | | | | | | | | | | | | | | |
| | | | | | | | | | | | | | | | | | | | | | | | | | | | | | | | | | | | | | | | | | | | | | | | | | | | | | | | | | | | | | | | | | | | | | | | | | | | | | | | |
| | | | | | | | | | | | | | | | | | | | | | | | | | | | | | | | | | | | | | | | | | | | | | | | | | | | | | | | | | | | | | | | | | | | | | | | | | | | | | | | |
| | | | | | | | | | | | | | | | | | | | | | | | | | | | | | | | | | | | | | | | | | | | | | | | | | | | | | | | | | | | | | | | | | | | | | | | | | | | | | | | |
| | | | | | | | | | | | | | | | | | | | | | | | | | | | | | | | | | | | | | | | | | | | | | | | | | | | | | | | | | | | | | | | | | | | | | | | | | | | | | | | |
| | | | | | | | | | | | | | | | | | | | | | | | | | | | | | | | | | | | | | | | | | | | | | | | | | | | | | | | | | | | | | | | | | | | | | | | | | | | | | | | |
| | | | | | | | | | | | | | | | | | | | | | | | | | | | | | | | | | | | | | | | | | | | | | | | | | | | | | | | | | | | | | | | | | | | | | | | | | | | | | | | |
| | | | | | | | | | | | | | | | | | | | | | | | | | | | | | | | | | | | | | | | | | | | | | | | | | | | | | | | | | | | | | | | | | | | | | | | | | | | | | | | |
| | | | | | | | | | | | | | | | | | | | | | | | | | | | | | | | | | | | | | | | | | | | | | | | | | | | | | | | | | | | | | | | | | | | | | | | | | | | | | | | |
| | | | | | | | | | | | | | | | | | | | | | | | | | | | | | | | | | | | | | | | | | | | | | | | | | | | | | | | | | | | | | | | | | | | | | | | | | | | | | | | |
| | | | | | | | | | | | | | | | | | | | | | | | | | | | | | | | | | | | | | | | | | | | | | | | | | | | | | | | | | | | | | | | | | | | | | | | | | | | | | | | |
| | | | | | | | | | | | | | | | | | | | | | | | | | | | | | | | | | | | | | | | | | | | | | | | | | | | | | | | | | | | | | | | | | | | | | | | | | | | | | | | |
| | | | | | | | | | | | | | | | | | | | | | | | | | | | | | | | | | | | | | | | | | | | | | | | | | | | | | | | | | | | | | | | | | | | | | | | | | | | | | | | |
| Post - 0 Miss - 2 Block - 0 | Post - 0 Miss - 0 Block - 0 | Post - 0 Miss - 0 Block - 0 | Post - 0 Miss - 0 Block - 0 | Post - 0 Miss - 0 Block - 0 | Post - 0 Miss - 0 Block - 0 | Post - 0 Miss - 0 Block - 0 | Post - 0 Miss - 0 Block - 0 | | | | | | | | | | | | | | | | | | | | | | | | | | | | | | | | | | | | | | | | | | | | | | | | | | | | | | | | | | | | | | | | | | | | | | | | |

1 苟嘉毅

| | | |
|-----|-----|-----|
| 0/4 | 1/1 | 0/3 |
| 1/4 | | 0/1 |
| 1/2 | | 0/2 |

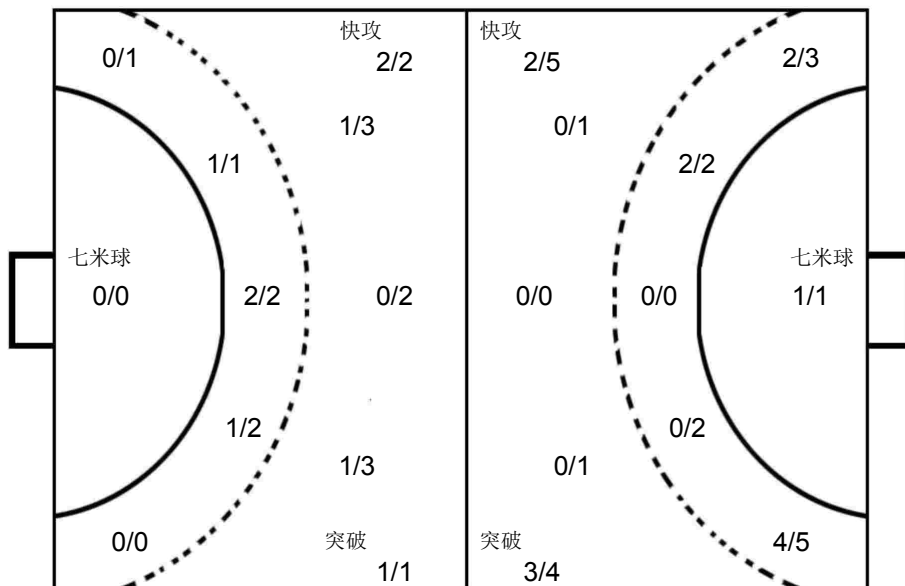

1 江力为

| | | |
|-----|-----|-----|
| | | |
| 1/1 | 1/1 | 1/3 |
| | | 0/1 |

22 吴泽斌

| | | |
|--|--|-----|
| | | 0/1 |
| | | 1/2 |
| | | 0/1 |

99 苏俊轩

| | | |
|-----|-----|-----|
| 0/1 | | 0/1 |
| | | |
| | 0/1 | |

中国香港

| | | | | | | | | | | | | | | | | | | | | | | | | | | | | | | | | | | | | | | | | | | | | | | | | | | | | | | | | | | | | | | | | | | | | | | | | | | | | | | | |
|---|-----------------------------|-----------------------------|-----------------------------|-----------------------------|-----------------------------|-----------------------------|-----------------------------|--|--|--|---|--|--|---|--|--|--|--|--|--|--|--|--|--|--|--|--|--|--|--|--|--|--|--|--|--|--|--|--|---|---|--|--|--|--|--|--|--|--|--|---|--|---|--|--|---|--|--|--|--|--|--|--|--|--|--|--|--|--|---|--|--|---|--|--|--|--|--|--|
| 1 江力为 | 2 梁凯乔 | 3 陈嘉熙 | 10 叶滋权 | 15 梁栢朗 | 16 冯智聪 | 22 吴泽斌 | 23 石铭泽 | | | | | | | | | | | | | | | | | | | | | | | | | | | | | | | | | | | | | | | | | | | | | | | | | | | | | | | | | | | | | | | | | | | | | | | | |
| <table border="1"><tr><td></td><td></td><td></td></tr><tr><td></td><td></td><td></td></tr><tr><td></td><td></td><td></td></tr></table> | | | | | | | | | | <table border="1"><tr><td></td><td></td><td></td></tr><tr><td></td><td></td><td></td></tr><tr><td></td><td></td><td></td></tr></table> | | | | | | | | | | <table border="1"><tr><td></td><td></td><td></td></tr><tr><td></td><td></td><td></td></tr><tr><td></td><td></td><td></td></tr></table> | | | | | | | | | | <table border="1"><tr><td></td><td></td><td></td></tr><tr><td></td><td></td><td></td></tr><tr><td></td><td></td><td></td></tr></table> | | | | | | | | | | <table border="1"><tr><td>1</td><td></td><td></td></tr><tr><td></td><td></td><td></td></tr><tr><td></td><td></td><td></td></tr></table> | 1 | | | | | | | | | <table border="1"><tr><td>2</td><td></td><td></td></tr><tr><td></td><td></td><td></td></tr><tr><td></td><td></td><td></td></tr></table> | 2 | | | | | | | | | <table border="1"><tr><td></td><td></td><td></td></tr><tr><td></td><td></td><td></td></tr><tr><td></td><td></td><td></td></tr></table> | | | | | | | | | | <table border="1"><tr><td></td><td></td><td>1</td></tr><tr><td></td><td></td><td></td></tr><tr><td></td><td></td><td></td></tr></table> | | | 1 | | | | | | |
| | | | | | | | | | | | | | | | | | | | | | | | | | | | | | | | | | | | | | | | | | | | | | | | | | | | | | | | | | | | | | | | | | | | | | | | | | | | | | | | |
| | | | | | | | | | | | | | | | | | | | | | | | | | | | | | | | | | | | | | | | | | | | | | | | | | | | | | | | | | | | | | | | | | | | | | | | | | | | | | | | |
| | | | | | | | | | | | | | | | | | | | | | | | | | | | | | | | | | | | | | | | | | | | | | | | | | | | | | | | | | | | | | | | | | | | | | | | | | | | | | | | |
| | | | | | | | | | | | | | | | | | | | | | | | | | | | | | | | | | | | | | | | | | | | | | | | | | | | | | | | | | | | | | | | | | | | | | | | | | | | | | | | |
| | | | | | | | | | | | | | | | | | | | | | | | | | | | | | | | | | | | | | | | | | | | | | | | | | | | | | | | | | | | | | | | | | | | | | | | | | | | | | | | |
| | | | | | | | | | | | | | | | | | | | | | | | | | | | | | | | | | | | | | | | | | | | | | | | | | | | | | | | | | | | | | | | | | | | | | | | | | | | | | | | |
| | | | | | | | | | | | | | | | | | | | | | | | | | | | | | | | | | | | | | | | | | | | | | | | | | | | | | | | | | | | | | | | | | | | | | | | | | | | | | | | |
| | | | | | | | | | | | | | | | | | | | | | | | | | | | | | | | | | | | | | | | | | | | | | | | | | | | | | | | | | | | | | | | | | | | | | | | | | | | | | | | |
| | | | | | | | | | | | | | | | | | | | | | | | | | | | | | | | | | | | | | | | | | | | | | | | | | | | | | | | | | | | | | | | | | | | | | | | | | | | | | | | |
| | | | | | | | | | | | | | | | | | | | | | | | | | | | | | | | | | | | | | | | | | | | | | | | | | | | | | | | | | | | | | | | | | | | | | | | | | | | | | | | |
| | | | | | | | | | | | | | | | | | | | | | | | | | | | | | | | | | | | | | | | | | | | | | | | | | | | | | | | | | | | | | | | | | | | | | | | | | | | | | | | |
| | | | | | | | | | | | | | | | | | | | | | | | | | | | | | | | | | | | | | | | | | | | | | | | | | | | | | | | | | | | | | | | | | | | | | | | | | | | | | | | |
| 1 | | | | | | | | | | | | | | | | | | | | | | | | | | | | | | | | | | | | | | | | | | | | | | | | | | | | | | | | | | | | | | | | | | | | | | | | | | | | | | | |
| | | | | | | | | | | | | | | | | | | | | | | | | | | | | | | | | | | | | | | | | | | | | | | | | | | | | | | | | | | | | | | | | | | | | | | | | | | | | | | | |
| | | | | | | | | | | | | | | | | | | | | | | | | | | | | | | | | | | | | | | | | | | | | | | | | | | | | | | | | | | | | | | | | | | | | | | | | | | | | | | | |
| 2 | | | | | | | | | | | | | | | | | | | | | | | | | | | | | | | | | | | | | | | | | | | | | | | | | | | | | | | | | | | | | | | | | | | | | | | | | | | | | | | |
| | | | | | | | | | | | | | | | | | | | | | | | | | | | | | | | | | | | | | | | | | | | | | | | | | | | | | | | | | | | | | | | | | | | | | | | | | | | | | | | |
| | | | | | | | | | | | | | | | | | | | | | | | | | | | | | | | | | | | | | | | | | | | | | | | | | | | | | | | | | | | | | | | | | | | | | | | | | | | | | | | |
| | | | | | | | | | | | | | | | | | | | | | | | | | | | | | | | | | | | | | | | | | | | | | | | | | | | | | | | | | | | | | | | | | | | | | | | | | | | | | | | |
| | | | | | | | | | | | | | | | | | | | | | | | | | | | | | | | | | | | | | | | | | | | | | | | | | | | | | | | | | | | | | | | | | | | | | | | | | | | | | | | |
| | | | | | | | | | | | | | | | | | | | | | | | | | | | | | | | | | | | | | | | | | | | | | | | | | | | | | | | | | | | | | | | | | | | | | | | | | | | | | | | |
| | | 1 | | | | | | | | | | | | | | | | | | | | | | | | | | | | | | | | | | | | | | | | | | | | | | | | | | | | | | | | | | | | | | | | | | | | | | | | | | | | | |
| | | | | | | | | | | | | | | | | | | | | | | | | | | | | | | | | | | | | | | | | | | | | | | | | | | | | | | | | | | | | | | | | | | | | | | | | | | | | | | | |
| | | | | | | | | | | | | | | | | | | | | | | | | | | | | | | | | | | | | | | | | | | | | | | | | | | | | | | | | | | | | | | | | | | | | | | | | | | | | | | | |
| Post - 0 Miss - 0 Block - 0 | Post - 0 Miss - 1 Block - 0 | Post - 0 Miss - 0 Block - 0 | Post - 0 Miss - 1 Block - 0 | Post - 0 Miss - 0 Block - 0 | Post - 0 Miss - 0 Block - 0 | Post - 0 Miss - 0 Block - 0 | Post - 0 Miss - 0 Block - 0 | | | | | | | | | | | | | | | | | | | | | | | | | | | | | | | | | | | | | | | | | | | | | | | | | | | | | | | | | | | | | | | | | | | | | | | | |
| 27 巫迪涛 | 28 关键辉 | 30 陈永曦 | 41 莫敬朗 | 47 薛浩锋 | 73 黄望臻 | 79 吴坤霖 | 99 苏俊轩 | | | | | | | | | | | | | | | | | | | | | | | | | | | | | | | | | | | | | | | | | | | | | | | | | | | | | | | | | | | | | | | | | | | | | | | | |
| <table border="1"><tr><td>1</td><td></td><td></td></tr><tr><td></td><td></td><td></td></tr><tr><td></td><td></td><td></td></tr></table> | 1 | | | | | | | | | <table border="1"><tr><td>1</td><td></td><td></td></tr><tr><td>2</td><td></td><td></td></tr><tr><td></td><td></td><td></td></tr></table> | 1 | | | 2 | | | | | | <table border="1"><tr><td></td><td></td><td></td></tr><tr><td></td><td></td><td></td></tr><tr><td></td><td></td><td></td></tr></table> | | | | | | | | | | <table border="1"><tr><td></td><td></td><td></td></tr><tr><td></td><td></td><td></td></tr><tr><td></td><td></td><td></td></tr></table> | | | | | | | | | | <table border="1"><tr><td></td><td></td><td></td></tr><tr><td></td><td></td><td></td></tr><tr><td></td><td></td><td></td></tr></table> | | | | | | | | | | <table border="1"><tr><td></td><td></td><td>2</td></tr><tr><td></td><td></td><td>1</td></tr><tr><td></td><td></td><td></td></tr></table> | | | 2 | | | 1 | | | | <table border="1"><tr><td></td><td></td><td></td></tr><tr><td></td><td></td><td></td></tr><tr><td></td><td></td><td></td></tr></table> | | | | | | | | | | <table border="1"><tr><td></td><td></td><td></td></tr><tr><td></td><td></td><td></td></tr><tr><td></td><td></td><td></td></tr></table> | | | | | | | | | |
| 1 | | | | | | | | | | | | | | | | | | | | | | | | | | | | | | | | | | | | | | | | | | | | | | | | | | | | | | | | | | | | | | | | | | | | | | | | | | | | | | | |
| | | | | | | | | | | | | | | | | | | | | | | | | | | | | | | | | | | | | | | | | | | | | | | | | | | | | | | | | | | | | | | | | | | | | | | | | | | | | | | | |
| | | | | | | | | | | | | | | | | | | | | | | | | | | | | | | | | | | | | | | | | | | | | | | | | | | | | | | | | | | | | | | | | | | | | | | | | | | | | | | | |
| 1 | | | | | | | | | | | | | | | | | | | | | | | | | | | | | | | | | | | | | | | | | | | | | | | | | | | | | | | | | | | | | | | | | | | | | | | | | | | | | | | |
| 2 | | | | | | | | | | | | | | | | | | | | | | | | | | | | | | | | | | | | | | | | | | | | | | | | | | | | | | | | | | | | | | | | | | | | | | | | | | | | | | | |
| | | | | | | | | | | | | | | | | | | | | | | | | | | | | | | | | | | | | | | | | | | | | | | | | | | | | | | | | | | | | | | | | | | | | | | | | | | | | | | | |
| | | | | | | | | | | | | | | | | | | | | | | | | | | | | | | | | | | | | | | | | | | | | | | | | | | | | | | | | | | | | | | | | | | | | | | | | | | | | | | | |
| | | | | | | | | | | | | | | | | | | | | | | | | | | | | | | | | | | | | | | | | | | | | | | | | | | | | | | | | | | | | | | | | | | | | | | | | | | | | | | | |
| | | | | | | | | | | | | | | | | | | | | | | | | | | | | | | | | | | | | | | | | | | | | | | | | | | | | | | | | | | | | | | | | | | | | | | | | | | | | | | | |
| | | | | | | | | | | | | | | | | | | | | | | | | | | | | | | | | | | | | | | | | | | | | | | | | | | | | | | | | | | | | | | | | | | | | | | | | | | | | | | | |
| | | | | | | | | | | | | | | | | | | | | | | | | | | | | | | | | | | | | | | | | | | | | | | | | | | | | | | | | | | | | | | | | | | | | | | | | | | | | | | | |
| | | | | | | | | | | | | | | | | | | | | | | | | | | | | | | | | | | | | | | | | | | | | | | | | | | | | | | | | | | | | | | | | | | | | | | | | | | | | | | | |
| | | | | | | | | | | | | | | | | | | | | | | | | | | | | | | | | | | | | | | | | | | | | | | | | | | | | | | | | | | | | | | | | | | | | | | | | | | | | | | | |
| | | | | | | | | | | | | | | | | | | | | | | | | | | | | | | | | | | | | | | | | | | | | | | | | | | | | | | | | | | | | | | | | | | | | | | | | | | | | | | | |
| | | | | | | | | | | | | | | | | | | | | | | | | | | | | | | | | | | | | | | | | | | | | | | | | | | | | | | | | | | | | | | | | | | | | | | | | | | | | | | | |
| | | 2 | | | | | | | | | | | | | | | | | | | | | | | | | | | | | | | | | | | | | | | | | | | | | | | | | | | | | | | | | | | | | | | | | | | | | | | | | | | | | |
| | | 1 | | | | | | | | | | | | | | | | | | | | | | | | | | | | | | | | | | | | | | | | | | | | | | | | | | | | | | | | | | | | | | | | | | | | | | | | | | | | | |
| | | | | | | | | | | | | | | | | | | | | | | | | | | | | | | | | | | | | | | | | | | | | | | | | | | | | | | | | | | | | | | | | | | | | | | | | | | | | | | | |
| | | | | | | | | | | | | | | | | | | | | | | | | | | | | | | | | | | | | | | | | | | | | | | | | | | | | | | | | | | | | | | | | | | | | | | | | | | | | | | | |
| | | | | | | | | | | | | | | | | | | | | | | | | | | | | | | | | | | | | | | | | | | | | | | | | | | | | | | | | | | | | | | | | | | | | | | | | | | | | | | | |
| | | | | | | | | | | | | | | | | | | | | | | | | | | | | | | | | | | | | | | | | | | | | | | | | | | | | | | | | | | | | | | | | | | | | | | | | | | | | | | | |
| | | | | | | | | | | | | | | | | | | | | | | | | | | | | | | | | | | | | | | | | | | | | | | | | | | | | | | | | | | | | | | | | | | | | | | | | | | | | | | | |
| | | | | | | | | | | | | | | | | | | | | | | | | | | | | | | | | | | | | | | | | | | | | | | | | | | | | | | | | | | | | | | | | | | | | | | | | | | | | | | | |
| | | | | | | | | | | | | | | | | | | | | | | | | | | | | | | | | | | | | | | | | | | | | | | | | | | | | | | | | | | | | | | | | | | | | | | | | | | | | | | | |
| Post - 0 Miss - 2 Block - 0 | Post - 0 Miss - 1 Block - 0 | Post - 1 Miss - 0 Block - 0 | Post - 0 Miss - 0 Block - 0 | Post - 1 Miss - 0 Block - 0 | Post - 0 Miss - 0 Block - 0 | Post - 0 Miss - 0 Block - 0 | Post - 0 Miss - 0 Block - 0 | | | | | | | | | | | | | | | | | | | | | | | | | | | | | | | | | | | | | | | | | | | | | | | | | | | | | | | | | | | | | | | | | | | | | | | | |



| | | |
|--------|--------|--------------|
| Team A | Team B | Match Number |
| A 江苏苏州 | B 福建龙岩 | 28 |

| | | | | |
|-----------|-------------|------------|-------|------------|
| Played in | in the hall | on | at | Spepectors |
| 安徽滁州 | 滁州国际手球馆 | 2019-06-02 | 20:00 | hours |

| | | | | | | | | | | | | | | |
|----------------|----|---|---------------------|----|---|----------------|---|---|----------------|---|---|----------------------|---|---|
| Half-time(30') | A | B | End of playing time | A | B | 1st extra time | A | B | 2nd extra time | A | B | After penalty throws | A | B |
| | 10 | 3 | | 21 | 9 | | | | | | | | | |

| | | | | | | | | | | |
|---------------|-----|---------------|-------|---|------------------------------------|---------------|-------|-------|-----|---------------|
| Number of 7 m | A | Team time-out | | | Full name of players and officials | Team time-out | | | B | Number of 7 m |
| | 1/1 | 1 | 2 | 3 | | 1 | 2 | 3 | 0/0 | |
| | | | 34:40 | | | 05:39 | 32:02 | 37:48 | | |

| No. | Team A | G | W | 2' | D | DR | No. | Team B | G | W | 2' | D | DR |
|-----|--------|---|---|----|---|----|-----|--------|---|---|----|---|----|
| 1 | 邹明轩 | | | | | | 1 | 刘子豪 | | | | | |
| 2 | 马力 | 1 | | | | | 5 | 郭雨强 | 4 | | | | |
| 4 | 孙钊 | 5 | | | | | 6 | 刘阳 | | | | | |
| 5 | 马奔 | 2 | | | | | 7 | 王晨旭 | 2 | | | | |
| 6 | 潘超群 | 4 | | | | | 8 | 杨鑫祥 | | | | | |
| 8 | 王震 | 2 | | | | | 9 | 荆胤丞 | | | | | |
| 9 | 李文俊 | 3 | 1 | | | | 10 | 赵一 | | | | | |
| 10 | 朱红雨 | 1 | | | | | 15 | 刘家良 | 1 | | | | |
| 11 | 许多 | | | | | | 16 | 李凯锋 | | | | | |
| 12 | 周文贤 | | | | | | 17 | 陈锐涛 | | | | | |
| 13 | 蒋超 | | | | | | 18 | 奚尧 | 1 | | | | |
| 14 | 刘亚力 | | | | | | 21 | 刘晓青 | | | | | |
| 15 | 刘成果 | 1 | | | | | 23 | 朱天一 | 1 | | | | |
| 18 | 何志伟 | 1 | | | | | 24 | 钟盛发 | | | 1 | | |
| 23 | 张铮洋 | 1 | | | | | 27 | 邓可钊 | | | | | |
| | | | | | | | 36 | 陈泽锟 | | | | | |
| A | 周清 | | | | | | B | 杜长义 | | | | | |
| C | 郝可鑫 | | | | | | C | 饶开发 | | | | | |
| D | 陈冬冬 | | | | | | D | 李绍南 | | | | | |
| E | 陈伟 | | | | | | | | | | | | |

| | | |
|---|--|---|
| A | Signatures of responsables for the teams (Off.A) | B |
|---|--|---|

| | | |
|----|-----------------------------------|----|
| TP | Remarks of referees / HF Official | TP |
|----|-----------------------------------|----|

| | | | |
|------------|-----------|-----------|--|
| Signatures | | | |
| Referees | 尹静阳 (CHN) | 王雨洋 (CHN) | |
| T.D. | 吴国忠 (CHN) | 李兆蒙 (CHN) | |
| CHA Off. | | | |

Note: Number of 7m Throws Awarded to Team A and B, Goals (G), Warnings (W), Suspensions (2'), Direct Disqualification (D), Disqualification With Report (DR) and Team Penalty (TP).

Table Officials: 刘洋洋 许修凯 Statisticians: 王梓衡 童佩瑶

第二届全国青年运动会男子手球乙组决赛 体校组 (U16)

PHMS Pictorial Handball Match Statistics

IHF Official System

竞赛技术统计

手球
青年男子

四分之一决赛
轮次 4

组别 X
场次 28

滁州国际手球馆
2019-06-02 20:00

| | | | |
|-----------|------------------------|---------|-------------|
| Referees: | 尹静阳 (CHN) / 王雨洋 (CHN) | Result: | 21:9 (10:3) |
| Teams: | 江苏苏州 (苏州) VS 福建龙岩 (龙岩) | | |

| 苏州 | | 远 | 近 | 边 | 快 | 突 | 任意 | 7m | 合计 | % | 助攻 | 失误 | 警告 | 2' | D+DR |
|----------|-----|-------|-----|-----|-----|-----|-----|-----|-------|------|----|----|----|----|------|
| 主教练: 陈冬冬 | | 射 | 射 | 射 | 攻 | 破 | 球 | 球 | | | | | | | |
| 1 | 邹明轩 | | | | | | | | | | | | | | |
| 2 | 马力 | | | | | | | 1/1 | 1/1 | 100 | | 1 | | | |
| 4 | 孙钊 | 3/6 | 2/2 | | | 0/1 | | | 5/9 | 55.6 | 2 | 2 | | | |
| 5 | 马奔 | | 2/3 | | | | | | 2/3 | 66.7 | | 1 | | | |
| 6 | 潘超群 | 4/7 | | | | | | | 4/7 | 57.1 | | | | | |
| 8 | 王震 | 2/6 | | | | | | | 2/6 | 33.3 | | | | | |
| 9 | 李文俊 | | | 1/1 | 2/2 | | | | 3/3 | 100 | | 1 | 1 | | |
| 10 | 朱红雨 | | | 1/1 | | | | | 1/1 | 100 | | | | | |
| 11 | 许多 | | | | | | | | | | | | | | |
| 12 | 周文贤 | | | | | | | | | | | | | | |
| 13 | 蒋超 | | | | | 0/1 | | | 0/1 | 0.0 | | | | | |
| 14 | 刘亚力 | | | | | | | | | | | | | | |
| 15 | 刘成果 | 1/1 | | | | | | | 1/1 | 100 | | | | | |
| 18 | 何志伟 | | | 0/1 | 1/1 | | | | 1/2 | 50.0 | | | | | |
| 23 | 张铮洋 | 0/1 | | | 1/2 | | | | 1/3 | 33.3 | | 1 | | | |
| 运动员 | 合计 | 10/21 | 4/5 | 2/3 | 4/6 | 0/1 | | 1/1 | 21/37 | 56.8 | 2 | 6 | 1 | | |
| 12 | 周文贤 | 3/8 | 1/4 | 3/4 | 2/2 | | 1/1 | | 10/19 | 52.6 | | | | | |
| 守门员 | 合计 | 3/8 | 1/4 | 3/4 | 2/2 | | 1/1 | | 10/19 | 52.6 | | | | | |

| 苏州 | 比赛进程 | 龙岩 |
|----------|--------------|----------|
| 1st Half | | |
| 0 | 01:12 | 1 5 郭雨强 |
| 4 | 孙钊 1 01:41 | 1 |
| 8 | 王震 2 02:57 | 1 |
| | 2 04:05 | 2 23 朱天一 |
| 4 | 孙钊 3 04:59 | 2 |
| 6 | 潘超群 4 06:50 | 2 |
| 4 | 孙钊 5 08:28 | 2 |
| | 5 08:51 | 3 5 郭雨强 |
| 6 | 潘超群 6 09:19 | 3 |
| 4 | 孙钊 7 10:08 | 3 |
| 8 | 王震 8 11:11 | 3 |
| 18 | 何志伟 9 12:26 | 3 |
| 23 | 张铮洋 10 14:53 | 3 |
| 2nd Half | | |
| 5 | 马奔 11 00:33 | 3 |
| | 11 01:02 | 4 5 郭雨强 |
| 4 | 孙钊 12 01:37 | 4 |
| | 12 02:25 | 5 5 郭雨强 |
| | 12 03:15 | 6 15 刘家良 |
| | 12 04:17 | 7 18 奚尧 |
| 5 | 马奔 13 05:06 | 7 |
| 6 | 潘超群 14 05:40 | 7 |
| 6 | 潘超群 15 07:47 | 7 |
| 9 | 李文俊 16 08:11 | 7 |
| 9 | 李文俊 17 09:11 | 7 |
| 10 | 朱红雨 18 10:12 | 7 |
| | 18 10:43 | 8 7 王晨旭 |
| 2 | 马力 19 11:14 | 8 |
| | 19 11:44 | 9 7 王晨旭 |
| 9 | 李文俊 20 13:46 | 9 |
| 15 | 刘成果 21 14:35 | 9 |

| 龙岩 | | 远 | 近 | 边 | 快 | 突 | 任意 | 7m | 合计 | % | 助攻 | 失误 | 警告 | 2' | D+DR |
|----------|-----|------|-----|-----|-----|-----|-----|-----|-------|------|----|----|----|----|------|
| 主教练: 李绍南 | | 射 | 射 | 射 | 攻 | 破 | 球 | 球 | | | | | | | |
| 1 | 刘子豪 | | | | | | | | | | | | | | |
| 5 | 郭雨强 | 4/7 | | | | | 0/1 | | 4/8 | 50.0 | | 1 | | | |
| 6 | 刘阳 | | | 0/2 | | | | | 0/2 | 0.0 | | 1 | | | |
| 7 | 王晨旭 | | 2/2 | 0/1 | | | | | 2/3 | 66.7 | | | | | |
| 8 | 杨鑫祥 | | | | | | | | | | | | | | |
| 9 | 荆胤丞 | | 0/1 | | | | | | 0/1 | 0.0 | | 1 | | | |
| 10 | 赵一 | 0/3 | | | 0/1 | 0/1 | | | 0/5 | 0.0 | 3 | 3 | | | |
| 15 | 刘家良 | 1/4 | | | | | | | 1/4 | 25.0 | | 1 | | | |
| 16 | 李凯锋 | | | | | | | | | | | | | | |
| 17 | 陈锐涛 | | | | | | | | | | | | | | |
| 18 | 奚尧 | 0/1 | | 1/1 | | | | | 1/2 | 50.0 | | 2 | | | |
| 21 | 刘晓青 | | | | | | | | | | | | | | |
| 23 | 朱天一 | | 1/1 | | | | | | 1/1 | 100 | | 2 | | | |
| 24 | 钟盛发 | | | | | | | | | | | 1 | | 1 | |
| 27 | 邓可帆 | | | | 0/1 | | | | 0/1 | 0.0 | | | | | |
| 36 | 陈泽银 | | | | | | | | | | | 1 | | | |
| 运动员 | 合计 | 5/15 | 3/4 | 1/4 | 0/2 | 0/1 | 0/1 | | 9/27 | 33.3 | 3 | 13 | | 1 | |
| 1 | 刘子豪 | 8/18 | 0/4 | 1/3 | 1/5 | 1/1 | | 0/1 | 11/32 | 34.4 | | | | | |
| 守门员 | 合计 | 8/18 | 0/4 | 1/3 | 1/5 | 1/1 | | 0/1 | 11/32 | 34.4 | | | | | |

场上队员: 得分 / 射门

守门员: 救球 / 射门

| | | | |
|---|------|----|---------|
| D | 取消资格 | DR | 取消资格+报告 |
|---|------|----|---------|



个人/全队技术统计表

手球 四分之一决赛 组别 X
青年男子 轮次 4 场次 28
滁州国际手球馆
2019-06-02 20:00

| 号码 | 姓名 | 远射 | 近射 | 边射 | 快攻 | 突破 | 任意 | 七米 | 合计 | % | 助攻 | 失误 | 警告 | 2' | 取消 | 时间 |
|----------|-----|-------|-----|-----|-----|-----|-----|-----|-------|-------|----|----|----|----|----|----------|
| 江苏苏州(苏州) | | | | | | | | | | | | | | | | |
| (场上队员) | | | | | | | | | | | | | | | | |
| 1 | 邹明轩 | | | | | | | | | 0.0% | | | | | | 00:00:00 |
| 2 | 马力 | | | | | | | 1/1 | 1/1 | 100% | | 1 | | | | 00:06:17 |
| 4 | 孙钊 | 3/6 | 2/2 | | | 0/1 | | | 5/9 | 55.6% | 2 | 2 | | | | 00:14:50 |
| 5 | 马奔 | | 2/3 | | | | | | 2/3 | 66.7% | | 1 | | | | 00:23:42 |
| 6 | 潘超群 | 4/7 | | | | | | | 4/7 | 57.1% | | | | | | 00:24:45 |
| 8 | 王震 | 2/6 | | | | | | | 2/6 | 33.3% | | | | | | 00:23:40 |
| 9 | 李文俊 | | | 1/1 | 2/2 | | | | 3/3 | 100% | | 1 | 1 | | | 00:06:16 |
| 10 | 朱红雨 | | | 1/1 | | | | | 1/1 | 100% | | | | | | 00:06:15 |
| 11 | 许多 | | | | | | | | | 0.0% | | | | | | 00:04:12 |
| 12 | 周文贤 | | | | | | | | | 0.0% | | | | | | 00:30:00 |
| 13 | 蒋超 | | | | 0/1 | | | | 0/1 | 0.0% | | | | | | 00:23:39 |
| 14 | 刘亚力 | | | | | | | | | 0.0% | | | | | | 00:04:12 |
| 15 | 刘成果 | 1/1 | | | | | | | 1/1 | 100% | | | | | | 00:05:13 |
| 18 | 何志伟 | | | 0/1 | 1/1 | | | | 1/2 | 50.0% | | | | | | 00:23:38 |
| 23 | 张铮洋 | 0/1 | | | 1/2 | | | | 1/3 | 33.3% | | 1 | | | | 00:12:37 |
| 合计 | | 10/21 | 4/5 | 2/3 | 4/6 | 0/1 | | 1/1 | 21/37 | 56.8% | 2 | 6 | 1 | | | |
| (守门员) | | | | | | | | | | | | | | | | |
| 12 | 周文贤 | 3/8 | 1/4 | 3/4 | 2/2 | | 1/1 | | 10/19 | 52.6% | | | | | | 00:30:00 |
| 合计 | | 3/8 | 1/4 | 3/4 | 2/2 | | 1/1 | | 10/19 | 52.6% | | | | | | |

场上队员： 得分/射门

守门员： 救球/射门

| 全队合计 | 得分 | 被救 | 射失 | 击柱 | 封球 | 合计 | % |
|------|----|----|----|----|----|----|--------|
| 远射 | 10 | 8 | 2 | 1 | | 21 | 47.6% |
| 近射 | 4 | | | 1 | | 5 | 80.0% |
| 边射 | 2 | 1 | | | | 3 | 66.7% |
| 快攻 | 4 | 1 | 1 | | | 6 | 66.7% |
| 突破 | | 1 | | | | 1 | 0.0% |
| 任意 | | | | | | | 0.0% |
| 七米 | 1 | | | | | 1 | 100.0% |

个人/全队技术统计表

手球 四分之一决赛 组别 X
青年男子 轮次 4 场次 28
滁州国际手球馆
2019-06-02 20:00

| 号码 | 姓名 | 远射 | 近射 | 边射 | 快攻 | 突破 | 任意 | 七米 | 合计 | % | 助攻 | 失误 | 警告 | 2' | 取消 | 时间 |
|----------|-----|------|-----|-----|-----|-----|-----|-----|-------|-------|----|----|----|----|----|----------|
| 福建龙岩(龙岩) | | | | | | | | | | | | | | | | |
| (场上队员) | | | | | | | | | | | | | | | | |
| 1 | 刘子豪 | | | | | | | | | 0.0% | | | | | | 00:30:00 |
| 5 | 郭雨强 | 4/7 | | | | | 0/1 | | 4/8 | 50.0% | | 1 | | | | 00:24:21 |
| 6 | 刘阳 | | | 0/2 | | | | | 0/2 | 0.0% | | 1 | | | | 00:09:55 |
| 7 | 王晨旭 | | 2/2 | 0/1 | | | | | 2/3 | 66.7% | | | | | | 00:18:36 |
| 8 | 杨鑫祥 | | | | | | | | | 0.0% | | | | | | 00:00:00 |
| 9 | 荆胤丞 | | 0/1 | | | | | | 0/1 | 0.0% | | 1 | | | | 00:07:40 |
| 10 | 赵一 | 0/3 | | | 0/1 | 0/1 | | | 0/5 | 0.0% | 3 | 3 | | | | 00:30:00 |
| 15 | 刘家良 | 1/4 | | | | | | | 1/4 | 25.0% | | 1 | | | | 00:23:12 |
| 16 | 李凯锋 | | | | | | | | | 0.0% | | | | | | 00:00:00 |
| 17 | 陈锐涛 | | | | | | | | | 0.0% | | | | | | 00:00:00 |
| 18 | 奚尧 | 0/1 | | 1/1 | | | | | 1/2 | 50.0% | | 2 | | | | 00:30:00 |
| 21 | 刘晓青 | | | | | | | | | 0.0% | | | | | | 00:00:00 |
| 23 | 朱天一 | | 1/1 | | | | | | 1/1 | 100% | | 2 | | | | 00:23:18 |
| 24 | 钟盛发 | | | | | | | | | 0.0% | | 1 | | 1 | | 00:05:04 |
| 27 | 邓可钊 | | | | 0/1 | | | | 0/1 | 0.0% | | | | | | 00:07:02 |
| 36 | 陈泽锟 | | | | | | | | | 0.0% | | 1 | | | | 00:00:41 |
| 合计 | | 5/15 | 3/4 | 1/4 | 0/2 | 0/1 | 0/1 | | 9/27 | 33.3% | 3 | 13 | | 1 | | |
| (守门员) | | | | | | | | | | | | | | | | |
| 1 | 刘子豪 | 8/18 | 0/4 | 1/3 | 1/5 | 1/1 | | 0/1 | 11/32 | 34.4% | | | | | | 00:30:00 |
| 合计 | | 8/18 | 0/4 | 1/3 | 1/5 | 1/1 | | 0/1 | 11/32 | 34.4% | | | | | | |

场上队员：得分/射门

守门员：救球/射门

| 全队合计 | 得分 | 被救 | 射失 | 击柱 | 封球 | 合计 | % |
|------|----|----|----|----|----|----|-------|
| 远射 | 5 | 3 | 4 | 1 | 2 | 15 | 33.3% |
| 近射 | 3 | 1 | | | | 4 | 75.0% |
| 边射 | 1 | 3 | | | | 4 | 25.0% |
| 快攻 | | 2 | | | | 2 | 0.0% |
| 突破 | | | 1 | | | 1 | 0.0% |
| 任意 | | 1 | | | | 1 | 0.0% |
| 七米 | | | | | | | 0.0% |

图式比赛技术统计表

手球
青年男子

四分之一决赛
轮次 4

组别 X
场次 28

滁州国际手球馆
2019-06-02 20:00

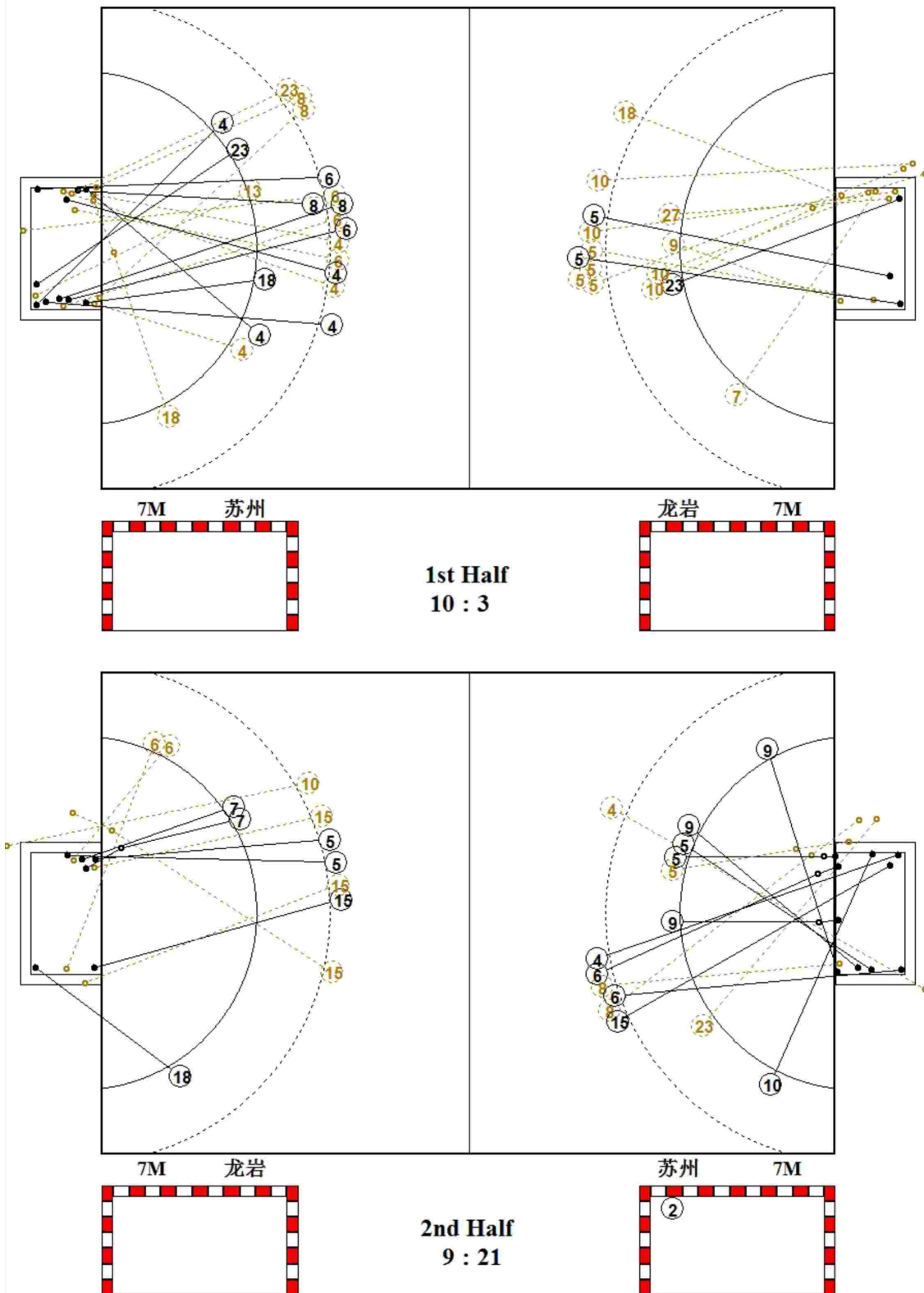

图式射门区域统计

手球
青年男子

四分之一决赛
轮次 4

组别 X
场次 28

滁州国际手球馆
2019-06-02 20:00

江苏苏州

| | | | | | | | |
|--------------------------------------|--|--|---|--|---|--|--|
| 1 邹明轩 Post - 0 Miss - 0 Block - 0 | 2 马力 1 Post - 0 Miss - 0 Block - 0 | 4 孙轲 3 1 1 Post - 0 Miss - 1 Block - 0 | 5 马奔 1 1 Post - 1 Miss - 0 Block - 0 | 6 潘超群 1 1 Post - 1 Miss - 0 Block - 0 | 8 王震 1 1 Post - 0 Miss - 1 Block - 0 | 9 李文俊 1 1 Post - 0 Miss - 0 Block - 0 | 10 朱红雨 1 Post - 0 Miss - 0 Block - 0 |
| 11 许多 Post - 0 Miss - 0 Block - 0 | 12 周文贤 Post - 0 Miss - 0 Block - 0 | 13 蒋超 Post - 0 Miss - 0 Block - 0 | 14 刘亚力 Post - 0 Miss - 0 Block - 0 | 15 刘成果 1 Post - 0 Miss - 0 Block - 0 | 18 何志伟 1 Post - 0 Miss - 0 Block - 0 | 23 张铮洋 1 Post - 0 Miss - 1 Block - 0 | |

12 周文贤

| | |
|-----|-----|
| 2/4 | 0/2 |
| 3/3 | 2/3 |
| 1/2 | 2/5 |

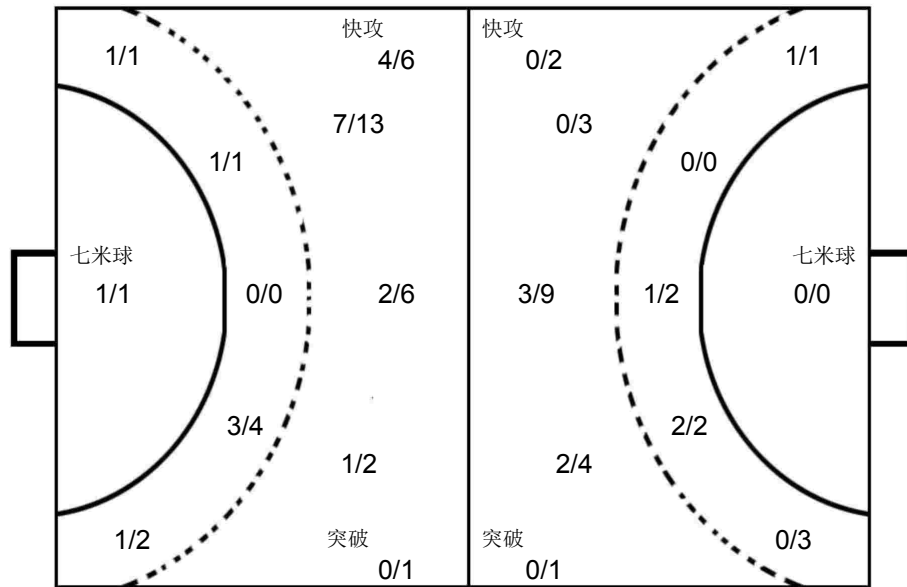

1 刘子豪

| | |
|-----|-----|
| 1/7 | 0/2 |
| 1/4 | 3/7 |
| 2/5 | 0/1 |
| | 4/6 |

福建龙岩

| | | | | | | | |
|---------------------------------------|---|---|---|--|---------------------------------------|---------------------------------------|--|
| 1 刘子豪 Post - 0 Miss - 0 Block - 0 | 5 郭雨强 2 1 1 Post - 0 Miss - 1 Block - 2 | 6 刘阳 Post - 0 Miss - 0 Block - 0 | 7 王晨旭 2 Post - 0 Miss - 0 Block - 0 | 8 杨鑫祥 Post - 0 Miss - 0 Block - 0 | 9 荆胤丞 Post - 0 Miss - 0 Block - 0 | 10 赵一 Post - 0 Miss - 3 Block - 0 | 15 刘家良 1 Post - 1 Miss - 1 Block - 0 |
| 16 李凯锋 Post - 0 Miss - 0 Block - 0 | 17 陈锐涛 Post - 0 Miss - 0 Block - 0 | 18 奚尧 1 Post - 0 Miss - 0 Block - 0 | 21 刘晓青 Post - 0 Miss - 0 Block - 0 | 23 朱天一 1 Post - 0 Miss - 0 Block - 0 | 24 钟盛发 Post - 0 Miss - 0 Block - 0 | 27 邓可钊 Post - 0 Miss - 0 Block - 0 | 36 陈泽锟 Post - 0 Miss - 0 Block - 0 |

PHMS Pictorial Handball Match Statistics **IHF** Official System

| | | |
|--------|--------|--------------|
| Team A | Team B | Match Number |
| A 山东济南 | B 辽宁抚顺 | 32 |

| | | | | |
|-----------|-------------|------------|-------|------------|
| Played in | in the hall | on | at | Spepectors |
| 安徽滁州 | 滁州国际手球馆 | 2019-06-04 | 14:00 | hours |

| | | | | | | | | | | | | | | |
|----------------|---|----|---------------------|---|----|----------------|---|---|----------------|---|---|----------------------|---|---|
| Half-time(30') | A | B | End of playing time | A | B | 1st extra time | A | B | 2nd extra time | A | B | After penalty throws | A | B |
| | 3 | 10 | | 7 | 21 | | | | | | | | | |

| | | | | | | | | | | |
|---------------|-----|---------------|---|---|------------------------------------|---------------|---|-------|-----|---------------|
| Number of 7 m | A | Team time-out | | | Full name of players and officials | Team time-out | | | B | Number of 7 m |
| | 1/1 | 1 | 2 | 3 | | 1 | 2 | 3 | 1/4 | |
| | | 08:37 | | | | | | 39:11 | | |

| No. | Team A | G | W | 2' | D | DR | No. | Team B | G | W | 2' | D | DR |
|-----|--------|---|---|----|---|----|-----|--------|---|---|----|---|----|
| 1 | 刘在攀 | | | | | | 2 | 赫天铭 | 1 | | | | |
| 4 | 张广一 | | | | | | 5 | 王梓翹 | | | | | |
| 6 | 刘尊哲 | 2 | 1 | | | | 6 | 尚禹辰 | 1 | | | | |
| 7 | 王帅 | | | | | | 7 | 张羽虹冰 | 1 | | | | |
| 8 | 金正凯 | | | | | | 9 | 隋博 | 3 | | | | |
| 9 | 张嘉树 | 2 | | | | | 11 | 陈思 | | | | | |
| 10 | 颜同霖 | | | 1 | | | 13 | 高鑫 | 7 | | | | |
| 11 | 李延舒 | | 1 | | | | 17 | 杨宇 | 4 | | | | |
| 13 | 刘振宇 | 1 | | | | | 19 | 靳皓童 | 1 | | | | |
| 16 | 高宇轩 | | | | | | 22 | 杨辰 | | | | | |
| 17 | 张昊 | | | | | | 28 | 靳皓添 | 3 | | | | |
| 21 | 杨明毅 | 2 | | 1 | | | 32 | 袁梓赫 | | | | | |
| 24 | 于昊 | | | | | | | | | | | | |
| 26 | 曹立志 | | | | | | | | | | | | |
| 40 | 鹿智豪 | | | | | | | | | | | | |
| 88 | 王麒翔 | | | | | | | | | | | | |

| | | | | | | | | | | | | | |
|---|-----------|--|--|--|--|--|---|-----|--|--|--|--|--|
| A | 李楠 | | | | | | C | 刘启迪 | | | | | |
| B | 陈鹏波 (主教练) | | | | | | | | | | | | |
| C | 陶丛龙 | | | | | | | | | | | | |
| E | 郭军旗 | | | | | | | | | | | | |

| | | |
|---|--|---|
| A | Signatures of responsables for the teams (Off.A) | B |
|---|--|---|

| | | |
|----|-----------------------------------|----|
| TP | Remarks of referees / HF Official | TP |
| | | |
| | | |
| | | |

| | | | |
|------------|-----------|-----------|--|
| Signatures | | | |
| Referees | 许翔 (CHN) | 刘禹 (CHN) | |
| T.D. | 李兆蒙 (CHN) | 许宜扬 (CHN) | |
| CHA Off. | | | |

Note: Number of 7m Throws Awarded to Team A and B, Goals (G), Warnings (W), Suspensions (2'), Direct Disqualification (D), Disqualification With Report (DR) and Team Penalty (TP).

Table Officials: 刘洋洋 许修凯 Statisticians: 马安兴 沈家洛

第二届全国青年运动会男子手球乙组决赛 体校组 (U16)

PHMS Pictorial Handball Match Statistics

IHF Official System

竞赛技术统计

手球
青年男子

5-8名
轮次 5

组别 X
场次 32

滁州国际手球馆
2019-06-04 14:00

| | | | |
|-----------|----------------------|---------|-------------|
| Referees: | 许翔 (CHN) / 刘禹 (CHN) | Result: | 7:21 (3:10) |
| Teams: | 山东济南(济南) VS 辽宁抚顺(抚顺) | | |

| 济南 | | 远射 | 近射 | 边射 | 快攻 | 突破 | 任意球 | 7m球 | 合计 | % | 助攻 | 失误 | 警告 | 2' | D+DR |
|----------|-----|------|------|-----|-----|-----|-----|-----|------|------|----|----|----|----|------|
| 主教练: 陈鹏波 | | | | | | | | | | | | | | | |
| 1 | 刘在攀 | | | | | | | | | | | | | | |
| 4 | 张广一 | 0/1 | 0/2 | 0/2 | | | | | 0/5 | 0.0 | | 1 | | | |
| 6 | 刘尊哲 | 0/4 | | | 1/1 | | | 1/1 | 2/6 | 33.3 | | 2 | 1 | | |
| 7 | 王帅 | 0/3 | | 0/1 | | | | | 0/4 | 0.0 | | 1 | | | |
| 8 | 金正凯 | | | 0/1 | | | | | 0/1 | 0.0 | | | | | |
| 9 | 张嘉树 | 1/2 | | | | 1/1 | | | 2/3 | 66.7 | | | | | |
| 10 | 颜同霖 | 0/1 | | | | | 0/1 | | 0/2 | 0.0 | | | | 1 | |
| 11 | 李延舒 | | | | | | | | | | | | 1 | | |
| 13 | 刘振宇 | 0/3 | 1/1 | | | | 0/1 | | 1/5 | 20.0 | | 2 | | | |
| 16 | 高宇轩 | | | | | | | | | | | | | | |
| 17 | 张昊 | | | | | | | | | | | | | | |
| 21 | 杨明毅 | 1/1 | 1/1 | | | | | | 2/2 | 100 | | 3 | | 1 | |
| 24 | 于昊 | | | | | | | | | | | 1 | | | |
| 26 | 曹立志 | | | | | | | | | | | | | | |
| 40 | 鹿智豪 | | | | | | | | | | | | | | |
| 88 | 王麒麟 | | | | | | | | | | | | | | |
| 运动员 | 合计 | 2/15 | 2/4 | 0/4 | 1/1 | 1/1 | 0/2 | 1/1 | 7/28 | 25.0 | | 10 | 2 | 2 | |
| 1 | 刘在攀 | 1/3 | 3/14 | 0/4 | 0/2 | | 0/1 | 2/3 | 6/27 | 22.2 | | | | | |
| 守门员 | 合计 | 1/3 | 3/14 | 0/4 | 0/2 | | 0/1 | 2/3 | 6/27 | 22.2 | | | | | |

| 济南 | 比赛进程 | 抚顺 |
|----------|-------|-----------|
| 1st Half | | |
| 0 | 01:11 | 1 13 高鑫 |
| 0 | 01:59 | 2 28 靳皓添 |
| 6 | 03:39 | 2 |
| 1 | 04:09 | 3 17 杨宇 |
| 6 | 04:57 | 3 |
| 2 | 06:27 | 4 9 隋博 |
| 2 | 07:32 | 5 9 隋博 |
| 2 | 08:31 | 6 17 杨宇 |
| 2 | 11:08 | 7 13 高鑫 |
| 2 | 12:22 | 8 13 高鑫 |
| 2 | 14:18 | 9 28 靳皓添 |
| 13 | 14:28 | 9 |
| 3 | 14:44 | 10 17 杨宇 |
| 2nd Half | | |
| 3 | 02:35 | 11 9 隋博 |
| 3 | 02:50 | 12 13 高鑫 |
| 3 | 03:29 | 13 28 靳皓添 |
| 3 | 04:17 | 14 19 靳皓童 |
| 3 | 05:14 | 15 13 高鑫 |
| 9 | 05:44 | 15 |
| 4 | 06:04 | 16 6 尚禹辰 |
| 9 | 08:14 | 16 |
| 21 | 08:39 | 16 |
| 6 | 09:33 | 17 13 高鑫 |
| 21 | 10:48 | 17 |
| 7 | 11:23 | 18 13 高鑫 |
| 7 | 12:42 | 19 2 赫天铭 |
| 7 | 13:23 | 20 7 张羽虹冰 |
| 7 | 14:32 | 21 17 杨宇 |

| 抚顺 | | 远射 | 近射 | 边射 | 快攻 | 突破 | 任意球 | 7m球 | 合计 | % | 助攻 | 失误 | 警告 | 2' | D+DR |
|---------|------|-----|-------|-----|-----|-----|-----|-----|-------|------|----|----|----|----|------|
| 主教练: 徐毅 | | | | | | | | | | | | | | | |
| 2 | 赫天铭 | | 1/1 | | | | | | 1/1 | 100 | | | | | |
| 5 | 王梓翹 | | | | | | | | | | | | | | |
| 6 | 尚禹辰 | | 1/1 | | | | | | 1/1 | 100 | | 1 | | | |
| 7 | 张羽虹冰 | | | 1/1 | | | | | 1/1 | 100 | | | | | |
| 9 | 隋博 | | | 3/3 | | | | | 3/3 | 100 | | | | | |
| 11 | 陈思 | | | | | | | | | | | | | | |
| 13 | 高鑫 | 1/1 | 4/5 | | 1/1 | | | 1/4 | 7/11 | 63.6 | 1 | 1 | | | |
| 17 | 杨宇 | 1/2 | 1/1 | | 1/1 | | 1/1 | | 4/5 | 80.0 | 1 | 2 | | | |
| 19 | 靳皓童 | | 1/3 | | | | 0/1 | | 1/4 | 25.0 | 2 | 3 | | | |
| 22 | 杨辰 | | | | | | | | | | | | | | |
| 28 | 靳皓添 | | 3/4 | | | | | | 3/4 | 75.0 | | 2 | | | |
| 32 | 袁梓赫 | | | | | | | | | | | | | | |
| 运动员 | 合计 | 2/3 | 11/15 | 4/4 | 2/2 | | 1/2 | 1/4 | 21/30 | 70.0 | 4 | 9 | | | |
| 2 | 赫天铭 | 3/5 | 2/4 | 3/3 | 0/1 | 0/1 | | 0/1 | 8/15 | 53.3 | | | | | |
| 32 | 袁梓赫 | | | | | | | | | | | | | | |
| 守门员 | 合计 | 3/5 | 2/4 | 3/3 | 0/1 | 0/1 | | 0/1 | 8/15 | 53.3 | | | | | |

场上队员: 得分 / 射门

守门员: 救球 / 射门

| | | | |
|---|------|----|---------|
| D | 取消资格 | DR | 取消资格+报告 |
|---|------|----|---------|



个人/全队技术统计表

手球 5-8名 组别 X 滁州国际手球馆
青年男子 轮次 5 场次 32 2019-06-04 14:00

| 号码 | 姓名 | 远射 | 近射 | 边射 | 快攻 | 突破 | 任意 | 七米 | 合计 | % | 助攻 | 失误 | 警告 | 2' | 取消 | 时间 |
|----------|-----|------|------|-----|-----|-----|-----|-----|------|-------|----|----|----|----|----|----------|
| 山东济南(济南) | | | | | | | | | | | | | | | | |
| (场上队员) | | | | | | | | | | | | | | | | |
| 1 | 刘在攀 | | | | | | | | | 0.0% | | | | | | 00:30:00 |
| 4 | 张广一 | 0/1 | 0/2 | 0/2 | | | | | 0/5 | 0.0% | 1 | | | | | 00:16:08 |
| 6 | 刘尊哲 | 0/4 | | | 1/1 | | | 1/1 | 2/6 | 33.3% | 2 | 1 | | | | 00:15:00 |
| 7 | 王帅 | 0/3 | | 0/1 | | | | | 0/4 | 0.0% | 1 | | | | | 00:24:25 |
| 8 | 金正凯 | | | 0/1 | | | | | 0/1 | 0.0% | | | | | | 00:15:00 |
| 9 | 张嘉树 | 1/2 | | | | 1/1 | | | 2/3 | 66.7% | | | | | | 00:17:18 |
| 10 | 颜同霖 | 0/1 | | | | | 0/1 | | 0/2 | 0.0% | | | | 1 | | 00:12:41 |
| 11 | 李延舒 | | | | | | | | | 0.0% | | | 1 | | | 00:15:00 |
| 13 | 刘振宇 | 0/3 | 1/1 | | | | 0/1 | | 1/5 | 20.0% | 2 | | | | | 00:17:02 |
| 16 | 高宇轩 | | | | | | | | | 0.0% | | | | | | 00:00:00 |
| 17 | 张昊 | | | | | | | | | 0.0% | | | | | | 00:00:00 |
| 21 | 杨明毅 | 1/1 | 1/1 | | | | | | 2/2 | 100% | 3 | | | 1 | | 00:15:00 |
| 24 | 于昊 | | | | | | | | | 0.0% | 1 | | | | | 00:17:08 |
| 26 | 曹立志 | | | | | | | | | 0.0% | | | | | | 00:15:00 |
| 40 | 鹿智豪 | | | | | | | | | 0.0% | | | | | | 00:00:00 |
| 88 | 王麒翔 | | | | | | | | | 0.0% | | | | | | 00:00:00 |
| | 合计 | 2/15 | 2/4 | 0/4 | 1/1 | 1/1 | 0/2 | 1/1 | 7/28 | 25.0% | 10 | 2 | | 2 | | |
| (守门员) | | | | | | | | | | | | | | | | |
| 1 | 刘在攀 | 1/3 | 3/14 | 0/4 | 0/2 | | 0/1 | 2/3 | 6/27 | 22.2% | | | | | | 00:30:00 |
| | 合计 | 1/3 | 3/14 | 0/4 | 0/2 | | 0/1 | 2/3 | 6/27 | 22.2% | | | | | | |

场上队员：得分/射门

守门员：救球/射门

| 全队合计 | 得分 | 被救 | 射失 | 击柱 | 封球 | 合计 | % |
|------|----|----|----|----|----|----|--------|
| 远射 | 2 | 3 | 6 | 2 | 2 | 15 | 13.3% |
| 近射 | 2 | 2 | | | | 4 | 50.0% |
| 边射 | | 3 | 1 | | | 4 | 0.0% |
| 快攻 | 1 | | | | | 1 | 100.0% |
| 突破 | 1 | | | | | 1 | 100.0% |
| 任意 | | | 1 | 1 | | 2 | 0.0% |
| 七米 | 1 | | | | | 1 | 100.0% |

个人/全队技术统计表

手球 5-8名 组别 X 滁州国际手球馆
青年男子 轮次 5 场次 32 2019-06-04 14:00

| 号码 | 姓名 | 远射 | 近射 | 边射 | 快攻 | 突破 | 任意 | 七米 | 合计 | % | 助攻 | 失误 | 警告 | 2' | 取消 | 时间 |
|----------|------|-----|-------|-----|-----|----|-----|-----|-------|-------|----|----|----|----|----|----------|
| 辽宁抚顺(抚顺) | | | | | | | | | | | | | | | | |
| (场上队员) | | | | | | | | | | | | | | | | |
| 2 | 赫天铭 | | 1/1 | | | | | | 1/1 | 100% | | | | | | 00:28:49 |
| 5 | 王梓翹 | | | | | | | | | 0.0% | | | | | | 00:04:09 |
| 6 | 尚禹辰 | | 1/1 | | | | | | 1/1 | 100% | | 1 | | | | 00:27:30 |
| 7 | 张羽虹冰 | | | 1/1 | | | | | 1/1 | 100% | | | | | | 00:09:09 |
| 9 | 隋博 | | | 3/3 | | | | | 3/3 | 100% | | | | | | 00:20:50 |
| 11 | 陈思 | | | | | | | | | 0.0% | | | | | | 00:02:29 |
| 13 | 高鑫 | 1/1 | 4/5 | | 1/1 | | | 1/4 | 7/11 | 63.6% | 1 | 1 | | | | 00:30:00 |
| 17 | 杨宇 | 1/2 | 1/1 | | 1/1 | | 1/1 | | 4/5 | 80.0% | 1 | 2 | | | | 00:30:00 |
| 19 | 靳皓童 | | 1/3 | | | | 0/1 | | 1/4 | 25.0% | 2 | 3 | | | | 00:30:00 |
| 22 | 杨辰 | | | | | | | | | 0.0% | | | | | | 00:00:00 |
| 28 | 靳皓添 | | 3/4 | | | | | | 3/4 | 75.0% | | 2 | | | | 00:25:49 |
| 32 | 袁梓赫 | | | | | | | | | 0.0% | | | | | | 00:01:11 |
| 合计 | | 2/3 | 11/15 | 4/4 | 2/2 | | 1/2 | 1/4 | 21/30 | 70.0% | 4 | 9 | | | | |

| | | | | | | | | | | | | | | | | |
|-------|-----|-----|-----|-----|-----|-----|--|-----|------|-------|--|--|--|--|--|----------|
| (守门员) | | | | | | | | | | | | | | | | |
| 2 | 赫天铭 | 3/5 | 2/4 | 3/3 | 0/1 | 0/1 | | 0/1 | 8/15 | 53.3% | | | | | | 00:28:49 |
| 32 | 袁梓赫 | | | | | | | | | 0.0% | | | | | | 00:01:11 |
| 合计 | | 3/5 | 2/4 | 3/3 | 0/1 | 0/1 | | 0/1 | 8/15 | 53.3% | | | | | | |

场上队员：得分/射门

守门员：救球/射门

| 全队合计 | 得分 | 被救 | 射失 | 击柱 | 封球 | 合计 | % |
|------|----|----|----|----|----|----|--------|
| 远射 | 2 | 1 | | | | 3 | 66.7% |
| 近射 | 11 | 3 | | 1 | | 15 | 73.3% |
| 边射 | 4 | | | | | 4 | 100.0% |
| 快攻 | 2 | | | | | 2 | 100.0% |
| 突破 | | | | | | | 0.0% |
| 任意 | 1 | | 1 | | | 2 | 50.0% |
| 七米 | 1 | 2 | 1 | | | 4 | 25.0% |

图式比赛技术统计表

手球
青年男子

5-8名
轮次 5

组别 X
场次 32

滁州国际手球馆
2019-06-04 14:00

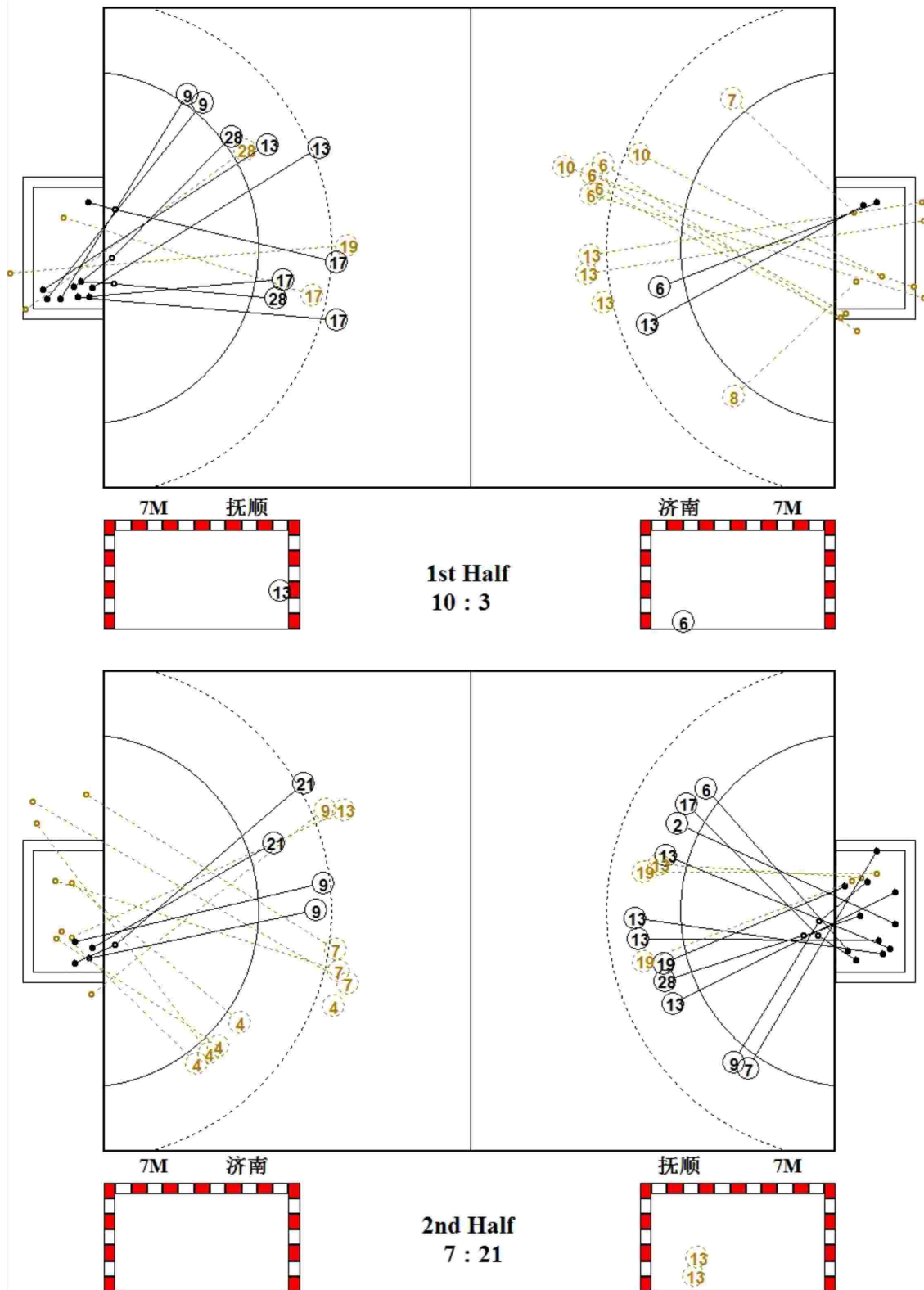

图式射门区域统计

手球
青年男子

5-8名
轮次 5

组别 X
场次 32

滁州国际手球馆
2019-06-04 14:00

山东济南

| | | | | | | | | | | | | | | | | | | | | | | | | | | | | | | | | | | | | | | | | | | | | | | | | | | | | | | | | | | | | | | | | | | | | | | | | | | | | | | | |
|---|-----------------------------|-----------------------------|-----------------------------|-----------------------------|-----------------------------|-----------------------------|-----------------------------|--|--|--|--|--|--|--|--|--|--|--|--|--|--|--|--|---|--|--|---|--|--|--|--|--|--|---|--|--|---|--|--|--|--|--|--|--|--|--|--|--|--|--|--|--|--|---|--|--|---|--|--|--|--|--|--|--|--|--|--|--|--|--|--|--|--|--|--|--|--|--|--|
| 1 刘在攀 | 4 张广一 | 6 刘尊哲 | 7 王帅 | 8 金正凯 | 9 张嘉树 | 10 颜同霖 | 11 李延舒 | | | | | | | | | | | | | | | | | | | | | | | | | | | | | | | | | | | | | | | | | | | | | | | | | | | | | | | | | | | | | | | | | | | | | | | | |
| <table border="1"><tr><td></td><td></td><td></td></tr><tr><td></td><td></td><td></td></tr><tr><td></td><td></td><td></td></tr></table> | | | | | | | | | | <table border="1"><tr><td></td><td></td><td></td></tr><tr><td></td><td></td><td></td></tr><tr><td></td><td></td><td></td></tr></table> | | | | | | | | | | <table border="1"><tr><td></td><td></td><td></td></tr><tr><td>1</td><td></td><td></td></tr><tr><td>1</td><td></td><td></td></tr></table> | | | | 1 | | | 1 | | | <table border="1"><tr><td></td><td></td><td></td></tr><tr><td></td><td></td><td></td></tr><tr><td></td><td></td><td></td></tr></table> | | | | | | | | | | <table border="1"><tr><td></td><td></td><td></td></tr><tr><td></td><td></td><td></td></tr><tr><td></td><td></td><td></td></tr></table> | | | | | | | | | | <table border="1"><tr><td></td><td></td><td></td></tr><tr><td>1</td><td></td><td></td></tr><tr><td>1</td><td></td><td></td></tr></table> | | | | 1 | | | 1 | | | <table border="1"><tr><td></td><td></td><td></td></tr><tr><td></td><td></td><td></td></tr><tr><td></td><td></td><td></td></tr></table> | | | | | | | | | | <table border="1"><tr><td></td><td></td><td></td></tr><tr><td></td><td></td><td></td></tr><tr><td></td><td></td><td></td></tr></table> | | | | | | | | | |
| | | | | | | | | | | | | | | | | | | | | | | | | | | | | | | | | | | | | | | | | | | | | | | | | | | | | | | | | | | | | | | | | | | | | | | | | | | | | | | | |
| | | | | | | | | | | | | | | | | | | | | | | | | | | | | | | | | | | | | | | | | | | | | | | | | | | | | | | | | | | | | | | | | | | | | | | | | | | | | | | | |
| | | | | | | | | | | | | | | | | | | | | | | | | | | | | | | | | | | | | | | | | | | | | | | | | | | | | | | | | | | | | | | | | | | | | | | | | | | | | | | | |
| | | | | | | | | | | | | | | | | | | | | | | | | | | | | | | | | | | | | | | | | | | | | | | | | | | | | | | | | | | | | | | | | | | | | | | | | | | | | | | | |
| | | | | | | | | | | | | | | | | | | | | | | | | | | | | | | | | | | | | | | | | | | | | | | | | | | | | | | | | | | | | | | | | | | | | | | | | | | | | | | | |
| | | | | | | | | | | | | | | | | | | | | | | | | | | | | | | | | | | | | | | | | | | | | | | | | | | | | | | | | | | | | | | | | | | | | | | | | | | | | | | | |
| | | | | | | | | | | | | | | | | | | | | | | | | | | | | | | | | | | | | | | | | | | | | | | | | | | | | | | | | | | | | | | | | | | | | | | | | | | | | | | | |
| 1 | | | | | | | | | | | | | | | | | | | | | | | | | | | | | | | | | | | | | | | | | | | | | | | | | | | | | | | | | | | | | | | | | | | | | | | | | | | | | | | |
| 1 | | | | | | | | | | | | | | | | | | | | | | | | | | | | | | | | | | | | | | | | | | | | | | | | | | | | | | | | | | | | | | | | | | | | | | | | | | | | | | | |
| | | | | | | | | | | | | | | | | | | | | | | | | | | | | | | | | | | | | | | | | | | | | | | | | | | | | | | | | | | | | | | | | | | | | | | | | | | | | | | | |
| | | | | | | | | | | | | | | | | | | | | | | | | | | | | | | | | | | | | | | | | | | | | | | | | | | | | | | | | | | | | | | | | | | | | | | | | | | | | | | | |
| | | | | | | | | | | | | | | | | | | | | | | | | | | | | | | | | | | | | | | | | | | | | | | | | | | | | | | | | | | | | | | | | | | | | | | | | | | | | | | | |
| | | | | | | | | | | | | | | | | | | | | | | | | | | | | | | | | | | | | | | | | | | | | | | | | | | | | | | | | | | | | | | | | | | | | | | | | | | | | | | | |
| | | | | | | | | | | | | | | | | | | | | | | | | | | | | | | | | | | | | | | | | | | | | | | | | | | | | | | | | | | | | | | | | | | | | | | | | | | | | | | | |
| | | | | | | | | | | | | | | | | | | | | | | | | | | | | | | | | | | | | | | | | | | | | | | | | | | | | | | | | | | | | | | | | | | | | | | | | | | | | | | | |
| | | | | | | | | | | | | | | | | | | | | | | | | | | | | | | | | | | | | | | | | | | | | | | | | | | | | | | | | | | | | | | | | | | | | | | | | | | | | | | | |
| 1 | | | | | | | | | | | | | | | | | | | | | | | | | | | | | | | | | | | | | | | | | | | | | | | | | | | | | | | | | | | | | | | | | | | | | | | | | | | | | | | |
| 1 | | | | | | | | | | | | | | | | | | | | | | | | | | | | | | | | | | | | | | | | | | | | | | | | | | | | | | | | | | | | | | | | | | | | | | | | | | | | | | | |
| | | | | | | | | | | | | | | | | | | | | | | | | | | | | | | | | | | | | | | | | | | | | | | | | | | | | | | | | | | | | | | | | | | | | | | | | | | | | | | | |
| | | | | | | | | | | | | | | | | | | | | | | | | | | | | | | | | | | | | | | | | | | | | | | | | | | | | | | | | | | | | | | | | | | | | | | | | | | | | | | | |
| | | | | | | | | | | | | | | | | | | | | | | | | | | | | | | | | | | | | | | | | | | | | | | | | | | | | | | | | | | | | | | | | | | | | | | | | | | | | | | | |
| | | | | | | | | | | | | | | | | | | | | | | | | | | | | | | | | | | | | | | | | | | | | | | | | | | | | | | | | | | | | | | | | | | | | | | | | | | | | | | | |
| | | | | | | | | | | | | | | | | | | | | | | | | | | | | | | | | | | | | | | | | | | | | | | | | | | | | | | | | | | | | | | | | | | | | | | | | | | | | | | | |
| | | | | | | | | | | | | | | | | | | | | | | | | | | | | | | | | | | | | | | | | | | | | | | | | | | | | | | | | | | | | | | | | | | | | | | | | | | | | | | | |
| Post - 0 Miss - 0 Block - 0 | Post - 0 Miss - 1 Block - 1 | Post - 2 Miss - 2 Block - 0 | Post - 0 Miss - 2 Block - 0 | Post - 0 Miss - 0 Block - 0 | Post - 0 Miss - 1 Block - 0 | Post - 1 Miss - 0 Block - 0 | Post - 0 Miss - 0 Block - 0 | | | | | | | | | | | | | | | | | | | | | | | | | | | | | | | | | | | | | | | | | | | | | | | | | | | | | | | | | | | | | | | | | | | | | | | | |
| 13 刘振宇 | 16 高宇轩 | 17 张昊 | 21 杨明毅 | 24 于昊 | 26 曹立志 | 40 鹿智豪 | 88 王麒麟 | | | | | | | | | | | | | | | | | | | | | | | | | | | | | | | | | | | | | | | | | | | | | | | | | | | | | | | | | | | | | | | | | | | | | | | | |
| <table border="1"><tr><td>1</td><td></td><td></td></tr><tr><td></td><td></td><td></td></tr><tr><td></td><td></td><td></td></tr></table> | 1 | | | | | | | | | <table border="1"><tr><td></td><td></td><td></td></tr><tr><td></td><td></td><td></td></tr><tr><td></td><td></td><td></td></tr></table> | | | | | | | | | | <table border="1"><tr><td></td><td></td><td></td></tr><tr><td></td><td></td><td></td></tr><tr><td></td><td></td><td></td></tr></table> | | | | | | | | | | <table border="1"><tr><td></td><td></td><td></td></tr><tr><td>1</td><td></td><td></td></tr><tr><td>1</td><td></td><td></td></tr></table> | | | | 1 | | | 1 | | | <table border="1"><tr><td></td><td></td><td></td></tr><tr><td></td><td></td><td></td></tr><tr><td></td><td></td><td></td></tr></table> | | | | | | | | | | <table border="1"><tr><td></td><td></td><td></td></tr><tr><td></td><td></td><td></td></tr><tr><td></td><td></td><td></td></tr></table> | | | | | | | | | | <table border="1"><tr><td></td><td></td><td></td></tr><tr><td></td><td></td><td></td></tr><tr><td></td><td></td><td></td></tr></table> | | | | | | | | | | <table border="1"><tr><td></td><td></td><td></td></tr><tr><td></td><td></td><td></td></tr><tr><td></td><td></td><td></td></tr></table> | | | | | | | | | |
| 1 | | | | | | | | | | | | | | | | | | | | | | | | | | | | | | | | | | | | | | | | | | | | | | | | | | | | | | | | | | | | | | | | | | | | | | | | | | | | | | | |
| | | | | | | | | | | | | | | | | | | | | | | | | | | | | | | | | | | | | | | | | | | | | | | | | | | | | | | | | | | | | | | | | | | | | | | | | | | | | | | | |
| | | | | | | | | | | | | | | | | | | | | | | | | | | | | | | | | | | | | | | | | | | | | | | | | | | | | | | | | | | | | | | | | | | | | | | | | | | | | | | | |
| | | | | | | | | | | | | | | | | | | | | | | | | | | | | | | | | | | | | | | | | | | | | | | | | | | | | | | | | | | | | | | | | | | | | | | | | | | | | | | | |
| | | | | | | | | | | | | | | | | | | | | | | | | | | | | | | | | | | | | | | | | | | | | | | | | | | | | | | | | | | | | | | | | | | | | | | | | | | | | | | | |
| | | | | | | | | | | | | | | | | | | | | | | | | | | | | | | | | | | | | | | | | | | | | | | | | | | | | | | | | | | | | | | | | | | | | | | | | | | | | | | | |
| | | | | | | | | | | | | | | | | | | | | | | | | | | | | | | | | | | | | | | | | | | | | | | | | | | | | | | | | | | | | | | | | | | | | | | | | | | | | | | | |
| | | | | | | | | | | | | | | | | | | | | | | | | | | | | | | | | | | | | | | | | | | | | | | | | | | | | | | | | | | | | | | | | | | | | | | | | | | | | | | | |
| | | | | | | | | | | | | | | | | | | | | | | | | | | | | | | | | | | | | | | | | | | | | | | | | | | | | | | | | | | | | | | | | | | | | | | | | | | | | | | | |
| | | | | | | | | | | | | | | | | | | | | | | | | | | | | | | | | | | | | | | | | | | | | | | | | | | | | | | | | | | | | | | | | | | | | | | | | | | | | | | | |
| 1 | | | | | | | | | | | | | | | | | | | | | | | | | | | | | | | | | | | | | | | | | | | | | | | | | | | | | | | | | | | | | | | | | | | | | | | | | | | | | | | |
| 1 | | | | | | | | | | | | | | | | | | | | | | | | | | | | | | | | | | | | | | | | | | | | | | | | | | | | | | | | | | | | | | | | | | | | | | | | | | | | | | | |
| | | | | | | | | | | | | | | | | | | | | | | | | | | | | | | | | | | | | | | | | | | | | | | | | | | | | | | | | | | | | | | | | | | | | | | | | | | | | | | | |
| | | | | | | | | | | | | | | | | | | | | | | | | | | | | | | | | | | | | | | | | | | | | | | | | | | | | | | | | | | | | | | | | | | | | | | | | | | | | | | | |
| | | | | | | | | | | | | | | | | | | | | | | | | | | | | | | | | | | | | | | | | | | | | | | | | | | | | | | | | | | | | | | | | | | | | | | | | | | | | | | | |
| | | | | | | | | | | | | | | | | | | | | | | | | | | | | | | | | | | | | | | | | | | | | | | | | | | | | | | | | | | | | | | | | | | | | | | | | | | | | | | | |
| | | | | | | | | | | | | | | | | | | | | | | | | | | | | | | | | | | | | | | | | | | | | | | | | | | | | | | | | | | | | | | | | | | | | | | | | | | | | | | | |
| | | | | | | | | | | | | | | | | | | | | | | | | | | | | | | | | | | | | | | | | | | | | | | | | | | | | | | | | | | | | | | | | | | | | | | | | | | | | | | | |
| | | | | | | | | | | | | | | | | | | | | | | | | | | | | | | | | | | | | | | | | | | | | | | | | | | | | | | | | | | | | | | | | | | | | | | | | | | | | | | | |
| | | | | | | | | | | | | | | | | | | | | | | | | | | | | | | | | | | | | | | | | | | | | | | | | | | | | | | | | | | | | | | | | | | | | | | | | | | | | | | | |
| | | | | | | | | | | | | | | | | | | | | | | | | | | | | | | | | | | | | | | | | | | | | | | | | | | | | | | | | | | | | | | | | | | | | | | | | | | | | | | | |
| | | | | | | | | | | | | | | | | | | | | | | | | | | | | | | | | | | | | | | | | | | | | | | | | | | | | | | | | | | | | | | | | | | | | | | | | | | | | | | | |
| | | | | | | | | | | | | | | | | | | | | | | | | | | | | | | | | | | | | | | | | | | | | | | | | | | | | | | | | | | | | | | | | | | | | | | | | | | | | | | | |
| | | | | | | | | | | | | | | | | | | | | | | | | | | | | | | | | | | | | | | | | | | | | | | | | | | | | | | | | | | | | | | | | | | | | | | | | | | | | | | | |
| Post - 0 Miss - 2 Block - 1 | Post - 0 Miss - 0 Block - 0 | Post - 0 Miss - 0 Block - 0 | Post - 0 Miss - 0 Block - 0 | Post - 0 Miss - 0 Block - 0 | Post - 0 Miss - 0 Block - 0 | Post - 0 Miss - 0 Block - 0 | Post - 0 Miss - 0 Block - 0 | | | | | | | | | | | | | | | | | | | | | | | | | | | | | | | | | | | | | | | | | | | | | | | | | | | | | | | | | | | | | | | | | | | | | | | | |

1 刘在攀

| | | |
|-----|-----|-----|
| 0/2 | 0/2 | 0/2 |
| 3/8 | 0/1 | 1/3 |
| 2/6 | | 0/3 |

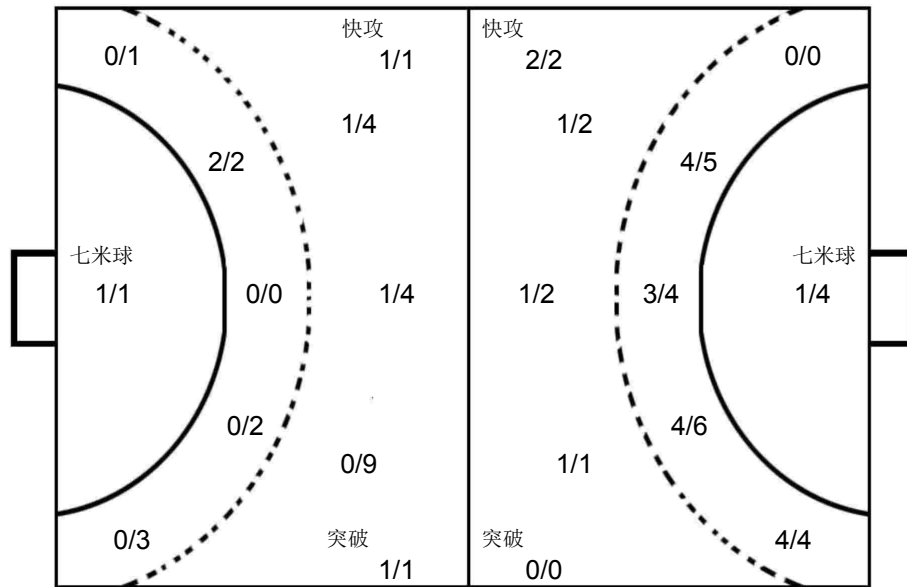

2 赫天铭

| | | |
|-----|-----|-----|
| 1/1 | | 2/2 |
| 1/5 | 1/1 | 1/1 |
| 1/4 | | 1/1 |

32 袁梓赫

| | | |
|--|--|--|
| | | |
| | | |
| | | |

辽宁抚顺

| | | | | | | | | | | | | | | | | | | | | | | | | | | | | | | | | | | | | | | | | | | | | | | | | | | | | | | | | | | | | | | | | | | | | | | | | | | | | | | | |
|---|-----------------------------|-----------------------------|-----------------------------|-----------------------------|-----------------------------|-----------------------------|-----------------------------|--|--|--|--|--|--|--|--|--|--|--|--|---|--|--|--|---|---|--|---|--|---|---|--|--|--|---|--|--|--|--|--|--|---|--|--|---|--|--|--|--|--|--|--|--|--|--|--|--|--|--|--|---|---|---|---|--|--|---|---|--|--|--|--|--|--|---|--|--|--|--|---|
| 2 赫天铭 | 5 王梓翾 | 6 尚禹辰 | 7 张羽虹冰 | 9 隋博 | 11 陈思 | 13 高鑫 | 17 杨宇 | | | | | | | | | | | | | | | | | | | | | | | | | | | | | | | | | | | | | | | | | | | | | | | | | | | | | | | | | | | | | | | | | | | | | | | | |
| <table border="1"><tr><td></td><td>1</td><td></td></tr><tr><td></td><td></td><td></td></tr><tr><td></td><td></td><td></td></tr></table> | | 1 | | | | | | | | <table border="1"><tr><td></td><td></td><td></td></tr><tr><td></td><td></td><td></td></tr><tr><td></td><td></td><td></td></tr></table> | | | | | | | | | | <table border="1"><tr><td></td><td></td><td></td></tr><tr><td></td><td></td><td></td></tr><tr><td></td><td></td><td>1</td></tr></table> | | | | | | | | | 1 | <table border="1"><tr><td></td><td></td><td></td></tr><tr><td>1</td><td></td><td></td></tr><tr><td></td><td></td><td></td></tr></table> | | | | 1 | | | | | | <table border="1"><tr><td>1</td><td></td><td></td></tr><tr><td>2</td><td></td><td></td></tr><tr><td></td><td></td><td></td></tr></table> | 1 | | | 2 | | | | | | <table border="1"><tr><td></td><td></td><td></td></tr><tr><td></td><td></td><td></td></tr><tr><td></td><td></td><td></td></tr></table> | | | | | | | | | | <table border="1"><tr><td>1</td><td>1</td><td>2</td></tr><tr><td></td><td></td><td>2</td></tr><tr><td>1</td><td></td><td></td></tr></table> | 1 | 1 | 2 | | | 2 | 1 | | | <table border="1"><tr><td></td><td></td><td></td></tr><tr><td>1</td><td></td><td></td></tr><tr><td></td><td></td><td>2</td></tr></table> | | | | 1 | | | | | 2 |
| | 1 | | | | | | | | | | | | | | | | | | | | | | | | | | | | | | | | | | | | | | | | | | | | | | | | | | | | | | | | | | | | | | | | | | | | | | | | | | | | | | |
| | | | | | | | | | | | | | | | | | | | | | | | | | | | | | | | | | | | | | | | | | | | | | | | | | | | | | | | | | | | | | | | | | | | | | | | | | | | | | | | |
| | | | | | | | | | | | | | | | | | | | | | | | | | | | | | | | | | | | | | | | | | | | | | | | | | | | | | | | | | | | | | | | | | | | | | | | | | | | | | | | |
| | | | | | | | | | | | | | | | | | | | | | | | | | | | | | | | | | | | | | | | | | | | | | | | | | | | | | | | | | | | | | | | | | | | | | | | | | | | | | | | |
| | | | | | | | | | | | | | | | | | | | | | | | | | | | | | | | | | | | | | | | | | | | | | | | | | | | | | | | | | | | | | | | | | | | | | | | | | | | | | | | |
| | | | | | | | | | | | | | | | | | | | | | | | | | | | | | | | | | | | | | | | | | | | | | | | | | | | | | | | | | | | | | | | | | | | | | | | | | | | | | | | |
| | | | | | | | | | | | | | | | | | | | | | | | | | | | | | | | | | | | | | | | | | | | | | | | | | | | | | | | | | | | | | | | | | | | | | | | | | | | | | | | |
| | | | | | | | | | | | | | | | | | | | | | | | | | | | | | | | | | | | | | | | | | | | | | | | | | | | | | | | | | | | | | | | | | | | | | | | | | | | | | | | |
| | | 1 | | | | | | | | | | | | | | | | | | | | | | | | | | | | | | | | | | | | | | | | | | | | | | | | | | | | | | | | | | | | | | | | | | | | | | | | | | | | | |
| | | | | | | | | | | | | | | | | | | | | | | | | | | | | | | | | | | | | | | | | | | | | | | | | | | | | | | | | | | | | | | | | | | | | | | | | | | | | | | | |
| 1 | | | | | | | | | | | | | | | | | | | | | | | | | | | | | | | | | | | | | | | | | | | | | | | | | | | | | | | | | | | | | | | | | | | | | | | | | | | | | | | |
| | | | | | | | | | | | | | | | | | | | | | | | | | | | | | | | | | | | | | | | | | | | | | | | | | | | | | | | | | | | | | | | | | | | | | | | | | | | | | | | |
| 1 | | | | | | | | | | | | | | | | | | | | | | | | | | | | | | | | | | | | | | | | | | | | | | | | | | | | | | | | | | | | | | | | | | | | | | | | | | | | | | | |
| 2 | | | | | | | | | | | | | | | | | | | | | | | | | | | | | | | | | | | | | | | | | | | | | | | | | | | | | | | | | | | | | | | | | | | | | | | | | | | | | | | |
| | | | | | | | | | | | | | | | | | | | | | | | | | | | | | | | | | | | | | | | | | | | | | | | | | | | | | | | | | | | | | | | | | | | | | | | | | | | | | | | |
| | | | | | | | | | | | | | | | | | | | | | | | | | | | | | | | | | | | | | | | | | | | | | | | | | | | | | | | | | | | | | | | | | | | | | | | | | | | | | | | |
| | | | | | | | | | | | | | | | | | | | | | | | | | | | | | | | | | | | | | | | | | | | | | | | | | | | | | | | | | | | | | | | | | | | | | | | | | | | | | | | |
| | | | | | | | | | | | | | | | | | | | | | | | | | | | | | | | | | | | | | | | | | | | | | | | | | | | | | | | | | | | | | | | | | | | | | | | | | | | | | | | |
| 1 | 1 | 2 | | | | | | | | | | | | | | | | | | | | | | | | | | | | | | | | | | | | | | | | | | | | | | | | | | | | | | | | | | | | | | | | | | | | | | | | | | | | | |
| | | 2 | | | | | | | | | | | | | | | | | | | | | | | | | | | | | | | | | | | | | | | | | | | | | | | | | | | | | | | | | | | | | | | | | | | | | | | | | | | | | |
| 1 | | | | | | | | | | | | | | | | | | | | | | | | | | | | | | | | | | | | | | | | | | | | | | | | | | | | | | | | | | | | | | | | | | | | | | | | | | | | | | | |
| | | | | | | | | | | | | | | | | | | | | | | | | | | | | | | | | | | | | | | | | | | | | | | | | | | | | | | | | | | | | | | | | | | | | | | | | | | | | | | | |
| 1 | | | | | | | | | | | | | | | | | | | | | | | | | | | | | | | | | | | | | | | | | | | | | | | | | | | | | | | | | | | | | | | | | | | | | | | | | | | | | | | |
| | | 2 | | | | | | | | | | | | | | | | | | | | | | | | | | | | | | | | | | | | | | | | | | | | | | | | | | | | | | | | | | | | | | | | | | | | | | | | | | | | | |
| Post - 0 Miss - 0 Block - 0 | Post - 0 Miss - 0 Block - 0 | Post - 0 Miss - 0 Block - 0 | Post - 0 Miss - 0 Block - 0 | Post - 0 Miss - 0 Block - 0 | Post - 0 Miss - 0 Block - 0 | Post - 0 Miss - 1 Block - 0 | Post - 0 Miss - 0 Block - 0 | | | | | | | | | | | | | | | | | | | | | | | | | | | | | | | | | | | | | | | | | | | | | | | | | | | | | | | | | | | | | | | | | | | | | | | | |
| 19 靳皓童 | 22 杨辰 | 28 靳皓添 | 32 袁梓赫 | | | | | | | | | | | | | | | | | | | | | | | | | | | | | | | | | | | | | | | | | | | | | | | | | | | | | | | | | | | | | | | | | | | | | | | | | | | | |
| <table border="1"><tr><td></td><td></td><td></td></tr><tr><td></td><td></td><td></td></tr><tr><td>1</td><td></td><td></td></tr></table> | | | | | | | 1 | | | <table border="1"><tr><td></td><td></td><td></td></tr><tr><td></td><td></td><td></td></tr><tr><td></td><td></td><td></td></tr></table> | | | | | | | | | | <table border="1"><tr><td></td><td></td><td></td></tr><tr><td>1</td><td>1</td><td></td></tr><tr><td>1</td><td></td><td></td></tr></table> | | | | 1 | 1 | | 1 | | | <table border="1"><tr><td></td><td></td><td></td></tr><tr><td></td><td></td><td></td></tr><tr><td></td><td></td><td></td></tr></table> | | | | | | | | | | | | | | | | | | | | | | | | | | | | | | | | | | | | | | | | | | | | | | | | | |
| | | | | | | | | | | | | | | | | | | | | | | | | | | | | | | | | | | | | | | | | | | | | | | | | | | | | | | | | | | | | | | | | | | | | | | | | | | | | | | | |
| | | | | | | | | | | | | | | | | | | | | | | | | | | | | | | | | | | | | | | | | | | | | | | | | | | | | | | | | | | | | | | | | | | | | | | | | | | | | | | | |
| 1 | | | | | | | | | | | | | | | | | | | | | | | | | | | | | | | | | | | | | | | | | | | | | | | | | | | | | | | | | | | | | | | | | | | | | | | | | | | | | | | |
| | | | | | | | | | | | | | | | | | | | | | | | | | | | | | | | | | | | | | | | | | | | | | | | | | | | | | | | | | | | | | | | | | | | | | | | | | | | | | | | |
| | | | | | | | | | | | | | | | | | | | | | | | | | | | | | | | | | | | | | | | | | | | | | | | | | | | | | | | | | | | | | | | | | | | | | | | | | | | | | | | |
| | | | | | | | | | | | | | | | | | | | | | | | | | | | | | | | | | | | | | | | | | | | | | | | | | | | | | | | | | | | | | | | | | | | | | | | | | | | | | | | |
| | | | | | | | | | | | | | | | | | | | | | | | | | | | | | | | | | | | | | | | | | | | | | | | | | | | | | | | | | | | | | | | | | | | | | | | | | | | | | | | |
| 1 | 1 | | | | | | | | | | | | | | | | | | | | | | | | | | | | | | | | | | | | | | | | | | | | | | | | | | | | | | | | | | | | | | | | | | | | | | | | | | | | | | |
| 1 | | | | | | | | | | | | | | | | | | | | | | | | | | | | | | | | | | | | | | | | | | | | | | | | | | | | | | | | | | | | | | | | | | | | | | | | | | | | | | | |
| | | | | | | | | | | | | | | | | | | | | | | | | | | | | | | | | | | | | | | | | | | | | | | | | | | | | | | | | | | | | | | | | | | | | | | | | | | | | | | | |
| | | | | | | | | | | | | | | | | | | | | | | | | | | | | | | | | | | | | | | | | | | | | | | | | | | | | | | | | | | | | | | | | | | | | | | | | | | | | | | | |
| | | | | | | | | | | | | | | | | | | | | | | | | | | | | | | | | | | | | | | | | | | | | | | | | | | | | | | | | | | | | | | | | | | | | | | | | | | | | | | | |
| Post - 0 Miss - 1 Block - 0 | Post - 0 Miss - 0 Block - 0 | Post - 1 Miss - 0 Block - 0 | Post - 0 Miss - 0 Block - 0 | | | | | | | | | | | | | | | | | | | | | | | | | | | | | | | | | | | | | | | | | | | | | | | | | | | | | | | | | | | | | | | | | | | | | | | | | | | | |

PHMS Pictorial Handball Match Statistics **IHF** Official System

| | | |
|-------------------------|-------------------------|---------------------------|
| Team A A 安徽淮南 | Team B B 福建龙岩 | Match Number 33 |
|-------------------------|-------------------------|---------------------------|

| | | | | | |
|-------------------|------------------------|------------------|-------------|-------|------------|
| Played in 安徽滁州 | in the hall 滁州国际手球馆 | on 2019-06-04 | at 15:00 | hours | Spectators |
|-------------------|------------------------|------------------|-------------|-------|------------|

| | | | | | | | | | | | | | | |
|----------------|--------|--------|---------------------|---------|---------|----------------|---|---|----------------|---|---|----------------------|---|---|
| Half-time(30') | A 6 | B 6 | End of playing time | A 13 | B 15 | 1st extra time | A | B | 2nd extra time | A | B | After penalty throws | A | B |
|----------------|--------|--------|---------------------|---------|---------|----------------|---|---|----------------|---|---|----------------------|---|---|

| | | | | | | | | | | |
|---------------|------------|---------------|------------|------------|------------------------------------|---------------|---|--|----------|---------------|
| Number of 7 m | A 4/4 | Team time-out | | | Full name of players and officials | Team time-out | | | B 1/1 | Number of 7 m |
| | 1 10:07 | 2 35:46 | 3 43:17 | 1 07:49 | | 2 | 3 | | | |

| No. | Team A | G | W | 2' | D | DR | No. | Team B | G | W | 2' | D | DR |
|-----|-----------|---|---|----|---|----|-----|--------|---|---|----|---|----|
| 1 | 苟嘉毅 | | | | | | 1 | 刘子豪 | | | | | |
| 2 | 邹俊洁 | | | | | | 5 | 郭雨强 | 4 | 1 | | | |
| 3 | 童守宣 | | | | | | 6 | 刘阳 | 2 | | | | |
| 4 | 李攀 | | | | | | 7 | 王晨旭 | | | | | |
| 5 | 吴修民 | | | | | | 8 | 杨鑫祥 | | | | | |
| 6 | 童浩宇 | | | | | | 9 | 荆胤丞 | | | | | |
| 7 | 赵琨鹏 | | | | | | 10 | 赵一 | 3 | 1 | | | |
| 8 | 陈子涵 | 2 | 1 | | | | 15 | 刘家良 | 4 | | | | |
| 9 | 杨金龙 | 7 | | | | | 16 | 李凯锋 | | | | | |
| 10 | 孙飞扬 | 4 | | 1 | | | 17 | 陈锐涛 | | | | | |
| 11 | 刘新然 | | | | | | 18 | 奚尧 | 1 | 1 | 1 | | |
| 13 | 张昊燃 | | | | | | 21 | 刘晓青 | | | | | |
| 14 | 单中宝 | | | | | | 23 | 朱天一 | | | | | |
| 15 | 刘淇 | | | | | | 24 | 钟盛发 | | | | | |
| 16 | 胡文柯 | | | | | | 27 | 邓可钊 | 1 | | | | |
| 17 | 徐鹏辉 | | | | | | 36 | 陈泽锟 | | | | | |
| A | 常洪飞 | | 1 | | | | B | 杜长义 | | | | | |
| B | 阮圣杰 (主教练) | | | | | | C | 饶开发 | | | | | |
| | | | | | | | D | 李绍南 | | | | | |

| | | |
|---|--|---|
| A | Signatures of responsables for the teams (Off.A) | B |
|---|--|---|

| | | |
|----|-----------------------------------|----|
| TP | Remarks of referees / HF Official | TP |
|----|-----------------------------------|----|

| | | | |
|------------|-----------|-----------|--|
| Signatures | | | |
| Referees | 徐健 (CHN) | 王羚 (CHN) | |
| T.D. | 吴国忠 (CHN) | 龙佩莉 (CHN) | |
| CHA Off. | | | |

Note: Number of 7m Throws Awarded to Team A and B, Goals (G), Warnings (W), Suspensions (2'), Direct Disqualification (D), Disqualification With Report (DR) and Team Penalty (TP).

Table Officials: 李莉君 吴荣 Statisticians: 沈家洛 马安兴

第二届全国青年运动会男子手球乙组决赛 体校组 (U16)

PHMS Pictorial Handball Match Statistics

IHF Official System

竞赛技术统计

手球
青年男子

5-8名
轮次 5

组别 X
场次 33

滁州国际手球馆
2019-06-04 15:00

| | | | |
|-----------|----------------------|---------|------------|
| Referees: | 徐健 (CHN) / 王羚 (CHN) | Result: | 13:15(6:6) |
| Teams: | 安徽淮南(淮南) VS 福建龙岩(龙岩) | | |

| 淮南 | | 远射 | 近射 | 边射 | 快攻 | 突破 | 任意球 | 7m球 | 合计 | % | 助攻 | 失误 | 警告 | 2' | D+DR | 淮南 | 比赛进程 | 龙岩 |
|----------|-----|-----|-----|-----|-----|-----|-----|-----|-------|------|----|----|----|----|------|----|----------|-------------|
| 主教练: 阮圣杰 | | | | | | | | | | | | | | | | | 1st Half | |
| 1 | 苟嘉毅 | | | | | | | | | | | | | | | 9 | 杨金龙 | 1 02:59 0 |
| 2 | 邹俊洁 | | | | | | | | | | | | | | | | 1 03:19 | 1 5 郭雨强 |
| 3 | 童守宣 | | | | | | | | | | | | | | | | 1 04:29 | 2 5 郭雨强 |
| 4 | 李攀 | | | | | | | | | | | | | | | | 1 06:22 | 3 10 赵一 |
| 5 | 吴修民 | | | | | | | | | | | | | | | 9 | 杨金龙 | 2 06:53 3 |
| 6 | 童浩宇 | | 0/1 | 0/1 | | | | 0/2 | 0.0 | | | | | | | 9 | 杨金龙 | 3 08:50 3 |
| 7 | 赵琨鹏 | | | | | | | | | | | | | | | 10 | 孙飞扬 | 4 10:31 3 |
| 8 | 陈子涵 | | 1/1 | | | 1/1 | | 2/2 | 100 | | 1 | 1 | | | | 4 | 11:10 | 4 5 郭雨强 |
| 9 | 杨金龙 | 3/4 | | | | | 0/1 | 4/4 | 77.8 | 1 | 2 | | | | | 5 | 11:54 | 4 |
| 10 | 孙飞扬 | 0/2 | 1/2 | | | 1/1 | 2/3 | 4/8 | 50.0 | 1 | 1 | | 1 | | | 5 | 12:05 | 5 15 刘家良 |
| 11 | 刘新然 | 0/1 | | | | | | 0/1 | 0.0 | | | | | | | 6 | 13:04 | 5 |
| 13 | 张昊燃 | | | | | | | | | | | | | | | 6 | 14:15 | 6 6 刘阳 |
| 14 | 单中宝 | | | | | | | | | | | | | | | | 2nd Half | |
| 15 | 刘淇 | | | | | | | | | | | 3 | | | | 6 | 02:18 | 7 6 刘阳 |
| 16 | 胡文柯 | | | | | | | | | | | | | | | 6 | 03:18 | 8 10 赵一 |
| 17 | 徐鹏辉 | | | | | | | | | | | | | | | 7 | 03:28 | 8 |
| 运动员 合计 | | 3/7 | 2/4 | 0/1 | | 2/2 | 2/4 | 4/4 | 13/22 | 59.1 | 2 | 9 | 1 | 1 | | 7 | 04:28 | 9 15 刘家良 |
| 1 | 苟嘉毅 | 2/7 | 3/4 | 0/4 | 0/2 | 0/2 | 1/1 | 0/1 | 6/21 | 28.6 | | | | | | 7 | 05:07 | 10 18 奚尧 |
| 守门员 合计 | | 2/7 | 3/4 | 0/4 | 0/2 | 0/2 | 1/1 | 0/1 | 6/21 | 28.6 | | | | | | 8 | 06:20 | 10 |
| | | | | | | | | | | | | | | | | 8 | 07:15 | 11 15 刘家良 |
| | | | | | | | | | | | | | | | | 9 | 07:40 | 11 |
| | | | | | | | | | | | | | | | | 9 | 08:26 | 12 27 邓可钊 |
| | | | | | | | | | | | | | | | | 10 | 08:51 | 12 |
| | | | | | | | | | | | | | | | | 10 | 09:48 | 13 15 刘家良 |
| | | | | | | | | | | | | | | | | 10 | 11:20 | 14 5 郭雨强 |
| | | | | | | | | | | | | | | | | 8 | 陈子涵 | 11 11:43 14 |
| | | | | | | | | | | | | | | | | 10 | 孙飞扬 | 12 13:23 14 |
| | | | | | | | | | | | | | | | | 12 | 13:36 | 15 10 赵一 |
| | | | | | | | | | | | | | | | | 8 | 陈子涵 | 13 14:32 15 |

| 龙岩 | | 远射 | 近射 | 边射 | 快攻 | 突破 | 任意球 | 7m球 | 合计 | % | 助攻 | 失误 | 警告 | 2' | D+DR |
|----------|-----|-----|-----|-----|-----|-----|-----|-----|-------|------|----|----|----|----|------|
| 主教练: 李绍南 | | | | | | | | | | | | | | | |
| 1 | 刘子豪 | | | | | | | | | | | | | | |
| 5 | 郭雨强 | 3/4 | | | | | 0/1 | 1/1 | 4/6 | 66.7 | | | 1 | | |
| 6 | 刘阳 | | | 2/2 | | | | | 2/2 | 100 | | | | | |
| 7 | 王晨旭 | | | | | | | | | | | 1 | | | |
| 8 | 杨鑫祥 | | | | | | | | | | | | | | |
| 9 | 荆胤丞 | | | | | | | | | | | | | | |
| 10 | 赵一 | 1/1 | | | 1/1 | 1/1 | | 3/3 | 100 | 1 | | 1 | | | |
| 15 | 刘家良 | 1/3 | 1/3 | | 1/1 | 1/2 | | 4/9 | 44.4 | | 2 | | | | |
| 16 | 李凯锋 | | | | | | | | | | | | | | |
| 17 | 陈锐涛 | | | | | | | | | | | | | | |
| 18 | 奚尧 | | | 1/1 | | | | 1/1 | 100 | | | | 1 | 1 | |
| 21 | 刘晓青 | | | | | | | | | | | | | | |
| 23 | 朱天一 | | 0/2 | | | | | 0/2 | 0.0 | | | | | | |
| 24 | 钟盛发 | | | | | | | | | | | | | | |
| 27 | 邓可钊 | | | 1/1 | | | | 1/1 | 100 | | | | | | |
| 36 | 陈泽锟 | | | | | | | | | | | | | | |
| 运动员 合计 | | 5/8 | 1/5 | 4/4 | 2/2 | 2/3 | 0/1 | 1/1 | 15/24 | 62.5 | 1 | 3 | 3 | 1 | |
| 1 | 刘子豪 | 2/5 | 1/3 | 1/1 | | 0/2 | 0/2 | 0/4 | 4/17 | 23.5 | | | | | |
| 守门员 合计 | | 2/5 | 1/3 | 1/1 | | 0/2 | 0/2 | 0/4 | 4/17 | 23.5 | | | | | |

场上队员: 得分 / 射门

守门员: 救球 / 射门

| | | | |
|---|------|----|---------|
| D | 取消资格 | DR | 取消资格+报告 |
|---|------|----|---------|



个人/全队技术统计表

手球 青年男子 5-8名 轮次 5 组别 X 场次 33 滁州国际手球馆 2019-06-04 15:00

| 号码 | 姓名 | 远射 | 近射 | 边射 | 快攻 | 突破 | 任意 | 七米 | 合计 | % | 助攻 | 失误 | 警告 | 2' | 取消 | 时间 |
|-----------------|-----|------------|------------|------------|------------|------------|------------|------------|--------------|--------------|----------|----------|----------|----------|----|----------|
| 安徽淮南(淮南) | | | | | | | | | | | | | | | | |
| (场上队员) | | | | | | | | | | | | | | | | |
| 1 | 苟嘉毅 | | | | | | | | | 0.0% | | | | | | 00:30:00 |
| 2 | 邹俊洁 | | | | | | | | | 0.0% | | | | | | 00:00:00 |
| 3 | 童守宣 | | | | | | | | | 0.0% | | | | | | 00:00:00 |
| 4 | 李攀 | | | | | | | | | 0.0% | | | | | | 00:00:00 |
| 5 | 吴修民 | | | | | | | | | 0.0% | | | | | | 00:00:00 |
| 6 | 童浩宇 | | 0/1 | 0/1 | | | | | 0/2 | 0.0% | | | | | | 00:30:00 |
| 7 | 赵琨鹏 | | | | | | | | | 0.0% | | | | | | 00:00:00 |
| 8 | 陈子涵 | | 1/1 | | | 1/1 | | | 2/2 | 100% | 1 | 1 | | | | 00:28:15 |
| 9 | 杨金龙 | 3/4 | | | | | 0/1 | 4/4 | 7/9 | 77.8% | 1 | 2 | | | | 00:30:00 |
| 10 | 孙飞扬 | 0/2 | 1/2 | | | 1/1 | 2/3 | | 4/8 | 50.0% | 1 | 1 | | 1 | | 00:30:00 |
| 11 | 刘新然 | 0/1 | | | | | | | 0/1 | 0.0% | | 2 | | | | 00:30:00 |
| 13 | 张昊燃 | | | | | | | | | 0.0% | | | | | | 00:00:00 |
| 14 | 单中宝 | | | | | | | | | 0.0% | | | | | | 00:00:00 |
| 15 | 刘淇 | | | | | | | | | 0.0% | | 3 | | | | 00:30:00 |
| 16 | 胡文柯 | | | | | | | | | 0.0% | | | | | | 00:00:00 |
| 17 | 徐鹏辉 | | | | | | | | | 0.0% | | | | | | 00:01:43 |
| 合计 | | 3/7 | 2/4 | 0/1 | | 2/2 | 2/4 | 4/4 | 13/22 | 59.1% | 2 | 9 | 1 | 1 | | |
| (守门员) | | | | | | | | | | | | | | | | |
| 1 | 苟嘉毅 | 2/7 | 3/4 | 0/4 | 0/2 | 0/2 | 1/1 | 0/1 | 6/21 | 28.6% | | | | | | 00:30:00 |
| 合计 | | 2/7 | 3/4 | 0/4 | 0/2 | 0/2 | 1/1 | 0/1 | 6/21 | 28.6% | | | | | | |

场上队员：得分/射门

守门员：救球/射门

| 全队合计 | 得分 | 被救 | 射失 | 击柱 | 封球 | 合计 | % |
|------|----|----|----|----|----|----|--------|
| 远射 | 3 | 2 | | | 2 | 7 | 42.9% |
| 近射 | 2 | 1 | | 1 | | 4 | 50.0% |
| 边射 | | 1 | | | | 1 | 0.0% |
| 快攻 | | | | | | | 0.0% |
| 突破 | 2 | | | | | 2 | 100.0% |
| 任意 | 2 | | 2 | | | 4 | 50.0% |
| 七米 | 4 | | | | | 4 | 100.0% |

个人/全队技术统计表

手球 5-8名 组别 X 滁州国际手球馆
青年男子 轮次 5 场次 33 2019-06-04 15:00

| 号码 | 姓名 | 远射 | 近射 | 边射 | 快攻 | 突破 | 任意 | 七米 | 合计 | % | 助攻 | 失误 | 警告 | 2' | 取消 | 时间 |
|----------|-----|-----|-----|-----|-----|-----|-----|-----|-------|-------|----|----|----|----|----|----------|
| 福建龙岩(龙岩) | | | | | | | | | | | | | | | | |
| (场上队员) | | | | | | | | | | | | | | | | |
| 1 | 刘子豪 | | | | | | | | | 0.0% | | | | | | 00:30:00 |
| 5 | 郭雨强 | 3/4 | | | | | 0/1 | 1/1 | 4/6 | 66.7% | | | 1 | | | 00:30:00 |
| 6 | 刘阳 | | | 2/2 | | | | | 2/2 | 100% | | | | | | 00:18:48 |
| 7 | 王晨旭 | | | | | | | | | 0.0% | | 1 | | | | 00:02:36 |
| 8 | 杨鑫祥 | | | | | | | | | 0.0% | | | | | | 00:00:00 |
| 9 | 荆胤丞 | | | | | | | | | 0.0% | | | | | | 00:00:00 |
| 10 | 赵一 | 1/1 | | | 1/1 | 1/1 | | | 3/3 | 100% | 1 | | 1 | | | 00:27:22 |
| 15 | 刘家良 | 1/3 | 1/3 | | 1/1 | 1/2 | | | 4/9 | 44.4% | | | 2 | | | 00:30:00 |
| 16 | 李凯锋 | | | | | | | | | 0.0% | | | | | | 00:00:00 |
| 17 | 陈锐涛 | | | | | | | | | 0.0% | | | | | | 00:00:00 |
| 18 | 奚尧 | | | 1/1 | | | | | 1/1 | 100% | | | 1 | 1 | | 00:30:00 |
| 21 | 刘晓青 | | | | | | | | | 0.0% | | | | | | 00:00:00 |
| 23 | 朱天一 | | 0/2 | | | | | | 0/2 | 0.0% | | | | | | 00:30:00 |
| 24 | 钟盛发 | | | | | | | | | 0.0% | | | | | | 00:00:00 |
| 27 | 邓可钊 | | | 1/1 | | | | | 1/1 | 100% | | | | | | 00:11:11 |
| 36 | 陈泽锟 | | | | | | | | | 0.0% | | | | | | 00:00:00 |
| 合计 | | 5/8 | 1/5 | 4/4 | 2/2 | 2/3 | 0/1 | 1/1 | 15/24 | 62.5% | 1 | 3 | 3 | 1 | | |
| (守门员) | | | | | | | | | | | | | | | | |
| 1 | 刘子豪 | 2/5 | 1/3 | 1/1 | | 0/2 | 0/2 | 0/4 | 4/17 | 23.5% | | | | | | 00:30:00 |
| 合计 | | 2/5 | 1/3 | 1/1 | | 0/2 | 0/2 | 0/4 | 4/17 | 23.5% | | | | | | |

场上队员：得分/射门

守门员：救球/射门

| 全队合计 | 得分 | 被救 | 射失 | 击柱 | 封球 | 合计 | % |
|------|----|----|----|----|----|----|--------|
| 远射 | 5 | 2 | 1 | | | 8 | 62.5% |
| 近射 | 1 | 3 | 1 | | | 5 | 20.0% |
| 边射 | 4 | | | | | 4 | 100.0% |
| 快攻 | 2 | | | | | 2 | 100.0% |
| 突破 | 2 | | 1 | | | 3 | 66.7% |
| 任意 | | 1 | | | | 1 | 0.0% |
| 七米 | 1 | | | | | 1 | 100.0% |

图式比赛技术统计表

手球
青年男子

5-8名
轮次 5

组别 X
场次 33

滁州国际手球馆
2019-06-04 15:00

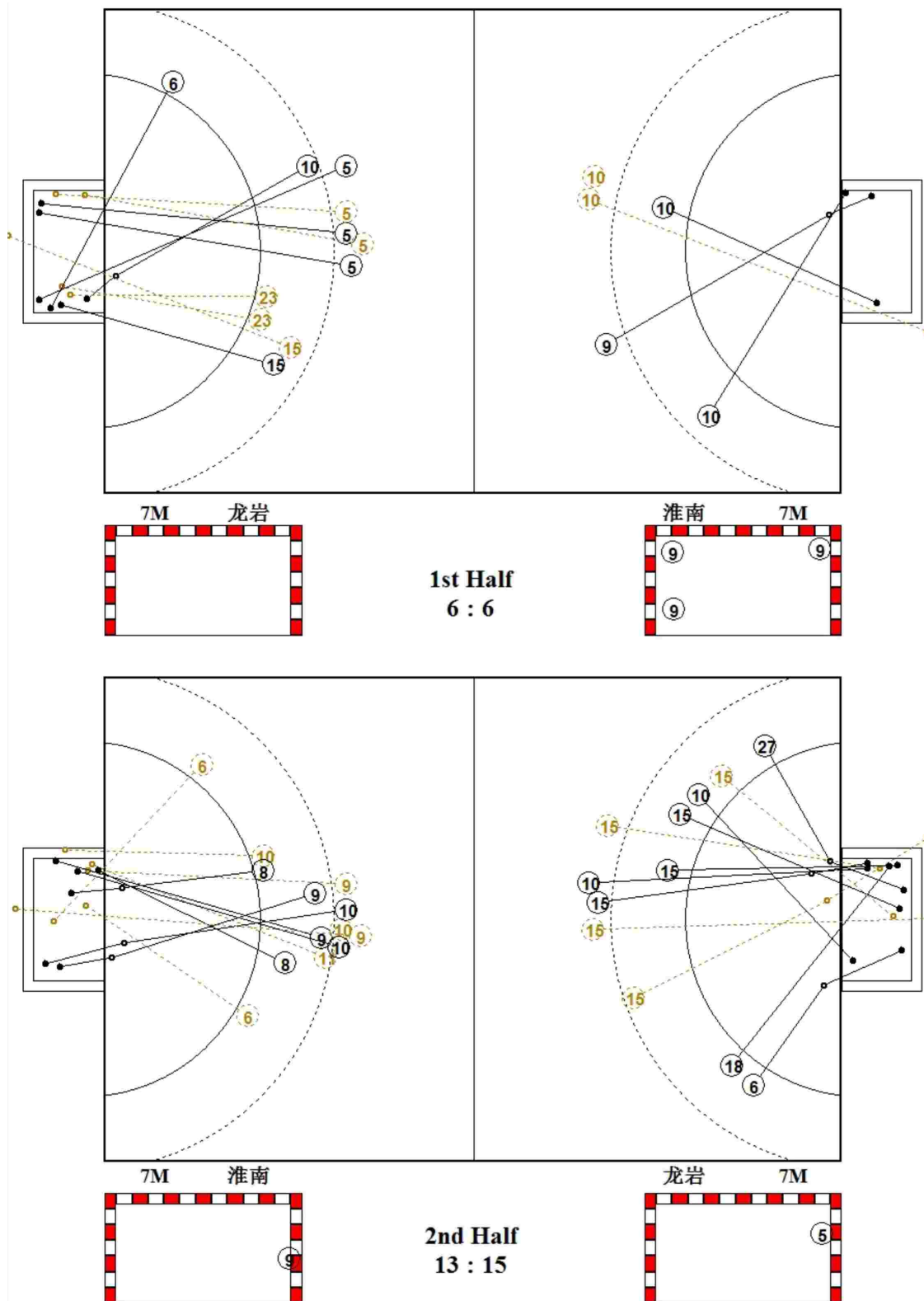

图式射门区域统计

手球
青年男子

5-8名
轮次 5

组别 X
场次 33

滁州国际手球馆
2019-06-04 15:00

安徽淮南

| | | | | | | | | | | | | | | | | | | | | | | | | | | | | | | | | | | | | | | | | | | | | | | | | | | | | | | | | | | | | | | | | | | | | | | | | | | | | | | | |
|---|-----------------------------|-----------------------------|-----------------------------|-----------------------------|-----------------------------|-----------------------------|-----------------------------|--|--|---|---|--|--|--|--|---|---|--|--|--|--|--|--|--|--|--|--|--|--|--|--|--|--|--|--|--|--|--|--|--|--|--|--|--|--|--|--|--|--|--|--|--|--|--|--|--|--|--|--|--|--|--|--|--|--|--|--|--|--|--|--|--|---|--|--|---|--|--|--|
| 1 苟嘉毅 | 2 邹俊洁 | 3 童守宣 | 4 李攀 | 5 吴修民 | 6 童浩宇 | 7 赵琨鹏 | 8 陈子涵 | | | | | | | | | | | | | | | | | | | | | | | | | | | | | | | | | | | | | | | | | | | | | | | | | | | | | | | | | | | | | | | | | | | | | | | | |
| <table border="1"><tr><td></td><td></td><td></td></tr><tr><td></td><td></td><td></td></tr><tr><td></td><td></td><td></td></tr></table> | | | | | | | | | | <table border="1"><tr><td></td><td></td><td></td></tr><tr><td></td><td></td><td></td></tr><tr><td></td><td></td><td></td></tr></table> | | | | | | | | | | <table border="1"><tr><td></td><td></td><td></td></tr><tr><td></td><td></td><td></td></tr><tr><td></td><td></td><td></td></tr></table> | | | | | | | | | | <table border="1"><tr><td></td><td></td><td></td></tr><tr><td></td><td></td><td></td></tr><tr><td></td><td></td><td></td></tr></table> | | | | | | | | | | <table border="1"><tr><td></td><td></td><td></td></tr><tr><td></td><td></td><td></td></tr><tr><td></td><td></td><td></td></tr></table> | | | | | | | | | | <table border="1"><tr><td></td><td></td><td></td></tr><tr><td></td><td></td><td></td></tr><tr><td></td><td></td><td></td></tr></table> | | | | | | | | | | <table border="1"><tr><td></td><td></td><td></td></tr><tr><td></td><td></td><td></td></tr><tr><td></td><td></td><td></td></tr></table> | | | | | | | | | | <table border="1"><tr><td></td><td></td><td>1</td></tr><tr><td></td><td></td><td>1</td></tr><tr><td></td><td></td><td></td></tr></table> | | | 1 | | | 1 | | | |
| | | | | | | | | | | | | | | | | | | | | | | | | | | | | | | | | | | | | | | | | | | | | | | | | | | | | | | | | | | | | | | | | | | | | | | | | | | | | | | | |
| | | | | | | | | | | | | | | | | | | | | | | | | | | | | | | | | | | | | | | | | | | | | | | | | | | | | | | | | | | | | | | | | | | | | | | | | | | | | | | | |
| | | | | | | | | | | | | | | | | | | | | | | | | | | | | | | | | | | | | | | | | | | | | | | | | | | | | | | | | | | | | | | | | | | | | | | | | | | | | | | | |
| | | | | | | | | | | | | | | | | | | | | | | | | | | | | | | | | | | | | | | | | | | | | | | | | | | | | | | | | | | | | | | | | | | | | | | | | | | | | | | | |
| | | | | | | | | | | | | | | | | | | | | | | | | | | | | | | | | | | | | | | | | | | | | | | | | | | | | | | | | | | | | | | | | | | | | | | | | | | | | | | | |
| | | | | | | | | | | | | | | | | | | | | | | | | | | | | | | | | | | | | | | | | | | | | | | | | | | | | | | | | | | | | | | | | | | | | | | | | | | | | | | | |
| | | | | | | | | | | | | | | | | | | | | | | | | | | | | | | | | | | | | | | | | | | | | | | | | | | | | | | | | | | | | | | | | | | | | | | | | | | | | | | | |
| | | | | | | | | | | | | | | | | | | | | | | | | | | | | | | | | | | | | | | | | | | | | | | | | | | | | | | | | | | | | | | | | | | | | | | | | | | | | | | | |
| | | | | | | | | | | | | | | | | | | | | | | | | | | | | | | | | | | | | | | | | | | | | | | | | | | | | | | | | | | | | | | | | | | | | | | | | | | | | | | | |
| | | | | | | | | | | | | | | | | | | | | | | | | | | | | | | | | | | | | | | | | | | | | | | | | | | | | | | | | | | | | | | | | | | | | | | | | | | | | | | | |
| | | | | | | | | | | | | | | | | | | | | | | | | | | | | | | | | | | | | | | | | | | | | | | | | | | | | | | | | | | | | | | | | | | | | | | | | | | | | | | | |
| | | | | | | | | | | | | | | | | | | | | | | | | | | | | | | | | | | | | | | | | | | | | | | | | | | | | | | | | | | | | | | | | | | | | | | | | | | | | | | | |
| | | | | | | | | | | | | | | | | | | | | | | | | | | | | | | | | | | | | | | | | | | | | | | | | | | | | | | | | | | | | | | | | | | | | | | | | | | | | | | | |
| | | | | | | | | | | | | | | | | | | | | | | | | | | | | | | | | | | | | | | | | | | | | | | | | | | | | | | | | | | | | | | | | | | | | | | | | | | | | | | | |
| | | | | | | | | | | | | | | | | | | | | | | | | | | | | | | | | | | | | | | | | | | | | | | | | | | | | | | | | | | | | | | | | | | | | | | | | | | | | | | | |
| | | | | | | | | | | | | | | | | | | | | | | | | | | | | | | | | | | | | | | | | | | | | | | | | | | | | | | | | | | | | | | | | | | | | | | | | | | | | | | | |
| | | | | | | | | | | | | | | | | | | | | | | | | | | | | | | | | | | | | | | | | | | | | | | | | | | | | | | | | | | | | | | | | | | | | | | | | | | | | | | | |
| | | | | | | | | | | | | | | | | | | | | | | | | | | | | | | | | | | | | | | | | | | | | | | | | | | | | | | | | | | | | | | | | | | | | | | | | | | | | | | | |
| | | | | | | | | | | | | | | | | | | | | | | | | | | | | | | | | | | | | | | | | | | | | | | | | | | | | | | | | | | | | | | | | | | | | | | | | | | | | | | | |
| | | | | | | | | | | | | | | | | | | | | | | | | | | | | | | | | | | | | | | | | | | | | | | | | | | | | | | | | | | | | | | | | | | | | | | | | | | | | | | | |
| | | | | | | | | | | | | | | | | | | | | | | | | | | | | | | | | | | | | | | | | | | | | | | | | | | | | | | | | | | | | | | | | | | | | | | | | | | | | | | | |
| | | 1 | | | | | | | | | | | | | | | | | | | | | | | | | | | | | | | | | | | | | | | | | | | | | | | | | | | | | | | | | | | | | | | | | | | | | | | | | | | | | |
| | | 1 | | | | | | | | | | | | | | | | | | | | | | | | | | | | | | | | | | | | | | | | | | | | | | | | | | | | | | | | | | | | | | | | | | | | | | | | | | | | | |
| | | | | | | | | | | | | | | | | | | | | | | | | | | | | | | | | | | | | | | | | | | | | | | | | | | | | | | | | | | | | | | | | | | | | | | | | | | | | | | | |
| Post - 0 Miss - 0 Block - 0 | Post - 0 Miss - 0 Block - 0 | Post - 0 Miss - 0 Block - 0 | Post - 0 Miss - 0 Block - 0 | Post - 0 Miss - 0 Block - 0 | Post - 0 Miss - 0 Block - 0 | Post - 0 Miss - 0 Block - 0 | Post - 0 Miss - 0 Block - 0 | | | | | | | | | | | | | | | | | | | | | | | | | | | | | | | | | | | | | | | | | | | | | | | | | | | | | | | | | | | | | | | | | | | | | | | | |
| 9 杨金龙 | 10 孙飞扬 | 11 刘新然 | 13 张昊燃 | 14 单中宝 | 15 刘淇 | 16 胡文柯 | 17 徐鹏辉 | | | | | | | | | | | | | | | | | | | | | | | | | | | | | | | | | | | | | | | | | | | | | | | | | | | | | | | | | | | | | | | | | | | | | | | | |
| <table border="1"><tr><td>1</td><td></td><td>2</td></tr><tr><td>2</td><td></td><td>1</td></tr><tr><td>1</td><td></td><td></td></tr></table> | 1 | | 2 | 2 | | 1 | 1 | | | <table border="1"><tr><td>1</td><td></td><td></td></tr><tr><td></td><td></td><td>2</td></tr><tr><td>1</td><td></td><td></td></tr></table> | 1 | | | | | 2 | 1 | | | <table border="1"><tr><td></td><td></td><td></td></tr><tr><td></td><td></td><td></td></tr><tr><td></td><td></td><td></td></tr></table> | | | | | | | | | | <table border="1"><tr><td></td><td></td><td></td></tr><tr><td></td><td></td><td></td></tr><tr><td></td><td></td><td></td></tr></table> | | | | | | | | | | <table border="1"><tr><td></td><td></td><td></td></tr><tr><td></td><td></td><td></td></tr><tr><td></td><td></td><td></td></tr></table> | | | | | | | | | | <table border="1"><tr><td></td><td></td><td></td></tr><tr><td></td><td></td><td></td></tr><tr><td></td><td></td><td></td></tr></table> | | | | | | | | | | <table border="1"><tr><td></td><td></td><td></td></tr><tr><td></td><td></td><td></td></tr><tr><td></td><td></td><td></td></tr></table> | | | | | | | | | | <table border="1"><tr><td></td><td></td><td></td></tr><tr><td></td><td></td><td></td></tr><tr><td></td><td></td><td></td></tr></table> | | | | | | | | | |
| 1 | | 2 | | | | | | | | | | | | | | | | | | | | | | | | | | | | | | | | | | | | | | | | | | | | | | | | | | | | | | | | | | | | | | | | | | | | | | | | | | | | | |
| 2 | | 1 | | | | | | | | | | | | | | | | | | | | | | | | | | | | | | | | | | | | | | | | | | | | | | | | | | | | | | | | | | | | | | | | | | | | | | | | | | | | | |
| 1 | | | | | | | | | | | | | | | | | | | | | | | | | | | | | | | | | | | | | | | | | | | | | | | | | | | | | | | | | | | | | | | | | | | | | | | | | | | | | | | |
| 1 | | | | | | | | | | | | | | | | | | | | | | | | | | | | | | | | | | | | | | | | | | | | | | | | | | | | | | | | | | | | | | | | | | | | | | | | | | | | | | | |
| | | 2 | | | | | | | | | | | | | | | | | | | | | | | | | | | | | | | | | | | | | | | | | | | | | | | | | | | | | | | | | | | | | | | | | | | | | | | | | | | | | |
| 1 | | | | | | | | | | | | | | | | | | | | | | | | | | | | | | | | | | | | | | | | | | | | | | | | | | | | | | | | | | | | | | | | | | | | | | | | | | | | | | | |
| | | | | | | | | | | | | | | | | | | | | | | | | | | | | | | | | | | | | | | | | | | | | | | | | | | | | | | | | | | | | | | | | | | | | | | | | | | | | | | | |
| | | | | | | | | | | | | | | | | | | | | | | | | | | | | | | | | | | | | | | | | | | | | | | | | | | | | | | | | | | | | | | | | | | | | | | | | | | | | | | | |
| | | | | | | | | | | | | | | | | | | | | | | | | | | | | | | | | | | | | | | | | | | | | | | | | | | | | | | | | | | | | | | | | | | | | | | | | | | | | | | | |
| | | | | | | | | | | | | | | | | | | | | | | | | | | | | | | | | | | | | | | | | | | | | | | | | | | | | | | | | | | | | | | | | | | | | | | | | | | | | | | | |
| | | | | | | | | | | | | | | | | | | | | | | | | | | | | | | | | | | | | | | | | | | | | | | | | | | | | | | | | | | | | | | | | | | | | | | | | | | | | | | | |
| | | | | | | | | | | | | | | | | | | | | | | | | | | | | | | | | | | | | | | | | | | | | | | | | | | | | | | | | | | | | | | | | | | | | | | | | | | | | | | | |
| | | | | | | | | | | | | | | | | | | | | | | | | | | | | | | | | | | | | | | | | | | | | | | | | | | | | | | | | | | | | | | | | | | | | | | | | | | | | | | | |
| | | | | | | | | | | | | | | | | | | | | | | | | | | | | | | | | | | | | | | | | | | | | | | | | | | | | | | | | | | | | | | | | | | | | | | | | | | | | | | | |
| | | | | | | | | | | | | | | | | | | | | | | | | | | | | | | | | | | | | | | | | | | | | | | | | | | | | | | | | | | | | | | | | | | | | | | | | | | | | | | | |
| | | | | | | | | | | | | | | | | | | | | | | | | | | | | | | | | | | | | | | | | | | | | | | | | | | | | | | | | | | | | | | | | | | | | | | | | | | | | | | | |
| | | | | | | | | | | | | | | | | | | | | | | | | | | | | | | | | | | | | | | | | | | | | | | | | | | | | | | | | | | | | | | | | | | | | | | | | | | | | | | | |
| | | | | | | | | | | | | | | | | | | | | | | | | | | | | | | | | | | | | | | | | | | | | | | | | | | | | | | | | | | | | | | | | | | | | | | | | | | | | | | | |
| | | | | | | | | | | | | | | | | | | | | | | | | | | | | | | | | | | | | | | | | | | | | | | | | | | | | | | | | | | | | | | | | | | | | | | | | | | | | | | | |
| | | | | | | | | | | | | | | | | | | | | | | | | | | | | | | | | | | | | | | | | | | | | | | | | | | | | | | | | | | | | | | | | | | | | | | | | | | | | | | | |
| | | | | | | | | | | | | | | | | | | | | | | | | | | | | | | | | | | | | | | | | | | | | | | | | | | | | | | | | | | | | | | | | | | | | | | | | | | | | | | | |
| | | | | | | | | | | | | | | | | | | | | | | | | | | | | | | | | | | | | | | | | | | | | | | | | | | | | | | | | | | | | | | | | | | | | | | | | | | | | | | | |
| | | | | | | | | | | | | | | | | | | | | | | | | | | | | | | | | | | | | | | | | | | | | | | | | | | | | | | | | | | | | | | | | | | | | | | | | | | | | | | | |
| | | | | | | | | | | | | | | | | | | | | | | | | | | | | | | | | | | | | | | | | | | | | | | | | | | | | | | | | | | | | | | | | | | | | | | | | | | | | | | | |
| Post - 0 Miss - 1 Block - 0 | Post - 1 Miss - 1 Block - 2 | Post - 0 Miss - 0 Block - 0 | Post - 0 Miss - 0 Block - 0 | Post - 0 Miss - 0 Block - 0 | Post - 0 Miss - 0 Block - 0 | Post - 0 Miss - 0 Block - 0 | Post - 0 Miss - 0 Block - 0 | | | | | | | | | | | | | | | | | | | | | | | | | | | | | | | | | | | | | | | | | | | | | | | | | | | | | | | | | | | | | | | | | | | | | | | | |

1 苟嘉毅

| | | |
|-----|-----|-----|
| 0/5 | 1/2 | 1/5 |
| 3/6 | | |
| 0/1 | | 1/2 |

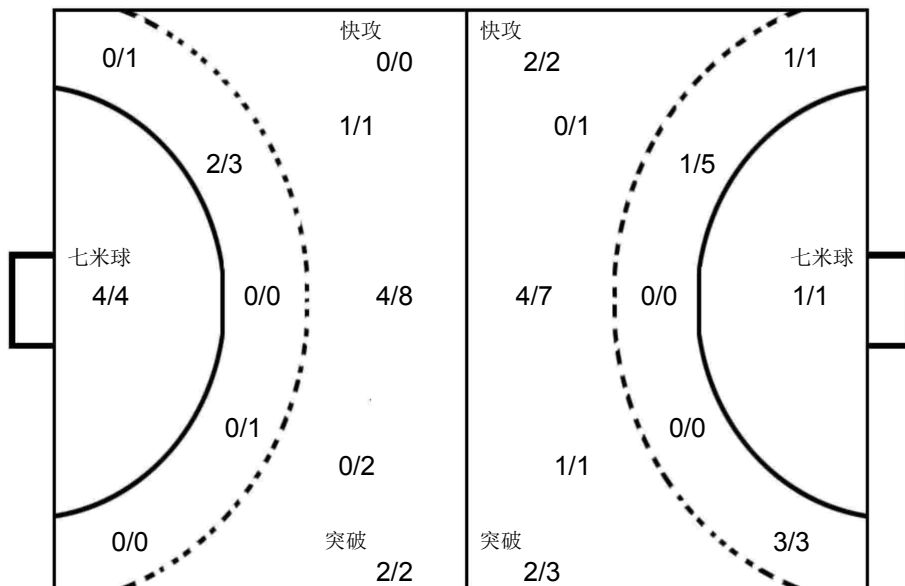

1 刘子豪

| | | |
|-----|-----|-----|
| 0/2 | 1/1 | 0/2 |
| 0/2 | | 0/4 |
| 0/2 | 1/1 | 2/3 |

福建龙岩

| | | | | | | | | | | | | | | | | | | | | | | | | | | | | | | | | | | | | | | | | | | | | | | | | | | | | | | | | | | | | | | | | | | | | | | | | | | | | | | | |
|--|-----------------------------|-----------------------------|-----------------------------|-----------------------------|-----------------------------|-----------------------------|-----------------------------|--|--|--|---|--|---|--|--|--|--|--|--|--|---|--|---|--|--|--|--|--|--|--|--|--|--|--|--|--|--|--|--|--|--|--|--|--|--|--|--|--|--|--|--|--|--|--|--|--|--|--|--|---|--|--|--|---|--|--|---|--|---|---|---|---|--|---|--|--|--|--|--|
| 1 刘子豪 | 5 郭雨强 | 6 刘阳 | 7 王晨旭 | 8 杨鑫祥 | 9 荆胤丞 | 10 赵一 | 15 刘家良 | | | | | | | | | | | | | | | | | | | | | | | | | | | | | | | | | | | | | | | | | | | | | | | | | | | | | | | | | | | | | | | | | | | | | | | | |
| <table border="1"><tr><td></td><td></td><td></td></tr><tr><td></td><td></td><td></td></tr><tr><td></td><td></td><td></td></tr></table> | | | | | | | | | | <table border="1"><tr><td>1</td><td></td><td>3</td></tr><tr><td></td><td></td><td></td></tr><tr><td></td><td></td><td></td></tr></table> | 1 | | 3 | | | | | | | <table border="1"><tr><td>1</td><td></td><td>1</td></tr><tr><td></td><td></td><td></td></tr><tr><td></td><td></td><td></td></tr></table> | 1 | | 1 | | | | | | | <table border="1"><tr><td></td><td></td><td></td></tr><tr><td></td><td></td><td></td></tr><tr><td></td><td></td><td></td></tr></table> | | | | | | | | | | <table border="1"><tr><td></td><td></td><td></td></tr><tr><td></td><td></td><td></td></tr><tr><td></td><td></td><td></td></tr></table> | | | | | | | | | | <table border="1"><tr><td></td><td></td><td></td></tr><tr><td></td><td></td><td></td></tr><tr><td></td><td></td><td></td></tr></table> | | | | | | | | | | <table border="1"><tr><td></td><td></td><td></td></tr><tr><td>1</td><td></td><td></td></tr><tr><td>1</td><td></td><td>1</td></tr></table> | | | | 1 | | | 1 | | 1 | <table border="1"><tr><td>1</td><td>1</td><td></td></tr><tr><td>2</td><td></td><td></td></tr><tr><td></td><td></td><td></td></tr></table> | 1 | 1 | | 2 | | | | | |
| | | | | | | | | | | | | | | | | | | | | | | | | | | | | | | | | | | | | | | | | | | | | | | | | | | | | | | | | | | | | | | | | | | | | | | | | | | | | | | | |
| | | | | | | | | | | | | | | | | | | | | | | | | | | | | | | | | | | | | | | | | | | | | | | | | | | | | | | | | | | | | | | | | | | | | | | | | | | | | | | | |
| | | | | | | | | | | | | | | | | | | | | | | | | | | | | | | | | | | | | | | | | | | | | | | | | | | | | | | | | | | | | | | | | | | | | | | | | | | | | | | | |
| 1 | | 3 | | | | | | | | | | | | | | | | | | | | | | | | | | | | | | | | | | | | | | | | | | | | | | | | | | | | | | | | | | | | | | | | | | | | | | | | | | | | | |
| | | | | | | | | | | | | | | | | | | | | | | | | | | | | | | | | | | | | | | | | | | | | | | | | | | | | | | | | | | | | | | | | | | | | | | | | | | | | | | | |
| | | | | | | | | | | | | | | | | | | | | | | | | | | | | | | | | | | | | | | | | | | | | | | | | | | | | | | | | | | | | | | | | | | | | | | | | | | | | | | | |
| 1 | | 1 | | | | | | | | | | | | | | | | | | | | | | | | | | | | | | | | | | | | | | | | | | | | | | | | | | | | | | | | | | | | | | | | | | | | | | | | | | | | | |
| | | | | | | | | | | | | | | | | | | | | | | | | | | | | | | | | | | | | | | | | | | | | | | | | | | | | | | | | | | | | | | | | | | | | | | | | | | | | | | | |
| | | | | | | | | | | | | | | | | | | | | | | | | | | | | | | | | | | | | | | | | | | | | | | | | | | | | | | | | | | | | | | | | | | | | | | | | | | | | | | | |
| | | | | | | | | | | | | | | | | | | | | | | | | | | | | | | | | | | | | | | | | | | | | | | | | | | | | | | | | | | | | | | | | | | | | | | | | | | | | | | | |
| | | | | | | | | | | | | | | | | | | | | | | | | | | | | | | | | | | | | | | | | | | | | | | | | | | | | | | | | | | | | | | | | | | | | | | | | | | | | | | | |
| | | | | | | | | | | | | | | | | | | | | | | | | | | | | | | | | | | | | | | | | | | | | | | | | | | | | | | | | | | | | | | | | | | | | | | | | | | | | | | | |
| | | | | | | | | | | | | | | | | | | | | | | | | | | | | | | | | | | | | | | | | | | | | | | | | | | | | | | | | | | | | | | | | | | | | | | | | | | | | | | | |
| | | | | | | | | | | | | | | | | | | | | | | | | | | | | | | | | | | | | | | | | | | | | | | | | | | | | | | | | | | | | | | | | | | | | | | | | | | | | | | | |
| | | | | | | | | | | | | | | | | | | | | | | | | | | | | | | | | | | | | | | | | | | | | | | | | | | | | | | | | | | | | | | | | | | | | | | | | | | | | | | | |
| | | | | | | | | | | | | | | | | | | | | | | | | | | | | | | | | | | | | | | | | | | | | | | | | | | | | | | | | | | | | | | | | | | | | | | | | | | | | | | | |
| | | | | | | | | | | | | | | | | | | | | | | | | | | | | | | | | | | | | | | | | | | | | | | | | | | | | | | | | | | | | | | | | | | | | | | | | | | | | | | | |
| | | | | | | | | | | | | | | | | | | | | | | | | | | | | | | | | | | | | | | | | | | | | | | | | | | | | | | | | | | | | | | | | | | | | | | | | | | | | | | | |
| | | | | | | | | | | | | | | | | | | | | | | | | | | | | | | | | | | | | | | | | | | | | | | | | | | | | | | | | | | | | | | | | | | | | | | | | | | | | | | | |
| 1 | | | | | | | | | | | | | | | | | | | | | | | | | | | | | | | | | | | | | | | | | | | | | | | | | | | | | | | | | | | | | | | | | | | | | | | | | | | | | | | |
| 1 | | 1 | | | | | | | | | | | | | | | | | | | | | | | | | | | | | | | | | | | | | | | | | | | | | | | | | | | | | | | | | | | | | | | | | | | | | | | | | | | | | |
| 1 | 1 | | | | | | | | | | | | | | | | | | | | | | | | | | | | | | | | | | | | | | | | | | | | | | | | | | | | | | | | | | | | | | | | | | | | | | | | | | | | | | |
| 2 | | | | | | | | | | | | | | | | | | | | | | | | | | | | | | | | | | | | | | | | | | | | | | | | | | | | | | | | | | | | | | | | | | | | | | | | | | | | | | | |
| | | | | | | | | | | | | | | | | | | | | | | | | | | | | | | | | | | | | | | | | | | | | | | | | | | | | | | | | | | | | | | | | | | | | | | | | | | | | | | | |
| Post - 0 Miss - 0 Block - 0 | Post - 0 Miss - 0 Block - 0 | Post - 0 Miss - 0 Block - 0 | Post - 0 Miss - 0 Block - 0 | Post - 0 Miss - 0 Block - 0 | Post - 0 Miss - 0 Block - 0 | Post - 0 Miss - 0 Block - 0 | Post - 0 Miss - 3 Block - 0 | | | | | | | | | | | | | | | | | | | | | | | | | | | | | | | | | | | | | | | | | | | | | | | | | | | | | | | | | | | | | | | | | | | | | | | | |
| 16 李凯锋 | 17 陈锐涛 | 18 奚尧 | 21 刘晓青 | 23 朱天一 | 24 钟盛发 | 27 邓可钊 | 36 陈泽锟 | | | | | | | | | | | | | | | | | | | | | | | | | | | | | | | | | | | | | | | | | | | | | | | | | | | | | | | | | | | | | | | | | | | | | | | | |
| <table border="1"><tr><td></td><td></td><td></td></tr><tr><td></td><td></td><td></td></tr><tr><td></td><td></td><td></td></tr></table> | | | | | | | | | | <table border="1"><tr><td></td><td></td><td></td></tr><tr><td></td><td></td><td></td></tr><tr><td></td><td></td><td></td></tr></table> | | | | | | | | | | <table border="1"><tr><td>1</td><td></td><td></td></tr><tr><td></td><td></td><td></td></tr><tr><td></td><td></td><td></td></tr></table> | 1 | | | | | | | | | <table border="1"><tr><td></td><td></td><td></td></tr><tr><td></td><td></td><td></td></tr><tr><td></td><td></td><td></td></tr></table> | | | | | | | | | | <table border="1"><tr><td></td><td></td><td></td></tr><tr><td></td><td></td><td></td></tr><tr><td></td><td></td><td></td></tr></table> | | | | | | | | | | <table border="1"><tr><td></td><td></td><td></td></tr><tr><td></td><td></td><td></td></tr><tr><td></td><td></td><td></td></tr></table> | | | | | | | | | | <table border="1"><tr><td></td><td></td><td></td></tr><tr><td>1</td><td></td><td></td></tr><tr><td></td><td></td><td></td></tr></table> | | | | 1 | | | | | | <table border="1"><tr><td></td><td></td><td></td></tr><tr><td></td><td></td><td></td></tr><tr><td></td><td></td><td></td></tr></table> | | | | | | | | | |
| | | | | | | | | | | | | | | | | | | | | | | | | | | | | | | | | | | | | | | | | | | | | | | | | | | | | | | | | | | | | | | | | | | | | | | | | | | | | | | | |
| | | | | | | | | | | | | | | | | | | | | | | | | | | | | | | | | | | | | | | | | | | | | | | | | | | | | | | | | | | | | | | | | | | | | | | | | | | | | | | | |
| | | | | | | | | | | | | | | | | | | | | | | | | | | | | | | | | | | | | | | | | | | | | | | | | | | | | | | | | | | | | | | | | | | | | | | | | | | | | | | | |
| | | | | | | | | | | | | | | | | | | | | | | | | | | | | | | | | | | | | | | | | | | | | | | | | | | | | | | | | | | | | | | | | | | | | | | | | | | | | | | | |
| | | | | | | | | | | | | | | | | | | | | | | | | | | | | | | | | | | | | | | | | | | | | | | | | | | | | | | | | | | | | | | | | | | | | | | | | | | | | | | | |
| | | | | | | | | | | | | | | | | | | | | | | | | | | | | | | | | | | | | | | | | | | | | | | | | | | | | | | | | | | | | | | | | | | | | | | | | | | | | | | | |
| 1 | | | | | | | | | | | | | | | | | | | | | | | | | | | | | | | | | | | | | | | | | | | | | | | | | | | | | | | | | | | | | | | | | | | | | | | | | | | | | | | |
| | | | | | | | | | | | | | | | | | | | | | | | | | | | | | | | | | | | | | | | | | | | | | | | | | | | | | | | | | | | | | | | | | | | | | | | | | | | | | | | |
| | | | | | | | | | | | | | | | | | | | | | | | | | | | | | | | | | | | | | | | | | | | | | | | | | | | | | | | | | | | | | | | | | | | | | | | | | | | | | | | |
| | | | | | | | | | | | | | | | | | | | | | | | | | | | | | | | | | | | | | | | | | | | | | | | | | | | | | | | | | | | | | | | | | | | | | | | | | | | | | | | |
| | | | | | | | | | | | | | | | | | | | | | | | | | | | | | | | | | | | | | | | | | | | | | | | | | | | | | | | | | | | | | | | | | | | | | | | | | | | | | | | |
| | | | | | | | | | | | | | | | | | | | | | | | | | | | | | | | | | | | | | | | | | | | | | | | | | | | | | | | | | | | | | | | | | | | | | | | | | | | | | | | |
| | | | | | | | | | | | | | | | | | | | | | | | | | | | | | | | | | | | | | | | | | | | | | | | | | | | | | | | | | | | | | | | | | | | | | | | | | | | | | | | |
| | | | | | | | | | | | | | | | | | | | | | | | | | | | | | | | | | | | | | | | | | | | | | | | | | | | | | | | | | | | | | | | | | | | | | | | | | | | | | | | |
| | | | | | | | | | | | | | | | | | | | | | | | | | | | | | | | | | | | | | | | | | | | | | | | | | | | | | | | | | | | | | | | | | | | | | | | | | | | | | | | |
| | | | | | | | | | | | | | | | | | | | | | | | | | | | | | | | | | | | | | | | | | | | | | | | | | | | | | | | | | | | | | | | | | | | | | | | | | | | | | | | |
| | | | | | | | | | | | | | | | | | | | | | | | | | | | | | | | | | | | | | | | | | | | | | | | | | | | | | | | | | | | | | | | | | | | | | | | | | | | | | | | |
| | | | | | | | | | | | | | | | | | | | | | | | | | | | | | | | | | | | | | | | | | | | | | | | | | | | | | | | | | | | | | | | | | | | | | | | | | | | | | | | |
| | | | | | | | | | | | | | | | | | | | | | | | | | | | | | | | | | | | | | | | | | | | | | | | | | | | | | | | | | | | | | | | | | | | | | | | | | | | | | | | |
| 1 | | | | | | | | | | | | | | | | | | | | | | | | | | | | | | | | | | | | | | | | | | | | | | | | | | | | | | | | | | | | | | | | | | | | | | | | | | | | | | | |
| | | | | | | | | | | | | | | | | | | | | | | | | | | | | | | | | | | | | | | | | | | | | | | | | | | | | | | | | | | | | | | | | | | | | | | | | | | | | | | | |
| | | | | | | | | | | | | | | | | | | | | | | | | | | | | | | | | | | | | | | | | | | | | | | | | | | | | | | | | | | | | | | | | | | | | | | | | | | | | | | | |
| | | | | | | | | | | | | | | | | | | | | | | | | | | | | | | | | | | | | | | | | | | | | | | | | | | | | | | | | | | | | | | | | | | | | | | | | | | | | | | | |
| | | | | | | | | | | | | | | | | | | | | | | | | | | | | | | | | | | | | | | | | | | | | | | | | | | | | | | | | | | | | | | | | | | | | | | | | | | | | | | | |
| Post - 0 Miss - 0 Block - 0 | Post - 0 Miss - 0 Block - 0 | Post - 0 Miss - 0 Block - 0 | Post - 0 Miss - 0 Block - 0 | Post - 0 Miss - 0 Block - 0 | Post - 0 Miss - 0 Block - 0 | Post - 0 Miss - 0 Block - 0 | Post - 0 Miss - 0 Block - 0 | | | | | | | | | | | | | | | | | | | | | | | | | | | | | | | | | | | | | | | | | | | | | | | | | | | | | | | | | | | | | | | | | | | | | | | | |



| | | |
|---------|--------|--------------|
| Team A | Team B | Match Number |
| A 安徽省体校 | B 上海宝山 | 34 |

| | | | | |
|-----------|-------------|------------|-------|------------|
| Played in | in the hall | on | at | Spepectors |
| 安徽滁州 | 滁州国际手球馆 | 2019-06-04 | 16:00 | hours |

| | | | | | | | | | | | | | | |
|----------------|---|---|---------------------|----|---|----------------|---|---|----------------|---|---|----------------------|---|---|
| Half-time(30') | A | B | End of playing time | A | B | 1st extra time | A | B | 2nd extra time | A | B | After penalty throws | A | B |
| | 8 | 6 | 17 | 11 | | | | | | | | | | |

| | | | | | | | | | | |
|---------------|-----|---------------|---|---|------------------------------------|---------------|-------|---|-----|---------------|
| Number of 7 m | A | Team time-out | | | Full name of players and officials | Team time-out | | | B | Number of 7 m |
| | 1/1 | 1 | 2 | 3 | | 1 | 2 | 3 | 1/1 | |
| | | | | | | 13:49 | 38:04 | | | |

| No. | Team A | G | W | 2' | D | DR | No. | Team B | G | W | 2' | D | DR |
|-----|--------|---|---|----|---|----|-----|-----------|---|---|----|---|----|
| 52 | 花驰 | | | | | | 3 | 侯俊杰 | 1 | | | | |
| 53 | 叶天赐 | | | | | | 5 | 范斯哲 | 1 | | | | |
| 54 | 姚幸运 | 1 | | | | | 6 | 吴梓涵 | | | | | |
| 55 | 苏凯 | 2 | | | | | 7 | 彭意焱 | 1 | | | | |
| 56 | 王健鹏 | 3 | 1 | | | | 10 | 马涛 | 2 | | | | |
| 57 | 朱正翔 | | | | | | 13 | 刘启群 | | | 1 | | |
| 58 | 蔡博飞 | 3 | | | | | 21 | 曾新宇 | 1 | | | | |
| 59 | 毛饶翔 | | | | | | 22 | 马浩东 | 1 | | | | |
| 60 | 朱超 | 3 | | | | | 25 | 江锦 | 1 | | | | |
| 61 | 钮伟豪 | | | | | | 35 | 刘子杰 | 3 | | | | |
| 62 | 赵俊阳 | 2 | | | | | 39 | 陆毅泽 | | | | | |
| 64 | 章道胜 | 3 | | | | | 66 | 黄嘉遥 | | | | | |
| 65 | 韩伟伦 | | | | | | 68 | 陈沁磊 | | | | | |
| 66 | 刘家豪 | | | | | | | | | | | | |
| 68 | 黄天源 | | | | | | | | | | | | |
| A | 赵前军 | | | | | | B | 徐聪豪 (主教练) | | | | | |
| C | 吕串 | | | | | | D | 赵时俊 | | | | | |
| D | 沈强 | | | | | | | | | | | | |
| E | 李煜 | | | | | | | | | | | | |

| | | |
|---|--|---|
| A | Signatures of responsables for the teams (Off.A) | B |
|---|--|---|

| | | |
|----|-----------------------------------|----|
| TP | Remarks of referees / HF Official | TP |
|----|-----------------------------------|----|

| | | | |
|------------|-----------|-----------|--|
| Signatures | | | |
| Referees | 李兆蒙 (CHN) | 马晓晔 (CHN) | |
| T.D. | 吴瑞亭 (CHN) | 王洋 (CHN) | |
| CHA Off. | | | |

Note: Number of 7m Throws Awarded to Team A and B, Goals (G), Warnings (W), Suspensions (2'), Direct Disqualification (D), Disqualification With Report (DR) and Team Penalty (TP).

Table Officials: 刘洋洋 许修凯 Statisticians: 童佩瑶 王梓衡

第二届全国青年运动会男子手球乙组决赛 体校组 (U16)

PHMS Pictorial Handball Match Statistics

IHF Official System

竞赛技术统计

手球
青年男子

半决赛
轮次 5

组别 X
场次 34

滁州国际手球馆
2019-06-04 16:00

Referees: 李兆蒙 (CHN) / 马晓晔 (CHN)

Result: 17:11(8:6)

Teams: 安徽省体校(安徽) VS 上海宝山(宝山)

| 安徽 | | 远射 | 近射 | 边射 | 快攻 | 突破 | 任意球 | 7m球 | 合计 | % | 助攻 | 失误 | 警告 | 2' | D+DR |
|---------|-----|-----|-----|-----|-----|-----|-----|-----|-------|------|----|----|----|----|------|
| 主教练: 张林 | | | | | | | | | | | | | | | |
| 52 | 花驰 | | | | | | | | | | 1 | 2 | | | |
| 53 | 叶天赐 | | | | | | | | | | | | | | |
| 54 | 姚幸运 | | 1/1 | | | | | 1/1 | 100 | | 1 | | | | |
| 55 | 苏凯 | | | 2/2 | | | | 2/2 | 100 | | 2 | | | | |
| 56 | 王健鹏 | 1/2 | 1/1 | | 0/1 | 1/2 | | 3/6 | 50.0 | 1 | | 1 | | | |
| 57 | 朱正翔 | | | | | | | | | | | | | | |
| 58 | 蔡博飞 | | 1/1 | | 1/1 | | | 1/1 | 3/3 | 100 | | 1 | | | |
| 59 | 毛饶翔 | 0/1 | 0/1 | | | 0/1 | | 0/3 | 0.0 | 1 | 2 | | | | |
| 60 | 朱超 | 1/1 | 2/3 | | | | | 3/4 | 75.0 | 1 | | | | | |
| 61 | 钮伟豪 | | | | | | | | | | | | | | |
| 62 | 赵俊阳 | | | 1/1 | 1/1 | | | 2/2 | 100 | | 1 | | | | |
| 64 | 章道胜 | | 1/1 | | 2/2 | | | 3/3 | 100 | | 1 | | | | |
| 65 | 韩伟伦 | | | | | | | | | | | | | | |
| 66 | 刘家豪 | | | | | | | | | | | | | | |
| 68 | 黄天源 | | | | | | | | | | | | | | |
| 运动员 | 合计 | 2/4 | 6/8 | 3/3 | 4/5 | 1/3 | | 1/1 | 17/24 | 70.8 | 4 | 10 | 1 | | |
| 52 | 花驰 | 4/6 | 1/4 | 1/3 | | 1/3 | 1/2 | 0/1 | 8/19 | 42.1 | 1 | 2 | | | |
| 守门员 | 合计 | 4/6 | 1/4 | 1/3 | | 1/3 | 1/2 | 0/1 | 8/19 | 42.1 | 1 | 2 | | | |

| 安徽 | 比赛进程 | 宝山 |
|----------|----------|----------|
| 1st Half | | |
| 55 苏凯 | 1 01:34 | 0 |
| 60 朱超 | 2 02:49 | 0 |
| 64 章道胜 | 3 04:47 | 0 |
| | 3 05:21 | 1 21 曾新宇 |
| 56 王健鹏 | 4 05:47 | 1 |
| | 4 06:19 | 2 35 刘子杰 |
| | 4 07:26 | 3 25 江锦 |
| 55 苏凯 | 5 07:47 | 3 |
| | 5 08:23 | 4 10 马涛 |
| 60 朱超 | 6 09:17 | 4 |
| | 6 10:01 | 5 22 马浩东 |
| 56 王健鹏 | 7 10:33 | 5 |
| | 7 12:56 | 6 3 侯俊杰 |
| 62 赵俊阳 | 8 15:00 | 6 |
| 2nd Half | | |
| | 8 01:54 | 7 35 刘子杰 |
| 62 赵俊阳 | 9 02:26 | 7 |
| | 9 03:29 | 8 10 马涛 |
| 56 王健鹏 | 10 04:06 | 8 |
| | 10 04:12 | 9 35 刘子杰 |
| 60 朱超 | 11 04:30 | 9 |
| 64 章道胜 | 12 05:44 | 9 |
| 64 章道胜 | 13 07:38 | 9 |
| 58 蔡博飞 | 14 08:25 | 9 |
| | 14 10:05 | 10 5 范斯哲 |
| 54 姚幸运 | 15 10:47 | 10 |
| 58 蔡博飞 | 16 11:25 | 10 |
| | 16 13:46 | 11 7 彭意焱 |
| 58 蔡博飞 | 17 14:20 | 11 |

| 宝山 | | 远射 | 近射 | 边射 | 快攻 | 突破 | 任意球 | 7m球 | 合计 | % | 助攻 | 失误 | 警告 | 2' | D+DR |
|----------|-----|------|-----|-----|-----|-----|-----|------|-------|------|----|----|----|----|------|
| 主教练: 徐聪豪 | | | | | | | | | | | | | | | |
| 3 | 侯俊杰 | | | 1/1 | | | | 1/1 | 100 | | 2 | | | | |
| 5 | 范斯哲 | | | | | | | 1/1 | 100 | | | | | | |
| 6 | 吴梓涵 | | | | | | | | | | 2 | | | | |
| 7 | 彭意焱 | | | | | | 1/1 | 1/1 | 100 | | | | | | |
| 10 | 马涛 | 0/2 | 1/2 | | | 1/1 | | 2/5 | 40.0 | | 1 | | | | |
| 13 | 刘启群 | | | | | | | | | | | | | 1 | |
| 21 | 曾新宇 | 1/1 | | | | | | 1/1 | 100 | | 3 | | | | |
| 22 | 马浩东 | 0/3 | | 0/1 | | 1/1 | | 1/5 | 20.0 | | | | | | |
| 25 | 江锦 | | 0/1 | 1/1 | | | | 1/2 | 50.0 | | | | | | |
| 35 | 刘子杰 | 1/4 | 2/2 | | | 0/1 | 0/2 | 3/9 | 33.3 | | 1 | | | | |
| 39 | 陆毅泽 | | | 0/1 | | | | 0/1 | 0.0 | | | | | | |
| 66 | 黄嘉遥 | | | | | | | | | | | | | | |
| 68 | 陈沁磊 | | | | | | | | | | | | | | |
| 运动员 | 合计 | 2/10 | 3/5 | 2/4 | | 2/3 | 1/3 | 1/1 | 11/26 | 42.3 | 9 | | | 1 | |
| 35 | 刘子杰 | | | | 0/1 | | | 0/1 | 0/2 | 0.0 | | | | | |
| 66 | 黄嘉遥 | 1/3 | 0/6 | 0/3 | 0/3 | 0/1 | | 1/16 | 6.3 | | | | | | |
| 守门员 | 合计 | 1/3 | 0/6 | 0/3 | 0/4 | 0/1 | | 0/1 | 1/18 | 5.6 | | | | | |

场上队员: 得分 / 射门

守门员: 救球 / 射门

| | | | |
|---|------|----|---------|
| D | 取消资格 | DR | 取消资格+报告 |
|---|------|----|---------|

个人/全队技术统计表

手球 半决赛 组别 X
青年男子 轮次 5 场次 34
滁州国际手球馆
2019-06-04 16:00

| 号码 | 姓名 | 远射 | 近射 | 边射 | 快攻 | 突破 | 任意 | 七米 | 合计 | % | 助攻 | 失误 | 警告 | 2' | 取消 | 时间 |
|------------------|-----|-----|-----|-----|-----|-----|-----|-----|-------|-------|----|----|----|----|----|----------|
| 安徽省体校(安徽) | | | | | | | | | | | | | | | | |
| (场上队员) | | | | | | | | | | | | | | | | |
| 52 | 花驰 | | | | | | | | | 0.0% | 1 | 2 | | | | 00:30:00 |
| 53 | 叶天赐 | | | | | | | | | 0.0% | | | | | | 00:00:00 |
| 54 | 姚幸运 | | 1/1 | | | | | | 1/1 | 100% | | 1 | | | | 00:15:00 |
| 55 | 苏凯 | | | 2/2 | | | | | 2/2 | 100% | | 2 | | | | 00:15:00 |
| 56 | 王健鹏 | 1/2 | 1/1 | | 0/1 | 1/2 | | | 3/6 | 50.0% | 1 | | 1 | | | 00:21:17 |
| 57 | 朱正翔 | | | | | | | | | 0.0% | | | | | | 00:02:10 |
| 58 | 蔡博飞 | | 1/1 | | 1/1 | | | 1/1 | 3/3 | 100% | | 1 | | | | 00:11:23 |
| 59 | 毛饶翔 | 0/1 | 0/1 | | | 0/1 | | | 0/3 | 0.0% | 1 | 2 | | | | 00:25:02 |
| 60 | 朱超 | 1/1 | 2/3 | | | | | | 3/4 | 75.0% | 1 | | | | | 00:30:00 |
| 61 | 钮伟豪 | | | | | | | | | 0.0% | | | | | | 00:00:00 |
| 62 | 赵俊阳 | | | 1/1 | 1/1 | | | | 2/2 | 100% | | 1 | | | | 00:30:00 |
| 64 | 章道胜 | | 1/1 | | 2/2 | | | | 3/3 | 100% | | 1 | | | | 00:28:50 |
| 65 | 韩伟伦 | | | | | | | | | 0.0% | | | | | | 00:00:00 |
| 66 | 刘家豪 | | | | | | | | | 0.0% | | | | | | 00:00:00 |
| 68 | 黄天源 | | | | | | | | | 0.0% | | | | | | 00:01:09 |
| 合计 | | 2/4 | 6/8 | 3/3 | 4/5 | 1/3 | | 1/1 | 17/24 | 70.8% | 4 | 10 | 1 | | | |
| (守门员) | | | | | | | | | | | | | | | | |
| 52 | 花驰 | 4/6 | 1/4 | 1/3 | | 1/3 | 1/2 | 0/1 | 8/19 | 42.1% | 1 | 2 | | | | 00:30:00 |
| 合计 | | 4/6 | 1/4 | 1/3 | | 1/3 | 1/2 | 0/1 | 8/19 | 42.1% | 1 | 2 | | | | |

场上队员：得分/射门

守门员：救球/射门

| 全队合计 | 得分 | 被救 | 射失 | 击柱 | 封球 | 合计 | % |
|------|----|----|----|----|----|----|--------|
| 远射 | 2 | 1 | | | 1 | 4 | 50.0% |
| 近射 | 6 | | 1 | 1 | | 8 | 75.0% |
| 边射 | 3 | | | | | 3 | 100.0% |
| 快攻 | 4 | | 1 | | | 5 | 80.0% |
| 突破 | 1 | | | 2 | | 3 | 33.3% |
| 任意 | | | | | | | 0.0% |
| 七米 | 1 | | | | | 1 | 100.0% |

个人/全队技术统计表

手球 半决赛 组别 X
青年男子 轮次 5 场次 34
滁州国际手球馆
2019-06-04 16:00

| 号码 | 姓名 | 远射 | 近射 | 边射 | 快攻 | 突破 | 任意 | 七米 | 合计 | % | 助攻 | 失误 | 警告 | 2' | 取消 | 时间 |
|----------|-----|------|-----|-----|----|-----|-----|-----|-------|-------|----|----|----|----|----|----------|
| 上海宝山(宝山) | | | | | | | | | | | | | | | | |
| (场上队员) | | | | | | | | | | | | | | | | |
| 3 | 侯俊杰 | | | 1/1 | | | | | 1/1 | 100% | | 2 | | | | 00:30:00 |
| 5 | 范斯哲 | | | | | | | 1/1 | 1/1 | 100% | | | | | | 00:22:07 |
| 6 | 吴梓涵 | | | | | | | | | 0.0% | | 2 | | | | 00:06:24 |
| 7 | 彭意焱 | | | | | | 1/1 | | 1/1 | 100% | | | | | | 00:06:24 |
| 10 | 马涛 | 0/2 | 1/2 | | | 1/1 | | | 2/5 | 40.0% | | 1 | | | | 00:23:33 |
| 13 | 刘启群 | | | | | | | | | 0.0% | | | | 1 | | 00:02:04 |
| 21 | 曾新宇 | 1/1 | | | | | | | 1/1 | 100% | | 3 | | | | 00:09:47 |
| 22 | 马浩东 | 0/3 | | 0/1 | | 1/1 | | | 1/5 | 20.0% | | | | | | 00:23:39 |
| 25 | 江锦 | | 0/1 | 1/1 | | | | | 1/2 | 50.0% | | | | | | 00:30:00 |
| 35 | 刘子杰 | 1/4 | 2/2 | | | 0/1 | 0/2 | | 3/9 | 33.3% | | 1 | | | | 00:27:38 |
| 39 | 陆毅泽 | | | 0/1 | | | | | 0/1 | 0.0% | | | | | | 00:02:15 |
| 66 | 黄嘉遥 | | | | | | | | | 0.0% | | | | | | 00:25:56 |
| 68 | 陈沁磊 | | | | | | | | | 0.0% | | | | | | 00:00:00 |
| 合计 | | 2/10 | 3/5 | 2/4 | | 2/3 | 1/3 | 1/1 | 11/26 | 42.3% | | 9 | | 1 | | |

(守门员)

| | | | | | | | | | | | | | | | | |
|----|-----|-----|-----|-----|-----|-----|--|-----|------|------|--|--|--|--|--|----------|
| 35 | 刘子杰 | | | | | 0/1 | | 0/1 | 0/2 | 0.0% | | | | | | 00:27:38 |
| 66 | 黄嘉遥 | 1/3 | 0/6 | 0/3 | 0/3 | 0/1 | | | 1/16 | 6.3% | | | | | | 00:25:56 |
| 合计 | | 1/3 | 0/6 | 0/3 | 0/4 | 0/1 | | 0/1 | 1/18 | 5.6% | | | | | | |

场上队员：得分/射门

守门员：救球/射门

| 全队合计 | 得分 | 被救 | 射失 | 击柱 | 封球 | 合计 | % |
|------|----|----|----|----|----|----|--------|
| 远射 | 2 | 4 | 1 | 1 | 2 | 10 | 20.0% |
| 近射 | 3 | 1 | | 1 | | 5 | 60.0% |
| 边射 | 2 | 1 | | 1 | | 4 | 50.0% |
| 快攻 | | | | | | | 0.0% |
| 突破 | 2 | 1 | | | | 3 | 66.7% |
| 任意 | 1 | 1 | | 1 | | 3 | 33.3% |
| 七米 | 1 | | | | | 1 | 100.0% |

图式比赛技术统计表

手球
青年男子

半决赛
轮次 5

组别 X
场次 34

滁州国际手球馆
2019-06-04 16:00

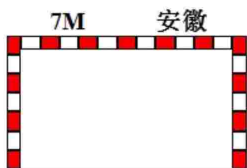
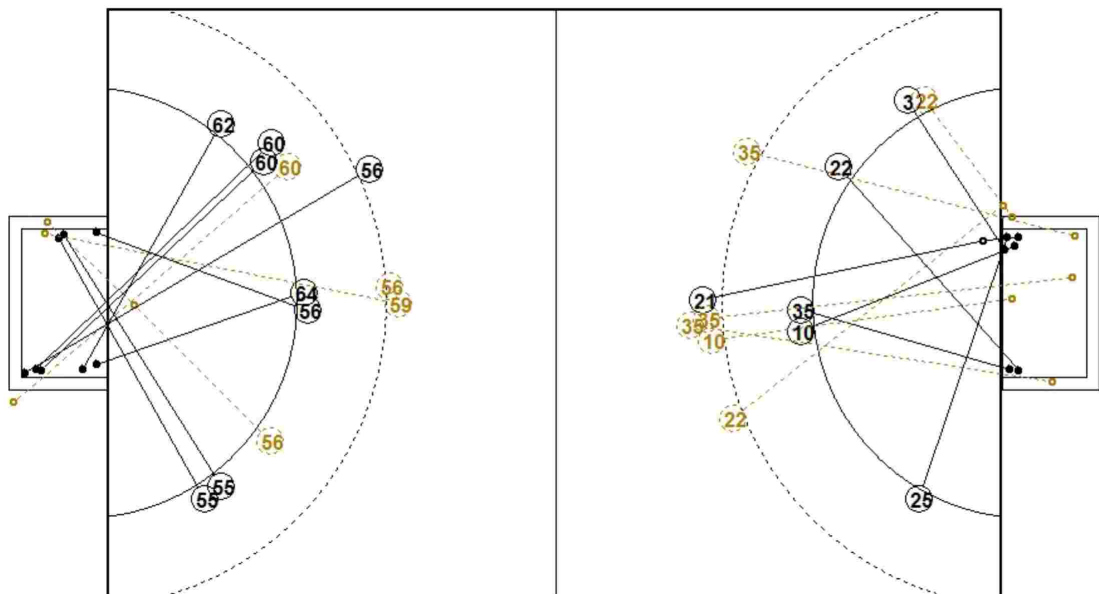

1st Half
8 : 6

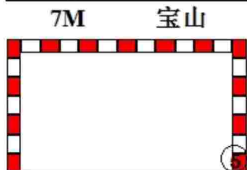
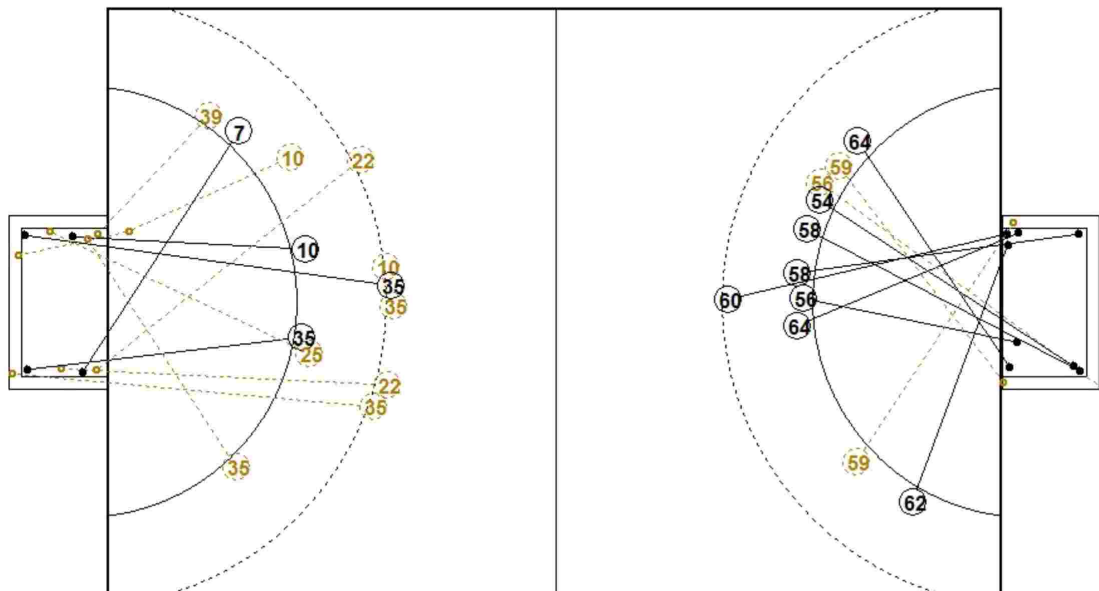
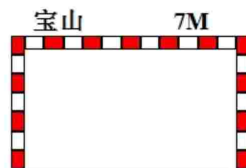

2nd Half
11 : 17

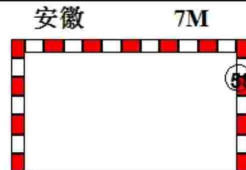

图式射门区域统计

手球
青年男子

半决赛
轮次 5

组别 X
场次 34

滁州国际手球馆
2019-06-04 16:00

安徽省体校

| | | | | | | | | | | | | | | | | | | | | | | | | | | | | | | | | | | | | | | | | | | | | | | | | | | | | | | | | | | | | | | | | | | | | | | | | | | | | | | | |
|--|---|---|--|--|--|--|---|--|--|---|--|--|--|--|--|--|--|--|--|--|--|--|---|--|--|--|---|--|--|---|--|--|---|--|--|--|---|--|---|---|---|--|--|--|--|--|--|--|---|---|--|--|--|--|--|--|--|--|--|---|---|--|---|--|--|--|--|--|--|---|--|--|--|--|--|--|--|--|--|
| 52 花驰 <table border="1"><tr><td></td><td></td><td></td></tr><tr><td></td><td></td><td></td></tr><tr><td></td><td></td><td></td></tr></table> Post - 0 Miss - 0 Block - 0 | | | | | | | | | | 53 叶天赐 <table border="1"><tr><td></td><td></td><td></td></tr><tr><td></td><td></td><td></td></tr><tr><td></td><td></td><td></td></tr></table> Post - 0 Miss - 0 Block - 0 | | | | | | | | | | 54 姚幸运 <table border="1"><tr><td></td><td></td><td>1</td></tr><tr><td></td><td></td><td></td></tr><tr><td></td><td></td><td></td></tr></table> Post - 0 Miss - 0 Block - 0 | | | 1 | | | | | | | 55 苏凯 <table border="1"><tr><td></td><td></td><td>2</td></tr><tr><td></td><td></td><td></td></tr><tr><td></td><td></td><td></td></tr></table> Post - 0 Miss - 0 Block - 0 | | | 2 | | | | | | | 56 王健鹏 <table border="1"><tr><td>1</td><td></td><td></td></tr><tr><td></td><td></td><td></td></tr><tr><td></td><td></td><td>2</td></tr></table> Post - 1 Miss - 1 Block - 1 | 1 | | | | | | | | 2 | 57 朱正翔 <table border="1"><tr><td></td><td></td><td></td></tr><tr><td></td><td></td><td></td></tr><tr><td></td><td></td><td></td></tr></table> Post - 0 Miss - 0 Block - 0 | | | | | | | | | | 58 蔡博飞 <table border="1"><tr><td>1</td><td></td><td>2</td></tr><tr><td></td><td></td><td></td></tr><tr><td></td><td></td><td></td></tr></table> Post - 0 Miss - 0 Block - 0 | 1 | | 2 | | | | | | | 59 毛饶翔 <table border="1"><tr><td></td><td></td><td></td></tr><tr><td></td><td></td><td></td></tr><tr><td></td><td></td><td></td></tr></table> Post - 2 Miss - 0 Block - 0 | | | | | | | | | |
| | | | | | | | | | | | | | | | | | | | | | | | | | | | | | | | | | | | | | | | | | | | | | | | | | | | | | | | | | | | | | | | | | | | | | | | | | | | | | | | |
| | | | | | | | | | | | | | | | | | | | | | | | | | | | | | | | | | | | | | | | | | | | | | | | | | | | | | | | | | | | | | | | | | | | | | | | | | | | | | | | |
| | | | | | | | | | | | | | | | | | | | | | | | | | | | | | | | | | | | | | | | | | | | | | | | | | | | | | | | | | | | | | | | | | | | | | | | | | | | | | | | |
| | | | | | | | | | | | | | | | | | | | | | | | | | | | | | | | | | | | | | | | | | | | | | | | | | | | | | | | | | | | | | | | | | | | | | | | | | | | | | | | |
| | | | | | | | | | | | | | | | | | | | | | | | | | | | | | | | | | | | | | | | | | | | | | | | | | | | | | | | | | | | | | | | | | | | | | | | | | | | | | | | |
| | | | | | | | | | | | | | | | | | | | | | | | | | | | | | | | | | | | | | | | | | | | | | | | | | | | | | | | | | | | | | | | | | | | | | | | | | | | | | | | |
| | | 1 | | | | | | | | | | | | | | | | | | | | | | | | | | | | | | | | | | | | | | | | | | | | | | | | | | | | | | | | | | | | | | | | | | | | | | | | | | | | | |
| | | | | | | | | | | | | | | | | | | | | | | | | | | | | | | | | | | | | | | | | | | | | | | | | | | | | | | | | | | | | | | | | | | | | | | | | | | | | | | | |
| | | | | | | | | | | | | | | | | | | | | | | | | | | | | | | | | | | | | | | | | | | | | | | | | | | | | | | | | | | | | | | | | | | | | | | | | | | | | | | | |
| | | 2 | | | | | | | | | | | | | | | | | | | | | | | | | | | | | | | | | | | | | | | | | | | | | | | | | | | | | | | | | | | | | | | | | | | | | | | | | | | | | |
| | | | | | | | | | | | | | | | | | | | | | | | | | | | | | | | | | | | | | | | | | | | | | | | | | | | | | | | | | | | | | | | | | | | | | | | | | | | | | | | |
| | | | | | | | | | | | | | | | | | | | | | | | | | | | | | | | | | | | | | | | | | | | | | | | | | | | | | | | | | | | | | | | | | | | | | | | | | | | | | | | |
| 1 | | | | | | | | | | | | | | | | | | | | | | | | | | | | | | | | | | | | | | | | | | | | | | | | | | | | | | | | | | | | | | | | | | | | | | | | | | | | | | | |
| | | | | | | | | | | | | | | | | | | | | | | | | | | | | | | | | | | | | | | | | | | | | | | | | | | | | | | | | | | | | | | | | | | | | | | | | | | | | | | | |
| | | 2 | | | | | | | | | | | | | | | | | | | | | | | | | | | | | | | | | | | | | | | | | | | | | | | | | | | | | | | | | | | | | | | | | | | | | | | | | | | | | |
| | | | | | | | | | | | | | | | | | | | | | | | | | | | | | | | | | | | | | | | | | | | | | | | | | | | | | | | | | | | | | | | | | | | | | | | | | | | | | | | |
| | | | | | | | | | | | | | | | | | | | | | | | | | | | | | | | | | | | | | | | | | | | | | | | | | | | | | | | | | | | | | | | | | | | | | | | | | | | | | | | |
| | | | | | | | | | | | | | | | | | | | | | | | | | | | | | | | | | | | | | | | | | | | | | | | | | | | | | | | | | | | | | | | | | | | | | | | | | | | | | | | |
| 1 | | 2 | | | | | | | | | | | | | | | | | | | | | | | | | | | | | | | | | | | | | | | | | | | | | | | | | | | | | | | | | | | | | | | | | | | | | | | | | | | | | |
| | | | | | | | | | | | | | | | | | | | | | | | | | | | | | | | | | | | | | | | | | | | | | | | | | | | | | | | | | | | | | | | | | | | | | | | | | | | | | | | |
| | | | | | | | | | | | | | | | | | | | | | | | | | | | | | | | | | | | | | | | | | | | | | | | | | | | | | | | | | | | | | | | | | | | | | | | | | | | | | | | |
| | | | | | | | | | | | | | | | | | | | | | | | | | | | | | | | | | | | | | | | | | | | | | | | | | | | | | | | | | | | | | | | | | | | | | | | | | | | | | | | |
| | | | | | | | | | | | | | | | | | | | | | | | | | | | | | | | | | | | | | | | | | | | | | | | | | | | | | | | | | | | | | | | | | | | | | | | | | | | | | | | |
| | | | | | | | | | | | | | | | | | | | | | | | | | | | | | | | | | | | | | | | | | | | | | | | | | | | | | | | | | | | | | | | | | | | | | | | | | | | | | | | |
| 60 朱超 <table border="1"><tr><td>2</td><td></td><td></td></tr><tr><td></td><td></td><td></td></tr><tr><td>1</td><td></td><td></td></tr></table> Post - 0 Miss - 1 Block - 0 | 2 | | | | | | 1 | | | 61 钮伟豪 <table border="1"><tr><td></td><td></td><td></td></tr><tr><td></td><td></td><td></td></tr><tr><td></td><td></td><td></td></tr></table> Post - 0 Miss - 0 Block - 0 | | | | | | | | | | 62 赵俊阳 <table border="1"><tr><td></td><td></td><td></td></tr><tr><td></td><td></td><td></td></tr><tr><td>2</td><td></td><td></td></tr></table> Post - 0 Miss - 0 Block - 0 | | | | | | | 2 | | | 64 章道胜 <table border="1"><tr><td></td><td></td><td></td></tr><tr><td></td><td></td><td></td></tr><tr><td>2</td><td></td><td>1</td></tr></table> Post - 0 Miss - 0 Block - 0 | | | | | | | 2 | | 1 | 65 韩伟伦 <table border="1"><tr><td></td><td></td><td></td></tr><tr><td></td><td></td><td></td></tr><tr><td></td><td></td><td></td></tr></table> Post - 0 Miss - 0 Block - 0 | | | | | | | | | | 66 刘家豪 <table border="1"><tr><td></td><td></td><td></td></tr><tr><td></td><td></td><td></td></tr><tr><td></td><td></td><td></td></tr></table> Post - 0 Miss - 0 Block - 0 | | | | | | | | | | 68 黄天源 <table border="1"><tr><td></td><td></td><td></td></tr><tr><td></td><td></td><td></td></tr><tr><td></td><td></td><td></td></tr></table> Post - 0 Miss - 0 Block - 0 | | | | | | | | | | | | | | | | | | | |
| 2 | | | | | | | | | | | | | | | | | | | | | | | | | | | | | | | | | | | | | | | | | | | | | | | | | | | | | | | | | | | | | | | | | | | | | | | | | | | | | | | |
| | | | | | | | | | | | | | | | | | | | | | | | | | | | | | | | | | | | | | | | | | | | | | | | | | | | | | | | | | | | | | | | | | | | | | | | | | | | | | | | |
| 1 | | | | | | | | | | | | | | | | | | | | | | | | | | | | | | | | | | | | | | | | | | | | | | | | | | | | | | | | | | | | | | | | | | | | | | | | | | | | | | | |
| | | | | | | | | | | | | | | | | | | | | | | | | | | | | | | | | | | | | | | | | | | | | | | | | | | | | | | | | | | | | | | | | | | | | | | | | | | | | | | | |
| | | | | | | | | | | | | | | | | | | | | | | | | | | | | | | | | | | | | | | | | | | | | | | | | | | | | | | | | | | | | | | | | | | | | | | | | | | | | | | | |
| | | | | | | | | | | | | | | | | | | | | | | | | | | | | | | | | | | | | | | | | | | | | | | | | | | | | | | | | | | | | | | | | | | | | | | | | | | | | | | | |
| | | | | | | | | | | | | | | | | | | | | | | | | | | | | | | | | | | | | | | | | | | | | | | | | | | | | | | | | | | | | | | | | | | | | | | | | | | | | | | | |
| | | | | | | | | | | | | | | | | | | | | | | | | | | | | | | | | | | | | | | | | | | | | | | | | | | | | | | | | | | | | | | | | | | | | | | | | | | | | | | | |
| 2 | | | | | | | | | | | | | | | | | | | | | | | | | | | | | | | | | | | | | | | | | | | | | | | | | | | | | | | | | | | | | | | | | | | | | | | | | | | | | | | |
| | | | | | | | | | | | | | | | | | | | | | | | | | | | | | | | | | | | | | | | | | | | | | | | | | | | | | | | | | | | | | | | | | | | | | | | | | | | | | | | |
| | | | | | | | | | | | | | | | | | | | | | | | | | | | | | | | | | | | | | | | | | | | | | | | | | | | | | | | | | | | | | | | | | | | | | | | | | | | | | | | |
| 2 | | 1 | | | | | | | | | | | | | | | | | | | | | | | | | | | | | | | | | | | | | | | | | | | | | | | | | | | | | | | | | | | | | | | | | | | | | | | | | | | | | |
| | | | | | | | | | | | | | | | | | | | | | | | | | | | | | | | | | | | | | | | | | | | | | | | | | | | | | | | | | | | | | | | | | | | | | | | | | | | | | | | |
| | | | | | | | | | | | | | | | | | | | | | | | | | | | | | | | | | | | | | | | | | | | | | | | | | | | | | | | | | | | | | | | | | | | | | | | | | | | | | | | |
| | | | | | | | | | | | | | | | | | | | | | | | | | | | | | | | | | | | | | | | | | | | | | | | | | | | | | | | | | | | | | | | | | | | | | | | | | | | | | | | |
| | | | | | | | | | | | | | | | | | | | | | | | | | | | | | | | | | | | | | | | | | | | | | | | | | | | | | | | | | | | | | | | | | | | | | | | | | | | | | | | |
| | | | | | | | | | | | | | | | | | | | | | | | | | | | | | | | | | | | | | | | | | | | | | | | | | | | | | | | | | | | | | | | | | | | | | | | | | | | | | | | |
| | | | | | | | | | | | | | | | | | | | | | | | | | | | | | | | | | | | | | | | | | | | | | | | | | | | | | | | | | | | | | | | | | | | | | | | | | | | | | | | |
| | | | | | | | | | | | | | | | | | | | | | | | | | | | | | | | | | | | | | | | | | | | | | | | | | | | | | | | | | | | | | | | | | | | | | | | | | | | | | | | |
| | | | | | | | | | | | | | | | | | | | | | | | | | | | | | | | | | | | | | | | | | | | | | | | | | | | | | | | | | | | | | | | | | | | | | | | | | | | | | | | |
| | | | | | | | | | | | | | | | | | | | | | | | | | | | | | | | | | | | | | | | | | | | | | | | | | | | | | | | | | | | | | | | | | | | | | | | | | | | | | | | |

52 花驰

| | | |
|-----|-----|-----|
| 1/2 | 1/1 | 1/2 |
| 1/1 | | 0/1 |
| 1/6 | 1/1 | 2/5 |

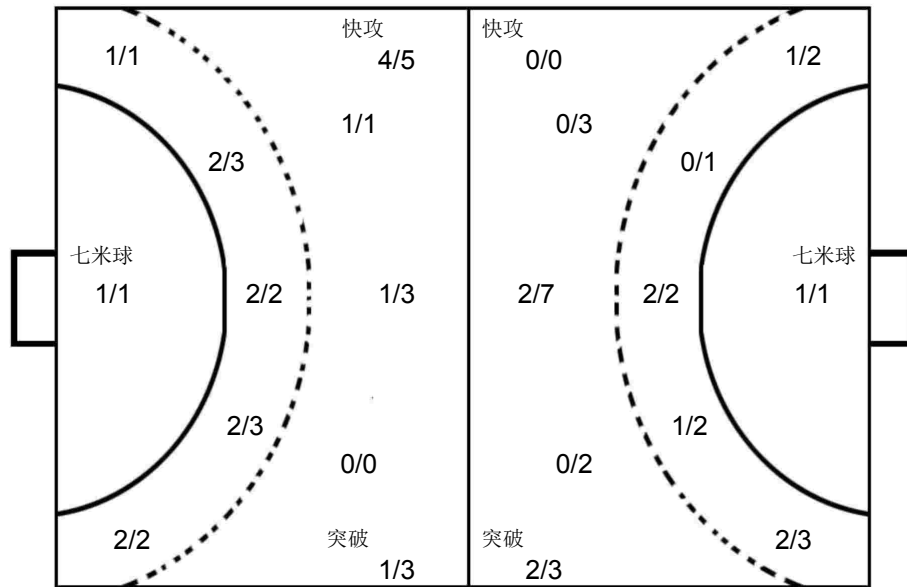

35 刘子杰

| | | |
|--|--|-----|
| | | 0/2 |
| | | |
| | | |

66 黄嘉遥

| | | |
|-----|--|-----|
| 0/4 | | 1/2 |
| | | 0/2 |
| 0/5 | | 0/3 |

上海宝山

| | | | | | | | | | | | | | | | | | | | | | | | | | | | | | | | | | | | | | | | | | | | | | | | | | | | | | | | | | | | | | | | | | | | | | | | | | | | | | | | |
|---|--|---|--|--|--|--|---|--|--|--|---|--|---|--|--|--|--|--|---|---|--|--|--|--|--|--|--|--|--|---|--|--|--|--|--|--|---|--|--|--|--|--|--|--|--|--|---|--|---|---|--|--|--|--|--|--|--|--|--|--|--|--|--|--|--|--|---|--|--|--|--|--|--|--|--|--|--|--|---|
| 3 侯俊杰 <table border="1"><tr><td></td><td></td><td></td></tr><tr><td></td><td></td><td></td></tr><tr><td>1</td><td></td><td></td></tr></table> Post - 0 Miss - 0 Block - 0 | | | | | | | 1 | | | 5 范斯哲 <table border="1"><tr><td></td><td></td><td></td></tr><tr><td></td><td></td><td></td></tr><tr><td></td><td></td><td>1</td></tr></table> Post - 0 Miss - 0 Block - 0 | | | | | | | | | 1 | 6 吴梓涵 <table border="1"><tr><td></td><td></td><td></td></tr><tr><td></td><td></td><td></td></tr><tr><td></td><td></td><td></td></tr></table> Post - 0 Miss - 0 Block - 0 | | | | | | | | | | 7 彭意焱 <table border="1"><tr><td></td><td></td><td></td></tr><tr><td></td><td></td><td></td></tr><tr><td>1</td><td></td><td></td></tr></table> Post - 0 Miss - 0 Block - 0 | | | | | | | 1 | | | 10 马涛 <table border="1"><tr><td></td><td></td><td></td></tr><tr><td></td><td></td><td></td></tr><tr><td>1</td><td></td><td>1</td></tr></table> Post - 1 Miss - 0 Block - 1 | | | | | | | 1 | | 1 | 13 刘启群 <table border="1"><tr><td></td><td></td><td></td></tr><tr><td></td><td></td><td></td></tr><tr><td></td><td></td><td></td></tr></table> Post - 0 Miss - 0 Block - 0 | | | | | | | | | | 21 曾新宇 <table border="1"><tr><td></td><td></td><td></td></tr><tr><td></td><td></td><td></td></tr><tr><td>1</td><td></td><td></td></tr></table> Post - 0 Miss - 0 Block - 0 | | | | | | | 1 | | | 22 马浩东 <table border="1"><tr><td></td><td></td><td></td></tr><tr><td></td><td></td><td></td></tr><tr><td></td><td></td><td>1</td></tr></table> Post - 1 Miss - 1 Block - 0 | | | | | | | | | 1 |
| | | | | | | | | | | | | | | | | | | | | | | | | | | | | | | | | | | | | | | | | | | | | | | | | | | | | | | | | | | | | | | | | | | | | | | | | | | | | | | | |
| | | | | | | | | | | | | | | | | | | | | | | | | | | | | | | | | | | | | | | | | | | | | | | | | | | | | | | | | | | | | | | | | | | | | | | | | | | | | | | | |
| 1 | | | | | | | | | | | | | | | | | | | | | | | | | | | | | | | | | | | | | | | | | | | | | | | | | | | | | | | | | | | | | | | | | | | | | | | | | | | | | | | |
| | | | | | | | | | | | | | | | | | | | | | | | | | | | | | | | | | | | | | | | | | | | | | | | | | | | | | | | | | | | | | | | | | | | | | | | | | | | | | | | |
| | | | | | | | | | | | | | | | | | | | | | | | | | | | | | | | | | | | | | | | | | | | | | | | | | | | | | | | | | | | | | | | | | | | | | | | | | | | | | | | |
| | | 1 | | | | | | | | | | | | | | | | | | | | | | | | | | | | | | | | | | | | | | | | | | | | | | | | | | | | | | | | | | | | | | | | | | | | | | | | | | | | | |
| | | | | | | | | | | | | | | | | | | | | | | | | | | | | | | | | | | | | | | | | | | | | | | | | | | | | | | | | | | | | | | | | | | | | | | | | | | | | | | | |
| | | | | | | | | | | | | | | | | | | | | | | | | | | | | | | | | | | | | | | | | | | | | | | | | | | | | | | | | | | | | | | | | | | | | | | | | | | | | | | | |
| | | | | | | | | | | | | | | | | | | | | | | | | | | | | | | | | | | | | | | | | | | | | | | | | | | | | | | | | | | | | | | | | | | | | | | | | | | | | | | | |
| | | | | | | | | | | | | | | | | | | | | | | | | | | | | | | | | | | | | | | | | | | | | | | | | | | | | | | | | | | | | | | | | | | | | | | | | | | | | | | | |
| | | | | | | | | | | | | | | | | | | | | | | | | | | | | | | | | | | | | | | | | | | | | | | | | | | | | | | | | | | | | | | | | | | | | | | | | | | | | | | | |
| 1 | | | | | | | | | | | | | | | | | | | | | | | | | | | | | | | | | | | | | | | | | | | | | | | | | | | | | | | | | | | | | | | | | | | | | | | | | | | | | | | |
| | | | | | | | | | | | | | | | | | | | | | | | | | | | | | | | | | | | | | | | | | | | | | | | | | | | | | | | | | | | | | | | | | | | | | | | | | | | | | | | |
| | | | | | | | | | | | | | | | | | | | | | | | | | | | | | | | | | | | | | | | | | | | | | | | | | | | | | | | | | | | | | | | | | | | | | | | | | | | | | | | |
| 1 | | 1 | | | | | | | | | | | | | | | | | | | | | | | | | | | | | | | | | | | | | | | | | | | | | | | | | | | | | | | | | | | | | | | | | | | | | | | | | | | | | |
| | | | | | | | | | | | | | | | | | | | | | | | | | | | | | | | | | | | | | | | | | | | | | | | | | | | | | | | | | | | | | | | | | | | | | | | | | | | | | | | |
| | | | | | | | | | | | | | | | | | | | | | | | | | | | | | | | | | | | | | | | | | | | | | | | | | | | | | | | | | | | | | | | | | | | | | | | | | | | | | | | |
| | | | | | | | | | | | | | | | | | | | | | | | | | | | | | | | | | | | | | | | | | | | | | | | | | | | | | | | | | | | | | | | | | | | | | | | | | | | | | | | |
| | | | | | | | | | | | | | | | | | | | | | | | | | | | | | | | | | | | | | | | | | | | | | | | | | | | | | | | | | | | | | | | | | | | | | | | | | | | | | | | |
| | | | | | | | | | | | | | | | | | | | | | | | | | | | | | | | | | | | | | | | | | | | | | | | | | | | | | | | | | | | | | | | | | | | | | | | | | | | | | | | |
| 1 | | | | | | | | | | | | | | | | | | | | | | | | | | | | | | | | | | | | | | | | | | | | | | | | | | | | | | | | | | | | | | | | | | | | | | | | | | | | | | | |
| | | | | | | | | | | | | | | | | | | | | | | | | | | | | | | | | | | | | | | | | | | | | | | | | | | | | | | | | | | | | | | | | | | | | | | | | | | | | | | | |
| | | | | | | | | | | | | | | | | | | | | | | | | | | | | | | | | | | | | | | | | | | | | | | | | | | | | | | | | | | | | | | | | | | | | | | | | | | | | | | | |
| | | 1 | | | | | | | | | | | | | | | | | | | | | | | | | | | | | | | | | | | | | | | | | | | | | | | | | | | | | | | | | | | | | | | | | | | | | | | | | | | | | |
| 25 江锦 <table border="1"><tr><td></td><td></td><td></td></tr><tr><td></td><td></td><td></td></tr><tr><td>1</td><td></td><td></td></tr></table> Post - 0 Miss - 0 Block - 0 | | | | | | | 1 | | | 35 刘子杰 <table border="1"><tr><td>1</td><td></td><td>1</td></tr><tr><td></td><td></td><td></td></tr><tr><td></td><td></td><td>1</td></tr></table> Post - 2 Miss - 0 Block - 1 | 1 | | 1 | | | | | | 1 | 39 陆毅洋 <table border="1"><tr><td></td><td></td><td></td></tr><tr><td></td><td></td><td></td></tr><tr><td></td><td></td><td></td></tr></table> Post - 0 Miss - 0 Block - 0 | | | | | | | | | | 66 黄嘉遥 <table border="1"><tr><td></td><td></td><td></td></tr><tr><td></td><td></td><td></td></tr><tr><td></td><td></td><td></td></tr></table> Post - 0 Miss - 0 Block - 0 | | | | | | | | | | 68 陈沁磊 <table border="1"><tr><td></td><td></td><td></td></tr><tr><td></td><td></td><td></td></tr><tr><td></td><td></td><td></td></tr></table> Post - 0 Miss - 0 Block - 0 | | | | | | | | | | | | | | | | | | | | | | | | | | | | | | | | | | | | | | | |
| | | | | | | | | | | | | | | | | | | | | | | | | | | | | | | | | | | | | | | | | | | | | | | | | | | | | | | | | | | | | | | | | | | | | | | | | | | | | | | | |
| | | | | | | | | | | | | | | | | | | | | | | | | | | | | | | | | | | | | | | | | | | | | | | | | | | | | | | | | | | | | | | | | | | | | | | | | | | | | | | | |
| 1 | | | | | | | | | | | | | | | | | | | | | | | | | | | | | | | | | | | | | | | | | | | | | | | | | | | | | | | | | | | | | | | | | | | | | | | | | | | | | | | |
| 1 | | 1 | | | | | | | | | | | | | | | | | | | | | | | | | | | | | | | | | | | | | | | | | | | | | | | | | | | | | | | | | | | | | | | | | | | | | | | | | | | | | |
| | | | | | | | | | | | | | | | | | | | | | | | | | | | | | | | | | | | | | | | | | | | | | | | | | | | | | | | | | | | | | | | | | | | | | | | | | | | | | | | |
| | | 1 | | | | | | | | | | | | | | | | | | | | | | | | | | | | | | | | | | | | | | | | | | | | | | | | | | | | | | | | | | | | | | | | | | | | | | | | | | | | | |
| | | | | | | | | | | | | | | | | | | | | | | | | | | | | | | | | | | | | | | | | | | | | | | | | | | | | | | | | | | | | | | | | | | | | | | | | | | | | | | | |
| | | | | | | | | | | | | | | | | | | | | | | | | | | | | | | | | | | | | | | | | | | | | | | | | | | | | | | | | | | | | | | | | | | | | | | | | | | | | | | | |
| | | | | | | | | | | | | | | | | | | | | | | | | | | | | | | | | | | | | | | | | | | | | | | | | | | | | | | | | | | | | | | | | | | | | | | | | | | | | | | | |
| | | | | | | | | | | | | | | | | | | | | | | | | | | | | | | | | | | | | | | | | | | | | | | | | | | | | | | | | | | | | | | | | | | | | | | | | | | | | | | | |
| | | | | | | | | | | | | | | | | | | | | | | | | | | | | | | | | | | | | | | | | | | | | | | | | | | | | | | | | | | | | | | | | | | | | | | | | | | | | | | | |
| | | | | | | | | | | | | | | | | | | | | | | | | | | | | | | | | | | | | | | | | | | | | | | | | | | | | | | | | | | | | | | | | | | | | | | | | | | | | | | | |
| | | | | | | | | | | | | | | | | | | | | | | | | | | | | | | | | | | | | | | | | | | | | | | | | | | | | | | | | | | | | | | | | | | | | | | | | | | | | | | | |
| | | | | | | | | | | | | | | | | | | | | | | | | | | | | | | | | | | | | | | | | | | | | | | | | | | | | | | | | | | | | | | | | | | | | | | | | | | | | | | | |
| | | | | | | | | | | | | | | | | | | | | | | | | | | | | | | | | | | | | | | | | | | | | | | | | | | | | | | | | | | | | | | | | | | | | | | | | | | | | | | | |



| Team A | | | | | Team B | | | | | Match Number | | | | | | | | | | | |
|----------------|-----------------------------------|---------------|---------------------|---|------------------------------------|------------|----------------|----|-------|--------------|--|------------|---|-----|----------------------|--|---|---|----|---|----|
| A 中国香港 | | | | | B 江苏苏州 | | | | | 35 | | | | | | | | | | | |
| Played in | | | in the hall | | | on | | | at | | | Spectators | | | | | | | | | |
| 安徽滁州 | | | 滁州国际手球馆 | | | 2019-06-04 | | | 17:00 | | | hours | | | | | | | | | |
| Half-time(30') | A | B | End of playing time | | A | B | 1st extra time | | A | B | 2nd extra time | | A | B | After penalty throws | | A | B | | | |
| | 5 | 5 | 13 | | 11 | | | | | | | | | | | | | | | | |
| Number of 7 m | A | Team time-out | | | Full name of players and officials | | | | | | Team time-out | | | B | Number of 7 m | | | | | | |
| | 1/1 | 1 | 2 | 3 | | | | | | | 1 | 2 | 3 | B | | | | | | | |
| | | 09:34 | 44:35 | | | | | | | | 12:13 | 37:40 | | 1/1 | | | | | | | |
| No. | Team A | | | | | G | W | 2' | D | DR | No. | Team B | | | | | G | W | 2' | D | DR |
| 1 | 江力为 | | | | | | | | | | 1 | 邹明轩 | | | | | | | | | |
| 2 | 梁凯乔 | | | | | | | | | | 2 | 马力 | | | | | | | | | |
| 3 | 陈嘉熙 | | | | | | | | | | 4 | 孙钊 | | | | | 1 | | | | |
| 10 | 叶滋权 | | | | | 1 | | | | | 5 | 马奔 | | | | | | | | | |
| 15 | 梁栢朗 | | | | | 1 | | | | | 6 | 潘超群 | | | | | 4 | | | | |
| 16 | 冯智聪 | | | | | | | | | | 8 | 王震 | | | | | 1 | | | | |
| 22 | 吴泽斌 | | | | | | | | | | 9 | 李文俊 | | | | | | | | | |
| 23 | 石铭泽 | | | | | | | | | | 10 | 朱红雨 | | | | | | | | | |
| 27 | 巫迪涛 | | | | | 5 | | | | | 11 | 许多 | | | | | 2 | | | | |
| 28 | 关健辉 | | | | | 2 | | | | | 12 | 周文贤 | | | | | | | | | |
| 30 | 陈永曦 | | | | | | | | | | 13 | 蒋超 | | | | | | | 1 | | |
| 41 | 莫敬朗 | | | | | | | | | | 14 | 刘亚力 | | | | | | | | | |
| 47 | 薛浩锋 | | | | | 3 | | | | | 15 | 刘成果 | | | | | | | | | |
| 73 | 黄塋鎏 | | | | | | | | | | 18 | 何志伟 | | | | | 2 | 1 | | | |
| 79 | 吴坤霖 | | | | | 1 | | | | | 19 | 夏思毅 | | | | | | | | | |
| 99 | 苏俊轩 | | | | | | | | | | 23 | 张铮洋 | | | | | 1 | | | | |
| B | 练明辉 (主教练) | | | | | | | | | | A | 周清 | | | | | | | | | |
| C | 钟昀延 | | | | | | | | | | C | 郝可鑫 | | | | | | | | | |
| | | | | | | | | | | | D | 陈冬冬 | | | | | | | | | |
| | | | | | | | | | | | E | 陈伟 | | | | | | | | | |
| A | | | | | | | | | | | Signatures of responsables for the teams (Off.A) | | | | | | | | | | B |
| TP | Remarks of referees / HF Official | | | | | | | | | | | | | | | | | | | | TP |

Signatures

| | | | | |
|----------|-----------|-----------|--|--|
| Referees | 尹静阳 (CHN) | 马晓晔 (CHN) | | |
| T.D. | 吴瑞亭 (CHN) | 许宜扬 (CHN) | | |
| CHA Off. | | | | |

Note: Number of 7m Throws Awarded to Team A and B, Goals (G), Warnings (W), Suspensions (2'), Direct Disqualification (D), Disqualification With Report (DR) and Team Penalty (TP).

Table Officials: 李莉君 吴荣 Statisticians: 王梓衡 童佩瑶

竞赛技术统计

手球
青年男子

半决赛
轮次 5

组别 X
场次 35

滁州国际手球馆
2019-06-04 17:00

Referees: 尹静阳 (CHN) / 马晓晔 (CHN)

Result: 13:11 (5:5)

Teams: 中国香港(香港) VS 江苏苏州(苏州)

| 香港 | | 远 | 近 | 边 | 快 | 突 | 任意 | 7m | 合计 | % | 助攻 | 失误 | 警告 | 2' | D+DR |
|----------|-----|-----|-----|-----|-----|-----|-----|-----|-------|------|----|----|----|----|------|
| 主教练: 练明辉 | | 射 | 射 | 射 | 攻 | 破 | 球 | 球 | | | | | | | |
| 1 | 江力为 | | | | | | | | | | | | | | |
| 2 | 梁凯乔 | | | | | | | | | | | | | | |
| 3 | 陈嘉熙 | | | | | | | | | | | | 2 | | |
| 10 | 叶滋权 | 1/1 | | | | | | | 1/1 | 100 | | | | | |
| 15 | 梁栢朗 | | | | 1/1 | | | | 1/1 | 100 | | | | | |
| 16 | 冯智聪 | | | | | | | | | | | | | | |
| 22 | 吴泽斌 | | | | | | | | | | | | | | |
| 23 | 石铭泽 | | | | | | | | | | | | | | |
| 27 | 巫迪涛 | 1/1 | | | | 3/3 | 0/1 | 1/1 | 5/6 | 83.3 | | 3 | | | |
| 28 | 关键辉 | | | 2/3 | | | | | 2/3 | 66.7 | | | | | |
| 30 | 陈永曦 | | | | | | | | | | | 3 | | | |
| 41 | 莫敬朗 | | | | | | | | | | | | | | |
| 47 | 薛浩锋 | 3/3 | | | | 0/1 | | | 3/4 | 75.0 | 1 | 3 | | | |
| 73 | 黄堃臻 | | | | | | | | | | | | | | |
| 79 | 吴坤霖 | | 1/1 | | | | | | 1/1 | 100 | | | | | |
| 99 | 苏俊轩 | | | | | | | | | | | | | | |
| 运动员 合计 | | 5/5 | 1/1 | 2/3 | 1/1 | 3/4 | 0/1 | 1/1 | 13/16 | 81.3 | 1 | 11 | | | |
| 1 | 江力为 | 0/3 | | 0/1 | | | | | 0/4 | 0.0 | | | | | |
| 22 | 吴泽斌 | 4/6 | | 1/1 | 1/3 | 0/2 | | 0/1 | 6/13 | 46.2 | | | | | |
| 守门员 合计 | | 4/9 | | 1/2 | 1/3 | 0/2 | | 0/1 | 6/17 | 35.3 | | | | | |

| 香港 | 比赛 进程 | 苏州 |
|----------|----------|-------------|
| 1st Half | | |
| 0 | 00:45 | 1 8 王震 |
| 27 | 巫迪涛 | 1 01:26 1 |
| | 1 01:55 | 2 6 潘超群 |
| | 1 02:53 | 3 4 孙钊 |
| 27 | 巫迪涛 | 2 07:16 3 |
| 10 | 叶滋权 | 3 08:17 3 |
| | 3 08:36 | 4 18 何志伟 |
| | 3 09:22 | 5 18 何志伟 |
| 28 | 关键辉 | 4 10:00 5 |
| 15 | 梁栢朗 | 5 12:02 5 |
| 2nd Half | | |
| 27 | 巫迪涛 | 6 00:31 5 |
| | 6 01:10 | 6 6 潘超群 |
| 27 | 巫迪涛 | 7 01:43 6 |
| 79 | 吴坤霖 | 8 05:05 6 |
| | 8 06:19 | 7 11 许多 |
| 47 | 薛浩锋 | 9 06:44 7 |
| 47 | 薛浩锋 | 10 07:38 7 |
| 27 | 巫迪涛 | 11 08:38 7 |
| | 11 09:43 | 8 6 潘超群 |
| | 11 10:18 | 9 6 潘超群 |
| 28 | 关键辉 | 12 13:29 9 |
| | 12 13:53 | 10 11 许多 |
| 47 | 薛浩锋 | 13 14:11 10 |
| | 13 14:42 | 11 23 张铮洋 |

| 苏州 | | 远 | 近 | 边 | 快 | 突 | 任意 | 7m | 合计 | % | 助攻 | 失误 | 警告 | 2' | D+DR |
|----------|-----|------|-----|-----|-----|-----|-----|-----|-------|------|----|----|----|----|------|
| 主教练: 陈冬冬 | | 射 | 射 | 射 | 攻 | 破 | 球 | 球 | | | | | | | |
| 1 | 邹明轩 | | | | | | | | | | | | | | |
| 2 | 马力 | | | | | | | | | | | | | | |
| 4 | 孙钊 | 1/2 | | 0/1 | | | | | 1/3 | 33.3 | | | | | |
| 5 | 马奔 | | | | | | | | | | 1 | 2 | | | |
| 6 | 潘超群 | 3/8 | | | | | | 1/1 | 4/9 | 44.4 | | 3 | | | |
| 8 | 王震 | 1/1 | | | | | 0/1 | | 1/2 | 50.0 | | 2 | | | |
| 9 | 李文俊 | | | | | | | | | | | | | | |
| 10 | 朱红雨 | | | | | | | | | | | | | | |
| 11 | 许多 | 0/2 | | | | 2/3 | | | 2/5 | 40.0 | | 1 | | | |
| 12 | 周文贤 | | | | | | | | | | | | | | |
| 13 | 蒋超 | | | | 0/1 | | | | 0/1 | 0.0 | | | | 1 | |
| 14 | 刘亚力 | | | | | | | | | | | | | | |
| 15 | 刘成果 | | | | | | | | | | | | | | |
| 18 | 何志伟 | | | 1/3 | 1/1 | | | | 2/4 | 50.0 | | | 1 | | |
| 19 | 夏思毅 | | | | | | | | | | | | | | |
| 23 | 张铮洋 | | | | 1/1 | | | | 1/1 | 100 | | | | | |
| 运动员 合计 | | 5/13 | | 1/4 | 2/3 | 2/3 | 0/1 | 1/1 | 11/25 | 44.0 | 1 | 8 | 1 | 1 | |
| 1 | 邹明轩 | 0/4 | 0/1 | | | 1/3 | 1/1 | 0/1 | 2/10 | 20.0 | | | | | |
| 12 | 周文贤 | 0/1 | | 0/2 | 0/1 | 0/1 | | | 0/5 | 0.0 | | | | | |
| 守门员 合计 | | 0/5 | 0/1 | 0/2 | 0/1 | 1/4 | 1/1 | 0/1 | 2/15 | 13.3 | | | | | |

场上队员: 得分 / 射门

守门员: 救球 / 射门

| | | | |
|---|------|----|---------|
| D | 取消资格 | DR | 取消资格+报告 |
|---|------|----|---------|

个人/全队技术统计表

手球 半决赛 组别 X 滁州国际手球馆
青年男子 轮次 5 场次 35 2019-06-04 17:00

| 号码 | 姓名 | 远射 | 近射 | 边射 | 快攻 | 突破 | 任意 | 七米 | 合计 | % | 助攻 | 失误 | 警告 | 2' | 取消 | 时间 |
|----------|-----|-----|-----|-----|-----|-----|-----|-----|-------|-------|----|----|----|----|----|----------|
| 中国香港(香港) | | | | | | | | | | | | | | | | |
| (场上队员) | | | | | | | | | | | | | | | | |
| 1 | 江力为 | | | | | | | | | 0.0% | | | | | | 00:09:00 |
| 2 | 梁凯乔 | | | | | | | | | 0.0% | | | | | | 00:00:00 |
| 3 | 陈嘉熙 | | | | | | | | | 0.0% | | 2 | | | | 00:11:51 |
| 10 | 叶滋权 | 1/1 | | | | | | | 1/1 | 100% | | | | | | 00:18:23 |
| 15 | 梁栢朗 | | | | 1/1 | | | | 1/1 | 100% | | | | | | 00:11:59 |
| 16 | 冯智聪 | | | | | | | | | 0.0% | | | | | | 00:00:00 |
| 22 | 吴泽斌 | | | | | | | | | 0.0% | | | | | | 00:21:00 |
| 23 | 石铭泽 | | | | | | | | | 0.0% | | | | | | 00:18:28 |
| 27 | 巫迪涛 | 1/1 | | | | 3/3 | 0/1 | 1/1 | 5/6 | 83.3% | | 3 | | | | 00:23:44 |
| 28 | 关键辉 | | | 2/3 | | | | | 2/3 | 66.7% | | | | | | 00:30:00 |
| 30 | 陈永曦 | | | | | | | | | 0.0% | | 3 | | | | 00:12:53 |
| 41 | 莫敬朗 | | | | | | | | | 0.0% | | | | | | 00:00:00 |
| 47 | 薛浩锋 | 3/3 | | | | 0/1 | | | 3/4 | 75.0% | 1 | 3 | | | | 00:22:37 |
| 73 | 黄望婆 | | | | | | | | | 0.0% | | | | | | 00:00:00 |
| 79 | 吴坤霖 | | 1/1 | | | | | | 1/1 | 100% | | | | | | 00:30:00 |
| 99 | 苏俊轩 | | | | | | | | | 0.0% | | | | | | 00:00:00 |
| 合计 | | 5/5 | 1/1 | 2/3 | 1/1 | 3/4 | 0/1 | 1/1 | 13/16 | 81.3% | 1 | 11 | | | | |
| (守门员) | | | | | | | | | | | | | | | | |
| 1 | 江力为 | 0/3 | | 0/1 | | | | | 0/4 | 0.0% | | | | | | 00:09:00 |
| 22 | 吴泽斌 | 4/6 | | 1/1 | 1/3 | 0/2 | | 0/1 | 6/13 | 46.2% | | | | | | 00:21:00 |
| 合计 | | 4/9 | | 1/2 | 1/3 | 0/2 | | 0/1 | 6/17 | 35.3% | | | | | | |

场上队员：得分/射门

守门员：救球/射门

| 全队合计 | 得分 | 被救 | 射失 | 击柱 | 封球 | 合计 | % |
|------|----|----|----|----|----|----|--------|
| 远射 | 5 | | | | | 5 | 100.0% |
| 近射 | 1 | | | | | 1 | 100.0% |
| 边射 | 2 | | | 1 | | 3 | 66.7% |
| 快攻 | 1 | | | | | 1 | 100.0% |
| 突破 | 3 | 1 | | | | 4 | 75.0% |
| 任意 | | 1 | | | | 1 | 0.0% |
| 七米 | 1 | | | | | 1 | 100.0% |

个人/全队技术统计表

手球 半决赛 组别 X 滁州国际手球馆
青年男子 轮次 5 场次 35 2019-06-04 17:00

| 号码 | 姓名 | 远射 | 近射 | 边射 | 快攻 | 突破 | 任意 | 七米 | 合计 | % | 助攻 | 失误 | 警告 | 2' | 取消 | 时间 |
|----------|-----|------|-----|-----|-----|-----|-----|-----|-------|-------|----|----|----|----|----|----------|
| 江苏苏州(苏州) | | | | | | | | | | | | | | | | |
| (场上队员) | | | | | | | | | | | | | | | | |
| 1 | 邹明轩 | | | | | | | | | 0.0% | | | | | | 00:16:22 |
| 2 | 马力 | | | | | | | | | 0.0% | | | | | | 00:00:00 |
| 4 | 孙钊 | 1/2 | | 0/1 | | | | | 1/3 | 33.3% | | | | | | 00:07:32 |
| 5 | 马奔 | | | | | | | | | 0.0% | 1 | 2 | | | | 00:30:00 |
| 6 | 潘超群 | 3/8 | | | | | | 1/1 | 4/9 | 44.4% | | 3 | | | | 00:30:00 |
| 8 | 王震 | 1/1 | | | | | 0/1 | | 1/2 | 50.0% | | 2 | | | | 00:30:00 |
| 9 | 李文俊 | | | | | | | | | 0.0% | | | | | | 00:00:00 |
| 10 | 朱红雨 | | | | | | | | | 0.0% | | | | | | 00:00:00 |
| 11 | 许多 | 0/2 | | | | 2/3 | | | 2/5 | 40.0% | | 1 | | | | 00:05:49 |
| 12 | 周文贤 | | | | | | | | | 0.0% | | | | | | 00:13:38 |
| 13 | 蒋超 | | | | 0/1 | | | | 0/1 | 0.0% | | | | 1 | | 00:30:00 |
| 14 | 刘亚力 | | | | | | | | | 0.0% | | | | | | 00:00:00 |
| 15 | 刘成果 | | | | | | | | | 0.0% | | | | | | 00:00:00 |
| 18 | 何志伟 | | | 1/3 | 1/1 | | | | 2/4 | 50.0% | | | 1 | | | 00:30:00 |
| 19 | 夏思毅 | | | | | | | | | 0.0% | | | | | | 00:00:00 |
| 23 | 张铮洋 | | | | 1/1 | | | | 1/1 | 100% | | | | | | 00:16:37 |
| | 合计 | 5/13 | | 1/4 | 2/3 | 2/3 | 0/1 | 1/1 | 11/25 | 44.0% | 1 | 8 | 1 | 1 | | |
| (守门员) | | | | | | | | | | | | | | | | |
| 1 | 邹明轩 | 0/4 | 0/1 | | | 1/3 | 1/1 | 0/1 | 2/10 | 20.0% | | | | | | 00:16:22 |
| 12 | 周文贤 | 0/1 | | 0/2 | 0/1 | 0/1 | | | 0/5 | 0.0% | | | | | | 00:13:38 |
| | 合计 | 0/5 | 0/1 | 0/2 | 0/1 | 1/4 | 1/1 | 0/1 | 2/15 | 13.3% | | | | | | |

场上队员：得分/射门

守门员：救球/射门

| 全队合计 | 得分 | 被救 | 射失 | 击柱 | 封球 | 合计 | % |
|------|----|----|----|----|----|----|--------|
| 远射 | 5 | 4 | 1 | | 3 | 13 | 38.5% |
| 近射 | | | | | | | 0.0% |
| 边射 | 1 | 1 | 1 | 1 | | 4 | 25.0% |
| 快攻 | 2 | 1 | | | | 3 | 66.7% |
| 突破 | 2 | | 1 | | | 3 | 66.7% |
| 任意 | | | 1 | | | 1 | 0.0% |
| 七米 | 1 | | | | | 1 | 100.0% |

图式比赛技术统计表

手球
青年男子

半决赛
轮次 5

组别 X
场次 35

滁州国际手球馆
2019-06-04 17:00

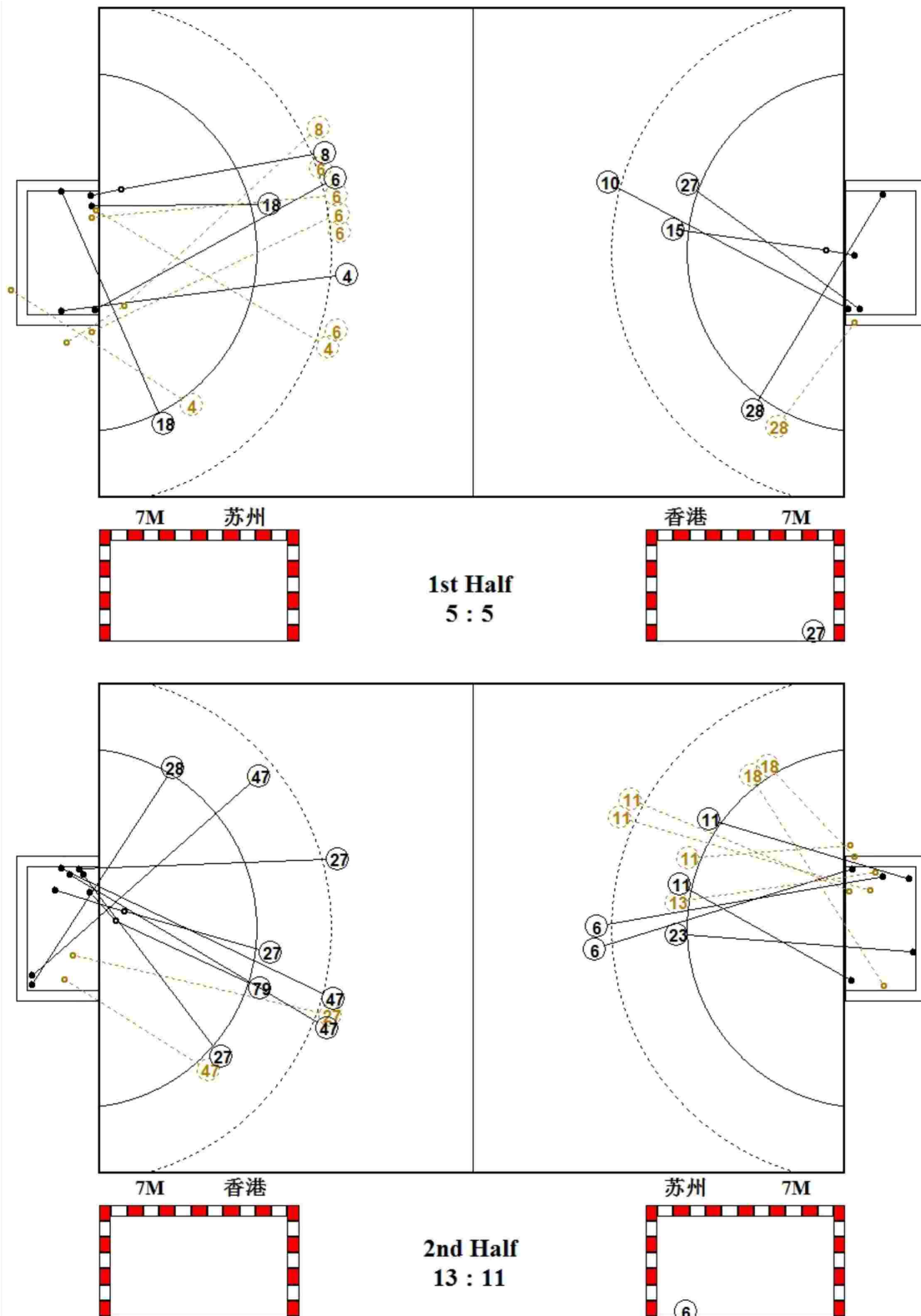

图式射门区域统计

手球
青年男子

半决赛
轮次 5

组别 X
场次 35

滁州国际手球馆
2019-06-04 17:00

中国香港

| | | | | | | | | | | | | | | | | | | | | | | | | | | | | | | | | | | | | | | | | | | | | | | | | | | | | | | | | | | | | | | | | | | | | | | | | | | | | | | | |
|--|--------|--------|--------|--------|--------|--------|--------|--|--|--|---|--|--|---|--|--|--|--|--|--|--|--|--|--|--|--|--|--|--|---|--|--|---|--|--|--|--|--|--|--|---|--|---|--|--|---|--|--|--|--|--|--|--|--|--|--|--|--|--|---|--|--|---|--|--|--|--|--|--|--|--|--|--|--|--|--|--|--|--|
| 1 江力为 | 2 梁凯乔 | 3 陈嘉熙 | 10 叶滋权 | 15 梁栢朗 | 16 冯智聪 | 22 吴泽斌 | 23 石铭泽 | | | | | | | | | | | | | | | | | | | | | | | | | | | | | | | | | | | | | | | | | | | | | | | | | | | | | | | | | | | | | | | | | | | | | | | | |
| <table border="1"><tr><td></td><td></td><td></td></tr><tr><td></td><td></td><td></td></tr><tr><td></td><td></td><td></td></tr></table> | | | | | | | | | | <table border="1"><tr><td></td><td></td><td></td></tr><tr><td></td><td></td><td></td></tr><tr><td></td><td></td><td></td></tr></table> | | | | | | | | | | <table border="1"><tr><td></td><td></td><td></td></tr><tr><td></td><td></td><td></td></tr><tr><td></td><td></td><td></td></tr></table> | | | | | | | | | | <table border="1"><tr><td></td><td></td><td>1</td></tr><tr><td></td><td></td><td></td></tr><tr><td></td><td></td><td></td></tr></table> | | | 1 | | | | | | | <table border="1"><tr><td></td><td></td><td>1</td></tr><tr><td></td><td></td><td></td></tr><tr><td></td><td></td><td></td></tr></table> | | | 1 | | | | | | | <table border="1"><tr><td></td><td></td><td></td></tr><tr><td></td><td></td><td></td></tr><tr><td></td><td></td><td></td></tr></table> | | | | | | | | | | <table border="1"><tr><td></td><td></td><td></td></tr><tr><td></td><td></td><td></td></tr><tr><td></td><td></td><td></td></tr></table> | | | | | | | | | | <table border="1"><tr><td></td><td></td><td></td></tr><tr><td></td><td></td><td></td></tr><tr><td></td><td></td><td></td></tr></table> | | | | | | | | | |
| | | | | | | | | | | | | | | | | | | | | | | | | | | | | | | | | | | | | | | | | | | | | | | | | | | | | | | | | | | | | | | | | | | | | | | | | | | | | | | | |
| | | | | | | | | | | | | | | | | | | | | | | | | | | | | | | | | | | | | | | | | | | | | | | | | | | | | | | | | | | | | | | | | | | | | | | | | | | | | | | | |
| | | | | | | | | | | | | | | | | | | | | | | | | | | | | | | | | | | | | | | | | | | | | | | | | | | | | | | | | | | | | | | | | | | | | | | | | | | | | | | | |
| | | | | | | | | | | | | | | | | | | | | | | | | | | | | | | | | | | | | | | | | | | | | | | | | | | | | | | | | | | | | | | | | | | | | | | | | | | | | | | | |
| | | | | | | | | | | | | | | | | | | | | | | | | | | | | | | | | | | | | | | | | | | | | | | | | | | | | | | | | | | | | | | | | | | | | | | | | | | | | | | | |
| | | | | | | | | | | | | | | | | | | | | | | | | | | | | | | | | | | | | | | | | | | | | | | | | | | | | | | | | | | | | | | | | | | | | | | | | | | | | | | | |
| | | | | | | | | | | | | | | | | | | | | | | | | | | | | | | | | | | | | | | | | | | | | | | | | | | | | | | | | | | | | | | | | | | | | | | | | | | | | | | | |
| | | | | | | | | | | | | | | | | | | | | | | | | | | | | | | | | | | | | | | | | | | | | | | | | | | | | | | | | | | | | | | | | | | | | | | | | | | | | | | | |
| | | | | | | | | | | | | | | | | | | | | | | | | | | | | | | | | | | | | | | | | | | | | | | | | | | | | | | | | | | | | | | | | | | | | | | | | | | | | | | | |
| | | 1 | | | | | | | | | | | | | | | | | | | | | | | | | | | | | | | | | | | | | | | | | | | | | | | | | | | | | | | | | | | | | | | | | | | | | | | | | | | | | |
| | | | | | | | | | | | | | | | | | | | | | | | | | | | | | | | | | | | | | | | | | | | | | | | | | | | | | | | | | | | | | | | | | | | | | | | | | | | | | | | |
| | | | | | | | | | | | | | | | | | | | | | | | | | | | | | | | | | | | | | | | | | | | | | | | | | | | | | | | | | | | | | | | | | | | | | | | | | | | | | | | |
| | | 1 | | | | | | | | | | | | | | | | | | | | | | | | | | | | | | | | | | | | | | | | | | | | | | | | | | | | | | | | | | | | | | | | | | | | | | | | | | | | | |
| | | | | | | | | | | | | | | | | | | | | | | | | | | | | | | | | | | | | | | | | | | | | | | | | | | | | | | | | | | | | | | | | | | | | | | | | | | | | | | | |
| | | | | | | | | | | | | | | | | | | | | | | | | | | | | | | | | | | | | | | | | | | | | | | | | | | | | | | | | | | | | | | | | | | | | | | | | | | | | | | | |
| | | | | | | | | | | | | | | | | | | | | | | | | | | | | | | | | | | | | | | | | | | | | | | | | | | | | | | | | | | | | | | | | | | | | | | | | | | | | | | | |
| | | | | | | | | | | | | | | | | | | | | | | | | | | | | | | | | | | | | | | | | | | | | | | | | | | | | | | | | | | | | | | | | | | | | | | | | | | | | | | | |
| | | | | | | | | | | | | | | | | | | | | | | | | | | | | | | | | | | | | | | | | | | | | | | | | | | | | | | | | | | | | | | | | | | | | | | | | | | | | | | | |
| | | | | | | | | | | | | | | | | | | | | | | | | | | | | | | | | | | | | | | | | | | | | | | | | | | | | | | | | | | | | | | | | | | | | | | | | | | | | | | | |
| | | | | | | | | | | | | | | | | | | | | | | | | | | | | | | | | | | | | | | | | | | | | | | | | | | | | | | | | | | | | | | | | | | | | | | | | | | | | | | | |
| | | | | | | | | | | | | | | | | | | | | | | | | | | | | | | | | | | | | | | | | | | | | | | | | | | | | | | | | | | | | | | | | | | | | | | | | | | | | | | | |
| | | | | | | | | | | | | | | | | | | | | | | | | | | | | | | | | | | | | | | | | | | | | | | | | | | | | | | | | | | | | | | | | | | | | | | | | | | | | | | | |
| | | | | | | | | | | | | | | | | | | | | | | | | | | | | | | | | | | | | | | | | | | | | | | | | | | | | | | | | | | | | | | | | | | | | | | | | | | | | | | | |
| | | | | | | | | | | | | | | | | | | | | | | | | | | | | | | | | | | | | | | | | | | | | | | | | | | | | | | | | | | | | | | | | | | | | | | | | | | | | | | | |
| 27 巫迪涛 | 28 关健辉 | 30 陈永曦 | 41 莫敬朗 | 47 薛浩锋 | 73 黄望鏊 | 79 吴坤霖 | 99 苏俊轩 | | | | | | | | | | | | | | | | | | | | | | | | | | | | | | | | | | | | | | | | | | | | | | | | | | | | | | | | | | | | | | | | | | | | | | | | |
| <table border="1"><tr><td></td><td></td><td>1</td></tr><tr><td></td><td></td><td>4</td></tr><tr><td></td><td></td><td></td></tr></table> | | | 1 | | | 4 | | | | <table border="1"><tr><td>1</td><td></td><td></td></tr><tr><td>1</td><td></td><td></td></tr><tr><td></td><td></td><td></td></tr></table> | 1 | | | 1 | | | | | | <table border="1"><tr><td></td><td></td><td></td></tr><tr><td></td><td></td><td></td></tr><tr><td></td><td></td><td></td></tr></table> | | | | | | | | | | <table border="1"><tr><td></td><td></td><td></td></tr><tr><td></td><td></td><td></td></tr><tr><td></td><td></td><td></td></tr></table> | | | | | | | | | | <table border="1"><tr><td>1</td><td></td><td></td></tr><tr><td></td><td></td><td>2</td></tr><tr><td></td><td></td><td></td></tr></table> | 1 | | | | | 2 | | | | <table border="1"><tr><td></td><td></td><td></td></tr><tr><td></td><td></td><td></td></tr><tr><td></td><td></td><td></td></tr></table> | | | | | | | | | | <table border="1"><tr><td></td><td></td><td>1</td></tr><tr><td></td><td></td><td></td></tr><tr><td></td><td></td><td></td></tr></table> | | | 1 | | | | | | | <table border="1"><tr><td></td><td></td><td></td></tr><tr><td></td><td></td><td></td></tr><tr><td></td><td></td><td></td></tr></table> | | | | | | | | | |
| | | 1 | | | | | | | | | | | | | | | | | | | | | | | | | | | | | | | | | | | | | | | | | | | | | | | | | | | | | | | | | | | | | | | | | | | | | | | | | | | | | |
| | | 4 | | | | | | | | | | | | | | | | | | | | | | | | | | | | | | | | | | | | | | | | | | | | | | | | | | | | | | | | | | | | | | | | | | | | | | | | | | | | | |
| | | | | | | | | | | | | | | | | | | | | | | | | | | | | | | | | | | | | | | | | | | | | | | | | | | | | | | | | | | | | | | | | | | | | | | | | | | | | | | | |
| 1 | | | | | | | | | | | | | | | | | | | | | | | | | | | | | | | | | | | | | | | | | | | | | | | | | | | | | | | | | | | | | | | | | | | | | | | | | | | | | | | |
| 1 | | | | | | | | | | | | | | | | | | | | | | | | | | | | | | | | | | | | | | | | | | | | | | | | | | | | | | | | | | | | | | | | | | | | | | | | | | | | | | | |
| | | | | | | | | | | | | | | | | | | | | | | | | | | | | | | | | | | | | | | | | | | | | | | | | | | | | | | | | | | | | | | | | | | | | | | | | | | | | | | | |
| | | | | | | | | | | | | | | | | | | | | | | | | | | | | | | | | | | | | | | | | | | | | | | | | | | | | | | | | | | | | | | | | | | | | | | | | | | | | | | | |
| | | | | | | | | | | | | | | | | | | | | | | | | | | | | | | | | | | | | | | | | | | | | | | | | | | | | | | | | | | | | | | | | | | | | | | | | | | | | | | | |
| | | | | | | | | | | | | | | | | | | | | | | | | | | | | | | | | | | | | | | | | | | | | | | | | | | | | | | | | | | | | | | | | | | | | | | | | | | | | | | | |
| | | | | | | | | | | | | | | | | | | | | | | | | | | | | | | | | | | | | | | | | | | | | | | | | | | | | | | | | | | | | | | | | | | | | | | | | | | | | | | | |
| | | | | | | | | | | | | | | | | | | | | | | | | | | | | | | | | | | | | | | | | | | | | | | | | | | | | | | | | | | | | | | | | | | | | | | | | | | | | | | | |
| | | | | | | | | | | | | | | | | | | | | | | | | | | | | | | | | | | | | | | | | | | | | | | | | | | | | | | | | | | | | | | | | | | | | | | | | | | | | | | | |
| 1 | | | | | | | | | | | | | | | | | | | | | | | | | | | | | | | | | | | | | | | | | | | | | | | | | | | | | | | | | | | | | | | | | | | | | | | | | | | | | | | |
| | | 2 | | | | | | | | | | | | | | | | | | | | | | | | | | | | | | | | | | | | | | | | | | | | | | | | | | | | | | | | | | | | | | | | | | | | | | | | | | | | | |
| | | | | | | | | | | | | | | | | | | | | | | | | | | | | | | | | | | | | | | | | | | | | | | | | | | | | | | | | | | | | | | | | | | | | | | | | | | | | | | | |
| | | | | | | | | | | | | | | | | | | | | | | | | | | | | | | | | | | | | | | | | | | | | | | | | | | | | | | | | | | | | | | | | | | | | | | | | | | | | | | | |
| | | | | | | | | | | | | | | | | | | | | | | | | | | | | | | | | | | | | | | | | | | | | | | | | | | | | | | | | | | | | | | | | | | | | | | | | | | | | | | | |
| | | | | | | | | | | | | | | | | | | | | | | | | | | | | | | | | | | | | | | | | | | | | | | | | | | | | | | | | | | | | | | | | | | | | | | | | | | | | | | | |
| | | 1 | | | | | | | | | | | | | | | | | | | | | | | | | | | | | | | | | | | | | | | | | | | | | | | | | | | | | | | | | | | | | | | | | | | | | | | | | | | | | |
| | | | | | | | | | | | | | | | | | | | | | | | | | | | | | | | | | | | | | | | | | | | | | | | | | | | | | | | | | | | | | | | | | | | | | | | | | | | | | | | |
| | | | | | | | | | | | | | | | | | | | | | | | | | | | | | | | | | | | | | | | | | | | | | | | | | | | | | | | | | | | | | | | | | | | | | | | | | | | | | | | |
| | | | | | | | | | | | | | | | | | | | | | | | | | | | | | | | | | | | | | | | | | | | | | | | | | | | | | | | | | | | | | | | | | | | | | | | | | | | | | | | |
| | | | | | | | | | | | | | | | | | | | | | | | | | | | | | | | | | | | | | | | | | | | | | | | | | | | | | | | | | | | | | | | | | | | | | | | | | | | | | | | |
| | | | | | | | | | | | | | | | | | | | | | | | | | | | | | | | | | | | | | | | | | | | | | | | | | | | | | | | | | | | | | | | | | | | | | | | | | | | | | | | |

1 江力为

| | | |
|-----|--|-----|
| | | |
| 0/1 | | 0/1 |
| 0/1 | | 0/1 |

22 吴泽斌

| | | |
|-----|--|-----|
| 0/1 | | 0/1 |
| 2/3 | | 1/1 |
| 1/3 | | 2/4 |

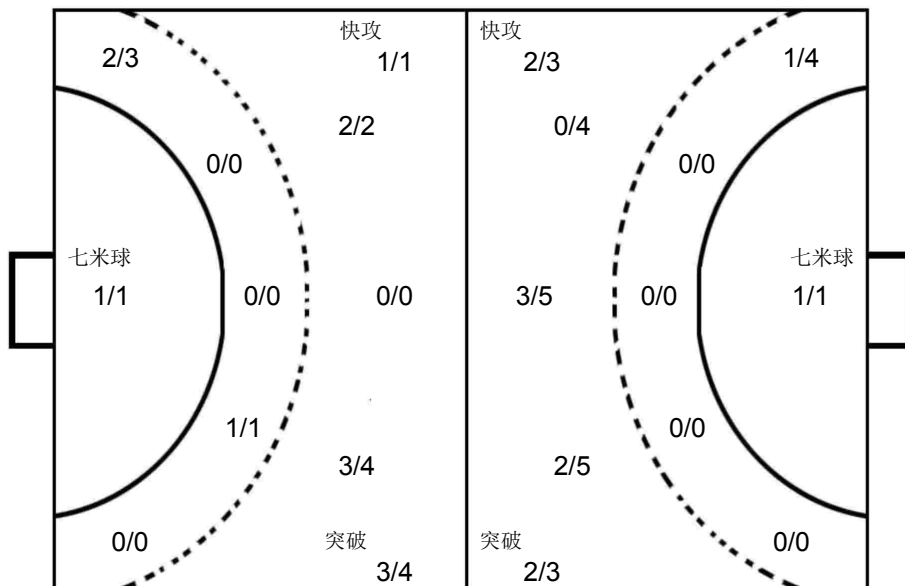

1 邹明轩

| | | |
|-----|--|-----|
| | | |
| 2/2 | | 0/3 |
| | | 0/5 |

12 周文贤

| | | |
|-----|-----|-----|
| 0/2 | | |
| 0/1 | | |
| | 0/1 | 0/1 |

江苏苏州

| | | | | | | | | | | | | | | | | | | | | | | | | | | | | | | | | | | | | | | | | | | | | | | | | | | | | | | | | | | | | | | | | | | | | | | | | | | | | | | | |
|--|--------|-------|--------|--------|--------|--------|--------|--|---|--|--|--|--|--|--|--|--|--|--|---|--|--|---|--|--|--|--|--|--|--|--|--|--|--|--|--|--|--|--|--|--|--|---|--|--|---|--|--|--|---|--|--|--|--|--|---|--|--|---|--|--|--|--|--|--|--|--|--|--|---|--|--|---|--|--|--|--|--|--|
| 1 邹明轩 | 2 马力 | 4 孙钊 | 5 马奔 | 6 潘超群 | 8 王震 | 9 李文俊 | 10 朱红雨 | | | | | | | | | | | | | | | | | | | | | | | | | | | | | | | | | | | | | | | | | | | | | | | | | | | | | | | | | | | | | | | | | | | | | | | | |
| <table border="1"><tr><td></td><td></td><td></td></tr><tr><td></td><td></td><td></td></tr><tr><td></td><td></td><td></td></tr></table> | | | | | | | | | | <table border="1"><tr><td></td><td></td><td></td></tr><tr><td></td><td></td><td></td></tr><tr><td></td><td></td><td></td></tr></table> | | | | | | | | | | <table border="1"><tr><td></td><td></td><td>1</td></tr><tr><td></td><td></td><td></td></tr><tr><td></td><td></td><td></td></tr></table> | | | 1 | | | | | | | <table border="1"><tr><td></td><td></td><td></td></tr><tr><td></td><td></td><td></td></tr><tr><td></td><td></td><td></td></tr></table> | | | | | | | | | | <table border="1"><tr><td></td><td></td><td>1</td></tr><tr><td></td><td></td><td>3</td></tr><tr><td></td><td></td><td></td></tr></table> | | | 1 | | | 3 | | | | <table border="1"><tr><td></td><td></td><td></td></tr><tr><td></td><td></td><td>1</td></tr><tr><td></td><td></td><td></td></tr></table> | | | | | | 1 | | | | <table border="1"><tr><td></td><td></td><td></td></tr><tr><td></td><td></td><td></td></tr><tr><td></td><td></td><td></td></tr></table> | | | | | | | | | | <table border="1"><tr><td></td><td></td><td></td></tr><tr><td></td><td></td><td></td></tr><tr><td></td><td></td><td></td></tr></table> | | | | | | | | | |
| | | | | | | | | | | | | | | | | | | | | | | | | | | | | | | | | | | | | | | | | | | | | | | | | | | | | | | | | | | | | | | | | | | | | | | | | | | | | | | | |
| | | | | | | | | | | | | | | | | | | | | | | | | | | | | | | | | | | | | | | | | | | | | | | | | | | | | | | | | | | | | | | | | | | | | | | | | | | | | | | | |
| | | | | | | | | | | | | | | | | | | | | | | | | | | | | | | | | | | | | | | | | | | | | | | | | | | | | | | | | | | | | | | | | | | | | | | | | | | | | | | | |
| | | | | | | | | | | | | | | | | | | | | | | | | | | | | | | | | | | | | | | | | | | | | | | | | | | | | | | | | | | | | | | | | | | | | | | | | | | | | | | | |
| | | | | | | | | | | | | | | | | | | | | | | | | | | | | | | | | | | | | | | | | | | | | | | | | | | | | | | | | | | | | | | | | | | | | | | | | | | | | | | | |
| | | | | | | | | | | | | | | | | | | | | | | | | | | | | | | | | | | | | | | | | | | | | | | | | | | | | | | | | | | | | | | | | | | | | | | | | | | | | | | | |
| | | 1 | | | | | | | | | | | | | | | | | | | | | | | | | | | | | | | | | | | | | | | | | | | | | | | | | | | | | | | | | | | | | | | | | | | | | | | | | | | | | |
| | | | | | | | | | | | | | | | | | | | | | | | | | | | | | | | | | | | | | | | | | | | | | | | | | | | | | | | | | | | | | | | | | | | | | | | | | | | | | | | |
| | | | | | | | | | | | | | | | | | | | | | | | | | | | | | | | | | | | | | | | | | | | | | | | | | | | | | | | | | | | | | | | | | | | | | | | | | | | | | | | |
| | | | | | | | | | | | | | | | | | | | | | | | | | | | | | | | | | | | | | | | | | | | | | | | | | | | | | | | | | | | | | | | | | | | | | | | | | | | | | | | |
| | | | | | | | | | | | | | | | | | | | | | | | | | | | | | | | | | | | | | | | | | | | | | | | | | | | | | | | | | | | | | | | | | | | | | | | | | | | | | | | |
| | | | | | | | | | | | | | | | | | | | | | | | | | | | | | | | | | | | | | | | | | | | | | | | | | | | | | | | | | | | | | | | | | | | | | | | | | | | | | | | |
| | | 1 | | | | | | | | | | | | | | | | | | | | | | | | | | | | | | | | | | | | | | | | | | | | | | | | | | | | | | | | | | | | | | | | | | | | | | | | | | | | | |
| | | 3 | | | | | | | | | | | | | | | | | | | | | | | | | | | | | | | | | | | | | | | | | | | | | | | | | | | | | | | | | | | | | | | | | | | | | | | | | | | | | |
| | | | | | | | | | | | | | | | | | | | | | | | | | | | | | | | | | | | | | | | | | | | | | | | | | | | | | | | | | | | | | | | | | | | | | | | | | | | | | | | |
| | | | | | | | | | | | | | | | | | | | | | | | | | | | | | | | | | | | | | | | | | | | | | | | | | | | | | | | | | | | | | | | | | | | | | | | | | | | | | | | |
| | | 1 | | | | | | | | | | | | | | | | | | | | | | | | | | | | | | | | | | | | | | | | | | | | | | | | | | | | | | | | | | | | | | | | | | | | | | | | | | | | | |
| | | | | | | | | | | | | | | | | | | | | | | | | | | | | | | | | | | | | | | | | | | | | | | | | | | | | | | | | | | | | | | | | | | | | | | | | | | | | | | | |
| | | | | | | | | | | | | | | | | | | | | | | | | | | | | | | | | | | | | | | | | | | | | | | | | | | | | | | | | | | | | | | | | | | | | | | | | | | | | | | | |
| | | | | | | | | | | | | | | | | | | | | | | | | | | | | | | | | | | | | | | | | | | | | | | | | | | | | | | | | | | | | | | | | | | | | | | | | | | | | | | | |
| | | | | | | | | | | | | | | | | | | | | | | | | | | | | | | | | | | | | | | | | | | | | | | | | | | | | | | | | | | | | | | | | | | | | | | | | | | | | | | | |
| | | | | | | | | | | | | | | | | | | | | | | | | | | | | | | | | | | | | | | | | | | | | | | | | | | | | | | | | | | | | | | | | | | | | | | | | | | | | | | | |
| | | | | | | | | | | | | | | | | | | | | | | | | | | | | | | | | | | | | | | | | | | | | | | | | | | | | | | | | | | | | | | | | | | | | | | | | | | | | | | | |
| | | | | | | | | | | | | | | | | | | | | | | | | | | | | | | | | | | | | | | | | | | | | | | | | | | | | | | | | | | | | | | | | | | | | | | | | | | | | | | | |
| 11 许多 | 12 周文贤 | 13 蒋超 | 14 刘亚力 | 15 刘成果 | 18 何志伟 | 19 夏思毅 | 23 张铮洋 | | | | | | | | | | | | | | | | | | | | | | | | | | | | | | | | | | | | | | | | | | | | | | | | | | | | | | | | | | | | | | | | | | | | | | | | |
| <table border="1"><tr><td>1</td><td></td><td></td></tr><tr><td></td><td></td><td></td></tr><tr><td></td><td></td><td>1</td></tr></table> | 1 | | | | | | | | 1 | <table border="1"><tr><td></td><td></td><td></td></tr><tr><td></td><td></td><td></td></tr><tr><td></td><td></td><td></td></tr></table> | | | | | | | | | | <table border="1"><tr><td></td><td></td><td></td></tr><tr><td></td><td></td><td></td></tr><tr><td></td><td></td><td></td></tr></table> | | | | | | | | | | <table border="1"><tr><td></td><td></td><td></td></tr><tr><td></td><td></td><td></td></tr><tr><td></td><td></td><td></td></tr></table> | | | | | | | | | | <table border="1"><tr><td></td><td></td><td></td></tr><tr><td></td><td></td><td></td></tr><tr><td></td><td></td><td></td></tr></table> | | | | | | | | | | <table border="1"><tr><td></td><td></td><td></td></tr><tr><td></td><td></td><td></td></tr><tr><td></td><td></td><td>1</td></tr></table> | | | | | | | | | 1 | <table border="1"><tr><td></td><td></td><td></td></tr><tr><td></td><td></td><td></td></tr><tr><td></td><td></td><td></td></tr></table> | | | | | | | | | | <table border="1"><tr><td></td><td></td><td>1</td></tr><tr><td></td><td></td><td></td></tr><tr><td></td><td></td><td></td></tr></table> | | | 1 | | | | | | |
| 1 | | | | | | | | | | | | | | | | | | | | | | | | | | | | | | | | | | | | | | | | | | | | | | | | | | | | | | | | | | | | | | | | | | | | | | | | | | | | | | | |
| | | | | | | | | | | | | | | | | | | | | | | | | | | | | | | | | | | | | | | | | | | | | | | | | | | | | | | | | | | | | | | | | | | | | | | | | | | | | | | | |
| | | 1 | | | | | | | | | | | | | | | | | | | | | | | | | | | | | | | | | | | | | | | | | | | | | | | | | | | | | | | | | | | | | | | | | | | | | | | | | | | | | |
| | | | | | | | | | | | | | | | | | | | | | | | | | | | | | | | | | | | | | | | | | | | | | | | | | | | | | | | | | | | | | | | | | | | | | | | | | | | | | | | |
| | | | | | | | | | | | | | | | | | | | | | | | | | | | | | | | | | | | | | | | | | | | | | | | | | | | | | | | | | | | | | | | | | | | | | | | | | | | | | | | |
| | | | | | | | | | | | | | | | | | | | | | | | | | | | | | | | | | | | | | | | | | | | | | | | | | | | | | | | | | | | | | | | | | | | | | | | | | | | | | | | |
| | | | | | | | | | | | | | | | | | | | | | | | | | | | | | | | | | | | | | | | | | | | | | | | | | | | | | | | | | | | | | | | | | | | | | | | | | | | | | | | |
| | | | | | | | | | | | | | | | | | | | | | | | | | | | | | | | | | | | | | | | | | | | | | | | | | | | | | | | | | | | | | | | | | | | | | | | | | | | | | | | |
| | | | | | | | | | | | | | | | | | | | | | | | | | | | | | | | | | | | | | | | | | | | | | | | | | | | | | | | | | | | | | | | | | | | | | | | | | | | | | | | |
| | | | | | | | | | | | | | | | | | | | | | | | | | | | | | | | | | | | | | | | | | | | | | | | | | | | | | | | | | | | | | | | | | | | | | | | | | | | | | | | |
| | | | | | | | | | | | | | | | | | | | | | | | | | | | | | | | | | | | | | | | | | | | | | | | | | | | | | | | | | | | | | | | | | | | | | | | | | | | | | | | |
| | | | | | | | | | | | | | | | | | | | | | | | | | | | | | | | | | | | | | | | | | | | | | | | | | | | | | | | | | | | | | | | | | | | | | | | | | | | | | | | |
| | | | | | | | | | | | | | | | | | | | | | | | | | | | | | | | | | | | | | | | | | | | | | | | | | | | | | | | | | | | | | | | | | | | | | | | | | | | | | | | |
| | | | | | | | | | | | | | | | | | | | | | | | | | | | | | | | | | | | | | | | | | | | | | | | | | | | | | | | | | | | | | | | | | | | | | | | | | | | | | | | |
| | | | | | | | | | | | | | | | | | | | | | | | | | | | | | | | | | | | | | | | | | | | | | | | | | | | | | | | | | | | | | | | | | | | | | | | | | | | | | | | |
| | | | | | | | | | | | | | | | | | | | | | | | | | | | | | | | | | | | | | | | | | | | | | | | | | | | | | | | | | | | | | | | | | | | | | | | | | | | | | | | |
| | | | | | | | | | | | | | | | | | | | | | | | | | | | | | | | | | | | | | | | | | | | | | | | | | | | | | | | | | | | | | | | | | | | | | | | | | | | | | | | |
| | | 1 | | | | | | | | | | | | | | | | | | | | | | | | | | | | | | | | | | | | | | | | | | | | | | | | | | | | | | | | | | | | | | | | | | | | | | | | | | | | | |
| | | | | | | | | | | | | | | | | | | | | | | | | | | | | | | | | | | | | | | | | | | | | | | | | | | | | | | | | | | | | | | | | | | | | | | | | | | | | | | | |
| | | | | | | | | | | | | | | | | | | | | | | | | | | | | | | | | | | | | | | | | | | | | | | | | | | | | | | | | | | | | | | | | | | | | | | | | | | | | | | | |
| | | | | | | | | | | | | | | | | | | | | | | | | | | | | | | | | | | | | | | | | | | | | | | | | | | | | | | | | | | | | | | | | | | | | | | | | | | | | | | | |
| | | 1 | | | | | | | | | | | | | | | | | | | | | | | | | | | | | | | | | | | | | | | | | | | | | | | | | | | | | | | | | | | | | | | | | | | | | | | | | | | | | |
| | | | | | | | | | | | | | | | | | | | | | | | | | | | | | | | | | | | | | | | | | | | | | | | | | | | | | | | | | | | | | | | | | | | | | | | | | | | | | | | |
| | | | | | | | | | | | | | | | | | | | | | | | | | | | | | | | | | | | | | | | | | | | | | | | | | | | | | | | | | | | | | | | | | | | | | | | | | | | | | | | |



PHMS Pictorial Handball Match Statistics **IHF** Official System

| | | |
|--------|--------|--------------|
| Team A | Team B | Match Number |
| A 山东济南 | B 安徽淮南 | 36 |

| | | | | |
|-----------|-------------|------------|-------|------------|
| Played in | in the hall | on | at | Spepectors |
| 安徽滁州 | 滁州国际手球馆 | 2019-06-05 | 08:30 | hours |

| | | | | | | | | | | | | | | |
|----------------|---|----|---------------------|----|---|----------------|---|---|----------------|---|---|----------------------|---|---|
| Half-time(30') | A | B | End of playing time | A | B | 1st extra time | A | B | 2nd extra time | A | B | After penalty throws | A | B |
| | 9 | 14 | 14 | 23 | | | | | | | | | | |

| | | | | | | | | | | |
|---------------|-----|---------------|-------|---|------------------------------------|---------------|-------|---|-----|---------------|
| Number of 7 m | A | Team time-out | | | Full name of players and officials | Team time-out | | | B | Number of 7 m |
| | 1/1 | 1 | 2 | 3 | | 1 | 2 | 3 | 1/2 | |
| | | 02:50 | 10:39 | | | 14:02 | 32:54 | | | |

| No. | Team A | G | W | 2' | D | DR | No. | Team B | G | W | 2' | D | DR |
|-----|-----------|---|---|----|---|----|-----|-----------|---|---|----|---|----|
| 1 | 刘在攀 | | | | | | 1 | 苟嘉毅 | | | | | |
| 4 | 张广一 | | | | | | 2 | 邹俊洁 | 1 | | | | |
| 6 | 刘尊哲 | 4 | | | | | 3 | 童守宣 | | | | | |
| 7 | 王帅 | 2 | | 1 | | | 4 | 李攀 | | | | | |
| 8 | 金正凯 | | | | | | 5 | 吴修民 | | | | | |
| 9 | 张嘉树 | | | | | | 6 | 童浩宇 | | | | | |
| 10 | 颜同霖 | 2 | | 1 | | | 7 | 赵琨鹏 | | | | | |
| 11 | 李延舒 | 1 | 1 | | | | 8 | 陈子涵 | 5 | | 1 | | |
| 13 | 刘振宇 | 5 | 1 | 1 | | | 9 | 杨金龙 | 8 | | | | |
| 16 | 高宇轩 | | | | | | 10 | 孙飞扬 | 5 | | | | |
| 17 | 张昊 | | | | | | 11 | 刘新然 | 2 | | | | |
| 21 | 杨明毅 | | | | | | 13 | 张昊燃 | | | | | |
| 24 | 于昊 | | | | | | 14 | 单中宝 | | | | | |
| 26 | 曹立志 | | | | | | 15 | 刘淇 | | | | | |
| 40 | 鹿智豪 | | | | | | 16 | 胡文柯 | | | | | |
| 88 | 王麒翔 | | | | | | 17 | 徐鹏辉 | 2 | | | | |
| A | 李楠 | | | | | | A | 常洪飞 | | | | | |
| B | 陈鹏波 (主教练) | | | | | | B | 阮圣杰 (主教练) | | | | | |
| C | 陶丛龙 | | | | | | | | | | | | |
| E | 郭军旗 | | | | | | | | | | | | |

| | | |
|---|--|---|
| A | Signatures of responsables for the teams (Off.A) | B |
|---|--|---|

| | | |
|----|-----------------------------------|----|
| TP | Remarks of referees / HF Official | TP |
|----|-----------------------------------|----|

| | | | |
|------------|-----------|-----------|--|
| Signatures | | | |
| Referees | 王羚 (CHN) | 刘晓辉 (CHN) | |
| T.D. | 李兆蒙 (CHN) | 徐健 (CHN) | |
| CHA Off. | | | |

Note: Number of 7m Throws Awarded to Team A and B, Goals (G), Warnings (W), Suspensions (2'), Direct Disqualification (D), Disqualification With Report (DR) and Team Penalty (TP).

Table Officials: 刘洋洋 许修凯 Statisticians: 马安兴 沈家洛

第二届全国青年运动会男子手球乙组决赛 体校组 (U16)

PHMS Pictorial Handball Match Statistics

IHF Official System

竞赛技术统计

手球
青年男子

7-8名
轮次 6

组别 X
场次 36

滁州国际手球馆
2019-06-05 08:30

| | | | |
|-----------|----------------------|---------|--------------|
| Referees: | 王聆 (CHN) / 刘晓辉 (CHN) | Result: | 14:23 (9:14) |
| Teams: | 山东济南(济南) VS 安徽淮南(淮南) | | |

| 济南 | | 远射 | 近射 | 边射 | 快攻 | 突破 | 任意球 | 7m球 | 合计 | % | 助攻 | 失误 | 警告 | 2' | D+DR |
|----------|-----|-----|------|-----|-----|-----|-----|-----|-------|------|----|----|----|----|------|
| 主教练: 陈鹏波 | | | | | | | | | | | | | | | |
| 1 | 刘在攀 | | | | | | | | | | | | | | |
| 4 | 张广一 | | | | | | | | | | | | | | |
| 6 | 刘尊哲 | | 0/2 | | | 3/3 | | 1/1 | 4/6 | 66.7 | 1 | 4 | | | |
| 7 | 王帅 | | 2/4 | | | | | | 2/4 | 50.0 | | 2 | | 1 | |
| 8 | 金正凯 | | | | | | | | | | | 1 | | | |
| 9 | 张嘉树 | | | | | | | | | | | | | | |
| 10 | 颜同霖 | 0/1 | | | | 2/2 | 0/1 | | 2/4 | 50.0 | 1 | 3 | | 1 | |
| 11 | 李延舒 | | 1/1 | | | | | | 1/1 | 100 | | | 1 | | |
| 13 | 刘振宇 | 1/4 | 1/1 | | | | 3/3 | | 5/8 | 62.5 | 1 | 2 | 1 | 1 | |
| 16 | 高宇轩 | | | | | | | | | | | | | | |
| 17 | 张昊 | | | | | | | | | | | | | | |
| 21 | 杨明毅 | | | | | | | | | | | | | | |
| 24 | 于昊 | | | | | | | | | | | | | | |
| 26 | 曹立志 | | | | | | | | | | | | | | |
| 40 | 鹿智豪 | | | | | | | | | | | | | | |
| 88 | 王麒麟 | | | | | | | | | | | | | | |
| 运动员 | 合计 | 1/5 | 4/8 | | | 5/5 | 3/4 | 1/1 | 14/23 | 60.9 | 3 | 12 | 2 | 3 | |
| 1 | 刘在攀 | 1/6 | 2/13 | 0/2 | 0/1 | 0/3 | | 0/1 | 3/26 | 11.5 | | | | | |
| 守门员 | 合计 | 1/6 | 2/13 | 0/2 | 0/1 | 0/3 | | 0/1 | 3/26 | 11.5 | | | | | |

| 淮南 | | 远射 | 近射 | 边射 | 快攻 | 突破 | 任意球 | 7m球 | 合计 | % | 助攻 | 失误 | 警告 | 2' | D+DR |
|----------|-----|------|-------|-----|-----|-----|-----|-----|-------|------|----|----|----|----|------|
| 主教练: 阮圣杰 | | | | | | | | | | | | | | | |
| 1 | 苟嘉毅 | | | | | | | | | | | | | | |
| 2 | 邹俊洁 | | 1/1 | | | | | | 1/1 | 100 | | | | | |
| 3 | 童守宣 | | | | | | | | | | | | | | |
| 4 | 李攀 | | | | | | | | | | | | | | |
| 5 | 吴修民 | | | | | | | | | | | | | | |
| 6 | 童浩宇 | | | | | | | | | | | 1 | | | |
| 7 | 赵琨鹏 | | | | | | | | | | | | | | |
| 8 | 陈子涵 | 1/2 | 2/3 | 1/1 | | 1/1 | | | 5/7 | 71.4 | | 1 | | 1 | |
| 9 | 杨金龙 | 1/2 | 4/5 | | 1/1 | 1/1 | | 1/2 | 8/11 | 72.7 | 1 | 1 | | | |
| 10 | 孙飞扬 | 3/6 | 1/1 | | | 1/1 | | | 5/8 | 62.5 | | 2 | | | |
| 11 | 刘新然 | | 1/1 | 1/1 | | | | | 2/2 | 100 | | | | | |
| 13 | 张昊然 | | | | | | | | | | | | | | |
| 14 | 单中宝 | | | | | | | | | | | | | | |
| 15 | 刘淇 | | 0/1 | | | | | | 0/1 | 0.0 | | | | | |
| 16 | 胡文柯 | | | | | | | | | | | | | | |
| 17 | 徐鹏辉 | | 2/3 | | | | | | 2/3 | 66.7 | | 2 | | | |
| 运动员 | 合计 | 5/10 | 11/15 | 2/2 | 1/1 | 3/3 | | 1/2 | 23/33 | 69.7 | 1 | 7 | | 1 | |
| 1 | 苟嘉毅 | 0/1 | 1/4 | | | 0/2 | 1/4 | 0/1 | 2/12 | 16.7 | | | | | |
| 16 | 胡文柯 | | 1/2 | | | 0/3 | | | 1/5 | 20.0 | | | | | |
| 守门员 | 合计 | 0/1 | 2/6 | | | 0/5 | 1/4 | 0/1 | 3/17 | 17.6 | | | | | |

| 济南 | 比赛进程 | 淮南 |
|--------|----------|-----------|
| | 1st Half | |
| | 0 00:56 | 1 9 杨金龙 |
| 10 颜同霖 | 1 01:08 | 1 |
| | 1 01:46 | 2 17 徐鹏辉 |
| | 1 02:31 | 3 10 孙飞扬 |
| | 1 03:40 | 4 8 陈子涵 |
| 11 李延舒 | 2 04:03 | 4 |
| | 2 04:38 | 5 17 徐鹏辉 |
| 13 刘振宇 | 3 05:04 | 5 |
| | 3 06:09 | 6 9 杨金龙 |
| 6 刘尊哲 | 4 06:57 | 6 |
| | 4 07:21 | 7 11 刘新然 |
| 6 刘尊哲 | 5 07:39 | 7 |
| | 5 08:46 | 8 10 孙飞扬 |
| | 5 09:30 | 9 9 杨金龙 |
| | 5 10:15 | 10 8 陈子涵 |
| | 5 10:35 | 11 9 杨金龙 |
| 13 刘振宇 | 6 11:24 | 11 |
| | 6 11:47 | 12 8 陈子涵 |
| | 6 12:40 | 13 8 陈子涵 |
| 7 王帅 | 7 12:55 | 13 |
| | 7 13:21 | 14 10 孙飞扬 |
| 10 颜同霖 | 8 13:33 | 14 |
| 6 刘尊哲 | 9 14:53 | 14 |
| | 2nd Half | |
| | 9 00:12 | 15 11 刘新然 |
| 13 刘振宇 | 10 01:39 | 15 |
| | 10 04:40 | 16 9 杨金龙 |
| 13 刘振宇 | 11 05:59 | 16 |
| | 11 06:22 | 17 9 杨金龙 |
| | 11 08:14 | 18 10 孙飞扬 |
| 13 刘振宇 | 12 08:24 | 18 |
| | 12 08:56 | 19 9 杨金龙 |
| | 12 12:00 | 20 8 陈子涵 |
| 7 王帅 | 13 12:22 | 20 |
| | 13 12:47 | 21 10 孙飞扬 |
| | 13 13:50 | 22 9 杨金龙 |
| | 13 14:47 | 23 2 邹俊洁 |
| 6 刘尊哲 | 14 14:58 | 23 |

场上队员: 得分 / 射门

守门员: 救球 / 射门

| | | | |
|---|------|----|---------|
| D | 取消资格 | DR | 取消资格+报告 |
|---|------|----|---------|



个人/全队技术统计表

手球 青年男子 7-8名 轮次 6 组别 X 场次 36 滁州国际手球馆 2019-06-05 08:30

| 号码 | 姓名 | 远射 | 近射 | 边射 | 快攻 | 突破 | 任意 | 七米 | 合计 | % | 助攻 | 失误 | 警告 | 2' | 取消 | 时间 |
|----------|-----|-----|------|-----|-----|-----|-----|-----|-------|-------|----|----|----|----|----|----------|
| 山东济南(济南) | | | | | | | | | | | | | | | | |
| (场上队员) | | | | | | | | | | | | | | | | |
| 1 | 刘在攀 | | | | | | | | | 0.0% | | | | | | 00:30:00 |
| 4 | 张广一 | | | | | | | | | 0.0% | | | | | | 00:00:00 |
| 6 | 刘尊哲 | | 0/2 | | | 3/3 | | 1/1 | 4/6 | 66.7% | 1 | 4 | | | | 00:29:57 |
| 7 | 王帅 | | 2/4 | | | | | | 2/4 | 50.0% | | 2 | | 1 | | 00:29:56 |
| 8 | 金正凯 | | | | | | | | | 0.0% | | 1 | | | | 00:18:31 |
| 9 | 张嘉树 | | | | | | | | | 0.0% | | | | | | 00:00:00 |
| 10 | 颜同霖 | 0/1 | | | | 2/2 | 0/1 | | 2/4 | 50.0% | 1 | 3 | | 1 | | 00:30:00 |
| 11 | 李延舒 | | 1/1 | | | | | | 1/1 | 100% | | | 1 | | | 00:30:00 |
| 13 | 刘振宇 | 1/4 | 1/1 | | | | 3/3 | | 5/8 | 62.5% | 1 | 2 | 1 | 1 | | 00:29:54 |
| 16 | 高宇轩 | | | | | | | | | 0.0% | | | | | | 00:00:00 |
| 17 | 张昊 | | | | | | | | | 0.0% | | | | | | 00:00:00 |
| 21 | 杨明毅 | | | | | | | | | 0.0% | | | | | | 00:00:00 |
| 24 | 于昊 | | | | | | | | | 0.0% | | | | | | 00:00:00 |
| 26 | 曹立志 | | | | | | | | | 0.0% | | | | | | 00:11:21 |
| 40 | 鹿智豪 | | | | | | | | | 0.0% | | | | | | 00:00:00 |
| 88 | 王麒翔 | | | | | | | | | 0.0% | | | | | | 00:00:00 |
| | 合计 | 1/5 | 4/8 | | | 5/5 | 3/4 | 1/1 | 14/23 | 60.9% | 3 | 12 | 2 | 3 | | |
| (守门员) | | | | | | | | | | | | | | | | |
| 1 | 刘在攀 | 1/6 | 2/13 | 0/2 | 0/1 | 0/3 | | 0/1 | 3/26 | 11.5% | | | | | | 00:30:00 |
| | 合计 | 1/6 | 2/13 | 0/2 | 0/1 | 0/3 | | 0/1 | 3/26 | 11.5% | | | | | | |

场上队员：得分/射门

守门员：救球/射门

| 全队合计 | 得分 | 被救 | 射失 | 击柱 | 封球 | 合计 | % |
|------|----|----|----|----|----|----|--------|
| 远射 | 1 | | 3 | 1 | | 5 | 20.0% |
| 近射 | 4 | 2 | 2 | | | 8 | 50.0% |
| 边射 | | | | | | | 0.0% |
| 快攻 | | | | | | | 0.0% |
| 突破 | 5 | | | | | 5 | 100.0% |
| 任意 | 3 | 1 | | | | 4 | 75.0% |
| 七米 | 1 | | | | | 1 | 100.0% |

个人/全队技术统计表

手球 7-8名 组别 X 滁州国际手球馆
青年男子 轮次 6 场次 36 2019-06-05 08:30

| 号码 | 姓名 | 远射 | 近射 | 边射 | 快攻 | 突破 | 任意 | 七米 | 合计 | % | 助攻 | 失误 | 警告 | 2' | 取消 | 时间 |
|----------|-----|------|-------|-----|-----|-----|-----|-----|-------|-------|----|----|----|----|----|----------|
| 安徽淮南(淮南) | | | | | | | | | | | | | | | | |
| (场上队员) | | | | | | | | | | | | | | | | |
| 1 | 苟嘉毅 | | | | | | | | | 0.0% | | | | | | 00:24:45 |
| 2 | 邹俊洁 | | 1/1 | | | | | | 1/1 | 100% | | | | | | 00:02:25 |
| 3 | 童守宣 | | | | | | | | | 0.0% | | | | | | 00:00:00 |
| 4 | 李攀 | | | | | | | | | 0.0% | | | | | | 00:00:00 |
| 5 | 吴修民 | | | | | | | | | 0.0% | | | | | | 00:00:00 |
| 6 | 童浩宇 | | | | | | | | | 0.0% | 1 | | | | | 00:27:30 |
| 7 | 赵琨鹏 | | | | | | | | | 0.0% | | | | | | 00:07:07 |
| 8 | 陈子涵 | 1/2 | 2/3 | 1/1 | | 1/1 | | | 5/7 | 71.4% | 1 | | | 1 | | 00:30:00 |
| 9 | 杨金龙 | 1/2 | 4/5 | | 1/1 | 1/1 | | 1/2 | 8/11 | 72.7% | 1 | 1 | | | | 00:30:00 |
| 10 | 孙飞扬 | 3/6 | 1/1 | | | 1/1 | | | 5/8 | 62.5% | | 2 | | | | 00:30:00 |
| 11 | 刘新然 | | 1/1 | 1/1 | | | | | 2/2 | 100% | | | | | | 00:26:45 |
| 13 | 张昊燃 | | | | | | | | | 0.0% | | | | | | 00:00:00 |
| 14 | 单中宝 | | | | | | | | | 0.0% | | | | | | 00:00:00 |
| 15 | 刘淇 | | 0/1 | | | | | | 0/1 | 0.0% | | | | | | 00:02:57 |
| 16 | 胡文柯 | | | | | | | | | 0.0% | | | | | | 00:05:15 |
| 17 | 徐鹏辉 | | 2/3 | | | | | | 2/3 | 66.7% | | 2 | | | | 00:22:49 |
| 合计 | | 5/10 | 11/15 | 2/2 | 1/1 | 3/3 | | 1/2 | 23/33 | 69.7% | 1 | 7 | | 1 | | |
| (守门员) | | | | | | | | | | | | | | | | |
| 1 | 苟嘉毅 | 0/1 | 1/4 | | | 0/2 | 1/4 | 0/1 | 2/12 | 16.7% | | | | | | 00:24:45 |
| 16 | 胡文柯 | | 1/2 | | | 0/3 | | | 1/5 | 20.0% | | | | | | 00:05:15 |
| 合计 | | 0/1 | 2/6 | | | 0/5 | 1/4 | 0/1 | 3/17 | 17.6% | | | | | | |

场上队员：得分/射门

守门员：救球/射门

| 全队合计 | 得分 | 被救 | 射失 | 击柱 | 封球 | 合计 | % |
|------|----|----|----|----|----|----|--------|
| 远射 | 5 | 1 | | 1 | 3 | 10 | 50.0% |
| 近射 | 11 | 2 | 1 | 1 | | 15 | 73.3% |
| 边射 | 2 | | | | | 2 | 100.0% |
| 快攻 | 1 | | | | | 1 | 100.0% |
| 突破 | 3 | | | | | 3 | 100.0% |
| 任意 | | | | | | | 0.0% |
| 七米 | 1 | | | 1 | | 2 | 50.0% |

图式比赛技术统计表

手球
青年男子

7-8名
轮次 6

组别 X
场次 36

滁州国际手球馆
2019-06-05 08:30

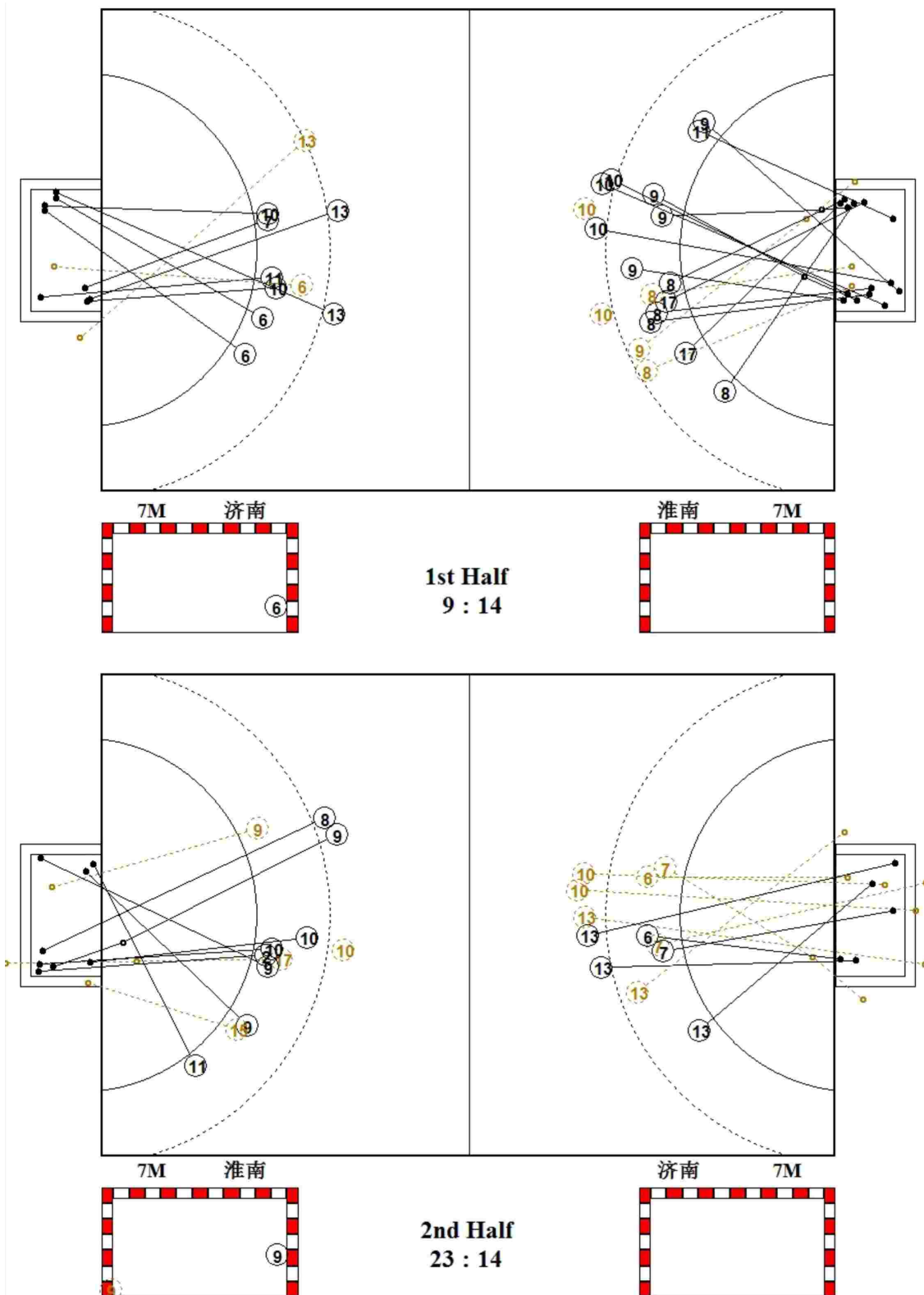

图式射门区域统计

手球
青年男子

7-8名
轮次 6

组别 X
场次 36

滁州国际手球馆
2019-06-05 08:30

山东济南

| | | | | | | | | | | | | | | | | | | | | | | | | | | | | | | | | | | | | | | | | | | | | | | | | | | | | | | | | | | | | | | | | | | | | | | | | | | | | | | | |
|---|-----------------------------|-----------------------------|-----------------------------|-----------------------------|-----------------------------|-----------------------------|-----------------------------|--|---|--|--|--|--|--|--|--|--|--|--|---|--|--|---|--|--|---|--|--|---|--|--|---|--|--|--|--|---|--|--|--|--|--|--|--|--|--|--|--|--|--|--|--|--|--|--|--|--|--|--|--|--|--|---|--|--|--|---|--|--|---|---|--|--|--|--|--|--|--|--|
| 1 刘在攀 | 4 张广一 | 6 刘尊哲 | 7 王帅 | 8 金正凯 | 9 张嘉树 | 10 颜同霖 | 11 李延舒 | | | | | | | | | | | | | | | | | | | | | | | | | | | | | | | | | | | | | | | | | | | | | | | | | | | | | | | | | | | | | | | | | | | | | | | | |
| <table border="1"><tr><td></td><td></td><td></td></tr><tr><td></td><td></td><td></td></tr><tr><td></td><td></td><td></td></tr></table> | | | | | | | | | | <table border="1"><tr><td></td><td></td><td></td></tr><tr><td></td><td></td><td></td></tr><tr><td></td><td></td><td></td></tr></table> | | | | | | | | | | <table border="1"><tr><td></td><td></td><td>1</td></tr><tr><td></td><td></td><td>1</td></tr><tr><td></td><td></td><td>2</td></tr></table> | | | 1 | | | 1 | | | 2 | <table border="1"><tr><td></td><td>1</td><td></td></tr><tr><td></td><td></td><td></td></tr><tr><td>1</td><td></td><td></td></tr></table> | | 1 | | | | | 1 | | | <table border="1"><tr><td></td><td></td><td></td></tr><tr><td></td><td></td><td></td></tr><tr><td></td><td></td><td></td></tr></table> | | | | | | | | | | <table border="1"><tr><td></td><td></td><td></td></tr><tr><td></td><td></td><td></td></tr><tr><td></td><td></td><td></td></tr></table> | | | | | | | | | | <table border="1"><tr><td></td><td></td><td>1</td></tr><tr><td></td><td></td><td></td></tr><tr><td>1</td><td></td><td></td></tr></table> | | | 1 | | | | 1 | | | <table border="1"><tr><td>1</td><td></td><td></td></tr><tr><td></td><td></td><td></td></tr><tr><td></td><td></td><td></td></tr></table> | 1 | | | | | | | | |
| | | | | | | | | | | | | | | | | | | | | | | | | | | | | | | | | | | | | | | | | | | | | | | | | | | | | | | | | | | | | | | | | | | | | | | | | | | | | | | | |
| | | | | | | | | | | | | | | | | | | | | | | | | | | | | | | | | | | | | | | | | | | | | | | | | | | | | | | | | | | | | | | | | | | | | | | | | | | | | | | | |
| | | | | | | | | | | | | | | | | | | | | | | | | | | | | | | | | | | | | | | | | | | | | | | | | | | | | | | | | | | | | | | | | | | | | | | | | | | | | | | | |
| | | | | | | | | | | | | | | | | | | | | | | | | | | | | | | | | | | | | | | | | | | | | | | | | | | | | | | | | | | | | | | | | | | | | | | | | | | | | | | | |
| | | | | | | | | | | | | | | | | | | | | | | | | | | | | | | | | | | | | | | | | | | | | | | | | | | | | | | | | | | | | | | | | | | | | | | | | | | | | | | | |
| | | | | | | | | | | | | | | | | | | | | | | | | | | | | | | | | | | | | | | | | | | | | | | | | | | | | | | | | | | | | | | | | | | | | | | | | | | | | | | | |
| | | 1 | | | | | | | | | | | | | | | | | | | | | | | | | | | | | | | | | | | | | | | | | | | | | | | | | | | | | | | | | | | | | | | | | | | | | | | | | | | | | |
| | | 1 | | | | | | | | | | | | | | | | | | | | | | | | | | | | | | | | | | | | | | | | | | | | | | | | | | | | | | | | | | | | | | | | | | | | | | | | | | | | | |
| | | 2 | | | | | | | | | | | | | | | | | | | | | | | | | | | | | | | | | | | | | | | | | | | | | | | | | | | | | | | | | | | | | | | | | | | | | | | | | | | | | |
| | 1 | | | | | | | | | | | | | | | | | | | | | | | | | | | | | | | | | | | | | | | | | | | | | | | | | | | | | | | | | | | | | | | | | | | | | | | | | | | | | | |
| | | | | | | | | | | | | | | | | | | | | | | | | | | | | | | | | | | | | | | | | | | | | | | | | | | | | | | | | | | | | | | | | | | | | | | | | | | | | | | | |
| 1 | | | | | | | | | | | | | | | | | | | | | | | | | | | | | | | | | | | | | | | | | | | | | | | | | | | | | | | | | | | | | | | | | | | | | | | | | | | | | | | |
| | | | | | | | | | | | | | | | | | | | | | | | | | | | | | | | | | | | | | | | | | | | | | | | | | | | | | | | | | | | | | | | | | | | | | | | | | | | | | | | |
| | | | | | | | | | | | | | | | | | | | | | | | | | | | | | | | | | | | | | | | | | | | | | | | | | | | | | | | | | | | | | | | | | | | | | | | | | | | | | | | |
| | | | | | | | | | | | | | | | | | | | | | | | | | | | | | | | | | | | | | | | | | | | | | | | | | | | | | | | | | | | | | | | | | | | | | | | | | | | | | | | |
| | | | | | | | | | | | | | | | | | | | | | | | | | | | | | | | | | | | | | | | | | | | | | | | | | | | | | | | | | | | | | | | | | | | | | | | | | | | | | | | |
| | | | | | | | | | | | | | | | | | | | | | | | | | | | | | | | | | | | | | | | | | | | | | | | | | | | | | | | | | | | | | | | | | | | | | | | | | | | | | | | |
| | | | | | | | | | | | | | | | | | | | | | | | | | | | | | | | | | | | | | | | | | | | | | | | | | | | | | | | | | | | | | | | | | | | | | | | | | | | | | | | |
| | | 1 | | | | | | | | | | | | | | | | | | | | | | | | | | | | | | | | | | | | | | | | | | | | | | | | | | | | | | | | | | | | | | | | | | | | | | | | | | | | | |
| | | | | | | | | | | | | | | | | | | | | | | | | | | | | | | | | | | | | | | | | | | | | | | | | | | | | | | | | | | | | | | | | | | | | | | | | | | | | | | | |
| 1 | | | | | | | | | | | | | | | | | | | | | | | | | | | | | | | | | | | | | | | | | | | | | | | | | | | | | | | | | | | | | | | | | | | | | | | | | | | | | | | |
| 1 | | | | | | | | | | | | | | | | | | | | | | | | | | | | | | | | | | | | | | | | | | | | | | | | | | | | | | | | | | | | | | | | | | | | | | | | | | | | | | | |
| | | | | | | | | | | | | | | | | | | | | | | | | | | | | | | | | | | | | | | | | | | | | | | | | | | | | | | | | | | | | | | | | | | | | | | | | | | | | | | | |
| | | | | | | | | | | | | | | | | | | | | | | | | | | | | | | | | | | | | | | | | | | | | | | | | | | | | | | | | | | | | | | | | | | | | | | | | | | | | | | | |
| Post - 0 Miss - 0 Block - 0 | Post - 0 Miss - 0 Block - 0 | Post - 0 Miss - 0 Block - 0 | Post - 0 Miss - 2 Block - 0 | Post - 0 Miss - 0 Block - 0 | Post - 0 Miss - 0 Block - 0 | Post - 1 Miss - 0 Block - 0 | Post - 0 Miss - 0 Block - 0 | | | | | | | | | | | | | | | | | | | | | | | | | | | | | | | | | | | | | | | | | | | | | | | | | | | | | | | | | | | | | | | | | | | | | | | | |
| 13 刘振宇 | 16 高宇轩 | 17 张昊 | 21 杨明毅 | 24 于昊 | 26 曹立志 | 40 鹿智豪 | 88 王麒麟 | | | | | | | | | | | | | | | | | | | | | | | | | | | | | | | | | | | | | | | | | | | | | | | | | | | | | | | | | | | | | | | | | | | | | | | | |
| <table border="1"><tr><td>1</td><td></td><td></td></tr><tr><td>1</td><td></td><td>1</td></tr><tr><td>1</td><td></td><td>1</td></tr></table> | 1 | | | 1 | | 1 | 1 | | 1 | <table border="1"><tr><td></td><td></td><td></td></tr><tr><td></td><td></td><td></td></tr><tr><td></td><td></td><td></td></tr></table> | | | | | | | | | | <table border="1"><tr><td></td><td></td><td></td></tr><tr><td></td><td></td><td></td></tr><tr><td></td><td></td><td></td></tr></table> | | | | | | | | | | <table border="1"><tr><td></td><td></td><td></td></tr><tr><td></td><td></td><td></td></tr><tr><td></td><td></td><td></td></tr></table> | | | | | | | | | | <table border="1"><tr><td></td><td></td><td></td></tr><tr><td></td><td></td><td></td></tr><tr><td></td><td></td><td></td></tr></table> | | | | | | | | | | <table border="1"><tr><td></td><td></td><td></td></tr><tr><td></td><td></td><td></td></tr><tr><td></td><td></td><td></td></tr></table> | | | | | | | | | | <table border="1"><tr><td></td><td></td><td></td></tr><tr><td></td><td></td><td></td></tr><tr><td></td><td></td><td></td></tr></table> | | | | | | | | | | <table border="1"><tr><td></td><td></td><td></td></tr><tr><td></td><td></td><td></td></tr><tr><td></td><td></td><td></td></tr></table> | | | | | | | | | |
| 1 | | | | | | | | | | | | | | | | | | | | | | | | | | | | | | | | | | | | | | | | | | | | | | | | | | | | | | | | | | | | | | | | | | | | | | | | | | | | | | | |
| 1 | | 1 | | | | | | | | | | | | | | | | | | | | | | | | | | | | | | | | | | | | | | | | | | | | | | | | | | | | | | | | | | | | | | | | | | | | | | | | | | | | | |
| 1 | | 1 | | | | | | | | | | | | | | | | | | | | | | | | | | | | | | | | | | | | | | | | | | | | | | | | | | | | | | | | | | | | | | | | | | | | | | | | | | | | | |
| | | | | | | | | | | | | | | | | | | | | | | | | | | | | | | | | | | | | | | | | | | | | | | | | | | | | | | | | | | | | | | | | | | | | | | | | | | | | | | | |
| | | | | | | | | | | | | | | | | | | | | | | | | | | | | | | | | | | | | | | | | | | | | | | | | | | | | | | | | | | | | | | | | | | | | | | | | | | | | | | | |
| | | | | | | | | | | | | | | | | | | | | | | | | | | | | | | | | | | | | | | | | | | | | | | | | | | | | | | | | | | | | | | | | | | | | | | | | | | | | | | | |
| | | | | | | | | | | | | | | | | | | | | | | | | | | | | | | | | | | | | | | | | | | | | | | | | | | | | | | | | | | | | | | | | | | | | | | | | | | | | | | | |
| | | | | | | | | | | | | | | | | | | | | | | | | | | | | | | | | | | | | | | | | | | | | | | | | | | | | | | | | | | | | | | | | | | | | | | | | | | | | | | | |
| | | | | | | | | | | | | | | | | | | | | | | | | | | | | | | | | | | | | | | | | | | | | | | | | | | | | | | | | | | | | | | | | | | | | | | | | | | | | | | | |
| | | | | | | | | | | | | | | | | | | | | | | | | | | | | | | | | | | | | | | | | | | | | | | | | | | | | | | | | | | | | | | | | | | | | | | | | | | | | | | | |
| | | | | | | | | | | | | | | | | | | | | | | | | | | | | | | | | | | | | | | | | | | | | | | | | | | | | | | | | | | | | | | | | | | | | | | | | | | | | | | | |
| | | | | | | | | | | | | | | | | | | | | | | | | | | | | | | | | | | | | | | | | | | | | | | | | | | | | | | | | | | | | | | | | | | | | | | | | | | | | | | | |
| | | | | | | | | | | | | | | | | | | | | | | | | | | | | | | | | | | | | | | | | | | | | | | | | | | | | | | | | | | | | | | | | | | | | | | | | | | | | | | | |
| | | | | | | | | | | | | | | | | | | | | | | | | | | | | | | | | | | | | | | | | | | | | | | | | | | | | | | | | | | | | | | | | | | | | | | | | | | | | | | | |
| | | | | | | | | | | | | | | | | | | | | | | | | | | | | | | | | | | | | | | | | | | | | | | | | | | | | | | | | | | | | | | | | | | | | | | | | | | | | | | | |
| | | | | | | | | | | | | | | | | | | | | | | | | | | | | | | | | | | | | | | | | | | | | | | | | | | | | | | | | | | | | | | | | | | | | | | | | | | | | | | | |
| | | | | | | | | | | | | | | | | | | | | | | | | | | | | | | | | | | | | | | | | | | | | | | | | | | | | | | | | | | | | | | | | | | | | | | | | | | | | | | | |
| | | | | | | | | | | | | | | | | | | | | | | | | | | | | | | | | | | | | | | | | | | | | | | | | | | | | | | | | | | | | | | | | | | | | | | | | | | | | | | | |
| | | | | | | | | | | | | | | | | | | | | | | | | | | | | | | | | | | | | | | | | | | | | | | | | | | | | | | | | | | | | | | | | | | | | | | | | | | | | | | | |
| | | | | | | | | | | | | | | | | | | | | | | | | | | | | | | | | | | | | | | | | | | | | | | | | | | | | | | | | | | | | | | | | | | | | | | | | | | | | | | | |
| | | | | | | | | | | | | | | | | | | | | | | | | | | | | | | | | | | | | | | | | | | | | | | | | | | | | | | | | | | | | | | | | | | | | | | | | | | | | | | | |
| | | | | | | | | | | | | | | | | | | | | | | | | | | | | | | | | | | | | | | | | | | | | | | | | | | | | | | | | | | | | | | | | | | | | | | | | | | | | | | | |
| | | | | | | | | | | | | | | | | | | | | | | | | | | | | | | | | | | | | | | | | | | | | | | | | | | | | | | | | | | | | | | | | | | | | | | | | | | | | | | | |
| | | | | | | | | | | | | | | | | | | | | | | | | | | | | | | | | | | | | | | | | | | | | | | | | | | | | | | | | | | | | | | | | | | | | | | | | | | | | | | | |
| Post - 0 Miss - 3 Block - 0 | Post - 0 Miss - 0 Block - 0 | Post - 0 Miss - 0 Block - 0 | Post - 0 Miss - 0 Block - 0 | Post - 0 Miss - 0 Block - 0 | Post - 0 Miss - 0 Block - 0 | Post - 0 Miss - 0 Block - 0 | Post - 0 Miss - 0 Block - 0 | | | | | | | | | | | | | | | | | | | | | | | | | | | | | | | | | | | | | | | | | | | | | | | | | | | | | | | | | | | | | | | | | | | | | | | | |

1 刘在攀

| | | |
|-----|-----|-----|
| 0/5 | | 1/5 |
| 0/1 | | 0/3 |
| 0/5 | 1/1 | 1/6 |

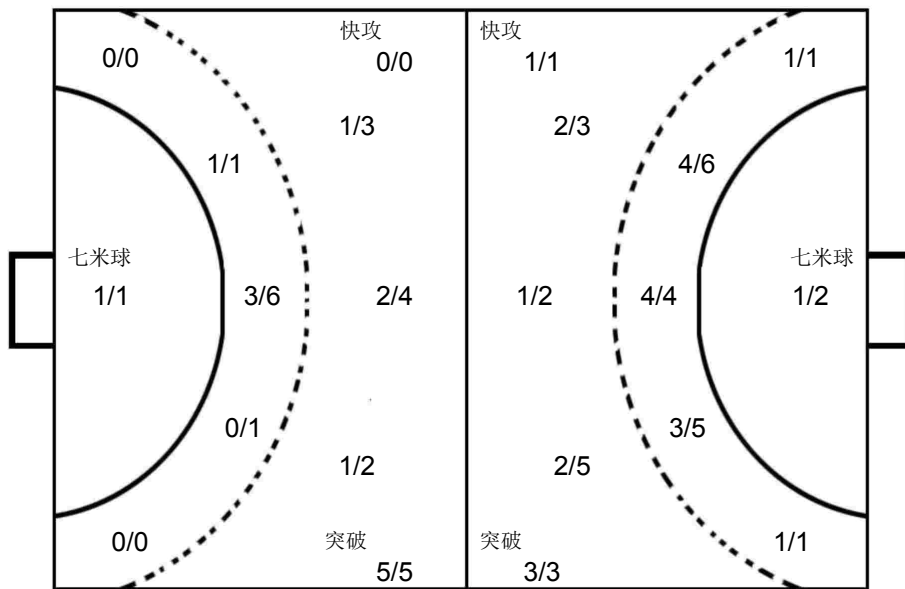

1 苟嘉毅

| | | |
|-----|-----|-----|
| 1/3 | 1/2 | 0/2 |
| 0/1 | | 0/1 |
| 0/1 | | 0/2 |

16 胡文柯

| | | |
|-----|--|-----|
| | | |
| | | 0/1 |
| 1/3 | | 0/1 |

安徽淮南

| | | | | | | | | | | | | | | | | | | | | | | | | | | | | | | | | | | | | | | | | | | | | | | | | | | | | | | | | | | | | | | | | | | | | | | | | | | | | | | | |
|---|-----------------------------|-----------------------------|-----------------------------|-----------------------------|-----------------------------|-----------------------------|-----------------------------|--|---|--|---|--|---|--|--|--|---|--|---|--|---|--|--|--|--|--|--|--|---|--|--|--|--|--|--|--|--|--|--|--|--|--|--|--|--|--|--|--|--|--|--|--|--|--|--|--|--|--|--|--|--|--|--|--|--|--|--|--|--|---|---|--|--|---|--|---|---|--|--|
| 1 苟嘉毅 | 2 邹俊洁 | 3 童守宣 | 4 李攀 | 5 吴修民 | 6 童浩宇 | 7 赵琨鹏 | 8 陈子涵 | | | | | | | | | | | | | | | | | | | | | | | | | | | | | | | | | | | | | | | | | | | | | | | | | | | | | | | | | | | | | | | | | | | | | | | | |
| <table border="1"><tr><td></td><td></td><td></td></tr><tr><td></td><td></td><td></td></tr><tr><td></td><td></td><td></td></tr></table> | | | | | | | | | | <table border="1"><tr><td>1</td><td></td><td></td></tr><tr><td></td><td></td><td></td></tr><tr><td></td><td></td><td></td></tr></table> | 1 | | | | | | | | | <table border="1"><tr><td></td><td></td><td></td></tr><tr><td></td><td></td><td></td></tr><tr><td></td><td></td><td></td></tr></table> | | | | | | | | | | <table border="1"><tr><td></td><td></td><td></td></tr><tr><td></td><td></td><td></td></tr><tr><td></td><td></td><td></td></tr></table> | | | | | | | | | | <table border="1"><tr><td></td><td></td><td></td></tr><tr><td></td><td></td><td></td></tr><tr><td></td><td></td><td></td></tr></table> | | | | | | | | | | <table border="1"><tr><td></td><td></td><td></td></tr><tr><td></td><td></td><td></td></tr><tr><td></td><td></td><td></td></tr></table> | | | | | | | | | | <table border="1"><tr><td></td><td></td><td></td></tr><tr><td></td><td></td><td></td></tr><tr><td></td><td></td><td></td></tr></table> | | | | | | | | | | <table border="1"><tr><td>1</td><td></td><td></td></tr><tr><td></td><td></td><td>2</td></tr><tr><td>2</td><td></td><td></td></tr></table> | 1 | | | | | 2 | 2 | | |
| | | | | | | | | | | | | | | | | | | | | | | | | | | | | | | | | | | | | | | | | | | | | | | | | | | | | | | | | | | | | | | | | | | | | | | | | | | | | | | | |
| | | | | | | | | | | | | | | | | | | | | | | | | | | | | | | | | | | | | | | | | | | | | | | | | | | | | | | | | | | | | | | | | | | | | | | | | | | | | | | | |
| | | | | | | | | | | | | | | | | | | | | | | | | | | | | | | | | | | | | | | | | | | | | | | | | | | | | | | | | | | | | | | | | | | | | | | | | | | | | | | | |
| 1 | | | | | | | | | | | | | | | | | | | | | | | | | | | | | | | | | | | | | | | | | | | | | | | | | | | | | | | | | | | | | | | | | | | | | | | | | | | | | | | |
| | | | | | | | | | | | | | | | | | | | | | | | | | | | | | | | | | | | | | | | | | | | | | | | | | | | | | | | | | | | | | | | | | | | | | | | | | | | | | | | |
| | | | | | | | | | | | | | | | | | | | | | | | | | | | | | | | | | | | | | | | | | | | | | | | | | | | | | | | | | | | | | | | | | | | | | | | | | | | | | | | |
| | | | | | | | | | | | | | | | | | | | | | | | | | | | | | | | | | | | | | | | | | | | | | | | | | | | | | | | | | | | | | | | | | | | | | | | | | | | | | | | |
| | | | | | | | | | | | | | | | | | | | | | | | | | | | | | | | | | | | | | | | | | | | | | | | | | | | | | | | | | | | | | | | | | | | | | | | | | | | | | | | |
| | | | | | | | | | | | | | | | | | | | | | | | | | | | | | | | | | | | | | | | | | | | | | | | | | | | | | | | | | | | | | | | | | | | | | | | | | | | | | | | |
| | | | | | | | | | | | | | | | | | | | | | | | | | | | | | | | | | | | | | | | | | | | | | | | | | | | | | | | | | | | | | | | | | | | | | | | | | | | | | | | |
| | | | | | | | | | | | | | | | | | | | | | | | | | | | | | | | | | | | | | | | | | | | | | | | | | | | | | | | | | | | | | | | | | | | | | | | | | | | | | | | |
| | | | | | | | | | | | | | | | | | | | | | | | | | | | | | | | | | | | | | | | | | | | | | | | | | | | | | | | | | | | | | | | | | | | | | | | | | | | | | | | |
| | | | | | | | | | | | | | | | | | | | | | | | | | | | | | | | | | | | | | | | | | | | | | | | | | | | | | | | | | | | | | | | | | | | | | | | | | | | | | | | |
| | | | | | | | | | | | | | | | | | | | | | | | | | | | | | | | | | | | | | | | | | | | | | | | | | | | | | | | | | | | | | | | | | | | | | | | | | | | | | | | |
| | | | | | | | | | | | | | | | | | | | | | | | | | | | | | | | | | | | | | | | | | | | | | | | | | | | | | | | | | | | | | | | | | | | | | | | | | | | | | | | |
| | | | | | | | | | | | | | | | | | | | | | | | | | | | | | | | | | | | | | | | | | | | | | | | | | | | | | | | | | | | | | | | | | | | | | | | | | | | | | | | |
| | | | | | | | | | | | | | | | | | | | | | | | | | | | | | | | | | | | | | | | | | | | | | | | | | | | | | | | | | | | | | | | | | | | | | | | | | | | | | | | |
| | | | | | | | | | | | | | | | | | | | | | | | | | | | | | | | | | | | | | | | | | | | | | | | | | | | | | | | | | | | | | | | | | | | | | | | | | | | | | | | |
| | | | | | | | | | | | | | | | | | | | | | | | | | | | | | | | | | | | | | | | | | | | | | | | | | | | | | | | | | | | | | | | | | | | | | | | | | | | | | | | |
| | | | | | | | | | | | | | | | | | | | | | | | | | | | | | | | | | | | | | | | | | | | | | | | | | | | | | | | | | | | | | | | | | | | | | | | | | | | | | | | |
| | | | | | | | | | | | | | | | | | | | | | | | | | | | | | | | | | | | | | | | | | | | | | | | | | | | | | | | | | | | | | | | | | | | | | | | | | | | | | | | |
| 1 | | | | | | | | | | | | | | | | | | | | | | | | | | | | | | | | | | | | | | | | | | | | | | | | | | | | | | | | | | | | | | | | | | | | | | | | | | | | | | | |
| | | 2 | | | | | | | | | | | | | | | | | | | | | | | | | | | | | | | | | | | | | | | | | | | | | | | | | | | | | | | | | | | | | | | | | | | | | | | | | | | | | |
| 2 | | | | | | | | | | | | | | | | | | | | | | | | | | | | | | | | | | | | | | | | | | | | | | | | | | | | | | | | | | | | | | | | | | | | | | | | | | | | | | | |
| Post - 0 Miss - 0 Block - 0 | Post - 0 Miss - 0 Block - 0 | Post - 0 Miss - 0 Block - 0 | Post - 0 Miss - 0 Block - 0 | Post - 0 Miss - 0 Block - 0 | Post - 0 Miss - 0 Block - 0 | Post - 0 Miss - 0 Block - 0 | Post - 0 Miss - 0 Block - 0 | | | | | | | | | | | | | | | | | | | | | | | | | | | | | | | | | | | | | | | | | | | | | | | | | | | | | | | | | | | | | | | | | | | | | | | | |
| 9 杨金龙 | 10 孙飞扬 | 11 刘新然 | 13 张昊燃 | 14 单中宝 | 15 刘淇 | 16 胡文柯 | 17 徐鹏辉 | | | | | | | | | | | | | | | | | | | | | | | | | | | | | | | | | | | | | | | | | | | | | | | | | | | | | | | | | | | | | | | | | | | | | | | | |
| <table border="1"><tr><td>1</td><td></td><td>2</td></tr><tr><td></td><td></td><td>1</td></tr><tr><td>1</td><td></td><td>3</td></tr></table> | 1 | | 2 | | | 1 | 1 | | 3 | <table border="1"><tr><td>1</td><td></td><td>2</td></tr><tr><td></td><td></td><td></td></tr><tr><td>1</td><td></td><td>1</td></tr></table> | 1 | | 2 | | | | 1 | | 1 | <table border="1"><tr><td>1</td><td></td><td></td></tr><tr><td></td><td></td><td></td></tr><tr><td></td><td></td><td>1</td></tr></table> | 1 | | | | | | | | 1 | <table border="1"><tr><td></td><td></td><td></td></tr><tr><td></td><td></td><td></td></tr><tr><td></td><td></td><td></td></tr></table> | | | | | | | | | | <table border="1"><tr><td></td><td></td><td></td></tr><tr><td></td><td></td><td></td></tr><tr><td></td><td></td><td></td></tr></table> | | | | | | | | | | <table border="1"><tr><td></td><td></td><td></td></tr><tr><td></td><td></td><td></td></tr><tr><td></td><td></td><td></td></tr></table> | | | | | | | | | | <table border="1"><tr><td></td><td></td><td></td></tr><tr><td></td><td></td><td></td></tr><tr><td></td><td></td><td></td></tr></table> | | | | | | | | | | <table border="1"><tr><td></td><td></td><td></td></tr><tr><td>1</td><td></td><td></td></tr><tr><td>1</td><td></td><td></td></tr></table> | | | | 1 | | | 1 | | |
| 1 | | 2 | | | | | | | | | | | | | | | | | | | | | | | | | | | | | | | | | | | | | | | | | | | | | | | | | | | | | | | | | | | | | | | | | | | | | | | | | | | | | |
| | | 1 | | | | | | | | | | | | | | | | | | | | | | | | | | | | | | | | | | | | | | | | | | | | | | | | | | | | | | | | | | | | | | | | | | | | | | | | | | | | | |
| 1 | | 3 | | | | | | | | | | | | | | | | | | | | | | | | | | | | | | | | | | | | | | | | | | | | | | | | | | | | | | | | | | | | | | | | | | | | | | | | | | | | | |
| 1 | | 2 | | | | | | | | | | | | | | | | | | | | | | | | | | | | | | | | | | | | | | | | | | | | | | | | | | | | | | | | | | | | | | | | | | | | | | | | | | | | | |
| | | | | | | | | | | | | | | | | | | | | | | | | | | | | | | | | | | | | | | | | | | | | | | | | | | | | | | | | | | | | | | | | | | | | | | | | | | | | | | | |
| 1 | | 1 | | | | | | | | | | | | | | | | | | | | | | | | | | | | | | | | | | | | | | | | | | | | | | | | | | | | | | | | | | | | | | | | | | | | | | | | | | | | | |
| 1 | | | | | | | | | | | | | | | | | | | | | | | | | | | | | | | | | | | | | | | | | | | | | | | | | | | | | | | | | | | | | | | | | | | | | | | | | | | | | | | |
| | | | | | | | | | | | | | | | | | | | | | | | | | | | | | | | | | | | | | | | | | | | | | | | | | | | | | | | | | | | | | | | | | | | | | | | | | | | | | | | |
| | | 1 | | | | | | | | | | | | | | | | | | | | | | | | | | | | | | | | | | | | | | | | | | | | | | | | | | | | | | | | | | | | | | | | | | | | | | | | | | | | | |
| | | | | | | | | | | | | | | | | | | | | | | | | | | | | | | | | | | | | | | | | | | | | | | | | | | | | | | | | | | | | | | | | | | | | | | | | | | | | | | | |
| | | | | | | | | | | | | | | | | | | | | | | | | | | | | | | | | | | | | | | | | | | | | | | | | | | | | | | | | | | | | | | | | | | | | | | | | | | | | | | | |
| | | | | | | | | | | | | | | | | | | | | | | | | | | | | | | | | | | | | | | | | | | | | | | | | | | | | | | | | | | | | | | | | | | | | | | | | | | | | | | | |
| | | | | | | | | | | | | | | | | | | | | | | | | | | | | | | | | | | | | | | | | | | | | | | | | | | | | | | | | | | | | | | | | | | | | | | | | | | | | | | | |
| | | | | | | | | | | | | | | | | | | | | | | | | | | | | | | | | | | | | | | | | | | | | | | | | | | | | | | | | | | | | | | | | | | | | | | | | | | | | | | | |
| | | | | | | | | | | | | | | | | | | | | | | | | | | | | | | | | | | | | | | | | | | | | | | | | | | | | | | | | | | | | | | | | | | | | | | | | | | | | | | | |
| | | | | | | | | | | | | | | | | | | | | | | | | | | | | | | | | | | | | | | | | | | | | | | | | | | | | | | | | | | | | | | | | | | | | | | | | | | | | | | | |
| | | | | | | | | | | | | | | | | | | | | | | | | | | | | | | | | | | | | | | | | | | | | | | | | | | | | | | | | | | | | | | | | | | | | | | | | | | | | | | | |
| | | | | | | | | | | | | | | | | | | | | | | | | | | | | | | | | | | | | | | | | | | | | | | | | | | | | | | | | | | | | | | | | | | | | | | | | | | | | | | | |
| | | | | | | | | | | | | | | | | | | | | | | | | | | | | | | | | | | | | | | | | | | | | | | | | | | | | | | | | | | | | | | | | | | | | | | | | | | | | | | | |
| | | | | | | | | | | | | | | | | | | | | | | | | | | | | | | | | | | | | | | | | | | | | | | | | | | | | | | | | | | | | | | | | | | | | | | | | | | | | | | | |
| | | | | | | | | | | | | | | | | | | | | | | | | | | | | | | | | | | | | | | | | | | | | | | | | | | | | | | | | | | | | | | | | | | | | | | | | | | | | | | | |
| | | | | | | | | | | | | | | | | | | | | | | | | | | | | | | | | | | | | | | | | | | | | | | | | | | | | | | | | | | | | | | | | | | | | | | | | | | | | | | | |
| 1 | | | | | | | | | | | | | | | | | | | | | | | | | | | | | | | | | | | | | | | | | | | | | | | | | | | | | | | | | | | | | | | | | | | | | | | | | | | | | | | |
| 1 | | | | | | | | | | | | | | | | | | | | | | | | | | | | | | | | | | | | | | | | | | | | | | | | | | | | | | | | | | | | | | | | | | | | | | | | | | | | | | | |
| Post - 2 Miss - 0 Block - 0 | Post - 0 Miss - 0 Block - 3 | Post - 0 Miss - 0 Block - 0 | Post - 0 Miss - 0 Block - 0 | Post - 0 Miss - 0 Block - 0 | Post - 1 Miss - 0 Block - 0 | Post - 0 Miss - 0 Block - 0 | Post - 0 Miss - 1 Block - 0 | | | | | | | | | | | | | | | | | | | | | | | | | | | | | | | | | | | | | | | | | | | | | | | | | | | | | | | | | | | | | | | | | | | | | | | | |



PHMS Pictorial Handball Match Statistics **IHF** Official System

| | | |
|-------------------------|-------------------------|---------------------------|
| Team A A 辽宁抚顺 | Team B B 福建龙岩 | Match Number 37 |
|-------------------------|-------------------------|---------------------------|

| | | | | | |
|-------------------|------------------------|------------------|-------------|-------|------------|
| Played in 安徽滁州 | in the hall 滁州国际手球馆 | on 2019-06-05 | at 09:30 | hours | Spepectors |
|-------------------|------------------------|------------------|-------------|-------|------------|

| | | | | | | | | | | | | | | |
|----------------|--------|--------|---------------------|---------|---------|----------------|---|---|----------------|---|---|----------------------|---|---|
| Half-time(30') | A 6 | B 8 | End of playing time | A 13 | B 16 | 1st extra time | A | B | 2nd extra time | A | B | After penalty throws | A | B |
|----------------|--------|--------|---------------------|---------|---------|----------------|---|---|----------------|---|---|----------------------|---|---|

| | | | | | | | | | | |
|---------------|----------|---------------|---|---|------------------------------------|---------------|---|--|----------|---------------|
| Number of 7 m | A 1/1 | Team time-out | | | Full name of players and officials | Team time-out | | | B 1/2 | Number of 7 m |
| | 1 | 2 | 3 | 1 | | 2 | 3 | | | |

| No. | Team A | G | W | 2' | D | DR | No. | Team B | G | W | 2' | D | DR |
|-----|--------|---|---|----|---|----|-----|--------|---|---|----|---|----|
| 2 | 赫天铭 | | | | | | 1 | 刘子豪 | | | | | |
| 5 | 王梓翺 | | | | | | 5 | 郭雨强 | 9 | | | | |
| 6 | 尚禹辰 | 1 | | | | | 6 | 刘阳 | 1 | | | | |
| 7 | 张羽虹冰 | | | | | | 7 | 王晨旭 | | | | | |
| 9 | 隋博 | 2 | | 1 | | | 8 | 杨鑫祥 | | | | | |
| 11 | 陈思 | | | | | | 9 | 荆胤丞 | 1 | | | | |
| 13 | 高鑫 | 2 | | | | | 10 | 赵一 | 1 | 1 | | | |
| 17 | 杨宇 | 6 | | | | | 15 | 刘家良 | 2 | 1 | | | |
| 19 | 靳皓童 | | | | | | 16 | 李凯锋 | | | | | |
| 22 | 杨辰 | | | | | | 17 | 陈锐涛 | | | | | |
| 28 | 靳皓添 | 2 | | | | | 18 | 奚尧 | 1 | | 1 | | |
| 32 | 袁梓赫 | | | | | | 21 | 刘晓青 | | | | | |
| | | | | | | | 23 | 朱天一 | | | | | |
| | | | | | | | 24 | 钟盛发 | | | | | |
| | | | | | | | 27 | 邓可钊 | 1 | | | | |
| | | | | | | | 36 | 陈泽锟 | | | | | |
| C | 刘启迪 | | | | | | B | 杜长义 | | | | | |
| | | | | | | | C | 饶开发 | | | | | |
| | | | | | | | D | 李绍南 | | | | | |

| | | |
|---|--|---|
| A | Signatures of responsables for the teams (Off.A) | B |
|---|--|---|

| | | |
|----|-----------------------------------|----|
| TP | Remarks of referees / HF Official | TP |
|----|-----------------------------------|----|

| | | | |
|------------|-----------|----------|--|
| Signatures | | | |
| Referees | 尹静阳 (CHN) | 严璐 (CHN) | |
| T.D. | 许宜扬 (CHN) | 徐健 (CHN) | |
| CHA Off. | | | |

Note: Number of 7m Throws Awarded to Team A and B, Goals (G), Warnings (W), Suspensions (2'), Direct Disqualification (D), Disqualification With Report (DR) and Team Penalty (TP).

Table Officials: 李莉君 吴荣 Statisticians: 沈家洛 马安兴

竞赛技术统计

手球
青年男子

5-6名
轮次 6

组别 X
场次 37

滁州国际手球馆
2019-06-05 09:30

| | | | |
|-----------|----------------------|---------|------------|
| Referees: | 尹静阳 (CHN) / 严璐 (CHN) | Result: | 13:16(6:8) |
| Teams: | 辽宁抚顺(抚顺) VS 福建龙岩(龙岩) | | |

| 抚顺 | | 远射 | 近射 | 边射 | 快攻 | 突破 | 任意球 | 7m球 | 合计 | % | 助攻 | 失误 | 警告 | 2' | D+DR |
|---------|------|------|-----|-----|-----|-----|-----|-----|-------|------|----|----|----|----|------|
| 主教练: 徐毅 | | | | | | | | | | | | | | | |
| 2 | 赫天铭 | | | | | | | | | | | | | | |
| 5 | 王梓翹 | | | | | | | | | | | | | | |
| 6 | 尚禹辰 | | 1/1 | | | | | | 1/1 | 100 | | | | | |
| 7 | 张羽虹冰 | | | | | | | | | | | | | | |
| 9 | 隋博 | | 1/1 | 1/2 | | | | | 2/3 | 66.7 | | 2 | | 1 | |
| 11 | 陈思 | | | | | | | | | | | | | | |
| 13 | 高鑫 | 1/2 | | 0/1 | | 0/2 | | 1/1 | 2/6 | 33.3 | 1 | | | | |
| 17 | 杨宇 | 4/9 | 0/1 | | 1/1 | 1/1 | | | 6/12 | 50.0 | 2 | 3 | | | |
| 19 | 靳皓童 | | | | | | | | | | 1 | 2 | | | |
| 22 | 杨辰 | | | | | | | | | | | | | | |
| 28 | 靳皓添 | | 2/3 | | | | | | 2/3 | 66.7 | | 1 | | | |
| 32 | 袁梓赫 | | | | | | | | | | | | | | |
| 运动员 | 合计 | 5/11 | 4/6 | 1/3 | 1/1 | 1/3 | | 1/1 | 13/25 | 52.0 | 4 | 8 | | 1 | |
| 2 | 赫天铭 | 1/6 | 1/5 | 2/2 | 0/2 | 0/3 | 0/1 | 0/1 | 4/20 | 20.0 | | | | | |
| 守门员 | 合计 | 1/6 | 1/5 | 2/2 | 0/2 | 0/3 | 0/1 | 0/1 | 4/20 | 20.0 | | | | | |

| 抚顺 | 比赛进程 | 龙岩 |
|----------|-------------|-----------|
| 1st Half | | |
| 0 | 00:21 | 1 15 刘家良 |
| 17 | 杨宇 1 01:42 | 1 |
| | 1 03:09 | 2 6 刘阳 |
| 13 | 高鑫 2 04:17 | 2 |
| | 2 04:32 | 3 5 郭雨强 |
| 6 | 尚禹辰 3 05:32 | 3 |
| 17 | 杨宇 4 06:30 | 3 |
| | 4 07:08 | 4 5 郭雨强 |
| 28 | 靳皓添 5 07:58 | 4 |
| | 5 08:24 | 5 5 郭雨强 |
| | 5 09:56 | 6 18 奚尧 |
| | 5 11:03 | 7 15 刘家良 |
| | 5 11:37 | 8 5 郭雨强 |
| 28 | 靳皓添 6 13:18 | 8 |
| 2nd Half | | |
| 9 | 隋博 7 00:52 | 8 |
| 13 | 高鑫 8 03:27 | 8 |
| 17 | 杨宇 9 04:37 | 8 |
| | 9 04:54 | 9 5 郭雨强 |
| | 9 06:30 | 10 5 郭雨强 |
| 17 | 杨宇 10 07:21 | 10 |
| | 10 08:02 | 11 10 赵一 |
| | 10 08:51 | 12 5 郭雨强 |
| | 10 10:27 | 13 5 郭雨强 |
| 9 | 隋博 11 11:05 | 13 |
| | 11 12:26 | 14 5 郭雨强 |
| 17 | 杨宇 12 13:37 | 14 |
| | 12 14:19 | 15 9 荆胤丞 |
| 17 | 杨宇 13 14:31 | 15 |
| | 13 15:00 | 16 27 邓可钊 |

| 龙岩 | | 远射 | 近射 | 边射 | 快攻 | 突破 | 任意球 | 7m球 | 合计 | % | 助攻 | 失误 | 警告 | 2' | D+DR |
|----------|-----|------|-----|-----|-----|-----|-----|-----|-------|------|----|----|----|----|------|
| 主教练: 李绍南 | | | | | | | | | | | | | | | |
| 1 | 刘子豪 | | | | | | | | | | | | | | |
| 5 | 郭雨强 | 4/8 | 1/1 | | 1/1 | 2/2 | 1/1 | 0/1 | 9/14 | 64.3 | | 3 | | | |
| 6 | 刘阳 | | | 0/1 | | 1/1 | | | 1/2 | 50.0 | | 1 | | | |
| 7 | 王晨旭 | | | | | | | | | | | | | | |
| 8 | 杨鑫祥 | | | | | | | | | | | | | | |
| 9 | 荆胤丞 | | 1/1 | | | | | | 1/1 | 100 | 1 | | | | |
| 10 | 赵一 | 0/1 | | | | | | 1/1 | 1/2 | 50.0 | | 1 | 1 | | |
| 15 | 刘家良 | 1/1 | 1/2 | | | | | | 2/3 | 66.7 | | 1 | 1 | | |
| 16 | 李凯锋 | | | | | | | | | | | | | | |
| 17 | 陈锐涛 | | | | | | | | | | | | | | |
| 18 | 奚尧 | | 1/1 | 0/1 | | | | | 1/2 | 50.0 | | | | 1 | |
| 21 | 刘晓青 | | | | | | | | | | | | | | |
| 23 | 朱天一 | | | | | | | | | | | | | | |
| 24 | 钟盛发 | | | | | | | | | | | | | | |
| 27 | 邓可钊 | | | | 1/1 | | | | 1/1 | 100 | | | | | |
| 36 | 陈泽锟 | | | | | | | | | | | | | | |
| 运动员 | 合计 | 5/10 | 4/5 | 0/2 | 2/2 | 3/3 | 1/1 | 1/2 | 16/25 | 64.0 | 1 | 6 | 2 | 1 | |
| 1 | 刘子豪 | 2/7 | 0/4 | 2/3 | 0/1 | 2/3 | | 0/1 | 6/19 | 31.6 | | | | | |
| 守门员 | 合计 | 2/7 | 0/4 | 2/3 | 0/1 | 2/3 | | 0/1 | 6/19 | 31.6 | | | | | |

场上队员: 得分 / 射门

守门员: 救球 / 射门

| | | | |
|---|------|----|---------|
| D | 取消资格 | DR | 取消资格+报告 |
|---|------|----|---------|

第二届全国青年运动会男子手球乙组决赛 体校组 (U16)

PHMS Pictorial Handball Match Statistics

IHF Official System

个人/全队技术统计表

手球 青年男子 5-6名 轮次 6 组别 X 场次 37 滁州国际手球馆 2019-06-05 09:30

| 号码 | 姓名 | 远射 | 近射 | 边射 | 快攻 | 突破 | 任意 | 七米 | 合计 | % | 助攻 | 失误 | 警告 | 2' | 取消 | 时间 |
|----------|------|------|-----|-----|-----|-----|-----|-----|-------|-------|----|----|----|----|----|----------|
| 辽宁抚顺(抚顺) | | | | | | | | | | | | | | | | |
| (场上队员) | | | | | | | | | | | | | | | | |
| 2 | 赫天铭 | | | | | | | | | 0.0% | | | | | | 00:30:00 |
| 5 | 王梓翹 | | | | | | | | | 0.0% | | | | | | 00:01:14 |
| 6 | 尚禹辰 | | 1/1 | | | | | | 1/1 | 100% | | | | | | 00:15:00 |
| 7 | 张羽虹冰 | | | | | | | | | 0.0% | | | | | | 00:15:00 |
| 9 | 隋博 | | 1/1 | 1/2 | | | | | 2/3 | 66.7% | 2 | | | 1 | | 00:30:00 |
| 11 | 陈思 | | | | | | | | | 0.0% | | | | | | 00:00:00 |
| 13 | 高鑫 | 1/2 | | 0/1 | | 0/2 | | 1/1 | 2/6 | 33.3% | 1 | | | | | 00:30:00 |
| 17 | 杨宇 | 4/9 | 0/1 | | 1/1 | 1/1 | | | 6/12 | 50.0% | 2 | 3 | | | | 00:30:00 |
| 19 | 靳皓童 | | | | | | | | | 0.0% | 1 | 2 | | | | 00:30:00 |
| 22 | 杨辰 | | | | | | | | | 0.0% | | | | | | 00:00:00 |
| 28 | 靳皓添 | | 2/3 | | | | | | 2/3 | 66.7% | | 1 | | | | 00:28:46 |
| 32 | 袁梓赫 | | | | | | | | | 0.0% | | | | | | 00:00:00 |
| 合计 | | 5/11 | 4/6 | 1/3 | 1/1 | 1/3 | | 1/1 | 13/25 | 52.0% | 4 | 8 | | 1 | | |
| (守门员) | | | | | | | | | | | | | | | | |
| 2 | 赫天铭 | 1/6 | 1/5 | 2/2 | 0/2 | 0/3 | 0/1 | 0/1 | 4/20 | 20.0% | | | | | | 00:30:00 |
| 合计 | | 1/6 | 1/5 | 2/2 | 0/2 | 0/3 | 0/1 | 0/1 | 4/20 | 20.0% | | | | | | |

场上队员：得分/射门

守门员：救球/射门

| 全队合计 | 得分 | 被救 | 射失 | 击柱 | 封球 | 合计 | % |
|------|----|----|----|----|----|----|--------|
| 远射 | 5 | 2 | 1 | 2 | 1 | 11 | 45.5% |
| 近射 | 4 | | 2 | | | 6 | 66.7% |
| 边射 | 1 | 2 | | | | 3 | 33.3% |
| 快攻 | 1 | | | | | 1 | 100.0% |
| 突破 | 1 | 2 | | | | 3 | 33.3% |
| 任意 | | | | | | | 0.0% |
| 七米 | 1 | | | | | 1 | 100.0% |

个人/全队技术统计表

手球 青年男子 5-6名 轮次 6 组别 X 场次 37 滁州国际手球馆 2019-06-05 09:30

| 号码 | 姓名 | 远射 | 近射 | 边射 | 快攻 | 突破 | 任意 | 七米 | 合计 | % | 助攻 | 失误 | 警告 | 2' | 取消 | 时间 |
|----------|-----|------|-----|-----|-----|-----|-----|-----|-------|-------|----|----|----|----|----|----------|
| 福建龙岩(龙岩) | | | | | | | | | | | | | | | | |
| (场上队员) | | | | | | | | | | | | | | | | |
| 1 | 刘子豪 | | | | | | | | | 0.0% | | | | | | 00:30:00 |
| 5 | 郭雨强 | 4/8 | 1/1 | | 1/1 | 2/2 | 1/1 | 0/1 | 9/14 | 64.3% | | 3 | | | | 00:30:00 |
| 6 | 刘阳 | | | 0/1 | | 1/1 | | | 1/2 | 50.0% | | 1 | | | | 00:23:05 |
| 7 | 王晨旭 | | | | | | | | | 0.0% | | | | | | 00:00:00 |
| 8 | 杨鑫祥 | | | | | | | | | 0.0% | | | | | | 00:00:00 |
| 9 | 荆胤丞 | | 1/1 | | | | | | 1/1 | 100% | 1 | | | | | 00:11:39 |
| 10 | 赵一 | 0/1 | | | | | | 1/1 | 1/2 | 50.0% | | 1 | 1 | | | 00:30:00 |
| 15 | 刘家良 | 1/1 | 1/2 | | | | | | 2/3 | 66.7% | | 1 | 1 | | | 00:30:00 |
| 16 | 李凯锋 | | | | | | | | | 0.0% | | | | | | 00:00:00 |
| 17 | 陈锐涛 | | | | | | | | | 0.0% | | | | | | 00:00:00 |
| 18 | 奚尧 | | 1/1 | 0/1 | | | | | 1/2 | 50.0% | | | | 1 | | 00:30:00 |
| 21 | 刘晓青 | | | | | | | | | 0.0% | | | | | | 00:00:00 |
| 23 | 朱天一 | | | | | | | | | 0.0% | | | | | | 00:18:20 |
| 24 | 钟盛发 | | | | | | | | | 0.0% | | | | | | 00:00:00 |
| 27 | 邓可钊 | | | | 1/1 | | | | 1/1 | 100% | | | | | | 00:06:54 |
| 36 | 陈泽锟 | | | | | | | | | 0.0% | | | | | | 00:00:00 |
| 合计 | | 5/10 | 4/5 | 0/2 | 2/2 | 3/3 | 1/1 | 1/2 | 16/25 | 64.0% | 1 | 6 | 2 | 1 | | |
| (守门员) | | | | | | | | | | | | | | | | |
| 1 | 刘子豪 | 2/7 | 0/4 | 2/3 | 0/1 | 2/3 | | 0/1 | 6/19 | 31.6% | | | | | | 00:30:00 |
| 合计 | | 2/7 | 0/4 | 2/3 | 0/1 | 2/3 | | 0/1 | 6/19 | 31.6% | | | | | | |

场上队员：得分/射门

守门员：救球/射门

| 全队合计 | 得分 | 被救 | 射失 | 击柱 | 封球 | 合计 | % |
|------|----|----|----|----|----|----|--------|
| 远射 | 5 | 1 | 1 | 3 | | 10 | 50.0% |
| 近射 | 4 | 1 | | | | 5 | 80.0% |
| 边射 | | 2 | | | | 2 | 0.0% |
| 快攻 | 2 | | | | | 2 | 100.0% |
| 突破 | 3 | | | | | 3 | 100.0% |
| 任意 | 1 | | | | | 1 | 100.0% |
| 七米 | 1 | | | 1 | | 2 | 50.0% |

图式比赛技术统计表

手球
青年男子

5-6名
轮次 6

组别 X
场次 37

滁州国际手球馆
2019-06-05 09:30

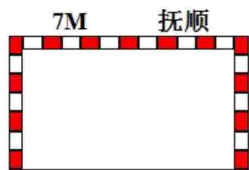
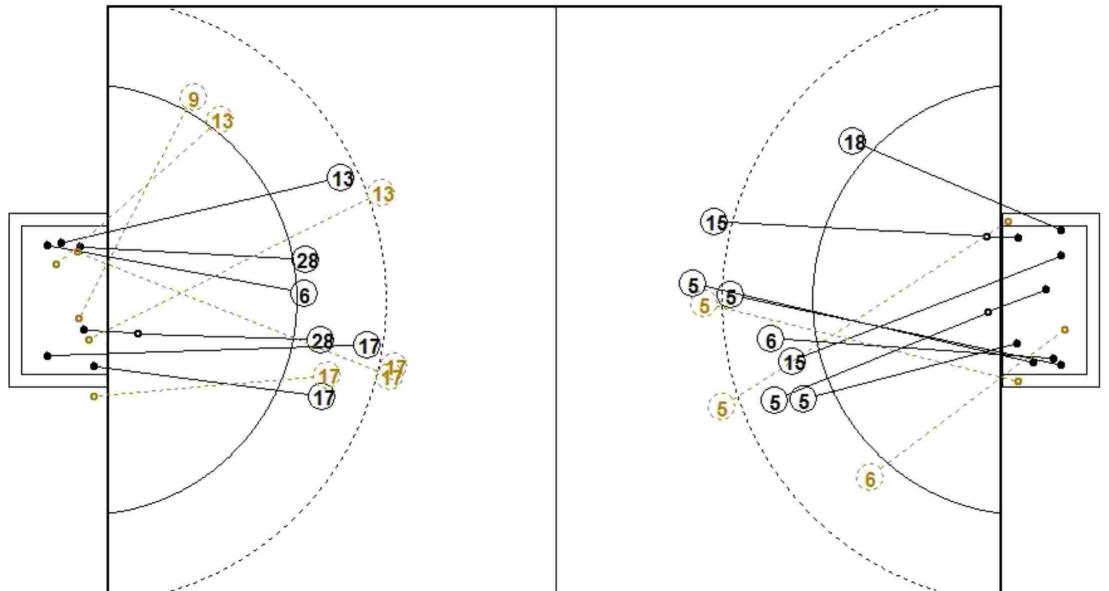

1st Half
6 : 8

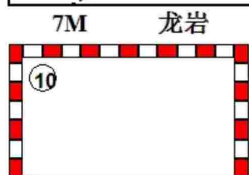
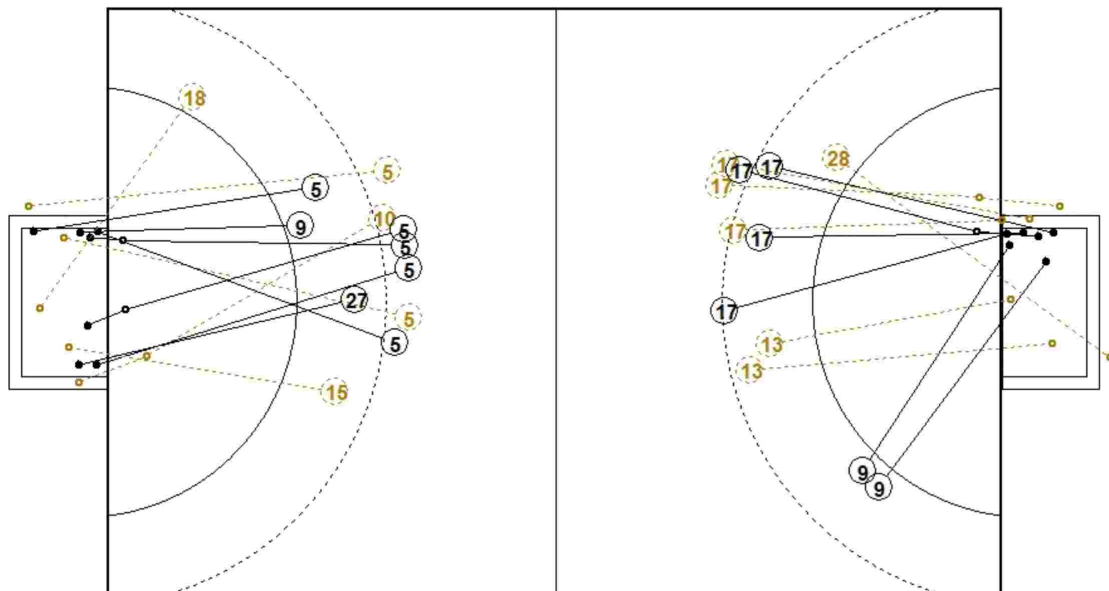
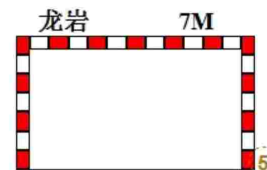

2nd Half
16 : 13

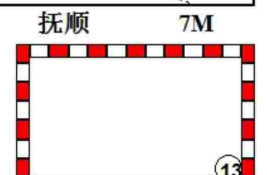

图式射门区域统计

手球
青年男子

5-6名
轮次 6

组别 X
场次 37

滁州国际手球馆
2019-06-05 09:30

辽宁抚顺

| | | | | | | | | | | | | | | | | | | | | | | | | | | | | | | | | | | | | | | | | | | | | | | | | | | | | | | | | | | | | | | | | | | | | | | | | | | | | | | | |
|---|--|---|--|--|--|--|--|--|--|--|--|--|--|--|--|--|--|--|--|---|--|--|---|--|--|--|---|--|---|---|--|--|--|--|--|--|--|--|--|---|--|--|--|---|--|--|---|--|--|--|--|--|--|--|--|--|--|--|--|--|--|--|--|--|--|---|--|--|---|---|---|--|--|---|--|--|---|--|--|
| 2 赫天铭 <table border="1"><tr><td></td><td></td><td></td></tr><tr><td></td><td></td><td></td></tr><tr><td></td><td></td><td></td></tr></table> Post - 0 Miss - 0 Block - 0 | | | | | | | | | | 5 王梓翹 <table border="1"><tr><td></td><td></td><td></td></tr><tr><td></td><td></td><td></td></tr><tr><td></td><td></td><td></td></tr></table> Post - 0 Miss - 0 Block - 0 | | | | | | | | | | 6 尚禹辰 <table border="1"><tr><td></td><td></td><td>1</td></tr><tr><td></td><td></td><td></td></tr><tr><td></td><td></td><td></td></tr></table> Post - 0 Miss - 0 Block - 0 | | | 1 | | | | | | | 7 张羽虹冰 <table border="1"><tr><td></td><td></td><td></td></tr><tr><td></td><td></td><td></td></tr><tr><td></td><td></td><td></td></tr></table> Post - 0 Miss - 0 Block - 0 | | | | | | | | | | 9 隋博 <table border="1"><tr><td></td><td></td><td></td></tr><tr><td>1</td><td></td><td></td></tr><tr><td>1</td><td></td><td></td></tr></table> Post - 0 Miss - 0 Block - 0 | | | | 1 | | | 1 | | | 11 陈思 <table border="1"><tr><td></td><td></td><td></td></tr><tr><td></td><td></td><td></td></tr><tr><td></td><td></td><td></td></tr></table> Post - 0 Miss - 0 Block - 0 | | | | | | | | | | 13 高鑫 <table border="1"><tr><td></td><td></td><td></td></tr><tr><td></td><td></td><td>1</td></tr><tr><td></td><td></td><td>1</td></tr></table> Post - 0 Miss - 0 Block - 0 | | | | | | 1 | | | 1 | 17 杨宇 <table border="1"><tr><td>1</td><td></td><td></td></tr><tr><td>2</td><td></td><td></td></tr><tr><td>3</td><td></td><td></td></tr></table> Post - 2 Miss - 2 Block - 1 | 1 | | | 2 | | | 3 | | |
| | | | | | | | | | | | | | | | | | | | | | | | | | | | | | | | | | | | | | | | | | | | | | | | | | | | | | | | | | | | | | | | | | | | | | | | | | | | | | | | |
| | | | | | | | | | | | | | | | | | | | | | | | | | | | | | | | | | | | | | | | | | | | | | | | | | | | | | | | | | | | | | | | | | | | | | | | | | | | | | | | |
| | | | | | | | | | | | | | | | | | | | | | | | | | | | | | | | | | | | | | | | | | | | | | | | | | | | | | | | | | | | | | | | | | | | | | | | | | | | | | | | |
| | | | | | | | | | | | | | | | | | | | | | | | | | | | | | | | | | | | | | | | | | | | | | | | | | | | | | | | | | | | | | | | | | | | | | | | | | | | | | | | |
| | | | | | | | | | | | | | | | | | | | | | | | | | | | | | | | | | | | | | | | | | | | | | | | | | | | | | | | | | | | | | | | | | | | | | | | | | | | | | | | |
| | | | | | | | | | | | | | | | | | | | | | | | | | | | | | | | | | | | | | | | | | | | | | | | | | | | | | | | | | | | | | | | | | | | | | | | | | | | | | | | |
| | | 1 | | | | | | | | | | | | | | | | | | | | | | | | | | | | | | | | | | | | | | | | | | | | | | | | | | | | | | | | | | | | | | | | | | | | | | | | | | | | | |
| | | | | | | | | | | | | | | | | | | | | | | | | | | | | | | | | | | | | | | | | | | | | | | | | | | | | | | | | | | | | | | | | | | | | | | | | | | | | | | | |
| | | | | | | | | | | | | | | | | | | | | | | | | | | | | | | | | | | | | | | | | | | | | | | | | | | | | | | | | | | | | | | | | | | | | | | | | | | | | | | | |
| | | | | | | | | | | | | | | | | | | | | | | | | | | | | | | | | | | | | | | | | | | | | | | | | | | | | | | | | | | | | | | | | | | | | | | | | | | | | | | | |
| | | | | | | | | | | | | | | | | | | | | | | | | | | | | | | | | | | | | | | | | | | | | | | | | | | | | | | | | | | | | | | | | | | | | | | | | | | | | | | | |
| | | | | | | | | | | | | | | | | | | | | | | | | | | | | | | | | | | | | | | | | | | | | | | | | | | | | | | | | | | | | | | | | | | | | | | | | | | | | | | | |
| | | | | | | | | | | | | | | | | | | | | | | | | | | | | | | | | | | | | | | | | | | | | | | | | | | | | | | | | | | | | | | | | | | | | | | | | | | | | | | | |
| 1 | | | | | | | | | | | | | | | | | | | | | | | | | | | | | | | | | | | | | | | | | | | | | | | | | | | | | | | | | | | | | | | | | | | | | | | | | | | | | | | |
| 1 | | | | | | | | | | | | | | | | | | | | | | | | | | | | | | | | | | | | | | | | | | | | | | | | | | | | | | | | | | | | | | | | | | | | | | | | | | | | | | | |
| | | | | | | | | | | | | | | | | | | | | | | | | | | | | | | | | | | | | | | | | | | | | | | | | | | | | | | | | | | | | | | | | | | | | | | | | | | | | | | | |
| | | | | | | | | | | | | | | | | | | | | | | | | | | | | | | | | | | | | | | | | | | | | | | | | | | | | | | | | | | | | | | | | | | | | | | | | | | | | | | | |
| | | | | | | | | | | | | | | | | | | | | | | | | | | | | | | | | | | | | | | | | | | | | | | | | | | | | | | | | | | | | | | | | | | | | | | | | | | | | | | | |
| | | | | | | | | | | | | | | | | | | | | | | | | | | | | | | | | | | | | | | | | | | | | | | | | | | | | | | | | | | | | | | | | | | | | | | | | | | | | | | | |
| | | 1 | | | | | | | | | | | | | | | | | | | | | | | | | | | | | | | | | | | | | | | | | | | | | | | | | | | | | | | | | | | | | | | | | | | | | | | | | | | | | |
| | | 1 | | | | | | | | | | | | | | | | | | | | | | | | | | | | | | | | | | | | | | | | | | | | | | | | | | | | | | | | | | | | | | | | | | | | | | | | | | | | | |
| 1 | | | | | | | | | | | | | | | | | | | | | | | | | | | | | | | | | | | | | | | | | | | | | | | | | | | | | | | | | | | | | | | | | | | | | | | | | | | | | | | |
| 2 | | | | | | | | | | | | | | | | | | | | | | | | | | | | | | | | | | | | | | | | | | | | | | | | | | | | | | | | | | | | | | | | | | | | | | | | | | | | | | | |
| 3 | | | | | | | | | | | | | | | | | | | | | | | | | | | | | | | | | | | | | | | | | | | | | | | | | | | | | | | | | | | | | | | | | | | | | | | | | | | | | | | |
| 19 靳皓童 <table border="1"><tr><td></td><td></td><td></td></tr><tr><td></td><td></td><td></td></tr><tr><td></td><td></td><td></td></tr></table> Post - 0 Miss - 0 Block - 0 | | | | | | | | | | 22 杨辰 <table border="1"><tr><td></td><td></td><td></td></tr><tr><td></td><td></td><td></td></tr><tr><td></td><td></td><td></td></tr></table> Post - 0 Miss - 0 Block - 0 | | | | | | | | | | 28 靳皓添 <table border="1"><tr><td></td><td></td><td></td></tr><tr><td></td><td></td><td></td></tr><tr><td>1</td><td></td><td>1</td></tr></table> Post - 0 Miss - 1 Block - 0 | | | | | | | 1 | | 1 | 32 袁梓赫 <table border="1"><tr><td></td><td></td><td></td></tr><tr><td></td><td></td><td></td></tr><tr><td></td><td></td><td></td></tr></table> Post - 0 Miss - 0 Block - 0 | | | | | | | | | | | | | | | | | | | | | | | | | | | | | | | | | | | | | | | | | | | | | | | | | |
| | | | | | | | | | | | | | | | | | | | | | | | | | | | | | | | | | | | | | | | | | | | | | | | | | | | | | | | | | | | | | | | | | | | | | | | | | | | | | | | |
| | | | | | | | | | | | | | | | | | | | | | | | | | | | | | | | | | | | | | | | | | | | | | | | | | | | | | | | | | | | | | | | | | | | | | | | | | | | | | | | |
| | | | | | | | | | | | | | | | | | | | | | | | | | | | | | | | | | | | | | | | | | | | | | | | | | | | | | | | | | | | | | | | | | | | | | | | | | | | | | | | |
| | | | | | | | | | | | | | | | | | | | | | | | | | | | | | | | | | | | | | | | | | | | | | | | | | | | | | | | | | | | | | | | | | | | | | | | | | | | | | | | |
| | | | | | | | | | | | | | | | | | | | | | | | | | | | | | | | | | | | | | | | | | | | | | | | | | | | | | | | | | | | | | | | | | | | | | | | | | | | | | | | |
| | | | | | | | | | | | | | | | | | | | | | | | | | | | | | | | | | | | | | | | | | | | | | | | | | | | | | | | | | | | | | | | | | | | | | | | | | | | | | | | |
| | | | | | | | | | | | | | | | | | | | | | | | | | | | | | | | | | | | | | | | | | | | | | | | | | | | | | | | | | | | | | | | | | | | | | | | | | | | | | | | |
| | | | | | | | | | | | | | | | | | | | | | | | | | | | | | | | | | | | | | | | | | | | | | | | | | | | | | | | | | | | | | | | | | | | | | | | | | | | | | | | |
| 1 | | 1 | | | | | | | | | | | | | | | | | | | | | | | | | | | | | | | | | | | | | | | | | | | | | | | | | | | | | | | | | | | | | | | | | | | | | | | | | | | | | |
| | | | | | | | | | | | | | | | | | | | | | | | | | | | | | | | | | | | | | | | | | | | | | | | | | | | | | | | | | | | | | | | | | | | | | | | | | | | | | | | |
| | | | | | | | | | | | | | | | | | | | | | | | | | | | | | | | | | | | | | | | | | | | | | | | | | | | | | | | | | | | | | | | | | | | | | | | | | | | | | | | |
| | | | | | | | | | | | | | | | | | | | | | | | | | | | | | | | | | | | | | | | | | | | | | | | | | | | | | | | | | | | | | | | | | | | | | | | | | | | | | | | |

2 赫天铭

| | | |
|-----|-----|-----|
| 0/3 | 1/1 | 1/3 |
| 1/2 | 0/1 | 1/3 |
| 0/2 | 0/1 | 0/4 |

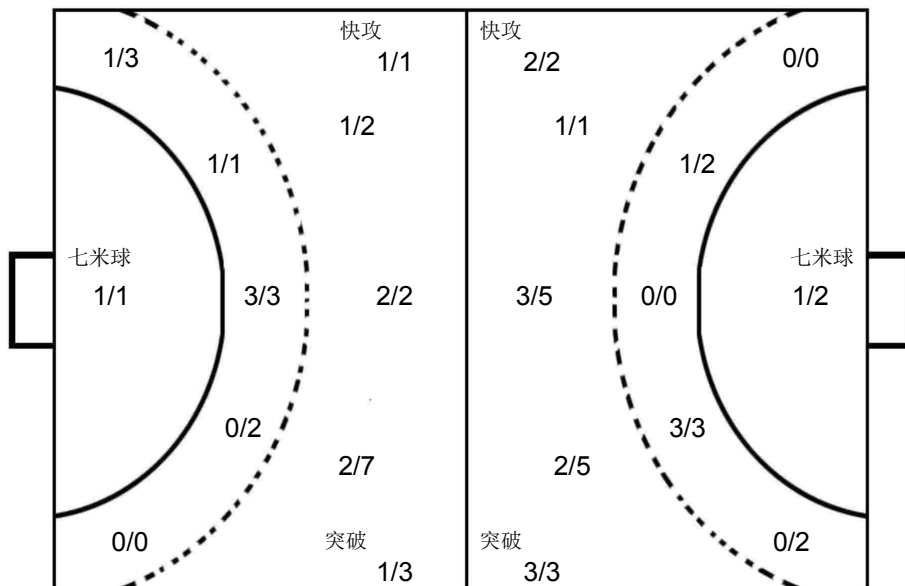

1 刘子豪

| | | |
|-----|-----|-----|
| 0/1 | | 0/1 |
| 0/3 | 1/1 | 3/4 |
| 1/6 | 1/1 | 0/2 |

福建龙岩

| | | | | | | | | | | | | | | | | | | | | | | | | | | | | | | | | | | | | | | | | | | | | | | | | | | | | | | | | | | | | | | | | | | | | | | | | | | | | | | | |
|---|---|---|--|--|--|--|--|--|--|--|--|--|---|--|---|---|---|---|---|---|--|---|--|--|--|---|--|--|--|---|--|--|--|--|--|--|--|--|--|---|--|--|--|--|--|--|--|--|--|---|--|--|--|--|--|--|--|--|---|--|--|---|--|--|--|--|--|--|--|---|--|---|--|--|--|--|--|---|--|
| 1 刘子豪 <table border="1"><tr><td></td><td></td><td></td></tr><tr><td></td><td></td><td></td></tr><tr><td></td><td></td><td></td></tr></table> Post - 0 Miss - 0 Block - 0 | | | | | | | | | | 5 郭雨强 <table border="1"><tr><td></td><td></td><td>2</td></tr><tr><td></td><td>1</td><td>1</td></tr><tr><td>1</td><td>1</td><td>3</td></tr></table> Post - 3 Miss - 1 Block - 0 | | | 2 | | 1 | 1 | 1 | 1 | 3 | 6 刘阳 <table border="1"><tr><td></td><td></td><td></td></tr><tr><td></td><td></td><td>1</td></tr><tr><td></td><td></td><td></td></tr></table> Post - 0 Miss - 0 Block - 0 | | | | | | 1 | | | | 7 王晨旭 <table border="1"><tr><td></td><td></td><td></td></tr><tr><td></td><td></td><td></td></tr><tr><td></td><td></td><td></td></tr></table> Post - 0 Miss - 0 Block - 0 | | | | | | | | | | 8 杨鑫祥 <table border="1"><tr><td></td><td></td><td></td></tr><tr><td></td><td></td><td></td></tr><tr><td></td><td></td><td></td></tr></table> Post - 0 Miss - 0 Block - 0 | | | | | | | | | | 9 荆胤丞 <table border="1"><tr><td></td><td></td><td></td></tr><tr><td></td><td></td><td></td></tr><tr><td></td><td></td><td>1</td></tr></table> Post - 0 Miss - 0 Block - 0 | | | | | | | | | 1 | 10 赵一 <table border="1"><tr><td></td><td>1</td><td></td></tr><tr><td></td><td></td><td></td></tr><tr><td></td><td></td><td></td></tr></table> Post - 1 Miss - 0 Block - 0 | | 1 | | | | | | | | 15 刘家良 <table border="1"><tr><td></td><td>1</td><td></td></tr><tr><td></td><td></td><td></td></tr><tr><td></td><td>1</td><td></td></tr></table> Post - 0 Miss - 0 Block - 0 | | 1 | | | | | | 1 | |
| | | | | | | | | | | | | | | | | | | | | | | | | | | | | | | | | | | | | | | | | | | | | | | | | | | | | | | | | | | | | | | | | | | | | | | | | | | | | | | | |
| | | | | | | | | | | | | | | | | | | | | | | | | | | | | | | | | | | | | | | | | | | | | | | | | | | | | | | | | | | | | | | | | | | | | | | | | | | | | | | | |
| | | | | | | | | | | | | | | | | | | | | | | | | | | | | | | | | | | | | | | | | | | | | | | | | | | | | | | | | | | | | | | | | | | | | | | | | | | | | | | | |
| | | 2 | | | | | | | | | | | | | | | | | | | | | | | | | | | | | | | | | | | | | | | | | | | | | | | | | | | | | | | | | | | | | | | | | | | | | | | | | | | | | |
| | 1 | 1 | | | | | | | | | | | | | | | | | | | | | | | | | | | | | | | | | | | | | | | | | | | | | | | | | | | | | | | | | | | | | | | | | | | | | | | | | | | | | |
| 1 | 1 | 3 | | | | | | | | | | | | | | | | | | | | | | | | | | | | | | | | | | | | | | | | | | | | | | | | | | | | | | | | | | | | | | | | | | | | | | | | | | | | | |
| | | | | | | | | | | | | | | | | | | | | | | | | | | | | | | | | | | | | | | | | | | | | | | | | | | | | | | | | | | | | | | | | | | | | | | | | | | | | | | | |
| | | 1 | | | | | | | | | | | | | | | | | | | | | | | | | | | | | | | | | | | | | | | | | | | | | | | | | | | | | | | | | | | | | | | | | | | | | | | | | | | | | |
| | | | | | | | | | | | | | | | | | | | | | | | | | | | | | | | | | | | | | | | | | | | | | | | | | | | | | | | | | | | | | | | | | | | | | | | | | | | | | | | |
| | | | | | | | | | | | | | | | | | | | | | | | | | | | | | | | | | | | | | | | | | | | | | | | | | | | | | | | | | | | | | | | | | | | | | | | | | | | | | | | |
| | | | | | | | | | | | | | | | | | | | | | | | | | | | | | | | | | | | | | | | | | | | | | | | | | | | | | | | | | | | | | | | | | | | | | | | | | | | | | | | |
| | | | | | | | | | | | | | | | | | | | | | | | | | | | | | | | | | | | | | | | | | | | | | | | | | | | | | | | | | | | | | | | | | | | | | | | | | | | | | | | |
| | | | | | | | | | | | | | | | | | | | | | | | | | | | | | | | | | | | | | | | | | | | | | | | | | | | | | | | | | | | | | | | | | | | | | | | | | | | | | | | |
| | | | | | | | | | | | | | | | | | | | | | | | | | | | | | | | | | | | | | | | | | | | | | | | | | | | | | | | | | | | | | | | | | | | | | | | | | | | | | | | |
| | | | | | | | | | | | | | | | | | | | | | | | | | | | | | | | | | | | | | | | | | | | | | | | | | | | | | | | | | | | | | | | | | | | | | | | | | | | | | | | |
| | | | | | | | | | | | | | | | | | | | | | | | | | | | | | | | | | | | | | | | | | | | | | | | | | | | | | | | | | | | | | | | | | | | | | | | | | | | | | | | |
| | | | | | | | | | | | | | | | | | | | | | | | | | | | | | | | | | | | | | | | | | | | | | | | | | | | | | | | | | | | | | | | | | | | | | | | | | | | | | | | |
| | | 1 | | | | | | | | | | | | | | | | | | | | | | | | | | | | | | | | | | | | | | | | | | | | | | | | | | | | | | | | | | | | | | | | | | | | | | | | | | | | | |
| | 1 | | | | | | | | | | | | | | | | | | | | | | | | | | | | | | | | | | | | | | | | | | | | | | | | | | | | | | | | | | | | | | | | | | | | | | | | | | | | | | |
| | | | | | | | | | | | | | | | | | | | | | | | | | | | | | | | | | | | | | | | | | | | | | | | | | | | | | | | | | | | | | | | | | | | | | | | | | | | | | | | |
| | | | | | | | | | | | | | | | | | | | | | | | | | | | | | | | | | | | | | | | | | | | | | | | | | | | | | | | | | | | | | | | | | | | | | | | | | | | | | | | |
| | 1 | | | | | | | | | | | | | | | | | | | | | | | | | | | | | | | | | | | | | | | | | | | | | | | | | | | | | | | | | | | | | | | | | | | | | | | | | | | | | | |
| | | | | | | | | | | | | | | | | | | | | | | | | | | | | | | | | | | | | | | | | | | | | | | | | | | | | | | | | | | | | | | | | | | | | | | | | | | | | | | | |
| | 1 | | | | | | | | | | | | | | | | | | | | | | | | | | | | | | | | | | | | | | | | | | | | | | | | | | | | | | | | | | | | | | | | | | | | | | | | | | | | | | |
| 16 李凯锋 <table border="1"><tr><td></td><td></td><td></td></tr><tr><td></td><td></td><td></td></tr><tr><td></td><td></td><td></td></tr></table> Post - 0 Miss - 0 Block - 0 | | | | | | | | | | 17 陈锐涛 <table border="1"><tr><td></td><td></td><td></td></tr><tr><td></td><td></td><td></td></tr><tr><td></td><td></td><td></td></tr></table> Post - 0 Miss - 0 Block - 0 | | | | | | | | | | 18 奚尧 <table border="1"><tr><td></td><td>1</td><td></td></tr><tr><td></td><td></td><td></td></tr><tr><td></td><td></td><td></td></tr></table> Post - 0 Miss - 0 Block - 0 | | 1 | | | | | | | | 21 刘晓青 <table border="1"><tr><td></td><td></td><td></td></tr><tr><td></td><td></td><td></td></tr><tr><td></td><td></td><td></td></tr></table> Post - 0 Miss - 0 Block - 0 | | | | | | | | | | 23 朱天一 <table border="1"><tr><td></td><td></td><td></td></tr><tr><td></td><td></td><td></td></tr><tr><td></td><td></td><td></td></tr></table> Post - 0 Miss - 0 Block - 0 | | | | | | | | | | 24 钟盛发 <table border="1"><tr><td></td><td></td><td></td></tr><tr><td></td><td></td><td></td></tr><tr><td></td><td></td><td></td></tr></table> Post - 0 Miss - 0 Block - 0 | | | | | | | | | | 27 邓可钊 <table border="1"><tr><td></td><td>1</td><td></td></tr><tr><td></td><td></td><td></td></tr><tr><td></td><td></td><td></td></tr></table> Post - 0 Miss - 0 Block - 0 | | 1 | | | | | | | | 36 陈泽锟 <table border="1"><tr><td></td><td></td><td></td></tr><tr><td></td><td></td><td></td></tr><tr><td></td><td></td><td></td></tr></table> Post - 0 Miss - 0 Block - 0 | | | | | | | | | |
| | | | | | | | | | | | | | | | | | | | | | | | | | | | | | | | | | | | | | | | | | | | | | | | | | | | | | | | | | | | | | | | | | | | | | | | | | | | | | | | |
| | | | | | | | | | | | | | | | | | | | | | | | | | | | | | | | | | | | | | | | | | | | | | | | | | | | | | | | | | | | | | | | | | | | | | | | | | | | | | | | |
| | | | | | | | | | | | | | | | | | | | | | | | | | | | | | | | | | | | | | | | | | | | | | | | | | | | | | | | | | | | | | | | | | | | | | | | | | | | | | | | |
| | | | | | | | | | | | | | | | | | | | | | | | | | | | | | | | | | | | | | | | | | | | | | | | | | | | | | | | | | | | | | | | | | | | | | | | | | | | | | | | |
| | | | | | | | | | | | | | | | | | | | | | | | | | | | | | | | | | | | | | | | | | | | | | | | | | | | | | | | | | | | | | | | | | | | | | | | | | | | | | | | |
| | | | | | | | | | | | | | | | | | | | | | | | | | | | | | | | | | | | | | | | | | | | | | | | | | | | | | | | | | | | | | | | | | | | | | | | | | | | | | | | |
| | 1 | | | | | | | | | | | | | | | | | | | | | | | | | | | | | | | | | | | | | | | | | | | | | | | | | | | | | | | | | | | | | | | | | | | | | | | | | | | | | | |
| | | | | | | | | | | | | | | | | | | | | | | | | | | | | | | | | | | | | | | | | | | | | | | | | | | | | | | | | | | | | | | | | | | | | | | | | | | | | | | | |
| | | | | | | | | | | | | | | | | | | | | | | | | | | | | | | | | | | | | | | | | | | | | | | | | | | | | | | | | | | | | | | | | | | | | | | | | | | | | | | | |
| | | | | | | | | | | | | | | | | | | | | | | | | | | | | | | | | | | | | | | | | | | | | | | | | | | | | | | | | | | | | | | | | | | | | | | | | | | | | | | | |
| | | | | | | | | | | | | | | | | | | | | | | | | | | | | | | | | | | | | | | | | | | | | | | | | | | | | | | | | | | | | | | | | | | | | | | | | | | | | | | | |
| | | | | | | | | | | | | | | | | | | | | | | | | | | | | | | | | | | | | | | | | | | | | | | | | | | | | | | | | | | | | | | | | | | | | | | | | | | | | | | | |
| | | | | | | | | | | | | | | | | | | | | | | | | | | | | | | | | | | | | | | | | | | | | | | | | | | | | | | | | | | | | | | | | | | | | | | | | | | | | | | | |
| | | | | | | | | | | | | | | | | | | | | | | | | | | | | | | | | | | | | | | | | | | | | | | | | | | | | | | | | | | | | | | | | | | | | | | | | | | | | | | | |
| | | | | | | | | | | | | | | | | | | | | | | | | | | | | | | | | | | | | | | | | | | | | | | | | | | | | | | | | | | | | | | | | | | | | | | | | | | | | | | | |
| | | | | | | | | | | | | | | | | | | | | | | | | | | | | | | | | | | | | | | | | | | | | | | | | | | | | | | | | | | | | | | | | | | | | | | | | | | | | | | | |
| | | | | | | | | | | | | | | | | | | | | | | | | | | | | | | | | | | | | | | | | | | | | | | | | | | | | | | | | | | | | | | | | | | | | | | | | | | | | | | | |
| | | | | | | | | | | | | | | | | | | | | | | | | | | | | | | | | | | | | | | | | | | | | | | | | | | | | | | | | | | | | | | | | | | | | | | | | | | | | | | | |
| | 1 | | | | | | | | | | | | | | | | | | | | | | | | | | | | | | | | | | | | | | | | | | | | | | | | | | | | | | | | | | | | | | | | | | | | | | | | | | | | | | |
| | | | | | | | | | | | | | | | | | | | | | | | | | | | | | | | | | | | | | | | | | | | | | | | | | | | | | | | | | | | | | | | | | | | | | | | | | | | | | | | |
| | | | | | | | | | | | | | | | | | | | | | | | | | | | | | | | | | | | | | | | | | | | | | | | | | | | | | | | | | | | | | | | | | | | | | | | | | | | | | | | |
| | | | | | | | | | | | | | | | | | | | | | | | | | | | | | | | | | | | | | | | | | | | | | | | | | | | | | | | | | | | | | | | | | | | | | | | | | | | | | | | |
| | | | | | | | | | | | | | | | | | | | | | | | | | | | | | | | | | | | | | | | | | | | | | | | | | | | | | | | | | | | | | | | | | | | | | | | | | | | | | | | |
| | | | | | | | | | | | | | | | | | | | | | | | | | | | | | | | | | | | | | | | | | | | | | | | | | | | | | | | | | | | | | | | | | | | | | | | | | | | | | | | |



| | | |
|--------|--------|--------------|
| Team A | Team B | Match Number |
| A 上海宝山 | B 江苏苏州 | 41 |

| | | | | |
|-----------|-------------|------------|-------|------------|
| Played in | in the hall | on | at | Spepectors |
| 安徽滁州 | 滁州国际手球馆 | 2019-06-05 | 16:00 | hours |

| | | | | | | | | | | | | | | |
|----------------|---|---|---------------------|----|---|----------------|---|---|----------------|---|---|----------------------|---|---|
| Half-time(30') | A | B | End of playing time | A | B | 1st extra time | A | B | 2nd extra time | A | B | After penalty throws | A | B |
| | 6 | 7 | 12 | 13 | | | | | | | | | | |

| | | | | | | | | | | |
|---------------|-----|---------------|-------|-------|------------------------------------|---------------|-------|---|-----|---------------|
| Number of 7 m | A | Team time-out | | | Full name of players and officials | Team time-out | | | B | Number of 7 m |
| | 3/3 | 1 | 2 | 3 | | 1 | 2 | 3 | 1/3 | |
| | | 12:04 | 34:39 | 42:36 | | 12:42 | 41:34 | | | |

| No. | Team A | G | W | 2' | D | DR | No. | Team B | G | W | 2' | D | DR |
|-----|-----------|---|---|----|---|----|-----|--------|---|---|----|---|----|
| 3 | 侯俊杰 | | | | | | 1 | 邹明轩 | | | | | |
| 5 | 范斯哲 | | | | | | 2 | 马力 | | | | | |
| 6 | 吴梓涵 | | | | | | 4 | 孙钊 | | | | | |
| 7 | 彭意焱 | | | | | | 5 | 马奔 | 2 | | | | |
| 10 | 马涛 | 1 | | | | | 6 | 潘超群 | 4 | | | | |
| 12 | 薛凯 | | | | | | 8 | 王震 | 2 | | 1 | | |
| 13 | 刘启群 | 3 | | 1 | | | 9 | 李文俊 | | | | | |
| 19 | 张申杰 | | | | | | 10 | 朱红雨 | | | | | |
| 21 | 曾新宇 | 2 | | | | | 11 | 许多 | | | | | |
| 22 | 马浩东 | 1 | 1 | | | | 12 | 周文贤 | | | | | |
| 25 | 江锦 | | | | | | 13 | 蒋超 | | | | | |
| 30 | 戴泽昊 | | | | | | 14 | 刘亚力 | | | | | |
| 35 | 刘子杰 | 5 | | | | | 15 | 刘成果 | | | | | |
| 39 | 陆毅泽 | | | | | | 18 | 何志伟 | 4 | | | | |
| 66 | 黄嘉遥 | | | | | | 19 | 夏思毅 | | | | | |
| 68 | 陈沁磊 | | | | | | 23 | 张铮洋 | 1 | | | | |
| A | 马革 | | | | | | A | 周清 | | | | | |
| B | 徐聪豪 (主教练) | | | | | | C | 郝可鑫 | | | | | |
| D | 赵时俊 | | | | | | D | 陈冬冬 | | | | | |
| | | | | | | | E | 陈伟 | | | | | |

| | | |
|---|--|---|
| A | Signatures of responsables for the teams (Off.A) | B |
|---|--|---|

| | | |
|----|-----------------------------------|----|
| TP | Remarks of referees / HF Official | TP |
|----|-----------------------------------|----|

| | | | |
|------------|-----------|-----------|--|
| Signatures | | | |
| Referees | 许翔 (CHN) | 刘禹 (CHN) | |
| T.D. | 许宜扬 (CHN) | 尹静阳 (CHN) | |
| CHA Off. | | | |

Note: Number of 7m Throws Awarded to Team A and B, Goals (G), Warnings (W), Suspensions (2'), Direct Disqualification (D), Disqualification With Report (DR) and Team Penalty (TP).

Table Officials: 刘洋洋 许修凯 Statisticians: 沈家洛 马安兴

第二届全国青年运动会男子手球乙组决赛 体校组 (U16)

竞赛技术统计

手球
青年男子

3-4名
轮次 6

组别 X
场次 41

滁州国际手球馆
2019-06-05 16:00

| | | | |
|-----------|----------------------|---------|------------|
| Referees: | 许翔 (CHN) / 刘禹 (CHN) | Result: | 12:13(6:7) |
| Teams: | 上海宝山(宝山) VS 江苏苏州(苏州) | | |

| 宝山 | | 远射 | 近射 | 边射 | 快攻 | 突破 | 任意球 | 7m球 | 合计 | % | 助攻 | 失误 | 警告 | 2' | D+DR |
|----------|-----|------|-----|-----|-----|-----|-----|-----|-------|------|----|----|----|----|------|
| 主教练: 徐聪豪 | | | | | | | | | | | | | | | |
| 3 | 侯俊杰 | | | | | | | | | | | | | | |
| 5 | 范斯哲 | | | | | | | | | | | | | | |
| 6 | 吴梓涵 | | | | | | | | | | | | | | |
| 7 | 彭意焱 | | | | | | | | | | | | | | |
| 10 | 马涛 | 1/2 | | 0/1 | | | | 1/3 | 33.3 | | 1 | | | | |
| 12 | 薛凯 | | | | | | | | | | | | | | |
| 13 | 刘启群 | 0/1 | | 3/5 | | | | 3/6 | 50.0 | | 3 | | | 1 | |
| 19 | 张申杰 | | | 0/1 | | | | 0/1 | 0.0 | | 2 | | | | |
| 21 | 曾新宇 | 1/6 | | | 1/1 | | | 2/7 | 28.6 | 2 | 2 | | | | |
| 22 | 马浩东 | 1/2 | | 0/1 | | | | 1/3 | 33.3 | | 3 | 1 | | | |
| 25 | 江锦 | | | | | | | | | | | | | | |
| 30 | 戴泽昊 | | | | | | | | | | | | | | |
| 35 | 刘子杰 | 1/1 | 1/3 | | | | | 3/3 | 5/7 | 71.4 | 1 | | | | |
| 39 | 陆毅泽 | | | | | | | | | | | | | | |
| 66 | 黄嘉遥 | | | | | | | | | | | | | | |
| 68 | 陈沁磊 | | | | | | | | | | | | | | |
| 运动员 合计 | | 4/12 | 1/3 | 3/8 | 1/1 | | | 3/3 | 12/27 | 44.4 | 2 | 12 | 1 | 1 | |
| 12 | 薛凯 | 3/7 | 1/4 | 2/3 | 0/2 | | 1/1 | 1/2 | 8/19 | 42.1 | | | | | |
| 66 | 黄嘉遥 | | 0/1 | | | 0/1 | | | 0/2 | 0.0 | | | | | |
| 守门员 合计 | | 3/7 | 1/5 | 2/3 | 0/2 | 0/1 | 1/1 | 1/2 | 8/21 | 38.1 | | | | | |

| 宝山 | 比赛进程 | 苏州 |
|----------|----------|-----------|
| 1st Half | | |
| 35 刘子杰 | 1 01:09 | 0 |
| 21 曾新宇 | 2 01:28 | 0 |
| | 2 02:42 | 1 6 潘超群 |
| | 2 04:10 | 2 8 王震 |
| 35 刘子杰 | 3 04:46 | 2 |
| | 3 05:00 | 3 6 潘超群 |
| | 3 06:37 | 4 5 马奔 |
| | 3 07:29 | 5 6 潘超群 |
| 13 刘启群 | 4 08:17 | 5 |
| | 4 10:22 | 6 18 何志伟 |
| 21 曾新宇 | 5 10:46 | 6 |
| | 5 11:53 | 7 23 张铮洋 |
| 10 马涛 | 6 13:11 | 7 |
| 2nd Half | | |
| | 6 00:31 | 8 6 潘超群 |
| | 6 03:20 | 9 8 王震 |
| | 6 04:07 | 10 18 何志伟 |
| 13 刘启群 | 7 05:27 | 10 |
| | 7 05:56 | 11 5 马奔 |
| 22 马浩东 | 8 06:15 | 11 |
| 35 刘子杰 | 9 07:33 | 11 |
| | 9 08:56 | 12 18 何志伟 |
| 35 刘子杰 | 10 11:08 | 12 |
| | 10 12:13 | 13 18 何志伟 |
| 35 刘子杰 | 11 14:11 | 13 |
| 13 刘启群 | 12 14:55 | 13 |

| 苏州 | | 远射 | 近射 | 边射 | 快攻 | 突破 | 任意球 | 7m球 | 合计 | % | 助攻 | 失误 | 警告 | 2' | D+DR |
|----------|-----|------|-----|-----|-----|-----|-----|-----|-------|------|----|----|----|----|------|
| 主教练: 陈冬冬 | | | | | | | | | | | | | | | |
| 1 | 邹明轩 | | | | | | | | | | | | | | |
| 2 | 马力 | | | | | | | | | | | | | | |
| 4 | 孙钊 | | | | | | | | | | | | | | |
| 5 | 马奔 | | 2/3 | | | | | 2/3 | 66.7 | | | | | | |
| 6 | 潘超群 | 2/4 | | | | 1/1 | 0/1 | 1/3 | 4/9 | 44.4 | 3 | 4 | | | |
| 8 | 王震 | 2/4 | | | | | 0/1 | | 2/5 | 40.0 | | 2 | | 1 | |
| 9 | 李文俊 | | | | | | | | | | | | | | |
| 10 | 朱红雨 | | | | | | | | | | | | | | |
| 11 | 许多 | | | | | | | | | | | | | | |
| 12 | 周文贤 | | | | | | | | | | | 1 | | | |
| 13 | 蒋超 | | | 0/1 | | | | 0/1 | 0.0 | | | | | | |
| 14 | 刘亚力 | | | | | | | | | | | | | | |
| 15 | 刘成果 | | | | | | | | | | | | | | |
| 18 | 何志伟 | | 1/2 | 1/2 | 2/2 | | | 4/6 | 66.7 | 2 | 2 | | | | |
| 19 | 夏思毅 | | | | | | | | | | | | | | |
| 23 | 张铮洋 | 0/3 | 1/1 | | | | | 1/4 | 25.0 | 1 | 2 | | | | |
| 运动员 合计 | | 4/11 | 4/6 | 1/3 | 2/2 | 1/1 | 0/2 | 1/3 | 13/28 | 46.4 | 6 | 11 | | 1 | |
| 12 | 周文贤 | 2/6 | 1/2 | 5/8 | 0/1 | | | 0/3 | 8/20 | 40.0 | | 1 | | | |
| 守门员 合计 | | 2/6 | 1/2 | 5/8 | 0/1 | | | 0/3 | 8/20 | 40.0 | | 1 | | | |

场上队员: 得分 / 射门

守门员: 救球 / 射门

| | | | |
|---|------|----|---------|
| D | 取消资格 | DR | 取消资格+报告 |
|---|------|----|---------|

个人/全队技术统计表

手球 3-4名 组别 X 滁州国际手球馆
青年男子 轮次 6 场次 41 2019-06-05 16:00

| 号码 | 姓名 | 远射 | 近射 | 边射 | 快攻 | 突破 | 任意 | 七米 | 合计 | % | 助攻 | 失误 | 警告 | 2' | 取消 | 时间 |
|----------|-----|------|-----|-----|-----|-----|-----|-----|-------|-------|----|----|----|----|----|----------|
| 上海宝山(宝山) | | | | | | | | | | | | | | | | |
| (场上队员) | | | | | | | | | | | | | | | | |
| 3 | 侯俊杰 | | | | | | | | | 0.0% | | | | | | 00:00:00 |
| 5 | 范斯哲 | | | | | | | | | 0.0% | | | | | | 00:00:00 |
| 6 | 吴梓涵 | | | | | | | | | 0.0% | | | | | | 00:00:00 |
| 7 | 彭意焱 | | | | | | | | | 0.0% | | | | | | 00:00:00 |
| 10 | 马涛 | 1/2 | | 0/1 | | | | | 1/3 | 33.3% | 1 | | | | | 00:25:21 |
| 12 | 薛凯 | | | | | | | | | 0.0% | | | | | | 00:27:47 |
| 13 | 刘启群 | 0/1 | | 3/5 | | | | | 3/6 | 50.0% | 3 | | | 1 | | 00:30:00 |
| 19 | 张申杰 | | | 0/1 | | | | | 0/1 | 0.0% | 2 | | | | | 00:30:00 |
| 21 | 曾新宇 | 1/6 | | | 1/1 | | | | 2/7 | 28.6% | 2 | 2 | | | | 00:30:00 |
| 22 | 马浩东 | 1/2 | | 0/1 | | | | | 1/3 | 33.3% | 3 | | 1 | | | 00:30:00 |
| 25 | 江锦 | | | | | | | | | 0.0% | | | | | | 00:00:00 |
| 30 | 戴泽昊 | | | | | | | | | 0.0% | | | | | | 00:04:39 |
| 35 | 刘子杰 | 1/1 | 1/3 | | | | | 3/3 | 5/7 | 71.4% | 1 | | | | | 00:30:00 |
| 39 | 陆毅泽 | | | | | | | | | 0.0% | | | | | | 00:00:00 |
| 66 | 黄嘉遥 | | | | | | | | | 0.0% | | | | | | 00:02:13 |
| 68 | 陈沁磊 | | | | | | | | | 0.0% | | | | | | 00:00:00 |
| | 合计 | 4/12 | 1/3 | 3/8 | 1/1 | | | 3/3 | 12/27 | 44.4% | 2 | 12 | 1 | 1 | | |
| (守门员) | | | | | | | | | | | | | | | | |
| 12 | 薛凯 | 3/7 | 1/4 | 2/3 | 0/2 | | 1/1 | 1/2 | 8/19 | 42.1% | | | | | | 00:27:47 |
| 66 | 黄嘉遥 | | 0/1 | | | 0/1 | | | 0/2 | 0.0% | | | | | | 00:02:13 |
| | 合计 | 3/7 | 1/5 | 2/3 | 0/2 | 0/1 | 1/1 | 1/2 | 8/21 | 38.1% | | | | | | |

场上队员：得分/射门

守门员：救球/射门

| 全队合计 | 得分 | 被救 | 射失 | 击柱 | 封球 | 合计 | % |
|------|----|----|----|----|----|----|--------|
| 远射 | 4 | 2 | 3 | 1 | 2 | 12 | 33.3% |
| 近射 | 1 | 1 | 1 | | | 3 | 33.3% |
| 边射 | 3 | 5 | | | | 8 | 37.5% |
| 快攻 | 1 | | | | | 1 | 100.0% |
| 突破 | | | | | | | 0.0% |
| 任意 | | | | | | | 0.0% |
| 七米 | 3 | | | | | 3 | 100.0% |

个人/全队技术统计表

手球 3-4名 组别 X 滁州国际手球馆
青年男子 轮次 6 场次 41 2019-06-05 16:00

| 号码 | 姓名 | 远射 | 近射 | 边射 | 快攻 | 突破 | 任意 | 七米 | 合计 | % | 助攻 | 失误 | 警告 | 2' | 取消 | 时间 |
|----------|-----|------|-----|-----|-----|-----|-----|-----|-------|-------|----|----|----|----|----|----------|
| 江苏苏州(苏州) | | | | | | | | | | | | | | | | |
| (场上队员) | | | | | | | | | | | | | | | | |
| 1 | 邹明轩 | | | | | | | | | 0.0% | | | | | | 00:00:00 |
| 2 | 马力 | | | | | | | | | 0.0% | | | | | | 00:00:00 |
| 4 | 孙钊 | | | | | | | | | 0.0% | | | | | | 00:00:00 |
| 5 | 马奔 | | 2/3 | | | | | | 2/3 | 66.7% | | | | | | 00:30:00 |
| 6 | 潘超群 | 2/4 | | | | 1/1 | 0/1 | 1/3 | 4/9 | 44.4% | 3 | 4 | | | | 00:30:00 |
| 8 | 王震 | 2/4 | | | | | 0/1 | | 2/5 | 40.0% | | 2 | | 1 | | 00:30:00 |
| 9 | 李文俊 | | | | | | | | | 0.0% | | | | | | 00:00:00 |
| 10 | 朱红雨 | | | | | | | | | 0.0% | | | | | | 00:15:00 |
| 11 | 许多 | | | | | | | | | 0.0% | | | | | | 00:00:00 |
| 12 | 周文贤 | | | | | | | | | 0.0% | | 1 | | | | 00:30:00 |
| 13 | 蒋超 | | | 0/1 | | | | | 0/1 | 0.0% | | | | | | 00:15:00 |
| 14 | 刘亚力 | | | | | | | | | 0.0% | | | | | | 00:00:00 |
| 15 | 刘成果 | | | | | | | | | 0.0% | | | | | | 00:00:00 |
| 18 | 何志伟 | | 1/2 | 1/2 | 2/2 | | | | 4/6 | 66.7% | 2 | 2 | | | | 00:30:00 |
| 19 | 夏思毅 | | | | | | | | | 0.0% | | | | | | 00:00:00 |
| 23 | 张铮洋 | 0/3 | 1/1 | | | | | | 1/4 | 25.0% | 1 | 2 | | | | 00:30:00 |
| | 合计 | 4/11 | 4/6 | 1/3 | 2/2 | 1/1 | 0/2 | 1/3 | 13/28 | 46.4% | 6 | 11 | | 1 | | |
| (守门员) | | | | | | | | | | | | | | | | |
| 12 | 周文贤 | 2/6 | 1/2 | 5/8 | 0/1 | | | 0/3 | 8/20 | 40.0% | | 1 | | | | 00:30:00 |
| | 合计 | 2/6 | 1/2 | 5/8 | 0/1 | | | 0/3 | 8/20 | 40.0% | | 1 | | | | |

场上队员：得分/射门

守门员：救球/射门

| 全队合计 | 得分 | 被救 | 射失 | 击柱 | 封球 | 合计 | % |
|------|----|----|----|----|----|----|--------|
| 远射 | 4 | 3 | 1 | | 3 | 11 | 36.4% |
| 近射 | 4 | 1 | 1 | | | 6 | 66.7% |
| 边射 | 1 | 2 | | | | 3 | 33.3% |
| 快攻 | 2 | | | | | 2 | 100.0% |
| 突破 | 1 | | | | | 1 | 100.0% |
| 任意 | | 1 | | 1 | | 2 | 0.0% |
| 七米 | 1 | 1 | | 1 | | 3 | 33.3% |

图式比赛技术统计表

手球
青年男子

3-4名
轮次 6

组别 X
场次 41

滁州国际手球馆
2019-06-05 16:00

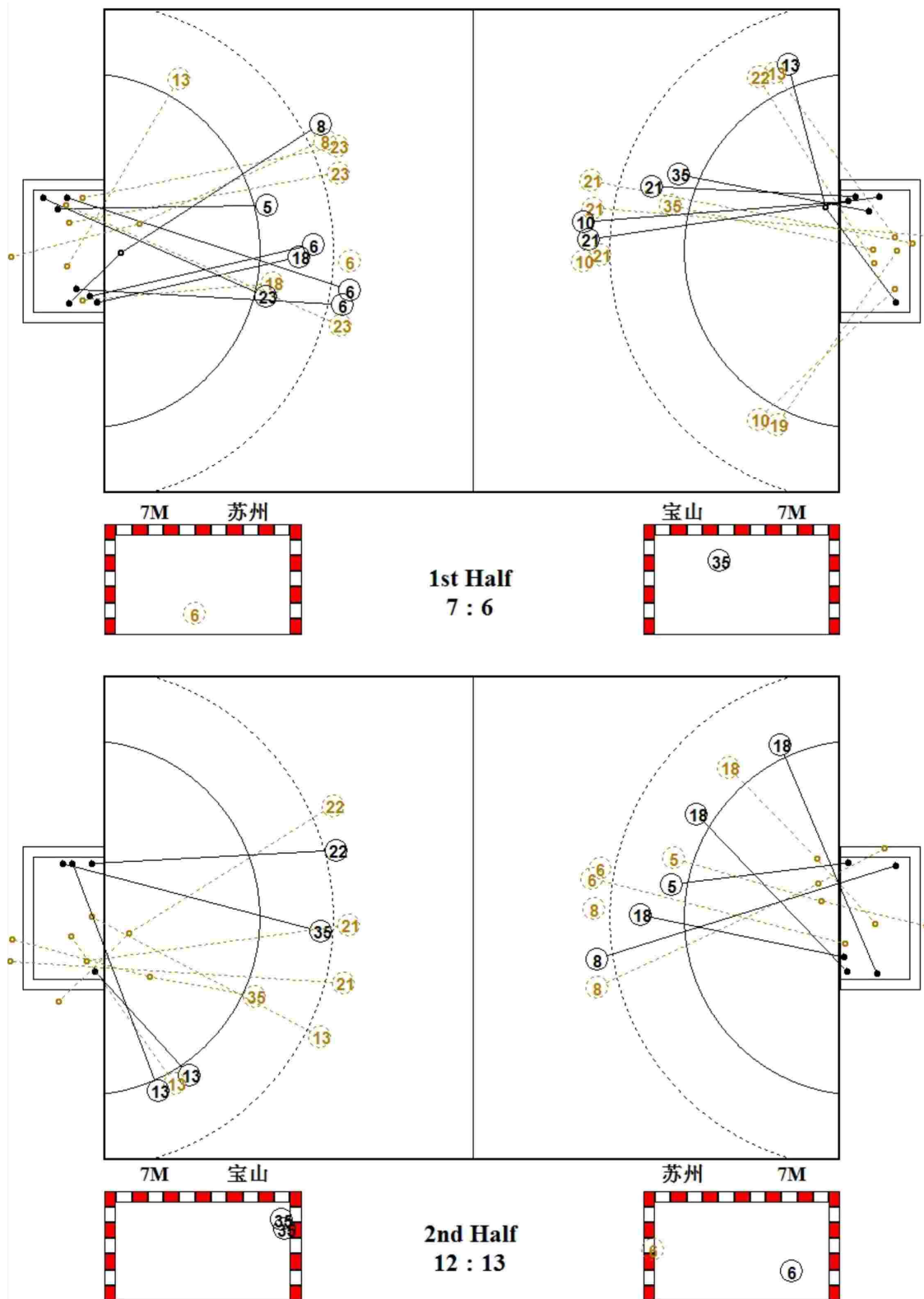

图式射门区域统计

手球
青年男子

3-4名
轮次 6

组别 X
场次 41

滁州国际手球馆
2019-06-05 16:00

上海宝山

| | | | | | | | | | | | | | | | | | | | | | | | | | | | | | | | | | | | | | | | | | | | | | | | | | | | | | | | | | | | | | | | | | | | | | | | | | | | | | | | |
|--|-----------------------------|-----------------------------|-----------------------------|-----------------------------|-----------------------------|-----------------------------|-----------------------------|--|--|---|--|--|--|--|--|--|--|--|---|--|--|--|--|--|--|--|--|--|--|--|--|--|--|--|--|--|--|--|--|--|--|--|--|--|---|---|---|--|---|--|--|--|--|--|--|--|--|--|--|--|--|--|---|--|--|---|--|--|--|--|--|--|--|--|--|--|--|--|--|
| 3 侯俊杰 | 5 范斯哲 | 6 吴梓涵 | 7 彭意焱 | 10 马涛 | 12 薛凯 | 13 刘启群 | 19 张申杰 | | | | | | | | | | | | | | | | | | | | | | | | | | | | | | | | | | | | | | | | | | | | | | | | | | | | | | | | | | | | | | | | | | | | | | | | |
| <table border="1"><tr><td></td><td></td><td></td></tr><tr><td></td><td></td><td></td></tr><tr><td></td><td></td><td></td></tr></table> | | | | | | | | | | <table border="1"><tr><td></td><td></td><td></td></tr><tr><td></td><td></td><td></td></tr><tr><td></td><td></td><td></td></tr></table> | | | | | | | | | | <table border="1"><tr><td></td><td></td><td></td></tr><tr><td></td><td></td><td></td></tr><tr><td></td><td></td><td></td></tr></table> | | | | | | | | | | <table border="1"><tr><td></td><td></td><td></td></tr><tr><td></td><td></td><td></td></tr><tr><td></td><td></td><td></td></tr></table> | | | | | | | | | | <table border="1"><tr><td></td><td></td><td></td></tr><tr><td></td><td></td><td></td></tr><tr><td>1</td><td></td><td></td></tr></table> | | | | | | | 1 | | | <table border="1"><tr><td></td><td></td><td></td></tr><tr><td></td><td></td><td></td></tr><tr><td></td><td></td><td></td></tr></table> | | | | | | | | | | <table border="1"><tr><td></td><td></td><td>1</td></tr><tr><td></td><td></td><td>1</td></tr><tr><td></td><td></td><td></td></tr></table> | | | 1 | | | 1 | | | | <table border="1"><tr><td></td><td></td><td></td></tr><tr><td></td><td></td><td></td></tr><tr><td></td><td></td><td></td></tr></table> | | | | | | | | | |
| | | | | | | | | | | | | | | | | | | | | | | | | | | | | | | | | | | | | | | | | | | | | | | | | | | | | | | | | | | | | | | | | | | | | | | | | | | | | | | | |
| | | | | | | | | | | | | | | | | | | | | | | | | | | | | | | | | | | | | | | | | | | | | | | | | | | | | | | | | | | | | | | | | | | | | | | | | | | | | | | | |
| | | | | | | | | | | | | | | | | | | | | | | | | | | | | | | | | | | | | | | | | | | | | | | | | | | | | | | | | | | | | | | | | | | | | | | | | | | | | | | | |
| | | | | | | | | | | | | | | | | | | | | | | | | | | | | | | | | | | | | | | | | | | | | | | | | | | | | | | | | | | | | | | | | | | | | | | | | | | | | | | | |
| | | | | | | | | | | | | | | | | | | | | | | | | | | | | | | | | | | | | | | | | | | | | | | | | | | | | | | | | | | | | | | | | | | | | | | | | | | | | | | | |
| | | | | | | | | | | | | | | | | | | | | | | | | | | | | | | | | | | | | | | | | | | | | | | | | | | | | | | | | | | | | | | | | | | | | | | | | | | | | | | | |
| | | | | | | | | | | | | | | | | | | | | | | | | | | | | | | | | | | | | | | | | | | | | | | | | | | | | | | | | | | | | | | | | | | | | | | | | | | | | | | | |
| | | | | | | | | | | | | | | | | | | | | | | | | | | | | | | | | | | | | | | | | | | | | | | | | | | | | | | | | | | | | | | | | | | | | | | | | | | | | | | | |
| | | | | | | | | | | | | | | | | | | | | | | | | | | | | | | | | | | | | | | | | | | | | | | | | | | | | | | | | | | | | | | | | | | | | | | | | | | | | | | | |
| | | | | | | | | | | | | | | | | | | | | | | | | | | | | | | | | | | | | | | | | | | | | | | | | | | | | | | | | | | | | | | | | | | | | | | | | | | | | | | | |
| | | | | | | | | | | | | | | | | | | | | | | | | | | | | | | | | | | | | | | | | | | | | | | | | | | | | | | | | | | | | | | | | | | | | | | | | | | | | | | | |
| | | | | | | | | | | | | | | | | | | | | | | | | | | | | | | | | | | | | | | | | | | | | | | | | | | | | | | | | | | | | | | | | | | | | | | | | | | | | | | | |
| | | | | | | | | | | | | | | | | | | | | | | | | | | | | | | | | | | | | | | | | | | | | | | | | | | | | | | | | | | | | | | | | | | | | | | | | | | | | | | | |
| | | | | | | | | | | | | | | | | | | | | | | | | | | | | | | | | | | | | | | | | | | | | | | | | | | | | | | | | | | | | | | | | | | | | | | | | | | | | | | | |
| 1 | | | | | | | | | | | | | | | | | | | | | | | | | | | | | | | | | | | | | | | | | | | | | | | | | | | | | | | | | | | | | | | | | | | | | | | | | | | | | | | |
| | | | | | | | | | | | | | | | | | | | | | | | | | | | | | | | | | | | | | | | | | | | | | | | | | | | | | | | | | | | | | | | | | | | | | | | | | | | | | | | |
| | | | | | | | | | | | | | | | | | | | | | | | | | | | | | | | | | | | | | | | | | | | | | | | | | | | | | | | | | | | | | | | | | | | | | | | | | | | | | | | |
| | | | | | | | | | | | | | | | | | | | | | | | | | | | | | | | | | | | | | | | | | | | | | | | | | | | | | | | | | | | | | | | | | | | | | | | | | | | | | | | |
| | | 1 | | | | | | | | | | | | | | | | | | | | | | | | | | | | | | | | | | | | | | | | | | | | | | | | | | | | | | | | | | | | | | | | | | | | | | | | | | | | | |
| | | 1 | | | | | | | | | | | | | | | | | | | | | | | | | | | | | | | | | | | | | | | | | | | | | | | | | | | | | | | | | | | | | | | | | | | | | | | | | | | | | |
| | | | | | | | | | | | | | | | | | | | | | | | | | | | | | | | | | | | | | | | | | | | | | | | | | | | | | | | | | | | | | | | | | | | | | | | | | | | | | | | |
| | | | | | | | | | | | | | | | | | | | | | | | | | | | | | | | | | | | | | | | | | | | | | | | | | | | | | | | | | | | | | | | | | | | | | | | | | | | | | | | |
| | | | | | | | | | | | | | | | | | | | | | | | | | | | | | | | | | | | | | | | | | | | | | | | | | | | | | | | | | | | | | | | | | | | | | | | | | | | | | | | |
| | | | | | | | | | | | | | | | | | | | | | | | | | | | | | | | | | | | | | | | | | | | | | | | | | | | | | | | | | | | | | | | | | | | | | | | | | | | | | | | |
| Post - 0 Miss - 0 Block - 0 | Post - 0 Miss - 0 Block - 0 | Post - 0 Miss - 0 Block - 0 | Post - 0 Miss - 0 Block - 0 | Post - 0 Miss - 0 Block - 1 | Post - 0 Miss - 0 Block - 0 | Post - 0 Miss - 0 Block - 0 | Post - 0 Miss - 0 Block - 0 | | | | | | | | | | | | | | | | | | | | | | | | | | | | | | | | | | | | | | | | | | | | | | | | | | | | | | | | | | | | | | | | | | | | | | | | |
| 21 曾新宇 | 22 马浩东 | 25 江锦 | 30 戴泽昊 | 35 刘子杰 | 39 陆毅泽 | 66 黄嘉遥 | 68 陈沁磊 | | | | | | | | | | | | | | | | | | | | | | | | | | | | | | | | | | | | | | | | | | | | | | | | | | | | | | | | | | | | | | | | | | | | | | | | |
| <table border="1"><tr><td></td><td></td><td></td></tr><tr><td>1</td><td></td><td></td></tr><tr><td>1</td><td></td><td></td></tr></table> | | | | 1 | | | 1 | | | <table border="1"><tr><td></td><td></td><td></td></tr><tr><td></td><td></td><td></td></tr><tr><td></td><td></td><td>1</td></tr></table> | | | | | | | | | 1 | <table border="1"><tr><td></td><td></td><td></td></tr><tr><td></td><td></td><td></td></tr><tr><td></td><td></td><td></td></tr></table> | | | | | | | | | | <table border="1"><tr><td></td><td></td><td></td></tr><tr><td></td><td></td><td></td></tr><tr><td></td><td></td><td></td></tr></table> | | | | | | | | | | <table border="1"><tr><td></td><td></td><td></td></tr><tr><td></td><td>1</td><td>2</td></tr><tr><td>1</td><td></td><td>1</td></tr></table> | | | | | 1 | 2 | 1 | | 1 | <table border="1"><tr><td></td><td></td><td></td></tr><tr><td></td><td></td><td></td></tr><tr><td></td><td></td><td></td></tr></table> | | | | | | | | | | <table border="1"><tr><td></td><td></td><td></td></tr><tr><td></td><td></td><td></td></tr><tr><td></td><td></td><td></td></tr></table> | | | | | | | | | | <table border="1"><tr><td></td><td></td><td></td></tr><tr><td></td><td></td><td></td></tr><tr><td></td><td></td><td></td></tr></table> | | | | | | | | | |
| | | | | | | | | | | | | | | | | | | | | | | | | | | | | | | | | | | | | | | | | | | | | | | | | | | | | | | | | | | | | | | | | | | | | | | | | | | | | | | | |
| 1 | | | | | | | | | | | | | | | | | | | | | | | | | | | | | | | | | | | | | | | | | | | | | | | | | | | | | | | | | | | | | | | | | | | | | | | | | | | | | | | |
| 1 | | | | | | | | | | | | | | | | | | | | | | | | | | | | | | | | | | | | | | | | | | | | | | | | | | | | | | | | | | | | | | | | | | | | | | | | | | | | | | | |
| | | | | | | | | | | | | | | | | | | | | | | | | | | | | | | | | | | | | | | | | | | | | | | | | | | | | | | | | | | | | | | | | | | | | | | | | | | | | | | | |
| | | | | | | | | | | | | | | | | | | | | | | | | | | | | | | | | | | | | | | | | | | | | | | | | | | | | | | | | | | | | | | | | | | | | | | | | | | | | | | | |
| | | 1 | | | | | | | | | | | | | | | | | | | | | | | | | | | | | | | | | | | | | | | | | | | | | | | | | | | | | | | | | | | | | | | | | | | | | | | | | | | | | |
| | | | | | | | | | | | | | | | | | | | | | | | | | | | | | | | | | | | | | | | | | | | | | | | | | | | | | | | | | | | | | | | | | | | | | | | | | | | | | | | |
| | | | | | | | | | | | | | | | | | | | | | | | | | | | | | | | | | | | | | | | | | | | | | | | | | | | | | | | | | | | | | | | | | | | | | | | | | | | | | | | |
| | | | | | | | | | | | | | | | | | | | | | | | | | | | | | | | | | | | | | | | | | | | | | | | | | | | | | | | | | | | | | | | | | | | | | | | | | | | | | | | |
| | | | | | | | | | | | | | | | | | | | | | | | | | | | | | | | | | | | | | | | | | | | | | | | | | | | | | | | | | | | | | | | | | | | | | | | | | | | | | | | |
| | | | | | | | | | | | | | | | | | | | | | | | | | | | | | | | | | | | | | | | | | | | | | | | | | | | | | | | | | | | | | | | | | | | | | | | | | | | | | | | |
| | | | | | | | | | | | | | | | | | | | | | | | | | | | | | | | | | | | | | | | | | | | | | | | | | | | | | | | | | | | | | | | | | | | | | | | | | | | | | | | |
| | | | | | | | | | | | | | | | | | | | | | | | | | | | | | | | | | | | | | | | | | | | | | | | | | | | | | | | | | | | | | | | | | | | | | | | | | | | | | | | |
| | 1 | 2 | | | | | | | | | | | | | | | | | | | | | | | | | | | | | | | | | | | | | | | | | | | | | | | | | | | | | | | | | | | | | | | | | | | | | | | | | | | | | |
| 1 | | 1 | | | | | | | | | | | | | | | | | | | | | | | | | | | | | | | | | | | | | | | | | | | | | | | | | | | | | | | | | | | | | | | | | | | | | | | | | | | | | |
| | | | | | | | | | | | | | | | | | | | | | | | | | | | | | | | | | | | | | | | | | | | | | | | | | | | | | | | | | | | | | | | | | | | | | | | | | | | | | | | |
| | | | | | | | | | | | | | | | | | | | | | | | | | | | | | | | | | | | | | | | | | | | | | | | | | | | | | | | | | | | | | | | | | | | | | | | | | | | | | | | |
| | | | | | | | | | | | | | | | | | | | | | | | | | | | | | | | | | | | | | | | | | | | | | | | | | | | | | | | | | | | | | | | | | | | | | | | | | | | | | | | |
| | | | | | | | | | | | | | | | | | | | | | | | | | | | | | | | | | | | | | | | | | | | | | | | | | | | | | | | | | | | | | | | | | | | | | | | | | | | | | | | |
| | | | | | | | | | | | | | | | | | | | | | | | | | | | | | | | | | | | | | | | | | | | | | | | | | | | | | | | | | | | | | | | | | | | | | | | | | | | | | | | |
| | | | | | | | | | | | | | | | | | | | | | | | | | | | | | | | | | | | | | | | | | | | | | | | | | | | | | | | | | | | | | | | | | | | | | | | | | | | | | | | |
| | | | | | | | | | | | | | | | | | | | | | | | | | | | | | | | | | | | | | | | | | | | | | | | | | | | | | | | | | | | | | | | | | | | | | | | | | | | | | | | |
| | | | | | | | | | | | | | | | | | | | | | | | | | | | | | | | | | | | | | | | | | | | | | | | | | | | | | | | | | | | | | | | | | | | | | | | | | | | | | | | |
| | | | | | | | | | | | | | | | | | | | | | | | | | | | | | | | | | | | | | | | | | | | | | | | | | | | | | | | | | | | | | | | | | | | | | | | | | | | | | | | |
| Post - 1 Miss - 2 Block - 1 | Post - 0 Miss - 1 Block - 0 | Post - 0 Miss - 0 Block - 0 | Post - 0 Miss - 0 Block - 0 | Post - 0 Miss - 1 Block - 0 | Post - 0 Miss - 0 Block - 0 | Post - 0 Miss - 0 Block - 0 | Post - 0 Miss - 0 Block - 0 | | | | | | | | | | | | | | | | | | | | | | | | | | | | | | | | | | | | | | | | | | | | | | | | | | | | | | | | | | | | | | | | | | | | | | | | |

12 薛凯

| | | |
|-----|-----|-----|
| 0/1 | | 0/1 |
| 0/2 | 2/2 | 2/5 |
| 1/3 | 1/1 | 2/4 |

66 黄嘉遥

| | | |
|-----|--|-----|
| | | 0/1 |
| | | |
| 0/1 | | |

12 周文贤

| | | |
|-----|-----|-----|
| | 2/3 | 1/4 |
| 0/2 | 3/3 | 0/2 |
| 1/4 | 1/1 | 0/1 |

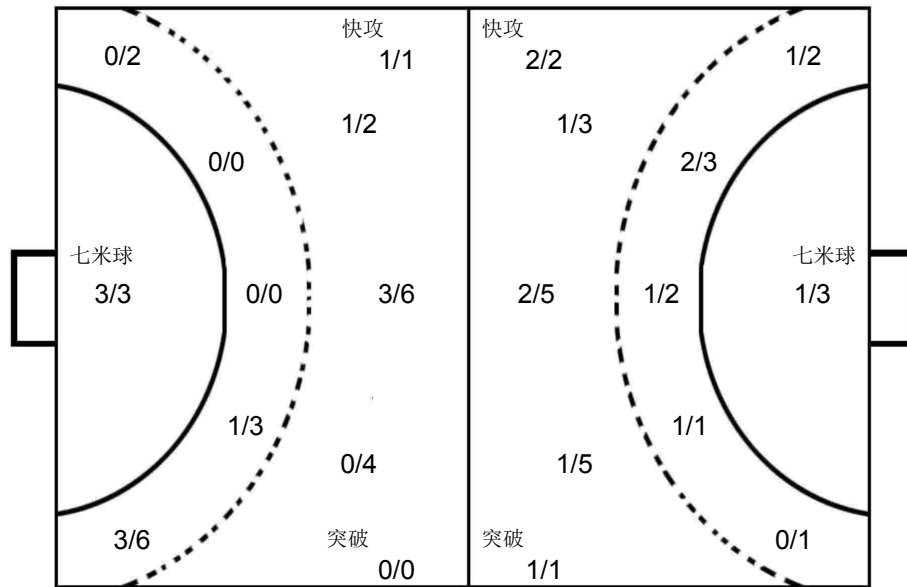

江苏苏州

| | | | | | | | | | | | | | | | | | | | | | | | | | | | | | | | | | | | | | | | | | | | | | | | | | | | | | | | | | | | | | | | | | | | | | | | | | | | | | | | |
|--|-----------------------------|-----------------------------|-----------------------------|-----------------------------|-----------------------------|-----------------------------|-----------------------------|--|--|--|--|--|--|--|--|--|--|--|--|--|--|--|--|--|--|--|--|--|--|--|--|--|---|--|--|--|---|--|--|---|--|--|--|---|--|---|---|--|--|---|---|--|--|---|--|---|---|--|---|--|--|--|--|--|--|--|--|--|--|---|--|--|---|--|--|--|--|--|--|
| 1 邹明轩 | 2 马力 | 4 孙钊 | 5 马奔 | 6 潘超群 | 8 王震 | 9 李文俊 | 10 朱红雨 | | | | | | | | | | | | | | | | | | | | | | | | | | | | | | | | | | | | | | | | | | | | | | | | | | | | | | | | | | | | | | | | | | | | | | | | |
| <table border="1"><tr><td></td><td></td><td></td></tr><tr><td></td><td></td><td></td></tr><tr><td></td><td></td><td></td></tr></table> | | | | | | | | | | <table border="1"><tr><td></td><td></td><td></td></tr><tr><td></td><td></td><td></td></tr><tr><td></td><td></td><td></td></tr></table> | | | | | | | | | | <table border="1"><tr><td></td><td></td><td></td></tr><tr><td></td><td></td><td></td></tr><tr><td></td><td></td><td></td></tr></table> | | | | | | | | | | <table border="1"><tr><td></td><td></td><td>1</td></tr><tr><td></td><td></td><td></td></tr><tr><td>1</td><td></td><td></td></tr></table> | | | 1 | | | | 1 | | | <table border="1"><tr><td></td><td></td><td></td></tr><tr><td>1</td><td></td><td>2</td></tr><tr><td>1</td><td></td><td></td></tr></table> | | | | 1 | | 2 | 1 | | | <table border="1"><tr><td>1</td><td></td><td></td></tr><tr><td>1</td><td></td><td></td></tr><tr><td></td><td></td><td></td></tr></table> | 1 | | | 1 | | | | | | <table border="1"><tr><td></td><td></td><td></td></tr><tr><td></td><td></td><td></td></tr><tr><td></td><td></td><td></td></tr></table> | | | | | | | | | | <table border="1"><tr><td></td><td></td><td></td></tr><tr><td></td><td></td><td></td></tr><tr><td></td><td></td><td></td></tr></table> | | | | | | | | | |
| | | | | | | | | | | | | | | | | | | | | | | | | | | | | | | | | | | | | | | | | | | | | | | | | | | | | | | | | | | | | | | | | | | | | | | | | | | | | | | | |
| | | | | | | | | | | | | | | | | | | | | | | | | | | | | | | | | | | | | | | | | | | | | | | | | | | | | | | | | | | | | | | | | | | | | | | | | | | | | | | | |
| | | | | | | | | | | | | | | | | | | | | | | | | | | | | | | | | | | | | | | | | | | | | | | | | | | | | | | | | | | | | | | | | | | | | | | | | | | | | | | | |
| | | | | | | | | | | | | | | | | | | | | | | | | | | | | | | | | | | | | | | | | | | | | | | | | | | | | | | | | | | | | | | | | | | | | | | | | | | | | | | | |
| | | | | | | | | | | | | | | | | | | | | | | | | | | | | | | | | | | | | | | | | | | | | | | | | | | | | | | | | | | | | | | | | | | | | | | | | | | | | | | | |
| | | | | | | | | | | | | | | | | | | | | | | | | | | | | | | | | | | | | | | | | | | | | | | | | | | | | | | | | | | | | | | | | | | | | | | | | | | | | | | | |
| | | | | | | | | | | | | | | | | | | | | | | | | | | | | | | | | | | | | | | | | | | | | | | | | | | | | | | | | | | | | | | | | | | | | | | | | | | | | | | | |
| | | | | | | | | | | | | | | | | | | | | | | | | | | | | | | | | | | | | | | | | | | | | | | | | | | | | | | | | | | | | | | | | | | | | | | | | | | | | | | | |
| | | | | | | | | | | | | | | | | | | | | | | | | | | | | | | | | | | | | | | | | | | | | | | | | | | | | | | | | | | | | | | | | | | | | | | | | | | | | | | | |
| | | 1 | | | | | | | | | | | | | | | | | | | | | | | | | | | | | | | | | | | | | | | | | | | | | | | | | | | | | | | | | | | | | | | | | | | | | | | | | | | | | |
| | | | | | | | | | | | | | | | | | | | | | | | | | | | | | | | | | | | | | | | | | | | | | | | | | | | | | | | | | | | | | | | | | | | | | | | | | | | | | | | |
| 1 | | | | | | | | | | | | | | | | | | | | | | | | | | | | | | | | | | | | | | | | | | | | | | | | | | | | | | | | | | | | | | | | | | | | | | | | | | | | | | | |
| | | | | | | | | | | | | | | | | | | | | | | | | | | | | | | | | | | | | | | | | | | | | | | | | | | | | | | | | | | | | | | | | | | | | | | | | | | | | | | | |
| 1 | | 2 | | | | | | | | | | | | | | | | | | | | | | | | | | | | | | | | | | | | | | | | | | | | | | | | | | | | | | | | | | | | | | | | | | | | | | | | | | | | | |
| 1 | | | | | | | | | | | | | | | | | | | | | | | | | | | | | | | | | | | | | | | | | | | | | | | | | | | | | | | | | | | | | | | | | | | | | | | | | | | | | | | |
| 1 | | | | | | | | | | | | | | | | | | | | | | | | | | | | | | | | | | | | | | | | | | | | | | | | | | | | | | | | | | | | | | | | | | | | | | | | | | | | | | | |
| 1 | | | | | | | | | | | | | | | | | | | | | | | | | | | | | | | | | | | | | | | | | | | | | | | | | | | | | | | | | | | | | | | | | | | | | | | | | | | | | | | |
| | | | | | | | | | | | | | | | | | | | | | | | | | | | | | | | | | | | | | | | | | | | | | | | | | | | | | | | | | | | | | | | | | | | | | | | | | | | | | | | |
| | | | | | | | | | | | | | | | | | | | | | | | | | | | | | | | | | | | | | | | | | | | | | | | | | | | | | | | | | | | | | | | | | | | | | | | | | | | | | | | |
| | | | | | | | | | | | | | | | | | | | | | | | | | | | | | | | | | | | | | | | | | | | | | | | | | | | | | | | | | | | | | | | | | | | | | | | | | | | | | | | |
| | | | | | | | | | | | | | | | | | | | | | | | | | | | | | | | | | | | | | | | | | | | | | | | | | | | | | | | | | | | | | | | | | | | | | | | | | | | | | | | |
| | | | | | | | | | | | | | | | | | | | | | | | | | | | | | | | | | | | | | | | | | | | | | | | | | | | | | | | | | | | | | | | | | | | | | | | | | | | | | | | |
| | | | | | | | | | | | | | | | | | | | | | | | | | | | | | | | | | | | | | | | | | | | | | | | | | | | | | | | | | | | | | | | | | | | | | | | | | | | | | | | |
| | | | | | | | | | | | | | | | | | | | | | | | | | | | | | | | | | | | | | | | | | | | | | | | | | | | | | | | | | | | | | | | | | | | | | | | | | | | | | | | |
| Post - 0 Miss - 0 Block - 0 | Post - 0 Miss - 0 Block - 0 | Post - 0 Miss - 0 Block - 0 | Post - 0 Miss - 1 Block - 0 | Post - 1 Miss - 0 Block - 2 | Post - 1 Miss - 1 Block - 1 | Post - 0 Miss - 0 Block - 0 | Post - 0 Miss - 0 Block - 0 | | | | | | | | | | | | | | | | | | | | | | | | | | | | | | | | | | | | | | | | | | | | | | | | | | | | | | | | | | | | | | | | | | | | | | | | |
| 11 许多 | 12 周文贤 | 13 蒋超 | 14 刘亚力 | 15 刘成果 | 18 何志伟 | 19 夏思毅 | 23 张铮洋 | | | | | | | | | | | | | | | | | | | | | | | | | | | | | | | | | | | | | | | | | | | | | | | | | | | | | | | | | | | | | | | | | | | | | | | | |
| <table border="1"><tr><td></td><td></td><td></td></tr><tr><td></td><td></td><td></td></tr><tr><td></td><td></td><td></td></tr></table> | | | | | | | | | | <table border="1"><tr><td></td><td></td><td></td></tr><tr><td></td><td></td><td></td></tr><tr><td></td><td></td><td></td></tr></table> | | | | | | | | | | <table border="1"><tr><td></td><td></td><td></td></tr><tr><td></td><td></td><td></td></tr><tr><td></td><td></td><td></td></tr></table> | | | | | | | | | | <table border="1"><tr><td></td><td></td><td></td></tr><tr><td></td><td></td><td></td></tr><tr><td></td><td></td><td></td></tr></table> | | | | | | | | | | <table border="1"><tr><td></td><td></td><td></td></tr><tr><td></td><td></td><td></td></tr><tr><td></td><td></td><td></td></tr></table> | | | | | | | | | | <table border="1"><tr><td></td><td></td><td></td></tr><tr><td></td><td></td><td>1</td></tr><tr><td>1</td><td></td><td>2</td></tr></table> | | | | | | 1 | 1 | | 2 | <table border="1"><tr><td></td><td></td><td></td></tr><tr><td></td><td></td><td></td></tr><tr><td></td><td></td><td></td></tr></table> | | | | | | | | | | <table border="1"><tr><td></td><td></td><td>1</td></tr><tr><td></td><td></td><td></td></tr><tr><td></td><td></td><td></td></tr></table> | | | 1 | | | | | | |
| | | | | | | | | | | | | | | | | | | | | | | | | | | | | | | | | | | | | | | | | | | | | | | | | | | | | | | | | | | | | | | | | | | | | | | | | | | | | | | | |
| | | | | | | | | | | | | | | | | | | | | | | | | | | | | | | | | | | | | | | | | | | | | | | | | | | | | | | | | | | | | | | | | | | | | | | | | | | | | | | | |
| | | | | | | | | | | | | | | | | | | | | | | | | | | | | | | | | | | | | | | | | | | | | | | | | | | | | | | | | | | | | | | | | | | | | | | | | | | | | | | | |
| | | | | | | | | | | | | | | | | | | | | | | | | | | | | | | | | | | | | | | | | | | | | | | | | | | | | | | | | | | | | | | | | | | | | | | | | | | | | | | | |
| | | | | | | | | | | | | | | | | | | | | | | | | | | | | | | | | | | | | | | | | | | | | | | | | | | | | | | | | | | | | | | | | | | | | | | | | | | | | | | | |
| | | | | | | | | | | | | | | | | | | | | | | | | | | | | | | | | | | | | | | | | | | | | | | | | | | | | | | | | | | | | | | | | | | | | | | | | | | | | | | | |
| | | | | | | | | | | | | | | | | | | | | | | | | | | | | | | | | | | | | | | | | | | | | | | | | | | | | | | | | | | | | | | | | | | | | | | | | | | | | | | | |
| | | | | | | | | | | | | | | | | | | | | | | | | | | | | | | | | | | | | | | | | | | | | | | | | | | | | | | | | | | | | | | | | | | | | | | | | | | | | | | | |
| | | | | | | | | | | | | | | | | | | | | | | | | | | | | | | | | | | | | | | | | | | | | | | | | | | | | | | | | | | | | | | | | | | | | | | | | | | | | | | | |
| | | | | | | | | | | | | | | | | | | | | | | | | | | | | | | | | | | | | | | | | | | | | | | | | | | | | | | | | | | | | | | | | | | | | | | | | | | | | | | | |
| | | | | | | | | | | | | | | | | | | | | | | | | | | | | | | | | | | | | | | | | | | | | | | | | | | | | | | | | | | | | | | | | | | | | | | | | | | | | | | | |
| | | | | | | | | | | | | | | | | | | | | | | | | | | | | | | | | | | | | | | | | | | | | | | | | | | | | | | | | | | | | | | | | | | | | | | | | | | | | | | | |
| | | | | | | | | | | | | | | | | | | | | | | | | | | | | | | | | | | | | | | | | | | | | | | | | | | | | | | | | | | | | | | | | | | | | | | | | | | | | | | | |
| | | | | | | | | | | | | | | | | | | | | | | | | | | | | | | | | | | | | | | | | | | | | | | | | | | | | | | | | | | | | | | | | | | | | | | | | | | | | | | | |
| | | | | | | | | | | | | | | | | | | | | | | | | | | | | | | | | | | | | | | | | | | | | | | | | | | | | | | | | | | | | | | | | | | | | | | | | | | | | | | | |
| | | | | | | | | | | | | | | | | | | | | | | | | | | | | | | | | | | | | | | | | | | | | | | | | | | | | | | | | | | | | | | | | | | | | | | | | | | | | | | | |
| | | 1 | | | | | | | | | | | | | | | | | | | | | | | | | | | | | | | | | | | | | | | | | | | | | | | | | | | | | | | | | | | | | | | | | | | | | | | | | | | | | |
| 1 | | 2 | | | | | | | | | | | | | | | | | | | | | | | | | | | | | | | | | | | | | | | | | | | | | | | | | | | | | | | | | | | | | | | | | | | | | | | | | | | | | |
| | | | | | | | | | | | | | | | | | | | | | | | | | | | | | | | | | | | | | | | | | | | | | | | | | | | | | | | | | | | | | | | | | | | | | | | | | | | | | | | |
| | | | | | | | | | | | | | | | | | | | | | | | | | | | | | | | | | | | | | | | | | | | | | | | | | | | | | | | | | | | | | | | | | | | | | | | | | | | | | | | |
| | | | | | | | | | | | | | | | | | | | | | | | | | | | | | | | | | | | | | | | | | | | | | | | | | | | | | | | | | | | | | | | | | | | | | | | | | | | | | | | |
| | | 1 | | | | | | | | | | | | | | | | | | | | | | | | | | | | | | | | | | | | | | | | | | | | | | | | | | | | | | | | | | | | | | | | | | | | | | | | | | | | | |
| | | | | | | | | | | | | | | | | | | | | | | | | | | | | | | | | | | | | | | | | | | | | | | | | | | | | | | | | | | | | | | | | | | | | | | | | | | | | | | | |
| | | | | | | | | | | | | | | | | | | | | | | | | | | | | | | | | | | | | | | | | | | | | | | | | | | | | | | | | | | | | | | | | | | | | | | | | | | | | | | | |
| Post - 0 Miss - 0 Block - 0 | Post - 0 Miss - 0 Block - 0 | Post - 0 Miss - 0 Block - 0 | Post - 0 Miss - 0 Block - 0 | Post - 0 Miss - 0 Block - 0 | Post - 0 Miss - 0 Block - 0 | Post - 0 Miss - 0 Block - 0 | Post - 0 Miss - 0 Block - 0 | | | | | | | | | | | | | | | | | | | | | | | | | | | | | | | | | | | | | | | | | | | | | | | | | | | | | | | | | | | | | | | | | | | | | | | | |

比赛进程表

手球 青年男子 3-4名 轮次 6 组别 X 场次 41 滁州国际手球馆 2019-06-05 16:00

| 时间 | 队员 | 动作 | 比分 | 队员 | 动作 | | | |
|-------|--------|---------|-----|--------|---------|------|--|--|
| 上海宝山 | | | 上半时 | | | 江苏苏州 | | |
| 00:23 | 12 薛凯 | 挡住球 | 0-0 | 23 张铮洋 | 右远射 被救 | | | |
| 00:45 | 35 刘子杰 | 近射 被救 | | 12 周文贤 | 挡住球 | | | |
| 00:51 | | | | 8 王震 | 接球失误 | | | |
| 00:58 | 13 刘启群 | 造7M | | 13 蒋超 | 使被罚7M球 | | | |
| 01:09 | 35 刘子杰 | 7M球 得分 | 1-0 | 12 周文贤 | 被射入 | | | |
| 01:25 | 21 曾新宇 | 断球 | | 6 潘超群 | 传球失误 | | | |
| 01:28 | 21 曾新宇 | 一传快攻 得分 | 2-0 | 12 周文贤 | 被射入 | | | |
| 01:43 | 22 马浩东 | 断球 | | 8 王震 | 传球失误 | | | |
| 02:06 | 21 曾新宇 | 左远射 射失 | | | | | | |
| 02:42 | 12 薛凯 | 被射入 | 2-1 | 6 潘超群 | 中远射 得分 | | | |
| 03:31 | 10 马涛 | 接球失误 | | 18 何志伟 | 抢球 | | | |
| 03:34 | 22 马浩东 | 警告 | | | | | | |
| 04:10 | 12 薛凯 | 被射入 | 2-2 | 8 王震 | 右远射 得分 | | | |
| 04:46 | 35 刘子杰 | 近射 得分 | 3-2 | 12 周文贤 | 被射入 | | | |
| 04:49 | 21 曾新宇 | 助攻 | | | | | | |
| 05:00 | 12 薛凯 | 被射入 | 3-3 | 6 潘超群 | 左远射 得分 | | | |
| 05:32 | 21 曾新宇 | 传球失误 | | | | | | |
| 05:38 | 21 曾新宇 | 断球 | | 12 周文贤 | 快攻 传球失误 | | | |
| 05:56 | 22 马浩东 | 传球失误 | | | | | | |
| 06:37 | 66 黄嘉遥 | 被射入 | 3-4 | 5 马奔 | 近射 得分 | | | |
| 06:39 | | | | 18 何志伟 | 助攻 | | | |
| 07:01 | 22 马浩东 | 左边射 被救 | | 12 周文贤 | 挡住球 | | | |
| 07:12 | 19 张申杰 | 其它失误 | | | | | | |
| 07:29 | 66 黄嘉遥 | 被射入 | 3-5 | 6 潘超群 | 突破 得分 | | | |
| 08:17 | 13 刘启群 | 左边射 得分 | 4-5 | 12 周文贤 | 被射入 | | | |
| 08:29 | 12 薛凯 | 挡住球 | | 18 何志伟 | 近射 被救 | | | |
| 08:32 | | | | 23 张铮洋 | 助攻 | | | |
| 08:44 | 12 薛凯 | 挡住球 | | 23 张铮洋 | 右远射 被救 | | | |
| 08:46 | 35 刘子杰 | 使被罚7M球 | | 5 马奔 | 造7M | | | |
| 08:59 | 12 薛凯 | 挡住球 | | 6 潘超群 | 7M球 被救 | | | |
| 09:10 | 22 马浩东 | 四步 | | | | | | |
| 09:51 | | | | 8 王震 | 右远射 射失 | | | |
| 10:17 | 10 马涛 | 中远射 被封 | | 6 潘超群 | 封球 | | | |
| 10:22 | 12 薛凯 | 被射入 | 4-6 | 18 何志伟 | 一传快攻 得分 | | | |
| 10:46 | 21 曾新宇 | 中远射 得分 | 5-6 | 12 周文贤 | 被射入 | | | |
| 10:57 | 10 马涛 | 封球 | | 6 潘超群 | 中远射 被封 | | | |
| 11:26 | 10 马涛 | 右边射 被救 | | 12 周文贤 | 挡住球 | | | |
| 11:53 | 12 薛凯 | 被射入 | 5-7 | 23 张铮洋 | 近射 得分 | | | |
| 11:56 | | | | 6 潘超群 | 助攻 | | | |
| 12:04 | | 球队暂停 | | | | | | |
| 12:29 | 22 马浩东 | 传球失误 | | 18 何志伟 | 断球 | | | |

比赛进程表

手球 青年男子 3-4名 轮次 6 组别 X 场次 41 滁州国际手球馆 2019-06-05 16:00

| 时间 | 队员 | 动作 | 比分 | 队员 | 动作 |
|-------|--------|--------|-----|--------|---------|
| 上海宝山 | | | 上半时 | 江苏苏州 | |
| 12:32 | | | 5-7 | 18 何志伟 | 快攻 运球失误 |
| 12:39 | 13 刘启群 | 左边射 被救 | | 12 周文贤 | 挡住球 |
| 12:42 | | | | | 球队暂停 |
| 12:58 | 12 薛凯 | 挡住球 | | 13 蒋超 | 右边射 被救 |
| 13:11 | 10 马涛 | 中远射 得分 | 6-7 | 12 周文贤 | 被射入 |
| 13:25 | 12 薛凯 | 挡住球 | | 23 张铮洋 | 左远射 被救 |
| 14:01 | 21 曾新宇 | 左远射 击柱 | | | |
| 14:02 | | 裁判暂停 | | | |
| 14:02 | | | | 8 王震 | 罚出场2分钟 |
| 14:16 | 19 张申杰 | 右边射 被救 | | 12 周文贤 | 挡住球 |
| 14:51 | | | | 6 潘超群 | 四步 |
| 15:00 | 21 曾新宇 | 中远射 被封 | | 23 张铮洋 | 封球 |

比赛进程表

手球 3-4名 组别 X 滁州国际手球馆
青年男子 轮次 6 场次 41 2019-06-05 16:00

| 时间 | 队员 | 动作 | 比分 | 队员 | 动作 |
|-------|--------|--------|-------|--------|---------|
| 上海宝山 | | | 江苏苏州 | | |
| 00:14 | 13 刘启群 | 侵区 | 6-7 | | |
| 00:30 | | 裁判暂停 | | | |
| 00:30 | 13 刘启群 | 使被罚7M球 | | 10 朱红雨 | 造7M |
| 00:30 | 13 刘启群 | 罚出场2分钟 | | | |
| 00:31 | 12 薛凯 | 被射入 | 6-8 | 6 潘超群 | 7M球 得分 |
| 01:12 | 35 刘子杰 | 进攻犯规 | | 10 朱红雨 | 造犯规 |
| 01:26 | 22 马浩东 | 抢球 | | 23 张铮洋 | 接球失误 |
| 01:45 | 21 曾新宇 | 左远射 射失 | | | |
| 02:00 | 30 戴泽昊 | 封球 | | 6 潘超群 | 左远射 被封 |
| 02:28 | 22 马浩东 | 右远射 射失 | | | |
| 02:44 | | 裁判暂停 | | | |
| 03:20 | 12 薛凯 | 被射入 | 6-9 | 8 王震 | 中远射 得分 |
| 03:43 | 13 刘启群 | 四步 | | | |
| 04:07 | 12 薛凯 | 被射入 | 6-10 | 18 何志伟 | 左边射 得分 |
| 04:39 | | 球队暂停 | | | |
| 04:55 | 35 刘子杰 | 近射 射失 | | | |
| 05:17 | | | | 6 潘超群 | 传球失误 |
| 05:27 | 13 刘启群 | 左边射 得分 | 7-10 | 12 周文贤 | 被射入 |
| 05:56 | 12 薛凯 | 被射入 | 7-11 | 5 马奔 | 近射 得分 |
| 05:57 | | | | 6 潘超群 | 助攻 |
| 06:15 | 22 马浩东 | 右远射 得分 | 8-11 | 12 周文贤 | 被射入 |
| 06:42 | 10 马涛 | 使被罚7M球 | | 5 马奔 | 造7M |
| 06:43 | | | | 6 潘超群 | 助攻 |
| 07:04 | | | | 6 潘超群 | 7M球 击柱 |
| 07:33 | 35 刘子杰 | 中远射 得分 | 9-11 | 12 周文贤 | 被射入 |
| 08:20 | | | | 8 王震 | 任意球 击柱 |
| 08:51 | 21 曾新宇 | 传球失误 | | 18 何志伟 | 断球 |
| 08:56 | 12 薛凯 | 被射入 | 9-12 | 18 何志伟 | 一传快攻 得分 |
| 09:11 | 13 刘启群 | 接球失误 | | | |
| 10:09 | 12 薛凯 | 挡住球 | | 6 潘超群 | 任意球 被救 |
| 10:59 | 35 刘子杰 | 造7M | | 8 王震 | 使被罚7M球 |
| 11:02 | 21 曾新宇 | 助攻 | | | |
| 11:08 | 35 刘子杰 | 7M球 得分 | 10-12 | 12 周文贤 | 被射入 |
| 11:34 | | | | | 球队暂停 |
| 12:11 | 35 刘子杰 | 封球 | | 8 王震 | 中远射 被封 |
| 12:13 | 12 薛凯 | 被射入 | 10-13 | 18 何志伟 | 近射 得分 |
| 12:36 | | 球队暂停 | | | |
| 12:53 | 21 曾新宇 | 中远射 被救 | | 12 周文贤 | 挡住球 |
| 13:07 | | | | 23 张铮洋 | 侵区 |
| 13:17 | 13 刘启群 | 左边射 被救 | | 12 周文贤 | 挡住球 |
| 13:50 | 10 马涛 | 断球 | | 18 何志伟 | 传球失误 |

比赛进程表

手球 3-4名 组别 X 滁州国际手球馆
青年男子 轮次 6 场次 41 2019-06-05 16:00

| 时间 | 队员 | 动作 | 比分 | 队员 | 动作 |
|-------|--------|---------|-------|--------|--------|
| 上海宝山 | | | 江苏苏州 | | |
| | | | 下半时 | | |
| 13:55 | 19 张申杰 | 快攻 传球失误 | 10-13 | 8 王震 | 断球 |
| 14:01 | 19 张申杰 | 断球 | | 6 潘超群 | 传球失误 |
| 14:08 | 10 马涛 | 快攻 造7M | | 6 潘超群 | 使被罚7M球 |
| 14:11 | 35 刘子杰 | 7M球 得分 | 11-13 | 12 周文贤 | 被射入 |
| 14:23 | 12 薛凯 | 挡住球 | | 18 何志伟 | 左边射 被救 |
| 14:32 | 13 刘启群 | 左远射 被救 | | 12 周文贤 | 挡住球 |
| 14:47 | | | | 5 马奔 | 近射 射失 |
| 14:49 | | | | 18 何志伟 | 助攻 |
| 14:55 | 13 刘启群 | 左边射 得分 | 12-13 | 12 周文贤 | 被射入 |

| Team A | | | | | Team B | | | | | Match Number | | | | | | | | | | | |
|----------------|--|---------------|---------------------|----|------------------------------------|----------------|---|----|----------------|---------------|-----|----------------------|-----|---------------|--|--|---|---|----|---|----|
| A 安徽省体校 | | | | | B 中国香港 | | | | | 42 | | | | | | | | | | | |
| Played in | | | in the hall | | | on | | | at | | | Spectators | | | | | | | | | |
| 安徽滁州 | | | 滁州国际手球馆 | | | 2019-06-05 | | | 17:00 | | | hours | | | | | | | | | |
| Half-time(30') | A | B | End of playing time | A | B | 1st extra time | A | B | 2nd extra time | A | B | After penalty throws | A | B | | | | | | | |
| | 9 | 2 | 15 | 10 | | | | | | | | | | | | | | | | | |
| Number of 7 m | A | Team time-out | | | Full name of players and officials | | | | | Team time-out | | | B | Number of 7 m | | | | | | | |
| | 0/0 | 1 | 2 | 3 | | | | | | 1 | 2 | 3 | 2/3 | | | | | | | | |
| | | | 40:57 | | | | | | 07:25 | 44:22 | | | | | | | | | | | |
| No. | Team A | | | | | G | W | 2' | D | DR | No. | Team B | | | | | G | W | 2' | D | DR |
| 52 | 花驰 | | | | | | | | | | 1 | 江力为 | | | | | | | | | |
| 53 | 叶天赐 | | | | | | | | | | 2 | 梁凯乔 | | | | | | | | | |
| 54 | 姚幸运 | | | | | | | | | | 3 | 陈嘉熙 | | | | | | | | | |
| 55 | 苏凯 | | | | | 2 | | | | | 10 | 叶滋权 | | | | | 5 | | | | |
| 56 | 王健鹏 | | | | | 4 | | | | | 15 | 梁栢朗 | | | | | | | | | |
| 57 | 朱正翔 | | | | | 3 | | 1 | | | 16 | 冯智聪 | | | | | | | | | |
| 58 | 蔡博飞 | | | | | | | | | | 22 | 吴泽斌 | | | | | | | | | |
| 59 | 毛饶翔 | | | | | 4 | | 1 | | | 23 | 石铭泽 | | | | | | | 1 | | |
| 60 | 朱超 | | | | | | | | | | 27 | 巫迪涛 | | | | | 1 | | | | |
| 61 | 钮伟豪 | | | | | | | | | | 28 | 关健辉 | | | | | 1 | | | | |
| 62 | 赵俊阳 | | | | | 1 | | | | | 30 | 陈永曦 | | | | | | | | | |
| 64 | 章道胜 | | | | | 1 | | | | | 41 | 莫敬朗 | | | | | | | | | |
| 65 | 韩伟伦 | | | | | | | | | | 47 | 薛浩锋 | | | | | 2 | | | | |
| 66 | 刘家豪 | | | | | | | | | | 73 | 黄塋鏊 | | | | | 1 | | | | |
| 67 | 江文 | | | | | | | | | | 79 | 吴坤霖 | | | | | | | | | |
| 68 | 黄天源 | | | | | | | | | | 99 | 苏俊轩 | | | | | | | | | |
| A | 赵前军 | | | | | | | | | | B | 练明辉 (主教练) | | | | | | | | | |
| C | 吕串 | | | | | | | | | | C | 钟昀延 | | | | | | | | | |
| D | 沈强 | | | | | | | | | | | | | | | | | | | | |
| E | 李煜 | | | | | | | | | | | | | | | | | | | | |
| A | Signatures of responsables for the teams (Off.A) | | | | | | | | | | B | | | | | | | | | | |
| TP | Remarks of referees / HF Official | | | | | | | | | | TP | | | | | | | | | | |

Signatures

| | | | | |
|----------|-----------|-----------|--|--|
| Referees | 李兆蒙 (CHN) | 徐健 (CHN) | | |
| T.D. | 吴瑞亭 (CHN) | 吴国忠 (CHN) | | |
| CHA Off. | | | | |

Note: Number of 7m Throws Awarded to Team A and B, Goals (G), Warnings (W), Suspensions (2'), Direct Disqualification (D), Disqualification With Report (DR) and Team Penalty (TP).

Table Officials: 李莉君 吴荣 Statisticians: 马安兴 沈家洛

第二届全国青年运动会男子手球乙组决赛 体校组 (U16)

PHMS Pictorial Handball Match Statistics

IHF Official System

竞赛技术统计

手球
青年男子

决赛
轮次 6

组别 X
场次 42

滁州国际手球馆
2019-06-05 17:00

Referees: 李兆蒙 (CHN) / 徐健 (CHN)

Result: 15:10(9:2)

Teams: 安徽省体校(安徽) VS 中国香港(香港)

| 安徽 | | 远射 | 近射 | 边射 | 快攻 | 突破 | 任意球 | 7m球 | 合计 | % | 助攻 | 失误 | 警告 | 2' | D+DR |
|---------|-----|------|-----|-----|-----|-----|-----|-------|-------|------|----|----|----|----|------|
| 主教练: 张林 | | | | | | | | | | | | | | | |
| 52 | 花驰 | | | | | | | | | | | | | | |
| 53 | 叶天赐 | | | | | | | | | | | | | | |
| 54 | 姚幸运 | | | | | | | | | | | | | | |
| 55 | 苏凯 | | 1/1 | 1/1 | 0/1 | | | 2/3 | 66.7 | | 2 | | | | |
| 56 | 王健鹏 | 1/3 | 3/3 | | | | | 4/6 | 66.7 | 1 | | | | | |
| 57 | 朱正翔 | 1/3 | 1/1 | 1/1 | | | | 3/5 | 60.0 | | | | | 1 | |
| 58 | 蔡博飞 | | 0/1 | | | | | 0/1 | 0.0 | 1 | 1 | | | | |
| 59 | 毛饶翔 | 1/4 | | | 2/2 | 1/1 | 0/1 | 4/8 | 50.0 | 1 | 1 | | | 1 | |
| 60 | 朱超 | | | 0/1 | | | | 0/1 | 0.0 | | | | | | |
| 61 | 钮伟豪 | | | | | | | | | | | | | | |
| 62 | 赵俊阳 | | 1/1 | | | | | 1/1 | 100 | | 2 | | | | |
| 64 | 章道胜 | | 1/1 | | | | | 1/1 | 100 | | 1 | | | | |
| 65 | 韩伟伦 | | | | | | | | | | | | | | |
| 66 | 刘家豪 | | | | | | | | | | | | | | |
| 67 | 江文 | | | | | | | | | | | | | | |
| 68 | 黄天源 | | | | | | | | | | | | | | |
| 运动员 | 合计 | 3/10 | 7/8 | 2/3 | 2/3 | 1/1 | 0/1 | 15/26 | 57.7 | 3 | 7 | | | 2 | |
| 52 | 花驰 | 2/2 | 2/4 | 2/4 | 0/1 | 2/5 | 1/1 | 1/3 | 10/20 | 50.0 | | | | | |
| 守门员 | 合计 | 2/2 | 2/4 | 2/4 | 0/1 | 2/5 | 1/1 | 1/3 | 10/20 | 50.0 | | | | | |

| 安徽 | 比赛进程 | 香港 |
|----------|----------|-----------|
| 1st Half | | |
| 57 朱正翔 | 1 00:28 | 0 |
| 56 王健鹏 | 2 01:15 | 0 |
| | 2 02:37 | 1 27 巫迪涛 |
| 55 苏凯 | 3 04:09 | 1 |
| | 3 05:16 | 2 47 薛浩锋 |
| 56 王健鹏 | 4 05:33 | 2 |
| 59 毛饶翔 | 5 07:16 | 2 |
| 55 苏凯 | 6 09:07 | 2 |
| 59 毛饶翔 | 7 10:06 | 2 |
| 59 毛饶翔 | 8 13:47 | 2 |
| 59 毛饶翔 | 9 14:52 | 2 |
| 2nd Half | | |
| | 9 00:28 | 3 28 关健辉 |
| 56 王健鹏 | 10 01:49 | 3 |
| | 10 02:57 | 4 47 薛浩锋 |
| | 10 03:44 | 5 10 叶滋权 |
| 62 赵俊阳 | 11 04:19 | 5 |
| | 11 05:11 | 6 73 黄望臻 |
| | 11 07:23 | 7 10 叶滋权 |
| 56 王健鹏 | 12 10:10 | 7 |
| | 12 10:57 | 8 10 叶滋权 |
| | 12 11:33 | 9 10 叶滋权 |
| 64 章道胜 | 13 12:02 | 9 |
| | 13 12:44 | 10 10 叶滋权 |
| 57 朱正翔 | 14 13:26 | 10 |
| 57 朱正翔 | 15 15:00 | 10 |

| 香港 | | 远射 | 近射 | 边射 | 快攻 | 突破 | 任意球 | 7m球 | 合计 | % | 助攻 | 失误 | 警告 | 2' | D+DR |
|----------|-----|-----|-----|-----|-----|-----|-----|------|-------|------|----|----|----|----|------|
| 主教练: 练明辉 | | | | | | | | | | | | | | | |
| 1 | 江力为 | | | | | | | | | | | | | | |
| 2 | 梁凯乔 | | | | | | | | | | | 1 | | | |
| 3 | 陈嘉熙 | | | | | | | | | | 1 | | | | |
| 10 | 叶滋权 | 0/2 | 1/1 | | | 3/4 | | 1/1 | 5/8 | 62.5 | | 1 | | | |
| 15 | 梁栢朗 | | | | | | | | | | | | | | |
| 16 | 冯智聪 | | | | | | | | | | | | | | |
| 22 | 吴泽斌 | | | | | | | | | | | | | | |
| 23 | 石铭泽 | | 0/1 | | | | | 0/1 | 0.0 | | | | | 1 | |
| 27 | 巫迪涛 | 0/1 | 0/1 | | | | 0/2 | 1/1 | 1/5 | 20.0 | | 2 | | | |
| 28 | 关健辉 | | | 1/1 | | | | 1/1 | 100 | | | | | | |
| 30 | 陈永曦 | | | | | | | | | | | | | | |
| 41 | 莫敬朗 | | | 0/1 | | | | 0/1 | 0.0 | | 1 | | | | |
| 47 | 薛浩锋 | 0/2 | 1/2 | 1/2 | | 0/1 | | 0/1 | 2/8 | 25.0 | | 1 | | | |
| 73 | 黄望臻 | | | | 1/1 | | | 1/1 | 100 | | | | | | |
| 79 | 吴坤霖 | | | | | | | | | | | | | | |
| 99 | 苏俊轩 | | | | | | | | | | | | | | |
| 运动员 | 合计 | 0/5 | 2/5 | 2/4 | 1/1 | 3/5 | 0/2 | 2/3 | 10/25 | 40.0 | 1 | 6 | | 1 | |
| 1 | 江力为 | 0/2 | 0/3 | 0/1 | | | | 0/6 | 0.0 | | | | | | |
| 22 | 吴泽斌 | 1/2 | | 1/2 | 1/3 | 0/1 | | 3/8 | 37.5 | | | | | | |
| 99 | 苏俊轩 | 1/1 | 1/5 | | | | | 2/6 | 33.3 | | | | | | |
| 守门员 | 合计 | 2/5 | 1/8 | 1/3 | 1/3 | 0/1 | | 5/20 | 25.0 | | | | | | |

场上队员: 得分 / 射门

守门员: 救球 / 射门

| | | | |
|---|------|----|---------|
| D | 取消资格 | DR | 取消资格+报告 |
|---|------|----|---------|

个人/全队技术统计表

手球 青年男子 决赛 轮次 6 组别 X 场次 42 滁州国际手球馆 2019-06-05 17:00

| 号码 | 姓名 | 远射 | 近射 | 边射 | 快攻 | 突破 | 任意 | 七米 | 合计 | % | 助攻 | 失误 | 警告 | 2' | 取消 | 时间 |
|-----------|-----|------|-----|-----|-----|-----|-----|-----|-------|-------|----|----|----|----|----|----------|
| 安徽省体校(安徽) | | | | | | | | | | | | | | | | |
| (场上队员) | | | | | | | | | | | | | | | | |
| 52 | 花驰 | | | | | | | | | 0.0% | | | | | | 00:30:00 |
| 53 | 叶天赐 | | | | | | | | | 0.0% | | | | | | 00:00:00 |
| 54 | 姚幸运 | | | | | | | | | 0.0% | | | | | | 00:00:00 |
| 55 | 苏凯 | | 1/1 | 1/1 | 0/1 | | | | 2/3 | 66.7% | | 2 | | | | 00:29:22 |
| 56 | 王健鹏 | 1/3 | 3/3 | | | | | | 4/6 | 66.7% | 1 | | | | | 00:23:07 |
| 57 | 朱正翔 | 1/3 | 1/1 | 1/1 | | | | | 3/5 | 60.0% | | | | 1 | | 00:27:40 |
| 58 | 蔡博飞 | | 0/1 | | | | | | 0/1 | 0.0% | 1 | 1 | | | | 00:11:09 |
| 59 | 毛饶翔 | 1/4 | | | 2/2 | 1/1 | 0/1 | | 4/8 | 50.0% | 1 | 1 | | 1 | | 00:30:00 |
| 60 | 朱超 | | | 0/1 | | | | | 0/1 | 0.0% | | | | | | 00:21:28 |
| 61 | 钮伟豪 | | | | | | | | | 0.0% | | | | | | 00:00:00 |
| 62 | 赵俊阳 | | 1/1 | | | | | | 1/1 | 100% | | 2 | | | | 00:09:07 |
| 64 | 章道胜 | | 1/1 | | | | | | 1/1 | 100% | | 1 | | | | 00:27:20 |
| 65 | 韩伟伦 | | | | | | | | | 0.0% | | | | | | 00:00:38 |
| 66 | 刘家豪 | | | | | | | | | 0.0% | | | | | | 00:00:00 |
| 67 | 江文 | | | | | | | | | 0.0% | | | | | | 00:00:00 |
| 68 | 黄天源 | | | | | | | | | 0.0% | | | | | | 00:00:00 |
| | 合计 | 3/10 | 7/8 | 2/3 | 2/3 | 1/1 | 0/1 | | 15/26 | 57.7% | 3 | 7 | | 2 | | |
| (守门员) | | | | | | | | | | | | | | | | |
| 52 | 花驰 | 2/2 | 2/4 | 2/4 | 0/1 | 2/5 | 1/1 | 1/3 | 10/20 | 50.0% | | | | | | 00:30:00 |
| | 合计 | 2/2 | 2/4 | 2/4 | 0/1 | 2/5 | 1/1 | 1/3 | 10/20 | 50.0% | | | | | | |

场上队员：得分/射门

守门员：救球/射门

| 全队合计 | 得分 | 被救 | 射失 | 击柱 | 封球 | 合计 | % |
|------|----|----|----|----|----|----|--------|
| 远射 | 3 | 2 | | 1 | 4 | 10 | 30.0% |
| 近射 | 7 | 1 | | | | 8 | 87.5% |
| 边射 | 2 | 1 | | | | 3 | 66.7% |
| 快攻 | 2 | 1 | | | | 3 | 66.7% |
| 突破 | 1 | | | | | 1 | 100.0% |
| 任意 | | | | 1 | | 1 | 0.0% |
| 七米 | | | | | | | 0.0% |

个人/全队技术统计表

手球 青年男子 决赛 轮次 6 组别 X 场次 42 滁州国际手球馆 2019-06-05 17:00

| 号码 | 姓名 | 远射 | 近射 | 边射 | 快攻 | 突破 | 任意 | 七米 | 合计 | % | 助攻 | 失误 | 警告 | 2' | 取消 | 时间 |
|----------|-----|-----|-----|-----|-----|-----|-----|-----|-------|-------|----|----|----|----|----|----------|
| 中国香港(香港) | | | | | | | | | | | | | | | | |
| (场上队员) | | | | | | | | | | | | | | | | |
| 1 | 江力为 | | | | | | | | | 0.0% | | | | | | 00:08:39 |
| 2 | 梁凯乔 | | | | | | | | | 0.0% | | 1 | | | | 00:10:57 |
| 3 | 陈嘉熙 | | | | | | | | | 0.0% | 1 | | | | | 00:08:30 |
| 10 | 叶滋权 | 0/2 | 1/1 | | | 3/4 | | 1/1 | 5/8 | 62.5% | | 1 | | | | 00:14:13 |
| 15 | 梁栢朗 | | | | | | | | | 0.0% | | | | | | 00:13:33 |
| 16 | 冯智聪 | | | | | | | | | 0.0% | | | | | | 00:00:00 |
| 22 | 吴泽斌 | | | | | | | | | 0.0% | | | | | | 00:09:11 |
| 23 | 石铭泽 | | 0/1 | | | | | | 0/1 | 0.0% | | | | 1 | | 00:22:39 |
| 27 | 巫迪涛 | 0/1 | 0/1 | | | | 0/2 | 1/1 | 1/5 | 20.0% | | 2 | | | | 00:15:00 |
| 28 | 关键辉 | | | 1/1 | | | | | 1/1 | 100% | | | | | | 00:14:32 |
| 30 | 陈永曦 | | | | | | | | | 0.0% | | | | | | 00:08:13 |
| 41 | 莫敬朗 | | | 0/1 | | | | | 0/1 | 0.0% | | 1 | | | | 00:11:50 |
| 47 | 薛浩锋 | 0/2 | 1/2 | 1/2 | | 0/1 | | 0/1 | 2/8 | 25.0% | | 1 | | | | 00:29:52 |
| 73 | 黄望婆 | | | | 1/1 | | | | 1/1 | 100% | | | | | | 00:14:35 |
| 79 | 吴坤霖 | | | | | | | | | 0.0% | | | | | | 00:15:00 |
| 99 | 苏俊轩 | | | | | | | | | 0.0% | | | | | | 00:12:10 |
| 合计 | | 0/5 | 2/5 | 2/4 | 1/1 | 3/5 | 0/2 | 2/3 | 10/25 | 40.0% | 1 | 6 | | 1 | | |

(守门员)

| | | | | | | | | | | | | | | | | |
|----|-----|-----|-----|-----|-----|-----|--|--|------|-------|--|--|--|--|--|----------|
| 1 | 江力为 | 0/2 | 0/3 | 0/1 | | | | | 0/6 | 0.0% | | | | | | 00:08:39 |
| 22 | 吴泽斌 | 1/2 | | 1/2 | 1/3 | 0/1 | | | 3/8 | 37.5% | | | | | | 00:09:11 |
| 99 | 苏俊轩 | 1/1 | 1/5 | | | | | | 2/6 | 33.3% | | | | | | 00:12:10 |
| 合计 | | 2/5 | 1/8 | 1/3 | 1/3 | 0/1 | | | 5/20 | 25.0% | | | | | | |

场上队员：得分/射门

守门员：救球/射门

| 全队合计 | 得分 | 被救 | 射失 | 击柱 | 封球 | 合计 | % |
|------|----|----|----|----|----|----|--------|
| 远射 | | 2 | 2 | | 1 | 5 | 0.0% |
| 近射 | 2 | 2 | 1 | | | 5 | 40.0% |
| 边射 | 2 | 2 | | | | 4 | 50.0% |
| 快攻 | 1 | | | | | 1 | 100.0% |
| 突破 | 3 | 2 | | | | 5 | 60.0% |
| 任意 | | 1 | 1 | | | 2 | 0.0% |
| 七米 | 2 | 1 | | | | 3 | 66.7% |

图式比赛技术统计表

手球
青年男子

决赛
轮次 6

组别 X
场次 42

滁州国际手球馆
2019-06-05 17:00

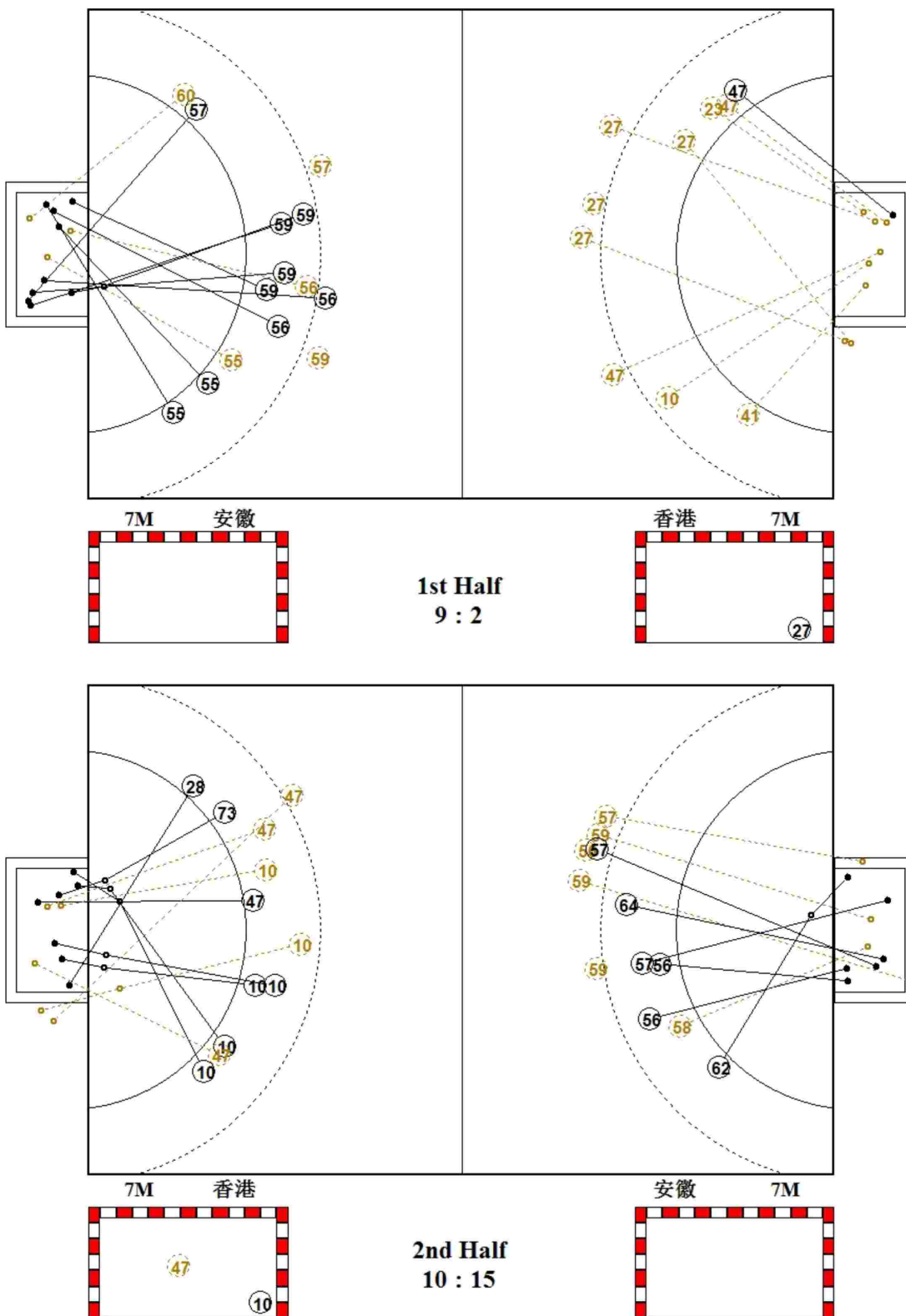

图式射门区域统计

手球
青年男子

决赛
轮次 6

组别 X
场次 42

滁州国际手球馆
2019-06-05 17:00

安徽省体校

| | | | | | | | | | | | | | | | | | | | | | | | | | | | | | | | | | | | | | | | | | | | | | | | | | | | | | | | | | | | | | | | | | | | | | | | | | | | | | | | |
|--|-----------------------------|-----------------------------|-----------------------------|-----------------------------|-----------------------------|-----------------------------|-----------------------------|--|--|--|--|--|--|--|--|--|--|--|--|---|--|--|--|--|--|--|---|--|--|---|--|--|---|--|--|--|--|--|--|---|--|---|---|--|--|---|--|--|--|--|---|--|--|--|--|---|--|--|--|--|--|--|--|--|--|--|--|--|--|---|---|--|--|--|--|--|---|--|---|
| 52 花驰 | 53 叶天赐 | 54 姚幸运 | 55 苏凯 | 56 王健鹏 | 57 朱正翔 | 58 蔡博飞 | 59 毛饶翔 | | | | | | | | | | | | | | | | | | | | | | | | | | | | | | | | | | | | | | | | | | | | | | | | | | | | | | | | | | | | | | | | | | | | | | | | |
| <table border="1"><tr><td></td><td></td><td></td></tr><tr><td></td><td></td><td></td></tr><tr><td></td><td></td><td></td></tr></table> | | | | | | | | | | <table border="1"><tr><td></td><td></td><td></td></tr><tr><td></td><td></td><td></td></tr><tr><td></td><td></td><td></td></tr></table> | | | | | | | | | | <table border="1"><tr><td></td><td></td><td></td></tr><tr><td></td><td></td><td></td></tr><tr><td></td><td></td><td></td></tr></table> | | | | | | | | | | <table border="1"><tr><td></td><td></td><td>2</td></tr><tr><td></td><td></td><td></td></tr><tr><td></td><td></td><td></td></tr></table> | | | 2 | | | | | | | <table border="1"><tr><td></td><td>1</td><td>1</td></tr><tr><td></td><td></td><td>2</td></tr><tr><td></td><td></td><td></td></tr></table> | | 1 | 1 | | | 2 | | | | <table border="1"><tr><td>2</td><td></td><td></td></tr><tr><td></td><td></td><td>1</td></tr><tr><td></td><td></td><td></td></tr></table> | 2 | | | | | 1 | | | | <table border="1"><tr><td></td><td></td><td></td></tr><tr><td></td><td></td><td></td></tr><tr><td></td><td></td><td></td></tr></table> | | | | | | | | | | <table border="1"><tr><td>2</td><td></td><td></td></tr><tr><td></td><td></td><td></td></tr><tr><td>1</td><td></td><td>1</td></tr></table> | 2 | | | | | | 1 | | 1 |
| | | | | | | | | | | | | | | | | | | | | | | | | | | | | | | | | | | | | | | | | | | | | | | | | | | | | | | | | | | | | | | | | | | | | | | | | | | | | | | | |
| | | | | | | | | | | | | | | | | | | | | | | | | | | | | | | | | | | | | | | | | | | | | | | | | | | | | | | | | | | | | | | | | | | | | | | | | | | | | | | | |
| | | | | | | | | | | | | | | | | | | | | | | | | | | | | | | | | | | | | | | | | | | | | | | | | | | | | | | | | | | | | | | | | | | | | | | | | | | | | | | | |
| | | | | | | | | | | | | | | | | | | | | | | | | | | | | | | | | | | | | | | | | | | | | | | | | | | | | | | | | | | | | | | | | | | | | | | | | | | | | | | | |
| | | | | | | | | | | | | | | | | | | | | | | | | | | | | | | | | | | | | | | | | | | | | | | | | | | | | | | | | | | | | | | | | | | | | | | | | | | | | | | | |
| | | | | | | | | | | | | | | | | | | | | | | | | | | | | | | | | | | | | | | | | | | | | | | | | | | | | | | | | | | | | | | | | | | | | | | | | | | | | | | | |
| | | | | | | | | | | | | | | | | | | | | | | | | | | | | | | | | | | | | | | | | | | | | | | | | | | | | | | | | | | | | | | | | | | | | | | | | | | | | | | | |
| | | | | | | | | | | | | | | | | | | | | | | | | | | | | | | | | | | | | | | | | | | | | | | | | | | | | | | | | | | | | | | | | | | | | | | | | | | | | | | | |
| | | | | | | | | | | | | | | | | | | | | | | | | | | | | | | | | | | | | | | | | | | | | | | | | | | | | | | | | | | | | | | | | | | | | | | | | | | | | | | | |
| | | 2 | | | | | | | | | | | | | | | | | | | | | | | | | | | | | | | | | | | | | | | | | | | | | | | | | | | | | | | | | | | | | | | | | | | | | | | | | | | | | |
| | | | | | | | | | | | | | | | | | | | | | | | | | | | | | | | | | | | | | | | | | | | | | | | | | | | | | | | | | | | | | | | | | | | | | | | | | | | | | | | |
| | | | | | | | | | | | | | | | | | | | | | | | | | | | | | | | | | | | | | | | | | | | | | | | | | | | | | | | | | | | | | | | | | | | | | | | | | | | | | | | |
| | 1 | 1 | | | | | | | | | | | | | | | | | | | | | | | | | | | | | | | | | | | | | | | | | | | | | | | | | | | | | | | | | | | | | | | | | | | | | | | | | | | | | |
| | | 2 | | | | | | | | | | | | | | | | | | | | | | | | | | | | | | | | | | | | | | | | | | | | | | | | | | | | | | | | | | | | | | | | | | | | | | | | | | | | | |
| | | | | | | | | | | | | | | | | | | | | | | | | | | | | | | | | | | | | | | | | | | | | | | | | | | | | | | | | | | | | | | | | | | | | | | | | | | | | | | | |
| 2 | | | | | | | | | | | | | | | | | | | | | | | | | | | | | | | | | | | | | | | | | | | | | | | | | | | | | | | | | | | | | | | | | | | | | | | | | | | | | | | |
| | | 1 | | | | | | | | | | | | | | | | | | | | | | | | | | | | | | | | | | | | | | | | | | | | | | | | | | | | | | | | | | | | | | | | | | | | | | | | | | | | | |
| | | | | | | | | | | | | | | | | | | | | | | | | | | | | | | | | | | | | | | | | | | | | | | | | | | | | | | | | | | | | | | | | | | | | | | | | | | | | | | | |
| | | | | | | | | | | | | | | | | | | | | | | | | | | | | | | | | | | | | | | | | | | | | | | | | | | | | | | | | | | | | | | | | | | | | | | | | | | | | | | | |
| | | | | | | | | | | | | | | | | | | | | | | | | | | | | | | | | | | | | | | | | | | | | | | | | | | | | | | | | | | | | | | | | | | | | | | | | | | | | | | | |
| | | | | | | | | | | | | | | | | | | | | | | | | | | | | | | | | | | | | | | | | | | | | | | | | | | | | | | | | | | | | | | | | | | | | | | | | | | | | | | | |
| 2 | | | | | | | | | | | | | | | | | | | | | | | | | | | | | | | | | | | | | | | | | | | | | | | | | | | | | | | | | | | | | | | | | | | | | | | | | | | | | | | |
| | | | | | | | | | | | | | | | | | | | | | | | | | | | | | | | | | | | | | | | | | | | | | | | | | | | | | | | | | | | | | | | | | | | | | | | | | | | | | | | |
| 1 | | 1 | | | | | | | | | | | | | | | | | | | | | | | | | | | | | | | | | | | | | | | | | | | | | | | | | | | | | | | | | | | | | | | | | | | | | | | | | | | | | |
| Post - 0 Miss - 0 Block - 0 | Post - 0 Miss - 0 Block - 0 | Post - 0 Miss - 0 Block - 0 | Post - 0 Miss - 0 Block - 0 | Post - 0 Miss - 0 Block - 1 | Post - 1 Miss - 0 Block - 1 | Post - 0 Miss - 0 Block - 0 | Post - 1 Miss - 0 Block - 2 | | | | | | | | | | | | | | | | | | | | | | | | | | | | | | | | | | | | | | | | | | | | | | | | | | | | | | | | | | | | | | | | | | | | | | | | |
| 60 朱超 | 61 钮伟豪 | 62 赵俊阳 | 64 章道胜 | 65 韩伟伦 | 66 刘家豪 | 67 江文 | 68 黄天源 | | | | | | | | | | | | | | | | | | | | | | | | | | | | | | | | | | | | | | | | | | | | | | | | | | | | | | | | | | | | | | | | | | | | | | | | |
| <table border="1"><tr><td></td><td></td><td></td></tr><tr><td></td><td></td><td></td></tr><tr><td></td><td></td><td></td></tr></table> | | | | | | | | | | <table border="1"><tr><td></td><td></td><td></td></tr><tr><td></td><td></td><td></td></tr><tr><td></td><td></td><td></td></tr></table> | | | | | | | | | | <table border="1"><tr><td></td><td></td><td></td></tr><tr><td></td><td></td><td></td></tr><tr><td>1</td><td></td><td></td></tr></table> | | | | | | | 1 | | | <table border="1"><tr><td></td><td></td><td>1</td></tr><tr><td></td><td></td><td></td></tr><tr><td></td><td></td><td></td></tr></table> | | | 1 | | | | | | | <table border="1"><tr><td></td><td></td><td></td></tr><tr><td></td><td></td><td></td></tr><tr><td></td><td></td><td></td></tr></table> | | | | | | | | | | <table border="1"><tr><td></td><td></td><td></td></tr><tr><td></td><td></td><td></td></tr><tr><td></td><td></td><td></td></tr></table> | | | | | | | | | | <table border="1"><tr><td></td><td></td><td></td></tr><tr><td></td><td></td><td></td></tr><tr><td></td><td></td><td></td></tr></table> | | | | | | | | | | <table border="1"><tr><td></td><td></td><td></td></tr><tr><td></td><td></td><td></td></tr><tr><td></td><td></td><td></td></tr></table> | | | | | | | | | |
| | | | | | | | | | | | | | | | | | | | | | | | | | | | | | | | | | | | | | | | | | | | | | | | | | | | | | | | | | | | | | | | | | | | | | | | | | | | | | | | |
| | | | | | | | | | | | | | | | | | | | | | | | | | | | | | | | | | | | | | | | | | | | | | | | | | | | | | | | | | | | | | | | | | | | | | | | | | | | | | | | |
| | | | | | | | | | | | | | | | | | | | | | | | | | | | | | | | | | | | | | | | | | | | | | | | | | | | | | | | | | | | | | | | | | | | | | | | | | | | | | | | |
| | | | | | | | | | | | | | | | | | | | | | | | | | | | | | | | | | | | | | | | | | | | | | | | | | | | | | | | | | | | | | | | | | | | | | | | | | | | | | | | |
| | | | | | | | | | | | | | | | | | | | | | | | | | | | | | | | | | | | | | | | | | | | | | | | | | | | | | | | | | | | | | | | | | | | | | | | | | | | | | | | |
| | | | | | | | | | | | | | | | | | | | | | | | | | | | | | | | | | | | | | | | | | | | | | | | | | | | | | | | | | | | | | | | | | | | | | | | | | | | | | | | |
| | | | | | | | | | | | | | | | | | | | | | | | | | | | | | | | | | | | | | | | | | | | | | | | | | | | | | | | | | | | | | | | | | | | | | | | | | | | | | | | |
| | | | | | | | | | | | | | | | | | | | | | | | | | | | | | | | | | | | | | | | | | | | | | | | | | | | | | | | | | | | | | | | | | | | | | | | | | | | | | | | |
| 1 | | | | | | | | | | | | | | | | | | | | | | | | | | | | | | | | | | | | | | | | | | | | | | | | | | | | | | | | | | | | | | | | | | | | | | | | | | | | | | | |
| | | 1 | | | | | | | | | | | | | | | | | | | | | | | | | | | | | | | | | | | | | | | | | | | | | | | | | | | | | | | | | | | | | | | | | | | | | | | | | | | | | |
| | | | | | | | | | | | | | | | | | | | | | | | | | | | | | | | | | | | | | | | | | | | | | | | | | | | | | | | | | | | | | | | | | | | | | | | | | | | | | | | |
| | | | | | | | | | | | | | | | | | | | | | | | | | | | | | | | | | | | | | | | | | | | | | | | | | | | | | | | | | | | | | | | | | | | | | | | | | | | | | | | |
| | | | | | | | | | | | | | | | | | | | | | | | | | | | | | | | | | | | | | | | | | | | | | | | | | | | | | | | | | | | | | | | | | | | | | | | | | | | | | | | |
| | | | | | | | | | | | | | | | | | | | | | | | | | | | | | | | | | | | | | | | | | | | | | | | | | | | | | | | | | | | | | | | | | | | | | | | | | | | | | | | |
| | | | | | | | | | | | | | | | | | | | | | | | | | | | | | | | | | | | | | | | | | | | | | | | | | | | | | | | | | | | | | | | | | | | | | | | | | | | | | | | |
| | | | | | | | | | | | | | | | | | | | | | | | | | | | | | | | | | | | | | | | | | | | | | | | | | | | | | | | | | | | | | | | | | | | | | | | | | | | | | | | |
| | | | | | | | | | | | | | | | | | | | | | | | | | | | | | | | | | | | | | | | | | | | | | | | | | | | | | | | | | | | | | | | | | | | | | | | | | | | | | | | |
| | | | | | | | | | | | | | | | | | | | | | | | | | | | | | | | | | | | | | | | | | | | | | | | | | | | | | | | | | | | | | | | | | | | | | | | | | | | | | | | |
| | | | | | | | | | | | | | | | | | | | | | | | | | | | | | | | | | | | | | | | | | | | | | | | | | | | | | | | | | | | | | | | | | | | | | | | | | | | | | | | |
| | | | | | | | | | | | | | | | | | | | | | | | | | | | | | | | | | | | | | | | | | | | | | | | | | | | | | | | | | | | | | | | | | | | | | | | | | | | | | | | |
| | | | | | | | | | | | | | | | | | | | | | | | | | | | | | | | | | | | | | | | | | | | | | | | | | | | | | | | | | | | | | | | | | | | | | | | | | | | | | | | |
| | | | | | | | | | | | | | | | | | | | | | | | | | | | | | | | | | | | | | | | | | | | | | | | | | | | | | | | | | | | | | | | | | | | | | | | | | | | | | | | |
| | | | | | | | | | | | | | | | | | | | | | | | | | | | | | | | | | | | | | | | | | | | | | | | | | | | | | | | | | | | | | | | | | | | | | | | | | | | | | | | |
| | | | | | | | | | | | | | | | | | | | | | | | | | | | | | | | | | | | | | | | | | | | | | | | | | | | | | | | | | | | | | | | | | | | | | | | | | | | | | | | |
| Post - 0 Miss - 0 Block - 0 | Post - 0 Miss - 0 Block - 0 | Post - 0 Miss - 0 Block - 0 | Post - 0 Miss - 0 Block - 0 | Post - 0 Miss - 0 Block - 0 | Post - 0 Miss - 0 Block - 0 | Post - 0 Miss - 0 Block - 0 | Post - 0 Miss - 0 Block - 0 | | | | | | | | | | | | | | | | | | | | | | | | | | | | | | | | | | | | | | | | | | | | | | | | | | | | | | | | | | | | | | | | | | | | | | | | |

52 花驰

| | | |
|-----|-----|-----|
| 2/3 | 1/1 | 0/1 |
| 2/3 | 2/3 | 3/4 |
| 0/1 | | 0/4 |

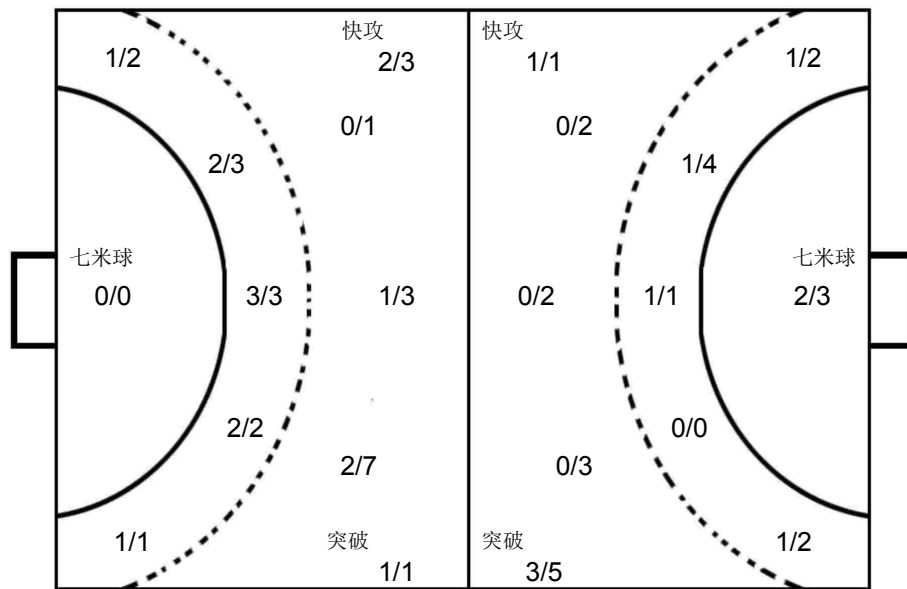

1 江力为

| | | |
|-----|--|-----|
| 0/2 | | |
| 0/1 | | 0/3 |
| | | |

22 吴泽斌

| | | |
|-----|-----|-----|
| 0/2 | | 1/1 |
| | 1/1 | 0/1 |
| 0/1 | | 1/2 |

99 苏俊轩

| | | |
|-----|-----|-----|
| | | 0/1 |
| | 2/2 | |
| 0/1 | | 0/2 |

中国香港

| | | | | | | | | | | | | | | | | | | | | | | | | | | | | | | | | | | | | | | | | | | | | | | | | | | | | | | | | | | | | | | | | | | | | | | | | | | | | | | | |
|---|-----------------------------|-----------------------------|-----------------------------|-----------------------------|-----------------------------|-----------------------------|-----------------------------|--|--|---|--|--|--|--|---|--|--|--|--|--|--|--|--|--|--|--|--|--|--|---|--|---|---|--|--|---|--|--|--|--|--|---|---|--|--|--|--|--|--|---|--|--|---|--|--|--|--|--|--|--|--|--|--|--|--|--|--|--|--|--|--|--|--|--|--|--|--|--|--|
| 1 江力为 | 2 梁凯乔 | 3 陈嘉熙 | 10 叶滋权 | 15 梁栢朗 | 16 冯智聪 | 22 吴泽斌 | 23 石铭泽 | | | | | | | | | | | | | | | | | | | | | | | | | | | | | | | | | | | | | | | | | | | | | | | | | | | | | | | | | | | | | | | | | | | | | | | | |
| <table border="1"><tr><td></td><td></td><td></td></tr><tr><td></td><td></td><td></td></tr><tr><td></td><td></td><td></td></tr></table> | | | | | | | | | | <table border="1"><tr><td></td><td></td><td></td></tr><tr><td></td><td></td><td></td></tr><tr><td></td><td></td><td></td></tr></table> | | | | | | | | | | <table border="1"><tr><td></td><td></td><td></td></tr><tr><td></td><td></td><td></td></tr><tr><td></td><td></td><td></td></tr></table> | | | | | | | | | | <table border="1"><tr><td></td><td>1</td><td>1</td></tr><tr><td></td><td></td><td>3</td></tr><tr><td></td><td></td><td></td></tr></table> | | 1 | 1 | | | 3 | | | | <table border="1"><tr><td></td><td></td><td></td></tr><tr><td></td><td></td><td></td></tr><tr><td></td><td></td><td></td></tr></table> | | | | | | | | | | <table border="1"><tr><td></td><td></td><td></td></tr><tr><td></td><td></td><td></td></tr><tr><td></td><td></td><td></td></tr></table> | | | | | | | | | | <table border="1"><tr><td></td><td></td><td></td></tr><tr><td></td><td></td><td></td></tr><tr><td></td><td></td><td></td></tr></table> | | | | | | | | | | <table border="1"><tr><td></td><td></td><td></td></tr><tr><td></td><td></td><td></td></tr><tr><td></td><td></td><td></td></tr></table> | | | | | | | | | |
| | | | | | | | | | | | | | | | | | | | | | | | | | | | | | | | | | | | | | | | | | | | | | | | | | | | | | | | | | | | | | | | | | | | | | | | | | | | | | | | |
| | | | | | | | | | | | | | | | | | | | | | | | | | | | | | | | | | | | | | | | | | | | | | | | | | | | | | | | | | | | | | | | | | | | | | | | | | | | | | | | |
| | | | | | | | | | | | | | | | | | | | | | | | | | | | | | | | | | | | | | | | | | | | | | | | | | | | | | | | | | | | | | | | | | | | | | | | | | | | | | | | |
| | | | | | | | | | | | | | | | | | | | | | | | | | | | | | | | | | | | | | | | | | | | | | | | | | | | | | | | | | | | | | | | | | | | | | | | | | | | | | | | |
| | | | | | | | | | | | | | | | | | | | | | | | | | | | | | | | | | | | | | | | | | | | | | | | | | | | | | | | | | | | | | | | | | | | | | | | | | | | | | | | |
| | | | | | | | | | | | | | | | | | | | | | | | | | | | | | | | | | | | | | | | | | | | | | | | | | | | | | | | | | | | | | | | | | | | | | | | | | | | | | | | |
| | | | | | | | | | | | | | | | | | | | | | | | | | | | | | | | | | | | | | | | | | | | | | | | | | | | | | | | | | | | | | | | | | | | | | | | | | | | | | | | |
| | | | | | | | | | | | | | | | | | | | | | | | | | | | | | | | | | | | | | | | | | | | | | | | | | | | | | | | | | | | | | | | | | | | | | | | | | | | | | | | |
| | | | | | | | | | | | | | | | | | | | | | | | | | | | | | | | | | | | | | | | | | | | | | | | | | | | | | | | | | | | | | | | | | | | | | | | | | | | | | | | |
| | 1 | 1 | | | | | | | | | | | | | | | | | | | | | | | | | | | | | | | | | | | | | | | | | | | | | | | | | | | | | | | | | | | | | | | | | | | | | | | | | | | | | |
| | | 3 | | | | | | | | | | | | | | | | | | | | | | | | | | | | | | | | | | | | | | | | | | | | | | | | | | | | | | | | | | | | | | | | | | | | | | | | | | | | | |
| | | | | | | | | | | | | | | | | | | | | | | | | | | | | | | | | | | | | | | | | | | | | | | | | | | | | | | | | | | | | | | | | | | | | | | | | | | | | | | | |
| | | | | | | | | | | | | | | | | | | | | | | | | | | | | | | | | | | | | | | | | | | | | | | | | | | | | | | | | | | | | | | | | | | | | | | | | | | | | | | | |
| | | | | | | | | | | | | | | | | | | | | | | | | | | | | | | | | | | | | | | | | | | | | | | | | | | | | | | | | | | | | | | | | | | | | | | | | | | | | | | | |
| | | | | | | | | | | | | | | | | | | | | | | | | | | | | | | | | | | | | | | | | | | | | | | | | | | | | | | | | | | | | | | | | | | | | | | | | | | | | | | | |
| | | | | | | | | | | | | | | | | | | | | | | | | | | | | | | | | | | | | | | | | | | | | | | | | | | | | | | | | | | | | | | | | | | | | | | | | | | | | | | | |
| | | | | | | | | | | | | | | | | | | | | | | | | | | | | | | | | | | | | | | | | | | | | | | | | | | | | | | | | | | | | | | | | | | | | | | | | | | | | | | | |
| | | | | | | | | | | | | | | | | | | | | | | | | | | | | | | | | | | | | | | | | | | | | | | | | | | | | | | | | | | | | | | | | | | | | | | | | | | | | | | | |
| | | | | | | | | | | | | | | | | | | | | | | | | | | | | | | | | | | | | | | | | | | | | | | | | | | | | | | | | | | | | | | | | | | | | | | | | | | | | | | | |
| | | | | | | | | | | | | | | | | | | | | | | | | | | | | | | | | | | | | | | | | | | | | | | | | | | | | | | | | | | | | | | | | | | | | | | | | | | | | | | | |
| | | | | | | | | | | | | | | | | | | | | | | | | | | | | | | | | | | | | | | | | | | | | | | | | | | | | | | | | | | | | | | | | | | | | | | | | | | | | | | | |
| | | | | | | | | | | | | | | | | | | | | | | | | | | | | | | | | | | | | | | | | | | | | | | | | | | | | | | | | | | | | | | | | | | | | | | | | | | | | | | | |
| | | | | | | | | | | | | | | | | | | | | | | | | | | | | | | | | | | | | | | | | | | | | | | | | | | | | | | | | | | | | | | | | | | | | | | | | | | | | | | | |
| | | | | | | | | | | | | | | | | | | | | | | | | | | | | | | | | | | | | | | | | | | | | | | | | | | | | | | | | | | | | | | | | | | | | | | | | | | | | | | | |
| Post - 0 Miss - 0 Block - 0 | Post - 0 Miss - 0 Block - 0 | Post - 0 Miss - 0 Block - 0 | Post - 0 Miss - 1 Block - 0 | Post - 0 Miss - 0 Block - 0 | Post - 0 Miss - 0 Block - 0 | Post - 0 Miss - 0 Block - 0 | Post - 0 Miss - 0 Block - 0 | | | | | | | | | | | | | | | | | | | | | | | | | | | | | | | | | | | | | | | | | | | | | | | | | | | | | | | | | | | | | | | | | | | | | | | | |
| 27 巫迪涛 | 28 关键辉 | 30 陈永曦 | 41 莫敬朗 | 47 薛浩锋 | 73 黄望懿 | 79 吴坤霖 | 99 苏俊轩 | | | | | | | | | | | | | | | | | | | | | | | | | | | | | | | | | | | | | | | | | | | | | | | | | | | | | | | | | | | | | | | | | | | | | | | | |
| <table border="1"><tr><td></td><td></td><td></td></tr><tr><td></td><td></td><td>1</td></tr><tr><td></td><td></td><td></td></tr></table> | | | | | | 1 | | | | <table border="1"><tr><td></td><td></td><td></td></tr><tr><td></td><td>1</td><td></td></tr><tr><td></td><td></td><td></td></tr></table> | | | | | 1 | | | | | <table border="1"><tr><td></td><td></td><td></td></tr><tr><td></td><td></td><td></td></tr><tr><td></td><td></td><td></td></tr></table> | | | | | | | | | | <table border="1"><tr><td></td><td></td><td></td></tr><tr><td></td><td></td><td></td></tr><tr><td></td><td></td><td></td></tr></table> | | | | | | | | | | <table border="1"><tr><td></td><td>1</td><td>1</td></tr><tr><td></td><td></td><td></td></tr><tr><td></td><td></td><td></td></tr></table> | | 1 | 1 | | | | | | | <table border="1"><tr><td></td><td></td><td>1</td></tr><tr><td></td><td></td><td></td></tr><tr><td></td><td></td><td></td></tr></table> | | | 1 | | | | | | | <table border="1"><tr><td></td><td></td><td></td></tr><tr><td></td><td></td><td></td></tr><tr><td></td><td></td><td></td></tr></table> | | | | | | | | | | <table border="1"><tr><td></td><td></td><td></td></tr><tr><td></td><td></td><td></td></tr><tr><td></td><td></td><td></td></tr></table> | | | | | | | | | |
| | | | | | | | | | | | | | | | | | | | | | | | | | | | | | | | | | | | | | | | | | | | | | | | | | | | | | | | | | | | | | | | | | | | | | | | | | | | | | | | |
| | | 1 | | | | | | | | | | | | | | | | | | | | | | | | | | | | | | | | | | | | | | | | | | | | | | | | | | | | | | | | | | | | | | | | | | | | | | | | | | | | | |
| | | | | | | | | | | | | | | | | | | | | | | | | | | | | | | | | | | | | | | | | | | | | | | | | | | | | | | | | | | | | | | | | | | | | | | | | | | | | | | | |
| | | | | | | | | | | | | | | | | | | | | | | | | | | | | | | | | | | | | | | | | | | | | | | | | | | | | | | | | | | | | | | | | | | | | | | | | | | | | | | | |
| | 1 | | | | | | | | | | | | | | | | | | | | | | | | | | | | | | | | | | | | | | | | | | | | | | | | | | | | | | | | | | | | | | | | | | | | | | | | | | | | | | |
| | | | | | | | | | | | | | | | | | | | | | | | | | | | | | | | | | | | | | | | | | | | | | | | | | | | | | | | | | | | | | | | | | | | | | | | | | | | | | | | |
| | | | | | | | | | | | | | | | | | | | | | | | | | | | | | | | | | | | | | | | | | | | | | | | | | | | | | | | | | | | | | | | | | | | | | | | | | | | | | | | |
| | | | | | | | | | | | | | | | | | | | | | | | | | | | | | | | | | | | | | | | | | | | | | | | | | | | | | | | | | | | | | | | | | | | | | | | | | | | | | | | |
| | | | | | | | | | | | | | | | | | | | | | | | | | | | | | | | | | | | | | | | | | | | | | | | | | | | | | | | | | | | | | | | | | | | | | | | | | | | | | | | |
| | | | | | | | | | | | | | | | | | | | | | | | | | | | | | | | | | | | | | | | | | | | | | | | | | | | | | | | | | | | | | | | | | | | | | | | | | | | | | | | |
| | | | | | | | | | | | | | | | | | | | | | | | | | | | | | | | | | | | | | | | | | | | | | | | | | | | | | | | | | | | | | | | | | | | | | | | | | | | | | | | |
| | | | | | | | | | | | | | | | | | | | | | | | | | | | | | | | | | | | | | | | | | | | | | | | | | | | | | | | | | | | | | | | | | | | | | | | | | | | | | | | |
| | 1 | 1 | | | | | | | | | | | | | | | | | | | | | | | | | | | | | | | | | | | | | | | | | | | | | | | | | | | | | | | | | | | | | | | | | | | | | | | | | | | | | |
| | | | | | | | | | | | | | | | | | | | | | | | | | | | | | | | | | | | | | | | | | | | | | | | | | | | | | | | | | | | | | | | | | | | | | | | | | | | | | | | |
| | | | | | | | | | | | | | | | | | | | | | | | | | | | | | | | | | | | | | | | | | | | | | | | | | | | | | | | | | | | | | | | | | | | | | | | | | | | | | | | |
| | | 1 | | | | | | | | | | | | | | | | | | | | | | | | | | | | | | | | | | | | | | | | | | | | | | | | | | | | | | | | | | | | | | | | | | | | | | | | | | | | | |
| | | | | | | | | | | | | | | | | | | | | | | | | | | | | | | | | | | | | | | | | | | | | | | | | | | | | | | | | | | | | | | | | | | | | | | | | | | | | | | | |
| | | | | | | | | | | | | | | | | | | | | | | | | | | | | | | | | | | | | | | | | | | | | | | | | | | | | | | | | | | | | | | | | | | | | | | | | | | | | | | | |
| | | | | | | | | | | | | | | | | | | | | | | | | | | | | | | | | | | | | | | | | | | | | | | | | | | | | | | | | | | | | | | | | | | | | | | | | | | | | | | | |
| | | | | | | | | | | | | | | | | | | | | | | | | | | | | | | | | | | | | | | | | | | | | | | | | | | | | | | | | | | | | | | | | | | | | | | | | | | | | | | | |
| | | | | | | | | | | | | | | | | | | | | | | | | | | | | | | | | | | | | | | | | | | | | | | | | | | | | | | | | | | | | | | | | | | | | | | | | | | | | | | | |
| | | | | | | | | | | | | | | | | | | | | | | | | | | | | | | | | | | | | | | | | | | | | | | | | | | | | | | | | | | | | | | | | | | | | | | | | | | | | | | | |
| | | | | | | | | | | | | | | | | | | | | | | | | | | | | | | | | | | | | | | | | | | | | | | | | | | | | | | | | | | | | | | | | | | | | | | | | | | | | | | | |
| | | | | | | | | | | | | | | | | | | | | | | | | | | | | | | | | | | | | | | | | | | | | | | | | | | | | | | | | | | | | | | | | | | | | | | | | | | | | | | | |
| Post - 0 Miss - 2 Block - 1 | Post - 0 Miss - 0 Block - 0 | Post - 0 Miss - 0 Block - 0 | Post - 0 Miss - 0 Block - 0 | Post - 0 Miss - 1 Block - 0 | Post - 0 Miss - 0 Block - 0 | Post - 0 Miss - 0 Block - 0 | Post - 0 Miss - 0 Block - 0 | | | | | | | | | | | | | | | | | | | | | | | | | | | | | | | | | | | | | | | | | | | | | | | | | | | | | | | | | | | | | | | | | | | | | | | | |

第二届全国青年运动会男子手球乙组决赛 体校组 (U16)

PHMS Pictorial Handball Match Statistics

IHF Official System

比赛进程表

手球 青年男子 决赛 轮次 6 组别 X 场次 42 滁州国际手球馆 2019-06-05 17:00

| 时间 | 队员 | 动作 | 比分 | 队员 | 动作 |
|-------|--------|---------|------|--------|--------|
| 安徽省体校 | | | 中国香港 | | |
| 上半时 | | | | | |
| 00:28 | 57 朱正翔 | 右边射 得分 | 1-0 | 1 江力为 | 被射入 |
| 01:05 | 52 花驰 | 挡住球 | | 10 叶滋权 | 右远射 被救 |
| 01:15 | 56 王健鹏 | 近射 得分 | 2-0 | 1 江力为 | 被射入 |
| 02:08 | 52 花驰 | 挡住球 | | 47 薛浩锋 | 左边射 被救 |
| 02:16 | 59 毛饶翔 | 快攻 运球失误 | | 47 薛浩锋 | 造失误 |
| 02:18 | 59 毛饶翔 | 使被罚7M球 | | 47 薛浩锋 | 快攻 造7M |
| 02:37 | 52 花驰 | 被射入 | 2-1 | 27 巫迪涛 | 7M球 得分 |
| 03:12 | 57 朱正翔 | 右远射 被封 | | 47 薛浩锋 | 封球 |
| 03:58 | 59 毛饶翔 | 左远射 被封 | | 23 石铭泽 | 封球 |
| 04:09 | 55 苏凯 | 近射 得分 | 3-1 | 1 江力为 | 被射入 |
| 04:10 | 56 王健鹏 | 助攻 | | | |
| 05:16 | 52 花驰 | 被射入 | 3-2 | 47 薛浩锋 | 左边射 得分 |
| 05:33 | 56 王健鹏 | 左远射 得分 | 4-2 | 1 江力为 | 被射入 |
| 06:23 | | | | 27 巫迪涛 | 近射 射失 |
| 06:38 | 60 朱超 | 右边射 被救 | | 22 吴泽斌 | 挡住球 |
| 07:13 | 59 毛饶翔 | 断球 | | 41 莫敬朗 | 传球失误 |
| 07:16 | 59 毛饶翔 | 一传快攻 得分 | 5-2 | 22 吴泽斌 | 被射入 |
| 07:25 | | | | | 球队暂停 |
| 07:56 | 57 朱正翔 | 断球 | | 27 巫迪涛 | 传球失误 |
| 08:02 | 55 苏凯 | 一传快攻 被救 | | 22 吴泽斌 | 挡住球 |
| 08:04 | 59 毛饶翔 | 助攻 | | | |
| 08:36 | 56 王健鹏 | 中远射 被救 | | 22 吴泽斌 | 挡住球 |
| 08:55 | | | | 27 巫迪涛 | 传球失误 |
| 09:07 | 55 苏凯 | 左边射 得分 | 6-2 | 22 吴泽斌 | 被射入 |
| 10:04 | 59 毛饶翔 | 断球 | | 47 薛浩锋 | 传球失误 |
| 10:06 | 59 毛饶翔 | 一传快攻 得分 | 7-2 | 22 吴泽斌 | 被射入 |
| 11:03 | 52 花驰 | 挡住球 | | 23 石铭泽 | 近射 被救 |
| 11:10 | 64 章道胜 | 快攻 侵区 | | | |
| 12:02 | 57 朱正翔 | 封球 | | 27 巫迪涛 | 左远射 被封 |
| 12:22 | 52 花驰 | 挡住球 | | 41 莫敬朗 | 右边射 被救 |
| 12:34 | 52 花驰 | 挡住球 | | 47 薛浩锋 | 右远射 被救 |
| 12:37 | 55 苏凯 | 快攻 接球失误 | | | |
| 13:36 | 52 花驰 | 挡住球 | | 27 巫迪涛 | 任意球 被救 |
| 13:47 | 59 毛饶翔 | 突破 得分 | 8-2 | 22 吴泽斌 | 被射入 |
| 14:41 | | | | 27 巫迪涛 | 任意球 射失 |
| 14:52 | 59 毛饶翔 | 中远射 得分 | 9-2 | 22 吴泽斌 | 被射入 |

比赛进程表

手球 青年男子 决赛 轮次 6 组别 X 场次 42 滁州国际手球馆 2019-06-05 17:00

| 时间 | 队员 | 动作 | 比分 | 队员 | 动作 |
|-------|--------|--------|-------|--------|---------|
| 安徽省体校 | | | 中国香港 | | |
| 下半场 | | | | | |
| 00:28 | 52 花驰 | 被射入 | 9-3 | 28 关键辉 | 右边射 得分 |
| 01:23 | 59 毛饶翔 | 中远射 被封 | | 23 石铭泽 | 封球 |
| 01:49 | 56 王健鹏 | 近射 得分 | 10-3 | 99 苏俊轩 | 被射入 |
| 02:32 | 56 王健鹏 | 使被罚7M球 | | 47 薛浩锋 | 造7M |
| 02:52 | 52 花驰 | 挡住球 | | 47 薛浩锋 | 7M球 被救 |
| 02:57 | 52 花驰 | 被射入 | 10-4 | 47 薛浩锋 | 近射 得分 |
| 03:05 | 62 赵俊阳 | 侵区 | | | |
| 03:44 | 52 花驰 | 被射入 | 10-5 | 10 叶滋权 | 近射 得分 |
| 04:19 | 62 赵俊阳 | 近射 得分 | 11-5 | 99 苏俊轩 | 被射入 |
| 04:50 | | | | 10 叶滋权 | 中远射 射失 |
| 05:06 | 58 蔡博飞 | 传球失误 | | 23 石铭泽 | 断球 |
| 05:11 | 52 花驰 | 被射入 | 11-6 | 73 黄望鎏 | 短传快攻 得分 |
| 05:41 | 62 赵俊阳 | 侵区 | | | |
| 06:08 | | | | 2 梁凯乔 | 传球失误 |
| 06:31 | 59 毛饶翔 | 任意球 击柱 | | | |
| 07:23 | 52 花驰 | 被射入 | 11-7 | 10 叶滋权 | 突破 得分 |
| 07:24 | | 裁判暂停 | | | |
| 07:24 | 57 朱正翔 | 罚出场2分钟 | | | |
| 08:11 | 59 毛饶翔 | 左远射 被救 | | 99 苏俊轩 | 挡住球 |
| 08:23 | | | | 47 薛浩锋 | 右远射 射失 |
| 08:50 | 55 苏凯 | 侵区 | | | |
| 09:02 | 52 花驰 | 挡住球 | | 10 叶滋权 | 突破 被救 |
| 09:21 | | | | 10 叶滋权 | 传球失误 |
| 10:07 | 58 蔡博飞 | 近射 被救 | | 99 苏俊轩 | 挡住球 |
| 10:10 | 56 王健鹏 | 近射 得分 | 12-7 | 99 苏俊轩 | 被射入 |
| 10:53 | 59 毛饶翔 | 使被罚7M球 | | 23 石铭泽 | 造7M |
| 10:54 | | 裁判暂停 | | | |
| 10:54 | 59 毛饶翔 | 罚出场2分钟 | | | |
| 10:54 | | | | 3 陈嘉熙 | 助攻 |
| 10:57 | 52 花驰 | 被射入 | 12-8 | 10 叶滋权 | 7M球 得分 |
| 10:57 | | 球队暂停 | | | |
| 11:04 | | 裁判暂停 | | | |
| 11:04 | | | | 23 石铭泽 | 罚出场2分钟 |
| 11:13 | 56 王健鹏 | 左远射 被封 | | 47 薛浩锋 | 封球 |
| 11:33 | 52 花驰 | 被射入 | 12-9 | 10 叶滋权 | 突破 得分 |
| 11:48 | | 裁判暂停 | | | |
| 12:02 | 64 章道胜 | 近射 得分 | 13-9 | 99 苏俊轩 | 被射入 |
| 12:04 | 58 蔡博飞 | 助攻 | | | |
| 12:44 | 52 花驰 | 被射入 | 13-10 | 10 叶滋权 | 突破 得分 |
| 13:26 | 57 朱正翔 | 近射 得分 | 14-10 | 1 江力为 | 被射入 |
| 13:45 | 52 花驰 | 挡住球 | | 47 薛浩锋 | 突破 被救 |

比赛进程表

手球 青年男子 决赛 轮次 6 组别 X 场次 42 滁州国际手球馆 2019-06-05 17:00

| 时间 | 队员 | 动作 | 比分 | 队员 | 动作 |
|-------|--------|--------|-------|--------|-------|
| 安徽省体校 | | | 中国香港 | | |
| 下半时 | | | | | |
| 14:06 | 57 朱正翔 | 左远射 击柱 | 14-10 | | |
| 14:22 | | | | | 球队暂停 |
| 14:49 | 52 花驰 | 挡住球 | | 47 薛浩锋 | 近射 被救 |
| 15:00 | 57 朱正翔 | 左远射 得分 | 15-10 | 1 江力为 | 被射入 |