

2019 第二届全国青年运动会男子手球 甲组决赛 体校组(U18)

成绩与技术统计数据册



中国手球协会
CHINESE HANDBALL ASSOCIATION



数据由PHMS收集生成



PHMS 国际手球联合会官方技术统计系统

成绩与技术统计数据册目录

- 1 比赛结果
 - 1) 名次
 - 2) 获奖队员名单
 - 3) 场次成绩
 - 4) 分组成绩
- 2 运动员排名
 - 1) 得分
 - 2) 助攻
 - 3) 封球
 - 4) 防守
 - 5) 失误
 - 6) 受罚
- 3 守门员排名
 - 1) 救球
 - 2) 救7M球
- 4 球队总体比较
- 5 球队受罚表
- 6 球队累计
 - 1) 球队名单
 - 2) 个人/全队技术累计表
 - 3) 图式射门区域累计
- 7 每场比赛统计
 - 1) 比赛报告表
 - 2) 竞赛技术统计表
 - 3) 个人/全队技术统计表
 - 4) 图式比赛技术统计
 - 5) 图式射门区域统计
 - 6) 比赛进程表(决赛场次)

注：如需更多比赛统计数据，请通过以下电邮联络：handball@126.com



第二届全国青年运动会男子手球甲组决赛 体校组 (U18)

PHMS Pictorial Handball Match Statistics

IHF Official System

大赛名次

手球
青年男子

截止至第85场

山西晋中
2019-06-23

奖牌	名次	缩写	队名
Gold	1	潍坊	山东潍坊
Silver	2	合肥	安徽合肥
Bronze	3	西安	陕西西安
	4	北京	北京市
	5	泉港	福建泉港
	6	辽宁	辽宁体校
	7	深圳	广东深圳
	8	天津	天津市





第二届全国青年运动会男子手球甲组决赛 体校组 (U18)

PHMS Pictorial Handball Match Statistics

IHF Official System

获奖队员名单

手球
青年男子

山西晋中
2019-06-23

金牌	银牌	铜牌
潍坊-山东潍坊	合肥-安徽合肥	西安-陕西西安
1 鲁世豪	2 张天进	1 陈昊
3 李相杰	13 沈威	2 张兴彬
5 刘天驰	26 饶原源	3 丁玉冰
6 张智超	27 王东昇	5 隋家乐
8 薛瑞寒	29 梅少聪	6 李梦豪
9 杜忠浩	30 单习振	7 黄金伟
11 杨毅	31 张宇	8 张领
12 黄晓春	33 於晓祺	9 陈孝天
15 宋子阳	35 李宝松	10 王凯强
17 王子涵	36 刘耀奇	11 孔宇豪
19 汤雨扬	39 汤鸿宇	12 朱正顺
20 刘文东	40 陈欢	13 徐昊天
21 张宋帅	41 管家乐	14 孙旭
24 王宇恒	42 刘军波	15 陈冉
25 郭昊文	43 王久源	16 金筠峰
33 吴夏冰	50 刘欣洋	17 刘世昌



场次成绩

 手球
青年男子

截止至第85场

 山西晋中
2019-06-23

日期	时间	场次	体育馆	组别	球队	成绩 (半时)	阶段
20-06-19	17:30	49	晋中体育馆	X	潍坊-深圳	24-9 (14-4)	四分之一决赛
	18:40	50	晋中体育馆	X	北京-泉港	22-18 (12-7)	四分之一决赛
	19:50	51	晋中体育馆	X	辽宁-西安	15-20 (8-11)	四分之一决赛
	21:00	52	晋中体育馆	X	合肥-天津	24-11 (14-3)	四分之一决赛
21-06-19	17:30	63	晋中体育馆	X	深圳-泉港	16-19 (9-11)	5-8名
	18:40	64	晋中体育馆	X	辽宁-天津	23-19 (13-11)	5-8名
22-06-19	17:30	79	晋中体育馆	X	深圳-天津	20-14 (9-7)	7-8名
	18:40	74	晋中体育馆	X	潍坊-北京	22-13 (12-7)	半决赛
	18:40	80	晋中体育馆	X	泉港-辽宁	18-17 (8-7)	5-6名
	19:50	75	晋中体育馆	X	西安-合肥	15-21 (10-8)	半决赛
23-06-19	09:00	81	晋中体育馆	X	北京-西安	17-21 (5-10)	3-4名
	16:20	85	晋中体育馆	X	潍坊-合肥	23-22 (10-10)	决赛

分组成绩

手球
青年男子

截止至第85场

山西晋中
2019-06-23

组别: A 预赛

名次	球队	积	场	胜	平	负	得分	失分	净胜
1	潍坊	6	3	3	0	0	81	49	32
2	辽宁	4	3	2	0	1	65	57	8
3	泉港	2	3	1	0	2	68	78	-10
4	天津	0	3	0	0	3	49	79	-30

球队	潍坊	辽宁	泉港	天津
潍坊		20-17	30-17	31-15
辽宁	17-20		26-25	22-12
泉港	17-30	25-26		26-22
天津	15-31	12-22	22-26	

组别: B 预赛

名次	球队	积	场	胜	平	负	得分	失分	净胜
1	合肥	6	3	3	0	0	68	48	20
2	北京	4	3	2	0	1	50	56	-6
3	西安	2	3	1	0	2	63	55	8
4	深圳	0	3	0	0	3	43	65	-22

球队	合肥	北京	西安	深圳
合肥		24-14	22-21	22-13
北京	14-24		18-17	18-15
西安	21-22	17-18		25-15
深圳	13-22	15-18	15-25	

Legend:

积	积分	■	已比赛场次	胜	胜场	平	平场
负	负场	得分	得分累计	失分	失分累计	净胜	净胜分

得分排名表(场上队员)

 手球
青年男子

 截止至第85场
按总得分排序

 山西晋中
2019-06-23

排序	号码	姓名	球队	远射	近射	边射	快攻	突破	任意	七米	合计	%	助攻	场数
1	20	吴兆瑞	泉港	9-25	12-20	1-1	2-3	17-19	1-2	3-4	45-74	60.8	5	6
2	11	杨毅	潍坊	19-26	4-7	0-2	10-11	4-5	1-2	4-5	42-58	72.4	2	6
3	9	陈孝天	西安	22-38	3-4	0-0	1-1	1-1	9-11	4-6	40-61	65.6	7	6
4	23	庞佳明	北京	9-27	5-7	2-2	3-4	4-4	7-7	8-9	38-60	63.3	6	6
5	2	张天进	合肥	15-35	3-6	0-1	4-5	7-8	4-5	2-2	35-62	56.5	4	6
6	6	赵晨阳	天津	12-38	4-7	0-1	2-3	7-14	4-6	4-7	33-76	43.4	1	6
7	15	陈冉	西安	4-7	2-2	9-18	8-8	4-4	1-1	1-1	29-41	70.7	1	6
8	26	李海龙	天津	10-22	5-8	1-1	0-1	11-13	0-0	0-1	27-46	58.7	0	6
9	26	饶原源	合肥	8-13	5-5	0-1	5-7	5-10	0-0	3-5	26-41	63.4	13	6
10	4	刘旭	辽宁	19-53	1-3	0-1	1-1	2-2	2-4	1-1	26-65	40.0	9	6
11	9	张鹏	辽宁	6-16	1-5	1-1	5-6	6-6	1-2	4-7	24-43	55.8	7	6
12	3	李相杰	潍坊	5-11	4-7	1-2	5-6	6-9	0-0	2-2	23-37	62.2	6	6
13	13	周忠迪	泉港	3-9	6-8	5-9	2-4	0-0	0-0	7-8	23-38	60.5	1	6
14	5	刘天驰	潍坊	7-16	6-7	0-1	3-3	5-6	1-1	0-0	22-34	64.7	6	6
15	21	张路	泉港	7-15	2-5	1-2	1-1	7-12	0-0	3-4	21-39	53.8	11	6
16	2	关贺元	辽宁	0-0	17-23	0-1	1-1	1-1	0-0	1-2	20-28	71.4	2	6
17	8	张领	西安	3-11	6-10	1-1	2-2	7-10	0-0	1-1	20-35	57.1	4	6
18	7	曾繁泳	深圳	2-4	2-2	8-14	3-5	1-2	0-0	1-1	17-28	60.7	0	6
19	6	苑宾	北京	1-2	2-3	6-14	2-3	0-0	0-0	6-8	17-30	56.7	0	6
20	24	邢洪铭	辽宁	10-27	3-6	1-2	0-1	3-6	0-3	0-0	17-45	37.8	2	6
21	29	蒋效峰	辽宁	0-1	5-8	0-1	5-5	6-6	0-1	0-0	16-22	72.7	1	6
22	30	单习振	合肥	0-0	2-3	5-10	7-9	1-2	0-0	1-1	16-25	64.0	2	6
23	13	沈威	合肥	4-11	2-4	0-0	4-5	6-6	0-0	0-0	16-26	61.5	7	6
24	9	曹智栋	北京	7-18	3-4	2-5	1-1	2-2	1-1	0-1	16-32	50.0	2	6
25	15	刘大明	北京	6-21	2-3	2-3	0-0	4-5	1-1	1-1	16-34	47.1	2	6
26	8	罗霖泽	深圳	0-0	3-3	7-12	2-5	1-1	0-0	2-3	15-24	62.5	2	6
27	8	薛瑞寒	潍坊	2-3	3-7	2-3	7-8	0-0	0-1	0-0	14-22	63.6	0	6
28	6	李梦豪	西安	5-9	2-4	0-1	2-2	4-4	0-0	0-0	13-20	65.0	8	6
29	16	谢思远	深圳	1-8	5-5	2-2	2-4	3-3	0-0	0-0	13-22	59.1	1	6
30	6	董佳辉	深圳	4-24	4-12	0-2	0-0	5-7	0-0	0-2	13-47	27.7	2	6
31	25	郝一铮	天津	2-6	4-6	2-2	1-2	3-3	0-0	0-0	12-19	63.2	1	6
32	3	李朗轩	深圳	3-8	1-6	2-3	3-4	3-3	0-0	0-0	12-24	50.0	3	6
33	43	王久源	合肥	0-1	1-3	5-6	4-4	1-2	0-1	0-0	11-17	64.7	1	6
34	15	宋子阳	潍坊	0-0	1-2	5-9	5-6	0-0	0-0	0-0	11-17	64.7	0	6
35	29	梅少聪	合肥	0-0	6-10	1-1	4-8	0-0	0-0	0-0	11-19	57.9	1	6
36	9	左典	深圳	5-10	0-2	0-0	1-2	5-5	0-0	0-1	11-20	55.0	5	6
37	6	张智超	潍坊	1-1	1-1	2-5	3-3	3-3	0-0	0-0	10-13	76.9	1	6
38	31	张宇	合肥	4-8	1-2	0-0	1-1	3-3	0-0	1-1	10-15	66.7	1	6
39	9	杜忠浩	潍坊	4-7	5-5	0-3	0-0	1-1	0-0	0-1	10-17	58.8	2	6
40	10	王新開	辽宁	0-3	1-3	4-6	3-4	2-4	0-0	0-1	10-21	47.6	3	6

得分排名表(场上队员)

 手球
青年男子

 截止至第85场
按助攻次数排序

 山西晋中
2019-06-23

排序	号码	姓名	球队	远射	近射	边射	快攻	突破	任意	七米	合计	%	助攻	场数
1	26	饶原源	合肥	8-13	5-5	0-1	5-7	5-10	0-0	3-5	26-41	63.4	13	6
2	21	张路	泉港	7-15	2-5	1-2	1-1	7-12	0-0	3-4	21-39	53.8	11	6
3	4	刘旭	辽宁	19-53	1-3	0-1	1-1	2-2	2-4	1-1	26-65	40.0	9	6
4	6	李梦豪	西安	5-9	2-4	0-1	2-2	4-4	0-0	0-0	13-20	65.0	8	6
5	12	黄晓春	潍坊	4-4	0-0	0-0	0-0	0-0	0-0	0-0	4-4	100.0	8	6
6	9	陈孝天	西安	22-38	3-4	0-0	1-1	1-1	9-11	4-6	40-61	65.6	7	6
7	9	张鹏	辽宁	6-16	1-5	1-1	5-6	6-6	1-2	4-7	24-43	55.8	7	6
8	13	沈威	合肥	4-11	2-4	0-0	4-5	6-6	0-0	0-0	16-26	61.5	7	6
9	23	庞佳明	北京	9-27	5-7	2-2	3-4	4-4	7-7	8-9	38-60	63.3	6	6
10	3	李相杰	潍坊	5-11	4-7	1-2	5-6	6-9	0-0	2-2	23-37	62.2	6	6
11	5	刘天驰	潍坊	7-16	6-7	0-1	3-3	5-6	1-1	0-0	22-34	64.7	6	6
12	20	吴兆瑞	泉港	9-25	12-20	1-1	2-3	17-19	1-2	3-4	45-74	60.8	5	6
13	9	左典	深圳	5-10	0-2	0-0	1-2	5-5	0-0	0-1	11-20	55.0	5	6
14	2	张天进	合肥	15-35	3-6	0-1	4-5	7-8	4-5	2-2	35-62	56.5	4	6
15	8	张领	西安	3-11	6-10	1-1	2-2	7-10	0-0	1-1	20-35	57.1	4	6
16	15	刘小龙	泉港	1-9	3-6	0-0	0-0	5-6	0-0	0-0	9-21	42.9	4	6
17	3	李朗轩	深圳	3-8	1-6	2-3	3-4	3-3	0-0	0-0	12-24	50.0	3	6
18	10	王新開	辽宁	0-3	1-3	4-6	3-4	2-4	0-0	0-1	10-21	47.6	3	6
19	17	黄春瑞	天津	4-8	2-5	1-5	0-1	0-0	0-0	0-0	7-19	36.8	3	6
20	10	李剑琛	深圳	0-1	2-6	1-3	2-4	0-0	0-0	0-0	5-14	35.7	3	6
21	11	杨毅	潍坊	19-26	4-7	0-2	10-11	4-5	1-2	4-5	42-58	72.4	2	6
22	2	关贺元	辽宁	0-0	17-23	0-1	1-1	1-1	0-0	1-2	20-28	71.4	2	6
23	24	邢洪銘	辽宁	10-27	3-6	1-2	0-1	3-6	0-3	0-0	17-45	37.8	2	6
24	30	单习振	合肥	0-0	2-3	5-10	7-9	1-2	0-0	1-1	16-25	64.0	2	6
25	9	曹智栋	北京	7-18	3-4	2-5	1-1	2-2	1-1	0-1	16-32	50.0	2	6
26	15	刘大明	北京	6-21	2-3	2-3	0-0	4-5	1-1	1-1	16-34	47.1	2	6
27	8	罗霖泽	深圳	0-0	3-3	7-12	2-5	1-1	0-0	2-3	15-24	62.5	2	6
28	6	董佳辉	深圳	4-24	4-12	0-2	0-0	5-7	0-0	0-2	13-47	27.7	2	6
29	9	杜忠浩	潍坊	4-7	5-5	0-3	0-0	1-1	0-0	0-1	10-17	58.8	2	6
30	18	刘少杰	泉港	0-0	6-9	0-0	1-1	0-0	0-0	0-0	7-10	70.0	2	6
31	24	王宇恒	潍坊	3-5	1-4	0-1	0-0	0-0	0-1	1-1	5-12	41.7	2	6
32	6	赵晨阳	天津	12-38	4-7	0-1	2-3	7-14	4-6	4-7	33-76	43.4	1	6
33	15	陈冉	西安	4-7	2-2	9-18	8-8	4-4	1-1	1-1	29-41	70.7	1	6
34	13	周忠迪	泉港	3-9	6-8	5-9	2-4	0-0	0-0	7-8	23-38	60.5	1	6
35	29	蒋效峰	辽宁	0-1	5-8	0-1	5-5	6-6	0-1	0-0	16-22	72.7	1	6
36	16	谢思远	深圳	1-8	5-5	2-2	2-4	3-3	0-0	0-0	13-22	59.1	1	6
37	25	郝一铮	天津	2-6	4-6	2-2	1-2	3-3	0-0	0-0	12-19	63.2	1	6
38	43	王久源	合肥	0-1	1-3	5-6	4-4	1-2	0-1	0-0	11-17	64.7	1	6
39	29	梅少聪	合肥	0-0	6-10	1-1	4-8	0-0	0-0	0-0	11-19	57.9	1	6
40	6	张智超	潍坊	1-1	1-1	2-5	3-3	3-3	0-0	0-0	10-13	76.9	1	6

得分排名表(场上队员)

 手球
青年男子

 截止至第85场
按封球次数排序

 山西晋中
2019-06-23

名次	号码	姓名	球队	抢球	断球	造失误	造犯规	合计	封球	场数
1	3	丁玉冰	西安	0	0	0	0	0	8	6
2	33	吴夏冰	潍坊	0	0	0	1	1	7	6
3	23	庞佳明	北京	0	2	2	0	4	6	6
4	9	曹智栋	北京	1	1	1	0	3	5	6
5	18	刘少杰	泉港	0	3	0	0	3	5	6
6	5	刘天驰	潍坊	0	6	0	0	6	4	6
7	8	张领	西安	0	0	0	0	0	4	6
8	2	张天进	合肥	2	2	3	0	7	3	6
9	9	杜忠浩	潍坊	0	0	0	0	0	2	6
10	26	李海龙	天津	1	1	4	1	7	2	6
11	13	蓝心凯	北京	0	1	0	0	1	2	6
12	30	单习振	合肥	0	1	0	1	2	2	6
13	15	金硕	深圳	0	0	0	0	0	1	3
14	2	关贺元	辽宁	0	3	0	1	4	1	6
15	3	李朗轩	深圳	0	1	1	0	2	1	6
16	9	周星晨	泉港	0	0	0	0	0	1	6
17	24	邢洪铭	辽宁	1	2	2	0	5	1	6
18	21	张路	泉港	0	5	0	0	5	1	6
19	6	赵晨阳	天津	0	1	2	0	3	1	6
20	6	董佳辉	深圳	1	2	0	1	4	1	6
21	6	苑宾	北京	0	2	0	0	2	1	6
22	25	郝一铮	天津	0	1	1	0	2	1	6
23	9	陈孝天	西安	1	0	0	0	1	1	6
24	16	谢思远	深圳	0	4	0	0	4	1	6
25	10	王凯强	西安	0	1	0	0	1	1	6
26	6	李梦豪	西安	4	7	0	0	11	1	6
27	15	陈冉	西安	1	2	1	1	5	1	6
28	21	蒋中健	辽宁	0	0	0	0	0	0	2
29	28	孙经伟	天津	0	0	0	0	0	0	3
30	10	黄嘉俊	天津	0	0	0	0	0	0	3
31	4	常艳鹏	天津	0	0	0	0	0	0	3
32	18	祝慧翔昊	辽宁	0	0	0	0	0	0	4
33	8	郭嘉尧	辽宁	0	0	0	0	0	0	4
34	14	戴云鹏	天津	0	0	0	0	0	0	4
35	2	祝安南	深圳	0	0	0	0	0	0	4
36	17	王子涵	潍坊	0	0	0	0	0	0	4
37	3	贾博	辽宁	0	0	0	0	0	0	6
38	9	张鹏	辽宁	3	2	1	0	6	0	6
39	1	何振楠	辽宁	0	0	0	0	0	0	6
40	12	吴禹宽	辽宁	0	0	0	0	0	0	6

得分排名表(场上队员)

 手球
青年男子

 截止至第85场
按防守成功总数排序

 山西晋中
2019-06-23

名次	号码	姓名	球队	抢球	断球	造失误	造犯规	合计	封球	场数
1	6	李梦豪	西安	4	7	0	0	11	1	6
2	26	李海龙	天津	1	1	4	1	7	2	6
3	13	沈威	合肥	0	3	4	0	7	0	6
4	2	张天进	合肥	2	2	3	0	7	3	6
5	9	张鹏	辽宁	3	2	1	0	6	0	6
6	3	李相杰	潍坊	0	5	0	1	6	0	6
7	26	饶原源	合肥	1	2	2	1	6	0	6
8	5	刘天驰	潍坊	0	6	0	0	6	4	6
9	24	邢洪铭	辽宁	1	2	2	0	5	1	6
10	21	张路	泉港	0	5	0	0	5	1	6
11	15	陈冉	西安	1	2	1	1	5	1	6
12	4	刘旭	辽宁	2	2	1	0	5	0	6
13	10	王新刚	辽宁	1	3	1	0	5	0	6
14	11	杨毅	潍坊	1	3	0	1	5	0	6
15	9	左典	深圳	1	0	2	1	4	0	6
16	7	曾繁泳	深圳	1	2	1	0	4	0	6
17	8	薛瑞寒	潍坊	0	3	1	0	4	0	6
18	6	董佳辉	深圳	1	2	0	1	4	1	6
19	16	谢思远	深圳	0	4	0	0	4	1	6
20	41	管家乐	合肥	2	2	0	0	4	0	6
21	29	蒋效峰	辽宁	3	1	0	0	4	0	6
22	23	庞佳明	北京	0	2	2	0	4	6	6
23	2	关贺元	辽宁	0	3	0	1	4	1	6
24	13	周忠迪	泉港	0	4	0	0	4	0	6
25	17	黄春瑞	天津	1	0	1	1	3	0	6
26	24	周亚龙	天津	0	1	0	2	3	0	6
27	18	刘少杰	泉港	0	3	0	0	3	5	6
28	6	赵晨阳	天津	0	1	2	0	3	1	6
29	43	王久源	合肥	0	3	0	0	3	0	6
30	9	曹智栋	北京	1	1	1	0	3	5	6
31	13	徐昊天	西安	0	2	1	0	3	0	6
32	10	李剑琛	深圳	0	3	0	0	3	0	6
33	30	单习振	合肥	0	1	0	1	2	2	6
34	13	赵子凯	辽宁	0	2	0	0	2	0	6
35	3	李朗轩	深圳	0	1	1	0	2	1	6
36	20	吴兆瑞	泉港	0	2	0	0	2	0	6
37	6	苑宾	北京	0	2	0	0	2	1	6
38	15	刘小龙	泉港	0	1	0	1	2	0	6
39	29	梅少聪	合肥	1	1	0	0	2	0	6
40	15	宋子阳	潍坊	0	2	0	0	2	0	6

得分排名表(场上队员)

 手球
青年男子

 截止至第85场
按失误总数排序

 山西晋中
2019-06-23

排序	号码	姓名	球队	传失	接失	两次	四步	侵区	进犯	其它	合计	场数
1	6	赵晨阳	天津	9	1	7	6	0	0	2	25	6
2	21	张路	泉港	13	0	2	4	0	1	0	20	6
3	26	李海龙	天津	10	1	4	3	1	0	1	20	6
4	9	张鹏	辽宁	9	2	1	3	1	0	0	16	6
5	4	刘旭	辽宁	9	4	1	1	0	0	0	15	6
6	23	庞佳明	北京	8	0	0	3	0	0	3	14	6
7	15	刘小龙	泉港	5	3	3	3	0	0	0	14	6
8	20	吴兆瑞	泉港	5	1	3	3	0	2	0	14	6
9	9	左典	深圳	2	4	2	4	0	0	1	13	6
10	16	谢思远	深圳	6	2	1	2	1	0	1	13	6
11	8	张颂	西安	3	2	1	5	2	0	0	13	6
12	25	郝一铮	天津	6	2	2	2	1	0	0	13	6
13	13	沈威	合肥	5	1	1	4	0	1	0	12	6
14	17	黄春瑞	天津	3	3	1	0	1	2	0	10	6
15	24	周亚龙	天津	4	4	1	1	0	0	0	10	6
16	3	李相杰	潍坊	4	1	1	0	3	1	0	10	6
17	5	刘天驰	潍坊	3	0	1	2	3	0	0	9	6
18	15	刘大明	北京	0	2	2	3	1	1	0	9	6
19	13	周忠迪	泉港	3	2	0	0	1	0	3	9	6
20	6	董佳辉	深圳	4	1	1	1	0	1	1	9	6
21	9	曹智栋	北京	4	1	1	1	1	0	0	8	6
22	6	段家乐	泉港	2	1	1	0	2	0	2	8	6
23	9	陈孝天	西安	1	2	2	2	1	0	0	8	6
24	3	李朗轩	深圳	6	0	0	2	0	0	0	8	6
25	29	蒋效峰	辽宁	3	1	1	1	1	1	0	8	6
26	8	罗霖泽	深圳	1	3	0	0	2	0	1	7	6
27	6	李梦豪	西安	1	2	1	2	0	0	1	7	6
28	26	饶源源	合肥	2	0	2	1	0	0	2	7	6
29	10	李剑琛	深圳	1	0	0	0	4	1	0	6	6
30	8	薛瑞寒	潍坊	1	0	2	2	0	0	1	6	6
31	30	单习振	合肥	3	0	1	1	0	1	0	6	6
32	10	王新開	辽宁	1	0	1	1	2	0	1	6	6
33	10	王凯强	西安	1	1	0	1	1	0	1	5	6
34	11	杨毅	潍坊	3	1	0	0	1	0	0	5	6
35	7	曾繁泳	深圳	2	1	1	0	1	0	0	5	6
36	20	王澎	天津	1	1	0	1	2	0	0	5	6
37	35	李宝松	合肥	2	0	0	1	1	0	0	4	6
38	15	陈冉	西安	0	2	2	0	0	0	0	4	6
39	18	刘少杰	泉港	1	1	0	0	1	0	1	4	6
40	13	徐昊天	西安	0	0	0	0	4	0	0	4	6

得分排名表(场上队员)

 手球
青年男子

 截止至第85场
接受罚次数排序

 山西晋中
2019-06-23

排序	号码	姓名	球队	警告	罚2分钟	D	DR	场数
1	20	刘文东	潍坊	0	3	1	0	6
2	9	陈孝天	西安	0	2	1	0	6
3	20	吴兆瑞	泉港	1	5	0	0	6
4	41	管家乐	合肥	3	4	0	0	6
5	33	吴夏冰	潍坊	3	4	0	0	6
6	2	关贺元	辽宁	1	4	0	0	6
7	30	单习振	合肥	3	3	0	0	6
8	8	罗霖泽	深圳	2	3	0	0	6
9	8	张领	西安	2	3	0	0	6
10	26	郑铭境	北京	1	3	0	0	6
11	29	梅少聪	合肥	0	3	0	0	6
12	13	周忠迪	泉港	0	3	0	0	6
13	21	张路	泉港	0	3	0	0	6
14	15	陈冉	西安	0	3	0	0	6
15	10	王新開	辽宁	4	2	0	0	6
16	8	薛瑞寒	潍坊	2	2	0	0	6
17	5	刘天驰	潍坊	2	2	0	0	6
18	9	张鹏	辽宁	1	2	0	0	6
19	6	段家乐	泉港	1	2	0	0	6
20	23	卓世胜	泉港	1	2	0	0	6
21	4	刘旭	辽宁	1	2	0	0	6
22	11	杨毅	潍坊	1	2	0	0	6
23	6	董佳辉	深圳	1	2	0	0	6
24	3	李相杰	潍坊	0	2	0	0	6
25	6	李梦豪	西安	4	1	0	0	6
26	10	李剑琛	深圳	3	1	0	0	6
27	15	刘小龙	泉港	3	1	0	0	6
28	43	王久源	合肥	3	1	0	0	6
29	24	周亚龙	天津	2	1	0	0	6
30	18	刘少杰	泉港	2	1	0	0	6
31	29	蒋效峰	辽宁	2	1	0	0	6
32	13	蓝心凯	北京	1	1	0	0	6
33	17	黄春瑞	天津	1	1	0	0	6
34	3	丁玉冰	西安	1	1	0	0	6
35	26	饶原源	合肥	1	1	0	0	6
36	6	苑宾	北京	1	1	0	0	6
37	33	於晓祺	合肥	0	1	0	0	6
38	13	沈威	合肥	0	1	0	0	6
39	13	徐昊天	西安	0	1	0	0	6
40	23	庞佳明	北京	0	1	0	0	6

排名表(守门员)

 手球
青年男子

 截止至第85场
按总救球数排序

 山西晋中
2019-06-23

排序	号码	姓名	球队	远射	近射	边射	快攻	突破	任意	七米	得分	%	助攻	场数
1	23	谭元春	天津	29-70	10-44	8-23	0-28	3-24	0-2	2-7	52-198	26.3	1	6
2	12	黄晓春	潍坊	23-44	18-34	4-10	1-6	2-15	0-2	3-6	51-117	43.6	8	6
3	40	陈欢	合肥	15-34	11-23	12-26	1-6	4-13	2-12	1-9	46-123	37.4	0	6
4	1	陈昊	西安	17-41	8-28	10-18	6-26	2-17	0-4	2-12	45-146	30.8	1	6
5	12	汪琪坤	泉港	13-21	10-27	7-22	3-17	1-21	2-3	4-11	40-122	32.8	0	6
6	16	王鑫宇	北京	16-52	9-31	0-6	7-21	4-19	1-4	0-3	37-136	27.2	1	6
7	12	吴禹宽	辽宁	13-25	8-16	6-11	0-5	4-20	2-4	0-0	33-81	40.7	0	6
8	1	何振楠	辽宁	10-27	4-14	6-12	1-6	2-17	0-1	3-15	26-92	28.3	0	6
9	1	鲁世豪	潍坊	5-11	4-10	2-10	3-4	2-6	1-1	2-4	19-46	41.3	0	6
10	19	齐振东	深圳	3-13	3-11	6-9	6-10	1-7	0-2	0-3	19-55	34.5	0	6
11	12	戴景伟	深圳	6-25	5-22	5-8	1-9	2-12	0-3	0-6	19-85	22.4	0	6
12	1	周铁程	泉港	4-18	4-10	3-7	3-18	1-8	0-1	3-7	18-69	26.1	0	6
13	39	汤鸿宇	合肥	4-9	1-4	1-2	0-4	0-5	0-1	0-1	6-26	23.1	0	6
14	1	陶钜	北京	2-6	0-3	2-4	0-3	0-4	0-2	0-0	4-22	18.2	0	6
15	18	曾笑童	深圳	1-3	2-7	1-4	0-6	0-1	0-0	0-3	4-24	16.7	0	6
16	12	朱正顺	西安	0-2	0-2	0-2	0-0	0-0	0-0	0-1	0-7	0.0	0	6

排名表(守门员)

 手球
青年男子

 截止至第85场
按救七米球数排序

 山西晋中
2019-06-23

排序	号码	姓名	球队	远射	近射	边射	快攻	突破	任意	七米	得分	%	助攻	场数
1	12	汪琪坤	泉港	13-21	10-27	7-22	3-17	1-21	2-3	4-11	40-122	36.4	0	6
2	12	黄晓春	潍坊	23-44	18-34	4-10	1-6	2-15	0-2	3-6	51-117	50.0	8	6
3	1	周铁程	泉港	4-18	4-10	3-7	3-18	1-8	0-1	3-7	18-69	42.9	0	6
4	1	何振楠	辽宁	10-27	4-14	6-12	1-6	2-17	0-1	3-15	26-92	20.0	0	6
5	1	鲁世豪	潍坊	5-11	4-10	2-10	3-4	2-6	1-1	2-4	19-46	50.0	0	6
6	23	谭元春	天津	29-70	10-44	8-23	0-28	3-24	0-2	2-7	52-198	28.6	1	6
7	1	陈昊	西安	17-41	8-28	10-18	6-26	2-17	0-4	2-12	45-146	16.7	1	6
8	40	陈欢	合肥	15-34	11-23	12-26	1-6	4-13	2-12	1-9	46-123	11.1	0	6
9	12	吴禹宽	辽宁	13-25	8-16	6-11	0-5	4-20	2-4	0-0	33-81	0	0	6
10	1	陶钜	北京	2-6	0-3	2-4	0-3	0-4	0-2	0-0	4-22	0	0	6
11	39	汤鸿宇	合肥	4-9	1-4	1-2	0-4	0-5	0-1	0-1	6-26	0.0	0	6
12	12	朱正顺	西安	0-2	0-2	0-2	0-0	0-0	0-0	0-1	0-7	0.0	0	6
13	16	王鑫宇	北京	16-52	9-31	0-6	7-21	4-19	1-4	0-3	37-136	0.0	1	6
14	19	齐振东	深圳	3-13	3-11	6-9	6-10	1-7	0-2	0-3	19-55	0.0	0	6
15	18	曾笑童	深圳	1-3	2-7	1-4	0-6	0-1	0-0	0-3	4-24	0.0	0	6
16	12	戴景伟	深圳	6-25	5-22	5-8	1-9	2-12	0-3	0-6	19-85	0.0	0	6

第二届全国青年运动会男子手球甲组决赛 体校组 (U18)

攻防成功率统计总表

手球
青年男子

截止至第85场

山西晋中
2019-06-23

序号	球队	比分	进攻成功率												助攻	防守成功率											
			阵地进攻			一传快攻			短传快攻			合计				多打少			少打多			封打抢断	守门员	对方射失	对方失误	合计	%
			得分	进攻	%	得分	进攻	%	得分	进攻	%	得分	进攻	%		得分	进攻	%	得分	进攻	%						
1	北京	102:117	96	219	43.8	6	8	75.0	0	4	0.0	102	231	44.2	15	23	65.2	7	10	70.0	14	25	41	23	36	125	51.7
2	合肥	135:97	104	229	45.4	13	16	81.3	18	35	51.4	135	280	48.2	13	22	59.1	15	27	55.6	31	39	52	41	40	172	63.9
3	辽宁	120:114	102	268	38.1	8	9	88.9	10	19	52.6	120	296	40.5	12	23	52.2	5	18	27.8	25	34	59	33	41	167	59.4
4	泉港	123:133	115	269	42.8	5	6	83.3	3	12	25.0	123	287	42.9	11	15	73.3	10	16	62.5	23	23	58	26	44	151	53.2
5	深圳	88:122	74	222	33.3	4	12	33.3	10	20	50.0	88	255	34.5	10	18	55.6	7	11	63.6	16	27	42	22	38	129	51.4
6	天津	93:146	85	257	33.1	4	5	80.0	4	18	22.2	93	280	33.2	17	35	48.6	0	3	0.0	8	23	52	36	34	145	49.8
7	潍坊	150:93	115	226	50.9	22	25	88.0	13	23	56.5	150	274	54.7	7	12	58.3	17	27	63.0	27	39	70	35	44	188	66.9
8	西安	119:108	102	222	45.9	6	7	85.7	11	21	52.4	119	250	47.6	10	16	62.5	10	15	66.7	22	37	45	36	28	146	57.5

注释:

进攻	进攻次数 (射门 + 进攻失误)	对方射失	对方射门失误 (射失 + 击柱)	防守成功率%	本方防守合计 / 对方进攻合计
----	------------------	------	------------------	--------	-----------------

防守技术统计总表

 手球
青年男子

截止至第85场

 山西晋中
2019-06-23

序号	球队	比分	防守成功						防守 (成功 : 失误)							处罚					守门员			
			封球	抢球	断球	造失	造犯	合计	选位	顶贴	观察	移动	换防	其他	合计	警告	2'	取消	DR	合计	救球	射门	%	
1	北京	102:117	14	1	6	4	0	25	0:0	0:0	0:0	0:0	0:0	0:0	0:0	0:0	3	8	0	0	11	41	158	25.9
2	合肥	135:97	5	6	17	9	2	39	0:0	0:0	0:0	0:0	0:0	0:0	0:0	0:0	11	15	0	0	26	52	149	34.9
3	辽宁	120:114	2	11	15	5	1	34	0:0	0:0	0:0	0:0	0:0	0:0	0:0	0:0	10	12	0	0	22	59	173	34.1
4	泉港	123:133	7	0	15	0	1	23	0:0	0:0	0:0	0:0	0:0	0:0	0:0	0:0	8	18	0	0	26	58	191	30.4
5	深圳	88:122	4	3	14	4	2	27	0:0	0:0	0:0	0:0	0:0	0:0	0:0	0:0	12	6	0	0	18	42	164	25.6
6	天津	93:146	4	2	5	8	4	23	0:0	0:0	0:0	0:0	0:0	0:0	0:0	0:0	6	3	0	0	9	52	198	26.3
7	潍坊	150:93	13	1	20	2	3	39	0:0	0:0	0:0	0:0	0:0	0:0	0:0	0:0	9	17	1	0	27	70	163	42.9
8	西安	119:108	16	6	12	2	1	37	0:0	0:0	0:0	0:0	0:0	0:0	0:0	0:0	9	11	1	0	21	45	153	29.4

注释:

造失	造对方失误	造犯	造对方犯规	DR	取消资格+报告
----	-------	----	-------	----	---------

球队名单

山西晋中

2019-06-15

山东潍坊

号码	姓名	位置	生日	年龄	俱乐部	身高 (CM)	体重 (KG)	国际场次	国际进球
1	鲁世豪	守门员	24/04/2001	18		195	80		
3	李相杰	右边锋	02/05/2001	18		178	76		
5	刘天驰	左后卫	28/01/2001	18		192	83		
6	张智超	右边锋	01/01/2001	18		180	87		
8	薛瑞寒	左后卫	11/02/2001	18		180	100		
9	杜忠浩	中后卫	29/07/2001	17		186	85		
11	杨毅	左后卫	14/08/2001	17		186	80		
12	黄晓春	守门员	18/02/2001	18		185	80		
15	宋子阳	左边锋	06/02/2002	17		182	72		
17	王子涵	底线	26/02/2002	17		180	100		
19	汤雨扬	左边锋	24/09/2002	16		174	70		
20	刘文东	底线	27/03/2001	18		190	95		
21	张宋帅	底线	31/10/2001	17		195	90		
24	王宇恒	右后卫	03/02/2001	18		183	80		
25	郭昊文	右后卫	30/12/2001	17		185	80		
33	吴夏冰	底线	29/06/2001	17		191	92		
	平均			17.4		185.1	84.4		

编码	姓名	职务
B	赵鑫	主教练
C	王平	助理教练
E	陈琪	医生
A	傅益民	领队
D	邱心杰	助理教练

手球
青年男子

个人/全队技术累计表

 山西晋中
2019-06-23

截止至第85场

号码	姓名	远射	近射	边射	快攻	突破	任意	七米	合计	%	助攻	失误	警告	2'	取消	场次	时间
山东潍坊																	
(场上队员)																	
1	鲁世豪															6	01:07:08
3	李相杰	5/11	4/7	1/2	5/6	6/9		2/2	23/37	62.2%	6	10		2		6	03:17:15
5	刘天驰	7/16	6/7	0/1	3/3	5/6	1/1		22/34	64.7%	6	9	2	2		6	03:00:02
6	张智超	1/1	1/1	2/5	3/3	3/3			10/13	76.9%	1	1		1		6	01:27:44
8	薛瑞寒	2/3	3/7	2/3	7/8		0/1		14/22	63.6%		6	2	2		6	03:10:01
9	杜忠浩	4/7	5/5	0/3		1/1		0/1	10/17	58.8%	2	4				6	01:21:02
11	杨毅	19/26	4/7	0/2	10/11	4/5	1/2	4/5	42/58	72.4%	2	5	1	2		6	03:02:24
12	黄晓春	4/4							4/4	100%	8					6	02:52:50
15	宋子阳		1/2	5/9	5/6				11/17	64.7%		3	1			6	02:49:04
17	王子涵															4	00:00:02
19	汤雨扬			1/1					1/1	100%						6	00:10:26
20	刘文东		3/4		1/1	0/1			4/6	66.7%		1		3	1	6	01:03:29
21	张宋帅													1		6	00:15:18
24	王宇恒	3/5	1/4	0/1			0/1	1/1	5/12	41.7%	2	4				6	01:30:19
25	郭昊文															6	00:10:30
33	吴夏冰		3/5		1/1				4/6	66.7%		4	3	4		6	02:36:01
合计		45/73	31/49	11/27	35/39	19/25	2/5	7/9	150/227	66.1%	27	47	9	17	1	94	
(守门员)																	
1	鲁世豪	5/11	4/10	2/10	3/4	2/6	1/1	2/4	19/46	41.3%						6	01:07:08
12	黄晓春	23/44	18/34	4/10	1/6	2/15	0/2	3/6	51/117	43.6%	8					6	02:52:50
合计		28/55	22/44	6/20	4/10	4/21	1/3	5/10	70/163	42.9%	8					12	

场上队员：得分/射门

守门员：救球/射门

已打比赛

全队合计	进球	被救	射失	击柱	封球	合计	%	阶段	场次	对手	比分
远射	45	14	7	4	3	73	61.6%	预赛	2	天津	31:15 (17:5)
近射	31	14	1	3		49	63.3%	预赛	19	泉港	30:17 (15:8)
边射	11	12	3	1		27	40.7%	预赛	42	辽宁	20:17 (12:11)
快攻	35	2	2			39	89.7%	四分之一决赛	49	深圳	24:9 (14:4)
突破	19	4	1	1		25	76.0%	半决赛	74	北京	22:13 (12:7)
任意	2	1	2			5	40.0%	决赛	85	合肥	23:22 (10:10)
七米	7	2				9	77.8%				

图式射门区域累计

手球
青年男子

截止至第85场

山西晋中
2019-06-23

山东潍坊

1 鲁世豪 Post - 0 Miss - 0 Block - 0	3 李相杰 Post - 1 Miss - 4 Block - 0	5 刘天驰 Post - 2 Miss - 4 Block - 1	6 张智超 Post - 0 Miss - 0 Block - 0	8 薛瑞寒 Post - 1 Miss - 1 Block - 0	9 杜忠浩 Post - 0 Miss - 1 Block - 1	11 杨毅 Post - 3 Miss - 3 Block - 0	12 黄晓春 Post - 0 Miss - 0 Block - 0
15 宋子阳 Post - 0 Miss - 2 Block - 0	17 王子涵 Post - 0 Miss - 0 Block - 0	19 汤雨扬 Post - 0 Miss - 0 Block - 0	20 刘文东 Post - 0 Miss - 0 Block - 0	21 张宋帅 Post - 0 Miss - 0 Block - 0	24 王宇恒 Post - 2 Miss - 1 Block - 1	25 郭昊文 Post - 0 Miss - 0 Block - 0	33 吴夏冰 Post - 0 Miss - 0 Block - 0

1 鲁世豪
0/5 1/2 2/4
5/10 2/2 6/9
1/7 1/2 1/5

12 黄晓春
4/12 6/9 1/9
13/20 10/10 6/12
3/23 1/1 7/21

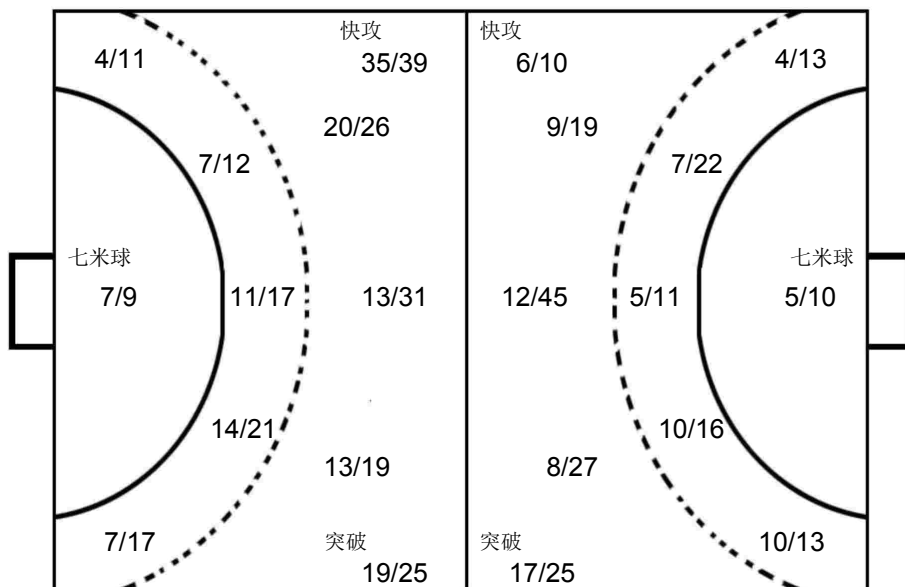

天津
23 谭元春
2/3 1/2 0/1
2/7 1/1 1/10
1/5 2/4 1/9

合肥
40 陈欢
2/4 1/2 1/4
0/6 1/1 2/4
0/4 1/3

辽宁
12 吴禹宽
1/1 2/3
3/4 0/1
0/3 1/4

OPPONENT

泉港 20 吴兆瑞 Post - 0 Miss - 0 Block - 0	合肥 2 张天进 Post - 1 Miss - 2 Block - 0	合肥 26 饶原源 Post - 0 Miss - 0 Block - 0	辽宁 24 邢洪铭 Post - 3 Miss - 1 Block - 0	辽宁 4 刘旭 Post - 1 Miss - 0 Block - 1	北京 23 庞佳明 Post - 0 Miss - 0 Block - 1	合肥 13 沈威 Post - 0 Miss - 1 Block - 2	天津 25 郝一铮 Post - 0 Miss - 1 Block - 0
天津 26 李海龙 Post - 1 Miss - 0 Block - 0	北京 15 刘大明 Post - 0 Miss - 0 Block - 2	深圳 8 罗霖泽 Post - 0 Miss - 0 Block - 0	天津 6 赵晨阳 Post - 0 Miss - 2 Block - 1	北京 6 苑宾 Post - 0 Miss - 0 Block - 0	合肥 29 梅少聪 Post - 0 Miss - 0 Block - 0	合肥 43 王久源 Post - 0 Miss - 0 Block - 0	辽宁 9 张鹏 Post - 0 Miss - 0 Block - 0



球队名单

安徽合肥

山西晋中

2019-06-15

号码	姓名	位置	生日	年龄	俱乐部	身高 (CM)	体重 (KG)	国际场次	国际进球
2	张天进	左后卫	07/10/2001	17	安徽省合肥市	184	82	25	111
13	沈威	右后卫	10/03/2001	18	安徽省合肥市	170	66	24	159
26	饶原源	中后卫	08/09/2001	17	安徽省合肥市	183	74	16	121
27	王东昇	底线	22/03/2002	17	安徽省合肥市	194	108	27	120
29	梅少聪	底线	13/02/2001	18	安徽省合肥市	193	78	19	132
30	单习振	左边锋	04/03/2001	18	安徽省合肥市	186	70	24	115
31	张宇	中后卫	17/03/2001	18	安徽省合肥市	183	78	15	109
33	於晓祺	右边锋	24/03/2002	17	安徽省合肥市	181	80	25	123
35	李宝松	边锋	26/01/2001	18	安徽省合肥市	185	75	26	190
36	刘耀奇	边锋	27/01/2002	17	安徽省合肥市	182	74	24	129
39	汤鸿宇	守门员	15/05/2001	18	安徽省合肥市	191	82	25	
40	陈欢	守门员	15/11/2001	17	安徽省合肥市	190	90	28	
41	管家乐	右后卫	17/10/2002	16	安徽省合肥市	188	78	23	110
42	刘军波	右边锋	20/02/2002	17	安徽省合肥市	186	75	18	129
43	王久源	中后卫	18/12/2001	17	安徽省合肥市	174	71	22	114
50	刘欣洋	底线	18/09/2001	17	安徽省合肥市	180	95	20	124
	平均			17.3		184.4	79.8	22.6	127.6

编码	姓名	职务
A	王德勇	主教练
C	陆万红	教练
D	王明星	领队
B	李晓鹏	教练
E	陈玉翔	医生

手球
青年男子

个人/全队技术累计表

山西晋中
2019-06-23

截止至第85场

号码	姓名	远射	近射	边射	快攻	突破	任意	七米	合计	%	助攻	失误	警告	2'	取消	场次	时间
安徽合肥																	
(场上队员)																	
2	张天进	15/35	3/6	0/1	4/5	7/8	4/5	2/2	35/62	56.5%	4	4	1			6	03:27:01
13	沈威	4/11	2/4		4/5	6/6			16/26	61.5%	7	12		1		6	02:55:22
26	饶源源	8/13	5/5	0/1	5/7	5/10		3/5	26/41	63.4%	13	7	1	1		6	03:27:01
27	王东昇															6	00:06:07
29	梅少聪		6/10	1/1	4/8				11/19	57.9%	1	3		3		6	03:28:46
30	单习振		2/3	5/10	7/9	1/2		1/1	16/25	64.0%	2	6	3	3		6	03:28:17
31	张宇	4/8	1/2		1/1	3/3		1/1	10/15	66.7%	1	4				6	00:40:40
33	於晓祺		0/1			0/1			0/2	0.0%		1		1		6	00:31:01
35	李宝松					1/1			1/1	100%	1	4		1		6	00:31:01
36	刘耀奇			0/1	1/1			3/5	4/7	57.1%		1				6	00:29:22
39	汤鸿宇															6	00:44:03
40	陈欢															6	03:15:57
41	管家乐	1/4	2/2	0/2	1/4	0/1			4/13	30.8%	1	1	3	4		6	01:44:54
42	刘军波	1/1		0/1					1/2	50.0%		2				6	00:09:15
43	王久源	0/1	1/3	5/6	4/4	1/2	0/1		11/17	64.7%	1	3	3	1		6	02:33:43
50	刘欣洋		0/1						0/1	0.0%		1				6	00:24:52
合计		33/73	22/37	11/23	31/44	24/34	4/6	10/14	135/231	58.4%	31	49	11	15		96	
(守门员)																	
39	汤鸿宇	4/9	1/4	1/2	0/4	0/5	0/1	0/1	6/26	23.1%						6	00:44:03
40	陈欢	15/34	11/23	12/26	1/6	4/13	2/12	1/9	46/123	37.4%						6	03:15:57
合计		19/43	12/27	13/28	1/10	4/18	2/13	1/10	52/149	34.9%						12	

场上队员：得分/射门

守门员：救球/射门

已打比赛

全队合计	进球	被救	射失	击柱	封球	合计	%	阶段	场次	对手	比分
远射	33	11	11	7	11	73	45.2%	预赛	3	北京	24:14 (9:8)
近射	22	12	2	1		37	59.5%	预赛	24	深圳	22:13 (11:5)
边射	11	6	5	1		23	47.8%	预赛	37	西安	22:21 (9:10)
快攻	31	12		1		44	70.5%	四分之一决赛	52	天津	24:11 (14:3)
突破	24	7	1	2		34	70.6%	半决赛	75	西安	21:15 (8:10)
任意	4	1	1			6	66.7%	决赛	85	潍坊	22:23 (10:10)
七米	10	3	1			14	71.4%				

图式射门区域累计

手球
青年男子

截止至第85场

山西晋中
2019-06-23

安徽合肥

2 张天进 6 6 2 1 4 10 6 Post - 4 Miss - 7 Block - 4	13 沈威 4 7 1 2 2 Post - 0 Miss - 3 Block - 3	26 饶原源 4 8 4 3 3 4 Post - 3 Miss - 2 Block - 2	27 王东昇 Post - 0 Miss - 0 Block - 0	29 梅少聪 1 2 1 6 1 Post - 1 Miss - 0 Block - 0	30 单习振 2 5 3 2 4 Post - 1 Miss - 4 Block - 0	31 张宇 1 2 3 3 1 Post - 0 Miss - 3 Block - 1	33 於晓祺 Post - 0 Miss - 0 Block - 0
35 李宝松 1 Post - 0 Miss - 0 Block - 0	36 刘耀奇 1 3 Post - 0 Miss - 0 Block - 0	39 汤鸿宇 Post - 0 Miss - 0 Block - 0	40 陈欢 Post - 0 Miss - 0 Block - 0	41 管家乐 1 2 1 Post - 3 Miss - 1 Block - 0	42 刘军波 1 Post - 0 Miss - 0 Block - 0	43 王久源 3 5 Post - 0 Miss - 1 Block - 1	50 刘欣洋 Post - 0 Miss - 0 Block - 0

39 汤鸿宇

2/7		1/3
0/5		
1/4	1/1	1/6

40 陈欢

5/16	3/5	5/18
3/10	5/5	14/28
5/16	1/6	5/19

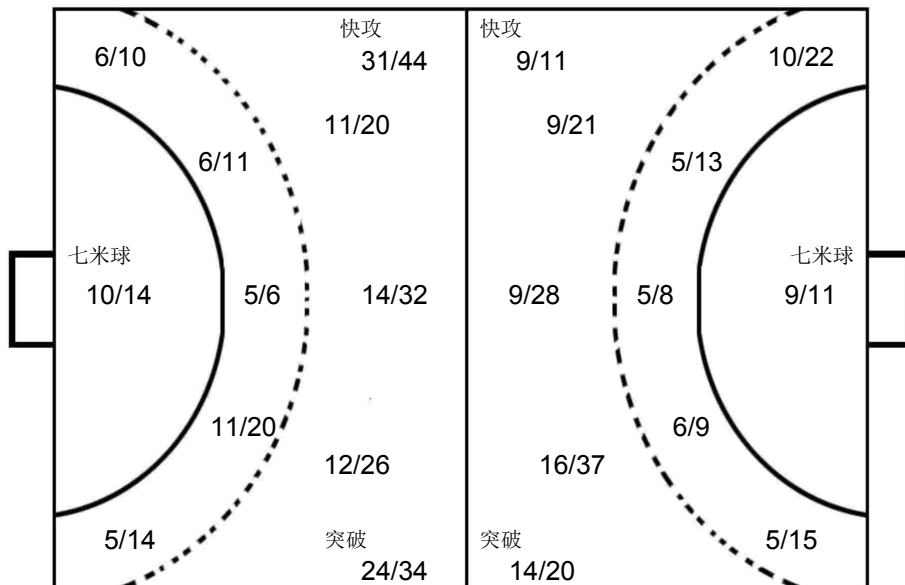

西安

1 陈昊

0/5	1/1	0/7
5/11	1/1	3/8
5/17	2/2	0/8

深圳

19 齐振东

1/4		0/3
2/3	2/3	0/4
2/4	2/2	2/4

北京

16 王鑫宇

2/3		2/9
3/6		0/2
1/6		2/7

OPPONENT

西安 9 陈孝天 6 3 1 1 1 1 Post - 1 Miss - 3 Block - 0	北京 23 庞佳明 2 1 6 Post - 0 Miss - 1 Block - 2	西安 15 陈冉 1 1 2 4 Post - 3 Miss - 3 Block - 0	潍坊 11 杨毅 1 3 1 1 1 Post - 0 Miss - 2 Block - 0	西安 8 张领 1 1 3 2 Post - 0 Miss - 2 Block - 0	潍坊 3 李相杰 3 1 1 1 Post - 0 Miss - 2 Block - 0	深圳 16 谢思远 1 2 1 1 Post - 0 Miss - 0 Block - 0	深圳 7 曾繁泳 1 1 1 Post - 0 Miss - 0 Block - 0
天津 26 李海龙 2 1 1 Post - 1 Miss - 2 Block - 0	潍坊 5 刘天驰 3 1 Post - 0 Miss - 1 Block - 0	西安 6 李梦豪 1 1 1 Post - 0 Miss - 0 Block - 0	天津 6 赵晨阳 1 1 1 Post - 2 Miss - 1 Block - 0	潍坊 15 宋子阳 3 Post - 0 Miss - 0 Block - 0	北京 9 曹智栋 1 1 Post - 1 Miss - 2 Block - 1	北京 15 刘大明 1 1 Post - 0 Miss - 2 Block - 1	天津 17 黄春瑞 1 1 Post - 0 Miss - 2 Block - 0



第二届全国青年运动会男子手球甲组决赛 体校组 (U18)

球队名单

山西晋中

陕西西安

2019-06-15

号码	姓名	位置	生日	年龄	俱乐部	身高 (CM)	体重 (KG)	国际场次	国际进球
1	陈昊	守门员	05/01/2002	17		198	95		
2	张兴彬	右边锋	08/03/2002	17		184	65		
3	丁玉冰	底线	17/12/2001	17		188	78		
5	隋家乐	底线	24/04/2001	18		188	85		
6	李梦豪	中后卫	09/12/2001	17		183	68		
7	黄金伟	中后卫	07/12/2001	17		185	70		
8	张领	左后卫	19/01/2001	18		190	87		
9	陈孝天	右后卫	16/02/2001	18		195	90		
10	王凯强	左后卫	08/02/2001	18		194	75		
11	孔宇豪	底线	03/04/2001	18		185	76		
12	朱正顺	守门员	11/07/2001	17		183	71		
13	徐昊天	右边锋	19/06/2002	16		184	81		
14	孙旭	左边锋	18/03/2001	18		182	83		
15	陈冉	左边锋	23/02/2001	18		185	78		
16	金筠峰	左边锋	31/12/2001	17					
17	刘世昌	右边锋	16/11/2001	17		180	68		
	平均			17.4		186.9	78.0		

编码	姓名	职务
B	李安	教练
C	郝可鑫	教练
D	王少杰	医生
E	陈冬冬	教练
A	王刚	领队

手球
青年男子

个人/全队技术累计表

 山西晋中
2019-06-23

截止至第85场

号码	姓名	远射	近射	边射	快攻	突破	任意	七米	合计	%	助攻	失误	警告	2'	取消	场次	时间
陕西西安																	
(场上队员)																	
1	陈昊	1/1				0/1			1/2	50.0%	1	2				6	03:45:49
2	张兴彬															6	00:00:00
3	丁玉冰	0/1	3/9						3/10	30.0%		3	1	1		6	03:35:03
5	隋家乐															6	00:00:00
6	李梦豪	5/9	2/4	0/1	2/2	4/4			13/20	65.0%	8	7	4	1		6	03:45:55
7	黄金伟			0/1				0/1	0/2	0.0%						6	00:03:50
8	张领	3/11	6/10	1/1	2/2	7/10		1/1	20/35	57.1%	4	13	2	3		6	03:38:35
9	陈孝天	22/38	3/4		1/1	1/1	9/11	4/6	40/61	65.6%	7	8		2	1	6	03:57:01
10	王凯强	0/2	3/5	0/1	1/4	0/1		1/1	5/14	35.7%	1	5	2			6	01:06:56
11	孔宇豪															6	00:00:02
12	朱正顺											1				6	00:14:11
13	徐昊天	1/2	1/2	3/6	3/3	0/1			8/14	57.1%		4		1		6	02:47:52
14	孙旭															6	00:02:58
15	陈冉	4/7	2/2	9/18	8/8	4/4	1/1	1/1	29/41	70.7%	1	4		3		6	03:57:02
16	金鹤峰															6	00:00:00
17	刘世昌		0/1						0/1	0.0%		3				6	01:04:29
合计		36/71	20/37	13/28	17/21	16/21	10/12	7/10	119/200	59.5%	22	50	9	11	1	96	
(守门员)																	
1	陈昊	17/41	8/28	10/18	6/26	2/17	0/4	2/12	45/146	30.8%	1	2				6	03:45:49
12	朱正顺	0/2	0/2	0/2				0/1	0/7	0.0%		1				6	00:14:11
合计		17/43	8/30	10/20	6/26	2/17	0/4	2/13	45/153	29.4%	1	3				12	

场上队员：得分/射门

守门员：救球/射门

已打比赛

全队合计	进球	被救	射失	击柱	封球	合计	%	阶段	场次	对手	比分
远射	36	16	12	2	5	71	50.7%	预赛	4	深圳	25:15 (12:8)
近射	20	14	1	2		37	54.1%	预赛	25	北京	17:18 (7:7)
边射	13	8	3	4		28	46.4%	预赛	37	合肥	21:22 (10:9)
快攻	17	3	1			21	81.0%	四分之一决赛	51	辽宁	20:15 (11:8)
突破	16	5				21	76.2%	半决赛	75	合肥	15:21 (10:8)
任意	10	1	1			12	83.3%	3-4名	81	北京	21:17 (10:5)
七米	7	1	2			10	70.0%				

图式射门区域累计

手球
青年男子

截止至第85场

山西晋中
2019-06-23

陕西西安

1 陈昊 1 Post - 0 Miss - 1 Block - 0	2 张兴彬 Post - 0 Miss - 0 Block - 0	3 丁玉冰 1 1 Post - 1 Miss - 0 Block - 0	5 隋家乐 Post - 0 Miss - 0 Block - 0	6 李梦豪 2 1 3 1 4 Post - 0 Miss - 2 Block - 0	7 黄金伟 Post - 0 Miss - 0 Block - 0	8 张颌 1 1 3 6 5 1 3 Post - 0 Miss - 4 Block - 2	9 陈孝天 9 8 2 1 8 5 1 6 Post - 2 Miss - 6 Block - 3
10 王凯强 1 2 1 1 Post - 0 Miss - 2 Block - 0	11 孔宇豪 Post - 0 Miss - 0 Block - 0	12 朱正顺 Post - 0 Miss - 0 Block - 0	13 徐昊天 2 2 2 2 Post - 2 Miss - 0 Block - 0	14 孙旭 Post - 0 Miss - 0 Block - 0	15 陈冉 3 2 3 10 1 10 Post - 3 Miss - 4 Block - 0	16 金筠峰 Post - 0 Miss - 0 Block - 0	17 刘世昌 Post - 0 Miss - 1 Block - 0

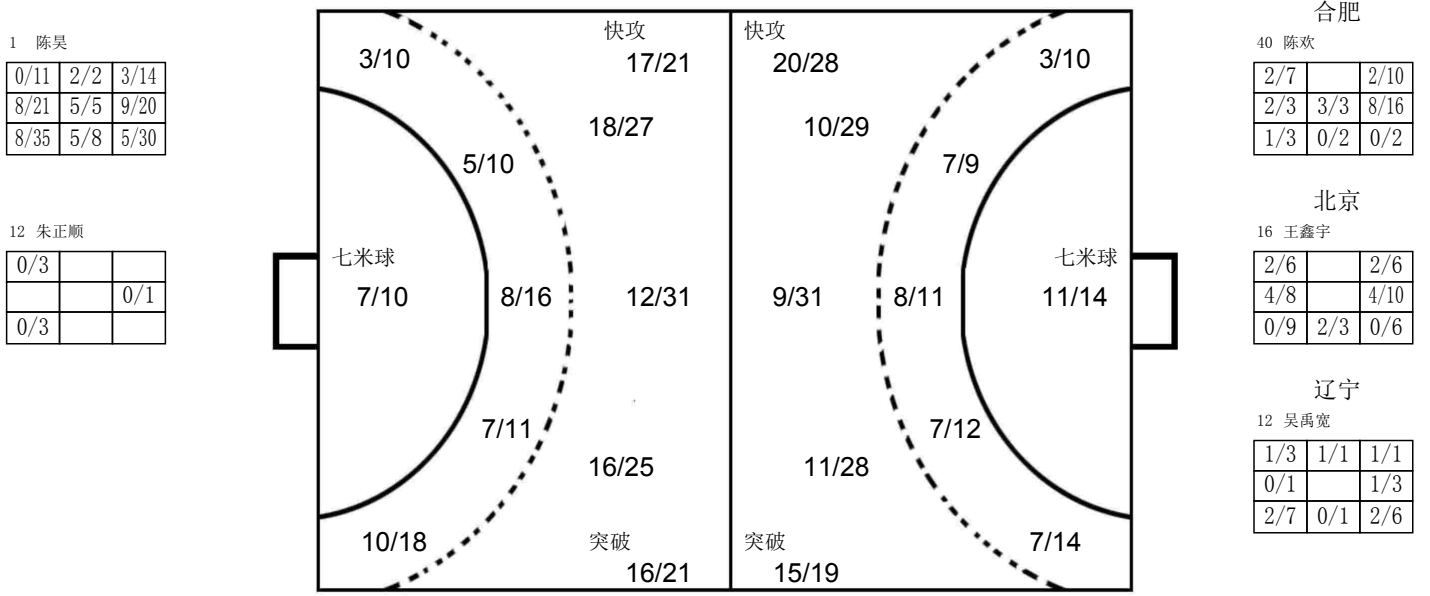

OPPONENT

北京 23 庞佳明 1 1 2 1 4 3 Post - 0 Miss - 1 Block - 1	合肥 2 张天进 2 1 5 2 Post - 0 Miss - 4 Block - 4	合肥 26 饶原源 2 1 3 2 1 Post - 2 Miss - 1 Block - 2	北京 9 曹智栋 3 1 2 1 Post - 0 Miss - 1 Block - 1	北京 15 刘大明 1 1 1 1 1 2 Post - 0 Miss - 3 Block - 0	合肥 29 梅少聪 1 1 1 1 3 Post - 0 Miss - 0 Block - 0	合肥 30 单习振 1 2 1 2 Post - 1 Miss - 3 Block - 0	深圳 3 李朗轩 2 1 1 1 Post - 0 Miss - 0 Block - 0
北京 6 苑宾 1 1 1 Post - 1 Miss - 0 Block - 0	合肥 43 王久源 1 2 1 2 Post - 0 Miss - 1 Block - 1	辽宁 2 关贺元 1 3 Post - 0 Miss - 0 Block - 0	辽宁 4 刘旭 4 Post - 1 Miss - 4 Block - 2	辽宁 29 蒋效峰 2 2 Post - 0 Miss - 0 Block - 0	北京 13 蓝心凯 1 1 Post - 0 Miss - 0 Block - 0	合肥 13 沈威 2 1 Post - 0 Miss - 2 Block - 1	深圳 8 罗霖泽 2 1 Post - 1 Miss - 0 Block - 0

球队名单

山西晋中

北京市

2019-06-15

号码	姓名	位置	生日	年龄	俱乐部	身高 (CM)	体重 (KG)	国际场次	国际进球
1	陶钜	守门员	23/06/2002	16	北京男子手球队	186	80		
3	魏豪	边锋	03/07/2001	17	北京男子手球队	185	78		
4	李博仔	左边锋	23/12/2004	14	北京男子手球队	173	110		
6	苑宾	左边锋	02/07/2001	17	北京男子手球队	188	80		
7	侯博耀	中后卫	23/12/2002	16	北京男子手球队	184	75		
8	孙铂力	左后卫	05/03/2002	17	北京男子手球队	190	85		
9	曹智栋	左后卫	31/10/2002	16	北京男子手球队	197	85		
13	蓝心凯	底线	29/06/2001	17	北京男子手球队	192	89		
14	杜俊林	右边锋	02/07/2002	16	北京男子手球队	195	85		
15	刘大明	右后卫	28/05/2001	18	北京男子手球队	180	67		
16	王鑫宇	守门员	27/06/2001	17	北京男子手球队	200	87		
18	宋昱鹏	底线	30/01/2002	17	北京男子手球队	190	95		
23	庞佳明	左后卫	07/03/2001	18	北京男子手球队	194	85		
26	郑铭境	右后卫	03/02/2002	17	北京男子手球队	173	70		
29	赵熹瑞	底线	12/04/2001	18	北京男子手球队	190	100		
32	张珂宁	左后卫	28/04/2002	17	北京男子手球队	196	80		
	平均			16.8		188.3	84.4		

编码	姓名	职务
A	吴健	教练
B	翟彦戎	医生

手球
青年男子

个人/全队技术累计表

 山西晋中
2019-06-23

截止至第85场

号码	姓名	远射	近射	边射	快攻	突破	任意	七米	合计	%	助攻	失误	警告	2'	取消	场次	时间
北京市																	
(场上队员)																	
1	陶钜															6	00:36:36
3	魏豪															6	00:05:52
4	李博仔															6	00:00:00
6	苑宾	1/2	2/3	6/14	2/3			6/8	17/30	56.7%		3	1	1		6	03:55:00
7	侯博耀	1/4	0/2						1/6	16.7%						6	00:15:29
8	孙铂力										1	2				6	00:16:01
9	曹智栋	7/18	3/4	2/5	1/1	2/2	1/1	0/1	16/32	50.0%	2	8		1		6	03:41:06
13	蓝心凯		4/5	4/6					8/11	72.7%		4	1	1		6	03:08:00
14	杜俊林															6	00:04:52
15	刘大明	6/21	2/3	2/3		4/5	1/1	1/1	16/34	47.1%	2	9				6	03:44:24
16	王鑫宇										1					6	03:23:24
18	宋昱鹏															6	00:00:00
23	庞佳明	9/27	5/7	2/2	3/4	4/4	7/7	8/9	38/60	63.3%	6	14		1		6	03:38:36
26	郑铭境	0/2	1/2	0/1					1/5	20.0%	1	2	1	3		6	01:25:02
29	赵熹瑞		5/6						5/6	83.3%	1	3		1		6	03:38:19
32	张珂宁	0/1							0/1	0.0%		1				6	00:05:25
合计		24/75	22/32	16/31	6/8	10/11	9/9	15/19	102/185	55.1%	14	46	3	8		96	
(守门员)																	
1	陶钜	2/6	0/3	2/4	0/3	0/4	0/2		4/22	18.2%						6	00:36:36
16	王鑫宇	16/52	9/31	0/6	7/21	4/19	1/4	0/3	37/136	27.2%	1					6	03:23:24
合计		18/58	9/34	2/10	7/24	4/23	1/6	0/3	41/158	25.9%	1					12	

场上队员：得分/射门

守门员：救球/射门

已打比赛

全队合计	进球	被救	射失	击柱	封球	合计	%	阶段	场次	对手	比分
远射	24	25	11	5	10	75	32.0%	预赛	3	合肥	14:24 (8:9)
近射	22	8	2			32	68.8%	预赛	25	西安	18:17 (7:7)
边射	16	12	2	1		31	51.6%	预赛	36	深圳	18:15 (9:7)
快攻	6	1	1			8	75.0%	四分之一决赛	50	泉港	22:18 (12:7)
突破	10		1			11	90.9%	半决赛	74	潍坊	13:22 (7:12)
任意	9					9	100.0%	3-4名	81	西安	17:21 (5:10)
七米	15	2	1	1		19	78.9%				

图式射门区域累计

手球
青年男子

截止至第85场

山西晋中
2019-06-23

北京市

1 陶钜 [] [] [] [] [] [] Post - 0 Miss - 0 Block - 0	3 魏豪 [] [] [] [] [] [] Post - 0 Miss - 0 Block - 0	4 李博仔 [] [] [] [] [] [] Post - 0 Miss - 0 Block - 0	6 苑宾 1 [] [] 4 2 [] [] 2 4 [] 1 [] 3 Post - 1 Miss - 2 Block - 0	7 侯博耀 [] [] [] [] [] [] Post - 0 Miss - 1 Block - 0	8 孙铂力 [] [] [] [] [] [] Post - 0 Miss - 0 Block - 0	9 曹智栋 4 [] [] 1 3 [] [] 3 3 [] 1 [] 1 Post - 2 Miss - 3 Block - 2	13 蓝心凯 [] [] [] [] [] [] 3 [] 1 [] 2 Post - 0 Miss - 0 Block - 0
14 杜俊林 [] [] [] [] [] [] Post - 0 Miss - 0 Block - 0	15 刘大明 4 [] 1 [] 1 4 [] [] 2 2 [] [] 2 Post - 1 Miss - 6 Block - 3	16 王鑫宇 [] [] [] [] [] [] Post - 0 Miss - 0 Block - 0	18 宋昱鹏 [] [] [] [] [] [] Post - 0 Miss - 0 Block - 0	23 庞佳明 3 [] 1 [] 4 5 [] [] 4 8 [] [] 13 Post - 2 Miss - 6 Block - 5	26 郑铭境 [] [] [] [] [] [] Post - 1 Miss - 0 Block - 0	29 赵熹瑞 [] [] [] [] [] [] 1 [] 1 [] 2 Post - 0 Miss - 0 Block - 0	32 张珂宁 [] [] [] [] [] [] Post - 0 Miss - 0 Block - 0

1 陶钜

[]	[]	0/2
1/1	1/2	1/4
0/5	1/1	0/7

16 王鑫宇

6/15	0/5	4/18
14/29	1/1	5/15
3/23	2/9	2/21

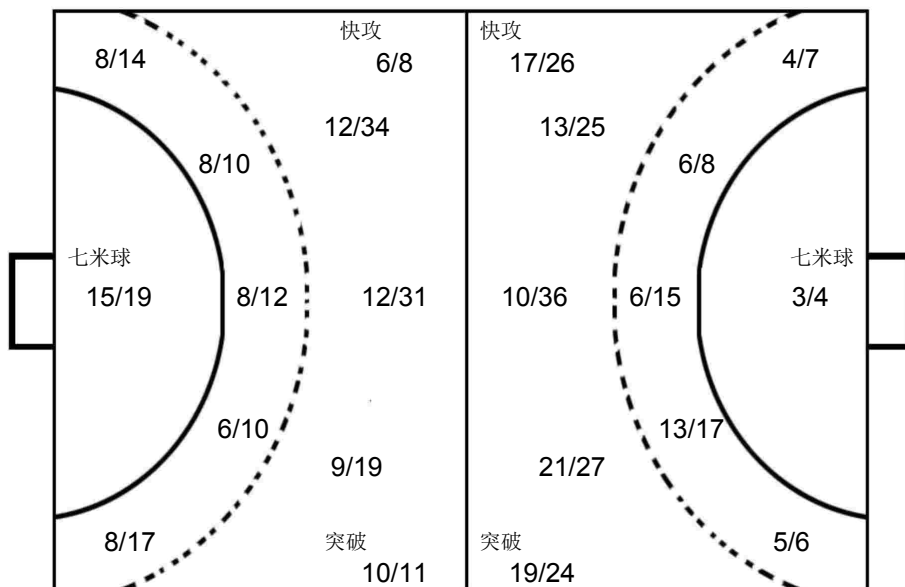

西安

1 陈昊

0/5	1/1	1/3
3/7	4/4	2/6
1/7	0/2	2/9

潍坊

12 黄晓春

0/1	2/3	0/1
2/3	5/5	1/3
0/4	1/1	0/2

合肥

40 陈欢

0/1	2/3	[]
[]	[]	1/3
3/5	0/1	2/9

OPPONENT

西安 9 陈孝天 1 [] [] 2 1 [] 1 3 3 [] [] 3 Post - 0 Miss - 2 Block - 2	西安 15 陈冉 2 [] [] 1 [] [] [] 4 [] [] 2 Post - 0 Miss - 1 Block - 0	合肥 2 张天进 1 [] [] 2 1 [] [] 1 2 [] [] 1 Post - 1 Miss - 0 Block - 0	泉港 20 吴兆瑞 [] [] 1 [] 1 [] [] 3 1 [] [] 2 Post - 0 Miss - 0 Block - 2	潍坊 11 杨毅 1 [] 1 [] 1 [] [] [] 1 [] 1 [] 2 Post - 1 Miss - 1 Block - 0	西安 8 张领 [] [] [] 2 [] [] 3 1 [] 1 [] [] Post - 0 Miss - 2 Block - 2	深圳 3 李朗轩 [] [] [] 2 [] [] [] [] 1 [] 1 Post - 0 Miss - 1 Block - 1	合肥 26 饶原源 [] [] [] 2 [] [] [] [] [] [] 2 Post - 1 Miss - 1 Block - 0
合肥 30 单习振 [] [] [] 1 [] [] [] 1 1 [] [] [] 1 Post - 0 Miss - 0 Block - 0	深圳 16 谢思远 [] [] [] [] [] [] [] [] 1 [] 1 [] 2 Post - 1 Miss - 0 Block - 1	潍坊 5 刘天驰 [] [] [] 1 1 [] [] [] 1 [] [] 1 [] [] Post - 0 Miss - 2 Block - 0	潍坊 12 黄晓春 1 [] 3 [] [] [] [] [] [] [] [] [] [] Post - 0 Miss - 0 Block - 0	西安 6 李梦豪 [] [] [] 1 1 [] [] [] 1 [] [] 1 [] Post - 0 Miss - 1 Block - 0	合肥 13 沈威 [] [] [] 3 [] [] [] [] [] [] [] [] Post - 0 Miss - 0 Block - 0	深圳 8 罗霖泽 [] [] [] [] [] [] [] [] [] [] [] 3 Post - 0 Miss - 0 Block - 0	合肥 29 梅少聪 [] [] [] [] 1 [] [] [] 1 [] [] [] Post - 1 Miss - 0 Block - 0



球队名单

福建泉港

山西晋中

2019-06-15

号码	姓名	位置	生日	年龄	俱乐部	身高 (CM)	体重 (KG)	国际场次	国际进球
1	周铁程	守门员	25/07/2003	15		191	80		
6	段家乐	右边锋	15/12/2002	16		182	62		
7	王嘉靖	左后卫	13/12/2002	16		180	70		
9	周星晨	后卫	04/04/2001	18		179	70		
10	陈臻	左边锋	28/12/2002	16		176	60		
11	钟宏韬	左后卫	15/11/2002	16		180	70		
12	汪琪坤	守门员	18/12/2001	17		192	72		
13	周忠迪	后卫	30/09/2001	17		177	64		
15	刘小龙	中后卫	09/10/2001	17		178	68		
17	左兆坤	左后卫	30/03/2001	18		187	72		
18	刘少杰	底线	14/05/2001	18		177	67		
20	吴兆瑞	右后卫	21/10/2001	17		180	69		
21	张路	右后卫	28/02/2001	18		180	70		
23	卓世胜	左边锋	13/02/2002	17		177	67		
25	张杰	右边锋	15/09/2001	17		175	66		
34	王涛	左边锋	04/04/2001	18		175	65		
	平均			16.9		180.4	68.3		

编码	姓名	职务
B	王卫	教练
C	刘德东	教练
E	薛裕安	医生
A	庄学培	领队
D	庄清斌	教练

手球
青年男子

个人/全队技术累计表

 山西晋中
2019-06-23

截止至第85场

号码	姓名	远射	近射	边射	快攻	突破	任意	七米	合计	%	助攻	失误	警告	2'	取消	场次	时间
福建泉港																	
(场上队员)																	
1	周铁程															6	01:20:05
6	段家乐	1/2	1/1	2/3	1/1			0/1	5/8	62.5%		8	1	2		6	01:23:04
7	王嘉靖															6	00:00:00
9	周星晨		1/1	1/2	0/1	1/2		1/1	4/7	57.1%		2		1		6	01:48:49
10	陈臻															6	00:00:22
11	钟宏韬															6	00:01:55
12	汪琪坤	1/1							1/1	100%		1				6	02:39:55
13	周忠迪	3/9	6/8	5/9	2/4			7/8	23/38	60.5%	1	9		3		6	03:38:10
15	刘小龙	1/9	3/6			5/6			9/21	42.9%	4	14	3	1		6	02:28:46
17	左兆坤	0/2						1/1	1/3	33.3%		1				6	00:18:39
18	刘少杰		6/9		1/1				7/10	70.0%	2	4	2	1		6	03:59:51
20	吴兆瑞	9/25	12/20	1/1	2/3	17/19	1/2	3/4	45/74	60.8%	5	14	1	5		6	03:44:02
21	张路	7/15	2/5	1/2	1/1	7/12		3/4	21/39	53.8%	11	20		3		6	03:46:28
23	卓世胜			5/8	1/1		1/1		7/10	70.0%		3	1	2		6	02:48:16
25	张杰															6	00:00:00
34	王涛															6	00:00:00
合计		22/63	31/50	15/25	8/12	30/39	2/3	15/19	123/211	58.3%	23	76	8	18		96	
(守门员)																	
1	周铁程	4/18	4/10	3/7	3/18	1/8	0/1	3/7	18/69	26.1%						6	01:20:05
12	汪琪坤	13/21	10/27	7/22	3/17	1/21	2/3	4/11	40/122	32.8%		1				6	02:39:55
合计		17/39	14/37	10/29	6/35	2/29	2/4	7/18	58/191	30.4%		1				12	

场上队员：得分/射门

守门员：救球/射门

已打比赛

全队合计	进球	被救	射失	击柱	封球	合计	%	阶段	场次	对手	比分
远射	22	21	8	5	7	63	34.9%	预赛	1	辽宁	25:26 (13:9)
近射	31	13	4	1	1	50	62.0%	预赛	19	潍坊	17:30 (8:15)
边射	15	8		2		25	60.0%	预赛	41	天津	26:22 (14:11)
快攻	8	3	1			12	66.7%	四分之一决赛	50	北京	18:22 (7:12)
突破	30	4	2	3		39	76.9%	5-8名	63	深圳	19:16 (11:9)
任意	2	1				3	66.7%	5-6名	80	辽宁	18:17 (8:7)
七米	15	2	1	1		19	78.9%				

图式射门区域累计

手球
青年男子

截止至第85场

山西晋中
2019-06-23

福建泉港

1 周铁程 Post - 0 Miss - 0 Block - 0	6 段家乐 Post - 0 Miss - 0 Block - 1	7 王嘉靖 Post - 0 Miss - 0 Block - 0	9 周星晨 Post - 1 Miss - 1 Block - 0	10 陈臻 Post - 0 Miss - 0 Block - 0	11 钟宏韬 Post - 0 Miss - 0 Block - 0	12 汪琪坤 Post - 0 Miss - 0 Block - 0	13 周忠迪 Post - 2 Miss - 4 Block - 1
15 刘小龙 Post - 2 Miss - 2 Block - 1	17 左兆坤 Post - 0 Miss - 1 Block - 1	18 刘少杰 Post - 1 Miss - 0 Block - 0	20 吴兆瑞 Post - 2 Miss - 4 Block - 3	21 张路 Post - 4 Miss - 4 Block - 1	23 卓世胜 Post - 0 Miss - 0 Block - 0	25 张杰 Post - 0 Miss - 0 Block - 0	34 王涛 Post - 0 Miss - 0 Block - 0

1 周铁程	0/8	1/4
10/21	1/1	3/12
2/11	0/1	1/11

12 汪琪坤	3/12	4/5	7/22
5/18	1/1	5/20	
7/14	0/1	8/29	

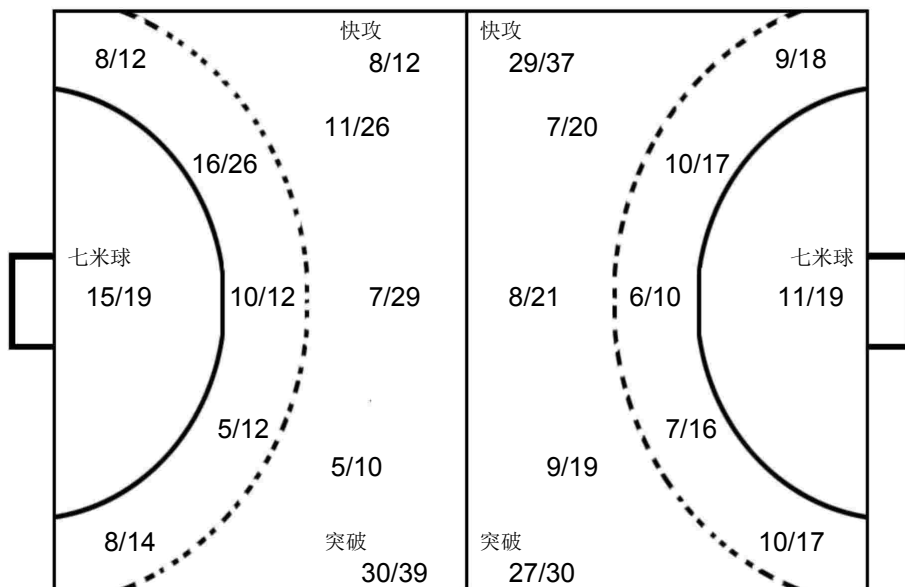

天津

23 谭元春	0/3	0/1	2/3
2/5	2/2	2/10	
1/5	0/3	1/4	

辽宁

1 何振楠	1/5	1/1	1/5
2/6		1/4	
4/15		0/7	

潍坊

1 鲁世豪	0/2	1/1	1/1
1/2		3/4	
0/3	1/1	1/3	

OPPONENT

辽宁 9 张鹏 Post - 0 Miss - 1 Block - 0	辽宁 2 关贺元 Post - 0 Miss - 1 Block - 0	天津 6 赵晨阳 Post - 1 Miss - 2 Block - 0	天津 26 李海龙 Post - 0 Miss - 1 Block - 0	辽宁 4 刘旭 Post - 0 Miss - 1 Block - 5	辽宁 29 蒋效峰 Post - 0 Miss - 0 Block - 0	潍坊 11 杨毅 Post - 1 Miss - 0 Block - 0	北京 6 苑宾 Post - 0 Miss - 1 Block - 0
北京 23 庞佳明 Post - 0 Miss - 2 Block - 0	深圳 7 曾繁泳 Post - 0 Miss - 0 Block - 0	潍坊 3 李相杰 Post - 1 Miss - 0 Block - 0	北京 9 曹智栋 Post - 1 Miss - 0 Block - 0	辽宁 10 王新開 Post - 0 Miss - 1 Block - 0	辽宁 24 邢洪銘 Post - 1 Miss - 1 Block - 1	潍坊 6 张智超 Post - 0 Miss - 0 Block - 0	潍坊 15 宋子阳 Post - 0 Miss - 1 Block - 0



球队名单

山西晋中

2019-06-15

辽宁体校

号码	姓名	位置	生日	年龄	俱乐部	身高 (CM)	体重 (KG)	国际场次	国际进球
1	何振楠	守门员	29/01/2003	16		180	65		
2	关贺元	底线	23/04/2001	18		183	90		
3	贾博	左边锋	29/11/2001	17		174	61		
4	刘旭	左后卫	05/06/2002	17		190	80		
5	关棋	后卫	05/09/2002	16		178	75		
7	姜珺	左后卫	09/12/2001	17		183	75		
8	郭嘉尧	右边锋	14/04/2001	18		175	65		
9	张鹏	左后卫	27/01/2002	17		178	65		
10	王新開	中后卫	08/07/2002	16		173	70		
11	颜科研	右边锋	04/02/2002	17		178	65		
12	吴禹宽	守门员	06/04/2002	17		190	90		
13	赵子凯	右后卫	18/02/2002	17		184	73		
18	祝慧翔昊	后卫	22/03/2002	17		175	75		
21	蒋申健	右边锋	31/01/2002	17		179	80		
24	邢洪銘	右后卫	30/10/2001	17		190	85		
29	蒋效峰	中后卫	11/04/2002	17		181	90		
	平均			16.9		180.7	75.3		

编码	姓名	职务
B	张瑜	领队
C	罗帅	教练
D	王译	教练
A	陈宏瑞	主教练
E	桂海旭	医生

手球
青年男子

个人/全队技术累计表

山西晋中
2019-06-23

截止至第85场

号码	姓名	远射	近射	边射	快攻	突破	任意	七米	合计	%	助攻	失误	警告	2'	取消	场次	时间
辽宁体校																	
(场上队员)																	
1	何振楠															6	01:56:56
2	关贺元		17/23	0/1	1/1	1/1		1/2	20/28	71.4%	2	3	1	4		6	03:51:52
3	贾博															6	00:00:24
4	刘旭	19/53	1/3	0/1	1/1	2/2	2/4	1/1	26/65	40.0%	9	15	1	2		6	03:45:19
5	关棋															6	00:00:00
7	姜珺															6	00:00:00
8	郭嘉尧															4	00:00:00
9	张鹏	6/16	1/5	1/1	5/6	6/6	1/2	4/7	24/43	55.8%	7	16	1	2		6	03:33:12
10	王新開	0/3	1/3	4/6	3/4	2/4		0/1	10/21	47.6%	3	6	4	2		6	03:39:13
11	颜科研			1/2	3/3				4/5	80.0%		4	1			6	02:45:52
12	吴禹宽											1				6	02:03:04
13	赵子凯	1/3	0/2	1/2				1/1	3/8	37.5%	1	3				6	00:33:33
18	祝慧翔昊															4	00:04:02
21	蒋申健															2	00:00:00
24	邢洪銘	10/27	3/6	1/2	0/1	3/6	0/3		17/45	37.8%	2	3		1		6	03:15:03
29	蒋效峰	0/1	5/8	0/1	5/5	6/6	0/1		16/22	72.7%	1	8	2	1		6	02:30:12
	合计	36/103	28/50	8/16	18/21	20/25	3/10	7/12	120/237	50.6%	25	59	10	12		88	
(守门员)																	
1	何振楠	10/27	4/14	6/12	1/6	2/17	0/1	3/15	26/92	28.3%						6	01:56:56
12	吴禹宽	13/25	8/16	6/11	0/5	4/20	2/4		33/81	40.7%		1				6	02:03:04
	合计	23/52	12/30	12/23	1/11	6/37	2/5	3/15	59/173	34.1%		1				12	

场上队员：得分/射门

守门员：救球/射门

已打比赛

全队合计	进球	被救	射失	击柱	封球	合计	%	阶段	场次	对手	比分
远射	36	32	17	5	13	103	35.0%	预赛	1	泉港	26:25 (9:13)
近射	28	17	3	1	1	50	56.0%	预赛	20	天津	22:12 (9:7)
边射	8	5	2	1		16	50.0%	预赛	42	潍坊	17:20 (11:12)
快攻	18	2		1		21	85.7%	四分之一决赛	51	西安	15:20 (8:11)
突破	20	3		2		25	80.0%	5-8名	64	天津	23:19 (13:11)
任意	3	2	3	2		10	30.0%	5-6名	80	泉港	17:18 (7:8)
七米	7	4		1		12	58.3%				

图式射门区域累计

手球
青年男子

截止至第85场

山西晋中
2019-06-23

辽宁体校

1 何振楠 Post - 0 Miss - 0 Block - 0	2 关贺元 Post - 1 Miss - 1 Block - 0	3 贾博 Post - 0 Miss - 0 Block - 0	4 刘旭 Post - 4 Miss - 11 Block - 8	5 关棋 Post - 0 Miss - 0 Block - 0	7 姜琨 Post - 0 Miss - 0 Block - 0	8 郭嘉尧 Post - 0 Miss - 0 Block - 0	9 张鹏 Post - 0 Miss - 5 Block - 1
10 王新開 Post - 1 Miss - 2 Block - 1	11 颜科研 Post - 0 Miss - 1 Block - 0	12 吴禹宽 Post - 0 Miss - 0 Block - 0	13 赵子凯 Post - 1 Miss - 0 Block - 0	18 祝慧翔昊 Post - 0 Miss - 0 Block - 0	21 蒋申健 Post - 0 Miss - 0 Block - 0	24 邢洪銘 Post - 5 Miss - 5 Block - 4	29 蒋效峰 Post - 1 Miss - 0 Block - 0

1 何振楠

2/7	1/1	2/14
8/17	1/1	5/10
6/26	0/1	1/15

12 吴禹宽

2/7	2/2	5/7
8/14		5/10
7/23	0/2	4/16

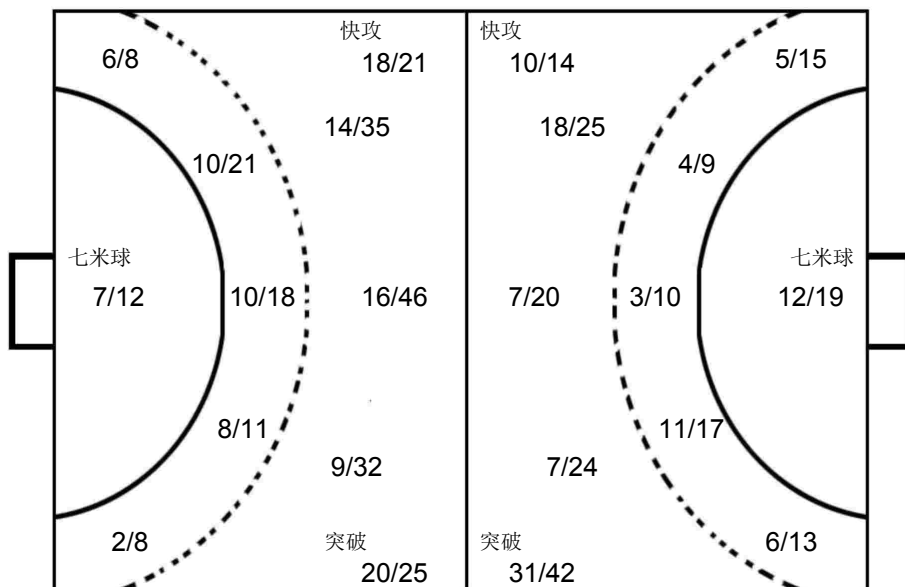

天津

23 譚元春

2/10		1/5
5/12		3/7
4/13	0/1	3/15

潍坊

12 黄晓春

1/4	2/4	
4/5	4/4	2/2
1/5		3/6

泉港

12 汪琪坤

1/7	1/1	5/9
2/8		1/5
1/3		6/15

OPPONENT

6 赵晨阳 Post - 2 Miss - 3 Block - 0	20 吴兆瑞 Post - 1 Miss - 1 Block - 0	13 周忠迪 Post - 1 Miss - 3 Block - 0	21 张路 Post - 3 Miss - 1 Block - 0	15 陈冉 Post - 0 Miss - 0 Block - 0	25 郝一铮 Post - 1 Miss - 0 Block - 0	3 李相杰 Post - 0 Miss - 1 Block - 0	11 杨毅 Post - 1 Miss - 0 Block - 0
26 李海龙 Post - 3 Miss - 0 Block - 1	5 刘天驰 Post - 0 Miss - 1 Block - 0	9 陈孝天 Post - 0 Miss - 1 Block - 1	9 周星晨 Post - 1 Miss - 0 Block - 0	15 刘小龙 Post - 1 Miss - 1 Block - 0	20 王澎 Post - 0 Miss - 0 Block - 0	13 徐昊天 Post - 0 Miss - 0 Block - 0	17 黄春瑞 Post - 1 Miss - 1 Block - 0



第二届全国青年运动会男子手球甲组决赛 体校组 (U18)

球队名单

广东深圳

山西晋中

2019-06-15

号码	姓名	位置	生日	年龄	俱乐部	身高 (CM)	体重 (KG)	国际场次	国际进球
2	祝安南	后卫	18/09/2003	15	深圳	172	60		
3	李朗轩	左后卫	24/02/2003	16	深圳	185	75		
5	陈俊延	右边锋	22/07/2001	17	深圳	173	65		
6	董佳辉	左后卫	28/02/2002	17	深圳	193	90		
7	曾繁泳	左边锋	12/08/2001	17	深圳	172	63		
8	罗霖泽	右边锋	18/08/2001	17	深圳	172	64		
9	左典	后卫	08/04/2002	17	深圳	175	65		
10	李剑琛	底线	11/01/2001	18	深圳	173	70		
11	万泽峰	底线	21/02/2001	18	深圳	191	80		
12	戴景伟	守门员	26/09/2002	16	深圳	190	110		
13	赵世豪	右后卫	11/08/2002	16	深圳	190	75		
15	金硕	左后卫	01/06/2004	15	深圳	193	80		
16	谢思远	后卫	12/08/2001	17	深圳	190	70		
18	曾笑童	守门员	05/12/2001	17	深圳	182	66		
19	齐振东	守门员	01/07/2002	16	深圳	193	85		
	平均			16.6		182.9	74.5		

编码	姓名	职务
A	张斌	领队
D	张广建	教练
C	李中洲	主教练
F	蒋光华	医生
E	曲汝洋	教练

手球
青年男子

个人/全队技术累计表

 山西晋中
2019-06-23

截止至第85场

号码	姓名	远射	近射	边射	快攻	突破	任意	七米	合计	%	助攻	失误	警告	2'	取消	场次	时间
广东深圳																	
(场上队员)																	
2	祝安南															4	00:19:52
3	李朗轩	3/8	1/6	2/3	3/4	3/3			12/24	50.0%	3	8	3			6	03:24:29
5	陈俊延															6	00:00:04
6	董佳辉	4/24	4/12	0/2		5/7		0/2	13/47	27.7%	2	9	1	2		6	03:22:51
7	曾繁泳	2/4	2/2	8/14	3/5	1/2		1/1	17/28	60.7%		5	2			6	03:34:22
8	罗霖泽		3/3	7/12	2/5	1/1		2/3	15/24	62.5%	2	7	2	3		6	03:33:30
9	左典	5/10	0/2		1/2	5/5		0/1	11/20	55.0%	5	13	1			6	03:02:45
10	李剑琛	0/1	2/6	1/3	2/4				5/14	35.7%	3	6	3	1		6	03:23:06
11	万泽峰		1/2						1/2	50.0%		2				6	00:45:00
12	戴景伟											2				6	02:08:37
13	赵世豪			0/1	1/1				1/2	50.0%		1				6	00:12:57
15	金硕	0/1							0/1	0.0%		4				3	00:11:57
16	谢思远	1/8	5/5	2/2	2/4	3/3			13/22	59.1%	1	13				6	02:07:05
18	曾笑童											1				6	00:30:28
19	齐振东															6	01:21:23
	合计	15/56	18/38	20/37	14/25	18/21		3/7	88/184	47.8%	16	71	12	6		85	
(守门员)																	
12	戴景伟	6/25	5/22	5/8	1/9	2/12	0/3	0/6	19/85	22.4%		2				6	02:08:37
18	曾笑童	1/3	2/7	1/4	0/6	0/1		0/3	4/24	16.7%		1				6	00:30:28
19	齐振东	3/13	3/11	6/9	6/10	1/7	0/2	0/3	19/55	34.5%						6	01:21:23
	合计	10/41	10/40	12/21	7/25	3/20	0/5	0/12	42/164	25.6%		3				18	

场上队员：得分/射门

守门员：救球/射门

已打比赛

全队合计	进球	被救	射失	击柱	封球	合计	%	阶段	场次	对手	比分
远射	15	17	13	3	8	56	26.8%	预赛	4	西安	15:25 (8:12)
近射	18	11	6	3		38	47.4%	预赛	24	合肥	13:22 (5:11)
边射	20	12	5			37	54.1%	预赛	36	北京	15:18 (7:9)
快攻	14	7	1	2	1	25	56.0%	四分之一决赛	49	潍坊	9:24 (4:14)
突破	18	2	1			21	85.7%	5-8名	63	泉港	16:19 (9:11)
任意							0.0%	7-8名	79	天津	20:14 (9:7)
七米	3	4				7	42.9%				

图式射门区域累计

手球
青年男子

截止至第85场

山西晋中
2019-06-23

广东深圳

2 祝安南 Post - 0 Miss - 0 Block - 0	3 李朗轩 Post - 0 Miss - 4 Block - 1	5 陈俊延 Post - 0 Miss - 0 Block - 0	6 董佳辉 Post - 2 Miss - 11 Block - 4	7 曾繁泳 Post - 2 Miss - 4 Block - 0	8 罗霖泽 Post - 1 Miss - 1 Block - 0	9 左典 Post - 1 Miss - 1 Block - 2	10 李剑琛 Post - 1 Miss - 3 Block - 0
11 万泽峰 Post - 0 Miss - 0 Block - 0	12 戴景伟 Post - 0 Miss - 0 Block - 0	13 赵世豪 Post - 0 Miss - 0 Block - 0	15 金硕 Post - 0 Miss - 1 Block - 0	16 谢思远 Post - 1 Miss - 1 Block - 2	18 曾笑童 Post - 0 Miss - 0 Block - 0	19 齐振东 Post - 0 Miss - 0 Block - 0	

12 戴景伟
0/6 1/2 4/10
3/9 2/18
4/19 1/3 4/18

18 曾笑童
1/1 1/2
1/5 0/1 0/6
0/5 1/4

19 齐振东
1/5 1/10
3/6 2/3 1/6
4/12 2/2 5/11

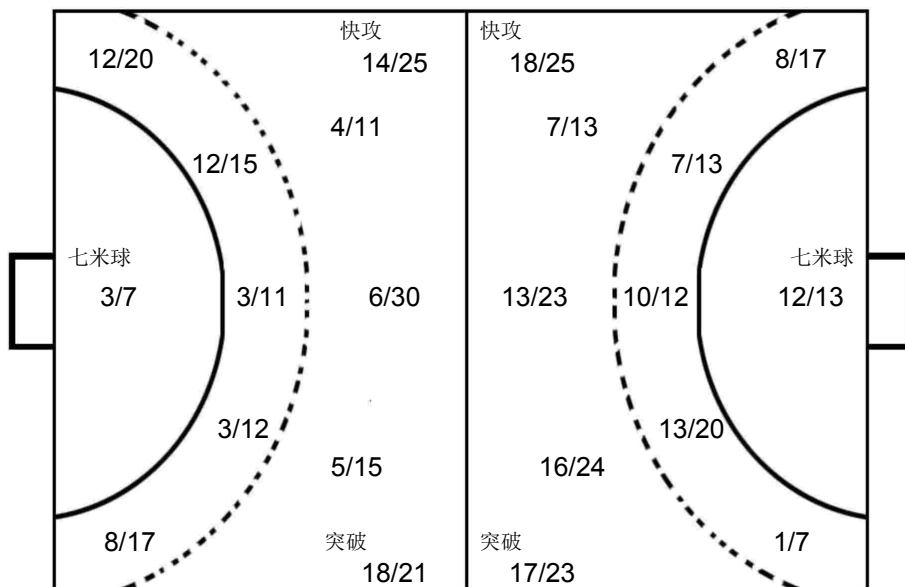

泉港
12 汪琪坤
1/2 1/2 1/3
2/4 2/7
4/4 2/7

西安
1 陈昊
0/1 2/3
0/2 1/3
1/5 3/4 2/6

潍坊
12 黄晓春
3/3 2/2
1/4 1/2

OPPONENT

潍坊 11 杨毅 Post - 0 Miss - 0 Block - 0	北京 23 庞佳明 Post - 2 Miss - 2 Block - 1	泉港 20 吴兆瑞 Post - 1 Miss - 3 Block - 1	西安 9 陈孝天 Post - 1 Miss - 0 Block - 0	合肥 2 张天进 Post - 0 Miss - 0 Block - 0	天津 26 李海龙 Post - 0 Miss - 2 Block - 1	北京 6 苑宾 Post - 0 Miss - 1 Block - 0	泉港 13 周忠迪 Post - 0 Miss - 0 Block - 0
天津 6 赵晨阳 Post - 1 Miss - 2 Block - 0	合肥 26 饶原源 Post - 0 Miss - 0 Block - 0	西安 8 张领 Post - 0 Miss - 0 Block - 0	西安 10 王凯强 Post - 0 Miss - 0 Block - 0	西安 15 陈冉 Post - 0 Miss - 0 Block - 0	合肥 13 沈威 Post - 0 Miss - 0 Block - 0	合肥 31 张宇 Post - 0 Miss - 1 Block - 0	泉港 21 张路 Post - 0 Miss - 1 Block - 0



第二届全国青年运动会男子手球甲组决赛 体校组 (U18)

球队名单

天津市

山西晋中

2019-06-15

号码	姓名	位置	生日	年龄	俱乐部	身高 (CM)	体重 (KG)	国际场次	国际进球
4	常艳鹏	右后卫	21/07/2003	15	天津	192	80		
6	赵晨阳	左后卫	31/01/2001	18	天津	191	88		
10	黄嘉俊	后卫	17/04/2004	15	天津	187	70		
14	戴云鹏	左边锋	06/10/2003	15	天津	182	65		
17	黄春瑞	左后卫	25/09/2002	16	天津	193	86		
19	万朋	右边锋	15/02/2002	17	天津	190	80		
20	王澎	底线	26/02/2001	18	天津	186	90		
23	谭元春	守门员	29/03/2001	18	天津	190	76		
24	周亚龙	右边锋	04/08/2001	17	天津	189	78		
25	郝一铮	左后卫	27/05/2002	17	天津	194	85		
26	李海龙	中后卫	22/06/2001	17	天津	195	88		
27	吕华宇	中后卫	03/01/2001	18	天津	194	86		
28	孙经伟	底线	06/05/2003	16	天津	188	90		
	平均			16.7		190.1	81.7		

编码	姓名	职务
A	贾守信	领队
B	李志成	主教练
D	潘玉强	教练
C	田剑侠	教练

手球
青年男子

个人/全队技术累计表

 山西晋中
2019-06-23

截止至第85场

号码	姓名	远射	近射	边射	快攻	突破	任意	七米	合计	%	助攻	失误	警告	2'	取消	场次	时间
天津市																	
(场上队员)																	
4	常艳鹏															3	00:00:00
6	赵晨阳	12/38	4/7	0/1	2/3	7/14	4/6	4/7	33/76	43.4%	1	25	1			6	03:59:08
10	黄嘉俊															3	00:00:00
14	戴云鹏															4	00:00:00
17	黄春瑞	4/8	2/5	1/5	0/1				7/19	36.8%	3	10	1	1		6	03:56:25
19	万朋				1/1				1/1	100%	1	3				6	00:47:36
20	王澎	1/5	1/2	2/7	1/1	3/3			8/18	44.4%		5				6	03:11:30
23	谭元春										1	2				6	03:59:50
24	周亚龙		1/2	1/6	3/3				5/11	45.5%	1	10	2	1		6	03:35:11
25	郝一铮	2/6	4/6	2/2	1/2	3/3			12/19	63.2%	1	13	2			6	03:47:44
26	李海龙	10/22	5/8	1/1	0/1	11/13		0/1	27/46	58.7%		20		1		6	03:59:01
27	吕华宇			0/1					0/1	0.0%		1				6	00:36:58
28	孙经纬															3	00:00:00
	合计	29/79	17/30	7/23	8/12	24/33	4/6	4/8	93/191	48.7%	8	89	6	3		67	
(守门员)																	
23	谭元春	29/70	10/44	8/23	0/28	3/24	0/2	2/7	52/198	26.3%	1	2				6	03:59:50
	合计	29/70	10/44	8/23	0/28	3/24	0/2	2/7	52/198	26.3%	1	2				6	

场上队员: 得分/射门

守门员: 救球/射门

已打比赛

全队合计	进球	被救	射失	击柱	封球	合计	%	阶段	场次	对手	比分
远射	29	25	14	6	5	79	36.7%	预赛	2	潍坊	15:31 (5:17)
近射	17	8	2	3		30	56.7%	预赛	20	辽宁	12:22 (7:9)
边射	7	10	4	2		23	30.4%	预赛	41	泉港	22:26 (11:14)
快攻	8	2	1	1		12	66.7%	四分之一决赛	52	合肥	11:24 (3:14)
突破	24	3	3	3		33	72.7%	5-8名	64	辽宁	19:23 (11:13)
任意	4	2				6	66.7%	7-8名	79	深圳	14:20 (7:9)
七米	4	2	1	1		8	50.0%				

图式射门区域累计

手球
青年男子

截止至第85场

山西晋中
2019-06-23

天津市

4 常艳鹏 Post - 0 Miss - 0 Block - 0	6 赵晨阳 Post - 6 Miss - 10 Block - 2	10 黄嘉俊 Post - 0 Miss - 0 Block - 0	14 戴云鹏 Post - 0 Miss - 0 Block - 0	17 黄春瑞 Post - 1 Miss - 6 Block - 0	19 万朋 Post - 0 Miss - 0 Block - 0	20 王澎 Post - 0 Miss - 1 Block - 1	23 谭元春 Post - 0 Miss - 0 Block - 0
24 周亚龙 Post - 1 Miss - 1 Block - 0	25 郝一铮 Post - 2 Miss - 2 Block - 0	26 李海龙 Post - 5 Miss - 5 Block - 2	27 吕华宇 Post - 1 Miss - 0 Block - 0	28 孙经伟 Post - 0 Miss - 0 Block - 0			

23 谭元春

4/20	1/3	3/13
12/38	4/4	9/35
9/31	2/9	8/45

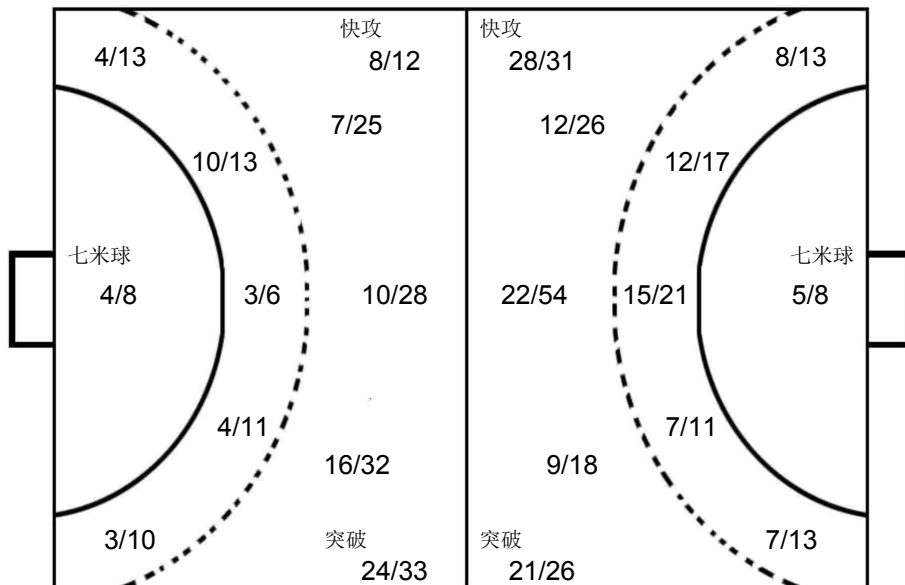

辽宁

12 吴禹宽

1/2		
4/6		4/5
3/10		1/4

泉港

1 周铁程

		0/2
5/12	1/1	1/5
1/3		0/1

辽宁

1 何振楠

1/1		1/5
3/5		1/2
2/7		0/5

OPPONENT

辽宁 4 刘旭 Post - 2 Miss - 6 Block - 0	辽宁 2 关贺元 Post - 1 Miss - 0 Block - 0	辽宁 9 张鹏 Post - 0 Miss - 1 Block - 0	泉港 20 吴兆瑞 Post - 0 Miss - 0 Block - 0	深圳 6 董佳辉 Post - 1 Miss - 2 Block - 0	潍坊 11 杨毅 Post - 0 Miss - 0 Block - 0	合肥 31 张宇 Post - 0 Miss - 1 Block - 0	辽宁 24 邢洪铭 Post - 1 Miss - 2 Block - 2
泉港 21 张路 Post - 1 Miss - 0 Block - 0	深圳 9 左典 Post - 0 Miss - 0 Block - 0	潍坊 8 薛瑞寒 Post - 1 Miss - 0 Block - 0	辽宁 29 蒋效峰 Post - 0 Miss - 0 Block - 0	泉港 15 刘小龙 Post - 1 Miss - 1 Block - 0	泉港 23 卓世胜 Post - 0 Miss - 0 Block - 0	深圳 7 曾繁泳 Post - 2 Miss - 1 Block - 0	潍坊 5 刘天驰 Post - 0 Miss - 0 Block - 0





第二届全国青年运动会男子手球甲组决赛 体校组 (U18)

青年男子 全国比赛

预赛 Group A

PHMS Pictorial Handball Match Statistics IHF Official System

Team A A 山东潍坊				Team B B 福建泉港				Match Number 19			
------------------	--	--	--	------------------	--	--	--	---------------------------	--	--	--

Played in 山西晋中	in the hall 晋中体育馆	on 2019-06-16	at 18:40	hours	Speakers
-------------------	----------------------	------------------	-------------	-------	----------

Half-time(30')	A 15	B 8	End of playing time	A 30	B 17	1st extra time	A	B	2nd extra time	A	B	After penalty throws	A	B
----------------	---------	--------	---------------------	---------	---------	----------------	---	---	----------------	---	---	----------------------	---	---

Number of 7 m	A 2/3	Team time-out			Full name of players and officials	Team time-out			B 1/1	Number of 7 m
	1 16:36	2 36:21	3	1 05:47		2	3			

No.	Team A	G	W	2'	D	DR	No.	Team B	G	W	2'	D	DR
1	鲁世豪						1	周铁程					
3	李相杰	5					6	段家乐	2		1		
5	刘天驰	2					7	王嘉靖					
6	张智超	4					9	周星晨	1				
8	薛瑞寒	3	1	1			10	陈臻					
9	杜忠浩	1					11	钟宏韬					
11	杨毅	6					12	汪琪坤					
12	黄晓春						13	周忠迪	2				
15	宋子阳	4					15	刘小龙	1	1			
17	王子涵						17	左兆坤					
19	汤雨扬						18	刘少杰	2		1		
20	刘文东	2		1			20	吴兆瑞	8				
21	张宋帅						21	张路	1				
24	王宇恒	3					23	卓世胜					
25	郭昊文						25	张杰					
33	吴夏冰			1			34	王涛					
B	赵鑫 (主教练)						B	王卫					
C	王平						C	刘德东					
E	陈琪						E	薛裕安					
A		Signatures of responsables for the teams (Off.A)											B
TP	Remarks of referees / HF Official												TP

Referees	严璐 (CHN)	许翔 (CHN)		
T.D.	吴瑞亭 (CHN)	王洋 (CHN)		
CHA Off.				

Note: Number of 7m Throws Awarded to Team A and B, Goals (G), Warnings (W), Suspensions (2'), Direct Disqualification (D), Disqualification With Report (DR) and Team Penalty (TP).

Table Officials: 王志超 宋昌鑫 Statisticians: 王梓衡 刘笑



第二届全国青年运动会男子手球甲组决赛 体校组 (U18)

PHMS Pictorial Handball Match Statistics

IHF Official System

竞赛技术统计

手球
青年男子

预赛
轮次 2

组别 A
场次 19

晋中体育馆
2019-06-16 18:40

Referees: 严璐 (CHN) / 许翔 (CHN) Result: 30:17 (15:8)
Teams: 山东潍坊(潍坊) VS 福建泉港(泉港)

潍坊		远	近	边	快	突	任意	7m	合计	%	助攻	失误	警告	2'	D+DR
主教练: 赵鑫		射	射	射	攻	破	球	球							
1	鲁世豪														
3	李相杰	0/1	1/1	1/1		2/2		1/1	5/6	83.3	1				
5	刘天驰	0/1		0/1	2/2				2/4	50.0	1	2			
6	张智超			2/2	1/1	1/1			4/4	100					
8	薛瑞寒				3/3				3/3	100		2	1	1	
9	杜忠浩		1/1					0/1	1/2	50.0		3			
11	杨毅	3/3		0/1	2/3	1/1			6/8	75.0		1			
12	黄晓春										2				
15	宋子阳			2/2	2/3				4/5	80.0					
17	王子涵														
19	汤雨扬														
20	刘文东		1/1		1/1				2/2	100				1	
21	张宋帅														
24	王宇恒	2/2	0/1					1/1	3/4	75.0	1				
25	郭昊文														
33	吴夏冰													1	
运动员 合计		5/7	3/4	5/7	11/13	4/4		2/3	30/38	78.9	5	8	1	3	
1	鲁世豪	1/3	1/4	2/4	1/1	2/4	1/1		8/17	47.1					
12	黄晓春	3/5	4/6		0/1	0/2		0/1	7/15	46.7	2				
守门员 合计		4/8	5/10	2/4	1/2	2/6	1/1	0/1	15/32	46.9	2				

泉港		远	近	边	快	突	任意	7m	合计	%	助攻	失误	警告	2'	D+DR
主教练: 庄清斌		射	射	射	攻	破	球	球							
1	周铁程														
6	段家乐	1/1		1/1					2/2	100		1		1	
7	王嘉靖														
9	周星晨		1/1		0/1	0/1			1/3	33.3					
10	陈臻														
11	钟宏韬														
12	汪琪坤														
13	周忠迪	1/4	0/1	1/3					2/8	25.0		1			
15	刘小龙	0/2	1/2						1/4	25.0		4	1		
17	左兆坤	0/1							0/1	0.0		1			
18	刘少杰		1/2		1/1				2/3	66.7		1		1	
20	吴兆瑞	2/4	2/5			3/4	0/1	1/1	8/15	53.3	1	2			
21	张路	0/2				1/3			1/5	20.0	3	2			
23	卓世胜														
25	张杰														
34	王涛														
运动员 合计		4/14	5/11	2/4	1/2	4/8	0/1	1/1	17/41	41.5	4	12	1	2	
1	周铁程	0/3	0/1	1/4	1/11	0/3		0/1	2/23	8.7					
12	汪琪坤	0/2	1/3	0/2	0/1	0/1		1/2	2/11	18.2					
守门员 合计		0/5	1/4	1/6	1/12	0/4		1/3	4/34	11.8					

潍坊	比赛进程	泉港
1st Half		
3	李相杰 1 00:43	0
15	宋子阳 2 01:14	0
5	刘天驰 3 01:33	0
	3 04:40	1 13 周忠迪
3	李相杰 4 06:07	1
5	刘天驰 5 07:11	1
	5 08:02	2 20 吴兆瑞
11	杨毅 6 08:11	2
	6 08:55	3 6 段家乐
15	宋子阳 7 10:41	3
	7 11:18	4 20 吴兆瑞
3	李相杰 8 11:52	4
8	薛瑞寒 9 12:15	4
8	薛瑞寒 10 12:56	4
11	杨毅 11 13:35	4
	12 14:38	4
	12 15:31	5 20 吴兆瑞
11	杨毅 13 15:38	5
	13 17:09	6 18 刘少杰
11	杨毅 14 18:30	6
	14 19:06	7 20 吴兆瑞
11	杨毅 15 19:42	7
	15 19:56	8 20 吴兆瑞
2nd Half		
	15 00:49	9 21 张路
8	薛瑞寒 16 02:55	9
	16 03:16	10 20 吴兆瑞
9	杜忠浩 17 03:48	10
24	王宇恒 18 05:29	10
24	王宇恒 19 06:15	10
6	张智超 20 06:53	10
	20 07:31	11 20 吴兆瑞
20	刘文东 21 09:42	11
	21 10:00	12 9 周星晨
24	王宇恒 22 10:32	12
15	宋子阳 23 11:44	12
6	张智超 24 14:29	12
20	刘文东 25 15:30	12
6	张智超 26 15:54	12
	26 16:19	13 20 吴兆瑞
3	李相杰 27 17:00	13
	27 17:18	14 18 刘少杰
6	张智超 28 17:41	14
	28 18:07	15 13 周忠迪
15	宋子阳 29 18:32	15
	29 19:20	16 15 刘小龙
3	李相杰 30 19:44	16
	30 20:00	17 6 段家乐

场上队员: 得分 / 射门

守门员: 救球 / 射门

D	取消资格	DR	取消资格+报告
---	------	----	---------



个人/全队技术统计表

手球 青年男子 预赛 轮次 2 组别 A 场次 19 晋中体育馆 2019-06-16 18:40

号码	姓名	远射	近射	边射	快攻	突破	任意	七米	合计	%	助攻	失误	警告	2'	取消	时间
山东潍坊(潍坊)																
(场上队员)																
1	鲁世豪									0.0%						00:20:00
3	李相杰	0/1	1/1	1/1		2/2		1/1	5/6	83.3%	1					00:34:58
5	刘天驰	0/1		0/1	2/2				2/4	50.0%	1	2				00:23:45
6	张智超			2/2	1/1	1/1			4/4	100%						00:19:24
8	薛瑞寒				3/3				3/3	100%		2	1	1		00:36:59
9	杜忠浩		1/1					0/1	1/2	50.0%		3				00:16:05
11	杨毅	3/3		0/1	2/3	1/1			6/8	75.0%		1				00:22:33
12	黄晓春									0.0%	2					00:20:00
15	宋子阳			2/2	2/3				4/5	80.0%						00:28:55
17	王子涵									0.0%						00:00:00
19	汤雨扬									0.0%						00:00:00
20	刘文东		1/1		1/1				2/2	100%				1		00:16:41
21	张宋帅									0.0%						00:00:00
24	王宇恒	2/2	0/1					1/1	3/4	75.0%	1					00:17:15
25	郭昊文									0.0%						00:01:05
33	吴夏冰									0.0%				1		00:22:09
合计		5/7	3/4	5/7	11/13	4/4		2/3	30/38	78.9%	5	8	1	3		
(守门员)																
1	鲁世豪	1/3	1/4	2/4	1/1	2/4	1/1		8/17	47.1%						00:20:00
12	黄晓春	3/5	4/6		0/1	0/2		0/1	7/15	46.7%	2					00:20:00
合计		4/8	5/10	2/4	1/2	2/6	1/1	0/1	15/32	46.9%	2					

场上队员：得分/射门

守门员：救球/射门

全队合计	得分	被救	射失	击柱	封球	合计	%
远射	5			2		7	71.4%
近射	3	1				4	75.0%
边射	5	1		1		7	71.4%
快攻	11	1	1			13	84.6%
突破	4					4	100.0%
任意							0.0%
七米	2	1				3	66.7%

第二届全国青年运动会男子手球甲组决赛 体校组 (U18)

PHMS Pictorial Handball Match Statistics

IHF Official System

个人/全队技术统计表

手球 青年男子 预赛 轮次 2 组别 A 场次 19 晋中体育馆 2019-06-16 18:40

号码	姓名	远射	近射	边射	快攻	突破	任意	七米	合计	%	助攻	失误	警告	2'	取消	时间
福建泉港(泉港)																
(场上队员)																
1	周铁程									0.0%						00:25:24
6	段家乐	1/1		1/1					2/2	100%		1		1		00:40:00
7	王嘉靖									0.0%						00:00:00
9	周星晨		1/1		0/1	0/1			1/3	33.3%						00:13:15
10	陈臻									0.0%						00:00:00
11	钟宏韬									0.0%						00:00:00
12	汪琪坤									0.0%						00:14:36
13	周忠迪	1/4	0/1	1/3					2/8	25.0%	1					00:29:48
15	刘小龙	0/2	1/2						1/4	25.0%	4	1				00:26:56
17	左兆坤	0/1							0/1	0.0%	1					00:07:15
18	刘少杰		1/2		1/1				2/3	66.7%	1			1		00:40:00
20	吴兆瑞	2/4	2/5			3/4	0/1	1/1	8/15	53.3%	1	2				00:32:43
21	张路	0/2				1/3			1/5	20.0%	3	2				00:29:52
23	卓世胜									0.0%						00:20:00
25	张杰									0.0%						00:00:00
34	王涛									0.0%						00:00:00
合计		4/14	5/11	2/4	1/2	4/8	0/1	1/1	17/41	41.5%	4	12	1	2		
(守门员)																
1	周铁程	0/3	0/1	1/4	1/11	0/3		0/1	2/23	8.7%						00:25:24
12	汪琪坤	0/2	1/3	0/2	0/1	0/1		1/2	2/11	18.2%						00:14:36
合计		0/5	1/4	1/6	1/12	0/4		1/3	4/34	11.8%						

场上队员：得分/射门

守门员：救球/射门

全队合计	得分	被救	射失	击柱	封球	合计	%
远射	4	4	3	1	2	14	28.6%
近射	5	5		1		11	45.5%
边射	2	2				4	50.0%
快攻	1	1				2	50.0%
突破	4	2	2			8	50.0%
任意		1				1	0.0%
七米	1					1	100.0%

图式比赛技术统计表

手球
青年男子

预赛
轮次 2

组别 A
场次 19

晋中体育馆
2019-06-16 18:40

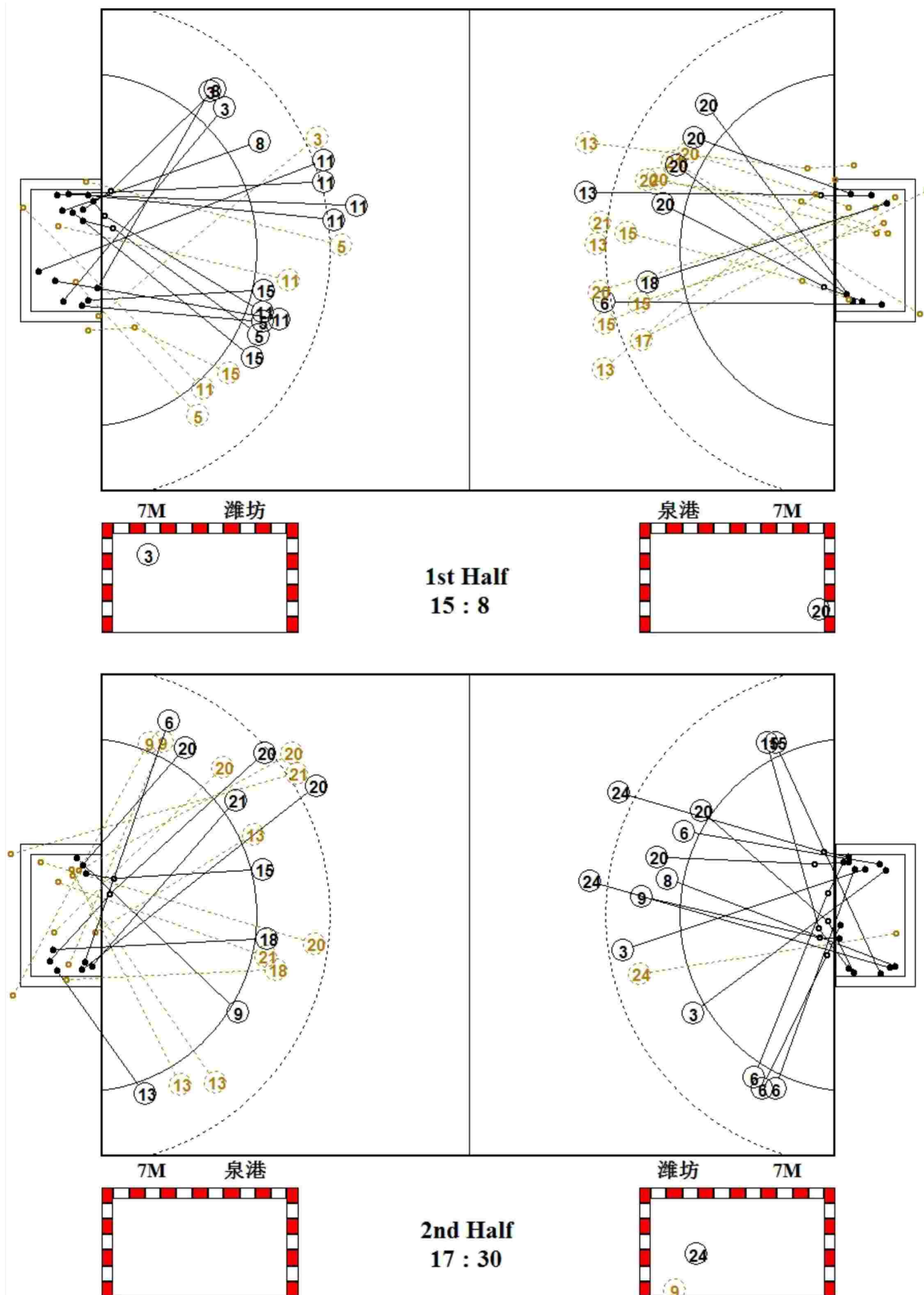

图式射门区域统计

手球
青年男子

预赛
轮次 2

组别 A
场次 19

晋中体育馆
2019-06-16 18:40

山东潍坊

1 鲁世豪 Post - 0 Miss - 0 Block - 0	3 李相杰 Post - 1 Miss - 0 Block - 0	5 刘天驰 Post - 1 Miss - 0 Block - 0	6 张智超 Post - 0 Miss - 0 Block - 0	8 薛瑞寒 Post - 0 Miss - 0 Block - 0	9 杜忠浩 Post - 0 Miss - 0 Block - 0	11 杨毅 Post - 1 Miss - 0 Block - 0	12 黄晓春 Post - 0 Miss - 0 Block - 0
15 宋子阳 Post - 0 Miss - 1 Block - 0	17 王子涵 Post - 0 Miss - 0 Block - 0	19 汤雨扬 Post - 0 Miss - 0 Block - 0	20 刘文东 Post - 0 Miss - 0 Block - 0	21 张宋帅 Post - 0 Miss - 0 Block - 0	24 王宇恒 Post - 0 Miss - 0 Block - 0	25 郭昊文 Post - 0 Miss - 0 Block - 0	33 吴夏冰 Post - 0 Miss - 0 Block - 0

1 鲁世豪	0/2	1/1	1/1
	1/2		3/4
	0/3	1/1	1/3

12 黄晓春	2/3	1/1	0/1
	1/2	1/1	0/1
	1/2		1/4

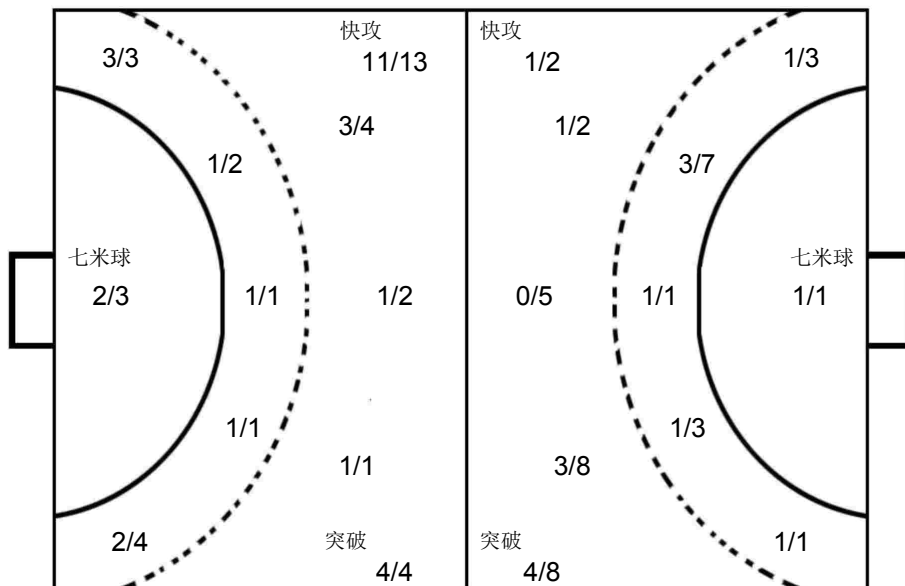

1 周铁程	0/4		
	1/4		1/5
	0/4	0/1	0/5

12 汪琪坤		1/1	0/3
	0/1		
	1/4		0/2

福建泉港

1 周铁程 Post - 0 Miss - 0 Block - 0	6 段家乐 Post - 0 Miss - 0 Block - 0	7 王嘉靖 Post - 0 Miss - 0 Block - 0	9 周星晨 Post - 0 Miss - 1 Block - 0	10 陈臻 Post - 0 Miss - 0 Block - 0	11 钟宏韬 Post - 0 Miss - 0 Block - 0	12 汪琪坤 Post - 0 Miss - 0 Block - 0	13 周忠迪 Post - 1 Miss - 1 Block - 1
15 刘小龙 Post - 0 Miss - 0 Block - 0	17 左兆坤 Post - 0 Miss - 1 Block - 0	18 刘少杰 Post - 1 Miss - 0 Block - 0	20 吴兆瑞 Post - 0 Miss - 0 Block - 0	21 张路 Post - 0 Miss - 2 Block - 1	23 卓世胜 Post - 0 Miss - 0 Block - 0	25 张杰 Post - 0 Miss - 0 Block - 0	34 王涛 Post - 0 Miss - 0 Block - 0



第二届全国青年运动会男子手球甲组决赛 体校组 (U18)

青年男子 全国比赛

预赛 Group A

PHMS Pictorial Handball Match Statistics IHF Official System

Team A A 辽宁体校				Team B B 天津市				Match Number 20			
------------------	--	--	--	-----------------	--	--	--	---------------------------	--	--	--

Played in 山西晋中	in the hall 晋中体育馆	on 2019-06-16	at 19:50	hours	Speakers
-------------------	----------------------	------------------	-------------	-------	----------

Half-time(30')	A 9	B 7	End of playing time	A 22	B 12	1st extra time	A	B	2nd extra time	A	B	After penalty throws	A	B
----------------	--------	--------	---------------------	---------	---------	----------------	---	---	----------------	---	---	----------------------	---	---

Number of 7 m	A 1/1	Team time-out			Full name of players and officials	Team time-out			B 1/2	Number of 7 m
	1 10:44	2 35:20	3	1 02:52		2 18:22	3 25:11			

No.	Team A	G	W	2'	D	DR	No.	Team B	G	W	2'	D	DR
1	何振楠						6	赵晨阳	6				
2	关贺元	7					17	黄春瑞					
3	贾博						19	万朋					
4	刘旭	2		1			20	王澎	1				
5	关棋						23	谭元春					
7	姜珺						24	周亚龙		1	1		
8	郭嘉尧						25	郝一铮	3	1			
9	张鹏	4					26	李海龙	2				
10	王新開	3	1	1			27	吕华宇					
11	颜科研												
12	吴禹宽												
13	赵子凯	2											
21	蒋申健												
24	邢洪銘	2											
29	蒋效峰	2	1										
B	张瑜						A	贾守信					
C	罗帅						B	李志成 (主教练)					
D	王译						D	潘玉强					
E	桂海旭												

A	Signatures of responsables for the teams (Off.A)												B
---	--	--	--	--	--	--	--	--	--	--	--	--	---

TP	Remarks of referees / HF Official													TP
----	-----------------------------------	--	--	--	--	--	--	--	--	--	--	--	--	----

Referees	马晓晔 (CHN)	宋优悠 (CHN)		
T.D.	柴业宏 (CHN)	陈晓波 (CHN)		
CHA Off.				

Note: Number of 7m Throws Awarded to Team A and B, Goals (G), Warnings (W), Suspensions (2'), Direct Disqualification (D), Disqualification With Report (DR) and Team Penalty (TP).

Table Officials: 王志超 马迪 Statisticians: 王梓衡 刘笑

第二届全国青年运动会男子手球甲组决赛 体校组 (U18)

PHMS Pictorial Handball Match Statistics

IHF Official System

竞赛技术统计

手球
青年男子

预赛
轮次 2

组别 A
场次 20

晋中体育馆
2019-06-16 19:50

Referees:	马晓晔 (CHN) / 宋优悠 (CHN)	Result:	22:12(9:7)
Teams:	辽宁体校(辽宁) VS 天津市(天津)		

辽宁																天津		
主教练: 陈宏瑞																比赛进程		
	远射	近射	边射	快攻	突破	任意球	7m球	合计	%	助攻	失误	警告	2'	D+DR				
1 何振楠																		
2 关贺元		6/8		1/1				7/9	77.8		1							
3 贾博																		
4 刘旭	0/4	1/1				1/2		2/7	28.6	2	3		1					
5 关棋																		
7 姜珺																		
8 郭嘉尧																		
9 张鹏	0/2	1/1	1/1	1/1			1/1	4/6	66.7	4								
10 王新開	0/1		1/1	2/2	0/2			3/6	50.0	2	1	1	1					
11 颜科研																		
12 吴禹宽																		
13 赵子凯	1/1		1/1					2/2	100		2							
21 蒋申健																		
24 邢洪銘	1/5		0/1		1/1			2/7	28.6									
29 蒋效峰	0/1	0/1		2/2				2/4	50.0		3	1						
运动员 合计	2/14	8/11	3/4	6/6	1/3	1/2	1/1	22/41	53.7	8	10	2	2					
1 何振楠	0/3	0/1	2/2				0/1	2/7	28.6									
12 吴禹宽	2/4	0/2	1/1	0/1	0/2	2/2		5/12	41.7									
守门员 合计	2/7	0/3	3/3	0/1	0/2	2/2	0/1	7/19	36.8									

天津																1st Half		
主教练: 李志成																2nd Half		
	远射	近射	边射	快攻	突破	任意球	7m球	合计	%	助攻	失误	警告	2'	D+DR				
6 赵晨阳	4/6				1/3	0/2	1/2	6/13	46.2		6							
17 黄春瑞			0/1					0/1	0.0		1							
19 万朋											1							
20 王澎	1/1							1/1	100		2							
23 谭元春											1							
24 周亚龙			0/3					0/3	0.0		5	1	1					
25 郝一铮	0/1	1/1		1/1	1/1			3/4	75.0		1	1						
26 李海龙	0/1	2/2		0/1	0/1			2/5	40.0		7							
27 吕华宇																		
运动员 合计	5/9	3/3	0/4	1/2	2/5	0/2	1/2	12/27	44.4		24	2	1					
23 谭元春	6/8	3/11	1/4	0/6	1/2	0/1	0/1	11/33	33.3		1							
守门员 合计	6/8	3/11	1/4	0/6	1/2	0/1	0/1	11/33	33.3		1							

场上队员: 得分 / 射门

守门员: 救球 / 射门

D	取消资格	DR	取消资格+报告
---	------	----	---------



个人/全队技术统计表

手球 青年男子 预赛 轮次 2 组别 A 场次 20 晋中体育馆 2019-06-16 19:50

号码	姓名	远射	近射	边射	快攻	突破	任意	七米	合计	%	助攻	失误	警告	2'	取消	时间
辽宁体校(辽宁)																
(场上队员)																
1	何振楠									0.0%						00:17:30
2	关贺元		6/8		1/1				7/9	77.8%		1				00:40:00
3	贾博									0.0%						00:00:00
4	刘旭	0/4	1/1				1/2		2/7	28.6%	2	3		1		00:34:03
5	关棋									0.0%						00:00:00
7	姜珺									0.0%						00:00:00
8	郭嘉尧									0.0%						00:00:00
9	张鹏	0/2	1/1	1/1	1/1			1/1	4/6	66.7%	4					00:40:00
10	王新開	0/1		1/1	2/2	0/2			3/6	50.0%	2	1	1	1		00:38:09
11	颜科研									0.0%						00:25:23
12	吴禹宽									0.0%						00:22:30
13	赵子凯	1/1		1/1					2/2	100%		2				00:05:54
21	蒋申健									0.0%						00:00:00
24	邢洪銘	1/5		0/1		1/1			2/7	28.6%						00:26:27
29	蒋效峰	0/1	0/1		2/2				2/4	50.0%		3	1			00:29:54
合计		2/14	8/11	3/4	6/6	1/3	1/2	1/1	22/41	53.7%	8	10	2	2		
(守门员)																
1	何振楠	0/3	0/1	2/2				0/1	2/7	28.6%						00:17:30
12	吴禹宽	2/4	0/2	1/1	0/1	0/2	2/2		5/12	41.7%						00:22:30
合计		2/7	0/3	3/3	0/1	0/2	2/2	0/1	7/19	36.8%						

场上队员： 得分/射门

守门员： 救球/射门

全队合计	得分	被救	射失	击柱	封球	合计	%
远射	2	6	3	2	1	14	14.3%
近射	8	3				11	72.7%
边射	3	1				4	75.0%
快攻	6					6	100.0%
突破	1	1		1		3	33.3%
任意	1		1			2	50.0%
七米	1					1	100.0%

第二届全国青年运动会男子手球甲组决赛 体校组 (U18)

PHMS Pictorial Handball Match Statistics

IHF Official System

个人/全队技术统计表

手球 青年男子 预赛 轮次 2 组别 A 场次 20 晋中体育馆 2019-06-16 19:50

号码	姓名	远射	近射	边射	快攻	突破	任意	七米	合计	%	助攻	失误	警告	2'	取消	时间
天津市(天津)																
(场上队员)																
6	赵晨阳	4/6				1/3	0/2	1/2	6/13	46.2%		6				00:40:00
17	黄春瑞			0/1					0/1	0.0%		1				00:40:00
19	万朋									0.0%		1				00:05:16
20	王澎	1/1							1/1	100%		2				00:33:34
23	谭元春									0.0%		1				00:40:00
24	周亚龙			0/3					0/3	0.0%		5	1	1		00:40:00
25	郝一铮	0/1	1/1		1/1	1/1			3/4	75.0%		1	1			00:40:00
26	李海龙	0/1	2/2		0/1	0/1			2/5	40.0%		7				00:40:00
27	吕华宇									0.0%						00:01:08
合计		5/9	3/3	0/4	1/2	2/5	0/2	1/2	12/27	44.4%		24	2	1		
(守门员)																
23	谭元春	6/8	3/11	1/4	0/6	1/2	0/1	0/1	11/33	33.3%		1				00:40:00
合计		6/8	3/11	1/4	0/6	1/2	0/1	0/1	11/33	33.3%		1				

场上队员： 得分/射门

守门员： 救球/射门

全队合计	得分	被救	射失	击柱	封球	合计	%
远射	5	2		1	1	9	55.6%
近射	3					3	100.0%
边射		3		1		4	0.0%
快攻	1			1		2	50.0%
突破	2		1	2		5	40.0%
任意		2				2	0.0%
七米	1		1			2	50.0%

图式比赛技术统计表

手球
青年男子

预赛
轮次 2

组别 A
场次 20

晋中体育馆
2019-06-16 19:50

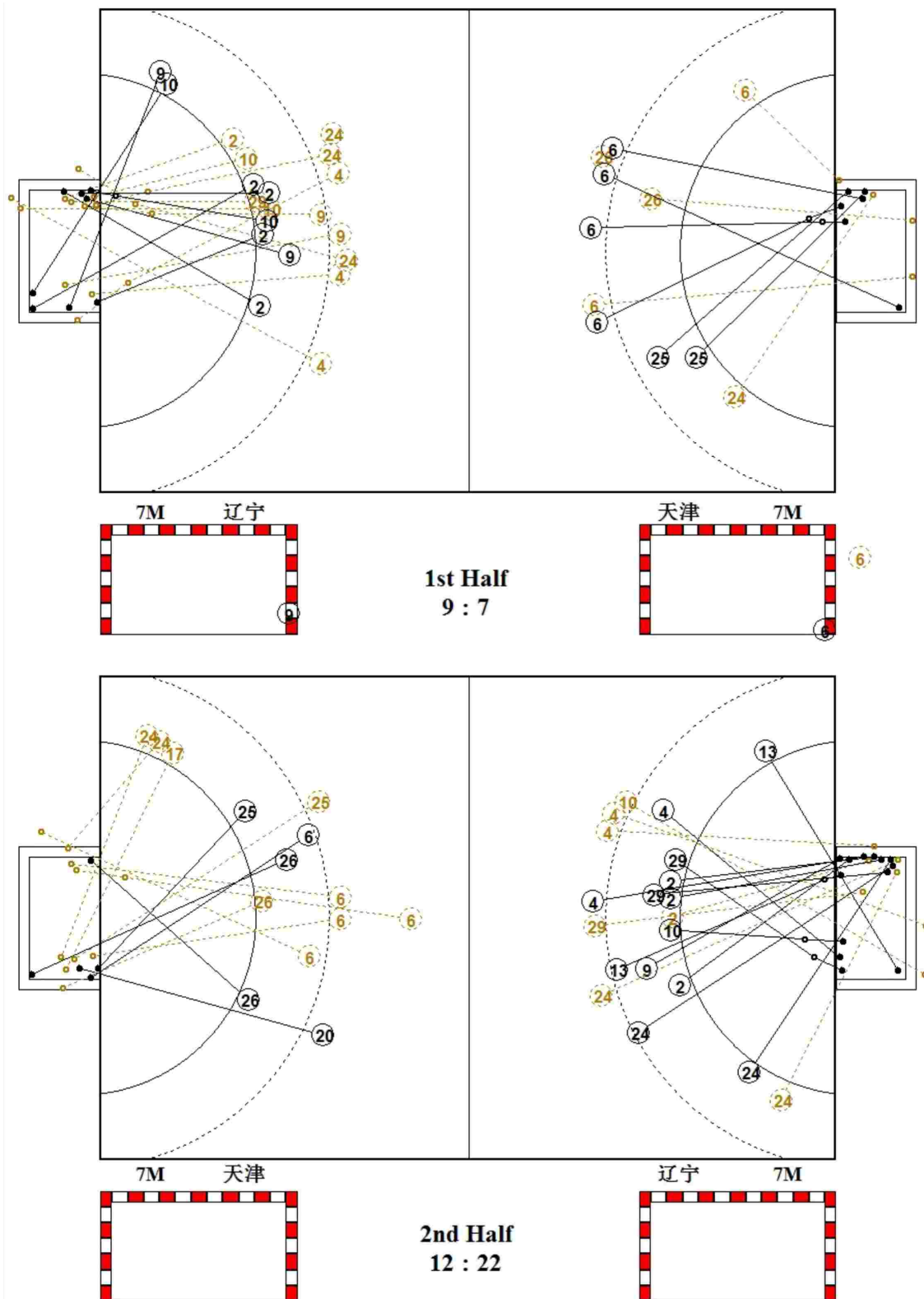

图式射门区域统计

手球
青年男子

预赛
轮次 2

组别 A
场次 20

晋中体育馆
2019-06-16 19:50

辽宁体校

1 何振楠 Post - 0 Miss - 0 Block - 0	2 关贺元 Post - 0 Miss - 0 Block - 0	3 贾博 Post - 0 Miss - 0 Block - 0	4 刘旭 Post - 2 Miss - 2 Block - 0	5 关棋 Post - 0 Miss - 0 Block - 0	7 姜璐 Post - 0 Miss - 0 Block - 0	8 郭嘉尧 Post - 0 Miss - 0 Block - 0	9 张鹏 Post - 0 Miss - 0 Block - 0
10 王新開 Post - 1 Miss - 1 Block - 0	11 颜科研 Post - 0 Miss - 0 Block - 0	12 吴禹宽 Post - 0 Miss - 0 Block - 0	13 赵子凯 Post - 0 Miss - 0 Block - 0	21 蒋申健 Post - 0 Miss - 0 Block - 0	24 邢洪銘 Post - 0 Miss - 1 Block - 1	29 蒋效峰 Post - 0 Miss - 0 Block - 0	

1 何振楠	0/1
2/2	0/1
0/3	

12 吴禹宽	0/1
2/4	2/2
1/4	0/1

23 谭元春	2/8	0/1
3/6	2/3	
1/5	3/10	

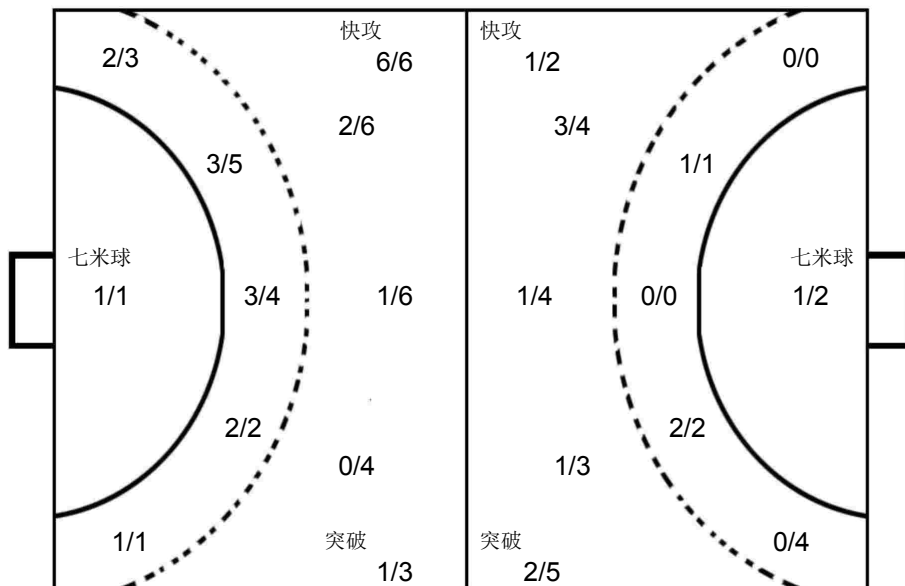

天津市

6 赵晨阳 Post - 2 Miss - 2 Block - 0	17 黄春瑞 Post - 0 Miss - 0 Block - 0	19 万朋 Post - 0 Miss - 0 Block - 0	20 王澎 Post - 0 Miss - 0 Block - 0	23 谭元春 Post - 0 Miss - 0 Block - 0	24 周亚龙 Post - 1 Miss - 0 Block - 0	25 郝一铮 Post - 0 Miss - 0 Block - 0	26 李海龙 Post - 2 Miss - 0 Block - 1
27 吕华宇 Post - 0 Miss - 0 Block - 0							





第二届全国青年运动会男子手球甲组决赛 体校组 (U18)

青年男子 全国比赛

预赛 Group B

PHMS Pictorial Handball Match Statistics IHF Official System

Team A A 广东深圳				Team B B 安徽合肥				Match Number 24			
------------------	--	--	--	------------------	--	--	--	---------------------------	--	--	--

Played in 山西晋中	in the hall 晋中体育馆	on 2019-06-16	at 17:30	hours	Speakers
-------------------	----------------------	------------------	-------------	-------	----------

Half-time(30')	A 5	B 11	End of playing time	A 13	B 22	1st extra time	A	B	2nd extra time	A	B	After penalty throws	A	B
----------------	--------	---------	---------------------	---------	---------	----------------	---	---	----------------	---	---	----------------------	---	---

Number of 7 m	A 1/1	Team time-out			Full name of players and officials	Team time-out			B 1/1	Number of 7 m
	1	2	3	1		2	3			

No.	Team A	G	W	2'	D	DR	No.	Team B	G	W	2'	D	DR
2	祝安南						2	张天进	7	1			
3	李朗轩		1				13	沈威	3				
5	陈俊延						26	饶原源	4				
6	董佳辉			1			27	王东昇					
7	曾繁泳	4					29	梅少聪			1		
8	罗霖泽	1					30	单习振	2	1			
9	左典	1	1				31	张宇	3				
10	李剑琛	1					33	於晓祺			1		
11	万泽峰	1					35	李宝松					
12	戴景伟						36	刘耀奇	1				
13	赵世豪						39	汤鸿宇					
16	谢思远	5					40	陈欢					
18	曾笑童						41	管家乐	2		1		
19	齐振东						42	刘军波					
							43	王久源					
							50	刘欣洋					
A	张斌						A	王德勇 (主教练)					
C	李中洲 (主教练)						C	陆万红					
D	张广建						D	王明星					
F	蒋光华						E	陈玉翔					

A	Signatures of responsables for the teams (Off.A)												B
---	--	--	--	--	--	--	--	--	--	--	--	--	---

TP	Remarks of referees / HF Official													TP
----	-----------------------------------	--	--	--	--	--	--	--	--	--	--	--	--	----

Referees	伍豪 (CHN)	张智伟 (CHN)		
T.D.	张耿 (CHN)	叶霄雪 (CHN)		
CHA Off.				

Note: Number of 7m Throws Awarded to Team A and B, Goals (G), Warnings (W), Suspensions (2'), Direct Disqualification (D), Disqualification With Report (DR) and Team Penalty (TP).

Table Officials: 李莉君 许瑛 Statisticians: 陈柱 谢扬



第二届全国青年运动会男子手球甲组决赛 体校组 (U18)

PHMS Pictorial Handball Match Statistics

IHF Official System

竞赛技术统计

手球
青年男子

预赛
轮次 2

组别 B
场次 24

晋中体育馆
2019-06-16 17:30

Referees:	伍豪 (CHN) / 张智伟 (CHN)	Result:	13:22 (5:11)
Teams:	广东深圳(深圳) VS 安徽合肥(合肥)		

深圳		远	近	边	快	突	任意	7m	合计	%	助攻	失误	警告	2'	D+DR
主教练: 李中洲		射	射	射	攻	破	球	球							
2	祝安南														
3	李朗轩			0/1					0/1	0.0	2	5	1		
5	陈俊延														
6	董佳辉	0/4	0/1	0/2					0/7	0.0		2		1	
7	曾繁泳		1/1	2/3				1/1	4/5	80.0					
8	罗霖泽			1/1					1/1	100		1			
9	左典					1/1			1/1	100		2	1		
10	李剑琛	0/1	1/1						1/2	50.0		2			
11	万泽峰		1/1						1/1	100		1			
12	戴景伟														
13	赵世豪														
16	谢思远	1/3	1/1	1/1	2/2				5/7	71.4	1	4			
18	曾笑童														
19	齐振东														
运动员 合计		1/8	4/5	4/8	2/2	1/1		1/1	13/25	52.0	3	17	2	1	
12	戴景伟	0/1	1/4		0/1		0/1		1/7	14.3					
19	齐振东	1/6	3/6	3/3	3/6	1/4	0/1	0/1	11/27	40.7					
守门员 合计		1/7	4/10	3/3	3/7	1/4	0/2	0/1	12/34	35.3					

合肥		远	近	边	快	突	任意	7m	合计	%	助攻	失误	警告	2'	D+DR
主教练: 王德勇		射	射	射	攻	破	球	球							
2	张天进	4/5		0/1	1/1		2/2		7/9	77.8	2		1		
13	沈威		2/2			1/1			3/3	100		1			
26	饶源源	2/2			2/2				4/4	100	3				
27	王东昇														
29	梅少聪		0/1		0/1				0/2	0.0	1	2		1	
30	单习振		1/2	0/1	1/2				2/5	40.0	1	1	1		
31	张宇		1/2			2/2			3/4	75.0		1			
33	於晓祺		0/1						0/1	0.0				1	
35	李宝松										1	2			
36	刘耀奇							1/1	1/1	100					
39	汤鸿宇														
40	陈欢														
41	管家乐		2/2		0/1	0/1			2/4	50.0		1		1	
42	刘军波			0/1					0/1	0.0		1			
43	王久源														
50	刘欣洋		0/1						0/1	0.0		1			
运动员 合计		6/7	6/11	0/3	4/7	3/4	2/2	1/1	22/35	62.9	8	10	2	3	
39	汤鸿宇	1/1				0/1			1/2	50.0					
40	陈欢	2/3	1/5	2/6	0/2			0/1	5/17	29.4					
守门员 合计		3/4	1/5	2/6	0/2	0/1		0/1	6/19	31.6					

深圳	比赛 进程	合肥
1st Half		
	0 01:16	1 2 张天进
	0 05:03	2 30 单习振
	0 05:39	3 13 沈威
	0 06:34	4 2 张天进
16 谢思远	1 08:11	4
	1 08:37	5 2 张天进
	1 09:51	6 36 刘耀奇
16 谢思远	2 10:13	6
16 谢思远	3 11:14	6
16 谢思远	4 11:47	6
	4 12:23	7 2 张天进
	4 15:13	8 2 张天进
	4 16:52	9 26 饶源源
	4 17:48	10 13 沈威
	4 18:57	11 2 张天进
16 谢思远	5 19:44	11
2nd Half		
10 李剑琛	6 00:33	11
8 罗霖泽	7 01:07	11
	7 01:40	12 41 管家乐
	7 02:24	13 26 饶源源
7 曾繁泳	8 02:53	13
	8 03:21	14 26 饶源源
7 曾繁泳	9 04:23	14
	9 05:16	15 2 张天进
	9 05:50	16 13 沈威
	9 06:22	17 41 管家乐
	9 07:29	18 26 饶源源
	9 08:14	19 30 单习振
11 万泽峰	10 09:25	19
	10 10:49	20 31 张宇
7 曾繁泳	11 11:22	20
	11 13:04	21 31 张宇
7 曾繁泳	12 14:48	21
	12 15:16	22 31 张宇
9 左典	13 18:53	22

场上队员: 得分 / 射门

守门员: 救球 / 射门

D	取消资格	DR	取消资格+报告
---	------	----	---------



个人/全队技术统计表

手球 青年男子 预赛 轮次 2 组别 B 场次 24 晋中体育馆 2019-06-16 17:30

号码	姓名	远射	近射	边射	快攻	突破	任意	七米	合计	%	助攻	失误	警告	2'	取消	时间
广东深圳(深圳)																
(场上队员)																
2	祝安南									0.0%						00:07:35
3	李朗轩			0/1					0/1	0.0%	2	5	1			00:40:00
5	陈俊延									0.0%						00:00:04
6	董佳辉	0/4	0/1	0/2					0/7	0.0%		2		1		00:37:48
7	曾繁冰		1/1	2/3				1/1	4/5	80.0%						00:32:23
8	罗霖泽			1/1					1/1	100%		1				00:28:45
9	左典					1/1			1/1	100%		2	1			00:27:05
10	李剑琛	0/1	1/1						1/2	50.0%		2				00:27:46
11	万泽峰		1/1						1/1	100%		1				00:12:04
12	戴景伟									0.0%						00:06:43
13	赵世豪									0.0%						00:00:00
16	谢思远	1/3	1/1	1/1	2/2				5/7	71.4%	1	4				00:26:09
18	曾笑童									0.0%						00:00:00
19	齐振东									0.0%						00:33:17
合计		1/8	4/5	4/8	2/2	1/1		1/1	13/25	52.0%	3	17	2	1		
(守门员)																
12	戴景伟	0/1	1/4		0/1		0/1		1/7	14.3%						00:06:43
19	齐振东	1/6	3/6	3/3	3/6	1/4	0/1	0/1	11/27	40.7%						00:33:17
合计		1/7	4/10	3/3	3/7	1/4	0/2	0/1	12/34	35.3%						

场上队员： 得分/射门

守门员： 救球/射门

全队合计	得分	被救	射失	击柱	封球	合计	%
远射	1	3	3		1	8	12.5%
近射	4	1				5	80.0%
边射	4	2	2			8	50.0%
快攻	2					2	100.0%
突破	1					1	100.0%
任意							0.0%
七米	1					1	100.0%

第二届全国青年运动会男子手球甲组决赛 体校组 (U18)

PHMS Pictorial Handball Match Statistics

IHF Official System

个人/全队技术统计表

手球 青年男子 预赛 轮次 2 组别 B 场次 24 晋中体育馆 2019-06-16 17:30

号码	姓名	远射	近射	边射	快攻	突破	任意	七米	合计	%	助攻	失误	警告	2'	取消	时间
安徽合肥(合肥)																
(场上队员)																
2	张天进	4/5		0/1	1/1		2/2		7/9	77.8%	2		1			00:28:39
13	沈威		2/2			1/1			3/3	100%		1				00:28:20
26	饶原源	2/2				2/2			4/4	100%	3					00:28:48
27	王东昇									0.0%						00:00:00
29	梅少聪		0/1		0/1				0/2	0.0%	1	2		1		00:28:46
30	单习振		1/2	0/1	1/2				2/5	40.0%	1	1	1			00:28:47
31	张宇		1/2			2/2			3/4	75.0%		1				00:11:06
33	於晓祺		0/1						0/1	0.0%				1		00:11:01
35	李宝松									0.0%	1	2				00:11:01
36	刘耀奇							1/1	1/1	100%						00:09:04
39	汤鸿宇									0.0%						00:05:07
40	陈欢									0.0%						00:34:53
41	管家乐		2/2		0/1	0/1			2/4	50.0%		1		1		00:27:58
42	刘军波			0/1					0/1	0.0%		1				00:03:00
43	王久源									0.0%						00:11:01
50	刘欣洋		0/1						0/1	0.0%		1				00:11:01
合计		6/7	6/11	0/3	4/7	3/4	2/2	1/1	22/35	62.9%	8	10	2	3		
(守门员)																
39	汤鸿宇	1/1				0/1			1/2	50.0%						00:05:07
40	陈欢	2/3	1/5	2/6	0/2			0/1	5/17	29.4%						00:34:53
合计		3/4	1/5	2/6	0/2	0/1		0/1	6/19	31.6%						

场上队员： 得分/射门

守门员： 救球/射门

全队合计	得分	被救	射失	击柱	封球	合计	%
远射	6	1				7	85.7%
近射	6	4	1			11	54.5%
边射		3				3	0.0%
快攻	4	3				7	57.1%
突破	3	1				4	75.0%
任意	2					2	100.0%
七米	1					1	100.0%

图式比赛技术统计表

手球
青年男子

预赛
轮次 2

组别 B
场次 24

晋中体育馆
2019-06-16 17:30

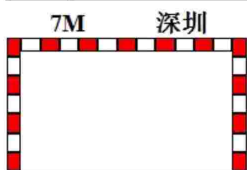
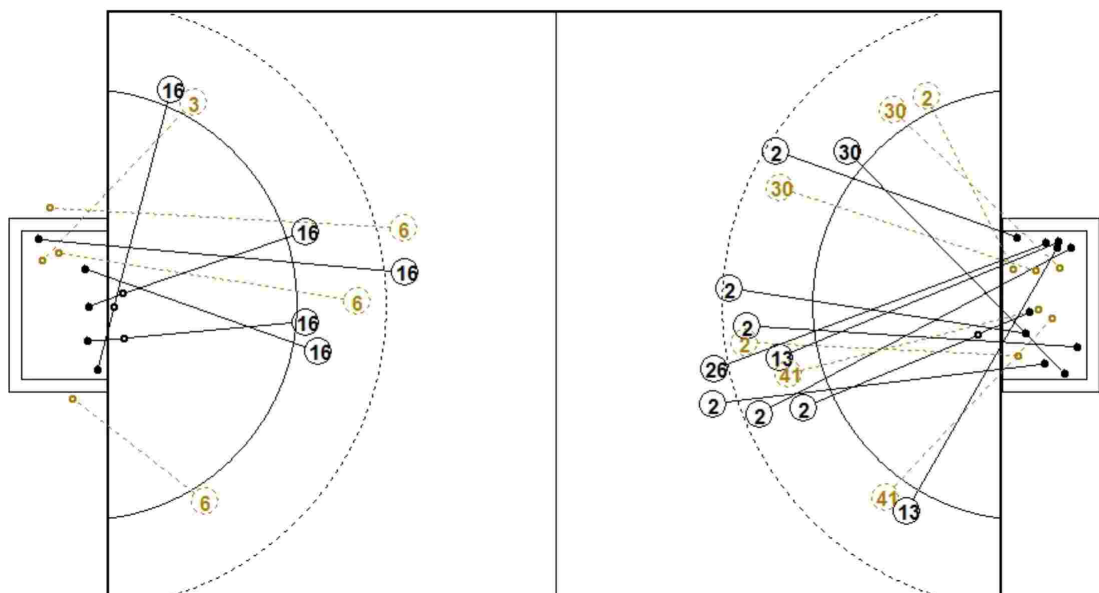

1st Half
5 : 11

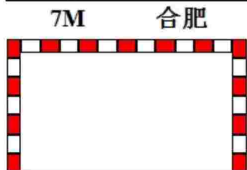
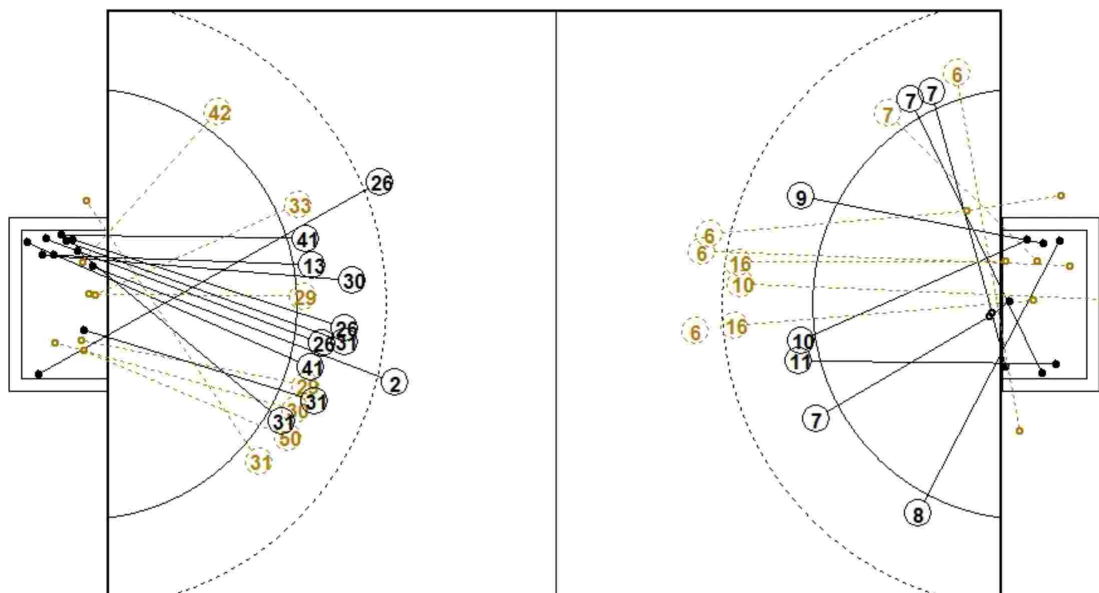
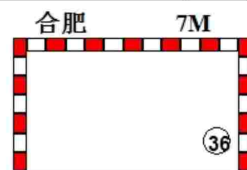

2nd Half
22 : 13

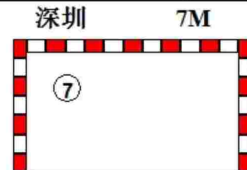

图式射门区域统计

手球
青年男子

预赛
轮次 2

组别 B
场次 24

晋中体育馆
2019-06-16 17:30

广东深圳

2 祝安南 Post - 0 Miss - 0 Block - 0	3 李朗轩 Post - 0 Miss - 0 Block - 0	5 陈俊延 Post - 0 Miss - 0 Block - 0	6 董佳辉 Post - 0 Miss - 4 Block - 1	7 曾繁泳 Post - 0 Miss - 0 Block - 0	8 罗霖泽 Post - 0 Miss - 0 Block - 0	9 左典 Post - 0 Miss - 0 Block - 0	10 李剑琛 Post - 0 Miss - 1 Block - 0
--------------------------------------	--------------------------------------	--------------------------------------	--------------------------------------	--------------------------------------	--------------------------------------	-------------------------------------	---------------------------------------

11 万泽峰 Post - 0 Miss - 0 Block - 0	12 戴景伟 Post - 0 Miss - 0 Block - 0	13 赵世豪 Post - 0 Miss - 0 Block - 0	16 谢思远 Post - 0 Miss - 0 Block - 0	18 曾笑童 Post - 0 Miss - 0 Block - 0	19 齐振东 Post - 0 Miss - 0 Block - 0
---------------------------------------	---------------------------------------	---------------------------------------	---------------------------------------	---------------------------------------	---------------------------------------

12 戴景伟
0/1
0/2
1/1

19 齐振东
1/4
2/3
2/4

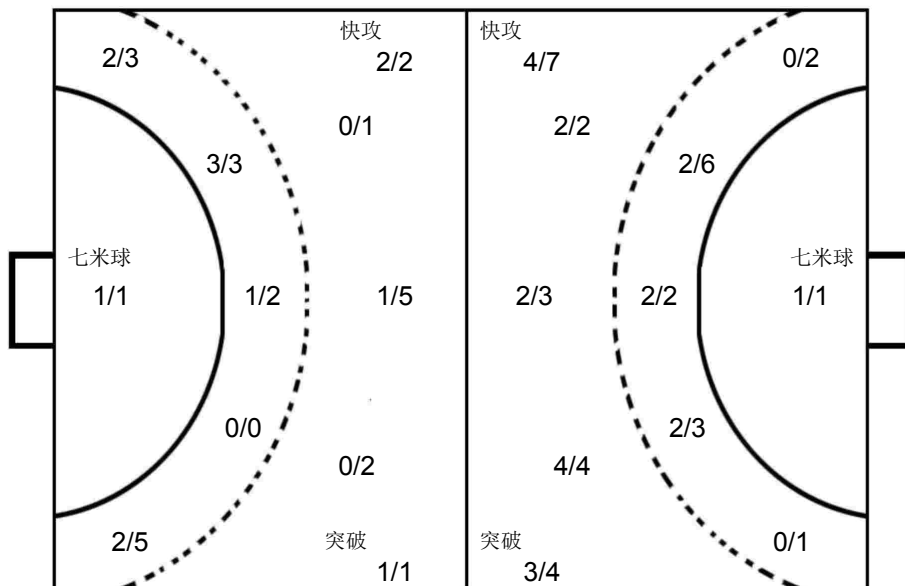

39 汤鸿宇
1/1
0/1

40 陈欢
0/2
1/1
1/4

安徽合肥

2 张天进 Post - 0 Miss - 0 Block - 0	13 沈威 Post - 0 Miss - 0 Block - 0	26 饶原源 Post - 0 Miss - 0 Block - 0	27 王东昇 Post - 0 Miss - 0 Block - 0	29 梅少聪 Post - 0 Miss - 0 Block - 0	30 单习振 Post - 0 Miss - 0 Block - 0	31 张宇 Post - 0 Miss - 1 Block - 0	33 於晓祺 Post - 0 Miss - 0 Block - 0
--------------------------------------	--------------------------------------	---------------------------------------	---------------------------------------	---------------------------------------	---------------------------------------	--------------------------------------	---------------------------------------

35 李宝松 Post - 0 Miss - 0 Block - 0	36 刘耀奇 Post - 0 Miss - 0 Block - 0	39 汤鸿宇 Post - 0 Miss - 0 Block - 0	40 陈欢 Post - 0 Miss - 0 Block - 0	41 管家乐 Post - 0 Miss - 0 Block - 0	42 刘军波 Post - 0 Miss - 0 Block - 0	43 王久源 Post - 0 Miss - 0 Block - 0	50 刘欣洋 Post - 0 Miss - 0 Block - 0
---------------------------------------	---------------------------------------	---------------------------------------	--------------------------------------	---------------------------------------	---------------------------------------	---------------------------------------	---------------------------------------



第二届全国青年运动会男子手球甲组决赛 体校组 (U18)

青年男子 全国比赛

预赛 Group B

PHMS Pictorial Handball Match Statistics IHF Official System

Team A A 北京市				Team B B 陕西西安				Match Number 25			
-----------------	--	--	--	------------------	--	--	--	---------------------------	--	--	--

Played in 山西晋中	in the hall 晋中体育馆	on 2019-06-16	at 18:40	hours	Speakers
-------------------	----------------------	------------------	-------------	-------	----------

Half-time(30')	A 7	B 7	End of playing time	A 18	B 17	1st extra time	A	B	2nd extra time	A	B	After penalty throws	A	B
----------------	--------	--------	---------------------	---------	---------	----------------	---	---	----------------	---	---	----------------------	---	---

Number of 7 m	A 1/2	Team time-out			Full name of players and officials	Team time-out			B 2/2	Number of 7 m
	1 10:37	2 37:02	3	1 12:57		2 28:24	3 31:59			

No.	Team A	G	W	2'	D	DR	No.	Team B	G	W	2'	D	DR
1	陶钜						1	陈昊					
3	魏豪						2	张兴彬					
4	李博仔						3	丁玉冰					
6	苑宾	2	1				5	隋家乐					
7	侯博耀						6	李梦豪	2	1			
8	孙铂力						7	黄金伟					
9	曹智栋	4					8	张领	4	1			
13	蓝心凯	2					9	陈孝天	8		1		
14	杜俊林						10	王凯强		1			
15	刘大明	1					11	孔宇豪					
16	王鑫宇						12	朱正顺					
18	宋昱鹏						13	徐昊天					
23	庞佳明	7		1			14	孙旭					
26	郑铭境			1			15	陈冉	3		1		
29	赵熹瑞	2		1			16	金筠峰					
32	张珂宁						17	刘世昌					
A	吴健						A	王刚					
B	翟彦戎						B	李安					
							C	郝可鑫		1			
							D	王少杰					

A	Signatures of responsables for the teams (Off.A)												B
---	--	--	--	--	--	--	--	--	--	--	--	--	---

TP	Remarks of referees / HF Official													TP
----	-----------------------------------	--	--	--	--	--	--	--	--	--	--	--	--	----

Referees	孟凡刚 (CHN)	康曦 (CHN)		
T.D.	叶霄雪 (CHN)	张耿 (CHN)		
CHA Off.				

Note: Number of 7m Throws Awarded to Team A and B, Goals (G), Warnings (W), Suspensions (2'), Direct Disqualification (D), Disqualification With Report (DR) and Team Penalty (TP).

Table Officials: 张琦 宣海波 Statisticians: 陈柱 谢扬

第二届全国青年运动会男子手球甲组决赛 体校组 (U18)

PHMS Pictorial Handball Match Statistics

IHF Official System

竞赛技术统计

手球
青年男子

预赛
轮次 2

组别 B
场次 25

晋中体育馆
2019-06-16 18:40

Referees: 孟凡刚 (CHN) / 康曦 (CHN)

Result: 18:17 (7:7)

Teams: 北京市(北京) VS 陕西西安(西安)

北京		远射	近射	边射	快攻	突破	任意球	7m球	合计	%	助攻	失误	警告	2'	D+DR
主教练: 吴健															
1	陶钜														
3	魏豪														
4	李博仔														
6	苑宾			1/2	1/1			2/3	66.7		1	1			
7	侯博耀														
8	孙铂力														
9	曹智栋	3/5	0/1		1/1			0/1	4/8	50.0	1	2			
13	蓝心凯		2/2					2/2	100						
14	杜俊林														
15	刘大明	0/2				1/1		1/3	33.3		2				
16	王鑫宇										1				
18	宋昱鹏														
23	庞佳明	1/6	1/1	1/1	1/1		2/2	1/1	7/12	58.3	2	2		1	
26	郑铭境											1		1	
29	赵熹瑞		2/2					2/2	100					1	
32	张珂宁														
运动员	合计	4/13	5/6	2/3	3/3	1/1	2/2	1/2	18/30	60.0	4	8	1	3	
16	王鑫宇	5/11	0/1		0/3	1/5	0/1	0/2	6/23	26.1	1				
守门员	合计	5/11	0/1		0/3	1/5	0/1	0/2	6/23	26.1	1				

西安		远射	近射	边射	快攻	突破	任意球	7m球	合计	%	助攻	失误	警告	2'	D+DR
主教练: 郝可鑫															
1	陈昊											1			
2	张兴彬														
3	丁玉冰	0/1	0/1					0/2	0.0		1				
5	隋家乐														
6	李梦豪	0/1				2/2		2/3	66.7			1			
7	黄金伟														
8	张领	1/2	1/1			2/3		4/6	66.7		5	1			
9	陈孝天	4/10			1/1		1/1	2/2	8/14	57.1	1	1		1	
10	王凯强	0/1						0/1	0.0		1	1			
11	孔宇豪														
12	朱正顺														
13	徐昊天		0/1					0/1	0.0						
14	孙旭														
15	陈冉	1/1			2/2			3/3	100					1	
16	金筠峰														
17	刘世昌											1			
运动员	合计	6/16	1/3		3/3	4/5	1/1	2/2	17/30	56.7	1	10	3	2	
1	陈昊	6/10	1/6	1/3	0/3	0/1	0/2	0/1	8/26	30.8		1			
守门员	合计	6/10	1/6	1/3	0/3	0/1	0/2	0/1	8/26	30.8		1			

北京	比赛进程	西安
1st Half		
23 庞佳明	1 02:13	0
23 庞佳明	2 03:20	0
	2 05:38	1 15 陈冉
29 赵熹瑞	3 12:29	1
	3 13:17	2 8 张领
	3 15:03	3 8 张领
	3 15:42	4 15 陈冉
6 苑宾	4 16:22	4
9 曹智栋	5 17:09	4
	5 17:39	5 9 陈孝天
29 赵熹瑞	6 18:22	5
	6 18:43	6 8 张领
9 曹智栋	7 19:32	6
	7 19:57	7 9 陈孝天
2nd Half		
9 曹智栋	8 00:27	7
	8 01:27	8 9 陈孝天
	8 03:05	9 9 陈孝天
	8 04:36	10 6 李梦豪
6 苑宾	9 05:15	10
23 庞佳明	10 06:11	10
	10 06:38	11 9 陈孝天
23 庞佳明	11 07:19	11
9 曹智栋	12 08:09	11
13 蓝心凯	13 10:37	11
23 庞佳明	14 11:13	11
23 庞佳明	15 13:45	11
23 庞佳明	16 15:06	11
	16 15:13	12 15 陈冉
	16 16:22	13 8 张领
	16 16:55	14 9 陈孝天
	16 18:16	15 6 李梦豪
15 刘大明	17 18:55	15
	17 19:07	16 9 陈孝天
13 蓝心凯	18 19:31	16
	18 19:39	17 9 陈孝天

场上队员: 得分 / 射门

守门员: 救球 / 射门

D	取消资格	DR	取消资格+报告
---	------	----	---------



第二届全国青年运动会男子手球甲组决赛 体校组 (U18)

个人/全队技术统计表

手球 青年男子 预赛 轮次 2 组别 B 场次 25 晋中体育馆 2019-06-16 18:40

号码	姓名	远射	近射	边射	快攻	突破	任意	七米	合计	%	助攻	失误	警告	2'	取消	时间
北京市(北京)																
(场上队员)																
1	陶钜									0.0%						00:00:00
3	魏豪									0.0%						00:00:00
4	李博仔									0.0%						00:00:00
6	苑宾			1/2	1/1				2/3	66.7%		1	1			00:40:00
7	侯博耀									0.0%						00:00:00
8	孙铂力									0.0%						00:00:00
9	曹智栋	3/5	0/1		1/1			0/1	4/8	50.0%	1	2				00:40:00
13	蓝心凯		2/2						2/2	100%						00:27:18
14	杜俊林									0.0%						00:00:00
15	刘大明	0/2				1/1			1/3	33.3%		2				00:34:20
16	王鑫宇									0.0%	1					00:40:00
18	宋昱鹏									0.0%						00:00:00
23	庞佳明	1/6	1/1	1/1	1/1		2/2	1/1	7/12	58.3%	2	2		1		00:40:00
26	郑铭境									0.0%		1		1		00:23:54
29	赵熹瑞		2/2						2/2	100%				1		00:33:56
32	张珂宁									0.0%						00:00:00
合计		4/13	5/6	2/3	3/3	1/1	2/2	1/2	18/30	60.0%	4	8	1	3		
(守门员)																
16	王鑫宇	5/11	0/1		0/3	1/5	0/1	0/2	6/23	26.1%	1					00:40:00
合计		5/11	0/1		0/3	1/5	0/1	0/2	6/23	26.1%	1					

场上队员：得分/射门

守门员：救球/射门

全队合计	得分	被救	射失	击柱	封球	合计	%
远射	4	6	2		1	13	30.8%
近射	5	1				6	83.3%
边射	2	1				3	66.7%
快攻	3					3	100.0%
突破	1					1	100.0%
任意	2					2	100.0%
七米	1		1			2	50.0%

第二届全国青年运动会男子手球甲组决赛 体校组 (U18)

PHMS Pictorial Handball Match Statistics

IHF Official System

个人/全队技术统计表

手球 青年男子 预赛 轮次 2 组别 B 场次 25 晋中体育馆 2019-06-16 18:40

号码	姓名	远射	近射	边射	快攻	突破	任意	七米	合计	%	助攻	失误	警告	2'	取消	时间
陕西西安(西安)																
(场上队员)																
1	陈昊									0.0%		1				00:40:00
2	张兴彬									0.0%						00:00:00
3	丁玉冰	0/1	0/1						0/2	0.0%		1				00:39:03
5	隋家乐									0.0%						00:00:00
6	李梦豪	0/1				2/2			2/3	66.7%			1			00:40:00
7	黄金伟									0.0%						00:00:00
8	张领	1/2	1/1			2/3			4/6	66.7%		5	1			00:32:42
9	陈孝天	4/10			1/1		1/1	2/2	8/14	57.1%	1	1		1		00:39:59
10	王凯强	0/1							0/1	0.0%		1	1			00:07:15
11	孔宇豪									0.0%						00:00:00
12	朱正顺									0.0%						00:00:00
13	徐昊天		0/1						0/1	0.0%						00:00:57
14	孙旭									0.0%						00:00:00
15	陈冉	1/1			2/2				3/3	100%				1		00:40:00
16	金筠峰									0.0%						00:00:00
17	刘世昌									0.0%		1				00:40:00
合计		6/16	1/3		3/3	4/5	1/1	2/2	17/30	56.7%	1	10	3	2		
(守门员)																
1	陈昊	6/10	1/6	1/3	0/3	0/1	0/2	0/1	8/26	30.8%		1				00:40:00
合计		6/10	1/6	1/3	0/3	0/1	0/2	0/1	8/26	30.8%		1				

场上队员： 得分/射门

守门员： 救球/射门

全队合计	得分	被救	射失	击柱	封球	合计	%
远射	6	5	4		1	16	37.5%
近射	1			2		3	33.3%
边射							0.0%
快攻	3					3	100.0%
突破	4	1				5	80.0%
任意	1					1	100.0%
七米	2					2	100.0%

图式比赛技术统计表

手球
青年男子

预赛
轮次 2

组别 B
场次 25

晋中体育馆
2019-06-16 18:40

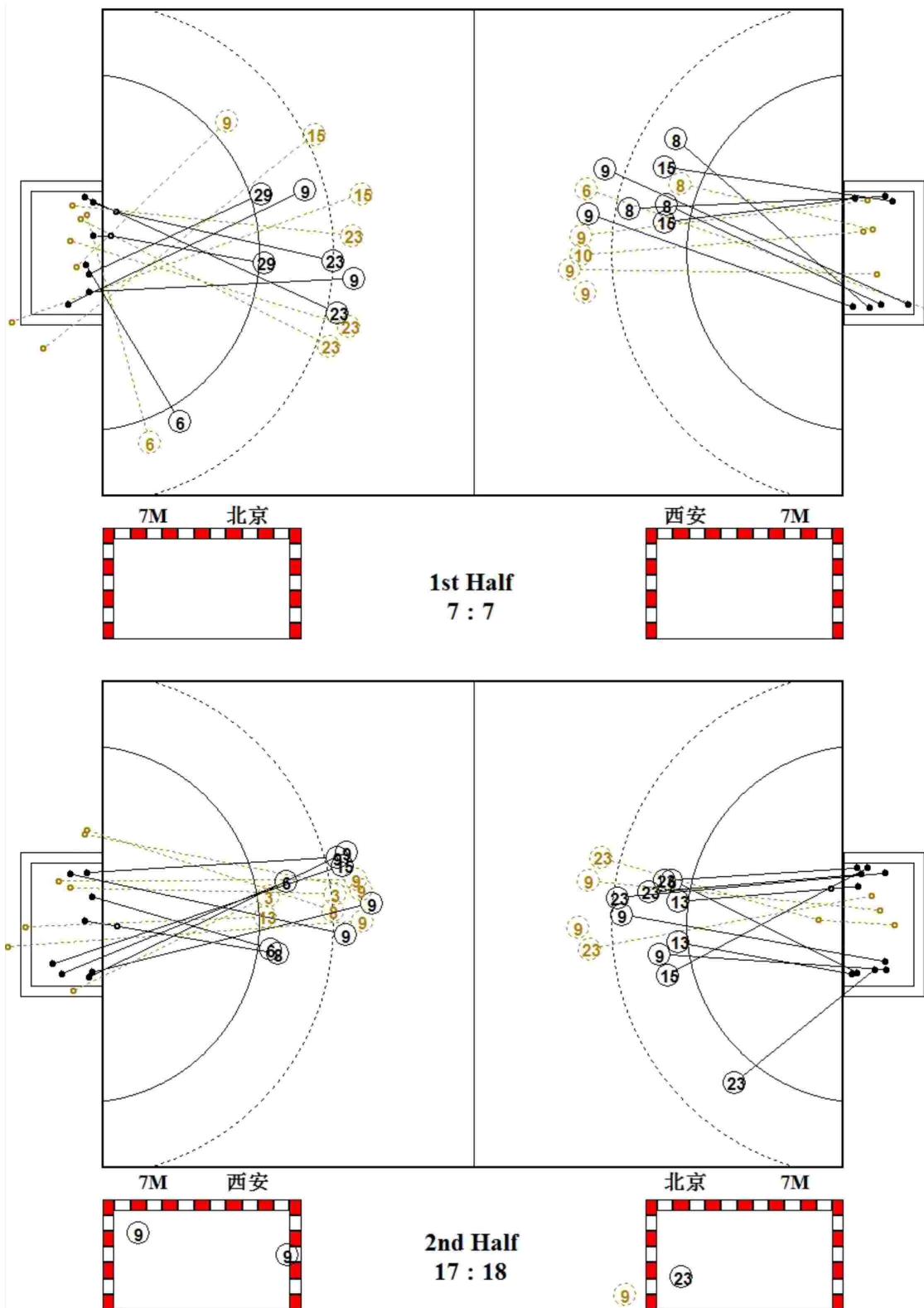

图式射门区域统计

手球
青年男子

预赛
轮次 2

组别 B
场次 25

晋中体育馆
2019-06-16 18:40

北京市

1 陶钜	3 魏豪	4 李博仔	6 苑宾	7 侯博耀	8 孙铂力	9 曹智栋	13 蓝心凯																																																																								
<table border="1"><tr><td></td><td></td><td></td></tr><tr><td></td><td></td><td></td></tr><tr><td></td><td></td><td></td></tr></table>										<table border="1"><tr><td></td><td></td><td></td></tr><tr><td></td><td></td><td></td></tr><tr><td></td><td></td><td></td></tr></table>										<table border="1"><tr><td></td><td></td><td></td></tr><tr><td></td><td></td><td></td></tr><tr><td></td><td></td><td></td></tr></table>										<table border="1"><tr><td></td><td></td><td></td></tr><tr><td></td><td>1</td><td>1</td></tr><tr><td></td><td></td><td></td></tr></table>					1	1				<table border="1"><tr><td></td><td></td><td></td></tr><tr><td></td><td></td><td></td></tr><tr><td></td><td></td><td></td></tr></table>										<table border="1"><tr><td></td><td></td><td></td></tr><tr><td></td><td></td><td></td></tr><tr><td></td><td></td><td></td></tr></table>										<table border="1"><tr><td></td><td></td><td></td></tr><tr><td>1</td><td></td><td>2</td></tr><tr><td>1</td><td></td><td></td></tr></table>				1		2	1			<table border="1"><tr><td></td><td></td><td></td></tr><tr><td></td><td></td><td></td></tr><tr><td>1</td><td></td><td>1</td></tr></table>							1		1
	1	1																																																																													
1		2																																																																													
1																																																																															
1		1																																																																													
Post - 0 Miss - 0 Block - 0	Post - 0 Miss - 0 Block - 0	Post - 0 Miss - 0 Block - 0	Post - 0 Miss - 0 Block - 0	Post - 0 Miss - 0 Block - 0	Post - 0 Miss - 0 Block - 0	Post - 0 Miss - 1 Block - 1	Post - 0 Miss - 0 Block - 0																																																																								
14 杜俊林	15 刘大明	16 王鑫宇	18 宋昱鹏	23 庞佳明	26 郑铭境	29 赵熹瑞	32 张珂宁																																																																								
<table border="1"><tr><td></td><td></td><td></td></tr><tr><td></td><td></td><td></td></tr><tr><td></td><td></td><td></td></tr></table>										<table border="1"><tr><td></td><td></td><td></td></tr><tr><td>1</td><td></td><td></td></tr><tr><td></td><td></td><td></td></tr></table>				1						<table border="1"><tr><td></td><td></td><td></td></tr><tr><td></td><td></td><td></td></tr><tr><td></td><td></td><td></td></tr></table>										<table border="1"><tr><td></td><td></td><td></td></tr><tr><td></td><td></td><td></td></tr><tr><td></td><td></td><td></td></tr></table>										<table border="1"><tr><td></td><td></td><td></td></tr><tr><td>2</td><td></td><td>1</td></tr><tr><td>2</td><td></td><td>2</td></tr></table>				2		1	2		2	<table border="1"><tr><td></td><td></td><td></td></tr><tr><td></td><td></td><td></td></tr><tr><td></td><td></td><td></td></tr></table>										<table border="1"><tr><td></td><td></td><td></td></tr><tr><td></td><td></td><td></td></tr><tr><td>1</td><td>1</td><td></td></tr></table>							1	1		<table border="1"><tr><td></td><td></td><td></td></tr><tr><td></td><td></td><td></td></tr><tr><td></td><td></td><td></td></tr></table>									
1																																																																															
2		1																																																																													
2		2																																																																													
1	1																																																																														
Post - 0 Miss - 0 Block - 0	Post - 0 Miss - 2 Block - 0	Post - 0 Miss - 0 Block - 0	Post - 0 Miss - 0 Block - 0	Post - 0 Miss - 0 Block - 0	Post - 0 Miss - 0 Block - 0	Post - 0 Miss - 0 Block - 0	Post - 0 Miss - 0 Block - 0																																																																								

16 王鑫宇

0/3		0/1
2/4		3/7
0/3	1/2	0/3

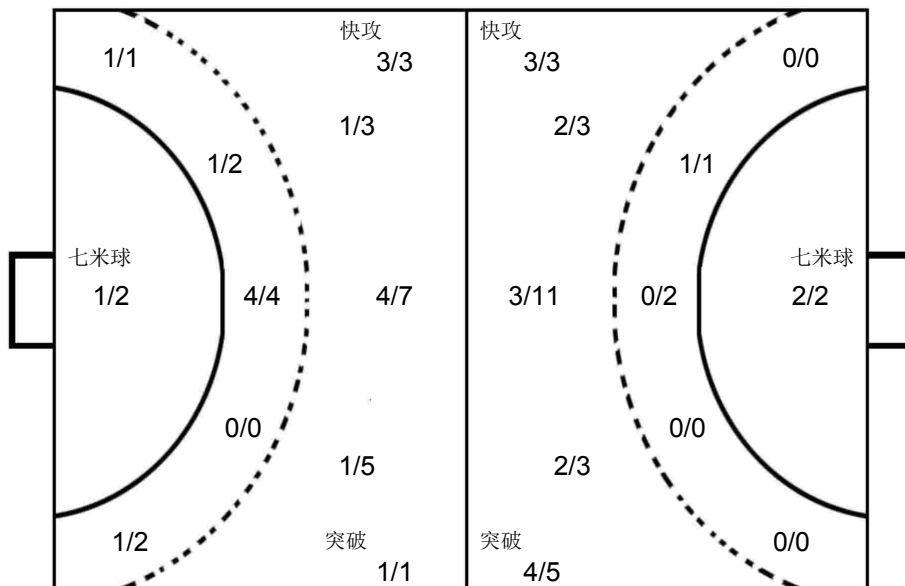

1 陈昊

	1/1	
1/5	3/3	1/4
0/5	0/2	2/6

陕西西安

1 陈昊	2 张兴彬	3 丁玉冰	5 隋家乐	6 李梦豪	7 黄金伟	8 张领	9 陈孝天																																																																								
<table border="1"><tr><td></td><td></td><td></td></tr><tr><td></td><td></td><td></td></tr><tr><td></td><td></td><td></td></tr></table>										<table border="1"><tr><td></td><td></td><td></td></tr><tr><td></td><td></td><td></td></tr><tr><td></td><td></td><td></td></tr></table>										<table border="1"><tr><td></td><td></td><td></td></tr><tr><td></td><td></td><td></td></tr><tr><td></td><td></td><td></td></tr></table>										<table border="1"><tr><td></td><td></td><td></td></tr><tr><td></td><td></td><td></td></tr><tr><td></td><td></td><td></td></tr></table>										<table border="1"><tr><td></td><td></td><td></td></tr><tr><td>1</td><td></td><td></td></tr><tr><td></td><td></td><td>1</td></tr></table>				1					1	<table border="1"><tr><td></td><td></td><td></td></tr><tr><td></td><td></td><td></td></tr><tr><td></td><td></td><td></td></tr></table>										<table border="1"><tr><td></td><td></td><td></td></tr><tr><td>1</td><td></td><td>2</td></tr><tr><td></td><td>1</td><td></td></tr></table>				1		2		1		<table border="1"><tr><td></td><td></td><td></td></tr><tr><td>1</td><td></td><td></td></tr><tr><td>2</td><td></td><td>2</td></tr></table>				1			2		2
1																																																																															
		1																																																																													
1		2																																																																													
	1																																																																														
1																																																																															
2		2																																																																													
Post - 0 Miss - 0 Block - 0	Post - 0 Miss - 0 Block - 0	Post - 1 Miss - 0 Block - 0	Post - 0 Miss - 0 Block - 0	Post - 0 Miss - 1 Block - 0	Post - 0 Miss - 0 Block - 0	Post - 0 Miss - 1 Block - 0	Post - 0 Miss - 2 Block - 1																																																																								
10 王凯强	11 孔宇豪	12 朱正顺	13 徐昊天	14 孙旭	15 陈冉	16 金筠峰	17 刘世昌																																																																								
<table border="1"><tr><td></td><td></td><td></td></tr><tr><td></td><td></td><td></td></tr><tr><td></td><td></td><td></td></tr></table>										<table border="1"><tr><td></td><td></td><td></td></tr><tr><td></td><td></td><td></td></tr><tr><td></td><td></td><td></td></tr></table>										<table border="1"><tr><td></td><td></td><td></td></tr><tr><td></td><td></td><td></td></tr><tr><td></td><td></td><td></td></tr></table>										<table border="1"><tr><td></td><td></td><td></td></tr><tr><td></td><td></td><td></td></tr><tr><td></td><td></td><td></td></tr></table>										<table border="1"><tr><td></td><td></td><td></td></tr><tr><td></td><td></td><td></td></tr><tr><td></td><td></td><td></td></tr></table>										<table border="1"><tr><td></td><td></td><td></td></tr><tr><td>2</td><td></td><td></td></tr><tr><td></td><td></td><td></td></tr></table>				2						<table border="1"><tr><td></td><td></td><td></td></tr><tr><td></td><td></td><td></td></tr><tr><td></td><td></td><td></td></tr></table>										<table border="1"><tr><td></td><td></td><td></td></tr><tr><td></td><td></td><td></td></tr><tr><td></td><td></td><td></td></tr></table>									
2																																																																															
Post - 0 Miss - 0 Block - 0	Post - 0 Miss - 0 Block - 0	Post - 0 Miss - 0 Block - 0	Post - 1 Miss - 0 Block - 0	Post - 0 Miss - 0 Block - 0	Post - 0 Miss - 0 Block - 0	Post - 0 Miss - 0 Block - 0	Post - 0 Miss - 0 Block - 0																																																																								





第二届全国青年运动会男子手球甲组决赛 体校组 (U18)

青年男子 全国比赛

预赛 Group B

PHMS Pictorial Handball Match Statistics IHF Official System

Team A A 北京市				Team B B 广东深圳				Match Number 36			
-----------------	--	--	--	------------------	--	--	--	---------------------------	--	--	--

Played in 山西晋中	in the hall 晋中体育馆	on 2019-06-18	at 14:00	hours	Speakers
-------------------	----------------------	------------------	-------------	-------	----------

Half-time(30')	A 9	B 7	End of playing time	A 18	B 15	1st extra time	A	B	2nd extra time	A	B	After penalty throws	A	B
----------------	--------	--------	---------------------	---------	---------	----------------	---	---	----------------	---	---	----------------------	---	---

Number of 7 m 6/7	Team time-out			Full name of players and officials	Team time-out			B 0/0	Number of 7 m
	1 16:29	2 29:30	3 39:12		1 13:29	2 31:47	3		

No.	Team A	G	W	2'	D	DR	No.	Team B	G	W	2'	D	DR
1	陶钜						2	祝安南					
3	魏豪						3	李朗轩	5	1			
4	李博仔						5	陈俊延					
6	苑宾	6		1			6	董佳辉	2		1		
7	侯博耀						7	曾繁泳	1				
8	孙铂力						8	罗霖泽	3	1	1		
9	曹智栋	2					9	左典					
13	蓝心凯	1		1			10	李剑琛		1			
14	杜俊林						11	万泽峰					
15	刘大明	1					12	戴景伟					
16	王鑫宇						13	赵世豪					
18	宋昱鹏						16	谢思远	4				
23	庞佳明	8					18	曾笑童					
26	郑铭境						19	齐振东					
29	赵熹瑞												
32	张珂宁												
A	吴健						A	张斌					
B	翟彦戎						C	李中洲 (主教练)					
							D	张广建					
							F	蒋光华					

A	Signatures of responsables for the teams (Off.A)												B
---	--	--	--	--	--	--	--	--	--	--	--	--	---

TP	Remarks of referees / HF Official													TP
----	-----------------------------------	--	--	--	--	--	--	--	--	--	--	--	--	----

Referees	许翔 (CHN)	严璐 (CHN)		
T.D.	柴业宏 (CHN)	王洋 (CHN)		
CHA Off.				

Note: Number of 7m Throws Awarded to Team A and B, Goals (G), Warnings (W), Suspensions (2'), Direct Disqualification (D), Disqualification With Report (DR) and Team Penalty (TP).

Table Officials: 孙龙龙 戴莹莹 Statisticians: 刘笑 王梓衡

第二届全国青年运动会男子手球甲组决赛 体校组 (U18)

PHMS Pictorial Handball Match Statistics

IHF Official System

竞赛技术统计

手球
青年男子

预赛
轮次 3

组别 B
场次 36

晋中体育馆
2019-06-18 14:00

Referees:	许翔 (CHN) / 严璐 (CHN)	Result:	18:15(9:7)
Teams:	北京市(北京) VS 广东深圳(深圳)		

北京														北京		比赛 进程		深圳	
主教练: 吴健																			
	远射	近射	边射	快攻	突破	任意球	7m球	合计	%	助攻	失误	警告	2'	D+DR					
1 陶钜																			
3 魏豪																			
4 李博仔																			
6 苑宾			2/5				4/4	6/9	66.7				1						
7 侯博耀																			
8 孙铂力																			
9 曹智栋		1/1	0/1		1/1			2/3	66.7		1								
13 蓝心凯		1/1						1/1	100					1					
14 杜俊林																			
15 刘大明	0/2		1/1					1/3	33.3	2									
16 王鑫宇																			
18 宋昱鹏																			
23 庞佳明	1/5	2/3			2/2	1/1	2/3	8/14	57.1	2	1								
26 郑铭境																			
29 赵熹瑞										1	1								
32 张珂宁																			
运动员 合计	1/7	4/5	3/7		3/3	1/1	6/7	18/30	60.0	5	3		2						
1 陶钜	1/3	0/1	0/1		0/1			1/6	16.7										
16 王鑫宇	1/3	2/7	0/1	1/2	1/2			5/15	33.3										
守门员 合计	2/6	2/8	0/2	1/2	1/3			6/21	28.6										
深圳																			
主教练: 李中洲																			
	远射	近射	边射	快攻	突破	任意球	7m球	合计	%	助攻	失误	警告	2'	D+DR					
2 祝安南																			
3 李朗轩	3/6	1/1		1/1				5/8	62.5	1		1							
5 陈俊延																			
6 董佳辉	1/5	1/1			0/1			2/7	28.6	1	1		1						
7 曾繁泳					1/1			1/1	100		2								
8 罗霖泽		1/1	2/2	0/1				3/4	75.0	1		1	1						
9 左典	0/1							0/1	0.0	1	1								
10 李剑琛		0/3						0/3	0.0	1		1							
11 万泽峰		0/1						0/1	0.0										
12 戴景伟																			
13 赵世豪																			
16 谢思远	0/1	3/3		0/1	1/1			4/6	66.7		2								
18 曾笑童																			
19 齐振东																			
运动员 合计	4/13	6/10	2/2	1/3	2/3			15/31	48.4	5	6	3	2						
12 戴景伟			1/1				0/2	1/3	33.3										
18 曾笑童							0/2	0/2	0.0										
19 齐振东	2/3	0/4	2/5		0/3	0/1	0/2	4/18	22.2										
守门员 合计	2/3	0/4	3/6		0/3	0/1	0/6	5/23	21.7										

		1st Half		2nd Half	
6 苑宾	1	03:02	0		
	1	03:35	1	3	李朗轩
23 庞佳明	2	05:20	1		
23 庞佳明	3	07:29	1		
	3	07:57	2	3	李朗轩
	3	09:20	3	16	谢思远
15 刘大明	4	09:58	3		
23 庞佳明	5	11:25	3		
	5	12:01	4	3	李朗轩
6 苑宾	6	13:17	4		
	6	16:13	5	8	罗霖泽
9 曹智栋	7	16:51	5		
	7	17:25	6	6	董佳辉
9 曹智栋	8	18:12	6		
6 苑宾	9	19:45	6		
	9	19:59	7	16	谢思远
23 庞佳明	10	00:33	7		
23 庞佳明	11	02:18	7		
	11	03:32	8	16	谢思远
6 苑宾	12	04:14	8		
	12	04:55	9	3	李朗轩
23 庞佳明	13	05:36	9		
	13	05:57	10	7	曾繁泳
23 庞佳明	14	07:48	10		
	14	07:59	11	3	李朗轩
13 蓝心凯	15	09:53	11		
	15	11:05	12	8	罗霖泽
23 庞佳明	16	11:29	12		
6 苑宾	17	14:33	12		
	17	14:43	13	6	董佳辉
	17	16:39	14	8	罗霖泽
6 苑宾	18	17:11	14		
	18	18:44	15	16	谢思远

场上队员: 得分 / 射门

守门员: 救球 / 射门

D	取消资格	DR	取消资格+报告
---	------	----	---------



个人/全队技术统计表

手球 青年男子 预赛 轮次 3 组别 B 场次 36 晋中体育馆 2019-06-18 14:00

号码	姓名	远射	近射	边射	快攻	突破	任意	七米	合计	%	助攻	失误	警告	2'	取消	时间
北京市(北京)																
(场上队员)																
1	陶钜									0.0%						00:13:05
3	魏豪									0.0%						00:00:00
4	李博仔									0.0%						00:00:00
6	苑宾			2/5				4/4	6/9	66.7%				1		00:40:00
7	侯博耀									0.0%						00:00:00
8	孙铂力									0.0%						00:00:02
9	曹智栋		1/1	0/1		1/1			2/3	66.7%		1				00:40:00
13	蓝心凯		1/1						1/1	100%				1		00:33:39
14	杜俊林									0.0%						00:00:00
15	刘大明	0/2		1/1					1/3	33.3%	2					00:40:00
16	王鑫宇									0.0%						00:26:55
18	宋昱鹏									0.0%						00:00:00
23	庞佳明	1/5	2/3			2/2	1/1	2/3	8/14	57.1%	2	1				00:40:00
26	郑铭境									0.0%						00:06:07
29	赵熹瑞									0.0%	1	1				00:40:00
32	张珂宁									0.0%						00:00:00
	合计	1/7	4/5	3/7		3/3	1/1	6/7	18/30	60.0%	5	3		2		
(守门员)																
1	陶钜	1/3	0/1	0/1		0/1			1/6	16.7%						00:13:05
16	王鑫宇	1/3	2/7	0/1	1/2	1/2			5/15	33.3%						00:26:55
	合计	2/6	2/8	0/2	1/2	1/3			6/21	28.6%						

场上队员：得分/射门

守门员：救球/射门

全队合计	得分	被救	射失	击柱	封球	合计	%
远射	1	2	1	2	1	7	14.3%
近射	4		1			5	80.0%
边射	3	3	1			7	42.9%
快攻							0.0%
突破	3					3	100.0%
任意	1					1	100.0%
七米	6			1		7	85.7%

第二届全国青年运动会男子手球甲组决赛 体校组 (U18)

PHMS Pictorial Handball Match Statistics

IHF Official System

个人/全队技术统计表

手球 青年男子 预赛 轮次 3 组别 B 场次 36 晋中体育馆 2019-06-18 14:00

号码	姓名	远射	近射	边射	快攻	突破	任意	七米	合计	%	助攻	失误	警告	2'	取消	时间
广东深圳(深圳)																
(场上队员)																
2	祝安南									0.0%						00:00:00
3	李朗轩	3/6	1/1		1/1				5/8	62.5%	1		1			00:34:41
5	陈俊延									0.0%						00:00:00
6	董佳辉	1/5	1/1			0/1			2/7	28.6%	1	1		1		00:34:54
7	曾繁泳					1/1			1/1	100%		2				00:39:58
8	罗霖泽		1/1	2/2	0/1				3/4	75.0%	1		1	1		00:38:55
9	左典	0/1							0/1	0.0%	1	1				00:21:47
10	李剑琛		0/3						0/3	0.0%	1		1			00:34:06
11	万泽峰		0/1						0/1	0.0%						00:05:46
12	戴景伟									0.0%						00:02:19
13	赵世豪									0.0%						00:00:00
16	谢思远	0/1	3/3		0/1	1/1			4/6	66.7%		2				00:29:26
18	曾笑童									0.0%						00:01:02
19	齐振东									0.0%						00:36:39
合计		4/13	6/10	2/2	1/3	2/3			15/31	48.4%	5	6	3	2		
(守门员)																
12	戴景伟			1/1				0/2	1/3	33.3%						00:02:19
18	曾笑童							0/2	0/2	0.0%						00:01:02
19	齐振东	2/3	0/4	2/5		0/3	0/1	0/2	4/18	22.2%						00:36:39
合计		2/3	0/4	3/6		0/3	0/1	0/6	5/23	21.7%						

场上队员： 得分/射门

守门员： 救球/射门

全队合计	得分	被救	射失	击柱	封球	合计	%
远射	4	2	1	2	4	13	30.8%
近射	6	2	1	1		10	60.0%
边射	2					2	100.0%
快攻	1	1			1	3	33.3%
突破	2	1				3	66.7%
任意							0.0%
七米							0.0%

图式比赛技术统计表

手球
青年男子

预赛
轮次 3

组别 B
场次 36

晋中体育馆
2019-06-18 14:00

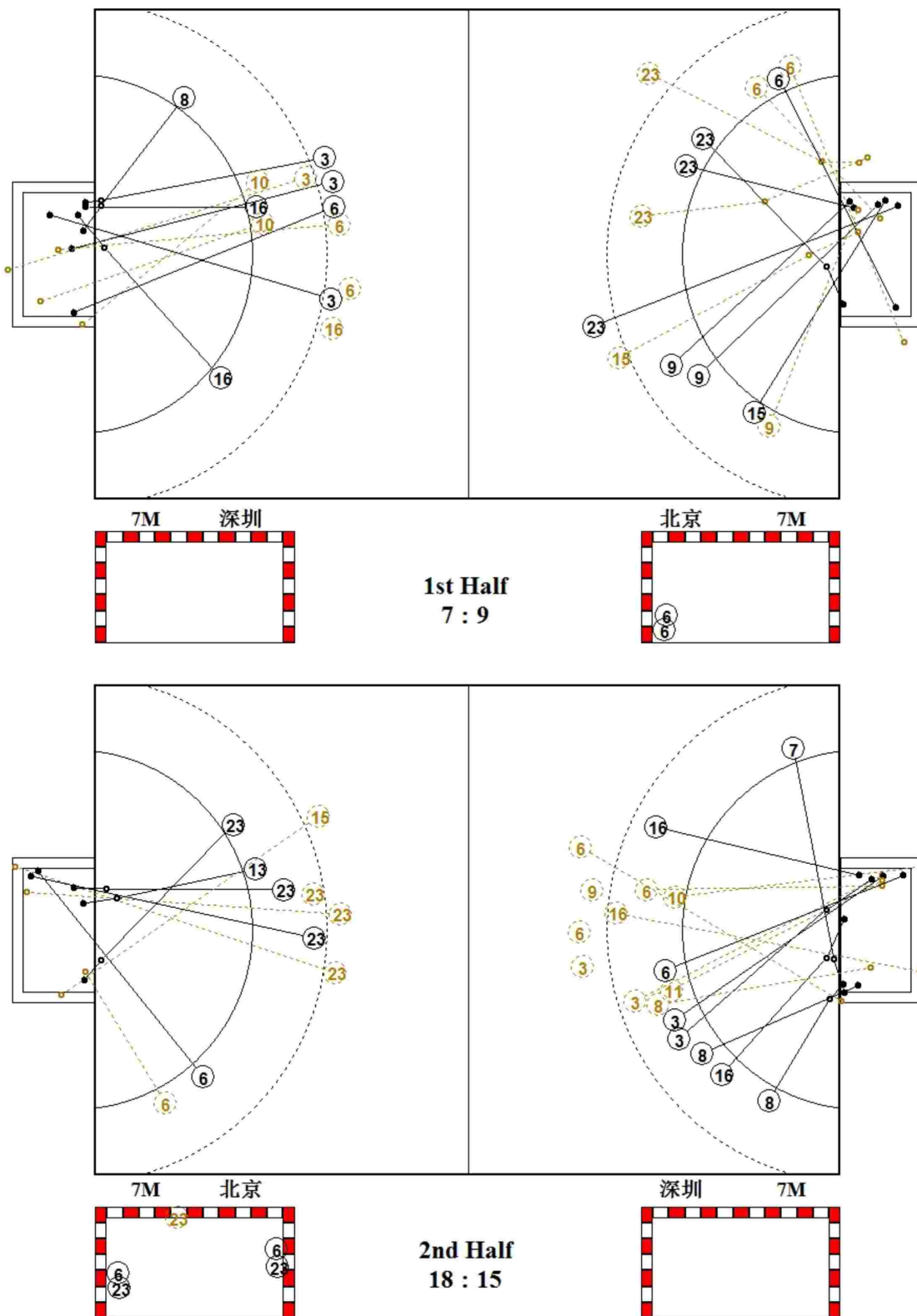

图式射门区域统计

手球
青年男子

预赛
轮次 3

组别 B
场次 36

晋中体育馆
2019-06-18 14:00

北京市

1 陶钜	3 魏豪	4 李博仔	6 苑宾	7 侯博耀	8 孙铂力	9 曹智栋	13 蓝心凯																																																																											
<table border="1"><tr><td></td><td></td><td></td></tr><tr><td></td><td></td><td></td></tr><tr><td></td><td></td><td></td></tr></table>										<table border="1"><tr><td></td><td></td><td></td></tr><tr><td></td><td></td><td></td></tr><tr><td></td><td></td><td></td></tr></table>										<table border="1"><tr><td></td><td></td><td></td></tr><tr><td></td><td></td><td></td></tr><tr><td></td><td></td><td></td></tr></table>										<table border="1"><tr><td></td><td></td><td>3</td></tr><tr><td>1</td><td></td><td></td></tr><tr><td>2</td><td></td><td></td></tr></table>			3	1			2			<table border="1"><tr><td></td><td></td><td></td></tr><tr><td></td><td></td><td></td></tr><tr><td></td><td></td><td></td></tr></table>										<table border="1"><tr><td></td><td></td><td></td></tr><tr><td></td><td></td><td></td></tr><tr><td></td><td></td><td></td></tr></table>										<table border="1"><tr><td></td><td></td><td></td></tr><tr><td>1</td><td></td><td></td></tr><tr><td>1</td><td></td><td></td></tr></table>				1			1			<table border="1"><tr><td></td><td></td><td></td></tr><tr><td></td><td></td><td></td></tr><tr><td></td><td></td><td>1</td></tr></table>									1			
		3																																																																																
1																																																																																		
2																																																																																		
1																																																																																		
1																																																																																		
		1																																																																																
Post - 0 Miss - 0 Block - 0	Post - 0 Miss - 0 Block - 0	Post - 0 Miss - 0 Block - 0	Post - 0 Miss - 1 Block - 0	Post - 0 Miss - 0 Block - 0	Post - 0 Miss - 0 Block - 0	Post - 0 Miss - 0 Block - 0	Post - 0 Miss - 0 Block - 0																																																																											
14 杜俊林	15 刘大明	16 王鑫宇	18 宋昱鹏	23 庞佳明	26 郑铭境	29 赵熹瑞	32 张珂宁																																																																											
<table border="1"><tr><td></td><td></td><td></td></tr><tr><td></td><td></td><td></td></tr><tr><td></td><td></td><td></td></tr></table>										<table border="1"><tr><td></td><td></td><td></td></tr><tr><td>1</td><td></td><td></td></tr><tr><td></td><td></td><td></td></tr></table>				1						<table border="1"><tr><td></td><td></td><td></td></tr><tr><td></td><td></td><td></td></tr><tr><td></td><td></td><td></td></tr></table>										<table border="1"><tr><td></td><td></td><td></td></tr><tr><td></td><td></td><td></td></tr><tr><td></td><td></td><td></td></tr></table>										<table border="1"><tr><td></td><td></td><td></td></tr><tr><td>1</td><td></td><td>1</td></tr><tr><td>1</td><td></td><td>1</td></tr><tr><td>2</td><td></td><td>2</td></tr></table>				1		1	1		1	2		2	<table border="1"><tr><td></td><td></td><td></td></tr><tr><td></td><td></td><td></td></tr><tr><td></td><td></td><td></td></tr></table>										<table border="1"><tr><td></td><td></td><td></td></tr><tr><td></td><td></td><td></td></tr><tr><td></td><td></td><td></td></tr></table>										<table border="1"><tr><td></td><td></td><td></td></tr><tr><td></td><td></td><td></td></tr><tr><td></td><td></td><td></td></tr></table>									
1																																																																																		
1		1																																																																																
1		1																																																																																
2		2																																																																																
Post - 0 Miss - 0 Block - 0	Post - 1 Miss - 0 Block - 0	Post - 0 Miss - 0 Block - 0	Post - 0 Miss - 0 Block - 0	Post - 2 Miss - 2 Block - 1	Post - 0 Miss - 0 Block - 0	Post - 0 Miss - 0 Block - 0	Post - 0 Miss - 0 Block - 0																																																																											

1 陶钜

	1/1	0/1
0/1		0/3

16 王鑫宇

1/2		
3/5		1/1
0/1	0/2	0/4

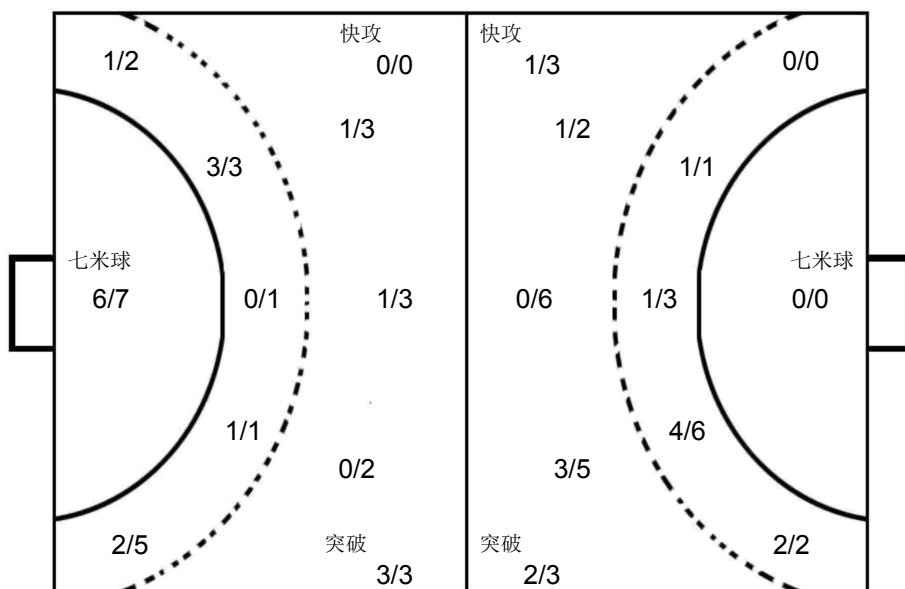

12 戴景伟

0/1		0/1
1/1		

18 曾笑童

0/1		
0/1		

19 齐振东

0/1		1/5
1/3		
2/6		0/3

广东深圳

2 祝安南	3 李朗轩	5 陈俊延	6 董佳辉	7 曾繁泳	8 罗霖泽	9 左典	10 李剑琛																																																																								
<table border="1"><tr><td></td><td></td><td></td></tr><tr><td></td><td></td><td></td></tr><tr><td></td><td></td><td></td></tr></table>										<table border="1"><tr><td></td><td></td><td></td></tr><tr><td>2</td><td></td><td>1</td></tr><tr><td></td><td>1</td><td>1</td></tr></table>				2		1		1	1	<table border="1"><tr><td></td><td></td><td></td></tr><tr><td></td><td></td><td></td></tr><tr><td></td><td></td><td></td></tr></table>										<table border="1"><tr><td></td><td></td><td></td></tr><tr><td>1</td><td></td><td></td></tr><tr><td>1</td><td></td><td></td></tr></table>				1			1			<table border="1"><tr><td></td><td></td><td></td></tr><tr><td></td><td></td><td></td></tr><tr><td></td><td></td><td>1</td></tr></table>									1	<table border="1"><tr><td></td><td></td><td></td></tr><tr><td></td><td></td><td></td></tr><tr><td></td><td></td><td>3</td></tr></table>									3	<table border="1"><tr><td></td><td></td><td></td></tr><tr><td></td><td></td><td></td></tr><tr><td></td><td></td><td></td></tr></table>										<table border="1"><tr><td></td><td></td><td></td></tr><tr><td></td><td></td><td></td></tr><tr><td></td><td></td><td></td></tr></table>									
2		1																																																																													
	1	1																																																																													
1																																																																															
1																																																																															
		1																																																																													
		3																																																																													
Post - 0 Miss - 0 Block - 0	Post - 0 Miss - 1 Block - 1	Post - 0 Miss - 0 Block - 0	Post - 1 Miss - 0 Block - 2	Post - 0 Miss - 0 Block - 0	Post - 0 Miss - 0 Block - 0	Post - 0 Miss - 0 Block - 1	Post - 1 Miss - 1 Block - 0																																																																								
11 万泽峰	12 戴景伟	13 赵世豪	16 谢思远	18 曾笑童	19 齐振东																																																																										
<table border="1"><tr><td></td><td></td><td></td></tr><tr><td></td><td></td><td></td></tr><tr><td></td><td></td><td></td></tr></table>										<table border="1"><tr><td></td><td></td><td></td></tr><tr><td></td><td></td><td></td></tr><tr><td></td><td></td><td></td></tr></table>										<table border="1"><tr><td></td><td></td><td></td></tr><tr><td></td><td></td><td></td></tr><tr><td></td><td></td><td></td></tr></table>										<table border="1"><tr><td></td><td></td><td></td></tr><tr><td></td><td></td><td></td></tr><tr><td>1</td><td>1</td><td>2</td></tr></table>							1	1	2	<table border="1"><tr><td></td><td></td><td></td></tr><tr><td></td><td></td><td></td></tr><tr><td></td><td></td><td></td></tr></table>										<table border="1"><tr><td></td><td></td><td></td></tr><tr><td></td><td></td><td></td></tr><tr><td></td><td></td><td></td></tr></table>																													
1	1	2																																																																													
Post - 0 Miss - 0 Block - 0	Post - 0 Miss - 0 Block - 0	Post - 0 Miss - 0 Block - 0	Post - 1 Miss - 0 Block - 1	Post - 0 Miss - 0 Block - 0	Post - 0 Miss - 0 Block - 0																																																																										



第二届全国青年运动会男子手球甲组决赛 体校组 (U18)

青年男子 全国比赛

预赛 Group B

PHMS Pictorial Handball Match Statistics IHF Official System

Team A A 安徽合肥				Team B B 陕西西安				Match Number 37			
------------------	--	--	--	------------------	--	--	--	---------------------------	--	--	--

Played in 山西晋中	in the hall 晋中体育馆	on 2019-06-18	at 15:10	hours	Speakers
-------------------	----------------------	------------------	-------------	-------	----------

Half-time(30')	A 9	B 10	End of playing time	A 17	B 17	1st extra time	A	B	2nd extra time	A	B	After penalty throws	A 22	B 21
----------------	--------	---------	---------------------	---------	---------	----------------	---	---	----------------	---	---	----------------------	---------	---------

Number of 7 m	A 5/5	Team time-out			Full name of players and officials	Team time-out			B 4/5	Number of 7 m
	1	2	3	1		2	3			

No.	Team A	G	W	2'	D	DR	No.	Team B	G	W	2'	D	DR
2	张天进	7					1	陈昊					
13	沈威	1					2	张兴彬					
26	饶原源	4	1				3	丁玉冰	1				
27	王东昇						5	隋家乐					
29	梅少聪	4					6	李梦豪	1	1	1		
30	单习振	2		1			7	黄金伟					
31	张宇	1					8	张领	3				
33	於晓祺						9	陈孝天	8				
35	李宝松						10	王凯强	1				
36	刘耀奇	1					11	孔宇豪					
39	汤鸿宇						12	朱正顺					
40	陈欢						13	徐昊天	1		1		
41	管家乐	1	1	1			14	孙旭					
42	刘军波						15	陈冉	6		1		
43	王久源	1	1				16	金筠峰					
50	刘欣洋						17	刘世昌					
A	王德勇 (主教练)						A	王刚					
C	陆万红						B	李安					
D	王明星						C	郝可鑫					
E	陈玉翔						D	王少杰					

A	Signatures of responsables for the teams (Off.A)												B
---	--	--	--	--	--	--	--	--	--	--	--	--	---

TP	Remarks of referees / HF Official													TP
----	-----------------------------------	--	--	--	--	--	--	--	--	--	--	--	--	----

Referees	陈晓波 (CHN)	程钰峰 (CHN)		
T.D.	吴瑞亭 (CHN)	王洋 (CHN)		
CHA Off.				

Note: Number of 7m Throws Awarded to Team A and B, Goals (G), Warnings (W), Suspensions (2'), Direct Disqualification (D), Disqualification With Report (DR) and Team Penalty (TP).

Table Officials: 王志超 贾腾 Statisticians: 王梓衡 刘笑



第二届全国青年运动会男子手球甲组决赛 体校组 (U18)

PHMS Pictorial Handball Match Statistics

IHF Official System

竞赛技术统计

手球
青年男子

预赛
轮次 3

组别 B
场次 37

晋中体育馆
2019-06-18 15:10

Referees: 陈晓波 (CHN) / 程钰峰 (CHN)

Result: 22:21 (9:10)

Teams: 安徽合肥(合肥) VS 陕西西安(西安)

合肥		远	近	边	快	突	任意	7m	合计	%	助攻	失误	警告	2'	D+DR
主教练: 王德勇		射	射	射	攻	破	球	球							
2	张天进	3/10	0/2		1/2	2/2		1/1	7/17	41.2					
13	沈威	0/1			1/1				1/2	50.0	1	2			
26	饶源源	1/3				2/3		1/1	4/7	57.1	2	1	1		
27	王东昇														
29	梅少聪		2/2		2/3				4/5	80.0					
30	单习振			1/4				1/1	2/5	40.0				1	
31	张宇							1/1	1/1	100					
33	於晓祺														
35	李宝松														
36	刘耀奇							1/1	1/1	100					
39	汤鸿宇														
40	陈欢														
41	管家乐			0/1	1/1				1/2	50.0			1	1	
42	刘军波														
43	王久源	0/1	0/2	1/1		0/1			1/5	20.0			1		
50	刘欣洋														
运动员 合计		4/15	2/6	2/6	5/7	4/6		5/5	22/45	48.9	3	3	3	2	
39	汤鸿宇	0/1	0/2	1/2	0/2	0/2			1/9	11.1					
40	陈欢	1/3	2/4	2/2		0/1	0/4	1/5	6/19	31.6					
守门员 合计		1/4	2/6	3/4	0/2	0/3	0/4	1/5	7/28	25.0					

西安		远	近	边	快	突	任意	7m	合计	%	助攻	失误	警告	2'	D+DR
主教练: 郝可鑫		射	射	射	攻	破	球	球							
1	陈昊														
2	张兴彬														
3	丁玉冰		1/3						1/3	33.3					
5	隋家乐														
6	李梦豪					1/1			1/1	100	4	2	1	1	
7	黄金伟							0/1	0/1	0.0					
8	张领	0/2	1/1			1/1		1/1	3/5	60.0	1				
9	陈孝天	3/5					4/5	1/1	8/11	72.7	1	3			
10	王凯强			0/1				1/1	1/2	50.0					
11	孔宇豪														
12	朱正顺														
13	徐昊天		1/1	0/1					1/2	50.0		1		1	
14	孙旭														
15	陈冉	0/1	1/1	1/4	2/2	1/1		1/1	6/10	60.0		1		1	
16	金筠峰														
17	刘世昌														
运动员 合计		3/8	4/6	1/6	2/2	3/3	4/5	4/5	21/35	60.0	6	7	1	3	
1	陈昊	2/6	4/6	0/2	2/7	0/4		0/5	8/30	26.7					
守门员 合计		2/6	4/6	0/2	2/7	0/4		0/5	8/30	26.7					

合肥	比赛 进程	西安
1st Half		
0	01:00	1 9 陈孝天
29	梅少聪	1 01:09 1
13	沈威	2 03:28 1
2	张天进	2 04:07 2 6 李梦豪
26	饶源源	3 04:14 2
30	单习振	4 04:57 2
4	05:28	3 9 陈孝天
4	07:36	4 9 陈孝天
26	饶源源	5 07:53 4
5	08:46	5 9 陈孝天
5	09:14	6 15 陈冉
5	12:35	7 3 丁玉冰
2	张天进	6 13:21 7
26	饶源源	7 14:43 7
7	14:54	8 15 陈冉
7	15:45	9 15 陈冉
2	张天进	8 16:19 9
8	18:14	10 15 陈冉
2	张天进	9 20:00 10
2nd Half		
9	01:08	11 15 陈冉
9	02:55	12 8 张领
2	张天进	10 03:15 12
10	05:46	13 9 陈孝天
29	梅少聪	11 05:59 13
29	梅少聪	12 06:22 13
41	管家乐	13 06:45 13
2	张天进	14 07:34 13
2	张天进	15 08:19 13
15	09:10	14 8 张领
15	10:40	15 9 陈孝天
43	王久源	16 11:23 15
29	梅少聪	17 13:35 15
17	17:25	16 13 徐昊天
17	18:58	17 9 陈孝天
7M		
17	00:00	18 9 陈孝天
36	刘耀奇	18 00:00 18
18	00:00	19 8 张领
31	张宇	19 00:00 19
19	00:00	20 15 陈冉
2	张天进	20 00:00 20
26	饶源源	21 00:00 20
21	00:00	21 10 王凯强
30	单习振	22 00:00 21

场上队员: 得分 / 射门

守门员: 救球 / 射门

D	取消资格	DR	取消资格+报告
---	------	----	---------



个人/全队技术统计表

手球 青年男子 预赛 轮次 3 组别 B 场次 37 晋中体育馆 2019-06-18 15:10

号码	姓名	远射	近射	边射	快攻	突破	任意	七米	合计	%	助攻	失误	警告	2'	取消	时间
安徽合肥(合肥)																
(场上队员)																
2	张天进	3/10	0/2		1/2	2/2		1/1	7/17	41.2%						00:40:00
13	沈威	0/1			1/1				1/2	50.0%	1	2				00:22:57
26	饶源源	1/3				2/3		1/1	4/7	57.1%	2	1	1			00:39:59
27	王东昇									0.0%						00:00:00
29	梅少聪		2/2		2/3				4/5	80.0%						00:40:00
30	单习振			1/4				1/1	2/5	40.0%				1		00:40:00
31	张宇							1/1	1/1	100%						00:00:00
33	於晓祺									0.0%						00:00:00
35	李宝松									0.0%						00:00:00
36	刘耀奇							1/1	1/1	100%						00:00:00
39	汤鸿宇									0.0%						00:17:03
40	陈欢									0.0%						00:22:57
41	管家乐			0/1	1/1				1/2	50.0%			1	1		00:24:21
42	刘军波									0.0%						00:00:00
43	王久源	0/1	0/2	1/1		0/1			1/5	20.0%			1			00:32:40
50	刘欣洋									0.0%						00:00:00
	合计	4/15	2/6	2/6	5/7	4/6		5/5	22/45	48.9%	3	3	3	2		
(守门员)																
39	汤鸿宇	0/1	0/2	1/2	0/2	0/2			1/9	11.1%						00:17:03
40	陈欢	1/3	2/4	2/2		0/1	0/4	1/5	6/19	31.6%						00:22:57
	合计	1/4	2/6	3/4	0/2	0/3	0/4	1/5	7/28	25.0%						

场上队员：得分/射门

守门员：救球/射门

全队合计	得分	被救	射失	击柱	封球	合计	%
远射	4	2	3		6	15	26.7%
近射	2	4				6	33.3%
边射	2		3	1		6	33.3%
快攻	5	2				7	71.4%
突破	4		1	1		6	66.7%
任意							0.0%
七米	5					5	100.0%

个人/全队技术统计表

手球 青年男子 预赛 轮次 3 组别 B 场次 37 晋中体育馆 2019-06-18 15:10

号码	姓名	远射	近射	边射	快攻	突破	任意	七米	合计	%	助攻	失误	警告	2'	取消	时间
陕西西安(西安)																
(场上队员)																
1	陈昊									0.0%						00:40:00
2	张兴彬									0.0%						00:00:00
3	丁玉冰		1/3						1/3	33.3%						00:36:00
5	隋家乐									0.0%						00:00:00
6	李梦豪					1/1			1/1	100%	4	2	1	1		00:40:00
7	黄金伟							0/1	0/1	0.0%						00:00:00
8	张领	0/2	1/1			1/1		1/1	3/5	60.0%	1					00:40:00
9	陈孝天	3/5					4/5	1/1	8/11	72.7%	1	3				00:40:00
10	王凯强			0/1				1/1	1/2	50.0%						00:04:12
11	孔宇豪									0.0%						00:00:00
12	朱正顺									0.0%						00:00:00
13	徐昊天		1/1	0/1					1/2	50.0%		1		1		00:39:44
14	孙旭									0.0%						00:00:00
15	陈冉	0/1	1/1	1/4	2/2	1/1		1/1	6/10	60.0%		1		1		00:40:00
16	金筠峰									0.0%						00:00:00
17	刘世昌									0.0%						00:00:00
	合计	3/8	4/6	1/6	2/2	3/3	4/5	4/5	21/35	60.0%	6	7	1	3		
(守门员)																
1	陈昊	2/6	4/6	0/2	2/7	0/4		0/5	8/30	26.7%						00:40:00
	合计	2/6	4/6	0/2	2/7	0/4		0/5	8/30	26.7%						

场上队员：得分/射门

守门员：救球/射门

全队合计	得分	被救	射失	击柱	封球	合计	%
远射	3	1	4			8	37.5%
近射	4	2				6	66.7%
边射	1	3	1	1		6	16.7%
快攻	2					2	100.0%
突破	3					3	100.0%
任意	4		1			5	80.0%
七米	4	1				5	80.0%

图式比赛技术统计表

手球
青年男子

预赛
轮次 3

组别 B
场次 37

晋中体育馆
2019-06-18 15:10

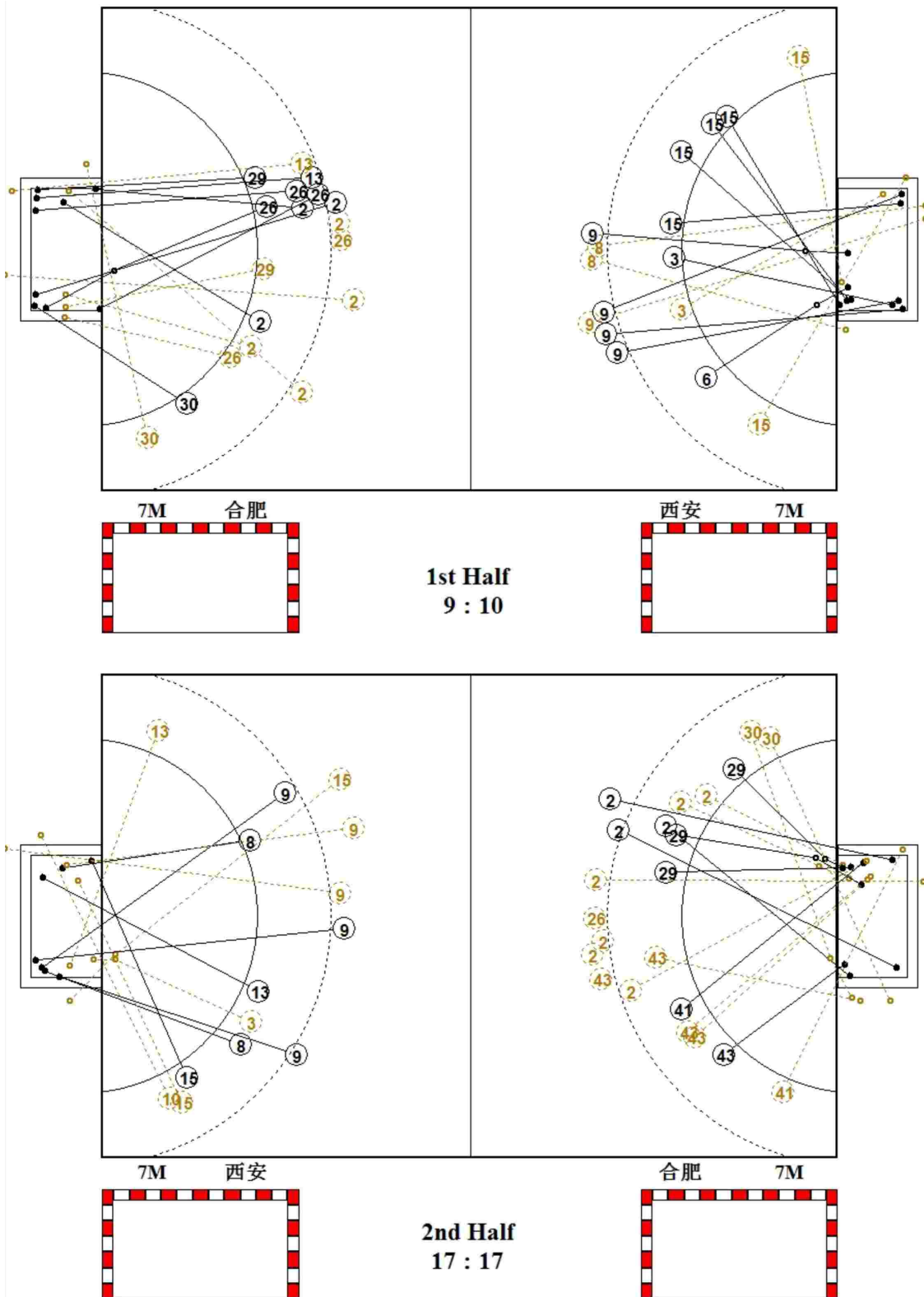

PICTORIAL MATCH STATISTICS

HANDBALL
青年男子

预赛
ROUND 3

GROUP B
MATCH 37

晋中体育馆
2019-06-18 15:10

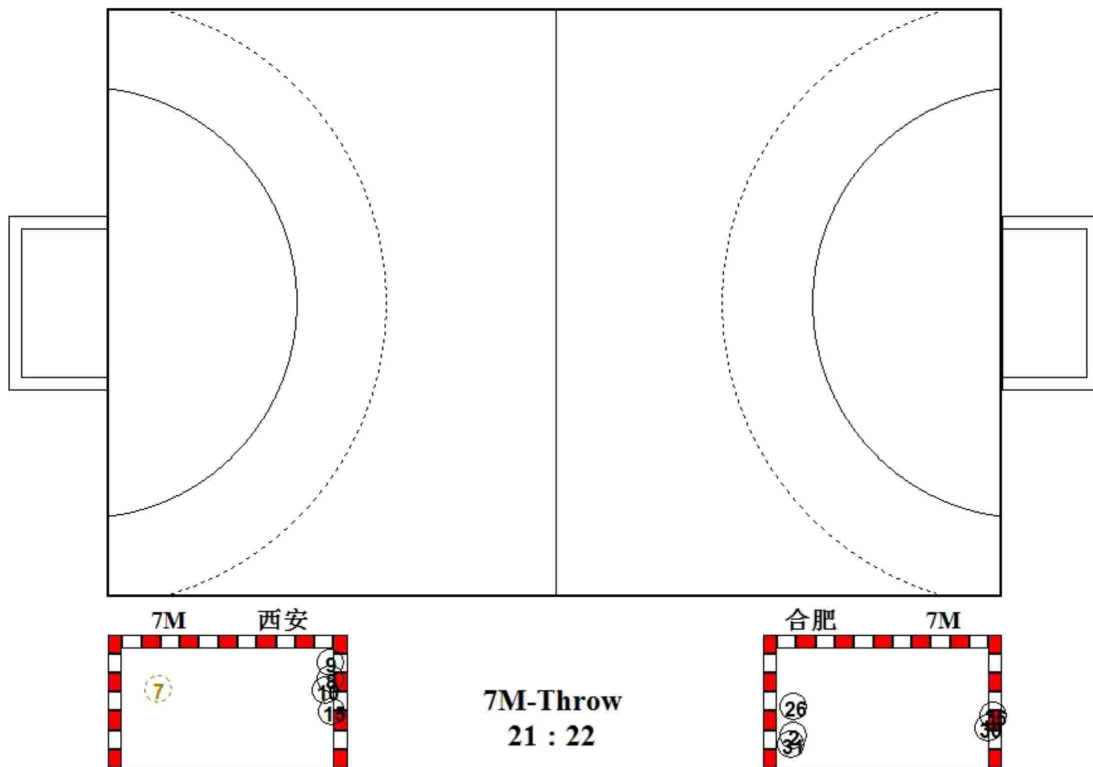

图式射门区域统计

手球
青年男子

预赛
轮次 3

组别 B
场次 37

晋中体育馆
2019-06-18 15:10

安徽合肥

2 张天进 <table border="1"><tr><td>2</td><td></td><td>1</td></tr><tr><td></td><td></td><td>1</td></tr><tr><td>1</td><td></td><td>2</td></tr></table> Post - 0 Miss - 2 Block - 3	2		1			1	1		2	13 沈威 <table border="1"><tr><td></td><td></td><td>1</td></tr><tr><td></td><td></td><td></td></tr><tr><td></td><td></td><td></td></tr></table> Post - 0 Miss - 1 Block - 0			1							26 饶原源 <table border="1"><tr><td>1</td><td></td><td>1</td></tr><tr><td>1</td><td></td><td></td></tr><tr><td>1</td><td></td><td></td></tr></table> Post - 1 Miss - 0 Block - 2	1		1	1			1			27 王东昇 <table border="1"><tr><td></td><td></td><td></td></tr><tr><td></td><td></td><td></td></tr><tr><td></td><td></td><td></td></tr></table> Post - 0 Miss - 0 Block - 0										29 梅少聪 <table border="1"><tr><td></td><td></td><td>1</td></tr><tr><td>1</td><td></td><td></td></tr><tr><td>2</td><td></td><td></td></tr></table> Post - 0 Miss - 0 Block - 0			1	1			2			30 单习振 <table border="1"><tr><td>1</td><td></td><td></td></tr><tr><td></td><td></td><td>1</td></tr><tr><td></td><td></td><td></td></tr></table> Post - 0 Miss - 3 Block - 0	1					1				31 张宇 <table border="1"><tr><td></td><td></td><td></td></tr><tr><td></td><td></td><td></td></tr><tr><td>1</td><td></td><td></td></tr></table> Post - 0 Miss - 0 Block - 0							1			33 於晓祺 <table border="1"><tr><td></td><td></td><td></td></tr><tr><td></td><td></td><td></td></tr><tr><td></td><td></td><td></td></tr></table> Post - 0 Miss - 0 Block - 0									
2		1																																																																													
		1																																																																													
1		2																																																																													
		1																																																																													
1		1																																																																													
1																																																																															
1																																																																															
		1																																																																													
1																																																																															
2																																																																															
1																																																																															
		1																																																																													
1																																																																															
35 李宝松 <table border="1"><tr><td></td><td></td><td></td></tr><tr><td></td><td></td><td></td></tr><tr><td></td><td></td><td></td></tr></table> Post - 0 Miss - 0 Block - 0										36 刘耀奇 <table border="1"><tr><td></td><td></td><td>1</td></tr><tr><td></td><td></td><td></td></tr><tr><td></td><td></td><td></td></tr></table> Post - 0 Miss - 0 Block - 0			1							39 汤鸿宇 <table border="1"><tr><td></td><td></td><td></td></tr><tr><td></td><td></td><td></td></tr><tr><td></td><td></td><td></td></tr></table> Post - 0 Miss - 0 Block - 0										40 陈欢 <table border="1"><tr><td></td><td></td><td></td></tr><tr><td></td><td></td><td></td></tr><tr><td></td><td></td><td></td></tr></table> Post - 0 Miss - 0 Block - 0										41 管家乐 <table border="1"><tr><td>1</td><td></td><td></td></tr><tr><td></td><td></td><td></td></tr><tr><td></td><td></td><td></td></tr></table> Post - 1 Miss - 0 Block - 0	1									42 刘军波 <table border="1"><tr><td></td><td></td><td></td></tr><tr><td></td><td></td><td></td></tr><tr><td></td><td></td><td></td></tr></table> Post - 0 Miss - 0 Block - 0										43 王久源 <table border="1"><tr><td></td><td></td><td>1</td></tr><tr><td></td><td></td><td></td></tr><tr><td></td><td></td><td></td></tr></table> Post - 0 Miss - 1 Block - 1			1							50 刘欣洋 <table border="1"><tr><td></td><td></td><td></td></tr><tr><td></td><td></td><td></td></tr><tr><td></td><td></td><td></td></tr></table> Post - 0 Miss - 0 Block - 0									
		1																																																																													
1																																																																															
		1																																																																													

39 汤鸿宇

0/3		0/1
		1/5

40 陈欢

2/4		0/6
1/2		2/4
1/1	0/1	0/1

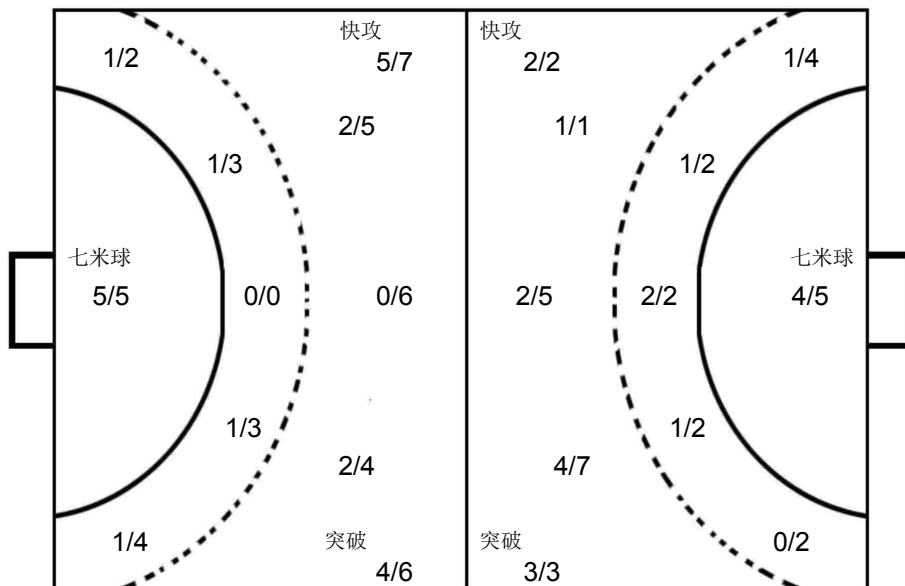

1 陈昊

0/4		0/4
5/8		1/4
2/7		0/3

陕西西安

1 陈昊 <table border="1"><tr><td></td><td></td><td></td></tr><tr><td></td><td></td><td></td></tr><tr><td></td><td></td><td></td></tr></table> Post - 0 Miss - 0 Block - 0										2 张兴彬 <table border="1"><tr><td></td><td></td><td></td></tr><tr><td></td><td></td><td></td></tr><tr><td></td><td></td><td></td></tr></table> Post - 0 Miss - 0 Block - 0										3 丁玉冰 <table border="1"><tr><td></td><td></td><td>1</td></tr><tr><td></td><td></td><td></td></tr><tr><td></td><td></td><td></td></tr></table> Post - 0 Miss - 0 Block - 0			1							5 隋家乐 <table border="1"><tr><td></td><td></td><td></td></tr><tr><td></td><td></td><td></td></tr><tr><td></td><td></td><td></td></tr></table> Post - 0 Miss - 0 Block - 0										6 李梦豪 <table border="1"><tr><td></td><td></td><td></td></tr><tr><td></td><td></td><td>1</td></tr><tr><td></td><td></td><td></td></tr></table> Post - 0 Miss - 0 Block - 0						1				7 黄金伟 <table border="1"><tr><td></td><td></td><td></td></tr><tr><td></td><td></td><td></td></tr><tr><td></td><td></td><td></td></tr></table> Post - 0 Miss - 0 Block - 0										8 张领 <table border="1"><tr><td>1</td><td></td><td>1</td></tr><tr><td></td><td></td><td>1</td></tr><tr><td></td><td></td><td></td></tr></table> Post - 0 Miss - 2 Block - 0	1		1			1				9 陈孝天 <table border="1"><tr><td>3</td><td></td><td>3</td></tr><tr><td>1</td><td></td><td></td></tr><tr><td></td><td>1</td><td></td></tr></table> Post - 0 Miss - 2 Block - 0	3		3	1				1	
		1																																																																													
		1																																																																													
1		1																																																																													
		1																																																																													
3		3																																																																													
1																																																																															
	1																																																																														
10 王凯强 <table border="1"><tr><td></td><td></td><td>1</td></tr><tr><td></td><td></td><td></td></tr><tr><td></td><td></td><td></td></tr></table> Post - 0 Miss - 1 Block - 0			1							11 孔宇豪 <table border="1"><tr><td></td><td></td><td></td></tr><tr><td></td><td></td><td></td></tr><tr><td></td><td></td><td></td></tr></table> Post - 0 Miss - 0 Block - 0										12 朱正顺 <table border="1"><tr><td></td><td></td><td></td></tr><tr><td></td><td></td><td></td></tr><tr><td></td><td></td><td></td></tr></table> Post - 0 Miss - 0 Block - 0										13 徐昊天 <table border="1"><tr><td></td><td></td><td>1</td></tr><tr><td></td><td></td><td></td></tr><tr><td></td><td></td><td></td></tr></table> Post - 0 Miss - 0 Block - 0			1							14 孙旭 <table border="1"><tr><td></td><td></td><td></td></tr><tr><td></td><td></td><td></td></tr><tr><td></td><td></td><td></td></tr></table> Post - 0 Miss - 0 Block - 0										15 陈冉 <table border="1"><tr><td>1</td><td></td><td></td></tr><tr><td></td><td></td><td>1</td></tr><tr><td></td><td></td><td>4</td></tr></table> Post - 1 Miss - 1 Block - 0	1					1			4	16 金筠峰 <table border="1"><tr><td></td><td></td><td></td></tr><tr><td></td><td></td><td></td></tr><tr><td></td><td></td><td></td></tr></table> Post - 0 Miss - 0 Block - 0										17 刘世昌 <table border="1"><tr><td></td><td></td><td></td></tr><tr><td></td><td></td><td></td></tr><tr><td></td><td></td><td></td></tr></table> Post - 0 Miss - 0 Block - 0									
		1																																																																													
		1																																																																													
1																																																																															
		1																																																																													
		4																																																																													



第二届全国青年运动会男子手球甲组决赛 体校组 (U18)

青年男子 全国比赛

预赛 Group A

PHMS Pictorial Handball Match Statistics IHF Official System

Team A A 福建泉港				Team B B 天津市				Match Number 41			
------------------	--	--	--	-----------------	--	--	--	---------------------------	--	--	--

Played in 山西晋中	in the hall 晋中体育馆	on 2019-06-18	at 14:00	hours	Spectators
-------------------	----------------------	------------------	-------------	-------	------------

Half-time(30')	A 14	B 11	End of playing time	A 26	B 22	1st extra time	A	B	2nd extra time	A	B	After penalty throws	A	B
----------------	---------	---------	---------------------	---------	---------	----------------	---	---	----------------	---	---	----------------------	---	---

Number of 7 m 3/3	Team time-out			Full name of players and officials	Team time-out			B 1/3	Number of 7 m
	1 12:38	2	3		1 15:56	2 31:23	3		

No.	Team A	G	W	2'	D	DR	No.	Team B	G	W	2'	D	DR
1	周铁程						4	常艳鹏					
6	段家乐			1			6	赵晨阳	7				
7	王嘉靖						10	黄嘉俊					
9	周星晨						14	戴云鹏					
10	陈臻						17	黄春瑞	1				
11	钟宏韬						19	万朋					
12	汪琪坤						20	王澎	3				
13	周忠迪	2					23	谭元春					
15	刘小龙	4	1				24	周亚龙	2				
17	左兆坤						25	郝一铮	2	1			
18	刘少杰	2	1				26	李海龙	7		1		
20	吴兆瑞	8		1			27	吕华宇					
21	张路	6					28	孙经纬					
23	卓世胜	4											
25	张杰												
34	王涛												
C	刘德东						A	贾守信					
E	薛裕安						B	李志成 (主教练)					
							C	田剑侠					
							D	潘玉强					

A	Signatures of responsables for the teams (Off.A)												B
---	--	--	--	--	--	--	--	--	--	--	--	--	---

TP	Remarks of referees / HF Official													TP
----	-----------------------------------	--	--	--	--	--	--	--	--	--	--	--	--	----

Referees	康曦 (CHN)	王亚光 (CHN)		
T.D.	张耿 (CHN)	刘凤娟 (CHN)		
CHA Off.				

Note: Number of 7m Throws Awarded to Team A and B, Goals (G), Warnings (W), Suspensions (2'), Direct Disqualification (D), Disqualification With Report (DR) and Team Penalty (TP).

Table Officials: 宣海波 张琦 Statisticians: 陈柱 谢扬



第二届全国青年运动会男子手球甲组决赛 体校组 (U18)

PHMS Pictorial Handball Match Statistics

IHF Official System

竞赛技术统计

手球
青年男子

预赛
轮次 3

组别 A
场次 41

晋中体育馆
2019-06-18 14:00

Referees: 康曦 (CHN) / 王亚光 (CHN)
Teams: 福建泉港(泉港) VS 天津市(天津)

Result: 26:22(14:11)

泉港		远	近	边	快	突	任意	7m	合计	%	助攻	失误	警告	2'	D+DR
主教练: 庄清斌		射	射	射	攻	破	球	球							
1	周铁程														
6	段家乐	0/1							0/1	0.0				1	
7	王嘉靖														
9	周星晨														
10	陈臻														
11	钟宏韬														
12	汪琪坤														
13	周忠迪		1/1					1/1	2/2	100		2			
15	刘小龙	1/3				3/4			4/7	57.1	3	2	1		
17	左兆坤														
18	刘少杰		2/3						2/3	66.7			1		
20	吴兆瑞	1/5	4/4			3/3			8/12	66.7	1	3		1	
21	张路	2/5	0/1	1/1		1/1		2/2	6/10	60.0	2	1			
23	卓世胜			3/4	1/1				4/5	80.0					
25	张杰														
34	王涛														
运动员 合计		4/14	7/9	4/5	1/1	7/8		3/3	26/40	65.0	6	8	2	2	
1	周铁程	2/8	3/5	1/2	1/4	0/2	0/1	1/2	8/24	33.3					
12	汪琪坤	1/1	0/2	0/2		0/2			1/7	14.3					
守门员 合计		3/9	3/7	1/4	1/4	0/4	0/1	1/2	9/31	29.0					

天津		远	近	边	快	突	任意	7m	合计	%	助攻	失误	警告	2'	D+DR
主教练: 李志成		射	射	射	攻	破	球	球							
4	常艳鹏														
6	赵晨阳	3/9	1/2		1/1		1/1	1/3	7/16	43.8		3			
10	黄嘉俊														
14	戴云鹏														
17	黄春瑞	1/1		0/2					1/3	33.3		2			
19	万朋														
20	王澎		1/2	2/2					3/4	75.0					
23	谭元春										1	1			
24	周亚龙				2/2				2/2	100		1			
25	郝一铮	0/1	1/3	1/1	0/1				2/6	33.3		2	1		
26	李海龙	2/3	1/1			4/4			7/8	87.5		1		1	
27	吕华宇														
28	孙经纬														
运动员 合计		6/14	4/8	3/5	3/4	4/4	1/1	1/3	22/39	56.4	1	10	1	1	
23	谭元春	7/11	2/9	1/5	0/1	0/7		0/3	10/36	27.8	1	1			
守门员 合计		7/11	2/9	1/5	0/1	0/7		0/3	10/36	27.8	1	1			

泉港	比赛进程	天津
1st Half		
20 吴兆瑞	1 01:49	0
15 刘小龙	2 02:10	0
	2 02:36	1 26 李海龙
20 吴兆瑞	3 03:00	1
	3 03:30	2 26 李海龙
20 吴兆瑞	4 04:03	2
21 张路	5 04:42	2
	5 05:40	3 20 王澎
21 张路	6 06:23	3
18 刘少杰	7 06:59	3
	7 07:10	4 6 赵晨阳
	7 07:53	5 20 王澎
21 张路	8 08:34	5
	8 08:49	6 25 郝一铮
23 卓世胜	9 09:51	6
	9 12:03	7 6 赵晨阳
	9 12:36	8 24 周亚龙
15 刘小龙	10 13:17	8
20 吴兆瑞	11 15:00	8
18 刘少杰	12 16:40	8
	12 17:00	9 26 李海龙
21 张路	13 17:23	9
	13 17:34	10 24 周亚龙
20 吴兆瑞	14 18:06	10
	14 20:00	11 6 赵晨阳
2nd Half		
	14 02:55	12 26 李海龙
	14 03:24	13 6 赵晨阳
15 刘小龙	15 04:31	13
	15 05:29	14 26 李海龙
20 吴兆瑞	16 06:25	14
	16 06:58	15 6 赵晨阳
23 卓世胜	17 08:10	15
13 周忠迪	18 09:08	15
13 周忠迪	19 10:10	15
	19 10:31	16 6 赵晨阳
15 刘小龙	20 10:56	16
23 卓世胜	21 12:01	16
	21 12:21	17 26 李海龙
21 张路	22 12:51	17
	22 13:03	18 6 赵晨阳
20 吴兆瑞	23 13:44	18
20 吴兆瑞	24 14:27	18
23 卓世胜	25 16:13	18
	25 16:42	19 17 黄春瑞
	25 17:39	20 20 王澎
21 张路	26 18:11	20
	26 18:20	21 25 郝一铮
	26 19:03	22 26 李海龙

场上队员: 得分 / 射门

守门员: 救球 / 射门

D	取消资格	DR	取消资格+报告
---	------	----	---------



个人/全队技术统计表

手球 青年男子 预赛 轮次 3 组别 A 场次 41 晋中体育馆 2019-06-18 14:00

号码	姓名	远射	近射	边射	快攻	突破	任意	七米	合计	%	助攻	失误	警告	2'	取消	时间
福建泉港(泉港)																
(场上队员)																
1	周铁程									0.0%						00:30:51
6	段家乐	0/1							0/1	0.0%				1		00:04:20
7	王嘉靖									0.0%						00:00:00
9	周星晨									0.0%						00:00:00
10	陈臻									0.0%						00:00:00
11	钟宏韬									0.0%						00:00:00
12	汪琪坤									0.0%						00:09:09
13	周忠迪		1/1					1/1	2/2	100%		2				00:39:47
15	刘小龙	1/3				3/4			4/7	57.1%	3	2	1			00:38:17
17	左兆坤									0.0%						00:00:00
18	刘少杰		2/3						2/3	66.7%			1			00:39:55
20	吴兆瑞	1/5	4/4			3/3			8/12	66.7%	1	3		1		00:39:57
21	张路	2/5	0/1	1/1		1/1		2/2	6/10	60.0%	2	1				00:37:01
23	卓世胜			3/4	1/1				4/5	80.0%						00:39:58
25	张杰									0.0%						00:00:00
34	王涛									0.0%						00:00:00
	合计	4/14	7/9	4/5	1/1	7/8		3/3	26/40	65.0%	6	8	2	2		
(守门员)																
1	周铁程	2/8	3/5	1/2	1/4	0/2	0/1	1/2	8/24	33.3%						00:30:51
12	汪琪坤	1/1	0/2	0/2		0/2			1/7	14.3%						00:09:09
	合计	3/9	3/7	1/4	1/4	0/4	0/1	1/2	9/31	29.0%						

场上队员：得分/射门

守门员：救球/射门

全队合计	得分	被救	射失	击柱	封球	合计	%
远射	4	7	1	1	1	14	28.6%
近射	7	2				9	77.8%
边射	4	1				5	80.0%
快攻	1					1	100.0%
突破	7			1		8	87.5%
任意							0.0%
七米	3					3	100.0%

第二届全国青年运动会男子手球甲组决赛 体校组 (U18)

PHMS Pictorial Handball Match Statistics

IHF Official System

个人/全队技术统计表

手球 青年男子 预赛 轮次 3 组别 A 场次 41 晋中体育馆
2019-06-18 14:00

号码	姓名	远射	近射	边射	快攻	突破	任意	七米	合计	%	助攻	失误	警告	2'	取消	时间
天津市(天津)																
(场上队员)																
4	常艳鹏									0.0%						00:00:00
6	赵晨阳	3/9	1/2		1/1		1/1	1/3	7/16	43.8%		3				00:40:00
10	黄嘉俊									0.0%						00:00:00
14	戴云鹏									0.0%						00:00:00
17	黄春瑞	1/1		0/2					1/3	33.3%		2				00:40:00
19	万朋									0.0%						00:00:00
20	王澎		1/2	2/2					3/4	75.0%						00:40:00
23	谭元春									0.0%	1	1				00:40:00
24	周亚龙				2/2				2/2	100%		1				00:40:00
25	郝一铮	0/1	1/3	1/1	0/1				2/6	33.3%		2	1			00:40:00
26	李海龙	2/3	1/1			4/4			7/8	87.5%		1		1		00:40:00
27	吕华宇									0.0%						00:00:00
28	孙经纬									0.0%						00:00:00
合计		6/14	4/8	3/5	3/4	4/4	1/1	1/3	22/39	56.4%	1	10	1	1		
(守门员)																
23	谭元春	7/11	2/9	1/5	0/1	0/7		0/3	10/36	27.8%	1	1				00:40:00
合计		7/11	2/9	1/5	0/1	0/7		0/3	10/36	27.8%	1	1				

场上队员： 得分/射门

守门员： 救球/射门

全队合计	得分	被救	射失	击柱	封球	合计	%
远射	6	3	4		1	14	42.9%
近射	4	3		1		8	50.0%
边射	3	1	1			5	60.0%
快攻	3	1				4	75.0%
突破	4					4	100.0%
任意	1					1	100.0%
七米	1	1		1		3	33.3%

图式比赛技术统计表

手球
青年男子

预赛
轮次 3

组别 A
场次 41

晋中体育馆
2019-06-18 14:00

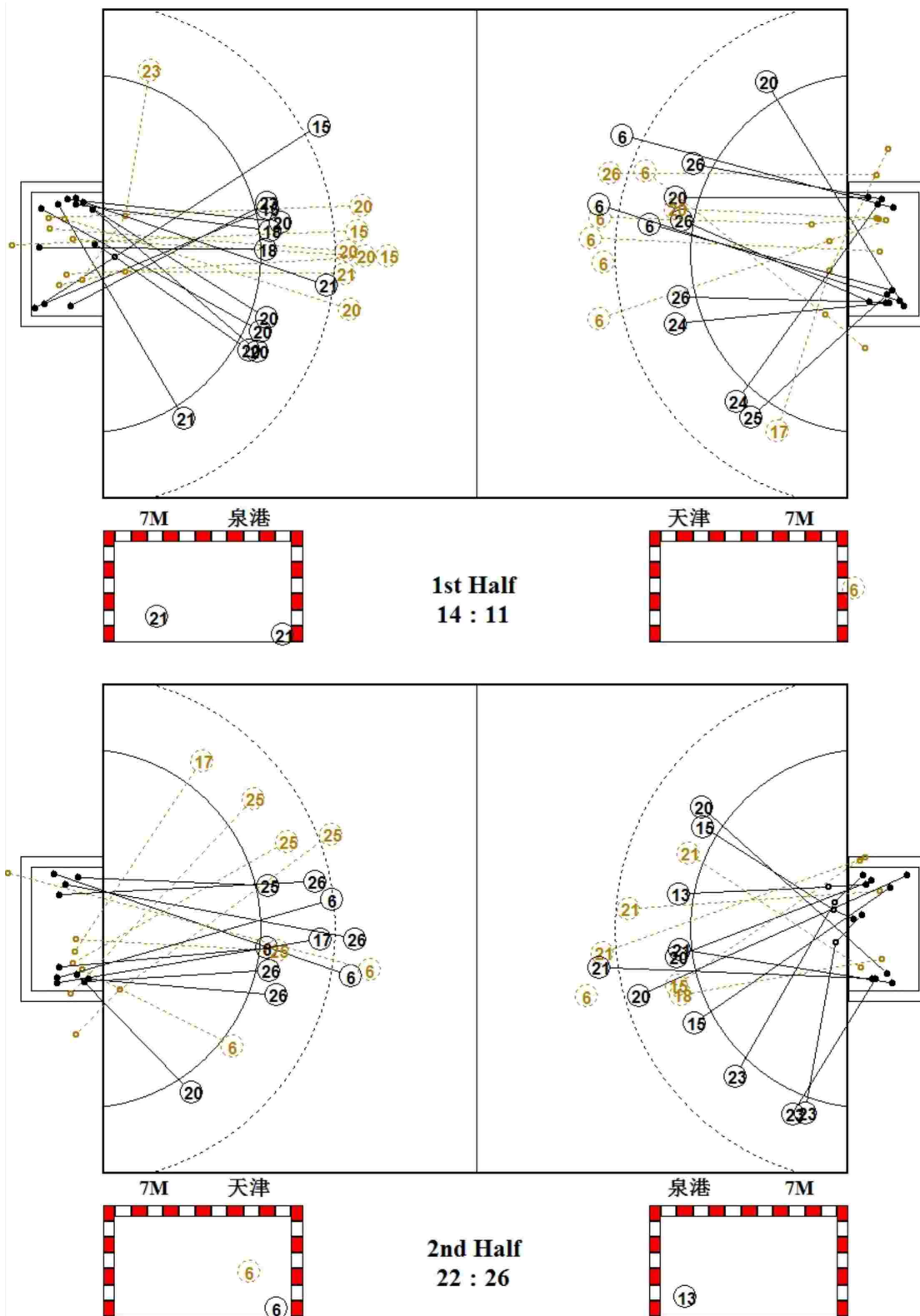

图式射门区域统计

手球
青年男子

预赛
轮次 3

组别 A
场次 41

晋中体育馆
2019-06-18 14:00

福建泉港

1 周铁程 Post - 0 Miss - 0 Block - 0	6 段家乐 Post - 0 Miss - 0 Block - 1	7 王嘉靖 Post - 0 Miss - 0 Block - 0	9 周星辰 Post - 0 Miss - 0 Block - 0	10 陈臻 Post - 0 Miss - 0 Block - 0	11 钟宏韬 Post - 0 Miss - 0 Block - 0	12 汪琪坤 Post - 0 Miss - 0 Block - 0	13 周忠迪 Post - 0 Miss - 0 Block - 0
15 刘小龙 Post - 1 Miss - 1 Block - 0	17 左兆坤 Post - 0 Miss - 0 Block - 0	18 刘少杰 Post - 0 Miss - 0 Block - 0	20 吴兆瑞 Post - 0 Miss - 0 Block - 0	21 张路 Post - 1 Miss - 0 Block - 0	23 卓世胜 Post - 0 Miss - 0 Block - 0	25 张杰 Post - 0 Miss - 0 Block - 0	34 王涛 Post - 0 Miss - 0 Block - 0

1 周铁程	0/2
5/12	1/1
1/3	0/1

12 汪琪坤	0/1
1/1	0/3
0/1	0/1

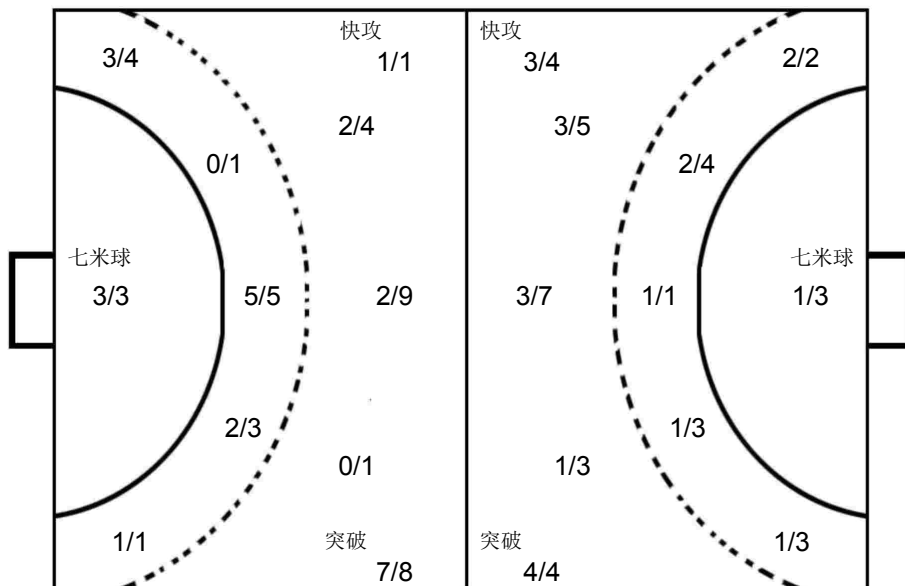

23 谭元春	0/3	0/1	2/3
2/5	2/2	2/10	
1/5	0/3	1/4	

天津市

4 常艳鹏 Post - 0 Miss - 0 Block - 0	6 赵晨阳 Post - 1 Miss - 2 Block - 1	10 黄嘉俊 Post - 0 Miss - 0 Block - 0	14 戴云鹏 Post - 0 Miss - 0 Block - 0	17 黄春瑞 Post - 0 Miss - 1 Block - 0	19 万朋 Post - 0 Miss - 0 Block - 0	20 王澎 Post - 0 Miss - 0 Block - 0	23 谭元春 Post - 0 Miss - 0 Block - 0
24 周亚龙 Post - 0 Miss - 0 Block - 0	25 郝一铮 Post - 1 Miss - 1 Block - 0	26 李海龙 Post - 0 Miss - 1 Block - 0	27 吕华宇 Post - 0 Miss - 0 Block - 0	28 孙经伟 Post - 0 Miss - 0 Block - 0			





第二届全国青年运动会男子手球甲组决赛 体校组 (U18)

青年男子 全国比赛

预赛 Group A

PHMS Pictorial Handball Match Statistics IHF Official System

Team A A 山东潍坊				Team B B 辽宁体校				Match Number 42			
------------------	--	--	--	------------------	--	--	--	---------------------------	--	--	--

Played in 山西晋中	in the hall 晋中体育馆	on 2019-06-18	at 15:10	hours	Speakers
-------------------	----------------------	------------------	-------------	-------	----------

Half-time(30')	A 12	B 11	End of playing time	A 20	B 17	1st extra time	A	B	2nd extra time	A	B	After penalty throws	A	B
----------------	---------	---------	---------------------	---------	---------	----------------	---	---	----------------	---	---	----------------------	---	---

Number of 7 m 0/0	Team time-out			Full name of players and officials	Team time-out			B 0/1	Number of 7 m
	1 08:13	2 28:57	3		1 11:36	2	3		

No.	Team A	G	W	2'	D	DR	No.	Team B	G	W	2'	D	DR
1	鲁世豪						1	何振楠					
3	李相杰	6		1			2	关贺元			2		
5	刘天驰	5	1				3	贾博					
6	张智超						4	刘旭	5				
8	薛瑞寒	2					5	关棋					
9	杜忠浩						7	姜珺					
11	杨毅	6		1			9	张鹏	2				
12	黄晓春						10	王新開	2				
15	宋子阳						11	颜科研					
17	王子涵						12	吴禹宽					
19	汤雨扬						13	赵子凯					
20	刘文东	1		1			21	蒋申健					
21	张宋帅						24	邢洪銘	6				
24	王宇恒						29	蒋效峰	2		1		
25	郭昊文												
33	吴夏冰			1									
B	赵鑫 (主教练)						B	张瑜					
C	王平						C	罗帅					
E	陈琪						D	王译					
							E	桂海旭					

A	Signatures of responsables for the teams (Off.A)												B
---	--	--	--	--	--	--	--	--	--	--	--	--	---

TP	Remarks of referees / HF Official													TP
----	-----------------------------------	--	--	--	--	--	--	--	--	--	--	--	--	----

Referees	宋优悠 (CHN)	李巧宁 (CHN)		
T.D.	叶霄雪 (CHN)	刘凤娟 (CHN)		
CHA Off.				

Note: Number of 7m Throws Awarded to Team A and B, Goals (G), Warnings (W), Suspensions (2'), Direct Disqualification (D), Disqualification With Report (DR) and Team Penalty (TP).

Table Officials: 吴鹏凯 杜鸿 Statisticians: 谢扬 陈柱

第二届全国青年运动会男子手球甲组决赛 体校组 (U18)

PHMS Pictorial Handball Match Statistics

IHF Official System

竞赛技术统计

手球
青年男子

预赛
轮次 3

组别 A
场次 42

晋中体育馆
2019-06-18 15:10

Referees: 宋优悠 (CHN) / 李巧宁 (CHN)

Result: 20:17(12:11)

Teams: 山东潍坊(潍坊) VS 辽宁体校(辽宁)

潍坊		远	近	边	快	突	任意	7m	合计	%	助攻	失误	警告	2'	D+DR
主教练: 赵鑫		射	射	射	攻	破	球	球							
1	鲁世豪														
3	李相杰	1/2	2/4		1/2	2/3			6/11	54.5	2	2		1	
5	刘天驰	1/4	1/1			3/3			5/8	62.5	3	1	1		
6	张智超														
8	薛瑞寒		0/1		2/2				2/3	66.7					
9	杜忠浩														
11	杨毅	4/6	1/3	0/1	1/1	0/1			6/12	50.0	2	2		1	
12	黄晓春														
15	宋子阳		0/1	0/2					0/3	0.0					
17	王子涵														
19	汤雨扬														
20	刘文东		1/1						1/1	100				1	
21	张宋帅														
24	王宇恒											1			
25	郭昊文														
33	吴夏冰		0/1						0/1	0.0		1		1	
运动员 合计		6/12	5/12	0/3	4/5	5/7			20/39	51.3	7	7	1	4	
1	鲁世豪	1/3	0/1	0/1					1/5	20.0					
12	黄晓春	10/17	4/6	2/3	0/1	0/2		1/1	17/30	56.7					
守门员 合计		11/20	4/7	2/4	0/1	0/2		1/1	18/35	51.4					

辽宁		远	近	边	快	突	任意	7m	合计	%	助攻	失误	警告	2'	D+DR
主教练: 陈宏瑞		射	射	射	攻	破	球	球							
1	何振楠														
2	关贺元			0/1					0/1	0.0				2	
3	贾博														
4	刘旭	5/11	0/1						5/12	41.7	3	1			
5	关棋														
7	姜珺														
9	张鹏	1/3			1/1			0/1	2/5	40.0		2			
10	王新開	0/1	1/2	1/1					2/4	50.0					
11	颜科研														
12	吴禹宽														
13	赵子凯	0/1		0/1					0/2	0.0					
21	蒋申健														
24	邢洪銘	3/9	1/1	1/1		1/2	0/1		6/14	42.9		1			
29	蒋效峰		1/3	0/1		1/1	0/1		2/6	33.3		3		1	
运动员 合计		9/25	3/7	2/5	1/1	2/3	0/2	0/1	17/44	38.6	3	7		3	
1	何振楠	2/7	3/6		0/2	2/3			7/18	38.9					
12	吴禹宽	3/4	2/4	2/2	0/2	0/4			7/16	43.8					
守门员 合计		5/11	5/10	2/2	0/4	2/7			14/34	41.2					

潍坊	比赛 进程	辽宁
1st Half		
5 刘天驰	1 01:03	0
11 杨毅	2 01:13	0
	2 01:56	1 4 刘旭
3 李相杰	3 03:50	1
	3 04:04	2 24 邢洪銘
8 薛瑞寒	4 06:01	2
	4 06:36	3 10 王新開
5 刘天驰	5 07:05	3
	5 07:24	4 24 邢洪銘
3 李相杰	6 07:49	4
	6 08:07	5 4 刘旭
3 李相杰	7 08:29	5
	7 09:21	6 4 刘旭
11 杨毅	8 09:28	6
11 杨毅	9 11:12	6
5 刘天驰	10 11:31	6
	10 13:30	7 24 邢洪銘
11 杨毅	11 14:26	7
	11 15:13	8 24 邢洪銘
5 刘天驰	12 15:43	8
	12 16:30	9 4 刘旭
	12 17:36	10 29 蒋效峰
	12 18:48	11 29 蒋效峰
2nd Half		
	12 00:31	12 4 刘旭
3 李相杰	13 01:39	12
	13 03:09	13 24 邢洪銘
3 李相杰	14 04:34	13
11 杨毅	15 04:57	13
	15 05:37	14 10 王新開
8 薛瑞寒	16 06:28	14
11 杨毅	17 07:02	14
3 李相杰	18 09:09	14
	18 11:41	15 9 张鹏
5 刘天驰	19 12:09	15
	19 14:24	16 9 张鹏
20 刘文东	20 16:53	16
	20 17:48	17 24 邢洪銘

场上队员: 得分 / 射门

守门员: 救球 / 射门

D	取消资格	DR	取消资格+报告
---	------	----	---------



个人/全队技术统计表

手球 青年男子 预赛 轮次 3 组别 A 场次 42 晋中体育馆 2019-06-18 15:10

号码	姓名	远射	近射	边射	快攻	突破	任意	七米	合计	%	助攻	失误	警告	2'	取消	时间
山东潍坊(潍坊)																
(场上队员)																
1	鲁世豪									0.0%						00:04:38
3	李相杰	1/2	2/4		1/2	2/3			6/11	54.5%	2	2		1		00:39:49
5	刘天驰	1/4	1/1			3/3			5/8	62.5%	3	1	1			00:36:38
6	张智超									0.0%						00:07:58
8	薛瑞寒		0/1		2/2				2/3	66.7%						00:29:15
9	杜忠浩									0.0%						00:06:44
11	杨毅	4/6	1/3	0/1	1/1	0/1			6/12	50.0%	2	2		1		00:40:00
12	黄晓春									0.0%						00:35:22
15	宋子阳		0/1	0/2					0/3	0.0%						00:19:36
17	王子涵									0.0%						00:00:00
19	汤雨扬									0.0%						00:00:00
20	刘文东		1/1						1/1	100%				1		00:09:02
21	张宋帅									0.0%						00:00:00
24	王宇恒									0.0%		1				00:20:03
25	郭昊文									0.0%						00:00:00
33	吴夏冰		0/1						0/1	0.0%		1		1		00:29:10
	合计	6/12	5/12	0/3	4/5	5/7			20/39	51.3%	7	7	1	4		

(守门员)

1	鲁世豪	1/3	0/1	0/1					1/5	20.0%						00:04:38
12	黄晓春	10/17	4/6	2/3	0/1	0/2		1/1	17/30	56.7%						00:35:22
	合计	11/20	4/7	2/4	0/1	0/2		1/1	18/35	51.4%						

场上队员：得分/射门

守门员：救球/射门

全队合计	得分	被救	射失	击柱	封球	合计	%
远射	6	5	1			12	50.0%
近射	5	5	1	1		12	41.7%
边射		2	1			3	0.0%
快攻	4		1			5	80.0%
突破	5	2				7	71.4%
任意							0.0%
七米							0.0%

个人/全队技术统计表

手球 青年男子 预赛 轮次 3 组别 A 场次 42 晋中体育馆 2019-06-18 15:10

号码	姓名	远射	近射	边射	快攻	突破	任意	七米	合计	%	助攻	失误	警告	2'	取消	时间
辽宁体校(辽宁)																
(场上队员)																
1	何振楠									0.0%						00:19:58
2	关贺元			0/1					0/1	0.0%				2		00:31:52
3	贾博									0.0%						00:00:24
4	刘旭	5/11	0/1						5/12	41.7%	3	1				00:40:00
5	关棋									0.0%						00:00:00
7	姜珺									0.0%						00:00:00
9	张鹏	1/3			1/1			0/1	2/5	40.0%		2				00:17:55
10	王新開	0/1	1/2	1/1					2/4	50.0%						00:39:55
11	颜科研									0.0%						00:20:00
12	吴禹宽									0.0%						00:20:02
13	赵子凯	0/1		0/1					0/2	0.0%						00:14:54
21	蒋申健									0.0%						00:00:00
24	邢洪銘	3/9	1/1	1/1		1/2	0/1		6/14	42.9%		1				00:39:53
29	蒋效峰		1/3	0/1		1/1	0/1		2/6	33.3%		3		1		00:34:52
合计		9/25	3/7	2/5	1/1	2/3	0/2	0/1	17/44	38.6%	3	7		3		
(守门员)																
1	何振楠	2/7	3/6		0/2	2/3			7/18	38.9%						00:19:58
12	吴禹宽	3/4	2/4	2/2	0/2	0/4			7/16	43.8%						00:20:02
合计		5/11	5/10	2/2	0/4	2/7			14/34	41.2%						

场上队员： 得分/射门

守门员： 救球/射门

全队合计	得分	被救	射失	击柱	封球	合计	%
远射	9	11	1	2	2	25	36.0%
近射	3	4				7	42.9%
边射	2	2		1		5	40.0%
快攻	1					1	100.0%
突破	2			1		3	66.7%
任意				2		2	0.0%
七米		1				1	0.0%

图式比赛技术统计表

手球
青年男子

预赛
轮次 3

组别 A
场次 42

晋中体育馆
2019-06-18 15:10

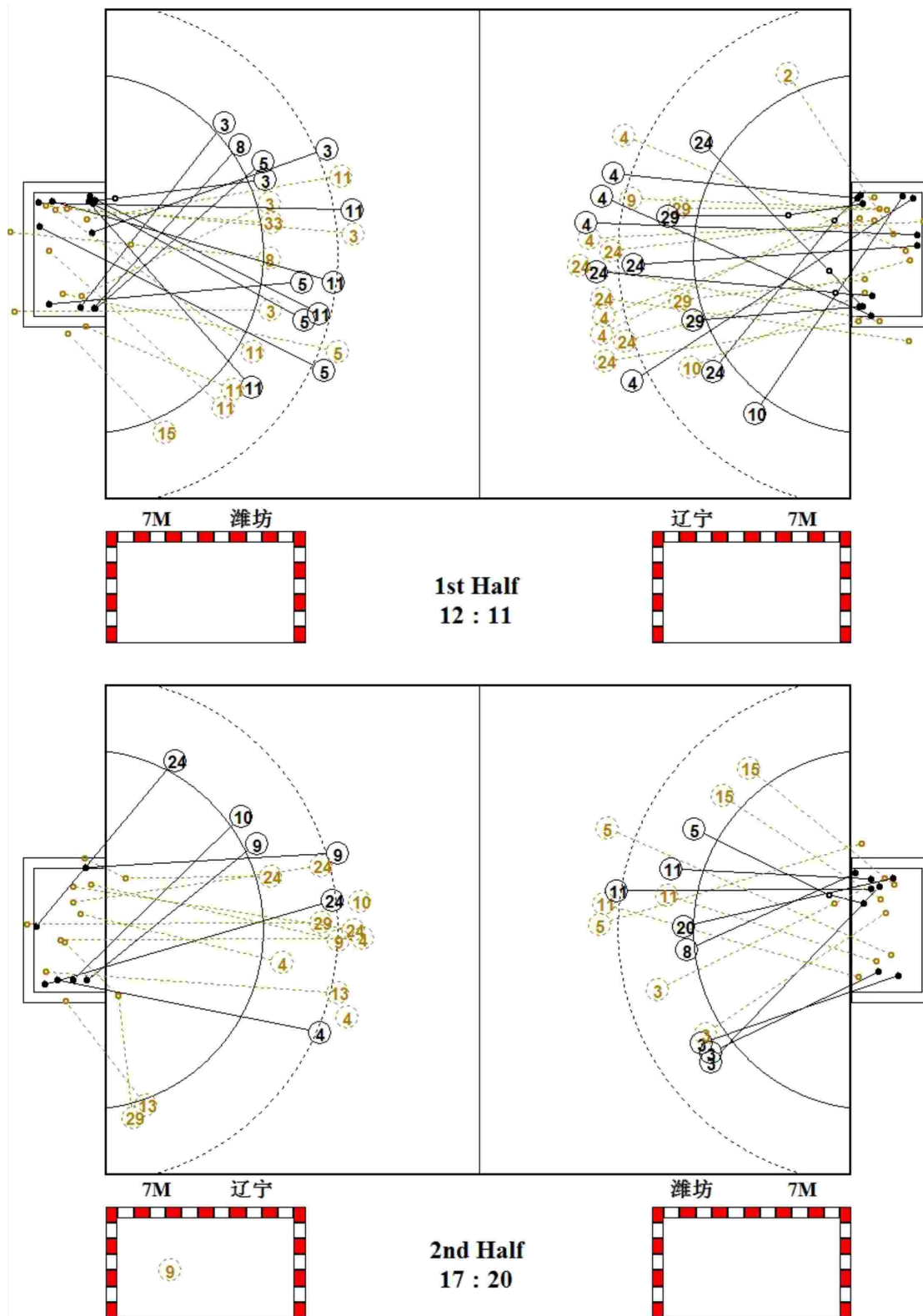

图式射门区域统计

手球
青年男子

预赛
轮次 3

组别 A
场次 42

晋中体育馆
2019-06-18 15:10

山东潍坊

1 鲁世豪 Post - 0 Miss - 0 Block - 0	3 李相杰 Post - 0 Miss - 1 Block - 0	5 刘天驰 Post - 0 Miss - 1 Block - 0	6 张智超 Post - 0 Miss - 0 Block - 0	8 薛瑞寒 Post - 0 Miss - 1 Block - 0	9 杜忠浩 Post - 0 Miss - 0 Block - 0	11 杨毅 Post - 1 Miss - 0 Block - 0	12 黄晓春 Post - 0 Miss - 0 Block - 0
15 宋子阳 Post - 0 Miss - 1 Block - 0	17 王子涵 Post - 0 Miss - 0 Block - 0	19 汤雨扬 Post - 0 Miss - 0 Block - 0	20 刘文东 Post - 0 Miss - 0 Block - 0	21 张宋帅 Post - 0 Miss - 0 Block - 0	24 王宇恒 Post - 0 Miss - 0 Block - 0	25 郭昊文 Post - 0 Miss - 0 Block - 0	33 吴昊冰 Post - 0 Miss - 0 Block - 0

1 鲁世豪
0/1 0/1
1/1
0/2

12 黄晓春
1/4 2/4
4/5 4/4 2/2
1/5 3/6

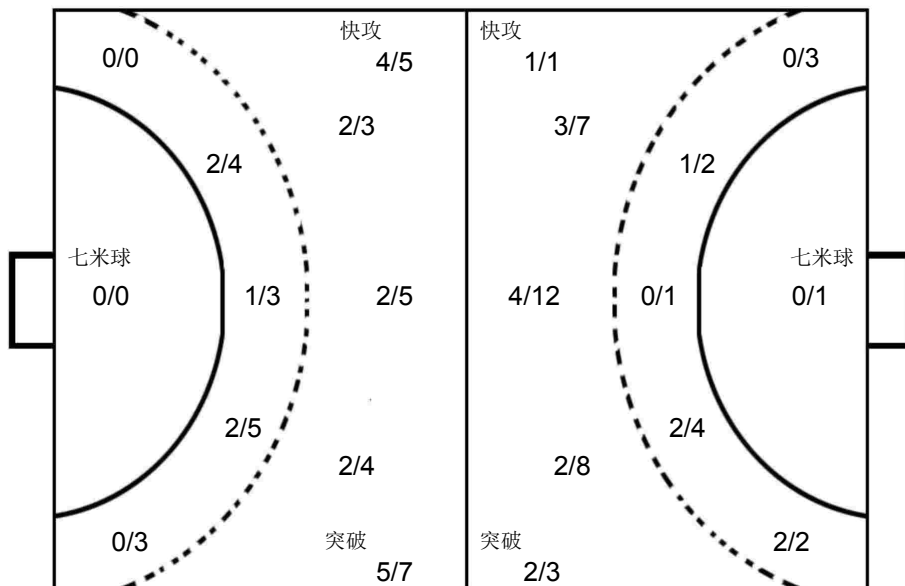

1 何振楠
0/1 0/3
2/4 1/1 3/3
0/3 0/1 1/2

12 吴禹宽
1/1 2/3
3/4 0/1
0/3 1/4

辽宁体校

1 何振楠 Post - 0 Miss - 0 Block - 0	2 关贺元 Post - 0 Miss - 0 Block - 0	3 贾博 Post - 0 Miss - 0 Block - 0	4 刘旭 Post - 1 Miss - 0 Block - 1	5 关棋 Post - 0 Miss - 0 Block - 0	7 姜珺 Post - 0 Miss - 0 Block - 0	9 张鹏 Post - 0 Miss - 0 Block - 0	10 王新開 Post - 0 Miss - 0 Block - 1
11 颜科研 Post - 0 Miss - 0 Block - 0	12 吴禹宽 Post - 0 Miss - 0 Block - 0	13 赵子凯 Post - 1 Miss - 0 Block - 0	21 蒋申健 Post - 0 Miss - 0 Block - 0	24 邢洪銘 Post - 3 Miss - 1 Block - 0	29 蒋效峰 Post - 1 Miss - 0 Block - 0		





第二届全国青年运动会男子手球甲组决赛 体校组 (U18)

青年男子 全国比赛

四分之一决赛

PHMS Pictorial Handball Match Statistics IHF Official System

Team A A 山东潍坊				Team B B 广东深圳				Match Number 49			
------------------	--	--	--	------------------	--	--	--	---------------------------	--	--	--

Played in 山西晋中	in the hall 晋中体育馆	on 2019-06-20	at 17:30	hours	Speakers
-------------------	----------------------	------------------	-------------	-------	----------

Half-time(30')	A 14	B 4	End of playing time	A 24	B 9	1st extra time	A	B	2nd extra time	A	B	After penalty throws	A	B
----------------	---------	--------	---------------------	---------	--------	----------------	---	---	----------------	---	---	----------------------	---	---

Number of 7 m 2/2	Team time-out			Full name of players and officials	Team time-out			B 0/1	Number of 7 m
	1 13:45	2 34:21	3		1 07:21	2 25:53	3		

No.	Team A	G	W	2'	D	DR	No.	Team B	G	W	2'	D	DR
1	鲁世豪						2	祝安南					
3	李相杰	2					3	李朗轩					
5	刘天驰	3	1				5	陈俊延					
6	张智超	1		1			6	董佳辉		1			
8	薛瑞寒	2		1			7	曾繁泳	2	1			
9	杜忠浩	2					8	罗霖泽	3				
11	杨毅	9					9	左典	2				
12	黄晓春						10	李剑琛	1				
15	宋子阳	1					11	万泽峰					
17	王子涵						12	戴景伟					
19	汤雨扬						13	赵世豪					
20	刘文东	1		1			15	金硕					
21	张宋帅						16	谢思远	1				
24	王宇恒	1					18	曾笑童					
25	郭昊文						19	齐振东					
33	吴夏冰	2	1										
B	赵鑫 (主教练)						A	张斌					
C	王平						C	李中洲 (主教练)					
E	陈琪						D	张广建					
							F	蒋光华					

A	Signatures of responsables for the teams (Off.A)												B
---	--	--	--	--	--	--	--	--	--	--	--	--	---

TP	Remarks of referees / HF Official													TP
----	-----------------------------------	--	--	--	--	--	--	--	--	--	--	--	--	----

Referees	王亚光 (CHN)	王柏淇 (CHN)		
T.D.	柴业宏 (CHN)	陈晓波 (CHN)		
CHA Off.				

Note: Number of 7m Throws Awarded to Team A and B, Goals (G), Warnings (W), Suspensions (2'), Direct Disqualification (D), Disqualification With Report (DR) and Team Penalty (TP).

Table Officials: 李莉君 王志超 Statisticians: 刘笑 王梓衡

竞赛技术统计

手球
青年男子

四分之一决赛
轮次 4

组别 X
场次 49

晋中体育馆
2019-06-20 17:30

Referees: 王亚光 (CHN) / 王柏淇 (CHN)

Result: 24:9 (14:4)

Teams: 山东潍坊(潍坊) VS 广东深圳(深圳)

潍坊		远	近	边	快	突	任意	7m	合计	%	助攻	失误	警告	2'	D+DR
主教练: 赵鑫		射	射	射	攻	破	球	球							
1	鲁世豪														
3	李相杰	1/2		0/1	1/1				2/4	50.0		2			
5	刘天驰	1/2	1/1		1/1	0/1			3/5	60.0	2	1	1		
6	张智超			0/1	1/1				1/2	50.0	1			1	
8	薛瑞寒		0/1	1/2	1/2				2/5	40.0				1	
9	杜忠浩	2/2							2/2	100	2	1			
11	杨毅	3/3			2/2	2/2		2/2	9/9	100		1			
12	黄晓春										1				
15	宋子阳			1/2					1/2	50.0					
17	王子涵														
19	汤雨扬														
20	刘文东		1/1			0/1			1/2	50.0		1		1	
21	张宋帅														
24	王宇恒	1/1							1/2	50.0		2			
25	郭昊文														
33	吴夏冰		2/2						2/2	100		1	1		
运动员	合计	8/10	4/5	2/6	6/7	2/4	0/1	2/2	24/35	68.6	6	9	2	3	
1	鲁世豪	1/2	1/1	0/3	1/1	0/1		1/1	4/9	44.4					
12	黄晓春	1/1	5/5	1/2	0/1	0/2			7/11	63.6	1				
守门员	合计	2/3	6/6	1/5	1/2	0/3		1/1	11/20	55.0	1				

潍坊	比赛 进程	深圳
1st Half		
11 杨毅	1 00:26	0
3 李相杰	2 01:38	0
5 刘天驰	3 02:53	0
11 杨毅	4 05:05	0
11 杨毅	4 05:45	1 8 罗霖泽
33 吴夏冰	5 06:18	1
5 刘天驰	6 07:15	1
11 杨毅	7 08:37	1
11 杨毅	8 09:48	1
8 薛瑞寒	9 12:15	1
11 杨毅	9 13:43	2 8 罗霖泽
11 杨毅	10 14:14	2
11 杨毅	11 15:21	2
5 刘天驰	12 16:14	2
	12 16:59	3 9 左典
	12 18:20	4 7 曾繁泳
11 杨毅	13 18:27	4
6 张智超	14 19:15	4
2nd Half		
	14 00:47	5 7 曾繁泳
	14 02:13	6 16 谢思远
15 宋子阳	15 03:12	6
24 王宇恒	16 05:01	6
	16 06:33	7 8 罗霖泽
20 刘文东	17 08:52	7
	17 09:03	8 10 李剑琛
8 薛瑞寒	18 10:35	8
9 杜忠浩	19 11:32	8
	19 12:17	9 9 左典
9 杜忠浩	20 12:44	9
33 吴夏冰	21 15:26	9
11 杨毅	22 18:13	9
11 杨毅	23 18:19	9
3 李相杰	24 19:09	9

深圳		远	近	边	快	突	任意	7m	合计	%	助攻	失误	警告	2'	D+DR
主教练: 李中洲		射	射	射	攻	破	球	球							
2	祝安南														
3	李明轩	0/1	0/4						0/5	0.0		1			
5	陈俊延														
6	董佳辉	0/2	0/2						0/4	0.0		1	1		
7	曾繁泳	1/1		1/2		0/1			2/4	50.0		1	1		
8	罗霖泽			1/2	1/2	1/1			3/5	60.0		1			
9	左典	0/2	0/1			2/2		0/1	2/6	33.3	2	4			
10	李剑琛		0/1	1/1					1/2	50.0	1				
11	万泽峰														
12	戴景伟														
13	赵世豪											1			
15	金硕	0/1							0/1	0.0		3			
16	谢思远	0/2		1/1					1/3	33.3		3			
18	曾笑童														
19	齐振东														
运动员	合计	1/9	0/8	4/6	1/2	3/4		0/1	9/30	30.0	3	15	2		
12	戴景伟	1/9	1/4	2/4	1/4	1/3		0/2	6/26	23.1					
18	曾笑童		0/1	1/1	0/3				1/5	20.0					
守门员	合计	1/9	1/5	3/5	1/7	1/3		0/2	7/31	22.6					

场上队员: 得分 / 射门

守门员: 救球 / 射门

D	取消资格	DR	取消资格+报告
---	------	----	---------

个人/全队技术统计表

 手球 四分之一决赛 组别 X 晋中体育馆
 青年男子 轮次 4 场次 49 2019-06-20 17:30

号码	姓名	远射	近射	边射	快攻	突破	任意	七米	合计	%	助攻	失误	警告	2'	取消	时间
山东潍坊(潍坊)																
(场上队员)																
1	鲁世豪									0.0%						00:20:14
3	李相杰	1/2		0/1	1/1				2/4	50.0%		2				00:25:39
5	刘天驰	1/2	1/1		1/1	0/1			3/5	60.0%	2	1	1			00:25:39
6	张智超			0/1	1/1				1/2	50.0%	1			1		00:23:38
8	薛瑞寒		0/1	1/2	1/2				2/5	40.0%				1		00:29:55
9	杜忠浩	2/2							2/2	100%	2	1				00:15:18
11	杨毅	3/3			2/2	2/2		2/2	9/9	100%		1				00:21:50
12	黄晓春									0.0%	1					00:19:46
15	宋子阳			1/2					1/2	50.0%						00:30:39
17	王子涵									0.0%						00:00:00
19	汤雨扬									0.0%						00:00:00
20	刘文东		1/1			0/1			1/2	50.0%		1		1		00:19:42
21	张宋帅									0.0%						00:00:00
24	王宇恒	1/1					0/1		1/2	50.0%		2				00:19:36
25	郭昊文									0.0%						00:00:00
33	吴夏冰		2/2						2/2	100%		1	1			00:28:00
	合计	8/10	4/5	2/6	6/7	2/4	0/1	2/2	24/35	68.6%	6	9	2	3		
(守门员)																
1	鲁世豪	1/2	1/1	0/3	1/1	0/1		1/1	4/9	44.4%						00:20:14
12	黄晓春	1/1	5/5	1/2	0/1	0/2			7/11	63.6%	1					00:19:46
	合计	2/3	6/6	1/5	1/2	0/3		1/1	11/20	55.0%	1					

场上队员：得分/射门

守门员：救球/射门

全队合计	得分	被救	射失	击柱	封球	合计	%
远射	8	1			1	10	80.0%
近射	4	1				5	80.0%
边射	2	3	1			6	33.3%
快攻	6	1				7	85.7%
突破	2	1		1		4	50.0%
任意			1			1	0.0%
七米	2					2	100.0%

第二届全国青年运动会男子手球甲组决赛 体校组 (U18)

PHMS Pictorial Handball Match Statistics

IHF Official System

个人/全队技术统计表

手球 青年男子 四分之一决赛 轮次 4 组别 X 场次 49 晋中体育馆 2019-06-20 17:30

号码	姓名	远射	近射	边射	快攻	突破	任意	七米	合计	%	助攻	失误	警告	2'	取消	时间
广东深圳(深圳)																
(场上队员)																
2	祝安南									0.0%						00:09:07
3	李朗轩	0/1	0/4						0/5	0.0%	1					00:33:23
5	陈俊延									0.0%						00:00:00
6	董佳辉	0/2	0/2						0/4	0.0%	1	1				00:22:07
7	曾繁泳	1/1		1/2		0/1			2/4	50.0%	1	1				00:30:51
8	罗霖泽			1/2	1/2	1/1			3/5	60.0%		1				00:30:56
9	左典	0/2	0/1			2/2		0/1	2/6	33.3%	2	4				00:33:47
10	李剑琛		0/1	1/1					1/2	50.0%	1					00:32:18
11	万泽峰									0.0%						00:13:11
12	戴景伟									0.0%						00:32:53
13	赵世豪									0.0%		1				00:09:02
15	金硕	0/1							0/1	0.0%	3					00:08:22
16	谢思远	0/2		1/1					1/3	33.3%		3				00:16:27
18	曾笑童									0.0%						00:07:07
19	齐振东									0.0%						00:00:00
合计		1/9	0/8	4/6	1/2	3/4		0/1	9/30	30.0%	3	15	2			
(守门员)																
12	戴景伟	1/9	1/4	2/4	1/4	1/3		0/2	6/26	23.1%						00:32:53
18	曾笑童		0/1	1/1	0/3				1/5	20.0%						00:07:07
合计		1/9	1/5	3/5	1/7	1/3		0/2	7/31	22.6%						

场上队员：得分/射门

守门员：救球/射门

全队合计	得分	被救	射失	击柱	封球	合计	%
远射	1	2	4		2	9	11.1%
近射		6	1	1		8	0.0%
边射	4	1	1			6	66.7%
快攻	1	1				2	50.0%
突破	3		1			4	75.0%
任意							0.0%
七米		1				1	0.0%

图式比赛技术统计表

手球
青年男子

四分之一决赛
轮次 4

组别 X
场次 49

晋中体育馆
2019-06-20 17:30

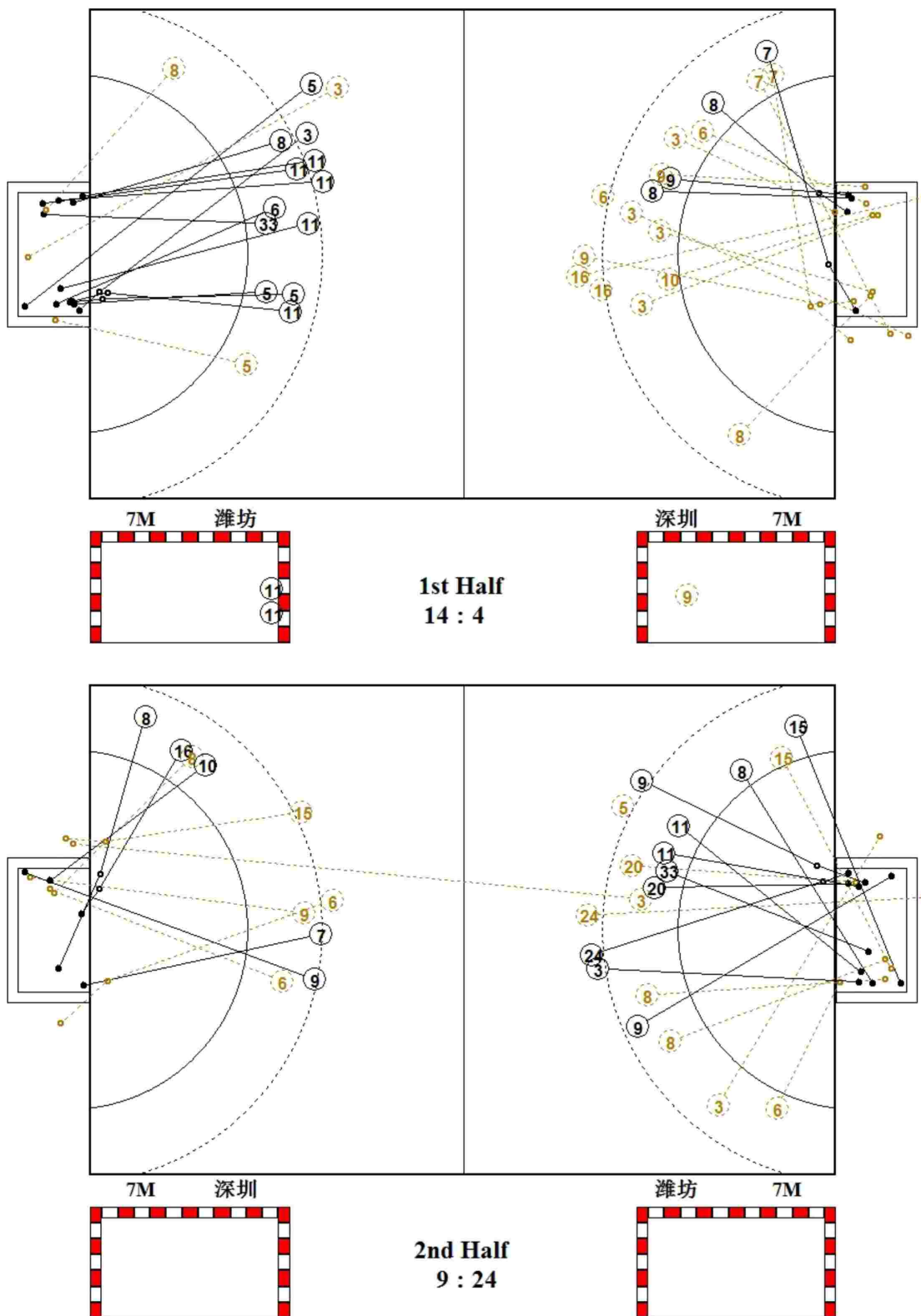

图式射门区域统计

手球
青年男子

四分之一决赛
轮次 4

组别 X
场次 49

晋中体育馆
2019-06-20 17:30

山东潍坊

1 鲁世豪 Post - 0 Miss - 0 Block - 0	3 李相杰 Post - 0 Miss - 1 Block - 0	5 刘天驰 Post - 1 Miss - 0 Block - 1	6 张智超 Post - 0 Miss - 0 Block - 0	8 薛瑞寒 Post - 0 Miss - 0 Block - 0	9 杜忠浩 Post - 0 Miss - 0 Block - 0	11 杨毅 Post - 0 Miss - 0 Block - 0	12 黄晓春 Post - 0 Miss - 0 Block - 0
15 宋子阳 Post - 0 Miss - 0 Block - 0	17 王子涵 Post - 0 Miss - 0 Block - 0	19 汤雨扬 Post - 0 Miss - 0 Block - 0	20 刘文东 Post - 0 Miss - 0 Block - 0	21 张宋帅 Post - 0 Miss - 0 Block - 0	24 王宇恒 Post - 0 Miss - 1 Block - 0	25 郭昊文 Post - 0 Miss - 0 Block - 0	33 吴昊冰 Post - 0 Miss - 0 Block - 0

1 鲁世豪
1/2
0/1

12 黄晓春
3/3
1/4

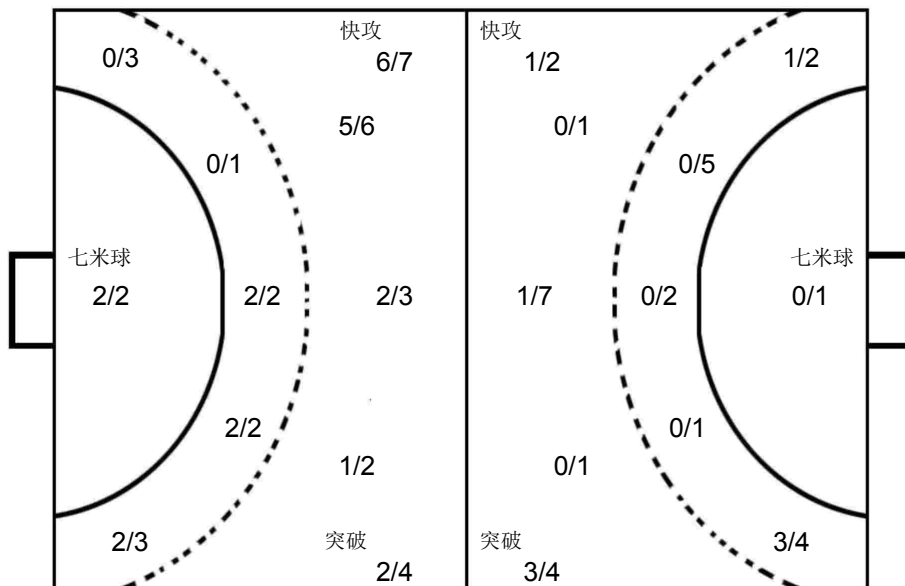

12 戴景伟
0/2
0/3
1/7

18 曾笑童
1/1
0/3

广东深圳

2 祝安南 Post - 0 Miss - 0 Block - 0	3 李朗轩 Post - 0 Miss - 2 Block - 0	5 陈俊延 Post - 0 Miss - 0 Block - 0	6 董佳辉 Post - 0 Miss - 1 Block - 1	7 曾繁泳 Post - 0 Miss - 2 Block - 0	8 罗霖泽 Post - 0 Miss - 0 Block - 0	9 左典 Post - 1 Miss - 0 Block - 0	10 李剑琛 Post - 0 Miss - 0 Block - 0
11 万泽峰 Post - 0 Miss - 0 Block - 0	12 戴景伟 Post - 0 Miss - 0 Block - 0	13 赵世豪 Post - 0 Miss - 0 Block - 0	15 金硕 Post - 0 Miss - 1 Block - 0	16 谢思远 Post - 0 Miss - 1 Block - 1	18 曾笑童 Post - 0 Miss - 0 Block - 0	19 齐振东 Post - 0 Miss - 0 Block - 0	





第二届全国青年运动会男子手球甲组决赛 体校组 (U18)

青年男子 全国比赛

四分之一决赛

PHMS Pictorial Handball Match Statistics IHF Official System

Team A A 北京市				Team B B 福建泉港				Match Number 50			
-----------------	--	--	--	------------------	--	--	--	---------------------------	--	--	--

Played in 山西晋中	in the hall 晋中体育馆	on 2019-06-20	at 18:40	hours	Speakers
-------------------	----------------------	------------------	-------------	-------	----------

Half-time(30')	A 12	B 7	End of playing time	A 22	B 18	1st extra time	A	B	2nd extra time	A	B	After penalty throws	A	B
----------------	---------	--------	---------------------	---------	---------	----------------	---	---	----------------	---	---	----------------------	---	---

Number of 7 m	A 1/2	Team time-out			Full name of players and officials	Team time-out			B 0/0	Number of 7 m
	1 12:42	2 24:34	3 39:13	1 08:58		2	3			

No.	Team A	G	W	2'	D	DR	No.	Team B	G	W	2'	D	DR
1	陶钜						1	周铁程					
3	魏豪						6	段家乐	2	1			
4	李博仔						7	王嘉靖					
6	苑宾	5					9	周星晨					
7	侯博耀						10	陈臻					
8	孙铂力						11	钟宏韬					
9	曹智栋	4					12	汪琪坤	1				
13	蓝心凯	2	1				13	周忠迪	2				
14	杜俊林						15	刘小龙	1				
15	刘大明	3					17	左兆坤					
16	王鑫宇						18	刘少杰	1				
18	宋昱鹏						20	吴兆瑞	8		2		
23	庞佳明	5					21	张路	1		1		
26	郑铭境	1		1			23	卓世胜	2				
29	赵熹瑞	2					25	张杰					
32	张珂宁						34	王涛					
A	吴健						B	王卫					
B	翟彦戎						C	刘德东					
							E	薛裕安					

A	Signatures of responsables for the teams (Off.A)												B
---	--	--	--	--	--	--	--	--	--	--	--	--	---

TP	Remarks of referees / HF Official													TP
----	-----------------------------------	--	--	--	--	--	--	--	--	--	--	--	--	----

Referees	许翔 (CHN)	严璐 (CHN)		
T.D.	柴业宏 (CHN)	陈晓波 (CHN)		
CHA Off.				

Note: Number of 7m Throws Awarded to Team A and B, Goals (G), Warnings (W), Suspensions (2'), Direct Disqualification (D), Disqualification With Report (DR) and Team Penalty (TP).

Table Officials: 戴莹莹 马迪 Statisticians: 王梓衡 刘笑



第二届全国青年运动会男子手球甲组决赛 体校组 (U18)

PHMS Pictorial Handball Match Statistics

IHF Official System

竞赛技术统计

手球
青年男子

四分之一决赛
轮次 4

组别 X
场次 50

晋中体育馆
2019-06-20 18:40

Referees: 许翔 (CHN) / 严璐 (CHN)
Teams: 北京市(北京) VS 福建泉港(泉港)

Result: 22:18 (12:7)

北京		远射	近射	边射	快攻	突破	任意球	7m球	合计	%	助攻	失误	警告	2'	D+DR
主教练: 吴健															
1	陶钜														
3	魏豪														
4	李博仔														
6	苑宾		1/1	2/5	1/1			1/2	5/9	55.6					
7	侯博耀														
8	孙铂力														
9	曹智栋	2/3	1/1	1/2					4/6	66.7	1	3			
13	蓝心凯			2/2					2/2	100			1		
14	杜俊林														
15	刘大明	1/1				2/3			3/4	75.0		1			
16	王鑫宇														
18	宋昱鹏														
23	庞佳明	0/3	1/2		2/3	1/1	1/1		5/10	50.0	2	3			
26	郑铭境		1/1						1/1	100				1	
29	赵熹瑞		2/2						2/2	100					
32	张珂宁														
运动员 合计		3/7	6/7	5/9	3/4	3/4	1/1	1/2	22/34	64.7	3	7	1	1	
1	陶钜	0/1	0/2	2/2	0/1	0/2	0/1		2/9	22.2					
16	王鑫宇	1/3	2/5	0/2	1/2	1/3	0/1		5/16	31.3					
守门员 合计		1/4	2/7	2/4	1/3	1/5	0/2		7/25	28.0					

泉港		远射	近射	边射	快攻	突破	任意球	7m球	合计	%	助攻	失误	警告	2'	D+DR
主教练: 庄清斌															
1	周铁程														
6	段家乐		1/1		1/1				2/2	100		2	1		
7	王嘉靖														
9	周星晨														
10	陈臻														
11	钟宏韬														
12	汪琪坤	1/1							1/1	100					
13	周忠迪	0/1		1/2	1/1				2/4	50.0					
15	刘小龙	0/1	1/1						1/2	50.0		2			
17	左兆坤	0/1							0/1	0.0					
18	刘少杰		1/1						1/1	100					
20	吴兆瑞	2/3	2/4		0/1	3/3	1/1		8/12	66.7		4		2	
21	张路		0/1			1/2			1/3	33.3	2	4		1	
23	卓世胜			1/2			1/1		2/3	66.7		3			
25	张杰														
34	王涛														
运动员 合计		3/7	5/8	2/4	2/3	4/5	2/2		18/29	62.1	2	15	1	3	
1	周铁程	0/2							0/2	0.0					
12	汪琪坤	3/4	1/7	2/7	0/3	0/3	0/1	1/2	7/27	25.9					
守门员 合计		3/6	1/7	2/7	0/3	0/3	0/1	1/2	7/29	24.1					

北京	比赛进程	泉港
1st Half		
23 庞佳明	1 00:35 0	
	1 01:13 1 15 刘小龙	
	1 02:24 2 6 段家乐	
23 庞佳明	2 03:08 2	
15 刘大明	3 05:14 2	
	3 06:37 3 6 段家乐	
23 庞佳明	4 07:24 3	
	4 09:18 4 20 吴兆瑞	
15 刘大明	5 09:40 4	
	5 10:07 5 13 周忠迪	
9 曹智栋	6 11:01 5	
23 庞佳明	7 12:11 5	
6 苑宾	8 13:26 5	
	8 14:36 6 12 汪琪坤	
6 苑宾	9 17:00 6	
6 苑宾	10 18:14 6	
6 苑宾	11 19:03 6	
	11 19:29 7 23 卓世胜	
29 赵熹瑞	12 19:54 7	
2nd Half		
	12 00:26 8 20 吴兆瑞	
	12 01:26 9 20 吴兆瑞	
	12 03:48 10 20 吴兆瑞	
	12 05:46 11 20 吴兆瑞	
13 蓝心凯	13 06:15 11	
	13 07:38 12 20 吴兆瑞	
6 苑宾	14 09:30 12	
29 赵熹瑞	15 10:35 12	
	15 11:14 13 21 张路	
	15 12:34 14 13 周忠迪	
9 曹智栋	16 12:57 14	
26 郑铭境	17 14:07 14	
	17 14:25 15 20 吴兆瑞	
9 曹智栋	18 15:33 15	
	18 17:05 16 20 吴兆瑞	
15 刘大明	19 17:26 16	
	19 17:37 17 18 刘少杰	
13 蓝心凯	20 18:30 17	
23 庞佳明	21 18:44 17	
	21 19:06 18 23 卓世胜	
9 曹智栋	22 19:48 18	

场上队员: 得分 / 射门

守门员: 救球 / 射门

D	取消资格	DR	取消资格+报告
---	------	----	---------



个人/全队技术统计表

手球 青年男子 四分之一决赛 轮次 4 组别 X 场次 50 晋中体育馆 2019-06-20 18:40

号码	姓名	远射	近射	边射	快攻	突破	任意	七米	合计	%	助攻	失误	警告	2'	取消	时间
北京市(北京)																
(场上队员)																
1	陶钜									0.0%						00:14:10
3	魏豪									0.0%						00:00:00
4	李博仔									0.0%						00:00:00
6	苑宾		1/1	2/5	1/1			1/2	5/9	55.6%						00:40:00
7	侯博耀									0.0%						00:00:00
8	孙铂力									0.0%						00:00:00
9	曹智栋	2/3	1/1	1/2					4/6	66.7%	1	3				00:40:00
13	蓝心凯			2/2					2/2	100%			1			00:32:08
14	杜俊林									0.0%						00:00:00
15	刘大明	1/1				2/3			3/4	75.0%		1				00:40:00
16	王鑫宇									0.0%						00:25:50
18	宋昱鹏									0.0%						00:00:00
23	庞佳明	0/3	1/2		2/3	1/1	1/1		5/10	50.0%	2	3				00:40:00
26	郑铭境		1/1						1/1	100%				1		00:07:36
29	赵熹瑞		2/2						2/2	100%						00:40:00
32	张珂宁									0.0%						00:00:00
	合计	3/7	6/7	5/9	3/4	3/4	1/1	1/2	22/34	64.7%	3	7	1	1		
(守门员)																
1	陶钜	0/1	0/2	2/2	0/1	0/2	0/1		2/9	22.2%						00:14:10
16	王鑫宇	1/3	2/5	0/2	1/2	1/3	0/1		5/16	31.3%						00:25:50
	合计	1/4	2/7	2/4	1/3	1/5	0/2		7/25	28.0%						

场上队员：得分/射门

守门员：救球/射门

全队合计	得分	被救	射失	击柱	封球	合计	%
远射	3	3	1			7	42.9%
近射	6	1				7	85.7%
边射	5	2	1	1		9	55.6%
快攻	3		1			4	75.0%
突破	3		1			4	75.0%
任意	1					1	100.0%
七米	1	1				2	50.0%

第二届全国青年运动会男子手球甲组决赛 体校组 (U18)

个人/全队技术统计表

手球 四分之一决赛 组别 X 晋中体育馆
青年男子 轮次 4 场次 50 2019-06-20 18:40

号码	姓名	远射	近射	边射	快攻	突破	任意	七米	合计	%	助攻	失误	警告	2'	取消	时间
福建泉港(泉港)																
(场上队员)																
1	周铁程									0.0%						00:03:40
6	段家乐		1/1		1/1				2/2	100%	2	1				00:15:58
7	王嘉靖									0.0%						00:00:00
9	周星晨									0.0%						00:00:00
10	陈臻									0.0%						00:00:00
11	钟宏韬									0.0%						00:00:00
12	汪琪坤	1/1							1/1	100%						00:36:20
13	周忠迪	0/1		1/2	1/1				2/4	50.0%						00:40:00
15	刘小龙	0/1	1/1						1/2	50.0%	2					00:21:04
17	左兆坤	0/1							0/1	0.0%						00:02:55
18	刘少杰		1/1						1/1	100%						00:40:00
20	吴兆瑞	2/3	2/4		0/1	3/3	1/1		8/12	66.7%	4			2		00:40:00
21	张路		0/1			1/2			1/3	33.3%	2	4		1		00:40:00
23	卓世胜			1/2			1/1		2/3	66.7%	3					00:40:00
25	张杰									0.0%						00:00:00
34	王涛									0.0%						00:00:00
合计		3/7	5/8	2/4	2/3	4/5	2/2		18/29	62.1%	2	15	1	3		

(守门员)																
1	周铁程	0/2							0/2	0.0%						00:03:40
12	汪琪坤	3/4	1/7	2/7	0/3	0/3	0/1	1/2	7/27	25.9%						00:36:20
合计		3/6	1/7	2/7	0/3	0/3	0/1	1/2	7/29	24.1%						

场上队员：得分/射门 守门员：救球/射门

全队合计	得分	被救	射失	击柱	封球	合计	%
远射	3	1			3	7	42.9%
近射	5	2			1	8	62.5%
边射	2	2				4	50.0%
快攻	2	1				3	66.7%
突破	4	1				5	80.0%
任意	2					2	100.0%
七米							0.0%

图式比赛技术统计表

手球
青年男子

四分之一决赛
轮次 4

组别 X
场次 50

晋中体育馆
2019-06-20 18:40

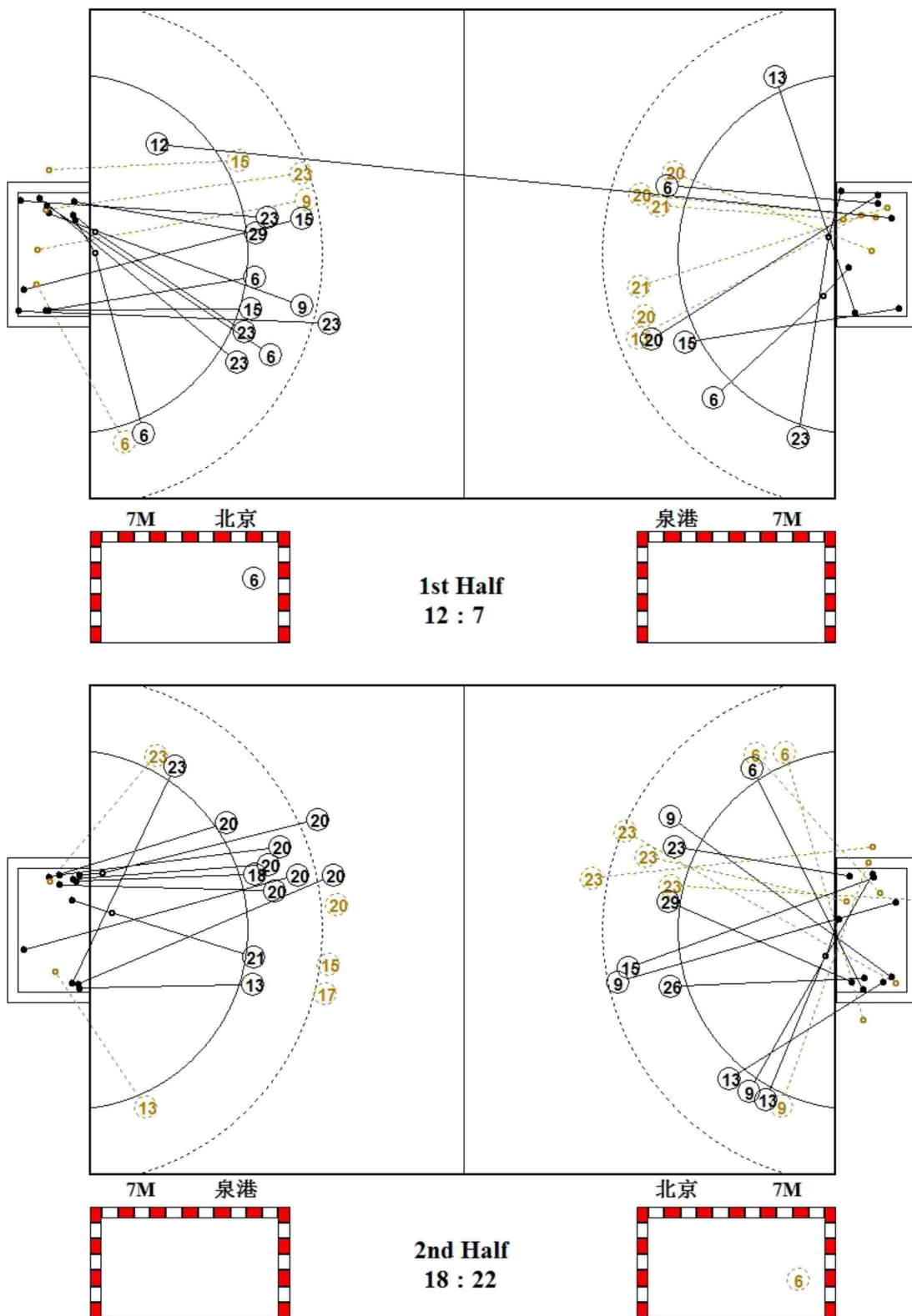

图式射门区域统计

手球
青年男子

四分之一决赛
轮次 4

组别 X
场次 50

晋中体育馆
2019-06-20 18:40

北京市

1 陶钜 <table border="1"><tr><td></td><td></td><td></td></tr><tr><td></td><td></td><td></td></tr><tr><td></td><td></td><td></td></tr></table> Post - 0 Miss - 0 Block - 0										3 魏豪 <table border="1"><tr><td></td><td></td><td></td></tr><tr><td></td><td></td><td></td></tr><tr><td></td><td></td><td></td></tr></table> Post - 0 Miss - 0 Block - 0										4 李博仔 <table border="1"><tr><td></td><td></td><td></td></tr><tr><td></td><td></td><td></td></tr><tr><td></td><td></td><td></td></tr></table> Post - 0 Miss - 0 Block - 0										6 苑宾 <table border="1"><tr><td></td><td></td><td>1</td></tr><tr><td>1</td><td></td><td>2</td></tr><tr><td></td><td></td><td>1</td></tr></table> Post - 0 Miss - 1 Block - 0			1	1		2			1	7 侯博耀 <table border="1"><tr><td></td><td></td><td></td></tr><tr><td></td><td></td><td></td></tr><tr><td></td><td></td><td></td></tr></table> Post - 0 Miss - 0 Block - 0										8 孙铂力 <table border="1"><tr><td></td><td></td><td></td></tr><tr><td></td><td></td><td></td></tr><tr><td></td><td></td><td></td></tr></table> Post - 0 Miss - 0 Block - 0										9 曹智栋 <table border="1"><tr><td>1</td><td></td><td>1</td></tr><tr><td>1</td><td></td><td>1</td></tr><tr><td></td><td></td><td></td></tr></table> Post - 1 Miss - 0 Block - 0	1		1	1		1				13 蓝心凯 <table border="1"><tr><td></td><td></td><td>1</td></tr><tr><td></td><td></td><td></td></tr><tr><td></td><td>1</td><td></td></tr></table> Post - 0 Miss - 0 Block - 0			1					1	
		1																																																																													
1		2																																																																													
		1																																																																													
1		1																																																																													
1		1																																																																													
		1																																																																													
	1																																																																														
14 杜俊林 <table border="1"><tr><td></td><td></td><td></td></tr><tr><td></td><td></td><td></td></tr><tr><td></td><td></td><td></td></tr></table> Post - 0 Miss - 0 Block - 0										15 刘大明 <table border="1"><tr><td>1</td><td></td><td></td></tr><tr><td>2</td><td></td><td></td></tr><tr><td></td><td></td><td></td></tr></table> Post - 0 Miss - 1 Block - 0	1			2						16 王鑫宇 <table border="1"><tr><td></td><td></td><td></td></tr><tr><td></td><td></td><td></td></tr><tr><td></td><td></td><td></td></tr></table> Post - 0 Miss - 0 Block - 0										18 宋昱鹏 <table border="1"><tr><td></td><td></td><td></td></tr><tr><td></td><td></td><td></td></tr><tr><td></td><td></td><td></td></tr></table> Post - 0 Miss - 0 Block - 0										23 庞佳明 <table border="1"><tr><td>1</td><td></td><td>2</td></tr><tr><td></td><td></td><td></td></tr><tr><td>1</td><td></td><td>1</td></tr></table> Post - 0 Miss - 2 Block - 0	1		2				1		1	26 郑铭境 <table border="1"><tr><td></td><td></td><td></td></tr><tr><td></td><td></td><td>1</td></tr><tr><td></td><td></td><td></td></tr></table> Post - 0 Miss - 0 Block - 0						1				29 赵熹瑞 <table border="1"><tr><td></td><td></td><td></td></tr><tr><td></td><td></td><td></td></tr><tr><td></td><td></td><td>2</td></tr></table> Post - 0 Miss - 0 Block - 0									2	32 张珂宁 <table border="1"><tr><td></td><td></td><td></td></tr><tr><td></td><td></td><td></td></tr><tr><td></td><td></td><td></td></tr></table> Post - 0 Miss - 0 Block - 0									
1																																																																															
2																																																																															
1		2																																																																													
1		1																																																																													
		1																																																																													
		2																																																																													

1 陶钜

1/1		1/3
0/2		0/3

16 王鑫宇

1/2	0/1	0/1
2/4	1/1	0/1
1/3	0/1	0/2

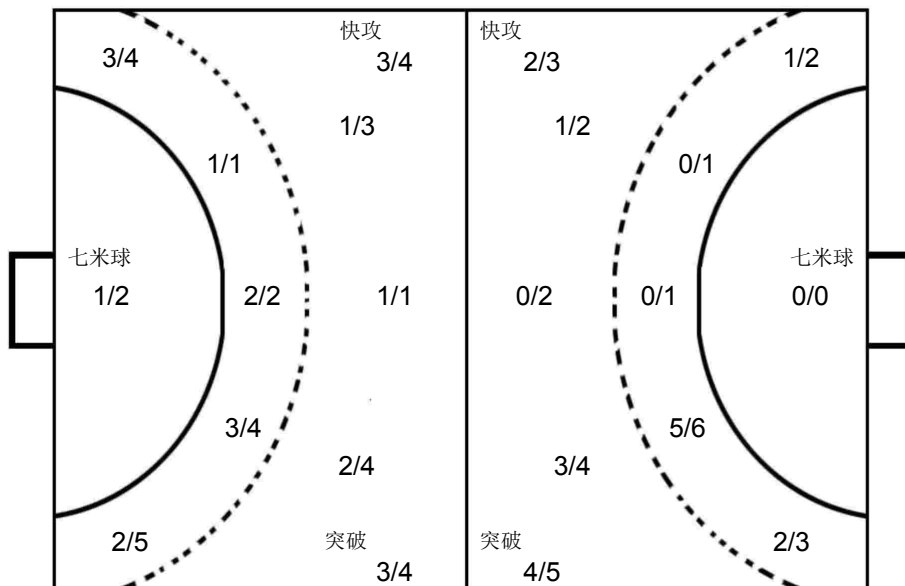

1 周铁程

0/1		
		0/1

12 汪琪坤

1/3	1/1	1/6
1/5		2/5
1/2	0/1	0/4

福建泉港

1 周铁程 <table border="1"><tr><td></td><td></td><td></td></tr><tr><td></td><td></td><td></td></tr><tr><td></td><td></td><td></td></tr></table> Post - 0 Miss - 0 Block - 0										6 段家乐 <table border="1"><tr><td></td><td></td><td></td></tr><tr><td>1</td><td></td><td></td></tr><tr><td></td><td>1</td><td></td></tr></table> Post - 0 Miss - 0 Block - 0				1				1		7 王嘉靖 <table border="1"><tr><td></td><td></td><td></td></tr><tr><td></td><td></td><td></td></tr><tr><td></td><td></td><td></td></tr></table> Post - 0 Miss - 0 Block - 0										9 周星晨 <table border="1"><tr><td></td><td></td><td></td></tr><tr><td></td><td></td><td></td></tr><tr><td></td><td></td><td></td></tr></table> Post - 0 Miss - 0 Block - 0										10 陈臻 <table border="1"><tr><td></td><td></td><td></td></tr><tr><td></td><td></td><td></td></tr><tr><td></td><td></td><td></td></tr></table> Post - 0 Miss - 0 Block - 0										11 钟宏韬 <table border="1"><tr><td></td><td></td><td></td></tr><tr><td></td><td></td><td></td></tr><tr><td></td><td></td><td></td></tr></table> Post - 0 Miss - 0 Block - 0										12 汪琪坤 <table border="1"><tr><td>1</td><td></td><td></td></tr><tr><td></td><td></td><td></td></tr><tr><td></td><td></td><td></td></tr></table> Post - 0 Miss - 0 Block - 0	1									13 周忠迪 <table border="1"><tr><td></td><td></td><td></td></tr><tr><td></td><td></td><td></td></tr><tr><td>1</td><td></td><td>1</td></tr></table> Post - 0 Miss - 0 Block - 0							1		1
1																																																																															
	1																																																																														
1																																																																															
1		1																																																																													
15 刘小龙 <table border="1"><tr><td></td><td></td><td>1</td></tr><tr><td></td><td></td><td></td></tr><tr><td></td><td></td><td></td></tr></table> Post - 0 Miss - 0 Block - 1			1							17 左兆坤 <table border="1"><tr><td></td><td></td><td></td></tr><tr><td></td><td></td><td></td></tr><tr><td></td><td></td><td></td></tr></table> Post - 0 Miss - 0 Block - 1										18 刘少杰 <table border="1"><tr><td></td><td></td><td></td></tr><tr><td></td><td></td><td></td></tr><tr><td></td><td></td><td>1</td></tr></table> Post - 0 Miss - 0 Block - 0									1	20 吴兆瑞 <table border="1"><tr><td></td><td>1</td><td></td></tr><tr><td>1</td><td></td><td>3</td></tr><tr><td>1</td><td></td><td>2</td></tr></table> Post - 0 Miss - 0 Block - 2		1		1		3	1		2	21 张路 <table border="1"><tr><td></td><td></td><td></td></tr><tr><td></td><td></td><td></td></tr><tr><td></td><td></td><td>1</td></tr></table> Post - 0 Miss - 0 Block - 0									1	23 卓世胜 <table border="1"><tr><td></td><td></td><td></td></tr><tr><td></td><td></td><td></td></tr><tr><td>2</td><td></td><td></td></tr></table> Post - 0 Miss - 0 Block - 0							2			25 张杰 <table border="1"><tr><td></td><td></td><td></td></tr><tr><td></td><td></td><td></td></tr><tr><td></td><td></td><td></td></tr></table> Post - 0 Miss - 0 Block - 0										34 王涛 <table border="1"><tr><td></td><td></td><td></td></tr><tr><td></td><td></td><td></td></tr><tr><td></td><td></td><td></td></tr></table> Post - 0 Miss - 0 Block - 0									
		1																																																																													
		1																																																																													
	1																																																																														
1		3																																																																													
1		2																																																																													
		1																																																																													
2																																																																															





第二届全国青年运动会男子手球甲组决赛 体校组 (U18)

青年男子 全国比赛

四分之一决赛

PHMS Pictorial Handball Match Statistics IHF Official System

Team A A 辽宁体校				Team B B 陕西西安				Match Number 51			
------------------	--	--	--	------------------	--	--	--	---------------------------	--	--	--

Played in 山西晋中	in the hall 晋中体育馆	on 2019-06-20	at 19:50	hours	Speakers
-------------------	----------------------	------------------	-------------	-------	----------

Half-time(30')	A 8	B 11	End of playing time	A 15	B 20	1st extra time	A	B	2nd extra time	A	B	After penalty throws	A	B
----------------	--------	---------	---------------------	---------	---------	----------------	---	---	----------------	---	---	----------------------	---	---

Number of 7 m 0/0	Team time-out			Full name of players and officials	Team time-out			B 1/2	Number of 7 m
	1 13:19	2 27:44	3 35:26		1 09:43	2 31:58	3 37:48		

No.	Team A	G	W	2'	D	DR	No.	Team B	G	W	2'	D	DR
1	何振楠						1	陈昊					
2	关贺元	4		1			2	张兴彬					
3	贾博						3	丁玉冰					
4	刘旭	4					5	隋家乐					
5	关棋						6	李梦豪	2				
7	姜珺						7	黄金伟					
8	郭嘉尧						8	张领	2				
9	张鹏	1					9	陈孝天	5		1		
10	王新開	1	1				10	王凯强		1			
11	颜科研						11	孔宇豪					
12	吴禹宽						12	朱正顺					
13	赵子凯						13	徐昊天	3				
18	祝慧翔昊						14	孙旭					
24	邢洪銘	1					15	陈冉	8		1		
29	蒋效峰	4					16	金筠峰					
							17	刘世昌					
A	陈宏瑞 (主教练)						B	李安					
B	张瑜						C	郝可鑫					
C	罗帅						D	王少杰					
D	王译						E	陈冬冬					

A	Signatures of responsables for the teams (Off.A)												B
---	--	--	--	--	--	--	--	--	--	--	--	--	---

TP	Remarks of referees / HF Official													TP
----	-----------------------------------	--	--	--	--	--	--	--	--	--	--	--	--	----

Referees	李兆蒙 (CHN)	马晓晔 (CHN)		
T.D.	陈晓波 (CHN)	柴业宏 (CHN)		
CHA Off.				

Note: Number of 7m Throws Awarded to Team A and B, Goals (G), Warnings (W), Suspensions (2'), Direct Disqualification (D), Disqualification With Report (DR) and Team Penalty (TP).

Table Officials: 王志超 孙龙龙 Statisticians: 刘笑 王梓衡

第二届全国青年运动会男子手球甲组决赛 体校组 (U18)

PHMS Pictorial Handball Match Statistics

IHF Official System

竞赛技术统计

手球
青年男子

四分之一决赛
轮次 4

组别 X
场次 51

晋中体育馆
2019-06-20 19:50

Referees: 李兆蒙 (CHN) / 马晓晔 (CHN)

Result: 15:20 (8:11)

Teams: 辽宁体校(辽宁) VS 陕西西安(西安)

辽宁																西安													
主教练: 陈宏瑞		远射	近射	边射	快攻	突破	任意球	7m球	合计	%	助攻	失误	警告	2'	D+DR	比赛进程													
1	何振楠															1st Half		0	01:02	1	8	张领							
2	关贺元		4/4					4/4	100	1	1			1		4		刘旭	1	04:12	1								
3	贾博															4		刘旭	1	04:37	2	9	陈孝天						
4	刘旭	3/10	0/1			1/1		4/12	33.3	1	4				4		刘旭	2	04:55	2									
5	关棋														2		关贺元	3	08:00	3	13	徐昊天							
7	姜珺														29		蒋效峰	4	08:16	3									
8	郭嘉尧														5			5	12:00	4	15	陈冉							
9	张鹏	0/4	0/2		0/1		1/1	1/8	12.5	1	3				5			5	13:15	5	15	陈冉							
10	王新開			1/2				1/2	50.0		2	1			2		关贺元	6	15:01	5									
11	颜科研														4		刘旭	6	15:51	6	6	李梦豪							
12	吴禹宽														7			7	16:18	6									
13	赵子凯														7			7	16:43	7	15	陈冉							
18	祝慧翔昊														7			7	17:04	8	15	陈冉							
24	邢洪銘	1/2					0/1	1/3	33.3						7			7	17:35	9	15	陈冉							
29	蒋效峰		1/1		2/2	1/1		4/4	100						2		关贺元	8	17:57	9									
运动员 合计		4/16	5/8	1/2	2/3	2/2	1/2	15/33	45.5	3	11	1	1		8			8	18:39	10	13	徐昊天							
1	何振楠			1/3	0/1	0/1	0/1	1/6	16.7						8			8	19:53	11	15	陈冉							
12	吴禹宽	2/7	3/4	1/4	0/2	2/5	0/1	8/23	34.8			1			8			8	01:18	12	9	陈孝天							
守门员 合计		2/7	3/4	2/7	0/2	2/6	0/2	9/29	31.0			1			9		张鹏	9	02:51	12									
														2nd Half															
														9		张鹏		9		03:04		13		15		陈冉			
														2		关贺元		10		03:39		13							
														10				10		05:02		14		9		陈孝天			
														10				10		06:11		15		13		徐昊天			
														10		王新開		11		11:23		15							
														24		邢洪銘		11		12:46		16		6		李梦豪			
														24				12		14:19		16							
														29		蒋效峰		12		14:57		17		9		陈孝天			
														29				13		17:25		17							
														13				13		18:02		18		8		张领			
														29		蒋效峰		13		18:48		19		9		陈孝天			
														29				14		18:54		19							
														29		蒋效峰		14		19:55		20		15		陈冉			
														29				15		20:00		20							

场上队员: 得分 / 射门

守门员: 救球 / 射门

D	取消资格	DR	取消资格+报告
---	------	----	---------



个人/全队技术统计表

手球 四分之一决赛 组别 X 晋中体育馆
青年男子 轮次 4 场次 51 2019-06-20 19:50

号码	姓名	远射	近射	边射	快攻	突破	任意	七米	合计	%	助攻	失误	警告	2'	取消	时间
辽宁体校(辽宁)																
(场上队员)																
1	何振楠									0.0%						00:07:50
2	关贺元		4/4						4/4	100%	1	1		1		00:40:00
3	贾博									0.0%						00:00:00
4	刘旭	3/10	0/1			1/1			4/12	33.3%	1	4				00:39:58
5	关棋									0.0%						00:00:00
7	姜珺									0.0%						00:00:00
8	郭嘉尧									0.0%						00:00:00
9	张鹏	0/4	0/2		0/1		1/1		1/8	12.5%	1	3				00:39:29
10	王新開			1/2					1/2	50.0%		2	1			00:40:00
11	颜科研									0.0%						00:00:29
12	吴禹宽									0.0%		1				00:32:10
13	赵子凯									0.0%						00:00:00
18	祝慧翔昊									0.0%						00:00:00
24	邢洪銘	1/2					0/1		1/3	33.3%						00:40:00
29	蒋效峰		1/1		2/2	1/1			4/4	100%						00:39:53
合计		4/16	5/8	1/2	2/3	2/2	1/2		15/33	45.5%	3	11	1	1		
(守门员)																
1	何振楠			1/3		0/1	0/1	0/1	1/6	16.7%						00:07:50
12	吴禹宽	2/7	3/4	1/4	0/2	2/5	0/1		8/23	34.8%		1				00:32:10
合计		2/7	3/4	2/7	0/2	2/6	0/2	0/1	9/29	31.0%		1				

场上队员：得分/射门

守门员：救球/射门

全队合计	得分	被救	射失	击柱	封球	合计	%
远射	4	1	6	1	4	16	25.0%
近射	5	2	1			8	62.5%
边射	1	1				2	50.0%
快攻	2	1				3	66.7%
突破	2					2	100.0%
任意	1		1			2	50.0%
七米							0.0%

第二届全国青年运动会男子手球甲组决赛 体校组 (U18)

PHMS Pictorial Handball Match Statistics

IHF Official System

个人/全队技术统计表

手球 青年男子 四分之一决赛 轮次 4 组别 X 场次 51 晋中体育馆 2019-06-20 19:50

号码	姓名	远射	近射	边射	快攻	突破	任意	七米	合计	%	助攻	失误	警告	2'	取消	时间
陕西西安(西安)																
(场上队员)																
1	陈昊									0.0%						00:31:37
2	张兴彬									0.0%						00:00:00
3	丁玉冰		0/1						0/1	0.0%		1				00:40:00
5	隋家乐									0.0%						00:00:00
6	李梦豪	2/2		0/1					2/3	66.7%	1					00:30:04
7	黄金伟									0.0%						00:00:00
8	张领	0/1	0/2			2/3			2/6	33.3%		2				00:40:00
9	陈孝天	2/3					2/2	1/2	5/7	71.4%	2			1		00:40:00
10	王凯强	0/1				0/1			0/2	0.0%		1	1			00:09:48
11	孔宇豪									0.0%						00:00:02
12	朱正顺									0.0%		1				00:08:23
13	徐昊天	0/1		3/3					3/4	75.0%						00:40:00
14	孙旭									0.0%						00:00:00
15	陈冉	1/1	1/1	2/4	2/2	2/2			8/10	80.0%				1		00:40:00
16	金筠峰									0.0%						00:00:00
17	刘世昌									0.0%						00:00:00
合计		5/9	1/4	5/8	2/2	4/6	2/2	1/2	20/33	60.6%	3	5	1	2		
(守门员)																
1	陈昊	1/5	2/6	1/1	1/3	0/2	0/1		5/18	27.8%						00:31:37
12	朱正顺		0/1	0/1					0/2	0.0%		1				00:08:23
合计		1/5	2/7	1/2	1/3	0/2	0/1		5/20	25.0%		1				

场上队员：得分/射门

守门员：救球/射门

全队合计	得分	被救	射失	击柱	封球	合计	%
远射	5	2	1		1	9	55.6%
近射	1	3				4	25.0%
边射	5	2	1			8	62.5%
快攻	2					2	100.0%
突破	4	2				6	66.7%
任意	2					2	100.0%
七米	1		1			2	50.0%

图式比赛技术统计表

手球
青年男子

四分之一决赛
轮次 4

组别 X
场次 51

晋中体育馆
2019-06-20 19:50

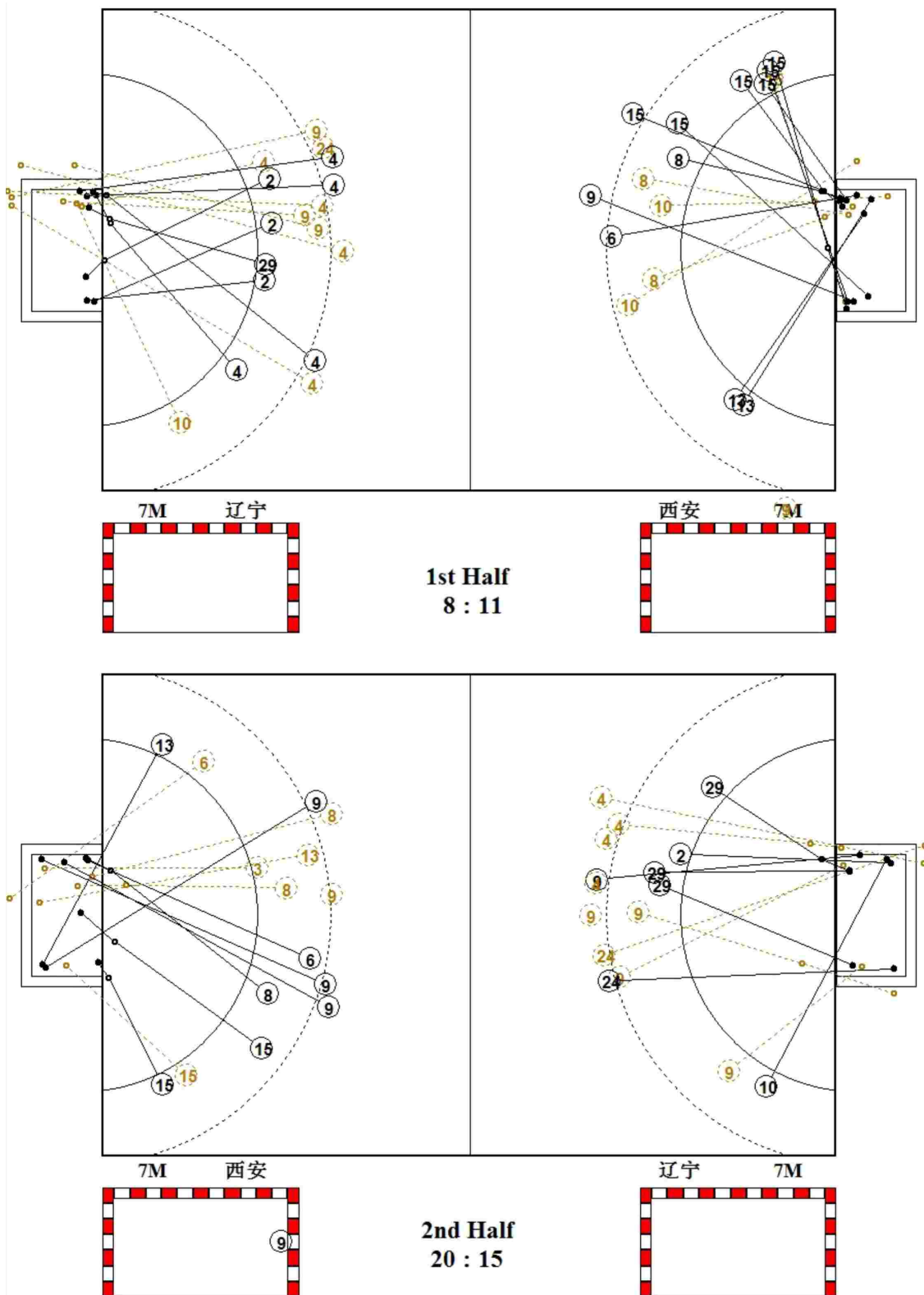

图式射门区域统计

手球
青年男子

四分之一决赛
轮次 4

组别 X
场次 51

晋中体育馆
2019-06-20 19:50

辽宁体校

1 何振楠 Post - 0 Miss - 0 Block - 0	2 关贺元 1 3 Post - 0 Miss - 0 Block - 0	3 贾博 Post - 0 Miss - 0 Block - 0	4 刘旭 4 Post - 1 Miss - 4 Block - 2	5 关棋 Post - 0 Miss - 0 Block - 0	7 姜珺 Post - 0 Miss - 0 Block - 0	8 郭嘉尧 Post - 0 Miss - 0 Block - 0	9 张鹏 1 Post - 0 Miss - 3 Block - 1
10 王新開 1 Post - 0 Miss - 0 Block - 0	11 颜科研 Post - 0 Miss - 0 Block - 0	12 吴禹宽 Post - 0 Miss - 0 Block - 0	13 赵子凯 Post - 0 Miss - 0 Block - 0	18 祝慧翔昊 Post - 0 Miss - 0 Block - 0	24 邢洪銘 1 Post - 0 Miss - 1 Block - 1	29 蒋效峰 2 2 Post - 0 Miss - 0 Block - 0	

1 何振楠
0/1
1/2 0/1
0/1 0/1

12 吴禹宽
1/3 1/1 1/1
0/1 1/3
2/7 0/1 2/6

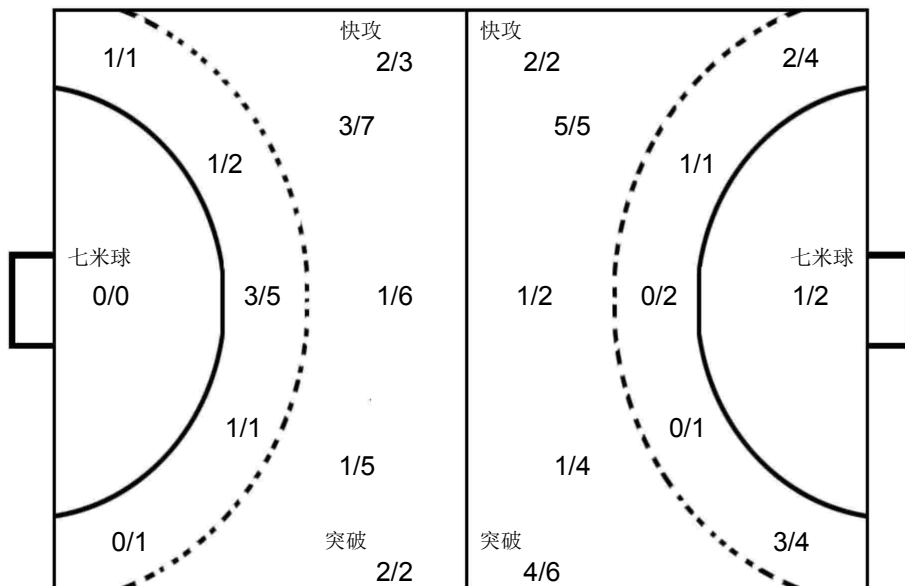

1 陈昊
0/1
0/1 3/3
1/6 1/7

12 朱正顺
0/2

陕西西安

1 陈昊 Post - 0 Miss - 0 Block - 0	2 张兴彬 Post - 0 Miss - 0 Block - 0	3 丁玉冰 Post - 0 Miss - 0 Block - 0	5 隋家乐 Post - 0 Miss - 0 Block - 0	6 李梦豪 1 1 Post - 0 Miss - 1 Block - 0	7 黄金伟 Post - 0 Miss - 0 Block - 0	8 张领 1 1 Post - 0 Miss - 0 Block - 0	9 陈孝天 1 1 2 1 Post - 0 Miss - 1 Block - 1
10 王凯强 Post - 0 Miss - 1 Block - 0	11 孔宇豪 Post - 0 Miss - 0 Block - 0	12 朱正顺 Post - 0 Miss - 0 Block - 0	13 徐昊天 1 2 Post - 0 Miss - 0 Block - 0	14 孙旭 Post - 0 Miss - 0 Block - 0	15 陈冉 4 1 2 Post - 0 Miss - 0 Block - 0	16 金筠峰 Post - 0 Miss - 0 Block - 0	17 刘世昌 Post - 0 Miss - 0 Block - 0





第二届全国青年运动会男子手球甲组决赛 体校组 (U18)

青年男子 全国比赛

四分之一决赛

PHMS Pictorial Handball Match Statistics IHF Official System

Team A A 安徽合肥				Team B B 天津市				Match Number 52			
------------------	--	--	--	-----------------	--	--	--	---------------------------	--	--	--

Played in 山西晋中	in the hall 晋中体育馆	on 2019-06-20	at 21:00	hours	Speakers
-------------------	----------------------	------------------	-------------	-------	----------

Half-time(30')	A 14	B 3	End of playing time	A 24	B 11	1st extra time	A	B	2nd extra time	A	B	After penalty throws	A	B
----------------	---------	--------	---------------------	---------	---------	----------------	---	---	----------------	---	---	----------------------	---	---

Number of 7 m 0/0	Team time-out			Full name of players and officials	Team time-out			B 0/0	Number of 7 m
	1	2	3		1	2	3		

No.	Team A	G	W	2'	D	DR	No.	Team B	G	W	2'	D	DR
2	张天进	1					6	赵晨阳	3				
13	沈威	3					10	黄嘉俊					
26	饶原源	3					14	戴云鹏					
27	王东昇						17	黄春瑞	2		1		
29	梅少聪	1					19	万朋	1				
30	单习振	3	1				20	王澎	1				
31	张宇	6					23	谭元春					
33	於晓祺						24	周亚龙					
35	李宝松	1		1			25	郝一铮					
36	刘耀奇	1					26	李海龙	4				
39	汤鸿宇						27	吕华宇					
40	陈欢						28	孙经纬					
41	管家乐	1	1	2									
42	刘军波	1											
43	王久源	3	1										
50	刘欣洋												
A	王德勇 (主教练)						A	贾守信					
C	陆万红						B	李志成 (主教练)					
D	王明星						C	田剑侠					
E	陈玉翔						D	潘玉强					

A	Signatures of responsables for the teams (Off.A)												B
---	--	--	--	--	--	--	--	--	--	--	--	--	---

TP	Remarks of referees / HF Official													TP
----	-----------------------------------	--	--	--	--	--	--	--	--	--	--	--	--	----

Referees	张智伟 (CHN)	伍豪 (CHN)		
T.D.	吴瑞亭 (CHN)	王洋 (CHN)		
CHA Off.				

Note: Number of 7m Throws Awarded to Team A and B, Goals (G), Warnings (W), Suspensions (2'), Direct Disqualification (D), Disqualification With Report (DR) and Team Penalty (TP).

Table Officials: 马迪 李莉君 Statisticians: 王梓衡 刘笑

第二届全国青年运动会男子手球甲组决赛 体校组 (U18)

PHMS Pictorial Handball Match Statistics

IHF Official System

竞赛技术统计

手球
青年男子

四分之一决赛
轮次 4

组别 X
场次 52

晋中体育馆
2019-06-20 21:00

Referees: 张智伟 (CHN) / 伍豪 (CHN) Result: 24:11 (14:3)
Teams: 安徽合肥(合肥) VS 天津市(天津)

合肥																合肥		比赛 进程		天津	
主教练: 王德勇																					
		远	近	边	快	突	任意	7m	合计	%	助攻	失误	警告	2'	D+DR						
		射	射	射	攻	破	球	球													
2	张天进	0/3	1/1			0/1			1/5	20.0		1									
13	沈威	1/2			2/2				3/4	75.0	1	1									
26	饶原源	1/1	1/1		1/1				3/3	100	3										
27	王东昇																				
29	梅少聪		1/2						1/2	50.0											
30	单习振		1/1	1/1	1/1				3/3	100		2	1								
31	张宇	4/5			1/1	1/1			6/7	85.7	1	3									
33	於晓祺					0/1			0/1	0.0		1									
35	李宝松					1/1			1/1	100		2		1							
36	刘耀奇			0/1	1/1				1/2	50.0		1									
39	汤鸿宇																				
40	陈欢																				
41	管家乐	1/3		0/1					1/4	25.0	1		1	2							
42	刘军波	1/1							1/1	100		1									
43	王久源				2/2	1/1			3/3	100	1	1	1								
50	刘欣洋																				
运动员 合计		8/15	4/5	1/3	8/8	3/5			24/36	66.7	7	13	3	3							
39	汤鸿宇	3/7			0/2	0/2			3/11	27.3											
40	陈欢	5/5		1/2		1/3			7/10	70.0											
守门员 合计		8/12		1/2	0/2	1/5			10/21	47.6											
天津																					
主教练: 李志成																					
		远	近	边	快	突	任意	7m	合计	%	助攻	失误	警告	2'	D+DR						
		射	射	射	攻	破	球	球													
6	赵晨阳	1/8			1/1	1/3			3/12	25.0		6									
10	黄嘉俊																				
14	戴云鹏																				
17	黄春瑞	2/4			0/1				2/5	40.0	2			1							
19	万朋				1/1				1/1	100											
20	王澎	0/1		0/1		1/1			1/3	33.3		2									
23	谭元春																				
24	周亚龙																				
25	郝一铮											5									
26	李海龙	1/6		1/1		2/2			4/9	44.4		4									
27	吕华宇											1									
28	孙经纬																				
运动员 合计		4/19		1/2	2/3	4/6			11/30	36.7	2	18		1							
23	谭元春	2/10	1/5	1/2	0/8	2/5			6/30	20.0											
守门员 合计		2/10	1/5	1/2	0/8	2/5			6/30	20.0											

场上队员: 得分 / 射门

守门员: 救球 / 射门

D	取消资格	DR	取消资格+报告
---	------	----	---------



个人/全队技术统计表

手球 四分之一决赛 组别 X 晋中体育馆
青年男子 轮次 4 场次 52 2019-06-20 21:00

号码	姓名	远射	近射	边射	快攻	突破	任意	七米	合计	%	助攻	失误	警告	2'	取消	时间
安徽合肥(合肥)																
(场上队员)																
2	张天进	0/3	1/1			0/1			1/5	20.0%		1				00:20:00
13	沈威	1/2				2/2			3/4	75.0%	1	1				00:20:00
26	饶源源	1/1	1/1			1/1			3/3	100%	3					00:20:00
27	王东昇									0.0%						00:06:07
29	梅少聪		1/2						1/2	50.0%						00:20:00
30	单习振		1/1	1/1	1/1				3/3	100%		2	1			00:20:00
31	张宇	4/5				1/1	1/1		6/7	85.7%	1	3				00:20:00
33	於晓祺					0/1			0/1	0.0%		1				00:20:00
35	李宝松					1/1			1/1	100%		2		1		00:20:00
36	刘耀奇			0/1	1/1				1/2	50.0%		1				00:20:00
39	汤鸿宇									0.0%						00:18:03
40	陈欢									0.0%						00:21:57
41	管家乐	1/3		0/1					1/4	25.0%	1		1	2		00:21:51
42	刘军波	1/1							1/1	100%		1				00:06:15
43	王久源					2/2	1/1		3/3	100%	1	1	1			00:11:56
50	刘欣洋									0.0%						00:13:51
	合计	8/15	4/5	1/3	8/8	3/5			24/36	66.7%	7	13	3	3		
(守门员)																
39	汤鸿宇	3/7				0/2	0/2		3/11	27.3%						00:18:03
40	陈欢	5/5		1/2			1/3		7/10	70.0%						00:21:57
	合计	8/12		1/2		0/2	1/5		10/21	47.6%						

场上队员：得分/射门

守门员：救球/射门

全队合计	得分	被救	射失	击柱	封球	合计	%
远射	8	2	2	3		15	53.3%
近射	4	1				5	80.0%
边射	1	1	1			3	33.3%
快攻	8					8	100.0%
突破	3	2				5	60.0%
任意							0.0%
七米							0.0%

个人/全队技术统计表

 手球 四分之一决赛 组别 X 晋中体育馆
 青年男子 轮次 4 场次 52 2019-06-20 21:00

号码	姓名	远射	近射	边射	快攻	突破	任意	七米	合计	%	助攻	失误	警告	2'	取消	时间
天津市(天津)																
(场上队员)																
6	赵晨阳	1/8			1/1	1/3			3/12	25.0%		6				00:40:00
10	黄嘉俊									0.0%						00:00:00
14	戴云鹏									0.0%						00:00:00
17	黄春瑞	2/4			0/1				2/5	40.0%	2			1	00:40:00	
19	万朋				1/1				1/1	100%					00:14:51	
20	王澎	0/1		0/1		1/1			1/3	33.3%	2				00:33:19	
23	谭元春									0.0%					00:40:00	
24	周亚龙									0.0%					00:16:47	
25	郝一铮									0.0%	5				00:28:27	
26	李海龙	1/6		1/1		2/2			4/9	44.4%	4				00:40:00	
27	吕华宇									0.0%	1				00:26:36	
28	孙经纬									0.0%					00:00:00	
	合计	4/19		1/2	2/3	4/6			11/30	36.7%	2	18		1		
(守门员)																
23	谭元春	2/10	1/5	1/2	0/8	2/5			6/30	20.0%						00:40:00
	合计	2/10	1/5	1/2	0/8	2/5			6/30	20.0%						

场上队员： 得分/射门

守门员： 救球/射门

全队合计	得分	被救	射失	击柱	封球	合计	%
远射	4	8	5	2		19	21.1%
近射							0.0%
边射	1	1				2	50.0%
快攻	2		1			3	66.7%
突破	4	1		1		6	66.7%
任意							0.0%
七米							0.0%

图式比赛技术统计表

手球
青年男子

四分之一决赛
轮次 4

组别 X
场次 52

晋中体育馆
2019-06-20 21:00

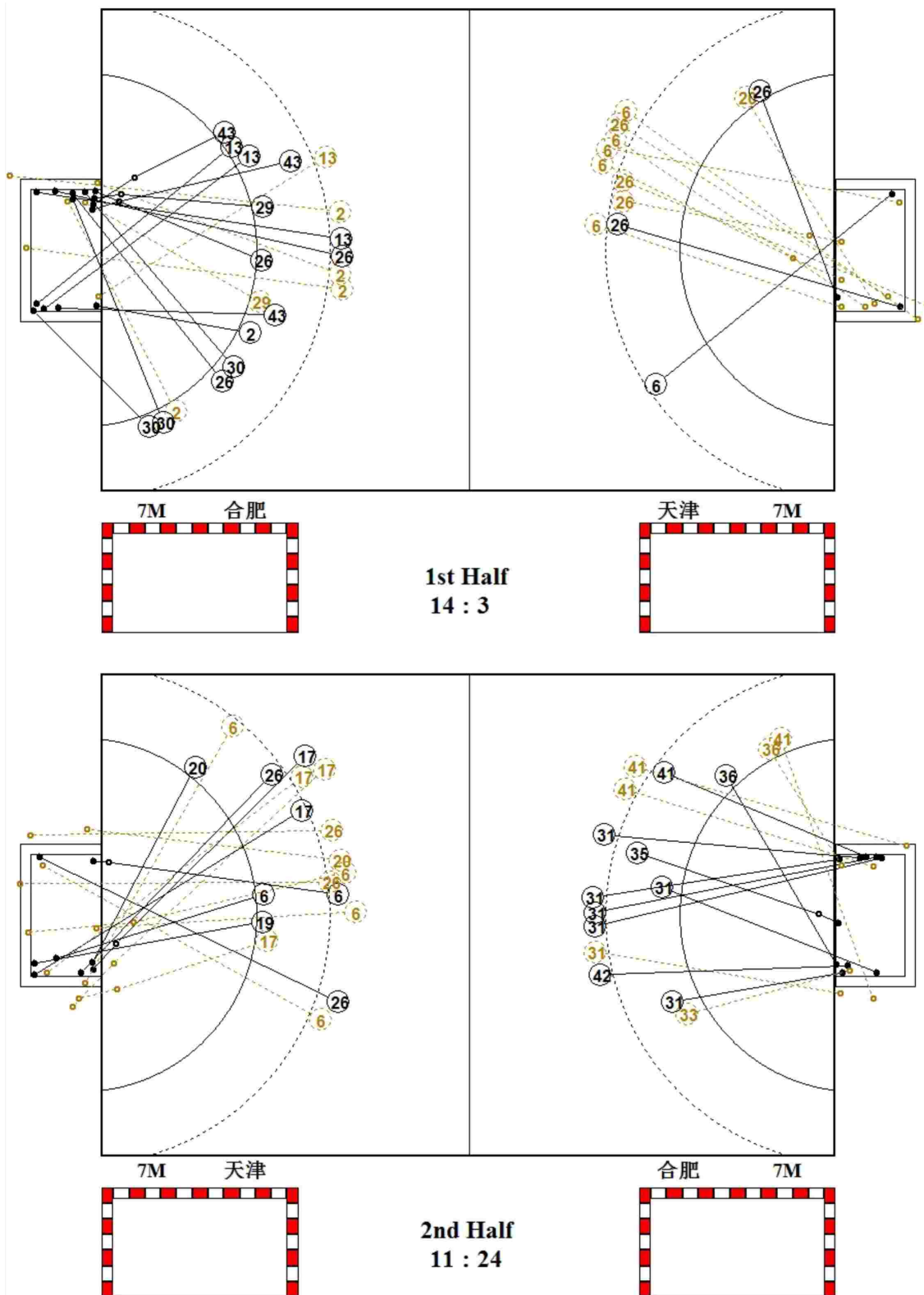

图式射门区域统计

手球
青年男子

四分之一决赛
轮次 4

组别 X
场次 52

晋中体育馆
2019-06-20 21:00

安徽合肥

2 张天进 <table border="1"><tr><td></td><td></td><td></td></tr><tr><td></td><td></td><td></td></tr><tr><td>1</td><td></td><td></td></tr></table> Post - 2 Miss - 1 Block - 0							1			13 沈威 <table border="1"><tr><td>2</td><td></td><td>1</td></tr><tr><td></td><td></td><td></td></tr><tr><td></td><td></td><td></td></tr></table> Post - 0 Miss - 0 Block - 0	2		1							26 饶原源 <table border="1"><tr><td></td><td></td><td>1</td></tr><tr><td></td><td></td><td>1</td></tr><tr><td></td><td></td><td>1</td></tr></table> Post - 0 Miss - 0 Block - 0			1			1			1	27 王东昇 <table border="1"><tr><td></td><td></td><td></td></tr><tr><td></td><td></td><td></td></tr><tr><td></td><td></td><td></td></tr></table> Post - 0 Miss - 0 Block - 0										29 梅少聪 <table border="1"><tr><td></td><td></td><td></td></tr><tr><td></td><td></td><td></td></tr><tr><td></td><td></td><td>1</td></tr></table> Post - 0 Miss - 0 Block - 0									1	30 单习振 <table border="1"><tr><td>1</td><td></td><td></td></tr><tr><td></td><td></td><td>1</td></tr><tr><td></td><td></td><td>1</td></tr></table> Post - 0 Miss - 0 Block - 0	1					1			1	31 张宇 <table border="1"><tr><td>1</td><td></td><td></td></tr><tr><td>2</td><td></td><td>1</td></tr><tr><td>1</td><td></td><td>1</td></tr></table> Post - 0 Miss - 1 Block - 0	1			2		1	1		1	33 於晓祺 <table border="1"><tr><td></td><td></td><td></td></tr><tr><td></td><td></td><td></td></tr><tr><td></td><td></td><td></td></tr></table> Post - 0 Miss - 0 Block - 0									
1																																																																															
2		1																																																																													
		1																																																																													
		1																																																																													
		1																																																																													
		1																																																																													
1																																																																															
		1																																																																													
		1																																																																													
1																																																																															
2		1																																																																													
1		1																																																																													
35 李宝松 <table border="1"><tr><td></td><td></td><td></td></tr><tr><td></td><td></td><td></td></tr><tr><td></td><td>1</td><td></td></tr></table> Post - 0 Miss - 0 Block - 0								1		36 刘耀奇 <table border="1"><tr><td></td><td></td><td></td></tr><tr><td></td><td></td><td></td></tr><tr><td></td><td></td><td>1</td></tr></table> Post - 0 Miss - 0 Block - 0									1	39 汤鸿宇 <table border="1"><tr><td></td><td></td><td></td></tr><tr><td></td><td></td><td></td></tr><tr><td></td><td></td><td></td></tr></table> Post - 0 Miss - 0 Block - 0										40 陈欢 <table border="1"><tr><td></td><td></td><td></td></tr><tr><td></td><td></td><td></td></tr><tr><td></td><td></td><td></td></tr></table> Post - 0 Miss - 0 Block - 0										41 管家乐 <table border="1"><tr><td>1</td><td></td><td></td></tr><tr><td></td><td></td><td></td></tr><tr><td></td><td></td><td></td></tr></table> Post - 1 Miss - 1 Block - 0	1									42 刘军波 <table border="1"><tr><td></td><td></td><td></td></tr><tr><td></td><td></td><td></td></tr><tr><td></td><td></td><td>1</td></tr></table> Post - 0 Miss - 0 Block - 0									1	43 王久源 <table border="1"><tr><td></td><td></td><td></td></tr><tr><td></td><td></td><td></td></tr><tr><td>1</td><td></td><td></td></tr></table> Post - 0 Miss - 0 Block - 0							1			50 刘欣洋 <table border="1"><tr><td></td><td></td><td></td></tr><tr><td></td><td></td><td></td></tr><tr><td></td><td></td><td></td></tr></table> Post - 0 Miss - 0 Block - 0									
	1																																																																														
		1																																																																													
1																																																																															
		1																																																																													
1																																																																															

39 汤鸿宇

1/3		1/2
0/1		
0/3	1/1	0/1

40 陈欢

1/2		1/2
		2/2
	1/1	2/3

23 谭元春

0/4		0/2
1/5		1/4
2/4	0/1	2/10

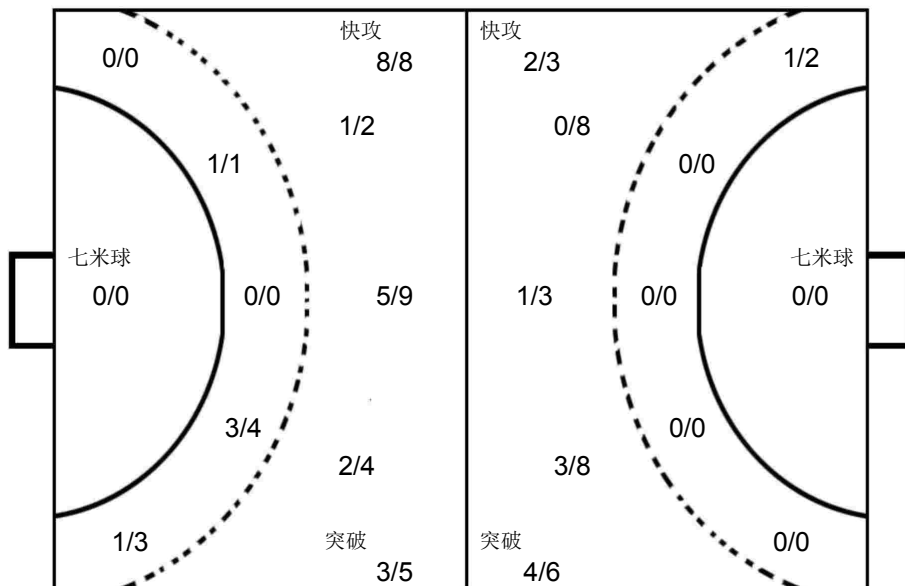

天津市

6 赵晨阳 <table border="1"><tr><td>1</td><td></td><td></td></tr><tr><td>1</td><td></td><td></td></tr><tr><td></td><td></td><td>1</td></tr></table> Post - 2 Miss - 1 Block - 0	1			1					1	10 黄嘉俊 <table border="1"><tr><td></td><td></td><td></td></tr><tr><td></td><td></td><td></td></tr><tr><td></td><td></td><td></td></tr></table> Post - 0 Miss - 0 Block - 0										14 戴云鹏 <table border="1"><tr><td></td><td></td><td></td></tr><tr><td></td><td></td><td></td></tr><tr><td></td><td></td><td></td></tr></table> Post - 0 Miss - 0 Block - 0										17 黄春瑞 <table border="1"><tr><td>1</td><td></td><td></td></tr><tr><td></td><td></td><td></td></tr><tr><td>1</td><td></td><td></td></tr></table> Post - 0 Miss - 2 Block - 0	1						1			19 万朋 <table border="1"><tr><td>1</td><td></td><td></td></tr><tr><td></td><td></td><td></td></tr><tr><td></td><td></td><td></td></tr></table> Post - 0 Miss - 0 Block - 0	1									20 王澎 <table border="1"><tr><td></td><td></td><td></td></tr><tr><td></td><td></td><td></td></tr><tr><td>1</td><td></td><td></td></tr></table> Post - 0 Miss - 1 Block - 0							1			23 谭元春 <table border="1"><tr><td></td><td></td><td></td></tr><tr><td></td><td></td><td></td></tr><tr><td></td><td></td><td></td></tr></table> Post - 0 Miss - 0 Block - 0										24 周亚龙 <table border="1"><tr><td></td><td></td><td></td></tr><tr><td></td><td></td><td></td></tr><tr><td></td><td></td><td></td></tr></table> Post - 0 Miss - 0 Block - 0									
1																																																																															
1																																																																															
		1																																																																													
1																																																																															
1																																																																															
1																																																																															
1																																																																															
25 郝一铮 <table border="1"><tr><td></td><td></td><td></td></tr><tr><td></td><td></td><td></td></tr><tr><td></td><td></td><td></td></tr></table> Post - 0 Miss - 0 Block - 0										26 李海龙 <table border="1"><tr><td></td><td></td><td>2</td></tr><tr><td></td><td></td><td></td></tr><tr><td>1</td><td></td><td>1</td></tr></table> Post - 1 Miss - 2 Block - 0			2				1		1	27 吕华宇 <table border="1"><tr><td></td><td></td><td></td></tr><tr><td></td><td></td><td></td></tr><tr><td></td><td></td><td></td></tr></table> Post - 0 Miss - 0 Block - 0										28 孙经伟 <table border="1"><tr><td></td><td></td><td></td></tr><tr><td></td><td></td><td></td></tr><tr><td></td><td></td><td></td></tr></table> Post - 0 Miss - 0 Block - 0																																																	
		2																																																																													
1		1																																																																													





第二届全国青年运动会男子手球甲组决赛 体校组 (U18)

青年男子 全国比赛

5-8名

PHMS Pictorial Handball Match Statistics IHF Official System

Team A A 广东深圳				Team B B 福建泉港				Match Number 63			
------------------	--	--	--	------------------	--	--	--	---------------------------	--	--	--

Played in 山西晋中	in the hall 晋中体育馆	on 2019-06-21	at 17:30	hours	Speakers
-------------------	----------------------	------------------	-------------	-------	----------

Half-time(30')	A 9	B 11	End of playing time	A 16	B 19	1st extra time	A	B	2nd extra time	A	B	After penalty throws	A	B
----------------	--------	---------	---------------------	---------	---------	----------------	---	---	----------------	---	---	----------------------	---	---

Number of 7 m	A 1/2	Team time-out			Full name of players and officials	Team time-out			B 2/2	Number of 7 m
	1 14:44	2 28:31	3	1 18:44		2 37:36	3			

No.	Team A	G	W	2'	D	DR	No.	Team B	G	W	2'	D	DR
3	李朗轩	2					1	周铁程					
5	陈俊延						6	段家乐					
6	董佳辉	2					7	王嘉靖					
7	曾繁泳	5	1				9	周星晨					
8	罗霖泽	3					10	陈臻					
9	左典	1					11	钟宏韬					
10	李剑琛	1	1				12	汪琪坤					
11	万泽峰						13	周忠迪	6				
12	戴景伟						15	刘小龙					
13	赵世豪	1					17	左兆坤					
15	金硕						18	刘少杰	1				
16	谢思远	1					20	吴兆瑞	8		1		
18	曾笑童						21	张路	3		1		
19	齐振东						23	卓世胜	1		1		
							25	张杰					
							34	王涛					
A	张斌						B	王卫					
C	李中洲 (主教练)						C	刘德东					
D	张广建						E	薛裕安					
F	蒋光华												

A	Signatures of responsables for the teams (Off.A)												B
---	--	--	--	--	--	--	--	--	--	--	--	--	---

TP	Remarks of referees / HF Official													TP
----	-----------------------------------	--	--	--	--	--	--	--	--	--	--	--	--	----

Referees	张智伟 (CHN)	伍豪 (CHN)		
T.D.	柴业宏 (CHN)	陈晓波 (CHN)		
CHA Off.				

Note: Number of 7m Throws Awarded to Team A and B, Goals (G), Warnings (W), Suspensions (2'), Direct Disqualification (D), Disqualification With Report (DR) and Team Penalty (TP).

Table Officials: 马迪 戴莹莹 Statisticians: 刘笑 王梓衡

第二届全国青年运动会男子手球甲组决赛 体校组 (U18)

PHMS Pictorial Handball Match Statistics

IHF Official System

竞赛技术统计

手球
青年男子

5-8名
轮次 5

组别 X
场次 63

晋中体育馆
2019-06-21 17:30

Referees:	张智伟 (CHN) / 伍豪 (CHN)	Result:	16:19 (9:11)
Teams:	广东深圳(深圳) VS 福建泉港(泉港)		

深圳		远	近	边	快	突	任意	7m	合计	%	助攻	失误	警告	2'	D+DR	深圳	比赛 进程	泉港
主教练: 李中洲		射	射	射	攻	破	球	球										
3	李朗轩			1/1		1/1			2/2	100		1					1st Half	
5	陈俊延															3	00:27	1 13 周忠迪
6	董佳辉	1/5	0/3			1/1			2/9	22.2	1	1				李朗轩	01:05	1
7	曾繁泳			3/5	2/3				5/8	62.5		1	1			7	02:52	2 18 刘少杰
8	罗霖泽			1/2	1/1			1/2	3/5	60.0		2				2	04:06	3 20 吴兆瑞
9	左典					1/1			1/1	100		4				6	05:28	3
10	李剑琛			0/2	1/2				1/4	25.0		1	1			8	08:00	3
11	万泽峰															4	08:29	4 20 吴兆瑞
12	戴景伟															4	10:18	5 23 卓世胜
13	赵世豪			0/1	1/1				1/2	50.0						5	11:10	5
15	金硕															5	11:34	6 13 周忠迪
16	谢思远	0/1			0/1	1/1			1/3	33.3						5	13:07	7 13 周忠迪
18	曾笑童															5	14:12	8 20 吴兆瑞
19	齐振东															5	15:12	9 13 周忠迪
运动员 合计		1/6	0/3	5/11	5/8	4/4		1/2	16/34	47.1	1	12	2			5	16:28	10 20 吴兆瑞
12	戴景伟	1/4	1/7	2/3		0/2		0/1	4/17	23.5		2				6	17:03	10
18	曾笑童	0/1	1/2	0/1	0/1	0/1		0/1	1/7	14.3						6	17:21	11 13 周忠迪
守门员 合计		1/5	2/9	2/4	0/1	0/3		0/2	5/24	20.8		2				7	17:44	11
																3	18:22	11
																8	19:15	11
																2nd Half		
																9	00:43	12 20 吴兆瑞
																9	01:44	13 21 张路
																10	02:33	13
																10	02:44	14 13 周忠迪
																9	03:41	14
																7	06:37	14
																12	07:06	15 20 吴兆瑞
																12	08:05	16 20 吴兆瑞
																12	10:02	17 21 张路
																12	10:45	18 20 吴兆瑞
																12	15:22	19 21 张路
																7	16:06	19
																7	17:23	19
																13	18:06	19
																6	19:27	19

场上队员: 得分 / 射门

守门员: 救球 / 射门

D	取消资格	DR	取消资格+报告
---	------	----	---------



个人/全队技术统计表

 手球 5-8名 组别 X 晋中体育馆
 青年男子 轮次 5 场次 63 2019-06-21 17:30

号码	姓名	远射	近射	边射	快攻	突破	任意	七米	合计	%	助攻	失误	警告	2'	取消	时间
广东深圳(深圳)																
(场上队员)																
3	李朗轩			1/1		1/1			2/2	100%		1				00:39:56
5	陈俊延									0.0%						00:00:00
6	董佳辉	1/5	0/3			1/1			2/9	22.2%	1	1				00:37:58
7	曾繁泳			3/5	2/3				5/8	62.5%		1	1			00:39:55
8	罗霖泽			1/2	1/1			1/2	3/5	60.0%		2				00:34:55
9	左典					1/1			1/1	100%		4				00:30:12
10	李剑琛			0/2	1/2				1/4	25.0%		1	1			00:31:02
11	万泽峰									0.0%						00:11:01
12	戴景伟									0.0%		2				00:31:50
13	赵世豪			0/1	1/1				1/2	50.0%						00:03:55
15	金硕									0.0%						00:00:00
16	谢思远	0/1			0/1	1/1			1/3	33.3%						00:10:40
18	曾笑童									0.0%						00:08:34
19	齐振东									0.0%						00:00:00
	合计	1/6	0/3	5/11	5/8	4/4		1/2	16/34	47.1%	1	12	2			
(守门员)																
12	戴景伟	1/4	1/7	2/3		0/2		0/1	4/17	23.5%		2				00:31:50
18	曾笑童	0/1	1/2	0/1	0/1	0/1		0/1	1/7	14.3%						00:08:34
	合计	1/5	2/9	2/4	0/1	0/3		0/2	5/24	20.8%		2				

场上队员：得分/射门

守门员：救球/射门

全队合计	得分	被救	射失	击柱	封球	合计	%
远射	1	3	2			6	16.7%
近射		2	1			3	0.0%
边射	5	5	1			11	45.5%
快攻	5	3				8	62.5%
突破	4					4	100.0%
任意							0.0%
七米	1	1				2	50.0%

第二届全国青年运动会男子手球甲组决赛 体校组 (U18)

个人/全队技术统计表

手球 5-8名 组别 X 晋中体育馆
青年男子 轮次 5 场次 63 2019-06-21 17:30

号码	姓名	远射	近射	边射	快攻	突破	任意	七米	合计	%	助攻	失误	警告	2'	取消	时间
福建泉港(泉港)																
(场上队员)																
1	周铁程									0.0%						00:00:10
6	段家乐									0.0%		1				00:10:53
7	王嘉靖									0.0%						00:00:00
9	周星晨									0.0%		1				00:33:18
10	陈臻									0.0%						00:00:00
11	钟宏韬									0.0%						00:01:55
12	汪琪坤									0.0%						00:39:50
13	周忠迪	1/1	4/4		1/1				6/6	100%		2				00:34:34
15	刘小龙									0.0%						00:00:00
17	左兆坤									0.0%						00:00:00
18	刘少杰		1/2						1/2	50.0%	1	1				00:39:56
20	吴兆瑞	1/6	2/4	1/1		3/3		1/1	8/15	53.3%	1	1		1		00:39:56
21	张路	2/3		0/1				1/1	3/5	60.0%	1	9		1		00:39:35
23	卓世胜			1/2					1/2	50.0%				1		00:39:51
25	张杰									0.0%						00:00:00
34	王涛									0.0%						00:00:00
合计		4/10	7/10	2/4	1/1	3/3		2/2	19/30	63.3%	3	15		3		
(守门员)																
1	周铁程							1/1	1/1	100%						00:00:10
12	汪琪坤	3/4	2/2	5/10	3/8	0/4		0/1	13/29	44.8%						00:39:50
合计		3/4	2/2	5/10	3/8	0/4		1/2	14/30	46.7%						

场上队员：得分/射门

守门员：救球/射门

全队合计	得分	被救	射失	击柱	封球	合计	%
远射	4	1	3	1	1	10	40.0%
近射	7	2	1			10	70.0%
边射	2	2				4	50.0%
快攻	1					1	100.0%
突破	3					3	100.0%
任意							0.0%
七米	2					2	100.0%

图式比赛技术统计表

手球
青年男子

5-8名
轮次 5

组别 X
场次 63

晋中体育馆
2019-06-21 17:30

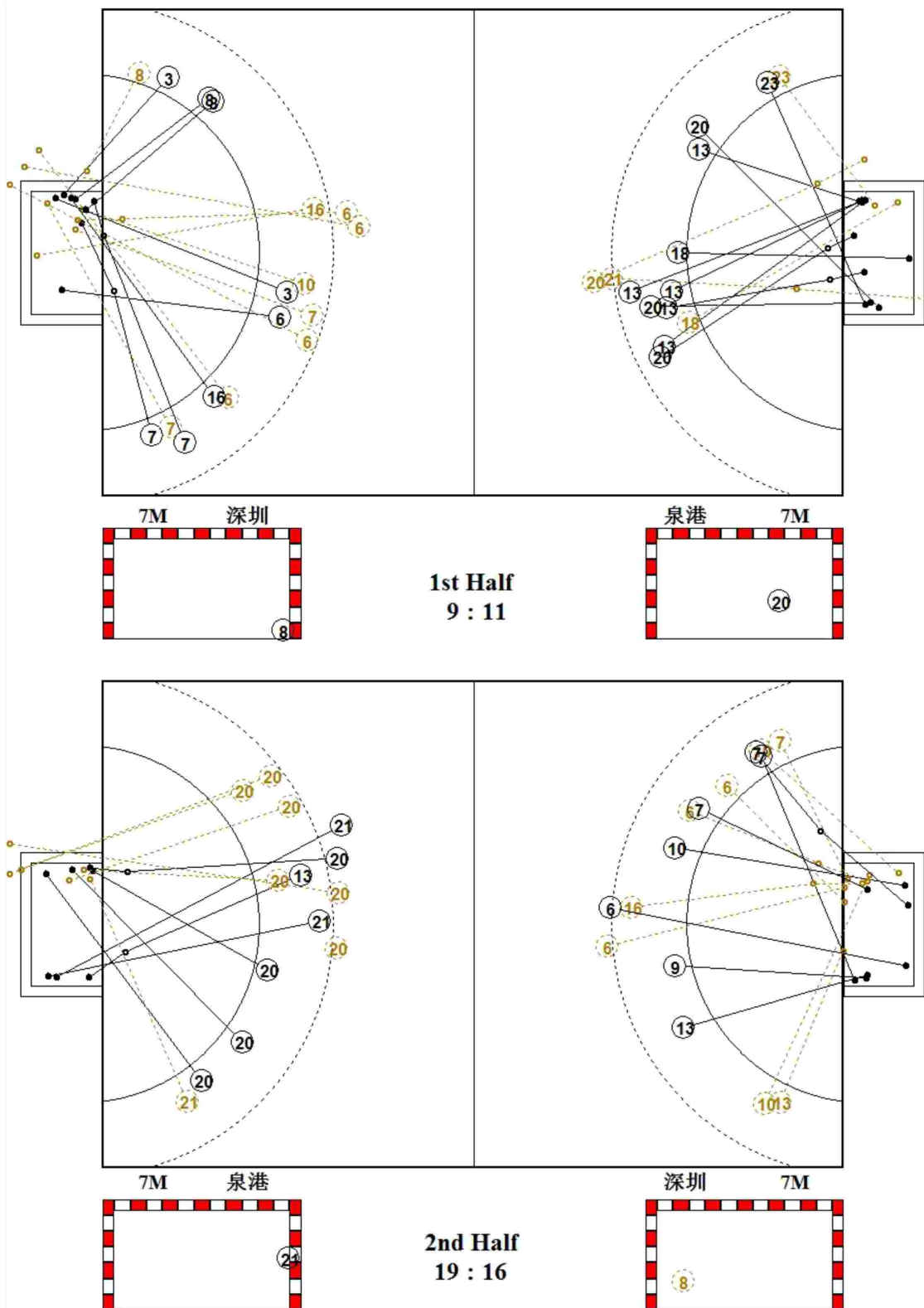

图式射门区域统计

手球
青年男子

5-8名
轮次 5

组别 X
场次 63

晋中体育馆
2019-06-21 17:30

广东深圳

3 李朗轩 <table border="1"><tr><td></td><td></td><td>1</td></tr><tr><td></td><td></td><td>1</td></tr></table> Post - 0 Miss - 0 Block - 0			1			1	5 陈俊延 <table border="1"><tr><td></td><td></td><td></td></tr><tr><td></td><td></td><td></td></tr></table> Post - 0 Miss - 0 Block - 0							6 董佳辉 <table border="1"><tr><td></td><td></td><td>1</td></tr><tr><td>1</td><td></td><td></td></tr></table> Post - 0 Miss - 3 Block - 0			1	1			7 曾繁泳 <table border="1"><tr><td></td><td>1</td><td></td></tr><tr><td>1</td><td></td><td></td></tr><tr><td></td><td></td><td>3</td></tr></table> Post - 0 Miss - 0 Block - 0		1		1					3	8 罗霖泽 <table border="1"><tr><td></td><td></td><td></td></tr><tr><td></td><td></td><td>1</td></tr><tr><td></td><td></td><td>2</td></tr></table> Post - 0 Miss - 1 Block - 0						1			2	9 左典 <table border="1"><tr><td></td><td></td><td></td></tr><tr><td></td><td></td><td>1</td></tr></table> Post - 0 Miss - 0 Block - 0						1	10 李剑琛 <table border="1"><tr><td>1</td><td></td><td></td></tr><tr><td></td><td></td><td></td></tr></table> Post - 0 Miss - 0 Block - 0	1						11 万泽峰 <table border="1"><tr><td></td><td></td><td></td></tr><tr><td></td><td></td><td></td></tr></table> Post - 0 Miss - 0 Block - 0						
		1																																																											
		1																																																											
		1																																																											
1																																																													
	1																																																												
1																																																													
		3																																																											
		1																																																											
		2																																																											
		1																																																											
1																																																													
12 戴景伟 <table border="1"><tr><td></td><td></td><td></td></tr><tr><td></td><td></td><td></td></tr></table> Post - 0 Miss - 0 Block - 0							13 赵世豪 <table border="1"><tr><td></td><td></td><td></td></tr><tr><td></td><td></td><td>1</td></tr></table> Post - 0 Miss - 0 Block - 0						1	15 金硕 <table border="1"><tr><td></td><td></td><td></td></tr><tr><td></td><td></td><td></td></tr></table> Post - 0 Miss - 0 Block - 0							16 谢思远 <table border="1"><tr><td></td><td></td><td></td></tr><tr><td></td><td></td><td>1</td></tr></table> Post - 0 Miss - 0 Block - 0						1	18 曾笑童 <table border="1"><tr><td></td><td></td><td></td></tr><tr><td></td><td></td><td></td></tr></table> Post - 0 Miss - 0 Block - 0							19 齐振东 <table border="1"><tr><td></td><td></td><td></td></tr><tr><td></td><td></td><td></td></tr></table> Post - 0 Miss - 0 Block - 0																										
		1																																																											
		1																																																											

12 戴景伟

0/1	0/1	
1/1		1/4
0/3	0/2	2/5

18 曾笑童

1/1		0/1
0/1	0/1	0/1
0/2		

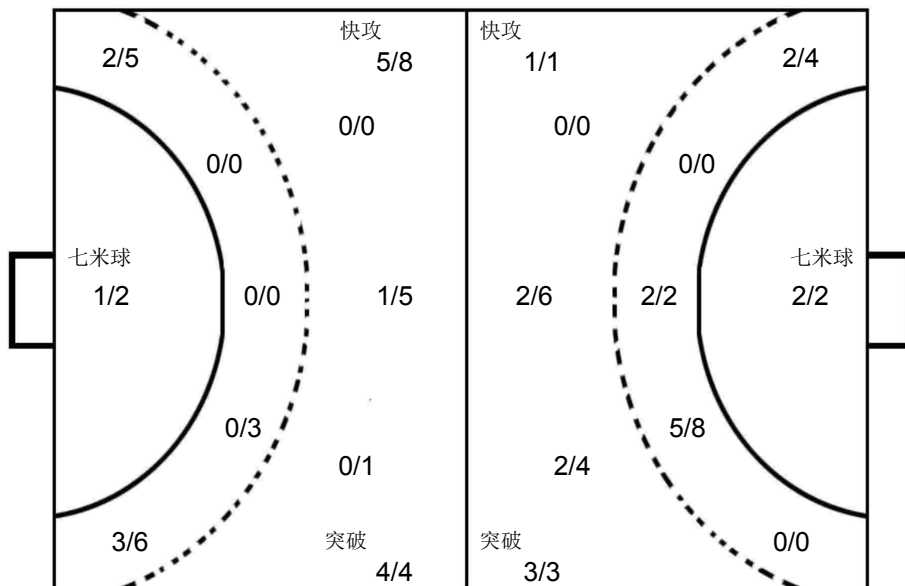

1 周铁程

1/1		

12 汪琪坤

1/2	1/2	1/3
2/4		2/7
4/4		2/7

福建泉港

1 周铁程 <table border="1"><tr><td></td><td></td><td></td></tr><tr><td></td><td></td><td></td></tr></table> Post - 0 Miss - 0 Block - 0							6 段家乐 <table border="1"><tr><td></td><td></td><td></td></tr><tr><td></td><td></td><td></td></tr></table> Post - 0 Miss - 0 Block - 0							7 王嘉靖 <table border="1"><tr><td></td><td></td><td></td></tr><tr><td></td><td></td><td></td></tr></table> Post - 0 Miss - 0 Block - 0							9 周星晨 <table border="1"><tr><td></td><td></td><td></td></tr><tr><td></td><td></td><td></td></tr></table> Post - 0 Miss - 0 Block - 0							10 陈臻 <table border="1"><tr><td></td><td></td><td></td></tr><tr><td></td><td></td><td></td></tr></table> Post - 0 Miss - 0 Block - 0							11 钟宏韬 <table border="1"><tr><td></td><td></td><td></td></tr><tr><td></td><td></td><td></td></tr></table> Post - 0 Miss - 0 Block - 0							12 汪琪坤 <table border="1"><tr><td></td><td></td><td></td></tr><tr><td></td><td></td><td></td></tr></table> Post - 0 Miss - 0 Block - 0							13 周忠迪 <table border="1"><tr><td></td><td></td><td></td></tr><tr><td>5</td><td>1</td><td></td></tr></table> Post - 0 Miss - 0 Block - 0				5	1				
5	1																																																									
15 刘小龙 <table border="1"><tr><td></td><td></td><td></td></tr><tr><td></td><td></td><td></td></tr></table> Post - 0 Miss - 0 Block - 0							17 左兆坤 <table border="1"><tr><td></td><td></td><td></td></tr><tr><td></td><td></td><td></td></tr></table> Post - 0 Miss - 0 Block - 0							18 刘少杰 <table border="1"><tr><td></td><td>1</td><td></td></tr><tr><td></td><td></td><td></td></tr></table> Post - 0 Miss - 0 Block - 0		1					20 吴兆瑞 <table border="1"><tr><td></td><td></td><td>1</td></tr><tr><td></td><td>1</td><td>3</td></tr><tr><td></td><td>1</td><td>2</td></tr></table> Post - 1 Miss - 3 Block - 1			1		1	3		1	2	21 张路 <table border="1"><tr><td>1</td><td></td><td></td></tr><tr><td>1</td><td></td><td>1</td></tr></table> Post - 0 Miss - 1 Block - 0	1			1		1	23 卓世胜 <table border="1"><tr><td></td><td></td><td></td></tr><tr><td></td><td></td><td>1</td></tr></table> Post - 0 Miss - 0 Block - 0						1	25 张杰 <table border="1"><tr><td></td><td></td><td></td></tr><tr><td></td><td></td><td></td></tr></table> Post - 0 Miss - 0 Block - 0							34 王涛 <table border="1"><tr><td></td><td></td><td></td></tr><tr><td></td><td></td><td></td></tr></table> Post - 0 Miss - 0 Block - 0						
	1																																																									
		1																																																								
	1	3																																																								
	1	2																																																								
1																																																										
1		1																																																								
		1																																																								



第二届全国青年运动会男子手球甲组决赛 体校组 (U18)

青年男子 全国比赛

5-8名

Team A A 辽宁体校				Team B B 天津市				Match Number 64			
------------------	--	--	--	-----------------	--	--	--	---------------------------	--	--	--

Played in 山西晋中	in the hall 晋中体育馆	on 2019-06-21	at 18:40	hours	Spectators
-------------------	----------------------	------------------	-------------	-------	------------

Half-time(30')	A 13	B 11	End of playing time	A 23	B 19	1st extra time	A	B	2nd extra time	A	B	After penalty throws	A	B
----------------	---------	---------	---------------------	---------	---------	----------------	---	---	----------------	---	---	----------------------	---	---

Number of 7 m 0/1	Team time-out			Full name of players and officials	Team time-out			B 1/2	Number of 7 m
	1 16:27	2 31:31	3		1 13:41	2 33:13	3		

No.	Team A	G	W	2'	D	DR	No.	Team B	G	W	2'	D	DR
1	何振楠						4	常艳鹏					
2	关贺元	2		1			6	赵晨阳	8				
3	贾博						14	戴云鹏					
4	刘旭	9					17	黄春瑞	2				
5	关棋						19	万朋					
7	姜珺						20	王澎	2				
8	郭嘉尧						23	谭元春					
9	张鹏	4	1	1			24	周亚龙	1	1			
10	王新開		1	1			25	郝一铮	3				
11	颜科研	2					26	李海龙	3				
12	吴禹宽						27	吕华宇					
13	赵子凯						28	孙经纬					
18	祝慧翔昊												
24	邢洪銘	4		1									
29	蒋效峰	2	1										
A	陈宏瑞 (主教练)						A	贾守信					
B	张瑜						B	李志成 (主教练)					
C	罗帅						C	田剑侠					
D	王译						D	潘玉强					

A	Signatures of responsables for the teams (Off.A)												B
---	--	--	--	--	--	--	--	--	--	--	--	--	---

TP	Remarks of referees / HF Official													TP
----	-----------------------------------	--	--	--	--	--	--	--	--	--	--	--	--	----

Referees	许翔 (CHN)	严璐 (CHN)		
T.D.	吴瑞亭 (CHN)	柴业宏 (CHN)		
CHA Off.				

Note: Number of 7m Throws Awarded to Team A and B, Goals (G), Warnings (W), Suspensions (2'), Direct Disqualification (D), Disqualification With Report (DR) and Team Penalty (TP).

Table Officials: 李莉君 孙龙龙 Statisticians: 王梓衡 刘笑





第二届全国青年运动会男子手球甲组决赛 体校组 (U18)

PHMS Pictorial Handball Match Statistics

IHF Official System

竞赛技术统计

手球
青年男子

5-8名
轮次 5

组别 X
场次 64

晋中体育馆
2019-06-21 18:40

Referees:	许翔 (CHN) / 严璐 (CHN)	Result:	23:19(13:11)
Teams:	辽宁体校(辽宁) VS 天津市(天津)		

辽宁		远	近	边	快	突	任意	7m	合计	%	助攻	失误	警告	2'	D+DR
主教练: 陈宏瑞		射	射	射	攻	破	球	球							
1	何振楠														
2	关贺元		2/3					0/1	2/4	50.0				1	
3	贾博														
4	刘旭	8/17					1/1		9/18	50.0		1			
5	关棋														
7	姜珺														
8	郭嘉尧														
9	张鹏	3/4				1/1	0/1		4/6	66.7		2	1	1	
10	王新開										1	2	1	1	
11	颜科研			1/2	1/1				2/3	66.7		2			
12	吴禹宽														
13	赵子凯														
18	祝慧翔昊														
24	邢洪銘	3/5			0/1	1/1			4/7	57.1				1	
29	蒋效峰				1/1	1/1			2/2	100	1	1	1		
运动员 合计		14/26	2/3	1/2	2/3	3/3	1/2	0/1	23/40	57.5	2	8	3	4	
1	何振楠	3/7	0/1	2/3		0/5		1/2	6/18	33.3					
12	吴禹宽	3/5	2/3	2/2		1/4	0/1		8/15	53.3					
守门员 合计		6/12	2/4	4/5		1/9	0/1	1/2	14/33	42.4					

天津		远	近	边	快	突	任意	7m	合计	%	助攻	失误	警告	2'	D+DR
主教练: 李志成		射	射	射	攻	破	球	球							
4	常艳鹏														
6	赵晨阳	2/7				4/5	1/1	1/1	8/14	57.1	1	3			
14	戴云鹏														
17	黄春瑞	1/2	1/3						2/5	40.0	1	3			
19	万朋										1	1			
20	王澎	0/1		0/4		2/2			2/7	28.6					
23	谭元春														
24	周亚龙		0/1	1/1					1/2	50.0			1		
25	郝一铮	1/2	1/1			1/1			3/4	75.0	1	2			
26	李海龙	2/4				1/1		0/1	3/6	50.0		2			
27	吕华宇														
28	孙经纬														
运动员 合计		6/16	2/5	1/5		8/9	1/1	1/2	19/38	50.0	4	11	1		
23	谭元春	6/20	1/3	0/1	0/2	0/3	0/1		7/30	23.3					
守门员 合计		6/20	1/3	0/1	0/2	0/3	0/1		7/30	23.3					

辽宁	比赛 进程	天津
1st Half		
9 张鹏	1 00:32	0
4 刘旭	1 01:38	1 6 赵晨阳
24 邢洪銘	2 02:10	1
	3 03:12	1
	3 03:48	2 20 王澎
	3 04:29	3 26 李海龙
24 邢洪銘	4 04:43	3
24 邢洪銘	5 06:09	3
	5 07:14	4 6 赵晨阳
	5 07:41	5 20 王澎
4 刘旭	6 08:17	5
2 关贺元	7 09:16	5
	7 10:41	6 25 郝一铮
2 关贺元	8 12:11	6
4 刘旭	9 13:39	6
	9 13:55	7 17 黄春瑞
4 刘旭	10 14:23	7
	10 15:09	8 6 赵晨阳
24 邢洪銘	11 16:49	8
	11 17:28	9 26 李海龙
4 刘旭	12 17:52	9
	12 18:42	10 6 赵晨阳
11 颜科研	13 18:49	10
	13 19:43	11 24 周亚龙
2nd Half		
	13 00:19	12 6 赵晨阳
	13 01:13	13 17 黄春瑞
9 张鹏	14 01:30	13
	14 01:40	14 6 赵晨阳
	14 03:55	15 6 赵晨阳
29 蒋效峰	15 04:04	15
4 刘旭	16 05:01	15
	16 06:34	16 6 赵晨阳
29 蒋效峰	17 06:43	16
	17 07:56	17 25 郝一铮
4 刘旭	18 11:49	17
	18 12:15	18 26 李海龙
9 张鹏	19 12:27	18
4 刘旭	20 13:13	18
4 刘旭	21 18:00	18
11 颜科研	22 18:43	18
	22 19:05	19 25 郝一铮
9 张鹏	23 19:41	19

场上队员: 得分 / 射门

守门员: 救球 / 射门

D	取消资格	DR	取消资格+报告
---	------	----	---------



个人/全队技术统计表

手球 5-8名 组别 X 晋中体育馆
青年男子 轮次 5 场次 64 2019-06-21 18:40

号码	姓名	远射	近射	边射	快攻	突破	任意	七米	合计	%	助攻	失误	警告	2'	取消	时间
辽宁体校(辽宁)																
(场上队员)																
1	何振楠									0.0%						00:15:35
2	关贺元		2/3					0/1	2/4	50.0%				1		00:40:00
3	贾博									0.0%						00:00:00
4	刘旭	8/17					1/1		9/18	50.0%		1				00:40:00
5	关棋									0.0%						00:00:00
7	姜珺									0.0%						00:00:00
8	郭嘉尧									0.0%						00:00:00
9	张鹏	3/4				1/1	0/1		4/6	66.7%		2	1	1		00:40:00
10	王新開									0.0%	1	2	1	1		00:36:55
11	颜科研			1/2	1/1				2/3	66.7%		2				00:40:00
12	吴禹宽									0.0%						00:24:25
13	赵子凯									0.0%						00:00:00
18	祝慧翔昊									0.0%						00:00:00
24	邢洪銘	3/5			0/1	1/1			4/7	57.1%				1		00:21:29
29	蒋效峰				1/1	1/1			2/2	100%	1	1	1			00:21:26
合计		14/26	2/3	1/2	2/3	3/3	1/2	0/1	23/40	57.5%	2	8	3	4		
(守门员)																
1	何振楠	3/7	0/1	2/3		0/5		1/2	6/18	33.3%						00:15:35
12	吴禹宽	3/5	2/3	2/2		1/4	0/1		8/15	53.3%						00:24:25
合计		6/12	2/4	4/5		1/9	0/1	1/2	14/33	42.4%						

场上队员： 得分/射门

守门员： 救球/射门

全队合计	得分	被救	射失	击柱	封球	合计	%
远射	14	6	5		1	26	53.8%
近射	2	1				3	66.7%
边射	1		1			2	50.0%
快攻	2			1		3	66.7%
突破	3					3	100.0%
任意	1		1			2	50.0%
七米				1		1	0.0%

第二届全国青年运动会男子手球甲组决赛 体校组 (U18)

个人/全队技术统计表

手球 青年男子 5-8名 轮次 5 组别 X 场次 64 晋中体育馆 2019-06-21 18:40

号码	姓名	远射	近射	边射	快攻	突破	任意	七米	合计	%	助攻	失误	警告	2'	取消	时间
天津市(天津)																
(场上队员)																
4	常艳鹏									0.0%						00:00:00
6	赵晨阳	2/7				4/5	1/1	1/1	8/14	57.1%	1	3				00:40:00
14	戴云鹏									0.0%						00:00:00
17	黄春瑞	1/2	1/3						2/5	40.0%	1	3				00:40:00
19	万朋									0.0%	1	1				00:03:35
20	王澎	0/1		0/4		2/2			2/7	28.6%						00:36:22
23	谭元春									0.0%						00:40:00
24	周亚龙		0/1	1/1					1/2	50.0%			1			00:40:00
25	郝一铮	1/2	1/1			1/1			3/4	75.0%	1	2				00:40:00
26	李海龙	2/4				1/1		0/1	3/6	50.0%		2				00:40:00
27	吕华宇									0.0%						00:00:00
28	孙经纬									0.0%						00:00:00
合计		6/16	2/5	1/5		8/9	1/1	1/2	19/38	50.0%	4	11	1			
(守门员)																
23	谭元春	6/20	1/3	0/1	0/2	0/3	0/1		7/30	23.3%						00:40:00
合计		6/20	1/3	0/1	0/2	0/3	0/1		7/30	23.3%						

场上队员： 得分/射门

守门员： 救球/射门

全队合计	得分	被救	射失	击柱	封球	合计	%
远射	6	6	2	2		16	37.5%
近射	2	2		1		5	40.0%
边射	1	4				5	20.0%
快攻							0.0%
突破	8	1				9	88.9%
任意	1					1	100.0%
七米	1	1				2	50.0%

图式比赛技术统计表

手球
青年男子

5-8名
轮次 5

组别 X
场次 64

晋中体育馆
2019-06-21 18:40

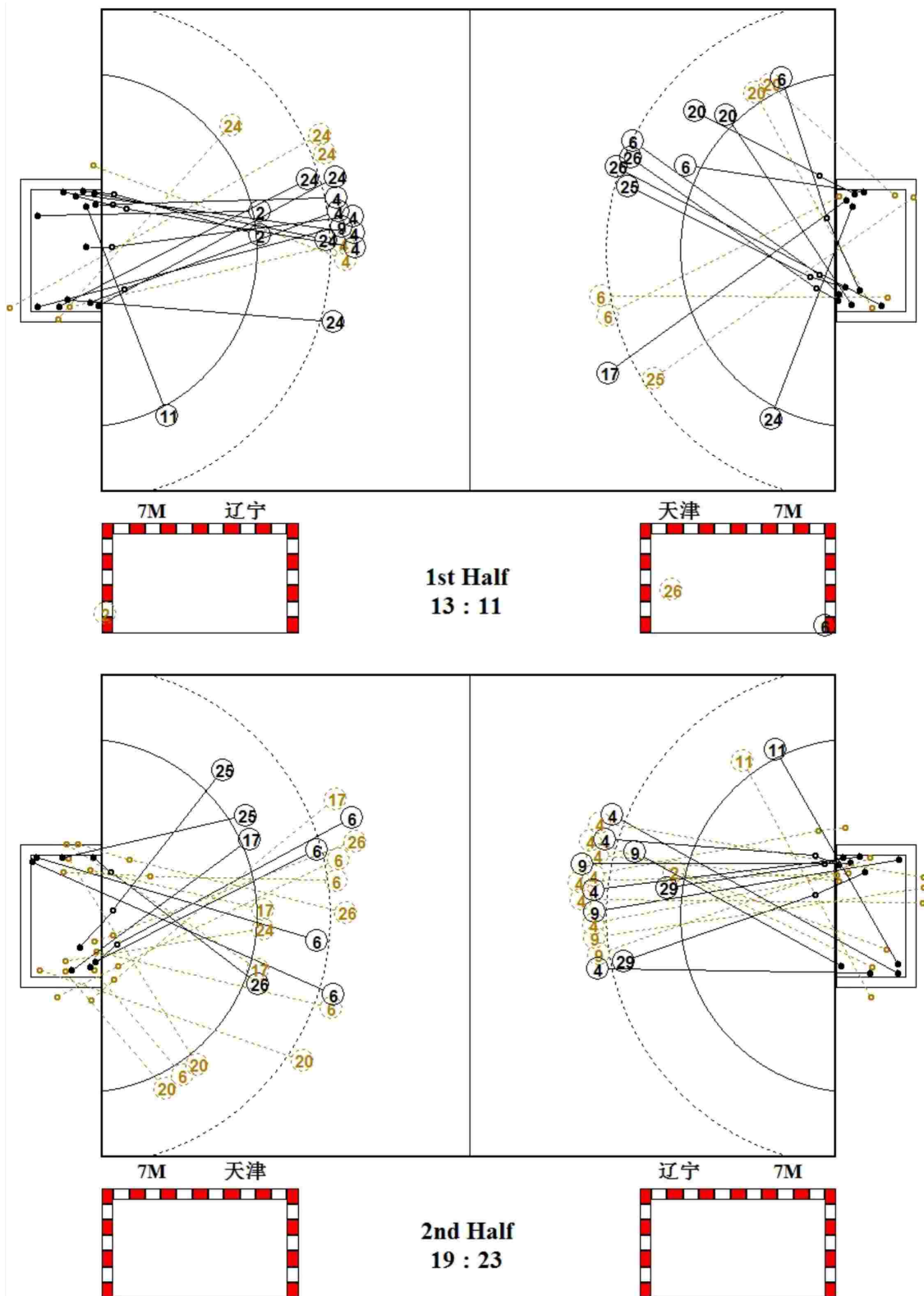

图式射门区域统计

手球
青年男子

5-8名
轮次 5

组别 X
场次 64

晋中体育馆
2019-06-21 18:40

辽宁体校

1 何振楠 <table border="1"><tr><td></td><td></td><td></td></tr><tr><td></td><td></td><td></td></tr><tr><td></td><td></td><td></td></tr></table> Post - 0 Miss - 0 Block - 0										2 关贺元 <table border="1"><tr><td></td><td></td><td>1</td></tr><tr><td></td><td></td><td></td></tr><tr><td></td><td></td><td>1</td></tr></table> Post - 1 Miss - 0 Block - 0			1						1	3 贾博 <table border="1"><tr><td></td><td></td><td></td></tr><tr><td></td><td></td><td></td></tr><tr><td></td><td></td><td></td></tr></table> Post - 0 Miss - 0 Block - 0										4 刘旭 <table border="1"><tr><td></td><td></td><td>1</td></tr><tr><td>1</td><td></td><td>3</td></tr><tr><td>2</td><td>1</td><td>1</td></tr></table> Post - 0 Miss - 4 Block - 0			1	1		3	2	1	1	5 关棋 <table border="1"><tr><td></td><td></td><td></td></tr><tr><td></td><td></td><td></td></tr><tr><td></td><td></td><td></td></tr></table> Post - 0 Miss - 0 Block - 0										7 姜璐 <table border="1"><tr><td></td><td></td><td></td></tr><tr><td></td><td></td><td></td></tr><tr><td></td><td></td><td></td></tr></table> Post - 0 Miss - 0 Block - 0										8 郭嘉尧 <table border="1"><tr><td></td><td></td><td></td></tr><tr><td></td><td></td><td></td></tr><tr><td></td><td></td><td></td></tr></table> Post - 0 Miss - 0 Block - 0										9 张鹏 <table border="1"><tr><td>2</td><td></td><td></td></tr><tr><td></td><td></td><td></td></tr><tr><td>1</td><td></td><td>1</td></tr></table> Post - 0 Miss - 1 Block - 0	2						1		1
		1																																																																													
		1																																																																													
		1																																																																													
1		3																																																																													
2	1	1																																																																													
2																																																																															
1		1																																																																													
10 王新開 <table border="1"><tr><td></td><td></td><td></td></tr><tr><td></td><td></td><td></td></tr><tr><td></td><td></td><td></td></tr></table> Post - 0 Miss - 0 Block - 0										11 颜科研 <table border="1"><tr><td></td><td></td><td>1</td></tr><tr><td></td><td></td><td></td></tr><tr><td></td><td></td><td>1</td></tr></table> Post - 0 Miss - 1 Block - 0			1						1	12 吴禹宽 <table border="1"><tr><td></td><td></td><td></td></tr><tr><td></td><td></td><td></td></tr><tr><td></td><td></td><td></td></tr></table> Post - 0 Miss - 0 Block - 0										13 赵子凯 <table border="1"><tr><td></td><td></td><td></td></tr><tr><td></td><td></td><td></td></tr><tr><td></td><td></td><td></td></tr></table> Post - 0 Miss - 0 Block - 0										18 祝慧翔昊 <table border="1"><tr><td></td><td></td><td></td></tr><tr><td></td><td></td><td></td></tr><tr><td></td><td></td><td></td></tr></table> Post - 0 Miss - 0 Block - 0										24 邢洪銘 <table border="1"><tr><td></td><td></td><td></td></tr><tr><td>2</td><td></td><td></td></tr><tr><td>1</td><td></td><td>1</td></tr></table> Post - 1 Miss - 1 Block - 1				2			1		1	29 蒋效峰 <table border="1"><tr><td></td><td></td><td></td></tr><tr><td></td><td></td><td></td></tr><tr><td>1</td><td></td><td></td></tr></table> Post - 0 Miss - 0 Block - 0							1												
		1																																																																													
		1																																																																													
2																																																																															
1		1																																																																													
1																																																																															

1 何振楠

1/1		1/4
1/3		1/2
2/4		0/4

12 吴禹宽

1/1		
2/2		2/3
2/6		1/3

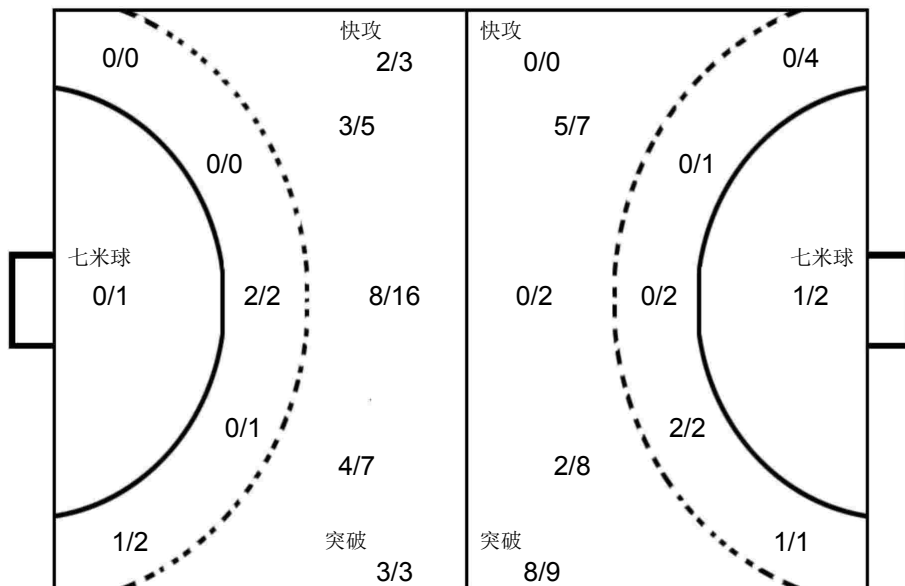

23 谭元春

0/2		1/4
2/6		1/4
3/8	0/1	0/5

天津市

4 常艳鹏 <table border="1"><tr><td></td><td></td><td></td></tr><tr><td></td><td></td><td></td></tr><tr><td></td><td></td><td></td></tr></table> Post - 0 Miss - 0 Block - 0										6 赵晨阳 <table border="1"><tr><td></td><td></td><td>2</td></tr><tr><td>1</td><td></td><td>1</td></tr><tr><td>2</td><td></td><td>2</td></tr></table> Post - 0 Miss - 1 Block - 0			2	1		1	2		2	14 戴云鹏 <table border="1"><tr><td></td><td></td><td></td></tr><tr><td></td><td></td><td></td></tr><tr><td></td><td></td><td></td></tr></table> Post - 0 Miss - 0 Block - 0										17 黄春瑞 <table border="1"><tr><td></td><td></td><td></td></tr><tr><td>1</td><td></td><td></td></tr><tr><td>1</td><td></td><td></td></tr></table> Post - 1 Miss - 1 Block - 0				1			1			19 万朋 <table border="1"><tr><td></td><td></td><td></td></tr><tr><td></td><td></td><td></td></tr><tr><td></td><td></td><td></td></tr></table> Post - 0 Miss - 0 Block - 0										20 王澎 <table border="1"><tr><td></td><td></td><td></td></tr><tr><td></td><td></td><td></td></tr><tr><td>1</td><td></td><td>1</td></tr></table> Post - 0 Miss - 0 Block - 0							1		1	23 谭元春 <table border="1"><tr><td></td><td></td><td></td></tr><tr><td></td><td></td><td></td></tr><tr><td></td><td></td><td></td></tr></table> Post - 0 Miss - 0 Block - 0										24 周亚龙 <table border="1"><tr><td></td><td></td><td></td></tr><tr><td></td><td></td><td></td></tr><tr><td>1</td><td></td><td></td></tr></table> Post - 0 Miss - 0 Block - 0							1		
		2																																																																													
1		1																																																																													
2		2																																																																													
1																																																																															
1																																																																															
1		1																																																																													
1																																																																															
25 郝一铮 <table border="1"><tr><td></td><td></td><td></td></tr><tr><td></td><td></td><td>1</td></tr><tr><td>1</td><td></td><td>1</td></tr></table> Post - 1 Miss - 0 Block - 0						1	1		1	26 李海龙 <table border="1"><tr><td></td><td></td><td>1</td></tr><tr><td></td><td></td><td></td></tr><tr><td></td><td></td><td>2</td></tr></table> Post - 1 Miss - 0 Block - 0			1						2	27 吕华宇 <table border="1"><tr><td></td><td></td><td></td></tr><tr><td></td><td></td><td></td></tr><tr><td></td><td></td><td></td></tr></table> Post - 0 Miss - 0 Block - 0										28 孙经纬 <table border="1"><tr><td></td><td></td><td></td></tr><tr><td></td><td></td><td></td></tr><tr><td></td><td></td><td></td></tr></table> Post - 0 Miss - 0 Block - 0																																																	
		1																																																																													
1		1																																																																													
		1																																																																													
		2																																																																													



第二届全国青年运动会男子手球甲组决赛 体校组 (U18)

青年男子 全国比赛

7-8名

PHMS Pictorial Handball Match Statistics IHF Official System

Team A A 广东深圳				Team B B 天津市				Match Number 79			
------------------	--	--	--	-----------------	--	--	--	---------------------------	--	--	--

Played in 山西晋中	in the hall 晋中体育馆	on 2019-06-22	at 17:30	hours	Spectators
-------------------	----------------------	------------------	-------------	-------	------------

Half-time(30')	A 9	B 7	End of playing time	A 20	B 14	1st extra time	A	B	2nd extra time	A	B	After penalty throws	A	B
----------------	--------	--------	---------------------	---------	---------	----------------	---	---	----------------	---	---	----------------------	---	---

Number of 7 m 0/1	Team time-out			Full name of players and officials	Team time-out			B 1/1	Number of 7 m
	1 08:28	2 29:54	3		1 16:57	2 27:31	3		

No.	Team A	G	W	2'	D	DR	No.	Team B	G	W	2'	D	DR
3	李朗轩						4	常艳鹏					
5	陈俊延						6	赵晨阳	6				
6	董佳辉	7					10	黄嘉俊					
7	曾繁泳	4					14	戴云鹏					
8	罗霖泽	2	1	2			17	黄春瑞		1			
9	左典	5					19	万朋					
10	李剑琛	1		1			20	王澎	1				
11	万泽峰						23	谭元春					
12	戴景伟						24	周亚龙					
13	赵世豪						25	郝一铮					
15	金硕						26	李海龙	7				
16	谢思远	1					27	吕华宇					
18	曾笑童												
19	齐振东												
A	张斌						A	贾守信					
C	李中洲 (主教练)						B	李志成 (主教练)					
D	张广建						C	田剑侠					
F	蒋光华						D	潘玉强					

A	Signatures of responsables for the teams (Off.A)												B
---	--	--	--	--	--	--	--	--	--	--	--	--	---

TP	Remarks of referees / HF Official													TP
----	-----------------------------------	--	--	--	--	--	--	--	--	--	--	--	--	----

Referees	王亚光 (CHN)	康曦 (CHN)		
T.D.	许宜扬 (CHN)	叶霄雪 (CHN)		
CHA Off.				

Note: Number of 7m Throws Awarded to Team A and B, Goals (G), Warnings (W), Suspensions (2'), Direct Disqualification (D), Disqualification With Report (DR) and Team Penalty (TP).

Table Officials: 宣海波 张琦 Statisticians: 王梓衡 刘笑

第二届全国青年运动会男子手球甲组决赛 体校组 (U18)

PHMS Pictorial Handball Match Statistics

IHF Official System

竞赛技术统计

手球
青年男子

7-8名
轮次 6

组别 X
场次 79

晋中体育馆
2019-06-22 17:30

Referees:	王亚光 (CHN) / 康曦 (CHN)	Result:	20:14(9:7)
Teams:	广东深圳(深圳) VS 天津市(天津)		

深圳		远	近	边	快	突	任意	7m	合计	%	助攻	失误	警告	2'	D+DR	深圳		天津	
主教练: 李中洲		射	射	射	攻	破	球	球								比赛 进程		天津	
3	李朗轩		0/1						0/1	0.0						1st Half			
5	陈俊延															1 01:08 0			
6	董佳辉	2/5	2/4			3/3		0/1	7/13	53.8		1				2 03:57 0		6 赵晨阳	
7	曾繁泳	1/2		2/3	1/2				4/7	57.1		1				3 05:52 1		26 李海龙	
8	罗霖泽			2/4					2/4	50.0	1	2	1	2		3 08:24 2 6 赵晨阳		6 董佳辉	
9	左典	4/5				1/1			5/6	83.3						4 12:02 3		26 李海龙	
10	李剑琛				1/2				1/2	50.0		2		1		4 14:06 4 26 李海龙		6 董佳辉	
11	万泽峰															5 14:45 4		5 26 李海龙	
12	戴景伟															5 15:59 5		9 左典	
13	赵世豪															6 16:35 5		10 李剑琛	
15	金硕											1				7 16:53 5		6 董佳辉	
16	谢思远	0/1				1/1			1/2	50.0		2				7 17:10 6 6 赵晨阳		7 左典	
18	曾笑童															8 18:03 6		8 罗霖泽	
19	齐振东															8 18:40 7 6 赵晨阳		9 左典	
运动员 合计		7/13	2/5	4/7	2/4	5/5		0/1	20/35	57.1	1	9	1	3		9 19:30 7		7 曾繁泳	
12	戴景伟	4/6	2/5		0/1	1/6	0/2	0/1	7/21	33.3						9 00:52 8 26 李海龙		10 戴景伟	
守门员 合计		4/6	2/5		0/1	1/6	0/2	0/1	7/21	33.3						10 02:32 8		10 曾繁泳	
天津		远	近	边	快	突	任意	7m	合计	%	助攻	失误	警告	2'	D+DR	10 02:49 9 26 李海龙			
主教练: 李志成		射	射	射	攻	破	球	球								10 03:22 9			
4	常艳鹏															10 04:49 9		9 左典	
6	赵晨阳	0/2	2/4			1/3	2/2	1/1	6/12	50.0		3				11 03:22 9		8 罗霖泽	
10	黄嘉俊															12 03:46 9		7 曾繁泳	
14	戴云鹏															13 06:32 9		16 谢思远	
17	黄春瑞		0/1						0/1	0.0		3	1			14 07:27 9		9 左典	
19	万朋															15 07:50 9		15 曾繁泳	
20	王澎	0/1			1/1				1/2	50.0		1				15 09:27 10 20 王澎		16 戴景伟	
23	谭元春															16 10:13 10		17 曾繁泳	
24	周亚龙			0/1					0/1	0.0		3				17 12:47 10		9 左典	
25	郝一铮											1				18 13:56 10		18 戴景伟	
26	李海龙	2/5	1/2			4/5			7/12	58.3		2				18 14:08 11 6 赵晨阳		18 戴景伟	
27	吕华宇															18 17:05 12 26 李海龙		19 曾繁泳	
运动员 合计		2/8	3/7	0/1	1/1	5/8	2/2	1/1	14/28	50.0		13	1			19 17:40 12		6 董佳辉	
23	谭元春	4/11	0/2	2/6	0/2	0/5		1/1	7/27	25.9						19 17:50 13 6 赵晨阳		19 曾繁泳	
守门员 合计		4/11	0/2	2/6	0/2	0/5		1/1	7/27	25.9						19 19:01 14 26 李海龙		6 董佳辉	

场上队员: 得分 / 射门

守门员: 救球 / 射门

D	取消资格	DR	取消资格+报告
---	------	----	---------



个人/全队技术统计表

手球 7-8名 组别 X 晋中体育馆
 青年男子 轮次 6 场次 79 2019-06-22 17:30

号码	姓名	远射	近射	边射	快攻	突破	任意	七米	合计	%	助攻	失误	警告	2'	取消	时间
广东深圳(深圳)																
(场上队员)																
3	李朗轩		0/1						0/1	0.0%						00:17:21
5	陈俊延									0.0%						00:00:00
6	董佳辉	2/5	2/4			3/3		0/1	7/13	53.8%	1					00:40:00
7	曾繁泳	1/2		2/3	1/2				4/7	57.1%		1				00:31:15
8	罗霖泽			2/4					2/4	50.0%	1	2	1	2		00:39:59
9	左典	4/5				1/1			5/6	83.3%						00:39:53
10	李剑琛				1/2				1/2	50.0%		2		1		00:37:54
11	万泽峰									0.0%						00:00:00
12	戴景伟									0.0%						00:40:00
13	赵世豪									0.0%						00:00:00
15	金硕									0.0%		1				00:03:35
16	谢思远	0/1				1/1			1/2	50.0%		2				00:30:03
18	曾笑童									0.0%						00:00:00
19	齐振东									0.0%						00:00:00
	合计	7/13	2/5	4/7	2/4	5/5		0/1	20/35	57.1%	1	9	1	3		
(守门员)																
12	戴景伟	4/6	2/5		0/1	1/6	0/2	0/1	7/21	33.3%						00:40:00
	合计	4/6	2/5		0/1	1/6	0/2	0/1	7/21	33.3%						

场上队员：得分/射门

守门员：救球/射门

全队合计	得分	被救	射失	击柱	封球	合计	%
远射	7	4	1	1		13	53.8%
近射	2		2	1		5	40.0%
边射	4	2	1			7	57.1%
快攻	2		1	1		4	50.0%
突破	5					5	100.0%
任意							0.0%
七米		1				1	0.0%

第二届全国青年运动会男子手球甲组决赛 体校组 (U18)

个人/全队技术统计表

手球 7-8名 组别 X 晋中体育馆
青年男子 轮次 6 场次 79 2019-06-22 17:30

号码	姓名	远射	近射	边射	快攻	突破	任意	七米	合计	%	助攻	失误	警告	2'	取消	时间
天津市(天津)																
(场上队员)																
4	常艳鹏									0.0%						00:00:00
6	赵晨阳	0/2	2/4			1/3	2/2	1/1	6/12	50.0%		3				00:40:00
10	黄嘉俊									0.0%						00:00:00
14	戴云鹏									0.0%						00:00:00
17	黄春瑞		0/1						0/1	0.0%		3	1			00:37:37
19	万朋									0.0%						00:00:00
20	王澎	0/1			1/1				1/2	50.0%		1				00:40:00
23	谭元春									0.0%						00:40:00
24	周亚龙			0/1					0/1	0.0%		3				00:40:00
25	郝一铮									0.0%		1				00:40:00
26	李海龙	2/5	1/2			4/5			7/12	58.3%		2				00:40:00
27	吕华宇									0.0%						00:02:21
合计		2/8	3/7	0/1	1/1	5/8	2/2	1/1	14/28	50.0%		13	1			
(守门员)																
23	谭元春	4/11	0/2	2/6	0/2	0/5		1/1	7/27	25.9%						00:40:00
合计		4/11	0/2	2/6	0/2	0/5		1/1	7/27	25.9%						

场上队员： 得分/射门

守门员： 救球/射门

全队合计	得分	被救	射失	击柱	封球	合计	%
远射	2	4		1	1	8	25.0%
近射	3	2	2			7	42.9%
边射			1			1	0.0%
快攻	1					1	100.0%
突破	5	1	2			8	62.5%
任意	2					2	100.0%
七米	1					1	100.0%

图式比赛技术统计表

手球
青年男子

7-8名
轮次 6

组别 X
场次 79

晋中体育馆
2019-06-22 17:30

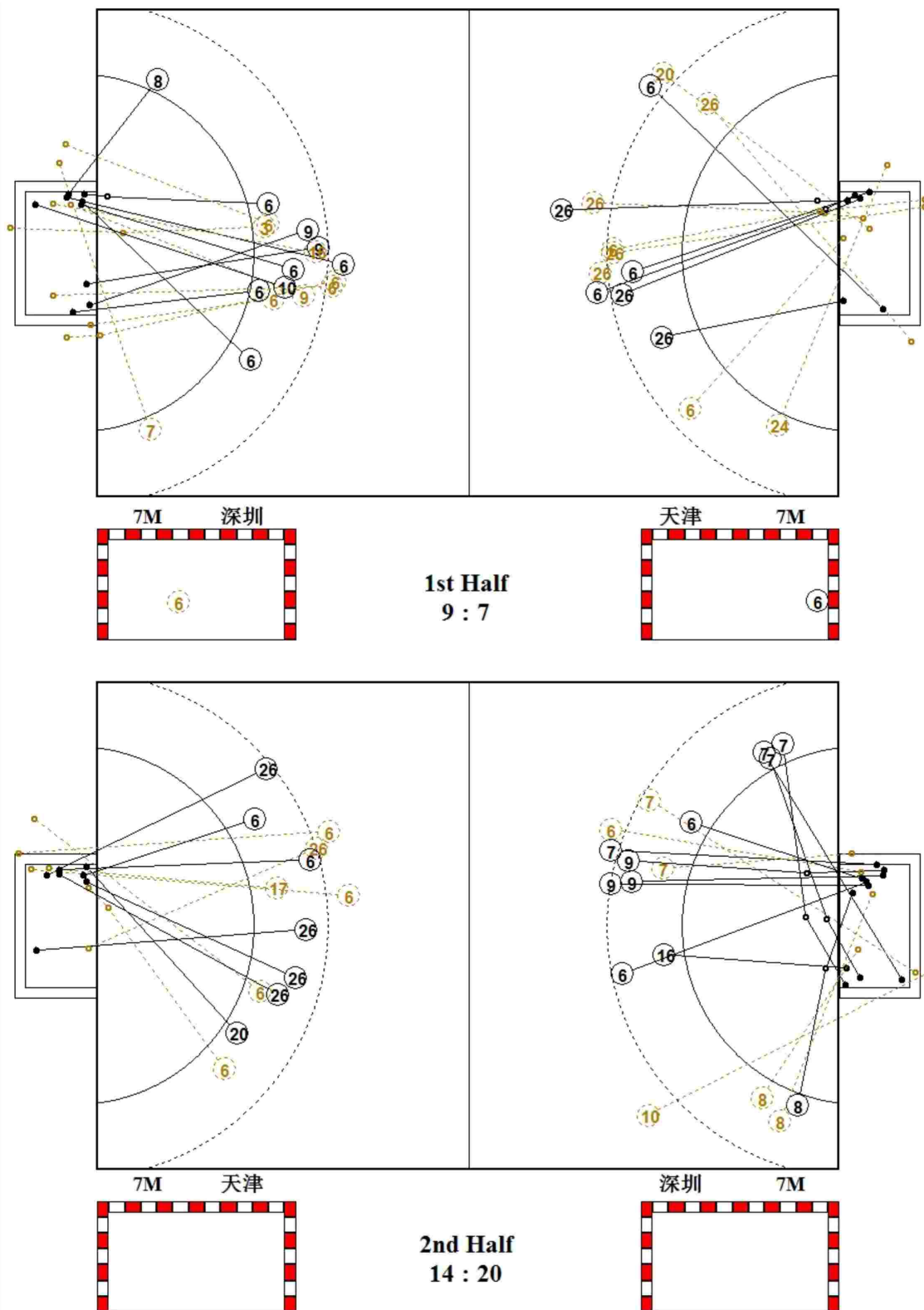

图式射门区域统计

手球
青年男子

7-8名
轮次 6

组别 X
场次 79

晋中体育馆
2019-06-22 17:30

广东深圳

3 李朗轩	5 陈俊延	6 董佳辉	7 曾繁泳	8 罗霖泽	9 左典	10 李剑琛	11 万泽峰																																																																								
<table border="1"><tr><td></td><td></td><td></td></tr><tr><td></td><td></td><td></td></tr><tr><td></td><td></td><td></td></tr></table>										<table border="1"><tr><td></td><td></td><td></td></tr><tr><td></td><td></td><td></td></tr><tr><td></td><td></td><td></td></tr></table>										<table border="1"><tr><td></td><td></td><td></td></tr><tr><td>3</td><td></td><td>1</td></tr><tr><td></td><td></td><td>3</td></tr></table>				3		1			3	<table border="1"><tr><td></td><td></td><td>1</td></tr><tr><td>1</td><td></td><td></td></tr><tr><td></td><td></td><td>2</td></tr></table>			1	1					2	<table border="1"><tr><td></td><td></td><td></td></tr><tr><td></td><td></td><td>1</td></tr><tr><td>1</td><td></td><td></td></tr></table>						1	1			<table border="1"><tr><td></td><td></td><td></td></tr><tr><td>3</td><td></td><td></td></tr><tr><td>2</td><td></td><td></td></tr></table>				3			2			<table border="1"><tr><td></td><td></td><td>1</td></tr><tr><td></td><td></td><td></td></tr><tr><td></td><td></td><td></td></tr></table>			1							<table border="1"><tr><td></td><td></td><td></td></tr><tr><td></td><td></td><td></td></tr><tr><td></td><td></td><td></td></tr></table>									
3		1																																																																													
		3																																																																													
		1																																																																													
1																																																																															
		2																																																																													
		1																																																																													
1																																																																															
3																																																																															
2																																																																															
		1																																																																													
Post - 0 Miss - 1 Block - 0	Post - 0 Miss - 0 Block - 0	Post - 1 Miss - 2 Block - 0	Post - 2 Miss - 1 Block - 0	Post - 0 Miss - 0 Block - 0	Post - 0 Miss - 0 Block - 0	Post - 0 Miss - 1 Block - 0	Post - 0 Miss - 0 Block - 0																																																																								

12 戴景伟	13 赵世豪	15 金硕	16 谢思远	18 曾笑童	19 齐振东																																																						
<table border="1"><tr><td></td><td></td><td></td></tr><tr><td></td><td></td><td></td></tr><tr><td></td><td></td><td></td></tr></table>										<table border="1"><tr><td></td><td></td><td></td></tr><tr><td></td><td></td><td></td></tr><tr><td></td><td></td><td></td></tr></table>										<table border="1"><tr><td></td><td></td><td></td></tr><tr><td></td><td></td><td></td></tr><tr><td></td><td></td><td></td></tr></table>										<table border="1"><tr><td></td><td></td><td></td></tr><tr><td></td><td></td><td>1</td></tr><tr><td></td><td></td><td></td></tr></table>						1				<table border="1"><tr><td></td><td></td><td></td></tr><tr><td></td><td></td><td></td></tr><tr><td></td><td></td><td></td></tr></table>										<table border="1"><tr><td></td><td></td><td></td></tr><tr><td></td><td></td><td></td></tr><tr><td></td><td></td><td></td></tr></table>									
		1																																																									
Post - 0 Miss - 0 Block - 0	Post - 0 Miss - 0 Block - 0	Post - 0 Miss - 0 Block - 0	Post - 0 Miss - 0 Block - 0	Post - 0 Miss - 0 Block - 0	Post - 0 Miss - 0 Block - 0																																																						

12 戴景伟

0/1		2/3
2/3		0/4
1/4	1/1	1/5

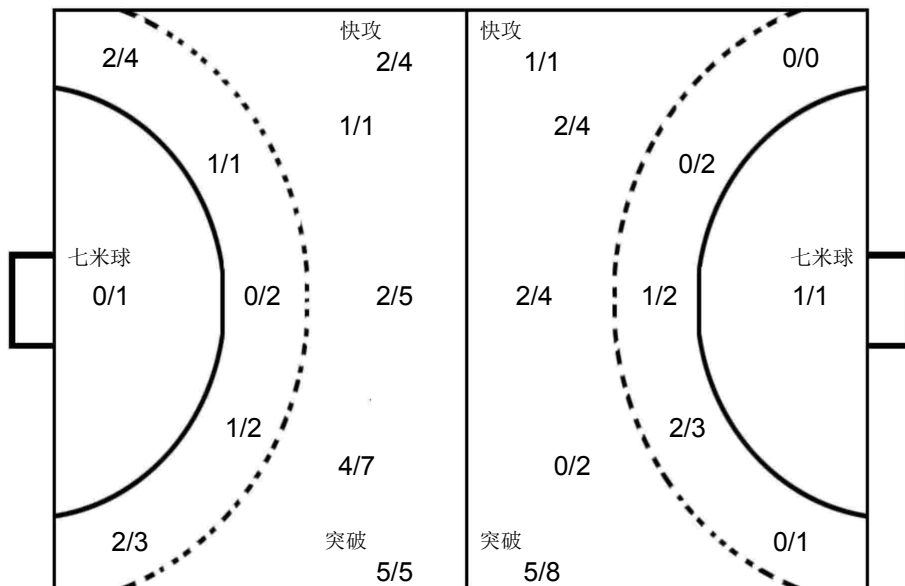

23 谭元春

		0/2
2/9	1/1	2/4
1/4		1/7

天津市

4 常艳鹏	6 赵晨阳	10 黄嘉俊	14 戴云鹏	17 黄春瑞	19 万朋	20 王澎	23 谭元春																																																																								
<table border="1"><tr><td></td><td></td><td></td></tr><tr><td></td><td></td><td></td></tr><tr><td></td><td></td><td></td></tr></table>										<table border="1"><tr><td></td><td></td><td></td></tr><tr><td>1</td><td></td><td>3</td></tr><tr><td>1</td><td></td><td>1</td></tr></table>				1		3	1		1	<table border="1"><tr><td></td><td></td><td></td></tr><tr><td></td><td></td><td></td></tr><tr><td></td><td></td><td></td></tr></table>										<table border="1"><tr><td></td><td></td><td></td></tr><tr><td></td><td></td><td></td></tr><tr><td></td><td></td><td></td></tr></table>										<table border="1"><tr><td></td><td></td><td></td></tr><tr><td></td><td></td><td></td></tr><tr><td></td><td></td><td></td></tr></table>										<table border="1"><tr><td></td><td></td><td></td></tr><tr><td></td><td></td><td></td></tr><tr><td></td><td></td><td></td></tr></table>										<table border="1"><tr><td></td><td></td><td></td></tr><tr><td></td><td></td><td></td></tr><tr><td></td><td></td><td>1</td></tr></table>									1	<table border="1"><tr><td></td><td></td><td></td></tr><tr><td></td><td></td><td></td></tr><tr><td></td><td></td><td></td></tr></table>									
1		3																																																																													
1		1																																																																													
		1																																																																													
Post - 0 Miss - 0 Block - 0	Post - 1 Miss - 2 Block - 0	Post - 0 Miss - 0 Block - 0	Post - 0 Miss - 0 Block - 0	Post - 0 Miss - 0 Block - 0	Post - 0 Miss - 0 Block - 0	Post - 0 Miss - 0 Block - 0	Post - 0 Miss - 0 Block - 0																																																																								

24 周亚龙	25 郝一铮	26 李海龙	27 吕华宇																																							
<table border="1"><tr><td></td><td></td><td></td></tr><tr><td></td><td></td><td></td></tr><tr><td></td><td></td><td></td></tr></table>										<table border="1"><tr><td></td><td></td><td></td></tr><tr><td></td><td></td><td></td></tr><tr><td></td><td></td><td></td></tr></table>										<table border="1"><tr><td></td><td></td><td></td></tr><tr><td>1</td><td></td><td>1</td></tr><tr><td></td><td></td><td>1</td></tr><tr><td>2</td><td></td><td>2</td></tr></table>				1		1			1	2		2	<table border="1"><tr><td></td><td></td><td></td></tr><tr><td></td><td></td><td></td></tr><tr><td></td><td></td><td></td></tr></table>									
1		1																																								
		1																																								
2		2																																								
Post - 0 Miss - 1 Block - 0	Post - 0 Miss - 0 Block - 0	Post - 0 Miss - 2 Block - 1	Post - 0 Miss - 0 Block - 0																																							





第二届全国青年运动会男子手球甲组决赛 体校组 (U18)

青年男子 全国比赛

5-6名

PHMS Pictorial Handball Match Statistics IHF Official System

Team A A 福建泉港				Team B B 辽宁体校				Match Number 80			
------------------	--	--	--	------------------	--	--	--	---------------------------	--	--	--

Played in 山西晋中	in the hall 晋中体育馆	on 2019-06-22	at 18:40	hours	Speakers
-------------------	----------------------	------------------	-------------	-------	----------

Half-time(30')	A 8	B 7	End of playing time	A 18	B 17	1st extra time	A	B	2nd extra time	A	B	After penalty throws	A	B
----------------	--------	--------	---------------------	---------	---------	----------------	---	---	----------------	---	---	----------------------	---	---

Number of 7 m	A 4/5	Team time-out			Full name of players and officials	Team time-out			B 1/1	Number of 7 m
	1 14:13	2	3	1		2 37:00	3			

No.	Team A	G	W	2'	D	DR	No.	Team B	G	W	2'	D	DR
1	周铁程						1	何振楠					
6	段家乐	1					2	关贺元	5				
7	王嘉靖						3	贾博					
9	周星晨						4	刘旭	1	1	1		
10	陈臻						5	关棋					
11	钟宏韬						7	姜珺					
12	汪琪坤						8	郭嘉尧					
13	周忠迪	7					9	张鹏	7		1		
15	刘小龙	1					10	王新開		1			
17	左兆坤						11	颜科研	1				
18	刘少杰	1	1				12	吴禹宽					
20	吴兆瑞	4		1			13	赵子凯					
21	张路	4					18	祝慧翔昊					
23	卓世胜		1				24	邢洪銘	2				
25	张杰						29	蒋效峰	1				
34	王涛												
B	王卫						A	陈宏瑞 (主教练)					
C	刘德东						B	张瑜					
E	薛裕安						C	罗帅					
							D	王译					

A	Signatures of responsables for the teams (Off.A)												B
---	--	--	--	--	--	--	--	--	--	--	--	--	---

TP	Remarks of referees / HF Official													TP
----	-----------------------------------	--	--	--	--	--	--	--	--	--	--	--	--	----

Referees	伍豪 (CHN)	张智伟 (CHN)		
T.D.	李兆蒙 (CHN)	叶霄雪 (CHN)		
CHA Off.				

Note: Number of 7m Throws Awarded to Team A and B, Goals (G), Warnings (W), Suspensions (2'), Direct Disqualification (D), Disqualification With Report (DR) and Team Penalty (TP).

Table Officials: 宋昌鑫 张琦 Statisticians: 王梓衡 刘笑



第二届全国青年运动会男子手球甲组决赛 体校组 (U18)

PHMS Pictorial Handball Match Statistics

IHF Official System

竞赛技术统计

手球
青年男子

5-6名
轮次 6

组别 X
场次 80

晋中体育馆
2019-06-22 18:40

Referees: 伍豪 (CHN) / 张智伟 (CHN)

Result: 18:17(8:7)

Teams: 福建泉港(泉港) VS 辽宁体校(辽宁)

泉港														比赛进程		辽宁			
主教练: 庄清斌																			
	远射	近射	边射	快攻	突破	任意球	7m球	合计	%	助攻	失误	警告	2'	D+DR	1st Half				
1 周铁程															21 张路	1 00:30	0		
6 段家乐			1/2					1/2	50.0		3				1 03:11	1	2	关贺元	
7 王嘉靖															21 张路	2 04:41	1		
9 周晨晨			0/1					0/1	0.0						13 周忠迪	3 06:04	1		
10 陈臻															3 06:49	2	9	张鹏	
11 钟宏韬															20 吴兆瑞	4 08:48	3		
12 汪琪坤															18 刘少杰	5 09:51	3		
13 周忠迪	1/3		2/2	0/1			4/5	7/11	63.6		2				5 13:03	4	9	张鹏	
15 刘小龙	0/1	1/2						1/3	33.3		4				5 14:03	5	9	张鹏	
17 左兆坤															5 15:08	6	29	蒋效峰	
18 刘少杰		1/1						1/1	100		2	1			13 周忠迪	6 15:41	6		
20 吴兆瑞	2/4			1/1	1/1			4/6	66.7	2	1		1		6 16:49	7	9	张鹏	
21 张路	2/2			1/1	1/2			4/5	80.0	3					13 周忠迪	7 18:42	7		
23 卓世胜												1			21 张路	8 19:37	7		
25 张杰															2nd Half				
34 王涛															20 吴兆瑞	9 01:03	7		
运动员 合计	5/10	2/3	3/5	2/3	2/3		4/5	18/29	62.1	5	12	2	1		21 张路	10 01:57	7		
1 周铁程	2/5	1/4	1/1	1/3	1/3			6/16	37.5						10 02:29	8	4	刘旭	
12 汪琪坤	1/1	0/2		0/2	1/3	1/1	0/1	3/10	30.0						10 03:15	9	2	关贺元	
守门员 合计	3/6	1/6	1/1	1/5	2/6	1/1	0/1	9/26	34.6						10 03:58	10	9	张鹏	
辽宁																			
主教练: 陈宏瑞																			
	远射	近射	边射	快攻	突破	任意球	7m球	合计	%	助攻	失误	警告	2'	D+DR					
1 何振楠															6 段家乐	11 04:23	10		
2 关贺元		4/5			1/1			5/6	83.3	1	1				13 周忠迪	12 07:21	11		
3 贾博															12 08:10	12	2	关贺元	
4 刘旭	1/5		0/1			0/1		1/7	14.3	2	4	1	1		15 刘小龙	13 08:50	12		
5 关棋															13 09:11	13	2	关贺元	
7 姜珺															13 11:07	14	24	邢洪铭	
8 郭嘉尧															13 12:11	15	9	张鹏	
9 张鹏	0/1			3/3	3/3		1/1	7/8	87.5	2	3		1		13 13:20	16	9	张鹏	
10 王新開				0/1				0/1	0.0			1			13 13:52	16			
11 颜科研				1/1				1/1	100		2				14 15:07	17	24	邢洪铭	
12 吴禹宽															15 16:14	17			
13 赵子凯															20 吴兆瑞	16 16:53	17		
18 祝慧翔昊															20 吴兆瑞	17 19:30	17		
24 邢洪铭	2/4	0/1			0/2			2/7	28.6	1	1				13 周忠迪	18 20:00	17		
29 蒋效峰		1/1						1/1	100		1								
运动员 合计	3/10	5/7	0/1	4/5	4/6	0/1	1/1	17/31	54.8	6	12	2	2						
1 何振楠	4/8	0/2	1/3	0/2	0/2		0/4	5/21	23.8										
12 吴禹宽	1/2		0/1					1/3	33.3										
守门员 合计	5/10	0/2	1/4	0/2	0/2		0/4	6/24	25.0										

场上队员: 得分 / 射门

守门员: 救球 / 射门

D	取消资格	DR	取消资格+报告
---	------	----	---------



个人/全队技术统计表

手球 青年男子 5-6名 轮次 6 组别 X 场次 80 晋中体育馆 2019-06-22 18:40

号码	姓名	远射	近射	边射	快攻	突破	任意	七米	合计	%	助攻	失误	警告	2'	取消	时间
福建泉港(泉港)																
(场上队员)																
1	周铁程									0.0%						00:20:00
6	段家乐			1/2					1/2	50.0%		3				00:09:32
7	王嘉靖									0.0%						00:00:00
9	周星晨			0/1					0/1	0.0%						00:22:16
10	陈臻									0.0%						00:00:22
11	钟宏韬									0.0%						00:00:00
12	汪琪坤									0.0%						00:20:00
13	周忠迪	1/3		2/2	0/1			4/5	7/11	63.6%		2				00:40:00
15	刘小龙	0/1	1/2						1/3	33.3%		4				00:27:37
17	左兆坤									0.0%						00:04:43
18	刘少杰		1/1						1/1	100%		2	1			00:40:00
20	吴兆瑞	2/4			1/1	1/1			4/6	66.7%	2	1		1		00:35:15
21	张路	2/2			1/1	1/2			4/5	80.0%	3					00:40:00
23	卓世胜									0.0%			1			00:19:47
25	张杰									0.0%						00:00:00
34	王涛									0.0%						00:00:00
	合计	5/10	2/3	3/5	2/3	2/3		4/5	18/29	62.1%	5	12	2	1		
(守门员)																
1	周铁程	2/5	1/4	1/1	1/3	1/3			6/16	37.5%						00:20:00
12	汪琪坤	1/1	0/2		0/2	1/3	1/1	0/1	3/10	30.0%						00:20:00
	合计	3/6	1/6	1/1	1/5	2/6	1/1	0/1	9/26	34.6%						

场上队员：得分/射门

守门员：救球/射门

全队合计	得分	被救	射失	击柱	封球	合计	%
远射	5	5				10	50.0%
近射	2		1			3	66.7%
边射	3	1		1		5	60.0%
快攻	2		1			3	66.7%
突破	2			1		3	66.7%
任意							0.0%
七米	4		1			5	80.0%

第二届全国青年运动会男子手球甲组决赛 体校组 (U18)

个人/全队技术统计表

手球 5-6名 组别 X 晋中体育馆
青年男子 轮次 6 场次 80 2019-06-22 18:40

号码	姓名	远射	近射	边射	快攻	突破	任意	七米	合计	%	助攻	失误	警告	2'	取消	时间
辽宁体校(辽宁)																
(场上队员)																
1	何振楠									0.0%						00:32:24
2	关贺元		4/5			1/1			5/6	83.3%	1	1				00:40:00
3	贾博									0.0%						00:00:00
4	刘旭	1/5		0/1			0/1		1/7	14.3%	2	4	1	1		00:40:00
5	关棋									0.0%						00:00:00
7	姜珺									0.0%						00:00:00
8	郭嘉尧									0.0%						00:00:00
9	张鹏	0/1			3/3	3/3		1/1	7/8	87.5%	2	3		1		00:35:48
10	王新開				0/1				0/1	0.0%			1			00:24:14
11	颜科研				1/1				1/1	100%		2				00:40:00
12	吴禹宽									0.0%						00:07:36
13	赵子凯									0.0%						00:00:00
18	祝慧翔昊									0.0%						00:04:02
24	邢洪銘	2/4	0/1			0/2			2/7	28.6%	1	1				00:40:00
29	蒋效峰		1/1						1/1	100%		1				00:15:26
合计		3/10	5/7	0/1	4/5	4/6	0/1	1/1	17/31	54.8%	6	12	2	2		
(守门员)																
1	何振楠	4/8	0/2	1/3	0/2	0/2		0/4	5/21	23.8%						00:32:24
12	吴禹宽	1/2		0/1					1/3	33.3%						00:07:36
合计		5/10	0/2	1/4	0/2	0/2		0/4	6/24	25.0%						

场上队员：得分/射门

守门员：救球/射门

全队合计	得分	被救	射失	击柱	封球	合计	%
远射	3	3	1		3	10	30.0%
近射	5	1			1	7	71.4%
边射		1				1	0.0%
快攻	4	1				5	80.0%
突破	4	2				6	66.7%
任意		1				1	0.0%
七米	1					1	100.0%

图式比赛技术统计表

手球
青年男子

5-6名
轮次 6

组别 X
场次 80

晋中体育馆
2019-06-22 18:40

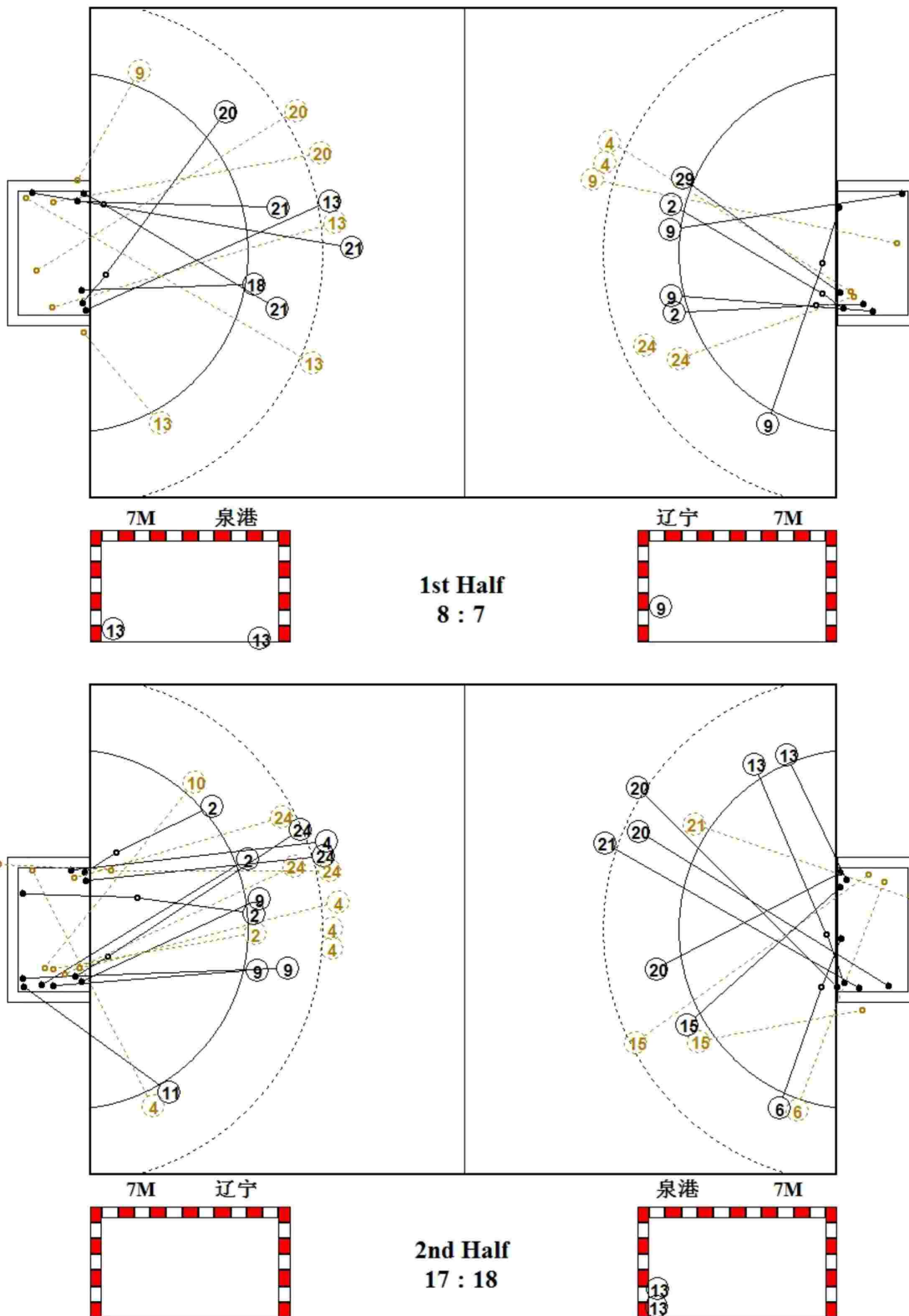

图式射门区域统计

手球
青年男子

5-6名
轮次 6

组别 X
场次 80

晋中体育馆
2019-06-22 18:40

福建泉港

1 周铁程 Post - 0 Miss - 0 Block - 0	6 段家乐 Post - 0 Miss - 0 Block - 0	7 王嘉靖 Post - 0 Miss - 0 Block - 0	9 周星晨 Post - 1 Miss - 0 Block - 0	10 陈臻 Post - 0 Miss - 0 Block - 0	11 钟宏韬 Post - 0 Miss - 0 Block - 0	12 汪琪坤 Post - 0 Miss - 0 Block - 0	13 周忠迪 Post - 0 Miss - 2 Block - 0
15 刘小龙 Post - 0 Miss - 1 Block - 0	17 左兆坤 Post - 0 Miss - 0 Block - 0	18 刘少杰 Post - 0 Miss - 0 Block - 0	20 吴兆瑞 Post - 0 Miss - 0 Block - 0	21 张路 Post - 1 Miss - 0 Block - 0	23 卓世胜 Post - 0 Miss - 0 Block - 0	25 张杰 Post - 0 Miss - 0 Block - 0	34 王涛 Post - 0 Miss - 0 Block - 0

1 周铁程
0/3
3/4
1/3
1/2
1/4

12 汪琪坤
0/1
1/1
0/1
0/2
0/1
2/4

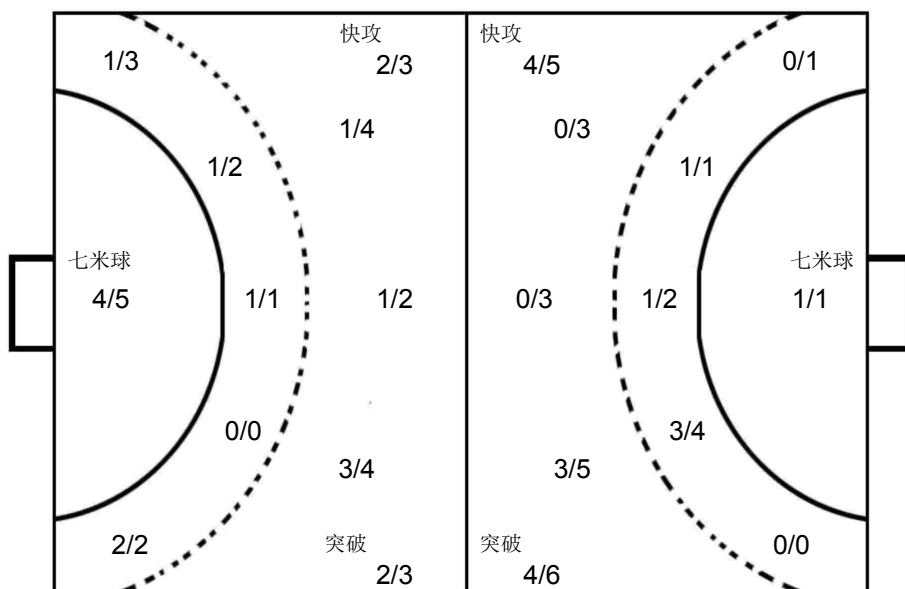

1 何振楠
1/1
1/1
1/3
1/2
1/1
0/8
0/5

12 吴禹宽
1/1
0/1
0/1

辽宁体校

1 何振楠 Post - 0 Miss - 0 Block - 0	2 关贺元 Post - 0 Miss - 0 Block - 0	3 贾博 Post - 0 Miss - 0 Block - 0	4 刘旭 Post - 0 Miss - 0 Block - 3	5 关棋 Post - 0 Miss - 0 Block - 0	7 姜珺 Post - 0 Miss - 0 Block - 0	8 郭嘉尧 Post - 0 Miss - 0 Block - 0	9 张鹏 Post - 0 Miss - 0 Block - 0
10 王新開 Post - 0 Miss - 0 Block - 0	11 颜科研 Post - 0 Miss - 0 Block - 0	12 吴禹宽 Post - 0 Miss - 0 Block - 0	13 赵子凯 Post - 0 Miss - 0 Block - 0	18 祝慧翔昊 Post - 0 Miss - 0 Block - 0	24 邢洪銘 Post - 0 Miss - 1 Block - 1	29 蒋效峰 Post - 0 Miss - 0 Block - 0	



第二届全国青年运动会男子手球甲组决赛 体校组 (U18)

青年男子 全国比赛

半决赛

PHMS Pictorial Handball Match Statistics IHF Official System

Team A A 山东潍坊				Team B B 北京市				Match Number 74			
------------------	--	--	--	-----------------	--	--	--	---------------------------	--	--	--

Played in 山西晋中	in the hall 晋中体育馆	on 2019-06-22	at 18:40	hours	Speakers
-------------------	----------------------	------------------	-------------	-------	----------

Half-time(30')	A 12	B 7	End of playing time	A 22	B 13	1st extra time	A	B	2nd extra time	A	B	After penalty throws	A	B
----------------	---------	--------	---------------------	---------	---------	----------------	---	---	----------------	---	---	----------------------	---	---

Number of 7 m 0/0	Team time-out			Full name of players and officials	Team time-out			B 2/3	Number of 7 m
	1 05:49	2 23:20	3 34:35		1 11:23	2 29:47	3		

No.	Team A	G	W	2'	D	DR	No.	Team B	G	W	2'	D	DR
1	鲁世豪						1	陶钜					
3	李相杰	1		1			3	魏豪					
5	刘天驰	4					4	李博仔					
6	张智超	2					6	苑宾	2				
8	薛瑞寒	1					7	侯博耀	1				
9	杜忠浩	1					8	孙铂力					
11	杨毅	7		1			9	曹智栋	1				
12	黄晓春	4					13	蓝心凯	1				
15	宋子阳	1	1				14	杜俊林					
19	汤雨扬						15	刘大明	3				
20	刘文东						16	王鑫宇					
21	张宋帅						18	宋昱鹏					
24	王宇恒						23	庞佳明	4				
25	郭昊文						26	郑铭境					
33	吴夏冰	1					29	赵熹瑞	1				
							32	张珂宁					

B	赵鑫 (主教练)						A	吴健					
---	----------	--	--	--	--	--	---	----	--	--	--	--	--

C	王平						B	翟彦戎					
---	----	--	--	--	--	--	---	-----	--	--	--	--	--

E	陈琪												
---	----	--	--	--	--	--	--	--	--	--	--	--	--

A	Signatures of responsables for the teams (Off.A)												B
---	--	--	--	--	--	--	--	--	--	--	--	--	---

TP	Remarks of referees / HF Official												TP
----	-----------------------------------	--	--	--	--	--	--	--	--	--	--	--	----

Referees	陈晓波 (CHN)	张耿 (CHN)		
T.D.	柴业宏 (CHN)	王洋 (CHN)		
CHA Off.				

Note: Number of 7m Throws Awarded to Team A and B, Goals (G), Warnings (W), Suspensions (2'), Direct Disqualification (D), Disqualification With Report (DR) and Team Penalty (TP).

Table Officials: 马迪 戴莹莹 Statisticians: 陈柱 谢扬

第二届全国青年运动会男子手球甲组决赛 体校组 (U18)

PHMS Pictorial Handball Match Statistics

IHF Official System

竞赛技术统计

手球
青年男子

半决赛
轮次 5

组别 X
场次 74

晋中体育馆
2019-06-22 18:40

Referees: 陈晓波 (CHN) / 张耿 (CHN)

Result: 22:13 (12:7)

Teams: 山东潍坊(潍坊) VS 北京市(北京)

潍坊		远	近	边	快	突	任意	7m	合计	%	助攻	失误	警告	2'	D+DR
主教练: 赵鑫		射	射	射	攻	破	球	球							
1	鲁世豪														
3	李相杰	1/3	0/1						1/4	25.0	3	1		1	
5	刘天驰	2/4	1/1			1/1			4/6	66.7		3			
6	张智超	1/1				1/1			2/2	100					
8	薛瑞寒	1/1							1/1	100					
9	杜忠浩	0/2	1/1	0/1					1/4	25.0					
11	杨毅	3/5	2/2		2/2				7/9	77.8		1		1	
12	黄晓春	4/4							4/4	100	1				
15	宋子阳				1/1				1/1	100		1	1		
19	汤雨扬														
20	刘文东														
21	张宋帅														
24	王宇恒											1			
25	郭昊文														
33	吴夏冰		1/1						1/1	100		2			
运动员 合计		12/20	5/6	0/1	3/3	2/2			22/32	68.8	4	9	1	2	
1	鲁世豪	2/2	1/1					0/1	3/4	75.0					
12	黄晓春	6/9	4/9	0/1			0/2	1/2	11/23	47.8	1				
守门员 合计		8/11	5/10	0/1			0/2	1/3	14/27	51.9	1				

北京		远	近	边	快	突	任意	7m	合计	%	助攻	失误	警告	2'	D+DR
主教练: 吴健		射	射	射	攻	破	球	球							
1	陶钜														
3	魏豪														
4	李博仔														
6	苑宾		0/1	1/1				1/2	2/4	50.0		2			
7	侯博耀	1/3	0/1						1/4	25.0					
8	孙铂力										1	1			
9	曹智栋	0/2	1/1						1/3	33.3		1			
13	蓝心凯		1/2						1/2	50.0		2			
14	杜俊林														
15	刘大明	1/5	2/3						3/8	37.5		1			
16	王鑫宇														
18	宋昱鹏														
23	庞佳明	1/2					2/2	1/1	4/5	80.0		3			
26	郑铭境	0/2							0/2	0.0	1	1			
29	赵焱瑞		1/2						1/2	50.0		1			
32	张珂宁	0/1							0/1	0.0		1			
运动员 合计		3/15	5/10	1/1			2/2	2/3	13/31	41.9	2	13			
1	陶钜	1/1				0/1			1/2	50.0					
16	王鑫宇	2/14	1/6		0/3	0/1			3/24	12.5					
守门员 合计		3/15	1/6		0/3	0/2			4/26	15.4					

潍坊	比赛 进程	北京
1st Half		
5	刘天驰 1 01:03	0
5	刘天驰 2 02:28	0
15	宋子阳 3 03:06	0
	3 03:53	1 23 庞佳明
	3 05:20	2 15 刘大明
	3 07:21	3 6 苑宾
12	黄晓春 4 08:31	3
12	黄晓春 5 09:06	3
12	黄晓春 6 09:45	3
	6 10:22	4 29 赵焱瑞
11	杨毅 7 12:11	4
	7 13:01	5 23 庞佳明
	7 13:46	6 9 曹智栋
11	杨毅 8 14:20	6
33	吴夏冰 9 14:48	6
12	黄晓春 10 15:39	6
3	李相杰 11 16:50	6
	11 18:36	7 23 庞佳明
11	杨毅 12 19:19	7
2nd Half		
5	刘天驰 13 00:26	7
	13 01:05	8 23 庞佳明
9	杜忠浩 14 03:28	8
5	刘天驰 15 04:25	8
6	张智超 16 05:37	8
11	杨毅 17 08:10	8
	17 09:06	9 6 苑宾
11	杨毅 18 09:15	9
	18 10:11	10 15 刘大明
	18 11:55	11 7 侯博耀
11	杨毅 19 12:45	11
	19 13:13	12 15 刘大明
	19 14:30	13 13 蓝心凯
8	薛瑞寒 20 14:59	13
11	杨毅 21 15:39	13
6	张智超 22 19:51	13

场上队员: 得分 / 射门

守门员: 救球 / 射门

D	取消资格	DR	取消资格+报告
---	------	----	---------



个人/全队技术统计表

 手球 半决赛 组别 X 晋中体育馆
 青年男子 轮次 5 场次 74 2019-06-22 18:40

号码	姓名	远射	近射	边射	快攻	突破	任意	七米	合计	%	助攻	失误	警告	2'	取消	时间
山东潍坊 (潍坊)																
(场上队员)																
1	鲁世豪									0.0%						00:03:57
3	李相杰	1/3	0/1						1/4	25.0%	3	1		1		00:37:09
5	刘天驰	2/4	1/1			1/1			4/6	66.7%		3				00:34:44
6	张智超	1/1				1/1			2/2	100%						00:09:00
8	薛瑞寒	1/1							1/1	100%						00:31:02
9	杜忠浩	0/2	1/1	0/1					1/4	25.0%						00:11:10
11	杨毅	3/5	2/2		2/2				7/9	77.8%		1		1		00:36:02
12	黄晓春	4/4							4/4	100%	1					00:36:03
15	宋子阳				1/1				1/1	100%		1	1			00:32:39
19	汤雨扬									0.0%						00:00:00
20	刘文东									0.0%						00:10:18
21	张宋帅									0.0%						00:02:26
24	王宇恒									0.0%		1				00:05:15
25	郭昊文									0.0%						00:00:00
33	吴夏冰		1/1						1/1	100%		2				00:29:41
合计		12/20	5/6	0/1	3/3	2/2			22/32	68.8%	4	9	1	2		
(守门员)																
1	鲁世豪	2/2	1/1					0/1	3/4	75.0%						00:03:57
12	黄晓春	6/9	4/9	0/1			0/2	1/2	11/23	47.8%	1					00:36:03
合计		8/11	5/10	0/1			0/2	1/3	14/27	51.9%	1					

场上队员： 得分/射门

守门员： 救球/射门

全队合计	得分	被救	射失	击柱	封球	合计	%
远射	12	3	3	1	1	20	60.0%
近射	5	1				6	83.3%
边射			1			1	0.0%
快攻	3					3	100.0%
突破	2					2	100.0%
任意							0.0%
七米							0.0%

第二届全国青年运动会男子手球甲组决赛 体校组 (U18)

PHMS Pictorial Handball Match Statistics

IHF Official System

个人/全队技术统计表

手球 半决赛 组别 X 晋中体育馆
青年男子 轮次 5 场次 74 2019-06-22 18:40

号码	姓名	远射	近射	边射	快攻	突破	任意	七米	合计	%	助攻	失误	警告	2'	取消	时间
北京市(北京)																
(场上队员)																
1	陶钜									0.0%						00:04:11
3	魏豪									0.0%						00:05:52
4	李博仔									0.0%						00:00:00
6	苑宾		0/1	1/1				1/2	2/4	50.0%		2				00:35:01
7	侯博耀	1/3	0/1						1/4	25.0%						00:11:36
8	孙铂力									0.0%	1	1				00:10:38
9	曹智栋	0/2	1/1						1/3	33.3%		1				00:29:21
13	蓝心凯		1/2						1/2	50.0%		2				00:33:48
14	杜俊林									0.0%						00:04:52
15	刘大明	1/5	2/3						3/8	37.5%		1				00:34:03
16	王鑫宇									0.0%						00:35:49
18	宋昱鹏									0.0%						00:00:00
23	庞佳明	1/2				2/2		1/1	4/5	80.0%		3				00:25:44
26	郑铭境	0/2							0/2	0.0%	1	1				00:08:44
29	赵熹瑞		1/2						1/2	50.0%		1				00:34:35
32	张珂宁	0/1							0/1	0.0%		1				00:05:25
	合计	3/15	5/10	1/1		2/2		2/3	13/31	41.9%	2	13				
(守门员)																
1	陶钜	1/1				0/1			1/2	50.0%						00:04:11
16	王鑫宇	2/14	1/6		0/3	0/1			3/24	12.5%						00:35:49
	合计	3/15	1/6		0/3	0/2			4/26	15.4%						

场上队员：得分/射门

守门员：救球/射门

全队合计	得分	被救	射失	击柱	封球	合计	%
远射	3	8		1	3	15	20.0%
近射	5	5				10	50.0%
边射	1					1	100.0%
快攻							0.0%
突破							0.0%
任意	2					2	100.0%
七米	2	1				3	66.7%

图式比赛技术统计表

手球
青年男子

半决赛
轮次 5

组别 X
场次 74

晋中体育馆
2019-06-22 18:40

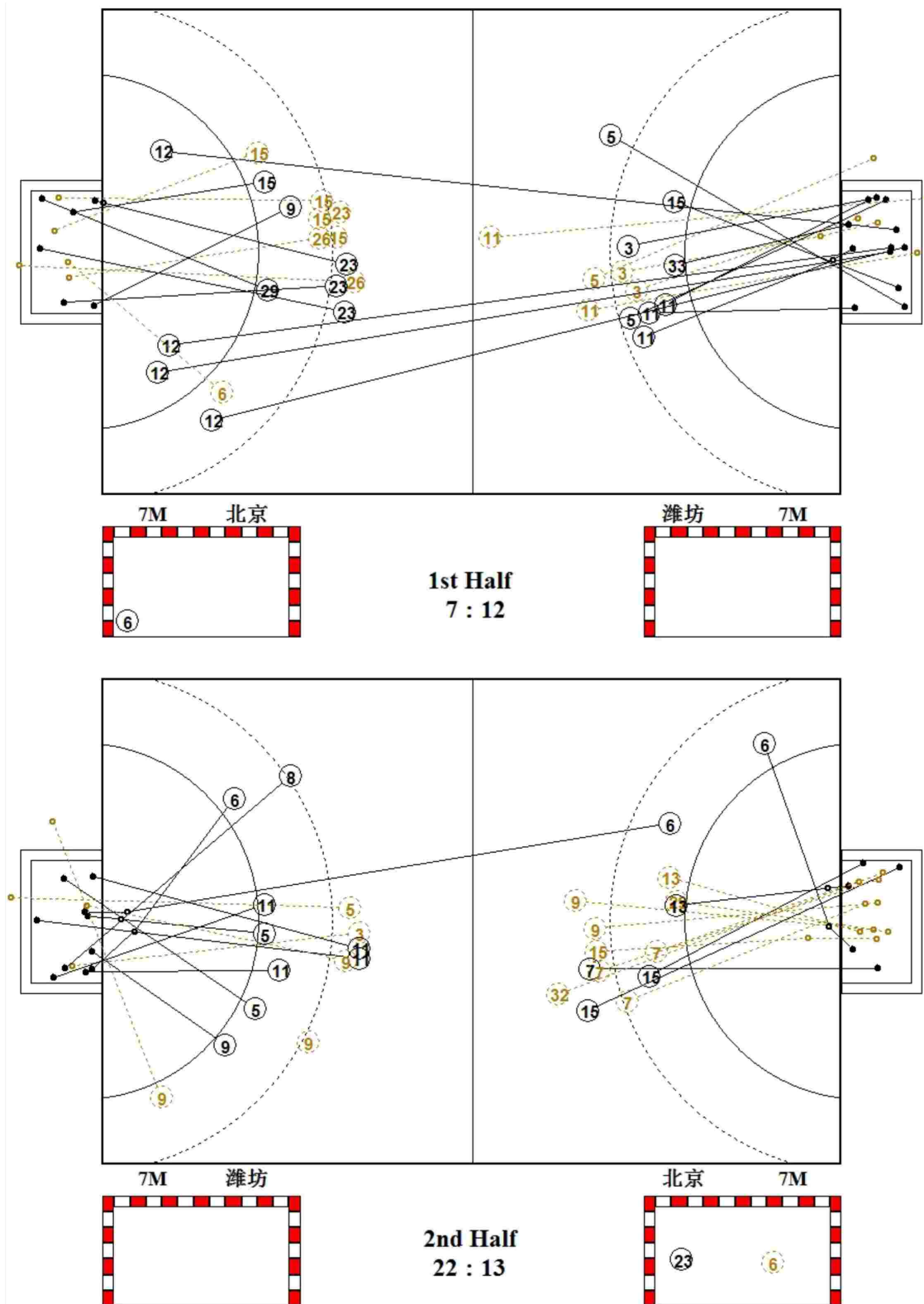

图式射门区域统计

手球
青年男子

半决赛
轮次 5

组别 X
场次 74

晋中体育馆
2019-06-22 18:40

山东潍坊

1 鲁世豪 Post - 0 Miss - 0 Block - 0	3 李相杰 Post - 0 Miss - 0 Block - 0	5 刘天驰 Post - 0 Miss - 2 Block - 0	6 张智超 Post - 0 Miss - 0 Block - 0	8 薛瑞寒 Post - 0 Miss - 0 Block - 0	9 杜忠浩 Post - 0 Miss - 1 Block - 1	11 杨毅 Post - 1 Miss - 1 Block - 0	12 黄晓春 Post - 0 Miss - 0 Block - 0
15 宋子阳 Post - 0 Miss - 0 Block - 0	19 汤雨扬 Post - 0 Miss - 0 Block - 0	20 刘文东 Post - 0 Miss - 0 Block - 0	21 张宋帅 Post - 0 Miss - 0 Block - 0	24 王宇恒 Post - 0 Miss - 0 Block - 0	25 郭昊文 Post - 0 Miss - 0 Block - 0	33 吴夏冰 Post - 0 Miss - 0 Block - 0	

1 鲁世豪		
1/2	1/1	
1/1		

12 黄晓春			
0/1	2/3	0/1	
2/3	5/5	1/3	
0/4	1/1	0/2	

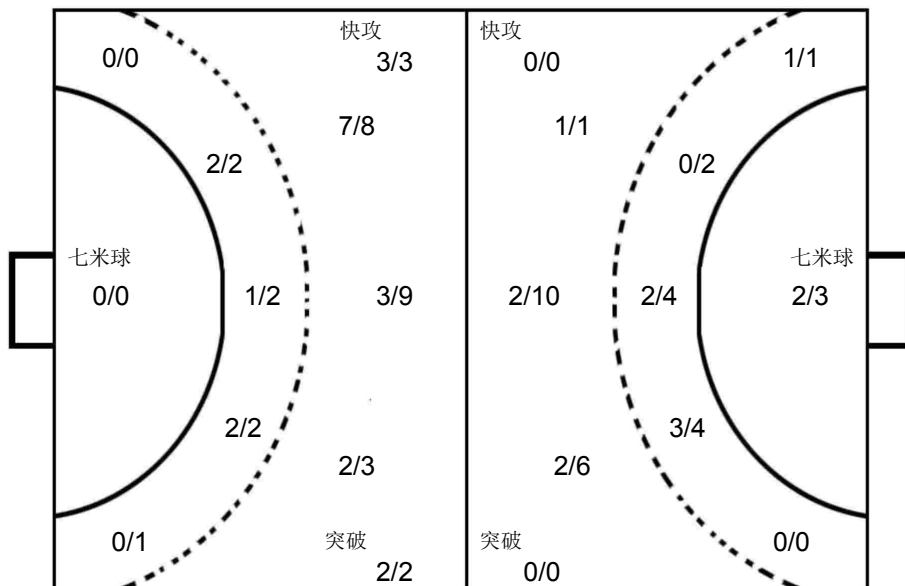

1 陶钜		
0/1	1/1	

16 王鑫宇			
0/2	0/4	0/2	
2/6		0/1	
1/4	0/3	0/2	

北京市

1 陶钜 Post - 0 Miss - 0 Block - 0	3 魏豪 Post - 0 Miss - 0 Block - 0	4 李博仔 Post - 0 Miss - 0 Block - 0	6 苑宾 Post - 0 Miss - 0 Block - 0	7 侯博耀 Post - 0 Miss - 0 Block - 0	8 孙铂力 Post - 0 Miss - 0 Block - 0	9 曹智栋 Post - 0 Miss - 0 Block - 0	13 蓝心凯 Post - 0 Miss - 0 Block - 0
14 杜俊林 Post - 0 Miss - 0 Block - 0	15 刘大明 Post - 0 Miss - 0 Block - 2	16 王鑫宇 Post - 0 Miss - 0 Block - 0	18 宋昱鹏 Post - 0 Miss - 0 Block - 0	23 庞佳明 Post - 0 Miss - 0 Block - 1	26 郑铭境 Post - 1 Miss - 0 Block - 0	29 赵熹瑞 Post - 0 Miss - 0 Block - 0	32 张珂宁 Post - 0 Miss - 0 Block - 0

第二届全国青年运动会男子手球甲组决赛 体校组 (U18)

比赛进程表

手球 半决赛 组别 X 晋中体育馆
青年男子 轮次 5 场次 74 2019-06-22 18:40

时间	队员	动作	比分	队员	动作
山东潍坊			北京市		
上半时			上半时		
00:33			0-0	23 庞佳明	传球失误
01:03	5 刘天驰	右远射 得分	1-0	16 王鑫宇	被射入
01:54	12 黄晓春	挡住球		15 刘大明	右远射 被救
02:28	5 刘天驰	左远射 得分	2-0	16 王鑫宇	被射入
03:00	33 吴夏冰	封球		15 刘大明	中远射 被封
03:06	15 宋子阳	一传快攻 得分	3-0	16 王鑫宇	被射入
03:08	12 黄晓春	助攻			
03:53	12 黄晓春	被射入	3-1	23 庞佳明	中远射 得分
04:00	5 刘天驰	中远射 射失			
05:20	12 黄晓春	被射入	3-2	15 刘大明	近射 得分
05:22	15 宋子阳	警告			
05:34	3 李相杰	近射 被救		16 王鑫宇	挡住球
05:49		球队暂停			
06:21	15 宋子阳	进攻犯规			
07:10	15 宋子阳	使被罚7M球		13 蓝心凯	造7M
07:21	12 黄晓春	被射入	3-3	6 苑宾	7M球 得分
07:45	3 李相杰	中远射 被救		16 王鑫宇	挡住球
08:26				26 郑铭境	中远射 击柱
08:31	12 黄晓春	左远射 得分	4-3	16 王鑫宇	被射入
09:01	12 黄晓春	挡住球		26 郑铭境	中远射 被救
09:06	12 黄晓春	右远射 得分	5-3	16 王鑫宇	被射入
09:40	12 黄晓春	挡住球		15 刘大明	近射 被救
09:45	12 黄晓春	右远射 得分	6-3	16 王鑫宇	被射入
10:22	12 黄晓春	被射入	6-4	29 赵焯瑞	近射 得分
10:26				26 郑铭境	助攻
11:17	11 杨毅	右远射 击柱			
11:18		裁判暂停			
11:23					球队暂停
11:56				13 蓝心凯	传球失误
12:11	11 杨毅	近射 得分	7-4	16 王鑫宇	被射入
13:01	12 黄晓春	被射入	7-5	23 庞佳明	任意球 得分
13:11	11 杨毅	中远射 射失			
13:46	12 黄晓春	被射入	7-6	9 曹智栋	近射 得分
14:20	11 杨毅	近射 得分	8-6	16 王鑫宇	被射入
14:38				15 刘大明	运球失误
14:48	33 吴夏冰	近射 得分	9-6	16 王鑫宇	被射入
15:29				6 苑宾	运球失误
15:39	12 黄晓春	右远射 得分	10-6	16 王鑫宇	被射入
16:22				26 郑铭境	传球失误
16:50	3 李相杰	中远射 得分	11-6	16 王鑫宇	被射入
17:33	33 吴夏冰	封球		23 庞佳明	中远射 被封

比赛进程表

手球 半决赛 组别 X 晋中体育馆
 青年男子 轮次 5 场次 74 2019-06-22 18:40

时间	队员	动作	比分	队员	动作
山东潍坊			上半时		
17:39	33 吴夏冰	快攻 传球失误	11-6		
18:36	12 黄晓春	被射入	11-7	23 庞佳明	任意球 得分
19:19	11 杨毅	右远射 得分	12-7	16 王鑫宇	被射入
19:55	5 刘天驰	封球		15 刘大明	中远射 被封
20:00	12 黄晓春	挡住球		6 苑宾	近射 被救

第二届全国青年运动会男子手球甲组决赛 体校组 (U18)

比赛进程表

手球 半决赛 组别 X 晋中体育馆
 青年男子 轮次 5 场次 74 2019-06-22 18:40

时间	队员	动作	比分	队员	动作
山东潍坊			下半时		
00:26	5 刘天驰	近射 得分	13-7	16 王鑫宇	被射入
00:29	3 李相杰	助攻			
01:01		裁判暂停			
01:01	11 杨毅	使被罚7M球		15 刘大明	造7M
01:01	11 杨毅	罚出场2分钟			
01:05	1 鲁世豪	被射入	13-8	23 庞佳明	7M球 得分
01:46	5 刘天驰	四步			
01:55				23 庞佳明	传球失误
02:23	3 李相杰	中远射 被救		16 王鑫宇	挡住球
02:34	12 黄晓春	挡住球		29 赵熹瑞	近射 被救
02:34		裁判暂停			
02:34	3 李相杰	使被罚7M球		6 苑宾	造7M
02:34	3 李相杰	罚出场2分钟			
02:34	12 黄晓春	挡住球		6 苑宾	7M球 被救
03:12	9 杜忠浩	左远射 被封		9 曹智栋	封球
03:20		球队暂停			
03:28	9 杜忠浩	近射 得分	14-8	16 王鑫宇	被射入
03:52	12 黄晓春	挡住球		9 曹智栋	中远射 被救
03:55		裁判暂停			
04:15	5 刘天驰	断球		13 蓝心凯	传球失误
04:25	5 刘天驰	突破 得分	15-8	16 王鑫宇	被射入
05:25				23 庞佳明	其它失误
05:37	6 张智超	右远射 得分	16-8	16 王鑫宇	被射入
06:09	12 黄晓春	挡住球		9 曹智栋	中远射 被救
06:28	5 刘天驰	断球		9 曹智栋	传球失误
06:31	5 刘天驰	快攻 侵区			
06:51	12 黄晓春	挡住球		13 蓝心凯	近射 被救
07:02	9 杜忠浩	左边射 射失			
07:31	12 黄晓春	挡住球		15 刘大明	中远射 被救
07:33		裁判暂停			
08:10	11 杨毅	中远射 得分	17-8	16 王鑫宇	被射入
09:06	12 黄晓春	被射入	17-9	6 苑宾	左边射 得分
09:15	11 杨毅	中远射 得分	18-9	16 王鑫宇	被射入
09:47					球队暂停
10:11	12 黄晓春	被射入	18-10	15 刘大明	右远射 得分
10:39	5 刘天驰	侵区			
10:40	3 李相杰	助攻			
11:16	15 宋子阳	断球		29 赵熹瑞	传球失误
11:42	3 李相杰	快攻 侵区			
11:55	12 黄晓春	被射入	18-11	7 侯博耀	右远射 得分
12:28	5 刘天驰	中远射 射失			

第二届全国青年运动会男子手球甲组决赛 体校组 (U18)

比赛进程表

手球
青年男子

半决赛
轮次 5

组别 X
场次 74

晋中体育馆
2019-06-22 18:40

时间	队员	动作	比分	队员	动作
山东潍坊			北京市		
			下半场		
12:39			18-11	6 苑宾	接球失误
12:45	11 杨毅	短传快攻 得分	19-11	16 王鑫宇	被射入
13:13	12 黄晓春	被射入	19-12	15 刘大明	近射 得分
13:57	11 杨毅	传球失误			
14:30	12 黄晓春	被射入	19-13	13 蓝心凯	近射 得分
14:33				8 孙铂力	助攻
14:35		球队暂停			
14:59	8 薛瑞寒	右远射 得分	20-13	16 王鑫宇	被射入
15:33	3 李相杰	造犯规		8 孙铂力	进攻犯规
15:39	11 杨毅	一传快攻 得分	21-13	16 王鑫宇	被射入
16:01	12 黄晓春	挡住球		32 张珂宁	右远射 被救
16:53	33 吴夏冰	侵区			
16:55	3 李相杰	助攻			
16:55		裁判暂停			
17:23				32 张珂宁	接球失误
17:44	24 王宇恒	运球失误			
18:14	1 鲁世豪	挡住球		7 侯博耀	右远射 被救
18:19	1 鲁世豪	挡住球		7 侯博耀	近射 被救
18:37	9 杜忠浩	中远射 被救		1 陶钜	挡住球
19:15	1 鲁世豪	挡住球		7 侯博耀	右远射 被救
19:51	6 张智超	突破 得分	22-13	1 陶钜	被射入



第二届全国青年运动会男子手球甲组决赛 体校组 (U18)

青年男子 全国比赛

半决赛

PHMS Pictorial Handball Match Statistics IHF Official System

Team A A 陕西西安				Team B B 安徽合肥				Match Number 75			
------------------	--	--	--	------------------	--	--	--	---------------------------	--	--	--

Played in 山西晋中	in the hall 晋中体育馆	on 2019-06-22	at 19:50	hours	Spepectors
-------------------	----------------------	------------------	-------------	-------	------------

Half-time(30')	A 10	B 8	End of playing time	A 15	B 21	1st extra time	A	B	2nd extra time	A	B	After penalty throws	A	B
----------------	---------	--------	---------------------	---------	---------	----------------	---	---	----------------	---	---	----------------------	---	---

Number of 7 m	A 0/1	Team time-out			Full name of players and officials	Team time-out			B 1/2	Number of 7 m
	1 13:48	2 24:08	3	1 09:18		2 33:48	3 37:28			

No.	Team A	G	W	2'	D	DR	No.	Team B	G	W	2'	D	DR
1	陈昊						2	张天进	5				
2	张兴彬						13	沈威	2				
3	丁玉冰	1					26	饶原源	5				
5	隋家乐						27	王东昇					
6	李梦豪	3	1				29	梅少聪	2		1		
7	黄金伟						30	单习振	4				
8	张领	4		1			31	张宇					
9	陈孝天	5					33	於晓祺					
10	王凯强						35	李宝松					
11	孔宇豪						36	刘耀奇					
12	朱正顺						39	汤鸿宇					
13	徐昊天						40	陈欢					
14	孙旭						41	管家乐					
15	陈冉	2					42	刘军波					
16	金筠峰						43	王久源	3	1	1		
17	刘世昌						50	刘欣洋					
B	李安						A	王德勇 (主教练)					
C	郝可鑫						C	陆万红					
D	王少杰						D	王明星					
E	陈冬冬						E	陈玉翔					

A	Signatures of responsables for the teams (Off.A)												B
---	--	--	--	--	--	--	--	--	--	--	--	--	---

TP	Remarks of referees / HF Official													TP
----	-----------------------------------	--	--	--	--	--	--	--	--	--	--	--	--	----

Referees	李兆蒙 (CHN)	马晓晔 (CHN)		
T.D.	陈晓波 (CHN)	王洋 (CHN)		
CHA Off.				

Note: Number of 7m Throws Awarded to Team A and B, Goals (G), Warnings (W), Suspensions (2'), Direct Disqualification (D), Disqualification With Report (DR) and Team Penalty (TP).

Table Officials: 王志超 孙龙龙 Statisticians: 谢扬 陈柱

第二届全国青年运动会男子手球甲组决赛 体校组 (U18)

PHMS Pictorial Handball Match Statistics

IHF Official System

竞赛技术统计

手球
青年男子

半决赛
轮次 5

组别 X
场次 75

晋中体育馆
2019-06-22 19:50

Referees: 李兆蒙 (CHN) / 马晓晔 (CHN)

Result: 15:21 (10:8)

Teams: 陕西西安(西安) VS 安徽合肥(合肥)

西安		远射	近射	边射	快攻	突破	任意球	7m球	合计	%	助攻	失误	警告	2'	D+DR
主教练: 郝可鑫															
1	陈昊														
2	张兴彬														
3	丁玉冰		1/2					1/2	50.0		1				
5	隋家乐														
6	李梦豪	1/2	1/2		1/1			3/5	60.0	1	1	1			
7	黄金伟			0/1				0/1	0.0						
8	张领	0/1	2/4	1/1		1/2		4/8	50.0	1	4			1	
9	陈孝天	2/3				1/1	2/3	0/1	5/8	62.5	1				
10	王凯强		0/1					0/1	0.0		2				
11	孔宇豪														
12	朱正顺														
13	徐昊天			0/2		0/1		0/3	0.0		2				
14	孙旭														
15	陈冉	0/1		2/5				2/6	33.3	1	3				
16	金筠峰														
17	刘世昌		0/1					0/1	0.0		1				
运动员 合计		3/7	4/10	3/9	1/1	2/4	2/3	0/1	15/35	42.9	4	14	1	1	
1	陈昊	3/8	1/3	2/5	1/8	1/3	0/1	1/2	9/30	30.0					
守门员 合计		3/8	1/3	2/5	1/8	1/3	0/1	1/2	9/30	30.0					

合肥		远射	近射	边射	快攻	突破	任意球	7m球	合计	%	助攻	失误	警告	2'	D+DR
主教练: 王德勇															
2	张天进	2/7			1/1	1/1	1/1		5/10	50.0	1				
13	沈威	2/4	0/1						2/5	40.0	2	4			
26	饶原源	1/3	1/1	0/1	1/1	1/2		1/1	5/9	55.6		2			
27	王东昇														
29	梅少聪		1/1	1/1	0/1				2/3	66.7		1		1	
30	单习振			1/1	3/4				4/5	80.0					
31	张宇	0/3							0/3	0.0					
33	於晓祺														
35	李宝松														
36	刘耀奇							0/1	0/1	0.0					
39	汤鸿宇														
40	陈欢														
41	管家乐	0/1							0/1	0.0					
42	刘军波														
43	王久源			1/2	2/2				3/4	75.0		2	1	1	
50	刘欣洋														
运动员 合计		5/18	2/3	3/5	7/9	2/3	1/1	1/2	21/41	51.2	3	9	1	2	
40	陈欢	2/5	5/9	2/5	0/1	2/4	1/3		12/27	44.4					
守门员 合计		2/5	5/9	2/5	0/1	2/4	1/3		12/27	44.4					

西安	比赛进程	合肥
1st Half		
0	01:29	1 29 梅少聪
6	李梦豪 1 02:35	1
9	陈孝天 2 04:06	1
2	05:00	2 30 单习振
8	张领 3 05:42	2
8	张领 4 06:52	2
9	陈孝天 5 09:12	2
5	09:33	3 2 张天进
5	11:14	4 2 张天进
15	陈冉 6 11:41	4
9	陈孝天 7 12:41	4
7	12:51	5 26 饶原源
6	李梦豪 8 15:26	5
8	张领 9 17:30	5
9	18:23	6 43 王久源
9	19:27	7 30 单习振
9	19:53	8 43 王久源
9	陈孝天 10 19:57	8
2nd Half		
10	00:08	9 2 张天进
10	01:24	10 26 饶原源
10	02:28	11 13 沈威
10	03:27	12 2 张天进
10	05:08	13 26 饶原源
6	李梦豪 11 05:25	13
11	06:19	14 26 饶原源
11	07:01	15 26 饶原源
15	陈冉 12 08:29	15
12	09:14	16 2 张天进
12	09:37	17 43 王久源
12	10:27	18 13 沈威
9	陈孝天 13 12:19	18
13	16:27	19 29 梅少聪
13	16:43	20 30 单习振
8	张领 14 17:08	20
14	19:10	21 30 单习振
3	丁玉冰 15 19:28	21

场上队员: 得分 / 射门

守门员: 救球 / 射门

D	取消资格	DR	取消资格+报告
---	------	----	---------



个人/全队技术统计表

 手球 半决赛 组别 X 晋中体育馆
 青年男子 轮次 5 场次 75 2019-06-22 19:50

号码	姓名	远射	近射	边射	快攻	突破	任意	七米	合计	%	助攻	失误	警告	2'	取消	时间
陕西西安(西安)																
(场上队员)																
1	陈昊									0.0%						00:40:00
2	张兴彬									0.0%						00:00:00
3	丁玉冰		1/2						1/2	50.0%		1				00:40:00
5	隋家乐									0.0%						00:00:00
6	李梦豪	1/2	1/2		1/1				3/5	60.0%	1	1	1			00:37:03
7	黄金伟			0/1					0/1	0.0%						00:03:50
8	张领	0/1	2/4	1/1		1/2			4/8	50.0%	1	4		1		00:37:44
9	陈孝天	2/3				1/1	2/3	0/1	5/8	62.5%	1					00:40:00
10	王凯强		0/1						0/1	0.0%		2				00:09:42
11	孔宇豪									0.0%						00:00:00
12	朱正顺									0.0%						00:00:00
13	徐昊天			0/2		0/1			0/3	0.0%		2				00:27:11
14	孙旭									0.0%						00:00:00
15	陈冉	0/1		2/5					2/6	33.3%	1	3				00:40:00
16	金筠峰									0.0%						00:00:00
17	刘世昌		0/1						0/1	0.0%		1				00:04:29
合计		3/7	4/10	3/9	1/1	2/4	2/3	0/1	15/35	42.9%	4	14	1	1		
(守门员)																
1	陈昊	3/8	1/3	2/5	1/8	1/3	0/1	1/2	9/30	30.0%						00:40:00
合计		3/8	1/3	2/5	1/8	1/3	0/1	1/2	9/30	30.0%						

场上队员：得分/射门

守门员：救球/射门

全队合计	得分	被救	射失	击柱	封球	合计	%
远射	3	2	1	1		7	42.9%
近射	4	5	1			10	40.0%
边射	3	2	1	3		9	33.3%
快攻	1					1	100.0%
突破	2	2				4	50.0%
任意	2	1				3	66.7%
七米			1			1	0.0%

第二届全国青年运动会男子手球甲组决赛 体校组 (U18)

个人/全队技术统计表

手球 半决赛 组别 X 晋中体育馆
青年男子 轮次 5 场次 75 2019-06-22 19:50

号码	姓名	远射	近射	边射	快攻	突破	任意	七米	合计	%	助攻	失误	警告	2'	取消	时间
安徽合肥(合肥)																
(场上队员)																
2	张天进	2/7			1/1	1/1	1/1		5/10	50.0%	1					00:38:27
13	沈威	2/4	0/1						2/5	40.0%	2	4				00:32:14
26	饶源源	1/3	1/1	0/1	1/1	1/2		1/1	5/9	55.6%		2				00:38:14
27	王东昇									0.0%						00:00:00
29	梅少聪		1/1	1/1	0/1				2/3	66.7%		1		1		00:40:00
30	单习振			1/1	3/4				4/5	80.0%						00:40:00
31	张宇	0/3							0/3	0.0%						00:09:34
33	於晓祺									0.0%						00:00:00
35	李宝松									0.0%						00:00:00
36	刘耀奇							0/1	0/1	0.0%						00:00:00
39	汤鸿宇									0.0%						00:00:00
40	陈欢									0.0%						00:40:00
41	管家乐	0/1							0/1	0.0%						00:15:48
42	刘军波									0.0%						00:00:00
43	王久源			1/2	2/2				3/4	75.0%		2	1	1		00:25:42
50	刘欣洋									0.0%						00:00:00
	合计	5/18	2/3	3/5	7/9	2/3	1/1	1/2	21/41	51.2%	3	9	1	2		
(守门员)																
40	陈欢	2/5	5/9	2/5	0/1	2/4	1/3		12/27	44.4%						00:40:00
	合计	2/5	5/9	2/5	0/1	2/4	1/3		12/27	44.4%						

场上队员：得分/射门

守门员：救球/射门

全队合计	得分	被救	射失	击柱	封球	合计	%
远射	5	3	5	2	3	18	27.8%
近射	2	1				3	66.7%
边射	3	2				5	60.0%
快攻	7	1		1		9	77.8%
突破	2	1				3	66.7%
任意	1					1	100.0%
七米	1	1				2	50.0%

图式比赛技术统计表

手球
青年男子

半决赛
轮次 5

组别 X
场次 75

晋中体育馆
2019-06-22 19:50

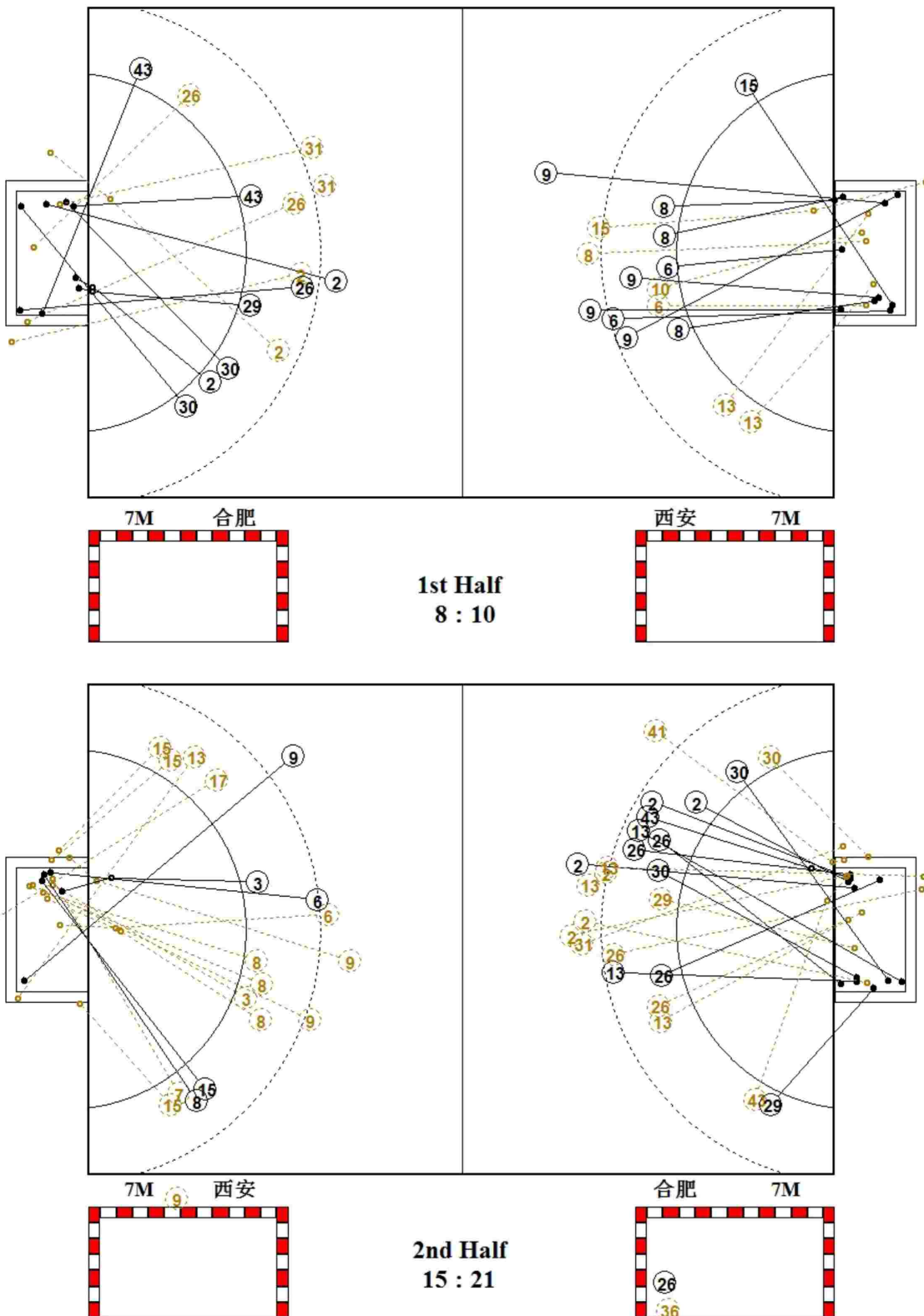

图式射门区域统计

手球
青年男子

半决赛
轮次 5

组别 X
场次 75

晋中体育馆
2019-06-22 19:50

陕西西安

1 陈昊 <table border="1"><tr><td></td><td></td><td></td></tr><tr><td></td><td></td><td></td></tr><tr><td></td><td></td><td></td></tr></table> Post - 0 Miss - 0 Block - 0										2 张兴彬 <table border="1"><tr><td></td><td></td><td></td></tr><tr><td></td><td></td><td></td></tr><tr><td></td><td></td><td></td></tr></table> Post - 0 Miss - 0 Block - 0										3 丁玉冰 <table border="1"><tr><td></td><td></td><td></td></tr><tr><td></td><td></td><td>1</td></tr><tr><td></td><td></td><td></td></tr></table> Post - 0 Miss - 0 Block - 0						1				5 隋家乐 <table border="1"><tr><td></td><td></td><td></td></tr><tr><td></td><td></td><td></td></tr><tr><td></td><td></td><td></td></tr></table> Post - 0 Miss - 0 Block - 0										6 李梦豪 <table border="1"><tr><td></td><td></td><td>1</td></tr><tr><td></td><td></td><td>1</td></tr><tr><td></td><td>1</td><td></td></tr></table> Post - 0 Miss - 0 Block - 0			1			1		1		7 黄金伟 <table border="1"><tr><td></td><td></td><td></td></tr><tr><td></td><td></td><td></td></tr><tr><td></td><td></td><td></td></tr></table> Post - 0 Miss - 0 Block - 0										8 张领 <table border="1"><tr><td></td><td></td><td></td></tr><tr><td></td><td></td><td>2</td></tr><tr><td>2</td><td></td><td></td></tr></table> Post - 0 Miss - 0 Block - 0						2	2			9 陈孝天 <table border="1"><tr><td>3</td><td></td><td></td></tr><tr><td></td><td></td><td>1</td></tr><tr><td></td><td></td><td>1</td></tr></table> Post - 1 Miss - 1 Block - 0	3					1			1
		1																																																																													
		1																																																																													
		1																																																																													
	1																																																																														
		2																																																																													
2																																																																															
3																																																																															
		1																																																																													
		1																																																																													
10 王凯强 <table border="1"><tr><td></td><td></td><td></td></tr><tr><td></td><td></td><td></td></tr><tr><td></td><td></td><td></td></tr></table> Post - 0 Miss - 0 Block - 0										11 孔宇豪 <table border="1"><tr><td></td><td></td><td></td></tr><tr><td></td><td></td><td></td></tr><tr><td></td><td></td><td></td></tr></table> Post - 0 Miss - 0 Block - 0										12 朱正顺 <table border="1"><tr><td></td><td></td><td></td></tr><tr><td></td><td></td><td></td></tr><tr><td></td><td></td><td></td></tr></table> Post - 0 Miss - 0 Block - 0										13 徐昊天 <table border="1"><tr><td></td><td></td><td></td></tr><tr><td></td><td></td><td></td></tr><tr><td></td><td></td><td></td></tr></table> Post - 1 Miss - 0 Block - 0										14 孙旭 <table border="1"><tr><td></td><td></td><td></td></tr><tr><td></td><td></td><td></td></tr><tr><td></td><td></td><td></td></tr></table> Post - 0 Miss - 0 Block - 0										15 陈冉 <table border="1"><tr><td></td><td></td><td>1</td></tr><tr><td></td><td></td><td>1</td></tr><tr><td></td><td></td><td></td></tr></table> Post - 2 Miss - 2 Block - 0			1			1				16 金筠峰 <table border="1"><tr><td></td><td></td><td></td></tr><tr><td></td><td></td><td></td></tr><tr><td></td><td></td><td></td></tr></table> Post - 0 Miss - 0 Block - 0										17 刘世昌 <table border="1"><tr><td></td><td></td><td></td></tr><tr><td></td><td></td><td></td></tr><tr><td></td><td></td><td></td></tr></table> Post - 0 Miss - 1 Block - 0									
		1																																																																													
		1																																																																													

1 陈昊

0/1	1/1	0/3
0/3	1/1	2/4
3/10	2/2	0/5

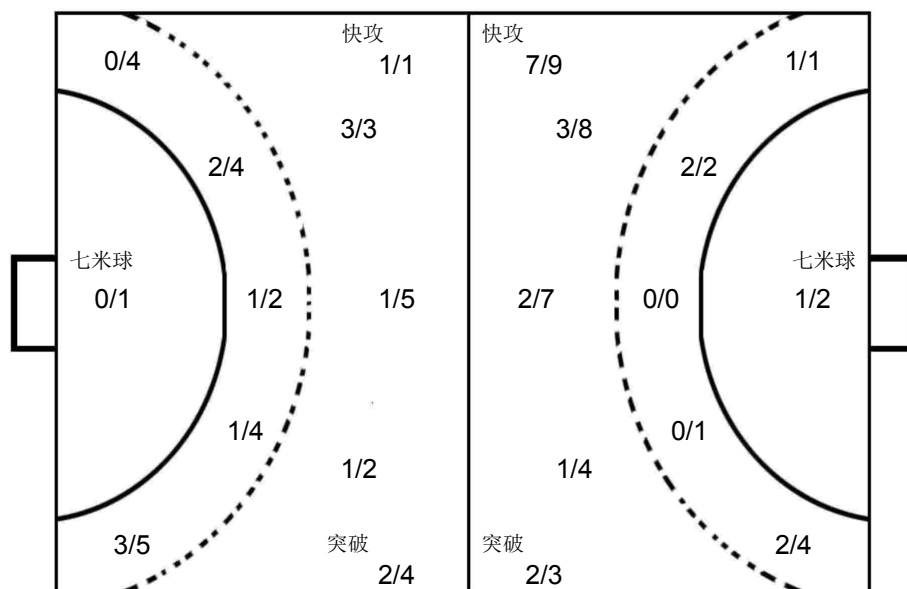

40 陈欢

0/3		2/4
1/1	3/3	6/12
0/2	0/1	0/1

安徽合肥

2 张天进 <table border="1"><tr><td></td><td></td><td></td></tr><tr><td></td><td></td><td>1</td></tr><tr><td>4</td><td></td><td></td></tr></table> Post - 0 Miss - 2 Block - 1						1	4			13 沈威 <table border="1"><tr><td></td><td></td><td>1</td></tr><tr><td></td><td></td><td></td></tr><tr><td></td><td></td><td>1</td></tr></table> Post - 0 Miss - 1 Block - 1			1						1	26 饶原源 <table border="1"><tr><td>1</td><td></td><td></td></tr><tr><td>2</td><td></td><td></td></tr><tr><td>1</td><td></td><td>1</td></tr></table> Post - 1 Miss - 1 Block - 0	1			2			1		1	27 王东昇 <table border="1"><tr><td></td><td></td><td></td></tr><tr><td></td><td></td><td></td></tr><tr><td></td><td></td><td></td></tr></table> Post - 0 Miss - 0 Block - 0										29 梅少聪 <table border="1"><tr><td></td><td></td><td></td></tr><tr><td></td><td></td><td>1</td></tr><tr><td>1</td><td></td><td></td></tr></table> Post - 0 Miss - 0 Block - 0						1	1			30 单习振 <table border="1"><tr><td></td><td></td><td>2</td></tr><tr><td></td><td></td><td></td></tr><tr><td></td><td></td><td>2</td></tr></table> Post - 1 Miss - 0 Block - 0			2						2	31 张宇 <table border="1"><tr><td></td><td></td><td></td></tr><tr><td></td><td></td><td></td></tr><tr><td></td><td></td><td></td></tr></table> Post - 0 Miss - 1 Block - 1										33 於晓祺 <table border="1"><tr><td></td><td></td><td></td></tr><tr><td></td><td></td><td></td></tr><tr><td></td><td></td><td></td></tr></table> Post - 0 Miss - 0 Block - 0									
		1																																																																													
4																																																																															
		1																																																																													
		1																																																																													
1																																																																															
2																																																																															
1		1																																																																													
		1																																																																													
1																																																																															
		2																																																																													
		2																																																																													
35 李宝松 <table border="1"><tr><td></td><td></td><td></td></tr><tr><td></td><td></td><td></td></tr><tr><td></td><td></td><td></td></tr></table> Post - 0 Miss - 0 Block - 0										36 刘耀奇 <table border="1"><tr><td></td><td></td><td></td></tr><tr><td></td><td></td><td></td></tr><tr><td></td><td></td><td></td></tr></table> Post - 0 Miss - 0 Block - 0										39 汤鸿宇 <table border="1"><tr><td></td><td></td><td></td></tr><tr><td></td><td></td><td></td></tr><tr><td></td><td></td><td></td></tr></table> Post - 0 Miss - 0 Block - 0										40 陈欢 <table border="1"><tr><td></td><td></td><td></td></tr><tr><td></td><td></td><td></td></tr><tr><td></td><td></td><td></td></tr></table> Post - 0 Miss - 0 Block - 0										41 管家乐 <table border="1"><tr><td></td><td></td><td></td></tr><tr><td></td><td></td><td></td></tr><tr><td></td><td></td><td></td></tr></table> Post - 1 Miss - 0 Block - 0										42 刘军波 <table border="1"><tr><td></td><td></td><td></td></tr><tr><td></td><td></td><td></td></tr><tr><td></td><td></td><td></td></tr></table> Post - 0 Miss - 0 Block - 0										43 王久源 <table border="1"><tr><td></td><td></td><td></td></tr><tr><td>1</td><td></td><td></td></tr><tr><td>1</td><td></td><td>1</td></tr></table> Post - 0 Miss - 0 Block - 0				1			1		1	50 刘欣洋 <table border="1"><tr><td></td><td></td><td></td></tr><tr><td></td><td></td><td></td></tr><tr><td></td><td></td><td></td></tr></table> Post - 0 Miss - 0 Block - 0									
1																																																																															
1		1																																																																													

第二届全国青年运动会男子手球甲组决赛 体校组 (U18)

比赛进程表

 手球 半决赛 组别 X 晋中体育馆
 青年男子 轮次 5 场次 75 2019-06-22 19:50

时间	队员	动作	比分	队员	动作
陕西西安			上半时	安徽合肥	
00:57	3 丁玉冰	传球失误	0-0		
01:29	1 陈昊	被射入	0-1	29 梅少聪	近射 得分
01:31				2 张天进	助攻
01:38	13 徐昊天	突破 被救		40 陈欢	挡住球
02:28	15 陈冉	断球		26 饶原源	传球失误
02:35	6 李梦豪	短传快攻 得分	1-1	40 陈欢	被射入
03:04				13 沈威	传球失误
04:06	9 陈孝天	右远射 得分	2-1	40 陈欢	被射入
04:22				26 饶原源	其它失误
04:37	8 张领	中远射 被救		40 陈欢	挡住球
04:47	1 陈昊	挡住球		26 饶原源	右边射 被救
04:55	6 李梦豪	近射 被救		40 陈欢	挡住球
05:00	1 陈昊	被射入	2-2	30 单习振	短传快攻 得分
05:42	8 张领	突破 得分	3-2	40 陈欢	被射入
05:53	15 陈冉	造犯规		13 沈威	进攻犯规
06:52	8 张领	近射 得分	4-2	40 陈欢	被射入
06:55	15 陈冉	助攻			
07:08	13 徐昊天	断球		13 沈威	传球失误
07:10	13 徐昊天	侵区			
08:06	8 张领	封球		31 张宇	右远射 被封
08:25	1 陈昊	挡住球		31 张宇	右远射 被救
09:12	9 陈孝天	任意球 得分	5-2	40 陈欢	被射入
09:18					球队暂停
09:33	1 陈昊	被射入	5-3	2 张天进	中远射 得分
11:04	13 徐昊天	右边射 被救		40 陈欢	挡住球
11:14	1 陈昊	被射入	5-4	2 张天进	突破 得分
11:41	15 陈冉	左边射 得分	6-4	40 陈欢	被射入
12:14				2 张天进	中远射 射失
12:41	9 陈孝天	突破 得分	7-4	40 陈欢	被射入
12:51	1 陈昊	被射入	7-5	26 饶原源	中远射 得分
13:48		球队暂停			
14:14				43 王久源	警告
14:28	8 张领	传球失误			
14:38				26 饶原源	右远射 击柱
15:02	6 李梦豪	断球		13 沈威	传球失误
15:26	6 李梦豪	近射 得分	8-5	40 陈欢	被射入
15:28	8 张领	助攻			
15:36	6 李梦豪	警告			
15:59	6 李梦豪	断球		29 梅少聪	传球失误
16:46	15 陈冉	运球失误			
16:55				43 王久源	快攻 接球失误

比赛进程表

手球 半决赛 组别 X 晋中体育馆
青年男子 轮次 5 场次 75 2019-06-22 19:50

时间	队员	动作	比分	队员	动作
陕西西安			上半时		
安徽合肥					
17:30	8 张领	近射 得分	9-5	40 陈欢	被射入
17:44				2 张天进	左远射 射失
18:16	10 王凯强	其它失误		2 张天进	造失误
18:23	1 陈昊	被射入	9-6	43 王久源	短传快攻 得分
19:07	10 王凯强	近射 被救		40 陈欢	挡住球
19:14	15 陈冉	中远射 射失			
19:27	1 陈昊	被射入	9-7	30 单习振	左边射 得分
19:41	10 王凯强	侵区			
19:53	1 陈昊	被射入	9-8	43 王久源	右边射 得分
19:56		裁判暂停			
19:56	8 张领	罚出场2分钟			
19:57	9 陈孝天	左远射 得分	10-8	40 陈欢	被射入

比赛进程表

手球 青年男子 半决赛 轮次 5 组别 X 场次 75 晋中体育馆 2019-06-22 19:50

时间	队员	动作	比分	队员	动作
陕西西安			安徽合肥		
下半场					
00:08	1 陈昊	被射入	10-9	2 张天进	左远射 得分
00:35	1 陈昊	挡住球		29 梅少聪	短传快攻 被救
01:19	15 陈冉	左边射 击柱			
01:24	1 陈昊	被射入	10-10	26 饶原源	短传快攻 得分
02:00	6 李梦豪	接球失误		29 梅少聪	抢球
02:28	1 陈昊	被射入	10-11	13 沈威	右远射 得分
02:51	9 陈孝天	中远射 击柱			
03:27	1 陈昊	被射入	10-12	2 张天进	任意球 得分
03:59	6 李梦豪	中远射 被救		40 陈欢	挡住球
04:08		球队暂停			
05:03	13 徐昊天	右边射 击柱			
05:08	1 陈昊	被射入	10-13	26 饶原源	近射 得分
05:25	6 李梦豪	中远射 得分	11-13	40 陈欢	被射入
05:36	13 徐昊天	使被罚7M球		2 张天进	造7M
05:38		裁判暂停			
05:53	1 陈昊	挡住球		36 刘耀奇	7M球 被救
06:06	8 张领	突破 被救		40 陈欢	挡住球
06:16	3 丁玉冰	使被罚7M球		43 王久源	造7M
06:17		裁判暂停			
06:19	1 陈昊	被射入	11-14	26 饶原源	7M球 得分
06:51	13 徐昊天	侵区			
07:01	1 陈昊	被射入	11-15	26 饶原源	突破 得分
07:46	9 陈孝天	任意球 被救		40 陈欢	挡住球
07:59		裁判暂停			
08:21				26 饶原源	中远射 射失
08:29	15 陈冉	左边射 得分	12-15	40 陈欢	被射入
09:01				13 沈威	左远射 射失
09:12	15 陈冉	运球失误		13 沈威	造失误
09:14	1 陈昊	被射入	12-16	2 张天进	短传快攻 得分
09:33	17 刘世昌	传球失误		43 王久源	断球
09:37	1 陈昊	被射入	12-17	43 王久源	一传快攻 得分
10:01	3 丁玉冰	近射 被救		40 陈欢	挡住球
10:03	9 陈孝天	助攻			
10:27	1 陈昊	被射入	12-18	13 沈威	左远射 得分
10:53	8 张领	近射 被救		40 陈欢	挡住球
10:58	17 刘世昌	近射 射失			
11:35	1 陈昊	挡住球		2 张天进	中远射 被救
12:19	9 陈孝天	任意球 得分	13-18	40 陈欢	被射入
13:01	1 陈昊	挡住球		26 饶原源	突破 被救
13:14		裁判暂停			
13:18	15 陈冉	右边射 击柱			

第二届全国青年运动会男子手球甲组决赛 体校组 (U18)

比赛进程表

 手球 半决赛 组别 X 晋中体育馆
 青年男子 轮次 5 场次 75 2019-06-22 19:50

时间	队员	动作	比分	队员	动作
陕西西安			安徽合肥		
			下半时		
13:28			13-18	30 单习振	一传快攻 击柱
13:48					球队暂停
14:16	1 陈昊	挡住球		43 王久源	右边射 被救
14:31	7 黄金伟	左边射 被救		40 陈欢	挡住球
14:38	15 陈冉	右边射 射失			
14:44	1 陈昊	挡住球		13 沈威	近射 被救
14:51	15 陈冉	快攻 接球失误			
15:29	3 丁玉冰	封球		2 张天进	左远射 被封
15:31				43 王久源	侵入
15:46	8 张领	近射 被救		40 陈欢	挡住球
15:48				43 王久源	罚出场2分钟
15:57	8 张领	侵入			
16:27	1 陈昊	被射入	13-19	29 梅少聪	右边射 得分
16:33				13 沈威	助攻
16:37	8 张领	传球失误		30 单习振	断球
16:43	1 陈昊	被射入	13-20	30 单习振	短传快攻 得分
17:08	8 张领	左边射 得分	14-20	40 陈欢	被射入
17:28					球队暂停
17:51	1 陈昊	挡住球		2 张天进	中远射 被救
18:01	10 王凯强	造7M		29 梅少聪	使被罚7M球
18:02		裁判暂停			
18:02				29 梅少聪	罚出场2分钟
18:07	9 陈孝天	7M球 射失			
18:55	10 王凯强	封球		13 沈威	左远射 被封
18:59				31 张宇	中远射 射失
19:06	8 张领	快攻 接球失误			
19:10	1 陈昊	被射入	14-21	30 单习振	一传快攻 得分
19:12				13 沈威	助攻
19:28	3 丁玉冰	近射 得分	15-21	40 陈欢	被射入
19:32	6 李梦豪	助攻			
20:00				41 管家乐	左远射 击柱



第二届全国青年运动会男子手球甲组决赛 体校组 (U18)

青年男子 全国比赛

3-4名

Team A A 北京市				Team B B 陕西西安				Match Number 81			
-----------------	--	--	--	------------------	--	--	--	---------------------------	--	--	--

Played in 山西晋中	in the hall 晋中体育馆	on 2019-06-23	at 09:00	hours	Speakers
-------------------	----------------------	------------------	-------------	-------	----------

Half-time(30')	A 5	B 10	End of playing time	A 17	B 21	1st extra time	A	B	2nd extra time	A	B	After penalty throws	A	B
----------------	--------	---------	---------------------	---------	---------	----------------	---	---	----------------	---	---	----------------------	---	---

Number of 7 m 3/3	Team time-out			Full name of players and officials	Team time-out			B 0/0	Number of 7 m
	1 09:44	2 27:10	3 34:12		1	2 38:49	3		

No.	Team A	G	W	2'	D	DR	No.	Team B	G	W	2'	D	DR
1	陶钜						1	陈昊	1				
3	魏豪						2	张兴彬					
4	李博仔						3	丁玉冰	1	1	1		
6	苑宾	2					5	隋家乐					
7	侯博耀						6	李梦豪	2				
8	孙铂力						7	黄金伟					
9	曹智栋	3					8	张领	3	1	1		
13	蓝心凯	1					9	陈孝天	6				
14	杜俊林						10	王凯强					
15	刘大明	6					11	孔宇豪					
16	王鑫宇						12	朱正顺					
18	宋昱鹏						13	徐昊天	2				
23	庞佳明	5					14	孙旭					
26	郑铭境		1				15	陈冉	6				
29	赵熹瑞						16	金筠峰					
32	张珂宁						17	刘世昌					
A	吴健						B	李安					
B	翟彦戎						C	郝可鑫					
							D	王少杰					
							E	陈冬冬					

A	Signatures of responsables for the teams (Off.A)												B
---	--	--	--	--	--	--	--	--	--	--	--	--	---

TP	Remarks of referees / HF Official													TP
----	-----------------------------------	--	--	--	--	--	--	--	--	--	--	--	--	----

Referees	陈晓波 (CHN)	康曦 (CHN)		
T.D.	张耿 (CHN)	王洋 (CHN)		
CHA Off.				

Note: Number of 7m Throws Awarded to Team A and B, Goals (G), Warnings (W), Suspensions (2'), Direct Disqualification (D), Disqualification With Report (DR) and Team Penalty (TP).

Table Officials: 贾腾 王志超 Statisticians: 王梓衡 刘笑

第二届全国青年运动会男子手球甲组决赛 体校组 (U18)

PHMS Pictorial Handball Match Statistics

IHF Official System

竞赛技术统计

手球
青年男子

3-4名
轮次 5

组别 X
场次 81

晋中体育馆
2019-06-23 09:00

Referees: 陈晓波 (CHN) / 康曦 (CHN) Result: 17:21 (5:10)
Teams: 北京市(北京) VS 陕西西安(西安)

北京		远	近	边	快	突	任意	7m	合计	%	助攻	失误	警告	2'	D+DR
主教练: 吴健		射	射	射	攻	破	球	球							
1	陶钜														
3	魏豪														
4	李博仔														
6	苑宾	1/2	1/1	0/1					2/4	50.0					
7	侯博耀														
8	孙铂力														
9	曹智栋	2/2				1/1			3/3	100		1			
13	蓝心凯			1/3					1/3	33.3					
14	杜俊林														
15	刘大明	4/7		0/1		1/1		1/1	6/10	60.0		3			
16	王鑫宇														
18	宋昱鹏														
23	庞佳明	1/3	1/1			1/1		2/2	5/7	71.4		2			
26	郑铭境												1		
29	赵嘉瑞														
32	张珂宁														
运动员	合计	8/14	2/2	1/5		3/3		3/3	17/27	63.0		6	1		
1	陶钜	0/1		0/1	0/1		0/1		0/4	0.0					
16	王鑫宇	5/13	3/7	0/1	0/2	0/2			8/25	32.0					
守门员	合计	5/14	3/7	0/2	0/3	0/2	0/1		8/29	27.6					

西安		远	近	边	快	突	任意	7m	合计	%	助攻	失误	警告	2'	D+DR
主教练: 郝可鑫		射	射	射	攻	破	球	球							
1	陈昊	1/1			0/1				1/2	50.0					
2	张兴彬														
3	丁玉冰		1/2						1/2	50.0			1	1	
5	隋家乐														
6	李梦豪	1/3	0/1			1/1			2/5	40.0					
7	黄金伟														
8	张领	1/4	1/1			1/1			3/6	50.0	2	2	1	1	
9	陈孝天	4/8	2/3						6/11	54.5		1			
10	王凯强														
11	孔宇豪														
12	朱正顺														
13	徐昊天				2/2				2/2	100					
14	孙旭														
15	陈冉	2/3		2/2	1/1		1/1		6/7	85.7					
16	金筠峰														
17	刘世昌														
运动员	合计	9/19	4/7	2/2	3/4	2/2	1/1		21/35	60.0	2	3	2	2	
1	陈昊	2/8	0/1	4/4		0/3		0/2	6/18	33.3					
12	朱正顺	0/2	0/1	0/1				0/1	0/5	0.0					
守门员	合计	2/10	0/2	4/5		0/3		0/3	6/23	26.1					

北京	比赛 进程	西安
1st Half		
15 刘大明	1 01:06 0	
	1 01:48 1 15 陈冉	
	1 05:59 2 9 陈孝天	
	1 08:22 3 15 陈冉	
	1 09:37 4 3 丁玉冰	
23 庞佳明	2 10:34 4	
15 刘大明	3 12:20 4	
	3 12:47 5 9 陈孝天	
	3 13:34 6 1 陈昊	
23 庞佳明	4 15:13 6	
	4 15:37 7 6 李梦豪	
	4 16:21 8 8 张领	
15 刘大明	5 16:55 8	
	5 18:22 9 6 李梦豪	
	5 20:00 10 13 徐昊天	
2nd Half		
6 苑宾	6 01:33 10	
	6 01:46 11 8 张领	
	6 02:39 12 8 张领	
15 刘大明	7 03:09 12	
	7 03:37 13 15 陈冉	
9 曹智栋	8 04:09 13	
	8 04:28 14 15 陈冉	
6 苑宾	9 05:44 14	
	9 06:27 15 15 陈冉	
	9 06:56 16 13 徐昊天	
15 刘大明	10 07:25 16	
	10 08:06 17 9 陈孝天	
9 曹智栋	11 09:52 17	
23 庞佳明	12 12:35 17	
	12 12:49 18 15 陈冉	
9 曹智栋	13 14:28 18	
	13 16:53 19 9 陈孝天	
15 刘大明	14 17:54 19	
23 庞佳明	15 18:23 19	
23 庞佳明	16 19:21 19	
	16 19:35 20 9 陈孝天	
13 蓝心凯	17 19:54 20	
	17 19:59 21 9 陈孝天	

场上队员: 得分 / 射门

守门员: 救球 / 射门

D	取消资格	DR	取消资格+报告
---	------	----	---------



个人/全队技术统计表

 手球 3-4名 组别 X 晋中体育馆
 青年男子 轮次 5 场次 81 2019-06-23 09:00

号码	姓名	远射	近射	边射	快攻	突破	任意	七米	合计	%	助攻	失误	警告	2'	取消	时间
北京市(北京)																
(场上队员)																
1	陶钜									0.0%						00:04:21
3	魏豪									0.0%						00:00:00
4	李博仔									0.0%						00:00:00
6	苑宾	1/2	1/1	0/1					2/4	50.0%						00:39:59
7	侯博耀									0.0%						00:00:00
8	孙铂力									0.0%						00:00:00
9	曹智栋	2/2				1/1			3/3	100%	1					00:39:59
13	蓝心凯			1/3					1/3	33.3%						00:35:01
14	杜俊林									0.0%						00:00:00
15	刘大明	4/7		0/1		1/1		1/1	6/10	60.0%	3					00:39:57
16	王鑫宇									0.0%						00:35:39
18	宋昱鹏									0.0%						00:00:00
23	庞佳明	1/3	1/1			1/1		2/2	5/7	71.4%	2					00:39:55
26	郑铭境									0.0%			1			00:04:47
29	赵熹瑞									0.0%						00:39:56
32	张珂宁									0.0%						00:00:00
	合计	8/14	2/2	1/5		3/3		3/3	17/27	63.0%	6		1			
(守门员)																
1	陶钜	0/1		0/1	0/1		0/1		0/4	0.0%						00:04:21
16	王鑫宇	5/13	3/7	0/1	0/2	0/2			8/25	32.0%						00:35:39
	合计	5/14	3/7	0/2	0/3	0/2	0/1		8/29	27.6%						

场上队员：得分/射门

守门员：救球/射门

全队合计	得分	被救	射失	击柱	封球	合计	%
远射	8	2	2	1	1	14	57.1%
近射	2					2	100.0%
边射	1	4				5	20.0%
快攻							0.0%
突破	3					3	100.0%
任意							0.0%
七米	3					3	100.0%

第二届全国青年运动会男子手球甲组决赛 体校组 (U18)

PHMS Pictorial Handball Match Statistics

IHF Official System

个人/全队技术统计表

手球 3-4名 组别 X 晋中体育馆
青年男子 轮次 5 场次 81 2019-06-23 09:00

号码	姓名	远射	近射	边射	快攻	突破	任意	七米	合计	%	助攻	失误	警告	2'	取消	时间
陕西西安(西安)																
(场上队员)																
1	陈昊	1/1				0/1			1/2	50.0%						00:34:12
2	张兴彬									0.0%						00:00:00
3	丁玉冰		1/2						1/2	50.0%			1	1		00:40:00
5	隋家乐									0.0%						00:00:00
6	李梦豪	1/3	0/1			1/1			2/5	40.0%						00:40:00
7	黄金伟									0.0%						00:00:00
8	张领	1/4	1/1			1/1			3/6	50.0%	2	2	1	1		00:39:04
9	陈孝天	4/8	2/3						6/11	54.5%		1				00:40:00
10	王凯强									0.0%						00:00:56
11	孔宇豪									0.0%						00:00:00
12	朱正顺									0.0%						00:05:48
13	徐昊天					2/2			2/2	100%						00:40:00
14	孙旭									0.0%						00:00:00
15	陈冉	2/3		2/2	1/1		1/1		6/7	85.7%						00:40:00
16	金筠峰									0.0%						00:00:00
17	刘世昌									0.0%						00:00:00
合计		9/19	4/7	2/2	3/4	2/2	1/1		21/35	60.0%	2	3	2	2		
(守门员)																
1	陈昊	2/8	0/1	4/4		0/3		0/2	6/18	33.3%						00:34:12
12	朱正顺	0/2	0/1	0/1				0/1	0/5	0.0%						00:05:48
合计		2/10	0/2	4/5		0/3		0/3	6/23	26.1%						

场上队员：得分/射门

守门员：救球/射门

全队合计	得分	被救	射失	击柱	封球	合计	%
远射	9	5	2		3	19	47.4%
近射	4	3				7	57.1%
边射	2					2	100.0%
快攻	3		1			4	75.0%
突破	2					2	100.0%
任意	1					1	100.0%
七米							0.0%

图式比赛技术统计表

手球
青年男子

3-4名
轮次 5

组别 X
场次 81

晋中体育馆
2019-06-23 09:00

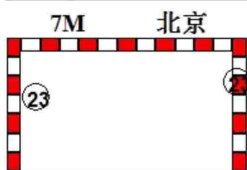
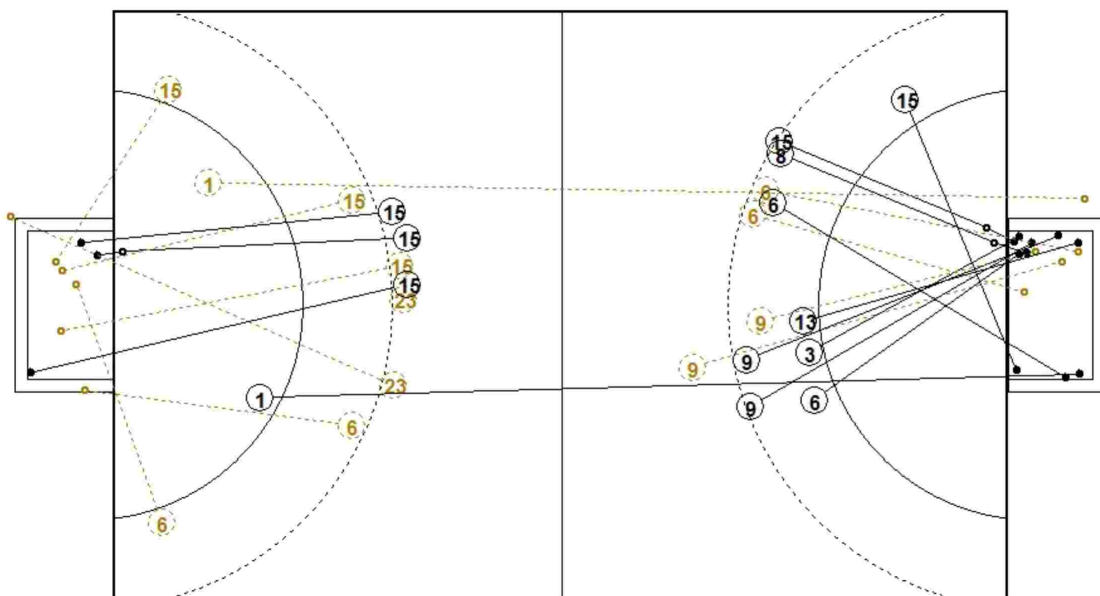

1st Half
5 : 10

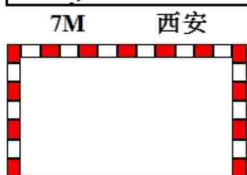
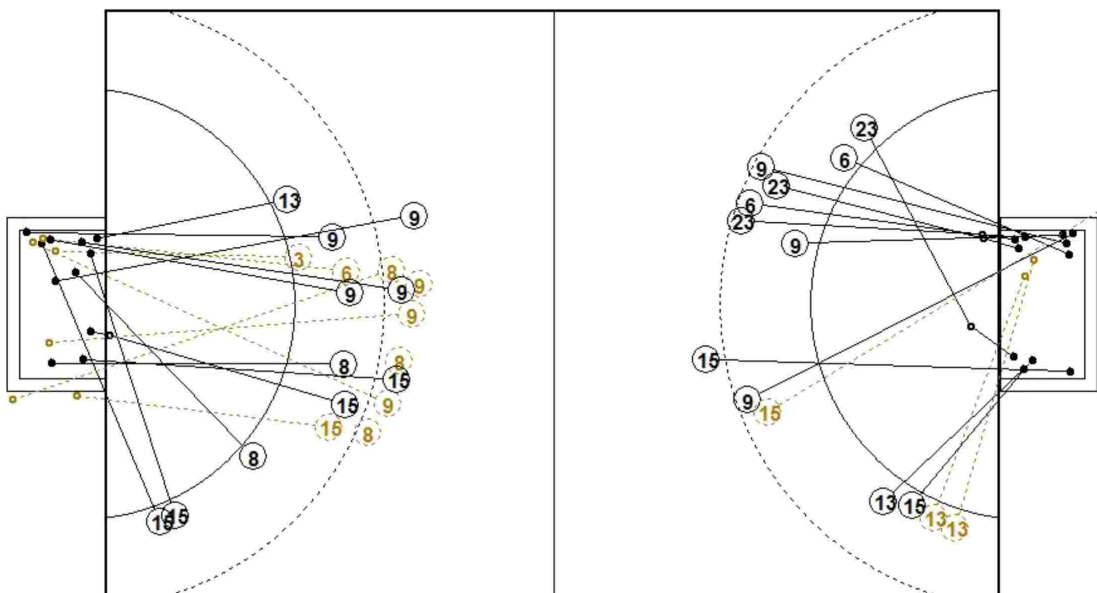
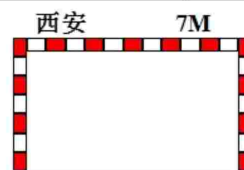

2nd Half
21 : 17

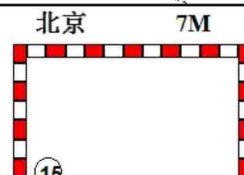

图式射门区域统计

手球
青年男子

3-4名
轮次 5

组别 X
场次 81

晋中体育馆
2019-06-23 09:00

北京市

1 陶钜	3 魏豪	4 李博仔	6 苑宾	7 侯博耀	8 孙铂力	9 曹智栋	13 蓝心凯																																																																								
<table border="1"><tr><td></td><td></td><td></td></tr><tr><td></td><td></td><td></td></tr><tr><td></td><td></td><td></td></tr></table>										<table border="1"><tr><td></td><td></td><td></td></tr><tr><td></td><td></td><td></td></tr><tr><td></td><td></td><td></td></tr></table>										<table border="1"><tr><td></td><td></td><td></td></tr><tr><td></td><td></td><td></td></tr><tr><td></td><td></td><td></td></tr></table>										<table border="1"><tr><td>1</td><td></td><td></td></tr><tr><td></td><td></td><td></td></tr><tr><td>1</td><td></td><td></td></tr></table>	1						1			<table border="1"><tr><td></td><td></td><td></td></tr><tr><td></td><td></td><td></td></tr><tr><td></td><td></td><td></td></tr></table>										<table border="1"><tr><td></td><td></td><td></td></tr><tr><td></td><td></td><td></td></tr><tr><td></td><td></td><td></td></tr></table>										<table border="1"><tr><td>3</td><td></td><td></td></tr><tr><td></td><td></td><td></td></tr><tr><td></td><td></td><td></td></tr></table>	3									<table border="1"><tr><td></td><td></td><td></td></tr><tr><td></td><td></td><td></td></tr><tr><td></td><td></td><td>1</td></tr></table>									1
1																																																																															
1																																																																															
3																																																																															
		1																																																																													
Post - 0 Miss - 0 Block - 0	Post - 0 Miss - 0 Block - 0	Post - 0 Miss - 0 Block - 0	Post - 1 Miss - 0 Block - 0	Post - 0 Miss - 0 Block - 0	Post - 0 Miss - 0 Block - 0	Post - 0 Miss - 0 Block - 0	Post - 0 Miss - 0 Block - 0																																																																								
14 杜俊林	15 刘大明	16 王鑫宇	18 宋昱鹏	23 庞佳明	26 郑铭境	29 赵熹瑞	32 张珂宁																																																																								
<table border="1"><tr><td></td><td></td><td></td></tr><tr><td></td><td></td><td></td></tr><tr><td></td><td></td><td></td></tr></table>										<table border="1"><tr><td>1</td><td></td><td>1</td></tr><tr><td></td><td></td><td>1</td></tr><tr><td>1</td><td></td><td>2</td></tr></table>	1		1			1	1		2	<table border="1"><tr><td></td><td></td><td></td></tr><tr><td></td><td></td><td></td></tr><tr><td></td><td></td><td></td></tr></table>										<table border="1"><tr><td></td><td></td><td></td></tr><tr><td></td><td></td><td></td></tr><tr><td></td><td></td><td></td></tr></table>										<table border="1"><tr><td>1</td><td></td><td>1</td></tr><tr><td></td><td></td><td></td></tr><tr><td>2</td><td></td><td>1</td></tr></table>	1		1				2		1	<table border="1"><tr><td></td><td></td><td></td></tr><tr><td></td><td></td><td></td></tr><tr><td></td><td></td><td></td></tr></table>										<table border="1"><tr><td></td><td></td><td></td></tr><tr><td></td><td></td><td></td></tr><tr><td></td><td></td><td></td></tr></table>										<table border="1"><tr><td></td><td></td><td></td></tr><tr><td></td><td></td><td></td></tr><tr><td></td><td></td><td></td></tr></table>									
1		1																																																																													
		1																																																																													
1		2																																																																													
1		1																																																																													
2		1																																																																													
Post - 0 Miss - 0 Block - 0	Post - 0 Miss - 1 Block - 0	Post - 0 Miss - 0 Block - 0	Post - 0 Miss - 0 Block - 0	Post - 0 Miss - 1 Block - 1	Post - 0 Miss - 0 Block - 0	Post - 0 Miss - 0 Block - 0	Post - 0 Miss - 0 Block - 0																																																																								

1 陶钜

		0/1
	0/1	
0/1		0/1

16 王鑫宇

2/3		2/5
2/4		1/3
0/6	1/1	0/3

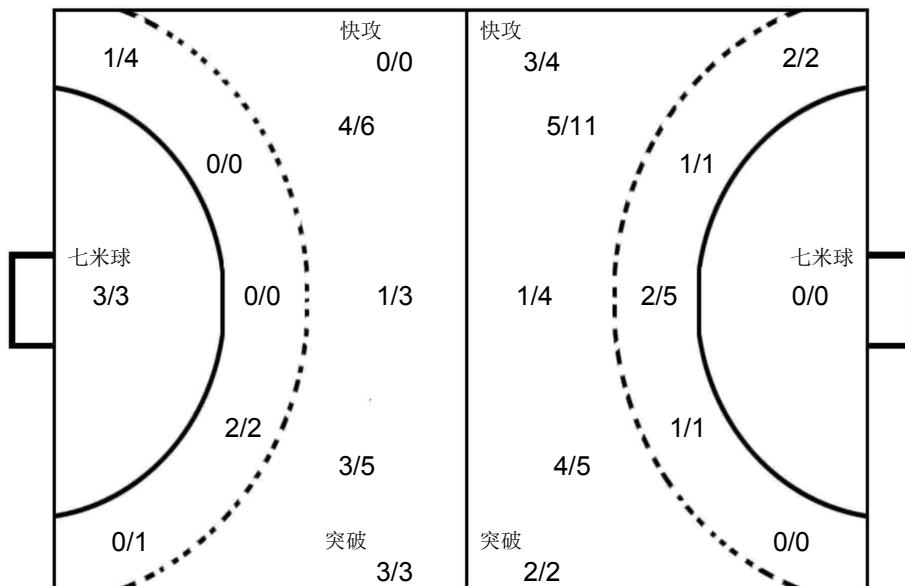

1 陈昊

0/5		1/3
2/2	1/1	1/2
1/2		0/3

12 朱正顺

0/1		
		0/1
0/3		

陕西西安

1 陈昊	2 张兴彬	3 丁玉冰	5 隋家乐	6 李梦豪	7 黄金伟	8 张领	9 陈孝天																																																																								
<table border="1"><tr><td></td><td></td><td>1</td></tr><tr><td></td><td></td><td></td></tr><tr><td></td><td></td><td></td></tr></table>			1							<table border="1"><tr><td></td><td></td><td></td></tr><tr><td></td><td></td><td></td></tr><tr><td></td><td></td><td></td></tr></table>										<table border="1"><tr><td></td><td></td><td></td></tr><tr><td></td><td></td><td></td></tr><tr><td>1</td><td></td><td></td></tr></table>							1			<table border="1"><tr><td></td><td></td><td></td></tr><tr><td></td><td></td><td></td></tr><tr><td></td><td></td><td></td></tr></table>										<table border="1"><tr><td></td><td></td><td>1</td></tr><tr><td></td><td></td><td></td></tr><tr><td>1</td><td></td><td></td></tr></table>			1				1			<table border="1"><tr><td></td><td></td><td></td></tr><tr><td></td><td></td><td></td></tr><tr><td></td><td></td><td></td></tr></table>										<table border="1"><tr><td></td><td></td><td></td></tr><tr><td>1</td><td></td><td>1</td></tr><tr><td>1</td><td></td><td></td></tr></table>				1		1	1			<table border="1"><tr><td></td><td></td><td>1</td></tr><tr><td>1</td><td>1</td><td>1</td></tr><tr><td>1</td><td></td><td>1</td></tr></table>			1	1	1	1	1		1
		1																																																																													
1																																																																															
		1																																																																													
1																																																																															
1		1																																																																													
1																																																																															
		1																																																																													
1	1	1																																																																													
1		1																																																																													
Post - 0 Miss - 1 Block - 0	Post - 0 Miss - 0 Block - 0	Post - 0 Miss - 0 Block - 0	Post - 0 Miss - 0 Block - 0	Post - 0 Miss - 0 Block - 0	Post - 0 Miss - 0 Block - 0	Post - 0 Miss - 1 Block - 2	Post - 0 Miss - 0 Block - 1																																																																								
10 王凯强	11 孔宇豪	12 朱正顺	13 徐昊天	14 孙旭	15 陈冉	16 金筠峰	17 刘世昌																																																																								
<table border="1"><tr><td></td><td></td><td></td></tr><tr><td></td><td></td><td></td></tr><tr><td></td><td></td><td></td></tr></table>										<table border="1"><tr><td></td><td></td><td></td></tr><tr><td></td><td></td><td></td></tr><tr><td></td><td></td><td></td></tr></table>										<table border="1"><tr><td></td><td></td><td></td></tr><tr><td></td><td></td><td></td></tr><tr><td></td><td></td><td></td></tr></table>										<table border="1"><tr><td>1</td><td></td><td></td></tr><tr><td></td><td></td><td></td></tr><tr><td></td><td></td><td>1</td></tr></table>	1								1	<table border="1"><tr><td></td><td></td><td></td></tr><tr><td></td><td></td><td></td></tr><tr><td></td><td></td><td></td></tr></table>										<table border="1"><tr><td></td><td></td><td>1</td></tr><tr><td></td><td></td><td></td></tr><tr><td>3</td><td></td><td>2</td></tr></table>			1				3		2	<table border="1"><tr><td></td><td></td><td></td></tr><tr><td></td><td></td><td></td></tr><tr><td></td><td></td><td></td></tr></table>										<table border="1"><tr><td></td><td></td><td></td></tr><tr><td></td><td></td><td></td></tr><tr><td></td><td></td><td></td></tr></table>									
1																																																																															
		1																																																																													
		1																																																																													
3		2																																																																													
Post - 0 Miss - 0 Block - 0	Post - 0 Miss - 0 Block - 0	Post - 0 Miss - 0 Block - 0	Post - 0 Miss - 0 Block - 0	Post - 0 Miss - 0 Block - 0	Post - 0 Miss - 1 Block - 0	Post - 0 Miss - 0 Block - 0	Post - 0 Miss - 0 Block - 0																																																																								



第二届全国青年运动会男子手球甲组决赛 体校组 (U18)

比赛进程表

 手球 3-4名 组别 X 晋中体育馆
 青年男子 轮次 5 场次 81 2019-06-23 09:00

时间	队员	动作	比分	队员	动作
北京市			上半时		
陕西省西安					
01:06	15 刘大明	右远射 得分	1-0	1 陈昊	被射入
01:48	16 王鑫宇	被射入	1-1	15 陈冉	左远射 得分
03:24	23 庞佳明	中远射 被封		3 丁玉冰	封球
04:03	16 王鑫宇	挡住球		6 李梦豪	左远射 被救
05:01	6 苑宾	左远射 击柱		9 陈孝天	右远射 被救
05:16	16 王鑫宇	挡住球			
05:50	15 刘大明	侵区			
05:59	16 王鑫宇	被射入	1-2	9 陈孝天	右远射 得分
06:36	6 苑宾	左边射 被救		1 陈昊	挡住球
07:10				9 陈孝天	运球失误
08:08	15 刘大明	右边射 被救		1 陈昊	挡住球
08:22	16 王鑫宇	被射入	1-3	15 陈冉	短传快攻 得分
09:10	15 刘大明	中远射 被救		1 陈昊	挡住球
09:37	16 王鑫宇	被射入	1-4	3 丁玉冰	近射 得分
09:40				8 张领	助攻
09:44		球队暂停			
10:18	29 赵熹瑞	造7M		8 张领	使被罚7M球
10:34	23 庞佳明	7M球 得分	2-4	1 陈昊	被射入
11:05	16 王鑫宇	挡住球		6 李梦豪	左远射 被救
11:41	23 庞佳明	左远射 射失		1 陈昊	一传快攻 射失
12:05					
12:20	15 刘大明	中远射 得分	3-4	1 陈昊	被射入
12:47	16 王鑫宇	被射入	3-5	9 陈孝天	右远射 得分
13:25	15 刘大明	右远射 被救		1 陈昊	挡住球
13:34	16 王鑫宇	被射入	3-6	1 陈昊	右远射 得分
14:10				8 张领	警告
14:52	6 苑宾	造7M		13 徐昊天	使被罚7M球
15:13	23 庞佳明	7M球 得分	4-6	1 陈昊	被射入
15:37	16 王鑫宇	被射入	4-7	6 李梦豪	左远射 得分
16:11	23 庞佳明	传球失误		13 徐昊天	断球
16:21	16 王鑫宇	被射入	4-8	8 张领	左远射 得分
16:55	15 刘大明	右远射 得分	5-8	1 陈昊	被射入
17:21	16 王鑫宇	挡住球		9 陈孝天	近射 被救
17:53	26 郑铭境	警告			
18:22	16 王鑫宇	被射入	5-9	6 李梦豪	突破 得分
19:26				3 丁玉冰	警告
19:57	23 庞佳明	其它失误			
20:00	16 王鑫宇	被射入	5-10	13 徐昊天	短传快攻 得分

第二届全国青年运动会男子手球甲组决赛 体校组 (U18)

比赛进程表

手球 3-4名 组别 X 晋中体育馆
 青年男子 轮次 5 场次 81 2019-06-23 09:00

时间	队员	动作	比分	队员	动作
北京市			下半时		
陕西省西安					
00:44	16 王鑫宇	挡住球	5-10	9 陈孝天	左远射 被救
01:33	6 苑宾	左远射 得分	6-10	1 陈昊	被射入
01:46	16 王鑫宇	被射入	6-11	8 张领	近射 得分
02:28	15 刘大明	四步			
02:39	16 王鑫宇	被射入	6-12	8 张领	突破 得分
03:09	15 刘大明	突破 得分	7-12	1 陈昊	被射入
03:37	16 王鑫宇	被射入	7-13	15 陈冉	左远射 得分
04:09	9 曹智栋	右远射 得分	8-13	1 陈昊	被射入
04:22	9 曹智栋	封球		8 张领	左远射 被封
04:28	1 陶钜	被射入	8-14	15 陈冉	左边射 得分
04:59				8 张领	罚出场2分钟
05:44	6 苑宾	近射 得分	9-14	1 陈昊	被射入
06:27	1 陶钜	被射入	9-15	15 陈冉	任意球 得分
06:48	13 蓝心凯	右边射 被救		1 陈昊	挡住球
06:56	1 陶钜	被射入	9-16	13 徐昊天	短传快攻 得分
07:10		球队暂停			
07:25	15 刘大明	右远射 得分	10-16	1 陈昊	被射入
07:37	23 庞佳明	封球		9 陈孝天	中远射 被封
08:06	1 陶钜	被射入	10-17	9 陈孝天	右远射 得分
09:10	13 蓝心凯	右边射 被救		1 陈昊	挡住球
09:20				3 丁玉冰	罚出场2分钟
09:26		裁判暂停			
09:52	9 曹智栋	突破 得分	11-17	1 陈昊	被射入
10:29				15 陈冉	左远射 射失
10:50	9 曹智栋	四步			
11:34	16 王鑫宇	挡住球		3 丁玉冰	近射 被救
11:36				8 张领	助攻
11:49				8 张领	四步
12:35	23 庞佳明	突破 得分	12-17	1 陈昊	被射入
12:49	16 王鑫宇	被射入	12-18	15 陈冉	左边射 得分
13:42	15 刘大明	四步			
13:51				8 张领	四步
14:12		球队暂停			
14:28	9 曹智栋	左远射 得分	13-18	12 朱正顺	被射入
15:32	16 王鑫宇	挡住球		9 陈孝天	中远射 被救
16:07	15 刘大明	右远射 射失			
16:41	13 蓝心凯	封球		8 张领	左远射 被封
16:53	16 王鑫宇	被射入	13-19	9 陈孝天	近射 得分
17:43	15 刘大明	造7M		15 陈冉	使被罚7M球
17:54	15 刘大明	7M球 得分	14-19	12 朱正顺	被射入
18:08	16 王鑫宇	挡住球		6 李梦豪	近射 被救

比赛进程表

手球 3-4名 组别 X 晋中体育馆
 青年男子 轮次 5 场次 81 2019-06-23 09:00

时间	队员	动作	比分	队员	动作
北京市			陕西西安		
下半时					
18:23	23 庞佳明	左远射 得分	15-19	12 朱正顺	被射入
18:49					球队暂停
19:03				8 张领	中远射 射失
19:04		裁判暂停			
19:21	23 庞佳明	近射 得分	16-19	12 朱正顺	被射入
19:35	16 王鑫宇	被射入	16-20	9 陈孝天	中远射 得分
19:54	13 蓝心凯	右边射 得分	17-20	12 朱正顺	被射入
19:59	16 王鑫宇	被射入	17-21	9 陈孝天	近射 得分

个人/全队技术统计表

手球 青年男子 决赛 轮次 6 组别 X 场次 85 晋中体育馆 2019-06-23 16:20

号码	姓名	远射	近射	边射	快攻	突破	任意	七米	合计	%	助攻	失误	警告	2'	取消	时间
山东潍坊 (潍坊)																
(场上队员)																
1	鲁世豪									0.0%						00:00:21
3	李相杰	2/3			1/1	2/4		1/1	6/9	66.7%		5				00:40:00
5	刘天驰	2/3	1/2				1/1		4/6	66.7%		2		2		00:38:06
6	张智超			0/1					0/1	0.0%						00:08:21
8	薛瑞寒		0/1	1/1			0/1		1/3	33.3%		1				00:31:33
9	杜忠浩	1/1		0/1		1/1			2/3	66.7%						00:16:44
11	杨毅	3/5	1/2			1/1	1/2	1/1	7/11	63.6%			1			00:40:00
12	黄晓春									0.0%	2					00:39:39
15	宋子阳		1/1	1/1	1/1				3/3	100%		1				00:37:50
19	汤雨扬									0.0%						00:00:00
20	刘文东									0.0%						00:00:00
21	张宋帅									0.0%						00:00:00
24	王宇恒			0/1					0/1	0.0%						00:02:34
25	郭昊文									0.0%						00:00:00
33	吴夏冰									0.0%			1	1		00:24:52
合计		8/12	3/6	2/5	2/2	4/6	2/4	2/2	23/37	62.2%	2	9	2	3		
(守门员)																
1	鲁世豪							1/2	1/2	50.0%						00:00:21
12	黄晓春	1/5	1/5	0/3	1/3	2/9		1/2	6/27	22.2%	2					00:39:39
合计		1/5	1/5	0/3	1/3	2/9		2/4	7/29	24.1%	2					

场上队员：得分/射门

守门员：救球/射门

全队合计	得分	被救	射失	击柱	封球	合计	%
远射	8	1	3			12	66.7%
近射	3	3				6	50.0%
边射	2	3				5	40.0%
快攻	2					2	100.0%
突破	4	1	1			6	66.7%
任意	2	1	1			4	50.0%
七米	2					2	100.0%

第二届全国青年运动会男子手球甲组决赛 体校组 (U18)

PHMS Pictorial Handball Match Statistics

IHF Official System

个人/全队技术统计表

手球 青年男子 决赛 轮次 6 组别 X 场次 85 晋中体育馆
2019-06-23 16:20

号码	姓名	远射	近射	边射	快攻	突破	任意	七米	合计	%	助攻	失误	警告	2'	取消	时间
安徽合肥(合肥)																
(场上队员)																
2	张天进	2/5	2/3			2/2	0/1	1/1	7/12	58.3%		3				00:40:00
13	沈威	0/2	0/1		1/1	3/3			4/7	57.1%	2	1				00:40:00
26	饶源源	2/2	1/1		0/1	2/3		1/2	6/9	66.7%	3	4		1		00:40:00
27	王东昇									0.0%						00:00:00
29	梅少聪		1/1		1/1				2/2	100%				1		00:40:00
30	单习振			1/2		0/1			1/3	33.3%	1	2	1			00:40:00
31	张宇									0.0%						00:00:00
33	於晓祺									0.0%						00:00:00
35	李宝松									0.0%						00:00:00
36	刘耀奇							0/1	0/1	0.0%						00:00:14
39	汤鸿宇									0.0%						00:03:50
40	陈欢									0.0%						00:36:10
41	管家乐									0.0%						00:00:00
42	刘军波									0.0%						00:00:00
43	王久源			2/2					2/2	100%						00:39:46
50	刘欣洋									0.0%						00:00:00
	合计	4/9	4/6	3/4	2/3	7/9	0/1	2/4	22/36	61.1%	6	10	1	2		
(守门员)																
39	汤鸿宇		1/2			0/1	0/1	1/4		25.0%						00:03:50
40	陈欢	1/9	2/4	3/5	0/2	1/5	1/2	0/1	8/28	28.6%						00:36:10
	合计	1/9	3/6	3/5	0/2	1/5	1/3	0/2	9/32	28.1%						

场上队员： 得分/射门

守门员： 救球/射门

全队合计	得分	被救	射失	击柱	封球	合计	%
远射	4	1	1	1	2	9	44.4%
近射	4	1	1			6	66.7%
边射	3		1			4	75.0%
快攻	2	1				3	66.7%
突破	7	2				9	77.8%
任意			1			1	0.0%
七米	2	2				4	50.0%

图式比赛技术统计表

手球
青年男子

决赛
轮次 6

组别 X
场次 85

晋中体育馆
2019-06-23 16:20

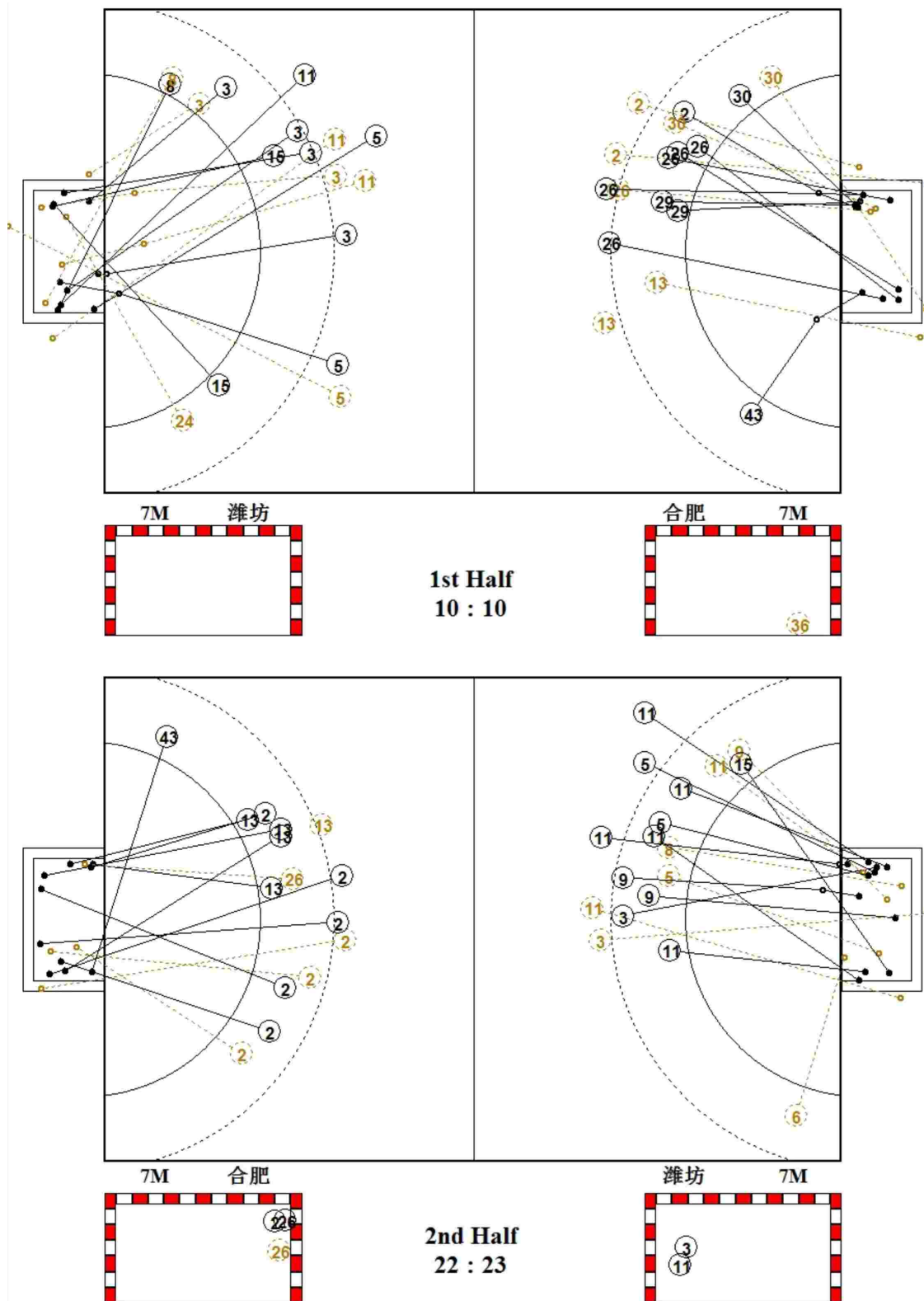

图式射门区域统计

手球
青年男子

决赛
轮次 6

组别 X
场次 85

晋中体育馆
2019-06-23 16:20

山东潍坊

1 鲁世豪	3 李相杰	5 刘天驰	6 张智超	8 薛瑞寒	9 杜忠浩	11 杨毅	12 黄晓春																																																																								
<table border="1"><tr><td></td><td></td><td></td></tr><tr><td></td><td></td><td></td></tr><tr><td></td><td></td><td></td></tr></table>										<table border="1"><tr><td></td><td></td><td></td></tr><tr><td>3</td><td></td><td>1</td></tr><tr><td>1</td><td></td><td>1</td></tr></table>				3		1	1		1	<table border="1"><tr><td></td><td></td><td></td></tr><tr><td>3</td><td></td><td></td></tr><tr><td>1</td><td></td><td></td></tr></table>				3			1			<table border="1"><tr><td></td><td></td><td></td></tr><tr><td></td><td></td><td></td></tr><tr><td></td><td></td><td></td></tr></table>										<table border="1"><tr><td>1</td><td></td><td></td></tr><tr><td></td><td></td><td></td></tr><tr><td></td><td></td><td></td></tr></table>	1									<table border="1"><tr><td></td><td>1</td><td></td></tr><tr><td></td><td></td><td></td></tr><tr><td>1</td><td></td><td></td></tr></table>		1					1			<table border="1"><tr><td>1</td><td></td><td></td></tr><tr><td>3</td><td></td><td>1</td></tr><tr><td>1</td><td></td><td>1</td></tr></table>	1			3		1	1		1	<table border="1"><tr><td></td><td></td><td></td></tr><tr><td></td><td></td><td></td></tr><tr><td></td><td></td><td></td></tr></table>									
3		1																																																																													
1		1																																																																													
3																																																																															
1																																																																															
1																																																																															
	1																																																																														
1																																																																															
1																																																																															
3		1																																																																													
1		1																																																																													
Post - 0 Miss - 0 Block - 0	Post - 0 Miss - 2 Block - 0	Post - 0 Miss - 1 Block - 0	Post - 0 Miss - 0 Block - 0	Post - 0 Miss - 0 Block - 0	Post - 0 Miss - 0 Block - 0	Post - 0 Miss - 2 Block - 0	Post - 0 Miss - 0 Block - 0																																																																								
15 宋子阳	19 汤雨扬	20 刘文东	21 张宋帅	24 王宇恒	25 郭昊文	33 吴夏冰																																																																									
<table border="1"><tr><td></td><td></td><td>3</td></tr><tr><td></td><td></td><td></td></tr><tr><td></td><td></td><td></td></tr></table>			3							<table border="1"><tr><td></td><td></td><td></td></tr><tr><td></td><td></td><td></td></tr><tr><td></td><td></td><td></td></tr></table>										<table border="1"><tr><td></td><td></td><td></td></tr><tr><td></td><td></td><td></td></tr><tr><td></td><td></td><td></td></tr></table>										<table border="1"><tr><td></td><td></td><td></td></tr><tr><td></td><td></td><td></td></tr><tr><td></td><td></td><td></td></tr></table>										<table border="1"><tr><td></td><td></td><td></td></tr><tr><td></td><td></td><td></td></tr><tr><td></td><td></td><td></td></tr></table>										<table border="1"><tr><td></td><td></td><td></td></tr><tr><td></td><td></td><td></td></tr><tr><td></td><td></td><td></td></tr></table>										<table border="1"><tr><td></td><td></td><td></td></tr><tr><td></td><td></td><td></td></tr><tr><td></td><td></td><td></td></tr></table>																			
		3																																																																													
Post - 0 Miss - 0 Block - 0	Post - 0 Miss - 0 Block - 0	Post - 0 Miss - 0 Block - 0	Post - 0 Miss - 0 Block - 0	Post - 0 Miss - 0 Block - 0	Post - 0 Miss - 0 Block - 0	Post - 0 Miss - 0 Block - 0																																																																									

1 鲁世豪									
<table border="1"><tr><td></td><td></td><td>0/1</td></tr><tr><td></td><td></td><td>1/1</td></tr><tr><td></td><td></td><td></td></tr></table>			0/1			1/1			
		0/1							
		1/1							

12 黄晓春									
<table border="1"><tr><td>1/4</td><td></td><td>0/5</td></tr><tr><td>3/5</td><td></td><td>0/2</td></tr><tr><td>0/6</td><td></td><td>2/5</td></tr></table>	1/4		0/5	3/5		0/2	0/6		2/5
1/4		0/5							
3/5		0/2							
0/6		2/5							

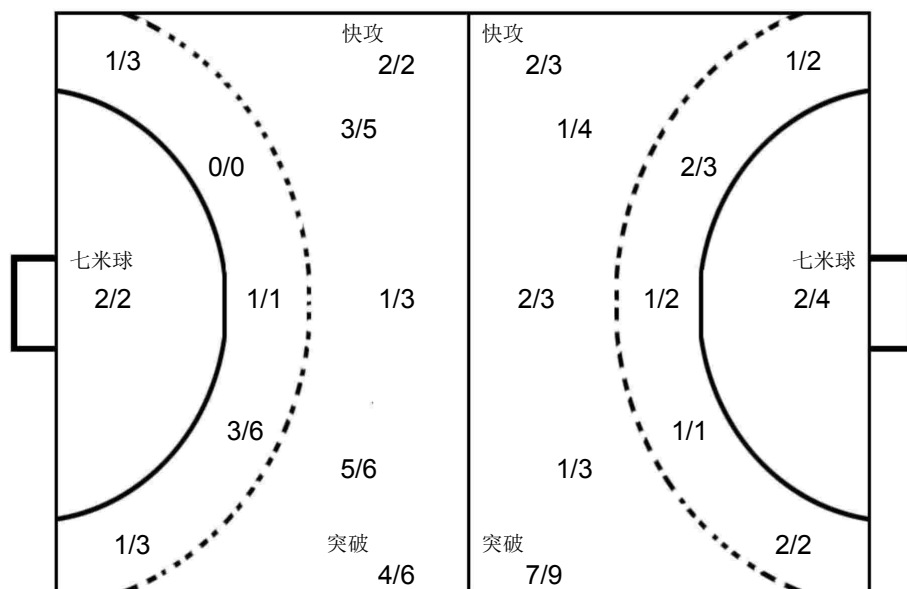

39 汤鸿宇									
<table border="1"><tr><td></td><td></td><td></td></tr><tr><td>0/3</td><td></td><td></td></tr><tr><td>1/1</td><td></td><td></td></tr></table>				0/3			1/1		
0/3									
1/1									

40 陈欢									
<table border="1"><tr><td>2/4</td><td>1/2</td><td>1/4</td></tr><tr><td>0/6</td><td>1/1</td><td>2/4</td></tr><tr><td>0/4</td><td></td><td>1/3</td></tr></table>	2/4	1/2	1/4	0/6	1/1	2/4	0/4		1/3
2/4	1/2	1/4							
0/6	1/1	2/4							
0/4		1/3							

安徽合肥

2 张天进	13 沈威	26 饶原源	27 王东昇	29 梅少聪	30 单习振	31 张宇	33 於晓祺																																																																								
<table border="1"><tr><td>2</td><td></td><td>2</td></tr><tr><td>1</td><td></td><td></td></tr><tr><td>1</td><td></td><td>1</td></tr></table>	2		2	1			1		1	<table border="1"><tr><td></td><td></td><td>1</td></tr><tr><td>1</td><td></td><td>1</td></tr><tr><td></td><td></td><td>1</td></tr></table>			1	1		1			1	<table border="1"><tr><td>1</td><td></td><td>3</td></tr><tr><td></td><td></td><td>1</td></tr><tr><td>1</td><td></td><td></td></tr></table>	1		3			1	1			<table border="1"><tr><td></td><td></td><td></td></tr><tr><td></td><td></td><td></td></tr><tr><td></td><td></td><td></td></tr></table>										<table border="1"><tr><td></td><td></td><td></td></tr><tr><td></td><td></td><td></td></tr><tr><td>2</td><td></td><td></td></tr></table>							2			<table border="1"><tr><td></td><td></td><td></td></tr><tr><td></td><td></td><td></td></tr><tr><td>1</td><td></td><td></td></tr></table>							1			<table border="1"><tr><td></td><td></td><td></td></tr><tr><td></td><td></td><td></td></tr><tr><td></td><td></td><td></td></tr></table>										<table border="1"><tr><td></td><td></td><td></td></tr><tr><td></td><td></td><td></td></tr><tr><td></td><td></td><td></td></tr></table>									
2		2																																																																													
1																																																																															
1		1																																																																													
		1																																																																													
1		1																																																																													
		1																																																																													
1		3																																																																													
		1																																																																													
1																																																																															
2																																																																															
1																																																																															
Post - 1 Miss - 2 Block - 0	Post - 0 Miss - 1 Block - 2	Post - 0 Miss - 0 Block - 0	Post - 0 Miss - 0 Block - 0	Post - 0 Miss - 0 Block - 0	Post - 0 Miss - 1 Block - 0	Post - 0 Miss - 0 Block - 0	Post - 0 Miss - 0 Block - 0																																																																								
35 李宝松	36 刘耀奇	39 汤鸿宇	40 陈欢	41 管家乐	42 刘军波	43 王久源	50 刘欣洋																																																																								
<table border="1"><tr><td></td><td></td><td></td></tr><tr><td></td><td></td><td></td></tr><tr><td></td><td></td><td></td></tr></table>										<table border="1"><tr><td></td><td></td><td></td></tr><tr><td></td><td></td><td></td></tr><tr><td></td><td></td><td></td></tr></table>										<table border="1"><tr><td></td><td></td><td></td></tr><tr><td></td><td></td><td></td></tr><tr><td></td><td></td><td></td></tr></table>										<table border="1"><tr><td></td><td></td><td></td></tr><tr><td></td><td></td><td></td></tr><tr><td></td><td></td><td></td></tr></table>										<table border="1"><tr><td></td><td></td><td></td></tr><tr><td></td><td></td><td></td></tr><tr><td></td><td></td><td></td></tr></table>										<table border="1"><tr><td></td><td></td><td></td></tr><tr><td></td><td></td><td></td></tr><tr><td></td><td></td><td></td></tr></table>										<table border="1"><tr><td></td><td></td><td></td></tr><tr><td></td><td></td><td></td></tr><tr><td>1</td><td></td><td>1</td></tr></table>							1		1	<table border="1"><tr><td></td><td></td><td></td></tr><tr><td></td><td></td><td></td></tr><tr><td></td><td></td><td></td></tr></table>									
1		1																																																																													
Post - 0 Miss - 0 Block - 0	Post - 0 Miss - 0 Block - 0	Post - 0 Miss - 0 Block - 0	Post - 0 Miss - 0 Block - 0	Post - 0 Miss - 0 Block - 0	Post - 0 Miss - 0 Block - 0	Post - 0 Miss - 0 Block - 0	Post - 0 Miss - 0 Block - 0																																																																								



第二届全国青年运动会男子手球甲组决赛 体校组 (U18)

青年男子 全国比赛

决赛

Team A A 山东潍坊				Team B B 安徽合肥				Match Number 85			
------------------	--	--	--	------------------	--	--	--	---------------------------	--	--	--

Played in 山西晋中	in the hall 晋中体育馆	on 2019-06-23	at 16:20	hours	Speakers
-------------------	----------------------	------------------	-------------	-------	----------

Half-time(30')	A 10	B 10	End of playing time	A 23	B 22	1st extra time	A	B	2nd extra time	A	B	After penalty throws	A	B
----------------	---------	---------	---------------------	---------	---------	----------------	---	---	----------------	---	---	----------------------	---	---

Number of 7 m 2/2	Team time-out			Full name of players and officials	Team time-out			B 2/4	Number of 7 m
	1 08:04	2 25:12	3 39:28		1	2 29:53	3		

No.	Team A	G	W	2'	D	DR	No.	Team B	G	W	2'	D	DR
1	鲁世豪						2	张天进	7				
3	李相杰	6					13	沈威	4				
5	刘天驰	4		2			26	饶原源	6		1		
6	张智超						27	王东昇					
8	薛瑞寒	1					29	梅少聪	2		1		
9	杜忠浩	2					30	单习振	1	1			
11	杨毅	7	1				31	张宇					
12	黄晓春						33	於晓祺					
15	宋子阳	3					35	李宝松					
19	汤雨扬						36	刘耀奇					
20	刘文东						39	汤鸿宇					
21	张宋帅						40	陈欢					
24	王宇恒						41	管家乐					
25	郭昊文						42	刘军波					
33	吴夏冰			1	1		43	王久源	2				
							50	刘欣洋					
B	赵鑫 (主教练)						A	王德勇 (主教练)					
C	王平						B	李晓鹏					
E	陈琪						C	陆万红					
							D	王明星					

A	Signatures of responsables for the teams (Off.A)												B
---	--	--	--	--	--	--	--	--	--	--	--	--	---

TP	Remarks of referees / HF Official													TP
----	-----------------------------------	--	--	--	--	--	--	--	--	--	--	--	--	----

Referees	李兆蒙 (CHN)	马晓晔 (CHN)		
T.D.	吴瑞亭 (CHN)	陈晓波 (CHN)		
CHA Off.				

Note: Number of 7m Throws Awarded to Team A and B, Goals (G), Warnings (W), Suspensions (2'), Direct Disqualification (D), Disqualification With Report (DR) and Team Penalty (TP).

Table Officials: 王志超 马迪 Statisticians: 王梓衡 刘笑

竞赛技术统计

手球
青年男子

决赛
轮次 6

组别 X
场次 85

晋中体育馆
2019-06-23 16:20

Referees: 李兆蒙 (CHN) / 马晓晔 (CHN)

Result: 23:22(10:10)

Teams: 山东潍坊(潍坊) VS 安徽合肥(合肥)

潍坊		远射	近射	边射	快攻	突破	任意球	7m球	合计	%	助攻	失误	警告	2'	D+DR
主教练: 赵鑫															
1	鲁世豪														
3	李相杰	2/3			1/1	2/4		1/1	6/9	66.7		5			
5	刘天驰	2/3	1/2				1/1		4/6	66.7		2		2	
6	张智超			0/1					0/1	0.0					
8	薛瑞寒		0/1	1/1			0/1		1/3	33.3		1			
9	杜忠浩	1/1		0/1		1/1			2/3	66.7					
11	杨毅	3/5	1/2			1/1	1/2	1/1	7/11	63.6			1		
12	黄晓春										2				
15	宋子阳		1/1	1/1	1/1				3/3	100		1			
19	汤雨扬														
20	刘文东														
21	张宋帅														
24	王宇恒			0/1					0/1	0.0					
25	郭昊文														
33	吴夏冰												1	1	
运动员 合计		8/12	3/6	2/5	2/2	4/6	2/4	2/2	23/37	62.2	2	9	2	3	
1	鲁世豪							1/2	1/2	50.0					
12	黄晓春	1/5	1/5	0/3	1/3	2/9		1/2	6/27	22.2	2				
守门员 合计		1/5	1/5	0/3	1/3	2/9		2/4	7/29	24.1	2				

潍坊	比赛进程	合肥
1st Half		
0	00:41	1 2 张天进
0	01:12	2 29 梅少聪
0	01:44	3 26 饶源源
3	02:05	3
3	02:31	3
	04:19	4 30 单习振
	08:01	5 26 饶源源
5	08:28	5
	09:09	6 26 饶源源
5	10:15	6
	11:01	7 43 王久源
15	11:51	7
15	12:10	7
	12:53	8 26 饶源源
3	13:38	8
	15:46	9 29 梅少聪
8	15:56	9
3	17:32	9
	18:56	10 26 饶源源
11	19:17	10
2nd Half		
11	00:31	10
11	01:26	10
	02:03	11 13 沈威
	02:39	12 26 饶源源
	04:26	13 43 王久源
	04:59	14 13 沈威
9	06:09	14
3	08:50	14
11	09:47	14
	10:05	15 2 张天进
11	10:51	15
	11:22	16 2 张天进
15	11:55	16
	12:31	17 13 沈威
9	13:02	17
11	14:31	17
	14:43	18 2 张天进
11	16:02	18
	16:19	19 2 张天进
3	17:27	19
	17:42	20 2 张天进
	18:23	21 2 张天进
5	18:39	21
	19:26	22 13 沈威
5	20:00	22

场上队员: 得分 / 射门

守门员: 救球 / 射门

D	取消资格	DR	取消资格+报告
---	------	----	---------



比赛进程表

 手球
青年男子

 决赛
轮次 6

 组别 X
场次 85

 晋中体育馆
2019-06-23 16:20

时间	队员	动作	比分	队员	动作
山东潍坊			上半时	安徽合肥	
00:41	12 黄晓春	被射入	0-1	2 张天进	突破 得分
00:56	3 李相杰	运球失误		2 张天进	造失误
01:12	12 黄晓春	被射入	0-2	29 梅少聪	近射 得分
01:14				26 饶原源	助攻
01:29	3 李相杰	突破 射失			
01:38	12 黄晓春	挡住球		26 饶原源	短传快攻 被救
01:44	12 黄晓春	被射入	0-3	26 饶原源	近射 得分
01:46				30 单习振	助攻
02:05	3 李相杰	中远射 得分	1-3	40 陈欢	被射入
02:25				26 饶原源	运球失误
02:31	3 李相杰	一传快攻 得分	2-3	40 陈欢	被射入
02:33	12 黄晓春	助攻			
03:15	5 刘天驰	封球		13 沈威	右远射 被封
03:30	3 李相杰	传球失误		13 沈威	断球
03:30		裁判暂停			
03:30	5 刘天驰	罚出场2分钟			
03:52				30 单习振	左边射 射失
04:10	15 宋子阳	接球失误			
04:19	12 黄晓春	被射入	2-4	30 单习振	左边射 得分
04:21				26 饶原源	助攻
05:28	3 李相杰	突破 被救		40 陈欢	挡住球
05:48				2 张天进	任意球 射失
05:59	11 杨毅	右远射 射失			
06:12	11 杨毅	使被罚7M球		13 沈威	造7M
06:18	11 杨毅	警告			
06:34	12 黄晓春	挡住球		36 刘耀奇	7M球 被救
07:01	24 王宇恒	左边射 被救		40 陈欢	挡住球
07:10				2 张天进	左远射 射失
07:42	11 杨毅	右远射 被救		40 陈欢	挡住球
08:01	12 黄晓春	被射入	2-5	26 饶原源	中远射 得分
08:04		球队暂停			
08:28	5 刘天驰	右远射 得分	3-5	40 陈欢	被射入
09:09	12 黄晓春	被射入	3-6	26 饶原源	突破 得分
09:28	5 刘天驰	左远射 射失			
09:54				2 张天进	运球失误
10:15	5 刘天驰	左远射 得分	4-6	40 陈欢	被射入
11:01	12 黄晓春	被射入	4-7	43 王久源	右边射 得分
11:35				30 单习振	警告
11:39		裁判暂停			
11:51	15 宋子阳	近射 得分	5-7	40 陈欢	被射入
12:06				13 沈威	近射 射失

比赛进程表

 手球
青年男子

 决赛
轮次 6

 组别 X
场次 85

 晋中体育馆
2019-06-23 16:20

时间	队员	动作	比分	队员	动作
山东潍坊			上半时	安徽合肥	
12:10	15 宋子阳	一传快攻 得分	6-7	40 陈欢	被射入
12:13	12 黄晓春	助攻			
12:53	12 黄晓春	被射入	6-8	26 饶原源	左远射 得分
13:38	3 李相杰	右远射 得分	7-8	40 陈欢	被射入
13:51				26 饶原源	传球失误
14:33	3 李相杰	传球失误		26 饶原源	其它失误
15:11				26 饶原源	罚出场2分钟
15:23		裁判暂停		26 饶原源	断球
15:23				43 王久源	断球
15:39	5 刘天驰	传球失误		29 梅少聪	一传快攻 得分
15:46	12 黄晓春	被射入	7-9	13 沈威	助攻
15:48				40 陈欢	被射入
15:56	8 薛瑞寒	右边射 得分	8-9	30 单习振	传球失误
16:26				40 陈欢	挡住球
17:00	8 薛瑞寒	任意球 被救		30 单习振	突破 被救
17:18	12 黄晓春	挡住球		40 陈欢	被射入
17:32	3 李相杰	突破 得分	9-9		
18:28	33 吴夏冰	警告			
18:56	12 黄晓春	被射入	9-10	26 饶原源	突破 得分
19:17	11 杨毅	右远射 得分	10-10	40 陈欢	被射入
19:57				2 张天进	运球失误

第二届全国青年运动会男子手球甲组决赛 体校组 (U18)

比赛进程表

手球
青年男子

决赛
轮次 6

组别 X
场次 85

晋中体育馆
2019-06-23 16:20

时间	队员	动作	比分	队员	动作
山东潍坊			安徽合肥		
下半场					
00:31	11 杨毅	突破 得分	11-10	40 陈欢	被射入
00:40				2 张天进	中远射 击柱
01:26	11 杨毅	任意球 得分	12-10	40 陈欢	被射入
02:03	12 黄晓春	被射入	12-11	13 沈威	突破 得分
02:26	8 薛瑞寒	传球失误		2 张天进	断球
02:33	33 吴夏冰	使被罚7M球		26 饶原源	造7M
02:35		裁判暂停			
02:35	33 吴夏冰	罚出场2分钟			
02:39	12 黄晓春	被射入	12-12	26 饶原源	7M球 得分
03:02	5 刘天驰	传球失误		26 饶原源	断球
03:15				2 张天进	传球失误
03:47		裁判暂停			
04:04	11 杨毅	任意球 射失			
04:16		裁判暂停			
04:16	5 刘天驰	罚出场2分钟			
04:26	12 黄晓春	被射入	12-13	43 王久源	右边射 得分
04:30				26 饶原源	助攻
04:48	3 李相杰	侵区			
04:59	12 黄晓春	被射入	12-14	13 沈威	突破 得分
05:12		球队暂停			
06:09	9 杜忠浩	突破 得分	13-14	40 陈欢	被射入
06:23	11 杨毅	造犯规		30 单习振	快攻 进攻犯规
07:17	9 杜忠浩	左边射 被救		40 陈欢	挡住球
07:19	5 刘天驰	近射 被救		40 陈欢	挡住球
07:25	12 黄晓春	挡住球		2 张天进	近射 被救
07:40	8 薛瑞寒	近射 被救		40 陈欢	挡住球
07:42	8 薛瑞寒	使被罚7M球		29 梅少聪	快攻 造7M
07:48		裁判暂停			
07:54	1 鲁世豪	挡住球		26 饶原源	7M球 被救
08:50	3 李相杰	突破 得分	14-14	40 陈欢	被射入
09:00				26 饶原源	四步
09:35	15 宋子阳	造7M		43 王久源	使被罚7M球
09:47	11 杨毅	7M球 得分	15-14	40 陈欢	被射入
09:53					球队暂停
10:05	12 黄晓春	被射入	15-15	2 张天进	近射 得分
10:51	11 杨毅	左远射 得分	16-15	40 陈欢	被射入
11:22	12 黄晓春	被射入	16-16	2 张天进	中远射 得分
11:55	15 宋子阳	左边射 得分	17-16	40 陈欢	被射入
12:31	12 黄晓春	被射入	17-17	13 沈威	突破 得分
13:02	9 杜忠浩	左远射 得分	18-17	40 陈欢	被射入
13:12	12 黄晓春	挡住球		2 张天进	左远射 被救

比赛进程表

手球 青年男子 决赛 轮次 6 组别 X 场次 85 晋中体育馆 2019-06-23 16:20

时间	队员	动作	比分	队员	动作
山东潍坊			安徽合肥		
			下半时		
13:38		裁判暂停	18-17		
13:53	6 张智超	右边射 被救		40 陈欢	挡住球
14:03	9 杜忠浩	封球		13 沈威	右远射 被封
14:31	11 杨毅	近射 得分	19-17	40 陈欢	被射入
14:35		裁判暂停			
14:35				29 梅少聪	罚出场2分钟
14:43	12 黄晓春	被射入	19-18	2 张天进	突破 得分
15:19	3 李相杰	中远射 射失			
15:36				13 沈威	运球失误
16:02	11 杨毅	左远射 得分	20-18	40 陈欢	被射入
16:19	12 黄晓春	被射入	20-19	2 张天进	右远射 得分
17:14	6 张智超	造7M		29 梅少聪	使被罚7M球
17:27	3 李相杰	7M球 得分	21-19	39 汤鸿宇	被射入
17:42	12 黄晓春	被射入	21-20	2 张天进	近射 得分
17:47				13 沈威	助攻
18:08	11 杨毅	近射 被救		39 汤鸿宇	挡住球
18:16	33 吴夏冰	使被罚7M球		26 饶原源	造7M
18:20		裁判暂停			
18:23	1 鲁世豪	被射入	21-21	2 张天进	7M球 得分
18:39	5 刘天驰	近射 得分	22-21	39 汤鸿宇	被射入
18:56	12 黄晓春	挡住球		26 饶原源	突破 被救
19:20	3 李相杰	进攻犯规		26 饶原源	造犯规
19:26	12 黄晓春	被射入	22-22	13 沈威	一传快攻 得分
19:28		球队暂停			
20:00	5 刘天驰	任意球 得分	23-22	39 汤鸿宇	被射入