

# 2019 第二届全国青年运动会女子手球 甲组决赛 体校组(U18)

## 成绩与技术统计数据册



中国手球协会  
CHINESE HANDBALL ASSOCIATION



数据由PHMS收集生成



PHMS 国际手球联合会官方技术统计系统

## 成绩与技术统计数据册目录

- 1 比赛结果
  - 1) 名次
  - 2) 获奖队员名单
  - 3) 场次成绩
  - 4) 分组成绩
- 2 运动员排名
  - 1) 得分
  - 2) 助攻
  - 3) 封球
  - 4) 防守
  - 5) 失误
  - 6) 受罚
- 3 守门员排名
  - 1) 救球
  - 2) 救7M球
- 4 球队总体比较
- 5 球队受罚表
- 6 球队累计
  - 1) 球队名单
  - 2) 个人/全队技术累计表
  - 3) 图式射门区域累计
- 7 每场比赛统计
  - 1) 比赛报告表
  - 2) 竞赛技术统计表
  - 3) 个人/全队技术统计表
  - 4) 图式比赛技术统计
  - 5) 图式射门区域统计
  - 6) 比赛进程表(决赛场次)

注：如需更多比赛统计数据，请通过以下电邮联络：[handball@126.com](mailto:handball@126.com)



第二届全国青年运动会女子手球甲组决赛 体校组 (U18)



PHMS Pictorial Handball Match Statistics

IHF Official System

大赛名次

手球  
青年女子

截止至第90场

山西晋中  
2019-06-23

奖牌	名次	缩写	队名
Gold	1	常州	江苏常州
Silver	2	滁州	安徽滁州
Bronze	3	淄博	山东淄博
	4	深圳	广东深圳
	5	北京	北京市
	6	香港	香港
	7	澳门	澳门





第二届全国青年运动会女子手球甲组决赛 体校组 (U18)



PHMS Pictorial Handball Match Statistics

IHF Official System

获奖队员名单

手球  
青年女子

山西晋中  
2019-06-23

金牌	银牌	铜牌
常州-江苏常州	滁州-安徽滁州	淄博-山东淄博
1 胡雨诺	1 张家轩	3 王静雯
7 张嘉朔	2 钟梦	5 张素娟
8 董桂林	3 孙明月	6 孙玉坤
9 顾霞光	4 龚铭	7 辛彤慧
14 庄红艳	7 丁洁	8 王锦琦
15 王艺儒	9 窦海乐	9 高梦洁
19 焦雅	16 刘子琪	10 崔佳惠
20 渠文娜	25 耿雨萍	14 韩睿洁
21 吴静雯	26 张雅婷	15 李骞飞
22 彭如玉	28 马雯怡	16 王启欣
24 王铃娜	30 罗佳乐	17 蒋松妍
25 李秋淇	32 王小雅	19 户晴
26 邱聿芳	34 姜影	21 赵欣瑶
27 李袁梦	35 李旭	22 邢力丹
28 黄奕涵	36 高奇欣	23 王家琪
29 陈赛楠	38 潘楠	28 江迎新





第二届全国青年运动会女子手球甲组决赛 体校组 (U18)



PHMS Pictorial Handball Match Statistics

IHF Official System

场次成绩

手球  
青年女子

截止至第90场

山西晋中  
2019-06-23

日期	时间	场次	体育馆	组别	球队	成绩 (半时)	阶段
23-06-19	15:10	84	晋中体育馆	X	滁州-常州	17-20 (9-10)	决赛
	15:10	89	晋中体育馆	X	北京-香港	21-12 (12-6)	5-6名
	16:20	90	晋中体育馆	X	淄博-深圳	20-14 (8-5)	3-4名



第二届全国青年运动会女子手球甲组决赛 体校组 (U18)

分组成绩

手球  
青年女子

截止至第90场

山西晋中  
2019-06-23

组别: A 预赛

名次	球队	积	场	胜	平	负	得分	失分	净胜
1	滁州	12	6	6	0	0	120	70	50
2	常州	10	6	5	0	1	140	72	68
3	淄博	6	6	3	0	3	104	68	36
4	深圳	6	6	3	0	3	93	83	10
5	北京	6	6	3	0	3	113	105	8
6	香港	2	6	1	0	5	76	128	-52
7	澳门	0	6	0	0	6	38	158	-120

球队	滁州	常州	淄博	深圳	北京	香港	澳门
滁州		15-14	13-10	18-15	23-16	27-9	24-6
常州	14-15		18-15	20-12	23-13	34-12	31-5
淄博	10-13	15-18		12-14	18-16	18-6	31-1
深圳	15-18	12-20	14-12		14-15	15-11	23-7
北京	16-23	13-23	16-18	15-14		26-16	27-11
香港	9-27	12-34	6-18	11-15	16-26		22-8
澳门	6-24	5-31	1-31	7-23	11-27	8-22	

Legend:

积	积分	■	已比赛场次	胜	胜场	平	平场
负	负场	■	得分累计	失分	失分累计	净胜	净胜分

第二届全国青年运动会女子手球甲组决赛 体校组 (U18)

PHMS Pictorial Handball Match Statistics

IHF Official System

得分排名表(场上队员)

手球  
青年女子

截止至第90场  
按总得分排序

山西晋中  
2019-06-23

排序	号码	姓名	球队	远射	近射	边射	快攻	突破	任意	七米	合计	%	助攻	场数
1	14	庄红艳	常州	2-11	3-3	1-7	28-32	5-5	1-1	2-2	42-61	68.9	6	7
2	11	陈丽婷	北京	9-24	4-9	0-0	2-2	14-15	0-6	12-16	41-72	56.9	5	7
3	19	焦雅	常州	9-24	3-7	3-3	3-4	2-4	6-9	4-5	30-56	53.6	1	7
4	3	孙明月	滁州	9-26	2-3	1-1	10-14	3-5	0-0	3-4	28-53	52.8	6	7
5	3	王静雯	淄博	3-15	1-3	3-6	6-7	2-3	0-0	12-14	27-48	56.3	1	7
6	8	武宏业	北京	4-13	2-3	1-1	2-2	8-9	0-0	9-9	26-37	70.3	1	7
7	38	潘楠	滁州	1-2	3-3	5-10	7-9	6-6	0-0	1-1	23-31	74.2	7	7
8	21	赵欣瑶	淄博	0-1	3-5	12-19	8-8	0-0	0-0	0-0	23-33	69.7	0	7
9	24	王铃娜	常州	0-1	5-7	8-20	8-11	2-2	0-0	0-0	23-41	56.1	0	7
10	5	朱嘉盈	深圳	4-11	5-11	1-6	5-6	7-10	0-0	1-1	23-45	51.1	5	7
11	3	赵晔	深圳	12-36	3-8	1-5	2-2	2-3	1-4	2-4	23-62	37.1	1	7
12	20	渠文娜	常州	8-19	2-2	1-1	6-8	5-7	0-1	0-0	22-38	57.9	4	7
13	34	姜影	滁州	0-0	2-3	8-13	10-11	1-2	0-0	0-0	21-29	72.4	3	7
14	35	李旭	滁州	3-12	6-11	1-3	7-8	3-4	0-0	0-0	20-38	52.6	7	7
15	2	唐悦	深圳	8-27	3-8	0-0	3-4	3-4	0-1	3-6	20-50	40.0	6	7
16	88	彭爽爽	北京	2-5	0-2	6-8	6-6	2-3	1-1	0-0	17-25	68.0	1	7
17	12	李芷棋	澳门	0-2	13-19	0-1	0-0	0-0	0-0	4-6	17-28	60.7	0	6
18	9	窦海乐	滁州	11-21	1-2	1-1	2-2	1-1	1-1	0-1	17-29	58.6	9	7
19	6	孙玉坤	淄博	4-12	6-8	0-0	2-3	3-4	2-2	0-0	17-29	58.6	6	7
20	36	高奇欣	滁州	1-1	11-14	1-3	2-3	1-1	0-0	0-0	16-22	72.7	2	7
21	17	蒋松妍	淄博	0-0	10-12	0-0	4-4	0-0	0-0	0-0	14-16	87.5	0	7
22	10	胡冰心	北京	0-0	4-5	5-15	5-6	0-0	0-0	0-0	14-26	53.8	1	7
23	6	朱嘉晴	深圳	1-3	2-7	8-18	2-2	1-1	0-0	0-2	14-33	42.4	0	7
24	21	吴静雯	常州	2-9	3-8	1-6	2-3	3-4	3-4	0-1	14-35	40.0	3	7
25	16	曾婉琳	香港	2-13	2-5	3-8	1-2	6-9	0-2	0-0	14-39	35.9	0	7
26	11	庄斯琪	香港	5-17	2-3	3-5	0-0	0-0	3-4	0-1	13-30	43.3	1	7
27	9	高梦洁	淄博	4-12	3-9	0-0	3-3	3-8	0-0	0-0	13-32	40.6	5	7
28	5	卓凯晴	香港	0-1	0-1	0-0	0-0	0-0	0-0	10-16	10-18	55.6	0	7
29	9	张雨乐	深圳	0-0	0-1	5-18	5-5	0-0	0-0	0-0	10-24	41.7	0	7
30	8	李芷欣	香港	4-21	2-4	0-2	0-0	3-3	0-0	1-3	10-33	30.3	0	7
31	15	张雪琳	澳门	4-28	3-4	0-2	0-0	2-4	1-11	0-1	10-50	20.0	5	6
32	15	李鹏飞	淄博	0-0	0-1	6-7	2-3	1-3	0-0	0-0	9-14	64.3	2	7
33	13	刘培天	深圳	0-0	6-8	0-1	2-3	0-0	0-0	0-0	8-12	66.7	0	7
34	9	徐慧敏	北京	5-8	1-1	0-0	1-2	0-0	0-0	0-0	7-11	63.6	0	5
35	21	林乐儿	香港	1-4	1-1	1-4	3-3	1-2	0-0	0-0	7-14	50.0	0	7
36	7	丁洁	滁州	3-4	0-0	2-2	1-1	0-0	0-0	0-0	6-7	85.7	1	7
37	8	董桂林	常州	0-0	1-1	1-2	4-4	0-0	0-0	0-0	6-7	85.7	0	7
38	25	李秋淇	常州	0-0	1-1	1-2	3-4	0-1	0-0	1-1	6-9	66.7	0	7
39	4	何丹仪	香港	2-4	1-1	0-1	1-1	2-4	0-0	0-0	6-11	54.5	0	7
40	19	卢晴	淄博	0-0	1-5	2-8	3-5	0-0	0-0	0-0	6-18	33.3	0	7

## 得分排名表(场上队员)

 手球  
青年女子

 截止至第90场  
按助攻次数排序

 山西晋中  
2019-06-23

排序	号码	姓名	球队	远射	近射	边射	快攻	突破	任意	七米	合计	%	助攻	场数
1	9	窦海乐	滁州	11-21	1-2	1-1	2-2	1-1	1-1	0-1	17-29	58.6	9	7
2	22	彭如玉	常州	1-1	0-0	0-0	0-0	0-0	0-0	0-0	1-1	100.0	9	7
3	38	潘楠	滁州	1-2	3-3	5-10	7-9	6-6	0-0	1-1	23-31	74.2	7	7
4	35	李旭	滁州	3-12	6-11	1-3	7-8	3-4	0-0	0-0	20-38	52.6	7	7
5	22	苏萱婷	澳门	5-35	1-2	0-0	0-0	0-0	0-3	0-0	6-40	15.0	7	6
6	16	刘子琪	滁州	0-0	0-0	0-0	0-0	0-0	0-0	0-0	0-0	0	7	7
7	1	张家轩	滁州	0-0	0-0	0-0	0-1	0-0	0-0	0-0	0-1	0.0	7	7
8	14	庄红艳	常州	2-11	3-3	1-7	28-32	5-5	1-1	2-2	42-61	68.9	6	7
9	3	孙明月	滁州	9-26	2-3	1-1	10-14	3-5	0-0	3-4	28-53	52.8	6	7
10	2	唐悦	深圳	8-27	3-8	0-0	3-4	3-4	0-1	3-6	20-50	40.0	6	7
11	6	孙玉坤	淄博	4-12	6-8	0-0	2-3	3-4	2-2	0-0	17-29	58.6	6	7
12	11	陈丽婷	北京	9-24	4-9	0-0	2-2	14-15	0-6	12-16	41-72	56.9	5	7
13	5	朱嘉盈	深圳	4-11	5-11	1-6	5-6	7-10	0-0	1-1	23-45	51.1	5	7
14	9	高梦洁	淄博	4-12	3-9	0-0	3-3	3-8	0-0	0-0	13-32	40.6	5	7
15	15	张雪琳	澳门	4-28	3-4	0-2	0-0	2-4	1-11	0-1	10-50	20.0	5	6
16	14	侯美林	北京	0-0	1-4	0-0	1-2	2-5	0-0	1-3	5-14	35.7	5	7
17	22	邢力丹	淄博	0-0	0-0	0-0	0-0	0-0	0-0	0-0	0-0	0	5	7
18	20	渠文娜	常州	8-19	2-2	1-1	6-8	5-7	0-1	0-0	22-38	57.9	4	7
19	23	王家琪	淄博	0-3	0-0	1-1	0-0	2-4	0-0	0-0	3-8	37.5	4	7
20	34	姜影	滁州	0-0	2-3	8-13	10-11	1-2	0-0	0-0	21-29	72.4	3	7
21	21	吴静雯	常州	2-9	3-8	1-6	2-3	3-4	3-4	0-1	14-35	40.0	3	7
22	17	冯颖慧	深圳	0-0	0-0	0-0	0-0	0-0	0-0	0-0	0-0	0	3	7
23	36	高奇欣	滁州	1-1	11-14	1-3	2-3	1-1	0-0	0-0	16-22	72.7	2	7
24	15	李骞飞	淄博	0-0	0-1	6-7	2-3	1-3	0-0	0-0	9-14	64.3	2	7
25	3	黄秋婷	香港	0-0	0-1	2-10	2-4	2-6	0-0	0-0	6-21	28.6	2	7
26	1	胡雨诺	常州	1-1	0-0	0-0	0-0	0-0	0-0	0-0	1-1	100.0	2	7
27	16	王启欣	淄博	0-0	0-0	0-0	0-0	0-0	0-0	0-0	0-0	0	2	7
28	19	焦雅	常州	9-24	3-7	3-3	3-4	2-4	6-9	4-5	30-56	53.6	1	7
29	3	王静雯	淄博	3-15	1-3	3-6	6-7	2-3	0-0	12-14	27-48	56.3	1	7
30	8	武宏业	北京	4-13	2-3	1-1	2-2	8-9	0-0	9-9	26-37	70.3	1	7
31	3	赵晔	深圳	12-36	3-8	1-5	2-2	2-3	1-4	2-4	23-62	37.1	1	7
32	88	彭爽爽	北京	2-5	0-2	6-8	6-6	2-3	1-1	0-0	17-25	68.0	1	7
33	10	胡冰心	北京	0-0	4-5	5-15	5-6	0-0	0-0	0-0	14-26	53.8	1	7
34	11	庄斯琪	香港	5-17	2-3	3-5	0-0	0-0	3-4	0-1	13-30	43.3	1	7
35	7	丁洁	滁州	3-4	0-0	2-2	1-1	0-0	0-0	0-0	6-7	85.7	1	7
36	18	唐文杰	北京	0-0	5-5	0-2	0-0	0-0	0-0	0-0	5-7	71.4	1	7
37	7	翟乃迪	北京	0-0	0-1	2-3	0-1	2-3	1-1	0-0	5-9	55.6	1	7
38	7	张嘉朔	常州	0-0	0-1	1-5	4-4	0-0	0-0	0-0	5-10	50.0	1	7
39	5	常凯旋	北京	0-0	0-0	0-0	3-3	1-2	0-0	0-0	4-5	80.0	1	6
40	28	江迎新	淄博	1-1	1-2	0-3	1-2	1-1	0-1	0-0	4-10	40.0	1	7



## 得分排名表(场上队员)

 手球  
青年女子

 截止至第90场  
按封球次数排序

 山西晋中  
2019-06-23

名次	号码	姓名	球队	抢球	断球	造失误	造犯规	合计	封球	场数
1	9	高梦洁	淄博	0	2	0	0	2	5	7
2	18	唐文杰	北京	1	2	0	0	3	5	7
3	11	陈丽婷	北京	0	6	0	0	6	4	7
4	27	李袁梦	常州	1	2	0	0	3	4	7
5	17	蒋松妍	淄博	0	0	0	0	0	4	7
6	6	孙玉坤	淄博	1	2	1	1	5	3	7
7	5	常凯旋	北京	1	0	0	0	1	2	6
8	23	霍思允	澳门	0	4	0	0	4	2	6
9	14	韩睿洁	淄博	0	0	0	0	0	2	7
10	5	张素娟	淄博	2	0	1	0	3	2	7
11	8	武宏业	北京	1	0	0	0	1	2	7
12	3	孙明月	滁州	0	3	1	3	7	2	7
13	9	徐慧敏	北京	0	0	0	0	0	1	5
14	10	徐瑜琳	深圳	0	0	0	0	0	1	7
15	5	朱嘉盈	深圳	3	6	1	0	10	1	7
16	19	焦雅	常州	1	1	2	0	4	1	7
17	11	庄斯琪	香港	0	1	0	0	1	1	7
18	36	高奇欣	滁州	0	3	2	0	5	1	7
19	35	李旭	滁州	5	7	2	1	15	1	7
20	27	田苗	北京	0	2	0	0	2	1	7
21	28	黄奕涵	常州	0	0	0	0	0	1	7
22	13	刘培天	深圳	1	0	0	1	2	1	7
23	4	龚铭	滁州	0	0	0	0	0	0	2
24	58	林诗雅	澳门	0	0	0	0	0	0	4
25	18	曾華恩	澳门	1	0	0	1	2	0	6
26	11	李君移	澳门	0	0	0	1	1	0	6
27	22	蘇萱婷	澳门	0	1	0	0	1	0	6
28	15	張雪琳	澳门	0	0	1	1	2	0	6
29	8	譚嘉雯	澳门	0	0	0	0	0	0	6
30	12	李芷棋	澳门	0	1	0	0	1	0	6
31	44	李嵐	澳门	0	0	0	0	0	0	6
32	10	盧曉汶	澳门	0	0	0	0	0	0	6
33	19	馮楚瑩	澳门	0	0	0	0	0	0	6
34	81	王木子	北京	2	0	0	0	2	0	6
35	22	彭如玉	常州	0	0	0	0	0	0	7
36	28	马雯怡	滁州	0	0	0	0	0	0	7
37	23	黄文文	北京	0	0	1	0	1	0	7
38	2	钟梦	滁州	0	1	0	0	1	0	7
39	14	侯美林	北京	0	0	0	3	3	0	7
40	29	陈赛楠	常州	0	0	0	0	0	0	7

## 得分排名表(场上队员)

 手球  
青年女子

 截止至第90场  
按防守成功总数排序

 山西晋中  
2019-06-23

名次	号码	姓名	球队	抢球	断球	造失误	造犯规	合计	封球	场数
1	35	李旭	滁州	5	7	2	1	15	1	7
2	14	庄红艳	常州	3	7	1	1	12	0	7
3	5	朱嘉盈	深圳	3	6	1	0	10	1	7
4	38	潘楠	滁州	1	6	0	1	8	0	7
5	3	孙明月	滁州	0	3	1	3	7	2	7
6	23	王家琪	淄博	1	3	1	1	6	0	7
7	9	窦海乐	滁州	2	3	0	1	6	0	7
8	11	陈丽婷	北京	0	6	0	0	6	4	7
9	16	曾婉琳	香港	1	2	0	3	6	0	7
10	3	黄秋婷	香港	0	5	0	1	6	0	7
11	36	高奇欣	滁州	0	3	2	0	5	1	7
12	6	孙玉坤	淄博	1	2	1	1	5	3	7
13	24	王铃娜	常州	1	3	1	0	5	0	7
14	7	翟乃迪	北京	0	4	0	1	5	0	7
15	3	王静雯	淄博	3	1	0	0	4	0	7
16	15	李騫飞	淄博	1	1	0	2	4	0	7
17	19	焦雅	常州	1	1	2	0	4	1	7
18	17	梁艺	香港	1	2	0	1	4	0	7
19	34	姜影	滁州	2	2	0	0	4	0	7
20	23	霍思允	澳门	0	4	0	0	4	2	6
21	25	戴子怡	香港	0	1	1	1	3	0	7
22	21	吴静雯	常州	1	2	0	0	3	0	7
23	18	唐文杰	北京	1	2	0	0	3	5	7
24	27	李袁梦	常州	1	2	0	0	3	4	7
25	8	董桂林	常州	2	1	0	0	3	0	7
26	88	彭爽爽	北京	1	2	0	0	3	0	7
27	9	张雨乐	深圳	0	3	0	0	3	0	7
28	20	渠文娜	常州	0	2	0	1	3	0	7
29	21	赵欣瑶	淄博	1	2	0	0	3	0	7
30	14	侯美林	北京	0	0	0	3	3	0	7
31	7	张嘉朔	常州	0	3	0	0	3	0	7
32	5	张素娟	淄博	2	0	1	0	3	2	7
33	27	田苗	北京	0	2	0	0	2	1	7
34	13	刘培天	深圳	1	0	0	1	2	1	7
35	9	高梦洁	淄博	0	2	0	0	2	5	7
36	21	林乐儿	香港	1	1	0	0	2	0	7
37	8	李芷欣	香港	0	1	0	1	2	0	7
38	3	赵晔	深圳	0	2	0	0	2	0	7
39	81	王木子	北京	2	0	0	0	2	0	6
40	18	曾华恩	澳门	1	0	0	1	2	0	6

第二届全国青年运动会女子手球甲组决赛 体校组 (U18)

PHMS Pictorial Handball Match Statistics

IHF Official System

得分排名表(场上队员)

手球  
青年女子

截止至第90场  
按失误总数排序

山西晋中  
2019-06-23

排序	号码	姓名	球队	传失	接失	两次	四步	侵区	进犯	其它	合计	场数
1	15	張雪琳	澳门	10	11	4	7	1	0	1	34	6
2	22	蘇萱婷	澳门	13	4	2	5	0	0	3	27	6
3	18	曾華恩	澳门	5	11	2	2	3	0	0	23	6
4	23	霍思允	澳门	9	10	1	1	0	2	0	23	6
5	16	曾婉琳	香港	8	4	2	5	0	2	1	22	7
6	5	朱嘉盈	深圳	10	2	2	2	1	1	0	18	7
7	35	李旭	滁州	2	4	2	7	1	1	0	17	7
8	3	孙明月	滁州	6	3	0	3	3	1	0	16	7
9	38	潘楠	滁州	5	3	2	3	1	0	1	15	7
10	4	何丹仪	香港	8	4	3	0	0	0	0	15	7
11	11	庄斯琪	香港	7	3	1	1	0	1	1	14	7
12	9	高梦洁	淄博	4	3	1	6	0	0	0	14	7
13	14	庄红艳	常州	5	2	3	1	1	1	0	13	7
14	34	姜影	滁州	2	2	0	1	8	0	0	13	7
15	3	黄秋婷	香港	3	4	2	4	0	0	0	13	7
16	9	窦海乐	滁州	7	0	3	1	0	0	1	12	7
17	14	侯美林	北京	4	1	0	3	1	1	1	11	7
18	8	李芷欣	香港	6	1	2	1	0	0	1	11	7
19	23	王家琪	淄博	6	2	1	2	0	0	0	11	7
20	2	唐悦	深圳	8	1	0	0	0	1	0	10	7
21	7	翟乃迪	北京	3	0	0	3	4	0	0	10	7
22	9	林卓琪	香港	2	5	0	1	0	0	1	9	7
23	8	武宏业	北京	3	1	1	2	1	1	0	9	7
24	11	陈丽婷	北京	3	0	0	4	0	1	1	9	7
25	18	唐文杰	北京	1	2	1	2	2	0	1	9	7
26	3	赵晔	深圳	6	0	0	2	1	0	0	9	7
27	6	朱嘉晴	深圳	3	1	0	0	3	0	2	9	7
28	11	李君移	澳门	3	4	1	1	0	0	0	9	6
29	12	李芷棋	澳门	4	2	1	1	1	0	0	9	6
30	21	吴静雯	常州	4	0	1	2	0	1	0	8	7
31	19	焦雅	常州	3	0	0	2	0	3	0	8	7
32	20	渠文娜	常州	5	2	0	0	0	1	0	8	7
33	6	孙玉坤	淄博	3	1	1	0	1	1	0	7	7
34	3	王静雯	淄博	4	0	0	3	0	0	0	7	7
35	91	孔倩瑜	香港	1	1	0	0	3	0	1	6	7
36	10	胡冰心	北京	1	2	1	0	2	0	0	6	7
37	36	高奇欣	滁州	1	1	0	1	3	0	0	6	7
38	24	王铃娜	常州	1	1	0	1	1	2	0	6	7
39	23	王洁桦	香港	1	1	0	1	1	1	0	5	7
40	88	彭爽爽	北京	1	2	1	0	0	0	1	5	7

## 得分排名表(场上队员)

 手球  
青年女子

 截止至第90场  
接受罚次数排序

 山西晋中  
2019-06-23

排序	号码	姓名	球队	警告	罚2分钟	D	DR	场数
1	9	高梦洁	淄博	2	0	1	0	7
2	5	朱嘉盈	深圳	2	6	0	0	7
3	7	张嘉朔	常州	2	6	0	0	7
4	35	李旭	滁州	3	5	0	0	7
5	6	孙玉坤	淄博	2	3	0	0	7
6	8	武宏业	北京	0	3	0	0	7
7	14	庄红艳	常州	2	2	0	0	7
8	20	渠文娜	常州	2	2	0	0	7
9	3	赵晔	深圳	2	2	0	0	7
10	3	王静雯	淄博	1	2	0	0	7
11	38	潘楠	滁州	1	2	0	0	7
12	9	张雨乐	深圳	1	2	0	0	7
13	18	唐文杰	北京	1	2	0	0	7
14	81	王木子	北京	1	2	0	0	6
15	34	姜影	滁州	0	2	0	0	7
16	87	王奥	北京	0	2	0	0	7
17	8	李芷欣	香港	4	1	0	0	7
18	9	窦海乐	滁州	3	1	0	0	7
19	27	李袁梦	常州	2	1	0	0	7
20	3	孙明月	滁州	2	1	0	0	7
21	28	郭芷彤	香港	1	1	0	0	7
22	19	焦雅	常州	1	1	0	0	7
23	11	陈丽婷	北京	1	1	0	0	7
24	23	王家琪	淄博	1	1	0	0	7
25	28	江迎新	淄博	1	1	0	0	7
26	11	庄斯琪	香港	1	1	0	0	7
27	22	苏萱婷	澳门	1	1	0	0	6
28	9	徐慧敏	北京	1	1	0	0	5
29	2	钟梦	滁州	0	1	0	0	7
30	18	谢宛彤	深圳	0	1	0	0	7
31	10	徐瑜琳	深圳	0	1	0	0	7
32	25	李秋淇	常州	0	1	0	0	7
33	21	林乐儿	香港	0	1	0	0	7
34	9	林卓琪	香港	0	1	0	0	7
35	16	周晓雨	北京	0	1	0	0	7
36	28	黄奕涵	常州	0	1	0	0	7
37	14	韩睿洁	淄博	0	1	0	0	7
38	15	李鹏飞	淄博	0	1	0	0	7
39	44	李嵐	澳门	0	1	0	0	6
40	12	李芷棋	澳门	0	1	0	0	6

## 排名表(守门员)

 手球  
青年女子

 截止至第90场  
按总救球数排序

 山西晋中  
2019-06-23

排序	号码	姓名	球队	远射	近射	边射	快攻	突破	任意	七米	得分	%	助攻	场数
1	1	张家轩	滁州	23-34	13-21	19-32	1-10	6-19	4-6	2-11	68-133	51.1	7	7
2	1	靳爽	北京	14-41	15-36	26-44	3-18	2-18	0-4	2-4	62-165	37.6	0	7
3	16	邹童羽	深圳	17-22	4-22	16-26	3-15	6-15	1-3	2-12	49-115	42.6	1	7
4	22	彭如玉	常州	20-29	10-24	8-16	1-5	4-11	1-3	2-9	46-97	47.4	9	7
5	16	王启欣	淄博	21-35	6-15	10-20	1-2	1-9	1-2	5-6	45-89	50.6	2	7
6	1	郑晓容	香港	12-19	5-21	9-22	7-44	1-13	4-6	2-12	40-137	29.2	0	7
7	22	邢力丹	淄博	15-25	5-9	16-25	2-7	1-8	0-0	0-3	39-77	50.6	5	7
8	19	馮楚瑩	澳门	6-22	6-24	7-20	12-70	2-11	1-2	0-3	34-152	22.4	0	6
9	1	胡雨诺	常州	17-28	1-7	3-10	1-4	0-6	0-0	4-9	26-64	40.6	2	7
10	17	冯颖慧	深圳	8-10	5-11	2-8	1-7	3-11	2-4	1-5	22-56	39.3	3	7
11	16	刘子琪	滁州	6-10	3-10	4-8	0-1	1-2	4-7	1-6	19-44	43.2	7	7
12	6	洪卓翹	香港	8-15	3-12	3-8	2-21	2-6	0-1	0-5	18-68	26.5	1	7
13	10	盧曉汶	澳门	1-5	2-11	5-9	0-14	1-8	0-1	0-1	9-49	18.4	0	6
14	16	周晓雨	北京	3-7	0-4	2-2	0-2	0-1	0-0	1-4	6-20	30.0	0	7
15	12	于雅梦	深圳	3-3	2-5	0-0	0-0	0-0	0-0	0-0	5-8	62.5	0	7
16	16	曾婉琳	香港	1-1	0-1	0-0	0-0	0-1	0-0	0-0	1-3	33.3	0	7
17	11	王文卉	深圳	0-0	0-0	0-0	0-0	0-0	0-0	0-0	0-0	0	0	7

## 排名表(守门员)

 手球  
青年女子

 截止至第90场  
按救七米球数排序

 山西晋中  
2019-06-23

排序	号码	姓名	球队	远射	近射	边射	快攻	突破	任意	七米	得分	%	助攻	场数
1	16	王启欣	淄博	21-35	6-15	10-20	1-2	1-9	1-2	5-6	45-89	83.3	2	7
2	1	胡雨诺	常州	17-28	1-7	3-10	1-4	0-6	0-0	4-9	26-64	44.4	2	7
3	1	靳爽	北京	14-41	15-36	26-44	3-18	2-18	0-4	2-4	62-165	50.0	0	7
4	22	彭如玉	常州	20-29	10-24	8-16	1-5	4-11	1-3	2-9	46-97	22.2	9	7
5	1	张家轩	滁州	23-34	13-21	19-32	1-10	6-19	4-6	2-11	68-133	18.2	7	7
6	16	邹童羽	深圳	17-22	4-22	16-26	3-15	6-15	1-3	2-12	49-115	16.7	1	7
7	1	郑晓容	香港	12-19	5-21	9-22	7-44	1-13	4-6	2-12	40-137	16.7	0	7
8	16	周晓雨	北京	3-7	0-4	2-2	0-2	0-1	0-0	1-4	6-20	25.0	0	7
9	17	冯颖慧	深圳	8-10	5-11	2-8	1-7	3-11	2-4	1-5	22-56	20.0	3	7
10	16	刘子琪	滁州	6-10	3-10	4-8	0-1	1-2	4-7	1-6	19-44	16.7	7	7
11	12	于雅梦	深圳	3-3	2-5	0-0	0-0	0-0	0-0	0-0	5-8	0	0	7
12	16	曾婉琳	香港	1-1	0-1	0-0	0-0	0-1	0-0	0-0	1-3	0	0	7
13	11	王文卉	深圳	0-0	0-0	0-0	0-0	0-0	0-0	0-0	0-0	0	0	7
14	10	盧曉汶	澳门	1-5	2-11	5-9	0-14	1-8	0-1	0-1	9-49	0.0	0	6
15	22	邢力丹	淄博	15-25	5-9	16-25	2-7	1-8	0-0	0-3	39-77	0.0	5	7
16	19	馮楚瑩	澳门	6-22	6-24	7-20	12-70	2-11	1-2	0-3	34-152	0.0	0	6
17	6	洪卓翹	香港	8-15	3-12	3-8	2-21	2-6	0-1	0-5	18-68	0.0	1	7

第二届全国青年运动会女子手球甲组决赛 体校组 (U18)

攻防成功率统计总表

手球  
青年女子

截止至第90场

山西晋中  
2019-06-23

序号	球队	比分	进攻成功率															助攻	防守成功率								
			阵地进攻			一传快攻			短传快攻			合计			多打少				少打多			封打抢断	守门员	对方射失	对方失误	合计	%
			得分	进攻	%	得分	进攻	%	得分	进攻	%	得分	进攻	%	得分	进攻	%		得分	进攻	%						
1	澳门	38:158	38	275	13.8	0	0	0	0	1	0.0	38	276	13.8	4	8	50.0	1	3	33.3	13	13	43	30	45	131	45.3
2	北京	134:117	112	265	42.3	11	12	91.7	11	24	45.8	134	301	44.5	15	22	68.2	7	12	58.3	17	43	68	42	40	193	62.3
3	常州	160:89	98	244	40.2	36	41	87.8	26	45	57.8	160	330	48.5	13	18	72.2	15	26	57.7	26	44	72	45	77	238	72.8
4	滁州	137:90	98	251	39.0	29	37	78.4	10	26	38.5	137	314	43.6	4	8	50.0	7	19	36.8	49	51	87	35	56	229	71.8
5	深圳	107:103	88	274	32.1	10	11	90.9	9	24	37.5	107	309	34.6	12	21	57.1	8	20	40.0	16	22	76	27	64	189	64.7
6	香港	88:149	77	318	24.2	4	7	57.1	7	14	50.0	88	339	26.0	15	40	37.5	2	6	33.3	4	31	59	31	57	178	54.4
7	淄博	124:82	91	237	38.4	14	18	77.8	19	34	55.9	124	289	42.9	6	11	54.5	5	13	38.5	29	44	84	31	53	212	72.1

注释:

进攻	进攻次数 (射门 + 进攻失误)	对方射失	对方射门失误 (射失 + 击柱)	防守成功率%	本方防守合计 / 对方进攻合计
----	------------------	------	------------------	--------	-----------------

第二届全国青年运动会女子手球甲组决赛 体校组 (U18)

PHMS Pictorial Handball Match Statistics

IHF Official System

防守技术统计总表

手球  
青年女子

截止至第90场

山西晋中  
2019-06-23

序号	球队	比分	防守成功						防守 (成功 : 失误)							处罚					守门员			
			封球	抢球	断球	造失	造犯	合计	选位	顶贴	观察	移动	换防	其他	合计	警告	2'	取消	DR	合计	救球	射门	%	
1	澳门	38:158	2	1	6	1	3	13	0:0	0:0	0:0	0:0	0:0	0:0	0:0	0:0	3	3	0	0	6	43	201	21.4
2	北京	134:117	15	6	16	1	5	43	0:0	0:0	0:0	0:0	0:0	0:0	0:0	0:0	10	12	0	0	22	68	185	36.8
3	常州	160:89	6	9	23	4	2	44	0:0	0:0	0:0	0:0	0:0	0:0	0:0	0:0	10	14	0	0	24	72	161	44.7
4	滁州	137:90	4	10	26	5	6	51	0:0	0:0	0:0	0:0	0:0	0:0	0:0	0:0	11	12	0	0	23	87	177	49.2
5	深圳	107:103	3	6	11	1	1	22	0:0	0:0	0:0	0:0	0:0	0:0	0:0	0:0	9	12	0	0	21	76	179	42.5
6	香港	88:149	1	4	16	2	8	31	0:0	0:0	0:0	0:0	0:0	0:0	0:0	0:0	9	5	0	0	14	59	208	28.4
7	淄博	124:82	16	10	11	3	4	44	0:0	0:0	0:0	0:0	0:0	0:0	0:0	0:0	11	9	1	0	21	84	166	50.6

注释:

造失	造对方失误	造犯	造对方犯规	DR	取消资格+报告
----	-------	----	-------	----	---------



第二届全国青年运动会女子手球甲组决赛 体校组 (U18)

球队名单

江苏常州

山西晋中

2019-06-15

号码	姓名	位置	生日	年龄	俱乐部	身高 (CM)	体重 (KG)	国际场次	国际进球
1	胡雨诺	守门员	26/08/2002	16	江苏女子手球青年队	180	75		
7	张嘉朔	底线	07/03/2001	18	江苏女子手球青年队	171	72		
8	董桂林	左边锋	27/04/2001	18	江苏女子手球青年队	168	81		
9	顾霞光	底线	03/05/2001	18	江苏女子手球青年队	170	70		
14	庄红艳	右后卫	26/03/2004	15	江苏女子手球青年队	163	55		
15	王艺儒	左后卫	22/02/2002	17	江苏女子手球青年队	176	69		
19	焦雅	左后卫	03/04/2001	18	江苏女子手球青年队	176	72		
20	渠文娜	左边锋	02/01/2002	17	江苏女子手球青年队	170	56		
21	吴静雯	左后卫	24/12/2001	17	江苏女子手球青年队	163	68		
22	彭如玉	守门员	23/05/2001	18	江苏女子手球青年队	184	82		
24	王铃娜	左后卫	28/04/2002	17	江苏女子手球青年队	174	67		
25	李秋淇	底线	10/08/2001	17	江苏女子手球青年队	165	66		
26	邱聿芳	右边锋	21/02/2002	17	江苏女子手球青年队	161	52		
27	李袁梦	底线	24/12/2002	16	江苏女子手球青年队	167	75		
28	黄奕涵	底线	04/09/2001	17	江苏女子手球青年队	183	80		
29	陈赛楠	左边锋	14/06/2001	18	江苏女子手球青年队	166	57		
	平均			17.1		171.1	68.6		

编码	姓名	职务
A	金甲洙	主教练
B	马彪	教练
C	李海鹰	教练
D	陈志伟	医生
F	姚治前	领队

手球  
青年女子

## 个人/全队技术累计表

 山西晋中  
2019-06-23

截止至第90场

号码	姓名	远射	近射	边射	快攻	突破	任意	七米	合计	%	助攻	失误	警告	2'	取消	场次	时间
江苏常州																	
(场上队员)																	
1	胡雨诺	1/1							1/1	100%	2					7	01:58:00
7	张嘉朔		0/1	1/5	4/4				5/10	50.0%	1	3	2	6		7	03:12:53
8	董桂林		1/1	1/2	4/4				6/7	85.7%		3				7	00:40:56
9	顾霞光				3/3				3/3	100%		1				7	00:29:28
14	庄红艳	2/11	3/3	1/7	28/32	5/5	1/1	2/2	42/61	68.9%	6	13	2	2		7	03:42:31
15	王艺儒				0/2				0/2	0.0%						7	00:13:37
19	焦雅	9/24	3/7	3/3	3/4	2/4	6/9	4/5	30/56	53.6%	1	8	1	1		7	03:59:16
20	渠文娜	8/19	2/2	1/1	6/8	5/7	0/1		22/38	57.9%	4	8	2	2		7	03:10:19
21	吴静雯	2/9	3/8	1/6	2/3	3/4	3/4	0/1	14/35	40.0%	3	8	1			7	03:02:15
22	彭如玉	1/1							1/1	100%	9	1				7	02:42:04
24	王铃娜	0/1	5/7	8/20	8/11	2/2			23/41	56.1%		6				7	03:38:50
25	李秋淇		1/1	1/2	3/4	0/1		1/1	6/9	66.7%		2		1		7	01:10:54
26	邱聿芳		1/1			1/1			2/2	100%						7	00:14:56
27	李袁梦		4/4						4/4	100%		2	2	1		7	03:16:04
28	黄奕涵				1/1				1/1	100%		4		1		7	01:04:04
29	陈赛楠															7	00:00:02
合计		23/66	23/35	17/46	62/76	18/24	10/15	7/9	160/271	59.0%	26	59	10	14		112	
(守门员)																	
1	胡雨诺	17/28	1/7	3/10	1/4	0/6		4/9	26/64	40.6%	2					7	01:58:00
22	彭如玉	20/29	10/24	8/16	1/5	4/11	1/3	2/9	46/97	47.4%	9	1				7	02:42:04
合计		37/57	11/31	11/26	2/9	4/17	1/3	6/18	72/161	44.7%	11	1				14	

场上队员：得分/射门

守门员：救球/射门

已打比赛

全队合计	进球	被救	射失	击柱	封球	合计	%	阶段	场次	对手	比分
远射	23	21	10	6	6	66	34.8%	预赛	5	香港	34:12 (15:5)
近射	23	6	3	3		35	65.7%	预赛	22	滁州	14:15 (6:2)
边射	17	22	3	4		46	37.0%	预赛	35	北京	23:13 (12:6)
快攻	62	9	2	3		76	81.6%	预赛	39	淄博	18:15 (7:7)
突破	18	3	2	1		24	75.0%	预赛	69	深圳	20:12 (9:5)
任意	10	2	2	1		15	66.7%	预赛	71	澳门	31:5 (15:0)
七米	7	2				9	77.8%	决赛	84	滁州	20:17 (10:9)



图式射门区域累计

手球  
青年女子

截止至第90场

山西晋中  
2019-06-23

江苏常州

1 胡雨诺 1 Post - 0 Miss - 0 Block - 0	7 张嘉朔 1 2 Post - 2 Miss - 0 Block - 0	8 董桂林 1 2 Post - 0 Miss - 1 Block - 0	9 顾霞光 2 Post - 0 Miss - 0 Block - 0	14 庄红艳 11 11 8 3 7 2 Post - 3 Miss - 3 Block - 0	15 王艺儒 Post - 1 Miss - 0 Block - 0	19 焦雅 9 1 5 6 7 2 Post - 2 Miss - 7 Block - 4	20 渠文娜 2 5 1 7 3 4 Post - 6 Miss - 2 Block - 1
21 吴静雯 1 3 5 2 3 Post - 2 Miss - 4 Block - 1	22 彭如玉 1 Post - 0 Miss - 0 Block - 0	24 王铃娜 2 8 2 4 2 1 4 Post - 2 Miss - 4 Block - 0	25 李秋淇 1 1 2 1 1 Post - 0 Miss - 1 Block - 0	26 邱聿芳 2 Post - 0 Miss - 0 Block - 0	27 李袁梦 2 1 1 Post - 0 Miss - 0 Block - 0	28 黄奕涵 1 Post - 0 Miss - 0 Block - 0	29 陈赛楠 Post - 0 Miss - 0 Block - 0

1 胡雨诺
1/7 0/1 5/12
8/11 1/2 7/15
2/7 2/9

22 彭如玉
5/11 3/5 4/9
6/15 4/4 12/18
8/21 2/2 2/12

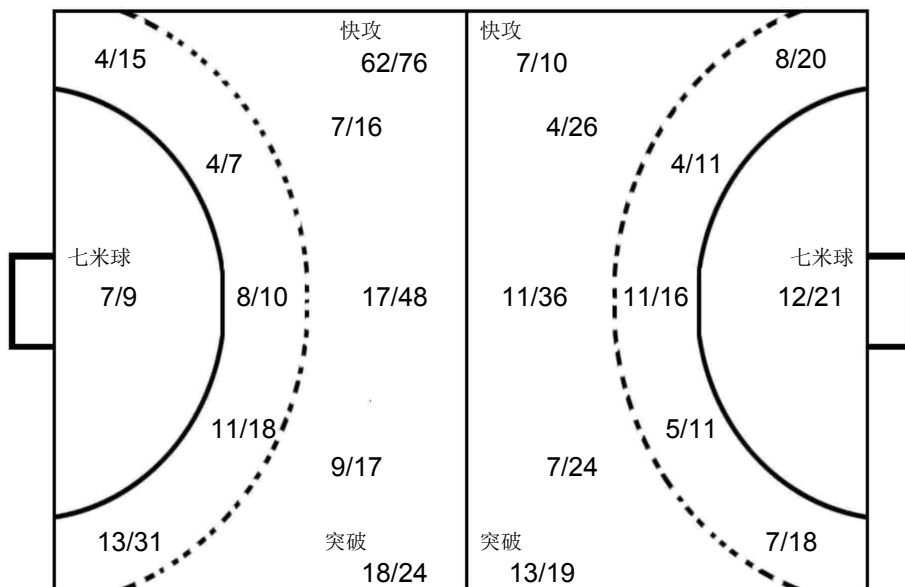

滁州

1 张家轩
2/10 2/3 3/14
3/6 3/3 5/10
2/3 0/1 3/7

淄博

22 邢力丹
1/6 3/5
1/4 4/7
0/3 1/3

深圳

16 邹童羽
0/2 2/3
2/4 1/4
2/8 2/2 0/1

OPPONENT

淄博 3 王静雯 1 2 3 1 1 Post - 0 Miss - 1 Block - 0	滁州 38 潘楠 3 Post - 0 Miss - 1 Block - 0	滁州 3 孙明月 2 1 1 2 Post - 3 Miss - 1 Block - 0	北京 11 陈丽婷 2 1 1 1 Post - 2 Miss - 1 Block - 0	滁州 9 赛海乐 1 1 1 2 Post - 0 Miss - 1 Block - 1	北京 8 武宏业 2 1 1 1 Post - 0 Miss - 1 Block - 0	滁州 34 姜影 1 1 1 1 1 Post - 0 Miss - 0 Block - 0	滁州 35 李旭 1 1 1 1 Post - 2 Miss - 0 Block - 2
滁州 36 高奇欣 1 1 1 1 Post - 0 Miss - 1 Block - 0	深圳 6 朱嘉晴 1 2 1 Post - 0 Miss - 1 Block - 0	淄博 6 孙玉坤 1 1 1 1 Post - 0 Miss - 1 Block - 1	北京 7 翟乃迪 2 1 1 Post - 0 Miss - 0 Block - 0	深圳 5 朱嘉盈 1 2 Post - 0 Miss - 0 Block - 0	香港 4 何丹仪 1 1 1 Post - 0 Miss - 0 Block - 0	香港 8 李芷欣 1 2 Post - 0 Miss - 0 Block - 0	澳门 11 李君移 1 1 1 1 Post - 0 Miss - 2 Block - 0



第二届全国青年运动会女子手球甲组决赛 体校组 (U18)

球队名单

安徽滁州

山西晋中

2019-06-15

号码	姓名	位置	生日	年龄	俱乐部	身高 (CM)	体重 (KG)	国际场次	国际进球
1	张家轩	守门员	24/12/2002	16		180	65		
2	钟梦	中后卫	10/01/2001	18		167	54		
3	孙明月	左后卫	09/09/2002	16		175	64		
4	龚铭	左后卫	28/11/2001	17		181	72		
7	丁洁	左后卫	16/12/2001	17		173	65		
9	窦海乐	右后卫	28/12/2001	17		180	61		
16	刘子琪	守门员	12/09/2001	17		175	64		
25	耿雨萍	右边锋	05/03/2001	18		167	59		
26	张雅婷	右后卫	22/03/2001	18		173	65		
28	马雯怡	右后卫	28/08/2001	17		170	63		
30	罗佳乐	底线	08/06/2001	18		182	70		
32	王小雅	右边锋	27/08/2002	16		173	65		
34	姜影	右边锋	25/06/2002	16		169	60		
35	李旭	中后卫	17/09/2002	16		170	65		
36	高奇欣	底线	28/07/2001	17		178	70		
38	潘楠	中后卫	25/07/2002	16		165	65		
	平均			16.9		173.6	64.2		

编码	姓名	职务
B	陆广红	主教练
C	岳连娥	教练
D	李莉	教练
A	王明星	领队
E	朱双华	医生

手球  
青年女子

## 个人/全队技术累计表

 山西晋中  
2019-06-23

截止至第90场

号码	姓名	远射	近射	边射	快攻	突破	任意	七米	合计	%	助攻	失误	警告	2'	取消	场次	时间
<b>安徽滁州</b>																	
<b>(场上队员)</b>																	
1	张家轩				0/1				0/1	0.0%	7					7	03:37:16
2	钟梦		1/1	1/3	0/2	1/1			3/7	42.9%		4		1		7	00:59:57
3	孙明月	9/26	2/3	1/1	10/14	3/5		3/4	28/53	52.8%	6	16	2	1		7	04:19:24
4	龚铭															2	00:00:00
7	丁洁	3/4		2/2	1/1				6/7	85.7%	1	2				7	00:29:17
9	窦海乐	11/21	1/2	1/1	2/2	1/1	1/1	0/1	17/29	58.6%	9	12	3	1		7	04:12:16
16	刘子琪										7	2				7	01:04:05
25	耿雨萍			1/1					1/1	100%		1				7	00:10:46
26	张雅婷			1/1			0/1		1/2	50.0%			1			7	00:19:35
28	马雯怡			0/1					0/1	0.0%		3				7	00:17:59
30	罗佳乐		1/1					0/1	1/2	50.0%						7	00:12:07
32	王小雅															7	00:01:29
34	姜影		2/3	8/13	10/11	1/2			21/29	72.4%	3	13		2		7	03:49:06
35	李旭	3/12	6/11	1/3	7/8	3/4			20/38	52.6%	7	17	3	5		7	04:25:21
36	高奇欣	1/1	11/14	1/3	2/3	1/1			16/22	72.7%	2	6	1			7	04:27:25
38	潘楠	1/2	3/3	5/10	7/9	6/6		1/1	23/31	74.2%	7	15	1	2		7	04:12:26
	<b>合计</b>	<b>28/66</b>	<b>27/38</b>	<b>22/39</b>	<b>39/51</b>	<b>16/20</b>	<b>1/2</b>	<b>4/7</b>	<b>137/223</b>	<b>61.4%</b>	<b>49</b>	<b>91</b>	<b>11</b>	<b>12</b>		<b>107</b>	
<b>(守门员)</b>																	
1	张家轩	23/34	13/21	19/32	1/10	6/19	4/6	2/11	68/133	51.1%	7					7	03:37:16
16	刘子琪	6/10	3/10	4/8	0/1	1/2	4/7	1/6	19/44	43.2%	7	2				7	01:04:05
	<b>合计</b>	<b>29/44</b>	<b>16/31</b>	<b>23/40</b>	<b>1/11</b>	<b>7/21</b>	<b>8/13</b>	<b>3/17</b>	<b>87/177</b>	<b>49.2%</b>	<b>14</b>	<b>2</b>				<b>14</b>	

场上队员：得分/射门

守门员：救球/射门

已打比赛

全队合计	进球	被救	射失	击柱	封球	合计	%	阶段	场次	对手	比分
远射	28	20	6	8	4	66	42.4%	预赛	7	北京	23:16 (12:6)
近射	27	7	2	2		38	71.1%	预赛	22	常州	15:14 (2:6)
边射	22	11	3	3		39	56.4%	预赛	34	淄博	13:10 (7:6)
快攻	39	8	1	3		51	76.5%	预赛	55	深圳	18:15 (9:3)
突破	16	2		2		20	80.0%	预赛	60	澳门	24:6 (16:1)
任意	1	1				2	50.0%	预赛	76	香港	27:9 (15:3)
七米	4	2	1			7	57.1%	决赛	84	常州	17:20 (9:10)

图式射门区域累计

手球  
青年女子

截止至第90场

山西晋中  
2019-06-23

安徽滁州

1 张家轩 Post - 1 Miss - 0 Block - 0	2 钟梦 Post - 0 Miss - 1 Block - 0	3 孙明月 Post - 8 Miss - 3 Block - 0	4 龚铭 Post - 0 Miss - 0 Block - 0	7 丁洁 Post - 1 Miss - 0 Block - 0	9 樊海乐 Post - 0 Miss - 4 Block - 2	16 刘子琪 Post - 0 Miss - 0 Block - 0	25 耿雨萍 Post - 0 Miss - 0 Block - 0
26 张雅婷 Post - 0 Miss - 0 Block - 0	28 马雯怡 Post - 1 Miss - 0 Block - 0	30 罗佳乐 Post - 0 Miss - 1 Block - 0	32 王小雅 Post - 0 Miss - 0 Block - 0	34 姜影 Post - 1 Miss - 0 Block - 0	35 李旭 Post - 5 Miss - 2 Block - 2	36 高奇欣 Post - 1 Miss - 1 Block - 0	38 潘楠 Post - 0 Miss - 1 Block - 0

10/23	5/6	8/28
11/16	4/4	10/22
7/16	2/3	11/15

3/6	2/3	1/5
0/3		8/13
1/5	0/1	4/8

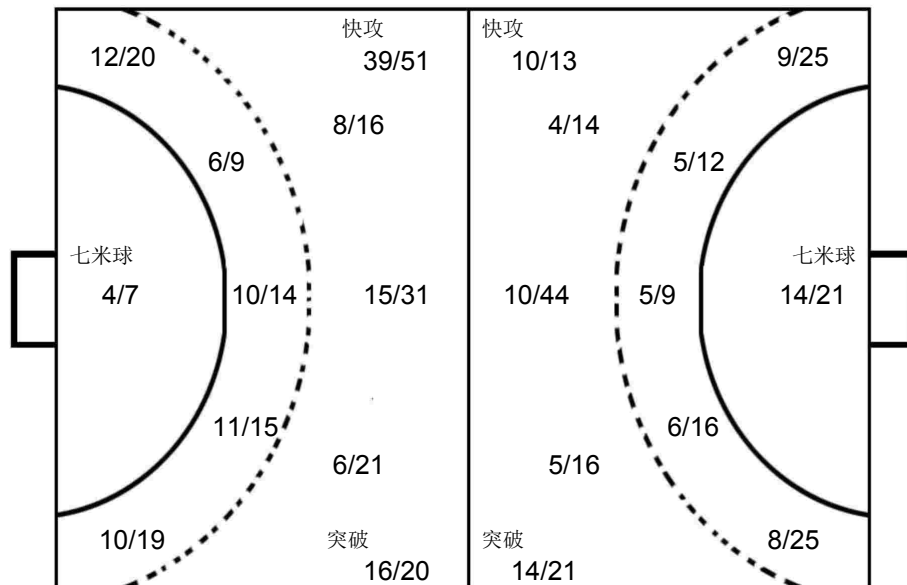

常州

1/3	1/3	2/5
1/3	3/3	1/3
1/4	1/1	0/2

深圳

0/2	1/4	0/1
1/3	2/2	1/1
1/4	1/3	3/5

常州

1/2	0/1	1/4
1/3	0/1	4/5
1/3		0/5

OPPONENT

北京 11 陈丽婷 Post - 0 Miss - 2 Block - 0	常州 19 焦雅 Post - 2 Miss - 1 Block - 0	常州 24 王铃娜 Post - 1 Miss - 1 Block - 0	常州 20 渠文娜 Post - 3 Miss - 0 Block - 0	深圳 5 朱嘉盈 Post - 0 Miss - 0 Block - 0	常州 14 庄红艳 Post - 1 Miss - 2 Block - 0	澳门 12 李芷棋 Post - 0 Miss - 1 Block - 0	香港 5 卓凯晴 Post - 1 Miss - 0 Block - 0
淄博 3 王静雯 Post - 1 Miss - 1 Block - 1	淄博 6 孙玉坤 Post - 0 Miss - 0 Block - 0	北京 8 武宏业 Post - 0 Miss - 0 Block - 0	深圳 6 朱嘉晴 Post - 0 Miss - 0 Block - 0	北京 10 胡冰心 Post - 0 Miss - 0 Block - 0	常州 21 吴静雯 Post - 0 Miss - 2 Block - 0	常州 27 李袁梦 Post - 0 Miss - 0 Block - 0	深圳 3 赵晔 Post - 1 Miss - 2 Block - 1

第二届全国青年运动会女子手球甲组决赛 体校组 (U18)

球队名单

山东淄博

山西晋中

2019-06-15

号码	姓名	位置	生日	年龄	俱乐部	身高 (CM)	体重 (KG)	国际场次	国际进球
3	王静雯	后卫	15/10/2001	17	淄博市体育运动学校	175	66		
5	张素娟	后卫	07/02/2002	17	淄博市体育运动学校	175	71		
6	孙玉坤	右后卫	03/03/2002	17	淄博市体育运动学校	180	70		
7	辛彤慧	后卫	25/12/2002	16	淄博市体育运动学校	170	70		
8	王锦琦	边锋	29/03/2002	17	淄博市体育运动学校	170	60		
9	高梦洁	左后卫	25/05/2001	18	淄博市体育运动学校	173	65		
10	崔佳惠	后卫	10/02/2001	18	淄博市体育运动学校	167	68		
14	韩睿洁	底线	17/09/2001	17	淄博市体育运动学校	180	90		
15	李骞飞	边锋	09/01/2001	18	淄博市体育运动学校	165	60		
16	王启欣	守门员	25/02/2002	17	淄博市体育运动学校	175	70		
17	蒋松妍	底线	12/08/2002	16	淄博市体育运动学校	180	82		
19	户晴	边锋	07/07/2002	16	淄博市体育运动学校	170	62		
21	赵欣瑶	边锋	17/05/2002	17	淄博市体育运动学校	177	65		
22	邢力丹	守门员	06/08/2002	16	淄博市体育运动学校	170	68		
23	王家琪	中后卫	21/03/2002	17	淄博市体育运动学校	170	68		
28	江迎新	左后卫	29/01/2001	18	淄博市体育运动学校	175	66		
	平均			17.0		173.3	68.8		

编码	姓名	职务
B	徐美凤	教练
C	翟乾坤	主教练
D	段文钰	教练
E	王日东	医生
A	左玉峰	领队

手球  
青年女子

## 个人/全队技术累计表

 山西晋中  
2019-06-23

截止至第90场

号码	姓名	远射	近射	边射	快攻	突破	任意	七米	合计	%	助攻	失误	警告	2'	取消	场次	时间
<b>山东淄博</b>																	
<b>(场上队员)</b>																	
3	王静雯	3/15	1/3	3/6	6/7	2/3		12/14	27/48	56.3%	1	7	1	2		7	03:21:30
5	张素娟		0/1	1/1	1/1	1/1			3/4	75.0%	1	5				7	00:40:47
6	孙玉坤	4/12	6/8		2/3	3/4	2/2		17/29	58.6%	6	7	2	3		7	03:57:23
7	辛彤慧			1/2					1/2	50.0%	1	1				7	00:15:01
8	王锦琦			0/2	3/5				3/7	42.9%		4				7	00:41:17
9	高梦洁	4/12	3/9		3/3	3/8			13/32	40.6%	5	14	2		1	7	03:50:05
10	崔佳惠				0/1			1/3	1/4	25.0%	1	1				7	00:35:43
14	韩睿洁													1		7	00:54:47
15	李睿飞		0/1	6/7	2/3	1/3			9/14	64.3%	2	4		1		7	02:13:01
16	王启欣										2	1				7	02:30:47
17	蒋松妍		10/12		4/4				14/16	87.5%		2	3			7	02:22:58
19	户晴		1/5	2/8	3/5				6/18	33.3%		4				7	02:24:31
21	赵欣瑶	0/1	3/5	12/19	8/8				23/33	69.7%		3	1			7	03:50:29
22	邢力丹										5					7	02:09:13
23	王家琪	0/3		1/1		2/4			3/8	37.5%	4	11	1	1		7	02:09:13
28	江迎新	1/1	1/2	0/3	1/2	1/1	0/1		4/10	40.0%	1		1	1		7	00:42:22
<b>合计</b>		<b>12/44</b>	<b>25/46</b>	<b>26/49</b>	<b>33/42</b>	<b>13/24</b>	<b>2/3</b>	<b>13/17</b>	<b>124/225</b>	<b>55.1%</b>	<b>29</b>	<b>64</b>	<b>11</b>	<b>9</b>	<b>1</b>	<b>112</b>	
<b>(守门员)</b>																	
16	王启欣	21/35	6/15	10/20	1/2	1/9	1/2	5/6	45/89	50.6%	2	1				7	02:30:47
22	邢力丹	15/25	5/9	16/25	2/7	1/8		0/3	39/77	50.6%	5					7	02:09:13
<b>合计</b>		<b>36/60</b>	<b>11/24</b>	<b>26/45</b>	<b>3/9</b>	<b>2/17</b>	<b>1/2</b>	<b>5/9</b>	<b>84/166</b>	<b>50.6%</b>	<b>7</b>	<b>1</b>				<b>14</b>	

场上队员：得分/射门

守门员：救球/射门

已打比赛

全队合计	进球	被救	射失	击柱	封球	合计	%	阶段	场次	对手	比分
远射	12	19	5	6	2	44	27.3%	预赛	6	澳门	31:1 (16:1)
近射	25	15	5	1		46	54.3%	预赛	23	香港	18:6 (11:4)
边射	26	17	2	4		49	53.1%	预赛	34	滁州	10:13 (6:7)
快攻	33	6		3		42	78.6%	预赛	39	常州	15:18 (7:7)
突破	13	10		1		24	54.2%	预赛	53	北京	18:16 (8:6)
任意	2	1				3	66.7%	预赛	70	深圳	12:14 (4:6)
七米	13	3	1			17	76.5%	3-4名	90	深圳	20:14 (8:5)





图式射门区域累计

手球  
青年女子

截止至第90场

山西晋中  
2019-06-23

山东淄博

3 王静雯 4 4 3 5 8 3 Post - 1 Miss - 5 Block - 1	5 张素娟 1 1 1 Post - 0 Miss - 1 Block - 0	6 孙玉坤 1 1 3 2 5 4 1 Post - 3 Miss - 1 Block - 1	7 辛彤慧 1 Post - 0 Miss - 0 Block - 0	8 王锦琦 1 2 Post - 2 Miss - 0 Block - 0	9 高梦洁 1 2 5 1 1 3 Post - 3 Miss - 2 Block - 0	10 崔佳惠 1 Post - 0 Miss - 1 Block - 0	14 韩睿洁 Post - 0 Miss - 0 Block - 0
15 李鹏飞 1 1 1 1 3 2 Post - 0 Miss - 1 Block - 0	16 王启欣 Post - 0 Miss - 0 Block - 0	17 蒋松妍 1 2 3 1 6 1 Post - 1 Miss - 0 Block - 0	19 卢晴 2 2 1 1 Post - 3 Miss - 1 Block - 0	21 赵欣瑶 6 3 4 3 4 Post - 1 Miss - 0 Block - 0	22 邢力丹 Post - 0 Miss - 0 Block - 0	23 王家琪 1 2 Post - 1 Miss - 0 Block - 0	28 江迎新 2 2 Post - 0 Miss - 1 Block - 0

16 王启欣

1/7	2/3	8/16
6/9	2/2	8/14
3/13	3/5	12/20

22 邢力丹

4/15	3/3	4/10
7/10	4/4	9/15
4/9	3/4	1/7

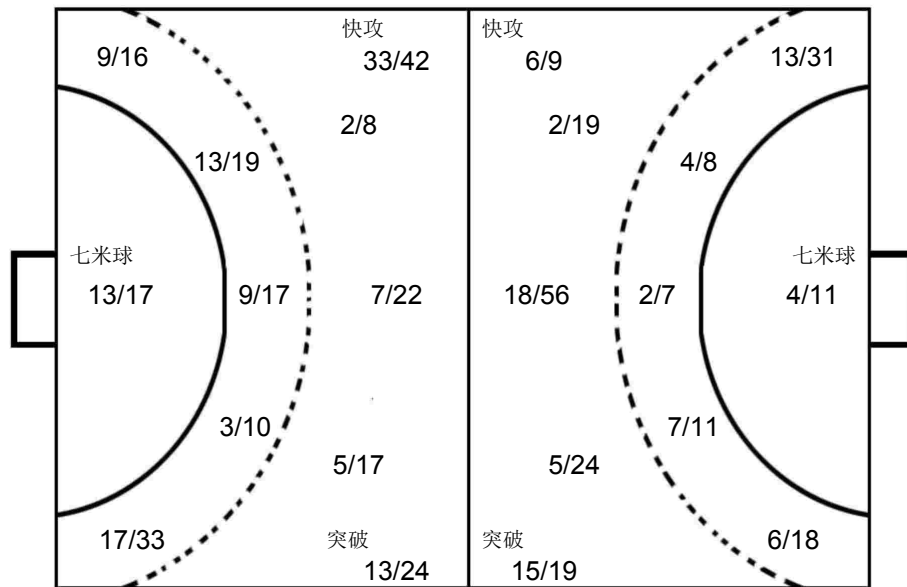

滁州  
1 张家轩

2/4	1/1	3/7
3/3		1/4
0/1		2/2

深圳  
16 邹童羽

0/5	1/1	2/3
1/3	3/3	2/4
1/4		0/2

深圳  
17 冯颖慧

1/2		1/1
1/5	1/1	4/6
1/6	0/3	1/3

OPPONENT

深圳 3 赵晔 1 1 5 1 1 Post - 1 Miss - 1 Block - 3	深圳 2 唐悦 4 1 2 1 Post - 2 Miss - 2 Block - 5	北京 11 陈丽婷 1 2 3 Post - 0 Miss - 2 Block - 2	常州 14 庄红艳 2 2 1 1 Post - 1 Miss - 0 Block - 0	常州 19 焦雅 1 1 2 1 2 Post - 0 Miss - 1 Block - 0	深圳 6 朱嘉晴 2 1 1 1 1 Post - 1 Miss - 1 Block - 0	常州 20 渠文娜 1 2 1 Post - 1 Miss - 0 Block - 0	滁州 36 高奇欣 1 1 1 Post - 0 Miss - 0 Block - 0
北京 8 武宏业 1 2 Post - 0 Miss - 0 Block - 0	北京 88 彭爽爽 1 1 Post - 0 Miss - 0 Block - 0	滁州 38 潘楠 1 1 1 Post - 0 Miss - 0 Block - 0	深圳 9 张雨乐 2 1 Post - 0 Miss - 0 Block - 0	香港 16 曾婉琳 1 1 1 Post - 0 Miss - 1 Block - 0	滁州 9 窦海乐 2 Post - 0 Miss - 1 Block - 0	滁州 35 李旭 1 1 Post - 1 Miss - 1 Block - 0	深圳 5 朱嘉盈 1 1 Post - 0 Miss - 0 Block - 1



第二届全国青年运动会女子手球甲组决赛 体校组 (U18)

球队名单

广东深圳

山西晋中

2019-06-15

号码	姓名	位置	生日	年龄	俱乐部	身高 (CM)	体重 (KG)	国际场次	国际进球
2	唐悦	后卫	06/08/2002	16	深圳	165	64		
3	赵晔	左后卫	16/04/2001	18	深圳	173	64		
5	朱嘉盈	右后卫	23/07/2001	17	深圳	165	58		
6	朱嘉晴	后卫	07/07/2002	16	深圳	179	71		
7	曾妮	底线	29/04/2001	18	深圳	165	61		
9	张雨乐	右边锋	28/03/2002	17	深圳	167	55		
10	徐瑜琳	右后卫	20/08/2002	16	深圳	173	69		
11	王文卉	右边锋	29/08/2001	17	深圳	167	58		
12	于雅梦	守门员	18/12/2001	17	深圳	186	80		
13	刘培天	左边锋	10/11/2001	17	深圳	171	62		
16	邹童羽	守门员	18/03/2002	17	深圳	180	72		
17	冯颖慧	守门员	05/09/2003	15	深圳	174	70		
18	谢宛彤	左边锋	23/08/2002	16	深圳	168	68		
20	岳欣华	左后卫	25/09/2001	17	深圳	169	62		
	平均			16.7		171.6	65.3		

编码	姓名	职务
B	张敬敏	教练
C	常敏	主教练
D	蒋光华	医生
A	张斌	教练
E	夏恒	领队

手球  
青年女子

## 个人/全队技术累计表

 山西晋中  
2019-06-23

截止至第90场

号码	姓名	远射	近射	边射	快攻	突破	任意	七米	合计	%	助攻	失误	警告	2'	取消	场次	时间
<b>广东深圳</b>																	
<b>(场上队员)</b>																	
2	唐悦	8/27	3/8		3/4	3/4	0/1	3/6	20/50	40.0%	6	10				7	03:01:13
3	赵晔	12/36	3/8	1/5	2/2	2/3	1/4	2/4	23/62	37.1%	1	9	2	2		7	04:31:56
5	朱嘉盈	4/11	5/11	1/6	5/6	7/10		1/1	23/45	51.1%	5	18	2	6		7	04:31:08
6	朱嘉晴	1/3	2/7	8/18	2/2	1/1		0/2	14/33	42.4%		9	1			7	03:53:43
7	曾妮		1/3	1/5		1/1			3/9	33.3%		2	1			7	01:17:15
9	张雨乐		0/1	5/18	5/5				10/24	41.7%		4	1	2		7	03:28:35
10	徐瑜琳			1/1					1/1	100%				1		7	01:24:46
11	王文卉											2				7	00:06:19
12	于雅梦															7	00:10:17
13	刘培天		6/8	0/1	2/3				8/12	66.7%		3	2			7	03:43:20
16	邹童羽											1	2			7	03:02:57
17	冯颖慧											3	1			7	01:26:14
18	谢宛彤			0/3	0/1				0/4	0.0%				1		7	00:10:21
20	岳欣华		2/2	3/6					5/8	62.5%		1				7	01:48:35
	<b>合计</b>	<b>25/77</b>	<b>22/48</b>	<b>20/63</b>	<b>19/23</b>	<b>14/19</b>	<b>1/5</b>	<b>6/13</b>	<b>107/248</b>	<b>43.1%</b>	<b>16</b>	<b>61</b>	<b>9</b>	<b>12</b>		<b>98</b>	
<b>(守门员)</b>																	
11	王文卉															7	00:00:35
12	于雅梦	3/3	2/5						5/8	62.5%						7	00:10:17
16	邹童羽	17/22	4/22	16/26	3/15	6/15	1/3	2/12	49/115	42.6%	1	2				7	03:02:57
17	冯颖慧	8/10	5/11	2/8	1/7	3/11	2/4	1/5	22/56	39.3%	3	1				7	01:26:14
	<b>合计</b>	<b>28/35</b>	<b>11/38</b>	<b>18/34</b>	<b>4/22</b>	<b>9/26</b>	<b>3/7</b>	<b>3/17</b>	<b>76/179</b>	<b>42.5%</b>	<b>4</b>	<b>3</b>				<b>28</b>	

场上队员：得分/射门

守门员：救球/射门

已打比赛

全队合计	进球	被救	射失	击柱	封球	合计	%	阶段	场次	对手	比分
远射	25	25	7	5	15	77	32.5%	预赛	21	北京	14:15 (7:7)
近射	22	21	2	2	1	48	45.8%	预赛	33	澳门	23:7 (13:2)
边射	20	31	5	7		63	31.7%	预赛	38	香港	15:11 (8:7)
快攻	19	3	1			23	82.6%	预赛	55	滁州	15:18 (3:9)
突破	14	4	1			19	73.7%	预赛	69	常州	12:20 (5:9)
任意	1	4				5	20.0%	预赛	70	淄博	14:12 (6:4)
七米	6	3	1	3		13	46.2%	3-4名	90	淄博	14:20 (5:8)

图式射门区域累计

手球  
青年女子

截止至第90场

山西晋中  
2019-06-23

广东深圳

2 唐悦 7 3 5 2 3 Post - 4 Miss - 3 Block - 9	3 赵晔 1 7 2 9 1 3 Post - 5 Miss - 5 Block - 6	5 朱嘉盈 1 2 6 9 2 3 Post - 2 Miss - 1 Block - 1	6 朱嘉晴 3 1 3 1 5 1 Post - 1 Miss - 4 Block - 0	7 曾妮 1 1 1 Post - 4 Miss - 1 Block - 0	9 张雨乐 4 1 3 1 1 Post - 1 Miss - 1 Block - 0	10 徐瑜琳 1 Post - 0 Miss - 0 Block - 0	11 王文卉 Post - 0 Miss - 0 Block - 0
12 于雅梦 Post - 0 Miss - 0 Block - 0	13 刘培天 2 1 1 1 2 1 Post - 0 Miss - 1 Block - 0	16 邹童羽 Post - 0 Miss - 0 Block - 0	17 冯颖慧 Post - 0 Miss - 0 Block - 0	18 谢宛彤 Post - 0 Miss - 0 Block - 0	20 岳欣华 1 3 1 Post - 0 Miss - 1 Block - 0		

11 王文卉

12 于雅梦
1/1
2/3 2/3
0/1

16 邹童羽
0/11 2/5 5/8
8/19 9/10 7/14
8/27 5/7 5/14

17 冯颖慧
3/4 1/2 1/7
6/12 2/2 5/9
2/13 1/4 1/3

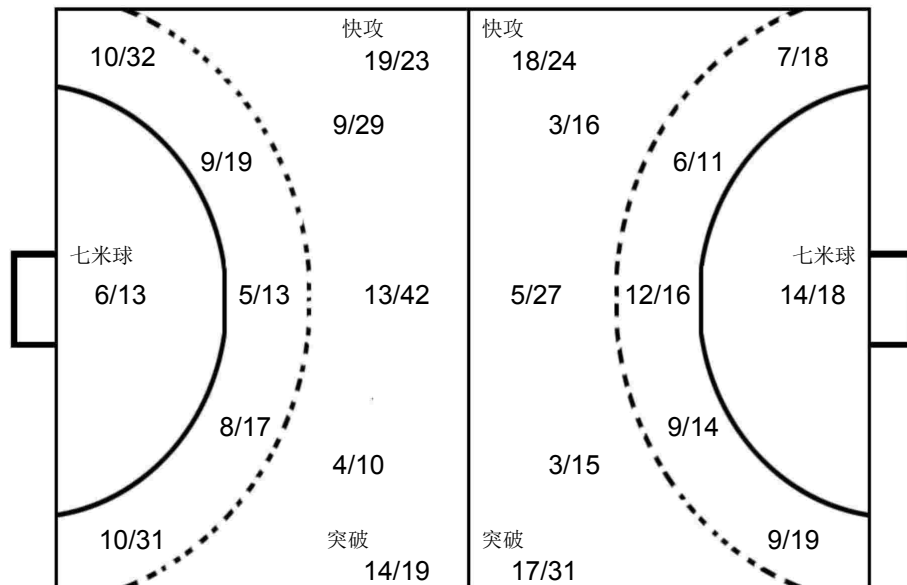

北京

1 靳爽
0/1 3/3 2/4
3/4 4/8
3/7 1/3 3/3

香港

1 郑晓容
1/2 2/3
3/7 4/5
3/8 1/2 2/4

淄博

16 王启欣
0/1 3/7
1/3 1/1 1/2
1/9 3/4 3/6

OPPONENT

淄博 21 赵欣瑶 4 3 2 Post - 1 Miss - 0 Block - 0	北京 11 陈丽婷 1 2 2 1 1 1 Post - 1 Miss - 2 Block - 0	常州 14 庄红艳 1 1 2 4 Post - 0 Miss - 0 Block - 0	滁州 34 姜影 2 2 1 1 1 Post - 0 Miss - 0 Block - 0	淄博 3 王静雯 1 1 2 1 1 Post - 0 Miss - 2 Block - 0	淄博 17 蒋松妍 2 1 3 Post - 0 Miss - 0 Block - 0	香港 5 卓凯晴 1 1 3 Post - 0 Miss - 1 Block - 0	淄博 15 李赛飞 1 1 2 1 Post - 0 Miss - 1 Block - 0
---	--	--	---	---	---	--	--



第二届全国青年运动会女子手球甲组决赛 体校组 (U18)



PHMS Pictorial Handball Match Statistics

IHF Official System

图式射门区域累计

手球  
青年女子

截止至第90场

山西晋中  
2019-06-23

澳门	常州	常州	滁州	滁州	香港	滁州	淄博																																																																								
15 張雪琳	19 焦雅	21 吴静雯	3 孙明月	38 潘楠	16 曾婉琳	35 李旭	6 孙玉坤																																																																								
<table border="1"><tr><td></td><td></td><td></td></tr><tr><td>1</td><td></td><td></td></tr><tr><td>3</td><td></td><td></td></tr></table>				1			3			<table border="1"><tr><td></td><td></td><td></td></tr><tr><td>1</td><td></td><td></td></tr><tr><td>3</td><td></td><td></td></tr></table>				1			3			<table border="1"><tr><td></td><td></td><td>1</td></tr><tr><td></td><td></td><td>1</td></tr><tr><td>2</td><td></td><td></td></tr></table>			1			1	2			<table border="1"><tr><td></td><td>1</td><td></td></tr><tr><td>1</td><td></td><td>1</td></tr><tr><td>1</td><td></td><td></td></tr></table>		1		1		1	1			<table border="1"><tr><td></td><td></td><td></td></tr><tr><td></td><td></td><td></td></tr><tr><td>2</td><td>1</td><td>1</td></tr></table>							2	1	1	<table border="1"><tr><td></td><td></td><td></td></tr><tr><td></td><td></td><td>1</td></tr><tr><td></td><td></td><td>3</td></tr></table>						1			3	<table border="1"><tr><td></td><td></td><td>1</td></tr><tr><td>1</td><td></td><td></td></tr><tr><td></td><td></td><td>1</td></tr></table>			1	1					1	<table border="1"><tr><td></td><td></td><td></td></tr><tr><td></td><td></td><td>1</td></tr><tr><td>1</td><td></td><td>1</td></tr></table>						1	1		1
1																																																																															
3																																																																															
1																																																																															
3																																																																															
		1																																																																													
		1																																																																													
2																																																																															
	1																																																																														
1		1																																																																													
1																																																																															
2	1	1																																																																													
		1																																																																													
		3																																																																													
		1																																																																													
1																																																																															
		1																																																																													
		1																																																																													
1		1																																																																													
Post - 0 Miss - 4 Block - 0	Post - 0 Miss - 0 Block - 2	Post - 0 Miss - 1 Block - 0	Post - 0 Miss - 0 Block - 0	Post - 0 Miss - 0 Block - 0	Post - 1 Miss - 3 Block - 0	Post - 0 Miss - 1 Block - 0	Post - 1 Miss - 0 Block - 0																																																																								



第二届全国青年运动会女子手球甲组决赛 体校组 (U18)

球队名单

北京市

山西晋中

2019-06-15

号码	姓名	位置	生日	年龄	俱乐部	身高 (CM)	体重 (KG)	国际场次	国际进球
1	靳爽	守门员	26/07/2002	16		181	72		
5	常凯旋	右后卫	05/02/2002	17		176	72		
7	翟乃迪	中后卫	02/03/2002	17		170	67		
8	武宏业	左后卫	22/03/2002	17		173	69		
9	徐慧敏	左边锋	15/02/2001	18		175	62		
10	胡冰心	右边锋	26/05/2001	18		162	56		
11	陈丽婷	中后卫	05/01/2001	18		177	57		
14	侯美林	右后卫	29/01/2001	18		170	68		
16	周晓雨	守门员	31/05/2002	17		176	65		
18	唐文杰	底线	28/06/2001	17		170	67		
23	黄文文	左边锋	16/04/2002	17		162	53		
25	赵楠	左后卫	03/04/2001	18		176	80		
27	田苗	底线	24/12/2001	17		170	62		
81	王木子	底线	01/08/2002	16		170	73		
87	王奥	底线	07/08/2001	17		172	70		
88	彭爽爽	左边锋	28/12/2001	17		162	53		
	平均			17.2		171.4	65.4		

编码	姓名	职务
B	黄承	主教练
E	刘文勇	医生
C	栾征	教练
A	宋刚	领队
D	石伟	教练

手球  
青年女子

## 个人/全队技术累计表

 山西晋中  
2019-06-23

截止至第90场

号码	姓名	远射	近射	边射	快攻	突破	任意	七米	合计	%	助攻	失误	警告	2'	取消	场次	时间
北京市																	
(场上队员)																	
1	靳爽															7	04:02:52
5	常凯旋				3/3	1/2			4/5	80.0%	1	3	1			6	00:56:47
7	翟乃迪		0/1	2/3	0/1	2/3	1/1		5/9	55.6%	1	10	2			7	02:45:43
8	武宏业	4/13	2/3	1/1	2/2	8/9		9/9	26/37	70.3%	1	9		3		7	02:15:16
9	徐慧敏	5/8	1/1		1/2				7/11	63.6%		2	1	1		5	00:31:10
10	胡冰心		4/5	5/15	5/6				14/26	53.8%	1	6				7	03:21:03
11	陈丽婷	9/24	4/9		2/2	14/15	0/6	12/16	41/72	56.9%	5	9	1	1		7	03:45:44
14	侯美林		1/4		1/2	2/5		1/3	5/14	35.7%	5	11	3			7	03:29:26
16	周晓雨													1		7	00:37:08
18	唐文杰		5/5	0/2					5/7	71.4%	1	9	1	2		7	02:27:24
23	黄文文			1/2		0/1			1/3	33.3%		2				7	01:20:42
27	田苗		0/1		1/1				1/2	50.0%		5				7	02:09:32
81	王木子		2/3	1/1	0/1				3/5	60.0%	1	1	1	2		6	00:39:55
87	王奥	0/1	1/3	2/2	1/2		1/1		5/9	55.6%		4		2		7	01:41:30
88	彭爽爽	2/5	0/2	6/8	6/6	2/3	1/1		17/25	68.0%	1	5				7	02:49:57
	合计	20/51	20/37	18/34	22/28	29/38	3/9	22/28	134/225	59.6%	17	76	10	12		101	
(守门员)																	
1	靳爽	14/41	15/36	26/44	3/18	2/18	0/4	2/4	62/165	37.6%						7	04:02:52
16	周晓雨	3/7	0/4	2/2	0/2	0/1		1/4	6/20	30.0%						7	00:37:08
	合计	17/48	15/40	28/46	3/20	2/19	0/4	3/8	68/185	36.8%						14	

场上队员：得分/射门

守门员：救球/射门

已打比赛

全队合计	进球	被救	射失	击柱	封球	合计	%	阶段	场次	对手	比分
远射	20	22	5	2	2	51	39.2%	预赛	7	滁州	16:23 (6:12)
近射	20	10	3	4		37	54.1%	预赛	21	深圳	15:14 (7:7)
边射	18	13	1	2		34	52.9%	预赛	35	常州	13:23 (6:12)
快攻	22	4	1	1		28	78.6%	预赛	40	澳门	27:11 (16:4)
突破	29	4	2	3		38	76.3%	预赛	53	淄博	16:18 (6:8)
任意	3	4	2			9	33.3%	预赛	68	香港	26:16 (12:8)
七米	22	4	1	1		28	78.6%	5-6名	89	香港	21:12 (12:6)

图式射门区域累计

手球  
青年女子

截止至第90场

山西晋中  
2019-06-23

北京市

1 靳爽 Post - 0 Miss - 0 Block - 0	5 常凯旋 Post - 0 Miss - 0 Block - 0	7 翟乃迪 Post - 1 Miss - 1 Block - 0	8 武宏业 Post - 0 Miss - 2 Block - 0	9 徐慧敏 Post - 1 Miss - 0 Block - 0	10 胡冰心 Post - 1 Miss - 1 Block - 0	11 陈丽婷 Post - 3 Miss - 7 Block - 2	14 侯美林 Post - 2 Miss - 1 Block - 0
16 周晓雨 Post - 0 Miss - 0 Block - 0	18 唐文杰 Post - 0 Miss - 0 Block - 0	23 黄文文 Post - 2 Miss - 0 Block - 0	27 田苗 Post - 1 Miss - 0 Block - 0	81 王木子 Post - 0 Miss - 2 Block - 0	87 王奥 Post - 2 Miss - 1 Block - 0	88 彭爽爽 Post - 0 Miss - 0 Block - 0	

1 靳爽	4/18	5/6	3/18
	12/22	8/8	11/34
	10/26	4/6	5/27

16 周晓雨	0/3	1/2	0/2
	1/3	1/1	1/2
	0/1	1/2	1/4

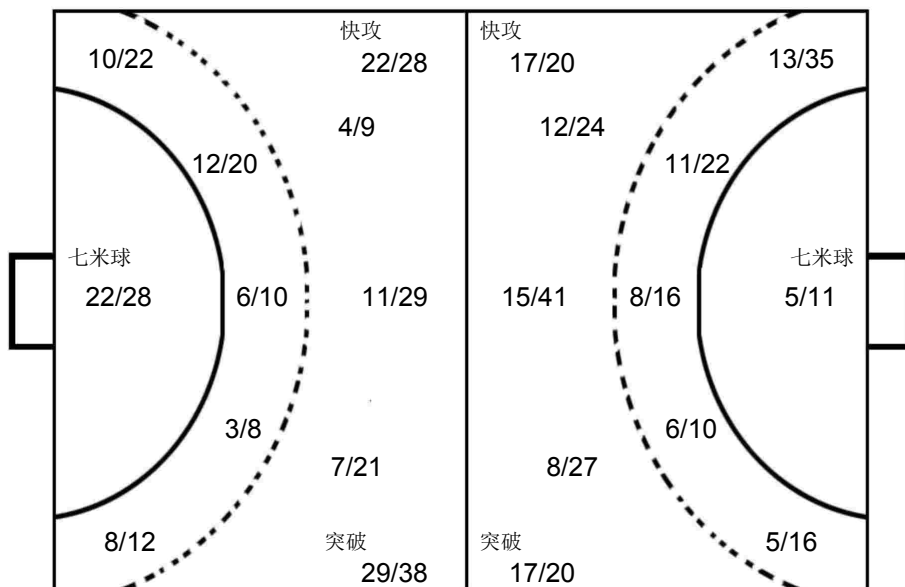

滁州

1 张家轩	2/3	0/4
	1/1	2/4
	2/4	1/1

香港

1 郑晓容	1/8	1/5
	5/10	0/5
	1/8	1/2

淄博

16 王启欣	1/4	2/3
	2/3	1/1
	1/3	0/3

OPPONENT

香港 11 庄斯琪 Post - 1 Miss - 1 Block - 2	香港 16 曾婉琳 Post - 1 Miss - 3 Block - 2	常州 14 庄红艳 Post - 0 Miss - 0 Block - 0	滁州 3 孙明月 Post - 1 Miss - 1 Block - 0	滁州 9 窦海乐 Post - 0 Miss - 0 Block - 0	澳门 12 李芷棋 Post - 1 Miss - 1 Block - 0	常州 19 焦雅 Post - 0 Miss - 1 Block - 2	滁州 38 潘楠 Post - 0 Miss - 0 Block - 0
深圳 5 朱嘉盈 Post - 1 Miss - 0 Block - 0	澳门 22 苏萱婷 Post - 0 Miss - 1 Block - 1	常州 24 王铃娜 Post - 1 Miss - 1 Block - 0	深圳 2 唐悦 Post - 0 Miss - 0 Block - 3	香港 8 李芷欣 Post - 1 Miss - 0 Block - 2	淄博 9 高梦洁 Post - 2 Miss - 1 Block - 0	淄博 21 赵欣瑶 Post - 0 Miss - 0 Block - 0	常州 20 渠文娜 Post - 2 Miss - 1 Block - 1



## 第二届全国青年运动会女子手球甲组决赛 体校组 (U18)

## 球队名单

香港

山西晋中

2019-06-15

号码	姓名	位置	生日	年龄	俱乐部	身高 (CM)	体重 (KG)	国际场次	国际进球
1	郑晓容	守门员	17/01/2001	18	香港	173	65		
3	黄秋婷	左后卫	09/05/2001	18	香港	163	55		
4	何丹仪	右后卫	03/01/2002	17	香港	158	50		
5	卓凯晴	右后卫	25/10/2002	16	香港	158	59		
6	洪卓翘	守门员	03/09/2001	17	香港	177	61		
8	李芷欣	中后卫	27/09/2001	17	香港	169	58		
9	林卓琪	左后卫	10/03/2002	17	香港	165	53		
11	庄斯琪	右后卫	18/01/2002	17	香港	172	65		
16	曾婉琳	左后卫	16/11/2001	17	香港	170	65		
17	梁艺	右边锋	07/09/2002	16	香港	159	55		
18	吴嘉妮	中后卫	20/09/2001	17	香港	165	54		
21	林乐儿	左边锋	25/03/2002	17	香港	168	58		
23	王洁桦	左边锋	14/02/2001	18	香港	163	55		
25	戴子怡	底线	13/04/2001	18	香港	165	65		
28	郭芷彤	底线	25/09/2002	16	香港	169	80		
91	孔倩瑜	右边锋	20/10/2001	17	香港	163	60		
	平均			17.1		166.1	59.9		

编码	姓名	职务
A	杨开将	领队
B	何颂邦	教练
C	梁倩盈	教练

手球  
青年女子

## 个人/全队技术累计表

 山西晋中  
2019-06-23

截止至第90场

号码	姓名	远射	近射	边射	快攻	突破	任意	七米	合计	%	助攻	失误	警告	2'	取消	场次	时间
<b>香港</b>																	
<b>(场上队员)</b>																	
1	郑晓容											1				7	02:52:22
3	黄秋婷		0/1	2/10	2/4	2/6			6/21	28.6%	2	13				7	02:19:02
4	何丹仪	2/4	1/1	0/1	1/1	2/4			6/11	54.5%		15	2			7	02:30:00
5	卓凯晴	0/1	0/1					10/16	10/18	55.6%						7	00:09:45
6	洪卓翹										1	2				7	01:41:20
8	李芷欣	4/21	2/4	0/2		3/3		1/3	10/33	30.3%		11	4	1		7	02:52:10
9	林卓琪	0/4	0/1	2/8	1/1	2/2			5/16	31.3%		9		1		7	02:32:44
11	庄斯琪	5/17	2/3	3/5			3/4	0/1	13/30	43.3%	1	14	1	1		7	02:34:18
16	曾婉琳	2/13	2/5	3/8	1/2	6/9	0/2		14/39	35.9%		22	1			7	03:22:24
17	梁艺			1/6		1/1			2/7	28.6%		2				7	01:18:59
18	吴嘉妮	0/2	1/4	2/4	1/2			0/1	4/13	30.8%		3				7	01:09:12
21	林乐儿	1/4	1/1	1/4	3/3	1/2			7/14	50.0%		2		1		7	01:05:53
23	王洁桦		0/2	0/1	2/2				2/5	40.0%		5				7	00:51:07
25	戴子怡		3/5						3/5	60.0%		2				7	03:26:04
28	郭芷彤		3/4						3/4	75.0%			1	1		7	01:11:41
91	孔倩瑜	0/1	1/2	1/9				1/4	3/16	18.8%		6				7	02:36:05
	<b>合计</b>	<b>14/67</b>	<b>16/34</b>	<b>15/58</b>	<b>11/15</b>	<b>17/27</b>	<b>3/6</b>	<b>12/25</b>	<b>88/232</b>	<b>37.9%</b>	<b>4</b>	<b>107</b>	<b>9</b>	<b>5</b>		<b>112</b>	
<b>(守门员)</b>																	
1	郑晓容	12/19	5/21	9/22	7/44	1/13	4/6	2/12	40/137	29.2%		1				7	02:52:22
6	洪卓翹	8/15	3/12	3/8	2/21	2/6	0/1	0/5	18/68	26.5%	1	2				7	01:41:20
16	曾婉琳	1/1	0/1			0/1			1/3	33.3%						7	00:06:18
	<b>合计</b>	<b>21/35</b>	<b>8/34</b>	<b>12/30</b>	<b>9/65</b>	<b>3/20</b>	<b>4/7</b>	<b>2/17</b>	<b>59/208</b>	<b>28.4%</b>	<b>1</b>	<b>3</b>				<b>21</b>	

场上队员：得分/射门

守门员：救球/射门

已打比赛

全队合计	进球	被救	射失	击柱	封球	合计	%	阶段	场次	对手	比分
远射	14	25	14	5	9	67	20.9%	预赛	5	常州	12:34 (5:15)
近射	16	12	3	3		34	47.1%	预赛	23	淄博	6:18 (4:11)
边射	15	32	6	5		58	25.9%	预赛	38	深圳	11:15 (7:8)
快攻	11	4				15	73.3%	预赛	54	澳门	22:8 (7:3)
突破	17	6	3	1		27	63.0%	预赛	68	北京	16:26 (8:12)
任意	3	2	1			6	50.0%	预赛	76	滁州	9:27 (3:15)
七米	12	7	3	3		25	48.0%	5-6名	89	北京	12:21 (6:12)

图式射门区域累计

手球  
青年女子

截止至第90场

山西晋中  
2019-06-23

香港

1 郑晓容 [0][0][0] [0][0][0] Post - 0 Miss - 0 Block - 0	3 黄秋婷 [0][0][0] [0][0][3] [1][2][0] Post - 0 Miss - 1 Block - 0	4 何丹仪 [1][0][1] [2][0][1] [1][0][0] Post - 0 Miss - 0 Block - 1	5 卓凯晴 [1][0][1] [1][0][1] [5][1][0] Post - 3 Miss - 1 Block - 1	6 洪卓翘 [0][0][0] [0][0][0] [0][0][0] Post - 0 Miss - 0 Block - 0	8 李芷欣 [0][0][1] [1][0][3] [4][0][1] Post - 2 Miss - 2 Block - 3	9 林卓琪 [0][0][0] [1][0][1] [1][0][2] Post - 5 Miss - 1 Block - 0	11 庄斯琪 [6][0][0] [3][0][2] [1][0][1] Post - 2 Miss - 3 Block - 2
16 曾婉琳 [3][0][2] [0][0][3] [0][0][6] Post - 2 Miss - 9 Block - 2	17 梁艺 [1][0][0] [0][0][0] [1][0][0] Post - 0 Miss - 2 Block - 0	18 吴嘉妮 [1][0][1] [1][0][0] [1][0][0] Post - 0 Miss - 3 Block - 0	21 林乐儿 [1][0][1] [1][0][1] [0][1][2] Post - 1 Miss - 2 Block - 0	23 王洁桦 [0][0][0] [0][0][1] [1][0][0] Post - 0 Miss - 1 Block - 0	25 戴子怡 [0][0][0] [1][0][0] [2][0][0] Post - 1 Miss - 0 Block - 0	28 郭芷彤 [0][0][0] [0][0][1] [1][1][0] Post - 0 Miss - 1 Block - 0	91 孔倩瑜 [1][0][0] [0][0][2] [0][0][0] Post - 1 Miss - 4 Block - 0

1 郑晓容

2/20	1/1	5/19
10/23	2/2	10/32
4/19	2/4	4/17

6 洪卓翘

2/11	1/2	0/7
5/13	1/1	1/9
0/8	2/4	6/13

16 曾婉琳

[0][0][0]	1/1	[0][0][0]
0/1	[0][0][0]	[0][0][0]
[0][0][0]	0/1	[0][0][0]

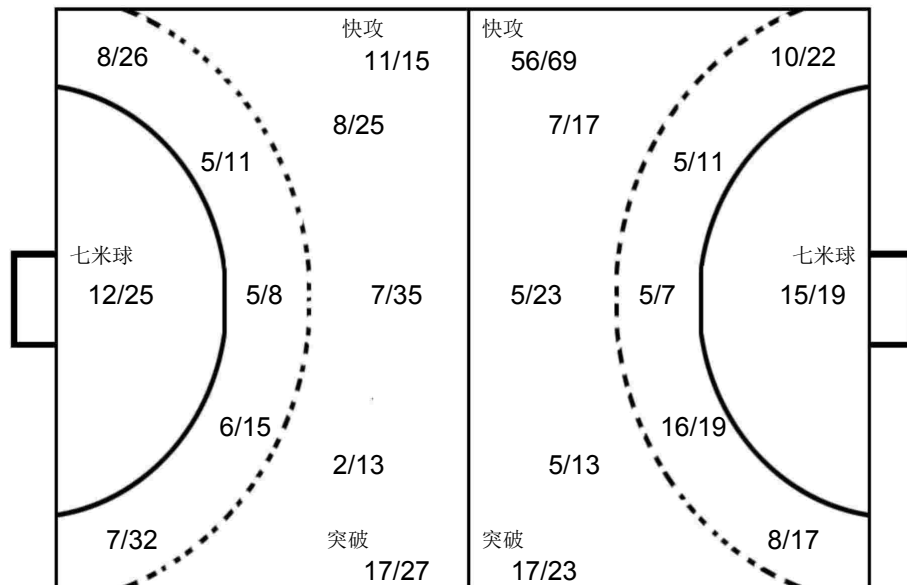

北京

1 靳爽

1/9	1/1	1/3
5/8	3/3	3/9
4/6	2/2	1/7

澳门

19 冯楚莹

1/2	1/1	1/4
3/6	1/1	3/7
1/5	2/4	0/2

深圳

16 邹童羽

0/1	[0][0][0]	[0][0][0]
3/4	1/1	2/3
4/8	[0][0][0]	1/4

OPPONENT

北京 8 武宏业 [5][0][1] [2][0][2] [0][0][2] Post - 0 Miss - 1 Block - 0	常州 14 庄红艳 [4][0][2] [1][0][0] [2][0][2] Post - 1 Miss - 0 Block - 0	北京 10 胡冰心 [1][0][0] [3][0][3] [1][1][0] Post - 0 Miss - 0 Block - 0	北京 88 彭爽爽 [4][1][1] [0][0][0] [3][0][0] Post - 0 Miss - 0 Block - 0	滁州 3 孙明月 [2][0][0] [4][0][1] [1][0][1] Post - 1 Miss - 1 Block - 0	北京 11 陈丽婷 [0][0][1] [1][0][1] [2][1][1] Post - 0 Miss - 0 Block - 0	常州 19 焦雅 [0][0][0] [0][0][4] [1][0][0] Post - 0 Miss - 2 Block - 0	滁州 35 李旭 [0][0][3] [0][0][1] [0][0][1] Post - 1 Miss - 0 Block - 0
深圳 5 朱嘉盈 [0][0][0] [0][0][1] [2][0][2] Post - 1 Miss - 1 Block - 0	澳门 12 李芷琪 [0][0][1] [0][0][2] [0][1][0] Post - 0 Miss - 0 Block - 1	常州 20 渠文娜 [0][0][1] [0][0][3] [0][0][0] Post - 0 Miss - 1 Block - 0	滁州 36 高奇欣 [3][0][1] [0][0][0] [0][0][0] Post - 0 Miss - 0 Block - 0	淄博 9 高梦洁 [1][0][1] [1][0][1] [0][0][0] Post - 0 Miss - 0 Block - 0	淄博 17 蒋松妍 [1][0][2] [0][0][0] [1][0][0] Post - 0 Miss - 0 Block - 0	北京 5 常凯旋 [0][0][1] [0][0][0] [2][0][0] Post - 0 Miss - 0 Block - 0	北京 18 唐文杰 [0][0][1] [0][0][1] [0][0][1] Post - 0 Miss - 0 Block - 0

第二届全国青年运动会女子手球甲组决赛 体校组 (U18)

PHMS Pictorial Handball Match Statistics

IHF Official System

球队名单

山西晋中

2019-06-15

澳门

号码	姓名	位置	生日	年龄	俱乐部	身高 (CM)	体重 (KG)	国际场次	国际进球
8	譚嘉雯	底线	18/08/2001	17		158	52		
10	盧曉汶	守门员	15/09/2001	17		162	70		
11	李君移	左边锋	11/01/2003	16		151	49		
12	李芷棋	底线	12/09/2002	16		167	78		
15	張雪琳	右后卫	30/10/2002	16		170	54		
18	曾華恩	左边锋	15/08/2001	17		161	59		
19	馮楚瑩	守门员	02/09/2003	15		171	82		
22	蘇萱婷	后卫	09/11/2001	17		166	56		
23	霍思允	后卫	09/04/2002	17		164	58		
44	李嵐	底线	04/04/2001	18		160	57		
58	林诗雅		11/06/2001	18					
64	蔡諾琳	左边锋	04/06/2001	18		151	45		
	平均			16.8		161.9	60.0		

编码	姓名	职务
A	蘇沛祺	领队
C	霍俊浩	教练
B	陳嘉聰	主教练

手球  
青年女子

## 个人/全队技术累计表

 山西晋中  
2019-06-23

截止至第90场

号码	姓名	远射	近射	边射	快攻	突破	任意	七米	合计	%	助攻	失误	警告	2'	取消	场次	时间
<b>澳门</b>																	
<b>(场上队员)</b>																	
8	譚嘉雯											4				6	00:45:49
10	盧曉汶											1				6	01:06:34
11	李君移	0/6	0/2	2/4					2/12	16.7%	1	9				6	03:45:50
12	李芷棋	0/2	13/19	0/1				4/6	17/28	60.7%		9		1		6	03:55:15
15	張雪琳	4/28	3/4	0/2		2/4	1/11	0/1	10/50	20.0%	5	34				6	03:50:40
18	曾華恩		1/1						1/1	100%		23	2			6	03:21:34
19	馮楚瑩															6	02:56:27
22	蘇萱婷	5/35	1/2				0/3		6/40	15.0%	7	27	1	1		6	03:19:39
23	霍思允	0/5	0/1						0/6	0.0%		23				6	02:38:35
44	李嵐	0/2	2/2						2/4	50.0%		3		1		6	01:50:22
58	林诗雅											2				4	00:27:57
<b>合计</b>		<b>9/78</b>	<b>20/31</b>	<b>2/7</b>		<b>2/4</b>	<b>1/14</b>	<b>4/7</b>	<b>38/141</b>	<b>27.0%</b>	<b>13</b>	<b>135</b>	<b>3</b>	<b>3</b>		<b>64</b>	
<b>(守门员)</b>																	
10	盧曉汶	1/5	2/11	5/9	0/14	1/8	0/1	0/1	9/49	18.4%		1				6	01:06:34
19	馮楚瑩	6/22	6/24	7/20	12/70	2/11	1/2	0/3	34/152	22.4%						6	02:56:27
<b>合计</b>		<b>7/27</b>	<b>8/35</b>	<b>12/29</b>	<b>12/84</b>	<b>3/19</b>	<b>1/3</b>	<b>0/4</b>	<b>43/201</b>	<b>21.4%</b>		<b>1</b>				<b>12</b>	

场上队员：得分/射门

守门员：救球/射门

已打比赛

全队合计	进球	被救	射失	击柱	封球	合计	%	阶段	场次	对手	比分
远射	9	43	18		8	78	11.5%	预赛	6	淄博	1:31 (1:16)
近射	20	9	2			31	64.5%	预赛	33	深圳	7:23 (2:13)
边射	2	4		1		7	28.6%	预赛	40	北京	11:27 (4:16)
快攻							0.0%	预赛	54	香港	8:22 (3:7)
突破	2	1	1			4	50.0%	预赛	60	滁州	6:24 (1:16)
任意	1	4	9			14	7.1%	预赛	71	常州	5:31 (0:15)
七米	4	1	1	1		7	57.1%				

图式射门区域累计

手球  
青年女子

截止至第90场

山西晋中  
2019-06-23

澳门

8 譚嘉雯 Post - 0 Miss - 0 Block - 0	10 盧曉汶 Post - 0 Miss - 0 Block - 0	11 李君移 Post - 0 Miss - 2 Block - 0	12 李芷棋 Post - 1 Miss - 3 Block - 2	15 張雪琳 Post - 1 Miss - 18 Block - 2	18 曾華恩 Post - 0 Miss - 0 Block - 0	19 馮楚瑩 Post - 0 Miss - 0 Block - 0	22 蘇宣婷 Post - 0 Miss - 4 Block - 4
23 霍思允 Post - 0 Miss - 2 Block - 0	44 李嵐 Post - 0 Miss - 2 Block - 0	58 林詩雅 Post - 0 Miss - 0 Block - 0					

10 盧曉汶
1/6 1/1 0/9
2/6 2/9
2/11 1/7

19 馮楚瑩
1/20 2/5 2/26
6/22 5/5 5/18
4/28 5/8 4/20

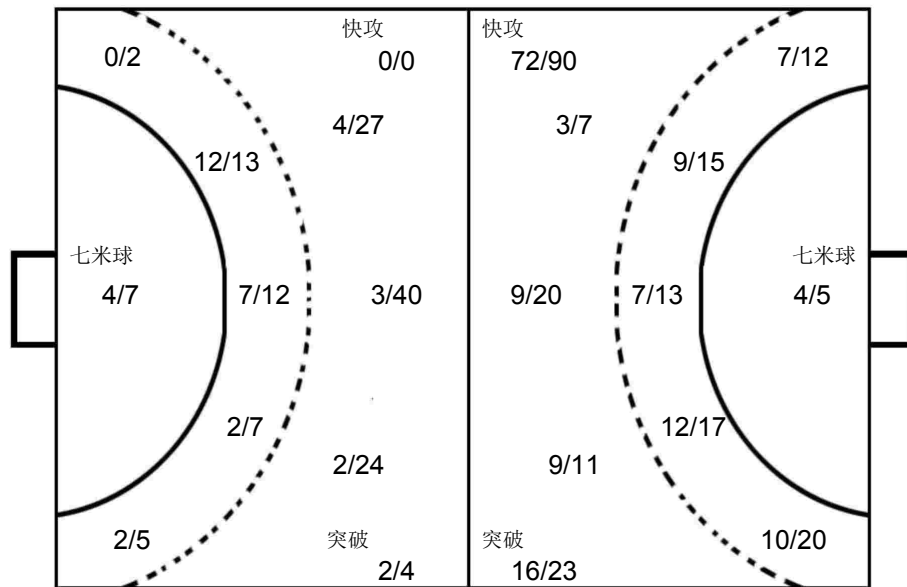

16 王启欣
2/2
1/1 3/3
7/8

6 洪卓超
1/1 0/2
3/3 0/2
0/1 0/1 2/2

17 冯颖慧
1/1 1/1
2/2 1/1
1/3

OPPONENT

北京 11 陈丽婷 Post - 0 Miss - 0 Block - 0	滁州 7 丁洁 Post - 1 Miss - 0 Block - 0	深圳 3 赵晔 Post - 2 Miss - 0 Block - 1	香港 21 林乐儿 Post - 1 Miss - 1 Block - 0	北京 9 徐慧敏 Post - 0 Miss - 0 Block - 0	常州 14 庄红艳 Post - 0 Miss - 1 Block - 0	常州 24 王铃娜 Post - 0 Miss - 0 Block - 0	深圳 2 唐悦 Post - 0 Miss - 0 Block - 0
淄博 3 王静雯 Post - 0 Miss - 0 Block - 0	滁州 35 李旭 Post - 0 Miss - 0 Block - 0	深圳 9 张雨乐 Post - 0 Miss - 0 Block - 0	淄博 21 赵欣瑶 Post - 0 Miss - 0 Block - 0	淄博 28 江迎新 Post - 0 Miss - 1 Block - 0	北京 88 彭爽爽 Post - 0 Miss - 0 Block - 0	常州 8 董桂林 Post - 0 Miss - 0 Block - 0	常州 9 顾霞光 Post - 0 Miss - 0 Block - 0



第二届全国青年运动会女子手球甲组决赛 体校组 (U18)

青年女子 国内比赛

预赛 Group A



PHMS Pictorial Handball Match Statistics

IHF Official System

Team A A 江苏常州		Team B B 香港		Match Number <b>5</b>
------------------	--	----------------	--	--------------------------

Played in 山西晋中	in the hall 晋中体育馆	on 2019-06-15	at 19:40	hours	Spectators
-------------------	----------------------	------------------	-------------	-------	------------

Half-time(30')	A 15	B 5	End of playing time	A 34	B 12	1st extra time	A	B	2nd extra time	A	B	After penalty throws	A	B
----------------	---------	--------	---------------------	---------	---------	----------------	---	---	----------------	---	---	----------------------	---	---

Number of 7 m	A 1/1	Team time-out			Full name of players and officials	Team time-out			B 2/6	Number of 7 m
	1	2	3	1		2	3	15:20		

No.	Team A	G	W	2'	D	DR	No.	Team B	G	W	2'	D	DR
1	胡雨诺						1	郑晓容					
7	张嘉朔	2	1	1			3	黄秋婷					
8	董桂林	3					4	何丹仪	3				
9	顾霞光						5	卓凯晴					
14	庄红艳	11	1				6	洪卓翹					
15	王艺儒						8	李芷欣	3				
19	焦雅	5					9	林卓琪	1				
20	渠文娜	4		1			11	庄斯琪		1			
21	吴静雯	3					16	曾婉琳					
22	彭如玉						17	梁艺	1				
24	王铃娜	3					18	吴嘉妮					
25	李秋淇	2		1			21	林乐儿	1		1		
26	邱聿芳						23	王洁桦					
27	李袁梦	1	1				25	戴子怡					
28	黄奕涵			1			28	郭芷彤	1				
29	陈赛楠						91	孔倩瑜	2				
A	金甲洙 (主教练)						A	杨开将					
B	马彪						B	何颂邦					
C	李海鹰						C	梁倩盈					
D	陈志伟												

A	Signatures of responsables for the teams (Off.A)												B
---	--	--	--	--	--	--	--	--	--	--	--	--	---

TP	Remarks of referees / HF Official													TP
----	-----------------------------------	--	--	--	--	--	--	--	--	--	--	--	--	----

Referees	王亚光 (CHN)	宋优悠 (CHN)		
T.D.	吴瑞亭 (CHN)	柴业宏 (CHN)		
CHA Off.				

Note: Number of 7m Throws Awarded to Team A and B, Goals (G), Warnings (W), Suspensions (2'), Direct Disqualification (D), Disqualification With Report (DR) and Team Penalty (TP).

Table Officials: 戴莹莹 李莉君 Statisticians: 王梓衡 刘笑



## 第二届全国青年运动会女子手球甲组决赛 体校组 (U18)

PHMS Pictorial Handball Match Statistics

IHF Official System

### 竞赛技术统计

手球  
青年女子

预赛  
轮次 1

组别 A  
场次 5

晋中体育馆  
2019-06-15 19:40

Referees:	王亚光 (CHN) / 宋优悠 (CHN)	Result:	34:12 (15:5)
Teams:	江苏常州(常州) VS 香港(香港)		

常州																常州		比赛 进程		香港	
主教练: 金甲洙																					
	远射	近射	边射	快攻	突破	任意球	7m球	合计	%	助攻	失误	警告	2'	D+DR							
1 胡雨诺																					
7 张嘉朔				2/2				2/2	100			1	1								
8 董桂林			0/1	3/3				3/4	75.0		1							8 李芷欣			
9 顾霞光																					
14 庄红艳			1/3	8/8	2/2			11/13	84.6	3	1	1									
15 王艺儒																					
19 焦雅	1/3	0/1	1/1	1/1		1/1	1/1	5/8	62.5		1							91 孔倩瑜			
20 渠文娜	1/1			3/4	0/1			4/6	66.7		1		1					4 何丹仪			
21 吴静雯		1/1	0/1		1/1	1/1		3/4	75.0		2										
22 彭如玉										2	1										
24 王铃娜			1/2	2/3				3/5	60.0												
25 李秋淇				2/2				2/2	100				1								
26 邱聿芳																					
27 李袁梦		1/1						1/1	100			1									
28 黄奕涵											1		1								
29 陈赛楠																					
运动员 合计	2/4	2/3	3/8	21/23	3/4	2/2	1/1	34/45	75.6	5	8	3	4								
1 胡雨诺	0/1	0/1	2/3		0/2		2/3	4/10	40.0												
22 彭如玉	4/5	0/2	2/3		2/3		0/1	8/14	57.1	2	1										
守门员 合计	4/6	0/3	4/6		2/5		2/4	12/24	50.0	2	1										
香港																					
主教练: 梁倩盈																					
	远射	近射	边射	快攻	突破	任意球	7m球	合计	%	助攻	失误	警告	2'	D+DR							
1 郑晓容																					
3 黄秋婷			0/2		0/2			0/4	0.0	1	3										
4 何丹仪	1/1	1/1			1/1			3/3	100		5										
5 卓凯晴																					
6 洪卓翹																					
8 李芷欣	1/3	1/1					1/3	3/7	42.9		3										
9 林卓琪	0/1		0/1		1/1			1/3	33.3		2										
11 庄斯琪	0/2	0/1	0/1					0/4	0.0		2	1									
16 曾婉琳			0/1					0/1	0.0		3										
17 梁艺			0/1		1/1			1/2	50.0		1										
18 吴嘉妮											1										
21 林乐儿	0/1		1/1					1/2	50.0				1								
23 王洁桦											1										
25 戴子怡		0/1						0/1	0.0												
28 郭芷彤		1/1						1/1	100												
91 孔倩瑜			1/2				1/3	2/5	40.0		2										
运动员 合计	2/8	3/5	2/9		3/5		2/6	12/33	36.4	1	23	1	1								
1 郑晓容	0/1	1/3	0/3	1/16	0/2	0/1	2/26	7.7													
6 洪卓翹	0/1		2/2	0/6	0/1	0/1	0/1	2/12	16.7												
守门员 合计	0/2	1/3	2/5	1/22	0/3	0/2	0/1	4/38	10.5												

场上队员: 得分 / 射门

守门员: 救球 / 射门

D	取消资格	DR	取消资格+报告
---	------	----	---------



## 个人/全队技术统计表

手球 青年女子 预赛 轮次 1 组别 A 场次 5 晋中体育馆 2019-06-15 19:40

号码	姓名	远射	近射	边射	快攻	突破	任意	七米	合计	%	助攻	失误	警告	2'	取消	时间
江苏常州(常州)																
(场上队员)																
1	胡雨诺									0.0%						00:21:20
7	张嘉朔				2/2				2/2	100%			1	1		00:35:11
8	董桂林			0/1	3/3				3/4	75.0%		1				00:09:38
9	顾霞光									0.0%						00:01:46
14	庄红艳			1/3	8/8	2/2			11/13	84.6%	3	1	1			00:30:10
15	王艺儒									0.0%						00:01:58
19	焦雅	1/3	0/1	1/1	1/1		1/1	1/1	5/8	62.5%		1				00:27:02
20	渠文娜	1/1			3/4	0/1			4/6	66.7%		1		1		00:23:17
21	吴静雯		1/1	0/1		1/1	1/1		3/4	75.0%		2				00:24:39
22	彭如玉									0.0%	2	1				00:18:40
24	王铃娜			1/2	2/3				3/5	60.0%						00:37:54
25	李秋淇				2/2				2/2	100%				1		00:12:54
26	邱聿芳									0.0%						00:02:05
27	李袁梦		1/1						1/1	100%			1			00:22:11
28	黄奕涵									0.0%		1		1		00:10:39
29	陈赛楠									0.0%						00:00:00
合计		2/4	2/3	3/8	21/23	3/4	2/2	1/1	34/45	75.6%	5	8	3	4		
(守门员)																
1	胡雨诺	0/1	0/1	2/3		0/2		2/3	4/10	40.0%						00:21:20
22	彭如玉	4/5	0/2	2/3		2/3		0/1	8/14	57.1%	2	1				00:18:40
合计		4/6	0/3	4/6		2/5		2/4	12/24	50.0%	2	1				

场上队员：得分/射门

守门员：救球/射门

全队合计	得分	被救	射失	击柱	封球	合计	%
远射	2		2			4	50.0%
近射	2	1				3	66.7%
边射	3	2	1	2		8	37.5%
快攻	21	1	1			23	91.3%
突破	3		1			4	75.0%
任意	2					2	100.0%
七米	1					1	100.0%

第二届全国青年运动会女子手球甲组决赛 体校组 (U18)

PHMS Pictorial Handball Match Statistics

IHF Official System

个人/全队技术统计表

手球 预赛 组别 A 晋中体育馆  
青年女子 轮次 1 场次 5 2019-06-15 19:40

号码	姓名	远射	近射	边射	快攻	突破	任意	七米	合计	%	助攻	失误	警告	2'	取消	时间
香港(香港)																
(场上队员)																
1	郑晓容									0.0%						00:24:37
3	黄秋婷			0/2		0/2			0/4	0.0%	1	3				00:22:24
4	何丹仪	1/1	1/1			1/1			3/3	100%		5				00:24:04
5	卓凯晴									0.0%						00:00:00
6	洪卓翘									0.0%						00:15:23
8	李芷欣	1/3	1/1					1/3	3/7	42.9%		3				00:22:54
9	林卓琪	0/1		0/1		1/1			1/3	33.3%		2				00:17:39
11	庄斯琪	0/2	0/1	0/1					0/4	0.0%		2	1			00:20:12
16	曾婉琳			0/1					0/1	0.0%		3				00:29:15
17	梁艺			0/1		1/1			1/2	50.0%		1				00:19:29
18	吴嘉妮									0.0%		1				00:05:33
21	林乐儿	0/1		1/1					1/2	50.0%				1		00:07:22
23	王洁桦									0.0%		1				00:12:07
25	戴子怡		0/1						0/1	0.0%						00:30:00
28	郭芷彤		1/1						1/1	100%						00:08:06
91	孔倩瑜			1/2				1/3	2/5	40.0%		2				00:16:07
	合计	2/8	3/5	2/9		3/5		2/6	12/33	36.4%	1	23	1	1		

(守门员)

1	郑晓容	0/1	1/3	0/3	1/16	0/2	0/1		2/26	7.7%						00:24:37
6	洪卓翘	0/1		2/2	0/6	0/1	0/1	0/1	2/12	16.7%						00:15:23
	合计	0/2	1/3	2/5	1/22	0/3	0/2	0/1	4/38	10.5%						

场上队员：得分/射门

守门员：救球/射门

全队合计	得分	被救	射失	击柱	封球	合计	%
远射	2	4	2			8	25.0%
近射	3			2		5	60.0%
边射	2	4	2	1		9	22.2%
快攻							0.0%
突破	3	2				5	60.0%
任意							0.0%
七米	2	2	2			6	33.3%

图式比赛技术统计表

手球  
青年女子

预赛  
轮次 1

组别 A  
场次 5

晋中体育馆  
2019-06-15 19:40

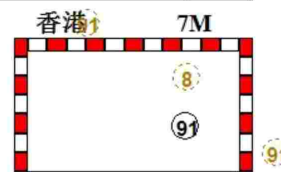
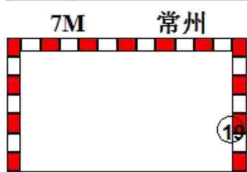
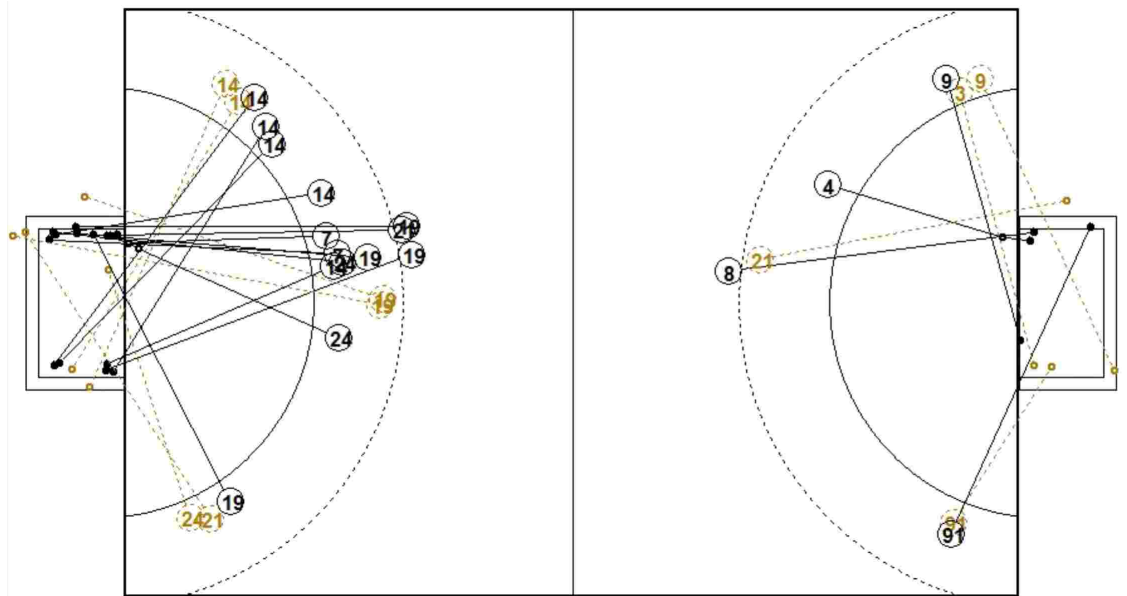

1st Half  
15 : 5

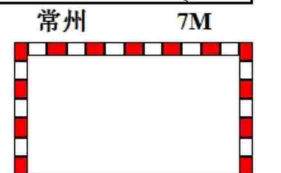
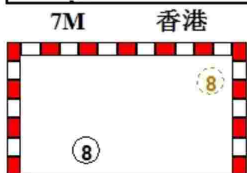
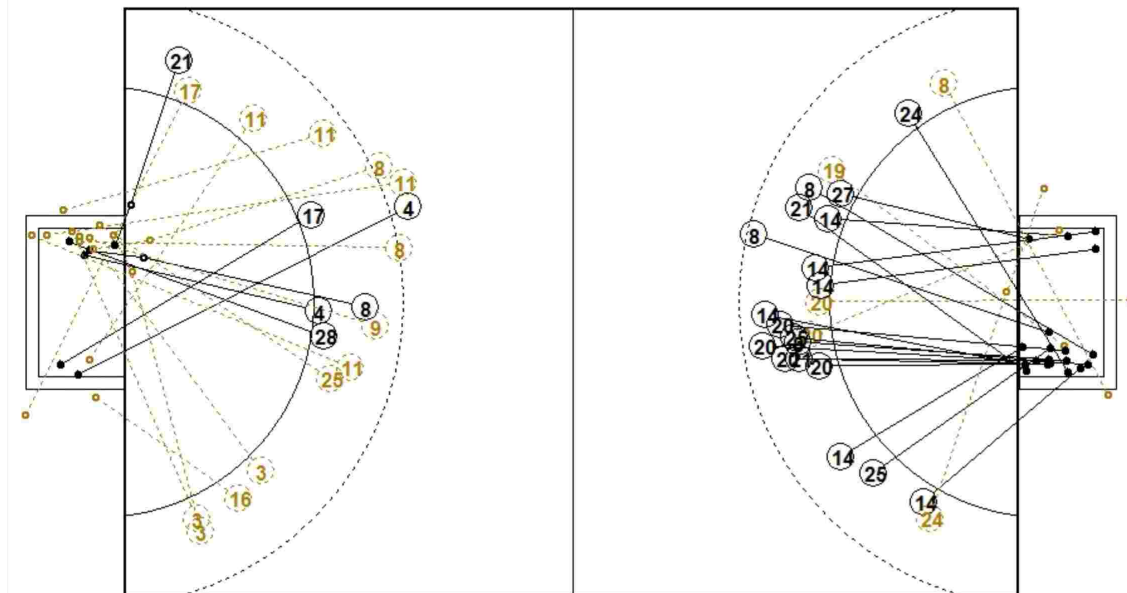

2nd Half  
12 : 34

图式射门区域统计

手球  
青年女子

预赛  
轮次 1

组别 A  
场次 5

晋中体育馆  
2019-06-15 19:40

江苏常州

1 胡雨诺 Post - 0 Miss - 0 Block - 0	7 张嘉朔 Post - 0 Miss - 0 Block - 0	8 董桂林 Post - 0 Miss - 1 Block - 0	9 顾霞光 Post - 0 Miss - 0 Block - 0	14 庄红艳 Post - 1 Miss - 0 Block - 0	15 王艺儒 Post - 0 Miss - 0 Block - 0	19 焦雅 Post - 0 Miss - 2 Block - 0	20 渠文娜 Post - 0 Miss - 1 Block - 0
21 吴静雯 Post - 1 Miss - 0 Block - 0	22 彭如玉 Post - 0 Miss - 0 Block - 0	24 王铃娜 Post - 0 Miss - 1 Block - 0	25 李秋淇 Post - 0 Miss - 0 Block - 0	26 邱聿芳 Post - 0 Miss - 0 Block - 0	27 李袁梦 Post - 0 Miss - 0 Block - 0	28 黄奕涵 Post - 0 Miss - 0 Block - 0	29 陈赛楠 Post - 0 Miss - 0 Block - 0

1 胡雨诺	2/2	1/3
0/1	1/2	1/2

22 彭如玉	1/1	5/7
0/1	1/2	1/2

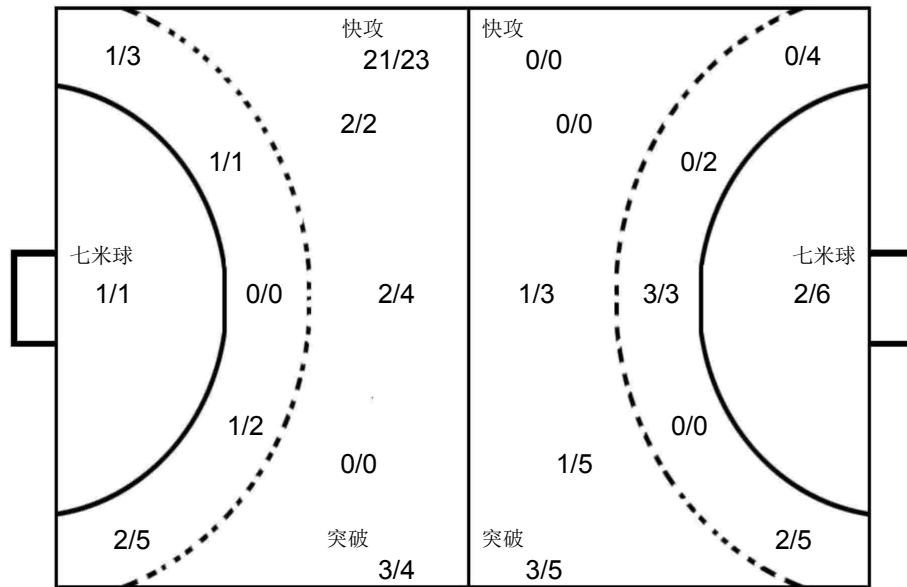

1 郑晓容	0/3	1/11
0/4	0/5	1/2

6 洪卓翹	0/3	1/3
1/1	0/2	0/3

香港

1 郑晓容 Post - 0 Miss - 0 Block - 0	3 黄秋婷 Post - 0 Miss - 0 Block - 0	4 何丹仪 Post - 0 Miss - 0 Block - 0	5 卓凯晴 Post - 0 Miss - 0 Block - 0	6 洪卓翹 Post - 0 Miss - 0 Block - 0	8 李芷欣 Post - 0 Miss - 0 Block - 0	9 林卓琪 Post - 1 Miss - 0 Block - 0	11 庄斯琪 Post - 1 Miss - 1 Block - 0
16 曾婉琳 Post - 0 Miss - 1 Block - 0	17 梁艺 Post - 0 Miss - 1 Block - 0	18 吴嘉妮 Post - 0 Miss - 0 Block - 0	21 林乐儿 Post - 0 Miss - 1 Block - 0	23 王洁桦 Post - 0 Miss - 0 Block - 0	25 戴子怡 Post - 1 Miss - 0 Block - 0	28 郭芷彤 Post - 0 Miss - 0 Block - 0	91 孔倩瑜 Post - 0 Miss - 2 Block - 0



第二届全国青年运动会女子手球甲组决赛 体校组 (U18)

青年女子 国内比赛

预赛 Group A



PHMS Pictorial Handball Match Statistics

IHF Official System

Team A					Team B					Match Number											
A 澳门					B 山东淄博					6											
Played in			in the hall			on			at			Spectators									
山西晋中			晋中体育馆			2019-06-15			20:50			hours									
Half-time(30')	A	B	End of playing time		A	B	1st extra time		A	B	2nd extra time		A	B	After penalty throws						
	1	16	1	31																	
Number of 7 m	A	Team time-out			Full name of players and officials						Team time-out			B	Number of 7 m						
	0/1	1	2	3							1	2	3	1/1							
		07:17	26:29									29:54									
No.	Team A					G	W	2'	D	DR	No.	Team B					G	W	2'	D	DR
8	譚嘉雯										3	王静雯					5				
10	盧曉汶										5	张素娟					2				
11	李君移										6	孙玉坤					3				
12	李芷棋					1					7	辛彤慧					1				
15	張雪琳										8	王锦琦					2				
18	曾華恩										9	高梦洁					2				
19	馮楚瑩										10	崔佳惠					1				
22	蘇萱婷						1				14	韩睿洁									
23	霍思允										15	李骞飞					2				
44	李嵐										16	王启欣									
											17	蒋松妍					2	1			
											19	户晴					3				
											21	赵欣瑶					4				
											22	邢力丹									
											23	王家琪							1		
											28	江迎新					4				
A	蘇沛祺										B	徐美凤									
C	霍俊浩										C	翟乾坤 (主教练)									
											D	段文钰									
											E	王日东									
A											Signatures of responsables for the teams (Off.A)										B
TP	Remarks of referees / HF Official																				TP

Signatures

Referees	刘晓辉 (CHN)	冯雨生 (CHN)		
T.D.	陈晓波 (CHN)	柴业宏 (CHN)		
CHA Off.				

Note: Number of 7m Throws Awarded to Team A and B, Goals (G), Warnings (W), Suspensions (2'), Direct Disqualification (D), Disqualification With Report (DR) and Team Penalty (TP).

Table Officials: 张琦 宣海波 Statisticians: 王梓衡 刘笑





第二届全国青年运动会女子手球甲组决赛 体校组 (U18)



PHMS Pictorial Handball Match Statistics

IHF Official System

竞赛技术统计

手球  
青年女子

预赛  
轮次 1

组别 A  
场次 6

晋中体育馆  
2019-06-15 20:50

Referees:	刘晓辉 (CHN) / 冯雨生 (CHN)	Result:	1:31 (1:16)
Teams:	澳门(澳门) VS 山东淄博(淄博)		

澳门		远射	近射	边射	快攻	突破	任意球	7m球	合计	%	助攻	失误	警告	2'	D+DR
主教练: 陳嘉聰															
8	譚嘉雯														
10	盧曉汶														
11	李君移			0/1					0/1	0.0					
12	李芷棋	0/1	1/3	0/1					1/5	20.0		1			
15	張雪琳	0/5	0/1				0/1	0/1	0/8	0.0		11			
18	曾華恩											2			
19	馮楚瑩														
22	蘇萱婷	0/10	0/1				0/1		0/12	0.0		4	1		
23	霍思允											6			
44	李嵐											1			
运动员 合计		0/16	1/5	0/2			0/2	0/1	1/26	3.8		25	1		
10	盧曉汶	0/1	2/6	2/4	0/3	0/1		0/1	4/16	25.0					
19	馮楚瑩		0/1	1/3	2/17	0/1			3/22	13.6					
守门员 合计		0/1	2/7	3/7	2/20	0/2		0/1	7/38	18.4					

澳门	比赛进程	淄博
1st Half		
0	01:06	1 17 蒋松妍
0	01:53	2 6 孙玉坤
0	02:41	3 15 李赛飞
0	03:18	4 17 蒋松妍
0	04:54	5 9 高梦洁
0	05:36	6 15 李赛飞
0	06:06	7 21 赵欣瑶
0	06:31	8 21 赵欣瑶
0	07:12	9 21 赵欣瑶
0	07:39	10 9 高梦洁
0	08:34	11 28 江迎新
0	09:13	12 6 孙玉坤
0	10:14	13 0 崔佳惠
12	李芷棋	1 14:18 13
1	14:50	14 28 江迎新
1	16:16	15 6 孙玉坤
1	19:28	16 28 江迎新
2nd Half		
1	01:30	17 3 王静雯
1	02:41	18 19 户晴
1	03:28	19 19 户晴
1	04:15	20 28 江迎新
1	05:59	21 5 张素娟
1	06:24	22 3 王静雯
1	06:57	23 5 张素娟
1	10:50	24 8 王锦琦
1	13:40	25 3 王静雯
1	14:40	26 7 辛彤慧
1	16:47	27 19 户晴
1	18:14	28 3 王静雯
1	18:37	29 8 王锦琦
1	19:05	30 21 赵欣瑶
1	19:24	31 3 王静雯

淄博		远射	近射	边射	快攻	突破	任意球	7m球	合计	%	助攻	失误	警告	2'	D+DR
主教练: 翟乾坤															
3	王静雯				5/6				5/6	83.3	1	1			
5	张素娟		0/1	1/1	1/1				2/3	66.7		2			
6	孙玉坤		3/3						3/3	100	1				
7	辛彤慧			1/2					1/2	50.0	1	1			
8	王锦琦				2/2				2/2	100		1			
9	高梦洁	0/1			1/1	1/1			2/3	66.7		1			
10	崔佳惠				0/1			1/1	1/2	50.0					
14	韩睿洁														
15	李赛飞				2/2				2/2	100					
16	王启欣										1	1			
17	蒋松妍		0/1		2/2				2/3	66.7		1	1		
19	户晴		1/3	1/2	1/2				3/7	42.9					
21	赵欣瑶			1/1	3/3				4/4	100					
22	邢力丹										2				
23	王家琪													1	
28	江迎新	1/1	1/1	0/2	1/1	1/1			4/6	66.7	1				
运动员 合计		1/2	5/9	4/8	18/21	2/2		1/1	31/43	72.1	7	8	1	1	
16	王启欣	8/8	2/3	2/2				1/1	13/14	92.9	1	1			
22	邢力丹	2/2	2/2						4/4	100	2				
守门员 合计		10/10	4/5	2/2				1/1	17/18	94.4	3	1			

场上队员: 得分 / 射门

守门员: 救球 / 射门

D	取消资格	DR	取消资格+报告
---	------	----	---------



## 个人/全队技术统计表

 手球 预赛 组别 A 晋中体育馆  
 青年女子 轮次 1 场次 6 2019-06-15 20:50

号码	姓名	远射	近射	边射	快攻	突破	任意	七米	合计	%	助攻	失误	警告	2'	取消	时间
<b>澳门(澳门)</b>																
<b>(场上队员)</b>																
8	譚嘉雯									0.0%						00:05:41
10	盧曉汶									0.0%						00:21:19
11	李君移			0/1					0/1	0.0%						00:40:00
12	李芷棋	0/1	1/3	0/1					1/5	20.0%	1					00:39:59
15	張雪琳	0/5	0/1				0/1	0/1	0/8	0.0%	11					00:40:00
18	曾華恩									0.0%	2					00:31:12
19	馮楚瑩									0.0%						00:21:34
22	蘇萱婷	0/10	0/1				0/1		0/12	0.0%	4	1				00:40:00
23	霍思允									0.0%	6					00:33:12
44	李嵐									0.0%	1					00:06:40
<b>合计</b>		0/16	1/5	0/2			0/2	0/1	1/26	3.8%	25	1				
<b>(守门员)</b>																
10	盧曉汶	0/1	2/6	2/4	0/3	0/1		0/1	4/16	25.0%						00:21:19
19	馮楚瑩		0/1	1/3	2/17	0/1			3/22	13.6%						00:21:34
<b>合计</b>		0/1	2/7	3/7	2/20	0/2		0/1	7/38	18.4%						

场上队员： 得分/射门

守门员： 救球/射门

全队合计	得分	被救	射失	击柱	封球	合计	%
远射		10	3		3	16	0.0%
近射	1	4				5	20.0%
边射		2				2	0.0%
快攻							0.0%
突破							0.0%
任意			2			2	0.0%
七米		1				1	0.0%

## 第二届全国青年运动会女子手球甲组决赛 体校组 (U18)

**PHMS** Pictorial Handball Match Statistics

**IHF** Official System

### 个人/全队技术统计表

手球 青年女子 预赛 轮次 1 组别 A 场次 6 晋中体育馆 2019-06-15 20:50

号码	姓名	远射	近射	边射	快攻	突破	任意	七米	合计	%	助攻	失误	警告	2'	取消	时间
<b>山东淄博(淄博)</b>																
<b>(场上队员)</b>																
3	王静雯				5/6				5/6	83.3%	1	1				00:20:00
5	张素娟		0/1	1/1	1/1				2/3	66.7%		2				00:20:00
6	孙玉坤		3/3						3/3	100%	1					00:20:00
7	辛彤慧			1/2					1/2	50.0%	1	1				00:14:46
8	王锦琦				2/2				2/2	100%		1				00:14:18
9	高梦洁	0/1			1/1	1/1			2/3	66.7%		1				00:15:43
10	崔佳惠				0/1			1/1	1/2	50.0%						00:19:27
14	韩春洁									0.0%						00:20:00
15	李骞飞				2/2				2/2	100%						00:12:50
16	王启欣									0.0%	1	1				00:20:00
17	蒋松妍		0/1		2/2				2/3	66.7%		1	1			00:20:00
19	卢晴		1/3	1/2	1/2				3/7	42.9%						00:18:47
21	赵欣瑶			1/1	3/3				4/4	100%						00:10:23
22	邢力丹									0.0%	2					00:20:00
23	王家琪									0.0%				1		00:16:24
28	江迎新	1/1	1/1	0/2	1/1	1/1			4/6	66.7%	1					00:17:01
<b>合计</b>		<b>1/2</b>	<b>5/9</b>	<b>4/8</b>	<b>18/21</b>	<b>2/2</b>		<b>1/1</b>	<b>31/43</b>	<b>72.1%</b>	<b>7</b>	<b>8</b>	<b>1</b>	<b>1</b>		
<b>(守门员)</b>																
16	王启欣	8/8	2/3	2/2				1/1	13/14	92.9%	1	1				00:20:00
22	邢力丹	2/2	2/2						4/4	100%	2					00:20:00
<b>合计</b>		<b>10/10</b>	<b>4/5</b>	<b>2/2</b>				<b>1/1</b>	<b>17/18</b>	<b>94.4%</b>	<b>3</b>	<b>1</b>				

场上队员：得分/射门

守门员：救球/射门

全队合计	得分	被救	射失	击柱	封球	合计	%
远射	1			1		2	50.0%
近射	5	2	1	1		9	55.6%
边射	4	3	1			8	50.0%
快攻	18	2		1		21	85.7%
突破	2					2	100.0%
任意							0.0%
七米	1					1	100.0%



图式比赛技术统计表

手球  
青年女子

预赛  
轮次 1

组别 A  
场次 6

晋中体育馆  
2019-06-15 20:50

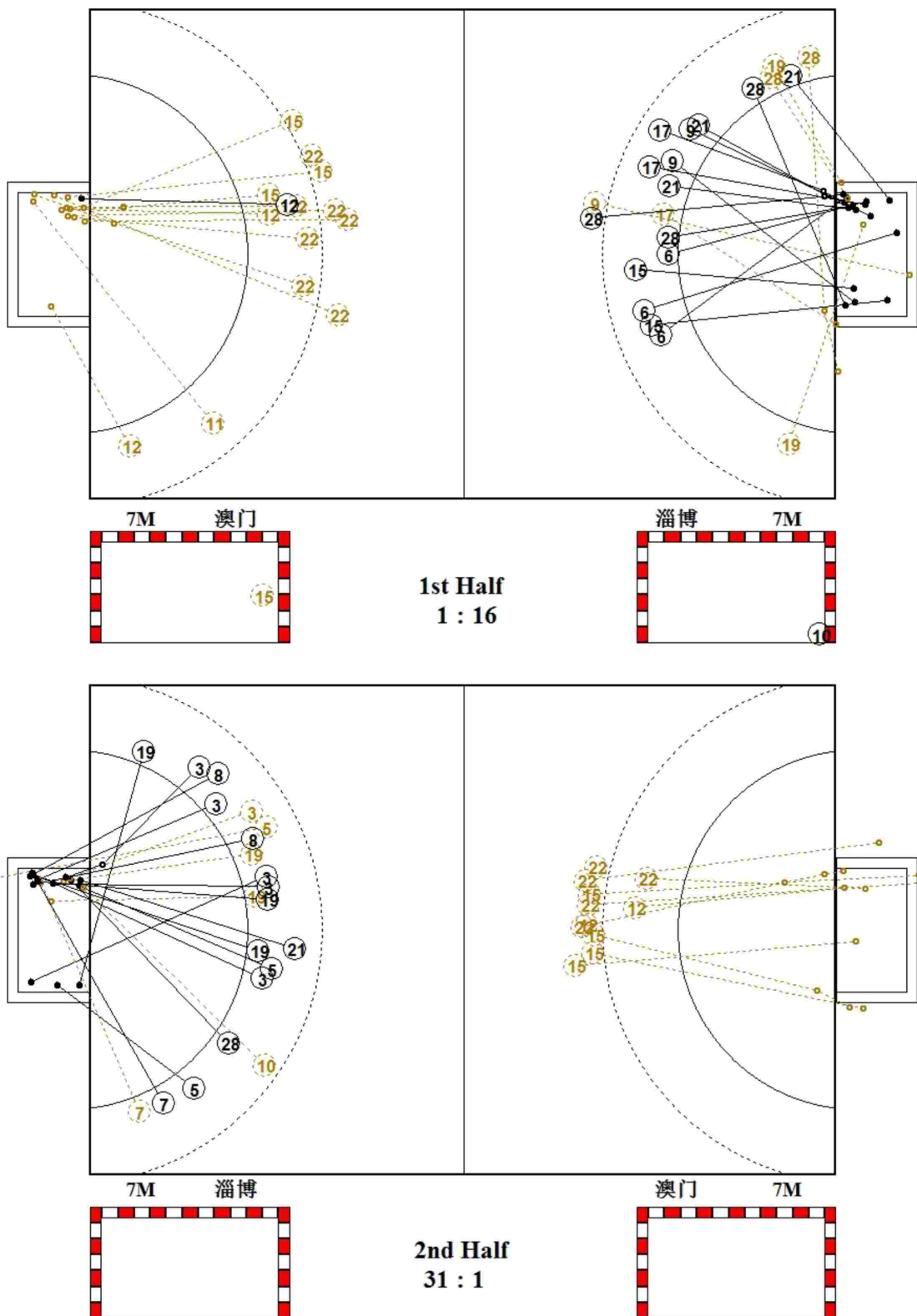

图式射门区域统计

手球  
青年女子

预赛  
轮次 1

组别 A  
场次 6

晋中体育馆  
2019-06-15 20:50

澳门

8 譚嘉雯	10 盧曉汶	11 李君移	12 李芷棋	15 張雪琳	18 曾華恩	19 馮楚瑩	22 蘇宣婷																																																																								
<table border="1"><tr><td></td><td></td><td></td></tr><tr><td></td><td></td><td></td></tr><tr><td></td><td></td><td></td></tr></table>										<table border="1"><tr><td></td><td></td><td></td></tr><tr><td></td><td></td><td></td></tr><tr><td></td><td></td><td></td></tr></table>										<table border="1"><tr><td></td><td></td><td></td></tr><tr><td></td><td></td><td></td></tr><tr><td></td><td></td><td></td></tr></table>										<table border="1"><tr><td></td><td></td><td></td></tr><tr><td></td><td></td><td>1</td></tr><tr><td></td><td></td><td></td></tr></table>						1				<table border="1"><tr><td></td><td></td><td></td></tr><tr><td></td><td></td><td></td></tr><tr><td></td><td></td><td></td></tr></table>										<table border="1"><tr><td></td><td></td><td></td></tr><tr><td></td><td></td><td></td></tr><tr><td></td><td></td><td></td></tr></table>										<table border="1"><tr><td></td><td></td><td></td></tr><tr><td></td><td></td><td></td></tr><tr><td></td><td></td><td></td></tr></table>										<table border="1"><tr><td></td><td></td><td></td></tr><tr><td></td><td></td><td></td></tr><tr><td></td><td></td><td></td></tr></table>									
		1																																																																													
Post - 0 Miss - 0 Block - 0	Post - 0 Miss - 0 Block - 0	Post - 0 Miss - 0 Block - 0	Post - 0 Miss - 0 Block - 1	Post - 0 Miss - 3 Block - 0	Post - 0 Miss - 0 Block - 0	Post - 0 Miss - 0 Block - 0	Post - 0 Miss - 2 Block - 2																																																																								
23 霍思允	44 李嵐																																																																														
<table border="1"><tr><td></td><td></td><td></td></tr><tr><td></td><td></td><td></td></tr><tr><td></td><td></td><td></td></tr></table>										<table border="1"><tr><td></td><td></td><td></td></tr><tr><td></td><td></td><td></td></tr><tr><td></td><td></td><td></td></tr></table>																																																																					
Post - 0 Miss - 0 Block - 0	Post - 0 Miss - 0 Block - 0																																																																														

10 盧曉汶

0/1		0/1
1/3		2/3
1/5		0/3

19 馮楚瑩

0/1	0/1	1/8
0/2		0/1
0/3		2/6

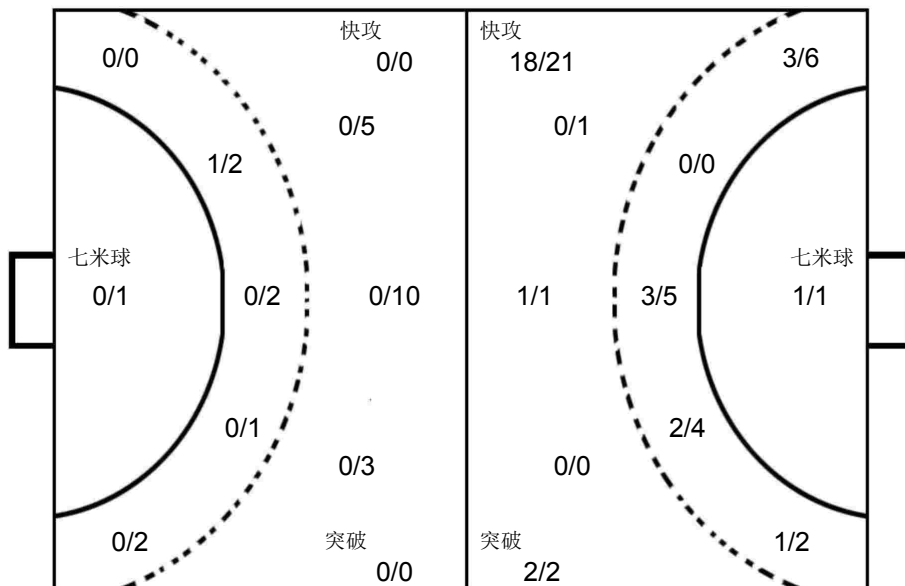

16 王启欣

		2/2
1/1		3/3
		7/8

22 邢力丹

1/1		
2/2	1/1	

山东淄博

3 王静雯	5 张素娟	6 孙玉坤	7 辛彤慧	8 王锦琦	9 高梦洁	10 崔佳惠	14 韩睿洁																																																																								
<table border="1"><tr><td>1</td><td></td><td>2</td></tr><tr><td></td><td></td><td>2</td></tr><tr><td></td><td></td><td></td></tr></table>	1		2			2				<table border="1"><tr><td></td><td></td><td></td></tr><tr><td>1</td><td></td><td></td></tr><tr><td></td><td></td><td>1</td></tr></table>				1					1	<table border="1"><tr><td></td><td>1</td><td></td></tr><tr><td>1</td><td></td><td></td></tr><tr><td>1</td><td></td><td></td></tr></table>		1		1			1			<table border="1"><tr><td></td><td></td><td>1</td></tr><tr><td></td><td></td><td></td></tr><tr><td></td><td></td><td></td></tr></table>			1							<table border="1"><tr><td></td><td></td><td>2</td></tr><tr><td></td><td></td><td></td></tr><tr><td></td><td></td><td></td></tr></table>			2							<table border="1"><tr><td></td><td></td><td></td></tr><tr><td>1</td><td></td><td></td></tr><tr><td></td><td></td><td>1</td></tr></table>				1					1	<table border="1"><tr><td></td><td></td><td></td></tr><tr><td></td><td></td><td></td></tr><tr><td></td><td></td><td>1</td></tr></table>									1	<table border="1"><tr><td></td><td></td><td></td></tr><tr><td></td><td></td><td></td></tr><tr><td></td><td></td><td></td></tr></table>									
1		2																																																																													
		2																																																																													
1																																																																															
		1																																																																													
	1																																																																														
1																																																																															
1																																																																															
		1																																																																													
		2																																																																													
1																																																																															
		1																																																																													
		1																																																																													
Post - 0 Miss - 0 Block - 0	Post - 0 Miss - 1 Block - 0	Post - 0 Miss - 0 Block - 0	Post - 0 Miss - 0 Block - 0	Post - 0 Miss - 0 Block - 0	Post - 1 Miss - 0 Block - 0	Post - 0 Miss - 0 Block - 0	Post - 0 Miss - 0 Block - 0																																																																								
15 李赛飞	16 王启欣	17 蒋松妍	19 户晴	21 赵欣瑶	22 邢力丹	23 王家琪	28 江迎新																																																																								
<table border="1"><tr><td></td><td></td><td>1</td></tr><tr><td></td><td></td><td>1</td></tr><tr><td></td><td></td><td></td></tr></table>			1			1				<table border="1"><tr><td></td><td></td><td></td></tr><tr><td></td><td></td><td></td></tr><tr><td></td><td></td><td></td></tr></table>										<table border="1"><tr><td></td><td></td><td></td></tr><tr><td>1</td><td></td><td></td></tr><tr><td>1</td><td></td><td></td></tr></table>				1			1			<table border="1"><tr><td></td><td></td><td>2</td></tr><tr><td></td><td></td><td></td></tr><tr><td>1</td><td></td><td></td></tr></table>			2				1			<table border="1"><tr><td></td><td></td><td></td></tr><tr><td>1</td><td></td><td></td></tr><tr><td>2</td><td></td><td>1</td></tr></table>				1			2		1	<table border="1"><tr><td></td><td></td><td></td></tr><tr><td></td><td></td><td></td></tr><tr><td></td><td></td><td></td></tr></table>										<table border="1"><tr><td></td><td></td><td></td></tr><tr><td></td><td></td><td></td></tr><tr><td></td><td></td><td></td></tr></table>										<table border="1"><tr><td></td><td></td><td></td></tr><tr><td></td><td></td><td></td></tr><tr><td>2</td><td></td><td>2</td></tr></table>							2		2
		1																																																																													
		1																																																																													
1																																																																															
1																																																																															
		2																																																																													
1																																																																															
1																																																																															
2		1																																																																													
2		2																																																																													
Post - 0 Miss - 0 Block - 0	Post - 0 Miss - 0 Block - 0	Post - 1 Miss - 0 Block - 0	Post - 1 Miss - 0 Block - 0	Post - 0 Miss - 0 Block - 0	Post - 0 Miss - 0 Block - 0	Post - 0 Miss - 0 Block - 0	Post - 0 Miss - 1 Block - 0																																																																								



第二届全国青年运动会女子手球甲组决赛 体校组 (U18)

青年女子 国内比赛

预赛 Group A



PHMS Pictorial Handball Match Statistics

IHF Official System

Team A					Team B					Match Number											
A 安徽滁州					B 北京市					7											
Played in			in the hall			on			at			Spectators									
山西晋中			晋中体育馆			2019-06-15			22:00			hours									
Half-time(30')	A	B	End of playing time		A	B	1st extra time		A	B	2nd extra time		A	B	After penalty throws						
	12	6	23		16																
Number of 7 m	A	Team time-out			Full name of players and officials						Team time-out			B	Number of 7 m						
	2/3	1	2	3							1	2	3	B							
			33:27								13:42	37:18		4/6							
No.	Team A					G	W	2'	D	DR	No.	Team B					G	W	2'	D	DR
1	张家轩										1	靳爽									
2	钟梦										5	常凯旋									
3	孙明月					6					7	翟乃迪									
7	丁洁										8	武宏业					3				
9	窦海乐					6					10	胡冰心					2				
16	刘子琪										11	陈丽婷					9				
25	耿雨萍										14	侯美林									
26	张雅婷										16	周晓雨							1		
28	马雯怡										18	唐文杰						1			
30	罗佳乐										23	黄文文									
32	王小雅										27	田苗									
34	姜影					3		1			81	王木子									
35	李旭					2		1			87	王奥					1				
36	高奇欣					1					88	彭爽爽					1				
38	潘楠					5		1													
	A 王明星											B 黄承 (主教练)									
	B 陆广红 (主教练)											C 栾征									
	C 岳连娥											D 石伟									
	D 李莉											E 刘文勇									
A	Signatures of responsables for the teams (Off.A)										B										
TP	Remarks of referees / HF Official										TP										

Signatures

Referees	刘明华 (CHN)	吴佳 (CHN)		
T.D.	陈晓波 (CHN)	王洋 (CHN)		
CHA Off.				

Note: Number of 7m Throws Awarded to Team A and B, Goals (G), Warnings (W), Suspensions (2'), Direct Disqualification (D), Disqualification With Report (DR) and Team Penalty (TP).

Table Officials: 王志超 吴鹏凯 Statisticians: 王梓衡 刘笑



## 第二届全国青年运动会女子手球甲组决赛 体校组 (U18)

PHMS Pictorial Handball Match Statistics

IHF Official System

### 竞赛技术统计

手球  
青年女子

预赛  
轮次 1

组别 A  
场次 7

晋中体育馆  
2019-06-15 22:00

Referees: 刘明华 (CHN) / 吴佳 (CHN)  
Teams: 安徽滁州(滁州) VS 北京市(北京)

Result: 23:16 (12:6)

滁州		远射	近射	边射	快攻	突破	任意球	7m球	合计	%	助攻	失误	警告	2'	D+DR
主教练: 陆广红															
1	张家轩										1				
2	钟梦			0/1				0/1	0.0						
3	孙明月	3/5	1/1			1/1		1/1	6/8	75.0		2			
7	丁洁										1				
9	窦海乐	4/4	1/1		1/1			0/1	6/7	85.7	1	1			
16	刘子琪														
25	耿雨萍														
26	张雅婷														
28	马雯怡														
30	罗佳乐														
32	王小雅														
34	姜影			2/2		1/1		3/3	100		2			1	
35	李旭	0/1	1/2		1/1			2/4	50.0	1	3			1	
36	高奇欣		1/2					1/2	50.0	1	1				
38	潘楠	1/1		1/1	2/2			1/1	5/5	100	1			1	
运动员 合计		8/11	4/6	3/4	4/4	2/2		2/3	23/30	76.7	5	10		3	
1	张家轩	4/5	2/2	2/3		1/6	2/2	1/3	12/21	57.1	1				
16	刘子琪	0/2	2/2	1/3			0/1	0/2	3/10	30.0					
守门员 合计		4/7	4/4	3/6		1/6	2/3	1/5	15/31	48.4	1				

北京		远射	近射	边射	快攻	突破	任意球	7m球	合计	%	助攻	失误	警告	2'	D+DR
主教练: 黄承															
1	靳爽														
5	常凯旋											1			
7	翟乃迪														
8	武宏业	1/1				1/1		1/1	3/3	100					
10	胡冰心			2/3				2/3	66.7		1				
11	陈丽婷	2/6	0/4			4/4	0/2	3/4	9/20	45.0	1	1			
14	侯美林		0/1			0/1		0/1	0/3	0.0		4			
16	周晓雨													1	
18	唐文杰			0/2				0/2	0.0		1	1			
23	黄文文														
27	田苗											1			
81	王木子														
87	王奥			1/1				1/1	100						
88	彭爽爽		0/1				1/1	1/2	50.0						
运动员 合计		3/7	0/6	3/6		5/6	1/3	4/6	16/34	47.1	1	9	1	1	
1	靳爽	0/6	1/4	0/3	0/2	0/2		0/1	1/18	5.6					
16	周晓雨	0/2	0/1	1/1	0/2			1/2	2/8	25.0					
守门员 合计		0/8	1/5	1/4	0/4	0/2		1/3	3/26	11.5					

滁州	比赛进程	北京
1st Half		
3 孙明月	1 02:16	0
3 孙明月	2 04:20	0
	2 05:26	1 11 陈丽婷
38 潘楠	3 06:09	1
	3 09:06	2 11 陈丽婷
9 窦海乐	4 09:35	2
	4 10:17	3 11 陈丽婷
9 窦海乐	5 10:44	3
	5 11:02	4 11 陈丽婷
34 姜影	6 11:37	4
3 孙明月	7 12:44	4
35 李旭	8 14:00	4
3 孙明月	9 16:14	4
36 高奇欣	10 17:16	4
	10 17:31	5 11 陈丽婷
3 孙明月	11 19:08	5
	11 19:41	6 10 胡冰心
34 姜影	12 19:58	6
2nd Half		
9 窦海乐	13 00:37	6
3 孙明月	14 00:49	6
9 窦海乐	15 02:36	6
34 姜影	16 03:50	6
	16 04:47	7 8 武宏业
38 潘楠	17 05:10	7
	17 08:38	8 11 陈丽婷
35 李旭	18 09:04	8
9 窦海乐	19 10:45	8
	19 11:36	9 11 陈丽婷
38 潘楠	20 12:06	9
	20 12:23	10 87 王奥
	20 13:16	11 88 彭爽爽
	20 14:17	12 11 陈丽婷
9 窦海乐	21 14:38	12
	21 14:47	13 11 陈丽婷
	21 16:34	14 10 胡冰心
38 潘楠	22 17:17	14
	22 17:27	15 8 武宏业
38 潘楠	23 19:19	15
	23 19:50	16 8 武宏业

场上队员: 得分 / 射门

守门员: 救球 / 射门

D	取消资格	DR	取消资格+报告
---	------	----	---------

## 个人/全队技术统计表

手球 青年女子 预赛 轮次 1 组别 A 场次 7 晋中体育馆 2019-06-15 22:00

号码	姓名	远射	近射	边射	快攻	突破	任意	七米	合计	%	助攻	失误	警告	2'	取消	时间
<b>安徽滁州(滁州)</b>																
<b>(场上队员)</b>																
1	张家轩									0.0%	1					00:31:45
2	钟梦			0/1					0/1	0.0%						00:05:30
3	孙明月	3/5	1/1			1/1		1/1	6/8	75.0%		2				00:37:18
7	丁洁									0.0%		1				00:04:59
9	窦海乐	4/4	1/1		1/1			0/1	6/7	85.7%	1	1				00:38:47
16	刘子琪									0.0%						00:09:36
25	耿雨萍									0.0%						00:00:00
26	张雅婷									0.0%						00:00:00
28	马雯怡									0.0%						00:01:10
30	罗佳乐									0.0%						00:00:00
32	王小雅									0.0%						00:00:00
34	姜影			2/2		1/1			3/3	100%		2		1		00:35:02
35	李旭	0/1	1/2		1/1				2/4	50.0%	1	3		1		00:37:11
36	高奇欣		1/2						1/2	50.0%	1	1				00:40:00
38	潘楠	1/1		1/1	2/2			1/1	5/5	100%	1			1		00:38:42
<b>合计</b>		<b>8/11</b>	<b>4/6</b>	<b>3/4</b>	<b>4/4</b>	<b>2/2</b>		<b>2/3</b>	<b>23/30</b>	<b>76.7%</b>	<b>5</b>	<b>10</b>		<b>3</b>		
<b>(守门员)</b>																
1	张家轩	4/5	2/2	2/3		1/6	2/2	1/3	12/21	57.1%	1					00:31:45
16	刘子琪	0/2	2/2	1/3			0/1	0/2	3/10	30.0%						00:09:36
<b>合计</b>		<b>4/7</b>	<b>4/4</b>	<b>3/6</b>		<b>1/6</b>	<b>2/3</b>	<b>1/5</b>	<b>15/31</b>	<b>48.4%</b>	<b>1</b>					

场上队员：得分/射门

守门员：救球/射门

全队合计	得分	被救	射失	击柱	封球	合计	%
远射	8		1	2		11	72.7%
近射	4	1		1		6	66.7%
边射	3	1				4	75.0%
快攻	4					4	100.0%
突破	2					2	100.0%
任意							0.0%
七米	2	1				3	66.7%

## 第二届全国青年运动会女子手球甲组决赛 体校组 (U18)

**PHMS** Pictorial Handball Match Statistics

**IHF** Official System

### 个人/全队技术统计表

手球 青年女子 预赛 轮次 1 组别 A 场次 7 晋中体育馆 2019-06-15 22:00

号码	姓名	远射	近射	边射	快攻	突破	任意	七米	合计	%	助攻	失误	警告	2'	取消	时间
<b>北京市(北京)</b>																
<b>(场上队员)</b>																
1	靳爽									0.0%						00:27:07
5	常凯旋									0.0%		1				00:01:21
7	翟乃迪									0.0%						00:09:44
8	武宏业	1/1				1/1		1/1	3/3	100%						00:10:18
10	胡冰心			2/3					2/3	66.7%		1				00:31:15
11	陈丽婷	2/6	0/4			4/4	0/2	3/4	9/20	45.0%	1	1				00:37:18
14	侯美林		0/1			0/1		0/1	0/3	0.0%		4				00:37:18
16	周晓雨									0.0%				1		00:12:53
18	唐文杰			0/2					0/2	0.0%		1	1			00:38:24
23	黄文文									0.0%						00:22:41
27	田苗									0.0%		1				00:28:33
81	王木子									0.0%						00:00:00
87	王奥			1/1					1/1	100%						00:11:48
88	彭爽爽		0/1				1/1		1/2	50.0%						00:11:20
	<b>合计</b>	<b>3/7</b>	<b>0/6</b>	<b>3/6</b>		<b>5/6</b>	<b>1/3</b>	<b>4/6</b>	<b>16/34</b>	<b>47.1%</b>	<b>1</b>	<b>9</b>	<b>1</b>	<b>1</b>		
<b>(守门员)</b>																
1	靳爽	0/6	1/4	0/3	0/2	0/2		0/1	1/18	5.6%						00:27:07
16	周晓雨	0/2	0/1	1/1	0/2			1/2	2/8	25.0%						00:12:53
	<b>合计</b>	<b>0/8</b>	<b>1/5</b>	<b>1/4</b>	<b>0/4</b>	<b>0/2</b>		<b>1/3</b>	<b>3/26</b>	<b>11.5%</b>						

场上队员： 得分/射门

守门员： 救球/射门

全队合计	得分	被救	射失	击柱	封球	合计	%
远射	3	4				7	42.9%
近射		4	2			6	0.0%
边射	3	3				6	50.0%
快攻							0.0%
突破	5	1				6	83.3%
任意	1	2				3	33.3%
七米	4	1	1			6	66.7%

图式比赛技术统计表

手球  
青年女子

预赛  
轮次 1

组别 A  
场次 7

晋中体育馆  
2019-06-15 22:00

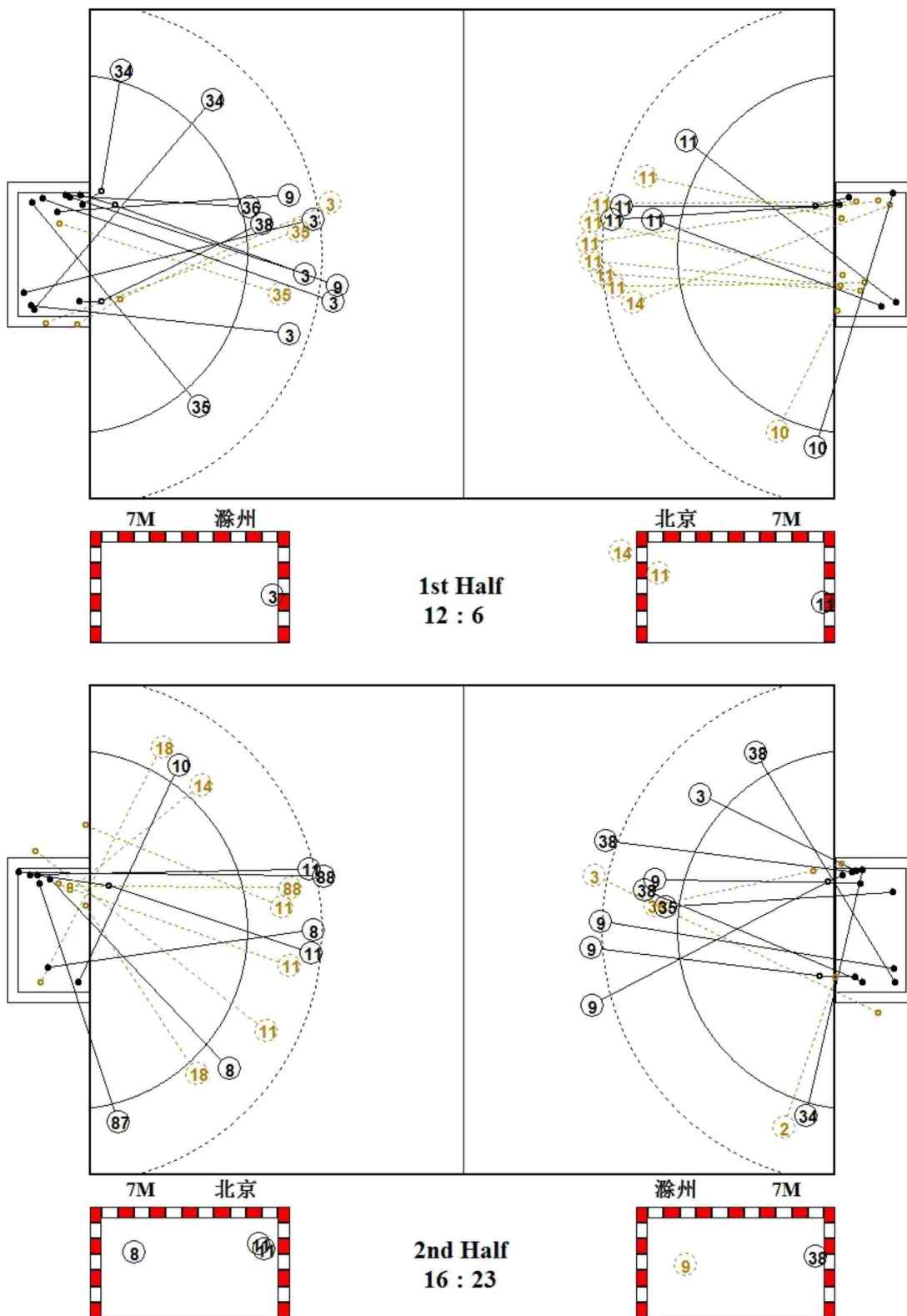

图式射门区域统计

手球  
青年女子

预赛  
轮次 1

组别 A  
场次 7

晋中体育馆  
2019-06-15 22:00

安徽滁州

1 张家轩 <table border="1"><tr><td></td><td></td><td></td></tr><tr><td></td><td></td><td></td></tr><tr><td></td><td></td><td></td></tr></table> Post - 0 Miss - 0 Block - 0										2 钟梦 <table border="1"><tr><td></td><td></td><td></td></tr><tr><td></td><td></td><td></td></tr><tr><td></td><td></td><td></td></tr></table> Post - 0 Miss - 0 Block - 0										3 孙明月 <table border="1"><tr><td>2</td><td></td><td>1</td></tr><tr><td></td><td></td><td>1</td></tr><tr><td>1</td><td></td><td>1</td></tr></table> Post - 1 Miss - 1 Block - 0	2		1			1	1		1	7 丁洁 <table border="1"><tr><td></td><td></td><td></td></tr><tr><td></td><td></td><td></td></tr><tr><td></td><td></td><td></td></tr></table> Post - 0 Miss - 0 Block - 0										9 窦海乐 <table border="1"><tr><td></td><td></td><td>1</td></tr><tr><td>1</td><td></td><td>1</td></tr><tr><td>1</td><td></td><td>2</td></tr></table> Post - 0 Miss - 0 Block - 0			1	1		1	1		2	16 刘子琪 <table border="1"><tr><td></td><td></td><td></td></tr><tr><td></td><td></td><td></td></tr><tr><td></td><td></td><td></td></tr></table> Post - 0 Miss - 0 Block - 0										25 耿雨萍 <table border="1"><tr><td></td><td></td><td></td></tr><tr><td></td><td></td><td></td></tr><tr><td></td><td></td><td></td></tr></table> Post - 0 Miss - 0 Block - 0										26 张雅婷 <table border="1"><tr><td></td><td></td><td></td></tr><tr><td></td><td></td><td></td></tr><tr><td></td><td></td><td></td></tr></table> Post - 0 Miss - 0 Block - 0									
2		1																																																																													
		1																																																																													
1		1																																																																													
		1																																																																													
1		1																																																																													
1		2																																																																													
28 马雯怡 <table border="1"><tr><td></td><td></td><td></td></tr><tr><td></td><td></td><td></td></tr><tr><td></td><td></td><td></td></tr></table> Post - 0 Miss - 0 Block - 0										30 罗佳乐 <table border="1"><tr><td></td><td></td><td></td></tr><tr><td></td><td></td><td></td></tr><tr><td></td><td></td><td></td></tr></table> Post - 0 Miss - 0 Block - 0										32 王小雅 <table border="1"><tr><td></td><td></td><td></td></tr><tr><td></td><td></td><td></td></tr><tr><td></td><td></td><td></td></tr></table> Post - 0 Miss - 0 Block - 0										34 姜影 <table border="1"><tr><td>1</td><td></td><td></td></tr><tr><td>1</td><td></td><td></td></tr><tr><td></td><td></td><td>1</td></tr></table> Post - 0 Miss - 0 Block - 0	1			1					1	35 李旭 <table border="1"><tr><td>1</td><td></td><td>1</td></tr><tr><td></td><td></td><td></td></tr><tr><td></td><td></td><td></td></tr></table> Post - 1 Miss - 0 Block - 0	1		1							36 高奇欣 <table border="1"><tr><td></td><td></td><td></td></tr><tr><td></td><td></td><td>1</td></tr><tr><td></td><td></td><td></td></tr></table> Post - 1 Miss - 0 Block - 0						1				38 潘楠 <table border="1"><tr><td></td><td></td><td>2</td></tr><tr><td></td><td></td><td>1</td></tr><tr><td>2</td><td></td><td></td></tr></table> Post - 0 Miss - 0 Block - 0			2			1	2												
1																																																																															
1																																																																															
		1																																																																													
1		1																																																																													
		1																																																																													
		2																																																																													
		1																																																																													
2																																																																															

1 张家轩

2/3		0/4
1/1		2/4
2/4	1/1	4/4

16 刘子琪

1/2		0/4
0/1		1/1
0/1		1/1

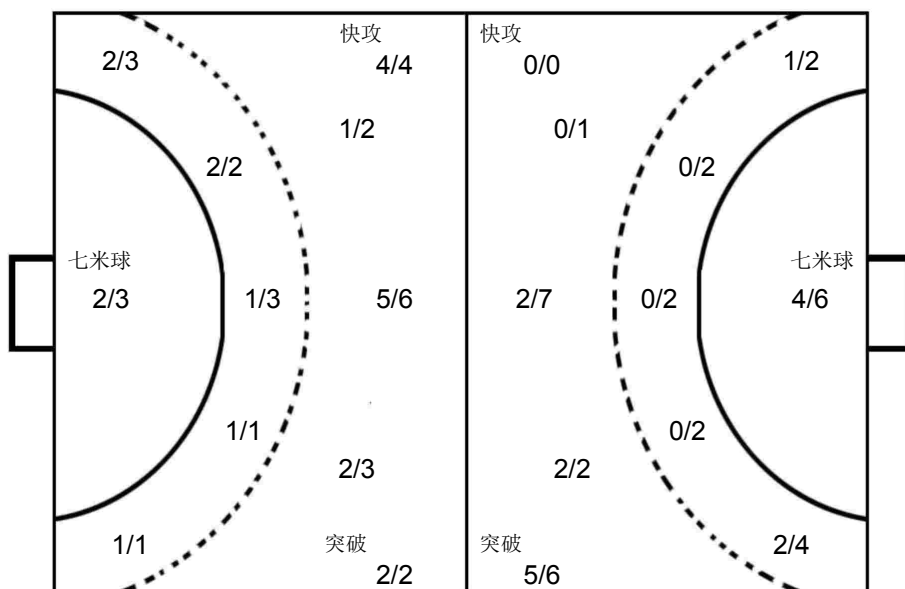

1 靳爽

0/3		0/3
0/1		1/4
0/3		0/4

16 周晓雨

0/1		0/2
1/2		0/1
0/1		1/1

北京市

1 靳爽 <table border="1"><tr><td></td><td></td><td></td></tr><tr><td></td><td></td><td></td></tr><tr><td></td><td></td><td></td></tr></table> Post - 0 Miss - 0 Block - 0										5 常凯旋 <table border="1"><tr><td></td><td></td><td></td></tr><tr><td></td><td></td><td></td></tr><tr><td></td><td></td><td></td></tr></table> Post - 0 Miss - 0 Block - 0										7 翟乃迪 <table border="1"><tr><td></td><td></td><td></td></tr><tr><td></td><td></td><td></td></tr><tr><td></td><td></td><td></td></tr></table> Post - 0 Miss - 0 Block - 0										8 武宏业 <table border="1"><tr><td>1</td><td></td><td></td></tr><tr><td>1</td><td></td><td>1</td></tr><tr><td></td><td></td><td></td></tr></table> Post - 0 Miss - 0 Block - 0	1			1		1				10 胡冰心 <table border="1"><tr><td>1</td><td></td><td></td></tr><tr><td></td><td></td><td></td></tr><tr><td>1</td><td></td><td></td></tr></table> Post - 0 Miss - 0 Block - 0	1						1			11 陈丽婷 <table border="1"><tr><td></td><td></td><td>6</td></tr><tr><td></td><td></td><td>1</td></tr><tr><td>2</td><td></td><td></td></tr></table> Post - 0 Miss - 2 Block - 0			6			1	2			14 侯美林 <table border="1"><tr><td></td><td></td><td></td></tr><tr><td></td><td></td><td></td></tr><tr><td></td><td></td><td></td></tr></table> Post - 0 Miss - 1 Block - 0										16 周晓雨 <table border="1"><tr><td></td><td></td><td></td></tr><tr><td></td><td></td><td></td></tr><tr><td></td><td></td><td></td></tr></table> Post - 0 Miss - 0 Block - 0									
1																																																																															
1		1																																																																													
1																																																																															
1																																																																															
		6																																																																													
		1																																																																													
2																																																																															
18 唐文杰 <table border="1"><tr><td></td><td></td><td></td></tr><tr><td></td><td></td><td></td></tr><tr><td></td><td></td><td></td></tr></table> Post - 0 Miss - 0 Block - 0										23 黄文文 <table border="1"><tr><td></td><td></td><td></td></tr><tr><td></td><td></td><td></td></tr><tr><td></td><td></td><td></td></tr></table> Post - 0 Miss - 0 Block - 0										27 田苗 <table border="1"><tr><td></td><td></td><td></td></tr><tr><td></td><td></td><td></td></tr><tr><td></td><td></td><td></td></tr></table> Post - 0 Miss - 0 Block - 0										81 王木子 <table border="1"><tr><td></td><td></td><td></td></tr><tr><td></td><td></td><td></td></tr><tr><td></td><td></td><td></td></tr></table> Post - 0 Miss - 0 Block - 0										87 王奥 <table border="1"><tr><td></td><td></td><td>1</td></tr><tr><td></td><td></td><td></td></tr><tr><td></td><td></td><td></td></tr></table> Post - 0 Miss - 0 Block - 0			1							88 彭爽爽 <table border="1"><tr><td></td><td></td><td>1</td></tr><tr><td></td><td></td><td></td></tr><tr><td></td><td></td><td></td></tr></table> Post - 0 Miss - 0 Block - 0			1																										
		1																																																																													
		1																																																																													





第二届全国青年运动会女子手球甲组决赛 体校组 (U18)

青年女子 国内比赛

预赛 Group A



PHMS Pictorial Handball Match Statistics

IHF Official System

Team A A 北京市					Team B B 广东深圳					Match Number <b>21</b>											
Played in 山西晋中			in the hall 晋中体育馆			on 2019-06-16		at 14:00		hours			Spectators								
Half-time(30')	A 7	B 7	End of playing time	A 15	B 14	1st extra time	A	B	2nd extra time	A	B	After penalty throws	A	B							
Number of 7 m	A 5/5	Team time-out			Full name of players and officials					Team time-out			B 1/1	Number of 7 m							
		1 15:13	2 28:42	3 39:58						1 05:47	2 39:50	3									
No.	Team A					G	W	2'	D	DR	No.	Team B					G	W	2'	D	DR
1	靳爽										2	唐悦					4				
5	常凯旋										3	赵晔					1		1		
7	翟乃迪										5	朱嘉盈					5	1	2		
8	武宏业					2					6	朱嘉晴					2	1			
9	徐慧敏										7	曾妮									
10	胡冰心					1					9	张雨乐					1		1		
11	陈丽婷					8					10	徐瑜琳									
14	侯美林					1	1				11	王文卉									
16	周晓雨										12	于雅梦									
18	唐文杰					2		1			13	刘培天					1	1			
23	黄文文										16	邹童羽									
27	田苗										17	冯颖慧									
87	王奥										18	谢宛彤									
88	彭爽爽					1					20	岳欣华									
B	黄承 (主教练)										B	张敬敏									
C	栾征										C	常敏 (主教练)									
D	石伟										D	蒋光华									
E	刘文勇										E	夏恒									
A	Signatures of responsables for the teams (Off.A)															B					
TP	Remarks of referees / HF Official															TP					

Signatures

Referees	王亚光 (CHN)	宋优悠 (CHN)		
T.D.	刘凤娟 (CHN)	叶霄雪 (CHN)		
CHA Off.				

Note: Number of 7m Throws Awarded to Team A and B, Goals (G), Warnings (W), Suspensions (2'), Direct Disqualification (D), Disqualification With Report (DR) and Team Penalty (TP).

Table Officials: 宣海波

李莉君

Statisticians: 陈柱

谢扬



竞赛技术统计

手球  
青年女子

预赛  
轮次 2

组别 A  
场次 21

晋中体育馆  
2019-06-16 14:00

Referees:	王亚光 (CHN) / 宋优悠 (CHN)	Result:	15:14 (7:7)
Teams:	北京市(北京) VS 广东深圳(深圳)		

北京		远射	近射	边射	快攻	突破	任意球	7m球	合计	%	助攻	失误	警告	2'	D+DR
主教练: 黄承															
1	靳爽														
5	常凯旋														
7	翟乃迪										4				
8	武宏业					2/2			2/2	100					
9	徐慧敏														
10	胡冰心			1/4					1/4	25.0		1			
11	陈丽婷		1/1			2/3	0/2	5/5	8/11	72.7	1	4			
14	侯美林		0/2			1/2			1/4	25.0	2		1		
16	周晓雨														
18	唐文杰		2/2						2/2	100		2		1	
23	黄文文														
27	田苗										2				
87	王奥		0/1						0/1	0.0		1			
88	彭爽爽	0/2	0/1			1/2			1/5	20.0					
运动员 合计		0/2	3/7	1/4		6/9	0/2	5/5	15/29	51.7	3	14	1	1	
1	靳爽	5/5	4/6	7/8	1/4	2/9		0/1	19/33	57.6					
守门员 合计		5/5	4/6	7/8	1/4	2/9		0/1	19/33	57.6					

北京	比赛进程	深圳
1st Half		
11 陈丽婷	1 03:24 0	
	1 03:52 1 2 唐悦	
	1 06:06 2 5 朱嘉盈	
11 陈丽婷	2 06:24 2	
	2 06:36 3 2 唐悦	
10 胡冰心	3 07:26 3	
18 唐文杰	4 08:01 3	
	4 12:32 4 5 朱嘉盈	
88 彭爽爽	5 14:23 4	
	5 14:43 5 2 唐悦	
	5 16:15 6 3 赵晔	
11 陈丽婷	6 17:08 6	
	6 17:32 7 5 朱嘉盈	
11 陈丽婷	7 18:44 7	
2nd Half		
	7 02:21 8 5 朱嘉盈	
	7 03:25 9 13 刘培天	
11 陈丽婷	8 05:20 9	
8 武宏业	9 06:46 9	
8 武宏业	10 09:11 9	
	10 10:32 10 2 唐悦	
11 陈丽婷	11 10:55 10	
	11 11:24 11 6 朱嘉晴	
11 陈丽婷	12 11:58 11	
	12 12:39 12 6 朱嘉晴	
	12 15:04 13 9 张雨乐	
14 侯美林	13 15:16 13	
	13 17:41 14 5 朱嘉盈	
18 唐文杰	14 18:02 14	
11 陈丽婷	15 19:32 14	

深圳		远射	近射	边射	快攻	突破	任意球	7m球	合计	%	助攻	失误	警告	2'	D+DR
主教练: 常敏															
2	唐悦	0/6	0/2		1/2	2/2		1/1	4/13	30.8	1	1			
3	赵晔	0/1	0/1			1/1			1/3	33.3		1		1	
5	朱嘉盈		2/3	0/3		3/5			5/11	45.5		1	1	2	
6	朱嘉晴	0/1	0/1	1/3		1/1			2/6	33.3		2	1		
7	曾妮														
9	张雨乐			0/2	1/1				1/3	33.3		1		1	
10	徐瑜琳														
11	王文卉														
12	于雅梦														
13	刘培天			0/1	1/1				1/2	50.0		1	1		
16	邹童羽											1			
17	冯颖慧										1				
18	谢宛彤														
20	岳欣华														
运动员 合计		0/8	2/7	1/9	3/4	7/9		1/1	14/38	36.8	2	8	3	4	
11	王文卉														
16	邹童羽	2/2	1/3	2/3		1/3		0/4	6/15	40.0		1			
17	冯颖慧		1/2			1/5		0/1	2/8	25.0	1				
守门员 合计		2/2	2/5	2/3		2/8		0/5	8/23	34.8	1	1			

场上队员: 得分 / 射门

守门员: 救球 / 射门

D	取消资格	DR	取消资格+报告
---	------	----	---------

## 个人/全队技术统计表

手球 青年女子 预赛 轮次 2 组别 A 场次 21 晋中体育馆 2019-06-16 14:00

号码	姓名	远射	近射	边射	快攻	突破	任意	七米	合计	%	助攻	失误	警告	2'	取消	时间
北京市(北京)																
(场上队员)																
1	靳爽									0.0%						00:40:00
5	常凯旋									0.0%						00:00:00
7	翟乃迪									0.0%	4					00:24:57
8	武宏业					2/2			2/2	100%						00:03:18
9	徐慧敏									0.0%						00:00:00
10	胡冰心			1/4					1/4	25.0%	1					00:30:57
11	陈丽婷		1/1			2/3	0/2	5/5	8/11	72.7%	1	4				00:36:31
14	侯美林		0/2			1/2			1/4	25.0%	2		1			00:39:50
16	周晓雨									0.0%						00:00:00
18	唐文杰		2/2						2/2	100%	2			1		00:39:41
23	黄文文									0.0%						00:00:00
27	田苗									0.0%	2					00:35:46
87	王奥		0/1						0/1	0.0%	1					00:04:00
88	彭爽爽	0/2	0/1			1/2			1/5	20.0%						00:23:09
合计		0/2	3/7	1/4		6/9	0/2	5/5	15/29	51.7%	3	14	1	1		
(守门员)																
1	靳爽	5/5	4/6	7/8	1/4	2/9		0/1	19/33	57.6%						00:40:00
合计		5/5	4/6	7/8	1/4	2/9		0/1	19/33	57.6%						

场上队员： 得分/射门

守门员： 救球/射门

全队合计	得分	被救	射失	击柱	封球	合计	%
远射		2				2	0.0%
近射	3	2		2		7	42.9%
边射	1	2	1			4	25.0%
快攻							0.0%
突破	6	2		1		9	66.7%
任意			2			2	0.0%
七米	5					5	100.0%

第二届全国青年运动会女子手球甲组决赛 体校组 (U18)

PHMS Pictorial Handball Match Statistics

IHF Official System

个人/全队技术统计表

手球 青年女子 预赛 轮次 2 组别 A 场次 21 晋中体育馆 2019-06-16 14:00

号码	姓名	远射	近射	边射	快攻	突破	任意	七米	合计	%	助攻	失误	警告	2'	取消	时间
广东深圳(深圳)																
(场上队员)																
2	唐悦	0/6	0/2		1/2	2/2		1/1	4/13	30.8%	1	1				00:39:57
3	赵晔	0/1	0/1			1/1			1/3	33.3%		1		1		00:39:33
5	朱嘉盈		2/3	0/3		3/5			5/11	45.5%		1	1	2		00:39:34
6	朱嘉晴	0/1	0/1	1/3		1/1			2/6	33.3%		2	1			00:39:28
7	曾妮									0.0%						00:00:00
9	张雨乐			0/2	1/1				1/3	33.3%		1		1		00:39:37
10	徐瑜琳									0.0%						00:00:00
11	王文卉									0.0%						00:00:05
12	于雅梦									0.0%						00:00:00
13	刘培天			0/1	1/1				1/2	50.0%		1	1			00:39:30
16	邹童羽									0.0%		1				00:28:19
17	冯颖慧									0.0%	1					00:11:36
18	谢宛彤									0.0%						00:00:00
20	岳欣华									0.0%						00:00:00
合计		0/8	2/7	1/9	3/4	7/9		1/1	14/38	36.8%	2	8	3	4		
(守门员)																
11	王文卉									0.0%						00:00:05
16	邹童羽	2/2	1/3	2/3		1/3		0/4	6/15	40.0%		1				00:28:19
17	冯颖慧		1/2			1/5		0/1	2/8	25.0%	1					00:11:36
合计		2/2	2/5	2/3		2/8		0/5	8/23	34.8%	1	1				

场上队员：得分/射门

守门员：救球/射门

全队合计	得分	被救	射失	击柱	封球	合计	%
远射		5			3	8	0.0%
近射	2	4	1			7	28.6%
边射	1	7		1		9	11.1%
快攻	3	1				4	75.0%
突破	7	2				9	77.8%
任意							0.0%
七米	1					1	100.0%

图式比赛技术统计表

手球  
青年女子

预赛  
轮次 2

组别 A  
场次 21

晋中体育馆  
2019-06-16 14:00

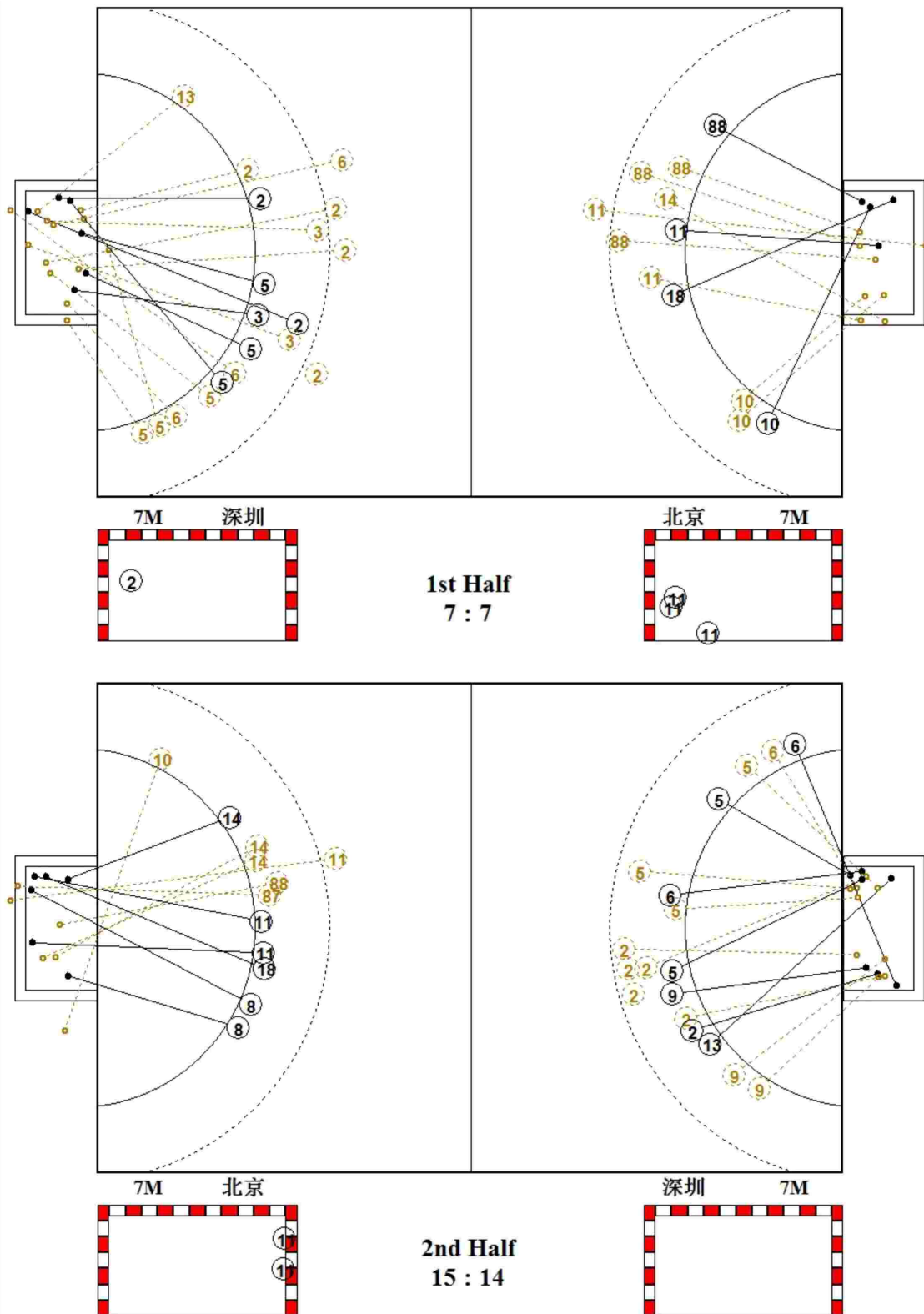

图式射门区域统计

手球  
青年女子

预赛  
轮次 2

组别 A  
场次 21

晋中体育馆  
2019-06-16 14:00

北京市

1 靳爽	5 常凯旋	7 翟乃迪	8 武宏业	9 徐慧敏	10 胡冰心	11 陈丽婷	14 侯美林																																																																								
<table border="1"><tr><td></td><td></td><td></td></tr><tr><td></td><td></td><td></td></tr><tr><td></td><td></td><td></td></tr></table>										<table border="1"><tr><td></td><td></td><td></td></tr><tr><td></td><td></td><td></td></tr><tr><td></td><td></td><td></td></tr></table>										<table border="1"><tr><td></td><td></td><td></td></tr><tr><td></td><td></td><td></td></tr><tr><td></td><td></td><td></td></tr></table>										<table border="1"><tr><td></td><td></td><td>1</td></tr><tr><td>1</td><td></td><td></td></tr><tr><td></td><td></td><td></td></tr></table>			1	1						<table border="1"><tr><td></td><td></td><td></td></tr><tr><td></td><td></td><td></td></tr><tr><td></td><td></td><td></td></tr></table>										<table border="1"><tr><td></td><td></td><td></td></tr><tr><td>1</td><td></td><td></td></tr><tr><td></td><td></td><td></td></tr></table>				1						<table border="1"><tr><td></td><td>1</td><td>2</td></tr><tr><td>2</td><td>1</td><td>1</td></tr><tr><td>1</td><td></td><td></td></tr></table>		1	2	2	1	1	1			<table border="1"><tr><td></td><td></td><td></td></tr><tr><td></td><td></td><td></td></tr><tr><td></td><td></td><td>1</td></tr></table>									1
		1																																																																													
1																																																																															
1																																																																															
	1	2																																																																													
2	1	1																																																																													
1																																																																															
		1																																																																													
Post - 0 Miss - 0 Block - 0	Post - 0 Miss - 0 Block - 0	Post - 0 Miss - 0 Block - 0	Post - 0 Miss - 0 Block - 0	Post - 0 Miss - 0 Block - 0	Post - 0 Miss - 1 Block - 0	Post - 1 Miss - 2 Block - 0	Post - 1 Miss - 0 Block - 0																																																																								
16 周晓雨	18 唐文杰	23 黄文文	27 田苗	87 王奥	88 彭爽爽																																																																										
<table border="1"><tr><td></td><td></td><td></td></tr><tr><td></td><td></td><td></td></tr><tr><td></td><td></td><td></td></tr></table>										<table border="1"><tr><td>1</td><td></td><td>1</td></tr><tr><td></td><td></td><td></td></tr><tr><td></td><td></td><td></td></tr></table>	1		1							<table border="1"><tr><td></td><td></td><td></td></tr><tr><td></td><td></td><td></td></tr><tr><td></td><td></td><td></td></tr></table>										<table border="1"><tr><td></td><td></td><td></td></tr><tr><td></td><td></td><td></td></tr><tr><td></td><td></td><td></td></tr></table>										<table border="1"><tr><td></td><td></td><td></td></tr><tr><td></td><td></td><td></td></tr><tr><td></td><td></td><td></td></tr></table>										<table border="1"><tr><td></td><td></td><td></td></tr><tr><td></td><td></td><td></td></tr><tr><td>1</td><td></td><td></td></tr></table>							1																						
1		1																																																																													
1																																																																															
Post - 0 Miss - 0 Block - 0	Post - 0 Miss - 0 Block - 0	Post - 0 Miss - 0 Block - 0	Post - 0 Miss - 0 Block - 0	Post - 1 Miss - 0 Block - 0	Post - 0 Miss - 0 Block - 0																																																																										

1 靳爽
0/1 3/3 2/4
3/4 4/8
3/7 1/3 3/3

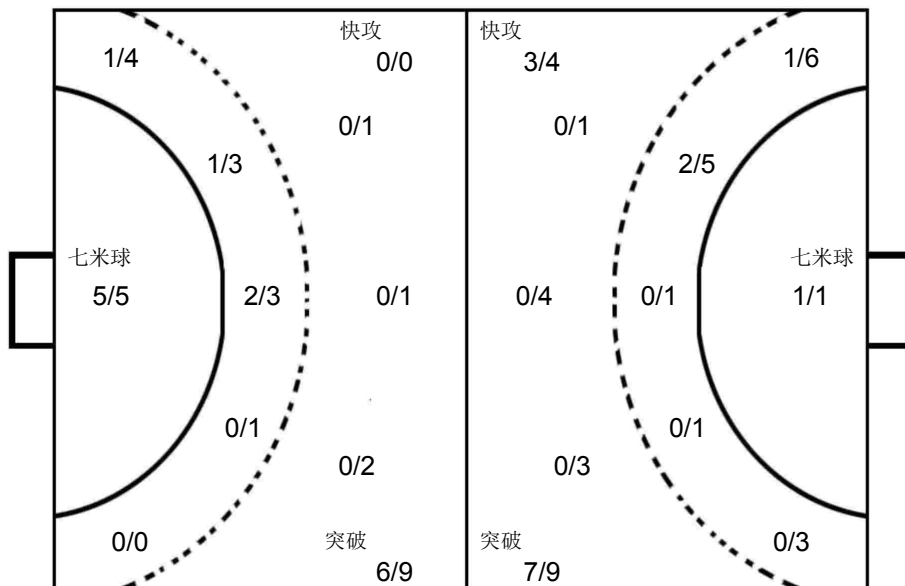

11 王文卉

16 邹童羽
0/1
0/4 2/3 1/2
0/2 2/2 1/1

17 冯颖慧
1/1 0/1 0/4
1/1 0/1

广东深圳

2 唐悦	3 赵晔	5 朱嘉盈	6 朱嘉晴	7 曾妮	9 张雨乐	10 徐瑜琳	11 王文卉																																																																								
<table border="1"><tr><td></td><td></td><td>1</td></tr><tr><td>1</td><td></td><td>2</td></tr><tr><td></td><td></td><td></td></tr></table>			1	1		2				<table border="1"><tr><td></td><td></td><td></td></tr><tr><td></td><td></td><td></td></tr><tr><td></td><td></td><td></td></tr></table>										<table border="1"><tr><td></td><td></td><td></td></tr><tr><td></td><td></td><td>1</td></tr><tr><td>2</td><td>2</td><td></td></tr></table>						1	2	2		<table border="1"><tr><td></td><td></td><td>1</td></tr><tr><td>1</td><td></td><td></td></tr><tr><td></td><td></td><td></td></tr></table>			1	1						<table border="1"><tr><td></td><td></td><td></td></tr><tr><td></td><td></td><td></td></tr><tr><td></td><td></td><td></td></tr></table>										<table border="1"><tr><td></td><td></td><td></td></tr><tr><td></td><td></td><td>1</td></tr><tr><td></td><td></td><td></td></tr></table>						1				<table border="1"><tr><td></td><td></td><td></td></tr><tr><td></td><td></td><td></td></tr><tr><td></td><td></td><td></td></tr></table>										<table border="1"><tr><td></td><td></td><td></td></tr><tr><td></td><td></td><td></td></tr><tr><td></td><td></td><td></td></tr></table>									
		1																																																																													
1		2																																																																													
		1																																																																													
2	2																																																																														
		1																																																																													
1																																																																															
		1																																																																													
Post - 0 Miss - 0 Block - 3	Post - 0 Miss - 0 Block - 0	Post - 1 Miss - 0 Block - 0	Post - 0 Miss - 1 Block - 0	Post - 0 Miss - 0 Block - 0	Post - 0 Miss - 0 Block - 0	Post - 0 Miss - 0 Block - 0	Post - 0 Miss - 0 Block - 0																																																																								
12 于雅梦	13 刘培天	16 邹童羽	17 冯颖慧	18 谢宛彤	20 岳欣华																																																																										
<table border="1"><tr><td></td><td></td><td></td></tr><tr><td></td><td></td><td></td></tr><tr><td></td><td></td><td></td></tr></table>										<table border="1"><tr><td>1</td><td></td><td></td></tr><tr><td></td><td></td><td></td></tr><tr><td></td><td></td><td></td></tr></table>	1									<table border="1"><tr><td></td><td></td><td></td></tr><tr><td></td><td></td><td></td></tr><tr><td></td><td></td><td></td></tr></table>										<table border="1"><tr><td></td><td></td><td></td></tr><tr><td></td><td></td><td></td></tr><tr><td></td><td></td><td></td></tr></table>										<table border="1"><tr><td></td><td></td><td></td></tr><tr><td></td><td></td><td></td></tr><tr><td></td><td></td><td></td></tr></table>										<table border="1"><tr><td></td><td></td><td></td></tr><tr><td></td><td></td><td></td></tr><tr><td></td><td></td><td></td></tr></table>																													
1																																																																															
Post - 0 Miss - 0 Block - 0	Post - 0 Miss - 0 Block - 0	Post - 0 Miss - 0 Block - 0	Post - 0 Miss - 0 Block - 0	Post - 0 Miss - 0 Block - 0	Post - 0 Miss - 0 Block - 0																																																																										



第二届全国青年运动会女子手球甲组决赛 体校组 (U18)

青年女子 国内比赛

预赛 Group A



PHMS Pictorial Handball Match Statistics

IHF Official System

Team A				Team B				Match Number			
A 江苏常州				B 安徽滁州				22			

Played in	in the hall	on	at	Spepectors
山西晋中	晋中体育馆	2019-06-16	15:10	hours

Half-time(30')	A	B	End of playing time	A	B	1st extra time	A	B	2nd extra time	A	B	After penalty throws	A	B
	6	2	14	15										

Number of 7 m	A	Team time-out			Full name of players and officials	Team time-out			B	Number of 7 m
	1/1	1	2	3		1	2	3	0/1	
		23:46	37:51			03:59	32:34	39:57		

No.	Team A	G	W	2'	D	DR	No.	Team B	G	W	2'	D	DR
1	胡雨诺						1	张家轩					
7	张嘉朔	1					2	钟梦	2				
8	董桂林						3	孙明月	3		1		
9	顾霞光						7	丁洁					
14	庄红艳	2		1			9	窦海乐	3				
15	王艺儒						16	刘子琪					
19	焦雅	3					25	耿雨萍					
20	渠文娜	3	1				26	张雅婷					
21	吴静雯	1					28	马雯怡					
22	彭如玉						30	罗佳乐					
24	王铃娜	2					32	王小雅					
25	李秋淇						34	姜影	3				
26	邱聿芳						35	李旭	1	1	1		
27	李袁梦	2					36	高奇欣					
28	黄奕涵						38	潘楠	3				
29	陈赛楠												
A	金甲洙 (主教练)						A	王明星					
B	马彪						B	陆广红 (主教练)					
C	李海鹰						C	岳连娥					
D	陈志伟						D	李莉					

A	Signatures of responsables for the teams (Off.A)										B
---	--	--	--	--	--	--	--	--	--	--	---

TP	Remarks of referees / HF Official											TP
----	-----------------------------------	--	--	--	--	--	--	--	--	--	--	----

Referees	程钰峰 (CHN)	康曦 (CHN)		
T.D.	张耿 (CHN)	叶霄雪 (CHN)		
CHA Off.				

Note: Number of 7m Throws Awarded to Team A and B, Goals (G), Warnings (W), Suspensions (2'), Direct Disqualification (D), Disqualification With Report (DR) and Team Penalty (TP).

Table Officials: 张琦 吴鹏凯 Statisticians: 谢扬 陈柱

## 第二届全国青年运动会女子手球甲组决赛 体校组 (U18)

PHMS Pictorial Handball Match Statistics

IHF Official System

### 竞赛技术统计

手球  
青年女子

预赛  
轮次 2

组别 A  
场次 22

晋中体育馆  
2019-06-16 15:10

Referees: 程钰峰 (CHN) / 康曦 (CHN)

Result: 14:15(6:2)

Teams: 江苏常州(常州) VS 安徽滁州(滁州)

常州		远射	近射	边射	快攻	突破	任意球	7m球	合计	%	助攻	失误	警告	2'	D+DR
主教练: 金甲洙															
1	胡雨诺														
7	张嘉朔			1/4					1/4	25.0		2			
8	董桂林														
9	顾霞光														
14	庄红艳	1/4	1/1						2/5	40.0		4		1	
15	王艺儒														
19	焦雅	0/4					2/3	1/1	3/8	37.5	1	1			
20	渠文娜	0/1			2/2	1/1			3/4	75.0		3	1		
21	吴静雯	1/2	0/1	0/1			0/1		1/5	20.0	1	2			
22	彭如玉														
24	王铃娜			2/6					2/6	33.3		1			
25	李秋淇														
26	邱聿芳														
27	李袁梦		2/2						2/2	100		2			
28	黄奕涵														
29	陈赛楠														
运动员 合计		2/11	3/4	3/11	2/2	1/1	2/4	1/1	14/34	41.2	2	15	1	1	
1	胡雨诺	1/3	1/5	0/1	1/3	0/1		1/1	4/14	28.6					
22	彭如玉	3/3	1/1	2/2	1/2	0/3	0/1		7/12	58.3					
守门员 合计		4/6	2/6	2/3	2/5	0/4	0/1	1/1	11/26	42.3					

常州	比赛进程	滁州
1st Half		
21 吴静雯	1 02:58	0
19 焦雅	2 03:52	0
	2 04:35	1 9 窦海乐
24 王铃娜	3 05:03	1
	3 13:45	2 2 钟梦
7 张嘉朔	4 15:15	2
20 渠文娜	5 17:02	2
20 渠文娜	6 19:00	2
2nd Half		
	6 00:26	3 3 孙明月
19 焦雅	7 01:03	3
	7 02:13	4 3 孙明月
	7 03:20	5 9 窦海乐
20 渠文娜	8 04:56	5
	8 05:19	6 35 李旭
27 李袁梦	9 07:21	6
	9 08:16	7 2 钟梦
24 王铃娜	10 09:30	7
	10 10:38	8 34 姜影
19 焦雅	11 11:25	8
	11 11:46	9 38 潘楠
27 李袁梦	12 12:25	9
	12 13:06	10 9 窦海乐
14 庄红艳	13 13:17	10
	13 13:49	11 3 孙明月
	13 15:21	12 38 潘楠
	13 16:48	13 38 潘楠
	13 18:55	14 34 姜影
	13 19:46	15 34 姜影
14 庄红艳	14 19:55	15

滁州		远射	近射	边射	快攻	突破	任意球	7m球	合计	%	助攻	失误	警告	2'	D+DR
主教练: 陆广红															
1	张家轩														
2	钟梦			1/2	0/2	1/1			2/5	40.0		1			
3	孙明月	1/4			1/1	1/1		0/1	3/7	42.9		1		1	
7	丁洁														
9	窦海乐	1/3				1/1	1/1		3/5	60.0		4			
16	刘子琪														
25	耿雨萍														
26	张雅婷														
28	马雯怡														
30	罗佳乐														
32	王小雅														
34	姜影		1/1	0/1	2/2				3/4	75.0		3			
35	李旭		1/3						1/3	33.3	1	5	1	1	
36	高奇欣		0/1	0/1					0/2	0.0		1			
38	潘楠		2/2			1/1			3/3	100	1	5			
运动员 合计		2/7	4/7	1/4	3/5	4/4	1/1	0/1	15/29	51.7	2	20	1	2	
1	张家轩	6/8	1/4	6/9	0/2	0/1	0/2	0/1	13/27	48.1					
守门员 合计		6/8	1/4	6/9	0/2	0/1	0/2	0/1	13/27	48.1					

场上队员: 得分 / 射门

守门员: 救球 / 射门

D	取消资格	DR	取消资格+报告
---	------	----	---------



## 个人/全队技术统计表

手球 青年女子 预赛 轮次 2 组别 A 场次 22 晋中体育馆 2019-06-16 15:10

号码	姓名	远射	近射	边射	快攻	突破	任意	七米	合计	%	助攻	失误	警告	2'	取消	时间
江苏常州(常州)																
(场上队员)																
1	胡雨诺									0.0%						00:16:14
7	张嘉朔			1/4					1/4	25.0%		2				00:29:55
8	董桂林									0.0%						00:00:00
9	顾霞光									0.0%						00:00:00
14	庄红艳	1/4	1/1						2/5	40.0%		4		1		00:37:28
15	王艺儒									0.0%						00:00:00
19	焦雅	0/4					2/3	1/1	3/8	37.5%	1	1				00:38:56
20	渠文娜	0/1			2/2	1/1			3/4	75.0%		3	1			00:32:30
21	吴静雯	1/2	0/1	0/1			0/1		1/5	20.0%	1	2				00:32:18
22	彭如玉									0.0%						00:23:46
24	王铃娜			2/6					2/6	33.3%		1				00:34:47
25	李秋淇									0.0%						00:00:00
26	邱聿芳									0.0%						00:00:00
27	李袁梦		2/2						2/2	100%		2				00:32:41
28	黄奕涵									0.0%						00:00:00
29	陈赛楠									0.0%						00:00:00
合计		2/11	3/4	3/11	2/2	1/1	2/4	1/1	14/34	41.2%	2	15	1	1		
(守门员)																
1	胡雨诺	1/3	1/5	0/1	1/3	0/1		1/1	4/14	28.6%						00:16:14
22	彭如玉	3/3	1/1	2/2	1/2	0/3	0/1		7/12	58.3%						00:23:46
合计		4/6	2/6	2/3	2/5	0/4	0/1	1/1	11/26	42.3%						

场上队员：得分/射门

守门员：救球/射门

全队合计	得分	被救	射失	击柱	封球	合计	%
远射	2	6	2	1		11	18.2%
近射	3	1				4	75.0%
边射	3	6		2		11	27.3%
快攻	2					2	100.0%
突破	1					1	100.0%
任意	2		1	1		4	50.0%
七米	1					1	100.0%

## 第二届全国青年运动会女子手球甲组决赛 体校组 (U18)

PHMS Pictorial Handball Match Statistics

IHF Official System

### 个人/全队技术统计表

手球 青年女子 预赛 轮次 2 组别 A 场次 22 晋中体育馆 2019-06-16 15:10

号码	姓名	远射	近射	边射	快攻	突破	任意	七米	合计	%	助攻	失误	警告	2'	取消	时间
<b>安徽滁州(滁州)</b>																
<b>(场上队员)</b>																
1	张家轩									0.0%						00:40:00
2	钟梦			1/2	0/2	1/1			2/5	40.0%		1				00:23:10
3	孙明月	1/4			1/1	1/1		0/1	3/7	42.9%		1		1		00:40:00
7	丁洁									0.0%						00:00:00
9	窦海乐	1/3				1/1	1/1		3/5	60.0%		4				00:40:00
16	刘子琪									0.0%						00:00:00
25	耿雨萍									0.0%						00:00:00
26	张雅婷									0.0%						00:00:00
28	马雯怡									0.0%						00:00:00
30	罗佳乐									0.0%						00:00:00
32	王小雅									0.0%						00:00:00
34	姜影		1/1	0/1	2/2				3/4	75.0%		3				00:19:48
35	李旭		1/3						1/3	33.3%	1	5	1	1		00:38:45
36	高奇欣		0/1	0/1					0/2	0.0%		1				00:40:00
38	潘楠		2/2			1/1			3/3	100%	1	5				00:38:09
<b>合计</b>		<b>2/7</b>	<b>4/7</b>	<b>1/4</b>	<b>3/5</b>	<b>4/4</b>	<b>1/1</b>	<b>0/1</b>	<b>15/29</b>	<b>51.7%</b>	<b>2</b>	<b>20</b>	<b>1</b>	<b>2</b>		
<b>(守门员)</b>																
1	张家轩	6/8	1/4	6/9	0/2	0/1	0/2	0/1	13/27	48.1%						00:40:00
<b>合计</b>		<b>6/8</b>	<b>1/4</b>	<b>6/9</b>	<b>0/2</b>	<b>0/1</b>	<b>0/2</b>	<b>0/1</b>	<b>13/27</b>	<b>48.1%</b>						

场上队员： 得分/射门

守门员： 救球/射门

全队合计	得分	被救	射失	击柱	封球	合计	%
远射	2	4			1	7	28.6%
近射	4	2		1		7	57.1%
边射	1	2	1			4	25.0%
快攻	3	2				5	60.0%
突破	4					4	100.0%
任意	1					1	100.0%
七米		1				1	0.0%

图式比赛技术统计表

手球  
青年女子

预赛  
轮次 2

组别 A  
场次 22

晋中体育馆  
2019-06-16 15:10

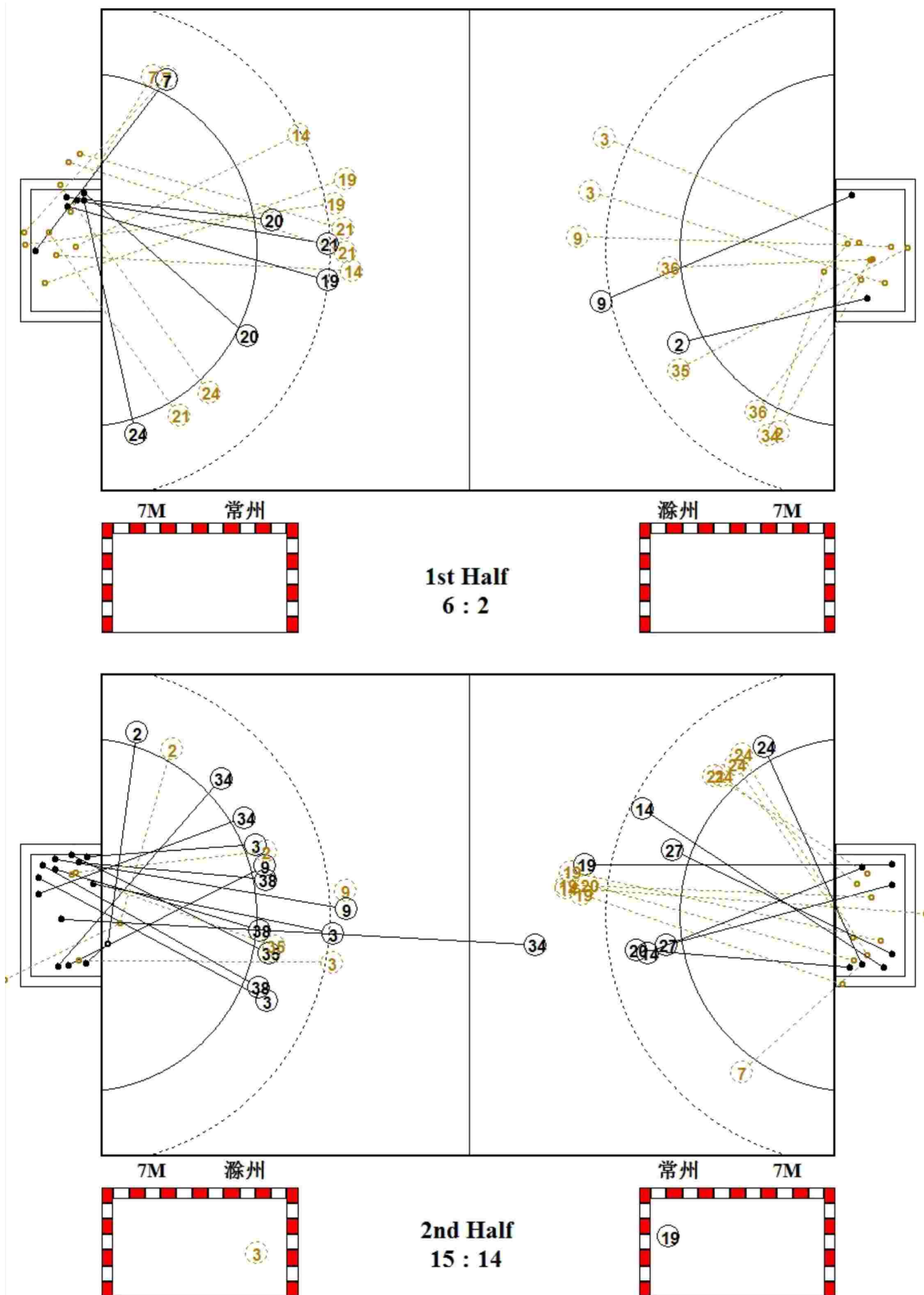

图式射门区域统计

手球  
青年女子

预赛  
轮次 2

组别 A  
场次 22

晋中体育馆  
2019-06-16 15:10

江苏常州

1 胡雨诺 <table border="1"><tr><td></td><td></td><td></td></tr><tr><td></td><td></td><td></td></tr><tr><td></td><td></td><td></td></tr></table> Post - 0 Miss - 0 Block - 0										7 张嘉朔 <table border="1"><tr><td></td><td>1</td><td></td></tr><tr><td></td><td></td><td></td></tr><tr><td></td><td></td><td></td></tr></table> Post - 1 Miss - 0 Block - 0		1								8 董桂林 <table border="1"><tr><td></td><td></td><td></td></tr><tr><td></td><td></td><td></td></tr><tr><td></td><td></td><td></td></tr></table> Post - 0 Miss - 0 Block - 0										9 顾霞光 <table border="1"><tr><td></td><td></td><td></td></tr><tr><td></td><td></td><td></td></tr><tr><td></td><td></td><td></td></tr></table> Post - 0 Miss - 0 Block - 0										14 庄红艳 <table border="1"><tr><td></td><td></td><td>1</td></tr><tr><td>1</td><td></td><td></td></tr><tr><td></td><td></td><td></td></tr></table> Post - 0 Miss - 1 Block - 0			1	1						15 王艺儒 <table border="1"><tr><td></td><td></td><td></td></tr><tr><td></td><td></td><td></td></tr><tr><td></td><td></td><td></td></tr></table> Post - 0 Miss - 0 Block - 0										19 焦雅 <table border="1"><tr><td>2</td><td></td><td></td></tr><tr><td></td><td></td><td>1</td></tr><tr><td></td><td></td><td></td></tr></table> Post - 2 Miss - 0 Block - 0	2					1				20 渠文娜 <table border="1"><tr><td></td><td></td><td></td></tr><tr><td></td><td></td><td>1</td></tr><tr><td></td><td></td><td>2</td></tr></table> Post - 0 Miss - 0 Block - 0						1			2
	1																																																																														
		1																																																																													
1																																																																															
2																																																																															
		1																																																																													
		1																																																																													
		2																																																																													
21 吴静雯 <table border="1"><tr><td></td><td></td><td>1</td></tr><tr><td></td><td></td><td></td></tr><tr><td></td><td></td><td></td></tr></table> Post - 0 Miss - 2 Block - 0			1							22 彭如玉 <table border="1"><tr><td></td><td></td><td></td></tr><tr><td></td><td></td><td></td></tr><tr><td></td><td></td><td></td></tr></table> Post - 0 Miss - 0 Block - 0										24 王铃娜 <table border="1"><tr><td></td><td></td><td></td></tr><tr><td></td><td></td><td>1</td></tr><tr><td></td><td></td><td>1</td></tr></table> Post - 1 Miss - 0 Block - 0						1			1	25 李秋淇 <table border="1"><tr><td></td><td></td><td></td></tr><tr><td></td><td></td><td></td></tr><tr><td></td><td></td><td></td></tr></table> Post - 0 Miss - 0 Block - 0										26 邱聿芳 <table border="1"><tr><td></td><td></td><td></td></tr><tr><td></td><td></td><td></td></tr><tr><td></td><td></td><td></td></tr></table> Post - 0 Miss - 0 Block - 0										27 李袁梦 <table border="1"><tr><td>1</td><td></td><td>1</td></tr><tr><td></td><td></td><td></td></tr><tr><td></td><td></td><td></td></tr></table> Post - 0 Miss - 0 Block - 0	1		1							28 黄奕涵 <table border="1"><tr><td></td><td></td><td></td></tr><tr><td></td><td></td><td></td></tr><tr><td></td><td></td><td></td></tr></table> Post - 0 Miss - 0 Block - 0										29 陈赛楠 <table border="1"><tr><td></td><td></td><td></td></tr><tr><td></td><td></td><td></td></tr><tr><td></td><td></td><td></td></tr></table> Post - 0 Miss - 0 Block - 0									
		1																																																																													
		1																																																																													
		1																																																																													
1		1																																																																													

1 胡雨诺

	0/1	0/3
0/1	0/1	3/4
1/2		0/2

22 彭如玉

	1/1	1/2
0/1	3/3	1/2
0/1	1/1	0/1

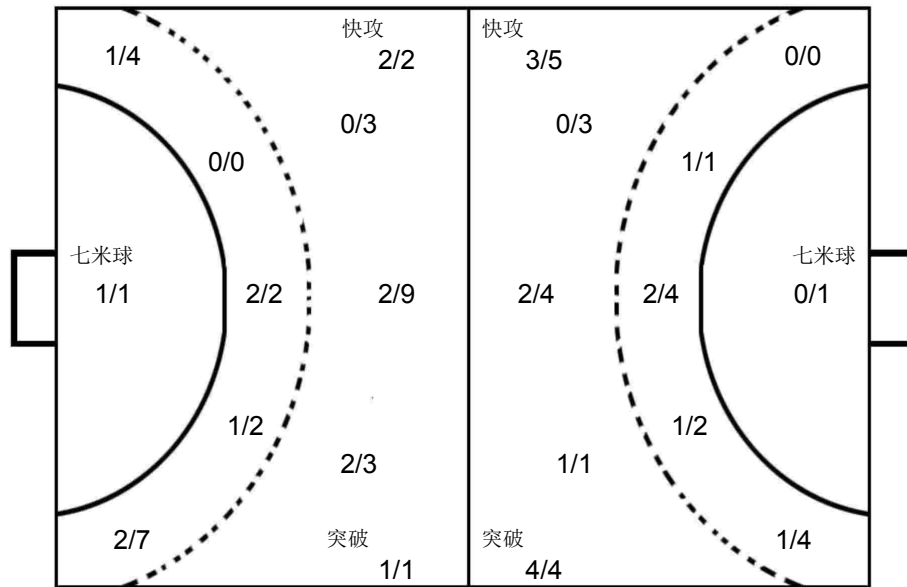

1 张家轩

1/4	1/2	1/3
1/2	3/3	3/7
1/1		2/5

安徽滁州

1 张家轩 <table border="1"><tr><td></td><td></td><td></td></tr><tr><td></td><td></td><td></td></tr><tr><td></td><td></td><td></td></tr></table> Post - 0 Miss - 0 Block - 0										2 钟梦 <table border="1"><tr><td></td><td></td><td></td></tr><tr><td></td><td></td><td>1</td></tr><tr><td>1</td><td></td><td></td></tr></table> Post - 0 Miss - 1 Block - 0						1	1			3 孙明月 <table border="1"><tr><td></td><td></td><td>1</td></tr><tr><td></td><td></td><td></td></tr><tr><td></td><td></td><td>2</td></tr></table> Post - 0 Miss - 0 Block - 0			1						2	7 丁洁 <table border="1"><tr><td></td><td></td><td></td></tr><tr><td></td><td></td><td></td></tr><tr><td></td><td></td><td></td></tr></table> Post - 0 Miss - 0 Block - 0										9 窦海乐 <table border="1"><tr><td></td><td></td><td>1</td></tr><tr><td>1</td><td></td><td></td></tr><tr><td>1</td><td></td><td></td></tr></table> Post - 0 Miss - 0 Block - 1			1	1			1			16 刘子琪 <table border="1"><tr><td></td><td></td><td></td></tr><tr><td></td><td></td><td></td></tr><tr><td></td><td></td><td></td></tr></table> Post - 0 Miss - 0 Block - 0										25 耿雨萍 <table border="1"><tr><td></td><td></td><td></td></tr><tr><td></td><td></td><td></td></tr><tr><td></td><td></td><td></td></tr></table> Post - 0 Miss - 0 Block - 0										26 张雅婷 <table border="1"><tr><td></td><td></td><td></td></tr><tr><td></td><td></td><td></td></tr><tr><td></td><td></td><td></td></tr></table> Post - 0 Miss - 0 Block - 0									
		1																																																																													
1																																																																															
		1																																																																													
		2																																																																													
		1																																																																													
1																																																																															
1																																																																															
28 马雯怡 <table border="1"><tr><td></td><td></td><td></td></tr><tr><td></td><td></td><td></td></tr><tr><td></td><td></td><td></td></tr></table> Post - 0 Miss - 0 Block - 0										30 罗佳乐 <table border="1"><tr><td></td><td></td><td></td></tr><tr><td></td><td></td><td></td></tr><tr><td></td><td></td><td></td></tr></table> Post - 0 Miss - 0 Block - 0										32 王小雅 <table border="1"><tr><td></td><td></td><td></td></tr><tr><td></td><td></td><td></td></tr><tr><td></td><td></td><td></td></tr></table> Post - 0 Miss - 0 Block - 0										34 姜影 <table border="1"><tr><td></td><td>1</td><td></td></tr><tr><td>1</td><td>1</td><td></td></tr><tr><td></td><td></td><td></td></tr></table> Post - 0 Miss - 0 Block - 0		1		1	1					35 李旭 <table border="1"><tr><td></td><td></td><td></td></tr><tr><td></td><td></td><td>1</td></tr><tr><td></td><td></td><td></td></tr></table> Post - 1 Miss - 0 Block - 0						1				36 高奇欣 <table border="1"><tr><td></td><td></td><td></td></tr><tr><td></td><td></td><td></td></tr><tr><td></td><td></td><td></td></tr></table> Post - 0 Miss - 0 Block - 0										38 潘楠 <table border="1"><tr><td></td><td></td><td>2</td></tr><tr><td></td><td></td><td></td></tr><tr><td></td><td></td><td>1</td></tr></table> Post - 0 Miss - 0 Block - 0			2						1										
	1																																																																														
1	1																																																																														
		1																																																																													
		2																																																																													
		1																																																																													



第二届全国青年运动会女子手球甲组决赛 体校组 (U18)

青年女子 国内比赛

预赛 Group A



PHMS Pictorial Handball Match Statistics

IHF Official System

Team A A 山东淄博				Team B B 香港				Match Number <b>23</b>			
------------------	--	--	--	----------------	--	--	--	---------------------------	--	--	--

Played in 山西晋中	in the hall 晋中体育馆	on 2019-06-16	at 16:20	hours	Spectators
-------------------	----------------------	------------------	-------------	-------	------------

Half-time(30')	A 11	B 4	End of playing time	A 18	B 6	1st extra time	A	B	2nd extra time	A	B	After penalty throws	A	B
----------------	---------	--------	---------------------	---------	--------	----------------	---	---	----------------	---	---	----------------------	---	---

Number of 7 m	A 1/2	Team time-out			Full name of players and officials	Team time-out			B 0/1	Number of 7 m
	1	2	3	1		2	3			

No.	Team A	G	W	2'	D	DR	No.	Team B	G	W	2'	D	DR
3	王静雯	1		1			1	郑晓容					
5	张素娟						3	黄秋婷	1				
6	孙玉坤	1	1	1			4	何丹仪					
7	辛彤慧						5	卓凯晴					
8	王锦琦	1					6	洪卓翹					
9	高梦洁	4					8	李芷欣	2	1			
10	崔佳惠						9	林卓琪					
14	韩睿洁			1			11	庄斯琪					
15	李騫飞	1		1			16	曾婉琳	3				
16	王启欣						17	梁艺					
17	蒋松妍	4					18	吴嘉妮					
19	户晴	1					21	林乐儿					
21	赵欣瑶	3					23	王洁桦					
22	邢力丹						25	戴子怡					
23	王家琪	2					28	郭芷彤					
28	江迎新						91	孔倩瑜					
B	徐美凤						A	杨开将					
C	翟乾坤 (主教练)						B	何颂邦					
D	段文钰						C	梁倩盈					
E	王日东												

A	Signatures of responsables for the teams (Off.A)												B
---	--	--	--	--	--	--	--	--	--	--	--	--	---

TP	Remarks of referees / HF Official													TP
----	-----------------------------------	--	--	--	--	--	--	--	--	--	--	--	--	----

Referees	王柏淇 (CHN)	黄一凡 (CHN)		
T.D.	许宜扬 (CHN)	张耿 (CHN)		
CHA Off.				

Note: Number of 7m Throws Awarded to Team A and B, Goals (G), Warnings (W), Suspensions (2'), Direct Disqualification (D), Disqualification With Report (DR) and Team Penalty (TP).

Table Officials: 吴鹏凯 宁佳龙 Statisticians: 陈柱 谢扬



## 第二届全国青年运动会女子手球甲组决赛 体校组 (U18)

PHMS Pictorial Handball Match Statistics

IHF Official System

### 竞赛技术统计

手球  
青年女子

预赛  
轮次 2

组别 A  
场次 23

晋中体育馆  
2019-06-16 16:20

Referees:	王柏淇 (CHN) / 黄一凡 (CHN)	Result:	18:6 (11:4)
Teams:	山东淄博(淄博) VS 香港(香港)		

淄博															淄博		比赛 进程		香港	
主教练: 翟乾坤																				
	远射	近射	边射	快攻	突破	任意球	7m球	合计	%	助攻	失误	警告	2'	D+DR						
3	王静雯						1/1	1/1	100				1							
5	张素娟										1									
6	孙玉坤				1/1			1/1	100	1	4	1	1							
7	辛彤慧																			
8	王锦琦			0/1	1/3			1/4	25.0		2									
9	高梦洁	2/4	0/1		1/1	1/1		4/7	57.1	1	1									
10	崔佳惠						0/1	0/1	0.0	1										
14	韩睿洁														1					
15	李鹏飞			1/1				1/1	100	1			1							
16	王启欣									1										
17	蒋松妍		3/3		1/1			4/4	100											
19	户晴				1/1			1/1	100		1									
21	赵欣瑶	0/1		1/3	2/2			3/6	50.0		1									
22	邢力丹									2										
23	王家琪	0/2		1/1		1/2		2/5	40.0	1										
28	江迎新						0/1	0/1	0.0											
运动员 合计		2/7	3/4	3/6	7/9	2/3	0/1	1/2	18/32	56.3	8	10	1	4						
16	王启欣	5/5	0/1	2/3		0/2		1/1	8/12	66.7	1									
22	邢力丹	4/4	0/1	3/3		1/2		8/10	80.0	2										
守门员 合计		9/9	0/2	5/6		1/4		1/1	16/22	72.7	3									
香港																				
主教练: 梁倩盈																				
	远射	近射	边射	快攻	突破	任意球	7m球	合计	%	助攻	失误	警告	2'	D+DR						
1	郑晓容																			
3	黄秋婷			1/4				1/4	25.0		1									
4	何丹仪	0/2				0/1		0/3	0.0		2									
5	卓凯晴																			
6	洪卓翘																			
8	李芷欣	0/8	1/1			1/1		2/10	20.0		1	1								
9	林卓琪	0/2						0/2	0.0											
11	庄斯琪	0/2						0/2	0.0		1									
16	曾婉琳	0/2	1/1			2/2		3/5	60.0		5									
17	梁艺			0/1				0/1	0.0											
18	吴嘉妮																			
21	林乐儿			0/1				0/1	0.0											
23	王洁桦																			
25	戴子怡																			
28	郭芷彤																			
91	孔倩瑜			0/1				0/1	0.0		1									
运动员 合计		0/16	2/2	1/7		3/4		0/1	6/30	20.0	11	1								
1	郑晓容	3/4	0/2	1/2	1/5	1/1	0/1	6/15	40.0											
6	洪卓翘	1/2	1/2	1/3	0/3	1/3		4/13	30.8											
守门员 合计		4/6	1/4	2/5	1/8	1/3	1/1	10/28	35.7											

		1st Half	
15	李鹏飞	1	00:30 0
17	蒋松妍	2	01:24 0
6	孙玉坤	3	03:25 1 3 黄秋婷
9	高梦洁	4	04:00 1
23	王家琪	5	05:13 1
9	高梦洁	5	05:48 2 16 曾婉琳
9	高梦洁	6	06:33 2
9	高梦洁	7	10:20 2
21	赵欣瑶	8	11:59 2
8	户晴	8	12:40 3 8 李芷欣
21	赵欣瑶	9	16:21 3
3	王静雯	10	17:32 4 16 曾婉琳
10	王静雯	10	18:09 4
23	王家琪	11	19:14 4
		2nd Half	
17	蒋松妍	12	01:31 4
12	02:05	5	8 李芷欣
12	03:36	6	16 曾婉琳
9	高梦洁	13	06:58 6
21	赵欣瑶	14	10:00 6
8	王锦琦	15	11:33 6
19	户晴	16	15:40 6
17	蒋松妍	17	17:18 6
17	蒋松妍	18	19:43 6

场上队员: 得分 / 射门

守门员: 救球 / 射门

D	取消资格	DR	取消资格+报告
---	------	----	---------

## 个人/全队技术统计表

手球 青年女子 预赛 轮次 2 组别 A 场次 23 晋中体育馆 2019-06-16 16:20

号码	姓名	远射	近射	边射	快攻	突破	任意	七米	合计	%	助攻	失误	警告	2'	取消	时间
山东淄博(淄博)																
(场上队员)																
3	王静雯							1/1	1/1	100%					1	00:10:01
5	张素娟									0.0%		1				00:02:27
6	孙玉坤				1/1				1/1	100%	1	4	1	1		00:31:43
7	辛彤慧									0.0%						00:00:00
8	王锦琦			0/1	1/3				1/4	25.0%		2				00:08:56
9	高梦洁	2/4	0/1		1/1	1/1			4/7	57.1%	1	1				00:31:38
10	崔佳惠							0/1	0/1	0.0%	1					00:08:36
14	韩春洁									0.0%				1		00:13:52
15	李骞飞			1/1					1/1	100%	1			1		00:26:40
16	王启欣									0.0%	1					00:20:00
17	蒋松妍		3/3		1/1				4/4	100%						00:18:42
19	户晴				1/1				1/1	100%		1				00:13:26
21	赵欣瑶	0/1		1/3	2/2				3/6	50.0%		1				00:34:23
22	邢力丹									0.0%	2					00:20:00
23	王家琪	0/2		1/1		1/2			2/5	40.0%	1					00:34:45
28	江迎新						0/1		0/1	0.0%						00:02:39
合计		2/7	3/4	3/6	7/9	2/3	0/1	1/2	18/32	56.3%	8	10	1	4		
(守门员)																
16	王启欣	5/5	0/1	2/3		0/2		1/1	8/12	66.7%	1					00:20:00
22	邢力丹	4/4	0/1	3/3		1/2			8/10	80.0%	2					00:20:00
合计		9/9	0/2	5/6		1/4		1/1	16/22	72.7%	3					

场上队员：得分/射门

守门员：救球/射门

全队合计	得分	被救	射失	击柱	封球	合计	%
远射	2	4		1		7	28.6%
近射	3	1				4	75.0%
边射	3	2		1		6	50.0%
快攻	7	1		1		9	77.8%
突破	2	1				3	66.7%
任意		1				1	0.0%
七米	1		1			2	50.0%

第二届全国青年运动会女子手球甲组决赛 体校组 (U18)

PHMS Pictorial Handball Match Statistics

IHF Official System

个人/全队技术统计表

手球 预赛 组别 A 晋中体育馆  
青年女子 轮次 2 场次 23 2019-06-16 16:20

号码	姓名	远射	近射	边射	快攻	突破	任意	七米	合计	%	助攻	失误	警告	2'	取消	时间
香港(香港)																
(场上队员)																
1	郑晓容									0.0%						00:22:09
3	黄秋婷			1/4					1/4	25.0%	1					00:25:05
4	何丹仪	0/2				0/1			0/3	0.0%	2					00:30:20
5	卓凯晴									0.0%						00:00:00
6	洪卓翘									0.0%						00:17:51
8	李芷欣	0/8	1/1			1/1			2/10	20.0%	1	1				00:20:27
9	林卓琪	0/2							0/2	0.0%						00:20:26
11	庄斯琪	0/2							0/2	0.0%	1					00:23:51
16	曾婉琳	0/2	1/1			2/2			3/5	60.0%	5					00:39:08
17	梁艺			0/1					0/1	0.0%						00:05:48
18	吴嘉妮									0.0%						00:00:00
21	林乐儿			0/1					0/1	0.0%						00:08:00
23	王洁桦									0.0%						00:00:52
25	戴子怡									0.0%						00:29:35
28	郭芷彤									0.0%						00:10:21
91	孔倩瑜			0/1				0/1	0/2	0.0%	1					00:25:42
	合计	0/16	2/2	1/7		3/4		0/1	6/30	20.0%	11	1				
(守门员)																
1	郑晓容	3/4	0/2	1/2	1/5	1/1	0/1	6/15	40.0%							00:22:09
6	洪卓翘	1/2	1/2	1/3	0/3	1/3		4/13	30.8%							00:17:51
	合计	4/6	1/4	2/5	1/8	1/3	1/1	10/28	35.7%							

场上队员：得分/射门

守门员：救球/射门

全队合计	得分	被救	射失	击柱	封球	合计	%
远射		9	4	1	2	16	0.0%
近射	2					2	100.0%
边射	1	5	1			7	14.3%
快攻							0.0%
突破	3	1				4	75.0%
任意							0.0%
七米		1				1	0.0%



图式比赛技术统计表

手球  
青年女子

预赛  
轮次 2

组别 A  
场次 23

晋中体育馆  
2019-06-16 16:20

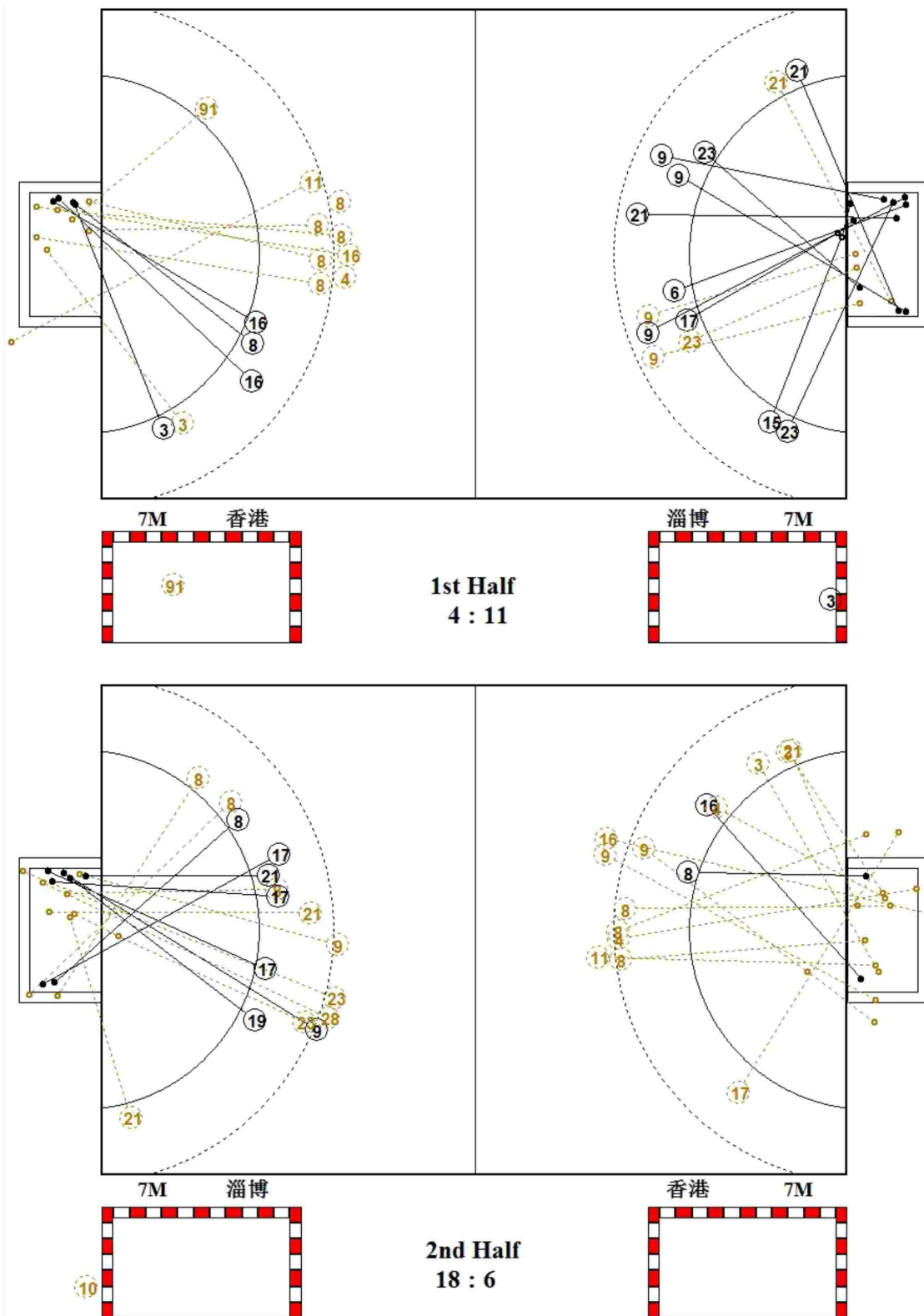

图式射门区域统计

手球  
青年女子

预赛  
轮次 2

组别 A  
场次 23

晋中体育馆  
2019-06-16 16:20

山东淄博

3 王静雯 <table border="1"><tr><td></td><td></td><td>1</td></tr><tr><td></td><td></td><td></td></tr><tr><td></td><td></td><td></td></tr></table> Post - 0 Miss - 0 Block - 0			1							5 张素娟 <table border="1"><tr><td></td><td></td><td></td></tr><tr><td></td><td></td><td></td></tr><tr><td></td><td></td><td></td></tr></table> Post - 0 Miss - 0 Block - 0										6 孙玉坤 <table border="1"><tr><td>1</td><td></td><td></td></tr><tr><td></td><td></td><td></td></tr><tr><td></td><td></td><td></td></tr></table> Post - 0 Miss - 0 Block - 0	1									7 辛彤慧 <table border="1"><tr><td></td><td></td><td></td></tr><tr><td></td><td></td><td></td></tr><tr><td></td><td></td><td></td></tr></table> Post - 0 Miss - 0 Block - 0										8 王锦琦 <table border="1"><tr><td>1</td><td></td><td></td></tr><tr><td></td><td></td><td></td></tr><tr><td></td><td></td><td></td></tr></table> Post - 2 Miss - 0 Block - 0	1									9 高梦洁 <table border="1"><tr><td>1</td><td></td><td>1</td></tr><tr><td>1</td><td></td><td>1</td></tr><tr><td></td><td></td><td></td></tr></table> Post - 0 Miss - 0 Block - 0	1		1	1		1				10 崔佳惠 <table border="1"><tr><td></td><td></td><td></td></tr><tr><td></td><td></td><td></td></tr><tr><td></td><td></td><td></td></tr></table> Post - 0 Miss - 1 Block - 0										14 韩睿洁 <table border="1"><tr><td></td><td></td><td></td></tr><tr><td></td><td></td><td></td></tr><tr><td></td><td></td><td></td></tr></table> Post - 0 Miss - 0 Block - 0									
		1																																																																													
1																																																																															
1																																																																															
1		1																																																																													
1		1																																																																													
15 李骞飞 <table border="1"><tr><td></td><td></td><td></td></tr><tr><td>1</td><td></td><td></td></tr><tr><td></td><td></td><td></td></tr></table> Post - 0 Miss - 0 Block - 0				1						16 王启欣 <table border="1"><tr><td></td><td></td><td></td></tr><tr><td></td><td></td><td></td></tr><tr><td></td><td></td><td></td></tr></table> Post - 0 Miss - 0 Block - 0										17 蒋松妍 <table border="1"><tr><td>1</td><td></td><td>2</td></tr><tr><td></td><td></td><td></td></tr><tr><td>1</td><td></td><td></td></tr></table> Post - 0 Miss - 0 Block - 0	1		2				1			19 卢晴 <table border="1"><tr><td></td><td></td><td></td></tr><tr><td></td><td></td><td>1</td></tr><tr><td></td><td></td><td></td></tr></table> Post - 0 Miss - 0 Block - 0						1				21 赵欣瑶 <table border="1"><tr><td>1</td><td></td><td>1</td></tr><tr><td></td><td></td><td></td></tr><tr><td></td><td></td><td>1</td></tr></table> Post - 0 Miss - 0 Block - 0	1		1						1	22 邢力丹 <table border="1"><tr><td></td><td></td><td></td></tr><tr><td></td><td></td><td></td></tr><tr><td></td><td></td><td></td></tr></table> Post - 0 Miss - 0 Block - 0										23 王家琪 <table border="1"><tr><td>1</td><td></td><td></td></tr><tr><td></td><td></td><td></td></tr><tr><td></td><td></td><td>1</td></tr></table> Post - 1 Miss - 0 Block - 0	1								1	28 江迎新 <table border="1"><tr><td></td><td></td><td></td></tr><tr><td></td><td></td><td></td></tr><tr><td></td><td></td><td></td></tr></table> Post - 0 Miss - 0 Block - 0									
1																																																																															
1		2																																																																													
1																																																																															
		1																																																																													
1		1																																																																													
		1																																																																													
1																																																																															
		1																																																																													

16 王启欣

	2/2	1/2
1/1		2/5
		2/2

22 邢力丹

1/1		
3/3		2/2
1/2	1/1	0/1

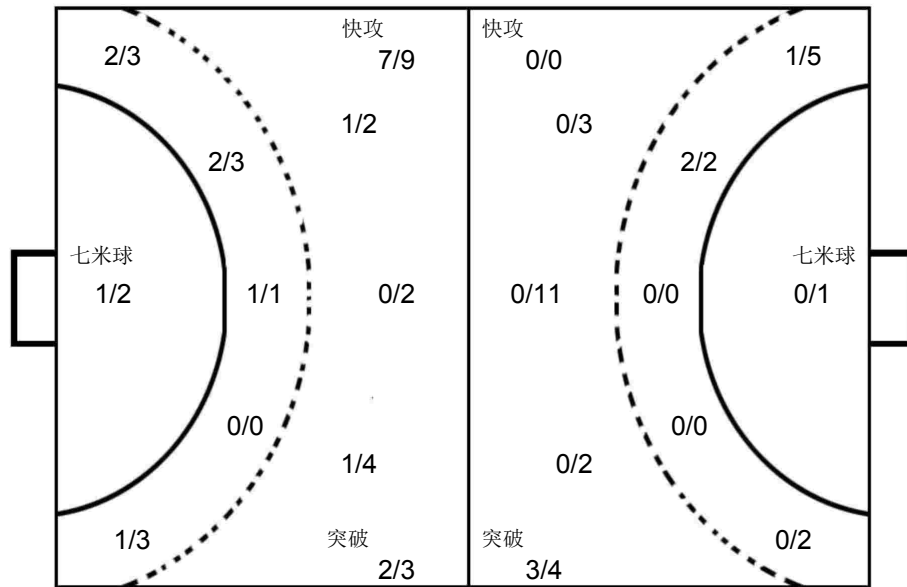

1 郑晓容

0/3	1/1	1/3
	2/2	1/4
		1/2

6 洪卓翹

0/3		0/2
0/1		1/1
0/2	2/2	1/2

香港

1 郑晓容 <table border="1"><tr><td></td><td></td><td></td></tr><tr><td></td><td></td><td></td></tr><tr><td></td><td></td><td></td></tr></table> Post - 0 Miss - 0 Block - 0										3 黄秋婷 <table border="1"><tr><td></td><td></td><td>1</td></tr><tr><td></td><td></td><td></td></tr><tr><td></td><td></td><td></td></tr></table> Post - 0 Miss - 0 Block - 0			1							4 何丹仪 <table border="1"><tr><td></td><td></td><td></td></tr><tr><td></td><td></td><td></td></tr><tr><td></td><td></td><td></td></tr></table> Post - 0 Miss - 0 Block - 1										5 卓凯晴 <table border="1"><tr><td></td><td></td><td></td></tr><tr><td></td><td></td><td></td></tr><tr><td></td><td></td><td></td></tr></table> Post - 0 Miss - 0 Block - 0										6 洪卓翹 <table border="1"><tr><td></td><td></td><td></td></tr><tr><td></td><td></td><td></td></tr><tr><td></td><td></td><td></td></tr></table> Post - 0 Miss - 0 Block - 0										8 李芷欣 <table border="1"><tr><td></td><td></td><td>1</td></tr><tr><td>1</td><td></td><td>1</td></tr><tr><td></td><td></td><td></td></tr></table> Post - 0 Miss - 1 Block - 1			1	1		1				9 林卓琪 <table border="1"><tr><td></td><td></td><td></td></tr><tr><td></td><td></td><td></td></tr><tr><td></td><td></td><td></td></tr></table> Post - 1 Miss - 1 Block - 0										11 庄斯琪 <table border="1"><tr><td></td><td></td><td></td></tr><tr><td></td><td></td><td></td></tr><tr><td></td><td></td><td></td></tr></table> Post - 0 Miss - 1 Block - 0									
		1																																																																													
		1																																																																													
1		1																																																																													
16 曾婉琳 <table border="1"><tr><td></td><td></td><td>1</td></tr><tr><td></td><td></td><td>1</td></tr><tr><td></td><td></td><td>1</td></tr></table> Post - 0 Miss - 1 Block - 0			1			1			1	17 梁艺 <table border="1"><tr><td></td><td></td><td></td></tr><tr><td></td><td></td><td></td></tr><tr><td></td><td></td><td></td></tr></table> Post - 0 Miss - 1 Block - 0										18 吴嘉妮 <table border="1"><tr><td></td><td></td><td></td></tr><tr><td></td><td></td><td></td></tr><tr><td></td><td></td><td></td></tr></table> Post - 0 Miss - 0 Block - 0										21 林乐儿 <table border="1"><tr><td></td><td></td><td></td></tr><tr><td></td><td></td><td></td></tr><tr><td></td><td></td><td></td></tr></table> Post - 0 Miss - 0 Block - 0										23 王洁桦 <table border="1"><tr><td></td><td></td><td></td></tr><tr><td></td><td></td><td></td></tr><tr><td></td><td></td><td></td></tr></table> Post - 0 Miss - 0 Block - 0										25 戴子怡 <table border="1"><tr><td></td><td></td><td></td></tr><tr><td></td><td></td><td></td></tr><tr><td></td><td></td><td></td></tr></table> Post - 0 Miss - 0 Block - 0										28 郭芷彤 <table border="1"><tr><td></td><td></td><td></td></tr><tr><td></td><td></td><td></td></tr><tr><td></td><td></td><td></td></tr></table> Post - 0 Miss - 0 Block - 0										91 孔倩瑜 <table border="1"><tr><td></td><td></td><td></td></tr><tr><td></td><td></td><td></td></tr><tr><td></td><td></td><td></td></tr></table> Post - 0 Miss - 0 Block - 0									
		1																																																																													
		1																																																																													
		1																																																																													



第二届全国青年运动会女子手球甲组决赛 体校组 (U18)

青年女子 国内比赛

预赛 Group A



PHMS Pictorial Handball Match Statistics

IHF Official System

Team A A 广东深圳					Team B B 澳门					Match Number <b>33</b>				
------------------	--	--	--	--	----------------	--	--	--	--	---------------------------	--	--	--	--

Played in 山西晋中			in the hall 晋中体育馆			on 2019-06-17		at 16:20		hours Spectators		
-------------------	--	--	----------------------	--	--	------------------	--	-------------	--	---------------------	--	--

Half-time(30')	A 13	B 2	End of playing time	A 23	B 7	1st extra time	A	B	2nd extra time	A	B	After penalty throws	A	B
----------------	---------	--------	---------------------	---------	--------	----------------	---	---	----------------	---	---	----------------------	---	---

Number of 7 m 0/0	Team time-out			Full name of players and officials	Team time-out			B 1/1	Number of 7 m
	1	2	3		1	2	3		

No.	Team A	G	W	2'	D	DR	No.	Team B	G	W	2'	D	DR
2	唐悦	5					8	譚嘉雯					
3	赵晔	6	1				10	盧曉汶					
5	朱嘉盈	1					11	李君移					
6	朱嘉晴						12	李芷棋	2				
7	曾妮	2					15	張雪琳	4				
9	张雨乐	4					18	曾華恩					
10	徐瑜琳	1					19	馮楚瑩					
11	王文卉						22	蘇萱婷	1				
12	于雅梦						23	霍思允					
13	刘培天	3					44	李嵐					
16	邹童羽												
17	冯颖慧												
18	谢宛彤			1									
20	岳欣华	1											
B	张敬敏						A	蘇沛祺					
C	常敏 (主教练)						C	霍俊浩					
D	蒋光华												
E	夏恒												

A	Signatures of responsables for the teams (Off.A)												B
---	--	--	--	--	--	--	--	--	--	--	--	--	---

TP	Remarks of referees / HF Official													TP
----	-----------------------------------	--	--	--	--	--	--	--	--	--	--	--	--	----

Referees	刘晓辉 (CHN)	冯雨生 (CHN)		
T.D.	叶霄雪 (CHN)	张耿 (CHN)		
CHA Off.				

Note: Number of 7m Throws Awarded to Team A and B, Goals (G), Warnings (W), Suspensions (2'), Direct Disqualification (D), Disqualification With Report (DR) and Team Penalty (TP).

Table Officials: 戴莹莹 王志超 Statisticians: 陈柱 谢扬

竞赛技术统计

手球  
青年女子

预赛  
轮次 3

组别 A  
场次 33

晋中体育馆  
2019-06-17 16:20

Referees:	刘晓辉 (CHN) / 冯雨生 (CHN)	Result:	23:7 (13:2)
Teams:	广东深圳(深圳) VS 澳门(澳门)		

深圳		远射	近射	边射	快攻	突破	任意球	7m球	合计	%	助攻	失误	警告	2'	D+DR
主教练: 常敏															
2	唐悦	1/1	2/2		1/1	1/1			5/5	100	1				
3	赵晔	4/8	1/1		1/1				6/10	60.0		1	1		
5	朱嘉盈		0/1			1/1			1/2	50.0	1	4			
6	朱嘉晴														
7	曾妮		1/2			1/1			2/3	66.7					
9	张雨乐			2/3	2/2				4/5	80.0		1			
10	徐瑜琳			1/1					1/1	100					
11	王文卉											2			
12	于雅梦														
13	刘培天		2/2		1/2				3/4	75.0					
16	邹童羽														
17	冯颖慧										1	1			
18	谢宛彤			0/3	0/1				0/4	0.0				1	
20	岳欣华		1/1						1/1	100					
运动员 合计		5/9	7/9	3/7	5/7	3/3			23/35	65.7	3	9	1	1	
12	于雅梦	3/3	2/5						5/8	62.5					
16	邹童羽	3/4						0/1	3/5	60.0					
17	冯颖慧	3/4		1/1		0/1	2/2		6/8	75.0	1	1			
守门员 合计		9/11	2/5	1/1		0/1	2/2	0/1	14/21	66.7	1	1			

澳门		远射	近射	边射	快攻	突破	任意球	7m球	合计	%	助攻	失误	警告	2'	D+DR
主教练: 陈嘉聪															
8	谭嘉雯														
10	卢晓汶											1			
11	李君移		0/1	0/1					0/2	0.0					
12	李芷棋		1/1					1/1	2/2	100		2			
15	张雪琳	1/4	2/2			1/2	0/2		4/10	40.0		2			
18	曾华恩											5			
19	冯楚莹														
22	苏萱婷	1/8					0/2		1/10	10.0	1	3			
23	霍思允	0/1	0/1						0/2	0.0		3			
44	李嵐														
运动员 合计		2/13	3/5	0/1		1/2	0/4	1/1	7/26	26.9	1	16			
10	卢晓汶	1/3	0/1		0/2	0/2			1/8	12.5		1			
19	冯楚莹	0/3	1/7	4/7	1/4	0/1			6/22	27.3					
守门员 合计		1/6	1/8	4/7	1/6	0/3			7/30	23.3		1			

深圳	比赛进程	澳门
1st Half		
9 张雨乐	1 02:03 0	
	1 02:31 1 22 苏萱婷	
2 唐悦	2 02:41 1	
2 唐悦	3 03:22 1	
13 刘培天	4 07:22 1	
9 张雨乐	5 08:34 1	
2 唐悦	6 11:22 1	
9 张雨乐	7 12:05 1	
	7 13:42 2 15 张雪琳	
2 唐悦	8 15:05 2	
3 赵晔	9 16:08 2	
9 张雨乐	10 16:48 2	
5 朱嘉盈	11 17:33 2	
2 唐悦	12 19:25 2	
13 刘培天	13 19:55 2	
2nd Half		
7 曾妮	14 00:20 2	
	14 00:54 3 12 李芷棋	
3 赵晔	15 01:09 3	
3 赵晔	16 02:04 3	
	16 04:17 4 15 张雪琳	
13 刘培天	17 04:31 4	
10 徐瑜琳	18 06:41 4	
20 岳欣华	19 10:05 4	
7 曾妮	20 13:19 4	
3 赵晔	21 16:39 4	
	21 17:16 5 15 张雪琳	
3 赵晔	22 17:36 5	
	22 18:01 6 15 张雪琳	
	22 19:37 7 12 李芷棋	
3 赵晔	23 19:57 7	

场上队员: 得分 / 射门

守门员: 救球 / 射门

D	取消资格	DR	取消资格+报告
---	------	----	---------

## 个人/全队技术统计表

手球 青年女子 预赛 轮次 3 组别 A 场次 33 晋中体育馆 2019-06-17 16:20

号码	姓名	远射	近射	边射	快攻	突破	任意	七米	合计	%	助攻	失误	警告	2'	取消	时间
广东深圳(深圳)																
(场上队员)																
2	唐悦	1/1	2/2		1/1	1/1			5/5	100%	1					00:20:00
3	赵晔	4/8	1/1		1/1				6/10	60.0%		1	1			00:39:57
5	朱嘉盈		0/1			1/1			1/2	50.0%	1	4				00:34:13
6	朱嘉晴									0.0%						00:00:00
7	曾妮		1/2			1/1			2/3	66.7%						00:20:00
9	张雨乐			2/3	2/2				4/5	80.0%		1				00:20:00
10	徐瑜琳			1/1					1/1	100%						00:40:00
11	王文卉									0.0%		2				00:05:44
12	于雅梦									0.0%						00:10:17
13	刘培天		2/2		1/2				3/4	75.0%						00:29:33
16	邹童羽									0.0%						00:09:43
17	冯颖慧									0.0%	1	1				00:20:00
18	谢宛彤			0/3	0/1				0/4	0.0%				1		00:10:21
20	岳欣华		1/1						1/1	100%						00:20:00
	合计	5/9	7/9	3/7	5/7	3/3			23/35	65.7%	3	9	1	1		
(守门员)																
12	于雅梦	3/3	2/5						5/8	62.5%						00:10:17
16	邹童羽	3/4						0/1	3/5	60.0%						00:09:43
17	冯颖慧	3/4		1/1		0/1	2/2		6/8	75.0%	1	1				00:20:00
	合计	9/11	2/5	1/1		0/1	2/2	0/1	14/21	66.7%	1	1				

场上队员： 得分/射门

守门员： 救球/射门

全队合计	得分	被救	射失	击柱	封球	合计	%
远射	5	1		2	1	9	55.6%
近射	7	1		1		9	77.8%
边射	3	4				7	42.9%
快攻	5	1	1			7	71.4%
突破	3					3	100.0%
任意							0.0%
七米							0.0%

第二届全国青年运动会女子手球甲组决赛 体校组 (U18)

PHMS Pictorial Handball Match Statistics

IHF Official System

个人/全队技术统计表

手球 预赛 组别 A 晋中体育馆  
青年女子 轮次 3 场次 33 2019-06-17 16:20

号码	姓名	远射	近射	边射	快攻	突破	任意	七米	合计	%	助攻	失误	警告	2'	取消	时间
<b>澳门(澳门)</b>																
<b>(场上队员)</b>																
8	譚嘉雯									0.0%						00:05:11
10	盧曉汶									0.0%		1				00:09:54
11	李君移		0/1	0/1					0/2	0.0%						00:40:00
12	李芷棋		1/1					1/1	2/2	100%		2				00:39:52
15	張雪琳	1/4	2/2			1/2	0/2		4/10	40.0%		2				00:40:00
18	曾華恩									0.0%		5				00:35:50
19	馮楚瑩									0.0%						00:30:06
22	蘇萱婷	1/8					0/2		1/10	10.0%	1	3				00:38:54
23	霍思允	0/1	0/1						0/2	0.0%		3				00:22:16
44	李嵐									0.0%						00:17:42
<b>合计</b>		<b>2/13</b>	<b>3/5</b>	<b>0/1</b>		<b>1/2</b>	<b>0/4</b>	<b>1/1</b>	<b>7/26</b>	<b>26.9%</b>	<b>1</b>	<b>16</b>				
<b>(守门员)</b>																
10	盧曉汶	1/3	0/1		0/2	0/2			1/8	12.5%		1				00:09:54
19	馮楚瑩	0/3	1/7	4/7	1/4	0/1			6/22	27.3%						00:30:06
<b>合计</b>		<b>1/6</b>	<b>1/8</b>	<b>4/7</b>	<b>1/6</b>	<b>0/3</b>			<b>7/30</b>	<b>23.3%</b>		<b>1</b>				

场上队员：得分/射门

守门员：救球/射门

全队合计	得分	被救	射失	击柱	封球	合计	%
远射	2	9	2			13	15.4%
近射	3	2				5	60.0%
边射		1				1	0.0%
快攻							0.0%
突破	1		1			2	50.0%
任意		2	2			4	0.0%
七米	1					1	100.0%

图式比赛技术统计表

手球  
青年女子

预赛  
轮次 3

组别 A  
场次 33

晋中体育馆  
2019-06-17 16:20

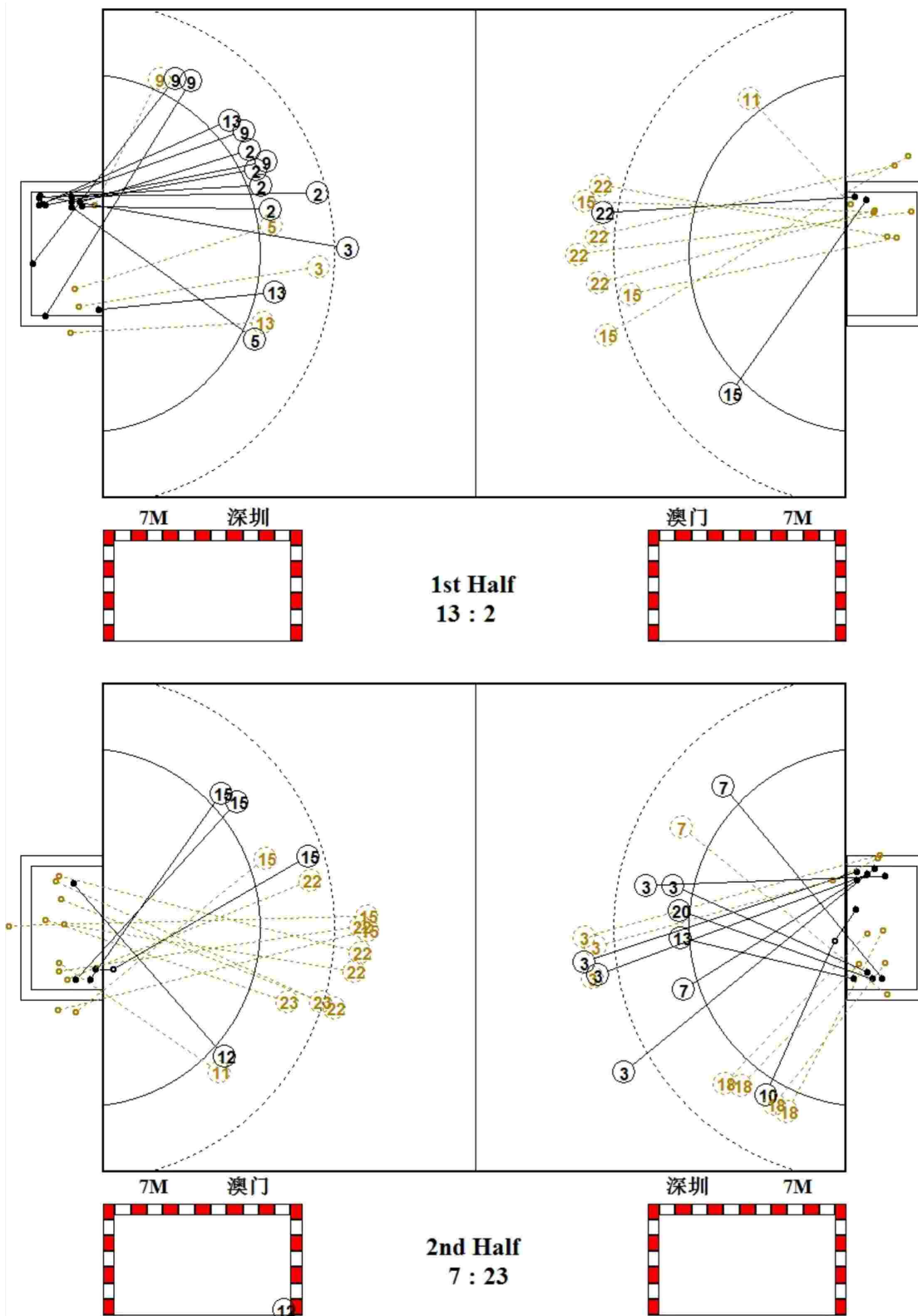

图式射门区域统计

手球  
青年女子

预赛  
轮次 3

组别 A  
场次 33

晋中体育馆  
2019-06-17 16:20

广东深圳

2 唐悦 <table border="1"><tr><td></td><td></td><td>1</td></tr><tr><td></td><td></td><td>2</td></tr><tr><td></td><td></td><td>2</td></tr></table> Post - 0 Miss - 0 Block - 0			1			2			2	3 赵晔 <table border="1"><tr><td></td><td></td><td>1</td></tr><tr><td>2</td><td></td><td></td></tr><tr><td>2</td><td></td><td>1</td></tr></table> Post - 2 Miss - 0 Block - 1			1	2			2		1	5 朱嘉盈 <table border="1"><tr><td></td><td></td><td></td></tr><tr><td></td><td></td><td>1</td></tr><tr><td></td><td></td><td></td></tr></table> Post - 0 Miss - 0 Block - 0						1				6 朱嘉晴 <table border="1"><tr><td></td><td></td><td></td></tr><tr><td></td><td></td><td></td></tr><tr><td></td><td></td><td></td></tr></table> Post - 0 Miss - 0 Block - 0										7 曾妮 <table border="1"><tr><td></td><td></td><td></td></tr><tr><td></td><td></td><td>1</td></tr><tr><td>1</td><td></td><td></td></tr></table> Post - 1 Miss - 0 Block - 0						1	1			9 张雨乐 <table border="1"><tr><td>1</td><td>1</td><td>2</td></tr><tr><td></td><td></td><td></td></tr><tr><td></td><td></td><td></td></tr></table> Post - 0 Miss - 0 Block - 0	1	1	2							10 徐瑜琳 <table border="1"><tr><td></td><td></td><td></td></tr><tr><td></td><td></td><td></td></tr><tr><td></td><td>1</td><td></td></tr></table> Post - 0 Miss - 0 Block - 0								1		11 王文卉 <table border="1"><tr><td></td><td></td><td></td></tr><tr><td></td><td></td><td></td></tr><tr><td></td><td></td><td></td></tr></table> Post - 0 Miss - 0 Block - 0									
		1																																																																													
		2																																																																													
		2																																																																													
		1																																																																													
2																																																																															
2		1																																																																													
		1																																																																													
		1																																																																													
1																																																																															
1	1	2																																																																													
	1																																																																														
12 于雅梦 <table border="1"><tr><td></td><td></td><td></td></tr><tr><td></td><td></td><td></td></tr><tr><td></td><td></td><td></td></tr></table> Post - 0 Miss - 0 Block - 0										13 刘培天 <table border="1"><tr><td></td><td></td><td>1</td></tr><tr><td>1</td><td></td><td>1</td></tr><tr><td></td><td></td><td></td></tr></table> Post - 0 Miss - 1 Block - 0			1	1		1				16 邹童羽 <table border="1"><tr><td></td><td></td><td></td></tr><tr><td></td><td></td><td></td></tr><tr><td></td><td></td><td></td></tr></table> Post - 0 Miss - 0 Block - 0										17 冯颖慧 <table border="1"><tr><td></td><td></td><td></td></tr><tr><td></td><td></td><td></td></tr><tr><td></td><td></td><td></td></tr></table> Post - 0 Miss - 0 Block - 0										18 谢宛彤 <table border="1"><tr><td></td><td></td><td></td></tr><tr><td></td><td></td><td></td></tr><tr><td></td><td></td><td></td></tr></table> Post - 0 Miss - 0 Block - 0										20 岳欣华 <table border="1"><tr><td></td><td></td><td></td></tr><tr><td></td><td></td><td>1</td></tr><tr><td></td><td></td><td></td></tr></table> Post - 0 Miss - 0 Block - 0						1																							
		1																																																																													
1		1																																																																													
		1																																																																													

12 于雅梦

	1/1	
2/3		2/3
0/1		

16 邹童羽

		1/1
1/1	1/1	
0/1		0/1

17 冯颖慧

1/1	1/1	
2/2	1/1	
1/3		

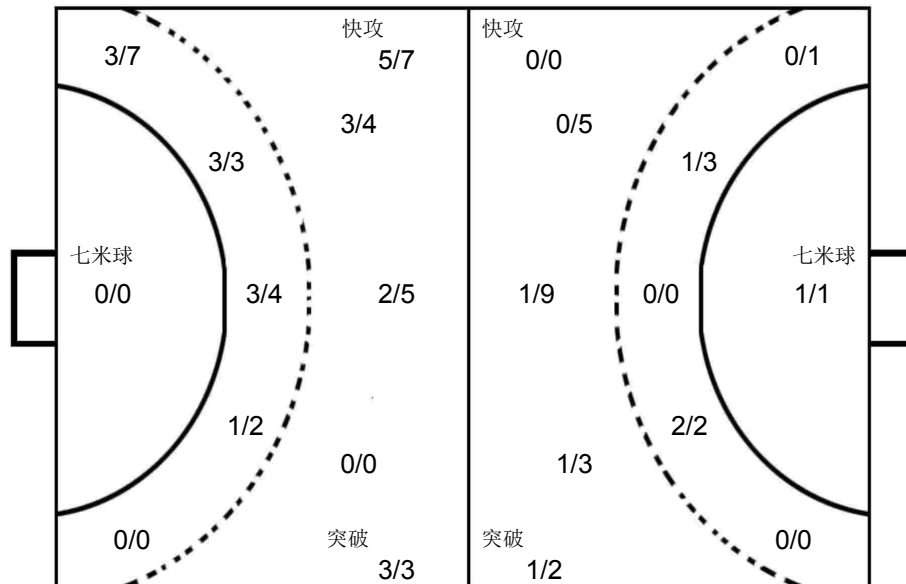

10 盧曉汶

		0/3
1/2		0/2
		0/1

19 馮楚瑩

0/1	0/1	0/2
1/2	1/1	1/4
0/4	1/2	2/5

澳门

8 譚嘉雯 <table border="1"><tr><td></td><td></td><td></td></tr><tr><td></td><td></td><td></td></tr><tr><td></td><td></td><td></td></tr></table> Post - 0 Miss - 0 Block - 0										10 盧曉汶 <table border="1"><tr><td></td><td></td><td></td></tr><tr><td></td><td></td><td></td></tr><tr><td></td><td></td><td></td></tr></table> Post - 0 Miss - 0 Block - 0										11 李君移 <table border="1"><tr><td></td><td></td><td></td></tr><tr><td></td><td></td><td></td></tr><tr><td></td><td></td><td></td></tr></table> Post - 0 Miss - 0 Block - 0										12 李芷棋 <table border="1"><tr><td></td><td></td><td>1</td></tr><tr><td></td><td></td><td>1</td></tr><tr><td></td><td></td><td></td></tr></table> Post - 0 Miss - 0 Block - 0			1			1				15 張雪琳 <table border="1"><tr><td>1</td><td></td><td></td></tr><tr><td>3</td><td></td><td></td></tr><tr><td></td><td></td><td></td></tr></table> Post - 0 Miss - 4 Block - 0	1			3						18 曾華恩 <table border="1"><tr><td></td><td></td><td></td></tr><tr><td></td><td></td><td></td></tr><tr><td></td><td></td><td></td></tr></table> Post - 0 Miss - 0 Block - 0										19 馮楚瑩 <table border="1"><tr><td></td><td></td><td></td></tr><tr><td></td><td></td><td></td></tr><tr><td></td><td></td><td></td></tr></table> Post - 0 Miss - 0 Block - 0										22 蘇萱婷 <table border="1"><tr><td></td><td></td><td></td></tr><tr><td>1</td><td></td><td></td></tr><tr><td></td><td></td><td></td></tr></table> Post - 0 Miss - 1 Block - 0				1					
		1																																																																													
		1																																																																													
1																																																																															
3																																																																															
1																																																																															
23 霍思允 <table border="1"><tr><td></td><td></td><td></td></tr><tr><td></td><td></td><td></td></tr><tr><td></td><td></td><td></td></tr></table> Post - 0 Miss - 0 Block - 0										44 李嵐 <table border="1"><tr><td></td><td></td><td></td></tr><tr><td></td><td></td><td></td></tr><tr><td></td><td></td><td></td></tr></table> Post - 0 Miss - 0 Block - 0																																																																					





第二届全国青年运动会女子手球甲组决赛 体校组 (U18)

青年女子 国内比赛

预赛 Group A



PHMS Pictorial Handball Match Statistics

IHF Official System

Team A A 山东淄博				Team B B 安徽滁州				Match Number <b>34</b>			
------------------	--	--	--	------------------	--	--	--	---------------------------	--	--	--

Played in 山西晋中	in the hall 晋中体育馆	on 2019-06-17	at 17:30	hours	Speakers
-------------------	----------------------	------------------	-------------	-------	----------

Half-time(30')	A 6	B 7	End of playing time	A 10	B 13	1st extra time	A	B	2nd extra time	A	B	After penalty throws	A	B
----------------	--------	--------	---------------------	---------	---------	----------------	---	---	----------------	---	---	----------------------	---	---

Number of 7 m 2/2	Team time-out			Full name of players and officials	Team time-out			B 1/1	Number of 7 m
	1 19:07	2 31:58	3 34:49		1 14:33	2 27:15	3 37:14		

No.	Team A	G	W	2'	D	DR	No.	Team B	G	W	2'	D	DR
3	王静雯	4	1				1	张家轩					
5	张素娟						2	钟梦			1		
6	孙玉坤	4					3	孙明月	1	1			
7	辛彤慧						7	丁洁					
8	王锦琦						9	窦海乐	2	1	1		
9	高梦洁	1					16	刘子琪					
10	崔佳惠						25	耿雨萍					
14	韩睿洁						26	张雅婷					
15	李骞飞	1					28	马雯怡					
16	王启欣						30	罗佳乐					
17	蒋松妍						32	王小雅					
19	户晴						34	姜影	1				
21	赵欣瑶						35	李旭	2				
22	邢力丹						36	高奇欣	4				
23	王家琪						38	潘楠	3				
28	江迎新												
B	徐美凤						A	王明星					
C	翟乾坤 (主教练)						B	陆广红 (主教练)					
D	段文钰						C	岳连娥					
E	王日东						D	李莉					

A	Signatures of responsables for the teams (Off.A)												B
---	--	--	--	--	--	--	--	--	--	--	--	--	---

TP	Remarks of referees / HF Official													TP
----	-----------------------------------	--	--	--	--	--	--	--	--	--	--	--	--	----

Referees	马晓晔 (CHN)	伍豪 (CHN)		
T.D.	张耿 (CHN)	刘凤娟 (CHN)		
CHA Off.				

Note: Number of 7m Throws Awarded to Team A and B, Goals (G), Warnings (W), Suspensions (2'), Direct Disqualification (D), Disqualification With Report (DR) and Team Penalty (TP).

Table Officials: 杜鸿 宁佳龙 Statisticians: 陈柱 谢扬

## 竞赛技术统计

 手球  
青年女子

 预赛  
轮次 3

 组别 A  
场次 34

 晋中体育馆  
2019-06-17 17:30

Referees: 马晓晔 (CHN) / 伍豪 (CHN)

Result: 10:13(6:7)

Teams: 山东淄博(淄博) VS 安徽滁州(滁州)

淄博		远	近	边	快	突	任意	7m	合计	%	助攻	失误	警告	2'	D+DR
主教练: 翟乾坤		射	射	射	攻	破	球	球							
3	王静雯	0/3	0/1	2/5				2/2	4/11	36.4		2	1		
5	张素娟														
6	孙玉坤	1/1	1/1			2/3			4/5	80.0	1	1			
7	辛彤慧														
8	王锦琦			0/1					0/1	0.0		1			
9	高梦洁	0/1				1/3			1/4	25.0	1	4			
10	崔佳惠														
14	韩春洁														
15	李鹏飞			1/1					1/1	100		2			
16	王启欣														
17	蒋松妍														
19	户晴		0/2						0/2	0.0					
21	赵欣瑶		0/1						0/1	0.0		1			
22	邢力丹														
23	王家琪					0/1			0/1	0.0		3			
28	江迎新														
运动员 合计		1/5	1/5	3/7		3/7		2/2	10/26	38.5	2	14	1		
16	王启欣	2/5	0/1	1/4		0/1			3/11	27.3					
22	邢力丹	2/3	0/2	1/1		0/1		0/1	3/8	37.5					
守门员 合计		4/8	0/3	2/5		0/2		0/1	6/19	31.6					

淄博	比赛 进程	滁州
1st Half		
0	01:15	1 35 李旭
6 孙玉坤	1 01:57	1
1	05:41	2 38 潘楠
3 王静雯	2 06:26	2
2	06:49	3 38 潘楠
2	08:19	4 36 高奇欣
9 高梦洁	3 08:48	4
3 王静雯	4 11:23	4
3 王静雯	5 14:19	4
3 王静雯	6 15:09	4
6	16:47	5 3 孙明月
6	17:55	6 36 高奇欣
6	19:53	7 9 窦海乐
2nd Half		
6 孙玉坤	6 02:16	8 36 高奇欣
7	03:45	8
6 孙玉坤	8 07:13	8
8	08:24	9 35 李旭
8	10:53	10 36 高奇欣
8	11:50	11 38 潘楠
8	14:42	12 9 窦海乐
6 孙玉坤	9 17:35	12
15 李鹏飞	10 18:22	12
10	18:45	13 34 姜影

滁州		远	近	边	快	突	任意	7m	合计	%	助攻	失误	警告	2'	D+DR
主教练: 陆广红		射	射	射	攻	破	球	球							
1	张家轩														
2	钟梦													1	
3	孙明月	0/3						1/1	1/4	25.0		4	1		
7	丁洁														
9	窦海乐	2/4							2/4	50.0	3	3	1	1	
16	刘子琪														
25	耿雨萍														
26	张雅婷														
28	马雯怡														
30	罗佳乐														
32	王小雅														
34	姜影			1/2					1/2	50.0		3			
35	李旭	1/5	1/1						2/6	33.3		4			
36	高奇欣	1/1	2/2			1/1			4/4	100		2			
38	潘楠			2/3		1/1			3/4	75.0	1				
运动员 合计		4/13	3/3	3/5		2/2		1/1	13/24	54.2	4	16	2	2	
1	张家轩	2/3	3/4	3/6		4/7		0/2	12/22	54.5					
守门员 合计		2/3	3/4	3/6		4/7		0/2	12/22	54.5					

场上队员: 得分 / 射门

守门员: 救球 / 射门

D	取消资格	DR	取消资格+报告
---	------	----	---------

## 个人/全队技术统计表

手球 青年女子 预赛 轮次 3 组别 A 场次 34 晋中体育馆 2019-06-17 17:30

号码	姓名	远射	近射	边射	快攻	突破	任意	七米	合计	%	助攻	失误	警告	2'	取消	时间
山东淄博(淄博)																
(场上队员)																
3	王静雯	0/3	0/1	2/5				2/2	4/11	36.4%		2	1			00:36:37
5	张素娟									0.0%						00:00:00
6	孙玉坤	1/1	1/1			2/3			4/5	80.0%	1	1				00:39:56
7	辛彤慧									0.0%						00:00:00
8	王锦琦			0/1					0/1	0.0%		1				00:12:07
9	高梦洁	0/1				1/3			1/4	25.0%	1	4				00:38:39
10	崔佳惠									0.0%						00:02:18
14	韩春洁									0.0%						00:00:00
15	李鹏飞			1/1					1/1	100%		2				00:26:29
16	王启欣									0.0%						00:27:07
17	蒋松妍									0.0%						00:00:54
19	卢晴		0/2						0/2	0.0%						00:13:02
21	赵欣瑶		0/1						0/1	0.0%		1				00:40:00
22	邢力丹									0.0%						00:12:53
23	王家琪					0/1			0/1	0.0%		3				00:29:41
28	江迎新									0.0%						00:00:00
	合计	1/5	1/5	3/7		3/7		2/2	10/26	38.5%	2	14	1			
(守门员)																
16	王启欣	2/5	0/1	1/4		0/1			3/11	27.3%						00:27:07
22	邢力丹	2/3	0/2	1/1		0/1		0/1	3/8	37.5%						00:12:53
	合计	4/8	0/3	2/5		0/2		0/1	6/19	31.6%						

场上队员：得分/射门

守门员：救球/射门

全队合计	得分	被救	射失	击柱	封球	合计	%
远射	1	2	1		1	5	20.0%
近射	1	3	1			5	20.0%
边射	3	3		1		7	42.9%
快攻							0.0%
突破	3	4				7	42.9%
任意							0.0%
七米	2					2	100.0%

## 第二届全国青年运动会女子手球甲组决赛 体校组 (U18)

PHMS Pictorial Handball Match Statistics

IHF Official System

### 个人/全队技术统计表

手球 青年女子      预赛 轮次 3      组别 A 场次 34      晋中体育馆  
2019-06-17 17:30

号码	姓名	远射	近射	边射	快攻	突破	任意	七米	合计	%	助攻	失误	警告	2'	取消	时间
<b>安徽滁州(滁州)</b>																
<b>(场上队员)</b>																
1	张家轩									0.0%						00:40:00
2	钟梦									0.0%				1		00:04:30
3	孙明月	0/3						1/1	1/4	25.0%		4	1			00:40:00
7	丁洁									0.0%						00:00:00
9	窦海乐	2/4							2/4	50.0%	3	3	1	1		00:40:00
16	刘子琪									0.0%						00:00:00
25	耿雨萍									0.0%						00:00:00
26	张雅婷									0.0%						00:00:00
28	马雯怡									0.0%						00:00:00
30	罗佳乐									0.0%						00:00:00
32	王小雅									0.0%						00:00:00
34	姜影			1/2					1/2	50.0%		3				00:40:00
35	李旭	1/5	1/1						2/6	33.3%		4				00:40:00
36	高奇欣	1/1	2/2			1/1			4/4	100%		2				00:40:00
38	潘楠			2/3		1/1			3/4	75.0%	1					00:35:29
<b>合计</b>		<b>4/13</b>	<b>3/3</b>	<b>3/5</b>		<b>2/2</b>		<b>1/1</b>	<b>13/24</b>	<b>54.2%</b>	<b>4</b>	<b>16</b>	<b>2</b>	<b>2</b>		
<b>(守门员)</b>																
1	张家轩	2/3	3/4	3/6		4/7		0/2	12/22	54.5%						00:40:00
<b>合计</b>		<b>2/3</b>	<b>3/4</b>	<b>3/6</b>		<b>4/7</b>		<b>0/2</b>	<b>12/22</b>	<b>54.5%</b>						

场上队员： 得分/射门

守门员： 救球/射门

全队合计	得分	被救	射失	击柱	封球	合计	%
远射	4	4	2	3		13	30.8%
近射	3					3	100.0%
边射	3	2				5	60.0%
快攻							0.0%
突破	2					2	100.0%
任意							0.0%
七米	1					1	100.0%

图式比赛技术统计表

手球  
青年女子

预赛  
轮次 3

组别 A  
场次 34

晋中体育馆  
2019-06-17 17:30

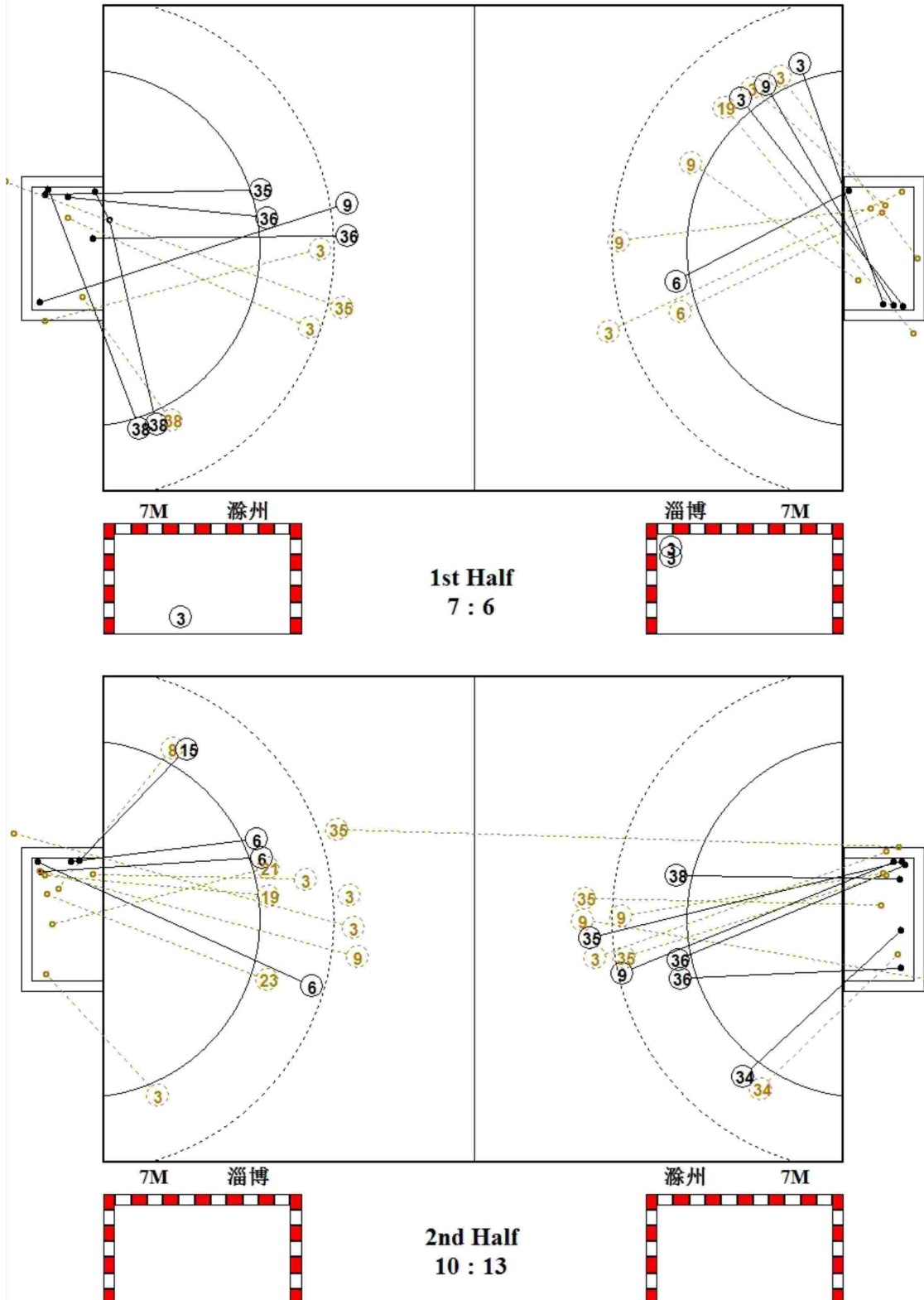

图式射门区域统计

手球  
青年女子

预赛  
轮次 3

组别 A  
场次 34

晋中体育馆  
2019-06-17 17:30

山东淄博

3 王静雯 <table border="1"><tr><td>2</td><td></td><td>1</td></tr><tr><td></td><td></td><td>1</td></tr><tr><td></td><td></td><td></td></tr></table> Post - 1 Miss - 1 Block - 1	2		1			1				5 张素娟 <table border="1"><tr><td></td><td></td><td></td></tr><tr><td></td><td></td><td></td></tr><tr><td></td><td></td><td></td></tr></table> Post - 0 Miss - 0 Block - 0										6 孙玉坤 <table border="1"><tr><td></td><td></td><td>2</td></tr><tr><td></td><td></td><td>1</td></tr><tr><td>1</td><td></td><td></td></tr></table> Post - 0 Miss - 0 Block - 0			2			1	1			7 辛彤慧 <table border="1"><tr><td></td><td></td><td></td></tr><tr><td></td><td></td><td></td></tr><tr><td></td><td></td><td></td></tr></table> Post - 0 Miss - 0 Block - 0										8 王锦琦 <table border="1"><tr><td></td><td></td><td></td></tr><tr><td></td><td></td><td></td></tr><tr><td></td><td></td><td></td></tr></table> Post - 0 Miss - 0 Block - 0										9 高梦洁 <table border="1"><tr><td></td><td></td><td>1</td></tr><tr><td></td><td></td><td></td></tr><tr><td></td><td></td><td></td></tr></table> Post - 0 Miss - 0 Block - 0			1							10 崔佳惠 <table border="1"><tr><td></td><td></td><td></td></tr><tr><td></td><td></td><td></td></tr><tr><td></td><td></td><td></td></tr></table> Post - 0 Miss - 0 Block - 0										14 韩睿洁 <table border="1"><tr><td></td><td></td><td></td></tr><tr><td></td><td></td><td></td></tr><tr><td></td><td></td><td></td></tr></table> Post - 0 Miss - 0 Block - 0									
2		1																																																																													
		1																																																																													
		2																																																																													
		1																																																																													
1																																																																															
		1																																																																													
15 李鹏飞 <table border="1"><tr><td></td><td></td><td>1</td></tr><tr><td></td><td></td><td></td></tr><tr><td></td><td></td><td></td></tr></table> Post - 0 Miss - 0 Block - 0			1							16 王启欣 <table border="1"><tr><td></td><td></td><td></td></tr><tr><td></td><td></td><td></td></tr><tr><td></td><td></td><td></td></tr></table> Post - 0 Miss - 0 Block - 0										17 蒋松妍 <table border="1"><tr><td></td><td></td><td></td></tr><tr><td></td><td></td><td></td></tr><tr><td></td><td></td><td></td></tr></table> Post - 0 Miss - 0 Block - 0										19 卢晴 <table border="1"><tr><td></td><td></td><td></td></tr><tr><td></td><td></td><td></td></tr><tr><td></td><td></td><td></td></tr></table> Post - 0 Miss - 1 Block - 0										21 赵欣瑶 <table border="1"><tr><td></td><td></td><td></td></tr><tr><td></td><td></td><td></td></tr><tr><td></td><td></td><td></td></tr></table> Post - 0 Miss - 0 Block - 0										22 邢力丹 <table border="1"><tr><td></td><td></td><td></td></tr><tr><td></td><td></td><td></td></tr><tr><td></td><td></td><td></td></tr></table> Post - 0 Miss - 0 Block - 0										23 王家琪 <table border="1"><tr><td></td><td></td><td></td></tr><tr><td></td><td></td><td></td></tr><tr><td></td><td></td><td></td></tr></table> Post - 0 Miss - 0 Block - 0										28 江迎新 <table border="1"><tr><td></td><td></td><td></td></tr><tr><td></td><td></td><td></td></tr><tr><td></td><td></td><td></td></tr></table> Post - 0 Miss - 0 Block - 0									
		1																																																																													

16 王启欣

0/2	0/1	0/2
1/1		1/2
1/1	0/1	0/1

22 邢力丹

0/3		1/2
1/1	1/1	
	0/1	

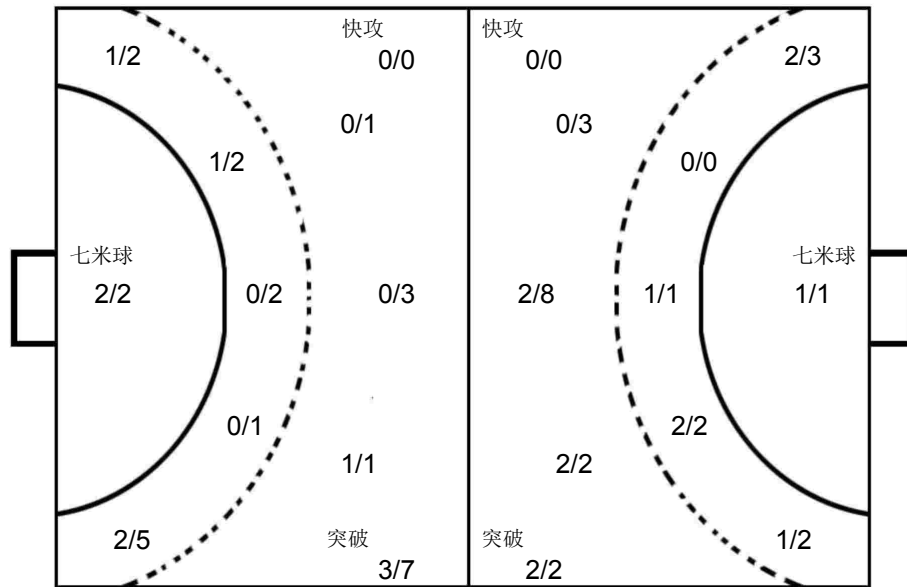

1 张家轩

2/4	1/1	3/7
3/3		1/4
0/1		2/2

安徽滁州

1 张家轩 <table border="1"><tr><td></td><td></td><td></td></tr><tr><td></td><td></td><td></td></tr><tr><td></td><td></td><td></td></tr></table> Post - 0 Miss - 0 Block - 0										2 钟梦 <table border="1"><tr><td></td><td></td><td></td></tr><tr><td></td><td></td><td></td></tr><tr><td></td><td></td><td></td></tr></table> Post - 0 Miss - 0 Block - 0										3 孙明月 <table border="1"><tr><td></td><td></td><td></td></tr><tr><td></td><td></td><td>1</td></tr><tr><td></td><td></td><td></td></tr></table> Post - 2 Miss - 0 Block - 0						1				7 丁洁 <table border="1"><tr><td></td><td></td><td></td></tr><tr><td></td><td></td><td></td></tr><tr><td></td><td></td><td></td></tr></table> Post - 0 Miss - 0 Block - 0										9 窦海乐 <table border="1"><tr><td>2</td><td></td><td></td></tr><tr><td></td><td></td><td></td></tr><tr><td></td><td></td><td></td></tr></table> Post - 0 Miss - 1 Block - 0	2									16 刘子琪 <table border="1"><tr><td></td><td></td><td></td></tr><tr><td></td><td></td><td></td></tr><tr><td></td><td></td><td></td></tr></table> Post - 0 Miss - 0 Block - 0										25 耿雨萍 <table border="1"><tr><td></td><td></td><td></td></tr><tr><td></td><td></td><td></td></tr><tr><td></td><td></td><td></td></tr></table> Post - 0 Miss - 0 Block - 0										26 张雅婷 <table border="1"><tr><td></td><td></td><td></td></tr><tr><td></td><td></td><td></td></tr><tr><td></td><td></td><td></td></tr></table> Post - 0 Miss - 0 Block - 0									
		1																																																																													
2																																																																															
28 马雯怡 <table border="1"><tr><td></td><td></td><td></td></tr><tr><td></td><td></td><td></td></tr><tr><td></td><td></td><td></td></tr></table> Post - 0 Miss - 0 Block - 0										30 罗佳乐 <table border="1"><tr><td></td><td></td><td></td></tr><tr><td></td><td></td><td></td></tr><tr><td></td><td></td><td></td></tr></table> Post - 0 Miss - 0 Block - 0										32 王小雅 <table border="1"><tr><td></td><td></td><td></td></tr><tr><td></td><td></td><td></td></tr><tr><td></td><td></td><td></td></tr></table> Post - 0 Miss - 0 Block - 0										34 姜影 <table border="1"><tr><td></td><td>1</td><td></td></tr><tr><td></td><td></td><td></td></tr><tr><td></td><td></td><td></td></tr></table> Post - 0 Miss - 0 Block - 0		1								35 李旭 <table border="1"><tr><td>1</td><td></td><td>1</td></tr><tr><td></td><td></td><td></td></tr><tr><td></td><td></td><td></td></tr></table> Post - 1 Miss - 1 Block - 0	1		1							36 高奇欣 <table border="1"><tr><td>1</td><td></td><td>1</td></tr><tr><td></td><td></td><td>1</td></tr><tr><td></td><td>1</td><td></td></tr></table> Post - 0 Miss - 0 Block - 0	1		1			1		1		38 潘楠 <table border="1"><tr><td>1</td><td></td><td>1</td></tr><tr><td></td><td></td><td></td></tr><tr><td></td><td></td><td>1</td></tr></table> Post - 0 Miss - 0 Block - 0	1		1						1										
	1																																																																														
1		1																																																																													
1		1																																																																													
		1																																																																													
	1																																																																														
1		1																																																																													
		1																																																																													



第二届全国青年运动会女子手球甲组决赛 体校组 (U18)

青年女子 国内比赛

预赛 Group A



PHMS Pictorial Handball Match Statistics

IHF Official System

Team A					Team B					Match Number											
A 北京市					B 江苏常州					35											
Played in			in the hall			on			at			Spectators									
山西晋中			晋中体育馆			2019-06-17			18:40			hours									
Half-time(30')	A	B	End of playing time	A	B	1st extra time	A	B	2nd extra time	A	B	After penalty throws	A	B							
	6	12		13	23																
Number of 7 m	A	Team time-out			Full name of players and officials						Team time-out			B	Number of 7 m						
	2/4	1	2	3							1	2	3	0/0							
		11:47	15:04	34:56																	
No.	Team A					G	W	2'	D	DR	No.	Team B					G	W	2'	D	DR
1	靳爽										1	胡雨诺					1				
5	常凯旋										7	张嘉朔							2		
7	翟乃迪					3	1				8	董桂林									
8	武宏业					4		1			9	顾霞光									
10	胡冰心										14	庄红艳					6				
11	陈丽婷					5					15	王艺儒									
14	侯美林					1					19	焦雅					5	1			
16	周晓雨										20	渠文娜					3				
18	唐文杰										21	吴静雯					2				
23	黄文文										22	彭如玉					1				
27	田苗										24	王铃娜					4				
81	王木子										25	李秋淇					1				
87	王奥							2			26	邱聿芳									
88	彭爽爽										27	李袁梦									
											28	黄奕涵									
											29	陈赛楠									
B	黄承 (主教练)										A	金甲洙 (主教练)									
C	栾征										B	马彪									
D	石伟										C	李海鹰									
E	刘文勇										D	陈志伟									
A	Signatures of responsables for the teams (Off.A)															B					
TP	Remarks of referees / HF Official															TP					

Signatures

Referees	李巧宁 (CHN)	宋优悠 (CHN)		
T.D.	刘凤娟 (CHN)	叶霄雪 (CHN)		
CHA Off.				

Note: Number of 7m Throws Awarded to Team A and B, Goals (G), Warnings (W), Suspensions (2'), Direct Disqualification (D), Disqualification With Report (DR) and Team Penalty (TP).

Table Officials: 贾腾 宋昌鑫 Statisticians: 谢扬 陈柱





第二届全国青年运动会女子手球甲组决赛 体校组 (U18)



PHMS Pictorial Handball Match Statistics

IHF Official System

竞赛技术统计

手球  
青年女子

预赛  
轮次 3

组别 A  
场次 35

晋中体育馆  
2019-06-17 18:40

Referees:	李巧宁 (CHN) / 宋优悠 (CHN)	Result:	13:23 (6:12)
Teams:	北京市(北京) VS 江苏常州(常州)		

北京		远射	近射	边射	快攻	突破	任意球	7m球	合计	%	助攻	失误	警告	2'	D+DR
主教练: 黄承															
1	靳爽														
5	常凯旋														
7	翟乃迪		0/1	2/2		1/1			3/4	75.0		3	1		
8	武宏业	2/6	1/1			1/1			4/8	50.0		2		1	
10	胡冰心			0/1					0/1	0.0					
11	陈丽婷	2/7	1/2			1/1	0/1	1/2	5/13	38.5		1			
14	侯美林							1/2	1/2	50.0		2			
16	周晓雨														
18	唐文杰											2			
23	黄文文			0/1					0/1	0.0					
27	田苗														
81	王木子													2	
87	王奥											1			
88	彭爽爽											1			
运动员 合计		4/13	2/4	2/4		3/3	0/1	2/4	13/29	44.8		12	1	3	
1	靳爽	2/8	1/5	5/7	1/8	0/2	0/2		9/32	28.1					
守门员 合计		2/8	1/5	5/7	1/8	0/2	0/2		9/32	28.1					

北京	比赛进程	常州
1st Half		
0	01:16	1 20 渠文娜
0	01:37	2 24 王铃娜
11 陈丽婷	1 02:42	2
	1 04:27	3 24 王铃娜
	1 05:03	4 14 庄红艳
14 侯美林	2 05:57	4
11 陈丽婷	3 07:14	4
	3 07:39	5 21 吴静雯
	3 09:06	6 1 胡雨诺
	3 09:43	7 14 庄红艳
11 陈丽婷	4 10:26	7
	4 12:22	8 19 焦雅
	4 13:22	9 14 庄红艳
	4 14:18	10 21 吴静雯
	4 15:28	11 14 庄红艳
8 武宏业	5 16:44	11
11 陈丽婷	6 18:53	11
	6 19:10	12 19 焦雅
2nd Half		
11 陈丽婷	7 00:34	12
	7 00:43	13 19 焦雅
7 翟乃迪	8 01:19	13
8 武宏业	9 03:16	13
	9 04:51	14 19 焦雅
	9 05:34	15 20 渠文娜
7 翟乃迪	10 06:29	15
	10 09:21	16 14 庄红艳
	10 10:07	17 24 王铃娜
7 翟乃迪	11 10:46	17
	11 10:54	18 24 王铃娜
	11 12:18	19 20 渠文娜
	11 14:46	20 25 李秋淇
8 武宏业	12 15:40	20
	12 16:46	21 19 焦雅
	12 17:17	22 14 庄红艳
8 武宏业	13 18:12	22
	13 20:00	23 22 彭如玉

常州		远射	近射	边射	快攻	突破	任意球	7m球	合计	%	助攻	失误	警告	2'	D+DR
主教练: 金甲洙															
1	胡雨诺	1/1							1/1	100					
7	张嘉朔													2	
8	董桂林														
9	顾霞光														
14	庄红艳	1/1		0/1	5/5				6/7	85.7					
15	王艺儒														
19	焦雅	1/5	3/3				1/1		5/9	55.6		1	1		
20	渠文娜	2/6				1/1			3/7	42.9					
21	吴静雯	0/2		0/2	0/1	1/1	1/1		2/7	28.6		1			
22	彭如玉	1/1							1/1	100	1				
24	王铃娜	0/1	1/3	1/3	2/2				4/9	44.4		2			
25	李秋淇			1/2					1/2	50.0					
26	邱聿芳														
27	李袁梦														
28	黄奕涵														
29	陈赛楠														
运动员 合计		6/17	4/6	2/8	7/8	2/2	2/2		23/43	53.5	1	4	1	2	
1	胡雨诺	3/6	0/1	1/2		0/2		1/3	5/14	35.7					
22	彭如玉	3/4	2/3	0/1		0/1	1/1		6/10	60.0	1				
守门员 合计		6/10	2/4	1/3		0/3	1/1	1/3	11/24	45.8	1				

场上队员: 得分 / 射门

守门员: 救球 / 射门

D	取消资格	DR	取消资格+报告
---	------	----	---------





## 个人/全队技术统计表

手球 青年女子 预赛 轮次 3 组别 A 场次 35 晋中体育馆 2019-06-17 18:40

号码	姓名	远射	近射	边射	快攻	突破	任意	七米	合计	%	助攻	失误	警告	2'	取消	时间
北京市(北京)																
(场上队员)																
1	靳爽								3/4	75.0%						00:40:00
5	常凯旋								0/1	0.0%						00:04:54
7	翟乃迪		0/1	2/2		1/1			3/4	75.0%	3		1			00:25:31
8	武宏业	2/6	1/1			1/1			4/8	50.0%	2			1		00:26:16
10	胡冰心			0/1					0/1	0.0%						00:23:51
11	陈丽婷	2/7	1/2			1/1	0/1	1/2	5/13	38.5%	1					00:35:33
14	侯美林							1/2	1/2	50.0%	2					00:31:09
16	周晓雨								0/1	0.0%						00:00:00
18	唐文杰								0/1	0.0%		2				00:20:00
23	黄文文			0/1					0/1	0.0%						00:12:06
27	田苗								0/1	0.0%						00:13:32
81	王木子								0/1	0.0%						00:04:56
87	王奥								0/1	0.0%	1			2		00:20:00
88	彭爽爽								0/1	0.0%	1					00:21:28
合计		4/13	2/4	2/4		3/3	0/1	2/4	13/29	44.8%	12		1	3		

## (守门员)

1	靳爽	2/8	1/5	5/7	1/8	0/2	0/2		9/32	28.1%						00:40:00
合计		2/8	1/5	5/7	1/8	0/2	0/2		9/32	28.1%						

场上队员：得分/射门

守门员：救球/射门

全队合计	得分	被救	射失	击柱	封球	合计	%
远射	4	6	2	1		13	30.8%
近射	2	2				4	50.0%
边射	2	1		1		4	50.0%
快攻							0.0%
突破	3					3	100.0%
任意		1				1	0.0%
七米	2	1		1		4	50.0%

## 第二届全国青年运动会女子手球甲组决赛 体校组 (U18)

PHMS Pictorial Handball Match Statistics

IHF Official System

### 个人/全队技术统计表

手球 青年女子 预赛 轮次 3 组别 A 场次 35 晋中体育馆 2019-06-17 18:40

号码	姓名	远射	近射	边射	快攻	突破	任意	七米	合计	%	助攻	失误	警告	2'	取消	时间
<b>江苏常州(常州)</b>																
<b>(场上队员)</b>																
1	胡雨诺	1/1							1/1	100%						00:23:24
7	张嘉朔									0.0%				2		00:35:05
8	董桂林									0.0%						00:00:00
9	顾霞光									0.0%						00:00:00
14	庄红艳	1/1		0/1	5/5				6/7	85.7%						00:37:20
15	王艺儒									0.0%						00:00:00
19	焦雅	1/5	3/3				1/1		5/9	55.6%		1	1			00:36:46
20	渠文娜	2/6				1/1			3/7	42.9%						00:31:27
21	吴静雯	0/2		0/2	0/1	1/1	1/1		2/7	28.6%		1				00:29:15
22	彭如玉	1/1							1/1	100%	1					00:16:36
24	王铃娜	0/1	1/3	1/3	2/2				4/9	44.4%		2				00:35:30
25	李秋淇			1/2					1/2	50.0%						00:08:05
26	邱聿芳									0.0%						00:00:00
27	李袁梦									0.0%						00:16:31
28	黄奕涵									0.0%						00:09:21
29	陈赛楠									0.0%						00:00:02
<b>合计</b>		<b>6/17</b>	<b>4/6</b>	<b>2/8</b>	<b>7/8</b>	<b>2/2</b>	<b>2/2</b>		<b>23/43</b>	<b>53.5%</b>	<b>1</b>	<b>4</b>	<b>1</b>	<b>2</b>		
<b>(守门员)</b>																
1	胡雨诺	3/6	0/1	1/2		0/2		1/3	5/14	35.7%						00:23:24
22	彭如玉	3/4	2/3	0/1		0/1	1/1		6/10	60.0%	1					00:16:36
<b>合计</b>		<b>6/10</b>	<b>2/4</b>	<b>1/3</b>		<b>0/3</b>	<b>1/1</b>	<b>1/3</b>	<b>11/24</b>	<b>45.8%</b>	<b>1</b>					

场上队员：得分/射门

守门员：救球/射门

全队合计	得分	被救	射失	击柱	封球	合计	%
远射	6	2	3	2	4	17	35.3%
近射	4	1		1		6	66.7%
边射	2	5	1			8	25.0%
快攻	7	1				8	87.5%
突破	2					2	100.0%
任意	2					2	100.0%
七米							0.0%

图式比赛技术统计表

手球  
青年女子

预赛  
轮次 3

组别 A  
场次 35

晋中体育馆  
2019-06-17 18:40

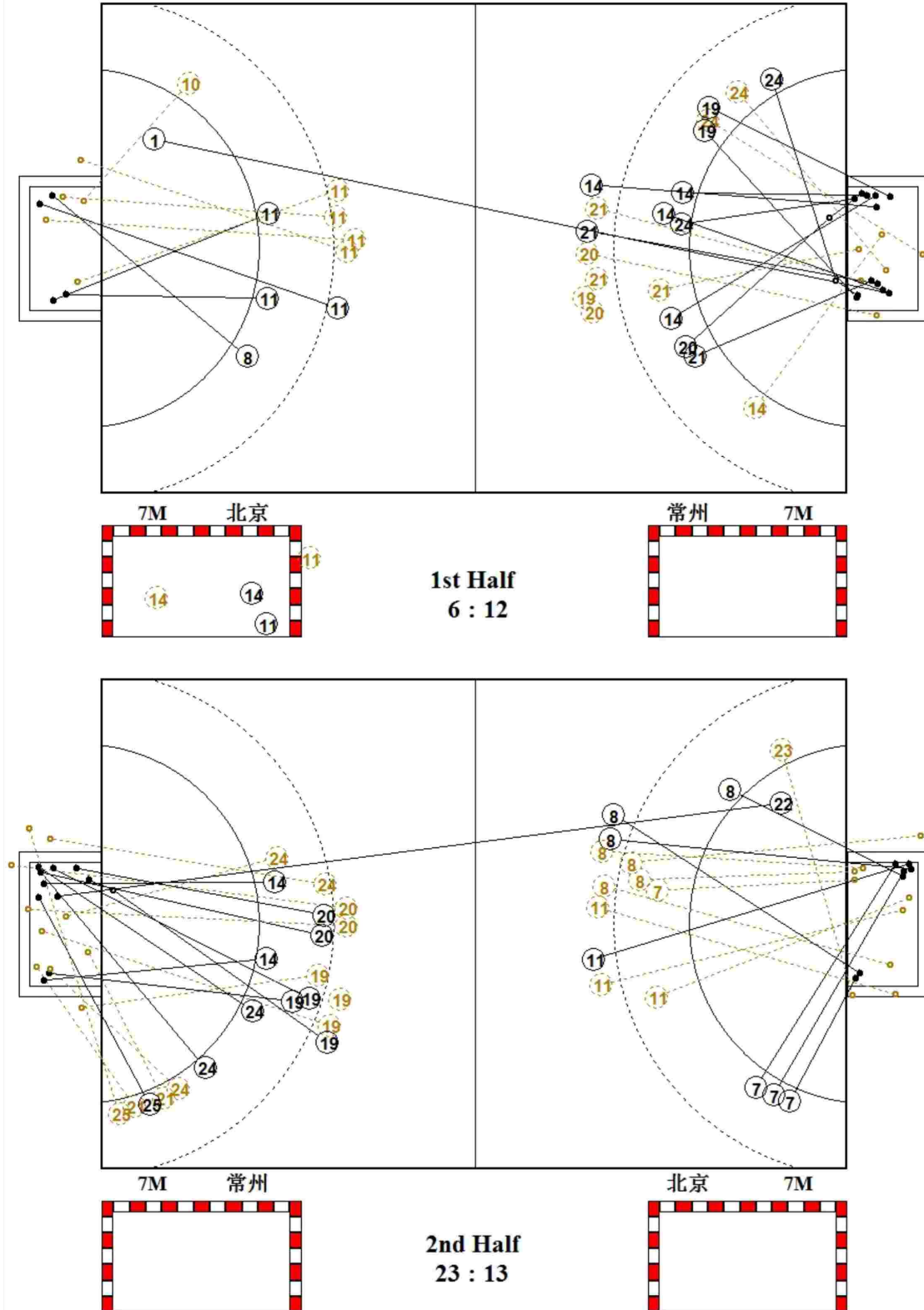

图式射门区域统计

手球  
青年女子

预赛  
轮次 3

组别 A  
场次 35

晋中体育馆  
2019-06-17 18:40

北京市

1 靳爽 Post - 0 Miss - 0 Block - 0	5 常凯旋 Post - 0 Miss - 0 Block - 0	7 翟乃迪 Post - 0 Miss - 0 Block - 0	8 武宏业 Post - 0 Miss - 1 Block - 0	10 胡冰心 Post - 0 Miss - 0 Block - 0	11 陈丽婷 Post - 2 Miss - 1 Block - 0	14 侯美林 Post - 0 Miss - 0 Block - 0	16 周晓雨 Post - 0 Miss - 0 Block - 0
18 唐文杰 Post - 0 Miss - 0 Block - 0	23 黄文文 Post - 1 Miss - 0 Block - 0	27 田苗 Post - 0 Miss - 0 Block - 0	81 王木子 Post - 0 Miss - 0 Block - 0	87 王奥 Post - 0 Miss - 0 Block - 0	88 彭爽爽 Post - 0 Miss - 0 Block - 0		

1 靳爽	2/4	1/1	0/6
	0/3	2/2	1/7
	1/4	1/1	1/4

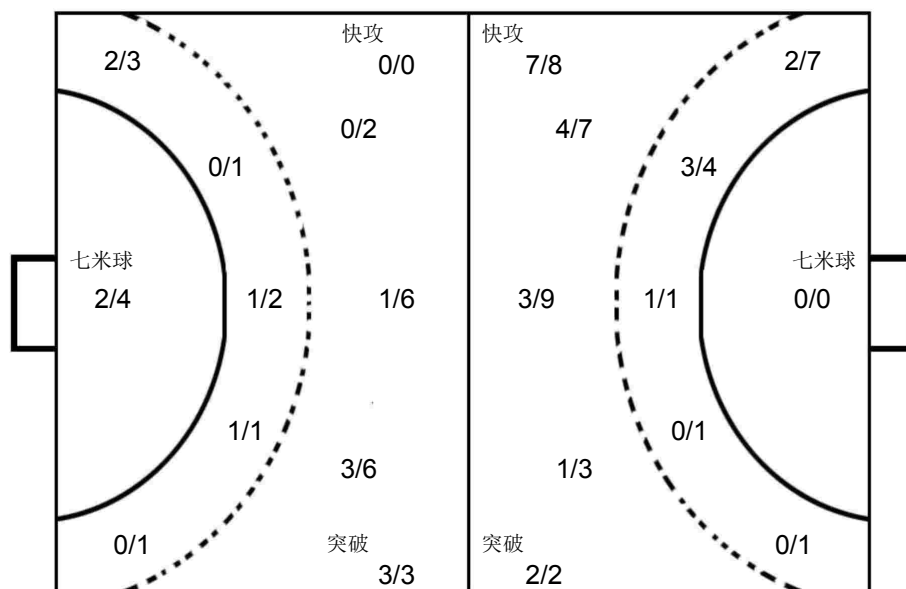

1 胡雨诺	0/4	1/3
	2/3	1/2
		1/2

22 彭如玉	1/3	1/1
		1/1
	3/3	0/2

江苏常州

1 胡雨诺 Post - 0 Miss - 0 Block - 0	7 张嘉朔 Post - 0 Miss - 0 Block - 0	8 董桂林 Post - 0 Miss - 0 Block - 0	9 顾霞光 Post - 0 Miss - 0 Block - 0	14 庄红艳 Post - 0 Miss - 0 Block - 0	15 王艺儒 Post - 0 Miss - 0 Block - 0	19 焦雅 Post - 0 Miss - 1 Block - 2	20 渠文娜 Post - 2 Miss - 1 Block - 1
21 吴静雯 Post - 0 Miss - 0 Block - 1	22 彭如玉 Post - 0 Miss - 0 Block - 0	24 王铃娜 Post - 1 Miss - 1 Block - 0	25 李秋淇 Post - 0 Miss - 1 Block - 0	26 邱聿芳 Post - 0 Miss - 0 Block - 0	27 李袁梦 Post - 0 Miss - 0 Block - 0	28 黄奕涵 Post - 0 Miss - 0 Block - 0	29 陈赛楠 Post - 0 Miss - 0 Block - 0



第二届全国青年运动会女子手球甲组决赛 体校组 (U18)

青年女子 国内比赛

预赛 Group A



PHMS Pictorial Handball Match Statistics

IHF Official System

Team A				Team B				Match Number													
A 广东深圳				B 香港				38													
Played in		in the hall		on		at		Spectators													
山西晋中		晋中体育馆		2019-06-18		16:20		hours													
Half-time(30')	A	B	End of playing time	A	B	1st extra time	A	B	2nd extra time	A	B	After penalty throws	A	B							
	8	7	15	11																	
Number of 7 m	A	Team time-out			Full name of players and officials			Team time-out			B	Number of 7 m									
	1/3	1	2	3				1	2	3	5/7										
			36:46				08:29	25:08	31:12												
No.	Team A					G	W	2'	D	DR	No.	Team B					G	W	2'	D	DR
2	唐悦					2					1	郑晓容									
3	赵晔					3	1	1			3	黄秋婷									
5	朱嘉盈					5		1			4	何丹仪									
6	朱嘉晴										5	卓凯晴					5				
7	曾妮										6	洪卓翹									
9	张雨乐					2	1				8	李芷欣						1			
10	徐瑜琳							1			9	林卓琪							1		
11	王文卉										11	庄斯琪					1				
12	于雅梦										16	曾婉琳					4				
13	刘培天					1					17	梁艺									
16	邹童羽										18	吴嘉妮									
17	冯颖慧										21	林乐儿									
18	谢宛彤										23	王洁桦									
20	岳欣华					2					25	戴子怡					1				
											28	郭芷彤									
											91	孔倩瑜									
B	张敬敏										A	杨开将									
C	常敏 (主教练)										B	何颂邦									
D	蒋光华										C	梁倩盈									
E	夏恒																				
A	Signatures of responsables for the teams (Off.A)										B										
TP	Remarks of referees / HF Official										TP										

Signatures

Referees	冯雨生 (CHN)	刘晓辉 (CHN)		
T.D.	吴瑞亭 (CHN)	柴业宏 (CHN)		
CHA Off.				

Note: Number of 7m Throws Awarded to Team A and B, Goals (G), Warnings (W), Suspensions (2'), Direct Disqualification (D), Disqualification With Report (DR) and Team Penalty (TP).

Table Officials: 马迪

王志超

Statisticians: 刘笑

王梓衡



竞赛技术统计

手球  
青年女子

预赛  
轮次 4

组别 A  
场次 38

晋中体育馆  
2019-06-18 16:20

Referees:	冯雨生 (CHN) / 刘晓辉 (CHN)	Result:	15:11(8:7)
Teams:	广东深圳(深圳) VS 香港(香港)		

深圳		远射	近射	边射	快攻	突破	任意球	7m球	合计	%	助攻	失误	警告	2'	D+DR
主教练:	常敏														
2	唐悦	0/2	1/3				0/1	1/2	2/8	25.0	4	2			
3	赵晔	2/3		0/1	1/1	0/1	0/2	0/1	3/9	33.3	1		1	1	
5	朱嘉盈	1/5		1/2	3/4				5/11	45.5	2	4		1	
6	朱嘉晴		0/1	0/1					0/2	0.0		2			
7	曾妮														
9	张雨乐			0/2	2/2				2/4	50.0			1		
10	徐瑜琳													1	
11	王文卉														
12	于雅梦														
13	刘培天		1/1					1/1	1/1	100		1			
16	邹童羽										1	1			
17	冯颖慧														
18	谢宛彤														
20	岳欣华		1/1	1/2				2/3	66.7						
运动员	合计	3/10	3/6	2/8	6/7	0/1	0/3	1/3	15/38	39.5	8	10	2	3	
16	邹童羽	3/3	0/1	5/6		1/5	1/1	1/5	11/21	52.4	1	1			
17	冯颖慧							0/1	0/1	0.0					
守门员	合计	3/3	0/1	5/6		1/5	1/1	1/6	11/22	50.0	1	1			

深圳	比赛进程	香港
	1st Half	
0	00:36	1 16 曾婉琳
5 朱嘉盈	1 01:45	1
	1 03:19	2 5 卓凯晴
5 朱嘉盈	2 05:59	2
2 唐悦	3 07:13	2
2 唐悦	4 09:08	2
	4 09:47	3 11 庄斯琪
3 赵晔	5 11:36	3
9 张雨乐	6 12:22	3
3 赵晔	7 16:05	3
	7 16:17	4 16 曾婉琳
13 刘培天	8 16:43	4
	8 18:01	5 5 卓凯晴
	8 19:03	6 16 曾婉琳
	8 19:59	7 16 曾婉琳
	2nd Half	
3 赵晔	9 00:10	7
	9 04:21	8 25 戴子怡
5 朱嘉盈	10 08:21	8
9 张雨乐	11 09:58	8
5 朱嘉盈	12 11:52	8
	12 13:56	9 5 卓凯晴
20 岳欣华	13 14:51	9
	13 16:26	10 5 卓凯晴
20 岳欣华	14 18:03	10
5 朱嘉盈	15 19:12	10
	15 19:51	11 5 卓凯晴

香港		远射	近射	边射	快攻	突破	任意球	7m球	合计	%	助攻	失误	警告	2'	D+DR
主教练:	梁倩盈														
1	郑晓容														
3	黄秋婷			0/2					0/2	0.0		1			
4	何丹仪														
5	卓凯晴							5/6	5/6	83.3					
6	洪卓翹														
8	李芷欣	0/3							0/3	0.0		2	1		
9	林卓琪	0/1							0/1	0.0		3		1	
11	庄斯琪			1/2			0/1		1/3	33.3		1			
16	曾婉琳	0/3				4/7			4/10	40.0		4			
17	梁艺														
18	吴嘉妮							0/1	0/1	0.0					
21	林乐儿														
23	王洁桦														
25	戴子怡		1/1						1/1	100		1			
28	郭芷彤														
91	孔倩瑜			0/2					0/2	0.0		2			
运动员	合计	0/7	1/1	1/6		4/7	0/1	5/7	11/29	37.9		14	1	1	
1	郑晓容	4/7	3/6	3/5	1/7	1/1	3/3	1/2	16/31	51.6					
守门员	合计	4/7	3/6	3/5	1/7	1/1	3/3	1/2	16/31	51.6					

场上队员: 得分 / 射门

守门员: 救球 / 射门

D	取消资格	DR	取消资格+报告
---	------	----	---------

## 个人/全队技术统计表

 手球 预赛 组别 A 晋中体育馆  
 青年女子 轮次 4 场次 38 2019-06-18 16:20

号码	姓名	远射	近射	边射	快攻	突破	任意	七米	合计	%	助攻	失误	警告	2'	取消	时间
广东深圳(深圳)																
(场上队员)																
2	唐悦	0/2	1/3			0/1	1/2	2/8	25.0%	4	2					00:25:33
3	赵晔	2/3		0/1	1/1	0/1	0/2	0/1	3/9	33.3%	1		1	1		00:39:58
5	朱嘉盈	1/5		1/2	3/4			5/11	45.5%	2	4			1		00:39:56
6	朱嘉晴		0/1	0/1				0/2	0.0%		2					00:39:55
7	曾妮								0.0%							00:00:00
9	张雨乐			0/2	2/2			2/4	50.0%				1			00:39:55
10	徐瑜琳								0.0%					1		00:14:24
11	王文卉								0.0%							00:00:00
12	于雅梦								0.0%							00:00:00
13	刘培天		1/1					1/1	100%			1				00:34:17
16	邹童羽								0.0%	1	1					00:39:35
17	冯颖慧								0.0%							00:00:25
18	谢宛彤								0.0%							00:00:00
20	岳欣华		1/1	1/2				2/3	66.7%							00:05:27
	合计	3/10	3/6	2/8	6/7	0/1	0/3	1/3	15/38	39.5%	8	10	2	3		
(守门员)																
16	邹童羽	3/3	0/1	5/6		1/5	1/1	1/5	11/21	52.4%	1	1				00:39:35
17	冯颖慧							0/1	0/1	0.0%						00:00:25
	合计	3/3	0/1	5/6		1/5	1/1	1/6	11/22	50.0%	1	1				

场上队员： 得分/射门

守门员： 救球/射门

全队合计	得分	被救	射失	击柱	封球	合计	%
远射	3	4	2	1		10	30.0%
近射	3	3				6	50.0%
边射	2	3	2	1		8	25.0%
快攻	6	1				7	85.7%
突破		1				1	0.0%
任意		3				3	0.0%
七米	1	1		1		3	33.3%

## 第二届全国青年运动会女子手球甲组决赛 体校组 (U18)

PHMS Pictorial Handball Match Statistics

IHF Official System

### 个人/全队技术统计表

手球 青年女子 预赛 轮次 4 组别 A 场次 38 晋中体育馆 2019-06-18 16:20

号码	姓名	远射	近射	边射	快攻	突破	任意	七米	合计	%	助攻	失误	警告	2'	取消	时间
香港(香港)																
(场上队员)																
1	郑晓容									0.0%						00:40:00
3	黄秋婷			0/2					0/2	0.0%	1					00:34:59
4	何丹仪									0.0%						00:10:28
5	卓凯晴							5/6	5/6	83.3%						00:02:14
6	洪卓翘									0.0%						00:00:00
8	李芷欣	0/3							0/3	0.0%	2	1				00:29:05
9	林卓琪	0/1							0/1	0.0%	3		1			00:26:59
11	庄斯琪			1/2			0/1		1/3	33.3%	1					00:21:37
16	曾婉琳	0/3				4/7			4/10	40.0%	4					00:39:41
17	梁艺									0.0%						00:02:18
18	吴嘉妮							0/1	0/1	0.0%						00:00:35
21	林乐儿									0.0%						00:00:00
23	王洁桦									0.0%						00:00:00
25	戴子怡		1/1						1/1	100%	1					00:39:27
28	郭芷彤									0.0%						00:00:00
91	孔倩瑜			0/2					0/2	0.0%	2					00:32:22
合计		0/7	1/1	1/6		4/7	0/1	5/7	11/29	37.9%	14	1	1			
(守门员)																
1	郑晓容	4/7	3/6	3/5	1/7	1/1	3/3	1/2	16/31	51.6%						00:40:00
合计		4/7	3/6	3/5	1/7	1/1	3/3	1/2	16/31	51.6%						

场上队员： 得分/射门

守门员： 救球/射门

全队合计	得分	被救	射失	击柱	封球	合计	%
远射		3	3	1		7	0.0%
近射	1					1	100.0%
边射	1	5				6	16.7%
快攻							0.0%
突破	4	1	1	1		7	57.1%
任意		1				1	0.0%
七米	5	1	1			7	71.4%



图式比赛技术统计表

手球  
青年女子

预赛  
轮次 4

组别 A  
场次 38

晋中体育馆  
2019-06-18 16:20

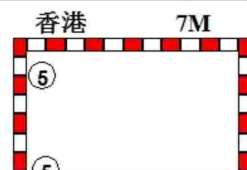
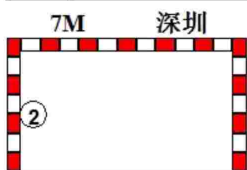
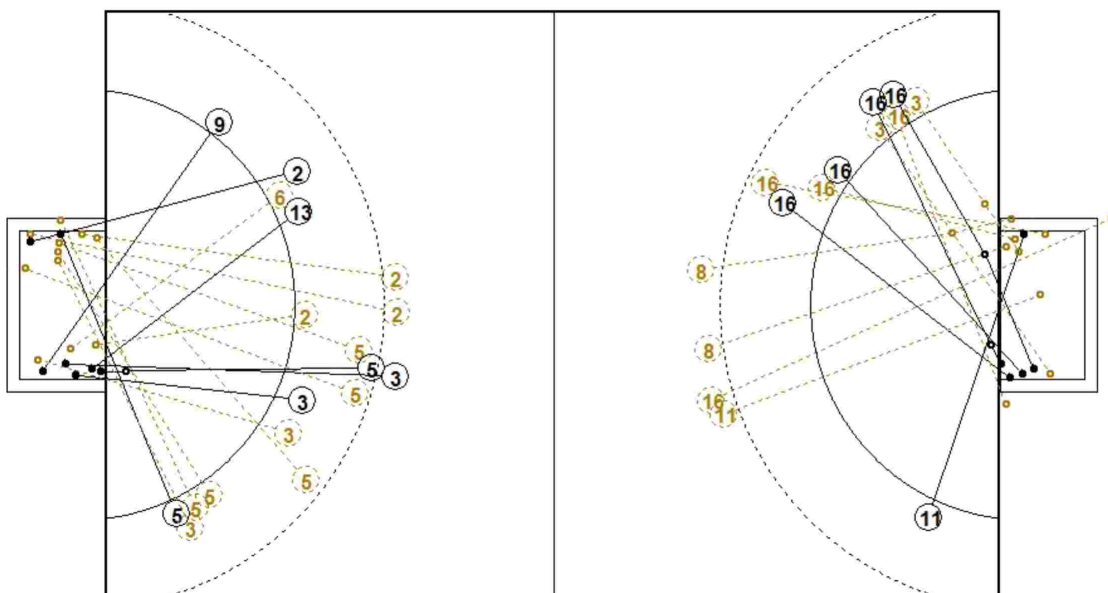

1st Half  
8 : 7

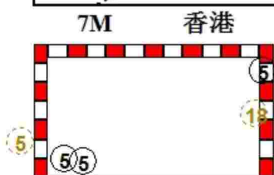
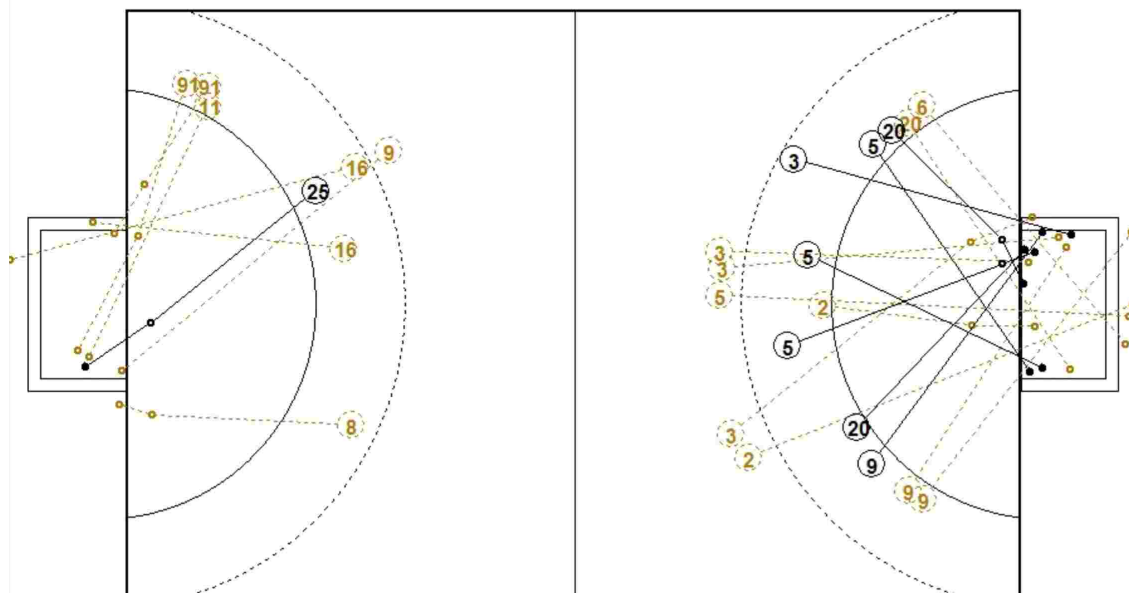

2nd Half  
11 : 15

图式射门区域统计

手球  
青年女子

预赛  
轮次 4

组别 A  
场次 38

晋中体育馆  
2019-06-18 16:20

广东深圳

2 唐悦	3 赵晔	5 朱嘉盈	6 朱嘉晴	7 曾妮	9 张雨乐	10 徐瑜琳	11 王文卉																																																																								
<table border="1"><tr><td></td><td></td><td>1</td></tr><tr><td>1</td><td></td><td></td></tr><tr><td></td><td></td><td></td></tr></table>			1	1						<table border="1"><tr><td></td><td></td><td></td></tr><tr><td>3</td><td></td><td></td></tr><tr><td></td><td></td><td></td></tr></table>				3						<table border="1"><tr><td></td><td></td><td></td></tr><tr><td></td><td></td><td>1</td></tr><tr><td>2</td><td></td><td>2</td></tr></table>						1	2		2	<table border="1"><tr><td></td><td></td><td></td></tr><tr><td></td><td></td><td></td></tr><tr><td></td><td></td><td></td></tr></table>										<table border="1"><tr><td></td><td></td><td></td></tr><tr><td></td><td></td><td></td></tr><tr><td></td><td></td><td></td></tr></table>										<table border="1"><tr><td>1</td><td></td><td></td></tr><tr><td></td><td></td><td></td></tr><tr><td>1</td><td></td><td></td></tr></table>	1						1			<table border="1"><tr><td></td><td></td><td></td></tr><tr><td></td><td></td><td></td></tr><tr><td></td><td></td><td></td></tr></table>										<table border="1"><tr><td></td><td></td><td></td></tr><tr><td></td><td></td><td></td></tr><tr><td></td><td></td><td></td></tr></table>									
		1																																																																													
1																																																																															
3																																																																															
		1																																																																													
2		2																																																																													
1																																																																															
1																																																																															
Post - 1 Miss - 1 Block - 0	Post - 1 Miss - 0 Block - 0	Post - 1 Miss - 1 Block - 0	Post - 0 Miss - 1 Block - 0	Post - 0 Miss - 0 Block - 0	Post - 0 Miss - 1 Block - 0	Post - 0 Miss - 0 Block - 0	Post - 0 Miss - 0 Block - 0																																																																								
12 于雅梦	13 刘培天	16 邹童羽	17 冯颖慧	18 谢宛彤	20 岳欣华																																																																										
<table border="1"><tr><td></td><td></td><td></td></tr><tr><td></td><td></td><td></td></tr><tr><td></td><td></td><td></td></tr></table>										<table border="1"><tr><td></td><td></td><td></td></tr><tr><td>1</td><td></td><td></td></tr><tr><td></td><td></td><td></td></tr></table>				1						<table border="1"><tr><td></td><td></td><td></td></tr><tr><td></td><td></td><td></td></tr><tr><td></td><td></td><td></td></tr></table>										<table border="1"><tr><td></td><td></td><td></td></tr><tr><td></td><td></td><td></td></tr><tr><td></td><td></td><td></td></tr></table>										<table border="1"><tr><td></td><td></td><td></td></tr><tr><td></td><td></td><td></td></tr><tr><td></td><td></td><td></td></tr></table>										<table border="1"><tr><td></td><td></td><td></td></tr><tr><td>1</td><td>1</td><td></td></tr><tr><td></td><td></td><td></td></tr></table>				1	1																								
1																																																																															
1	1																																																																														
Post - 0 Miss - 0 Block - 0	Post - 0 Miss - 0 Block - 0	Post - 0 Miss - 0 Block - 0	Post - 0 Miss - 0 Block - 0	Post - 0 Miss - 0 Block - 0	Post - 0 Miss - 0 Block - 0																																																																										

16 邹童羽

0/1		
3/4	1/1	2/3
4/8		1/4

17 冯颖慧

		0/1

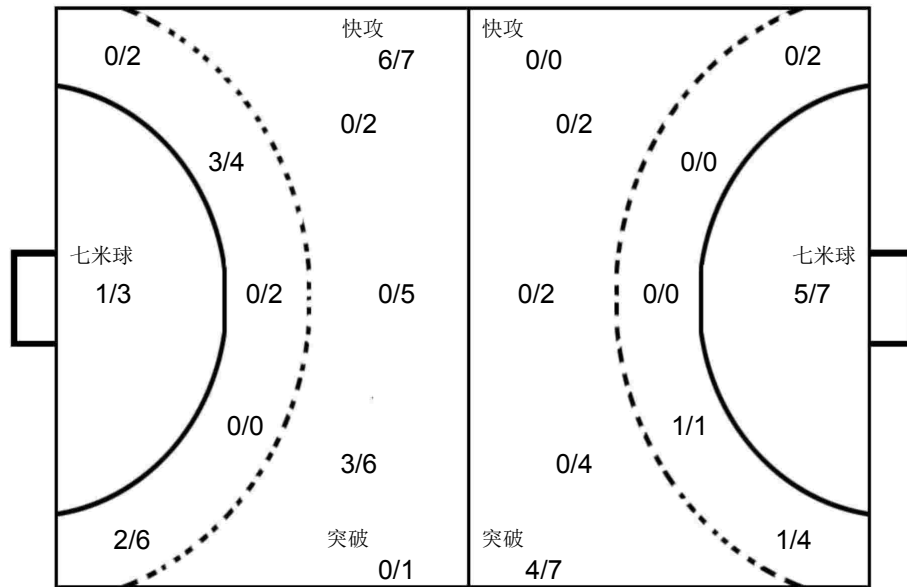

1 郑晓容

1/2		2/3
3/7		4/5
3/8	1/2	2/4

香港

1 郑晓容	3 黄秋婷	4 何丹仪	5 卓凯晴	6 洪卓翘	8 李芷欣	9 林卓琪	11 庄斯琪																																																																								
<table border="1"><tr><td></td><td></td><td></td></tr><tr><td></td><td></td><td></td></tr><tr><td></td><td></td><td></td></tr></table>										<table border="1"><tr><td></td><td></td><td></td></tr><tr><td></td><td></td><td></td></tr><tr><td></td><td></td><td></td></tr></table>										<table border="1"><tr><td></td><td></td><td></td></tr><tr><td></td><td></td><td></td></tr><tr><td></td><td></td><td></td></tr></table>										<table border="1"><tr><td>1</td><td></td><td>1</td></tr><tr><td></td><td></td><td></td></tr><tr><td>3</td><td></td><td></td></tr></table>	1		1				3			<table border="1"><tr><td></td><td></td><td></td></tr><tr><td></td><td></td><td></td></tr><tr><td></td><td></td><td></td></tr></table>										<table border="1"><tr><td></td><td></td><td></td></tr><tr><td></td><td></td><td></td></tr><tr><td></td><td></td><td></td></tr></table>										<table border="1"><tr><td></td><td></td><td></td></tr><tr><td></td><td></td><td></td></tr><tr><td></td><td></td><td></td></tr></table>										<table border="1"><tr><td></td><td></td><td></td></tr><tr><td></td><td></td><td></td></tr><tr><td></td><td></td><td></td></tr></table>									
1		1																																																																													
3																																																																															
Post - 0 Miss - 0 Block - 0	Post - 0 Miss - 0 Block - 0	Post - 0 Miss - 0 Block - 0	Post - 0 Miss - 1 Block - 0	Post - 0 Miss - 0 Block - 0	Post - 1 Miss - 1 Block - 0	Post - 0 Miss - 0 Block - 0	Post - 0 Miss - 0 Block - 0																																																																								
16 曾婉琳	17 梁艺	18 吴嘉妮	21 林乐儿	23 王洁桦	25 戴子怡	28 郭芷彤	91 孔倩瑜																																																																								
<table border="1"><tr><td></td><td></td><td></td></tr><tr><td></td><td></td><td>1</td></tr><tr><td></td><td></td><td>3</td></tr></table>						1			3	<table border="1"><tr><td></td><td></td><td></td></tr><tr><td></td><td></td><td></td></tr><tr><td></td><td></td><td></td></tr></table>										<table border="1"><tr><td></td><td></td><td></td></tr><tr><td></td><td></td><td></td></tr><tr><td></td><td></td><td></td></tr></table>										<table border="1"><tr><td></td><td></td><td></td></tr><tr><td></td><td></td><td></td></tr><tr><td></td><td></td><td></td></tr></table>										<table border="1"><tr><td></td><td></td><td></td></tr><tr><td></td><td></td><td></td></tr><tr><td></td><td></td><td></td></tr></table>										<table border="1"><tr><td></td><td></td><td></td></tr><tr><td>1</td><td></td><td></td></tr><tr><td></td><td></td><td></td></tr></table>				1						<table border="1"><tr><td></td><td></td><td></td></tr><tr><td></td><td></td><td></td></tr><tr><td></td><td></td><td></td></tr></table>										<table border="1"><tr><td></td><td></td><td></td></tr><tr><td></td><td></td><td></td></tr><tr><td></td><td></td><td></td></tr></table>									
		1																																																																													
		3																																																																													
1																																																																															
Post - 1 Miss - 3 Block - 0	Post - 0 Miss - 0 Block - 0	Post - 0 Miss - 0 Block - 0	Post - 0 Miss - 0 Block - 0	Post - 0 Miss - 0 Block - 0	Post - 0 Miss - 0 Block - 0	Post - 0 Miss - 0 Block - 0	Post - 0 Miss - 0 Block - 0																																																																								



第二届全国青年运动会女子手球甲组决赛 体校组 (U18)

青年女子 国内比赛

预赛 Group A



PHMS Pictorial Handball Match Statistics

IHF Official System

Team A					Team B					Match Number											
A 山东淄博					B 江苏常州					39											
Played in			in the hall			on			at			Spectators									
山西晋中			晋中体育馆			2019-06-18			17:30			hours									
Half-time(30')	A	B	End of playing time		A	B	1st extra time		A	B	2nd extra time		A	B	After penalty throws						
	7	7	15	18																	
Number of 7 m	A	Team time-out			Full name of players and officials						Team time-out			B	Number of 7 m						
	6/8	1	2	3							1	2	3	2/2							
		12:10	29:05	36:44																	
No.	Team A					G	W	2'	D	DR	No.	Team B					G	W	2'	D	DR
3	王静雯					8					1	胡雨诺									
5	张素娟										7	张嘉朔					1				
6	孙玉坤					4	1	1			8	董桂林									
7	辛彤慧										9	顾霞光									
8	王锦琦										14	庄红艳					6		1		
9	高梦洁					1					15	王艺儒									
10	崔佳惠										19	焦雅					6				
14	韩睿洁										20	渠文娜					4	1	1		
15	李骞飞										21	吴静雯									
16	王启欣										22	彭如玉									
17	蒋松妍										24	王铃娜					1				
19	户晴										25	李秋淇									
21	赵欣瑶					2					26	邱聿芳									
22	邢力丹										27	李袁梦					1				
23	王家琪										28	黄奕涵									
28	江迎新										29	陈赛楠									
B	徐美凤										A	金甲洙 (主教练)									
C	翟乾坤 (主教练)					1					B	马彪									
D	段文钰										C	李海鹰									
E	王日东										D	陈志伟									
Signatures of responsables for the teams (Off.A)																					
A																			B		
TP	Remarks of referees / HF Official																		TP		

Signatures

Referees	张耿 (CHN)	马晓晔 (CHN)		
T.D.	王洋 (CHN)	陈晓波 (CHN)		
CHA Off.				

Note: Number of 7m Throws Awarded to Team A and B, Goals (G), Warnings (W), Suspensions (2'), Direct Disqualification (D), Disqualification With Report (DR) and Team Penalty (TP).

Table Officials: 贾腾 孙龙龙 Statisticians: 王梓衡 刘笑



## 第二届全国青年运动会女子手球甲组决赛 体校组 (U18)

PHMS Pictorial Handball Match Statistics

IHF Official System

### 竞赛技术统计

手球  
青年女子

预赛  
轮次 4

组别 A  
场次 39

晋中体育馆  
2019-06-18 17:30

Referees:	张耿 (CHN) / 马晓晔 (CHN)	Result:	15:18(7:7)
Teams:	山东淄博(淄博) VS 江苏常州(常州)		

淄博		远	近	边	快	突	任意	7m	合计	%	助攻	失误	警告	2'	D+DR	淄博		常州	
主教练: 翟乾坤		射	射	射	攻	破	球	球								比赛 进程			
3	王静雯	1/6		1/1				6/7	8/14	57.1		1				1st Half			
5	张素娟															0 00:52		1 20 渠文娜	
6	孙玉坤	1/3	1/2			1/1	1/1	4/7	4/7	57.1			1	1		3 王静雯		2 02:21 1	
7	辛彤慧															2 03:35		2 14 庄红艳	
8	王锦琦															3 王静雯		3 05:48 2	
9	高梦洁	0/2	0/1		1/1	0/1		1/5	1/5	20.0		2				3 06:19		3 19 焦雅	
10	崔佳惠							0/1	0/1	0.0						3 07:17		4 14 庄红艳	
14	韩睿洁															3 08:37		5 27 李袁梦	
15	李鹏飞															4 08:50		5 5	
16	王启欣															4 09:38		6 20 渠文娜	
17	蒋松妍															5 11:16		6 6	
19	户晴			0/2					0/2	0.0		1				5 11:37		7 20 渠文娜	
21	赵欣瑶			1/2	1/1				2/3	66.7						6 14:38		7 7	
22	邢力丹															3 王静雯		6 14:38 7	
23	王家琪															3 王静雯		7 18:56 7	
28	江迎新												6			2nd Half			
运动员 合计		2/11	1/3	2/5	2/2	1/2	1/1	6/8	15/32	46.9		10	1	1		8 00:52		7	
22 邢力丹		3/7	1/2	4/7	2/7	0/3		0/2	10/28	35.7						9 04:04		8 20 渠文娜	
守门员 合计		3/7	1/2	4/7	2/7	0/3		0/2	10/28	35.7						9 04:58		9 14 庄红艳	
常州		远	近	边	快	突	任意	7m	合计	%	助攻	失误	警告	2'	D+DR	9 08:12		10 14 庄红艳	
主教练: 金甲洙		射	射	射	攻	破	球	球								10 09:36		10	
1	胡雨诺															3 王静雯		10 10:38 11	
7	张嘉朔			0/1												11 11:38		11 19 焦雅	
8	董桂林															11 12:06		12 19 焦雅	
9	顾霞光															11 13:53		13 14 庄红艳	
14	庄红艳	0/1		0/1	4/5	2/2		6/9	6/9	66.7	1	6		1		12 14:48		13	
15	王艺儒															12 15:30		14 19 焦雅	
19	焦雅	1/2	0/1	2/2	0/1	1/1		2/2	6/9	66.7		2				12 16:33		15 14 庄红艳	
20	渠文娜	3/3		1/1		0/1		4/5	4/5	80.0			1	1		12 17:16		16 19 焦雅	
21	吴静雯	0/2	0/1					0/3	0/3	0.0		1				13 17:25		16	
22	彭如玉										1					14 18:32		16	
24	王铃娜			0/2	1/1			1/3	1/3	33.3						14 19:08		17 19 焦雅	
25	李秋淇															14 19:37		18 24 王铃娜	
26	邱聿芳															15 19:48		18	
27	李袁梦		1/1					1/1	1/1	100									
28	黄奕涵																		
29	陈赛楠																		
运动员 合计		4/8	1/3	3/7	5/7	3/4		2/2	18/31	58.1	2	9	2	2					
1 胡雨诺		4/5		0/2	0/1			0/2	4/10	40.0									
22 彭如玉		2/3	1/2	2/2	0/1	1/2	0/1	2/6	8/17	47.1	1								
守门员 合计		6/8	1/2	2/4	0/2	1/2	0/1	2/8	12/27	44.4	1								

场上队员: 得分 / 射门

守门员: 救球 / 射门

D	取消资格	DR	取消资格+报告
---	------	----	---------

## 个人/全队技术统计表

手球 青年女子 预赛 轮次 4 组别 A 场次 39 晋中体育馆 2019-06-18 17:30

号码	姓名	远射	近射	边射	快攻	突破	任意	七米	合计	%	助攻	失误	警告	2'	取消	时间
<b>山东淄博(淄博)</b>																
<b>(场上队员)</b>																
3	王静雯	1/6		1/1				6/7	8/14	57.1%		1				00:40:00
5	张素娟									0.0%						00:00:00
6	孙玉坤	1/3	1/2			1/1	1/1		4/7	57.1%			1	1		00:40:00
7	辛彤慧									0.0%						00:00:00
8	王锦琦									0.0%						00:05:56
9	高梦洁	0/2	0/1		1/1	0/1			1/5	20.0%		2				00:39:50
10	崔佳惠							0/1	0/1	0.0%						00:02:50
14	韩春洁									0.0%						00:20:55
15	李骞飞									0.0%						00:00:00
16	王启欣									0.0%						00:00:00
17	蒋松妍									0.0%						00:00:00
19	卢晴			0/2					0/2	0.0%		1				00:39:08
21	赵欣瑶			1/2	1/1				2/3	66.7%						00:35:18
22	邢力丹									0.0%						00:40:00
23	王家琪									0.0%		6				00:16:03
28	江迎新									0.0%						00:00:00
	<b>合计</b>	<b>2/11</b>	<b>1/3</b>	<b>2/5</b>	<b>2/2</b>	<b>1/2</b>	<b>1/1</b>	<b>6/8</b>	<b>15/32</b>	<b>46.9%</b>		<b>10</b>	<b>1</b>	<b>1</b>		
<b>(守门员)</b>																
22	邢力丹	3/7	1/2	4/7	2/7	0/3		0/2	10/28	35.7%						00:40:00
	<b>合计</b>	<b>3/7</b>	<b>1/2</b>	<b>4/7</b>	<b>2/7</b>	<b>0/3</b>		<b>0/2</b>	<b>10/28</b>	<b>35.7%</b>						

场上队员：得分/射门

守门员：救球/射门

全队合计	得分	被救	射失	击柱	封球	合计	%
远射	2	6	2		1	11	18.2%
近射	1	1	1			3	33.3%
边射	2	2		1		5	40.0%
快攻	2					2	100.0%
突破	1	1				2	50.0%
任意	1					1	100.0%
七米	6	2				8	75.0%

## 第二届全国青年运动会女子手球甲组决赛 体校组 (U18)

**PHMS** Pictorial Handball Match Statistics

**IHF** Official System

### 个人/全队技术统计表

手球 青年女子 预赛 轮次 4 组别 A 场次 39 晋中体育馆 2019-06-18 17:30

号码	姓名	远射	近射	边射	快攻	突破	任意	七米	合计	%	助攻	失误	警告	2'	取消	时间
<b>江苏常州(常州)</b>																
<b>(场上队员)</b>																
1	胡雨诺									0.0%						00:12:03
7	张嘉朔			0/1					0/1	0.0%			1			00:26:21
8	董桂林									0.0%						00:00:00
9	顾霞光									0.0%						00:00:00
14	庄红艳	0/1		0/1	4/5	2/2			6/9	66.7%	1	6		1		00:39:16
15	王艺儒									0.0%						00:00:00
19	焦雅	1/2	0/1	2/2	0/1	1/1		2/2	6/9	66.7%		2				00:40:00
20	渠文娜	3/3		1/1		0/1			4/5	80.0%			1	1		00:39:35
21	吴静雯	0/2	0/1						0/3	0.0%		1				00:23:35
22	彭如玉									0.0%	1					00:28:01
24	王铃娜			0/2	1/1				1/3	33.3%						00:30:37
25	李秋淇									0.0%						00:00:00
26	邱聿芳									0.0%						00:00:00
27	李袁梦		1/1						1/1	100%						00:40:00
28	黄奕涵									0.0%						00:00:00
29	陈赛楠									0.0%						00:00:00
<b>合计</b>		<b>4/8</b>	<b>1/3</b>	<b>3/7</b>	<b>5/7</b>	<b>3/4</b>		<b>2/2</b>	<b>18/31</b>	<b>58.1%</b>	<b>2</b>	<b>9</b>	<b>2</b>	<b>2</b>		
<b>(守门员)</b>																
1	胡雨诺	4/5		0/2	0/1			0/2	4/10	40.0%						00:12:03
22	彭如玉	2/3	1/2	2/2	0/1	1/2	0/1	2/6	8/17	47.1%	1					00:28:01
<b>合计</b>		<b>6/8</b>	<b>1/2</b>	<b>2/4</b>	<b>0/2</b>	<b>1/2</b>	<b>0/1</b>	<b>2/8</b>	<b>12/27</b>	<b>44.4%</b>	<b>1</b>					

场上队员：得分/射门

守门员：救球/射门

全队合计	得分	被救	射失	击柱	封球	合计	%
远射	4	3		1		8	50.0%
近射	1	1	1			3	33.3%
边射	3	4				7	42.9%
快攻	5	2				7	71.4%
突破	3			1		4	75.0%
任意							0.0%
七米	2					2	100.0%

图式比赛技术统计表

手球  
青年女子

预赛  
轮次 4

组别 A  
场次 39

晋中体育馆  
2019-06-18 17:30

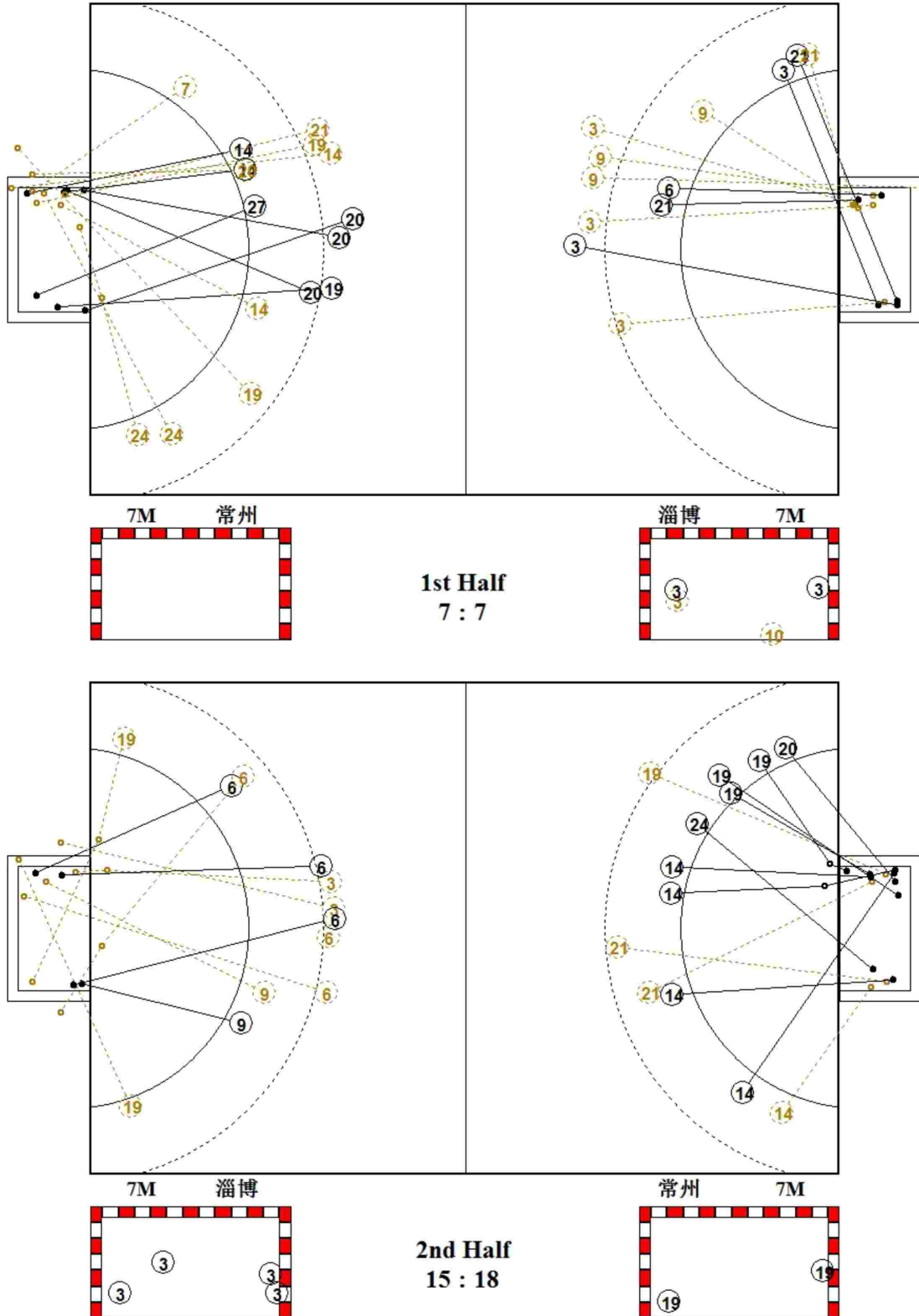

图式射门区域统计

手球  
青年女子

预赛  
轮次 4

组别 A  
场次 39

晋中体育馆  
2019-06-18 17:30

山东淄博

3 王静雯 <table border="1"><tr><td></td><td></td><td>1</td></tr><tr><td>2</td><td></td><td>3</td></tr><tr><td>1</td><td></td><td>1</td></tr></table> Post - 0 Miss - 1 Block - 0			1	2		3	1		1	5 张素娟 <table border="1"><tr><td></td><td></td><td></td></tr><tr><td></td><td></td><td></td></tr><tr><td></td><td></td><td></td></tr></table> Post - 0 Miss - 0 Block - 0										6 孙玉坤 <table border="1"><tr><td></td><td></td><td>1</td></tr><tr><td>1</td><td></td><td>1</td></tr><tr><td>1</td><td></td><td></td></tr></table> Post - 0 Miss - 1 Block - 1			1	1		1	1			7 辛彤慧 <table border="1"><tr><td></td><td></td><td></td></tr><tr><td></td><td></td><td></td></tr><tr><td></td><td></td><td></td></tr></table> Post - 0 Miss - 0 Block - 0										8 王锦琦 <table border="1"><tr><td></td><td></td><td></td></tr><tr><td></td><td></td><td></td></tr><tr><td></td><td></td><td></td></tr></table> Post - 0 Miss - 0 Block - 0										9 高梦洁 <table border="1"><tr><td></td><td></td><td></td></tr><tr><td></td><td></td><td></td></tr><tr><td>1</td><td></td><td></td></tr></table> Post - 0 Miss - 1 Block - 0							1			10 崔佳惠 <table border="1"><tr><td></td><td></td><td></td></tr><tr><td></td><td></td><td></td></tr><tr><td></td><td></td><td></td></tr></table> Post - 0 Miss - 0 Block - 0										14 韩睿洁 <table border="1"><tr><td></td><td></td><td></td></tr><tr><td></td><td></td><td></td></tr><tr><td></td><td></td><td></td></tr></table> Post - 0 Miss - 0 Block - 0									
		1																																																																													
2		3																																																																													
1		1																																																																													
		1																																																																													
1		1																																																																													
1																																																																															
1																																																																															
15 李鹏飞 <table border="1"><tr><td></td><td></td><td></td></tr><tr><td></td><td></td><td></td></tr><tr><td></td><td></td><td></td></tr></table> Post - 0 Miss - 0 Block - 0										16 王启欣 <table border="1"><tr><td></td><td></td><td></td></tr><tr><td></td><td></td><td></td></tr><tr><td></td><td></td><td></td></tr></table> Post - 0 Miss - 0 Block - 0										17 蒋松妍 <table border="1"><tr><td></td><td></td><td></td></tr><tr><td></td><td></td><td></td></tr><tr><td></td><td></td><td></td></tr></table> Post - 0 Miss - 0 Block - 0										19 卢晴 <table border="1"><tr><td></td><td></td><td></td></tr><tr><td></td><td></td><td></td></tr><tr><td></td><td></td><td></td></tr></table> Post - 1 Miss - 0 Block - 0										21 赵欣瑶 <table border="1"><tr><td></td><td></td><td>1</td></tr><tr><td></td><td></td><td></td></tr><tr><td>1</td><td></td><td></td></tr></table> Post - 0 Miss - 0 Block - 0			1				1			22 邢力丹 <table border="1"><tr><td></td><td></td><td></td></tr><tr><td></td><td></td><td></td></tr><tr><td></td><td></td><td></td></tr></table> Post - 0 Miss - 0 Block - 0										23 王家琪 <table border="1"><tr><td></td><td></td><td></td></tr><tr><td></td><td></td><td></td></tr><tr><td></td><td></td><td></td></tr></table> Post - 0 Miss - 0 Block - 0										28 江迎新 <table border="1"><tr><td></td><td></td><td></td></tr><tr><td></td><td></td><td></td></tr><tr><td></td><td></td><td></td></tr></table> Post - 0 Miss - 0 Block - 0									
		1																																																																													
1																																																																															

22 邢力丹

1/6		3/5
1/4		4/7
0/3		1/3

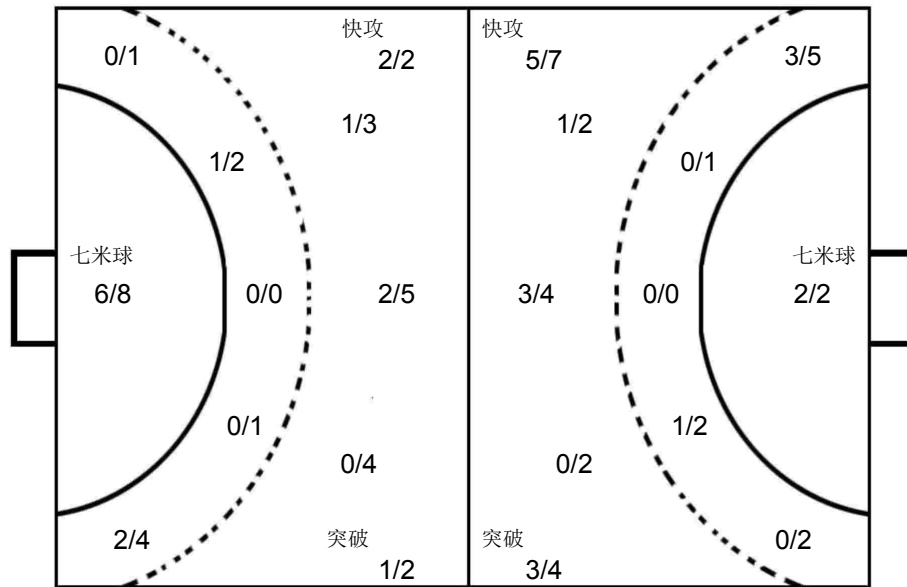

1 胡雨诺

		0/2
2/2		1/4
1/2		

22 彭如玉

1/1		1/2
1/4		1/2
2/5	1/1	1/2

江苏常州

1 胡雨诺 <table border="1"><tr><td></td><td></td><td></td></tr><tr><td></td><td></td><td></td></tr><tr><td></td><td></td><td></td></tr></table> Post - 0 Miss - 0 Block - 0										7 张嘉朔 <table border="1"><tr><td></td><td></td><td></td></tr><tr><td></td><td></td><td></td></tr><tr><td></td><td></td><td></td></tr></table> Post - 0 Miss - 0 Block - 0										8 董桂林 <table border="1"><tr><td></td><td></td><td></td></tr><tr><td></td><td></td><td></td></tr><tr><td></td><td></td><td></td></tr></table> Post - 0 Miss - 0 Block - 0										9 顾霞光 <table border="1"><tr><td></td><td></td><td></td></tr><tr><td></td><td></td><td></td></tr><tr><td></td><td></td><td></td></tr></table> Post - 0 Miss - 0 Block - 0										14 庄红艳 <table border="1"><tr><td>2</td><td></td><td>2</td></tr><tr><td>1</td><td></td><td>1</td></tr><tr><td></td><td></td><td></td></tr></table> Post - 1 Miss - 0 Block - 0	2		2	1		1				15 王艺儒 <table border="1"><tr><td></td><td></td><td></td></tr><tr><td></td><td></td><td></td></tr><tr><td></td><td></td><td></td></tr></table> Post - 0 Miss - 0 Block - 0										19 焦雅 <table border="1"><tr><td>1</td><td></td><td></td></tr><tr><td>2</td><td></td><td>1</td></tr><tr><td>2</td><td></td><td></td></tr></table> Post - 0 Miss - 1 Block - 0	1			2		1	2			20 渠文娜 <table border="1"><tr><td>1</td><td></td><td></td></tr><tr><td></td><td></td><td></td></tr><tr><td>1</td><td></td><td>2</td></tr></table> Post - 1 Miss - 0 Block - 0	1						1		2
2		2																																																																													
1		1																																																																													
1																																																																															
2		1																																																																													
2																																																																															
1																																																																															
1		2																																																																													
21 吴静雯 <table border="1"><tr><td></td><td></td><td></td></tr><tr><td></td><td></td><td></td></tr><tr><td></td><td></td><td></td></tr></table> Post - 0 Miss - 0 Block - 0										22 彭如玉 <table border="1"><tr><td></td><td></td><td></td></tr><tr><td></td><td></td><td></td></tr><tr><td></td><td></td><td></td></tr></table> Post - 0 Miss - 0 Block - 0										24 王铃娜 <table border="1"><tr><td></td><td></td><td></td></tr><tr><td></td><td></td><td>1</td></tr><tr><td></td><td></td><td></td></tr></table> Post - 0 Miss - 0 Block - 0						1				25 李秋淇 <table border="1"><tr><td></td><td></td><td></td></tr><tr><td></td><td></td><td></td></tr><tr><td></td><td></td><td></td></tr></table> Post - 0 Miss - 0 Block - 0										26 邱聿芳 <table border="1"><tr><td></td><td></td><td></td></tr><tr><td></td><td></td><td></td></tr><tr><td></td><td></td><td></td></tr></table> Post - 0 Miss - 0 Block - 0										27 李袁梦 <table border="1"><tr><td></td><td></td><td>1</td></tr><tr><td></td><td></td><td></td></tr><tr><td></td><td></td><td></td></tr></table> Post - 0 Miss - 0 Block - 0			1							28 黄奕涵 <table border="1"><tr><td></td><td></td><td></td></tr><tr><td></td><td></td><td></td></tr><tr><td></td><td></td><td></td></tr></table> Post - 0 Miss - 0 Block - 0										29 陈赛楠 <table border="1"><tr><td></td><td></td><td></td></tr><tr><td></td><td></td><td></td></tr><tr><td></td><td></td><td></td></tr></table> Post - 0 Miss - 0 Block - 0									
		1																																																																													
		1																																																																													





第二届全国青年运动会女子手球甲组决赛 体校组 (U18)

青年女子 国内比赛

预赛 Group A



PHMS Pictorial Handball Match Statistics

IHF Official System

Team A					Team B					Match Number											
A 澳门					B 北京市					40											
Played in			in the hall			on			at			Spectators									
山西晋中			晋中体育馆			2019-06-18			16:40			hours									
Half-time(30')	A	B	End of playing time		A	B	1st extra time		A	B	2nd extra time		A	B	After penalty throws						
	4	16	11 27																		
Number of 7 m	A	Team time-out			Full name of players and officials						Team time-out			B	Number of 7 m						
	2/3	1	2	3							1	2	3	1/1							
		07:49	31:51	38:16																	
No.	Team A					G	W	2'	D	DR	No.	Team B					G	W	2'	D	DR
8	譚嘉雯										1	靳爽									
10	盧曉汶										5	常凯旋					1	1			
11	李君移										7	翟乃迪					1				
12	李芷棋					5					8	武宏业					2				
15	張雪琳					2					9	徐慧敏					5	1			
18	曾華恩										10	胡冰心					2				
19	馮楚瑩										11	陈丽婷					6				
22	蘇萱婷					4					14	侯美林					2				
23	霍思允										16	周晓雨									
44	李嵐										18	唐文杰									
58	林诗雅										23	黄文文									
											27	田苗					1				
											81	王木子					2		1		
											87	王奥					2				
											88	彭爽爽					3				
A	蘇沛祺										B	黄承 (主教练)									
B	陳嘉聰 (主教练)										C	栾征									
C	霍俊浩										E	刘文勇									
Signatures of responsables for the teams (Off.A)																					
A																			B		
TP	Remarks of referees / HF Official																		TP		

Signatures

Referees	孟凡刚 (CHN)	刘斌 (CHN)		
T.D.	陈晓波 (CHN)	柴业宏 (CHN)		
CHA Off.				

Note: Number of 7m Throws Awarded to Team A and B, Goals (G), Warnings (W), Suspensions (2'), Direct Disqualification (D), Disqualification With Report (DR) and Team Penalty (TP).

Table Officials: 戴莹莹 马迪 Statisticians: 刘笑 王梓衡



竞赛技术统计

手球  
青年女子

预赛  
轮次 4

组别 A  
场次 40

晋中体育馆  
2019-06-18 16:40

Referees:	孟凡刚 (CHN) / 刘斌 (CHN)	Result:	11:27 (4:16)
Teams:	澳门(澳门) VS 北京市(北京)		

澳门		远射	近射	边射	快攻	突破	任意球	7m球	合计	%	助攻	失误	警告	2'	D+DR
主教练: 陳嘉聰															
8	譚嘉雯														
10	盧曉汶														
11	李君移	0/1							0/1	0.0					
12	李芷棋		3/5					2/3	5/8	62.5		2			
15	張雪琳	2/6					0/1		2/7	28.6	2	6			
18	曾華恩											2			
19	馮楚瑩														
22	蘇萱婷	3/6	1/1						4/7	57.1	4	4			
23	霍思允	0/1							0/1	0.0		4			
44	李嵐	0/2							0/2	0.0					
58	林詩雅														
运动员 合计		5/16	4/6				0/1	2/3	11/26	42.3	6	18			
10	盧曉汶	0/1	0/2	2/3	0/3	1/4	0/1		3/14	21.4					
19	馮楚瑩	0/5	0/1	0/1	0/8			0/1	0/16	0.0					
守门员 合计		0/6	0/3	2/4	0/11	1/4	0/1	0/1	3/30	10.0					

北京		远射	近射	边射	快攻	突破	任意球	7m球	合计	%	助攻	失误	警告	2'	D+DR
主教练: 黃承															
1	靳爽														
5	常凱旋				1/1	0/1			1/2	50.0		2	1		
7	翟乃迪						1/1		1/1	100					
8	武宏業				1/1			1/1	2/2	100		1			
9	徐慧敏	3/3	1/1		1/1				5/5	100		1	1		
10	胡冰心		1/2	0/1	1/1				2/4	50.0					
11	陳麗婷	2/2			2/2	2/2			6/6	100	1				
14	侯美林				1/1	1/2			2/3	66.7	2				
16	周曉雨														
18	唐文杰										1				
23	黃文文					0/1			0/1	0.0		1			
27	田苗				1/1				1/1	100		1			
81	王木子		1/1	1/1	0/1				2/3	66.7	1	1		1	
87	王奧			1/1	1/2				2/3	66.7		2			
88	彭爽爽	1/1		0/1	2/2				3/4	75.0					
运动员 合计		6/6	3/4	2/4	11/13	3/6	1/1	1/1	27/35	77.1	5	9	2	1	
1	靳爽	1/4	1/2						2/6	33.3					
16	周曉雨	2/4	0/3					0/2	2/9	22.2					
守门员 合计		3/8	1/5					0/2	4/15	26.7					

澳门	比赛进程	北京
1st Half		
0	01:00	1 11 陳麗婷
0	02:58	2 8 武宏業
0	03:28	3 11 陳麗婷
22 蘇萱婷	1 03:50	3
	1 04:01	4 88 彭爽爽
	1 04:37	5 10 胡冰心
	1 05:39	6 88 彭爽爽
	1 06:10	7 11 陳麗婷
	1 07:45	8 14 侯美林
22 蘇萱婷	2 08:11	8
	2 10:41	9 11 陳麗婷
	2 13:08	10 11 陳麗婷
22 蘇萱婷	3 13:35	10
	3 13:49	11 10 胡冰心
	3 14:25	12 88 彭爽爽
	3 16:16	13 11 陳麗婷
15 張雪琳	4 17:36	13
	4 18:49	14 27 田苗
	4 19:16	15 14 侯美林
	4 19:48	16 8 武宏業
2nd Half		
12 李芷棋	4 00:21	17 81 王木子
	5 01:22	17
	5 01:57	18 9 徐慧敏
	5 03:16	19 5 常凱旋
	5 03:49	20 9 徐慧敏
15 張雪琳	6 05:58	20
	6 06:06	21 9 徐慧敏
12 李芷棋	7 07:38	21
	7 08:05	22 9 徐慧敏
22 蘇萱婷	8 10:50	22
	8 11:35	23 81 王木子
	8 12:16	24 87 王奧
12 李芷棋	9 13:52	24
	9 14:19	25 87 王奧
12 李芷棋	10 14:46	25
	10 18:15	26 9 徐慧敏
12 李芷棋	11 19:22	26
	11 19:40	27 7 翟乃迪

场上队员: 得分 / 射门

守门员: 救球 / 射门

D	取消资格	DR	取消资格+报告
---	------	----	---------

## 个人/全队技术统计表

手球 预赛 组别 A 晋中体育馆  
青年女子 轮次 4 场次 40 2019-06-18 16:40

号码	姓名	远射	近射	边射	快攻	突破	任意	七米	合计	%	助攻	失误	警告	2'	取消	时间
澳门(澳门)																
(场上队员)																
8	譚嘉雯									0.0%						00:03:29
10	盧曉汶									0.0%						00:21:55
11	李君移	0/1							0/1	0.0%						00:37:55
12	李芷棋		3/5					2/3	5/8	62.5%		2				00:40:00
15	張雪琳	2/6					0/1		2/7	28.6%	2	6				00:34:20
18	曾華恩									0.0%		2				00:36:30
19	馮楚瑩									0.0%						00:18:05
22	蘇萱婷	3/6	1/1						4/7	57.1%	4	4				00:40:00
23	霍思允	0/1							0/1	0.0%		4				00:35:26
44	李嵐	0/2							0/2	0.0%						00:10:11
58	林詩雅									0.0%						00:02:04
	合计	5/16	4/6				0/1	2/3	11/26	42.3%	6	18				
(守门员)																
10	盧曉汶	0/1	0/2	2/3	0/3	1/4	0/1		3/14	21.4%						00:21:55
19	馮楚瑩	0/5	0/1	0/1	0/8			0/1	0/16	0.0%						00:18:05
	合计	0/6	0/3	2/4	0/11	1/4	0/1	0/1	3/30	10.0%						

场上队员： 得分/射门

守门员： 救球/射门

全队合计	得分	被救	射失	击柱	封球	合计	%
远射	5	3	6		2	16	31.3%
近射	4	1	1			6	66.7%
边射							0.0%
快攻							0.0%
突破							0.0%
任意			1			1	0.0%
七米	2			1		3	66.7%

## 第二届全国青年运动会女子手球甲组决赛 体校组 (U18)

PHMS Pictorial Handball Match Statistics

IHF Official System

### 个人/全队技术统计表

手球 青年女子 预赛 轮次 4 组别 A 场次 40 晋中体育馆 2019-06-18 16:40

号码	姓名	远射	近射	边射	快攻	突破	任意	七米	合计	%	助攻	失误	警告	2'	取消	时间
<b>北京市(北京)</b>																
<b>(场上队员)</b>																
1	靳爽									0.0%						00:20:00
5	常凯旋				1/1	0/1			1/2	50.0%	2	1				00:20:00
7	翟乃迪						1/1		1/1	100%						00:34:31
8	武宏业				1/1			1/1	2/2	100%	1					00:20:00
9	徐慧敏	3/3	1/1		1/1				5/5	100%	1	1				00:20:00
10	胡冰心		1/2	0/1	1/1				2/4	50.0%						00:05:01
11	陈丽婷	2/2			2/2	2/2			6/6	100%	1					00:20:00
14	侯美林				1/1	1/2			2/3	66.7%	2					00:20:00
16	周晓雨									0.0%						00:20:00
18	唐文杰									0.0%	1					00:00:00
23	黄文文					0/1			0/1	0.0%		1				00:23:57
27	田苗				1/1				1/1	100%	1					00:20:00
81	王木子		1/1	1/1	0/1				2/3	66.7%	1	1		1		00:20:00
87	王奥			1/1	1/2				2/3	66.7%		2				00:20:00
88	彭爽爽	1/1		0/1	2/2				3/4	75.0%						00:16:00
<b>合计</b>		<b>6/6</b>	<b>3/4</b>	<b>2/4</b>	<b>11/13</b>	<b>3/6</b>	<b>1/1</b>	<b>1/1</b>	<b>27/35</b>	<b>77.1%</b>	<b>5</b>	<b>9</b>	<b>2</b>	<b>1</b>		
<b>(守门员)</b>																
1	靳爽	1/4	1/2						2/6	33.3%						00:20:00
16	周晓雨	2/4	0/3					0/2	2/9	22.2%						00:20:00
<b>合计</b>		<b>3/8</b>	<b>1/5</b>					<b>0/2</b>	<b>4/15</b>	<b>26.7%</b>						

场上队员：得分/射门

守门员：救球/射门

全队合计	得分	被救	射失	击柱	封球	合计	%
远射	6					6	100.0%
近射	3			1		4	75.0%
边射	2	2				4	50.0%
快攻	11		1	1		13	84.6%
突破	3	1		2		6	50.0%
任意	1					1	100.0%
七米	1					1	100.0%

图式比赛技术统计表

手球  
青年女子

预赛  
轮次 4

组别 A  
场次 40

晋中体育馆  
2019-06-18 16:40

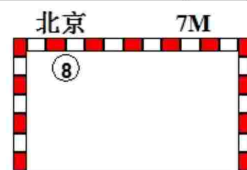
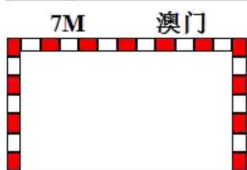
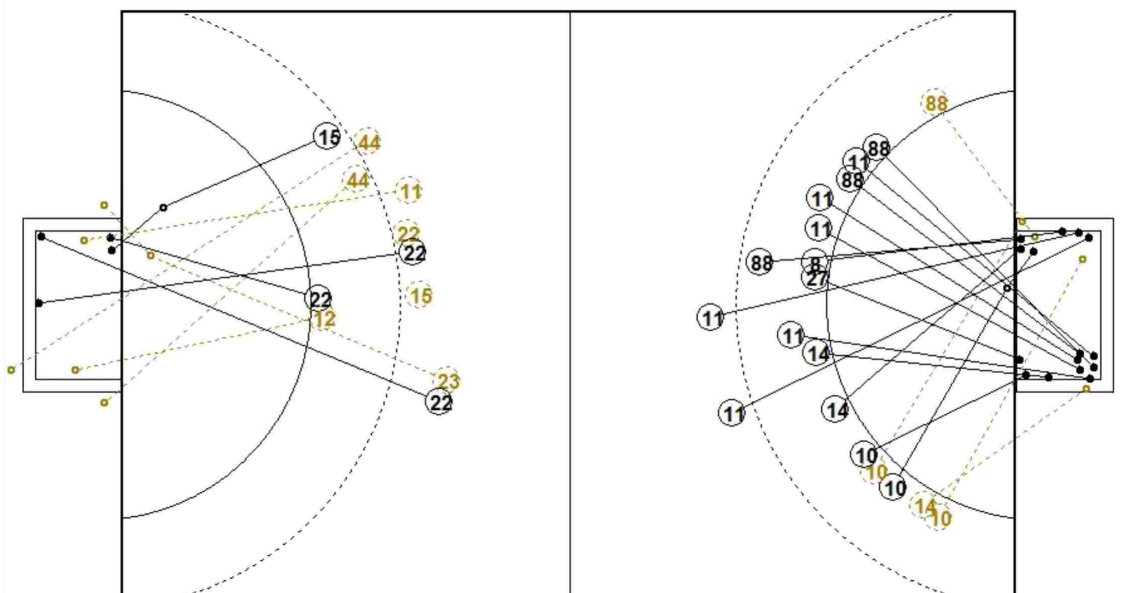

1st Half  
4 : 16

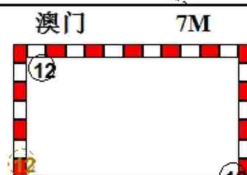
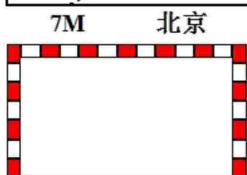
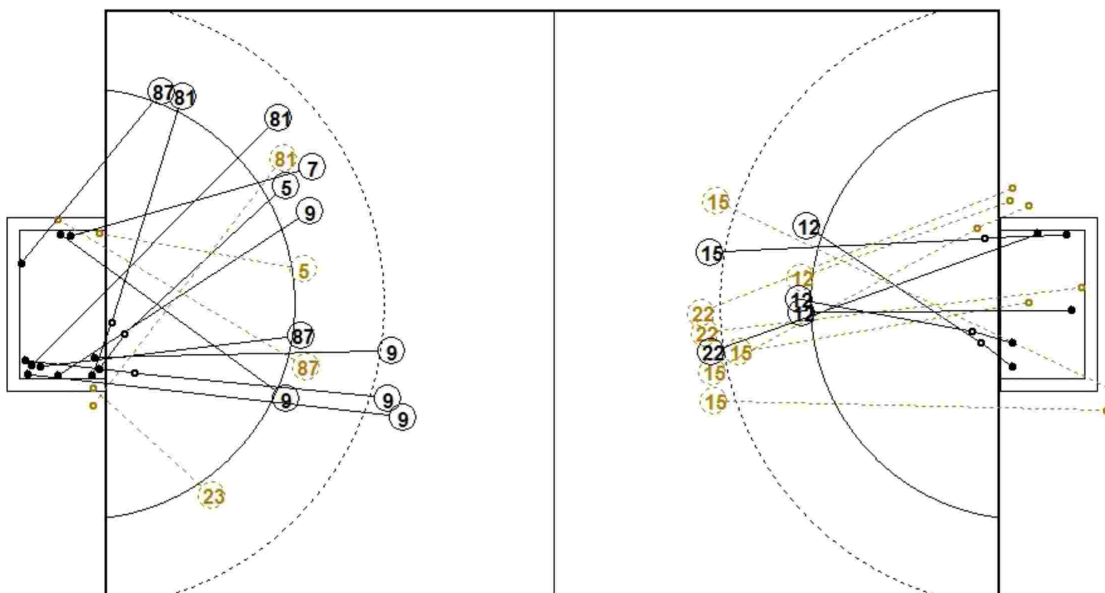

2nd Half  
27 : 11

图式射门区域统计

手球  
青年女子

预赛  
轮次 4

组别 A  
场次 40

晋中体育馆  
2019-06-18 16:40

澳门

8 譚嘉雯 Post - 0 Miss - 0 Block - 0	10 盧曉汶 Post - 0 Miss - 0 Block - 0	11 李君移 Post - 0 Miss - 0 Block - 0	12 李芷棋 Post - 1 Miss - 1 Block - 0	15 張雪琳 Post - 0 Miss - 3 Block - 1	18 曾華恩 Post - 0 Miss - 0 Block - 0	19 馮楚瑩 Post - 0 Miss - 0 Block - 0	22 蘇宣婷 Post - 0 Miss - 1 Block - 1	
23 霍思允 Post - 0 Miss - 1 Block - 0	44 李嵐 Post - 0 Miss - 2 Block - 0	58 林詩雅 Post - 0 Miss - 0 Block - 0						

10 盧曉汶	1/3	0/4
		0/2
	1/3	1/2

19 馮楚瑩	0/5	0/3
	0/2	0/1
	0/4	0/1

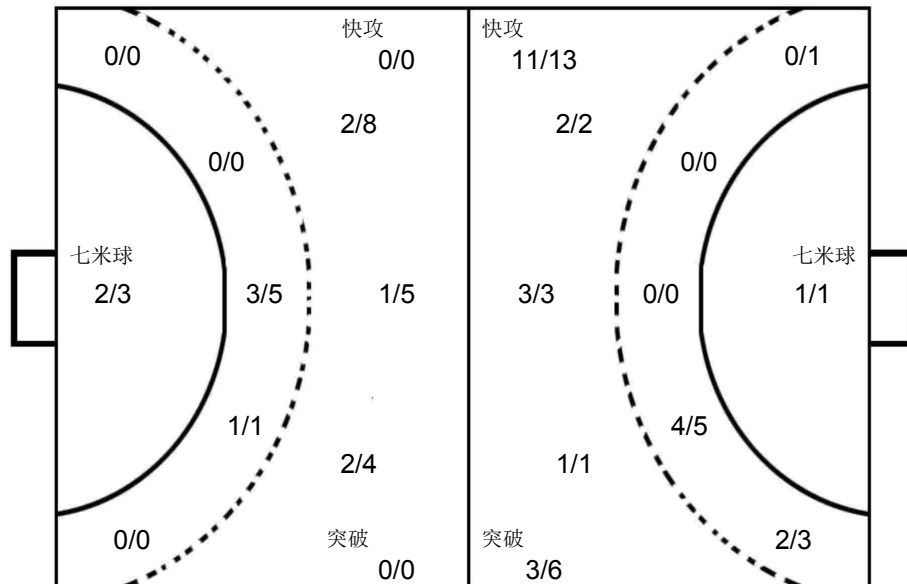

1 靳爽	0/1	0/1
	1/1	1/1
		0/2

16 周晓雨	0/2	1/2
	0/1	1/1
		0/3

北京市

1 靳爽 Post - 0 Miss - 0 Block - 0	5 常凯旋 Post - 0 Miss - 0 Block - 0	7 翟乃迪 Post - 0 Miss - 0 Block - 0	8 武宏业 Post - 0 Miss - 0 Block - 0	9 徐慧敏 Post - 0 Miss - 0 Block - 0	10 胡冰心 Post - 1 Miss - 0 Block - 0	11 陈丽婷 Post - 0 Miss - 0 Block - 0	14 侯美林 Post - 1 Miss - 0 Block - 0
16 周晓雨 Post - 0 Miss - 0 Block - 0	18 唐文杰 Post - 0 Miss - 0 Block - 0	23 黄文文 Post - 1 Miss - 0 Block - 0	27 田苗 Post - 0 Miss - 0 Block - 0	81 王木子 Post - 0 Miss - 1 Block - 0	87 王奥 Post - 1 Miss - 0 Block - 0	88 彭爽爽 Post - 0 Miss - 0 Block - 0	



第二届全国青年运动会女子手球甲组决赛 体校组 (U18)

青年女子 国内比赛

预赛 Group A



PHMS Pictorial Handball Match Statistics

IHF Official System

Team A					Team B					Match Number											
A 北京市					B 山东淄博					53											
Played in			in the hall			on			at			Spectators									
山西晋中			晋中体育馆			2019-06-20			14:00			hours									
Half-time(30')	A	B	End of playing time		A	B	1st extra time		A	B	2nd extra time		A	B	After penalty throws		A	B			
	6	8	16		18																
Number of 7 m	A	Team time-out			Full name of players and officials						Team time-out			B	Number of 7 m						
	0/1	1	2	3							1	2	3	B							
		07:55	29:56	36:54									0/0								
No.	Team A					G	W	2'	D	DR	No.	Team B					G	W	2'	D	DR
1	靳爽										3	王静雯					3				
7	翟乃迪					1					5	张素娟									
8	武宏业					3					6	孙玉坤					2		1		
9	徐慧敏					1		1			7	辛彤慧									
10	胡冰心										8	王锦琦									
11	陈丽婷					6	1				9	高梦洁					4	1			
14	侯美林					1					10	崔佳惠									
16	周晓雨										14	韩睿洁									
18	唐文杰										15	李骞飞									
23	黄文文										16	王启欣									
27	田苗										17	蒋松妍					2				
81	王木子					1	1				19	户晴					2				
87	王奥										21	赵欣瑶					4				
88	彭爽爽					3					22	邢力丹									
											23	王家琪					1	1			
											28	江迎新									
B	黄承 (主教练)										B	徐美凤									
C	栾征										C	翟乾坤 (主教练)									
D	石伟										D	段文钰									
E	刘文勇										E	王日东									
A	Signatures of responsables for the teams (Off.A)										B										
TP	Remarks of referees / HF Official										TP										

Signatures

Referees	李巧宁 (CHN)	宋优悠 (CHN)		
T.D.	叶霄雪 (CHN)	刘凤娟 (CHN)		
CHA Off.				

Note: Number of 7m Throws Awarded to Team A and B, Goals (G), Warnings (W), Suspensions (2'), Direct Disqualification (D), Disqualification With Report (DR) and Team Penalty (TP).

Table Officials: 杜鸿 宣海波 Statisticians: 陈柱 谢扬



## 第二届全国青年运动会女子手球甲组决赛 体校组 (U18)

PHMS Pictorial Handball Match Statistics

IHF Official System

### 竞赛技术统计

手球  
青年女子

预赛  
轮次 5

组别 A  
场次 53

晋中体育馆  
2019-06-20 14:00

Referees:	李巧宁 (CHN) / 宋优悠 (CHN)	Result:	16:18(6:8)
Teams:	北京市(北京) VS 山东淄博(淄博)		

北京		远	近	边	快	突	任意	7m	合计	%	助攻	失误	警告	2'	D+DR
主教练: 黄承		射	射	射	攻	破	球	球							
1	靳爽														
7	翟乃迪					1/1			1/1	100		1			
8	武宏业	0/1	1/1			2/2			3/4	75.0					
9	徐慧敏	1/1			0/1				1/2	50.0				1	
10	胡冰心			0/2					0/2	0.0		2			
11	陈丽婷	3/9	1/1			2/2	0/1	0/1	6/14	42.9		2	1		
14	侯美林		1/1						1/1	100	1				
16	周晓雨														
18	唐文杰											1			
23	黄文文														
27	田苗														
81	王木子		1/1						1/1	100			1		
87	王奥	0/1	0/1						0/2	0.0					
88	彭爽爽	0/1		3/3					3/4	75.0					
运动员 合计		4/13	4/5	3/5	0/1	5/5	0/1	0/1	16/31	51.6	1	6	2	1	
1	靳爽	2/6	4/10	4/8	0/2	0/2			10/28	35.7					
守门员 合计		2/6	4/10	4/8	0/2	0/2			10/28	35.7					

淄博		远	近	边	快	突	任意	7m	合计	%	助攻	失误	警告	2'	D+DR
主教练: 翟乾坤		射	射	射	攻	破	球	球							
3	王静雯	1/2	0/1		1/1	1/1			3/5	60.0		1			
5	张素娟														
6	孙玉坤	1/3	1/2						2/5	40.0	2			1	
7	辛彤慧														
8	王锦琦														
9	高梦洁	2/3	2/5			0/1			4/9	44.4		1	1		
10	崔佳惠														
14	韩睿洁														
15	李鹏飞														
16	王启欣														
17	蒋松妍		2/3						2/3	66.7					
19	户晴			1/2	1/1				2/3	66.7		1			
21	赵欣瑶		1/1	3/6					4/7	57.1					
22	邢力丹														
23	王家琪	0/1				1/1			1/2	50.0	3		1		
28	江迎新														
运动员 合计		4/9	6/12	4/8	2/2	2/3			18/34	52.9	5	3	2	1	
16	王启欣	3/5	1/5	1/3	1/1	0/3	1/1	1/1	8/19	42.1					
22	邢力丹	1/3		1/2		0/2			2/7	28.6					
守门员 合计		4/8	1/5	2/5	1/1	0/5	1/1	1/1	10/26	38.5					

北京	比赛 进程	淄博
1st Half		
	0 01:39	1 17 蒋松妍
11 陈丽婷	1 02:12	1
	1 02:34	2 6 孙玉坤
	1 03:37	3 17 蒋松妍
	1 05:18	4 19 户晴
	1 05:59	5 9 高梦洁
11 陈丽婷	2 06:32	5
	2 08:46	6 21 赵欣瑶
11 陈丽婷	3 09:27	6
	3 12:12	7 19 户晴
7 翟乃迪	4 13:40	7
	4 16:35	8 9 高梦洁
9 徐慧敏	5 18:32	8
81 王木子	6 19:36	8
2nd Half		
	6 00:41	9 9 高梦洁
	6 02:09	10 6 孙玉坤
8 武宏业	7 03:03	10
88 彭爽爽	8 04:14	10
11 陈丽婷	9 06:14	10
	9 07:42	11 3 王静雯
11 陈丽婷	10 08:24	11
	10 08:36	12 21 赵欣瑶
11 陈丽婷	11 08:48	12
	11 11:02	13 21 赵欣瑶
	11 11:30	14 23 王家琪
88 彭爽爽	12 11:54	14
14 侯美林	13 12:58	14
	13 15:59	15 21 赵欣瑶
8 武宏业	14 17:25	15
	14 17:54	16 3 王静雯
8 武宏业	15 18:27	16
	15 19:03	17 9 高梦洁
	15 19:20	18 3 王静雯
88 彭爽爽	16 19:36	18

场上队员: 得分 / 射门

守门员: 救球 / 射门

D	取消资格	DR	取消资格+报告
---	------	----	---------





## 个人/全队技术统计表

手球 青年女子 预赛 轮次 5 组别 A 场次 53 晋中体育馆 2019-06-20 14:00

号码	姓名	远射	近射	边射	快攻	突破	任意	七米	合计	%	助攻	失误	警告	2'	取消	时间
北京市(北京)																
(场上队员)																
1	靳爽									0.0%						00:40:00
7	翟乃迪					1/1			1/1	100%	1					00:15:44
8	武宏业	0/1	1/1			2/2			3/4	75.0%						00:12:22
9	徐慧敏	1/1			0/1				1/2	50.0%				1		00:04:25
10	胡冰心			0/2					0/2	0.0%	2					00:39:49
11	陈丽婷	3/9	1/1			2/2	0/1	0/1	6/14	42.9%	2	1				00:37:31
14	侯美林		1/1						1/1	100%	1					00:40:00
16	周晓雨									0.0%						00:00:00
18	唐文杰									0.0%	1					00:10:52
23	黄文文									0.0%						00:00:00
27	田苗									0.0%						00:00:00
81	王木子		1/1						1/1	100%			1			00:10:14
87	王奥	0/1	0/1						0/2	0.0%						00:28:28
88	彭爽爽	0/1		3/3					3/4	75.0%						00:39:59
合计		4/13	4/5	3/5	0/1	5/5	0/1	0/1	16/31	51.6%	1	6	2	1		
(守门员)																
1	靳爽	2/6	4/10	4/8	0/2	0/2			10/28	35.7%						00:40:00
合计		2/6	4/10	4/8	0/2	0/2			10/28	35.7%						

场上队员：得分/射门

守门员：救球/射门

全队合计	得分	被救	射失	击柱	封球	合计	%
远射	4	4	3		2	13	30.8%
近射	4	1				5	80.0%
边射	3	2				5	60.0%
快攻		1				1	0.0%
突破	5					5	100.0%
任意		1				1	0.0%
七米		1				1	0.0%

第二届全国青年运动会女子手球甲组决赛 体校组 (U18)

PHMS Pictorial Handball Match Statistics

IHF Official System

个人/全队技术统计表

手球 青年女子 预赛 轮次 5 组别 A 场次 53 晋中体育馆 2019-06-20 14:00

号码	姓名	远射	近射	边射	快攻	突破	任意	七米	合计	%	助攻	失误	警告	2'	取消	时间
山东淄博(淄博)																
(场上队员)																
3	王静雯	1/2	0/1		1/1	1/1			3/5	60.0%		1				00:22:58
5	张素娟									0.0%						00:00:00
6	孙玉坤	1/3	1/2						2/5	40.0%	2			1		00:39:03
7	辛彤慧									0.0%						00:00:00
8	王锦琦									0.0%						00:00:00
9	高梦洁	2/3	2/5			0/1			4/9	44.4%		1	1			00:34:15
10	崔佳惠									0.0%						00:00:00
14	韩春洁									0.0%						00:00:00
15	李骞飞									0.0%						00:00:00
16	王启欣									0.0%						00:30:19
17	蒋松妍		2/3						2/3	66.7%						00:39:50
19	户晴			1/2	1/1				2/3	66.7%		1				00:40:00
21	赵欣瑶		1/1	3/6					4/7	57.1%						00:40:00
22	邢力丹									0.0%						00:09:41
23	王家琪	0/1				1/1			1/2	50.0%	3		1			00:23:28
28	江迎新									0.0%						00:00:00
	合计	4/9	6/12	4/8	2/2	2/3			18/34	52.9%	5	3	2	1		
(守门员)																
16	王启欣	3/5	1/5	1/3	1/1	0/3	1/1	1/1	8/19	42.1%						00:30:19
22	邢力丹	1/3		1/2		0/2			2/7	28.6%						00:09:41
	合计	4/8	1/5	2/5	1/1	0/5	1/1	1/1	10/26	38.5%						

场上队员：得分/射门

守门员：救球/射门

全队合计	得分	被救	射失	击柱	封球	合计	%
远射	4	2		3		9	44.4%
近射	6	4	2			12	50.0%
边射	4	4				8	50.0%
快攻	2					2	100.0%
突破	2			1		3	66.7%
任意							0.0%
七米							0.0%

图式比赛技术统计表

手球  
青年女子

预赛  
轮次 5

组别 A  
场次 53

晋中体育馆  
2019-06-20 14:00

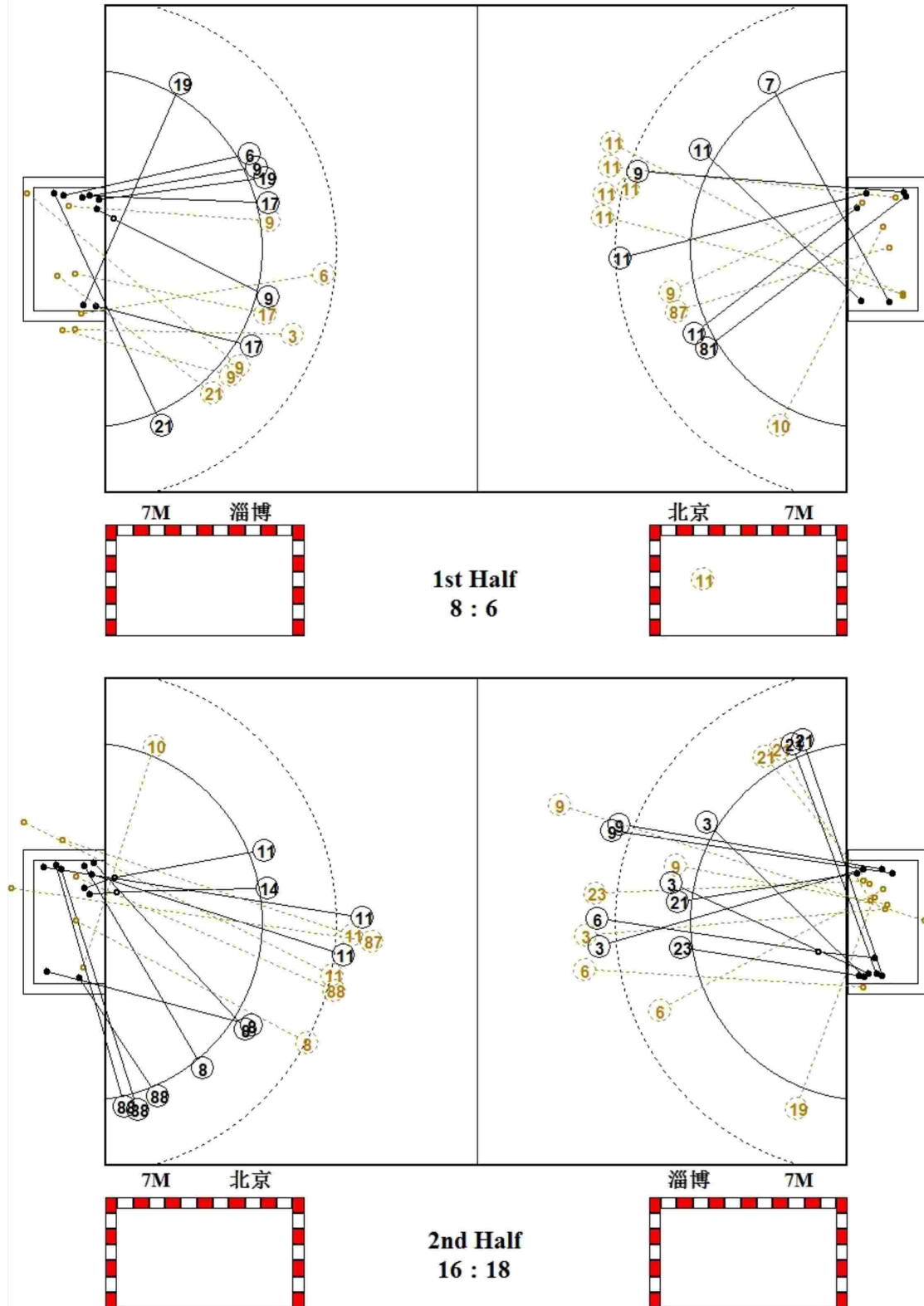

图式射门区域统计

手球  
青年女子

预赛  
轮次 5

组别 A  
场次 53

晋中体育馆  
2019-06-20 14:00

北京市

1 靳爽 Post - 0 Miss - 0 Block - 0	7 翟乃迪 Post - 0 Miss - 0 Block - 0	8 武宏业 Post - 0 Miss - 0 Block - 0	9 徐慧敏 Post - 0 Miss - 0 Block - 0	10 胡冰心 Post - 0 Miss - 0 Block - 0	11 陈丽婷 Post - 0 Miss - 2 Block - 2	14 侯美林 Post - 0 Miss - 0 Block - 0	16 周晓雨 Post - 0 Miss - 0 Block - 0
18 唐文杰 Post - 0 Miss - 0 Block - 0	23 黄文文 Post - 0 Miss - 0 Block - 0	27 田苗 Post - 0 Miss - 0 Block - 0	81 王木子 Post - 0 Miss - 0 Block - 0	87 王奥 Post - 0 Miss - 1 Block - 0	88 彭爽爽 Post - 0 Miss - 0 Block - 0		

1 靳爽	1/1	0/1
	3/5	3/3
	2/6	0/7

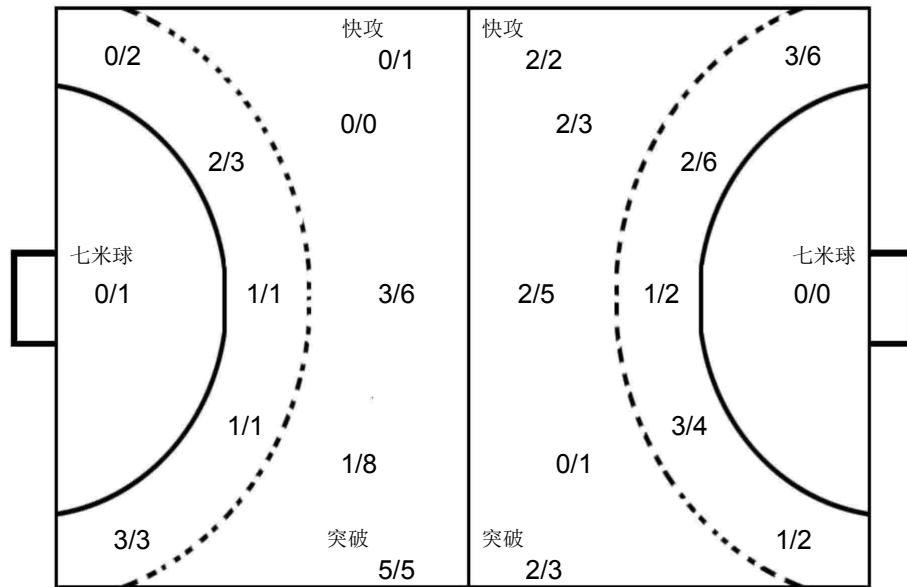

16 王启欣	1/4	2/3
	2/3	1/1
	1/3	0/3

22 邢力丹		0/1
	1/1	0/1
	1/1	0/3

山东淄博

3 王静雯 Post - 0 Miss - 1 Block - 0	5 张素娟 Post - 0 Miss - 0 Block - 0	6 孙玉坤 Post - 2 Miss - 0 Block - 0	7 辛彤慧 Post - 0 Miss - 0 Block - 0	8 王锦琦 Post - 0 Miss - 0 Block - 0	9 高梦洁 Post - 2 Miss - 1 Block - 0	10 崔佳惠 Post - 0 Miss - 0 Block - 0	14 韩睿洁 Post - 0 Miss - 0 Block - 0
15 李赛飞 Post - 0 Miss - 0 Block - 0	16 王启欣 Post - 0 Miss - 0 Block - 0	17 蒋松妍 Post - 0 Miss - 0 Block - 0	19 户晴 Post - 0 Miss - 0 Block - 0	21 赵欣瑶 Post - 0 Miss - 0 Block - 0	22 邢力丹 Post - 0 Miss - 0 Block - 0	23 王家琪 Post - 0 Miss - 0 Block - 0	28 江迎新 Post - 0 Miss - 0 Block - 0



第二届全国青年运动会女子手球甲组决赛 体校组 (U18)

青年女子 国内比赛

预赛 Group A



PHMS Pictorial Handball Match Statistics

IHF Official System

Team A					Team B					Match Number											
A 香港					B 澳门					54											
Played in			in the hall			on			at			Spectators									
山西晋中			晋中体育馆			2019-06-20			15:10			hours									
Half-time(30')	A	B	End of playing time		A	B	1st extra time		A	B	2nd extra time		A	B	After penalty throws						
	7	3	22		8																
Number of 7 m	A	Team time-out			Full name of players and officials						Team time-out			B	Number of 7 m						
	1/1	1	2	3							1	2	3	B							
		16:01	39:46						12:48	25:23	37:04	1/1									
No.	Team A					G	W	2'	D	DR	No.	Team B					G	W	2'	D	DR
1	郑晓容										8	譚嘉雯									
3	黄秋婷					2					10	盧曉汶									
4	何丹仪					3	1				11	李君移									
5	卓凯晴					1					12	李芷棋					4		1		
6	洪卓翹										15	張雪琳					2				
8	李芷欣					1					18	曾華恩						1			
9	林卓琪					1					19	馮楚瑩									
11	庄斯琪					2					22	蘇萱婷					1		1		
16	曾婉琳										23	霍思允									
17	梁艺										44	李嵐					1				
18	吴嘉妮					2					58	林诗雅									
21	林乐儿					6															
23	王洁桦					2															
25	戴子怡																				
28	郭芷彤					2	1	1													
91	孔倩瑜																				
A	杨开将										A	蘇沛祺									
B	何颂邦										B	陳嘉聰 (主教练)									
C	梁倩盈										C	霍俊浩									
A	Signatures of responsables for the teams (Off.A)															B					
TP	Remarks of referees / HF Official															TP					

Signatures

Referees	王柏淇 (CHN)	黄一凡 (CHN)		
T.D.	许宜扬 (CHN)	张耿 (CHN)		
CHA Off.				

Note: Number of 7m Throws Awarded to Team A and B, Goals (G), Warnings (W), Suspensions (2'), Direct Disqualification (D), Disqualification With Report (DR) and Team Penalty (TP).

Table Officials: 杜鸿 宋昌鑫 Statisticians: 谢扬 陈柱



## 第二届全国青年运动会女子手球甲组决赛 体校组 (U18)

PHMS Pictorial Handball Match Statistics

IHF Official System

### 竞赛技术统计

手球  
青年女子

预赛  
轮次 5

组别 A  
场次 54

晋中体育馆  
2019-06-20 15:10

Referees: 王柏淇 (CHN) / 黄一凡 (CHN)

Result: 22:8(7:3)

Teams: 香港(香港) VS 澳门(澳门)

香港																比赛进程		澳门	
主教练: 梁倩盈																			
	远射	近射	边射	快攻	突破	任意球	7m球	合计	%	助攻	失误	警告	2'	D+DR					
1 郑晓容																			
3 黄秋婷		0/1		2/4	0/1			2/6	33.3										
4 何丹仪	1/1			1/1	1/2			3/4	75.0		2	1							
5 卓凯晴	0/1						1/1	1/2	50.0										
6 洪卓翹										1	1								
8 李芷欣					1/1			1/1	100										
9 林卓琪		0/1		1/1				1/2	50.0										
11 庄斯琪	2/2							2/2	100		3								
16 曾婉琳																			
17 梁艺			0/2					0/2	0.0		1								
18 吴嘉妮	0/1	1/3	0/1	1/2				2/7	28.6										
21 林乐儿	1/3	1/1		3/3	1/2			6/9	66.7		1								
23 王洁桦		0/2		2/2				2/4	50.0		3								
25 戴子怡																			
28 郭芷彤		2/2						2/2	100			1	1						
91 孔倩瑜																			
运动员 合计	4/8	4/10	0/3	10/13	3/6		1/1	22/41	53.7	1	11	2	1						
1 郑晓容	1/1	0/1					0/1	1/3	33.3										
6 洪卓翹	4/5	1/4			1/1			6/10	60.0	1	1								
16 曾婉琳	1/1	0/1			0/1			1/3	33.3										
守门员 合计	6/7	1/6			1/2		0/1	8/16	50.0	1	1								
澳门																			
主教练: 陈嘉聪																			
	远射	近射	边射	快攻	突破	任意球	7m球	合计	%	助攻	失误	警告	2'	D+DR					
8 譚嘉雯											1								
10 盧曉汶																			
11 李君移											1								
12 李芷棋	0/1	3/4					1/1	4/6	66.7				1						
15 張雪琳	0/4	1/1			1/2	0/2		2/9	22.2	2	4								
18 曾華恩											6	1							
19 馮楚瑩																			
22 蘇萱婷	1/3							1/3	33.3	1	8		1						
23 霍思允											2								
44 李嵐		1/1						1/1	100		1								
58 林诗雅																			
运动员 合计	1/8	5/6			1/2	0/2	1/1	8/19	42.1	3	23	1	2						
10 盧曉汶		0/1	1/1	0/2				1/4	25.0										
19 馮楚瑩	2/6	5/8	2/2	3/11	1/4		0/1	13/32	40.6										
守门员 合计	2/6	5/9	3/3	3/13	1/4		0/1	14/36	38.9										

场上队员: 得分 / 射门

守门员: 救球 / 射门

D	取消资格	DR	取消资格+报告
---	------	----	---------

## 个人/全队技术统计表

手球 青年女子 预赛 轮次 5 组别 A 场次 54 晋中体育馆 2019-06-20 15:10

号码	姓名	远射	近射	边射	快攻	突破	任意	七米	合计	%	助攻	失误	警告	2'	取消	时间
香港(香港)																
(场上队员)																
1	郑晓容									0.0%						00:07:59
3	黄秋婷		0/1		2/4	0/1			2/6	33.3%						00:09:22
4	何丹仪	1/1			1/1	1/2			3/4	75.0%		2	1			00:30:38
5	卓凯晴	0/1						1/1	1/2	50.0%						00:00:05
6	洪卓翘									0.0%	1	1				00:25:43
8	李芷欣					1/1			1/1	100%						00:09:22
9	林卓琪		0/1		1/1				1/2	50.0%						00:09:22
11	庄斯琪	2/2							2/2	100%		3				00:09:22
16	曾婉琳									0.0%						00:06:18
17	梁艺			0/2					0/2	0.0%		1				00:30:38
18	吴嘉妮	0/1	1/3	0/1	1/2				2/7	28.6%						00:30:38
21	林乐儿	1/3	1/1		3/3	1/2			6/9	66.7%		1				00:30:38
23	王洁桦		0/2		2/2				2/4	50.0%		3				00:30:35
25	戴子怡									0.0%						00:09:23
28	郭芷彤		2/2						2/2	100%			1	1		00:30:38
91	孔倩瑜									0.0%						00:09:16
	合计	4/8	4/10	0/3	10/13	3/6		1/1	22/41	53.7%	1	11	2	1		

## (守门员)

1	郑晓容	1/1	0/1					0/1	1/3	33.3%						00:07:59
6	洪卓翘	4/5	1/4			1/1			6/10	60.0%	1	1				00:25:43
16	曾婉琳	1/1	0/1			0/1			1/3	33.3%						00:06:18
	合计	6/7	1/6			1/2		0/1	8/16	50.0%	1	1				

场上队员： 得分/射门

守门员： 救球/射门

全队合计	得分	被救	射失	击柱	封球	合计	%
远射	4	2		1	1	8	50.0%
近射	4	5	1			10	40.0%
边射		3				3	0.0%
快攻	10	3				13	76.9%
突破	3	1	2			6	50.0%
任意							0.0%
七米	1					1	100.0%

第二届全国青年运动会女子手球甲组决赛 体校组 (U18)

PHMS Pictorial Handball Match Statistics

IHF Official System

个人/全队技术统计表

手球 预赛 组别 A 晋中体育馆  
青年女子 轮次 5 场次 54 2019-06-20 15:10

号码	姓名	远射	近射	边射	快攻	突破	任意	七米	合计	%	助攻	失误	警告	2'	取消	时间
澳门(澳门)																
(场上队员)																
8	譚嘉雯									0.0%		1				00:12:56
10	盧曉汶									0.0%						00:05:13
11	李君移									0.0%		1				00:27:55
12	李芷棋	0/1	3/4					1/1	4/6	66.7%				1		00:35:24
15	張雪琳	0/4	1/1			1/2	0/2		2/9	22.2%	2	4				00:37:02
18	曾華恩									0.0%		6	1			00:33:30
19	馮楚瑩									0.0%						00:34:47
22	蘇萱婷	1/3							1/3	33.3%	1	8		1		00:31:40
23	霍思允									0.0%		2				00:27:20
44	李嵐		1/1						1/1	100%		1				00:21:53
58	林詩雅									0.0%						00:12:02
合计		1/8	5/6			1/2	0/2	1/1	8/19	42.1%	3	23	1	2		

(守门员)																
10	盧曉汶		0/1	1/1	0/2				1/4	25.0%						00:05:13
19	馮楚瑩	2/6	5/8	2/2	3/11	1/4		0/1	13/32	40.6%						00:34:47
合计		2/6	5/9	3/3	3/13	1/4		0/1	14/36	38.9%						

场上队员： 得分/射门 守门员： 救球/射门

全队合计	得分	被救	射失	击柱	封球	合计	%
远射	1	6			1	8	12.5%
近射	5	1				6	83.3%
边射							0.0%
快攻							0.0%
突破	1	1				2	50.0%
任意			2			2	0.0%
七米	1					1	100.0%



图式比赛技术统计表

手球  
青年女子

预赛  
轮次 5

组别 A  
场次 54

晋中体育馆  
2019-06-20 15:10

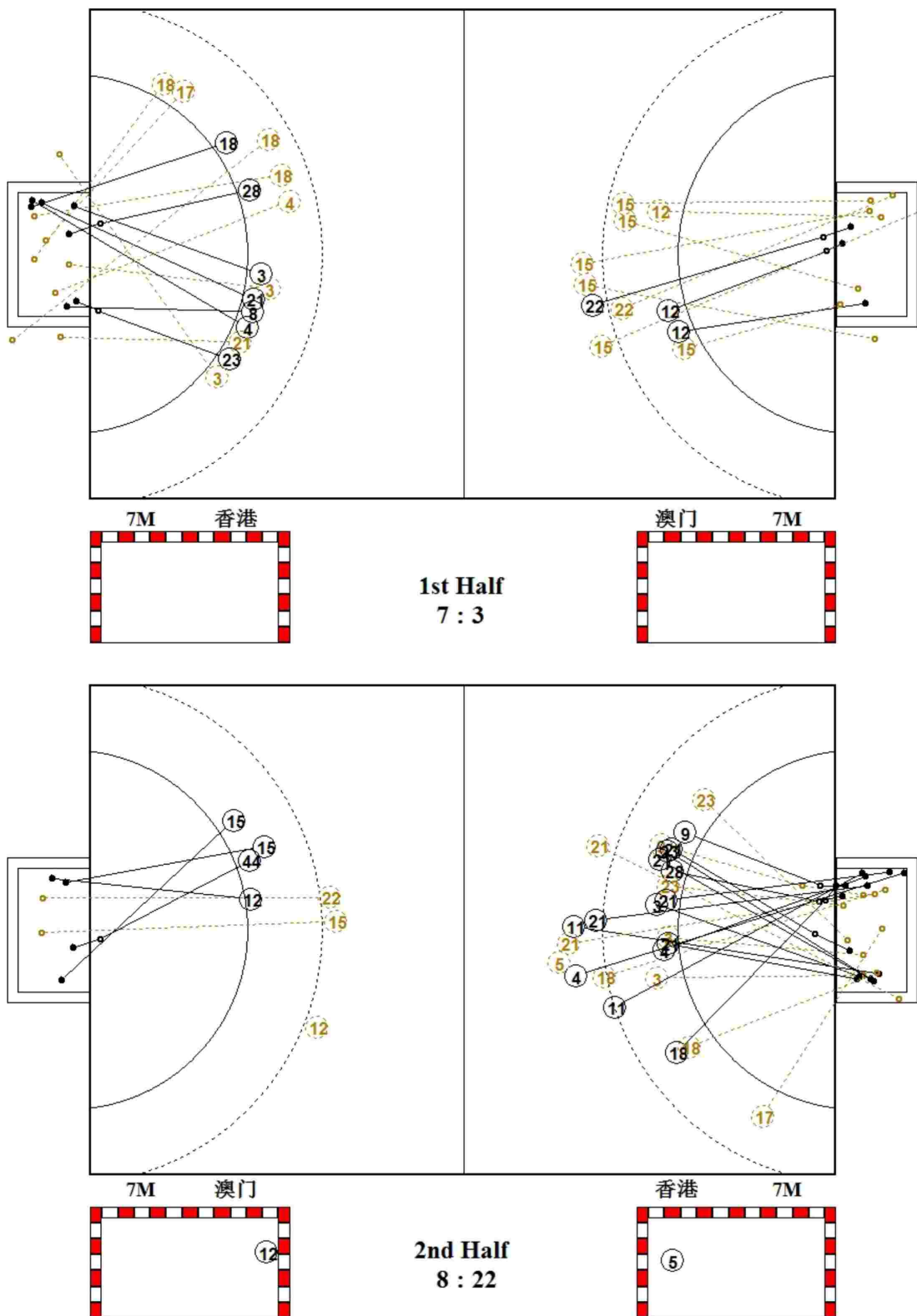

图式射门区域统计

手球  
青年女子

预赛  
轮次 5

组别 A  
场次 54

晋中体育馆  
2019-06-20 15:10

香港

1 郑晓容 <table border="1"><tr><td></td><td></td><td></td></tr><tr><td></td><td></td><td></td></tr><tr><td></td><td></td><td></td></tr></table> Post - 0 Miss - 0 Block - 0										3 黄秋婷 <table border="1"><tr><td></td><td></td><td></td></tr><tr><td></td><td></td><td>1</td></tr><tr><td></td><td></td><td>1</td></tr></table> Post - 0 Miss - 1 Block - 0						1			1	4 何丹仪 <table border="1"><tr><td>1</td><td></td><td>1</td></tr><tr><td>1</td><td></td><td></td></tr><tr><td></td><td></td><td></td></tr></table> Post - 0 Miss - 0 Block - 0	1		1	1						5 卓凯晴 <table border="1"><tr><td></td><td></td><td></td></tr><tr><td>1</td><td></td><td></td></tr><tr><td></td><td></td><td></td></tr></table> Post - 0 Miss - 0 Block - 1				1						6 洪卓翘 <table border="1"><tr><td></td><td></td><td></td></tr><tr><td></td><td></td><td></td></tr><tr><td></td><td></td><td></td></tr></table> Post - 0 Miss - 0 Block - 0										8 李芷欣 <table border="1"><tr><td></td><td></td><td></td></tr><tr><td></td><td></td><td></td></tr><tr><td>1</td><td></td><td></td></tr></table> Post - 0 Miss - 0 Block - 0							1			9 林卓琪 <table border="1"><tr><td></td><td></td><td></td></tr><tr><td></td><td></td><td></td></tr><tr><td>1</td><td></td><td></td></tr></table> Post - 0 Miss - 0 Block - 0							1			11 庄斯琪 <table border="1"><tr><td></td><td></td><td></td></tr><tr><td>1</td><td></td><td>1</td></tr><tr><td></td><td></td><td></td></tr></table> Post - 0 Miss - 0 Block - 0				1		1			
		1																																																																													
		1																																																																													
1		1																																																																													
1																																																																															
1																																																																															
1																																																																															
1																																																																															
1		1																																																																													
16 曾婉琳 <table border="1"><tr><td></td><td></td><td></td></tr><tr><td></td><td></td><td></td></tr><tr><td></td><td></td><td></td></tr></table> Post - 0 Miss - 0 Block - 0										17 梁艺 <table border="1"><tr><td></td><td></td><td></td></tr><tr><td></td><td></td><td></td></tr><tr><td></td><td></td><td></td></tr></table> Post - 0 Miss - 0 Block - 0										18 吴嘉妮 <table border="1"><tr><td></td><td></td><td>1</td></tr><tr><td></td><td></td><td></td></tr><tr><td>1</td><td></td><td></td></tr></table> Post - 0 Miss - 1 Block - 0			1				1			21 林乐儿 <table border="1"><tr><td>1</td><td></td><td>1</td></tr><tr><td>1</td><td></td><td>1</td></tr><tr><td></td><td>1</td><td>1</td></tr></table> Post - 1 Miss - 1 Block - 0	1		1	1		1		1	1	23 王洁桦 <table border="1"><tr><td></td><td></td><td></td></tr><tr><td></td><td></td><td>1</td></tr><tr><td>1</td><td></td><td></td></tr></table> Post - 0 Miss - 0 Block - 0						1	1			25 戴子怡 <table border="1"><tr><td></td><td></td><td></td></tr><tr><td></td><td></td><td></td></tr><tr><td></td><td></td><td></td></tr></table> Post - 0 Miss - 0 Block - 0										28 郭芷彤 <table border="1"><tr><td></td><td></td><td></td></tr><tr><td></td><td></td><td></td></tr><tr><td>1</td><td>1</td><td></td></tr></table> Post - 0 Miss - 0 Block - 0							1	1		91 孔倩瑜 <table border="1"><tr><td></td><td></td><td></td></tr><tr><td></td><td></td><td></td></tr><tr><td></td><td></td><td></td></tr></table> Post - 0 Miss - 0 Block - 0									
		1																																																																													
1																																																																															
1		1																																																																													
1		1																																																																													
	1	1																																																																													
		1																																																																													
1																																																																															
1	1																																																																														

1 郑晓容

		1/2
		0/1

6 洪卓翘

1/1		
3/3		0/2
0/1	0/1	2/2

16 曾婉琳

	1/1	
0/1		
	0/1	

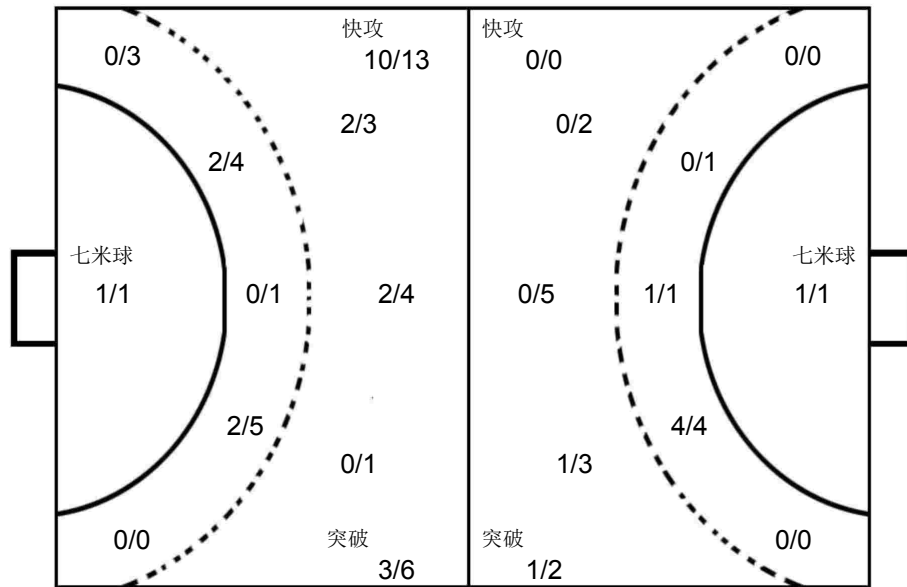

10 卢晓汶

0/1	1/1	
0/1		
0/1		

19 冯楚莹

1/2	1/1	1/4
3/6	1/1	3/7
1/5	2/4	0/2

澳门

8 谭嘉雯 <table border="1"><tr><td></td><td></td><td></td></tr><tr><td></td><td></td><td></td></tr><tr><td></td><td></td><td></td></tr></table> Post - 0 Miss - 0 Block - 0										10 卢晓汶 <table border="1"><tr><td></td><td></td><td></td></tr><tr><td></td><td></td><td></td></tr><tr><td></td><td></td><td></td></tr></table> Post - 0 Miss - 0 Block - 0										11 李君移 <table border="1"><tr><td></td><td></td><td></td></tr><tr><td></td><td></td><td></td></tr><tr><td></td><td></td><td></td></tr></table> Post - 0 Miss - 0 Block - 0										12 李芷棋 <table border="1"><tr><td></td><td></td><td>1</td></tr><tr><td></td><td></td><td>2</td></tr><tr><td></td><td>1</td><td></td></tr></table> Post - 0 Miss - 0 Block - 1			1			2		1		15 张雪琳 <table border="1"><tr><td></td><td></td><td></td></tr><tr><td>1</td><td></td><td>1</td></tr><tr><td></td><td></td><td></td></tr></table> Post - 0 Miss - 2 Block - 0				1		1				18 曾华恩 <table border="1"><tr><td></td><td></td><td></td></tr><tr><td></td><td></td><td></td></tr><tr><td></td><td></td><td></td></tr></table> Post - 0 Miss - 0 Block - 0										19 冯楚莹 <table border="1"><tr><td></td><td></td><td></td></tr><tr><td></td><td></td><td></td></tr><tr><td></td><td></td><td></td></tr></table> Post - 0 Miss - 0 Block - 0										22 苏宣婷 <table border="1"><tr><td></td><td></td><td></td></tr><tr><td></td><td></td><td></td></tr><tr><td>1</td><td></td><td></td></tr></table> Post - 0 Miss - 0 Block - 0							1		
		1																																																																													
		2																																																																													
	1																																																																														
1		1																																																																													
1																																																																															
23 霍思允 <table border="1"><tr><td></td><td></td><td></td></tr><tr><td></td><td></td><td></td></tr><tr><td></td><td></td><td></td></tr></table> Post - 0 Miss - 0 Block - 0										44 李嵐 <table border="1"><tr><td></td><td></td><td></td></tr><tr><td></td><td></td><td></td></tr><tr><td></td><td>1</td><td></td></tr></table> Post - 0 Miss - 0 Block - 0								1		58 林诗雅 <table border="1"><tr><td></td><td></td><td></td></tr><tr><td></td><td></td><td></td></tr><tr><td></td><td></td><td></td></tr></table> Post - 0 Miss - 0 Block - 0																																																											
	1																																																																														



第二届全国青年运动会女子手球甲组决赛 体校组 (U18)

青年女子 国内比赛

预赛 Group A



PHMS Pictorial Handball Match Statistics

IHF Official System

Team A A 安徽滁州				Team B B 广东深圳				Match Number <b>55</b>			
------------------	--	--	--	------------------	--	--	--	---------------------------	--	--	--

Played in 山西晋中	in the hall 晋中体育馆	on 2019-06-20	at 16:20	hours	Speakers
-------------------	----------------------	------------------	-------------	-------	----------

Half-time(30')	A 9	B 3	End of playing time	A 18	B 15	1st extra time	A	B	2nd extra time	A	B	After penalty throws	A	B
----------------	--------	--------	---------------------	---------	---------	----------------	---	---	----------------	---	---	----------------------	---	---

Number of 7 m 0/0	Team time-out			Full name of players and officials	Team time-out			B 1/2	Number of 7 m
	1	2	3		1	2	3		

No.	Team A	G	W	2'	D	DR	No.	Team B	G	W	2'	D	DR
1	张家轩						2	唐悦	1				
2	钟梦						3	赵晔	2				
3	孙明月	4					5	朱嘉盈	7				
7	丁洁						6	朱嘉晴	3				
9	窦海乐		1				7	曾妮		1			
16	刘子琪						9	张雨乐					
25	耿雨萍						10	徐瑜琳					
26	张雅婷						11	王文卉					
28	马雯怡						12	于雅梦					
30	罗佳乐						13	刘培天	2				
32	王小雅						16	邹童羽					
34	姜影	7					17	冯颖慧					
35	李旭	3	1	2			18	谢宛彤					
36	高奇欣						20	岳欣华					
38	潘楠	4		1									
A	王明星						A	张斌					
B	陆广红 (主教练)						B	张敬敏					
C	岳连娥						C	常敏 (主教练)					
D	李莉						D	蒋光华					

A	Signatures of responsables for the teams (Off.A)												B
---	--	--	--	--	--	--	--	--	--	--	--	--	---

TP	Remarks of referees / HF Official													TP
----	-----------------------------------	--	--	--	--	--	--	--	--	--	--	--	--	----

Referees	康曦 (CHN)	吴佳 (CHN)		
T.D.	刘凤娟 (CHN)	叶霄雪 (CHN)		
CHA Off.				

Note: Number of 7m Throws Awarded to Team A and B, Goals (G), Warnings (W), Suspensions (2'), Direct Disqualification (D), Disqualification With Report (DR) and Team Penalty (TP).

Table Officials: 吴鹏凯 张琦 Statisticians: 陈柱 谢扬

## 第二届全国青年运动会女子手球甲组决赛 体校组 (U18)

PHMS Pictorial Handball Match Statistics

IHF Official System

### 竞赛技术统计

手球  
青年女子

预赛  
轮次 5

组别 A  
场次 55

晋中体育馆  
2019-06-20 16:20

Referees: 康曦 (CHN) / 吴佳 (CHN)

Result: 18:15(9:3)

Teams: 安徽滁州(滁州) VS 广东深圳(深圳)

滁州		远射	近射	边射	快攻	突破	任意球	7m球	合计	%	助攻	失误	警告	2'	D+DR
主教练: 陆广红															
1	张家轩										1				
2	钟梦											2			
3	孙明月	0/3	0/1	1/1	2/2	1/1			4/8	50.0		3			
7	丁洁														
9	窦海乐	0/1							0/1	0.0	2	2	1		
16	刘子琪										1				
25	耿雨萍														
26	张雅婷														
28	马雯怡														
30	罗佳乐														
32	王小雅														
34	姜影		1/2	3/4	3/3	0/1			7/10	70.0		2			
35	李旭		2/3	0/1	1/1				3/5	60.0		1	1	2	
36	高奇欣											2			
38	潘楠		1/1	0/2	1/1	2/2			4/6	66.7	1	3		1	
运动员 合计		0/4	4/7	4/8	7/7	3/4			18/30	60.0	5	15	2	3	
1	张家轩	3/4	4/7	4/5	0/3			0/1	11/20	55.0	1				
16	刘子琪	2/4	0/2		0/1	0/1	1/1		3/9	33.3	1				
守门员 合计		5/8	4/9	4/5	0/4	0/1	1/1	0/1	14/29	48.3	2				
深圳		远射	近射	边射	快攻	突破	任意球	7m球	合计	%	助攻	失误	警告	2'	D+DR
主教练: 常敏															
2	唐悦	0/1			1/1			0/1	1/3	33.3		3			
3	赵晔	1/9	1/3				0/1		2/13	15.4		1			
5	朱嘉盈	2/2	1/3		2/2	1/1		1/1	7/9	77.8	2	2			
6	朱嘉晴	0/1	1/1	1/2	1/1				3/5	60.0		2			
7	曾妮											1	1		
9	张雨乐			0/4					0/4	0.0		2			
10	徐瑜琳														
11	王文卉														
12	于雅梦														
13	刘培天		2/2						2/2	100					
16	邹童羽														
17	冯颖慧														
18	谢宛彤														
20	岳欣华														
运动员 合计		3/13	5/9	1/6	4/4	1/1	0/1	1/2	15/36	41.7	2	11	1		
16	邹童羽	3/3	2/5	4/8	0/6	1/3			10/25	40.0					
17	冯颖慧		0/1		0/1	0/1			0/3	0.0					
守门员 合计		3/3	2/6	4/8	0/7	1/4			10/28	35.7					

滁州	比赛进程	深圳
1st Half		
	0 01:15	1 5 朱嘉盈
38 潘楠	1 01:29	1
3 孙明月	2 02:00	1
	2 06:51	2 13 刘培天
	2 07:36	3 6 朱嘉晴
34 姜影	3 08:13	3
3 孙明月	4 09:37	3
35 李旭	5 10:23	3
38 潘楠	6 11:11	3
34 姜影	7 12:49	3
38 潘楠	8 14:46	3
34 姜影	9 18:04	3
2nd Half		
34 姜影	10 00:57	3
	10 01:36	4 3 赵晔
34 姜影	11 02:04	4
	11 02:43	5 3 赵晔
	11 03:50	6 5 朱嘉盈
38 潘楠	12 04:11	6
3 孙明月	13 05:35	6
	13 06:07	7 5 朱嘉盈
35 李旭	14 06:55	7
	14 07:38	8 13 刘培天
	14 07:54	9 6 朱嘉晴
34 姜影	15 08:03	9
	15 09:08	10 5 朱嘉盈
	15 09:35	11 5 朱嘉盈
	15 11:19	12 6 朱嘉晴
35 李旭	16 11:34	12
	16 13:35	13 5 朱嘉盈
	16 15:14	14 5 朱嘉盈
	16 18:11	15 2 唐悦
34 姜影	17 18:51	15
3 孙明月	18 19:42	15

场上队员: 得分 / 射门

守门员: 救球 / 射门

D	取消资格	DR	取消资格+报告
---	------	----	---------

## 个人/全队技术统计表

手球 青年女子 预赛 轮次 5 组别 A 场次 55 晋中体育馆 2019-06-20 16:20

号码	姓名	远射	近射	边射	快攻	突破	任意	七米	合计	%	助攻	失误	警告	2'	取消	时间
安徽滁州(滁州)																
(场上队员)																
1	张家轩									0.0%	1					00:30:56
2	钟梦									0.0%		2				00:04:17
3	孙明月	0/3	0/1	1/1	2/2	1/1			4/8	50.0%		3				00:39:36
7	丁洁									0.0%						00:00:00
9	窦海乐	0/1							0/1	0.0%	2	2	1			00:35:37
16	刘子琪									0.0%	1					00:09:04
25	耿雨萍									0.0%						00:00:00
26	张雅婷									0.0%						00:00:00
28	马雯怡									0.0%						00:00:00
30	罗佳乐									0.0%						00:00:00
32	王小雅									0.0%						00:00:00
34	姜影		1/2	3/4	3/3	0/1			7/10	70.0%		2				00:39:55
35	李旭		2/3	0/1	1/1				3/5	60.0%		1	1	2		00:39:51
36	高奇欣									0.0%		2				00:39:53
38	潘楠		1/1	0/2	1/1	2/2			4/6	66.7%	1	3		1		00:39:39
合计		0/4	4/7	4/8	7/7	3/4			18/30	60.0%	5	15	2	3		
(守门员)																
1	张家轩	3/4	4/7	4/5	0/3			0/1	11/20	55.0%	1					00:30:56
16	刘子琪	2/4	0/2		0/1	0/1	1/1		3/9	33.3%	1					00:09:04
合计		5/8	4/9	4/5	0/4	0/1	1/1	0/1	14/29	48.3%	2					

场上队员：得分/射门

守门员：救球/射门

全队合计	得分	被救	射失	击柱	封球	合计	%
远射		3			1	4	0.0%
近射	4	2	1			7	57.1%
边射	4	4				8	50.0%
快攻	7					7	100.0%
突破	3	1				4	75.0%
任意							0.0%
七米							0.0%

## 第二届全国青年运动会女子手球甲组决赛 体校组 (U18)

PHMS Pictorial Handball Match Statistics

IHF Official System

## 个人/全队技术统计表

 手球 预赛 组别 A 晋中体育馆  
 青年女子 轮次 5 场次 55 2019-06-20 16:20

号码	姓名	远射	近射	边射	快攻	突破	任意	七米	合计	%	助攻	失误	警告	2'	取消	时间
广东深圳(深圳)																
(场上队员)																
2	唐悦	0/1			1/1			0/1	1/3	33.3%		3				00:18:32
3	赵晔	1/9	1/3				0/1		2/13	15.4%		1				00:40:00
5	朱嘉盈	2/2	1/3		2/2	1/1		1/1	7/9	77.8%	2	2				00:40:00
6	朱嘉晴	0/1	1/1	1/2	1/1				3/5	60.0%		2				00:40:00
7	曾妮									0.0%		1	1			00:21:27
9	张雨乐			0/4					0/4	0.0%		2				00:40:00
10	徐瑜琳									0.0%						00:00:00
11	王文卉									0.0%						00:00:00
12	于雅梦									0.0%						00:00:00
13	刘培天		2/2						2/2	100%						00:40:00
16	邹童羽									0.0%						00:35:10
17	冯颖慧									0.0%						00:04:50
18	谢宛彤									0.0%						00:00:00
20	岳欣华									0.0%						00:00:00
合计		3/13	5/9	1/6	4/4	1/1	0/1	1/2	15/36	41.7%	2	11	1			
(守门员)																
16	邹童羽	3/3	2/5	4/8	0/6	1/3			10/25	40.0%						00:35:10
17	冯颖慧		0/1		0/1	0/1			0/3	0.0%						00:04:50
合计		3/3	2/6	4/8	0/7	1/4			10/28	35.7%						

场上队员：得分/射门

守门员：救球/射门

全队合计	得分	被救	射失	击柱	封球	合计	%
远射	3	5	2	1	2	13	23.1%
近射	5	4				9	55.6%
边射	1	4		1		6	16.7%
快攻	4					4	100.0%
突破	1					1	100.0%
任意		1				1	0.0%
七米	1			1		2	50.0%

图式比赛技术统计表

手球  
青年女子

预赛  
轮次 5

组别 A  
场次 55

晋中体育馆  
2019-06-20 16:20

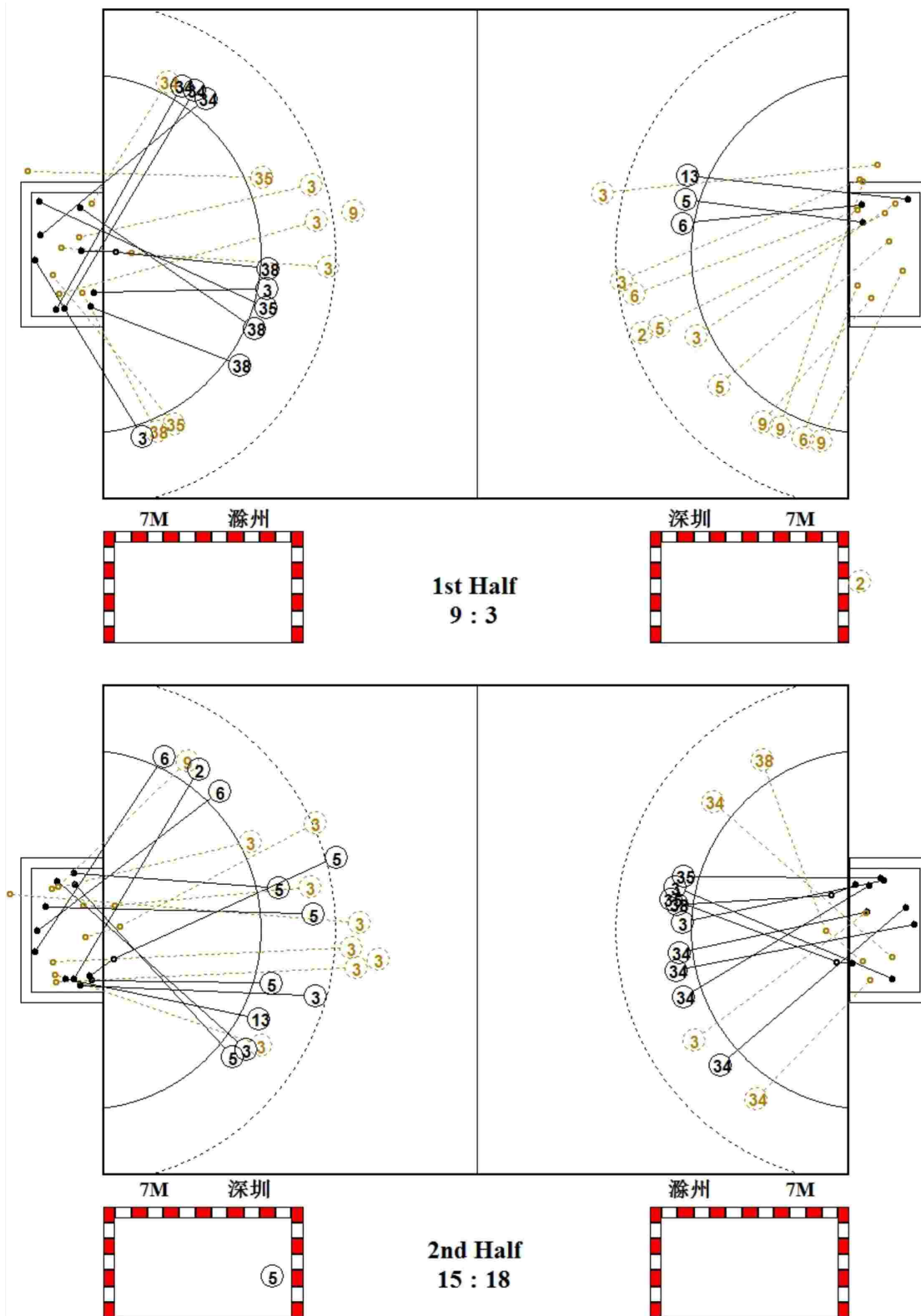

图式射门区域统计

手球  
青年女子

预赛  
轮次 5

组别 A  
场次 55

晋中体育馆  
2019-06-20 16:20

安徽滁州

1 张家轩 <table border="1"><tr><td></td><td></td><td></td></tr><tr><td></td><td></td><td></td></tr><tr><td></td><td></td><td></td></tr></table> Post - 0 Miss - 0 Block - 0										2 钟梦 <table border="1"><tr><td></td><td></td><td></td></tr><tr><td></td><td></td><td></td></tr><tr><td></td><td></td><td></td></tr></table> Post - 0 Miss - 0 Block - 0										3 孙明月 <table border="1"><tr><td></td><td>1</td><td></td></tr><tr><td>1</td><td></td><td>1</td></tr><tr><td>1</td><td></td><td></td></tr></table> Post - 0 Miss - 0 Block - 0		1		1		1	1			7 丁洁 <table border="1"><tr><td></td><td></td><td></td></tr><tr><td></td><td></td><td></td></tr><tr><td></td><td></td><td></td></tr></table> Post - 0 Miss - 0 Block - 0										9 窦海乐 <table border="1"><tr><td></td><td></td><td></td></tr><tr><td></td><td></td><td></td></tr><tr><td></td><td></td><td></td></tr></table> Post - 0 Miss - 0 Block - 1										16 刘子琪 <table border="1"><tr><td></td><td></td><td></td></tr><tr><td></td><td></td><td></td></tr><tr><td></td><td></td><td></td></tr></table> Post - 0 Miss - 0 Block - 0										25 耿雨萍 <table border="1"><tr><td></td><td></td><td></td></tr><tr><td></td><td></td><td></td></tr><tr><td></td><td></td><td></td></tr></table> Post - 0 Miss - 0 Block - 0										26 张雅婷 <table border="1"><tr><td></td><td></td><td></td></tr><tr><td></td><td></td><td></td></tr><tr><td></td><td></td><td></td></tr></table> Post - 0 Miss - 0 Block - 0									
	1																																																																														
1		1																																																																													
1																																																																															
28 马雯怡 <table border="1"><tr><td></td><td></td><td></td></tr><tr><td></td><td></td><td></td></tr><tr><td></td><td></td><td></td></tr></table> Post - 0 Miss - 0 Block - 0										30 罗佳乐 <table border="1"><tr><td></td><td></td><td></td></tr><tr><td></td><td></td><td></td></tr><tr><td></td><td></td><td></td></tr></table> Post - 0 Miss - 0 Block - 0										32 王小雅 <table border="1"><tr><td></td><td></td><td></td></tr><tr><td></td><td></td><td></td></tr><tr><td></td><td></td><td></td></tr></table> Post - 0 Miss - 0 Block - 0										34 姜影 <table border="1"><tr><td>2</td><td>2</td><td></td></tr><tr><td>1</td><td></td><td></td></tr><tr><td>1</td><td>1</td><td></td></tr></table> Post - 0 Miss - 0 Block - 0	2	2		1			1	1		35 李旭 <table border="1"><tr><td></td><td></td><td>1</td></tr><tr><td>1</td><td></td><td></td></tr><tr><td></td><td></td><td>1</td></tr></table> Post - 0 Miss - 1 Block - 0			1	1					1	36 高奇欣 <table border="1"><tr><td></td><td></td><td></td></tr><tr><td></td><td></td><td></td></tr><tr><td></td><td></td><td></td></tr></table> Post - 0 Miss - 0 Block - 0										38 潘楠 <table border="1"><tr><td></td><td></td><td></td></tr><tr><td></td><td></td><td></td></tr><tr><td>2</td><td>1</td><td>1</td></tr></table> Post - 0 Miss - 0 Block - 0							2	1	1										
2	2																																																																														
1																																																																															
1	1																																																																														
		1																																																																													
1																																																																															
		1																																																																													
2	1	1																																																																													

1 张家轩

2/4	1/1	1/2
1/2	1/1	1/3
1/4	1/1	2/2

16 刘子琪

2/2	0/1	
0/1		0/2
0/2		1/1

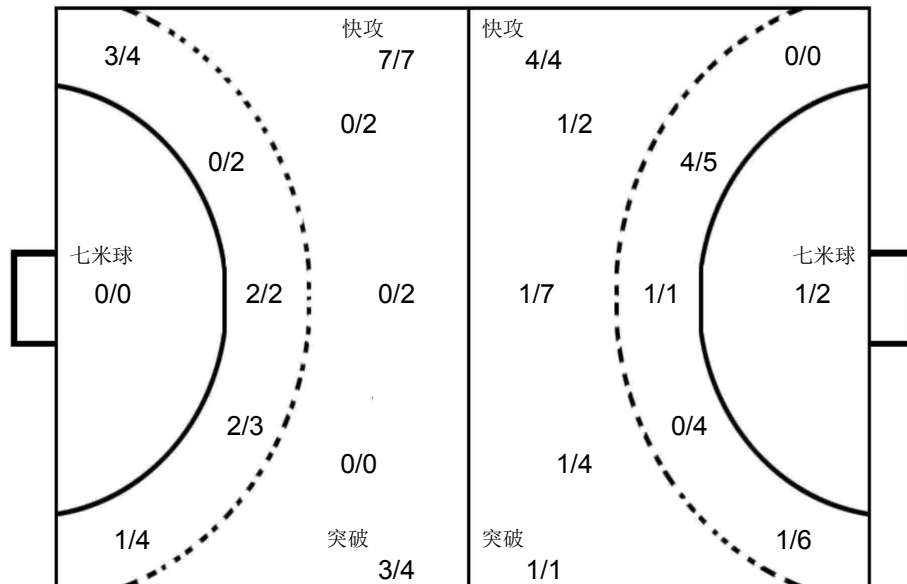

16 邹童羽

0/2	1/4	0/1
1/3	2/2	1/1
1/4	1/3	3/5

17 冯颖慧

0/1		0/1
0/1		

广东深圳

2 唐悦 <table border="1"><tr><td></td><td></td><td></td></tr><tr><td>1</td><td></td><td></td></tr><tr><td></td><td></td><td></td></tr></table> Post - 1 Miss - 0 Block - 1				1						3 赵晔 <table border="1"><tr><td></td><td></td><td></td></tr><tr><td></td><td></td><td>1</td></tr><tr><td>1</td><td></td><td></td></tr></table> Post - 1 Miss - 2 Block - 1						1	1			5 朱嘉盈 <table border="1"><tr><td></td><td></td><td>1</td></tr><tr><td></td><td></td><td>3</td></tr><tr><td>3</td><td></td><td></td></tr></table> Post - 0 Miss - 0 Block - 0			1			3	3			6 朱嘉晴 <table border="1"><tr><td>1</td><td>1</td><td></td></tr><tr><td></td><td></td><td></td></tr><tr><td>1</td><td></td><td></td></tr></table> Post - 0 Miss - 0 Block - 0	1	1					1			7 曾妮 <table border="1"><tr><td></td><td></td><td></td></tr><tr><td></td><td></td><td></td></tr><tr><td></td><td></td><td></td></tr></table> Post - 0 Miss - 0 Block - 0										9 张雨乐 <table border="1"><tr><td></td><td></td><td></td></tr><tr><td></td><td></td><td></td></tr><tr><td></td><td></td><td></td></tr></table> Post - 1 Miss - 0 Block - 0										10 徐瑜琳 <table border="1"><tr><td></td><td></td><td></td></tr><tr><td></td><td></td><td></td></tr><tr><td></td><td></td><td></td></tr></table> Post - 0 Miss - 0 Block - 0										11 王文卉 <table border="1"><tr><td></td><td></td><td></td></tr><tr><td></td><td></td><td></td></tr><tr><td></td><td></td><td></td></tr></table> Post - 0 Miss - 0 Block - 0									
1																																																																															
		1																																																																													
1																																																																															
		1																																																																													
		3																																																																													
3																																																																															
1	1																																																																														
1																																																																															
12 于雅梦 <table border="1"><tr><td></td><td></td><td></td></tr><tr><td></td><td></td><td></td></tr><tr><td></td><td></td><td></td></tr></table> Post - 0 Miss - 0 Block - 0										13 刘培天 <table border="1"><tr><td>1</td><td></td><td></td></tr><tr><td>1</td><td></td><td></td></tr><tr><td></td><td></td><td></td></tr></table> Post - 0 Miss - 0 Block - 0	1			1						16 邹童羽 <table border="1"><tr><td></td><td></td><td></td></tr><tr><td></td><td></td><td></td></tr><tr><td></td><td></td><td></td></tr></table> Post - 0 Miss - 0 Block - 0										17 冯颖慧 <table border="1"><tr><td></td><td></td><td></td></tr><tr><td></td><td></td><td></td></tr><tr><td></td><td></td><td></td></tr></table> Post - 0 Miss - 0 Block - 0										18 谢宛彤 <table border="1"><tr><td></td><td></td><td></td></tr><tr><td></td><td></td><td></td></tr><tr><td></td><td></td><td></td></tr></table> Post - 0 Miss - 0 Block - 0										20 岳欣华 <table border="1"><tr><td></td><td></td><td></td></tr><tr><td></td><td></td><td></td></tr><tr><td></td><td></td><td></td></tr></table> Post - 0 Miss - 0 Block - 0																													
1																																																																															
1																																																																															





第二届全国青年运动会女子手球甲组决赛 体校组 (U18)

青年女子 国内比赛

预赛 Group A



PHMS Pictorial Handball Match Statistics

IHF Official System

Team A A 澳门				Team B B 安徽滁州				Match Number <b>60</b>			
----------------	--	--	--	------------------	--	--	--	---------------------------	--	--	--

Played in 山西晋中	in the hall 晋中体育馆	on 2019-06-21	at 14:00	hours	Speakers
-------------------	----------------------	------------------	-------------	-------	----------

Half-time(30')	A 1	B 16	End of playing time	A 6	B 24	1st extra time	A	B	2nd extra time	A	B	After penalty throws	A	B
----------------	--------	---------	---------------------	--------	---------	----------------	---	---	----------------	---	---	----------------------	---	---

Number of 7 m 0/1	Team time-out			Full name of players and officials	Team time-out			B 0/1	Number of 7 m
	1 06:28	2 30:57	3		1	2	3		

No.	Team A	G	W	2'	D	DR	No.	Team B	G	W	2'	D	DR
8	譚嘉雯						1	张家轩					
10	盧曉汶						2	钟梦					
11	李君移						3	孙明月	2				
12	李芷棋	4					4	龚铭					
15	張雪琳	1					7	丁洁	6				
18	曾華恩	1	1				9	窦海乐	1				
19	馮楚瑩						16	刘子琪					
22	蘇萱婷						25	耿雨萍	1				
23	霍思允						26	张雅婷	1	1			
44	李嵐			1			28	马雯怡					
58	林诗雅						30	罗佳乐	1				
							32	王小雅					
							34	姜影	3				
							35	李旭	4				
							36	高奇欣	3				
							38	潘楠	2				
A	蘇沛祺						B	陆广红 (主教练)					
B	陳嘉聰 (主教练)						C	岳连娥					
C	霍俊浩						D	李莉					

A	Signatures of responsables for the teams (Off.A)												B
---	--	--	--	--	--	--	--	--	--	--	--	--	---

TP	Remarks of referees / HF Official													TP
----	-----------------------------------	--	--	--	--	--	--	--	--	--	--	--	--	----

Referees	马文 (CHN)	张晓虎 (CHN)		
T.D.	吴瑞亭 (CHN)	王洋 (CHN)		
CHA Off.				

Note: Number of 7m Throws Awarded to Team A and B, Goals (G), Warnings (W), Suspensions (2'), Direct Disqualification (D), Disqualification With Report (DR) and Team Penalty (TP).

Table Officials: 贾腾 马迪 Statisticians: 王梓衡 刘笑

竞赛技术统计

手球  
青年女子

预赛  
轮次 6

组别 A  
场次 60

晋中体育馆  
2019-06-21 14:00

Referees:	马文 (CHN) / 张晓虎 (CHN)	Result:	6:24 (1:16)
Teams:	澳门(澳门) VS 安徽滁州(滁州)		

澳门		远射	近射	边射	快攻	突破	任意球	7m球	合计	%	助攻	失误	警告	2'	D+DR
主教练: 陈嘉聪															
8	谭嘉雯														
10	卢晓汶														
11	李君移	0/1							0/1	0.0		3			
12	李芷棋		4/4					0/1	4/5	80.0		2			
15	张雪琳	0/3		0/2			1/3		1/8	12.5		4			
18	曾华恩		1/1						1/1	100		4	1		
19	冯楚莹														
22	苏萱婷	0/6							0/6	0.0	1	6			
23	霍思允											3			
44	李胤													1	
58	林诗雅														
运动员	合计	0/10	5/5	0/2			1/3	0/1	6/21	28.6	1	22	1	1	
10	卢晓汶			0/1	0/1				0/2	0.0					
19	冯楚莹	2/6	0/2	0/5	3/14		1/1		6/28	21.4					
守门员	合计	2/6	0/2	0/6	3/15		1/1		6/30	20.0					

澳门	比赛进程	滁州
1st Half		
0	00:38	1 35 李旭
0	02:04	2 9 窦海乐
0	03:02	3 38 潘楠
0	03:36	4 34 姜影
0	04:21	5 3 孙明月
0	05:49	6 34 姜影
0	06:24	7 34 姜影
0	07:41	8 36 高奇欣
0	08:41	9 35 李旭
0	09:42	10 7 丁洁
0	11:13	11 35 李旭
0	12:50	12 7 丁洁
0	14:00	13 3 孙明月
0	15:06	14 7 丁洁
0	15:52	15 7 丁洁
0	17:23	16 26 张雅婷
12	李芷棋	1 18:47 16
2nd Half		
1	00:37	17 25 耿雨萍
1	00:58	18 7 丁洁
18	曾华恩	2 02:31 18
12	李芷棋	3 07:26 18
15	张雪琳	4 08:49 18
	4 09:05	19 7 丁洁
	4 10:36	20 30 罗佳乐
	4 13:31	21 38 潘楠
	4 15:57	22 36 高奇欣
	4 17:25	23 35 李旭
12	李芷棋	5 17:54 23
12	李芷棋	6 18:49 23
	6 19:13	24 36 高奇欣

滁州		远射	近射	边射	快攻	突破	任意球	7m球	合计	%	助攻	失误	警告	2'	D+DR
主教练: 陆广红															
1	张家轩										2				
2	钟梦											1			
3	孙明月	0/1			2/3				2/4	50.0	2	2			
4	龚铭														
7	丁洁	3/4		2/2	1/1				6/7	85.7	1				
9	窦海乐	1/1							1/1	100	1				
16	刘子琪										3	1			
25	耿雨萍			1/1					1/1	100		1			
26	张雅婷			1/1			0/1		1/2	50.0			1		
28	马雯怡			0/1					0/1	0.0		3			
30	罗佳乐		1/1					0/1	1/2	50.0					
32	王小雅														
34	姜影			0/1	3/4				3/5	60.0					
35	李旭	0/1			4/4				4/5	80.0	1				
36	高奇欣		1/1	1/1	1/2				3/4	75.0					
38	潘楠			1/1	1/2				2/3	66.7	1	2			
运动员	合计	4/7	2/2	6/8	12/16		0/1	0/1	24/35	68.6	11	10	1		
1	张家轩	4/4		1/1					5/5	100	2				
16	刘子琪	4/4	0/5				2/3		6/12	50.0	3	1			
守门员	合计	8/8	0/5	1/1			2/3		11/17	64.7	5	1			

场上队员: 得分 / 射门

守门员: 救球 / 射门

D	取消资格	DR	取消资格+报告
---	------	----	---------

## 个人/全队技术统计表

 手球 预赛 组别 A 晋中体育馆  
 青年女子 轮次 6 场次 60 2019-06-21 14:00

号码	姓名	远射	近射	边射	快攻	突破	任意	七米	合计	%	助攻	失误	警告	2'	取消	时间
澳门(澳门)																
(场上队员)																
8	譚嘉雯									0.0%						00:07:10
10	盧曉汶									0.0%						00:02:19
11	李君移	0/1							0/1	0.0%	3					00:40:00
12	李芷棋		4/4					0/1	4/5	80.0%	2					00:40:00
15	張雪琳	0/3		0/2			1/3		1/8	12.5%	4					00:39:18
18	曾華恩		1/1						1/1	100%	4	1				00:35:59
19	馮楚瑩									0.0%						00:37:49
22	蘇萱婷	0/6							0/6	0.0%	1	6				00:37:24
23	霍思允									0.0%		3				00:12:55
44	李嵐									0.0%				1		00:26:58
58	林詩雅									0.0%						00:00:00
合计		0/10	5/5	0/2			1/3	0/1	6/21	28.6%	1	22	1	1		

(守门员)																
10	盧曉汶			0/1	0/1				0/2	0.0%						00:02:19
19	馮楚瑩	2/6	0/2	0/5	3/14		1/1		6/28	21.4%						00:37:49
合计		2/6	0/2	0/6	3/15		1/1		6/30	20.0%						

场上队员： 得分/射门

守门员： 救球/射门

全队合计	得分	被救	射失	击柱	封球	合计	%
远射		8	1		1	10	0.0%
近射	5					5	100.0%
边射		1		1		2	0.0%
快攻							0.0%
突破							0.0%
任意	1	2				3	33.3%
七米			1			1	0.0%

第二届全国青年运动会女子手球甲组决赛 体校组 (U18)

PHMS Pictorial Handball Match Statistics

IHF Official System

个人/全队技术统计表

手球 青年女子 预赛 轮次 6 组别 A 场次 60 晋中体育馆 2019-06-21 14:00

号码	姓名	远射	近射	边射	快攻	突破	任意	七米	合计	%	助攻	失误	警告	2'	取消	时间
<b>安徽滁州(滁州)</b>																
<b>(场上队员)</b>																
1	张家轩									0.0%	2					00:14:35
2	钟梦									0.0%		1				00:18:02
3	孙明月	0/1			2/3				2/4	50.0%	2	2				00:23:10
4	龚铭									0.0%						00:00:00
7	丁洁	3/4		2/2	1/1				6/7	85.7%	1					00:22:07
9	窦海乐	1/1							1/1	100%	1					00:17:52
16	刘子琪									0.0%	3	1				00:25:25
25	耿雨萍			1/1					1/1	100%		1				00:10:46
26	张雅婷			1/1			0/1		1/2	50.0%			1			00:19:35
28	马雯怡			0/1					0/1	0.0%		3				00:16:49
30	罗佳乐		1/1					0/1	1/2	50.0%						00:12:07
32	王小雅									0.0%						00:00:00
34	姜影			0/1	3/4				3/5	60.0%						00:20:33
35	李旭	0/1			4/4				4/5	80.0%	1					00:27:51
36	高奇欣		1/1	1/1	1/2				3/4	75.0%						00:29:03
38	潘楠			1/1	1/2				2/3	66.7%	1	2				00:21:57
	<b>合计</b>	<b>4/7</b>	<b>2/2</b>	<b>6/8</b>	<b>12/16</b>	<b>合计</b>	<b>0/1</b>	<b>0/1</b>	<b>24/35</b>	<b>68.6%</b>	<b>11</b>	<b>10</b>	<b>1</b>			
<b>(守门员)</b>																
1	张家轩	4/4		1/1					5/5	100%	2					00:14:35
16	刘子琪	4/4	0/5				2/3		6/12	50.0%	3	1				00:25:25
	<b>合计</b>	<b>8/8</b>	<b>0/5</b>	<b>1/1</b>			<b>2/3</b>		<b>11/17</b>	<b>64.7%</b>	<b>5</b>	<b>1</b>				

场上队员：得分/射门

守门员：救球/射门

全队合计	得分	被救	射失	击柱	封球	合计	%
远射	4	2		1		7	57.1%
近射	2					2	100.0%
边射	6			2		8	75.0%
快攻	12	3		1		16	75.0%
突破							0.0%
任意		1				1	0.0%
七米			1			1	0.0%

图式比赛技术统计表

手球  
青年女子

预赛  
轮次 6

组别 A  
场次 60

晋中体育馆  
2019-06-21 14:00

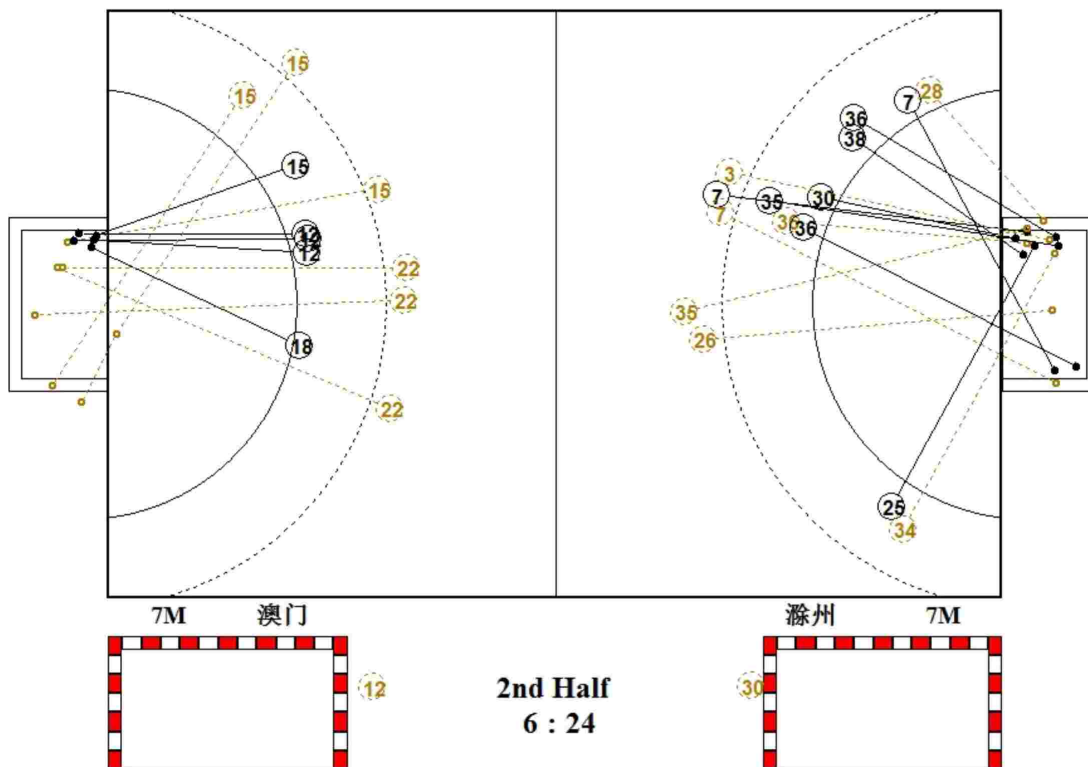
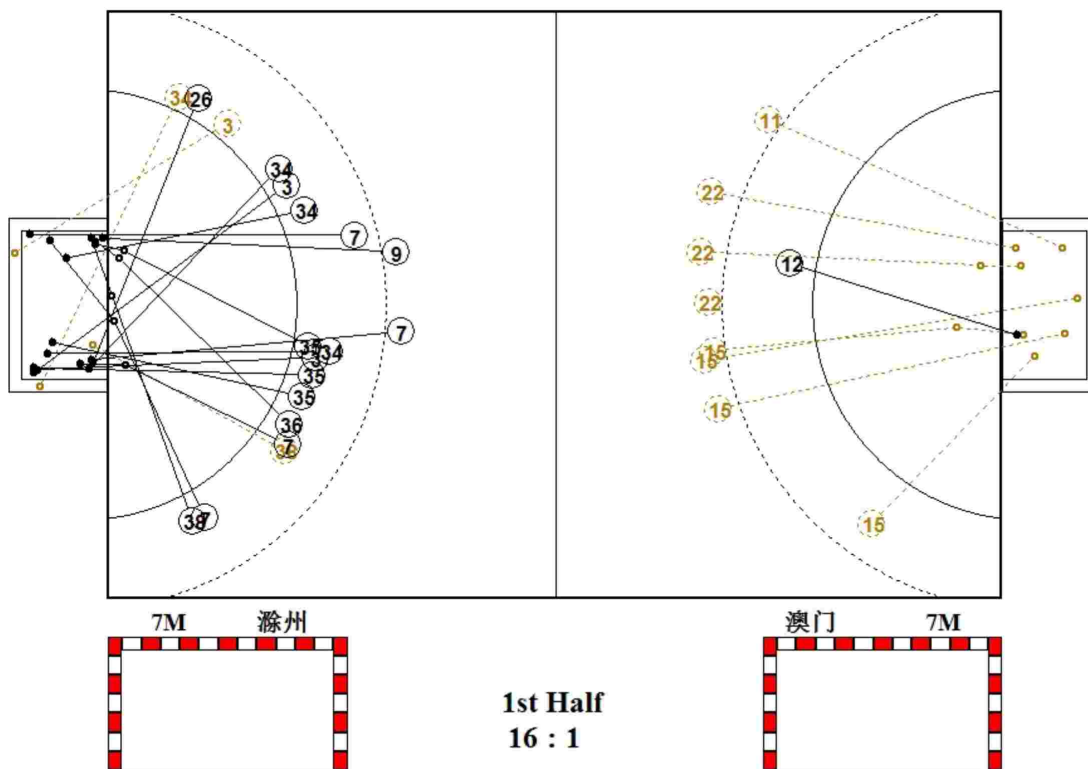

图式射门区域统计

手球  
青年女子

预赛  
轮次 6

组别 A  
场次 60

晋中体育馆  
2019-06-21 14:00

澳门

8 譚嘉雯	10 盧曉汶	11 李君移	12 李芷棋	15 張雪琳	18 曾華恩	19 馮楚瑩	22 蘇萱婷																																																																								
<table border="1"><tr><td></td><td></td><td></td></tr><tr><td></td><td></td><td></td></tr><tr><td></td><td></td><td></td></tr></table>										<table border="1"><tr><td></td><td></td><td></td></tr><tr><td></td><td></td><td></td></tr><tr><td></td><td></td><td></td></tr></table>										<table border="1"><tr><td></td><td></td><td></td></tr><tr><td></td><td></td><td></td></tr><tr><td></td><td></td><td></td></tr></table>										<table border="1"><tr><td></td><td></td><td>2</td></tr><tr><td></td><td></td><td>2</td></tr><tr><td></td><td></td><td></td></tr></table>			2			2				<table border="1"><tr><td></td><td></td><td></td></tr><tr><td></td><td></td><td>1</td></tr><tr><td></td><td></td><td></td></tr></table>						1				<table border="1"><tr><td></td><td></td><td></td></tr><tr><td></td><td></td><td>1</td></tr><tr><td></td><td></td><td></td></tr></table>						1				<table border="1"><tr><td></td><td></td><td></td></tr><tr><td></td><td></td><td></td></tr><tr><td></td><td></td><td></td></tr></table>										<table border="1"><tr><td></td><td></td><td></td></tr><tr><td></td><td></td><td></td></tr><tr><td></td><td></td><td></td></tr></table>									
		2																																																																													
		2																																																																													
		1																																																																													
		1																																																																													
Post - 0 Miss - 0 Block - 0	Post - 0 Miss - 0 Block - 0	Post - 0 Miss - 0 Block - 0	Post - 0 Miss - 1 Block - 0	Post - 1 Miss - 1 Block - 0	Post - 0 Miss - 0 Block - 0	Post - 0 Miss - 0 Block - 0	Post - 0 Miss - 0 Block - 1																																																																								

23 霍思允	44 李嵐	58 林詩雅																											
<table border="1"><tr><td></td><td></td><td></td></tr><tr><td></td><td></td><td></td></tr><tr><td></td><td></td><td></td></tr></table>										<table border="1"><tr><td></td><td></td><td></td></tr><tr><td></td><td></td><td></td></tr><tr><td></td><td></td><td></td></tr></table>										<table border="1"><tr><td></td><td></td><td></td></tr><tr><td></td><td></td><td></td></tr><tr><td></td><td></td><td></td></tr></table>									
Post - 0 Miss - 0 Block - 0	Post - 0 Miss - 0 Block - 0	Post - 0 Miss - 0 Block - 0																											

10 盧曉汶									
<table border="1"><tr><td>0/1</td><td></td><td>0/1</td></tr><tr><td></td><td></td><td></td></tr><tr><td></td><td></td><td></td></tr></table>	0/1		0/1						
0/1		0/1							

19 馮楚瑩									
<table border="1"><tr><td>0/4</td><td></td><td>0/2</td></tr><tr><td>2/5</td><td>1/1</td><td>0/2</td></tr><tr><td>3/10</td><td></td><td>0/4</td></tr></table>	0/4		0/2	2/5	1/1	0/2	3/10		0/4
0/4		0/2							
2/5	1/1	0/2							
3/10		0/4							

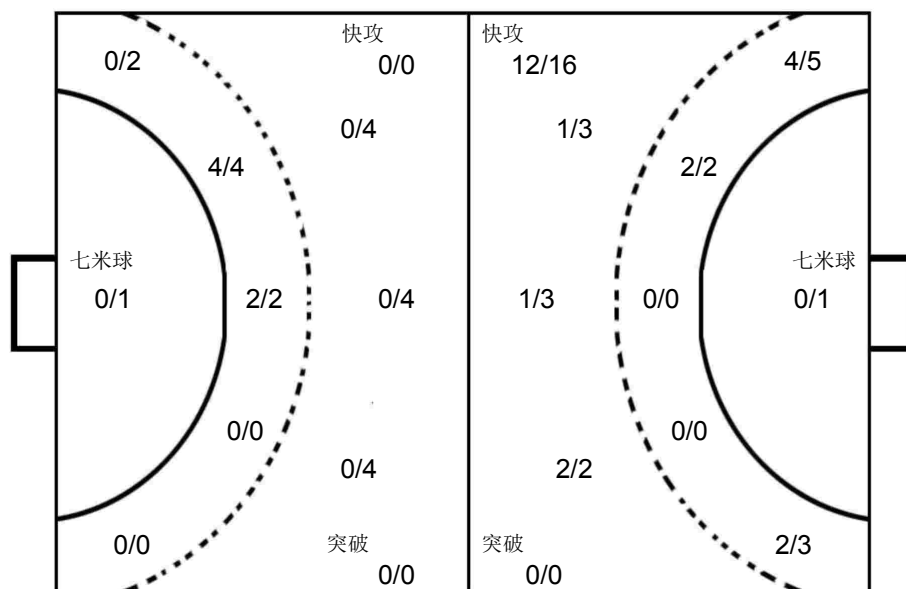

1 張家軒									
<table border="1"><tr><td>1/1</td><td></td><td>1/1</td></tr><tr><td></td><td></td><td>1/1</td></tr><tr><td>2/2</td><td></td><td></td></tr></table>	1/1		1/1			1/1	2/2		
1/1		1/1							
		1/1							
2/2									

16 劉子琪									
<table border="1"><tr><td></td><td>2/2</td><td></td></tr><tr><td></td><td></td><td>3/5</td></tr><tr><td></td><td></td><td>1/5</td></tr></table>		2/2				3/5			1/5
	2/2								
		3/5							
		1/5							

安徽滁州

1 張家軒	2 鐘夢	3 孫明月	4 龔銘	7 丁潔	9 龔海樂	16 劉子琪	25 耿雨萍																																																																																	
<table border="1"><tr><td></td><td></td><td></td></tr><tr><td></td><td></td><td></td></tr><tr><td></td><td></td><td></td></tr></table>										<table border="1"><tr><td></td><td></td><td></td></tr><tr><td></td><td></td><td></td></tr><tr><td></td><td></td><td></td></tr></table>										<table border="1"><tr><td>2</td><td></td><td></td></tr><tr><td></td><td></td><td></td></tr><tr><td></td><td></td><td></td></tr></table>	2									<table border="1"><tr><td></td><td></td><td></td></tr><tr><td></td><td></td><td></td></tr><tr><td></td><td></td><td></td></tr></table>										<table border="1"><tr><td></td><td></td><td>2</td></tr><tr><td></td><td></td><td>1</td></tr><tr><td>3</td><td></td><td></td></tr></table>			2			1	3			<table border="1"><tr><td></td><td></td><td></td></tr><tr><td></td><td></td><td></td></tr><tr><td></td><td></td><td>1</td></tr></table>									1	<table border="1"><tr><td></td><td></td><td></td></tr><tr><td></td><td></td><td></td></tr><tr><td></td><td></td><td></td></tr></table>										<table border="1"><tr><td></td><td></td><td></td></tr><tr><td></td><td></td><td></td></tr><tr><td></td><td></td><td></td></tr></table>																		
2																																																																																								
		2																																																																																						
		1																																																																																						
3																																																																																								
		1																																																																																						
Post - 0 Miss - 0 Block - 0	Post - 0 Miss - 0 Block - 0	Post - 1 Miss - 0 Block - 0	Post - 0 Miss - 0 Block - 0	Post - 1 Miss - 0 Block - 0	Post - 0 Miss - 0 Block - 0	Post - 0 Miss - 0 Block - 0	Post - 0 Miss - 0 Block - 0																																																																																	
26 張雅婷	28 馬雯怡	30 羅佳樂	32 王小雅	34 姜影	35 李旭	36 高奇欣	38 潘楠																																																																																	
<table border="1"><tr><td></td><td></td><td></td></tr><tr><td></td><td></td><td></td></tr><tr><td>1</td><td></td><td></td></tr></table>							1			<table border="1"><tr><td></td><td></td><td></td></tr><tr><td></td><td></td><td></td></tr><tr><td></td><td></td><td></td></tr></table>										<table border="1"><tr><td></td><td></td><td></td></tr><tr><td></td><td></td><td></td></tr><tr><td>1</td><td></td><td></td></tr></table>							1			<table border="1"><tr><td></td><td></td><td></td></tr><tr><td></td><td></td><td></td></tr><tr><td></td><td></td><td></td></tr></table>										<table border="1"><tr><td></td><td></td><td>1</td></tr><tr><td></td><td></td><td>1</td></tr><tr><td>1</td><td></td><td></td></tr></table>			1			1	1			<table border="1"><tr><td></td><td></td><td></td></tr><tr><td></td><td></td><td></td></tr><tr><td>2</td><td></td><td></td></tr><tr><td>1</td><td></td><td></td></tr><tr><td></td><td></td><td>1</td></tr></table>							2			1					1	<table border="1"><tr><td></td><td></td><td>1</td></tr><tr><td></td><td></td><td></td></tr><tr><td>1</td><td></td><td></td></tr><tr><td></td><td></td><td>1</td></tr></table>			1				1					1	<table border="1"><tr><td></td><td></td><td></td></tr><tr><td></td><td></td><td></td></tr><tr><td></td><td></td><td></td></tr></table>									
1																																																																																								
1																																																																																								
		1																																																																																						
		1																																																																																						
1																																																																																								
2																																																																																								
1																																																																																								
		1																																																																																						
		1																																																																																						
1																																																																																								
		1																																																																																						
Post - 0 Miss - 0 Block - 0	Post - 1 Miss - 0 Block - 0	Post - 0 Miss - 1 Block - 0	Post - 0 Miss - 0 Block - 0	Post - 1 Miss - 0 Block - 0	Post - 0 Miss - 0 Block - 0	Post - 0 Miss - 0 Block - 0	Post - 0 Miss - 0 Block - 0																																																																																	



第二届全国青年运动会女子手球甲组决赛 体校组 (U18)

青年女子 国内比赛

预赛 Group A



PHMS Pictorial Handball Match Statistics

IHF Official System

Team A					Team B					Match Number											
A 香港					B 北京市					68											
Played in			in the hall			on			at			Spectators									
山西晋中			晋中体育馆			2019-06-21			17:30			hours									
Half-time(30')	A	B	End of playing time		A	B	1st extra time		A	B	2nd extra time		A	B	After penalty throws						
	8	12	16		26																
Number of 7 m	A	Team time-out			Full name of players and officials						Team time-out			B	Number of 7 m						
	0/1	1	2	3							1	2	3	B							
		09:03	27:00	32:29							25:07	39:14	3/3								
No.	Team A					G	W	2'	D	DR	No.	Team B					G	W	2'	D	DR
1	郑晓容										1	靳爽									
3	黄秋婷					1					5	常凯旋					2				
4	何丹仪										7	翟乃迪						1			
5	卓凯晴										8	武宏业					6		1		
6	洪卓翹										9	徐慧敏									
8	李芷欣					3	1				10	胡冰心					5				
9	林卓琪										11	陈丽婷					4		1		
11	庄斯琪					3		1			14	侯美林						1			
16	曾婉琳					7					16	周晓雨									
17	梁艺										18	唐文杰					3		1		
18	吴嘉妮										23	黄文文									
21	林乐儿										27	田苗									
23	王洁桦										81	王木子									
25	戴子怡					2					87	王奥									
28	郭芷彤										88	彭爽爽					6				
91	孔倩瑜																				
A	杨开将										B	黄承 (主教练)									
B	何颂邦										C	栾征									
C	梁倩盈										D	石伟									
											E	刘文勇									
A											Signatures of responsables for the teams (Off.A)										B
TP	Remarks of referees / HF Official																				TP

Signatures

Referees	康曦 (CHN)	吴佳 (CHN)		
T.D.	叶霄雪 (CHN)	张耿 (CHN)		
CHA Off.				

Note: Number of 7m Throws Awarded to Team A and B, Goals (G), Warnings (W), Suspensions (2'), Direct Disqualification (D), Disqualification With Report (DR) and Team Penalty (TP).

Table Officials: 张琦 吴鹏凯 Statisticians: 陈柱 谢扬



## 第二届全国青年运动会女子手球甲组决赛 体校组 (U18)

PHMS Pictorial Handball Match Statistics

IHF Official System

### 竞赛技术统计

手球  
青年女子

预赛  
轮次 6

组别 A  
场次 68

晋中体育馆  
2019-06-21 17:30

Referees:	康曦 (CHN) / 吴佳 (CHN)	Result:	16:26 (8:12)
Teams:	香港(香港) VS 北京市(北京)		

香港																北京													
主教练: 梁倩盈																主教练: 黄承													
	远射	近射	边射	快攻	突破	任意球	7m球	合计	%	助攻	失误	警告	2'	D+DR	比赛进程														
1 郑晓容															1st Half														
3 黄秋婷			1/1					1/1	100	1	2				11 庄斯琪	0 01:17 1 88 彭爽爽													
4 何丹仪											1				1 02:34 1														
5 卓凯晴							0/1	0/1	0.0						8 李芷欣	1 03:25 2 10 胡冰心													
6 洪卓翹															2 03:49 2														
8 李芷欣	2/2				1/1			3/3	100		3	1			16 曾婉琳	3 04:36 2													
9 林卓琪			0/1					0/1	0.0						3 05:53 3 88 彭爽爽														
11 庄斯琪	2/6		1/1					3/7	42.9					1	3 07:26 4 11 陈丽婷														
16 曾婉琳	2/4	1/3	3/5	1/1		0/1		7/14	50.0		2				3 08:23 5 11 陈丽婷														
17 梁艺			0/1					0/1	0.0						3 08:58 6 10 胡冰心														
18 吴嘉妮		0/1	0/1					0/2	0.0		1				16 曾婉琳	4 09:46 6													
21 林乐儿															4 10:01 7 88 彭爽爽														
23 王洁桦															4 11:45 8 88 彭爽爽														
25 戴子怡		2/2						2/2	100						16 曾婉琳	5 12:14 8													
28 郭芷彤															5 13:30 9 11 陈丽婷														
91 孔倩瑜	0/1		0/1					0/2	0.0		1				5 14:45 10 11 陈丽婷														
<b>运动员 合计</b>	<b>6/13</b>	<b>3/6</b>	<b>5/11</b>	<b>1/1</b>	<b>1/1</b>	<b>0/1</b>	<b>0/1</b>	<b>16/34</b>	<b>47.1</b>	<b>1</b>	<b>14</b>	<b>1</b>	<b>1</b>		25 戴子怡	6 16:12 10													
1 郑晓容	2/2	0/3	2/6	1/4	0/6		0/2	5/23	21.7						16 曾婉琳	7 17:39 10													
6 洪卓翹	0/2	0/2		0/3			0/1	0/8	0.0						16 曾婉琳	8 18:38 10													
<b>守门员 合计</b>	<b>2/4</b>	<b>0/5</b>	<b>2/6</b>	<b>1/7</b>	<b>0/6</b>		<b>0/3</b>	<b>5/31</b>	<b>16.1</b>						8 李芷欣	8 19:04 11 8 武宏业													
<b>北京</b>														2nd Half															
1 靳爽															8 19:52 12 10 胡冰心														
5 常凯旋				1/1	1/1			2/2	100	1					25 戴子怡	9 01:21 12													
7 翟乃迪			0/1	0/1				0/2	0.0	1	2	1			16 曾婉琳	10 02:53 12													
8 武宏业	1/3			1/1	2/3		2/2	6/9	66.7	1	3		1		16 曾婉琳	11 04:57 12													
9 徐慧敏															8 李芷欣	12 07:17 13													
10 胡冰心		2/2	1/2	2/2				5/6	83.3	1	1				3 黄秋婷	13 08:03 14													
11 陈丽婷					3/3		1/1	4/4	100						11 庄斯琪	14 09:10 14													
14 侯美林											2	1			14 09:44 15 5 常凯旋														
16 周晓雨															14 10:13 16 10 胡冰心														
18 唐文杰		3/3						3/3	100		2		1		11 庄斯琪	15 10:33 16													
23 黄文文															15 10:49 17 8 武宏业														
27 田苗		0/1						0/1	0.0						15 11:21 18 8 武宏业														
81 王木子															15 12:26 19 18 唐文杰														
87 王奥															15 12:54 20 5 常凯旋														
88 彭爽爽	1/1		3/4	2/2				6/7	85.7		3				8 李芷欣	16 13:08 20													
<b>运动员 合计</b>	<b>2/4</b>	<b>5/6</b>	<b>4/7</b>	<b>6/7</b>	<b>6/7</b>		<b>3/3</b>	<b>26/34</b>	<b>76.5</b>	<b>4</b>	<b>14</b>	<b>2</b>	<b>3</b>		16 14:32 21 10 胡冰心														
1 靳爽	3/9	2/5	4/9	0/1	0/1			9/25	36.0						16 14:54 22 18 唐文杰														
<b>守门员 合计</b>	<b>3/9</b>	<b>2/5</b>	<b>4/9</b>	<b>0/1</b>	<b>0/1</b>			<b>9/25</b>	<b>36.0</b>						16 16:05 23 8 武宏业														
															16 18:10 24 88 彭爽爽														
															16 18:54 25 8 武宏业														
															16 19:30 26 8 武宏业														

场上队员: 得分 / 射门

守门员: 救球 / 射门

D	取消资格	DR	取消资格+报告
---	------	----	---------



## 个人/全队技术统计表

 手球 预赛 组别 A 晋中体育馆  
 青年女子 轮次 6 场次 68 2019-06-21 17:30

号码	姓名	远射	近射	边射	快攻	突破	任意	七米	合计	%	助攻	失误	警告	2'	取消	时间
香港(香港)																
(场上队员)																
1	郑晓容									0.0%						00:31:34
3	黄秋婷			1/1					1/1	100%	1	2				00:16:21
4	何丹仪									0.0%		1				00:07:01
5	卓凯晴							0/1	0/1	0.0%						00:00:27
6	洪卓翹									0.0%						00:08:26
8	李芷欣	2/2				1/1			3/3	100%		3	1			00:38:47
9	林卓琪			0/1					0/1	0.0%		1				00:29:43
11	庄斯琪	2/6		1/1					3/7	42.9%		3		1		00:23:19
16	曾婉琳	2/4	1/3	3/5	1/1		0/1		7/14	50.0%		2				00:33:36
17	梁艺			0/1					0/1	0.0%						00:00:46
18	吴嘉妮		0/1	0/1					0/2	0.0%		1				00:14:58
21	林乐儿									0.0%						00:00:00
23	王洁桦									0.0%						00:00:00
25	戴子怡		2/2						2/2	100%						00:29:59
28	郭芷彤									0.0%						00:09:35
91	孔倩瑜	0/1		0/1					0/2	0.0%		1				00:34:59
	合计	6/13	3/6	5/11	1/1	1/1	0/1	0/1	16/34	47.1%	1	14	1	1		
(守门员)																
1	郑晓容	2/2	0/3	2/6	1/4	0/6		0/2	5/23	21.7%						00:31:34
6	洪卓翹	0/2	0/2		0/3			0/1	0/8	0.0%						00:08:26
	合计	2/4	0/5	2/6	1/7	0/6		0/3	5/31	16.1%						

场上队员：得分/射门

守门员：救球/射门

全队合计	得分	被救	射失	击柱	封球	合计	%
远射	6	3	1	1	2	13	46.2%
近射	3	2		1		6	50.0%
边射	5	4	1	1		11	45.5%
快攻	1					1	100.0%
突破	1					1	100.0%
任意			1			1	0.0%
七米				1		1	0.0%

## 第二届全国青年运动会女子手球甲组决赛 体校组 (U18)

PHMS Pictorial Handball Match Statistics

IHF Official System

### 个人/全队技术统计表

手球 青年女子 预赛 轮次 6 组别 A 场次 68 晋中体育馆 2019-06-21 17:30

号码	姓名	远射	近射	边射	快攻	突破	任意	七米	合计	%	助攻	失误	警告	2'	取消	时间
北京市(北京)																
(场上队员)																
1	靳爽									0.0%						00:40:00
5	常凯旋				1/1	1/1			2/2	100%	1					00:17:37
7	翟乃迪			0/1	0/1				0/2	0.0%	1	2	1			00:30:08
8	武宏业	1/3			1/1	2/3		2/2	6/9	66.7%	1	3		1		00:43:58
9	徐慧敏									0.0%						00:00:00
10	胡冰心		2/2	1/2	2/2				5/6	83.3%	1	1				00:40:00
11	陈丽婷					3/3		1/1	4/4	100%		1		1		00:28:41
14	侯美林									0.0%		2	1			00:14:28
16	周晓雨									0.0%						00:00:00
18	唐文杰		3/3						3/3	100%		2		1		00:22:09
23	黄文文									0.0%						00:00:00
27	田苗		0/1						0/1	0.0%						00:22:03
81	王木子									0.0%						00:00:00
87	王奥									0.0%						00:00:00
88	彭爽爽	1/1		3/4	2/2				6/7	85.7%		3				00:40:00
合计		2/4	5/6	4/7	6/7	6/7		3/3	26/34	76.5%	4	14	2	3		

(守门员)																
1	靳爽	3/9	2/5	4/9	0/1	0/1			9/25	36.0%						00:40:00
合计		3/9	2/5	4/9	0/1	0/1			9/25	36.0%						

场上队员： 得分/射门                      守门员： 救球/射门

全队合计	得分	被救	射失	击柱	封球	合计	%
远射	2	2				4	50.0%
近射	5			1		6	83.3%
边射	4	2		1		7	57.1%
快攻	6	1				7	85.7%
突破	6		1			7	85.7%
任意							0.0%
七米	3					3	100.0%

图式比赛技术统计表

手球  
青年女子

预赛  
轮次 6

组别 A  
场次 68

晋中体育馆  
2019-06-21 17:30

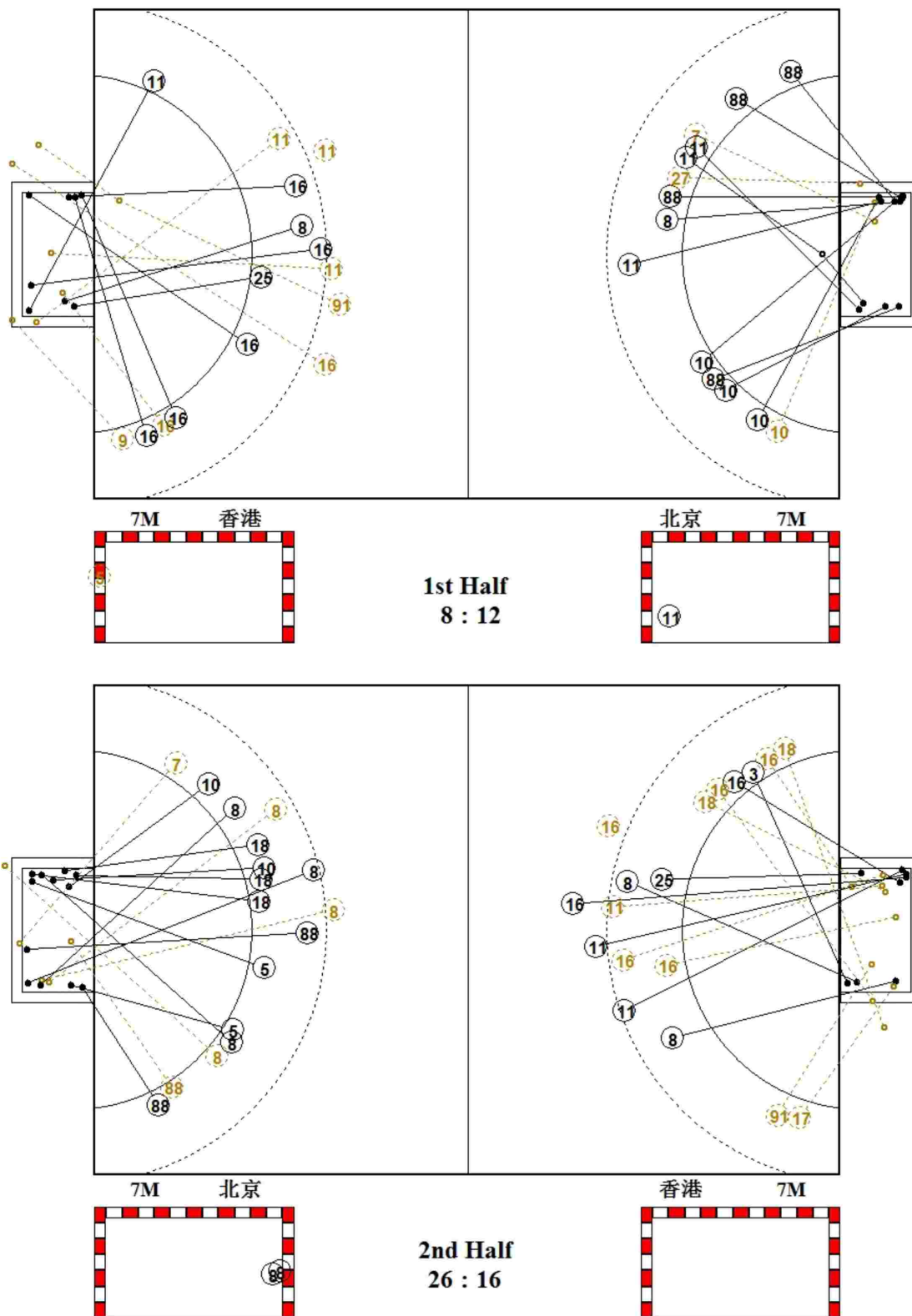

图式射门区域统计

手球  
青年女子

预赛  
轮次 6

组别 A  
场次 68

晋中体育馆  
2019-06-21 17:30

香港

1 郑晓容 Post - 0 Miss - 0 Block - 0	3 黄秋婷 Post - 0 Miss - 0 Block - 0	4 何丹仪 Post - 0 Miss - 0 Block - 0	5 卓凯晴 Post - 1 Miss - 0 Block - 0	6 洪卓翹 Post - 0 Miss - 0 Block - 0	8 李芷欣 Post - 0 Miss - 0 Block - 0	9 林卓琪 Post - 1 Miss - 0 Block - 0	11 庄斯琪 Post - 1 Miss - 0 Block - 1
16 曾婉琳 Post - 1 Miss - 1 Block - 1	17 梁艺 Post - 0 Miss - 0 Block - 0	18 吴嘉妮 Post - 0 Miss - 1 Block - 0	21 林乐儿 Post - 0 Miss - 0 Block - 0	23 王洁桦 Post - 0 Miss - 0 Block - 0	25 戴子怡 Post - 0 Miss - 0 Block - 0	28 郭芷彤 Post - 0 Miss - 0 Block - 0	91 孔倩瑜 Post - 0 Miss - 1 Block - 0

1 郑晓容	1/6	0/3
	3/5	0/4
	0/3	1/1
		0/1

6 洪卓翹	0/2	0/1	0/1
			0/3
			0/1

1 靳爽	0/6	1/1	1/3
	4/5	1/1	1/2
	1/3		0/4

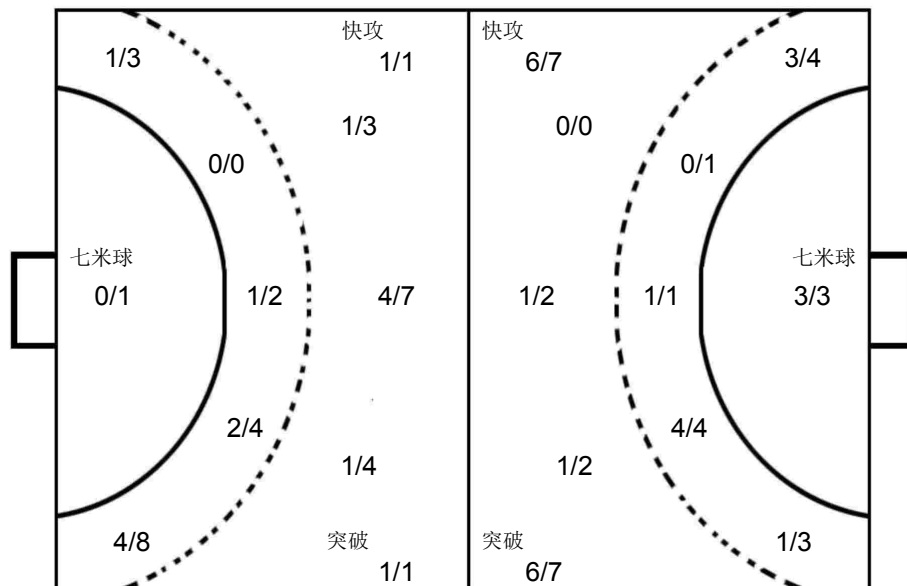

北京市

1 靳爽 Post - 0 Miss - 0 Block - 0	5 常凯旋 Post - 0 Miss - 0 Block - 0	7 翟乃迪 Post - 1 Miss - 0 Block - 0	8 武宏业 Post - 0 Miss - 1 Block - 0	9 徐慧敏 Post - 0 Miss - 0 Block - 0	10 胡冰心 Post - 0 Miss - 0 Block - 0	11 陈丽婷 Post - 0 Miss - 0 Block - 0	14 侯美林 Post - 0 Miss - 0 Block - 0
16 周晓雨 Post - 0 Miss - 0 Block - 0	18 唐文杰 Post - 0 Miss - 0 Block - 0	23 黄文文 Post - 0 Miss - 0 Block - 0	27 田苗 Post - 1 Miss - 0 Block - 0	81 王木子 Post - 0 Miss - 0 Block - 0	87 王奥 Post - 0 Miss - 0 Block - 0	88 彭爽爽 Post - 0 Miss - 0 Block - 0	



第二届全国青年运动会女子手球甲组决赛 体校组 (U18)

青年女子 国内比赛

预赛 Group A



PHMS Pictorial Handball Match Statistics

IHF Official System

Team A				Team B				Match Number	
A 广东深圳				B 江苏常州				69	

Played in	in the hall	on	at	Spepectors
山西晋中	晋中体育馆	2019-06-21	18:40	hours

Half-time(30')	A	B	End of playing time	A	B	1st extra time	A	B	2nd extra time	A	B	After penalty throws	A	B
	5	9	12	20										

Number of 7 m	A	Team time-out			Full name of players and officials	Team time-out			B	Number of 7 m
	2/2	1	2	3		1	2	3	0/1	
		07:10								

No.	Team A	G	W	2'	D	DR	No.	Team B	G	W	2'	D	DR
2	唐悦						1	胡雨诺					
3	赵晔	2					7	张嘉朔			2		
5	朱嘉盈	3					8	董桂林					
6	朱嘉晴	4					9	顾霞光					
7	曾妮	1					14	庄红艳	8	1			
9	张雨乐						15	王艺儒					
10	徐瑜琳						19	焦雅	4		1		
11	王文卉						20	渠文娜	2				
12	于雅梦						21	吴静雯	4				
13	刘培天	1					22	彭如玉					
16	邹童羽						24	王铃娜	2				
17	冯颖慧						25	李秋淇					
18	谢宛彤						26	邱聿芳					
20	岳欣华	1					27	李袁梦		1	1		
							28	黄奕涵					
							29	陈赛楠					
A	张斌						A	金甲洙 (主教练)					
B	张敬敏						B	马彪					
C	常敏 (主教练)						C	李海鹰					
D	蒋光华						D	陈志伟					

A	Signatures of responsables for the teams (Off.A)												B
---	--	--	--	--	--	--	--	--	--	--	--	--	---

TP	Remarks of referees / HF Official													TP
----	-----------------------------------	--	--	--	--	--	--	--	--	--	--	--	--	----

Referees	李巧宁 (CHN)	宋优悠 (CHN)		
T.D.	许宜扬 (CHN)	刘凤娟 (CHN)		
CHA Off.				

Note: Number of 7m Throws Awarded to Team A and B, Goals (G), Warnings (W), Suspensions (2'), Direct Disqualification (D), Disqualification With Report (DR) and Team Penalty (TP).

Table Officials: 宋昌鑫 许瑛 Statisticians: 陈柱 谢扬

竞赛技术统计

手球  
青年女子

预赛  
轮次 6

组别 A  
场次 69

晋中体育馆  
2019-06-21 18:40

Referees:	李巧宁 (CHN) / 宋优悠 (CHN)	Result:	12:20(5:9)
Teams:	广东深圳(深圳) VS 江苏常州(常州)		

深圳		远射	近射	边射	快攻	突破	任意球	7m球	合计	%	助攻	失误	警告	2'	D+DR
主教练: 常敏															
2	唐悦							2/2	2/8	25.0		2			
3	赵晔	0/4	0/1	0/1											
5	朱嘉盈	1/3	1/1			1/1			3/5	60.0		4			
6	朱嘉晴	1/1	1/3	2/2					4/6	66.7		2			
7	曾妮		0/1	1/3					1/4	25.0					
9	张雨乐		0/1	0/2					0/3	0.0					
10	徐瑜琳														
11	王文卉														
12	于雅梦														
13	刘培天		1/2						1/2	50.0		1			
16	邹童羽														
17	冯颖慧														
18	谢宛彤														
20	岳欣华			1/2					1/2	50.0					
运动员 合计		2/8	3/9	4/10		1/1		2/2	12/30	40.0		9			
16	邹童羽	4/6	0/6	2/2	1/6	1/1	0/2	1/1	9/24	37.5					
17	冯颖慧	2/3	1/2	1/1	0/2	0/1			4/9	44.4					
守门员 合计		6/9	1/8	3/3	1/8	1/1	0/3	1/1	13/33	39.4					

常州		远射	近射	边射	快攻	突破	任意球	7m球	合计	%	助攻	失误	警告	2'	D+DR
主教练: 金甲洙															
1	胡雨诺														
7	张嘉朔													2	
8	董桂林														
9	顾霞光														
14	庄红艳	0/2	2/2		5/6		1/1		8/11	72.7	1	1	1		
15	王艺儒														
19	焦雅	2/4				0/1	2/2		4/7	57.1		2		1	
20	渠文娜	0/3	2/2						2/5	40.0					
21	吴静雯	1/2	2/3	0/1	1/1	0/1		0/1	4/9	44.4		1			
22	彭如玉										4				
24	王铃娜		1/1	0/2	1/2				2/5	40.0					
25	李秋淇														
26	邱聿芳														
27	李袁梦												1	1	
28	黄奕涵											1			
29	陈赛楠														
运动员 合计		3/11	7/8	0/3	7/9	0/2	3/3	0/1	20/37	54.1	5	5	2	4	
1	胡雨诺														
22	彭如玉	4/6	4/7	2/6		0/1		0/2	10/22	45.5	4				
守门员 合计		4/6	4/7	2/6		0/1		0/2	10/22	45.5	4				

深圳	比赛进程	常州
1st Half		
0	01:52	1 14 庄红艳
0	02:40	2 14 庄红艳
5 朱嘉盈	1 03:56	2
	1 05:33	3 21 吴静雯
	1 10:01	4 14 庄红艳
6 朱嘉晴	2 11:27	4
6 朱嘉晴	3 12:14	4
	3 12:38	5 19 焦雅
	3 13:42	6 14 庄红艳
5 朱嘉盈	4 15:22	6
3 赵晔	5 16:36	6
	5 17:12	7 24 王铃娜
	5 18:41	8 19 焦雅
	5 19:31	9 14 庄红艳
2nd Half		
5 朱嘉盈	6 01:38	9
	6 01:45	10 20 渠文娜
	6 02:35	11 14 庄红艳
	6 05:19	12 20 渠文娜
	6 06:02	13 14 庄红艳
	6 06:42	14 24 王铃娜
3 赵晔	7 07:46	14
	7 08:14	15 19 焦雅
6 朱嘉晴	8 08:56	15
	8 11:37	16 14 庄红艳
6 朱嘉晴	9 12:56	16
7 曾妮	10 14:35	16
20 岳欣华	11 15:52	16
	11 16:11	17 19 焦雅
13 刘培天	12 16:50	17
	12 17:51	18 21 吴静雯
	12 18:48	19 21 吴静雯
	12 19:59	20 21 吴静雯

场上队员: 得分 / 射门

守门员: 救球 / 射门

D	取消资格	DR	取消资格+报告
---	------	----	---------

## 个人/全队技术统计表

 手球 预赛 组别 A 晋中体育馆  
 青年女子 轮次 6 场次 69 2019-06-21 18:40

号码	姓名	远射	近射	边射	快攻	突破	任意	七米	合计	%	助攻	失误	警告	2'	取消	时间
广东深圳(深圳)																
(场上队员)																
2	唐悦									0.0%						00:00:00
3	赵晔	0/4	0/1	0/1				2/2	2/8	25.0%		2				00:32:28
5	朱嘉盈	1/3	1/1			1/1			3/5	60.0%		4				00:40:00
6	朱嘉晴	1/1	1/3	2/2					4/6	66.7%		2				00:40:00
7	曾妮		0/1	1/3					1/4	25.0%						00:17:04
9	张雨乐		0/1	0/2					0/3	0.0%						00:29:03
10	徐瑜琳									0.0%						00:30:22
11	王文卉									0.0%						00:00:00
12	于雅梦									0.0%						00:00:00
13	刘培天		1/2						1/2	50.0%		1				00:40:00
16	邹童羽									0.0%						00:28:31
17	冯颖慧									0.0%						00:11:29
18	谢宛彤									0.0%						00:00:00
20	岳欣华			1/2					1/2	50.0%						00:10:55
	合计	2/8	3/9	4/10		1/1		2/2	12/30	40.0%		9				
(守门员)																
16	邹童羽	4/6	0/6	2/2	1/6	1/1	0/2	1/1	9/24	37.5%						00:28:31
17	冯颖慧	2/3	1/2	1/1	0/2		0/1		4/9	44.4%						00:11:29
	合计	6/9	1/8	3/3	1/8	1/1	0/3	1/1	13/33	39.4%						

场上队员： 得分/射门

守门员： 救球/射门

全队合计	得分	被救	射失	击柱	封球	合计	%
远射	2	4	1		1	8	25.0%
近射	3	4	1	1		9	33.3%
边射	4	2	3	1		10	40.0%
快攻							0.0%
突破	1					1	100.0%
任意							0.0%
七米	2					2	100.0%

## 第二届全国青年运动会女子手球甲组决赛 体校组 (U18)

PHMS Pictorial Handball Match Statistics

IHF Official System

### 个人/全队技术统计表

手球 青年女子 预赛 轮次 6 组别 A 场次 69 晋中体育馆 2019-06-21 18:40

号码	姓名	远射	近射	边射	快攻	突破	任意	七米	合计	%	助攻	失误	警告	2'	取消	时间
<b>江苏常州(常州)</b>																
<b>(场上队员)</b>																
1	胡雨诺									0.0%						00:00:00
7	张嘉朔									0.0%				2		00:20:00
8	董桂林									0.0%						00:00:00
9	顾霞光									0.0%						00:00:00
14	庄红艳	0/2	2/2		5/6		1/1		8/11	72.7%	1	1	1			00:31:42
15	王艺儒									0.0%						00:00:00
19	焦雅	2/4				0/1	2/2		4/7	57.1%		2		1		00:40:00
20	渠文娜	0/3	2/2						2/5	40.0%						00:20:00
21	吴静雯	1/2	2/3	0/1	1/1	0/1		0/1	4/9	44.4%		1				00:30:35
22	彭如玉									0.0%	4					00:40:00
24	王铃娜		1/1	0/2	1/2				2/5	40.0%						00:30:04
25	李秋淇									0.0%						00:09:55
26	邱聿芳									0.0%						00:00:00
27	李袁梦									0.0%			1	1		00:40:00
28	黄奕涵									0.0%		1				00:17:33
29	陈赛楠									0.0%						00:00:00
<b>合计</b>		<b>3/11</b>	<b>7/8</b>	<b>0/3</b>	<b>7/9</b>	<b>0/2</b>	<b>3/3</b>	<b>0/1</b>	<b>20/37</b>	<b>54.1%</b>	<b>5</b>	<b>5</b>	<b>2</b>	<b>4</b>		
<b>(守门员)</b>																
1	胡雨诺									0.0%						00:00:00
22	彭如玉	4/6	4/7	2/6		0/1		0/2	10/22	45.5%	4					00:40:00
<b>合计</b>		<b>4/6</b>	<b>4/7</b>	<b>2/6</b>		<b>0/1</b>		<b>0/2</b>	<b>10/22</b>	<b>45.5%</b>	<b>4</b>					

场上队员：得分/射门

守门员：救球/射门

全队合计	得分	被救	射失	击柱	封球	合计	%
远射	3	6			2	11	27.3%
近射	7	1				8	87.5%
边射		3				3	0.0%
快攻	7	1	1			9	77.8%
突破		1	1			2	0.0%
任意	3					3	100.0%
七米		1				1	0.0%



图式比赛技术统计表

手球  
青年女子

预赛  
轮次 6

组别 A  
场次 69

晋中体育馆  
2019-06-21 18:40

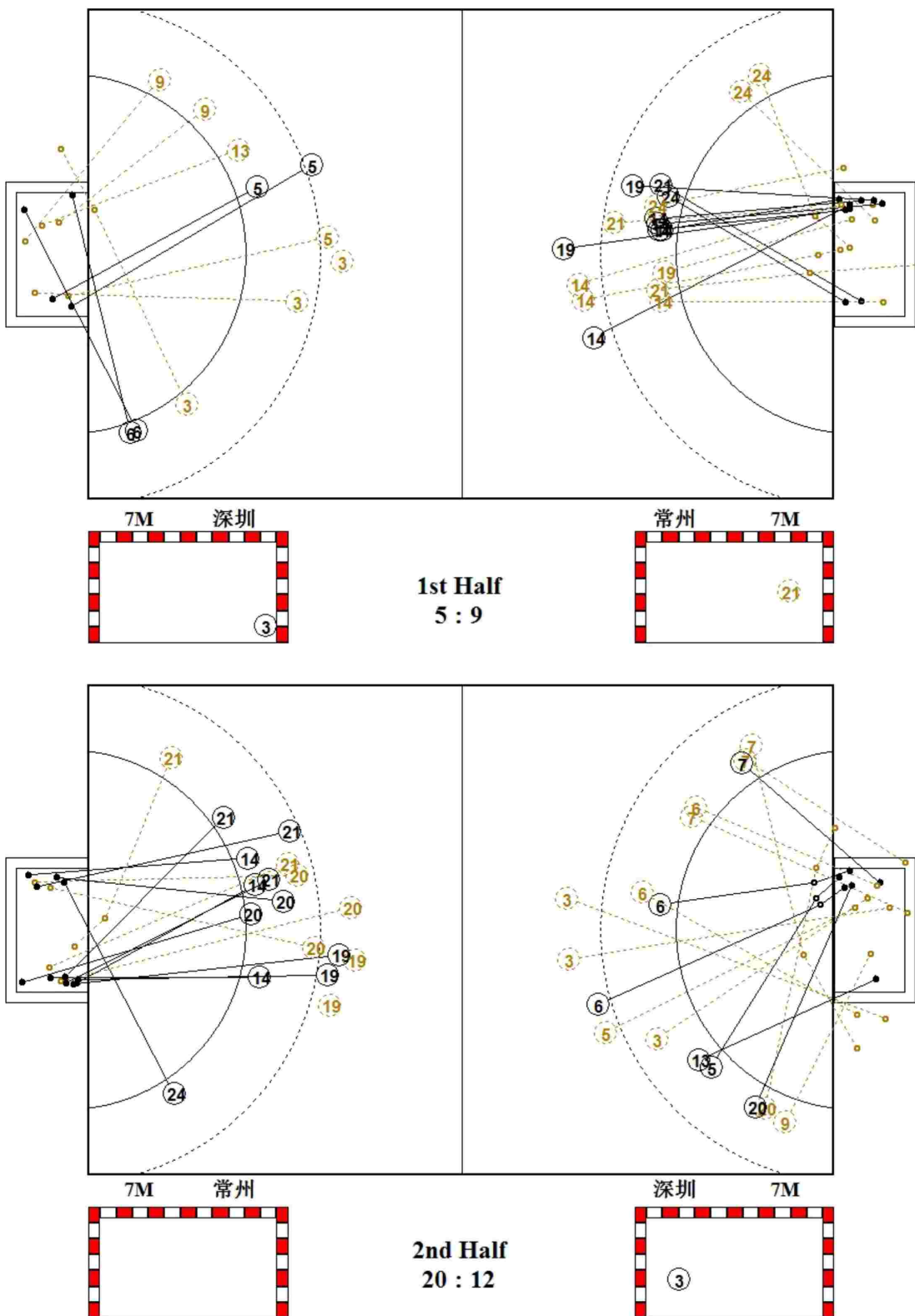

图式射门区域统计

手球  
青年女子

预赛  
轮次 6

组别 A  
场次 69

晋中体育馆  
2019-06-21 18:40

广东深圳

2 唐悦	3 赵晔	5 朱嘉盈	6 朱嘉晴	7 曾妮	9 张雨乐	10 徐瑜琳	11 王文卉																																																																								
<table border="1"><tr><td></td><td></td><td></td></tr><tr><td></td><td></td><td></td></tr><tr><td></td><td></td><td></td></tr></table>										<table border="1"><tr><td></td><td></td><td></td></tr><tr><td>1</td><td></td><td></td></tr><tr><td></td><td></td><td>1</td></tr></table>				1					1	<table border="1"><tr><td></td><td></td><td></td></tr><tr><td>1</td><td></td><td></td></tr><tr><td>2</td><td></td><td></td></tr></table>				1			2			<table border="1"><tr><td></td><td></td><td>1</td></tr><tr><td></td><td></td><td></td></tr><tr><td>2</td><td></td><td>1</td></tr></table>			1				2		1	<table border="1"><tr><td>1</td><td></td><td></td></tr><tr><td></td><td></td><td></td></tr><tr><td></td><td></td><td></td></tr></table>	1									<table border="1"><tr><td></td><td></td><td></td></tr><tr><td></td><td></td><td></td></tr><tr><td></td><td></td><td></td></tr></table>										<table border="1"><tr><td></td><td></td><td></td></tr><tr><td></td><td></td><td></td></tr><tr><td></td><td></td><td></td></tr></table>										<table border="1"><tr><td></td><td></td><td></td></tr><tr><td></td><td></td><td></td></tr><tr><td></td><td></td><td></td></tr></table>									
1																																																																															
		1																																																																													
1																																																																															
2																																																																															
		1																																																																													
2		1																																																																													
1																																																																															
Post - 0 Miss - 0 Block - 0	Post - 0 Miss - 2 Block - 1	Post - 0 Miss - 0 Block - 0	Post - 0 Miss - 1 Block - 0	Post - 2 Miss - 1 Block - 0	Post - 0 Miss - 0 Block - 0	Post - 0 Miss - 0 Block - 0	Post - 0 Miss - 0 Block - 0																																																																								
12 于雅梦	13 刘培天	16 邹童羽	17 冯颖慧	18 谢宛彤	20 岳欣华																																																																										
<table border="1"><tr><td></td><td></td><td></td></tr><tr><td></td><td></td><td></td></tr><tr><td></td><td></td><td></td></tr></table>										<table border="1"><tr><td></td><td></td><td></td></tr><tr><td></td><td></td><td>1</td></tr><tr><td></td><td></td><td></td></tr></table>						1				<table border="1"><tr><td></td><td></td><td></td></tr><tr><td></td><td></td><td></td></tr><tr><td></td><td></td><td></td></tr></table>										<table border="1"><tr><td></td><td></td><td></td></tr><tr><td></td><td></td><td></td></tr><tr><td></td><td></td><td></td></tr></table>										<table border="1"><tr><td></td><td></td><td></td></tr><tr><td></td><td></td><td></td></tr><tr><td></td><td></td><td></td></tr></table>										<table border="1"><tr><td></td><td></td><td></td></tr><tr><td></td><td></td><td></td></tr><tr><td>1</td><td></td><td></td></tr></table>							1																						
		1																																																																													
1																																																																															
Post - 0 Miss - 0 Block - 0	Post - 0 Miss - 0 Block - 0	Post - 0 Miss - 0 Block - 0	Post - 0 Miss - 0 Block - 0	Post - 0 Miss - 0 Block - 0	Post - 0 Miss - 1 Block - 0																																																																										

16 邹童羽

0/2		2/3
2/4		1/4
2/8	2/2	0/1

17 冯颖慧

		0/1
2/3		1/1
0/3	1/1	

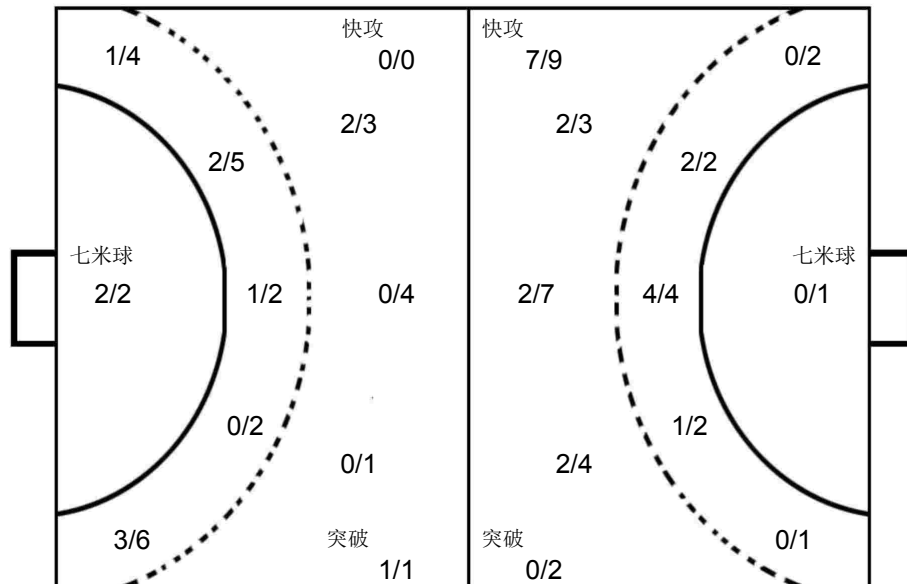

1 胡雨诺

22 彭如玉

2/3	1/1	0/1
2/4		3/4
2/7		0/2

江苏常州

1 胡雨诺	7 张嘉朔	8 董桂林	9 顾霞光	14 庄红艳	15 王艺儒	19 焦雅	20 渠文娜																																																																								
<table border="1"><tr><td></td><td></td><td></td></tr><tr><td></td><td></td><td></td></tr><tr><td></td><td></td><td></td></tr></table>										<table border="1"><tr><td></td><td></td><td></td></tr><tr><td></td><td></td><td></td></tr><tr><td></td><td></td><td></td></tr></table>										<table border="1"><tr><td></td><td></td><td></td></tr><tr><td></td><td></td><td></td></tr><tr><td></td><td></td><td></td></tr></table>										<table border="1"><tr><td></td><td></td><td></td></tr><tr><td></td><td></td><td></td></tr><tr><td></td><td></td><td></td></tr></table>										<table border="1"><tr><td>1</td><td></td><td>1</td></tr><tr><td>2</td><td></td><td></td></tr><tr><td>4</td><td></td><td></td></tr></table>	1		1	2			4			<table border="1"><tr><td></td><td></td><td></td></tr><tr><td></td><td></td><td></td></tr><tr><td></td><td></td><td></td></tr></table>										<table border="1"><tr><td></td><td></td><td></td></tr><tr><td>1</td><td></td><td></td></tr><tr><td>3</td><td></td><td></td></tr></table>				1			3			<table border="1"><tr><td>1</td><td></td><td></td></tr><tr><td></td><td></td><td>1</td></tr><tr><td></td><td></td><td></td></tr></table>	1					1			
1		1																																																																													
2																																																																															
4																																																																															
1																																																																															
3																																																																															
1																																																																															
		1																																																																													
Post - 0 Miss - 0 Block - 0	Post - 0 Miss - 0 Block - 0	Post - 0 Miss - 0 Block - 0	Post - 0 Miss - 0 Block - 0	Post - 0 Miss - 0 Block - 0	Post - 0 Miss - 0 Block - 0	Post - 0 Miss - 0 Block - 2	Post - 0 Miss - 0 Block - 0																																																																								
21 吴静雯	22 彭如玉	24 王铃娜	25 李秋淇	26 邱聿芳	27 李袁梦	28 黄奕涵	29 陈赛楠																																																																								
<table border="1"><tr><td></td><td></td><td>1</td></tr><tr><td></td><td></td><td>1</td></tr><tr><td>2</td><td></td><td></td></tr></table>			1			1	2			<table border="1"><tr><td></td><td></td><td></td></tr><tr><td></td><td></td><td></td></tr><tr><td></td><td></td><td></td></tr></table>										<table border="1"><tr><td></td><td></td><td></td></tr><tr><td></td><td></td><td>1</td></tr><tr><td></td><td></td><td>1</td></tr></table>						1			1	<table border="1"><tr><td></td><td></td><td></td></tr><tr><td></td><td></td><td></td></tr><tr><td></td><td></td><td></td></tr></table>										<table border="1"><tr><td></td><td></td><td></td></tr><tr><td></td><td></td><td></td></tr><tr><td></td><td></td><td></td></tr></table>										<table border="1"><tr><td></td><td></td><td></td></tr><tr><td></td><td></td><td></td></tr><tr><td></td><td></td><td></td></tr></table>										<table border="1"><tr><td></td><td></td><td></td></tr><tr><td></td><td></td><td></td></tr><tr><td></td><td></td><td></td></tr></table>										<table border="1"><tr><td></td><td></td><td></td></tr><tr><td></td><td></td><td></td></tr><tr><td></td><td></td><td></td></tr></table>									
		1																																																																													
		1																																																																													
2																																																																															
		1																																																																													
		1																																																																													
Post - 0 Miss - 1 Block - 0	Post - 0 Miss - 0 Block - 0	Post - 0 Miss - 1 Block - 0	Post - 0 Miss - 0 Block - 0	Post - 0 Miss - 0 Block - 0	Post - 0 Miss - 0 Block - 0	Post - 0 Miss - 0 Block - 0	Post - 0 Miss - 0 Block - 0																																																																								



第二届全国青年运动会女子手球甲组决赛 体校组 (U18)

青年女子 国内比赛

预赛 Group A



PHMS Pictorial Handball Match Statistics

IHF Official System

Team A					Team B					Match Number											
A 广东深圳					B 山东淄博					70											
Played in			in the hall			on			at			Spectators									
山西晋中			晋中体育馆			2019-06-22			14:00			hours									
Half-time(30')	A	B	End of playing time		A	B	1st extra time		A	B	2nd extra time		A	B	After penalty throws						
	6	4	14		12																
Number of 7 m	A	Team time-out			Full name of players and officials						Team time-out			B	Number of 7 m						
	0/2	1	2	3							1	2	3	2/3							
		08:13	27:42	38:14							17:55										
No.	Team A					G	W	2'	D	DR	No.	Team B					G	W	2'	D	DR
2	唐悦					4					3	王静雯					5				
3	赵晔					4					5	张素娟									
5	朱嘉盈					1		1			6	孙玉坤					1				
6	朱嘉晴					2					7	辛彤慧									
7	曾妮										8	王锦琦									
9	张雨乐					3		1			9	高梦洁									
10	徐瑜琳										10	崔佳惠									
11	王文卉										14	韩睿洁									
12	于雅梦										15	李骞飞					2				
13	刘培天										16	王启欣									
16	邹童羽										17	蒋松妍					1	1			
17	冯颖慧										19	户晴									
18	谢宛彤										21	赵欣瑶					3				
20	岳欣华										22	邢力丹									
											23	王家琪									
											28	江迎新						1			
A	张斌										B	徐美凤									
B	张敬敏						1				C	翟乾坤 (主教练)									
C	常敏 (主教练)										D	段文钰									
D	蒋光华										E	王日东									
Signatures of responsables for the teams (Off.A)																					
A																			B		
TP	Remarks of referees / HF Official																		TP		

Signatures

Referees	李巧宁 (CHN)	宋优悠 (CHN)		
T.D.	吴瑞亭 (CHN)	王洋 (CHN)		
CHA Off.				

Note: Number of 7m Throws Awarded to Team A and B, Goals (G), Warnings (W), Suspensions (2'), Direct Disqualification (D), Disqualification With Report (DR) and Team Penalty (TP).

Table Officials: 李莉君 戴莹莹 Statisticians: 陈柱 谢扬



## 第二届全国青年运动会女子手球甲组决赛 体校组 (U18)

**PHMS** Pictorial Handball Match Statistics

**IHF** Official System

### 竞赛技术统计

手球  
青年女子

预赛  
轮次 7

组别 A  
场次 70

晋中体育馆  
2019-06-22 14:00

Referees: 李巧宁 (CHN) / 宋优悠 (CHN)

Result: 14:12 (6:4)

Teams: 广东深圳(深圳) VS 山东淄博(淄博)

深圳		远射	近射	边射	快攻	突破	任意球	7m球	合计	%	助攻	失误	警告	2'	D+DR
主教练: 常敏															
2	唐悦	4/10							4/10	40.0		2			
3	赵晔	2/6	1/2				1/1	0/1	4/10	40.0		1			
5	朱嘉盈		1/1			0/1			1/2	50.0		2		1	
6	朱嘉晴			2/5				0/1	2/6	33.3		1			
7	曾妮														
9	张雨乐			3/5					3/5	60.0				1	
10	徐瑜琳														
11	王文卉														
12	于雅梦														
13	刘培天														
16	邹童羽														
17	冯颖慧														
18	谢宛彤														
20	岳欣华														
运动员 合计		6/16	2/3	5/10		0/1	1/1	0/2	14/33	42.4		6		2	
11	王文卉														
16	邹童羽	2/4	0/2	3/5	2/2	2/3			9/16	56.3					
17	冯颖慧	2/2	1/2	0/2	1/1			1/3	5/10	50.0					
守门员 合计		4/6	1/4	3/7	3/3	2/3		1/3	14/26	53.8					

深圳	比赛进程	淄博
1st Half		
	0 04:25	1 3 王静雯
2 唐悦	1 06:06	1
	1 06:23	2 3 王静雯
2 唐悦	2 08:39	2
6 朱嘉晴	3 09:02	2
	3 10:11	3 21 赵欣瑶
9 张雨乐	4 11:01	3
9 张雨乐	5 12:37	3
6 朱嘉晴	6 14:02	3
	6 19:57	4 15 李鹏飞
2nd Half		
9 张雨乐	7 00:22	4
5 朱嘉盈	8 01:18	4
	8 01:27	5 6 孙玉坤
3 赵晔	9 05:42	5
	9 06:06	6 3 王静雯
2 唐悦	10 06:46	6
	10 06:58	7 21 赵欣瑶
3 赵晔	11 07:56	7
	11 08:42	8 21 赵欣瑶
	11 11:10	9 3 王静雯
3 赵晔	12 11:57	9
	12 12:41	10 3 王静雯
2 唐悦	13 15:56	10
3 赵晔	14 17:34	10
	14 17:52	11 15 李鹏飞
	14 19:01	12 17 蒋松妍

淄博		远射	近射	边射	快攻	突破	任意球	7m球	合计	%	助攻	失误	警告	2'	D+DR
主教练: 翟乾坤															
3	王静雯	1/3	1/1			1/2		2/3	5/9	55.6		1			
5	张素娟											1			
6	孙玉坤	1/4			0/1				1/5	20.0	1	2			
7	辛彤慧														
8	王锦琦														
9	高梦洁	0/1				0/1			0/2	0.0	3	3			
10	崔佳惠														
14	韩睿洁														
15	李鹏飞			2/3	0/1				2/4	50.0		1			
16	王启欣														
17	蒋松妍		1/1						1/1	100			1		
19	户晴			0/2	0/1				0/3	0.0		1			
21	赵欣瑶		1/2	2/2					3/4	75.0					
22	邢力丹										1				
23	王家琪											2			
28	江迎新			0/1	0/1				0/2	0.0			1		
运动员 合计		2/8	3/4	4/8	0/4	1/3		2/3	12/30	40.0	5	11	2		
16	王启欣	2/6	1/3	1/2		1/1	0/1	1/1	6/14	42.9					
22	邢力丹	2/4		3/7					5/11	45.5	1				
守门员 合计		4/10	1/3	4/9		1/1	0/1	1/1	11/25	44.0	1				

场上队员: 得分 / 射门

守门员: 救球 / 射门

D	取消资格	DR	取消资格+报告
---	------	----	---------

## 个人/全队技术统计表

手球 青年女子 预赛 轮次 7 组别 A 场次 70 晋中体育馆 2019-06-22 14:00

号码	姓名	远射	近射	边射	快攻	突破	任意	七米	合计	%	助攻	失误	警告	2'	取消	时间
广东深圳(深圳)																
(场上队员)																
2	唐悦	4/10							4/10	40.0%		2				00:40:00
3	赵晔	2/6	1/2				1/1	0/1	4/10	40.0%		1				00:40:00
5	朱嘉盈		1/1			0/1			1/2	50.0%		2		1		00:40:00
6	朱嘉晴			2/5				0/1	2/6	33.3%		1				00:40:00
7	曾妮									0.0%						00:00:00
9	张雨乐			3/5					3/5	60.0%				1		00:40:00
10	徐瑜琳									0.0%						00:00:00
11	王文卉									0.0%						00:00:30
12	于雅梦									0.0%						00:00:00
13	刘培天									0.0%						00:00:00
16	邹童羽									0.0%						00:26:32
17	冯颖慧									0.0%						00:13:01
18	谢宛彤									0.0%						00:00:00
20	岳欣华									0.0%						00:40:00
	合计	6/16	2/3	5/10		0/1	1/1	0/2	14/33	42.4%		6		2		
(守门员)																
11	王文卉									0.0%						00:00:30
16	邹童羽	2/4	0/2	3/5	2/2	2/3			9/16	56.3%						00:26:32
17	冯颖慧	2/2	1/2	0/2	1/1			1/3	5/10	50.0%						00:13:01
	合计	4/6	1/4	3/7	3/3	2/3		1/3	14/26	53.8%						

场上队员：得分/射门

守门员：救球/射门

全队合计	得分	被救	射失	击柱	封球	合计	%
远射	6	4	1		5	16	37.5%
近射	2	1				3	66.7%
边射	5	4		1		10	50.0%
快攻							0.0%
突破		1				1	0.0%
任意	1					1	100.0%
七米		1	1			2	0.0%

第二届全国青年运动会女子手球甲组决赛 体校组 (U18)

PHMS Pictorial Handball Match Statistics

IHF Official System

个人/全队技术统计表

手球 青年女子 预赛 轮次 7 组别 A 场次 70 晋中体育馆 2019-06-22 14:00

号码	姓名	远射	近射	边射	快攻	突破	任意	七米	合计	%	助攻	失误	警告	2'	取消	时间
<b>山东淄博(淄博)</b>																
<b>(场上队员)</b>																
3	王静雯	1/3	1/1			1/2		2/3	5/9	55.6%		1				00:38:47
5	张素娟									0.0%		1				00:04:32
6	孙玉坤	1/4				0/1			1/5	20.0%	1	2				00:37:02
7	辛彤慧									0.0%						00:00:00
8	王锦琦									0.0%						00:00:00
9	高梦洁	0/1				0/1			0/2	0.0%	3	3				00:39:58
10	崔佳惠									0.0%						00:00:00
14	韩春洁									0.0%						00:00:00
15	李鹏飞			2/3	0/1				2/4	50.0%		1				00:27:02
16	王启欣									0.0%						00:24:08
17	蒋松妍		1/1						1/1	100%			1			00:23:32
19	户晴			0/2	0/1				0/3	0.0%		1				00:20:08
21	赵欣瑶		1/2	2/2					3/4	75.0%						00:33:00
22	邢力丹									0.0%	1					00:15:52
23	王家琪									0.0%		2				00:02:36
28	江迎新			0/1	0/1				0/2	0.0%			1			00:12:45
<b>合计</b>		<b>2/8</b>	<b>3/4</b>	<b>4/8</b>	<b>0/4</b>	<b>1/3</b>		<b>2/3</b>	<b>12/30</b>	<b>40.0%</b>	<b>5</b>	<b>11</b>	<b>2</b>			
<b>(守门员)</b>																
16	王启欣	2/6	1/3	1/2		1/1	0/1	1/1	6/14	42.9%						00:24:08
22	邢力丹	2/4		3/7					5/11	45.5%	1					00:15:52
<b>合计</b>		<b>4/10</b>	<b>1/3</b>	<b>4/9</b>		<b>1/1</b>	<b>0/1</b>	<b>1/1</b>	<b>11/25</b>	<b>44.0%</b>	<b>1</b>					

场上队员：得分/射门

守门员：救球/射门

全队合计	得分	被救	射失	击柱	封球	合计	%
远射	2	4	1	1		8	25.0%
近射	3	1				4	75.0%
边射	4	3	1			8	50.0%
快攻		3		1		4	0.0%
突破	1	2				3	33.3%
任意							0.0%
七米	2	1				3	66.7%

图式比赛技术统计表

手球  
青年女子

预赛  
轮次 7

组别 A  
场次 70

晋中体育馆  
2019-06-22 14:00

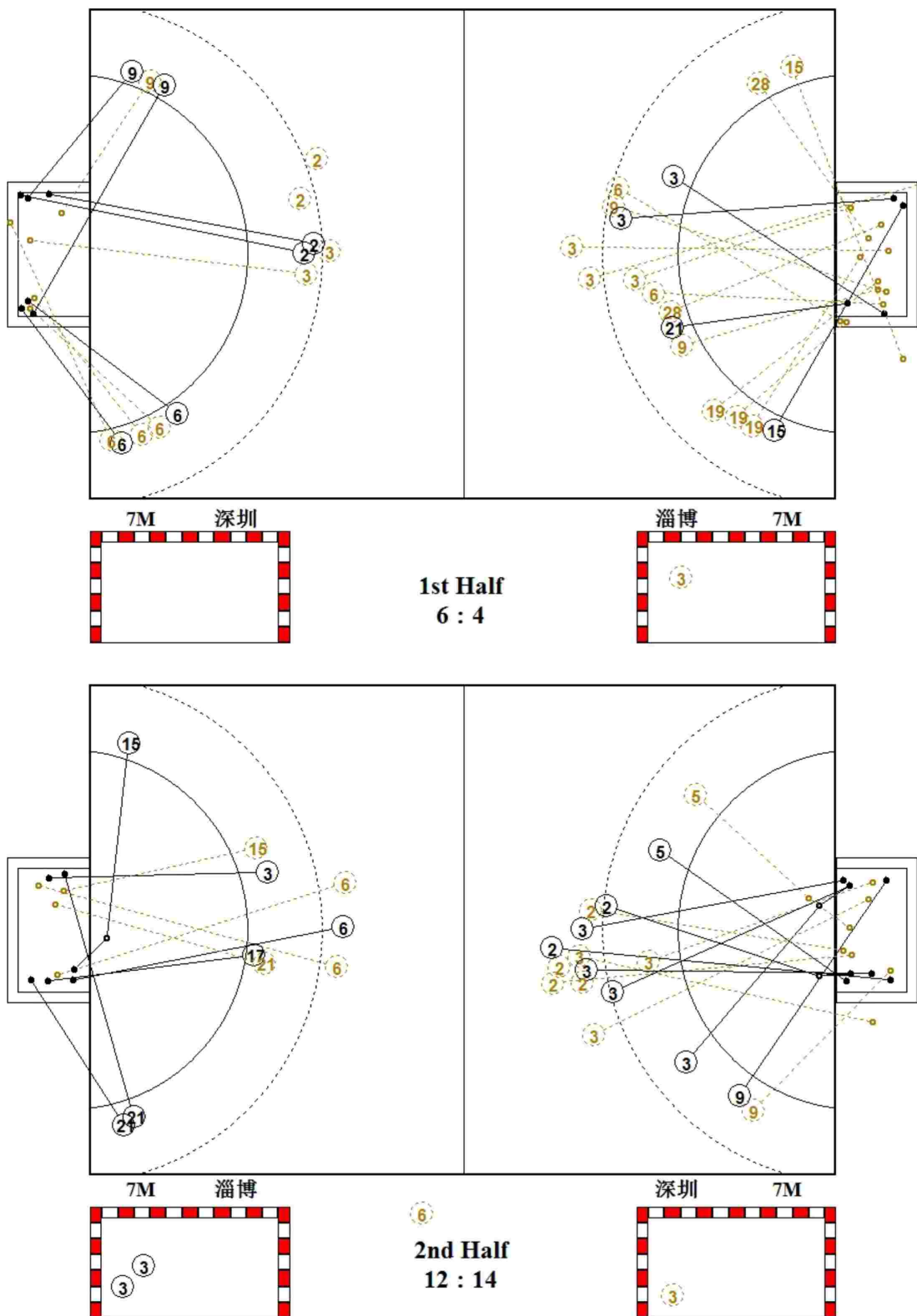

图式射门区域统计

手球  
青年女子

预赛  
轮次 7

组别 A  
场次 70

晋中体育馆  
2019-06-22 14:00

广东深圳

2 唐悦	3 赵晔	5 朱嘉盈	6 朱嘉晴	7 曾妮	9 张雨乐	10 徐瑜琳	11 王文卉																																																																								
<table border="1"><tr><td></td><td></td><td>2</td></tr><tr><td></td><td></td><td>1</td></tr><tr><td></td><td></td><td>1</td></tr></table>			2			1			1	<table border="1"><tr><td></td><td></td><td></td></tr><tr><td></td><td></td><td>1</td></tr><tr><td>3</td><td></td><td></td></tr></table>						1	3			<table border="1"><tr><td></td><td></td><td></td></tr><tr><td></td><td></td><td>1</td></tr><tr><td></td><td></td><td></td></tr></table>						1				<table border="1"><tr><td>2</td><td></td><td></td></tr><tr><td></td><td></td><td></td></tr><tr><td></td><td></td><td></td></tr></table>	2									<table border="1"><tr><td></td><td></td><td></td></tr><tr><td></td><td></td><td></td></tr><tr><td></td><td></td><td></td></tr></table>										<table border="1"><tr><td>2</td><td></td><td>1</td></tr><tr><td></td><td></td><td></td></tr><tr><td></td><td></td><td></td></tr></table>	2		1							<table border="1"><tr><td></td><td></td><td></td></tr><tr><td></td><td></td><td></td></tr><tr><td></td><td></td><td></td></tr></table>										<table border="1"><tr><td></td><td></td><td></td></tr><tr><td></td><td></td><td></td></tr><tr><td></td><td></td><td></td></tr></table>									
		2																																																																													
		1																																																																													
		1																																																																													
		1																																																																													
3																																																																															
		1																																																																													
2																																																																															
2		1																																																																													
Post - 0 Miss - 0 Block - 4	Post - 0 Miss - 1 Block - 1	Post - 0 Miss - 0 Block - 0	Post - 1 Miss - 1 Block - 0	Post - 0 Miss - 0 Block - 0	Post - 0 Miss - 0 Block - 0	Post - 0 Miss - 0 Block - 0	Post - 0 Miss - 0 Block - 0																																																																								
12 于雅梦	13 刘培天	16 邹童羽	17 冯颖慧	18 谢宛彤	20 岳欣华																																																																										
<table border="1"><tr><td></td><td></td><td></td></tr><tr><td></td><td></td><td></td></tr><tr><td></td><td></td><td></td></tr></table>										<table border="1"><tr><td></td><td></td><td></td></tr><tr><td></td><td></td><td></td></tr><tr><td></td><td></td><td></td></tr></table>										<table border="1"><tr><td></td><td></td><td></td></tr><tr><td></td><td></td><td></td></tr><tr><td></td><td></td><td></td></tr></table>										<table border="1"><tr><td></td><td></td><td></td></tr><tr><td></td><td></td><td></td></tr><tr><td></td><td></td><td></td></tr></table>										<table border="1"><tr><td></td><td></td><td></td></tr><tr><td></td><td></td><td></td></tr><tr><td></td><td></td><td></td></tr></table>										<table border="1"><tr><td></td><td></td><td></td></tr><tr><td></td><td></td><td></td></tr><tr><td></td><td></td><td></td></tr></table>																													
Post - 0 Miss - 0 Block - 0	Post - 0 Miss - 0 Block - 0	Post - 0 Miss - 0 Block - 0	Post - 0 Miss - 0 Block - 0	Post - 0 Miss - 0 Block - 0	Post - 0 Miss - 0 Block - 0																																																																										

11 王文卉

16 邹童羽

0/3	1/1	2/3
1/1	2/2	2/3
1/2		0/1

17 冯颖慧

1/1		1/1
1/4		2/3
0/1		

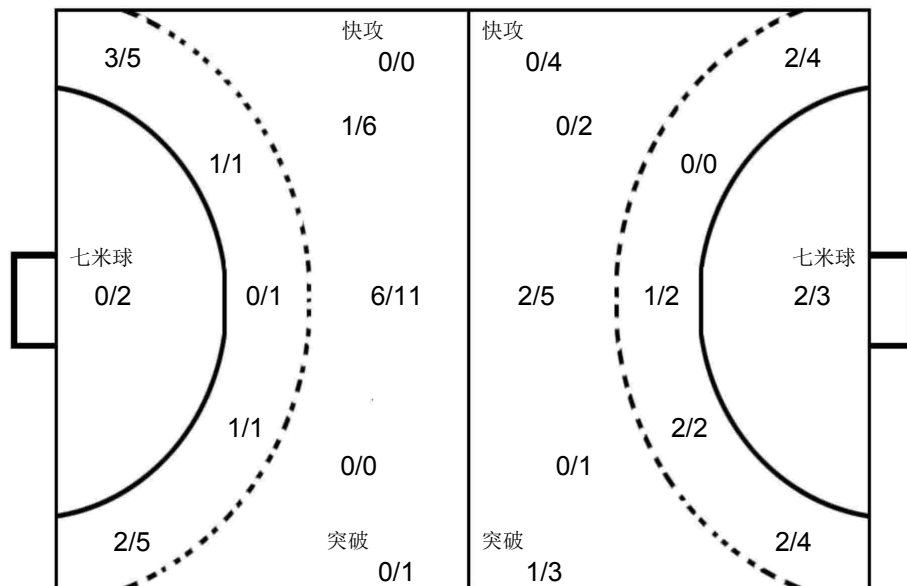

16 王启欣

0/1		1/2
1/1		0/1
1/4	2/2	1/3

22 邢力丹

2/5	1/1	0/2
1/1		1/2

山东淄博

3 王静雯	5 张素娟	6 孙玉坤	7 辛彤慧	8 王锦琦	9 高梦洁	10 崔佳惠	14 韩睿洁																																																																								
<table border="1"><tr><td>1</td><td></td><td>1</td></tr><tr><td>2</td><td></td><td>1</td></tr><tr><td></td><td></td><td></td></tr></table>	1		1	2		1				<table border="1"><tr><td></td><td></td><td></td></tr><tr><td></td><td></td><td></td></tr><tr><td></td><td></td><td></td></tr></table>										<table border="1"><tr><td></td><td></td><td></td></tr><tr><td></td><td></td><td></td></tr><tr><td>1</td><td></td><td></td></tr></table>							1			<table border="1"><tr><td></td><td></td><td></td></tr><tr><td></td><td></td><td></td></tr><tr><td></td><td></td><td></td></tr></table>										<table border="1"><tr><td></td><td></td><td></td></tr><tr><td></td><td></td><td></td></tr><tr><td></td><td></td><td></td></tr></table>										<table border="1"><tr><td></td><td></td><td></td></tr><tr><td></td><td></td><td></td></tr><tr><td></td><td></td><td></td></tr></table>										<table border="1"><tr><td></td><td></td><td></td></tr><tr><td></td><td></td><td></td></tr><tr><td></td><td></td><td></td></tr></table>										<table border="1"><tr><td></td><td></td><td></td></tr><tr><td></td><td></td><td></td></tr><tr><td></td><td></td><td></td></tr></table>									
1		1																																																																													
2		1																																																																													
1																																																																															
Post - 0 Miss - 1 Block - 0	Post - 0 Miss - 0 Block - 0	Post - 1 Miss - 0 Block - 0	Post - 0 Miss - 0 Block - 0	Post - 0 Miss - 0 Block - 0	Post - 0 Miss - 0 Block - 0	Post - 0 Miss - 0 Block - 0	Post - 0 Miss - 0 Block - 0																																																																								
15 李赛飞	16 王启欣	17 蒋松妍	19 户晴	21 赵欣瑶	22 邢力丹	23 王家琪	28 江迎新																																																																								
<table border="1"><tr><td>1</td><td></td><td></td></tr><tr><td></td><td></td><td></td></tr><tr><td>1</td><td></td><td></td></tr></table>	1						1			<table border="1"><tr><td></td><td></td><td></td></tr><tr><td></td><td></td><td></td></tr><tr><td></td><td></td><td></td></tr></table>										<table border="1"><tr><td></td><td></td><td></td></tr><tr><td></td><td></td><td></td></tr><tr><td>1</td><td></td><td></td></tr></table>							1			<table border="1"><tr><td></td><td></td><td></td></tr><tr><td></td><td></td><td></td></tr><tr><td></td><td></td><td></td></tr></table>										<table border="1"><tr><td>1</td><td></td><td></td></tr><tr><td></td><td></td><td>1</td></tr><tr><td></td><td></td><td>1</td></tr></table>	1					1			1	<table border="1"><tr><td></td><td></td><td></td></tr><tr><td></td><td></td><td></td></tr><tr><td></td><td></td><td></td></tr></table>										<table border="1"><tr><td></td><td></td><td></td></tr><tr><td></td><td></td><td></td></tr><tr><td></td><td></td><td></td></tr></table>										<table border="1"><tr><td></td><td></td><td></td></tr><tr><td></td><td></td><td></td></tr><tr><td></td><td></td><td></td></tr></table>									
1																																																																															
1																																																																															
1																																																																															
1																																																																															
		1																																																																													
		1																																																																													
Post - 0 Miss - 1 Block - 0	Post - 0 Miss - 0 Block - 0	Post - 0 Miss - 0 Block - 0	Post - 1 Miss - 0 Block - 0	Post - 0 Miss - 0 Block - 0	Post - 0 Miss - 0 Block - 0	Post - 0 Miss - 0 Block - 0	Post - 0 Miss - 0 Block - 0																																																																								





第二届全国青年运动会女子手球甲组决赛 体校组 (U18)

青年女子 国内比赛

预赛 Group A



PHMS Pictorial Handball Match Statistics

IHF Official System

Team A					Team B					Match Number											
A 江苏常州					B 澳门					71											
Played in			in the hall			on		at		Spectators											
山西晋中			晋中体育馆			2019-06-22		15:10		hours											
Half-time(30')	A	B	End of playing time	A	B	1st extra time	A	B	2nd extra time	A	B	After penalty throws	A	B							
	15	0		31	5																
Number of 7 m	A	Team time-out			Full name of players and officials					Team time-out			B	Number of 7 m							
	1/1	1	2	3						1	2	3	0/0								
							08:42	28:38													
No.	Team A					G	W	2'	D	DR	No.	Team B					G	W	2'	D	DR
1	胡雨诺										8	譚嘉雯									
7	张嘉朔					2					10	盧曉汶									
8	董桂林					3					11	李君移					2				
9	顾霞光					3					12	李芷棋					1				
14	庄红艳					5					15	張雪琳					1				
15	王艺儒										18	曾華恩									
19	焦雅					2					19	馮楚瑩									
20	渠文娜					2					22	蘇萱婷									
21	吴静雯					3	1				23	霍思允									
22	彭如玉										44	李嵐					1				
24	王铃娜					5					58	林诗雅									
25	李秋淇					3															
26	邱聿芳					2															
27	李袁梦																				
28	黄奕涵					1															
29	陈赛楠																				
A	金甲洙 (主教练)										A	蘇沛祺									
B	马彪										B	陳嘉聰 (主教练)									
C	李海鹰										C	霍俊浩									
D	陈志伟																				
A	Signatures of responsables for the teams (Off.A)												B								
TP	Remarks of referees / HF Official												TP								

Signatures

Referees	张晓虎 (CHN)	马文 (CHN)		
T.D.	柴业宏 (CHN)	陈晓波 (CHN)		
CHA Off.				

Note: Number of 7m Throws Awarded to Team A and B, Goals (G), Warnings (W), Suspensions (2'), Direct Disqualification (D), Disqualification With Report (DR) and Team Penalty (TP).

Table Officials: 王志超

马迪

Statisticians: 谢扬

陈柱



## 第二届全国青年运动会女子手球甲组决赛 体校组 (U18)

PHMS Pictorial Handball Match Statistics

IHF Official System

### 竞赛技术统计

手球  
青年女子

预赛  
轮次 7

组别 A  
场次 71

晋中体育馆  
2019-06-22 15:10

Referees:	张晓虎 (CHN) / 马文 (CHN)	Result:	31:5 (15:0)
Teams:	江苏常州(常州) VS 澳门(澳门)		

常州																常州		比赛 进程		澳门	
主教练：金甲洙																					
	远射	近射	边射	快攻	突破	任意球	7m球	合计	%	助攻	失误	警告	2'	D+DR							
1 胡雨诺										1											
7 张嘉朔		0/1		2/2				2/3	66.7												
8 董桂林		1/1	1/1	1/1				3/3	100		2										
9 顾霞光				3/3				3/3	100		1										
14 庄红艳	0/1			4/4	1/1			5/6	83.3	1											
15 王艺儒				0/2				0/2	0.0												
19 焦雅	0/1	0/1		2/2				2/4	50.0												
20 渠文娜	0/1				2/2			2/3	66.7	1											
21 吴静雯	0/1	0/2	1/1	1/1		1/1		3/6	50.0	2		1									
22 彭如玉										1											
24 王铃娜		3/3		1/2	1/1			5/6	83.3		2										
25 李秋淇		1/1		1/2	0/1		1/1	3/5	60.0		2										
26 邱聿芳		1/1			1/1			2/2	100												
27 李袁梦																					
28 黄奕涵				1/1				1/1	100		2										
29 陈赛楠																					
运动员 合计	0/4	6/10	2/2	16/20	5/6	1/1	1/1	31/44	70.5	6	9	1									
1 胡雨诺	5/6							5/6	83.3	1											
22 彭如玉	2/2	1/3	0/2					3/7	42.9	1											
守门员 合计	7/8	1/3	0/2					8/13	61.5	2											
澳门																					
主教练：陈嘉聪																					
	远射	近射	边射	快攻	突破	任意球	7m球	合计	%	助攻	失误	警告	2'	D+DR							
8 谭嘉雯											3										
10 卢晓汶																					
11 李君移	0/4	0/1	2/2					2/7	28.6	1	5										
12 李芷棋		1/2						1/2	50.0		2										
15 张雪琳	1/6					0/2		1/8	12.5	1	7										
18 曾华恩											4										
19 冯楚莹																					
22 苏萱婷	0/2							0/2	0.0		2										
23 霍思允	0/3							0/3	0.0		5										
44 李嵐		1/1						1/1	100		1										
58 林诗雅											2										
运动员 合计	1/15	2/4	2/2			0/2		5/23	21.7	2	31										
10 卢晓汶		0/1		0/3	0/1			0/5	0.0												
19 冯楚莹	2/2	0/5	0/2	3/16	1/5	0/1	0/1	6/32	18.8												
守门员 合计	2/2	0/6	0/2	3/19	1/6	0/1	0/1	6/37	16.2												

		常州		澳门	
1st Half					
14 庄红艳	1	01:00	0		
14 庄红艳	2	02:55	0		
7 张嘉朔	3	03:55	0		
25 李秋淇	4	04:40	0		
14 庄红艳	5	05:11	0		
14 庄红艳	6	06:35	0		
14 庄红艳	7	07:35	0		
7 张嘉朔	8	08:36	0		
21 吴静雯	9	09:09	0		
19 焦雅	10	11:10	0		
21 吴静雯	11	12:15	0		
8 董桂林	12	14:26	0		
19 焦雅	13	16:24	0		
21 吴静雯	14	18:22	0		
24 王铃娜	15	19:12	0		
2nd Half					
24 王铃娜	16	00:17	0		
25 李秋淇	17	00:45	0		
24 王铃娜	18	04:50	0		
24 王铃娜	19	05:23	0		
24 王铃娜	20	06:37	0		
20 渠文娜	20	07:06	1	15 张雪琳	
20 渠文娜	21	07:23	1		
20 渠文娜	22	08:35	1		
9 顾霞光	22	08:56	2	11 李君移	
26 邱聿芳	23	09:46	2		
26 邱聿芳	24	11:14	2		
28 黄奕涵	24	11:47	3	12 李芷棋	
26 邱聿芳	25	12:44	3		
8 董桂林	26	13:42	3		
8 董桂林	27	14:27	3		
8 董桂林	27	14:51	4	11 李君移	
8 董桂林	28	15:00	4		
9 顾霞光	29	16:11	4		
25 李秋淇	30	18:23	4		
9 顾霞光	31	18:58	4		
9 顾霞光	31	19:43	5	44 李嵐	

场上队员：得分 / 射门

守门员：救球 / 射门

D	取消资格	DR	取消资格+报告
---	------	----	---------

## 个人/全队技术统计表

手球 青年女子 预赛 轮次 7 组别 A 场次 71 晋中体育馆 2019-06-22 15:10

号码	姓名	远射	近射	边射	快攻	突破	任意	七米	合计	%	助攻	失误	警告	2'	取消	时间
江苏常州(常州)																
(场上队员)																
1	胡雨诺									0.0%	1					00:28:44
7	张嘉朔		0/1		2/2				2/3	66.7%						00:20:00
8	董桂林		1/1	1/1	1/1				3/3	100%		2				00:31:18
9	顾霞光				3/3				3/3	100%		1				00:27:42
14	庄红艳	0/1			4/4	1/1			5/6	83.3%	1					00:08:42
15	王艺儒				0/2				0/2	0.0%						00:11:39
19	焦雅	0/1	0/1		2/2				2/4	50.0%						00:16:32
20	渠文娜	0/1				2/2			2/3	66.7%	1					00:09:52
21	吴静雯	0/1	0/2	1/1	1/1		1/1		3/6	50.0%	2		1			00:20:00
22	彭如玉									0.0%	1					00:11:16
24	王铃娜		3/3		1/2	1/1			5/6	83.3%		2				00:09:58
25	李秋淇		1/1		1/2	0/1		1/1	3/5	60.0%		2				00:40:00
26	邱聿芳		1/1			1/1			2/2	100%						00:12:51
27	李袁梦									0.0%						00:12:17
28	黄奕涵				1/1				1/1	100%		2				00:18:56
29	陈赛楠									0.0%						00:00:00
	合计	0/4	6/10	2/2	16/20	5/6	1/1	1/1	31/44	70.5%	6	9	1			
(守门员)																
1	胡雨诺	5/6							5/6	83.3%	1					00:28:44
22	彭如玉	2/2	1/3	0/2					3/7	42.9%	1					00:11:16
	合计	7/8	1/3	0/2					8/13	61.5%	2					

场上队员：得分/射门

守门员：救球/射门

全队合计	得分	被救	射失	击柱	封球	合计	%
远射		2	2			4	0.0%
近射	6		2	2		10	60.0%
边射	2					2	100.0%
快攻	16	3		1		20	80.0%
突破	5	1				6	83.3%
任意	1					1	100.0%
七米	1					1	100.0%

第二届全国青年运动会女子手球甲组决赛 体校组 (U18)

PHMS Pictorial Handball Match Statistics

IHF Official System

个人/全队技术统计表

手球 预赛 组别 A 晋中体育馆  
青年女子 轮次 7 场次 71 2019-06-22 15:10

号码	姓名	远射	近射	边射	快攻	突破	任意	七米	合计	%	助攻	失误	警告	2'	取消	时间
澳门(澳门)																
(场上队员)																
8	譚嘉雯									0.0%		3				00:11:22
10	盧曉汶									0.0%						00:05:54
11	李君移	0/4	0/1	2/2					2/7	28.6%	1	5				00:40:00
12	李芷棋		1/2						1/2	50.0%		2				00:40:00
15	張雪琳	1/6					0/2		1/8	12.5%	1	7				00:40:00
18	曾華恩									0.0%		4				00:28:33
19	馮楚瑩									0.0%						00:34:06
22	蘇萱婷	0/2							0/2	0.0%		2				00:11:41
23	霍思允	0/3							0/3	0.0%		5				00:27:26
44	李嵐		1/1						1/1	100%		1				00:26:58
58	林詩雅									0.0%		2				00:13:51
合计		1/15	2/4	2/2			0/2		5/23	21.7%	2	31				

(守门员)																
10	盧曉汶		0/1			0/3	0/1		0/5	0.0%						00:05:54
19	馮楚瑩	2/2	0/5	0/2	3/16	1/5	0/1	0/1	6/32	18.8%						00:34:06
合计		2/2	0/6	0/2	3/19	1/6	0/1	0/1	6/37	16.2%						

场上队员： 得分/射门

守门员： 救球/射门

全队合计	得分	被救	射失	击柱	封球	合计	%
远射	1	7	6		1	15	6.7%
近射	2	1	1			4	50.0%
边射	2					2	100.0%
快攻							0.0%
突破							0.0%
任意			2			2	0.0%
七米							0.0%

图式比赛技术统计表

手球  
青年女子

预赛  
轮次 7

组别 A  
场次 71

晋中体育馆  
2019-06-22 15:10

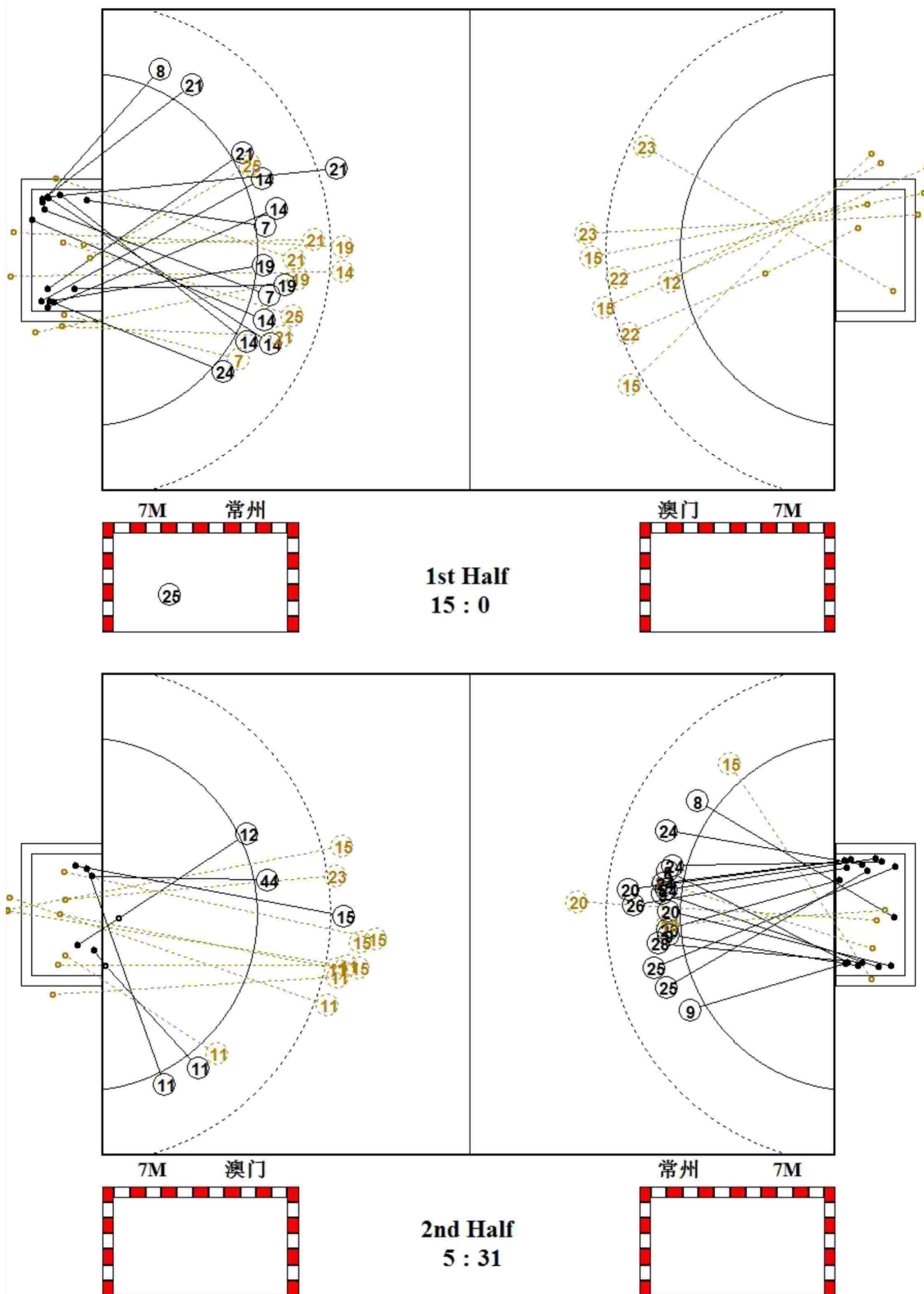

图式射门区域统计

手球  
青年女子

预赛  
轮次 7

组别 A  
场次 71

晋中体育馆  
2019-06-22 15:10

江苏常州

1 胡雨诺 <table border="1"><tr><td></td><td></td><td></td></tr><tr><td></td><td></td><td></td></tr><tr><td></td><td></td><td></td></tr></table> Post - 0 Miss - 0 Block - 0										7 张嘉朔 <table border="1"><tr><td></td><td></td><td>1</td></tr><tr><td></td><td></td><td></td></tr><tr><td></td><td></td><td>1</td></tr></table> Post - 1 Miss - 0 Block - 0			1						1	8 董桂林 <table border="1"><tr><td></td><td>1</td><td>1</td></tr><tr><td></td><td></td><td></td></tr><tr><td></td><td></td><td>1</td></tr></table> Post - 0 Miss - 0 Block - 0		1	1						1	9 顾霞光 <table border="1"><tr><td></td><td></td><td></td></tr><tr><td></td><td></td><td>2</td></tr><tr><td></td><td></td><td>1</td></tr></table> Post - 0 Miss - 0 Block - 0						2			1	14 庄红艳 <table border="1"><tr><td>2</td><td></td><td>2</td></tr><tr><td></td><td></td><td>1</td></tr><tr><td></td><td></td><td></td></tr></table> Post - 0 Miss - 1 Block - 0	2		2			1				15 王艺儒 <table border="1"><tr><td></td><td></td><td></td></tr><tr><td></td><td></td><td></td></tr><tr><td></td><td></td><td></td></tr></table> Post - 1 Miss - 0 Block - 0										19 焦雅 <table border="1"><tr><td>1</td><td></td><td></td></tr><tr><td>1</td><td></td><td></td></tr><tr><td></td><td></td><td></td></tr></table> Post - 0 Miss - 2 Block - 0	1			1						20 渠文娜 <table border="1"><tr><td></td><td></td><td>1</td></tr><tr><td></td><td></td><td></td></tr><tr><td>1</td><td></td><td></td></tr></table> Post - 0 Miss - 0 Block - 0			1				1		
		1																																																																													
		1																																																																													
	1	1																																																																													
		1																																																																													
		2																																																																													
		1																																																																													
2		2																																																																													
		1																																																																													
1																																																																															
1																																																																															
		1																																																																													
1																																																																															
21 吴静雯 <table border="1"><tr><td>1</td><td></td><td>2</td></tr><tr><td></td><td></td><td></td></tr><tr><td></td><td></td><td></td></tr></table> Post - 1 Miss - 1 Block - 0	1		2							22 彭如玉 <table border="1"><tr><td></td><td></td><td></td></tr><tr><td></td><td></td><td></td></tr><tr><td></td><td></td><td></td></tr></table> Post - 0 Miss - 0 Block - 0										24 王铃娜 <table border="1"><tr><td>2</td><td></td><td></td></tr><tr><td>2</td><td></td><td></td></tr><tr><td>1</td><td></td><td></td></tr></table> Post - 0 Miss - 0 Block - 0	2			2			1			25 李秋淇 <table border="1"><tr><td>1</td><td></td><td></td></tr><tr><td>2</td><td></td><td></td></tr><tr><td></td><td></td><td></td></tr></table> Post - 0 Miss - 0 Block - 0	1			2						26 邱聿芳 <table border="1"><tr><td></td><td></td><td></td></tr><tr><td></td><td></td><td></td></tr><tr><td>2</td><td></td><td></td></tr></table> Post - 0 Miss - 0 Block - 0							2			27 李袁梦 <table border="1"><tr><td></td><td></td><td></td></tr><tr><td></td><td></td><td></td></tr><tr><td></td><td></td><td></td></tr></table> Post - 0 Miss - 0 Block - 0										28 黄奕涵 <table border="1"><tr><td></td><td></td><td></td></tr><tr><td></td><td></td><td>1</td></tr><tr><td></td><td></td><td></td></tr></table> Post - 0 Miss - 0 Block - 0						1				29 陈赛楠 <table border="1"><tr><td></td><td></td><td></td></tr><tr><td></td><td></td><td></td></tr><tr><td></td><td></td><td></td></tr></table> Post - 0 Miss - 0 Block - 0									
1		2																																																																													
2																																																																															
2																																																																															
1																																																																															
1																																																																															
2																																																																															
2																																																																															
		1																																																																													

1 胡雨诺

		1/1
3/3	1/1	0/1

22 彭如玉

1/2	1/1	1/1
0/1		0/2

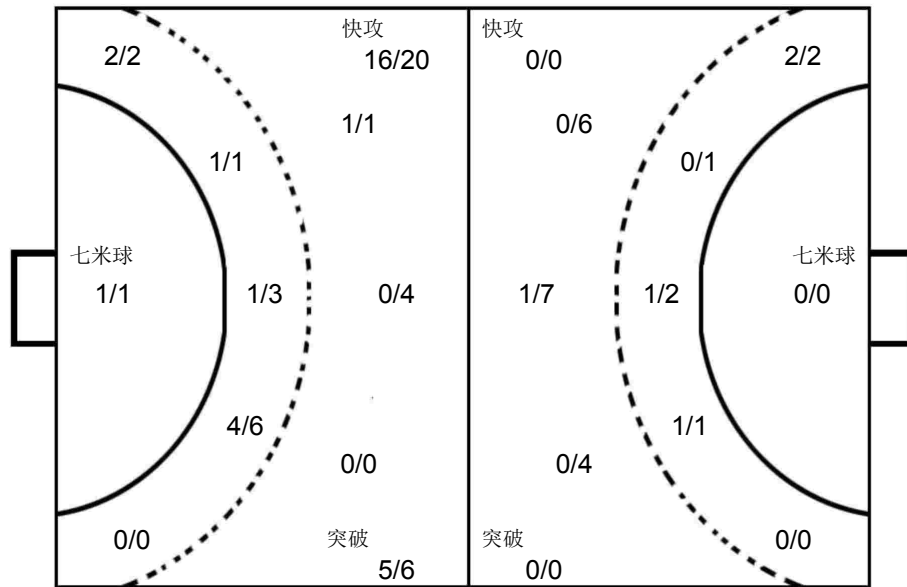

10 盧曉汶

		0/2
0/2		0/1

19 馮楚瑩

0/7	1/2	0/7
0/5	2/2	1/3
0/2	2/2	0/2

澳门

8 譚嘉雯 <table border="1"><tr><td></td><td></td><td></td></tr><tr><td></td><td></td><td></td></tr><tr><td></td><td></td><td></td></tr></table> Post - 0 Miss - 0 Block - 0										10 盧曉汶 <table border="1"><tr><td></td><td></td><td></td></tr><tr><td></td><td></td><td></td></tr><tr><td></td><td></td><td></td></tr></table> Post - 0 Miss - 0 Block - 0										11 李君移 <table border="1"><tr><td></td><td></td><td></td></tr><tr><td></td><td></td><td></td></tr><tr><td>1</td><td></td><td>1</td></tr></table> Post - 0 Miss - 2 Block - 0							1		1	12 李芷棋 <table border="1"><tr><td></td><td></td><td></td></tr><tr><td>1</td><td></td><td></td></tr><tr><td></td><td></td><td></td></tr></table> Post - 0 Miss - 1 Block - 0				1						15 張雪琳 <table border="1"><tr><td></td><td></td><td></td></tr><tr><td></td><td></td><td></td></tr><tr><td></td><td></td><td>1</td></tr></table> Post - 0 Miss - 5 Block - 1									1	18 曾華恩 <table border="1"><tr><td></td><td></td><td></td></tr><tr><td></td><td></td><td></td></tr><tr><td></td><td></td><td></td></tr></table> Post - 0 Miss - 0 Block - 0										19 馮楚瑩 <table border="1"><tr><td></td><td></td><td></td></tr><tr><td></td><td></td><td></td></tr><tr><td></td><td></td><td></td></tr></table> Post - 0 Miss - 0 Block - 0										22 蘇萱婷 <table border="1"><tr><td></td><td></td><td></td></tr><tr><td></td><td></td><td></td></tr><tr><td></td><td></td><td></td></tr></table> Post - 0 Miss - 0 Block - 0									
1		1																																																																													
1																																																																															
		1																																																																													
23 霍思允 <table border="1"><tr><td></td><td></td><td></td></tr><tr><td></td><td></td><td></td></tr><tr><td></td><td></td><td></td></tr></table> Post - 0 Miss - 1 Block - 0										44 李嵐 <table border="1"><tr><td></td><td></td><td></td></tr><tr><td></td><td></td><td></td></tr><tr><td></td><td></td><td>1</td></tr></table> Post - 0 Miss - 0 Block - 0									1	58 林诗雅 <table border="1"><tr><td></td><td></td><td></td></tr><tr><td></td><td></td><td></td></tr><tr><td></td><td></td><td></td></tr></table> Post - 0 Miss - 0 Block - 0																																																											
		1																																																																													



第二届全国青年运动会女子手球甲组决赛 体校组 (U18)

青年女子 国内比赛

预赛 Group A



PHMS Pictorial Handball Match Statistics

IHF Official System

Team A				Team B				Match Number	
A 安徽滁州				B 香港				76	

Played in	in the hall	on	at	Spepectors
山西晋中	晋中体育馆	2019-06-22	14:00	hours

Half-time(30')	A	B	End of playing time	A	B	1st extra time	A	B	2nd extra time	A	B	After penalty throws	A	B
	15	3	27	9										

Number of 7 m	A	Team time-out			Full name of players and officials	Team time-out			B	Number of 7 m
	1/1	1	2	3		1	2	3	4/6	

No.	Team A	G	W	2'	D	DR	No.	Team B	G	W	2'	D	DR
1	张家轩						1	郑晓容					
2	钟梦	1					3	黄秋婷					
3	孙明月	9					4	何丹仪		1			
4	龚铭						5	卓凯晴	4				
7	丁洁						6	洪卓翹					
9	窦海乐	3	1				8	李芷欣					
16	刘子琪						9	林卓琪					
25	耿雨萍						11	庄斯琪	2				
26	张雅婷						16	曾婉琳					
28	马雯怡						17	梁艺	1				
30	罗佳乐						18	吴嘉妮	2				
32	王小雅						21	林乐儿					
34	姜影	3					23	王洁桦					
35	李旭	5		1			25	戴子怡					
36	高奇欣	4					28	郭芷彤					
38	潘楠	2	1				91	孔倩瑜					
B	陆广红 (主教练)						A	杨开将					
C	岳连娥						B	何颂邦					
D	李莉						C	梁倩盈					

A	Signatures of responsables for the teams (Off.A)												B
---	--	--	--	--	--	--	--	--	--	--	--	--	---

TP	Remarks of referees / HF Official													TP
----	-----------------------------------	--	--	--	--	--	--	--	--	--	--	--	--	----

Signatures													
Referees	刘晓辉 (CHN)	冯雨生 (CHN)											
T.D.	刘凤娟 (CHN)	张耿 (CHN)											
CHA Off.													

Note: Number of 7m Throws Awarded to Team A and B, Goals (G), Warnings (W), Suspensions (2'), Direct Disqualification (D), Disqualification With Report (DR) and Team Penalty (TP).

Table Officials: 杜鸿 宣海波 Statisticians: 刘笑 王梓衡





## 个人/全队技术统计表

手球 青年女子 预赛 轮次 7 组别 A 场次 76 晋中体育馆 2019-06-22 14:00

号码	姓名	远射	近射	边射	快攻	突破	任意	七米	合计	%	助攻	失误	警告	2'	取消	时间
安徽滁州(滁州)																
(场上队员)																
1	张家轩									0.0%	2					00:20:00
2	钟梦		1/1						1/1	100%						00:04:28
3	孙明月	2/2	1/1		5/8			1/1	9/12	75.0%	2	1				00:39:20
4	龚铭									0.0%						00:00:00
7	丁洁									0.0%		1				00:02:11
9	窦海乐	1/2	0/1	1/1	1/1				3/5	60.0%	1	1	1			00:40:00
16	刘子琪									0.0%	3	1				00:20:00
25	耿雨萍									0.0%						00:00:00
26	张雅婷									0.0%						00:00:00
28	马雯怡									0.0%						00:00:00
30	罗佳乐									0.0%						00:00:00
32	王小雅									0.0%						00:01:29
34	姜影			1/2	2/2				3/4	75.0%	3	1				00:33:48
35	李旭		0/1	1/2	1/2	3/3			5/8	62.5%	1	3		1		00:41:43
36	高奇欣		3/3		1/1				4/4	100%	1					00:38:29
38	潘楠	0/1		0/1	1/2	1/1			2/5	40.0%		2	1			00:38:30
	合计	3/5	5/7	3/6	11/16	4/4		1/1	27/39	69.2%	13	10	2	1		
(守门员)																
1	张家轩	2/2	2/3	1/2				0/1	5/8	62.5%	2					00:20:00
16	刘子琪		1/1	3/5		1/1	1/2	1/4	7/13	53.8%	3	1				00:20:00
	合计	2/2	3/4	4/7		1/1	1/2	1/5	12/21	57.1%	5	1				

场上队员：得分/射门

守门员：救球/射门

全队合计	得分	被救	射失	击柱	封球	合计	%
远射	3	1	1			5	60.0%
近射	5	1	1			7	71.4%
边射	3	2		1		6	50.0%
快攻	11	3	1	1		16	68.8%
突破	4					4	100.0%
任意							0.0%
七米	1					1	100.0%

第二届全国青年运动会女子手球甲组决赛 体校组 (U18)

PHMS Pictorial Handball Match Statistics

IHF Official System

个人/全队技术统计表

手球 预赛 组别 A 晋中体育馆  
青年女子 轮次 7 场次 76 2019-06-22 14:00

号码	姓名	远射	近射	边射	快攻	突破	任意	七米	合计	%	助攻	失误	警告	2'	取消	时间
香港(香港)																
(场上队员)																
1	郑晓容									0.0%		1				00:24:36
3	黄秋婷					0/1			0/1	0.0%		5				00:19:36
4	何丹仪			0/1					0/1	0.0%		5	1			00:33:37
5	卓凯晴							4/5	4/5	80.0%						00:01:37
6	洪卓翘									0.0%						00:15:24
8	李芷欣	0/1	0/1	0/1					0/3	0.0%		1				00:18:38
9	林卓琪			0/1					0/1	0.0%		2				00:12:25
11	庄斯琪		1/1				1/1	0/1	2/3	66.7%		3				00:22:55
16	曾婉琳	0/1	0/1	0/1			0/1		0/4	0.0%		4				00:22:59
17	梁艺			1/1					1/1	100%						00:20:00
18	吴嘉妮	0/1		2/2					2/3	66.7%						00:11:45
21	林乐儿			0/2					0/2	0.0%		1				00:19:53
23	王洁桦			0/1					0/1	0.0%		1				00:07:33
25	戴子怡		0/1						0/1	0.0%						00:27:59
28	郭芷彤		0/1						0/1	0.0%						00:13:01
91	孔倩瑜			0/1					0/1	0.0%						00:08:00
合计		0/3	1/5	3/11		0/1	1/2	4/6	9/28	32.1%		23	1			

(守门员)																
1	郑晓容	0/2	1/4	2/3	3/8	0/3		0/1	6/21	28.6%		1				00:24:36
6	洪卓翘	1/2	0/2	0/2	0/6	0/1			1/13	7.7%						00:15:24
合计		1/4	1/6	2/5	3/14	0/4		0/1	7/34	20.6%		1				

场上队员：得分/射门 守门员：救球/射门

全队合计	得分	被救	射失	击柱	封球	合计	%
远射		2	1			3	0.0%
近射	1	3	1			5	20.0%
边射	3	4	2	2		11	27.3%
快攻							0.0%
突破		1				1	0.0%
任意	1	1				2	50.0%
七米	4	1		1		6	66.7%

图式比赛技术统计表

手球  
青年女子

预赛  
轮次 7

组别 A  
场次 76

晋中体育馆  
2019-06-22 14:00

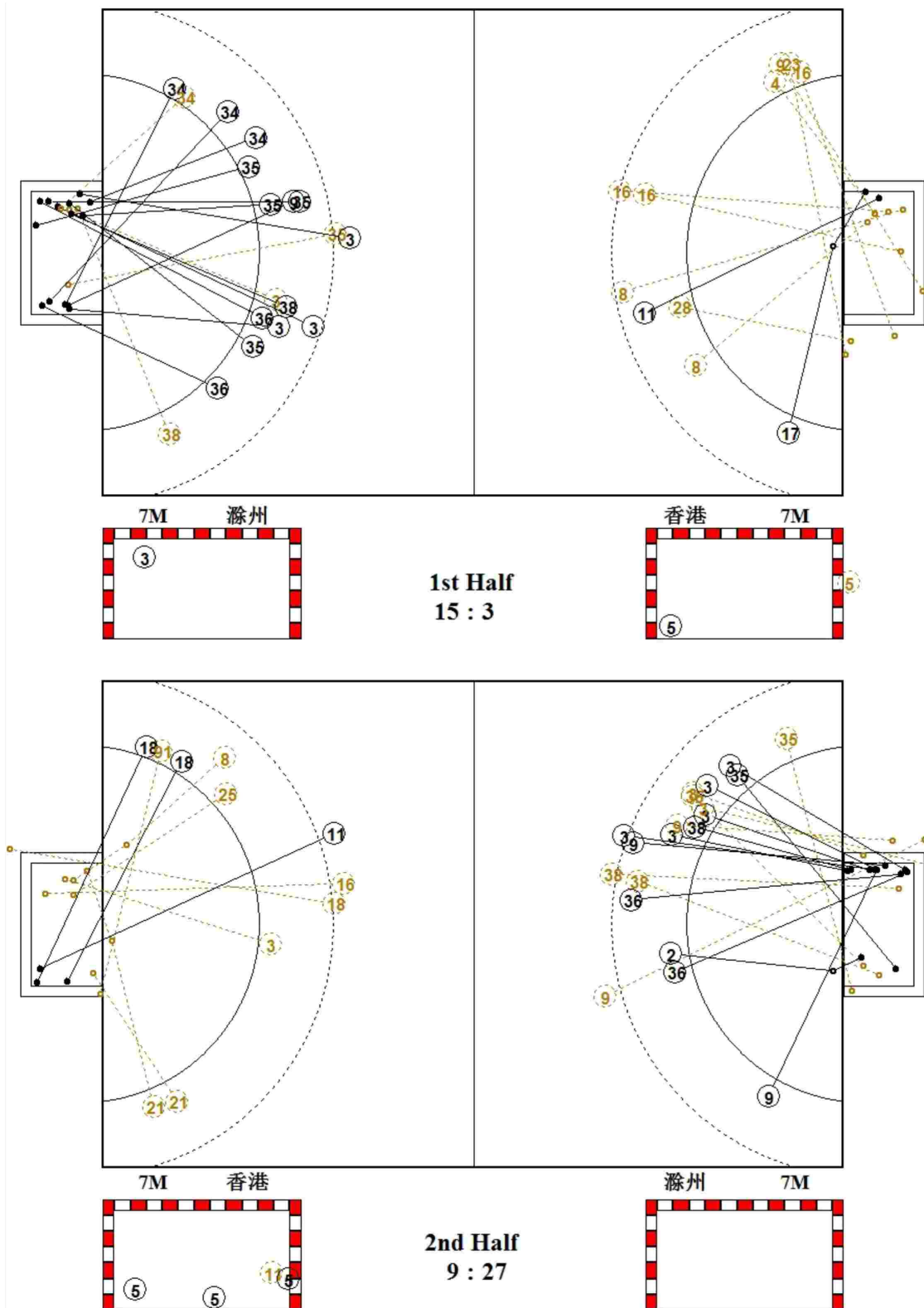

图式射门区域统计

手球  
青年女子

预赛  
轮次 7

组别 A  
场次 76

晋中体育馆  
2019-06-22 14:00

安徽滁州

1 张家轩	2 钟梦	3 孙明月	4 龚铭	7 丁洁	9 窦海乐	16 刘子琪	25 耿雨萍																																																																								
<table border="1"><tr><td></td><td></td><td></td></tr><tr><td></td><td></td><td></td></tr><tr><td></td><td></td><td></td></tr></table>										<table border="1"><tr><td></td><td></td><td></td></tr><tr><td></td><td></td><td></td></tr><tr><td></td><td></td><td>1</td></tr></table>									1	<table border="1"><tr><td>2</td><td></td><td></td></tr><tr><td>4</td><td></td><td>1</td></tr><tr><td>1</td><td></td><td>1</td></tr></table>	2			4		1	1		1	<table border="1"><tr><td></td><td></td><td></td></tr><tr><td></td><td></td><td></td></tr><tr><td></td><td></td><td></td></tr></table>										<table border="1"><tr><td></td><td></td><td></td></tr><tr><td></td><td></td><td></td></tr><tr><td></td><td></td><td></td></tr></table>										<table border="1"><tr><td></td><td></td><td></td></tr><tr><td></td><td></td><td></td></tr><tr><td>3</td><td></td><td></td></tr></table>							3			<table border="1"><tr><td></td><td></td><td></td></tr><tr><td></td><td></td><td></td></tr><tr><td></td><td></td><td></td></tr></table>										<table border="1"><tr><td></td><td></td><td></td></tr><tr><td></td><td></td><td></td></tr><tr><td></td><td></td><td></td></tr></table>									
		1																																																																													
2																																																																															
4		1																																																																													
1		1																																																																													
3																																																																															
Post - 0 Miss - 0 Block - 0	Post - 0 Miss - 0 Block - 0	Post - 1 Miss - 1 Block - 0	Post - 0 Miss - 0 Block - 0	Post - 0 Miss - 0 Block - 0	Post - 0 Miss - 2 Block - 0	Post - 0 Miss - 0 Block - 0	Post - 0 Miss - 0 Block - 0																																																																								
26 张雅婷	28 马雯怡	30 罗佳乐	32 王小雅	34 姜影	35 李旭	36 高奇欣	38 潘楠																																																																								
<table border="1"><tr><td></td><td></td><td></td></tr><tr><td></td><td></td><td></td></tr><tr><td></td><td></td><td></td></tr></table>										<table border="1"><tr><td></td><td></td><td></td></tr><tr><td></td><td></td><td></td></tr><tr><td></td><td></td><td></td></tr></table>										<table border="1"><tr><td></td><td></td><td></td></tr><tr><td></td><td></td><td></td></tr><tr><td></td><td></td><td></td></tr></table>										<table border="1"><tr><td></td><td></td><td></td></tr><tr><td></td><td></td><td></td></tr><tr><td></td><td></td><td></td></tr></table>										<table border="1"><tr><td>1</td><td></td><td></td></tr><tr><td>1</td><td></td><td></td></tr><tr><td></td><td></td><td>1</td></tr></table>	1			1					1	<table border="1"><tr><td></td><td></td><td>3</td></tr><tr><td></td><td></td><td>1</td></tr><tr><td></td><td></td><td>1</td></tr></table>			3			1			1	<table border="1"><tr><td>3</td><td></td><td>1</td></tr><tr><td></td><td></td><td></td></tr><tr><td></td><td></td><td></td></tr></table>	3		1							<table border="1"><tr><td></td><td></td><td></td></tr><tr><td></td><td></td><td></td></tr><tr><td></td><td></td><td>1</td></tr></table>									1
1																																																																															
1																																																																															
		1																																																																													
		3																																																																													
		1																																																																													
		1																																																																													
3		1																																																																													
		1																																																																													
Post - 0 Miss - 0 Block - 0	Post - 0 Miss - 0 Block - 0	Post - 0 Miss - 0 Block - 0	Post - 0 Miss - 0 Block - 0	Post - 0 Miss - 0 Block - 0	Post - 1 Miss - 0 Block - 0	Post - 0 Miss - 0 Block - 0	Post - 0 Miss - 0 Block - 0																																																																								

1 张家轩

1/1	1/1	
3/4		
0/2		

16 刘子琪

0/2		1/1
0/1		4/5
1/2	0/1	1/1

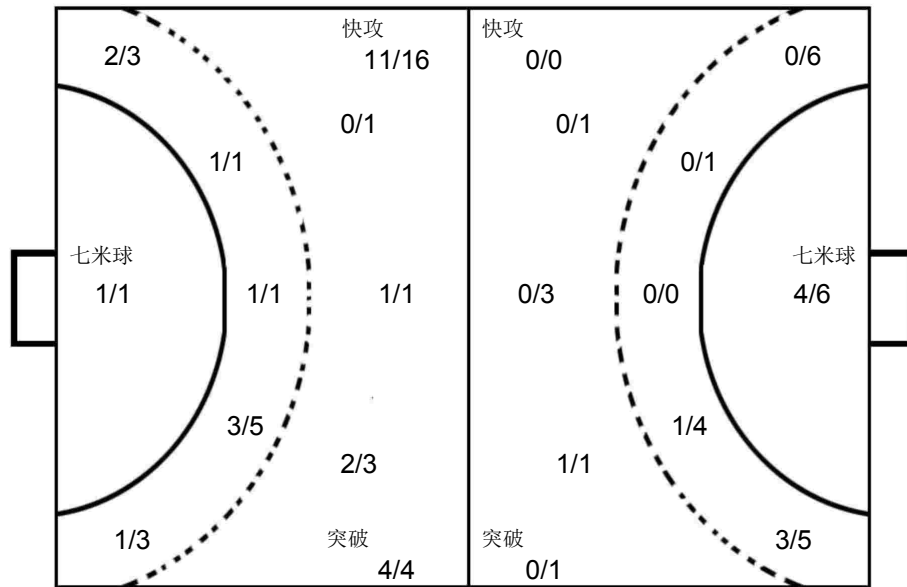

1 郑晓容

0/3		0/3
1/4		4/6
0/2		1/3

6 洪卓翹

1/4		0/1
0/5		0/1
		0/2

香港

1 郑晓容	3 黄秋婷	4 何丹仪	5 卓凯晴	6 洪卓翹	8 李芷欣	9 林卓琪	11 庄斯琪																																																																								
<table border="1"><tr><td></td><td></td><td></td></tr><tr><td></td><td></td><td></td></tr><tr><td></td><td></td><td></td></tr></table>										<table border="1"><tr><td></td><td></td><td></td></tr><tr><td></td><td></td><td></td></tr><tr><td></td><td></td><td></td></tr></table>										<table border="1"><tr><td></td><td></td><td></td></tr><tr><td></td><td></td><td></td></tr><tr><td></td><td></td><td></td></tr></table>										<table border="1"><tr><td></td><td></td><td>1</td></tr><tr><td>2</td><td>1</td><td></td></tr><tr><td></td><td></td><td></td></tr></table>			1	2	1					<table border="1"><tr><td></td><td></td><td></td></tr><tr><td></td><td></td><td></td></tr><tr><td></td><td></td><td></td></tr></table>										<table border="1"><tr><td></td><td></td><td></td></tr><tr><td></td><td></td><td></td></tr><tr><td></td><td></td><td></td></tr></table>										<table border="1"><tr><td></td><td></td><td></td></tr><tr><td></td><td></td><td></td></tr><tr><td></td><td></td><td></td></tr></table>										<table border="1"><tr><td>1</td><td></td><td></td></tr><tr><td>1</td><td></td><td></td></tr><tr><td></td><td></td><td></td></tr></table>	1			1					
		1																																																																													
2	1																																																																														
1																																																																															
1																																																																															
Post - 0 Miss - 0 Block - 0	Post - 0 Miss - 0 Block - 0	Post - 0 Miss - 0 Block - 0	Post - 1 Miss - 0 Block - 0	Post - 0 Miss - 0 Block - 0	Post - 0 Miss - 0 Block - 0	Post - 1 Miss - 0 Block - 0	Post - 0 Miss - 0 Block - 0																																																																								
16 曾婉琳	17 梁艺	18 吴嘉妮	21 林乐儿	23 王洁桦	25 戴子怡	28 郭芷彤	91 孔倩瑜																																																																								
<table border="1"><tr><td></td><td></td><td></td></tr><tr><td></td><td></td><td></td></tr><tr><td></td><td></td><td></td></tr></table>										<table border="1"><tr><td></td><td></td><td></td></tr><tr><td></td><td></td><td></td></tr><tr><td>1</td><td></td><td></td></tr></table>							1			<table border="1"><tr><td>1</td><td></td><td></td></tr><tr><td>1</td><td></td><td></td></tr><tr><td></td><td></td><td></td></tr></table>	1			1						<table border="1"><tr><td></td><td></td><td></td></tr><tr><td></td><td></td><td></td></tr><tr><td></td><td></td><td></td></tr></table>										<table border="1"><tr><td></td><td></td><td></td></tr><tr><td></td><td></td><td></td></tr><tr><td></td><td></td><td></td></tr></table>										<table border="1"><tr><td></td><td></td><td></td></tr><tr><td></td><td></td><td></td></tr><tr><td></td><td></td><td></td></tr></table>										<table border="1"><tr><td></td><td></td><td></td></tr><tr><td></td><td></td><td></td></tr><tr><td></td><td></td><td></td></tr></table>										<table border="1"><tr><td></td><td></td><td></td></tr><tr><td></td><td></td><td></td></tr><tr><td></td><td></td><td></td></tr></table>									
1																																																																															
1																																																																															
1																																																																															
Post - 0 Miss - 1 Block - 0	Post - 0 Miss - 0 Block - 0	Post - 0 Miss - 1 Block - 0	Post - 0 Miss - 0 Block - 0	Post - 0 Miss - 1 Block - 0	Post - 0 Miss - 0 Block - 0	Post - 0 Miss - 1 Block - 0	Post - 1 Miss - 0 Block - 0																																																																								



第二届全国青年运动会女子手球甲组决赛 体校组 (U18)

青年女子 国内比赛

5-6名



PHMS Pictorial Handball Match Statistics

IHF Official System

Team A					Team B					Match Number											
A 北京市					B 香港					89											
Played in			in the hall			on			at			Spectators									
山西晋中			晋中体育馆			2019-06-23			15:10			hours									
Half-time(30')	A	B	End of playing time	A	B	1st extra time	A	B	2nd extra time	A	B	After penalty throws	A	B							
	12	6		21	12																
Number of 7 m	A	Team time-out			Full name of players and officials					Team time-out			B	Number of 7 m							
	7/8	1	2	3						1	2	3	0/3								
			35:12						07:49	17:51	30:10										
No.	Team A					G	W	2'	D	DR	No.	Team B					G	W	2'	D	DR
1	靳爽										1	郑晓容									
5	常凯旋					1					3	黄秋婷					2				
7	翟乃迪										4	何丹仪									
8	武宏业					6		1			5	卓凯晴									
9	徐慧敏					1					6	洪卓翹									
10	胡冰心					4					8	李芷欣					1	1	1		
11	陈丽婷					3					9	林卓琪					3				
14	侯美林						1				11	庄斯琪					5				
16	周晓雨										16	曾婉琳						1			
18	唐文杰										17	梁艺									
23	黄文文					1					18	吴嘉妮									
27	田苗										21	林乐儿									
81	王木子							1			23	王洁桦									
87	王奥					2					25	戴子怡									
88	彭爽爽					3					28	郭芷彤									
											91	孔倩瑜					1				
B	黄承 (主教练)										A	杨开将									
C	栾征										B	何颂邦									
D	石伟										C	梁倩盈									
E	刘文勇																				
A	Signatures of responsables for the teams (Off.A)															B					
TP	Remarks of referees / HF Official															TP					

Signatures

Referees	王亚光 (CHN)	吴佳 (CHN)		
T.D.	刘凤娟 (CHN)	叶霄雪 (CHN)		
CHA Off.				

Note: Number of 7m Throws Awarded to Team A and B, Goals (G), Warnings (W), Suspensions (2'), Direct Disqualification (D), Disqualification With Report (DR) and Team Penalty (TP).

Table Officials: 宣海波 张琦 Statisticians: 陈柱 谢扬





## 第二届全国青年运动会女子手球甲组决赛 体校组 (U18)

PHMS Pictorial Handball Match Statistics

IHF Official System

### 竞赛技术统计

手球  
青年女子

5-6名  
轮次 8

组别 X  
场次 89

晋中体育馆  
2019-06-23 15:10

Referees:	王亚光 (CHN) / 吴佳 (CHN)	Result:	21:12 (12:6)
Teams:	北京市(北京) VS 香港(香港)		

北京		远	近	边	快	突	任意	7m	合计	%	助攻	失误	警告	2'	D+DR
主教练: 黄承		射	射	射	攻	破	球	球							
1	靳爽														
5	常凯旋				1/1				1/1	100					
7	翟乃迪					0/1			0/1	0.0					
8	武宏业	0/2	0/1	1/1				5/5	6/9	66.7		3		1	
9	徐慧敏	1/4							1/4	25.0		1			
10	胡冰心		1/1	1/2	2/3				4/6	66.7		1			
11	陈丽婷		1/1					2/3	3/4	75.0	2				
14	侯美林				0/1				0/1	0.0		3	1		
16	周晓雨														
18	唐文杰											1			
23	黄文文			1/1					1/1	100		1			
27	田苗											1			
81	王木子		0/1						0/1	0.0				1	
87	王奥		1/1				1/1		2/2	100					
88	彭爽爽				2/2	1/1			3/3	100	1	1			
运动员 合计		1/6	3/5	3/4	5/7	1/2	1/1	7/8	21/33	63.6	3	12	1	2	
1	靳爽	1/3	2/4	6/9	1/1	0/2	0/2	2/2	12/23	52.2					
16	周晓雨	1/1		1/1		0/1			2/3	66.7					
守门员 合计		2/4	2/4	7/10	1/1	0/3	0/2	2/2	14/26	53.8					

北京	比赛 进程	香港
1st Half		
0	00:24	1 8 李芷欣
11	陈丽婷	1 02:35 1
87	王奥	2 05:15 1
88	彭爽爽	3 05:57 1
88	彭爽爽	4 06:32 1
11	陈丽婷	5 07:48 1
10	胡冰心	6 10:25 1
		6 10:52 2 11 庄斯琪
87	王奥	7 11:53 2
		7 12:24 3 11 庄斯琪
11	陈丽婷	8 13:10 3
		8 14:38 4 91 孔倩瑜
10	胡冰心	9 15:06 4
		9 15:30 5 9 林卓琪
88	彭爽爽	10 16:06 5
5	常凯旋	11 17:36 5
8	武宏业	12 18:53 5
		12 19:26 6 11 庄斯琪
2nd Half		
8	武宏业	13 00:47 6
		13 01:42 7 11 庄斯琪
8	武宏业	14 02:16 7
		14 02:58 8 9 林卓琪
23	黄文文	15 03:26 8
8	武宏业	16 05:20 8
10	胡冰心	17 05:52 8
10	胡冰心	18 07:26 8
8	武宏业	19 08:30 8
		19 13:50 9 11 庄斯琪
		19 14:34 10 3 黄秋婷
		19 15:36 11 9 林卓琪
9	徐慧敏	20 17:01 11
		20 19:06 12 3 黄秋婷
8	武宏业	21 19:24 12

场上队员: 得分 / 射门

守门员: 救球 / 射门

D	取消资格	DR	取消资格+报告
---	------	----	---------



## 个人/全队技术统计表

 手球 5-6名 组别 X 晋中体育馆  
 青年女子 轮次 8 场次 89 2019-06-23 15:10

号码	姓名	远射	近射	边射	快攻	突破	任意	七米	合计	%	助攻	失误	警告	2'	取消	时间
北京市(北京)																
(场上队员)																
1	靳爽									0.0%						00:35:45
5	常凯旋				1/1				1/1	100%						00:12:55
7	翟乃迪					0/1			0/1	0.0%						00:25:08
8	武宏业	0/2	0/1	1/1				5/5	6/9	66.7%	3			1		00:19:04
9	徐慧敏	1/4							1/4	25.0%	1					00:06:45
10	胡冰心		1/1	1/2	2/3				4/6	66.7%	1					00:30:10
11	陈丽婷		1/1					2/3	3/4	75.0%	2					00:30:10
14	侯美林				0/1				0/1	0.0%	3		1			00:26:41
16	周晓雨									0.0%						00:04:15
18	唐文杰									0.0%	1					00:16:18
23	黄文文			1/1					1/1	100%	1					00:21:58
27	田苗									0.0%	1					00:09:38
81	王木子		0/1						0/1	0.0%				1		00:04:45
87	王奥		1/1				1/1		2/2	100%						00:17:14
88	彭爽爽				2/2	1/1			3/3	100%	1	1				00:18:01
合计		1/6	3/5	3/4	5/7	1/2	1/1	7/8	21/33	63.6%	3	12	1	2		
(守门员)																
1	靳爽	1/3	2/4	6/9	1/1	0/2	0/2	2/2	12/23	52.2%						00:35:45
16	周晓雨	1/1		1/1		0/1			2/3	66.7%						00:04:15
合计		2/4	2/4	7/10	1/1	0/3	0/2	2/2	14/26	53.8%						

场上队员：得分/射门

守门员：救球/射门

全队合计	得分	被救	射失	击柱	封球	合计	%
远射	1	4		1		6	16.7%
近射	3	1	1			5	60.0%
边射	3	1				4	75.0%
快攻	5	2				7	71.4%
突破	1		1			2	50.0%
任意	1					1	100.0%
七米	7	1				8	87.5%

第二届全国青年运动会女子手球甲组决赛 体校组 (U18)

PHMS Pictorial Handball Match Statistics

IHF Official System

个人/全队技术统计表

手球 青年女子 5-6名 轮次 8 组别 X 场次 89 晋中体育馆 2019-06-23 15:10

号码	姓名	远射	近射	边射	快攻	突破	任意	七米	合计	%	助攻	失误	警告	2'	取消	时间
香港(香港)																
(场上队员)																
1	郑晓容									0.0%						00:21:27
3	黄秋婷			0/1		2/2			2/3	66.7%	1					00:11:15
4	何丹仪									0.0%						00:13:52
5	卓凯晴		0/1					0/3	0/4	0.0%						00:05:22
6	洪卓翹									0.0%	1					00:18:33
8	李芷欣	1/4	0/1	0/1					1/6	16.7%	1	1	1			00:32:57
9	林卓琪			2/5		1/1			3/6	50.0%	1					00:36:10
11	庄斯琪	1/5	1/1	1/1			2/2		5/9	55.6%	1	1				00:33:02
16	曾婉琳	0/3		0/1	0/1				0/5	0.0%	4	1				00:31:27
17	梁艺									0.0%						00:00:00
18	吴嘉妮									0.0%	1					00:05:43
21	林乐儿									0.0%						00:00:00
23	王洁桦									0.0%						00:00:00
25	戴子怡									0.0%	1					00:39:41
28	郭芷彤									0.0%						00:00:00
91	孔倩瑜		1/2	0/2					1/4	25.0%						00:29:39
合计		2/12	2/5	3/11	0/1	3/3	2/2	0/3	12/37	32.4%	1	11	2	1		
(守门员)																
1	郑晓容	2/2	0/2	1/3	0/4	0/1	0/1	1/5	4/18	22.2%						00:21:27
6	洪卓翹	2/3	1/2	0/1	2/3			0/3	5/12	41.7%	1					00:18:33
合计		4/5	1/4	1/4	2/7	0/1	0/1	1/8	9/30	30.0%	1					

场上队员： 得分/射门

守门员： 救球/射门

全队合计	得分	被救	射失	击柱	封球	合计	%
远射	2	2	3	1	4	12	16.7%
近射	2	2	1			5	40.0%
边射	3	7		1		11	27.3%
快攻		1				1	0.0%
突破	3					3	100.0%
任意	2					2	100.0%
七米		2		1		3	0.0%



图式比赛技术统计表

手球  
青年女子

5-6名  
轮次 8

组别 X  
场次 89

晋中体育馆  
2019-06-23 15:10

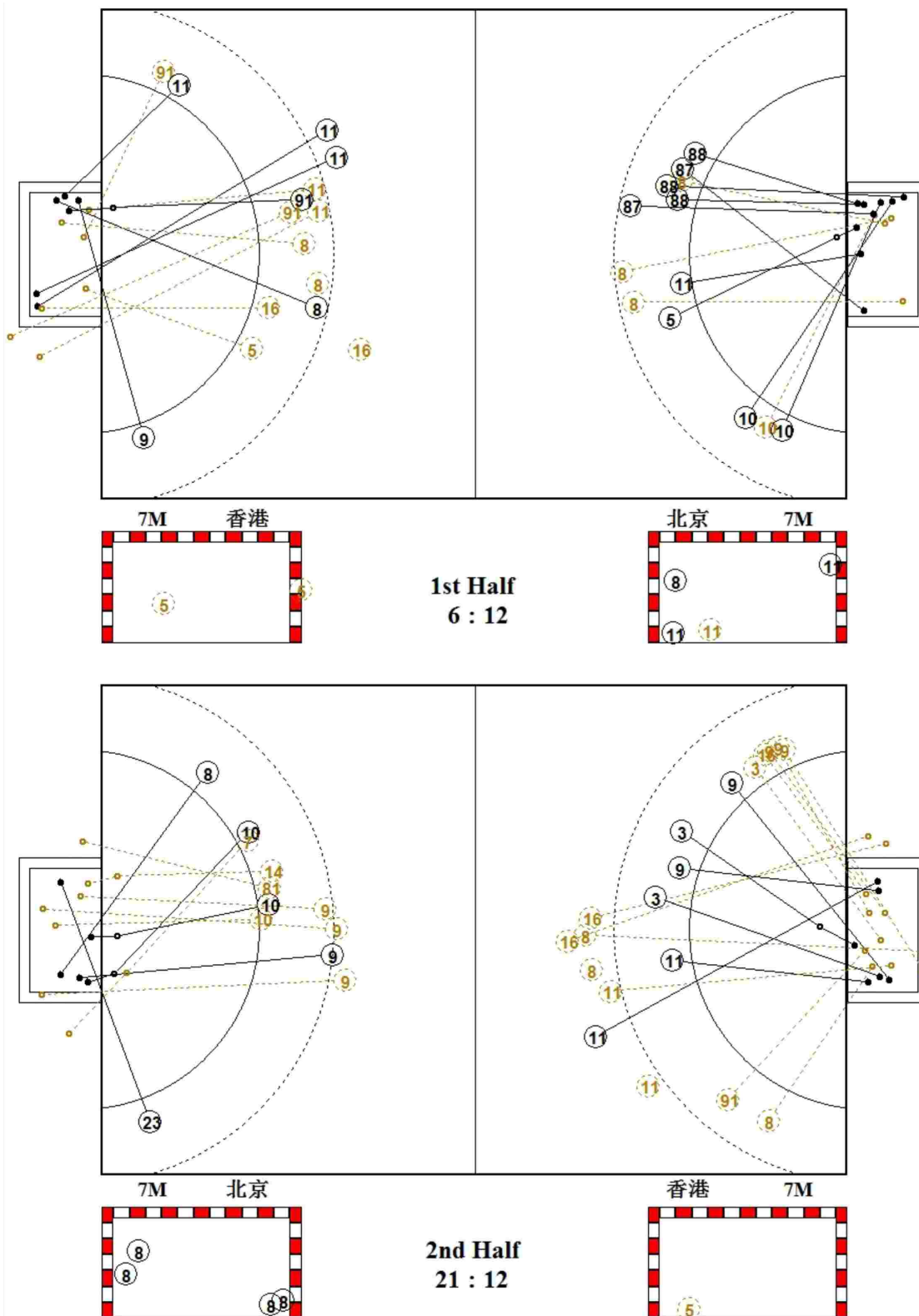

图式射门区域统计

手球  
青年女子

5-6名  
轮次 8

组别 X  
场次 89

晋中体育馆  
2019-06-23 15:10

北京市

1 靳爽 Post - 0 Miss - 0 Block - 0	5 常凯旋 Post - 0 Miss - 0 Block - 0	7 翟乃迪 Post - 0 Miss - 1 Block - 0	8 武宏业 Post - 0 Miss - 0 Block - 0	9 徐慧敏 Post - 1 Miss - 0 Block - 0	10 胡冰心 Post - 0 Miss - 0 Block - 0	11 陈丽婷 Post - 0 Miss - 0 Block - 0	14 侯美林 Post - 0 Miss - 0 Block - 0
16 周晓雨 Post - 0 Miss - 0 Block - 0	18 唐文杰 Post - 0 Miss - 0 Block - 0	23 黄文文 Post - 0 Miss - 0 Block - 0	27 田苗 Post - 0 Miss - 0 Block - 0	81 王木子 Post - 0 Miss - 1 Block - 0	87 王奥 Post - 0 Miss - 0 Block - 0	88 彭爽爽 Post - 0 Miss - 0 Block - 0	

1 靳爽 1/3 2/2 2/7 1/3 2/2 1/3 3/3 2/2 1/3
16 周晓雨 1/1 1/2

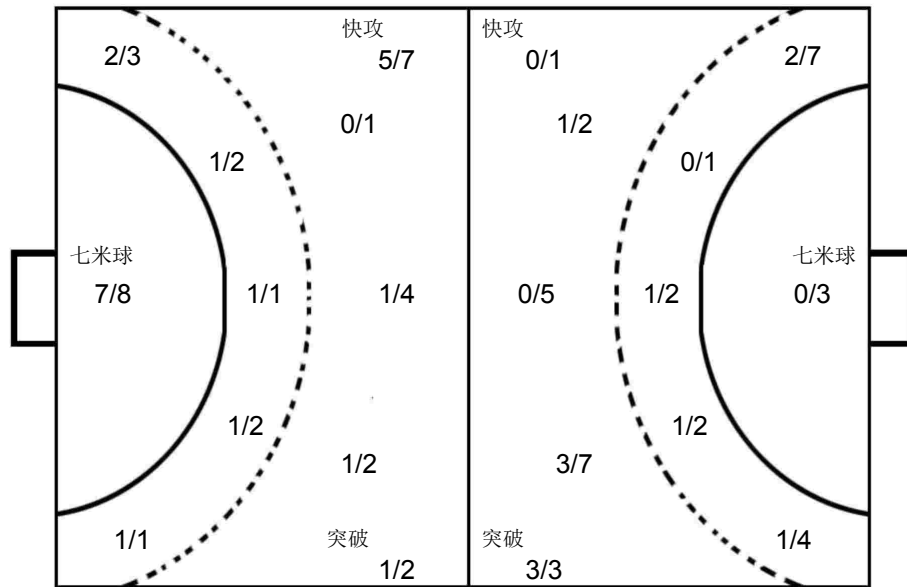

1 郑晓容 0/2 1/2 2/5 0/1 1/5 0/1 0/2
6 洪卓翹 0/1 1/1 1/3 1/1 0/2 0/1 2/3

香港

1 郑晓容 Post - 0 Miss - 0 Block - 0	3 黄秋婷 Post - 0 Miss - 0 Block - 0	4 何丹仪 Post - 0 Miss - 0 Block - 0	5 卓凯晴 Post - 1 Miss - 0 Block - 0	6 洪卓翹 Post - 0 Miss - 0 Block - 0	8 李芷欣 Post - 1 Miss - 0 Block - 2	9 林卓琪 Post - 1 Miss - 0 Block - 0	11 庄斯琪 Post - 0 Miss - 1 Block - 1
16 曾婉琳 Post - 0 Miss - 2 Block - 1	17 梁艺 Post - 0 Miss - 0 Block - 0	18 吴嘉妮 Post - 0 Miss - 0 Block - 0	21 林乐儿 Post - 0 Miss - 0 Block - 0	23 王洁桦 Post - 0 Miss - 0 Block - 0	25 戴子怡 Post - 0 Miss - 0 Block - 0	28 郭芷彤 Post - 0 Miss - 0 Block - 0	91 孔倩瑜 Post - 0 Miss - 1 Block - 0



第二届全国青年运动会女子手球甲组决赛 体校组 (U18)

青年女子 国内比赛

3-4名



PHMS Pictorial Handball Match Statistics

IHF Official System

Team A					Team B					Match Number											
A 山东淄博					B 广东深圳					90											
Played in			in the hall			on		at		Spectators											
山西晋中			晋中体育馆			2019-06-23		16:20		hours											
Half-time(30')	A	B	End of playing time		A	B	1st extra time		A	B	After penalty throws										
	8	5	20		14																
Number of 7 m	A	Team time-out			Full name of players and officials						Team time-out			B	Number of 7 m						
	1/1	1	2	3							1	2	3	B							
		13:55	27:21								04:59			1/3							
No.	Team A					G	W	2'	D	DR	No.	Team B					G	W	2'	D	DR
3	王静雯					1		1			2	唐悦					4				
5	张素娟					1					3	赵晔					5				
6	孙玉坤					2					5	朱嘉盈					1	1	2		
7	辛彤慧										6	朱嘉晴					3				
8	王锦琦										7	曾妮									
9	高梦洁					1	1		1		9	张雨乐									
10	崔佳惠										10	徐瑜琳									
14	韩睿洁										11	王文卉									
15	李骞飞					3					12	于雅梦									
16	王启欣										13	刘培天						1			
17	蒋松妍					5	1				16	邹童羽									
19	户晴										17	冯颖慧									
21	赵欣瑶					7	1				18	谢宛彤									
22	邢力丹										20	岳欣华					1				
23	王家琪																				
28	江迎新							1													
B	徐美凤										A	张斌									
C	翟乾坤 (主教练)										B	张敬敏									
D	段文钰										C	常敏 (主教练)									
E	王日东										D	蒋光华									
A	Signatures of responsables for the teams (Off.A)															B					
TP	Remarks of referees / HF Official															TP					

Signatures

Referees	许翔 (CHN)	严璐 (CHN)		
T.D.	刘凤娟 (CHN)	叶霄雪 (CHN)		
CHA Off.				

Note: Number of 7m Throws Awarded to Team A and B, Goals (G), Warnings (W), Suspensions (2'), Direct Disqualification (D), Disqualification With Report (DR) and Team Penalty (TP).

Table Officials: 杜鸿 吴鹏凯 Statisticians: 谢扬 陈柱





## 第二届全国青年运动会女子手球甲组决赛 体校组 (U18)



PHMS Pictorial Handball Match Statistics

IHF Official System

### 竞赛技术统计

手球  
青年女子

3-4名  
轮次 8

组别 X  
场次 90

晋中体育馆  
2019-06-23 16:20

Referees: 许翔 (CHN) / 严璐 (CHN)  
Teams: 山东淄博(淄博) VS 广东深圳(深圳)

Result: 20:14(8:5)

淄博		远射	近射	边射	快攻	突破	任意球	7m球	合计	%	助攻	失误	警告	2'	D+DR
主教练: 翟乾坤															
3	王静雯	0/1						1/1	1/2	50.0		1		1	
5	张素娟					1/1			1/1	100	1	1			
6	孙玉坤	0/1			1/1		1/1		2/3	66.7					
7	辛彤慧														
8	王锦琦														
9	高梦洁		1/2						1/2	50.0		2	1	1	
10	崔佳惠											1			
14	韩春洁														
15	李鹏飞		0/1	2/2		1/3			3/6	50.0	1	1			
16	王启欣														
17	蒋松妍		4/4		1/1				5/5	100		1	1		
19	卢晴														
21	赵欣瑶		1/1	4/5	2/2				7/8	87.5		1	1		
22	邢力丹														
23	王家琪														
28	江迎新		0/1						0/1	0.0				1	
运动员 合计		0/2	6/9	6/7	4/4	2/4	1/1	1/1	20/28	71.4	2	8	3	2	1
16	王启欣	1/6	2/2	3/6	0/1	0/2		1/2	7/19	36.8					
22	邢力丹	1/2	2/2	4/5					7/9	77.8					
守门员 合计		2/8	4/4	7/11	0/1	0/2		1/2	14/28	50.0					

深圳		远射	近射	边射	快攻	突破	任意球	7m球	合计	%	助攻	失误	警告	2'	D+DR
主教练: 常敏															
2	唐悦	3/7	0/1			0/1		1/2	4/11	36.4		2			
3	赵晔	3/5		1/3		1/1			5/9	55.6		3			
5	朱嘉盈	0/1	0/2	0/1		1/1			1/5	20.0		1	1	2	
6	朱嘉晴		0/1	2/5	1/1			0/1	3/8	37.5					
7	曾妮			0/2					0/2	0.0		1			
9	张雨乐														
10	徐瑜琳														
11	王文卉														
12	于雅梦														
13	刘培天		0/1						0/1	0.0			1		
16	邹童羽														
17	冯颖慧											1			
18	谢宛彤														
20	岳欣华			1/2					1/2	50.0		1			
运动员 合计		6/13	0/5	4/13	1/1	2/3		1/3	14/38	36.8	1	8	2	2	
16	邹童羽		1/5	0/2	0/1			0/1	1/9	11.1					
17	冯颖慧	1/1	2/4	0/4	0/3	2/4	0/1		5/17	29.4	1				
守门员 合计		1/1	3/9	0/6	0/4	2/4	0/1	0/1	6/26	23.1	1				

淄博	比赛进程	深圳
1st Half		
0	00:31	1 5 朱嘉盈
3	03:09	1
9	04:23	1
17	05:40	1
21	09:03	1
4	11:00	2 6 朱嘉晴
15	11:16	2
5	13:53	3 3 赵晔
5	14:21	4 2 唐悦
5	15:29	4
17	16:12	4
21	17:01	4
8	18:54	5 2 唐悦
2nd Half		
17	00:16	5
17	01:16	5
10	02:40	6 2 唐悦
10	03:45	7 3 赵晔
10	04:48	8 3 赵晔
10	06:12	9 20 岳欣华
15	06:45	9
11	07:08	10 3 赵晔
15	07:42	10
12	08:11	11 3 赵晔
12	09:09	12 6 朱嘉晴
6	09:46	12
17	10:55	12
21	11:29	12
6	12:28	12
16	13:02	13 6 朱嘉晴
21	15:02	13
21	16:05	13
18	17:12	14 2 唐悦
21	17:40	14
21	19:05	14

场上队员: 得分 / 射门

守门员: 救球 / 射门

D	取消资格	DR	取消资格+报告
---	------	----	---------



## 个人/全队技术统计表

 手球 3-4名 组别 X 晋中体育馆  
 青年女子 轮次 8 场次 90 2019-06-23 16:20

号码	姓名	远射	近射	边射	快攻	突破	任意	七米	合计	%	助攻	失误	警告	2'	取消	时间
<b>山东淄博(淄博)</b>																
<b>(场上队员)</b>																
3	王静雯	0/1						1/1	1/2	50.0%		1		1		00:33:07
5	张素娟					1/1			1/1	100%	1	1				00:13:48
6	孙玉坤	0/1			1/1		1/1		2/3	66.7%						00:29:39
7	辛彤慧									0.0%						00:00:15
8	王锦琦									0.0%						00:00:00
9	高梦洁		1/2						1/2	50.0%		2	1		1	00:30:02
10	崔佳惠									0.0%		1				00:02:32
14	韩春洁									0.0%						00:00:00
15	李鹏飞		0/1	2/2		1/3			3/6	50.0%	1	1				00:40:00
16	王启欣									0.0%						00:29:13
17	蒋松妍		4/4		1/1				5/5	100%		1	1			00:40:00
19	卢晴									0.0%						00:00:00
21	赵欣瑶		1/1	4/5	2/2				7/8	87.5%		1	1			00:37:25
22	邢力丹									0.0%						00:10:47
23	王家琪									0.0%						00:06:16
28	江迎新		0/1						0/1	0.0%					1	00:09:57
<b>合计</b>		<b>0/2</b>	<b>6/9</b>	<b>6/7</b>	<b>4/4</b>	<b>2/4</b>	<b>1/1</b>	<b>1/1</b>	<b>20/28</b>	<b>71.4%</b>	<b>2</b>	<b>8</b>	<b>3</b>	<b>2</b>	<b>1</b>	
<b>(守门员)</b>																
16	王启欣	1/6	2/2	3/6	0/1	0/2		1/2	7/19	36.8%						00:29:13
22	邢力丹	1/2	2/2	4/5					7/9	77.8%						00:10:47
<b>合计</b>		<b>2/8</b>	<b>4/4</b>	<b>7/11</b>	<b>0/1</b>	<b>0/2</b>		<b>1/2</b>	<b>14/28</b>	<b>50.0%</b>						

场上队员：得分/射门

守门员：救球/射门

全队合计	得分	被救	射失	击柱	封球	合计	%
远射		1	1			2	0.0%
近射	6	3				9	66.7%
边射	6			1		7	85.7%
快攻	4					4	100.0%
突破	2	2				4	50.0%
任意	1					1	100.0%
七米	1					1	100.0%

第二届全国青年运动会女子手球甲组决赛 体校组 (U18)

PHMS Pictorial Handball Match Statistics

IHF Official System

个人/全队技术统计表

手球 3-4名 组别 X 晋中体育馆  
青年女子 轮次 8 场次 90 2019-06-23 16:20

号码	姓名	远射	近射	边射	快攻	突破	任意	七米	合计	%	助攻	失误	警告	2'	取消	时间
广东深圳(深圳)																
(场上队员)																
2	唐悦	3/7	0/1			0/1		1/2	4/11	36.4%		2				00:37:11
3	赵晔	3/5		1/3		1/1			5/9	55.6%		3				00:40:00
5	朱嘉盈	0/1	0/2	0/1		1/1			1/5	20.0%		1	1	2		00:37:25
6	朱嘉晴		0/1	2/5	1/1			0/1	3/8	37.5%						00:34:20
7	曾妮			0/2					0/2	0.0%		1				00:18:44
9	张雨乐									0.0%						00:00:00
10	徐瑜琳									0.0%						00:00:00
11	王文卉									0.0%						00:00:00
12	于雅梦									0.0%						00:00:00
13	刘培天		0/1						0/1	0.0%			1			00:40:00
16	邹童羽									0.0%						00:15:07
17	冯颖慧									0.0%	1					00:24:53
18	谢宛彤									0.0%						00:00:00
20	岳欣华			1/2					1/2	50.0%		1				00:32:13
合计		6/13	0/5	4/13	1/1	2/3		1/3	14/38	36.8%	1	8	2	2		
(守门员)																
16	邹童羽		1/5	0/2	0/1			0/1	1/9	11.1%						00:15:07
17	冯颖慧	1/1	2/4	0/4	0/3	2/4	0/1		5/17	29.4%	1					00:24:53
合计		1/1	3/9	0/6	0/4	2/4	0/1	0/1	6/26	23.1%	1					

场上队员：得分/射门

守门员：救球/射门

全队合计	得分	被救	射失	击柱	封球	合计	%
远射	6	2	1	1	3	13	46.2%
近射		4			1	5	0.0%
边射	4	7		2		13	30.8%
快攻	1					1	100.0%
突破	2		1			3	66.7%
任意							0.0%
七米	1	1		1		3	33.3%

图式比赛技术统计表

手球  
青年女子

3-4名  
轮次 8

组别 X  
场次 90

晋中体育馆  
2019-06-23 16:20

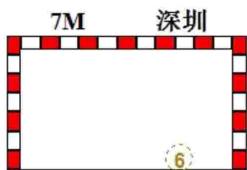
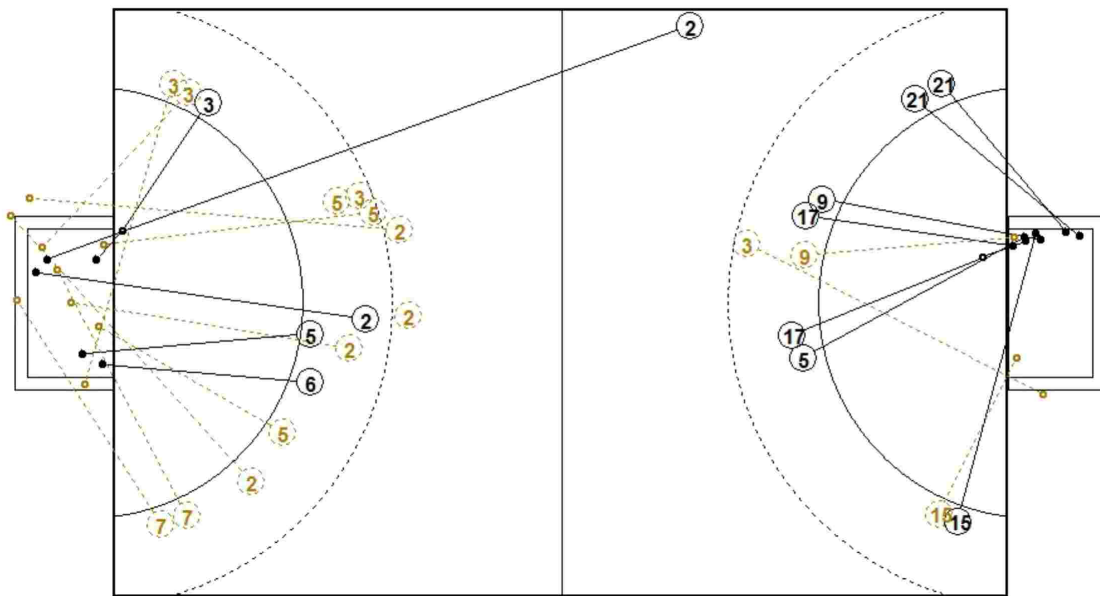

1st Half  
5 : 8

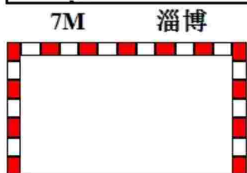
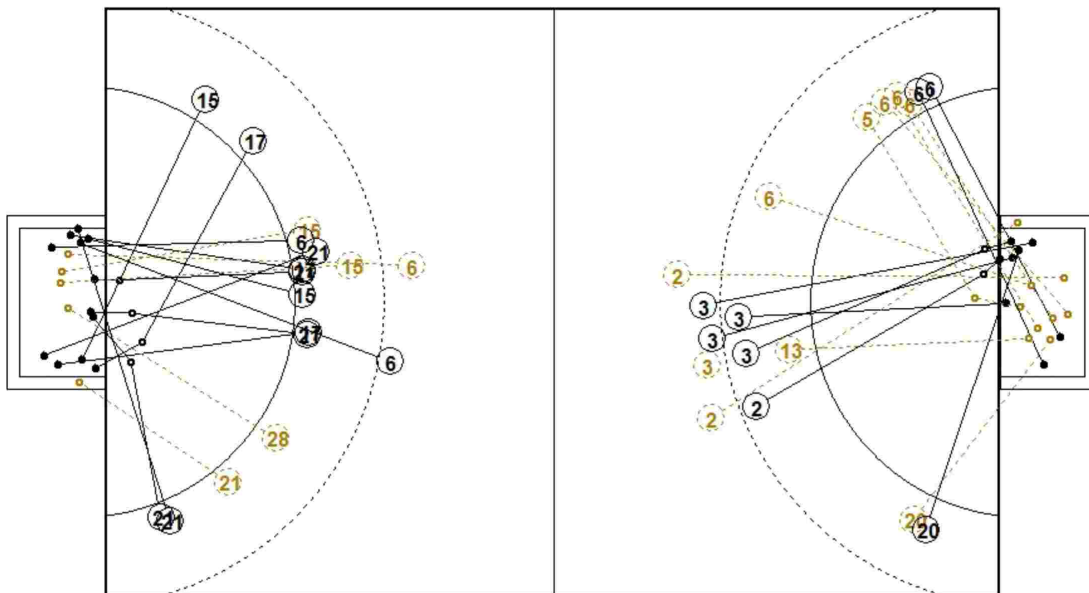
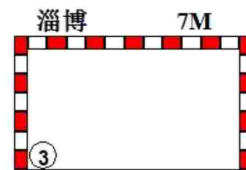

2nd Half  
20 : 14

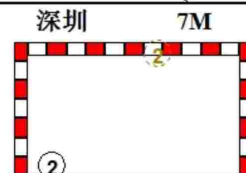

图式射门区域统计

手球  
青年女子

3-4名  
轮次 8

组别 X  
场次 90

晋中体育馆  
2019-06-23 16:20

山东淄博

3 王静雯 <table border="1"><tr><td></td><td></td><td></td></tr><tr><td>1</td><td></td><td></td></tr></table> Post - 0 Miss - 1 Block - 0				1			5 张素娟 <table border="1"><tr><td></td><td></td><td></td></tr><tr><td>1</td><td></td><td></td></tr></table> Post - 0 Miss - 0 Block - 0				1			6 孙玉坤 <table border="1"><tr><td></td><td></td><td></td></tr><tr><td></td><td></td><td>1</td></tr><tr><td></td><td></td><td>1</td></tr></table> Post - 0 Miss - 0 Block - 0						1			1	7 辛彤慧 <table border="1"><tr><td></td><td></td><td></td></tr><tr><td></td><td></td><td></td></tr></table> Post - 0 Miss - 0 Block - 0							8 王锦琦 <table border="1"><tr><td></td><td></td><td></td></tr><tr><td></td><td></td><td></td></tr></table> Post - 0 Miss - 0 Block - 0							9 高梦洁 <table border="1"><tr><td></td><td></td><td></td></tr><tr><td>1</td><td></td><td></td></tr></table> Post - 0 Miss - 0 Block - 0				1			10 崔佳惠 <table border="1"><tr><td></td><td></td><td></td></tr><tr><td></td><td></td><td></td></tr></table> Post - 0 Miss - 0 Block - 0							14 韩睿洁 <table border="1"><tr><td></td><td></td><td></td></tr><tr><td></td><td></td><td></td></tr></table> Post - 0 Miss - 0 Block - 0												
1																																																																
1																																																																
		1																																																														
		1																																																														
1																																																																
15 李鹏飞 <table border="1"><tr><td></td><td></td><td></td></tr><tr><td>1</td><td></td><td></td></tr><tr><td>1</td><td></td><td>1</td></tr></table> Post - 0 Miss - 0 Block - 0				1			1		1	16 王启欣 <table border="1"><tr><td></td><td></td><td></td></tr><tr><td></td><td></td><td></td></tr></table> Post - 0 Miss - 0 Block - 0							17 蒋松妍 <table border="1"><tr><td></td><td></td><td></td></tr><tr><td>1</td><td></td><td>1</td></tr><tr><td>3</td><td></td><td></td></tr></table> Post - 0 Miss - 0 Block - 0				1		1	3			19 卢晴 <table border="1"><tr><td></td><td></td><td></td></tr><tr><td></td><td></td><td></td></tr></table> Post - 0 Miss - 0 Block - 0							21 赵欣瑶 <table border="1"><tr><td></td><td></td><td></td></tr><tr><td>3</td><td></td><td></td></tr><tr><td></td><td>3</td><td>1</td></tr></table> Post - 1 Miss - 0 Block - 0				3				3	1	22 邢力丹 <table border="1"><tr><td></td><td></td><td></td></tr><tr><td></td><td></td><td></td></tr></table> Post - 0 Miss - 0 Block - 0							23 王家琪 <table border="1"><tr><td></td><td></td><td></td></tr><tr><td></td><td></td><td></td></tr></table> Post - 0 Miss - 0 Block - 0							28 江迎新 <table border="1"><tr><td></td><td></td><td></td></tr><tr><td></td><td></td><td></td></tr></table> Post - 0 Miss - 0 Block - 0						
1																																																																
1		1																																																														
1		1																																																														
3																																																																
3																																																																
	3	1																																																														

16 王启欣

		2/5
0/2	1/1	1/1
0/5	1/2	2/3

22 邢力丹

	2/2	
	2/2	2/3
0/1	1/1	

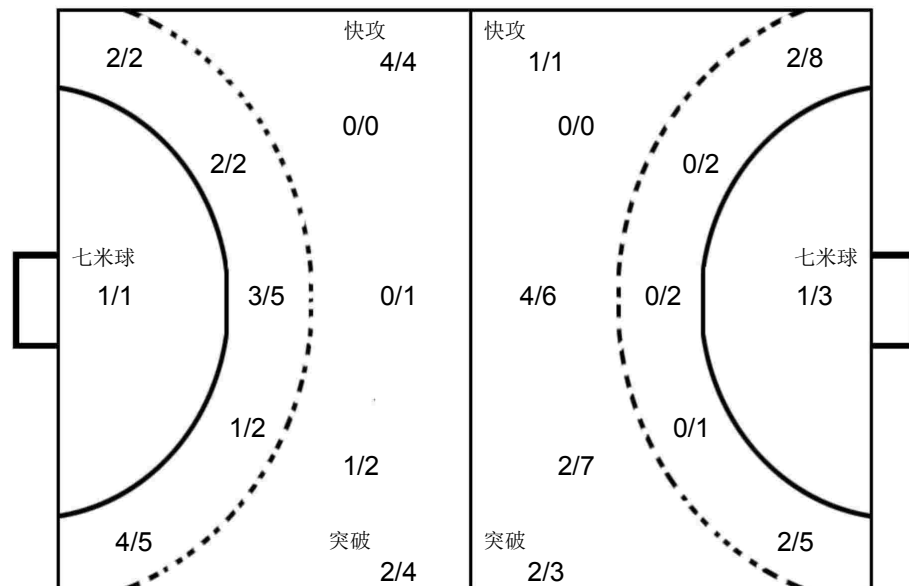

16 邹童羽

0/2		
0/2	1/1	0/1
0/2		0/1

17 冯颖慧

0/1		
0/1	1/1	2/3
1/5	0/3	1/3

广东深圳

2 唐悦 <table border="1"><tr><td></td><td></td><td>2</td></tr><tr><td>2</td><td></td><td></td></tr></table> Post - 2 Miss - 2 Block - 1			2	2			3 赵晔 <table border="1"><tr><td></td><td></td><td></td></tr><tr><td>1</td><td></td><td></td></tr><tr><td>2</td><td>1</td><td>1</td></tr></table> Post - 1 Miss - 0 Block - 2				1			2	1	1	5 朱嘉盈 <table border="1"><tr><td></td><td></td><td></td></tr><tr><td>1</td><td></td><td></td></tr></table> Post - 0 Miss - 0 Block - 1				1			6 朱嘉晴 <table border="1"><tr><td></td><td></td><td>1</td></tr><tr><td></td><td></td><td>1</td></tr></table> Post - 0 Miss - 0 Block - 0			1			1	7 曾妮 <table border="1"><tr><td></td><td></td><td></td></tr><tr><td></td><td></td><td></td></tr></table> Post - 1 Miss - 0 Block - 0							9 张雨乐 <table border="1"><tr><td></td><td></td><td></td></tr><tr><td></td><td></td><td></td></tr></table> Post - 0 Miss - 0 Block - 0							10 徐瑜琳 <table border="1"><tr><td></td><td></td><td></td></tr><tr><td></td><td></td><td></td></tr></table> Post - 0 Miss - 0 Block - 0							11 王文卉 <table border="1"><tr><td></td><td></td><td></td></tr><tr><td></td><td></td><td></td></tr></table> Post - 0 Miss - 0 Block - 0						
		2																																																								
2																																																										
1																																																										
2	1	1																																																								
1																																																										
		1																																																								
		1																																																								
12 于雅梦 <table border="1"><tr><td></td><td></td><td></td></tr><tr><td></td><td></td><td></td></tr></table> Post - 0 Miss - 0 Block - 0							13 刘培天 <table border="1"><tr><td></td><td></td><td></td></tr><tr><td></td><td></td><td></td></tr></table> Post - 0 Miss - 0 Block - 0							16 邹童羽 <table border="1"><tr><td></td><td></td><td></td></tr><tr><td></td><td></td><td></td></tr></table> Post - 0 Miss - 0 Block - 0							17 冯颖慧 <table border="1"><tr><td></td><td></td><td></td></tr><tr><td></td><td></td><td></td></tr></table> Post - 0 Miss - 0 Block - 0							18 谢宛彤 <table border="1"><tr><td></td><td></td><td></td></tr><tr><td></td><td></td><td></td></tr></table> Post - 0 Miss - 0 Block - 0							20 岳欣华 <table border="1"><tr><td></td><td></td><td></td></tr><tr><td>1</td><td></td><td></td></tr></table> Post - 0 Miss - 0 Block - 0				1																			
1																																																										



第二届全国青年运动会女子手球甲组决赛 体校组 (U18)

PHMS Pictorial Handball Match Statistics

IHF Official System

比赛进程表

手球 3-4名 组别 X 晋中体育馆  
青年女子 轮次 8 场次 90 2019-06-23 16:20

时间	队员	动作	比分	队员	动作
山东淄博			广东深圳		
上半时			上半时		
00:31	16 王启欣	被射入	0-1	5 朱嘉盈	突破 得分
00:46				5 朱嘉盈	警告
01:24	3 王静雯	左远射 射失		2 唐悦	传球失误
01:57				2 唐悦	传球失误
02:08	9 高梦洁	接球失误		2 唐悦	传球失误
02:38				5 朱嘉盈	使被罚7M球
02:52	15 李骞飞	造7M		5 朱嘉盈	使被罚7M球
03:09	3 王静雯	7M球 得分	1-1	16 邹童羽	被射入
03:50	16 王启欣	挡住球		2 唐悦	近射 被救
04:23	9 高梦洁	近射 得分	2-1	16 邹童羽	被射入
04:27				5 朱嘉盈	罚出场2分钟
04:59					球队暂停
05:33	23 王家琪	断球		3 赵晔	传球失误
05:40	17 蒋松妍	短传快攻 得分	3-1	16 邹童羽	被射入
06:07	21 赵欣瑶	警告			
06:59	9 高梦洁	使被罚7M球		3 赵晔	造7M
07:02	9 高梦洁	警告			
07:18	16 王启欣	挡住球		6 朱嘉晴	7M球 被救
07:48	17 蒋松妍	警告			
08:38				7 曾妮	左边射 击柱
09:03	21 赵欣瑶	左边射 得分	4-1	17 冯颖慧	被射入
09:31	9 高梦洁	封球		3 赵晔	右远射 被封
09:52	16 王启欣	挡住球		5 朱嘉盈	右远射 被救
10:28	16 王启欣	挡住球		5 朱嘉盈	近射 被救
10:53	9 高梦洁	近射 被救		17 冯颖慧	挡住球
11:00	16 王启欣	被射入	4-2	6 朱嘉晴	一传快攻 得分
11:02				17 冯颖慧	助攻
11:16	15 李骞飞	右边射 得分	5-2	17 冯颖慧	被射入
12:32	5 张素娟	封球		2 唐悦	中远射 被封
12:33		裁判暂停			
12:33	3 王静雯	罚出场2分钟			
12:45				2 唐悦	突破 射失
13:27	15 李骞飞	突破 被救		17 冯颖慧	挡住球
13:53	16 王启欣	被射入	5-3	3 赵晔	右边射 得分
13:55		球队暂停			
14:07	5 张素娟	传球失误			
14:21	16 王启欣	被射入	5-4	2 唐悦	右远射 得分
14:43				13 刘培天	警告
15:29	5 张素娟	突破 得分	6-4	17 冯颖慧	被射入
15:59	16 王启欣	挡住球		7 曾妮	左边射 被救
16:12	17 蒋松妍	近射 得分	7-4	17 冯颖慧	被射入

## 比赛进程表

手球 3-4名 组别 X 晋中体育馆  
 青年女子 轮次 8 场次 90 2019-06-23 16:20

时间	队员	动作	比分	队员	动作
山东淄博			上半时		
广东深圳					
16:14	5 张素娟	助攻	7-4		
16:54				3 赵晔	右边射 击柱
17:01	21 赵欣瑶	左边射 得分	8-4	16 邹童羽	被射入
17:34	16 王启欣	挡住球		3 赵晔	右边射 被救
18:15	3 王静雯	四步			
18:47	9 高梦洁	封球		5 朱嘉盈	近射 被封
18:54		裁判暂停			
18:54	16 王启欣	被射入	8-5	2 唐悦	中远射 得分
18:54	21 赵欣瑶	接球失误			
20:00				2 唐悦	右远射 射失

第二届全国青年运动会女子手球甲组决赛 体校组 (U18)

比赛进程表

手球 3-4名 组别 X 晋中体育馆  
 青年女子 轮次 8 场次 90 2019-06-23 16:20

时间	队员	动作	比分	队员	动作
山东淄博			广东深圳		
下半场					
00:16	17 蒋松妍	近射 得分	9-5	16 邹童羽	被射入
00:43	16 王启欣	挡住球		20 岳欣华	右边射 被救
01:07	15 李骞飞	断球		3 赵晔	传球失误
01:16	17 蒋松妍	近射 得分	10-5	16 邹童羽	被射入
01:18	15 李骞飞	助攻			
01:46	17 蒋松妍	封球		3 赵晔	右远射 被封
02:11	3 王静雯	使被罚7M球		5 朱嘉盈	造7M
02:40	16 王启欣	被射入	10-6	2 唐悦	7M球 得分
03:17	21 赵欣瑶	左边射 击柱			
03:45	16 王启欣	被射入	10-7	3 赵晔	突破 得分
04:11	9 高梦洁	四步			
04:48	16 王启欣	被射入	10-8	3 赵晔	中远射 得分
05:43	10 崔佳惠	接球失误			
06:12	16 王启欣	被射入	10-9	20 岳欣华	右边射 得分
06:45	15 李骞飞	右边射 得分	11-9	17 冯颖慧	被射入
07:08	16 王启欣	被射入	11-10	3 赵晔	中远射 得分
07:17	6 孙玉坤	中远射 被救		17 冯颖慧	挡住球
07:21		球队暂停			
07:42	15 李骞飞	突破 得分	12-10	17 冯颖慧	被射入
08:00		裁判暂停			
08:00	9 高梦洁	取消比赛资格			
08:11	16 王启欣	被射入	12-11	3 赵晔	中远射 得分
08:38	15 李骞飞	突破 被救		17 冯颖慧	挡住球
09:09	16 王启欣	被射入	12-12	6 朱嘉晴	左边射 得分
09:46	6 孙玉坤	任意球 得分	13-12	17 冯颖慧	被射入
10:09				3 赵晔	传球失误
10:55	17 蒋松妍	近射 得分	14-12	17 冯颖慧	被射入
11:19	22 邢力丹	挡住球		6 朱嘉晴	近射 被救
11:29	21 赵欣瑶	短传快攻 得分	15-12	17 冯颖慧	被射入
12:17	22 邢力丹	挡住球		5 朱嘉盈	左边射 被救
12:28	6 孙玉坤	短传快攻 得分	16-12	17 冯颖慧	被射入
12:55	22 邢力丹	挡住球		6 朱嘉晴	左边射 被救
13:02	22 邢力丹	被射入	16-13	6 朱嘉晴	左边射 得分
13:41	15 李骞飞	侵区			
14:22	22 邢力丹	挡住球		6 朱嘉晴	左边射 被救
14:24	22 邢力丹	挡住球		13 刘培天	近射 被救
14:31	28 江迎新	近射 被救		17 冯颖慧	挡住球
14:51	6 孙玉坤	抢球		5 朱嘉盈	接球失误
15:02	21 赵欣瑶	一传快攻 得分	17-13	17 冯颖慧	被射入
15:36	22 邢力丹	挡住球		6 朱嘉晴	左边射 被救
16:05	21 赵欣瑶	左边射 得分	18-13	17 冯颖慧	被射入

## 比赛进程表

手球 3-4名 组别 X 晋中体育馆  
 青年女子 轮次 8 场次 90 2019-06-23 16:20

时间	队员	动作	比分	队员	动作
山东淄博			广东深圳		
			下半场		
16:26			18-13	2 唐悦	右远射 击柱
16:41	22 邢力丹	挡住球		2 唐悦	中远射 被救
16:54	15 李骞飞	近射 被救		16 邹童羽	挡住球
17:12	22 邢力丹	被射入	18-14	2 唐悦	右远射 得分
17:35				5 朱嘉盈	罚出场2分钟
17:35		裁判暂停			
17:40	21 赵欣瑶	左边射 得分	19-14	16 邹童羽	被射入
18:19		裁判暂停			
18:19	28 江迎新	使被罚7M球		7 曾妮	造7M
18:19	28 江迎新	罚出场2分钟			
18:23				2 唐悦	7M球 击柱
18:35	17 蒋松妍	侵区			
18:43				20 岳欣华	接球失误
19:05	21 赵欣瑶	近射 得分	20-14	16 邹童羽	被射入
19:28				7 曾妮	传球失误



第二届全国青年运动会女子手球甲组决赛 体校组 (U18)

青年女子 国内比赛

决赛



PHMS Pictorial Handball Match Statistics

IHF Official System

Team A A 安徽滁州				Team B B 江苏常州				Match Number <b>84</b>			
------------------	--	--	--	------------------	--	--	--	---------------------------	--	--	--

Played in 山西晋中	in the hall 晋中体育馆	on 2019-06-23	at 15:10	hours	Speakers
-------------------	----------------------	------------------	-------------	-------	----------

Half-time(30')	A 9	B 10	End of playing time	A 17	B 20	1st extra time	A	B	2nd extra time	A	B	After penalty throws	A	B
----------------	--------	---------	---------------------	---------	---------	----------------	---	---	----------------	---	---	----------------------	---	---

Number of 7 m 0/0	Team time-out			Full name of players and officials	Team time-out			B 2/3	Number of 7 m
	1 14:21	2 34:24	3		1 08:42	2 27:44	3 39:32		

No.	Team A	G	W	2'	D	DR	No.	Team B	G	W	2'	D	DR
1	张家轩						1	胡雨诺					
2	钟梦						7	张嘉朔			1		
3	孙明月	3	1				8	董桂林					
7	丁洁						9	顾霞光					
9	窦海乐	2					14	庄红艳	4				
16	刘子琪						15	王艺儒					
25	耿雨萍						19	焦雅	5				
26	张雅婷						20	渠文娜	4				
28	马雯怡						21	吴静雯	1				
30	罗佳乐						22	彭如玉					
32	王小雅						24	王铃娜	6				
34	姜影	1		1			25	李秋淇					
35	李旭	3	1				26	邱聿芳					
36	高奇欣	4	1				27	李袁梦					
38	潘楠	4					28	黄奕涵					
							29	陈赛楠					
A	王明星						A	金甲洙 (主教练)					
B	陆广红 (主教练)						B	马彪					
C	岳连娥						C	李海鹰					
D	李莉						D	陈志伟					

A	Signatures of responsables for the teams (Off.A)												B
---	--	--	--	--	--	--	--	--	--	--	--	--	---

TP	Remarks of referees / HF Official													TP
----	-----------------------------------	--	--	--	--	--	--	--	--	--	--	--	--	----

Referees	陈晓波 (CHN)	康曦 (CHN)		
T.D.	吴瑞亭 (CHN)	王洋 (CHN)		
CHA Off.				

Note: Number of 7m Throws Awarded to Team A and B, Goals (G), Warnings (W), Suspensions (2'), Direct Disqualification (D), Disqualification With Report (DR) and Team Penalty (TP).

Table Officials: 赵琦 贾腾 Statisticians: 刘笑 王梓衡

## 第二届全国青年运动会女子手球甲组决赛 体校组 (U18)

**PHMS** Pictorial Handball Match Statistics

**IHF** Official System

### 竞赛技术统计

手球  
青年女子

决赛  
轮次 8

组别 X  
场次 84

晋中体育馆  
2019-06-23 15:10

Referees: 陈晓波 (CHN) / 康曦 (CHN)  
Teams: 安徽滁州(滁州) VS 江苏常州(常州)

Result: 17:20 (9:10)

滁州		远	近	边	快	突	任意	7m	合计	%	助攻	失误	警告	2'	D+DR
主教练: 陆广红		射	射	射	攻	破	球	球							
1	张家轩				0/1				0/1	0.0	1				
2	钟梦														
3	孙明月	3/8				0/2			3/10	30.0	2	3	1		
7	丁洁														
9	窦海乐	2/6							2/6	33.3	1	1			
16	刘子琪														
25	耿雨萍														
26	张雅婷														
28	马雯怡														
30	罗佳乐														
32	王小雅														
34	姜影			1/1					1/1	100		2		1	
35	李旭	2/5	1/1			0/1			3/7	42.9	3	1	1		
36	高奇欣		4/5	0/1					4/6	66.7				1	
38	潘楠			1/2	2/2	1/1			4/5	80.0	2	3			
运动员 合计		7/19	5/6	2/4	2/3	1/4			17/36	47.2	9	10	3	1	
1	张家轩	2/8	1/1	2/6	1/5	1/5	2/2	1/3	10/30	33.3	1				
守门员 合计		2/8	1/1	2/6	1/5	1/5	2/2	1/3	10/30	33.3	1				
常州		远	近	边	快	突	任意	7m	合计	%	助攻	失误	警告	2'	D+DR
主教练: 金甲洙		射	射	射	攻	破	球	球							
1	胡雨诺										1				
7	张嘉朔										1	1		1	
8	董桂林														
9	顾霞光														
14	庄红艳	0/2		0/2	2/4			2/2	4/10	40.0		1			
15	王艺儒														
19	焦雅	4/5	0/1			1/2	0/2	0/1	5/11	45.5		1			
20	渠文娜	2/4			1/2	1/1	0/1		4/8	50.0	3	4			
21	吴静雯					1/1			1/1	100		1			
22	彭如玉														
24	王铃娜			4/5	1/1	1/1			6/7	85.7		1			
25	李秋淇														
26	邱聿芳														
27	李袁梦														
28	黄奕涵														
29	陈赛楠														
运动员 合计		6/11	0/1	4/7	4/7	4/5	0/3	2/3	20/37	54.1	5	9		1	
1	胡雨诺	4/7		0/2		0/1			4/10	40.0	1				
22	彭如玉	2/6	1/6		0/2	1/1			4/15	26.7					
守门员 合计		6/13	1/6	0/2	0/2	1/2			8/25	32.0	1				

滁州	比赛进程		常州
1st Half			
	0	00:30	1 24 王铃娜
35	李旭	1 00:47	1
	1	02:20	2 19 焦雅
36	高奇欣	2 02:35	2
38	潘楠	3 04:07	2
	3	05:04	3 24 王铃娜
36	高奇欣	4 06:33	3
	4	07:20	4 19 焦雅
36	高奇欣	5 07:48	4
9	窦海乐	6 10:24	4
	6	10:52	5 14 庄红艳
35	李旭	7 11:52	5
	7	13:39	6 14 庄红艳
	7	14:20	7 14 庄红艳
	7	14:47	8 24 王铃娜
38	潘楠	8 16:11	8
35	李旭	9 16:55	8
	9	17:17	9 20 渠文娜
	9	18:22	10 20 渠文娜
2nd Half			
	9	02:00	11 20 渠文娜
	9	03:16	12 19 焦雅
3	孙明月	10 03:56	12
38	潘楠	11 06:10	12
34	姜影	12 06:47	12
	12	08:08	13 24 王铃娜
3	孙明月	13 08:44	13
	13	09:00	14 24 王铃娜
	13	10:09	15 14 庄红艳
3	孙明月	14 11:14	15
	14	13:08	16 24 王铃娜
	14	14:21	17 21 吴静雯
38	潘楠	15 15:38	17
	15	15:50	18 19 焦雅
36	高奇欣	16 18:37	18
	16	18:55	19 20 渠文娜
	16	19:42	20 19 焦雅
9	窦海乐	17 19:54	20

场上队员: 得分 / 射门

守门员: 救球 / 射门

D	取消资格	DR	取消资格+报告



## 个人/全队技术统计表

手球 青年女子 决赛 轮次 8 组别 X 场次 84 晋中体育馆 2019-06-23 15:10

号码	姓名	远射	近射	边射	快攻	突破	任意	七米	合计	%	助攻	失误	警告	2'	取消	时间
<b>安徽滁州(滁州)</b>																
<b>(场上队员)</b>																
1	张家轩				0/1				0/1	0.0%	1					00:40:00
2	钟梦									0.0%						00:00:00
3	孙明月	3/8				0/2			3/10	30.0%	2	3	1			00:40:00
7	丁洁									0.0%						00:00:00
9	窦海乐	2/6							2/6	33.3%	1	1				00:40:00
16	刘子琪									0.0%						00:00:00
25	耿雨萍									0.0%						00:00:00
26	张雅婷									0.0%						00:00:00
28	马雯怡									0.0%						00:00:00
30	罗佳乐									0.0%						00:00:00
32	王小雅									0.0%						00:00:00
34	姜影			1/1					1/1	100%		2		1		00:40:00
35	李旭	2/5	1/1			0/1			3/7	42.9%	3	1	1			00:40:00
36	高奇欣		4/5	0/1					4/6	66.7%			1			00:40:00
38	潘楠			1/2	2/2	1/1			4/5	80.0%	2	3				00:40:00
<b>合计</b>		<b>7/19</b>	<b>5/6</b>	<b>2/4</b>	<b>2/3</b>	<b>1/4</b>			<b>17/36</b>	<b>47.2%</b>	<b>9</b>	<b>10</b>	<b>3</b>	<b>1</b>		
<b>(守门员)</b>																
1	张家轩	2/8	1/1	2/6	1/5	1/5	2/2	1/3	10/30	33.3%	1					00:40:00
<b>合计</b>		<b>2/8</b>	<b>1/1</b>	<b>2/6</b>	<b>1/5</b>	<b>1/5</b>	<b>2/2</b>	<b>1/3</b>	<b>10/30</b>	<b>33.3%</b>	<b>1</b>					

场上队员： 得分/射门

守门员： 救球/射门

全队合计	得分	被救	射失	击柱	封球	合计	%
远射	7	6	2	2	2	19	36.8%
近射	5	1				6	83.3%
边射	2		2			4	50.0%
快攻	2			1		3	66.7%
突破	1	1		2		4	25.0%
任意							0.0%
七米							0.0%

## 第二届全国青年运动会女子手球甲组决赛 体校组 (U18)

PHMS Pictorial Handball Match Statistics

IHF Official System

### 个人/全队技术统计表

手球 青年女子      决赛 轮次 8      组别 X 场次 84      晋中体育馆  
2019-06-23 15:10

号码	姓名	远射	近射	边射	快攻	突破	任意	七米	合计	%	助攻	失误	警告	2'	取消	时间
<b>江苏常州(常州)</b>																
<b>(场上队员)</b>																
1	胡雨诺									0.0%	1					00:16:15
7	张嘉朔									0.0%	1	1		1		00:26:21
8	董桂林									0.0%						00:00:00
9	顾霞光									0.0%						00:00:00
14	庄红艳	0/2		0/2	2/4			2/2	4/10	40.0%		1				00:37:53
15	王艺儒									0.0%						00:00:00
19	焦雅	4/5	0/1			1/2	0/2	0/1	5/11	45.5%		1				00:40:00
20	渠文娜	2/4			1/2	1/1	0/1		4/8	50.0%	3	4				00:33:38
21	吴静雯					1/1			1/1	100%		1				00:21:53
22	彭如玉									0.0%						00:23:45
24	王铃娜			4/5	1/1	1/1			6/7	85.7%		1				00:40:00
25	李秋淇									0.0%						00:00:00
26	邱聿芳									0.0%						00:00:00
27	李袁梦									0.0%						00:32:24
28	黄奕涵									0.0%						00:07:35
29	陈赛楠									0.0%						00:00:00
<b>合计</b>		<b>6/11</b>	<b>0/1</b>	<b>4/7</b>	<b>4/7</b>	<b>4/5</b>	<b>0/3</b>	<b>2/3</b>	<b>20/37</b>	<b>54.1%</b>	<b>5</b>	<b>9</b>		<b>1</b>		
<b>(守门员)</b>																
1	胡雨诺	4/7		0/2		0/1			4/10	40.0%	1					00:16:15
22	彭如玉	2/6	1/6		0/2	1/1			4/15	26.7%						00:23:45
<b>合计</b>		<b>6/13</b>	<b>1/6</b>	<b>0/2</b>	<b>0/2</b>	<b>1/2</b>			<b>8/25</b>	<b>32.0%</b>	<b>1</b>					

场上队员：得分/射门

守门员：救球/射门

全队合计	得分	被救	射失	击柱	封球	合计	%
远射	6	2	1	2		11	54.5%
近射		1				1	0.0%
边射	4	2	1			7	57.1%
快攻	4	1		2		7	57.1%
突破	4	1				5	80.0%
任意		2	1			3	0.0%
七米	2	1				3	66.7%



图式比赛技术统计表

手球  
青年女子

决赛  
轮次 8

组别 X  
场次 84

晋中体育馆  
2019-06-23 15:10

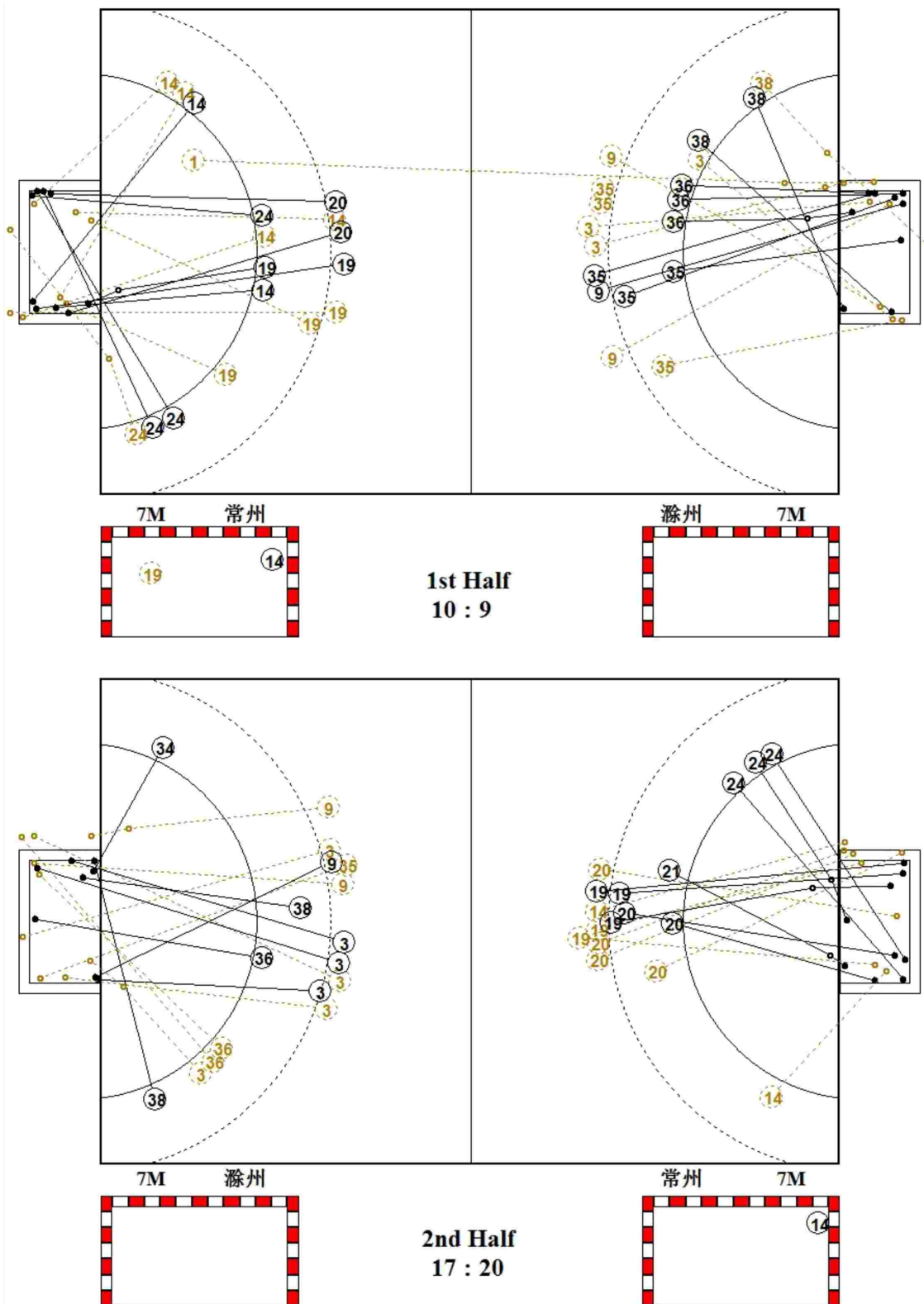

图式射门区域统计

手球  
青年女子

决赛  
轮次 8

组别 X  
场次 84

晋中体育馆  
2019-06-23 15:10

安徽滁州

1 张家轩 <table border="1"><tr><td></td><td></td><td></td></tr><tr><td></td><td></td><td></td></tr><tr><td></td><td></td><td></td></tr></table> Post - 1 Miss - 0 Block - 0										2 钟梦 <table border="1"><tr><td></td><td></td><td></td></tr><tr><td></td><td></td><td></td></tr><tr><td></td><td></td><td></td></tr></table> Post - 0 Miss - 0 Block - 0										3 孙明月 <table border="1"><tr><td></td><td></td><td>1</td></tr><tr><td></td><td></td><td>1</td></tr><tr><td>1</td><td></td><td></td></tr></table> Post - 3 Miss - 1 Block - 0			1			1	1			7 丁洁 <table border="1"><tr><td></td><td></td><td></td></tr><tr><td></td><td></td><td></td></tr><tr><td></td><td></td><td></td></tr></table> Post - 0 Miss - 0 Block - 0										9 窦海乐 <table border="1"><tr><td>1</td><td></td><td></td></tr><tr><td></td><td></td><td></td></tr><tr><td>1</td><td></td><td></td></tr></table> Post - 0 Miss - 1 Block - 0	1						1			16 刘子琪 <table border="1"><tr><td></td><td></td><td></td></tr><tr><td></td><td></td><td></td></tr><tr><td></td><td></td><td></td></tr></table> Post - 0 Miss - 0 Block - 0										25 耿雨萍 <table border="1"><tr><td></td><td></td><td></td></tr><tr><td></td><td></td><td></td></tr><tr><td></td><td></td><td></td></tr></table> Post - 0 Miss - 0 Block - 0										26 张雅婷 <table border="1"><tr><td></td><td></td><td></td></tr><tr><td></td><td></td><td></td></tr><tr><td></td><td></td><td></td></tr></table> Post - 0 Miss - 0 Block - 0									
		1																																																																													
		1																																																																													
1																																																																															
1																																																																															
1																																																																															
28 马雯怡 <table border="1"><tr><td></td><td></td><td></td></tr><tr><td></td><td></td><td></td></tr><tr><td></td><td></td><td></td></tr></table> Post - 0 Miss - 0 Block - 0										30 罗佳乐 <table border="1"><tr><td></td><td></td><td></td></tr><tr><td></td><td></td><td></td></tr><tr><td></td><td></td><td></td></tr></table> Post - 0 Miss - 0 Block - 0										32 王小雅 <table border="1"><tr><td></td><td></td><td></td></tr><tr><td></td><td></td><td></td></tr><tr><td></td><td></td><td></td></tr></table> Post - 0 Miss - 0 Block - 0										34 姜影 <table border="1"><tr><td></td><td></td><td></td></tr><tr><td></td><td></td><td></td></tr><tr><td></td><td></td><td>1</td></tr></table> Post - 0 Miss - 0 Block - 0									1	35 李旭 <table border="1"><tr><td>1</td><td>1</td><td></td></tr><tr><td>1</td><td></td><td></td></tr><tr><td></td><td></td><td></td></tr></table> Post - 1 Miss - 0 Block - 2	1	1		1						36 高奇欣 <table border="1"><tr><td>1</td><td>1</td><td></td></tr><tr><td>1</td><td></td><td></td></tr><tr><td>1</td><td></td><td></td></tr></table> Post - 0 Miss - 1 Block - 0	1	1		1			1			38 潘楠 <table border="1"><tr><td></td><td></td><td>1</td></tr><tr><td></td><td></td><td></td></tr><tr><td></td><td></td><td>3</td></tr></table> Post - 0 Miss - 1 Block - 0			1						3										
		1																																																																													
1	1																																																																														
1																																																																															
1	1																																																																														
1																																																																															
1																																																																															
		1																																																																													
		3																																																																													

1 张家轩

1/6	1/1	2/11
2/4		2/3
1/2	0/1	1/2

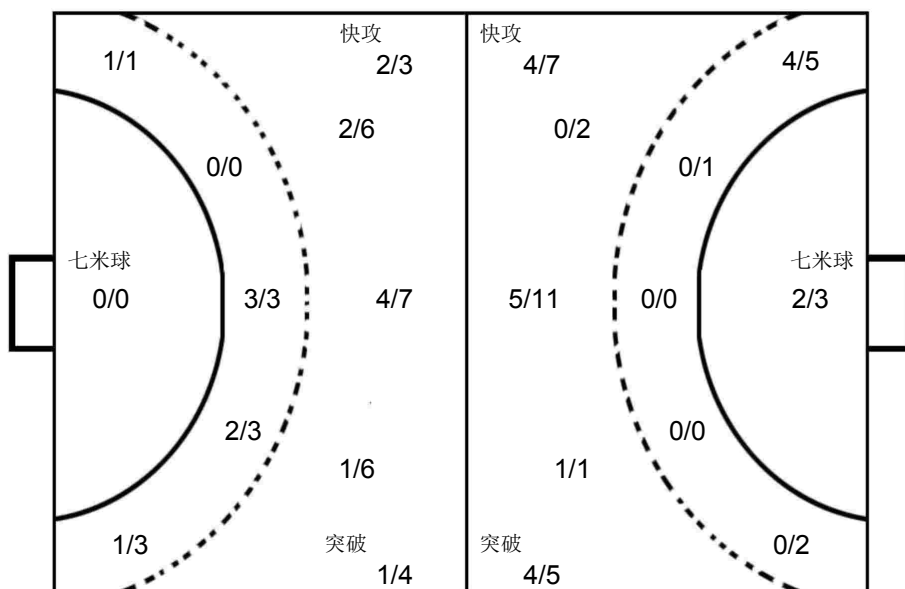

1 胡雨诺

1/2		1/1
1/2		1/1
0/1		0/3

22 彭如玉

1/3	0/2	1/3
1/2		0/1
1/3		0/1

江苏常州

1 胡雨诺 <table border="1"><tr><td></td><td></td><td></td></tr><tr><td></td><td></td><td></td></tr><tr><td></td><td></td><td></td></tr></table> Post - 0 Miss - 0 Block - 0										7 张嘉朔 <table border="1"><tr><td></td><td></td><td></td></tr><tr><td></td><td></td><td></td></tr><tr><td></td><td></td><td></td></tr></table> Post - 0 Miss - 0 Block - 0										8 董桂林 <table border="1"><tr><td></td><td></td><td></td></tr><tr><td></td><td></td><td></td></tr><tr><td></td><td></td><td></td></tr></table> Post - 0 Miss - 0 Block - 0										9 顾霞光 <table border="1"><tr><td></td><td></td><td></td></tr><tr><td></td><td></td><td></td></tr><tr><td></td><td></td><td></td></tr></table> Post - 0 Miss - 0 Block - 0										14 庄红艳 <table border="1"><tr><td>1</td><td>2</td><td></td></tr><tr><td>1</td><td></td><td></td></tr><tr><td></td><td></td><td></td></tr></table> Post - 1 Miss - 1 Block - 0	1	2		1						15 王艺儒 <table border="1"><tr><td></td><td></td><td></td></tr><tr><td></td><td></td><td></td></tr><tr><td></td><td></td><td></td></tr></table> Post - 0 Miss - 0 Block - 0										19 焦雅 <table border="1"><tr><td>4</td><td></td><td></td></tr><tr><td></td><td></td><td></td></tr><tr><td>1</td><td></td><td></td></tr></table> Post - 0 Miss - 1 Block - 0	4						1			20 渠文娜 <table border="1"><tr><td></td><td></td><td>2</td></tr><tr><td>1</td><td></td><td>1</td></tr><tr><td></td><td></td><td></td></tr></table> Post - 3 Miss - 0 Block - 0			2	1		1			
1	2																																																																														
1																																																																															
4																																																																															
1																																																																															
		2																																																																													
1		1																																																																													
21 吴静雯 <table border="1"><tr><td></td><td></td><td></td></tr><tr><td></td><td></td><td>1</td></tr><tr><td></td><td></td><td></td></tr></table> Post - 0 Miss - 0 Block - 0						1				22 彭如玉 <table border="1"><tr><td></td><td></td><td></td></tr><tr><td></td><td></td><td></td></tr><tr><td></td><td></td><td></td></tr></table> Post - 0 Miss - 0 Block - 0										24 王铃娜 <table border="1"><tr><td></td><td></td><td>5</td></tr><tr><td></td><td></td><td></td></tr><tr><td>1</td><td></td><td></td></tr></table> Post - 0 Miss - 1 Block - 0			5				1			25 李秋淇 <table border="1"><tr><td></td><td></td><td></td></tr><tr><td></td><td></td><td></td></tr><tr><td></td><td></td><td></td></tr></table> Post - 0 Miss - 0 Block - 0										26 邱聿芳 <table border="1"><tr><td></td><td></td><td></td></tr><tr><td></td><td></td><td></td></tr><tr><td></td><td></td><td></td></tr></table> Post - 0 Miss - 0 Block - 0										27 李袁梦 <table border="1"><tr><td></td><td></td><td></td></tr><tr><td></td><td></td><td></td></tr><tr><td></td><td></td><td></td></tr></table> Post - 0 Miss - 0 Block - 0										28 黄奕涵 <table border="1"><tr><td></td><td></td><td></td></tr><tr><td></td><td></td><td></td></tr><tr><td></td><td></td><td></td></tr></table> Post - 0 Miss - 0 Block - 0										29 陈赛楠 <table border="1"><tr><td></td><td></td><td></td></tr><tr><td></td><td></td><td></td></tr><tr><td></td><td></td><td></td></tr></table> Post - 0 Miss - 0 Block - 0									
		1																																																																													
		5																																																																													
1																																																																															

第二届全国青年运动会女子手球甲组决赛 体校组 (U18)

PHMS Pictorial Handball Match Statistics

IHF Official System

比赛进程表

手球  
青年女子

决赛  
轮次 8

组别 X  
场次 84

晋中体育馆  
2019-06-23 15:10

时间	队员	动作	比分	队员	动作
安徽滁州			江苏常州		
上半时					
00:30	1 张家轩	被射入	0-1	24 王铃娜	左边射 得分
00:47	35 李旭	近射 得分	1-1	22 彭如玉	被射入
00:49	9 窦海乐	助攻			
01:26	1 张家轩	挡住球		19 焦雅	近射 被救
01:28				20 渠文娜	助攻
02:06	35 李旭	突破 击柱			
02:14		裁判暂停			
02:14	35 李旭	警告			
02:20	1 张家轩	被射入	1-2	19 焦雅	中远射 得分
02:35	36 高奇欣	近射 得分	2-2	22 彭如玉	被射入
02:38	3 孙明月	助攻			
03:02				20 渠文娜	传球失误
03:30	38 潘楠	左边射 射失			
03:33	35 李旭	助攻			
03:42		裁判暂停			
03:42	36 高奇欣	警告			
04:02	9 窦海乐	抢球		20 渠文娜	接球失误
04:07	38 潘楠	一传快攻 得分	3-2	22 彭如玉	被射入
04:38	1 张家轩	挡住球		14 庄红艳	右边射 被救
04:47	1 张家轩	一传快攻 击柱			
05:04	1 张家轩	被射入	3-3	24 王铃娜	左边射 得分
05:21	35 李旭	四步			
06:19				19 焦雅	传球失误
06:33	36 高奇欣	近射 得分	4-3	22 彭如玉	被射入
06:38	35 李旭	助攻			
07:20	1 张家轩	被射入	4-4	19 焦雅	突破 得分
07:35	38 潘楠	运球失误		24 王铃娜	造失误
07:40				14 庄红艳	短传快攻 击柱
07:48	36 高奇欣	近射 得分	5-4	22 彭如玉	被射入
07:51	3 孙明月	助攻			
08:14				14 庄红艳	运球失误
08:22	34 姜影	侵区			
08:42					球队暂停
09:00	1 张家轩	挡住球		14 庄红艳	右边射 被救
09:09	38 潘楠	运球失误		19 焦雅	造失误
09:50				19 焦雅	任意球 射失
10:24	9 窦海乐	中远射 得分	6-4	22 彭如玉	被射入
10:40	3 孙明月	使被罚7M球		21 吴静雯	造7M
10:43	3 孙明月	警告			
10:48		裁判暂停			
10:52	1 张家轩	被射入	6-5	14 庄红艳	7M球 得分

第二届全国青年运动会女子手球甲组决赛 体校组 (U18)

PHMS Pictorial Handball Match Statistics

IHF Official System

比赛进程表

手球  
青年女子

决赛  
轮次 8

组别 X  
场次 84

晋中体育馆  
2019-06-23 15:10

时间	队员	动作	比分	队员	动作			
安徽滁州			上半时			江苏常州		
11:25	9 窦海乐	左远射 被救	6-5	1 胡雨诺	挡住球			
11:43	1 张家轩	挡住球		19 焦雅	突破 被救			
11:52	35 李旭	右远射 得分	7-5	1 胡雨诺	被射入			
12:22		裁判暂停						
12:22	34 姜影	罚出场2分钟						
12:42	3 孙明月	使被罚7M球		27 李袁梦	造7M			
12:57	1 张家轩	挡住球		19 焦雅	7M球 被救			
13:32	35 李旭	左远射 被封		27 李袁梦	封球			
13:39	1 张家轩	被射入	7-6	14 庄红艳	短传快攻 得分			
14:18	35 李旭	左远射 被封		27 李袁梦	封球			
14:20	1 张家轩	被射入	7-7	14 庄红艳	一传快攻 得分			
14:21		球队暂停						
14:41	3 孙明月	中远射 被救		1 胡雨诺	挡住球			
14:47	1 张家轩	被射入	7-8	24 王铃娜	一传快攻 得分			
14:50				1 胡雨诺	助攻			
15:12	3 孙明月	突破 击柱						
15:15				21 吴静雯	快攻 四步			
15:42	9 窦海乐	传球失误		24 王铃娜	断球			
15:56	3 孙明月	造犯规		24 王铃娜	进攻犯规			
16:11	38 潘楠	突破 得分	8-8	1 胡雨诺	被射入			
16:41	1 张家轩	挡住球		14 庄红艳	中远射 被救			
16:55	35 李旭	中远射 得分	9-8	1 胡雨诺	被射入			
17:17	1 张家轩	被射入	9-9	20 渠文娜	中远射 得分			
18:15	9 窦海乐	右远射 被救		1 胡雨诺	挡住球			
18:22	1 张家轩	被射入	9-10	20 渠文娜	右远射 得分			
19:24	3 孙明月	中远射 击柱						
19:42				24 王铃娜	左边射 射失			

第二届全国青年运动会女子手球甲组决赛 体校组 (U18)

PHMS Pictorial Handball Match Statistics

IHF Official System

比赛进程表

手球 青年女子 决赛 轮次 8 组别 X 场次 84 晋中体育馆 2019-06-23 15:10

时间	队员	动作	比分	队员	动作
安徽滁州			江苏常州		
下半场					
00:48	3 孙明月	左远射 射失	9-10		
01:40				14 庄红艳	中远射 射失
01:56	3 孙明月	传球失误		27 李袁梦	断球
02:00	1 张家轩	被射入	9-11	20 渠文娜	一传快攻 得分
02:04				7 张嘉朔	助攻
02:31	9 窦海乐	中远射 被救		1 胡雨诺	挡住球
03:16	1 张家轩	被射入	9-12	19 焦雅	中远射 得分
03:56	3 孙明月	左远射 得分	10-12	1 胡雨诺	被射入
04:23	9 窦海乐	断球		20 渠文娜	传球失误
05:10	38 潘楠	接球失误		27 李袁梦	抢球
05:13	35 李旭	造犯规		7 张嘉朔	快攻 进攻犯规
05:44		裁判暂停			
05:44				7 张嘉朔	罚出场2分钟
06:10	38 潘楠	左边射 得分	11-12	1 胡雨诺	被射入
06:37	1 张家轩	挡住球		19 焦雅	中远射 被救
06:47	34 姜影	右边射 得分	12-12	1 胡雨诺	被射入
07:19				20 渠文娜	中远射 击柱
07:29	3 孙明月	突破 被救		22 彭如玉	挡住球
07:44					球队暂停
08:08	1 张家轩	被射入	12-13	24 王铃娜	突破 得分
08:44	3 孙明月	中远射 得分	13-13	22 彭如玉	被射入
09:00	1 张家轩	被射入	13-14	24 王铃娜	左边射 得分
09:04				20 渠文娜	助攻
09:20	3 孙明月	传球失误			
09:25		裁判暂停			
09:50	38 潘楠	使被罚7M球		14 庄红艳	造7M
10:09	1 张家轩	被射入	13-15	14 庄红艳	7M球 得分
10:52	35 李旭	右远射 被救		22 彭如玉	挡住球
11:00				20 渠文娜	短传快攻 击柱
11:14	3 孙明月	中远射 得分	14-15	22 彭如玉	被射入
12:09	1 张家轩	挡住球		20 渠文娜	任意球 被救
12:18	9 窦海乐	右远射 射失			
13:08	1 张家轩	被射入	14-16	24 王铃娜	左边射 得分
13:10				20 渠文娜	助攻
13:46	3 孙明月	传球失误		7 张嘉朔	断球
14:21	1 张家轩	被射入	14-17	21 吴静雯	突破 得分
14:24		球队暂停			
14:58	36 高奇欣	左边射 射失			
15:00	38 潘楠	助攻			
15:04	1 张家轩	挡住球		14 庄红艳	短传快攻 被救
15:06		裁判暂停			

## 比赛进程表

手球 青年女子 决赛 轮次 8 组别 X 场次 84 晋中体育馆 2019-06-23 15:10

时间	队员	动作	比分	队员	动作
安徽滁州			江苏常州		
			下半场		
15:32			14-17	20 渠文娜	传球失误
15:38	38 潘楠	一传快攻 得分	15-17	22 彭如玉	被射入
15:41	1 张家轩	助攻			
15:50	1 张家轩	被射入	15-18	19 焦雅	中远射 得分
16:25	3 孙明月	左远射 被救		22 彭如玉	挡住球
17:06				20 渠文娜	中远射 击柱
17:37	34 姜影	侵区			
17:41	35 李旭	助攻			
18:18	1 张家轩	挡住球		19 焦雅	任意球 被救
18:34	3 孙明月	右远射 击柱			
18:37	36 高奇欣	近射 得分	16-18	22 彭如玉	被射入
18:55	1 张家轩	被射入	16-19	20 渠文娜	突破 得分
19:10	36 高奇欣	近射 被救		22 彭如玉	挡住球
19:14	38 潘楠	助攻			
19:32					球队暂停
19:42	1 张家轩	被射入	16-20	19 焦雅	中远射 得分
19:54	9 窦海乐	右远射 得分	17-20	22 彭如玉	被射入