

# 2019 第二届全国青年运动会女子手球 甲组决赛 社会俱乐部组(U18)

## 成绩与技术统计数据册



中国手球协会  
CHINESE HANDBALL ASSOCIATION



数据由PHMS收集生成



PHMS 国际手球联合会官方技术统计系统

## 成绩与技术统计数据册目录

- 1 比赛结果
  - 1) 名次
  - 2) 获奖队员名单
  - 3) 场次成绩
  - 4) 分组成绩
- 2 运动员排名
  - 1) 得分
  - 2) 助攻
  - 3) 封球
  - 4) 防守
  - 5) 失误
  - 6) 受罚
- 3 守门员排名
  - 1) 救球
  - 2) 救7M球
- 4 球队总体比较
- 5 球队受罚表
- 6 球队累计
  - 1) 球队名单
  - 2) 个人/全队技术累计表
  - 3) 图式射门区域累计
- 7 每场比赛统计
  - 1) 比赛报告表
  - 2) 竞赛技术统计表
  - 3) 个人/全队技术统计表
  - 4) 图式比赛技术统计
  - 5) 图式射门区域统计
  - 6) 比赛进程表(决赛场次)

注：如需更多比赛统计数据，请通过以下电邮联络：[handball@126.com](mailto:handball@126.com)



第二届全国青年运动会女子手球甲组决赛 俱乐部组 (U18)



PHMS Pictorial Handball Match Statistics

IHF Official System

大赛名次

手球  
青年女子

截止至第87场

山西晋中  
2019-06-23

奖牌	名次	缩写	队名
Gold	1	平遥	山西平遥
Silver	2	晋中	山西晋中
Bronze	3	宿州	安徽宿州
	4	淮南	安徽淮南
	5	汉得堡	福建汉得堡
	6	桃渚	浙江桃渚



获奖队员名单

手球  
青年女子

山西晋中  
2019-06-23

金牌	银牌	铜牌
平遥-山西平遥	晋中-山西晋中	宿州-安徽宿州
1 战泳亨	1 邓雅楠	1 陈文娟
2 胡嘉雯	2 付雪杰	3 姜景媛
3 宫訢	5 王晓敏	5 单文静
5 李楠	6 张雪	7 刘文秀
6 王雅静	7 郭敏婷	8 李伟伟
7 陈亚轩	8 孙雨菲	9 李旗
8 吴名茜	9 杨婷	10 杨晓晓
9 马文龙	10 王玮	12 黄紫蝶
10 张越	11 李卓怡	15 乔思雨
11 张楠	12 郭佳	17 田伊阳
12 战慧	13 李心怡	18 刘怡涵
15 徐翹悦	15 杜佳奕	21 王嫚丽
18 范小雁	18 于聪	22 钦马晴
20 崔嘉欣	19 于颖	23 郭茹文
26 李言娜	20 尹艺霖	25 郑睿涵
27 孙玟		26 刘洋

场次成绩

手球  
青年女子

截止至第87场

山西晋中  
2019-06-23

日期	时间	场次	体育馆	组别	球队	成绩 (半时)	阶段
23-06-19	09:00	86	晋中体育馆	X	汉堡堡-桃渚	23-5 (8-4)	5-6名
	10:10	82	晋中体育馆	X	晋中-平遥	16-22 (7-11)	决赛
	10:10	87	晋中体育馆	X	宿州-淮南	24-15 (12-8)	3-4名

## 分组成绩

 手球  
青年女子

截止至第87场

 山西晋中  
2019-06-23

组别: A 预赛

名次	球队	积	场	胜	平	负	得分	失分	净胜
1	晋中	10	5	5	0	0	105	58	47
2	平遥	8	5	4	0	1	100	64	36
3	宿州	6	5	3	0	2	85	67	18
4	淮南	4	5	2	0	3	89	76	13
5	汉得堡	2	5	1	0	4	63	75	-12
6	桃渚	0	5	0	0	5	12	114	-102

球队	晋中	平遥	宿州	淮南	汉得堡	桃渚
晋中		18-15	17-12	18-14	19-11	33-6
平遥	15-18		18-15	22-19	20-10	25-2
宿州	12-17	15-18		21-20	16-11	21-1
淮南	14-18	19-22	20-21		19-13	17-2
汉得堡	11-19	10-20	11-16	13-19		18-1
桃渚	6-33	2-25	1-21	2-17	1-18	

Legend:

积	积分	胜	已比赛场次	胜	胜场	平	平场
负	负场	得分	得分累计	失分	失分累计	净胜	净胜分

第二届全国青年运动会女子手球甲组决赛 俱乐部组 (U18)

PHMS Pictorial Handball Match Statistics

IHF Official System

得分排名表(场上队员)

手球  
青年女子

截止至第87场  
按总得分排序

山西晋中  
2019-06-23

排序	号码	姓名	球队	远射	近射	边射	快攻	突破	任意	七米	合计	%	助攻	场数
1	9	李旗	宿州	3-6	0-1	0-3	5-8	5-9	5-8	16-16	34-51	66.7	2	6
2	7	承然	淮南	7-23	11-17	0-0	5-6	6-10	1-5	2-2	32-63	50.8	4	6
3	7	郭敏婷	晋中	3-8	4-6	0-1	4-4	12-16	0-2	8-12	31-49	63.3	4	6
4	13	杨梦颖	淮南	10-31	5-6	0-0	6-8	6-10	0-4	3-5	30-64	46.9	7	6
5	20	崔嘉欣	平遥	1-1	4-6	10-19	7-7	3-3	0-0	0-0	25-36	69.4	1	6
6	14	尹春霞	汉得堡	9-24	2-6	1-3	4-5	0-0	2-3	7-8	25-49	51.0	4	6
7	22	钦马晴	宿州	7-13	3-3	0-1	0-0	9-11	2-6	1-1	22-35	62.9	4	5
8	18	刘怡涵	宿州	2-3	3-4	1-1	1-1	12-12	1-1	1-3	21-25	84.0	0	6
9	4	张天琦	淮南	9-20	5-6	2-3	3-4	1-1	0-1	1-1	21-36	58.3	2	6
10	9	马文龙	平遥	5-17	7-9	0-1	4-4	5-7	0-2	0-0	21-40	52.5	5	6
11	9	张晓静	汉得堡	5-14	3-4	1-2	2-3	4-6	0-0	4-4	19-33	57.6	1	6
12	27	孙玟	平遥	0-3	6-12	0-2	2-3	9-11	0-0	1-1	18-32	56.3	4	6
13	10	张越	平遥	1-2	4-4	4-9	4-5	3-4	0-0	0-1	16-25	64.0	4	6
14	2	付雪杰	晋中	2-2	3-3	2-5	7-9	1-2	0-0	0-0	15-21	71.4	0	6
15	15	徐翹悦	平遥	0-1	2-6	0-0	4-5	1-1	1-3	7-9	15-25	60.0	2	6
16	3	宫訢	平遥	0-0	7-8	1-2	5-8	0-0	1-1	0-0	14-19	73.7	0	6
17	20	尹艺霖	晋中	1-1	0-1	1-3	6-6	4-10	0-0	0-0	12-21	57.1	5	6
18	21	张雪梅	汉得堡	0-0	0-1	2-11	4-4	4-4	0-0	2-2	12-22	54.5	3	6
19	6	张雪	晋中	0-2	3-5	0-0	4-4	4-4	0-0	0-0	11-15	73.3	2	5
20	15	杜佳奕	晋中	0-1	2-3	6-8	2-4	1-1	0-0	0-0	11-17	64.7	1	6
21	21	王嫚丽	宿州	0-0	3-4	5-6	1-2	0-1	0-0	1-1	10-14	71.4	0	5
22	10	王玮	晋中	3-8	2-7	1-3	2-4	1-1	1-2	0-1	10-26	38.5	2	6
23	11	孙瑞	汉得堡	0-0	0-1	6-7	2-2	0-0	0-0	1-1	9-11	81.8	0	6
24	8	孙雨菲	晋中	0-1	2-5	0-0	6-6	0-0	0-0	1-1	9-13	69.2	2	6
25	9	杨婷	晋中	2-6	1-1	2-6	4-5	0-0	0-1	0-0	9-19	47.4	1	6
26	9	叶飞雪	淮南	1-1	1-3	4-10	0-0	2-3	0-0	0-1	8-18	44.4	0	6
27	3	崔艳菲	汉得堡	1-3	3-3	0-7	2-3	2-3	0-0	0-0	8-19	42.1	0	6
28	10	穆梦欣	汉得堡	1-8	4-8	0-3	1-1	2-3	0-1	0-0	8-24	33.3	1	6
29	5	周佩芸	桃渚	1-33	3-6	1-18	0-1	1-2	1-24	1-2	8-86	9.3	0	6
30	1	万文倩	淮南	2-2	0-1	0-0	2-3	0-0	0-0	2-4	6-10	60.0	2	6
31	23	郭茹文	宿州	0-0	1-1	5-13	0-0	0-0	0-0	0-0	6-14	42.9	1	5
32	18	范小雁	平遥	1-6	0-1	0-3	3-3	1-2	0-0	1-4	6-19	31.6	2	6
33	26	刘洋	宿州	2-3	1-2	0-0	0-0	2-2	0-0	0-0	5-7	71.4	0	6
34	2	骆佩瑶	桃渚	1-8	1-5	0-0	0-0	1-1	2-9	0-0	5-23	21.7	1	6
35	19	于颖	晋中	0-0	0-0	3-4	0-0	0-0	0-0	1-1	4-5	80.0	0	6
36	15	乔思雨	宿州	0-0	2-4	0-0	0-0	1-1	0-0	1-1	4-6	66.7	0	4
37	7	李珂欣	汉得堡	0-2	3-3	0-1	1-1	0-0	0-1	0-0	4-8	50.0	1	6
38	26	李言娜	平遥	0-0	0-0	3-5	0-0	1-2	0-0	0-1	4-8	50.0	0	6
39	11	张楠	平遥	1-1	0-0	0-0	2-3	0-0	0-0	0-0	3-4	75.0	0	6
40	15	陈可怡	淮南	0-0	1-1	1-2	0-0	0-0	0-0	1-1	3-4	75.0	2	6
41	13	李心怡	晋中	0-0	3-4	0-0	0-0	0-0	0-0	0-0	3-4	75.0	0	6

## 第二届全国青年运动会女子手球甲组决赛 俱乐部组 (U18)

PHMS Pictorial Handball Match Statistics

IHF Official System

## 得分排名表(场上队员)

 手球  
青年女子

 截止至第87场  
按助攻次数排序

 山西晋中  
2019-06-23

排序	号码	姓名	球队	远射	近射	边射	快攻	突破	任意	七米	合计	%	助攻	场数
1	1	邓雅楠	晋中	0-0	0-0	0-0	0-0	0-0	0-0	1-1	1-1	100.0	8	6
2	13	杨梦颖	淮南	10-31	5-6	0-0	6-8	6-10	0-4	3-5	30-64	46.9	7	6
3	9	马文龙	平遥	5-17	7-9	0-1	4-4	5-7	0-2	0-0	21-40	52.5	5	6
4	20	尹艺霖	晋中	1-1	0-1	1-3	6-6	4-10	0-0	0-0	12-21	57.1	5	6
5	5	单文静	宿州	0-0	2-4	0-0	0-0	1-1	0-1	0-0	3-6	50.0	5	6
6	12	战慧	平遥	0-0	0-0	0-0	0-0	0-0	0-0	0-0	0-0	0	5	6
7	7	承然	淮南	7-23	11-17	0-0	5-6	6-10	1-5	2-2	32-63	50.8	4	6
8	7	郭敏婷	晋中	3-8	4-6	0-1	4-4	12-16	0-2	8-12	31-49	63.3	4	6
9	14	尹春霞	汉得堡	9-24	2-6	1-3	4-5	0-0	2-3	7-8	25-49	51.0	4	6
10	22	钦马晴	宿州	7-13	3-3	0-1	0-0	9-11	2-6	1-1	22-35	62.9	4	5
11	27	孙玟	平遥	0-3	6-12	0-2	2-3	9-11	0-0	1-1	18-32	56.3	4	6
12	10	张越	平遥	1-2	4-4	4-9	4-5	3-4	0-0	0-1	16-25	64.0	4	6
13	12	郭佳	晋中	0-0	0-0	0-0	0-0	0-0	0-0	0-1	0-1	0.0	4	6
14	21	张雪梅	汉得堡	0-0	0-1	2-11	4-4	4-4	0-0	2-2	12-22	54.5	3	6
15	9	李旗	宿州	3-6	0-1	0-3	5-8	5-9	5-8	16-16	34-51	66.7	2	6
16	4	张天琦	淮南	9-20	5-6	2-3	3-4	1-1	0-1	1-1	21-36	58.3	2	6
17	15	徐翹悦	平遥	0-1	2-6	0-0	4-5	1-1	1-3	7-9	15-25	60.0	2	6
18	6	张雪	晋中	0-2	3-5	0-0	4-4	4-4	0-0	0-0	11-15	73.3	2	5
19	10	王玮	晋中	3-8	2-7	1-3	2-4	1-1	1-2	0-1	10-26	38.5	2	6
20	8	孙雨菲	晋中	0-1	2-5	0-0	6-6	0-0	0-0	1-1	9-13	69.2	2	6
21	1	万文倩	淮南	2-2	0-1	0-0	2-3	0-0	0-0	2-4	6-10	60.0	2	6
22	18	范小雁	平遥	1-6	0-1	0-3	3-3	1-2	0-0	1-4	6-19	31.6	2	6
23	15	陈可怡	淮南	0-0	1-1	1-2	0-0	0-0	0-0	1-1	3-4	75.0	2	6
24	20	崔嘉欣	平遥	1-1	4-6	10-19	7-7	3-3	0-0	0-0	25-36	69.4	1	6
25	9	张晓静	汉得堡	5-14	3-4	1-2	2-3	4-6	0-0	4-4	19-33	57.6	1	6
26	15	杜佳奕	晋中	0-1	2-3	6-8	2-4	1-1	0-0	0-0	11-17	64.7	1	6
27	9	杨婷	晋中	2-6	1-1	2-6	4-5	0-0	0-1	0-0	9-19	47.4	1	6
28	10	穆梦欣	汉得堡	1-8	4-8	0-3	1-1	2-3	0-1	0-0	8-24	33.3	1	6
29	23	郭茹文	宿州	0-0	1-1	5-13	0-0	0-0	0-0	0-0	6-14	42.9	1	5
30	2	骆佩瑶	桃渚	1-8	1-5	0-0	0-0	1-1	2-9	0-0	5-23	21.7	1	6
31	7	李珂欣	汉得堡	0-2	3-3	0-1	1-1	0-0	0-1	0-0	4-8	50.0	1	6
32	18	于聪	晋中	0-0	0-2	1-1	0-1	1-2	0-0	0-0	2-6	33.3	1	6
33	8	董安心	桃渚	0-0	0-0	0-1	0-0	0-0	0-0	0-0	0-1	0.0	1	6
34	18	刘怡涵	宿州	2-3	3-4	1-1	1-1	12-12	1-1	1-3	21-25	84.0	0	6
35	2	付雪杰	晋中	2-2	3-3	2-5	7-9	1-2	0-0	0-0	15-21	71.4	0	6
36	3	宫訢	平遥	0-0	7-8	1-2	5-8	0-0	1-1	0-0	14-19	73.7	0	6
37	21	王嫚丽	宿州	0-0	3-4	5-6	1-2	0-1	0-0	1-1	10-14	71.4	0	5
38	11	孙瑞	汉得堡	0-0	0-1	6-7	2-2	0-0	0-0	1-1	9-11	81.8	0	6
39	9	叶飞雪	淮南	1-1	1-3	4-10	0-0	2-3	0-0	0-1	8-18	44.4	0	6
40	3	崔艳菲	汉得堡	1-3	3-3	0-7	2-3	2-3	0-0	0-0	8-19	42.1	0	6



## 得分排名表(场上队员)

 手球  
青年女子

 截止至第87场  
按封球次数排序

 山西晋中  
2019-06-23

名次	号码	姓名	球队	抢球	断球	造失误	造犯规	合计	封球	场数
1	13	李心怡	晋中	1	2	1	0	4	5	6
2	7	李珂欣	汉得堡	2	2	0	1	5	4	6
3	13	杨梦颖	淮南	5	7	0	1	13	3	6
4	7	郭敏婷	晋中	3	8	0	0	11	2	6
5	8	孙雨菲	晋中	0	3	0	0	3	2	6
6	7	承然	淮南	3	8	0	0	11	2	6
7	2	孙雨欣	淮南	0	0	0	0	0	2	6
8	15	乔思雨	宿州	0	0	0	0	0	1	4
9	15	杜佳奕	晋中	0	0	0	0	0	1	6
10	10	穆梦欣	汉得堡	0	6	1	1	8	1	6
11	17	田伊阳	宿州	0	1	0	0	1	1	6
12	14	尹春霞	汉得堡	2	1	0	0	3	1	6
13	20	尹艺霖	晋中	0	4	0	0	4	1	6
14	5	王晓敏	晋中	1	1	0	0	2	1	6
15	3	宫訢	平遥	0	3	0	0	3	1	6
16	10	王玮	晋中	0	0	0	0	0	1	6
17	19	林舒婧	汉得堡	0	0	0	0	0	0	3
18	18	邱兰晴	汉得堡	0	0	0	0	0	0	3
19	17	邱兰曦	汉得堡	0	0	0	0	0	0	3
20	10	杨晓晓	宿州	0	0	0	0	0	0	3
21	8	吴名茜	平遥	0	0	0	0	0	0	4
22	2	张心茹	汉得堡	0	1	0	0	1	0	5
23	22	钦马晴	宿州	1	1	2	0	4	0	5
24	6	张雪	晋中	0	2	0	0	2	0	5
25	1	陈文娟	宿州	0	0	0	0	0	0	5
26	12	金小清	桃渚	0	0	0	0	0	0	5
27	21	王嫚丽	宿州	0	2	0	0	2	0	5
28	11	李盼	桃渚	0	0	0	0	0	0	5
29	23	郭茹文	宿州	1	1	0	0	2	0	5
30	4	张天琦	淮南	1	0	0	0	1	0	6
31	6	吕少华	淮南	0	0	0	0	0	0	6
32	3	陈杨	淮南	0	1	0	0	1	0	6
33	9	杨婷	晋中	1	0	0	1	2	0	6
34	14	张美琪	淮南	0	0	0	0	0	0	6
35	15	陈可怡	淮南	0	1	0	0	1	0	6
36	11	徐静	淮南	0	2	0	0	2	0	6
37	9	黄琼妮	桃渚	0	0	0	0	0	0	6
38	10	王梦皖	淮南	0	5	0	1	6	0	6
39	8	董婧	淮南	0	0	0	0	0	0	6
40	13	陈梦瑶	桃渚	1	0	0	0	1	0	6

## 得分排名表(场上队员)

 手球  
青年女子

 截止至第87场  
按防守成功总数排序

 山西晋中  
2019-06-23

名次	号码	姓名	球队	抢球	断球	造失误	造犯规	合计	封球	场数
1	13	杨梦颖	淮南	5	7	0	1	13	3	6
2	7	郭敏婷	晋中	3	8	0	0	11	2	6
3	7	承然	淮南	3	8	0	0	11	2	6
4	18	刘怡涵	宿州	1	4	2	1	8	0	6
5	10	穆梦欣	汉得堡	0	6	1	1	8	1	6
6	10	张越	平遥	1	6	1	0	8	0	6
7	9	马文龙	平遥	0	6	2	0	8	0	6
8	10	王梦皖	淮南	0	5	0	1	6	0	6
9	27	孙玟	平遥	1	4	1	0	6	0	6
10	15	徐翘悦	平遥	2	3	0	1	6	0	6
11	9	张晓静	汉得堡	0	6	0	0	6	0	6
12	5	周佩芸	桃渚	2	2	2	0	6	0	6
13	7	李珂欣	汉得堡	2	2	0	1	5	4	6
14	20	尹艺霖	晋中	0	4	0	0	4	1	6
15	2	骆佩瑶	桃渚	2	0	1	1	4	0	6
16	13	李心怡	晋中	1	2	1	0	4	5	6
17	22	钦马晴	宿州	1	1	2	0	4	0	5
18	3	宫訢	平遥	0	3	0	0	3	1	6
19	18	范小雁	平遥	0	3	0	0	3	0	6
20	8	孙雨菲	晋中	0	3	0	0	3	2	6
21	14	尹春霞	汉得堡	2	1	0	0	3	1	6
22	11	孙瑞	汉得堡	0	3	0	0	3	0	6
23	2	付雪杰	晋中	1	1	0	0	2	0	6
24	11	张楠	平遥	0	2	0	0	2	0	6
25	7	黄亚楠	桃渚	0	0	1	1	2	0	6
26	3	崔艳菲	汉得堡	1	1	0	0	2	0	6
27	5	王晓敏	晋中	1	1	0	0	2	1	6
28	9	杨婷	晋中	1	0	0	1	2	0	6
29	8	魏雅欣	汉得堡	0	1	0	1	2	0	6
30	7	刘文秀	宿州	0	2	0	0	2	0	6
31	8	李伟伟	宿州	1	1	0	0	2	0	6
32	11	徐静	淮南	0	2	0	0	2	0	6
33	21	张雪梅	汉得堡	2	0	0	0	2	0	6
34	26	刘洋	宿州	0	2	0	0	2	0	6
35	6	张雪	晋中	0	2	0	0	2	0	5
36	23	郭茹文	宿州	1	1	0	0	2	0	5
37	21	王嫚丽	宿州	0	2	0	0	2	0	5
38	18	陈曼莎	桃渚	0	0	1	0	1	0	6
39	15	陈可怡	淮南	0	1	0	0	1	0	6
40	6	黄心怡	桃渚	1	0	0	0	1	0	6

第二届全国青年运动会女子手球甲组决赛 俱乐部组 (U18)

PHMS Pictorial Handball Match Statistics

IHF Official System

得分排名表(场上队员)

手球  
青年女子

截止至第87场  
按失误总数排序

山西晋中  
2019-06-23

排序	号码	姓名	球队	传失	接失	两次	四步	侵区	进犯	其它	合计	场数
1	5	周佩芸	桃渚	24	5	5	3	0	1	2	40	6
2	7	黄亚楠	桃渚	24	3	5	1	0	0	4	37	6
3	9	张晓静	汉得堡	7	4	4	10	2	0	2	29	6
4	2	骆佩瑶	桃渚	15	7	2	1	0	0	2	27	6
5	14	尹春霞	汉得堡	10	2	4	5	0	2	1	24	6
6	7	承然	淮南	11	5	4	2	1	1	0	24	6
7	10	穆梦欣	汉得堡	5	6	3	6	1	0	0	21	6
8	10	王玮	晋中	14	1	0	2	0	0	1	18	6
9	9	马文龙	平遥	8	0	2	3	2	0	0	15	6
10	15	徐翹悦	平遥	7	1	4	1	1	0	1	15	6
11	22	钦马晴	宿州	5	2	1	4	2	1	0	15	5
12	9	李旗	宿州	7	2	2	3	0	0	0	14	6
13	27	孙玟	平遥	2	2	3	3	2	1	0	13	6
14	13	杨梦颖	淮南	8	0	0	3	0	1	0	12	6
15	4	张天琦	淮南	5	3	2	0	0	1	0	11	6
16	3	崔艳菲	汉得堡	2	3	1	1	4	0	0	11	6
17	21	王嫚丽	宿州	2	4	0	1	3	1	0	11	5
18	5	单文静	宿州	5	0	0	2	2	0	1	10	6
19	15	杜佳奕	晋中	4	2	0	1	3	0	0	10	6
20	18	陈曼莎	桃渚	2	5	1	0	0	0	2	10	6
21	21	张雪梅	汉得堡	2	2	3	0	0	0	3	10	6
22	20	崔嘉欣	平遥	2	5	0	1	1	0	0	9	6
23	11	孙瑞	汉得堡	0	2	2	0	2	0	3	9	6
24	18	刘怡涵	宿州	0	1	1	5	0	0	1	8	6
25	9	杨婷	晋中	2	1	2	1	1	0	1	8	6
26	6	张雪	晋中	5	0	0	2	0	0	1	8	5
27	6	黄心怡	桃渚	1	2	2	1	0	0	1	7	6
28	8	董安心	桃渚	2	3	0	0	1	0	1	7	6
29	7	郭敏婷	晋中	3	1	1	1	0	0	0	6	6
30	10	王梦皖	淮南	2	1	1	0	1	0	1	6	6
31	23	郭茹文	宿州	0	3	0	0	0	1	2	6	5
32	20	尹艺霖	晋中	2	1	0	1	1	0	0	5	6
33	7	李珂欣	汉得堡	0	0	1	0	2	0	2	5	6
34	10	张越	平遥	0	1	1	1	0	0	2	5	6
35	1	万文倩	淮南	1	0	2	1	1	0	0	5	6
36	2	付雪杰	晋中	1	0	2	0	1	0	0	4	6
37	3	宫訢	平遥	3	1	0	0	0	0	0	4	6
38	26	刘洋	宿州	0	0	1	2	1	0	0	4	6
39	9	叶飞雪	淮南	1	1	0	0	0	0	1	3	6
40	5	王晓敏	晋中	0	1	2	0	0	0	0	3	6

## 得分排名表(场上队员)

 手球  
青年女子

 截止至第87场  
接受罚次数排序

 山西晋中  
2019-06-23

排序	号码	姓名	球队	警告	罚2分钟	D	DR	场数
1	27	孙玟	平遥	4	9	0	0	6
2	10	穆梦欣	汉得堡	2	7	0	0	6
3	3	宫訢	平遥	1	5	0	0	6
4	7	李珂欣	汉得堡	4	4	0	0	6
5	4	张天琦	淮南	1	4	0	0	6
6	13	杨梦颖	淮南	1	4	0	0	6
7	14	尹春霞	汉得堡	1	4	0	0	6
8	22	钦马晴	宿州	1	4	0	0	5
9	7	承然	淮南	1	3	0	0	6
10	15	陈可怡	淮南	0	3	0	0	6
11	13	陈梦瑶	桃渚	0	3	0	0	6
12	5	周佩芸	桃渚	0	3	0	0	6
13	18	刘怡涵	宿州	3	2	0	0	6
14	7	郭敏婷	晋中	3	2	0	0	6
15	6	黄心怡	桃渚	2	2	0	0	6
16	9	张晓静	汉得堡	2	2	0	0	6
17	9	马文龙	平遥	2	2	0	0	6
18	20	尹艺霖	晋中	2	2	0	0	6
19	8	董安心	桃渚	1	2	0	0	6
20	2	付雪杰	晋中	1	2	0	0	6
21	21	王嫚丽	宿州	1	2	0	0	5
22	9	李旗	宿州	2	1	0	0	6
23	7	刘文秀	宿州	1	1	0	0	6
24	15	徐翹悦	平遥	1	1	0	0	6
25	20	崔嘉欣	平遥	1	1	0	0	6
26	17	田伊阳	宿州	1	1	0	0	6
27	11	孙瑞	汉得堡	1	1	0	0	6
28	2	骆佩瑶	桃渚	1	1	0	0	6
29	7	黄亚楠	桃渚	1	1	0	0	6
30	21	张雪梅	汉得堡	1	1	0	0	6
31	8	李伟伟	宿州	0	1	0	0	6
32	3	姜景媛	宿州	0	1	0	0	6
33	9	杨婷	晋中	0	1	0	0	6
34	9	叶飞雪	淮南	0	1	0	0	6
35	10	张越	平遥	2	0	0	0	6
36	18	范小雁	平遥	2	0	0	0	6
37	10	王梦皖	淮南	1	0	0	0	6
38	8	孙雨菲	晋中	1	0	0	0	6
39	3	陈杨	淮南	0	0	0	0	6
40	6	吕少华	淮南	0	0	0	0	6

## 排名表(守门员)

 手球  
青年女子

 截止至第87场  
按总救球数排序

 山西晋中  
2019-06-23

排序	号码	姓名	球队	远射	近射	边射	快攻	突破	任意	七米	得分	%	助攻	场数
1	12	黄紫蝶	宿州	27-39	9-32	10-14	1-9	7-25	10-10	1-12	65-141	46.1	0	6
2	1	邓雅楠	晋中	12-19	10-24	14-16	1-7	2-12	4-5	3-5	46-88	52.3	8	6
3	12	战慧	平遥	12-23	7-15	9-22	3-11	3-14	8-11	3-7	45-103	43.7	5	6
4	16	王红	汉得堡	11-26	4-16	13-25	2-18	3-12	8-9	1-6	42-112	37.5	0	6
5	9	黄琼妮	桃渚	7-25	10-28	6-24	9-62	3-20	1-4	1-11	37-174	21.3	0	6
6	1	万文倩	淮南	5-9	6-26	10-20	4-17	5-29	3-9	0-21	33-131	25.2	2	6
7	12	郭佳	晋中	5-11	6-16	6-12	1-2	1-12	2-3	0-3	21-59	35.6	4	6
8	1	战泳享	平遥	8-13	0-5	4-4	1-4	0-5	0-0	2-6	15-37	40.5	0	6
9	12	张跃	汉得堡	3-4	1-5	2-3	1-1	1-2	2-4	0-1	10-20	50.0	0	6
10	16	陈静文	淮南	3-4	1-2	0-0	0-0	0-0	0-0	0-0	4-6	66.7	0	6
11	1	陈文娟	宿州	0-1	0-0	0-0	0-1	0-1	0-0	0-3	0-6	0.0	0	5

## 排名表(守门员)

 手球  
青年女子

 截止至第87场  
按救七米球数排序

 山西晋中  
2019-06-23

排序	号码	姓名	球队	远射	近射	边射	快攻	突破	任意	七米	得分	%	助攻	场数
1	1	邓雅楠	晋中	12-19	10-24	14-16	1-7	2-12	4-5	3-5	46-88	60.0	8	6
2	12	战慧	平遥	12-23	7-15	9-22	3-11	3-14	8-11	3-7	45-103	42.9	5	6
3	1	战泳享	平遥	8-13	0-5	4-4	1-4	0-5	0-0	2-6	15-37	33.3	0	6
4	16	王红	汉得堡	11-26	4-16	13-25	2-18	3-12	8-9	1-6	42-112	16.7	0	6
5	9	黄琼妮	桃渚	7-25	10-28	6-24	9-62	3-20	1-4	1-11	37-174	9.1	0	6
6	12	黄紫蝶	宿州	27-39	9-32	10-14	1-9	7-25	10-10	1-12	65-141	8.3	0	6
7	16	陈静文	淮南	3-4	1-2	0-0	0-0	0-0	0-0	0-0	4-6	0	0	6
8	12	张跃	汉得堡	3-4	1-5	2-3	1-1	1-2	2-4	0-1	10-20	0.0	0	6
9	12	郭佳	晋中	5-11	6-16	6-12	1-2	1-12	2-3	0-3	21-59	0.0	4	6
10	1	陈文娟	宿州	0-1	0-0	0-0	0-1	0-1	0-0	0-3	0-6	0.0	0	5
11	1	万文倩	淮南	5-9	6-26	10-20	4-17	5-29	3-9	0-21	33-131	0.0	2	6

第二届全国青年运动会女子手球甲组决赛 俱乐部组 (U18)

攻防成功率统计总表

手球  
青年女子

截止至第87场

山西晋中  
2019-06-23

序号	球队	比分	进攻成功率															助攻	防守成功率								
			阵地进攻			一传快攻			短传快攻			合计			多打少				少打多			封打抢断	守门员	对方射失	对方失误	合计	%
			得分	进攻	%	得分	进攻	%	得分	进攻	%	得分	进攻	%	得分	进攻	%		得分	进攻	%						
1	汉得堡	86:80	70	248	28.2	7	8	87.5	9	31	29.0	86	287	30.0	13	21	61.9	9	15	60.0	10	39	52	28	65	184	69.7
2	淮南	104:100	87	247	35.2	9	11	81.8	8	20	40.0	104	278	37.4	10	20	50.0	8	19	42.1	17	43	37	40	66	186	65.0
3	晋中	121:80	84	220	38.2	24	26	92.3	13	29	44.8	121	275	44.0	14	23	60.9	2	5	40.0	30	43	67	27	55	192	70.6
4	平遥	122:80	91	229	39.7	14	15	93.3	17	35	48.6	122	279	43.7	11	19	57.9	12	17	70.6	23	39	60	30	67	196	71.0
5	宿州	109:82	101	232	43.5	2	4	50.0	6	17	35.3	109	253	43.1	25	34	73.5	2	8	25.0	12	27	65	27	50	169	67.3
6	桃渚	17:137	17	257	6.6	0	1	0.0	0	1	0.0	17	259	6.6	0	10	0.0	1	9	11.1	2	15	37	33	60	145	51.4

注释:

进攻	进攻次数 (射门 + 进攻失误)	对方射失	对方射门失误 (射失 + 击柱)	防守成功率%	本方防守合计 / 对方进攻合计
----	------------------	------	------------------	--------	-----------------

第二届全国青年运动会女子手球甲组决赛 俱乐部组 (U18)

防守技术统计总表

手球  
青年女子

截止至第87场

山西晋中  
2019-06-23

序号	球队	比分	防守成功						防守 (成功 : 失误)							处罚					守门员			
			封球	抢球	断球	造失	造犯	合计	选位	顶贴	观察	移动	换防	其他	合计	警告	2'	取消	DR	合计	救球	射门	%	
1	汉得堡	86:80	6	7	22	1	3	39	0:0	0:0	0:0	0:0	0:0	0:0	0:0	0:0	11	19	0	0	30	52	132	39.4
2	淮南	104:100	7	10	24	0	2	43	0:0	0:0	0:0	0:0	0:0	0:0	0:0	0:0	4	15	0	0	19	37	137	27.0
3	晋中	121:80	13	7	21	1	1	43	0:0	0:0	0:0	0:0	0:0	0:0	0:0	0:0	7	7	0	0	14	67	147	45.6
4	平遥	122:80	1	4	29	4	1	39	0:0	0:0	0:0	0:0	0:0	0:0	0:0	0:0	13	18	0	0	31	60	140	42.9
5	宿州	109:82	2	4	15	4	2	27	0:0	0:0	0:0	0:0	0:0	0:0	0:0	0:0	9	13	0	0	22	65	147	44.2
6	桃渚	17:137	0	6	2	5	2	15	0:0	0:0	0:0	0:0	0:0	0:0	0:0	0:0	5	12	0	0	17	37	174	21.3

注释:

造失	造对方失误	造犯	造对方犯规	DR	取消资格+报告
----	-------	----	-------	----	---------



## 第二届全国青年运动会女子手球甲组决赛 俱乐部组 (U18)

PHMS Pictorial Handball Match Statistics

IHF Official System

## 球队名单

山西平遥

山西晋中

2019-06-15

号码	姓名	位置	生日	年龄	俱乐部	身高 (CM)	体重 (KG)	国际场次	国际进球
1	战泳享	守门员	13/01/2002	17	平遥现代	170	62	10	
2	胡嘉雯	右后卫	18/10/2001	17	平遥现代	174	55	2	
3	宫訢		12/10/2002	16					
5	李楠	左后卫	28/08/2002	16	平遥现代	170	62	2	15
6	王雅静	后卫	19/11/2002	16	平遥现代	172	60	4	2
7	陈亚轩		12/10/2002	16					
8	吴名茜	右边锋	08/09/2004	14	平遥现代	167	60	2	
9	马文龙		21/01/2003	16					
10	张越	右后卫	23/02/2002	17	平遥现代	170	63	10	60
11	张楠	底线	17/10/2002	16	平遥现代	167	65	8	20
12	战慧	守门员	25/05/2001	18	平遥现代	170	70	8	
15	徐翹悦	后卫	04/05/2001	18	平遥现代	168	70	11	100
18	范小雁	左后卫	16/01/2002	17	平遥现代	163	65	10	60
20	崔嘉欣	右边锋	05/05/2002	17	平遥现代	168	56	10	19
26	李言娜	左边锋	15/05/2002	17	平遥现代	170	60	10	18
27	孙玟	右后卫	04/06/2001	18	平遥现代	171	67	10	84
	平均			16.6		169.2	62.7	7.5	42.0

编码	姓名	职务
B	黄翠红	主教练
E	陶岩	医生
A	张栋	领队
C	赵洋	教练
D	吕恒福	教练

手球  
青年女子

## 个人/全队技术累计表

 山西晋中  
2019-06-23

截止至第87场

号码	姓名	远射	近射	边射	快攻	突破	任意	七米	合计	%	助攻	失误	警告	2'	取消	场次	时间
山西平遥																	
(场上队员)																	
1	战泳享															6	01:06:00
2	胡嘉雯															6	00:00:45
3	宫訢		7/8	1/2	5/8		1/1		14/19	73.7%		4	1	5		6	03:02:24
5	李楠															6	00:01:57
6	王雅静															6	00:23:30
8	吴名茜															4	00:00:00
9	马文龙	5/17	7/9	0/1	4/4	5/7	0/2		21/40	52.5%	5	15	2	2		6	03:07:59
10	张越	1/2	4/4	4/9	4/5	3/4		0/1	16/25	64.0%	4	5	2			6	03:46:03
11	张楠	1/1			2/3				3/4	75.0%		2				6	00:56:11
12	战慧										5	3				6	02:54:00
15	徐翹悦	0/1	2/6		4/5	1/1	1/3	7/9	15/25	60.0%	2	15	1	1		6	02:51:52
18	范小雁	1/6	0/1	0/3	3/3	1/2		1/4	6/19	31.6%	2	2	2			6	01:40:22
20	崔嘉欣	1/1	4/6	10/19	7/7	3/3			25/36	69.4%	1	9	1	1		6	03:58:55
26	李言娜			3/5		1/2		0/1	4/8	50.0%		3				6	00:29:53
27	孙玟	0/3	6/12	0/2	2/3	9/11		1/1	18/32	56.3%	4	13	4	9		6	03:35:02
	合计	9/31	30/46	18/41	31/38	23/30	2/6	9/16	122/208	58.7%	23	71	13	18		88	
(守门员)																	
1	战泳享	8/13	0/5	4/4	1/4	0/5		2/6	15/37	40.5%						6	01:06:00
12	战慧	12/23	7/15	9/22	3/11	3/14	8/11	3/7	45/103	43.7%	5	3				6	02:54:00
	合计	20/36	7/20	13/26	4/15	3/19	8/11	5/13	60/140	42.9%	5	3				12	

场上队员：得分/射门

守门员：救球/射门

已打比赛

全队合计	进球	被救	射失	击柱	封球	合计	%	阶段	场次	对手	比分
远射	9	11	2	1	8	31	29.0%	预赛	14	晋中	15:18 (9:10)
近射	30	12	2	2		46	65.2%	预赛	26	桃渚	25:2 (15:0)
边射	18	13	4	6		41	43.9%	预赛	45	宿州	18:15 (9:7)
快攻	31	6		1		38	81.6%	预赛	47	淮南	22:19 (13:8)
突破	23	4	2	1		30	76.7%	预赛	65	汉得堡	20:10 (8:3)
任意	2	3	1			6	33.3%	决赛	82	晋中	22:16 (11:7)
七米	9	4	2	1		16	56.3%				



图式射门区域累计

手球  
青年女子

截止至第87场

山西晋中  
2019-06-23

山西平遥

1 战泳享 Post - 0 Miss - 0 Block - 0	2 胡嘉雯 Post - 0 Miss - 0 Block - 0	3 宫訢 Post - 1 Miss - 0 Block - 0	5 李楠 Post - 0 Miss - 0 Block - 0	6 王雅静 Post - 0 Miss - 0 Block - 0	8 吴名茜 Post - 0 Miss - 0 Block - 0	9 马文龙 Post - 0 Miss - 2 Block - 6	10 张越 Post - 2 Miss - 0 Block - 0
11 张楠 Post - 0 Miss - 0 Block - 0	12 战慧 Post - 0 Miss - 0 Block - 0	15 徐翹悦 Post - 1 Miss - 0 Block - 0	18 范小雁 Post - 2 Miss - 2 Block - 2	20 崔嘉欣 Post - 2 Miss - 3 Block - 0	26 李言娜 Post - 2 Miss - 2 Block - 0	27 孙玟 Post - 2 Miss - 4 Block - 0	

1 战泳享	1/6	1/1	3/7
	3/7	1/2	2/5
	2/4		2/5

12 战慧	7/20	3/6	1/13
	10/17	6/6	6/11
	4/16	0/2	8/12

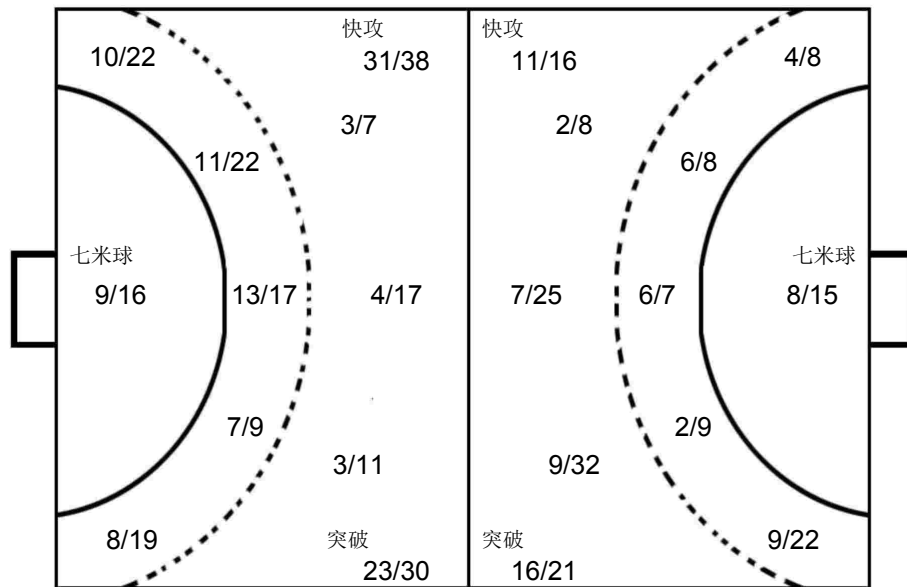

宿州	12 黄紫蝶	1/4	2/2	0/3
		2/5	3/3	0/3
		0/5	2/2	1/2

晋中	1 邓雅楠	0/2	1/1	1/6
		1/2	3/3	1/1
		2/7	0/3	2/2

晋中	12 郭佳	1/3		1/4
		1/3	3/4	0/3
		1/5	1/2	1/6

OPPONENT

晋中 7 郭婷婷 Post - 1 Miss - 0 Block - 0	淮南 13 杨梦颖 Post - 2 Miss - 0 Block - 0	汉得堡 14 尹春霞 Post - 0 Miss - 0 Block - 1	淮南 7 承然 Post - 0 Miss - 5 Block - 0	晋中 6 张雪 Post - 0 Miss - 0 Block - 0	晋中 2 付雪杰 Post - 1 Miss - 0 Block - 0	晋中 9 杨婷 Post - 1 Miss - 0 Block - 0	晋中 10 王玮 Post - 0 Miss - 1 Block - 0
宿州 9 李旗 Post - 0 Miss - 1 Block - 0	淮南 4 张天琦 Post - 0 Miss - 0 Block - 0	晋中 15 杜佳奕 Post - 0 Miss - 1 Block - 0	宿州 18 刘怡涵 Post - 0 Miss - 0 Block - 0	宿州 21 王嫒丽 Post - 1 Miss - 0 Block - 0	宿州 22 钦马晴 Post - 0 Miss - 0 Block - 0	淮南 9 叶飞雪 Post - 0 Miss - 0 Block - 0	晋中 13 李心怡 Post - 0 Miss - 0 Block - 0



第二届全国青年运动会女子手球甲组决赛 俱乐部组 (U18)

球队名单

山西晋中

山西晋中

2019-06-15

号码	姓名	位置	生日	年龄	俱乐部	身高 (CM)	体重 (KG)	国际场次	国际进球
1	邓雅楠	守门员	26/06/2001	17	晋中市捷耀手球俱乐部	188	80		
2	付雪杰	后卫	08/12/2002	16	晋中市捷耀手球俱乐部	175	65		
5	王晓敏		28/12/2002	16					
6	张雪	后卫	15/01/2001	18	晋中市捷耀手球俱乐部	170	57		
7	郭敏婷	后卫	16/07/2002	16	晋中市捷耀手球俱乐部	167	58		
8	孙雨菲	底线	02/06/2002	17	晋中市捷耀手球俱乐部	177	79		
9	杨婷	边锋	28/02/2002	17	晋中市捷耀手球俱乐部	172	62		
10	王玮	后卫	26/10/2001	17	晋中市捷耀手球俱乐部	171	60		
11	李卓怡		12/08/2002	16					
12	郭佳	守门员	02/09/2002	16	晋中市捷耀手球俱乐部	182	62		
13	李心怡	底线	08/10/2001	17	晋中市捷耀手球俱乐部	181	75		
15	杜佳奕		14/06/2001	18					
18	于聪	边锋	23/11/2002	16	晋中市捷耀手球俱乐部	172	66		
19	于颖	边锋	23/11/2002	16	晋中市捷耀手球俱乐部	170	65		
20	尹艺霖	右边锋	16/02/2002	17	晋中市捷耀手球俱乐部	172	66		
	平均			16.7		174.8	66.3		

编码	姓名	职务
A	张栋	领队
B	徐熙围	主教练
C	侯建涛	教练

## 个人/全队技术累计表

 手球  
青年女子

截止至第87场

 山西晋中  
2019-06-23

号码	姓名	远射	近射	边射	快攻	突破	任意	七米	合计	%	助攻	失误	警告	2'	取消	场次	时间
山西晋中																	
(场上队员)																	
1	邓雅楠							1/1	1/1	100%	8	2				6	02:06:22
2	付雪杰	2/2	3/3	2/5	7/9	1/2			15/21	71.4%		4	1	2		6	02:10:57
5	王晓敏	0/2		1/2	2/2				3/6	50.0%		3				6	01:03:35
6	张雪	0/2	3/5		4/4	4/4			11/15	73.3%	2	8				5	01:07:40
7	郭敏婷	3/8	4/6	0/1	4/4	12/16	0/2	8/12	31/49	63.3%	4	6	3	2		6	02:59:10
8	孙雨菲	0/1	2/5		6/6			1/1	9/13	69.2%	2	2	1			6	01:37:40
9	杨婷	2/6	1/1	2/6	4/5		0/1		9/19	47.4%	1	8		1		6	02:32:35
10	王玮	3/8	2/7	1/3	2/4	1/1	1/2	0/1	10/26	38.5%	2	18				6	02:39:18
12	郭佳							0/1	0/1	0.0%	4	1				6	01:53:35
13	李心怡		3/4						3/4	75.0%		2				6	02:22:11
15	杜佳奕	0/1	2/3	6/8	2/4	1/1			11/17	64.7%	1	10				6	02:51:54
18	于聪		0/2	1/1	0/1	1/2			2/6	33.3%	1	1				6	00:57:16
19	于颖			3/4				1/1	4/5	80.0%		1				6	00:55:28
20	尹艺霖	1/1	0/1	1/3	6/6	4/10			12/21	57.1%	5	5	2	2		6	02:38:48
	合计	11/31	20/37	17/33	37/45	24/36	1/5	11/17	121/204	59.3%	30	71	7	7		83	
(守门员)																	
1	邓雅楠	12/19	10/24	14/16	1/7	2/12	4/5	3/5	46/88	52.3%	8	2				6	02:06:22
12	郭佳	5/11	6/16	6/12	1/2	1/12	2/3	0/3	21/59	35.6%	4	1				6	01:53:35
	合计	17/30	16/40	20/28	2/9	3/24	6/8	3/8	67/147	45.6%	12	3				12	

场上队员：得分/射门

守门员：救球/射门

已打比赛

全队合计	进球	被救	射失	击柱	封球	合计	%	阶段	场次	对手	比分
远射	11	10	6	2	2	31	35.5%	预赛	14	平遥	18:15 (10:9)
近射	20	11	3	3		37	54.1%	预赛	28	汉得堡	19:11 (11:6)
边射	17	11	3	2		33	51.5%	预赛	43	淮南	18:14 (7:8)
快攻	37	6		2		45	82.2%	预赛	46	桃渚	33:6 (19:0)
突破	24	6	2	4		36	66.7%	预赛	66	宿州	17:12 (8:7)
任意	1	3	1			5	20.0%	决赛	82	平遥	16:22 (7:11)
七米	11	4	1	1		17	64.7%				

图式射门区域累计

手球  
青年女子

截止至第87场

山西晋中  
2019-06-23

山西晋中

1 邓雅楠 Post - 0 Miss - 0 Block - 0	2 付雪杰 Post - 1 Miss - 0 Block - 0	5 王晓敏 Post - 0 Miss - 2 Block - 0	6 张雪 Post - 0 Miss - 1 Block - 0	7 郭敏婷 Post - 1 Miss - 7 Block - 1	8 孙雨菲 Post - 1 Miss - 2 Block - 0	9 杨婷 Post - 3 Miss - 1 Block - 0	10 王玮 Post - 2 Miss - 2 Block - 1
12 郭佳 Post - 0 Miss - 0 Block - 0	13 李心怡 Post - 0 Miss - 0 Block - 0	15 杜佳奕 Post - 1 Miss - 1 Block - 0	18 于聪 Post - 2 Miss - 0 Block - 0	19 于颖 Post - 0 Miss - 0 Block - 0	20 尹艺霖 Post - 3 Miss - 0 Block - 0		

1 邓雅楠	4/9	4/5	9/16
	3/7	8/8	7/11
	4/15	1/5	6/12

12 郭佳	2/5		3/11
	5/10	4/5	1/6
	1/6	1/3	4/13

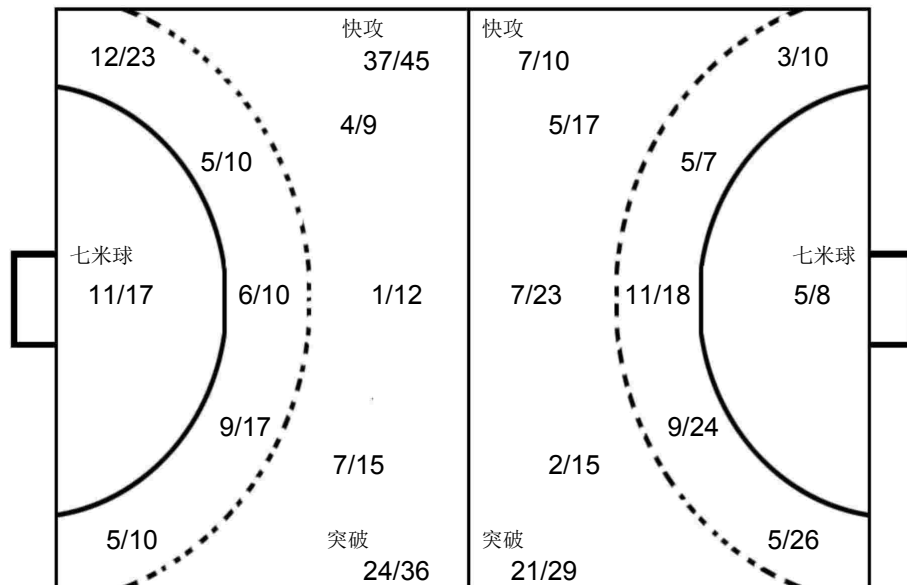

平遥

12 战慧	3/12	1/3	0/5
	2/5	2/2	1/2
	3/7	0/1	3/5

宿州

12 黄紫蝶	2/3	1/1	2/3
	2/3		0/1
	3/11	0/2	0/1

汉得堡

16 王红	3/5		3/7
	2/6		0/1
	0/5	1/1	0/2

OPPONENT

平遥 27 孙旻 Post - 1 Miss - 1 Block - 0	平遥 9 马文龙 Post - 0 Miss - 0 Block - 4	汉得堡 9 张晓静 Post - 0 Miss - 0 Block - 2	淮南 7 承然 Post - 0 Miss - 1 Block - 0	平遥 10 张越 Post - 1 Miss - 0 Block - 0	平遥 20 崔嘉欣 Post - 0 Miss - 1 Block - 0	平遥 3 宫訢 Post - 1 Miss - 0 Block - 0	宿州 22 狄马晴 Post - 1 Miss - 1 Block - 1
宿州 9 李旗 Post - 0 Miss - 0 Block - 0	宿州 26 刘洋 Post - 0 Miss - 1 Block - 0	汉得堡 3 崔艳菲 Post - 0 Miss - 0 Block - 0	汉得堡 21 张雪梅 Post - 0 Miss - 0 Block - 0	淮南 4 张天琦 Post - 0 Miss - 1 Block - 0	淮南 9 叶飞雪 Post - 1 Miss - 0 Block - 0	淮南 13 杨梦颖 Post - 0 Miss - 1 Block - 1	平遥 18 范小雁 Post - 0 Miss - 0 Block - 2



## 第二届全国青年运动会女子手球甲组决赛 俱乐部组 (U18)

## 球队名单

安徽宿州

山西晋中

2019-06-15

号码	姓名	位置	生日	年龄	俱乐部	身高 (CM)	体重 (KG)	国际场次	国际进球
1	陈文娟	守门员	25/09/2003	15	宿州市第九中学青少年体育俱乐部	163	60		
3	姜景媛	右边锋	03/01/2006	13	宿州市第九中学青少年体育俱乐部	170	60		
5	单文静	右后卫	17/10/2001	17	宿州市第九中学青少年体育俱乐部	175	65		
7	刘文秀	后卫	04/01/2001	18	宿州市第九中学青少年体育俱乐部	175	60		
8	李伟伟	右边锋	14/06/2004	15	宿州市第九中学青少年体育俱乐部	160	55		
9	李旗	左边锋	01/07/2003	15	宿州市第九中学青少年体育俱乐部	170	60		
10	杨晓晓	左边锋	10/10/2004	14	宿州市第九中学青少年体育俱乐部	165	60		
12	黄紫蝶	守门员	18/10/2006	12	宿州市第九中学青少年体育俱乐部	173	60		
15	乔思雨	底线	07/07/2002	16	宿州市第九中学青少年体育俱乐部	175	65		
17	田伊阳	底线	17/08/2003	15	宿州市第九中学青少年体育俱乐部	172	75		
18	刘怡涵	左后卫	18/08/2003	15	宿州市第九中学青少年体育俱乐部	166	61		
21	王嫚丽	右边锋	24/08/2004	14	宿州市第九中学青少年体育俱乐部	168	58		
22	钦马晴	后卫	28/12/2004	14	宿州市第九中学青少年体育俱乐部	165	60		
23	郭茹文	左边锋	29/07/2004	14	宿州市第九中学青少年体育俱乐部	169	64		
25	郑睿涵	底线	26/08/2002	16	宿州市第九中学青少年体育俱乐部	170	63		
26	刘洋	右后卫	23/06/2002	16	宿州市第九中学青少年体育俱乐部	172	68		
	平均			14.9		169.3	62.1		

编码	姓名	职务
A	李红太	领队
B	吴昊	主教练
C	李绍魁	助理教练
D	赵萌萌	助理教练
E	王路路	医生

手球  
青年女子

## 个人/全队技术累计表

 山西晋中  
2019-06-23

截止至第87场

号码	姓名	远射	近射	边射	快攻	突破	任意	七米	合计	%	助攻	失误	警告	2'	取消	场次	时间
<b>安徽宿州</b>																	
<b>(场上队员)</b>																	
1	陈文娟															5	00:04:35
3	姜景媛				0/1				0/1	0.0%		1		1		6	00:32:04
5	单文静		2/4			1/1	0/1		3/6	50.0%	5	10				6	02:56:20
7	刘文秀	0/2	1/2				0/2	0/1	1/7	14.3%		3	1	1		6	00:47:06
8	李伟伟											1		1		6	00:12:53
9	李旗	3/6	0/1	0/3	5/8	5/9	5/8	16/16	34/51	66.7%	2	14	2	1		6	03:13:51
10	杨晓晓											1				3	00:03:28
12	黄紫蝶											2				6	03:54:58
15	乔思雨		2/4			1/1		1/1	4/6	66.7%		3				4	00:45:18
17	田伊阳		1/1		1/2				2/3	66.7%		2	1	1		6	01:28:56
18	刘怡涵	2/3	3/4	1/1	1/1	12/12	1/1	1/3	21/25	84.0%		8	3	2		6	02:48:17
21	王嫚丽		3/4	5/6	1/2	0/1		1/1	10/14	71.4%		11	1	2		5	03:17:58
22	钦马晴	7/13	3/3	0/1		9/11	2/6	1/1	22/35	62.9%	4	15	1	4		5	03:17:14
23	郭茹文		1/1	5/13					6/14	42.9%	1	6				5	03:13:31
25	郑睿涵		1/1		0/1				1/2	50.0%		1				6	00:19:25
26	刘洋	2/3	1/2			2/2			5/7	71.4%		4				6	00:57:14
<b>合计</b>		<b>14/27</b>	<b>18/27</b>	<b>11/24</b>	<b>8/15</b>	<b>30/37</b>	<b>8/18</b>	<b>20/23</b>	<b>109/171</b>	<b>63.7%</b>	<b>12</b>	<b>82</b>	<b>9</b>	<b>13</b>		<b>87</b>	
<b>(守门员)</b>																	
1	陈文娟	0/1			0/1	0/1		0/3	0/6	0.0%						5	00:04:35
12	黄紫蝶	27/39	9/32	10/14	1/9	7/25	10/10	1/12	65/141	46.1%		2				6	03:54:58
<b>合计</b>		<b>27/40</b>	<b>9/32</b>	<b>10/14</b>	<b>1/10</b>	<b>7/26</b>	<b>10/10</b>	<b>1/15</b>	<b>65/147</b>	<b>44.2%</b>		<b>2</b>				<b>11</b>	

场上队员：得分/射门

守门员：救球/射门

已打比赛

全队合计	进球	被救	射失	击柱	封球	合计	%	阶段	场次	对手	比分
远射	14	4	4		5	27	51.9%	预赛	13	桃渚	21:1 (11:0)
近射	18	6	2	1		27	66.7%	预赛	27	淮南	21:20 (7:7)
边射	11	4		9		24	45.8%	预赛	45	平遥	15:18 (7:9)
快攻	8	5	1	1		15	53.3%	预赛	48	汉得堡	16:11 (7:5)
突破	30	3	2	2		37	81.1%	预赛	66	晋中	12:17 (7:8)
任意	8	7	3			18	44.4%	3-4名	87	淮南	24:15 (12:8)
七米	20		2	1		23	87.0%				



图式射门区域累计

手球  
青年女子

截止至第87场

山西晋中  
2019-06-23

安徽宿州

1 陈文娟 Post - 0 Miss - 0 Block - 0	3 姜景媛 Post - 0 Miss - 0 Block - 0	5 单文静 Post - 0 Miss - 1 Block - 0	7 刘文秀 Post - 0 Miss - 1 Block - 1	8 李伟伟 Post - 0 Miss - 0 Block - 0	9 李旗 Post - 4 Miss - 2 Block - 3	10 杨晓晓 Post - 0 Miss - 0 Block - 0	12 黄紫蝶 Post - 0 Miss - 0 Block - 0
15 乔思雨 Post - 0 Miss - 0 Block - 0	17 田伊阳 Post - 0 Miss - 0 Block - 0	18 刘怡涵 Post - 1 Miss - 2 Block - 0	21 王嫚丽 Post - 1 Miss - 0 Block - 0	22 钦马晴 Post - 2 Miss - 5 Block - 1	23 郭茹文 Post - 6 Miss - 0 Block - 0	25 郑睿涵 Post - 0 Miss - 1 Block - 0	26 刘洋 Post - 0 Miss - 2 Block - 0

1 陈文娟	0/1
0/2	0/1
0/2	

12 黄紫蝶	10/16	5/6	7/16
	8/19	9/9	7/20
	9/33	6/8	4/14

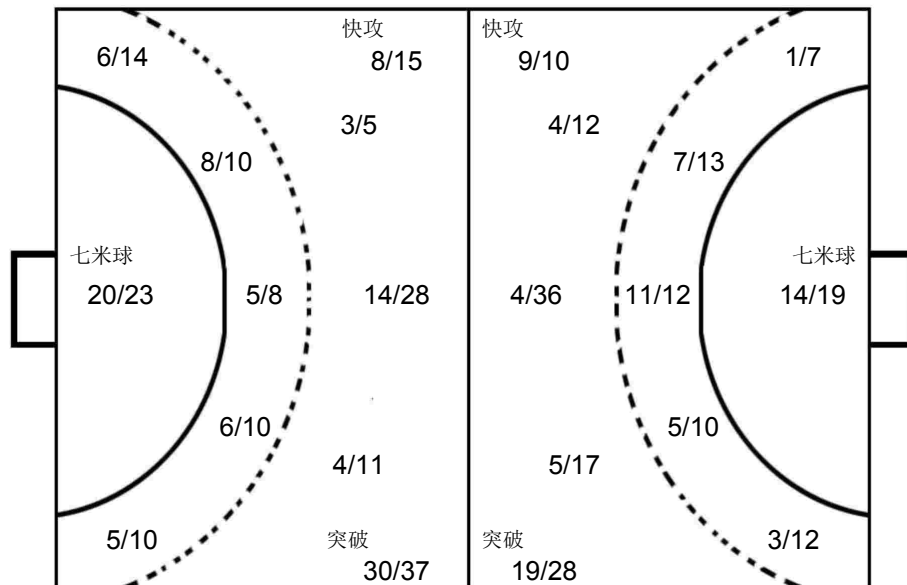

桃渚

9 黄琼妮	0/1	2/2	0/5
	1/2		3/9
	0/5		1/4

淮南

1 万文倩	2/6		1/4
	2/9	1/1	0/15
	0/8	1/2	0/7

汉得堡

16 王红	1/3		4/8
	1/2		0/4
	0/3		0/2

OPPONENT

淮南 7 承然 Post - 1 Miss - 1 Block - 1	淮南 13 杨梦颖 Post - 1 Miss - 6 Block - 0	淮南 4 张天琦 Post - 0 Miss - 1 Block - 0	平遥 15 徐翹悦 Post - 0 Miss - 0 Block - 0	晋中 7 郭敏婷 Post - 0 Miss - 3 Block - 0	晋中 20 尹艺霖 Post - 2 Miss - 0 Block - 0	平遥 27 孙玟 Post - 0 Miss - 0 Block - 0	汉得堡 9 张晓静 Post - 0 Miss - 0 Block - 0
晋中 6 张雪 Post - 0 Miss - 1 Block - 0	平遥 9 马文龙 Post - 0 Miss - 0 Block - 0	汉得堡 3 崔艳菲 Post - 1 Miss - 0 Block - 0	汉得堡 14 尹春霞 Post - 5 Miss - 1 Block - 1	汉得堡 21 张雪梅 Post - 0 Miss - 0 Block - 0	晋中 2 付雪杰 Post - 0 Miss - 0 Block - 0	晋中 9 杨婷 Post - 1 Miss - 0 Block - 0	平遥 3 宫訢 Post - 0 Miss - 0 Block - 0

## 第二届全国青年运动会女子手球甲组决赛 俱乐部组 (U18)

## 球队名单

安徽淮南

山西晋中

2019-06-15

号码	姓名	位置	生日	年龄	俱乐部	身高 (CM)	体重 (KG)	国际场次	国际进球
1	万文倩	守门员	09/01/2003	16	淮南市向日葵青少年体育俱乐部	178	68	8	
2	孙雨欣	右边锋	03/08/2003	15	淮南市向日葵青少年体育俱乐部	165	59	11	31
3	陈杨	左后卫	22/05/2003	16	淮南市向日葵青少年体育俱乐部	165	65	11	14
4	张天琦	右边锋	15/12/2001	17	淮南市向日葵青少年体育俱乐部	174	68	34	56
5	高鑫艺	右边锋	26/03/2003	16	淮南市向日葵青少年体育俱乐部	165	57	11	16
6	吕少华	后卫	20/01/2004	15	淮南市向日葵青少年体育俱乐部	168	56	11	18
7	承然	后卫	27/03/2002	17	淮南市向日葵青少年体育俱乐部	165	57	11	14
8	董婧	左后卫	02/12/2003	15	淮南市向日葵青少年体育俱乐部	178	68	11	21
9	叶飞雪	右后卫	05/01/2004	15	淮南市向日葵青少年体育俱乐部	177	75	11	53
10	王梦皖	底线	07/08/2003	15	淮南市向日葵青少年体育俱乐部	165	67	11	22
11	徐静	右边锋	15/02/2004	15	淮南市向日葵青少年体育俱乐部				
12	宋诗情	右边锋	20/07/2003	15	淮南市向日葵青少年体育俱乐部	165	54	11	18
13	杨梦颖	中后卫	16/12/2001	17	淮南市向日葵青少年体育俱乐部	174	65	28	34
14	张美琪	左边锋	12/11/2002	16	淮南市向日葵青少年体育俱乐部	174	62	11	11
15	陈可怡	左后卫	30/11/2003	15	淮南市向日葵青少年体育俱乐部	176	73	11	31
16	陈静文	守门员	21/06/2003	15	淮南市向日葵青少年体育俱乐部	174	60	11	
	平均			15.6		170.9	63.6	13.5	26.1

编码	姓名	职务
B	孙永永	
A	常洪飞	
C	阮圣杰	教练

手球  
青年女子

## 个人/全队技术累计表

 山西晋中  
2019-06-23

截止至第87场

号码	姓名	远射	近射	边射	快攻	突破	任意	七米	合计	%	助攻	失误	警告	2'	取消	场次	时间
<b>安徽淮南</b>																	
<b>(场上队员)</b>																	
1	万文倩	2/2	0/1		2/3			2/4	6/10	60.0%	2	5				6	03:59:28
2	孙雨欣		1/2						1/2	50.0%		2				6	01:43:42
3	陈杨	0/1	0/1						0/2	0.0%						6	00:10:02
4	张天琦	9/20	5/6	2/3	3/4	1/1	0/1	1/1	21/36	58.3%	2	11	1	4		6	03:35:42
5	高鑫艺															6	00:15:37
6	吕少华															6	00:19:51
7	承然	7/23	11/17		5/6	6/10	1/5	2/2	32/63	50.8%	4	24	1	3		6	03:40:53
8	董婧	0/1							0/1	0.0%		2				6	00:08:47
9	叶飞雪	1/1	1/3	4/10		2/3		0/1	8/18	44.4%		3		1		6	03:12:57
10	王梦皖		0/1	1/5	1/2				2/8	25.0%		6	1			6	03:45:31
11	徐静		0/1						0/1	0.0%						6	00:09:12
12	宋诗情			1/1					1/1	100%		1				6	00:29:03
13	杨梦颖	10/31	5/6		6/8	6/10	0/4	3/5	30/64	46.9%	7	12	1	4		6	03:36:07
14	张美琪															6	00:03:10
15	陈可怡		1/1	1/2				1/1	3/4	75.0%	2	2		3		6	02:23:25
16	陈静文															6	00:23:44
<b>合计</b>		<b>29/79</b>	<b>24/39</b>	<b>9/21</b>	<b>17/23</b>	<b>15/24</b>	<b>1/10</b>	<b>9/14</b>	<b>104/210</b>	<b>49.5%</b>	<b>17</b>	<b>68</b>	<b>4</b>	<b>15</b>		<b>96</b>	
<b>(守门员)</b>																	
1	万文倩	5/9	6/26	10/20	4/17	5/29	3/9	0/21	33/131	25.2%	2	5				6	03:59:28
16	陈静文	3/4	1/2						4/6	66.7%						6	00:23:44
<b>合计</b>		<b>8/13</b>	<b>7/28</b>	<b>10/20</b>	<b>4/17</b>	<b>5/29</b>	<b>3/9</b>	<b>0/21</b>	<b>37/137</b>	<b>27.0%</b>	<b>2</b>	<b>5</b>				<b>12</b>	

场上队员：得分/射门

守门员：救球/射门

已打比赛

全队合计	进球	被救	射失	击柱	封球	合计	%	阶段	场次	对手	比分
远射	29	28	14	5	3	79	36.7%	预赛	12	汉得堡	19:13 (9:9)
近射	24	11	2	2		39	61.5%	预赛	27	宿州	20:21 (7:7)
边射	9	10		2		21	42.9%	预赛	43	晋中	14:18 (8:7)
快攻	17	4	1	1		23	73.9%	预赛	47	平遥	19:22 (8:13)
突破	15	9				24	62.5%	预赛	67	桃渚	17:2 (9:1)
任意	1	3	5	1		10	10.0%	3-4名	87	宿州	15:24 (8:12)
七米	9	2	2	1		14	64.3%				

图式射门区域累计

手球  
青年女子

截止至第87场

山西晋中  
2019-06-23

安徽淮南

1 万文倩 1 0 0 4 0 1 Post - 0 Miss - 0 Block - 0	2 孙雨欣 1 0 0 1 0 0 Post - 1 Miss - 0 Block - 0	3 陈杨 0 0 0 0 0 0 Post - 0 Miss - 0 Block - 0	4 张天琦 2 1 3 2 1 2 4 1 5 Post - 0 Miss - 4 Block - 1	5 高鑫艺 0 0 0 0 0 0 Post - 0 Miss - 0 Block - 0	6 吕少华 0 0 0 0 0 0 Post - 0 Miss - 0 Block - 0	7 承然 3 0 8 6 0 2 9 0 4 Post - 2 Miss - 10 Block - 1	8 董婧 0 0 0 0 0 0 Post - 0 Miss - 1 Block - 0
9 叶飞雪 2 1 0 1 0 0 2 0 2 Post - 2 Miss - 1 Block - 0	10 王梦皖 1 0 0 1 0 0 Post - 0 Miss - 0 Block - 0	11 徐静 0 0 0 0 0 0 Post - 0 Miss - 0 Block - 0	12 宋诗情 0 0 0 0 0 1 Post - 0 Miss - 0 Block - 0	13 杨梦颖 1 0 5 7 0 5 7 1 4 Post - 7 Miss - 8 Block - 1	14 张美琪 0 0 0 0 0 0 Post - 0 Miss - 0 Block - 0	15 陈可怡 1 0 0 0 0 2 Post - 0 Miss - 0 Block - 0	16 陈静文 0 0 0 0 0 0 Post - 0 Miss - 0 Block - 0

1 万文倩
7/20 1/2 3/14
8/24 1/1 5/24
2/24 2/3 4/19

16 陈静文
0/1 1/1
1/2
1/1 1/1

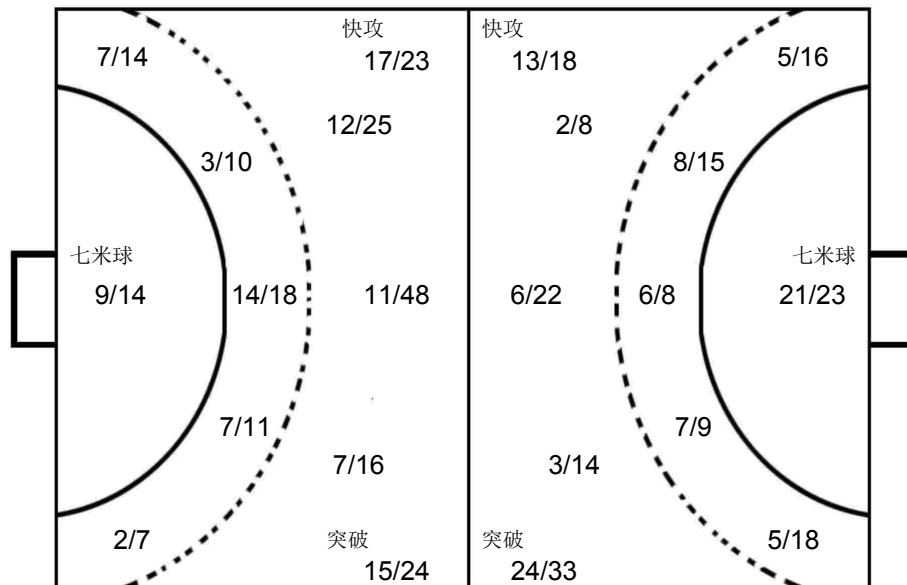

宿州
12 黄紫蝶
2/3 2/3 2/4
3/10 3/3 5/11
4/12 2/2 1/7

平遥
12 战慧
3/5 1/1 0/4
2/3 1/1 1/2
1/5 0/1 3/4

晋中
1 邓雅楠
1/1 0/1
1/1 4/4 2/2
1/5 1/1 1/4

OPPONENT

宿州 9 李旗 1 0 2 2 0 6 0 1 3 Post - 4 Miss - 1 Block - 2	宿州 18 刘怡涵 3 0 3 6 0 1 Post - 0 Miss - 1 Block - 0	宿州 22 钦马晴 1 0 0 2 0 4 1 0 2 Post - 1 Miss - 2 Block - 0	晋中 7 郭敬婷 2 0 0 1 0 2 3 0 1 Post - 0 Miss - 2 Block - 1	平遥 9 马文龙 0 0 3 0 0 2 1 0 1 Post - 0 Miss - 0 Block - 0	汉得堡 9 张晓静 1 0 0 1 0 0 2 0 1 Post - 2 Miss - 0 Block - 1	平遥 15 徐翹悦 1 0 0 0 0 0 3 0 0 Post - 0 Miss - 0 Block - 0	平遥 20 崔嘉欣 2 0 0 1 0 0 1 0 0 Post - 1 Miss - 0 Block - 0
宿州 21 王嫚丽 2 0 0 0 0 1 1 0 0 Post - 0 Miss - 0 Block - 0	汉得堡 14 尹春霞 0 0 1 1 0 0 0 0 1 Post - 1 Miss - 2 Block - 1	晋中 10 王玮 0 0 0 2 0 0 1 0 0 Post - 2 Miss - 1 Block - 1	晋中 15 杜佳奕 0 0 1 2 0 0 0 0 0 Post - 1 Miss - 0 Block - 0	平遥 3 宫訢 0 0 1 0 0 0 0 0 2 Post - 0 Miss - 0 Block - 0	平遥 10 张越 1 1 1 0 0 0 0 0 0 Post - 0 Miss - 0 Block - 0	汉得堡 3 崔艳菲 1 0 0 0 0 0 0 0 0 Post - 0 Miss - 1 Block - 0	汉得堡 10 穆梦欣 0 0 0 0 0 0 1 0 1 Post - 0 Miss - 0 Block - 0

第二届全国青年运动会女子手球甲组决赛 俱乐部组 (U18)

球队名单

福建汉得堡

山西晋中

2019-06-15

号码	姓名	位置	生日	年龄	俱乐部	身高 (CM)	体重 (KG)	国际场次	国际进球
2	张心茹	右后卫	27/09/2001	17		170	66		
3	崔艳菲	左边锋	04/02/2001	18		163	56		
5	李倩	底线	15/10/2003	15		163	53		
7	李珂欣	中后卫	31/01/2005	14		168	60		
8	魏雅欣	右后卫	12/04/2005	14		165	55		
9	张晓静	右后卫	19/07/2001	17		168	62		
10	穆梦欣	左后卫	19/06/2004	14		175	60		
11	孙瑞	右边锋	02/07/2002	16		175	70		
12	张跃	守门员	28/09/2002	16		175	57		
14	尹春霞	左后卫	02/04/2003	16		175	56		
15	万里云杉	左边锋	02/09/2004	14		167	63		
16	王红	守门员	14/01/2001	18		174	55		
17	邱兰曦	左边锋	06/11/2002	16		165	68		
18	邱兰晴	右边锋	06/11/2002	16		165	70		
19	林舒婧	右后卫	09/10/2002	16		162	52		
21	张雪梅	右边锋	24/05/2001	18		166	50		
	平均			15.9		168.5	59.6		

编码	姓名	职务
A	曾令斌	领队
B	王卫	主教练
C	辛英杰	教练
D	刘娜	教练
E	钟秀梅	医生

手球  
青年女子

## 个人/全队技术累计表

 山西晋中  
2019-06-23

截止至第87场

号码	姓名	远射	近射	边射	快攻	突破	任意	七米	合计	%	助攻	失误	警告	2'	取消	场次	时间
<b>福建汉得堡</b>																	
<b>(场上队员)</b>																	
2	张心茹		1/1						1/1	100%		2				5	00:24:49
3	崔艳菲	1/3	3/3	0/7	2/3	2/3			8/19	42.1%		11				6	02:51:02
5	李倩			0/1					0/1	0.0%		2				6	00:26:47
7	李珂欣	0/2	3/3	0/1	1/1		0/1		4/8	50.0%	1	5	4	4		6	03:39:00
8	魏雅欣			0/1					0/1	0.0%		1				6	00:31:23
9	张晓静	5/14	3/4	1/2	2/3	4/6		4/4	19/33	57.6%	1	29	2	2		6	03:18:18
10	穆梦欣	1/8	4/8	0/3	1/1	2/3	0/1		8/24	33.3%	1	21	2	7		6	03:52:04
11	孙瑞		0/1	6/7	2/2			1/1	9/11	81.8%		9	1	1		6	01:34:44
12	张跃															6	00:36:55
14	尹春霞	9/24	2/6	1/3	4/5		2/3	7/8	25/49	51.0%	4	24	1	4		6	03:45:53
15	万里云杉			0/1					0/1	0.0%						6	00:15:04
16	王红											3				6	03:23:05
17	邱兰曦															3	00:00:00
18	邱兰晴															3	00:00:00
19	林舒婧															3	00:00:00
21	张雪梅		0/1	2/11	4/4	4/4		2/2	12/22	54.5%	3	10	1	1		6	03:16:45
<b>合计</b>		<b>16/51</b>	<b>16/27</b>	<b>10/37</b>	<b>16/19</b>	<b>12/16</b>	<b>2/5</b>	<b>14/15</b>	<b>86/170</b>	<b>50.6%</b>	<b>10</b>	<b>117</b>	<b>11</b>	<b>19</b>		<b>86</b>	
<b>(守门员)</b>																	
12	张跃	3/4	1/5	2/3	1/1	1/2	2/4	0/1	10/20	50.0%						6	00:36:55
16	王红	11/26	4/16	13/25	2/18	3/12	8/9	1/6	42/112	37.5%		3				6	03:23:05
<b>合计</b>		<b>14/30</b>	<b>5/21</b>	<b>15/28</b>	<b>3/19</b>	<b>4/14</b>	<b>10/13</b>	<b>1/7</b>	<b>52/132</b>	<b>39.4%</b>		<b>3</b>				<b>12</b>	

场上队员：得分/射门

守门员：救球/射门

已打比赛

全队合计	进球	被救	射失	击柱	封球	合计	%	阶段	场次	对手	比分
远射	16	12	11	5	7	51	31.4%	预赛	12	淮南	13:19 (9:9)
近射	16	6	4	1		27	59.3%	预赛	28	晋中	11:19 (6:11)
边射	10	20	4	3		37	27.0%	预赛	44	桃渚	18:1 (9:0)
快攻	16	1	1	1		19	84.2%	预赛	48	宿州	11:16 (5:7)
突破	12	2	1	1		16	75.0%	预赛	65	平遥	10:20 (3:8)
任意	2	2		1		5	40.0%	5-6名	86	桃渚	23:5 (8:4)
七米	14			1		15	93.3%				

图式射门区域累计

手球  
青年女子

截止至第87场

山西晋中  
2019-06-23

福建汉得堡

2 张心茹 1 Post - 0 Miss - 0 Block - 0	3 崔艳菲 4 4 Post - 1 Miss - 2 Block - 0	5 李倩 Post - 0 Miss - 0 Block - 0	7 李珂欣 1 2 1 Post - 2 Miss - 0 Block - 0	8 魏雅欣 Post - 0 Miss - 0 Block - 0	9 张晓静 2 3 2 3 3 1 5 Post - 3 Miss - 1 Block - 3	10 穆梦欣 1 2 4 Post - 1 Miss - 6 Block - 1	11 孙瑞 2 1 2 1 3 Post - 0 Miss - 2 Block - 0
12 张跃 Post - 0 Miss - 0 Block - 0	14 尹春霞 7 5 2 3 5 3 Post - 6 Miss - 8 Block - 3	15 万里云杉 Post - 0 Miss - 1 Block - 0	16 王红 Post - 0 Miss - 0 Block - 0	17 邱兰曦 Post - 0 Miss - 0 Block - 0	18 邱兰晴 Post - 0 Miss - 0 Block - 0	19 林舒婧 Post - 0 Miss - 0 Block - 0	21 张雪梅 3 4 4 1 Post - 0 Miss - 1 Block - 0

12 张跃

2/3	2/3	1/2
3/5	0/1	1/2
0/1		1/3

16 王红

8/12	5/5	13/29
5/18	3/3	4/16
0/14	3/5	1/10

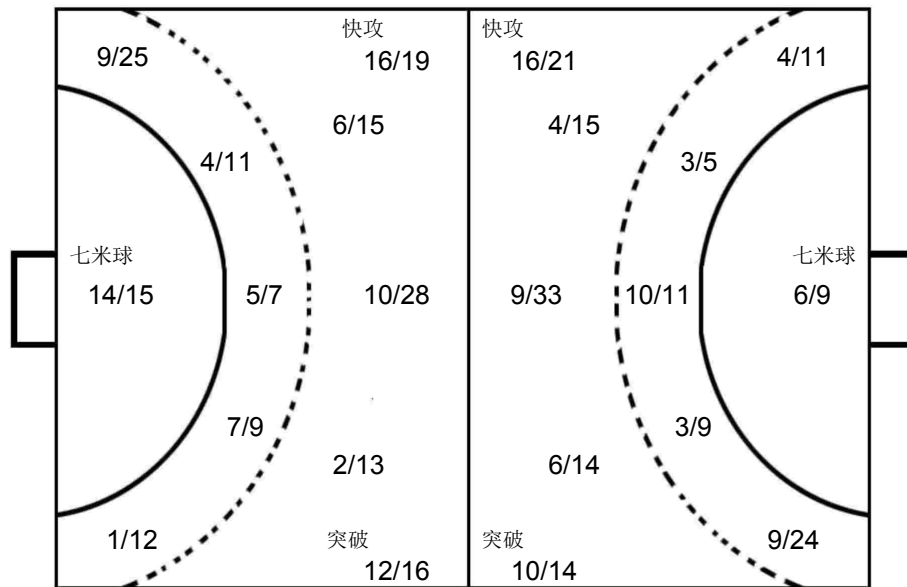

桃渚

9 黄琼妮

1/12	3/3	3/8
0/7	4/4	0/2
0/6	0/2	1/9

平遥

12 战慧

0/2		
1/1	3/3	3/5
0/3		

晋中

1 邓雅楠

1/2	1/1	2/3
		1/3
0/1		2/2

OPPONENT

平遥 20 崔嘉欣 5 2 1 Post - 1 Miss - 1 Block - 0	淮南 4 张天琦 1 1 1 1 1 Post - 0 Miss - 2 Block - 1	晋中 7 郭敏婷 2 1 1 Post - 0 Miss - 0 Block - 0	淮南 13 杨梦颖 2 2 1 Post - 3 Miss - 0 Block - 0	桃渚 2 骆佩瑶 1 1 3 Post - 0 Miss - 0 Block - 1	宿州 22 钦马晴 1 1 2 1 Post - 0 Miss - 2 Block - 0	淮南 7 承然 3 1 Post - 0 Miss - 1 Block - 0	晋中 8 孙雨菲 1 1 2 Post - 0 Miss - 0 Block - 0
平遥 10 张越 1 2 Post - 0 Miss - 0 Block - 0	宿州 23 郭茹文 2 1 Post - 0 Miss - 0 Block - 0	晋中 15 杜佳奕 1 1 Post - 0 Miss - 0 Block - 0	晋中 20 尹艺霖 1 1 Post - 0 Miss - 0 Block - 0	平遥 3 宫訢 1 1 Post - 0 Miss - 0 Block - 0	平遥 9 马文龙 2 Post - 0 Miss - 1 Block - 2	平遥 15 徐翹悦 1 1 Post - 0 Miss - 0 Block - 0	平遥 26 李言娜 2 Post - 0 Miss - 1 Block - 0

第二届全国青年运动会女子手球甲组决赛 俱乐部组 (U18)

球队名单

山西晋中

2019-06-15

浙江桃渚

号码	姓名	位置	生日	年龄	俱乐部	身高 (CM)	体重 (KG)	国际场次	国际进球
2	骆佩瑶	右边锋	23/04/2001	18	桃渚青少年体育俱乐部	174	68		
3	缪馨悦	后卫	03/07/2005	13	桃渚青少年体育俱乐部	160	45		
5	周佩芸	左边锋	29/10/2004	14	桃渚青少年体育俱乐部	171	60		
6	黄心怡	后卫	25/01/2006	13	桃渚青少年体育俱乐部	163	60		
7	黄亚楠	右边锋	29/06/2006	12	桃渚青少年体育俱乐部	162	55		
8	董安心	底线	29/03/2005	14	桃渚青少年体育俱乐部	165	53		
9	黄琼妮	守门员	06/05/2002	17	桃渚青少年体育俱乐部	170	58		
10	骆晶晶	中后卫	26/04/2005	14	桃渚青少年体育俱乐部	165	55		
11	李盼	底线	25/05/2004	15	桃渚青少年体育俱乐部	170	63		
12	金小清	后卫	13/09/2003	15	桃渚青少年体育俱乐部	165	63		
13	陈梦瑶	右边锋	11/12/2004	14	桃渚青少年体育俱乐部	165	50		
15	项嘉柔	中后卫	06/08/2005	13	桃渚青少年体育俱乐部	168	52		
16	王语嫣	守门员	18/04/2006	13	桃渚青少年体育俱乐部	173	60		
17	翟馨彤	底线	30/06/2005	13	桃渚青少年体育俱乐部	168	50		
18	陈曼莎	底线	14/08/2005	13	桃渚青少年体育俱乐部	175	80		
19	邢雅	后卫	24/10/2004	14	桃渚青少年体育俱乐部	170	60		
	平均			14.1		167.8	58.3		

编码	姓名	职务
C	项建生	教练
D	冯婷婷	教练
E	蒋云敏	医生
A	黄成省	领队
B	柳日祥	主教练



手球  
青年女子

## 个人/全队技术累计表

 山西晋中  
2019-06-23

截止至第87场

号码	姓名	远射	近射	边射	快攻	突破	任意	七米	合计	%	助攻	失误	警告	2'	取消	场次	时间
<b>浙江桃渚</b>																	
<b>(场上队员)</b>																	
2	骆佩瑶	1/8	1/5			1/1	2/9		5/23	21.7%	1	27	1	1		6	02:23:51
5	周佩芸	1/33	3/6	1/18	0/1	1/2	1/24	1/2	8/86	9.3%		40		3		6	03:53:57
6	黄心怡	0/1	2/3	0/1					2/5	40.0%		7	2	2		6	03:05:17
7	黄亚楠	0/3							0/3	0.0%		37	1	1		6	03:53:28
8	董安心			0/1					0/1	0.0%	1	7	1	2		6	02:57:50
9	黄琼妮															6	03:59:54
11	李盼		0/1						0/1	0.0%						5	01:11:20
12	金小清											2				5	00:45:48
13	陈梦瑶			0/2					0/2	0.0%		1		3		6	01:49:38
15	项嘉柔															6	00:00:00
16	王语嫣															6	00:00:00
17	翟馨彤															6	00:04:24
18	陈曼莎		1/5			1/2			2/7	28.6%		10				6	03:51:29
	<b>合计</b>	<b>2/45</b>	<b>7/20</b>	<b>1/22</b>	<b>0/1</b>	<b>3/5</b>	<b>3/33</b>	<b>1/2</b>	<b>17/128</b>	<b>13.3%</b>	<b>2</b>	<b>131</b>	<b>5</b>	<b>12</b>		<b>76</b>	
<b>(守门员)</b>																	
9	黄琼妮	7/25	10/28	6/24	9/62	3/20	1/4	1/11	37/174	21.3%						6	03:59:54
	<b>合计</b>	<b>7/25</b>	<b>10/28</b>	<b>6/24</b>	<b>9/62</b>	<b>3/20</b>	<b>1/4</b>	<b>1/11</b>	<b>37/174</b>	<b>21.3%</b>						<b>6</b>	

场上队员: 得分/射门

守门员: 救球/射门

## 已打比赛

全队合计	进球	被救	射失	击柱	封球	合计	%	阶段	场次	对手	比分
远射	2	28	10	2	3	45	4.4%	预赛	13	宿州	1:21 (0:11)
近射	7	8	2	2	1	20	35.0%	预赛	26	平遥	2:25 (0:15)
边射	1	16	5			22	4.5%	预赛	44	汉得堡	1:18 (0:9)
快攻		1				1	0.0%	预赛	46	晋中	6:33 (0:19)
突破	3	1	1			5	60.0%	预赛	67	淮南	2:17 (1:9)
任意	3	20	8	2		33	9.1%	5-6名	86	汉得堡	5:23 (4:8)
七米	1	1				2	50.0%				

图式射门区域累计

手球  
青年女子

截止至第87场

山西晋中  
2019-06-23

浙江桃渚

2 骆佩瑶	5 周佩芸	6 黄心怡	7 黄亚楠	8 董安心	9 黄琼妮	11 李盼	12 金小清																																																																								
<table border="1"><tr><td></td><td>1</td><td></td></tr><tr><td></td><td></td><td></td></tr><tr><td></td><td>1</td><td>3</td></tr></table>		1						1	3	<table border="1"><tr><td>3</td><td></td><td>1</td></tr><tr><td>1</td><td></td><td>3</td></tr><tr><td></td><td></td><td></td></tr></table>	3		1	1		3				<table border="1"><tr><td></td><td></td><td></td></tr><tr><td></td><td></td><td></td></tr><tr><td>2</td><td></td><td></td></tr></table>							2			<table border="1"><tr><td></td><td></td><td></td></tr><tr><td></td><td></td><td></td></tr><tr><td></td><td></td><td></td></tr></table>										<table border="1"><tr><td></td><td></td><td></td></tr><tr><td></td><td></td><td></td></tr><tr><td></td><td></td><td></td></tr></table>										<table border="1"><tr><td></td><td></td><td></td></tr><tr><td></td><td></td><td></td></tr><tr><td></td><td></td><td></td></tr></table>										<table border="1"><tr><td></td><td></td><td></td></tr><tr><td></td><td></td><td></td></tr><tr><td></td><td></td><td></td></tr></table>										<table border="1"><tr><td></td><td></td><td></td></tr><tr><td></td><td></td><td></td></tr><tr><td></td><td></td><td></td></tr></table>									
	1																																																																														
	1	3																																																																													
3		1																																																																													
1		3																																																																													
2																																																																															
Post - 0 Miss - 1 Block - 1	Post - 6 Miss - 19 Block - 2	Post - 0 Miss - 1 Block - 0	Post - 0 Miss - 1 Block - 0	Post - 0 Miss - 0 Block - 0	Post - 0 Miss - 0 Block - 0	Post - 0 Miss - 0 Block - 0	Post - 0 Miss - 0 Block - 0																																																																								
13 陈梦瑶	15 项嘉柔	16 王语嫣	17 翟馨彤	18 陈曼莎																																																																											
<table border="1"><tr><td></td><td></td><td></td></tr><tr><td></td><td></td><td></td></tr><tr><td></td><td></td><td></td></tr></table>										<table border="1"><tr><td></td><td></td><td></td></tr><tr><td></td><td></td><td></td></tr><tr><td></td><td></td><td></td></tr></table>										<table border="1"><tr><td></td><td></td><td></td></tr><tr><td></td><td></td><td></td></tr><tr><td></td><td></td><td></td></tr></table>										<table border="1"><tr><td></td><td></td><td></td></tr><tr><td></td><td></td><td></td></tr><tr><td></td><td></td><td></td></tr></table>										<table border="1"><tr><td></td><td></td><td></td></tr><tr><td></td><td></td><td></td></tr><tr><td>1</td><td></td><td>1</td></tr></table>							1		1																														
1		1																																																																													
Post - 0 Miss - 1 Block - 0	Post - 0 Miss - 0 Block - 0	Post - 0 Miss - 0 Block - 0	Post - 0 Miss - 0 Block - 0	Post - 0 Miss - 3 Block - 1																																																																											

9 黄琼妮

2/31	6/6	4/24
10/31	7/7	6/19
0/30	0/2	2/24

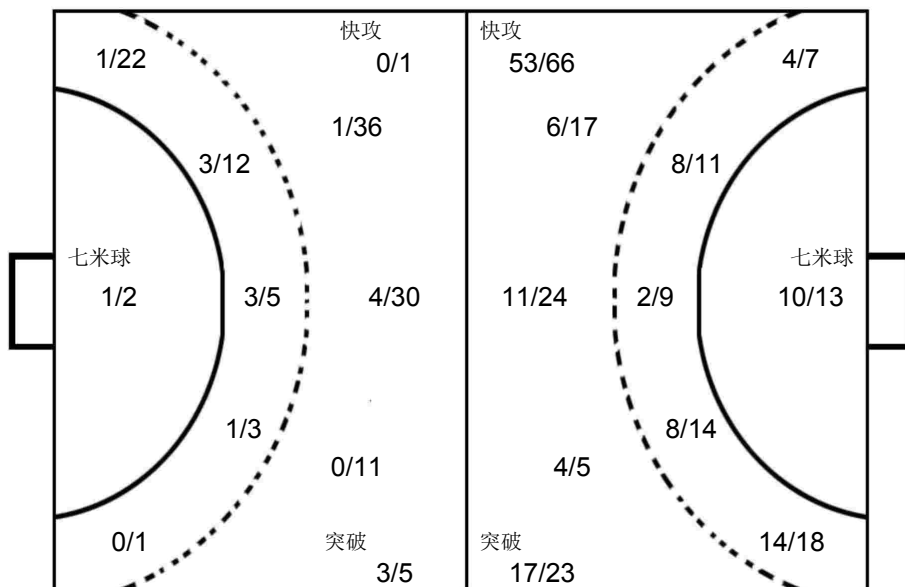

宿州

12 黄紫蝶

3/3		3/3
1/1	2/2	2/3
1/1	2/2	1/1

晋中

1 邓雅楠

	1/1	6/6
0/2	1/1	3/5
1/2		1/2

汉得堡

16 王红

1/1	2/2	5/5
	1/1	3/3
	0/1	1/2

OPPONENT

汉得堡	宿州	汉得堡	晋中	汉得堡	平遥	汉得堡	淮南																																																																								
14 尹春霞	9 李旗	11 孙瑞	2 付雪杰	21 张雪梅	20 崔嘉欣	9 张晓静	1 万文倩																																																																								
<table border="1"><tr><td>6</td><td></td><td>1</td></tr><tr><td>1</td><td></td><td>1</td></tr><tr><td>3</td><td></td><td>1</td></tr></table>	6		1	1		1	3		1	<table border="1"><tr><td></td><td></td><td>3</td></tr><tr><td></td><td></td><td>3</td></tr><tr><td>2</td><td></td><td>2</td></tr></table>			3			3	2		2	<table border="1"><tr><td>2</td><td></td><td></td></tr><tr><td>1</td><td></td><td></td></tr><tr><td>2</td><td>1</td><td>3</td></tr></table>	2			1			2	1	3	<table border="1"><tr><td>3</td><td></td><td>3</td></tr><tr><td></td><td></td><td>1</td></tr><tr><td></td><td></td><td>1</td></tr></table>	3		3			1			1	<table border="1"><tr><td>2</td><td></td><td></td></tr><tr><td>3</td><td></td><td></td></tr><tr><td>1</td><td></td><td></td></tr></table>	2			3			1			<table border="1"><tr><td></td><td></td><td></td></tr><tr><td>2</td><td></td><td>1</td></tr><tr><td>2</td><td></td><td>1</td></tr></table>				2		1	2		1	<table border="1"><tr><td></td><td></td><td>2</td></tr><tr><td></td><td></td><td>1</td></tr><tr><td></td><td>1</td><td>1</td></tr></table>			2			1		1	1	<table border="1"><tr><td>1</td><td></td><td></td></tr><tr><td></td><td></td><td></td></tr><tr><td>4</td><td></td><td></td></tr></table>	1						4		
6		1																																																																													
1		1																																																																													
3		1																																																																													
		3																																																																													
		3																																																																													
2		2																																																																													
2																																																																															
1																																																																															
2	1	3																																																																													
3		3																																																																													
		1																																																																													
		1																																																																													
2																																																																															
3																																																																															
1																																																																															
2		1																																																																													
2		1																																																																													
		2																																																																													
		1																																																																													
	1	1																																																																													
1																																																																															
4																																																																															
Post - 0 Miss - 4 Block - 0	Post - 0 Miss - 0 Block - 0	Post - 0 Miss - 1 Block - 0	Post - 0 Miss - 0 Block - 0	Post - 0 Miss - 0 Block - 0	Post - 0 Miss - 0 Block - 0	Post - 1 Miss - 1 Block - 0	Post - 0 Miss - 0 Block - 0																																																																								
淮南	晋中	汉得堡	晋中	平遥	汉得堡	淮南	晋中																																																																								
13 杨梦颖	8 孙雨菲	10 穆梦欣	19 于颖	18 范小雁	7 李珂欣	9 叶飞雪	5 王晓敏																																																																								
<table border="1"><tr><td></td><td></td><td></td></tr><tr><td>1</td><td></td><td>1</td></tr><tr><td>2</td><td></td><td>1</td></tr></table>				1		1	2		1	<table border="1"><tr><td></td><td></td><td>1</td></tr><tr><td></td><td></td><td></td></tr><tr><td>4</td><td></td><td></td></tr></table>			1				4			<table border="1"><tr><td></td><td></td><td>1</td></tr><tr><td></td><td></td><td></td></tr><tr><td></td><td></td><td>3</td></tr></table>			1						3	<table border="1"><tr><td></td><td></td><td></td></tr><tr><td>1</td><td></td><td></td></tr><tr><td>1</td><td></td><td>2</td></tr></table>				1			1		2	<table border="1"><tr><td>1</td><td></td><td></td></tr><tr><td>1</td><td></td><td></td></tr><tr><td></td><td></td><td>2</td></tr></table>	1			1					2	<table border="1"><tr><td></td><td></td><td>1</td></tr><tr><td>2</td><td></td><td></td></tr><tr><td></td><td></td><td></td></tr></table>			1	2						<table border="1"><tr><td>1</td><td></td><td></td></tr><tr><td>1</td><td></td><td></td></tr><tr><td></td><td></td><td>1</td></tr></table>	1			1					1	<table border="1"><tr><td>2</td><td></td><td></td></tr><tr><td></td><td></td><td></td></tr><tr><td>1</td><td></td><td></td></tr></table>	2						1		
1		1																																																																													
2		1																																																																													
		1																																																																													
4																																																																															
		1																																																																													
		3																																																																													
1																																																																															
1		2																																																																													
1																																																																															
1																																																																															
		2																																																																													
		1																																																																													
2																																																																															
1																																																																															
1																																																																															
		1																																																																													
2																																																																															
1																																																																															
Post - 1 Miss - 1 Block - 0	Post - 1 Miss - 2 Block - 0	Post - 0 Miss - 3 Block - 0	Post - 0 Miss - 0 Block - 0	Post - 0 Miss - 0 Block - 0	Post - 0 Miss - 0 Block - 0	Post - 0 Miss - 0 Block - 0	Post - 0 Miss - 0 Block - 0																																																																								



第二届全国青年运动会女子手球甲组决赛 俱乐部组 (U18)

青年女子 全国比赛

预赛 Group A



PHMS Pictorial Handball Match Statistics

IHF Official System

Team A A 安徽淮南				Team B B 福建汉得堡				Match Number <b>12</b>			
------------------	--	--	--	-------------------	--	--	--	---------------------------	--	--	--

Played in 山西晋中	in the hall 晋中体育馆	on 2019-06-15	at 19:40	hours	Spectators
-------------------	----------------------	------------------	-------------	-------	------------

Half-time(30')	A 9	B 9	End of playing time	A 19	B 13	1st extra time	A	B	2nd extra time	A	B	After penalty throws	A	B
----------------	--------	--------	---------------------	---------	---------	----------------	---	---	----------------	---	---	----------------------	---	---

Number of 7 m	A 1/1	Team time-out			Full name of players and officials	Team time-out			B 6/6	Number of 7 m
	1 09:05	2	3	1 04:22		2 25:24	3			

No.	Team A	G	W	2'	D	DR	No.	Team B	G	W	2'	D	DR
1	万文倩						2	张心茹					
2	孙雨欣						3	崔艳菲	2				
3	陈杨						5	李倩					
4	张天琦	7		1			7	李珂欣		1			
5	高鑫艺						8	魏雅欣					
6	吕少华						9	张晓静	5				
7	承然	4	1	1			10	穆梦欣	2	1			
8	董婧						11	孙瑞					
9	叶飞雪						12	张跃					
10	王梦皖	1	1				14	尹春霞	3				
11	徐静						15	万里云杉					
12	宋诗情	1					16	王红					
13	杨梦颖	6					21	张雪梅	1				
14	张美琪												
15	陈可怡												
16	陈静文												
A	常洪飞						A	曾令斌					
B	孙永永						B	王卫 (主教练)					
							C	辛英杰					
							D	刘娜					

A	Signatures of responsables for the teams (Off.A)												B
---	--	--	--	--	--	--	--	--	--	--	--	--	---

TP	Remarks of referees / HF Official													TP
----	-----------------------------------	--	--	--	--	--	--	--	--	--	--	--	--	----

Referees	马晓晔 (CHN)	孟凡刚 (CHN)		
T.D.	叶霄雪 (CHN)	刘凤娟 (CHN)		
CHA Off.				

Note: Number of 7m Throws Awarded to Team A and B, Goals (G), Warnings (W), Suspensions (2'), Direct Disqualification (D), Disqualification With Report (DR) and Team Penalty (TP).

Table Officials: 刘明华 黄一凡 Statisticians: 陈柱 谢杨

竞赛技术统计

手球  
青年女子

预赛  
轮次 1

组别 A  
场次 12

晋中体育馆  
2019-06-15 19:40

Referees: 马晓晔 (CHN) / 孟凡刚 (CHN)

Result: 19:13(9:9)

Teams: 安徽淮南(淮南) VS 福建汉得堡(汉得堡)

淮南		远射	近射	边射	快攻	突破	任意球	7m球	合计	%	助攻	失误	警告	2'	D+DR
主教练: 阮圣杰															
1	万文倩														
2	孙雨欣											1			
3	陈杨														
4	张天琦	1/4	3/3	1/1	1/2	1/1			7/11	63.6	1	5		1	
5	高鑫艺														
6	吕少华														
7	承然	2/3	1/2		1/1	0/1			4/7	57.1		6	1	1	
8	董婧														
9	叶飞雪			0/1					0/1	0.0		1			
10	王梦皖				1/1				1/1	100			1		
11	徐静														
12	宋诗情			1/1					1/1	100					
13	杨梦颖	2/6	1/1		1/2	1/1		1/1	6/11	54.5	1				
14	张美琪														
15	陈可怡			0/1					0/1	0.0		1			
16	陈静文														
运动员 合计		5/13	5/6	2/4	4/6	2/3		1/1	19/33	57.6	2	14	2	2	
1	万文倩		0/4	7/8	0/1	0/1		0/6	7/20	35.0					
守门员 合计			0/4	7/8	0/1	0/1		0/6	7/20	35.0					

汉得堡		远射	近射	边射	快攻	突破	任意球	7m球	合计	%	助攻	失误	警告	2'	D+DR
主教练: 王卫															
2	张心茹														
3	崔艳菲		1/1	0/3		1/1			2/5	40.0		2			
5	李倩														
7	李珂欣			0/1			0/1		0/2	0.0		1	1		
8	魏雅欣														
9	张晓静	0/1	0/1	1/1		0/1		4/4	5/8	62.5	1	8			
10	穆梦欣		2/2	0/2					2/4	50.0		3	1		
11	孙瑞														
12	张跃														
14	尹春霞	0/4	1/1					2/2	3/7	42.9		6			
15	万里云杉														
16	王红														
21	张雪梅			0/3	1/1				1/4	25.0		1			
运动员 合计		0/5	4/5	1/10	1/1	1/2	0/1	6/6	13/30	43.3	1	21	2		
12	张跃		0/2						0/2	0.0					
16	王红	3/8	1/4	1/3	0/4	1/3		0/1	6/23	26.1					
守门员 合计		3/8	1/6	1/3	0/4	1/3		0/1	6/25	24.0					

淮南	比赛进程	汉得堡
1st Half		
4 张天琦	1 00:27	0
13 杨梦颖	2 02:48	0
7 承然	3 04:09	0
	3 05:54	1 3 崔艳菲
4 张天琦	4 06:09	1
	4 08:55	2 21 张雪梅
13 杨梦颖	5 09:28	2
	5 10:02	3 3 崔艳菲
4 张天琦	6 10:53	3
	6 11:39	4 9 张晓静
4 张天琦	7 13:33	4
7 承然	8 14:28	4
	8 15:08	5 14 尹春霞
	8 15:48	6 9 张晓静
	8 16:41	7 14 尹春霞
7 承然	9 17:20	7
	9 18:30	8 9 张晓静
	9 19:51	9 14 尹春霞
2nd Half		
10 王梦皖	10 02:11	9
	10 02:47	10 10 穆梦欣
13 杨梦颖	11 03:08	10
	11 03:56	11 9 张晓静
13 杨梦颖	12 05:14	11
4 张天琦	13 07:46	11
	13 09:52	12 10 穆梦欣
13 杨梦颖	14 10:22	12
	14 11:26	13 9 张晓静
7 承然	15 14:42	13
12 宋诗情	16 17:45	13
4 张天琦	17 18:43	13
13 杨梦颖	18 19:26	13
4 张天琦	19 19:44	13

场上队员: 得分 / 射门

守门员: 救球 / 射门

D	取消资格	DR	取消资格+报告
---	------	----	---------

## 个人/全队技术统计表

手球 青年女子 预赛 轮次 1 组别 A 场次 12 晋中体育馆 2019-06-15 19:40

号码	姓名	远射	近射	边射	快攻	突破	任意	七米	合计	%	助攻	失误	警告	2'	取消	时间
安徽淮南(淮南)																
(场上队员)																
1	万文倩									0.0%						00:40:00
2	孙雨欣									0.0%		1				00:20:00
3	陈杨									0.0%						00:00:00
4	张天琦	1/4	3/3	1/1	1/2	1/1			7/11	63.6%	1	5		1		00:39:00
5	高鑫艺									0.0%						00:00:00
6	吕少华									0.0%						00:00:00
7	承然	2/3	1/2		1/1	0/1			4/7	57.1%		6	1	1		00:37:57
8	董婧									0.0%						00:00:00
9	叶飞雪			0/1					0/1	0.0%		1				00:07:52
10	王梦皖				1/1				1/1	100%			1			00:40:00
11	徐静									0.0%						00:00:00
12	宋诗情			1/1					1/1	100%						00:17:01
13	杨梦颖	2/6	1/1		1/2	1/1		1/1	6/11	54.5%	1					00:40:00
14	张美琪									0.0%						00:00:00
15	陈可怡			0/1					0/1	0.0%		1				00:37:40
16	陈静文									0.0%						00:00:00
合计		5/13	5/6	2/4	4/6	2/3		1/1	19/33	57.6%	2	14	2	2		
(守门员)																
1	万文倩		0/4	7/8	0/1	0/1		0/6	7/20	35.0%						00:40:00
合计			0/4	7/8	0/1	0/1		0/6	7/20	35.0%						

场上队员：得分/射门

守门员：救球/射门

全队合计	得分	被救	射失	击柱	封球	合计	%
远射	5	3	2	2	1	13	38.5%
近射	5	1				6	83.3%
边射	2	1		1		4	50.0%
快攻	4		1	1		6	66.7%
突破	2	1				3	66.7%
任意							0.0%
七米	1					1	100.0%

第二届全国青年运动会女子手球甲组决赛 俱乐部组 (U18)

PHMS Pictorial Handball Match Statistics

IHF Official System

个人/全队技术统计表

手球 青年女子 预赛 轮次 1 组别 A 场次 12 晋中体育馆 2019-06-15 19:40

号码	姓名	远射	近射	边射	快攻	突破	任意	七米	合计	%	助攻	失误	警告	2'	取消	时间
福建汉得堡(汉得堡)																
(场上队员)																
2	张心茹									0.0%						00:00:00
3	崔艳菲		1/1	0/3		1/1			2/5	40.0%		2				00:39:44
5	李倩									0.0%						00:01:41
7	李珂欣			0/1			0/1		0/2	0.0%		1	1			00:36:07
8	魏雅欣									0.0%						00:00:00
9	张晓静	0/1	0/1	1/1		0/1		4/4	5/8	62.5%	1	8				00:37:57
10	穆梦欣		2/2	0/2					2/4	50.0%		3	1			00:39:30
11	孙瑞									0.0%						00:00:00
12	张跃									0.0%						00:04:01
14	尹春霞	0/4	1/1					2/2	3/7	42.9%		6				00:39:48
15	万里云杉									0.0%						00:03:32
16	王红									0.0%						00:35:59
21	张雪梅			0/3	1/1				1/4	25.0%		1				00:39:28
	合计	0/5	4/5	1/10	1/1	1/2	0/1	6/6	13/30	43.3%	1	21	2			
(守门员)																
12	张跃		0/2						0/2	0.0%						00:04:01
16	王红	3/8	1/4	1/3	0/4	1/3		0/1	6/23	26.1%						00:35:59
	合计	3/8	1/6	1/3	0/4	1/3		0/1	6/25	24.0%						

场上队员：得分/射门

守门员：救球/射门

全队合计	得分	被救	射失	击柱	封球	合计	%
远射			2	1	2	5	0.0%
近射	4			1		5	80.0%
边射	1	7	1	1		10	10.0%
快攻	1					1	100.0%
突破	1			1		2	50.0%
任意				1		1	0.0%
七米	6					6	100.0%

图式比赛技术统计表

手球  
青年女子

预赛  
轮次 1

组别 A  
场次 12

晋中体育馆  
2019-06-15 19:40

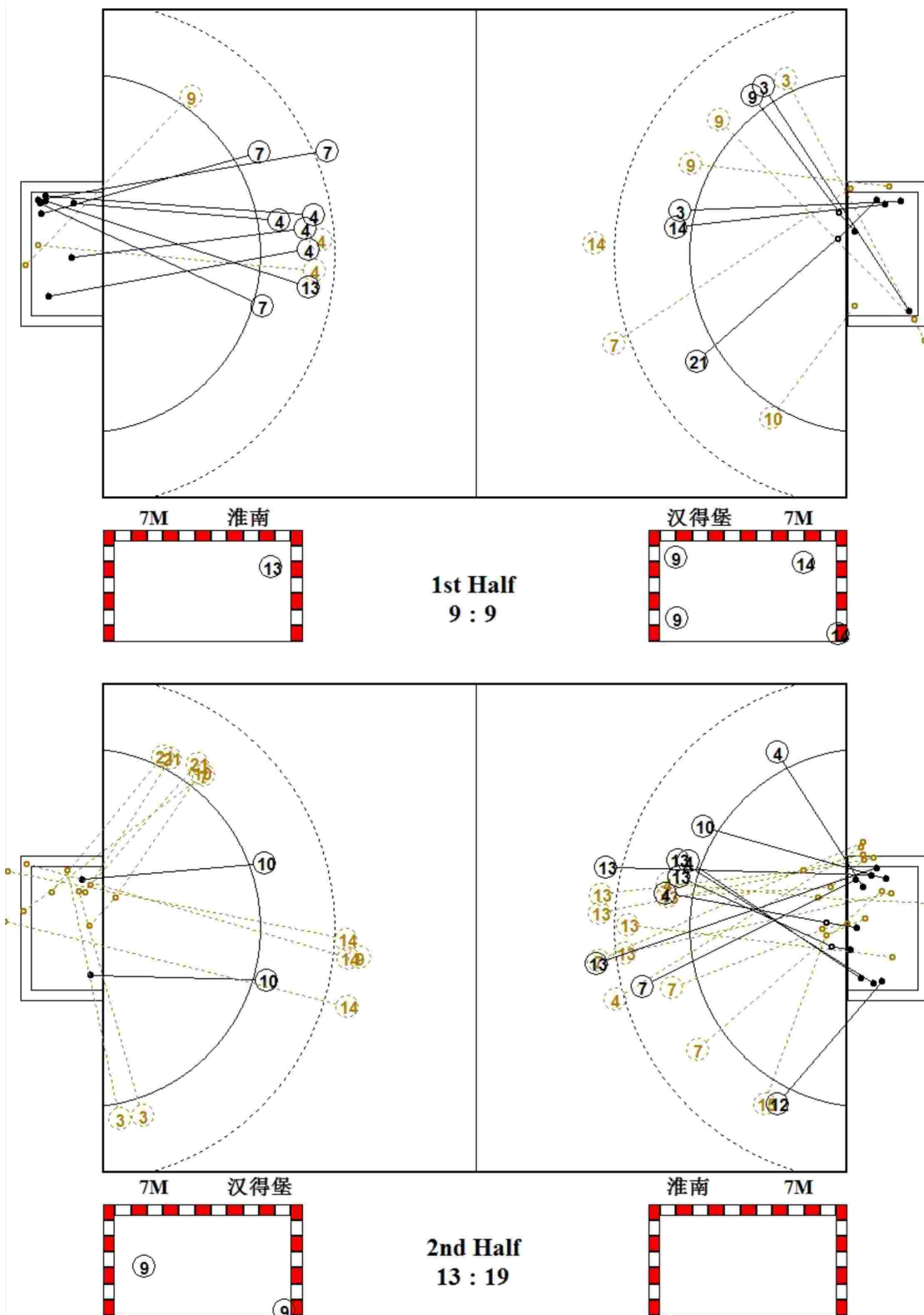

图式射门区域统计

手球  
青年女子

预赛  
轮次 1

组别 A  
场次 12

晋中体育馆  
2019-06-15 19:40

安徽淮南

1 万文倩 <table border="1"><tr><td></td><td></td><td></td></tr><tr><td></td><td></td><td></td></tr><tr><td></td><td></td><td></td></tr></table> Post - 0 Miss - 0 Block - 0										2 孙雨欣 <table border="1"><tr><td></td><td></td><td></td></tr><tr><td></td><td></td><td></td></tr><tr><td></td><td></td><td></td></tr></table> Post - 0 Miss - 0 Block - 0										3 陈杨 <table border="1"><tr><td></td><td></td><td></td></tr><tr><td></td><td></td><td></td></tr><tr><td></td><td></td><td></td></tr></table> Post - 0 Miss - 0 Block - 0										4 张天琦 <table border="1"><tr><td>1</td><td></td><td>1</td></tr><tr><td></td><td>1</td><td>1</td></tr><tr><td>1</td><td>1</td><td>1</td></tr></table> Post - 0 Miss - 2 Block - 1	1		1		1	1	1	1	1	5 高鑫艺 <table border="1"><tr><td></td><td></td><td></td></tr><tr><td></td><td></td><td></td></tr><tr><td></td><td></td><td></td></tr></table> Post - 0 Miss - 0 Block - 0										6 吕少华 <table border="1"><tr><td></td><td></td><td></td></tr><tr><td></td><td></td><td></td></tr><tr><td></td><td></td><td></td></tr></table> Post - 0 Miss - 0 Block - 0										7 承然 <table border="1"><tr><td></td><td></td><td>3</td></tr><tr><td></td><td></td><td></td></tr><tr><td>1</td><td></td><td></td></tr></table> Post - 0 Miss - 1 Block - 0			3				1			8 董婧 <table border="1"><tr><td></td><td></td><td></td></tr><tr><td></td><td></td><td></td></tr><tr><td></td><td></td><td></td></tr></table> Post - 0 Miss - 0 Block - 0									
1		1																																																																													
	1	1																																																																													
1	1	1																																																																													
		3																																																																													
1																																																																															
9 叶飞雪 <table border="1"><tr><td></td><td></td><td></td></tr><tr><td></td><td></td><td></td></tr><tr><td></td><td></td><td></td></tr></table> Post - 1 Miss - 0 Block - 0										10 王梦婉 <table border="1"><tr><td>1</td><td></td><td></td></tr><tr><td></td><td></td><td></td></tr><tr><td></td><td></td><td></td></tr></table> Post - 0 Miss - 0 Block - 0	1									11 徐静 <table border="1"><tr><td></td><td></td><td></td></tr><tr><td></td><td></td><td></td></tr><tr><td></td><td></td><td></td></tr></table> Post - 0 Miss - 0 Block - 0										12 宋诗情 <table border="1"><tr><td></td><td></td><td></td></tr><tr><td></td><td></td><td>1</td></tr><tr><td></td><td></td><td></td></tr></table> Post - 0 Miss - 0 Block - 0						1				13 杨梦颖 <table border="1"><tr><td></td><td></td><td>2</td></tr><tr><td>2</td><td></td><td>1</td></tr><tr><td></td><td></td><td>1</td></tr></table> Post - 3 Miss - 0 Block - 0			2	2		1			1	14 张美琪 <table border="1"><tr><td></td><td></td><td></td></tr><tr><td></td><td></td><td></td></tr><tr><td></td><td></td><td></td></tr></table> Post - 0 Miss - 0 Block - 0										15 陈可怡 <table border="1"><tr><td></td><td></td><td></td></tr><tr><td></td><td></td><td></td></tr><tr><td></td><td></td><td></td></tr></table> Post - 0 Miss - 0 Block - 0										16 陈静文 <table border="1"><tr><td></td><td></td><td></td></tr><tr><td></td><td></td><td></td></tr><tr><td></td><td></td><td></td></tr></table> Post - 0 Miss - 0 Block - 0									
1																																																																															
		1																																																																													
		2																																																																													
2		1																																																																													
		1																																																																													

1 万文倩

0/2		1/3
0/3		2/2
0/3	1/1	3/6

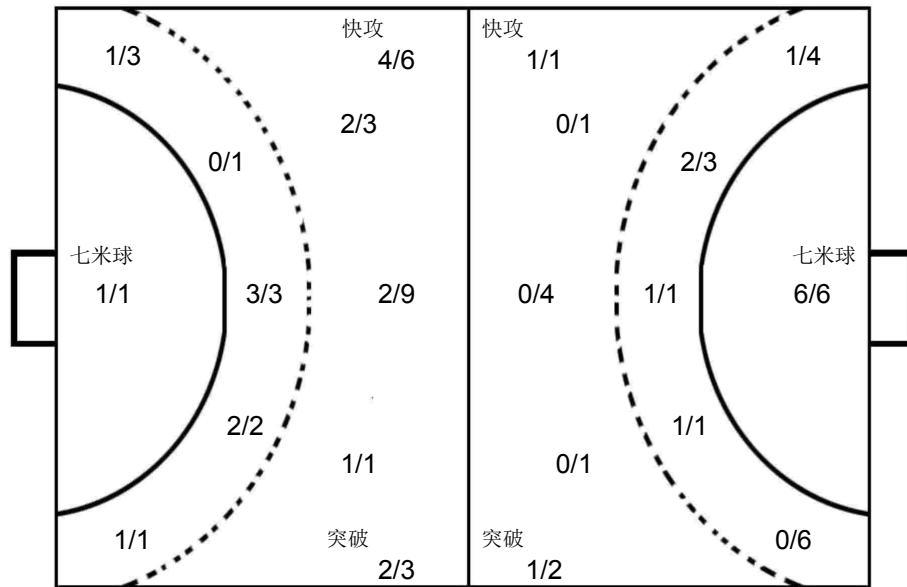

12 张跃

0/1		
	0/1	

16 王红

	1/1	0/6
2/5		1/4
0/2	2/3	0/2

福建汉得堡

2 张心茹 <table border="1"><tr><td></td><td></td><td></td></tr><tr><td></td><td></td><td></td></tr><tr><td></td><td></td><td></td></tr></table> Post - 0 Miss - 0 Block - 0										3 崔艳菲 <table border="1"><tr><td>1</td><td></td><td>1</td></tr><tr><td></td><td></td><td></td></tr><tr><td></td><td></td><td></td></tr></table> Post - 0 Miss - 1 Block - 0	1		1							5 李倩 <table border="1"><tr><td></td><td></td><td></td></tr><tr><td></td><td></td><td></td></tr><tr><td></td><td></td><td></td></tr></table> Post - 0 Miss - 0 Block - 0										7 李珂欣 <table border="1"><tr><td></td><td></td><td></td></tr><tr><td></td><td></td><td></td></tr><tr><td></td><td></td><td></td></tr></table> Post - 2 Miss - 0 Block - 0										8 魏雅欣 <table border="1"><tr><td></td><td></td><td></td></tr><tr><td></td><td></td><td></td></tr><tr><td></td><td></td><td></td></tr></table> Post - 0 Miss - 0 Block - 0										9 张晓静 <table border="1"><tr><td>1</td><td></td><td></td></tr><tr><td>1</td><td></td><td></td></tr><tr><td>2</td><td></td><td>1</td></tr></table> Post - 2 Miss - 0 Block - 1	1			1			2		1	10 穆梦欣 <table border="1"><tr><td></td><td></td><td></td></tr><tr><td></td><td></td><td></td></tr><tr><td></td><td></td><td></td></tr></table> Post - 0 Miss - 0 Block - 0										11 孙瑞 <table border="1"><tr><td></td><td></td><td></td></tr><tr><td></td><td></td><td></td></tr><tr><td></td><td></td><td></td></tr></table> Post - 0 Miss - 0 Block - 0									
1		1																																																																													
1																																																																															
1																																																																															
2		1																																																																													
12 张跃 <table border="1"><tr><td></td><td></td><td></td></tr><tr><td></td><td></td><td></td></tr><tr><td></td><td></td><td></td></tr></table> Post - 0 Miss - 0 Block - 0										14 尹春霞 <table border="1"><tr><td></td><td></td><td>1</td></tr><tr><td>1</td><td></td><td></td></tr><tr><td></td><td></td><td>1</td></tr></table> Post - 1 Miss - 2 Block - 1			1	1					1	15 万里云杉 <table border="1"><tr><td></td><td></td><td></td></tr><tr><td></td><td></td><td></td></tr><tr><td></td><td></td><td></td></tr></table> Post - 0 Miss - 0 Block - 0										16 王红 <table border="1"><tr><td></td><td></td><td></td></tr><tr><td></td><td></td><td></td></tr><tr><td></td><td></td><td></td></tr></table> Post - 0 Miss - 0 Block - 0										21 张雪梅 <table border="1"><tr><td></td><td></td><td></td></tr><tr><td></td><td></td><td></td></tr><tr><td>1</td><td></td><td></td></tr></table> Post - 0 Miss - 0 Block - 0							1																																
		1																																																																													
1																																																																															
		1																																																																													
1																																																																															





第二届全国青年运动会女子手球甲组决赛 俱乐部组 (U18)

青年女子 全国比赛

预赛 Group A



PHMS Pictorial Handball Match Statistics

IHF Official System

Team A A 浙江桃渚				Team B B 安徽宿州				Match Number <b>13</b>			
------------------	--	--	--	------------------	--	--	--	---------------------------	--	--	--

Played in 山西晋中	in the hall 晋中体育馆	on 2019-06-15	at 20:50	hours	Spectators
-------------------	----------------------	------------------	-------------	-------	------------

Half-time(30')	A 0	B 11	End of playing time	A 1	B 21	1st extra time	A	B	2nd extra time	A	B	After penalty throws	A	B
----------------	--------	---------	---------------------	--------	---------	----------------	---	---	----------------	---	---	----------------------	---	---

Number of 7 m 0/0	Team time-out			Full name of players and officials	Team time-out			B 2/3	Number of 7 m
	1 07:18	2 31:59	3		1	2	3		

No.	Team A	G	W	2'	D	DR	No.	Team B	G	W	2'	D	DR
2	骆佩瑶			1			3	姜景媛			1		
5	周佩芸	1		1			5	单文静	1				
6	黄心怡		1				7	刘文秀	1				
7	黄亚楠						8	李伟伟					
8	董安心		1	1			9	李旗	10				
9	黄琼妮						10	杨晓晓					
13	陈梦瑶			1			12	黄紫蝶					
15	项嘉柔						15	乔思雨	2				
16	王语嫣						17	田伊阳	1	1			
17	翟馨彤						18	刘怡涵	3	1			
18	陈曼莎						25	郑睿涵	1				
							26	刘洋	2				
C	项建生						B	吴昊 (主教练)					
D	冯婷婷						C	李绍魁					
							D	赵萌萌					

A	Signatures of responsables for the teams (Off.A)												B
---	--	--	--	--	--	--	--	--	--	--	--	--	---

TP	Remarks of referees / HF Official													TP
----	-----------------------------------	--	--	--	--	--	--	--	--	--	--	--	--	----

Referees	张晓虎 (CHN)	马文 (CHN)		
T.D.	刘凤娟 (CHN)	张耿 (CHN)		
CHA Off.				

Note: Number of 7m Throws Awarded to Team A and B, Goals (G), Warnings (W), Suspensions (2'), Direct Disqualification (D), Disqualification With Report (DR) and Team Penalty (TP).

Table Officials: 刘明华 黄一凡 Statisticians: 谢杨 陈柱

## 竞赛技术统计

 手球  
青年女子

 预赛  
轮次 1

 组别 A  
场次 13

 晋中体育馆  
2019-06-15 20:50

Referees: 张晓虎 (CHN) / 马文 (CHN)

Result: 1:21 (0:11)

Teams: 浙江桃渚(桃渚) VS 安徽宿州(宿州)

桃渚		远射	近射	边射	快攻	突破	任意球	7m球	合计	%	助攻	失误	警告	2'	D+DR
主教练: 柳日祥															
2	骆佩瑶	0/4	0/2				0/2		0/8	0.0	1	7		1	
5	周佩芸	0/4	1/1				0/4		1/9	11.1		4		1	
6	黄心怡											2	1		
7	黄亚楠											8			
8	董安心											1	1	1	
9	黄琼妮														
13	陈梦瑶													1	
15	项嘉柔														
16	王语嫣														
17	翟馨彤														
18	陈曼莎											2			
运动员 合计		0/8	1/3				0/6		1/17	5.9	1	24	2	4	
9	黄琼妮	0/4	1/5		4/9	1/6	1/2	0/2	7/28	25.0					
守门员 合计		0/4	1/5		4/9	1/6	1/2	0/2	7/28	25.0					

桃渚	比赛进程	宿州
1st Half		
0	00:31	1 26 刘洋
0	00:57	2 9 李旗
0	04:44	3 5 单文静
0	05:26	4 7 刘文秀
0	06:21	5 26 刘洋
0	12:28	6 9 李旗
0	13:44	7 15 乔思雨
0	14:21	8 9 李旗
0	15:21	9 9 李旗
0	16:54	10 18 刘怡涵
0	19:28	11 15 乔思雨
2nd Half		
0	02:33	12 18 刘怡涵
0	03:19	13 17 田伊阳
0	04:17	14 18 刘怡涵
5	05:19	14
1	07:15	15 9 李旗
1	09:14	16 9 李旗
1	11:02	17 9 李旗
1	11:39	18 9 李旗
1	14:59	19 9 李旗
1	16:40	20 25 郑睿涵
1	17:10	21 9 李旗

宿州		远射	近射	边射	快攻	突破	任意球	7m球	合计	%	助攻	失误	警告	2'	D+DR
主教练: 吴昊															
3	姜景媛				0/1				0/1	0.0		1		1	
5	单文静					1/1			1/1	100	5	4			
7	刘文秀		1/1				0/1		1/2	50.0					
8	李伟伟											1			
9	李旗	2/2			4/6	1/2	1/1	2/2	10/13	76.9		1			
10	杨晓晓											1			
12	黄紫蝶											1			
15	乔思雨		1/2			1/1			2/3	66.7					
17	田伊阳		1/1		0/1				1/2	50.0		2	1		
18	刘怡涵	0/1			1/1	2/2		0/1	3/5	60.0		3	1		
25	郑睿涵		1/1		0/1				1/2	50.0		1			
26	刘洋	2/2							2/2	100					
运动员 合计		4/5	4/5		5/10	5/6	1/2	2/3	21/31	67.7	5	15	2	1	
12	黄紫蝶	8/8	2/3				5/5		15/16	93.8		1			
守门员 合计		8/8	2/3				5/5		15/16	93.8		1			

场上队员: 得分 / 射门

守门员: 救球 / 射门

D	取消资格	DR	取消资格+报告
---	------	----	---------

## 个人/全队技术统计表

手球 预赛 组别 A 晋中体育馆  
青年女子 轮次 1 场次 13 2019-06-15 20:50

号码	姓名	远射	近射	边射	快攻	突破	任意	七米	合计	%	助攻	失误	警告	2'	取消	时间
<b>浙江桃渚(桃渚)</b>																
<b>(场上队员)</b>																
2	骆佩瑶	0/4	0/2			0/2			0/8	0.0%	1	7		1		00:39:51
5	周佩芸	0/4	1/1			0/4			1/9	11.1%		4		1		00:37:49
6	黄心怡									0.0%		2	1			00:35:52
7	黄亚楠									0.0%		8				00:39:52
8	董安心									0.0%		1	1	1		00:30:10
9	黄琼妮									0.0%						00:39:57
13	陈梦瑶									0.0%				1		00:15:33
15	项嘉柔									0.0%						00:00:00
16	王语嫣									0.0%						00:00:00
17	翟馨彤									0.0%						00:00:00
18	陈曼莎									0.0%		2				00:39:05
	<b>合计</b>	<b>0/8</b>	<b>1/3</b>			<b>0/6</b>			<b>1/17</b>	<b>5.9%</b>	<b>1</b>	<b>24</b>	<b>2</b>	<b>4</b>		
<b>(守门员)</b>																
9	黄琼妮	0/4	1/5		4/9	1/6	1/2	0/2	7/28	25.0%						00:39:57
	<b>合计</b>	<b>0/4</b>	<b>1/5</b>		<b>4/9</b>	<b>1/6</b>	<b>1/2</b>	<b>0/2</b>	<b>7/28</b>	<b>25.0%</b>						

场上队员：得分/射门

守门员：救球/射门

全队合计	得分	被救	射失	击柱	封球	合计	%
远射		8				8	0.0%
近射	1	2				3	33.3%
边射							0.0%
快攻							0.0%
突破							0.0%
任意		5	1			6	0.0%
七米							0.0%

第二届全国青年运动会女子手球甲组决赛 俱乐部组 (U18)

PHMS Pictorial Handball Match Statistics

IHF Official System

个人/全队技术统计表

手球 预赛 组别 A 晋中体育馆  
青年女子 轮次 1 场次 13 2019-06-15 20:50

号码	姓名	远射	近射	边射	快攻	突破	任意	七米	合计	%	助攻	失误	警告	2'	取消	时间
<b>安徽宿州(宿州)</b>																
<b>(场上队员)</b>																
3	姜景媛				0/1				0/1	0.0%		1		1		00:32:04
5	单文静					1/1			1/1	100%	5	4				00:38:38
7	刘文秀		1/1				0/1		1/2	50.0%						00:07:18
8	李伟伟									0.0%		1				00:07:53
9	李旗	2/2			4/6	1/2	1/1	2/2	10/13	76.9%		1				00:39:27
10	杨晓晓									0.0%		1				00:03:28
12	黄紫蝶									0.0%		1				00:39:36
15	乔思雨		1/2			1/1			2/3	66.7%						00:09:34
17	田伊阳		1/1		0/1				1/2	50.0%		2	1			00:39:19
18	刘怡涵	0/1			1/1	2/2		0/1	3/5	60.0%		3	1			00:31:21
25	郑睿涵		1/1		0/1				1/2	50.0%		1				00:19:25
26	刘洋	2/2							2/2	100%						00:07:19
<b>合计</b>		<b>4/5</b>	<b>4/5</b>		<b>5/10</b>	<b>5/6</b>	<b>1/2</b>	<b>2/3</b>	<b>21/31</b>	<b>67.7%</b>	<b>5</b>	<b>15</b>	<b>2</b>	<b>1</b>		
<b>(守门员)</b>																
12	黄紫蝶	8/8	2/3				5/5		15/16	93.8%		1				00:39:36
<b>合计</b>		<b>8/8</b>	<b>2/3</b>				<b>5/5</b>		<b>15/16</b>	<b>93.8%</b>		<b>1</b>				

场上队员： 得分/射门

守门员： 救球/射门

全队合计	得分	被救	射失	击柱	封球	合计	%
远射	4		1			5	80.0%
近射	4	1				5	80.0%
边射							0.0%
快攻	5	4	1			10	50.0%
突破	5	1				6	83.3%
任意	1	1				2	50.0%
七米	2			1		3	66.7%

图式比赛技术统计表

手球  
青年女子

预赛  
轮次 1

组别 A  
场次 13

晋中体育馆  
2019-06-15 20:50

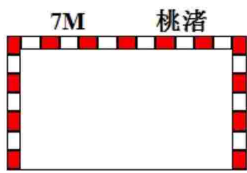
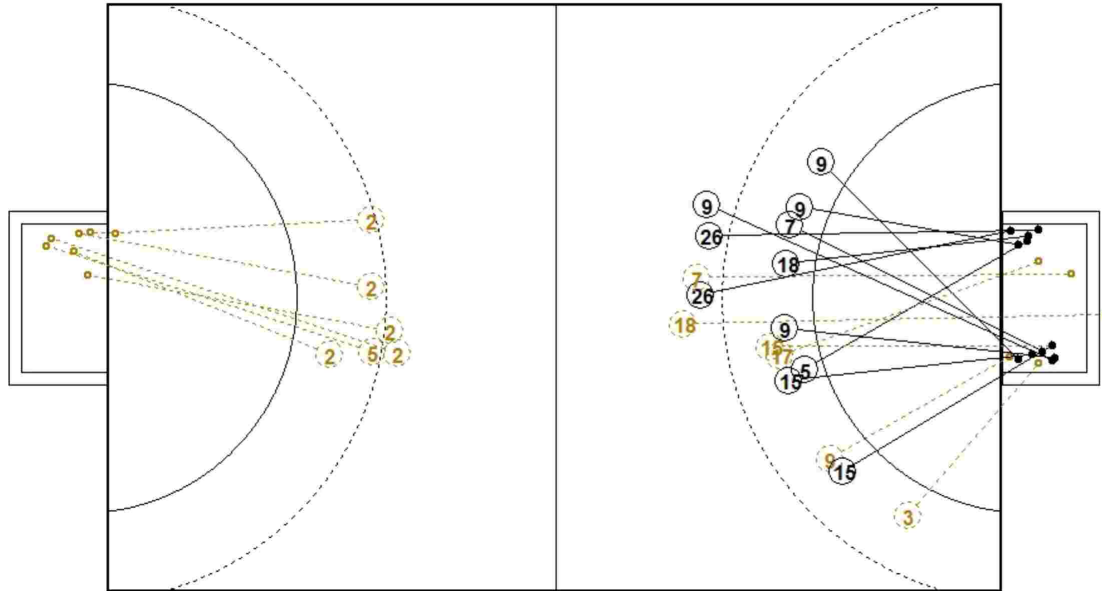

1st Half  
0 : 11

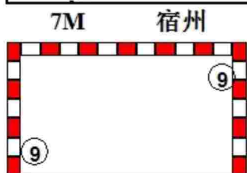
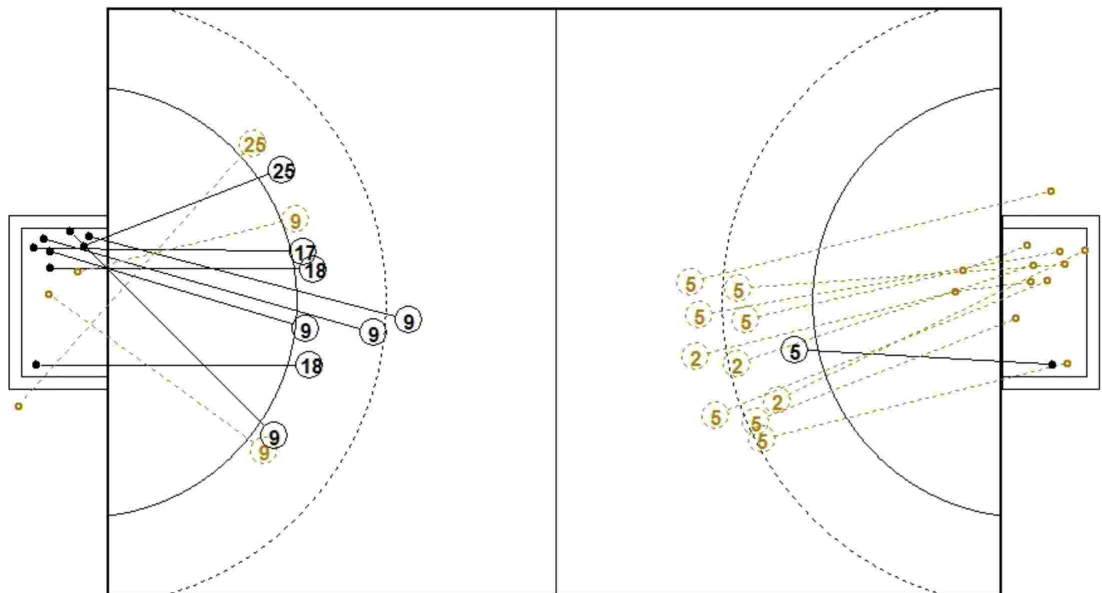
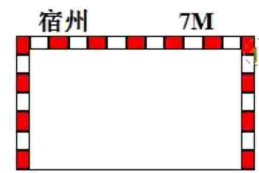

2nd Half  
21 : 1

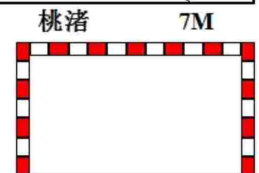

图式射门区域统计

手球  
青年女子

预赛  
轮次 1

组别 A  
场次 13

晋中体育馆  
2019-06-15 20:50

浙江桃渚

2 骆佩瑶	5 周佩芸	6 黄心怡	7 黄亚楠	8 董安心	9 黄琼妮	13 陈梦瑶	15 项嘉柔																																																																								
<table border="1"><tr><td></td><td></td><td></td></tr><tr><td></td><td></td><td></td></tr><tr><td></td><td></td><td></td></tr></table>										<table border="1"><tr><td></td><td></td><td>1</td></tr><tr><td></td><td></td><td></td></tr><tr><td></td><td></td><td></td></tr></table>			1							<table border="1"><tr><td></td><td></td><td></td></tr><tr><td></td><td></td><td></td></tr><tr><td></td><td></td><td></td></tr></table>										<table border="1"><tr><td></td><td></td><td></td></tr><tr><td></td><td></td><td></td></tr><tr><td></td><td></td><td></td></tr></table>										<table border="1"><tr><td></td><td></td><td></td></tr><tr><td></td><td></td><td></td></tr><tr><td></td><td></td><td></td></tr></table>										<table border="1"><tr><td></td><td></td><td></td></tr><tr><td></td><td></td><td></td></tr><tr><td></td><td></td><td></td></tr></table>										<table border="1"><tr><td></td><td></td><td></td></tr><tr><td></td><td></td><td></td></tr><tr><td></td><td></td><td></td></tr></table>										<table border="1"><tr><td></td><td></td><td></td></tr><tr><td></td><td></td><td></td></tr><tr><td></td><td></td><td></td></tr></table>									
		1																																																																													

Post - 0 Miss - 0 Block - 0    Post - 0 Miss - 1 Block - 0    Post - 0 Miss - 0 Block - 0    Post - 0 Miss - 0 Block - 0    Post - 0 Miss - 0 Block - 0    Post - 0 Miss - 0 Block - 0    Post - 0 Miss - 0 Block - 0    Post - 0 Miss - 0 Block - 0

16 王语嫣	17 翟馨彤	18 陈曼莎																											
<table border="1"><tr><td></td><td></td><td></td></tr><tr><td></td><td></td><td></td></tr><tr><td></td><td></td><td></td></tr></table>										<table border="1"><tr><td></td><td></td><td></td></tr><tr><td></td><td></td><td></td></tr><tr><td></td><td></td><td></td></tr></table>										<table border="1"><tr><td></td><td></td><td></td></tr><tr><td></td><td></td><td></td></tr><tr><td></td><td></td><td></td></tr></table>									

Post - 0 Miss - 0 Block - 0    Post - 0 Miss - 0 Block - 0    Post - 0 Miss - 0 Block - 0

9 黄琼妮

0/1	2/2	0/5
1/2		3/9
0/5		1/4

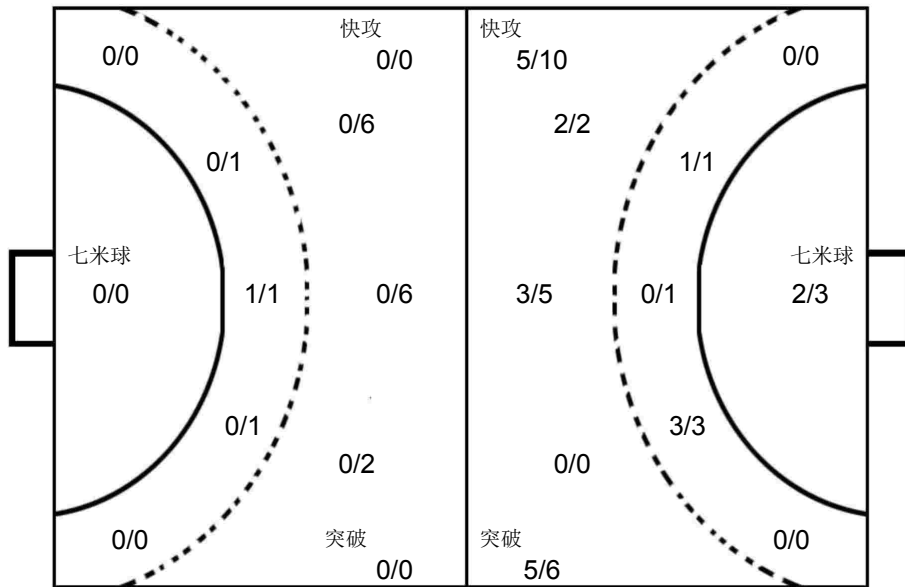

12 黄紫蝶

3/3		3/3
1/1	2/2	2/3
1/1	2/2	1/1

安徽宿州

3 姜景媛	5 单文静	7 刘文秀	8 李伟伟	9 李旗	10 杨晓晓	12 黄紫蝶	15 乔思雨																																																																								
<table border="1"><tr><td></td><td></td><td></td></tr><tr><td></td><td></td><td></td></tr><tr><td></td><td></td><td></td></tr></table>										<table border="1"><tr><td></td><td></td><td></td></tr><tr><td>1</td><td></td><td></td></tr><tr><td></td><td></td><td></td></tr></table>				1						<table border="1"><tr><td></td><td></td><td>1</td></tr><tr><td></td><td></td><td></td></tr><tr><td></td><td></td><td></td></tr></table>			1							<table border="1"><tr><td></td><td></td><td></td></tr><tr><td></td><td></td><td></td></tr><tr><td></td><td></td><td></td></tr></table>										<table border="1"><tr><td></td><td></td><td>3</td></tr><tr><td></td><td></td><td>3</td></tr><tr><td>2</td><td></td><td>2</td></tr></table>			3			3	2		2	<table border="1"><tr><td></td><td></td><td></td></tr><tr><td></td><td></td><td></td></tr><tr><td></td><td></td><td></td></tr></table>										<table border="1"><tr><td></td><td></td><td></td></tr><tr><td></td><td></td><td></td></tr><tr><td></td><td></td><td></td></tr></table>										<table border="1"><tr><td></td><td></td><td></td></tr><tr><td></td><td></td><td>2</td></tr><tr><td></td><td></td><td></td></tr></table>						2			
1																																																																															
		1																																																																													
		3																																																																													
		3																																																																													
2		2																																																																													
		2																																																																													

Post - 0 Miss - 0 Block - 0    Post - 0 Miss - 0 Block - 0    Post - 0 Miss - 0 Block - 0    Post - 0 Miss - 0 Block - 0    Post - 0 Miss - 0 Block - 0    Post - 0 Miss - 0 Block - 0    Post - 0 Miss - 0 Block - 0    Post - 0 Miss - 0 Block - 0

17 田伊阳	18 刘怡涵	25 郑睿涵	26 刘洋																																				
<table border="1"><tr><td></td><td></td><td>1</td></tr><tr><td></td><td></td><td></td></tr><tr><td></td><td></td><td></td></tr></table>			1							<table border="1"><tr><td>1</td><td></td><td>1</td></tr><tr><td></td><td></td><td></td></tr><tr><td>1</td><td></td><td></td></tr></table>	1		1				1			<table border="1"><tr><td></td><td></td><td></td></tr><tr><td></td><td></td><td>1</td></tr><tr><td></td><td></td><td></td></tr></table>						1				<table border="1"><tr><td></td><td></td><td></td></tr><tr><td>1</td><td></td><td></td></tr><tr><td>1</td><td></td><td></td></tr></table>				1			1		
		1																																					
1		1																																					
1																																							
		1																																					
1																																							
1																																							

Post - 0 Miss - 0 Block - 0    Post - 1 Miss - 1 Block - 0    Post - 0 Miss - 1 Block - 0    Post - 0 Miss - 0 Block - 0



第二届全国青年运动会女子手球甲组决赛 俱乐部组 (U18)

青年女子 全国比赛

预赛 Group A



PHMS Pictorial Handball Match Statistics

IHF Official System

Team A					Team B					Match Number											
A 山西晋中					B 山西平遥					14											
Played in			in the hall			on			at			Spectators									
山西晋中			晋中体育馆			2019-06-15			22:00			hours									
Half-time(30')	A	B	End of playing time		A	B	1st extra time		A	B	2nd extra time		A	B	After penalty throws		A	B			
	10	9	18		15																
Number of 7 m	A	Team time-out			Full name of players and officials						Team time-out			B	Number of 7 m						
	0/3	1	2	3							1	2	3	0/1							
		12:21	28:35								06:33										
No.	Team A					G	W	2'	D	DR	No.	Team B					G	W	2'	D	DR
1	邓雅楠										1	战泳享									
2	付雪杰					2					2	胡嘉雯									
5	王晓敏										3	宫訢									
6	张雪					6					5	李楠									
7	郭敏婷					2	1				6	王雅静									
8	孙雨菲										8	吴名茜									
9	杨婷					2					9	马文龙					3	1			
10	王玮					3					10	张越					1	1			
12	郭佳										11	张楠									
13	李心怡					2					12	战慧									
15	杜佳奕					1					15	徐翹悦									
18	于聪										18	范小雁					1				
19	于颖										20	崔嘉欣					4				
20	尹艺霖										26	李言娜					1				
											27	孙玟					5		2		
B	徐熙围 (主教练)										B	黄翠红 (主教练)									
											E	陶岩									
A											Signatures of responsables for the teams (Off.A)										B
TP	Remarks of referees / HF Official																				TP

Signatures

Referees	伍豪 (CHN)	徐依婷 (CHN)		
T.D.	许宜扬 (CHN)	叶霄雪 (CHN)		
CHA Off.				

Note: Number of 7m Throws Awarded to Team A and B, Goals (G), Warnings (W), Suspensions (2'), Direct Disqualification (D), Disqualification With Report (DR) and Team Penalty (TP).

Table Officials: 戴莹莹 马迪 Statisticians: 谢杨 陈柱



## 第二届全国青年运动会女子手球甲组决赛 俱乐部组 (U18)

PHMS Pictorial Handball Match Statistics

IHF Official System

### 竞赛技术统计

手球  
青年女子

预赛  
轮次 1

组别 A  
场次 14

晋中体育馆  
2019-06-15 22:00

Referees:	伍豪 (CHN) / 徐依婷 (CHN)	Result:	18:15 (10:9)
Teams:	山西晋中(晋中) VS 山西平遥(平遥)		

晋中		远	近	边	快	突	任意	7m	合计	%	助攻	失误	警告	2'	D+DR
主教练: 徐熙围		射	射	射	攻	破	球	球							
1	邓雅楠														
2	付雪杰			1/1	1/1				2/2	100		1			
5	王晓敏	0/1							0/1	0.0					
6	张雪	0/1	2/2		2/2	2/2			6/7	85.7	1	2			
7	郭敏婷				1/1	1/1		0/1	2/3	66.7		1	1		
8	孙雨菲										1				
9	杨婷	1/1		1/1					2/2	100		1			
10	王玮	1/3	1/2			1/1		0/1	3/7	42.9		6			
12	郭佳							0/1	0/1	0.0	1	1			
13	李心怡		2/2						2/2	100					
15	杜佳奕	0/1				1/1			1/2	50.0		6			
18	于聪		0/1						0/1	0.0		1			
19	于颖			0/1					0/1	0.0					
20	尹艺霖			0/1					0/1	0.0	1				
运动员 合计		2/7	5/7	2/4	4/4	5/5		0/3	18/30	60.0	4	19	1		
1	邓雅楠		2/4	1/1	0/1	0/2		1/1	4/9	44.4					
12	郭佳	0/2	1/4	0/2	1/2	1/3			3/13	23.1	1	1			
守门员 合计		0/2	3/8	1/3	1/3	1/5		1/1	7/22	31.8	1	1			

平遥		远	近	边	快	突	任意	7m	合计	%	助攻	失误	警告	2'	D+DR
主教练: 黄翠红		射	射	射	攻	破	球	球							
1	战泳享														
2	胡嘉雯														
3	宫訢				0/1				0/1	0.0		1			
5	李楠														
6	王雅静														
8	吴名茜														
9	马文龙	1/2	1/1		1/1				3/4	75.0	1	5	1		
10	张越			0/1		1/2		0/1	1/4	25.0		1	1		
11	张楠														
12	战慧														
15	徐翹悦														
18	范小雁	1/3	0/1						1/4	25.0	1	1			
20	崔嘉欣		1/1	2/4	1/1				4/6	66.7		3			
26	李言娜			0/1		1/1			1/2	50.0					
27	孙玫		3/5			2/4			5/9	55.6		4		2	
运动员 合计		2/5	5/8	2/6	2/3	4/7		0/1	15/30	50.0	2	15	2	2	
1	战泳享		0/3	1/1		0/1		1/1	2/6	33.3					
12	战慧	3/5	2/4	1/3	0/4	0/4		1/1	7/21	33.3					
守门员 合计		3/5	2/7	2/4	0/4	0/5		2/2	9/27	33.3					

晋中	比赛 进程	平遥
1st Half		
13 李心怡	1 01:26	0
6 张雪	1 01:49	1 18 范小雁
2 付雪杰	2 02:25	1
2 付雪杰	2 03:21	2 20 崔嘉欣
3 杨婷	3 03:49	2
3 杨婷	3 04:10	3 9 马文龙
2 付雪杰	4 04:34	3
7 郭敏婷	5 05:35	3
6 郭敏婷	6 06:29	3
6 郭敏婷	6 07:29	4 27 孙玫
10 王玮	7 08:18	4
7 王玮	7 10:17	5 27 孙玫
7 王玮	7 11:00	6 9 马文龙
7 王玮	7 13:14	7 20 崔嘉欣
7 郭敏婷	8 13:57	7
6 张雪	9 15:19	7
13 李心怡	10 18:19	7
10 李心怡	10 18:45	8 20 崔嘉欣
10 李心怡	10 19:17	9 20 崔嘉欣
2nd Half		
6 张雪	11 00:38	9
6 张雪	12 01:36	9
12 张雪	12 02:07	10 27 孙玫
12 张雪	12 03:22	11 27 孙玫
15 杜佳奕	13 04:03	11
13 杜佳奕	13 04:35	12 27 孙玫
6 张雪	14 06:20	12
14 张雪	14 06:35	13 10 张越
6 张雪	15 11:45	13
15 张雪	15 12:24	14 9 马文龙
10 王玮	16 12:36	14
10 王玮	17 13:46	14
9 杨婷	18 19:13	14
18 杨婷	18 19:41	15 26 李言娜

场上队员: 得分 / 射门

守门员: 救球 / 射门

D	取消资格	DR	取消资格+报告
---	------	----	---------



## 个人/全队技术统计表

 手球 预赛 组别 A 晋中体育馆  
 青年女子 轮次 1 场次 14 2019-06-15 22:00

号码	姓名	远射	近射	边射	快攻	突破	任意	七米	合计	%	助攻	失误	警告	2'	取消	时间
山西晋中(晋中)																
(场上队员)																
1	邓雅楠									0.0%						00:18:24
2	付雪杰			1/1	1/1				2/2	100%		1				00:14:16
5	王晓敏	0/1							0/1	0.0%						00:22:07
6	张雪	0/1	2/2		2/2	2/2			6/7	85.7%	1	2				00:18:27
7	郭敏婷				1/1	1/1		0/1	2/3	66.7%		1	1			00:18:02
8	孙雨菲									0.0%	1					00:16:04
9	杨婷	1/1		1/1					2/2	100%		1				00:21:50
10	王玮	1/3	1/2			1/1		0/1	3/7	42.9%		6				00:19:03
12	郭佳							0/1	0/1	0.0%	1	1				00:21:36
13	李心怡		2/2						2/2	100%						00:22:04
15	杜佳奕	0/1				1/1			1/2	50.0%		6				00:32:43
18	于聪		0/1						0/1	0.0%		1				00:22:28
19	于颖			0/1					0/1	0.0%						00:20:31
20	尹艺霖			0/1					0/1	0.0%	1					00:11:59
	合计	2/7	5/7	2/4	4/4	5/5		0/3	18/30	60.0%	4	19	1			
(守门员)																
1	邓雅楠		2/4	1/1	0/1	0/2		1/1	4/9	44.4%						00:18:24
12	郭佳	0/2	1/4	0/2	1/2	1/3			3/13	23.1%	1	1				00:21:36
	合计	0/2	3/8	1/3	1/3	1/5		1/1	7/22	31.8%	1	1				

场上队员： 得分/射门

守门员： 救球/射门

全队合计	得分	被救	射失	击柱	封球	合计	%
远射	2	3	2			7	28.6%
近射	5	2				7	71.4%
边射	2	2				4	50.0%
快攻	4					4	100.0%
突破	5					5	100.0%
任意							0.0%
七米		2		1		3	0.0%

第二届全国青年运动会女子手球甲组决赛 俱乐部组 (U18)

PHMS Pictorial Handball Match Statistics

IHF Official System

个人/全队技术统计表

手球 青年女子 预赛 轮次 1 组别 A 场次 14 晋中体育馆 2019-06-15 22:00

号码	姓名	远射	近射	边射	快攻	突破	任意	七米	合计	%	助攻	失误	警告	2'	取消	时间
山西平遥(平遥)																
(场上队员)																
1	战泳亨									0.0%						00:12:20
2	胡嘉雯									0.0%						00:00:00
3	宫訢				0/1				0/1	0.0%	1					00:40:00
5	李楠									0.0%						00:00:00
6	王雅静									0.0%						00:00:00
8	吴名茜									0.0%						00:00:00
9	马文龙	1/2	1/1		1/1				3/4	75.0%	1	5	1			00:35:50
10	张越			0/1		1/2		0/1	1/4	25.0%		1	1			00:40:00
11	张楠									0.0%						00:00:00
12	战慧									0.0%						00:27:40
15	徐翹悦									0.0%						00:00:00
18	范小雁	1/3	0/1						1/4	25.0%	1	1				00:40:00
20	崔嘉欣		1/1	2/4	1/1				4/6	66.7%		3				00:40:00
26	李言娜			0/1		1/1			1/2	50.0%						00:03:54
27	孙玟		3/5			2/4			5/9	55.6%		4		2		00:40:00
合计		2/5	5/8	2/6	2/3	4/7		0/1	15/30	50.0%	2	15	2	2		
(守门员)																
1	战泳亨		0/3	1/1		0/1		1/1	2/6	33.3%						00:12:20
12	战慧	3/5	2/4	1/3	0/4	0/4		1/1	7/21	33.3%						00:27:40
合计		3/5	2/7	2/4	0/4	0/5		2/2	9/27	33.3%						

场上队员：得分/射门

守门员：救球/射门

全队合计	得分	被救	射失	击柱	封球	合计	%
远射	2				3	5	40.0%
近射	5	3				8	62.5%
边射	2	1	1	2		6	33.3%
快攻	2	1				3	66.7%
突破	4	1	1	1		7	57.1%
任意							0.0%
七米		1				1	0.0%

图式比赛技术统计表

手球  
青年女子

预赛  
轮次 1

组别 A  
场次 14

晋中体育馆  
2019-06-15 22:00

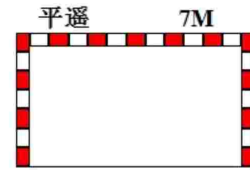
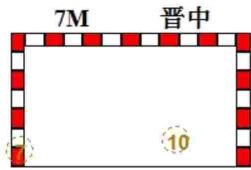
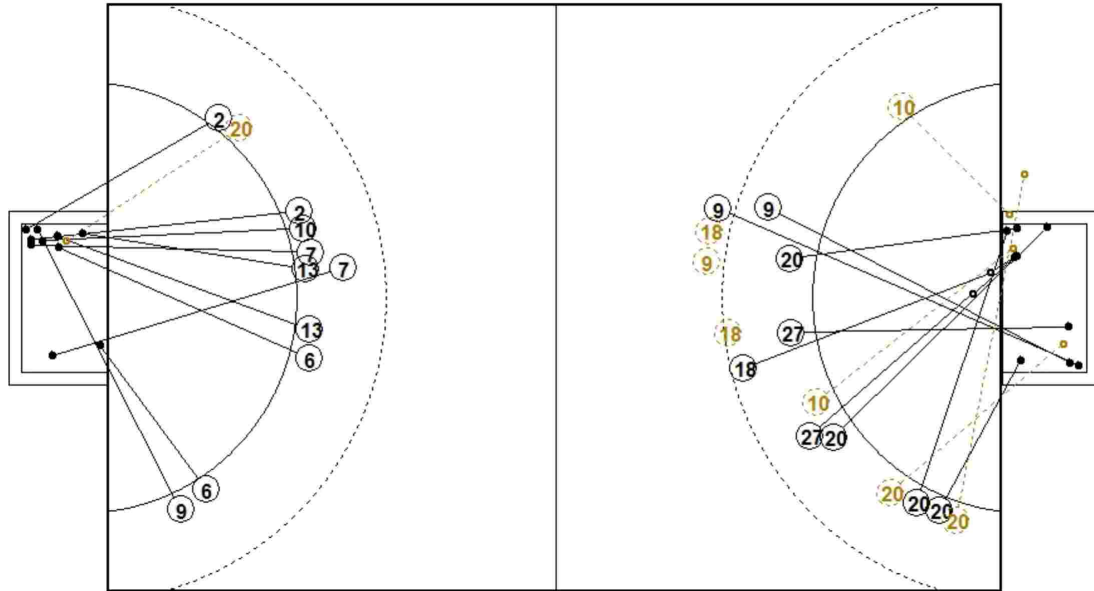

1st Half  
10 : 9

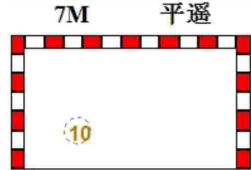
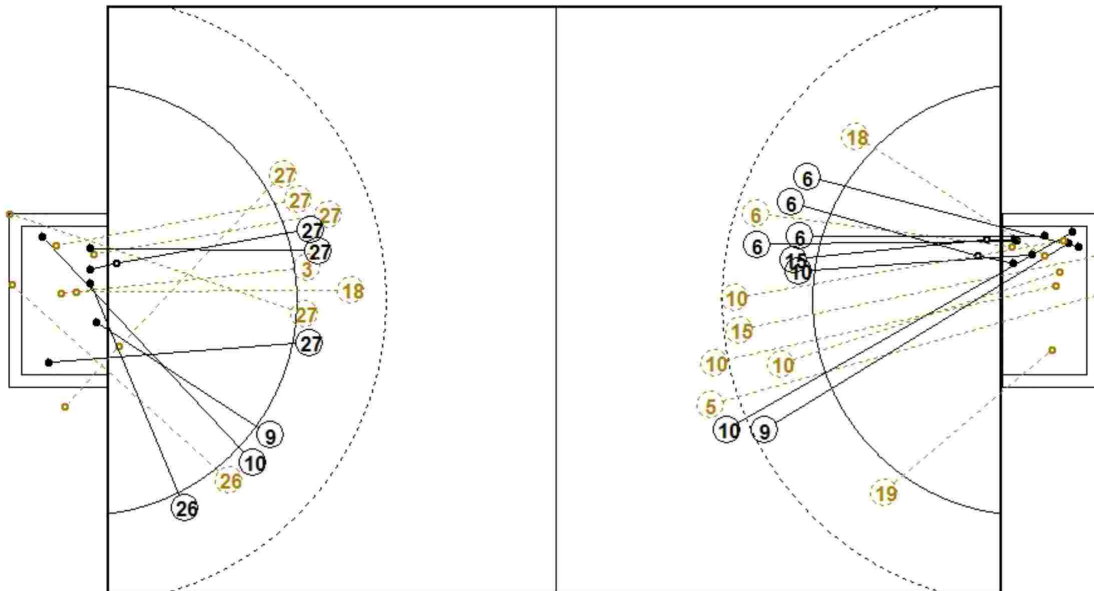

2nd Half  
15 : 18

图式射门区域统计

手球  
青年女子

预赛  
轮次 1

组别 A  
场次 14

晋中体育馆  
2019-06-15 22:00

山西晋中

1 邓雅楠	2 付雪杰	5 王晓敏	6 张雪	7 郭敏婷	8 孙雨菲	9 杨婷	10 王玮																																																																								
<table border="1"><tr><td></td><td></td><td></td></tr><tr><td></td><td></td><td></td></tr><tr><td></td><td></td><td></td></tr></table>										<table border="1"><tr><td></td><td></td><td>2</td></tr><tr><td></td><td></td><td></td></tr><tr><td></td><td></td><td></td></tr></table>			2							<table border="1"><tr><td></td><td></td><td></td></tr><tr><td></td><td></td><td></td></tr><tr><td></td><td></td><td></td></tr></table>										<table border="1"><tr><td>1</td><td></td><td></td></tr><tr><td>1</td><td></td><td>1</td></tr><tr><td>3</td><td></td><td></td></tr></table>	1			1		1	3			<table border="1"><tr><td></td><td></td><td>1</td></tr><tr><td></td><td></td><td></td></tr><tr><td></td><td></td><td></td></tr></table>			1							<table border="1"><tr><td></td><td></td><td></td></tr><tr><td></td><td></td><td></td></tr><tr><td></td><td></td><td></td></tr></table>										<table border="1"><tr><td>1</td><td></td><td>1</td></tr><tr><td></td><td></td><td></td></tr><tr><td></td><td></td><td></td></tr></table>	1		1							<table border="1"><tr><td>1</td><td></td><td>1</td></tr><tr><td>1</td><td></td><td></td></tr><tr><td></td><td></td><td></td></tr></table>	1		1	1					
		2																																																																													
1																																																																															
1		1																																																																													
3																																																																															
		1																																																																													
1		1																																																																													
1		1																																																																													
1																																																																															
Post - 0 Miss - 0 Block - 0	Post - 0 Miss - 0 Block - 0	Post - 0 Miss - 1 Block - 0	Post - 0 Miss - 0 Block - 0	Post - 1 Miss - 0 Block - 0	Post - 0 Miss - 0 Block - 0	Post - 0 Miss - 0 Block - 0	Post - 0 Miss - 0 Block - 0																																																																								
12 郭佳	13 李心怡	15 杜佳奕	18 于聪	19 于颖	20 尹艺霖																																																																										
<table border="1"><tr><td></td><td></td><td></td></tr><tr><td></td><td></td><td></td></tr><tr><td></td><td></td><td></td></tr></table>										<table border="1"><tr><td></td><td></td><td>1</td></tr><tr><td></td><td></td><td>1</td></tr><tr><td></td><td></td><td></td></tr></table>			1			1				<table border="1"><tr><td></td><td></td><td></td></tr><tr><td></td><td></td><td></td></tr><tr><td>1</td><td></td><td></td></tr></table>							1			<table border="1"><tr><td></td><td></td><td></td></tr><tr><td></td><td></td><td></td></tr><tr><td></td><td></td><td></td></tr></table>										<table border="1"><tr><td></td><td></td><td></td></tr><tr><td></td><td></td><td></td></tr><tr><td></td><td></td><td></td></tr></table>										<table border="1"><tr><td></td><td></td><td></td></tr><tr><td></td><td></td><td></td></tr><tr><td></td><td></td><td></td></tr></table>																													
		1																																																																													
		1																																																																													
1																																																																															
Post - 0 Miss - 0 Block - 0	Post - 0 Miss - 0 Block - 0	Post - 0 Miss - 1 Block - 0	Post - 0 Miss - 0 Block - 0	Post - 0 Miss - 0 Block - 0	Post - 0 Miss - 0 Block - 0																																																																										

1 邓雅楠									
<table border="1"><tr><td></td><td></td><td>1/3</td></tr><tr><td>1/1</td><td>1/1</td><td>1/1</td></tr><tr><td>0/1</td><td>0/2</td><td></td></tr></table>			1/3	1/1	1/1	1/1	0/1	0/2	
		1/3							
1/1	1/1	1/1							
0/1	0/2								

12 郭佳									
<table border="1"><tr><td>0/1</td><td></td><td>0/2</td></tr><tr><td>0/1</td><td>1/1</td><td></td></tr><tr><td>1/4</td><td></td><td>1/4</td></tr></table>	0/1		0/2	0/1	1/1		1/4		1/4
0/1		0/2							
0/1	1/1								
1/4		1/4							

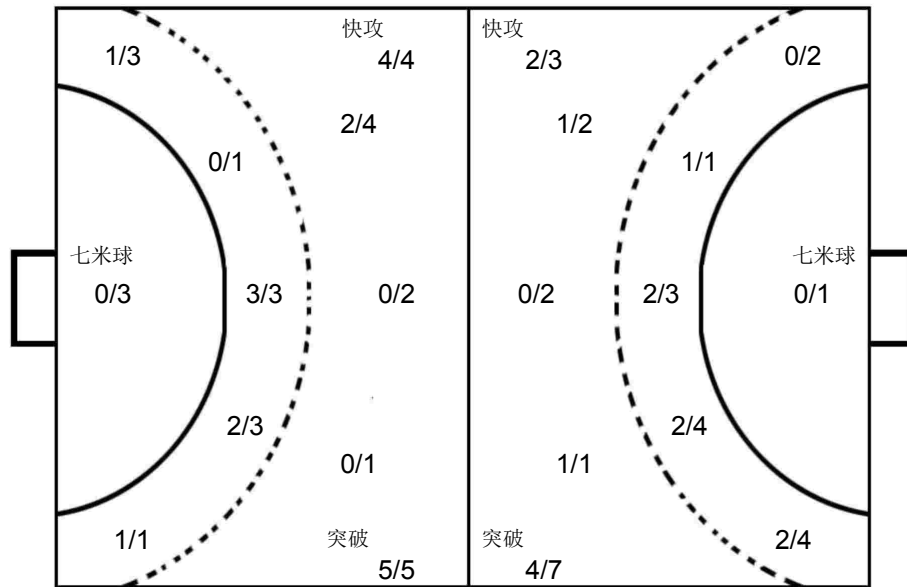

1 战泳亨									
<table border="1"><tr><td></td><td></td><td></td></tr><tr><td>0/1</td><td></td><td>1/2</td></tr><tr><td>0/1</td><td></td><td>1/2</td></tr></table>				0/1		1/2	0/1		1/2
0/1		1/2							
0/1		1/2							

12 战慧									
<table border="1"><tr><td>2/5</td><td></td><td>0/5</td></tr><tr><td>2/4</td><td>1/1</td><td>1/2</td></tr><tr><td>1/4</td><td></td><td></td></tr></table>	2/5		0/5	2/4	1/1	1/2	1/4		
2/5		0/5							
2/4	1/1	1/2							
1/4									

山西平遥

1 战泳亨	2 胡嘉雯	3 宫苒	5 李楠	6 王雅静	8 吴名茜	9 马文龙	10 张越																																																																								
<table border="1"><tr><td></td><td></td><td></td></tr><tr><td></td><td></td><td></td></tr><tr><td></td><td></td><td></td></tr></table>										<table border="1"><tr><td></td><td></td><td></td></tr><tr><td></td><td></td><td></td></tr><tr><td></td><td></td><td></td></tr></table>										<table border="1"><tr><td></td><td></td><td></td></tr><tr><td></td><td></td><td></td></tr><tr><td></td><td></td><td></td></tr></table>										<table border="1"><tr><td></td><td></td><td></td></tr><tr><td></td><td></td><td></td></tr><tr><td></td><td></td><td></td></tr></table>										<table border="1"><tr><td></td><td></td><td></td></tr><tr><td></td><td></td><td></td></tr><tr><td></td><td></td><td></td></tr></table>										<table border="1"><tr><td></td><td></td><td></td></tr><tr><td></td><td></td><td></td></tr><tr><td></td><td></td><td></td></tr></table>										<table border="1"><tr><td></td><td></td><td>2</td></tr><tr><td></td><td></td><td></td></tr><tr><td></td><td></td><td></td></tr></table>			2							<table border="1"><tr><td></td><td></td><td>1</td></tr><tr><td></td><td></td><td></td></tr><tr><td></td><td></td><td></td></tr></table>			1						
		2																																																																													
		1																																																																													
Post - 0 Miss - 0 Block - 0	Post - 0 Miss - 0 Block - 0	Post - 0 Miss - 0 Block - 0	Post - 0 Miss - 0 Block - 0	Post - 0 Miss - 0 Block - 0	Post - 0 Miss - 0 Block - 0	Post - 0 Miss - 0 Block - 1	Post - 1 Miss - 0 Block - 0																																																																								
11 张楠	12 战慧	15 徐翹悦	18 范小雁	20 崔嘉欣	26 李言娜	27 孙玟																																																																									
<table border="1"><tr><td></td><td></td><td></td></tr><tr><td></td><td></td><td></td></tr><tr><td></td><td></td><td></td></tr></table>										<table border="1"><tr><td></td><td></td><td></td></tr><tr><td></td><td></td><td></td></tr><tr><td></td><td></td><td></td></tr></table>										<table border="1"><tr><td></td><td></td><td></td></tr><tr><td></td><td></td><td></td></tr><tr><td></td><td></td><td></td></tr></table>										<table border="1"><tr><td></td><td></td><td></td></tr><tr><td></td><td></td><td></td></tr><tr><td>1</td><td></td><td></td></tr></table>							1			<table border="1"><tr><td></td><td></td><td></td></tr><tr><td>1</td><td></td><td></td></tr><tr><td>2</td><td></td><td>1</td></tr></table>				1			2		1	<table border="1"><tr><td></td><td></td><td></td></tr><tr><td></td><td></td><td></td></tr><tr><td></td><td></td><td></td></tr></table>										<table border="1"><tr><td>1</td><td></td><td>1</td></tr><tr><td></td><td></td><td></td></tr><tr><td>1</td><td></td><td>2</td></tr></table>	1		1				1		2										
1																																																																															
1																																																																															
2		1																																																																													
1		1																																																																													
1		2																																																																													
Post - 0 Miss - 0 Block - 0	Post - 0 Miss - 0 Block - 0	Post - 0 Miss - 0 Block - 0	Post - 0 Miss - 0 Block - 2	Post - 0 Miss - 1 Block - 0	Post - 1 Miss - 0 Block - 0	Post - 1 Miss - 1 Block - 0																																																																									



第二届全国青年运动会女子手球甲组决赛 俱乐部组 (U18)

青年女子 全国比赛

预赛 Group A



PHMS Pictorial Handball Match Statistics

IHF Official System

Team A A 浙江桃渚				Team B B 山西平遥				Match Number <b>26</b>			
------------------	--	--	--	------------------	--	--	--	---------------------------	--	--	--

Played in 山西晋中	in the hall 晋中体育馆	on 2019-06-17	at 14:00	hours	Speakers
-------------------	----------------------	------------------	-------------	-------	----------

Half-time(30')	A 0	B 15	End of playing time	A 2	B 25	1st extra time	A	B	2nd extra time	A	B	After penalty throws	A	B
----------------	--------	---------	---------------------	--------	---------	----------------	---	---	----------------	---	---	----------------------	---	---

Number of 7 m 1/2	Team time-out			Full name of players and officials	Team time-out			B 0/1	Number of 7 m
	1 12:43	2 29:29	3		1	2	3		

No.	Team A	G	W	2'	D	DR	No.	Team B	G	W	2'	D	DR
2	骆佩瑶		1				1	战泳享					
5	周佩芸	2					2	胡嘉雯					
6	黄心怡						3	宫訢	3				
7	黄亚楠						5	李楠					
8	董安心						6	王雅静					
9	黄琼妮						8	吴名茜					
11	李盼						9	马文龙	1				
12	金小清						10	张越	3				
13	陈梦瑶						11	张楠	3				
15	项嘉柔						12	战慧					
16	王语嫣						15	徐翹悦	2				
17	翟馨彤						18	范小雁	4	1			
18	陈曼莎						20	崔嘉欣	6				
							26	李言娜	1				
							27	孙玟	2				
C	项建生						A	张栋					
D	冯婷婷						B	黄翠红 (主教练)					
E	蒋云敏						E	陶岩					

A	Signatures of responsables for the teams (Off.A)												B
---	--	--	--	--	--	--	--	--	--	--	--	--	---

TP	Remarks of referees / HF Official													TP
----	-----------------------------------	--	--	--	--	--	--	--	--	--	--	--	--	----

Referees	孟凡刚 (CHN)	刘斌 (CHN)		
T.D.	柴业宏 (CHN)	陈晓波 (CHN)		
CHA Off.				

Note: Number of 7m Throws Awarded to Team A and B, Goals (G), Warnings (W), Suspensions (2'), Direct Disqualification (D), Disqualification With Report (DR) and Team Penalty (TP).

Table Officials: 孙龙龙 李莉君 Statisticians: 王梓衡 刘笑

## 第二届全国青年运动会女子手球甲组决赛 俱乐部组 (U18)

PHMS Pictorial Handball Match Statistics

IHF Official System

### 竞赛技术统计

手球  
青年女子

预赛  
轮次 2

组别 A  
场次 26

晋中体育馆  
2019-06-17 14:00

Referees:	孟凡刚 (CHN) / 刘斌 (CHN)	Result:	2:25 (0:15)
Teams:	浙江桃渚(桃渚) VS 山西平遥(平遥)		

桃渚		远	近	边	快	突	任意	7m	合计	%	助攻	失误	警告	2'	D+DR
主教练: 柳日祥		射	射	射	攻	破	球	球							
2	骆佩瑶	0/1					0/3		0/4	0.0		5	1		
5	周佩芸	0/7		0/3		1/1	0/8	1/2	2/21	9.5		8			
6	黄心怡			0/1					0/1	0.0					
7	黄亚楠											3			
8	董安心											1			
9	黄琼妮														
11	李盼														
12	金小清														
13	陈梦瑶														
15	项嘉柔														
16	王语嫣														
17	翟馨彤														
18	陈曼莎														
运动员 合计		0/8		0/4		1/1	0/11	1/2	2/26	7.7		17	1		
9	黄琼妮	1/2	2/5	0/2	0/13	0/6			3/28	10.7					
守门员 合计		1/2	2/5	0/2	0/13	0/6			3/28	10.7					

平遥		远	近	边	快	突	任意	7m	合计	%	助攻	失误	警告	2'	D+DR
主教练: 黄翠红		射	射	射	攻	破	球	球							
1	战泳享														
2	胡嘉雯														
3	官訢		1/1		2/2				3/3	100					
5	李楠														
6	王雅静														
8	吴名茜														
9	马文龙					1/1	0/1		1/2	50.0	1	1			
10	张越	0/1	1/1	1/1	1/1				3/4	75.0	2	3			
11	张楠	1/1			2/2				3/3	100		2			
12	战慧										3	1			
15	徐翹悦				1/1	1/1			2/2	100		1			
18	范小雁	0/1			3/3	1/1			4/5	80.0			1		
20	崔嘉欣		1/3		4/4	1/1			6/8	75.0	1	2			
26	李言娜			1/1		0/1		0/1	1/3	33.3		1			
27	孙玫					2/2			2/2	100	2				
运动员 合计		1/3	3/5	2/2	13/13	6/7	0/1	0/1	25/32	78.1	9	11	1		
1	战泳享	5/5		2/2		0/1		1/2	8/10	80.0					
12	战慧	1/1		2/2			6/6		9/9	100	3	1			
守门员 合计		6/6		4/4		0/1	6/6	1/2	17/19	89.5	3	1			

桃渚	比赛进程	平遥
1st Half		
0	01:07	1 27 孙玫
0	02:47	2 15 徐翹悦
0	03:52	3 9 马文龙
0	05:27	4 10 张越
0	06:10	5 3 官訢
0	09:07	6 3 官訢
0	11:21	7 3 官訢
0	12:10	8 20 崔嘉欣
0	12:36	9 10 张越
0	13:04	10 18 范小雁
0	14:11	11 27 孙玫
0	16:37	12 20 崔嘉欣
0	18:09	13 15 徐翹悦
0	18:48	14 18 范小雁
0	19:29	15 18 范小雁
2nd Half		
0	01:23	16 11 张楠
0	03:25	17 11 张楠
0	04:02	18 26 李言娜
0	07:38	19 18 范小雁
0	09:15	20 20 崔嘉欣
5	周佩芸	1 10:12 20
1	10:34	21 11 张楠
5	周佩芸	2 11:30 21
2	11:59	22 20 崔嘉欣
2	14:09	23 10 张越
2	19:03	24 20 崔嘉欣
2	19:43	25 20 崔嘉欣

场上队员: 得分 / 射门

守门员: 救球 / 射门

D	取消资格	DR	取消资格+报告
---	------	----	---------

## 个人/全队技术统计表

手球 预赛 组别 A 晋中体育馆  
青年女子 轮次 2 场次 26 2019-06-17 14:00

号码	姓名	远射	近射	边射	快攻	突破	任意	七米	合计	%	助攻	失误	警告	2'	取消	时间
<b>浙江桃渚(桃渚)</b>																
<b>(场上队员)</b>																
2	骆佩瑶	0/1				0/3			0/4	0.0%		5	1			00:33:06
5	周佩芸	0/7		0/3		1/1	0/8	1/2	2/21	9.5%		8				00:37:02
6	黄心怡			0/1					0/1	0.0%						00:38:49
7	黄亚楠									0.0%		3				00:38:48
8	董安心									0.0%		1				00:36:31
9	黄琼妮									0.0%						00:40:00
11	李盼									0.0%						00:00:00
12	金小清									0.0%						00:09:19
13	陈梦瑶									0.0%						00:06:40
15	项嘉柔									0.0%						00:00:00
16	王语嫣									0.0%						00:00:00
17	翟馨彤									0.0%						00:00:50
18	陈曼莎									0.0%						00:38:47
	<b>合计</b>	<b>0/8</b>		<b>0/4</b>		<b>1/1</b>	<b>0/11</b>	<b>1/2</b>	<b>2/26</b>	<b>7.7%</b>		<b>17</b>	<b>1</b>			
<b>(守门员)</b>																
9	黄琼妮	1/2	2/5	0/2	0/13	0/6			3/28	10.7%						00:40:00
	<b>合计</b>	<b>1/2</b>	<b>2/5</b>	<b>0/2</b>	<b>0/13</b>	<b>0/6</b>			<b>3/28</b>	<b>10.7%</b>						

场上队员： 得分/射门

守门员： 救球/射门

全队合计	得分	被救	射失	击柱	封球	合计	%
远射		6	1	1		8	0.0%
近射							0.0%
边射		4				4	0.0%
快攻							0.0%
突破	1					1	100.0%
任意		6	4	1		11	0.0%
七米	1	1				2	50.0%

## 第二届全国青年运动会女子手球甲组决赛 俱乐部组 (U18)

PHMS Pictorial Handball Match Statistics

IHF Official System

## 个人/全队技术统计表

手球 青年女子 预赛 轮次 2 组别 A 场次 26 晋中体育馆 2019-06-17 14:00

号码	姓名	远射	近射	边射	快攻	突破	任意	七米	合计	%	助攻	失误	警告	2'	取消	时间
山西平遥(平遥)																
(场上队员)																
1	战泳亨									0.0%						00:18:02
2	胡嘉雯									0.0%						00:00:45
3	宫訢		1/1		2/2				3/3	100%						00:12:44
5	李楠									0.0%						00:00:00
6	王雅静									0.0%						00:18:58
8	吴名茜									0.0%						00:00:00
9	马文龙					1/1	0/1		1/2	50.0%	1	1				00:08:30
10	张越	0/1	1/1	1/1	1/1				3/4	75.0%	2	3				00:38:55
11	张楠	1/1			2/2				3/3	100%		2				00:26:46
12	战慧									0.0%	3	1				00:21:58
15	徐翹悦				1/1	1/1			2/2	100%		1				00:20:00
18	范小雁	0/1			3/3	1/1			4/5	80.0%			1			00:34:01
20	崔嘉欣		1/3		4/4	1/1			6/8	75.0%	1	2				00:40:00
26	李言娜			1/1		0/1		0/1	1/3	33.3%		1				00:19:19
27	孙玟					2/2			2/2	100%	2					00:20:00
合计		1/3	3/5	2/2	13/13	6/7	0/1	0/1	25/32	78.1%	9	11	1			
(守门员)																
1	战泳亨	5/5		2/2		0/1		1/2	8/10	80.0%						00:18:02
12	战慧	1/1		2/2			6/6		9/9	100%	3	1				00:21:58
合计		6/6		4/4		0/1	6/6	1/2	17/19	89.5%	3	1				

场上队员： 得分/射门

守门员： 救球/射门

全队合计	得分	被救	射失	击柱	封球	合计	%
远射	1	1		1		3	33.3%
近射	3	2				5	60.0%
边射	2					2	100.0%
快攻	13					13	100.0%
突破	6		1			7	85.7%
任意			1			1	0.0%
七米				1		1	0.0%



图式比赛技术统计表

手球  
青年女子

预赛  
轮次 2

组别 A  
场次 26

晋中体育馆  
2019-06-17 14:00

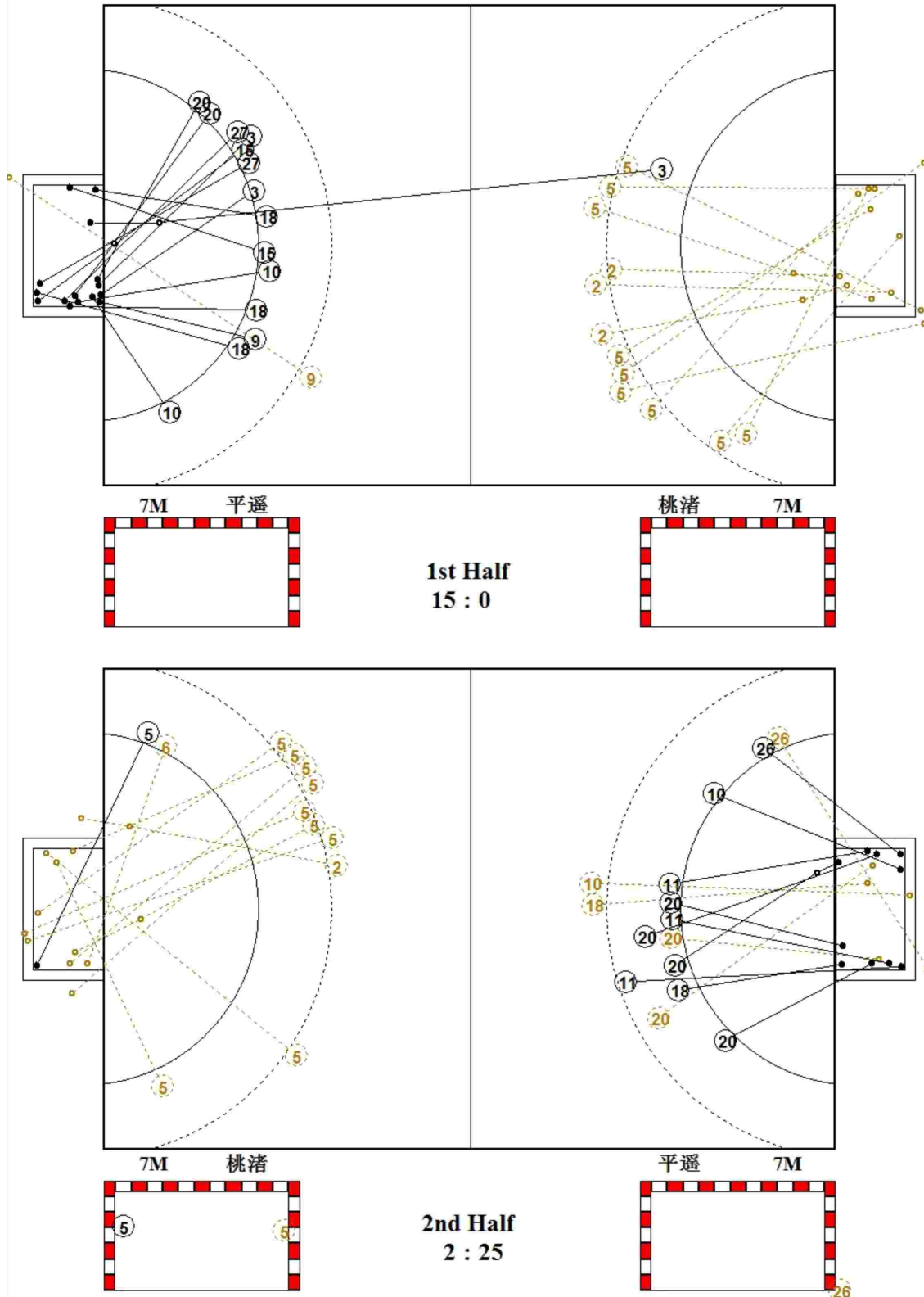

图式射门区域统计

手球  
青年女子

预赛  
轮次 2

组别 A  
场次 26

晋中体育馆  
2019-06-17 14:00

浙江桃渚

2 骆佩瑶	5 周佩芸	6 黄心怡	7 黄亚楠	8 董安心	9 黄琼妮	11 李盼	12 金小清
Post - 0 Miss - 1 Block - 0	Post - 2 Miss - 4 Block - 0	Post - 0 Miss - 0 Block - 0	Post - 0 Miss - 0 Block - 0	Post - 0 Miss - 0 Block - 0	Post - 0 Miss - 0 Block - 0	Post - 0 Miss - 0 Block - 0	Post - 0 Miss - 0 Block - 0
13 陈梦瑶	15 项嘉柔	16 王语嫣	17 翟馨彤	18 陈曼莎			
Post - 0 Miss - 0 Block - 0	Post - 0 Miss - 0 Block - 0	Post - 0 Miss - 0 Block - 0	Post - 0 Miss - 0 Block - 0	Post - 0 Miss - 0 Block - 0			

9 黄琼妮	
0/5	0/2
2/8	1/3
0/6	0/4

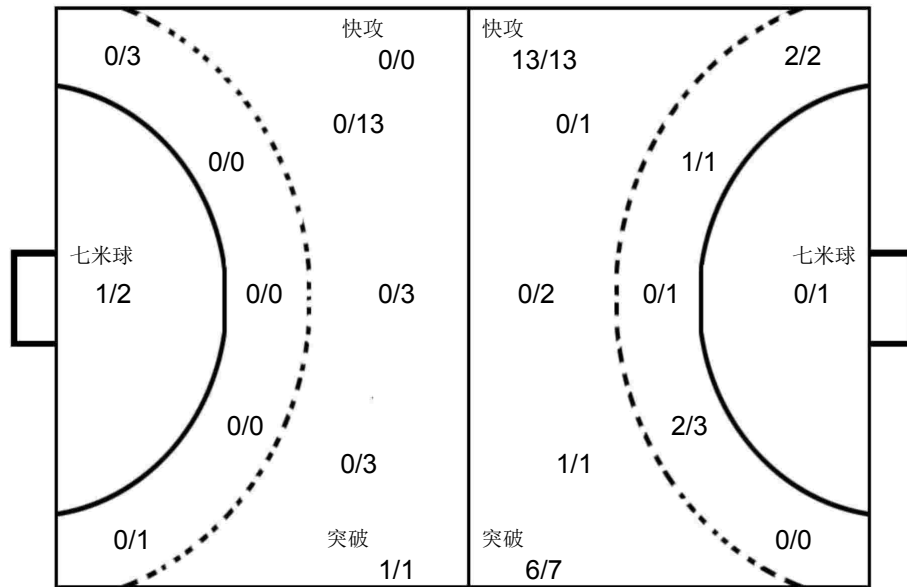

1 战泳亨		
0/2	1/1	3/3
2/2		1/1
1/1		

12 战慧		
	1/1	1/1
4/4		1/1
		2/2

山西平遥

1 战泳亨	2 胡嘉雯	3 宫訢	5 李楠	6 王雅静	8 吴名茜	9 马文龙	10 张越
Post - 0 Miss - 0 Block - 0	Post - 0 Miss - 0 Block - 0	Post - 0 Miss - 0 Block - 0	Post - 0 Miss - 0 Block - 0	Post - 0 Miss - 0 Block - 0	Post - 0 Miss - 0 Block - 0	Post - 0 Miss - 1 Block - 0	Post - 1 Miss - 0 Block - 0
11 张楠	12 战慧	15 徐翹悦	18 范小雁	20 崔嘉欣	26 李言娜	27 孙玟	
Post - 0 Miss - 0 Block - 0	Post - 0 Miss - 0 Block - 0	Post - 0 Miss - 0 Block - 0	Post - 0 Miss - 0 Block - 0	Post - 0 Miss - 0 Block - 0	Post - 1 Miss - 1 Block - 0	Post - 0 Miss - 0 Block - 0	



第二届全国青年运动会女子手球甲组决赛 俱乐部组 (U18)

青年女子 全国比赛

预赛 Group A



PHMS Pictorial Handball Match Statistics IHF Official System

Team A A 安徽宿州				Team B B 安徽淮南				Match Number <b>27</b>			
------------------	--	--	--	------------------	--	--	--	---------------------------	--	--	--

Played in 山西晋中	in the hall 晋中体育馆	on 2019-06-17	at 15:10	hours	Speakers
-------------------	----------------------	------------------	-------------	-------	----------

Half-time(30')	A 7	B 7	End of playing time	A 17	B 17	1st extra time	A	B	2nd extra time	A	B	After penalty throws	A 21	B 20
----------------	--------	--------	---------------------	---------	---------	----------------	---	---	----------------	---	---	----------------------	---------	---------

Number of 7 m 10/12	Team time-out			Full name of players and officials	Team time-out			B 4/6	Number of 7 m
	1	2	3		1	2	3		

No.	Team A	G	W	2'	D	DR	No.	Team B	G	W	2'	D	DR
1	陈文娟						1	万文倩					
3	姜景媛						2	孙雨欣					
5	单文静						3	陈杨					
7	刘文秀						4	张天琦	6	1	1		
8	李伟伟						5	高鑫艺					
9	李旗	9					6	吕少华					
12	黄紫蝶						7	承然	10		1		
15	乔思雨	2					8	董婧					
17	田伊阳						9	叶飞雪					
18	刘怡涵	3	1				10	王梦皖					
21	王嫚丽	3					11	徐静					
22	钦马晴	3	1				12	宋诗情					
23	郭茹文	1					13	杨梦颖	3		1		
25	郑睿涵						14	张美琪					
26	刘洋						15	陈可怡	1		2		
							16	陈静文					
B	吴昊 (主教练)						A	常洪飞					
D	赵萌萌						B	孙永永					
E	王路路												

A	Signatures of responsables for the teams (Off.A)												B
---	--	--	--	--	--	--	--	--	--	--	--	--	---

TP	Remarks of referees / HF Official													TP
----	-----------------------------------	--	--	--	--	--	--	--	--	--	--	--	--	----

Referees	程钰峰 (CHN)	康曦 (CHN)		
T.D.	吴瑞亭 (CHN)	王洋 (CHN)		
CHA Off.				

Note: Number of 7m Throws Awarded to Team A and B, Goals (G), Warnings (W), Suspensions (2'), Direct Disqualification (D), Disqualification With Report (DR) and Team Penalty (TP).

Table Officials: 吴鹏凯 宣海波 Statisticians: 王梓衡 刘笑

## 第二届全国青年运动会女子手球甲组决赛 俱乐部组 (U18)

PHMS Pictorial Handball Match Statistics

IHF Official System

### 竞赛技术统计

手球  
青年女子

预赛  
轮次 2

组别 A  
场次 27

晋中体育馆  
2019-06-17 15:10

Referees:	程钰峰 (CHN) / 康曦 (CHN)	Result:	21:20(7:7)
Teams:	安徽宿州(宿州) VS 安徽淮南(淮南)		

宿州		远射	近射	边射	快攻	突破	任意球	7m球	合计	%	助攻	失误	警告	2'	D+DR	宿州	比赛进程	淮南
主教练: 吴昊																	1st Half	
1	陈文娟															18	刘怡涵	0 01:32 1 4 张天琦
3	姜景媛															22	钦马晴	1 03:21 1
5	单文静															9	李旗	2 06:34 1
7	刘文秀		0/1					0/1	0/2	0.0						9	李旗	3 08:31 1
8	李伟伟															3	李旗	3 09:35 2 4 张天琦
9	李旗	0/1		0/1		1/3	2/3	6/6	9/14	64.3	1	3				3	李旗	3 11:15 3 13 杨梦颖
12	黄紫蝶															3	李旗	3 12:38 4 4 张天琦
15	乔思雨		1/2													15	乔思雨	4 13:17 4
17	田伊阳															21	王嫚丽	5 15:33 4
18	刘怡涵					2/2		1/2	3/4	75.0		1	1			5	王嫚丽	5 16:47 5 7 承然
21	王嫚丽		1/1	1/1				1/1	3/3	100		2				9	李旗	6 17:09 5
22	钦马晴		1/1	0/1		1/1	0/1	1/1	3/5	60.0	1	4	1			6	李旗	6 18:18 6 7 承然
23	郭茹文			1/3					1/3	33.3						9	李旗	7 18:43 6
25	郑睿涵															7	李旗	7 19:03 7 7 承然
26	刘洋															7	李旗	7 19:03 7 7 承然
运动员 合计		0/1	3/5	2/6		4/6	2/4	10/12	21/34	61.8	2	13	2				2nd Half	
1	陈文娟	0/1			0/1	0/1		0/3	0/3	0.0						7	李旗	7 00:34 8 13 杨梦颖
12	黄紫蝶	4/7	0/6	1/1	0/3	2/3		0/4	7/24	29.2						9	李旗	8 01:46 8
守门员 合计		4/8	0/6	1/1	0/4	2/4		0/4	7/27	25.9						8	李旗	8 03:08 9 7 承然
																22	钦马晴	9 04:17 9
																9	李旗	9 05:03 10 7 承然
																18	刘怡涵	10 05:18 10
																9	李旗	10 07:43 11 4 张天琦
																11	李旗	11 08:19 11
																11	李旗	11 09:05 12 7 承然
																11	李旗	11 11:04 13 7 承然
																11	李旗	11 12:15 14 13 杨梦颖
																9	李旗	12 12:32 14
																12	李旗	12 13:04 15 7 承然
																9	李旗	13 13:47 15
																15	乔思雨	14 14:51 15
																14	乔思雨	14 15:40 16 7 承然
																9	李旗	15 15:48 16
																21	王嫚丽	16 17:28 16
																16	王嫚丽	16 18:12 17 4 张天琦
																23	郭茹文	17 19:57 17
																	7M	
																18	刘怡涵	18 00:00 17
																18	刘怡涵	18 00:00 18 4 张天琦
																9	李旗	19 00:00 18
																19	李旗	19 00:00 19 7 承然
																22	钦马晴	20 00:00 19
																21	王嫚丽	21 00:00 19
																21	王嫚丽	21 00:00 20 15 陈可怡

场上队员: 得分 / 射门

守门员: 救球 / 射门

D	取消资格	DR	取消资格+报告
---	------	----	---------

## 第二届全国青年运动会女子手球甲组决赛 俱乐部组 (U18)

PHMS Pictorial Handball Match Statistics

IHF Official System

## 个人/全队技术统计表

 手球 预赛 组别 A 晋中体育馆  
 青年女子 轮次 2 场次 27 2019-06-17 15:10

号码	姓名	远射	近射	边射	快攻	突破	任意	七米	合计	%	助攻	失误	警告	2'	取消	时间
安徽宿州(宿州)																
(场上队员)																
1	陈文娟									0.0%						00:04:07
3	姜景媛									0.0%						00:00:00
5	单文静									0.0%						00:04:16
7	刘文秀		0/1					0/1	0/2	0.0%						00:00:00
8	李伟伟									0.0%						00:00:00
9	李旗	0/1		0/1		1/3	2/3	6/6	9/14	64.3%	1	3				00:40:00
12	黄紫蝶									0.0%						00:35:53
15	乔思雨		1/2					1/1	2/3	66.7%		3				00:35:44
17	田伊阳									0.0%						00:00:00
18	刘怡涵					2/2		1/2	3/4	75.0%		1	1			00:40:00
21	王嫚丽		1/1	1/1				1/1	3/3	100%		2				00:40:00
22	钦马晴		1/1	0/1		1/1	0/1	1/1	3/5	60.0%	1	4	1			00:40:00
23	郭茹文			1/3					1/3	33.3%						00:40:00
25	郑睿涵									0.0%						00:00:00
26	刘洋									0.0%						00:00:00
合计		0/1	3/5	2/6		4/6	2/4	10/12	21/34	61.8%	2	13	2			
(守门员)																
1	陈文娟	0/1			0/1	0/1			0/3	0.0%						00:04:07
12	黄紫蝶	4/7	0/6	1/1	0/3	2/3		0/4	7/24	29.2%						00:35:53
合计		4/8	0/6	1/1	0/4	2/4		0/4	7/27	25.9%						

场上队员： 得分/射门

守门员： 救球/射门

全队合计	得分	被救	射失	击柱	封球	合计	%
远射					1	1	0.0%
近射	3	2				5	60.0%
边射	2	1		3		6	33.3%
快攻							0.0%
突破	4		1	1		6	66.7%
任意	2	1	1			4	50.0%
七米	10		2			12	83.3%

第二届全国青年运动会女子手球甲组决赛 俱乐部组 (U18)

PHMS Pictorial Handball Match Statistics

IHF Official System

个人/全队技术统计表

手球 青年女子 预赛 轮次 2 组别 A 场次 27 晋中体育馆 2019-06-17 15:10

号码	姓名	远射	近射	边射	快攻	突破	任意	七米	合计	%	助攻	失误	警告	2'	取消	时间
安徽淮南(淮南)																
(场上队员)																
1	万文倩									0.0%		1				00:40:00
2	孙雨欣									0.0%						00:15:38
3	陈杨									0.0%						00:00:00
4	张天琦	2/4	1/1		2/2			1/1	6/8	75.0%			1	1		00:40:00
5	高鑫艺									0.0%						00:04:45
6	吕少华									0.0%						00:00:00
7	承然	2/4	5/6		2/2	0/1		1/1	10/14	71.4%		5		1		00:39:58
8	董婧									0.0%						00:00:00
9	叶飞雪							0/1	0/1	0.0%						00:40:00
10	王梦皖			0/1					0/1	0.0%		1				00:40:00
11	徐静									0.0%						00:00:00
12	宋诗情									0.0%						00:00:00
13	杨梦颖	0/3				2/3	0/2	1/2	3/10	30.0%	1	2		1		00:40:00
14	张美琪									0.0%						00:00:00
15	陈可怡							1/1	1/1	100%	1			2		00:19:39
16	陈静文									0.0%						00:00:00
合计		4/11	6/7	0/1	4/4	2/4	0/2	4/6	20/35	57.1%	2	9	1	5		
(守门员)																
1	万文倩		2/5	1/3		0/4	1/3	0/10	4/25	16.0%		1				00:40:00
合计			2/5	1/3		0/4	1/3	0/10	4/25	16.0%		1				

场上队员：得分/射门

守门员：救球/射门

全队合计	得分	被救	射失	击柱	封球	合计	%
远射	4	4	2		1	11	36.4%
近射	6		1			7	85.7%
边射		1				1	0.0%
快攻	4					4	100.0%
突破	2	2				4	50.0%
任意			2			2	0.0%
七米	4		2			6	66.7%

图式比赛技术统计表

手球  
青年女子

预赛  
轮次 2

组别 A  
场次 27

晋中体育馆  
2019-06-17 15:10

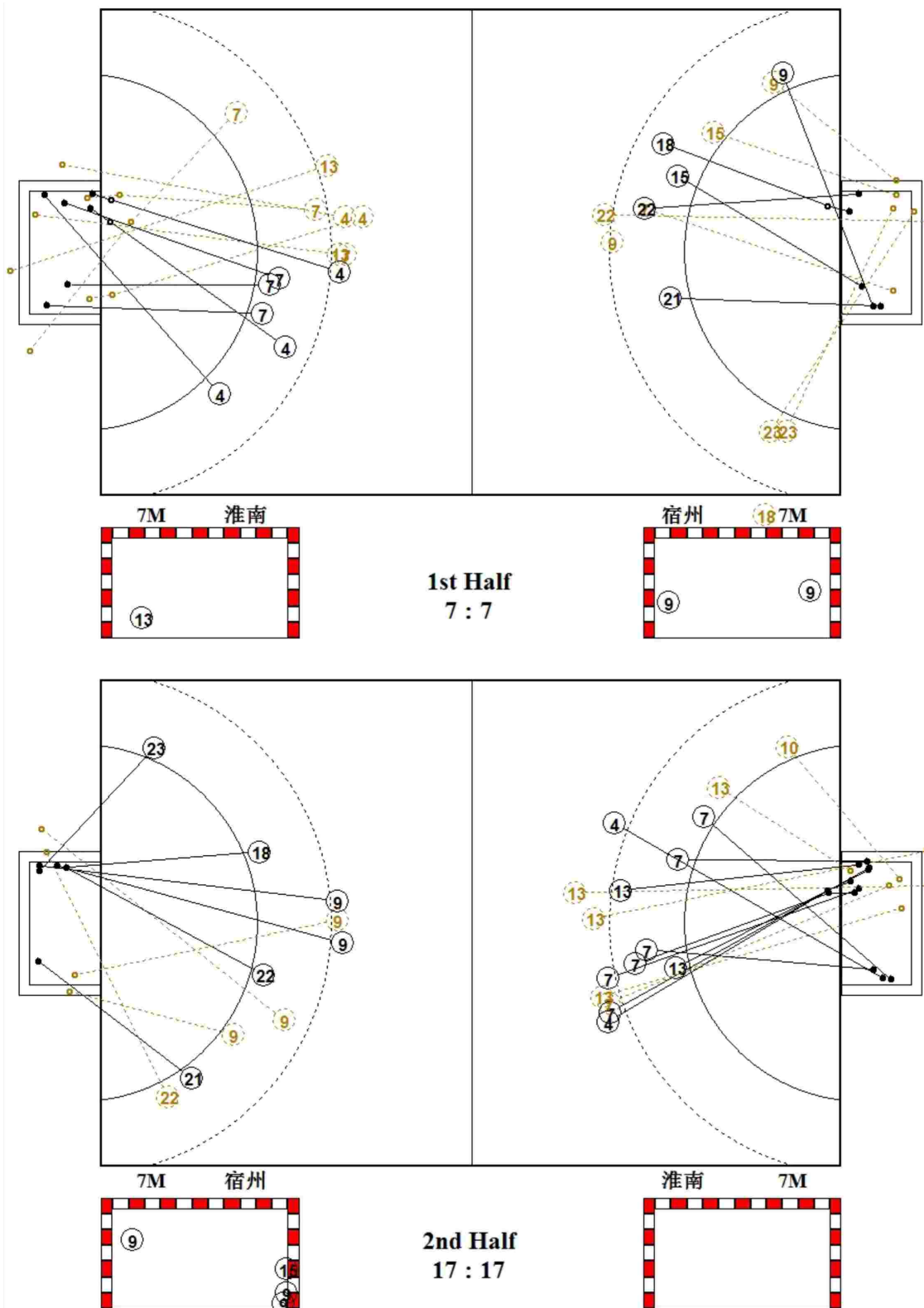

PICTORIAL MATCH STATISTICS

HANDBALL  
青年女子

预赛  
ROUND 2

GROUP A  
MATCH 27

晋中体育馆  
2019-06-17 15:10

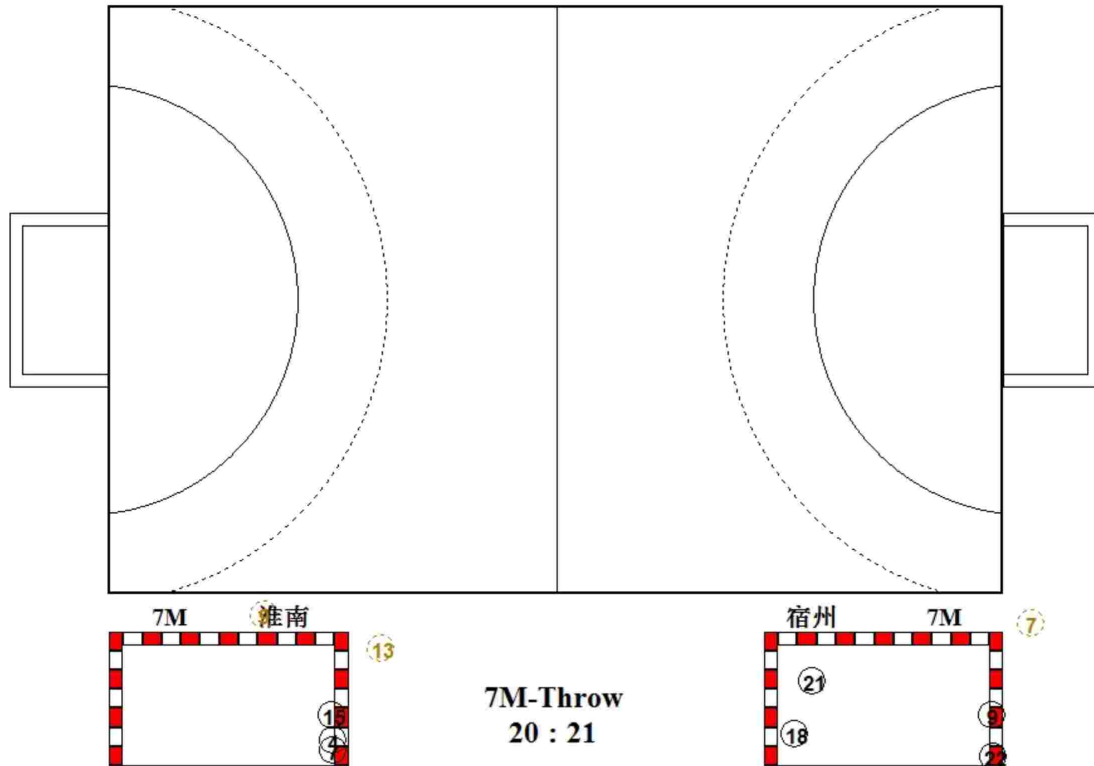



图式射门区域统计

手球  
青年女子

预赛  
轮次 2

组别 A  
场次 27

晋中体育馆  
2019-06-17 15:10

安徽宿州

1 陈文娟 <table border="1"><tr><td></td><td></td><td></td></tr><tr><td></td><td></td><td></td></tr><tr><td></td><td></td><td></td></tr></table> Post - 0 Miss - 0 Block - 0										3 姜景媛 <table border="1"><tr><td></td><td></td><td></td></tr><tr><td></td><td></td><td></td></tr><tr><td></td><td></td><td></td></tr></table> Post - 0 Miss - 0 Block - 0										5 单文静 <table border="1"><tr><td></td><td></td><td></td></tr><tr><td></td><td></td><td></td></tr><tr><td></td><td></td><td></td></tr></table> Post - 0 Miss - 0 Block - 0										7 刘文秀 <table border="1"><tr><td></td><td></td><td></td></tr><tr><td></td><td></td><td></td></tr><tr><td></td><td></td><td></td></tr></table> Post - 0 Miss - 1 Block - 0										8 李伟伟 <table border="1"><tr><td></td><td></td><td></td></tr><tr><td></td><td></td><td></td></tr><tr><td></td><td></td><td></td></tr></table> Post - 0 Miss - 0 Block - 0										9 李旗 <table border="1"><tr><td>1</td><td></td><td>1</td></tr><tr><td>1</td><td></td><td>4</td></tr><tr><td></td><td></td><td>2</td></tr></table> Post - 2 Miss - 1 Block - 1	1		1	1		4			2	12 黄紫蝶 <table border="1"><tr><td></td><td></td><td></td></tr><tr><td></td><td></td><td></td></tr><tr><td></td><td></td><td></td></tr></table> Post - 0 Miss - 0 Block - 0										15 乔思雨 <table border="1"><tr><td></td><td></td><td></td></tr><tr><td></td><td></td><td>1</td></tr><tr><td></td><td></td><td>1</td></tr></table> Post - 0 Miss - 0 Block - 0						1			1
1		1																																																																													
1		4																																																																													
		2																																																																													
		1																																																																													
		1																																																																													
17 田伊阳 <table border="1"><tr><td></td><td></td><td></td></tr><tr><td></td><td></td><td></td></tr><tr><td></td><td></td><td></td></tr></table> Post - 0 Miss - 0 Block - 0										18 刘怡涵 <table border="1"><tr><td></td><td></td><td>1</td></tr><tr><td>2</td><td></td><td></td></tr><tr><td></td><td></td><td></td></tr></table> Post - 0 Miss - 1 Block - 0			1	2						21 王嫚丽 <table border="1"><tr><td>2</td><td></td><td></td></tr><tr><td></td><td></td><td>1</td></tr><tr><td></td><td></td><td></td></tr></table> Post - 0 Miss - 0 Block - 0	2					1				22 钦马晴 <table border="1"><tr><td></td><td></td><td>1</td></tr><tr><td>1</td><td></td><td>1</td></tr><tr><td></td><td></td><td></td></tr></table> Post - 1 Miss - 1 Block - 0			1	1		1				23 郭茹文 <table border="1"><tr><td></td><td></td><td>1</td></tr><tr><td></td><td></td><td></td></tr><tr><td></td><td></td><td></td></tr></table> Post - 1 Miss - 0 Block - 0			1							25 郑睿涵 <table border="1"><tr><td></td><td></td><td></td></tr><tr><td></td><td></td><td></td></tr><tr><td></td><td></td><td></td></tr></table> Post - 0 Miss - 0 Block - 0										26 刘洋 <table border="1"><tr><td></td><td></td><td></td></tr><tr><td></td><td></td><td></td></tr><tr><td></td><td></td><td></td></tr></table> Post - 0 Miss - 0 Block - 0																			
		1																																																																													
2																																																																															
2																																																																															
		1																																																																													
		1																																																																													
1		1																																																																													
		1																																																																													

1 陈文娟

0/2		
0/1		

12 黄紫蝶

2/3	1/1	1/3
0/2		0/4
2/6		1/5

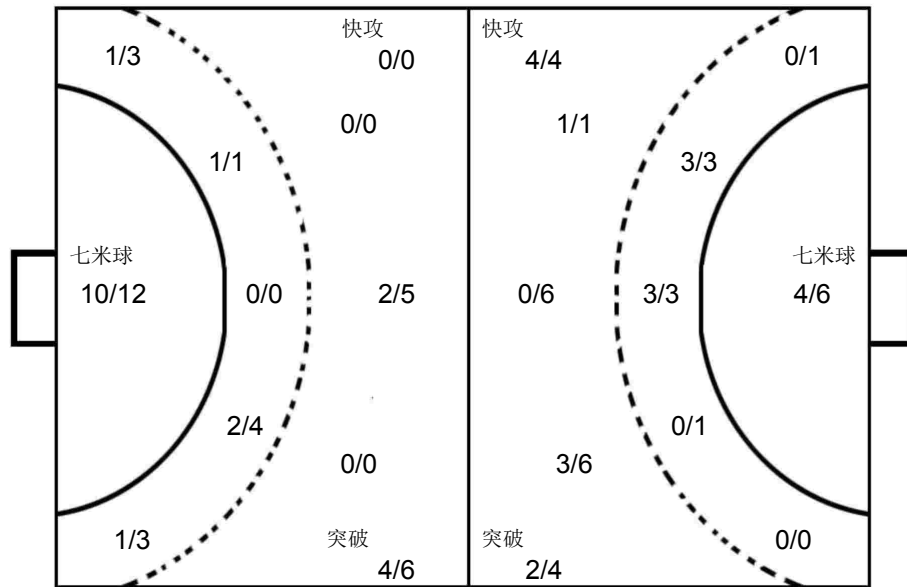

1 万文倩

2/5		1/3
1/2		0/8
0/3		0/4

安徽淮南

1 万文倩 <table border="1"><tr><td></td><td></td><td></td></tr><tr><td></td><td></td><td></td></tr><tr><td></td><td></td><td></td></tr></table> Post - 0 Miss - 0 Block - 0										2 孙雨欣 <table border="1"><tr><td></td><td></td><td></td></tr><tr><td></td><td></td><td></td></tr><tr><td></td><td></td><td></td></tr></table> Post - 0 Miss - 0 Block - 0										3 陈杨 <table border="1"><tr><td></td><td></td><td></td></tr><tr><td></td><td></td><td></td></tr><tr><td></td><td></td><td></td></tr></table> Post - 0 Miss - 0 Block - 0										4 张天琦 <table border="1"><tr><td></td><td></td><td>1</td></tr><tr><td></td><td></td><td>1</td></tr><tr><td>1</td><td></td><td>3</td></tr></table> Post - 0 Miss - 1 Block - 0			1			1	1		3	5 高鑫艺 <table border="1"><tr><td></td><td></td><td></td></tr><tr><td></td><td></td><td></td></tr><tr><td></td><td></td><td></td></tr></table> Post - 0 Miss - 0 Block - 0										6 吕少华 <table border="1"><tr><td></td><td></td><td></td></tr><tr><td></td><td></td><td></td></tr><tr><td></td><td></td><td></td></tr></table> Post - 0 Miss - 0 Block - 0										7 承然 <table border="1"><tr><td>1</td><td></td><td>1</td></tr><tr><td>3</td><td></td><td>2</td></tr><tr><td>2</td><td></td><td>1</td></tr></table> Post - 0 Miss - 1 Block - 1	1		1	3		2	2		1	8 董婧 <table border="1"><tr><td></td><td></td><td></td></tr><tr><td></td><td></td><td></td></tr><tr><td></td><td></td><td></td></tr></table> Post - 0 Miss - 0 Block - 0									
		1																																																																													
		1																																																																													
1		3																																																																													
1		1																																																																													
3		2																																																																													
2		1																																																																													
9 叶飞雪 <table border="1"><tr><td></td><td></td><td></td></tr><tr><td></td><td></td><td></td></tr><tr><td></td><td></td><td></td></tr></table> Post - 0 Miss - 1 Block - 0										10 王梦皖 <table border="1"><tr><td></td><td></td><td></td></tr><tr><td></td><td></td><td></td></tr><tr><td></td><td></td><td></td></tr></table> Post - 0 Miss - 0 Block - 0										11 徐静 <table border="1"><tr><td></td><td></td><td></td></tr><tr><td></td><td></td><td></td></tr><tr><td></td><td></td><td></td></tr></table> Post - 0 Miss - 0 Block - 0										12 宋诗情 <table border="1"><tr><td></td><td></td><td></td></tr><tr><td></td><td></td><td></td></tr><tr><td></td><td></td><td></td></tr></table> Post - 0 Miss - 0 Block - 0										13 杨梦颖 <table border="1"><tr><td>1</td><td></td><td></td></tr><tr><td>2</td><td></td><td></td></tr><tr><td></td><td></td><td></td></tr></table> Post - 0 Miss - 4 Block - 0	1			2						14 张美琪 <table border="1"><tr><td></td><td></td><td></td></tr><tr><td></td><td></td><td></td></tr><tr><td></td><td></td><td></td></tr></table> Post - 0 Miss - 0 Block - 0										15 陈可怡 <table border="1"><tr><td></td><td></td><td>1</td></tr><tr><td></td><td></td><td></td></tr><tr><td></td><td></td><td></td></tr></table> Post - 0 Miss - 0 Block - 0			1							16 陈静文 <table border="1"><tr><td></td><td></td><td></td></tr><tr><td></td><td></td><td></td></tr><tr><td></td><td></td><td></td></tr></table> Post - 0 Miss - 0 Block - 0									
1																																																																															
2																																																																															
		1																																																																													



第二届全国青年运动会女子手球甲组决赛 俱乐部组 (U18)

青年女子 全国比赛

预赛 Group A



PHMS Pictorial Handball Match Statistics

IHF Official System

Team A A 福建汉得堡				Team B B 山西晋中				Match Number <b>28</b>			
-------------------	--	--	--	------------------	--	--	--	---------------------------	--	--	--

Played in 山西晋中	in the hall 晋中体育馆	on 2019-06-17	at 16:20	hours	Spe ctators
-------------------	----------------------	------------------	-------------	-------	-------------

Half-time(30')	A 6	B 11	End of playing time	A 11	B 19	1st extra time	A	B	2nd extra time	A	B	After penalty throws	A	B
----------------	--------	---------	---------------------	---------	---------	----------------	---	---	----------------	---	---	----------------------	---	---

Number of 7 m 0/0	Team time-out			Full name of players and officials	Team time-out			B 4/4	Number of 7 m
	1 10:00	2 33:06	3		1 14:26	2 31:03	3		

No.	Team A	G	W	2'	D	DR	No.	Team B	G	W	2'	D	DR
2	张心茹						1	邓雅楠					
3	崔艳菲	2					2	付雪杰	1		1		
5	李倩						5	王晓敏					
7	李珂欣		1	2			6	张雪					
8	魏雅欣						7	郭敏婷	7		1		
9	张晓静	5	1				8	孙雨菲	4				
10	穆梦欣	1		1			9	杨婷	1				
11	孙瑞						10	王玮	1				
12	张跃						12	郭佳					
14	尹春霞	1		2			13	李心怡	1				
15	万里云杉						15	杜佳奕	2				
16	王红						18	于聪					
21	张雪梅	2	1				19	于颖					
							20	尹艺霖	2	1			
A	曾令斌						A	张栋					
B	王卫 (主教练)						B	徐熙围 (主教练)					
C	辛英杰												
D	刘娜												

A	Signatures of responsables for the teams (Off.A)												B
---	--	--	--	--	--	--	--	--	--	--	--	--	---

TP	Remarks of referees / HF Official													TP
----	-----------------------------------	--	--	--	--	--	--	--	--	--	--	--	--	----

Referees	许翔 (CHN)	严璐 (CHN)		
T.D.	柴业宏 (CHN)	柴业宏 (CHN)		
CHA Off.				

Note: Number of 7m Throws Awarded to Team A and B, Goals (G), Warnings (W), Suspensions (2'), Direct Disqualification (D), Disqualification With Report (DR) and Team Penalty (TP).

Table Officials: 李莉君 马迪 Statisticians: 刘笑 王梓衡

竞赛技术统计

手球  
青年女子

预赛  
轮次 2

组别 A  
场次 28

晋中体育馆  
2019-06-17 16:20

Referees:	许翔 (CHN) / 严璐 (CHN)	Result:	11:19 (6:11)
Teams:	福建汉得堡(汉得堡) VS 山西晋中(晋中)		

汉得堡		远射	近射	边射	快攻	突破	任意球	7m球	合计	%	助攻	失误	警告	2'	D+DR	汉得堡	比赛进程	晋中
主教练: 王卫																	1st Half	
2	张心茹															9	0 00:53	1 7 郭敏婷
3	崔艳菲			0/1	1/1	1/1			2/3	66.7		1					1 03:04	1
5	李倩											1					1 04:58	2 7 郭敏婷
7	李珂欣	0/2							0/2	0.0	1		1	2		3	1 06:19	3 7 郭敏婷
8	魏雅欣																2 06:54	3
9	张晓静	1/4			1/1	3/4			5/9	55.6		3	1			9	2 08:16	4 13 李心怡
10	穆梦欣	1/5	0/1			0/1			1/7	14.3		5		1			3 09:23	4
11	孙瑞			0/1					0/1	0.0						21	3 11:01	5 7 郭敏婷
12	张跃																4 11:22	5
14	尹春霞	1/2					0/1		1/3	33.3		4		2			4 11:57	6 8 孙雨菲
15	万里云杉															9	5 12:55	6
16	王红											2					5 13:09	7 7 郭敏婷
21	张雪梅			0/2	1/1	1/1			2/4	50.0		1	1				5 14:49	8 15 杜佳奕
运动员 合计		3/13	0/1	0/4	3/3	5/7	0/1		11/29	37.9	1	17	3	5			5 17:36	9 20 尹艺霖
12	张跃							0/1	0/1	0.0						9	5 17:52	10 8 孙雨菲
16	王红	1/6	1/2	4/6	0/4	1/4	2/2	0/3	9/27	33.3		2				9	6 19:28	10
守门员 合计		1/6	1/2	4/6	0/4	1/4	2/2	0/4	9/28	32.1		2				9	6 20:00	11 7 郭敏婷
晋中																	2nd Half	
主教练: 徐熙国																	6 03:07	12 15 杜佳奕
1	邓雅楠																6 06:25	13 20 尹艺霖
2	付雪杰	1/1		0/3					1/4	25.0		2		1			6 07:04	14 9 杨婷
5	王晓敏	0/1							0/1	0.0		1				9	7 10:12	14
6	张雪																7 10:30	15 10 王玮
7	郭敏婷	1/1				3/3	0/1	3/3	7/8	87.5	1	1		1		14	8 12:10	15
8	孙雨菲				3/3			1/1	4/4	100		1					8 13:01	16 7 郭敏婷
9	杨婷	1/2		0/1			0/1		1/4	25.0		2					8 13:39	17 8 孙雨菲
10	王玮	1/1							1/1	100		1	4			10	9 13:58	17
12	郭佳											1					9 14:15	18 2 付雪杰
13	李心怡		1/2						1/2	50.0						3	10 18:21	18
15	杜佳奕			2/3					2/3	66.7		1				21	11 18:53	18
18	于聪																11 19:42	19 8 孙雨菲
19	于颖																	
20	尹艺霖	1/1			1/1	0/1			2/3	66.7	1		1					
运动员 合计		5/7	1/2	2/7	4/4	3/4	0/2	4/4	19/30	63.3	4	12	1	2				
1	邓雅楠	3/5		2/2	0/3	1/1	1/1		7/12	58.3								
12	郭佳	2/3	1/1	1/1		0/5			4/10	40.0	1							
守门员 合计		5/8	1/1	3/3	0/3	1/6	1/1		11/22	50.0	1							

场上队员: 得分 / 射门

守门员: 救球 / 射门

D	取消资格	DR	取消资格+报告
---	------	----	---------

## 个人/全队技术统计表

手球 预赛 组别 A 晋中体育馆  
青年女子 轮次 2 场次 28 2019-06-17 16:20

号码	姓名	远射	近射	边射	快攻	突破	任意	七米	合计	%	助攻	失误	警告	2'	取消	时间
福建汉得堡(汉得堡)																
(场上队员)																
2	张心茹									0.0%						00:04:46
3	崔艳菲			0/1	1/1	1/1			2/3	66.7%		1				00:33:19
5	李倩									0.0%		1				00:07:22
7	李珂欣	0/2							0/2	0.0%	1		1	2		00:34:39
8	魏雅欣									0.0%						00:02:28
9	张晓静	1/4			1/1	3/4			5/9	55.6%		3	1			00:31:10
10	穆梦欣	1/5	0/1			0/1			1/7	14.3%		5		1		00:40:00
11	孙瑞			0/1					0/1	0.0%						00:16:01
12	张跃									0.0%						00:08:43
14	尹春霞	1/2					0/1		1/3	33.3%		4		2		00:31:30
15	万里云杉									0.0%						00:00:00
16	王红									0.0%		2				00:31:17
21	张雪梅			0/2	1/1	1/1			2/4	50.0%		1	1			00:38:40
	合计	3/13	0/1	0/4	3/3	5/7	0/1		11/29	37.9%	1	17	3	5		
(守门员)																
12	张跃							0/1	0/1	0.0%						00:08:43
16	王红	1/6	1/2	4/6	0/4	1/4	2/2	0/3	9/27	33.3%		2				00:31:17
	合计	1/6	1/2	4/6	0/4	1/4	2/2	0/4	9/28	32.1%		2				

场上队员：得分/射门

守门员：救球/射门

全队合计	得分	被救	射失	击柱	封球	合计	%
远射	3	5	1	1	3	13	23.1%
近射		1				1	0.0%
边射		3	1			4	0.0%
快攻	3					3	100.0%
突破	5	1	1			7	71.4%
任意		1				1	0.0%
七米							0.0%

## 第二届全国青年运动会女子手球甲组决赛 俱乐部组 (U18)

PHMS Pictorial Handball Match Statistics

IHF Official System

## 个人/全队技术统计表

手球 青年女子 预赛 轮次 2 组别 A 场次 28 晋中体育馆 2019-06-17 16:20

号码	姓名	远射	近射	边射	快攻	突破	任意	七米	合计	%	助攻	失误	警告	2'	取消	时间
山西晋中(晋中)																
(场上队员)																
1	邓雅楠									0.0%						00:11:19
2	付雪杰	1/1		0/3					1/4	25.0%		2		1		00:25:44
5	王晓敏	0/1							0/1	0.0%		1				00:07:54
6	张雪									0.0%						00:00:00
7	郭敏婷	1/1				3/3	0/1	3/3	7/8	87.5%	1	1		1		00:30:23
8	孙雨菲				3/3			1/1	4/4	100%		1				00:21:21
9	杨婷	1/2		0/1			0/1		1/4	25.0%		2				00:25:00
10	王玮	1/1							1/1	100%	1	4				00:31:40
12	郭佳									0.0%	1					00:28:41
13	李心怡		1/2						1/2	50.0%						00:21:32
15	杜佳奕			2/3					2/3	66.7%		1				00:32:16
18	于聪									0.0%						00:07:54
19	于颖									0.0%						00:07:54
20	尹艺霖	1/1			1/1	0/1			2/3	66.7%	1		1			00:28:18
	合计	5/7	1/2	2/7	4/4	3/4	0/2	4/4	19/30	63.3%	4	12	1	2		

(守门员)																
1	邓雅楠	3/5		2/2	0/3	1/1	1/1		7/12	58.3%						00:11:19
12	郭佳	2/3	1/1	1/1		0/5			4/10	40.0%	1					00:28:41
	合计	5/8	1/1	3/3	0/3	1/6	1/1		11/22	50.0%	1					

场上队员：得分/射门

守门员：救球/射门

全队合计	得分	被救	射失	击柱	封球	合计	%
远射	5	1	1			7	71.4%
近射	1	1				2	50.0%
边射	2	4		1		7	28.6%
快攻	4					4	100.0%
突破	3	1				4	75.0%
任意		2				2	0.0%
七米	4					4	100.0%

图式比赛技术统计表

手球  
青年女子

预赛  
轮次 2

组别 A  
场次 28

晋中体育馆  
2019-06-17 16:20

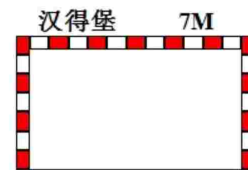
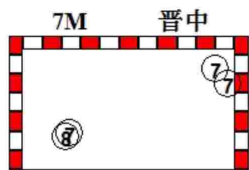
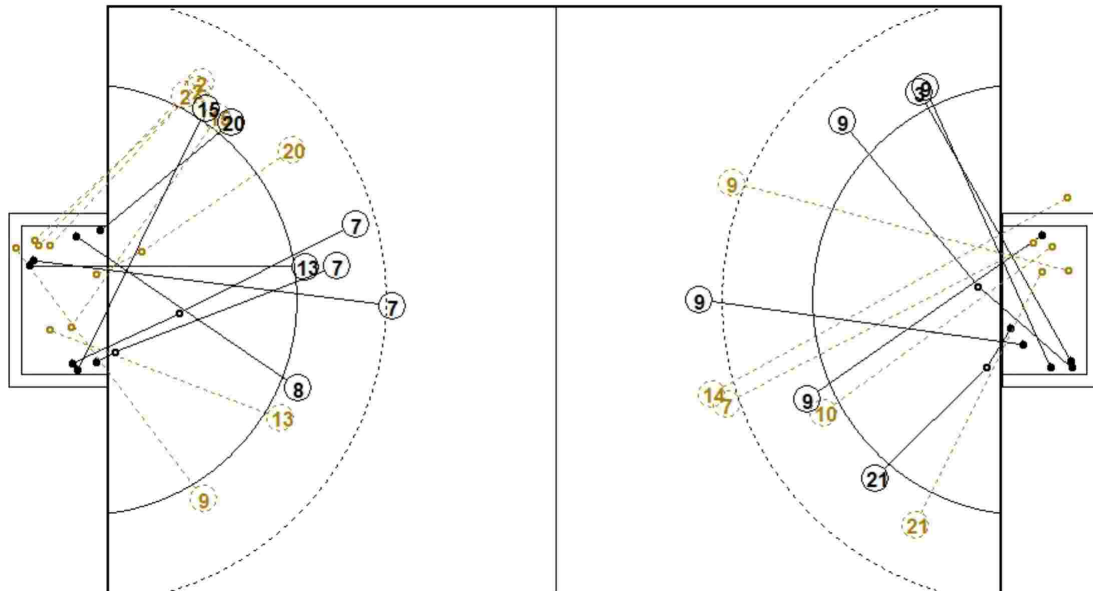

1st Half  
11 : 6

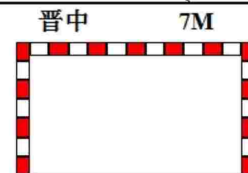
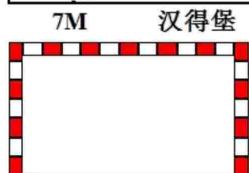
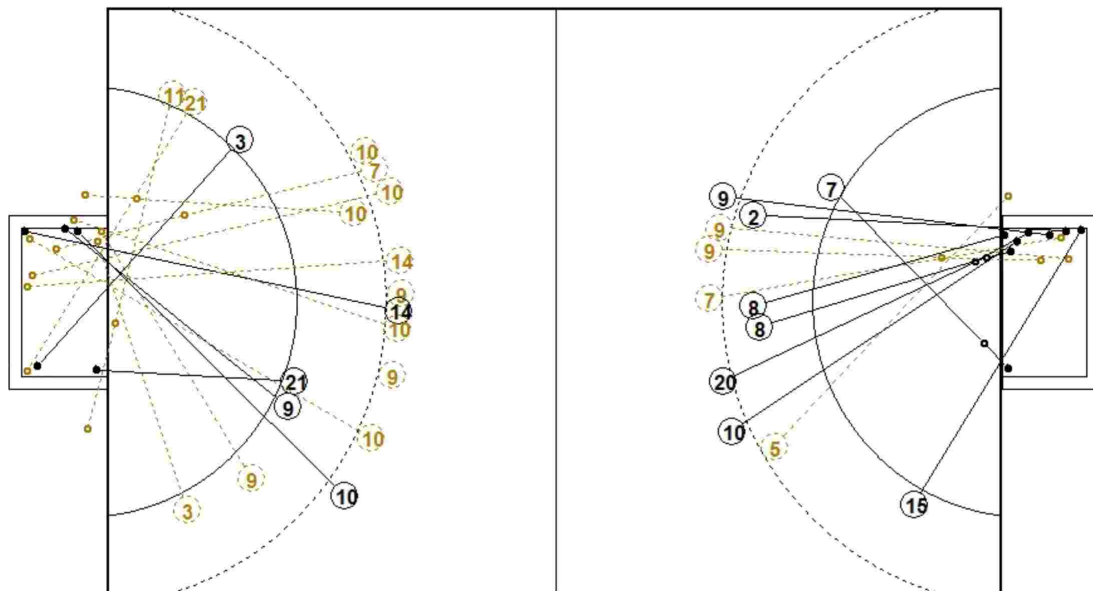

2nd Half  
11 : 19

图式射门区域统计

手球  
青年女子

预赛  
轮次 2

组别 A  
场次 28

晋中体育馆  
2019-06-17 16:20

福建汉得堡

2 张心茹 Post - 0 Miss - 0 Block - 0	3 崔艳菲 Post - 0 Miss - 0 Block - 0	5 李倩 Post - 0 Miss - 0 Block - 0	7 李珂欣 Post - 0 Miss - 0 Block - 0	8 魏雅欣 Post - 0 Miss - 0 Block - 0	9 张晓静 Post - 0 Miss - 0 Block - 2	10 穆梦欣 Post - 1 Miss - 1 Block - 1	11 孙瑞 Post - 0 Miss - 1 Block - 0
12 张跃 Post - 0 Miss - 0 Block - 0	14 尹春霞 Post - 0 Miss - 1 Block - 0	15 万里云杉 Post - 0 Miss - 0 Block - 0	16 王红 Post - 0 Miss - 0 Block - 0	21 张雪梅 Post - 0 Miss - 0 Block - 0			

12 张跃 0/1
--------------

16 王红 3/5 3/7	2/6 0/1	0/5 1/1 0/2
------------------	---------	-------------

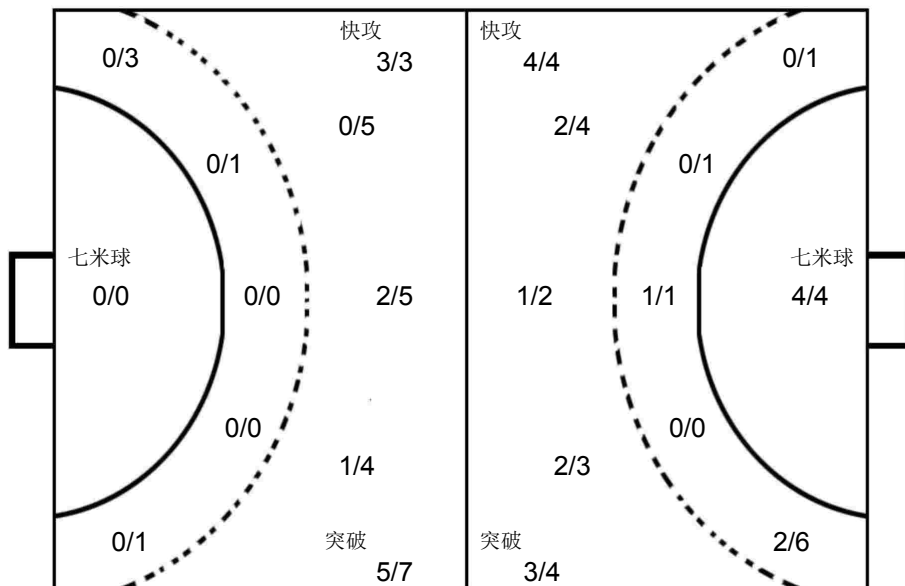

1 邓雅楠 1/2 1/1 2/3	0/1 1/3
0/1 2/2	

12 郭佳 1/1 0/2	3/4 0/1	0/2
------------------	---------	-----

山西晋中

1 邓雅楠 Post - 0 Miss - 0 Block - 0	2 付雪杰 Post - 0 Miss - 0 Block - 0	5 王晓敏 Post - 0 Miss - 1 Block - 0	6 张雪 Post - 0 Miss - 0 Block - 0	7 郭敏婷 Post - 0 Miss - 0 Block - 0	8 孙雨菲 Post - 0 Miss - 0 Block - 0	9 杨婷 Post - 1 Miss - 0 Block - 0	10 王玮 Post - 0 Miss - 0 Block - 0
12 郭佳 Post - 0 Miss - 0 Block - 0	13 李心怡 Post - 0 Miss - 0 Block - 0	15 杜佳奕 Post - 0 Miss - 0 Block - 0	18 于聪 Post - 0 Miss - 0 Block - 0	19 于颖 Post - 0 Miss - 0 Block - 0	20 尹艺霖 Post - 0 Miss - 0 Block - 0		



第二届全国青年运动会女子手球甲组决赛 俱乐部组 (U18)

青年女子 全国比赛

预赛 Group A



PHMS Pictorial Handball Match Statistics

IHF Official System

Team A					Team B					Match Number											
A 安徽淮南					B 山西晋中					43											
Played in			in the hall			on			at			Spectators									
山西晋中			晋中体育馆			2019-06-18			16:20			hours									
Half-time(30')	A	B	End of playing time		A	B	1st extra time		A	B	2nd extra time		A	B	After penalty throws		A	B			
	8	7	14		18																
Number of 7 m	A	Team time-out			Full name of players and officials						Team time-out			B	Number of 7 m						
	1/1	1	2	3							1	2	3	2/2							
			29:31																		
No.	Team A					G	W	2'	D	DR	No.	Team B					G	W	2'	D	DR
1	万文倩					1					1	邓雅楠									
2	孙雨欣					1					2	付雪杰							1		
3	陈杨										5	王晓敏									
4	张天琦					2		1			6	张雪					2				
5	高鑫艺										7	郭敏婷					9		1		
6	吕少华										8	孙雨菲									
7	承然					5		1			9	杨婷									
8	董婧										10	王玮					3				
9	叶飞雪					2					12	郭佳									
10	王梦皖										13	李心怡									
11	徐静										15	杜佳奕					3				
12	宋诗情										18	于聪									
13	杨梦颖					2					19	于颖									
14	张美琪										20	尹艺霖					1				
15	陈可怡					1															
16	陈静文																				
A	常洪飞										A	张栋									
B	孙永永										B	徐熙围 (主教练)									
A	Signatures of responsables for the teams (Off.A)															B					
TP	Remarks of referees / HF Official															TP					
Signatures																					
Referees	伍豪 (CHN)					张智伟 (CHN)															
T.D.	刘凤娟 (CHN)					叶霄雪 (CHN)															
CHA Off.																					

Note: Number of 7m Throws Awarded to Team A and B, Goals (G), Warnings (W), Suspensions (2'), Direct Disqualification (D), Disqualification With Report (DR) and Team Penalty (TP).

Table Officials: 李莉君

宣海波

Statisticians: 陈柱

谢杨





竞赛技术统计

手球  
青年女子

预赛  
轮次 3

组别 A  
场次 43

晋中体育馆  
2019-06-18 16:20

Referees:	伍豪 (CHN) / 张智伟 (CHN)	Result:	14:18(8:7)
Teams:	安徽淮南(淮南) VS 山西晋中(晋中)		

淮南		远射	近射	边射	快攻	突破	任意球	7m球	合计	%	助攻	失误	警告	2'	D+DR
主教练: 阮圣杰															
1	万文倩							1/1	1/1	100					
2	孙雨欣		1/1						1/1	100					
3	陈杨														
4	张天琦	2/4							2/4	50.0		3		1	
5	高鑫艺														
6	吕少华														
7	承然	2/6	1/4			2/2	0/1		5/13	38.5	2	4		1	
8	董婧														
9	叶飞雪		1/2	1/3					2/5	40.0		2			
10	王梦皖			0/2					0/2	0.0		2			
11	徐静														
12	宋诗情														
13	杨梦颖	0/3	1/2		1/1				2/6	33.3	3	2			
14	张美琪														
15	陈可怡		1/1						1/1	100					
16	陈静文														
运动员 合计		4/13	5/10	1/5	1/1	2/2	0/1	1/1	14/33	42.4	5	13		2	
1	万文倩	1/2	3/9	0/2	1/5	3/6		0/2	8/26	30.8					
守门员 合计		1/2	3/9	0/2	1/5	3/6		0/2	8/26	30.8					

晋中		远射	近射	边射	快攻	突破	任意球	7m球	合计	%	助攻	失误	警告	2'	D+DR
主教练: 徐熙国															
1	邓雅楠											2			
2	付雪杰													1	
5	王晓敏														
6	张雪		1/2		1/1				2/3	66.7		3			
7	郭敏婷	0/2	3/5		1/1	3/5		2/2	9/15	60.0	1	2		1	
8	孙雨菲											1			
9	杨婷			0/1	0/1				0/2	0.0		2			
10	王玮	1/4		1/2	1/2				3/8	37.5		3			
12	郭佳														
13	李心怡														
15	杜佳奕		2/3	1/1					3/4	75.0		2			
18	于聪														
19	于颖														
20	尹艺霖				1/1	0/2			1/3	33.3		1			
运动员 合计		1/6	6/10	2/4	4/6	3/7		2/2	18/35	51.4	1	16		2	
1	邓雅楠	4/6	4/7	2/3	0/1	0/1	1/1		11/19	57.9		2			
12	郭佳	2/4	0/2	1/1		0/1		0/1	3/9	33.3					
守门员 合计		6/10	4/9	3/4	0/1	0/2	1/1	0/1	14/28	50.0		2			

淮南	比赛进程	晋中
1st Half		
	0 00:55	1 20 尹艺霖
4 张天琦	1 01:21	1 郭敏婷
	1 02:12	2 7 郭敏婷
	1 03:01	3 15 杜佳奕
	1 04:07	4 7 郭敏婷
7 承然	2 05:35	4 郭敏婷
	2 08:50	5 7 郭敏婷
7 承然	3 11:03	5 郭敏婷
	3 12:01	6 7 郭敏婷
7 承然	4 12:23	6 郭敏婷
	4 13:26	7 10 王玮
15 陈可怡	5 13:59	7 郭敏婷
1 万文倩	6 14:47	7 郭敏婷
7 承然	7 18:12	7 郭敏婷
13 杨梦颖	8 18:37	7 郭敏婷
2nd Half		
9 叶飞雪	9 00:30	7 郭敏婷
	9 01:18	8 7 郭敏婷
	9 03:31	9 15 杜佳奕
	9 07:07	10 7 郭敏婷
9 叶飞雪	10 07:38	10 郭敏婷
	10 09:18	11 10 王玮
	10 09:53	12 7 郭敏婷
13 杨梦颖	11 11:36	12 郭敏婷
	11 12:04	13 7 郭敏婷
	11 12:32	14 6 张雪
7 承然	12 13:39	14 郭敏婷
	12 14:21	15 7 郭敏婷
2 孙雨欣	13 16:16	15 郭敏婷
	13 16:53	16 10 王玮
	13 18:01	17 6 张雪
4 张天琦	14 18:27	17 郭敏婷
	14 20:00	18 15 杜佳奕

场上队员: 得分 / 射门

守门员: 救球 / 射门

D	取消资格	DR	取消资格+报告
---	------	----	---------

## 个人/全队技术统计表

手球 预赛 组别 A 晋中体育馆  
青年女子 轮次 3 场次 43 2019-06-18 16:20

号码	姓名	远射	近射	边射	快攻	突破	任意	七米	合计	%	助攻	失误	警告	2'	取消	时间
安徽淮南(淮南)																
(场上队员)																
1	万文倩							1/1	1/1	100%						00:40:00
2	孙雨欣		1/1						1/1	100%						00:07:17
3	陈杨									0.0%						00:00:00
4	张天琦	2/4							2/4	50.0%		3		1		00:40:00
5	高鑫艺									0.0%						00:00:00
6	吕少华									0.0%						00:00:00
7	承然	2/6	1/4			2/2	0/1		5/13	38.5%	2	4		1		00:40:00
8	董婧									0.0%						00:00:00
9	叶飞雪		1/2	1/3					2/5	40.0%		2				00:40:00
10	王梦皖			0/2					0/2	0.0%		2				00:40:00
11	徐静									0.0%						00:00:00
12	宋诗情									0.0%						00:00:00
13	杨梦颖	0/3	1/2		1/1				2/6	33.3%	3	2				00:40:00
14	张美琪									0.0%						00:00:00
15	陈可怡		1/1						1/1	100%						00:32:41
16	陈静文									0.0%						00:00:00
合计		4/13	5/10	1/5	1/1	2/2	0/1	1/1	14/33	42.4%	5	13		2		
(守门员)																
1	万文倩	1/2	3/9	0/2	1/5	3/6		0/2	8/26	30.8%						00:40:00
合计		1/2	3/9	0/2	1/5	3/6		0/2	8/26	30.8%						

场上队员：得分/射门

守门员：救球/射门

全队合计	得分	被救	射失	击柱	封球	合计	%
远射	4	6	2		1	13	30.8%
近射	5	4	1			10	50.0%
边射	1	3		1		5	20.0%
快攻	1					1	100.0%
突破	2					2	100.0%
任意		1				1	0.0%
七米	1					1	100.0%

第二届全国青年运动会女子手球甲组决赛 俱乐部组 (U18)

PHMS Pictorial Handball Match Statistics

IHF Official System

个人/全队技术统计表

手球 预赛 组别 A 晋中体育馆  
青年女子 轮次 3 场次 43 2019-06-18 16:20

号码	姓名	远射	近射	边射	快攻	突破	任意	七米	合计	%	助攻	失误	警告	2'	取消	时间
山西晋中(晋中)																
(场上队员)																
1	邓雅楠									0.0%		2				00:24:59
2	付雪杰									0.0%				1		00:06:25
5	王晓敏									0.0%						00:00:00
6	张雪		1/2		1/1				2/3	66.7%		3				00:17:17
7	郭敏婷	0/2	3/5		1/1	3/5		2/2	9/15	60.0%	1	2		1		00:39:58
8	孙雨菲									0.0%		1				00:09:46
9	杨婷			0/1	0/1				0/2	0.0%		2				00:16:12
10	王玮	1/4		1/2	1/2				3/8	37.5%		3				00:39:56
12	郭佳									0.0%						00:15:01
13	李心怡									0.0%						00:30:10
15	杜佳奕		2/3	1/1					3/4	75.0%		2				00:39:59
18	于聪									0.0%						00:00:00
19	于颖									0.0%						00:00:00
20	尹艺霖				1/1	0/2			1/3	33.3%		1				00:39:58
	合计	1/6	6/10	2/4	4/6	3/7		2/2	18/35	51.4%	1	16		2		
(守门员)																
1	邓雅楠	4/6	4/7	2/3	0/1	0/1	1/1		11/19	57.9%		2				00:24:59
12	郭佳	2/4	0/2	1/1		0/1		0/1	3/9	33.3%						00:15:01
	合计	6/10	4/9	3/4	0/1	0/2	1/1	0/1	14/28	50.0%		2				

场上队员：得分/射门

守门员：救球/射门

全队合计	得分	被救	射失	击柱	封球	合计	%
远射	1	1	1	1	2	6	16.7%
近射	6	3		1		10	60.0%
边射	2		2			4	50.0%
快攻	4	1		1		6	66.7%
突破	3	3	1			7	42.9%
任意							0.0%
七米	2					2	100.0%

图式比赛技术统计表

手球  
青年女子

预赛  
轮次 3

组别 A  
场次 43

晋中体育馆  
2019-06-18 16:20

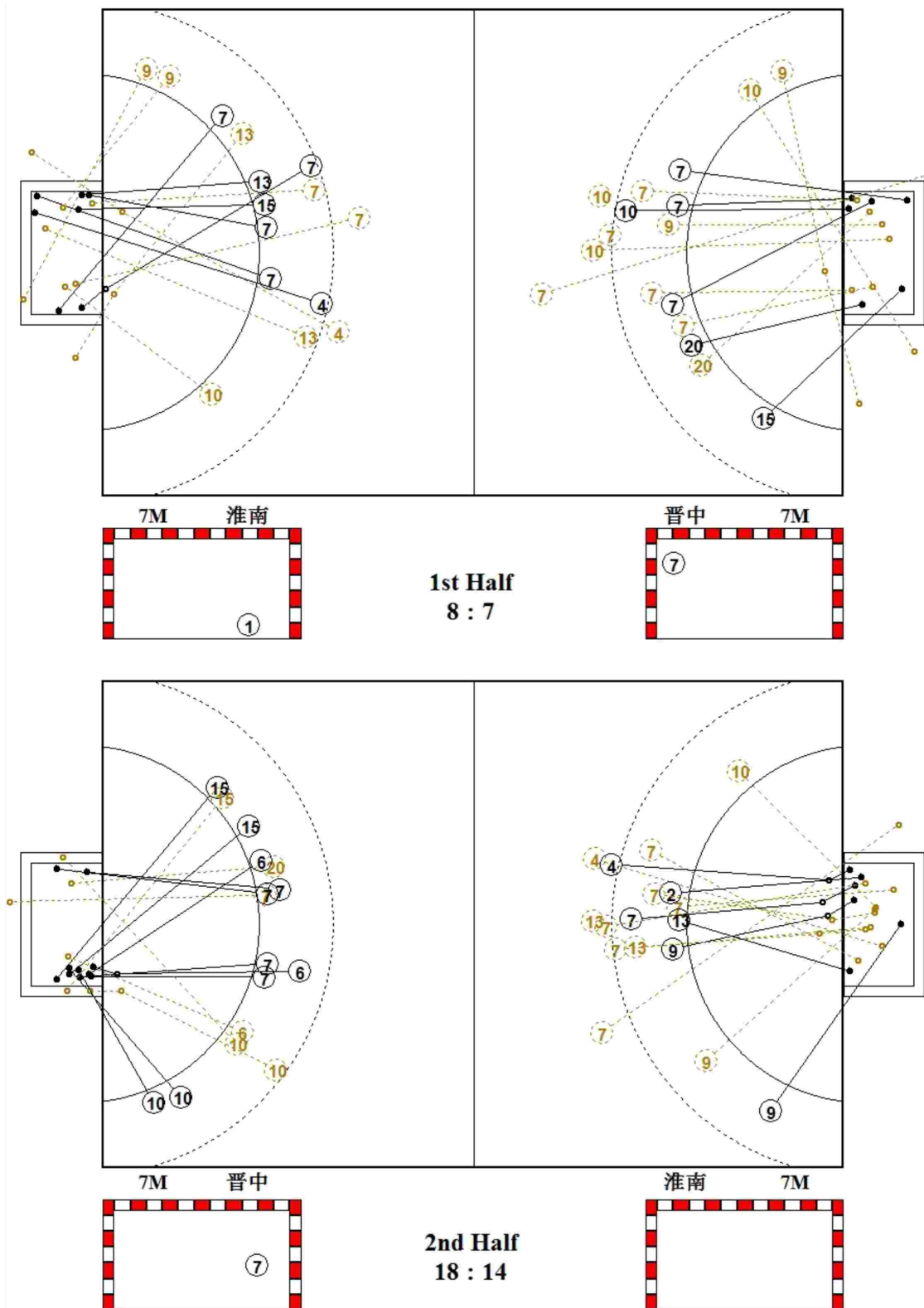

图式射门区域统计

手球  
青年女子

预赛  
轮次 3

组别 A  
场次 43

晋中体育馆  
2019-06-18 16:20

安徽淮南

1 万文倩 <table border="1"><tr><td></td><td></td><td></td></tr><tr><td></td><td></td><td>1</td></tr></table> Post - 0 Miss - 0 Block - 0						1	2 孙雨欣 <table border="1"><tr><td></td><td></td><td></td></tr><tr><td>1</td><td></td><td></td></tr></table> Post - 0 Miss - 0 Block - 0				1			3 陈杨 <table border="1"><tr><td></td><td></td><td></td></tr><tr><td></td><td></td><td></td></tr></table> Post - 0 Miss - 0 Block - 0							4 张天琦 <table border="1"><tr><td></td><td></td><td>1</td></tr><tr><td>1</td><td></td><td></td></tr></table> Post - 0 Miss - 1 Block - 0			1	1			5 高鑫艺 <table border="1"><tr><td></td><td></td><td></td></tr><tr><td></td><td></td><td></td></tr></table> Post - 0 Miss - 0 Block - 0							6 吕少华 <table border="1"><tr><td></td><td></td><td></td></tr><tr><td></td><td></td><td></td></tr></table> Post - 0 Miss - 0 Block - 0							7 承然 <table border="1"><tr><td></td><td></td><td>1</td></tr><tr><td>1</td><td></td><td></td></tr><tr><td>2</td><td></td><td>1</td></tr></table> Post - 0 Miss - 1 Block - 0			1	1			2		1	8 董婧 <table border="1"><tr><td></td><td></td><td></td></tr><tr><td></td><td></td><td></td></tr></table> Post - 0 Miss - 0 Block - 0						
		1																																																								
1																																																										
		1																																																								
1																																																										
		1																																																								
1																																																										
2		1																																																								
9 叶飞雪 <table border="1"><tr><td></td><td>1</td><td></td></tr><tr><td>1</td><td></td><td></td></tr></table> Post - 1 Miss - 0 Block - 0		1		1			10 王梦婉 <table border="1"><tr><td></td><td></td><td></td></tr><tr><td></td><td></td><td></td></tr></table> Post - 0 Miss - 0 Block - 0							11 徐静 <table border="1"><tr><td></td><td></td><td></td></tr><tr><td></td><td></td><td></td></tr></table> Post - 0 Miss - 0 Block - 0							12 宋诗情 <table border="1"><tr><td></td><td></td><td></td></tr><tr><td></td><td></td><td></td></tr></table> Post - 0 Miss - 0 Block - 0							13 杨梦颖 <table border="1"><tr><td></td><td></td><td></td></tr><tr><td></td><td></td><td>2</td></tr></table> Post - 0 Miss - 1 Block - 1						2	14 张美琪 <table border="1"><tr><td></td><td></td><td></td></tr><tr><td></td><td></td><td></td></tr></table> Post - 0 Miss - 0 Block - 0							15 陈可怡 <table border="1"><tr><td></td><td></td><td></td></tr><tr><td></td><td></td><td>1</td></tr></table> Post - 0 Miss - 0 Block - 0						1	16 陈静文 <table border="1"><tr><td></td><td></td><td></td></tr><tr><td></td><td></td><td></td></tr></table> Post - 0 Miss - 0 Block - 0									
	1																																																									
1																																																										
		2																																																								
		1																																																								

1 万文倩

0/2	1/1	0/1
3/8		2/4
1/7		1/3

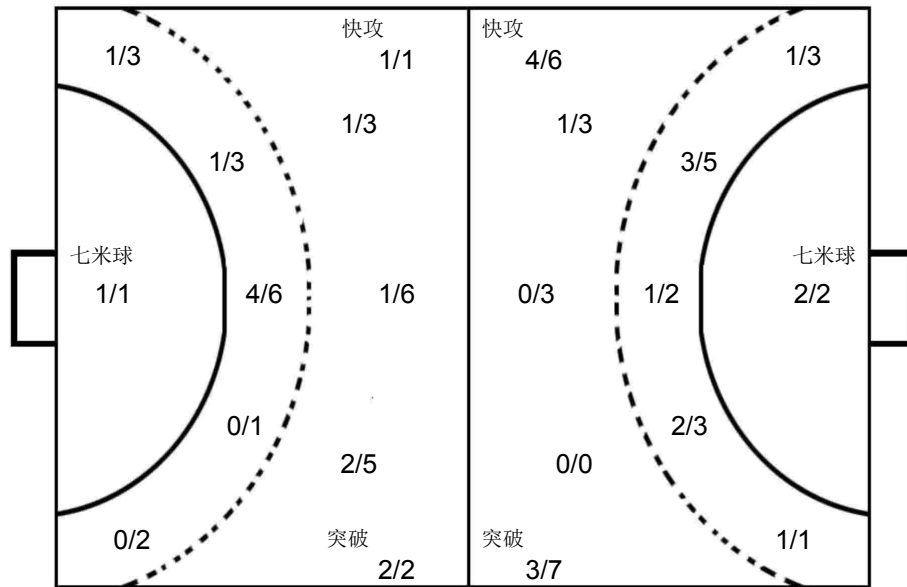

1 邓雅楠

1/1	0/1	
1/1	4/4	2/2
1/5	1/1	1/4

12 郭佳

		1/3
1/2		0/1
0/1		1/2

山西晋中

1 邓雅楠 <table border="1"><tr><td></td><td></td><td></td></tr><tr><td></td><td></td><td></td></tr></table> Post - 0 Miss - 0 Block - 0							2 付雪杰 <table border="1"><tr><td></td><td></td><td></td></tr><tr><td></td><td></td><td></td></tr></table> Post - 0 Miss - 0 Block - 0							5 王晓敏 <table border="1"><tr><td></td><td></td><td></td></tr><tr><td></td><td></td><td></td></tr></table> Post - 0 Miss - 0 Block - 0							6 张雪 <table border="1"><tr><td></td><td></td><td></td></tr><tr><td>2</td><td></td><td></td></tr></table> Post - 0 Miss - 0 Block - 0				2			7 郭敏婷 <table border="1"><tr><td>2</td><td></td><td></td></tr><tr><td>1</td><td>2</td><td></td></tr><tr><td>3</td><td>1</td><td></td></tr></table> Post - 0 Miss - 2 Block - 1	2			1	2		3	1		8 孙雨菲 <table border="1"><tr><td></td><td></td><td></td></tr><tr><td></td><td></td><td></td></tr></table> Post - 0 Miss - 0 Block - 0							9 杨婷 <table border="1"><tr><td></td><td></td><td></td></tr><tr><td></td><td></td><td></td></tr></table> Post - 0 Miss - 1 Block - 0							10 王玮 <table border="1"><tr><td></td><td></td><td></td></tr><tr><td>2</td><td></td><td></td></tr><tr><td>1</td><td></td><td></td></tr></table> Post - 2 Miss - 1 Block - 1				2			1		
2																																																													
2																																																													
1	2																																																												
3	1																																																												
2																																																													
1																																																													
12 郭佳 <table border="1"><tr><td></td><td></td><td></td></tr><tr><td></td><td></td><td></td></tr></table> Post - 0 Miss - 0 Block - 0							13 李心怡 <table border="1"><tr><td></td><td></td><td></td></tr><tr><td></td><td></td><td></td></tr></table> Post - 0 Miss - 0 Block - 0							15 杜佳奕 <table border="1"><tr><td></td><td></td><td>1</td></tr><tr><td>2</td><td></td><td></td></tr></table> Post - 1 Miss - 0 Block - 0			1	2			18 于聪 <table border="1"><tr><td></td><td></td><td></td></tr><tr><td></td><td></td><td></td></tr></table> Post - 0 Miss - 0 Block - 0							19 于颖 <table border="1"><tr><td></td><td></td><td></td></tr><tr><td></td><td></td><td></td></tr></table> Post - 0 Miss - 0 Block - 0							20 尹艺霖 <table border="1"><tr><td></td><td></td><td></td></tr><tr><td></td><td></td><td>1</td></tr></table> Post - 0 Miss - 0 Block - 0						1																				
		1																																																											
2																																																													
		1																																																											



**PHMS** Pictorial Handball Match Statistics

**IHF** Official System

Team A	Team B	Match Number
A 浙江桃渚	B 福建汉得堡	<b>44</b>

Played in	in the hall	on	at	Spectators
山西晋中	晋中体育馆	2019-06-18	17:30	hours

Half-time(30')	A	B	End of playing time	A	B	1st extra time	A	B	2nd extra time	A	B	After penalty throws	A	B
	0	9	1	18										

Number of 7 m	A	Team time-out			Full name of players and officials	Team time-out			B	Number of 7 m
	0/0	1	2	3		1	2	3	2/2	
		14:46				33:56				

No.	Team A	G	W	2'	D	DR	No.	Team B	G	W	2'	D	DR
2	骆佩瑶	1					2	张心茹					
5	周佩芸						3	崔艳菲	1				
6	黄心怡			1			5	李倩					
7	黄亚楠						7	李珂欣		1			
8	董安心			1			8	魏雅欣					
9	黄琼妮						9	张晓静	4				
11	李盼						10	穆梦欣	1		1		
12	金小清						11	孙瑞	3				
13	陈梦瑶						12	张跃					
15	项嘉柔						14	尹春霞	6				
16	王语嫣						15	万里云杉					
17	翟馨彤						16	王红					
18	陈曼莎						21	张雪梅	3				

C	项建生	A	曾令斌	G	W	2'	D	DR
D	冯婷婷	C	辛英杰					
		D	刘娜					

A	Signatures of responsables for the teams (Off.A)										B	
TP	Remarks of referees / HF Official											TP

Signatures											
Referees	黄一凡 (CHN)	王柏淇 (CHN)									
T.D.	许宜扬 (CHN)	叶霄雪 (CHN)									
CHA Off.											

Note: Number of 7m Throws Awarded to Team A and B, Goals (G), Warnings (W), Suspensions (2'), Direct Disqualification (D), Disqualification With Report (DR) and Team Penalty (TP).

Table Officials: 张琦                      杜鸿                      Statisticians: 谢杨                      陈柱

## 第二届全国青年运动会女子手球甲组决赛 俱乐部组 (U18)

PHMS Pictorial Handball Match Statistics

IHF Official System

### 竞赛技术统计

手球  
青年女子

预赛  
轮次 3

组别 A  
场次 44

晋中体育馆  
2019-06-18 17:30

Referees:	黄一凡 (CHN) / 王柏淇 (CHN)	Result:	1:18(0:9)
Teams:	浙江桃渚(桃渚) VS 福建汉得堡(汉得堡)		

桃渚		远	近	边	快	突	任意	7m	合计	%	助攻	失误	警告	2'	D+DR
主教练: 柳日祥		射	射	射	攻	破	球	球							
2	骆佩瑶	1/2							1/2	50.0		2			
5	周佩芸	0/8	0/2	0/2			0/2		0/14	0.0		12			
6	黄心怡													1	
7	黄亚楠	0/1							0/1	0.0		6			
8	董安心											2		1	
9	黄琼妮														
11	李盼														
12	金小清														
13	陈梦瑶												1		
15	项嘉柔														
16	王语嫣														
17	翟馨彤														
18	陈曼莎		0/1						0/1	0.0		3			
运动员 合计		1/11	0/3	0/2			0/2		1/18	5.6		26		2	
9	黄琼妮	2/7	1/3	3/5	1/6	0/2		0/2	7/25	28.0					
守门员 合计		2/7	1/3	3/5	1/6	0/2		0/2	7/25	28.0					

桃渚	比赛 进程	汉得堡
1st Half		
0	01:44	1 10 穆梦欣
0	02:25	2 14 尹春霞
0	03:43	3 3 崔艳菲
0	10:04	4 14 尹春霞
0	12:33	5 14 尹春霞
0	14:34	6 14 尹春霞
0	16:47	7 9 张晓静
0	18:10	8 11 孙瑞
0	19:34	9 11 孙瑞
2nd Half		
2	01:34	9
1	02:35	10 9 张晓静
1	05:17	11 14 尹春霞
1	06:10	12 21 张雪梅
1	07:46	13 21 张雪梅
1	11:09	14 21 张雪梅
1	14:01	15 11 孙瑞
1	15:26	16 14 尹春霞
1	16:21	17 9 张晓静
1	18:55	18 9 张晓静

汉得堡		远	近	边	快	突	任意	7m	合计	%	助攻	失误	警告	2'	D+DR
主教练: 王卫		射	射	射	攻	破	球	球							
2	张心茹											2			
3	崔艳菲	0/1	1/1	0/1	0/1				1/4	25.0		3			
5	李倩														
7	李珂欣												1		
8	魏雅欣														
9	张晓静	2/4	1/1		1/2				4/7	57.1		4			
10	穆梦欣	0/2	0/1			1/1			1/4	25.0		2		1	
11	孙瑞			1/1	1/1			1/1	3/3	100		1			
12	张跃														
14	尹春霞	3/6			2/2			1/1	6/9	66.7		1			
15	万里云杉														
16	王红														
21	张雪梅			1/3	1/1	1/1			3/5	60.0	1				
运动员 合计		5/13	2/3	2/5	5/7	2/2		2/2	18/32	56.3	1	13	1	1	
16	王红	5/6	1/1	1/1			1/1		8/9	88.9					
守门员 合计		5/6	1/1	1/1			1/1		8/9	88.9					

场上队员: 得分 / 射门

守门员: 救球 / 射门

D	取消资格	DR	取消资格+报告
---	------	----	---------

## 个人/全队技术统计表

手球 预赛 组别 A 晋中体育馆  
青年女子 轮次 3 场次 44 2019-06-18 17:30

号码	姓名	远射	近射	边射	快攻	突破	任意	七米	合计	%	助攻	失误	警告	2'	取消	时间
<b>浙江桃渚(桃渚)</b>																
<b>(场上队员)</b>																
2	骆佩瑶	1/2							1/2	50.0%		2				00:07:47
5	周佩芸	0/8	0/2	0/2			0/2		0/14	0.0%		12				00:39:58
6	黄心怡									0.0%				1		00:18:53
7	黄亚楠	0/1							0/1	0.0%		6				00:40:00
8	董安心									0.0%		2		1		00:35:39
9	黄琼妮									0.0%						00:40:00
11	李盼									0.0%						00:20:00
12	金小清									0.0%						00:12:12
13	陈梦瑶									0.0%		1				00:21:48
15	项嘉柔									0.0%						00:00:00
16	王语嫣									0.0%						00:00:00
17	翟馨彤									0.0%						00:03:34
18	陈曼莎		0/1						0/1	0.0%		3				00:39:55
	<b>合计</b>	1/11	0/3	0/2			0/2		1/18	5.6%		26		2		
<b>(守门员)</b>																
9	黄琼妮	2/7	1/3	3/5	1/6	0/2		0/2	7/25	28.0%						00:40:00
	<b>合计</b>	2/7	1/3	3/5	1/6	0/2		0/2	7/25	28.0%						

场上队员： 得分/射门

守门员： 救球/射门

全队合计	得分	被救	射失	击柱	封球	合计	%
远射	1	5	3		2	11	9.1%
近射		1	1	1		3	0.0%
边射		1	1			2	0.0%
快攻							0.0%
突破							0.0%
任意		1	1			2	0.0%
七米							0.0%



## 第二届全国青年运动会女子手球甲组决赛 俱乐部组 (U18)

PHMS Pictorial Handball Match Statistics

IHF Official System

## 个人/全队技术统计表

 手球 预赛 组别 A 晋中体育馆  
 青年女子 轮次 3 场次 44 2019-06-18 17:30

号码	姓名	远射	近射	边射	快攻	突破	任意	七米	合计	%	助攻	失误	警告	2'	取消	时间
福建汉得堡(汉得堡)																
(场上队员)																
2	张心茹									0.0%		2				00:15:20
3	崔艳菲	0/1	1/1	0/1	0/1				1/4	25.0%		3				00:25:00
5	李倩									0.0%						00:00:00
7	李珂欣									0.0%			1			00:35:26
8	魏雅欣									0.0%						00:06:50
9	张晓静	2/4	1/1		1/2				4/7	57.1%		4				00:31:20
10	穆梦欣	0/2	0/1			1/1			1/4	25.0%		2		1		00:38:14
11	孙瑞			1/1	1/1			1/1	3/3	100%		1				00:20:46
12	张跃									0.0%						00:00:00
14	尹春霞	3/6			2/2			1/1	6/9	66.7%		1				00:36:21
15	万里云杉									0.0%						00:02:20
16	王红									0.0%						00:40:00
21	张雪梅			1/3	1/1	1/1			3/5	60.0%	1					00:27:28
	合计	5/13	2/3	2/5	5/7	2/2		2/2	18/32	56.3%	1	13	1	1		
(守门员)																
16	王红	5/6	1/1	1/1			1/1		8/9	88.9%						00:40:00
	合计	5/6	1/1	1/1			1/1		8/9	88.9%						

场上队员： 得分/射门

守门员： 救球/射门

全队合计	得分	被救	射失	击柱	封球	合计	%
远射	5	2	6			13	38.5%
近射	2	1				3	66.7%
边射	2	3				5	40.0%
快攻	5	1		1		7	71.4%
突破	2					2	100.0%
任意							0.0%
七米	2					2	100.0%

图式比赛技术统计表

手球  
青年女子

预赛  
轮次 3

组别 A  
场次 44

晋中体育馆  
2019-06-18 17:30

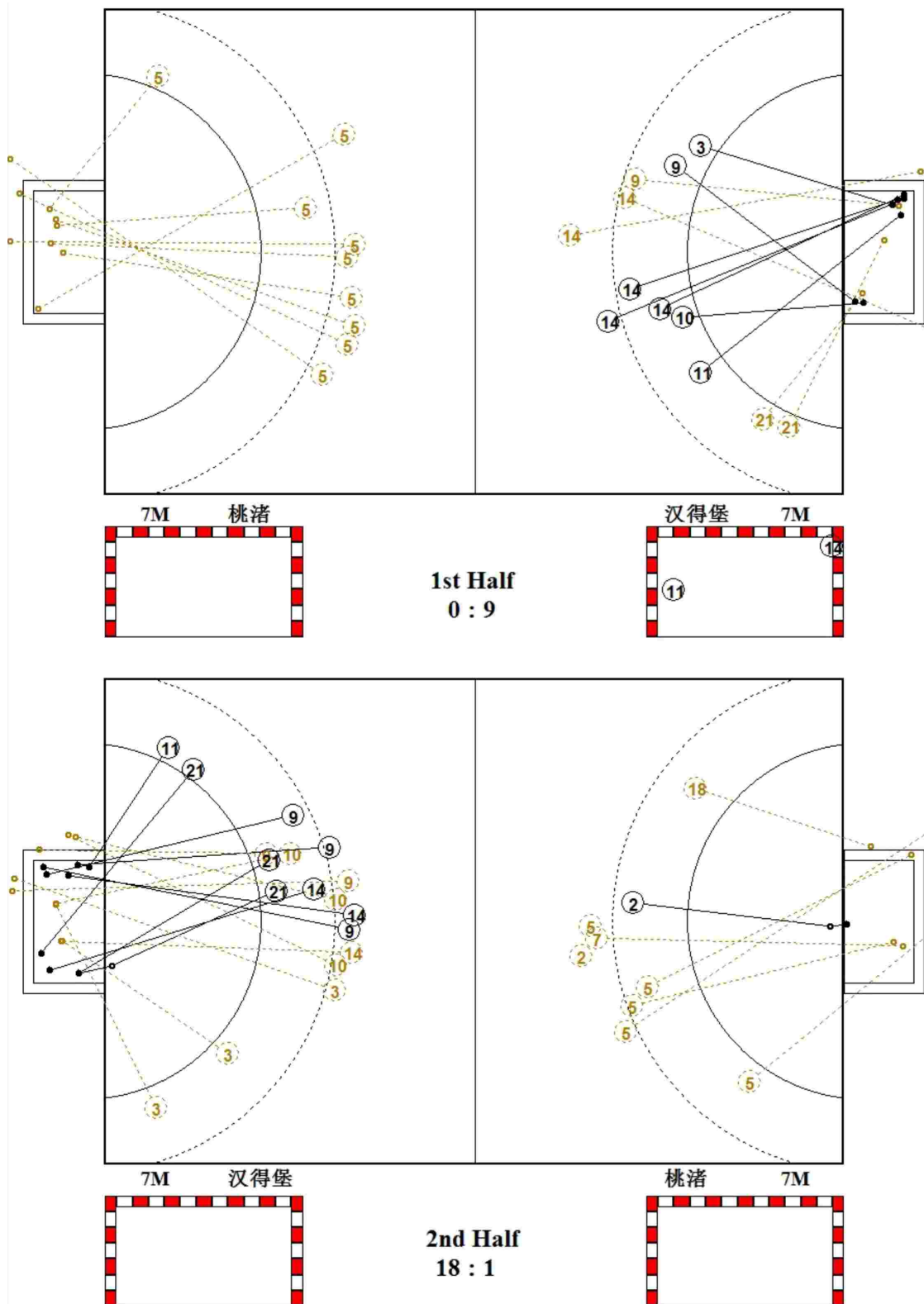

图式射门区域统计

手球  
青年女子

预赛  
轮次 3

组别 A  
场次 44

晋中体育馆  
2019-06-18 17:30

浙江桃渚

2 骆佩瑶 1 Post - 0 Miss - 0 Block - 1	5 周佩芸 Post - 1 Miss - 5 Block - 1	6 黄心怡 Post - 0 Miss - 0 Block - 0	7 黄亚楠 Post - 0 Miss - 0 Block - 0	8 董安心 Post - 0 Miss - 0 Block - 0	9 黄琼妮 Post - 0 Miss - 0 Block - 0	11 李盼 Post - 0 Miss - 0 Block - 0	12 金小清 Post - 0 Miss - 0 Block - 0
13 陈梦瑶 Post - 0 Miss - 0 Block - 0	15 项嘉柔 Post - 0 Miss - 0 Block - 0	16 王语嫣 Post - 0 Miss - 0 Block - 0	17 翟馨彤 Post - 0 Miss - 0 Block - 0	18 陈曼莎 Post - 0 Miss - 1 Block - 0			

9 黄琼妮
1/8 2/2 0/3
0/3 3/3 0/2
1/4

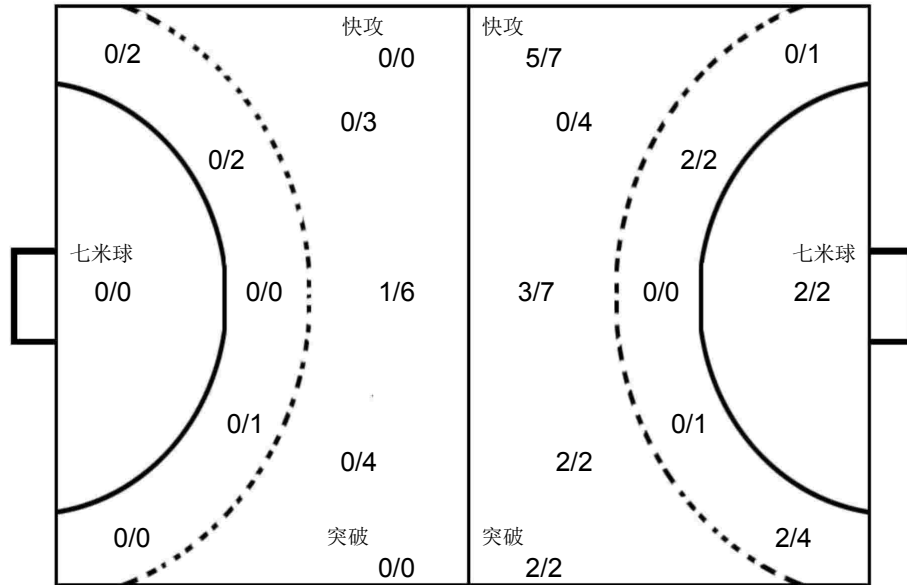

16 王红
1/1 2/2 4/4
1/1
0/1

福建汉得堡

2 张心茹 Post - 0 Miss - 0 Block - 0	3 崔艳菲 1 Post - 0 Miss - 1 Block - 0	5 李倩 Post - 0 Miss - 0 Block - 0	7 李珂欣 Post - 0 Miss - 0 Block - 0	8 魏雅欣 Post - 0 Miss - 0 Block - 0	9 张晓静 2 1 1 Post - 1 Miss - 1 Block - 0	10 穆梦欣 1 Post - 0 Miss - 2 Block - 0	11 孙瑞 1 1 1 Post - 0 Miss - 0 Block - 0
12 张跃 Post - 0 Miss - 0 Block - 0	14 尹春霞 4 1 1 Post - 0 Miss - 2 Block - 0	15 万里云杉 Post - 0 Miss - 0 Block - 0	16 王红 Post - 0 Miss - 0 Block - 0	21 张雪梅 1 2 Post - 0 Miss - 0 Block - 0			



第二届全国青年运动会女子手球甲组决赛 俱乐部组 (U18)

青年女子 全国比赛

预赛 Group A



PHMS Pictorial Handball Match Statistics

IHF Official System

Team A				Team B				Match Number	
A 安徽宿州				B 山西平遥				45	

Played in	in the hall	on	at	Spepectors
山西晋中	晋中体育馆	2019-06-18	18:40	hours

Half-time(30')	A	B	End of playing time	A	B	1st extra time	A	B	2nd extra time	A	B	After penalty throws	A	B
	7	9	15	18										

Number of 7 m	A	Team time-out			Full name of players and officials	Team time-out			B	Number of 7 m
	3/3	1	2	3		1	2	3	6/6	
		10:22				15:27	34:28			

No.	Team A	G	W	2'	D	DR	No.	Team B	G	W	2'	D	DR
1	陈文娟						1	战泳享					
3	姜景媛						2	胡嘉雯					
5	单文静						3	宫訔	2	1	3		
7	刘文秀						5	李楠					
8	李伟伟						6	王雅静					
9	李旗	4	1	1			9	马文龙	3				
10	杨晓晓						10	张越	1				
12	黄紫蝶						11	张楠					
17	田伊阳						12	战慧					
18	刘怡涵	3		1			15	徐翹悦	6		1		
21	王嫚丽	3		1			18	范小雁					
22	钦马晴	3		1			20	崔嘉欣	2	1			
23	郭茹文	2					26	李言娜					
25	郑睿涵						27	孙玟	4	1	1		
26	刘洋												
B	吴昊 (主教练)						A	张栋					
C	李绍魁						B	黄翠红 (主教练)					
D	赵萌萌						E	陶岩					
E	王路路												

A	Signatures of responsables for the teams (Off.A)												B
---	--	--	--	--	--	--	--	--	--	--	--	--	---

TP	Remarks of referees / HF Official													TP
----	-----------------------------------	--	--	--	--	--	--	--	--	--	--	--	--	----

Signatures														
Referees	伍豪 (CHN)				张智伟 (CHN)									
T.D.	叶霄雪 (CHN)				刘凤娟 (CHN)									
CHA Off.														

Note: Number of 7m Throws Awarded to Team A and B, Goals (G), Warnings (W), Suspensions (2'), Direct Disqualification (D), Disqualification With Report (DR) and Team Penalty (TP).

Table Officials: 李莉君 吴鹏凯 Statisticians: 陈柱 谢杨



## 第二届全国青年运动会女子手球甲组决赛 俱乐部组 (U18)

**PHMS** Pictorial Handball Match Statistics

**IHF** Official System

### 竞赛技术统计

手球  
青年女子

预赛  
轮次 3

组别 A  
场次 45

晋中体育馆  
2019-06-18 18:40

Referees:	伍豪 (CHN) / 张智伟 (CHN)	Result:	15:18(7:9)
Teams:	安徽宿州(宿州) VS 山西平遥(平遥)		

宿州		远	近	边	快	突	任意	7m	合计	%	助攻	失误	警告	2'	D+DR
主教练: 吴昊		射	射	射	攻	破	球	球							
1	陈文娟														
3	姜景媛														
5	单文静											1			
7	刘文秀														
8	李伟伟														
9	李旗					0/1	1/1	3/3	4/5	80.0		4	1	1	
10	杨晓晓														
12	黄紫蝶														
17	田伊阳														
18	刘怡涵		1/2			2/2			3/4	75.0		3		1	
21	王嫚丽			2/2	1/2				3/4	75.0				1	
22	钦马晴	2/3				1/1	0/1		3/5	60.0	1	5		1	
23	郭茹文		1/1	1/4					2/5	40.0		1			
25	郑睿涵														
26	刘洋	0/1							0/1	0.0		1			
运动员 合计		2/4	2/3	3/6	1/2	3/4	1/2	3/3	15/24	62.5	1	15	1	4	
12	黄紫蝶	4/6	2/7	2/4	0/1	1/3	2/2	0/6	11/29	37.9					
守门员 合计		4/6	2/7	2/4	0/1	1/3	2/2	0/6	11/29	37.9					

平遥		远	近	边	快	突	任意	7m	合计	%	助攻	失误	警告	2'	D+DR
主教练: 黄翠红		射	射	射	攻	破	球	球							
1	战泳享														
2	胡嘉雯														
3	宫訢		2/2						2/2	100			1	3	
5	李楠														
6	王雅静														
9	马文龙	2/4	1/2				0/1		3/7	42.9		1			
10	张越					1/1			1/1	100	1				
11	张楠														
12	战慧														
15	徐翹悦	0/1	1/2				0/1	5/5	6/9	66.7	1	5		1	
18	范小雁	0/1				0/1			0/2	0.0		1			
20	崔嘉欣			2/4					2/4	50.0			1		
26	李言娜														
27	孙玫		1/1	0/1	1/1	1/1		1/1	4/5	80.0	1	3	1	1	
运动员 合计		2/6	5/7	2/5	1/1	2/3	0/2	6/6	18/30	60.0	3	10	3	5	
1	战泳享	1/1	0/1			0/2		0/2	1/6	16.7					
12	战慧	0/2	1/2	0/3	0/1	0/1	1/2	0/1	2/12	16.7					
守门员 合计		1/3	1/3	0/3	0/1	0/3	1/2	0/3	3/18	16.7					

宿州	比赛 进程	平遥
1st Half		
	0 01:32	1 15 徐翹悦
	0 03:35	2 27 孙玫
9 李旗	1 05:30	2
21 王嫚丽	2 06:47	2
	2 08:09	3 15 徐翹悦
	2 09:26	4 3 宫訢
	2 10:17	5 9 马文龙
21 王嫚丽	3 11:47	5
	3 12:22	6 15 徐翹悦
23 郭茹文	4 12:42	6
9 李旗	5 13:53	6
	5 14:19	7 27 孙玫
18 刘怡涵	6 14:38	7
	6 17:45	8 3 宫訢
18 刘怡涵	7 18:09	8
	7 19:55	9 27 孙玫
2nd Half		
22 钦马晴	8 00:46	9
23 郭茹文	9 01:40	9
	9 02:18	10 27 孙玫
21 王嫚丽	10 02:40	10
	10 03:14	11 15 徐翹悦
	10 06:03	12 10 张越
9 李旗	11 06:39	12
18 刘怡涵	12 08:22	12
	12 08:49	13 9 马文龙
9 李旗	13 09:43	13
	13 10:30	14 20 崔嘉欣
	13 12:02	15 15 徐翹悦
22 钦马晴	14 14:28	15
22 钦马晴	15 16:13	15
	15 17:12	16 15 徐翹悦
	15 17:55	17 20 崔嘉欣
	15 19:15	18 9 马文龙

场上队员: 得分 / 射门

守门员: 救球 / 射门

D	取消资格	DR	取消资格+报告
---	------	----	---------

## 个人/全队技术统计表

手球 预赛 组别 A 晋中体育馆  
青年女子 轮次 3 场次 45 2019-06-18 18:40

号码	姓名	远射	近射	边射	快攻	突破	任意	七米	合计	%	助攻	失误	警告	2'	取消	时间
<b>安徽宿州(宿州)</b>																
<b>(场上队员)</b>																
1	陈文娟									0.0%						00:00:00
3	姜景媛									0.0%						00:00:00
5	单文静									0.0%		1				00:20:00
7	刘文秀									0.0%						00:00:00
8	李伟伟									0.0%						00:00:00
9	李旗					0/1	1/1	3/3	4/5	80.0%		4	1	1		00:34:37
10	杨晓晓									0.0%						00:00:00
12	黄紫蝶									0.0%						00:40:00
17	田伊阳									0.0%						00:19:42
18	刘怡涵		1/2			2/2			3/4	75.0%		3		1		00:39:42
21	王嫚丽			2/2	1/2				3/4	75.0%				1		00:39:52
22	钦马晴	2/3				1/1	0/1		3/5	60.0%	1	5		1		00:39:48
23	郭茹文		1/1	1/4					2/5	40.0%		1				00:39:58
25	郑睿涵									0.0%						00:00:00
26	刘洋	0/1							0/1	0.0%		1				00:05:10
<b>合计</b>		<b>2/4</b>	<b>2/3</b>	<b>3/6</b>	<b>1/2</b>	<b>3/4</b>	<b>1/2</b>	<b>3/3</b>	<b>15/24</b>	<b>62.5%</b>	<b>1</b>	<b>15</b>	<b>1</b>	<b>4</b>		
<b>(守门员)</b>																
12	黄紫蝶	4/6	2/7	2/4	0/1	1/3	2/2	0/6	11/29	37.9%						00:40:00
<b>合计</b>		<b>4/6</b>	<b>2/7</b>	<b>2/4</b>	<b>0/1</b>	<b>1/3</b>	<b>2/2</b>	<b>0/6</b>	<b>11/29</b>	<b>37.9%</b>						

场上队员：得分/射门

守门员：救球/射门

全队合计	得分	被救	射失	击柱	封球	合计	%
远射	2	1	1			4	50.0%
近射	2	1				3	66.7%
边射	3			3		6	50.0%
快攻	1			1		2	50.0%
突破	3		1			4	75.0%
任意	1	1				2	50.0%
七米	3					3	100.0%

## 个人/全队技术统计表

手球 青年女子 预赛 轮次 3 组别 A 场次 45 晋中体育馆 2019-06-18 18:40

号码	姓名	远射	近射	边射	快攻	突破	任意	七米	合计	%	助攻	失误	警告	2'	取消	时间
山西平遥(平遥)																
(场上队员)																
1	战泳亨									0.0%						00:13:02
2	胡嘉雯									0.0%						00:00:00
3	宫訢		2/2						2/2	100%			1	3		00:20:43
5	李楠									0.0%						00:00:00
6	王雅静									0.0%						00:00:00
9	马文龙	2/4	1/2				0/1		3/7	42.9%		1				00:30:52
10	张越					1/1			1/1	100%	1					00:39:52
11	张楠									0.0%						00:19:09
12	战慧									0.0%						00:26:58
15	徐翹悦	0/1	1/2				0/1	5/5	6/9	66.7%	1	5		1		00:39:25
18	范小雁	0/1				0/1			0/2	0.0%		1				00:09:26
20	崔嘉欣			2/4					2/4	50.0%			1			00:39:59
26	李言娜									0.0%						00:00:00
27	孙玟		1/1	0/1	1/1	1/1		1/1	4/5	80.0%	1	3	1	1		00:39:56
	合计	2/6	5/7	2/5	1/1	2/3	0/2	6/6	18/30	60.0%	3	10	3	5		
(守门员)																
1	战泳亨	1/1	0/1			0/2		0/2	1/6	16.7%						00:13:02
12	战慧	0/2	1/2	0/3	0/1	0/1	1/2	0/1	2/12	16.7%						00:26:58
	合计	1/3	1/3	0/3	0/1	0/3	1/2	0/3	3/18	16.7%						

场上队员：得分/射门

守门员：救球/射门

全队合计	得分	被救	射失	击柱	封球	合计	%
远射	2	4				6	33.3%
近射	5	2				7	71.4%
边射	2	2	1			5	40.0%
快攻	1					1	100.0%
突破	2	1				3	66.7%
任意		2				2	0.0%
七米	6					6	100.0%

图式比赛技术统计表

手球  
青年女子

预赛  
轮次 3

组别 A  
场次 45

晋中体育馆  
2019-06-18 18:40

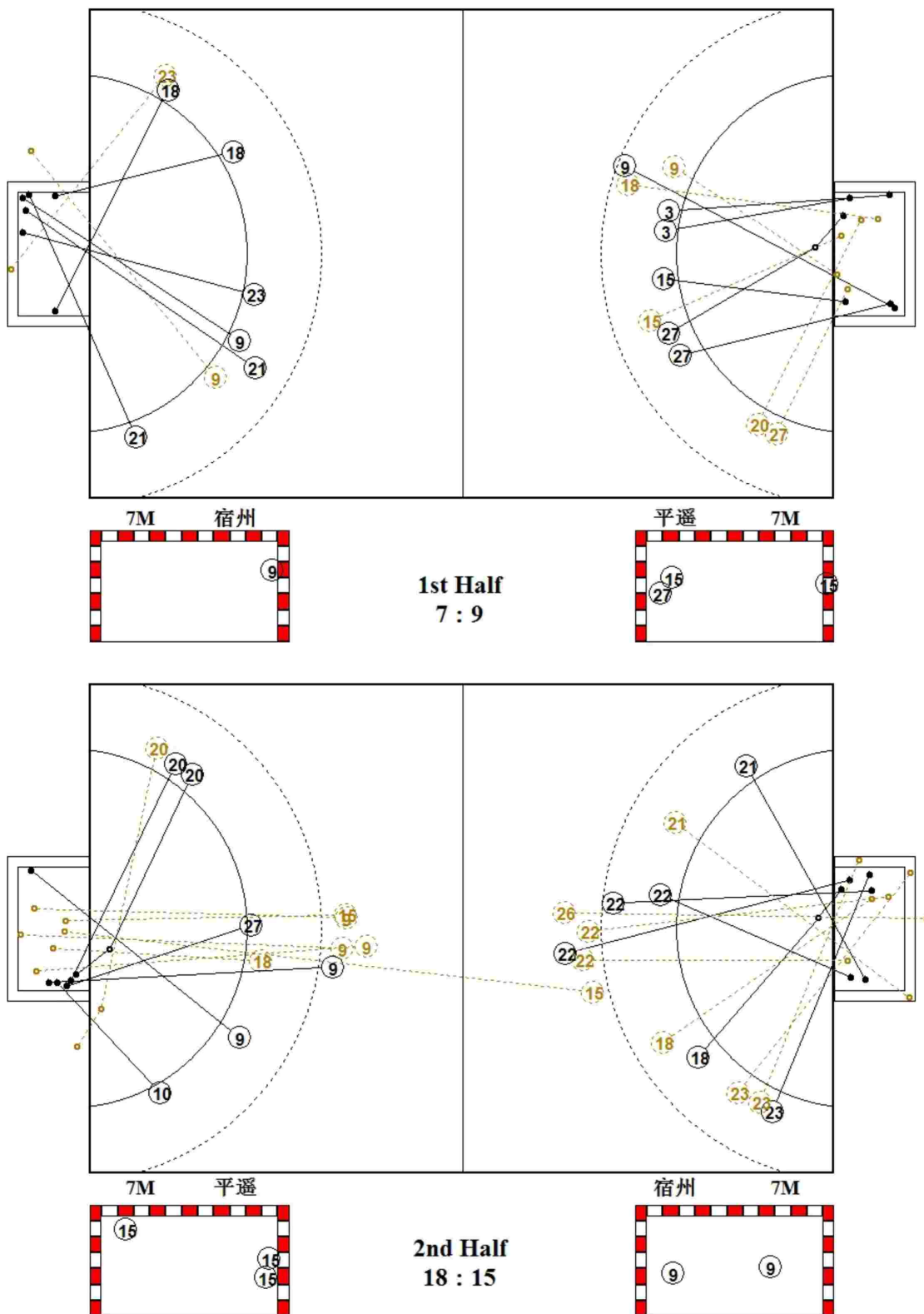



图式射门区域统计

手球  
青年女子

预赛  
轮次 3

组别 A  
场次 45

晋中体育馆  
2019-06-18 18:40

安徽宿州

1 陈文娟 <table border="1"><tr><td></td><td></td><td></td></tr><tr><td></td><td></td><td></td></tr><tr><td></td><td></td><td></td></tr></table> Post - 0 Miss - 0 Block - 0										3 姜景媛 <table border="1"><tr><td></td><td></td><td></td></tr><tr><td></td><td></td><td></td></tr><tr><td></td><td></td><td></td></tr></table> Post - 0 Miss - 0 Block - 0										5 单文静 <table border="1"><tr><td></td><td></td><td></td></tr><tr><td></td><td></td><td></td></tr><tr><td></td><td></td><td></td></tr></table> Post - 0 Miss - 0 Block - 0										7 刘文秀 <table border="1"><tr><td></td><td></td><td></td></tr><tr><td></td><td></td><td></td></tr><tr><td></td><td></td><td></td></tr></table> Post - 0 Miss - 0 Block - 0										8 李伟伟 <table border="1"><tr><td></td><td></td><td></td></tr><tr><td></td><td></td><td></td></tr><tr><td></td><td></td><td></td></tr></table> Post - 0 Miss - 0 Block - 0										9 李旗 <table border="1"><tr><td></td><td></td><td>2</td></tr><tr><td>1</td><td>1</td><td></td></tr><tr><td></td><td></td><td></td></tr></table> Post - 0 Miss - 1 Block - 0			2	1	1					10 杨晓晓 <table border="1"><tr><td></td><td></td><td></td></tr><tr><td></td><td></td><td></td></tr><tr><td></td><td></td><td></td></tr></table> Post - 0 Miss - 0 Block - 0										12 黄紫蝶 <table border="1"><tr><td></td><td></td><td></td></tr><tr><td></td><td></td><td></td></tr><tr><td></td><td></td><td></td></tr></table> Post - 0 Miss - 0 Block - 0									
		2																																																																													
1	1																																																																														
17 田伊阳 <table border="1"><tr><td></td><td></td><td></td></tr><tr><td></td><td></td><td></td></tr><tr><td></td><td></td><td></td></tr></table> Post - 0 Miss - 0 Block - 0										18 刘怡涵 <table border="1"><tr><td></td><td></td><td></td></tr><tr><td>1</td><td></td><td>1</td></tr><tr><td>1</td><td></td><td></td></tr></table> Post - 0 Miss - 0 Block - 0				1		1	1			21 王嫚丽 <table border="1"><tr><td></td><td></td><td>2</td></tr><tr><td></td><td></td><td>1</td></tr><tr><td></td><td></td><td></td></tr></table> Post - 1 Miss - 0 Block - 0			2			1				22 钦马晴 <table border="1"><tr><td></td><td></td><td></td></tr><tr><td>1</td><td></td><td></td></tr><tr><td>1</td><td></td><td>1</td></tr></table> Post - 0 Miss - 0 Block - 0				1			1		1	23 郭茹文 <table border="1"><tr><td></td><td>1</td><td></td></tr><tr><td>1</td><td></td><td></td></tr><tr><td></td><td></td><td></td></tr></table> Post - 3 Miss - 0 Block - 0		1		1						25 郑睿涵 <table border="1"><tr><td></td><td></td><td></td></tr><tr><td></td><td></td><td></td></tr><tr><td></td><td></td><td></td></tr></table> Post - 0 Miss - 0 Block - 0										26 刘洋 <table border="1"><tr><td></td><td></td><td></td></tr><tr><td></td><td></td><td></td></tr><tr><td></td><td></td><td></td></tr></table> Post - 0 Miss - 1 Block - 0																			
1		1																																																																													
1																																																																															
		2																																																																													
		1																																																																													
1																																																																															
1		1																																																																													
	1																																																																														
1																																																																															

12 黄紫蝶

1/4	2/2	0/3
2/5	3/3	0/3
0/5	2/2	1/2

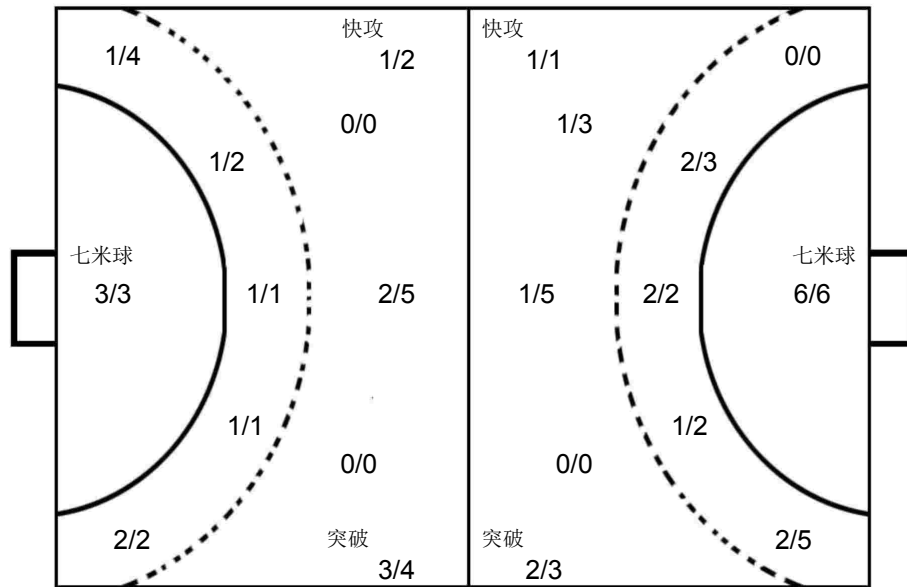

1 战泳亨

		0/1
0/1	0/1	0/1
0/1		1/1

12 战慧

1/1	0/1	0/3
1/4		0/1
0/1		0/1

山西平遥

1 战泳亨 <table border="1"><tr><td></td><td></td><td></td></tr><tr><td></td><td></td><td></td></tr><tr><td></td><td></td><td></td></tr></table> Post - 0 Miss - 0 Block - 0										2 胡嘉雯 <table border="1"><tr><td></td><td></td><td></td></tr><tr><td></td><td></td><td></td></tr><tr><td></td><td></td><td></td></tr></table> Post - 0 Miss - 0 Block - 0										3 宫訢 <table border="1"><tr><td>1</td><td></td><td></td></tr><tr><td>1</td><td></td><td></td></tr><tr><td></td><td></td><td></td></tr></table> Post - 0 Miss - 0 Block - 0	1			1						5 李楠 <table border="1"><tr><td></td><td></td><td></td></tr><tr><td></td><td></td><td></td></tr><tr><td></td><td></td><td></td></tr></table> Post - 0 Miss - 0 Block - 0										6 王雅静 <table border="1"><tr><td></td><td></td><td></td></tr><tr><td></td><td></td><td></td></tr><tr><td></td><td></td><td></td></tr></table> Post - 0 Miss - 0 Block - 0										9 马文龙 <table border="1"><tr><td></td><td></td><td>2</td></tr><tr><td>1</td><td></td><td></td></tr><tr><td></td><td></td><td></td></tr></table> Post - 0 Miss - 0 Block - 0			2	1						10 张越 <table border="1"><tr><td></td><td></td><td></td></tr><tr><td>1</td><td></td><td></td></tr><tr><td></td><td></td><td></td></tr></table> Post - 0 Miss - 0 Block - 0				1						11 张楠 <table border="1"><tr><td></td><td></td><td></td></tr><tr><td></td><td></td><td></td></tr><tr><td></td><td></td><td></td></tr></table> Post - 0 Miss - 0 Block - 0									
1																																																																															
1																																																																															
		2																																																																													
1																																																																															
1																																																																															
12 战慧 <table border="1"><tr><td></td><td></td><td></td></tr><tr><td></td><td></td><td></td></tr><tr><td></td><td></td><td></td></tr></table> Post - 0 Miss - 0 Block - 0										15 徐翹悦 <table border="1"><tr><td>2</td><td></td><td></td></tr><tr><td></td><td></td><td>3</td></tr><tr><td></td><td></td><td>1</td></tr></table> Post - 0 Miss - 0 Block - 0	2					3			1	18 范小雁 <table border="1"><tr><td></td><td></td><td></td></tr><tr><td></td><td></td><td></td></tr><tr><td></td><td></td><td></td></tr></table> Post - 0 Miss - 0 Block - 0										20 崔嘉欣 <table border="1"><tr><td></td><td></td><td></td></tr><tr><td>2</td><td></td><td></td></tr><tr><td></td><td></td><td></td></tr></table> Post - 0 Miss - 1 Block - 0				2						26 李言娜 <table border="1"><tr><td></td><td></td><td></td></tr><tr><td></td><td></td><td></td></tr><tr><td></td><td></td><td></td></tr></table> Post - 0 Miss - 0 Block - 0										27 孙玫 <table border="1"><tr><td></td><td></td><td>1</td></tr><tr><td>1</td><td></td><td></td></tr><tr><td>2</td><td></td><td></td></tr></table> Post - 0 Miss - 0 Block - 0			1	1			2																						
2																																																																															
		3																																																																													
		1																																																																													
2																																																																															
		1																																																																													
1																																																																															
2																																																																															



第二届全国青年运动会女子手球甲组决赛 俱乐部组 (U18)

青年女子 全国比赛

预赛 Group A



PHMS Pictorial Handball Match Statistics

IHF Official System

Team A A 山西晋中		Team B B 浙江桃渚		Match Number <b>46</b>
------------------	--	------------------	--	---------------------------

Played in 山西晋中	in the hall 晋中体育馆	on 2019-06-20	at 14:00	hours	Spectators
-------------------	----------------------	------------------	-------------	-------	------------

Half-time(30')	A 19	B 0	End of playing time	A 33	B 6	1st extra time	A	B	2nd extra time	A	B	After penalty throws	A	B
----------------	---------	--------	---------------------	---------	--------	----------------	---	---	----------------	---	---	----------------------	---	---

Number of 7 m	A 1/1	Team time-out			Full name of players and officials	Team time-out			B 0/0	Number of 7 m
	1 12:10	2	3	1 07:07		2	3			

No.	Team A	G	W	2'	D	DR	No.	Team B	G	W	2'	D	DR
1	邓雅楠						2	骆佩瑶					
2	付雪杰	8					5	周佩芸	2				
5	王晓敏	3					6	黄心怡	2		1		
7	郭敏婷	1					7	黄亚楠					
8	孙雨菲	5					8	董安心					
9	杨婷	2					9	黄琼妮					
10	王玮	2					11	李盼					
12	郭佳						12	金小清					
13	李心怡						13	陈梦瑶					
15	杜佳奕	3					15	项嘉柔					
18	于聪	2					16	王语嫣					
19	于颖	4					17	翟馨彤					
20	尹艺霖	3					18	陈曼莎	2				

A	张栋						C	项建生					
B	徐熙围 (主教练)						D	冯婷婷					
							E	蒋云敏					

A	Signatures of responsables for the teams (Off.A)												B
---	--	--	--	--	--	--	--	--	--	--	--	--	---

TP	Remarks of referees / HF Official													TP
----	-----------------------------------	--	--	--	--	--	--	--	--	--	--	--	--	----

Referees	孟凡刚 (CHN)	刘明华 (CHN)		
T.D.	柴业宏 (CHN)	陈晓波 (CHN)		
CHA Off.				

Note: Number of 7m Throws Awarded to Team A and B, Goals (G), Warnings (W), Suspensions (2'), Direct Disqualification (D), Disqualification With Report (DR) and Team Penalty (TP).

Table Officials: 孙龙龙 李莉君 Statisticians: 王梓衡 刘笑

## 第二届全国青年运动会女子手球甲组决赛 俱乐部组 (U18)

PHMS Pictorial Handball Match Statistics

IHF Official System

### 竞赛技术统计

手球  
青年女子

预赛  
轮次 4

组别 A  
场次 46

晋中体育馆  
2019-06-20 14:00

Referees:	孟凡刚 (CHN) / 刘明华 (CHN)	Result:	33:6 (19:0)
Teams:	山西晋中(晋中) VS 浙江桃渚(桃渚)		

晋中																晋中		比赛 进程		桃渚	
主教练: 徐熙围																					
	远射	近射	边射	快攻	突破	任意球	7m球	合计	%	助攻	失误	警告	2'	D+DR							
1 邓雅楠										8											
2 付雪杰	1/1	2/2		5/6				8/9	88.9												
5 王晓敏			1/1	2/2				3/3	100		2										
7 郭敏婷	0/1			1/1	0/2			1/4	25.0	1	1										
8 孙雨菲	0/1	2/4		3/3				5/8	62.5												
9 杨婷				2/2				2/2	100												
10 王玮				1/1		1/1		2/2	100	1											
12 郭佳										2											
13 李心怡																					
15 杜佳奕			1/1	2/4				3/5	60.0	1											
18 于聪		0/1	1/1	0/1	1/2			2/5	40.0	1											
19 于颖			3/3				1/1	4/4	100		1										
20 尹艺霖			1/2	2/2				3/4	75.0	1											
运动员 合计	1/3	4/7	7/8	18/22	1/4	1/1	1/1	33/46	71.7	15	4										
1 邓雅楠	3/3	2/6	7/8		0/1	1/1		13/19	68.4	8											
12 郭佳	1/1	1/1	1/1					3/3	100	2											
守门员 合计	4/4	3/7	8/9		0/1	1/1		16/22	72.7	10											
桃渚																					
主教练: 柳日祥																					
	远射	近射	边射	快攻	突破	任意球	7m球	合计	%	助攻	失误	警告	2'	D+DR							
2 骆佩瑶																					
5 周佩芸	0/4	1/2	1/9			0/2		2/17	11.8		6										
6 黄心怡		2/3						2/3	66.7		1		1								
7 黄亚楠	0/1							0/1	0.0		5										
8 董安心										1											
9 黄琼妮																					
11 李盼		0/1						0/1	0.0												
12 金小清																					
13 陈梦瑶			0/1					0/1	0.0												
15 项嘉柔																					
16 王语嫣																					
17 翟馨彤																					
18 陈曼莎		1/4			1/2			2/6	33.3		3										
运动员 合计	0/5	4/10	1/10		1/2	0/2		6/29	20.7	1	15		1								
9 黄琼妮	0/1	1/5	1/8	3/21	1/2	0/1	0/1	6/39	15.4												
守门员 合计	0/1	1/5	1/8	3/21	1/2	0/1	0/1	6/39	15.4												
桃渚																					
主教练: 柳日祥																					
	远射	近射	边射	快攻	突破	任意球	7m球	合计	%	助攻	失误	警告	2'	D+DR							
10 王玮																					
15 杜佳奕																					
15 杜佳奕																					
9 杨婷																					
9 杨婷																					
7 郭敏婷																					
10 王玮																					
20 尹艺霖																					
15 杜佳奕																					
20 尹艺霖																					
20 尹艺霖																					
19 于颖																					
5 王晓敏																					
8 孙雨菲																					
2 付雪杰																					
2 付雪杰																					
2 付雪杰																					
2 付雪杰																					
2 付雪杰																					
19 于颖																					
8 孙雨菲																					
2 付雪杰																					
21 01:00																					
21 03:32																	18 陈曼莎				
22 03:41																					
23 04:36																					
24 05:27																					
25 06:00																					
26 07:00																					
27 07:37																					
28 08:16																	6 黄心怡				
28 09:12																					
29 09:55																					
29 10:39																	5 周佩芸				
29 11:22																	6 黄心怡				
30 11:38																					
31 13:28																					
32 15:16																					
32 16:25																	5 周佩芸				
32 17:31																	18 陈曼莎				
33 19:48																	6				

场上队员: 得分 / 射门

守门员: 救球 / 射门

D	取消资格	DR	取消资格+报告
---	------	----	---------

## 个人/全队技术统计表

手球 青年女子 预赛 轮次 4 组别 A 场次 46 晋中体育馆 2019-06-20 14:00

号码	姓名	远射	近射	边射	快攻	突破	任意	七米	合计	%	助攻	失误	警告	2'	取消	时间
山西晋中(晋中)																
(场上队员)																
1	邓雅楠									0.0%	8					00:27:47
2	付雪杰	1/1	2/2		5/6				8/9	88.9%						00:24:56
5	王晓敏			1/1	2/2				3/3	100%		2				00:26:25
7	郭敏婷	0/1			1/1	0/2			1/4	25.0%	1	1				00:17:07
8	孙雨菲	0/1	2/4		3/3				5/8	62.5%						00:26:45
9	杨婷				2/2				2/2	100%						00:14:45
10	王玮				1/1		1/1		2/2	100%	1					00:12:56
12	郭佳									0.0%	2					00:12:10
13	李心怡									0.0%						00:13:29
15	杜佳奕			1/1	2/4				3/5	60.0%	1					00:37:21
18	于聪		0/1	1/1	0/1	1/2			2/5	40.0%	1					00:26:54
19	于颖			3/3				1/1	4/4	100%		1				00:27:03
20	尹艺霖			1/2	2/2				3/4	75.0%	1					00:12:21
合计		1/3	4/7	7/8	18/22	1/4	1/1	1/1	33/46	71.7%	15	4				
(守门员)																
1	邓雅楠	3/3	2/6	7/8		0/1	1/1		13/19	68.4%	8					00:27:47
12	郭佳	1/1	1/1	1/1					3/3	100%	2					00:12:10
合计		4/4	3/7	8/9		0/1	1/1		16/22	72.7%	10					

场上队员： 得分/射门

守门员： 救球/射门

全队合计	得分	被救	射失	击柱	封球	合计	%
远射	1		2			3	33.3%
近射	4	1	1	1		7	57.1%
边射	7	1				8	87.5%
快攻	18	3		1		22	81.8%
突破	1	1	1	1		4	25.0%
任意	1					1	100.0%
七米	1					1	100.0%

## 第二届全国青年运动会女子手球甲组决赛 俱乐部组 (U18)

PHMS Pictorial Handball Match Statistics

IHF Official System

## 个人/全队技术统计表

手球 青年女子 预赛 轮次 4 组别 A 场次 46 晋中体育馆 2019-06-20 14:00

号码	姓名	远射	近射	边射	快攻	突破	任意	七米	合计	%	助攻	失误	警告	2'	取消	时间
<b>浙江桃渚(桃渚)</b>																
<b>(场上队员)</b>																
2	骆佩瑶									0.0%						00:00:00
5	周佩芸	0/4	1/2	1/9			0/2		2/17	11.8%		6				00:39:56
6	黄心怡		2/3						2/3	66.7%		1		1		00:35:22
7	黄亚楠	0/1							0/1	0.0%		5				00:39:57
8	董安心									0.0%	1					00:13:21
9	黄琼妮									0.0%						00:39:57
11	李盼		0/1						0/1	0.0%						00:39:51
12	金小清									0.0%						00:00:00
13	陈梦瑶			0/1					0/1	0.0%						00:31:06
15	项嘉柔									0.0%						00:00:00
16	王语嫣									0.0%						00:00:00
17	翟馨彤									0.0%						00:00:00
18	陈曼莎		1/4			1/2			2/6	33.3%		3				00:39:55
	<b>合计</b>	<b>0/5</b>	<b>4/10</b>	<b>1/10</b>		<b>1/2</b>	<b>0/2</b>		<b>6/29</b>	<b>20.7%</b>	<b>1</b>	<b>15</b>		<b>1</b>		
<b>(守门员)</b>																
9	黄琼妮	0/1	1/5	1/8	3/21	1/2	0/1	0/1	6/39	15.4%						00:39:57
	<b>合计</b>	<b>0/1</b>	<b>1/5</b>	<b>1/8</b>	<b>3/21</b>	<b>1/2</b>	<b>0/1</b>	<b>0/1</b>	<b>6/39</b>	<b>15.4%</b>						

场上队员： 得分/射门

守门员： 救球/射门

全队合计	得分	被救	射失	击柱	封球	合计	%
远射		4	1			5	0.0%
近射	4	3	1	1	1	10	40.0%
边射	1	8	1			10	10.0%
快攻							0.0%
突破	1		1			2	50.0%
任意		1	1			2	0.0%
七米							0.0%

图式比赛技术统计表

手球  
青年女子

预赛  
轮次 4

组别 A  
场次 46

晋中体育馆  
2019-06-20 14:00

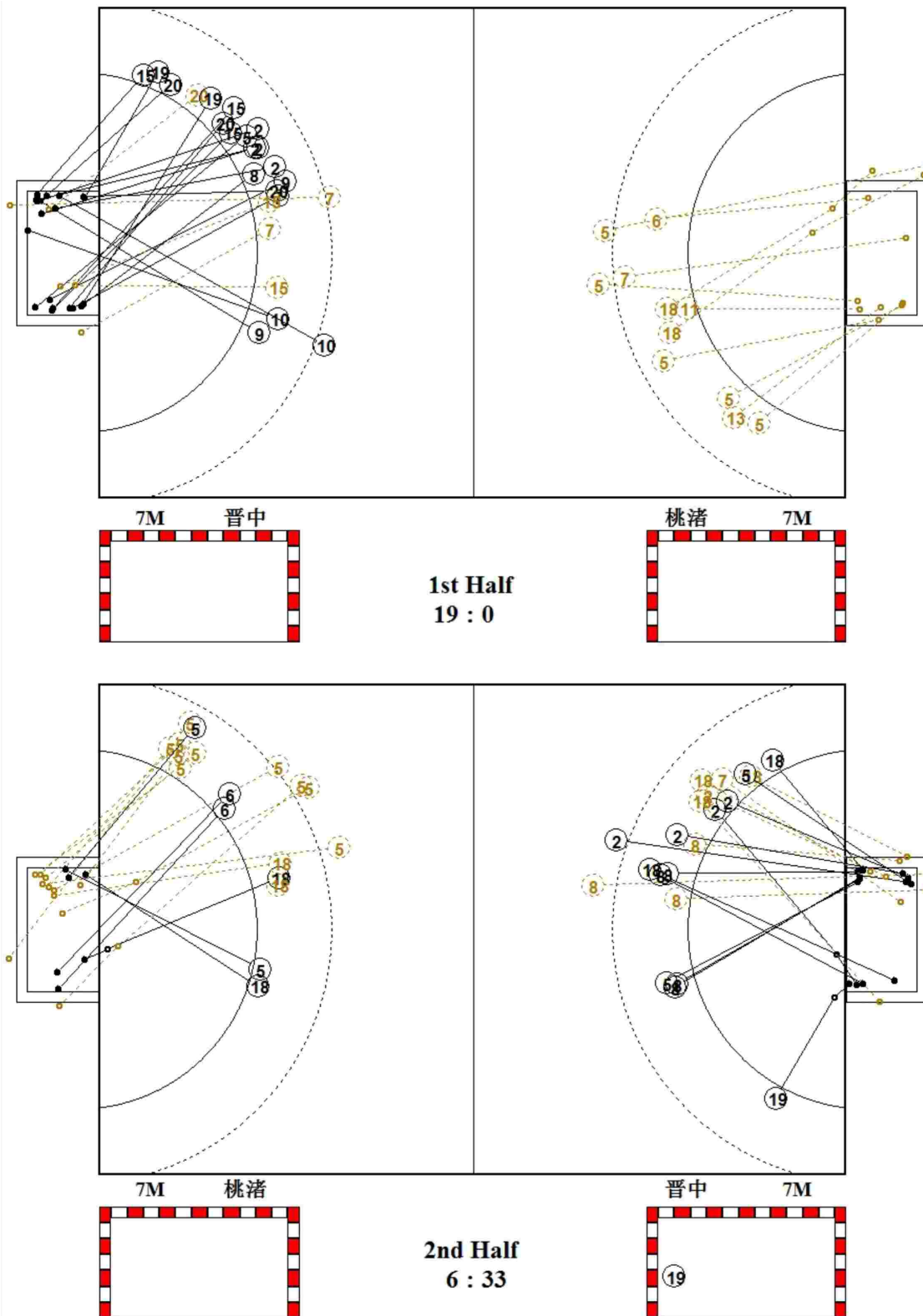

图式射门区域统计

手球  
青年女子

预赛  
轮次 4

组别 A  
场次 46

晋中体育馆  
2019-06-20 14:00

山西晋中

1 邓雅楠	2 付雪杰	5 王晓敏	7 郭敏婷	8 孙雨菲	9 杨婷	10 王玮	12 郭佳																																																																								
<table border="1"><tr><td></td><td></td><td></td></tr><tr><td></td><td></td><td></td></tr><tr><td></td><td></td><td></td></tr></table>										<table border="1"><tr><td>3</td><td></td><td>3</td></tr><tr><td></td><td></td><td>1</td></tr><tr><td></td><td></td><td>1</td></tr></table>	3		3			1			1	<table border="1"><tr><td>2</td><td></td><td></td></tr><tr><td></td><td></td><td></td></tr><tr><td>1</td><td></td><td></td></tr></table>	2						1			<table border="1"><tr><td></td><td></td><td></td></tr><tr><td>1</td><td></td><td></td></tr><tr><td></td><td></td><td></td></tr></table>				1						<table border="1"><tr><td></td><td></td><td>1</td></tr><tr><td></td><td></td><td></td></tr><tr><td>4</td><td></td><td></td></tr></table>			1				4			<table border="1"><tr><td>1</td><td></td><td>1</td></tr><tr><td></td><td></td><td></td></tr><tr><td></td><td></td><td></td></tr></table>	1		1							<table border="1"><tr><td></td><td></td><td>1</td></tr><tr><td></td><td></td><td>1</td></tr><tr><td></td><td></td><td></td></tr></table>			1			1				<table border="1"><tr><td></td><td></td><td></td></tr><tr><td></td><td></td><td></td></tr><tr><td></td><td></td><td></td></tr></table>									
3		3																																																																													
		1																																																																													
		1																																																																													
2																																																																															
1																																																																															
1																																																																															
		1																																																																													
4																																																																															
1		1																																																																													
		1																																																																													
		1																																																																													
13 李心怡	15 杜佳奕	18 于聪	19 于颖	20 尹艺霖																																																																											
<table border="1"><tr><td></td><td></td><td></td></tr><tr><td></td><td></td><td></td></tr><tr><td></td><td></td><td></td></tr></table>										<table border="1"><tr><td>1</td><td></td><td>1</td></tr><tr><td>1</td><td></td><td></td></tr><tr><td></td><td></td><td></td></tr></table>	1		1	1						<table border="1"><tr><td></td><td></td><td></td></tr><tr><td></td><td></td><td></td></tr><tr><td>1</td><td></td><td>1</td></tr></table>							1		1	<table border="1"><tr><td></td><td></td><td></td></tr><tr><td>1</td><td></td><td></td></tr><tr><td>1</td><td></td><td>2</td></tr></table>				1			1		2	<table border="1"><tr><td></td><td></td><td>1</td></tr><tr><td>1</td><td></td><td></td></tr><tr><td></td><td></td><td>1</td></tr></table>			1	1					1																														
1		1																																																																													
1																																																																															
1		1																																																																													
1																																																																															
1		2																																																																													
		1																																																																													
1																																																																															
		1																																																																													
<p>Post - 0 Miss - 0 Block - 0    Post - 0 Miss - 0 Block - 0    Post - 0 Miss - 0 Block - 0    Post - 0 Miss - 2 Block - 0    Post - 1 Miss - 2 Block - 0    Post - 0 Miss - 0 Block - 0    Post - 0 Miss - 0 Block - 0    Post - 0 Miss - 0 Block - 0</p>																																																																															

1 邓雅楠			
	1/1	6/6	
0/2	1/1	3/5	
1/2		1/2	

12 郭佳			1/1
			2/2

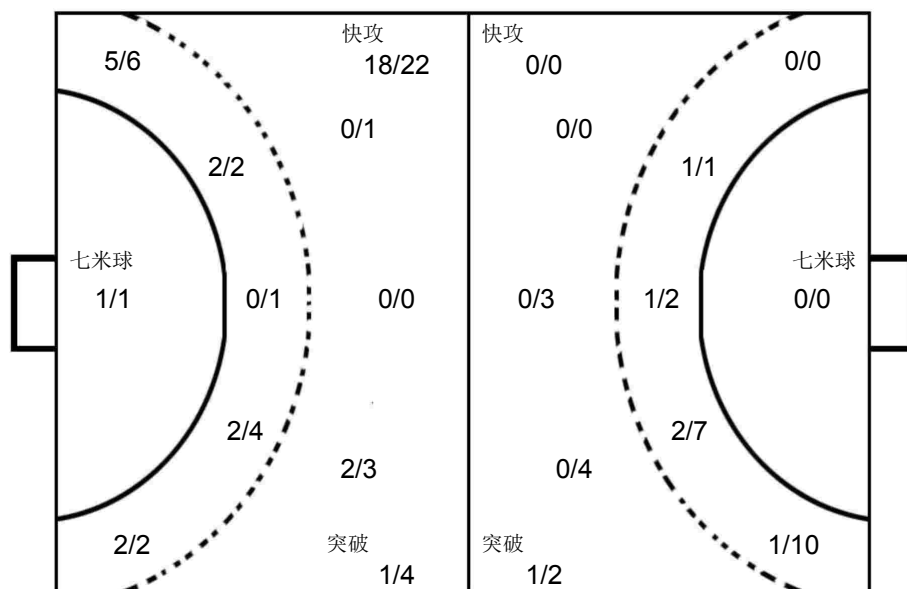

9 黄琼妮			1/9
1/8			0/2
4/8			0/5
0/7			

浙江桃渚

2 骆佩瑶	5 周佩芸	6 黄心怡	7 黄亚楠	8 董安心	9 黄琼妮	11 李盼	12 金小清																																																																								
<table border="1"><tr><td></td><td></td><td></td></tr><tr><td></td><td></td><td></td></tr><tr><td></td><td></td><td></td></tr></table>										<table border="1"><tr><td></td><td></td><td>2</td></tr><tr><td></td><td></td><td></td></tr><tr><td></td><td></td><td></td></tr></table>			2							<table border="1"><tr><td>2</td><td></td><td></td></tr><tr><td></td><td></td><td></td></tr><tr><td></td><td></td><td></td></tr></table>	2									<table border="1"><tr><td></td><td></td><td></td></tr><tr><td></td><td></td><td></td></tr><tr><td></td><td></td><td></td></tr></table>										<table border="1"><tr><td></td><td></td><td></td></tr><tr><td></td><td></td><td></td></tr><tr><td></td><td></td><td></td></tr></table>										<table border="1"><tr><td></td><td></td><td></td></tr><tr><td></td><td></td><td></td></tr><tr><td></td><td></td><td></td></tr></table>										<table border="1"><tr><td></td><td></td><td></td></tr><tr><td></td><td></td><td></td></tr><tr><td></td><td></td><td></td></tr></table>										<table border="1"><tr><td></td><td></td><td></td></tr><tr><td></td><td></td><td></td></tr><tr><td></td><td></td><td></td></tr></table>									
		2																																																																													
2																																																																															
13 陈梦瑶	15 项嘉柔	16 王语嫣	17 翟馨彤	18 陈曼莎																																																																											
<table border="1"><tr><td></td><td></td><td></td></tr><tr><td></td><td></td><td></td></tr><tr><td></td><td></td><td></td></tr></table>										<table border="1"><tr><td></td><td></td><td></td></tr><tr><td></td><td></td><td></td></tr><tr><td></td><td></td><td></td></tr></table>										<table border="1"><tr><td></td><td></td><td></td></tr><tr><td></td><td></td><td></td></tr><tr><td></td><td></td><td></td></tr></table>										<table border="1"><tr><td></td><td></td><td></td></tr><tr><td></td><td></td><td></td></tr><tr><td></td><td></td><td></td></tr></table>										<table border="1"><tr><td></td><td></td><td></td></tr><tr><td></td><td></td><td></td></tr><tr><td>1</td><td></td><td>1</td></tr></table>							1		1																														
1		1																																																																													
<p>Post - 0 Miss - 0 Block - 0    Post - 1 Miss - 3 Block - 0    Post - 0 Miss - 0 Block - 0    Post - 0 Miss - 0 Block - 0    Post - 0 Miss - 0 Block - 0    Post - 0 Miss - 0 Block - 0    Post - 0 Miss - 0 Block - 0    Post - 0 Miss - 0 Block - 0</p>																																																																															



第二届全国青年运动会女子手球甲组决赛 俱乐部组 (U18)

青年女子 全国比赛

预赛 Group A



PHMS Pictorial Handball Match Statistics

IHF Official System

Team A A 山西平遥				Team B B 安徽淮南				Match Number <b>47</b>			
------------------	--	--	--	------------------	--	--	--	---------------------------	--	--	--

Played in 山西晋中	in the hall 晋中体育馆	on 2019-06-20	at 15:10	hours	Spectators
-------------------	----------------------	------------------	-------------	-------	------------

Half-time(30')	A 13	B 8	End of playing time	A 22	B 19	1st extra time	A	B	2nd extra time	A	B	After penalty throws	A	B
----------------	---------	--------	---------------------	---------	---------	----------------	---	---	----------------	---	---	----------------------	---	---

Number of 7 m	A 1/1	Team time-out			Full name of players and officials	Team time-out			B 1/3	Number of 7 m
	1 10:57	2 27:34	3	1 18:15		2	3			

No.	Team A	G	W	2'	D	DR	No.	Team B	G	W	2'	D	DR
1	战泳享						1	万文倩					
2	胡嘉雯						2	孙雨欣					
3	宫訢	3		1			3	陈杨					
5	李楠						4	张天琦	3				
6	王雅静						5	高鑫艺					
9	马文龙	7		1			6	吕少华					
10	张越	3					7	承然	6				
11	张楠						8	董婧					
12	战慧						9	叶飞雪	2		1		
15	徐翹悦	4					10	王梦皖					
18	范小雁		1				11	徐静					
20	崔嘉欣	4					12	宋诗情					
26	李言娜						13	杨梦颖	8	1	1		
27	孙玟	1	1	2			14	张美琪					
							15	陈可怡					
							16	陈静文					
A	张栋						B	孙永永					
B	黄翠红 (主教练)												
E	陶岩												

A	Signatures of responsables for the teams (Off.A)												B
---	--	--	--	--	--	--	--	--	--	--	--	--	---

TP	Remarks of referees / HF Official													TP
----	-----------------------------------	--	--	--	--	--	--	--	--	--	--	--	--	----

Referees	李兆蒙 (CHN)	马晓晔 (CHN)		
T.D.	吴瑞亭 (CHN)	王洋 (CHN)		
CHA Off.				

Note: Number of 7m Throws Awarded to Team A and B, Goals (G), Warnings (W), Suspensions (2'), Direct Disqualification (D), Disqualification With Report (DR) and Team Penalty (TP).

Table Officials: 王志超 戴莹莹 Statisticians: 刘笑 王梓衡





第二届全国青年运动会女子手球甲组决赛 俱乐部组 (U18)

PHMS Pictorial Handball Match Statistics

IHF Official System

竞赛技术统计

手球  
青年女子

预赛  
轮次 4

组别 A  
场次 47

晋中体育馆  
2019-06-20 15:10

Referees:	李兆蒙 (CHN) / 马晓晔 (CHN)	Result:	22:19 (13:8)
Teams:	山西平遥(平遥) VS 安徽淮南(淮南)		

平遥		远	近	边	快	突	任意	7m	合计	%	助攻	失误	警告	2'	D+DR
主教练: 黄翠红		射	射	射	攻	破	球	球							
1	战泳享														
2	胡嘉雯														
3	宫訢		2/2		1/1				3/3	100		1		1	
5	李楠														
6	王雅静														
9	马文龙	1/4	2/2		2/2	2/3			7/11	63.6	1	3		1	
10	张越			2/2	1/2				3/4	75.0		1			
11	张楠														
12	战慧											1			
15	徐翹悦				2/2		1/1	1/1	4/4	100	1	2			
18	范小雁			0/3					0/3	0.0	1		1		
20	崔嘉欣			2/4		2/2			4/6	66.7		3			
26	李言娜														
27	孙玟	0/1	0/2		1/2				1/5	20.0	1	2	1	2	
运动员 合计		1/5	4/6	4/9	7/9	4/5	1/1	1/1	22/36	61.1	4	13	2	4	
1	战泳享	2/4	0/1		0/2				2/7	28.6					
12	战慧	5/10	0/2	1/4	2/2	3/5	0/1	1/2	12/26	46.2		1			
守门员 合计		7/14	0/3	1/4	2/4	3/5	0/1	1/2	14/33	42.4		1			

淮南		远	近	边	快	突	任意	7m	合计	%	助攻	失误	警告	2'	D+DR
主教练: 阮圣杰		射	射	射	攻	破	球	球							
1	万文倩							0/1	0/1	0.0	1				
2	孙雨欣														
3	陈杨														
4	张天琦	1/3	1/1	1/2					3/6	50.0	1	1			
5	高鑫艺														
6	吕少华														
7	承然	0/5	1/1		2/3	1/2	1/3	1/1	6/15	40.0	1	6			
8	董婧														
9	叶飞雪			2/2					2/2	100				1	
10	王梦皖														
11	徐静														
12	宋诗情														
13	杨梦颖	6/9	1/1		0/1	1/3	0/1	0/1	8/16	50.0	2	4	1	1	
14	张美琪														
15	陈可怡														
16	陈静文														
运动员 合计		7/17	3/3	3/4	2/4	2/5	1/4	1/3	19/40	47.5	5	11	1	2	
1	万文倩	3/4	1/5	2/6	2/9	1/5	0/1	0/1	9/31	29.0	1				
守门员 合计		3/4	1/5	2/6	2/9	1/5	0/1	0/1	9/31	29.0	1				

平遥	比赛 进程	淮南
1st Half		
	0 00:35	1 9 叶飞雪
	0 02:02	2 13 杨梦颖
15	徐翹悦	1 02:27 2
3	宫訢	2 03:16 2
9	马文龙	3 04:10 2
9	马文龙	4 04:57 2
	4 05:45	3 7 承然
20	崔嘉欣	5 06:24 3
	5 08:46	4 4 张天琦
	5 10:54	5 13 杨梦颖
	5 11:36	6 7 承然
20	崔嘉欣	6 12:00 6
9	马文龙	7 13:15 6
27	孙玟	8 13:47 6
	8 14:13	7 4 张天琦
	8 14:43	8 7 承然
10	张越	9 14:54 8
9	马文龙	10 15:39 8
9	马文龙	11 17:29 8
10	张越	12 18:14 8
15	徐翹悦	13 19:22 8
2nd Half		
20	崔嘉欣	14 00:16 8
15	徐翹悦	15 01:09 8
	15 01:35	9 13 杨梦颖
	15 02:10	10 13 杨梦颖
15	徐翹悦	16 03:57 10
3	宫訢	17 04:31 10
	17 07:20	11 13 杨梦颖
	17 08:27	12 13 杨梦颖
	17 10:47	13 7 承然
20	崔嘉欣	18 11:24 13
	18 12:02	14 7 承然
9	马文龙	19 12:25 14
	19 13:16	15 13 杨梦颖
	19 13:57	16 13 杨梦颖
3	宫訢	20 14:25 16
9	马文龙	21 15:02 16
10	张越	22 16:45 16
	22 17:07	17 4 张天琦
	22 18:00	18 7 承然
	22 20:00	19 9 叶飞雪

场上队员: 得分 / 射门

守门员: 救球 / 射门

D	取消资格	DR	取消资格+报告
---	------	----	---------



## 个人/全队技术统计表

手球 青年女子 预赛 轮次 4 组别 A 场次 47 晋中体育馆 2019-06-20 15:10

号码	姓名	远射	近射	边射	快攻	突破	任意	七米	合计	%	助攻	失误	警告	2'	取消	时间
山西平遥(平遥)																
(场上队员)																
1	战泳亨									0.0%						00:11:43
2	胡嘉雯									0.0%						00:00:00
3	宫訢		2/2		1/1				3/3	100%		1		1		00:31:11
5	李楠									0.0%						00:00:00
6	王雅静									0.0%						00:00:00
9	马文龙	1/4	2/2		2/2	2/3			7/11	63.6%	1	3		1		00:40:00
10	张越			2/2	1/2				3/4	75.0%		1				00:31:09
11	张楠									0.0%						00:08:45
12	战慧									0.0%		1				00:28:17
15	徐翹悦				2/2		1/1	1/1	4/4	100%	1	2				00:40:00
18	范小雁			0/3					0/3	0.0%	1		1			00:08:50
20	崔嘉欣			2/4		2/2			4/6	66.7%		3				00:40:00
26	李言娜									0.0%						00:00:00
27	孙玟	0/1	0/2		1/2				1/5	20.0%	1	2	1	2		00:40:00
	合计	1/5	4/6	4/9	7/9	4/5	1/1	1/1	22/36	61.1%	4	13	2	4		
(守门员)																
1	战泳亨	2/4	0/1		0/2				2/7	28.6%						00:11:43
12	战慧	5/10	0/2	1/4	2/2	3/5	0/1	1/2	12/26	46.2%		1				00:28:17
	合计	7/14	0/3	1/4	2/4	3/5	0/1	1/2	14/33	42.4%		1				

场上队员： 得分/射门

守门员： 救球/射门

全队合计	得分	被救	射失	击柱	封球	合计	%
远射	1	3	1			5	20.0%
近射	4	1	1			6	66.7%
边射	4	2		3		9	44.4%
快攻	7	2				9	77.8%
突破	4	1				5	80.0%
任意	1					1	100.0%
七米	1					1	100.0%

## 个人/全队技术统计表

 手球 预赛 组别 A 晋中体育馆  
 青年女子 轮次 4 场次 47 2019-06-20 15:10

号码	姓名	远射	近射	边射	快攻	突破	任意	七米	合计	%	助攻	失误	警告	2'	取消	时间
安徽淮南(淮南)																
(场上队员)																
1	万文倩							0/1	0/1	0.0%	1					00:40:00
2	孙雨欣									0.0%						00:40:00
3	陈杨									0.0%						00:00:00
4	张天琦	1/3	1/1	1/2					3/6	50.0%	1	1				00:40:00
5	高鑫艺									0.0%						00:00:00
6	吕少华									0.0%						00:00:00
7	承然	0/5	1/1		2/3	1/2	1/3	1/1	6/15	40.0%	1	6				00:40:00
8	董婧									0.0%						00:00:00
9	叶飞雪			2/2					2/2	100%				1		00:40:00
10	王梦皖									0.0%						00:40:00
11	徐静									0.0%						00:00:00
12	宋诗情									0.0%						00:00:00
13	杨梦颖	6/9	1/1		0/1	1/3	0/1	0/1	8/16	50.0%	2	4	1	1		00:40:00
14	张美琪									0.0%						00:00:00
15	陈可怡									0.0%						00:00:00
16	陈静文									0.0%						00:00:00
合计		7/17	3/3	3/4	2/4	2/5	1/4	1/3	19/40	47.5%	5	11	1	2		
(守门员)																
1	万文倩	3/4	1/5	2/6	2/9	1/5	0/1	0/1	9/31	29.0%	1					00:40:00
合计		3/4	1/5	2/6	2/9	1/5	0/1	0/1	9/31	29.0%	1					

场上队员：得分/射门

守门员：救球/射门

全队合计	得分	被救	射失	击柱	封球	合计	%
远射	7	7	3			17	41.2%
近射	3					3	100.0%
边射	3	1				4	75.0%
快攻	2	2				4	50.0%
突破	2	3				5	40.0%
任意	1		2	1		4	25.0%
七米	1	1		1		3	33.3%

图式比赛技术统计表

手球  
青年女子

预赛  
轮次 4

组别 A  
场次 47

晋中体育馆  
2019-06-20 15:10

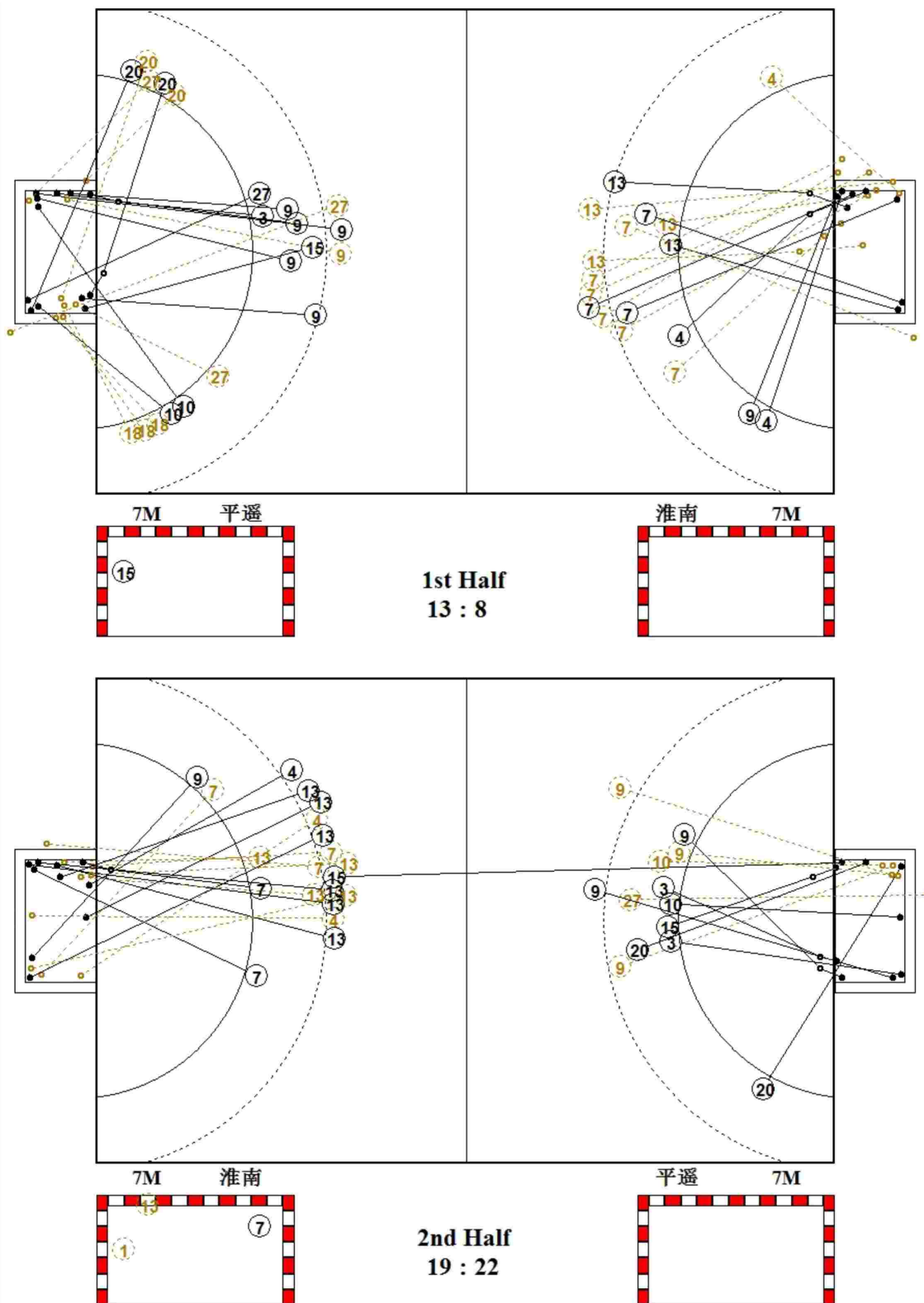

图式射门区域统计

手球  
青年女子

预赛  
轮次 4

组别 A  
场次 47

晋中体育馆  
2019-06-20 15:10

山西平遥

1 战泳享 Post - 0 Miss - 0 Block - 0	2 胡嘉雯 Post - 0 Miss - 0 Block - 0	3 宫訢 Post - 0 Miss - 0 Block - 0	5 李楠 Post - 0 Miss - 0 Block - 0	6 王雅静 Post - 0 Miss - 0 Block - 0	9 马文龙 Post - 0 Miss - 0 Block - 0	10 张越 Post - 0 Miss - 0 Block - 0	11 张楠 Post - 0 Miss - 0 Block - 0
12 战慧 Post - 0 Miss - 0 Block - 0	15 徐翹悦 Post - 0 Miss - 0 Block - 0	18 范小雁 Post - 2 Miss - 0 Block - 0	20 崔嘉欣 Post - 1 Miss - 0 Block - 0	26 李言娜 Post - 0 Miss - 0 Block - 0	27 孙玖 Post - 0 Miss - 2 Block - 0		

1 战泳享	0/1		0/2
	1/1		0/1
	1/1		0/1

12 战慧	3/5	1/1	0/4
	2/3	1/1	1/2
	1/5	0/1	3/4

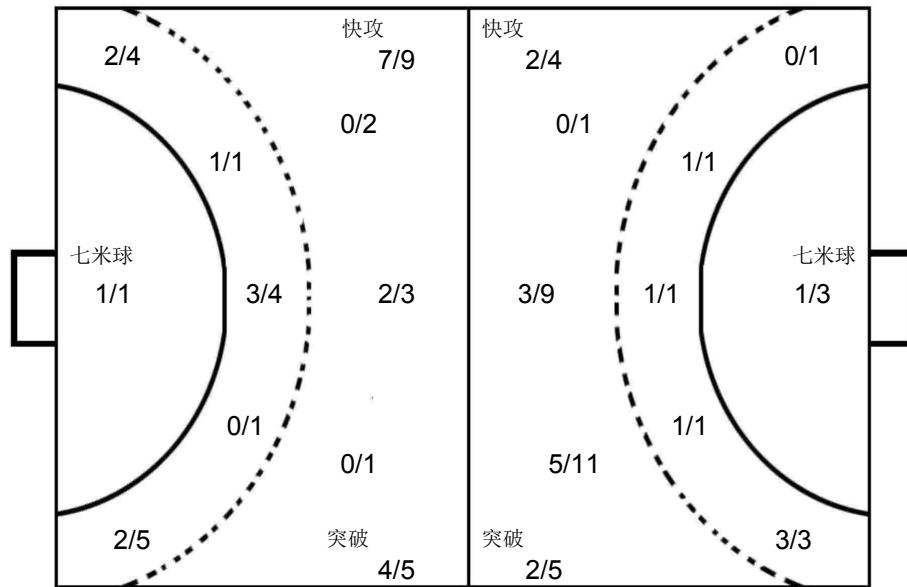

1 万文倩	4/9	0/1	1/6
	2/3		1/3
	1/6		0/3

安徽淮南

1 万文倩 Post - 0 Miss - 0 Block - 0	2 孙雨欣 Post - 0 Miss - 0 Block - 0	3 陈杨 Post - 0 Miss - 0 Block - 0	4 张天琦 Post - 0 Miss - 0 Block - 0	5 高鑫艺 Post - 0 Miss - 0 Block - 0	6 吕少华 Post - 0 Miss - 0 Block - 0	7 承然 Post - 0 Miss - 5 Block - 0	8 董婧 Post - 0 Miss - 0 Block - 0
9 叶飞雪 Post - 0 Miss - 0 Block - 0	10 王梦皖 Post - 0 Miss - 0 Block - 0	11 徐静 Post - 0 Miss - 0 Block - 0	12 宋诗情 Post - 0 Miss - 0 Block - 0	13 杨梦颖 Post - 2 Miss - 0 Block - 0	14 张美琪 Post - 0 Miss - 0 Block - 0	15 陈可怡 Post - 0 Miss - 0 Block - 0	16 陈静文 Post - 0 Miss - 0 Block - 0



第二届全国青年运动会女子手球甲组决赛 俱乐部组 (U18)

青年女子 全国比赛

预赛 Group A



PHMS Pictorial Handball Match Statistics

IHF Official System

Team A A 福建汉得堡				Team B B 安徽宿州				Match Number <b>48</b>			
-------------------	--	--	--	------------------	--	--	--	---------------------------	--	--	--

Played in 山西晋中	in the hall 晋中体育馆	on 2019-06-20	at 16:20	hours	Speakers
-------------------	----------------------	------------------	-------------	-------	----------

Half-time(30')	A 5	B 7	End of playing time	A 11	B 16	1st extra time	A	B	2nd extra time	A	B	After penalty throws	A	B
----------------	--------	--------	---------------------	---------	---------	----------------	---	---	----------------	---	---	----------------------	---	---

Number of 7 m	A 1/2	Team time-out			Full name of players and officials	Team time-out			B 0/0	Number of 7 m
	1 12:25	2 30:45	3	1		2 25:06	3			

No.	Team A	G	W	2'	D	DR	No.	Team B	G	W	2'	D	DR
2	张心茹						1	陈文娟					
3	崔艳菲	2					3	姜景媛					
5	李倩						5	单文静	1				
7	李珂欣	1					7	刘文秀					
8	魏雅欣						8	李伟伟					
9	张晓静	3		1			9	李旗	2				
10	穆梦欣	1	1	1			12	黄紫蝶					
11	孙瑞						17	田伊阳	1		1		
12	张跃						18	刘怡涵	2		1		
14	尹春霞	2	1	1			21	王嫚丽	2	1			
15	万里云杉						22	钦马晴	5				
16	王红						23	郭茹文	3				
17	邱兰曦						25	郑睿涵					
18	邱兰晴						26	刘洋					
19	林舒婧												
21	张雪梅	2											
A	曾令斌						A	李红太					
B	王卫 (主教练)						B	吴昊 (主教练)					
C	辛英杰						C	李绍魁					
D	刘娜						D	赵萌萌					

A	Signatures of responsables for the teams (Off.A)												B
---	--	--	--	--	--	--	--	--	--	--	--	--	---

TP	Remarks of referees / HF Official													TP
----	-----------------------------------	--	--	--	--	--	--	--	--	--	--	--	--	----

Referees	张智伟 (CHN)	伍豪 (CHN)		
T.D.	吴瑞亭 (CHN)	王洋 (CHN)		
CHA Off.				

Note: Number of 7m Throws Awarded to Team A and B, Goals (G), Warnings (W), Suspensions (2'), Direct Disqualification (D), Disqualification With Report (DR) and Team Penalty (TP).

Table Officials: 马迪 孙龙龙 Statisticians: 王梓衡 刘笑

## 第二届全国青年运动会女子手球甲组决赛 俱乐部组 (U18)

PHMS Pictorial Handball Match Statistics

IHF Official System

### 竞赛技术统计

手球  
青年女子

预赛  
轮次 4

组别 A  
场次 48

晋中体育馆  
2019-06-20 16:20

Referees:	张智伟 (CHN) / 伍豪 (CHN)	Result:	11:16(5:7)
Teams:	福建汉得堡(汉得堡) VS 安徽宿州(宿州)		

汉得堡		远	近	边	快	突	任意	7m	合计	%	助攻	失误	警告	2'	D+DR	比赛进程		
主教练: 王卫		射	射	射	攻	破	球	球									汉得堡	宿州
2	张心茹																1st Half	
3	崔艳菲	1/2		0/1	1/1	0/1			2/5	40.0		2					9 张晓静	1 00:41 0
5	李倩																21 张雪梅	2 01:49 0
7	李珂欣		1/1						1/1	100		2						2 03:21 1 23 郭茹文
8	魏雅欣																	2 05:07 2 22 钦马晴
9	张晓静	1/2	1/1			1/1			3/4	75.0		6		1			9 张晓静	3 06:03 2
10	穆梦欣		1/1						1/1	100		1	1	1				3 11:09 3 22 钦马晴
11	孙瑞																	3 13:12 4 23 郭茹文
12	张跃																	3 13:48 5 17 田伊阳
14	尹春霞	0/4	1/3	0/2				1/2	2/11	18.2		2	1	1			3 崔艳菲	4 14:59 5
15	万里云杉																	4 15:19 6 22 钦马晴
16	王红																	5 15:58 6
17	邱兰曦																	9 张晓静
18	邱兰晴																	5 19:44 7 21 王嫚丽
19	林舒婧																	
21	张雪梅			1/1		1/1			2/2	100		3						
运动员 合计		2/8	4/6	1/4	1/1	2/3		1/2	11/24	45.8		17	2	3			2nd Half	
16	王红	0/4	0/3	3/7	1/2	1/5	1/1		6/22	27.3							14 尹春霞	5 01:50 8 9 李旗
守门员 合计		0/4	0/3	3/7	1/2	1/5	1/1		6/22	27.3								6 02:51 8
宿州		远	近	边	快	突	任意	7m	合计	%	助攻	失误	警告	2'	D+DR			
主教练: 吴昊		射	射	射	攻	破	球	球										
1	陈文娟																	
3	姜景媛																	
5	单文静		1/1						1/1	100		1						
7	刘文秀																	
8	李伟伟																	
9	李旗	1/2		0/1	0/1	1/1	0/1		2/6	33.3	1	2						
12	黄紫蝶																	
17	田伊阳				1/1				1/1	100								
18	刘怡涵	1/1				1/1			2/2	100								
21	王嫚丽		1/1	1/2		0/1			2/4	50.0		5	1					
22	钦马晴	2/3	1/1			2/2	0/1		5/7	71.4	1	2						
23	郭茹文			3/4					3/4	75.0		1						
25	郑睿涵																	
26	刘洋																	
运动员 合计		4/6	3/3	4/7	1/2	4/5	0/2		16/25	64.0	2	11	1	2				
12	黄紫蝶	2/4	1/5	1/2	0/1	1/3		0/1	5/16	31.3								
守门员 合计		2/4	1/5	1/2	0/1	1/3		0/1	5/16	31.3								

场上队员: 得分 / 射门

守门员: 救球 / 射门

D	取消资格	DR	取消资格+报告
---	------	----	---------

## 个人/全队技术统计表

手球 青年女子 预赛 轮次 4 组别 A 场次 48 晋中体育馆 2019-06-20 16:20

号码	姓名	远射	近射	边射	快攻	突破	任意	七米	合计	%	助攻	失误	警告	2'	取消	时间
福建汉得堡(汉得堡)																
(场上队员)																
2	张心茹									0.0%						00:00:00
3	崔艳菲	1/2		0/1	1/1	0/1			2/5	40.0%		2				00:38:38
5	李倩									0.0%						00:00:00
7	李珂欣		1/1						1/1	100%		2				00:38:06
8	魏雅欣									0.0%						00:00:00
9	张晓静	1/2	1/1			1/1			3/4	75.0%		6		1		00:38:41
10	穆梦欣		1/1						1/1	100%		1	1	1		00:38:01
11	孙瑞									0.0%		1				00:09:45
12	张跃									0.0%						00:00:00
14	尹春霞	0/4	1/3	0/2				1/2	2/11	18.2%		2	1	1		00:38:36
15	万里云杉									0.0%						00:00:00
16	王红									0.0%						00:40:00
17	邱兰曦									0.0%						00:00:00
18	邱兰晴									0.0%						00:00:00
19	林舒婧									0.0%						00:00:00
21	张雪梅			1/1		1/1			2/2	100%		3				00:38:11
	合计	2/8	4/6	1/4	1/1	2/3		1/2	11/24	45.8%		17	2	3		
(守门员)																
16	王红	0/4	0/3	3/7	1/2	1/5	1/1		6/22	27.3%						00:40:00
	合计	0/4	0/3	3/7	1/2	1/5	1/1		6/22	27.3%						

场上队员：得分/射门

守门员：救球/射门

全队合计	得分	被救	射失	击柱	封球	合计	%
远射	2	2		3	1	8	25.0%
近射	4	1	1			6	66.7%
边射	1	1		2		4	25.0%
快攻	1					1	100.0%
突破	2	1				3	66.7%
任意							0.0%
七米	1			1		2	50.0%



第二届全国青年运动会女子手球甲组决赛 俱乐部组 (U18)

PHMS Pictorial Handball Match Statistics

IHF Official System

个人/全队技术统计表

手球 青年女子 预赛 轮次 4 组别 A 场次 48 晋中体育馆 2019-06-20 16:20

号码	姓名	远射	近射	边射	快攻	突破	任意	七米	合计	%	助攻	失误	警告	2'	取消	时间
安徽宿州(宿州)																
(场上队员)																
1	陈文娟									0.0%						00:00:00
3	姜景媛									0.0%						00:00:00
5	单文静		1/1						1/1	100%		1				00:37:46
7	刘文秀									0.0%						00:00:00
8	李伟伟									0.0%						00:00:00
9	李旗	1/2		0/1	0/1	1/1	0/1		2/6	33.3%	1	2				00:39:11
12	黄紫蝶									0.0%						00:39:57
17	田伊阳					1/1			1/1	100%				1		00:29:55
18	刘怡涵	1/1				1/1			2/2	100%				1		00:17:18
21	王嫚丽		1/1	1/2		0/1			2/4	50.0%		5	1			00:38:22
22	钦马晴	2/3	1/1			2/2	0/1		5/7	71.4%	1	2				00:38:56
23	郭茹文			3/4					3/4	75.0%		1				00:38:33
25	郑睿涵									0.0%						00:00:00
26	刘洋									0.0%						00:00:00
合计		4/6	3/3	4/7	1/2	4/5	0/2		16/25	64.0%	2	11	1	2		
(守门员)																
12	黄紫蝶	2/4	1/5	1/2	0/1	1/3		0/1	5/16	31.3%						00:39:57
合计		2/4	1/5	1/2	0/1	1/3		0/1	5/16	31.3%						

场上队员：得分/射门

守门员：救球/射门

全队合计	得分	被救	射失	击柱	封球	合计	%
远射	4		1		1	6	66.7%
近射	3					3	100.0%
边射	4	3				7	57.1%
快攻	1	1				2	50.0%
突破	4	1				5	80.0%
任意		1	1			2	0.0%
七米							0.0%

图式比赛技术统计表

手球  
青年女子

预赛  
轮次 4

组别 A  
场次 48

晋中体育馆  
2019-06-20 16:20

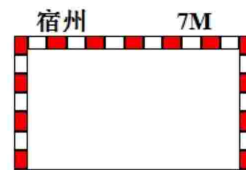
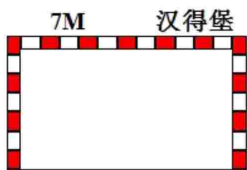
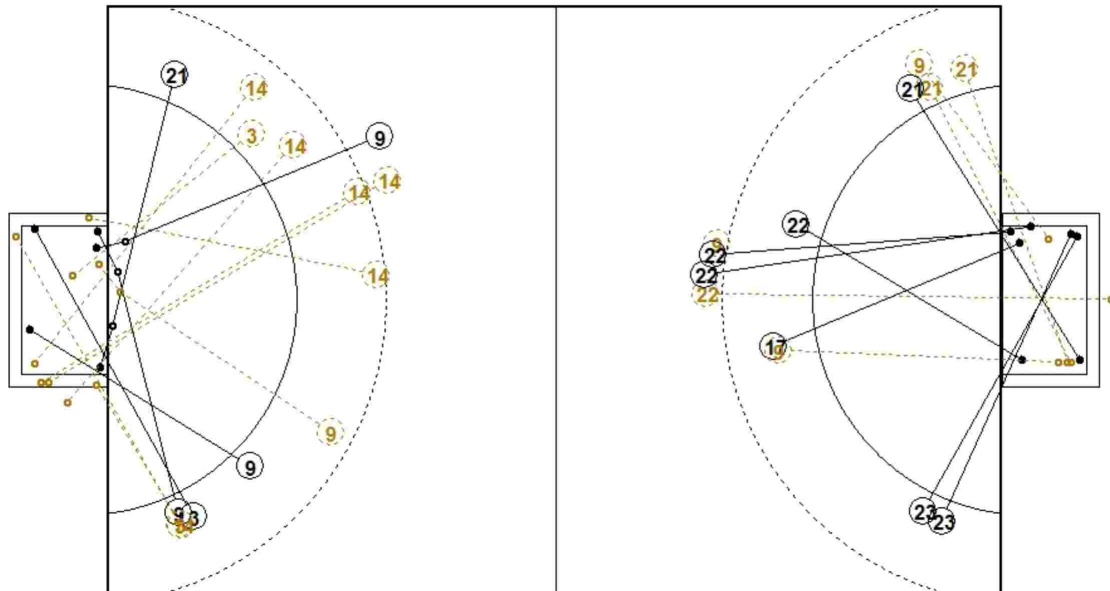

1st Half  
5 : 7

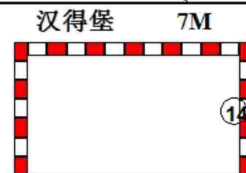
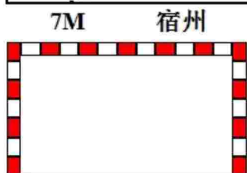
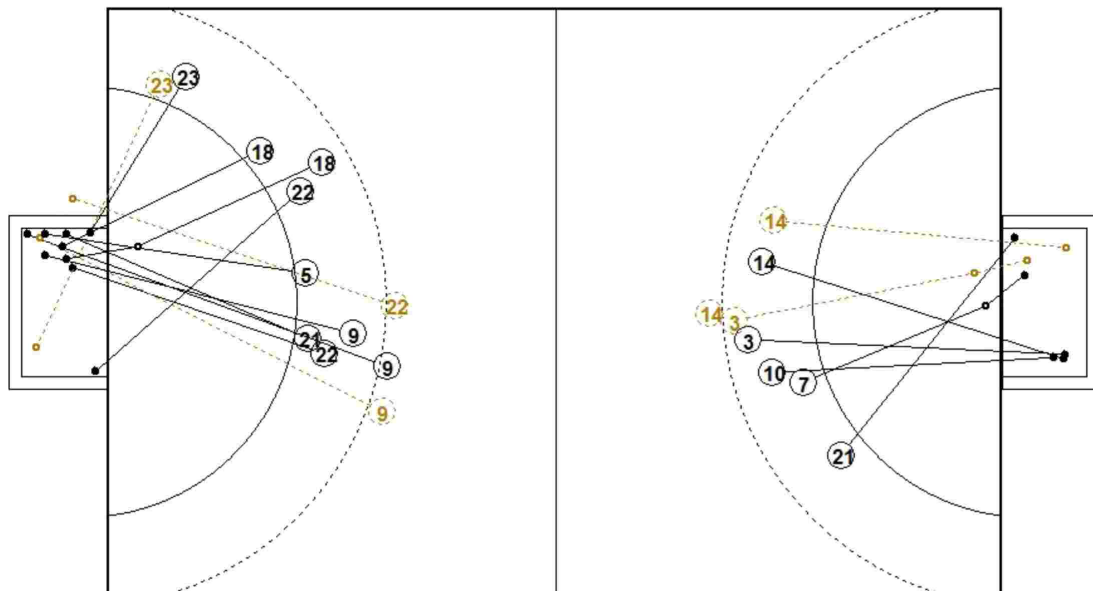

2nd Half  
16 : 11

图式射门区域统计

手球  
青年女子

预赛  
轮次 4

组别 A  
场次 48

晋中体育馆  
2019-06-20 16:20

福建汉得堡

2 张心茹	3 崔艳菲	5 李倩	7 李珂欣	8 魏雅欣	9 张晓静	10 穆梦欣	11 孙瑞																																																																								
<table border="1"><tr><td></td><td></td><td></td></tr><tr><td></td><td></td><td></td></tr><tr><td></td><td></td><td></td></tr></table>										<table border="1"><tr><td></td><td></td><td>2</td></tr><tr><td></td><td></td><td></td></tr><tr><td></td><td></td><td></td></tr></table>			2							<table border="1"><tr><td></td><td></td><td></td></tr><tr><td></td><td></td><td></td></tr><tr><td></td><td></td><td></td></tr></table>										<table border="1"><tr><td></td><td></td><td></td></tr><tr><td></td><td></td><td></td></tr><tr><td>1</td><td></td><td></td></tr></table>							1			<table border="1"><tr><td></td><td></td><td></td></tr><tr><td></td><td></td><td></td></tr><tr><td></td><td></td><td></td></tr></table>										<table border="1"><tr><td>1</td><td></td><td></td></tr><tr><td></td><td></td><td></td></tr><tr><td></td><td></td><td></td></tr></table>	1									<table border="1"><tr><td></td><td></td><td></td></tr><tr><td></td><td></td><td></td></tr><tr><td></td><td></td><td>1</td></tr></table>									1	<table border="1"><tr><td></td><td></td><td></td></tr><tr><td></td><td></td><td></td></tr><tr><td></td><td></td><td></td></tr></table>									
		2																																																																													
1																																																																															
1																																																																															
		1																																																																													
Post - 0 Miss - 0 Block - 0	Post - 1 Miss - 0 Block - 0	Post - 0 Miss - 0 Block - 0	Post - 0 Miss - 0 Block - 0	Post - 0 Miss - 0 Block - 0	Post - 0 Miss - 0 Block - 0	Post - 0 Miss - 0 Block - 0	Post - 0 Miss - 0 Block - 0																																																																								
12 张跃	14 尹春霞	15 万里云杉	16 王红	17 邱兰曦	18 邱兰晴	19 林舒婧	21 张雪梅																																																																								
<table border="1"><tr><td></td><td></td><td></td></tr><tr><td></td><td></td><td></td></tr><tr><td></td><td></td><td></td></tr></table>										<table border="1"><tr><td></td><td></td><td>1</td></tr><tr><td></td><td></td><td>1</td></tr><tr><td></td><td></td><td></td></tr></table>			1			1				<table border="1"><tr><td></td><td></td><td></td></tr><tr><td></td><td></td><td></td></tr><tr><td></td><td></td><td></td></tr></table>										<table border="1"><tr><td></td><td></td><td></td></tr><tr><td></td><td></td><td></td></tr><tr><td></td><td></td><td></td></tr></table>										<table border="1"><tr><td></td><td></td><td></td></tr><tr><td></td><td></td><td></td></tr><tr><td></td><td></td><td></td></tr></table>										<table border="1"><tr><td></td><td></td><td></td></tr><tr><td></td><td></td><td></td></tr><tr><td></td><td></td><td></td></tr></table>										<table border="1"><tr><td></td><td></td><td></td></tr><tr><td></td><td></td><td></td></tr><tr><td></td><td></td><td></td></tr></table>										<table border="1"><tr><td></td><td></td><td></td></tr><tr><td></td><td></td><td></td></tr><tr><td></td><td></td><td>2</td></tr></table>									2
		1																																																																													
		1																																																																													
		2																																																																													
Post - 0 Miss - 0 Block - 0	Post - 5 Miss - 1 Block - 1	Post - 0 Miss - 0 Block - 0	Post - 0 Miss - 0 Block - 0	Post - 0 Miss - 0 Block - 0	Post - 0 Miss - 0 Block - 0	Post - 0 Miss - 0 Block - 0	Post - 0 Miss - 0 Block - 0																																																																								

16 王红

1/3		4/8
1/2		0/4
0/3		0/2

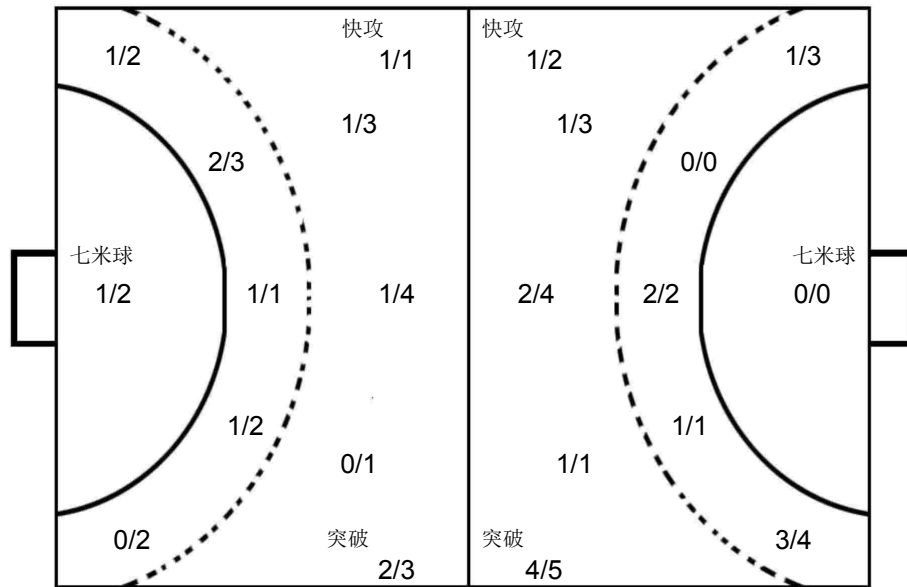

12 黄紫蝶

2/3		0/3
	1/1	0/2
1/4		1/3

安徽宿州

1 陈文娟	3 姜景媛	5 单文静	7 刘文秀	8 李伟伟	9 李旗	12 黄紫蝶	17 田伊阳																																																																								
<table border="1"><tr><td></td><td></td><td></td></tr><tr><td></td><td></td><td></td></tr><tr><td></td><td></td><td></td></tr></table>										<table border="1"><tr><td></td><td></td><td></td></tr><tr><td></td><td></td><td></td></tr><tr><td></td><td></td><td></td></tr></table>										<table border="1"><tr><td></td><td></td><td>1</td></tr><tr><td></td><td></td><td></td></tr><tr><td></td><td></td><td></td></tr></table>			1							<table border="1"><tr><td></td><td></td><td></td></tr><tr><td></td><td></td><td></td></tr><tr><td></td><td></td><td></td></tr></table>										<table border="1"><tr><td></td><td></td><td></td></tr><tr><td></td><td></td><td></td></tr><tr><td></td><td></td><td></td></tr></table>										<table border="1"><tr><td></td><td></td><td>2</td></tr><tr><td></td><td></td><td></td></tr><tr><td></td><td></td><td></td></tr></table>			2							<table border="1"><tr><td></td><td></td><td></td></tr><tr><td></td><td></td><td></td></tr><tr><td></td><td></td><td></td></tr></table>										<table border="1"><tr><td></td><td></td><td></td></tr><tr><td></td><td></td><td></td></tr><tr><td></td><td></td><td>1</td></tr></table>									1
		1																																																																													
		2																																																																													
		1																																																																													
Post - 0 Miss - 0 Block - 0	Post - 0 Miss - 0 Block - 0	Post - 0 Miss - 0 Block - 0	Post - 0 Miss - 0 Block - 0	Post - 0 Miss - 0 Block - 0	Post - 0 Miss - 0 Block - 1	Post - 0 Miss - 0 Block - 0	Post - 0 Miss - 0 Block - 0																																																																								
18 刘怡涵	21 王嫒丽	22 钦马晴	23 郭茹文	25 郑睿涵	26 刘洋																																																																										
<table border="1"><tr><td></td><td></td><td></td></tr><tr><td></td><td></td><td>2</td></tr><tr><td></td><td></td><td></td></tr></table>						2				<table border="1"><tr><td></td><td></td><td>1</td></tr><tr><td></td><td></td><td>1</td></tr><tr><td></td><td></td><td></td></tr></table>			1			1				<table border="1"><tr><td></td><td></td><td></td></tr><tr><td>1</td><td></td><td>1</td></tr><tr><td>2</td><td></td><td>1</td></tr></table>				1		1	2		1	<table border="1"><tr><td>2</td><td></td><td></td></tr><tr><td></td><td></td><td></td></tr><tr><td></td><td></td><td></td></tr></table>	2									<table border="1"><tr><td></td><td></td><td></td></tr><tr><td></td><td></td><td></td></tr><tr><td></td><td></td><td></td></tr></table>										<table border="1"><tr><td></td><td></td><td></td></tr><tr><td></td><td></td><td></td></tr><tr><td></td><td></td><td></td></tr></table>																													
		2																																																																													
		1																																																																													
		1																																																																													
1		1																																																																													
2		1																																																																													
2																																																																															
Post - 0 Miss - 0 Block - 0	Post - 0 Miss - 0 Block - 0	Post - 0 Miss - 2 Block - 0	Post - 0 Miss - 0 Block - 0	Post - 0 Miss - 0 Block - 0	Post - 0 Miss - 0 Block - 0																																																																										



第二届全国青年运动会女子手球甲组决赛 俱乐部组 (U18)

青年女子 全国比赛

预赛 Group A



PHMS Pictorial Handball Match Statistics

IHF Official System

Team A A 山西平遥				Team B B 福建汉堡				Match Number <b>65</b>			
------------------	--	--	--	------------------	--	--	--	---------------------------	--	--	--

Played in 山西晋中	in the hall 晋中体育馆	on 2019-06-21	at 14:00	hours	Speakers
-------------------	----------------------	------------------	-------------	-------	----------

Half-time(30')	A 8	B 3	End of playing time	A 20	B 10	1st extra time	A	B	2nd extra time	A	B	After penalty throws	A	B
----------------	--------	--------	---------------------	---------	---------	----------------	---	---	----------------	---	---	----------------------	---	---

Number of 7 m 1/4	Team time-out			Full name of players and officials	Team time-out			B 1/1	Number of 7 m
	1 16:01	2	3		1 06:59	2 29:50	3		

No.	Team A	G	W	2'	D	DR	No.	Team B	G	W	2'	D	DR
1	战泳享						2	张心茹	1				
2	胡嘉雯						3	崔艳菲	1				
3	宫訢	2		1			5	李倩					
5	李楠						7	李珂欣			1		
6	王雅静						8	魏雅欣					
8	吴名茜						9	张晓静	1	1	1		
9	马文龙	2					10	穆梦欣			1		
10	张越	4					11	孙瑞					
11	张楠						12	张跃					
12	战慧						14	尹春霞	6		1		
15	徐翹悦	2	1				15	万里云杉					
18	范小雁						16	王红					
20	崔嘉欣	8					17	邱兰曦					
26	李言娜	2					18	邱兰晴					
27	孙玟		1	1			19	林舒婧					
							21	张雪梅	1		1		
A	张栋						A	曾令斌					
B	黄翠红 (主教练)						B	王卫 (主教练)					
E	陶岩						C	辛英杰					
							D	刘娜					

A	Signatures of responsables for the teams (Off.A)												B
---	--	--	--	--	--	--	--	--	--	--	--	--	---

TP	Remarks of referees / HF Official													TP
----	-----------------------------------	--	--	--	--	--	--	--	--	--	--	--	--	----

Referees	王亚光 (CHN)	张智伟 (CHN)		
T.D.	叶霄雪 (CHN)	刘凤娟 (CHN)		
CHA Off.				

Note: Number of 7m Throws Awarded to Team A and B, Goals (G), Warnings (W), Suspensions (2'), Direct Disqualification (D), Disqualification With Report (DR) and Team Penalty (TP).

Table Officials: 张琦 宣海波 Statisticians: 陈柱 谢杨





第二届全国青年运动会女子手球甲组决赛 俱乐部组 (U18)

PHMS Pictorial Handball Match Statistics

IHF Official System

竞赛技术统计

手球  
青年女子

预赛  
轮次 5

组别 A  
场次 65

晋中体育馆  
2019-06-21 14:00

Referees: 王亚光 (CHN) / 张智伟 (CHN)

Result: 20:10(8:3)

Teams: 山西平遥(平遥) VS 福建汉得堡(汉得堡)

平遥		远射	近射	边射	快攻	突破	任意球	7m球	合计	%	助攻	失误	警告	2'	D+DR
主教练: 黄翠红															
1	战泳享														
2	胡嘉雯														
3	宫苒				2/3				2/3	66.7		1		1	
5	李楠														
6	王雅静														
8	吴名茜														
9	马文龙	0/3	2/3	0/1					2/7	28.6					
10	张越		2/2	0/2	2/2				4/6	66.7					
11	张楠				0/1				0/1	0.0					
12	战慧										2	1			
15	徐翹悦				1/1			1/2	2/3	66.7		5	1		
18	范小雁	0/1						0/2	0/3	0.0					
20	崔嘉欣	1/1	2/2	3/5	2/2				8/10	80.0		1			
26	李言娜			2/3					2/3	66.7		2			
27	孙玟	0/2	0/2						0/4	0.0		3	1	1	
运动员 合计		1/7	6/9	5/11	7/9			1/4	20/40	50.0	2	13	2	2	
1	战泳享	0/2		1/1				0/1	1/4	25.0					
12	战慧	0/2	2/4	4/5		0/1	1/2		7/14	50.0	2	1			
守门员 合计		0/4	2/4	5/6		0/1	1/2	0/1	8/18	44.4	2	1			

平遥	比赛进程	汉得堡
1st Half		
0	02:28	1 3 崔艳菲
20	崔嘉欣 1 05:42	1
20	崔嘉欣 2 06:20	1
9	马文龙 3 07:55	1
20	崔嘉欣 4 08:27	1
4	09:51	2 14 尹春霞
20	崔嘉欣 5 11:02	2
20	崔嘉欣 6 11:41	2
6	15:57	3 14 尹春霞
10	张越 7 17:38	3
20	崔嘉欣 8 19:03	3
2nd Half		
15	徐翹悦 9 00:46	3
9	01:16	4 14 尹春霞
3	宫苒 10 02:40	4
10	03:27	5 14 尹春霞
10	张越 11 04:31	5
11	05:07	6 14 尹春霞
3	宫苒 12 07:24	6
10	张越 13 07:58	6
13	08:18	7 14 尹春霞
9	马文龙 14 09:23	7
14	10:25	8 9 张晓静
15	徐翹悦 15 12:45	8
10	张越 16 13:17	8
26	李言娜 17 13:57	8
20	崔嘉欣 18 16:21	8
18	16:45	9 2 张心茹
18	18:42	10 21 张雪梅
20	崔嘉欣 19 19:01	10
26	李言娜 20 19:52	10

汉得堡		远射	近射	边射	快攻	突破	任意球	7m球	合计	%	助攻	失误	警告	2'	D+DR
主教练: 王卫															
2	张心茹		1/1						1/1	100					
3	崔艳菲		1/1	0/1					1/2	50.0		3			
5	李倩			0/1					0/1	0.0		1			
7	李珂欣											1		1	
8	魏雅欣														
9	张晓静	1/1		0/1					1/2	50.0		5	1	1	
10	穆梦欣	0/1	0/1	0/1			0/1		0/4	0.0		8		1	
11	孙瑞											2			
12	张跃														
14	尹春霞	3/4	0/1	1/1			1/1	1/1	6/8	75.0	1	6		1	
15	万里云杉														
16	王红											1			
17	邱兰曦														
18	邱兰晴														
19	林舒婧														
21	张雪梅		0/1	0/2			1/1		1/4	25.0	1	3		1	
运动员 合计		4/6	2/5	1/7			1/1	1/1	10/22	45.5	2	30	1	5	
12	张跃	1/2	0/1	0/1	1/1				2/5	40.0					
16	王红	2/2	1/6	3/7	1/8			1/2	8/25	32.0		1			
守门员 合计		3/4	1/7	3/8	2/9			1/2	10/30	33.3		1			

场上队员: 得分 / 射门

守门员: 救球 / 射门

D	取消资格	DR	取消资格+报告
---	------	----	---------



## 第二届全国青年运动会女子手球甲组决赛 俱乐部组 (U18)

PHMS Pictorial Handball Match Statistics

IHF Official System

## 个人/全队技术统计表

手球 青年女子 预赛 轮次 5 组别 A 场次 65 晋中体育馆 2019-06-21 14:00

号码	姓名	远射	近射	边射	快攻	突破	任意	七米	合计	%	助攻	失误	警告	2'	取消	时间
山西平遥(平遥)																
(场上队员)																
1	战泳亨									0.0%						00:07:15
2	胡嘉雯									0.0%						00:00:00
3	宫訔				2/3				2/3	66.7%	1			1		00:38:28
5	李楠									0.0%						00:01:57
6	王雅静									0.0%						00:04:32
8	吴名茜									0.0%						00:00:00
9	马文龙	0/3	2/3	0/1					2/7	28.6%						00:33:20
10	张越		2/2	0/2	2/2				4/6	66.7%						00:36:54
11	张楠				0/1				0/1	0.0%						00:01:31
12	战慧									0.0%	2	1				00:32:45
15	徐翹悦				1/1			1/2	2/3	66.7%	5		1			00:33:10
18	范小雁	0/1						0/2	0/3	0.0%						00:07:52
20	崔嘉欣	1/1	2/2	3/5	2/2				8/10	80.0%	1					00:40:00
26	李言娜			2/3					2/3	66.7%	2					00:06:40
27	孙玟	0/2	0/2						0/4	0.0%	3		1	1		00:35:27
合计		1/7	6/9	5/11	7/9			1/4	20/40	50.0%	2	13	2	2		
(守门员)																
1	战泳亨	0/2		1/1				0/1	1/4	25.0%						00:07:15
12	战慧	0/2	2/4	4/5		0/1	1/2		7/14	50.0%	2	1				00:32:45
合计		0/4	2/4	5/6		0/1	1/2	0/1	8/18	44.4%	2	1				

场上队员：得分/射门

守门员：救球/射门

全队合计	得分	被救	射失	击柱	封球	合计	%
远射	1	3	1		2	7	14.3%
近射	6	1	1	1		9	66.7%
边射	5	3	2	1		11	45.5%
快攻	7	2				9	77.8%
突破							0.0%
任意							0.0%
七米	1	1	2			4	25.0%

第二届全国青年运动会女子手球甲组决赛 俱乐部组 (U18)

PHMS Pictorial Handball Match Statistics

IHF Official System

个人/全队技术统计表

手球 青年女子 预赛 轮次 5 组别 A 场次 65 晋中体育馆 2019-06-21 14:00

号码	姓名	远射	近射	边射	快攻	突破	任意	七米	合计	%	助攻	失误	警告	2'	取消	时间
福建汉得堡(汉得堡)																
(场上队员)																
2	张心茹		1/1						1/1	100%						00:04:43
3	崔艳菲		1/1	0/1					1/2	50.0%		3				00:27:28
5	李倩			0/1					0/1	0.0%		1				00:06:14
7	李珂欣									0.0%		1		1		00:35:13
8	魏雅欣									0.0%						00:00:54
9	张晓静	1/1		0/1					1/2	50.0%		5	1	1		00:25:41
10	穆梦欣	0/1	0/1	0/1			0/1		0/4	0.0%		8		1		00:39:44
11	孙瑞									0.0%		2				00:13:44
12	张跃									0.0%						00:04:11
14	尹春霞	3/4	0/1	1/1			1/1	1/1	6/8	75.0%	1	6		1		00:39:56
15	万里云杉									0.0%						00:05:40
16	王红									0.0%		1				00:35:49
17	邱兰曦									0.0%						00:00:00
18	邱兰晴									0.0%						00:00:00
19	林舒婧									0.0%						00:00:00
21	张雪梅		0/1	0/2		1/1			1/4	25.0%	1	3		1		00:39:54
	合计	4/6	2/5	1/7		1/1	1/2	1/1	10/22	45.5%	2	30	1	5		
(守门员)																
12	张跃	1/2	0/1	0/1	1/1				2/5	40.0%						00:04:11
16	王红	2/2	1/6	3/7	1/8			1/2	8/25	32.0%		1				00:35:49
	合计	3/4	1/7	3/8	2/9			1/2	10/30	33.3%		1				

场上队员：得分/射门

守门员：救球/射门

全队合计	得分	被救	射失	击柱	封球	合计	%
远射	4		1		1	6	66.7%
近射	2	2	1			5	40.0%
边射	1	5	1			7	14.3%
快攻							0.0%
突破	1					1	100.0%
任意	1	1				2	50.0%
七米	1					1	100.0%

图式比赛技术统计表

手球  
青年女子

预赛  
轮次 5

组别 A  
场次 65

晋中体育馆  
2019-06-21 14:00

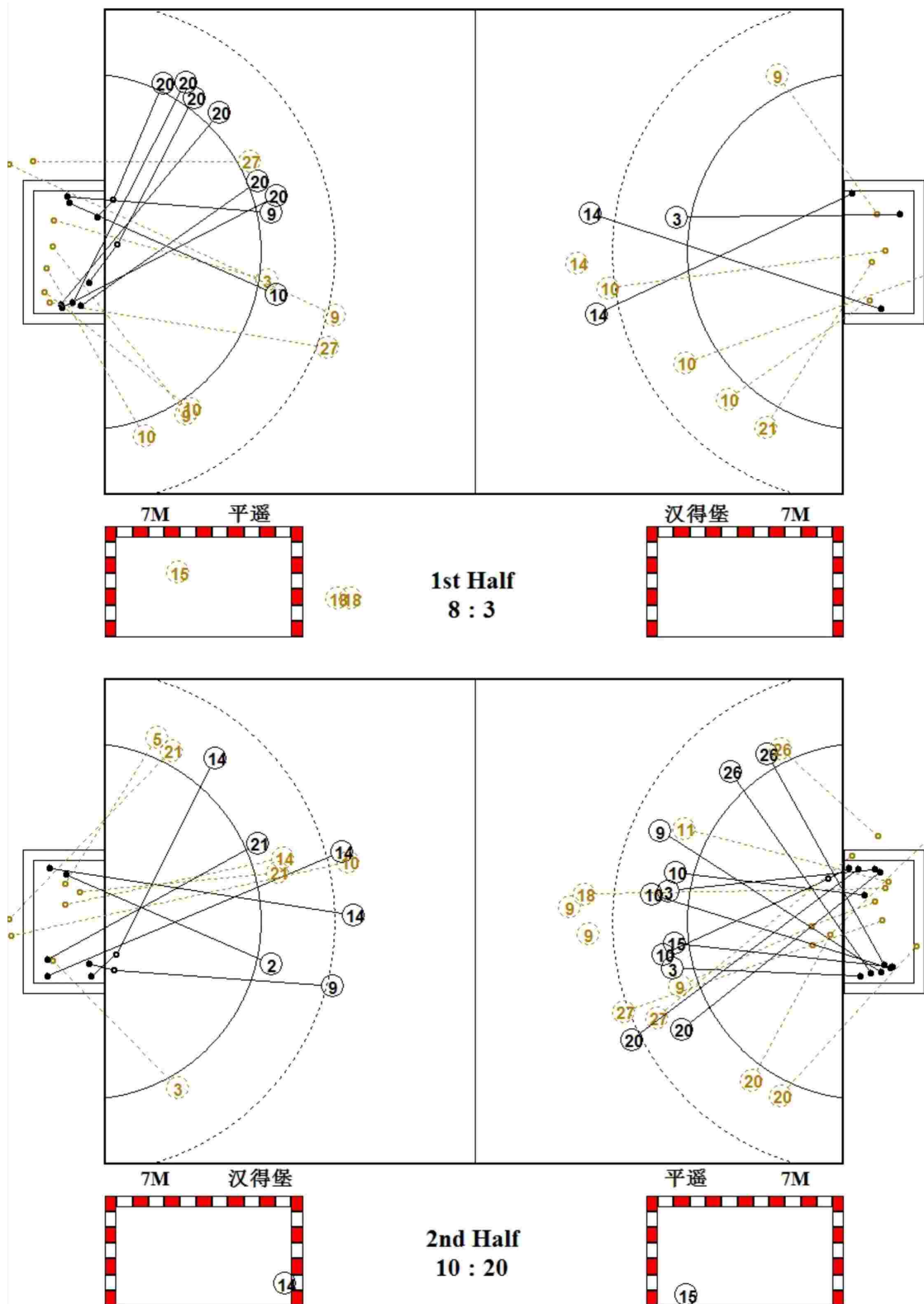



图式射门区域统计

手球  
青年女子

预赛  
轮次 5

组别 A  
场次 65

晋中体育馆  
2019-06-21 14:00

山西平遥

1 战泳享	2 胡嘉雯	3 宫訢	5 李楠	6 王雅静	8 吴名茜	9 马文龙	10 张越																																																																								
<table border="1"><tr><td></td><td></td><td></td></tr><tr><td></td><td></td><td></td></tr><tr><td></td><td></td><td></td></tr></table>										<table border="1"><tr><td></td><td></td><td></td></tr><tr><td></td><td></td><td></td></tr><tr><td></td><td></td><td></td></tr></table>										<table border="1"><tr><td></td><td></td><td></td></tr><tr><td>1</td><td></td><td></td></tr><tr><td></td><td></td><td>1</td></tr></table>				1					1	<table border="1"><tr><td></td><td></td><td></td></tr><tr><td></td><td></td><td></td></tr><tr><td></td><td></td><td></td></tr></table>										<table border="1"><tr><td></td><td></td><td></td></tr><tr><td></td><td></td><td></td></tr><tr><td></td><td></td><td></td></tr></table>										<table border="1"><tr><td></td><td></td><td></td></tr><tr><td></td><td></td><td></td></tr><tr><td></td><td></td><td></td></tr></table>										<table border="1"><tr><td></td><td></td><td></td></tr><tr><td></td><td></td><td>2</td></tr><tr><td></td><td></td><td></td></tr></table>						2				<table border="1"><tr><td></td><td></td><td>1</td></tr><tr><td></td><td></td><td>1</td></tr><tr><td>2</td><td></td><td></td></tr></table>			1			1	2		
1																																																																															
		1																																																																													
		2																																																																													
		1																																																																													
		1																																																																													
2																																																																															
Post - 0 Miss - 0 Block - 0	Post - 0 Miss - 0 Block - 0	Post - 0 Miss - 0 Block - 0	Post - 0 Miss - 0 Block - 0	Post - 0 Miss - 0 Block - 0	Post - 0 Miss - 0 Block - 0	Post - 0 Miss - 1 Block - 2	Post - 0 Miss - 0 Block - 0																																																																								
11 张楠	12 战慧	15 徐翹悦	18 范小雁	20 崔嘉欣	26 李言娜	27 孙玟																																																																									
<table border="1"><tr><td></td><td></td><td></td></tr><tr><td></td><td></td><td></td></tr><tr><td></td><td></td><td></td></tr></table>										<table border="1"><tr><td></td><td></td><td></td></tr><tr><td></td><td></td><td></td></tr><tr><td></td><td></td><td></td></tr></table>										<table border="1"><tr><td></td><td></td><td>1</td></tr><tr><td></td><td></td><td></td></tr><tr><td>1</td><td></td><td></td></tr></table>			1				1			<table border="1"><tr><td></td><td></td><td></td></tr><tr><td></td><td></td><td></td></tr><tr><td></td><td></td><td></td></tr></table>										<table border="1"><tr><td></td><td></td><td></td></tr><tr><td>5</td><td></td><td></td></tr><tr><td>2</td><td></td><td>1</td></tr></table>				5			2		1	<table border="1"><tr><td></td><td></td><td></td></tr><tr><td></td><td></td><td>2</td></tr><tr><td></td><td></td><td></td></tr></table>						2				<table border="1"><tr><td></td><td></td><td></td></tr><tr><td></td><td></td><td></td></tr><tr><td></td><td></td><td></td></tr></table>																			
		1																																																																													
1																																																																															
5																																																																															
2		1																																																																													
		2																																																																													
Post - 0 Miss - 0 Block - 0	Post - 0 Miss - 0 Block - 0	Post - 0 Miss - 0 Block - 0	Post - 0 Miss - 2 Block - 0	Post - 1 Miss - 1 Block - 0	Post - 0 Miss - 1 Block - 0	Post - 1 Miss - 1 Block - 0																																																																									

1 战泳享

1/2		0/1
		0/1

12 战慧

0/2		
1/1	3/3	3/5
0/3		

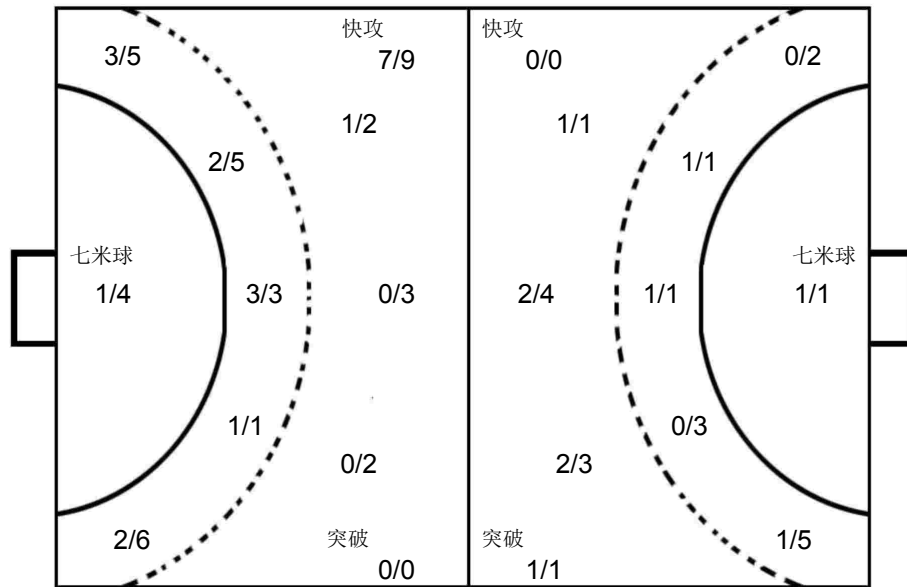

12 张跃

2/3		0/1
0/1		

16 王红

3/3	2/2	1/3
0/5	2/2	0/4
0/4		0/2

福建汉得堡

2 张心茹	3 崔艳菲	5 李倩	7 李珂欣	8 魏雅欣	9 张晓静	10 穆梦欣	11 孙瑞																																																																								
<table border="1"><tr><td></td><td></td><td></td></tr><tr><td></td><td></td><td>1</td></tr><tr><td></td><td></td><td></td></tr></table>						1				<table border="1"><tr><td>1</td><td></td><td></td></tr><tr><td></td><td></td><td></td></tr><tr><td></td><td></td><td></td></tr></table>	1									<table border="1"><tr><td></td><td></td><td></td></tr><tr><td></td><td></td><td></td></tr><tr><td></td><td></td><td></td></tr></table>										<table border="1"><tr><td></td><td></td><td></td></tr><tr><td></td><td></td><td></td></tr><tr><td></td><td></td><td></td></tr></table>										<table border="1"><tr><td></td><td></td><td></td></tr><tr><td></td><td></td><td></td></tr><tr><td></td><td></td><td></td></tr></table>										<table border="1"><tr><td></td><td></td><td></td></tr><tr><td></td><td></td><td></td></tr><tr><td></td><td></td><td></td></tr></table>										<table border="1"><tr><td></td><td></td><td></td></tr><tr><td></td><td></td><td></td></tr><tr><td></td><td></td><td></td></tr></table>										<table border="1"><tr><td></td><td></td><td></td></tr><tr><td></td><td></td><td></td></tr><tr><td></td><td></td><td></td></tr></table>									
		1																																																																													
1																																																																															
Post - 0 Miss - 0 Block - 0	Post - 0 Miss - 0 Block - 0	Post - 0 Miss - 0 Block - 0	Post - 0 Miss - 0 Block - 0	Post - 0 Miss - 0 Block - 0	Post - 0 Miss - 0 Block - 0	Post - 0 Miss - 2 Block - 0	Post - 0 Miss - 0 Block - 0																																																																								
12 张跃	14 尹春霞	15 万里云杉	16 王红	17 邱兰曦	18 邱兰晴	19 林舒婧	21 张雪梅																																																																								
<table border="1"><tr><td></td><td></td><td></td></tr><tr><td></td><td></td><td></td></tr><tr><td></td><td></td><td></td></tr></table>										<table border="1"><tr><td>1</td><td></td><td>1</td></tr><tr><td></td><td></td><td>1</td></tr><tr><td>2</td><td></td><td>1</td></tr></table>	1		1			1	2		1	<table border="1"><tr><td></td><td></td><td></td></tr><tr><td></td><td></td><td></td></tr><tr><td></td><td></td><td></td></tr></table>										<table border="1"><tr><td></td><td></td><td></td></tr><tr><td></td><td></td><td></td></tr><tr><td></td><td></td><td></td></tr></table>										<table border="1"><tr><td></td><td></td><td></td></tr><tr><td></td><td></td><td></td></tr><tr><td></td><td></td><td></td></tr></table>										<table border="1"><tr><td></td><td></td><td></td></tr><tr><td></td><td></td><td></td></tr><tr><td></td><td></td><td></td></tr></table>										<table border="1"><tr><td></td><td></td><td></td></tr><tr><td></td><td></td><td></td></tr><tr><td></td><td></td><td></td></tr></table>										<table border="1"><tr><td></td><td></td><td></td></tr><tr><td></td><td></td><td></td></tr><tr><td></td><td></td><td></td></tr></table>									
1		1																																																																													
		1																																																																													
2		1																																																																													
Post - 0 Miss - 0 Block - 0	Post - 0 Miss - 0 Block - 1	Post - 0 Miss - 0 Block - 0	Post - 0 Miss - 0 Block - 0	Post - 0 Miss - 0 Block - 0	Post - 0 Miss - 0 Block - 0	Post - 0 Miss - 0 Block - 0	Post - 0 Miss - 1 Block - 0																																																																								



第二届全国青年运动会女子手球甲组决赛 俱乐部组 (U18)

青年女子 全国比赛

预赛 Group A



PHMS Pictorial Handball Match Statistics

IHF Official System

Team A A 安徽宿州				Team B B 山西晋中				Match Number <b>66</b>			
------------------	--	--	--	------------------	--	--	--	---------------------------	--	--	--

Played in 山西晋中	in the hall 晋中体育馆	on 2019-06-21	at 15:10	hours	Speakers
-------------------	----------------------	------------------	-------------	-------	----------

Half-time(30')	A 7	B 8	End of playing time	A 12	B 17	1st extra time	A	B	2nd extra time	A	B	After penalty throws	A	B
----------------	--------	--------	---------------------	---------	---------	----------------	---	---	----------------	---	---	----------------------	---	---

Number of 7 m 3/3	Team time-out			Full name of players and officials	Team time-out			B 2/4	Number of 7 m
	1 11:58	2 35:00	3		1 18:08	2 31:25	3		

No.	Team A	G	W	2'	D	DR	No.	Team B	G	W	2'	D	DR
1	陈文娟						1	邓雅楠	1				
3	姜景媛						2	付雪杰	2				
5	单文静	1					5	王晓敏					
7	刘文秀		1	1			6	张雪	3				
8	李伟伟			1			7	郭敏婷	5	1			
9	李旗	3					8	孙雨菲					
10	杨晓晓						9	杨婷	2		1		
12	黄紫蝶						10	王玮					
15	乔思雨						12	郭佳					
17	田伊阳						13	李心怡					
18	刘怡涵						15	杜佳奕					
21	王嫚丽	1					18	于聪					
22	钦马晴	4		1			19	于颖					
23	郭茹文						20	尹艺霖	4	1	1		
25	郑睿涵												
26	刘洋	3											
B	吴昊 (主教练)						A	张栋					
C	李绍魁						B	徐熙围 (主教练)					
D	赵萌萌												
E	王路路												

A	Signatures of responsables for the teams (Off.A)												B
---	--	--	--	--	--	--	--	--	--	--	--	--	---

TP	Remarks of referees / HF Official													TP
----	-----------------------------------	--	--	--	--	--	--	--	--	--	--	--	--	----

Referees	李兆蒙 (CHN)	马晓晔 (CHN)		
T.D.	刘凤娟 (CHN)	叶霄雪 (CHN)		
CHA Off.				

Note: Number of 7m Throws Awarded to Team A and B, Goals (G), Warnings (W), Suspensions (2'), Direct Disqualification (D), Disqualification With Report (DR) and Team Penalty (TP).

Table Officials: 吴鹏凯 许瑛 Statisticians: 谢杨 陈柱

竞赛技术统计

手球  
青年女子

预赛  
轮次 5

组别 A  
场次 66

晋中体育馆  
2019-06-21 15:10

Referees:	李兆蒙 (CHN) / 马晓晔 (CHN)	Result:	12:17(7:8)
Teams:	安徽宿州(宿州) VS 山西晋中(晋中)		

宿州														宿州		晋中						
主教练: 吴昊														比赛进程								
远射	近射	边射	快攻	突破	任意球	7m球	合计	%	助攻	失误	警告	2'	D+DR	1st Half								
1	陈文娟														5	单文静	1	02:44	0			
3	姜景媛																1	03:08	1	7	郭敏婷	
5	单文静		1/3				1/4	25.0		2					22	钦马晴	2	05:15	1			
7	刘文秀	0/2					0/3	0.0		3	1	1			9	李旗	3	06:45	1			
8	李伟伟											1			21	王嫚丽	4	07:44	1			
9	李旗						3/3	100									4	08:30	2	9	杨婷	
10	杨晓晓																4	09:05	3	7	郭敏婷	
12	黄紫蝶																4	11:08	4	7	郭敏婷	
15	乔思雨																4	11:43	5	6	张雪	
17	田伊阳																					
18	刘怡涵																					
21	王嫚丽		0/1	1/1			1/2	50.0		2												
22	钦马晴	2/4	1/1			0/1	1/2	50.0	1	3		1			26	刘洋	5	13:32	6	20	尹艺霖	
23	郭茹文			0/2			0/2	0.0	1	2												
25	郑睿涵																					
26	刘洋		1/2			2/2	3/4	75.0		3												
运动员	合计	2/6	3/7	1/3		2/3	1/4	3/3	12/26	46.2	2	16	1	3								
1	陈文娟						0/2	0.0														
12	黄紫蝶	2/3	2/5	3/3	0/3	1/9	1/1	10/25	40.0		1											
守门员	合计	2/3	2/5	3/3	0/3	1/9	1/1	10/27	37.0		1											

晋中														宿州		晋中		
主教练: 徐熙围														2nd Half				
远射	近射	边射	快攻	突破	任意球	7m球	合计	%	助攻	失误	警告	2'	D+DR	2nd Half				
1	邓雅楠					1/1	1/1	100										
2	付雪杰		1/1		1/1		2/2	100										
5	王晓敏			0/1			0/1	0.0										
6	张雪	0/1	0/1	1/1	2/2		3/5	60.0	1	3								
7	郭敏婷	1/2	1/1	0/1	2/2	0/1	1/3	5/10	50.0	1		1						
8	孙雨菲									1								
9	杨婷		1/1	0/1	1/1		2/3	66.7		1		1						
10	王玮		0/2	0/1		0/1	0/4	0.0		1								
12	郭佳																	
13	李心怡																	
15	杜佳奕			0/1			0/1	0.0										
18	于聪																	
19	于颖																	
20	尹艺霖				1/1	3/6	4/7	57.1	2	1	1	1						
运动员	合计	1/3	3/6	0/5	3/3	8/11	0/2	2/4	17/34	50.0	5	7	2	2				
1	邓雅楠	2/4	1/3		0/2	1/1	0/1	4/11	36.4									
12	郭佳		1/2	0/1		1/2	0/2	2/7	28.6									
守门员	合计	2/4	2/5	0/1	0/2	2/3	0/3	6/18	33.3									

场上队员: 得分 / 射门

守门员: 救球 / 射门

D	取消资格	DR	取消资格+报告
---	------	----	---------

## 个人/全队技术统计表

 手球 预赛 组别 A 晋中体育馆  
 青年女子 轮次 5 场次 66 2019-06-21 15:10

号码	姓名	远射	近射	边射	快攻	突破	任意	七米	合计	%	助攻	失误	警告	2'	取消	时间
<b>安徽宿州(宿州)</b>																
<b>(场上队员)</b>																
1	陈文娟									0.0%						00:00:16
3	姜景媛									0.0%						00:00:00
5	单文静		1/3			0/1		1/4	1/4	25.0%		2				00:40:00
7	刘文秀	0/2				0/1		0/3	0/3	0.0%		3	1	1		00:39:48
8	李伟伟									0.0%				1		00:05:00
9	李旗							3/3	3/3	100%						00:00:41
10	杨晓晓									0.0%						00:00:00
12	黄紫蝶									0.0%		1				00:39:44
15	乔思雨									0.0%						00:00:00
17	田伊阳									0.0%						00:00:00
18	刘怡涵									0.0%						00:00:00
21	王嫚丽		0/1	1/1				1/2	1/2	50.0%		2				00:40:00
22	钦马晴	2/4	1/1			0/1	1/2	4/8	4/8	50.0%	1	3		1		00:38:30
23	郭茹文			0/2				0/2	0/2	0.0%	1	2				00:35:00
25	郑睿涵									0.0%						00:00:00
26	刘洋		1/2			2/2		3/4	3/4	75.0%		3				00:40:00
	<b>合计</b>	<b>2/6</b>	<b>3/7</b>	<b>1/3</b>		<b>2/3</b>	<b>1/4</b>	<b>3/3</b>	<b>12/26</b>	<b>46.2%</b>	<b>2</b>	<b>16</b>	<b>1</b>	<b>3</b>		
<b>(守门员)</b>																
1	陈文娟							0/2	0/2	0.0%						00:00:16
12	黄紫蝶	2/3	2/5	3/3	0/3	1/9	1/1	1/1	10/25	40.0%		1				00:39:44
	<b>合计</b>	<b>2/3</b>	<b>2/5</b>	<b>3/3</b>	<b>0/3</b>	<b>1/9</b>	<b>1/1</b>	<b>1/3</b>	<b>10/27</b>	<b>37.0%</b>		<b>1</b>				

场上队员： 得分/射门

守门员： 救球/射门

全队合计	得分	被救	射失	击柱	封球	合计	%
远射	2	2			2	6	33.3%
近射	3	2	2			7	42.9%
边射	1			2		3	33.3%
快攻							0.0%
突破	2			1		3	66.7%
任意	1	2	1			4	25.0%
七米	3					3	100.0%

第二届全国青年运动会女子手球甲组决赛 俱乐部组 (U18)

PHMS Pictorial Handball Match Statistics

IHF Official System

个人/全队技术统计表

手球 青年女子 预赛 轮次 5 组别 A 场次 66 晋中体育馆 2019-06-21 15:10

号码	姓名	远射	近射	边射	快攻	突破	任意	七米	合计	%	助攻	失误	警告	2'	取消	时间
山西晋中(晋中)																
(场上队员)																
1	邓雅楠							1/1	1/1	100%						00:23:53
2	付雪杰		1/1			1/1			2/2	100%						00:20:00
5	王晓敏			0/1					0/1	0.0%						00:04:02
6	张雪	0/1	0/1		1/1	2/2			3/5	60.0%	1	3				00:31:56
7	郭敏婷	1/2	1/1	0/1		2/2	0/1	1/3	5/10	50.0%	1		1			00:40:00
8	孙雨菲									0.0%	1					00:04:33
9	杨婷		1/1	0/1	1/1				2/3	66.7%		1		1		00:39:57
10	王玮		0/2	0/1			0/1		0/4	0.0%		1				00:16:06
12	郭佳									0.0%						00:16:07
13	李心怡									0.0%		1				00:35:25
15	杜佳奕			0/1					0/1	0.0%						00:07:51
18	于聪									0.0%						00:00:00
19	于颖									0.0%						00:00:00
20	尹艺霖				1/1	3/6			4/7	57.1%	2	1	1	1		00:40:00
	合计	1/3	3/6	0/5	3/3	8/11	0/2	2/4	17/34	50.0%	5	7	2	2		
(守门员)																
1	邓雅楠	2/4	1/3			0/2	1/1	0/1	4/11	36.4%						00:23:53
12	郭佳		1/2	0/1			1/2	0/2	2/7	28.6%						00:16:07
	合计	2/4	2/5	0/1		0/2	2/3	0/3	6/18	33.3%						

场上队员：得分/射门

守门员：救球/射门

全队合计	得分	被救	射失	击柱	封球	合计	%
远射	1	2				3	33.3%
近射	3	2	1			6	50.0%
边射		3	1	1		5	0.0%
快攻	3					3	100.0%
突破	8	1		2		11	72.7%
任意		1	1			2	0.0%
七米	2	1	1			4	50.0%

图式比赛技术统计表

手球  
青年女子

预赛  
轮次 5

组别 A  
场次 66

晋中体育馆  
2019-06-21 15:10

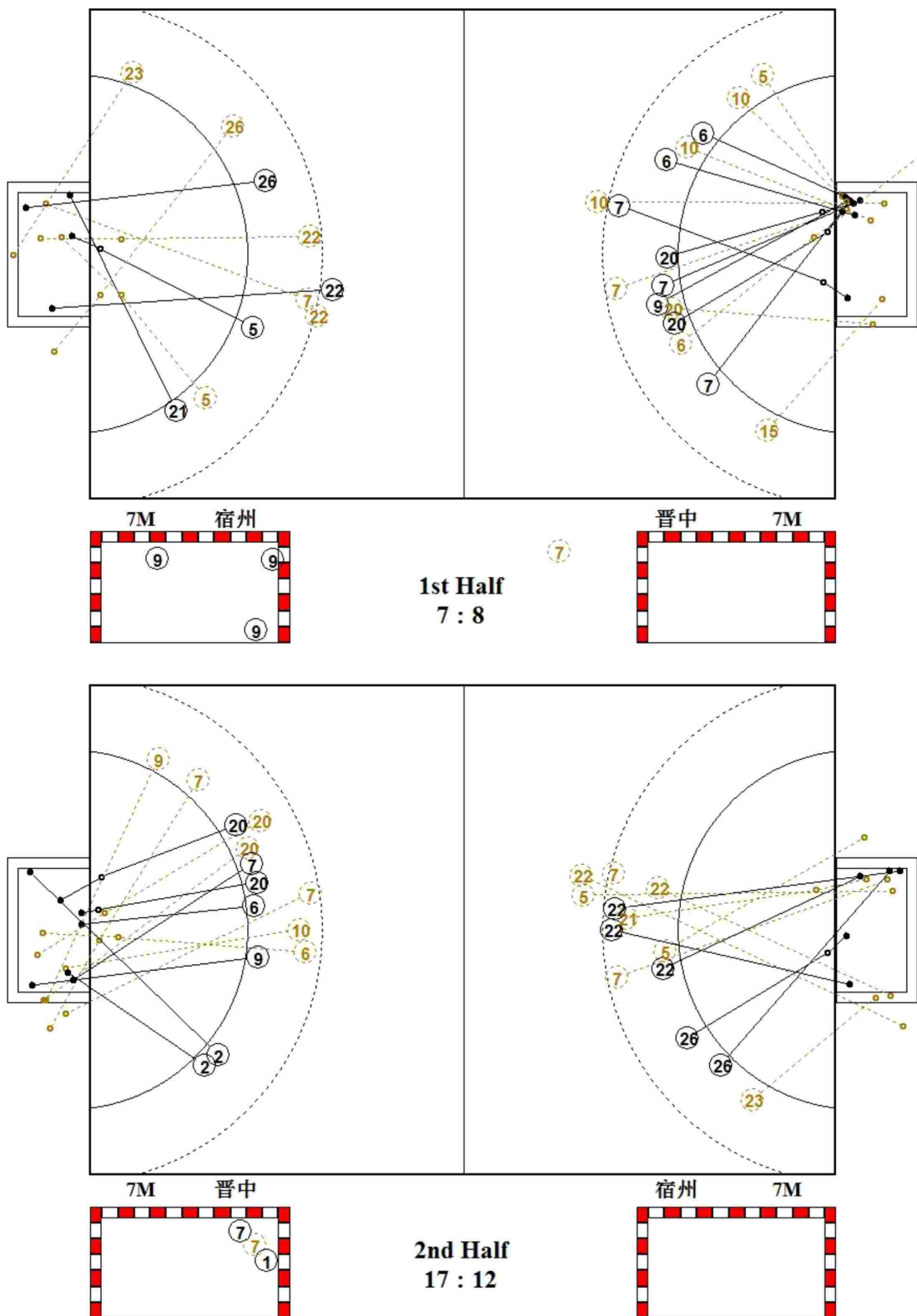

图式射门区域统计

手球  
青年女子

预赛  
轮次 5

组别 A  
场次 66

晋中体育馆  
2019-06-21 15:10

安徽宿州

1 陈文娟	3 姜景媛	5 单文静	7 刘文秀	8 李伟伟	9 李旗	10 杨晓晓	12 黄紫蝶																																																																								
<table border="1"><tr><td></td><td></td><td></td></tr><tr><td></td><td></td><td></td></tr><tr><td></td><td></td><td></td></tr></table>										<table border="1"><tr><td></td><td></td><td></td></tr><tr><td></td><td></td><td></td></tr><tr><td></td><td></td><td></td></tr></table>										<table border="1"><tr><td></td><td></td><td></td></tr><tr><td></td><td></td><td></td></tr><tr><td></td><td>1</td><td></td></tr></table>								1		<table border="1"><tr><td></td><td></td><td></td></tr><tr><td></td><td></td><td></td></tr><tr><td></td><td></td><td></td></tr></table>										<table border="1"><tr><td></td><td></td><td></td></tr><tr><td></td><td></td><td></td></tr><tr><td></td><td></td><td></td></tr></table>										<table border="1"><tr><td>1</td><td></td><td>1</td></tr><tr><td></td><td></td><td></td></tr><tr><td></td><td></td><td>1</td></tr></table>	1		1						1	<table border="1"><tr><td></td><td></td><td></td></tr><tr><td></td><td></td><td></td></tr><tr><td></td><td></td><td></td></tr></table>										<table border="1"><tr><td></td><td></td><td></td></tr><tr><td></td><td></td><td></td></tr><tr><td></td><td></td><td></td></tr></table>									
	1																																																																														
1		1																																																																													
		1																																																																													
Post - 0 Miss - 0 Block - 0	Post - 0 Miss - 0 Block - 0	Post - 0 Miss - 1 Block - 0	Post - 0 Miss - 0 Block - 1	Post - 0 Miss - 0 Block - 0	Post - 0 Miss - 0 Block - 0	Post - 0 Miss - 0 Block - 0	Post - 0 Miss - 0 Block - 0																																																																								
15 乔思雨	17 田伊阳	18 刘怡涵	21 王嫚丽	22 钦马晴	23 郭茹文	25 郑睿涵	26 刘洋																																																																								
<table border="1"><tr><td></td><td></td><td></td></tr><tr><td></td><td></td><td></td></tr><tr><td></td><td></td><td></td></tr></table>										<table border="1"><tr><td></td><td></td><td></td></tr><tr><td></td><td></td><td></td></tr><tr><td></td><td></td><td></td></tr></table>										<table border="1"><tr><td></td><td></td><td></td></tr><tr><td></td><td></td><td></td></tr><tr><td></td><td></td><td></td></tr></table>										<table border="1"><tr><td></td><td></td><td>1</td></tr><tr><td></td><td></td><td></td></tr><tr><td></td><td></td><td></td></tr></table>			1							<table border="1"><tr><td>1</td><td></td><td></td></tr><tr><td>2</td><td></td><td></td></tr><tr><td></td><td></td><td>1</td></tr></table>	1			2					1	<table border="1"><tr><td></td><td></td><td></td></tr><tr><td></td><td></td><td></td></tr><tr><td></td><td></td><td></td></tr></table>										<table border="1"><tr><td></td><td></td><td></td></tr><tr><td></td><td></td><td></td></tr><tr><td></td><td></td><td></td></tr></table>										<table border="1"><tr><td>1</td><td></td><td>1</td></tr><tr><td></td><td></td><td></td></tr><tr><td></td><td>1</td><td></td></tr></table>	1		1					1	
		1																																																																													
1																																																																															
2																																																																															
		1																																																																													
1		1																																																																													
	1																																																																														
Post - 0 Miss - 0 Block - 0	Post - 0 Miss - 0 Block - 0	Post - 0 Miss - 0 Block - 0	Post - 0 Miss - 0 Block - 0	Post - 1 Miss - 1 Block - 1	Post - 2 Miss - 0 Block - 0	Post - 0 Miss - 0 Block - 0	Post - 0 Miss - 1 Block - 0																																																																								

1 陈文娟

		0/1
		0/1

12 黄紫蝶

2/3	1/1	2/3
2/3		0/1
3/11	0/2	0/1

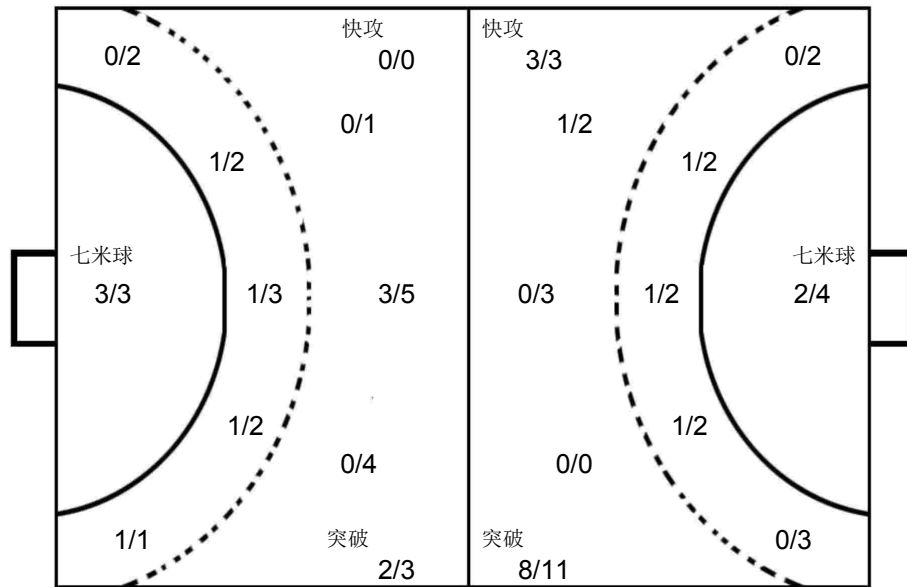

1 邓雅楠

2/4	1/1	0/1
1/2		
	0/1	0/2

12 郭佳

0/1		0/1
0/1	1/1	1/1
	0/1	0/1

山西晋中

1 邓雅楠	2 付雪杰	5 王晓敏	6 张雪	7 郭敏婷	8 孙雨菲	9 杨婷	10 王玮																																																																								
<table border="1"><tr><td></td><td></td><td></td></tr><tr><td></td><td></td><td>1</td></tr><tr><td></td><td></td><td></td></tr></table>						1				<table border="1"><tr><td></td><td></td><td>1</td></tr><tr><td></td><td></td><td></td></tr><tr><td>1</td><td></td><td></td></tr></table>			1				1			<table border="1"><tr><td></td><td></td><td></td></tr><tr><td></td><td></td><td></td></tr><tr><td></td><td></td><td></td></tr></table>										<table border="1"><tr><td></td><td></td><td></td></tr><tr><td>2</td><td>1</td><td></td></tr><tr><td></td><td></td><td></td></tr></table>				2	1					<table border="1"><tr><td></td><td></td><td>1</td></tr><tr><td>1</td><td></td><td></td></tr><tr><td>2</td><td>1</td><td></td></tr></table>			1	1			2	1		<table border="1"><tr><td></td><td></td><td></td></tr><tr><td></td><td></td><td></td></tr><tr><td></td><td></td><td></td></tr></table>										<table border="1"><tr><td>1</td><td></td><td></td></tr><tr><td></td><td></td><td></td></tr><tr><td>1</td><td></td><td></td></tr></table>	1						1			<table border="1"><tr><td></td><td></td><td></td></tr><tr><td></td><td></td><td></td></tr><tr><td></td><td></td><td></td></tr></table>									
		1																																																																													
		1																																																																													
1																																																																															
2	1																																																																														
		1																																																																													
1																																																																															
2	1																																																																														
1																																																																															
1																																																																															
Post - 0 Miss - 0 Block - 0	Post - 0 Miss - 0 Block - 0	Post - 0 Miss - 0 Block - 0	Post - 0 Miss - 1 Block - 0	Post - 0 Miss - 3 Block - 0	Post - 0 Miss - 0 Block - 0	Post - 1 Miss - 0 Block - 0	Post - 0 Miss - 0 Block - 0																																																																								
12 郭佳	13 李心怡	15 杜佳奕	18 于聪	19 于颖	20 尹艺霖																																																																										
<table border="1"><tr><td></td><td></td><td></td></tr><tr><td></td><td></td><td></td></tr><tr><td></td><td></td><td></td></tr></table>										<table border="1"><tr><td></td><td></td><td></td></tr><tr><td></td><td></td><td></td></tr><tr><td></td><td></td><td></td></tr></table>										<table border="1"><tr><td></td><td></td><td></td></tr><tr><td></td><td></td><td></td></tr><tr><td></td><td></td><td></td></tr></table>										<table border="1"><tr><td></td><td></td><td></td></tr><tr><td></td><td></td><td></td></tr><tr><td></td><td></td><td></td></tr></table>										<table border="1"><tr><td></td><td></td><td></td></tr><tr><td></td><td></td><td></td></tr><tr><td></td><td></td><td></td></tr></table>										<table border="1"><tr><td></td><td></td><td>1</td></tr><tr><td>2</td><td>1</td><td></td></tr><tr><td></td><td></td><td></td></tr></table>			1	2	1																								
		1																																																																													
2	1																																																																														
Post - 0 Miss - 0 Block - 0	Post - 0 Miss - 0 Block - 0	Post - 0 Miss - 0 Block - 0	Post - 0 Miss - 0 Block - 0	Post - 0 Miss - 0 Block - 0	Post - 2 Miss - 0 Block - 0																																																																										



第二届全国青年运动会女子手球甲组决赛 俱乐部组 (U18)

青年女子 全国比赛

预赛 Group A



PHMS Pictorial Handball Match Statistics

IHF Official System

Team A A 安徽淮南				Team B B 浙江桃渚				Match Number <b>67</b>			
------------------	--	--	--	------------------	--	--	--	---------------------------	--	--	--

Played in 山西晋中	in the hall 晋中体育馆	on 2019-06-21	at 16:20	hours	Spectators
-------------------	----------------------	------------------	-------------	-------	------------

Half-time(30')	A 9	B 1	End of playing time	A 17	B 2	1st extra time	A	B	2nd extra time	A	B	After penalty throws	A	B
----------------	--------	--------	---------------------	---------	--------	----------------	---	---	----------------	---	---	----------------------	---	---

Number of 7 m	A 1/2	Team time-out			Full name of players and officials	Team time-out			B 0/0	Number of 7 m
	1	2	3	1		2	3	14:47	30:53	

No.	Team A	G	W	2'	D	DR	No.	Team B	G	W	2'	D	DR
1	万文倩	5					2	骆佩瑶					
2	孙雨欣						5	周佩芸	2		1		
3	陈杨						6	黄心怡		1			
4	张天琦	1					7	黄亚楠		1	1		
5	高鑫艺						8	董安心					
6	吕少华						9	黄琼妮					
7	承然	2					11	李盼					
8	董婧						12	金小清					
9	叶飞雪	3					13	陈梦瑶					
10	王梦皖						15	项嘉柔					
11	徐静						16	王语嫣					
12	宋诗情						17	翟馨彤					
13	杨梦颖	5					18	陈曼莎					
14	张美琪												
15	陈可怡	1		1									
16	陈静文												
B	孙永永						C	项建生					
							D	冯婷婷					
							E	蒋云敏					

A	Signatures of responsables for the teams (Off.A)												B
---	--	--	--	--	--	--	--	--	--	--	--	--	---

TP	Remarks of referees / HF Official													TP
----	-----------------------------------	--	--	--	--	--	--	--	--	--	--	--	--	----

Referees	王柏淇 (CHN)	黄一凡 (CHN)		
T.D.	李兆蒙 (CHN)	张耿 (CHN)		
CHA Off.				

Note: Number of 7m Throws Awarded to Team A and B, Goals (G), Warnings (W), Suspensions (2'), Direct Disqualification (D), Disqualification With Report (DR) and Team Penalty (TP).

Table Officials: 宣海波                      宋昌鑫                      Statisticians: 陈柱                      谢杨



## 第二届全国青年运动会女子手球甲组决赛 俱乐部组 (U18)

PHMS Pictorial Handball Match Statistics

IHF Official System

### 竞赛技术统计

手球  
青年女子

预赛  
轮次 5

组别 A  
场次 67

晋中体育馆  
2019-06-21 16:20

Referees:	王柏淇 (CHN) / 黄一凡 (CHN)	Result:	17:2(9:1)
Teams:	安徽淮南(淮南) VS 浙江桃渚(桃渚)		

淮南		远	近	边	快	突	任意	7m	合计	%	助攻	失误	警告	2'	D+DR
主教练: 阮圣杰		射	射	射	攻	破	球	球							
1	万文倩	2/2	0/1		2/3			1/2	5/8	62.5		4			
2	孙雨欣		0/1						0/1	0.0					
3	陈杨	0/1	0/1						0/2	0.0					
4	张天琦	1/1							1/1	100					
5	高鑫艺														
6	吕少华														
7	承然	1/3	1/2						2/5	40.0	1	1			
8	董婧	0/1							0/1	0.0		2			
9	叶飞雪	1/1	0/1	1/2		1/2			3/6	50.0					
10	王梦皖											3			
11	徐静		0/1						0/1	0.0					
12	宋诗情											1			
13	杨梦颖	0/2			4/4	1/1			5/7	71.4		1			
14	张美琪														
15	陈可怡			1/1					1/1	100	1	1		1	
16	陈静文														
运动员 合计		5/11	1/7	2/3	6/7	2/3		1/2	17/33	51.5	2	13		1	
1	万文倩				1/1		1/1		2/2	100		4			
16	陈静文	3/4	1/2						4/6	66.7					
守门员 合计		3/4	1/2		1/1		1/1		6/8	75.0		4			

淮南	比赛 进程	桃渚
1st Half		
1 万文倩	1 03:49	0
13 杨梦颖	2 05:30	0
9 叶飞雪	3 06:45	0
13 杨梦颖	4 07:18	0
13 杨梦颖	5 08:14	0
13 杨梦颖	6 09:46	0
13 杨梦颖	7 12:29	0
4 张天琦	8 13:14	0
	8 17:55	1 5 周佩芸
1 万文倩	9 19:03	1
2nd Half		
7 承然	10 02:05	1
1 万文倩	11 03:31	1
1 万文倩	12 05:19	1
7 承然	13 05:59	1
1 万文倩	14 10:41	1
	14 11:17	2 5 周佩芸
15 陈可怡	15 12:05	2
9 叶飞雪	16 17:01	2
9 叶飞雪	17 19:20	2

桃渚		远	近	边	快	突	任意	7m	合计	%	助攻	失误	警告	2'	D+DR
主教练: 柳日祥		射	射	射	攻	破	球	球							
2	骆佩瑶		0/1						0/1	0.0		9			
5	周佩芸	1/9	1/1	0/2	0/1		0/2		2/15	13.3		4		1	
6	黄心怡											1	1		
7	黄亚楠	0/1							0/1	0.0		10	1	1	
8	董安心														
9	黄琼妮														
11	李盼														
12	金小清											2			
13	陈梦瑶			0/1					0/1	0.0					
15	项嘉柔														
16	王语嫣														
17	翟馨彤														
18	陈曼莎											1			
运动员 合计		1/10	1/2	0/3	0/1		0/2		2/18	11.1		27	2	2	
9	黄琼妮	1/6	4/5	1/3	1/7	1/3		1/2	9/26	34.6					
守门员 合计		1/6	4/5	1/3	1/7	1/3		1/2	9/26	34.6					

场上队员: 得分 / 射门

守门员: 救球 / 射门

D	取消资格	DR	取消资格+报告
---	------	----	---------

## 个人/全队技术统计表

手球 青年女子 预赛 轮次 5 组别 A 场次 67 晋中体育馆 2019-06-21 16:20

号码	姓名	远射	近射	边射	快攻	突破	任意	七米	合计	%	助攻	失误	警告	2'	取消	时间
<b>安徽淮南(淮南)</b>																
<b>(场上队员)</b>																
1	王文倩	2/2	0/1		2/3			1/2	5/8	62.5%		4				00:39:28
2	孙雨欣		0/1						0/1	0.0%						00:04:22
3	陈杨	0/1	0/1						0/2	0.0%						00:10:02
4	张天琦	1/1							1/1	100%						00:16:42
5	高鑫艺									0.0%						00:10:52
6	吕少华									0.0%						00:19:51
7	承然	1/3	1/2						2/5	40.0%	1	1				00:22:58
8	董婧	0/1							0/1	0.0%		2				00:08:47
9	叶飞雪	1/1	0/1	1/2		1/2			3/6	50.0%						00:25:05
10	王梦皖									0.0%		3				00:25:31
11	徐静		0/1						0/1	0.0%						00:09:12
12	宋诗情									0.0%		1				00:12:02
13	杨梦颖	0/2			4/4	1/1			5/7	71.4%		1				00:16:07
14	张美琪									0.0%						00:03:10
15	陈可怡			1/1					1/1	100%	1	1		1		00:29:50
16	陈静文									0.0%						00:23:44
	<b>合计</b>	<b>5/11</b>	<b>1/7</b>	<b>2/3</b>	<b>6/7</b>	<b>2/3</b>		<b>1/2</b>	<b>17/33</b>	<b>51.5%</b>	<b>2</b>	<b>13</b>		<b>1</b>		
<b>(守门员)</b>																
1	王文倩				1/1		1/1		2/2	100%		4				00:39:28
16	陈静文	3/4	1/2						4/6	66.7%						00:23:44
	<b>合计</b>	<b>3/4</b>	<b>1/2</b>		<b>1/1</b>		<b>1/1</b>		<b>6/8</b>	<b>75.0%</b>		<b>4</b>				

场上队员：得分/射门

守门员：救球/射门

全队合计	得分	被救	射失	击柱	封球	合计	%
远射	5	1	4	1		11	45.5%
近射	1	4		2		7	14.3%
边射	2	1				3	66.7%
快攻	6	1				7	85.7%
突破	2	1				3	66.7%
任意							0.0%
七米	1	1				2	50.0%

第二届全国青年运动会女子手球甲组决赛 俱乐部组 (U18)

PHMS Pictorial Handball Match Statistics

IHF Official System

个人/全队技术统计表

手球 预赛 组别 A 晋中体育馆  
青年女子 轮次 5 场次 67 2019-06-21 16:20

号码	姓名	远射	近射	边射	快攻	突破	任意	七米	合计	%	助攻	失误	警告	2'	取消	时间
<b>浙江桃渚(桃渚)</b>																
<b>(场上队员)</b>																
2	骆佩瑶		0/1						0/1	0.0%		9				00:37:22
5	周佩芸	1/9	1/1	0/2	0/1		0/2		2/15	13.3%		4		1		00:40:00
6	黄心怡									0.0%		1	1			00:18:18
7	黄亚楠	0/1							0/1	0.0%		10	1	1		00:40:00
8	董安心									0.0%						00:22:16
9	黄琼妮									0.0%						00:40:00
11	李盼									0.0%						00:06:30
12	金小清									0.0%		2				00:21:41
13	陈梦瑶			0/1					0/1	0.0%						00:19:46
15	项嘉柔									0.0%						00:00:00
16	王语嫣									0.0%						00:00:00
17	翟馨彤									0.0%						00:00:00
18	陈曼莎									0.0%		1				00:33:55
<b>合计</b>		1/10	1/2	0/3	0/1		0/2		2/18	11.1%		27	2	2		
<b>(守门员)</b>																
9	黄琼妮	1/6	4/5	1/3	1/7	1/3		1/2	9/26	34.6%						00:40:00
<b>合计</b>		1/6	4/5	1/3	1/7	1/3		1/2	9/26	34.6%						

场上队员： 得分/射门

守门员： 救球/射门

全队合计	得分	被救	射失	击柱	封球	合计	%
远射	1	3	4	1	1	10	10.0%
近射	1	1				2	50.0%
边射			3			3	0.0%
快攻		1				1	0.0%
突破							0.0%
任意		1	1			2	0.0%
七米							0.0%

图式比赛技术统计表

手球  
青年女子

预赛  
轮次 5

组别 A  
场次 67

晋中体育馆  
2019-06-21 16:20

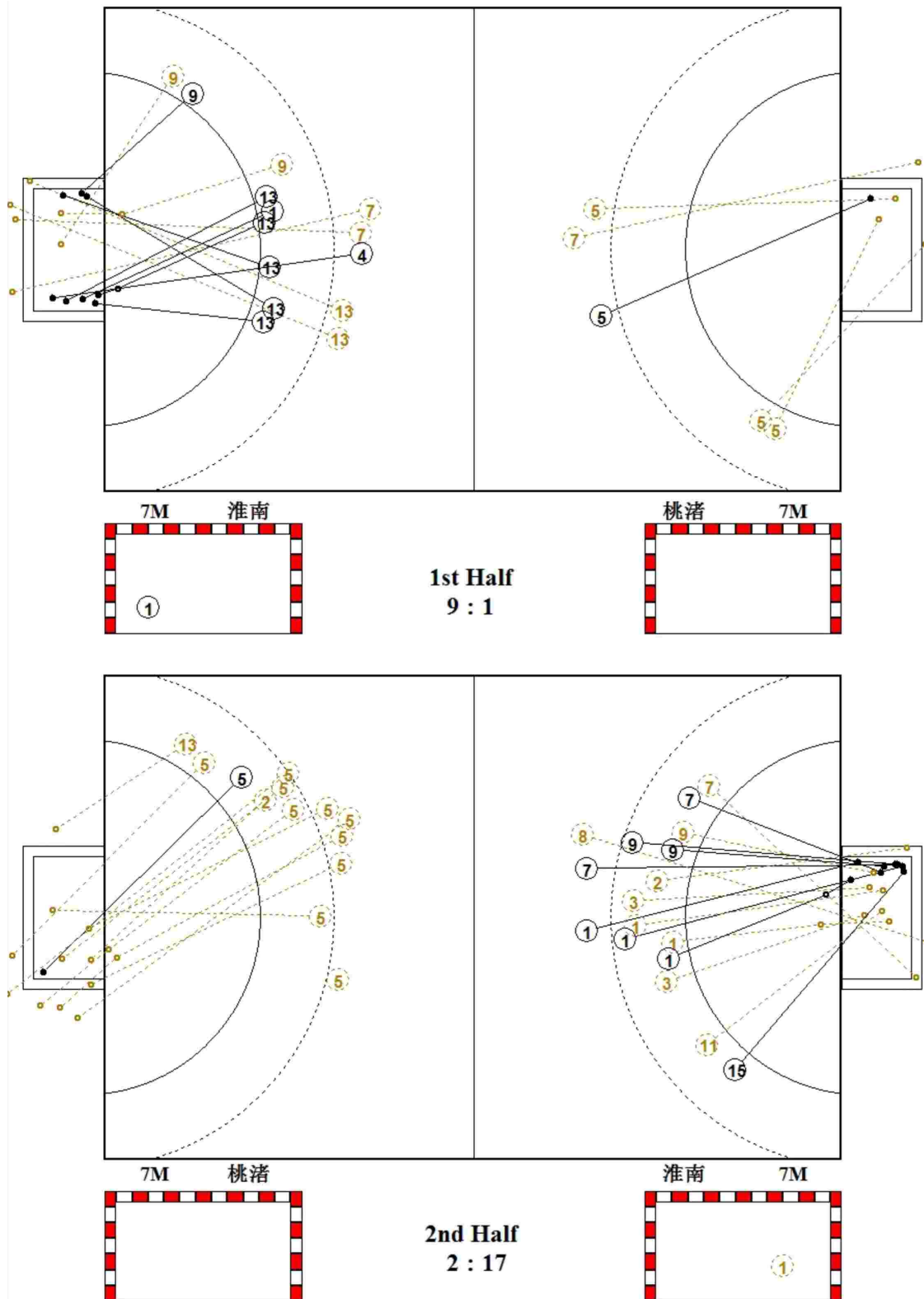

图式射门区域统计

手球  
青年女子

预赛  
轮次 5

组别 A  
场次 67

晋中体育馆  
2019-06-21 16:20

安徽淮南

1 万文倩 1 4 Post - 0 Miss - 0 Block - 0	2 孙雨欣 Post - 1 Miss - 0 Block - 0	3 陈杨 Post - 0 Miss - 0 Block - 0	4 张天琦 1 Post - 0 Miss - 0 Block - 0	5 高鑫艺 Post - 0 Miss - 0 Block - 0	6 吕少华 Post - 0 Miss - 0 Block - 0	7 承然 1 1 Post - 1 Miss - 2 Block - 0	8 董婧 Post - 0 Miss - 1 Block - 0
9 叶飞雪 1 1 1 Post - 0 Miss - 0 Block - 0	10 王梦婉 Post - 0 Miss - 0 Block - 0	11 徐静 Post - 0 Miss - 0 Block - 0	12 宋诗情 Post - 0 Miss - 0 Block - 0	13 杨梦颖 1 2 1 1 Post - 1 Miss - 1 Block - 0	14 张美琪 Post - 0 Miss - 0 Block - 0	15 陈可怡 1 Post - 0 Miss - 0 Block - 0	16 陈静文 Post - 0 Miss - 0 Block - 0

1 万文倩 1/1 1/1
---------------------

16 陈静文 0/1 1/1 1/2 1/1 1/1
---

9 黄琼妮 0/5 3/6 0/6	1/1 3/3	2/3 0/2
----------------------------	------------	------------

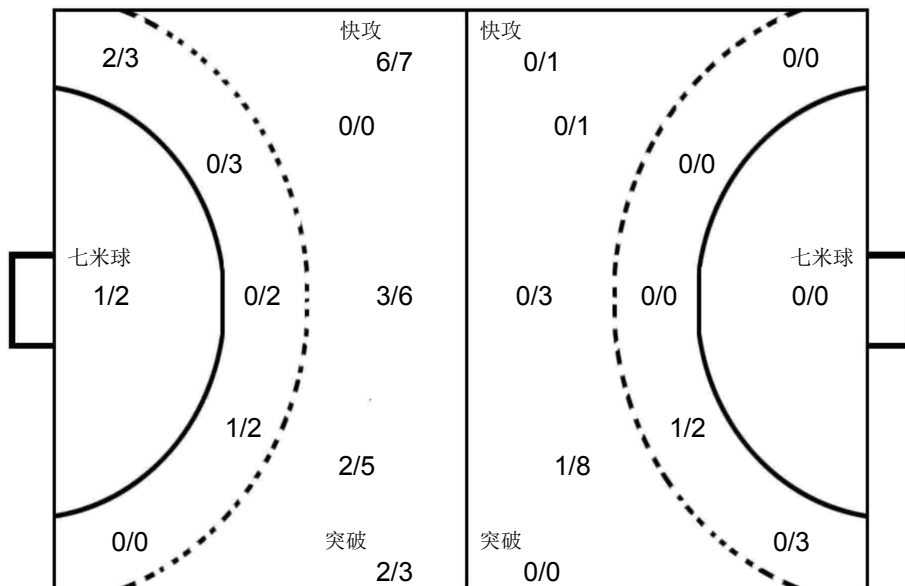

浙江桃渚

2 骆佩瑶 Post - 0 Miss - 0 Block - 0	5 周佩芸 1 1 Post - 1 Miss - 6 Block - 1	6 黄心怡 Post - 0 Miss - 0 Block - 0	7 黄亚楠 Post - 0 Miss - 1 Block - 0	8 董安心 Post - 0 Miss - 0 Block - 0	9 黄琼妮 Post - 0 Miss - 0 Block - 0	11 李盼 Post - 0 Miss - 0 Block - 0	12 金小清 Post - 0 Miss - 0 Block - 0
13 陈梦瑶 Post - 0 Miss - 1 Block - 0	15 项嘉柔 Post - 0 Miss - 0 Block - 0	16 王语嫣 Post - 0 Miss - 0 Block - 0	17 翟馨彤 Post - 0 Miss - 0 Block - 0	18 陈曼莎 Post - 0 Miss - 0 Block - 0			



第二届全国青年运动会女子手球甲组决赛 俱乐部组 (U18)

青年女子 全国比赛

5-6名



PHMS Pictorial Handball Match Statistics

IHF Official System

Team A					Team B					Match Number											
A 福建汉得堡					B 浙江桃渚					86											
Played in			in the hall			on			at			Spectators									
山西晋中			晋中体育馆			2019-06-23			09:00			hours									
Half-time(30')	A	B	End of playing time		A	B	1st extra time		A	B	2nd extra time		A	B	After penalty throws		A	B			
	8	4	23		5																
Number of 7 m	A	Team time-out			Full name of players and officials						Team time-out			B	Number of 7 m						
	4/4	1	2	3							1	2	3	B							
		14:35									17:43	38:07		0/0							
No.	Team A					G	W	2'	D	DR	No.	Team B					G	W	2'	D	DR
3	崔艳菲										2	骆佩瑶					4				
5	李倩										5	周佩芸					1		1		
7	李珂欣					3	1	1			6	黄心怡									
8	魏雅欣										7	黄亚楠									
9	张晓静					1					8	董安心									
10	穆梦欣					3		3			9	黄琼妮									
11	孙瑞					6	1	1			11	李盼									
12	张跃										12	金小清									
14	尹春霞					7					13	陈梦瑶							2		
15	万里云杉										15	项嘉柔									
16	王红										16	王语嫣									
17	邱兰曦										17	翟馨彤									
18	邱兰晴										18	陈曼莎									
19	林舒婧																				
21	张雪梅					3															
A	曾令斌										C	项建生									
C	辛英杰										D	冯婷婷									
D	刘娜										E	蒋云敏									
A	Signatures of responsables for the teams (Off.A)															B					
TP	Remarks of referees / HF Official															TP					

Signatures

Referees	王柏淇 (CHN)	黄一凡 (CHN)		
T.D.	叶霄雪 (CHN)	刘凤娟 (CHN)		
CHA Off.				

Note: Number of 7m Throws Awarded to Team A and B, Goals (G), Warnings (W), Suspensions (2'), Direct Disqualification (D), Disqualification With Report (DR) and Team Penalty (TP).

Table Officials: 宣海波

宋昌鑫

Statisticians: 陈柱

谢杨



## 第二届全国青年运动会女子手球甲组决赛 俱乐部组 (U18)

PHMS Pictorial Handball Match Statistics

IHF Official System

### 竞赛技术统计

手球  
青年女子

5-6名  
轮次 6

组别 X  
场次 86

晋中体育馆  
2019-06-23 09:00

Referees: 王柏淇 (CHN) / 黄一凡 (CHN)

Result: 23:5(8:4)

Teams: 福建汉得堡(汉得堡) VS 浙江桃渚(桃渚)

汉得堡		远	近	边	快	突	任意	7m	合计	%	助攻	失误	警告	2'	D+DR	汉得堡	比赛 进程	桃渚
主教练: 王卫		射	射	射	攻	破	球	球										
3	崔艳菲																	
5	李倩																	
7	李珂欣		2/2		1/1				3/3	100		1	1	1				
8	魏雅欣			0/1					0/1	0.0		1						
9	张晓静	0/2	1/1						1/3	33.3		3						
10	穆梦欣		1/2		1/1	1/1			3/4	75.0	1	2		3				
11	孙瑞		0/1	5/5	1/1				6/7	85.7		5	1	1				
12	张跃																	
14	尹春霞	2/4	0/1		2/3		1/1	2/2	7/11	63.6	3	5						
15	万里云杉			0/1					0/1	0.0								
16	王红																	
17	邱兰曦																	
18	邱兰晴																	
19	林舒婧																	
21	张雪梅				1/1			2/2	3/3	100	1	2						
运动员 合计		2/6	4/7	5/7	6/7	1/1	1/1	4/4	23/33	69.7	5	19	2	5				
12	张跃	2/2	1/2	2/2		1/2	2/4		8/12	66.7								
16	王红			1/1			4/5		5/6	83.3								
守门员 合计		2/2	1/2	3/3		1/2	6/9		13/18	72.2								

桃渚		远	近	边	快	突	任意	7m	合计	%	助攻	失误	警告	2'	D+DR		
主教练: 柳日祥		射	射	射	攻	破	球	球									
2	骆佩瑶	0/1	1/2			1/1	2/4		4/8	50.0		4					
5	周佩芸	0/1		0/2		0/1	1/6		1/10	10.0		6		1			
6	黄心怡	0/1							0/1	0.0		3					
7	黄亚楠											5					
8	董安心			0/1					0/1	0.0		3					
9	黄琼妮																
11	李盼																
12	金小清																
13	陈梦瑶																
15	项嘉柔																
16	王语嫣																
17	翟馨彤																
18	陈曼莎											1					
运动员 合计		0/3	1/2	0/3		1/2	3/10		5/20	25.0		22		3			
9	黄琼妮	3/5	1/5	1/6	0/6	0/1	0/1	0/4	5/28	17.9							
守门员 合计		3/5	1/5	1/6	0/6	0/1	0/1	0/4	5/28	17.9							

场上队员: 得分 / 射门

守门员: 救球 / 射门

D	取消资格	DR	取消资格+报告
---	------	----	---------

## 个人/全队技术统计表

手球 青年女子 5-6名 轮次 6 组别 X 场次 86 晋中体育馆 2019-06-23 09:00

号码	姓名	远射	近射	边射	快攻	突破	任意	七米	合计	%	助攻	失误	警告	2'	取消	时间
福建汉得堡(汉得堡)																
(场上队员)																
3	崔艳菲									0.0%						00:06:53
5	李倩									0.0%						00:11:30
7	李珂欣		2/2			1/1			3/3	100%		1	1	1		00:39:29
8	魏雅欣			0/1					0/1	0.0%		1				00:21:11
9	张晓静	0/2	1/1						1/3	33.3%		3				00:33:29
10	穆梦欣		1/2			1/1	1/1		3/4	75.0%	1	2		3		00:36:35
11	孙瑞		0/1	5/5		1/1			6/7	85.7%		5	1	1		00:34:28
12	张跃									0.0%						00:20:00
14	尹春霞	2/4	0/1			2/3		1/1	2/2	7/11	63.6%	3	5			00:39:42
15	万里云杉			0/1					0/1	0.0%						00:03:32
16	王红									0.0%						00:20:00
17	邱兰曦									0.0%						00:00:00
18	邱兰晴									0.0%						00:00:00
19	林舒婧									0.0%						00:00:00
21	张雪梅					1/1			2/2	3/3	100%	1	2			00:13:04
合计		2/6	4/7	5/7	6/7	1/1	1/1	4/4	23/33	69.7%	5	19	2	5		
(守门员)																
12	张跃	2/2	1/2	2/2		1/2	2/4		8/12	66.7%						00:20:00
16	王红			1/1			4/5		5/6	83.3%						00:20:00
合计		2/2	1/2	3/3		1/2	6/9		13/18	72.2%						

场上队员：得分/射门

守门员：救球/射门

全队合计	得分	被救	射失	击柱	封球	合计	%
远射	2	3	1			6	33.3%
近射	4	1	2			7	57.1%
边射	5	1	1			7	71.4%
快攻	6		1			7	85.7%
突破	1					1	100.0%
任意	1					1	100.0%
七米	4					4	100.0%



第二届全国青年运动会女子手球甲组决赛 俱乐部组 (U18)

PHMS Pictorial Handball Match Statistics

IHF Official System

个人/全队技术统计表

手球 5-6名 组别 X 晋中体育馆  
青年女子 轮次 6 场次 86 2019-06-23 09:00

号码	姓名	远射	近射	边射	快攻	突破	任意	七米	合计	%	助攻	失误	警告	2'	取消	时间
<b>浙江桃渚(桃渚)</b>																
<b>(场上队员)</b>																
2	骆佩瑶	0/1	1/2			1/1	2/4		4/8	50.0%		4				00:25:45
5	周佩芸	0/1		0/2		0/1	1/6		1/10	10.0%		6		1		00:39:12
6	黄心怡	0/1							0/1	0.0%		3				00:38:03
7	黄亚楠									0.0%		5				00:34:51
8	董安心			0/1					0/1	0.0%		3				00:39:53
9	黄琼妮									0.0%						00:40:00
11	李盼									0.0%						00:04:59
12	金小清									0.0%						00:02:36
13	陈梦瑶									0.0%				2		00:14:45
15	项嘉柔									0.0%						00:00:00
16	王语嫣									0.0%						00:00:00
17	翟馨彤									0.0%						00:00:00
18	陈曼莎									0.0%		1				00:39:52
	<b>合计</b>	0/3	1/2	0/3		1/2	3/10		5/20	25.0%		22		3		
<b>(守门员)</b>																
9	黄琼妮	3/5	1/5	1/6	0/6	0/1	0/1	0/4	5/28	17.9%						00:40:00
	<b>合计</b>	3/5	1/5	1/6	0/6	0/1	0/1	0/4	5/28	17.9%						

场上队员： 得分/射门

守门员： 救球/射门

全队合计	得分	被救	射失	击柱	封球	合计	%
远射		2	1			3	0.0%
近射	1	1				2	50.0%
边射		3				3	0.0%
快攻							0.0%
突破	1	1				2	50.0%
任意	3	6		1		10	30.0%
七米							0.0%

图式比赛技术统计表

手球  
青年女子

5-6名  
轮次 6

组别 X  
场次 86

晋中体育馆  
2019-06-23 09:00

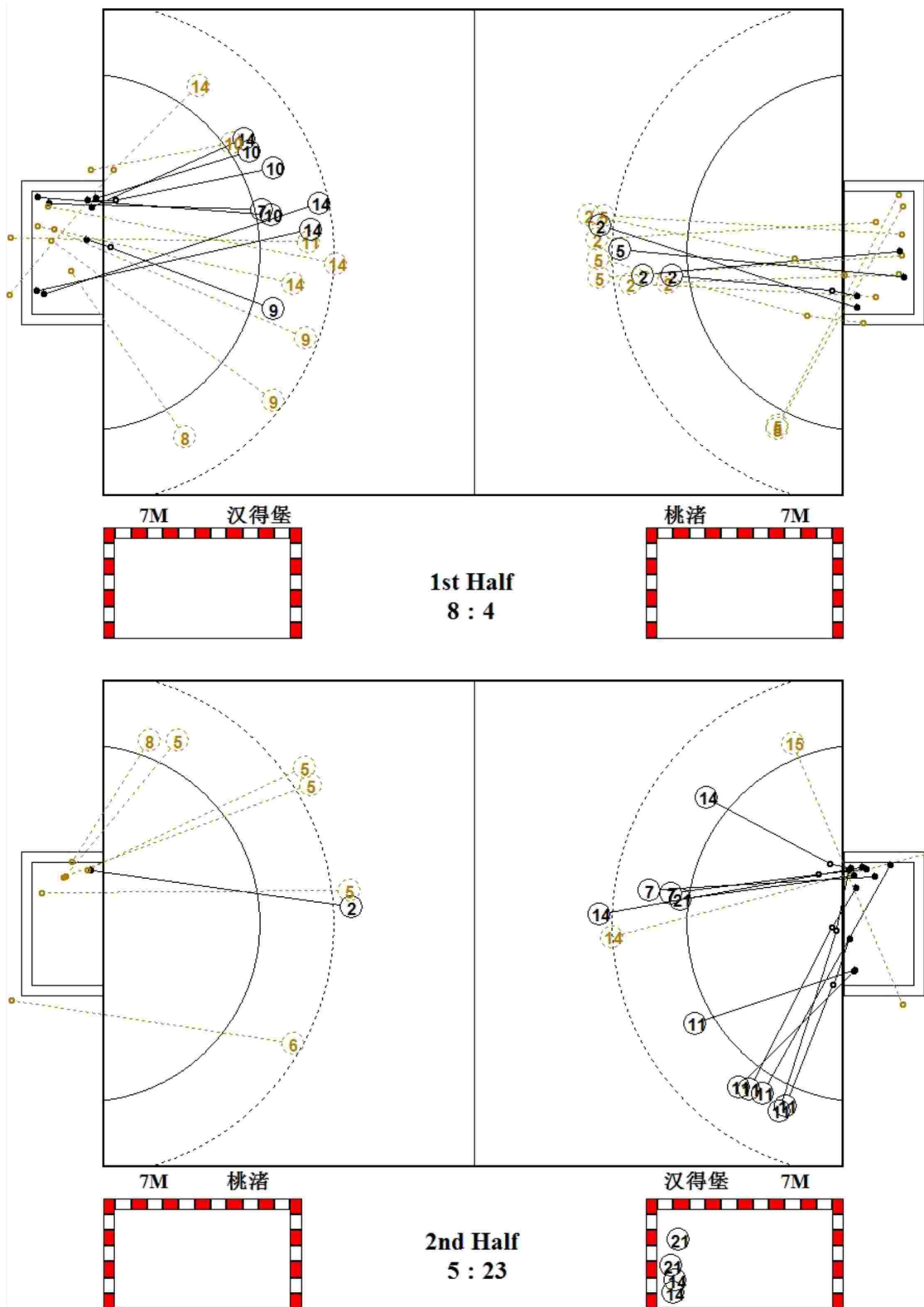

图式射门区域统计

手球  
青年女子

5-6名  
轮次 6

组别 X  
场次 86

晋中体育馆  
2019-06-23 09:00

福建汉得堡

3 崔艳菲 <table border="1"><tr><td></td><td></td><td></td></tr><tr><td></td><td></td><td></td></tr><tr><td></td><td></td><td></td></tr></table> Post - 0 Miss - 0 Block - 0										5 李倩 <table border="1"><tr><td></td><td></td><td></td></tr><tr><td></td><td></td><td></td></tr><tr><td></td><td></td><td></td></tr></table> Post - 0 Miss - 0 Block - 0										7 李珂欣 <table border="1"><tr><td></td><td></td><td>1</td></tr><tr><td>2</td><td></td><td></td></tr><tr><td></td><td></td><td></td></tr></table> Post - 0 Miss - 0 Block - 0			1	2						8 魏雅欣 <table border="1"><tr><td></td><td></td><td></td></tr><tr><td></td><td></td><td></td></tr><tr><td></td><td></td><td></td></tr></table> Post - 0 Miss - 0 Block - 0										9 张晓静 <table border="1"><tr><td></td><td></td><td></td></tr><tr><td></td><td></td><td></td></tr><tr><td>1</td><td></td><td></td></tr></table> Post - 0 Miss - 0 Block - 0							1			10 穆梦欣 <table border="1"><tr><td></td><td></td><td>1</td></tr><tr><td></td><td></td><td></td></tr><tr><td></td><td></td><td>2</td></tr></table> Post - 0 Miss - 1 Block - 0			1						2	11 孙瑞 <table border="1"><tr><td>1</td><td></td><td></td></tr><tr><td></td><td></td><td></td></tr><tr><td>2</td><td>1</td><td>2</td></tr></table> Post - 0 Miss - 1 Block - 0	1						2	1	2	12 张跃 <table border="1"><tr><td></td><td></td><td></td></tr><tr><td></td><td></td><td></td></tr><tr><td></td><td></td><td></td></tr></table> Post - 0 Miss - 0 Block - 0									
		1																																																																													
2																																																																															
1																																																																															
		1																																																																													
		2																																																																													
1																																																																															
2	1	2																																																																													
14 尹春霞 <table border="1"><tr><td>2</td><td></td><td></td></tr><tr><td>1</td><td></td><td></td></tr><tr><td>3</td><td></td><td>1</td></tr></table> Post - 0 Miss - 2 Block - 0	2			1			3		1	15 万里云杉 <table border="1"><tr><td></td><td></td><td></td></tr><tr><td></td><td></td><td></td></tr><tr><td></td><td></td><td></td></tr></table> Post - 0 Miss - 1 Block - 0										16 王红 <table border="1"><tr><td></td><td></td><td></td></tr><tr><td></td><td></td><td></td></tr><tr><td></td><td></td><td></td></tr></table> Post - 0 Miss - 0 Block - 0										17 邱兰曦 <table border="1"><tr><td></td><td></td><td></td></tr><tr><td></td><td></td><td></td></tr><tr><td></td><td></td><td></td></tr></table> Post - 0 Miss - 0 Block - 0										18 邱兰晴 <table border="1"><tr><td></td><td></td><td></td></tr><tr><td></td><td></td><td></td></tr><tr><td></td><td></td><td></td></tr></table> Post - 0 Miss - 0 Block - 0										19 林舒婧 <table border="1"><tr><td></td><td></td><td></td></tr><tr><td></td><td></td><td></td></tr><tr><td></td><td></td><td></td></tr></table> Post - 0 Miss - 0 Block - 0										21 张雪梅 <table border="1"><tr><td>1</td><td></td><td></td></tr><tr><td>1</td><td></td><td></td></tr><tr><td>1</td><td></td><td></td></tr></table> Post - 0 Miss - 0 Block - 0	1			1			1												
2																																																																															
1																																																																															
3		1																																																																													
1																																																																															
1																																																																															
1																																																																															

12 张跃

2/2	2/3	1/2
1/1		1/1
		1/3

16 王红

		1/1
		3/3
		1/2

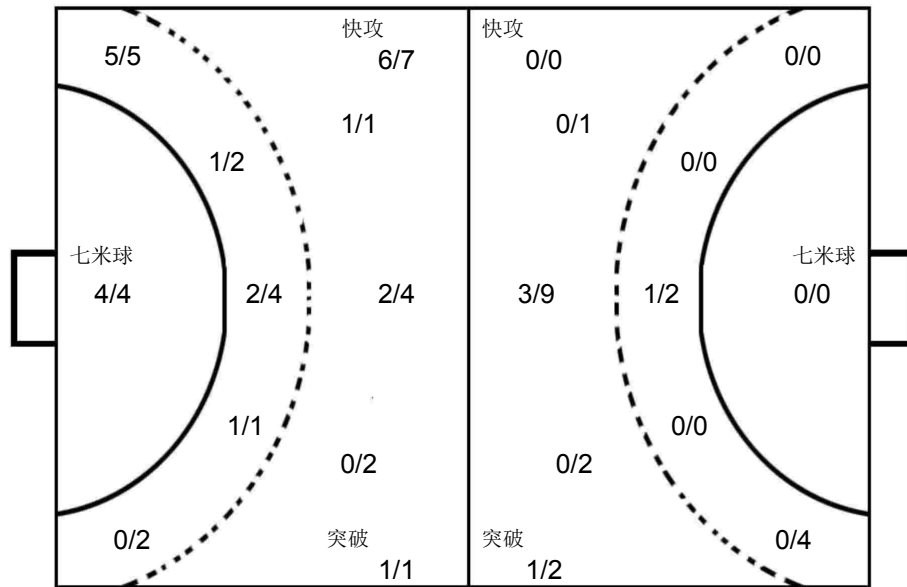

9 黄琼妮

0/4	1/1	3/5
0/4	1/1	
0/6	0/2	0/5

浙江桃渚

2 骆佩瑶 <table border="1"><tr><td></td><td>1</td><td></td></tr><tr><td></td><td></td><td></td></tr><tr><td></td><td></td><td>3</td></tr></table> Post - 0 Miss - 0 Block - 0		1							3	5 周佩芸 <table border="1"><tr><td></td><td></td><td>1</td></tr><tr><td></td><td></td><td></td></tr><tr><td></td><td></td><td></td></tr></table> Post - 1 Miss - 0 Block - 0			1							6 黄心怡 <table border="1"><tr><td></td><td></td><td></td></tr><tr><td></td><td></td><td></td></tr><tr><td></td><td></td><td></td></tr></table> Post - 0 Miss - 1 Block - 0										7 黄亚楠 <table border="1"><tr><td></td><td></td><td></td></tr><tr><td></td><td></td><td></td></tr><tr><td></td><td></td><td></td></tr></table> Post - 0 Miss - 0 Block - 0										8 董安心 <table border="1"><tr><td></td><td></td><td></td></tr><tr><td></td><td></td><td></td></tr><tr><td></td><td></td><td></td></tr></table> Post - 0 Miss - 0 Block - 0										9 黄琼妮 <table border="1"><tr><td></td><td></td><td></td></tr><tr><td></td><td></td><td></td></tr><tr><td></td><td></td><td></td></tr></table> Post - 0 Miss - 0 Block - 0										11 李盼 <table border="1"><tr><td></td><td></td><td></td></tr><tr><td></td><td></td><td></td></tr><tr><td></td><td></td><td></td></tr></table> Post - 0 Miss - 0 Block - 0										12 金小清 <table border="1"><tr><td></td><td></td><td></td></tr><tr><td></td><td></td><td></td></tr><tr><td></td><td></td><td></td></tr></table> Post - 0 Miss - 0 Block - 0									
	1																																																																														
		3																																																																													
		1																																																																													
13 陈梦瑶 <table border="1"><tr><td></td><td></td><td></td></tr><tr><td></td><td></td><td></td></tr><tr><td></td><td></td><td></td></tr></table> Post - 0 Miss - 0 Block - 0										15 项嘉柔 <table border="1"><tr><td></td><td></td><td></td></tr><tr><td></td><td></td><td></td></tr><tr><td></td><td></td><td></td></tr></table> Post - 0 Miss - 0 Block - 0										16 王语嫣 <table border="1"><tr><td></td><td></td><td></td></tr><tr><td></td><td></td><td></td></tr><tr><td></td><td></td><td></td></tr></table> Post - 0 Miss - 0 Block - 0										17 翟馨彤 <table border="1"><tr><td></td><td></td><td></td></tr><tr><td></td><td></td><td></td></tr><tr><td></td><td></td><td></td></tr></table> Post - 0 Miss - 0 Block - 0										18 陈曼莎 <table border="1"><tr><td></td><td></td><td></td></tr><tr><td></td><td></td><td></td></tr><tr><td></td><td></td><td></td></tr></table> Post - 0 Miss - 0 Block - 0																																							



第二届全国青年运动会女子手球甲组决赛 俱乐部组 (U18)

青年女子 全国比赛

3-4名



PHMS Pictorial Handball Match Statistics

IHF Official System

Team A				Team B				Match Number	
A 安徽宿州				B 安徽淮南				87	

Played in	in the hall	on	at	Speakers
山西晋中	晋中体育馆	2019-06-23	10:10	hours

Half-time(30')	A	B	End of playing time	A	B	1st extra time	A	B	2nd extra time	A	B	After penalty throws	A	B
	12	8	24	15										

Number of 7 m	A	Team time-out			Full name of players and officials	Team time-out			B	Number of 7 m
	2/2	1	2	3		1	2	3	1/1	

No.	Team A	G	W	2'	D	DR	No.	Team B	G	W	2'	D	DR
1	陈文娟						1	万文倩					
3	姜景媛						2	孙雨欣					
5	单文静						3	陈杨					
7	刘文秀						4	张天琦	2		1		
8	李伟伟						5	高鑫艺					
9	李旗	6	1				6	吕少华					
12	黄紫蝶						7	承然	5				
15	乔思雨						8	董婧					
17	田伊阳						9	叶飞雪	1				
18	刘怡涵	10	1				10	王梦皖	1				
21	王嫚丽	1		1			11	徐静					
22	钦马晴	7		2			12	宋诗情					
23	郭茹文						13	杨梦颖	6		2		
25	郑睿涵						14	张美琪					
26	刘洋						15	陈可怡					
							16	陈静文					
A	李红太						B	孙永永					
B	吴昊 (主教练)												
C	李绍魁												
E	王路路												

A	Signatures of responsables for the teams (Off.A)												B
---	--	--	--	--	--	--	--	--	--	--	--	--	---

TP	Remarks of referees / HF Official													TP
----	-----------------------------------	--	--	--	--	--	--	--	--	--	--	--	--	----

Signatures													
Referees	伍豪 (CHN)				张智伟 (CHN)								
T.D.	刘凤娟 (CHN)				叶霄雪 (CHN)								
CHA Off.													

Note: Number of 7m Throws Awarded to Team A and B, Goals (G), Warnings (W), Suspensions (2'), Direct Disqualification (D), Disqualification With Report (DR) and Team Penalty (TP).

Table Officials: 吴鹏凯 张琦 Statisticians: 谢杨 陈柱



## 第二届全国青年运动会女子手球甲组决赛 俱乐部组 (U18)

PHMS Pictorial Handball Match Statistics

IHF Official System

### 竞赛技术统计

手球  
青年女子

3-4名  
轮次 6

组别 X  
场次 87

晋中体育馆  
2019-06-23 10:10

Referees:	伍豪 (CHN) / 张智伟 (CHN)	Result:	24:15 (12:8)
Teams:	安徽宿州(宿州) VS 安徽淮南(淮南)		

宿州																宿州		淮南		
														比赛 进程						
														1st Half						
远射	近射	边射	快攻	突破	任意球	7m球	合计	%	助攻	失误	警告	2'	D+DR	18 刘怡涵	1 00:19	0				
主教练: 吴昊																				
1 陈文娟															22 钦马晴	2 03:16	1	7 承然		
3 姜景媛															9 李旗	3 05:01	2			
5 单文静															18 刘怡涵	4 05:46	2			
7 刘文秀																4 06:10	3	13 杨梦颖		
8 李伟伟																4 07:13	4	10 王梦皖		
9 李旗	0/1	0/1	0/1	1/1	2/2	1/2	2/2	6/10	60.0		4	1				4 08:22	5	7 承然		
12 黄紫蝶															18 刘怡涵	5 08:38	5			
15 乔思雨															18 刘怡涵	6 09:32	5			
17 田伊阳															9 李旗	7 10:43	5			
18 刘怡涵	1/1	2/2	1/1		5/5	1/1		10/10	100		1	1				7 12:01	6	13 杨梦颖		
21 王嫚丽		1/1						1/1	100		2		1			22 钦马晴	8 12:35	6		
22 钦马晴	1/3				5/6	1/1		7/10	70.0		1		2			22 钦马晴	9 13:38	6		
23 郭茹文															9 李旗	9 15:28	7	13 杨梦颖		
25 郑睿涵															18 刘怡涵	10 15:47	7			
26 刘洋															18 刘怡涵	10 16:13	8	7 承然		
运动员 合计	2/5	3/4	1/2	1/1	12/13	3/4	2/2	24/31	77.4		12	2	3			21 王嫚丽	12 19:44	8		
1 陈文娟							0/1	0/1	0.0						2nd Half					
12 黄紫蝶	7/11	2/6	3/4	1/1	2/7	2/2		17/31	54.8						9 李旗	13 00:58	8			
守门员 合计	7/11	2/6	3/4	1/1	2/7	2/2	0/1	17/32	53.1						9 李旗	14 03:40	9			
														14 04:02	10	7 承然				
														18 刘怡涵	15 06:35	10				
														22 钦马晴	15 07:43	11	13 杨梦颖			
														22 钦马晴	16 08:03	11				
														22 钦马晴	17 08:53	11				
														9 李旗	18 10:07	11				
														9 李旗	19 11:22	11				
														18 刘怡涵	19 11:45	12	4 张天琦			
														22 钦马晴	20 13:51	12				
														18 刘怡涵	21 16:04	12				
														22 钦马晴	22 16:59	12				
														22 钦马晴	22 17:19	13	13 杨梦颖			
														22 钦马晴	23 17:57	13				
														23 18:12	14	9 叶飞雪				
														23 19:21	15	4 张天琦				
														18 刘怡涵	24 19:51	15				
淮南																				
远射	近射	边射	快攻	突破	任意球	7m球	合计	%	助攻	失误	警告	2'	D+DR							
主教练: 阮圣杰																				
1 万文倩																				
2 孙雨欣																				
3 陈杨																				
4 张天琦	2/4	0/1					2/6	33.3		2		1								
5 高鑫艺																				
6 吕少华																				
7 承然	0/2	2/2			3/4	0/1	5/9	55.6		2										
8 董婧																				
9 叶飞雪			0/2		1/1		1/3	33.3												
10 王梦皖		0/1	1/2	0/1			1/4	25.0												
11 徐静																				
12 宋诗情																				
13 杨梦颖	2/8	2/2			1/2	0/1	6/14	42.9		3		2								
14 张美琪																				
15 陈可怡																				
16 陈静文																				
运动员 合计	4/14	4/6	1/4	0/1	5/7	0/3	1/1	15/36	41.7	1	8	3								
1 万文倩	1/3	0/3	0/1	0/1	1/13	1/4	0/2	3/27	11.1	1										
守门员 合计	1/3	0/3	0/1	0/1	1/13	1/4	0/2	3/27	11.1	1										

场上队员: 得分 / 射门

守门员: 救球 / 射门

D	取消资格	DR	取消资格+报告
---	------	----	---------

## 个人/全队技术统计表

 手球 3-4名 组别 X 晋中体育馆  
 青年女子 轮次 6 场次 87 2019-06-23 10:10

号码	姓名	远射	近射	边射	快攻	突破	任意	七米	合计	%	助攻	失误	警告	2'	取消	时间
<b>安徽宿州(宿州)</b>																
<b>(场上队员)</b>																
1	陈文娟									0.0%						00:00:12
3	姜景媛									0.0%						00:00:00
5	单文静									0.0%		2				00:35:40
7	刘文秀									0.0%						00:00:00
8	李伟伟									0.0%						00:00:00
9	李旗	0/1	0/1	0/1	1/1	2/2	1/2	2/2	6/10	60.0%		4	1			00:39:55
12	黄紫蝶									0.0%						00:39:48
15	乔思雨									0.0%						00:00:00
17	田伊阳									0.0%						00:00:00
18	刘怡涵	1/1	2/2	1/1		5/5	1/1		10/10	100%		1	1			00:39:56
21	王嫚丽		1/1						1/1	100%		2		1		00:39:44
22	钦马晴	1/3				5/6	1/1		7/10	70.0%		1		2		00:40:00
23	郭茹文									0.0%		2				00:40:00
25	郑睿涵									0.0%						00:00:00
26	刘洋									0.0%						00:04:45
<b>合计</b>		<b>2/5</b>	<b>3/4</b>	<b>1/2</b>	<b>1/1</b>	<b>12/13</b>	<b>3/4</b>	<b>2/2</b>	<b>24/31</b>	<b>77.4%</b>		<b>12</b>	<b>2</b>	<b>3</b>		
<b>(守门员)</b>																
1	陈文娟							0/1	0/1	0.0%						00:00:12
12	黄紫蝶	7/11	2/6	3/4	1/1	2/7	2/2		17/31	54.8%						00:39:48
<b>合计</b>		<b>7/11</b>	<b>2/6</b>	<b>3/4</b>	<b>1/1</b>	<b>2/7</b>	<b>2/2</b>	<b>0/1</b>	<b>17/32</b>	<b>53.1%</b>						

场上队员： 得分/射门

守门员： 救球/射门

全队合计	得分	被救	射失	击柱	封球	合计	%
远射	2	1	1		1	5	40.0%
近射	3			1		4	75.0%
边射	1			1		2	50.0%
快攻	1					1	100.0%
突破	12	1				13	92.3%
任意	3	1				4	75.0%
七米	2					2	100.0%

第二届全国青年运动会女子手球甲组决赛 俱乐部组 (U18)

PHMS Pictorial Handball Match Statistics

IHF Official System

个人/全队技术统计表

手球 3-4名 组别 X 晋中体育馆  
青年女子 轮次 6 场次 87 2019-06-23 10:10

号码	姓名	远射	近射	边射	快攻	突破	任意	七米	合计	%	助攻	失误	警告	2'	取消	时间
<b>安徽淮南(淮南)</b>																
<b>(场上队员)</b>																
1	万文倩									0.0%	1					00:40:00
2	孙雨欣									0.0%		1				00:16:25
3	陈杨									0.0%						00:00:00
4	张天琦	2/4	0/1				0/1		2/6	33.3%		2		1		00:40:00
5	高鑫艺									0.0%						00:00:00
6	吕少华									0.0%						00:00:00
7	承然	0/2	2/2			3/4	0/1		5/9	55.6%		2				00:40:00
8	董婧									0.0%						00:00:00
9	叶飞雪			0/2		1/1			1/3	33.3%						00:40:00
10	王梦皖		0/1	1/2	0/1				1/4	25.0%						00:40:00
11	徐静									0.0%						00:00:00
12	宋诗情									0.0%						00:00:00
13	杨梦颖	2/8	2/2			1/2	0/1	1/1	6/14	42.9%		3		2		00:40:00
14	张美琪									0.0%						00:00:00
15	陈可怡									0.0%						00:23:35
16	陈静文									0.0%						00:00:00
<b>合计</b>		<b>4/14</b>	<b>4/6</b>	<b>1/4</b>	<b>0/1</b>	<b>5/7</b>	<b>0/3</b>	<b>1/1</b>	<b>15/36</b>	<b>41.7%</b>	<b>1</b>	<b>8</b>		<b>3</b>		
<b>(守门员)</b>																
1	万文倩	1/3	0/3	0/1	0/1	1/13	1/4	0/2	3/27	11.1%	1					00:40:00
<b>合计</b>		<b>1/3</b>	<b>0/3</b>	<b>0/1</b>	<b>0/1</b>	<b>1/13</b>	<b>1/4</b>	<b>0/2</b>	<b>3/27</b>	<b>11.1%</b>	<b>1</b>					

场上队员：得分/射门

守门员：救球/射门

全队合计	得分	被救	射失	击柱	封球	合计	%
远射	4	7	1	2		14	28.6%
近射	4	2				6	66.7%
边射	1	3				4	25.0%
快攻		1				1	0.0%
突破	5	2				7	71.4%
任意		2	1			3	0.0%
七米	1					1	100.0%

图式比赛技术统计表

手球  
青年女子

3-4名  
轮次 6

组别 X  
场次 87

晋中体育馆  
2019-06-23 10:10

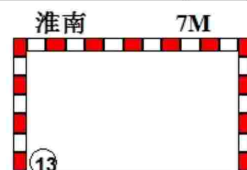
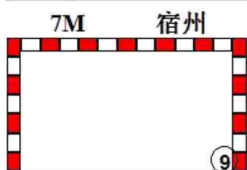
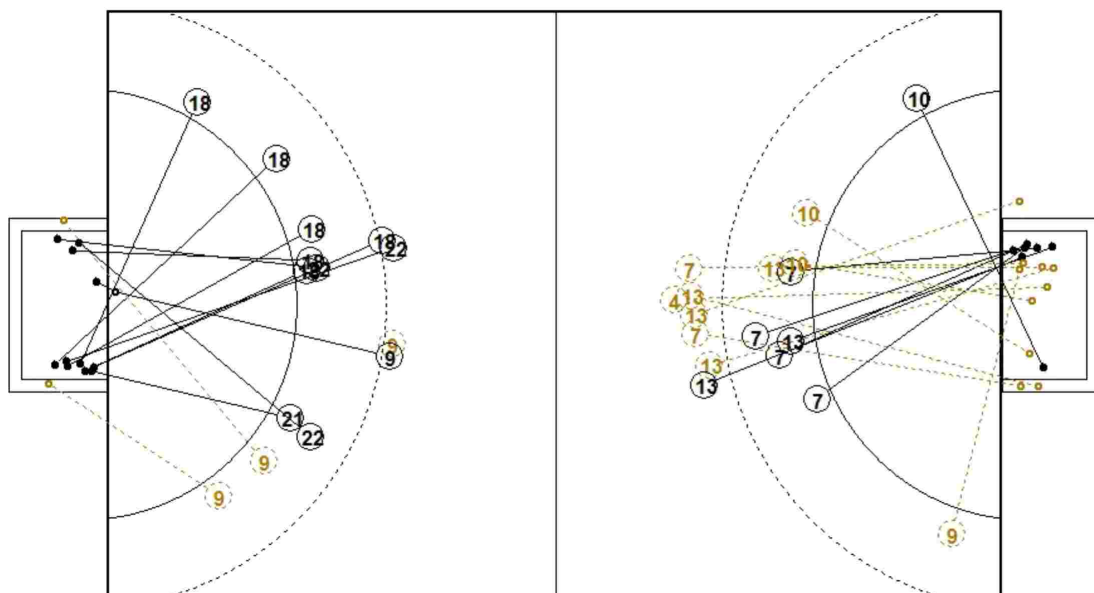

1st Half  
12 : 8

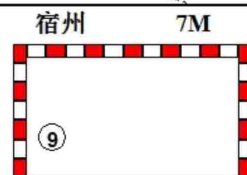
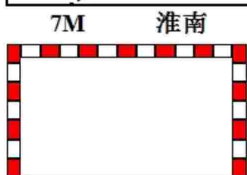
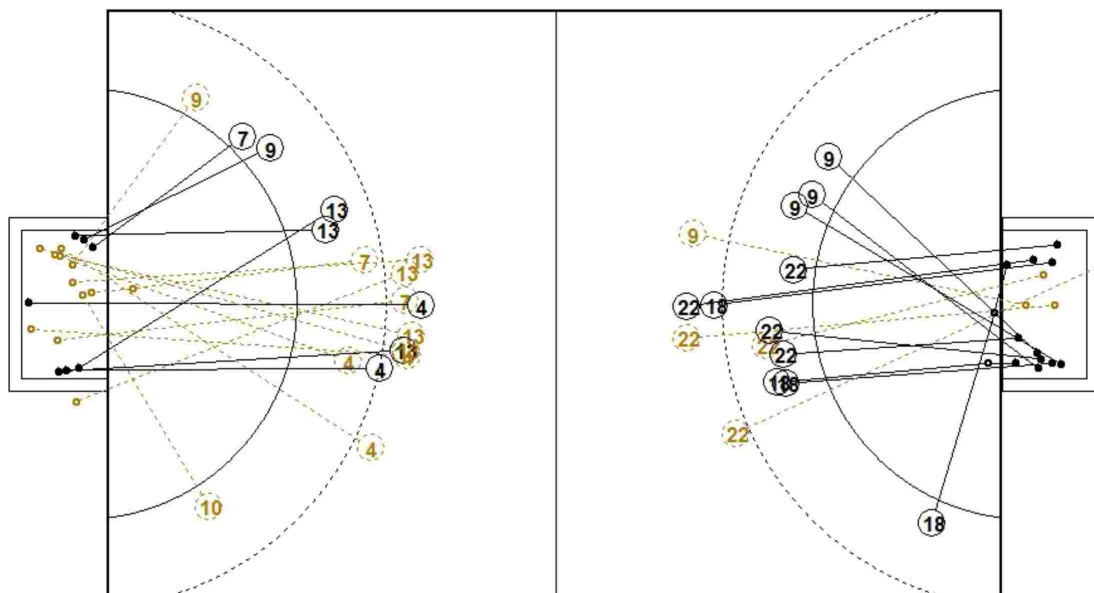

2nd Half  
15 : 24



图式射门区域统计

手球  
青年女子

3-4名  
轮次 6

组别 X  
场次 87

晋中体育馆  
2019-06-23 10:10

安徽宿州

1 陈文娟 <table border="1"><tr><td></td><td></td><td></td></tr><tr><td></td><td></td><td></td></tr></table> Post - 0 Miss - 0 Block - 0							3 姜景媛 <table border="1"><tr><td></td><td></td><td></td></tr><tr><td></td><td></td><td></td></tr></table> Post - 0 Miss - 0 Block - 0							5 单文静 <table border="1"><tr><td></td><td></td><td></td></tr><tr><td></td><td></td><td></td></tr></table> Post - 0 Miss - 0 Block - 0							7 刘文秀 <table border="1"><tr><td></td><td></td><td></td></tr><tr><td></td><td></td><td></td></tr></table> Post - 0 Miss - 0 Block - 0							8 李伟伟 <table border="1"><tr><td></td><td></td><td></td></tr><tr><td></td><td></td><td></td></tr></table> Post - 0 Miss - 0 Block - 0							9 李旗 <table border="1"><tr><td></td><td></td><td>1</td></tr><tr><td>1</td><td></td><td>2</td></tr><tr><td></td><td>1</td><td>1</td></tr></table> Post - 2 Miss - 0 Block - 1			1	1		2		1	1	12 黄紫蝶 <table border="1"><tr><td></td><td></td><td></td></tr><tr><td></td><td></td><td></td></tr></table> Post - 0 Miss - 0 Block - 0							15 乔思雨 <table border="1"><tr><td></td><td></td><td></td></tr><tr><td></td><td></td><td></td></tr></table> Post - 0 Miss - 0 Block - 0						
		1																																																								
1		2																																																								
	1	1																																																								
17 田伊阳 <table border="1"><tr><td></td><td></td><td></td></tr><tr><td></td><td></td><td></td></tr></table> Post - 0 Miss - 0 Block - 0							18 刘怡涵 <table border="1"><tr><td>3</td><td></td><td>2</td></tr><tr><td>4</td><td></td><td>1</td></tr></table> Post - 0 Miss - 0 Block - 0	3		2	4		1	21 王嫚丽 <table border="1"><tr><td></td><td></td><td></td></tr><tr><td></td><td></td><td></td></tr></table> Post - 0 Miss - 0 Block - 0							22 钦马晴 <table border="1"><tr><td>1</td><td></td><td></td></tr><tr><td>2</td><td></td><td>3</td></tr><tr><td></td><td></td><td>1</td></tr></table> Post - 0 Miss - 1 Block - 0	1			2		3			1	23 郭茹文 <table border="1"><tr><td></td><td></td><td></td></tr><tr><td></td><td></td><td></td></tr></table> Post - 0 Miss - 0 Block - 0							25 郑睿涵 <table border="1"><tr><td></td><td></td><td></td></tr><tr><td></td><td></td><td></td></tr></table> Post - 0 Miss - 0 Block - 0							26 刘洋 <table border="1"><tr><td></td><td></td><td></td></tr><tr><td></td><td></td><td></td></tr></table> Post - 0 Miss - 0 Block - 0													
3		2																																																								
4		1																																																								
1																																																										
2		3																																																								
		1																																																								

1 陈文娟

0/1		

12 黄紫蝶

	1/2	1/1
3/8	3/3	5/7
2/6	2/2	0/2

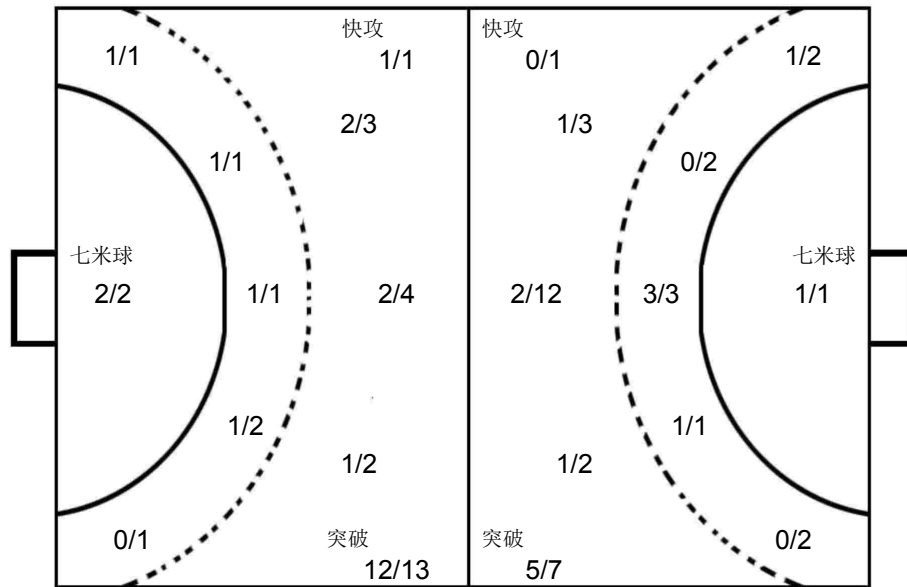

1 万文倩

0/1		0/1
1/7	1/1	0/7
0/5	1/2	0/3

安徽淮南

1 万文倩 <table border="1"><tr><td></td><td></td><td></td></tr><tr><td></td><td></td><td></td></tr></table> Post - 0 Miss - 0 Block - 0							2 孙雨欣 <table border="1"><tr><td></td><td></td><td></td></tr><tr><td></td><td></td><td></td></tr></table> Post - 0 Miss - 0 Block - 0							3 陈杨 <table border="1"><tr><td></td><td></td><td></td></tr><tr><td></td><td></td><td></td></tr></table> Post - 0 Miss - 0 Block - 0							4 张天琦 <table border="1"><tr><td></td><td>1</td><td></td></tr><tr><td>1</td><td></td><td></td></tr></table> Post - 0 Miss - 0 Block - 0		1		1			5 高鑫艺 <table border="1"><tr><td></td><td></td><td></td></tr><tr><td></td><td></td><td></td></tr></table> Post - 0 Miss - 0 Block - 0							6 吕少华 <table border="1"><tr><td></td><td></td><td></td></tr><tr><td></td><td></td><td></td></tr></table> Post - 0 Miss - 0 Block - 0							7 承然 <table border="1"><tr><td></td><td></td><td></td></tr><tr><td>1</td><td></td><td></td></tr><tr><td>3</td><td></td><td>1</td></tr></table> Post - 1 Miss - 0 Block - 0				1			3		1	8 董婧 <table border="1"><tr><td></td><td></td><td></td></tr><tr><td></td><td></td><td></td></tr></table> Post - 0 Miss - 0 Block - 0						
	1																																																									
1																																																										
1																																																										
3		1																																																								
9 叶飞雪 <table border="1"><tr><td></td><td></td><td></td></tr><tr><td></td><td></td><td>1</td></tr></table> Post - 0 Miss - 0 Block - 0						1	10 王梦皖 <table border="1"><tr><td></td><td></td><td>1</td></tr><tr><td></td><td></td><td></td></tr></table> Post - 0 Miss - 0 Block - 0			1				11 徐静 <table border="1"><tr><td></td><td></td><td></td></tr><tr><td></td><td></td><td></td></tr></table> Post - 0 Miss - 0 Block - 0							12 宋诗情 <table border="1"><tr><td></td><td></td><td></td></tr><tr><td></td><td></td><td></td></tr></table> Post - 0 Miss - 0 Block - 0							13 杨梦颖 <table border="1"><tr><td>3</td><td></td><td>1</td></tr><tr><td>2</td><td></td><td></td></tr></table> Post - 1 Miss - 2 Block - 0	3		1	2			14 张美琪 <table border="1"><tr><td></td><td></td><td></td></tr><tr><td></td><td></td><td></td></tr></table> Post - 0 Miss - 0 Block - 0							15 陈可怡 <table border="1"><tr><td></td><td></td><td></td></tr><tr><td></td><td></td><td></td></tr></table> Post - 0 Miss - 0 Block - 0							16 陈静文 <table border="1"><tr><td></td><td></td><td></td></tr><tr><td></td><td></td><td></td></tr></table> Post - 0 Miss - 0 Block - 0									
		1																																																								
		1																																																								
3		1																																																								
2																																																										

第二届全国青年运动会女子手球甲组决赛 俱乐部组 (U18)

比赛进程表

手球 3-4名 组别 X 晋中体育馆  
青年女子 轮次 6 场次 87 2019-06-23 10:10

时间	队员	动作	比分	队员	动作			
安徽宿州			上半时			安徽淮南		
00:19	18 刘怡涵	右远射 得分	1-0	1 王文倩	被射入			
00:59	18 刘怡涵	警告						
01:22				13 杨梦颖	中远射 击柱			
01:44	9 李旗	左边射 击柱						
02:23	21 王嫚丽	四步						
03:05	12 黄紫蝶	被射入	1-1	7 承然	突破 得分			
03:16	22 钦马晴	突破 得分	2-1	1 王文倩	被射入			
03:40				7 承然	中远射 击柱			
03:54	12 黄紫蝶	挡住球		13 杨梦颖	右远射 被救			
04:14	12 黄紫蝶	被射入	2-2	7 承然	近射 得分			
04:49	18 刘怡涵	造7M		4 张天琦	使被罚7M球			
05:01	9 李旗	7M球 得分	3-2	1 王文倩	被射入			
05:29	12 黄紫蝶	挡住球		9 叶飞雪	右边射 被救			
05:46	18 刘怡涵	突破 得分	4-2	1 王文倩	被射入			
06:10	12 黄紫蝶	被射入	4-3	13 杨梦颖	右远射 得分			
06:31	9 李旗	传球失误						
07:13	12 黄紫蝶	被射入	4-4	10 王梦皖	左边射 得分			
08:03	9 李旗	中远射 被封		13 杨梦颖	封球			
08:22	12 黄紫蝶	被射入	4-5	7 承然	突破 得分			
08:38	18 刘怡涵	近射 得分	5-5	1 王文倩	被射入			
09:06	9 李旗	造犯规		4 张天琦	进攻犯规			
09:21				13 杨梦颖	罚出场2分钟			
09:32	18 刘怡涵	突破 得分	6-5	1 王文倩	被射入			
09:57	12 黄紫蝶	挡住球		4 张天琦	中远射 被救			
10:43	9 李旗	任意球 得分	7-5	1 王文倩	被射入			
11:41	9 李旗	使被罚7M球		7 承然	造7M			
11:44	9 李旗	警告						
11:55		裁判暂停						
12:01	1 陈文娟	被射入	7-6	13 杨梦颖	7M球 得分			
12:35	22 钦马晴	突破 得分	8-6	1 王文倩	被射入			
13:10				13 杨梦颖	中远射 射失			
13:38	22 钦马晴	任意球 得分	9-6	1 王文倩	被射入			
14:07				4 张天琦	接球失误			
14:16	9 李旗	近射 击柱						
14:53	12 黄紫蝶	挡住球		13 杨梦颖	突破 被救			
15:28	12 黄紫蝶	被射入	9-7	13 杨梦颖	近射 得分			
15:47	18 刘怡涵	右边射 得分	10-7	1 王文倩	被射入			
16:03	22 钦马晴	罚出场2分钟						
16:13	12 黄紫蝶	被射入	10-8	7 承然	近射 得分			
16:35	18 刘怡涵	四步						
16:45	12 黄紫蝶	挡住球		10 王梦皖	一传快攻 被救			

## 比赛进程表

手球 3-4名 组别 X 晋中体育馆  
 青年女子 轮次 6 场次 87 2019-06-23 10:10

时间	队员	动作	比分	队员	动作			
安徽宿州			上半时			安徽淮南		
16:47			10-8	1 万文倩	助攻			
17:04	9 李旗	传球失误		7 承然	断球			
17:52	12 黄紫蝶	挡住球		10 王梦皖	近射 被救			
18:06	9 李旗	传球失误						
18:37	12 黄紫蝶	挡住球		7 承然	任意球 被救			
18:59	18 刘怡涵	近射 得分	11-8	1 万文倩	被射入			
19:23				13 杨梦颖	传球失误			
19:44	21 王嫚丽	近射 得分	12-8	1 万文倩	被射入			

第二届全国青年运动会女子手球甲组决赛 俱乐部组 (U18)

比赛进程表

手球 3-4名 组别 X 晋中体育馆  
 青年女子 轮次 6 场次 87 2019-06-23 10:10

时间	队员	动作	比分	队员	动作
安徽宿州			安徽淮南		
下半场					
00:37	12 黄紫蝶	挡住球	12-8	13 杨梦颖	中远射 被救
00:58	9 李旗	突破 得分	13-8	1 万文倩	被射入
01:19				7 承然	传球失误
01:42	23 郭茹文	进攻犯规		10 王梦皖	造犯规
01:53				13 杨梦颖	传球失误
02:37	9 李旗	任意球 被救		1 万文倩	挡住球
03:03	12 黄紫蝶	被射入	13-9	13 杨梦颖	中远射 得分
03:28	9 李旗	造7M		7 承然	使被罚7M球
03:40	9 李旗	7M球 得分	14-9	1 万文倩	被射入
04:02	12 黄紫蝶	被射入	14-10	7 承然	突破 得分
04:22	23 郭茹文	接球失误			
04:52	12 黄紫蝶	挡住球		4 张天琦	左远射 被救
05:15	21 王嫚丽	侵区			
06:20				13 杨梦颖	任意球 射失
06:35		裁判暂停			
06:35	18 刘怡涵	突破 得分	15-10	1 万文倩	被射入
06:35				4 张天琦	罚出场2分钟
06:49	12 黄紫蝶	挡住球		13 杨梦颖	中远射 被救
07:02	22 钦马晴	右远射 射失			
07:43	12 黄紫蝶	被射入	15-11	13 杨梦颖	近射 得分
08:03	22 钦马晴	突破 得分	16-11	1 万文倩	被射入
08:22				7 承然	运球失误
08:53	22 钦马晴	中远射 得分	17-11	1 万文倩	被射入
09:18	12 黄紫蝶	挡住球		7 承然	中远射 被救
09:39	22 钦马晴	中远射 被救		1 万文倩	挡住球
09:55				2 孙雨欣	其它失误
10:07	9 李旗	突破 得分	18-11	1 万文倩	被射入
10:36	12 黄紫蝶	挡住球		7 承然	突破 被救
11:16				13 杨梦颖	传球失误
11:22	9 李旗	短传快攻 得分	19-11	1 万文倩	被射入
11:30					球队暂停
11:45	12 黄紫蝶	被射入	19-12	4 张天琦	中远射 得分
12:03	22 钦马晴	突破 被救		1 万文倩	挡住球
12:13		裁判暂停			
12:18	22 钦马晴	罚出场2分钟			
12:44	12 黄紫蝶	挡住球		13 杨梦颖	中远射 被救
13:11		裁判暂停			
13:11				13 杨梦颖	罚出场2分钟
13:51	18 刘怡涵	突破 得分	20-12	1 万文倩	被射入
14:25	12 黄紫蝶	挡住球		9 叶飞雪	右边射 被救
14:30	5 单文静	其它失误			

## 比赛进程表

手球 3-4名 组别 X 晋中体育馆  
 青年女子 轮次 6 场次 87 2019-06-23 10:10

时间	队员	动作	比分	队员	动作
安徽宿州			安徽淮南		
			下半场		
14:36	12 黄紫蝶	挡住球	20-12	4 张天琦	近射 被救
14:46	5 单文静	侵区			
15:43	12 黄紫蝶	挡住球		10 王梦皖	左边射 被救
16:04	22 钦马晴	突破 得分	21-12	1 万文倩	被射入
16:36	12 黄紫蝶	挡住球		4 张天琦	任意球 被救
16:59	18 刘怡涵	突破 得分	22-12	1 万文倩	被射入
17:19	12 黄紫蝶	被射入	22-13	13 杨梦颖	突破 得分
17:57	22 钦马晴	突破 得分	23-13	1 万文倩	被射入
18:12	12 黄紫蝶	被射入	23-14	9 叶飞雪	突破 得分
18:14		裁判暂停			
18:14	21 王嫋丽	罚出场2分钟			
18:52	22 钦马晴	进攻犯规		13 杨梦颖	造犯规
19:03	9 李旗	四步			
19:21	12 黄紫蝶	被射入	23-15	4 张天琦	左远射 得分
19:51	18 刘怡涵	任意球 得分	24-15	1 万文倩	被射入



第二届全国青年运动会女子手球甲组决赛 俱乐部组 (U18)

青年女子 全国比赛

决赛



PHMS Pictorial Handball Match Statistics

IHF Official System

Team A					Team B					Match Number											
A 山西晋中					B 山西平遥					82											
Played in			in the hall			on			at			Spectators									
山西晋中			晋中体育馆			2019-06-23			10:10			hours									
Half-time(30')	A	B	End of playing time	A	B	1st extra time	A	B	2nd extra time	A	B	After penalty throws	A	B							
	7	11	16	22																	
Number of 7 m	A	Team time-out			Full name of players and officials					Team time-out			B	Number of 7 m							
	2/3	1	2	3						1	2	3	1/3								
		14:03	34:40							30:31											
No.	Team A					G	W	2'	D	DR	No.	Team B					G	W	2'	D	DR
1	邓雅楠										1	战泳享									
2	付雪杰					2	1				2	胡嘉雯									
5	王晓敏										3	宫訢					4				
6	张雪										5	李楠									
7	郭敏婷					7	1				6	王雅静									
8	孙雨菲						1				8	吴名茜									
9	杨婷					2					9	马文龙					5	1	1		
10	王玮					1					10	张越					4	1			
12	郭佳										11	张楠									
13	李心怡										12	战慧									
15	杜佳奕					2					15	徐翹悦					1				
18	于聪										18	范小雁					1				
19	于颖										20	崔嘉欣					1		1		
20	尹艺霖					2		1			26	李言娜									
											27	孙玟					6	1	3		
A	张栋										B	黄翠红 (主教练)									
B	徐熙围 (主教练)										E	陶岩									
A	Signatures of responsables for the teams (Off.A)										B										
TP	Remarks of referees / HF Official										TP										

Signatures

Referees	许翔 (CHN)	严璐 (CHN)		
T.D.	李兆蒙 (CHN)	柴业宏 (CHN)		
CHA Off.				

Note: Number of 7m Throws Awarded to Team A and B, Goals (G), Warnings (W), Suspensions (2'), Direct Disqualification (D), Disqualification With Report (DR) and Team Penalty (TP).

Table Officials: 马迪 李莉君 Statisticians: 刘笑 王梓衡



## 第二届全国青年运动会女子手球甲组决赛 俱乐部组 (U18)

PHMS Pictorial Handball Match Statistics

IHF Official System

### 竞赛技术统计

手球  
青年女子

决赛  
轮次 6

组别 X  
场次 82

晋中体育馆  
2019-06-23 10:10

Referees:	许翔 (CHN) / 严璐 (CHN)	Result:	16:22 (7:11)
Teams:	山西晋中(晋中) VS 山西平遥(平遥)		

晋中														晋中			平遥		
主教练: 徐熙围														比赛进程			平遥		
远射	近射	边射	快攻	突破	任意球	7m球	合计	%	助攻	失误	警告	2'	D+DR						
1 邓雅楠															1st Half				
2 付雪杰			1/1	1/2	0/1		2/4	50.0		1	1				9 杨婷 1 03:12 0				
5 王晓敏															1 03:54 1 15 徐翹悦				
6 张雪															2 付雪杰 2 04:20 1				
7 郭敏婷	1/2			1/1	3/3	2/3	7/9	77.8		1	1				2 04:41 2 27 孙玫				
8 孙雨菲		0/1					0/1	0.0				1			2 05:34 3 10 张越				
9 杨婷	0/3		1/2	1/1			2/6	33.3	1	2					2 06:17 4 9 马文龙				
10 王玮		1/3		0/1			1/4	25.0							3 06:50 4				
12 郭佳															3 07:50 5 18 范小雁				
13 李心怡															4 08:48 5				
15 杜佳奕			2/2				2/2	100		1					5 09:43 5				
18 于聪															5 10:55 6 9 马文龙				
19 于颖															5 13:18 7 3 宫苒				
20 尹艺霖		0/1		1/1	1/1		2/3	66.7		3		1			5 15:25 8 9 马文龙				
运动员 合计	1/5	1/5	4/5	4/6	4/5	2/3	16/29	55.2	1	13	3	1			6 15:49 8				
1 邓雅楠	0/1	1/4	2/2	1/2	1/5	0/1	2/3	7/18	38.9						7 17:51 9 10 张越				
12 郭佳	0/1	2/6	3/6		0/3	1/1	6/17	35.3							7 19:08 10 27 孙玫				
守门员 合计	0/2	3/10	5/8	1/2	1/8	1/2	2/3	13/35	37.1						7 19:34 11 27 孙玫				
平遥														2nd Half			平遥		
主教练: 黄翠红														7 00:37 12 9 马文龙			平遥		
远射	近射	边射	快攻	突破	任意球	7m球	合计	%	助攻	失误	警告	2'	D+DR						
1 战泳享															7 01:44 13 20 崔嘉欣				
2 胡嘉雯															8 03:33 13				
3 宫苒		2/3	1/2	0/1	1/1		4/7	57.1		1					9 04:49 13				
5 李楠															9 06:54 14 9 马文龙				
6 王雅静															7 07:24 14				
8 吴名茜															10 07:49 15 27 孙玫				
9 马文龙	1/4	1/1		1/1	2/3		5/9	55.6	2	5	1	1			10 09:25 16 3 宫苒				
10 张越	1/1	1/1	1/3		1/1		4/6	66.7	1		1				7 11:12 17 27 孙玫				
11 张楠															7 11:20 17				
12 战慧															7 13:07 17				
15 徐翹悦		1/4		0/1	0/1	0/1	1/7	14.3		2					7 13:25 18 10 张越				
18 范小雁						1/2	1/2	50.0							14 13:45 18				
20 崔嘉欣			1/2				1/2	50.0				1			14 16:30 19 10 张越				
26 李言娜															15 17:28 19				
27 孙玫		2/2	0/1		4/4		6/7	85.7		1	1	3			15 17:51 20 3 宫苒				
运动员 合计	2/5	7/11	3/8	1/3	7/8	1/2	1/3	22/40	55.0	3	9	3	5		16 18:26 20				
1 战泳享	0/1			1/2	0/1		1/4	25.0							16 18:42 21 3 宫苒				
12 战慧	3/3	2/3	1/5	1/4	0/3	1/3	8/21	38.1							16 19:21 22 27 孙玫				
守门员 合计	3/4	2/3	1/5	2/6	0/4	1/3	9/25	36.0											

场上队员: 得分 / 射门

守门员: 救球 / 射门

D	取消资格	DR	取消资格+报告
---	------	----	---------

## 个人/全队技术统计表

手球 青年女子 决赛 轮次 6 组别 X 场次 82 晋中体育馆 2019-06-23 10:10

号码	姓名	远射	近射	边射	快攻	突破	任意	七米	合计	%	助攻	失误	警告	2'	取消	时间
山西晋中(晋中)																
(场上队员)																
1	邓雅楠									0.0%						00:20:00
2	付雪杰			1/1	1/2	0/1			2/4	50.0%		1	1			00:39:36
5	王晓敏									0.0%						00:03:07
6	张雪									0.0%						00:00:00
7	郭敏婷	1/2			1/1	3/3		2/3	7/9	77.8%		1	1			00:33:40
8	孙雨菲		0/1						0/1	0.0%			1			00:19:11
9	杨婷	0/3		1/2	1/1				2/6	33.3%	1	2				00:34:51
10	王玮		1/3		0/1				1/4	25.0%		4				00:39:37
12	郭佳									0.0%						00:20:00
13	李心怡									0.0%		1				00:19:31
15	杜佳奕			2/2					2/2	100%		1				00:21:44
18	于聪									0.0%						00:00:00
19	于颖									0.0%						00:00:00
20	尹艺霖		0/1		1/1	1/1			2/3	66.7%		3		1		00:26:12
	合计	1/5	1/5	4/5	4/6	4/5		2/3	16/29	55.2%	1	13	3	1		
(守门员)																
1	邓雅楠	0/1	1/4	2/2	1/2	1/5	0/1	2/3	7/18	38.9%						00:20:00
12	郭佳	0/1	2/6	3/6		0/3	1/1		6/17	35.3%						00:20:00
	合计	0/2	3/10	5/8	1/2	1/8	1/2	2/3	13/35	37.1%						

场上队员： 得分/射门

守门员： 救球/射门

全队合计	得分	被救	射失	击柱	封球	合计	%
远射	1	3		1		5	20.0%
近射	1	2	1	1		5	20.0%
边射	4	1				5	80.0%
快攻	4	2				6	66.7%
突破	4			1		5	80.0%
任意							0.0%
七米	2	1				3	66.7%



第二届全国青年运动会女子手球甲组决赛 俱乐部组 (U18)

PHMS Pictorial Handball Match Statistics

IHF Official System

个人/全队技术统计表

手球 青年女子 决赛 轮次 6 组别 X 场次 82 晋中体育馆 2019-06-23 10:10

号码	姓名	远射	近射	边射	快攻	突破	任意	七米	合计	%	助攻	失误	警告	2'	取消	时间
山西平遥(平遥)																
(场上队员)																
1	战泳亨									0.0%						00:03:38
2	胡嘉雯									0.0%						00:00:00
3	宫訖		2/3	1/2	0/1		1/1		4/7	57.1%		1				00:39:18
5	李楠									0.0%						00:00:00
6	王雅静									0.0%						00:00:00
8	吴名茜									0.0%						00:00:00
9	马文龙	1/4	1/1		1/1	2/3			5/9	55.6%	2	5	1	1		00:39:27
10	张越	1/1	1/1	1/3		1/1			4/6	66.7%	1		1			00:39:13
11	张楠									0.0%						00:00:00
12	战慧									0.0%						00:36:22
15	徐翹悦		1/4		0/1		0/1	0/1	1/7	14.3%		2				00:39:17
18	范小雁							1/2	1/2	50.0%						00:00:13
20	崔嘉欣			1/2					1/2	50.0%				1		00:38:56
26	李言娜									0.0%						00:00:00
27	孙玟		2/2	0/1		4/4			6/7	85.7%		1	1	3		00:39:39
合计		2/5	7/11	3/8	1/3	7/8	1/2	1/3	22/40	55.0%	3	9	3	5		
(守门员)																
1	战泳亨	0/1			1/2	0/1			1/4	25.0%						00:03:38
12	战慧	3/3	2/3	1/5	1/4	0/3		1/3	8/21	38.1%						00:36:22
合计		3/4	2/3	1/5	2/6	0/4		1/3	9/25	36.0%						

场上队员： 得分/射门

守门员： 救球/射门

全队合计	得分	被救	射失	击柱	封球	合计	%
远射	2				3	5	40.0%
近射	7	3		1		11	63.6%
边射	3	5				8	37.5%
快攻	1	1		1		3	33.3%
突破	7	1				8	87.5%
任意	1	1				2	50.0%
七米	1	2				3	33.3%

图式比赛技术统计表

手球  
青年女子

决赛  
轮次 6

组别 X  
场次 82

晋中体育馆  
2019-06-23 10:10

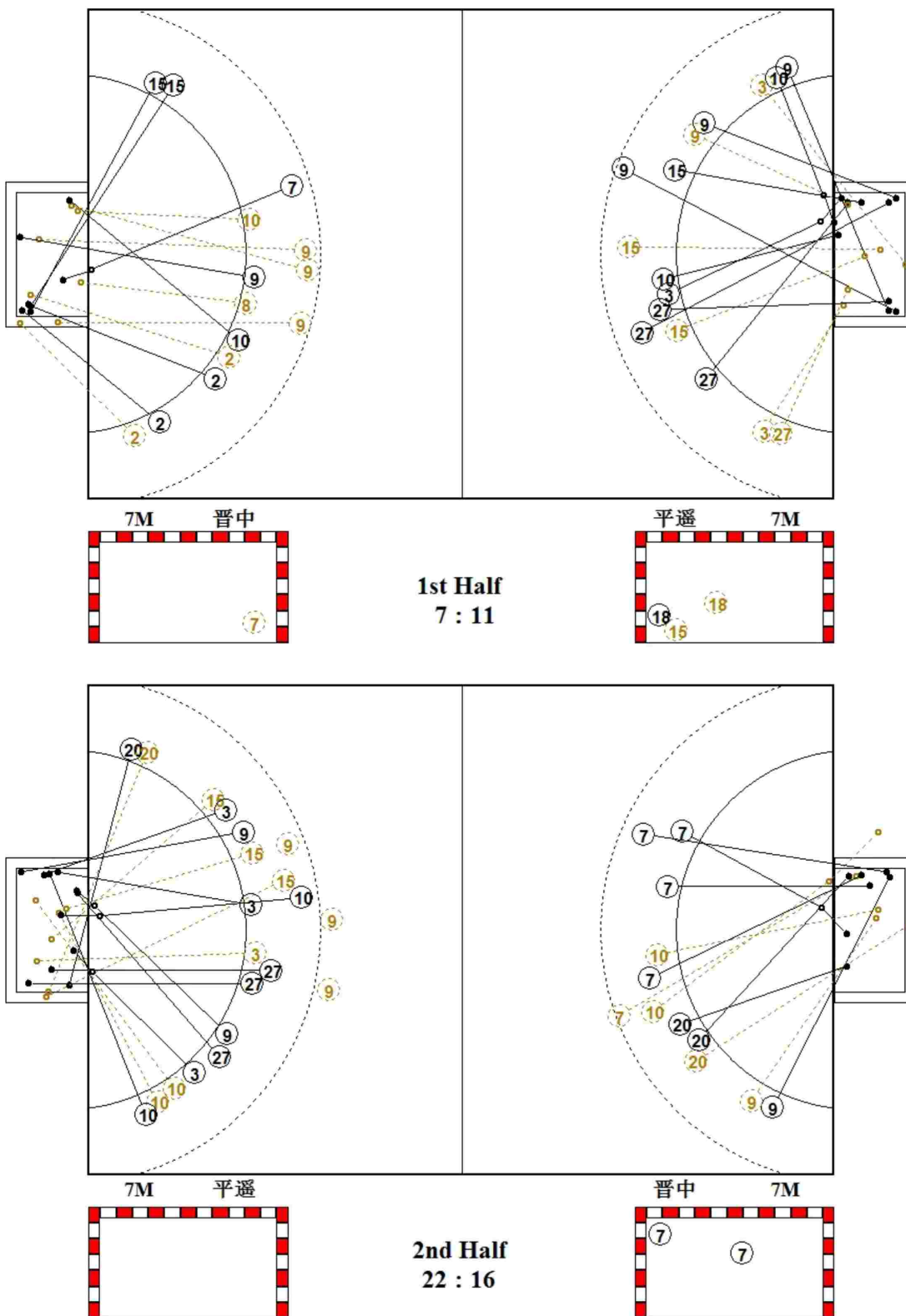

图式射门区域统计

手球  
青年女子

决赛  
轮次 6

组别 X  
场次 82

晋中体育馆  
2019-06-23 10:10

山西晋中

1 邓雅楠 <table border="1"><tr><td></td><td></td><td></td></tr><tr><td></td><td></td><td></td></tr><tr><td></td><td></td><td></td></tr></table> Post - 0 Miss - 0 Block - 0										2 付雪杰 <table border="1"><tr><td>2</td><td></td><td></td></tr><tr><td></td><td></td><td></td></tr><tr><td></td><td></td><td></td></tr></table> Post - 1 Miss - 0 Block - 0	2									5 王晓敏 <table border="1"><tr><td></td><td></td><td></td></tr><tr><td></td><td></td><td></td></tr><tr><td></td><td></td><td></td></tr></table> Post - 0 Miss - 0 Block - 0										6 张雪 <table border="1"><tr><td></td><td></td><td></td></tr><tr><td></td><td></td><td></td></tr><tr><td></td><td></td><td></td></tr></table> Post - 0 Miss - 0 Block - 0										7 郭敏婷 <table border="1"><tr><td>2</td><td>1</td><td></td></tr><tr><td>3</td><td></td><td></td></tr><tr><td></td><td>1</td><td></td></tr></table> Post - 0 Miss - 0 Block - 0	2	1		3				1		8 孙雨菲 <table border="1"><tr><td></td><td></td><td></td></tr><tr><td></td><td></td><td></td></tr><tr><td></td><td></td><td></td></tr></table> Post - 0 Miss - 0 Block - 0										9 杨婷 <table border="1"><tr><td>1</td><td>1</td><td></td></tr><tr><td></td><td></td><td></td></tr><tr><td></td><td></td><td></td></tr></table> Post - 1 Miss - 0 Block - 0	1	1								10 王玮 <table border="1"><tr><td></td><td></td><td></td></tr><tr><td></td><td></td><td></td></tr><tr><td></td><td></td><td>1</td></tr></table> Post - 0 Miss - 1 Block - 0									1
2																																																																															
2	1																																																																														
3																																																																															
	1																																																																														
1	1																																																																														
		1																																																																													
12 郭佳 <table border="1"><tr><td></td><td></td><td></td></tr><tr><td></td><td></td><td></td></tr><tr><td></td><td></td><td></td></tr></table> Post - 0 Miss - 0 Block - 0										13 李心怡 <table border="1"><tr><td></td><td></td><td></td></tr><tr><td></td><td></td><td></td></tr><tr><td></td><td></td><td></td></tr></table> Post - 0 Miss - 0 Block - 0										15 杜佳奕 <table border="1"><tr><td>2</td><td></td><td></td></tr><tr><td></td><td></td><td></td></tr><tr><td></td><td></td><td></td></tr></table> Post - 0 Miss - 0 Block - 0	2									18 于聪 <table border="1"><tr><td></td><td></td><td></td></tr><tr><td></td><td></td><td></td></tr><tr><td></td><td></td><td></td></tr></table> Post - 0 Miss - 0 Block - 0										19 于颖 <table border="1"><tr><td></td><td></td><td></td></tr><tr><td></td><td></td><td></td></tr><tr><td></td><td></td><td></td></tr></table> Post - 0 Miss - 0 Block - 0										20 尹艺霖 <table border="1"><tr><td></td><td></td><td></td></tr><tr><td>1</td><td></td><td>1</td></tr><tr><td></td><td></td><td></td></tr></table> Post - 1 Miss - 0 Block - 0				1		1																							
2																																																																															
1		1																																																																													

1 邓雅楠

0/2	1/1	0/3
0/1	2/2	
2/6	0/1	2/2

12 郭佳

1/2		1/2
1/2	2/3	0/3
0/1	1/2	0/2

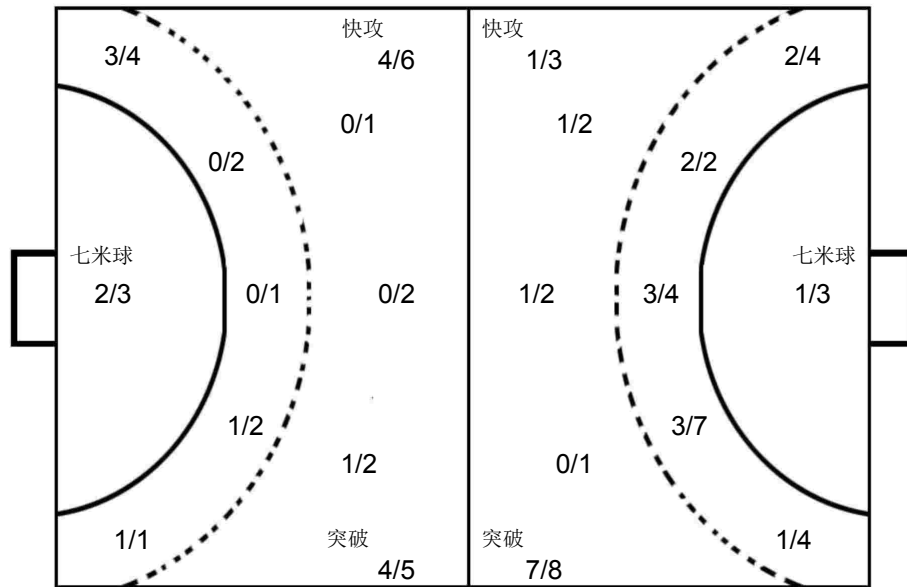

1 战泳亨

0/1		
0/2	1/1	

12 战慧

1/7	1/3	
0/1	1/1	
2/3	0/1	3/5

山西平遥

1 战泳亨 <table border="1"><tr><td></td><td></td><td></td></tr><tr><td></td><td></td><td></td></tr><tr><td></td><td></td><td></td></tr></table> Post - 0 Miss - 0 Block - 0										2 胡嘉雯 <table border="1"><tr><td></td><td></td><td></td></tr><tr><td></td><td></td><td></td></tr><tr><td></td><td></td><td></td></tr></table> Post - 0 Miss - 0 Block - 0										3 宫苒 <table border="1"><tr><td></td><td></td><td></td></tr><tr><td></td><td></td><td>2</td></tr><tr><td>1</td><td>1</td><td></td></tr></table> Post - 1 Miss - 0 Block - 0						2	1	1		5 李楠 <table border="1"><tr><td></td><td></td><td></td></tr><tr><td></td><td></td><td></td></tr><tr><td></td><td></td><td></td></tr></table> Post - 0 Miss - 0 Block - 0										6 王雅静 <table border="1"><tr><td></td><td></td><td></td></tr><tr><td></td><td></td><td></td></tr><tr><td></td><td></td><td></td></tr></table> Post - 0 Miss - 0 Block - 0										8 吴名茜 <table border="1"><tr><td></td><td></td><td></td></tr><tr><td></td><td></td><td></td></tr><tr><td></td><td></td><td></td></tr></table> Post - 0 Miss - 0 Block - 0										9 马文龙 <table border="1"><tr><td>1</td><td></td><td>3</td></tr><tr><td></td><td></td><td></td></tr><tr><td></td><td></td><td>1</td></tr></table> Post - 0 Miss - 0 Block - 3	1		3						1	10 张越 <table border="1"><tr><td></td><td></td><td></td></tr><tr><td></td><td>1</td><td>1</td></tr><tr><td>1</td><td>1</td><td></td></tr></table> Post - 0 Miss - 0 Block - 0					1	1	1	1	
		2																																																																													
1	1																																																																														
1		3																																																																													
		1																																																																													
	1	1																																																																													
1	1																																																																														
11 张楠 <table border="1"><tr><td></td><td></td><td></td></tr><tr><td></td><td></td><td></td></tr><tr><td></td><td></td><td></td></tr></table> Post - 0 Miss - 0 Block - 0										12 战慧 <table border="1"><tr><td></td><td></td><td></td></tr><tr><td></td><td></td><td></td></tr><tr><td></td><td></td><td></td></tr></table> Post - 0 Miss - 0 Block - 0										15 徐翹悦 <table border="1"><tr><td></td><td></td><td></td></tr><tr><td>1</td><td></td><td></td></tr><tr><td></td><td></td><td></td></tr></table> Post - 1 Miss - 0 Block - 0				1						18 范小雁 <table border="1"><tr><td></td><td></td><td></td></tr><tr><td>1</td><td></td><td></td></tr><tr><td></td><td></td><td></td></tr></table> Post - 0 Miss - 0 Block - 0				1						20 崔嘉欣 <table border="1"><tr><td></td><td></td><td></td></tr><tr><td>1</td><td></td><td></td></tr><tr><td></td><td></td><td></td></tr></table> Post - 0 Miss - 0 Block - 0				1						26 李言娜 <table border="1"><tr><td></td><td></td><td></td></tr><tr><td></td><td></td><td></td></tr><tr><td></td><td></td><td></td></tr></table> Post - 0 Miss - 0 Block - 0										27 孙玟 <table border="1"><tr><td>2</td><td></td><td>1</td></tr><tr><td>1</td><td></td><td></td></tr><tr><td>1</td><td></td><td>1</td></tr></table> Post - 0 Miss - 0 Block - 0	2		1	1			1		1										
1																																																																															
1																																																																															
1																																																																															
2		1																																																																													
1																																																																															
1		1																																																																													

第二届全国青年运动会女子手球甲组决赛 俱乐部组 (U18)

比赛进程表

手球 青年女子 决赛 轮次 6 组别 X 场次 82 晋中体育馆 2019-06-23 10:10

时间	队员	动作	比分	队员	动作			
山西晋中			上半时			山西平遥		
00:19	9 杨婷	传球失误	0-0	10 张越	断球			
00:27				3 宫訢	短传快攻 击柱			
01:29				27 孙玟	警告			
01:40	15 杜佳奕	接球失误						
02:02	8 孙雨菲	断球		9 马文龙	传球失误			
02:29	9 杨婷	中远射 被救		12 战慧	挡住球			
02:38	8 孙雨菲	造7M		9 马文龙	使被罚7M球			
02:40				9 马文龙	警告			
02:48	7 郭敏婷	7M球 被救		12 战慧	挡住球			
03:04	8 孙雨菲	断球		9 马文龙	传球失误			
03:12	9 杨婷	短传快攻 得分	1-0	12 战慧	被射入			
03:35	8 孙雨菲	使被罚7M球		27 孙玟	造7M			
03:37	8 孙雨菲	警告						
03:47	1 邓雅楠	挡住球		15 徐翹悦	7M球 被救			
03:54	1 邓雅楠	被射入	1-1	15 徐翹悦	近射 得分			
04:20	2 付雪杰	左边射 得分	2-1	12 战慧	被射入			
04:41	1 邓雅楠	被射入	2-2	27 孙玟	突破 得分			
05:20	2 付雪杰	突破 击柱						
05:34	1 邓雅楠	被射入	2-3	10 张越	近射 得分			
05:36				9 马文龙	助攻			
06:06	8 孙雨菲	近射 被救		12 战慧	挡住球			
06:08	9 杨婷	助攻						
06:17	1 邓雅楠	被射入	2-4	9 马文龙	短传快攻 得分			
06:50	15 杜佳奕	右边射 得分	3-4	12 战慧	被射入			
07:34	2 付雪杰	使被罚7M球		27 孙玟	造7M			
07:36	2 付雪杰	警告						
07:50	1 邓雅楠	被射入	3-5	18 范小雁	7M球 得分			
08:44				10 张越	警告			
08:48	15 杜佳奕	右边射 得分	4-5	12 战慧	被射入			
09:10	1 邓雅楠	挡住球		9 马文龙	突破 被救			
09:13				9 马文龙	侵区			
09:43	7 郭敏婷	突破 得分	5-5	12 战慧	被射入			
10:00				27 孙玟	四步			
10:41	9 杨婷	左远射 击柱						
10:55	1 邓雅楠	被射入	5-6	9 马文龙	突破 得分			
12:07	9 杨婷	其它失误		10 张越	造失误			
12:14				9 马文龙	运球失误			
12:40	10 王玮	传球失误						
13:08	7 郭敏婷	警告						
13:18	1 邓雅楠	被射入	5-7	3 宫訢	任意球 得分			
14:03		球队暂停						

## 比赛进程表

手球 青年女子 决赛 轮次 6 组别 X 场次 82 晋中体育馆 2019-06-23 10:10

时间	队员	动作	比分	队员	动作			
山西晋中			上半时			山西平遥		
15:09	9 杨婷	中远射 被救	5-7	12 战慧	挡住球			
15:25	1 邓雅楠	被射入	5-8	9 马文龙	左远射 得分			
15:49	10 王玮	近射 得分	6-8	12 战慧	被射入			
16:11	1 邓雅楠	挡住球		27 孙玟	右边射 被救			
16:23	2 付雪杰	短传快攻 被救		12 战慧	挡住球			
16:33	1 邓雅楠	挡住球		15 徐翹悦	短传快攻 被救			
16:37	2 付雪杰	短传快攻 得分	7-8	12 战慧	被射入			
17:04	2 付雪杰	使被罚7M球		3 宫訢	造7M			
17:37	1 邓雅楠	挡住球		18 范小雁	7M球 被救			
17:38	1 邓雅楠	挡住球		15 徐翹悦	近射 被救			
17:39				20 崔嘉欣	罚出场2分钟			
17:40		裁判暂停						
17:51	1 邓雅楠	被射入	7-9	10 张越	突破 得分			
18:17	10 王玮	近射 被救		12 战慧	挡住球			
18:35	1 邓雅楠	挡住球		3 宫訢	右边射 被救			
18:53	10 王玮	传球失误						
19:08	1 邓雅楠	被射入	7-10	27 孙玟	近射 得分			
19:28	10 王玮	其它失误						
19:34	1 邓雅楠	被射入	7-11	27 孙玟	突破 得分			
20:00				27 孙玟	罚出场2分钟			

第二届全国青年运动会女子手球甲组决赛 俱乐部组 (U18)

比赛进程表

手球 青年女子 决赛 轮次 6 组别 X 场次 82 晋中体育馆 2019-06-23 10:10

时间	队员	动作	比分	队员	动作
山西晋中			山西平遥		
			下半场		
00:37	12 郭佳	被射入	7-12	9 马文龙	近射 得分
01:17	7 郭敏婷	右远射 被救		12 战慧	挡住球
01:44	12 郭佳	被射入	7-13	20 崔嘉欣	右边射 得分
02:01	13 李心怡	传球失误		9 马文龙	断球
02:51	13 李心怡	封球		9 马文龙	左远射 被封
02:54	12 郭佳	挡住球		20 崔嘉欣	右边射 被救
03:22	7 郭敏婷	造7M		27 孙玫	使被罚7M球
03:33	7 郭敏婷	7M球 得分	8-13	12 战慧	被射入
04:18	12 郭佳	挡住球		15 徐翹悦	任意球 被救
04:36				15 徐翹悦	近射 击柱
04:49	20 尹艺霖	短传快攻 得分	9-13	12 战慧	被射入
05:03		裁判暂停			
05:03	20 尹艺霖	罚出场2分钟			
05:18				15 徐翹悦	传球失误
06:04	10 王玮	传球失误			
06:20	12 郭佳	挡住球		10 张越	左边射 被救
06:39	10 王玮	近射 射失			
06:54	12 郭佳	被射入	9-14	9 马文龙	突破 得分
07:24	7 郭敏婷	突破 得分	10-14	12 战慧	被射入
07:49	12 郭佳	被射入	10-15	27 孙玫	突破 得分
08:23	20 尹艺霖	侵区			
08:34	12 郭佳	挡住球		3 宫訢	近射 被救
08:37				9 马文龙	助攻
08:57	20 尹艺霖	四步			
09:25	12 郭佳	被射入	10-16	3 宫訢	近射 得分
09:57	7 郭敏婷	造7M		20 崔嘉欣	使被罚7M球
10:13	7 郭敏婷	7M球 得分	11-16	12 战慧	被射入
10:31					球队暂停
11:12	12 郭佳	被射入	11-17	27 孙玫	突破 得分
11:20	7 郭敏婷	短传快攻 得分	12-17	1 战泳享	被射入
12:19	20 尹艺霖	断球		3 宫訢	传球失误
12:23	10 王玮	短传快攻 被救		1 战泳享	挡住球
12:38	12 郭佳	挡住球		10 张越	左边射 被救
13:04	20 尹艺霖	近射 击柱			
13:07	7 郭敏婷	突破 得分	13-17	1 战泳享	被射入
13:25	12 郭佳	被射入	13-18	10 张越	左边射 得分
13:45	7 郭敏婷	左远射 得分	14-18	1 战泳享	被射入
14:13	7 郭敏婷	封球		9 马文龙	右远射 被封
14:30				15 徐翹悦	四步
14:40		球队暂停			
14:51	2 付雪杰	运球失误			

## 比赛进程表

手球 青年女子 决赛 轮次 6 组别 X 场次 82 晋中体育馆 2019-06-23 10:10

时间	队员	动作	比分	队员	动作
山西晋中			山西平遥		
			下半场		
15:27			14-18	9 马文龙	四步
15:35		裁判暂停			
15:35				27 孙玫	罚出场2分钟
15:56	7 郭敏婷	传球失误		15 徐翹悦	断球
16:30	12 郭佳	被射入	14-19	10 张越	中远射 得分
17:18		裁判暂停			
17:18				9 马文龙	罚出场2分钟
17:28	9 杨婷	右边射 得分	15-19	12 战慧	被射入
17:51	12 郭佳	被射入	15-20	3 宫訢	左边射 得分
18:26	20 尹艺霖	突破 得分	16-20	12 战慧	被射入
18:36	12 郭佳	挡住球		15 徐翹悦	近射 被救
18:42	12 郭佳	被射入	16-21	3 宫訢	近射 得分
19:00	9 杨婷	右边射 被救		12 战慧	挡住球
19:21	12 郭佳	被射入	16-22	27 孙玫	近射 得分
19:23				10 张越	助攻
19:41		裁判暂停			
19:41				27 孙玫	罚出场2分钟
19:44	20 尹艺霖	接球失误			
19:55	13 李心怡	封球		9 马文龙	中远射 被封