



2019中国男子手球超级联赛 (北京赛区)

成绩与技术统计数据册



中国手球协会
CHINESE HANDBALL ASSOCIATION



华体集团
CHINA NATIONAL SPORTS GROUP

下一站 2019
VS
胜利
中国男子手球超级联赛
CHINESE HANDBALL ASSOCIATION SUPER LEAGUE

数据由PHMS收集生成
PHMS国际手球联合会官方技术统计系统



成绩与技术统计数据册目录

- 1 比赛结果
 - 1) 名次
 - 2) 获奖队员名单
 - 3) 场次成绩
 - 4) 分组成绩
- 2 运动员排名
 - 1) 得分
 - 2) 助攻
 - 3) 封球
 - 4) 防守
 - 5) 失误
 - 6) 受罚
- 3 守门员排名
 - 1) 救球
 - 2) 救7M球
- 4 球队总体比较
- 5 球队受罚表
- 6 球队累计
 - 1) 球队名单
 - 2) 个人/全队技术累计表
 - 3) 图式射门区域累计
- 7 每场比赛统计
 - 1) 比赛报告表
 - 2) 竞赛技术统计表
 - 3) 个人/全队技术统计表
 - 4) 图式比赛技术统计
 - 5) 图式射门区域统计
 - 6) 比赛进程表(决赛场次)

注：如需更多比赛统计数据，请通过以下电邮联络：handball@126.com

中国男子手球超级联赛(北京)

PHMS Pictorial Handball Match Statistics

IHF Official System

大赛名次

手球 男子 截止至第6场 北京 2019-06-30

奖牌	名次	缩写	队名
Gold	1	华体	华体国家男子手球俱乐部
Silver	2	北京队	北京光彩男子手球俱乐部队
Bronze	3	江苏	太平洋保险江苏男子手球俱乐部
	4	广东	广东路环四庙男子手球俱乐部

中国男子手球超级联赛(北京)

PHMS Pictorial Handball Match Statistics

IHF Official System

获奖队员名单

手球
男子

北京
2019-06-30

金牌	银牌	铜牌
华体-华体国家男子手球俱乐部	北京队-北京光彩男子手球俱乐部队	江苏-太平洋保险江苏男子手球俱乐部
4 张家纬	2 解建飞	1 陈昊
5 贺政	7 马昌震	5 闫亮
6 赵晨	8 MagyarDavid	7 周傲
8 谢庆龙	10 MezeiRichard Bendeguz	9 许翔宇
10 李朝鹏	11 赵文宣	11 张天豪
11 郭世伟	12 高云健	15 李安
12 王权	13 王军鸣	16 张帅
16 刘迈科	14 逯明松	17 刘赵梁
18 李双	16 孟辉	18 赵楠
20 顾艳超	18 傅俊雄	19 庞连康
22 黄培杰	22 王超	21 刘江
23 曹悦	25 马明辉	22 罗尧尧
25 王杰缘	26 魏昂	23 宋继强
47 成亚	27 闫炳旗	26 MUCZA Nobert
88 王军程	29 杜龙飞	27 王伟强
99 王伟	32 蒋维一	28 SZRNKAlevente

中国男子手球超级联赛(北京)

PHMS Pictorial Handball Match Statistics

IHF Official System

分组成绩

 手球
 男子

截止至第6场

 北京
 2019-06-30

组别: X 预赛

名次	球队	积	场	胜	平	负	得分	失分	净胜
1	华体	6	3	3	0	0	110	77	33
2	江苏	2	3	1	0	2	79	82	-3
3	北京队	2	3	1	0	2	86	95	-9
4	广东	2	3	1	0	2	87	108	-21

球队	华体	江苏	北京队	广东
华体		33-26	37-24	40-27
江苏	26-33		21-26	32-23
北京队	24-37	26-21		36-37
广东	27-40	23-32	37-36	

Legend:

积	积分		已比赛场次	胜	胜场	平	平场
负	负场	得分	得分累计	失分	失分累计	净胜	净胜分

中国男子手球超级联赛(北京)

PHMS Pictorial Handball Match Statistics

IHF Official System

场次成绩

手球 男子 截止至第6场 北京 2019-06-30

日期	时间	场次	体育馆	组别	球队	成绩 (半时)	阶段
28-06-19	19:00	1	北京光彩体育馆	X	华体-江苏	33-26 (15-11)	预赛
	20:45	2	北京光彩体育馆	X	北京队-广东	36-37 (13-13)	预赛
29-06-19	19:00	3	北京光彩体育馆	X	江苏-广东	32-23 (14-8)	预赛
	20:45	4	北京光彩体育馆	X	华体-北京队	37-24 (14-10)	预赛
30-06-19	15:00	5	北京光彩体育馆	X	广东-华体	27-40 (13-16)	预赛
	16:45	6	北京光彩体育馆	X	北京队-江苏	26-21 (13-9)	预赛

中国男子手球超级联赛(北京)

PHMS Pictorial Handball Match Statistics

IHF Official System

得分排名表(场上队员)

手球 男子 截止至第6场 按总得分排序 北京 2019-06-30

排序	号码	姓名	球队	远射	近射	边射	快攻	突破	任意	七米	合计	%	助攻	场数
1	10	周仲坤	广东	6-16	4-6	0-3	1-3	1-3	2-2	8-8	22-41	53.7	3	3
2	10	MezeiRichard Be	北京队	5-14	3-4	0-1	3-3	2-3	1-2	6-7	20-34	58.8	6	3
3	22	黄培杰	华体	0-1	2-2	5-6	6-7	0-0	0-0	5-5	18-21	85.7	3	3
4	8	MagyarDavid	北京队	7-17	2-3	0-0	2-2	3-5	1-3	2-4	17-34	50.0	10	3
5	8	谢庆龙	华体	1-1	7-8	0-0	6-8	1-1	0-0	0-0	15-18	83.3	2	3
6	88	王军程	华体	6-16	2-2	0-0	1-1	4-4	0-0	0-0	13-23	56.5	1	3
7	27	王伟强	江苏	1-1	1-1	6-7	4-6	0-0	0-0	0-0	12-15	80.0	1	3
8	26	MUCZA Nobert	江苏	4-9	3-3	0-0	4-6	1-1	0-0	0-0	12-19	63.2	5	3
9	17	李中洲	广东	3-8	2-3	0-0	4-4	2-2	0-0	0-1	11-18	61.1	1	3
10	13	王军鸣	北京队	4-15	4-7	0-1	1-1	0-2	1-2	1-1	11-29	37.9	2	3
11	47	成亚	华体	3-5	2-2	1-1	2-2	2-3	0-0	0-1	10-14	71.4	5	3
12	18	赵楠	江苏	1-7	4-4	1-2	0-0	4-6	0-0	0-0	10-19	52.6	4	3
13	25	王杰缘	华体	0-0	1-1	1-2	5-7	0-0	0-0	2-3	9-13	69.2	0	3
14	20	顾艳超	华体	4-7	3-3	0-0	1-1	1-2	0-0	0-0	9-13	69.2	2	3
15	17	刘赵梁	江苏	0-1	0-2	2-6	4-6	3-4	0-0	0-0	9-19	47.4	2	3
16	4	ARPASI PATRIK	广东	1-2	7-8	0-0	0-0	0-0	0-0	0-0	8-10	80.0	0	3
17	28	SZRNKAlvente	江苏	0-1	7-10	0-0	1-1	0-0	0-1	0-0	8-13	61.5	2	3
18	15	李安	江苏	0-1	0-0	0-0	1-1	0-1	0-0	7-10	8-13	61.5	1	3
19	22	王超	北京队	0-0	2-6	2-3	4-5	0-0	0-0	0-0	8-14	57.1	1	3
20	8	DOLEZSAL KAROLY	广东	1-8	1-1	0-0	0-0	1-1	0-0	5-6	8-16	50.0	6	3
21	14	逯明松	北京队	2-7	0-2	0-1	1-2	5-5	0-1	0-0	8-18	44.4	2	3
22	6	毕晓晨	广东	0-3	2-4	0-3	3-5	3-4	0-0	0-1	8-20	40.0	1	3
23	3	曲汝洋	广东	3-10	1-4	0-1	2-2	1-2	0-2	1-1	8-22	36.4	8	3
24	27	闫炳旗	北京队	0-0	3-3	1-2	3-3	0-0	0-0	0-0	7-8	87.5	0	3
25	4	张家纬	华体	4-4	0-1	0-0	3-4	0-1	0-0	0-0	7-10	70.0	2	3
26	24	高玉杰	广东	0-0	1-1	4-4	2-6	0-0	0-0	0-0	7-11	63.6	3	3
27	10	李朝鹏	华体	5-10	0-0	0-0	2-2	0-2	0-0	0-0	7-14	50.0	5	3
28	19	庞连康	江苏	1-4	2-5	0-0	1-1	3-5	0-0	0-0	7-15	46.7	1	3
29	6	赵晨	华体	3-9	0-1	0-0	2-2	1-1	0-0	0-0	6-13	46.2	4	3
30	18	姚雪岩	广东	2-8	2-3	0-0	0-0	2-4	0-0	0-0	6-15	40.0	0	3
31	5	贺政	华体	1-1	0-1	3-4	1-1	0-0	0-0	0-0	5-7	71.4	1	3
32	21	刘江	江苏	1-1	2-3	0-0	2-3	0-1	0-0	0-0	5-8	62.5	1	3
33	7	马昌震	北京队	0-0	3-7	0-0	0-0	2-2	0-0	0-0	5-9	55.6	5	3
34	11	郭世伟	华体	0-1	1-1	2-3	2-5	0-0	0-0	0-0	5-10	50.0	0	3
35	7	周傲	江苏	1-5	1-2	1-2	0-1	2-6	0-0	0-0	5-16	31.3	4	3
36	32	蒋维一	北京队	0-0	2-2	0-0	1-1	1-1	0-0	0-0	4-4	100.0	2	3
37	7	王立隆	广东	0-0	0-0	0-0	4-5	0-0	0-0	0-0	4-5	80.0	1	3
38	18	李双	华体	1-1	0-0	0-0	1-1	1-1	0-0	0-0	3-3	100.0	0	3
39	26	魏昂	北京队	0-0	1-1	1-1	1-1	0-0	0-0	0-0	3-3	100.0	0	3
40	21	张昌轲	广东	0-2	0-0	0-0	2-3	1-1	0-0	0-0	3-6	50.0	0	3

中国男子手球超级联赛(北京)

PHMS Pictorial Handball Match Statistics

IHF Official System

得分排名表(场上队员)

手球 男子 截止至第6场 助攻次数排序 北京 2019-06-30

排序	号码	姓名	球队	远射	近射	边射	快攻	突破	任意	七米	合计	%	助攻	场数
1	8	MagyarDavid	北京队	7-17	2-3	0-0	2-2	3-5	1-3	2-4	17-34	50.0	10	3
2	3	曲汝洋	广东	3-10	1-4	0-1	2-2	1-2	0-2	1-1	8-22	36.4	8	3
3	10	MezeiRichard Be	北京队	5-14	3-4	0-1	3-3	2-3	1-2	6-7	20-34	58.8	6	3
4	8	DOLEZSAL KAROLY	广东	1-8	1-1	0-0	0-0	1-1	0-0	5-6	8-16	50.0	6	3
5	26	MUCZA Nobert	江苏	4-9	3-3	0-0	4-6	1-1	0-0	0-0	12-19	63.2	5	3
6	47	成亚	华体	3-5	2-2	1-1	2-2	2-3	0-0	0-1	10-14	71.4	5	3
7	10	李朝鹏	华体	5-10	0-0	0-0	2-2	0-2	0-0	0-0	7-14	50.0	5	3
8	7	马昌震	北京队	0-0	3-7	0-0	0-0	2-2	0-0	0-0	5-9	55.6	5	3
9	12	高云健	北京队	0-0	0-0	0-0	0-0	0-0	0-0	0-0	0-0	0	5	3
10	18	赵楠	江苏	1-7	4-4	1-2	0-0	4-6	0-0	0-0	10-19	52.6	4	3
11	6	赵晨	华体	3-9	0-1	0-0	2-2	1-1	0-0	0-0	6-13	46.2	4	3
12	7	周傲	江苏	1-5	1-2	1-2	0-1	2-6	0-0	0-0	5-16	31.3	4	3
13	10	周仲坤	广东	6-16	4-6	0-3	1-3	1-3	2-2	8-8	22-41	53.7	3	3
14	22	黄培杰	华体	0-1	2-2	5-6	6-7	0-0	0-0	5-5	18-21	85.7	3	3
15	24	高玉杰	广东	0-0	1-1	4-4	2-6	0-0	0-0	0-0	7-11	63.6	3	3
16	8	谢庆龙	华体	1-1	7-8	0-0	6-8	1-1	0-0	0-0	15-18	83.3	2	3
17	13	王军鸣	北京队	4-15	4-7	0-1	1-1	0-2	1-2	1-1	11-29	37.9	2	3
18	20	顾艳超	华体	4-7	3-3	0-0	1-1	1-2	0-0	0-0	9-13	69.2	2	3
19	17	刘赵梁	江苏	0-1	0-2	2-6	4-6	3-4	0-0	0-0	9-19	47.4	2	3
20	28	SZRNKAlvente	江苏	0-1	7-10	0-0	1-1	0-0	0-1	0-0	8-13	61.5	2	3
21	14	逯明松	北京队	2-7	0-2	0-1	1-2	5-5	0-1	0-0	8-18	44.4	2	3
22	4	张家纬	华体	4-4	0-1	0-0	3-4	0-1	0-0	0-0	7-10	70.0	2	3
23	32	蒋维一	北京队	0-0	2-2	0-0	1-1	1-1	0-0	0-0	4-4	100.0	2	3
24	25	马明辉	北京队	0-0	0-0	3-6	0-0	0-1	0-0	0-0	3-7	42.9	2	3
25	22	罗尧尧	江苏	0-0	0-0	0-1	0-1	0-0	0-0	0-0	0-2	0.0	2	3
26	88	王军程	华体	6-16	2-2	0-0	1-1	4-4	0-0	0-0	13-23	56.5	1	3
27	27	王伟强	江苏	1-1	1-1	6-7	4-6	0-0	0-0	0-0	12-15	80.0	1	3
28	17	李中洲	广东	3-8	2-3	0-0	4-4	2-2	0-0	0-1	11-18	61.1	1	3
29	15	李安	江苏	0-1	0-0	0-0	1-1	0-1	0-0	7-10	8-13	61.5	1	3
30	22	王超	北京队	0-0	2-6	2-3	4-5	0-0	0-0	0-0	8-14	57.1	1	3
31	6	毕晓晨	广东	0-3	2-4	0-3	3-5	3-4	0-0	0-1	8-20	40.0	1	3
32	19	庞连康	江苏	1-4	2-5	0-0	1-1	3-5	0-0	0-0	7-15	46.7	1	3
33	5	贺政	华体	1-1	0-1	3-4	1-1	0-0	0-0	0-0	5-7	71.4	1	3
34	21	刘江	江苏	1-1	2-3	0-0	2-3	0-1	0-0	0-0	5-8	62.5	1	3
35	7	王立隆	广东	0-0	0-0	0-0	4-5	0-0	0-0	0-0	4-5	80.0	1	3
36	16	张帅	江苏	0-0	0-0	0-0	0-0	0-0	0-0	0-0	0-0	0	1	3
37	2	解建飞	北京队	0-2	0-0	0-0	0-0	0-0	0-0	0-2	0-4	0.0	1	3
38	25	王杰缘	华体	0-0	1-1	1-2	5-7	0-0	0-0	2-3	9-13	69.2	0	3
39	4	ARPASI PATRIK	广东	1-2	7-8	0-0	0-0	0-0	0-0	0-0	8-10	80.0	0	3
40	27	闫炳旗	北京队	0-0	3-3	1-2	3-3	0-0	0-0	0-0	7-8	87.5	0	3

中国男子手球超级联赛(北京)

PHMS Pictorial Handball Match Statistics

IHF Official System

得分排名表(场上队员)

手球 男子 截止至第6场 按封球次数排序 北京 2019-06-30

名次	号码	姓名	球队	抢球	断球	造失误	造犯规	合计	封球	场数
1	2	解建飞	北京队	0	0	0	1	1	8	3
2	32	蒋维一	北京队	0	1	0	1	2	4	3
3	6	赵晨	华体	0	0	0	0	0	3	3
4	4	ARPASI PATRIK	广东	0	1	0	0	1	3	3
5	8	MagyarDavid	北京队	0	3	0	2	5	2	3
6	28	SZRNKalevente	江苏	0	0	0	0	0	2	3
7	21	刘江	江苏	0	0	0	0	0	2	3
8	10	周仲坤	广东	0	1	0	0	1	1	3
9	8	谢庆龙	华体	2	3	1	0	6	1	3
10	23	曹悦	华体	0	1	0	1	2	1	3
11	88	王军程	华体	0	0	0	0	0	1	3
12	10	MezeiRichard Be	北京队	0	0	0	1	1	1	3
13	18	李双	华体	0	1	0	0	1	1	3
14	47	成亚	华体	0	1	0	1	2	1	3
15	99	王伟	华体	0	0	0	0	0	1	3
16	5	闫亮	江苏	0	1	0	1	2	1	3
17	26	MUCZA Nobert	江苏	0	1	2	1	4	1	3
18	19	庞连康	江苏	1	0	0	0	1	1	3
19	3	曲汝洋	广东	0	0	0	0	0	0	3
20	11	房友屯	广东	2	0	0	0	2	0	3
21	9	范保坤	广东	0	0	0	0	0	0	3
22	7	王立隆	广东	0	1	0	0	1	0	3
23	6	毕晓晨	广东	0	2	0	0	2	0	3
24	13	王军鸣	北京队	0	1	0	0	1	0	3
25	5	曹景森	广东	0	0	0	0	0	0	3
26	27	闫炳旗	北京队	0	1	0	0	1	0	3
27	12	高云健	北京队	0	1	0	0	1	0	3
28	22	王超	北京队	0	0	1	0	1	0	3
29	14	逯明松	北京队	0	1	0	0	1	0	3
30	2	董佳辉	广东	0	0	0	0	0	0	3
31	1	王帅	广东	0	0	0	0	0	0	3
32	7	马昌震	北京队	0	1	0	1	2	0	3
33	18	傅俊雄	北京队	0	0	0	0	0	0	3
34	18	姚雪岩	广东	0	2	0	0	2	0	3
35	25	马明辉	北京队	0	0	0	0	0	0	3
36	26	魏昂	北京队	0	0	0	1	1	0	3
37	16	孟辉	北京队	0	0	0	0	0	0	3
38	29	杜龙飞	北京队	0	0	0	0	0	0	3
39	5	贺政	华体	0	2	0	0	2	0	3
40	27	王伟强	江苏	0	1	0	0	1	0	3

中国男子手球超级联赛(北京)

PHMS Pictorial Handball Match Statistics

IHF Official System

得分排名表(场上队员)

手球 男子 截止至第6场 按防守成功总数排序 北京 2019-06-30

名次	号码	姓名	球队	抢球	断球	造失误	造犯规	合计	封球	场数
1	8	谢庆龙	华体	2	3	1	0	6	1	3
2	24	高玉杰	广东	1	5	0	0	6	0	3
3	22	黄培杰	华体	1	4	1	0	6	0	3
4	8	MagyarDavid	北京队	0	3	0	2	5	2	3
5	25	王杰缘	华体	0	4	0	1	5	0	3
6	18	赵楠	江苏	0	3	0	1	4	0	3
7	26	MUCZA Nobert	江苏	0	1	2	1	4	1	3
8	17	李中洲	广东	1	2	0	1	4	0	3
9	17	刘赵梁	江苏	0	3	0	0	3	0	3
10	5	闫亮	江苏	0	1	0	1	2	1	3
11	11	房友屯	广东	2	0	0	0	2	0	3
12	47	成亚	华体	0	1	0	1	2	1	3
13	20	顾艳超	华体	0	1	0	1	2	0	3
14	23	曹悦	华体	0	1	0	1	2	1	3
15	5	贺政	华体	0	2	0	0	2	0	3
16	18	姚雪岩	广东	0	2	0	0	2	0	3
17	6	毕晓晨	广东	0	2	0	0	2	0	3
18	8	DOLEZSAL KAROLY	广东	0	2	0	0	2	0	3
19	32	蒋维一	北京队	0	1	0	1	2	4	3
20	7	马昌震	北京队	0	1	0	1	2	0	3
21	4	ARPASI PATRIK	广东	0	1	0	0	1	3	3
22	12	高云健	北京队	0	1	0	0	1	0	3
23	7	王立隆	广东	0	1	0	0	1	0	3
24	10	周仲坤	广东	0	1	0	0	1	1	3
25	14	逯明松	北京队	0	1	0	0	1	0	3
26	26	魏昂	北京队	0	0	0	1	1	0	3
27	22	王超	北京队	0	0	1	0	1	0	3
28	27	闫炳旗	北京队	0	1	0	0	1	0	3
29	13	王军鸣	北京队	0	1	0	0	1	0	3
30	2	解建飞	北京队	0	0	0	1	1	8	3
31	10	MezeiRichard Be	北京队	0	0	0	1	1	1	3
32	10	李朝鹏	华体	0	1	0	0	1	0	3
33	27	王伟强	江苏	0	1	0	0	1	0	3
34	9	许翔宇	江苏	0	1	0	0	1	0	3
35	15	李安	江苏	0	0	1	0	1	0	3
36	19	庞连康	江苏	1	0	0	0	1	1	3
37	11	郭世伟	华体	0	1	0	0	1	0	3
38	18	李双	华体	0	1	0	0	1	1	3
39	11	张天豪	江苏	0	0	0	0	0	0	3
40	16	孟辉	北京队	0	0	0	0	0	0	3

中国男子手球超级联赛(北京)

PHMS Pictorial Handball Match Statistics

IHF Official System

得分排名表(场上队员)

 手球
 男子

 截止至第6场
 按失误总数排序

 北京
 2019-06-30

排序	号码	姓名	球队	传失	接失	两次	四步	侵区	进犯	其它	合计	场数
1	17	李中洲	广东	4	0	0	0	2	3	0	9	3
2	13	王军鸣	北京队	6	1	0	0	0	1	1	9	3
3	26	MUCZA Nobert	江苏	5	2	1	0	0	0	1	9	3
4	10	周仲坤	广东	7	1	0	0	0	0	0	8	3
5	19	庞连康	江苏	3	1	1	1	0	1	0	7	3
6	10	李朝鹏	华体	3	1	1	0	1	0	1	7	3
7	8	DOLEZSAL KAROLY	广东	5	0	0	0	1	1	0	7	3
8	8	MagyarDavid	北京队	4	2	1	0	0	0	0	7	3
9	10	MezeiRichard Be	北京队	3	1	1	1	0	0	0	6	3
10	14	逯明松	北京队	3	1	0	0	0	2	0	6	3
11	7	周傲	江苏	4	0	0	1	0	0	0	5	3
12	3	曲汝洋	广东	4	0	0	1	0	0	0	5	3
13	88	王军程	华体	5	0	0	0	0	0	0	5	3
14	28	SZRNKAlévente	江苏	2	0	0	0	1	2	0	5	3
15	47	成亚	华体	2	1	1	0	0	0	0	4	3
16	22	黄培杰	华体	0	0	0	0	2	0	2	4	3
17	8	谢庆龙	华体	1	1	0	0	1	0	0	3	3
18	18	姚雪岩	广东	2	1	0	0	0	0	0	3	3
19	4	张家纬	华体	2	0	0	0	0	1	0	3	3
20	6	毕晓晨	广东	0	1	1	0	1	0	0	3	3
21	5	曹景森	广东	0	0	1	0	1	0	1	3	3
22	4	ARPASI PATRIK	广东	1	1	0	0	0	1	0	3	3
23	17	刘赵梁	江苏	2	0	0	0	0	1	0	3	3
24	18	赵楠	江苏	2	0	0	0	0	1	0	3	3
25	21	刘江	江苏	0	0	0	0	2	0	0	2	3
26	7	王立隆	广东	1	0	1	0	0	0	0	2	3
27	21	张昌轲	广东	1	0	0	1	0	0	0	2	3
28	24	高玉杰	广东	1	0	1	0	0	0	0	2	3
29	5	闫亮	江苏	2	0	0	0	0	0	0	2	3
30	16	刘迈科	华体	2	0	0	0	0	0	0	2	3
31	25	王杰缘	华体	0	0	0	0	2	0	0	2	3
32	99	王伟	华体	2	0	0	0	0	0	0	2	3
33	11	郭世伟	华体	1	0	0	1	0	0	0	2	3
34	27	王伟强	江苏	0	0	0	0	1	0	0	1	3
35	29	杜龙飞	北京队	0	0	0	1	0	0	0	1	3
36	7	马昌震	北京队	0	1	0	0	0	0	0	1	3
37	32	蒋维一	北京队	0	0	0	0	0	0	1	1	3
38	1	王帅	广东	1	0	0	0	0	0	0	1	3
39	12	王权	华体	1	0	0	0	0	0	0	1	3
40	20	顾艳超	华体	0	0	0	0	1	0	0	1	3

中国男子手球超级联赛(北京)

PHMS Pictorial Handball Match Statistics

IHF Official System

得分排名表(场上队员)

手球 男子 截止至第6场 接受罚次数排序 北京 2019-06-30

排序	号码	姓名	球队	警告	罚2分钟	D	DR	场数
1	13	王军鸣	北京队	0	5	0	0	3
2	18	赵楠	江苏	2	2	0	0	3
3	10	MezeiRichard Be	北京队	2	2	0	0	3
4	27	王伟强	江苏	1	2	0	0	3
5	24	高玉杰	广东	1	2	0	0	3
6	8	DOLEZSAL KAROLY	广东	0	2	0	0	3
7	28	SZRNKAlvente	江苏	2	1	0	0	3
8	22	黄培杰	华体	1	1	0	0	3
9	14	逯明松	北京队	1	1	0	0	3
10	23	曹悦	华体	1	1	0	0	3
11	9	范保坤	广东	0	1	0	0	3
12	18	李双	华体	0	1	0	0	3
13	10	李朝鹏	华体	0	1	0	0	3
14	11	房友屯	广东	0	1	0	0	3
15	47	成亚	华体	0	1	0	0	3
16	15	李安	江苏	0	1	0	0	3
17	26	魏昂	北京队	0	1	0	0	3
18	7	马昌震	北京队	0	1	0	0	3
19	22	王超	北京队	0	1	0	0	3
20	10	周仲坤	广东	0	1	0	0	3
21	4	ARPASI PATRIK	广东	3	0	0	0	3
22	6	赵晨	华体	2	0	0	0	3
23	2	解建飞	北京队	1	0	0	0	3
24	88	王军程	华体	1	0	0	0	3
25	17	刘赵梁	江苏	1	0	0	0	3
26	8	MagyarDavid	北京队	1	0	0	0	3
27	32	蒋维一	北京队	1	0	0	0	3
28	25	马明辉	北京队	0	0	0	0	3
29	3	曲汝洋	广东	0	0	0	0	3
30	2	董佳辉	广东	0	0	0	0	3
31	1	王帅	广东	0	0	0	0	3
32	12	高云健	北京队	0	0	0	0	3
33	19	庞连康	江苏	0	0	0	0	3
34	5	曹景森	广东	0	0	0	0	3
35	21	刘江	江苏	0	0	0	0	3
36	16	张帅	江苏	0	0	0	0	3
37	18	傅俊雄	北京队	0	0	0	0	3
38	22	罗尧尧	江苏	0	0	0	0	3
39	23	宋继强	江苏	0	0	0	0	3
40	29	杜龙飞	北京队	0	0	0	0	3

中国男子手球超级联赛(北京)

PHMS Pictorial Handball Match Statistics

IHF Official System

排名表(守门员)

手球 男子 截止至第6场 按总救球数排序 北京 2019-06-30

排序	号码	姓名	球队	远射	近射	边射	快攻	突破	任意	七米	得分	%	助攻	场数
1	16	张帅	江苏	24-41	5-23	4-9	4-21	2-9	1-1	3-7	43-111	38.7	1	3
2	16	刘迈科	华体	11-16	4-15	1-6	6-15	7-17	1-2	0-4	30-75	40.0	0	3
3	12	高云健	北京队	11-25	6-25	3-11	4-15	4-9	0-1	2-9	30-95	31.6	5	3
4	12	王权	华体	10-20	6-10	6-7	0-6	1-8	2-3	1-4	26-58	44.8	0	3
5	1	王帅	广东	5-13	4-16	2-7	3-22	5-9	0-2	0-5	19-74	25.7	0	3
6	19	王泽润	广东	3-7	2-14	2-9	5-19	1-15	0-0	3-5	16-69	23.2	0	3
7	23	宋继强	江苏	4-7	0-1	0-2	0-0	0-1	0-0	0-1	4-12	33.3	0	3
8	16	孟辉	北京队	1-8	0-5	0-2	1-8	0-0	0-0	2-11	4-34	11.8	0	3
9	1	陈昊	江苏	0-3	0-0	0-0	0-1	0-0	0-0	0-2	0-6	0.0	0	3

中国男子手球超级联赛(北京)

PHMS Pictorial Handball Match Statistics

IHF Official System

排名表(守门员)

手球 截止至第6场 北京
男子 按救七米球数排序 2019-06-30

排序	号码	姓名	球队	远射	近射	边射	快攻	突破	任意	七米	得分	%	助攻	场数
1	19	王泽润	广东	3-7	2-14	2-9	5-19	1-15	0-0	3-5	16-69	60.0	0	3
2	16	张帅	江苏	24-41	5-23	4-9	4-21	2-9	1-1	3-7	43-111	42.9	1	3
3	12	高云健	北京队	11-25	6-25	3-11	4-15	4-9	0-1	2-9	30-95	22.2	5	3
4	16	孟辉	北京队	1-8	0-5	0-2	1-8	0-0	0-0	2-11	4-34	18.2	0	3
5	12	王权	华体	10-20	6-10	6-7	0-6	1-8	2-3	1-4	26-58	25.0	0	3
6	23	宋继强	江苏	4-7	0-1	0-2	0-0	0-1	0-0	0-1	4-12	0.0	0	3
7	1	陈昊	江苏	0-3	0-0	0-0	0-1	0-0	0-0	0-2	0-6	0.0	0	3
8	16	刘迈科	华体	11-16	4-15	1-6	6-15	7-17	1-2	0-4	30-75	0.0	0	3
9	1	王帅	广东	5-13	4-16	2-7	3-22	5-9	0-2	0-5	19-74	0.0	0	3

中国男子手球超级联赛(北京)

PHMS Pictorial Handball Match Statistics

IHF Official System

攻防成功率统计总表

 手球
 男子

截止至第6场

 北京
 2019-06-30

序号	球队	比分	进攻成功率															助攻	防守成功率								
			阵地进攻			一传快攻			短传快攻			合计			多打少				少打多			封打抢断	守门员	对方射失	对方失误	合计	%
			得分	进攻	%	得分	进攻	%	得分	进攻	%	得分	进攻	%	得分	进攻	%		得分	进攻	%						
1	北京队	86:95	70	177	39.5	10	11	90.9	6	9	66.7	86	197	43.7	6	12	50.0	9	15	60.0	36	32	34	12	24	102	51.5
2	广东	87:108	68	180	37.8	10	16	62.5	9	25	36.0	87	221	39.4	9	19	47.4	4	7	57.1	23	25	35	21	21	102	48.6
3	华体	110:77	78	149	52.3	13	13	100.0	19	39	48.7	110	202	54.5	9	12	75.0	3	5	60.0	25	37	56	19	14	126	61.8
4	江苏	79:82	62	145	42.8	8	11	72.7	9	25	36.0	79	181	43.6	8	15	53.3	4	7	57.1	24	24	47	18	18	107	56.6

注释:

进攻	进攻次数 (射门 + 进攻失误)	对方射失	对方射门失误 (射失 + 击柱)	防守成功率%	本方防守合计 / 对方进攻合计
----	------------------	------	------------------	--------	-----------------

中国男子手球超级联赛(北京)

PHMS Pictorial Handball Match Statistics

IHF Official System

防守技术统计总表

 手球
 男子

截止至第6场

 北京
 2019-06-30

序号	球队	比分	防守成功						防守(成功 : 失误)							处罚					守门员		
			封球	抢球	断球	造失	造犯	合计	选位	顶贴	观察	移动	换防	其他	合计	警告	2'	取消	DR	合计	救球	射门	%
1	北京队	86:95	15	0	9	1	7	32	0:0	0:0	0:0	0:0	0:0	0:0	0:0	6	11	0	0	17	34	129	26.4
2	广东	87:108	4	4	16	0	1	25	0:0	0:0	0:0	0:0	0:0	0:0	4	7	0	0	11	35	143	24.5	
3	华体	110:77	9	3	19	2	4	37	0:0	0:0	0:0	0:0	0:0	0:0	5	5	0	0	10	56	133	42.1	
4	江苏	79:82	7	1	10	3	3	24	0:0	0:0	0:0	0:0	0:0	0:0	6	6	0	0	12	47	129	36.4	

注释:

造失	造对方失误	造犯	造对方犯规	DR	取消资格+报告
----	-------	----	-------	----	---------

中国男子手球超级联赛(北京)

PHMS Pictorial Handball Match Statistics

IHF Official System

球队名单

华体国家男子手球俱乐部

北京

2019-06-28

号码	姓名	位置	生日	年龄	俱乐部	身高 (CM)	体重 (KG)	国际场次	国际进球
4	张家纬	右后卫	25/09/1992	26		193	90		
5	贺政	右边锋	20/08/1996	22		186	86		
6	赵晨	左后卫	24/06/1989	30		202	110		
8	谢庆龙	底线	24/10/2000	18		192	115		
10	李朝鹏	后卫	05/12/1992	26		185	95		
11	郭世伟	后卫	18/02/1997	22		183	83		
12	王权	守门员	21/11/1992	26		205	110		
16	刘迈科	守门员	28/07/1994	24		188	100		
18	李双	右后卫	10/02/1997	22		192	74		
20	顾艳超	后卫	16/01/1993	26		188	86		
22	黄培杰	左边锋	15/01/1998	21		178	75		
23	曹悦	左后卫	23/05/1993	26		200	103		
25	王杰缘	右边锋	16/07/1994	24		180	75		
47	成亚	右后卫	14/06/1990	29		190	95		
88	王军程	左后卫	11/10/1995	23		198	94		
99	王伟	底线	18/11/1985	33		200	100		
	平均			24.9		191.3	93.2		

编码	姓名	职务
A	姚苏捷	领队
B	朱昕晨	主教练
D	付飞鹏	医生
C	王伟	教练

中国男子手球超级联赛(北京)

PHMS Pictorial Handball Match Statistics

IHF Official System

手球 男子 个人/全队技术累计表 截止至第6场 北京 2019-06-30

号码	姓名	远射	近射	边射	快攻	突破	任意	七米	合计	%	助攻	失误	警告	2'	取消	场次	时间
华体国家男子手球俱乐部																	
(场上队员)																	
4	张家纬	4/4	0/1		3/4	0/1			7/10	70.0%	2	3				3	01:06:40
5	贺政	1/1	0/1	3/4	1/1				5/7	71.4%	1	1				3	01:19:18
6	赵晨	3/9	0/1		2/2	1/1			6/13	46.2%	4		2			3	01:10:01
8	谢庆龙	1/1	7/8		6/8	1/1			15/18	83.3%	2	3				3	01:51:22
10	李朝鹏	5/10			2/2	0/2			7/14	50.0%	5	7		1		3	01:30:13
11	郭世伟	0/1	1/1	2/3	2/5				5/10	50.0%		2				3	00:52:22
12	王权											1				3	01:23:37
16	刘迈科											2				3	01:36:23
18	李双	1/1			1/1	1/1			3/3	100%	1	1		1		3	00:29:25
20	顾艳超	4/7	3/3		1/1	1/2			9/13	69.2%	2	1				3	01:03:39
22	黄培杰	0/1	2/2	5/6	6/7			5/5	18/21	85.7%	3	4	1	1		3	01:57:54
23	曹悦		1/1						1/1	100%		1	1	1		3	00:46:57
25	王杰缘		1/1	1/2	5/7			2/3	9/13	69.2%		2				3	01:41:00
47	成亚	3/5	2/2	1/1	2/2	2/3		0/1	10/14	71.4%	5	4		1		3	01:27:50
88	王军程	6/16	2/2		1/1	4/4			13/23	56.5%	1	5	1			3	01:43:07
99	王伟	0/1	2/2						2/3	66.7%		2				3	00:45:53
合计		28/57	21/25	12/16	32/41	10/15		7/9	110/163	67.5%	25	39	5	5		48	
(守门员)																	
12	王权	10/20	6/10	6/7	0/6	1/8	2/3	1/4	26/58	44.8%		1				3	01:23:37
16	刘迈科	11/16	4/15	1/6	6/15	7/17	1/2	0/4	30/75	40.0%		2				3	01:36:23
合计		21/36	10/25	7/13	6/21	8/25	3/5	1/8	56/133	42.1%		3				6	

场上队员：得分/射门

守门员：救球/射门

已打比赛

全队合计	进球	被救	射失	击柱	封球	合计	%	阶段	场次	对手	比分
远射	28	16	6	1	6	57	49.1%	预赛	1	江苏	33:26 (15:11)
近射	21	2	1		1	25	84.0%	预赛	4	北京队	37:24 (14:10)
边射	12	2	1	1		16	75.0%	预赛	5	广东	40:27 (16:13)
快攻	32	5	2	1	1	41	78.0%				
突破	10	3	2			15	66.7%				
任意							0.0%				
七米	7	2				9	77.8%				

中国男子手球超级联赛(北京)

PHMS Pictorial Handball Match Statistics

IHF Official System

图式射门区域累计

手球
男子

截止至第6场

北京
2019-06-30

华体国家男子手球俱乐部

4 张家纬	5 贺政	6 赵晨	8 谢庆龙	10 李朝鹏	11 郭世伟	12 王权	16 刘迈科																																																																								
<table border="1"><tr><td>1</td><td></td><td>1</td></tr><tr><td></td><td></td><td>1</td></tr><tr><td></td><td>3</td><td>1</td></tr></table>	1		1			1		3	1	<table border="1"><tr><td></td><td>1</td><td>2</td></tr><tr><td>1</td><td></td><td>1</td></tr><tr><td></td><td></td><td></td></tr></table>		1	2	1		1				<table border="1"><tr><td>1</td><td></td><td>1</td></tr><tr><td>1</td><td></td><td>1</td></tr><tr><td></td><td></td><td>2</td></tr></table>	1		1	1		1			2	<table border="1"><tr><td>2</td><td></td><td>3</td></tr><tr><td>3</td><td></td><td>3</td></tr><tr><td>2</td><td>2</td><td></td></tr></table>	2		3	3		3	2	2		<table border="1"><tr><td>1</td><td></td><td>1</td></tr><tr><td></td><td></td><td></td></tr><tr><td>4</td><td></td><td>1</td></tr></table>	1		1				4		1	<table border="1"><tr><td></td><td></td><td>2</td></tr><tr><td></td><td></td><td>2</td></tr><tr><td>1</td><td></td><td></td></tr></table>			2			2	1			<table border="1"><tr><td></td><td></td><td></td></tr><tr><td></td><td></td><td></td></tr><tr><td></td><td></td><td></td></tr></table>										<table border="1"><tr><td></td><td></td><td></td></tr><tr><td></td><td></td><td></td></tr><tr><td></td><td></td><td></td></tr></table>									
1		1																																																																													
		1																																																																													
	3	1																																																																													
	1	2																																																																													
1		1																																																																													
1		1																																																																													
1		1																																																																													
		2																																																																													
2		3																																																																													
3		3																																																																													
2	2																																																																														
1		1																																																																													
4		1																																																																													
		2																																																																													
		2																																																																													
1																																																																															
Post - 0 Miss - 1 Block - 1	Post - 1 Miss - 1 Block - 0	Post - 1 Miss - 1 Block - 2	Post - 0 Miss - 1 Block - 0	Post - 0 Miss - 2 Block - 1	Post - 0 Miss - 1 Block - 0	Post - 0 Miss - 0 Block - 0	Post - 0 Miss - 0 Block - 0																																																																								
18 李双	20 顾艳超	22 黄培杰	23 曹悦	25 王杰缘	47 成亚	88 王军程	99 王伟																																																																								
<table border="1"><tr><td></td><td></td><td>2</td></tr><tr><td></td><td></td><td></td></tr><tr><td>1</td><td></td><td></td></tr></table>			2				1			<table border="1"><tr><td>1</td><td></td><td>2</td></tr><tr><td>2</td><td></td><td>3</td></tr><tr><td></td><td></td><td>1</td></tr></table>	1		2	2		3			1	<table border="1"><tr><td>7</td><td></td><td>6</td></tr><tr><td>1</td><td></td><td></td></tr><tr><td>1</td><td></td><td>3</td></tr></table>	7		6	1			1		3	<table border="1"><tr><td></td><td></td><td></td></tr><tr><td></td><td></td><td></td></tr><tr><td></td><td></td><td>1</td></tr></table>									1	<table border="1"><tr><td>2</td><td>1</td><td>3</td></tr><tr><td></td><td></td><td></td></tr><tr><td>2</td><td></td><td>1</td></tr></table>	2	1	3				2		1	<table border="1"><tr><td>2</td><td></td><td>1</td></tr><tr><td>2</td><td></td><td></td></tr><tr><td>2</td><td>2</td><td>1</td></tr></table>	2		1	2			2	2	1	<table border="1"><tr><td>2</td><td>1</td><td>1</td></tr><tr><td></td><td></td><td>2</td></tr><tr><td>4</td><td></td><td>3</td></tr></table>	2	1	1			2	4		3	<table border="1"><tr><td></td><td>1</td><td></td></tr><tr><td></td><td></td><td></td></tr><tr><td></td><td></td><td>1</td></tr></table>		1							1
		2																																																																													
1																																																																															
1		2																																																																													
2		3																																																																													
		1																																																																													
7		6																																																																													
1																																																																															
1		3																																																																													
		1																																																																													
2	1	3																																																																													
2		1																																																																													
2		1																																																																													
2																																																																															
2	2	1																																																																													
2	1	1																																																																													
		2																																																																													
4		3																																																																													
	1																																																																														
		1																																																																													
Post - 0 Miss - 0 Block - 0	Post - 0 Miss - 0 Block - 1	Post - 0 Miss - 0 Block - 0	Post - 0 Miss - 0 Block - 0	Post - 1 Miss - 1 Block - 0	Post - 0 Miss - 3 Block - 0	Post - 0 Miss - 1 Block - 3	Post - 0 Miss - 0 Block - 0																																																																								

12 王权

2/10	2/2	4/7
4/4	5/5	2/2
2/11	4/8	1/9

16 刘迈科

3/7	1/4	5/13
3/7	2/4	3/9
5/14	4/6	4/11

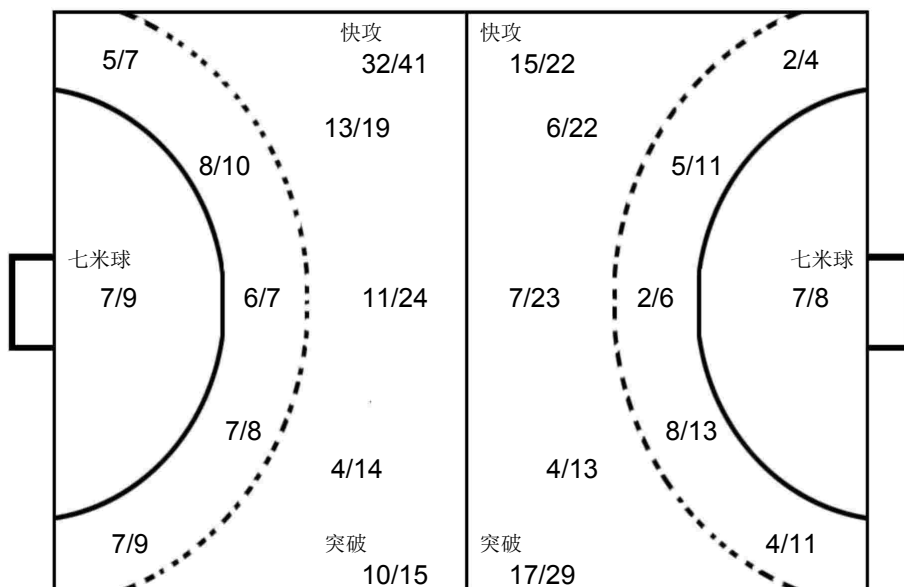

江苏

16 张帅

2/7		0/4
1/4		2/5
3/8	0/2	2/5

北京队

12 高云健

0/2	0/2	0/6
	2/2	0/2
2/4	1/4	1/2

广东

19 王泽润

1/6		0/2
0/2		3/9
1/6		0/3

OPPONENT

广东	北京队	北京队	广东	江苏	北京队	广东	广东																																																																								
10 周仲坤	10 MezeiRichard Be	14 逯明松	6 毕晓晨	18 赵楠	13 王军鸣	18 姚雪岩	24 高玉杰																																																																								
<table border="1"><tr><td>1</td><td></td><td>1</td></tr><tr><td></td><td></td><td>1</td></tr><tr><td>2</td><td></td><td>1</td></tr></table>	1		1			1	2		1	<table border="1"><tr><td>1</td><td></td><td></td></tr><tr><td></td><td></td><td></td></tr><tr><td>1</td><td>1</td><td>2</td></tr></table>	1						1	1	2	<table border="1"><tr><td>1</td><td></td><td>1</td></tr><tr><td></td><td></td><td></td></tr><tr><td>3</td><td></td><td></td></tr></table>	1		1				3			<table border="1"><tr><td>1</td><td></td><td></td></tr><tr><td></td><td>1</td><td></td></tr><tr><td>2</td><td>1</td><td></td></tr></table>	1				1		2	1		<table border="1"><tr><td></td><td></td><td></td></tr><tr><td></td><td></td><td>2</td></tr><tr><td>2</td><td></td><td>1</td></tr></table>						2	2		1	<table border="1"><tr><td></td><td></td><td>2</td></tr><tr><td></td><td></td><td></td></tr><tr><td></td><td>1</td><td>1</td></tr></table>			2					1	1	<table border="1"><tr><td></td><td></td><td>1</td></tr><tr><td></td><td></td><td></td></tr><tr><td>1</td><td></td><td>1</td></tr></table>			1				1		1	<table border="1"><tr><td>1</td><td></td><td>2</td></tr><tr><td></td><td></td><td>1</td></tr><tr><td></td><td></td><td></td></tr></table>	1		2			1			
1		1																																																																													
		1																																																																													
2		1																																																																													
1																																																																															
1	1	2																																																																													
1		1																																																																													
3																																																																															
1																																																																															
	1																																																																														
2	1																																																																														
		2																																																																													
2		1																																																																													
		2																																																																													
	1	1																																																																													
		1																																																																													
1		1																																																																													
1		2																																																																													
		1																																																																													
Post - 0 Miss - 1 Block - 2	Post - 0 Miss - 1 Block - 2	Post - 0 Miss - 0 Block - 0	Post - 0 Miss - 1 Block - 1	Post - 1 Miss - 1 Block - 0	Post - 0 Miss - 1 Block - 2	Post - 0 Miss - 1 Block - 0	Post - 0 Miss - 0 Block - 0																																																																								
江苏	北京队	广东	江苏	江苏	江苏	北京队	北京队																																																																								
15 李安	7 马昌震	21 张昌轲	19 庞连康	26 MUCZA Nobert	28 SZRNKAlvente	8 MagyarDavid	26 魏昂																																																																								
<table border="1"><tr><td>2</td><td></td><td></td></tr><tr><td></td><td></td><td></td></tr><tr><td>2</td><td></td><td></td></tr></table>	2						2			<table border="1"><tr><td>1</td><td></td><td></td></tr><tr><td></td><td></td><td></td></tr><tr><td>1</td><td>1</td><td></td></tr></table>	1						1	1		<table border="1"><tr><td></td><td></td><td></td></tr><tr><td>1</td><td></td><td>1</td></tr><tr><td></td><td></td><td>1</td></tr></table>				1		1			1	<table border="1"><tr><td></td><td></td><td></td></tr><tr><td></td><td></td><td></td></tr><tr><td></td><td></td><td>3</td></tr></table>									3	<table border="1"><tr><td></td><td></td><td>1</td></tr><tr><td></td><td>1</td><td>1</td></tr><tr><td></td><td></td><td></td></tr></table>			1		1	1				<table border="1"><tr><td></td><td>1</td><td></td></tr><tr><td></td><td></td><td></td></tr><tr><td></td><td></td><td>2</td></tr></table>		1							2	<table border="1"><tr><td>1</td><td></td><td></td></tr><tr><td></td><td></td><td></td></tr><tr><td>1</td><td></td><td></td></tr></table>	1						1			<table border="1"><tr><td></td><td></td><td></td></tr><tr><td></td><td></td><td></td></tr><tr><td></td><td>1</td><td>1</td></tr></table>								1	1
2																																																																															
2																																																																															
1																																																																															
1	1																																																																														
1		1																																																																													
		1																																																																													
		3																																																																													
		1																																																																													
	1	1																																																																													
	1																																																																														
		2																																																																													
1																																																																															
1																																																																															
	1	1																																																																													
Post - 0 Miss - 0 Block - 0	Post - 1 Miss - 0 Block - 0	Post - 0 Miss - 0 Block - 1	Post - 0 Miss - 0 Block - 1	Post - 0 Miss - 0 Block - 0	Post - 1 Miss - 0 Block - 0	Post - 0 Miss - 1 Block - 0	Post - 0 Miss - 0 Block - 0																																																																								



中国男子手球超级联赛(北京)

PHMS Pictorial Handball Match Statistics

IHF Official System

球队名单

北京光彩男子手球俱乐部队

北京

2019-06-28

号码	姓名	位置	生日	年龄	俱乐部	身高 (CM)	体重 (KG)	国际场次	国际进球
2	解建飞	右后卫	10/09/1989	29	北京男子手球队	198	100		
7	马昌震	底线	19/05/1993	26	北京男子手球队	188	95		
8	MagyarDavid	左后卫	21/07/1995	23	北京男子手球队	194	86		
10	MezeiRichard Bendeguz	右后卫	28/11/1996	22	北京男子手球队	189	105		
11	赵文宣	底线	10/06/1999	20	北京男子手球队	188	90		
12	高云健	守门员	26/11/1999	19	北京男子手球队	190	90		
13	王军鸣	中后卫	19/02/1999	20	北京男子手球队	195	120		
14	逯明松	右后卫	11/02/1998	21	北京男子手球队	192	85		
16	孟辉	守门员	10/10/1981	37	北京男子手球队	186	105		
18	傅俊雄	底线	20/01/1995	24	北京男子手球队	195	96		
22	王超	左边锋	12/11/1991	27	北京男子手球队	183	84		
25	马明辉	右后卫	16/07/1994	24	北京男子手球队	196	88		
26	魏昂	左边锋	29/12/1994	24	北京男子手球队	186	88		
27	闫炳旗	右边锋	30/01/1992	27	北京男子手球队	187	90		
29	杜龙飞	右边锋	29/03/1990	29	北京男子手球队	192	100		
32	蒋维一	底线	27/06/1987	32	北京男子手球队	195	100		
	平均			25.3		190.9	95.1		

编码	姓名	职务
A	郑永利	主教练
B	王泷	教练
C	陈璇	医生

中国男子手球超级联赛(北京)

PHMS Pictorial Handball Match Statistics

IHF Official System

手球 男子 个人/全队技术累计表 截止至第6场 北京 2019-06-30

号码	姓名	远射	近射	边射	快攻	突破	任意	七米	合计	%	助攻	失误	警告	2'	取消	场次	时间
北京光彩男子手球俱乐部队																	
(场上队员)																	
2	解建飞	0/2						0/2	0/4	0.0%	1		1			3	01:30:33
7	马昌震		3/7			2/2			5/9	55.6%	5	1		1		3	01:15:04
8	MagyarDavid	7/17	2/3		2/2	3/5	1/3	2/4	17/34	50.0%	10	7	1			3	03:10:50
10	MezeiRichard Be	5/14	3/4	0/1	3/3	2/3	1/2	6/7	20/34	58.8%	6	6	2	2		3	02:14:19
11	赵文宣											1				3	00:07:42
12	高云健										5					3	02:29:51
13	王军鸣	4/15	4/7	0/1	1/1	0/2	1/2	1/1	11/29	37.9%	2	9		5		3	02:18:39
14	逯明松	2/7	0/2	0/1	1/2	5/5	0/1		8/18	44.4%	2	6	1	1		3	01:31:46
16	孟辉															3	01:00:09
18	傅俊雄															3	00:00:00
22	王超		2/6	2/3	4/5				8/14	57.1%	1			1		3	02:07:19
25	马明辉			3/6		0/1			3/7	42.9%	2					3	01:23:55
26	魏昂		1/1	1/1	1/1				3/3	100%				1		3	00:52:02
27	闫炳旗		3/3	1/2	3/3				7/8	87.5%						3	01:36:11
29	杜龙飞							0/1	0/1	0.0%		1				3	00:32:20
32	蒋维一		2/2		1/1	1/1			4/4	100%	2	1	1			3	01:45:19
合计		18/55	20/35	7/15	16/18	13/19	3/8	9/15	86/165	52.1%	36	32	6	11		48	
(守门员)																	
12	高云健	11/25	6/25	3/11	4/15	4/9	0/1	2/9	30/95	31.6%	5					3	02:29:51
16	孟辉	1/8	0/5	0/2	1/8			2/11	4/34	11.8%						3	01:00:09
合计		12/33	6/30	3/13	5/23	4/9	0/1	4/20	34/129	26.4%	5					6	

场上队员：得分/射门

守门员：救球/射门

已打比赛

全队合计	进球	被救	射失	击柱	封球	合计	%	阶段	场次	对手	比分
远射	18	20	6	3	8	55	32.7%	预赛	2	广东	36:37 (13:13)
近射	20	12		3		35	57.1%	预赛	4	华体	24:37 (10:14)
边射	7	7		1		15	46.7%	预赛	6	江苏	26:21 (13:9)
快攻	16	2				18	88.9%				
突破	13	5		1		19	68.4%				
任意	3	2	1	2		8	37.5%				
七米	9	5	1			15	60.0%				

中国男子手球超级联赛(北京)

PHMS Pictorial Handball Match Statistics

IHF Official System

图式射门区域累计

手球
男子

截止至第6场

北京
2019-06-30

北京光彩男子手球俱乐部队

2 解建飞 Post - 2 Miss - 0 Block - 0	7 马昌震 Post - 1 Miss - 0 Block - 0	8 MagyarDavid Post - 2 Miss - 2 Block - 0	10 MezeiRichard Be Post - 1 Miss - 1 Block - 2	11 赵文宣 Post - 0 Miss - 0 Block - 0	12 高云健 Post - 0 Miss - 0 Block - 0	13 王军鸣 Post - 2 Miss - 3 Block - 4	14 透明松 Post - 1 Miss - 1 Block - 2
16 孟辉 Post - 0 Miss - 0 Block - 0	18 傅俊雄 Post - 0 Miss - 0 Block - 0	22 王超 Post - 1 Miss - 0 Block - 0	25 马明辉 Post - 0 Miss - 0 Block - 0	26 魏昂 Post - 0 Miss - 0 Block - 0	27 闫炳旗 Post - 0 Miss - 0 Block - 0	29 杜龙飞 Post - 0 Miss - 1 Block - 0	32 蒋维一 Post - 0 Miss - 0 Block - 0

12 高云健

1/11	1/5	2/15
3/9	6/8	3/11
5/12	5/13	4/11

16 孟辉

0/3	1/3	0/11
1/3	1/1	0/4
0/1	0/3	1/5

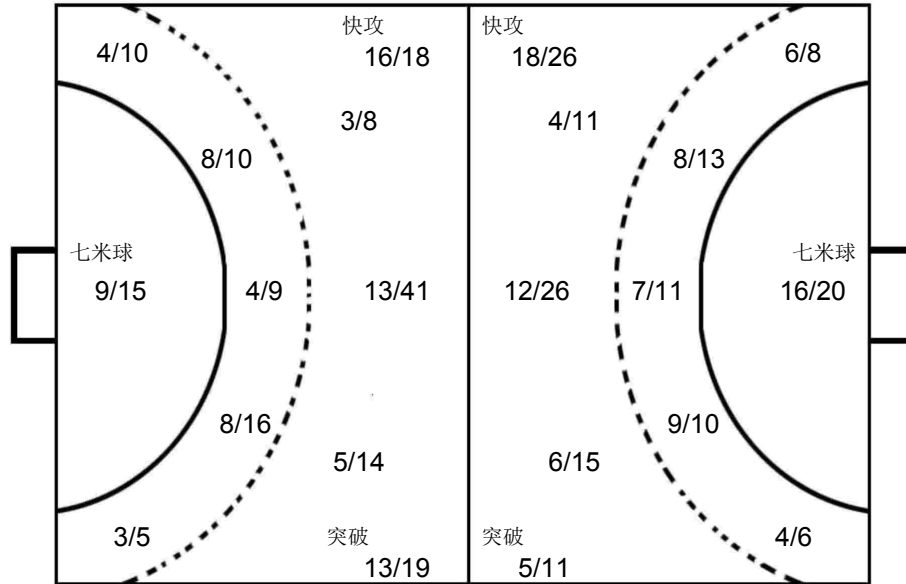

华体

12 王权

2/9	1/1	3/6
4/4	5/5	2/2
1/7	3/7	1/5

江苏

16 张帅

4/9	1/1	0/7
5/7	2/2	4/6
0/6	0/2	0/2

广东

1 王帅

2/6		0/8
	1/3	3/5
1/4	1/3	0/1

OPPONENT

广东 8 DOLEZSAL KAROLY Post - 0 Miss - 1 Block - 0	广东 17 李中洲 Post - 0 Miss - 0 Block - 2	广东 3 曲汝洋 Post - 1 Miss - 1 Block - 3	广东 4 ARPASI PATRIK Post - 0 Miss - 0 Block - 0	江苏 27 王伟强 Post - 0 Miss - 0 Block - 0	广东 10 周仲坤 Post - 0 Miss - 0 Block - 0	华体 6 赵晨 Post - 0 Miss - 1 Block - 2	华体 22 黄培杰 Post - 0 Miss - 0 Block - 0
华体 4 张家玮 Post - 0 Miss - 0 Block - 1	华体 25 王杰缘 Post - 0 Miss - 1 Block - 0	华体 5 贺政 Post - 0 Miss - 0 Block - 0	华体 8 谢庆龙 Post - 0 Miss - 0 Block - 0	华体 20 顾艳超 Post - 0 Miss - 0 Block - 1	江苏 26 MUCZA Nobert Post - 0 Miss - 0 Block - 0	广东 6 毕晓晨 Post - 0 Miss - 0 Block - 0	广东 24 高玉杰 Post - 0 Miss - 1 Block - 0



中国男子手球超级联赛(北京)

PHMS Pictorial Handball Match Statistics

IHF Official System

球队名单

太平洋保险江苏男子手球俱乐部

北京

2019-06-28

号码	姓名	位置	生日	年龄	俱乐部	身高 (CM)	体重 (KG)	国际场次	国际进球
1	陈昊	守门员	05/01/2002	17		195	98		
5	闫亮	左后卫	23/01/1985	34		202	94		
7	周傲	中后卫	08/09/1999	19		183	75		
9	许翔宇	左后卫	20/01/1997	22		190	80		
11	张天豪	左边锋	02/06/1998	21		185	83		
15	李安	左边锋	20/03/1987	32		183	88		
16	张帅	守门员	11/05/1994	25		187	86		
17	刘赵梁	右边锋	04/07/1997	21		186	90		
18	赵楠	左后卫	07/05/1993	26		188	91		
19	庞连康	左后卫	02/07/1996	22		192	96		
21	刘江	底线	23/03/1993	26		196	96		
22	罗尧尧	右后卫	28/07/1996	22		188	88		
23	宋继强	守门员	22/03/1997	22		190	85		
26	MUCZA Nobert	左后卫	26/05/1995	24		194	98		
27	王伟强	左边锋	07/01/1993	26		175	80		
28	SZRNKalevente	底线	10/11/1997	21		200	108		
	平均			23.8		189.6	89.8		

编码	姓名	职务
A	闫威名	主教练
B	叶强	教练
C	雷纳德	医生
D	王建国	医生

中国男子手球超级联赛(北京)

PHMS Pictorial Handball Match Statistics

IHF Official System

手球 男子 个人/全队技术累计表 截止至第6场 北京 2019-06-30

号码	姓名	远射	近射	边射	快攻	突破	任意	七米	合计	%	助攻	失误	警告	2'	取消	场次	时间
太平洋保险江苏男子手球俱乐部																	
(场上队员)																	
1	陈昊															3	00:06:57
5	闫亮											2				3	00:58:23
7	周傲	1/5	1/2	1/2	0/1	2/6			5/16	31.3%	4	5				3	00:59:34
9	许翔宇		0/1			1/1			1/2	50.0%		1				3	00:09:31
11	张天豪			2/2					2/2	100%						3	00:13:23
15	李安	0/1			1/1	0/1		7/10	8/13	61.5%	1			1		3	00:34:21
16	张帅										1					3	02:41:45
17	刘赵梁	0/1	0/2	2/6	4/6	3/4			9/19	47.4%	2	3	1			3	02:23:14
18	赵楠	1/7	4/4	1/2		4/6			10/19	52.6%	4	3	2	2		3	02:40:30
19	庞连康	1/4	2/5		1/1	3/5			7/15	46.7%	1	7				3	01:39:39
21	刘江	1/1	2/3		2/3	0/1			5/8	62.5%	1	2				3	01:05:53
22	罗尧尧			0/1	0/1				0/2	0.0%	2					3	00:25:46
23	宋继强															3	00:11:48
26	MUCZA Nobert	4/9	3/3		4/6	1/1			12/19	63.2%	5	9				3	01:56:20
27	王伟强	1/1	1/1	6/7	4/6				12/15	80.0%	1	1	1	2		3	02:34:53
28	SZRNKA levente	0/1	7/10		1/1		0/1		8/13	61.5%	2	5	2	1		3	02:13:49
合计		9/30	20/31	12/20	17/26	14/25	0/1	7/10	79/143	55.2%	24	38	6	6		48	
(守门员)																	
1	陈昊	0/3			0/1			0/2	0/6	0.0%						3	00:06:27
16	张帅	24/41	5/23	4/9	4/21	2/9	1/1	3/7	43/111	38.7%	1					3	02:41:45
23	宋继强	4/7	0/1	0/2		0/1		0/1	4/12	33.3%						3	00:11:48
合计		28/51	5/24	4/11	4/22	2/10	1/1	3/10	47/129	36.4%	1					9	

场上队员：得分/射门

守门员：救球/射门

已打比赛

全队合计	进球	被救	射失	击柱	封球	合计	%	阶段	场次	对手	比分
远射	9	12	5	3	1	30	30.0%	预赛	1	华体	26:33 (11:15)
近射	20	6	1	1	3	31	64.5%	预赛	3	广东	32:23 (14:8)
边射	12	4	3	1		20	60.0%	预赛	6	北京队	21:26 (9:13)
快攻	17	8	1			26	65.4%				
突破	14	7	3	1		25	56.0%				
任意			1			1	0.0%				
七米	7	2		1		10	70.0%				

中国男子手球超级联赛(北京)

PHMS Pictorial Handball Match Statistics

IHF Official System

图式射门区域累计

手球
男子

截止至第6场

北京
2019-06-30

太平洋保险江苏男子手球俱乐部

1 陈昊	5 闫亮	7 周傲	9 许翔宇	11 张天豪	15 李安	16 张帅	17 刘赵梁																																																																								
<table border="1"><tr><td></td><td></td><td></td></tr><tr><td></td><td></td><td></td></tr><tr><td></td><td></td><td></td></tr></table>										<table border="1"><tr><td></td><td></td><td></td></tr><tr><td></td><td></td><td></td></tr><tr><td></td><td></td><td></td></tr></table>										<table border="1"><tr><td></td><td></td><td></td></tr><tr><td>1</td><td></td><td></td></tr><tr><td>4</td><td></td><td></td></tr></table>				1			4			<table border="1"><tr><td></td><td></td><td></td></tr><tr><td></td><td></td><td>1</td></tr><tr><td></td><td></td><td></td></tr></table>						1				<table border="1"><tr><td></td><td></td><td>1</td></tr><tr><td></td><td></td><td></td></tr><tr><td>1</td><td></td><td></td></tr></table>			1				1			<table border="1"><tr><td></td><td></td><td>2</td></tr><tr><td></td><td></td><td>2</td></tr><tr><td>3</td><td></td><td>1</td></tr></table>			2			2	3		1	<table border="1"><tr><td></td><td></td><td></td></tr><tr><td></td><td></td><td></td></tr><tr><td></td><td></td><td></td></tr></table>										<table border="1"><tr><td></td><td></td><td>2</td></tr><tr><td></td><td></td><td>3</td></tr><tr><td>2</td><td></td><td>1</td></tr></table>			2			3	2		1
1																																																																															
4																																																																															
		1																																																																													
		1																																																																													
1																																																																															
		2																																																																													
		2																																																																													
3		1																																																																													
		2																																																																													
		3																																																																													
2		1																																																																													
Post - 0 Miss - 0 Block - 0	Post - 0 Miss - 0 Block - 0	Post - 0 Miss - 5 Block - 2	Post - 0 Miss - 0 Block - 0	Post - 0 Miss - 0 Block - 0	Post - 1 Miss - 0 Block - 0	Post - 0 Miss - 0 Block - 0	Post - 1 Miss - 1 Block - 1																																																																								
18 赵楠	19 庞连康	21 刘江	22 罗尧尧	23 宋继强	26 MUCZA Nobert	27 王伟强	28 SZRNKAlevente																																																																								
<table border="1"><tr><td>1</td><td></td><td></td></tr><tr><td></td><td></td><td>4</td></tr><tr><td>3</td><td></td><td>2</td></tr></table>	1					4	3		2	<table border="1"><tr><td></td><td></td><td>2</td></tr><tr><td></td><td></td><td>1</td></tr><tr><td></td><td></td><td>4</td></tr></table>			2			1			4	<table border="1"><tr><td>1</td><td></td><td></td></tr><tr><td>2</td><td></td><td></td></tr><tr><td></td><td>1</td><td>1</td></tr></table>	1			2				1	1	<table border="1"><tr><td></td><td></td><td></td></tr><tr><td></td><td></td><td></td></tr><tr><td></td><td></td><td></td></tr></table>										<table border="1"><tr><td></td><td></td><td></td></tr><tr><td></td><td></td><td></td></tr><tr><td></td><td></td><td></td></tr></table>										<table border="1"><tr><td>1</td><td></td><td>2</td></tr><tr><td></td><td>2</td><td>3</td></tr><tr><td>2</td><td>1</td><td>1</td></tr></table>	1		2		2	3	2	1	1	<table border="1"><tr><td>1</td><td>1</td><td>4</td></tr><tr><td>2</td><td></td><td>1</td></tr><tr><td></td><td></td><td>3</td></tr></table>	1	1	4	2		1			3	<table border="1"><tr><td></td><td></td><td>3</td></tr><tr><td></td><td></td><td></td></tr><tr><td>2</td><td>1</td><td>2</td></tr></table>			3				2	1	2
1																																																																															
		4																																																																													
3		2																																																																													
		2																																																																													
		1																																																																													
		4																																																																													
1																																																																															
2																																																																															
	1	1																																																																													
1		2																																																																													
	2	3																																																																													
2	1	1																																																																													
1	1	4																																																																													
2		1																																																																													
		3																																																																													
		3																																																																													
2	1	2																																																																													
Post - 1 Miss - 2 Block - 0	Post - 1 Miss - 1 Block - 1	Post - 0 Miss - 2 Block - 0	Post - 0 Miss - 1 Block - 0	Post - 0 Miss - 0 Block - 0	Post - 1 Miss - 1 Block - 0	Post - 1 Miss - 0 Block - 0	Post - 1 Miss - 1 Block - 0																																																																								

1 陈昊

0/1		0/1
		0/4

16 张帅

7/19	3/5	1/15
6/12	3/3	10/15
6/23	1/5	6/14

23 宋继强

0/1		
0/1		0/1
2/5		2/4

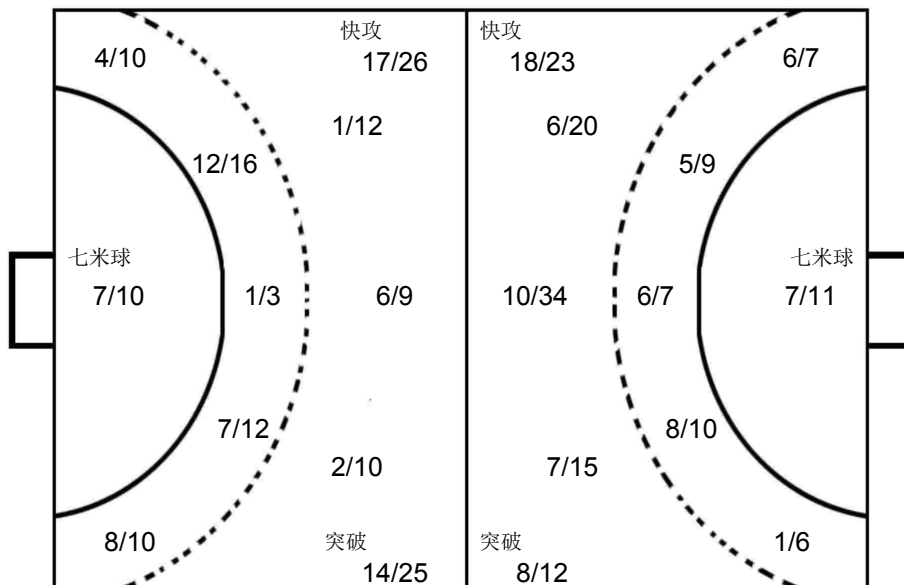

华体

16 刘迈科

2/3	0/2	4/6
1/3	0/1	0/3
1/4	1/1	2/6

北京队

12 高云健

1/5	0/1	1/5
1/3	2/2	3/6
1/4	2/4	0/2

广东

1 王帅

0/1		0/3
0/2	1/1	2/6
4/8	1/2	1/2

OPPONENT

广东	北京队	华体	华体	华体	北京队	广东	北京队																																																																								
10 周仲坤	10 MezeiRichard Be	22 黄培杰	88 王军程	20 顾艳超	8 MagyarDavid	7 王立隆	13 王军鸣																																																																								
<table border="1"><tr><td>1</td><td></td><td>1</td></tr><tr><td>2</td><td></td><td>1</td></tr><tr><td>1</td><td></td><td>5</td></tr></table>	1		1	2		1	1		5	<table border="1"><tr><td>1</td><td></td><td>3</td></tr><tr><td></td><td></td><td>1</td></tr><tr><td>1</td><td></td><td>1</td></tr></table>	1		3			1	1		1	<table border="1"><tr><td>3</td><td></td><td>1</td></tr><tr><td></td><td></td><td></td></tr><tr><td>1</td><td></td><td>1</td></tr></table>	3		1				1		1	<table border="1"><tr><td>1</td><td></td><td></td></tr><tr><td></td><td></td><td>1</td></tr><tr><td>3</td><td></td><td>1</td></tr></table>	1					1	3		1	<table border="1"><tr><td></td><td></td><td></td></tr><tr><td>2</td><td></td><td>2</td></tr><tr><td></td><td></td><td>1</td></tr></table>				2		2			1	<table border="1"><tr><td></td><td></td><td>2</td></tr><tr><td></td><td></td><td></td></tr><tr><td></td><td></td><td>2</td></tr></table>			2						2	<table border="1"><tr><td></td><td></td><td>1</td></tr><tr><td></td><td></td><td></td></tr><tr><td>2</td><td></td><td>1</td></tr></table>			1				2		1	<table border="1"><tr><td>1</td><td></td><td></td></tr><tr><td>1</td><td></td><td></td></tr><tr><td>1</td><td></td><td></td></tr></table>	1			1			1		
1		1																																																																													
2		1																																																																													
1		5																																																																													
1		3																																																																													
		1																																																																													
1		1																																																																													
3		1																																																																													
1		1																																																																													
1																																																																															
		1																																																																													
3		1																																																																													
2		2																																																																													
		1																																																																													
		2																																																																													
		2																																																																													
		1																																																																													
2		1																																																																													
1																																																																															
1																																																																															
1																																																																															
Post - 0 Miss - 1 Block - 1	Post - 1 Miss - 0 Block - 0	Post - 0 Miss - 0 Block - 0	Post - 0 Miss - 0 Block - 0	Post - 0 Miss - 0 Block - 0	Post - 2 Miss - 0 Block - 0	Post - 0 Miss - 0 Block - 0	Post - 1 Miss - 1 Block - 2																																																																								
北京队	北京队	华体	华体	北京队	北京队	广东	华体																																																																								
27 闫炳旗	32 蒋维一	4 张家伟	18 李双	7 马昌震	22 王超	17 李中洲	8 谢庆龙																																																																								
<table border="1"><tr><td>1</td><td></td><td>2</td></tr><tr><td></td><td></td><td></td></tr><tr><td></td><td></td><td></td></tr></table>	1		2							<table border="1"><tr><td>1</td><td></td><td></td></tr><tr><td></td><td></td><td></td></tr><tr><td>1</td><td></td><td>1</td></tr></table>	1						1		1	<table border="1"><tr><td>1</td><td></td><td></td></tr><tr><td></td><td></td><td>1</td></tr><tr><td></td><td></td><td>1</td></tr></table>	1					1			1	<table border="1"><tr><td></td><td></td><td>2</td></tr><tr><td></td><td></td><td></td></tr><tr><td>1</td><td></td><td></td></tr></table>			2				1			<table border="1"><tr><td></td><td></td><td></td></tr><tr><td></td><td></td><td>1</td></tr><tr><td>1</td><td></td><td></td></tr></table>						1	1			<table border="1"><tr><td></td><td></td><td></td></tr><tr><td></td><td></td><td></td></tr><tr><td>2</td><td></td><td></td></tr></table>							2			<table border="1"><tr><td>1</td><td></td><td>1</td></tr><tr><td></td><td></td><td></td></tr><tr><td></td><td></td><td></td></tr></table>	1		1							<table border="1"><tr><td></td><td></td><td></td></tr><tr><td></td><td></td><td></td></tr><tr><td></td><td></td><td>2</td></tr></table>									2
1		2																																																																													
1																																																																															
1		1																																																																													
1																																																																															
		1																																																																													
		1																																																																													
		2																																																																													
1																																																																															
		1																																																																													
1																																																																															
2																																																																															
1		1																																																																													
		2																																																																													
Post - 0 Miss - 0 Block - 0	Post - 0 Miss - 0 Block - 0	Post - 0 Miss - 1 Block - 0	Post - 0 Miss - 0 Block - 0	Post - 0 Miss - 0 Block - 0	Post - 0 Miss - 0 Block - 0	Post - 0 Miss - 0 Block - 1	Post - 0 Miss - 1 Block - 0																																																																								



中国男子手球超级联赛(北京)

PHMS Pictorial Handball Match Statistics

IHF Official System

球队名单

广东路环四庙男子手球俱乐部

北京

2019-06-28

号码	姓名	位置	生日	年龄	俱乐部	身高 (CM)	体重 (KG)	国际场次	国际进球
1	王帅	守门员	30/09/1997	21	广东环路四庙男子俱乐部	196	98		
2	董佳辉	左边锋	28/02/2002	17	广东环路四庙男子俱乐部	192	88		
3	曲汝洋	左边锋	07/01/1989	30	广东环路四庙男子俱乐部	185	85		
4	ARPASI PATRIK	底线	17/09/1996	22	广东环路四庙男子俱乐部	197	115		
5	曹景森	左边锋	14/12/2000	18	广东环路四庙男子俱乐部	190	106		
6	毕晓晨	左边锋	23/03/1995	24	广东环路四庙男子俱乐部	188	88		
7	王立隆	左边锋	04/01/1995	24	广东环路四庙男子俱乐部	194	87		
8	DOLEZSAL KAROLY	左后卫	01/12/1995	23	广东环路四庙男子俱乐部	190	86		
9	范保坤	左边锋	01/01/1999	20	广东环路四庙男子俱乐部	190	88		
10	周仲坤	左边锋	02/01/1997	22	广东环路四庙男子俱乐部	196	90		
11	房友屯	左边锋	03/02/1994	25	广东环路四庙男子俱乐部	183	88		
17	李中洲	左边锋	10/03/1989	30	广东环路四庙男子俱乐部	196	97		
18	姚雪岩	左边锋	19/11/1996	22	广东环路四庙男子俱乐部	202	105		
19	王泽润	守门员	19/02/1998	21	广东环路四庙男子俱乐部	192	95		
21	张昌轲	守门员	13/03/1999	20	广东环路四庙男子俱乐部	185	80		
24	高玉杰	守门员	16/10/1998	20	广东环路四庙男子俱乐部	190	83		
	平均			22.4		191.6	92.4		

编码	姓名	职务
A	刘康伶	主教练
B	郭艳辉	教练
C	贾章志	医生

中国男子手球超级联赛(北京)

PHMS Pictorial Handball Match Statistics

IHF Official System

 手球
 男子

个人/全队技术累计表

 北京
 2019-06-30

截止至第6场

号码	姓名	远射	近射	边射	快攻	突破	任意	七米	合计	%	助攻	失误	警告	2'	取消	场次	时间
广东路环四庙男子手球俱乐部																	
(场上队员)																	
1	王帅											1				3	01:26:53
2	董佳辉															3	00:00:30
3	曲汝洋	3/10	1/4	0/1	2/2	1/2	0/2	1/1	8/22	36.4%	8	5				3	01:50:39
4	ARPASI PATRIK	1/2	7/8						8/10	80.0%		3	3			3	01:44:26
5	曹景森				1/1				1/1	100%		3				3	00:41:04
6	毕晓晨	0/3	2/4	0/3	3/5	3/4		0/1	8/20	40.0%	1	3				3	02:15:28
7	王立隆				4/5				4/5	80.0%	1	2				3	01:08:46
8	DOLEZSAL KAROLY	1/8	1/1			1/1		5/6	8/16	50.0%	6	7		2		3	02:32:24
9	范保坤											1		1		3	00:05:25
10	周仲坤	6/16	4/6	0/3	1/3	1/3	2/2	8/8	22/41	53.7%	3	8		1		3	02:57:40
11	房友屯	0/3	1/1			0/1			1/5	20.0%		1		1		3	00:57:31
17	李中洲	3/8	2/3		4/4	2/2		0/1	11/18	61.1%	1	9				3	01:52:32
18	姚雪岩	2/8	2/3			2/4			6/15	40.0%		3				3	01:26:43
19	王泽润											1				3	02:03:07
21	张昌轲	0/2			2/3	1/1			3/6	50.0%		2				3	00:23:40
24	高玉杰		1/1	4/4	2/6				7/11	63.6%	3	2	1	2		3	02:30:55
合计		16/60	21/31	4/11	19/29	11/18	2/4	14/17	87/170	51.2%	23	51	4	7		48	
(守门员)																	
1	王帅	5/13	4/16	2/7	3/22	5/9	0/2	0/5	19/74	25.7%		1				3	01:26:53
19	王泽润	3/7	2/14	2/9	5/19	1/15		3/5	16/69	23.2%		1				3	02:03:07
合计		8/20	6/30	4/16	8/41	6/24	0/2	3/10	35/143	24.5%		2				6	

场上队员：得分/射门

守门员：救球/射门

已打比赛

全队合计	进球	被救	射失	击柱	封球	合计	%	阶段	场次	对手	比分
远射	16	21	7	2	14	60	26.7%	预赛	2	北京队	37:36 (13:13)
近射	21	7			3	31	67.7%	预赛	3	江苏	23:32 (8:14)
边射	4	5	1	1		11	36.4%	预赛	5	华体	27:40 (13:16)
快攻	19	8	2			29	65.5%				
突破	11	5	2			18	61.1%				
任意	2	2				4	50.0%				
七米	14	2	1			17	82.4%				

中国男子手球超级联赛(北京)

PHMS Pictorial Handball Match Statistics

IHF Official System

图式射门区域累计

手球
男子

截止至第6场

北京
2019-06-30

广东路环四庙男子手球俱乐部

1 王帅 <table border="1"><tr><td></td><td></td><td></td></tr><tr><td></td><td></td><td></td></tr><tr><td></td><td></td><td></td></tr></table> Post - 0 Miss - 0 Block - 0										2 董佳辉 <table border="1"><tr><td></td><td></td><td></td></tr><tr><td></td><td></td><td></td></tr><tr><td></td><td></td><td></td></tr></table> Post - 0 Miss - 0 Block - 0										3 曲汝洋 <table border="1"><tr><td>2</td><td></td><td>1</td></tr><tr><td>2</td><td>1</td><td></td></tr><tr><td>2</td><td></td><td></td></tr></table> Post - 2 Miss - 4 Block - 3	2		1	2	1		2			4 ARPASI PATRIK <table border="1"><tr><td>1</td><td>1</td><td>2</td></tr><tr><td></td><td></td><td></td></tr><tr><td>1</td><td>2</td><td>1</td></tr></table> Post - 0 Miss - 0 Block - 0	1	1	2				1	2	1	5 曹景森 <table border="1"><tr><td></td><td></td><td>1</td></tr><tr><td></td><td></td><td></td></tr><tr><td></td><td></td><td></td></tr></table> Post - 0 Miss - 0 Block - 0			1							6 毕晓晨 <table border="1"><tr><td>1</td><td></td><td></td></tr><tr><td></td><td>2</td><td>1</td></tr><tr><td>3</td><td>1</td><td></td></tr></table> Post - 0 Miss - 2 Block - 1	1				2	1	3	1		7 王立隆 <table border="1"><tr><td></td><td>1</td><td></td></tr><tr><td></td><td></td><td></td></tr><tr><td>2</td><td></td><td>1</td></tr></table> Post - 0 Miss - 0 Block - 0		1					2		1	8 DOLEZSAL KAROLY <table border="1"><tr><td>1</td><td></td><td>1</td></tr><tr><td>1</td><td></td><td>1</td></tr><tr><td></td><td></td><td>4</td></tr></table> Post - 0 Miss - 3 Block - 1	1		1	1		1			4
2		1																																																																													
2	1																																																																														
2																																																																															
1	1	2																																																																													
1	2	1																																																																													
		1																																																																													
1																																																																															
	2	1																																																																													
3	1																																																																														
	1																																																																														
2		1																																																																													
1		1																																																																													
1		1																																																																													
		4																																																																													
9 范保坤 <table border="1"><tr><td></td><td></td><td></td></tr><tr><td></td><td></td><td></td></tr><tr><td></td><td></td><td></td></tr></table> Post - 0 Miss - 0 Block - 0										10 周仲坤 <table border="1"><tr><td>2</td><td></td><td>4</td></tr><tr><td>3</td><td></td><td>2</td></tr><tr><td>3</td><td>1</td><td>7</td></tr></table> Post - 0 Miss - 2 Block - 3	2		4	3		2	3	1	7	11 房友屯 <table border="1"><tr><td></td><td></td><td></td></tr><tr><td></td><td></td><td></td></tr><tr><td></td><td>1</td><td></td></tr></table> Post - 0 Miss - 0 Block - 1								1		17 李中洲 <table border="1"><tr><td>2</td><td>1</td><td>2</td></tr><tr><td></td><td></td><td>3</td></tr><tr><td>2</td><td>1</td><td></td></tr></table> Post - 0 Miss - 0 Block - 3	2	1	2			3	2	1		18 姚雪岩 <table border="1"><tr><td></td><td>1</td><td>1</td></tr><tr><td>1</td><td></td><td></td></tr><tr><td>2</td><td></td><td>1</td></tr></table> Post - 1 Miss - 1 Block - 3		1	1	1			2		1	19 王泽润 <table border="1"><tr><td></td><td></td><td></td></tr><tr><td></td><td></td><td></td></tr><tr><td></td><td></td><td></td></tr></table> Post - 0 Miss - 0 Block - 0										21 张昌柯 <table border="1"><tr><td></td><td></td><td></td></tr><tr><td>1</td><td></td><td>1</td></tr><tr><td></td><td></td><td>1</td></tr></table> Post - 0 Miss - 0 Block - 2				1		1			1	24 高玉杰 <table border="1"><tr><td>1</td><td></td><td>2</td></tr><tr><td>2</td><td></td><td>1</td></tr><tr><td></td><td></td><td>1</td></tr></table> Post - 0 Miss - 1 Block - 0	1		2	2		1			1
2		4																																																																													
3		2																																																																													
3	1	7																																																																													
	1																																																																														
2	1	2																																																																													
		3																																																																													
2	1																																																																														
	1	1																																																																													
1																																																																															
2		1																																																																													
1		1																																																																													
		1																																																																													
1		2																																																																													
2		1																																																																													
		1																																																																													

1 王帅

2/11		0/15
0/6	2/4	6/12
5/14	2/5	2/7

19 王泽润

2/10	0/1	2/10
2/6	2/3	5/13
2/13	1/2	0/11

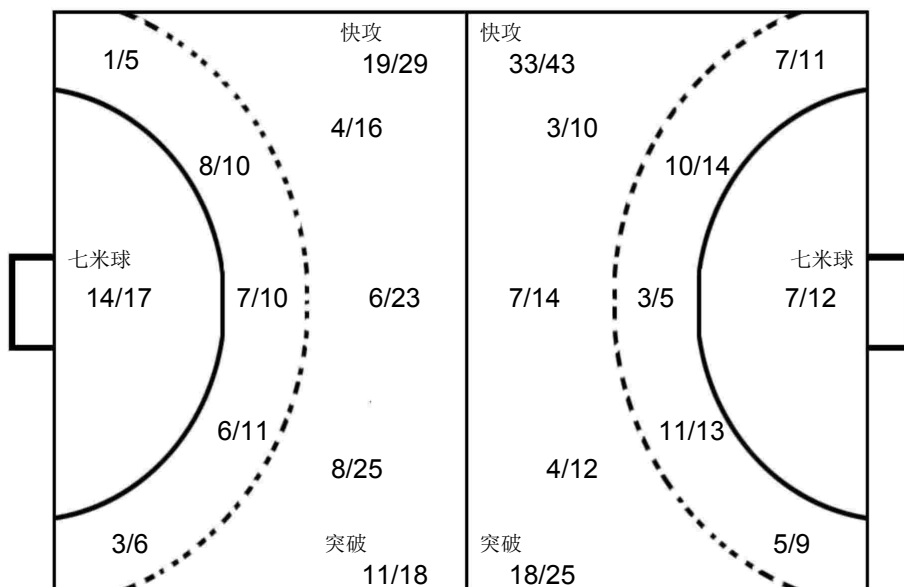

华体

16 刘迈科

1/4	1/2	1/7
2/4	2/3	3/6
4/10	3/5	2/5

江苏

16 张帅

1/3	2/4	1/4
0/1	1/1	4/4
3/9	1/1	4/7

北京队

12 高云健

0/4	1/2	1/4
2/6	2/4	0/3
2/4	2/5	3/7

OPPONENT

北京队 8 MagyarDavid <table border="1"><tr><td>2</td><td></td><td>2</td></tr><tr><td></td><td></td><td>2</td></tr><tr><td>2</td><td>2</td><td>1</td></tr></table> Post - 0 Miss - 1 Block - 0	2		2			2	2	2	1	华体 8 谢庆龙 <table border="1"><tr><td>2</td><td></td><td>1</td></tr><tr><td>3</td><td></td><td>3</td></tr><tr><td>1</td><td></td><td></td></tr></table> Post - 0 Miss - 0 Block - 0	2		1	3		3	1			北京队 10 MezeiRichard Be <table border="1"><tr><td></td><td></td><td>5</td></tr><tr><td></td><td>1</td><td></td></tr><tr><td></td><td>1</td><td>1</td></tr></table> Post - 0 Miss - 0 Block - 0			5		1			1	1	华体 22 黄培杰 <table border="1"><tr><td>3</td><td></td><td>2</td></tr><tr><td>1</td><td></td><td></td></tr><tr><td></td><td></td><td>1</td></tr></table> Post - 0 Miss - 0 Block - 0	3		2	1					1	北京队 22 王超 <table border="1"><tr><td></td><td></td><td>4</td></tr><tr><td></td><td></td><td>1</td></tr><tr><td>1</td><td></td><td></td></tr></table> Post - 1 Miss - 0 Block - 0			4			1	1			华体 47 成亚 <table border="1"><tr><td>2</td><td></td><td>1</td></tr><tr><td>1</td><td></td><td></td></tr><tr><td>1</td><td></td><td>1</td></tr></table> Post - 0 Miss - 3 Block - 0	2		1	1			1		1	江苏 17 刘赵梁 <table border="1"><tr><td>1</td><td></td><td></td></tr><tr><td>2</td><td></td><td>1</td></tr><tr><td>2</td><td></td><td></td></tr></table> Post - 0 Miss - 0 Block - 1	1			2		1	2			江苏 26 MUCZA Nobert <table border="1"><tr><td></td><td></td><td>1</td></tr><tr><td></td><td>1</td><td>1</td></tr><tr><td>2</td><td></td><td>1</td></tr></table> Post - 1 Miss - 1 Block - 0			1		1	1	2		1
2		2																																																																													
		2																																																																													
2	2	1																																																																													
2		1																																																																													
3		3																																																																													
1																																																																															
		5																																																																													
	1																																																																														
	1	1																																																																													
3		2																																																																													
1																																																																															
		1																																																																													
		4																																																																													
		1																																																																													
1																																																																															
2		1																																																																													
1																																																																															
1		1																																																																													
1																																																																															
2		1																																																																													
2																																																																															
		1																																																																													
	1	1																																																																													
2		1																																																																													
华体 88 王军程 <table border="1"><tr><td>1</td><td></td><td></td></tr><tr><td></td><td></td><td>1</td></tr><tr><td>1</td><td></td><td>2</td></tr></table> Post - 0 Miss - 0 Block - 1	1					1	1		2	北京队 13 王军鸣 <table border="1"><tr><td>2</td><td></td><td>1</td></tr><tr><td></td><td></td><td></td></tr><tr><td>1</td><td></td><td></td></tr></table> Post - 1 Miss - 1 Block - 0	2		1				1			华体 25 王杰缘 <table border="1"><tr><td>1</td><td></td><td>1</td></tr><tr><td></td><td></td><td></td></tr><tr><td>2</td><td></td><td></td></tr></table> Post - 1 Miss - 0 Block - 0	1		1				2			江苏 27 王伟强 <table border="1"><tr><td></td><td></td><td>1</td></tr><tr><td>1</td><td></td><td>1</td></tr><tr><td></td><td></td><td>1</td></tr></table> Post - 0 Miss - 0 Block - 0			1	1		1			1	江苏 28 SZRNKALEvente <table border="1"><tr><td></td><td>1</td><td></td></tr><tr><td></td><td></td><td></td></tr><tr><td>2</td><td>1</td><td></td></tr></table> Post - 0 Miss - 1 Block - 0		1					2	1		华体 10 李朝鹏 <table border="1"><tr><td></td><td></td><td></td></tr><tr><td></td><td></td><td></td></tr><tr><td>2</td><td></td><td>1</td></tr></table> Post - 0 Miss - 1 Block - 1							2		1	江苏 18 赵楠 <table border="1"><tr><td>1</td><td></td><td></td></tr><tr><td></td><td></td><td>1</td></tr><tr><td></td><td></td><td>1</td></tr></table> Post - 0 Miss - 1 Block - 0	1					1			1	北京队 14 逯明松 <table border="1"><tr><td></td><td></td><td></td></tr><tr><td></td><td></td><td></td></tr><tr><td></td><td></td><td>2</td></tr></table> Post - 0 Miss - 0 Block - 1									2
1																																																																															
		1																																																																													
1		2																																																																													
2		1																																																																													
1																																																																															
1		1																																																																													
2																																																																															
		1																																																																													
1		1																																																																													
		1																																																																													
	1																																																																														
2	1																																																																														
2		1																																																																													
1																																																																															
		1																																																																													
		1																																																																													
		2																																																																													



PHMS Pictorial Handball Match Statistics **IHF** Official System

Team A	Team B	Match Number
A 华体国家男子手球俱乐部	B 太平洋保险江苏男子手球俱乐部	1

Played in	in the hall	on	at	Spectators
北京	北京光彩体育馆	2019-06-28	19:00 hours	1500

Half-time(30')	A	B	End of playing time	A	B	1st extra time	A	B	2nd extra time	A	B	After penalty throws	A	B
	15	11	33	26										

Number of 7 m	A	Team time-out			Full name of players and officials	Team time-out			B	Number of 7 m
	1/2	1	2	3		1	2	3	3/3	
			51:20			17:59	40:34			

No.	Team A	G	W	2'	D	DR	No.	Team B	G	W	2'	D	DR
4	张家纬	3					1	陈昊					
5	贺政						5	闫亮					
6	赵晨	1	1				7	周傲	2				
8	谢庆龙	2					9	许翔宇					
10	李朝鹏	2					11	张天豪					
11	郭世伟	2					15	李安	4				
12	王权						16	张帅					
16	刘迈科						17	刘赵梁	2				
18	李双	3		1			18	赵楠	5	1			
20	顾艳超	5					19	庞连康	3				
22	黄培杰	6	1	1			21	刘江	2				
23	曹悦						22	罗尧尧					
25	王杰缘	1					23	宋继强					
47	成亚	2		1			26	MUCZA Nobert	3				
88	王军程	6					27	王伟强	2				
99	王伟						28	SZRNKAlvente	3				
A	姚苏捷						A	闫威名 (主教练)					
B	朱昕晨 (主教练)						B	叶强					
D	付飞鹏						C	雷纳德					
							D	王建国					

A	Signatures of responsables for the teams (Off.A)	B
---	--	---

TP	Remarks of referees / HF Official	TP

Signatures			
Referees	李兆蒙 (CHN)	王科 (CHN)	
T.D.	吴瑞亭 (CHN)	刘凤娟 (CHN)	
CHA Off.			

Note: Number of 7m Throws Awarded to Team A and B, Goals (G), Warnings (W), Suspensions (2'), Direct Disqualification (D), Disqualification With Report (DR) and Team Penalty (TP).

Table Officials: 刘志军 赵悦 Statisticians: 于兹香 谢杨

中国男子手球超级联赛(北京)

PHMS Pictorial Handball Match Statistics

IHF Official System

竞赛技术统计

手球 男子 预赛 轮次 1 组别 X 场次 1 北京光彩体育馆 2019-06-28 19:00

Referees: 李兆蒙 (CHN) / 王科 (CHN) Result: 33:26(15:11)
Teams: 华体国家男子手球俱乐部(华体) VS 太平洋保险江苏男子手球俱乐部(江苏)

华体		远	近	边	快	突	任意	7m	合计	%	助攻	失误	警告	2'	D+DR
主教练: 朱昕晨		射	射	射	攻	破	球	球							
4	张家纬	1/1	0/1		2/2	0/1			3/5	60.0	2	1			
5	贺政		0/1	0/1					0/2	0.0					
6	赵晨	0/3			1/1				1/4	25.0			1		
8	谢庆龙		1/1		1/2				2/3	66.7	1	1			
10	李朝鹏	2/3				0/1			2/4	50.0	1	2			
11	郭世伟		1/1	1/1	0/1				2/3	66.7		1			
12	王权											1			
16	刘迈科														
18	李双	1/1			1/1	1/1			3/3	100		1		1	
20	顾艳超	2/3	2/2			1/2			5/7	71.4					
22	黄培杰		2/2	3/3				1/1	6/6	100		2	1	1	
23	曹悦														
25	王杰缘				1/1				1/1	100					
47	成亚	1/1				1/1		0/1	2/3	66.7	2	1		1	
88	王军程	3/8	1/1		1/1	1/1			6/11	54.5		2			
99	王伟											1			
运动员 合计		10/20	7/9	4/5	7/9	4/7		1/2	33/52	63.5	6	13	2	3	
12	王权	3/5	0/1	1/1	0/2	0/3			4/12	33.3		1			
16	刘迈科	3/4	1/6	1/3	2/6	4/7		0/3	11/29	37.9					
守门员 合计		6/9	1/7	2/4	2/8	4/10		0/3	15/41	36.6		1			

江苏		远	近	边	快	突	任意	7m	合计	%	助攻	失误	警告	2'	D+DR
主教练: 闫威名		射	射	射	攻	破	球	球							
1	陈昊														
5	闫亮											1			
7	周傲	1/3				1/4			2/7	28.6	3	2			
9	许翔宇														
11	张天豪														
15	李安				1/1	0/1		3/3	4/5	80.0	1				
16	张帅														
17	刘赵梁			1/4	1/1				2/5	40.0		1			
18	赵楠	1/4		1/1		3/5			5/10	50.0	3	2	1		
19	庞连康	1/2	1/2			1/1			3/5	60.0		1			
21	刘江		1/2		1/1				2/3	66.7					
22	罗尧尧				0/1				0/1	0.0					
23	宋继强														
26	MUCZA Nober	0/2	1/1		1/1	1/1			3/5	60.0	1	3			
27	王伟强			0/1	2/3				2/4	50.0		1			
28	SZRNKAlvente	0/1	3/5						3/6	50.0	2	2			
运动员 合计		3/12	6/10	2/6	6/8	6/12		3/3	26/51	51.0	10	13	1		
16	张帅	5/12	1/7	0/2	1/8	2/5		1/1	10/35	28.6					
23	宋继强	4/7	0/1	0/2		0/1		0/1	4/12	33.3					
守门员 合计		9/19	1/8	0/4	1/8	2/6		1/2	14/47	29.8					

华体	比赛进程	江苏
1st Half		
0	02:32	1 18 赵楠
20	顾艳超	1 03:23 1
20	顾艳超	2 04:53 1
2	06:05	2 19 庞连康
20	顾艳超	3 06:41 2
3	07:08	3 19 庞连康
4	07:34	3
22	黄培杰	5 08:33 3
5	09:35	4 18 赵楠
6	09:44	4
25	王杰缘	7 10:29 4
4	11:05	4
8	11:51	5 7 周傲
8	12:00	6 17 刘赵梁
8	14:35	7 18 赵楠
22	黄培杰	9 15:30 7
8	17:01	7
4	17:55	7
11	19:32	8 15 李安
20	20:08	8
20	23:24	8
13	23:51	9 15 李安
13	24:36	10 21 刘江
88	27:25	10
14	28:49	11 15 李安
22	29:32	11
2nd Half		
15	00:27	12 7 周傲
88	01:16	12
16	01:57	13 28 SZRNKAleven
16	03:11	14 27 王伟强
10	03:37	14
11	05:28	14
10	07:51	14
18	09:05	14
8	09:28	14
88	10:20	14
22	10:55	15 19 庞连康
22	12:53	16 18 赵楠
18	13:46	16
18	14:34	16
11	17:18	16
22	18:13	16
26	19:03	17 27 王伟强
47	19:48	17
27	21:02	18 15 李安
27	21:53	19 17 刘赵梁
22	22:31	19
28	23:06	20 28 SZRNKAleven
28	24:25	21 26 MUCZA Nober
88	24:57	21
29	25:30	22 26 MUCZA Nober
47	26:01	22
30	26:18	23 18 赵楠
22	26:31	23
31	27:08	24 28 SZRNKAleven
88	27:24	24
32	28:06	25 21 刘江
88	28:58	25
33	29:34	26 26 MUCZA Nober

场上队员: 得分 / 射门

守门员: 救球 / 射门

D	取消资格	DR	取消资格+报告
---	------	----	---------



中国男子手球超级联赛(北京)

PHMS Pictorial Handball Match Statistics

IHF Official System

个人/全队技术统计表

手球 男子 预赛 轮次 1 组别 X 场次 1 北京光彩体育馆 2019-06-28 19:00

号码	姓名	远射	近射	边射	快攻	突破	任意	七米	合计	%	助攻	失误	警告	2'	取消	时间
华体国家男子手球俱乐部(华体)																
(场上队员)																
4	张家纬	1/1	0/1		2/2	0/1			3/5	60.0%	2	1				00:26:05
5	贺政		0/1	0/1					0/2	0.0%						00:30:00
6	赵晨	0/3			1/1				1/4	25.0%			1			00:27:40
8	谢庆龙		1/1		1/2				2/3	66.7%	1	1				00:35:20
10	李朝鹏	2/3				0/1			2/4	50.0%	1	2				00:16:36
11	郭世伟		1/1	1/1	0/1				2/3	66.7%		1				00:20:20
12	王权									0.0%		1				00:23:37
16	刘迈科									0.0%						00:36:23
18	李双	1/1			1/1	1/1			3/3	100%		1		1		00:20:46
20	顾艳超	2/3	2/2			1/2			5/7	71.4%						00:22:36
22	黄培杰		2/2	3/3				1/1	6/6	100%		2	1	1		00:40:23
23	曹悦									0.0%						00:12:37
25	王杰缘				1/1				1/1	100%						00:30:00
47	成亚	1/1				1/1		0/1	2/3	66.7%	2	1		1		00:17:10
88	王军程	3/8	1/1		1/1	1/1			6/11	54.5%		2				00:37:19
99	王伟									0.0%		1				00:21:31
合计		10/20	7/9	4/5	7/9	4/7		1/2	33/52	63.5%	6	13	2	3		
(守门员)																
12	王权	3/5	0/1	1/1	0/2	0/3			4/12	33.3%		1				00:23:37
16	刘迈科	3/4	1/6	1/3	2/6	4/7		0/3	11/29	37.9%						00:36:23
合计		6/9	1/7	2/4	2/8	4/10		0/3	15/41	36.6%		1				

场上队员：得分/射门

守门员：救球/射门

全队合计	得分	被救	射失	击柱	封球	合计	%
远射	10	9		1		20	50.0%
近射	7	1	1			9	77.8%
边射	4			1		5	80.0%
快攻	7	1	1			9	77.8%
突破	4	2	1			7	57.1%
任意							0.0%
七米	1	1				2	50.0%

中国男子手球超级联赛(北京)

PHMS Pictorial Handball Match Statistics

IHF Official System

个人/全队技术统计表

手球 预赛 组别 X 北京光彩体育馆
男子 轮次 1 场次 1 2019-06-28 19:00

号码	姓名	远射	近射	边射	快攻	突破	任意	七米	合计	%	助攻	失误	警告	2'	取消	时间
太平洋保险江苏男子手球俱乐部(江苏)																
(场上队员)																
1	陈昊									0.0%						00:00:00
5	闫亮									0.0%		1				00:14:28
7	周傲	1/3				1/4			2/7	28.6%	3	2				00:29:00
9	许翔宇									0.0%						00:00:00
11	张天豪									0.0%						00:00:00
15	李安				1/1	0/1		3/3	4/5	80.0%	1					00:13:37
16	张帅									0.0%						00:48:12
17	刘赵梁			1/4	1/1				2/5	40.0%		1				00:36:51
18	赵楠	1/4		1/1		3/5			5/10	50.0%	3	2	1			00:56:44
19	庞连康	1/2	1/2			1/1			3/5	60.0%		1				00:36:50
21	刘江		1/2		1/1				2/3	66.7%						00:19:33
22	罗尧尧				0/1				0/1	0.0%						00:12:43
23	宋继强									0.0%						00:11:48
26	MUCZA Nobert	0/2	1/1		1/1	1/1			3/5	60.0%	1	3				00:41:57
27	王伟强			0/1	2/3				2/4	50.0%		1				00:48:17
28	SZRNKAlevente	0/1	3/5						3/6	50.0%	2	2				00:48:12
合计		3/12	6/10	2/6	6/8	6/12		3/3	26/51	51.0%	10	13	1			
(守门员)																
16	张帅	5/12	1/7	0/2	1/8	2/5		1/1	10/35	28.6%						00:48:12
23	宋继强	4/7	0/1	0/2		0/1		0/1	4/12	33.3%						00:11:48
合计		9/19	1/8	0/4	1/8	2/6		1/2	14/47	29.8%						

场上队员：得分/射门

守门员：救球/射门

全队合计	得分	被救	射失	击柱	封球	合计	%
远射	3	6	2		1	12	25.0%
近射	6	1	1	1	1	10	60.0%
边射	2	2	1	1		6	33.3%
快攻	6	2				8	75.0%
突破	6	4	1	1		12	50.0%
任意							0.0%
七米	3					3	100.0%

中国男子手球超级联赛(北京)

PHMS Pictorial Handball Match Statistics

IHF Official System

图式比赛技术统计表

手球
男子

预赛
轮次 1

组别 X
场次 1

北京光彩体育馆
2019-06-28 19:00

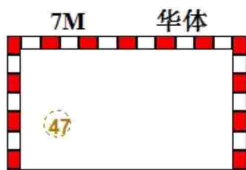
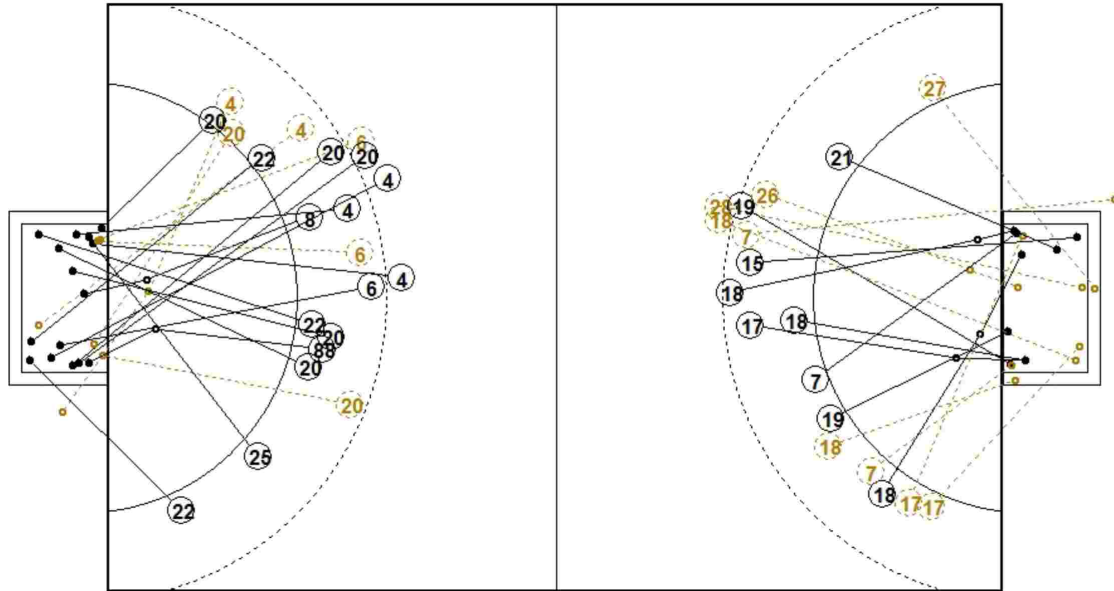

1st Half
15 : 11

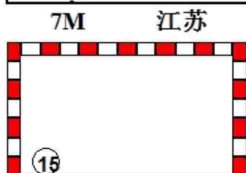
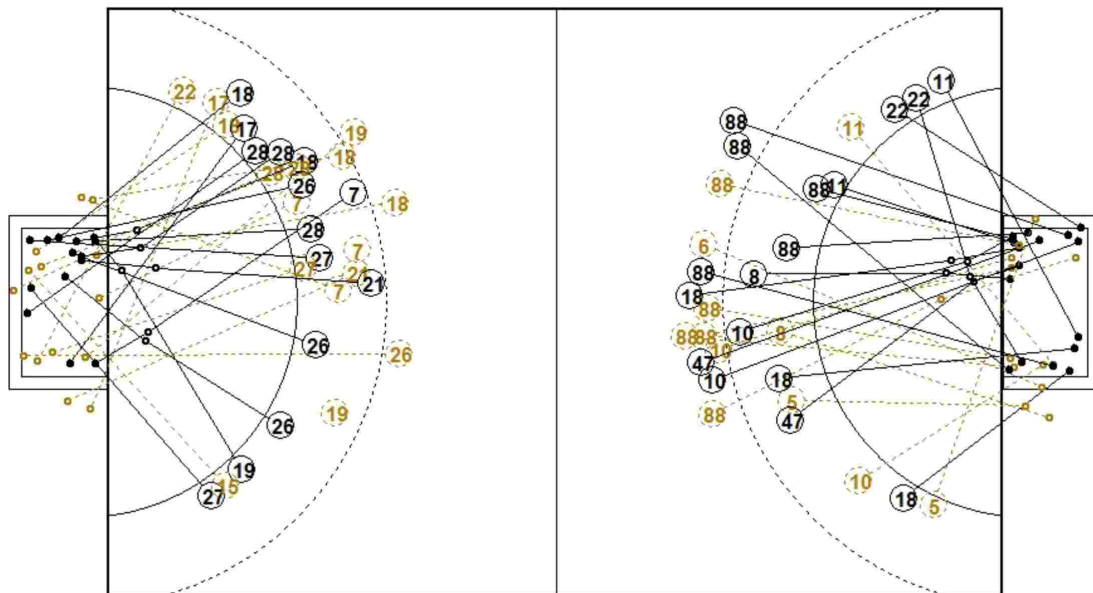
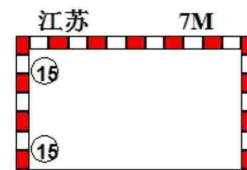

2nd Half
26 : 33

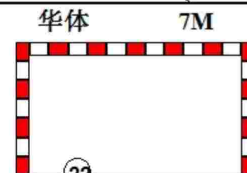

中国男子手球超级联赛(北京)

PHMS Pictorial Handball Match Statistics

IHF Official System

图式射门区域统计

手球
男子

预赛
轮次 1

组别 X
场次 1

北京光彩体育馆
2019-06-28 19:00

华体国家男子手球俱乐部

4 张家纬	5 贺政	6 赵晨	8 谢庆龙	10 李朝鹏	11 郭世伟	12 王权	16 刘迈科																																																																								
<table border="1"><tr><td>1</td><td></td><td></td></tr><tr><td></td><td></td><td>1</td></tr><tr><td></td><td></td><td>1</td></tr></table>	1					1			1	<table border="1"><tr><td></td><td></td><td></td></tr><tr><td></td><td></td><td></td></tr><tr><td></td><td></td><td></td></tr></table>										<table border="1"><tr><td></td><td></td><td></td></tr><tr><td>1</td><td></td><td></td></tr><tr><td></td><td></td><td></td></tr></table>				1						<table border="1"><tr><td></td><td></td><td></td></tr><tr><td></td><td></td><td></td></tr><tr><td></td><td>2</td><td></td></tr></table>								2		<table border="1"><tr><td>1</td><td></td><td></td></tr><tr><td></td><td></td><td></td></tr><tr><td>1</td><td></td><td></td></tr></table>	1						1			<table border="1"><tr><td></td><td></td><td>1</td></tr><tr><td></td><td></td><td></td></tr><tr><td>1</td><td></td><td></td></tr></table>			1				1			<table border="1"><tr><td></td><td></td><td></td></tr><tr><td></td><td></td><td></td></tr><tr><td></td><td></td><td></td></tr></table>										<table border="1"><tr><td></td><td></td><td></td></tr><tr><td></td><td></td><td></td></tr><tr><td></td><td></td><td></td></tr></table>									
1																																																																															
		1																																																																													
		1																																																																													
1																																																																															
	2																																																																														
1																																																																															
1																																																																															
		1																																																																													
1																																																																															
Post - 0 Miss - 1 Block - 0	Post - 1 Miss - 1 Block - 0	Post - 1 Miss - 0 Block - 0	Post - 0 Miss - 1 Block - 0	Post - 0 Miss - 0 Block - 0	Post - 0 Miss - 0 Block - 0	Post - 0 Miss - 0 Block - 0	Post - 0 Miss - 0 Block - 0																																																																								
18 李双	20 顾艳超	22 黄培杰	23 曹悦	25 王杰缘	47 成亚	88 王军程	99 王伟																																																																								
<table border="1"><tr><td></td><td></td><td>2</td></tr><tr><td></td><td></td><td></td></tr><tr><td>1</td><td></td><td></td></tr></table>			2				1			<table border="1"><tr><td></td><td></td><td></td></tr><tr><td>2</td><td></td><td>2</td></tr><tr><td></td><td></td><td>1</td></tr></table>				2		2			1	<table border="1"><tr><td>3</td><td></td><td>1</td></tr><tr><td></td><td></td><td></td></tr><tr><td>1</td><td></td><td>1</td></tr></table>	3		1				1		1	<table border="1"><tr><td></td><td></td><td></td></tr><tr><td></td><td></td><td></td></tr><tr><td></td><td></td><td></td></tr></table>										<table border="1"><tr><td></td><td></td><td></td></tr><tr><td></td><td></td><td></td></tr><tr><td></td><td></td><td>1</td></tr></table>									1	<table border="1"><tr><td></td><td></td><td></td></tr><tr><td>1</td><td></td><td></td></tr><tr><td>1</td><td></td><td></td></tr></table>				1			1			<table border="1"><tr><td>1</td><td></td><td></td></tr><tr><td></td><td></td><td>1</td></tr><tr><td>3</td><td></td><td>1</td></tr></table>	1					1	3		1	<table border="1"><tr><td></td><td></td><td></td></tr><tr><td></td><td></td><td></td></tr><tr><td></td><td></td><td></td></tr></table>									
		2																																																																													
1																																																																															
2		2																																																																													
		1																																																																													
3		1																																																																													
1		1																																																																													
		1																																																																													
1																																																																															
1																																																																															
1																																																																															
		1																																																																													
3		1																																																																													
Post - 0 Miss - 0 Block - 0	Post - 0 Miss - 0 Block - 0	Post - 0 Miss - 0 Block - 0	Post - 0 Miss - 0 Block - 0	Post - 0 Miss - 0 Block - 0	Post - 0 Miss - 0 Block - 0	Post - 0 Miss - 0 Block - 0	Post - 0 Miss - 0 Block - 0																																																																								

12 王权

0/1	1/1	1/1
1/4	1/1	0/4

16 刘迈科

2/3	0/2	4/6
1/3	0/1	0/3
1/4	1/1	2/6

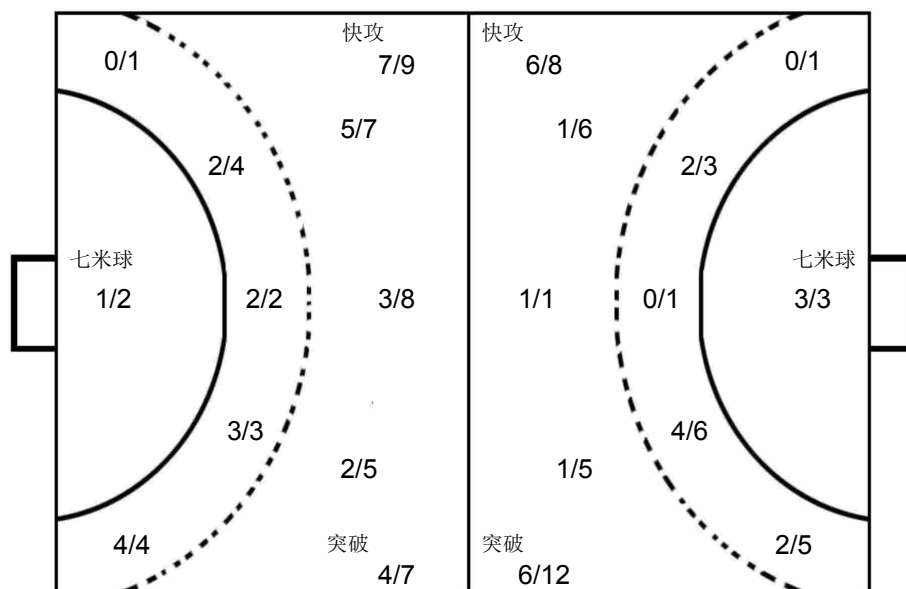

16 张帅

2/7		0/4
1/4		2/5
3/8	0/2	2/5

23 宋继强

0/1		
0/1		0/1
2/5		2/4

太平洋保险江苏男子手球俱乐部

1 陈昊	5 闫亮	7 周傲	9 许翔宇	11 张天豪	15 李安	16 张帅	17 刘赵梁																																																																								
<table border="1"><tr><td></td><td></td><td></td></tr><tr><td></td><td></td><td></td></tr><tr><td></td><td></td><td></td></tr></table>										<table border="1"><tr><td></td><td></td><td></td></tr><tr><td></td><td></td><td></td></tr><tr><td></td><td></td><td></td></tr></table>										<table border="1"><tr><td></td><td></td><td></td></tr><tr><td>2</td><td></td><td></td></tr><tr><td></td><td></td><td></td></tr></table>				2						<table border="1"><tr><td></td><td></td><td></td></tr><tr><td></td><td></td><td></td></tr><tr><td></td><td></td><td></td></tr></table>										<table border="1"><tr><td></td><td></td><td></td></tr><tr><td></td><td></td><td></td></tr><tr><td></td><td></td><td></td></tr></table>										<table border="1"><tr><td>2</td><td></td><td></td></tr><tr><td></td><td></td><td></td></tr><tr><td>2</td><td></td><td></td></tr></table>	2						2			<table border="1"><tr><td></td><td></td><td></td></tr><tr><td></td><td></td><td></td></tr><tr><td></td><td></td><td></td></tr></table>										<table border="1"><tr><td></td><td></td><td></td></tr><tr><td>1</td><td></td><td></td></tr><tr><td></td><td></td><td>1</td></tr></table>				1					1
2																																																																															
2																																																																															
2																																																																															
1																																																																															
		1																																																																													
Post - 0 Miss - 0 Block - 0	Post - 0 Miss - 0 Block - 0	Post - 0 Miss - 2 Block - 1	Post - 0 Miss - 0 Block - 0	Post - 0 Miss - 0 Block - 0	Post - 0 Miss - 0 Block - 0	Post - 0 Miss - 0 Block - 0	Post - 0 Miss - 1 Block - 0																																																																								
18 赵楠	19 庞连康	21 刘江	22 罗尧尧	23 宋继强	26 MUCZA Nobert	27 王伟强	28 SZRNKAlevente																																																																								
<table border="1"><tr><td></td><td></td><td></td></tr><tr><td></td><td></td><td>2</td></tr><tr><td>2</td><td></td><td>1</td></tr></table>						2	2		1	<table border="1"><tr><td></td><td></td><td></td></tr><tr><td></td><td></td><td></td></tr><tr><td></td><td></td><td>3</td></tr></table>									3	<table border="1"><tr><td></td><td></td><td></td></tr><tr><td>1</td><td></td><td></td></tr><tr><td></td><td></td><td>1</td></tr></table>				1					1	<table border="1"><tr><td></td><td></td><td></td></tr><tr><td></td><td></td><td></td></tr><tr><td></td><td></td><td></td></tr></table>										<table border="1"><tr><td></td><td></td><td></td></tr><tr><td></td><td></td><td></td></tr><tr><td></td><td></td><td></td></tr></table>										<table border="1"><tr><td></td><td></td><td>1</td></tr><tr><td></td><td>1</td><td>1</td></tr><tr><td></td><td></td><td></td></tr></table>			1		1	1				<table border="1"><tr><td></td><td>1</td><td>1</td></tr><tr><td></td><td></td><td></td></tr><tr><td></td><td></td><td></td></tr></table>		1	1							<table border="1"><tr><td></td><td></td><td></td></tr><tr><td></td><td></td><td>1</td></tr><tr><td></td><td></td><td>2</td></tr></table>						1			2
		2																																																																													
2		1																																																																													
		3																																																																													
1																																																																															
		1																																																																													
		1																																																																													
	1	1																																																																													
	1	1																																																																													
		1																																																																													
		2																																																																													
Post - 1 Miss - 1 Block - 0	Post - 0 Miss - 0 Block - 1	Post - 0 Miss - 1 Block - 0	Post - 0 Miss - 0 Block - 0	Post - 0 Miss - 0 Block - 0	Post - 0 Miss - 0 Block - 0	Post - 1 Miss - 0 Block - 0	Post - 1 Miss - 0 Block - 0																																																																								

Team A					Team B					Match Number											
A 北京光彩男子手球俱乐部队					B 广东路环四庙男子手球俱乐部					2											
Played in		in the hall			on		at		Spectators												
北京		北京光彩体育馆			2019-06-28		20:45		hours 1500												
Half-time(30')	A	B	End of playing time		A	B	1st extra time		A	B	After penalty throws										
	13	13	33 33								36 37										
Number of 7 m	A	Team time-out			Full name of players and officials					Team time-out			B	Number of 7 m							
	4/7	1	2	3						1	2	3	9/11								
		10:32	59:30						27:56	42:53											
No.	Team A					G	W	2'	D	DR	No.	Team B					G	W	2'	D	DR
2	解建飞										1	王帅									
7	马昌震										2	董佳辉									
8	MagyarDavid					11	1				3	曲汝洋					6				
10	MezeiRichard Bendeguz					8					4	ARPASI PATRIK					6	1			
11	赵文宣										5	曹景森									
12	高云健										6	毕晓晨					2				
13	王军鸣					4		2			7	王立隆									
14	逯明松					2	1	1			8	DOLEZSAL KAROLY					7		1		
16	孟辉										9	范保坤									
18	傅俊雄										10	周仲坤					5				
22	王超					6		1			11	房友屯					1				
25	马明辉					2					17	李中洲					7				
26	魏昂							1			18	姚雪岩					1				
27	闫炳旗					2					19	王泽润									
29	杜龙飞										21	张昌轲									
32	蒋维一					1	1				24	高玉杰					2	1	2		
A	郑永利 (主教练)										A	刘康伶 (主教练)									
B	王泷										B	郭艳辉									
C	陈璇										C	贾章志									
A	Signatures of responsables for the teams (Off.A)															B					
TP	Remarks of referees / HF Official															TP					

Signatures

Referees	许翔 (CHN)	刘禹 (CHN)		
T.D.	刘凤娟 (CHN)	郭剑 (CHN)		
CHA Off.				

Note: Number of 7m Throws Awarded to Team A and B, Goals (G), Warnings (W), Suspensions (2'), Direct Disqualification (D), Disqualification With Report (DR) and Team Penalty (TP).

Table Officials: 刘志军 赵悦 Statisticians: 谢杨 于兹香

中国男子手球超级联赛(北京)

PHMS Pictorial Handball Match Statistics

IHF Official System

个人/全队技术统计表

 手球 男子 预赛 轮次 1 组别 X 场次 2 北京光彩体育馆
 2019-06-28 20:45

号码	姓名	远射	近射	边射	快攻	突破	任意	七米	合计	%	助攻	失误	警告	2'	取消	时间
北京光彩男子手球俱乐部队(北京队)																
(场上队员)																
2	解建飞	0/1						0/2	0/3	0.0%						00:52:13
7	马昌震									0.0%	1	1				00:15:23
8	MagyarDavid	3/4	0/1		2/2	3/4	1/2	2/2	11/15	73.3%	6	6	1			01:27:56
10	MezeiRichard Be	0/2	3/3		2/2	1/1	1/1	1/1	8/10	80.0%	2	2				01:08:07
11	赵文宣									0.0%						00:00:00
12	高云健									0.0%	1					00:52:24
13	王军鸣	0/2	2/4		1/1	0/2		1/1	4/10	40.0%	2	5		2		01:07:20
14	逯明松	0/1			0/1	2/2			2/4	50.0%		1	1	1		00:21:40
16	孟辉									0.0%						00:37:36
18	傅俊雄									0.0%						00:00:00
22	王超		2/3	1/2	3/3				6/8	75.0%				1		01:00:00
25	马明辉			2/3		0/1			2/4	50.0%	2					01:00:00
26	魏昂									0.0%				1		00:00:00
27	闫炳旗		2/2						2/2	100%						00:01:15
29	杜龙飞							0/1	0/1	0.0%						00:30:00
32	蒋维一					1/1			1/1	100%	1		1			00:44:56
合计		3/10	9/13	3/5	8/9	7/11	2/3	4/7	36/58	62.1%	15	15	3	5		
(守门员)																
12	高云健	3/8	3/10	2/3	2/8	2/4	0/1	1/5	13/39	33.3%	1					00:52:24
16	孟辉	0/1	0/4		0/1			1/6	1/12	8.3%						00:37:36
合计		3/9	3/14	2/3	2/9	2/4	0/1	2/11	14/51	27.5%	1					

场上队员：得分/射门

守门员：救球/射门

全队合计	得分	被救	射失	击柱	封球	合计	%
远射	3	4	1	1	1	10	30.0%
近射	9	3		1		13	69.2%
边射	3	1		1		5	60.0%
快攻	8	1				9	88.9%
突破	7	4				11	63.6%
任意	2		1			3	66.7%
七米	4	2	1			7	57.1%

中国男子手球超级联赛(北京)

PHMS Pictorial Handball Match Statistics

IHF Official System

个人/全队技术统计表

手球 男子 预赛 轮次 1 组别 X 场次 2 北京光彩体育馆 2019-06-28 20:45

号码	姓名	远射	近射	边射	快攻	突破	任意	七米	合计	%	助攻	失误	警告	2'	取消	时间
广东路环四庙男子手球俱乐部(广东)																
(场上队员)																
1	王帅									0.0%						00:33:02
2	董佳辉									0.0%						00:00:30
3	曲汝洋	1/3	1/4	0/1	2/2	1/1		1/1	6/12	50.0%	3	2				01:08:40
4	ARPASI PATRIK	1/1	5/5						6/6	100%		2	1			00:33:16
5	曹景森									0.0%		1				00:13:07
6	毕晓晨	0/1	1/1		1/2	0/1		0/1	2/6	33.3%	1	1				01:14:57
7	王立隆									0.0%		1				00:15:01
8	DOLEZSAL KAROLY	1/2	1/1					5/5	7/8	87.5%	5	3		1		01:17:07
9	范保坤									0.0%						00:00:00
10	周仲坤	0/1	1/2	0/2		0/1	1/1	3/3	5/10	50.0%	1	2				01:14:03
11	房友屯	0/1	1/1						1/2	50.0%						00:13:03
17	李中洲	2/4	1/1		3/3	1/1		0/1	7/10	70.0%		3				01:04:47
18	姚雪岩	1/4	0/1						1/5	20.0%		1				00:29:18
19	王泽润									0.0%		1				00:56:58
21	张昌轲	0/1			0/1				0/2	0.0%						00:07:17
24	高玉杰			1/1	1/2				2/3	66.7%	1		1	2		00:38:52
合计		6/18	11/16	1/4	7/10	2/4	1/1	9/11	37/64	57.8%	11	17	2	3		

(守门员)

1	王帅	2/5	2/8	1/3	0/4	3/4	0/2	0/4	8/30	26.7%						00:33:02
19	王泽润	2/2	1/4	0/1	1/5	1/7		2/2	7/21	33.3%		1				00:56:58
合计		4/7	3/12	1/4	1/9	4/11	0/2	2/6	15/51	29.4%		1				

场上队员：得分/射门

守门员：救球/射门

全队合计	得分	被救	射失	击柱	封球	合计	%
远射	6	3	2		7	18	33.3%
近射	11	3			2	16	68.8%
边射	1	2		1		4	25.0%
快攻	7	2	1			10	70.0%
突破	2	2				4	50.0%
任意	1					1	100.0%
七米	9	2				11	81.8%

中国男子手球超级联赛(北京)

PHMS Pictorial Handball Match Statistics

IHF Official System

图式比赛技术统计表

手球
男子

预赛
轮次 1

组别 X
场次 2

北京光彩体育馆
2019-06-28 20:45

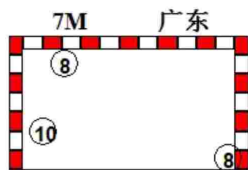
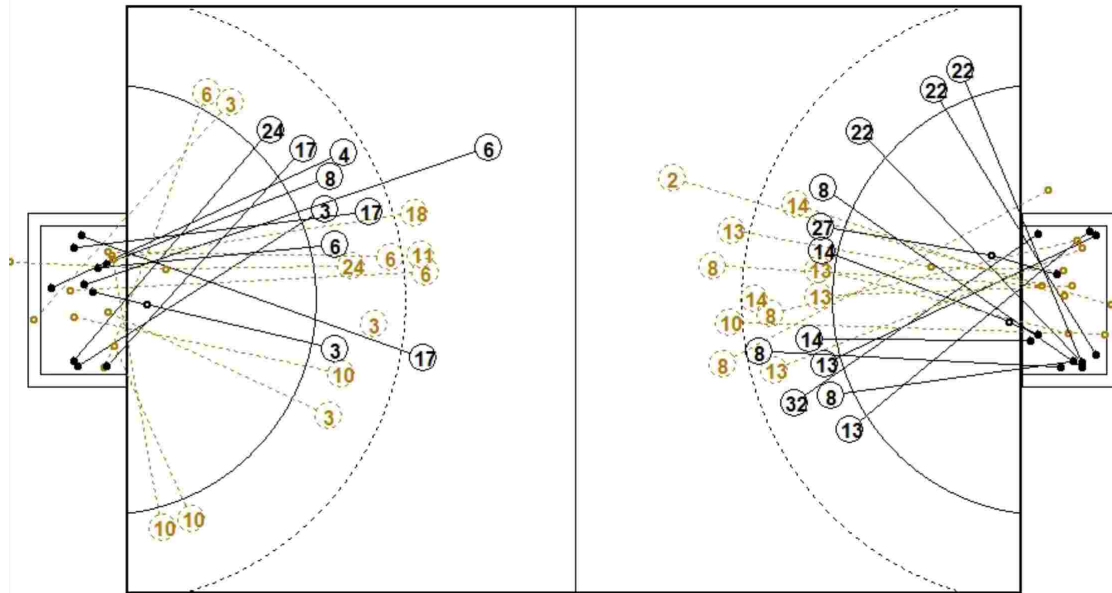

1st Half
13 : 13

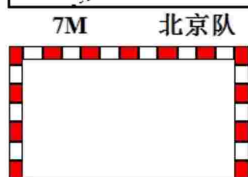
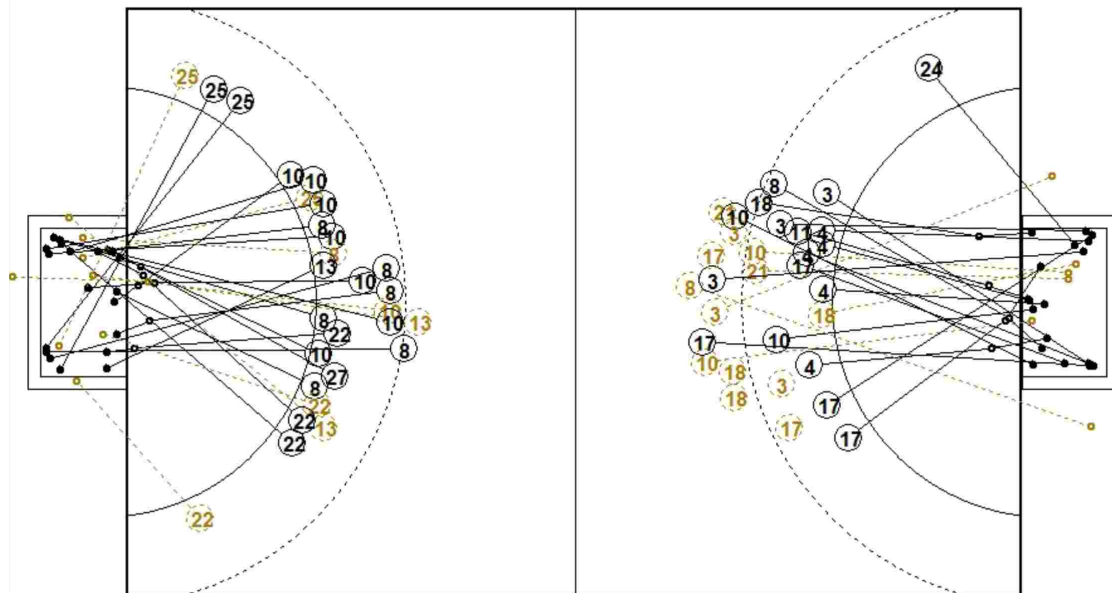
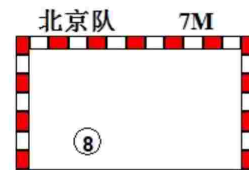

2nd Half
33 : 33

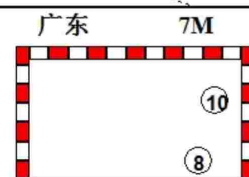

中国男子手球超级联赛(北京)

PHMS Pictorial Handball Match Statistics

IHF OFFICIAL System

PICTORIAL MATCH STATISTICS

HANDBALL
男子

预赛
ROUND 1

GROUP X
MATCH 2

北京光彩体育馆
2019-06-28 20:45

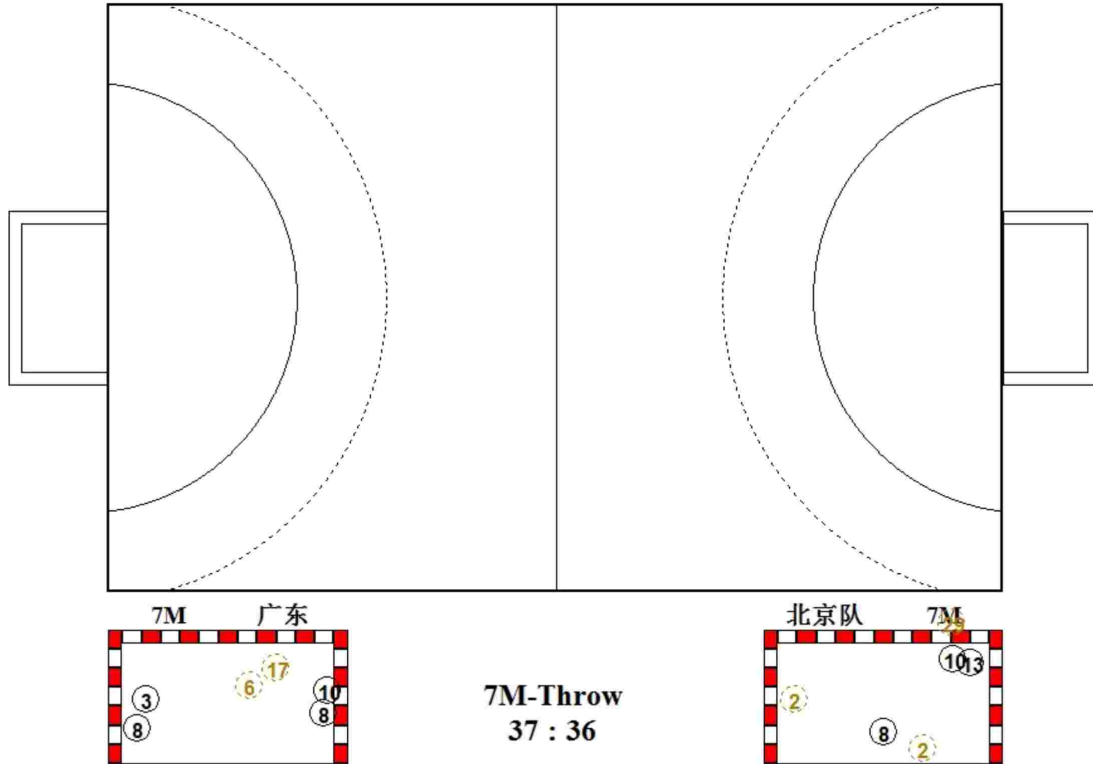

中国男子手球超级联赛(北京)

PHMS Pictorial Handball Match Statistics

IHF Official System

图式射门区域统计

手球
男子

预赛
轮次 1

组别 X
场次 2

北京光彩体育馆
2019-06-28 20:45

北京光彩男子手球俱乐部队

2 解建飞 <table border="1"><tr><td></td><td></td><td></td></tr><tr><td></td><td></td><td></td></tr><tr><td></td><td></td><td></td></tr></table> Post - 1 Miss - 0 Block - 0										7 马昌震 <table border="1"><tr><td></td><td></td><td></td></tr><tr><td></td><td></td><td></td></tr><tr><td></td><td></td><td></td></tr></table> Post - 0 Miss - 0 Block - 0										8 MagyarDavid <table border="1"><tr><td>2</td><td></td><td>2</td></tr><tr><td></td><td></td><td>2</td></tr><tr><td>2</td><td>2</td><td>1</td></tr></table> Post - 0 Miss - 1 Block - 0	2		2			2	2	2	1	10 MezeiRichard Be <table border="1"><tr><td></td><td></td><td>5</td></tr><tr><td></td><td>1</td><td></td></tr><tr><td></td><td>1</td><td>1</td></tr></table> Post - 0 Miss - 0 Block - 0			5		1			1	1	11 赵文宣 <table border="1"><tr><td></td><td></td><td></td></tr><tr><td></td><td></td><td></td></tr><tr><td></td><td></td><td></td></tr></table> Post - 0 Miss - 0 Block - 0										12 高云健 <table border="1"><tr><td></td><td></td><td></td></tr><tr><td></td><td></td><td></td></tr><tr><td></td><td></td><td></td></tr></table> Post - 0 Miss - 0 Block - 0										13 王军鸣 <table border="1"><tr><td>2</td><td></td><td>1</td></tr><tr><td></td><td></td><td></td></tr><tr><td>1</td><td></td><td></td></tr></table> Post - 1 Miss - 1 Block - 0	2		1				1			14 逯明松 <table border="1"><tr><td></td><td></td><td></td></tr><tr><td></td><td></td><td></td></tr><tr><td></td><td></td><td>2</td></tr></table> Post - 0 Miss - 0 Block - 1									2
2		2																																																																													
		2																																																																													
2	2	1																																																																													
		5																																																																													
	1																																																																														
	1	1																																																																													
2		1																																																																													
1																																																																															
		2																																																																													
16 孟辉 <table border="1"><tr><td></td><td></td><td></td></tr><tr><td></td><td></td><td></td></tr><tr><td></td><td></td><td></td></tr></table> Post - 0 Miss - 0 Block - 0										18 傅俊雄 <table border="1"><tr><td></td><td></td><td></td></tr><tr><td></td><td></td><td></td></tr><tr><td></td><td></td><td></td></tr></table> Post - 0 Miss - 0 Block - 0										22 王超 <table border="1"><tr><td></td><td></td><td>4</td></tr><tr><td></td><td></td><td>1</td></tr><tr><td>1</td><td></td><td></td></tr></table> Post - 1 Miss - 0 Block - 0			4			1	1			25 马明辉 <table border="1"><tr><td>2</td><td></td><td></td></tr><tr><td></td><td></td><td></td></tr><tr><td></td><td></td><td></td></tr></table> Post - 0 Miss - 0 Block - 0	2									26 魏昂 <table border="1"><tr><td></td><td></td><td></td></tr><tr><td></td><td></td><td></td></tr><tr><td></td><td></td><td></td></tr></table> Post - 0 Miss - 0 Block - 0										27 闫炳旗 <table border="1"><tr><td></td><td></td><td></td></tr><tr><td></td><td>1</td><td></td></tr><tr><td></td><td></td><td>1</td></tr></table> Post - 0 Miss - 0 Block - 0					1				1	29 杜龙飞 <table border="1"><tr><td></td><td></td><td></td></tr><tr><td></td><td></td><td></td></tr><tr><td></td><td></td><td></td></tr></table> Post - 0 Miss - 1 Block - 0										32 蒋维一 <table border="1"><tr><td></td><td></td><td></td></tr><tr><td></td><td></td><td></td></tr><tr><td>1</td><td></td><td></td></tr></table> Post - 0 Miss - 0 Block - 0							1		
		4																																																																													
		1																																																																													
1																																																																															
2																																																																															
	1																																																																														
		1																																																																													
1																																																																															

12 高云健

0/4	1/2	1/4
2/6	2/4	0/3
2/4	2/5	3/7

16 孟辉

0/1	1/1	0/2
0/2		0/2
0/1	0/1	0/2

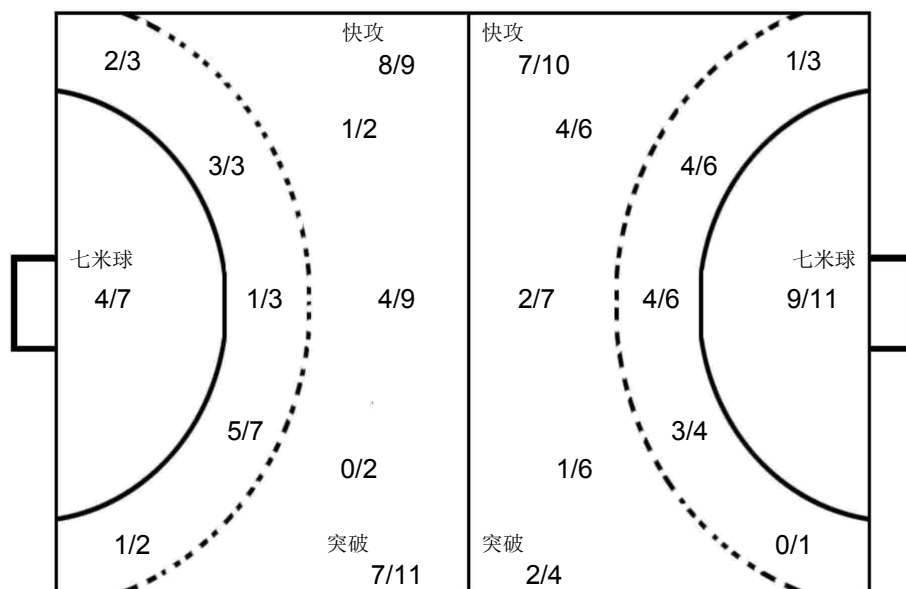

1 王帅

2/6		0/8
	1/3	3/5
1/4	1/3	0/1

19 王泽润

1/3		1/5
2/2	1/1	1/2
0/2	1/2	0/4

广东路环四庙男子手球俱乐部

1 王帅 <table border="1"><tr><td></td><td></td><td></td></tr><tr><td></td><td></td><td></td></tr><tr><td></td><td></td><td></td></tr></table> Post - 0 Miss - 0 Block - 0										2 董佳辉 <table border="1"><tr><td></td><td></td><td></td></tr><tr><td></td><td></td><td></td></tr><tr><td></td><td></td><td></td></tr></table> Post - 0 Miss - 0 Block - 0										3 曲汝洋 <table border="1"><tr><td>2</td><td></td><td>1</td></tr><tr><td>2</td><td>1</td><td></td></tr><tr><td></td><td></td><td></td></tr></table> Post - 1 Miss - 1 Block - 3	2		1	2	1					4 ARPASI PATRIK <table border="1"><tr><td>1</td><td>1</td><td>1</td></tr><tr><td></td><td></td><td></td></tr><tr><td></td><td>2</td><td>1</td></tr></table> Post - 0 Miss - 0 Block - 0	1	1	1					2	1	5 曹景森 <table border="1"><tr><td></td><td></td><td></td></tr><tr><td></td><td></td><td></td></tr><tr><td></td><td></td><td></td></tr></table> Post - 0 Miss - 0 Block - 0										6 毕晓晨 <table border="1"><tr><td></td><td></td><td></td></tr><tr><td></td><td>1</td><td>1</td></tr><tr><td></td><td></td><td></td></tr></table> Post - 0 Miss - 0 Block - 0					1	1				7 王立隆 <table border="1"><tr><td></td><td></td><td></td></tr><tr><td></td><td></td><td></td></tr><tr><td></td><td></td><td></td></tr></table> Post - 0 Miss - 0 Block - 0										8 DOLEZSAL KAROLY <table border="1"><tr><td>1</td><td></td><td></td></tr><tr><td>1</td><td></td><td>1</td></tr><tr><td></td><td></td><td>4</td></tr></table> Post - 0 Miss - 1 Block - 0	1			1		1			4
2		1																																																																													
2	1																																																																														
1	1	1																																																																													
	2	1																																																																													
	1	1																																																																													
1																																																																															
1		1																																																																													
		4																																																																													
9 范保坤 <table border="1"><tr><td></td><td></td><td></td></tr><tr><td></td><td></td><td></td></tr><tr><td></td><td></td><td></td></tr></table> Post - 0 Miss - 0 Block - 0										10 周仲坤 <table border="1"><tr><td></td><td></td><td>2</td></tr><tr><td>1</td><td></td><td></td></tr><tr><td></td><td>1</td><td>1</td></tr></table> Post - 0 Miss - 0 Block - 0			2	1				1	1	11 房友屯 <table border="1"><tr><td></td><td></td><td></td></tr><tr><td></td><td></td><td></td></tr><tr><td></td><td>1</td><td></td></tr></table> Post - 0 Miss - 0 Block - 1								1		17 李中洲 <table border="1"><tr><td>1</td><td></td><td>1</td></tr><tr><td></td><td></td><td>3</td></tr><tr><td>2</td><td></td><td></td></tr></table> Post - 0 Miss - 0 Block - 2	1		1			3	2			18 姚雪岩 <table border="1"><tr><td></td><td></td><td></td></tr><tr><td>1</td><td></td><td></td></tr><tr><td></td><td></td><td></td></tr></table> Post - 0 Miss - 0 Block - 2				1						19 王泽润 <table border="1"><tr><td></td><td></td><td></td></tr><tr><td></td><td></td><td></td></tr><tr><td></td><td></td><td></td></tr></table> Post - 0 Miss - 0 Block - 0										21 张昌轲 <table border="1"><tr><td></td><td></td><td></td></tr><tr><td></td><td></td><td></td></tr><tr><td></td><td></td><td></td></tr></table> Post - 0 Miss - 0 Block - 1										24 高玉杰 <table border="1"><tr><td></td><td></td><td></td></tr><tr><td>2</td><td></td><td></td></tr><tr><td></td><td></td><td></td></tr></table> Post - 0 Miss - 1 Block - 0				2					
		2																																																																													
1																																																																															
	1	1																																																																													
	1																																																																														
1		1																																																																													
		3																																																																													
2																																																																															
1																																																																															
2																																																																															



Team A					Team B					Match Number											
A 太平洋保险江苏男子手球俱乐部					B 广东路环四庙男子手球俱乐部					3											
Played in			in the hall			on			at			Spectators									
北京			北京光彩体育馆			2019-06-29			19:00			hours 1000									
Half-time(30')	A	B	End of playing time		A	B	1st extra time		A	B	2nd extra time		A	B	After penalty throws						
	14	8	32	23																	
Number of 7 m	A	Team time-out			Full name of players and officials						Team time-out			B	Number of 7 m						
	2/4	1	2	3							1	2	3	4/5							
		21:05	49:56	55:19				05:20	42:19	45:03											
No.	Team A					G	W	2'	D	DR	No.	Team B					G	W	2'	D	DR
1	陈昊										1	王帅									
5	闫亮										2	董佳辉									
7	周傲					1					3	曲汝洋					1				
9	许翔宇					1					4	ARPASI PATRIK					1	1			
11	张天豪					2					5	曹景森									
15	李安					2					6	毕晓晨					1				
16	张帅										7	王立隆					4				
17	刘赵梁					6					8	DOLEZSAL KAROLY					1		1		
18	赵楠					3	1				9	范保坤									
19	庞连康					2					10	周仲坤					11				
21	刘江					1					11	房友屯							1		
22	罗尧尧										17	李中洲					2				
23	宋继强										18	姚雪岩					1				
26	MUCZA Nobert					6					19	王泽润									
27	王伟强					4	1	2			21	张昌轲									
28	SZRNKAlevente					4	1	1			24	高玉杰					1				
A	闫威名 (主教练)										A	刘康伶 (主教练)									
B	叶强										B	郭艳辉									
C	雷纳德										C	贾章志									
D	王建国																				
A	Signatures of responsables for the teams (Off.A)															B					
TP	Remarks of referees / HF Official															TP					

Signatures

Referees	李兆蒙 (CHN)	程钰峰 (CHN)		
T.D.	吴瑞亭 (CHN)	刘凤娟 (CHN)		
CHA Off.				

Note: Number of 7m Throws Awarded to Team A and B, Goals (G), Warnings (W), Suspensions (2'), Direct Disqualification (D), Disqualification With Report (DR) and Team Penalty (TP).

Table Officials: 赵悦 刘志军 Statisticians: 于兹香 谢杨

中国男子手球超级联赛(北京)

PHMS Pictorial Handball Match Statistics

IHF Official System

竞赛技术统计

手球
男子

预赛
轮次 2

组别 X
场次 3

北京光彩体育馆
2019-06-29 19:00

Referees: 李兆蒙 (CHN) / 程钰峰 (CHN)

Result: 32:23 (14:8)

Teams: 太平洋保险江苏男子手球俱乐部(江苏) VS 广东路环四庙男子手球俱乐部(广东)

江苏		远	近	边	快	突	任意	7m	合计	%	助攻	失误	警告	2'	D+DR
主教练: 闫威名		射	射	射	攻	破	球	球							
1	陈昊														
5	闫亮														
7	周傲	0/2		0/1	0/1	1/1			1/5	20.0	1	2			
9	许翔宇		0/1			1/1			1/2	50.0		1			
11	张天豪			2/2					2/2	100					
15	李安							2/4	2/4	50.0					
16	张帅										1				
17	刘赵梁		0/2	1/1	2/3	3/3			6/9	66.7	2				
18	赵楠	0/2	3/3	0/1					3/6	50.0	1		1		
19	庞连康	0/1			1/1	1/2			2/4	50.0	1	2			
21	刘江		1/1						1/1	100	1	2			
22	罗尧尧			0/1					0/1	0.0	2				
23	宋继强														
26	MUCZA Nobert	3/5			3/5				6/10	60.0	2	3			
27	王伟强			2/2	2/3				4/5	80.0	1		1	2	
28	SZRNKALEvente		3/4		1/1		0/1		4/6	66.7			1	1	
运动员 合计		3/10	7/11	5/8	9/14	6/7	0/1	2/4	32/55	58.2	12	10	3	3	
1	陈昊	0/3			0/1			0/2	0/6	0.0					
16	张帅	10/13	1/5	3/3	2/8	0/2	1/1	0/2	17/34	50.0	1				
守门员 合计		10/16	1/5	3/3	2/9	0/2	1/1	0/4	17/40	42.5	1				

广东		远	近	边	快	突	任意	7m	合计	%	助攻	失误	警告	2'	D+DR
主教练: 刘康伶		射	射	射	攻	破	球	球							
1	王帅											1			
2	董佳辉														
3	曲汝洋	1/4					0/1		1/5	20.0	4	1			
4	ARPASI PATRIK		1/2						1/2	50.0		1	1		
5	曹景森											1			
6	毕晓晨			0/3	1/1				1/4	25.0		1			
7	王立隆				4/5				4/5	80.0	1	1			
8	DOLEZSAL KAROLY	0/5				1/1		0/1	1/7	14.3		1		1	
9	范保坤														
10	周仲坤	4/8	2/2	0/1	1/1			4/4	11/16	68.8		4			
11	房友屯	0/1							0/1	0.0		1		1	
17	李中洲	1/4			1/1				2/5	40.0	1	3			
18	姚雪岩	0/2				1/1			1/3	33.3					
19	王泽润														
21	张昌轲														
24	高玉杰		1/1		0/1				1/2	50.0	2	1			
运动员 合计		6/24	4/5	0/4	7/9	2/2	0/1	4/5	23/50	46.0	8	16	1	2	
1	王帅	3/5	2/6	1/1	2/9	1/3		0/1	9/25	36.0		1			
19	王泽润	0/1	1/4	0/5	2/4	0/4		1/2	4/20	20.0					
守门员 合计		3/6	3/10	1/6	4/13	1/7		1/3	13/45	28.9		1			

江苏	比赛进程	广东
1st Half		
26 MUCZA Nober	1 00:42	0
17 刘赵梁	2 02:15	0
17 刘赵梁	3 05:16	0
	3 05:32	1 李中洲
27 王伟强	4 05:45	1
	4 07:02	2 7 王立隆
19 庞连康	5 07:33	2
26 MUCZA Nober	6 09:54	2
	6 11:39	3 4 ARPASI PATR
	6 11:58	4 7 王立隆
	6 16:01	5 10 周仲坤
18 赵楠	7 17:03	5
17 刘赵梁	8 19:03	5
28 SZRNKAleven	9 19:44	5
	9 20:28	6 10 周仲坤
17 刘赵梁	10 22:12	6
15 李安	11 23:31	6
	11 25:22	7 7 王立隆
	11 27:05	8 18 姚雪岩
19 庞连康	12 28:42	8
27 王伟强	13 29:30	8
27 王伟强	14 29:58	8
2nd Half		
26 MUCZA Nober	15 00:28	8
28 SZRNKAleven	16 01:47	8
26 MUCZA Nober	17 02:12	8
	17 02:44	9 10 周仲坤
28 SZRNKAleven	18 03:18	9
	18 03:46	10 10 周仲坤
	18 05:18	11 6 毕晓晨
18 赵楠	19 06:06	11
	19 06:30	12 10 周仲坤
17 刘赵梁	20 08:21	12
26 MUCZA Nober	21 09:45	12
27 王伟强	22 10:44	12
15 李安	23 12:13	12
	23 12:40	13 3 曲汝洋
17 刘赵梁	24 12:57	13
	24 13:10	14 8 DOLEZSAL KA
26 MUCZA Nober	25 14:22	14
28 SZRNKAleven	26 16:11	15
	26 17:19	16 24 高玉杰
11 张天豪	27 17:59	16
	27 20:21	17 10 周仲坤
18 赵楠	28 20:49	17
	28 21:19	18 10 周仲坤
	28 21:49	19 10 周仲坤
21 刘江	29 22:42	19
	29 22:46	20 10 周仲坤
	29 23:37	21 7 王立隆
7 周傲	30 24:38	21
11 张天豪	31 25:55	21
	31 26:42	22 10 周仲坤
	31 27:48	23 10 周仲坤
9 许翔宇	32 28:45	23

场上队员: 得分 / 射门

守门员: 救球 / 射门

D	取消资格	DR	取消资格+报告
---	------	----	---------

中国男子手球超级联赛(北京)

PHMS Pictorial Handball Match Statistics

IHF Official System

个人/全队技术统计表

手球 男子 预赛 轮次 2 组别 X 场次 3 北京光彩体育馆 2019-06-29 19:00

号码	姓名	远射	近射	边射	快攻	突破	任意	七米	合计	%	助攻	失误	警告	2'	取消	时间
太平洋保险江苏男子手球俱乐部(江苏)																
(场上队员)																
1	陈昊									0.0%						00:06:27
5	闫亮									0.0%						00:21:16
7	周傲	0/2		0/1	0/1	1/1			1/5	20.0%	1	2				00:17:12
9	许翔宇		0/1			1/1			1/2	50.0%		1				00:09:31
11	张天豪			2/2					2/2	100%						00:13:23
15	李安							2/4	2/4	50.0%						00:05:16
16	张帅									0.0%	1					00:53:33
17	刘赵梁		0/2	1/1	2/3	3/3			6/9	66.7%	2					00:46:23
18	赵楠	0/2	3/3	0/1					3/6	50.0%	1		1			00:52:23
19	庞连康	0/1			1/1	1/2			2/4	50.0%	1	2				00:26:10
21	刘江		1/1						1/1	100%	1	2				00:16:24
22	罗尧尧			0/1					0/1	0.0%	2					00:13:03
23	宋继强									0.0%						00:00:00
26	MUCZA Nobert	3/5			3/5				6/10	60.0%	2	3				00:40:36
27	王伟强			2/2	2/3				4/5	80.0%	1		1	2		00:46:36
28	SZRNKAlvente		3/4		1/1		0/1		4/6	66.7%			1	1		00:50:32
合计		3/10	7/11	5/8	9/14	6/7	0/1	2/4	32/55	58.2%	12	10	3	3		

(守门员)

1	陈昊	0/3			0/1			0/2	0/6	0.0%						00:06:27
16	张帅	10/13	1/5	3/3	2/8	0/2	1/1	0/2	17/34	50.0%	1					00:53:33
合计		10/16	1/5	3/3	2/9	0/2	1/1	0/4	17/40	42.5%	1					

场上队员：得分/射门

守门员：救球/射门

全队合计	得分	被救	射失	击柱	封球	合计	%
远射	3	3	3	1		10	30.0%
近射	7	3			1	11	63.6%
边射	5	1	2			8	62.5%
快攻	9	4	1			14	64.3%
突破	6	1				7	85.7%
任意			1			1	0.0%
七米	2	1		1		4	50.0%

中国男子手球超级联赛(北京)

PHMS Pictorial Handball Match Statistics

IHF Official System

个人/全队技术统计表

手球 男子 预赛 轮次 2 组别 X 场次 3 北京光彩体育馆 2019-06-29 19:00

号码	姓名	远射	近射	边射	快攻	突破	任意	七米	合计	%	助攻	失误	警告	2'	取消	时间
广东路环四庙男子手球俱乐部(广东)																
(场上队员)																
1	王帅									0.0%		1				00:32:03
2	董佳辉									0.0%						00:00:00
3	曲汝洋	1/4				0/1			1/5	20.0%	4	1				00:24:20
4	ARPASI PATRIK		1/2						1/2	50.0%		1	1			00:44:00
5	曹景森									0.0%		1				00:10:31
6	毕晓晨			0/3	1/1				1/4	25.0%		1				00:12:19
7	王立隆				4/5				4/5	80.0%	1	1				00:47:08
8	DOLEZSAL KAROLY	0/5				1/1		0/1	1/7	14.3%		1		1		00:45:17
9	范保坤									0.0%						00:00:00
10	周仲坤	4/8	2/2	0/1	1/1			4/4	11/16	68.8%		4				00:53:37
11	房友屯	0/1							0/1	0.0%		1		1		00:19:08
17	李中洲	1/4			1/1				2/5	40.0%	1	3				00:31:07
18	姚雪岩	0/2				1/1			1/3	33.3%						00:17:55
19	王泽润									0.0%						00:27:57
21	张昌轲									0.0%						00:00:00
24	高玉杰		1/1		0/1				1/2	50.0%	2	1				00:53:23
合计		6/24	4/5	0/4	7/9	2/2	0/1	4/5	23/50	46.0%	8	16	1	2		
(守门员)																
1	王帅	3/5	2/6	1/1	2/9	1/3		0/1	9/25	36.0%		1				00:32:03
19	王泽润	0/1	1/4	0/5	2/4	0/4		1/2	4/20	20.0%						00:27:57
合计		3/6	3/10	1/6	4/13	1/7		1/3	13/45	28.9%		1				

场上队员：得分/射门

守门员：救球/射门

全队合计	得分	被救	射失	击柱	封球	合计	%
远射	6	10	3	1	4	24	25.0%
近射	4	1				5	80.0%
边射		3	1			4	0.0%
快攻	7	2				9	77.8%
突破	2					2	100.0%
任意		1				1	0.0%
七米	4		1			5	80.0%

中国男子手球超级联赛(北京)

PHMS Pictorial Handball Match Statistics

IHF Official System

图式比赛技术统计表

手球
男子

预赛
轮次 2

组别 X
场次 3

北京光彩体育馆
2019-06-29 19:00

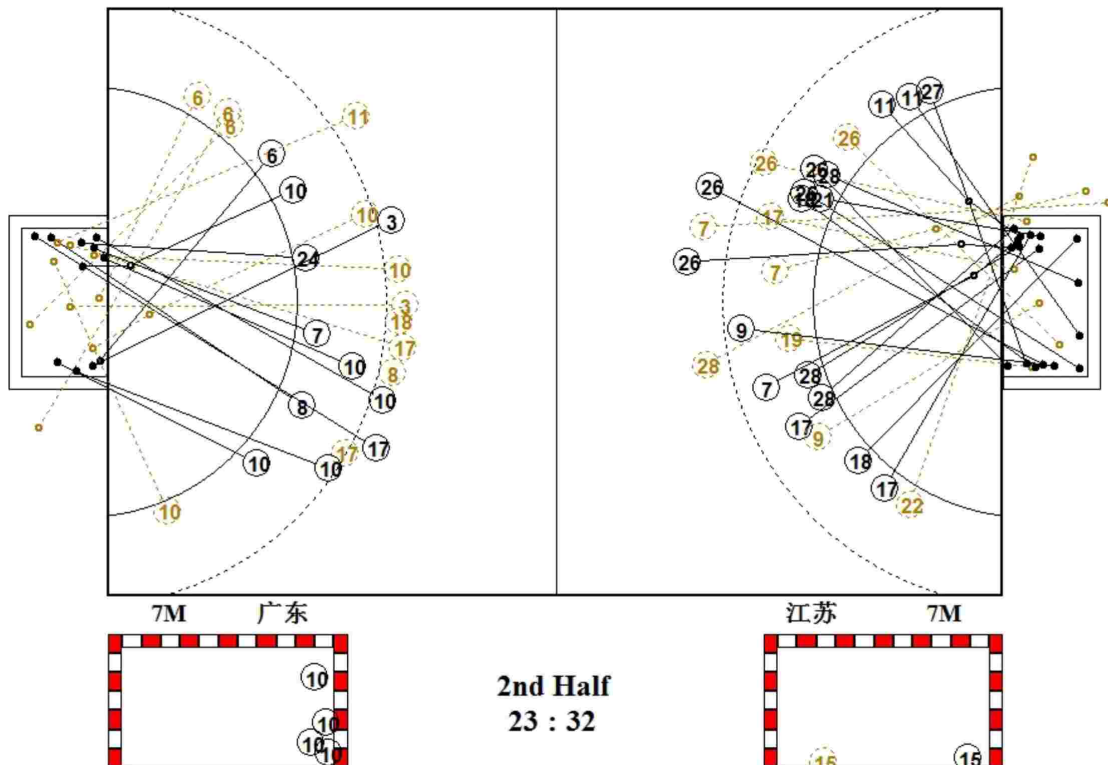
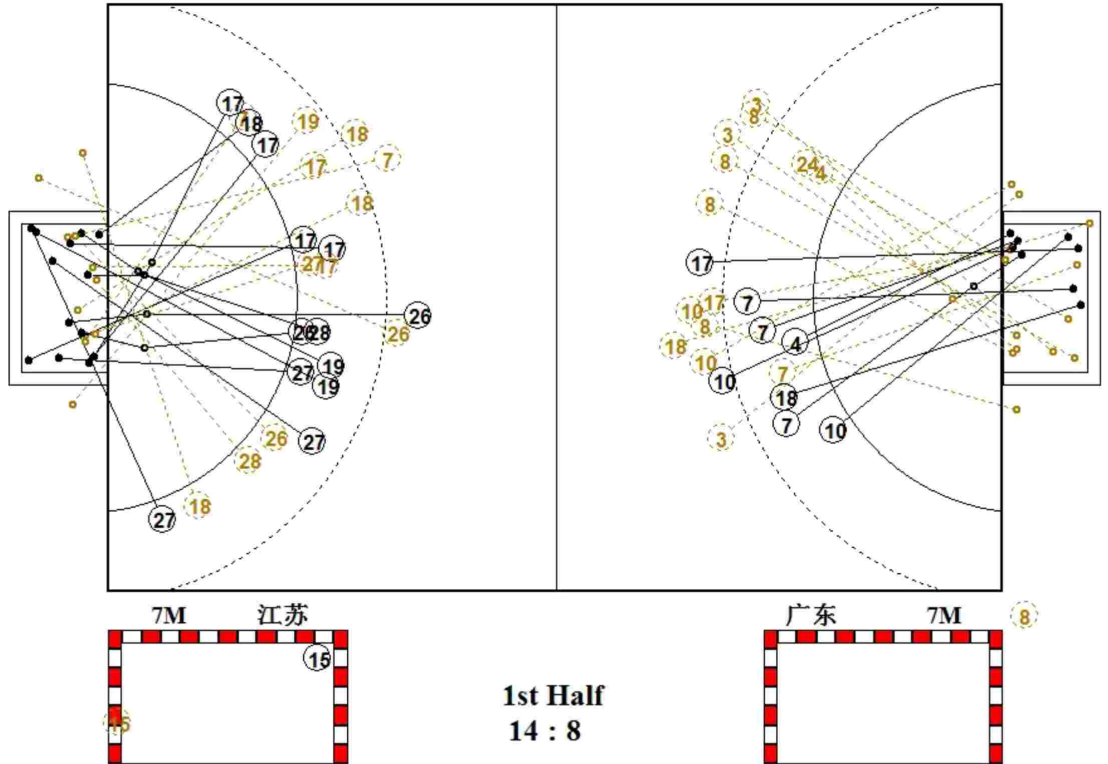

中国男子手球超级联赛(北京)

PHMS Pictorial Handball Match Statistics

IHF Official System

图式射门区域统计

手球
男子

预赛
轮次 2

组别 X
场次 3

北京光彩体育馆
2019-06-29 19:00

太平洋保险江苏男子手球俱乐部

1 陈昊 <table border="1"><tr><td></td><td></td><td></td></tr><tr><td></td><td></td><td></td></tr><tr><td></td><td></td><td></td></tr></table> Post - 0 Miss - 0 Block - 0										5 闫亮 <table border="1"><tr><td></td><td></td><td></td></tr><tr><td></td><td></td><td></td></tr><tr><td></td><td></td><td></td></tr></table> Post - 0 Miss - 0 Block - 0										7 周傲 <table border="1"><tr><td></td><td></td><td></td></tr><tr><td></td><td></td><td></td></tr><tr><td>1</td><td></td><td></td></tr></table> Post - 0 Miss - 2 Block - 0							1			9 许翔宇 <table border="1"><tr><td></td><td></td><td></td></tr><tr><td></td><td></td><td>1</td></tr><tr><td></td><td></td><td></td></tr></table> Post - 0 Miss - 0 Block - 0						1				11 张天豪 <table border="1"><tr><td></td><td></td><td>1</td></tr><tr><td></td><td></td><td></td></tr><tr><td>1</td><td></td><td></td></tr></table> Post - 0 Miss - 0 Block - 0			1				1			15 李安 <table border="1"><tr><td></td><td></td><td>1</td></tr><tr><td></td><td></td><td></td></tr><tr><td></td><td></td><td>1</td></tr></table> Post - 1 Miss - 0 Block - 0			1						1	16 张帅 <table border="1"><tr><td></td><td></td><td></td></tr><tr><td></td><td></td><td></td></tr><tr><td></td><td></td><td></td></tr></table> Post - 0 Miss - 0 Block - 0										17 刘赵梁 <table border="1"><tr><td>1</td><td></td><td></td></tr><tr><td>2</td><td></td><td>1</td></tr><tr><td>2</td><td></td><td></td></tr></table> Post - 0 Miss - 0 Block - 1	1			2		1	2		
1																																																																															
		1																																																																													
		1																																																																													
1																																																																															
		1																																																																													
		1																																																																													
1																																																																															
2		1																																																																													
2																																																																															
18 赵楠 <table border="1"><tr><td>1</td><td></td><td></td></tr><tr><td></td><td></td><td>1</td></tr><tr><td></td><td></td><td>1</td></tr></table> Post - 0 Miss - 1 Block - 0	1					1			1	19 庞连康 <table border="1"><tr><td></td><td></td><td>1</td></tr><tr><td></td><td></td><td></td></tr><tr><td></td><td></td><td>1</td></tr></table> Post - 0 Miss - 1 Block - 0			1						1	21 刘江 <table border="1"><tr><td></td><td></td><td></td></tr><tr><td>1</td><td></td><td></td></tr><tr><td></td><td></td><td></td></tr></table> Post - 0 Miss - 0 Block - 0				1						22 罗尧尧 <table border="1"><tr><td></td><td></td><td></td></tr><tr><td></td><td></td><td></td></tr><tr><td></td><td></td><td></td></tr></table> Post - 0 Miss - 1 Block - 0										23 宋继强 <table border="1"><tr><td></td><td></td><td></td></tr><tr><td></td><td></td><td></td></tr><tr><td></td><td></td><td></td></tr></table> Post - 0 Miss - 0 Block - 0										26 MUCZA Nobert <table border="1"><tr><td></td><td></td><td>1</td></tr><tr><td></td><td>1</td><td>1</td></tr><tr><td>2</td><td></td><td>1</td></tr></table> Post - 1 Miss - 1 Block - 0			1		1	1	2		1	27 王伟强 <table border="1"><tr><td></td><td></td><td>1</td></tr><tr><td>1</td><td></td><td>1</td></tr><tr><td></td><td></td><td>1</td></tr></table> Post - 0 Miss - 0 Block - 0			1	1		1			1	28 SZRNKAlevente <table border="1"><tr><td></td><td>1</td><td></td></tr><tr><td></td><td></td><td></td></tr><tr><td>2</td><td>1</td><td></td></tr></table> Post - 0 Miss - 1 Block - 0		1					2	1	
1																																																																															
		1																																																																													
		1																																																																													
		1																																																																													
		1																																																																													
1																																																																															
		1																																																																													
	1	1																																																																													
2		1																																																																													
		1																																																																													
1		1																																																																													
		1																																																																													
	1																																																																														
2	1																																																																														

1 陈昊

0/1		0/1
		0/4

16 张帅

1/3	2/4	1/4
0/1	1/1	4/4
3/9	1/1	4/7

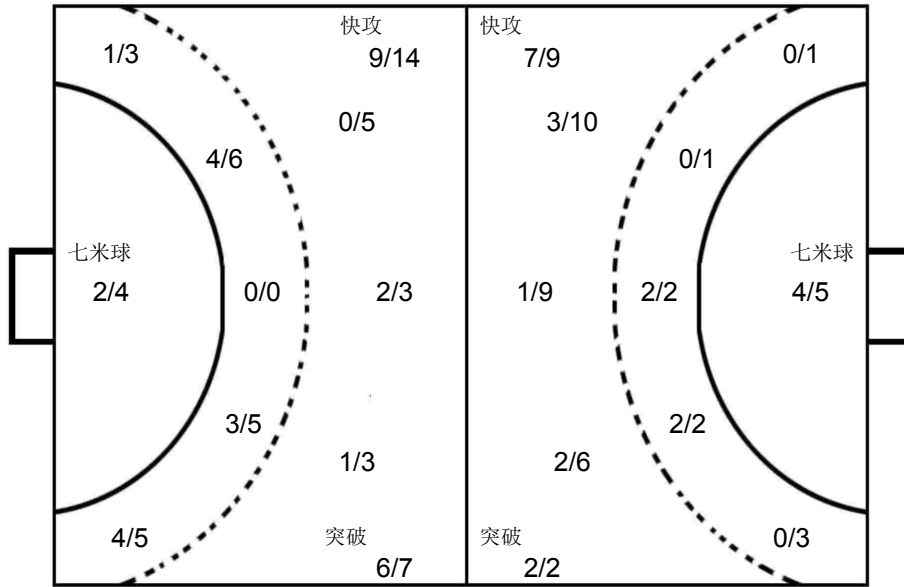

1 王帅

0/1		0/3
0/2	1/1	2/6
4/8	1/2	1/2

19 王泽润

0/1	0/1	1/3
0/2	1/2	1/2
1/5		0/4

广东路环四庙男子手球俱乐部

1 王帅 <table border="1"><tr><td></td><td></td><td></td></tr><tr><td></td><td></td><td></td></tr><tr><td></td><td></td><td></td></tr></table> Post - 0 Miss - 0 Block - 0										2 董佳辉 <table border="1"><tr><td></td><td></td><td></td></tr><tr><td></td><td></td><td></td></tr><tr><td></td><td></td><td></td></tr></table> Post - 0 Miss - 0 Block - 0										3 曲汝洋 <table border="1"><tr><td></td><td></td><td></td></tr><tr><td></td><td></td><td></td></tr><tr><td>1</td><td></td><td></td></tr></table> Post - 0 Miss - 1 Block - 0							1			4 ARPASI PATRIK <table border="1"><tr><td></td><td></td><td></td></tr><tr><td></td><td></td><td></td></tr><tr><td>1</td><td></td><td></td></tr></table> Post - 0 Miss - 0 Block - 0							1			5 曹景森 <table border="1"><tr><td></td><td></td><td></td></tr><tr><td></td><td></td><td></td></tr><tr><td></td><td></td><td></td></tr></table> Post - 0 Miss - 0 Block - 0										6 毕晓晨 <table border="1"><tr><td></td><td></td><td></td></tr><tr><td></td><td></td><td></td></tr><tr><td>1</td><td></td><td></td></tr></table> Post - 0 Miss - 1 Block - 0							1			7 王立隆 <table border="1"><tr><td></td><td>1</td><td></td></tr><tr><td>2</td><td></td><td>1</td></tr><tr><td></td><td></td><td></td></tr></table> Post - 0 Miss - 0 Block - 0		1		2		1				8 DOLEZSAL KAROLY <table border="1"><tr><td></td><td></td><td>1</td></tr><tr><td></td><td></td><td></td></tr><tr><td></td><td></td><td></td></tr></table> Post - 0 Miss - 2 Block - 1			1						
1																																																																															
1																																																																															
1																																																																															
	1																																																																														
2		1																																																																													
		1																																																																													
9 范保坤 <table border="1"><tr><td></td><td></td><td></td></tr><tr><td></td><td></td><td></td></tr><tr><td></td><td></td><td></td></tr></table> Post - 0 Miss - 0 Block - 0										10 周仲坤 <table border="1"><tr><td>1</td><td></td><td>1</td></tr><tr><td>2</td><td></td><td>1</td></tr><tr><td>1</td><td></td><td>5</td></tr></table> Post - 0 Miss - 1 Block - 1	1		1	2		1	1		5	11 房友屯 <table border="1"><tr><td></td><td></td><td></td></tr><tr><td></td><td></td><td></td></tr><tr><td></td><td></td><td></td></tr></table> Post - 0 Miss - 0 Block - 0										17 李中洲 <table border="1"><tr><td></td><td></td><td></td></tr><tr><td>1</td><td></td><td>1</td></tr><tr><td></td><td></td><td></td></tr></table> Post - 0 Miss - 0 Block - 1				1		1				18 姚雪岩 <table border="1"><tr><td></td><td>1</td><td></td></tr><tr><td></td><td></td><td></td></tr><tr><td></td><td></td><td></td></tr></table> Post - 1 Miss - 0 Block - 1		1								19 王泽润 <table border="1"><tr><td></td><td></td><td></td></tr><tr><td></td><td></td><td></td></tr><tr><td></td><td></td><td></td></tr></table> Post - 0 Miss - 0 Block - 0										21 张昌柯 <table border="1"><tr><td></td><td></td><td></td></tr><tr><td></td><td></td><td></td></tr><tr><td></td><td></td><td></td></tr></table> Post - 0 Miss - 0 Block - 0										24 高玉杰 <table border="1"><tr><td></td><td></td><td></td></tr><tr><td></td><td></td><td></td></tr><tr><td></td><td></td><td>1</td></tr></table> Post - 0 Miss - 0 Block - 0									1
1		1																																																																													
2		1																																																																													
1		5																																																																													
1		1																																																																													
	1																																																																														
		1																																																																													



Team A					Team B					Match Number											
A 华体国家男子手球俱乐部					B 北京光彩男子手球俱乐部队					4											
Played in			in the hall			on			at			Spectators									
北京			北京光彩体育馆			2019-06-29			20:45			hours									
Half-time(30')	A	B	End of playing time		A	B	1st extra time		A	B	2nd extra time		A	B	After penalty throws		A	B			
	14	10	37		24																
Number of 7 m	A	Team time-out			Full name of players and officials						Team time-out			B	Number of 7 m						
	5/6	1	2	3							1	2	3	3/4							
		18:38	50:40								14:39	47:56									
No.	Team A					G	W	2'	D	DR	No.	Team B					G	W	2'	D	DR
4	张家纬					4					2	解建飞									
5	贺政					3					7	马昌震					3				
6	赵晨					5	1				8	MagyarDavid					2				
8	谢庆龙					3					10	MezeiRichard Bendeguz					5	1	2		
10	李朝鹏					2					11	赵文宣									
11	郭世伟					2					12	高云健									
12	王权										13	王军鸣					4		2		
16	刘迈科										14	逯明松					5				
18	李双										16	孟辉									
20	顾艳超					3					18	傅俊雄									
22	黄培杰					5					22	王超									
23	曹悦							1			25	马明辉					1				
25	王杰缘					4					26	魏昂					2				
47	成亚					2					27	闫炳旗					2				
88	王军程					2					29	杜龙飞									
99	王伟					2					32	蒋维一									
A	姚苏捷										A	郑永利 (主教练)									
B	朱昕晨 (主教练)										B	王洸									
D	付飞鹏										C	陈璇									
A	Signatures of responsables for the teams (Off.A)															B					
TP	Remarks of referees / HF Official															TP					

Signatures

Referees	王科 (CHN)	伍豪 (CHN)		
T.D.	郭剑 (CHN)	刘凤娟 (CHN)		
CHA Off.				

Note: Number of 7m Throws Awarded to Team A and B, Goals (G), Warnings (W), Suspensions (2'), Direct Disqualification (D), Disqualification With Report (DR) and Team Penalty (TP).

Table Officials: 赵悦 刘志军 Statisticians: 谢杨 于兹香

中国男子手球超级联赛(北京)

PHMS Pictorial Handball Match Statistics

IHF Official System

个人/全队技术统计表

 手球 预赛 组别 X 北京光彩体育馆
 男子 轮次 2 场次 4 2019-06-29 20:45

号码	姓名	远射	近射	边射	快攻	突破	任意	七米	合计	%	助攻	失误	警告	2'	取消	时间
华体国家男子手球俱乐部(华体)																
(场上队员)																
4	张家伟	3/3				1/2			4/5	80.0%		2				00:40:35
5	贺政	1/1		2/2					3/3	100%	1	1				00:19:24
6	赵晨	3/6	0/1		1/1	1/1			5/9	55.6%	1		1			00:29:38
8	谢庆龙		1/2		2/3				3/5	60.0%						00:35:45
10	李朝鹏	2/4							2/4	50.0%	1					00:16:18
11	郭世伟			1/1	1/1				2/2	100%						00:11:52
12	王权									0.0%						01:00:00
16	刘迈科									0.0%						00:00:00
18	李双									0.0%						00:00:00
20	顾艳超	1/3	1/1		1/1				3/5	60.0%	2					00:38:53
22	黄培杰	0/1			2/2			3/3	5/6	83.3%	1					00:39:07
23	曹悦									0.0%		1		1		00:15:29
25	王杰缘			1/1	1/2			2/3	4/6	66.7%		2				00:41:00
47	成亚	1/1	1/1						2/2	100%		1				00:19:20
88	王军程	1/5	1/1						2/6	33.3%		1				00:16:44
99	王伟	0/1	2/2						2/3	66.7%		1				00:24:20
	合计	12/25	6/8	4/4	9/12	1/1		5/6	37/56	66.1%	6	9	1	1		
(守门员)																
12	王权	7/15	6/9	5/6	0/4	1/5	2/3	1/4	22/46	47.8%						01:00:00
	合计	7/15	6/9	5/6	0/4	1/5	2/3	1/4	22/46	47.8%						

场上队员：得分/射门

守门员：救球/射门

全队合计	得分	被救	射失	击柱	封球	合计	%
远射	12	6	3		4	25	48.0%
近射	6	1			1	8	75.0%
边射	4					4	100.0%
快攻	9	1	1		1	12	75.0%
突破	1					1	100.0%
任意							0.0%
七米	5	1				6	83.3%

中国男子手球超级联赛(北京)

PHMS Pictorial Handball Match Statistics

IHF Official System

个人/全队技术统计表

手球 男子 预赛 轮次 2 组别 X 场次 4 北京光彩体育馆
2019-06-29 20:45

号码	姓名	远射	近射	边射	快攻	突破	任意	七米	合计	%	助攻	失误	警告	2'	取消	时间
北京光彩男子手球俱乐部队(北京队)																
(场上队员)																
2	解建飞	0/1							0/1	0.0%						00:18:26
7	马昌震		2/6			1/1			3/7	42.9%	1					00:44:08
8	MagyarDavid	2/7					0/1	0/1	2/9	22.2%	2					00:48:45
10	MezeiRichard Be	1/7	0/1			1/2		3/3	5/13	38.5%	2	3	1	2		00:35:01
11	赵文宣									0.0%		1				00:05:31
12	高云健									0.0%	2					00:37:27
13	王军鸣	3/6	0/1	0/1			1/1		4/9	44.4%		3		2		00:35:51
14	逯明松	2/2	0/1	0/1	1/1	2/2	0/1		5/8	62.5%		3				00:34:28
16	孟辉									0.0%						00:22:33
18	傅俊雄									0.0%						00:00:00
22	王超									0.0%	1					00:19:40
25	马明辉			1/3					1/3	33.3%						00:21:41
26	魏昂		1/1			1/1			2/2	100%						00:40:01
27	闫炳旗			0/1		2/2			2/3	66.7%						00:45:05
29	杜龙飞									0.0%						00:00:00
32	蒋维一									0.0%		1				00:10:18
合计		8/23	3/10	1/6	4/4	4/5	1/3	3/4	24/55	43.6%	8	11	1	4		

(守门员)

12	高云健	5/11	1/6	0/2	0/3	0/1		0/1	6/24	25.0%	2					00:37:27
16	孟辉	1/7	0/1	0/2	1/7			1/5	3/22	13.6%						00:22:33
合计		6/18	1/7	0/4	1/10	0/1		1/6	9/46	19.6%	2					

场上队员：得分/射门

守门员：救球/射门

全队合计	得分	被救	射失	击柱	封球	合计	%
远射	8	7	3	1	4	23	34.8%
近射	3	6		1		10	30.0%
边射	1	5				6	16.7%
快攻	4					4	100.0%
突破	4	1				5	80.0%
任意	1	2				3	33.3%
七米	3	1				4	75.0%

中国男子手球超级联赛(北京)

PHMS Pictorial Handball Match Statistics

IHF Official System

图式比赛技术统计表

手球
男子

预赛
轮次 2

组别 X
场次 4

北京光彩体育馆
2019-06-29 20:45

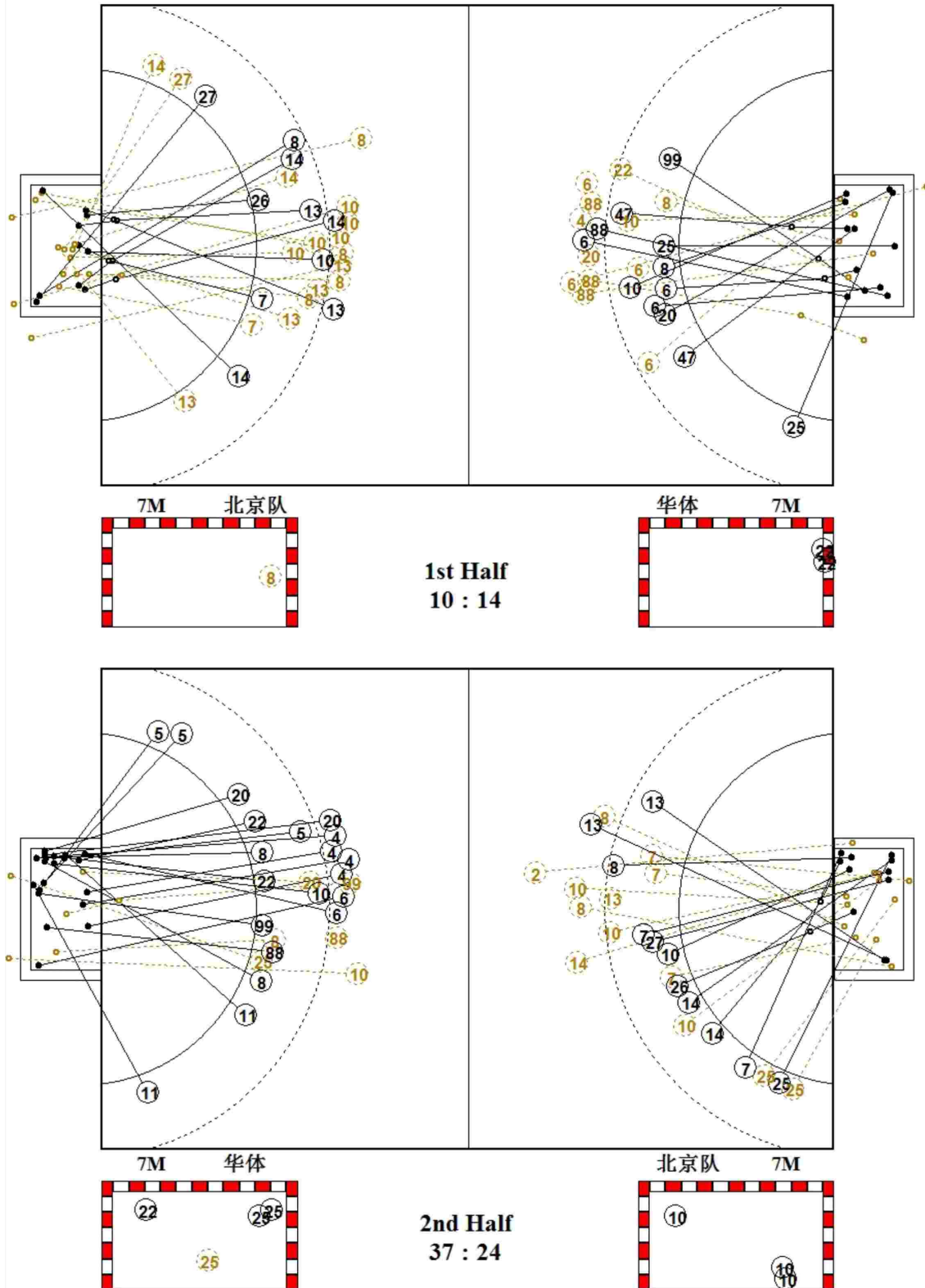

中国男子手球超级联赛(北京)

PHMS Pictorial Handball Match Statistics

IHF Official System

图式射门区域统计

手球
男子

预赛
轮次 2

组别 X
场次 4

北京光彩体育馆
2019-06-29 20:45

华体国家男子手球俱乐部

4 张家纬	5 贺政	6 赵晨	8 谢庆龙	10 李朝鹏	11 郭世伟	12 王权	16 刘迈科																																																																								
<table border="1"><tr><td></td><td></td><td>1</td></tr><tr><td></td><td></td><td></td></tr><tr><td>3</td><td></td><td></td></tr></table>			1				3			<table border="1"><tr><td></td><td>1</td><td>1</td></tr><tr><td></td><td></td><td>1</td></tr><tr><td></td><td></td><td></td></tr></table>		1	1			1				<table border="1"><tr><td>1</td><td></td><td>1</td></tr><tr><td></td><td></td><td>1</td></tr><tr><td></td><td></td><td>2</td></tr></table>	1		1			1			2	<table border="1"><tr><td></td><td></td><td>2</td></tr><tr><td></td><td></td><td></td></tr><tr><td>1</td><td></td><td></td></tr></table>			2				1			<table border="1"><tr><td></td><td></td><td>1</td></tr><tr><td></td><td></td><td></td></tr><tr><td>1</td><td></td><td></td></tr></table>			1				1			<table border="1"><tr><td></td><td></td><td>1</td></tr><tr><td></td><td></td><td>1</td></tr><tr><td></td><td></td><td></td></tr></table>			1			1				<table border="1"><tr><td></td><td></td><td></td></tr><tr><td></td><td></td><td></td></tr><tr><td></td><td></td><td></td></tr></table>										<table border="1"><tr><td></td><td></td><td></td></tr><tr><td></td><td></td><td></td></tr><tr><td></td><td></td><td></td></tr></table>									
		1																																																																													
3																																																																															
	1	1																																																																													
		1																																																																													
1		1																																																																													
		1																																																																													
		2																																																																													
		2																																																																													
1																																																																															
		1																																																																													
1																																																																															
		1																																																																													
		1																																																																													
Post - 0 Miss - 0 Block - 1	Post - 0 Miss - 0 Block - 0	Post - 0 Miss - 1 Block - 2	Post - 0 Miss - 0 Block - 0	Post - 0 Miss - 1 Block - 0	Post - 0 Miss - 0 Block - 0	Post - 0 Miss - 0 Block - 0	Post - 0 Miss - 0 Block - 0																																																																								
18 李双	20 顾艳超	22 黄培杰	23 曹悦	25 王杰缘	47 成亚	88 王军程	99 王伟																																																																								
<table border="1"><tr><td></td><td></td><td></td></tr><tr><td></td><td></td><td></td></tr><tr><td></td><td></td><td></td></tr></table>										<table border="1"><tr><td>1</td><td></td><td>2</td></tr><tr><td></td><td></td><td></td></tr><tr><td></td><td></td><td></td></tr></table>	1		2							<table border="1"><tr><td>1</td><td></td><td>3</td></tr><tr><td></td><td></td><td>1</td></tr><tr><td></td><td></td><td></td></tr></table>	1		3			1				<table border="1"><tr><td></td><td></td><td></td></tr><tr><td></td><td></td><td></td></tr><tr><td></td><td></td><td></td></tr></table>										<table border="1"><tr><td>1</td><td>1</td><td>2</td></tr><tr><td></td><td></td><td></td></tr><tr><td></td><td></td><td></td></tr></table>	1	1	2							<table border="1"><tr><td></td><td></td><td></td></tr><tr><td></td><td></td><td></td></tr><tr><td>2</td><td></td><td></td></tr></table>							2			<table border="1"><tr><td></td><td>1</td><td>1</td></tr><tr><td></td><td></td><td></td></tr><tr><td></td><td></td><td></td></tr></table>		1	1							<table border="1"><tr><td></td><td>1</td><td></td></tr><tr><td></td><td></td><td>1</td></tr><tr><td></td><td></td><td></td></tr></table>		1				1			
1		2																																																																													
1		3																																																																													
		1																																																																													
1	1	2																																																																													
2																																																																															
	1	1																																																																													
	1																																																																														
		1																																																																													
Post - 0 Miss - 0 Block - 0	Post - 0 Miss - 0 Block - 1	Post - 0 Miss - 0 Block - 0	Post - 0 Miss - 0 Block - 0	Post - 0 Miss - 1 Block - 0	Post - 0 Miss - 0 Block - 0	Post - 0 Miss - 1 Block - 2	Post - 0 Miss - 0 Block - 0																																																																								

12 王权

2/9	1/1	3/6
4/4	5/5	2/2
1/7	3/7	1/5

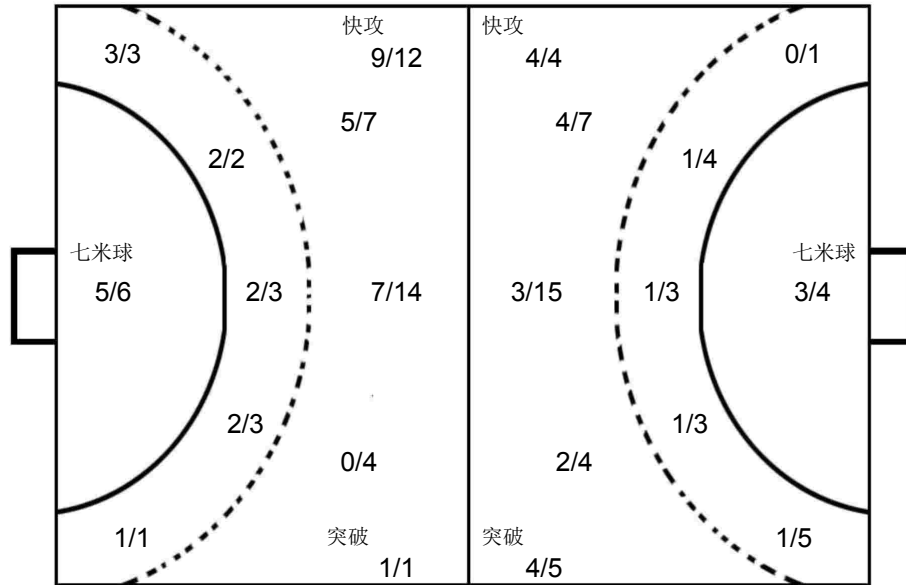

12 高云健

0/2	0/2	0/6
	2/2	0/2
2/4	1/4	1/2

16 孟辉

0/2	0/2	0/9
1/1	1/1	0/2
	0/2	1/3

北京光彩男子手球俱乐部队

2 解建飞	7 马昌震	8 MagyarDavid	10 MezeiRichard Be	11 赵文宣	12 高云健	13 王军鸣	14 透明松																																																																								
<table border="1"><tr><td></td><td></td><td></td></tr><tr><td></td><td></td><td></td></tr><tr><td></td><td></td><td></td></tr></table>										<table border="1"><tr><td>1</td><td></td><td></td></tr><tr><td></td><td></td><td></td></tr><tr><td>1</td><td>1</td><td></td></tr></table>	1						1	1		<table border="1"><tr><td>1</td><td></td><td></td></tr><tr><td></td><td></td><td></td></tr><tr><td>1</td><td></td><td></td></tr></table>	1						1			<table border="1"><tr><td>1</td><td></td><td></td></tr><tr><td></td><td></td><td></td></tr><tr><td>1</td><td>1</td><td>2</td></tr></table>	1						1	1	2	<table border="1"><tr><td></td><td></td><td></td></tr><tr><td></td><td></td><td></td></tr><tr><td></td><td></td><td></td></tr></table>										<table border="1"><tr><td></td><td></td><td></td></tr><tr><td></td><td></td><td></td></tr><tr><td></td><td></td><td></td></tr></table>										<table border="1"><tr><td></td><td></td><td>2</td></tr><tr><td></td><td></td><td></td></tr><tr><td></td><td>1</td><td>1</td></tr></table>			2					1	1	<table border="1"><tr><td>1</td><td></td><td>1</td></tr><tr><td></td><td></td><td></td></tr><tr><td>3</td><td></td><td></td></tr></table>	1		1				3		
1																																																																															
1	1																																																																														
1																																																																															
1																																																																															
1																																																																															
1	1	2																																																																													
		2																																																																													
	1	1																																																																													
1		1																																																																													
3																																																																															
Post - 1 Miss - 0 Block - 0	Post - 1 Miss - 0 Block - 0	Post - 0 Miss - 1 Block - 0	Post - 0 Miss - 1 Block - 2	Post - 0 Miss - 0 Block - 0	Post - 0 Miss - 0 Block - 0	Post - 0 Miss - 1 Block - 2	Post - 0 Miss - 0 Block - 0																																																																								
16 孟辉	18 傅俊雄	22 王超	25 马明辉	26 魏昂	27 闫炳旗	29 杜龙飞	32 蒋维一																																																																								
<table border="1"><tr><td></td><td></td><td></td></tr><tr><td></td><td></td><td></td></tr><tr><td></td><td></td><td></td></tr></table>										<table border="1"><tr><td></td><td></td><td></td></tr><tr><td></td><td></td><td></td></tr><tr><td></td><td></td><td></td></tr></table>										<table border="1"><tr><td></td><td></td><td></td></tr><tr><td></td><td></td><td></td></tr><tr><td></td><td></td><td></td></tr></table>										<table border="1"><tr><td>1</td><td></td><td></td></tr><tr><td></td><td></td><td></td></tr><tr><td></td><td></td><td></td></tr></table>	1									<table border="1"><tr><td></td><td></td><td></td></tr><tr><td></td><td></td><td></td></tr><tr><td></td><td>1</td><td>1</td></tr></table>								1	1	<table border="1"><tr><td>2</td><td></td><td></td></tr><tr><td></td><td></td><td></td></tr><tr><td></td><td></td><td></td></tr></table>	2									<table border="1"><tr><td></td><td></td><td></td></tr><tr><td></td><td></td><td></td></tr><tr><td></td><td></td><td></td></tr></table>										<table border="1"><tr><td></td><td></td><td></td></tr><tr><td></td><td></td><td></td></tr><tr><td></td><td></td><td></td></tr></table>									
1																																																																															
	1	1																																																																													
2																																																																															
Post - 0 Miss - 0 Block - 0	Post - 0 Miss - 0 Block - 0	Post - 0 Miss - 0 Block - 0	Post - 0 Miss - 0 Block - 0	Post - 0 Miss - 0 Block - 0	Post - 0 Miss - 0 Block - 0	Post - 0 Miss - 0 Block - 0	Post - 0 Miss - 0 Block - 0																																																																								



Team A					Team B					Match Number											
A 广东路环四庙男子手球俱乐部					B 华体国家男子手球俱乐部					5											
Played in			in the hall			on			at			Spectators									
北京			北京光彩体育馆			2019-06-30			15:00			hours 800									
Half-time(30')	A	B	End of playing time		A	B	1st extra time		A	B	2nd extra time		A	B	After penalty throws		A	B			
	13	16	27		40																
Number of 7 m	A	Team time-out			Full name of players and officials						Team time-out			B	Number of 7 m						
	1/1	1	2	3							1	2	3	1/1							
		14:32	37:31																		
No.	Team A					G	W	2'	D	DR	No.	Team B					G	W	2'	D	DR
1	王帅										4	张家纬									
2	董佳辉										5	贺政					2				
3	曲汝洋					1					6	赵晨									
4	ARPASI PATRIK					1	1				8	谢庆龙					10				
5	曹景森					1					10	李朝鹏					3		1		
6	毕晓晨					5					11	郭世伟					1				
7	王立隆										12	王权									
8	DOLEZSAL KAROLY										16	刘迈科									
9	范保坤							1			18	李双									
10	周仲坤					6		1			20	顾艳超					1				
11	房友屯										22	黄培杰					7				
17	李中洲					2					23	曹悦					1	1			
18	姚雪岩					4					25	王杰缘					4				
19	王泽润										47	成亚					6				
21	张昌轲					3					88	王军程					5	1			
24	高玉杰					4					99	王伟									
A	刘康伶 (主教练)										A	姚苏捷									
B	郭艳辉										B	朱昕晨 (主教练)									
C	贾章志										D	付飞鹏									
A	Signatures of responsables for the teams (Off.A)										B										
TP	Remarks of referees / HF Official										TP										

Signatures

Referees 程钰峰 (CHN)

伍豪 (CHN)

T.D. 吴瑞亭 (CHN)

刘凤娟 (CHN)

CHA Off.

Note: Number of 7m Throws Awarded to Team A and B, Goals (G), Warnings (W), Suspensions (2'), Direct Disqualification (D), Disqualification With Report (DR) and Team Penalty (TP).

Table Officials: 刘志军

赵悦

Statisticians: 于兹香

谢杨



中国男子手球超级联赛(北京)

PHMS Pictorial Handball Match Statistics IHF Official System

竞赛技术统计

手球 男子 预赛 轮次 3 组别 X 场次 5 北京光彩体育馆 2019-06-30 15:00

Referees: 程钰峰 (CHN) / 伍豪 (CHN) Result: 27:40(13:16)
Teams: 广东路环四庙男子手球俱乐部(广东) VS 华体国家男子手球俱乐部(华体)

Table with 14 columns: 广东 (Coach: 刘康伶), 远射, 近射, 边射, 快攻, 突破, 任意球, 7m球, 合计, %, 助攻, 失误, 警告, 2', D+DR. Rows include player stats for 王帅, 董佳辉, etc.

Table with 3 columns: 广东, 比赛进程, 华体. Rows show game time and player actions (e.g., 00:43 1 88 王军程).

Table with 14 columns: 华体 (Coach: 朱昕晨), 远射, 近射, 边射, 快攻, 突破, 任意球, 7m球, 合计, %, 助攻, 失误, 警告, 2', D+DR. Rows include player stats for 张家纬, 贺政, etc.

场上队员: 得分 / 射门 守门员: 救球 / 射门. Includes a small table with columns: D, 取消资格, DR, 取消资格+报告.

中国男子手球超级联赛(北京)

PHMS Pictorial Handball Match Statistics

IHF Official System

个人/全队技术统计表

手球 男子 预赛 轮次 3 组别 X 场次 5 北京光彩体育馆 2019-06-30 15:00

号码	姓名	远射	近射	边射	快攻	突破	任意	七米	合计	%	助攻	失误	警告	2'	取消	时间
广东路环四庙男子手球俱乐部(广东)																
(场上队员)																
1	王帅									0.0%						00:21:48
2	董佳辉									0.0%						00:00:00
3	曲汝洋	1/3				0/1	0/1		1/5	20.0%	1	2				00:17:39
4	ARPASI PATRIK	0/1	1/1						1/2	50.0%			1			00:27:10
5	曹景森				1/1				1/1	100%		1				00:17:26
6	毕晓晨	0/2	1/3		1/2	3/3			5/10	50.0%		1				00:48:12
7	王立隆									0.0%						00:06:37
8	DOLEZSAL KAROLY	0/1							0/1	0.0%	1	3				00:30:00
9	范保坤									0.0%		1		1		00:05:25
10	周仲坤	2/7	1/2		0/2	1/2	1/1	1/1	6/15	40.0%	2	2		1		00:50:00
11	房友屯	0/1				0/1			0/2	0.0%						00:25:20
17	李中洲		1/2			1/1			2/3	66.7%		3				00:16:38
18	姚雪岩	1/2	2/2			1/3			4/7	57.1%		2				00:39:30
19	王泽润									0.0%						00:38:12
21	张昌轲	0/1			2/2	1/1			3/4	75.0%		2				00:16:23
24	高玉杰			3/3	1/3				4/6	66.7%		1				00:58:40
合计		4/18	6/10	3/3	5/10	7/12	1/2	1/1	27/56	48.2%	4	18	1	2		
(守门员)																
1	王帅	0/3	0/2	0/3	1/9	1/2			2/19	10.5%						00:21:48
19	王泽润	1/4	0/6	2/3	2/10	0/4		0/1	5/28	17.9%						00:38:12
合计		1/7	0/8	2/6	3/19	1/6		0/1	7/47	14.9%						

场上队员：得分/射门

守门员：救球/射门

全队合计	得分	被救	射失	击柱	封球	合计	%
远射	4	8	2	1	3	18	22.2%
近射	6	3			1	10	60.0%
边射	3					3	100.0%
快攻	5	4	1			10	50.0%
突破	7	3	2			12	58.3%
任意	1	1				2	50.0%
七米	1					1	100.0%

中国男子手球超级联赛(北京)

PHMS Pictorial Handball Match Statistics

IHF Official System

个人/全队技术统计表

手球 预赛 组别 X
男子 轮次 3 场次 5
北京光彩体育馆
2019-06-30 15:00

号码	姓名	远射	近射	边射	快攻	突破	任意	七米	合计	%	助攻	失误	警告	2'	取消	时间
华体国家男子手球俱乐部(华体)																
(场上队员)																
4	张家纬									0.0%						00:00:00
5	贺政			1/1	1/1				2/2	100%						00:29:54
6	赵晨									0.0%	3					00:12:43
8	谢庆龙	1/1	5/5		3/3	1/1			10/10	100%	1	2				00:40:17
10	李朝鹏	1/3			2/2	0/1			3/6	50.0%	3	5		1		00:57:19
11	郭世伟	0/1		0/1	1/3				1/5	20.0%		1				00:20:10
12	王权									0.0%						00:00:00
16	刘迈科									0.0%		2				01:00:00
18	李双									0.0%						00:08:39
20	顾艳超	1/1							1/1	100%		1				00:02:10
22	黄培杰			2/3	4/5			1/1	7/9	77.8%	2	2				00:38:24
23	曹悦		1/1						1/1	100%			1			00:18:51
25	王杰缘		1/1	0/1	3/4				4/6	66.7%						00:30:00
47	成亚	1/3	1/1	1/1	2/2	1/2			6/9	66.7%	3	2				00:51:20
88	王军程	2/3				3/3			5/6	83.3%	1	2	1			00:49:04
99	王伟									0.0%						00:00:02
合计		6/12	8/8	4/7	16/20	5/7		1/1	40/55	72.7%	13	17	2	1		
(守门员)																
16	刘迈科	8/12	3/9	0/3	4/9	3/10	1/2	0/1	19/46	41.3%		2				01:00:00
合计		8/12	3/9	0/3	4/9	3/10	1/2	0/1	19/46	41.3%		2				

场上队员：得分/射门

守门员：救球/射门

全队合计	得分	被救	射失	击柱	封球	合计	%
远射	6	1	3		2	12	50.0%
近射	8					8	100.0%
边射	4	2	1			7	57.1%
快攻	16	3		1		20	80.0%
突破	5	1	1			7	71.4%
任意							0.0%
七米	1					1	100.0%

中国男子手球超级联赛(北京)

PHMS Pictorial Handball Match Statistics

IHF Official System

图式比赛技术统计表

手球
男子

预赛
轮次 3

组别 X
场次 5

北京光彩体育馆
2019-06-30 15:00

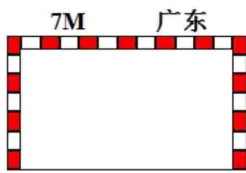
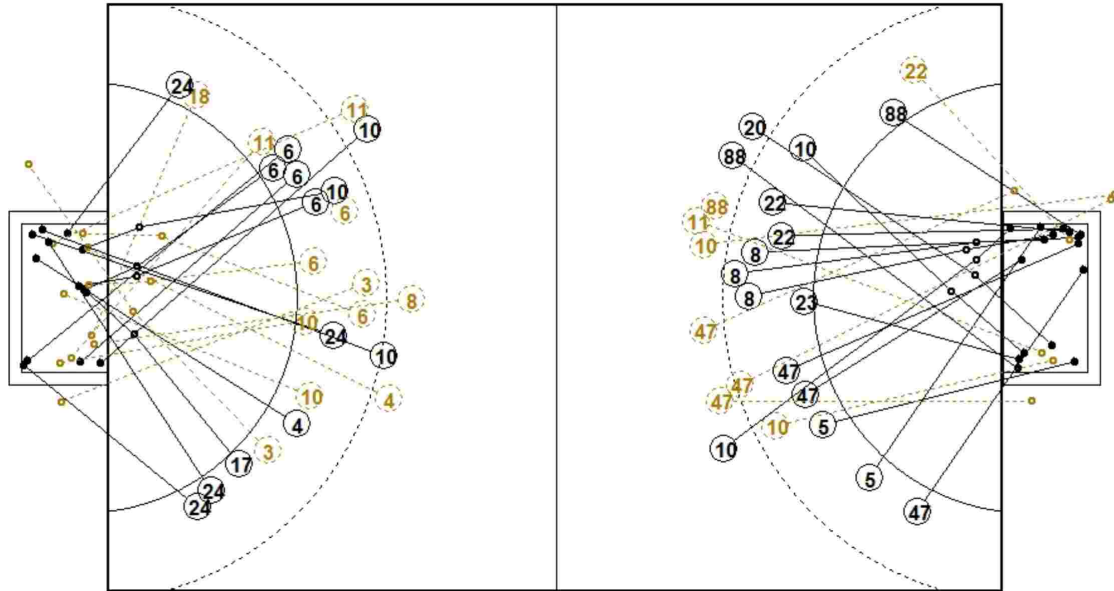

1st Half
13 : 16

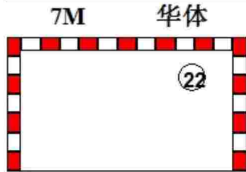
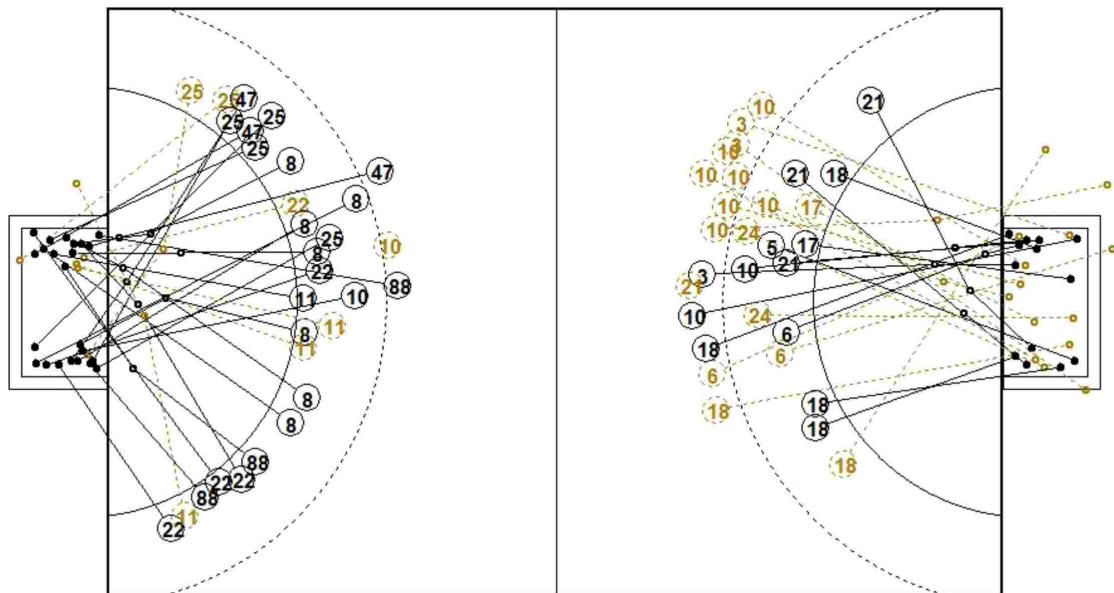
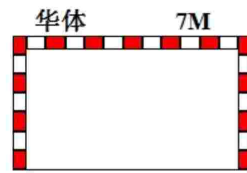

2nd Half
40 : 27

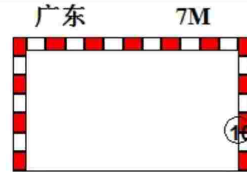

中国男子手球超级联赛(北京)

PHMS Pictorial Handball Match Statistics

IHF Official System

图式射门区域统计

手球
男子

预赛
轮次 3

组别 X
场次 5

北京光彩体育馆
2019-06-30 15:00

广东路环四庙男子手球俱乐部

1 王帅 <table border="1"><tr><td></td><td></td><td></td></tr><tr><td></td><td></td><td></td></tr><tr><td></td><td></td><td></td></tr></table> Post - 0 Miss - 0 Block - 0										2 董佳辉 <table border="1"><tr><td></td><td></td><td></td></tr><tr><td></td><td></td><td></td></tr><tr><td></td><td></td><td></td></tr></table> Post - 0 Miss - 0 Block - 0										3 曲汝洋 <table border="1"><tr><td></td><td></td><td></td></tr><tr><td></td><td></td><td></td></tr><tr><td>1</td><td></td><td></td></tr></table> Post - 1 Miss - 2 Block - 0							1			4 ARPASI PATRIK <table border="1"><tr><td></td><td></td><td>1</td></tr><tr><td></td><td></td><td></td></tr><tr><td></td><td></td><td></td></tr></table> Post - 0 Miss - 0 Block - 0			1							5 曹景森 <table border="1"><tr><td></td><td></td><td>1</td></tr><tr><td></td><td></td><td></td></tr><tr><td></td><td></td><td></td></tr></table> Post - 0 Miss - 0 Block - 0			1							6 毕晓晨 <table border="1"><tr><td>1</td><td></td><td></td></tr><tr><td></td><td>1</td><td></td></tr><tr><td>2</td><td>1</td><td></td></tr></table> Post - 0 Miss - 1 Block - 1	1				1		2	1		7 王立隆 <table border="1"><tr><td></td><td></td><td></td></tr><tr><td></td><td></td><td></td></tr><tr><td></td><td></td><td></td></tr></table> Post - 0 Miss - 0 Block - 0										8 DOLEZSAL KAROLY <table border="1"><tr><td></td><td></td><td></td></tr><tr><td></td><td></td><td></td></tr><tr><td></td><td></td><td></td></tr></table> Post - 0 Miss - 0 Block - 0									
1																																																																															
		1																																																																													
		1																																																																													
1																																																																															
	1																																																																														
2	1																																																																														
9 范保坤 <table border="1"><tr><td></td><td></td><td></td></tr><tr><td></td><td></td><td></td></tr><tr><td></td><td></td><td></td></tr></table> Post - 0 Miss - 0 Block - 0										10 周仲坤 <table border="1"><tr><td>1</td><td></td><td>1</td></tr><tr><td></td><td></td><td>1</td></tr><tr><td>2</td><td></td><td>1</td></tr></table> Post - 0 Miss - 1 Block - 2	1		1			1	2		1	11 房友屯 <table border="1"><tr><td></td><td></td><td></td></tr><tr><td></td><td></td><td></td></tr><tr><td></td><td></td><td></td></tr></table> Post - 0 Miss - 0 Block - 0										17 李中洲 <table border="1"><tr><td></td><td>1</td><td></td></tr><tr><td></td><td></td><td></td></tr><tr><td></td><td>1</td><td></td></tr></table> Post - 0 Miss - 0 Block - 0		1						1		18 姚雪岩 <table border="1"><tr><td></td><td></td><td>1</td></tr><tr><td>1</td><td></td><td></td></tr><tr><td>1</td><td></td><td>1</td></tr></table> Post - 0 Miss - 1 Block - 0			1	1			1		1	19 王泽润 <table border="1"><tr><td></td><td></td><td></td></tr><tr><td></td><td></td><td></td></tr><tr><td></td><td></td><td></td></tr></table> Post - 0 Miss - 0 Block - 0										21 张昌柯 <table border="1"><tr><td></td><td></td><td></td></tr><tr><td>1</td><td></td><td>1</td></tr><tr><td></td><td></td><td>1</td></tr></table> Post - 0 Miss - 0 Block - 1				1		1			1	24 高玉杰 <table border="1"><tr><td>1</td><td></td><td>2</td></tr><tr><td></td><td></td><td>1</td></tr><tr><td></td><td></td><td></td></tr></table> Post - 0 Miss - 0 Block - 0	1		2			1			
1		1																																																																													
		1																																																																													
2		1																																																																													
	1																																																																														
	1																																																																														
		1																																																																													
1																																																																															
1		1																																																																													
1		1																																																																													
		1																																																																													
1		2																																																																													
		1																																																																													

1 王帅

0/4		0/4
0/4		1/1
0/2		1/4

19 王泽润

1/6		0/2
0/2		3/9
1/6		0/3

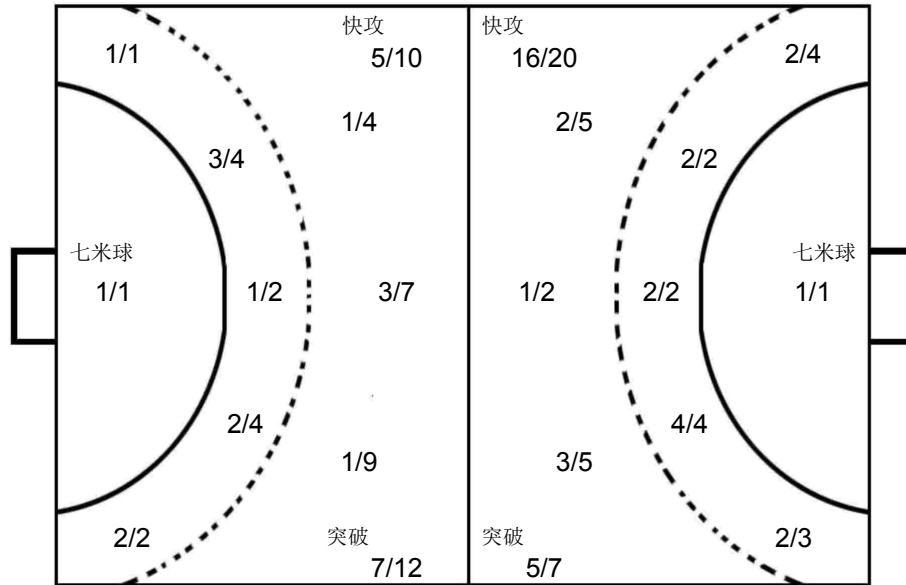

16 刘迈科

1/4	1/2	1/7
2/4	2/3	3/6
4/10	3/5	2/5

华体国家男子手球俱乐部

4 张家纬 <table border="1"><tr><td></td><td></td><td></td></tr><tr><td></td><td></td><td></td></tr><tr><td></td><td></td><td></td></tr></table> Post - 0 Miss - 0 Block - 0										5 贺政 <table border="1"><tr><td></td><td></td><td>1</td></tr><tr><td>1</td><td></td><td></td></tr><tr><td></td><td></td><td></td></tr></table> Post - 0 Miss - 0 Block - 0			1	1						6 赵晨 <table border="1"><tr><td></td><td></td><td></td></tr><tr><td></td><td></td><td></td></tr><tr><td></td><td></td><td></td></tr></table> Post - 0 Miss - 0 Block - 0										8 谢庆龙 <table border="1"><tr><td>2</td><td></td><td>1</td></tr><tr><td>3</td><td></td><td>3</td></tr><tr><td>1</td><td></td><td></td></tr></table> Post - 0 Miss - 0 Block - 0	2		1	3		3	1			10 李朝鹏 <table border="1"><tr><td></td><td></td><td></td></tr><tr><td></td><td></td><td></td></tr><tr><td>2</td><td></td><td>1</td></tr></table> Post - 0 Miss - 1 Block - 1							2		1	11 郭世伟 <table border="1"><tr><td></td><td></td><td></td></tr><tr><td></td><td></td><td></td></tr><tr><td></td><td></td><td>1</td></tr></table> Post - 0 Miss - 1 Block - 0									1	12 王权 <table border="1"><tr><td></td><td></td><td></td></tr><tr><td></td><td></td><td></td></tr><tr><td></td><td></td><td></td></tr></table> Post - 0 Miss - 0 Block - 0										16 刘迈科 <table border="1"><tr><td></td><td></td><td></td></tr><tr><td></td><td></td><td></td></tr><tr><td></td><td></td><td></td></tr></table> Post - 0 Miss - 0 Block - 0									
		1																																																																													
1																																																																															
2		1																																																																													
3		3																																																																													
1																																																																															
2		1																																																																													
		1																																																																													
18 李双 <table border="1"><tr><td></td><td></td><td></td></tr><tr><td></td><td></td><td></td></tr><tr><td></td><td></td><td></td></tr></table> Post - 0 Miss - 0 Block - 0										20 顾艳超 <table border="1"><tr><td></td><td></td><td></td></tr><tr><td></td><td></td><td>1</td></tr><tr><td></td><td></td><td></td></tr></table> Post - 0 Miss - 0 Block - 0						1				22 黄培杰 <table border="1"><tr><td>3</td><td></td><td>2</td></tr><tr><td>1</td><td></td><td></td></tr><tr><td></td><td></td><td>1</td></tr></table> Post - 0 Miss - 0 Block - 0	3		2	1					1	23 曹悦 <table border="1"><tr><td></td><td></td><td></td></tr><tr><td></td><td></td><td></td></tr><tr><td></td><td></td><td>1</td></tr></table> Post - 0 Miss - 0 Block - 0									1	25 王杰缘 <table border="1"><tr><td>1</td><td></td><td>1</td></tr><tr><td></td><td></td><td></td></tr><tr><td>2</td><td></td><td></td></tr></table> Post - 1 Miss - 0 Block - 0	1		1				2			47 成亚 <table border="1"><tr><td>2</td><td></td><td>1</td></tr><tr><td>1</td><td></td><td></td></tr><tr><td>1</td><td></td><td>1</td></tr></table> Post - 0 Miss - 3 Block - 0	2		1	1			1		1	88 王军程 <table border="1"><tr><td>1</td><td></td><td></td></tr><tr><td></td><td></td><td>1</td></tr><tr><td>1</td><td></td><td>2</td></tr></table> Post - 0 Miss - 0 Block - 1	1					1	1		2	99 王伟 <table border="1"><tr><td></td><td></td><td></td></tr><tr><td></td><td></td><td></td></tr><tr><td></td><td></td><td></td></tr></table> Post - 0 Miss - 0 Block - 0									
		1																																																																													
3		2																																																																													
1																																																																															
		1																																																																													
		1																																																																													
1		1																																																																													
2																																																																															
2		1																																																																													
1																																																																															
1		1																																																																													
1																																																																															
		1																																																																													
1		2																																																																													

Team A					Team B					Match Number											
A 北京光彩男子手球俱乐部队					B 太平洋保险江苏男子手球俱乐部					6											
Played in			in the hall			on			at			Spectators									
北京			北京光彩体育馆			2019-06-30			16:45			hours 1000									
Half-time(30')	A	B	End of playing time		A	B	1st extra time		A	B	2nd extra time		A	B	After penalty throws		A	B			
	13	9			26	21															
Number of 7 m	A	Team time-out			Full name of players and officials						Team time-out			B	Number of 7 m						
	2/4	1	2	3							1	2	3	2/3							
		29:44	39:35								18:43	47:48									
No.	Team A					G	W	2'	D	DR	No.	Team B					G	W	2'	D	DR
2	解建飞							1			1	陈昊									
7	马昌震					2		1			5	闫亮									
8	MagyarDavid					4					7	周傲					2				
10	MezeiRichard Bendeguz					7	1				9	许翔宇									
11	赵文宣										11	张天豪									
12	高云健										15	李安					2		1		
13	王军鸣					3		1			16	张帅									
14	逯明松					1					17	刘赵梁					1	1			
16	孟辉										18	赵楠					2		2		
18	傅俊雄										19	庞连康					2				
22	王超					2					21	刘江					2				
25	马明辉										22	罗尧尧									
26	魏昂					1					23	宋继强									
27	闫炳旗					3					26	MUCZA Nobert					3				
29	杜龙飞										27	王伟强					6				
32	蒋维一					3					28	SZRNKAlevente					1	1			
A	郑永利 (主教练)										A	闫威名 (主教练)									
B	王泷										B	叶强									
C	陈璇										C	雷纳德						1			
											D	王建国									
A	Signatures of responsables for the teams (Off.A)																B				
TP	Remarks of referees / HF Official																TP				

Signatures

Referees	刘禹 (CHN)	许翔 (CHN)		
T.D.	刘凤娟 (CHN)	郭剑 (CHN)		
CHA Off.				

Note: Number of 7m Throws Awarded to Team A and B, Goals (G), Warnings (W), Suspensions (2'), Direct Disqualification (D), Disqualification With Report (DR) and Team Penalty (TP).

Table Officials: 刘志军 赵悦 Statisticians: 谢杨 于兹香

中国男子手球超级联赛(北京)

PHMS Pictorial Handball Match Statistics

IHF Official System

竞赛技术统计

手球
男子

预赛
轮次 3

组别 X
场次 6

北京光彩体育馆
2019-06-30 16:45

Referees: 刘禹 (CHN) / 许翔 (CHN) Result: 26:21 (13:9)
Teams: 北京光彩男子手球俱乐部队(北京队) VS 太平洋保险江苏男子手球俱乐部(江苏)

北京队		远	近	边	快	突	任意	7m	合计	%	助攻	失误	警告	2'	D+DR
主教练: 郑永利		射	射	射	攻	破	球	球							
2	解建飞										1		1		
7	马昌震		1/1			1/1			2/2	100	3			1	
8	MagyarDavid	2/6	2/2			0/1		0/1	4/10	40.0	2	1			
10	MezeiRichard Be	4/5		0/1	1/1		0/1	2/3	7/11	63.6	2	1	1		
11	赵文宣														
12	高云健										2				
13	王军鸣	1/7	2/2				0/1		3/10	30.0		1		1	
14	逯明松	0/4	0/1			1/1			1/6	16.7	2	2			
16	孟辉														
18	傅俊雄														
22	王超		0/3	1/1	1/2				2/6	33.3					
25	马明辉														
26	魏昂			1/1					1/1	100					
27	闫炳旗		1/1	1/1	1/1				3/3	100					
29	杜龙飞											1			
32	蒋维一		2/2		1/1				3/3	100	1				
运动员	合计	7/22	8/12	3/4	4/5	2/3	0/2	2/4	26/52	50.0	13	6	2	2	
12	高云健	3/6	2/9	1/6	2/4	2/4		1/3	11/32	34.4	2				
守门员	合计	3/6	2/9	1/6	2/4	2/4		1/3	11/32	34.4	2				
江苏		远	近	边	快	突	任意	7m	合计	%	助攻	失误	警告	2'	D+DR
主教练: 闫威名		射	射	射	攻	破	球	球							
1	陈昊														
5	闫亮											1			
7	周傲		1/2	1/1		0/1			2/4	50.0		1			
9	许翔宇														
11	张天豪														
15	李安	0/1						2/3	2/4	50.0				1	
16	张帅														
17	刘赵梁	0/1		0/1	1/2	0/1			1/5	20.0		2	1		
18	赵楠	0/1	1/1			1/1			2/3	66.7		1		2	
19	庞连康	0/1	1/3			1/2			2/6	33.3		4			
21	刘江	1/1			1/2	0/1			2/4	50.0					
22	罗尧尧														
23	宋继强														
26	MUCZA Nobert	1/2	2/2						3/4	75.0	2	3			
27	王伟强	1/1	1/1	4/4					6/6	100					
28	SZRNKAlvente		1/1						1/1	100		3	1		
运动员	合计	3/8	7/10	5/6	2/4	2/6		2/3	21/37	56.8	2	15	2	3	
16	张帅	9/16	3/11	1/4	1/5	0/2		2/4	16/42	38.1					
守门员	合计	9/16	3/11	1/4	1/5	0/2		2/4	16/42	38.1					

北京队	比赛进程	江苏
1st Half		
27 闫炳旗	1 01:59 0	
32 蒋维一	2 02:41 0	
	2 03:40 1 26 MUCZA Nober	
32 蒋维一	3 05:02 1	
27 闫炳旗	4 05:49 1	
	4 06:36 2 26 MUCZA Nober	
10 MezeiRichar	5 07:31 2	
32 蒋维一	6 10:50 2	
	6 11:58 3 28 SZRNKAleven	
	6 12:28 4 17 刘赵梁	
13 王军鸣	7 13:10 4	
10 MezeiRichar	8 13:19 4	
	8 13:55 5 7 周傲	
13 王军鸣	9 14:26 5	
	9 14:53 6 27 王伟强	
22 王超	10 16:02 6	
27 闫炳旗	11 18:24 6	
	11 20:09 7 19 庞连康	
8 MagyarDavid	12 23:32 7	
	12 23:59 8 27 王伟强	
7 马昌震	13 28:11 8	
	13 28:54 9 27 王伟强	
2nd Half		
	13 00:27 10 18 赵楠	
13 王军鸣	14 01:08 10	
	14 01:43 11 27 王伟强	
10 MezeiRichar	15 02:53 11	
8 MagyarDavid	16 03:50 11	
8 MagyarDavid	17 05:09 11	
22 王超	18 05:43 11	
	18 06:18 12 27 王伟强	
14 逯明松	19 06:51 12	
	19 08:25 13 27 王伟强	
	19 09:20 14 21 刘江	
	19 10:25 15 21 刘江	
8 MagyarDavid	20 11:34 15	
	20 13:49 16 18 赵楠	
10 MezeiRichar	21 14:24 16	
	21 16:11 17 15 李安	
	21 18:37 18 19 庞连康	
10 MezeiRichar	22 21:15 18	
10 MezeiRichar	23 22:32 18	
10 MezeiRichar	24 24:22 18	
	24 24:53 19 7 周傲	
26 魏昂	25 25:34 19	
	25 27:29 20 15 李安	
	25 28:41 21 26 MUCZA Nober	
7 马昌震	26 29:58 21	

场上队员: 得分 / 射门

守门员: 救球 / 射门

D	取消资格	DR	取消资格+报告
---	------	----	---------

中国男子手球超级联赛(北京)

PHMS Pictorial Handball Match Statistics

IHF Official System

个人/全队技术统计表

手球 男子 预赛 轮次 3 组别 X 场次 6 北京光彩体育馆
2019-06-30 16:45

号码	姓名	远射	近射	边射	快攻	突破	任意	七米	合计	%	助攻	失误	警告	2'	取消	时间
北京光彩男子手球俱乐部队(北京队)																
(场上队员)																
2	解建飞									0.0%	1		1			00:19:54
7	马昌震		1/1			1/1			2/2	100%	3			1		00:15:33
8	MagyarDavid	2/6	2/2			0/1		0/1	4/10	40.0%	2	1				00:54:09
10	MezeiRichard Be	4/5		0/1	1/1		0/1	2/3	7/11	63.6%	2	1	1			00:31:11
11	赵文宣									0.0%						00:02:11
12	高云健									0.0%	2					01:00:00
13	王军鸣	1/7	2/2				0/1		3/10	30.0%		1		1		00:35:28
14	逯明松	0/4	0/1			1/1			1/6	16.7%	2	2				00:35:38
16	孟辉									0.0%						00:00:00
18	傅俊雄									0.0%						00:00:00
22	王超		0/3	1/1	1/2				2/6	33.3%						00:47:39
25	马明辉									0.0%						00:02:14
26	魏昂			1/1					1/1	100%						00:12:01
27	闫炳旗		1/1	1/1	1/1				3/3	100%						00:49:51
29	杜龙飞									0.0%		1				00:02:20
32	蒋维一		2/2		1/1				3/3	100%	1					00:50:05
合计		7/22	8/12	3/4	4/5	2/3	0/2	2/4	26/52	50.0%	13	6	2	2		
(守门员)																
12	高云健	3/6	2/9	1/6	2/4	2/4		1/3	11/32	34.4%	2					01:00:00
合计		3/6	2/9	1/6	2/4	2/4		1/3	11/32	34.4%	2					

场上队员：得分/射门

守门员：救球/射门

全队合计	得分	被救	射失	击柱	封球	合计	%
远射	7	9	2	1	3	22	31.8%
近射	8	3		1		12	66.7%
边射	3	1				4	75.0%
快攻	4	1				5	80.0%
突破	2			1		3	66.7%
任意				2		2	0.0%
七米	2	2				4	50.0%

中国男子手球超级联赛(北京)

PHMS Pictorial Handball Match Statistics

IHF Official System

个人/全队技术统计表

 手球 预赛 组别 X 北京光彩体育馆
 男子 轮次 3 场次 6 2019-06-30 16:45

号码	姓名	远射	近射	边射	快攻	突破	任意	七米	合计	%	助攻	失误	警告	2'	取消	时间
太平洋保险江苏男子手球俱乐部(江苏)																
(场上队员)																
1	陈昊									0.0%						00:00:30
5	闫亮									0.0%		1				00:22:39
7	周傲		1/2	1/1		0/1			2/4	50.0%		1				00:13:22
9	许翔宇									0.0%						00:00:00
11	张天豪									0.0%						00:00:00
15	李安	0/1						2/3	2/4	50.0%				1		00:15:28
16	张帅									0.0%						01:00:00
17	刘赵梁	0/1		0/1	1/2	0/1			1/5	20.0%		2	1			01:00:00
18	赵楠	0/1	1/1			1/1			2/3	66.7%		1		2		00:51:23
19	庞连康	0/1	1/3			1/2			2/6	33.3%		4				00:36:39
21	刘江	1/1			1/2	0/1			2/4	50.0%						00:29:56
22	罗尧尧									0.0%						00:00:00
23	宋继强									0.0%						00:00:00
26	MUCZA Nobert	1/2	2/2						3/4	75.0%	2	3				00:33:47
27	王伟强	1/1	1/1	4/4					6/6	100%						01:00:00
28	SZRNKAlvente		1/1						1/1	100%		3	1			00:35:05
	合计	3/8	7/10	5/6	2/4	2/6		2/3	21/37	56.8%	2	15	2	3		
(守门员)																
16	张帅	9/16	3/11	1/4	1/5	0/2		2/4	16/42	38.1%						01:00:00
	合计	9/16	3/11	1/4	1/5	0/2		2/4	16/42	38.1%						

场上队员：得分/射门

守门员：救球/射门

全队合计	得分	被救	射失	击柱	封球	合计	%
远射	3	3		2		8	37.5%
近射	7	2			1	10	70.0%
边射	5	1				6	83.3%
快攻	2	2				4	50.0%
突破	2	2	2			6	33.3%
任意							0.0%
七米	2	1				3	66.7%

中国男子手球超级联赛(北京)

PHMS Pictorial Handball Match Statistics

IHF Official System

图式比赛技术统计表

手球
男子

预赛
轮次 3

组别 X
场次 6

北京光彩体育馆
2019-06-30 16:45

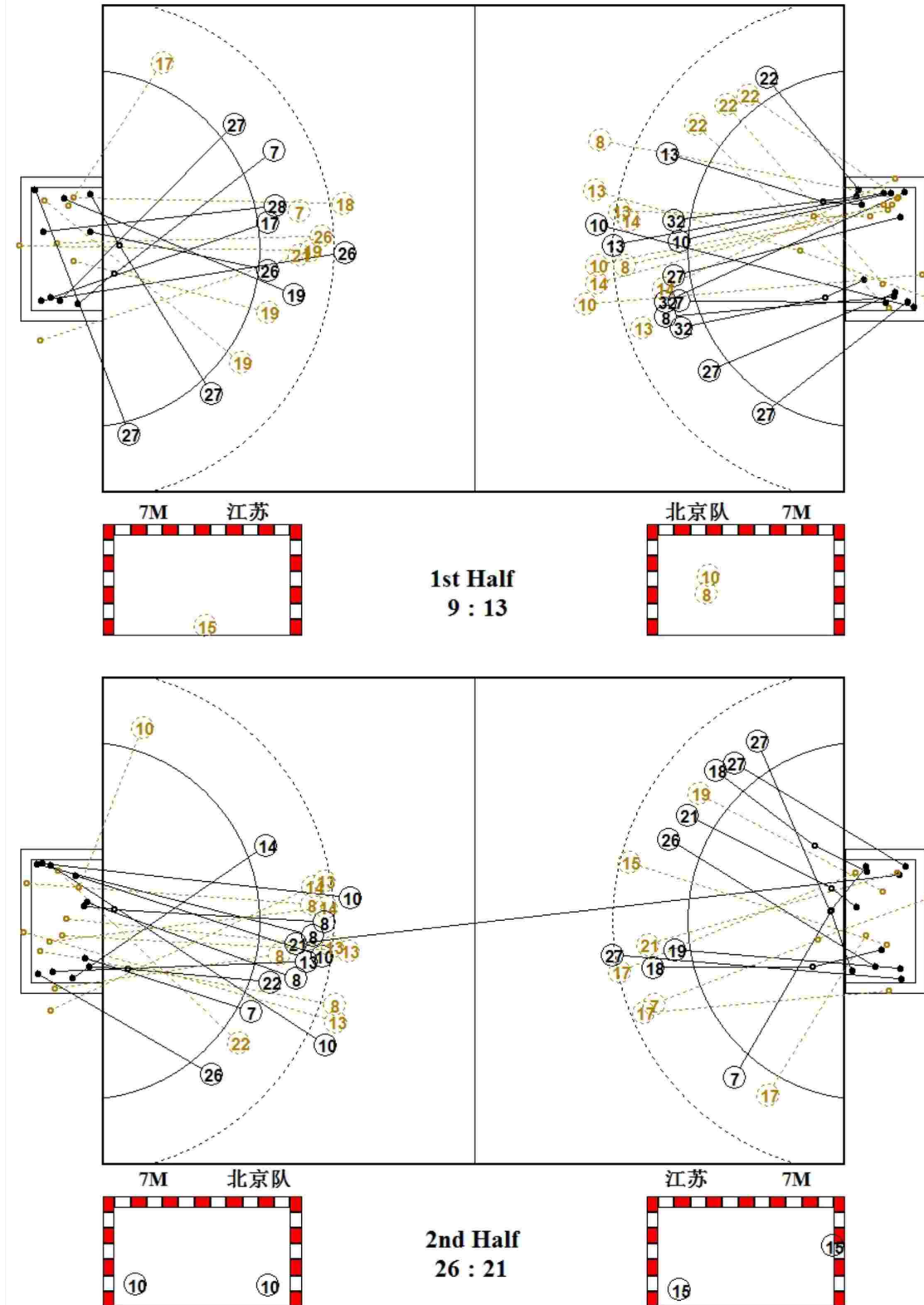

中国男子手球超级联赛(北京)

PHMS Pictorial Handball Match Statistics

IHF Official System

图式射门区域统计

手球
男子

预赛
轮次 3

组别 X
场次 6

北京光彩体育馆
2019-06-30 16:45

北京光彩男子手球俱乐部队

2 解建飞	7 马昌震	8 MagyarDavid	10 MezeiRichard Be	11 赵文宣	12 高云健	13 王军鸣	14 透明松																																																																								
<table border="1"><tr><td></td><td></td><td></td></tr><tr><td></td><td></td><td></td></tr><tr><td></td><td></td><td></td></tr></table>										<table border="1"><tr><td></td><td></td><td></td></tr><tr><td></td><td></td><td>1</td></tr><tr><td>1</td><td></td><td></td></tr></table>						1	1			<table border="1"><tr><td></td><td></td><td>2</td></tr><tr><td></td><td></td><td></td></tr><tr><td></td><td>2</td><td></td></tr></table>			2					2		<table border="1"><tr><td>1</td><td></td><td>3</td></tr><tr><td></td><td></td><td>1</td></tr><tr><td>1</td><td></td><td>1</td></tr></table>	1		3			1	1		1	<table border="1"><tr><td></td><td></td><td></td></tr><tr><td></td><td></td><td></td></tr><tr><td></td><td></td><td></td></tr></table>										<table border="1"><tr><td></td><td></td><td></td></tr><tr><td></td><td></td><td></td></tr><tr><td></td><td></td><td></td></tr></table>										<table border="1"><tr><td>1</td><td></td><td></td></tr><tr><td>1</td><td></td><td></td></tr><tr><td>1</td><td></td><td></td></tr></table>	1			1			1			<table border="1"><tr><td></td><td></td><td></td></tr><tr><td></td><td></td><td></td></tr><tr><td>1</td><td></td><td></td></tr></table>							1		
		1																																																																													
1																																																																															
		2																																																																													
	2																																																																														
1		3																																																																													
		1																																																																													
1		1																																																																													
1																																																																															
1																																																																															
1																																																																															
1																																																																															
Post - 0 Miss - 0 Block - 0	Post - 0 Miss - 0 Block - 0	Post - 2 Miss - 0 Block - 0	Post - 1 Miss - 0 Block - 0	Post - 0 Miss - 0 Block - 0	Post - 0 Miss - 0 Block - 0	Post - 1 Miss - 1 Block - 2	Post - 1 Miss - 1 Block - 1																																																																								
16 孟辉	18 傅俊雄	22 王超	25 马明辉	26 魏昂	27 闫炳旗	29 杜龙飞	32 蒋维一																																																																								
<table border="1"><tr><td></td><td></td><td></td></tr><tr><td></td><td></td><td></td></tr><tr><td></td><td></td><td></td></tr></table>										<table border="1"><tr><td></td><td></td><td></td></tr><tr><td></td><td></td><td></td></tr><tr><td></td><td></td><td></td></tr></table>										<table border="1"><tr><td></td><td></td><td></td></tr><tr><td></td><td></td><td></td></tr><tr><td>2</td><td></td><td></td></tr></table>							2			<table border="1"><tr><td></td><td></td><td></td></tr><tr><td></td><td></td><td></td></tr><tr><td></td><td></td><td></td></tr></table>										<table border="1"><tr><td>1</td><td></td><td></td></tr><tr><td></td><td></td><td></td></tr><tr><td></td><td></td><td></td></tr></table>	1									<table border="1"><tr><td>1</td><td></td><td>2</td></tr><tr><td></td><td></td><td></td></tr><tr><td></td><td></td><td></td></tr></table>	1		2							<table border="1"><tr><td></td><td></td><td></td></tr><tr><td></td><td></td><td></td></tr><tr><td></td><td></td><td></td></tr></table>										<table border="1"><tr><td>1</td><td></td><td></td></tr><tr><td></td><td></td><td></td></tr><tr><td>1</td><td></td><td>1</td></tr></table>	1						1		1
2																																																																															
1																																																																															
1		2																																																																													
1																																																																															
1		1																																																																													
Post - 0 Miss - 0 Block - 0	Post - 0 Miss - 0 Block - 0	Post - 0 Miss - 0 Block - 0	Post - 0 Miss - 0 Block - 0	Post - 0 Miss - 0 Block - 0	Post - 0 Miss - 0 Block - 0	Post - 0 Miss - 0 Block - 0	Post - 0 Miss - 0 Block - 0																																																																								

12 高云健

1/5	0/1	1/5
1/3	2/2	3/6
1/4	2/4	0/2

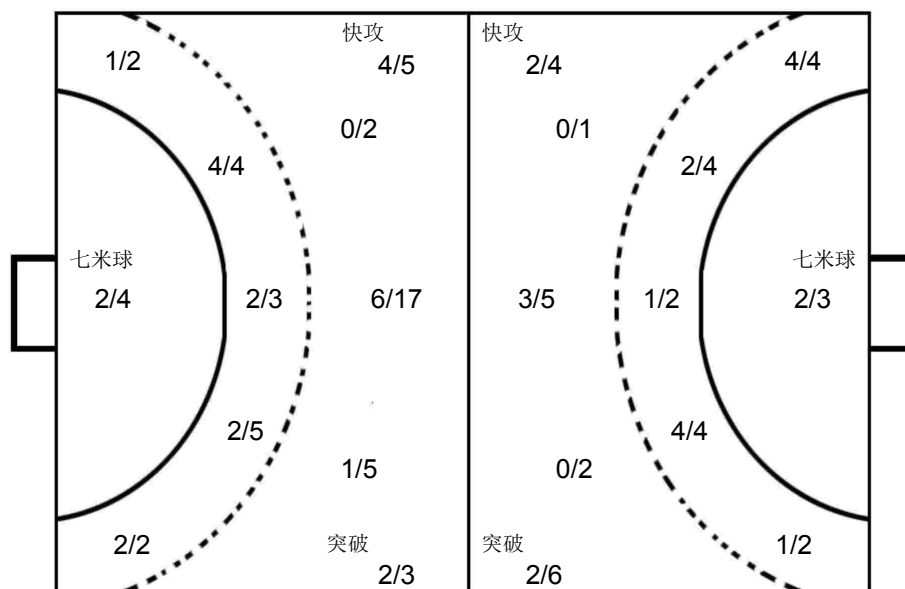

16 张帅

4/9	1/1	0/7
5/7	2/2	4/6
0/6	0/2	0/2

太平洋保险江苏男子手球俱乐部

1 陈昊	5 闫亮	7 周傲	9 许翔宇	11 张天豪	15 李安	16 张帅	17 刘赵梁																																																																								
<table border="1"><tr><td></td><td></td><td></td></tr><tr><td></td><td></td><td></td></tr><tr><td></td><td></td><td></td></tr></table>										<table border="1"><tr><td></td><td></td><td></td></tr><tr><td></td><td></td><td></td></tr><tr><td></td><td></td><td></td></tr></table>										<table border="1"><tr><td></td><td></td><td></td></tr><tr><td>1</td><td></td><td></td></tr><tr><td>1</td><td></td><td></td></tr></table>				1			1			<table border="1"><tr><td></td><td></td><td></td></tr><tr><td></td><td></td><td></td></tr><tr><td></td><td></td><td></td></tr></table>										<table border="1"><tr><td></td><td></td><td></td></tr><tr><td></td><td></td><td></td></tr><tr><td></td><td></td><td></td></tr></table>										<table border="1"><tr><td></td><td></td><td>1</td></tr><tr><td></td><td></td><td></td></tr><tr><td>1</td><td></td><td></td></tr></table>			1				1			<table border="1"><tr><td></td><td></td><td></td></tr><tr><td></td><td></td><td></td></tr><tr><td></td><td></td><td></td></tr></table>										<table border="1"><tr><td>1</td><td></td><td></td></tr><tr><td></td><td></td><td></td></tr><tr><td></td><td></td><td></td></tr></table>	1								
1																																																																															
1																																																																															
		1																																																																													
1																																																																															
1																																																																															
Post - 0 Miss - 0 Block - 0	Post - 0 Miss - 0 Block - 0	Post - 0 Miss - 1 Block - 1	Post - 0 Miss - 0 Block - 0	Post - 0 Miss - 0 Block - 0	Post - 0 Miss - 0 Block - 0	Post - 0 Miss - 0 Block - 0	Post - 1 Miss - 0 Block - 0																																																																								
18 赵楠	19 庞连康	21 刘江	22 罗尧尧	23 宋继强	26 MUCZA Nobert	27 王伟强	28 SZRNKAlevente																																																																								
<table border="1"><tr><td></td><td></td><td></td></tr><tr><td></td><td></td><td>1</td></tr><tr><td>1</td><td></td><td>1</td></tr></table>						1	1		1	<table border="1"><tr><td></td><td></td><td>1</td></tr><tr><td></td><td></td><td>1</td></tr><tr><td></td><td></td><td></td></tr></table>			1			1				<table border="1"><tr><td>1</td><td></td><td></td></tr><tr><td></td><td></td><td></td></tr><tr><td></td><td>1</td><td></td></tr></table>	1							1		<table border="1"><tr><td></td><td></td><td></td></tr><tr><td></td><td></td><td></td></tr><tr><td></td><td></td><td></td></tr></table>										<table border="1"><tr><td></td><td></td><td></td></tr><tr><td></td><td></td><td></td></tr><tr><td></td><td></td><td></td></tr></table>										<table border="1"><tr><td>1</td><td></td><td></td></tr><tr><td></td><td></td><td>1</td></tr><tr><td></td><td>1</td><td></td></tr></table>	1					1		1		<table border="1"><tr><td>1</td><td></td><td>2</td></tr><tr><td>1</td><td></td><td></td></tr><tr><td></td><td></td><td>2</td></tr></table>	1		2	1					2	<table border="1"><tr><td></td><td>1</td><td></td></tr><tr><td></td><td></td><td></td></tr><tr><td></td><td></td><td></td></tr></table>		1							
		1																																																																													
1		1																																																																													
		1																																																																													
		1																																																																													
1																																																																															
	1																																																																														
1																																																																															
		1																																																																													
	1																																																																														
1		2																																																																													
1																																																																															
		2																																																																													
	1																																																																														
Post - 0 Miss - 0 Block - 0	Post - 1 Miss - 0 Block - 0	Post - 0 Miss - 1 Block - 0	Post - 0 Miss - 0 Block - 0	Post - 0 Miss - 0 Block - 0	Post - 0 Miss - 0 Block - 0	Post - 0 Miss - 0 Block - 0	Post - 0 Miss - 0 Block - 0																																																																								

