



2019中国男子手球超级联赛 总决赛（青岛）

成绩与技术统计数据册



中国手球协会
CHINESE HANDBALL ASSOCIATION



华体集团
CHINA NATIONAL SPORTS GROUP

下一站 2019
VS
胜利
中国男子手球超级联赛
CHINESE HANDBALL ASSOCIATION SUPER LEAGUE

数据由PHMS收集生成
PHMS国际手球联合会官方技术统计系统



成绩与技术统计数据册目录

- 1 比赛结果
 - 1) 名次
 - 2) 获奖队员名单
 - 3) 场次成绩
 - 4) 分组成绩
- 2 运动员排名
 - 1) 得分
 - 2) 助攻
 - 3) 封球
 - 4) 防守
 - 5) 失误
 - 6) 受罚
- 3 守门员排名
 - 1) 救球
 - 2) 救7M球
- 4 球队总体比较
- 5 球队受罚表
- 6 球队累计
 - 1) 球队名单
 - 2) 个人/全队技术累计表
 - 3) 图式射门区域累计
- 7 每场比赛统计
 - 1) 比赛报告表
 - 2) 竞赛技术统计表
 - 3) 个人/全队技术统计表
 - 4) 图式比赛技术统计
 - 5) 图式射门区域统计
 - 6) 比赛进程表(决赛场次)

注：如需更多比赛统计数据，请通过以下电邮联络：handball@126.com

2019中国男子手球超级联赛总决赛（青岛）

PHMS Pictorial Handball Match Statistics

IHF Official System

大赛名次

手球
男子

截止至第24场

山东青岛
2019-07-30

奖牌	名次	缩写	队名
Gold	1	华体	中国华体
Silver	2	江苏	太平洋保险江苏
Bronze	3	北京	北京光彩
	4	广东	广东路环四庙

2019中国男子手球超级联赛总决赛（青岛）

PHMS Pictorial Handball Match Statistics

IHF Official System

获奖队员名单

手球
男子

山东青岛
2019-07-30

金牌	银牌	铜牌
华体-中国华体	江苏-太平洋保险江苏	北京-北京光彩
4 张家纬	1 陈昊	2 解建飞
5 贺政	5 闫亮	7 马昌震
8 谢庆龙	9 许翔宇	8 MAGYAR David
10 李朝鹏	11 张天豪	10 MEZEI Richard B.
12 王权	12 张睿梁	11 赵文宣
16 刘迈科	15 李安	12 高云健
17 胡晋铭	16 张帅	13 王军鸣
18 李双	17 刘赵梁	14 逯明松
20 顾艳超	18 赵楠	16 孟辉
22 黄培杰	19 庞连康	17 王哲一
23 曹悦	21 刘江	22 王超
25 王杰缘	22 罗尧尧	25 马明辉
47 成亚	25 陈孝天	26 魏昂
88 王军程	26 MUCZA Norbert	27 闫炳旗
97 张建杰	27 王伟强	29 杜龙飞
99 王伟	28 SZRNKA Levente	32 蒋唯一

2019中国男子手球超级联赛总决赛（青岛）

PHMS Pictorial Handball Match Statistics

IHF Official System

场次成绩

手球 男子 截止至第24场 山东青岛 2019-07-30

日期	时间	场次	体育馆	组别	球队	成绩（半时）	阶段
26-07-19	19:00	19	青岛市民健身中心	X	华体-广东	32-24 (13-13)	名次赛
	20:45	20	青岛市民健身中心	X	江苏-北京	29-23 (15-9)	名次赛
27-07-19	19:00	21	青岛市民健身中心	X	广东-北京	26-34 (11-17)	名次赛
	20:45	22	青岛市民健身中心	X	华体-江苏	34-22 (14-11)	名次赛
29-07-19	15:00	23	青岛市民健身中心	X	北京-江苏	27-31 (13-14)	名次赛
30-07-19	15:00	24	青岛市民健身中心	X	江苏-华体	30-35 (13-19)	决赛

2019中国男子手球超级联赛总决赛（青岛）

PHMS Pictorial Handball Match Statistics

IHF Official System

得分排名表(场上队员)

手球 男子 截止至第24场 按总得分排序 山东青岛 2019-07-30

排序	号码	姓名	球队	远射	近射	边射	快攻	突破	任意	七米	合计	%	助攻	场数
1	15	李安	江苏	2-7	4-4	0-0	0-0	4-4	0-0	12-17	22-32	68.8	4	4
2	32	蒋唯一	北京	0-0	8-9	0-0	3-5	2-4	0-0	7-7	20-25	80.0	0	3
3	22	黄培杰	华体	1-1	3-6	3-8	10-12	0-0	0-0	2-3	19-30	63.3	3	3
4	28	SZRKA Levente	江苏	0-1	13-17	0-0	1-2	0-0	0-1	0-0	14-21	66.7	1	4
5	27	王伟强	江苏	0-1	1-1	7-9	5-5	0-0	0-0	0-0	13-16	81.3	1	4
6	13	王军鸣	北京	8-16	3-3	0-1	0-0	1-1	1-1	0-0	13-22	59.1	5	3
7	8	谢庆龙	华体	0-1	9-11	0-0	3-4	0-1	0-0	0-1	12-18	66.7	3	3
8	26	MUCZA Norbert	江苏	7-16	1-3	0-0	3-3	1-2	0-0	0-0	12-24	50.0	5	4
9	4	ARPASI Patrik	广东	0-0	7-8	0-0	4-5	0-0	0-0	0-0	11-13	84.6	1	2
10	47	成亚	华体	2-4	4-5	1-1	2-3	0-0	0-0	2-3	11-16	68.8	3	3
11	88	王军程	华体	4-10	1-3	0-0	2-2	4-4	0-0	0-0	11-19	57.9	5	3
12	19	庞连康	江苏	5-12	4-7	0-0	0-0	2-2	0-0	0-0	11-21	52.4	2	4
13	97	张建杰	华体	6-11	3-3	0-0	0-3	1-1	0-0	0-0	10-18	55.6	1	3
14	21	刘江	江苏	2-3	5-7	0-0	1-3	1-1	0-0	0-0	9-14	64.3	4	4
15	14	逯明松	北京	3-11	5-6	0-0	0-0	1-2	0-0	0-0	9-19	47.4	2	3
16	26	魏昂	北京	0-0	0-0	2-3	5-5	1-2	0-0	0-0	8-10	80.0	0	3
17	25	王杰缘	华体	0-0	3-3	1-5	4-4	0-0	0-0	0-0	8-12	66.7	0	3
18	10	周仲坤	广东	4-14	1-2	0-0	0-0	0-0	1-1	2-3	8-20	40.0	1	2
19	22	王超	北京	0-0	2-2	1-3	3-5	1-2	0-0	0-0	7-12	58.3	4	3
20	5	贺政	华体	0-0	1-6	3-4	2-4	0-0	0-0	1-1	7-15	46.7	0	3
21	17	李中洲	广东	3-9	2-4	0-0	1-1	0-1	1-1	0-0	7-16	43.8	2	2
22	22	罗尧尧	江苏	0-1	2-3	2-2	1-1	0-0	0-0	1-1	6-8	75.0	1	4
23	4	张家纬	华体	2-4	1-1	0-0	0-0	3-3	0-0	0-0	6-8	75.0	0	3
24	17	王哲一	北京	1-6	3-4	0-0	0-1	1-2	0-0	1-2	6-15	40.0	4	3
25	18	赵楠	江苏	2-11	1-5	0-1	2-3	1-2	0-0	0-0	6-22	27.3	5	4
26	10	李朝鹏	华体	2-2	3-4	0-0	0-0	0-0	0-0	0-0	5-6	83.3	2	3
27	18	李双	华体	0-1	0-1	2-2	1-1	1-1	1-1	0-0	5-7	71.4	2	3
28	18	姚雪岩	广东	2-7	2-3	0-0	0-0	1-1	0-0	0-0	5-11	45.5	1	2
29	17	刘赵梁	江苏	2-4	1-3	0-1	0-1	2-4	0-0	0-0	5-13	38.5	5	4
30	7	马昌震	北京	0-0	4-5	0-0	0-0	0-0	0-0	0-0	4-5	80.0	1	3
31	27	闫炳旗	北京	0-0	1-2	1-3	2-2	0-0	0-0	0-0	4-7	57.1	0	3
32	5	闫亮	江苏	0-1	2-5	1-1	1-1	0-0	0-0	0-0	4-8	50.0	2	4
33	8	MAGYAR David	北京	2-7	2-2	0-0	0-0	0-0	0-0	0-0	4-9	44.4	3	3
34	23	曹悦	华体	2-6	1-1	0-0	1-2	0-0	0-0	0-0	4-9	44.4	2	3
35	6	毕晓晨	广东	0-1	0-1	1-2	3-4	0-1	0-0	0-0	4-9	44.4	2	2
36	9	许翔宇	江苏	3-9	1-2	0-0	0-0	0-0	0-0	0-0	4-11	36.4	4	4
37	11	张天豪	江苏	0-0	2-4	0-5	1-2	0-0	0-0	1-1	4-12	33.3	0	4
38	21	张昌轲	广东	0-3	1-4	1-2	2-3	0-0	0-0	0-0	4-12	33.3	3	2
39	17	胡晋铭	华体	0-0	3-4	0-0	0-0	0-0	0-0	0-0	3-4	75.0	1	3
40	11	赵文宣	北京	0-0	2-2	1-1	0-1	0-0	0-0	0-0	3-4	75.0	0	3

2019中国男子手球超级联赛总决赛（青岛）

PHMS Pictorial Handball Match Statistics

IHF Official System

得分排名表(场上队员)

手球 截止至第24场 山东青岛
男子 按助攻次数排序 2019-07-30

排序	号码	姓名	球队	远射	近射	边射	快攻	突破	任意	七米	合计	%	助攻	场数
1	13	王军鸣	北京	8-16	3-3	0-1	0-0	1-1	1-1	0-0	13-22	59.1	5	3
2	26	MUCZA Norbert	江苏	7-16	1-3	0-0	3-3	1-2	0-0	0-0	12-24	50.0	5	4
3	88	王军程	华体	4-10	1-3	0-0	2-2	4-4	0-0	0-0	11-19	57.9	5	3
4	18	赵楠	江苏	2-11	1-5	0-1	2-3	1-2	0-0	0-0	6-22	27.3	5	4
5	17	刘赵梁	江苏	2-4	1-3	0-1	0-1	2-4	0-0	0-0	5-13	38.5	5	4
6	3	曲汝洋	广东	1-6	1-4	0-0	0-0	0-0	0-0	0-0	2-10	20.0	5	2
7	16	刘迈科	华体	0-0	0-0	0-0	0-0	0-0	0-0	0-0	0-0	0	5	3
8	15	李安	江苏	2-7	4-4	0-0	0-0	4-4	0-0	12-17	22-32	68.8	4	4
9	21	刘江	江苏	2-3	5-7	0-0	1-3	1-1	0-0	0-0	9-14	64.3	4	4
10	22	王超	北京	0-0	2-2	1-3	3-5	1-2	0-0	0-0	7-12	58.3	4	3
11	17	王哲一	北京	1-6	3-4	0-0	0-1	1-2	0-0	1-2	6-15	40.0	4	3
12	9	许翔宇	江苏	3-9	1-2	0-0	0-0	0-0	0-0	0-0	4-11	36.4	4	4
13	12	高云健	北京	0-0	0-0	0-0	0-0	0-0	0-0	0-0	0-0	0	4	3
14	22	黄培杰	华体	1-1	3-6	3-8	10-12	0-0	0-0	2-3	19-30	63.3	3	3
15	8	谢庆龙	华体	0-1	9-11	0-0	3-4	0-1	0-0	0-1	12-18	66.7	3	3
16	47	成亚	华体	2-4	4-5	1-1	2-3	0-0	0-0	2-3	11-16	68.8	3	3
17	8	MAGYAR David	北京	2-7	2-2	0-0	0-0	0-0	0-0	0-0	4-9	44.4	3	3
18	21	张昌轲	广东	0-3	1-4	1-2	2-3	0-0	0-0	0-0	4-12	33.3	3	2
19	8	DOLEZSAL Karoly	广东	1-3	1-1	0-0	0-0	0-0	0-0	0-0	2-4	50.0	3	2
20	19	庞连康	江苏	5-12	4-7	0-0	0-0	2-2	0-0	0-0	11-21	52.4	2	4
21	14	逯明松	北京	3-11	5-6	0-0	0-0	1-2	0-0	0-0	9-19	47.4	2	3
22	17	李中洲	广东	3-9	2-4	0-0	1-1	0-1	1-1	0-0	7-16	43.8	2	2
23	10	李朝鹏	华体	2-2	3-4	0-0	0-0	0-0	0-0	0-0	5-6	83.3	2	3
24	18	李双	华体	0-1	0-1	2-2	1-1	1-1	1-1	0-0	5-7	71.4	2	3
25	5	闫亮	江苏	0-1	2-5	1-1	1-1	0-0	0-0	0-0	4-8	50.0	2	4
26	23	曹悦	华体	2-6	1-1	0-0	1-2	0-0	0-0	0-0	4-9	44.4	2	3
27	6	毕晓晨	广东	0-1	0-1	1-2	3-4	0-1	0-0	0-0	4-9	44.4	2	2
28	24	高玉杰	广东	0-0	0-0	0-1	2-2	0-0	0-0	0-0	2-3	66.7	2	2
29	29	杜龙飞	北京	1-4	1-1	0-2	0-0	0-0	0-0	0-0	2-7	28.6	2	3
30	20	顾艳超	华体	0-2	0-1	0-0	0-0	0-1	0-0	0-0	0-4	0.0	2	3
31	28	SZRKA Levente	江苏	0-1	13-17	0-0	1-2	0-0	0-1	0-0	14-21	66.7	1	4
32	27	王伟强	江苏	0-1	1-1	7-9	5-5	0-0	0-0	0-0	13-16	81.3	1	4
33	4	ARPASI Patrik	广东	0-0	7-8	0-0	4-5	0-0	0-0	0-0	11-13	84.6	1	2
34	97	张建杰	华体	6-11	3-3	0-0	0-3	1-1	0-0	0-0	10-18	55.6	1	3
35	10	周仲坤	广东	4-14	1-2	0-0	0-0	0-0	1-1	2-3	8-20	40.0	1	2
36	22	罗尧尧	江苏	0-1	2-3	2-2	1-1	0-0	0-0	1-1	6-8	75.0	1	4
37	18	姚雪岩	广东	2-7	2-3	0-0	0-0	1-1	0-0	0-0	5-11	45.5	1	2
38	7	马昌震	北京	0-0	4-5	0-0	0-0	0-0	0-0	0-0	4-5	80.0	1	3
39	17	胡晋铭	华体	0-0	3-4	0-0	0-0	0-0	0-0	0-0	3-4	75.0	1	3
40	2	解建飞	北京	3-3	0-0	0-0	0-0	0-0	0-0	0-2	3-5	60.0	1	3

2019中国男子手球超级联赛总决赛（青岛）

PHMS Pictorial Handball Match Statistics

IHF Official System

得分排名表(场上队员)

手球 男子 截止至第24场 按封球次数排序 山东青岛 2019-07-30

名次	号码	姓名	球队	抢球	断球	造失误	造犯规	合计	封球	场数
1	17	胡晋铭	华体	0	1	0	0	1	4	3
2	5	闫亮	江苏	1	1	0	0	2	4	4
3	8	谢庆龙	华体	0	3	0	1	4	3	3
4	23	曹悦	华体	1	1	0	1	3	2	3
5	2	解建飞	北京	0	3	0	3	6	2	3
6	32	蒋唯一	北京	0	0	1	0	1	2	3
7	97	张建杰	华体	0	0	0	0	0	2	3
8	11	赵文宣	北京	0	1	0	0	1	2	3
9	15	李安	江苏	0	0	0	3	3	2	4
10	4	ARPASI Patrik	广东	2	0	0	0	2	1	2
11	11	房友屯	广东	0	0	0	0	0	1	2
12	17	李中洲	广东	0	1	0	0	1	1	2
13	18	姚雪岩	广东	0	0	0	0	0	1	2
14	88	王军程	华体	0	1	0	0	1	1	3
15	47	成亚	华体	0	1	0	1	2	1	3
16	18	李双	华体	0	1	0	0	1	1	3
17	26	魏昂	北京	1	0	0	1	2	1	3
18	28	SZRKA Levente	江苏	1	1	0	0	2	1	4
19	21	刘江	江苏	0	1	0	2	3	1	4
20	10	周仲坤	广东	0	0	0	0	0	0	2
21	9	范保坤	广东	0	0	0	0	0	0	2
22	5	曹景森	广东	0	0	0	0	0	0	2
23	24	高玉杰	广东	0	1	0	0	1	0	2
24	19	王泽润	广东	0	0	0	0	0	0	2
25	7	王立隆	广东	0	0	0	0	0	0	2
26	21	张昌轲	广东	1	2	0	0	3	0	2
27	6	毕晓晨	广东	0	0	0	0	0	0	2
28	1	王帅	广东	0	0	0	0	0	0	2
29	3	曲汝洋	广东	0	1	0	0	1	0	2
30	8	DOLEZSAL Karoly	广东	0	2	0	0	2	0	2
31	7	马昌震	北京	0	0	0	1	1	0	3
32	29	杜龙飞	北京	1	0	0	0	1	0	3
33	25	马明辉	北京	0	1	0	0	1	0	3
34	12	高云健	北京	0	0	0	0	0	0	3
35	10	MEZEI Richard B.	北京	0	0	0	1	1	0	3
36	27	闫炳旗	北京	0	0	0	2	2	0	3
37	22	王超	北京	0	0	0	0	0	0	3
38	17	王哲一	北京	0	0	0	0	0	0	3
39	16	孟辉	北京	0	0	0	0	0	0	3
40	14	逯明松	北京	1	2	1	2	6	0	3

2019中国男子手球超级联赛总决赛（青岛）

PHMS Pictorial Handball Match Statistics

IHF Official System

得分排名表(场上队员)

手球
男子

截止至第24场
按防守成功总数排序

山东青岛
2019-07-30

名次	号码	姓名	球队	抢球	断球	造失误	造犯规	合计	封球	场数
1	14	逯明松	北京	1	2	1	2	6	0	3
2	2	解建飞	北京	0	3	0	3	6	2	3
3	18	赵楠	江苏	0	1	0	4	5	0	4
4	17	刘赵梁	江苏	1	4	0	0	5	0	4
5	8	谢庆龙	华体	0	3	0	1	4	3	3
6	21	刘江	江苏	0	1	0	2	3	1	4
7	26	MUCZA Norbert	江苏	2	0	0	1	3	0	4
8	15	李安	江苏	0	0	0	3	3	2	4
9	23	曹悦	华体	1	1	0	1	3	2	3
10	21	张昌轲	广东	1	2	0	0	3	0	2
11	19	庞连康	江苏	0	2	0	0	2	0	4
12	28	SZRANKA Levente	江苏	1	1	0	0	2	1	4
13	5	闫亮	江苏	1	1	0	0	2	4	4
14	5	贺政	华体	0	2	0	0	2	0	3
15	26	魏昂	北京	1	0	0	1	2	1	3
16	47	成亚	华体	0	1	0	1	2	1	3
17	27	闫炳旗	北京	0	0	0	2	2	0	3
18	4	ARPASI Patrik	广东	2	0	0	0	2	1	2
19	8	DOLEZSAL Karoly	广东	0	2	0	0	2	0	2
20	25	陈孝天	江苏	0	1	0	0	1	0	4
21	22	罗尧尧	江苏	0	1	0	0	1	0	4
22	9	许翔宇	江苏	1	0	0	0	1	0	4
23	27	王伟强	江苏	1	0	0	0	1	0	4
24	10	MEZEI Richard B.	北京	0	0	0	1	1	0	3
25	25	马明辉	北京	0	1	0	0	1	0	3
26	32	蒋唯一	北京	0	0	1	0	1	2	3
27	29	杜龙飞	北京	1	0	0	0	1	0	3
28	7	马昌震	北京	0	0	0	1	1	0	3
29	25	王杰缘	华体	1	0	0	0	1	0	3
30	10	李朝鹏	华体	1	0	0	0	1	0	3
31	13	王军鸣	北京	1	0	0	0	1	0	3
32	17	胡晋铭	华体	0	1	0	0	1	4	3
33	18	李双	华体	0	1	0	0	1	1	3
34	20	顾艳超	华体	0	1	0	0	1	0	3
35	22	黄培杰	华体	0	1	0	0	1	0	3
36	11	赵文宣	北京	0	1	0	0	1	2	3
37	99	王伟	华体	1	0	0	0	1	0	3
38	88	王军程	华体	0	1	0	0	1	1	3
39	8	MAGYAR David	北京	0	1	0	0	1	0	3
40	3	曲汝洋	广东	0	1	0	0	1	0	2

2019中国男子手球超级联赛总决赛（青岛）

PHMS Pictorial Handball Match Statistics

IHF Official System

得分排名表(场上队员)

手球 男子 截止至第24场 按失误总数排序 山东青岛 2019-07-30

排序	号码	姓名	球队	传失	接失	两次	四步	侵区	进犯	其它	合计	场数
1	26	MUCZA Norbert	江苏	4	3	1	1	0	0	0	9	4
2	9	许翔宇	江苏	2	3	0	0	1	3	0	9	4
3	8	谢庆龙	华体	3	3	0	0	0	2	1	9	3
4	17	王哲一	北京	4	0	1	2	0	0	0	7	3
5	8	MAGYAR David	北京	5	0	0	1	0	1	0	7	3
6	8	DOLEZSAL Karoly	广东	7	0	0	0	0	0	0	7	2
7	21	刘江	江苏	1	1	0	1	2	1	0	6	4
8	19	庞连康	江苏	3	1	0	1	0	1	0	6	4
9	13	王军鸣	北京	2	1	0	1	1	1	0	6	3
10	4	ARPASI Patrik	广东	2	1	0	0	1	1	1	6	2
11	15	李安	江苏	0	1	2	0	0	1	1	5	4
12	14	逯明松	北京	3	1	0	1	0	0	0	5	3
13	17	刘赵梁	江苏	1	0	1	2	0	0	0	4	4
14	27	王伟强	江苏	0	0	0	0	1	2	1	4	4
15	47	成亚	华体	2	0	0	1	0	1	0	4	3
16	22	黄培杰	华体	1	0	1	0	2	0	0	4	3
17	22	王超	北京	2	1	0	1	0	0	0	4	3
18	97	张建杰	华体	1	2	0	0	0	0	1	4	3
19	3	曲汝洋	广东	3	1	0	0	0	0	0	4	2
20	10	周仲坤	广东	3	0	0	1	0	0	0	4	2
21	18	赵楠	江苏	1	1	0	0	1	0	0	3	4
22	28	SZRANKA Levente	江苏	0	0	0	0	0	3	0	3	4
23	32	蒋唯一	北京	0	0	0	0	2	1	0	3	3
24	10	李朝鹏	华体	0	0	1	0	0	2	0	3	3
25	26	魏昂	北京	2	0	0	0	1	0	0	3	3
26	18	李双	华体	1	1	0	0	1	0	0	3	3
27	4	张家纬	华体	0	1	1	1	0	0	0	3	3
28	11	赵文宣	北京	0	0	0	0	1	2	0	3	3
29	7	马昌震	北京	0	2	0	0	1	0	0	3	3
30	25	陈孝天	江苏	0	1	0	0	1	0	0	2	4
31	11	张天豪	江苏	1	1	0	0	0	0	0	2	4
32	22	罗尧尧	江苏	2	0	0	0	0	0	0	2	4
33	29	杜龙飞	北京	1	1	0	0	0	0	0	2	3
34	20	顾艳超	华体	0	1	0	1	0	0	0	2	3
35	2	解建飞	北京	0	0	0	0	0	0	2	2	3
36	88	王军程	华体	1	0	0	1	0	0	0	2	3
37	21	张昌轲	广东	0	0	0	1	0	1	0	2	2
38	17	李中洲	广东	0	1	0	1	0	0	0	2	2
39	7	王立隆	广东	0	1	1	0	0	0	0	2	2
40	6	毕晓晨	广东	1	0	1	0	0	0	0	2	2

2019中国男子手球超级联赛总决赛（青岛）

PHMS Pictorial Handball Match Statistics

IHF Official System

得分排名表(场上队员)

手球 男子 截止至第24场 接受罚次数排序 山东青岛 2019-07-30

排序	号码	姓名	球队	警告	罚2分钟	D	DR	场数
1	21	刘江	江苏	0	3	1	0	4
2	7	马昌震	北京	1	4	0	0	3
3	28	SZRNKA Levente	江苏	2	3	0	0	4
4	18	赵楠	江苏	2	3	0	0	4
5	24	高玉杰	广东	2	3	0	0	2
6	88	王军程	华体	1	3	0	0	3
7	15	李安	江苏	0	3	0	0	4
8	2	解建飞	北京	3	2	0	0	3
9	97	张建杰	华体	0	2	0	0	3
10	17	王哲一	北京	0	2	0	0	3
11	26	魏昂	北京	0	2	0	0	3
12	27	闫炳旗	北京	1	1	0	0	3
13	23	曹悦	华体	1	1	0	0	3
14	25	马明辉	北京	1	1	0	0	3
15	14	逯明松	北京	1	1	0	0	3
16	10	周仲坤	广东	1	1	0	0	2
17	19	庞连康	江苏	0	1	0	0	4
18	10	李朝鹏	华体	0	1	0	0	3
19	99	王伟	华体	0	1	0	0	3
20	13	王军鸣	北京	0	1	0	0	3
21	47	成亚	华体	0	1	0	0	3
22	11	赵文宣	北京	0	1	0	0	3
23	17	胡晋铭	华体	0	1	0	0	3
24	17	李中洲	广东	0	1	0	0	2
25	21	张昌轲	广东	0	1	0	0	2
26	4	ARPASI Patrik	广东	0	1	0	0	2
27	26	MUCZA Norbert	江苏	2	0	0	0	4
28	4	张家纬	华体	2	0	0	0	3
29	5	闫亮	江苏	1	0	0	0	4
30	8	谢庆龙	华体	1	0	0	0	3
31	7	王立隆	广东	1	0	0	0	2
32	11	房友屯	广东	1	0	0	0	2
33	8	DOLEZSAL Karoly	广东	1	0	0	0	2
34	12	张睿梁	江苏	0	0	0	0	4
35	11	张天豪	江苏	0	0	0	0	4
36	9	许翔宇	江苏	0	0	0	0	4
37	17	刘赵梁	江苏	0	0	0	0	4
38	16	张帅	江苏	0	0	0	0	4
39	22	罗尧尧	江苏	0	0	0	0	4
40	1	陈昊	江苏	0	0	0	0	4

2019中国男子手球超级联赛总决赛（青岛）

PHMS Pictorial Handball Match Statistics

IHF Official System

排名表(守门员)

手球
男子

截止至第24场
按总救球数排序

山东青岛
2019-07-30

排序	号码	姓名	球队	远射	近射	边射	快攻	突破	任意	七米	得分	%	助攻	场数
1	16	刘迈科	华体	18-32	20-50	8-9	4-15	4-10	1-2	3-7	58-125	46.4	5	3
2	16	张帅	江苏	22-42	5-34	5-14	6-21	1-7	0-1	2-6	41-125	32.8	0	4
3	12	高云健	北京	18-37	10-29	4-14	1-13	0-5	0-1	0-8	33-107	30.8	4	3
4	1	王帅	广东	2-9	4-17	5-10	3-14	5-13	0-1	1-1	20-65	30.8	1	2
5	19	王泽润	广东	1-2	5-11	0-0	2-7	0-1	0-0	3-11	11-32	34.4	0	2
6	16	孟辉	北京	4-6	0-2	0-1	1-3	0-1	0-0	1-5	6-18	33.3	0	3
7	12	张睿梁	江苏	2-8	1-11	1-1	2-6	0-1	0-0	0-1	6-28	21.4	0	4
8	1	陈昊	江苏	0-3	3-8	0-2	1-4	0-0	0-0	0-0	4-17	23.5	0	4
9	12	王权	华体	0-1	2-6	0-0	0-4	0-0	0-0	0-0	2-11	18.2	0	3

2019中国男子手球超级联赛总决赛（青岛）

PHMS Pictorial Handball Match Statistics

IHF Official System

排名表(守门员)

手球
男子

截止至第24场
按救七米球数排序

山东青岛
2019-07-30

排序	号码	姓名	球队	远射	近射	边射	快攻	突破	任意	七米	得分	%	助攻	场数
1	16	刘迈科	华体	18-32	20-50	8-9	4-15	4-10	1-2	3-7	58-125	42.9	5	3
2	19	王泽润	广东	1-2	5-11	0-0	2-7	0-1	0-0	3-11	11-32	27.3	0	2
3	16	张帅	江苏	22-42	5-34	5-14	6-21	1-7	0-1	2-6	41-125	33.3	0	4
4	1	王帅	广东	2-9	4-17	5-10	3-14	5-13	0-1	1-1	20-65	100.0	1	2
5	16	孟辉	北京	4-6	0-2	0-1	1-3	0-1	0-0	1-5	6-18	20.0	0	3
6	1	陈昊	江苏	0-3	3-8	0-2	1-4	0-0	0-0	0-0	4-17	0	0	4
7	12	王权	华体	0-1	2-6	0-0	0-4	0-0	0-0	0-0	2-11	0	0	3
8	12	张睿梁	江苏	2-8	1-11	1-1	2-6	0-1	0-0	0-1	6-28	0.0	0	4
9	12	高云健	北京	18-37	10-29	4-14	1-13	0-5	0-1	0-8	33-107	0.0	4	3

2019中国男子手球超级联赛总决赛（青岛）

PHMS Pictorial Handball Match Statistics

IHF Official System

攻防成功率统计总表

手球
男子

截止至第24场

山东青岛
2019-07-30

序号	球队	比分	进攻成功率															助攻	防守成功率								
			阵地进攻			一传快攻			短传快攻			合计			多打少				少打多			封打抢断	守门员	对方射失	对方失误	合计	%
			得分	进攻	%	得分	进攻	%	得分	进攻	%	得分	进攻	%	得分	进攻	%		得分	进攻	%						
1	北京	84:86	71	166	42.8	7	10	70.0	6	16	37.5	84	192	43.8	11	18	61.1	12	17	70.6	26	31	39	16	23	109	55.9
2	广东	50:66	36	118	30.5	6	10	60.0	8	13	61.5	50	141	35.5	3	8	37.5	3	6	50.0	22	14	31	13	11	69	51.1
3	华体	101:76	76	162	46.9	11	14	78.6	14	27	51.9	101	203	49.8	6	13	46.2	9	12	75.0	29	33	60	22	23	138	64.5
4	江苏	112:119	97	245	39.6	6	8	75.0	9	15	60.0	112	268	41.8	22	29	75.9	9	13	69.2	34	37	51	18	35	141	54.2

注释:

进攻	进攻次数 (射门 + 进攻失误)	对方射失	对方射门失误 (射失 + 击柱)	防守成功率%	本方防守合计 / 对方进攻合计
----	------------------	------	------------------	--------	-----------------

2019中国男子手球超级联赛总决赛（青岛）

PHMS Pictorial Handball Match Statistics

IHF Official System

防守技术统计总表

手球
男子

截止至第24场

山东青岛
2019-07-30

序号	球队	比分	防守成功						防守（成功：失误）							处罚					守门员		
			封球	抢球	断球	造失	造犯	合计	选位	顶贴	观察	移动	换防	其他	合计	警告	2'	取消	DR	合计	救球	射门	%
1	北京	84:86	7	4	8	2	10	31	0:0	0:6	0:1	0:1	0:0	0:0	0:8	7	15	0	0	22	39	125	31.2
2	广东	50:66	4	3	7	0	0	14	0:0	0:6	0:0	0:3	0:0	0:0	0:9	6	7	0	0	13	31	97	32.0
3	华体	101:76	14	4	12	0	3	33	0:3	0:4	0:0	0:3	0:1	0:0	0:11	5	10	0	0	15	60	136	44.1
4	江苏	112:119	8	7	12	0	10	37	0:0	0:5	0:2	0:4	0:0	0:0	0:11	7	13	1	0	21	51	170	30.0

注释:

造失	造对方失误	造犯	造对方犯规	DR	取消资格+报告
----	-------	----	-------	----	---------

2019中国男子手球超级联赛总决赛（青岛）

PHMS Pictorial Handball Match Statistics

IHF Official System

球队名单

山东青岛

2019-07-26

中国华体

号码	姓名	位置	生日	年龄	俱乐部	身高 (CM)	体重 (KG)	国际场次	国际进球
4	张家纬	右后卫	25/09/1992	26	华体国家男子手球俱乐部	193	90		
5	贺政	右边锋	20/08/1996	22	华体国家男子手球俱乐部	186	86		
8	谢庆龙	底线	24/10/2000	18	华体国家男子手球俱乐部	192	115		
10	李朝鹏	后卫	05/12/1992	26	华体国家男子手球俱乐部	185	95		
12	王权	守门员	21/11/1992	26	华体国家男子手球俱乐部	205	110		
16	刘迈科	守门员	28/07/1994	24	华体国家男子手球俱乐部	188	100		
17	胡晋铭	底线	09/02/1997	22	华体国家男子手球俱乐部	197	113		
18	李双	右后卫	10/02/1997	22	华体国家男子手球俱乐部	192	74		
20	顾艳超	后卫	16/01/1993	26	华体国家男子手球俱乐部	188	86		
22	黄培杰	左边锋	15/01/1998	21	华体国家男子手球俱乐部	178	75		
23	曹悦	左后卫	23/05/1993	26	华体国家男子手球俱乐部	200	103		
25	王杰缘	右边锋	16/07/1994	25	华体国家男子手球俱乐部	180	75		
47	成亚	右后卫	14/06/1990	29	华体国家男子手球俱乐部	190	95		
88	王军程	左后卫	11/10/1995	23	华体国家男子手球俱乐部	198	94		
97	张建杰	左后卫	29/10/1997	21	华体国家男子手球俱乐部	197	101		
99	王伟	底线	18/11/1985	33	华体国家男子手球俱乐部	200	100		
	平均			24.4		191.8	94.5		

编码	姓名	职务
A	姚苏捷	领队
B	朱昕晨	主教练
D	付飞鹏	医生

2019中国男子手球超级联赛总决赛（青岛）

PHMS Pictorial Handball Match Statistics

IHF Official System

手球 男子 个人/全队技术累计表 截止至第24场 山东青岛 2019-07-30

号码	姓名	远射	近射	边射	快攻	突破	任意	七米	合计	%	助攻	失误	警告	2'	取消	场次	时间
中国华体																	
(场上队员)																	
4	张家纬	2/4	1/1			3/3			6/8	75.0%		3	2			3	00:56:58
5	贺政		1/6	3/4	2/4			1/1	7/15	46.7%		1				3	01:18:54
8	谢庆龙	0/1	9/11		3/4	0/1		0/1	12/18	66.7%	3	9	1			3	01:38:00
10	李朝鹏	2/2	3/4						5/6	83.3%	2	3		1		3	01:03:01
12	王权															3	00:17:24
16	刘迈科										5					3	02:42:36
17	胡晋铭		3/4						3/4	75.0%	1	1		1		3	01:16:15
18	李双	0/1	0/1	2/2	1/1	1/1	1/1		5/7	71.4%	2	3				3	01:01:59
20	顾艳超	0/2	0/1			0/1			0/4	0.0%	2	2				3	00:31:13
22	黄培杰	1/1	3/6	3/8	10/12			2/3	19/30	63.3%	3	4				3	02:52:03
23	曹悦	2/6	1/1		1/2				4/9	44.4%	2	1	1	1		3	01:05:30
25	王杰缘		3/3	1/5	4/4				8/12	66.7%						3	01:38:46
47	成亚	2/4	4/5	1/1	2/3			2/3	11/16	68.8%	3	4		1		3	01:22:40
88	王军程	4/10	1/3		2/2	4/4			11/19	57.9%	5	2	1	3		3	02:10:14
97	张建杰	6/11	3/3		0/3	1/1			10/18	55.6%	1	4		2		3	01:08:44
99	王伟													1		3	00:11:59
合计		19/42	32/49	10/20	25/35	9/11	1/1	5/8	101/166	60.8%	29	37	5	10		48	
(守门员)																	
12	王权	0/1	2/6		0/4				2/11	18.2%						3	00:17:24
16	刘迈科	18/32	20/50	8/9	4/15	4/10	1/2	3/7	58/125	46.4%	5					3	02:42:36
合计		18/33	22/56	8/9	4/19	4/10	1/2	3/7	60/136	44.1%	5					6	

场上队员：得分/射门

守门员：救球/射门

已打比赛

全队合计	进球	被救	射失	击柱	封球	合计	%	阶段	场次	对手	比分
远射	19	11	4	1	7	42	45.2%	名次赛	19	广东	32:24 (13:13)
近射	32	14	1	2		49	65.3%	名次赛	22	江苏	34:22 (14:11)
边射	10	5	2	3		20	50.0%	决赛	24	江苏	35:30 (19:13)
快攻	25	8	2			35	71.4%				
突破	9	2				11	81.8%				
任意	1					1	100.0%				
七米	5	3				8	62.5%				

2019中国男子手球超级联赛总决赛（青岛）

PHMS Pictorial Handball Match Statistics

IHF Official System

图式射门区域累计

手球
男子

山东青岛
2019-07-30

截止至第24场

中国华体

4 张家纬	5 贺政	8 谢庆龙	10 李朝鹏	12 王权	16 刘迈科	17 胡晋铭	18 李双																																																																								
<table border="1"><tr><td>1</td><td></td><td></td></tr><tr><td></td><td></td><td>1</td></tr><tr><td>3</td><td></td><td>1</td></tr></table>	1					1	3		1	<table border="1"><tr><td></td><td></td><td>3</td></tr><tr><td>1</td><td></td><td></td></tr><tr><td></td><td>1</td><td>2</td></tr></table>			3	1				1	2	<table border="1"><tr><td>1</td><td>1</td><td>3</td></tr><tr><td>2</td><td></td><td>1</td></tr><tr><td>2</td><td>1</td><td>1</td></tr></table>	1	1	3	2		1	2	1	1	<table border="1"><tr><td></td><td>1</td><td></td></tr><tr><td>1</td><td>1</td><td></td></tr><tr><td></td><td>1</td><td>1</td></tr></table>		1		1	1			1	1	<table border="1"><tr><td></td><td></td><td></td></tr><tr><td></td><td></td><td></td></tr><tr><td></td><td></td><td></td></tr></table>										<table border="1"><tr><td></td><td></td><td></td></tr><tr><td></td><td></td><td></td></tr><tr><td></td><td></td><td></td></tr></table>										<table border="1"><tr><td></td><td></td><td>2</td></tr><tr><td></td><td></td><td></td></tr><tr><td></td><td></td><td>1</td></tr></table>			2						1	<table border="1"><tr><td>1</td><td></td><td>1</td></tr><tr><td></td><td></td><td>1</td></tr><tr><td>1</td><td></td><td>1</td></tr></table>	1		1			1	1		1
1																																																																															
		1																																																																													
3		1																																																																													
		3																																																																													
1																																																																															
	1	2																																																																													
1	1	3																																																																													
2		1																																																																													
2	1	1																																																																													
	1																																																																														
1	1																																																																														
	1	1																																																																													
		2																																																																													
		1																																																																													
1		1																																																																													
		1																																																																													
1		1																																																																													
Post - 0 Miss - 0 Block - 0	Post - 2 Miss - 2 Block - 0	Post - 0 Miss - 0 Block - 1	Post - 0 Miss - 0 Block - 0	Post - 0 Miss - 0 Block - 0	Post - 0 Miss - 0 Block - 0	Post - 0 Miss - 0 Block - 0	Post - 0 Miss - 0 Block - 0																																																																								
20 顾艳超	22 黄培杰	23 曹悦	25 王杰缘	47 成亚	88 王军程	97 张建杰	99 王伟																																																																								
<table border="1"><tr><td></td><td></td><td></td></tr><tr><td></td><td></td><td></td></tr><tr><td></td><td></td><td></td></tr></table>										<table border="1"><tr><td>3</td><td>2</td><td>3</td></tr><tr><td>1</td><td>2</td><td>2</td></tr><tr><td>1</td><td>1</td><td>4</td></tr></table>	3	2	3	1	2	2	1	1	4	<table border="1"><tr><td>1</td><td>1</td><td></td></tr><tr><td></td><td></td><td></td></tr><tr><td>1</td><td></td><td>1</td></tr></table>	1	1					1		1	<table border="1"><tr><td>3</td><td></td><td>2</td></tr><tr><td>1</td><td></td><td></td></tr><tr><td>1</td><td></td><td>1</td></tr></table>	3		2	1			1		1	<table border="1"><tr><td>2</td><td>1</td><td>1</td></tr><tr><td>1</td><td></td><td></td></tr><tr><td>1</td><td>1</td><td>4</td></tr></table>	2	1	1	1			1	1	4	<table border="1"><tr><td>1</td><td>2</td><td>2</td></tr><tr><td></td><td></td><td></td></tr><tr><td>1</td><td></td><td>5</td></tr></table>	1	2	2				1		5	<table border="1"><tr><td></td><td>1</td><td></td></tr><tr><td>1</td><td></td><td>4</td></tr><tr><td>1</td><td></td><td>3</td></tr></table>		1		1		4	1		3	<table border="1"><tr><td></td><td></td><td></td></tr><tr><td></td><td></td><td></td></tr><tr><td></td><td></td><td></td></tr></table>									
3	2	3																																																																													
1	2	2																																																																													
1	1	4																																																																													
1	1																																																																														
1		1																																																																													
3		2																																																																													
1																																																																															
1		1																																																																													
2	1	1																																																																													
1																																																																															
1	1	4																																																																													
1	2	2																																																																													
1		5																																																																													
	1																																																																														
1		4																																																																													
1		3																																																																													
Post - 0 Miss - 0 Block - 0	Post - 2 Miss - 1 Block - 0	Post - 0 Miss - 1 Block - 1	Post - 1 Miss - 1 Block - 0	Post - 1 Miss - 0 Block - 1	Post - 0 Miss - 2 Block - 1	Post - 0 Miss - 2 Block - 3	Post - 0 Miss - 0 Block - 0																																																																								

12 王权

0/1		0/2
		1/2
0/4	1/2	

15 刘迈科

3/12	3/6	7/17
8/16	2/2	11/20
8/20	8/11	8/21

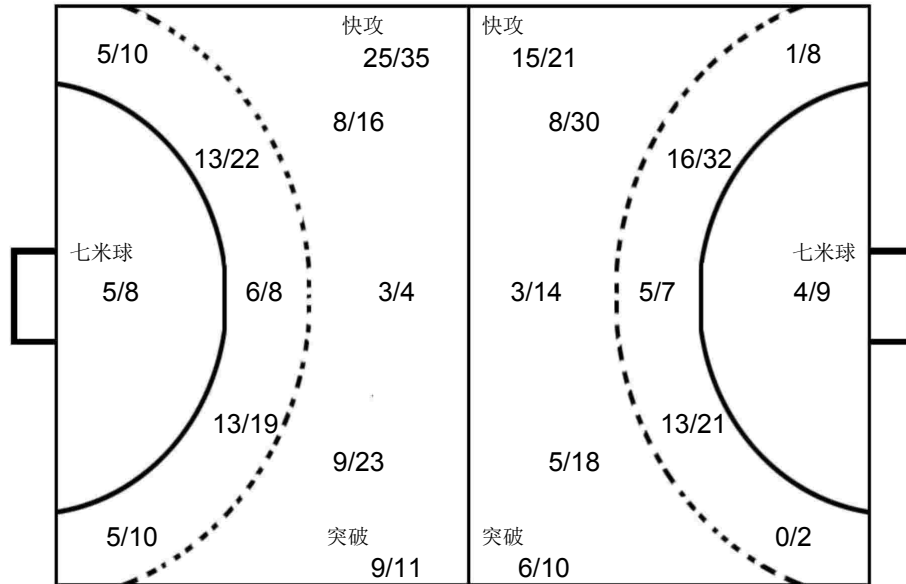

江苏

16 张帅

2/8	0/6	2/10
0/1	3/6	6/9
6/9	0/3	1/10

广东

19 王泽润

0/2	2/2	0/2
1/3		3/4
1/2	2/2	0/5

广东

1 王帅

1/3	0/1	0/2
1/4	1/1	2/2
2/6	1/1	0/7

OPPONENT

江苏	江苏	江苏	江苏	广东	广东	江苏	江苏																																																																								
15 李安	21 刘江	18 赵楠	19 庞连康	4 ARPASI Patrik	10 周仲坤	22 罗尧尧	28 SZRNKA Levente																																																																								
<table border="1"><tr><td></td><td></td><td>1</td></tr><tr><td>1</td><td></td><td>2</td></tr><tr><td>3</td><td>1</td><td>1</td></tr></table>			1	1		2	3	1	1	<table border="1"><tr><td>1</td><td></td><td>1</td></tr><tr><td></td><td></td><td>2</td></tr><tr><td>1</td><td>2</td><td>2</td></tr></table>	1		1			2	1	2	2	<table border="1"><tr><td></td><td></td><td>1</td></tr><tr><td></td><td></td><td>1</td></tr><tr><td>2</td><td></td><td>1</td></tr></table>			1			1	2		1	<table border="1"><tr><td></td><td></td><td>3</td></tr><tr><td></td><td></td><td></td></tr><tr><td></td><td></td><td>2</td></tr></table>			3						2	<table border="1"><tr><td></td><td></td><td></td></tr><tr><td></td><td></td><td></td></tr><tr><td>2</td><td>1</td><td>1</td></tr></table>							2	1	1	<table border="1"><tr><td>1</td><td></td><td></td></tr><tr><td>1</td><td></td><td>1</td></tr><tr><td></td><td></td><td>1</td></tr></table>	1			1		1			1	<table border="1"><tr><td>1</td><td></td><td></td></tr><tr><td>1</td><td></td><td></td></tr><tr><td>1</td><td></td><td>1</td></tr></table>	1			1			1		1	<table border="1"><tr><td>1</td><td></td><td></td></tr><tr><td>1</td><td></td><td></td></tr><tr><td>1</td><td></td><td>1</td></tr></table>	1			1			1		1
		1																																																																													
1		2																																																																													
3	1	1																																																																													
1		1																																																																													
		2																																																																													
1	2	2																																																																													
		1																																																																													
		1																																																																													
2		1																																																																													
		3																																																																													
		2																																																																													
2	1	1																																																																													
1																																																																															
1		1																																																																													
		1																																																																													
1																																																																															
1																																																																															
1		1																																																																													
1																																																																															
1																																																																															
1		1																																																																													
Post - 2 Miss - 1 Block - 0	Post - 1 Miss - 0 Block - 0	Post - 1 Miss - 1 Block - 1	Post - 0 Miss - 1 Block - 1	Post - 0 Miss - 0 Block - 0	Post - 1 Miss - 0 Block - 2	Post - 0 Miss - 0 Block - 0	Post - 0 Miss - 0 Block - 0																																																																								
广东	江苏	江苏	江苏	江苏	江苏	广东	广东																																																																								
7 王立隆	5 闫亮	9 许翔宇	11 张天豪	26 MUCZA Norbert	27 王伟强	5 曹景森	6 毕晓晨																																																																								
<table border="1"><tr><td>1</td><td></td><td>1</td></tr><tr><td></td><td></td><td></td></tr><tr><td>1</td><td></td><td></td></tr></table>	1		1				1			<table border="1"><tr><td>1</td><td>1</td><td></td></tr><tr><td>1</td><td></td><td></td></tr><tr><td></td><td></td><td></td></tr></table>	1	1		1						<table border="1"><tr><td></td><td>1</td><td>1</td></tr><tr><td></td><td></td><td></td></tr><tr><td></td><td></td><td>1</td></tr></table>		1	1						1	<table border="1"><tr><td></td><td></td><td></td></tr><tr><td></td><td></td><td></td></tr><tr><td>2</td><td></td><td>1</td></tr></table>							2		1	<table border="1"><tr><td>1</td><td></td><td></td></tr><tr><td>1</td><td></td><td></td></tr><tr><td></td><td></td><td>1</td></tr></table>	1			1					1	<table border="1"><tr><td>1</td><td></td><td>1</td></tr><tr><td></td><td></td><td>1</td></tr><tr><td></td><td></td><td></td></tr></table>	1		1			1				<table border="1"><tr><td>1</td><td></td><td></td></tr><tr><td></td><td></td><td></td></tr><tr><td></td><td></td><td>1</td></tr></table>	1								1	<table border="1"><tr><td></td><td></td><td></td></tr><tr><td></td><td></td><td></td></tr><tr><td>1</td><td></td><td></td></tr></table>							1		
1		1																																																																													
1																																																																															
1	1																																																																														
1																																																																															
	1	1																																																																													
		1																																																																													
2		1																																																																													
1																																																																															
1																																																																															
		1																																																																													
1		1																																																																													
		1																																																																													
1																																																																															
		1																																																																													
1																																																																															
Post - 0 Miss - 0 Block - 0	Post - 0 Miss - 0 Block - 0	Post - 1 Miss - 1 Block - 1	Post - 1 Miss - 1 Block - 0	Post - 0 Miss - 2 Block - 2	Post - 0 Miss - 1 Block - 0	Post - 0 Miss - 0 Block - 0	Post - 1 Miss - 0 Block - 0																																																																								



2019中国男子手球超级联赛总决赛（青岛）

PHMS Pictorial Handball Match Statistics

IHF Official System

球队名单

山东青岛

太平洋保险江苏

2019-07-26

号码	姓名	位置	生日	年龄	俱乐部	身高 (CM)	体重 (KG)	国际场次	国际进球
1	陈昊	守门员	05/01/2002	17	太平洋保险江苏男子手球俱乐部	195	98		
5	闫亮	左后卫	23/01/1985	34	太平洋保险江苏男子手球俱乐部	202	94		
9	许翔宇	左后卫	20/01/1997	22	太平洋保险江苏男子手球俱乐部	190	80		
11	张天豪	左边锋	02/06/1998	21	太平洋保险江苏男子手球俱乐部	185	83		
12	张睿梁	守门员	19/06/1998	21	太平洋保险江苏男子手球俱乐部	196	135		
15	李安	左边锋	20/03/1987	32	太平洋保险江苏男子手球俱乐部	183	88		
16	张帅	守门员	11/05/1994	25	太平洋保险江苏男子手球俱乐部	187	86		
17	刘赵梁	右边锋	04/07/1997	22	太平洋保险江苏男子手球俱乐部	186	90		
18	赵楠	左后卫	07/05/1993	26	太平洋保险江苏男子手球俱乐部	188	91		
19	庞连康	左后卫	02/07/1996	23	太平洋保险江苏男子手球俱乐部	192	96		
21	刘江	底线	23/03/1993	26	太平洋保险江苏男子手球俱乐部	196	96		
22	罗尧尧	右后卫	28/07/1996	22	太平洋保险江苏男子手球俱乐部	188	88		
25	陈孝天	右后卫	16/02/2001	18	太平洋保险江苏男子手球俱乐部	195	90		
26	MUCZA Norbert	左后卫	26/05/1995	24	太平洋保险江苏男子手球俱乐部	194	98		
27	王伟强	左边锋	07/01/1993	26	太平洋保险江苏男子手球俱乐部	175	80		
28	SZRANKA Levente	底线	10/11/1997	21	太平洋保险江苏男子手球俱乐部	200	108		
	平均			23.8		190.8	93.8		

编码	姓名	职务
A	闫威名	主教练
B	叶强	教练
C	雷纳德	教练
D	王建国	医生

2019中国男子手球超级联赛总决赛（青岛）

PHMS Pictorial Handball Match Statistics

IHF Official System

手球 男子 个人/全队技术累计表 截止至第24场 山东青岛 2019-07-30

号码	姓名	远射	近射	边射	快攻	突破	任意	七米	合计	%	助攻	失误	警告	2'	取消	场次	时间
太平洋保险江苏																	
(场上队员)																	
1	陈昊															4	00:20:50
5	闫亮	0/1	2/5	1/1	1/1				4/8	50.0%	2	1	1			4	01:16:50
9	许翔宇	3/9	1/2						4/11	36.4%	4	9				4	01:19:32
11	张天豪		2/4	0/5	1/2			1/1	4/12	33.3%		2				4	01:20:15
12	张春梁															4	00:35:07
15	李安	2/7	4/4			4/4		12/17	22/32	68.8%	4	5		3		4	01:25:15
16	张帅															4	03:04:03
17	刘赵梁	2/4	1/3	0/1	0/1	2/4			5/13	38.5%	5	4				4	02:14:32
18	赵楠	2/11	1/5	0/1	2/3	1/2			6/22	27.3%	5	3	2	3		4	03:15:00
19	庞连康	5/12	4/7			2/2			11/21	52.4%	2	6		1		4	01:35:02
21	刘江	2/3	5/7		1/3	1/1			9/14	64.3%	4	6		3	1	4	02:11:45
22	罗尧尧	0/1	2/3	2/2	1/1			1/1	6/8	75.0%	1	2				4	01:32:14
25	陈孝天	2/9					0/1		2/10	20.0%		2				4	00:59:00
26	MUCZA Norbert	7/16	1/3		3/3	1/2			12/24	50.0%	5	9	2			4	02:09:50
27	王伟强	0/1	1/1	7/9	5/5				13/16	81.3%	1	4				4	02:16:52
28	SZRKA Levente	0/1	13/17		1/2		0/1		14/21	66.7%	1	3	2	3		4	02:18:43
合计		25/75	37/61	10/19	15/21	11/15	0/2	14/19	112/212	52.8%	34	56	7	13	1	64	
(守门员)																	
1	陈昊	0/3	3/8	0/2	1/4				4/17	23.5%						4	00:20:50
12	张春梁	2/8	1/11	1/1	2/6	0/1		0/1	6/28	21.4%						4	00:35:07
16	张帅	22/42	5/34	5/14	6/21	1/7	0/1	2/6	41/125	32.8%						4	03:04:03
合计		24/53	9/53	6/17	9/31	1/8	0/1	2/7	51/170	30.0%						12	

场上队员：得分/射门

守门员：救球/射门

已打比赛

全队合计	进球	被救	射失	击柱	封球	合计	%	阶段	场次	对手	比分
远射	25	25	9	5	11	75	33.3%	名次赛	20	北京	29:23 (15:9)
近射	37	22	2			61	60.7%	名次赛	22	华体	22:34 (11:14)
边射	10	9				19	52.6%	名次赛	23	北京	31:27 (14:13)
快攻	15	2	2	2		21	71.4%	决赛	24	华体	30:35 (13:19)
突破	11	3		1		15	73.3%				
任意		1	1			2	0.0%				
七米	14	3	1	1		19	73.7%				

2019中国男子手球超级联赛总决赛（青岛）

PHMS Pictorial Handball Match Statistics

IHF Official System

图式射门区域累计

手球
男子

山东青岛
2019-07-30

截止至第24场

太平洋保险江苏

1 陈昊 0/0 0/0 0/0 Post - 0 Miss - 0 Block - 0	5 闫亮 1/1 1/1 1/1 Post - 0 Miss - 0 Block - 0	9 许翔宇 1/1 1/1 1/1 Post - 1 Miss - 1 Block - 1	11 张天豪 3/3 0/0 1/1 Post - 1 Miss - 1 Block - 0	12 张睿梁 0/0 0/0 0/0 Post - 0 Miss - 0 Block - 0	15 李安 1/2 2/4 7/4 Post - 2 Miss - 1 Block - 1	16 张帅 0/0 0/0 0/0 Post - 0 Miss - 0 Block - 0	17 刘赵梁 1/1 1/1 1/1 Post - 1 Miss - 1 Block - 0
18 赵楠 0/1 1/1 3/1 Post - 1 Miss - 2 Block - 1	19 庞连康 1/3 1/4 1/4 Post - 0 Miss - 2 Block - 3	21 刘江 1/1 0/2 1/2 Post - 1 Miss - 1 Block - 1	22 罗尧尧 1/1 2/1 2/1 Post - 0 Miss - 0 Block - 0	25 陈孝天 0/1 0/1 0/1 Post - 1 Miss - 1 Block - 2	26 MUCZA Norbert 3/2 1/1 2/2 Post - 1 Miss - 2 Block - 2	27 王伟强 3/3 1/2 2/2 Post - 0 Miss - 1 Block - 0	28 SZRNKA Levente 1/1 3/1 2/3 Post - 0 Miss - 2 Block - 0

1 陈昊	0/2	0/1	0/1
	2/3	1/1	0/1
	1/4	0/2	0/2

12 张睿梁	1/2	0/1	0/5
	1/3		1/6
	1/5	1/1	1/5

16 张帅	4/13	1/8	3/13
	2/9	4/8	12/20
	8/23	2/7	5/24

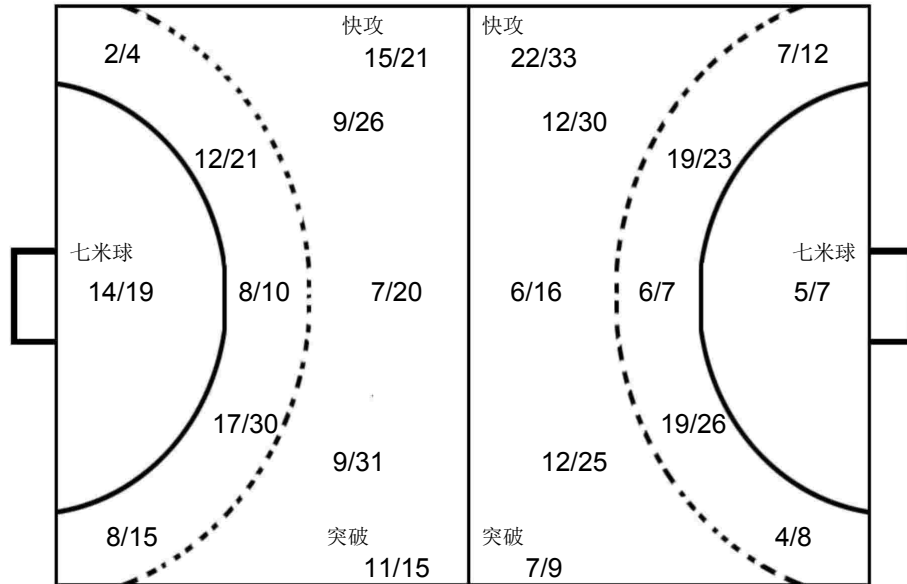

华体	2/8	2/4	4/13
16 刘迈科	7/12	2/2	6/12
	7/17	4/7	4/15

北京	0/6	0/4	0/8
12 高云健	6/12	3/6	5/9
	3/13	4/6	3/14

北京	0/1		1/1
16 孟辉			
	0/4	1/1	0/1

OPPONENT

华体 22 黄培杰 2/2 2/2 1/3 Post - 0 Miss - 0 Block - 0	北京 32 蒋唯一 1/1 0/1 1/5 Post - 0 Miss - 1 Block - 0	华体 8 谢庆龙 1/1 1/1 1/1 Post - 0 Miss - 0 Block - 1	华体 47 成亚 1/1 1/1 1/3 Post - 0 Miss - 0 Block - 1	北京 13 王军鸣 0/1 1/1 1/3 Post - 1 Miss - 2 Block - 0	华体 88 王军程 1/1 1/2 1/2 Post - 0 Miss - 1 Block - 1	华体 97 张建杰 0/1 1/3 1/1 Post - 0 Miss - 1 Block - 1	北京 14 逯明松 1/1 2/2 1/1 Post - 2 Miss - 0 Block - 1
北京 26 魏昂 0/2 4/4 Post - 0 Miss - 0 Block - 0	北京 22 王超 1/1 3/1 Post - 1 Miss - 0 Block - 0	华体 25 王杰缘 2/1 1/1 Post - 0 Miss - 0 Block - 0	北京 8 MAGYAR David 1/1 0/2 Post - 1 Miss - 0 Block - 0	华体 5 贺政 0/2 1/1 Post - 2 Miss - 2 Block - 0	华体 23 曹悦 1/1 1/1 Post - 0 Miss - 1 Block - 1	北京 2 解建飞 0/1 1/1 Post - 0 Miss - 0 Block - 0	北京 27 闫炳旗 1/1 0/2 Post - 0 Miss - 0 Block - 0



2019中国男子手球超级联赛总决赛（青岛）

PHMS Pictorial Handball Match Statistics

IHF Official System

球队名单

山东青岛

2019-07-26

北京光彩

号码	姓名	位置	生日	年龄	俱乐部	身高 (CM)	体重 (KG)	国际场次	国际进球
2	解建飞	右后卫	10/09/1989	29	北京光彩男子手球俱乐部	198	100		
7	马昌震	底线	19/05/1993	26	北京光彩男子手球俱乐部	188	95		
8	MAGYAR David	左后卫	21/07/1995	24	北京光彩男子手球俱乐部	194	86		
10	MEZEI Richard B.	右后卫	28/11/1996	22	北京光彩男子手球俱乐部	189	105		
11	赵文宣	底线	10/06/1999	20	北京光彩男子手球俱乐部	188	90		
12	高云健	守门员	26/11/1999	19	北京光彩男子手球俱乐部	190	90		
13	王军鸣	中后卫	19/02/1999	20	北京光彩男子手球俱乐部	195	120		
14	逯明松	右后卫	11/02/1998	21	北京光彩男子手球俱乐部	192	85		
16	孟辉	守门员	10/10/1981	37	北京光彩男子手球俱乐部	186	105		
17	王哲一	左边锋	14/06/1999	20	北京光彩男子手球俱乐部	184	69		
22	王超	左边锋	12/11/1991	27	北京光彩男子手球俱乐部	183	84		
25	马明辉	后卫	16/07/1994	25	北京光彩男子手球俱乐部	198	85		
26	魏昂	左边锋	29/12/1994	24	北京光彩男子手球俱乐部	186	88		
27	闫炳旗	右边锋	30/01/1992	27	北京光彩男子手球俱乐部	187	90		
29	杜龙飞	右边锋	29/03/1990	29	北京光彩男子手球俱乐部	192	100		
32	蒋唯一	底线	27/06/1987	32	北京光彩男子手球俱乐部	197	108		
	平均			25.1		190.4	93.8		

编码	姓名	职务
A	郑永利	主教练
F	王泷	教练
D	陈璇	医生

2019中国男子手球超级联赛总决赛（青岛）

PHMS Pictorial Handball Match Statistics

IHF Official System

手球 男子 个人/全队技术累计表 截止至第23场 山东青岛 2019-07-29

号码	姓名	远射	近射	边射	快攻	突破	任意	七米	合计	%	助攻	失误	警告	2'	取消	场次	时间
北京光彩																	
(场上队员)																	
2	解建飞	3/3						0/2	3/5	60.0%	1	2	3	2		3	01:20:07
7	马昌震		4/5						4/5	80.0%	1	3	1	4		3	01:13:09
8	MAGYAR David	2/7	2/2						4/9	44.4%	3	7				3	01:10:16
10	MEZEI Richard B.	0/1							0/1	0.0%		1				3	00:09:28
11	赵文宣		2/2	1/1	0/1				3/4	75.0%		3		1		3	00:32:18
12	高云健										4					3	02:30:44
13	王军鸣	8/16	3/3	0/1		1/1	1/1		13/22	59.1%	5	6		1		3	01:23:02
14	逯明松	3/11	5/6			1/2			9/19	47.4%	2	5	1	1		3	01:54:31
16	孟辉															3	00:29:16
17	王哲一	1/6	3/4		0/1	1/2		1/2	6/15	40.0%	4	7		2		3	01:24:43
22	王超		2/2	1/3	3/5	1/2			7/12	58.3%	4	4				3	01:29:46
25	马明辉			1/1	0/2				1/3	33.3%		1	1	1		3	00:40:44
26	魏昂			2/3	5/5	1/2			8/10	80.0%		3		2		3	02:05:16
27	闫炳旗		1/2	1/3	2/2				4/7	57.1%		1	1	1		3	02:17:08
29	杜龙飞	1/4	1/1	0/2					2/7	28.6%	2	2				3	00:52:20
32	蒋唯一		8/9		3/5	2/4		7/7	20/25	80.0%		3				3	01:20:40
合计		18/48	31/36	6/14	13/21	7/13	1/1	8/11	84/144	58.3%	26	48	7	15		48	
(守门员)																	
12	高云健	18/37	10/29	4/14	1/13	0/5	0/1	0/8	33/107	30.8%	4					3	02:30:44
16	孟辉	4/6	0/2	0/1	1/3	0/1		1/5	6/18	33.3%						3	00:29:16
合计		22/43	10/31	4/15	2/16	0/6	0/1	1/13	39/125	31.2%	4					6	

场上队员：得分/射门

守门员：救球/射门

已打比赛

全队合计	进球	被救	射失	击柱	封球	合计	%	阶段	场次	对手	比分
远射	18	16	6	3	5	48	37.5%	名次赛	20	江苏	23:29 (9:15)
近射	31	4		1		36	86.1%	名次赛	21	广东	34:26 (17:11)
边射	6	6	1	1		14	42.9%	名次赛	23	江苏	27:31 (13:14)
快攻	13	6	1	1		21	61.9%				
突破	7	4	1	1		13	53.8%				
任意	1					1	100.0%				
七米	8	3				11	72.7%				

2019中国男子手球超级联赛总决赛（青岛）

PHMS Pictorial Handball Match Statistics

IHF Official System

图式射门区域累计

手球
男子

截止至第23场

山东青岛
2019-07-29

北京光彩

2 解建飞 1 1 1 Post - 0 Miss - 0 Block - 0	7 马昌震 1 2 1 Post - 0 Miss - 0 Block - 0	8 MAGYAR David 1 1 2 Post - 1 Miss - 0 Block - 0	10 MEZEI Richard B. 1 1 1 Post - 0 Miss - 1 Block - 0	11 赵文宣 2 1 1 Post - 0 Miss - 0 Block - 0	12 高云健 1 1 2 Post - 0 Miss - 0 Block - 0	13 王军鸣 1 1 2 2 1 4 Post - 1 Miss - 2 Block - 0	14 透明松 2 1 3 1 1 2 Post - 2 Miss - 3 Block - 2
16 孟辉 1 1 3 Post - 0 Miss - 0 Block - 0	17 王哲一 1 1 3 Post - 1 Miss - 0 Block - 3	22 王超 1 5 1 Post - 2 Miss - 0 Block - 0	25 马明辉 1 1 1 Post - 0 Miss - 0 Block - 0	26 魏昂 1 1 2 4 1 1 Post - 0 Miss - 1 Block - 0	27 闫炳旗 1 1 1 2 1 1 Post - 0 Miss - 0 Block - 0	29 杜龙飞 1 1 1 Post - 0 Miss - 1 Block - 0	32 蒋唯一 3 1 4 2 1 9 Post - 0 Miss - 1 Block - 0

12 高云健

0/12	0/5	2/12
8/16	3/6	7/14
5/16	4/7	4/19

16 孟辉

1/4	1/2
0/1	1/1
0/6	2/2

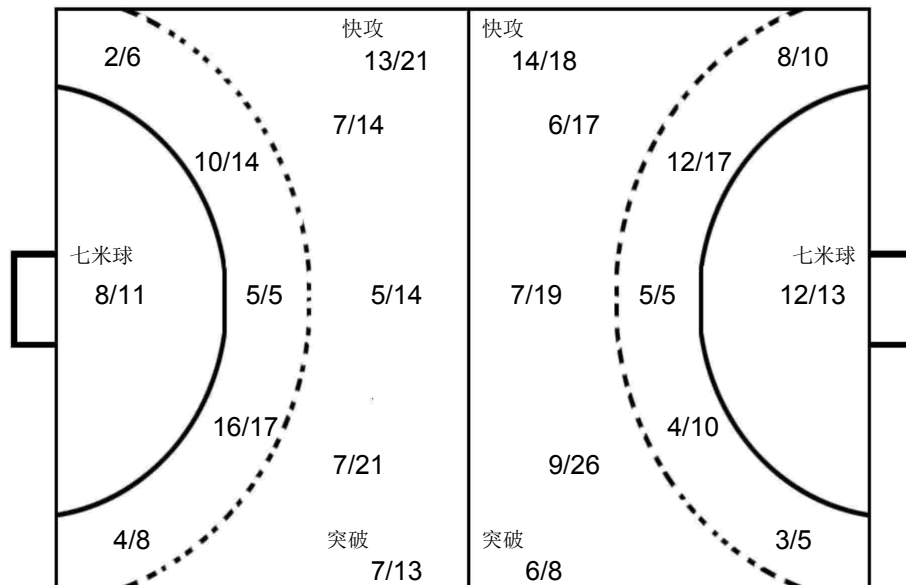

江苏

16 张帅

2/5	1/2	1/3
2/8	1/2	6/11
2/14	2/4	4/14

广东

1 王帅

1/4	1/2	1/3
1/3	3/7	
2/9	3/10	

江苏

12 张睿梁

1/1	0/1
0/1	1/2
1/4	1/3

OPPONENT

江苏 15 李安 1 1 1 1 1 2 4 3 Post - 0 Miss - 0 Block - 1	江苏 27 王伟强 2 1 2 1 1 2 2 Post - 0 Miss - 0 Block - 0	江苏 28 SZRNKA Levente 2 2 1 2 1 1 1 2 Post - 0 Miss - 2 Block - 0	江苏 26 MUCZA Norbert 2 2 2 1 1 1 2 1 Post - 1 Miss - 0 Block - 0	广东 4 ARPASI Patrik 4 1 1 1 1 1 1 Post - 0 Miss - 0 Block - 0	江苏 19 庞连康 1 1 2 1 1 2 1 1 2 Post - 0 Miss - 1 Block - 2	广东 17 李中洲 1 1 2 1 1 1 1 Post - 1 Miss - 1 Block - 0	江苏 17 刘赵梁 1 1 1 1 1 1 1 Post - 1 Miss - 1 Block - 0
广东 10 周仲坤 1 1 1 1 1 1 1 1 Post - 0 Miss - 1 Block - 1	广东 18 姚雪岩 1 1 1 1 1 1 1 1 Post - 1 Miss - 0 Block - 0	广东 3 曲汝洋 1 1 1 1 1 1 1 1 Post - 0 Miss - 1 Block - 1	广东 6 毕晓晨 2 1 1 1 1 1 1 1 Post - 0 Miss - 0 Block - 0	广东 21 张昌轲 1 1 1 1 1 1 1 1 Post - 0 Miss - 1 Block - 0	江苏 22 罗尧尧 1 1 1 1 1 1 1 1 Post - 0 Miss - 0 Block - 0	广东 24 高玉杰 1 1 1 1 1 1 1 1 Post - 0 Miss - 0 Block - 0	江苏 5 闫亮 1 1 1 1 1 1 1 1 Post - 0 Miss - 0 Block - 0



2019中国男子手球超级联赛总决赛（青岛）

PHMS Pictorial Handball Match Statistics

IHF Official System

球队名单

山东青岛

2019-07-26

广东路环四庙

号码	姓名	位置	生日	年龄	俱乐部	身高 (CM)	体重 (KG)	国际场次	国际进球
1	王帅	守门员	30/09/1997	21	广东路环四庙男子手球俱乐部	196	98		
2	董佳辉	右后卫	28/02/2002	17	广东路环四庙男子手球俱乐部	192	88		
3	曲汝洋	中后卫	07/01/1989	30	广东路环四庙男子手球俱乐部	185	85		
4	ARPASI Patrik	底线	17/09/1996	22	广东路环四庙男子手球俱乐部	197	115		
5	曹景森	底线	14/12/2000	18	广东路环四庙男子手球俱乐部	190	106		
6	毕晓晨	右边锋	23/03/1995	24	广东路环四庙男子手球俱乐部	188	88		
7	王立隆	右边锋	04/01/1995	24	广东路环四庙男子手球俱乐部	194	87		
8	DOLEZSAL Karoly	左后卫	01/12/1995	23	广东路环四庙男子手球俱乐部	190	86		
9	范保坤	底线	01/01/1999	20	广东路环四庙男子手球俱乐部	190	88		
10	周仲坤	左后卫	02/01/1997	22	广东路环四庙男子手球俱乐部	196	90		
11	房友屯	右后卫	03/02/1994	25	广东路环四庙男子手球俱乐部	183	88		
17	李中洲	左后卫	10/03/1989	30	广东路环四庙男子手球俱乐部	196	97		
18	姚雪岩	右后卫	19/11/1996	22	广东路环四庙男子手球俱乐部	202	105		
19	王泽润	守门员	19/02/1998	21	广东路环四庙男子手球俱乐部	192	95		
21	张昌轲	左边锋	13/03/1999	20	广东路环四庙男子手球俱乐部	185	80		
24	高玉杰	左边锋	16/10/1998	20	广东路环四庙男子手球俱乐部	190	83		
	平均			22.4		191.6	92.4		

编码	姓名	职务
A	刘康伶	主教练
B	郭艳辉	教练
C	贾章志	医生
D	李晓忠	领队

2019中国男子手球超级联赛总决赛（青岛）

PHMS Pictorial Handball Match Statistics

IHF Official System

手球 男子 个人/全队技术累计表 截止至第21场 山东青岛 2019-07-27

号码	姓名	远射	近射	边射	快攻	突破	任意	七米	合计	%	助攻	失误	警告	2'	取消	场次	时间
广东路环四庙																	
(场上队员)																	
1	王帅										1					2	01:34:07
3	曲汝洋	1/6	1/4						2/10	20.0%	5	4				2	00:42:07
4	ARPASI Patrik		7/8		4/5				11/13	84.6%	1	6		1		2	01:27:48
5	曹景森	0/1	2/3						2/4	50.0%		2				2	00:07:38
6	毕晓晨	0/1	0/1	1/2	3/4	0/1			4/9	44.4%	2	2				2	01:10:00
7	王立隆	0/1	1/1		2/2				3/4	75.0%		2	1			2	00:50:00
8	DOLEZSAL Karoly	1/3	1/1						2/4	50.0%	3	7	1			2	00:53:10
9	范保坤															2	00:00:00
10	周仲坤	4/14	1/2				1/1	2/3	8/20	40.0%	1	4	1	1		2	01:20:17
11	房友屯			0/1	0/1				0/2	0.0%	1	1	1			2	00:33:08
17	李中洲	3/9	2/4		1/1	0/1	1/1		7/16	43.8%	2	2		1		2	00:55:35
18	姚雪岩	2/7	2/3			1/1			5/11	45.5%	1	1				2	01:23:39
19	王泽润															2	00:25:53
21	张昌轲	0/3	1/4	1/2	2/3				4/12	33.3%	3	2		1		2	01:06:29
24	高玉杰			0/1	2/2				2/3	66.7%	2		2	3		2	01:23:00
	合计	11/45	18/31	2/6	14/18	1/3	2/2	2/3	50/108	46.3%	22	33	6	7		30	

(守门员)																	
1	王帅	2/9	4/17	5/10	3/14	5/13	0/1	1/1	20/65	30.8%	1					2	01:34:07
19	王泽润	1/2	5/11		2/7	0/1		3/11	11/32	34.4%						2	00:25:53
	合计	3/11	9/28	5/10	5/21	5/14	0/1	4/12	31/97	32.0%	1					4	

场上队员：得分/射门

守门员：救球/射门

已打比赛

全队合计	进球	被救	射失	击柱	封球	合计	%	阶段	场次	对手	比分
远射	11	15	6	4	9	45	24.4%	名次赛	19	华体	24:32 (13:13)
近射	18	10	1	1	1	31	58.1%	名次赛	21	北京	26:34 (11:17)
边射	2	3		1		6	33.3%				
快攻	14	4				18	77.8%				
突破	1	1		1		3	33.3%				
任意	2					2	100.0%				
七米	2	1				3	66.7%				

2019中国男子手球超级联赛总决赛（青岛）

PHMS Pictorial Handball Match Statistics

IHF Official System

图式射门区域累计

手球
男子

截止至第21场

山东青岛
2019-07-27

广东路环四庙

1 王帅 Post - 0 Miss - 0 Block - 0	3 曲汝洋 Post - 0 Miss - 1 Block - 3	4 ARPASI Patrik Post - 0 Miss - 0 Block - 0	5 曹景森 Post - 0 Miss - 0 Block - 0	6 毕晓晨 Post - 1 Miss - 0 Block - 0	7 王立隆 Post - 0 Miss - 0 Block - 0	8 DOLEZSAL Karoly Post - 2 Miss - 0 Block - 0	9 范保坤 Post - 0 Miss - 0 Block - 0
10 周仲坤 Post - 1 Miss - 1 Block - 3	11 房友屯 Post - 0 Miss - 0 Block - 0	17 李中洲 Post - 1 Miss - 2 Block - 1	18 姚雪岩 Post - 1 Miss - 1 Block - 1	19 王泽润 Post - 0 Miss - 0 Block - 0	21 张昌轲 Post - 0 Miss - 2 Block - 2	24 高玉杰 Post - 1 Miss - 0 Block - 0	

1 王帅
2/7 1/3 1/5
2/7 1/1 5/9
4/15 1/1 3/17

19 王泽润
0/4 2/2 0/2
1/4 4/6
1/3 2/2 1/9

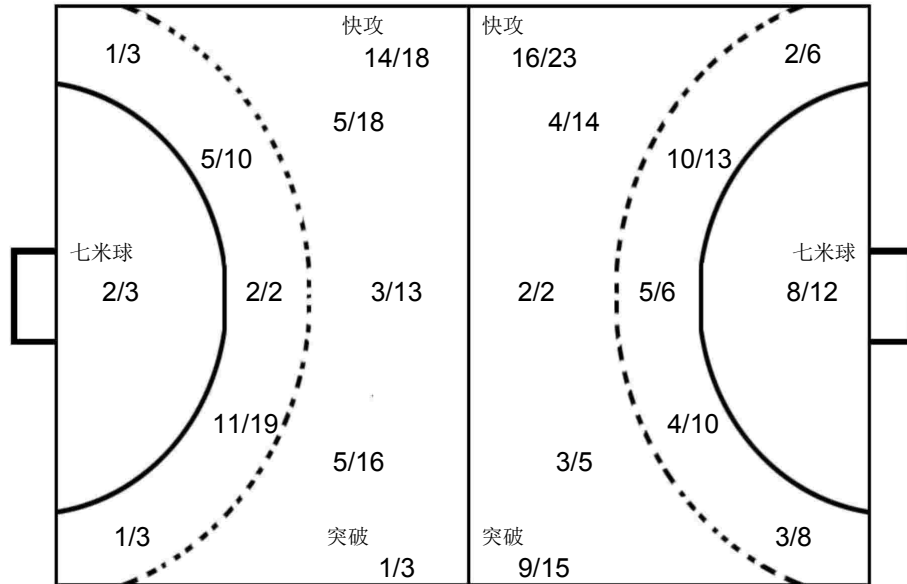

华体

16 刘迈科
1/4 1/2 3/4
1/4 5/8
1/3 4/4 4/6

北京

12 高云健
0/6 0/1 2/4
2/4 2/5
2/3 0/1 1/5

北京

16 孟辉
1/3 0/1
0/1 1/1 1/1
0/2 1/1

OPPONENT

北京 32 蒋唯一 Post - 0 Miss - 0 Block - 0	北京 13 王军鸣 Post - 0 Miss - 0 Block - 0	华体 22 黄培杰 Post - 2 Miss - 1 Block - 0	北京 17 王哲一 Post - 0 Miss - 0 Block - 1	华体 8 谢庆龙 Post - 0 Miss - 0 Block - 0	华体 88 王军程 Post - 0 Miss - 1 Block - 0	北京 7 马昌震 Post - 0 Miss - 0 Block - 0	北京 14 逯明松 Post - 0 Miss - 3 Block - 1
华体 4 张家纬 Post - 0 Miss - 0 Block - 0	华体 5 贺政 Post - 0 Miss - 0 Block - 0	华体 25 王杰缘 Post - 1 Miss - 1 Block - 0	华体 47 成亚 Post - 1 Miss - 0 Block - 0	华体 97 张建杰 Post - 0 Miss - 1 Block - 2	北京 22 王超 Post - 1 Miss - 0 Block - 0	北京 26 魏昂 Post - 0 Miss - 1 Block - 0	华体 10 李朝鹏 Post - 0 Miss - 0 Block - 0



PHMS Pictorial Handball Match Statistics

IHF Official System

Team A					Team B					Match Number														
A 中国华体					B 广东路环四庙					19														
Played in			in the hall			on		at		Spectators														
山东青岛			青岛市民健身中心			2019-07-26		19:00		hours 300														
Half-time(30')	A	B	End of playing time	A	B	1st extra time	A	B	2nd extra time	A	B	After penalty throws	A	B										
	13	13		32	24																			
Number of 7 m	A	Team time-out			Full name of players and officials					Team time-out			B	Number of 7 m										
	2/3	1	2	3						1	2	3	B											
		16:21								23:10	40:39		1/2											
No.	Team A					G	W	2'	D	DR	No.	Team B					G	W	2'	D	DR			
4	张家纬					3	1				1	王帅												
5	贺政					3					3	曲汝洋												
8	谢庆龙					4					4	ARPASI Patrik					4							
10	李朝鹏					2		1			5	曹景森					2							
12	王权										6	毕晓晨					2							
16	刘迈科										7	王立隆					3							
17	胡晋铭										8	DOLEZSAL Karoly					2	1						
18	李双					2					9	范保坤												
20	顾艳超										10	周仲坤					4							
22	黄培杰					5					11	房友屯						1						
23	曹悦										17	李中洲					2		1					
25	王杰缘					3					18	姚雪岩					2							
47	成亚					3					19	王泽润												
88	王军程					4		2			21	张昌轲					2							
97	张建杰					3		1			24	高玉杰					1	1	1					
99	王伟																							
A	姚苏捷										A	刘康伶 (主教练)												
B	朱昕晨 (主教练)										B	郭艳辉												
D	付飞鹏										C	贾章志												
Signatures of responsables for the teams (Off.A)																				B				
TP	Remarks of referees / HF Official																				TP			

Referees	刘禹 (CHN)	许翔 (CHN)		
T.D.	吴瑞亭 (CHN)	李兆蒙 (CHN)		
CHA Off.				

Note: Number of 7m Throws Awarded to Team A and B, Goals (G), Warnings (W), Suspensions (2'), Direct Disqualification (D), Disqualification With Report (DR) and Team Penalty (TP).

Table Officials: 康曦 刘斌 Statisticians: 李双 王玲

2019中国男子手球超级联赛总决赛（青岛）

PHMS Pictorial Handball Match Statistics

IHF Official System

竞赛技术统计

手球 男子 名次赛 轮次 1 组别 X 场次 19 青岛市民健身中心 2019-07-26 19:00

Referees: 刘禹 (CHN) / 许翔 (CHN) Result: 32:24(13:13)
Teams: 中国华体(华体) VS 广东路环四庙(广东)

华体		远	近	边	快	突	任意	7m	合计	%	助攻	失误	警告	2'	D+DR
主教练: 朱昕晨		射	射	射	攻	破	球	球							
4	张家纬	1/1	1/1			1/1			3/3	100			1		
5	贺政			1/1	1/1			1/1	3/3	100		1			
8	谢庆龙		3/4		1/1	0/1			4/6	66.7	1	3			
10	李朝鹏	1/1	1/2						2/3	66.7	1			1	
12	王权														
16	刘迈科										1				
17	胡晋铭		0/1						0/1	0.0					
18	李双		0/1		1/1	1/1			2/3	66.7	1				
20	顾艳超	0/1				0/1			0/2	0.0					
22	黄培杰		1/2	1/4	3/3			0/1	5/10	50.0	1	1			
23	曹悦	0/1			0/1				0/2	0.0	1				
25	王杰缘		1/1	1/4	1/1				3/6	50.0					
47	成亚	0/1	0/1		2/3			1/1	3/6	50.0	1	2			
88	王军程	0/1	0/1		1/1	3/3			4/6	66.7				2	
97	张建杰	2/4			0/3	1/1			3/8	37.5		2		1	
99	王伟														
运动员 合计		4/10	7/14	3/9	10/15	6/8		2/3	32/59	54.2	7	9	1	4	
12	王权	0/1	1/5		0/4				1/10	10.0					
16	刘迈科	4/6	8/14	3/3	3/8	1/1	0/1	1/2	20/35	57.1	1				
守门员 合计		4/7	9/19	3/3	3/12	1/1	0/1	1/2	21/45	46.7	1				

广东		远	近	边	快	突	任意	7m	合计	%	助攻	失误	警告	2'	D+DR
主教练: 刘康伶		射	射	射	攻	破	球	球							
1	王帅										1				
3	曲汝洋	0/1	0/3						0/4	0.0	3	3			
4	ARPASI Patrik		1/2		3/4				4/6	66.7		4			
5	曹景森	0/1	2/3						2/4	50.0		2			
6	毕晓晨		0/1	0/1	2/2	0/1			2/5	40.0		2			
7	王立隆		1/1		2/2				3/3	100		1			
8	DOLEZSAL Karoly	1/1	1/1						2/2	100	1	1	1		
9	范保坤														
10	周仲坤	1/7	1/2				1/1	1/2	4/12	33.3	1	3			
11	房友屯			0/1	0/1				0/2	0.0	1	1	1		
17	李中洲	1/3	1/3						2/6	33.3				1	
18	姚雪岩	0/2	2/3						2/5	40.0	1				
19	王泽润														
21	张昌轲	0/3	1/2	0/1	1/2				2/8	25.0	3				
24	高玉杰			0/1	1/1				1/2	50.0	1		1	1	
运动员 合计		3/18	10/21	0/4	9/12	0/1	1/1	1/2	24/59	40.7	12	17	3	2	
1	王帅	1/4	1/3	2/5	2/8	2/7			8/27	29.6	1				
19	王泽润	1/2	5/10		2/6	0/1		1/3	9/22	40.9					
守门员 合计		2/6	6/13	2/5	4/14	2/8		1/3	17/49	34.7	1				

华体	比赛进程	广东
1st Half		
88 王军程	1 01:04 0	
	1 01:16 1 18 姚雪岩	
4 张家纬	2 01:25 1	
	2 02:24 2 8 DOLEZSAL Ka	
8 谢庆龙	3 06:08 2	
	3 07:46 3 21 张昌轲	
	3 09:27 4 7 王立隆	
25 王杰缘	4 09:40 4	
	4 09:55 5 18 姚雪岩	
4 张家纬	5 10:35 5	
	5 11:17 6 4 ARPASI Patr	
	5 13:41 7 7 王立隆	
4 张家纬	6 14:29 7	
	6 14:38 8 4 ARPASI Patr	
88 王军程	7 15:18 8	
	7 16:15 9 7 王立隆	
10 李朝鹏	8 18:02 9	
	8 20:42 10 8 DOLEZSAL Ka	
22 黄培杰	9 20:50 10	
47 成亚	10 22:42 10	
25 王杰缘	11 23:08 10	
	11 24:36 11 10 周仲坤	
22 黄培杰	12 26:00 11	
25 王杰缘	13 28:00 11	
	13 29:09 12 10 周仲坤	
	13 29:50 13 6 毕晓晨	
2nd Half		
97 张建杰	14 01:24 13	
	14 02:28 14 4 ARPASI Patr	
88 王军程	15 02:41 14	
97 张建杰	16 03:56 14	
47 成亚	17 04:16 14	
	17 05:21 15 24 高玉杰	
47 成亚	18 06:26 15	
	18 06:56 16 10 周仲坤	
88 王军程	19 08:17 16	
	19 08:26 17 6 毕晓晨	
5 贺政	20 08:36 17	
5 贺政	21 10:35 17	
	21 12:03 18 4 ARPASI Patr	
97 张建杰	22 12:40 18	
22 黄培杰	23 13:04 18	
22 黄培杰	24 14:27 18	
5 贺政	25 15:36 18	
	25 16:57 19 17 李中洲	
8 谢庆龙	26 17:07 19	
	26 17:36 20 17 李中洲	
	26 22:06 21 21 张昌轲	
18 李双	27 22:15 21	
22 黄培杰	28 25:00 21	
	28 25:40 22 5 曹景森	
18 李双	29 25:55 22	
	29 27:23 23 10 周仲坤	
8 谢庆龙	30 27:33 23	
10 李朝鹏	31 28:56 23	
	31 29:24 24 5 曹景森	
8 谢庆龙	32 29:35 24	

场上队员: 得分 / 射门

守门员: 救球 / 射门

D	取消资格	DR	取消资格+报告
---	------	----	---------



2019中国男子手球超级联赛总决赛（青岛）

PHMS Pictorial Handball Match Statistics

IHF Official System

个人/全队技术统计表

手球 男子 预赛 轮次 1 组别 X 场次 19 青岛市民健身中心 2019-07-26 19:00

号码	姓名	远射	近射	边射	快攻	突破	任意	七米	合计	%	助攻	失误	警告	2'	取消	时间
中国华体(华体)																
(场上队员)																
4	张家纬	1/1	1/1			1/1			3/3	100%			1			00:18:15
5	贺政			1/1	1/1			1/1	3/3	100%		1				00:30:00
8	谢庆龙		3/4		1/1	0/1			4/6	66.7%	1	3				00:40:02
10	李朝鹏	1/1	1/2						2/3	66.7%	1			1		00:22:50
12	王权									0.0%						00:17:24
16	刘迈科									0.0%	1					00:42:36
17	胡晋铭		0/1						0/1	0.0%						00:19:57
18	李双		0/1		1/1	1/1			2/3	66.7%	1					00:18:56
20	顾艳超	0/1				0/1			0/2	0.0%						00:10:51
22	黄培杰		1/2	1/4	3/3			0/1	5/10	50.0%	1	1				01:13:35
23	曹悦	0/1			0/1				0/2	0.0%	1					00:17:08
25	王杰缘		1/1	1/4	1/1				3/6	50.0%						00:30:00
47	成亚	0/1	0/1		2/3			1/1	3/6	50.0%	1	2				00:23:39
88	王军程	0/1	0/1		1/1	3/3			4/6	66.7%				2		00:40:08
97	张建杰	2/4			0/3	1/1			3/8	37.5%		2		1		00:31:37
99	王伟									0.0%						00:00:00
	合计	4/10	7/14	3/9	10/15	6/8		2/3	32/59	54.2%	7	9	1	4		

(守门员)

12	王权	0/1	1/5		0/4				1/10	10.0%						00:17:24
16	刘迈科	4/6	8/14	3/3	3/8	1/1	0/1	1/2	20/35	57.1%	1					00:42:36
	合计	4/7	9/19	3/3	3/12	1/1	0/1	1/2	21/45	46.7%	1					

场上队员：得分/射门

守门员：救球/射门

全队合计	得分	被救	射失	击柱	封球	合计	%
远射	4	2	1	1	2	10	40.0%
近射	7	6		1		14	50.0%
边射	3	2	2	2		9	33.3%
快攻	10	4	1			15	66.7%
突破	6	2				8	75.0%
任意							0.0%
七米	2	1				3	66.7%

2019中国男子手球超级联赛总决赛（青岛）

PHMS Pictorial Handball Match Statistics

IHF Official System

个人/全队技术统计表

手球男子 预赛轮次 1 组别 X 场次 19 青岛市民健身中心 2019-07-26 19:00

号码	姓名	远射	近射	边射	快攻	突破	任意	七米	合计	%	助攻	失误	警告	2'	取消	时间
广东路环四庙(广东)																
(场上队员)																
1	王帅									0.0%	1					00:38:18
3	曲汝洋	0/1	0/3						0/4	0.0%	3	3				00:20:51
4	ARPASI Patrik		1/2		3/4				4/6	66.7%		4				00:45:31
5	曹景森	0/1	2/3						2/4	50.0%		2				00:07:38
6	毕晓晨		0/1	0/1	2/2	0/1			2/5	40.0%		2				00:40:00
7	王立隆		1/1		2/2				3/3	100%		1				00:20:00
8	DOLEZSAL Karoly	1/1	1/1						2/2	100%	1	1	1			00:23:10
9	范保坤									0.0%						00:00:00
10	周仲坤	1/7	1/2				1/1	1/2	4/12	33.3%	1	3				00:37:07
11	房友屯			0/1	0/1				0/2	0.0%	1	1	1			00:21:29
17	李中洲	1/3	1/3						2/6	33.3%				1		00:19:10
18	姚雪岩	0/2	2/3						2/5	40.0%	1					00:38:29
19	王泽润									0.0%						00:21:42
21	张昌轲	0/3	1/2	0/1	1/2				2/8	25.0%	3					00:32:00
24	高玉杰			0/1	1/1				1/2	50.0%	1		1	1		00:51:42
合计		3/18	10/21	0/4	9/12	0/1	1/1	1/2	24/59	40.7%	12	17	3	2		
(守门员)																
1	王帅	1/4	1/3	2/5	2/8	2/7			8/27	29.6%	1					00:38:18
19	王泽润	1/2	5/10		2/6	0/1		1/3	9/22	40.9%						00:21:42
合计		2/6	6/13	2/5	4/14	2/8		1/3	17/49	34.7%	1					

场上队员：得分/射门

守门员：救球/射门

全队合计	得分	被救	射失	击柱	封球	合计	%
远射	3	4	3	1	7	18	16.7%
近射	10	9		1	1	21	47.6%
边射		3		1		4	0.0%
快攻	9	3				12	75.0%
突破		1				1	0.0%
任意	1					1	100.0%
七米	1	1				2	50.0%

2019中国男子手球超级联赛总决赛（青岛）

PHMS Pictorial Handball Match Statistics

IHF Official System

图式比赛技术统计表

手球
男子

预赛
轮次 1

组别 X
场次 19

青岛市民健身中心
2019-07-26 19:00

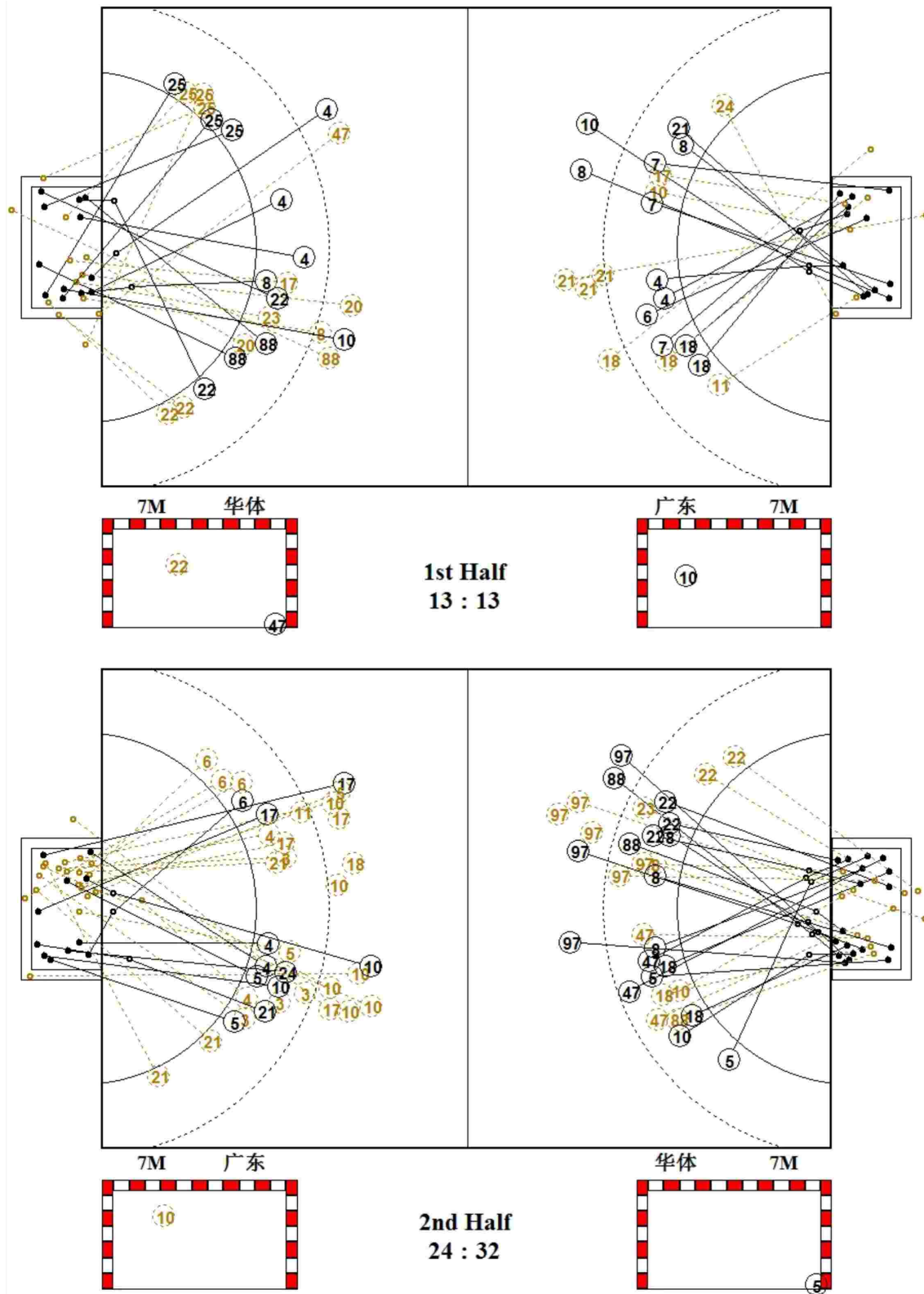

2019中国男子手球超级联赛总决赛（青岛）

PHMS Pictorial Handball Match Statistics

IHF Official System

图式射门区域统计

手球
男子

预赛
轮次 1

组别 X
场次 19

青岛市民健身中心
2019-07-26 19:00

中国华体

4 张家纬	5 贺政	8 谢庆龙	10 李朝鹏	12 王权	16 刘迈科	17 胡晋铭	18 李双																																																																								
<table border="1"><tr><td></td><td></td><td></td></tr><tr><td></td><td></td><td>1</td></tr><tr><td>2</td><td></td><td>1</td></tr></table>						1	2		1	<table border="1"><tr><td></td><td></td><td>1</td></tr><tr><td>1</td><td></td><td></td></tr><tr><td></td><td></td><td>1</td></tr></table>			1	1					1	<table border="1"><tr><td></td><td></td><td>1</td></tr><tr><td>1</td><td></td><td></td></tr><tr><td>1</td><td></td><td>1</td></tr></table>			1	1			1		1	<table border="1"><tr><td></td><td></td><td></td></tr><tr><td>1</td><td></td><td></td></tr><tr><td></td><td></td><td>1</td></tr></table>				1					1	<table border="1"><tr><td></td><td></td><td></td></tr><tr><td></td><td></td><td></td></tr><tr><td></td><td></td><td></td></tr></table>										<table border="1"><tr><td></td><td></td><td></td></tr><tr><td></td><td></td><td></td></tr><tr><td></td><td></td><td></td></tr></table>										<table border="1"><tr><td></td><td></td><td></td></tr><tr><td></td><td></td><td></td></tr><tr><td></td><td></td><td></td></tr></table>										<table border="1"><tr><td></td><td></td><td>1</td></tr><tr><td></td><td></td><td></td></tr><tr><td></td><td></td><td>1</td></tr></table>			1						1
		1																																																																													
2		1																																																																													
		1																																																																													
1																																																																															
		1																																																																													
		1																																																																													
1																																																																															
1		1																																																																													
1																																																																															
		1																																																																													
		1																																																																													
		1																																																																													
Post - 0 Miss - 0 Block - 0	Post - 0 Miss - 0 Block - 0	Post - 0 Miss - 0 Block - 0	Post - 0 Miss - 0 Block - 0	Post - 0 Miss - 0 Block - 0	Post - 0 Miss - 0 Block - 0	Post - 0 Miss - 0 Block - 0	Post - 0 Miss - 0 Block - 0																																																																								
20 顾艳超	22 黄培杰	23 曹悦	25 王杰缘	47 成亚	88 王军程	97 张建杰	99 王伟																																																																								
<table border="1"><tr><td></td><td></td><td></td></tr><tr><td></td><td></td><td></td></tr><tr><td></td><td></td><td></td></tr></table>										<table border="1"><tr><td>1</td><td></td><td>1</td></tr><tr><td>1</td><td></td><td></td></tr><tr><td>1</td><td></td><td>1</td></tr></table>	1		1	1			1		1	<table border="1"><tr><td></td><td></td><td></td></tr><tr><td></td><td></td><td></td></tr><tr><td></td><td></td><td></td></tr></table>										<table border="1"><tr><td>1</td><td></td><td>1</td></tr><tr><td>1</td><td></td><td></td></tr><tr><td></td><td></td><td></td></tr></table>	1		1	1						<table border="1"><tr><td>1</td><td></td><td></td></tr><tr><td></td><td></td><td></td></tr><tr><td>1</td><td></td><td>1</td></tr></table>	1						1		1	<table border="1"><tr><td></td><td>1</td><td></td></tr><tr><td></td><td></td><td></td></tr><tr><td></td><td></td><td>3</td></tr></table>		1							3	<table border="1"><tr><td></td><td></td><td>1</td></tr><tr><td></td><td></td><td></td></tr><tr><td></td><td></td><td>2</td></tr></table>			1						2	<table border="1"><tr><td></td><td></td><td></td></tr><tr><td></td><td></td><td></td></tr><tr><td></td><td></td><td></td></tr></table>									
1		1																																																																													
1																																																																															
1		1																																																																													
1		1																																																																													
1																																																																															
1																																																																															
1		1																																																																													
	1																																																																														
		3																																																																													
		1																																																																													
		2																																																																													
Post - 0 Miss - 0 Block - 0	Post - 2 Miss - 1 Block - 0	Post - 0 Miss - 0 Block - 0	Post - 1 Miss - 1 Block - 0	Post - 1 Miss - 0 Block - 0	Post - 0 Miss - 1 Block - 0	Post - 0 Miss - 1 Block - 2	Post - 0 Miss - 0 Block - 0																																																																								

12 王权

0/1		0/2
		0/1
0/4	1/2	

16 刘迈科

1/4	1/2	3/4
1/4		5/8
1/3	4/4	4/6

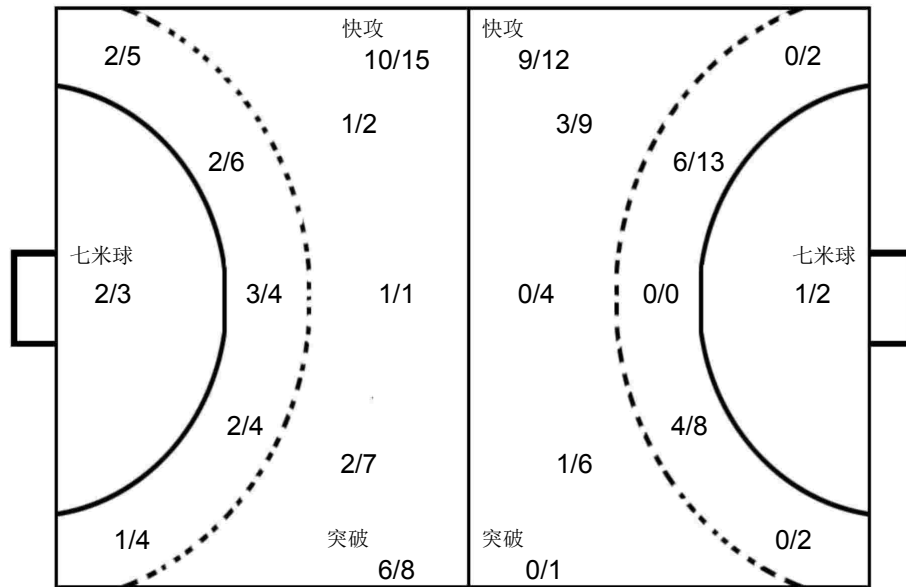

1 王帅

1/3	0/1	0/2
1/4	1/1	2/2
2/6	1/1	0/7

19 王泽润

0/2	2/2	0/2
1/3		3/4
1/2	2/2	0/5

广东路环四庙

1 王帅	3 曲汝洋	4 ARPASI Patrik	5 曹景森	6 毕晓晨	7 王立隆	8 DOLEZSAL Karoly	9 范保坤																																																																								
<table border="1"><tr><td></td><td></td><td></td></tr><tr><td></td><td></td><td></td></tr><tr><td></td><td></td><td></td></tr></table>										<table border="1"><tr><td></td><td></td><td></td></tr><tr><td></td><td></td><td></td></tr><tr><td></td><td></td><td></td></tr></table>										<table border="1"><tr><td></td><td></td><td></td></tr><tr><td>2</td><td>1</td><td>1</td></tr><tr><td></td><td></td><td></td></tr></table>				2	1	1				<table border="1"><tr><td>1</td><td></td><td></td></tr><tr><td></td><td></td><td>1</td></tr><tr><td></td><td></td><td></td></tr></table>	1					1				<table border="1"><tr><td></td><td></td><td></td></tr><tr><td>1</td><td></td><td></td></tr><tr><td>1</td><td></td><td></td></tr></table>				1			1			<table border="1"><tr><td>1</td><td></td><td>1</td></tr><tr><td></td><td></td><td></td></tr><tr><td>1</td><td></td><td></td></tr></table>	1		1				1			<table border="1"><tr><td></td><td></td><td>1</td></tr><tr><td></td><td></td><td>1</td></tr><tr><td></td><td></td><td></td></tr></table>			1			1				<table border="1"><tr><td></td><td></td><td></td></tr><tr><td></td><td></td><td></td></tr><tr><td></td><td></td><td></td></tr></table>									
2	1	1																																																																													
1																																																																															
		1																																																																													
1																																																																															
1																																																																															
1		1																																																																													
1																																																																															
		1																																																																													
		1																																																																													
Post - 0 Miss - 0 Block - 0	Post - 0 Miss - 0 Block - 2	Post - 0 Miss - 0 Block - 0	Post - 0 Miss - 0 Block - 0	Post - 1 Miss - 0 Block - 0	Post - 0 Miss - 0 Block - 0	Post - 0 Miss - 0 Block - 0	Post - 0 Miss - 0 Block - 0																																																																								
10 周仲坤	11 房友屯	17 李中洲	18 姚雪岩	19 王泽润	21 张昌轲	24 高玉杰																																																																									
<table border="1"><tr><td>1</td><td></td><td></td></tr><tr><td>1</td><td></td><td>1</td></tr><tr><td></td><td></td><td>1</td></tr></table>	1			1		1			1	<table border="1"><tr><td></td><td></td><td></td></tr><tr><td></td><td></td><td></td></tr><tr><td></td><td></td><td></td></tr></table>										<table border="1"><tr><td></td><td>1</td><td>1</td></tr><tr><td></td><td></td><td></td></tr><tr><td></td><td></td><td></td></tr></table>		1	1							<table border="1"><tr><td></td><td></td><td></td></tr><tr><td>2</td><td></td><td></td></tr><tr><td></td><td></td><td></td></tr></table>				2						<table border="1"><tr><td></td><td></td><td></td></tr><tr><td></td><td></td><td></td></tr><tr><td></td><td></td><td></td></tr></table>										<table border="1"><tr><td></td><td></td><td></td></tr><tr><td></td><td></td><td>1</td></tr><tr><td></td><td></td><td></td></tr></table>						1				<table border="1"><tr><td>1</td><td></td><td></td></tr><tr><td></td><td></td><td></td></tr><tr><td></td><td></td><td></td></tr></table>	1																		
1																																																																															
1		1																																																																													
		1																																																																													
	1	1																																																																													
2																																																																															
		1																																																																													
1																																																																															
Post - 1 Miss - 0 Block - 2	Post - 0 Miss - 0 Block - 0	Post - 0 Miss - 1 Block - 1	Post - 0 Miss - 1 Block - 1	Post - 0 Miss - 0 Block - 0	Post - 0 Miss - 1 Block - 2	Post - 1 Miss - 0 Block - 0																																																																									



PHMS Pictorial Handball Match Statistics

IHF Official System

Team A					Team B					Match Number											
A 太平洋保险江苏					B 北京光彩					20											
Played in			in the hall			on		at		Spectators											
山东青岛			青岛市民健身中心			2019-07-26		20:45		hours 400											
Half-time(30')	A	B	End of playing time		A	B	1st extra time		A	B	2nd extra time		A	B	After penalty throws						
	15	9	29 23																		
Number of 7 m	A	Team time-out			Full name of players and officials					Team time-out			B	Number of 7 m							
	7/8	1	2	3						1	2	3	B								
		21:09	47:29							07:17			1/1								
No.	Team A					G	W	2'	D	DR	No.	Team B					G	W	2'	D	DR
1	陈昊										2	解建飞					2	1	1		
5	闫亮					1					7	马昌震							1		
9	许翔宇					1					8	MAGYAR David					1				
11	张天豪					1					10	MEZEI Richard B.									
12	张睿梁										11	赵文宣					1		1		
15	李安					6		1			12	高云健									
16	张帅										13	王军鸣					1		1		
17	刘赵梁										14	逯明松							1		
18	赵楠					1	1				16	孟辉									
19	庞连康					4					17	王哲一					2				
21	刘江							1			22	王超					5				
22	罗尧尧					2					25	马明辉									
25	陈孝天					1					26	魏昂					5		1		
26	MUCZA Norbert					3					27	闫炳旗					1	1	1		
27	王伟强					3					29	杜龙飞									
28	SZRNKA Levente					6	1	1			32	蒋唯一					5				
A	闫威名 (主教练)										A	郑永利 (主教练)					1	1			
B	叶强										D	陈璇									
C	雷纳德										F	王洸									
D	王建国																				
A	Signatures of responsables for the teams (Off.A)															B					
TP	Remarks of referees / HF Official															TP					

Signatures

Referees MAZEIKA Vaidas (LTU)

GATELIS Mindaugas (LTU)

T.D. 许宜扬 (CHN)

王科 (CHN)

CHA Off.

Note: Number of 7m Throws Awarded to Team A and B, Goals (G), Warnings (W), Suspensions (2'), Direct Disqualification (D), Disqualification With Report (DR) and Team Penalty (TP).

Table Officials: 康曦

刘斌

Statisticians: 李双

王玲

2019中国男子手球超级联赛总决赛（青岛）

PHMS Pictorial Handball Match Statistics

IHF Official System

竞赛技术统计

手球 男子 名次赛 轮次 1 组别 X 场次 20 青岛市民健身中心 2019-07-26 20:45

Referees: MAZEIKA Vaidas (LTU) / GATELIS Mindaugas (LTU) Result: 29:23 (15:9)
Teams: 太平洋保险江苏(江苏) VS 北京光彩(北京)

江苏		远	近	边	快	突	任意	7m	合计	%	助攻	失误	警告	2'	D+DR
主教练: 闫威名		射	射	射	攻	破	球	球							
1	陈昊														
5	闫亮				1/1				1/1	100					
9	许翔宇	1/1							1/1	100	3				
11	张天豪							1/1	1/1	100	2				
12	张春梁														
15	李安	0/1						6/7	6/8	75.0	1		1		
16	张帅														
17	刘赵梁			0/1	0/1	0/1			0/3	0.0	2				
18	赵楠	0/2		0/1	1/1				1/4	25.0	2	1	1		
19	庞连康	3/4	1/1						4/5	80.0	3				
21	刘江	0/1			0/1				0/2	0.0	2			1	
22	罗尧尧			2/2					2/2	100	1				
25	陈孝天	1/2							1/2	50.0					
26	MUCZA Norbert	2/3	0/1		1/1				3/5	60.0	2	4			
27	王伟强			3/4					3/4	75.0	1	3			
28	SZRNKA Levente		5/5		1/2		0/1		6/8	75.0	1	1	1		
运动员	合计	7/14	6/7	5/8	4/7	0/1	0/1	7/8	29/46	63.0	5	23	2	3	
12	张春梁	1/3	0/1	1/1	1/3	0/1		0/1	3/10	30.0					
16	张帅	8/10	0/6	2/5	0/3	0/2			10/26	38.5					
守门员	合计	9/13	0/7	3/6	1/6	0/3		0/1	13/36	36.1					

江苏	比赛进程	北京
1st Half		
19 庞连康	1 00:28	0
18 赵楠	2 02:26	0
15 李安	3 04:26	0
	3 05:40	1 22 王超
15 李安	4 07:08	1
	4 07:55	2 13 王军鸣
28 SZRNKA Leve	5 08:22	2
	5 09:45	3 8 MAGYAR Davi
28 SZRNKA Leve	6 10:06	3
	6 10:41	4 32 蒋唯一
27 王伟强	7 11:56	4
	7 12:50	5 22 王超
15 李安	8 13:27	5
	8 15:09	6 32 蒋唯一
22 罗尧尧	9 16:08	6
	9 17:38	7 26 魏昂
28 SZRNKA Leve	10 18:09	7
26 MUCZA Norbe	11 20:04	7
	11 20:45	8 22 王超
19 庞连康	12 21:30	8
15 李安	13 23:25	8
27 王伟强	14 24:37	8
27 王伟强	15 28:06	8
	15 29:30	9 26 魏昂
2nd Half		
	15 00:34	10 32 蒋唯一
26 MUCZA Norbe	16 01:13	10
28 SZRNKA Leve	17 01:51	10
	17 03:51	11 32 蒋唯一
28 SZRNKA Leve	18 05:05	11
	18 05:42	12 17 王哲一
19 庞连康	19 08:10	12
	19 09:32	13 26 魏昂
15 李安	20 10:22	13
19 庞连康	21 11:44	13
	21 12:30	14 26 魏昂
	21 13:08	15 27 闫炳旗
15 李安	22 13:58	15
28 SZRNKA Leve	23 15:09	15
5 闫亮	24 16:01	15
26 MUCZA Norbe	25 16:44	15
	25 17:22	16 17 王哲一
22 罗尧尧	26 20:21	16
	26 21:55	17 32 蒋唯一
	26 23:29	18 22 王超
9 许翔宇	27 25:24	18
	27 26:28	19 11 赵文宣
	27 27:14	20 22 王超
	27 28:17	21 26 魏昂
11 张天豪	28 28:43	21
	28 29:08	22 2 解建飞
25 陈孝天	29 29:36	22
	29 29:53	23 2 解建飞

场上队员: 得分 / 射门

守门员: 救球 / 射门

D	取消资格	DR	取消资格+报告
---	------	----	---------



2019中国男子手球超级联赛总决赛（青岛）

PHMS Pictorial Handball Match Statistics

IHF Official System

个人/全队技术统计表

手球 男子 预赛 轮次 1 组别 X 场次 20 青岛市民健身中心 2019-07-26 20:45

号码	姓名	远射	近射	边射	快攻	突破	任意	七米	合计	%	助攻	失误	警告	2'	取消	时间
太平洋保险江苏(江苏)																
(场上队员)																
1	陈昊									0.0%						00:00:00
5	闫亮				1/1				1/1	100%						00:06:43
9	许翔宇	1/1							1/1	100%		3				00:09:53
11	张天豪							1/1	1/1	100%		2				00:13:07
12	张春梁									0.0%						00:12:28
15	李安	0/1						6/7	6/8	75.0%		1		1		00:10:29
16	张帅									0.0%						00:47:32
17	刘赵梁			0/1	0/1	0/1			0/3	0.0%		2				00:42:07
18	赵楠	0/2		0/1	1/1				1/4	25.0%	2	1	1			00:47:00
19	庞连康	3/4	1/1						4/5	80.0%		3				00:25:06
21	刘江	0/1			0/1				0/2	0.0%		2		1		00:34:42
22	罗尧尧			2/2					2/2	100%		1				00:17:42
25	陈孝天	1/2							1/2	50.0%						00:12:37
26	MUCZA Norbert	2/3	0/1		1/1				3/5	60.0%	2	4				00:47:20
27	王伟强			3/4					3/4	75.0%	1	3				00:46:52
28	SZRNKA Levente		5/5		1/2		0/1		6/8	75.0%		1	1	1		00:47:04
	合计	7/14	6/7	5/8	4/7	0/1	0/1	7/8	29/46	63.0%	5	23	2	3		
(守门员)																
12	张春梁	1/3	0/1	1/1	1/3	0/1		0/1	3/10	30.0%						00:12:28
16	张帅	8/10	0/6	2/5	0/3	0/2			10/26	38.5%						00:47:32
	合计	9/13	0/7	3/6	1/6	0/3		0/1	13/36	36.1%						

场上队员：得分/射门

守门员：救球/射门

全队合计	得分	被救	射失	击柱	封球	合计	%
远射	7	4	1		2	14	50.0%
近射	6	1				7	85.7%
边射	5	3				8	62.5%
快攻	4	1	2			7	57.1%
突破				1		1	0.0%
任意			1			1	0.0%
七米	7	1				8	87.5%

2019中国男子手球超级联赛总决赛（青岛）

PHMS Pictorial Handball Match Statistics

IHF Official System

个人/全队技术统计表

手球 预赛 组别 X 青岛市民健身中心
男子 轮次 1 场次 20 2019-07-26 20:45

号码	姓名	远射	近射	边射	快攻	突破	任意	七米	合计	%	助攻	失误	警告	2'	取消	时间
北京光彩(北京)																
(场上队员)																
2	解建飞	2/2							2/2	100%	1	1	1	1		00:25:07
7	马昌震									0.0%		2		1		00:17:48
8	MAGYAR David	0/3	1/1						1/4	25.0%	2	4				00:30:32
10	MEZEI Richard B.	0/1							0/1	0.0%		1				00:09:28
11	赵文宣		1/1		0/1				1/2	50.0%		2		1		00:19:11
12	高云健									0.0%	1					00:49:08
13	王军鸣	1/5		0/1					1/6	16.7%		4		1		00:21:13
14	逯明松	0/2				0/1			0/3	0.0%	1			1		00:26:16
16	孟辉									0.0%						00:10:52
17	王哲一	1/4	0/1			1/1			2/6	33.3%	1	3				00:32:08
22	王超		1/1	1/3	2/2	1/1			5/7	71.4%		1				00:29:17
25	马明辉									0.0%						00:08:34
26	魏昂			1/1	3/3	1/1			5/5	100%		1		1		00:39:59
27	闫炳旗			1/1					1/1	100%		1	1	1		00:48:07
29	杜龙飞	0/1		0/1					0/2	0.0%		2				00:22:13
32	蒋唯一		4/4					1/1	5/5	100%		1				00:26:18
	合计	4/18	7/8	3/7	5/6	3/4		1/1	23/44	52.3%	6	23	2	7		
(守门员)																
12	高云健	3/8	1/7	3/8	1/5			0/4	8/32	25.0%	1					00:49:08
16	孟辉	1/3						1/4	2/7	28.6%						00:10:52
	合计	4/11	1/7	3/8	1/5			1/8	10/39	25.6%	1					

场上队员：得分/射门

守门员：救球/射门

全队合计	得分	被救	射失	击柱	封球	合计	%
远射	4	9	2	1	2	18	22.2%
近射	7			1		8	87.5%
边射	3	3		1		7	42.9%
快攻	5	1				6	83.3%
突破	3			1		4	75.0%
任意							0.0%
七米	1					1	100.0%

2019中国男子手球超级联赛总决赛（青岛）

PHMS Pictorial Handball Match Statistics

IHF Official System

图式比赛技术统计表

手球
男子

预赛
轮次 1

组别 X
场次 20

青岛市民健身中心
2019-07-26 20:45

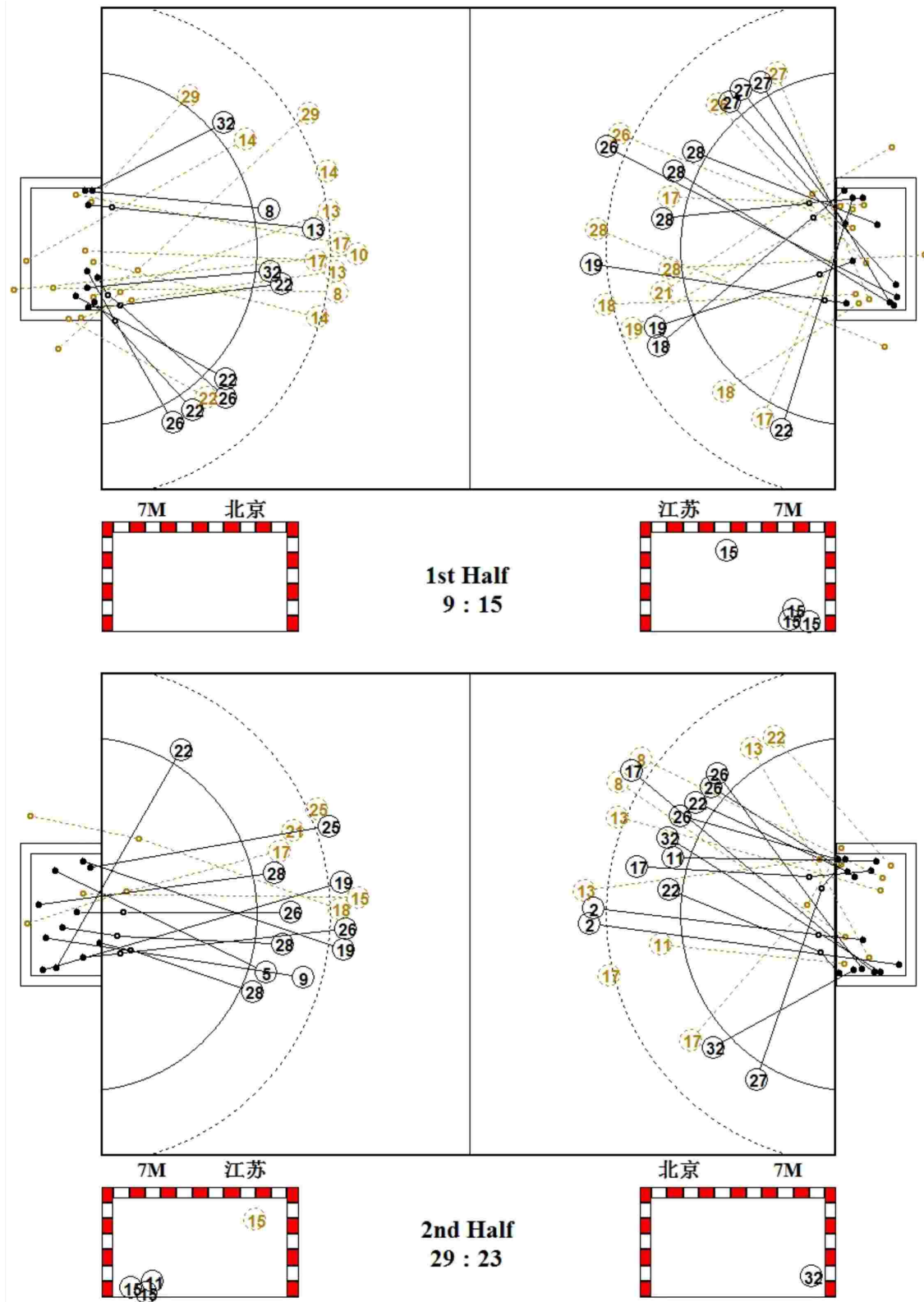

2019中国男子手球超级联赛总决赛（青岛）

PHMS Pictorial Handball Match Statistics

IHF Official System

图式射门区域统计

手球
男子

预赛
轮次 1

组别 X
场次 20

青岛市民健身中心
2019-07-26 20:45

太平洋保险江苏

1 陈昊	5 闫亮	9 许翔宇	11 张天豪	12 张睿梁	15 李安	16 张帅	17 刘赵梁																																																																								
<table border="1"><tr><td></td><td></td><td></td></tr><tr><td></td><td></td><td></td></tr><tr><td></td><td></td><td></td></tr></table>										<table border="1"><tr><td></td><td></td><td>1</td></tr><tr><td></td><td></td><td></td></tr><tr><td></td><td></td><td></td></tr></table>			1							<table border="1"><tr><td>1</td><td></td><td></td></tr><tr><td></td><td></td><td></td></tr><tr><td></td><td></td><td></td></tr></table>	1									<table border="1"><tr><td></td><td></td><td></td></tr><tr><td></td><td></td><td></td></tr><tr><td>1</td><td></td><td></td></tr></table>							1			<table border="1"><tr><td></td><td></td><td></td></tr><tr><td></td><td></td><td></td></tr><tr><td></td><td></td><td></td></tr></table>										<table border="1"><tr><td></td><td>1</td><td></td></tr><tr><td></td><td></td><td></td></tr><tr><td>2</td><td></td><td>3</td></tr></table>		1					2		3	<table border="1"><tr><td></td><td></td><td></td></tr><tr><td></td><td></td><td></td></tr><tr><td></td><td></td><td></td></tr></table>										<table border="1"><tr><td></td><td></td><td></td></tr><tr><td></td><td></td><td></td></tr><tr><td></td><td></td><td></td></tr></table>									
		1																																																																													
1																																																																															
1																																																																															
	1																																																																														
2		3																																																																													
Post - 0 Miss - 0 Block - 0	Post - 0 Miss - 0 Block - 0	Post - 0 Miss - 0 Block - 0	Post - 0 Miss - 0 Block - 0	Post - 0 Miss - 0 Block - 0	Post - 0 Miss - 0 Block - 0	Post - 0 Miss - 0 Block - 0	Post - 1 Miss - 0 Block - 0																																																																								
18 赵楠	19 庞连康	21 刘江	22 罗尧尧	25 陈孝天	26 MUCZA Norbert	27 王伟强	28 SZRNKA Levente																																																																								
<table border="1"><tr><td></td><td></td><td></td></tr><tr><td></td><td></td><td></td></tr><tr><td>1</td><td></td><td></td></tr></table>							1			<table border="1"><tr><td>1</td><td></td><td></td></tr><tr><td></td><td></td><td></td></tr><tr><td></td><td>1</td><td>2</td></tr></table>	1							1	2	<table border="1"><tr><td></td><td></td><td></td></tr><tr><td></td><td></td><td></td></tr><tr><td></td><td></td><td></td></tr></table>										<table border="1"><tr><td></td><td></td><td></td></tr><tr><td></td><td></td><td></td></tr><tr><td>1</td><td></td><td></td></tr></table>							1			<table border="1"><tr><td></td><td></td><td></td></tr><tr><td></td><td></td><td></td></tr><tr><td></td><td></td><td>1</td></tr></table>									1	<table border="1"><tr><td></td><td></td><td>1</td></tr><tr><td></td><td></td><td></td></tr><tr><td>1</td><td></td><td></td></tr></table>			1				1			<table border="1"><tr><td></td><td></td><td>2</td></tr><tr><td></td><td></td><td></td></tr><tr><td>1</td><td></td><td></td></tr></table>			2				1			<table border="1"><tr><td></td><td>1</td><td>1</td></tr><tr><td></td><td></td><td></td></tr><tr><td>2</td><td>1</td><td></td></tr></table>		1	1				2	1	
1																																																																															
1																																																																															
	1	2																																																																													
1																																																																															
		1																																																																													
		1																																																																													
1																																																																															
		2																																																																													
1																																																																															
	1	1																																																																													
2	1																																																																														
Post - 0 Miss - 1 Block - 0	Post - 0 Miss - 0 Block - 0	Post - 0 Miss - 1 Block - 1	Post - 0 Miss - 0 Block - 0	Post - 0 Miss - 0 Block - 1	Post - 0 Miss - 0 Block - 0	Post - 0 Miss - 0 Block - 0	Post - 0 Miss - 2 Block - 0																																																																								

12 张睿梁

1/1		0/1
0/1		0/1
1/3		1/3

16 张帅

2/2		
1/3		2/5
1/8	2/2	2/6

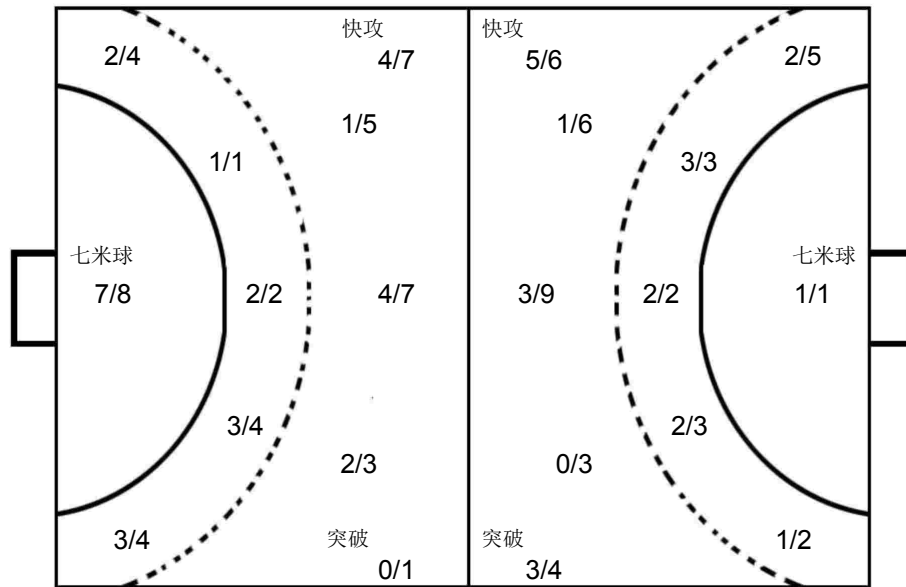

12 高云健

0/1	0/2	0/5
1/4	1/3	2/2
2/7	1/2	1/6

16 孟辉

0/1		1/1
0/3	1/1	0/1

北京光彩

2 解建飞	7 马昌震	8 MAGYAR David	10 MEZEI Richard B.	11 赵文宣	12 高云健	13 王军鸣	14 逯明松																																																																								
<table border="1"><tr><td></td><td></td><td>1</td></tr><tr><td></td><td></td><td>1</td></tr><tr><td></td><td></td><td></td></tr></table>			1			1				<table border="1"><tr><td></td><td></td><td></td></tr><tr><td></td><td></td><td></td></tr><tr><td></td><td></td><td></td></tr></table>										<table border="1"><tr><td></td><td></td><td></td></tr><tr><td></td><td></td><td></td></tr><tr><td></td><td></td><td>1</td></tr></table>									1	<table border="1"><tr><td></td><td></td><td></td></tr><tr><td></td><td></td><td></td></tr><tr><td></td><td></td><td></td></tr></table>										<table border="1"><tr><td></td><td></td><td></td></tr><tr><td></td><td></td><td></td></tr><tr><td>1</td><td></td><td></td></tr></table>							1			<table border="1"><tr><td></td><td></td><td></td></tr><tr><td></td><td></td><td></td></tr><tr><td></td><td></td><td></td></tr></table>										<table border="1"><tr><td></td><td></td><td></td></tr><tr><td></td><td></td><td></td></tr><tr><td></td><td></td><td>1</td></tr></table>									1	<table border="1"><tr><td></td><td></td><td></td></tr><tr><td></td><td></td><td></td></tr><tr><td></td><td></td><td></td></tr></table>									
		1																																																																													
		1																																																																													
		1																																																																													
1																																																																															
		1																																																																													
Post - 0 Miss - 0 Block - 0	Post - 0 Miss - 0 Block - 0	Post - 0 Miss - 0 Block - 0	Post - 0 Miss - 1 Block - 0	Post - 0 Miss - 0 Block - 0	Post - 0 Miss - 0 Block - 0	Post - 1 Miss - 1 Block - 0	Post - 1 Miss - 0 Block - 1																																																																								
16 孟辉	17 王哲一	22 王超	25 马明辉	26 魏昂	27 闫炳旗	29 杜龙飞	32 蒋唯一																																																																								
<table border="1"><tr><td></td><td></td><td></td></tr><tr><td></td><td></td><td></td></tr><tr><td></td><td></td><td></td></tr></table>										<table border="1"><tr><td></td><td>1</td><td>1</td></tr><tr><td></td><td></td><td></td></tr><tr><td></td><td></td><td></td></tr></table>		1	1							<table border="1"><tr><td></td><td>1</td><td></td></tr><tr><td></td><td>3</td><td>1</td></tr><tr><td></td><td></td><td></td></tr></table>		1			3	1				<table border="1"><tr><td></td><td></td><td></td></tr><tr><td></td><td></td><td></td></tr><tr><td></td><td></td><td></td></tr></table>										<table border="1"><tr><td></td><td></td><td></td></tr><tr><td></td><td></td><td></td></tr><tr><td>4</td><td></td><td>1</td></tr></table>							4		1	<table border="1"><tr><td></td><td></td><td></td></tr><tr><td></td><td></td><td></td></tr><tr><td>1</td><td></td><td></td></tr></table>							1			<table border="1"><tr><td></td><td></td><td></td></tr><tr><td></td><td></td><td></td></tr><tr><td></td><td></td><td></td></tr></table>										<table border="1"><tr><td></td><td></td><td>1</td></tr><tr><td></td><td></td><td>3</td></tr><tr><td></td><td></td><td></td></tr></table>			1			3			
	1	1																																																																													
	1																																																																														
	3	1																																																																													
4		1																																																																													
1																																																																															
		1																																																																													
		3																																																																													
Post - 0 Miss - 0 Block - 0	Post - 1 Miss - 0 Block - 1	Post - 1 Miss - 0 Block - 0	Post - 0 Miss - 0 Block - 0	Post - 0 Miss - 0 Block - 0	Post - 0 Miss - 0 Block - 0	Post - 0 Miss - 0 Block - 0	Post - 0 Miss - 0 Block - 0																																																																								



PHMS Pictorial Handball Match Statistics

IHF Official System

Team A					Team B					Match Number											
A 广东路环四庙					B 北京光彩					21											
Played in			in the hall			on			at			Spectators									
山东青岛			青岛市民健身中心			2019-07-27			19:00			hours 300									
Half-time(30')	A	B	End of playing time		A	B	1st extra time		A	B	2nd extra time		A	B	After penalty throws		A	B			
	11	17	26 34																		
Number of 7 m	A	Team time-out			Full name of players and officials						Team time-out			B	Number of 7 m						
	1/1	1	2	3							1	2	3	B							
		22:44									19:25	45:22		6/9							
No.	Team A					G	W	2'	D	DR	No.	Team B					G	W	2'	D	DR
1	王帅										2	解建飞						1			
3	曲汝洋					2					7	马昌震					3		1		
4	ARPASI Patrik					7		1			8	MAGYAR David									
5	曹景森										10	MEZEI Richard B.									
6	毕晓晨					2					11	赵文宣					1				
7	王立隆							1			12	高云健									
8	DOLEZSAL Karoly										13	王军鸣					6				
9	范保坤										14	逯明松					3	1			
10	周仲坤					4	1	1			16	孟辉									
11	房友屯										17	王哲一					4		1		
17	李中洲					5					22	王超					2				
18	姚雪岩					3					25	马明辉					1				
19	王泽润										26	魏昂					2		1		
21	张昌轲					2		1			27	闫炳旗					1				
24	高玉杰					1	1	2			29	杜龙飞									
											32	蒋唯一					11				
A	刘康伶 (主教练)										A	郑永利 (主教练)									
B	郭艳辉										D	陈璇									
C	贾章志										F	王洸									
A	Signatures of responsables for the teams (Off.A)															B					
TP	Remarks of referees / HF Official															TP					

Signatures

Referees	刘禹 (CHN)	许翔 (CHN)		
T.D.	许宜扬 (CHN)	郭剑 (CHN)		
CHA Off.				

Note: Number of 7m Throws Awarded to Team A and B, Goals (G), Warnings (W), Suspensions (2'), Direct Disqualification (D), Disqualification With Report (DR) and Team Penalty (TP).

Table Officials: 康曦 刘斌 Statisticians: 李双 王玲

2019中国男子手球超级联赛总决赛（青岛）

PHMS Pictorial Handball Match Statistics

IHF Official System

竞赛技术统计

手球 男子 名次赛 轮次 2 组别 X 场次 21 青岛市民健身中心 2019-07-27 19:00

Referees: 刘禹 (CHN) / 许翔 (CHN) Result: 26:34(11:17)
Teams: 广东路环四庙(广东) VS 北京光彩(北京)

广东		远射	近射	边射	快攻	突破	任意球	7m球	合计	%	助攻	失误	警告	2'	D+DR
主教练: 刘康伶															
1	王帅														
3	曲汝洋	1/5	1/1						2/6	33.3	2	1			
4	ARPASI Patrik		6/6		1/1				7/7	100	1	2		1	
5	曹景森														
6	毕晓晨	0/1		1/1	1/2				2/4	50.0	2				
7	王立隆	0/1							0/1	0.0		1	1		
8	DOLEZSAL Karoly	0/2							0/2	0.0	2	6			
9	范保坤														
10	周仲坤	3/7						1/1	4/8	50.0		1	1	1	
11	房友屯														
17	李中洲	2/6	1/1		1/1	0/1	1/1		5/10	50.0	2	2			
18	姚雪岩	2/5				1/1			3/6	50.0		1			
19	王泽润														
21	张昌珂		0/2	1/1	1/1				2/4	50.0		2		1	
24	高玉杰				1/1				1/1	100	1		1	2	
运动员 合计		8/27	8/10	2/2	5/6	1/2	1/1	1/1	26/49	53.1	10	16	3	5	
1	王帅	1/5	3/14	3/5	1/6	3/6	0/1	1/1	12/38	31.6					
19	王泽润		0/1		0/1			2/8	2/10	20.0					
守门员 合计		1/5	3/15	3/5	1/7	3/6	0/1	3/9	14/48	29.2					

北京		远射	近射	边射	快攻	突破	任意球	7m球	合计	%	助攻	失误	警告	2'	D+DR
主教练: 郑永利															
2	解建飞							0/2	0/2	0.0		1	1		
7	马昌震		3/4						3/4	75.0	1	1		1	
8	MAGYAR David														
10	MEZEI Richard B.														
11	赵文宣		1/1						1/1	100					
12	高云健											2			
13	王军鸣	3/3	1/1			1/1	1/1		6/6	100	3	1			
14	逯明松	1/5	2/3						3/8	37.5		3	1		
16	孟辉														
17	王哲一	0/1	3/3				0/1	1/2	4/7	57.1	2	2		1	
22	王超		1/1		1/2	0/1			2/4	50.0		3			
25	马明辉			1/1	0/1				1/2	50.0		1			
26	魏昂			1/2	1/1	0/1			2/4	50.0				1	
27	闫炳旗			0/2	1/1				1/3	33.3					
29	杜龙飞	0/1							0/1	0.0	1				
32	蒋唯一		1/2		3/3	2/3		5/5	11/13	84.6					
运动员 合计		4/10	12/15	2/5	6/8	3/7	1/1	6/9	34/55	61.8	9	12	2	3	
12	高云健	8/16	1/7	0/1	0/3		0/1	0/1	9/29	31.0	2				
16	孟辉	3/3	0/2	0/1	1/3	0/1			4/10	40.0					
守门员 合计		11/19	1/9	0/2	1/6	0/1	0/1	0/1	13/39	33.3	2				

广东	比赛进程	北京
1st Half		
17 李中洲	1 02:24 0	
	1 02:55 1 13 王军鸣	
	1 04:25 2 13 王军鸣	
3 曲汝洋	2 06:15 2	
21 张昌珂	3 07:08 2	
	3 08:28 3 26 魏昂	
	3 09:41 4 7 马昌震	
17 李中洲	4 12:30 4	
	4 12:57 5 17 王哲一	
17 李中洲	5 13:49 5	
	5 14:40 6 17 王哲一	
3 曲汝洋	6 15:13 6	
	6 16:27 7 17 王哲一	
10 周仲坤	7 16:58 7	
	7 18:35 8 7 马昌震	
	7 19:51 9 32 蒋唯一	
10 周仲坤	8 20:51 9	
	8 22:07 10 13 王军鸣	
4 ARPASI Patr	9 23:13 10	
	9 23:29 11 32 蒋唯一	
	9 24:13 12 14 逯明松	
	9 24:57 13 14 逯明松	
4 ARPASI Patr	10 25:41 13	
	10 26:22 14 13 王军鸣	
	10 27:00 15 27 闫炳旗	
	10 27:16 16 32 蒋唯一	
17 李中洲	11 28:20 16	
	11 28:23 17 32 蒋唯一	
2nd Half		
10 周仲坤	12 00:24 17	
	12 00:44 18 32 蒋唯一	
	12 01:55 19 32 蒋唯一	
4 ARPASI Patr	13 02:41 19	
	13 03:04 20 32 蒋唯一	
21 张昌珂	14 03:56 20	
4 ARPASI Patr	15 05:27 20	
	15 05:47 21 32 蒋唯一	
10 周仲坤	16 05:59 21	
18 姚雪岩	17 06:44 21	
	17 07:08 22 32 蒋唯一	
	17 08:26 23 22 王超	
6 毕晓晨	18 10:04 23	
	18 10:47 24 32 蒋唯一	
	18 11:50 25 26 魏昂	
17 李中洲	19 14:05 25	
	19 15:58 26 32 蒋唯一	
18 姚雪岩	20 16:30 26	
	20 17:00 27 7 马昌震	
	20 18:11 28 13 王军鸣	
4 ARPASI Patr	21 18:47 28	
18 姚雪岩	22 20:23 28	
	22 20:49 29 13 王军鸣	
6 毕晓晨	23 20:59 29	
	23 22:09 30 14 逯明松	
	23 22:43 31 22 王超	
4 ARPASI Patr	24 23:15 31	
	24 23:44 32 17 王哲一	
	24 25:48 33 25 马明辉	
24 高玉杰	25 28:31 33	
4 ARPASI Patr	26 29:02 33	
	26 29:36 34 11 赵文宣	

场上队员: 得分 / 射门 守门员: 救球 / 射门

D	取消资格	DR	取消资格+报告
---	------	----	---------

2019中国男子手球超级联赛总决赛（青岛）

PHMS Pictorial Handball Match Statistics

IHF Official System

个人/全队技术统计表

手球 名次赛 组别 X 青岛市民健身中心
男子 轮次 2 场次 21 2019-07-27 19:00

号码	姓名	远射	近射	边射	快攻	突破	任意	七米	合计	%	助攻	失误	警告	2'	取消	时间
广东路环四庙(广东)																
(场上队员)																
1	王帅									0.0%						00:55:49
3	曲汝洋	1/5	1/1						2/6	33.3%	2	1				00:21:16
4	ARPASI Patrik		6/6		1/1				7/7	100%	1	2		1		00:42:17
5	曹景森									0.0%						00:00:00
6	毕晓晨	0/1		1/1	1/2				2/4	50.0%	2					00:30:00
7	王立隆	0/1							0/1	0.0%		1	1			00:30:00
8	DOLEZSAL Karoly	0/2							0/2	0.0%	2	6				00:30:00
9	范保坤									0.0%						00:00:00
10	周仲坤	3/7						1/1	4/8	50.0%		1	1	1		00:43:10
11	房友屯									0.0%						00:11:39
17	李中洲	2/6	1/1		1/1	0/1	1/1		5/10	50.0%	2	2				00:36:25
18	姚雪岩	2/5				1/1			3/6	50.0%		1				00:45:10
19	王泽润									0.0%						00:04:11
21	张昌轲		0/2	1/1	1/1				2/4	50.0%		2		1		00:34:29
24	高玉杰				1/1				1/1	100%	1		1	2		00:31:18
合计		8/27	8/10	2/2	5/6	1/2	1/1	1/1	26/49	53.1%	10	16	3	5		
(守门员)																
1	王帅	1/5	3/14	3/5	1/6	3/6	0/1	1/1	12/38	31.6%						00:55:49
19	王泽润		0/1		0/1			2/8	2/10	20.0%						00:04:11
合计		1/5	3/15	3/5	1/7	3/6	0/1	3/9	14/48	29.2%						

场上队员：得分/射门

守门员：救球/射门

全队合计	得分	被救	射失	击柱	封球	合计	%
远射	8	11	3	3	2	27	29.6%
近射	8	1	1			10	80.0%
边射	2					2	100.0%
快攻	5	1				6	83.3%
突破	1			1		2	50.0%
任意	1					1	100.0%
七米	1					1	100.0%

2019中国男子手球超级联赛总决赛（青岛）

PHMS Pictorial Handball Match Statistics

IHF Official System

个人/全队技术统计表

手球 名次赛 组别 X 青岛市民健身中心
男子 轮次 2 场次 21 2019-07-27 19:00

号码	姓名	远射	近射	边射	快攻	突破	任意	七米	合计	%	助攻	失误	警告	2'	取消	时间
北京光彩(北京)																
(场上队员)																
2	解建飞							0/2	0/2	0.0%		1	1			00:27:05
7	马昌震		3/4						3/4	75.0%	1	1		1		00:32:50
8	MAGYAR David									0.0%						00:00:00
10	MEZEI Richard B.									0.0%						00:00:00
11	赵文宣		1/1						1/1	100%						00:01:21
12	高云健									0.0%	2					00:42:09
13	王军鸣	3/3	1/1			1/1	1/1		6/6	100%	3	1				00:28:53
14	逯明松	1/5	2/3						3/8	37.5%		3	1			00:48:22
16	孟辉									0.0%						00:17:51
17	王哲一	0/1	3/3			0/1		1/2	4/7	57.1%	2	2		1		00:34:12
22	王超		1/1		1/2	0/1			2/4	50.0%		3				00:33:15
25	马明辉			1/1	0/1				1/2	50.0%		1				00:19:22
26	魏昂			1/2	1/1	0/1			2/4	50.0%				1		00:53:05
27	闫炳旗			0/2	1/1				1/3	33.3%						00:40:26
29	杜龙飞	0/1							0/1	0.0%	1					00:11:37
32	蒋唯一		1/2		3/3	2/3		5/5	11/13	84.6%						00:27:28
	合计	4/10	12/15	2/5	6/8	3/7	1/1	6/9	34/55	61.8%	9	12	2	3		
(守门员)																
12	高云健	8/16	1/7	0/1	0/3		0/1	0/1	9/29	31.0%	2					00:42:09
16	孟辉	3/3	0/2	0/1	1/3	0/1			4/10	40.0%						00:17:51
	合计	11/19	1/9	0/2	1/6	0/1	0/1	0/1	13/39	33.3%	2					

场上队员：得分/射门

守门员：救球/射门

全队合计	得分	被救	射失	击柱	封球	合计	%
远射	4	1	3		2	10	40.0%
近射	12	3				15	80.0%
边射	2	3				5	40.0%
快攻	6	1		1		8	75.0%
突破	3	3	1			7	42.9%
任意	1					1	100.0%
七米	6	3				9	66.7%

2019中国男子手球超级联赛总决赛（青岛）

PHMS Pictorial Handball Match Statistics

IHF Official System

图式比赛技术统计表

手球
男子

名次赛
轮次 2

组别 X
场次 21

青岛市民健身中心
2019-07-27 19:00

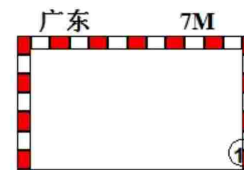
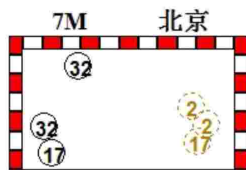
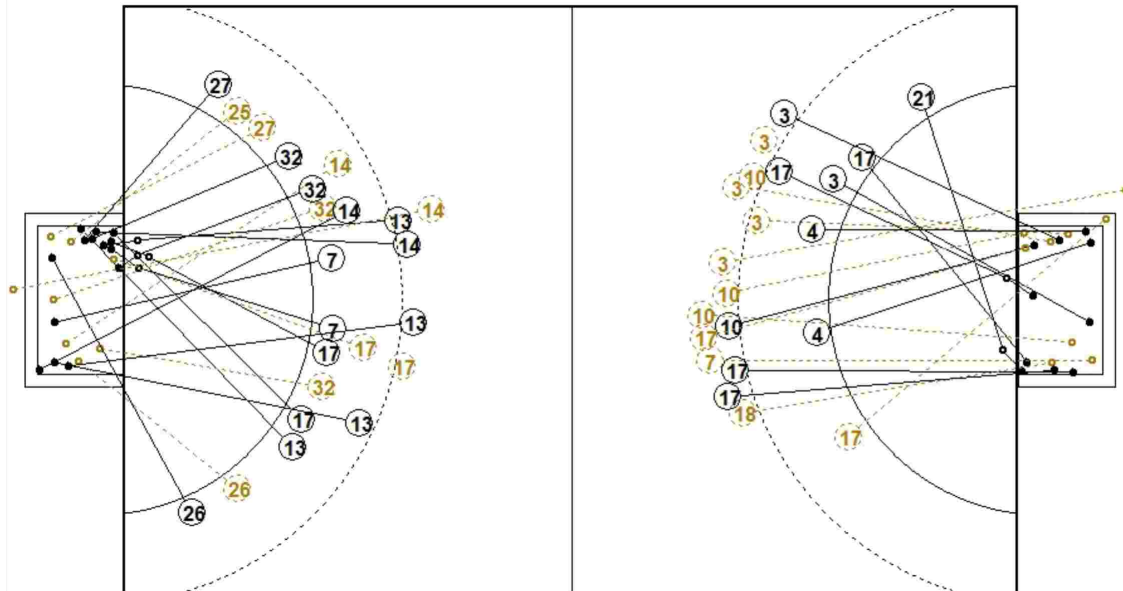

1st Half
17 : 11

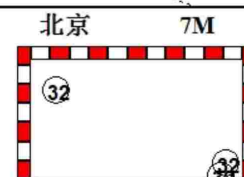
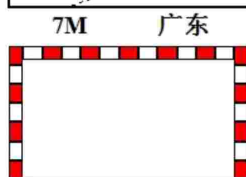
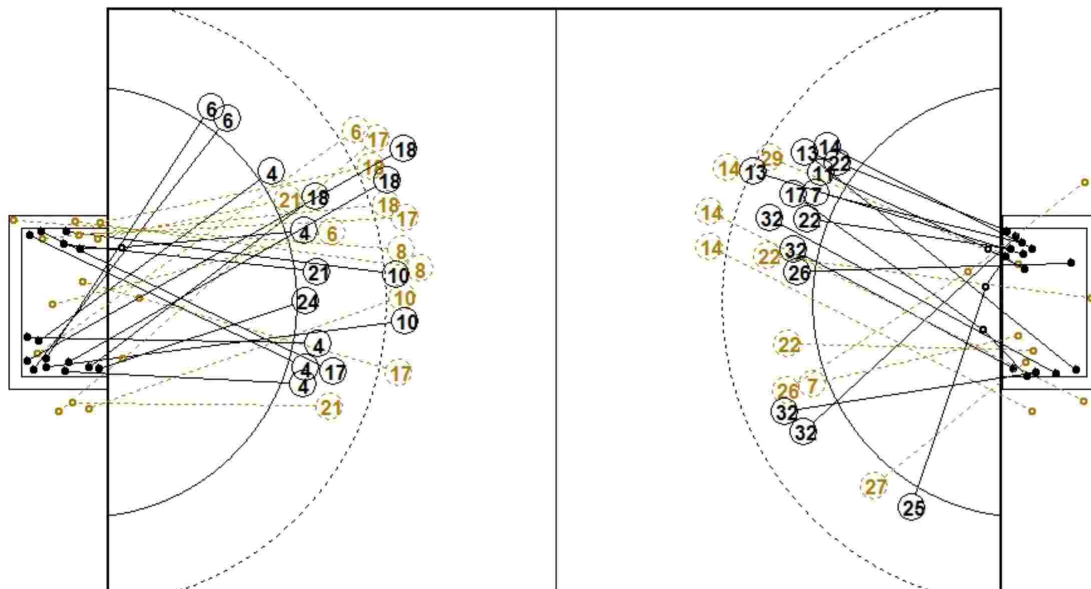

2nd Half
26 : 34

2019中国男子手球超级联赛总决赛（青岛）

PHMS Pictorial Handball Match Statistics

IHF Official System

图式射门区域统计

手球
男子

名次赛
轮次 2

组别 X
场次 21

青岛市民健身中心
2019-07-27 19:00

广东路环四庙

1 王帅 <table border="1"><tr><td></td><td></td><td></td></tr><tr><td></td><td></td><td></td></tr><tr><td></td><td></td><td></td></tr></table> Post - 0 Miss - 0 Block - 0										3 曲汝洋 <table border="1"><tr><td></td><td>1</td><td></td></tr><tr><td>1</td><td></td><td></td></tr><tr><td></td><td></td><td></td></tr></table> Post - 0 Miss - 1 Block - 1		1		1						4 ARPASI Patrik <table border="1"><tr><td>4</td><td></td><td>1</td></tr><tr><td>1</td><td></td><td></td></tr><tr><td></td><td></td><td>1</td></tr></table> Post - 0 Miss - 0 Block - 0	4		1	1					1	5 曹景森 <table border="1"><tr><td></td><td></td><td></td></tr><tr><td></td><td></td><td></td></tr><tr><td></td><td></td><td></td></tr></table> Post - 0 Miss - 0 Block - 0										6 毕晓晨 <table border="1"><tr><td>2</td><td></td><td></td></tr><tr><td></td><td></td><td></td></tr><tr><td></td><td></td><td></td></tr></table> Post - 0 Miss - 0 Block - 0	2									7 王立隆 <table border="1"><tr><td></td><td></td><td></td></tr><tr><td></td><td></td><td></td></tr><tr><td></td><td></td><td></td></tr></table> Post - 0 Miss - 0 Block - 0										8 DOLEZSAL Karoly <table border="1"><tr><td></td><td></td><td></td></tr><tr><td></td><td></td><td></td></tr><tr><td></td><td></td><td></td></tr></table> Post - 2 Miss - 0 Block - 0										9 范保坤 <table border="1"><tr><td></td><td></td><td></td></tr><tr><td></td><td></td><td></td></tr><tr><td></td><td></td><td></td></tr></table> Post - 0 Miss - 0 Block - 0									
	1																																																																														
1																																																																															
4		1																																																																													
1																																																																															
		1																																																																													
2																																																																															
10 周仲坤 <table border="1"><tr><td>1</td><td></td><td></td></tr><tr><td></td><td></td><td>1</td></tr><tr><td>1</td><td></td><td>1</td></tr></table> Post - 0 Miss - 1 Block - 1	1					1	1		1	11 房友屯 <table border="1"><tr><td></td><td></td><td></td></tr><tr><td></td><td></td><td></td></tr><tr><td></td><td></td><td></td></tr></table> Post - 0 Miss - 0 Block - 0										17 李中洲 <table border="1"><tr><td></td><td></td><td>2</td></tr><tr><td></td><td></td><td>1</td></tr><tr><td></td><td>1</td><td>1</td></tr></table> Post - 1 Miss - 1 Block - 0			2			1		1	1	18 姚雪岩 <table border="1"><tr><td>1</td><td></td><td></td></tr><tr><td>1</td><td></td><td></td></tr><tr><td>1</td><td></td><td></td></tr></table> Post - 1 Miss - 0 Block - 0	1			1			1			19 王泽润 <table border="1"><tr><td></td><td></td><td></td></tr><tr><td></td><td></td><td></td></tr><tr><td></td><td></td><td></td></tr></table> Post - 0 Miss - 0 Block - 0										21 张昌轲 <table border="1"><tr><td></td><td></td><td></td></tr><tr><td></td><td></td><td>1</td></tr><tr><td></td><td></td><td>1</td></tr></table> Post - 0 Miss - 1 Block - 0						1			1	24 高玉杰 <table border="1"><tr><td></td><td></td><td></td></tr><tr><td></td><td></td><td></td></tr><tr><td>1</td><td></td><td></td></tr></table> Post - 0 Miss - 0 Block - 0							1												
1																																																																															
		1																																																																													
1		1																																																																													
		2																																																																													
		1																																																																													
	1	1																																																																													
1																																																																															
1																																																																															
1																																																																															
		1																																																																													
		1																																																																													
1																																																																															

1 王帅

1/4	1/2	1/3
1/3		3/7
2/9		3/10

19 王泽润

0/2		
0/1		1/2
0/1		1/4

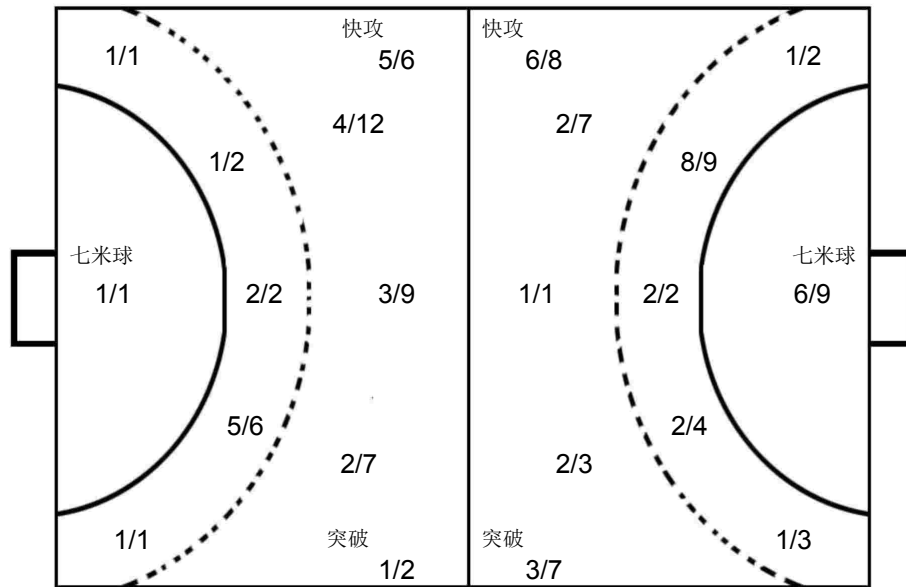

12 高云健

0/6	0/1	2/4
2/4		2/5
2/3	0/1	1/5

16 孟辉

1/3		0/1
0/1	1/1	1/1
0/2	1/1	

北京光彩

2 解建飞 <table border="1"><tr><td></td><td></td><td></td></tr><tr><td></td><td></td><td></td></tr><tr><td></td><td></td><td></td></tr></table> Post - 0 Miss - 0 Block - 0										7 马昌震 <table border="1"><tr><td></td><td>1</td><td></td></tr><tr><td>1</td><td></td><td>1</td></tr><tr><td></td><td></td><td></td></tr></table> Post - 0 Miss - 0 Block - 0		1		1		1				8 MAGYAR David <table border="1"><tr><td></td><td></td><td></td></tr><tr><td></td><td></td><td></td></tr><tr><td></td><td></td><td></td></tr></table> Post - 0 Miss - 0 Block - 0										10 MEZEI Richard B. <table border="1"><tr><td></td><td></td><td></td></tr><tr><td></td><td></td><td></td></tr><tr><td></td><td></td><td></td></tr></table> Post - 0 Miss - 0 Block - 0										11 赵文宣 <table border="1"><tr><td></td><td></td><td></td></tr><tr><td></td><td></td><td></td></tr><tr><td>1</td><td></td><td></td></tr></table> Post - 0 Miss - 0 Block - 0							1			12 高云健 <table border="1"><tr><td></td><td></td><td></td></tr><tr><td></td><td></td><td></td></tr><tr><td></td><td></td><td></td></tr></table> Post - 0 Miss - 0 Block - 0										13 王军鸣 <table border="1"><tr><td>1</td><td></td><td>1</td></tr><tr><td>1</td><td></td><td>1</td></tr><tr><td>1</td><td></td><td>1</td></tr></table> Post - 0 Miss - 0 Block - 0	1		1	1		1	1		1	14 逯明松 <table border="1"><tr><td>1</td><td></td><td></td></tr><tr><td>1</td><td></td><td></td></tr><tr><td></td><td></td><td>1</td></tr></table> Post - 0 Miss - 3 Block - 1	1			1					1
	1																																																																														
1		1																																																																													
1																																																																															
1		1																																																																													
1		1																																																																													
1		1																																																																													
1																																																																															
1																																																																															
		1																																																																													
16 孟辉 <table border="1"><tr><td></td><td></td><td></td></tr><tr><td></td><td></td><td></td></tr><tr><td></td><td></td><td></td></tr></table> Post - 0 Miss - 0 Block - 0										17 王哲一 <table border="1"><tr><td></td><td></td><td></td></tr><tr><td></td><td></td><td></td></tr><tr><td>1</td><td></td><td>3</td></tr></table> Post - 0 Miss - 0 Block - 1							1		3	22 王超 <table border="1"><tr><td></td><td></td><td></td></tr><tr><td></td><td></td><td></td></tr><tr><td>2</td><td></td><td></td></tr></table> Post - 1 Miss - 0 Block - 0							2			25 马明辉 <table border="1"><tr><td></td><td></td><td></td></tr><tr><td></td><td></td><td></td></tr><tr><td>1</td><td></td><td></td></tr></table> Post - 0 Miss - 0 Block - 0							1			26 魏昂 <table border="1"><tr><td>1</td><td></td><td>1</td></tr><tr><td></td><td></td><td></td></tr><tr><td></td><td></td><td></td></tr></table> Post - 0 Miss - 1 Block - 0	1		1							27 闫炳旗 <table border="1"><tr><td></td><td></td><td></td></tr><tr><td></td><td></td><td>1</td></tr><tr><td></td><td></td><td></td></tr></table> Post - 0 Miss - 0 Block - 0						1				29 杜龙飞 <table border="1"><tr><td></td><td></td><td></td></tr><tr><td></td><td></td><td></td></tr><tr><td></td><td></td><td></td></tr></table> Post - 0 Miss - 0 Block - 0										32 蒋唯一 <table border="1"><tr><td>2</td><td></td><td></td></tr><tr><td>1</td><td></td><td>3</td></tr><tr><td>1</td><td></td><td>4</td></tr></table> Post - 0 Miss - 0 Block - 0	2			1		3	1		4
1		3																																																																													
2																																																																															
1																																																																															
1		1																																																																													
		1																																																																													
2																																																																															
1		3																																																																													
1		4																																																																													



PHMS Pictorial Handball Match Statistics

IHF Official System

Team A					Team B					Match Number											
A 中国华体					B 太平洋保险江苏					22											
Played in			in the hall			on		at		Spectators											
山东青岛			青岛市民健身中心			2019-07-27		20:45		hours 420											
Half-time(30')	A	B	End of playing time		A	B	1st extra time		A	B	2nd extra time		A	B	After penalty throws						
	14	11	34		22																
Number of 7 m	A	Team time-out			Full name of players and officials					Team time-out			B	Number of 7 m							
	2/3	1	2	3						1	2	3	1/3								
			52:33	56:29																	
No.	Team A					G	W	2'	D	DR	No.	Team B					G	W	2'	D	DR
4	张家纬					1	1				1	陈昊									
5	贺政					3					5	闫亮									
8	谢庆龙					4					9	许翔宇					1				
10	李朝鹏					2					11	张天豪					1				
12	王权										12	张睿梁									
16	刘迈科										15	李安					2		1		
17	胡晋铭					2					16	张帅									
18	李双					1					17	刘赵梁									
20	顾艳超										18	赵楠					3	1			
22	黄培杰					7					19	庞连康					5				
23	曹悦					3					21	刘江					2		2		
25	王杰缘										22	罗尧尧					1				
47	成亚					4					25	陈孝天									
88	王军程					3					26	MUCZA Norbert					3				
97	张建杰					4					27	王伟强					3				
99	王伟										28	SZRNKA Levente					1	1			
A	姚苏捷										A	闫威名 (主教练)									
B	朱昕晨 (主教练)										B	叶强									
D	付飞鹏										C	雷纳德									
											D	王建国									
A	Signatures of responsables for the teams (Off.A)										B										
TP	Remarks of referees / HF Official										TP										

Signatures

Referees	王科 (CHN)	李兆蒙 (CHN)		
T.D.	吴瑞亭 (CHN)	许宜扬 (CHN)		
CHA Off.				

Note: Number of 7m Throws Awarded to Team A and B, Goals (G), Warnings (W), Suspensions (2'), Direct Disqualification (D), Disqualification With Report (DR) and Team Penalty (TP).

Table Officials: 刘斌 康曦 Statisticians: 王羚 李双

2019中国男子手球超级联赛总决赛（青岛）

PHMS Pictorial Handball Match Statistics

IHF Official System

竞赛技术统计

手球 名次赛 组别 X 青岛市民健身中心
男子 轮次 2 场次 22 2019-07-27 20:45

Referees: 王科 (CHN) / 李兆蒙 (CHN) Result: 34:22(14:11)
Teams: 中国华体(华体) VS 太平洋保险江苏(江苏)

华体		远	近	边	快	突	任意	7m	合计	%	助攻	失误	警告	2'	D+DR
主教练：朱昕晨		射	射	射	攻	破	球	球							
4	张家纬	1/2							1/2	50.0		2	1		
5	贺政		1/2	1/2	1/2				3/6	50.0					
8	谢庆龙		2/3		2/3				4/6	66.7		1			
10	李朝鹏	1/1	1/1						2/2	100	1				
12	王权														
16	刘迈科										2				
17	胡晋铭		2/2						2/2	100		1			
18	李双			1/1					1/1	100	1	1			
20	顾艳超	0/1	0/1						0/2	0.0	2				
22	黄培杰		2/3	1/3	3/4			1/1	7/11	63.6		2			
23	曹悦	1/2	1/1		1/1				3/4	75.0	1	1			
25	王杰缘			0/1					0/1	0.0					
47	成亚	1/2	2/2					1/2	4/6	66.7	1	1			
88	王军程	1/4			1/1	1/1			3/6	50.0	3	2			
97	张建杰	4/5							4/5	80.0		2			
99	王伟														
运动员 合计		9/17	11/15	3/7	8/11	1/1		2/3	34/54	63.0	11	13	1		
12	王权		1/1					1/1	1/1	100					
16	刘迈科	8/14	7/18	3/3	1/3	2/4	1/1	1/2	23/45	51.1	2				
守门员 合计		8/14	8/19	3/3	1/3	2/4	1/1	1/2	24/46	52.2	2				

江苏		远	近	边	快	突	任意	7m	合计	%	助攻	失误	警告	2'	D+DR
主教练：闫威名		射	射	射	攻	破	球	球							
1	陈昊														
5	闫亮		0/2						0/2	0.0	1				
9	许翔宇	0/4	1/2						1/6	16.7		2			
11	张天豪		1/1	0/3	0/1				1/5	20.0					
12	张睿梁														
15	李安		1/1					1/3	2/4	50.0	1	1		1	
16	张帅														
17	刘赵梁		0/1			0/1			0/2	0.0		1			
18	赵楠	2/5	1/4		0/1	0/1			3/11	27.3			1		
19	庞连康	1/4	3/4			1/1			5/9	55.6	2	1			
21	刘江		1/2		0/1	1/1			2/4	50.0	3	1		2	
22	罗尧尧		1/1						1/1	100	1	1			
25	陈孝天	0/4					0/1		0/5	0.0					
26	MUCZA Norbert	3/6							3/6	50.0	1	2			
27	王伟强	0/1	1/1		2/2				3/4	75.0		1			
28	SZRANKA Levente		1/1						1/1	100			1		
运动员 合计		6/24	11/20	0/3	2/5	2/4	0/1	1/3	22/60	36.7	9	10	2	3	
1	陈昊	0/3	3/8	0/2	1/4				4/17	23.5					
12	张睿梁	0/3	0/3		0/1				0/7	0.0					
16	张帅	3/6	1/4	3/4	1/5	0/1		1/3	9/23	39.1					
守门员 合计		3/12	4/15	3/6	2/10	0/1		1/3	13/47	27.7					

华体	比赛 进程	江苏
1st Half		
22 黄培杰	1 00:38 0	
	1 05:15 1 26 MUCZA Norbe	
	1 05:33 2 27 王伟强	
17 胡晋铭	2 05:53 2	
47 成亚	3 07:03 2	
	3 07:37 3 28 SZRNKA Leve	
4 张家纬	4 10:16 3	
	4 11:17 4 15 李安	
88 王军程	5 12:03 4	
23 曹悦	6 13:15 4	
	6 13:36 5 26 MUCZA Norbe	
	6 14:54 6 19 庞连康	
22 黄培杰	7 16:53 6	
	7 17:21 7 26 MUCZA Norbe	
22 黄培杰	8 17:40 7	
	8 18:30 8 19 庞连康	
88 王军程	9 18:42 8	
22 黄培杰	10 19:28 8	
47 成亚	11 23:16 8	
	11 23:50 9 27 王伟强	
47 成亚	12 24:22 9	
	12 25:36 10 18 赵楠	
	12 28:18 11 27 王伟强	
97 张建杰	13 28:58 11	
22 黄培杰	14 29:50 11	
2nd Half		
22 黄培杰	15 01:00 11	
	15 01:40 12 18 赵楠	
8 谢庆龙	16 02:53 12	
	16 03:24 13 21 刘江	
	16 03:47 14 18 赵楠	
23 曹悦	17 04:31 14	
	17 05:32 15 15 李安	
22 黄培杰	18 06:41 15	
5 贺政	19 08:01 15	
	19 09:41 16 11 张天豪	
	19 10:41 17 9 许翔宇	
47 成亚	20 11:07 17	
8 谢庆龙	21 11:48 17	
8 谢庆龙	22 12:25 17	
88 王军程	23 13:40 17	
	23 14:08 18 22 罗尧尧	
18 李双	24 14:23 18	
10 李朝鹏	25 16:18 18	
	25 16:55 19 19 庞连康	
23 曹悦	26 17:41 19	
10 李朝鹏	27 20:37 19	
5 贺政	28 21:12 19	
	28 22:18 20 19 庞连康	
97 张建杰	29 23:06 20	
	29 23:44 21 19 庞连康	
5 贺政	30 24:15 21	
	30 24:58 22 21 刘江	
97 张建杰	31 25:05 22	
97 张建杰	32 26:53 22	
17 胡晋铭	33 28:12 22	
8 谢庆龙	34 29:17 22	

场上队员：得分 / 射门

守门员：救球 / 射门

D	取消资格	DR	取消资格+报告
---	------	----	---------



2019中国男子手球超级联赛总决赛（青岛）

PHMS Pictorial Handball Match Statistics

IHF Official System

个人/全队技术统计表

手球 名次赛 组别 X 青岛市民健身中心
男子 轮次 2 场次 22 2019-07-27 20:45

号码	姓名	远射	近射	边射	快攻	突破	任意	七米	合计	%	助攻	失误	警告	2'	取消	时间
中国华体(华体)																
(场上队员)																
4	张家伟	1/2							1/2	50.0%		2	1			00:17:38
5	贺政		1/2	1/2	1/2				3/6	50.0%						00:26:55
8	谢庆龙		2/3		2/3				4/6	66.7%		1				00:30:52
10	李朝鹏	1/1	1/1						2/2	100%	1					00:19:10
12	王权									0.0%						00:00:00
16	刘迈科									0.0%	2					01:00:00
17	胡晋铭		2/2						2/2	100%		1				00:32:12
18	李双			1/1					1/1	100%	1	1				00:26:58
20	顾艳超	0/1	0/1						0/2	0.0%	2					00:10:39
22	黄培杰		2/3	1/3	3/4			1/1	7/11	63.6%		2				00:45:37
23	曹悦	1/2	1/1		1/1				3/4	75.0%	1	1				00:27:49
25	王杰缘			0/1					0/1	0.0%						00:29:59
47	成亚	1/2	2/2					1/2	4/6	66.7%	1	1				00:29:40
88	王军程	1/4			1/1	1/1			3/6	50.0%	3	2				00:44:28
97	张建杰	4/5							4/5	80.0%		2				00:17:40
99	王伟									0.0%						00:00:00
	合计	9/17	11/15	3/7	8/11	1/1		2/3	34/54	63.0%	11	13	1			
(守门员)																
12	王权		1/1						1/1	100%						00:00:00
16	刘迈科	8/14	7/18	3/3	1/3	2/4	1/1	1/2	23/45	51.1%	2					01:00:00
	合计	8/14	8/19	3/3	1/3	2/4	1/1	1/2	24/46	52.2%	2					

场上队员：得分/射门

守门员：救球/射门

全队合计	得分	被救	射失	击柱	封球	合计	%
远射	9	3	3		2	17	52.9%
近射	11	4				15	73.3%
边射	3	3		1		7	42.9%
快攻	8	2	1			11	72.7%
突破	1					1	100.0%
任意							0.0%
七米	2	1				3	66.7%

2019中国男子手球超级联赛总决赛（青岛）

PHMS Pictorial Handball Match Statistics

IHF Official System

个人/全队技术统计表

手球 名次赛 组别 X 青岛市民健身中心
男子 轮次 2 场次 22 2019-07-27 20:45

号码	姓名	远射	近射	边射	快攻	突破	任意	七米	合计	%	助攻	失误	警告	2'	取消	时间
----	----	----	----	----	----	----	----	----	----	---	----	----	----	----	----	----

太平洋保险江苏(江苏)

(场上队员)

1	陈昊									0.0%						00:20:50
5	闫亮		0/2						0/2	0.0%	1					00:18:06
9	许翔宇	0/4	1/2						1/6	16.7%		2				00:18:50
11	张天豪		1/1	0/3	0/1				1/5	20.0%						00:30:00
12	张春梁									0.0%						00:09:10
15	李安		1/1					1/3	2/4	50.0%	1	1		1		00:17:13
16	张帅									0.0%						00:30:00
17	刘赵梁		0/1			0/1			0/2	0.0%		1				00:39:04
18	赵楠	2/5	1/4		0/1	0/1			3/11	27.3%			1			00:42:39
19	庞连康	1/4	3/4			1/1			5/9	55.6%	2	1				00:46:09
21	刘江		1/2		0/1	1/1			2/4	50.0%	3	1		2		00:47:51
22	罗尧尧		1/1						1/1	100%	1	1				00:17:21
25	陈孝天	0/4					0/1		0/5	0.0%						00:20:56
26	MUCZA Norbert	3/6							3/6	50.0%	1	2				00:15:50
27	王伟强	0/1	1/1		2/2				3/4	75.0%		1				00:30:00
28	SZRNKA Levente		1/1						1/1	100%			1			00:15:02
合计		6/24	11/20	0/3	2/5	2/4	0/1	1/3	22/60	36.7%	9	10	2	3		

(守门员)

1	陈昊	0/3	3/8	0/2	1/4				4/17	23.5%						00:20:50
12	张春梁	0/3	0/3		0/1				0/7	0.0%						00:09:10
16	张帅	3/6	1/4	3/4	1/5	0/1		1/3	9/23	39.1%						00:30:00
合计		3/12	4/15	3/6	2/10	0/1		1/3	13/47	27.7%						

场上队员：得分/射门

守门员：救球/射门

全队合计	得分	被救	射失	击柱	封球	合计	%
远射	6	8	4	2	4	24	25.0%
近射	11	8	1			20	55.0%
边射		3				3	0.0%
快攻	2	1		2		5	40.0%
突破	2	2				4	50.0%
任意		1				1	0.0%
七米	1	1	1			3	33.3%

图式比赛技术统计表

手球
男子

名次赛
轮次 2

组别 X
场次 22

青岛市民健身中心
2019-07-27 20:45

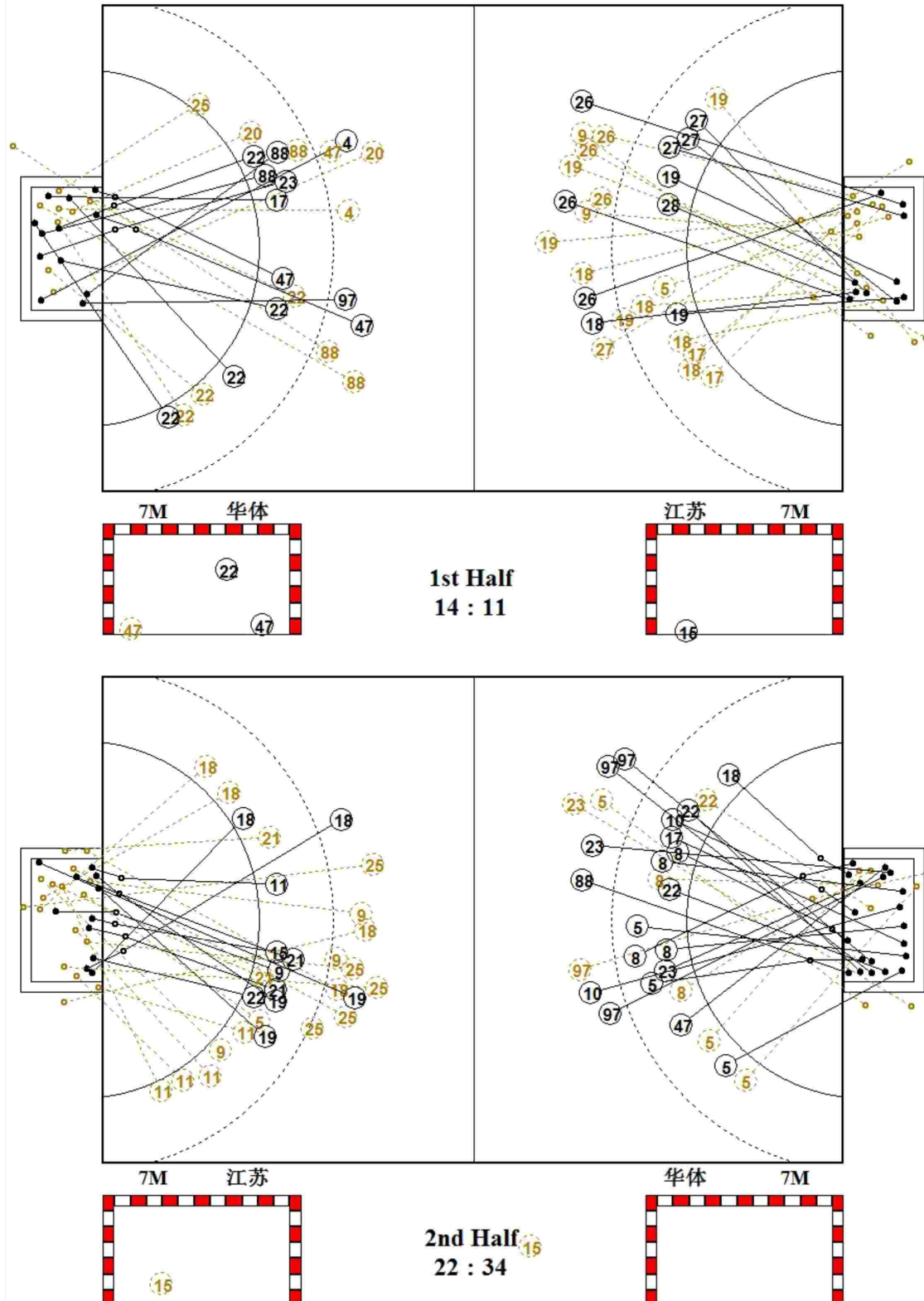

2019中国男子手球超级联赛总决赛（青岛）

PHMS Pictorial Handball Match Statistics

IHF Official System

图式射门区域统计

手球
男子

名次赛
轮次 2

组别 X
场次 22

青岛市民健身中心
2019-07-27 20:45

中国华体

4 张家纬 <table border="1"><tr><td>1</td><td></td><td></td></tr><tr><td></td><td></td><td></td></tr><tr><td></td><td></td><td></td></tr></table> Post - 0 Miss - 0 Block - 0	1									5 贺政 <table border="1"><tr><td></td><td></td><td>2</td></tr><tr><td></td><td></td><td></td></tr><tr><td></td><td></td><td>1</td></tr></table> Post - 1 Miss - 1 Block - 0			2						1	8 谢庆龙 <table border="1"><tr><td>1</td><td>1</td><td></td></tr><tr><td></td><td></td><td></td></tr><tr><td>1</td><td>1</td><td></td></tr></table> Post - 0 Miss - 0 Block - 0	1	1					1	1		10 李朝鹏 <table border="1"><tr><td></td><td>1</td><td></td></tr><tr><td></td><td></td><td></td></tr><tr><td></td><td>1</td><td></td></tr></table> Post - 0 Miss - 0 Block - 0		1						1		12 王权 <table border="1"><tr><td></td><td></td><td></td></tr><tr><td></td><td></td><td></td></tr><tr><td></td><td></td><td></td></tr></table> Post - 0 Miss - 0 Block - 0										16 刘迈科 <table border="1"><tr><td></td><td></td><td></td></tr><tr><td></td><td></td><td></td></tr><tr><td></td><td></td><td></td></tr></table> Post - 0 Miss - 0 Block - 0										17 胡晋铭 <table border="1"><tr><td></td><td></td><td>2</td></tr><tr><td></td><td></td><td></td></tr><tr><td></td><td></td><td></td></tr></table> Post - 0 Miss - 0 Block - 0			2							18 李双 <table border="1"><tr><td></td><td></td><td></td></tr><tr><td></td><td></td><td></td></tr><tr><td></td><td></td><td>1</td></tr></table> Post - 0 Miss - 0 Block - 0									1
1																																																																															
		2																																																																													
		1																																																																													
1	1																																																																														
1	1																																																																														
	1																																																																														
	1																																																																														
		2																																																																													
		1																																																																													
20 顾艳超 <table border="1"><tr><td></td><td></td><td></td></tr><tr><td></td><td></td><td></td></tr><tr><td></td><td></td><td></td></tr></table> Post - 0 Miss - 0 Block - 0										22 黄培杰 <table border="1"><tr><td></td><td>1</td><td>1</td></tr><tr><td></td><td>2</td><td>2</td></tr><tr><td></td><td></td><td>1</td></tr></table> Post - 0 Miss - 0 Block - 0		1	1		2	2			1	23 曹悦 <table border="1"><tr><td>1</td><td>1</td><td></td></tr><tr><td></td><td></td><td></td></tr><tr><td>1</td><td></td><td></td></tr></table> Post - 0 Miss - 1 Block - 0	1	1					1			25 王杰缘 <table border="1"><tr><td></td><td></td><td></td></tr><tr><td></td><td></td><td></td></tr><tr><td></td><td></td><td></td></tr></table> Post - 0 Miss - 0 Block - 0										47 成亚 <table border="1"><tr><td></td><td></td><td></td></tr><tr><td>1</td><td></td><td></td></tr><tr><td></td><td></td><td>3</td></tr></table> Post - 0 Miss - 0 Block - 1				1					3	88 王军程 <table border="1"><tr><td></td><td>1</td><td></td></tr><tr><td></td><td></td><td></td></tr><tr><td>1</td><td></td><td>1</td></tr></table> Post - 0 Miss - 1 Block - 1		1					1		1	97 张建杰 <table border="1"><tr><td></td><td></td><td></td></tr><tr><td>1</td><td></td><td>2</td></tr><tr><td>1</td><td></td><td></td></tr></table> Post - 0 Miss - 1 Block - 0				1		2	1			99 王伟 <table border="1"><tr><td></td><td></td><td></td></tr><tr><td></td><td></td><td></td></tr><tr><td></td><td></td><td></td></tr></table> Post - 0 Miss - 0 Block - 0									
	1	1																																																																													
	2	2																																																																													
		1																																																																													
1	1																																																																														
1																																																																															
1																																																																															
		3																																																																													
	1																																																																														
1		1																																																																													
1		2																																																																													
1																																																																															

12 王权

		1/1

16 刘迈科

0/2	1/2	3/7
5/6	1/1	3/5
6/10	1/3	3/9

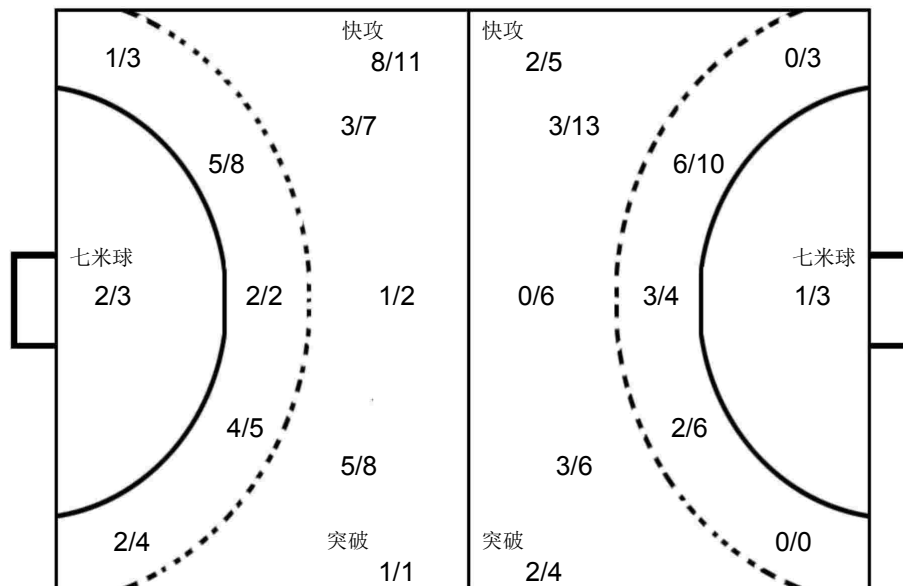

1 陈昊

0/2	0/1	0/1
2/3	1/1	0/1
1/4	0/2	0/2

12 张睿梁

	0/1	0/2
0/1		0/2
		0/1

16 张帅

2/3	0/3	1/3
	0/2	4/5
1/3		1/4

太平洋保险江苏

1 陈昊 <table border="1"><tr><td></td><td></td><td></td></tr><tr><td></td><td></td><td></td></tr><tr><td></td><td></td><td></td></tr></table> Post - 0 Miss - 0 Block - 0										5 闫亮 <table border="1"><tr><td></td><td></td><td></td></tr><tr><td></td><td></td><td></td></tr><tr><td></td><td></td><td></td></tr></table> Post - 0 Miss - 0 Block - 0										9 许翔宇 <table border="1"><tr><td></td><td>1</td><td></td></tr><tr><td></td><td></td><td></td></tr><tr><td></td><td></td><td></td></tr></table> Post - 0 Miss - 1 Block - 1		1								11 张天豪 <table border="1"><tr><td></td><td></td><td></td></tr><tr><td></td><td></td><td>1</td></tr><tr><td></td><td></td><td></td></tr></table> Post - 1 Miss - 0 Block - 0						1				12 张睿梁 <table border="1"><tr><td></td><td></td><td></td></tr><tr><td></td><td></td><td></td></tr><tr><td></td><td></td><td></td></tr></table> Post - 0 Miss - 0 Block - 0										15 李安 <table border="1"><tr><td></td><td></td><td></td></tr><tr><td>1</td><td>1</td><td></td></tr><tr><td></td><td></td><td></td></tr></table> Post - 0 Miss - 1 Block - 0				1	1					16 张帅 <table border="1"><tr><td></td><td></td><td></td></tr><tr><td></td><td></td><td></td></tr><tr><td></td><td></td><td></td></tr></table> Post - 0 Miss - 0 Block - 0										17 刘赵梁 <table border="1"><tr><td></td><td></td><td></td></tr><tr><td></td><td></td><td></td></tr><tr><td></td><td></td><td></td></tr></table> Post - 0 Miss - 0 Block - 0									
	1																																																																														
		1																																																																													
1	1																																																																														
18 赵楠 <table border="1"><tr><td></td><td></td><td></td></tr><tr><td>2</td><td></td><td>1</td></tr><tr><td></td><td></td><td></td></tr></table> Post - 1 Miss - 1 Block - 0				2		1				19 庞连康 <table border="1"><tr><td></td><td></td><td>3</td></tr><tr><td></td><td></td><td></td></tr><tr><td></td><td></td><td>2</td></tr></table> Post - 0 Miss - 1 Block - 1			3						2	21 刘江 <table border="1"><tr><td></td><td></td><td></td></tr><tr><td></td><td></td><td>1</td></tr><tr><td></td><td>1</td><td></td></tr></table> Post - 1 Miss - 0 Block - 0						1		1		22 罗尧尧 <table border="1"><tr><td></td><td></td><td></td></tr><tr><td>1</td><td></td><td></td></tr><tr><td></td><td></td><td></td></tr></table> Post - 0 Miss - 0 Block - 0				1						25 陈孝天 <table border="1"><tr><td></td><td></td><td></td></tr><tr><td></td><td></td><td></td></tr><tr><td></td><td></td><td></td></tr></table> Post - 1 Miss - 0 Block - 1										26 MUCZA Norbert <table border="1"><tr><td>1</td><td></td><td></td></tr><tr><td>1</td><td></td><td></td></tr><tr><td></td><td></td><td>1</td></tr></table> Post - 0 Miss - 1 Block - 1	1			1					1	27 王伟强 <table border="1"><tr><td>1</td><td></td><td>1</td></tr><tr><td></td><td></td><td>1</td></tr><tr><td></td><td></td><td></td></tr></table> Post - 0 Miss - 1 Block - 0	1		1			1				28 SZRNKA Levente <table border="1"><tr><td></td><td></td><td></td></tr><tr><td></td><td></td><td></td></tr><tr><td></td><td></td><td>1</td></tr></table> Post - 0 Miss - 0 Block - 0									1
2		1																																																																													
		3																																																																													
		2																																																																													
		1																																																																													
	1																																																																														
1																																																																															
1																																																																															
1																																																																															
		1																																																																													
1		1																																																																													
		1																																																																													
		1																																																																													



PHMS Pictorial Handball Match Statistics

IHF Official System

Team A					Team B					Match Number											
A 北京光彩					B 太平洋保险江苏					23											
Played in			in the hall			on			at			Spectators									
山东青岛			青岛市民健身中心			2019-07-29			15:00			hours 600									
Half-time(30')	A	B	End of playing time		A	B	1st extra time		A	B	2nd extra time		A	B	After penalty throws		A	B			
	13	14			27	31															
Number of 7 m	A	Team time-out			Full name of players and officials						Team time-out			B	Number of 7 m						
	1/1	1	2	3							1	2	3	B							
			40:19								24:57	51:19	58:18	4/4							
No.	Team A					G	W	2'	D	DR	No.	Team B					G	W	2'	D	DR
2	解建飞					1	1	1			1	陈昊									
7	马昌震					1	1	2			5	闫亮									
8	MAGYAR David					3					9	许翔宇									
10	MEZEI Richard B.										11	张天豪									
11	赵文宣					1					12	张睿梁									
12	高云健										15	李安					7				
13	王军鸣					6					16	张帅									
14	逯明松					6					17	刘赵梁					5				
16	孟辉										18	赵楠							1		
17	王哲一							1			19	庞连康					2		1		
22	王超										21	刘江								1	
25	马明辉						1	1			22	罗尧尧									
26	魏昂					1					25	陈孝天									
27	闫炳旗					2					26	MUCZA Norbert					6	1			
29	杜龙飞					2					27	王伟强					7				
32	蒋唯一					4					28	SZRNKA Levente					4		2		
A	郑永利 (主教练)										A	闫威名 (主教练)									
D	陈璇										B	叶强									
F	王泷										C	雷纳德									
											D	王建国									
A											Signatures of responsables for the teams (Off.A)										B
TP	Remarks of referees / HF Official																				TP

Signatures

Referees	MAZEIKA Vaidas (LTU)	GATELIS Mindaugas (LTU)		
T.D.	李之文 (CHN)	王科 (CHN)		
CHA Off.				

Note: Number of 7m Throws Awarded to Team A and B, Goals (G), Warnings (W), Suspensions (2'), Direct Disqualification (D), Disqualification With Report (DR) and Team Penalty (TP).

Table Officials: 康曦 刘斌 Statisticians: 李双 王玲

2019中国男子手球超级联赛总决赛（青岛）

PHMS Pictorial Handball Match Statistics

IHF Official System

竞赛技术统计

手球 名次赛 组别 X 青岛市民健身中心
男子 轮次 3 场次 23 2019-07-29 15:00

Referees: MAZEIKA Vaidas (LTU) / GATELIS Mindaugas (LTU) Result: 27:31(13:14)
Teams: 北京光彩(北京) VS 太平洋保险江苏(江苏)

北京		远	近	边	快	突	任意	7m	合计	%	助攻	失误	警告	2'	D+DR	北京	比赛	江苏
主教练：郑永利		射	射	射	攻	破	球	球								进程		
2	解建飞	1/1							1/1	100			1	1		14	1	01:55
7	马昌震		1/1						1/1	100			1	2		13	1	02:43
8	MAGYAR David	2/4	1/1						3/5	60.0	1	3				8	2	03:46
10	MEZEI Richard B.															14	2	05:41
11	赵文宣			1/1					1/1	100		1				8	2	06:19
12	高云健															14	2	06:48
13	王军鸣	4/8	2/2						6/10	60.0	2	1				4	3	07:39
14	逯明松	2/4	3/3			1/1			6/8	75.0	1	2				4	4	08:54
16	孟辉															14	4	09:58
17	王哲一	0/1			0/1				0/2	0.0	1	2		1		7	4	11:25
22	王超				0/1				0/1	0.0	4					14	4	13:33
25	马明辉				0/1				0/1	0.0			1	1		13	5	14:07
26	魏昂				1/1				1/1	100		2				8	6	15:08
27	闫炳旗		1/2		1/1				2/3	66.7						32	6	16:11
29	杜龙飞	1/2	1/1	0/1					2/4	50.0	1					26	6	17:02
32	蒋唯一		3/3		0/2	0/1		1/1	4/7	57.1		2				8	7	17:47
运动员 合计		10/20	12/13	1/2	2/7	1/2		1/1	27/45	60.0	11	13	3	5		9	8	18:40
12	高云健	7/13	8/15	1/5	0/5	0/5		0/3	16/46	34.8	1					8	8	20:27
16	孟辉							0/1	0/1	0.0						13	9	21:17
守门员 合计		7/13	8/15	1/5	0/5	0/5		0/4	16/47	34.0	1					13	9	22:27
																11	10	23:26
																11	11	26:20
																11	12	27:01
																32	13	27:31
																13	13	28:44
																13	14	29:54
																		2nd Half
																8	14	00:22
																32	14	01:12
																15	15	03:14
																29	16	05:22
																16	16	06:12
																16	17	07:11
																29	18	08:44
																17	18	09:42
																27	19	10:58
																18	20	11:05
																18	21	13:16
																13	21	13:30
																11	21	15:34
																32	21	16:15
																21	22	16:39
																21	23	17:52
																27	23	18:49
																22	24	19:53
																13	24	20:17
																23	25	20:31
																23	26	21:31
																23	27	22:54
																14	27	23:32
																14	28	23:58
																25	28	24:27
																25	29	24:44
																25	30	26:02
																14	31	27:10
																2	31	28:10
																2	31	29:37

场上队员：得分 / 射门 守门员：救球 / 射门

D	取消资格	DR	取消资格+报告
---	------	----	---------

2019中国男子手球超级联赛总决赛（青岛）

PHMS Pictorial Handball Match Statistics

IHF Official System

个人/全队技术统计表

手球 名次赛 组别 X 青岛市民健身中心
男子 轮次 3 场次 23 2019-07-29 15:00

号码	姓名	远射	近射	边射	快攻	突破	任意	七米	合计	%	助攻	失误	警告	2'	取消	时间
北京光彩(北京)																
(场上队员)																
2	解建飞	1/1							1/1	100%			1	1		00:27:55
7	马昌震		1/1						1/1	100%			1	2		00:22:31
8	MAGYAR David	2/4	1/1						3/5	60.0%	1	3				00:39:44
10	MEZEI Richard B.									0.0%						00:00:00
11	赵文宣			1/1					1/1	100%		1				00:11:46
12	高云健									0.0%	1					00:59:27
13	王军鸣	4/8	2/2						6/10	60.0%	2	1				00:32:56
14	逯明松	2/4	3/3			1/1			6/8	75.0%	1	2				00:39:53
16	孟辉									0.0%						00:00:33
17	王哲一	0/1			0/1				0/2	0.0%	1	2		1		00:18:23
22	王超				0/1				0/1	0.0%	4					00:27:14
25	马明辉				0/1				0/1	0.0%			1	1		00:12:48
26	魏昂				1/1				1/1	100%		2				00:32:12
27	闫炳旗		1/2		1/1				2/3	66.7%						00:48:35
29	杜龙飞	1/2	1/1	0/1					2/4	50.0%	1					00:18:30
32	蒋唯一		3/3		0/2	0/1		1/1	4/7	57.1%		2				00:26:54
	合计	10/20	12/13	1/2	2/7	1/2		1/1	27/45	60.0%	11	13	3	5		
(守门员)																
12	高云健	7/13	8/15	1/5	0/5	0/5		0/3	16/46	34.8%	1					00:59:27
16	孟辉							0/1	0/1	0.0%						00:00:33
	合计	7/13	8/15	1/5	0/5	0/5		0/4	16/47	34.0%	1					

场上队员：得分/射门

守门员：救球/射门

全队合计	得分	被救	射失	击柱	封球	合计	%
远射	10	6	1	2	1	20	50.0%
近射	12	1				13	92.3%
边射	1		1			2	50.0%
快攻	2	4	1			7	28.6%
突破	1	1				2	50.0%
任意							0.0%
七米	1					1	100.0%

2019中国男子手球超级联赛总决赛（青岛）

PHMS Pictorial Handball Match Statistics

IHF Official System

个人/全队技术统计表

 手球 名次赛 组别 X 青岛市民健身中心
 男子 轮次 3 场次 23 2019-07-29 15:00

号码	姓名	远射	近射	边射	快攻	突破	任意	七米	合计	%	助攻	失误	警告	2'	取消	时间
太平洋保险江苏(江苏)																
(场上队员)																
1	陈昊									0.0%						00:00:00
5	闫亮	0/1							0/1	0.0%						00:13:07
9	许翔宇									0.0%						00:00:00
11	张天豪									0.0%						00:00:00
12	张春梁									0.0%						00:01:42
15	李安	1/2	1/1			1/1		4/4	7/8	87.5%	1					00:21:11
16	张帅									0.0%						00:58:18
17	刘赵梁	2/4	1/2			2/2			5/8	62.5%	5	1				00:53:21
18	赵楠	0/2	0/1						0/3	0.0%				1		00:52:48
19	庞连康	1/4	0/2			1/1			2/7	28.6%		2		1		00:23:47
21	刘江									0.0%					1	00:09:35
22	罗尧尧									0.0%						00:09:05
25	陈孝天									0.0%						00:02:37
26	MUCZA Norbert	2/5	1/2		2/2	1/1			6/10	60.0%	1	3	1			00:54:01
27	王伟强			4/5	3/3				7/8	87.5%						01:00:00
28	SZRNKA Levente	0/1	4/7						4/8	50.0%	1	2		2		00:59:57
	合计	6/19	7/15	4/5	5/5	5/5		4/4	31/53	58.5%	8	8	1	4	1	
(守门员)																
12	张春梁	1/2							1/2	50.0%						00:01:42
16	张帅	5/14	1/13	0/1	4/6	1/2		0/1	11/37	29.7%						00:58:18
	合计	6/16	1/13	0/1	4/6	1/2		0/1	12/39	30.8%						

场上队员：得分/射门

守门员：救球/射门

全队合计	得分	被救	射失	击柱	封球	合计	%
远射	6	7	2	1	3	19	31.6%
近射	7	8				15	46.7%
边射	4	1				5	80.0%
快攻	5					5	100.0%
突破	5					5	100.0%
任意							0.0%
七米	4					4	100.0%

图式比赛技术统计表

手球
男子

名次赛
轮次 3

组别 X
场次 23

青岛市民健身中心
2019-07-29 15:00

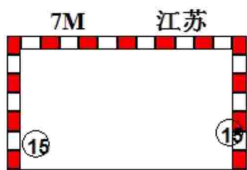
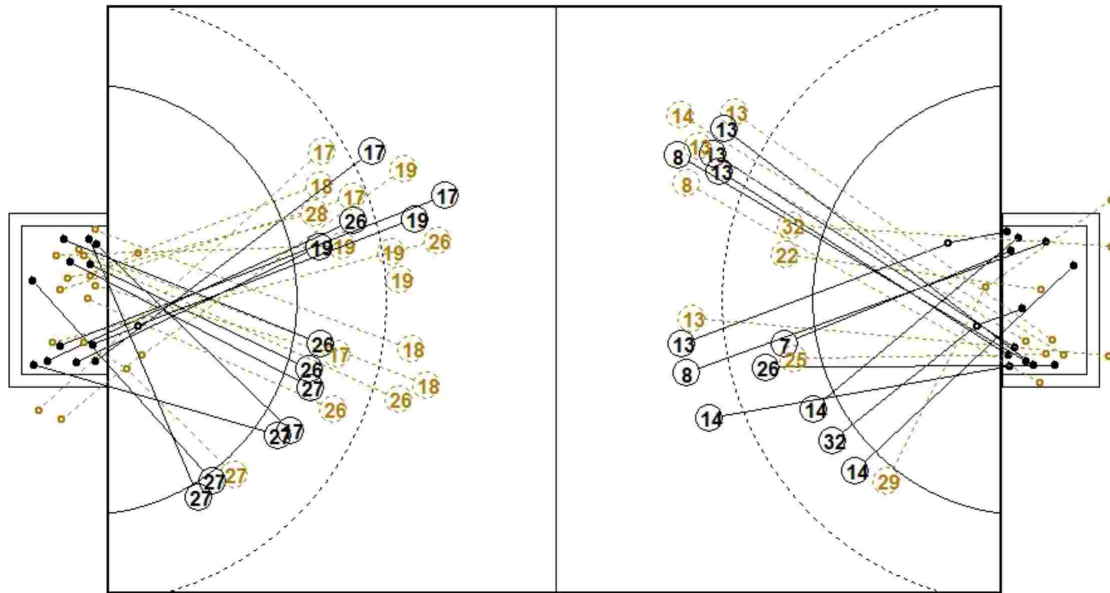

1st Half
14 : 13

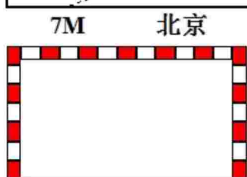
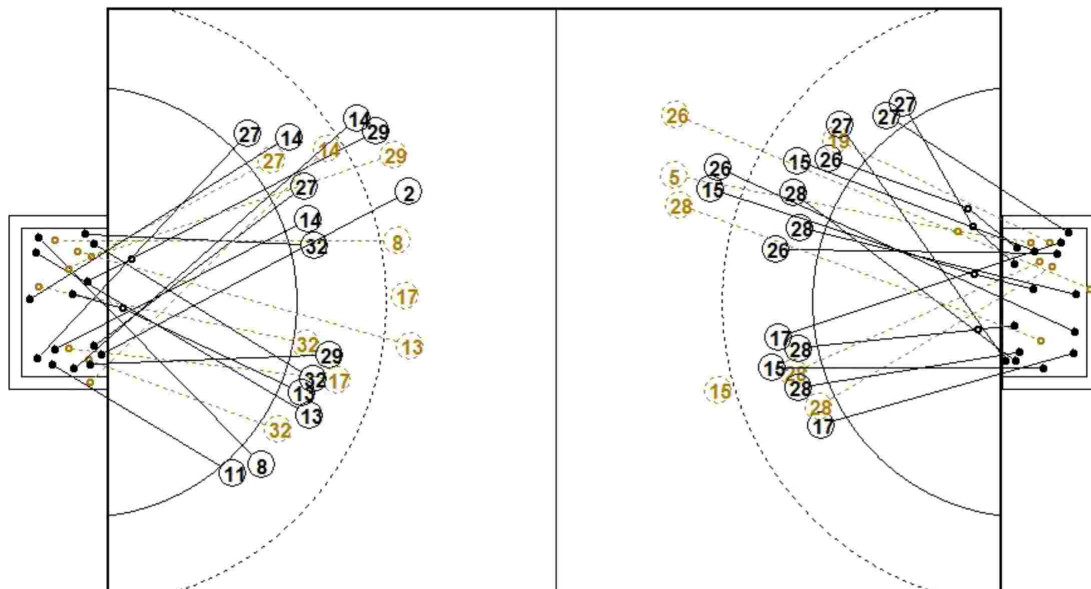
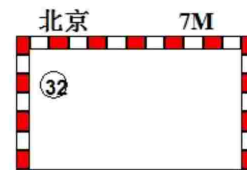

2nd Half
27 : 31

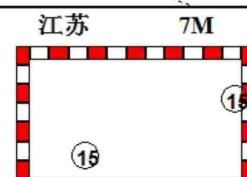

2019中国男子手球超级联赛总决赛（青岛）

PHMS Pictorial Handball Match Statistics

IHF Official System

图式射门区域统计

手球
男子

名次赛
轮次 3

组别 X
场次 23

青岛市民健身中心
2019-07-29 15:00

北京光彩

2 解建飞 <table border="1"><tr><td></td><td></td><td></td></tr><tr><td></td><td></td><td></td></tr><tr><td>1</td><td></td><td></td></tr></table> Post - 0 Miss - 0 Block - 0							1			7 马昌震 <table border="1"><tr><td></td><td></td><td></td></tr><tr><td></td><td></td><td></td></tr><tr><td>1</td><td></td><td></td></tr></table> Post - 0 Miss - 0 Block - 0							1			8 MAGYAR David <table border="1"><tr><td></td><td></td><td>1</td></tr><tr><td>1</td><td></td><td></td></tr><tr><td></td><td></td><td>1</td></tr></table> Post - 1 Miss - 0 Block - 0			1	1					1	10 MEZEI Richard B. <table border="1"><tr><td></td><td></td><td></td></tr><tr><td></td><td></td><td></td></tr><tr><td></td><td></td><td></td></tr></table> Post - 0 Miss - 0 Block - 0										11 赵文宣 <table border="1"><tr><td></td><td></td><td></td></tr><tr><td></td><td></td><td></td></tr><tr><td>1</td><td></td><td></td></tr></table> Post - 0 Miss - 0 Block - 0							1			12 高云健 <table border="1"><tr><td></td><td></td><td></td></tr><tr><td></td><td></td><td></td></tr><tr><td></td><td></td><td></td></tr></table> Post - 0 Miss - 0 Block - 0										13 王军鸣 <table border="1"><tr><td></td><td></td><td>1</td></tr><tr><td></td><td>1</td><td>1</td></tr><tr><td>1</td><td></td><td>2</td></tr></table> Post - 0 Miss - 1 Block - 0			1		1	1	1		2	14 透明松 <table border="1"><tr><td>1</td><td>1</td><td></td></tr><tr><td>2</td><td></td><td></td></tr><tr><td>1</td><td></td><td>1</td></tr></table> Post - 1 Miss - 0 Block - 0	1	1		2			1		1
1																																																																															
1																																																																															
		1																																																																													
1																																																																															
		1																																																																													
1																																																																															
		1																																																																													
	1	1																																																																													
1		2																																																																													
1	1																																																																														
2																																																																															
1		1																																																																													
16 孟辉 <table border="1"><tr><td></td><td></td><td></td></tr><tr><td></td><td></td><td></td></tr><tr><td></td><td></td><td></td></tr></table> Post - 0 Miss - 0 Block - 0										17 王哲一 <table border="1"><tr><td></td><td></td><td></td></tr><tr><td></td><td></td><td></td></tr><tr><td></td><td></td><td></td></tr></table> Post - 0 Miss - 0 Block - 1										22 王超 <table border="1"><tr><td></td><td></td><td></td></tr><tr><td></td><td></td><td></td></tr><tr><td></td><td></td><td></td></tr></table> Post - 0 Miss - 0 Block - 0										25 马明辉 <table border="1"><tr><td></td><td></td><td></td></tr><tr><td></td><td></td><td></td></tr><tr><td></td><td></td><td></td></tr></table> Post - 0 Miss - 0 Block - 0										26 魏昂 <table border="1"><tr><td></td><td></td><td></td></tr><tr><td></td><td></td><td>1</td></tr><tr><td></td><td></td><td></td></tr></table> Post - 0 Miss - 0 Block - 0						1				27 闫炳旗 <table border="1"><tr><td>1</td><td></td><td></td></tr><tr><td>1</td><td></td><td></td></tr><tr><td></td><td></td><td></td></tr></table> Post - 0 Miss - 0 Block - 0	1			1						29 杜龙飞 <table border="1"><tr><td></td><td></td><td></td></tr><tr><td></td><td></td><td></td></tr><tr><td>1</td><td>1</td><td></td></tr></table> Post - 0 Miss - 1 Block - 0							1	1		32 蒋唯一 <table border="1"><tr><td>1</td><td></td><td></td></tr><tr><td></td><td></td><td></td></tr><tr><td></td><td>1</td><td>2</td></tr></table> Post - 0 Miss - 1 Block - 0	1							1	2
		1																																																																													
1																																																																															
1																																																																															
1	1																																																																														
1																																																																															
	1	2																																																																													

12 高云健

0/5	0/2	0/3
5/8	2/3	3/7
1/6	3/4	2/8

16 孟辉

0/1		

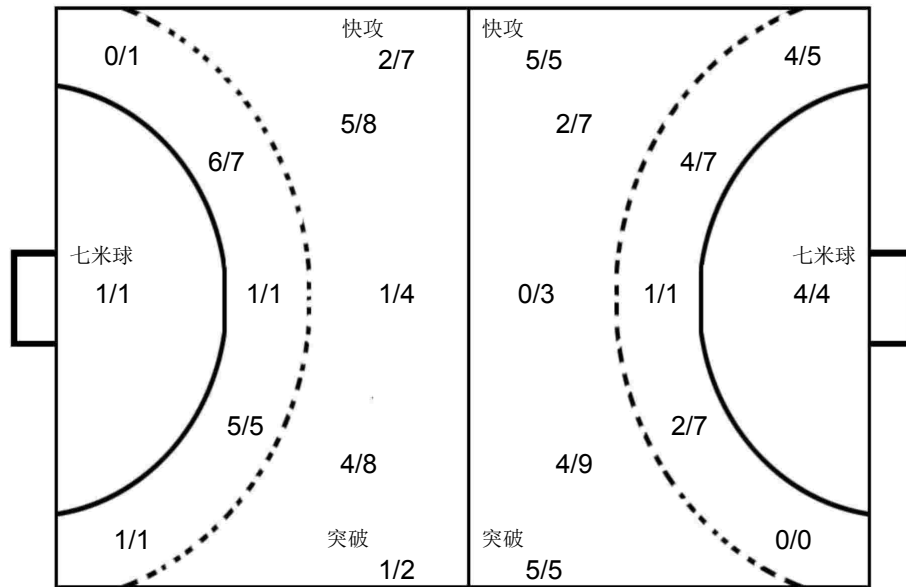

12 张睿梁

		1/1
0/1		

16 张帅

0/3	1/2	1/3
1/5	1/2	4/6
1/6	0/2	2/8

太平洋保险江苏

1 陈昊 <table border="1"><tr><td></td><td></td><td></td></tr><tr><td></td><td></td><td></td></tr><tr><td></td><td></td><td></td></tr></table> Post - 0 Miss - 0 Block - 0										5 闫亮 <table border="1"><tr><td></td><td></td><td></td></tr><tr><td></td><td></td><td></td></tr><tr><td></td><td></td><td></td></tr></table> Post - 0 Miss - 0 Block - 0										9 许翔宇 <table border="1"><tr><td></td><td></td><td></td></tr><tr><td></td><td></td><td></td></tr><tr><td></td><td></td><td></td></tr></table> Post - 0 Miss - 0 Block - 0										11 张天豪 <table border="1"><tr><td></td><td></td><td></td></tr><tr><td></td><td></td><td></td></tr><tr><td></td><td></td><td></td></tr></table> Post - 0 Miss - 0 Block - 0										12 张睿梁 <table border="1"><tr><td></td><td></td><td></td></tr><tr><td></td><td></td><td></td></tr><tr><td></td><td></td><td></td></tr></table> Post - 0 Miss - 0 Block - 0										15 李安 <table border="1"><tr><td></td><td></td><td>1</td></tr><tr><td>1</td><td>1</td><td>2</td></tr><tr><td>2</td><td></td><td></td></tr></table> Post - 0 Miss - 0 Block - 1			1	1	1	2	2			16 张帅 <table border="1"><tr><td></td><td></td><td></td></tr><tr><td></td><td></td><td></td></tr><tr><td></td><td></td><td></td></tr></table> Post - 0 Miss - 0 Block - 0										17 刘赵梁 <table border="1"><tr><td>1</td><td></td><td>1</td></tr><tr><td>1</td><td></td><td></td></tr><tr><td>1</td><td></td><td>1</td></tr></table> Post - 0 Miss - 1 Block - 0	1		1	1			1		1
		1																																																																													
1	1	2																																																																													
2																																																																															
1		1																																																																													
1																																																																															
1		1																																																																													
18 赵楠 <table border="1"><tr><td></td><td></td><td></td></tr><tr><td></td><td></td><td></td></tr><tr><td></td><td></td><td></td></tr></table> Post - 0 Miss - 0 Block - 0										19 庞连康 <table border="1"><tr><td></td><td></td><td></td></tr><tr><td>1</td><td></td><td></td></tr><tr><td>1</td><td></td><td></td></tr></table> Post - 0 Miss - 1 Block - 2				1			1			21 刘江 <table border="1"><tr><td></td><td></td><td></td></tr><tr><td></td><td></td><td></td></tr><tr><td></td><td></td><td></td></tr></table> Post - 0 Miss - 0 Block - 0										22 罗尧尧 <table border="1"><tr><td></td><td></td><td></td></tr><tr><td></td><td></td><td></td></tr><tr><td></td><td></td><td></td></tr></table> Post - 0 Miss - 0 Block - 0										25 陈孝天 <table border="1"><tr><td></td><td></td><td></td></tr><tr><td></td><td></td><td></td></tr><tr><td></td><td></td><td></td></tr></table> Post - 0 Miss - 0 Block - 0										26 MUCZA Norbert <table border="1"><tr><td>2</td><td></td><td>1</td></tr><tr><td></td><td></td><td>1</td></tr><tr><td>1</td><td></td><td>1</td></tr></table> Post - 1 Miss - 0 Block - 0	2		1			1	1		1	27 王伟强 <table border="1"><tr><td>2</td><td>1</td><td></td></tr><tr><td></td><td></td><td>1</td></tr><tr><td>1</td><td></td><td>2</td></tr></table> Post - 0 Miss - 0 Block - 0	2	1				1	1		2	28 SZRNKA Levente <table border="1"><tr><td></td><td>1</td><td></td></tr><tr><td></td><td></td><td></td></tr><tr><td></td><td>1</td><td>2</td></tr></table> Post - 0 Miss - 0 Block - 0		1						1	2
1																																																																															
1																																																																															
2		1																																																																													
		1																																																																													
1		1																																																																													
2	1																																																																														
		1																																																																													
1		2																																																																													
	1																																																																														
	1	2																																																																													



PHMS Pictorial Handball Match Statistics

IHF Official System

Team A					Team B					Match Number											
A 太平洋保险江苏					B 中国华体					24											
Played in			in the hall			on			at			Spectators									
山东青岛			青岛市民健身中心			2019-07-30			15:00			hours 700									
Half-time(30')	A	B	End of playing time		A	B	1st extra time		A	B	2nd extra time		A	B	After penalty throws						
	13	19	30	35																	
Number of 7 m	A	Team time-out			Full name of players and officials						Team time-out			B	Number of 7 m						
	2/4	1	2	3							1	2	3	B							
		16:39	39:00	54:04									1/2								
No.	Team A					G	W	2'	D	DR	No.	Team B					G	W	2'	D	DR
1	陈昊										4	张家纬					2				
5	闫亮					3	1				5	贺政					1				
9	许翔宇					2					8	谢庆龙					4	1			
11	张天豪					2					10	李朝鹏					1				
12	张睿梁										12	王权									
15	李安					7		1			16	刘迈科									
16	张帅										17	胡晋铭					1		1		
17	刘赵梁										18	李双					2				
18	赵楠					2		2			20	顾艳超									
19	庞连康										22	黄培杰					7				
21	刘江					7					23	曹悦					1	1	1		
22	罗尧尧					3					25	王杰缘					5				
25	陈孝天					1					47	成亚					4		1		
26	MUCZA Norbert						1				88	王军程					4	1	1		
27	王伟强										97	张建杰					3		1		
28	SZRNKA Levente					3					99	王伟							1		
A	闫威名 (主教练)										A	姚苏捷									
B	叶强										B	朱昕晨 (主教练)									
C	雷纳德										D	付飞鹏									
D	王建国																				
A	Signatures of responsables for the teams (Off.A)															B					
TP	Remarks of referees / HF Official															TP					

Signatures

Referees MAZEIKA Vaidas (LTU)

GATELIS Mindaugas (LTU)

T.D. 吴瑞亭 (CHN)

王科 (CHN)

CHA Off.

Note: Number of 7m Throws Awarded to Team A and B, Goals (G), Warnings (W), Suspensions (2'), Direct Disqualification (D), Disqualification With Report (DR) and Team Penalty (TP).

Table Officials: 康曦

刘斌

Statisticians: 李双

王玲

2019中国男子手球超级联赛总决赛（青岛）

PHMS Pictorial Handball Match Statistics

IHF Official System

竞赛技术统计

手球 男子 决赛 轮次 4 组别 X 场次 24 青岛市民健身中心 2019-07-30 15:00

Referees: MAZEIKA Vaidas (LTU) / GATELIS Mindaugas (LTU) Result: 30:35(13:19)
Teams: 太平洋保险江苏(江苏) VS 中国华体(华体)

江苏														江苏		比赛进程		华体	
主教练： 闫威名																			
	远射	近射	边射	快攻	突破	任意球	7m球	合计	%	助攻	失误	警告	2'	D+DR					
1 陈昊																			
5 闫亮		2/3	1/1					3/4	75.0	1	1	1							
9 许翔宇	2/4							2/4	50.0	4	4								
11 张天豪		1/3	0/2	1/1				2/6	33.3										
12 张春梁																			
15 李安	1/4	2/2			3/3		1/3	7/12	58.3	2	3		1						
16 张帅																			
17 刘赵梁																			
18 赵楠	0/2			1/1	1/1			2/4	50.0	3	2		2						
19 庞连康																			
21 刘江	2/2	4/5		1/1				7/8	87.5	1	3								
22 罗尧尧	0/1	1/2		1/1			1/1	3/5	60.0										
25 陈孝天	1/3							1/3	33.3			2							
26 MUCZA Norbert	0/2				0/1			0/3	0.0	1		1							
27 王伟强																			
28 SZRNKA Levente		3/4						3/4	75.0										
运动员 合计	6/18	13/19	1/3	4/4	4/5		2/4	30/53	56.6	12	15	2	3						
12 张春梁		1/7		1/2				2/9	22.2										
16 张帅	6/12	3/11	0/4	1/7	0/2	0/1	1/2	11/39	28.2										
守门员 合计	6/12	4/18	0/4	2/9	0/2	0/1	1/2	13/48	27.1										
华体														华体		2nd Half			
主教练： 朱昕晨																			
	远射	近射	边射	快攻	突破	任意球	7m球	合计	%	助攻	失误	警告	2'	D+DR					
4 张家纬	0/1				2/2			2/3	66.7		1								
5 贺政		0/4	1/1	0/1				1/6	16.7										
8 谢庆龙	0/1	4/4					0/1	4/6	66.7	2	5	1							
10 李朝鹏		1/1						1/1	100		3								
12 王权																			
16 刘迈科																			
17 胡晋铭		1/1						1/1	100	1			1						
18 李双	0/1		1/1			1/1		2/3	66.7		2								
20 顾艳超																			
22 黄培杰	1/1	0/1	1/1	4/5			1/1	7/9	77.8	2	1								
23 曹悦	1/3							1/3	33.3			1	1						
25 王杰缘		2/2		3/3				5/5	100										
47 成亚	1/1	2/2	1/1					4/4	100	1	1		1						
88 王军程	3/5	1/2						4/7	57.1	2		1	1						
97 张建杰	0/2	3/3						3/5	60.0	1									
99 王伟																			
运动员 合计	6/15	14/20	4/4	7/9	2/2	1/1	1/2	35/53	66.0	11	15	3	6						
16 刘迈科	6/12	5/18	2/3	0/4	1/5		1/3	15/45	33.3	2									
守门员 合计	6/12	5/18	2/3	0/4	1/5		1/3	15/45	33.3	2									
9 许翔宇																			
25 陈孝天																			
21 刘江																			
21 刘江																			
18 赵楠																			
5 闫亮																			
15 李安																			
18 赵楠																			
21 刘江																			
22 罗尧尧																			
15 李安																			
22 罗尧尧																			
21 刘江																			
22 罗尧尧																			
15 李安																			
5 闫亮																			

场上队员： 得分 / 射门 守门员： 救球 / 射门

D	取消资格	DR	取消资格+报告
---	------	----	---------

2019中国男子手球超级联赛总决赛（青岛）

PHMS Pictorial Handball Match Statistics

IHF Official System

个人/全队技术统计表

手球 男子 决赛 轮次 4 组别 X 场次 24 青岛市民健身中心 2019-07-30 15:00

号码	姓名	远射	近射	边射	快攻	突破	任意	七米	合计	%	助攻	失误	警告	2'	取消	时间
太平洋保险江苏(江苏)																
(场上队员)																
1	陈昊									0.0%						00:00:00
5	闫亮		2/3	1/1					3/4	75.0%	1	1	1			00:38:54
9	许翔宇	2/4							2/4	50.0%	4	4				00:50:49
11	张天豪		1/3	0/2	1/1				2/6	33.3%						00:37:08
12	张春梁									0.0%						00:11:47
15	李安	1/4	2/2			3/3		1/3	7/12	58.3%	2	3		1		00:36:22
16	张帅									0.0%						00:48:13
17	刘赵梁									0.0%						00:00:00
18	赵楠	0/2			1/1	1/1			2/4	50.0%	3	2		2		00:52:33
19	庞连康									0.0%						00:00:00
21	刘江	2/2	4/5		1/1				7/8	87.5%	1	3				00:39:37
22	罗尧尧	0/1	1/2		1/1			1/1	3/5	60.0%						00:48:06
25	陈孝天	1/3							1/3	33.3%		2				00:22:50
26	MUCZA Norbert	0/2				0/1			0/3	0.0%	1		1			00:16:39
27	王伟强									0.0%						00:00:00
28	SZRNKA Levente		3/4						3/4	75.0%						00:16:40
	合计	6/18	13/19	1/3	4/4	4/5		2/4	30/53	56.6%	12	15	2	3		
(守门员)																
12	张春梁		1/7		1/2				2/9	22.2%						00:11:47
16	张帅	6/12	3/11	0/4	1/7	0/2	0/1	1/2	11/39	28.2%						00:48:13
	合计	6/12	4/18	0/4	2/9	0/2	0/1	1/2	13/48	27.1%						

场上队员：得分/射门

守门员：救球/射门

全队合计	得分	被救	射失	击柱	封球	合计	%
远射	6	6	2	2	2	18	33.3%
近射	13	5	1			19	68.4%
边射	1	2				3	33.3%
快攻	4					4	100.0%
突破	4	1				5	80.0%
任意							0.0%
七米	2	1		1		4	50.0%

2019中国男子手球超级联赛总决赛（青岛）

PHMS Pictorial Handball Match Statistics

IHF Official System

个人/全队技术统计表

手球男子 决赛轮次 4 组别 X 场次 24 青岛市民健身中心 2019-07-30 15:00

号码	姓名	远射	近射	边射	快攻	突破	任意	七米	合计	%	助攻	失误	警告	2'	取消	时间
中国华体(华体)																
(场上队员)																
4	张家纬	0/1				2/2			2/3	66.7%		1				00:21:05
5	贺政		0/4	1/1	0/1				1/6	16.7%						00:21:59
8	谢庆龙	0/1	4/4					0/1	4/6	66.7%	2	5	1			00:27:06
10	李朝鹏		1/1						1/1	100%		3				00:21:01
12	王权									0.0%						00:00:00
16	刘迈科									0.0%	2					01:00:00
17	胡晋铭		1/1						1/1	100%	1			1		00:24:06
18	李双	0/1		1/1			1/1		2/3	66.7%		2				00:16:05
20	顾艳超									0.0%		2				00:09:43
22	黄培杰	1/1	0/1	1/1	4/5			1/1	7/9	77.8%	2	1				00:52:51
23	曹悦	1/3							1/3	33.3%			1	1		00:20:33
25	王杰缘		2/2		3/3				5/5	100%						00:38:47
47	成亚	1/1	2/2	1/1					4/4	100%	1	1		1		00:29:21
88	王军程	3/5	1/2						4/7	57.1%	2		1	1		00:45:38
97	张建杰	0/2	3/3						3/5	60.0%	1			1		00:19:27
99	王伟									0.0%				1		00:11:59
	合计	6/15	14/20	4/4	7/9	2/2	1/1	1/2	35/53	66.0%	11	15	3	6		
(守门员)																
16	刘迈科	6/12	5/18	2/3	0/4	1/5		1/3	15/45	33.3%	2					01:00:00
	合计	6/12	5/18	2/3	0/4	1/5		1/3	15/45	33.3%	2					

场上队员：得分/射门

守门员：救球/射门

全队合计	得分	被救	射失	击柱	封球	合计	%
远射	6	6			3	15	40.0%
近射	14	4	1	1		20	70.0%
边射	4					4	100.0%
快攻	7	2				9	77.8%
突破	2					2	100.0%
任意	1					1	100.0%
七米	1	1				2	50.0%

2019中国男子手球超级联赛总决赛（青岛）

PHMS Pictorial Handball Match Statistics

IHF Official System

图式比赛技术统计表

手球
男子

决赛
轮次 4

组别 X
场次 24

青岛市民健身中心
2019-07-30 15:00

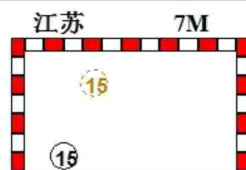
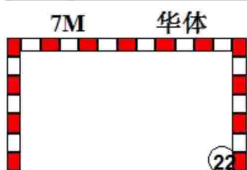
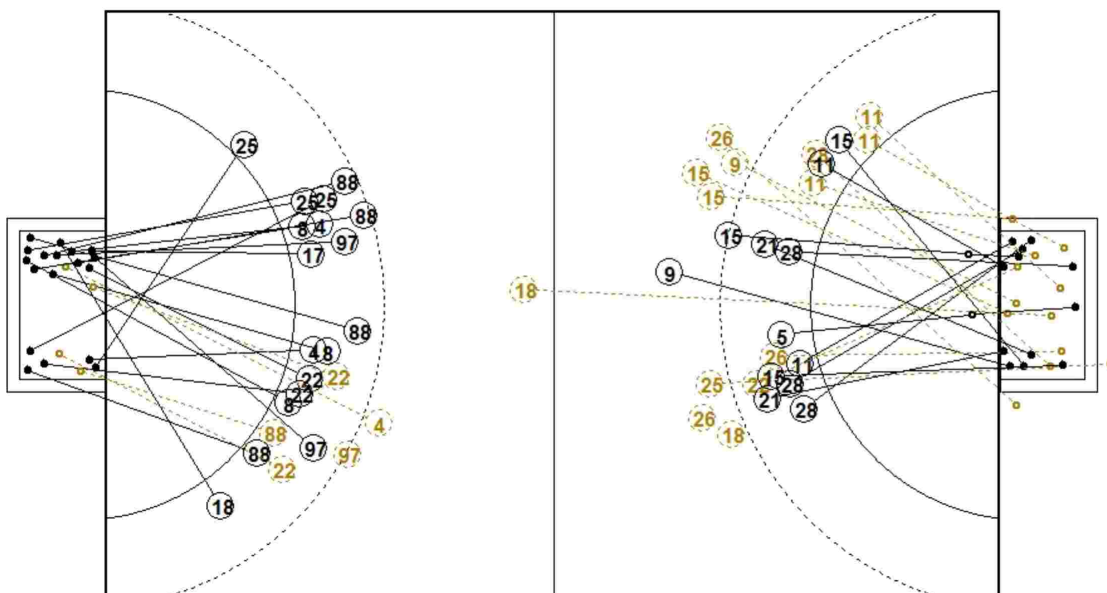

1st Half
19 : 13

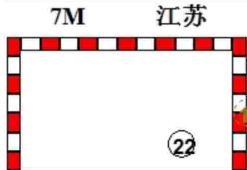
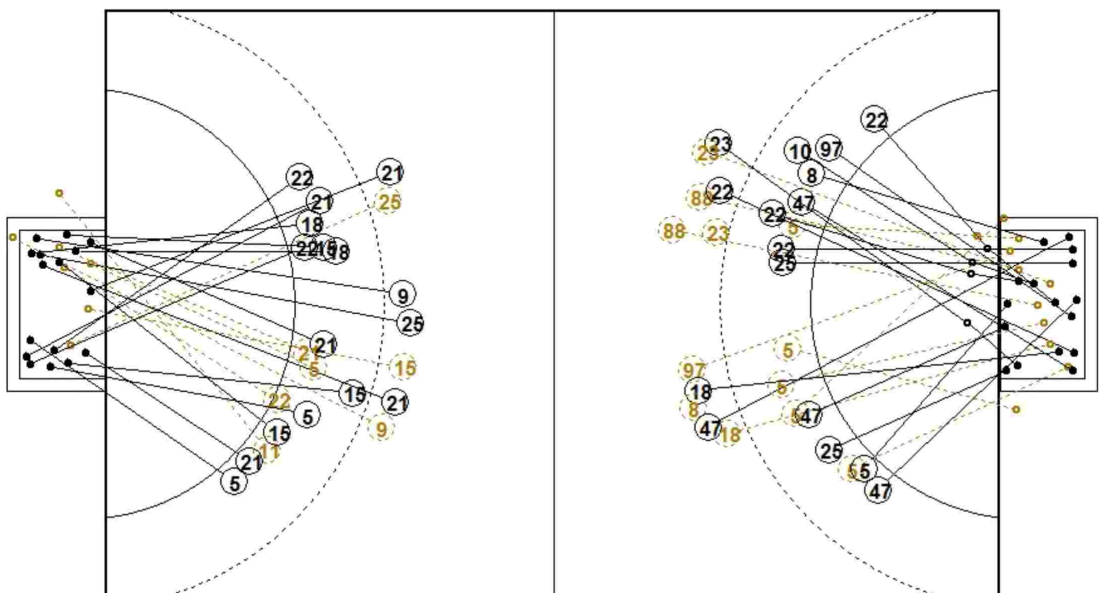

2nd Half
30 : 35



2019中国男子手球超级联赛总决赛（青岛）

PHMS Pictorial Handball Match Statistics

IHF Official System

图式射门区域统计

手球
男子

决赛
轮次 4

组别 X
场次 24

青岛市民健身中心
2019-07-30 15:00

太平洋保险江苏

1 陈昊	5 闫亮	9 许翔宇	11 张天豪	12 张睿梁	15 李安	16 张帅	17 刘赵梁																																																																								
<table border="1"><tr><td></td><td></td><td></td></tr><tr><td></td><td></td><td></td></tr><tr><td></td><td></td><td></td></tr></table>										<table border="1"><tr><td>1</td><td>1</td><td></td></tr><tr><td>1</td><td></td><td></td></tr><tr><td></td><td></td><td></td></tr></table>	1	1		1						<table border="1"><tr><td></td><td></td><td>1</td></tr><tr><td></td><td></td><td></td></tr><tr><td></td><td></td><td>1</td></tr></table>			1						1	<table border="1"><tr><td></td><td></td><td></td></tr><tr><td></td><td></td><td></td></tr><tr><td>2</td><td></td><td></td></tr></table>							2			<table border="1"><tr><td></td><td></td><td></td></tr><tr><td></td><td></td><td></td></tr><tr><td></td><td></td><td></td></tr></table>										<table border="1"><tr><td></td><td></td><td>1</td></tr><tr><td>1</td><td></td><td>2</td></tr><tr><td>2</td><td></td><td>1</td></tr></table>			1	1		2	2		1	<table border="1"><tr><td></td><td></td><td></td></tr><tr><td></td><td></td><td></td></tr><tr><td></td><td></td><td></td></tr></table>										<table border="1"><tr><td></td><td></td><td></td></tr><tr><td></td><td></td><td></td></tr><tr><td></td><td></td><td></td></tr></table>									
1	1																																																																														
1																																																																															
		1																																																																													
		1																																																																													
2																																																																															
		1																																																																													
1		2																																																																													
2		1																																																																													
Post - 0 Miss - 0 Block - 0	Post - 0 Miss - 0 Block - 0	Post - 1 Miss - 0 Block - 0	Post - 0 Miss - 1 Block - 0	Post - 0 Miss - 0 Block - 0	Post - 2 Miss - 0 Block - 0	Post - 0 Miss - 0 Block - 0	Post - 0 Miss - 0 Block - 0																																																																								
18 赵楠	19 庞连康	21 刘江	22 罗尧尧	25 陈孝天	26 MUCZA Norbert	27 王伟强	28 SZRNKA Levente																																																																								
<table border="1"><tr><td></td><td></td><td>1</td></tr><tr><td></td><td></td><td>1</td></tr><tr><td></td><td></td><td></td></tr></table>			1			1				<table border="1"><tr><td></td><td></td><td></td></tr><tr><td></td><td></td><td></td></tr><tr><td></td><td></td><td></td></tr></table>										<table border="1"><tr><td>1</td><td></td><td>1</td></tr><tr><td></td><td></td><td>1</td></tr><tr><td>1</td><td>1</td><td>2</td></tr></table>	1		1			1	1	1	2	<table border="1"><tr><td>1</td><td></td><td></td></tr><tr><td>1</td><td></td><td></td></tr><tr><td></td><td></td><td>1</td></tr></table>	1			1					1	<table border="1"><tr><td></td><td></td><td>1</td></tr><tr><td></td><td></td><td></td></tr><tr><td></td><td></td><td></td></tr></table>			1							<table border="1"><tr><td></td><td></td><td></td></tr><tr><td></td><td></td><td></td></tr><tr><td></td><td></td><td></td></tr></table>										<table border="1"><tr><td></td><td></td><td></td></tr><tr><td></td><td></td><td></td></tr><tr><td></td><td></td><td></td></tr></table>										<table border="1"><tr><td>1</td><td></td><td></td></tr><tr><td>1</td><td></td><td></td></tr><tr><td>1</td><td></td><td></td></tr></table>	1			1			1		
		1																																																																													
		1																																																																													
1		1																																																																													
		1																																																																													
1	1	2																																																																													
1																																																																															
1																																																																															
		1																																																																													
		1																																																																													
1																																																																															
1																																																																															
1																																																																															
Post - 0 Miss - 0 Block - 1	Post - 0 Miss - 0 Block - 0	Post - 0 Miss - 0 Block - 0	Post - 0 Miss - 0 Block - 0	Post - 0 Miss - 1 Block - 0	Post - 0 Miss - 1 Block - 1	Post - 0 Miss - 0 Block - 0	Post - 0 Miss - 0 Block - 0																																																																								

12 张睿梁

0/1		0/2
1/1		0/2
0/1	1/1	0/1

16 张帅

0/5	0/3	1/7
0/1	3/4	2/4
5/6	0/3	0/6

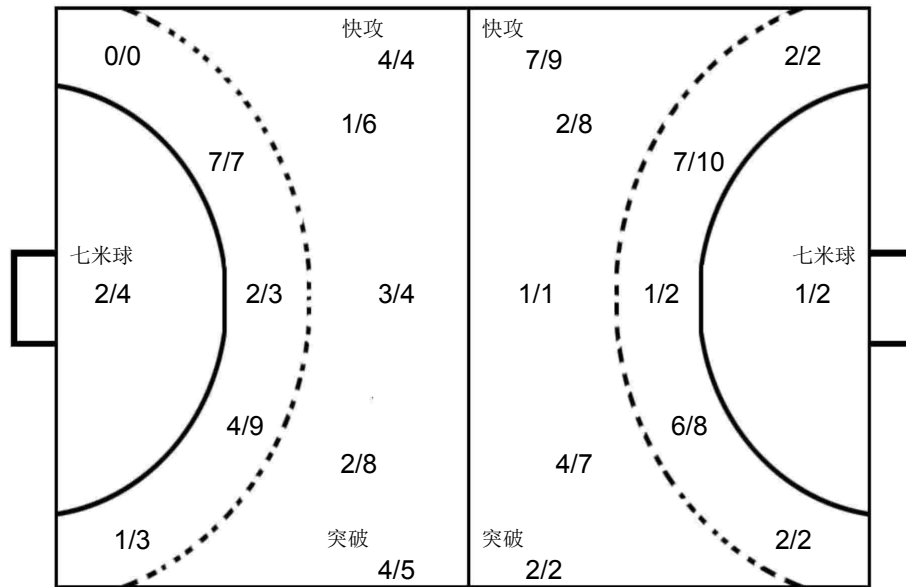

16 刘迈科

2/6	1/2	1/6
2/6	1/1	3/7
1/7	3/4	1/6

中国华体

4 张家纬	5 贺政	8 谢庆龙	10 李朝鹏	12 王权	16 刘迈科	17 胡晋铭	18 李双																																																																								
<table border="1"><tr><td></td><td></td><td></td></tr><tr><td></td><td></td><td>1</td></tr><tr><td>1</td><td></td><td></td></tr></table>						1	1			<table border="1"><tr><td></td><td></td><td></td></tr><tr><td></td><td></td><td></td></tr><tr><td></td><td>1</td><td></td></tr></table>								1		<table border="1"><tr><td></td><td></td><td>2</td></tr><tr><td>1</td><td></td><td>1</td></tr><tr><td></td><td></td><td></td></tr></table>			2	1		1				<table border="1"><tr><td></td><td></td><td></td></tr><tr><td></td><td></td><td></td></tr><tr><td></td><td>1</td><td></td></tr></table>								1		<table border="1"><tr><td></td><td></td><td></td></tr><tr><td></td><td></td><td></td></tr><tr><td></td><td></td><td></td></tr></table>										<table border="1"><tr><td></td><td></td><td></td></tr><tr><td></td><td></td><td></td></tr><tr><td></td><td></td><td></td></tr></table>										<table border="1"><tr><td></td><td></td><td></td></tr><tr><td></td><td></td><td></td></tr><tr><td></td><td></td><td>1</td></tr></table>									1	<table border="1"><tr><td></td><td></td><td></td></tr><tr><td></td><td></td><td>1</td></tr><tr><td></td><td></td><td></td></tr></table>						1			
		1																																																																													
1																																																																															
	1																																																																														
		2																																																																													
1		1																																																																													
	1																																																																														
		1																																																																													
		1																																																																													
Post - 0 Miss - 0 Block - 0	Post - 1 Miss - 1 Block - 0	Post - 0 Miss - 0 Block - 1	Post - 0 Miss - 0 Block - 0	Post - 0 Miss - 0 Block - 0	Post - 0 Miss - 0 Block - 0	Post - 0 Miss - 0 Block - 0	Post - 0 Miss - 0 Block - 0																																																																								
20 顾艳超	22 黄培杰	23 曹悦	25 王杰缘	47 成亚	88 王军程	97 张建杰	99 王伟																																																																								
<table border="1"><tr><td></td><td></td><td></td></tr><tr><td></td><td></td><td></td></tr><tr><td></td><td></td><td></td></tr></table>										<table border="1"><tr><td>2</td><td>1</td><td>1</td></tr><tr><td></td><td></td><td></td></tr><tr><td></td><td>1</td><td>2</td></tr></table>	2	1	1					1	2	<table border="1"><tr><td></td><td></td><td></td></tr><tr><td></td><td></td><td></td></tr><tr><td></td><td></td><td>1</td></tr></table>									1	<table border="1"><tr><td>2</td><td></td><td>1</td></tr><tr><td></td><td></td><td></td></tr><tr><td>1</td><td></td><td>1</td></tr></table>	2		1				1		1	<table border="1"><tr><td>1</td><td>1</td><td>1</td></tr><tr><td></td><td></td><td></td></tr><tr><td></td><td>1</td><td></td></tr></table>	1	1	1					1		<table border="1"><tr><td>1</td><td></td><td>2</td></tr><tr><td></td><td></td><td></td></tr><tr><td></td><td></td><td>1</td></tr></table>	1		2						1	<table border="1"><tr><td></td><td></td><td>1</td></tr><tr><td></td><td></td><td></td></tr><tr><td></td><td></td><td>1</td></tr></table>			1						1	<table border="1"><tr><td></td><td></td><td></td></tr><tr><td></td><td></td><td></td></tr><tr><td></td><td></td><td></td></tr></table>									
2	1	1																																																																													
	1	2																																																																													
		1																																																																													
2		1																																																																													
1		1																																																																													
1	1	1																																																																													
	1																																																																														
1		2																																																																													
		1																																																																													
		1																																																																													
		1																																																																													
Post - 0 Miss - 0 Block - 0	Post - 0 Miss - 0 Block - 0	Post - 0 Miss - 0 Block - 1	Post - 0 Miss - 0 Block - 0	Post - 0 Miss - 0 Block - 0	Post - 0 Miss - 0 Block - 0	Post - 0 Miss - 0 Block - 1	Post - 0 Miss - 0 Block - 0																																																																								

