

2017



第十三届全国运动会男子手球决赛

成绩与技术统计数据册

2017



2017

数据由PHMS收集生成



PHMS 国际手球联合会官方技术统计系统

成绩与技术统计数据册目录

1 比赛结果

- 1) 名次
- 2) 场次成绩
- 3) 分组成绩

2 运动员排名

- 1) 得分
- 2) 助攻
- 3) 封球
- 4) 防守
- 5) 失误
- 6) 受罚

3 守门员排名

- 1) 救球
- 2) 救 7M 球

4 球队累计表

5 球队受罚表

6 球队信息

- 1) 球队名单
- 2) 个人/全队技术累计表
- 3) 球队射门区域累计

7 比赛统计数据

- 1) 比赛记录表
- 2) 比赛统计(媒体表)
- 3) 每场个人/全队技术统计表
- 4) 图式统计表
- 5) 每场射门区域统计
- 6) 比赛进程表(决赛场次)

注：如需更多比赛统计数据，请通过以下电邮联络：handball@126.com

第十三届全国运动会男子手球决赛

PHMS Pictorial Handball Match Statistics

IHF Official System

大赛名次

手球
男子

截止至第24场

天津
2017-08-28

奖牌	名次	缩写	队名
Gold	1	江苏	江苏队
Silver	2	山东	山东队
Bronze	3	北京	北京队
	4	广东	广东队
	5	上海	上海队
	6	香港	香港队
	7	天津	天津队
	8	安徽	安徽队

第十三届全国运动会男子手球决赛

PHMS Pictorial Handball Match Statistics

IHF Official System

获奖队员名单

手球
男子

天津
2017-08-28

金牌	银牌	铜牌
江苏-江苏队	山东-山东队	北京-北京队
1 徐畅	3 尹杰	1 王泷
4 张家纬	4 田瑞	7 马昌震
5 闫亮	5 潘翔	8 王鹏
6 赵晨	6 李朝鹏	9 刘振
7 徐奕飞	8 王炳华	10 成亚
8 周小坚	9 赵鑫	16 刘迈科
9 王杰缘	11 宋朋强	21 胡瀛
10 郝可鑫	12 崔剑	22 王超
12 王权	13 刘晓	23 王军程
13 叶强	15 张继伟	25 马明辉
15 李安	16 于性哲	29 杜龙飞
17 王伟强	17 王旭东	39 张骥
18 赵楠	18 于亚男	66 解建飞
19 张志宇	19 李语庆	77 朱昕晨
20 顾艳超	20 杜在超	83 潘天
21 刘江	21 翟乾坤	99 蒋维一

第十三届全国运动会男子手球决赛

PHMS Pictorial Handball Match Statistics

IHF Official System

场次成绩

手球 男子 截止至第24场 天津 2017-08-28

日期	时间	场次	体育馆	组别	球队	成绩 (半时)	阶段
25-08-17	14:00	13	天津师范大学体育馆	X	山东-安徽	32-18 (12-7)	四分之一决赛
	15:45	14	天津师范大学体育馆	X	广东-上海	30-14 (13-5)	四分之一决赛
	17:30	15	天津师范大学体育馆	X	北京-香港	28-25 (16-12)	四分之一决赛
	19:15	16	天津师范大学体育馆	X	江苏-天津	35-21 (18-8)	四分之一决赛
26-08-17	14:00	17	天津师范大学体育馆	X	安徽-上海	21-25 (10-12)	5-8名
	15:45	18	天津师范大学体育馆	X	香港-天津	27-23 (14-12)	5-8名
	17:30	19	天津师范大学体育馆	X	山东-广东	28-27 (10-10)	半决赛
	19:15	20	天津师范大学体育馆	X	北京-江苏	22-25 (11-15)	半决赛
28-08-17	14:00	21	天津师范大学体育馆	X	安徽-天津	26-30 (11-13)	7-8名
	15:45	22	天津师范大学体育馆	X	上海-香港	29-26 (15-12)	5-6名
	17:30	23	天津师范大学体育馆	X	广东-北京	17-23 (8-13)	3-4名
	19:15	24	天津师范大学体育馆	X	山东-江苏	13-23 (5-11)	决赛

第十三届全国运动会男子手球决赛

PHMS Pictorial Handball Match Statistics

IHF Official System

分组成绩

 手球
 男子

截止至第24场

 天津
 2017-08-28

组别: A 预赛

名次	球队	积	场	胜	平	负	得分	失分	净胜
1	山东	4	3	2	0	1	75	54	21
2	北京	4	3	2	0	1	68	58	10
3	上海	4	3	2	0	1	65	71	-6
4	天津	0	3	0	0	3	54	79	-25

球队	山东	北京	上海	天津
山东		21-23	26-18	28-13
北京	23-21		20-21	25-16
上海	18-26	21-20		26-25
天津	13-28	16-25	25-26	

组别: B 预赛

名次	球队	积	场	胜	平	负	得分	失分	净胜
1	江苏	6	3	3	0	0	96	63	33
2	广东	4	3	2	0	1	88	76	12
3	香港	2	3	1	0	2	67	90	-23
4	安徽	0	3	0	0	3	67	89	-22

球队	江苏	广东	香港	安徽
江苏		26-20	35-21	35-22
广东	20-26		36-24	32-26
香港	21-35	24-36		22-19
安徽	22-35	26-32	19-22	

Legend:

积	积分	■	已比赛场次	胜	胜场	平	平场
负	负场	■	得分累计	失分	失分累计	净胜	净胜分

第十三届全国运动会男子手球决赛

PHMS Pictorial Handball Match Statistics

IHF Official System

得分排名表(场上队员)

手球 男子 截止至第24场 按总得分排序 天津 2017-08-28

排序	号码	姓名	球队	远射	近射	边射	快攻	突破	任意	七米	合计	%	助攻	场数
1	39	张骥	北京	8-28	11-13	0-2	1-2	2-3	1-1	16-17	39-66	59.1	5	6
2	8	董智景	安徽	7-15	5-7	11-19	7-11	1-2	0-0	2-2	33-56	58.9	2	6
3	7	张青	天津	4-16	14-18	1-1	3-3	1-2	0-0	5-9	28-49	57.1	2	6
4	6	赵晨	江苏	18-37	2-4	0-0	3-3	1-1	3-7	1-1	28-53	52.8	9	6
5	17	李中洲	广东	8-18	4-9	0-0	4-5	6-7	0-0	5-6	27-45	60.0	4	6
6	8	钱为玮	上海	5-14	6-10	7-19	7-8	1-1	1-4	0-0	27-56	48.2	5	6
7	3	曲汝洋	广东	7-15	10-17	1-2	5-7	2-2	0-0	0-0	25-43	58.1	3	6
8	4	徐俊吉	上海	0-0	14-17	1-1	1-2	1-1	0-0	7-11	24-32	75.0	0	6
9	15	李安	江苏	2-3	3-4	4-8	8-12	2-3	0-0	5-7	24-37	64.9	0	6
10	13	许松	天津	3-11	4-8	5-11	8-10	4-5	0-0	0-0	24-45	53.3	3	6
11	21	翟乾坤	山东	2-3	4-5	5-11	5-5	0-0	0-0	6-7	22-31	71.0	0	6
12	12	许文邦	香港	7-32	1-3	1-2	1-1	0-0	1-1	10-13	21-52	40.4	5	6
13	8	曹悦	天津	7-29	8-13	0-0	0-0	4-5	0-0	2-7	21-54	38.9	4	6
14	8	于彦江	广东	3-7	4-4	7-18	4-4	2-3	0-0	0-0	20-36	55.6	2	6
15	4	张家纬	江苏	12-25	5-9	0-0	1-1	2-2	0-1	0-0	20-38	52.6	3	6
16	9	赵鑫	山东	8-25	6-9	1-2	2-6	3-3	0-0	0-0	20-45	44.4	7	6
17	17	贺政	上海	0-0	0-1	13-21	2-3	0-0	0-0	4-4	19-29	65.5	1	6
18	9	王杰缘	江苏	0-2	6-9	1-1	9-11	0-0	0-0	2-2	18-25	72.0	0	6
19	9	刘振	北京	8-19	4-8	1-1	0-0	2-2	0-0	3-5	18-35	51.4	4	6
20	10	成亚	北京	4-11	6-11	2-5	2-4	4-4	0-0	0-0	18-35	51.4	8	6
21	4	李卓洋	广东	10-20	4-8	1-3	0-0	2-4	1-1	0-0	18-36	50.0	2	6
22	2	孙江山	广东	0-0	2-2	10-18	0-0	0-0	0-0	5-6	17-26	65.4	0	6
23	31	田剑侠	天津	3-16	9-14	0-0	0-0	4-4	0-0	1-2	17-36	47.2	5	6
24	14	沈吉磊	上海	11-21	3-4	1-1	0-0	0-0	1-2	0-0	16-28	57.1	0	6
25	20	顾艳超	江苏	4-14	3-4	0-0	2-2	6-7	0-1	1-1	16-29	55.2	1	6
26	18	马麟晓	上海	10-30	3-6	0-0	0-0	1-1	2-3	0-0	16-40	40.0	3	6
27	19	李语庆	山东	2-2	1-3	3-6	2-3	1-1	0-0	6-8	15-23	65.2	0	6
28	20	杜在超	山东	7-13	1-3	2-3	1-4	4-5	0-0	0-0	15-28	53.6	0	6
29	17	王旭东	山东	4-10	4-7	3-8	2-2	1-1	1-1	0-0	15-29	51.7	2	6
30	40	叶冠雄	香港	2-10	8-12	0-0	1-2	4-6	0-0	0-0	15-30	50.0	5	6
31	1	郭世伟	安徽	4-15	4-10	1-4	3-4	3-4	0-0	0-0	15-37	40.5	0	6
32	10	郝可鑫	江苏	13-22	0-0	0-0	0-0	0-0	0-0	1-1	14-23	60.9	2	6
33	10	谢永辉	香港	2-5	4-5	4-9	4-5	0-0	0-0	0-0	14-24	58.3	2	6
34	21	胡瀛	北京	3-3	3-10	6-8	2-3	0-0	0-0	0-0	14-24	58.3	0	6
35	11	黎涛	安徽	3-11	1-2	5-7	0-0	1-1	1-1	3-6	14-28	50.0	1	6
36	29	练明辉	香港	3-11	4-7	3-7	1-1	1-1	1-1	1-1	14-29	48.3	3	6
37	5	潘翔	山东	0-0	3-4	2-2	4-5	1-1	1-1	2-2	13-15	86.7	1	6
38	9	陈开勇	安徽	0-2	9-10	0-0	3-4	0-0	1-1	0-0	13-17	76.5	0	6
39	84	王伟	广东	0-3	10-13	0-1	3-3	0-0	0-0	0-0	13-20	65.0	1	6
40	5	黄胜业	香港	0-0	3-6	4-11	6-8	0-0	0-0	0-0	13-25	52.0	0	6

第十三届全国运动会男子手球决赛

PHMS Pictorial Handball Match Statistics

IHF Official System

得分排名表(场上队员)

手球 男子 截止至第24场 按助攻次数排序 天津 2017-08-28

排序	号码	姓名	球队	远射	近射	边射	快攻	突破	任意	七米	合计	%	助攻	场数
1	11	宋朋强	山东	5-16	3-5	0-0	2-3	3-4	0-1	0-0	13-29	44.8	11	6
2	6	赵晨	江苏	18-37	2-4	0-0	3-3	1-1	3-7	1-1	28-53	52.8	9	6
3	10	成亚	北京	4-11	6-11	2-5	2-4	4-4	0-0	0-0	18-35	51.4	8	6
4	9	赵鑫	山东	8-25	6-9	1-2	2-6	3-3	0-0	0-0	20-45	44.4	7	6
5	31	叶仕仁	香港	1-12	7-13	1-1	3-3	1-2	0-0	0-0	13-31	41.9	7	6
6	3	赵时俊	上海	2-6	3-3	2-10	1-1	1-1	0-1	1-4	10-26	38.5	6	6
7	39	张骥	北京	8-28	11-13	0-2	1-2	2-3	1-1	16-17	39-66	59.1	5	6
8	8	钱为玮	上海	5-14	6-10	7-19	7-8	1-1	1-4	0-0	27-56	48.2	5	6
9	12	许文邦	香港	7-32	1-3	1-2	1-1	0-0	1-1	10-13	21-52	40.4	5	6
10	31	田剑侠	天津	3-16	9-14	0-0	0-0	4-4	0-0	1-2	17-36	47.2	5	6
11	40	叶冠雄	香港	2-10	8-12	0-0	1-2	4-6	0-0	0-0	15-30	50.0	5	6
12	8	周小坚	江苏	0-1	9-10	0-0	1-1	1-1	0-0	0-0	11-13	84.6	5	6
13	17	李中洲	广东	8-18	4-9	0-0	4-5	6-7	0-0	5-6	27-45	60.0	4	6
14	8	曹悦	天津	7-29	8-13	0-0	0-0	4-5	0-0	2-7	21-54	38.9	4	6
15	9	刘振	北京	8-19	4-8	1-1	0-0	2-2	0-0	3-5	18-35	51.4	4	6
16	77	朱昕晨	北京	4-15	3-6	0-1	1-1	3-6	2-2	0-0	13-31	41.9	4	6
17	7	谭俊杰	香港	0-0	0-0	0-0	0-0	0-0	0-0	0-0	0-0	0	4	6
18	3	曲汝洋	广东	7-15	10-17	1-2	5-7	2-2	0-0	0-0	25-43	58.1	3	6
19	13	许松	天津	3-11	4-8	5-11	8-10	4-5	0-0	0-0	24-45	53.3	3	6
20	4	张家纬	江苏	12-25	5-9	0-0	1-1	2-2	0-1	0-0	20-38	52.6	3	6
21	18	马麟晓	上海	10-30	3-6	0-0	0-0	1-1	2-3	0-0	16-40	40.0	3	6
22	29	练明辉	香港	3-11	4-7	3-7	1-1	1-1	1-1	1-1	14-29	48.3	3	6
23	18	李双	安徽	5-14	4-5	1-2	0-0	2-2	0-1	0-0	12-24	50.0	3	6
24	17	王巨柱	安徽	7-22	1-8	0-1	1-1	0-0	1-1	1-2	11-35	31.4	3	5
25	7	付云博	广东	2-5	2-4	0-0	0-1	0-1	0-0	5-6	9-17	52.9	3	6
26	5	史小帆	安徽	2-8	3-4	0-1	1-1	2-3	0-0	0-0	8-17	47.1	3	6
27	1	叶冠英	香港	0-0	0-0	0-0	1-1	0-0	0-0	0-0	1-1	100.0	3	6
28	12	王权	江苏	0-0	0-0	0-0	0-0	0-0	0-0	0-0	0-0	0	3	6
29	16	马跃	广东	0-0	0-0	0-0	0-0	0-0	0-0	0-0	0-0	0	3	6
30	21	李明	安徽	0-0	0-0	0-0	0-0	0-0	0-0	0-0	0-0	0	3	6
31	8	董智景	安徽	7-15	5-7	11-19	7-11	1-2	0-0	2-2	33-56	58.9	2	6
32	7	张青	天津	4-16	14-18	1-1	3-3	1-2	0-0	5-9	28-49	57.1	2	6
33	8	于彦江	广东	3-7	4-4	7-18	4-4	2-3	0-0	0-0	20-36	55.6	2	6
34	4	李卓洋	广东	10-20	4-8	1-3	0-0	2-4	1-1	0-0	18-36	50.0	2	6
35	17	王旭东	山东	4-10	4-7	3-8	2-2	1-1	1-1	0-0	15-29	51.7	2	6
36	10	郝可鑫	江苏	13-22	0-0	0-0	0-0	0-0	0-0	1-1	14-23	60.9	2	6
37	10	谢永辉	香港	2-5	4-5	4-9	4-5	0-0	0-0	0-0	14-24	58.3	2	6
38	18	于亚男	山东	4-11	2-5	0-0	1-1	4-4	0-0	0-0	11-21	52.4	2	6
39	6	朱世杰	上海	4-13	2-10	0-0	1-3	4-7	0-0	0-0	11-33	33.3	2	6
40	19	张志宇	江苏	6-11	1-3	0-0	1-1	1-2	0-0	0-0	9-17	52.9	2	6

第十三届全国运动会男子手球决赛

PHMS Pictorial Handball Match Statistics

IHF Official System

得分排名表(场上队员)

 手球
 男子

 截止至第24场
 按封球次数排序

 天津
 2017-08-28

名次	号码	姓名	球队	抢球	断球	造失误	造犯规	合计	封球	场数
1	84	王伟	广东	0	1	0	3	4	13	6
2	66	解建飞	北京	0	0	0	1	1	13	6
3	8	周小坚	江苏	0	0	1	0	1	9	6
4	15	张继伟	山东	0	3	0	2	5	8	6
5	5	闫亮	江苏	0	3	0	0	3	7	6
6	6	赵晨	江苏	1	0	0	2	3	6	6
7	17	李中洲	广东	0	5	0	1	6	5	6
8	21	刘江	江苏	0	3	1	0	4	5	6
9	83	潘天	北京	0	1	1	6	8	4	6
10	8	于彦江	广东	0	5	0	2	7	4	6
11	18	李双	安徽	1	4	0	3	8	4	6
12	11	宋朋强	山东	0	6	0	1	7	4	6
13	9	陈开勇	安徽	1	3	0	0	4	3	6
14	10	吴璟	上海	0	0	0	0	0	3	6
15	99	蒋维一	北京	2	0	0	3	5	3	6
16	4	徐俊吉	上海	0	0	0	0	0	3	6
17	17	王旭东	山东	1	1	1	3	6	3	6
18	3	陈强龙	安徽	0	5	0	1	6	3	6
19	40	叶冠雄	香港	1	2	1	2	6	3	6
20	6	朱世杰	上海	1	7	0	0	8	2	6
21	5	潘翔	山东	0	2	0	2	4	2	6
22	31	田剑侠	天津	1	0	0	1	2	2	6
23	10	郝可鑫	江苏	1	2	0	3	6	2	6
24	11	蒋承骅	上海	1	2	1	2	6	2	6
25	8	李伟东	香港	0	0	0	0	0	2	6
26	23	郭斯鸣	香港	0	1	1	0	2	1	5
27	18	赵楠	江苏	0	2	0	1	3	1	6
28	20	顾艳超	江苏	0	0	1	1	2	1	6
29	8	王鹏	北京	0	0	0	0	0	1	6
30	23	于敏清	安徽	1	3	0	0	4	1	6
31	26	姚雪岩	广东	0	0	0	0	0	1	6
32	9	徐庆	广东	1	0	0	0	1	1	6
33	8	钱为玮	上海	0	4	1	3	8	1	6
34	15	李安	江苏	0	2	0	1	3	1	6
35	17	周群	天津	0	0	0	0	0	1	6
36	9	吴明远	天津	0	0	0	0	0	1	6
37	8	曹悦	天津	1	4	1	2	8	1	6
38	18	李鑫豪	香港	0	0	0	0	0	1	6
39	31	叶仕仁	香港	0	4	0	7	11	1	6
40	18	王晓琪	天津	0	0	0	0	0	1	6

第十三届全国运动会男子手球决赛

PHMS Pictorial Handball Match Statistics

IHF Official System

得分排名表(场上队员)

手球 男子 截止至第24场 按防守成功总数排序 天津 2017-08-28

名次	号码	姓名	球队	抢球	断球	造失误	造犯规	合计	封球	场数
1	31	叶仕仁	香港	0	4	0	7	11	1	6
2	9	王杰缘	江苏	1	4	0	4	9	0	6
3	13	许松	天津	0	4	2	2	8	0	6
4	6	朱世杰	上海	1	7	0	0	8	2	6
5	8	钱为玮	上海	0	4	1	3	8	1	6
6	18	李双	安徽	1	4	0	3	8	4	6
7	83	潘天	北京	0	1	1	6	8	4	6
8	8	曹悦	天津	1	4	1	2	8	1	6
9	5	黄胜业	香港	0	5	1	1	7	0	6
10	8	于彦江	广东	0	5	0	2	7	4	6
11	11	宋朋强	山东	0	6	0	1	7	4	6
12	18	马麟晓	上海	0	1	0	6	7	0	6
13	17	李中洲	广东	0	5	0	1	6	5	6
14	10	郝可鑫	江苏	1	2	0	3	6	2	6
15	3	曲汝洋	广东	0	5	0	1	6	0	6
16	11	蒋承骅	上海	1	2	1	2	6	2	6
17	17	王旭东	山东	1	1	1	3	6	3	6
18	3	陈强龙	安徽	0	5	0	1	6	3	6
19	8	董智景	安徽	1	4	1	0	6	0	6
20	40	叶冠雄	香港	1	2	1	2	6	3	6
21	2	刘健斌	香港	0	3	0	3	6	0	6
22	9	赵鑫	山东	0	4	0	1	5	0	6
23	21	胡瀛	北京	0	2	0	3	5	0	6
24	99	蒋维一	北京	2	0	0	3	5	3	6
25	5	史小帆	安徽	1	0	2	2	5	0	6
26	15	张继伟	山东	0	3	0	2	5	8	6
27	21	翟乾坤	山东	0	1	2	1	4	0	6
28	19	张志宇	江苏	0	2	0	2	4	0	6
29	5	潘翔	山东	0	2	0	2	4	2	6
30	17	王伟强	江苏	1	3	0	0	4	0	6
31	17	贺政	上海	0	1	0	3	4	0	6
32	18	于亚男	山东	0	4	0	0	4	0	6
33	9	陈开勇	安徽	1	3	0	0	4	3	6
34	10	成亚	北京	0	1	0	3	4	0	6
35	84	王伟	广东	0	1	0	3	4	13	6
36	7	张青	天津	0	3	0	1	4	0	6
37	21	刘江	江苏	0	3	1	0	4	5	6
38	3	陈梓朗	香港	1	2	1	0	4	0	6
39	6	王子欣	天津	1	1	0	2	4	0	6
40	39	张骥	北京	1	3	0	0	4	0	6

第十三届全国运动会男子手球决赛

PHMS Pictorial Handball Match Statistics

IHF Official System

得分排名表(场上队员)

 手球
 男子

 截止至第24场
 按失误总数排序

 天津
 2017-08-28

排序	号码	姓名	球队	传失	接失	两次	四步	侵区	进犯	其它	合计	场数
1	1	郭世伟	安徽	6	1	5	3	0	3	0	18	6
2	18	李双	安徽	12	0	2	1	0	2	0	17	6
3	8	曹悦	天津	7	2	0	4	0	2	1	16	6
4	18	马麟晓	上海	12	0	2	2	0	0	0	16	6
5	12	许文邦	香港	11	1	1	1	0	0	0	14	6
6	31	叶仕仁	香港	7	1	2	1	0	3	0	14	6
7	29	练明辉	香港	6	3	2	1	0	2	0	14	6
8	6	朱世杰	上海	5	0	1	4	0	3	1	14	6
9	17	王巨柱	安徽	10	3	0	1	0	0	0	14	5
10	77	朱昕晨	北京	3	1	1	3	0	4	1	13	6
11	7	张青	天津	2	0	1	2	0	7	0	12	6
12	11	黎涛	安徽	8	1	2	0	0	1	0	12	6
13	39	张骥	北京	4	2	1	3	0	1	0	11	6
14	3	曲汝洋	广东	7	0	0	3	0	1	0	11	6
15	17	李中洲	广东	6	1	1	1	0	0	2	11	6
16	10	成亚	北京	7	1	0	0	1	2	0	11	6
17	13	许松	天津	4	2	1	2	1	1	0	11	6
18	20	顾艳超	江苏	8	0	1	1	1	0	0	11	6
19	5	史小帆	安徽	2	2	2	3	0	2	0	11	6
20	40	叶冠雄	香港	7	1	0	1	0	1	0	10	6
21	31	田剑侠	天津	4	2	0	1	1	2	0	10	6
22	11	宋朋强	山东	6	1	0	1	0	1	1	10	6
23	8	钱为玮	上海	2	2	1	2	1	1	0	9	6
24	9	赵鑫	山东	4	1	2	1	0	1	0	9	6
25	84	王伟	广东	2	2	0	0	2	3	0	9	6
26	4	李卓洋	广东	2	3	1	1	0	2	0	9	6
27	23	郭斯鸣	香港	8	0	0	1	0	0	0	9	5
28	17	王旭东	山东	1	3	1	0	1	2	0	8	6
29	8	周小坚	江苏	0	4	1	0	0	2	1	8	6
30	8	于彦江	广东	5	0	1	0	1	1	0	8	6
31	7	付文博	广东	3	0	1	2	0	1	1	8	6
32	14	沈吉磊	上海	3	1	1	0	1	2	0	8	6
33	23	于敏清	安徽	3	2	2	0	1	0	0	8	6
34	10	谢永辉	香港	3	1	0	0	3	1	0	8	6
35	4	张家纬	江苏	4	1	0	0	1	1	0	7	6
36	1	叶冠英	香港	7	0	0	0	0	0	0	7	6
37	10	严龙	安徽	5	0	0	0	2	0	0	7	6
38	5	黄胜业	香港	4	2	0	0	0	1	0	7	6
39	10	郝可鑫	江苏	3	3	0	1	0	0	0	7	6
40	3	赵时俊	上海	5	1	0	0	0	0	1	7	6

第十三届全国运动会男子手球决赛

PHMS Pictorial Handball Match Statistics

IHF Official System

得分排名表(场上队员)

手球 男子 截止至第24场 接受罚次数排序 天津 2017-08-28

排序	号码	姓名	球队	警告	罚2分钟	D	DR	场数
1	17	王巨柱	安徽	1	1	1	0	5
2	23	郭斯鸣	香港	4	0	1	0	5
3	6	朱世杰	上海	3	6	0	0	6
4	66	解建飞	北京	5	5	0	0	6
5	17	李中洲	广东	4	4	0	0	6
6	18	马麟晓	上海	3	4	0	0	6
7	18	李双	安徽	3	4	0	0	6
8	17	王旭东	山东	1	4	0	0	6
9	99	蒋维一	北京	1	4	0	0	6
10	6	王子欣	天津	2	3	0	0	6
11	15	张继伟	山东	2	3	0	0	6
12	2	李岳朋	天津	2	3	0	0	6
13	29	练明辉	香港	1	3	0	0	6
14	8	钱为玮	上海	1	3	0	0	6
15	9	陈开勇	安徽	1	3	0	0	6
16	20	杜在超	山东	1	3	0	0	6
17	6	李朝鹏	山东	0	3	0	0	6
18	7	张青	天津	4	2	0	0	6
19	21	胡瀛	北京	3	2	0	0	6
20	8	曹悦	天津	3	2	0	0	6
21	18	于亚男	山东	2	2	0	0	6
22	11	宋朋强	山东	2	2	0	0	6
23	17	周群	天津	2	2	0	0	6
24	5	潘翔	山东	2	2	0	0	6
25	83	潘天	北京	2	2	0	0	6
26	13	刘晓	山东	1	2	0	0	6
27	9	赵鑫	山东	1	2	0	0	6
28	20	顾艳超	江苏	1	2	0	0	6
29	10	郝可鑫	江苏	1	2	0	0	6
30	3	赵时俊	上海	1	2	0	0	6
31	8	董智景	安徽	1	2	0	0	6
32	7	徐奕飞	江苏	0	2	0	0	6
33	77	朱昕晨	北京	0	2	0	0	6
34	10	严龙	安徽	0	2	0	0	6
35	21	刘江	江苏	0	2	0	0	6
36	17	贺政	上海	0	2	0	0	6
37	8	于彦江	广东	4	1	0	0	6
38	6	赵晨	江苏	4	1	0	0	6
39	4	张家纬	江苏	3	1	0	0	6
40	9	王杰缘	江苏	3	1	0	0	6

第十三届全国运动会男子手球决赛

PHMS Pictorial Handball Match Statistics

IHF Official System

排名表(守门员)

手球 男子 截止至第24场 按总救球数排序 天津 2017-08-28

排序	号码	姓名	球队	远射	近射	边射	快攻	突破	任意	七米	得分	%	助攻	场数
1	12	王权	江苏	37-59	8-26	12-22	3-14	4-9	1-3	1-10	66-143	46.2	3	6
2	16	刘迈科	北京	24-46	17-37	18-31	2-15	2-11	1-1	2-9	66-150	44.0	0	6
3	16	于性哲	山东	19-41	17-45	12-25	4-13	3-15	4-5	4-15	63-159	39.6	0	6
4	21	李明	安徽	19-50	19-69	9-26	6-29	4-13	0-0	2-12	59-199	29.6	3	6
5	1	叶冠英	香港	20-40	16-46	11-25	5-22	0-7	1-2	1-10	54-152	35.5	3	6
6	16	马跃	广东	29-67	11-31	10-19	1-17	0-8	0-5	1-12	52-159	32.7	3	6
7	12	周哲韬	上海	7-15	17-44	9-28	3-18	7-19	2-2	2-4	47-130	36.2	2	6
8	1	张峥	上海	8-19	13-33	4-13	6-14	0-10	0-1	3-9	34-99	34.3	1	6
9	7	谭俊杰	香港	13-30	4-19	12-25	1-14	0-7	1-1	1-8	32-104	30.8	4	6
10	1	刘宗其	天津	8-22	9-38	6-15	2-12	1-9	0-2	1-4	27-102	26.5	1	6
11	12	杨峻	天津	7-29	7-37	7-15	1-11	0-6	0-4	2-13	24-115	20.9	0	6
12	1	徐畅	江苏	6-14	6-13	3-10	1-6	1-1	0-0	2-3	19-47	40.4	2	6
13	1	王泷	北京	4-11	6-15	5-12	0-6	0-1	0-1	4-14	19-60	31.7	0	6
14	12	崔剑	山东	5-9	5-10	2-9	0-1	2-6	0-2	2-5	16-42	38.1	0	6
15	1	王帅	广东	5-16	5-15	1-6	1-5	1-2	0-0	1-4	14-48	29.2	0	6
16	12	曾献辰	安徽	5-13	1-8	1-5	1-10	0-5	0-0	1-4	9-45	20.0	1	6
17	16	刘海亮	天津	3-3	0-0	1-1	0-0	0-0	0-0	0-1	4-5	80.0	0	6
18	13	叶强	江苏	2-6	0-5	2-2	0-4	0-0	0-0	0-1	4-18	22.2	2	6
19	3	尹杰	山东	0-0	0-0	0-0	0-0	0-0	0-0	0-0	0-0	0	0	6

第十三届全国运动会男子手球决赛

PHMS Pictorial Handball Match Statistics

IHF Official System

排名表(守门员)

 手球
 男子

 截止至第24场
 按救七米球数排序

 天津
 2017-08-28

排序	号码	姓名	球队	远射	近射	边射	快攻	突破	任意	七米	得分	%	助攻	场数
1	1	王澍	北京	4-11	6-15	5-12	0-6	0-1	0-1	4-14	19-60	28.6	0	6
2	16	于性哲	山东	19-41	17-45	12-25	4-13	3-15	4-5	4-15	63-159	26.7	0	6
3	1	张崢	上海	8-19	13-33	4-13	6-14	0-10	0-1	3-9	34-99	33.3	1	6
4	1	徐畅	江苏	6-14	6-13	3-10	1-6	1-1	0-0	2-3	19-47	66.7	2	6
5	12	周哲韬	上海	7-15	17-44	9-28	3-18	7-19	2-2	2-4	47-130	50.0	2	6
6	12	崔剑	山东	5-9	5-10	2-9	0-1	2-6	0-2	2-5	16-42	40.0	0	6
7	16	刘迈科	北京	24-46	17-37	18-31	2-15	2-11	1-1	2-9	66-150	22.2	0	6
8	21	李明	安徽	19-50	19-69	9-26	6-29	4-13	0-0	2-12	59-199	16.7	3	6
9	12	杨峻	天津	7-29	7-37	7-15	1-11	0-6	0-4	2-13	24-115	15.4	0	6
10	1	刘宗其	天津	8-22	9-38	6-15	2-12	1-9	0-2	1-4	27-102	25.0	1	6
11	1	王帅	广东	5-16	5-15	1-6	1-5	1-2	0-0	1-4	14-48	25.0	0	6
12	12	曾献辰	安徽	5-13	1-8	1-5	1-10	0-5	0-0	1-4	9-45	25.0	1	6
13	7	谭俊杰	香港	13-30	4-19	12-25	1-14	0-7	1-1	1-8	32-104	12.5	4	6
14	12	王权	江苏	37-59	8-26	12-22	3-14	4-9	1-3	1-10	66-143	10.0	3	6
15	1	叶冠英	香港	20-40	16-46	11-25	5-22	0-7	1-2	1-10	54-152	10.0	3	6
16	16	马跃	广东	29-67	11-31	10-19	1-17	0-8	0-5	1-12	52-159	8.3	3	6
17	3	尹杰	山东	0-0	0-0	0-0	0-0	0-0	0-0	0-0	0-0	0	0	6
18	16	刘海亮	天津	3-3	0-0	1-1	0-0	0-0	0-0	0-1	4-5	0.0	0	6
19	13	叶强	江苏	2-6	0-5	2-2	0-4	0-0	0-0	0-1	4-18	0.0	2	6

第十三届全国运动会男子手球决赛
PHMS Pictorial Handball Match Statistics

IHF Official System

攻防成功率统计总表

 手球
 男子

截止至第24场

 天津
 2017-08-28

序号	球队	比分	进攻成功率															助攻	防守成功率								
			阵地进攻			一传快攻			短传快攻			合计			多打少				少打多			封打抢断	守门员	对方射失	对方失误	合计	%
			得分	进攻	%	得分	进攻	%	得分	进攻	%	得分	进攻	%	得分	进攻	%		得分	进攻	%						
1	安徽	132:176	113	337	33.5	11	17	64.7	8	25	32.0	132	379	34.8	10	16	62.5	8	19	42.1	20	49	68	44	41	202	53.4
2	北京	141:125	131	310	42.3	5	7	71.4	5	10	50.0	141	327	43.1	19	26	73.1	8	26	30.8	23	53	85	30	35	203	61.9
3	广东	162:141	138	303	45.5	13	18	72.2	11	18	61.1	162	339	47.8	18	25	72.0	5	8	62.5	20	59	66	38	31	194	57.9
4	江苏	179:119	138	292	47.3	16	21	76.2	25	44	56.8	179	357	50.1	19	36	52.8	7	14	50.0	31	75	89	39	56	259	68.5
5	山东	148:122	126	288	43.8	14	18	77.8	8	27	29.6	148	333	44.4	12	20	60.0	12	24	50.0	25	63	79	33	33	208	63.0
6	上海	133:148	121	312	38.8	5	7	71.4	7	23	30.4	133	342	38.9	12	26	46.2	10	21	47.6	22	50	81	17	41	189	56.1
7	天津	128:167	116	314	36.9	4	4	100.0	8	16	50.0	128	334	38.3	20	34	58.8	8	13	61.5	17	35	55	26	38	154	48.0
8	香港	145:170	111	336	33.0	16	19	84.2	18	39	46.2	145	394	36.8	18	38	47.4	6	10	60.0	31	54	86	44	44	228	57.3

注释:

进攻	进攻次数 (射门 + 进攻失误)	对方射失	对方射门失误 (射失 + 击柱)	防守成功率%	本方防守合计 / 对方进攻合计
----	------------------	------	------------------	--------	-----------------

第十三届全国运动会男子手球决赛

PHMS Pictorial Handball Match Statistics

IHF Official System

防守技术统计总表

 手球
 男子

截止至第24场

 天津
 2017-08-28

序号	球队	比分	防守成功						防守(成功 : 失误)							处罚					守门员		
			封球	抢球	断球	造失	造犯	合计	选位	顶贴	观察	移动	换防	其他	合计	警告	2'	取消	DR	合计	救球	射门	%
1	安徽	132:176	11	6	21	3	8	49	0:0	0:5	0:0	0:2	0:0	0:0	0:7	11	17	1	0	29	68	244	27.9
2	北京	141:125	21	4	8	1	19	53	0:0	0:1	0:0	0:4	0:0	0:0	0:5	15	22	0	0	37	85	210	40.5
3	广东	162:141	24	1	25	1	8	59	0:0	0:3	0:0	0:3	0:0	0:0	0:6	13	9	0	0	22	66	207	31.9
4	江苏	179:119	32	4	21	3	15	75	0:0	0:2	0:0	0:2	0:0	0:0	0:4	15	13	0	0	28	89	208	42.8
5	山东	148:122	17	3	25	5	13	63	0:0	0:6	0:0	0:4	0:0	0:0	0:10	15	23	0	0	38	79	201	39.3
6	上海	133:148	11	2	20	2	15	50	0:0	0:13	0:0	0:8	0:0	0:0	0:21	14	20	0	0	34	81	229	35.4
7	天津	128:167	7	3	13	4	8	35	0:0	0:4	0:0	0:7	0:0	0:0	0:11	16	16	0	0	32	55	222	24.8
8	香港	145:170	8	2	25	4	15	54	0:1	0:3	0:0	0:4	0:0	0:0	0:8	12	8	1	0	21	86	256	33.6

注释:

造失	造对方失误	造犯	造对方犯规	DR	取消资格+报告
----	-------	----	-------	----	---------

第十三届全国运动会男子手球决赛

PHMS Pictorial Handball Match Statistics

IHF Official System

球队名单

江苏队

天津

2017-08-21

号码	姓名	位置	生日	年龄	俱乐部	身高 (CM)	体重 (KG)	国际场次	国际进球
1	徐畅	守门员	22/03/1994	23		198	97		
4	张家纬	右后卫	25/09/1992	24		193	90		
5	闫亮	右后卫	23/01/1985	32		202	93		
6	赵晨	左后卫	24/06/1989	28		202	108		
7	徐奕飞	右边锋	13/03/1993	24		182	85		
8	周小坚	底线	13/01/1985	32		198	115		
9	王杰缘	右边锋	16/01/1995	22		180	75		
10	郝可鑫	中后卫	15/01/1986	31		197	105		
12	王权	守门员	21/11/1992	24		204	107		
13	叶强	守门员	16/06/1978	39		193	91		
15	李安	左边锋	20/03/1987	30		183	85		
17	王伟强	左边锋	07/01/1993	24		175	75		
18	赵楠	右边锋	07/05/1993	24		188	90		
19	张志宇	右后卫	16/06/1986	31		189	84		
20	顾艳超	中后卫	16/01/1993	24		188	84		
21	刘江	底线	23/03/1993	24		196	91		
	平均			27.3		191.8	92.2		

编码	姓名	职务
A	闫威名	主教练
C	雷纳德	教练
D	贾淑君	教练
E	王建国	医生
F	李加昌	工作人员
B	钱红	领队

第十三届全国运动会男子手球决赛

PHMS Pictorial Handball Match Statistics

IHF Official System

手球 男子 个人/全队技术累计表 截止至第24场 天津 2017-08-28

号码	姓名	远射	近射	边射	快攻	突破	任意	七米	合计	%	助攻	失误	警告	2'	取消	场次	时间
江苏队																	
(场上队员)																	
1	徐畅										2					6	01:25:42
4	张家伟	12/25	5/9		1/1	2/2	0/1		20/38	52.6%	3	7	3	1		6	03:23:57
5	闫亮		4/6		5/5				9/11	81.8%	1	1	2			6	02:03:22
6	赵晨	18/37	2/4		3/3	1/1	3/7	1/1	28/53	52.8%	9	6	4	1		6	04:15:54
7	徐奕飞		4/4	2/2	2/3				8/9	88.9%		2		2		6	01:08:25
8	周小坚	0/1	9/10		1/1	1/1			11/13	84.6%	5	8	1	1		6	04:32:03
9	王杰缘	0/2	6/9	1/1	9/11			2/2	18/25	72.0%		2	3	1		6	04:20:02
10	郝可鑫	13/22						1/1	14/23	60.9%	2	7	1	2		6	02:39:54
12	王权										3	1				6	04:09:51
13	叶强										2					6	00:24:27
15	李安	2/3	3/4	4/8	8/12	2/3		5/7	24/37	64.9%		5				6	04:13:57
17	王伟强	1/2	4/5	1/2	4/6				10/15	66.7%	1	4				6	01:53:01
18	赵楠	1/3	2/3		3/4	0/1			6/11	54.5%		3		1		6	01:24:23
19	张志宇	6/11	1/3		1/1	1/2			9/17	52.9%	2	4				6	01:39:16
20	顾艳超	4/14	3/4		2/2	6/7	0/1	1/1	16/29	55.2%	1	11	1	2		6	03:01:49
21	刘江	0/1	2/4	1/2	2/3			1/1	6/11	54.5%		4		2		6	02:03:15
	合计	57/121	45/65	9/15	41/52	13/17	3/9	11/13	179/292	61.3%	31	65	15	13		96	
(守门员)																	
1	徐畅	6/14	6/13	3/10	1/6	1/1		2/3	19/47	40.4%	2					6	01:25:42
12	王权	37/59	8/26	12/22	3/14	4/9	1/3	1/10	66/143	46.2%	3	1				6	04:09:51
13	叶强	2/6	0/5	2/2	0/4			0/1	4/18	22.2%	2					6	00:24:27
	合计	45/79	14/44	17/34	4/24	5/10	1/3	3/14	89/208	42.8%	7	1				18	

场上队员：得分/射门

守门员：救球/射门

已打比赛

全队合计	进球	被救	射失	击柱	封球	合计	%	阶段	场次	对手	比分
远射	57	32	13	2	17	121	47.1%	预赛	3	香港	35:21 (19:12)
近射	45	16		4		65	69.2%	预赛	7	安徽	35:22 (20:10)
边射	9	3	3			15	60.0%	预赛	12	广东	26:20 (12:10)
快攻	41	7	2	2		52	78.8%	四分之一决赛	16	天津	35:21 (18:8)
突破	13	4				17	76.5%	半决赛	20	北京	25:22 (15:11)
任意	3	3	1	2		9	33.3%	决赛	24	山东	23:13 (11:5)
七米	11	2				13	84.6%				

第十三届全国运动会男子手球决赛

PHMS Pictorial Handball Match Statistics

IHF Official System

图式射门区域累计

手球
男子

截止至第24场

天津
2017-08-28

江苏队

1 徐畅 Post - 0 Miss - 0 Block - 0	4 张家纬 Post - 3 Miss - 1 Block - 4	5 闫亮 Post - 1 Miss - 0 Block - 0	6 赵晨 Post - 1 Miss - 6 Block - 6	7 徐奕飞 Post - 0 Miss - 0 Block - 0	8 周小坚 Post - 1 Miss - 0 Block - 1	9 王杰缘 Post - 1 Miss - 0 Block - 0	10 郝可鑫 Post - 0 Miss - 2 Block - 2
12 王权 Post - 0 Miss - 0 Block - 0	13 叶强 Post - 0 Miss - 0 Block - 0	15 李安 Post - 0 Miss - 5 Block - 0	17 王伟强 Post - 1 Miss - 0 Block - 0	18 赵楠 Post - 0 Miss - 1 Block - 0	19 张志宇 Post - 2 Miss - 0 Block - 2	20 顾艳超 Post - 0 Miss - 3 Block - 2	21 刘江 Post - 0 Miss - 1 Block - 0

2/6	2/2	0/5
4/11	3/4	4/6
1/5	2/5	1/3

3/17	6/7	4/7
5/24	15/18	11/19
8/19	5/9	9/23

2/3	0/1	0/4
0/2	1/1	0/1
1/4		0/2

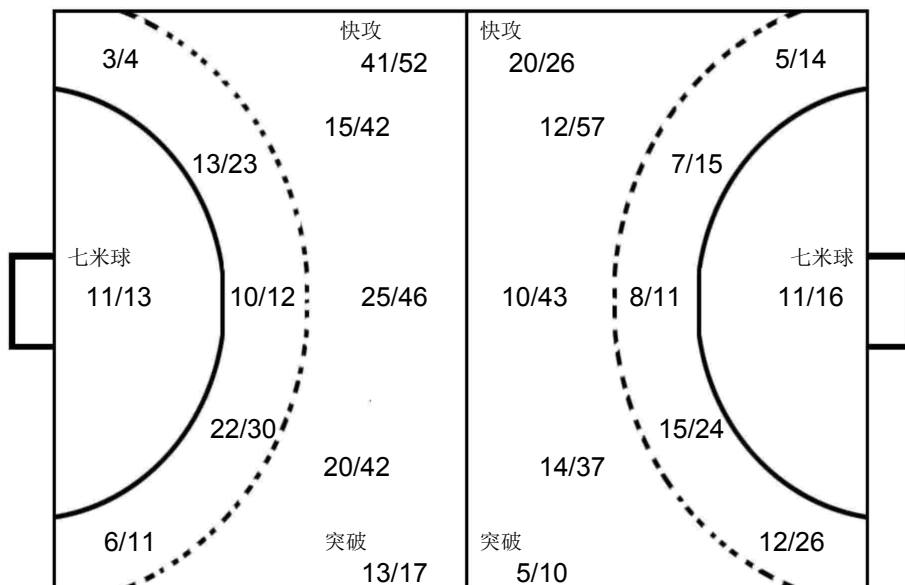

山东

16 于性哲		
0/2	3/4	
1/3	3/6	
2/6	2/3	2/8

安徽

21 李明		
0/1	1/1	1/5
2/4	1/2	1/5
1/3	2/3	2/8

香港

7 谭俊杰		
2/4	0/1	1/1
1/3	3/4	0/2
0/2	1/2	1/3

OPPONENT

7 张青 Post - 1 Miss - 1 Block - 0	9 刘振 Post - 1 Miss - 0 Block - 1	17 李中洲 Post - 0 Miss - 1 Block - 2	1 郭世伟 Post - 0 Miss - 2 Block - 0	39 张骥 Post - 2 Miss - 2 Block - 1	11 黎涛 Post - 0 Miss - 0 Block - 0	2 孙江山 Post - 0 Miss - 0 Block - 0	3 曲汝洋 Post - 0 Miss - 0 Block - 0
4 李卓洋 Post - 0 Miss - 0 Block - 3	20 杜在超 Post - 0 Miss - 0 Block - 0	31 田剑侠 Post - 1 Miss - 0 Block - 1	8 董智景 Post - 1 Miss - 1 Block - 0	10 严龙 Post - 0 Miss - 0 Block - 0	10 成亚 Post - 0 Miss - 0 Block - 0	99 蒋维一 Post - 0 Miss - 0 Block - 0	21 翟乾坤 Post - 0 Miss - 1 Block - 0



第十三届全国运动会男子手球决赛

PHMS Pictorial Handball Match Statistics

IHF Official System

球队名单

山东队

天津

2017-08-21

号码	姓名	位置	生日	年龄	俱乐部	身高 (CM)	体重 (KG)	国际场次	国际进球
3	尹杰	右边锋	06/03/1993	24		182	90		
4	田瑞	左边锋	21/03/1993	24		195	85		
5	潘翔	底线	04/10/1986	30		192	105		
6	李朝鹏	中后卫	05/12/1992	24		186	90		
8	王炳华	左后卫	10/05/1991	26		195	98		
9	赵鑫	左后卫	10/04/1987	30		183	88		
11	宋朋强	后卫	12/02/1987	30		194	92		
12	崔剑	守门员	18/11/1991	25		197	100		
13	刘晓	右后卫	30/03/1992	25		192	100		
15	张继伟	底线	02/02/1993	24		203	105		
16	于性哲	守门员	25/06/1993	24		192	88		
17	王旭东	右边锋	06/12/1989	27		189	90		
18	于亚男	左后卫	25/11/1990	26		188	97		
19	李语庆	右边锋	07/03/1990	27		180	82		
20	杜在超	右后卫	28/07/1988	29		194	100		
21	翟乾坤	左边锋	29/08/1986	30		187	96		
	平均			26.6		190.6	94.1		

编码	姓名	职务
A	王志峰	领队
B	王鸿斌	主教练
C	刘桂妮	教练
D	邢建刚	医生

第十三届全国运动会男子手球决赛

PHMS Pictorial Handball Match Statistics

IHF Official System

 手球
 男子

个人/全队技术累计表

 天津
 2017-08-28

截止至第24场

号码	姓名	远射	近射	边射	快攻	突破	任意	七米	合计	%	助攻	失误	警告	2'	取消	场次	时间
山东队																	
(场上队员)																	
3	尹杰			1/1					1/1	100%	1	2				6	00:43:04
4	田瑞				2/2				2/2	100%		4				6	00:44:07
5	潘翔		3/4	2/2	4/5	1/1	1/1	2/2	13/15	86.7%	1	6	2	2		6	03:25:25
6	李朝鹏	3/8	2/2	1/1	0/1	2/2	0/1		8/15	53.3%		5		3		6	00:54:44
8	王炳华	0/1	0/2		0/1				0/4	0.0%		3				6	00:18:35
9	赵鑫	8/25	6/9	1/2	2/6	3/3			20/45	44.4%	7	9	1	2		6	02:50:34
11	宋朋强	5/16	3/5		2/3	3/4	0/1		13/29	44.8%	11	10	2	2		6	04:06:31
12	崔剑															6	00:59:35
13	刘晓	1/6	4/6	1/3		2/2			8/17	47.1%	1	2	1	2		6	02:02:15
15	张继伟		4/4		1/1			0/1	5/6	83.3%		3	2	3		6	02:48:24
16	于性哲							0/1	0/1	0.0%		1				6	05:20:25
17	王旭东	4/10	4/7	3/8	2/2	1/1	1/1		15/29	51.7%	2	8	1	4		6	04:04:32
18	于亚男	4/11	2/5		1/1	4/4			11/21	52.4%	2	4	2	2		6	04:04:43
19	李语庆	2/2	1/3	3/6	2/3	1/1		6/8	15/23	65.2%		2	1			6	03:03:58
20	杜在超	7/13	1/3	2/3	1/4	4/5			15/28	53.6%		5	1	3		6	02:18:53
21	翟乾坤	2/3	4/5	5/11	5/5			6/7	22/31	71.0%		2	2			6	05:05:30
合计		36/95	34/55	19/37	22/34	21/23	2/4	14/19	148/267	55.4%	25	66	15	23		96	
(守门员)																	
3	尹杰															6	00:11:39
12	崔剑	5/9	5/10	2/9	0/1	2/6	0/2	2/5	16/42	38.1%						6	00:59:35
16	于性哲	19/41	17/45	12/25	4/13	3/15	4/5	4/15	63/159	39.6%		1				6	05:20:25
合计		24/50	22/55	14/34	4/14	5/21	4/7	6/20	79/201	39.3%		1				18	

场上队员：得分/射门

守门员：救球/射门

已打比赛

全队合计	进球	被救	射失	击柱	封球	合计	%	阶段	场次	对手	比分
远射	36	31	9	4	15	95	37.9%	预赛	2	北京	21:23 (9:11)
近射	34	17	1	2	1	55	61.8%	预赛	5	天津	28:13 (15:6)
边射	19	12	6			37	51.4%	预赛	9	上海	26:18 (13:9)
快攻	22	8	2	2		34	64.7%	四分之一决赛	13	安徽	32:18 (12:7)
突破	21	2				23	91.3%	半决赛	19	广东	28:27 (10:10)
任意	2	2				4	50.0%	决赛	24	江苏	13:23 (5:11)
七米	14	2		3		19	73.7%				

第十三届全国运动会男子手球决赛

PHMS Pictorial Handball Match Statistics

IHF Official System

图式射门区域累计

手球
男子

截止至第24场

天津
2017-08-28

山东队

3 尹杰 1 Post - 0 Miss - 0 Block - 0	4 田瑞 1 1 Post - 0 Miss - 0 Block - 0	5 潘翔 3 1 5 1 1 2 Post - 0 Miss - 1 Block - 0	6 李朝鹏 1 1 2 1 2 Post - 1 Miss - 0 Block - 2	8 王炳华 Post - 0 Miss - 0 Block - 1	9 赵鑫 2 1 1 4 3 4 1 1 3 Post - 2 Miss - 3 Block - 4	11 宋朋强 2 6 3 Post - 1 Miss - 4 Block - 3	12 崔剑 Post - 0 Miss - 0 Block - 0
13 刘晓 2 1 1 2 Post - 0 Miss - 1 Block - 1	15 张继伟 2 1 1 1 Post - 1 Miss - 0 Block - 0	16 于性哲 Post - 1 Miss - 0 Block - 0	17 王旭东 5 1 4 3 1 1 Post - 2 Miss - 6 Block - 2	18 于亚男 2 1 2 3 3 Post - 2 Miss - 1 Block - 2	19 李语庆 4 1 4 3 1 2 Post - 1 Miss - 1 Block - 0	20 杜在超 2 4 2 1 3 1 2 Post - 0 Miss - 0 Block - 1	21 翟乾坤 1 3 6 7 2 2 1 Post - 0 Miss - 1 Block - 0

3 尹杰

12 崔剑

16 于性哲

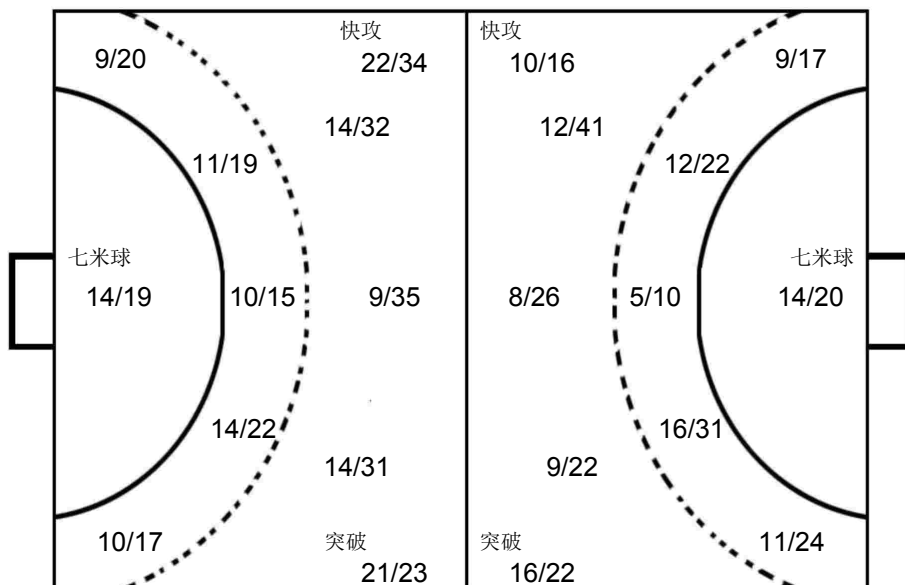

江苏
12 王权

广东
16 马跃

北京
16 刘迈科

OPPONENT

北京 39 张骥 1 3 2 2 Post - 1 Miss - 2 Block - 3	广东 3 曲汝洋 2 1 2 2 Post - 1 Miss - 4 Block - 1	安徽 8 董智景 1 1 1 1 1 Post - 1 Miss - 1 Block - 1	北京 77 朱昕晨 2 1 2 1 Post - 0 Miss - 1 Block - 1	江苏 20 顾艳超 2 1 3 Post - 0 Miss - 0 Block - 0	江苏 6 赵晨 1 1 2 Post - 0 Miss - 1 Block - 2	江苏 15 李安 4 1 Post - 0 Miss - 0 Block - 0	广东 4 李卓洋 1 2 1 Post - 0 Miss - 0 Block - 0
广东 5 侯生升 2 1 1 Post - 0 Miss - 0 Block - 0	广东 7 付云博 1 2 1 Post - 0 Miss - 0 Block - 0	上海 17 贺政 1 1 2 Post - 0 Miss - 1 Block - 0	广东 8 于彦江 1 1 1 Post - 1 Miss - 0 Block - 0	江苏 8 周小坚 1 1 Post - 0 Miss - 0 Block - 0	江苏 9 王杰缘 1 2 Post - 0 Miss - 0 Block - 0	上海 4 徐俊吉 1 1 1 Post - 0 Miss - 0 Block - 0	上海 14 沈磊磊 1 1 1 Post - 1 Miss - 0 Block - 0



第十三届全国运动会男子手球决赛

PHMS Pictorial Handball Match Statistics

IHF Official System

球队名单

北京队

天津

2017-08-21

号码	姓名	位置	生日	年龄	俱乐部	身高 (CM)	体重 (KG)	国际场次	国际进球
1	王洸	守门员	27/11/1985	31		195	100		
7	马昌震	底线	19/05/1995	22		188	95		
8	王鹏	底线	05/11/1989	27		195	96		
9	刘振	左后卫	14/02/1988	29		186	90		
10	成亚	中后卫	14/06/1990	27		190	95		
16	刘迈科	守门员	28/07/1994	23		188	100		
21	胡瀛	右后卫	21/07/1987	30		189	90		
22	王超	左边锋	12/11/1991	25		183	84		
23	王军程	左后卫	11/10/1995	21		195	88		
25	马明辉	右边锋	16/07/1994	23		190	88		
29	杜龙飞	右边锋	29/03/1990	27		192	95		
39	张骥	中后卫	05/11/1978	38		190	90		
66	解建飞	右后卫	10/09/1989	27		198	100		
77	朱昕晨	左后卫	26/08/1982	34		192	100		
83	潘天	底线	28/09/1983	33		190	100		
99	蒋维一	底线	27/06/1987	30		195	100		
	平均			27.9		191.0	94.4		

编码	姓名	职务
A	安福田	领队
B	郑永利	主教练
C	孟辉	教练
E	王长林	医生
D	张骥	教练

第十三届全国运动会男子手球决赛

PHMS Pictorial Handball Match Statistics

IHF Official System

手球 男子 个人/全队技术累计表 截止至第24场 天津 2017-08-28

号码	姓名	远射	近射	边射	快攻	突破	任意	七米	合计	%	助攻	失误	警告	2'	取消	场次	时间
北京队																	
(场上队员)																	
1	王泷															6	01:15:32
7	马昌震		1/1					1/1	100%		4	1				6	00:24:02
8	王鹏												1	1		6	01:00:16
9	刘振	8/19	4/8	1/1		2/2		3/5	18/35	51.4%	4	5	1			6	03:39:46
10	成亚	4/11	6/11	2/5	2/4	4/4			18/35	51.4%	8	11	1	1		6	04:19:59
16	刘迈科															6	04:44:28
21	胡瀛	3/3	3/10	6/8	2/3				14/24	58.3%		4	3	2		6	04:37:26
22	王超		1/2	5/6	1/1				7/9	77.8%	1	2		1		6	01:44:49
23	王军程	4/12	1/1		1/1		1/3		7/17	41.2%		3		1		6	01:09:22
25	马明辉		1/1						1/1	100%		1				6	00:27:40
29	杜龙飞			2/2	1/1				3/3	100%	1	4		1		6	00:55:56
39	张骥	8/28	11/13	0/2	1/2	2/3	1/1	16/17	39/66	59.1%	5	11	1	1		6	03:51:03
66	解建飞	1/3	2/5	6/14			0/1	1/1	10/24	41.7%		1	5	5		6	04:00:01
77	朱昕晨	4/15	3/6	0/1	1/1	3/6	2/2		13/31	41.9%	4	13		2		6	01:24:28
83	潘天												2	2		6	02:21:16
99	蒋维一	0/1	8/12	1/1	1/2				10/16	62.5%		6	1	4		6	04:23:29
合计		32/92	41/70	23/40	10/15	11/15	4/7	20/23	141/262	53.8%	23	65	15	22		96	
(守门员)																	
1	王泷	4/11	6/15	5/12	0/6	0/1	0/1	4/14	19/60	31.7%						6	01:15:32
16	刘迈科	24/46	17/37	18/31	2/15	2/11	1/1	2/9	66/150	44.0%						6	04:44:28
合计		28/57	23/52	23/43	2/21	2/12	1/2	6/23	85/210	40.5%						12	

场上队员：得分/射门

守门员：救球/射门

已打比赛

全队合计	进球	被救	射失	击柱	封球	合计	%	阶段	场次	对手	比分
远射	32	24	11	7	18	92	34.8%	预赛	2	山东	23:21 (11:9)
近射	41	20	4	5		70	58.6%	预赛	6	上海	20:21 (9:9)
边射	23	13	3	1		40	57.5%	预赛	10	天津	25:16 (13:3)
快攻	10	3	1	1		15	66.7%	四分之一决赛	15	香港	28:25 (16:12)
突破	11	3	1			15	73.3%	半决赛	20	江苏	22:25 (11:15)
任意	4	2	1			7	57.1%	3-4名	23	广东	23:17 (13:8)
七米	20	2		1		23	87.0%				

第十三届全国运动会男子手球决赛

PHMS Pictorial Handball Match Statistics

IHF Official System

图式射门区域累计

手球
男子

截止至第24场

天津
2017-08-28

北京队

1 王澍	7 马昌震	8 王鹏	9 刘振	10 成亚	16 刘迈科	21 胡瀛	22 王超																																																																								
<table border="1"><tr><td></td><td></td><td></td></tr><tr><td></td><td></td><td></td></tr><tr><td></td><td></td><td></td></tr></table>										<table border="1"><tr><td></td><td></td><td></td></tr><tr><td></td><td></td><td></td></tr><tr><td>1</td><td></td><td></td></tr></table>							1			<table border="1"><tr><td></td><td></td><td></td></tr><tr><td></td><td></td><td></td></tr><tr><td></td><td></td><td></td></tr></table>										<table border="1"><tr><td>4</td><td></td><td>3</td></tr><tr><td>2</td><td></td><td>1</td></tr><tr><td>4</td><td>2</td><td>2</td></tr></table>	4		3	2		1	4	2	2	<table border="1"><tr><td>1</td><td></td><td>2</td></tr><tr><td>4</td><td>2</td><td>2</td></tr><tr><td>1</td><td>1</td><td>5</td></tr></table>	1		2	4	2	2	1	1	5	<table border="1"><tr><td></td><td></td><td></td></tr><tr><td></td><td></td><td></td></tr><tr><td></td><td></td><td></td></tr></table>										<table border="1"><tr><td>2</td><td></td><td>3</td></tr><tr><td>3</td><td></td><td></td></tr><tr><td>3</td><td>2</td><td>1</td></tr></table>	2		3	3			3	2	1	<table border="1"><tr><td></td><td></td><td>1</td></tr><tr><td>2</td><td></td><td></td></tr><tr><td>1</td><td>1</td><td>2</td></tr></table>			1	2			1	1	2
1																																																																															
4		3																																																																													
2		1																																																																													
4	2	2																																																																													
1		2																																																																													
4	2	2																																																																													
1	1	5																																																																													
2		3																																																																													
3																																																																															
3	2	1																																																																													
		1																																																																													
2																																																																															
1	1	2																																																																													
Post - 0 Miss - 0 Block - 0	Post - 0 Miss - 0 Block - 0	Post - 0 Miss - 0 Block - 0	Post - 2 Miss - 1 Block - 3	Post - 2 Miss - 5 Block - 2	Post - 0 Miss - 0 Block - 0	Post - 1 Miss - 2 Block - 0	Post - 0 Miss - 0 Block - 0																																																																								
23 王军程	25 马明辉	29 杜龙飞	39 张骥	66 解建飞	77 朱昕晨	83 潘天	99 蒋维一																																																																								
<table border="1"><tr><td></td><td></td><td>1</td></tr><tr><td>2</td><td></td><td>1</td></tr><tr><td>2</td><td></td><td>1</td></tr></table>			1	2		1	2		1	<table border="1"><tr><td></td><td></td><td></td></tr><tr><td>1</td><td></td><td></td></tr><tr><td></td><td></td><td></td></tr></table>				1						<table border="1"><tr><td></td><td></td><td></td></tr><tr><td></td><td></td><td>1</td></tr><tr><td>1</td><td>1</td><td></td></tr></table>						1	1	1		<table border="1"><tr><td>5</td><td>2</td><td>4</td></tr><tr><td>5</td><td></td><td>10</td></tr><tr><td>4</td><td></td><td>9</td></tr></table>	5	2	4	5		10	4		9	<table border="1"><tr><td></td><td></td><td>1</td></tr><tr><td>3</td><td></td><td>3</td></tr><tr><td>1</td><td></td><td>2</td></tr></table>			1	3		3	1		2	<table border="1"><tr><td>1</td><td></td><td></td></tr><tr><td>3</td><td></td><td>2</td></tr><tr><td>3</td><td>1</td><td>3</td></tr></table>	1			3		2	3	1	3	<table border="1"><tr><td></td><td></td><td></td></tr><tr><td></td><td></td><td></td></tr><tr><td></td><td></td><td></td></tr></table>										<table border="1"><tr><td>1</td><td>1</td><td></td></tr><tr><td>1</td><td></td><td></td></tr><tr><td>6</td><td></td><td>1</td></tr></table>	1	1		1			6		1
		1																																																																													
2		1																																																																													
2		1																																																																													
1																																																																															
		1																																																																													
1	1																																																																														
5	2	4																																																																													
5		10																																																																													
4		9																																																																													
		1																																																																													
3		3																																																																													
1		2																																																																													
1																																																																															
3		2																																																																													
3	1	3																																																																													
1	1																																																																														
1																																																																															
6		1																																																																													
Post - 3 Miss - 3 Block - 1	Post - 0 Miss - 0 Block - 0	Post - 0 Miss - 0 Block - 0	Post - 4 Miss - 5 Block - 6	Post - 1 Miss - 2 Block - 0	Post - 1 Miss - 1 Block - 6	Post - 0 Miss - 0 Block - 0	Post - 1 Miss - 2 Block - 0																																																																								

1 王澍

1/8	0/2	1/5
3/11	5/6	5/13
2/8	1/2	1/5

16 刘迈科

5/16	3/6	1/5
12/31	10/12	12/25
8/18	6/14	9/23

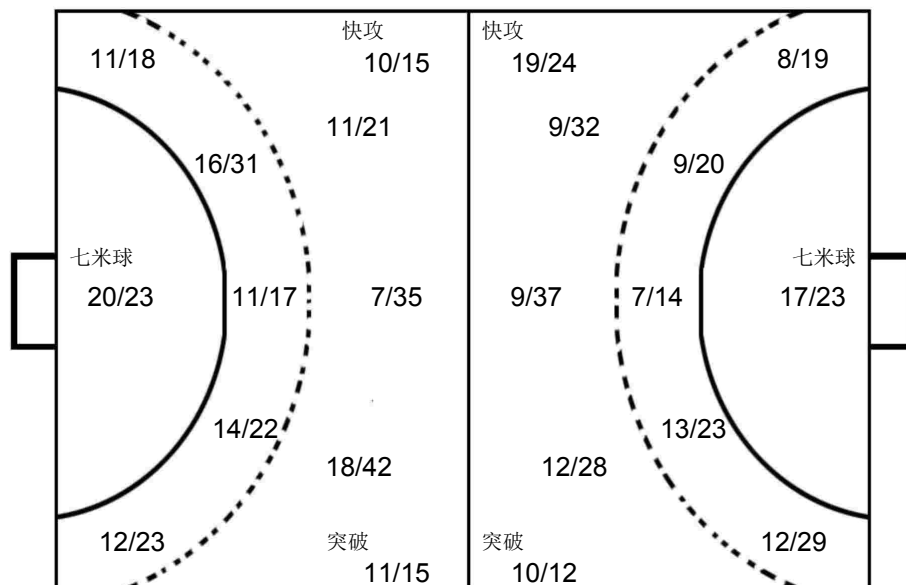

香港

1 叶冠英

2/4	1/2	0/3
2/4	1/1	1/3
2/6	0/2	2/3

山东

16 于性哲

0/2	2/2	
2/6	1/1	3/8
0/6	2/2	1/6

江苏

12 王权

0/4	1/2	1/4
2/4	4/6	2/5
0/3	1/2	0/3

OPPONENT

江苏 6 赵晨	广东 8 于彦江	山东 21 翟乾坤	上海 8 钱为玮	江苏 15 李安	山东 9 赵鑫	山东 19 李语庆	上海 3 赵时俊																																																																								
<table border="1"><tr><td></td><td></td><td>2</td></tr><tr><td>1</td><td></td><td>1</td></tr><tr><td>1</td><td></td><td>3</td></tr></table>			2	1		1	1		3	<table border="1"><tr><td></td><td></td><td></td></tr><tr><td>2</td><td></td><td>1</td></tr><tr><td></td><td>2</td><td></td></tr></table>				2		1		2		<table border="1"><tr><td></td><td></td><td>2</td></tr><tr><td>1</td><td></td><td>1</td></tr><tr><td></td><td></td><td>1</td></tr></table>			2	1		1			1	<table border="1"><tr><td></td><td></td><td></td></tr><tr><td>1</td><td>1</td><td>2</td></tr><tr><td></td><td>1</td><td></td></tr></table>				1	1	2		1		<table border="1"><tr><td></td><td></td><td></td></tr><tr><td>2</td><td>1</td><td></td></tr><tr><td></td><td></td><td>1</td></tr></table>				2	1				1	<table border="1"><tr><td></td><td>1</td><td></td></tr><tr><td></td><td></td><td>3</td></tr><tr><td></td><td></td><td></td></tr></table>		1				3				<table border="1"><tr><td>2</td><td></td><td></td></tr><tr><td>1</td><td></td><td></td></tr><tr><td></td><td></td><td>1</td></tr></table>	2			1					1	<table border="1"><tr><td>1</td><td></td><td></td></tr><tr><td>1</td><td></td><td></td></tr><tr><td>1</td><td></td><td>1</td></tr></table>	1			1			1		1
		2																																																																													
1		1																																																																													
1		3																																																																													
2		1																																																																													
	2																																																																														
		2																																																																													
1		1																																																																													
		1																																																																													
1	1	2																																																																													
	1																																																																														
2	1																																																																														
		1																																																																													
	1																																																																														
		3																																																																													
2																																																																															
1																																																																															
		1																																																																													
1																																																																															
1																																																																															
1		1																																																																													
Post - 0 Miss - 1 Block - 0	Post - 0 Miss - 1 Block - 0	Post - 0 Miss - 0 Block - 0	Post - 0 Miss - 0 Block - 1	Post - 0 Miss - 3 Block - 0	Post - 1 Miss - 0 Block - 0	Post - 0 Miss - 0 Block - 0	Post - 0 Miss - 0 Block - 0																																																																								
上海 4 徐俊吉	上海 17 贺政	香港 2 刘健斌	香港 5 黄胜业	香港 40 叶冠雄	广东 3 曲汝洋	江苏 5 闫亮	江苏 9 王杰缘																																																																								
<table border="1"><tr><td>2</td><td>1</td><td></td></tr><tr><td>1</td><td></td><td></td></tr><tr><td></td><td></td><td></td></tr></table>	2	1		1						<table border="1"><tr><td>2</td><td></td><td></td></tr><tr><td>2</td><td></td><td></td></tr><tr><td></td><td></td><td></td></tr></table>	2			2						<table border="1"><tr><td></td><td>1</td><td></td></tr><tr><td>1</td><td></td><td>1</td></tr><tr><td>1</td><td></td><td></td></tr></table>		1		1		1	1			<table border="1"><tr><td>2</td><td></td><td></td></tr><tr><td>2</td><td></td><td></td></tr><tr><td></td><td></td><td></td></tr></table>	2			2						<table border="1"><tr><td></td><td></td><td></td></tr><tr><td>2</td><td></td><td></td></tr><tr><td></td><td>1</td><td>1</td></tr></table>				2				1	1	<table border="1"><tr><td></td><td></td><td></td></tr><tr><td>1</td><td></td><td></td></tr><tr><td></td><td>1</td><td>1</td></tr></table>				1				1	1	<table border="1"><tr><td></td><td>1</td><td></td></tr><tr><td>1</td><td>1</td><td></td></tr><tr><td></td><td></td><td></td></tr></table>		1		1	1					<table border="1"><tr><td>1</td><td></td><td></td></tr><tr><td></td><td></td><td></td></tr><tr><td>1</td><td>1</td><td></td></tr></table>	1						1	1	
2	1																																																																														
1																																																																															
2																																																																															
2																																																																															
	1																																																																														
1		1																																																																													
1																																																																															
2																																																																															
2																																																																															
2																																																																															
	1	1																																																																													
1																																																																															
	1	1																																																																													
	1																																																																														
1	1																																																																														
1																																																																															
1	1																																																																														
Post - 1 Miss - 0 Block - 0	Post - 0 Miss - 0 Block - 0	Post - 0 Miss - 0 Block - 0	Post - 0 Miss - 1 Block - 0	Post - 1 Miss - 0 Block - 0	Post - 1 Miss - 0 Block - 0	Post - 0 Miss - 0 Block - 0	Post - 1 Miss - 0 Block - 0																																																																								



第十三届全国运动会男子手球决赛

PHMS Pictorial Handball Match Statistics

IHF Official System

球队名单

广东队

天津

2017-08-21

号码	姓名	位置	生日	年龄	俱乐部	身高 (CM)	体重 (KG)	国际场次	国际进球
1	王帅	守门员	30/09/1997	19		196	96		
2	孙江山	右边锋	23/01/1991	26		200	100		
3	曲汝洋	左边锋	07/01/1989	28		186	82		
4	李卓洋	左后卫	05/02/1990	27		195	96		
5	侯生升	左边锋	25/10/1989	27		187	93		
6	邓志贵	左边锋	25/05/1990	27		196	96		
7	付云博	中后卫	14/12/1990	26		190	93		
8	于彦江	右后卫	09/06/1990	27		197	97		
9	徐庆	底线	25/01/1991	26		197	98		
11	房友屯	左边锋	03/01/1995	22		181	90		
12	王雨	底线	21/06/1995	22		193	91		
15	张建杰	左后卫	29/10/1997	19		196	96		
16	马跃	守门员	04/12/1993	23		197	98		
17	李中洲	左后卫	10/03/1989	28		193	98		
26	姚雪岩	底线	19/11/1996	20		203	100		
84	王伟	底线	18/11/1985	31		200	100		
	平均			24.9		194.2	95.3		

编码	姓名	职务
B	王锋	主教练
C	刘康伶	教练
D	张广建	教练
E	王永存	医生
A	李晓忠	领队

第十三届全国运动会男子手球决赛

PHMS Pictorial Handball Match Statistics

IHF Official System

 手球 男子 个人/全队技术累计表
 截止至第24场 天津 2017-08-28

号码	姓名	远射	近射	边射	快攻	突破	任意	七米	合计	%	助攻	失误	警告	2'	取消	场次	时间
广东队																	
(场上队员)																	
1	王帅															6	01:13:21
2	孙江山		2/2	10/18				5/6	17/26	65.4%		2		1		6	02:42:55
3	曲汝洋	7/15	10/17	1/2	5/7	2/2			25/43	58.1%	3	11	1	1		6	04:12:09
4	李卓洋	10/20	4/8	1/3		2/4	1/1		18/36	50.0%	2	9				6	04:30:16
5	侯生升		2/5	3/5	4/4	1/1			10/15	66.7%		2	1			6	03:24:04
6	邓志贵		2/4	3/5	1/1				6/10	60.0%		1				6	03:04:07
7	付云博	2/5	2/4		0/1	0/1		5/6	9/17	52.9%	3	8				6	02:42:18
8	于彦江	3/7	4/4	7/18	4/4	2/3			20/36	55.6%	2	8	4	1		6	04:37:45
9	徐庆		3/3		2/2				5/5	100%		2				6	01:34:18
11	房友屯															6	00:00:00
12	王雨			1/1					1/1	100%						6	00:06:50
15	张建杰	8/12	1/1		1/2				10/15	66.7%		4				6	01:01:25
16	马跃										3	1				6	05:06:39
17	李中洲	8/18	4/9		4/5	6/7		5/6	27/45	60.0%	4	11	4	4		6	05:18:56
26	姚雪岩					1/1			1/1	100%	2	1		1		6	00:19:31
84	王伟	0/3	10/13	0/1	3/3				13/20	65.0%	1	9	3	1		6	04:46:00
	合计	38/80	44/70	26/53	24/29	14/19	1/1	15/18	162/270	60.0%	20	69	13	9		96	
(守门员)																	
1	王帅	5/16	5/15	1/6	1/5	1/2		1/4	14/48	29.2%						6	01:13:21
16	马跃	29/67	11/31	10/19	1/17	0/8	0/5	1/12	52/159	32.7%	3	1				6	05:06:39
	合计	34/83	16/46	11/25	2/22	1/10	0/5	2/16	66/207	31.9%	3	1				12	

场上队员：得分/射门

守门员：救球/射门

已打比赛

全队合计	进球	被救	射失	击柱	封球	合计	%	阶段	场次	对手	比分
远射	38	20	4	5	13	80	47.5%	预赛	4	安徽	32:26 (14:14)
近射	44	16	7	3		70	62.9%	预赛	8	香港	36:24 (17:8)
边射	26	23	2	2		53	49.1%	预赛	12	江苏	20:26 (10:12)
快攻	24	5				29	82.8%	四分之一决赛	14	上海	30:14 (13:5)
突破	14	4		1		19	73.7%	半决赛	19	山东	27:28 (10:10)
任意	1					1	100.0%	3-4名	23	北京	17:23 (8:13)
七米	15	3				18	83.3%				

第十三届全国运动会男子手球决赛

PHMS Pictorial Handball Match Statistics

IHF Official System

图式射门区域累计

手球
男子

截止至第24场

天津
2017-08-28

广东队

1 王帅 Post - 0 Miss - 0 Block - 0	2 孙江山 Post - 1 Miss - 0 Block - 0	3 曲汝洋 Post - 2 Miss - 5 Block - 1	4 李卓洋 Post - 1 Miss - 2 Block - 4	5 侯生升 Post - 0 Miss - 0 Block - 0	6 邓志贵 Post - 0 Miss - 0 Block - 0	7 付文博 Post - 0 Miss - 1 Block - 2	8 于彦江 Post - 2 Miss - 3 Block - 0
9 徐庆 Post - 0 Miss - 0 Block - 0	11 房友屯 Post - 0 Miss - 0 Block - 0	12 王雨 Post - 0 Miss - 0 Block - 0	15 张建杰 Post - 0 Miss - 0 Block - 2	16 马跃 Post - 0 Miss - 0 Block - 0	17 李中洲 Post - 4 Miss - 1 Block - 2	26 姚雪岩 Post - 0 Miss - 0 Block - 0	84 王伟 Post - 1 Miss - 1 Block - 2

1 王帅
0/3
1/7
1/5

16 马跃
1/9
5/19
7/28

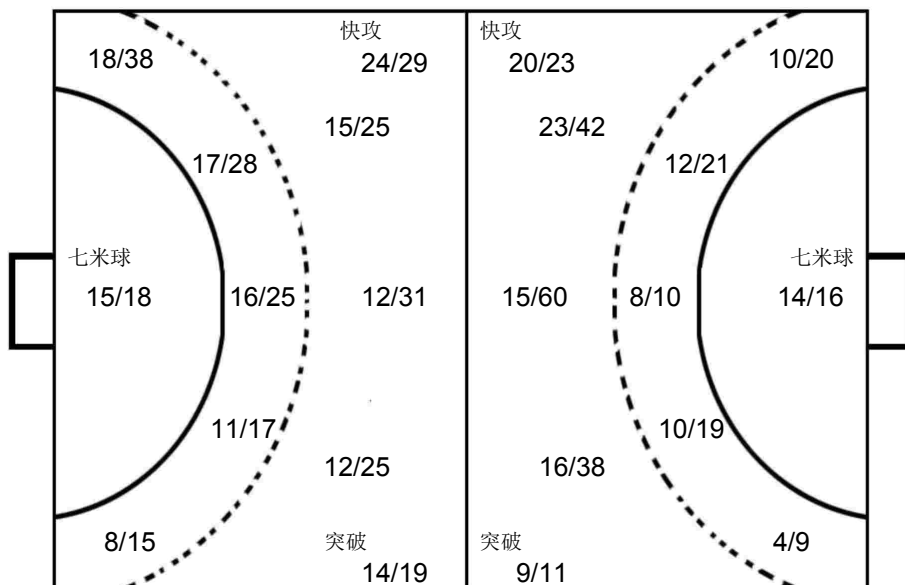

北京
16 刘迈科
1/1
2/6
3/4

山东
16 于性哲
0/3
2/11
0/2

江苏
12 王权
0/2
0/7
1/3

OPPONENT

北京 39 张骥 Post - 1 Miss - 0 Block - 1	山东 9 赵鑫 Post - 0 Miss - 2 Block - 2	安徽 17 王巨柱 Post - 0 Miss - 1 Block - 0	江苏 6 赵晨 Post - 0 Miss - 2 Block - 4	安徽 8 董智景 Post - 1 Miss - 0 Block - 0	香港 12 许文邦 Post - 0 Miss - 1 Block - 3	香港 23 郭斯鸣 Post - 1 Miss - 2 Block - 0	安徽 11 黎涛 Post - 0 Miss - 1 Block - 0
北京 9 刘振 Post - 0 Miss - 1 Block - 0	江苏 4 张家纬 Post - 1 Miss - 1 Block - 0	山东 21 翟乾坤 Post - 0 Miss - 0 Block - 0	上海 14 沈吉磊 Post - 2 Miss - 0 Block - 3	江苏 8 周小坚 Post - 0 Miss - 0 Block - 1	江苏 10 郝可鑫 Post - 0 Miss - 1 Block - 0	山东 5 潘翔 Post - 0 Miss - 0 Block - 0	山东 20 杜在超 Post - 0 Miss - 0 Block - 1



第十三届全国运动会男子手球决赛

PHMS Pictorial Handball Match Statistics

IHF Official System

球队名单

上海队

天津

2017-08-21

号码	姓名	位置	生日	年龄	俱乐部	身高 (CM)	体重 (KG)	国际场次	国际进球
1	张峥	守门员	01/04/1988	29		190	90		
2	张文斌	中后卫	14/01/1995	22		185	85		
3	赵时俊	右后卫	07/10/1991	25		182	85		
4	徐俊吉	底线	23/05/1989	28		195	108		
6	朱世杰	右后卫	20/05/1995	22		188	85		
7	周文龙	左边锋	12/01/1995	22		189	88		
8	钱为玮	左边锋	17/11/1988	28		197	95		
9	董凯	底线	08/01/1996	21		188	102		
10	吴璟	底线	11/10/1983	33		192	110		
11	蒋承骅	右边锋	20/01/1991	26		194	118		
12	周哲韬	守门员	13/03/1995	22		188	88		
14	沈吉磊	左后卫	25/04/1995	22		190	85		
16	朱春雷	守门员	19/04/1984	33		193	90		
17	贺政	左边锋	20/08/1996	21		187	80		
18	马麟晓	中后卫	03/09/1989	27		190	88		
19	祝君	右边锋	09/03/1989	28		188	90		
	平均			25.6		189.8	92.9		

编码	姓名	职务
A	郑益方	领队
B	张勇军	主教练
C	金迪琦	教练
D	杨时	医生

第十三届全国运动会男子手球决赛

PHMS Pictorial Handball Match Statistics

IHF Official System

手球 男子 个人/全队技术累计表 截止至第24场 天津 2017-08-28

号码	姓名	远射	近射	边射	快攻	突破	任意	七米	合计	%	助攻	失误	警告	2'	取消	场次	时间
上海队																	
(场上队员)																	
1	张崢										1					6	02:43:35
2	张文斌															1	00:00:00
3	赵时俊	2/6	3/3	2/10	1/1	1/1	0/1	1/4	10/26	38.5%	6	7	1	2		6	03:42:06
4	徐俊吉		14/17	1/1	1/2	1/1		7/11	24/32	75.0%		4	3			6	04:39:55
6	朱世杰	4/13	2/10		1/3	4/7			11/33	33.3%	2	14	3	6		6	04:48:05
7	周文龙							0/1	0/1	0.0%						6	00:17:38
8	钱为玮	5/14	6/10	7/19	7/8	1/1	1/4		27/56	48.2%	5	9	1	3		6	05:14:14
9	董凯		0/2					1/1	1/3	33.3%						6	00:04:54
10	吴璟		4/8	0/1				1/2	5/11	45.5%		1	1	1		6	01:51:45
11	蒋承骅	2/5	0/1	1/1					3/7	42.9%	1	6	1	1		6	02:56:26
12	周哲韬	1/1							1/1	100%	2					6	03:16:25
14	沈吉磊	11/21	3/4	1/1			1/2		16/28	57.1%		8				6	01:21:00
16	朱春雷															6	00:00:00
17	贺政		0/1	13/21	2/3			4/4	19/29	65.5%	1	5		2		6	04:50:19
18	马麟晓	10/30	3/6			1/1	2/3		16/40	40.0%	3	16	3	4		6	04:16:42
19	祝君	0/3							0/3	0.0%	1	2	1	1		6	00:44:19
合计		35/93	35/62	25/54	12/17	8/11	4/10	14/23	133/270	49.3%	22	72	14	20		91	
(守门员)																	
1	张崢	8/19	13/33	4/13	6/14	0/10	0/1	3/9	34/99	34.3%	1					6	02:43:35
12	周哲韬	7/15	17/44	9/28	3/18	7/19	2/2	2/4	47/130	36.2%	2					6	03:16:25
合计		15/34	30/77	13/41	9/32	7/29	2/3	5/13	81/229	35.4%	3					12	

场上队员：得分/射门

守门员：救球/射门

已打比赛

全队合计	进球	被救	射失	击柱	封球	合计	%	阶段	场次	对手	比分
远射	35	24	12	4	18	93	37.6%	预赛	1	天津	26:25 (10:9)
近射	35	20	6	1		62	56.5%	预赛	6	北京	21:20 (9:9)
边射	25	25	3	1		54	46.3%	预赛	9	山东	18:26 (9:13)
快攻	12	2	1	2		17	70.6%	四分之一决赛	14	广东	14:30 (5:13)
突破	8	3				11	72.7%	5-8名	17	安徽	25:21 (12:10)
任意	4	3	3			10	40.0%	5-6名	22	香港	29:26 (15:12)
七米	14	7	1	1		23	60.9%				

第十三届全国运动会男子手球决赛

PHMS Pictorial Handball Match Statistics

IHF Official System

图式射门区域累计

手球
男子

截止至第24场

天津
2017-08-28

上海队

1 张峥 Post - 0 Miss - 0 Block - 0	2 张文斌 Post - 0 Miss - 0 Block - 0	3 赵时俊 Post - 1 Miss - 5 Block - 1	4 徐俊吉 Post - 3 Miss - 1 Block - 0	6 朱世杰 Post - 1 Miss - 4 Block - 5	7 周文龙 Post - 0 Miss - 0 Block - 0	8 钱为玮 Post - 0 Miss - 3 Block - 2	9 董凯 Post - 0 Miss - 0 Block - 0
10 吴璟 Post - 0 Miss - 1 Block - 0	11 蒋承骅 Post - 0 Miss - 2 Block - 0	12 周哲韬 Post - 0 Miss - 0 Block - 0	14 沈吉磊 Post - 3 Miss - 2 Block - 4	16 朱春雷 Post - 0 Miss - 0 Block - 0	17 贺政 Post - 0 Miss - 2 Block - 0	18 马麟晓 Post - 1 Miss - 5 Block - 5	19 祝君 Post - 0 Miss - 1 Block - 1

1 张峥
1/10 6/6 0/9
2/15 9/10 10/24
2/10 3/6 1/9

12 周哲韬
2/10 1/2 3/10
11/33 6/13 8/18
7/23 7/12 2/9

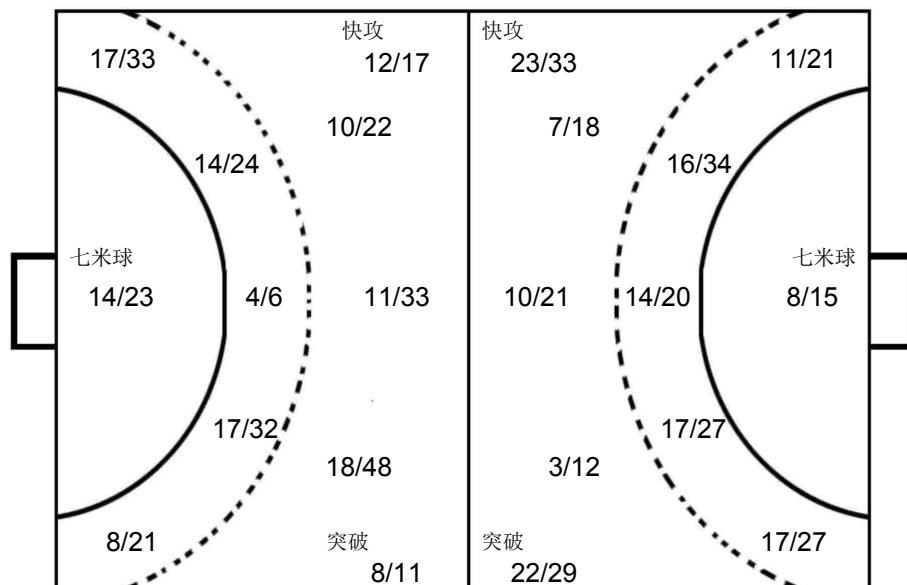

北京
16 刘迈科
1/6 1/1 0/1
1/7 5/6 1/3
2/4 2/3 2/3

山东
16 于性哲
1/3 0/1 1/2
3/3 1/3 2/3
2/3 2/5 1/3

安徽
21 李明
1/3 1/4 1/6
2/6 3/3 2/6
1/4 1/3 1/2

OPPONENT

7 张青 Post - 1 Miss - 0 Block - 0	8 董智景 Post - 1 Miss - 0 Block - 0	9 陈开勇 Post - 0 Miss - 0 Block - 1	15 张建杰 Post - 0 Miss - 0 Block - 1	10 谢永辉 Post - 1 Miss - 1 Block - 0	17 王旭东 Post - 0 Miss - 1 Block - 0	20 杜在超 Post - 0 Miss - 0 Block - 0	3 曲汝洋 Post - 0 Miss - 0 Block - 0
8 于彦江 Post - 0 Miss - 0 Block - 0	17 李中洲 Post - 1 Miss - 0 Block - 0	21 翟乾坤 Post - 0 Miss - 0 Block - 0	6 王子欣 Post - 1 Miss - 0 Block - 0	13 许松 Post - 1 Miss - 0 Block - 0	12 许文邦 Post - 0 Miss - 1 Block - 0	33 袁晔彦 Post - 0 Miss - 1 Block - 0	18 李双 Post - 0 Miss - 0 Block - 0



第十三届全国运动会男子手球决赛

PHMS Pictorial Handball Match Statistics

IHF Official System

球队名单

香港队

天津

2017-08-21

号码	姓名	位置	生日	年龄	俱乐部	身高 (CM)	体重 (KG)	国际场次	国际进球
1	叶冠英	守门员	06/04/1992	25		183	74		
2	刘健斌	后卫	10/10/1994	22		175	70		
3	陈梓朗	左边锋	11/03/1998	19		180	70		
5	黄胜业	右边锋	14/06/1991	26		175	70		
7	谭俊杰	守门员	13/12/1990	26		190	77		
8	李伟东	底线	17/09/1992	24		183	76		
10	谢永辉	中后卫	15/10/1994	22		173	70		
12	许文邦	中后卫	27/03/1986	31		175	73		
13	张伟浩	左后卫	17/05/1994	23		184	73		
18	李鑫豪	底线	23/04/1987	30		185	81		
23	郭斯鸣	左后卫	02/02/1994	23		183	80		
27	冼大维	底线	27/07/1995	22		178	80		
29	练明辉	右后卫	24/04/1984	33		181	75		
31	叶仕仁	左后卫	15/06/1986	31		175	70		
33	袁晞彦	左后卫	15/08/1993	24		183	83		
40	叶冠雄	左后卫	06/04/1992	25		183	74		
	平均			25.4		180.4	74.8		

编码	姓名	职务
A	杨开将	领队
B	王涛	教练
C	高梓欣	教练

第十三届全国运动会男子手球决赛

PHMS Pictorial Handball Match Statistics

IHF Official System

 手球 男子 个人/全队技术累计表
 截止至第24场 天津 2017-08-28

号码	姓名	远射	近射	边射	快攻	突破	任意	七米	合计	%	助攻	失误	警告	2'	取消	场次	时间
香港队																	
(场上队员)																	
1	叶冠英				1/1				1/1	100%	3	7				6	03:30:32
2	刘健斌		2/4	5/11	3/3	1/1			11/19	57.9%	1	5	1	1		6	02:16:34
3	陈梓朗		1/4	6/11	5/6				12/21	57.1%		7	1			6	02:39:54
5	黄胜业		3/6	4/11	6/8				13/25	52.0%		7				6	03:35:38
7	谭俊杰										4	2				6	02:29:28
8	李伟东				1/1				1/1	100%			1			6	02:15:12
10	谢永辉	2/5	4/5	4/9	4/5				14/24	58.3%	2	8		1		6	03:14:14
12	许文邦	7/32	1/3	1/2	1/1		1/1	10/13	21/52	40.4%	5	14				6	02:00:04
13	张伟浩			0/2					0/2	0.0%		1	1	1		6	00:56:09
18	李鑫豪		4/5	1/1	1/1				6/7	85.7%		4	1	1		6	02:15:06
23	郭斯鸣	3/11	2/3	0/2	5/6	2/3		1/1	13/26	50.0%	1	9	4		1	5	03:09:50
27	冼大维		1/2		0/1				1/3	33.3%		1				6	01:13:25
29	练明辉	3/11	4/7	3/7	1/1	1/1	1/1	1/1	14/29	48.3%	3	14	1	3		6	03:45:55
31	叶仕仁	1/12	7/13	1/1	3/3	1/2			13/31	41.9%	7	14				6	03:27:33
33	袁晞彦		8/14	0/2	2/2				10/18	55.6%		2	1	1		6	03:00:22
40	叶冠雄	2/10	8/12		1/2	4/6			15/30	50.0%	5	10	1			6	03:48:34
合计		18/81	45/78	25/59	34/41	9/13	2/2	12/15	145/289	50.2%	31	105	12	8	1	95	
(守门员)																	
1	叶冠英	20/40	16/46	11/25	5/22	0/7	1/2	1/10	54/152	35.5%	3	7				6	03:30:32
7	谭俊杰	13/30	4/19	12/25	1/14	0/7	1/1	1/8	32/104	30.8%	4	2				6	02:29:28
合计		33/70	20/65	23/50	6/36	0/14	2/3	2/18	86/256	33.6%	7	9				12	

场上队员：得分/射门

守门员：救球/射门

已打比赛

全队合计	进球	被救	射失	击柱	封球	合计	%	阶段	场次	对手	比分
远射	18	28	9	6	20	81	22.2%	预赛	3	江苏	21:35 (12:19)
近射	45	24	7	2		78	57.7%	预赛	8	广东	24:36 (8:17)
边射	25	20	8	6		59	42.4%	预赛	11	安徽	22:19 (11:9)
快攻	34	6		1		41	82.9%	四分之一决赛	15	北京	25:28 (12:16)
突破	9	3	1			13	69.2%	5-8名	18	天津	27:23 (14:12)
任意	2					2	100.0%	5-6名	22	上海	26:29 (12:15)
七米	12	2		1		15	80.0%				

第十三届全国运动会男子手球决赛

PHMS Pictorial Handball Match Statistics

IHF Official System

图式射门区域累计

手球
男子

截止至第24场

天津
2017-08-28

香港队

1 叶冠英 Post - 0 Miss - 0 Block - 0	2 刘健斌 Post - 1 Miss - 4 Block - 0	3 陈祥朗 Post - 1 Miss - 1 Block - 0	5 黄胜业 Post - 0 Miss - 3 Block - 0	7 谭俊杰 Post - 0 Miss - 0 Block - 0	8 李伟东 Post - 0 Miss - 0 Block - 0	10 谢永辉 Post - 2 Miss - 1 Block - 2	12 许文邦 Post - 5 Miss - 5 Block - 10
13 张伟浩 Post - 0 Miss - 0 Block - 0	18 李鑫豪 Post - 0 Miss - 0 Block - 0	23 郭斯鸣 Post - 1 Miss - 2 Block - 0	27 冼大维 Post - 0 Miss - 0 Block - 0	29 练明辉 Post - 1 Miss - 1 Block - 4	31 叶仕仁 Post - 1 Miss - 3 Block - 2	33 袁添彦 Post - 2 Miss - 3 Block - 0	40 叶冠雄 Post - 2 Miss - 2 Block - 2

1 叶冠英
4/15 6/9 3/11
8/22 9/9 11/29
6/29 2/7 5/21

7 谭俊杰
4/11 2/7 4/12
10/22 6/8 1/14
1/13 1/5 3/12

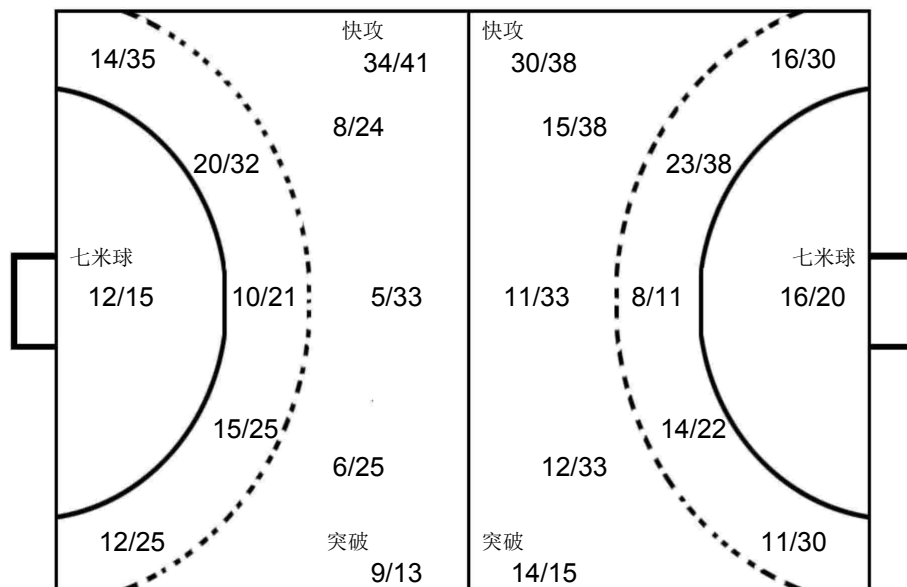

江苏

12 王权
1/3 2/2 1/1
0/3 5/5 2/4
2/4 1/5

上海

12 周哲韬
0/1 1/1 1/2
2/9 2/4 1/2
2/5 1/2 1/1

安徽

21 李明
0/2 2/4
2/8 4/4 0/5
0/2 1/1 0/5

OPPONENT

北京 39 张骥 Post - 0 Miss - 1 Block - 0	天津 8 曹悦 Post - 0 Miss - 1 Block - 0	上海 14 沈吉磊 Post - 0 Miss - 2 Block - 1	上海 4 徐俊吉 Post - 1 Miss - 0 Block - 0	广东 17 李中洲 Post - 2 Miss - 0 Block - 0	北京 23 王军程 Post - 3 Miss - 0 Block - 0	广东 2 孙江山 Post - 1 Miss - 0 Block - 0	江苏 6 赵晨 Post - 0 Miss - 1 Block - 0
江苏 20 顾艳超 Post - 0 Miss - 2 Block - 1	上海 17 贺政 Post - 0 Miss - 0 Block - 0	天津 13 许松 Post - 0 Miss - 0 Block - 0	广东 3 曲汝洋 Post - 0 Miss - 1 Block - 0	广东 5 侯生升 Post - 0 Miss - 0 Block - 0	广东 15 张建杰 Post - 0 Miss - 0 Block - 1	江苏 4 张家纬 Post - 1 Miss - 0 Block - 0	江苏 10 郝可鑫 Post - 0 Miss - 0 Block - 1



第十三届全国运动会男子手球决赛

PHMS Pictorial Handball Match Statistics

IHF Official System

球队名单

天津队

天津

2017-08-21

号码	姓名	位置	生日	年龄	俱乐部	身高 (CM)	体重 (KG)	国际场次	国际进球
1	刘宗其	守门员	31/03/1991	26		190	90		
2	李岳朋	中后卫	04/12/1986	30		195	96		
4	李松浩	中后卫	25/01/1993	24		194	95		
6	王子欣	右边锋	17/11/1995	21		193	88		
7	张青	右后卫	16/04/1989	28		190	100		
8	曹悦	左后卫	23/05/1993	24		200	100		
9	吴明远	右边锋	21/03/1996	21		188	90		
10	李帅	中后卫	14/07/1989	28		193	95		
11	王毅	左边锋	28/02/1995	22		195	90		
12	杨峻	守门员	24/09/1995	21		196	90		
13	许松	左边锋	02/04/1992	25		185	75		
16	刘海亮	守门员	07/08/1990	27		194	89		
17	周群	中后卫	04/04/1994	23		196	100		
18	王晓琪	右边锋	20/03/1997	20		190	90		
22	魏雨童	中后卫	05/10/1996	20		196	100		
31	田剑侠	中后卫	03/09/1986	30		190	98		
	平均			24.4		192.8	92.9		

编码	姓名	职务
A	贾守信	领队
B	杜瑞军	主教练
C	孟凡钢	教练
E	崔嘉禄	医生
D	潘玉强	教练

第十三届全国运动会男子手球决赛

PHMS Pictorial Handball Match Statistics

IHF Official System

 手球
 男子

个人/全队技术累计表

 天津
 2017-08-28

截止至第24场

号码	姓名	远射	近射	边射	快攻	突破	任意	七米	合计	%	助攻	失误	警告	2'	取消	场次	时间
天津队																	
(场上队员)																	
1	刘宗其										1	2				6	02:52:40
2	李岳朋	2/4	2/6	1/1	1/1	2/2			8/14	57.1%		3	2	3		6	02:53:48
4	李松浩					0/1			0/1	0.0%		2				6	00:08:48
6	王子欣	1/2	2/6	8/20		1/1			12/29	41.4%	1	3	2	3		6	05:04:44
7	张青	4/16	14/18	1/1	3/3	1/2		5/9	28/49	57.1%	2	12	4	2		6	05:05:56
8	曹悦	7/29	8/13			4/5		2/7	21/54	38.9%	4	16	3	2		6	04:25:34
9	吴明远		2/2						2/2	100%				1		6	00:44:26
10	李帅		1/1						1/1	100%		1				6	00:17:22
11	王毅	1/8	1/2	1/2		1/1		2/4	6/17	35.3%		3				6	01:21:10
12	杨峻															6	03:00:22
13	许松	3/11	4/8	5/11	8/10	4/5			24/45	53.3%	3	11	1	1		6	05:06:27
16	刘海亮															6	00:06:58
17	周群	1/1	6/9						7/10	70.0%		1	2	2		6	04:17:42
18	王晓琪	1/3		0/4					1/7	14.3%	1	2	1	1		6	01:11:14
22	魏雨童		1/1						1/1	100%		2	1			6	01:21:40
31	田剑侠	3/16	9/14			4/4		1/2	17/36	47.2%	5	10		1		6	04:02:47
	合计	23/90	50/80	16/39	12/14	17/21		10/22	128/266	48.1%	17	68	16	16		96	
(守门员)																	
1	刘宗其	8/22	9/38	6/15	2/12	1/9	0/2	1/4	27/102	26.5%	1	2				6	02:52:40
12	杨峻	7/29	7/37	7/15	1/11	0/6	0/4	2/13	24/115	20.9%						6	03:00:22
16	刘海亮	3/3		1/1				0/1	4/5	80.0%						6	00:06:58
	合计	18/54	16/75	14/31	3/23	1/15	0/6	3/18	55/222	24.8%	1	2				18	

场上队员：得分/射门

守门员：救球/射门

已打比赛

全队合计	进球	被救	射失	击柱	封球	合计	%	阶段	场次	对手	比分
远射	23	28	16	8	15	90	25.6%	预赛	1	上海	25:26 (9:10)
近射	50	26	2	2		80	62.5%	预赛	5	山东	13:28 (6:15)
边射	16	17	1	5		39	41.0%	预赛	10	北京	16:25 (3:13)
快攻	12	1	1			14	85.7%	四分之一决赛	16	江苏	21:35 (8:18)
突破	17	3		1		21	81.0%	5-8名	18	香港	23:27 (12:14)
任意							0.0%	7-8名	21	安徽	30:26 (13:11)
七米	10	9	1	2		22	45.5%				

第十三届全国运动会男子手球决赛

PHMS Pictorial Handball Match Statistics

IHF Official System

图式射门区域累计

手球
男子

截止至第24场

天津
2017-08-28

天津队

1 刘宗其 Post - 0 Miss - 0 Block - 0	2 李岳朋 Post - 0 Miss - 2 Block - 0	4 李松浩 Post - 0 Miss - 0 Block - 0	6 王子欣 Post - 4 Miss - 0 Block - 0	7 张青 Post - 4 Miss - 3 Block - 4	8 曹悦 Post - 3 Miss - 3 Block - 6	9 吴明远 Post - 0 Miss - 0 Block - 0	10 李帅 Post - 0 Miss - 0 Block - 0
11 王毅 Post - 0 Miss - 5 Block - 1	12 杨峻 Post - 0 Miss - 0 Block - 0	13 许松 Post - 5 Miss - 3 Block - 0	16 刘海亮 Post - 0 Miss - 0 Block - 0	17 周群 Post - 0 Miss - 0 Block - 0	18 王晓琪 Post - 1 Miss - 2 Block - 1	22 魏雨童 Post - 0 Miss - 0 Block - 0	31 田剑侠 Post - 1 Miss - 3 Block - 3

1 刘宗其
1/11 2/3 1/7
4/21 7/10 4/14
5/19 2/4 1/13

12 杨峻
2/10 2/5 0/8
6/22 5/7 4/20
1/20 1/5 3/18

16 刘海亮
1/1 1/1 2/2
0/1

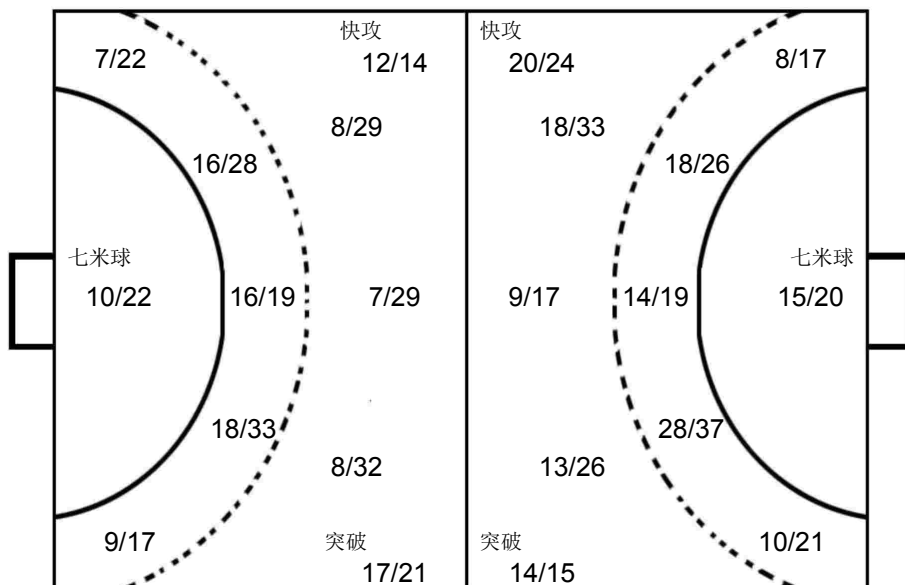

北京
16 刘迈科
1/3 1/1 0/1
5/5 4/4
0/1 2/4

安徽
21 李明
0/8 2/5 1/4
1/6 3/4 2/7
2/4 2/3 0/2

香港
7 谭俊杰
0/1 2/3
3/4 2/3 1/4
0/3 2/3

OPPONENT

安徽 8 董智景 Post - 2 Miss - 0 Block - 0	北京 10 成亚 Post - 0 Miss - 0 Block - 1	江苏 15 李安 Post - 0 Miss - 0 Block - 0	山东 17 王旭东 Post - 1 Miss - 1 Block - 0	香港 29 练明辉 Post - 0 Miss - 0 Block - 1	安徽 18 李双 Post - 1 Miss - 1 Block - 0	北京 39 张骥 Post - 0 Miss - 0 Block - 1	江苏 19 张志宇 Post - 0 Miss - 0 Block - 1
上海 8 钱为玮 Post - 0 Miss - 0 Block - 1	北京 21 胡瀛 Post - 0 Miss - 0 Block - 0	江苏 9 王杰缘 Post - 0 Miss - 0 Block - 0	山东 6 李朝鹏 Post - 1 Miss - 0 Block - 0	山东 19 李语庆 Post - 0 Miss - 0 Block - 0	上海 6 朱世杰 Post - 0 Miss - 0 Block - 0	香港 12 许文邦 Post - 0 Miss - 0 Block - 0	香港 31 叶仕仁 Post - 0 Miss - 0 Block - 0



第十三届全国运动会男子手球决赛

PHMS Pictorial Handball Match Statistics

IHF Official System

球队名单

安徽队

天津

2017-08-21

号码	姓名	位置	生日	年龄	俱乐部	身高 (CM)	体重 (KG)	国际场次	国际进球
1	郭世伟	左边锋	18/02/1997	20		185	75		
3	陈强龙	底线	11/11/1995	21		195	90		
5	史小帆	中后卫	15/03/1995	22		190	85		
7	姚雄敏	中后卫	17/02/1993	24		186	80		
8	董智景	左边锋	15/10/1993	23		188	78		
9	陈开勇	底线	18/02/1996	21		190	100		
10	严龙	中后卫	22/05/1994	23		192	78		
11	黎涛	右边锋	28/10/1994	22		188	78		
12	曾献辰	守门员	29/06/1990	27		190	90		
15	曹青福临	左边锋	14/07/1995	22		186	80		
16	杨洋	守门员	19/08/1995	22		193	85		
17	王巨柱	左后卫	17/08/1997	20		193	80		
18	李双	右后卫	10/02/1997	20		190	80		
21	李明	守门员	04/05/1997	20		195	90		
23	于敏清	右边锋	18/05/1991	26		190	78		
24	徐安格	底线	05/02/1998	19		192	100		
	平均			22.0		190.2	84.2		

编码	姓名	职务
B	沈强	主教练
C	吴翔	教练
D	黄红	教练
E	吴台锡	医生
A	韦中平	领队

第十三届全国运动会男子手球决赛

PHMS Pictorial Handball Match Statistics

IHF Official System

 手球
 男子

个人/全队技术累计表

 天津
 2017-08-28

截止至第24场

号码	姓名	远射	近射	边射	快攻	突破	任意	七米	合计	%	助攻	失误	警告	2'	取消	场次	时间
安徽队																	
(场上队员)																	
1	郭世伟	4/15	4/10	1/4	3/4	3/4			15/37	40.5%		18				6	03:35:36
3	陈强龙		4/6		2/3	1/1			7/10	70.0%	2	3	1			6	03:55:14
5	史小帆	2/8	3/4	0/1	1/1	2/3			8/17	47.1%	3	11	1	1		6	01:58:42
7	姚雄敏	0/1	1/1						1/2	50.0%		3				5	00:27:24
8	董智景	7/15	5/7	11/19	7/11	1/2		2/2	33/56	58.9%	2	6	1	2		6	04:35:03
9	陈开勇	0/2	9/10		3/4		1/1		13/17	76.5%		6	1	3		6	03:12:42
10	严龙	0/3	1/3	1/1		1/1		6/6	9/14	64.3%	1	7		2		6	01:51:24
11	黎涛	3/11	1/2	5/7		1/1	1/1	3/6	14/28	50.0%	1	12		1		6	03:36:19
12	曾献辰											1				6	00:49:36
15	曹青福临			0/1					0/1	0.0%		1		1		6	00:24:14
16	杨洋															6	00:00:00
17	王巨柱	7/22	1/8	0/1	1/1		1/1	1/2	11/35	31.4%	3	14	1	1	1	5	02:37:10
18	李双	5/14	4/5	1/2		2/2	0/1		12/24	50.0%	3	17	3	4		6	03:43:27
21	李明										3	5				6	05:10:24
23	于敏清	1/1	2/2	2/7	2/2				7/12	58.3%	1	8	4			6	04:11:12
24	徐安格	1/7	1/3						2/10	20.0%		5		1		6	01:02:02
合计		30/99	36/61	21/43	19/26	11/14	3/4	12/16	132/263	50.2%	20	116	11	17	1	94	
(守门员)																	
12	曾献辰	5/13	1/8	1/5	1/10	0/5		1/4	9/45	20.0%	1					6	00:49:36
21	李明	19/50	19/69	9/26	6/29	4/13		2/12	59/199	29.6%	3	5				6	05:10:24
合计		24/63	20/77	10/31	7/39	4/18		3/16	68/244	27.9%	4	5				12	

场上队员：得分/射门

守门员：救球/射门

已打比赛

全队合计	进球	被救	射失	击柱	封球	合计	%	阶段	场次	对手	比分
远射	30	34	13	8	14	99	30.3%	预赛	4	广东	26:32 (14:14)
近射	36	22	2	1		61	59.0%	预赛	7	江苏	22:35 (10:20)
边射	21	12	4	6		43	48.8%	预赛	11	香港	19:22 (9:11)
快攻	19	5	1	1		26	73.1%	四分之一决赛	13	山东	18:32 (7:12)
突破	11	3				14	78.6%	5-8名	17	上海	21:25 (10:12)
任意	3		1			4	75.0%	7-8名	21	天津	26:30 (11:13)
七米	12	3		1		16	75.0%				

第十三届全国运动会男子手球决赛

PHMS Pictorial Handball Match Statistics

IHF Official System

图式射门区域累计

手球
男子

截止至第24场

天津
2017-08-28

安徽队

1 郭世伟 1 3 4 Post - 2 Miss - 6 Block - 2	3 陈强龙 4 3 Post - 0 Miss - 0 Block - 0	5 史小帆 1 2 2 1 Post - 1 Miss - 0 Block - 2	7 姚雄敏 1 Post - 0 Miss - 0 Block - 0	8 董智景 2 2 7 3 4 1 5 Post - 6 Miss - 3 Block - 1	9 陈开勇 3 1 1 1 1 2 2 Post - 0 Miss - 1 Block - 1	10 严龙 1 1 1 3 2 Post - 0 Miss - 1 Block - 0	11 黎涛 2 2 1 5 1 2 1 Post - 2 Miss - 1 Block - 0
12 曾献辰 Post - 0 Miss - 0 Block - 0	15 曹青福临 Post - 1 Miss - 0 Block - 0	16 杨洋 Post - 0 Miss - 0 Block - 0	17 王巨柱 1 2 1 3 3 1 Post - 1 Miss - 4 Block - 4	18 李双 1 2 3 2 4 Post - 2 Miss - 3 Block - 2	21 李明 Post - 0 Miss - 0 Block - 0	23 于敏清 4 1 2 Post - 2 Miss - 1 Block - 0	24 徐安格 1 1 Post - 0 Miss - 1 Block - 2

12 曾献辰
0/3 0/3 0/3
0/5 4/5 3/13
1/4 1/3 0/6

21 李明
2/19 4/12 5/22
10/40 15/17 7/30
6/23 7/13 3/23

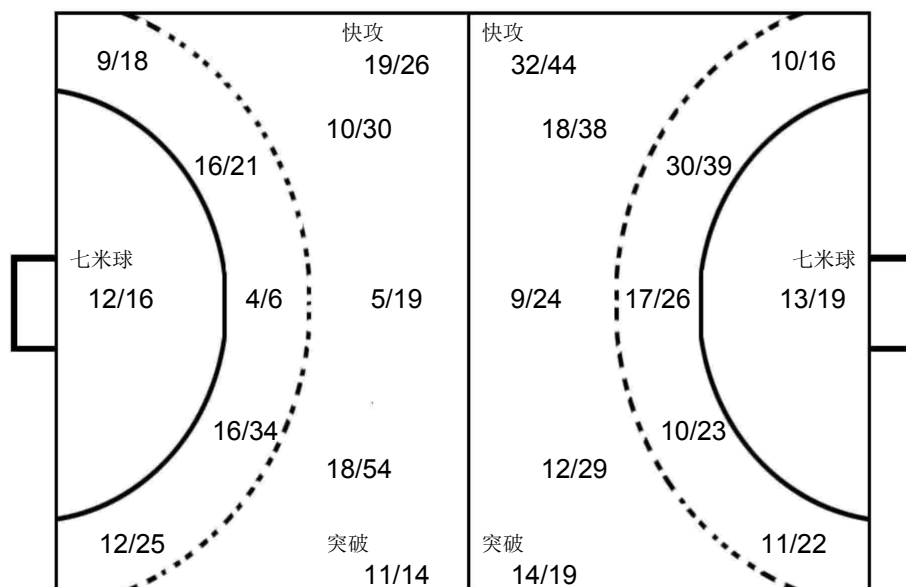

香港

1 叶冠英
1/3 2/3 2/3
2/4 4/4 2/6
0/4 2/2 1/3

上海

1 张峥
0/4 4/4 0/3
0/1 3/3 3/7
1/2 2/2 0/3

江苏

1 徐畅
2/4 2/2 0/4
1/5 1/2 2/2
1/4 1/3 1/2

OPPONENT

上海 13 马麟晓 1 2 2 3 Post - 0 Miss - 1 Block - 0	天津 13 许松 2 2 3 1 Post - 0 Miss - 1 Block - 0	广东 17 李中洲 1 3 2 1 Post - 0 Miss - 0 Block - 0	江苏 4 张家伟 1 3 3 Post - 1 Miss - 0 Block - 0	上海 8 钱为玮 2 1 1 2 Post - 0 Miss - 0 Block - 0	天津 7 张青 3 3 1 Post - 2 Miss - 1 Block - 0	广东 2 孙江山 1 2 Post - 0 Miss - 0 Block - 0	广东 8 于彦江 2 1 2 Post - 0 Miss - 0 Block - 0
江苏 17 王伟强 2 1 2 Post - 0 Miss - 0 Block - 0	山东 11 宋朋强 1 1 Post - 0 Miss - 0 Block - 0	山东 19 李语庆 2 2 1 Post - 0 Miss - 0 Block - 0	天津 31 田剑侠 1 2 1 Post - 0 Miss - 1 Block - 2	广东 4 李卓洋 1 1 Post - 0 Miss - 1 Block - 0	广东 84 王伟 2 1 1 Post - 1 Miss - 1 Block - 0	江苏 15 李安 1 3 Post - 0 Miss - 1 Block - 0	山东 21 翟乾坤 1 1 1 Post - 0 Miss - 0 Block - 0



Team A					Team B					Match Number											
A 上海队					B 天津队					1											
Played in			in the hall			on			at			Spectators									
天津			天津师范大学体育馆			2017-08-21			14:00			hours									
Half-time(30')	A	B	End of playing time		A	B	1st extra time		A	B	2nd extra time		A	B	After penalty throws		A	B			
	10	9	26		25																
Number of 7 m	A	Team time-out			Full name of players and officials						Team time-out			B	Number of 7 m						
	2/4	1	2	3							1	2	3	B							
		28:07	45:07	58:18							19:19	59:25		2/4							
No.	Team A					G	W	2'	D	DR	No.	Team B					G	W	2'	D	DR
1	张峥										1	刘宗其									
3	赵时俊					2		2			2	李岳朋					2	1	2		
4	徐俊吉					3					4	李松浩									
6	朱世杰					4	1	1			6	王子欣					4				
7	周文龙										7	张青					9				
8	钱为玮					5		1			8	曹悦					3	1			
9	董凯										9	吴明远									
10	吴璟					2					10	李帅									
11	蒋承骅					3					11	王毅									
12	周哲韬					1					12	杨峻									
14	沈吉磊										13	许松					4	1			
16	朱春雷										16	刘海亮									
17	贺政					3					17	周群					1		1		
18	马麟晓					3	1	1			18	王晓琪									
19	祝君							1			22	魏雨童									
											31	田剑侠					2				
A	郑益方										A	贾守信									
B	张勇军 (主教练)					1					B	杜瑞军 (主教练)									
C	金迪琦										D	潘玉强									
D	杨时										E	崔嘉禄									
Signatures of responsables for the teams (Off.A)																					
A																			B		
TP	Remarks of referees / HF Official																		TP		
Signatures																					
Referees	ALEXEI. COVALCIUC (MDA)					IGOR. COVALCIUC (MDA)															
T.D.	李长海 (CHN)					李刚 (CHN)															
CHA Off.																					

Note: Number of 7m Throws Awarded to Team A and B, Goals (G), Warnings (W), Suspensions (2'), Direct Disqualification (D), Disqualification With Report (DR) and Team Penalty (TP).

Table Officials: 隆晓磊 梅艳

Statisticians: 刘永欢

陈柱

第十三届全国运动会男子手球决赛

PHMS Pictorial Handball Match Statistics

IHF Official System

竞赛技术统计

手球 男子 预赛 轮次 1 组别 A 场次 1 天津师范大学体育馆 2017-08-21 14:00

 Referees: ALEXEI. COVALCIUC (MDA) / IGOR. COVALCIUC (MDA) Result: 26:25 (10:9)
 Teams: 上海队(上海) VS 天津队(天津)

上海		远射	近射	边射	快攻	突破	任意球	7m球	合计	%	助攻	失误	警告	2'	D+DR	上海	比赛进程	天津
主教练: 张勇军																	1st Half	
1	张峥															18	马麟晓	1 00:49 0
3	赵时俊	0/2	2/2	0/2				0/1	2/7	28.6	1	2		2			1 01:41 1 7 张青	
4	徐俊吉		2/2					1/2	3/4	75.0							1 03:02 2 8 曹悦	
6	朱世杰	1/1	2/2			1/2			4/5	80.0	1	1	1	1			1 04:24 3 8 曹悦	
7	周文龙															10	吴璟	2 08:21 3
8	钱为玮	1/4	1/2	1/3	1/1		1/1		5/11	45.5		2		1		17	贺政	3 09:23 3
9	董凯																3 10:13 4 6 王子欣	
10	吴璟		1/2					1/1	2/3	66.7						17	贺政	4 10:53 4
11	蒋承骅	2/2	0/1	1/1					3/4	75.0		1				3	赵时俊	5 11:49 4
12	周哲韬	1/1							1/1	100	1					5	5 13:11 5 6 王子欣	
14	沈吉磊															5	5 15:22 6 13 许松	
16	朱春雷															6	朱世杰	6 16:27 6
17	贺政			3/3					3/3	100						3	赵时俊	7 17:09 6
18	马麟晓	1/5	1/2				1/1		3/8	37.5	1		1	1		17	贺政	8 19:02 6
19	祝君													1		8	钱为玮	9 20:56 6
运动员 合计		6/15	9/13	5/9	1/1	1/2	2/2	2/4	26/46	56.5	4	6	2	6		9	24:18 7 7 张青	
1	张峥		2/4			0/3		1/1	3/8	37.5						9	27:32 8 8 曹悦	
12	周哲韬	0/2	7/15	1/4	0/3	2/4		0/2	10/30	33.3	1					10	吴璟	10 29:41 8
守门员 合计		0/2	9/19	1/4	0/3	2/7		1/3	13/38	34.2	1					10	29:51 9 7 张青	
天津																	2nd Half	
主教练: 杜瑞军																18	马麟晓	11 01:48 9
1	刘宗其										1	2					11 02:50 10 2 李岳朋	
2	李岳朋		0/3		1/1	1/1		2/5	40.0				1	2			11 03:44 11 13 许松	
4	李松浩															11	蒋承骅	12 04:40 11
6	王子欣	1/1	0/1	3/5				4/7	57.1							4	徐俊吉	13 07:34 11
7	张青		7/7			1/2		1/2	9/11	81.8	1	2				8	钱为玮	14 08:58 11
8	曹悦	0/2	1/2			1/1		1/2	3/7	42.9	1	3	1			8	钱为玮	14 10:14 12 13 许松
9	吴明远															15	10:58 12	
10	李帅															15	11:09 13 7 张青	
11	王毅															11	蒋承骅	16 11:47 13
12	杨峻															16	12:03 14 7 张青	
13	许松	1/2	0/3		2/2	1/2		4/9	44.4	1	1	1			6	朱世杰	17 12:46 14	
16	刘海亮															17	13:00 15 2 李岳朋	
17	周群		1/2					1/2	50.0		1			1		17	14:04 16 7 张青	
18	王晓琪															17	15:02 17 17 周群	
22	魏雨童															8	钱为玮	18 16:13 17
31	田剑侠		1/1			1/1		2/2	100	1	1					18	16:50 18 7 张青	
运动员 合计		2/5	10/19	3/5	3/3	5/7		2/4	25/43	58.1	5	10	3	3		19	17:29 18	
1	刘宗其	5/8	3/7	1/4	0/1	1/2	0/2	10/24	41.7	1	2					4	徐俊吉	19 17:56 19 31 田剑侠
12	杨峻	1/4	0/5	1/3				1/3	3/15	20.0						19	19:39 20 13 许松	
守门员 合计		6/12	3/12	2/7	0/1	1/2	0/2	1/3	13/39	33.3	1	2				8	钱为玮	20 20:23 20
																20	20:40 21 6 王子欣	
																6	朱世杰	21 22:09 21
																4	徐俊吉	21 22:46 22 7 张青
																11	蒋承骅	22 23:13 22
																22	23:55 23 7 张青	
																18	马麟晓	23 25:06 24 6 王子欣
																24	26:10 25 31 田剑侠	
																6	朱世杰	25 27:14 25
																12	周哲韬	26 29:52 25

场上队员: 得分 / 射门

守门员: 救球 / 射门

D	取消资格	DR	取消资格+报告
---	------	----	---------

第十三届全国运动会男子手球决赛

PHMS Pictorial Handball Match Statistics

IHF Official System

个人/全队技术统计表

手球 男子 预赛 轮次 1 组别 A 场次 1 天津师范大学体育馆 2017-08-21 14:00

号码	姓名	远射	近射	边射	快攻	突破	任意	七米	合计	%	助攻	失误	警告	2'	取消	时间
上海队(上海)																
(场上队员)																
1	张崢									0.0%						00:20:19
3	赵时俊	0/2	2/2	0/2				0/1	2/7	28.6%	1	2		2		01:00:00
4	徐俊吉		2/2					1/2	3/4	75.0%						00:39:46
6	朱世杰	1/1	2/2			1/2			4/5	80.0%	1	1	1	1		00:56:24
7	周文龙									0.0%						00:00:00
8	钱为玮	1/4	1/2	1/3	1/1		1/1		5/11	45.5%		2		1		01:00:00
9	董凯									0.0%						00:00:00
10	吴璟		1/2					1/1	2/3	66.7%						00:19:50
11	蒋承骅	2/2	0/1	1/1					3/4	75.0%		1				00:38:52
12	周哲韬	1/1							1/1	100%	1					00:39:41
14	沈吉磊									0.0%						00:00:00
16	朱春雷									0.0%						00:00:00
17	贺政			3/3					3/3	100%						00:40:45
18	马麟晓	1/5	1/2				1/1		3/8	37.5%	1		1	1		00:51:12
19	祝君									0.0%				1		00:11:48
合计		6/15	9/13	5/9	1/1	1/2	2/2	2/4	26/46	56.5%	4	6	2	6		
(守门员)																
1	张崢		2/4			0/3		1/1	3/8	37.5%						00:20:19
12	周哲韬	0/2	7/15	1/4	0/3	2/4		0/2	10/30	33.3%	1					00:39:41
合计		0/2	9/19	1/4	0/3	2/7		1/3	13/38	34.2%	1					

场上队员：得分/射门

守门员：救球/射门

全队合计	得分	被救	射失	击柱	封球	合计	%
远射	6	6	1		2	15	40.0%
近射	9	3	1			13	69.2%
边射	5	2	1	1		9	55.6%
快攻	1					1	100.0%
突破	1	1				2	50.0%
任意	2					2	100.0%
七米	2	1		1		4	50.0%

第十三届全国运动会男子手球决赛

PHMS Pictorial Handball Match Statistics

IHF Official System

个人/全队技术统计表

手球 男子 预赛 轮次 1 组别 A 场次 1 天津师范大学体育馆 2017-08-21 14:00

号码	姓名	远射	近射	边射	快攻	突破	任意	七米	合计	%	助攻	失误	警告	2'	取消	时间
天津队(天津)																
(场上队员)																
1	刘宗其									0.0%	1	2				00:41:05
2	李岳朋		0/3		1/1	1/1			2/5	40.0%			1	2		00:55:48
4	李松浩									0.0%						00:00:00
6	王子欣	1/1	0/1	3/5					4/7	57.1%						01:00:00
7	张青		7/7			1/2		1/2	9/11	81.8%	1	2				00:57:14
8	曹悦	0/2	1/2			1/1		1/2	3/7	42.9%	1	3	1			00:39:16
9	吴明远									0.0%						00:00:00
10	李帅									0.0%						00:00:00
11	王毅									0.0%						00:00:00
12	杨峻									0.0%						00:18:55
13	许松	1/2	0/3		2/2	1/2			4/9	44.4%	1	1	1			01:00:00
16	刘海亮									0.0%						00:00:00
17	周群		1/2						1/2	50.0%		1		1		01:00:00
18	王晓琪									0.0%						00:00:00
22	魏雨童									0.0%						00:05:49
31	田剑侠		1/1			1/1			2/2	100%	1	1				00:27:30
	合计	2/5	10/19	3/5	3/3	5/7		2/4	25/43	58.1%	5	10	3	3		
(守门员)																
1	刘宗其	5/8	3/7	1/4	0/1	1/2	0/2		10/24	41.7%	1	2				00:41:05
12	杨峻	1/4	0/5	1/3				1/3	3/15	20.0%						00:18:55
	合计	6/12	3/12	2/7	0/1	1/2	0/2	1/3	13/39	33.3%	1	2				

场上队员：得分/射门

守门员：救球/射门

全队合计	得分	被救	射失	击柱	封球	合计	%
远射	2			1	2	5	40.0%
近射	10	9				19	52.6%
边射	3	1		1		5	60.0%
快攻	3					3	100.0%
突破	5	2				7	71.4%
任意							0.0%
七米	2	1		1		4	50.0%

第十三届全国运动会男子手球决赛

PHMS Pictorial Handball Match Statistics

IHF Official System

图式比赛技术统计表

手球
男子

预赛
轮次 1

组别 A
场次 1

天津师范大学体育馆
2017-08-21 14:00

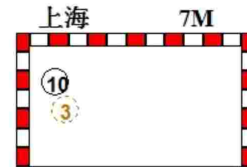
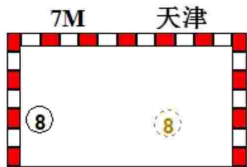
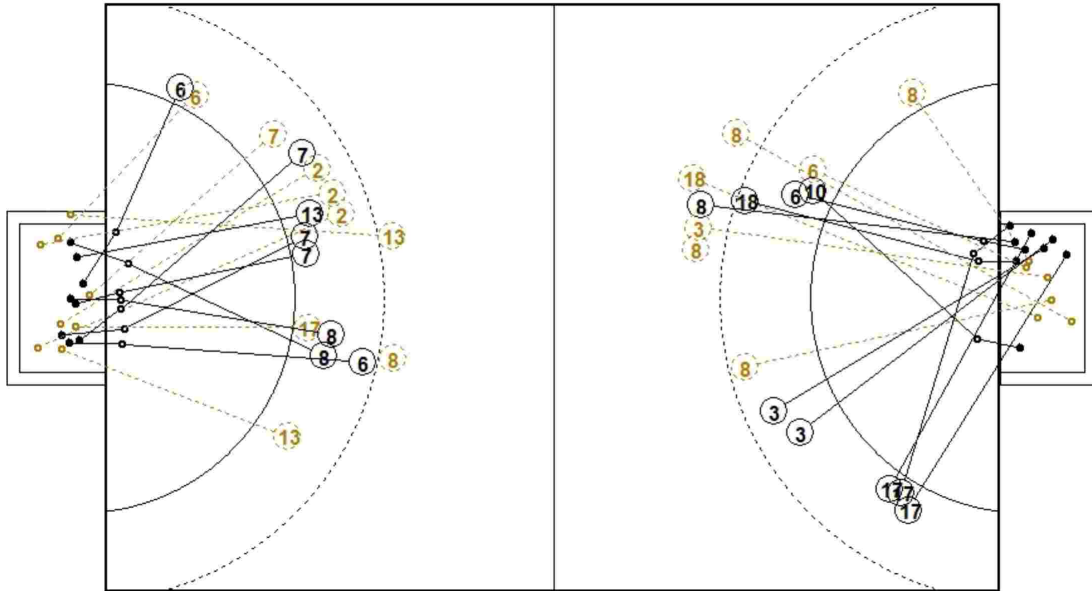

1st Half
9 : 10

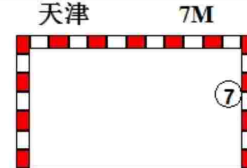
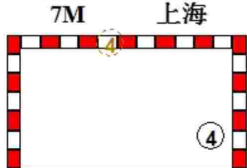
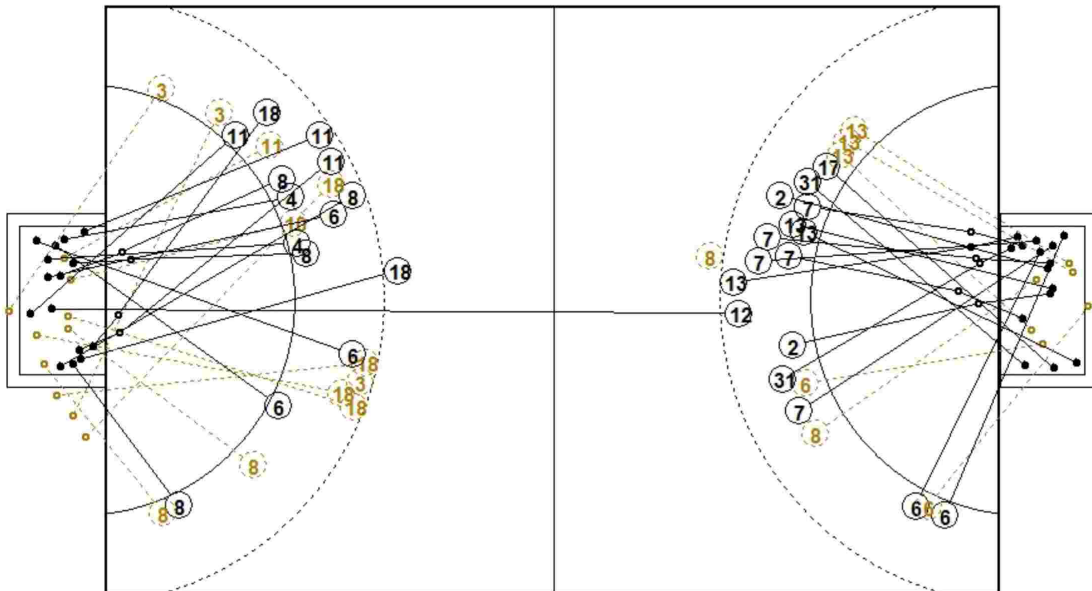

2nd Half
26 : 25

第十三届全国运动会男子手球决赛

PHMS Pictorial Handball Match Statistics

IHF Official System

图式射门区域统计

手球
男子

预赛
轮次 1

组别 A
场次 1

天津师范大学体育馆
2017-08-21 14:00

上海队

1 张峥	3 赵时俊	4 徐俊吉	6 朱世杰	7 周文龙	8 钱为玮	9 董凯	10 吴璟																																																																								
<table border="1"><tr><td></td><td></td><td></td></tr><tr><td></td><td></td><td></td></tr><tr><td></td><td></td><td></td></tr></table>										<table border="1"><tr><td></td><td></td><td></td></tr><tr><td>2</td><td></td><td></td></tr><tr><td></td><td></td><td></td></tr></table>				2						<table border="1"><tr><td></td><td></td><td>1</td></tr><tr><td></td><td></td><td>2</td></tr><tr><td></td><td></td><td></td></tr></table>			1			2				<table border="1"><tr><td></td><td>1</td><td>1</td></tr><tr><td></td><td></td><td>1</td></tr><tr><td>1</td><td></td><td></td></tr></table>		1	1			1	1			<table border="1"><tr><td></td><td></td><td></td></tr><tr><td></td><td></td><td></td></tr><tr><td></td><td></td><td></td></tr></table>										<table border="1"><tr><td></td><td></td><td></td></tr><tr><td>2</td><td>1</td><td>1</td></tr><tr><td>1</td><td></td><td></td></tr></table>				2	1	1	1			<table border="1"><tr><td></td><td></td><td></td></tr><tr><td></td><td></td><td></td></tr><tr><td></td><td></td><td></td></tr></table>										<table border="1"><tr><td></td><td></td><td></td></tr><tr><td>1</td><td></td><td></td></tr><tr><td></td><td></td><td>1</td></tr></table>				1					1
2																																																																															
		1																																																																													
		2																																																																													
	1	1																																																																													
		1																																																																													
1																																																																															
2	1	1																																																																													
1																																																																															
1																																																																															
		1																																																																													
Post - 0 Miss - 0 Block - 0	Post - 1 Miss - 1 Block - 1	Post - 1 Miss - 0 Block - 0	Post - 0 Miss - 0 Block - 0	Post - 0 Miss - 0 Block - 0	Post - 0 Miss - 0 Block - 1	Post - 0 Miss - 0 Block - 0	Post - 0 Miss - 0 Block - 0																																																																								
11 蒋承骅	12 周哲韬	14 沈吉磊	16 朱春雷	17 贺政	18 马麟晓	19 祝君																																																																									
<table border="1"><tr><td></td><td>1</td><td></td></tr><tr><td></td><td></td><td></td></tr><tr><td>1</td><td></td><td>1</td></tr></table>		1					1		1	<table border="1"><tr><td></td><td></td><td></td></tr><tr><td></td><td>1</td><td></td></tr><tr><td></td><td></td><td></td></tr></table>					1					<table border="1"><tr><td></td><td></td><td></td></tr><tr><td></td><td></td><td></td></tr><tr><td></td><td></td><td></td></tr></table>										<table border="1"><tr><td></td><td></td><td></td></tr><tr><td></td><td></td><td></td></tr><tr><td></td><td></td><td></td></tr></table>										<table border="1"><tr><td></td><td></td><td></td></tr><tr><td>1</td><td></td><td></td></tr><tr><td>1</td><td></td><td></td></tr><tr><td>1</td><td></td><td></td></tr></table>				1			1			1			<table border="1"><tr><td></td><td></td><td></td></tr><tr><td></td><td></td><td></td></tr><tr><td>3</td><td></td><td></td></tr></table>							3			<table border="1"><tr><td></td><td></td><td></td></tr><tr><td></td><td></td><td></td></tr><tr><td></td><td></td><td></td></tr></table>																
	1																																																																														
1		1																																																																													
	1																																																																														
1																																																																															
1																																																																															
1																																																																															
3																																																																															
Post - 0 Miss - 0 Block - 0	Post - 0 Miss - 0 Block - 0	Post - 0 Miss - 0 Block - 0	Post - 0 Miss - 0 Block - 0	Post - 0 Miss - 0 Block - 0	Post - 0 Miss - 2 Block - 0	Post - 0 Miss - 0 Block - 0																																																																									

1 □□									
<table border="1"><tr><td>1/1</td><td></td><td>0/1</td></tr><tr><td>0/2</td><td>1/1</td><td>1/2</td></tr><tr><td></td><td></td><td>0/1</td></tr></table>	1/1		0/1	0/2	1/1	1/2			0/1
1/1		0/1							
0/2	1/1	1/2							
		0/1							

12 □□□									
<table border="1"><tr><td>2/3</td><td></td><td>1/2</td></tr><tr><td>3/9</td><td>1/5</td><td>2/4</td></tr><tr><td>0/4</td><td>1/3</td><td></td></tr></table>	2/3		1/2	3/9	1/5	2/4	0/4	1/3	
2/3		1/2							
3/9	1/5	2/4							
0/4	1/3								

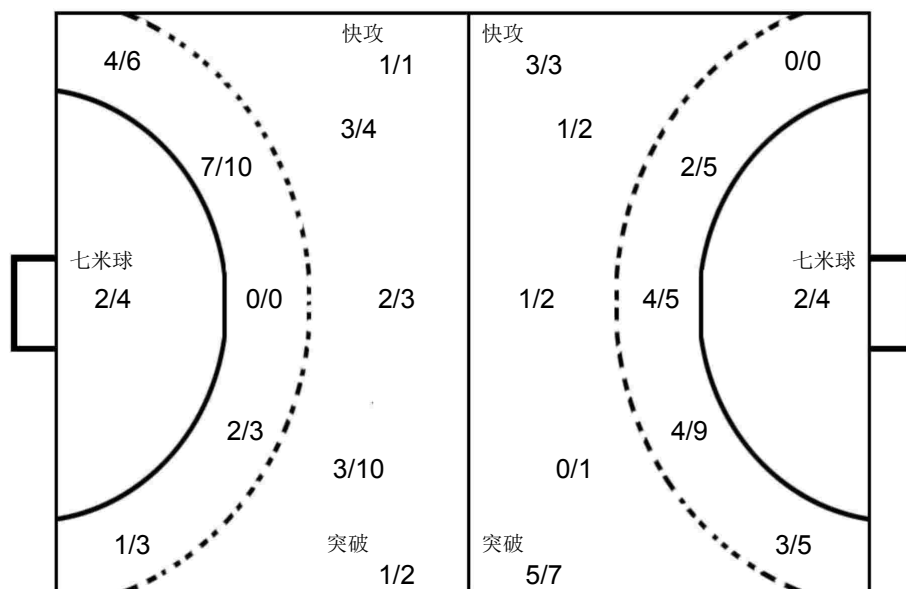

1 □□□									
<table border="1"><tr><td>1/2</td><td>1/1</td><td></td></tr><tr><td>2/5</td><td>4/5</td><td>1/2</td></tr><tr><td>1/7</td><td></td><td>0/2</td></tr></table>	1/2	1/1		2/5	4/5	1/2	1/7		0/2
1/2	1/1								
2/5	4/5	1/2							
1/7		0/2							

12 □□									
<table border="1"><tr><td>1/2</td><td>0/2</td><td>0/2</td></tr><tr><td>1/3</td><td>1/2</td><td>0/3</td></tr><tr><td>0/1</td><td></td><td></td></tr></table>	1/2	0/2	0/2	1/3	1/2	0/3	0/1		
1/2	0/2	0/2							
1/3	1/2	0/3							
0/1									

天津队

1 刘宗其	2 李岳朋	4 李松浩	6 王子欣	7 张青	8 曹悦	9 吴明远	10 李帅																																																																														
<table border="1"><tr><td></td><td></td><td></td></tr><tr><td></td><td></td><td></td></tr><tr><td></td><td></td><td></td></tr></table>										<table border="1"><tr><td></td><td></td><td></td></tr><tr><td>1</td><td>1</td><td></td></tr><tr><td></td><td></td><td></td></tr></table>				1	1					<table border="1"><tr><td></td><td></td><td></td></tr><tr><td></td><td></td><td></td></tr><tr><td></td><td></td><td></td></tr></table>										<table border="1"><tr><td></td><td></td><td></td></tr><tr><td>1</td><td></td><td></td></tr><tr><td>2</td><td></td><td></td></tr><tr><td></td><td>1</td><td></td></tr></table>				1			2				1		<table border="1"><tr><td></td><td></td><td></td></tr><tr><td></td><td></td><td>1</td></tr><tr><td>4</td><td>1</td><td></td></tr><tr><td>2</td><td>1</td><td></td></tr></table>						1	4	1		2	1		<table border="1"><tr><td></td><td></td><td></td></tr><tr><td>1</td><td>1</td><td>1</td></tr><tr><td></td><td></td><td></td></tr></table>				1	1	1				<table border="1"><tr><td></td><td></td><td></td></tr><tr><td></td><td></td><td></td></tr><tr><td></td><td></td><td></td></tr></table>										<table border="1"><tr><td></td><td></td><td></td></tr><tr><td></td><td></td><td></td></tr><tr><td></td><td></td><td></td></tr></table>									
1	1																																																																																				
1																																																																																					
2																																																																																					
	1																																																																																				
		1																																																																																			
4	1																																																																																				
2	1																																																																																				
1	1	1																																																																																			
Post - 0 Miss - 0 Block - 0	Post - 0 Miss - 0 Block - 0	Post - 0 Miss - 0 Block - 0	Post - 1 Miss - 0 Block - 0	Post - 1 Miss - 0 Block - 0	Post - 0 Miss - 0 Block - 2	Post - 0 Miss - 0 Block - 0	Post - 0 Miss - 0 Block - 0																																																																														
11 王毅	12 杨峻	13 许松	16 刘海亮	17 周群	18 王晓琪	22 魏雨童	31 田剑侠																																																																														
<table border="1"><tr><td></td><td></td><td></td></tr><tr><td></td><td></td><td></td></tr><tr><td></td><td></td><td></td></tr></table>										<table border="1"><tr><td></td><td></td><td></td></tr><tr><td></td><td></td><td></td></tr><tr><td></td><td></td><td></td></tr></table>										<table border="1"><tr><td></td><td></td><td>1</td></tr><tr><td></td><td>1</td><td>1</td></tr><tr><td>1</td><td></td><td></td></tr></table>			1		1	1	1			<table border="1"><tr><td></td><td></td><td></td></tr><tr><td></td><td></td><td></td></tr><tr><td></td><td></td><td></td></tr></table>										<table border="1"><tr><td></td><td></td><td></td></tr><tr><td></td><td></td><td></td></tr><tr><td></td><td></td><td>1</td></tr></table>									1	<table border="1"><tr><td></td><td></td><td></td></tr><tr><td></td><td></td><td></td></tr><tr><td></td><td></td><td></td></tr></table>										<table border="1"><tr><td></td><td></td><td></td></tr><tr><td></td><td></td><td></td></tr><tr><td></td><td></td><td></td></tr></table>										<table border="1"><tr><td></td><td></td><td></td></tr><tr><td></td><td></td><td></td></tr><tr><td>1</td><td></td><td>1</td></tr></table>							1		1						
		1																																																																																			
	1	1																																																																																			
1																																																																																					
		1																																																																																			
1		1																																																																																			
Post - 0 Miss - 0 Block - 0	Post - 0 Miss - 0 Block - 0	Post - 1 Miss - 0 Block - 0	Post - 0 Miss - 0 Block - 0	Post - 0 Miss - 0 Block - 0	Post - 0 Miss - 0 Block - 0	Post - 0 Miss - 0 Block - 0	Post - 0 Miss - 0 Block - 0																																																																														

PHMS Pictorial Handball Match Statistics

IHF Official System

Team A					Team B					Match Number											
A 山东队					B 北京队					2											
Played in			in the hall			on			at			Spectators									
天津			天津师范大学体育馆			2017-08-21			15:45			hours									
Half-time(30')	A	B	End of playing time		A	B	1st extra time		A	B	2nd extra time		A	B	After penalty throws		A	B			
	9	11	21		23																
Number of 7 m	A	Team time-out			Full name of players and officials						Team time-out			B	Number of 7 m						
	4/4	1	2	3							1	2	3	5/5							
		27:25	47:53	56:50							25:02	54:43									
No.	Team A					G	W	2'	D	DR	No.	Team B					G	W	2'	D	DR
3	尹杰										1	王洸									
4	田瑞										7	马昌震					1		1		
5	潘翔					2	1				8	王鹏									
6	李朝鹏										9	刘振					1				
8	王炳华										10	成亚					2				
9	赵鑫					4		1			16	刘迈科									
11	宋朋强					2	1	1			21	胡瀛					1		1		
12	崔剑										22	王超									
13	刘晓					1					23	王军程									
15	张继伟							1			25	马明辉									
16	于性哲										29	杜龙飞									
17	王旭东					1		2			39	张骥					8				
18	于亚男					2					66	解建飞					2	1	1		
19	李语庆					4					77	朱昕晨					6				
20	杜在超										83	潘天						1	1		
21	翟乾坤					5	1				99	蒋维一					2				
A	王志峰										A	安福田									
B	王鸿斌 (主教练)										B	郑永利 (主教练)									
C	刘桂妮										C	孟辉									
D	邢建刚										E	王长林									
A					Signatures of responsables for the teams (Off.A)										B						
TP		Remarks of referees / HF Official																		TP	

Signatures

Referees BALAZS. MARTON (HUN)

PETER. HORVATH (HUN)

T.D. 刘书勇 (CHN)

许宜扬 (CHN)

CHA Off.

Note: Number of 7m Throws Awarded to Team A and B, Goals (G), Warnings (W), Suspensions (2'), Direct Disqualification (D), Disqualification With Report (DR) and Team Penalty (TP).

Table Officials: 鲍瑀

李志成

Statisticians: 陈柱

黄岩

第十三届全国运动会男子手球决赛
PHMS Pictorial Handball Match Statistics

IHF Official System

竞赛技术统计

 手球
男子

 预赛
轮次 1

 组别 A
场次 2

 天津师范大学体育馆
2017-08-21 15:45

Referees: BALAZS. MARTON (HUN) / PETER. HORVATH (HUN)

Result: 21:23 (9:11)

Teams: 山东队(山东) VS 北京队(北京)

山东		远	近	边	快	突	任意	7m	合计	%	助攻	失误	警告	2'	D+DR	山东	比赛	北京
主教练: 王鸿斌		射	射	射	攻	破	球	球								进程		
3	尹杰															18	于亚男	1 00:41 0
4	田瑞															21	翟乾坤	1 02:41 1 39 张骥
5	潘翔				2/2			2/2	100		1	1				2	翟乾坤	2 05:19 1
6	李朝鹏															17	王旭东	2 06:55 2 10 成亚
8	王炳华		0/1					0/1	0.0							3	王旭东	3 09:41 2
9	赵鑫	1/2	2/2		0/1	1/1		4/6	66.7		5			1		3	王旭东	3 10:18 3 39 张骥
11	宋朋强	0/2	2/2					2/4	50.0	1	1	1	1			3	王旭东	3 11:53 4 39 张骥
12	崔剑															3	王旭东	3 12:42 5 39 张骥
13	刘晓		0/1	1/1				1/2	50.0							4	赵鑫	4 13:13 5
15	张继伟														1	9	赵鑫	4 17:20 6 99 蒋维一
16	于性哲										1					9	赵鑫	5 17:26 6
17	王旭东	1/2	0/1					1/3	33.3		1			2		5	赵鑫	5 18:43 7 66 解建飞
18	于亚男	1/4	1/2					2/6	33.3							21	翟乾坤	6 19:22 7
19	李语庆			1/2				3/3	80.0		2					6	翟乾坤	6 20:20 8 21 胡瀛
20	杜在超	0/1	0/1					0/2	0.0		2					7	李语庆	7 21:31 8
21	翟乾坤	1/1	0/1	3/3				1/1	5/6	83.3		1	1			7	李语庆	7 22:11 9 66 解建飞
运动员 合计		4/12	5/11	5/6	2/3	1/1		4/4	21/37	56.8	1	14	3	5		8	赵鑫	8 23:12 9
12	崔剑							0/1	0/1	0.0						8	于亚男	8 25:45 10 77 朱昕晨
16	于性哲	2/4	5/12	3/6	1/3	0/3	0/1	0/4	11/33	33.3		1				8	于亚男	8 27:17 11 39 张骥
守门员 合计		2/4	5/12	3/6	1/3	0/3	0/1	0/5	11/34	32.4		1				9	于亚男	9 28:00 11
北京		远	近	边	快	突	任意	7m	合计	%	助攻	失误	警告	2'	D+DR			
主教练: 郑永利		射	射	射	攻	破	球	球										
1	王洸															9	赵鑫	8 28:00 11
7	马昌震		1/1						1/1	100				1		9	于亚男	9 00:51 12 9 刘振
8	王鹏															10	翟乾坤	10 01:36 12
9	刘振	0/1						1/1	1/2	50.0	1					11	李语庆	11 03:25 12
10	成亚	0/1	0/2		1/1	1/1		2/5	40.0	1	4					11	李语庆	11 04:30 13 10 成亚
16	刘迈科															12	宋朋强	12 05:55 13
21	胡瀛		0/2	1/2				1/4	25.0							11	宋朋强	13 08:35 13
22	王超															13	宋朋强	13 10:02 14 77 朱昕晨
23	王军程	0/1						0/1	0.0							5	潘翔	14 10:45 14
25	马明辉															14	李语庆	14 11:07 15 99 蒋维一
29	杜龙飞															15	李语庆	15 11:53 15
39	张骥	1/5	3/3	0/1	1/2			3/3	8/14	57.1	1	1				15	李语庆	15 12:36 16 77 朱昕晨
66	解建飞	0/1		1/2				1/1	2/4	50.0			1	1		15	李语庆	15 13:17 17 77 朱昕晨
77	朱昕晨	1/2	2/4	0/1		2/3	1/1	6/11	54.5		1					16	宋朋强	16 14:57 17
83	潘天												1	1		16	宋朋强	16 16:09 18 39 张骥
99	蒋维一		1/3	1/1	0/1			2/5	40.0		1					16	宋朋强	16 17:24 19 77 朱昕晨
运动员 合计		2/11	7/15	3/7	2/4	3/4	1/1	5/5	23/47	48.9	3	7	2	4		17	赵鑫	17 18:28 19
1	王洸		1/2	0/1	0/2			0/2	1/7	14.3						17	于亚男	17 19:10 20 7 马昌震
16	刘迈科	4/8	5/9	1/5		0/1		0/2	10/25	40.0						17	于亚男	17 20:43 21 77 朱昕晨
守门员 合计		4/8	6/11	1/6	0/2	0/1		0/4	11/32	34.4						18	翟乾坤	18 22:20 21
																18	翟乾坤	18 26:40 22 39 张骥
																18	翟乾坤	18 27:37 23 39 张骥
																21	翟乾坤	19 28:21 23
																13	刘晓	20 29:07 23
																5	潘翔	21 29:36 23

场上队员: 得分 / 射门

守门员: 救球 / 射门

D	取消资格	DR	取消资格+报告

第十三届全国运动会男子手球决赛

PHMS Pictorial Handball Match Statistics

IHF Official System

个人/全队技术统计表

 手球 预赛 组别 A 天津师范大学体育馆
 男子 轮次 1 场次 2 2017-08-21 15:45

号码	姓名	远射	近射	边射	快攻	突破	任意	七米	合计	%	助攻	失误	警告	2'	取消	时间
山东队(山东)																
(场上队员)																
3	尹杰									0.0%						00:00:00
4	田瑞									0.0%						00:00:00
5	潘翔				2/2				2/2	100%	1	1				00:34:44
6	李朝鹏									0.0%						00:00:00
8	王炳华		0/1						0/1	0.0%						00:05:16
9	赵鑫	1/2	2/2		0/1	1/1			4/6	66.7%	5		1			00:31:26
11	宋朋强	0/2	2/2						2/4	50.0%	1	1	1	1		00:57:38
12	崔剑									0.0%						00:00:18
13	刘晓		0/1	1/1					1/2	50.0%						00:05:15
15	张继伟									0.0%				1		00:24:33
16	于性哲									0.0%	1					00:59:42
17	王旭东	1/2	0/1						1/3	33.3%	1			2		00:39:46
18	于亚男	1/4	1/2						2/6	33.3%						00:24:02
19	李语庆			1/2				3/3	4/5	80.0%	2					00:51:55
20	杜在超	0/1	0/1						0/2	0.0%	2					00:22:43
21	翟乾坤	1/1	0/1	3/3				1/1	5/6	83.3%	1	1				01:00:00
	合计	4/12	5/11	5/6	2/3	1/1		4/4	21/37	56.8%	1	14	3	5		
(守门员)																
12	崔剑							0/1	0/1	0.0%						00:00:18
16	于性哲	2/4	5/12	3/6	1/3	0/3	0/1	0/4	11/33	33.3%	1					00:59:42
	合计	2/4	5/12	3/6	1/3	0/3	0/1	0/5	11/34	32.4%	1					

场上队员：得分/射门

守门员：救球/射门

全队合计	得分	被救	射失	击柱	封球	合计	%
远射	4	4	2		2	12	33.3%
近射	5	6				11	45.5%
边射	5	1				6	83.3%
快攻	2			1		3	66.7%
突破	1					1	100.0%
任意							0.0%
七米	4					4	100.0%

第十三届全国运动会男子手球决赛

PHMS Pictorial Handball Match Statistics

IHF Official System

个人/全队技术统计表

手球 男子 预赛 轮次 1 组别 A 场次 2 天津师范大学体育馆 2017-08-21 15:45

号码	姓名	远射	近射	边射	快攻	突破	任意	七米	合计	%	助攻	失误	警告	2'	取消	时间
北京队(北京)																
(场上队员)																
1	王澍									0.0%						00:09:37
7	马昌震		1/1						1/1	100%				1		00:12:45
8	王鹏									0.0%						00:03:36
9	刘振	0/1						1/1	1/2	50.0%	1					00:16:27
10	成亚	0/1	0/2		1/1	1/1			2/5	40.0%	1	4				00:59:15
16	刘迈科									0.0%						00:50:23
21	胡瀛		0/2	1/2					1/4	25.0%				1		00:58:40
22	王超									0.0%						00:04:04
23	王军程	0/1							0/1	0.0%						00:16:48
25	马明辉									0.0%						00:00:00
29	杜龙飞									0.0%						00:00:00
39	张骥	1/5	3/3	0/1	1/2			3/3	8/14	57.1%	1	1				00:51:17
66	解建飞	0/1		1/2				1/1	2/4	50.0%			1	1		00:59:43
77	朱昕晨	1/2	2/4	0/1		2/3	1/1		6/11	54.5%		1				00:17:31
83	潘天									0.0%			1	1		00:15:55
99	蒋维一		1/3	1/1	0/1				2/5	40.0%		1				00:41:51
	合计	2/11	7/15	3/7	2/4	3/4	1/1	5/5	23/47	48.9%	3	7	2	4		
(守门员)																
1	王澍		1/2	0/1	0/2			0/2	1/7	14.3%						00:09:37
16	刘迈科	4/8	5/9	1/5		0/1		0/2	10/25	40.0%						00:50:23
	合计	4/8	6/11	1/6	0/2	0/1		0/4	11/32	34.4%						

场上队员：得分/射门

守门员：救球/射门

全队合计	得分	被救	射失	击柱	封球	合计	%
远射	2	2	2		5	11	18.2%
近射	7	5	1	2		15	46.7%
边射	3	3	1			7	42.9%
快攻	2	1		1		4	50.0%
突破	3		1			4	75.0%
任意	1					1	100.0%
七米	5					5	100.0%

第十三届全国运动会男子手球决赛

PHMS Pictorial Handball Match Statistics

IHF Official System

图式比赛技术统计表

手球
男子

预赛
轮次 1

组别 A
场次 2

天津师范大学体育馆
2017-08-21 15:45

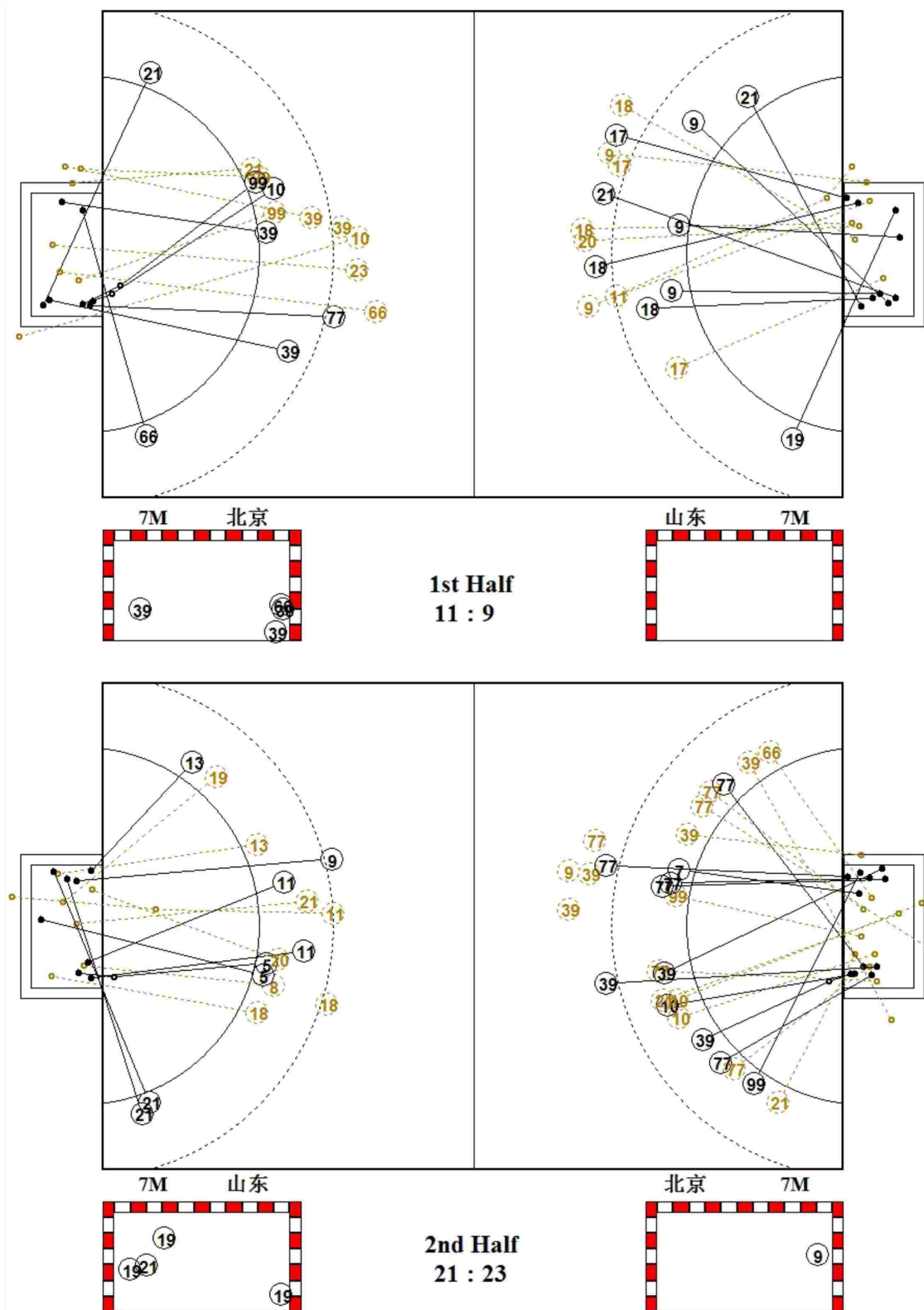

第十三届全国运动会男子手球决赛

PHMS Pictorial Handball Match Statistics

IHF Official System

图式射门区域统计

手球
男子

预赛
轮次 1

组别 A
场次 2

天津师范大学体育馆
2017-08-21 15:45

山东队

3 尹杰	4 田瑞	5 潘翔	6 李朝鹏	8 王炳华	9 赵鑫	11 宋朋强	12 崔剑																																																																								
<table border="1"><tr><td></td><td></td><td></td></tr><tr><td></td><td></td><td></td></tr><tr><td></td><td></td><td></td></tr></table>										<table border="1"><tr><td></td><td></td><td></td></tr><tr><td></td><td></td><td></td></tr><tr><td></td><td></td><td></td></tr></table>										<table border="1"><tr><td></td><td>1</td><td></td></tr><tr><td>1</td><td></td><td></td></tr><tr><td></td><td></td><td></td></tr></table>		1		1						<table border="1"><tr><td></td><td></td><td></td></tr><tr><td></td><td></td><td></td></tr><tr><td></td><td></td><td></td></tr></table>										<table border="1"><tr><td></td><td></td><td></td></tr><tr><td></td><td></td><td></td></tr><tr><td></td><td></td><td></td></tr></table>										<table border="1"><tr><td></td><td>1</td><td></td></tr><tr><td></td><td></td><td>3</td></tr><tr><td></td><td></td><td></td></tr></table>		1				3				<table border="1"><tr><td></td><td></td><td></td></tr><tr><td></td><td></td><td></td></tr><tr><td>2</td><td></td><td></td></tr></table>							2			<table border="1"><tr><td></td><td></td><td></td></tr><tr><td></td><td></td><td></td></tr><tr><td></td><td></td><td></td></tr></table>									
	1																																																																														
1																																																																															
	1																																																																														
		3																																																																													
2																																																																															
13 刘晓	15 张继伟	16 于性哲	17 王旭东	18 于亚男	19 李语庆	20 杜在超	21 翟乾坤																																																																								
<table border="1"><tr><td></td><td></td><td></td></tr><tr><td></td><td></td><td>1</td></tr><tr><td></td><td></td><td></td></tr></table>						1				<table border="1"><tr><td></td><td></td><td></td></tr><tr><td></td><td></td><td></td></tr><tr><td></td><td></td><td></td></tr></table>										<table border="1"><tr><td></td><td></td><td></td></tr><tr><td></td><td></td><td></td></tr><tr><td></td><td></td><td></td></tr></table>										<table border="1"><tr><td></td><td></td><td></td></tr><tr><td>1</td><td></td><td></td></tr><tr><td></td><td></td><td></td></tr></table>				1						<table border="1"><tr><td></td><td></td><td></td></tr><tr><td>1</td><td></td><td></td></tr><tr><td></td><td></td><td></td></tr></table>				1						<table border="1"><tr><td></td><td></td><td></td></tr><tr><td>2</td><td></td><td></td></tr><tr><td>1</td><td></td><td></td></tr></table>				2			1			<table border="1"><tr><td></td><td></td><td></td></tr><tr><td></td><td></td><td></td></tr><tr><td></td><td></td><td></td></tr></table>										<table border="1"><tr><td></td><td></td><td>2</td></tr><tr><td>1</td><td></td><td>1</td></tr><tr><td></td><td></td><td>1</td></tr></table>			2	1		1			1
		1																																																																													
1																																																																															
1																																																																															
2																																																																															
1																																																																															
		2																																																																													
1		1																																																																													
		1																																																																													
12 □□							1 □□																																																																								
<table border="1"><tr><td></td><td></td><td></td></tr><tr><td></td><td></td><td>0/1</td></tr><tr><td></td><td></td><td></td></tr></table>						0/1										<table border="1"><tr><td>0/1</td><td>0/1</td><td></td></tr><tr><td>0/1</td><td></td><td></td></tr><tr><td>1/2</td><td></td><td>0/2</td></tr></table>	0/1	0/1		0/1			1/2		0/2																																																						
		0/1																																																																													
0/1	0/1																																																																														
0/1																																																																															
1/2		0/2																																																																													
16 □□□							16 □□□																																																																								
<table border="1"><tr><td>0/2</td><td>2/2</td><td></td></tr><tr><td>2/6</td><td>1/1</td><td>3/8</td></tr><tr><td>0/6</td><td>2/2</td><td>1/6</td></tr></table>	0/2	2/2		2/6	1/1	3/8	0/6	2/2	1/6							<table border="1"><tr><td>1/2</td><td>0/1</td><td>0/2</td></tr><tr><td>1/3</td><td>1/1</td><td>3/8</td></tr><tr><td>2/5</td><td>1/1</td><td>1/2</td></tr></table>	1/2	0/1	0/2	1/3	1/1	3/8	2/5	1/1	1/2																																																						
0/2	2/2																																																																														
2/6	1/1	3/8																																																																													
0/6	2/2	1/6																																																																													
1/2	0/1	0/2																																																																													
1/3	1/1	3/8																																																																													
2/5	1/1	1/2																																																																													

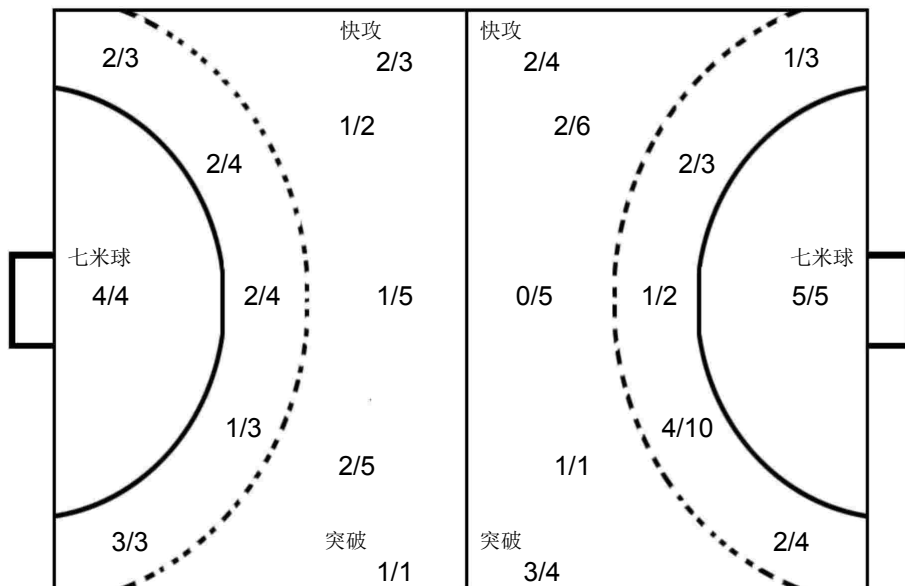

北京队

1 王澍	7 马昌震	8 王鹏	9 刘振	10 成亚	16 刘迈科	21 胡瀛	22 王超																																																																								
<table border="1"><tr><td></td><td></td><td></td></tr><tr><td></td><td></td><td></td></tr><tr><td></td><td></td><td></td></tr></table>										<table border="1"><tr><td></td><td></td><td></td></tr><tr><td>1</td><td></td><td></td></tr><tr><td></td><td></td><td></td></tr></table>				1						<table border="1"><tr><td></td><td></td><td></td></tr><tr><td></td><td></td><td></td></tr><tr><td></td><td></td><td></td></tr></table>										<table border="1"><tr><td></td><td></td><td></td></tr><tr><td></td><td></td><td>1</td></tr><tr><td></td><td></td><td></td></tr></table>						1				<table border="1"><tr><td></td><td></td><td></td></tr><tr><td>1</td><td></td><td>1</td></tr><tr><td></td><td></td><td></td></tr></table>				1		1				<table border="1"><tr><td></td><td></td><td></td></tr><tr><td></td><td></td><td></td></tr><tr><td></td><td></td><td></td></tr></table>										<table border="1"><tr><td></td><td></td><td></td></tr><tr><td>1</td><td></td><td></td></tr><tr><td></td><td></td><td></td></tr></table>				1						<table border="1"><tr><td></td><td></td><td></td></tr><tr><td></td><td></td><td></td></tr><tr><td></td><td></td><td></td></tr></table>									
1																																																																															
		1																																																																													
1		1																																																																													
1																																																																															
23 王军程	25 马明辉	29 杜龙飞	39 张骥	66 解建飞	77 朱昕晨	83 潘天	99 蒋维一																																																																								
<table border="1"><tr><td></td><td></td><td></td></tr><tr><td></td><td></td><td></td></tr><tr><td></td><td></td><td></td></tr></table>										<table border="1"><tr><td></td><td></td><td></td></tr><tr><td></td><td></td><td></td></tr><tr><td></td><td></td><td></td></tr></table>										<table border="1"><tr><td></td><td></td><td></td></tr><tr><td></td><td></td><td></td></tr><tr><td></td><td></td><td></td></tr></table>										<table border="1"><tr><td></td><td>1</td><td></td></tr><tr><td>2</td><td></td><td>3</td></tr><tr><td></td><td></td><td>2</td></tr></table>		1		2		3			2	<table border="1"><tr><td></td><td></td><td></td></tr><tr><td></td><td></td><td>1</td></tr><tr><td></td><td></td><td>1</td></tr></table>						1			1	<table border="1"><tr><td></td><td></td><td></td></tr><tr><td>2</td><td></td><td>1</td></tr><tr><td>2</td><td></td><td>1</td></tr></table>				2		1	2		1	<table border="1"><tr><td></td><td></td><td></td></tr><tr><td></td><td></td><td></td></tr><tr><td></td><td></td><td></td></tr></table>										<table border="1"><tr><td></td><td></td><td></td></tr><tr><td></td><td></td><td></td></tr><tr><td>2</td><td></td><td></td></tr></table>							2		
	1																																																																														
2		3																																																																													
		2																																																																													
		1																																																																													
		1																																																																													
2		1																																																																													
2		1																																																																													
2																																																																															
Post - 0 Miss - 0 Block - 0	Post - 0 Miss - 0 Block - 0	Post - 0 Miss - 0 Block - 0	Post - 0 Miss - 0 Block - 1	Post - 1 Miss - 1 Block - 0	Post - 0 Miss - 0 Block - 0	Post - 1 Miss - 0 Block - 0	Post - 0 Miss - 0 Block - 0																																																																								
Post - 0 Miss - 0 Block - 0	Post - 0 Miss - 0 Block - 0	Post - 0 Miss - 0 Block - 0	Post - 1 Miss - 2 Block - 3	Post - 0 Miss - 0 Block - 0	Post - 0 Miss - 1 Block - 1	Post - 0 Miss - 0 Block - 0	Post - 0 Miss - 1 Block - 0																																																																								



PHMS Pictorial Handball Match Statistics

IHF Official System

Team A					Team B					Match Number								
A 江苏队					B 香港队					3								
Played in			in the hall			on			at			Spectators						
天津			天津师范大学体育馆			2017-08-21			17:30			hours						
Half-time(30')	A	B	End of playing time		A	B	1st extra time		A	B	2nd extra time		A	B	After penalty throws		A	B
	19	12	35		21													
Number of 7 m	A	Team time-out			Full name of players and officials						Team time-out			B	Number of 7 m			
	2/2	1	2	3							1	2	3	1/1				
		19:22	53:00								29:30							

No.	Team A	G	W	2'	D	DR	No.	Team B	G	W	2'	D	DR
1	徐畅						1	叶冠英					
4	张家纬	4					2	刘健斌	2				
5	闫亮	1					3	陈梓朗	3				
6	赵晨	5	1				5	黄胜业	1				
7	徐奕飞	2		1			7	谭俊杰					
8	周小坚	1					8	李伟东	1				
9	王杰缘	3	1				10	谢永辉	1				
10	郝可鑫	4					12	许文邦	2				
12	王权						13	张伟浩			1		
13	叶强						18	李鑫豪	1				
15	李安	3					23	郭斯鸣	2	1			
17	王伟强	3					27	冼大维					
18	赵楠	1					29	练明辉	3		1		
19	张志宇	1					31	叶仕仁					
20	顾艳超	5		1			33	袁晞彦	2				
21	刘江	2					40	叶冠雄	3				
A	闫威名 (主教练)						A	杨开将					
C	雷纳德						B	王涛					
D	贾淑君						C	高梓欣					
E	王建国												
A	Signatures of responsables for the teams (Off.A)												B
TP	Remarks of referees / HF Official												TP

Signatures

Referees	李典 (CHN)	倪震 (CHN)	
T.D.	于中迅 (CHN)	门东山 (CHN)	
CHA Off.			

Note: Number of 7m Throws Awarded to Team A and B, Goals (G), Warnings (W), Suspensions (2'), Direct Disqualification (D), Disqualification With Report (DR) and Team Penalty (TP).

Table Officials: 鲍瑀 刘宇阳 Statisticians: 黄岩 刘永欢

第十三届全国运动会男子手球决赛

PHMS Pictorial Handball Match Statistics

IHF Official System

竞赛技术统计

手球 男子 预赛 轮次 1 组别 B 场次 3 天津师范大学体育馆 2017-08-21 17:30

 Referees: 李典 (CHN) / 倪震 (CHN) Result: 35:21(19:12)
 Teams: 江苏队(江苏) VS 香港队(香港)

江苏														江苏		比赛进程		香港	
主教练: 闫威名																			
	远射	近射	边射	快攻	突破	任意球	7m球	合计	%	助攻	失误	警告	2'	D+DR					
1	徐畅									2									
4	张家纬	3/6	1/1			0/1		4/8	50.0		1								
5	闫亮		1/1					1/1	100										
6	赵晨	4/7				0/1	1/1	5/9	55.6	1	2	1							
7	徐奕飞		1/1		1/1			2/2	100				1						
8	周小坚		1/2					1/2	50.0		1								
9	王杰缘				3/4			3/4	75.0			1							
10	郝可鑫	3/5					1/1	4/6	66.7		3								
12	王权																		
13	叶强									1									
15	李安		1/1		2/3			3/4	75.0		1								
17	王伟强	0/1	2/3	0/1	1/2			3/7	42.9	1	2								
18	赵楠	0/1			1/2			1/3	33.3		3								
19	张志宇	1/2	0/1					1/3	33.3		1								
20	顾艳超	1/5	3/3			1/1		5/9	55.6	1	3		1						
21	刘江		0/1		2/2			2/3	66.7										
运动员 合计		12/27	10/14	0/1	10/14	1/1	0/2	2/2	35/61	57.4	6	17	2	2					
1	徐畅	2/3	2/4	2/3	0/3	1/1		7/14	50.0	2									
12	王权	9/11	2/5	2/5	1/4	0/1	0/1	14/27	51.9										
13	叶强	0/1		1/1				1/2	50.0	1									
守门员 合计		11/15	4/9	5/9	1/7	1/2	0/1	22/43	51.2	3									
香港														江苏		比赛进程		香港	
主教练: 高梓欣																			
	远射	近射	边射	快攻	突破	任意球	7m球	合计	%	助攻	失误	警告	2'	D+DR					
1	叶冠英										4								
2	刘健斌			2/4				2/4	50.0		1								
3	陈梓朗		0/1	1/1	2/3			3/5	60.0										
5	黄胜业		1/1					1/1	100		2								
7	谭俊杰																		
8	李伟东				1/1			1/1	100										
10	谢永辉			1/2				1/2	50.0		3								
12	许文邦	1/13			1/1			2/14	14.3	2	4								
13	张伟浩			0/1				0/1	0.0		1		1						
18	李鑫豪		0/1		1/1			1/2	50.0		1								
23	郭斯鸣	0/3		0/1		1/1	1/1	2/6	33.3		2	1							
27	冼大维										1								
29	练明辉	2/3	1/1	0/1				3/5	60.0		3		1						
31	叶仕仁	0/1	0/1					0/2	0.0	1	4								
33	袁晞彦		2/2					2/2	100										
40	叶冠雄	1/3	1/2		1/1	0/1		3/7	42.9		1								
运动员 合计		4/23	5/9	4/10	6/7	1/2	1/1	21/52	40.4	3	27	1	2						
1	叶冠英	3/10	1/7	1/1	2/8	0/1	0/2	7/29	24.1		4								
7	谭俊杰	5/10	2/6		1/5	1/1		9/22	40.9										
守门员 合计		8/20	3/13	1/1	3/13	0/1	1/1	16/51	31.4		4								
														1st Half					
														6	赵晨	1	02:10	0	
																1	02:55	1	23 郭斯鸣
														20	顾艳超	2	03:24	1	
														4	张家纬	3	04:14	1	
																3	04:52	2	18 李鑫豪
														8	周小坚	4	05:28	2	
																4	05:56	3	40 叶冠雄
														6	赵晨	5	06:24	3	
																5	07:18	4	10 谢永辉
																5	08:10	5	40 叶冠雄
														6	赵晨	6	09:23	5	
														15	李安	7	10:30	5	
																7	11:01	6	33 袁晞彦
														4	张家纬	8	11:34	6	
														9	王杰缘	9	12:19	6	
																9	13:02	7	3 陈梓朗
														4	张家纬	10	13:54	7	
														15	李安	11	14:39	7	
														10	郝可鑫	12	16:51	7	
																12	18:13	8	33 袁晞彦
																12	19:07	9	23 郭斯鸣
														19	张志宇	13	22:16	9	
														9	王杰缘	14	23:39	9	
																14	24:18	10	8 李伟东
														10	郝可鑫	15	25:17	10	
																15	26:27	11	29 练明辉
														10	郝可鑫	16	27:03	11	
														15	李安	17	27:52	11	
																17	28:21	12	2 刘健斌
														5	闫亮	18	28:43	12	
														10	郝可鑫	19	29:20	12	
														2nd Half					
														19	00:54	13	5 黄胜业		
														4	张家纬	20	02:08	13	
														6	赵晨	21	03:51	13	
																21	05:28	14	3 陈梓朗
																21	07:22	15	3 陈梓朗
														17	王伟强	22	08:38	15	
														17	王伟强	23	11:24	15	
														9	王杰缘	24	12:03	15	
																24	12:28	16	2 刘健斌
														17	王伟强	25	14:04	16	
																25	14:34	17	12 许文邦
														20	顾艳超	26	14:58	17	
														6	赵晨	27	16:33	17	
														7	徐奕飞	28	18:25	17	
																28	18:59	18	29 练明辉
																28	19:39	19	12 许文邦
														20	顾艳超	29	21:03	19	
														18	赵楠	30	21:29	19	
														7	徐奕飞	31	22:11	19	
														20	顾艳超	32	23:39	19	
																32	24:27	20	40 叶冠雄
														21	刘江	33	25:54	20	
														20	顾艳超	34	27:41	20	
																34	28:08	21	29 练明辉
														21	刘江	35	29:45	21	

场上队员: 得分 / 射门

守门员: 救球 / 射门

D	取消资格	DR	取消资格+报告
---	------	----	---------



第十三届全国运动会男子手球决赛

PHMS Pictorial Handball Match Statistics

IHF Official System

个人/全队技术统计表

手球 男子 预赛 轮次 1 组别 B 场次 3 天津师范大学体育馆 2017-08-21 17:30

号码	姓名	远射	近射	边射	快攻	突破	任意	七米	合计	%	助攻	失误	警告	2'	取消	时间
江苏队(江苏)																
(场上队员)																
1	徐畅									0.0%	2					00:22:08
4	张家纬	3/6	1/1				0/1		4/8	50.0%		1				00:31:30
5	闫亮		1/1						1/1	100%						00:11:35
6	赵晨	4/7					0/1	1/1	5/9	55.6%	1	2	1			00:41:48
7	徐奕飞		1/1		1/1				2/2	100%				1		00:14:57
8	周小坚		1/2						1/2	50.0%		1				01:03:20
9	王杰缘				3/4				3/4	75.0%			1			00:43:18
10	郝可鑫	3/5						1/1	4/6	66.7%		3				00:21:47
12	王权									0.0%						00:34:51
13	叶强									0.0%	1					00:03:01
15	李安		1/1		2/3				3/4	75.0%		1				00:30:00
17	王伟强	0/1	2/3	0/1	1/2				3/7	42.9%	1	2				00:30:25
18	赵楠	0/1			1/2				1/3	33.3%		3				00:16:20
19	张志宇	1/2	0/1						1/3	33.3%		1				00:18:05
20	顾艳超	1/5	3/3			1/1			5/9	55.6%	1	3		1		00:42:00
21	刘江		0/1		2/2				2/3	66.7%						00:17:25
合计		12/27	10/14	0/1	10/14	1/1	0/2	2/2	35/61	57.4%	6	17	2	2		

(守门员)

1	徐畅	2/3	2/4	2/3	0/3	1/1			7/14	50.0%	2					00:22:08
12	王权	9/11	2/5	2/5	1/4	0/1		0/1	14/27	51.9%						00:34:51
13	叶强	0/1		1/1					1/2	50.0%	1					00:03:01
合计		11/15	4/9	5/9	1/7	1/2		0/1	22/43	51.2%	3					

场上队员：得分/射门

守门员：救球/射门

全队合计	得分	被救	射失	击柱	封球	合计	%
远射	12	8	4	1	2	27	44.4%
近射	10	3		1		14	71.4%
边射		1				1	0.0%
快攻	10	3		1		14	71.4%
突破	1					1	100.0%
任意		1		1		2	0.0%
七米	2					2	100.0%

第十三届全国运动会男子手球决赛

PHMS Pictorial Handball Match Statistics

IHF Official System

个人/全队技术统计表

 手球 预赛 组别 B 天津师范大学体育馆
 男子 轮次 1 场次 3 2017-08-21 17:30

号码	姓名	远射	近射	边射	快攻	突破	任意	七米	合计	%	助攻	失误	警告	2'	取消	时间
香港队(香港)																
(场上队员)																
1	叶冠英									0.0%		4				00:30:48
2	刘健斌			2/4					2/4	50.0%		1				00:24:31
3	陈梓朗		0/1	1/1	2/3				3/5	60.0%						00:30:04
5	黄胜业		1/1						1/1	100%		2				00:19:43
7	谭俊杰									0.0%						00:29:12
8	李伟东				1/1				1/1	100%						00:22:01
10	谢永辉			1/2					1/2	50.0%		3				00:26:59
12	许文邦	1/13			1/1				2/14	14.3%	2	4				00:26:35
13	张伟浩			0/1					0/1	0.0%		1		1		00:27:13
18	李鑫豪		0/1		1/1				1/2	50.0%		1				00:20:04
23	郭斯鸣	0/3		0/1		1/1		1/1	2/6	33.3%		2	1			00:29:52
27	冼大维									0.0%		1				00:27:08
29	练明辉	2/3	1/1	0/1					3/5	60.0%		3		1		00:33:26
31	叶仕仁	0/1	0/1						0/2	0.0%	1	4				00:38:20
33	袁晞彦		2/2						2/2	100%						00:13:09
40	叶冠雄	1/3	1/2		1/1	0/1			3/7	42.9%		1				00:32:47
	合计	4/23	5/9	4/10	6/7	1/2		1/1	21/52	40.4%	3	27	1	2		
(守门员)																
1	叶冠英	3/10	1/7	1/1	2/8	0/1		0/2	7/29	24.1%		4				00:30:48
7	谭俊杰	5/10	2/6		1/5		1/1		9/22	40.9%						00:29:12
	合计	8/20	3/13	1/1	3/13	0/1	1/1	0/2	16/51	31.4%		4				

场上队员：得分/射门

守门员：救球/射门

全队合计	得分	被救	射失	击柱	封球	合计	%
远射	4	11	1	1	6	23	17.4%
近射	5	4				9	55.6%
边射	4	5	1			10	40.0%
快攻	6	1				7	85.7%
突破	1	1				2	50.0%
任意							0.0%
七米	1					1	100.0%

第十三届全国运动会男子手球决赛

PHMS Pictorial Handball Match Statistics

IHF Official System

图式比赛技术统计表

手球
男子

预赛
轮次 1

组别 B
场次 3

天津师范大学体育馆
2017-08-21 17:30

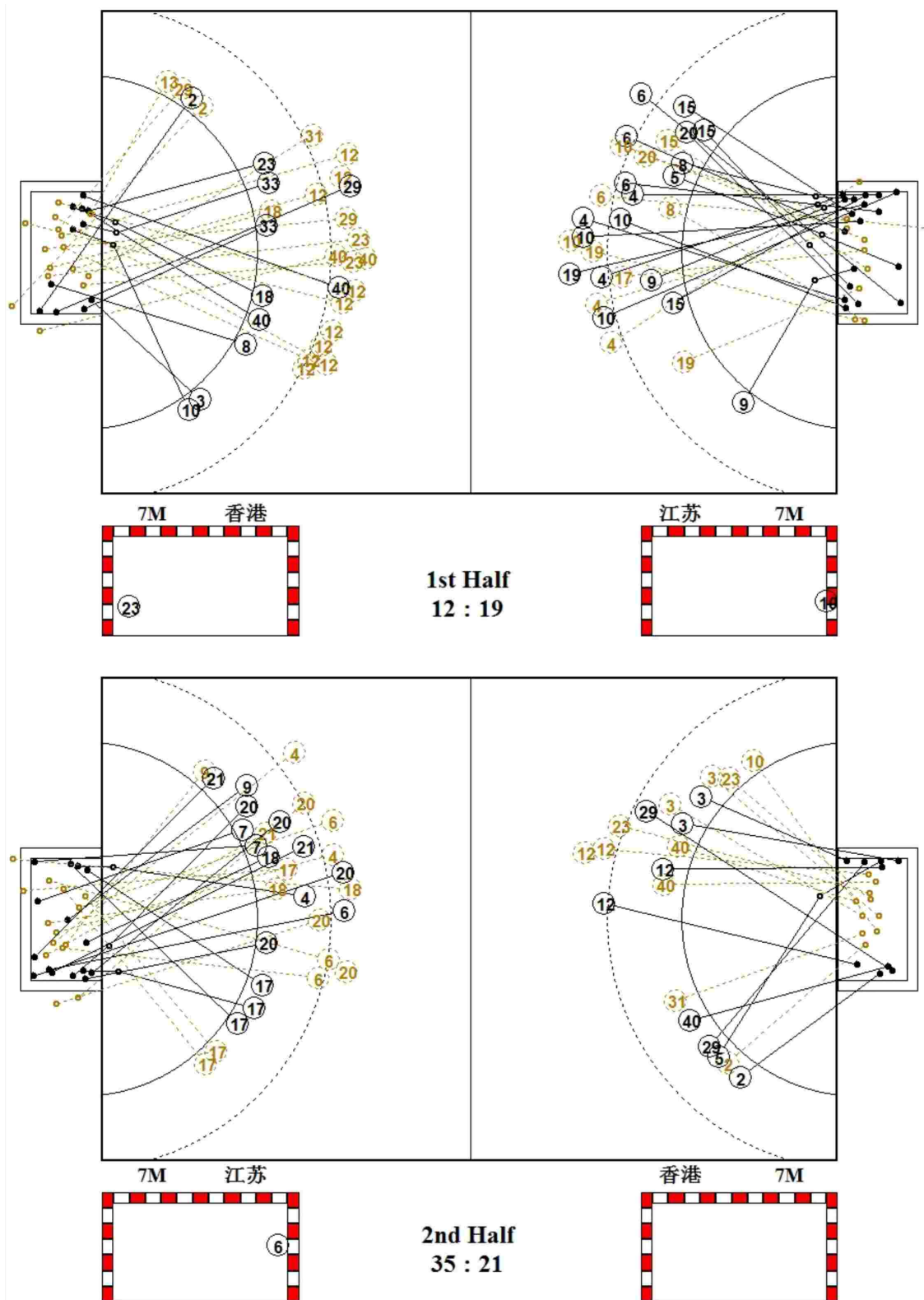

第十三届全国运动会男子手球决赛

PHMS Pictorial Handball Match Statistics

IHF Official System

图式射门区域统计

手球
男子

预赛
轮次 1

组别 B
场次 3

天津师范大学体育馆
2017-08-21 17:30

江苏队

1 徐畅	4 张家纬	5 闫亮	6 赵晨	7 徐奕飞	8 周小坚	9 王杰缘	10 郝可鑫																																																																								
<table border="1"><tr><td></td><td></td><td></td></tr><tr><td></td><td></td><td></td></tr><tr><td></td><td></td><td></td></tr></table>										<table border="1"><tr><td></td><td></td><td></td></tr><tr><td>1</td><td></td><td>1</td></tr><tr><td>1</td><td></td><td>1</td></tr></table>				1		1	1		1	<table border="1"><tr><td></td><td>1</td><td></td></tr><tr><td></td><td></td><td></td></tr><tr><td></td><td></td><td></td></tr></table>		1								<table border="1"><tr><td>1</td><td></td><td>1</td></tr><tr><td>1</td><td></td><td>1</td></tr><tr><td></td><td>1</td><td></td></tr></table>	1		1	1		1		1		<table border="1"><tr><td></td><td>1</td><td>1</td></tr><tr><td></td><td></td><td></td></tr><tr><td></td><td></td><td></td></tr></table>		1	1							<table border="1"><tr><td></td><td></td><td></td></tr><tr><td></td><td></td><td></td></tr><tr><td>1</td><td></td><td></td></tr></table>							1			<table border="1"><tr><td></td><td></td><td></td></tr><tr><td></td><td>1</td><td></td></tr><tr><td>1</td><td>1</td><td></td></tr></table>					1		1	1		<table border="1"><tr><td></td><td></td><td></td></tr><tr><td>1</td><td></td><td></td></tr><tr><td></td><td></td><td>1</td></tr></table>				1					1
1		1																																																																													
1		1																																																																													
	1																																																																														
1		1																																																																													
1		1																																																																													
	1																																																																														
	1	1																																																																													
1																																																																															
	1																																																																														
1	1																																																																														
1																																																																															
		1																																																																													
Post - 0 Miss - 0 Block - 0	Post - 1 Miss - 0 Block - 0	Post - 0 Miss - 0 Block - 0	Post - 0 Miss - 1 Block - 0	Post - 0 Miss - 0 Block - 0	Post - 1 Miss - 0 Block - 0	Post - 0 Miss - 0 Block - 0	Post - 0 Miss - 0 Block - 1																																																																								
12 王权	13 叶强	15 李安	17 王伟强	18 赵楠	19 张志宇	20 顾艳超	21 刘江																																																																								
<table border="1"><tr><td></td><td></td><td></td></tr><tr><td></td><td></td><td></td></tr><tr><td></td><td></td><td></td></tr></table>										<table border="1"><tr><td></td><td></td><td></td></tr><tr><td></td><td></td><td></td></tr><tr><td></td><td></td><td></td></tr></table>										<table border="1"><tr><td></td><td></td><td></td></tr><tr><td>1</td><td></td><td></td></tr><tr><td>1</td><td></td><td>1</td></tr></table>				1			1		1	<table border="1"><tr><td></td><td></td><td></td></tr><tr><td></td><td></td><td>1</td></tr><tr><td>1</td><td></td><td>1</td></tr></table>						1	1		1	<table border="1"><tr><td></td><td></td><td></td></tr><tr><td></td><td></td><td></td></tr><tr><td>1</td><td></td><td></td></tr></table>							1			<table border="1"><tr><td></td><td></td><td></td></tr><tr><td>1</td><td></td><td></td></tr><tr><td></td><td></td><td></td></tr></table>				1						<table border="1"><tr><td></td><td></td><td></td></tr><tr><td>1</td><td></td><td></td></tr><tr><td>2</td><td></td><td>1</td></tr></table>				1			2		1	<table border="1"><tr><td></td><td></td><td></td></tr><tr><td>2</td><td></td><td></td></tr><tr><td></td><td></td><td></td></tr></table>				2					
1																																																																															
1		1																																																																													
		1																																																																													
1		1																																																																													
1																																																																															
1																																																																															
1																																																																															
2		1																																																																													
2																																																																															
Post - 0 Miss - 0 Block - 0	Post - 0 Miss - 0 Block - 0	Post - 0 Miss - 0 Block - 0	Post - 1 Miss - 0 Block - 0	Post - 0 Miss - 1 Block - 0	Post - 1 Miss - 0 Block - 0	Post - 0 Miss - 2 Block - 1	Post - 0 Miss - 0 Block - 0																																																																								

1 □□

0/1		0/1
3/5	2/2	1/2
0/1	1/1	0/1

12 □□

1/3	2/2	1/1
0/3	5/5	2/4
2/4		1/5

13 □□

		0/1
	1/1	

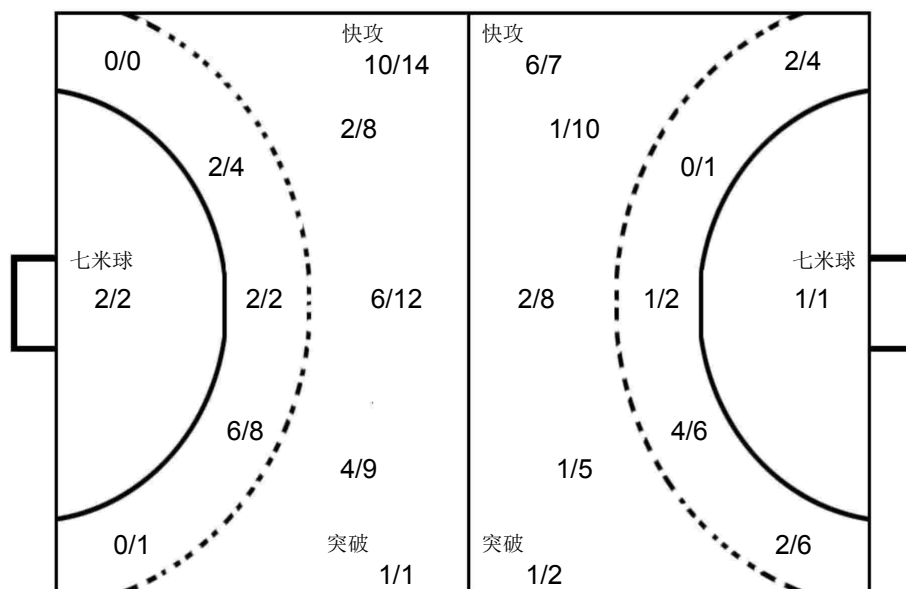

1 □□□

0/3	1/2	0/2
1/5	1/1	1/3
2/8	0/1	1/4

7 □□□

2/4	0/1	1/1
1/3	3/4	0/2
0/2	1/2	1/3

香港队

1 叶冠英	2 刘健斌	3 陈祥朗	5 黄胜业	7 谭俊杰	8 李伟东	10 谢永辉	12 许文邦																																																																								
<table border="1"><tr><td></td><td></td><td></td></tr><tr><td></td><td></td><td></td></tr><tr><td></td><td></td><td></td></tr></table>										<table border="1"><tr><td></td><td>1</td><td></td></tr><tr><td></td><td></td><td>1</td></tr><tr><td></td><td></td><td></td></tr></table>		1				1				<table border="1"><tr><td></td><td>1</td><td></td></tr><tr><td></td><td></td><td></td></tr><tr><td>2</td><td></td><td></td></tr></table>		1					2			<table border="1"><tr><td></td><td></td><td></td></tr><tr><td>1</td><td></td><td></td></tr><tr><td></td><td></td><td></td></tr></table>				1						<table border="1"><tr><td></td><td></td><td></td></tr><tr><td></td><td></td><td></td></tr><tr><td></td><td></td><td></td></tr></table>										<table border="1"><tr><td></td><td>1</td><td></td></tr><tr><td></td><td></td><td></td></tr><tr><td></td><td></td><td></td></tr></table>		1								<table border="1"><tr><td></td><td></td><td></td></tr><tr><td></td><td></td><td>1</td></tr><tr><td></td><td></td><td></td></tr></table>						1				<table border="1"><tr><td></td><td></td><td></td></tr><tr><td>1</td><td></td><td></td></tr><tr><td></td><td></td><td></td></tr></table>				1					
	1																																																																														
		1																																																																													
	1																																																																														
2																																																																															
1																																																																															
	1																																																																														
		1																																																																													
1																																																																															
Post - 0 Miss - 0 Block - 0	Post - 0 Miss - 1 Block - 0	Post - 0 Miss - 0 Block - 0	Post - 0 Miss - 0 Block - 0	Post - 0 Miss - 0 Block - 0	Post - 0 Miss - 0 Block - 0	Post - 0 Miss - 0 Block - 0	Post - 1 Miss - 0 Block - 5																																																																								
13 张伟浩	18 李鑫豪	23 郭斯鸣	27 冼大维	29 练明辉	31 叶仕仁	33 袁晔彦	40 叶冠雄																																																																								
<table border="1"><tr><td></td><td></td><td></td></tr><tr><td></td><td></td><td></td></tr><tr><td></td><td></td><td></td></tr></table>										<table border="1"><tr><td></td><td></td><td></td></tr><tr><td></td><td></td><td>1</td></tr><tr><td></td><td></td><td></td></tr></table>						1				<table border="1"><tr><td></td><td></td><td></td></tr><tr><td>1</td><td></td><td></td></tr><tr><td></td><td></td><td>1</td></tr></table>				1					1	<table border="1"><tr><td></td><td></td><td></td></tr><tr><td></td><td></td><td></td></tr><tr><td></td><td></td><td></td></tr></table>										<table border="1"><tr><td></td><td></td><td></td></tr><tr><td></td><td></td><td>1</td></tr><tr><td>2</td><td></td><td></td></tr></table>						1	2			<table border="1"><tr><td></td><td></td><td></td></tr><tr><td></td><td></td><td></td></tr><tr><td></td><td></td><td></td></tr></table>										<table border="1"><tr><td></td><td></td><td></td></tr><tr><td>1</td><td></td><td>1</td></tr><tr><td></td><td></td><td></td></tr></table>				1		1				<table border="1"><tr><td></td><td></td><td>1</td></tr><tr><td></td><td></td><td></td></tr><tr><td></td><td></td><td>2</td></tr></table>			1						2
		1																																																																													
1																																																																															
		1																																																																													
		1																																																																													
2																																																																															
1		1																																																																													
		1																																																																													
		2																																																																													
Post - 0 Miss - 0 Block - 0	Post - 0 Miss - 0 Block - 0	Post - 0 Miss - 0 Block - 0	Post - 0 Miss - 0 Block - 0	Post - 0 Miss - 0 Block - 0	Post - 0 Miss - 0 Block - 0	Post - 0 Miss - 0 Block - 0	Post - 0 Miss - 1 Block - 1																																																																								



PHMS Pictorial Handball Match Statistics

IHF Official System

Team A					Team B					Match Number											
A 广东队					B 安徽队					4											
Played in			in the hall			on			at			Spectators									
天津			天津师范大学体育馆			2017-08-21			19:15			hours									
Half-time(30')	A	B	End of playing time		A	B	1st extra time		A	B	2nd extra time		A	B	After penalty throws		A	B			
	14	14	32		26																
Number of 7 m	A	Team time-out			Full name of players and officials						Team time-out			B	Number of 7 m						
	2/2	1	2	3							1	2	3	B							
		13:51	55:48								18:48	43:07	48:43	5/5							
No.	Team A					G	W	2'	D	DR	No.	Team B					G	W	2'	D	DR
1	王帅										1	郭世伟					2				
2	孙江山					5		1			3	陈强龙					3				
3	曲汝洋					3					5	史小帆							1		
4	李卓洋					4					7	姚雄敏									
5	侯生升							1			8	董智景					6				
6	邓志贵					1					9	陈开勇					3	1			
7	付云博										10	严龙									
8	于彦江					5					11	黎涛					5				
9	徐庆					3					12	曾献辰									
11	房友屯										15	曹青福临									
12	王雨										16	杨洋									
15	张建杰										17	王巨柱					7				
16	马跃										18	李双									
17	李中洲					7					21	李明									
26	姚雪岩										23	于敏清						1			
84	王伟					4					24	徐安格									
B	王锋 (主教练)										B	沈强 (主教练)									
C	刘康伶										C	吴翔									
D	张广建										D	黄红									
E	王永存										E	吴台锡									
A	Signatures of responsables for the teams (Off.A)															B					
TP	Remarks of referees / HF Official															TP					

Signatures

Referees 李兆蒙 (CHN)

南金勇 (CHN)

T.D. 刘书勇 (CHN)

李刚 (CHN)

CHA Off.

Note: Number of 7m Throws Awarded to Team A and B, Goals (G), Warnings (W), Suspensions (2'), Direct Disqualification (D), Disqualification With Report (DR) and Team Penalty (TP).

Table Officials: 隆晓磊

梅艳

Statisticians: 刘永欢

陈柱

第十三届全国运动会男子手球决赛

PHMS Pictorial Handball Match Statistics

IHF Official System

竞赛技术统计

手球
男子

预赛
轮次 1

组别 B
场次 4

天津师范大学体育馆
2017-08-21 19:15

Referees: 李兆蒙 (CHN) / 南金勇 (CHN)

Result: 32:26(14:14)

Teams: 广东队(广东) VS 安徽队(安徽)

广东		远射	近射	边射	快攻	突破	任意球	7m球	合计	%	助攻	失误	警告	2'	D+DR
主教练: 王锋															
1	王帅														
2	孙江山			4/5				1/1	5/6	83.3		2		1	
3	曲汝洋	0/1	3/4						3/5	60.0	1	2			
4	李卓洋	2/2	1/2			1/2			4/6	66.7					
5	侯生升			0/1					0/1	0.0			1		
6	邓志贵		0/1	1/1					1/2	50.0					
7	付云博	0/1	0/1						0/2	0.0	1	2			
8	于彦江	1/2	2/2		1/1	1/1			5/6	83.3	1	4			
9	徐庆		1/1		2/2				3/3	100		1			
11	房友屯														
12	王雨														
15	张建杰														
16	马跃											1			
17	李中洲	4/5	0/1		2/2			1/1	7/9	77.8	2	2			
26	姚雪岩														
84	王伟		4/6						4/6	66.7		2			
运动员 合计		7/11	11/18	5/7	5/5	2/3		2/2	32/46	69.6	5	16	1	1	
1	王帅							0/1	0/1	0.0					
16	马跃	6/13	2/6	1/3	1/7	0/1	0/1	0/4	10/35	28.6		1			
守门员 合计		6/13	2/6	1/3	1/7	0/1	0/1	0/5	10/36	27.8		1			

安徽		远射	近射	边射	快攻	突破	任意球	7m球	合计	%	助攻	失误	警告	2'	D+DR
主教练: 沈强															
1	郭世伟	0/1	1/2		1/1				2/4	50.0		3			
3	陈强龙			1/1	2/2				3/3	100					
5	史小帆	0/1							0/1	0.0	1	5		1	
7	姚雄敏														
8	董智景	1/1		2/4	2/3			1/1	6/9	66.7		1			
9	陈开勇	0/1	2/2		1/1				3/4	75.0		2	1		
10	严龙											1			
11	黎涛	1/3				1/1		3/3	5/7	71.4		5			
12	曾献辰														
15	曹青福临														
16	杨洋														
17	王巨柱	5/10	0/1				1/1	1/1	7/13	53.8	1	1			
18	李双	0/1							0/1	0.0		1			
21	李明											1			
23	于敏清											1	1		
24	徐安格														
运动员 合计		7/18	4/6	2/4	6/7	1/1	1/1	5/5	26/42	61.9	4	19	2	1	
12	曾献辰	2/6	0/4	1/3	0/1	0/1			3/15	20.0					
21	李明	1/4	3/10	1/4	0/4	1/2		0/2	6/26	23.1	1				
守门员 合计		3/10	3/14	2/7	0/5	1/3		0/2	9/41	22.0	1				

广东	比赛进程	安徽
	1st Half	
0	00:33	1 8 董智景
2	01:09	1
8	02:43	1
17	02:59	1
3	04:19	2 8 董智景
2	04:59	2
9	05:49	2
5	06:23	3 11 黎涛
8	06:47	3
6	08:16	4 11 黎涛
6	09:34	5 3 陈强龙
6	12:14	6 8 董智景
6	12:33	7 3 陈强龙
3	15:47	7
7	16:19	8 17 王巨柱
4	16:58	8
8	17:38	9 3 陈强龙
84	17:54	9
17	18:32	9
6	19:17	9
11	20:16	10 17 王巨柱
4	22:06	10
12	22:50	11 郭世伟
84	23:27	11
13	24:06	12 17 王巨柱
13	25:08	13 17 王巨柱
13	26:14	14 11 黎涛
8	27:07	14
	2nd Half	
4	15:01:05	14
4	16:02:10	14
16	03:00	15 8 董智景
9	05:18	15
17	06:17	16 11 黎涛
2	06:49	16
8	07:47	17 8 董智景
19	08:28	17
19	09:23	18 9 陈开勇
9	10:15	18
20	10:31	19 9 陈开勇
17	11:48	19
17	12:42	19
17	14:50	19
23	15:30	20 17 王巨柱
17	16:31	20
84	18:35	20
2	19:36	20
8	20:25	20
27	20:58	21 11 黎涛
28	22:55	21
84	23:17	22 17 王巨柱
2	23:56	22
29	24:23	23 17 王巨柱
29	26:16	24 9 陈开勇
29	27:07	25 1 郭世伟
3	27:41	25
17	28:27	25
31	29:26	26 8 董智景
3	29:53	26

场上队员: 得分 / 射门

守门员: 救球 / 射门

D	取消资格	DR	取消资格+报告

第十三届全国运动会男子手球决赛
PHMS Pictorial Handball Match Statistics

IHF Official System

个人/全队技术统计表

手球 男子 预赛 轮次 1 组别 B 场次 4 天津师范大学体育馆 2017-08-21 19:15

号码	姓名	远射	近射	边射	快攻	突破	任意	七米	合计	%	助攻	失误	警告	2'	取消	时间
广东队(广东)																
(场上队员)																
1	王帅									0.0%						00:04:44
2	孙江山			4/5				1/1	5/6	83.3%		2		1		00:49:20
3	曲汝洋	0/1	3/4						3/5	60.0%	1	2				00:32:02
4	李卓洋	2/2	1/2			1/2			4/6	66.7%						00:40:41
5	侯生升			0/1					0/1	0.0%			1			00:24:51
6	邓志贵		0/1	1/1					1/2	50.0%						00:35:02
7	付云博	0/1	0/1						0/2	0.0%	1	2				00:27:54
8	于彦江	1/2	2/2		1/1	1/1			5/6	83.3%	1	4				00:48:16
9	徐庆		1/1		2/2				3/3	100%		1				00:30:28
11	房友屯									0.0%						00:00:00
12	王雨									0.0%						00:00:00
15	张建杰									0.0%						00:00:00
16	马跃									0.0%		1				00:55:16
17	李中洲	4/5	0/1		2/2			1/1	7/9	77.8%	2	2				00:41:33
26	姚雪岩									0.0%						00:00:00
84	王伟		4/6						4/6	66.7%		2				00:29:24
	合计	7/11	11/18	5/7	5/5	2/3		2/2	32/46	69.6%	5	16	1	1		
(守门员)																
1	王帅							0/1	0/1	0.0%						00:04:44
16	马跃	6/13	2/6	1/3	1/7	0/1	0/1	0/4	10/35	28.6%		1				00:55:16
	合计	6/13	2/6	1/3	1/7	0/1	0/1	0/5	10/36	27.8%		1				

场上队员：得分/射门

守门员：救球/射门

全队合计	得分	被救	射失	击柱	封球	合计	%
远射	7	3			1	11	63.6%
近射	11	3	3	1		18	61.1%
边射	5	2				7	71.4%
快攻	5					5	100.0%
突破	2	1				3	66.7%
任意							0.0%
七米	2					2	100.0%

第十三届全国运动会男子手球决赛

PHMS Pictorial Handball Match Statistics

IHF Official System

个人/全队技术统计表

 手球 预赛 组别 B 天津师范大学体育馆
 男子 轮次 1 场次 4 2017-08-21 19:15

号码	姓名	远射	近射	边射	快攻	突破	任意	七米	合计	%	助攻	失误	警告	2'	取消	时间
安徽队(安徽)																
(场上队员)																
1	郭世伟	0/1	1/2		1/1				2/4	50.0%		3				00:32:30
3	陈强龙		1/1		2/2				3/3	100%						00:34:03
5	史小帆	0/1							0/1	0.0%	1	5		1		00:27:10
7	姚雄敏									0.0%						00:14:22
8	董智景	1/1		2/4	2/3			1/1	6/9	66.7%		1				00:34:41
9	陈开勇	0/1	2/2		1/1				3/4	75.0%		2	1			00:38:32
10	严龙									0.0%		1				00:12:53
11	黎涛	1/3				1/1		3/3	5/7	71.4%		5				00:45:21
12	曾献辰									0.0%						00:24:19
15	曹青福临									0.0%						00:00:00
16	杨洋									0.0%						00:00:00
17	王巨柱	5/10	0/1				1/1	1/1	7/13	53.8%	1	1				00:51:19
18	李双	0/1							0/1	0.0%	1					00:07:53
21	李明									0.0%	1					00:35:41
23	于敏清									0.0%		1	1			01:00:00
24	徐安格									0.0%						00:00:00
	合计	7/18	4/6	2/4	6/7	1/1	1/1	5/5	26/42	61.9%	4	19	2	1		
(守门员)																
12	曾献辰	2/6	0/4	1/3	0/1	0/1			3/15	20.0%						00:24:19
21	李明	1/4	3/10	1/4	0/4	1/2		0/2	6/26	23.1%	1					00:35:41
	合计	3/10	3/14	2/7	0/5	1/3		0/2	9/41	22.0%	1					

场上队员：得分/射门

守门员：救球/射门

全队合计	得分	被救	射失	击柱	封球	合计	%
远射	7	6	3		2	18	38.9%
近射	4	2				6	66.7%
边射	2	1		1		4	50.0%
快攻	6	1				7	85.7%
突破	1					1	100.0%
任意	1					1	100.0%
七米	5					5	100.0%

第十三届全国运动会男子手球决赛

PHMS Pictorial Handball Match Statistics

IHF Official System

图式比赛技术统计表

手球
男子

预赛
轮次 1

组别 B
场次 4

天津师范大学体育馆
2017-08-21 19:15

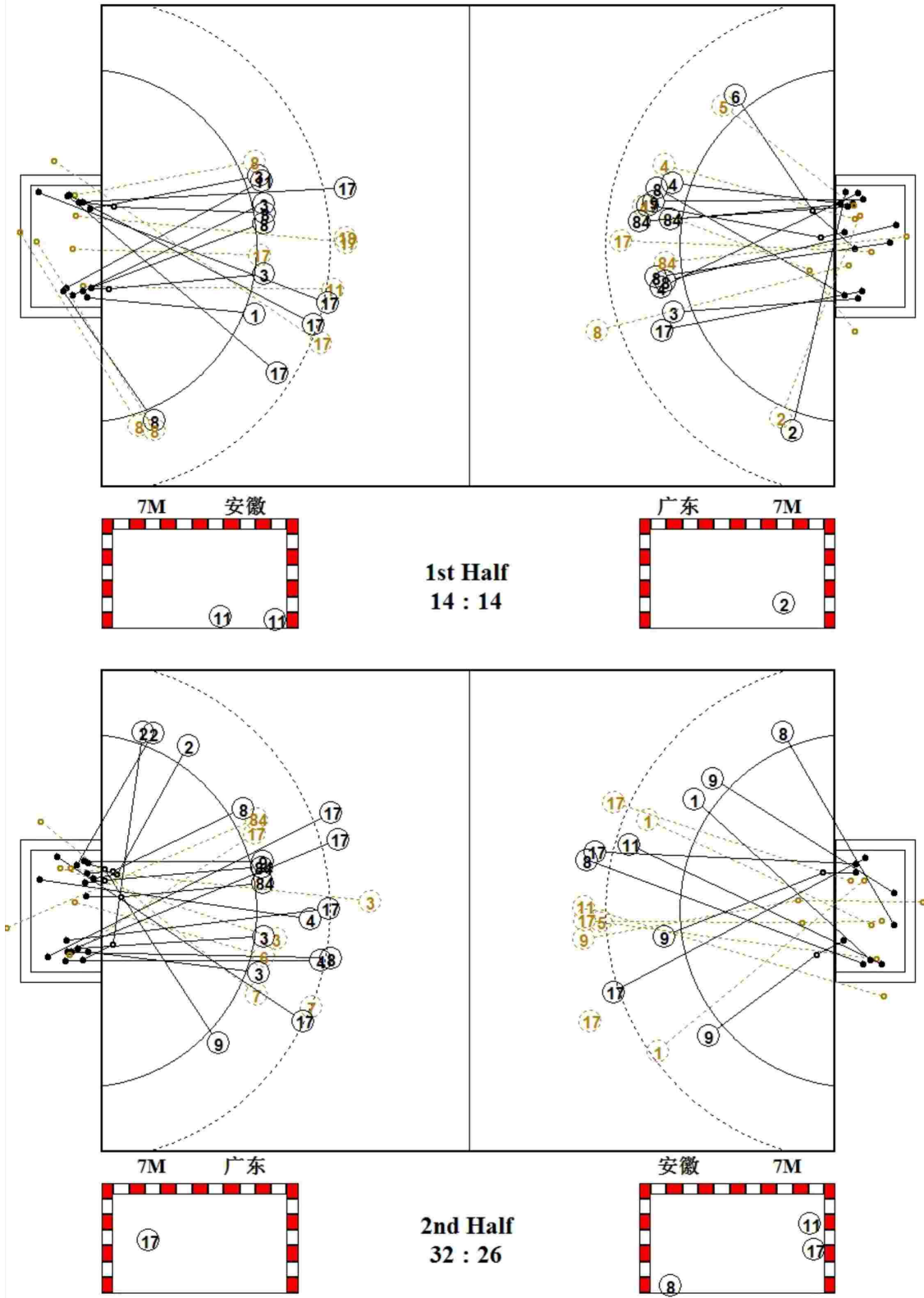

第十三届全国运动会男子手球决赛

PHMS Pictorial Handball Match Statistics

IHF Official System

图式射门区域统计

手球
男子

预赛
轮次 1

组别 B
场次 4

天津师范大学体育馆
2017-08-21 19:15

广东队

1 王帅	2 孙江山	3 曲汝洋	4 李卓洋	5 侯生升	6 邓志贵	7 付文博	8 于彦江																																																																								
<table border="1"><tr><td></td><td></td><td></td></tr><tr><td></td><td></td><td></td></tr><tr><td></td><td></td><td></td></tr></table>										<table border="1"><tr><td></td><td></td><td></td></tr><tr><td></td><td></td><td>1</td></tr><tr><td>2</td><td></td><td>2</td></tr></table>						1	2		2	<table border="1"><tr><td></td><td></td><td></td></tr><tr><td>1</td><td></td><td>1</td></tr><tr><td>1</td><td></td><td></td></tr></table>				1		1	1			<table border="1"><tr><td></td><td></td><td>1</td></tr><tr><td>2</td><td></td><td></td></tr><tr><td>1</td><td></td><td></td></tr></table>			1	2			1			<table border="1"><tr><td></td><td></td><td></td></tr><tr><td></td><td></td><td></td></tr><tr><td></td><td></td><td></td></tr></table>										<table border="1"><tr><td></td><td></td><td></td></tr><tr><td></td><td></td><td></td></tr><tr><td></td><td>1</td><td></td></tr></table>								1		<table border="1"><tr><td></td><td></td><td></td></tr><tr><td></td><td></td><td></td></tr><tr><td></td><td></td><td></td></tr></table>										<table border="1"><tr><td></td><td>2</td><td></td></tr><tr><td>1</td><td></td><td></td></tr><tr><td></td><td></td><td>2</td></tr></table>		2		1					2
		1																																																																													
2		2																																																																													
1		1																																																																													
1																																																																															
		1																																																																													
2																																																																															
1																																																																															
	1																																																																														
	2																																																																														
1																																																																															
		2																																																																													
Post - 0 Miss - 0 Block - 0	Post - 0 Miss - 0 Block - 0	Post - 0 Miss - 0 Block - 0	Post - 0 Miss - 1 Block - 0	Post - 0 Miss - 0 Block - 0	Post - 0 Miss - 0 Block - 0	Post - 0 Miss - 1 Block - 1	Post - 0 Miss - 0 Block - 0																																																																								
9 徐庆	11 房友屯	12 王雨	15 张建杰	16 马跃	17 李中洲	26 姚雪岩	84 王伟																																																																								
<table border="1"><tr><td></td><td></td><td></td></tr><tr><td>1</td><td></td><td></td></tr><tr><td></td><td></td><td>2</td></tr></table>				1					2	<table border="1"><tr><td></td><td></td><td></td></tr><tr><td></td><td></td><td></td></tr><tr><td></td><td></td><td></td></tr></table>										<table border="1"><tr><td></td><td></td><td></td></tr><tr><td></td><td></td><td></td></tr><tr><td></td><td></td><td></td></tr></table>										<table border="1"><tr><td></td><td></td><td></td></tr><tr><td></td><td></td><td></td></tr><tr><td></td><td></td><td></td></tr></table>										<table border="1"><tr><td></td><td></td><td></td></tr><tr><td></td><td></td><td></td></tr><tr><td></td><td></td><td></td></tr></table>										<table border="1"><tr><td>1</td><td></td><td></td></tr><tr><td>3</td><td></td><td>2</td></tr><tr><td></td><td>1</td><td></td></tr></table>	1			3		2		1		<table border="1"><tr><td></td><td></td><td></td></tr><tr><td></td><td></td><td></td></tr><tr><td></td><td></td><td></td></tr></table>										<table border="1"><tr><td></td><td></td><td></td></tr><tr><td></td><td></td><td></td></tr><tr><td>2</td><td>1</td><td>1</td></tr></table>							2	1	1
1																																																																															
		2																																																																													
1																																																																															
3		2																																																																													
	1																																																																														
2	1	1																																																																													
Post - 0 Miss - 0 Block - 0	Post - 0 Miss - 0 Block - 0	Post - 0 Miss - 0 Block - 0	Post - 0 Miss - 0 Block - 0	Post - 0 Miss - 0 Block - 0	Post - 0 Miss - 0 Block - 0	Post - 0 Miss - 0 Block - 0	Post - 1 Miss - 1 Block - 0																																																																								

1 □□

	0/1	

16 □□

	2/4	0/3
1/5	2/2	3/8
2/8		0/5

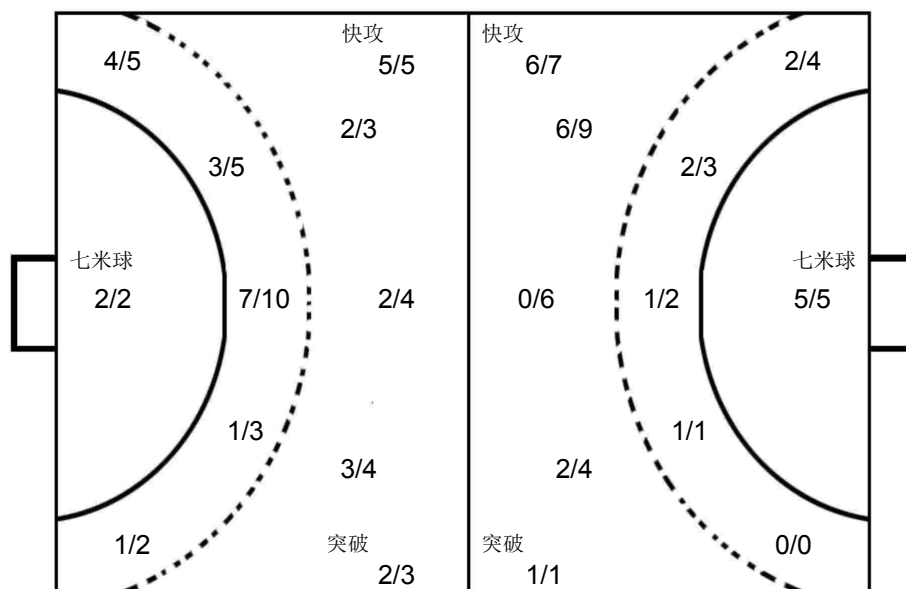

12 □□□

	0/1	0/1
0/3	1/1	0/1
1/3	1/2	0/3

21 □□

0/1	0/1	
2/7	1/1	2/5
1/5	0/2	0/4

安徽队

1 郭世伟	3 陈强龙	5 史小帆	7 姚雄敏	8 董智景	9 陈开勇	10 严龙	11 黎涛																																																																								
<table border="1"><tr><td></td><td></td><td></td></tr><tr><td></td><td></td><td>1</td></tr><tr><td>1</td><td></td><td></td></tr></table>						1	1			<table border="1"><tr><td></td><td></td><td></td></tr><tr><td></td><td></td><td></td></tr><tr><td>2</td><td></td><td>1</td></tr></table>							2		1	<table border="1"><tr><td></td><td></td><td></td></tr><tr><td></td><td></td><td></td></tr><tr><td></td><td></td><td></td></tr></table>										<table border="1"><tr><td></td><td></td><td></td></tr><tr><td></td><td></td><td></td></tr><tr><td></td><td></td><td></td></tr></table>										<table border="1"><tr><td></td><td>1</td><td></td></tr><tr><td>2</td><td></td><td>1</td></tr><tr><td>1</td><td></td><td>1</td></tr></table>		1		2		1	1		1	<table border="1"><tr><td></td><td>1</td><td></td></tr><tr><td></td><td></td><td></td></tr><tr><td>1</td><td></td><td>1</td></tr></table>		1					1		1	<table border="1"><tr><td></td><td></td><td></td></tr><tr><td></td><td></td><td></td></tr><tr><td></td><td></td><td></td></tr></table>										<table border="1"><tr><td></td><td></td><td>2</td></tr><tr><td>1</td><td></td><td></td></tr><tr><td></td><td>1</td><td>1</td></tr></table>			2	1				1	1
		1																																																																													
1																																																																															
2		1																																																																													
	1																																																																														
2		1																																																																													
1		1																																																																													
	1																																																																														
1		1																																																																													
		2																																																																													
1																																																																															
	1	1																																																																													
Post - 0 Miss - 0 Block - 0	Post - 0 Miss - 0 Block - 0	Post - 0 Miss - 0 Block - 0	Post - 0 Miss - 0 Block - 0	Post - 1 Miss - 0 Block - 0	Post - 0 Miss - 1 Block - 0	Post - 0 Miss - 0 Block - 0	Post - 0 Miss - 1 Block - 0																																																																								
12 曾献辰	15 曹青福临	16 杨洋	17 王巨柱	18 李双	21 李明	23 于敏清	24 徐安格																																																																								
<table border="1"><tr><td></td><td></td><td></td></tr><tr><td></td><td></td><td></td></tr><tr><td></td><td></td><td></td></tr></table>										<table border="1"><tr><td></td><td></td><td></td></tr><tr><td></td><td></td><td></td></tr><tr><td></td><td></td><td></td></tr></table>										<table border="1"><tr><td></td><td></td><td></td></tr><tr><td></td><td></td><td></td></tr><tr><td></td><td></td><td></td></tr></table>										<table border="1"><tr><td></td><td></td><td>1</td></tr><tr><td>1</td><td></td><td>3</td></tr><tr><td>1</td><td></td><td>1</td></tr></table>			1	1		3	1		1	<table border="1"><tr><td></td><td></td><td></td></tr><tr><td></td><td></td><td></td></tr><tr><td></td><td></td><td></td></tr></table>										<table border="1"><tr><td></td><td></td><td></td></tr><tr><td></td><td></td><td></td></tr><tr><td></td><td></td><td></td></tr></table>										<table border="1"><tr><td></td><td></td><td></td></tr><tr><td></td><td></td><td></td></tr><tr><td></td><td></td><td></td></tr></table>										<table border="1"><tr><td></td><td></td><td></td></tr><tr><td></td><td></td><td></td></tr><tr><td></td><td></td><td></td></tr></table>									
		1																																																																													
1		3																																																																													
1		1																																																																													
Post - 0 Miss - 0 Block - 0	Post - 0 Miss - 0 Block - 0	Post - 0 Miss - 0 Block - 0	Post - 0 Miss - 1 Block - 1	Post - 0 Miss - 0 Block - 1	Post - 0 Miss - 0 Block - 0	Post - 0 Miss - 0 Block - 0	Post - 0 Miss - 0 Block - 0																																																																								

PHMS Pictorial Handball Match Statistics

IHF Official System

Team A					Team B					Match Number					
A 天津队					B 山东队					5					
Played in			in the hall			on			at			Spectators			
天津			天津师范大学体育馆			2017-08-22			14:00			hours			
Half-time(30')	A	B	End of playing time	A	B	1st extra time	A	B	2nd extra time	A	B	After penalty throws	A	B	
	6	15		13	28										
Number of 7 m	A	Team time-out			Full name of players and officials						Team time-out			B	Number of 7 m
	1/4	1	2	3							1	2	3	0/2	
		11:13	41:36												

No.	Team A	G	W	2'	D	DR	No.	Team B	G	W	2'	D	DR
1	刘宗其						3	尹杰					
2	李岳朋	3					4	田瑞					
4	李松浩						5	潘翔	2				
6	王子欣	2					6	李朝鹏	4				
7	张青	1	1				8	王炳华					
8	曹悦	2		1			9	赵鑫	1				
9	吴明远						11	宋朋强	3	1	1		
10	李帅						12	崔剑					
11	王毅	2					13	刘晓	2		1		
12	杨峻						15	张继伟	3	1			
13	许松	1					16	于性哲					
16	刘海亮						17	王旭东	6				
17	周群		1				18	于亚男	2				
18	王晓琪	1					19	李语庆	4				
22	魏雨童						20	杜在超					
31	田剑侠	1					21	翟乾坤	1				
A	贾守信						A	王志峰					
B	杜瑞军 (主教练)						B	王鸿斌 (主教练)					
C	孟凡钢						C	刘桂妮					
E	崔嘉禄						D	邢建刚					
A	Signatures of responsables for the teams (Off.A)												B
TP	Remarks of referees / HF Official												TP

	Referees	Signatures	
	ALEXEI. COVALCIUC (MDA)	IGOR. COVALCIUC (MDA)	
	T.D. 刘书勇 (CHN)	李刚 (CHN)	
	CHA Off.		

Note: Number of 7m Throws Awarded to Team A and B, Goals (G), Warnings (W), Suspensions (2'), Direct Disqualification (D), Disqualification With Report (DR) and Team Penalty (TP).

Table Officials: 隆晓磊 刘宇阳 Statisticians: 陈柱 刘永欢



第十三届全国运动会男子手球决赛
PHMS Pictorial Handball Match Statistics

IHF Official System

竞赛技术统计

 手球
男子

 预赛
轮次 2

 组别 A
场次 5

 天津师范大学体育馆
2017-08-22 14:00

Referees:	ALEXEI. COVALCIUC (MDA) / IGOR. COVALCIUC (MDA)	Result:	13:28 (6:15)
Teams:	天津队(天津) VS 山东队(山东)		

天津		远	近	边	快	突	任意	7m	合计	%	助攻	失误	警告	2'	D+DR	天津	比赛 进程	山东
主教练: 杜瑞军		射	射	射	攻	破	球	球										
1	刘宗其																	
2	李岳朋	1/1	1/2			1/1			3/4	75.0		2				6	王子欣	0 00:43 1 17 王旭东
4	李松浩																	0 01:41 2 18 于亚男
7	王子欣	0/1	0/1	1/1		1/1			2/4	50.0	1	2						1 02:40 2
6	张青	0/3	0/1					1/2	1/6	16.7		3	1					1 03:14 3 17 王旭东
8	曹悦	1/6	1/2					0/1	2/9	22.2		3		1				2 05:16 3
9	吴明远																	3 06:25 3
10	李帅																	3 07:05 4 5 潘翔
11	王毅		1/1	1/1				0/1	2/3	66.7								3 08:29 5 17 王旭东
12	杨峻																	3 09:34 6 17 王旭东
13	许松			0/2	1/1				1/3	33.3								3 10:44 7 11 宋朋强
16	刘海亮																	4 11:48 7
17	周群												1					4 12:29 8 18 于亚男
18	王晓琪	1/1							1/1	100								4 13:55 9 21 翟乾坤
22	魏雨童																	4 15:46 10 17 王旭东
31	田剑侠	0/1				1/1			1/2	50.0	1	4						5 16:05 10
运动员 合计		3/13	3/7	2/4	1/1	3/3		1/4	13/32	40.6	2	14	2	1				5 18:58 11 5 潘翔
1	刘宗其	0/3	3/13	3/7	1/5	0/4		1/1	8/33	24.2								6 20:18 11
12	杨峻	0/1	0/1				0/1		0/3	0.0								6 22:03 12 19 李语庆
守门员 合计		0/4	3/14	3/7	1/5	0/4	0/1	1/1	8/36	22.2								6 24:00 13 19 李语庆
																		6 26:04 14 11 宋朋强
																		6 27:29 15 11 宋朋强
																		2nd Half
																		6 03:53 16 17 王旭东
																		8 曹悦
																		7 04:52 16
																		7 05:35 17 19 李语庆
																		11 王毅
																		8 08:15 17
																		8 09:34 18 19 李语庆
																		8 10:28 19 15 张继伟
																		8 13:27 20 13 刘晓
																		6 王子欣
																		9 14:04 20
																		9 14:42 21 13 刘晓
																		9 15:26 22 15 张继伟
																		31 田剑侠
																		10 17:15 22
																		10 17:53 23 6 李朝鹏
																		10 18:54 24 6 李朝鹏
																		7 张青
																		11 19:51 24
																		11 20:26 25 6 李朝鹏
																		11 22:39 26 15 张继伟
																		11 23:44 27 9 赵鑫
																		11 25:02 28 6 李朝鹏
																		11 王毅
																		12 27:24 28
																		18 王晓琪
																		13 28:03 28

场上队员: 得分 / 射门

守门员: 救球 / 射门

D	取消资格	DR	取消资格+报告
---	------	----	---------

第十三届全国运动会男子手球决赛

PHMS Pictorial Handball Match Statistics

IHF Official System

个人/全队技术统计表

 手球 预赛 组别 A 天津师范大学体育馆
 男子 轮次 2 场次 5 2017-08-22 14:00

号码	姓名	远射	近射	边射	快攻	突破	任意	七米	合计	%	助攻	失误	警告	2'	取消	时间
天津队(天津)																
(场上队员)																
1	刘宗其									0.0%						00:53:53
2	李岳朋	1/1	1/2			1/1			3/4	75.0%		2				00:47:07
4	李松浩									0.0%						00:00:00
6	王子欣	0/1	0/1	1/1		1/1			2/4	50.0%	1	2				01:00:00
7	张青	0/3	0/1					1/2	1/6	16.7%		3	1			00:45:17
8	曹悦	1/6	1/2					0/1	2/9	22.2%		3		1		00:41:21
9	吴明远									0.0%						00:00:00
10	李帅									0.0%						00:00:00
11	王毅		1/1	1/1				0/1	2/3	66.7%						00:32:45
12	杨峻									0.0%						00:06:07
13	许松			0/2	1/1				1/3	33.3%						00:27:13
16	刘海亮									0.0%						00:00:00
17	周群									0.0%			1			00:42:18
18	王晓琪	1/1							1/1	100%						00:04:43
22	魏雨童									0.0%						00:12:51
31	田剑侠	0/1				1/1			1/2	50.0%	1	4				00:44:49
	合计	3/13	3/7	2/4	1/1	3/3		1/4	13/32	40.6%	2	14	2	1		
(守门员)																
1	刘宗其	0/3	3/13	3/7	1/5	0/4		1/1	8/33	24.2%						00:53:53
12	杨峻	0/1	0/1				0/1		0/3	0.0%						00:06:07
	合计	0/4	3/14	3/7	1/5	0/4	0/1	1/1	8/36	22.2%						

场上队员：得分/射门

守门员：救球/射门

全队合计	得分	被救	射失	击柱	封球	合计	%
远射	3	5		1	4	13	23.1%
近射	3	3	1			7	42.9%
边射	2	1		1		4	50.0%
快攻	1					1	100.0%
突破	3					3	100.0%
任意							0.0%
七米	1	3				4	25.0%

第十三届全国运动会男子手球决赛

PHMS Pictorial Handball Match Statistics

IHF Official System

个人/全队技术统计表

 手球 预赛 组别 A 天津师范大学体育馆
 男子 轮次 2 场次 5 2017-08-22 14:00

号码	姓名	远射	近射	边射	快攻	突破	任意	七米	合计	%	助攻	失误	警告	2'	取消	时间
山东队(山东)																
(场上队员)																
3	尹杰									0.0%						00:11:29
4	田瑞									0.0%		1				00:09:22
5	潘翔		1/1	1/1					2/2	100%		1				00:27:02
6	李朝鹏	1/2	1/1	1/1		1/1			4/5	80.0%		2				00:18:12
8	王炳华		0/1						0/1	0.0%						00:05:27
9	赵鑫		0/1		1/2				1/3	33.3%	2					00:20:07
11	宋朋强		1/2		1/1	1/1			3/4	75.0%	2	1	1	1		00:39:09
12	崔剑									0.0%						00:16:07
13	刘晓		2/2	0/1					2/3	66.7%	1			1		00:25:44
15	张继伟		2/2		1/1			0/1	3/4	75.0%		1	1			00:31:45
16	于性哲									0.0%						00:43:53
17	王旭东	2/4	2/2	1/2			1/1		6/9	66.7%		1				00:34:23
18	于亚男		1/1			1/1			2/2	100%		1				00:36:30
19	李语庆	1/1	1/2	1/1		1/1		0/1	4/6	66.7%						00:48:29
20	杜在超									0.0%						00:14:02
21	翟乾坤			0/1	1/1				1/2	50.0%						00:36:28
合计		4/7	11/15	4/7	4/5	4/4	1/1	0/2	28/41	68.3%	5	8	2	2		
(守门员)																
12	崔剑	1/2	2/3	0/1		0/1		2/3	5/10	50.0%						00:16:07
16	于性哲	4/6	1/3	1/2	0/1	0/2		1/1	7/15	46.7%						00:43:53
合计		5/8	3/6	1/3	0/1	0/3		3/4	12/25	48.0%						

场上队员：得分/射门

守门员：救球/射门

全队合计	得分	被救	射失	击柱	封球	合计	%
远射	4		1	2		7	57.1%
近射	11	3		1		15	73.3%
边射	4	3				7	57.1%
快攻	4	1				5	80.0%
突破	4					4	100.0%
任意	1					1	100.0%
七米		1		1		2	0.0%

第十三届全国运动会男子手球决赛

PHMS Pictorial Handball Match Statistics

IHF Official System

图式比赛技术统计表

手球
男子

预赛
轮次 2

组别 A
场次 5

天津师范大学体育馆
2017-08-22 14:00

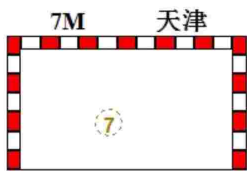
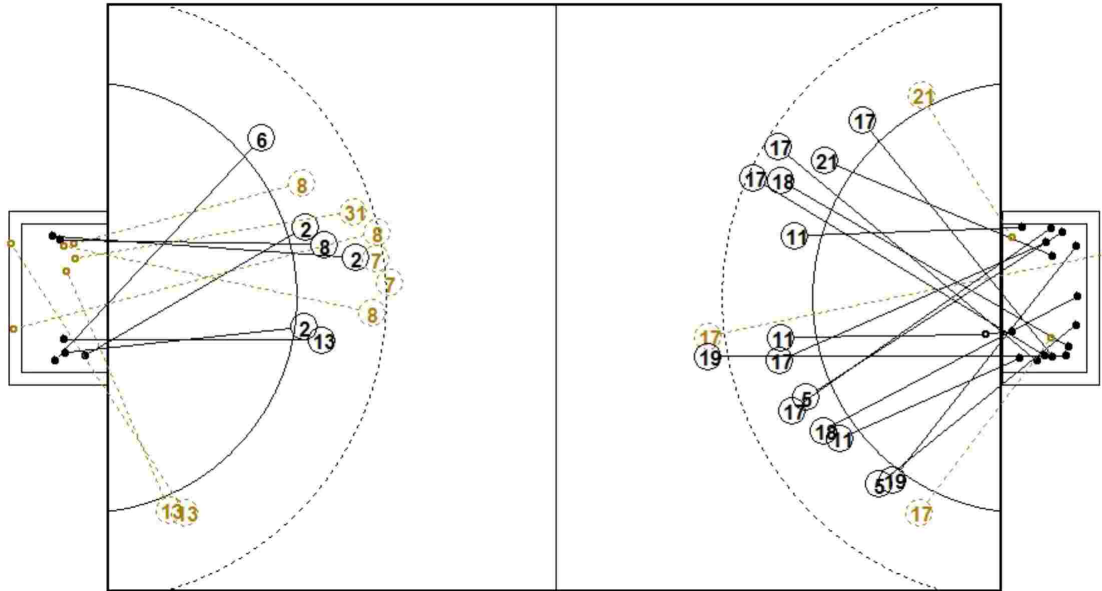

1st Half
6 : 15

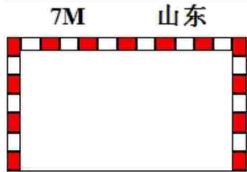
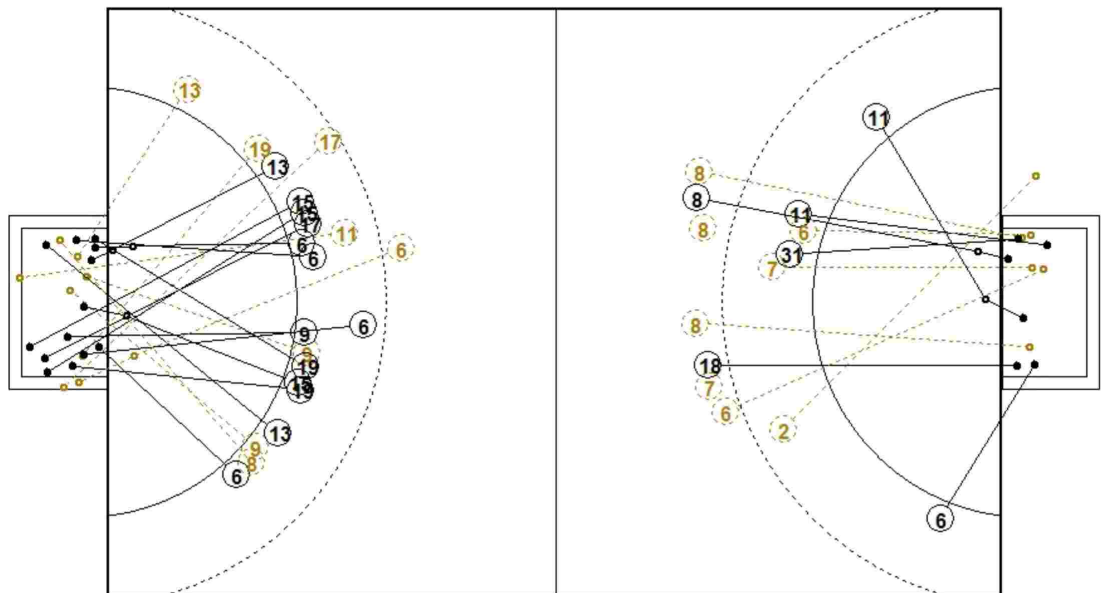
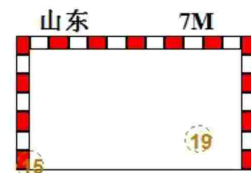

2nd Half
28 : 13

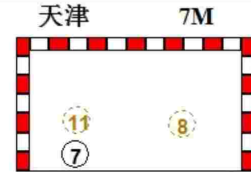

第十三届全国运动会男子手球决赛

PHMS Pictorial Handball Match Statistics

IHF Official System

图式射门区域统计

手球
男子

预赛
轮次 2

组别 A
场次 5

天津师范大学体育馆
2017-08-22 14:00

天津队

1 刘宗其	2 李岳朋	4 李松浩	6 王子欣	7 张青	8 曹悦	9 吴明远	10 李帅																																																																								
<table border="1"><tr><td></td><td></td><td></td></tr><tr><td></td><td></td><td></td></tr><tr><td></td><td></td><td></td></tr></table>										<table border="1"><tr><td></td><td></td><td></td></tr><tr><td>1</td><td></td><td>1</td></tr><tr><td>1</td><td></td><td></td></tr></table>				1		1	1			<table border="1"><tr><td></td><td></td><td></td></tr><tr><td></td><td></td><td></td></tr><tr><td></td><td></td><td></td></tr></table>										<table border="1"><tr><td></td><td></td><td></td></tr><tr><td>1</td><td></td><td>1</td></tr><tr><td></td><td></td><td></td></tr></table>				1		1				<table border="1"><tr><td></td><td></td><td></td></tr><tr><td></td><td></td><td></td></tr><tr><td>1</td><td></td><td></td></tr></table>							1			<table border="1"><tr><td></td><td></td><td></td></tr><tr><td></td><td></td><td>1</td></tr><tr><td>1</td><td></td><td></td></tr></table>						1	1			<table border="1"><tr><td></td><td></td><td></td></tr><tr><td></td><td></td><td></td></tr><tr><td></td><td></td><td></td></tr></table>										<table border="1"><tr><td></td><td></td><td></td></tr><tr><td></td><td></td><td></td></tr><tr><td></td><td></td><td></td></tr></table>									
1		1																																																																													
1																																																																															
1		1																																																																													
1																																																																															
		1																																																																													
1																																																																															
Post - 0 Miss - 0 Block - 0	Post - 0 Miss - 1 Block - 0	Post - 0 Miss - 0 Block - 0	Post - 0 Miss - 0 Block - 0	Post - 0 Miss - 0 Block - 3	Post - 1 Miss - 0 Block - 1	Post - 0 Miss - 0 Block - 0	Post - 0 Miss - 0 Block - 0																																																																								
11 王毅	12 杨峻	13 许松	16 刘海亮	17 周群	18 王晓琪	22 魏雨童	31 田剑侠																																																																								
<table border="1"><tr><td></td><td></td><td></td></tr><tr><td>1</td><td></td><td></td></tr><tr><td></td><td>1</td><td></td></tr></table>				1				1		<table border="1"><tr><td></td><td></td><td></td></tr><tr><td></td><td></td><td></td></tr><tr><td></td><td></td><td></td></tr></table>										<table border="1"><tr><td></td><td></td><td></td></tr><tr><td></td><td></td><td></td></tr><tr><td>1</td><td></td><td></td></tr></table>							1			<table border="1"><tr><td></td><td></td><td></td></tr><tr><td></td><td></td><td></td></tr><tr><td></td><td></td><td></td></tr></table>										<table border="1"><tr><td></td><td></td><td></td></tr><tr><td></td><td></td><td></td></tr><tr><td></td><td></td><td></td></tr></table>										<table border="1"><tr><td></td><td></td><td></td></tr><tr><td></td><td></td><td></td></tr><tr><td></td><td></td><td>1</td></tr></table>									1	<table border="1"><tr><td></td><td></td><td></td></tr><tr><td></td><td></td><td></td></tr><tr><td></td><td></td><td></td></tr></table>										<table border="1"><tr><td></td><td></td><td></td></tr><tr><td></td><td></td><td></td></tr><tr><td>1</td><td></td><td></td></tr></table>							1		
1																																																																															
	1																																																																														
1																																																																															
		1																																																																													
1																																																																															
Post - 0 Miss - 0 Block - 0	Post - 0 Miss - 0 Block - 0	Post - 1 Miss - 0 Block - 0	Post - 0 Miss - 0 Block - 0	Post - 0 Miss - 0 Block - 0	Post - 0 Miss - 0 Block - 0	Post - 0 Miss - 0 Block - 0	Post - 0 Miss - 0 Block - 0																																																																								

1 □□□

0/4	0/1	0/4
0/4	1/1	3/6
2/5	1/2	1/6

12 □□

0/1		
0/1		0/1

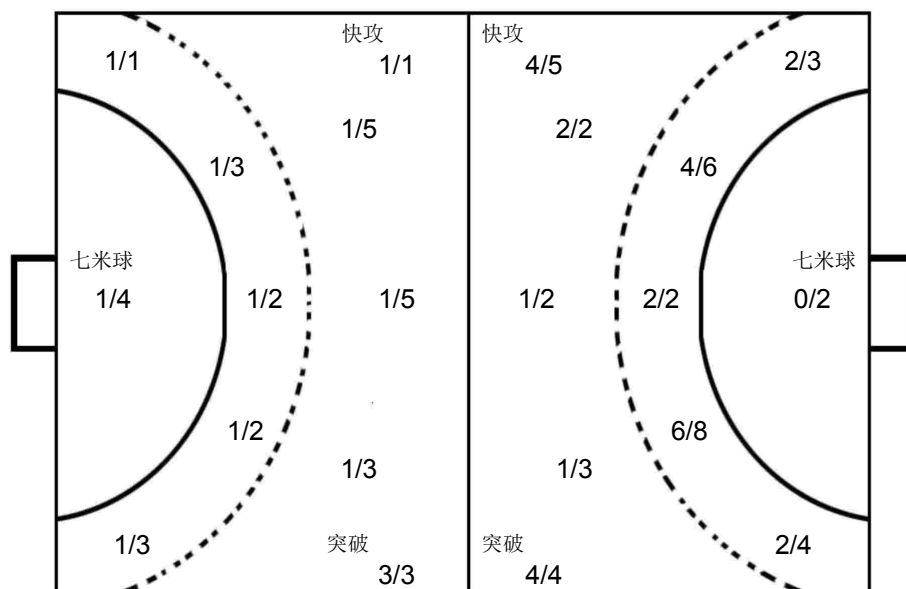

12 □□

4/5		1/1
0/2	0/1	0/1

16 □□□

0/3	1/1	5/8
1/3		

山东队

3 尹杰	4 田瑞	5 潘翔	6 李朝鹏	8 王炳华	9 赵鑫	11 宋朋强	12 崔剑																																																																								
<table border="1"><tr><td></td><td></td><td></td></tr><tr><td></td><td></td><td></td></tr><tr><td></td><td></td><td></td></tr></table>										<table border="1"><tr><td></td><td></td><td></td></tr><tr><td></td><td></td><td></td></tr><tr><td></td><td></td><td></td></tr></table>										<table border="1"><tr><td></td><td></td><td></td></tr><tr><td>1</td><td></td><td>1</td></tr><tr><td></td><td></td><td></td></tr></table>				1		1				<table border="1"><tr><td></td><td></td><td></td></tr><tr><td></td><td></td><td>1</td></tr><tr><td>2</td><td></td><td>1</td></tr></table>						1	2		1	<table border="1"><tr><td></td><td></td><td></td></tr><tr><td></td><td></td><td></td></tr><tr><td></td><td></td><td></td></tr></table>										<table border="1"><tr><td></td><td></td><td></td></tr><tr><td></td><td></td><td></td></tr><tr><td>1</td><td></td><td></td></tr></table>							1			<table border="1"><tr><td></td><td></td><td></td></tr><tr><td></td><td></td><td></td></tr><tr><td>1</td><td></td><td>2</td></tr></table>							1		2	<table border="1"><tr><td></td><td></td><td></td></tr><tr><td></td><td></td><td></td></tr><tr><td></td><td></td><td></td></tr></table>									
1		1																																																																													
		1																																																																													
2		1																																																																													
1																																																																															
1		2																																																																													
Post - 0 Miss - 0 Block - 0	Post - 0 Miss - 0 Block - 0	Post - 0 Miss - 0 Block - 0	Post - 1 Miss - 0 Block - 0	Post - 0 Miss - 0 Block - 0	Post - 0 Miss - 0 Block - 0	Post - 1 Miss - 0 Block - 0	Post - 0 Miss - 0 Block - 0																																																																								
13 刘晓	15 张继伟	16 于性哲	17 王旭东	18 于亚男	19 李语庆	20 杜在超	21 翟乾坤																																																																								
<table border="1"><tr><td></td><td></td><td></td></tr><tr><td></td><td></td><td>1</td></tr><tr><td></td><td></td><td>1</td></tr></table>						1			1	<table border="1"><tr><td></td><td></td><td></td></tr><tr><td>2</td><td></td><td></td></tr><tr><td></td><td>1</td><td></td></tr></table>				2				1		<table border="1"><tr><td></td><td></td><td></td></tr><tr><td></td><td></td><td></td></tr><tr><td></td><td></td><td></td></tr></table>										<table border="1"><tr><td></td><td></td><td></td></tr><tr><td>1</td><td></td><td></td></tr><tr><td>2</td><td></td><td>3</td></tr></table>				1			2		3	<table border="1"><tr><td></td><td></td><td></td></tr><tr><td></td><td>1</td><td>1</td></tr><tr><td></td><td></td><td></td></tr></table>					1	1				<table border="1"><tr><td></td><td></td><td></td></tr><tr><td>1</td><td></td><td>1</td></tr><tr><td>1</td><td></td><td></td></tr></table>				1		1	1			<table border="1"><tr><td></td><td></td><td></td></tr><tr><td></td><td></td><td></td></tr><tr><td></td><td></td><td></td></tr></table>										<table border="1"><tr><td></td><td></td><td></td></tr><tr><td></td><td></td><td></td></tr><tr><td>1</td><td></td><td></td></tr></table>							1		
		1																																																																													
		1																																																																													
2																																																																															
	1																																																																														
1																																																																															
2		3																																																																													
	1	1																																																																													
1		1																																																																													
1																																																																															
1																																																																															
Post - 0 Miss - 0 Block - 0	Post - 1 Miss - 0 Block - 0	Post - 0 Miss - 0 Block - 0	Post - 1 Miss - 1 Block - 0	Post - 0 Miss - 0 Block - 0	Post - 0 Miss - 0 Block - 0	Post - 0 Miss - 0 Block - 0	Post - 0 Miss - 0 Block - 0																																																																								

Team A				Team B				Match Number							
A 上海队				B 北京队				6							
Played in		in the hall		on		at		Spectators							
天津		天津师范大学体育馆		2017-08-22		15:45		hours							
Half-time(30')	A	B	End of playing time	A	B	1st extra time	A	B	2nd extra time	A	B	After penalty throws	A	B	
	9	9	21	20											
Number of 7 m	A	Team time-out			Full name of players and officials						Team time-out			B	Number of 7 m
	3/5	1	2	3							1	2	3	B	
		11:04	44:04	59:28							20:49	54:27		0/1	

No.	Team A	G	W	2'	D	DR	No.	Team B	G	W	2'	D	DR
1	张峥						1	王洸					
3	赵时俊	4					7	马昌震					
4	徐俊吉	4					8	王鹏					
6	朱世杰	3	1	1			9	刘振	2				
7	周文龙						10	成亚	3				
8	钱为玮	5					16	刘迈科					
9	董凯						21	胡瀛	3				
10	吴璟		1	1			22	王超	3				
11	蒋承骅						23	王军程					
12	周哲韬						25	马明辉					
14	沈吉磊						29	杜龙飞	1				
16	朱春雷						39	张骥	3	1			
17	贺政	4		2			66	解建飞	1	1	2		
18	马麟晓	1	1	1			77	朱昕晨	2				
19	祝君						83	潘天		1			
							99	蒋维一	2		1		
A	郑益方						A	安福田					
B	张勇军 (主教练)						B	郑永利 (主教练)					
C	金迪琦						C	孟辉					
D	杨时						E	王长林					
A		Signatures of responsables for the teams (Off.A)											B
TP	Remarks of referees / HF Official												TP

	Signatures											
Referees	BALAZS. MARTON (HUN)				PETER. HORVATH (HUN)							
T.D.	许宜扬 (CHN)				刘书勇 (CHN)							
CHA Off.												

Note: Number of 7m Throws Awarded to Team A and B, Goals (G), Warnings (W), Suspensions (2'), Direct Disqualification (D), Disqualification With Report (DR) and Team Penalty (TP).

Table Officials: 鲍瑀 李志成 Statisticians: 黄岩 刘永欢

第十三届全国运动会男子手球决赛

PHMS Pictorial Handball Match Statistics

IHF Official System

个人/全队技术统计表

手球 男子 预赛 轮次 2 组别 A 场次 6 天津师范大学体育馆 2017-08-22 15:45

号码	姓名	远射	近射	边射	快攻	突破	任意	七米	合计	%	助攻	失误	警告	2'	取消	时间
上海队(上海)																
(场上队员)																
1	张崢									0.0%						00:11:24
3	赵时俊	1/2	1/1	0/1	1/1	1/1		0/1	4/7	57.1%	2					00:45:11
4	徐俊吉		2/4					2/2	4/6	66.7%						00:35:23
6	朱世杰	2/5	0/2			1/2			3/9	33.3%	1	4	1	1		00:29:25
7	周文龙									0.0%						00:00:00
8	钱为玮	1/3	2/2		1/1	1/1	0/1		5/8	62.5%	1	1				00:30:00
9	董凯									0.0%						00:00:00
10	吴璟		0/1					0/1	0/2	0.0%		1	1	1		00:29:41
11	蒋承骅									0.0%	1					00:49:06
12	周哲韬									0.0%						00:48:36
14	沈吉磊									0.0%						00:00:00
16	朱春雷									0.0%						00:00:00
17	贺政			3/5				1/1	4/6	66.7%		2		2		01:00:00
18	马麟晓	0/6	1/1						1/7	14.3%	1	2	1	1		00:30:00
19	祝君									0.0%						00:00:00
合计		4/16	6/11	3/6	2/2	3/4	0/1	3/5	21/45	46.7%	6	10	3	5		
(守门员)																
1	张崢		1/2		2/3	0/1	0/1	1/1	4/8	50.0%						00:11:24
12	周哲韬	2/3	4/10	2/6	0/2	1/4	1/1		10/26	38.5%						00:48:36
合计		2/3	5/12	2/6	2/5	1/5	1/2	1/1	14/34	41.2%						

场上队员：得分/射门

守门员：救球/射门

全队合计	得分	被救	射失	击柱	封球	合计	%
远射	4	6	1		5	16	25.0%
近射	6	4		1		11	54.5%
边射	3	3				6	50.0%
快攻	2					2	100.0%
突破	3	1				4	75.0%
任意		1				1	0.0%
七米	3	2				5	60.0%

第十三届全国运动会男子手球决赛

PHMS Pictorial Handball Match Statistics

IHF Official System

个人/全队技术统计表

 手球 预赛 组别 A 天津师范大学体育馆
 男子 轮次 2 场次 6 2017-08-22 15:45

号码	姓名	远射	近射	边射	快攻	突破	任意	七米	合计	%	助攻	失误	警告	2'	取消	时间
北京队(北京)																
(场上队员)																
1	王澍									0.0%						00:01:03
7	马昌震									0.0%		1				00:04:24
8	王鹏									0.0%						00:04:05
9	刘振					2/2		0/1	2/3	66.7%	2	1				01:00:00
10	成亚		2/5		0/1	1/1			3/7	42.9%	2	2				00:27:32
16	刘迈科									0.0%						00:58:57
21	胡瀛		1/1	2/3	0/1				3/5	60.0%		1				00:15:36
22	王超			2/2	1/1				3/3	100%						00:10:36
23	王军程						0/1		0/1	0.0%						00:02:42
25	马明辉									0.0%						00:00:00
29	杜龙飞				1/1				1/1	100%	1					00:15:04
39	张骥	1/3	1/1			1/1			3/5	60.0%	1	3	1			00:39:42
66	解建飞		1/4	0/2					1/6	16.7%		1	1	2		00:18:09
77	朱昕晨				1/1	0/1	1/1		2/3	66.7%		4				00:13:07
83	潘天									0.0%			1			00:50:58
99	蒋维一		2/2						2/2	100%		2		1		00:14:52
	合计	1/3	7/13	4/7	3/5	4/5	1/2	0/1	20/36	55.6%	6	15	3	3		
(守门员)																
1	王澍							2/4	2/4	50.0%						00:01:03
16	刘迈科	6/10	4/10	3/6	0/2	1/4	1/1	0/1	15/34	44.1%						00:58:57
	合计	6/10	4/10	3/6	0/2	1/4	1/1	2/5	17/38	44.7%						

场上队员：得分/射门

守门员：救球/射门

全队合计	得分	被救	射失	击柱	封球	合计	%
远射	1	2				3	33.3%
近射	7	5		1		13	53.8%
边射	4	2	1			7	57.1%
快攻	3	2				5	60.0%
突破	4	1				5	80.0%
任意	1	1				2	50.0%
七米		1				1	0.0%

第十三届全国运动会男子手球决赛

PHMS Pictorial Handball Match Statistics

IHF Official System

图式比赛技术统计表

手球
男子

预赛
轮次 2

组别 A
场次 6

天津师范大学体育馆
2017-08-22 15:45

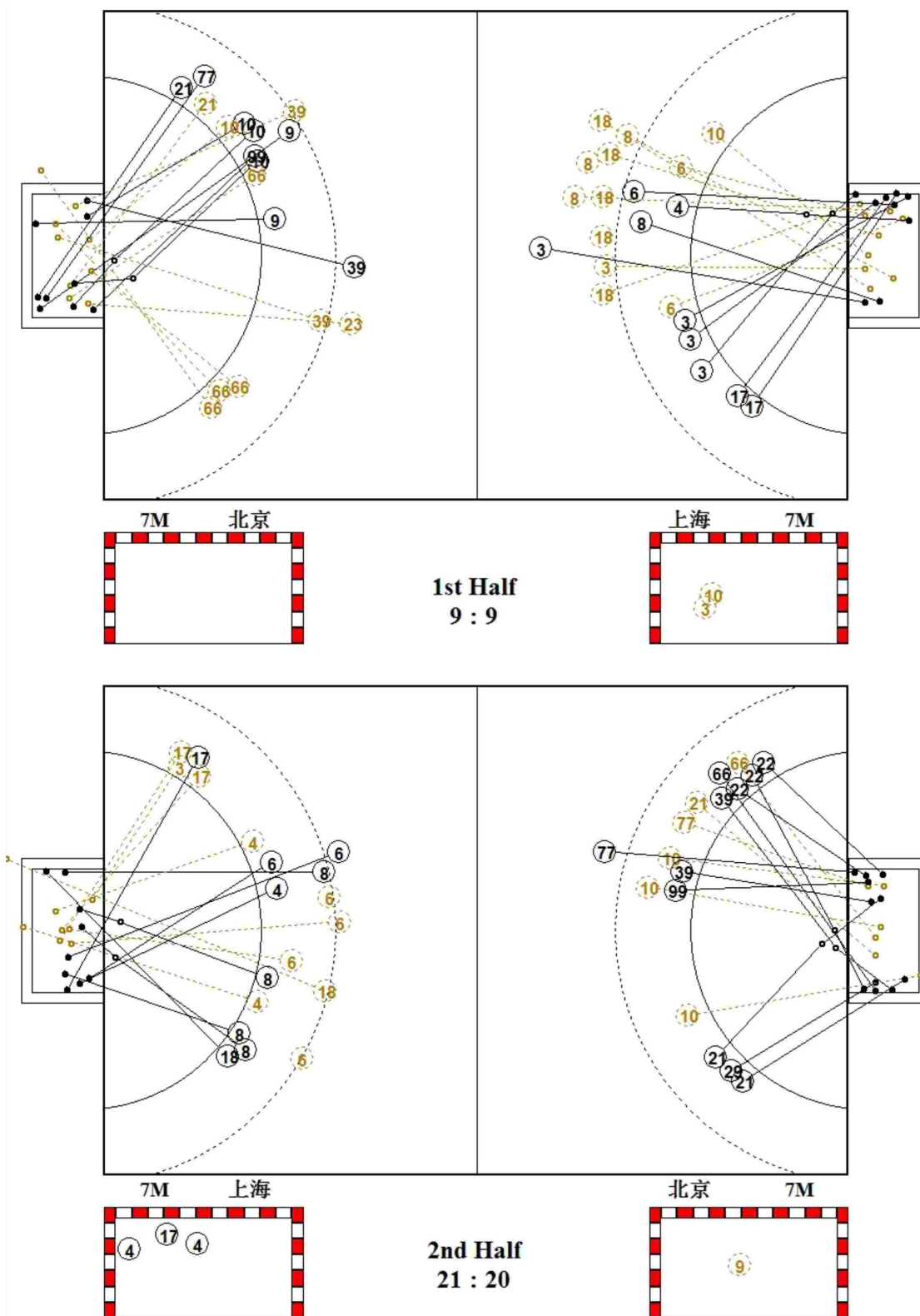

第十三届全国运动会男子手球决赛

PHMS Pictorial Handball Match Statistics

IHF Official System

图式射门区域统计

手球
男子

预赛
轮次 2

组别 A
场次 6

天津师范大学体育馆
2017-08-22 15:45

上海队

1 张峥	3 赵时俊	4 徐俊吉	6 朱世杰	7 周文龙	8 钱为玮	9 董凯	10 吴璟																																																																								
<table border="1"><tr><td></td><td></td><td></td></tr><tr><td></td><td></td><td></td></tr><tr><td></td><td></td><td></td></tr></table>										<table border="1"><tr><td>1</td><td></td><td></td></tr><tr><td>1</td><td></td><td></td></tr><tr><td>1</td><td></td><td>1</td></tr></table>	1			1			1		1	<table border="1"><tr><td>2</td><td>1</td><td></td></tr><tr><td>1</td><td></td><td></td></tr><tr><td></td><td></td><td></td></tr></table>	2	1		1						<table border="1"><tr><td>1</td><td></td><td></td></tr><tr><td>1</td><td></td><td></td></tr><tr><td>1</td><td></td><td></td></tr></table>	1			1			1			<table border="1"><tr><td></td><td></td><td></td></tr><tr><td></td><td></td><td></td></tr><tr><td></td><td></td><td></td></tr></table>										<table border="1"><tr><td></td><td></td><td></td></tr><tr><td>1</td><td>1</td><td>2</td></tr><tr><td></td><td>1</td><td></td></tr></table>				1	1	2		1		<table border="1"><tr><td></td><td></td><td></td></tr><tr><td></td><td></td><td></td></tr><tr><td></td><td></td><td></td></tr></table>										<table border="1"><tr><td></td><td></td><td></td></tr><tr><td></td><td></td><td></td></tr><tr><td></td><td></td><td></td></tr></table>									
1																																																																															
1																																																																															
1		1																																																																													
2	1																																																																														
1																																																																															
1																																																																															
1																																																																															
1																																																																															
1	1	2																																																																													
	1																																																																														
Post - 0 Miss - 0 Block - 0	Post - 0 Miss - 0 Block - 0	Post - 1 Miss - 0 Block - 0	Post - 0 Miss - 0 Block - 2	Post - 0 Miss - 0 Block - 0	Post - 0 Miss - 0 Block - 1	Post - 0 Miss - 0 Block - 0	Post - 0 Miss - 0 Block - 0																																																																								
11 蒋承骅	12 周哲韬	14 沈吉磊	16 朱春雷	17 贺政	18 马麟晓	19 祝君																																																																									
<table border="1"><tr><td></td><td></td><td></td></tr><tr><td></td><td></td><td></td></tr><tr><td></td><td></td><td></td></tr></table>										<table border="1"><tr><td></td><td></td><td></td></tr><tr><td></td><td></td><td></td></tr><tr><td></td><td></td><td></td></tr></table>										<table border="1"><tr><td></td><td></td><td></td></tr><tr><td></td><td></td><td></td></tr><tr><td></td><td></td><td></td></tr></table>										<table border="1"><tr><td></td><td></td><td></td></tr><tr><td></td><td></td><td></td></tr><tr><td></td><td></td><td></td></tr></table>										<table border="1"><tr><td>2</td><td></td><td></td></tr><tr><td>2</td><td></td><td></td></tr><tr><td></td><td></td><td></td></tr></table>	2			2						<table border="1"><tr><td></td><td></td><td></td></tr><tr><td></td><td></td><td>1</td></tr><tr><td></td><td></td><td></td></tr></table>						1				<table border="1"><tr><td></td><td></td><td></td></tr><tr><td></td><td></td><td></td></tr><tr><td></td><td></td><td></td></tr></table>																			
2																																																																															
2																																																																															
		1																																																																													
Post - 0 Miss - 0 Block - 0	Post - 0 Miss - 0 Block - 0	Post - 0 Miss - 0 Block - 0	Post - 0 Miss - 0 Block - 0	Post - 0 Miss - 0 Block - 0	Post - 0 Miss - 1 Block - 2	Post - 0 Miss - 0 Block - 0																																																																									

1 □□

1/2	2/2	1/3
0/1		

12 □□□

0/3		1/3
2/6	2/2	1/2
2/5	2/2	0/3

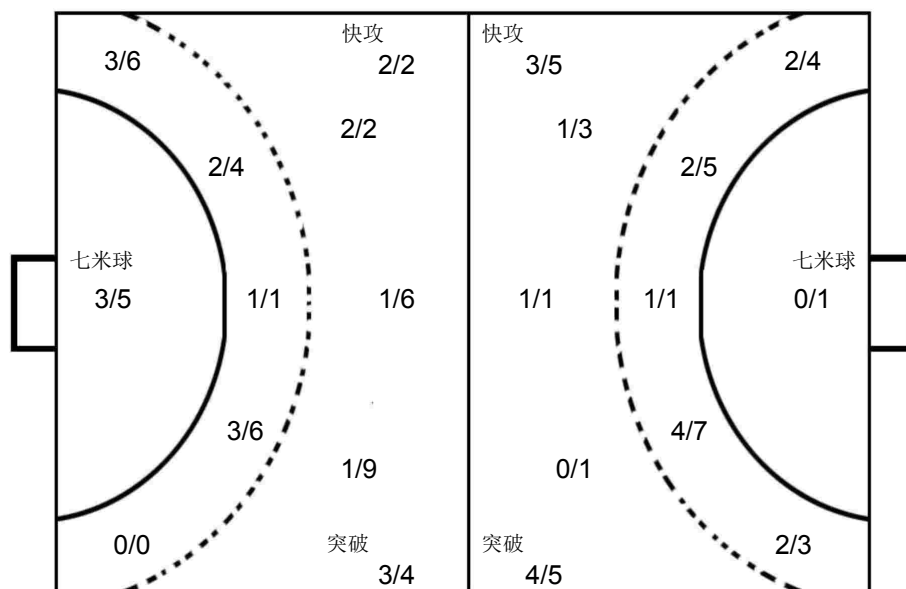

1 □□

0/1	0/1	
2/2		

16 □□□

1/6	1/1	0/1
1/7	5/6	1/3
2/4	2/3	2/3

北京队

1 王澍	7 马昌震	8 王鹏	9 刘振	10 成亚	16 刘迈科	21 胡瀛	22 王超																																																																								
<table border="1"><tr><td></td><td></td><td></td></tr><tr><td></td><td></td><td></td></tr><tr><td></td><td></td><td></td></tr></table>										<table border="1"><tr><td></td><td></td><td></td></tr><tr><td></td><td></td><td></td></tr><tr><td></td><td></td><td></td></tr></table>										<table border="1"><tr><td></td><td></td><td></td></tr><tr><td></td><td></td><td></td></tr><tr><td></td><td></td><td></td></tr></table>										<table border="1"><tr><td>1</td><td></td><td>1</td></tr><tr><td></td><td></td><td></td></tr><tr><td></td><td></td><td></td></tr></table>	1		1							<table border="1"><tr><td>2</td><td></td><td></td></tr><tr><td></td><td></td><td>1</td></tr><tr><td></td><td></td><td></td></tr></table>	2					1				<table border="1"><tr><td></td><td></td><td></td></tr><tr><td></td><td></td><td></td></tr><tr><td></td><td></td><td></td></tr></table>										<table border="1"><tr><td>1</td><td></td><td>1</td></tr><tr><td>1</td><td></td><td></td></tr><tr><td></td><td></td><td></td></tr></table>	1		1	1						<table border="1"><tr><td></td><td></td><td></td></tr><tr><td>1</td><td></td><td></td></tr><tr><td>1</td><td></td><td>1</td></tr></table>				1			1		1
1		1																																																																													
2																																																																															
		1																																																																													
1		1																																																																													
1																																																																															
1																																																																															
1		1																																																																													
Post - 0 Miss - 0 Block - 0	Post - 0 Miss - 0 Block - 0	Post - 0 Miss - 0 Block - 0	Post - 0 Miss - 0 Block - 0	Post - 1 Miss - 0 Block - 0	Post - 0 Miss - 0 Block - 0	Post - 0 Miss - 0 Block - 0	Post - 0 Miss - 0 Block - 0																																																																								
23 王军程	25 马明辉	29 杜龙飞	39 张骥	66 解建飞	77 朱昕晨	83 潘天	99 蒋维一																																																																								
<table border="1"><tr><td></td><td></td><td></td></tr><tr><td></td><td></td><td></td></tr><tr><td></td><td></td><td></td></tr></table>										<table border="1"><tr><td></td><td></td><td></td></tr><tr><td></td><td></td><td></td></tr><tr><td></td><td></td><td></td></tr></table>										<table border="1"><tr><td></td><td></td><td>1</td></tr><tr><td></td><td></td><td></td></tr><tr><td></td><td></td><td></td></tr></table>			1							<table border="1"><tr><td>1</td><td></td><td>1</td></tr><tr><td></td><td></td><td>1</td></tr><tr><td></td><td></td><td></td></tr></table>	1		1			1				<table border="1"><tr><td></td><td></td><td>1</td></tr><tr><td></td><td></td><td></td></tr><tr><td></td><td></td><td></td></tr></table>			1							<table border="1"><tr><td>1</td><td></td><td></td></tr><tr><td>1</td><td></td><td></td></tr><tr><td></td><td></td><td></td></tr></table>	1			1						<table border="1"><tr><td></td><td></td><td></td></tr><tr><td></td><td></td><td></td></tr><tr><td></td><td></td><td></td></tr></table>										<table border="1"><tr><td></td><td></td><td></td></tr><tr><td></td><td></td><td></td></tr><tr><td>2</td><td></td><td></td></tr></table>							2		
		1																																																																													
1		1																																																																													
		1																																																																													
		1																																																																													
1																																																																															
1																																																																															
2																																																																															
Post - 0 Miss - 0 Block - 0	Post - 0 Miss - 0 Block - 0	Post - 0 Miss - 0 Block - 0	Post - 0 Miss - 0 Block - 0	Post - 0 Miss - 1 Block - 0	Post - 0 Miss - 0 Block - 0	Post - 0 Miss - 0 Block - 0	Post - 0 Miss - 0 Block - 0																																																																								



Team A					Team B					Match Number								
A 安徽队					B 江苏队					7								
Played in			in the hall			on			at			Spectators						
天津			天津师范大学体育馆			2017-08-22			17:30			hours						
Half-time(30')	A	B	End of playing time		A	B	1st extra time		A	B	2nd extra time		A	B	After penalty throws		A	B
	10	20	22		35													
Number of 7 m	A	Team time-out			Full name of players and officials						Team time-out			B	Number of 7 m			
	1/3	1	2	3							1	2	3	2/2				
		06:21									23:29							

No.	Team A	G	W	2'	D	DR	No.	Team B	G	W	2'	D	DR
1	郭世伟	5					1	徐畅					
3	陈强龙	1					4	张家纬	7	1			
5	史小帆	2	1				5	闫亮	3				
8	董智景	3					6	赵晨	2				
9	陈开勇	1		1			7	徐奕飞	3				
10	严龙	3					8	周小坚	2				
11	黎涛	4					9	王杰缘	3				
12	曾献辰						10	郝可鑫	1	1			
15	曹青福临			1			12	王权					
16	杨洋						13	叶强					
17	王巨柱						15	李安	4				
18	李双						17	王伟强	5				
21	李明						18	赵楠	2				
23	于敏清	1	1				19	张志宇	2				
24	徐安格	2		1			20	顾艳超			1		
							21	刘江	1				
B	沈强 (主教练)						A	闫威名 (主教练)					
C	吴翔						C	雷纳德					
D	黄红						D	贾淑君					
E	吴台锡						E	王建国					
A		Signatures of responsables for the teams (Off.A)											B
TP	Remarks of referees / HF Official												TP

Signatures

Referees	南金勇 (CHN)	刘志军 (CHN)	
T.D.	门东山 (CHN)	于中迅 (CHN)	
CHA Off.			

Note: Number of 7m Throws Awarded to Team A and B, Goals (G), Warnings (W), Suspensions (2'), Direct Disqualification (D), Disqualification With Report (DR) and Team Penalty (TP).

Table Officials: 隆晓磊

李志成

Statisticians: 黄岩

陈柱

第十三届全国运动会男子手球决赛

PHMS Pictorial Handball Match Statistics

IHF Official System

竞赛技术统计

手球 男子 预赛 轮次 2 组别 B 场次 7 天津师范大学体育馆 2017-08-22 17:30

 Referees: 南金勇 (CHN) / 刘志军 (CHN) Result: 22:35(10:20)
 Teams: 安徽队(安徽) VS 江苏队(江苏)

安徽		远射	近射	边射	快攻	突破	任意球	7m球	合计	%	助攻	失误	警告	2'	D+DR	安徽	比赛进程	江苏
主教练: 沈强																	1st Half	
1	郭世伟	3/5	1/3		1/1				5/9	55.6		5					0 01:24	1 6 赵晨
3	陈强龙		1/1		0/1				1/2	50.0		1					0 02:58	2 6 赵晨
5	史小帆	0/3	1/1	0/1	1/1				2/6	33.3		5	1				0 03:47	3 4 张家纬
8	董智景	1/3	1/2	1/1					3/6	50.0	1						0 05:11	4 15 李安
9	陈开勇				1/1				1/1	100				1			0 05:54	5 5 闫亮
10	严龙	0/1	1/2	1/1				1/1	3/5	60.0	1	2				1	1 07:06	5
11	黎涛	0/1		3/3			1/1	0/2	4/7	57.1		3				1	1 07:51	6 9 王杰缘
12	曾献辰															1	2 08:37	6
15	曹青福临			0/1					0/1	0.0		1		1		11	2 09:12	7 4 张家纬
16	杨洋															11	3 10:56	7
17	王巨柱															3	3 12:00	8 9 王杰缘
18	李双															3	3 12:17	9 15 李安
21	李明										1	2				3	3 12:53	10 15 李安
23	于敏清				1/1				1/1	100			1			3	3 13:59	11 15 李安
24	徐安格	1/6	1/3						2/9	22.2		4		1		3	4 15:01	11
运动员 合计		5/19	6/12	5/7	4/5		1/1	1/3	22/47	46.8	3	24	2	3		5	5 15:32	11
12	曾献辰	1/3	0/1	0/1	0/6	0/3		0/1	1/15	6.7						5	5 16:14	13 4 张家纬
21	李明	5/9	2/10	0/2	2/8	2/2		0/1	11/32	34.4	1	2				5	5 15:59	12 4 张家纬
守门员 合计		6/12	2/11	0/3	2/14	2/5		0/2	12/47	25.5	1	2				5	5 16:24	13
主教练: 闫威名																6	6 16:24	13
1	徐畅															6	6 17:47	14 8 周小坚
4	张家纬	1/1	3/4		1/1	2/2			7/8	87.5	1	1	1			24	7 18:30	14
5	闫亮				3/3				3/3	100		1				5	8 19:47	14
6	赵晨	1/3				1/1	0/1		2/5	40.0	2	1				8	8 21:17	15 18 赵楠
7	徐奕飞		1/1	1/1	1/2				3/4	75.0		2				8	9 21:58	15
8	周小坚		2/2						2/2	100	1	1				1	10 23:57	16 17 王伟强
9	王杰缘		1/1	1/1	1/1				3/3	100						10	10 24:20	17 5 闫亮
10	郝可鑫	1/3							1/3	33.3	1	3	1			10	10 25:41	18 10 郝可鑫
12	王权															10	10 27:26	19 17 王伟强
13	叶强															10	10 29:23	20 18 赵楠
15	李安				3/4			1/1	4/5	80.0						10	10 01:08	21 5 闫亮
17	王伟强		2/2	1/1	2/3				5/6	83.3						10	10 02:23	22 9 王杰缘
18	赵楠	1/1	0/1	1/1	0/1				2/4	50.0						11	11 03:00	22
19	张志宇	2/3	0/1		0/1				2/5	40.0		1				11	12 03:35	22
20	顾艳超	0/4							0/4	0.0		3		1		11	12 04:27	23 4 张家纬
21	刘江		0/1					1/1	1/2	50.0						11	12 05:44	24 4 张家纬
运动员 合计		6/15	9/13	3/3	12/15	3/5	0/1	2/2	35/54	64.8	6	15	2	1		11	12 07:03	25 4 张家纬
1	徐畅	4/8	4/9	0/5	1/3			2/3	11/28	39.3						11	12 08:03	26 8 周小坚
12	王权	2/3	1/2	1/1	0/2		0/1		4/9	44.4	1					24	13 10:52	26
守门员 合计		6/11	5/11	1/6	1/5		0/1	2/3	15/37	40.5	1					10	13 14:15	27 7 徐奕飞
主教练: 闫威名																10	14 14:53	27
1	徐畅															14	14 16:07	28 17 王伟强
12	王权	2/3	1/2	1/1	0/2		0/1		4/9	44.4	1					14	14 20:12	29 7 徐奕飞
守门员 合计		6/11	5/11	1/6	1/5		0/1	2/3	15/37	40.5	1					14	14 21:00	30 19 张志宇
主教练: 闫威名																11	15 21:19	30
1	徐畅															11	16 22:14	30
12	王权	2/3	1/2	1/1	0/2		0/1		4/9	44.4	1					16	16 22:43	31 17 王伟强
守门员 合计		6/11	5/11	1/6	1/5		0/1	2/3	15/37	40.5	1					16	17 23:35	31
主教练: 闫威名																17	17 24:05	32 21 刘江
1	徐畅															17	17 24:50	33 7 徐奕飞
12	王权	2/3	1/2	1/1	0/2		0/1		4/9	44.4	1					8	18 25:29	33
守门员 合计		6/11	5/11	1/6	1/5		0/1	2/3	15/37	40.5	1					9	19 25:55	33
主教练: 闫威名																19	19 27:52	34 17 王伟强
1	徐畅															8	20 28:05	34
12	王权	2/3	1/2	1/1	0/2		0/1		4/9	44.4	1					1	21 29:06	34
守门员 合计		6/11	5/11	1/6	1/5		0/1	2/3	15/37	40.5	1					1	21 29:33	35 19 张志宇
主教练: 闫威名																10	22 29:49	35

场上队员: 得分 / 射门

守门员: 救球 / 射门

D	取消资格	DR	取消资格+报告
---	------	----	---------



第十三届全国运动会男子手球决赛

PHMS Pictorial Handball Match Statistics

IHF Official System

个人/全队技术统计表

 手球 预赛 组别 B 天津师范大学体育馆
 男子 轮次 2 场次 7 2017-08-22 17:30

号码	姓名	远射	近射	边射	快攻	突破	任意	七米	合计	%	助攻	失误	警告	2'	取消	时间
安徽队(安徽)																
(场上队员)																
1	郭世伟	3/5	1/3		1/1				5/9	55.6%		5				00:33:23
3	陈强龙		1/1		0/1				1/2	50.0%		1				00:36:55
5	史小帆	0/3	1/1	0/1	1/1				2/6	33.3%		5	1			00:04:51
8	董智景	1/3	1/2	1/1					3/6	50.0%	1					00:35:14
9	陈开勇				1/1				1/1	100%		1		1		00:39:48
10	严龙	0/1	1/2	1/1				1/1	3/5	60.0%	1	2				00:43:25
11	黎涛	0/1		3/3			1/1	0/2	4/7	57.1%		3				00:38:06
12	曾献辰									0.0%						00:11:36
15	曹青福临			0/1					0/1	0.0%		1		1		00:24:14
16	杨洋									0.0%						00:00:00
17	王巨柱									0.0%						00:00:00
18	李双									0.0%						00:00:00
21	李明									0.0%	1	2				00:48:24
23	于敏清				1/1				1/1	100%			1			00:05:41
24	徐安格	1/6	1/3						2/9	22.2%		4		1		00:53:08
合计		5/19	6/12	5/7	4/5		1/1	1/3	22/47	46.8%	3	24	2	3		
(守门员)																
12	曾献辰	1/3	0/1	0/1	0/6	0/3		0/1	1/15	6.7%						00:11:36
21	李明	5/9	2/10	0/2	2/8	2/2		0/1	11/32	34.4%	1	2				00:48:24
合计		6/12	2/11	0/3	2/14	2/5		0/2	12/47	25.5%	1	2				

场上队员：得分/射门

守门员：救球/射门

全队合计	得分	被救	射失	击柱	封球	合计	%
远射	5	6	3	1	4	19	26.3%
近射	6	5	1			12	50.0%
边射	5	1		1		7	71.4%
快攻	4	1				5	80.0%
突破							0.0%
任意	1					1	100.0%
七米	1	2				3	33.3%

第十三届全国运动会男子手球决赛

PHMS Pictorial Handball Match Statistics

IHF Official System

个人/全队技术统计表

手球 男子 预赛 轮次 2 组别 B 场次 7 天津师范大学体育馆 2017-08-22 17:30

号码	姓名	远射	近射	边射	快攻	突破	任意	七米	合计	%	助攻	失误	警告	2'	取消	时间
江苏队(江苏)																
(场上队员)																
1	徐畅									0.0%						00:45:40
4	张家纬	1/1	3/4		1/1	2/2			7/8	87.5%	1	1	1			00:18:10
5	闫亮				3/3				3/3	100%		1				00:27:48
6	赵晨	1/3				1/1	0/1		2/5	40.0%	2	1				00:28:34
7	徐奕飞		1/1	1/1	1/2				3/4	75.0%		2				00:20:17
8	周小坚		2/2						2/2	100%	1	1				00:27:42
9	王杰缘		1/1	1/1	1/1				3/3	100%						00:11:00
10	郝可鑫	1/3							1/3	33.3%	1	3	1			00:28:19
12	王权									0.0%	1					00:14:20
13	叶强									0.0%						00:00:00
15	李安				3/4			1/1	4/5	80.0%						00:18:20
17	王伟强		2/2	1/1	2/3				5/6	83.3%						00:48:21
18	赵楠	1/1	0/1		1/1	0/1			2/4	50.0%						00:38:02
19	张志宇	2/3	0/1			0/1			2/5	40.0%		1				00:18:58
20	顾艳超	0/4							0/4	0.0%		3		1		00:55:47
21	刘江		0/1					1/1	1/2	50.0%		2				00:38:43
	合计	6/15	9/13	3/3	12/15	3/5	0/1	2/2	35/54	64.8%	6	15	2	1		
(守门员)																
1	徐畅	4/8	4/9	0/5	1/3			2/3	11/28	39.3%						00:45:40
12	王权	2/3	1/2	1/1	0/2		0/1		4/9	44.4%	1					00:14:20
	合计	6/11	5/11	1/6	1/5		0/1	2/3	15/37	40.5%	1					

场上队员：得分/射门

守门员：救球/射门

全队合计	得分	被救	射失	击柱	封球	合计	%
远射	6	6	1		2	15	40.0%
近射	9	2		2		13	69.2%
边射	3					3	100.0%
快攻	12	2	1			15	80.0%
突破	3	2				5	60.0%
任意				1		1	0.0%
七米	2					2	100.0%

第十三届全国运动会男子手球决赛

PHMS Pictorial Handball Match Statistics

IHF Official System

图式比赛技术统计表

手球
男子

预赛
轮次 2

组别 B
场次 7

天津师范大学体育馆
2017-08-22 17:30

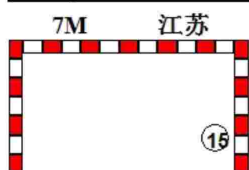
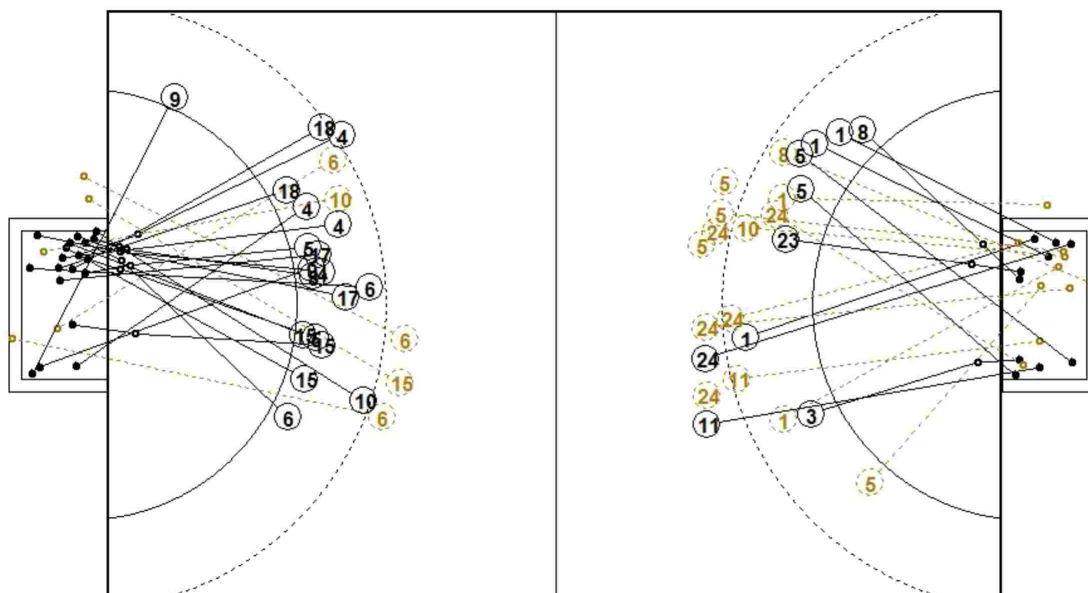

1st Half
20 : 10

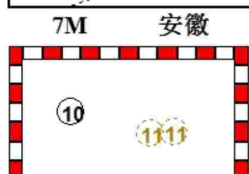
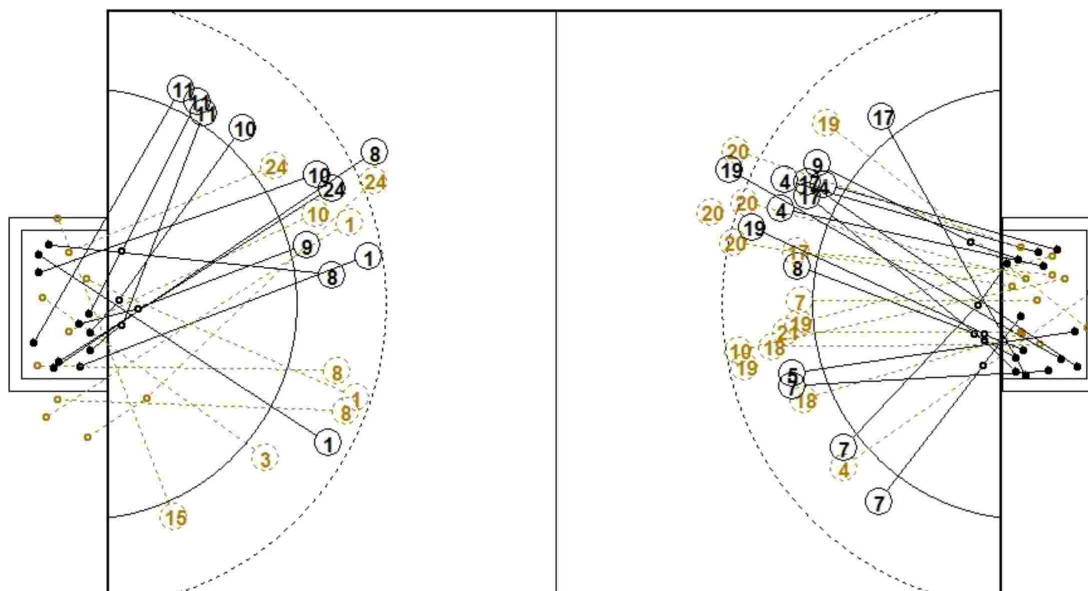
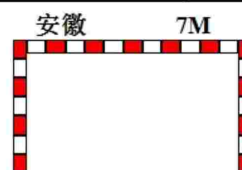

2nd Half
22 : 35

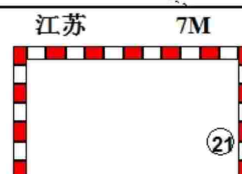

第十三届全国运动会男子手球决赛

PHMS Pictorial Handball Match Statistics

IHF Official System

图式射门区域统计

手球
男子

预赛
轮次 2

组别 B
场次 7

天津师范大学体育馆
2017-08-22 17:30

安徽队

1 郭世伟	3 陈强龙	5 史小帆	8 董智景	9 陈开勇	10 严龙	11 黎涛	12 曾献辰																																																																								
<table border="1"><tr><td></td><td></td><td>1</td></tr><tr><td>3</td><td></td><td></td></tr><tr><td>1</td><td></td><td></td></tr></table>			1	3			1			<table border="1"><tr><td></td><td></td><td></td></tr><tr><td></td><td></td><td></td></tr><tr><td></td><td></td><td>1</td></tr></table>									1	<table border="1"><tr><td></td><td></td><td>1</td></tr><tr><td></td><td></td><td></td></tr><tr><td></td><td></td><td>1</td></tr></table>			1						1	<table border="1"><tr><td></td><td></td><td>1</td></tr><tr><td>1</td><td></td><td></td></tr><tr><td></td><td>1</td><td></td></tr></table>			1	1				1		<table border="1"><tr><td></td><td></td><td></td></tr><tr><td></td><td>1</td><td></td></tr><tr><td></td><td></td><td></td></tr></table>					1					<table border="1"><tr><td></td><td></td><td>1</td></tr><tr><td>1</td><td></td><td></td></tr><tr><td>1</td><td></td><td></td></tr></table>			1	1			1			<table border="1"><tr><td>1</td><td></td><td></td></tr><tr><td></td><td></td><td>1</td></tr><tr><td>1</td><td>1</td><td></td></tr></table>	1					1	1	1		<table border="1"><tr><td></td><td></td><td></td></tr><tr><td></td><td></td><td></td></tr><tr><td></td><td></td><td></td></tr></table>									
		1																																																																													
3																																																																															
1																																																																															
		1																																																																													
		1																																																																													
		1																																																																													
		1																																																																													
1																																																																															
	1																																																																														
	1																																																																														
		1																																																																													
1																																																																															
1																																																																															
1																																																																															
		1																																																																													
1	1																																																																														
Post - 0 Miss - 2 Block - 0	Post - 0 Miss - 0 Block - 0	Post - 0 Miss - 0 Block - 2	Post - 1 Miss - 1 Block - 0	Post - 0 Miss - 0 Block - 0	Post - 0 Miss - 0 Block - 0	Post - 0 Miss - 0 Block - 0	Post - 0 Miss - 0 Block - 0																																																																								
15 曹青福临	16 杨洋	17 王巨柱	18 李双	21 李明	23 于敏清	24 徐安格																																																																									
<table border="1"><tr><td></td><td></td><td></td></tr><tr><td></td><td></td><td></td></tr><tr><td></td><td></td><td></td></tr></table>										<table border="1"><tr><td></td><td></td><td></td></tr><tr><td></td><td></td><td></td></tr><tr><td></td><td></td><td></td></tr></table>										<table border="1"><tr><td></td><td></td><td></td></tr><tr><td></td><td></td><td></td></tr><tr><td></td><td></td><td></td></tr></table>										<table border="1"><tr><td></td><td></td><td></td></tr><tr><td></td><td></td><td></td></tr><tr><td></td><td></td><td></td></tr></table>										<table border="1"><tr><td></td><td></td><td></td></tr><tr><td></td><td></td><td></td></tr><tr><td></td><td></td><td></td></tr></table>										<table border="1"><tr><td></td><td></td><td></td></tr><tr><td></td><td></td><td></td></tr><tr><td>1</td><td></td><td></td></tr></table>							1			<table border="1"><tr><td>1</td><td></td><td></td></tr><tr><td></td><td></td><td></td></tr><tr><td></td><td></td><td></td></tr></table>	1																		
1																																																																															
1																																																																															
Post - 1 Miss - 0 Block - 0	Post - 0 Miss - 0 Block - 0	Post - 0 Miss - 0 Block - 0	Post - 0 Miss - 0 Block - 0	Post - 0 Miss - 0 Block - 0	Post - 0 Miss - 0 Block - 0	Post - 0 Miss - 1 Block - 2																																																																									

12 □□□

0/2		0/1
0/1	1/2	0/6
		0/3

21 □□

0/1	1/1	1/5
2/4	1/2	1/5
1/3	2/3	2/8

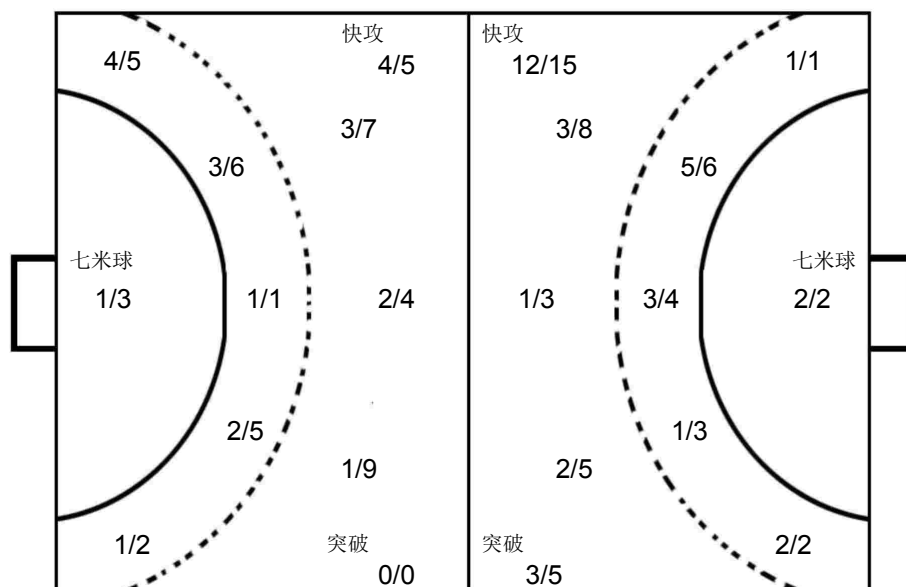

1 □□

2/4	2/2	0/4
1/5	1/2	2/2
1/4	1/3	1/2

12 □□

2/2		
0/2	1/1	1/2
0/1		0/1

江苏队

1 徐畅	4 张家纬	5 闫亮	6 赵晨	7 徐奕飞	8 周小坚	9 王杰缘	10 郝可鑫																																																																								
<table border="1"><tr><td></td><td></td><td></td></tr><tr><td></td><td></td><td></td></tr><tr><td></td><td></td><td></td></tr></table>										<table border="1"><tr><td>1</td><td></td><td></td></tr><tr><td>3</td><td></td><td>3</td></tr><tr><td></td><td></td><td></td></tr></table>	1			3		3				<table border="1"><tr><td></td><td></td><td>1</td></tr><tr><td></td><td></td><td></td></tr><tr><td></td><td></td><td>2</td></tr></table>			1						2	<table border="1"><tr><td></td><td></td><td>1</td></tr><tr><td></td><td></td><td></td></tr><tr><td></td><td></td><td>1</td></tr></table>			1						1	<table border="1"><tr><td></td><td></td><td></td></tr><tr><td></td><td></td><td>1</td></tr><tr><td>1</td><td>1</td><td></td></tr></table>						1	1	1		<table border="1"><tr><td></td><td></td><td></td></tr><tr><td></td><td></td><td></td></tr><tr><td></td><td></td><td>2</td></tr></table>									2	<table border="1"><tr><td>2</td><td></td><td></td></tr><tr><td></td><td></td><td></td></tr><tr><td>1</td><td></td><td></td></tr></table>	2						1			<table border="1"><tr><td></td><td></td><td></td></tr><tr><td></td><td></td><td></td></tr><tr><td></td><td></td><td>1</td></tr></table>									1
1																																																																															
3		3																																																																													
		1																																																																													
		2																																																																													
		1																																																																													
		1																																																																													
		1																																																																													
1	1																																																																														
		2																																																																													
2																																																																															
1																																																																															
		1																																																																													
Post - 0 Miss - 0 Block - 0	Post - 1 Miss - 0 Block - 0	Post - 0 Miss - 0 Block - 0	Post - 1 Miss - 1 Block - 0	Post - 0 Miss - 0 Block - 0	Post - 0 Miss - 0 Block - 0	Post - 0 Miss - 0 Block - 0	Post - 0 Miss - 0 Block - 0																																																																								
12 王权	13 叶强	15 李安	17 王伟强	18 赵楠	19 张志宇	20 顾艳超	21 刘江																																																																								
<table border="1"><tr><td></td><td></td><td></td></tr><tr><td></td><td></td><td></td></tr><tr><td></td><td></td><td></td></tr></table>										<table border="1"><tr><td></td><td></td><td></td></tr><tr><td></td><td></td><td></td></tr><tr><td></td><td></td><td></td></tr></table>										<table border="1"><tr><td></td><td></td><td></td></tr><tr><td></td><td>1</td><td>3</td></tr><tr><td></td><td></td><td></td></tr></table>					1	3				<table border="1"><tr><td></td><td></td><td>2</td></tr><tr><td></td><td>1</td><td></td></tr><tr><td></td><td></td><td>2</td></tr></table>			2		1				2	<table border="1"><tr><td></td><td></td><td></td></tr><tr><td></td><td></td><td>2</td></tr><tr><td></td><td></td><td></td></tr></table>						2				<table border="1"><tr><td></td><td></td><td>1</td></tr><tr><td></td><td></td><td></td></tr><tr><td></td><td></td><td>1</td></tr></table>			1						1	<table border="1"><tr><td></td><td></td><td></td></tr><tr><td></td><td></td><td></td></tr><tr><td></td><td></td><td></td></tr></table>										<table border="1"><tr><td></td><td></td><td></td></tr><tr><td></td><td></td><td>1</td></tr><tr><td></td><td></td><td></td></tr></table>						1			
	1	3																																																																													
		2																																																																													
	1																																																																														
		2																																																																													
		2																																																																													
		1																																																																													
		1																																																																													
		1																																																																													
Post - 0 Miss - 0 Block - 0	Post - 0 Miss - 0 Block - 0	Post - 0 Miss - 1 Block - 0	Post - 0 Miss - 0 Block - 0	Post - 0 Miss - 0 Block - 0	Post - 1 Miss - 0 Block - 1	Post - 0 Miss - 0 Block - 1	Post - 0 Miss - 0 Block - 0																																																																								

PHMS Pictorial Handball Match Statistics

IHF Official System

Team A					Team B					Match Number								
A 香港队					B 广东队					8								
Played in			in the hall			on			at			Spectators						
天津			天津师范大学体育馆			2017-08-22			19:15			hours						
Half-time(30')	A	B	End of playing time		A	B	1st extra time		A	B	2nd extra time		A	B	After penalty throws		A	B
	8	17	24		36													
Number of 7 m	A	Team time-out			Full name of players and officials						Team time-out			B	Number of 7 m			
	0/0	1	2	3							1	2	3	3/3				
		06:47	56:13															

No.	Team A	G	W	2'	D	DR	No.	Team B	G	W	2'	D	DR
1	叶冠英						1	王帅					
2	刘健斌	1		1			2	孙江山	5				
3	陈梓朗	2					3	曲汝洋	4				
5	黄胜业	1					4	李卓洋	2				
7	谭俊杰						5	侯生升	4				
8	李伟东						6	邓志贵	3				
10	谢永辉	1					7	付云博	2				
12	许文邦	6					8	于彦江	2	1			
13	张伟浩						9	徐庆	1				
18	李鑫豪	2	1				11	房友屯					
23	郭斯鸣	6	1				12	王雨	1				
27	冼大维	1					15	张建杰	4				
29	练明辉						16	马跃					
31	叶仕仁	2					17	李中洲	6	1			
33	袁晞彦	2					26	姚雪岩	1				
40	叶冠雄						84	王伟	1	1			
A	杨开将						B	王锋 (主教练)					
B	王涛						C	刘康伶					
C	高梓欣						D	张广建					
							E	王永存					
A	Signatures of responsables for the teams (Off.A)												B
TP	Remarks of referees / HF Official												TP

Signatures

Referees	李兆蒙 (CHN)	倪震 (CHN)	
T.D.	门东山 (CHN)	于中迅 (CHN)	
CHA Off.			

Note: Number of 7m Throws Awarded to Team A and B, Goals (G), Warnings (W), Suspensions (2'), Direct Disqualification (D), Disqualification With Report (DR) and Team Penalty (TP).

Table Officials: 鲍瑀 梅艳 Statisticians: 陈柱 刘永欢

第十三届全国运动会男子手球决赛
PHMS Pictorial Handball Match Statistics

IHF Official System

竞赛技术统计

 手球
男子

 预赛
轮次 2

 组别 B
场次 8

 天津师范大学体育馆
2017-08-22 19:15

Referees:	李兆蒙 (CHN) / 倪震 (CHN)	Result:	24:36 (8:17)
Teams:	香港队 (香港) VS 广东队 (广东)		

香港														香港		广东	
主教练: 高梓欣														比赛进程			
远射	近射	边射	快攻	突破	任意球	7m球	合计	%	助攻	失误	警告	2'	D+DR				
1	叶冠英																
2	刘健斌			1/1			1/1	100		1		1					
3	陈梓朗			2/2			2/2	100									
5	黄胜业		0/1	0/1	1/1		1/3	33.3		2							
7	谭俊杰									1	2						
8	李伟东																
10	谢永辉		1/2				1/2	50.0		1							
12	许文邦	3/8	1/1	1/1			6/11	54.5	1	3							
13	张伟浩																
18	李鑫豪		1/1	1/1			2/2	100		1	1						
23	郭斯鸣	3/7		0/1	2/2	1/2	6/12	50.0	1	2	1						
27	冼大维		1/1		0/1		1/2	50.0									
29	练明辉	0/2					0/2	0.0		2							
31	叶仕仁	1/2	1/1				2/3	66.7	1								
33	袁晞彦		1/2	0/1	1/1		2/4	50.0									
40	叶冠雄	0/3	0/1				0/4	0.0	1	1							
运动员 合计		7/22	6/10	5/8	4/5	1/2	1/1	24/48	50.0	5	15	2	1				
1	叶冠英	2/6	4/6	1/3	1/6	0/2	0/2	8/25	32.0								
7	谭俊杰	3/6	0/3	2/5	0/6	0/3	0/1	5/24	20.8	1	2						
守门员 合计		5/12	4/9	3/8	1/12	0/5	0/3	13/49	26.5	1	2						
广东														1st Half			
主教练: 王锋														2nd Half			
1	王帅																
2	孙江山		2/2	2/5			1/1	5/8	62.5								
3	曲汝洋	0/1			3/3	1/1	4/5	80.0		1							
4	李卓洋	1/3	0/2	1/1			2/6	33.3									
5	侯生升		0/1		3/3	1/1	4/5	80.0		1							
6	邓志贵		1/1	1/1	1/1		3/3	100									
7	付云博	2/2	0/1				2/3	66.7		1							
8	于彦江			0/2	2/2		2/4	50.0			1						
9	徐庆		1/1				1/1	100		1							
11	房友屯																
12	王雨			1/1			1/1	100									
15	张建杰	2/4	1/1		1/1		4/6	66.7		4							
16	马跃									2							
17	李中洲	2/4			0/1	2/3	2/2	6/10	60.0		1	1					
26	姚雪岩					1/1	1/1	100		1							
84	王伟	0/1	0/1		1/1		1/3	33.3		2	1						
运动员 合计		7/15	5/10	5/10	11/12	5/6	3/3	36/56	64.3	3	11	3					
1	王帅	3/8	3/8	0/2	1/4	0/1		7/23	30.4								
16	马跃	4/6	0/1	2/5	0/1		0/1	6/14	42.9	2							
守门员 合计		7/14	3/9	2/7	1/5	0/1	0/1	13/37	35.1	2							
场上队员: 得分 / 射门														守门员: 救球 / 射门			
D	取消资格			DR	取消资格+报告												

第十三届全国运动会男子手球决赛

PHMS Pictorial Handball Match Statistics

IHF Official System

个人/全队技术统计表

 手球 预赛 组别 B 天津师范大学体育馆
 男子 轮次 2 场次 8 2017-08-22 19:15

号码	姓名	远射	近射	边射	快攻	突破	任意	七米	合计	%	助攻	失误	警告	2'	取消	时间
香港队(香港)																
(场上队员)																
1	叶冠英									0.0%						00:30:18
2	刘健斌			1/1					1/1	100%	1			1		00:22:34
3	陈梓朗			2/2					2/2	100%						00:20:31
5	黄胜业		0/1	0/1	1/1				1/3	33.3%		2				00:51:43
7	谭俊杰									0.0%	1	2				00:29:42
8	李伟东									0.0%						00:21:58
10	谢永辉		1/2						1/2	50.0%		1				00:39:18
12	许文邦	3/8	1/1	1/1			1/1		6/11	54.5%	1	3				00:39:09
13	张伟浩									0.0%						00:15:26
18	李鑫豪		1/1	1/1					2/2	100%		1	1			00:22:38
23	郭斯鸣	3/7		0/1	2/2	1/2			6/12	50.0%	1	2	1			01:00:00
27	冼大维		1/1		0/1				1/2	50.0%						00:33:40
29	练明辉	0/2							0/2	0.0%		2				00:54:15
31	叶仕仁	1/2	1/1						2/3	66.7%	1					00:19:32
33	袁晞彦		1/2	0/1	1/1				2/4	50.0%						00:25:32
40	叶冠雄	0/3	0/1						0/4	0.0%	1	1				00:33:46
	合计	7/22	6/10	5/8	4/5	1/2	1/1		24/48	50.0%	5	15	2	1		
(守门员)																
1	叶冠英	2/6	4/6	1/3	1/6	0/2		0/2	8/25	32.0%						00:30:18
7	谭俊杰	3/6	0/3	2/5	0/6	0/3		0/1	5/24	20.8%	1	2				00:29:42
	合计	5/12	4/9	3/8	1/12	0/5		0/3	13/49	26.5%	1	2				

场上队员：得分/射门

守门员：救球/射门

全队合计	得分	被救	射失	击柱	封球	合计	%
远射	7	7	3	2	3	22	31.8%
近射	6	3	1			10	60.0%
边射	5	2		1		8	62.5%
快攻	4	1				5	80.0%
突破	1		1			2	50.0%
任意	1					1	100.0%
七米							0.0%

第十三届全国运动会男子手球决赛

PHMS Pictorial Handball Match Statistics

IHF Official System

个人/全队技术统计表

 手球 预赛 组别 B 天津师范大学体育馆
 男子 轮次 2 场次 8 2017-08-22 19:15

号码	姓名	远射	近射	边射	快攻	突破	任意	七米	合计	%	助攻	失误	警告	2'	取消	时间
广东队(广东)																
(场上队员)																
1	王帅									0.0%						00:30:00
2	孙江山		2/2	2/5				1/1	5/8	62.5%						00:38:31
3	曲汝洋	0/1			3/3	1/1			4/5	80.0%		1				00:29:21
4	李卓洋	1/3	0/2	1/1					2/6	33.3%						00:31:31
5	侯生升		0/1		3/3	1/1			4/5	80.0%		1				00:31:04
6	邓志贵		1/1	1/1	1/1				3/3	100%						00:46:44
7	付云博	2/2	0/1						2/3	66.7%		1				00:36:22
8	于彦江			0/2	2/2				2/4	50.0%			1			00:05:12
9	徐庆		1/1						1/1	100%		1				00:26:59
11	房友屯									0.0%						00:00:00
12	王雨			1/1					1/1	100%						00:06:50
15	张建杰	2/4	1/1		1/1				4/6	66.7%		4				00:46:51
16	马跃									0.0%	2					00:30:00
17	李中洲	2/4			0/1	2/3		2/2	6/10	60.0%		1	1			01:00:00
26	姚雪岩					1/1			1/1	100%	1					00:10:50
84	王伟	0/1	0/1		1/1				1/3	33.3%		2	1			00:35:04
	合计	7/15	5/10	5/10	11/12	5/6		3/3	36/56	64.3%	3	11	3			
(守门员)																
1	王帅	3/8	3/8	0/2	1/4	0/1			7/23	30.4%						00:30:00
16	马跃	4/6	0/1	2/5	0/1		0/1		6/14	42.9%	2					00:30:00
	合计	7/14	3/9	2/7	1/5	0/1	0/1		13/37	35.1%	2					

场上队员：得分/射门

守门员：救球/射门

全队合计	得分	被救	射失	击柱	封球	合计	%
远射	7	5	1	1	1	15	46.7%
近射	5	4	1			10	50.0%
边射	5	3	1	1		10	50.0%
快攻	11	1				12	91.7%
突破	5			1		6	83.3%
任意							0.0%
七米	3					3	100.0%

第十三届全国运动会男子手球决赛

PHMS Pictorial Handball Match Statistics

IHF Official System

图式比赛技术统计表

手球
男子

预赛
轮次 2

组别 B
场次 8

天津师范大学体育馆
2017-08-22 19:15

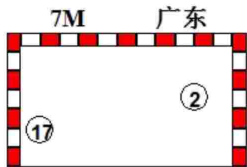
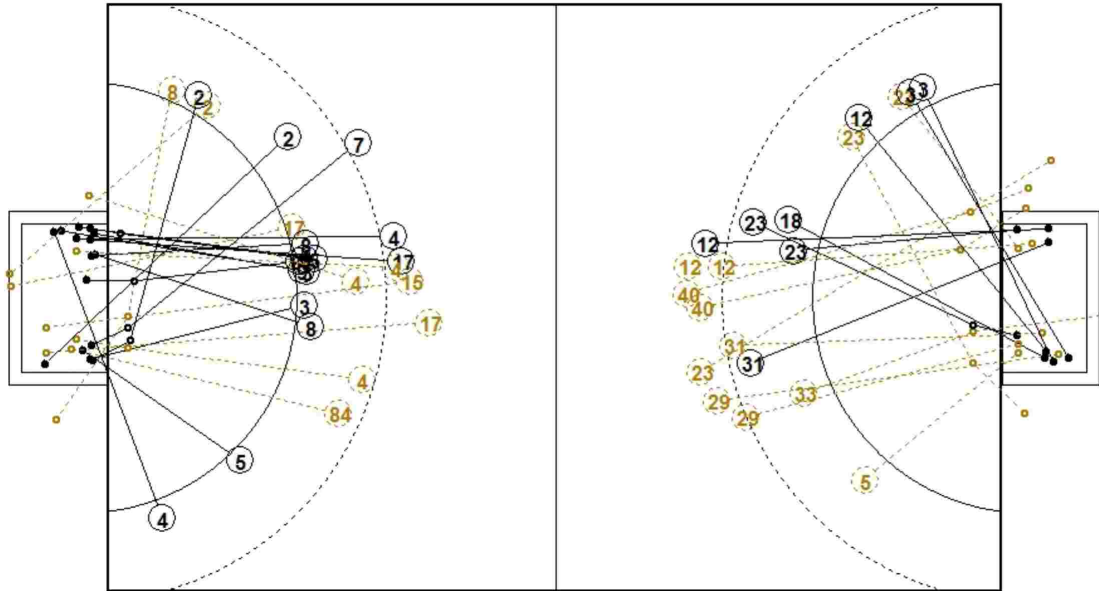

1st Half
17 : 8

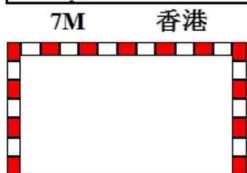
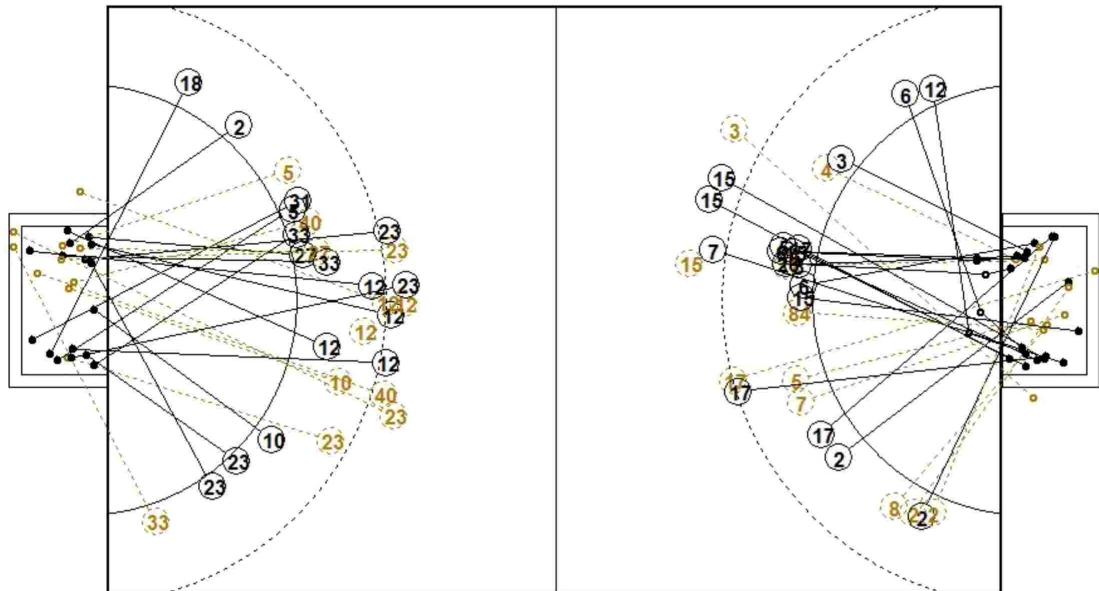
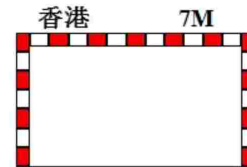

2nd Half
24 : 36

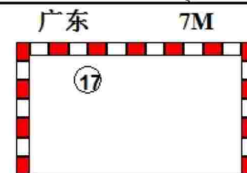

第十三届全国运动会男子手球决赛

PHMS Pictorial Handball Match Statistics

IHF Official System

图式射门区域统计

手球
男子

预赛
轮次 2

组别 B
场次 8

天津师范大学体育馆
2017-08-22 19:15

香港队

1 叶冠英	2 刘健斌	3 陈梓朗	5 黄胜业	7 谭俊杰	8 李伟东	10 谢永辉	12 许文邦																																																																								
<table border="1"><tr><td></td><td></td><td></td></tr><tr><td></td><td></td><td></td></tr><tr><td></td><td></td><td></td></tr></table>										<table border="1"><tr><td></td><td></td><td></td></tr><tr><td></td><td></td><td>1</td></tr><tr><td></td><td></td><td></td></tr></table>						1				<table border="1"><tr><td></td><td></td><td>1</td></tr><tr><td></td><td></td><td>1</td></tr><tr><td></td><td></td><td></td></tr></table>			1			1				<table border="1"><tr><td></td><td></td><td></td></tr><tr><td>1</td><td></td><td></td></tr><tr><td></td><td></td><td></td></tr></table>				1						<table border="1"><tr><td></td><td></td><td></td></tr><tr><td></td><td></td><td></td></tr><tr><td></td><td></td><td></td></tr></table>										<table border="1"><tr><td></td><td></td><td></td></tr><tr><td></td><td></td><td></td></tr><tr><td></td><td></td><td></td></tr></table>										<table border="1"><tr><td></td><td></td><td></td></tr><tr><td></td><td></td><td></td></tr><tr><td></td><td>1</td><td></td></tr></table>								1		<table border="1"><tr><td></td><td></td><td>1</td></tr><tr><td>2</td><td></td><td>2</td></tr><tr><td></td><td></td><td>1</td></tr></table>			1	2		2			1
		1																																																																													
		1																																																																													
		1																																																																													
1																																																																															
	1																																																																														
		1																																																																													
2		2																																																																													
		1																																																																													
Post - 0 Miss - 0 Block - 0	Post - 0 Miss - 0 Block - 0	Post - 0 Miss - 0 Block - 0	Post - 0 Miss - 0 Block - 0	Post - 0 Miss - 0 Block - 0	Post - 0 Miss - 0 Block - 0	Post - 0 Miss - 0 Block - 0	Post - 0 Miss - 1 Block - 3																																																																								
13 张伟浩	18 李鑫豪	23 郭斯鸣	27 冼大维	29 练明辉	31 叶仕仁	33 袁晞彦	40 叶冠雄																																																																								
<table border="1"><tr><td></td><td></td><td></td></tr><tr><td></td><td></td><td></td></tr><tr><td></td><td></td><td></td></tr></table>										<table border="1"><tr><td>1</td><td></td><td></td></tr><tr><td></td><td></td><td>1</td></tr><tr><td></td><td></td><td></td></tr></table>	1					1				<table border="1"><tr><td></td><td></td><td></td></tr><tr><td>1</td><td></td><td></td></tr><tr><td>2</td><td></td><td>3</td></tr></table>				1			2		3	<table border="1"><tr><td></td><td></td><td></td></tr><tr><td></td><td></td><td></td></tr><tr><td></td><td></td><td>1</td></tr></table>									1	<table border="1"><tr><td></td><td></td><td></td></tr><tr><td></td><td></td><td></td></tr><tr><td></td><td></td><td></td></tr></table>										<table border="1"><tr><td>1</td><td></td><td></td></tr><tr><td>1</td><td></td><td></td></tr><tr><td></td><td></td><td></td></tr></table>	1			1						<table border="1"><tr><td></td><td></td><td></td></tr><tr><td></td><td></td><td></td></tr><tr><td>1</td><td></td><td>1</td></tr></table>							1		1	<table border="1"><tr><td></td><td></td><td></td></tr><tr><td></td><td></td><td></td></tr><tr><td></td><td></td><td></td></tr></table>									
1																																																																															
		1																																																																													
1																																																																															
2		3																																																																													
		1																																																																													
1																																																																															
1																																																																															
1		1																																																																													
Post - 0 Miss - 0 Block - 0	Post - 0 Miss - 0 Block - 0	Post - 1 Miss - 2 Block - 0	Post - 0 Miss - 0 Block - 0	Post - 0 Miss - 0 Block - 0	Post - 0 Miss - 0 Block - 0	Post - 1 Miss - 1 Block - 0	Post - 1 Miss - 1 Block - 0																																																																								

1 □□□

1/3	1/1	
1/1	2/2	2/7
1/6		0/5

7 □□□

1/1	1/2	0/2
3/7		0/3
0/4	0/1	0/4

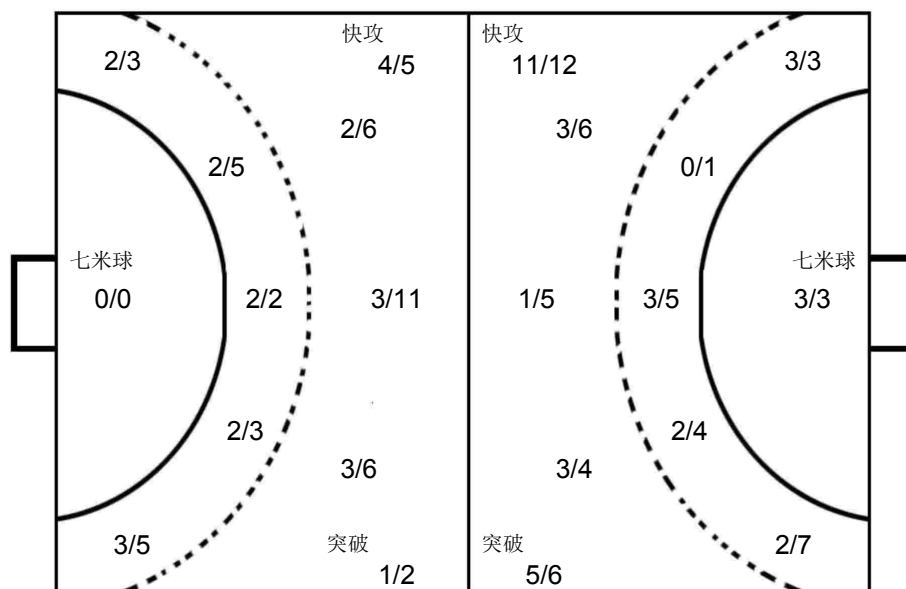

1 □□

0/2		1/2
1/4	2/2	2/5
0/2	0/1	1/5

16 □□

		1/2
1/3		1/4
1/2		2/3

广东队

1 王帅	2 孙江山	3 曲汝洋	4 李卓洋	5 侯生升	6 邓志贵	7 付文博	8 于彦江																																																																								
<table border="1"><tr><td></td><td></td><td></td></tr><tr><td></td><td></td><td></td></tr><tr><td></td><td></td><td></td></tr></table>										<table border="1"><tr><td>1</td><td>1</td><td></td></tr><tr><td>1</td><td></td><td>1</td></tr><tr><td>1</td><td></td><td></td></tr></table>	1	1		1		1	1			<table border="1"><tr><td></td><td></td><td></td></tr><tr><td></td><td></td><td></td></tr><tr><td>3</td><td></td><td>1</td></tr></table>							3		1	<table border="1"><tr><td></td><td></td><td></td></tr><tr><td></td><td></td><td>1</td></tr><tr><td></td><td></td><td></td></tr></table>						1				<table border="1"><tr><td></td><td></td><td></td></tr><tr><td></td><td></td><td>2</td></tr><tr><td>1</td><td></td><td>1</td></tr></table>						2	1		1	<table border="1"><tr><td></td><td></td><td></td></tr><tr><td>1</td><td></td><td></td></tr><tr><td>1</td><td></td><td>1</td></tr></table>				1			1		1	<table border="1"><tr><td></td><td></td><td>1</td></tr><tr><td></td><td></td><td></td></tr><tr><td></td><td></td><td></td></tr></table>			1							<table border="1"><tr><td></td><td></td><td></td></tr><tr><td></td><td></td><td></td></tr><tr><td></td><td></td><td>2</td></tr></table>									2
1	1																																																																														
1		1																																																																													
1																																																																															
3		1																																																																													
		1																																																																													
		2																																																																													
1		1																																																																													
1																																																																															
1		1																																																																													
		1																																																																													
		2																																																																													
Post - 0 Miss - 0 Block - 0	Post - 1 Miss - 0 Block - 0	Post - 0 Miss - 1 Block - 0	Post - 0 Miss - 1 Block - 0	Post - 0 Miss - 0 Block - 0	Post - 0 Miss - 0 Block - 0	Post - 0 Miss - 0 Block - 0	Post - 0 Miss - 1 Block - 0																																																																								
9 徐庆	11 房友屯	12 王雨	15 张建杰	16 马跃	17 李中洲	26 姚雪岩	84 王伟																																																																								
<table border="1"><tr><td></td><td></td><td></td></tr><tr><td></td><td></td><td>1</td></tr><tr><td></td><td></td><td></td></tr></table>						1				<table border="1"><tr><td></td><td></td><td></td></tr><tr><td></td><td></td><td></td></tr><tr><td></td><td></td><td></td></tr></table>										<table border="1"><tr><td></td><td></td><td></td></tr><tr><td></td><td></td><td></td></tr><tr><td></td><td></td><td>1</td></tr></table>									1	<table border="1"><tr><td></td><td></td><td>1</td></tr><tr><td></td><td></td><td>1</td></tr><tr><td>1</td><td></td><td>1</td></tr></table>			1			1	1		1	<table border="1"><tr><td></td><td></td><td></td></tr><tr><td></td><td></td><td></td></tr><tr><td></td><td></td><td></td></tr></table>										<table border="1"><tr><td>1</td><td></td><td></td></tr><tr><td>2</td><td></td><td>2</td></tr><tr><td></td><td></td><td>1</td></tr></table>	1			2		2			1	<table border="1"><tr><td></td><td></td><td></td></tr><tr><td></td><td></td><td></td></tr><tr><td>1</td><td></td><td></td></tr></table>							1			<table border="1"><tr><td></td><td></td><td></td></tr><tr><td></td><td></td><td></td></tr><tr><td></td><td></td><td>1</td></tr></table>									1
		1																																																																													
		1																																																																													
		1																																																																													
		1																																																																													
1		1																																																																													
1																																																																															
2		2																																																																													
		1																																																																													
1																																																																															
		1																																																																													
Post - 0 Miss - 0 Block - 0	Post - 0 Miss - 0 Block - 0	Post - 0 Miss - 0 Block - 0	Post - 0 Miss - 0 Block - 1	Post - 0 Miss - 0 Block - 0	Post - 2 Miss - 0 Block - 0	Post - 0 Miss - 0 Block - 0	Post - 0 Miss - 0 Block - 0																																																																								

PHMS Pictorial Handball Match Statistics

IHF Official System

Team A					Team B					Match Number											
A 山东队					B 上海队					9											
Played in			in the hall			on			at			Spectators									
天津			天津师范大学体育馆			2017-08-23			14:00			hours									
Half-time(30')	A	B	End of playing time		A	B	1st extra time		A	B	2nd extra time		A	B	After penalty throws		A	B			
	13	9	26		18																
Number of 7 m	A	Team time-out			Full name of players and officials						Team time-out			B	Number of 7 m						
	0/1	1	2	3							1	2	3	B							
			59:03								07:04	48:14		2/2							
No.	Team A					G	W	2'	D	DR	No.	Team B					G	W	2'	D	DR
3	尹杰										1	张峥									
4	田瑞										3	赵时俊					2				
5	潘翔					1					4	徐俊吉					3	1			
6	李朝鹏					2		1			6	朱世杰							2		
8	王炳华										7	周文龙									
9	赵鑫					3					8	钱为玮					2				
11	宋朋强										9	董凯									
12	崔剑										10	吴璟					1				
13	刘晓					2					11	蒋承骅									
15	张继伟					1					12	周哲韬									
16	于性哲										14	沈吉磊					3				
17	王旭东					5	1				16	朱春雷									
18	于亚男					3					17	贺政					4				
19	李语庆						1				18	马麟晓					3				
20	杜在超					5	1	1			19	祝君						1			
21	翟乾坤					4															
A	王志峰										A	郑益方									
B	王鸿斌 (主教练)										B	张勇军 (主教练)									
C	刘桂妮										C	金迪琦									
D	邢建刚										D	杨时									
					Signatures of responsables for the teams (Off.A)																
TP	Remarks of referees / HF Official															TP					

Signatures

Referees BALAZS. MARTON (HUN)

PETER. HORVATH (HUN)

T.D. 李长海 (CHN)

李刚 (CHN)

CHA Off.

Note: Number of 7m Throws Awarded to Team A and B, Goals (G), Warnings (W), Suspensions (2'), Direct Disqualification (D), Disqualification With Report (DR) and Team Penalty (TP).

Table Officials: 隆晓磊

李志成

Statisticians: 刘永欢

黄岩

第十三届全国运动会男子手球决赛

PHMS Pictorial Handball Match Statistics

IHF Official System

竞赛技术统计

手球
男子

预赛
轮次 3

组别 A
场次 9

天津师范大学体育馆
2017-08-23 14:00

Referees: BALAZS. MARTON (HUN) / PETER. HORVATH (HUN)

Result: 26:18 (13:9)

Teams: 山东队(山东) VS 上海队(上海)

山东		远射	近射	边射	快攻	突破	任意球	7m球	合计	%	助攻	失误	警告	2'	D+DR	山东	比赛进程	上海
主教练: 王鸿斌																1st Half		
3	尹杰										1	1				17	王旭东	1 01:04 0
4	田瑞											1				18	于亚男	2 04:24 0
5	潘翔					1/1			1/1	100	1	1				5	潘翔	3 06:19 0
6	李朝鹏	1/1	1/1						2/2	100				1		18	于亚男	4 07:03 0
8	王炳华				0/1				0/1	0.0		1				18	于亚男	5 08:28 0
9	赵鑫	0/2	1/1	1/1	1/1				3/5	60.0						5	08:53	1 8 钱为玮
11	宋朋强	0/2					0/1		0/3	0.0	3	3				5	11:43	2 3 赵时俊
12	崔剑															5	14:01	3 4 徐俊吉
13	刘晓	1/2				1/1			2/3	66.7						21	翟乾坤	6 14:54 3
15	张继伟		1/1						1/1	100		1				20	杜在超	7 16:34 3
16	于性哲															7	17:02	4 18 马麟晓
17	王旭东		1/2	2/3	1/1	1/1			5/7	71.4	1		1			7	19:01	5 14 沈吉磊
18	于亚男	2/2			1/1				3/3	100	1	2				17	王旭东	8 20:02 5
19	李语庆			0/1	0/1			0/1	0/3	0.0			1			8	20:23	6 3 赵时俊
20	杜在超		1/1	2/3	0/1	2/3			5/8	62.5		1	1	1		21	翟乾坤	9 21:07 6
21	翟乾坤		2/2	1/2	1/1				4/5	80.0						20	杜在超	10 22:17 6
运动员 合计		4/9	7/8	6/10	4/7	5/6	0/1	0/1	26/42	61.9	7	11	3	2		10	23:59	7 14 沈吉磊
12	崔剑	0/1	2/2	0/3			0/1		2/7	28.6						11	24:38	7
16	于性哲	4/8	1/2	5/10	1/1	0/1	2/2	0/2	13/26	50.0						11	25:33	8 17 贺政
守门员 合计		4/9	3/4	5/13	1/1	0/1	2/3	0/2	15/33	45.5						12	26:27	8
上海																12	28:31	9 17 贺政
主教练: 张勇军																13	28:31	9 17 贺政
1	张峥															13	29:51	9
3	赵时俊	1/1		0/2				1/1	2/4	50.0		1				13	03:15	10 4 徐俊吉
4	徐俊吉			1/1		1/1		1/1	3/3	100		1	1			21	翟乾坤	14 04:57 10
6	朱世杰				0/1				0/1	0.0				2		20	杜在超	15 06:49 10
7	周文龙															9	赵鑫	16 09:03 10
8	钱为玮	0/1	0/1	2/5			0/1		2/8	25.0		3				16	11:09	11 4 徐俊吉
9	董凯															9	赵鑫	17 11:43 11
10	吴璟		1/1						1/1	100						17	王旭东	18 15:03 11
11	蒋承骅	0/1							0/1	0.0		1				18	15:40	12 10 吴璟
12	周哲韬															17	王旭东	19 15:52 12
14	沈吉磊	2/3	0/1	1/1			0/1		3/6	50.0		5				19	16:35	13 18 马麟晓
16	朱春雷															6	李朝鹏	20 17:20 13
17	贺政		0/1	4/5					4/6	66.7		1				21	翟乾坤	21 18:10 13
18	马麟晓	2/6	0/1				1/1		3/8	37.5		3				6	李朝鹏	22 19:05 13
19	祝君												1			9	赵鑫	23 19:51 13
运动员 合计		5/12	1/5	8/14	0/1	1/1	1/3	2/2	18/38	47.4		15	2	2		13	刘晓	24 21:48 13
1	张峥	2/4	1/6	1/2	2/6	0/2			6/20	30.0						24	22:32	14 17 贺政
12	周哲韬	1/3	0/2	2/7	1/1	1/4	1/1		6/18	33.3						25	23:11	14
守门员 合计		3/7	1/8	3/9	3/7	1/6	1/1		12/38	31.6						25	25:06	15 18 马麟晓
																25	26:13	16 17 贺政
																26	26:49	16
																26	28:37	17 14 沈吉磊
																26	29:46	18 8 钱为玮

场上队员: 得分 / 射门

守门员: 救球 / 射门

D	取消资格	DR	取消资格+报告
---	------	----	---------

第十三届全国运动会男子手球决赛

PHMS Pictorial Handball Match Statistics

IHF Official System

个人/全队技术统计表

 手球 预赛 组别 A 天津师范大学体育馆
 男子 轮次 3 场次 9 2017-08-23 14:00

号码	姓名	远射	近射	边射	快攻	突破	任意	七米	合计	%	助攻	失误	警告	2'	取消	时间
山东队(山东)																
(场上队员)																
3	尹杰									0.0%	1	1				00:03:22
4	田瑞									0.0%		1				00:08:59
5	潘翔					1/1			1/1	100%	1	1				00:20:40
6	李朝鹏	1/1	1/1						2/2	100%				1		00:14:00
8	王炳华					0/1			0/1	0.0%		1				00:03:40
9	赵鑫	0/2	1/1	1/1	1/1				3/5	60.0%						00:16:24
11	宋朋强	0/2					0/1		0/3	0.0%	3	3				00:15:55
12	崔剑									0.0%						00:08:45
13	刘晓	1/2				1/1			2/3	66.7%						00:16:08
15	张继伟		1/1						1/1	100%		1				00:37:00
16	于性哲									0.0%						00:51:15
17	王旭东		1/2	2/3	1/1	1/1			5/7	71.4%	1		1			00:23:31
18	于亚男	2/2			1/1				3/3	100%	1	2				00:10:20
19	李语庆			0/1	0/1			0/1	0/3	0.0%				1		00:14:37
20	杜在超		1/1	2/3	0/1	2/3			5/8	62.5%		1	1	1		00:25:18
21	翟乾坤		2/2	1/2	1/1				4/5	80.0%						00:50:55
	合计	4/9	7/8	6/10	4/7	5/6	0/1	0/1	26/42	61.9%	7	11	3	2		
(守门员)																
12	崔剑	0/1	2/2	0/3			0/1		2/7	28.6%						00:08:45
16	于性哲	4/8	1/2	5/10	1/1	0/1	2/2	0/2	13/26	50.0%						00:51:15
	合计	4/9	3/4	5/13	1/1	0/1	2/3	0/2	15/33	45.5%						

场上队员：得分/射门

守门员：救球/射门

全队合计	得分	被救	射失	击柱	封球	合计	%
远射	4	3			2	9	44.4%
近射	7	1				8	87.5%
边射	6	3	1			10	60.0%
快攻	4	3				7	57.1%
突破	5	1				6	83.3%
任意		1				1	0.0%
七米				1		1	0.0%

第十三届全国运动会男子手球决赛

PHMS Pictorial Handball Match Statistics

IHF Official System

个人/全队技术统计表

 手球 预赛 组别 A 天津师范大学体育馆
 男子 轮次 3 场次 9 2017-08-23 14:00

号码	姓名	远射	近射	边射	快攻	突破	任意	七米	合计	%	助攻	失误	警告	2'	取消	时间
上海队(上海)																
(场上队员)																
1	张崢									0.0%						00:31:45
3	赵时俊	1/1		0/2				1/1	2/4	50.0%		1				00:26:24
4	徐俊吉			1/1		1/1		1/1	3/3	100%		1	1			00:41:50
6	朱世杰					0/1			0/1	0.0%				2		00:45:50
7	周文龙									0.0%						00:00:00
8	钱为玮	0/1	0/1	2/5			0/1		2/8	25.0%		3				00:46:28
9	董凯									0.0%						00:00:00
10	吴璟		1/1						1/1	100%						00:24:42
11	蒋承骅	0/1							0/1	0.0%		1				00:18:46
12	周哲韬									0.0%						00:28:15
14	沈吉磊	2/3	0/1	1/1			0/1		3/6	50.0%		5				00:21:51
16	朱春雷									0.0%						00:00:00
17	贺政		0/1	4/5					4/6	66.7%		1				00:49:54
18	马麟晓	2/6	0/1				1/1		3/8	37.5%		3				00:41:43
19	祝君									0.0%			1			00:06:12
合计		5/12	1/5	8/14	0/1	1/1	1/3	2/2	18/38	47.4%		15	2	2		
(守门员)																
1	张崢	2/4	1/6	1/2	2/6	0/2			6/20	30.0%						00:31:45
12	周哲韬	1/3	0/2	2/7	1/1	1/4	1/1		6/18	33.3%						00:28:15
合计		3/7	1/8	3/9	3/7	1/6	1/1		12/38	31.6%						

场上队员：得分/射门

守门员：救球/射门

全队合计	得分	被救	射失	击柱	封球	合计	%
远射	5	4		2	1	12	41.7%
近射	1	3	1			5	20.0%
边射	8	5	1			14	57.1%
快攻		1				1	0.0%
突破	1					1	100.0%
任意	1	2				3	33.3%
七米	2					2	100.0%

第十三届全国运动会男子手球决赛

PHMS Pictorial Handball Match Statistics

IHF Official System

图式比赛技术统计表

手球
男子

预赛
轮次 3

组别 A
场次 9

天津师范大学体育馆
2017-08-23 14:00

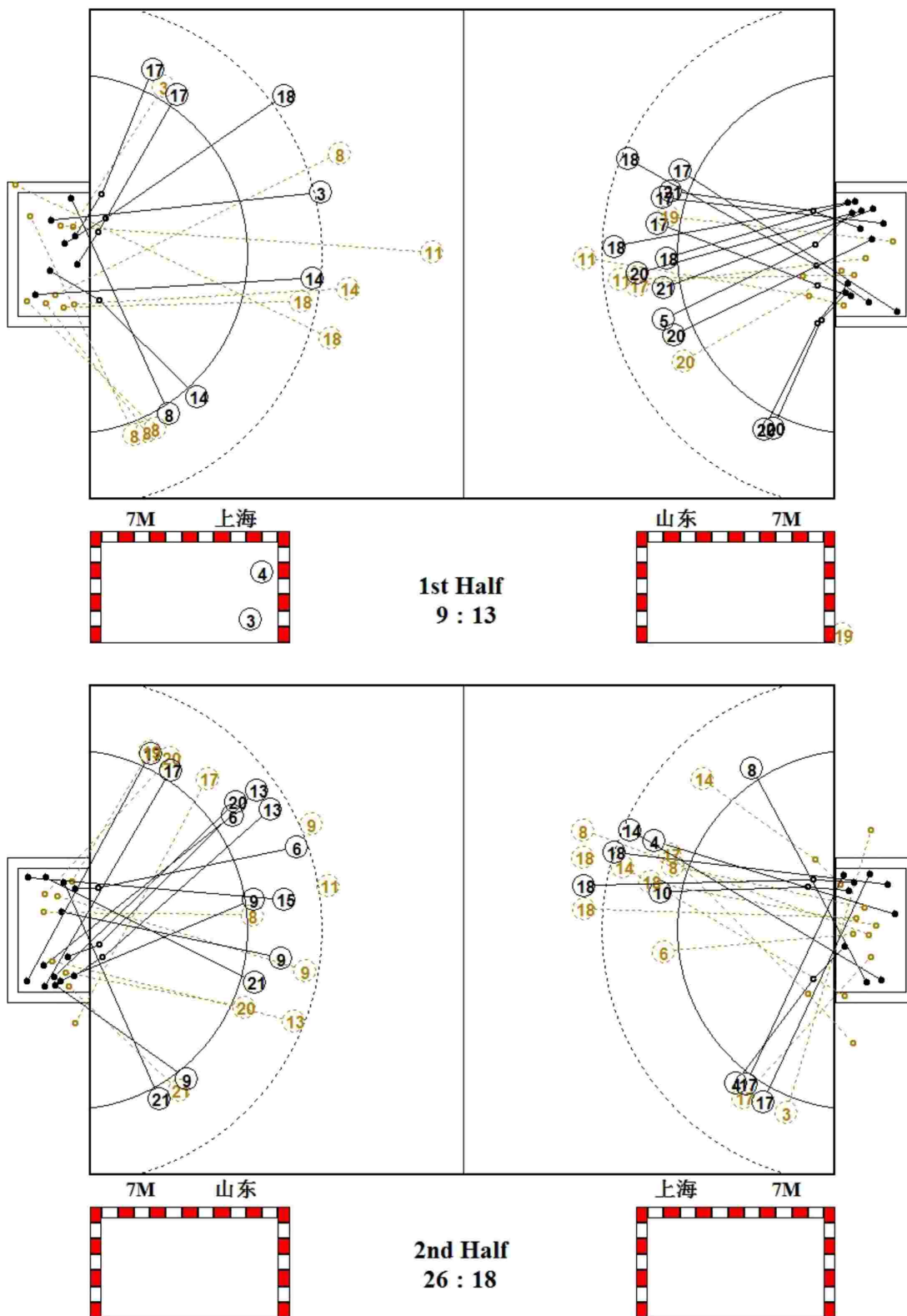

第十三届全国运动会男子手球决赛

PHMS Pictorial Handball Match Statistics

IHF Official System

图式射门区域统计

手球
男子

预赛
轮次 3

组别 A
场次 9

天津师范大学体育馆
2017-08-23 14:00

山东队

3 尹杰	4 田瑞	5 潘翔	6 李朝鹏	8 王炳华	9 赵鑫	11 宋朋强	12 崔剑																																																																								
<table border="1"><tr><td></td><td></td><td></td></tr><tr><td></td><td></td><td></td></tr><tr><td></td><td></td><td></td></tr></table>										<table border="1"><tr><td></td><td></td><td></td></tr><tr><td></td><td></td><td></td></tr><tr><td></td><td></td><td></td></tr></table>										<table border="1"><tr><td></td><td></td><td></td></tr><tr><td>1</td><td></td><td></td></tr><tr><td></td><td></td><td>1</td></tr></table>				1					1	<table border="1"><tr><td></td><td></td><td></td></tr><tr><td></td><td></td><td></td></tr><tr><td></td><td></td><td></td></tr></table>										<table border="1"><tr><td></td><td></td><td></td></tr><tr><td></td><td></td><td></td></tr><tr><td></td><td></td><td></td></tr></table>										<table border="1"><tr><td></td><td></td><td></td></tr><tr><td>2</td><td>1</td><td></td></tr><tr><td></td><td></td><td></td></tr></table>				2	1					<table border="1"><tr><td></td><td></td><td></td></tr><tr><td></td><td></td><td></td></tr><tr><td></td><td></td><td></td></tr></table>										<table border="1"><tr><td></td><td></td><td></td></tr><tr><td></td><td></td><td></td></tr><tr><td></td><td></td><td></td></tr></table>									
1																																																																															
		1																																																																													
2	1																																																																														
Post - 0 Miss - 0 Block - 0	Post - 0 Miss - 0 Block - 0	Post - 0 Miss - 0 Block - 0	Post - 0 Miss - 0 Block - 0	Post - 0 Miss - 0 Block - 0	Post - 0 Miss - 0 Block - 1	Post - 0 Miss - 0 Block - 1	Post - 0 Miss - 0 Block - 0																																																																								
13 刘晓	15 张继伟	16 于性哲	17 王旭东	18 于亚男	19 李语庆	20 杜在超	21 翟乾坤																																																																								
<table border="1"><tr><td></td><td></td><td></td></tr><tr><td>2</td><td></td><td></td></tr><tr><td></td><td></td><td></td></tr></table>				2						<table border="1"><tr><td></td><td></td><td>1</td></tr><tr><td></td><td></td><td></td></tr><tr><td></td><td></td><td></td></tr></table>			1							<table border="1"><tr><td></td><td></td><td></td></tr><tr><td></td><td></td><td></td></tr><tr><td></td><td></td><td></td></tr></table>										<table border="1"><tr><td></td><td></td><td></td></tr><tr><td>2</td><td></td><td>1</td></tr><tr><td>1</td><td></td><td></td></tr></table>				2		1	1			<table border="1"><tr><td></td><td></td><td></td></tr><tr><td></td><td></td><td></td></tr><tr><td></td><td></td><td></td></tr></table>										<table border="1"><tr><td></td><td></td><td></td></tr><tr><td></td><td></td><td></td></tr><tr><td></td><td></td><td></td></tr></table>										<table border="1"><tr><td></td><td></td><td></td></tr><tr><td>2</td><td>1</td><td></td></tr><tr><td></td><td></td><td>2</td></tr></table>				2	1				2	<table border="1"><tr><td></td><td></td><td></td></tr><tr><td>2</td><td></td><td></td></tr><tr><td></td><td></td><td>2</td></tr></table>				2					2
2																																																																															
		1																																																																													
2		1																																																																													
1																																																																															
2	1																																																																														
		2																																																																													
2																																																																															
		2																																																																													
Post - 0 Miss - 0 Block - 0	Post - 0 Miss - 0 Block - 0	Post - 0 Miss - 0 Block - 0	Post - 0 Miss - 1 Block - 0	Post - 0 Miss - 0 Block - 0	Post - 1 Miss - 0 Block - 0	Post - 0 Miss - 0 Block - 0	Post - 0 Miss - 0 Block - 0																																																																								

12 □□

		0/1
1/2	1/1	0/1
0/2		

16 □□□

1/3	0/1	1/2
3/3	1/3	2/3
2/3	2/5	1/3

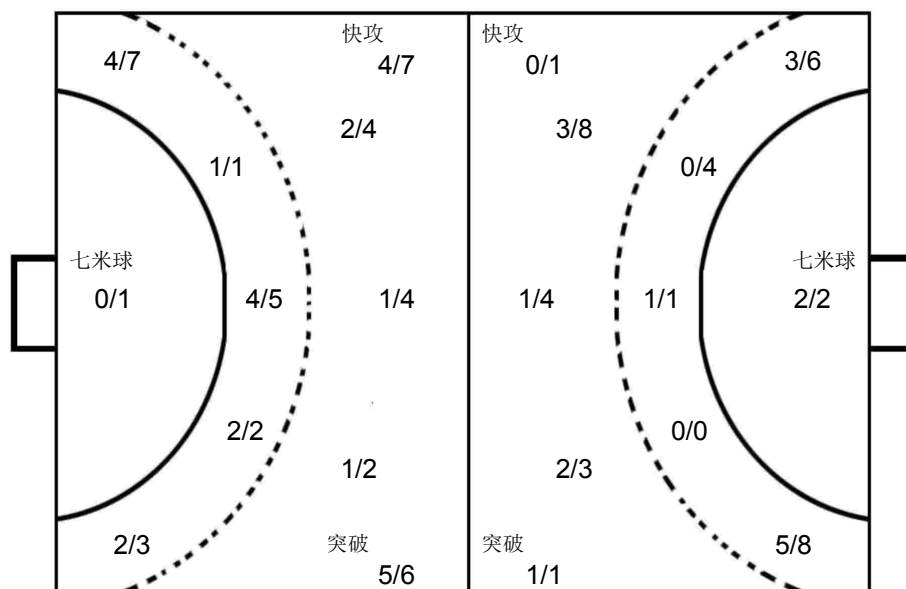

1 □□

0/1	1/1	0/1
1/6	2/3	0/1
0/3	1/1	1/3

12 □□□

0/1		0/1
1/4	0/1	2/4
1/3	1/1	1/3

上海队

1 张崢	3 赵时俊	4 徐俊吉	6 朱世杰	7 周文龙	8 钱为玮	9 董凯	10 吴璟																																																																								
<table border="1"><tr><td></td><td></td><td></td></tr><tr><td></td><td></td><td></td></tr><tr><td></td><td></td><td></td></tr></table>										<table border="1"><tr><td></td><td></td><td></td></tr><tr><td></td><td></td><td>1</td></tr><tr><td></td><td></td><td>1</td></tr></table>						1			1	<table border="1"><tr><td></td><td>1</td><td>1</td></tr><tr><td></td><td></td><td></td></tr><tr><td></td><td>1</td><td></td></tr></table>		1	1					1		<table border="1"><tr><td></td><td></td><td></td></tr><tr><td></td><td></td><td></td></tr><tr><td></td><td></td><td></td></tr></table>										<table border="1"><tr><td></td><td></td><td></td></tr><tr><td></td><td></td><td></td></tr><tr><td></td><td></td><td></td></tr></table>										<table border="1"><tr><td></td><td></td><td></td></tr><tr><td></td><td></td><td>1</td></tr><tr><td></td><td></td><td>1</td></tr></table>						1			1	<table border="1"><tr><td></td><td></td><td></td></tr><tr><td></td><td></td><td></td></tr><tr><td></td><td></td><td></td></tr></table>										<table border="1"><tr><td></td><td></td><td></td></tr><tr><td>1</td><td></td><td></td></tr><tr><td></td><td></td><td></td></tr></table>				1					
		1																																																																													
		1																																																																													
	1	1																																																																													
	1																																																																														
		1																																																																													
		1																																																																													
1																																																																															
Post - 0 Miss - 0 Block - 0	Post - 0 Miss - 1 Block - 0	Post - 0 Miss - 0 Block - 0	Post - 0 Miss - 0 Block - 0	Post - 0 Miss - 0 Block - 0	Post - 0 Miss - 0 Block - 0	Post - 0 Miss - 0 Block - 0	Post - 0 Miss - 0 Block - 0																																																																								
11 蒋承骅	12 周哲韬	14 沈吉磊	16 朱春雷	17 贺政	18 马麟晓	19 祝君																																																																									
<table border="1"><tr><td></td><td></td><td></td></tr><tr><td></td><td></td><td></td></tr><tr><td></td><td></td><td></td></tr></table>										<table border="1"><tr><td></td><td></td><td></td></tr><tr><td></td><td></td><td></td></tr><tr><td></td><td></td><td></td></tr></table>										<table border="1"><tr><td></td><td>1</td><td>1</td></tr><tr><td></td><td></td><td></td></tr><tr><td></td><td>1</td><td></td></tr></table>		1	1					1		<table border="1"><tr><td></td><td></td><td></td></tr><tr><td></td><td></td><td></td></tr><tr><td></td><td></td><td></td></tr></table>										<table border="1"><tr><td></td><td></td><td></td></tr><tr><td>1</td><td></td><td></td></tr><tr><td>1</td><td>2</td><td></td></tr></table>				1			1	2		<table border="1"><tr><td></td><td>1</td><td></td></tr><tr><td></td><td></td><td>1</td></tr><tr><td>1</td><td></td><td></td></tr></table>		1				1	1			<table border="1"><tr><td></td><td></td><td></td></tr><tr><td></td><td></td><td></td></tr><tr><td></td><td></td><td></td></tr></table>																			
	1	1																																																																													
	1																																																																														
1																																																																															
1	2																																																																														
	1																																																																														
		1																																																																													
1																																																																															
Post - 0 Miss - 0 Block - 0	Post - 0 Miss - 0 Block - 0	Post - 1 Miss - 0 Block - 0	Post - 0 Miss - 0 Block - 0	Post - 0 Miss - 1 Block - 0	Post - 1 Miss - 0 Block - 1	Post - 0 Miss - 0 Block - 0																																																																									

Team A					Team B					Match Number											
A 北京队					B 天津队					10											
Played in			in the hall			on			at			Spectators									
天津			天津师范大学体育馆			2017-08-23			15:45			hours									
Half-time(30')	A	B	End of playing time		A	B	1st extra time		A	B	2nd extra time		A	B	After penalty throws		A	B			
	13	3	25	16																	
Number of 7 m	A	Team time-out			Full name of players and officials						Team time-out			B	Number of 7 m						
	3/4	1	2	3							1	2	3	B							
		15:46	36:57	58:44									06:38	47:17		3/5					
No.	Team A					G	W	2'	D	DR	No.	Team B					G	W	2'	D	DR
1	王洸										1	刘宗其									
7	马昌震										2	李岳朋					2	1	1		
8	王鹏							1			4	李松浩									
9	刘振					3					6	王子欣					2		1		
10	成亚					6					7	张青						1			
16	刘迈科										8	曹悦					1				
21	胡瀛					4	1				9	吴明远					1				
22	王超					2		1			10	李帅					1				
23	王军程										11	王毅					3				
25	马明辉					1					12	杨峻									
29	杜龙飞										13	许松					3				
39	张骥					5		1			16	刘海亮									
66	解建飞					2	1	1			17	周群					1	1			
77	朱昕晨					1					18	王晓琪									
83	潘天										22	魏雨童									
99	蒋维一					1					31	田剑侠					2				
A	安福田										A	贾守信									
B	郑永利 (主教练)										B	杜瑞军 (主教练)									
C	孟辉										C	孟凡钢									
E	王长林										E	崔嘉禄									
A	Signatures of responsables for the teams (Off.A)																			B	
TP	Remarks of referees / HF Official																			TP	

Signatures

Referees ALEXEI. COVALCIUC (MDA)

IGOR. COVALCIUC (MDA)

T.D. 李长海 (CHN)

李刚 (CHN)

CHA Off.

Note: Number of 7m Throws Awarded to Team A and B, Goals (G), Warnings (W), Suspensions (2'), Direct Disqualification (D), Disqualification With Report (DR) and Team Penalty (TP).

Table Officials: 鲍瑀

刘宇阳

Statisticians: 黄岩

陈柱

第十三届全国运动会男子手球决赛
PHMS Pictorial Handball Match Statistics

IHF Official System

竞赛技术统计

 手球
男子

 预赛
轮次 3

 组别 A
场次 10

 天津师范大学体育馆
2017-08-23 15:45

Referees: ALEXEI. COVALCIUC (MDA) / IGOR. COVALCIUC (MDA)

Result: 25:16 (13:3)

Teams: 北京队(北京) VS 天津队(天津)

北京		远	近	边	快	突	任意	7m	合计	%	助攻	失误	警告	2'	D+DR
主教练: 郑永利		射	射	射	攻	破	球	球							
1	王澍														
7	马昌震										1				
8	王鹏													1	
9	刘振	1/2	1/2					1/2	3/6	50.0		1			
10	成亚	2/3	2/2	0/2		2/2			6/9	66.7	1	1			
16	刘迈科														
21	胡瀛	1/1	1/2	1/1	1/1				4/5	80.0			1		
22	王超		1/1	1/2					2/3	66.7		1		1	
23	王军程	0/2							0/2	0.0		1			
25	马明辉		1/1						1/1	100					
29	杜龙飞											1			
39	张骥	2/5	0/1				1/1	2/2	5/9	55.6	1	2		1	
66	解建飞	1/1	1/1	0/1					2/3	66.7			1	1	
77	朱昕晨	1/3	0/1						1/4	25.0	1	3			
83	潘天														
99	蒋维一		1/2						1/2	50.0		1			
运动员	合计	8/17	8/13	2/6	1/1	2/2	1/1	3/4	25/44	56.8	3	12	2	4	
1	王澍	1/3	1/3	1/4	0/1			1/3	4/14	28.6					
16	刘迈科	5/7	1/3	5/5		1/2		1/2	13/19	68.4					
守门员	合计	6/10	2/6	6/9	0/1	1/2		2/5	17/33	51.5					

天津		远	近	边	快	突	任意	7m	合计	%	助攻	失误	警告	2'	D+DR
主教练: 杜瑞军		射	射	射	攻	破	球	球							
1	刘宗其														
2	李岳朋	1/2	1/1						2/3	66.7		1	1	1	
4	李松浩					0/1			0/1	0.0		2			
6	王子欣			2/6					2/6	33.3				1	
7	张青	0/3						0/1	0/4	0.0		1	1		
8	曹悦	0/2						1/1	1/3	33.3		1			
9	吴明远		1/1						1/1	100					
10	李帅		1/1						1/1	100		1			
11	王毅	1/5		0/1		1/1		1/2	3/9	33.3		3			
12	杨峻														
13	许松	1/4		1/1	1/1				3/6	50.0		3			
16	刘海亮														
17	周群	1/1							1/1	100			1		
18	王晓琪	0/1		0/1					0/2	0.0	1				
22	魏雨童														
31	田剑侠	0/3	1/3					1/1	2/7	28.6		1			
运动员	合计	4/21	4/6	3/9	1/1	1/2		3/5	16/44	36.4	1	13	3	2	
1	刘宗其	0/2							0/2	0.0					
12	杨峻	1/7	4/12	2/4	0/1	0/2	0/1	1/3	8/30	26.7					
16	刘海亮	3/3		1/1				0/1	4/5	80.0					
守门员	合计	4/12	4/12	3/5	0/1	0/2	0/1	1/4	12/37	32.4					

北京	比赛进程	天津
1st Half		
39 张骥	1 02:06	0
10 成亚	2 04:15	0
10 成亚	3 06:32	0
39 张骥	4 08:55	0
4 张骥	4 14:41	1 31 田剑侠
10 成亚	5 16:13	1
66 解建飞	6 18:01	1
99 蒋维一	7 19:06	1
10 成亚	8 19:45	1
8 成亚	8 21:15	2 8 曹悦
10 成亚	9 21:40	2
77 朱昕晨	10 22:44	2
9 刘振	11 24:43	2
9 刘振	12 26:39	2
12 成亚	12 29:52	3 11 王毅
22 王超	13 30:00	3
2nd Half		
39 张骥	14 03:12	3
14 成亚	14 03:34	4 11 王毅
21 胡瀛	15 04:41	4
15 成亚	15 05:14	5 11 王毅
21 胡瀛	16 06:35	5
21 胡瀛	17 08:05	5
17 成亚	17 08:15	6 10 李帅
39 张骥	18 12:10	6
22 王超	19 13:25	6
19 成亚	19 14:24	7 13 许松
9 刘振	20 14:56	7
39 张骥	21 16:01	7
21 成亚	21 17:40	8 17 周群
21 成亚	21 19:12	9 13 许松
21 成亚	21 19:33	10 2 李岳朋
21 成亚	21 19:55	11 13 许松
10 成亚	23 22:29	11
23 成亚	23 24:29	12 2 李岳朋
25 成亚	24 26:23	12
24 成亚	24 27:03	13 31 田剑侠
66 解建飞	25 27:19	13
25 成亚	25 27:38	14 6 王子欣
25 成亚	25 28:11	15 9 吴明远
25 成亚	30:00	16 6 王子欣

场上队员: 得分 / 射门

守门员: 救球 / 射门

D	取消资格	DR	取消资格+报告

第十三届全国运动会男子手球决赛

PHMS Pictorial Handball Match Statistics

IHF Official System

个人/全队技术统计表

手球 男子 预赛 轮次 3 组别 A 场次 10 天津师范大学体育馆 2017-08-23 15:45

号码	姓名	远射	近射	边射	快攻	突破	任意	七米	合计	%	助攻	失误	警告	2'	取消	时间
北京队(北京)																
(场上队员)																
1	王澍									0.0%						00:15:22
7	马昌震									0.0%		1				00:02:14
8	王鹏									0.0%				1		00:04:50
9	刘振	1/2	1/2					1/2	3/6	50.0%		1				00:43:16
10	成亚	2/3	2/2	0/2		2/2			6/9	66.7%	1	1				00:50:13
16	刘迈科									0.0%						00:44:38
21	胡瀛	1/1	1/2	1/1	1/1				4/5	80.0%			1			00:56:35
22	王超		1/1	1/2					2/3	66.7%		1		1		00:20:20
23	王军程	0/2							0/2	0.0%		1				00:07:37
25	马明辉		1/1						1/1	100%						00:03:41
29	杜龙飞									0.0%		1				00:05:20
39	张骥	2/5	0/1				1/1	2/2	5/9	55.6%	1	2		1		00:37:02
66	解建飞	1/1	1/1	0/1					2/3	66.7%			1	1		00:45:08
77	朱昕晨	1/3	0/1						1/4	25.0%	1	3				00:14:18
83	潘天									0.0%						00:22:04
99	蒋维一		1/2						1/2	50.0%		1				00:45:25
	合计	8/17	8/13	2/6	1/1	2/2	1/1	3/4	25/44	56.8%	3	12	2	4		
(守门员)																
1	王澍	1/3	1/3	1/4	0/1			1/3	4/14	28.6%						00:15:22
16	刘迈科	5/7	1/3	5/5		1/2		1/2	13/19	68.4%						00:44:38
	合计	6/10	2/6	6/9	0/1	1/2		2/5	17/33	51.5%						

场上队员：得分/射门

守门员：救球/射门

全队合计	得分	被救	射失	击柱	封球	合计	%
远射	8	4	2		3	17	47.1%
近射	8	4		1		13	61.5%
边射	2	3	1			6	33.3%
快攻	1					1	100.0%
突破	2					2	100.0%
任意	1					1	100.0%
七米	3	1				4	75.0%

第十三届全国运动会男子手球决赛

PHMS Pictorial Handball Match Statistics

IHF Official System

个人/全队技术统计表

 手球 预赛 组别 A 天津师范大学体育馆
 男子 轮次 3 场次 10 2017-08-23 15:45

号码	姓名	远射	近射	边射	快攻	突破	任意	七米	合计	%	助攻	失误	警告	2'	取消	时间
天津队(天津)																
(场上队员)																
1	刘宗其									0.0%						00:04:41
2	李岳朋	1/2	1/1						2/3	66.7%		1	1	1		00:31:44
4	李松浩					0/1			0/1	0.0%		2				00:08:47
6	王子欣			2/6					2/6	33.3%				1		00:48:28
7	张青	0/3						0/1	0/4	0.0%		1	1			00:36:12
8	曹悦	0/2						1/1	1/3	33.3%		1				00:13:53
9	吴明远		1/1						1/1	100%						00:14:26
10	李帅		1/1						1/1	100%		1				00:17:22
11	王毅	1/5		0/1		1/1		1/2	3/9	33.3%		3				00:30:30
12	杨峻									0.0%						00:48:21
13	许松	1/4		1/1	1/1				3/6	50.0%		3				00:47:23
16	刘海亮									0.0%						00:06:58
17	周群	1/1							1/1	100%			1			00:42:38
18	王晓琪	0/1		0/1					0/2	0.0%	1					00:32:15
22	魏雨童									0.0%						00:00:00
31	田剑侠	0/3	1/3					1/1	2/7	28.6%		1				00:35:27
	合计	4/21	4/6	3/9	1/1	1/2		3/5	16/44	36.4%	1	13	3	2		

(守门员)

1	刘宗其	0/2							0/2	0.0%						00:04:41
12	杨峻	1/7	4/12	2/4	0/1	0/2	0/1	1/3	8/30	26.7%						00:48:21
16	刘海亮	3/3		1/1				0/1	4/5	80.0%						00:06:58
	合计	4/12	4/12	3/5	0/1	0/2	0/1	1/4	12/37	32.4%						

场上队员： 得分/射门

守门员： 救球/射门

全队合计	得分	被救	射失	击柱	封球	合计	%
远射	4	6	7	1	3	21	19.0%
近射	4	2				6	66.7%
边射	3	6				9	33.3%
快攻	1					1	100.0%
突破	1	1				2	50.0%
任意							0.0%
七米	3	2				5	60.0%

第十三届全国运动会男子手球决赛

PHMS Pictorial Handball Match Statistics

IHF Official System

图式比赛技术统计表

手球
男子

预赛
轮次 3

组别 A
场次 10

天津师范大学体育馆
2017-08-23 15:45

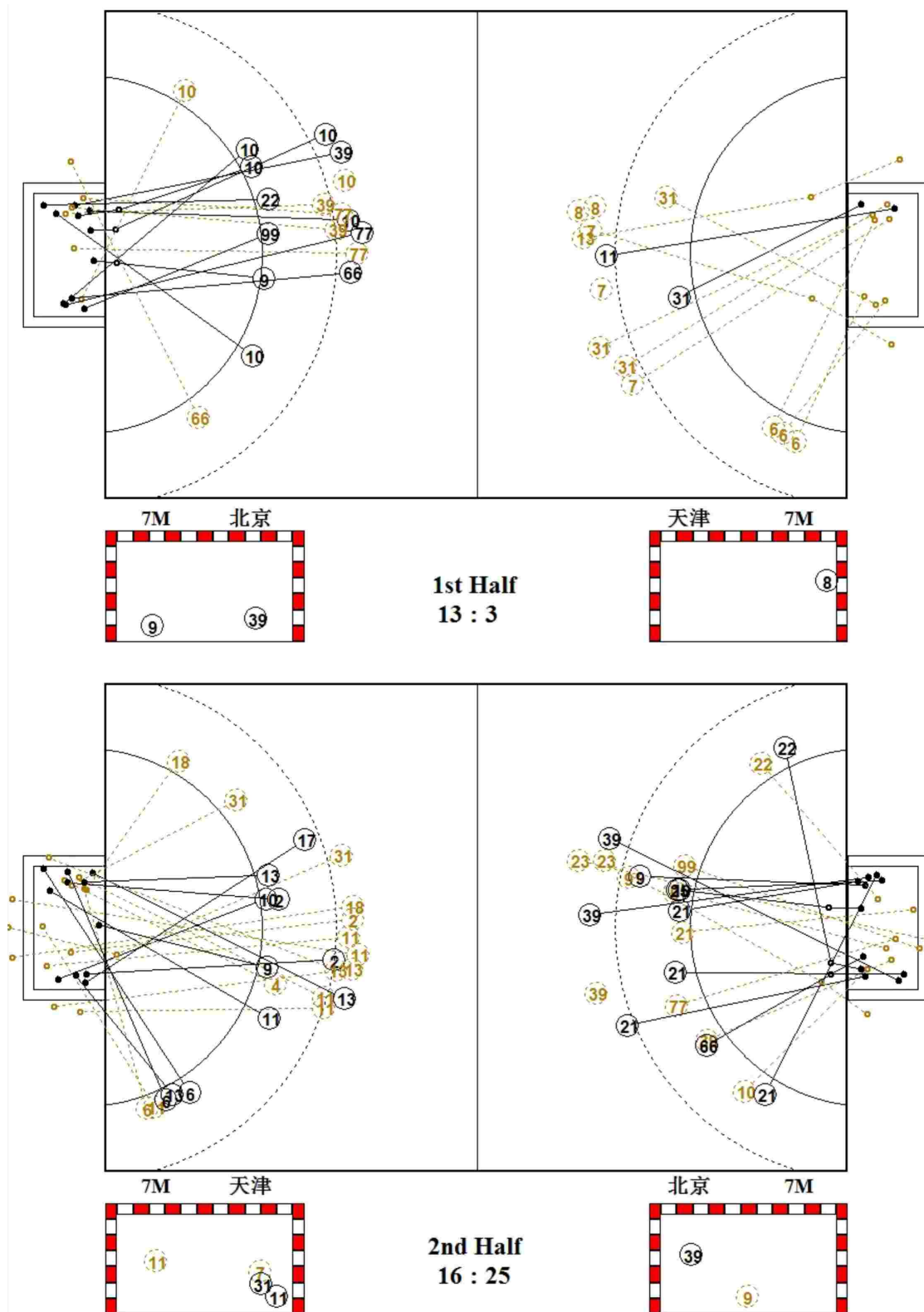

第十三届全国运动会男子手球决赛

PHMS Pictorial Handball Match Statistics

IHF Official System

图式射门区域统计

手球
男子

预赛
轮次 3

组别 A
场次 10

天津师范大学体育馆
2017-08-23 15:45

北京队

1 王洵	7 马昌震	8 王鹏	9 刘振	10 成亚	16 刘迈科	21 胡瀛	22 王超																																																																								
<table border="1"><tr><td></td><td></td><td></td></tr><tr><td></td><td></td><td></td></tr><tr><td></td><td></td><td></td></tr></table>										<table border="1"><tr><td></td><td></td><td></td></tr><tr><td></td><td></td><td></td></tr><tr><td></td><td></td><td></td></tr></table>										<table border="1"><tr><td></td><td></td><td></td></tr><tr><td></td><td></td><td></td></tr><tr><td></td><td></td><td></td></tr></table>										<table border="1"><tr><td></td><td></td><td></td></tr><tr><td>2</td><td>1</td><td></td></tr><tr><td></td><td></td><td></td></tr></table>				2	1					<table border="1"><tr><td></td><td></td><td>1</td></tr><tr><td>1</td><td></td><td>1</td></tr><tr><td></td><td>1</td><td>2</td></tr></table>			1	1		1		1	2	<table border="1"><tr><td></td><td></td><td></td></tr><tr><td></td><td></td><td></td></tr><tr><td></td><td></td><td></td></tr></table>										<table border="1"><tr><td></td><td></td><td>1</td></tr><tr><td>1</td><td></td><td></td></tr><tr><td>1</td><td></td><td>1</td></tr></table>			1	1			1		1	<table border="1"><tr><td></td><td></td><td></td></tr><tr><td></td><td></td><td></td></tr><tr><td></td><td></td><td></td></tr></table>									
2	1																																																																														
		1																																																																													
1		1																																																																													
	1	2																																																																													
		1																																																																													
1																																																																															
1		1																																																																													
Post - 0 Miss - 0 Block - 0	Post - 0 Miss - 0 Block - 0	Post - 0 Miss - 0 Block - 0	Post - 0 Miss - 0 Block - 1	Post - 0 Miss - 0 Block - 1	Post - 0 Miss - 0 Block - 0	Post - 0 Miss - 0 Block - 0	Post - 0 Miss - 0 Block - 0																																																																								
23 王军程	25 马明辉	29 杜龙飞	39 张骥	66 解建飞	77 朱昕晨	83 潘天	99 蒋维一																																																																								
<table border="1"><tr><td></td><td></td><td></td></tr><tr><td></td><td></td><td></td></tr><tr><td></td><td></td><td></td></tr></table>										<table border="1"><tr><td>1</td><td></td><td></td></tr><tr><td></td><td></td><td></td></tr><tr><td></td><td></td><td></td></tr></table>	1									<table border="1"><tr><td></td><td></td><td></td></tr><tr><td></td><td></td><td></td></tr><tr><td></td><td></td><td></td></tr></table>										<table border="1"><tr><td></td><td></td><td>1</td></tr><tr><td>1</td><td></td><td>1</td></tr><tr><td>1</td><td></td><td>1</td></tr></table>			1	1		1	1		1	<table border="1"><tr><td></td><td></td><td></td></tr><tr><td>1</td><td></td><td></td></tr><tr><td></td><td></td><td>1</td></tr></table>				1					1	<table border="1"><tr><td></td><td></td><td></td></tr><tr><td>1</td><td></td><td></td></tr><tr><td></td><td></td><td></td></tr></table>				1						<table border="1"><tr><td></td><td></td><td></td></tr><tr><td></td><td></td><td></td></tr><tr><td></td><td></td><td></td></tr></table>										<table border="1"><tr><td></td><td></td><td></td></tr><tr><td></td><td></td><td></td></tr><tr><td>1</td><td></td><td></td></tr></table>							1		
1																																																																															
		1																																																																													
1		1																																																																													
1		1																																																																													
1																																																																															
		1																																																																													
1																																																																															
1																																																																															
Post - 0 Miss - 2 Block - 0	Post - 0 Miss - 0 Block - 0	Post - 0 Miss - 0 Block - 0	Post - 0 Miss - 0 Block - 1	Post - 0 Miss - 1 Block - 0	Post - 0 Miss - 0 Block - 0	Post - 0 Miss - 0 Block - 0	Post - 1 Miss - 0 Block - 0																																																																								

1 □□

		0/1
1/2		2/6
0/2	0/1	1/2

16 □□□

1/3	1/1	0/1
5/5		4/4
0/1		2/4

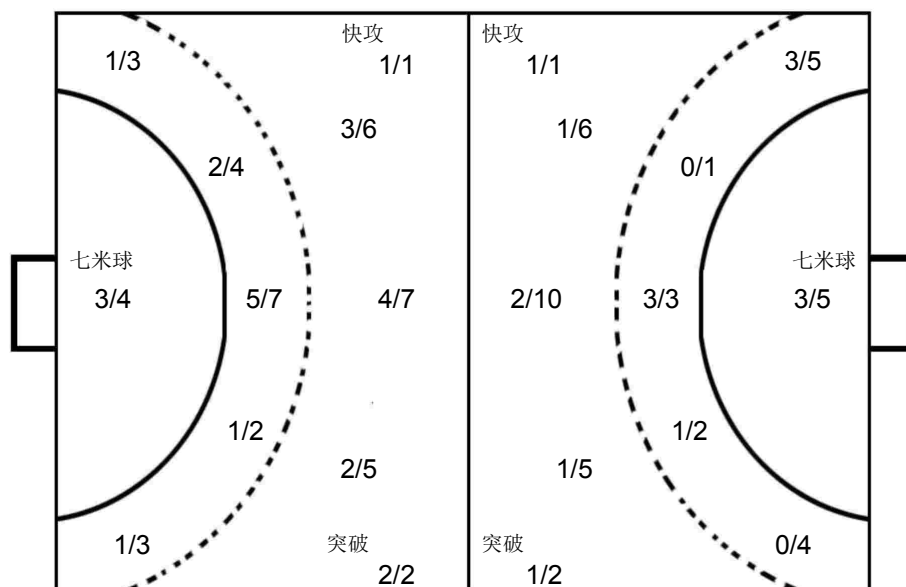

1 □□□

		0/1
		0/1

12 □□

	2/2	0/4
1/7	1/1	1/2
0/5	1/3	2/6

16 □□□

1/1	1/1	2/2
		0/1

天津队

1 刘宗其	2 李岳朋	4 李松浩	6 王子欣	7 张青	8 曹悦	9 吴明远	10 李帅																																																																								
<table border="1"><tr><td></td><td></td><td></td></tr><tr><td></td><td></td><td></td></tr><tr><td></td><td></td><td></td></tr></table>										<table border="1"><tr><td></td><td></td><td>1</td></tr><tr><td>1</td><td></td><td></td></tr><tr><td></td><td></td><td></td></tr></table>			1	1						<table border="1"><tr><td></td><td></td><td></td></tr><tr><td></td><td></td><td></td></tr><tr><td></td><td></td><td></td></tr></table>										<table border="1"><tr><td></td><td></td><td>1</td></tr><tr><td></td><td></td><td>1</td></tr><tr><td></td><td></td><td></td></tr></table>			1			1				<table border="1"><tr><td></td><td></td><td></td></tr><tr><td></td><td></td><td></td></tr><tr><td></td><td></td><td></td></tr></table>										<table border="1"><tr><td></td><td></td><td>1</td></tr><tr><td></td><td></td><td></td></tr><tr><td></td><td></td><td></td></tr></table>			1							<table border="1"><tr><td></td><td></td><td></td></tr><tr><td></td><td></td><td></td></tr><tr><td></td><td></td><td></td></tr></table>										<table border="1"><tr><td></td><td></td><td></td></tr><tr><td>1</td><td></td><td></td></tr><tr><td></td><td></td><td></td></tr></table>				1					
		1																																																																													
1																																																																															
		1																																																																													
		1																																																																													
		1																																																																													
1																																																																															
Post - 0 Miss - 0 Block - 0	Post - 0 Miss - 0 Block - 0	Post - 0 Miss - 0 Block - 0	Post - 0 Miss - 0 Block - 0	Post - 0 Miss - 1 Block - 1	Post - 0 Miss - 0 Block - 2	Post - 0 Miss - 0 Block - 0	Post - 0 Miss - 0 Block - 0																																																																								
11 王毅	12 杨峻	13 许松	16 刘海亮	17 周群	18 王晓琪	22 魏雨童	31 田剑侠																																																																								
<table border="1"><tr><td>1</td><td></td><td>1</td></tr><tr><td></td><td></td><td></td></tr><tr><td></td><td></td><td>1</td></tr></table>	1		1						1	<table border="1"><tr><td></td><td></td><td></td></tr><tr><td></td><td></td><td></td></tr><tr><td></td><td></td><td></td></tr></table>										<table border="1"><tr><td></td><td></td><td></td></tr><tr><td>1</td><td></td><td></td></tr><tr><td></td><td></td><td>2</td></tr></table>				1					2	<table border="1"><tr><td></td><td></td><td></td></tr><tr><td></td><td></td><td></td></tr><tr><td></td><td></td><td></td></tr></table>										<table border="1"><tr><td></td><td></td><td></td></tr><tr><td>1</td><td></td><td></td></tr><tr><td></td><td></td><td></td></tr></table>				1						<table border="1"><tr><td></td><td></td><td></td></tr><tr><td></td><td></td><td></td></tr><tr><td></td><td></td><td></td></tr></table>										<table border="1"><tr><td></td><td></td><td></td></tr><tr><td></td><td></td><td></td></tr><tr><td></td><td></td><td></td></tr></table>										<table border="1"><tr><td></td><td></td><td></td></tr><tr><td></td><td></td><td></td></tr><tr><td>1</td><td></td><td>1</td></tr></table>							1		1
1		1																																																																													
		1																																																																													
1																																																																															
		2																																																																													
1																																																																															
1		1																																																																													
Post - 0 Miss - 2 Block - 0	Post - 0 Miss - 0 Block - 0	Post - 1 Miss - 2 Block - 0	Post - 0 Miss - 0 Block - 0	Post - 0 Miss - 0 Block - 0	Post - 0 Miss - 1 Block - 0	Post - 0 Miss - 0 Block - 0	Post - 0 Miss - 1 Block - 0																																																																								

Team A					Team B					Match Number											
A 香港队					B 安徽队					11											
Played in			in the hall			on			at			Spectators									
天津			天津师范大学体育馆			2017-08-23			17:30			hours									
Half-time(30')	A	B	End of playing time		A	B	1st extra time		A	B	2nd extra time		A	B	After penalty throws		A	B			
	11	9			22	19															
Number of 7 m	A	Team time-out			Full name of players and officials						Team time-out			B	Number of 7 m						
	1/2	1	2	3							1	2	3	B							
		15:15	51:07	58:54							07:53	48:29		2/3							
No.	Team A					G	W	2'	D	DR	No.	Team B					G	W	2'	D	DR
1	叶冠英										1	郭世伟					3				
2	刘健斌										3	陈强龙					1		1		
3	陈梓朗					4					5	史小帆					1				
5	黄胜业					3					7	姚雄敏									
7	谭俊杰										8	董智景					3				
8	李伟东										9	陈开勇					1		1		
10	谢永辉					1					10	严龙					3		1		
12	许文邦					3					11	黎涛					1				
13	张伟浩										12	曾献辰									
18	李鑫豪					2					15	曹青福临									
23	郭斯鸣					1	1		1		16	杨洋									
27	冼大维										17	王巨柱					1		1		
29	练明辉					2		1			18	李双					2	1	2		
31	叶仕仁					3					21	李明									
33	袁晞彦					1		1			23	于敏清					3	1			
40	叶冠雄					2	1				24	徐安格									
A	杨开将										B	沈强 (主教练)									
B	王涛										C	吴翔									
C	高梓欣										D	黄红									
											E	吴台锡									
A											Signatures of responsables for the teams (Off.A)										B
TP	Remarks of referees / HF Official																				TP

Signatures

Referees BALAZS. MARTON (HUN)

PETER. HORVATH (HUN)

T.D. 于中迅 (CHN)

刘书勇 (CHN)

CHA Off.

Note: Number of 7m Throws Awarded to Team A and B, Goals (G), Warnings (W), Suspensions (2'), Direct Disqualification (D), Disqualification With Report (DR) and Team Penalty (TP).

Table Officials: 李志成

梅艳

Statisticians: 陈柱

刘永欢

第十三届全国运动会男子手球决赛
PHMS Pictorial Handball Match Statistics

IHF Official System

竞赛技术统计

 手球
男子

 预赛
轮次 3

 组别 B
场次 11

 天津师范大学体育馆
2017-08-23 17:30

Referees: BALAZS. MARTON (HUN) / PETER. HORVATH (HUN)

Result: 22:19 (11:9)

Teams: 香港队(香港) VS 安徽队(安徽)

香港		远射	近射	边射	快攻	突破	任意球	7m球	合计	%	助攻	失误	警告	2'	D+DR	香港	比赛进程	安徽
主教练: 高梓欣																1st Half		
1	叶冠英										2					33	袁晞彦	0 00:41 1 8 董智景
2	刘健斌		0/2	0/2				0/4	0.0									1 01:03 1
3	陈梓朗			3/5	1/1			4/6	66.7		2							1 02:50 2 23 于敏清
5	黄胜业		1/2	1/1	1/1			3/4	75.0							5	黄胜业	2 03:34 2
7	谭俊杰															3	陈梓朗	3 04:35 2
8	李伟东															5	黄胜业	4 04:53 2
10	谢永辉	0/1	1/1	0/1												12	许文邦	5 07:49 2
12	许文邦	3/8	0/1					0/1	3/10	30.0	2	4				23	郭斯鸣	6 08:42 2
13	张伟浩			0/1					0/1	0.0						6	郭斯鸣	6 08:54 3 1 郭世伟
18	李鑫豪		2/2					2/2	100		1					6	黎涛	6 11:22 4 11 黎涛
23	郭斯鸣				1/2			1/2	50.0		1	1		1		6	陈开勇	6 13:23 5 9 陈开勇
27	冼大维															12	许文邦	7 15:43 5
29	练明辉	0/2		1/1				1/1	2/4	50.0	3			1		5	黄胜业	8 18:43 5
31	叶仕仁	0/2	1/1		1/1	1/1		3/5	60.0		5					31	叶仕仁	9 22:22 5
33	袁晞彦		1/1	0/1				1/2	50.0					1		9	李双	9 23:09 6 18 李双
40	叶冠雄	0/1	2/2					2/3	66.7		1	1				9	王巨柱	9 24:56 7 17 王巨柱
运动员 合计		3/14	8/12	5/12	4/5	1/1		1/2	22/46	47.8	4	19	2	2	1	9	郭世伟	9 26:31 8 1 郭世伟
1	叶冠英	8/10	3/8	3/6	2/5	0/1		0/2	16/32	50.0	2					9	郭世伟	9 27:39 9 1 郭世伟
7	谭俊杰	0/1		0/2				0/3	0.0							40	叶冠雄	10 28:08 9
守门员 合计		8/11	3/8	3/8	2/5	0/1		0/2	16/35	45.7	2					18	李鑫豪	11 29:01 9
安徽		远射	近射	边射	快攻	突破	任意球	7m球	合计	%	助攻	失误	警告	2'	D+DR	2nd Half		
主教练: 沈强																3	陈梓朗	12 00:43 9
1	郭世伟	0/2	1/3	1/3	1/1				3/9	33.3		3				12	严龙	12 06:12 10 10 严龙
3	陈强龙			1/1					1/1	100	1	2		1		18	李鑫豪	13 06:57 10
5	史小帆	1/2							1/2	50.0						40	叶冠雄	13 07:30 11 3 陈强龙
7	姚雄敏															40	叶冠雄	14 08:06 11
8	董智景			2/3	1/3			3/6	50.0							14	李双	14 08:21 12 18 李双
9	陈开勇		1/1					1/1	100					1		14	严龙	14 09:14 13 10 严龙
10	严龙	0/2	0/1			1/1		2/2	3/6	50.0	3			1		3	陈梓朗	15 10:00 13
11	黎涛	1/3							1/3	33.3						31	叶仕仁	16 11:11 13
12	曾献辰															16	叶冠雄	16 12:49 14 10 严龙
15	曹青福临															12	许文邦	17 14:04 14
16	杨洋															29	练明辉	18 16:00 14
17	王巨柱	0/3	0/1		1/1			0/1	1/6	16.7	5			1		3	陈梓朗	19 18:27 14
18	李双	1/4	1/1				0/1	2/6	33.3		3	1		2		31	叶仕仁	20 19:12 14
21	李明										1	2				20	董智景	20 20:27 15 23 于敏清
23	于敏清		1/1	2/5				3/6	50.0		2	1				20	董智景	20 21:39 16 8 董智景
24	徐安格															10	谢永辉	21 23:50 16
运动员 合计		3/16	5/9	5/11	3/5	1/1	0/1	2/3	19/46	41.3	2	20	2	6		21	于敏清	21 27:10 17 23 于敏清
21	李明	4/7	2/10	2/7	1/5	0/1		0/1	9/31	29.0	1	2				29	练明辉	22 27:49 17
守门员 合计		4/7	2/10	2/7	1/5	0/1		0/1	9/31	29.0	1	2				22	董智景	22 27:59 18 5 史小帆

场上队员: 得分 / 射门

守门员: 救球 / 射门

D	取消资格	DR	取消资格+报告
---	------	----	---------

第十三届全国运动会男子手球决赛

PHMS Pictorial Handball Match Statistics

IHF Official System

个人/全队技术统计表

 手球 预赛 组别 B 天津师范大学体育馆
 男子 轮次 3 场次 11 2017-08-23 17:30

号码	姓名	远射	近射	边射	快攻	突破	任意	七米	合计	%	助攻	失误	警告	2'	取消	时间
香港队(香港)																
(场上队员)																
1	叶冠英									0.0%	2					00:56:03
2	刘健斌		0/2	0/2					0/4	0.0%						00:18:43
3	陈梓朗			3/5	1/1				4/6	66.7%		2				00:36:50
5	黄胜业		1/2	1/1	1/1				3/4	75.0%						00:48:10
7	谭俊杰									0.0%						00:03:57
8	李伟东									0.0%						00:20:26
10	谢永辉	0/1	1/1	0/1					1/3	33.3%		2				00:26:03
12	许文邦	3/8	0/1					0/1	3/10	30.0%	2	4				00:22:34
13	张伟浩			0/1					0/1	0.0%						00:00:00
18	李鑫豪		2/2						2/2	100%		1				00:25:01
23	郭斯鸣				1/2				1/2	50.0%		1	1		1	00:20:56
27	冼大维									0.0%						00:00:00
29	练明辉	0/2		1/1				1/1	2/4	50.0%		3			1	00:29:13
31	叶仕仁	0/2	1/1		1/1	1/1			3/5	60.0%		5				00:32:07
33	袁晞彦		1/1	0/1					1/2	50.0%					1	00:34:54
40	叶冠雄	0/1	2/2						2/3	66.7%		1	1			00:45:18
	合计	3/14	8/12	5/12	4/5	1/1		1/2	22/46	47.8%	4	19	2	2	1	
(守门员)																
1	叶冠英	8/10	3/8	3/6	2/5	0/1		0/2	16/32	50.0%	2					00:56:03
7	谭俊杰	0/1		0/2					0/3	0.0%						00:03:57
	合计	8/11	3/8	3/8	2/5	0/1		0/2	16/35	45.7%	2					

场上队员：得分/射门

守门员：救球/射门

全队合计	得分	被救	射失	击柱	封球	合计	%
远射	3	4	4	1	2	14	21.4%
近射	8	2	1	1		12	66.7%
边射	5	2	3	2		12	41.7%
快攻	4	1				5	80.0%
突破	1					1	100.0%
任意							0.0%
七米	1			1		2	50.0%

第十三届全国运动会男子手球决赛

PHMS Pictorial Handball Match Statistics

IHF Official System

个人/全队技术统计表

 手球 预赛 组别 B 天津师范大学体育馆
 男子 轮次 3 场次 11 2017-08-23 17:30

号码	姓名	远射	近射	边射	快攻	突破	任意	七米	合计	%	助攻	失误	警告	2'	取消	时间
安徽队(安徽)																
(场上队员)																
1	郭世伟	0/2	1/3	1/3	1/1				3/9	33.3%		3				00:46:59
3	陈强龙		1/1						1/1	100%	1	2		1		00:48:23
5	史小帆	1/2							1/2	50.0%						00:05:53
7	姚雄敏									0.0%						00:00:00
8	董智景			2/3	1/3				3/6	50.0%						00:34:29
9	陈开勇		1/1						1/1	100%				1		00:09:47
10	严龙	0/2	0/1			1/1		2/2	3/6	50.0%		3		1		00:39:33
11	黎涛	1/3							1/3	33.3%						00:22:32
12	曾献辰									0.0%						00:00:00
15	曹青福临									0.0%						00:00:00
16	杨洋									0.0%						00:00:00
17	王巨柱	0/3	0/1		1/1			0/1	1/6	16.7%		5		1		00:44:05
18	李双	1/4	1/1				0/1		2/6	33.3%		3	1	2		00:56:29
21	李明									0.0%	1	2				01:00:00
23	于敏清		1/1	2/5					3/6	50.0%		2	1			00:51:31
24	徐安格									0.0%						00:00:00
	合计	3/16	5/9	5/11	3/5	1/1	0/1	2/3	19/46	41.3%	2	20	2	6		
(守门员)																
21	李明	4/7	2/10	2/7	1/5	0/1		0/1	9/31	29.0%	1	2				01:00:00
	合计	4/7	2/10	2/7	1/5	0/1		0/1	9/31	29.0%	1	2				

场上队员：得分/射门

守门员：救球/射门

全队合计	得分	被救	射失	击柱	封球	合计	%
远射	3	8	1	2	2	16	18.8%
近射	5	3	1			9	55.6%
边射	5	3	2	1		11	45.5%
快攻	3	2				5	60.0%
突破	1					1	100.0%
任意			1			1	0.0%
七米	2			1		3	66.7%

图式比赛技术统计表

手球
男子

预赛
轮次 3

组别 B
场次 11

天津师范大学体育馆
2017-08-23 17:30

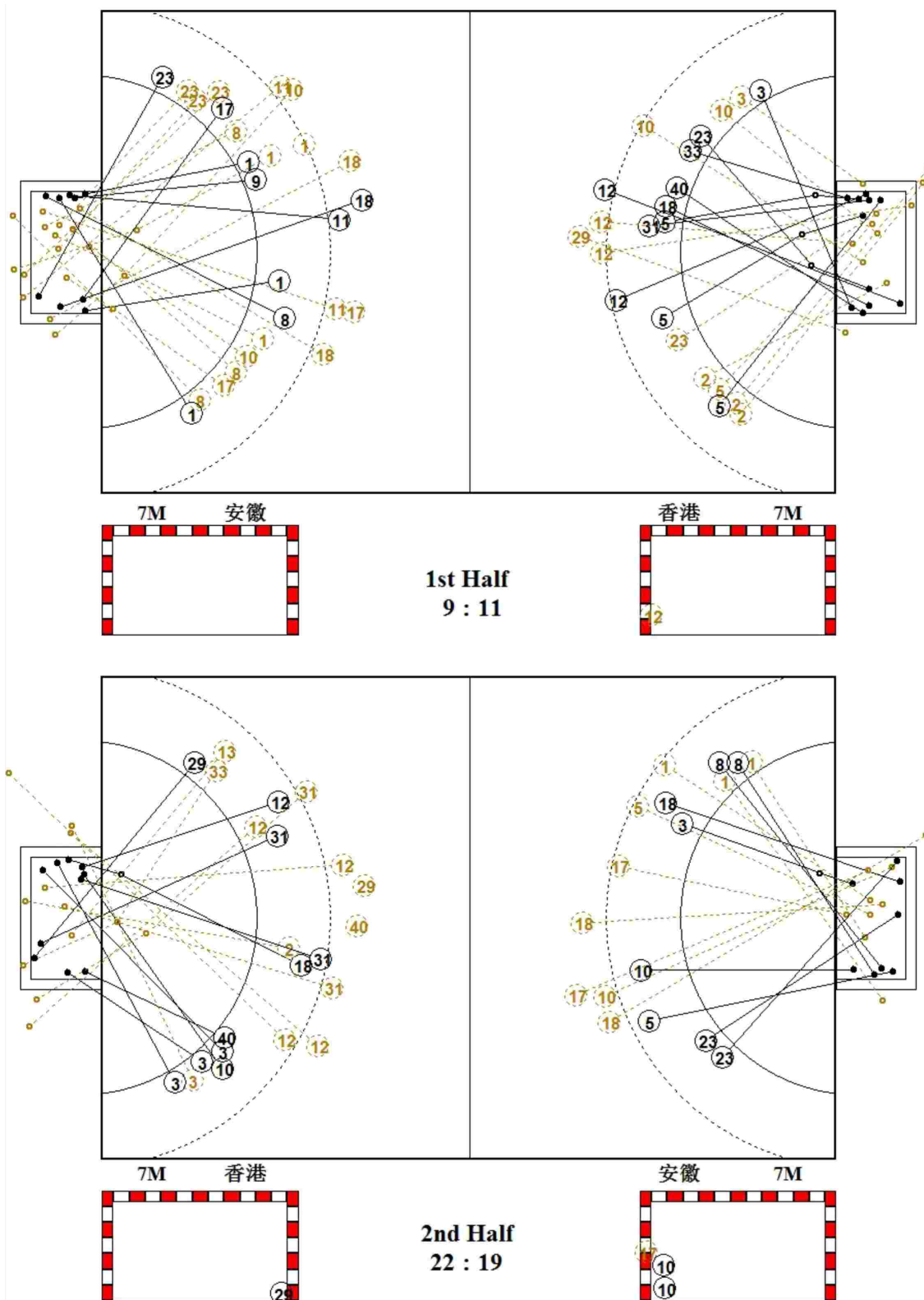

第十三届全国运动会男子手球决赛

PHMS Pictorial Handball Match Statistics

IHF Official System

图式射门区域统计

手球
男子

预赛
轮次 3

组别 B
场次 11

天津师范大学体育馆
2017-08-23 17:30

香港队

1 叶冠英 Post - 0 Miss - 0 Block - 0	2 刘健斌 Post - 1 Miss - 2 Block - 0	3 陈祥朗 Post - 1 Miss - 1 Block - 0	5 黄胜业 Post - 0 Miss - 0 Block - 0	7 谭俊杰 Post - 0 Miss - 0 Block - 0	8 李伟东 Post - 0 Miss - 0 Block - 0	10 谢永辉 Post - 0 Miss - 0 Block - 0	12 许文邦 Post - 2 Miss - 3 Block - 0
13 张伟浩 Post - 0 Miss - 0 Block - 0	18 李鑫豪 Post - 0 Miss - 0 Block - 0	23 郭斯吗 Post - 0 Miss - 0 Block - 0	27 冼大维 Post - 0 Miss - 0 Block - 0	29 练明辉 Post - 0 Miss - 1 Block - 1	31 叶仕仁 Post - 0 Miss - 1 Block - 0	33 袁晞彦 Post - 1 Miss - 0 Block - 0	40 叶冠雄 Post - 0 Miss - 0 Block - 1

1 □□□

1/3	2/3	2/3
2/4	4/4	2/6
0/4	2/2	1/3

7 □□□

0/1		0/2

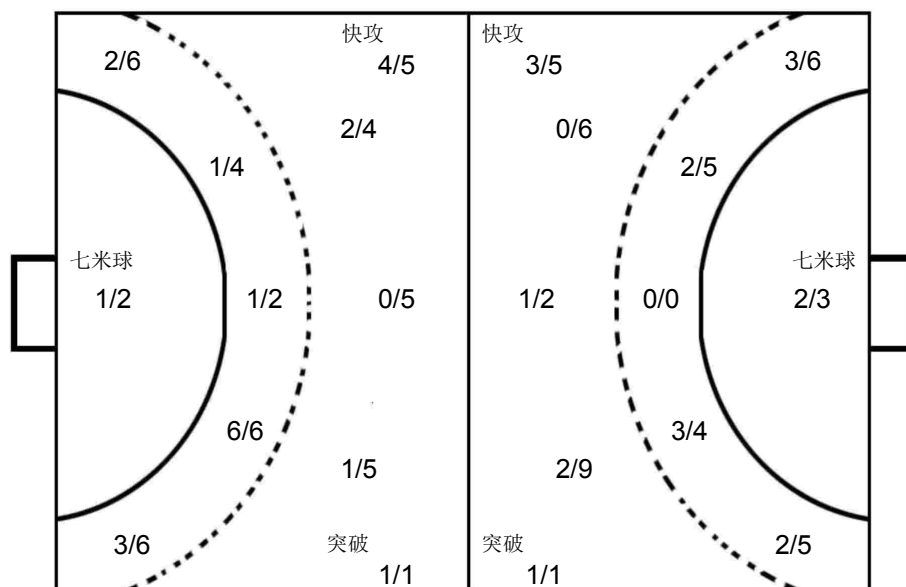

21 □□

0/2		2/4
2/8	4/4	0/5
0/2	1/1	0/5

安徽队

1 郭世伟 Post - 0 Miss - 2 Block - 1	3 陈强龙 Post - 0 Miss - 0 Block - 0	5 史小帆 Post - 0 Miss - 0 Block - 0	7 姚雄敏 Post - 0 Miss - 0 Block - 0	8 董智景 Post - 0 Miss - 1 Block - 0	9 陈开勇 Post - 0 Miss - 0 Block - 0	10 严龙 Post - 0 Miss - 1 Block - 0	11 黎涛 Post - 1 Miss - 0 Block - 0
12 曾献辰 Post - 0 Miss - 0 Block - 0	15 曹青福临 Post - 0 Miss - 0 Block - 0	16 杨洋 Post - 0 Miss - 0 Block - 0	17 王巨柱 Post - 1 Miss - 0 Block - 1	18 李双 Post - 1 Miss - 1 Block - 0	21 李明 Post - 0 Miss - 0 Block - 0	23 于敏清 Post - 1 Miss - 0 Block - 0	24 徐安格 Post - 0 Miss - 0 Block - 0

Team A					Team B					Match Number											
A 江苏队					B 广东队					12											
Played in			in the hall			on			at			Spectators									
天津			天津师范大学体育馆			2017-08-23			19:15			hours									
Half-time(30')	A	B	End of playing time		A	B	1st extra time		A	B	2nd extra time		A	B	After penalty throws		A	B			
	12	10	26		20																
Number of 7 m	A	Team time-out			Full name of players and officials						Team time-out			B	Number of 7 m						
	0/0	1	2	3							1	2	3	B							
		23:10	55:27								17:25	46:27	54:19	2/2							
No.	Team A					G	W	2'	D	DR	No.	Team B					G	W	2'	D	DR
1	徐畅										1	王帅									
4	张家纬					5					2	孙江山					4				
5	闫亮						1				3	曲汝洋					4	1			
6	赵晨					7	1				4	李卓洋					4				
7	徐奕飞										5	侯生升									
8	周小坚					4					6	邓志贵									
9	王杰缘					2	1				7	付文博									
10	郝可鑫					4		1			8	于彦江					1	1	1		
12	王权										9	徐庆									
13	叶强										11	房友屯									
15	李安					2					12	王雨									
17	王伟强										15	张建杰									
18	赵楠										16	马跃									
19	张志宇										17	李中洲					6	1			
20	顾艳超					2					26	姚雪岩									
21	刘江										84	王伟					1				
A	闫威名 (主教练)										B	王锋 (主教练)									
C	雷纳德										C	刘康伶									
D	贾淑君										D	张广建									
E	王建国										E	王永存									
A	Signatures of responsables for the teams (Off.A)										B										
TP	Remarks of referees / HF Official										TP										

Signatures

Referees IGOR. COVALCIUC (MDA)

ALEXEI. COVALCIUC (MDA)

T.D. 李刚 (CHN)

刘书勇 (CHN)

CHA Off.

Note: Number of 7m Throws Awarded to Team A and B, Goals (G), Warnings (W), Suspensions (2'), Direct Disqualification (D), Disqualification With Report (DR) and Team Penalty (TP).

Table Officials: 隆晓磊

刘宇阳

Statisticians: 刘永欢

陈柱

第十三届全国运动会男子手球决赛
PHMS Pictorial Handball Match Statistics

IHF Official System

竞赛技术统计

 手球
男子

 预赛
轮次 3

 组别 B
场次 12

 天津师范大学体育馆
2017-08-23 19:15

Referees: IGOR. COVALCIUC (MDA) / ALEXEI. COVALCIUC (MDA)

Result: 26:20(12:10)

Teams: 江苏队(江苏) VS 广东队(广东)

江苏		远	近	边	快	突	任意	7m	合计	%	助攻	失误	警告	2'	D+DR	江苏	比赛	广东
主教练: 闫威名		射	射	射	攻	破	球	球								进程		
1	徐畅															0	00:45	1 84 王伟
4	张家纬	4/8	1/1						5/9	55.6						1	01:41	1 李卓洋
5	闫亮		0/1						0/1	0.0			1			2	02:45	2 4 李卓洋
6	赵晨	4/11	1/2		1/1		1/2		7/16	43.8	1		1			3	03:19	2 李中洲
7	徐奕飞															3	04:00	2 李中洲
8	周小坚	0/1	4/4						4/5	80.0		1				4	06:40	3 曲汝洋
9	王杰缘				2/2				2/2	100			1			5	07:53	4 李卓洋
10	郝可鑫	4/5							4/5	80.0				1		6	08:30	5 李卓洋
12	王权															6	12:33	5 李中洲
13	叶强											1				6	13:52	6 17 李中洲
15	李安		0/1	2/3					2/4	50.0						6	15:46	7 17 李中洲
17	王伟强															7	16:34	7 曲汝洋
18	赵楠															8	17:25	7 李卓洋
19	张志宇															8	20:26	7 李卓洋
20	顾艳超				1/1	1/1			2/2	100		2				9	21:03	8 4 李卓洋
21	刘江	0/1							0/1	0.0		1				10	21:47	8 孙江山
运动员 合计		12/26	6/9	2/3	4/4	1/1	1/2		26/45	57.8	1	5	3	1		10	22:36	9 2 孙江山
1	徐畅	0/1		1/2					1/3	33.3						11	25:31	9 李卓洋
12	王权	2/8	1/6	6/8	0/1	2/3	0/1	0/2	11/29	37.9		1				12	26:59	9 李卓洋
守门员 合计		2/9	1/6	7/10	0/1	2/3	0/1	0/2	12/32	37.5		1				12	28:19	10 4 李卓洋
广东		远	近	边	快	突	任意	7m	合计	%	助攻	失误	警告	2'	D+DR	2nd Half		
主教练: 王锋		射	射	射	攻	破	球	球								6	00:40	10 曲汝洋
1	王帅															6	02:14	11 3 曲汝洋
2	孙江山			3/5				1/1	4/6	66.7						6	03:00	11 李卓洋
3	曲汝洋	3/4	1/1	0/1					4/6	66.7		2	1			9	05:33	11 李卓洋
4	李卓洋	2/5	1/1			0/1	1/1		4/8	50.0	2	3				4	06:59	11 李卓洋
5	侯生升															6	07:49	11 李卓洋
6	邓志贵			0/1					0/1	0.0						7	08:26	12 8 于彦江
7	付云博															8	08:59	12 孙江山
8	于彦江	1/3		0/3		0/1			1/7	14.3				1	1	8	11:15	13 2 孙江山
9	徐庆															9	11:53	13 孙江山
11	房友屯															10	12:50	14 2 孙江山
12	王雨															10	13:37	14 李卓洋
15	张建杰															10	14:08	15 2 孙江山
16	马跃															10	14:40	15 李卓洋
17	李中洲	1/5	2/3		1/1	1/1		1/1	6/11	54.5		2	1			10	16:23	15 李卓洋
26	姚雪岩															10	17:01	16 17 李中洲
84	王伟	0/2	1/1						1/3	33.3						10	17:29	16 李卓洋
运动员 合计		7/19	5/6	3/10	1/1	1/3	1/1	2/2	20/42	47.6	2	10	3	1		10	18:09	17 17 李中洲
1	王帅	1/4	0/1	0/1	0/1				1/7	14.3						4	19:04	17 李卓洋
16	马跃	4/13	3/8	0/1	0/3	0/1	0/1		7/27	25.9						15	22:08	18 3 曲汝洋
守门员 合计		5/17	3/9	0/2	0/4	0/1	0/1		8/34	23.5						15	22:45	18 曲汝洋
																15	28:59	19 3 曲汝洋
																26	29:27	20 17 李中洲

场上队员: 得分 / 射门

守门员: 救球 / 射门

D	取消资格	DR	取消资格+报告
---	------	----	---------

第十三届全国运动会男子手球决赛

PHMS Pictorial Handball Match Statistics

IHF Official System

个人/全队技术统计表

 手球 预赛 组别 B 天津师范大学体育馆
 男子 轮次 3 场次 12 2017-08-23 19:15

号码	姓名	远射	近射	边射	快攻	突破	任意	七米	合计	%	助攻	失误	警告	2'	取消	时间
江苏队(江苏)																
(场上队员)																
1	徐畅									0.0%						00:04:38
4	张家纬	4/8	1/1						5/9	55.6%						00:43:11
5	闫亮		0/1						0/1	0.0%			1			00:27:32
6	赵晨	4/11	1/2		1/1		1/2		7/16	43.8%	1		1			00:48:47
7	徐奕飞									0.0%						00:00:00
8	周小坚	0/1	4/4						4/5	80.0%		1				00:53:03
9	王杰缘				2/2				2/2	100%			1			00:59:13
10	郝可鑫	4/5							4/5	80.0%				1		00:38:36
12	王权									0.0%		1				00:55:22
13	叶强									0.0%						00:00:00
15	李安		0/1	2/3					2/4	50.0%						00:58:31
17	王伟强									0.0%						00:01:27
18	赵楠									0.0%						00:00:00
19	张志宇									0.0%						00:03:34
20	顾艳超				1/1	1/1			2/2	100%		2				00:15:40
21	刘江	0/1							0/1	0.0%		1				00:09:58
	合计	12/26	6/9	2/3	4/4	1/1	1/2		26/45	57.8%	1	5	3	1		
(守门员)																
1	徐畅	0/1		1/2					1/3	33.3%						00:04:38
12	王权	2/8	1/6	6/8	0/1	2/3	0/1	0/2	11/29	37.9%		1				00:55:22
	合计	2/9	1/6	7/10	0/1	2/3	0/1	0/2	12/32	37.5%		1				

场上队员：得分/射门

守门员：救球/射门

全队合计	得分	被救	射失	击柱	封球	合计	%
远射	12	5	3	1	5	26	46.2%
近射	6	3				9	66.7%
边射	2		1			3	66.7%
快攻	4					4	100.0%
突破	1					1	100.0%
任意	1		1			2	50.0%
七米							0.0%

第十三届全国运动会男子手球决赛

PHMS Pictorial Handball Match Statistics

IHF Official System

个人/全队技术统计表

 手球 预赛 组别 B 天津师范大学体育馆
 男子 轮次 3 场次 12 2017-08-23 19:15

号码	姓名	远射	近射	边射	快攻	突破	任意	七米	合计	%	助攻	失误	警告	2'	取消	时间
广东队(广东)																
(场上队员)																
1	王帅									0.0%						00:13:31
2	孙江山			3/5				1/1	4/6	66.7%						00:27:08
3	曲汝洋	3/4	1/1	0/1					4/6	66.7%		2	1			00:43:32
4	李卓洋	2/5	1/1			0/1	1/1		4/8	50.0%	2	3				00:50:29
5	侯生升									0.0%						00:32:59
6	邓志贵			0/1					0/1	0.0%						00:30:00
7	付云博									0.0%						00:13:24
8	于彦江	1/3		0/3		0/1			1/7	14.3%			1	1		00:44:00
9	徐庆									0.0%						00:00:00
11	房友屯									0.0%						00:00:00
12	王雨									0.0%						00:00:00
15	张建杰									0.0%						00:00:00
16	马跃									0.0%						00:46:29
17	李中洲	1/5	2/3		1/1	1/1		1/1	6/11	54.5%		2	1			00:57:38
26	姚雪岩									0.0%						00:00:00
84	王伟	0/2	1/1						1/3	33.3%		3				01:00:00
	合计	7/19	5/6	3/10	1/1	1/3	1/1	2/2	20/42	47.6%	2	10	3	1		
(守门员)																
1	王帅	1/4	0/1	0/1	0/1				1/7	14.3%						00:13:31
16	马跃	4/13	3/8	0/1	0/3	0/1	0/1		7/27	25.9%						00:46:29
	合计	5/17	3/9	0/2	0/4	0/1	0/1		8/34	23.5%						

场上队员：得分/射门

守门员：救球/射门

全队合计	得分	被救	射失	击柱	封球	合计	%
远射	7	2	2	1	7	19	36.8%
近射	5	1				6	83.3%
边射	3	7				10	30.0%
快攻	1					1	100.0%
突破	1	2				3	33.3%
任意	1					1	100.0%
七米	2					2	100.0%

第十三届全国运动会男子手球决赛

PHMS Pictorial Handball Match Statistics

IHF Official System

图式比赛技术统计表

手球
男子

预赛
轮次 3

组别 B
场次 12

天津师范大学体育馆
2017-08-23 19:15

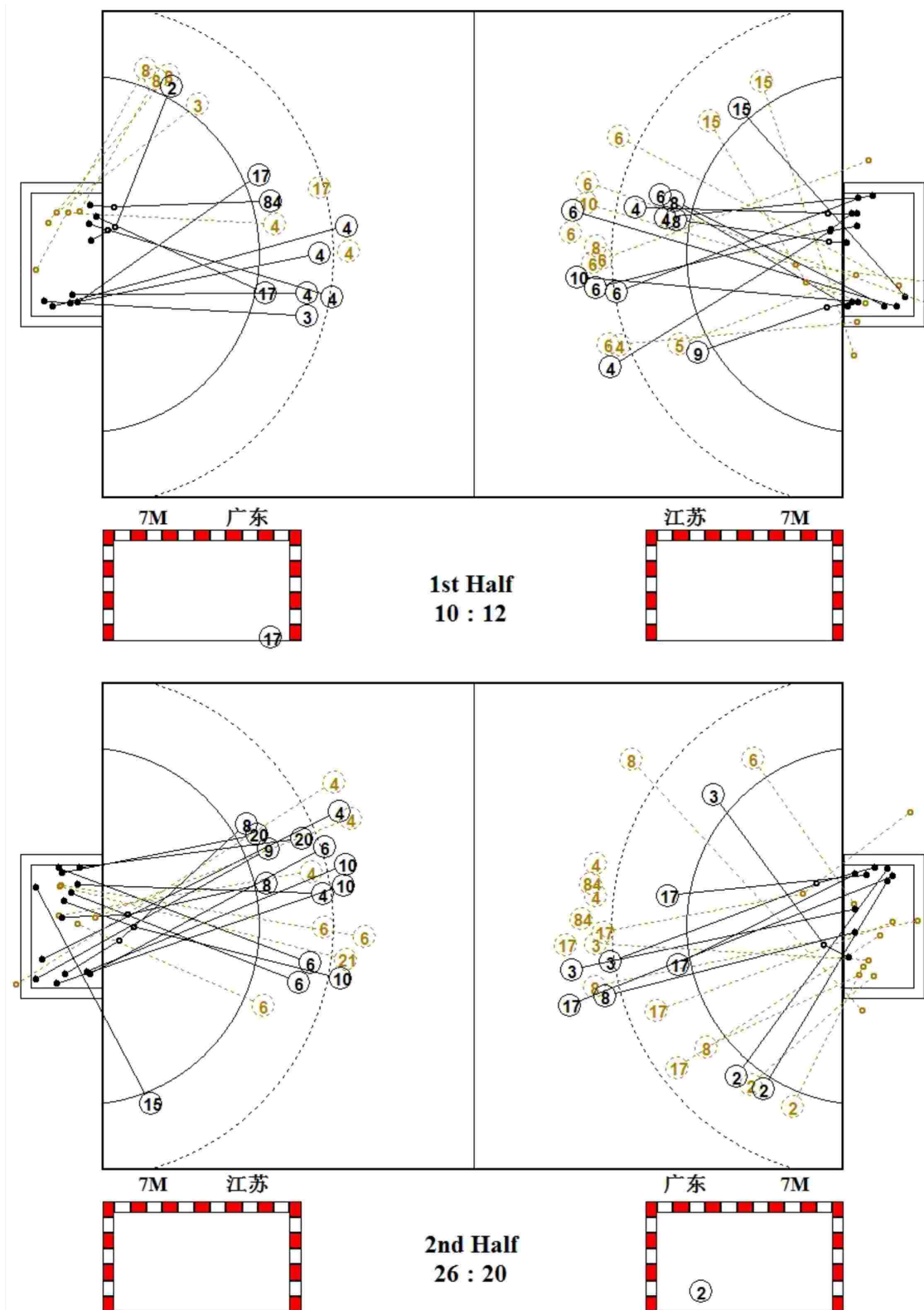

第十三届全国运动会男子手球决赛

PHMS Pictorial Handball Match Statistics

IHF Official System

图式射门区域统计

手球
男子

预赛
轮次 3

组别 B
场次 12

天津师范大学体育馆
2017-08-23 19:15

江苏队

1 徐畅	4 张家纬	5 闫亮	6 赵晨	7 徐奕飞	8 周小坚	9 王杰缘	10 郝可鑫																																																																								
<table border="1"><tr><td></td><td></td><td></td></tr><tr><td></td><td></td><td></td></tr><tr><td></td><td></td><td></td></tr></table>										<table border="1"><tr><td>1</td><td></td><td></td></tr><tr><td>1</td><td></td><td>1</td></tr><tr><td>2</td><td></td><td></td></tr></table>	1			1		1	2			<table border="1"><tr><td></td><td></td><td></td></tr><tr><td></td><td></td><td></td></tr><tr><td></td><td></td><td></td></tr></table>										<table border="1"><tr><td></td><td></td><td>1</td></tr><tr><td></td><td></td><td>2</td></tr><tr><td>3</td><td></td><td>1</td></tr></table>			1			2	3		1	<table border="1"><tr><td></td><td></td><td></td></tr><tr><td></td><td></td><td></td></tr><tr><td></td><td></td><td></td></tr></table>										<table border="1"><tr><td></td><td></td><td></td></tr><tr><td>1</td><td>1</td><td>1</td></tr><tr><td></td><td>1</td><td></td></tr></table>				1	1	1		1		<table border="1"><tr><td>1</td><td></td><td></td></tr><tr><td></td><td></td><td></td></tr><tr><td></td><td></td><td>1</td></tr></table>	1								1	<table border="1"><tr><td></td><td></td><td></td></tr><tr><td>1</td><td></td><td></td></tr><tr><td>1</td><td></td><td>1</td></tr></table>				1			1		1
1																																																																															
1		1																																																																													
2																																																																															
		1																																																																													
		2																																																																													
3		1																																																																													
1	1	1																																																																													
	1																																																																														
1																																																																															
		1																																																																													
1																																																																															
1		1																																																																													
Post - 0 Miss - 0 Block - 0	Post - 1 Miss - 1 Block - 0	Post - 0 Miss - 0 Block - 0	Post - 0 Miss - 2 Block - 4	Post - 0 Miss - 0 Block - 0	Post - 0 Miss - 0 Block - 1	Post - 0 Miss - 0 Block - 0	Post - 0 Miss - 1 Block - 0																																																																								
12 王权	13 叶强	15 李安	17 王伟强	18 赵楠	19 张志宇	20 顾艳超	21 刘江																																																																								
<table border="1"><tr><td></td><td></td><td></td></tr><tr><td></td><td></td><td></td></tr><tr><td></td><td></td><td></td></tr></table>										<table border="1"><tr><td></td><td></td><td></td></tr><tr><td></td><td></td><td></td></tr><tr><td></td><td></td><td></td></tr></table>										<table border="1"><tr><td></td><td></td><td>2</td></tr><tr><td></td><td></td><td></td></tr><tr><td></td><td></td><td></td></tr></table>			2							<table border="1"><tr><td></td><td></td><td></td></tr><tr><td></td><td></td><td></td></tr><tr><td></td><td></td><td></td></tr></table>										<table border="1"><tr><td></td><td></td><td></td></tr><tr><td></td><td></td><td></td></tr><tr><td></td><td></td><td></td></tr></table>										<table border="1"><tr><td></td><td></td><td></td></tr><tr><td></td><td></td><td></td></tr><tr><td></td><td></td><td></td></tr></table>										<table border="1"><tr><td></td><td></td><td></td></tr><tr><td></td><td></td><td>1</td></tr><tr><td></td><td></td><td>1</td></tr></table>						1			1	<table border="1"><tr><td></td><td></td><td></td></tr><tr><td></td><td></td><td></td></tr><tr><td></td><td></td><td></td></tr></table>									
		2																																																																													
		1																																																																													
		1																																																																													
Post - 0 Miss - 0 Block - 0	Post - 0 Miss - 0 Block - 0	Post - 0 Miss - 1 Block - 0	Post - 0 Miss - 0 Block - 0	Post - 0 Miss - 0 Block - 0	Post - 0 Miss - 0 Block - 0	Post - 0 Miss - 0 Block - 0	Post - 0 Miss - 0 Block - 0																																																																								

1 □□									
<table border="1"><tr><td>0/1</td><td></td><td></td></tr><tr><td></td><td></td><td>1/1</td></tr><tr><td></td><td>0/1</td><td></td></tr></table>	0/1					1/1		0/1	
0/1									
		1/1							
	0/1								

12 □□									
<table border="1"><tr><td>0/2</td><td>2/2</td><td>1/1</td></tr><tr><td>0/7</td><td>1/1</td><td>3/3</td></tr><tr><td>1/3</td><td>0/2</td><td>3/8</td></tr></table>	0/2	2/2	1/1	0/7	1/1	3/3	1/3	0/2	3/8
0/2	2/2	1/1							
0/7	1/1	3/3							
1/3	0/2	3/8							

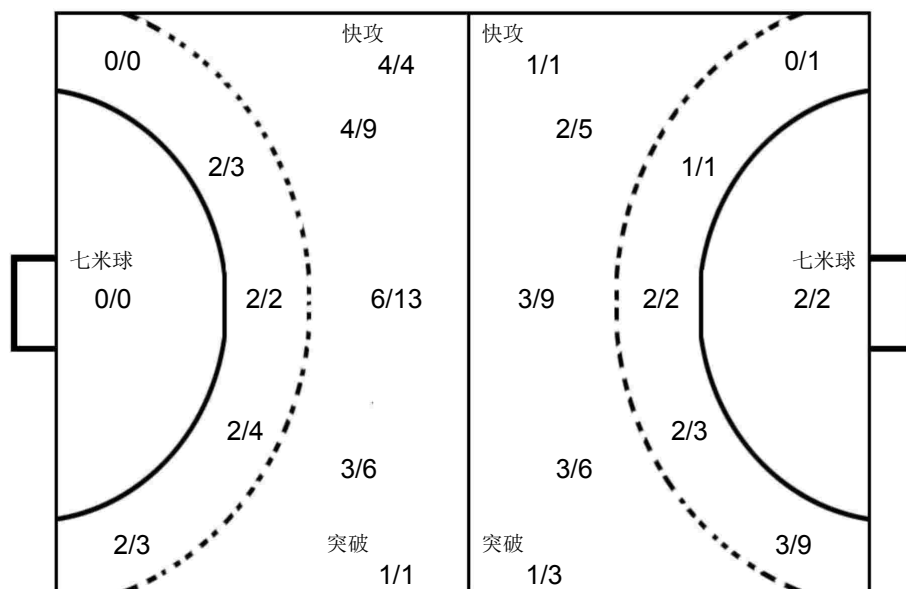

1 □□									
<table border="1"><tr><td></td><td></td><td>0/1</td></tr><tr><td>0/2</td><td></td><td>0/2</td></tr><tr><td>0/1</td><td>1/1</td><td></td></tr></table>			0/1	0/2		0/2	0/1	1/1	
		0/1							
0/2		0/2							
0/1	1/1								

16 □□									
<table border="1"><tr><td>0/2</td><td></td><td>1/3</td></tr><tr><td>0/1</td><td>2/3</td><td>2/6</td></tr><tr><td>0/5</td><td>1/2</td><td>1/5</td></tr></table>	0/2		1/3	0/1	2/3	2/6	0/5	1/2	1/5
0/2		1/3							
0/1	2/3	2/6							
0/5	1/2	1/5							

广东队

1 王帅	2 孙江山	3 曲汝洋	4 李卓洋	5 侯生升	6 邓志贵	7 付云博	8 于彦江																																																																								
<table border="1"><tr><td></td><td></td><td></td></tr><tr><td></td><td></td><td></td></tr><tr><td></td><td></td><td></td></tr></table>										<table border="1"><tr><td>2</td><td></td><td></td></tr><tr><td>1</td><td>1</td><td></td></tr><tr><td></td><td></td><td></td></tr></table>	2			1	1					<table border="1"><tr><td>1</td><td></td><td></td></tr><tr><td>1</td><td></td><td></td></tr><tr><td></td><td>1</td><td>1</td></tr></table>	1			1				1	1	<table border="1"><tr><td>1</td><td></td><td></td></tr><tr><td>2</td><td></td><td></td></tr><tr><td></td><td></td><td>1</td></tr></table>	1			2					1	<table border="1"><tr><td></td><td></td><td></td></tr><tr><td></td><td></td><td></td></tr><tr><td></td><td></td><td></td></tr></table>										<table border="1"><tr><td></td><td></td><td></td></tr><tr><td></td><td></td><td></td></tr><tr><td></td><td></td><td></td></tr></table>										<table border="1"><tr><td></td><td></td><td></td></tr><tr><td></td><td></td><td></td></tr><tr><td></td><td></td><td></td></tr></table>										<table border="1"><tr><td></td><td></td><td></td></tr><tr><td></td><td></td><td></td></tr><tr><td></td><td></td><td>1</td></tr></table>									1
2																																																																															
1	1																																																																														
1																																																																															
1																																																																															
	1	1																																																																													
1																																																																															
2																																																																															
		1																																																																													
		1																																																																													
Post - 0 Miss - 0 Block - 0	Post - 0 Miss - 0 Block - 0	Post - 0 Miss - 0 Block - 0	Post - 0 Miss - 0 Block - 3	Post - 0 Miss - 0 Block - 0	Post - 0 Miss - 0 Block - 0	Post - 0 Miss - 0 Block - 0	Post - 1 Miss - 1 Block - 0																																																																								
9 徐庆	11 房友屯	12 王雨	15 张建杰	16 马跃	17 李中洲	26 姚雪岩	84 王伟																																																																								
<table border="1"><tr><td></td><td></td><td></td></tr><tr><td></td><td></td><td></td></tr><tr><td></td><td></td><td></td></tr></table>										<table border="1"><tr><td></td><td></td><td></td></tr><tr><td></td><td></td><td></td></tr><tr><td></td><td></td><td></td></tr></table>										<table border="1"><tr><td></td><td></td><td></td></tr><tr><td></td><td></td><td></td></tr><tr><td></td><td></td><td></td></tr></table>										<table border="1"><tr><td></td><td></td><td></td></tr><tr><td></td><td></td><td></td></tr><tr><td></td><td></td><td></td></tr></table>										<table border="1"><tr><td></td><td></td><td></td></tr><tr><td></td><td></td><td></td></tr><tr><td></td><td></td><td></td></tr></table>										<table border="1"><tr><td>1</td><td></td><td></td></tr><tr><td>2</td><td></td><td></td></tr><tr><td>1</td><td></td><td>2</td></tr></table>	1			2			1		2	<table border="1"><tr><td></td><td></td><td></td></tr><tr><td></td><td></td><td></td></tr><tr><td></td><td></td><td></td></tr></table>										<table border="1"><tr><td></td><td></td><td></td></tr><tr><td></td><td></td><td></td></tr><tr><td></td><td></td><td>1</td></tr></table>									1
1																																																																															
2																																																																															
1		2																																																																													
		1																																																																													
Post - 0 Miss - 0 Block - 0	Post - 0 Miss - 0 Block - 0	Post - 0 Miss - 0 Block - 0	Post - 0 Miss - 0 Block - 0	Post - 0 Miss - 0 Block - 0	Post - 0 Miss - 1 Block - 2	Post - 0 Miss - 0 Block - 0	Post - 0 Miss - 0 Block - 2																																																																								

Team A					Team B					Match Number								
A 山东队					B 安徽队					13								
Played in			in the hall			on			at			Spectators						
天津			天津师范大学体育馆			2017-08-25			14:00			hours						
Half-time(30')	A	B	End of playing time		A	B	1st extra time		A	B	2nd extra time		A	B	After penalty throws		A	B
	12	7	32		18													
Number of 7 m	A	Team time-out			Full name of players and officials						Team time-out			B	Number of 7 m			
	3/3	1	2	3							1	2	3	0/0				
		19:23									43:58							

No.	Team A	G	W	2'	D	DR	No.	Team B	G	W	2'	D	DR
3	尹杰	1					1	郭世伟	2				
4	田瑞	1					3	陈强龙					
5	潘翔	3					5	史小帆	2				
6	李朝鹏	2		1			7	姚雄敏	1				
8	王炳华						8	董智景	6				
9	赵鑫	2					9	陈开勇					
11	宋朋强	5					10	严龙					
12	崔剑						11	黎涛	2				
13	刘晓	1					12	曾献辰					
15	张继伟	1	1				15	曹青福临					
16	于性哲						16	杨洋					
17	王旭东	2					17	王巨柱	1				
18	于亚男	3					18	李双	2				
19	李语庆	5					21	李明					
20	杜在超	2					23	于敏清	2	1			
21	翟乾坤	4					24	徐安格					
A	王志峰						B	沈强 (主教练)					
B	王鸿斌 (主教练)						C	吴翔					
C	刘桂妮						D	黄红					
D	邢建刚						E	吴台锡					
A	Signatures of responsables for the teams (Off.A)												B
TP	Remarks of referees / HF Official												TP

	Referees	李兆蒙 (CHN)	张耿 (CHN)
	T.D.	门东山 (CHN)	于中迅 (CHN)
	CHA Off.		

Note: Number of 7m Throws Awarded to Team A and B, Goals (G), Warnings (W), Suspensions (2'), Direct Disqualification (D), Disqualification With Report (DR) and Team Penalty (TP).

Table Officials: 隆晓磊 梅艳

Statisticians: 黄岩

陈柱

第十三届全国运动会男子手球决赛
PHMS Pictorial Handball Match Statistics

IHF Official System

竞赛技术统计

 手球
 男子

 四分之一决赛
 轮次 4

 组别 X
 场次 13

 天津师范大学体育馆
 2017-08-25 14:00

Referees:	李兆蒙 (CHN) / 张耿 (CHN)	Result:	32:18 (12:7)
Teams:	山东队(山东) VS 安徽队(安徽)		

山东		远	近	边	快	突	任意	7m	合计	%	助攻	失误	警告	2'	D+DR	山东	比赛	安徽
主教练: 王鸿斌		射	射	射	攻	破	球	球								进程		
3	尹杰			1/1					1/1	100						19	李语庆	1 02:27 0
4	田瑞				1/1				1/1	100						18	于亚男	2 04:37 0
5	潘翔		2/3		1/1				3/4	75.0		1				18	于亚男	3 06:00 0
6	李朝鹏	1/3				1/1			2/4	50.0		1		1		3	李双	3 06:15 1 18 李双
8	王炳华	0/1							0/1	0.0		2				3	李双	3 08:50 2 18 李双
9	赵鑫	2/3	0/1		0/2				2/6	33.3	3	1				4	于敏清	4 10:43 2
11	宋朋强	4/5			1/1				5/6	83.3	4	3				20	杜在超	4 11:52 3 23 于敏清
12	崔剑															20	杜在超	5 12:28 3
13	刘晓	0/1	1/1						1/2	50.0						5	史小帆	5 12:55 4 5 史小帆
15	张继伟		1/1						1/1	100		1	1			18	于亚男	6 13:31 4
16	于性哲															21	翟乾坤	7 14:01 4
17	王旭东	1/3	1/1	0/1					2/5	40.0	1	2				7	史小帆	7 16:41 5 5 史小帆
18	于亚男	1/3				2/2			3/5	60.0						8	董智景	8 17:25 5
19	李语庆	1/1	0/1	1/1	1/1			2/2	5/6	83.3						17	王旭东	9 20:40 5
20	杜在超	1/2			0/1	1/1			2/4	50.0						9	董智景	9 21:02 6 8 董智景
21	翟乾坤		1/1	0/1	2/2			1/1	4/5	80.0						10	董智景	10 23:24 6
运动员	合计	11/22	6/9	2/4	6/9	4/4		3/3	32/51	62.7	8	11	1	1		19	李语庆	10 25:34 7 8 董智景
3	尹杰															11	宋朋强	11 26:43 7
12	崔剑	4/6	1/5	2/4	0/1	2/4			9/20	45.0						5	潘翔	12 27:23 7
16	于性哲	3/6	2/5		0/1				5/12	41.7						11	宋朋强	13 00:27 7
守门员	合计	7/12	3/10	2/4	0/2	2/4			14/32	43.8						19	李语庆	14 01:15 7
安徽		远	近	边	快	突	任意	7m	合计	%	助攻	失误	警告	2'	D+DR			
主教练: 沈强		射	射	射	攻	破	球	球										
1	郭世伟			0/1	0/1	2/3			2/5	40.0		3				11	宋朋强	15 02:52 7
3	陈强龙		0/2						0/2	0.0						15	翟乾坤	15 03:46 8 11 黎涛
5	史小帆	1/2	1/1						2/3	66.7	1					17	王旭东	16 04:17 8
7	姚雄敏	0/1	1/1						1/2	50.0		2				16	郭世伟	16 05:08 9 1 郭世伟
8	董智景	2/7	2/2	1/2	1/1	0/1			6/13	46.2		1				9	赵鑫	17 05:39 9
9	陈开勇		0/1						0/1	0.0						17	董智景	17 05:52 10 8 董智景
10	严龙															17	于敏清	17 06:21 11 23 于敏清
11	黎涛	0/2	1/1	1/2					2/5	40.0	1	2				17	董智景	17 07:07 12 8 董智景
12	曾献辰															18	董智景	18 08:07 12
15	曹青福临															18	王巨柱	18 08:20 13 17 王巨柱
16	杨洋															19	郭世伟	19 09:00 13
17	王巨柱	1/4							1/4	25.0	1	1				11	宋朋强	20 11:42 13
18	李双	1/4	1/1						2/5	40.0	1	6				5	潘翔	21 13:07 13
21	李明															22	黎涛	22 13:45 13
23	于敏清		1/1	0/2	1/1				2/4	50.0	1	4	1			22	郭世伟	22 14:54 14 1 郭世伟
24	徐安格	0/1							0/1	0.0		1				11	宋朋强	23 15:37 14
运动员	合计	5/21	7/10	2/7	2/3	2/4			18/45	40.0	6	20	1			21	翟乾坤	24 16:50 14
12	曾献辰	2/4	1/3	0/1	1/3	0/1		0/1	4/13	30.8	1					24	董智景	24 17:41 15 8 董智景
21	李明	3/12	2/6	1/2	1/5	0/3		0/2	7/30	23.3						13	刘晓	25 18:29 15
守门员	合计	5/16	3/9	1/3	2/8	0/4		0/3	11/43	25.6	1					19	李语庆	26 19:14 15

场上队员: 得分 / 射门

守门员: 救球 / 射门

D	取消资格	DR	取消资格+报告
---	------	----	---------

第十三届全国运动会男子手球决赛

PHMS Pictorial Handball Match Statistics

IHF Official System

个人/全队技术统计表

 手球 四分之一决赛 组别 X 天津师范大学体育馆
 男子 轮次 4 场次 13 2017-08-25 14:00

号码	姓名	远射	近射	边射	快攻	突破	任意	七米	合计	%	助攻	失误	警告	2'	取消	时间
山东队(山东)																
(场上队员)																
3	尹杰			1/1					1/1	100%						00:11:39
4	田瑞				1/1				1/1	100%						00:09:22
5	潘翔		2/3		1/1				3/4	75.0%		1				00:34:02
6	李朝鹏	1/3				1/1			2/4	50.0%		1		1		00:07:22
8	王炳华	0/1							0/1	0.0%		2				00:04:12
9	赵鑫	2/3	0/1		0/2				2/6	33.3%	3	1				00:20:10
11	宋朋强	4/5			1/1				5/6	83.3%	4	3				00:39:02
12	崔剑									0.0%						00:30:00
13	刘晓	0/1	1/1						1/2	50.0%						00:12:12
15	张继伟		1/1						1/1	100%		1	1			00:25:21
16	于性哲									0.0%						00:30:00
17	王旭东	1/3	1/1	0/1					2/5	40.0%	1	2				00:37:19
18	于亚男	1/3				2/2			3/5	60.0%						01:37:29
19	李语庆	1/1	0/1	1/1	1/1			2/2	5/6	83.3%						00:54:22
20	杜在超	1/2			0/1	1/1			2/4	50.0%						00:10:27
21	翟乾坤		1/1	0/1	2/2			1/1	4/5	80.0%						00:50:37
合计		11/22	6/9	2/4	6/9	4/4		3/3	32/51	62.7%	8	11	1	1		
(守门员)																
3	尹杰									0.0%						00:11:39
12	崔剑	4/6	1/5	2/4	0/1	2/4			9/20	45.0%						00:30:00
16	于性哲	3/6	2/5		0/1				5/12	41.7%						00:30:00
合计		7/12	3/10	2/4	0/2	2/4			14/32	43.8%						

场上队员：得分/射门

守门员：救球/射门

全队合计	得分	被救	射失	击柱	封球	合计	%
远射	11	5	2	2	2	22	50.0%
近射	6	3				9	66.7%
边射	2	1	1			4	50.0%
快攻	6	2		1		9	66.7%
突破	4					4	100.0%
任意							0.0%
七米	3					3	100.0%

第十三届全国运动会男子手球决赛

PHMS Pictorial Handball Match Statistics

IHF Official System

个人/全队技术统计表

 手球 四分之一决赛 组别 X 天津师范大学体育馆
 男子 轮次 4 场次 13 2017-08-25 14:00

号码	姓名	远射	近射	边射	快攻	突破	任意	七米	合计	%	助攻	失误	警告	2'	取消	时间
安徽队(安徽)																
(场上队员)																
1	郭世伟			0/1	0/1	2/3			2/5	40.0%		3				00:31:51
3	陈强龙		0/2						0/2	0.0%						00:45:01
5	史小帆	1/2	1/1						2/3	66.7%	1					00:30:00
7	姚雄敏	0/1	1/1						1/2	50.0%		2				00:10:35
8	董智景	2/7	2/2	1/2	1/1	0/1			6/13	46.2%		1				00:59:53
9	陈开勇		0/1						0/1	0.0%						00:20:13
10	严龙									0.0%						00:00:00
11	黎涛	0/2	1/1	1/2					2/5	40.0%	1	2				00:44:52
12	曾献辰									0.0%	1					00:13:07
15	曹青福临									0.0%						00:00:00
16	杨洋									0.0%						00:00:00
17	王巨柱	1/4							1/4	25.0%	1	1				00:17:24
18	李双	1/4	1/1						2/5	40.0%	1	6				00:42:42
21	李明									0.0%						00:46:53
23	于敏清		1/1	0/2	1/1				2/4	50.0%	1	4	1			00:47:17
24	徐安格	0/1							0/1	0.0%		1				00:08:54
	合计	5/21	7/10	2/7	2/3	2/4			18/45	40.0%	6	20	1			
(守门员)																
12	曾献辰	2/4	1/3	0/1	1/3	0/1		0/1	4/13	30.8%	1					00:13:07
21	李明	3/12	2/6	1/2	1/5	0/3		0/2	7/30	23.3%						00:46:53
	合计	5/16	3/9	1/3	2/8	0/4		0/3	11/43	25.6%	1					

场上队员：得分/射门

守门员：救球/射门

全队合计	得分	被救	射失	击柱	封球	合计	%
远射	5	7	3	3	3	21	23.8%
近射	7	3				10	70.0%
边射	2	2	2	1		7	28.6%
快攻	2		1			3	66.7%
突破	2	2				4	50.0%
任意							0.0%
七米							0.0%

第十三届全国运动会男子手球决赛

PHMS Pictorial Handball Match Statistics

IHF Official System

图式比赛技术统计表

手球
男子

四分之一决赛
轮次 4

组别 X
场次 13

天津师范大学体育馆
2017-08-25 14:00

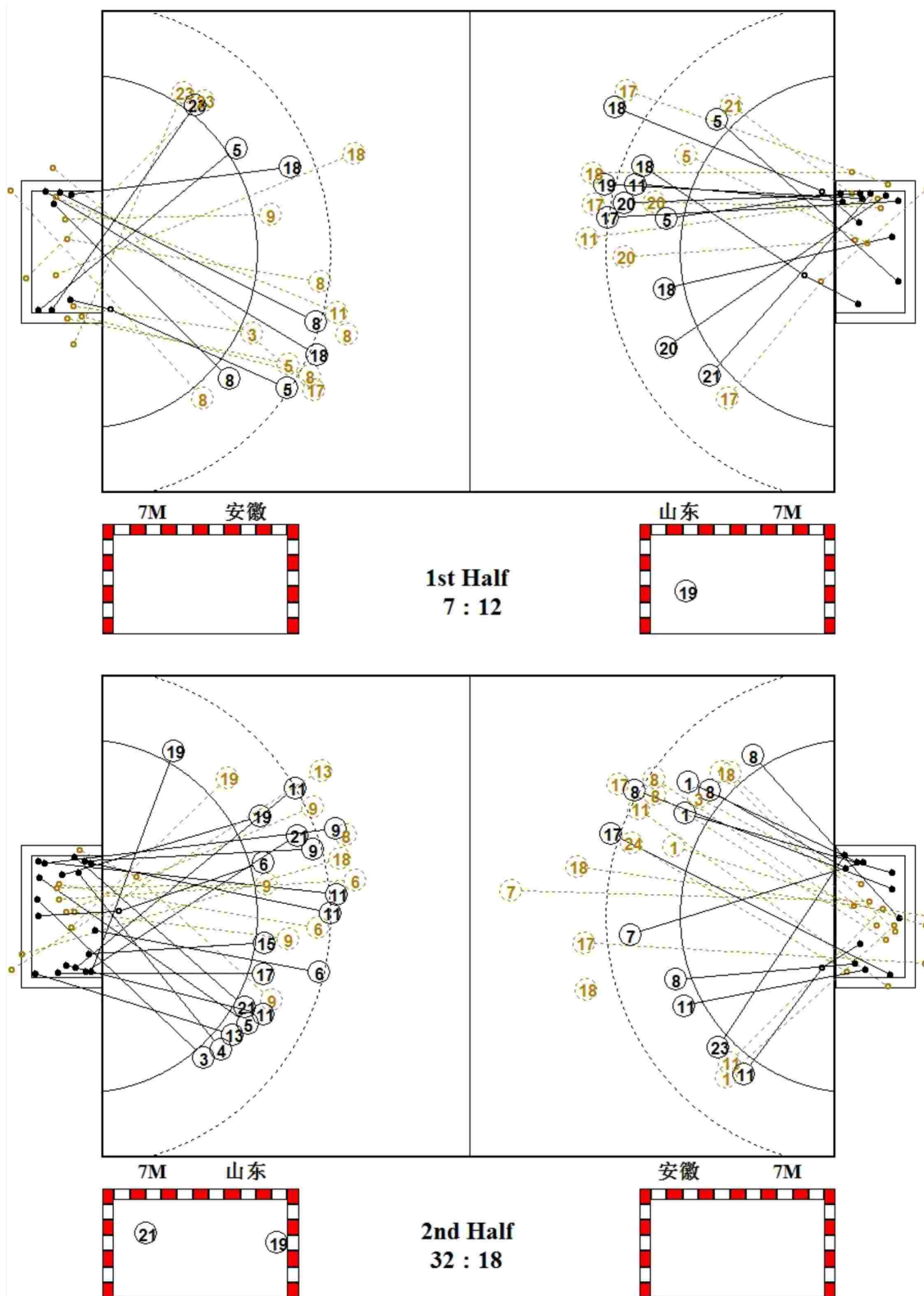

第十三届全国运动会男子手球决赛

PHMS Pictorial Handball Match Statistics

IHF Official System

图式射门区域统计

手球
男子

四分之一决赛
轮次 4

组别 X
场次 13

天津师范大学体育馆
2017-08-25 14:00

山东队

3 尹杰 <table border="1"><tr><td></td><td>1</td><td></td></tr><tr><td></td><td></td><td></td></tr><tr><td></td><td></td><td></td></tr></table> Post - 0 Miss - 0 Block - 0		1								4 田瑞 <table border="1"><tr><td></td><td></td><td></td></tr><tr><td></td><td></td><td>1</td></tr><tr><td></td><td></td><td></td></tr></table> Post - 0 Miss - 0 Block - 0						1				5 潘翔 <table border="1"><tr><td></td><td></td><td>2</td></tr><tr><td></td><td></td><td></td></tr><tr><td>1</td><td></td><td></td></tr></table> Post - 0 Miss - 0 Block - 0			2				1			6 李朝鹏 <table border="1"><tr><td></td><td>1</td><td></td></tr><tr><td></td><td></td><td></td></tr><tr><td></td><td>1</td><td></td></tr></table> Post - 0 Miss - 0 Block - 0		1						1		8 王炳华 <table border="1"><tr><td></td><td></td><td></td></tr><tr><td></td><td></td><td></td></tr><tr><td></td><td></td><td></td></tr></table> Post - 0 Miss - 0 Block - 1										9 赵鑫 <table border="1"><tr><td></td><td></td><td>1</td></tr><tr><td></td><td></td><td></td></tr><tr><td></td><td></td><td>1</td></tr></table> Post - 1 Miss - 0 Block - 0			1						1	11 宋朋强 <table border="1"><tr><td></td><td></td><td>1</td></tr><tr><td>2</td><td></td><td></td></tr><tr><td>1</td><td></td><td>1</td></tr></table> Post - 0 Miss - 0 Block - 0			1	2			1		1	12 崔剑 <table border="1"><tr><td></td><td></td><td></td></tr><tr><td></td><td></td><td></td></tr><tr><td></td><td></td><td></td></tr></table> Post - 0 Miss - 0 Block - 0									
	1																																																																														
		1																																																																													
		2																																																																													
1																																																																															
	1																																																																														
	1																																																																														
		1																																																																													
		1																																																																													
		1																																																																													
2																																																																															
1		1																																																																													
13 刘晓 <table border="1"><tr><td>1</td><td></td><td></td></tr><tr><td></td><td></td><td></td></tr><tr><td></td><td></td><td></td></tr></table> Post - 0 Miss - 1 Block - 0	1									15 张继伟 <table border="1"><tr><td></td><td></td><td></td></tr><tr><td></td><td></td><td></td></tr><tr><td>1</td><td></td><td></td></tr></table> Post - 0 Miss - 0 Block - 0							1			16 于性哲 <table border="1"><tr><td></td><td></td><td></td></tr><tr><td></td><td></td><td></td></tr><tr><td></td><td></td><td></td></tr></table> Post - 0 Miss - 0 Block - 0										17 王旭东 <table border="1"><tr><td>1</td><td></td><td></td></tr><tr><td>1</td><td></td><td></td></tr><tr><td></td><td></td><td></td></tr></table> Post - 1 Miss - 1 Block - 1	1			1						18 于亚男 <table border="1"><tr><td></td><td>1</td><td></td></tr><tr><td>1</td><td></td><td>1</td></tr><tr><td></td><td></td><td></td></tr></table> Post - 1 Miss - 1 Block - 0		1		1		1				19 李语庆 <table border="1"><tr><td></td><td></td><td></td></tr><tr><td>2</td><td></td><td>2</td></tr><tr><td>1</td><td></td><td></td></tr></table> Post - 0 Miss - 0 Block - 0				2		2	1			20 杜在超 <table border="1"><tr><td>1</td><td></td><td></td></tr><tr><td>1</td><td></td><td></td></tr><tr><td></td><td></td><td></td></tr></table> Post - 0 Miss - 0 Block - 0	1			1						21 翟乾坤 <table border="1"><tr><td>1</td><td></td><td></td></tr><tr><td>1</td><td></td><td>1</td></tr><tr><td>1</td><td></td><td></td></tr></table> Post - 0 Miss - 0 Block - 0	1			1		1	1		
1																																																																															
1																																																																															
1																																																																															
1																																																																															
	1																																																																														
1		1																																																																													
2		2																																																																													
1																																																																															
1																																																																															
1																																																																															
1																																																																															
1		1																																																																													
1																																																																															

3 □□

12 □□
0/2 3/4 1/2
1/2 2/2 0/2
0/3 1/1 1/2

16 □□□
1/3 1/3
1/2 1/1 1/3

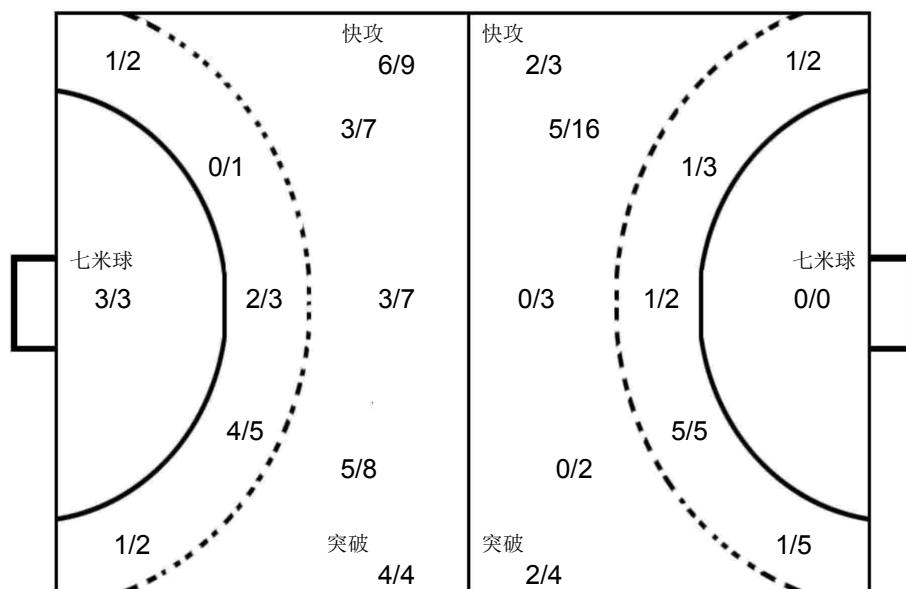

12 □□□
0/1 0/2 0/1
2/2 2/5
0/1 0/1

21 □□
1/4 0/1 0/3
1/9 3/3 0/2
1/5 1/1 0/2

安徽队

1 郭世伟 <table border="1"><tr><td>1</td><td></td><td></td></tr><tr><td></td><td></td><td></td></tr><tr><td>1</td><td></td><td></td></tr></table> Post - 0 Miss - 1 Block - 0	1						1			3 陈强龙 <table border="1"><tr><td></td><td></td><td></td></tr><tr><td></td><td></td><td></td></tr><tr><td></td><td></td><td></td></tr></table> Post - 0 Miss - 0 Block - 0										5 史小帆 <table border="1"><tr><td>1</td><td></td><td></td></tr><tr><td></td><td></td><td></td></tr><tr><td>1</td><td></td><td></td></tr></table> Post - 1 Miss - 0 Block - 0	1						1			7 姚雄敏 <table border="1"><tr><td></td><td></td><td></td></tr><tr><td>1</td><td></td><td></td></tr><tr><td></td><td></td><td></td></tr></table> Post - 0 Miss - 0 Block - 0				1						8 董智景 <table border="1"><tr><td>1</td><td>1</td><td>1</td></tr><tr><td></td><td></td><td>1</td></tr><tr><td>1</td><td></td><td>1</td></tr></table> Post - 1 Miss - 1 Block - 1	1	1	1			1	1		1	9 陈开勇 <table border="1"><tr><td></td><td></td><td></td></tr><tr><td></td><td></td><td></td></tr><tr><td></td><td></td><td></td></tr></table> Post - 0 Miss - 0 Block - 0										10 严龙 <table border="1"><tr><td></td><td></td><td></td></tr><tr><td></td><td></td><td></td></tr><tr><td></td><td></td><td></td></tr></table> Post - 0 Miss - 0 Block - 0										11 黎涛 <table border="1"><tr><td></td><td></td><td></td></tr><tr><td></td><td></td><td>2</td></tr><tr><td></td><td></td><td></td></tr></table> Post - 1 Miss - 0 Block - 0						2			
1																																																																															
1																																																																															
1																																																																															
1																																																																															
1																																																																															
1	1	1																																																																													
		1																																																																													
1		1																																																																													
		2																																																																													
12 曾献辰 <table border="1"><tr><td></td><td></td><td></td></tr><tr><td></td><td></td><td></td></tr><tr><td></td><td></td><td></td></tr></table> Post - 0 Miss - 0 Block - 0										15 曹青福临 <table border="1"><tr><td></td><td></td><td></td></tr><tr><td></td><td></td><td></td></tr><tr><td></td><td></td><td></td></tr></table> Post - 0 Miss - 0 Block - 0										16 杨洋 <table border="1"><tr><td></td><td></td><td></td></tr><tr><td></td><td></td><td></td></tr><tr><td></td><td></td><td></td></tr></table> Post - 0 Miss - 0 Block - 0										17 王巨柱 <table border="1"><tr><td></td><td></td><td>1</td></tr><tr><td></td><td></td><td></td></tr><tr><td></td><td></td><td></td></tr></table> Post - 0 Miss - 2 Block - 1			1							18 李双 <table border="1"><tr><td></td><td></td><td>1</td></tr><tr><td></td><td></td><td>1</td></tr><tr><td></td><td></td><td></td></tr></table> Post - 0 Miss - 1 Block - 1			1			1				21 李明 <table border="1"><tr><td></td><td></td><td></td></tr><tr><td></td><td></td><td></td></tr><tr><td></td><td></td><td></td></tr></table> Post - 0 Miss - 0 Block - 0										23 于敏清 <table border="1"><tr><td>1</td><td></td><td></td></tr><tr><td></td><td></td><td></td></tr><tr><td>1</td><td></td><td></td></tr></table> Post - 1 Miss - 1 Block - 0	1						1			24 徐安格 <table border="1"><tr><td></td><td></td><td></td></tr><tr><td></td><td></td><td></td></tr><tr><td></td><td></td><td></td></tr></table> Post - 0 Miss - 0 Block - 0									
		1																																																																													
		1																																																																													
		1																																																																													
1																																																																															
1																																																																															

Team A					Team B					Match Number											
A 广东队					B 上海队					14											
Played in			in the hall			on			at			Spectators									
天津			天津师范大学体育馆			2017-08-25			15:45			hours									
Half-time(30')	A	B	End of playing time		A	B	1st extra time		A	B	2nd extra time		A	B	After penalty throws		A	B			
	13	5	30		14																
Number of 7 m	A	Team time-out			Full name of players and officials						Team time-out			B	Number of 7 m						
	2/2	1	2	3							1	2	3	B							
		23:41	49:28								09:42	19:13		0/1							
No.	Team A					G	W	2'	D	DR	No.	Team B					G	W	2'	D	DR
1	王帅										1	张峥									
2	孙江山					2					3	赵时俊						1			
3	曲汝洋					4		1			4	徐俊吉					3	1			
4	李卓洋					2					6	朱世杰					1		1		
5	侯生升					2					7	周文龙									
6	邓志贵					1					8	钱为玮					4	1			
7	付云博					1					9	董凯									
8	于彦江					4	1				10	吴璟									
9	徐庆					1					11	蒋承骅									
11	房友屯										12	周哲韬									
12	王雨										14	沈吉磊					5				
15	张建杰					6					16	朱春雷									
16	马跃										17	贺政					1				
17	李中洲					4	1	1			18	马麟晓							2		
26	姚雪岩							1			19	祝君									
84	王伟					3															
B	王锋 (主教练)										A	郑益方									
C	刘康伶										B	张勇军 (主教练)									
D	张广建										C	金迪琦									
E	王永存										D	杨时									
A	Signatures of responsables for the teams (Off.A)															B					
TP	Remarks of referees / HF Official															TP					

Signatures

Referees ALEXEI. COVALCIUC (MDA)

IGOR. COVALCIUC (MDA)

T.D. 李长海 (CHN)

李刚 (CHN)

CHA Off.

Note: Number of 7m Throws Awarded to Team A and B, Goals (G), Warnings (W), Suspensions (2'), Direct Disqualification (D), Disqualification With Report (DR) and Team Penalty (TP).

Table Officials: 李志成

刘宇阳

Statisticians: 陈柱

刘永欢

第十三届全国运动会男子手球决赛
PHMS Pictorial Handball Match Statistics

IHF Official System

竞赛技术统计

 手球
男子

 四分之一决赛
轮次 4

 组别 X
场次 14

 天津师范大学体育馆
2017-08-25 15:45

Referees: ALEXEI. COVALCIUC (MDA) / IGOR. COVALCIUC (MDA)

Result: 30:14 (13:5)

Teams: 广东队(广东) VS 上海队(上海)

广东		远射	近射	边射	快攻	突破	任意球	7m球	合计	%	助攻	失误	警告	2'	D+DR	广东	比赛进程	上海			
主教练: 王锋																					
1	王帅																				
2	孙江山			1/2				1/1	2/3	66.7											
3	曲汝洋	1/1	1/1		1/1	1/1			4/4	100	1	2		1							
4	李卓洋	1/3		0/1		1/1			2/5	40.0		2									
5	侯生升			2/2					2/2	100											
6	邓志贵		1/1						1/1	100											
7	付文博	0/1	1/1						1/2	50.0		2									
8	于彦江	0/1	1/1	2/2	1/1				4/5	80.0	1	1	1								
9	徐庆		1/1						1/1	100											
11	房友屯																				
12	王雨																				
15	张建杰	6/8			0/1				6/9	66.7											
16	马跃																				
17	李中洲		1/3		1/1	1/1		1/1	4/6	66.7			1	1							
26	姚雪岩										1	1		1							
84	王伟		2/2	0/1	1/1				3/4	75.0	1										
运动员 合计		8/14	8/10	5/8	4/5	3/3		2/2	30/42	71.4	4	8	2	3							
1	王帅	1/4	2/3	0/1				1/1	4/9	44.4											
16	马跃	3/6	2/5	3/3	0/2	0/1			8/17	47.1											
守门员 合计		4/10	4/8	3/4	0/2	0/1		1/1	12/26	46.2											
上海		远射	近射	边射	快攻	突破	任意球	7m球	合计	%	助攻	失误	警告	2'	D+DR	广东	比赛进程	上海			
主教练: 张勇军																					
1	张峥																				
3	赵时俊	0/1					0/1		0/2	0.0	1	2	1								
4	徐俊吉		3/3					0/1	3/4	75.0		2	1								
6	朱世杰	0/3	0/2			1/1			1/6	16.7		3		1							
7	周文龙																				
8	钱为玮	2/3		0/2	2/2		0/1		4/8	50.0	2		1								
9	董凯		0/2						0/2	0.0											
10	吴璟																				
11	蒋承骅																				
12	周哲韬																				
14	沈吉磊	4/10	1/1						5/11	45.5		1									
16	朱春雷																				
17	贺政			1/2					1/2	50.0											
18	马麟晓	0/2	0/1						0/3	0.0		1		2							
19	祝君	0/3							0/3	0.0	1	2									
运动员 合计		6/22	4/9	1/4	2/2	1/1	0/2	0/1	14/41	34.1	4	11	3	3							
1	张峥	2/8	0/5	0/2	1/2			0/2	3/19	15.8											
12	周哲韬	1/3	1/4	3/6	0/3	0/3			5/19	26.3											
守门员 合计		3/11	1/9	3/8	1/5	0/3		0/2	8/38	21.1											
																	1st Half				
																	3	曲汝洋	1	00:52	0
																	17	李中洲	2	05:22	0
																	84	王伟	3	07:31	0
																	4	李卓洋	4	09:25	0
																	4	11:12	1	8	钱为玮
																	3	曲汝洋	5	12:20	1
																	8	于彦江	6	13:12	1
																	6	13:39	2	6	朱世杰
																	8	于彦江	7	14:26	2
																	84	王伟	8	16:10	2
																	3	曲汝洋	9	18:08	2
																	5	侯生升	10	19:02	2
																	10	20:34	3	14	沈吉磊
																	17	李中洲	11	21:05	3
																	11	21:42	4	14	沈吉磊
																	8	于彦江	12	22:20	4
																	17	李中洲	13	26:42	4
																	13	30:00	5	14	沈吉磊
																	2nd Half				
																	13	00:48	6	14	沈吉磊
																	2	孙江山	14	01:34	6
																	14	02:37	7	4	徐俊吉
																	4	李卓洋	15	03:12	7
																	15	05:53	8	8	钱为玮
																	84	王伟	16	06:32	8
																	3	曲汝洋	17	07:12	8
																	5	侯生升	18	07:55	8
																	17	李中洲	19	10:34	8
																	8	于彦江	20	11:42	8
																	7	付文博	21	13:50	8
																	21	15:17	9	4	徐俊吉
																	21	19:09	10	4	徐俊吉
																	2	孙江山	22	19:48	10
																	6	邓志贵	23	20:29	10
																	15	张建杰	24	21:53	10
																	15	张建杰	25	23:27	10
																	25	23:50	11	8	钱为玮
																	15	张建杰	26	24:19	11
																	26	24:43	12	8	钱为玮
																	15	张建杰	27	25:16	12
																	27	26:05	13	14	沈吉磊
																	15	张建杰	28	27:27	13
																	28	28:27	14	17	贺政
																	15	张建杰	29	28:55	14
																	9	徐庆	30	29:34	14

场上队员: 得分 / 射门

守门员: 救球 / 射门

D	取消资格	DR	取消资格+报告
---	------	----	---------

第十三届全国运动会男子手球决赛

PHMS Pictorial Handball Match Statistics

IHF Official System

个人/全队技术统计表

 手球 四分之一决赛 组别 X 天津师范大学体育馆
 男子 轮次 4 场次 14 2017-08-25 15:45

号码	姓名	远射	近射	边射	快攻	突破	任意	七米	合计	%	助攻	失误	警告	2'	取消	时间
广东队(广东)																
(场上队员)																
1	王帅									0.0%						00:11:51
2	孙江山			1/2				1/1	2/3	66.7%						00:32:06
3	曲汝洋	1/1	1/1		1/1	1/1			4/4	100%	1	2		1		00:29:22
4	李卓洋	1/3		0/1		1/1			2/5	40.0%		2				00:39:33
5	侯生升			2/2					2/2	100%						00:41:19
6	邓志贵		1/1						1/1	100%						00:17:09
7	付云博	0/1	1/1						1/2	50.0%		2				00:28:23
8	于彦江	0/1	1/1	2/2	1/1				4/5	80.0%	1	1	1			00:49:18
9	徐庆		1/1						1/1	100%						00:19:58
11	房友屯									0.0%						00:00:00
12	王雨									0.0%						00:00:00
15	张建杰	6/8			0/1				6/9	66.7%						00:14:34
16	马跃									0.0%						00:48:09
17	李中洲		1/3		1/1	1/1		1/1	4/6	66.7%			1	1		00:39:52
26	姚雪岩									0.0%	1	1		1		00:08:41
84	王伟		2/2	0/1	1/1				3/4	75.0%	1					00:39:14
	合计	8/14	8/10	5/8	4/5	3/3		2/2	30/42	71.4%	4	8	2	3		
(守门员)																
1	王帅	1/4	2/3	0/1				1/1	4/9	44.4%						00:11:51
16	马跃	3/6	2/5	3/3	0/2	0/1			8/17	47.1%						00:48:09
	合计	4/10	4/8	3/4	0/2	0/1		1/1	12/26	46.2%						

场上队员：得分/射门

守门员：救球/射门

全队合计	得分	被救	射失	击柱	封球	合计	%
远射	8	3		1	2	14	57.1%
近射	8	1		1		10	80.0%
边射	5	3				8	62.5%
快攻	4	1				5	80.0%
突破	3					3	100.0%
任意							0.0%
七米	2					2	100.0%

第十三届全国运动会男子手球决赛

PHMS Pictorial Handball Match Statistics

IHF Official System

个人/全队技术统计表

 手球 四分之一决赛 组别 X 天津师范大学体育馆
 男子 轮次 4 场次 14 2017-08-25 15:45

号码	姓名	远射	近射	边射	快攻	突破	任意	七米	合计	%	助攻	失误	警告	2'	取消	时间
上海队(上海)																
(场上队员)																
1	张崢									0.0%						00:25:23
3	赵时俊	0/1					0/1		0/2	0.0%	1	2	1			00:31:28
4	徐俊吉		3/3					0/1	3/4	75.0%		2	1			00:52:21
6	朱世杰	0/3	0/2			1/1			1/6	16.7%		3		1		00:49:36
7	周文龙									0.0%						00:17:13
8	钱为玮	2/3		0/2	2/2		0/1		4/8	50.0%	2		1			00:58:53
9	董凯		0/2						0/2	0.0%						00:04:35
10	吴璟									0.0%						00:08:54
11	蒋承骅									0.0%						00:09:55
12	周哲韬									0.0%						00:34:37
14	沈吉磊	4/10	1/1						5/11	45.5%		1				00:28:17
16	朱春雷									0.0%						00:00:00
17	贺政			1/2					1/2	50.0%						00:52:53
18	马麟晓	0/2	0/1						0/3	0.0%		1		2		00:23:28
19	祝君	0/3							0/3	0.0%	1	2				00:20:35
合计		6/22	4/9	1/4	2/2	1/1	0/2	0/1	14/41	34.1%	4	11	3	3		
(守门员)																
1	张崢	2/8	0/5	0/2	1/2			0/2	3/19	15.8%						00:25:23
12	周哲韬	1/3	1/4	3/6	0/3	0/3			5/19	26.3%						00:34:37
合计		3/11	1/9	3/8	1/5	0/3		0/2	8/38	21.1%						

场上队员：得分/射门

守门员：救球/射门

全队合计	得分	被救	射失	击柱	封球	合计	%
远射	6	4	4	2	6	22	27.3%
近射	4	4	1			9	44.4%
边射	1	3				4	25.0%
快攻	2					2	100.0%
突破	1					1	100.0%
任意			2			2	0.0%
七米		1				1	0.0%

第十三届全国运动会男子手球决赛

PHMS Pictorial Handball Match Statistics

IHF Official System

图式比赛技术统计表

手球
男子

四分之一决赛
轮次 4

组别 X
场次 14

天津师范大学体育馆
2017-08-25 15:45

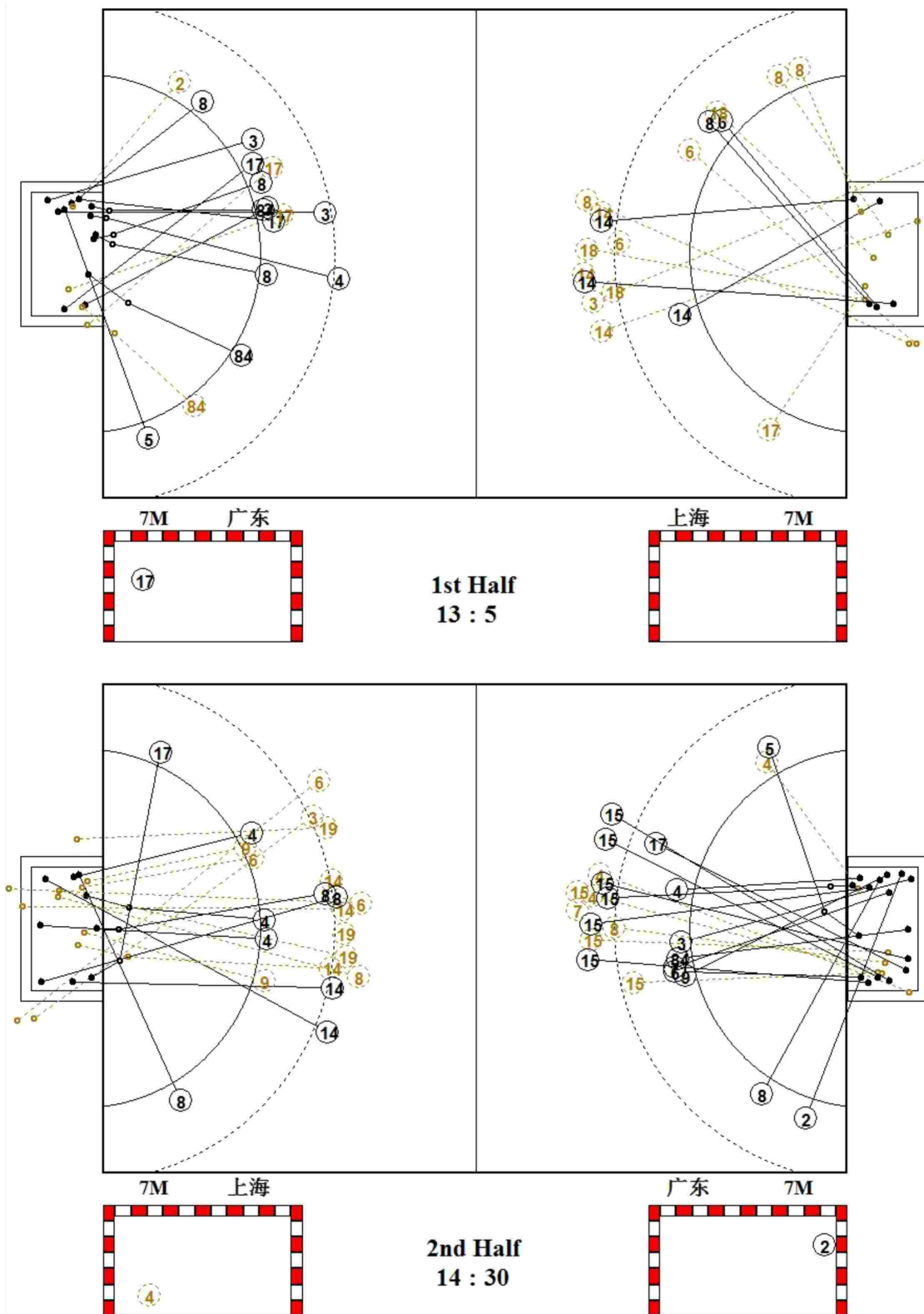

第十三届全国运动会男子手球决赛

PHMS Pictorial Handball Match Statistics

IHF Official System

图式射门区域统计

手球
男子

四分之一决赛
轮次 4

组别 X
场次 14

天津师范大学体育馆
2017-08-25 15:45

广东队

1 王帅 <table border="1"><tr><td></td><td></td><td></td></tr><tr><td></td><td></td><td></td></tr><tr><td></td><td></td><td></td></tr></table> Post - 0 Miss - 0 Block - 0										2 孙江山 <table border="1"><tr><td>1</td><td></td><td>1</td></tr><tr><td></td><td></td><td></td></tr><tr><td></td><td></td><td></td></tr></table> Post - 0 Miss - 0 Block - 0	1		1							3 曲汝洋 <table border="1"><tr><td>1</td><td></td><td>1</td></tr><tr><td></td><td></td><td>1</td></tr><tr><td>1</td><td></td><td></td></tr></table> Post - 0 Miss - 0 Block - 0	1		1			1	1			4 李卓洋 <table border="1"><tr><td></td><td></td><td></td></tr><tr><td></td><td></td><td></td></tr><tr><td>1</td><td></td><td>1</td></tr></table> Post - 1 Miss - 0 Block - 0							1		1	5 侯生升 <table border="1"><tr><td></td><td></td><td></td></tr><tr><td></td><td></td><td>1</td></tr><tr><td></td><td>1</td><td></td></tr></table> Post - 0 Miss - 0 Block - 0						1		1		6 邓志贵 <table border="1"><tr><td></td><td></td><td></td></tr><tr><td></td><td></td><td></td></tr><tr><td></td><td></td><td>1</td></tr></table> Post - 0 Miss - 0 Block - 0									1	7 付文博 <table border="1"><tr><td></td><td></td><td></td></tr><tr><td>1</td><td></td><td></td></tr><tr><td></td><td></td><td></td></tr></table> Post - 0 Miss - 0 Block - 1				1						8 于彦江 <table border="1"><tr><td></td><td></td><td></td></tr><tr><td>1</td><td></td><td>1</td></tr><tr><td></td><td>2</td><td></td></tr></table> Post - 0 Miss - 0 Block - 0				1		1		2	
1		1																																																																													
1		1																																																																													
		1																																																																													
1																																																																															
1		1																																																																													
		1																																																																													
	1																																																																														
		1																																																																													
1																																																																															
1		1																																																																													
	2																																																																														
9 徐庆 <table border="1"><tr><td></td><td></td><td></td></tr><tr><td>1</td><td></td><td></td></tr><tr><td></td><td></td><td></td></tr></table> Post - 0 Miss - 0 Block - 0				1						11 房友屯 <table border="1"><tr><td></td><td></td><td></td></tr><tr><td></td><td></td><td></td></tr><tr><td></td><td></td><td></td></tr></table> Post - 0 Miss - 0 Block - 0										12 王雨 <table border="1"><tr><td></td><td></td><td></td></tr><tr><td></td><td></td><td></td></tr><tr><td></td><td></td><td></td></tr></table> Post - 0 Miss - 0 Block - 0										15 张建杰 <table border="1"><tr><td></td><td></td><td>1</td></tr><tr><td></td><td></td><td>2</td></tr><tr><td>2</td><td></td><td>1</td></tr></table> Post - 0 Miss - 0 Block - 1			1			2	2		1	16 马跃 <table border="1"><tr><td></td><td></td><td></td></tr><tr><td></td><td></td><td></td></tr><tr><td></td><td></td><td></td></tr></table> Post - 0 Miss - 0 Block - 0										17 李中洲 <table border="1"><tr><td></td><td></td><td>1</td></tr><tr><td>1</td><td></td><td>1</td></tr><tr><td></td><td></td><td></td></tr></table> Post - 1 Miss - 0 Block - 0			1	1		1				26 姚雪岩 <table border="1"><tr><td></td><td></td><td></td></tr><tr><td></td><td></td><td></td></tr><tr><td></td><td></td><td></td></tr></table> Post - 0 Miss - 0 Block - 0										84 王伟 <table border="1"><tr><td></td><td></td><td>1</td></tr><tr><td></td><td></td><td></td></tr><tr><td></td><td>1</td><td>1</td></tr></table> Post - 0 Miss - 0 Block - 0			1					1	1
1																																																																															
		1																																																																													
		2																																																																													
2		1																																																																													
		1																																																																													
1		1																																																																													
		1																																																																													
	1	1																																																																													

1 □□

0/1		
0/1		1/1
1/2	1/2	1/2

16 □□

	0/1	0/2
0/1	3/3	1/4
1/2		3/4

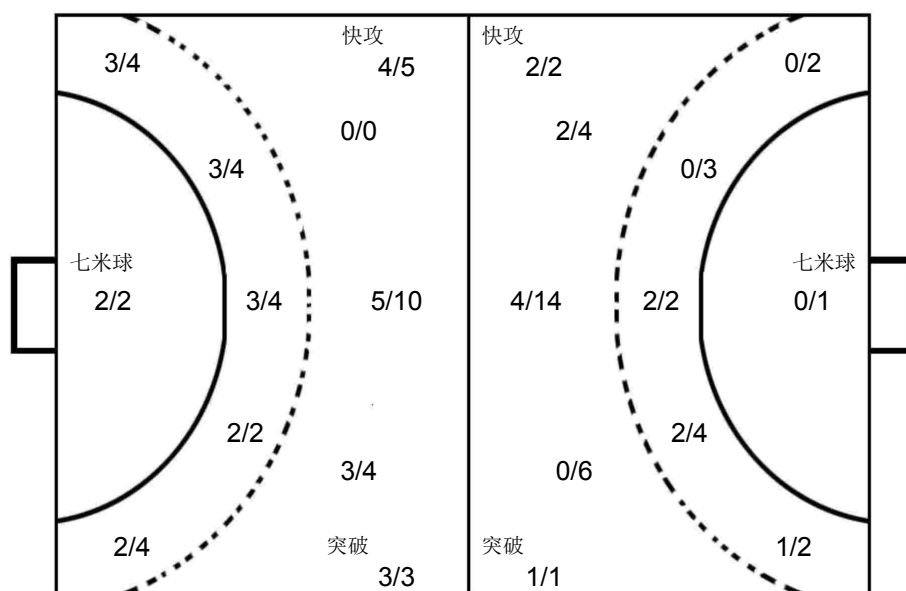

1 □□

0/2		0/3
0/2		3/6
0/2	0/2	0/2

12 □□□

0/1	0/1	0/1
1/3		2/5
2/4	0/2	0/2

上海队

1 张崢 <table border="1"><tr><td></td><td></td><td></td></tr><tr><td></td><td></td><td></td></tr><tr><td></td><td></td><td></td></tr></table> Post - 0 Miss - 0 Block - 0										3 赵时俊 <table border="1"><tr><td></td><td></td><td></td></tr><tr><td></td><td></td><td></td></tr><tr><td></td><td></td><td></td></tr></table> Post - 0 Miss - 2 Block - 0										4 徐俊吉 <table border="1"><tr><td></td><td>1</td><td></td></tr><tr><td></td><td></td><td>1</td></tr><tr><td></td><td></td><td>1</td></tr></table> Post - 0 Miss - 0 Block - 0		1				1			1	6 朱世杰 <table border="1"><tr><td></td><td></td><td></td></tr><tr><td></td><td></td><td>1</td></tr><tr><td></td><td></td><td></td></tr></table> Post - 0 Miss - 3 Block - 1						1				7 周文龙 <table border="1"><tr><td></td><td></td><td></td></tr><tr><td></td><td></td><td></td></tr><tr><td></td><td></td><td></td></tr></table> Post - 0 Miss - 0 Block - 0										8 钱为玮 <table border="1"><tr><td></td><td>1</td><td></td></tr><tr><td></td><td></td><td>1</td></tr><tr><td></td><td>1</td><td>1</td></tr></table> Post - 0 Miss - 1 Block - 0		1				1		1	1	9 董凯 <table border="1"><tr><td></td><td></td><td></td></tr><tr><td></td><td></td><td></td></tr><tr><td></td><td></td><td></td></tr></table> Post - 0 Miss - 0 Block - 0										10 吴璟 <table border="1"><tr><td></td><td></td><td></td></tr><tr><td></td><td></td><td></td></tr><tr><td></td><td></td><td></td></tr></table> Post - 0 Miss - 0 Block - 0									
	1																																																																														
		1																																																																													
		1																																																																													
		1																																																																													
	1																																																																														
		1																																																																													
	1	1																																																																													
11 蒋承骅 <table border="1"><tr><td></td><td></td><td></td></tr><tr><td></td><td></td><td></td></tr><tr><td></td><td></td><td></td></tr></table> Post - 0 Miss - 0 Block - 0										12 周哲韬 <table border="1"><tr><td></td><td></td><td></td></tr><tr><td></td><td></td><td></td></tr><tr><td></td><td></td><td></td></tr></table> Post - 0 Miss - 0 Block - 0										14 沈吉磊 <table border="1"><tr><td></td><td></td><td>2</td></tr><tr><td>2</td><td></td><td></td></tr><tr><td>1</td><td></td><td></td></tr></table> Post - 2 Miss - 0 Block - 3			2	2			1			16 朱春雷 <table border="1"><tr><td></td><td></td><td></td></tr><tr><td></td><td></td><td></td></tr><tr><td></td><td></td><td></td></tr></table> Post - 0 Miss - 0 Block - 0										17 贺政 <table border="1"><tr><td></td><td></td><td></td></tr><tr><td></td><td></td><td></td></tr><tr><td>1</td><td></td><td></td></tr></table> Post - 0 Miss - 0 Block - 0							1			18 马麟晓 <table border="1"><tr><td></td><td></td><td></td></tr><tr><td></td><td></td><td></td></tr><tr><td></td><td></td><td></td></tr></table> Post - 0 Miss - 0 Block - 1										19 祝君 <table border="1"><tr><td></td><td></td><td></td></tr><tr><td></td><td></td><td></td></tr><tr><td></td><td></td><td></td></tr></table> Post - 0 Miss - 1 Block - 1																			
		2																																																																													
2																																																																															
1																																																																															
1																																																																															

PHMS Pictorial Handball Match Statistics

IHF Official System

Team A					Team B					Match Number											
A 北京队					B 香港队					15											
Played in			in the hall			on			at			Spectators									
天津			天津师范大学体育馆			2017-08-25			17:30			hours									
Half-time(30')	A	B	End of playing time	A	B	1st extra time	A	B	2nd extra time	A	B	After penalty throws	A	B							
	16	12		28	25																
Number of 7 m	A	Team time-out			Full name of players and officials						Team time-out			B	Number of 7 m						
	5/5	1	2	3							1	2	3	B							
		16:13	59:49						08:50	35:52	52:10	2/2									
No.	Team A					G	W	2'	D	DR	No.	Team B					G	W	2'	D	DR
1	王洸										1	叶冠英									
7	马昌震										2	刘健斌					4	1			
8	王鹏						1				3	陈梓朗					2				
9	刘振					1					5	黄胜业					4				
10	成亚					2					7	谭俊杰									
16	刘迈科										8	李伟东									
21	胡瀛					2					10	谢永辉					3		1		
22	王超					2					12	许文邦					2				
23	王军程					5		1			13	张伟浩									
25	马明辉										18	李鑫豪					1				
29	杜龙飞					2		1			27	冼大维									
39	张骥					10					29	练明辉					2				
66	解建飞					3	1	1			31	叶仕仁					3				
77	朱昕晨							1			33	袁晞彦						1			
83	潘天										40	叶冠雄					4				
99	蒋维一					1	1	1													
A	安福田										A	杨开将									
B	郑永利 (主教练)										B	王涛									
C	孟辉										C	高梓欣									
E	王长林																				
A	Signatures of responsables for the teams (Off.A)															B					
TP	Remarks of referees / HF Official															TP					

Signatures

Referees 程钰峰 (CHN)

周云磊 (CHN)

T.D. 于中迅 (CHN)

刘书勇 (CHN)

CHA Off.

Note: Number of 7m Throws Awarded to Team A and B, Goals (G), Warnings (W), Suspensions (2'), Direct Disqualification (D), Disqualification With Report (DR) and Team Penalty (TP).

Table Officials: 鲍瑀

梅艳

Statisticians: 陈柱

刘永欢

第十三届全国运动会男子手球决赛

PHMS Pictorial Handball Match Statistics

IHF Official System

竞赛技术统计

 手球
男子

 四分之一决赛
轮次 4

 组别 X
场次 15

 天津师范大学体育馆
2017-08-25 17:30

Referees: 程钰峰 (CHN) / 周云磊 (CHN)

Result: 28:25(16:12)

Teams: 北京队(北京) VS 香港队(香港)

北京		远射	近射	边射	快攻	突破	任意球	7m球	合计	%	助攻	失误	警告	2'	D+DR	北京	比赛进程	香港
主教练: 郑永利																	1st Half	
1	王澍															66	解建飞 0 00:33 1 40 叶冠雄	
7	马昌震											2					1 01:23 1	
8	王鹏												1				1 01:48 2 3 陈梓朗	
9	刘振	0/2	1/2					1/4	25.0	1	1				66	解建飞 2 02:28 2		
10	成亚	1/3		0/1	1/1			2/5	40.0	3	1					2 03:06 3 12 许文邦		
16	刘迈科														29	杜龙飞 3 03:42 3		
21	胡瀛	1/1	0/2	1/1				2/4	50.0		1				39	张骥 4 05:11 3		
22	王超		0/1	2/2				2/3	66.7	1	1				10	成亚 5 06:03 3		
23	王军程	3/6	1/1		1/1			5/8	62.5					1	66	解建飞 6 07:34 3		
25	马明辉										1				39	张骥 7 08:24 3		
29	杜龙飞			2/2				2/2	100		3			1	39	张骥 8 09:34 3		
39	张骥	0/2	4/4			1/1		5/5	10/12 83.3						99	蒋维一 9 09:55 3		
66	解建飞			3/4			0/1	3/5	60.0			1		1		9 11:12 4 12 许文邦		
77	朱昕晨	0/2						0/2	0.0		1			1		9 12:40 5 31 叶仕仁		
83	潘天															9 13:21 6 2 刘健斌		
99	蒋维一		1/1					1/1	100			1		1		9 14:25 7 2 刘健斌		
运动员 合计		5/16	7/11	8/10	2/2	1/1	0/1	5/5	28/46 60.9	5	13	3		5		9 15:11 8 3 陈梓朗		
1	王澍	1/1	2/5	4/7	0/2	0/1		0/1	7/17 41.2						39	张骥 10 19:27 8		
16	刘迈科	0/1	3/7	4/5	0/6	0/2		0/1	7/22 31.8						21	胡瀛 10 20:08 9 10 谢永辉		
守门员 合计		1/2	5/12	8/12	0/8	0/3		0/2	14/39 35.9							11 20:50 10 40 叶冠雄		
香港		远射	近射	边射	快攻	突破	任意球	7m球	合计	%	助攻	失误	警告	2'	D+DR		2nd Half	
主教练: 高梓欣															39	张骥 16 01:02 13 29 练明辉		
1	叶冠英											2				16	02:19 14 29 练明辉	
2	刘健斌		1/1		2/2	1/1		4/4	100		1	1			39	张骥 17 03:22 14		
3	陈梓朗		1/2	0/3	1/1			2/6	33.3		2				10	成亚 18 04:48 14		
5	黄胜业		0/1	2/6	2/2			4/9	44.4						23	王军程 19 07:03 14		
7	谭俊杰										1				23	王军程 20 07:52 14		
8	李伟东														21	王军程 21 08:46 14		
10	谢永辉	1/3		1/2	1/1			3/6	50.0	1				1		21 09:17 15 31 叶仕仁		
12	许文邦	0/3		0/1				2/2	2/6 33.3						23	王军程 22 09:58 15		
13	张伟浩														39	张骥 22 10:36 16 5 黄胜业		
18	李鑫豪		1/1					1/1	100						22	王超 23 11:32 16		
27	冼大维		0/1					0/1	0.0						23	王军程 23 11:48 17 18 李鑫豪		
29	练明辉	0/1	0/3	1/2	1/1			2/7	28.6		1				22	王超 24 12:24 17		
31	叶仕仁	0/3	2/3		1/1			3/7	42.9	4	1				21	胡瀛 24 13:16 18 5 黄胜业		
33	袁晔彦											1	1			25 14:34 18		
40	叶冠雄	0/1	2/3			2/2		4/6	66.7		3				21	胡瀛 25 15:43 19 5 黄胜业		
运动员 合计		1/11	7/15	4/14	8/8	3/3		2/2	25/53 47.2	6	11	2		1	9	刘振 25 18:06 20 5 黄胜业		
1	叶冠英	5/8	3/8	2/8	0/1		1/1	0/2	11/28 39.3		2				22	王超 26 19:47 20		
7	谭俊杰	0/2	0/2	0/2	0/1	0/1		0/3	0/11 0.0	1					22	王超 27 21:57 20		
守门员 合计		5/10	3/10	2/10	0/2	0/1	1/1	0/5	11/39 28.2	1	2				23	王军程 28 23:36 20		

场上队员: 得分 / 射门

守门员: 救球 / 射门

D	取消资格	DR	取消资格+报告
---	------	----	---------

第十三届全国运动会男子手球决赛

PHMS Pictorial Handball Match Statistics

IHF Official System

个人/全队技术统计表

 手球 四分之一决赛 组别 X 天津师范大学体育馆
 男子 轮次 4 场次 15 2017-08-25 17:30

号码	姓名	远射	近射	边射	快攻	突破	任意	七米	合计	%	助攻	失误	警告	2'	取消	时间
北京队(北京)																
(场上队员)																
1	王澍									0.0%						00:23:43
7	马昌震									0.0%		2				00:04:37
8	王鹏									0.0%			1			00:20:59
9	刘振	0/2	1/2						1/4	25.0%	1	1				00:30:58
10	成亚	1/3		0/1	1/1				2/5	40.0%	3	1				00:25:06
16	刘迈科									0.0%						00:36:17
21	胡瀛	1/1	0/2	1/1					2/4	50.0%		1				00:45:03
22	王超		0/1	2/2					2/3	66.7%	1	1				00:41:15
23	王军程	3/6	1/1		1/1				5/8	62.5%		1		1		00:33:41
25	马明辉									0.0%		1				00:04:27
29	杜龙飞			2/2					2/2	100%		3		1		00:35:29
39	张骥	0/2	4/4			1/1		5/5	10/12	83.3%						00:22:38
66	解建飞			3/4			0/1		3/5	60.0%			1	1		00:25:43
77	朱昕晨	0/2							0/2	0.0%		1		1		00:06:40
83	潘天									0.0%						00:07:18
99	蒋维一		1/1						1/1	100%		1	1	1		00:49:47
	合计	5/16	7/11	8/10	2/2	1/1	0/1	5/5	28/46	60.9%	5	13	3	5		
(守门员)																
1	王澍	1/1	2/5	4/7	0/2	0/1		0/1	7/17	41.2%						00:23:43
16	刘迈科	0/1	3/7	4/5	0/6	0/2		0/1	7/22	31.8%						00:36:17
	合计	1/2	5/12	8/12	0/8	0/3		0/2	14/39	35.9%						

场上队员：得分/射门

守门员：救球/射门

全队合计	得分	被救	射失	击柱	封球	合计	%
远射	5	5	3	3		16	31.3%
近射	7	3		1		11	63.6%
边射	8	2				10	80.0%
快攻	2					2	100.0%
突破	1					1	100.0%
任意		1				1	0.0%
七米	5					5	100.0%

第十三届全国运动会男子手球决赛

PHMS Pictorial Handball Match Statistics

IHF Official System

个人/全队技术统计表

 手球 四分之一决赛 组别 X 天津师范大学体育馆
 男子 轮次 4 场次 15 2017-08-25 17:30

号码	姓名	远射	近射	边射	快攻	突破	任意	七米	合计	%	助攻	失误	警告	2'	取消	时间
香港队(香港)																
(场上队员)																
1	叶冠英									0.0%		2				00:48:53
2	刘健斌		1/1		2/2	1/1			4/4	100%		1	1			00:25:21
3	陈梓朗		1/2	0/3	1/1				2/6	33.3%		2				00:37:37
5	黄胜业		0/1	2/6	2/2				4/9	44.4%						00:29:42
7	谭俊杰									0.0%	1					00:11:07
8	李伟东									0.0%						00:24:16
10	谢永辉	1/3		1/2	1/1				3/6	50.0%	1			1		00:17:41
12	许文邦	0/3		0/1				2/2	2/6	33.3%						00:16:56
13	张伟浩									0.0%						00:06:32
18	李鑫豪		1/1						1/1	100%						00:17:36
27	冼大维		0/1						0/1	0.0%						00:06:41
29	练明辉	0/1	0/3	1/2	1/1				2/7	28.6%		1				00:43:36
31	叶仕仁	0/3	2/3		1/1				3/7	42.9%	4	1				00:44:02
33	袁晞彦									0.0%		1	1			00:41:39
40	叶冠雄	0/1	2/3			2/2			4/6	66.7%		3				00:44:02
合计		1/11	7/15	4/14	8/8	3/3		2/2	25/53	47.2%	6	11	2	1		
(守门员)																
1	叶冠英	5/8	3/8	2/8	0/1		1/1	0/2	11/28	39.3%		2				00:48:53
7	谭俊杰	0/2	0/2	0/2	0/1	0/1		0/3	0/11	0.0%	1					00:11:07
合计		5/10	3/10	2/10	0/2	0/1	1/1	0/5	11/39	28.2%	1	2				

场上队员：得分/射门

守门员：救球/射门

全队合计	得分	被救	射失	击柱	封球	合计	%
远射	1	1	1	2	6	11	9.1%
近射	7	5	2	1		15	46.7%
边射	4	8		2		14	28.6%
快攻	8					8	100.0%
突破	3					3	100.0%
任意							0.0%
七米	2					2	100.0%

第十三届全国运动会男子手球决赛

PHMS Pictorial Handball Match Statistics

IHF Official System

图式比赛技术统计表

手球
男子

四分之一决赛
轮次 4

组别 X
场次 15

天津师范大学体育馆
2017-08-25 17:30

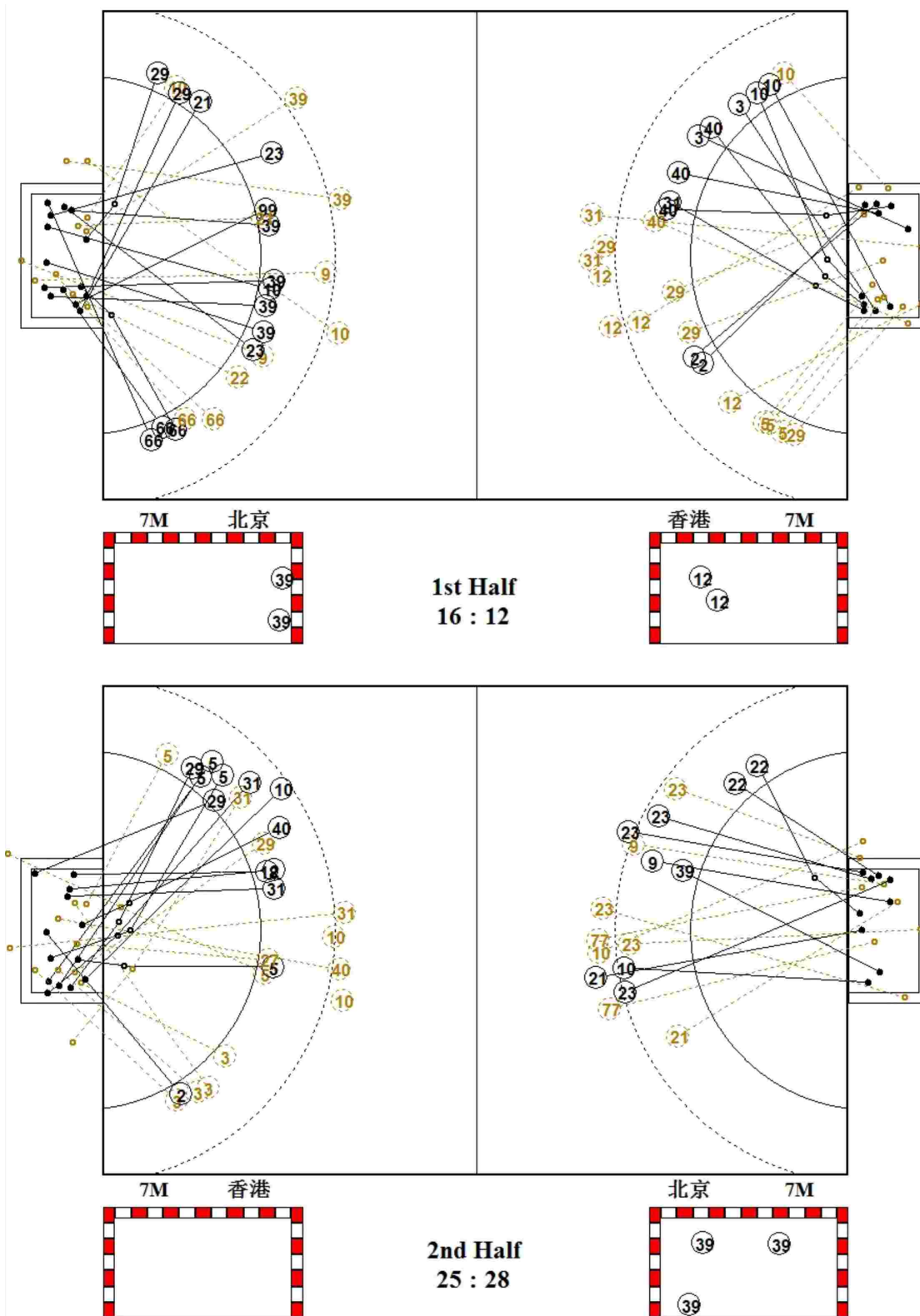

第十三届全国运动会男子手球决赛

PHMS Pictorial Handball Match Statistics

IHF Official System

图式射门区域统计

手球
男子

四分之一决赛
轮次 4

组别 X
场次 15

天津师范大学体育馆
2017-08-25 17:30

北京队

1 王洵	7 马昌震	8 王鹏	9 刘振	10 成亚	16 刘迈科	21 胡瀛	22 王超																																																																											
<table border="1"><tr><td></td><td></td><td></td></tr><tr><td></td><td></td><td></td></tr><tr><td></td><td></td><td></td></tr></table>										<table border="1"><tr><td></td><td></td><td></td></tr><tr><td></td><td></td><td></td></tr><tr><td></td><td></td><td></td></tr></table>										<table border="1"><tr><td></td><td></td><td></td></tr><tr><td></td><td></td><td></td></tr><tr><td></td><td></td><td></td></tr></table>										<table border="1"><tr><td></td><td></td><td></td></tr><tr><td>1</td><td></td><td></td></tr><tr><td></td><td></td><td></td></tr></table>				1						<table border="1"><tr><td></td><td></td><td>1</td></tr><tr><td></td><td></td><td></td></tr><tr><td></td><td></td><td>1</td></tr></table>			1						1	<table border="1"><tr><td></td><td></td><td></td></tr><tr><td></td><td></td><td></td></tr><tr><td></td><td></td><td></td></tr></table>										<table border="1"><tr><td></td><td></td><td></td></tr><tr><td>1</td><td>1</td><td></td></tr><tr><td></td><td></td><td></td></tr></table>				1	1					<table border="1"><tr><td></td><td></td><td></td></tr><tr><td>1</td><td></td><td></td></tr><tr><td></td><td></td><td></td></tr></table>				1								
1																																																																																		
		1																																																																																
		1																																																																																
1	1																																																																																	
1																																																																																		
Post - 0 Miss - 0 Block - 0	Post - 0 Miss - 0 Block - 0	Post - 0 Miss - 0 Block - 0	Post - 1 Miss - 0 Block - 0	Post - 0 Miss - 2 Block - 0	Post - 0 Miss - 0 Block - 0	Post - 0 Miss - 0 Block - 0	Post - 0 Miss - 0 Block - 0																																																																											
23 王军程	25 马明辉	29 杜龙飞	39 张骥	66 解建飞	77 朱昕晨	83 潘天	99 蒋维一																																																																											
<table border="1"><tr><td></td><td></td><td>1</td></tr><tr><td>2</td><td></td><td>1</td></tr><tr><td>1</td><td></td><td></td></tr></table>			1	2		1	1			<table border="1"><tr><td></td><td></td><td></td></tr><tr><td></td><td></td><td></td></tr><tr><td></td><td></td><td></td></tr></table>										<table border="1"><tr><td></td><td></td><td></td></tr><tr><td></td><td></td><td></td></tr><tr><td>1</td><td>1</td><td></td></tr></table>							1	1		<table border="1"><tr><td></td><td></td><td></td></tr><tr><td>3</td><td>2</td><td>1</td></tr><tr><td></td><td></td><td>2</td></tr><tr><td>1</td><td></td><td>1</td></tr></table>				3	2	1			2	1		1	<table border="1"><tr><td></td><td></td><td>1</td></tr><tr><td>1</td><td></td><td></td></tr><tr><td>1</td><td></td><td></td></tr></table>			1	1			1			<table border="1"><tr><td></td><td></td><td></td></tr><tr><td></td><td></td><td></td></tr><tr><td></td><td></td><td></td></tr></table>										<table border="1"><tr><td></td><td></td><td></td></tr><tr><td></td><td></td><td></td></tr><tr><td></td><td></td><td></td></tr></table>										<table border="1"><tr><td></td><td></td><td></td></tr><tr><td>1</td><td></td><td></td></tr><tr><td></td><td></td><td></td></tr></table>				1					
		1																																																																																
2		1																																																																																
1																																																																																		
1	1																																																																																	
3	2	1																																																																																
		2																																																																																
1		1																																																																																
		1																																																																																
1																																																																																		
1																																																																																		
1																																																																																		
Post - 3 Miss - 0 Block - 0	Post - 0 Miss - 0 Block - 0	Post - 0 Miss - 0 Block - 0	Post - 0 Miss - 1 Block - 0	Post - 0 Miss - 0 Block - 0	Post - 0 Miss - 0 Block - 0	Post - 0 Miss - 0 Block - 0	Post - 0 Miss - 0 Block - 0																																																																											

1 □□

0/3		1/2
0/4	2/2	3/5
1/1		

16 □□□

1/3	0/1	
2/5	1/1	1/4
1/3	0/1	1/4

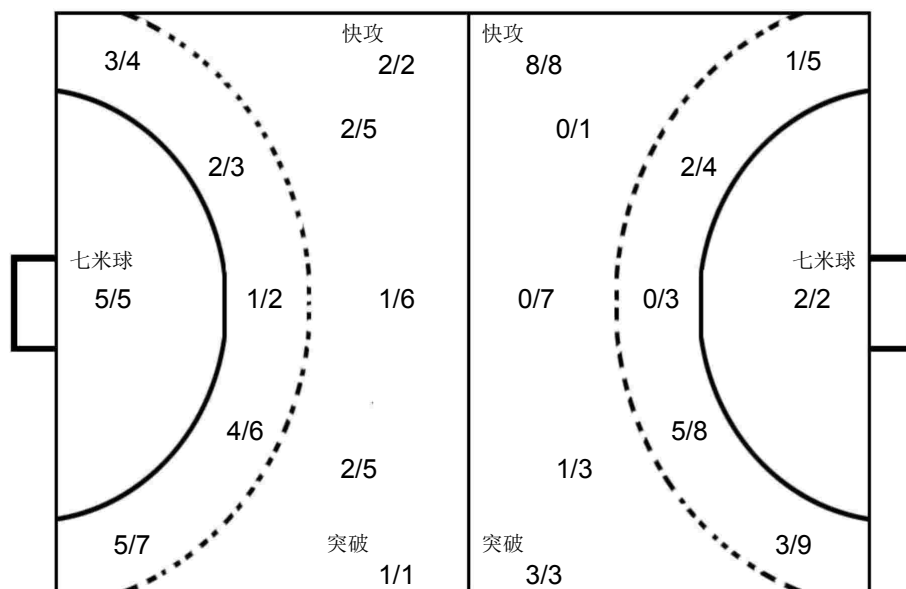

1 □□□

2/4	1/2	0/3
2/4	1/1	1/3
2/6	0/2	2/3

7 □□□

0/1	0/1	0/1
0/4		0/1
0/1	0/1	0/1

香港队

1 叶冠英	2 刘健斌	3 陈祥朗	5 黄胜业	7 谭俊杰	8 李伟东	10 谢永辉	12 许文邦																																																																								
<table border="1"><tr><td></td><td></td><td></td></tr><tr><td></td><td></td><td></td></tr><tr><td></td><td></td><td></td></tr></table>										<table border="1"><tr><td></td><td>1</td><td></td></tr><tr><td>1</td><td></td><td>1</td></tr><tr><td>1</td><td></td><td></td></tr></table>		1		1		1	1			<table border="1"><tr><td>1</td><td></td><td></td></tr><tr><td></td><td></td><td>1</td></tr><tr><td></td><td></td><td></td></tr></table>	1					1				<table border="1"><tr><td>2</td><td></td><td></td></tr><tr><td>2</td><td></td><td></td></tr><tr><td></td><td></td><td></td></tr></table>	2			2						<table border="1"><tr><td></td><td></td><td></td></tr><tr><td></td><td></td><td></td></tr><tr><td></td><td></td><td></td></tr></table>										<table border="1"><tr><td></td><td></td><td></td></tr><tr><td></td><td></td><td></td></tr><tr><td></td><td></td><td></td></tr></table>										<table border="1"><tr><td></td><td></td><td></td></tr><tr><td></td><td></td><td>1</td></tr><tr><td>1</td><td></td><td>1</td></tr></table>						1	1		1	<table border="1"><tr><td></td><td></td><td></td></tr><tr><td>1</td><td></td><td></td></tr><tr><td></td><td></td><td></td></tr></table>				1					
	1																																																																														
1		1																																																																													
1																																																																															
1																																																																															
		1																																																																													
2																																																																															
2																																																																															
		1																																																																													
1		1																																																																													
1																																																																															
Post - 0 Miss - 0 Block - 0	Post - 0 Miss - 0 Block - 0	Post - 0 Miss - 0 Block - 0	Post - 0 Miss - 1 Block - 0	Post - 0 Miss - 0 Block - 0	Post - 0 Miss - 0 Block - 0	Post - 1 Miss - 0 Block - 2	Post - 2 Miss - 0 Block - 2																																																																								
13 张伟浩	18 李鑫豪	27 冼大维	29 练明辉	31 叶仕仁	33 袁晔彦	40 叶冠雄																																																																									
<table border="1"><tr><td></td><td></td><td></td></tr><tr><td></td><td></td><td></td></tr><tr><td></td><td></td><td></td></tr></table>										<table border="1"><tr><td></td><td></td><td></td></tr><tr><td></td><td></td><td>1</td></tr><tr><td></td><td></td><td></td></tr></table>						1				<table border="1"><tr><td></td><td></td><td></td></tr><tr><td></td><td></td><td></td></tr><tr><td></td><td></td><td></td></tr></table>										<table border="1"><tr><td></td><td></td><td>1</td></tr><tr><td>1</td><td></td><td></td></tr><tr><td></td><td></td><td></td></tr></table>			1	1						<table border="1"><tr><td></td><td></td><td>1</td></tr><tr><td></td><td></td><td>1</td></tr><tr><td></td><td></td><td>1</td></tr></table>			1			1			1	<table border="1"><tr><td></td><td></td><td></td></tr><tr><td></td><td></td><td></td></tr><tr><td></td><td></td><td></td></tr></table>										<table border="1"><tr><td></td><td></td><td></td></tr><tr><td>2</td><td></td><td></td></tr><tr><td></td><td>1</td><td>1</td></tr></table>				2				1	1										
		1																																																																													
		1																																																																													
1																																																																															
		1																																																																													
		1																																																																													
		1																																																																													
2																																																																															
	1	1																																																																													
Post - 0 Miss - 0 Block - 0	Post - 0 Miss - 0 Block - 0	Post - 0 Miss - 0 Block - 0	Post - 0 Miss - 0 Block - 1	Post - 1 Miss - 2 Block - 1	Post - 0 Miss - 0 Block - 0	Post - 1 Miss - 0 Block - 0																																																																									

Team A					Team B					Match Number											
A 江苏队					B 天津队					16											
Played in			in the hall			on			at			Spectators									
天津			天津师范大学体育馆			2017-08-25			19:15			hours									
Half-time(30')	A	B	End of playing time		A	B	1st extra time		A	B	2nd extra time		A	B	After penalty throws		A	B			
	18	8			35	21															
Number of 7 m	A	Team time-out			Full name of players and officials						Team time-out			B	Number of 7 m						
	2/2	1	2	3							1	2	3	2/3							
		18:27	48:03								26:02										
No.	Team A					G	W	2'	D	DR	No.	Team B					G	W	2'	D	DR
1	徐畅										1	刘宗其									
4	张家纬					2	1				2	李岳朋									
5	闫亮					2					4	李松浩									
6	赵晨					1	1				6	王子欣							1		
7	徐奕飞					2		1			7	张青					9	1			
8	周小坚						1				8	曹悦					3	1			
9	王杰缘					4					9	吴明远					1		1		
10	郝可鑫					2					10	李帅									
12	王权										11	王毅									
13	叶强										12	杨峻									
15	李安					6					13	许松					3				
17	王伟强					2					16	刘海亮									
18	赵楠					3		1			17	周群					1				
19	张志宇					5					18	王晓琪									
20	顾艳超					3					22	魏雨童						1			
21	刘江					3					31	田剑侠					4		1		
A	闫威名 (主教练)										A	贾守信									
C	雷纳德										B	杜瑞军 (主教练)									
D	贾淑君										C	孟凡钢									
E	王建国										E	崔嘉禄									
A	Signatures of responsables for the teams (Off.A)										B										
TP	Remarks of referees / HF Official										TP										

Signatures

Referees BALAZS. MARTON (HUN)

PETER. HORVATH (HUN)

T.D. 刘书勇 (CHN)

李刚 (CHN)

CHA Off.

Note: Number of 7m Throws Awarded to Team A and B, Goals (G), Warnings (W), Suspensions (2'), Direct Disqualification (D), Disqualification With Report (DR) and Team Penalty (TP).

Table Officials: 隆晓磊

刘宇阳

Statisticians: 黄岩

刘永欢

第十三届全国运动会男子手球决赛

PHMS Pictorial Handball Match Statistics

IHF Official System

竞赛技术统计

 手球
男子

 四分之一决赛
轮次 4

 组别 X
场次 16

 天津师范大学体育馆
2017-08-25 19:15

Referees: BALAZS. MARTON (HUN) / PETER. HORVATH (HUN)

Result: 35:21 (18:8)

Teams: 江苏队(江苏) VS 天津队(天津)

江苏		远射	近射	边射	快攻	突破	任意球	7m球	合计	%	助攻	失误	警告	2'	D+DR	江苏	比赛进程	天津
主教练: 闫威名																	1st Half	
1	徐畅															15	1 00:52	0
4	张家纬	2/2							2/2	100		1	1			4	2 02:25	0
5	闫亮		2/3						2/3	66.7							2 03:03	1 8 曹悦
6	赵晨				1/1				1/1	100	1		1				3 03:20	1
7	徐奕飞		1/1	1/1					2/2	100				1			3 04:13	2 7 张青
8	周小坚										1	1	1				4 04:37	2
9	王杰缘		4/4						4/4	100		1					5 05:45	2
10	郝可鑫	2/3							2/3	66.7	1						6 07:00	2
12	王权										1						6 07:37	3 7 张青
13	叶强										1						7 07:52	3
15	李安	1/1	1/1	0/1	2/3	1/1		1/1	6/8	75.0		1					8 08:52	3
17	王伟强	1/1			1/1				2/2	100		2					9 10:14	3
18	赵楠	0/1	2/2		1/1				3/4	75.0				1			9 11:09	4 17 周群
19	张志宇	2/4	1/1		1/1	1/1			5/7	71.4	1						10 14:20	4
20	顾艳超	1/2	0/1		1/1			1/1	3/5	60.0		3					10 15:43	5 13 许松
21	刘江		2/2	1/2					3/4	75.0							11 16:07	5
运动员 合计		9/14	13/15	2/4	7/8	2/2		2/2	35/45	77.8	6	10	3	2			12 16:53	5
1	徐畅	0/2							0/2	0.0							13 18:35	5
12	王权	6/7	1/3	1/2	0/1			1/2	9/15	60.0	1						14 19:55	5
13	叶强	2/5	0/5	1/1	0/4			0/1	3/16	18.8	1						14 22:15	6 7 张青
守门员 合计		8/14	1/8	2/3	0/5			1/3	12/33	36.4	2						15 23:23	6
天津																	16 25:58	6
主教练: 杜瑞军																	17 27:53	6
1	刘宗其																17 28:11	7 7 张青
2	李岳朋																18 28:50	7
4	李松浩																18 29:54	8 31 田剑侠
6	王子欣			0/1					0/1	0.0				1			19 00:31	8
7	张青	2/5	1/1	1/1	3/3			2/2	9/12	75.0		1	1				19 02:12	8
8	曹悦	2/11	1/1					0/1	3/13	23.1	1	3	1				20 02:12	8
9	吴明远		1/1						1/1	100							21 02:51	8
10	李帅																22 04:02	8
11	王毅	0/3	0/1						0/4	0.0							23 05:35	8
12	杨峻																24 07:41	8
13	许松	0/2	1/1	0/1	2/2				3/6	50.0	1	4					25 08:20	8
16	刘海亮																25 10:10	9 8 曹悦
17	周群		1/2						1/2	50.0							26 10:35	9
18	王晓琪											1					27 11:42	9
22	魏雨童											2	1				27 12:24	10 7 张青
31	田剑侠	2/5	2/2						4/7	57.1		3		1			27 13:04	11 7 张青
运动员 合计		6/26	7/9	1/3	5/5			2/3	21/46	45.7	2	14	3	3			28 13:55	11
1	刘宗其	1/4	0/7	1/1	1/4	0/2		0/2	3/20	15.0							28 15:10	12 7 张青
12	杨峻	2/8	1/7	1/3	0/4				4/22	18.2							29 15:42	12
守门员 合计		3/12	1/14	2/4	1/8	0/2		0/2	7/42	16.7							29 16:23	13 7 张青
																	30 17:00	13
																	30 17:54	14 13 许松
																	31 18:32	14
																	32 19:41	14
																	32 21:27	15 31 田剑侠
																	32 22:01	16 8 曹悦
																	32 22:45	17 13 许松
																	33 23:15	17
																	33 23:58	18 31 田剑侠
																	33 26:54	19 7 张青
																	34 27:39	19
																	34 28:24	20 31 田剑侠
																	35 29:01	20
																	35 29:35	21 9 吴明远

场上队员: 得分 / 射门

守门员: 救球 / 射门

D	取消资格	DR	取消资格+报告
---	------	----	---------

第十三届全国运动会男子手球决赛

PHMS Pictorial Handball Match Statistics

IHF Official System

个人/全队技术统计表

 手球 四分之一决赛 组别 X 天津师范大学体育馆
 男子 轮次 4 场次 16 2017-08-25 19:15

号码	姓名	远射	近射	边射	快攻	突破	任意	七米	合计	%	助攻	失误	警告	2'	取消	时间
江苏队(江苏)																
(场上队员)																
1	徐畅									0.0%						00:13:16
4	张家纬	2/2							2/2	100%		1	1			00:17:04
5	闫亮		2/3						2/3	66.7%						00:15:47
6	赵晨				1/1				1/1	100%	1		1			00:27:11
7	徐奕飞		1/1	1/1					2/2	100%				1		00:29:46
8	周小坚									0.0%	1	1	1			00:24:45
9	王杰缘		4/4						4/4	100%		1				00:29:57
10	郝可鑫	2/3							2/3	66.7%	1					00:25:31
12	王权									0.0%	1					00:26:39
13	叶强									0.0%	1					00:20:05
15	李安	1/1	1/1	0/1	2/3	1/1		1/1	6/8	75.0%		1				00:27:25
17	王伟强	1/1			1/1				2/2	100%		2				00:32:48
18	赵楠	0/1	2/2		1/1				3/4	75.0%				1		00:30:01
19	张志宇	2/4	1/1		1/1	1/1			5/7	71.4%	1					00:32:01
20	顾艳超	1/2	0/1		1/1			1/1	3/5	60.0%		3				00:28:56
21	刘江		2/2	1/2					3/4	75.0%		1				00:38:05
合计		9/14	13/15	2/4	7/8	2/2		2/2	35/45	77.8%	6	10	3	2		

(守门员)

1	徐畅	0/2							0/2	0.0%						00:13:16
12	王权	6/7	1/3	1/2	0/1			1/2	9/15	60.0%	1					00:26:39
13	叶强	2/5	0/5	1/1	0/4			0/1	3/16	18.8%	1					00:20:05
合计		8/14	1/8	2/3	0/5			1/3	12/33	36.4%	2					

场上队员：得分/射门

守门员：救球/射门

全队合计	得分	被救	射失	击柱	封球	合计	%
远射	9	3	1		1	14	64.3%
近射	13	1		1		15	86.7%
边射	2	2				4	50.0%
快攻	7	1				8	87.5%
突破	2					2	100.0%
任意							0.0%
七米	2					2	100.0%

第十三届全国运动会男子手球决赛

PHMS Pictorial Handball Match Statistics

IHF Official System

个人/全队技术统计表

 手球 四分之一决赛 组别 X 天津师范大学体育馆
 男子 轮次 4 场次 16 2017-08-25 19:15

号码	姓名	远射	近射	边射	快攻	突破	任意	七米	合计	%	助攻	失误	警告	2'	取消	时间
天津队(天津)																
(场上队员)																
1	刘宗其									0.0%						00:29:29
2	李岳朋									0.0%						00:03:59
4	李松浩									0.0%						00:00:00
6	王子欣			0/1				0/1	0/1	0.0%				1		00:30:00
7	张青	2/5	1/1	1/1	3/3			2/2	9/12	75.0%		1	1			00:56:53
8	曹悦	2/11	1/1					0/1	3/13	23.1%	1	3	1			00:51:04
9	吴明远		1/1						1/1	100%				1		00:30:00
10	李帅									0.0%						00:00:00
11	王毅	0/3	0/1						0/4	0.0%						00:17:21
12	杨峻									0.0%						00:30:31
13	许松	0/2	1/1	0/1	2/2				3/6	50.0%	1	4				00:51:51
16	刘海亮									0.0%						00:00:00
17	周群		1/2						1/2	50.0%						00:18:27
18	王晓琪									0.0%		1				00:11:13
22	魏雨童									0.0%		2	1			00:41:33
31	田剑侠	2/5	2/2						4/7	57.1%		3		1		00:47:29
	合计	6/26	7/9	1/3	5/5			2/3	21/46	45.7%	2	14	3	3		
(守门员)																
1	刘宗其	1/4	0/7	1/1	1/4	0/2		0/2	3/20	15.0%						00:29:29
12	杨峻	2/8	1/7	1/3	0/4				4/22	18.2%						00:30:31
	合计	3/12	1/14	2/4	1/8	0/2		0/2	7/42	16.7%						

场上队员：得分/射门

守门员：救球/射门

全队合计	得分	被救	射失	击柱	封球	合计	%
远射	6	8	4	5	3	26	23.1%
近射	7	1	1			9	77.8%
边射	1	2				3	33.3%
快攻	5					5	100.0%
突破							0.0%
任意							0.0%
七米	2	1				3	66.7%

第十三届全国运动会男子手球决赛

PHMS Pictorial Handball Match Statistics

IHF Official System

图式比赛技术统计表

手球
男子

四分之一决赛
轮次 4

组别 X
场次 16

天津师范大学体育馆
2017-08-25 19:15

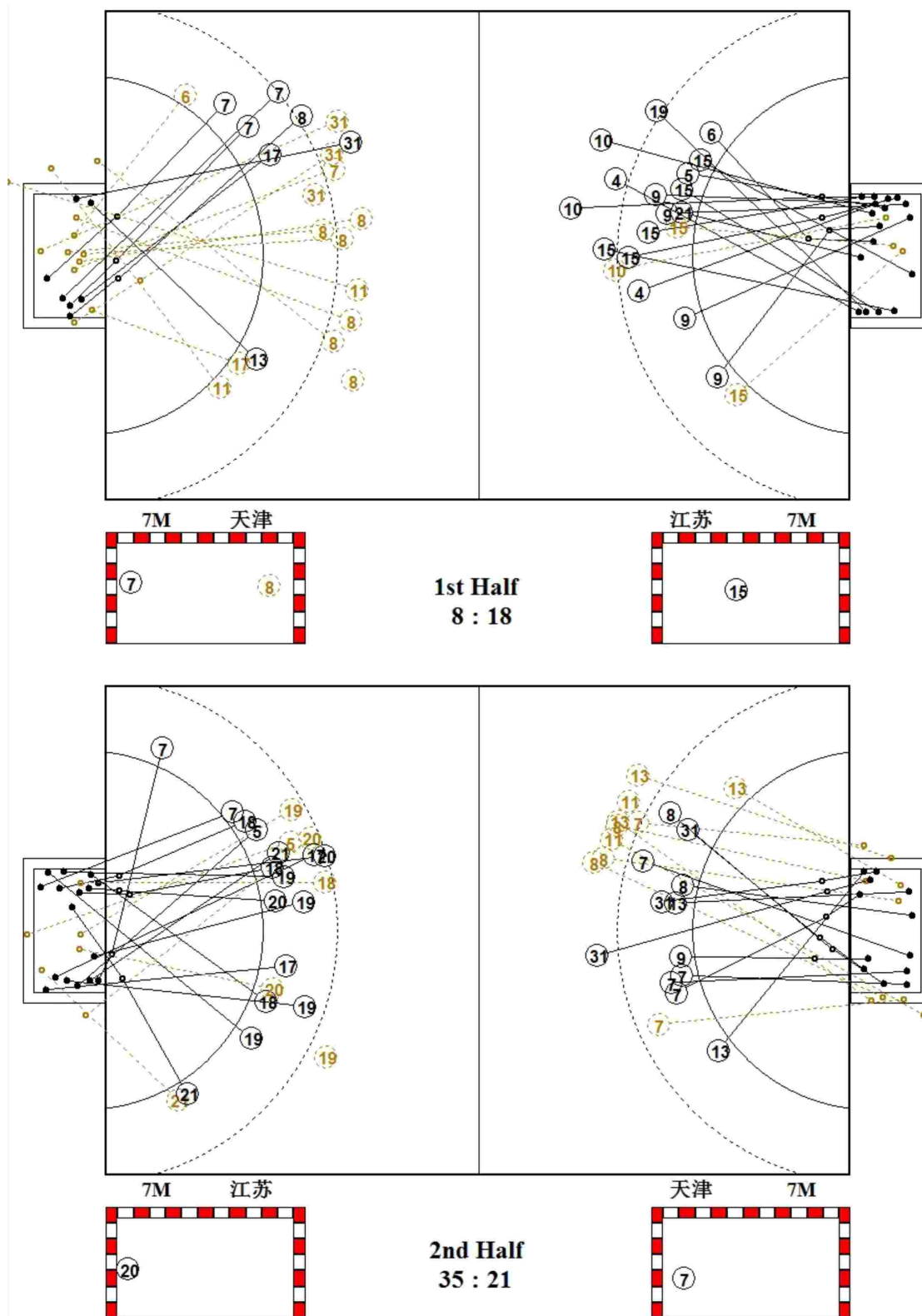

第十三届全国运动会男子手球决赛

PHMS Pictorial Handball Match Statistics

IHF Official System

图式射门区域统计

手球
男子

四分之一决赛
轮次 4

组别 X
场次 16

天津师范大学体育馆
2017-08-25 19:15

江苏队

1 徐畅	4 张家纬	5 闫亮	6 赵晨	7 徐奕飞	8 周小坚	9 王杰缘	10 郝可鑫																																																																								
<table border="1"><tr><td></td><td></td><td></td></tr><tr><td></td><td></td><td></td></tr><tr><td></td><td></td><td></td></tr></table>										<table border="1"><tr><td></td><td></td><td></td></tr><tr><td>1</td><td></td><td></td></tr><tr><td></td><td></td><td>1</td></tr></table>				1					1	<table border="1"><tr><td></td><td></td><td></td></tr><tr><td></td><td></td><td></td></tr><tr><td>2</td><td></td><td></td></tr></table>							2			<table border="1"><tr><td></td><td></td><td></td></tr><tr><td></td><td></td><td></td></tr><tr><td></td><td>1</td><td></td></tr></table>								1		<table border="1"><tr><td></td><td></td><td>1</td></tr><tr><td></td><td></td><td></td></tr><tr><td>1</td><td></td><td></td></tr></table>			1				1			<table border="1"><tr><td></td><td></td><td></td></tr><tr><td></td><td></td><td></td></tr><tr><td></td><td></td><td></td></tr></table>										<table border="1"><tr><td></td><td></td><td></td></tr><tr><td>2</td><td></td><td></td></tr><tr><td>2</td><td></td><td></td></tr></table>				2			2			<table border="1"><tr><td></td><td></td><td></td></tr><tr><td></td><td></td><td></td></tr><tr><td>1</td><td></td><td></td></tr></table>							1		
1																																																																															
		1																																																																													
2																																																																															
	1																																																																														
		1																																																																													
1																																																																															
2																																																																															
2																																																																															
1																																																																															
Post - 0 Miss - 0 Block - 0	Post - 0 Miss - 0 Block - 0	Post - 1 Miss - 0 Block - 0	Post - 0 Miss - 0 Block - 0	Post - 0 Miss - 0 Block - 0	Post - 0 Miss - 0 Block - 0	Post - 0 Miss - 0 Block - 0	Post - 0 Miss - 0 Block - 0																																																																								
12 王权	13 叶强	15 李安	17 王伟强	18 赵楠	19 张志宇	20 顾艳超	21 刘江																																																																								
<table border="1"><tr><td></td><td></td><td></td></tr><tr><td></td><td></td><td></td></tr><tr><td></td><td></td><td></td></tr></table>										<table border="1"><tr><td></td><td></td><td></td></tr><tr><td></td><td></td><td></td></tr><tr><td></td><td></td><td></td></tr></table>										<table border="1"><tr><td>1</td><td>1</td><td></td></tr><tr><td></td><td>1</td><td>2</td></tr><tr><td>1</td><td></td><td></td></tr></table>	1	1			1	2	1			<table border="1"><tr><td></td><td></td><td></td></tr><tr><td></td><td></td><td></td></tr><tr><td>2</td><td></td><td></td></tr></table>							2			<table border="1"><tr><td></td><td></td><td></td></tr><tr><td></td><td></td><td></td></tr><tr><td></td><td>2</td><td></td></tr></table>								2		<table border="1"><tr><td></td><td></td><td>1</td></tr><tr><td>1</td><td></td><td>1</td></tr><tr><td>1</td><td></td><td>1</td></tr></table>			1	1		1	1		1	<table border="1"><tr><td></td><td></td><td></td></tr><tr><td></td><td></td><td></td></tr><tr><td>1</td><td></td><td></td></tr></table>							1			<table border="1"><tr><td></td><td></td><td></td></tr><tr><td></td><td></td><td></td></tr><tr><td></td><td></td><td>1</td></tr></table>									1
1	1																																																																														
	1	2																																																																													
1																																																																															
2																																																																															
	2																																																																														
		1																																																																													
1		1																																																																													
1		1																																																																													
1																																																																															
		1																																																																													
Post - 0 Miss - 0 Block - 0	Post - 0 Miss - 0 Block - 0	Post - 0 Miss - 0 Block - 0	Post - 0 Miss - 0 Block - 0	Post - 0 Miss - 0 Block - 0	Post - 0 Miss - 0 Block - 1	Post - 0 Miss - 1 Block - 0	Post - 0 Miss - 0 Block - 0																																																																								

1 □□

0/1		0/1

12 □□

0/2	1/1	
0/3	4/4	2/2
1/1	1/1	0/1

13 □□

2/3	0/1	0/3
0/2		0/1
1/4		0/2

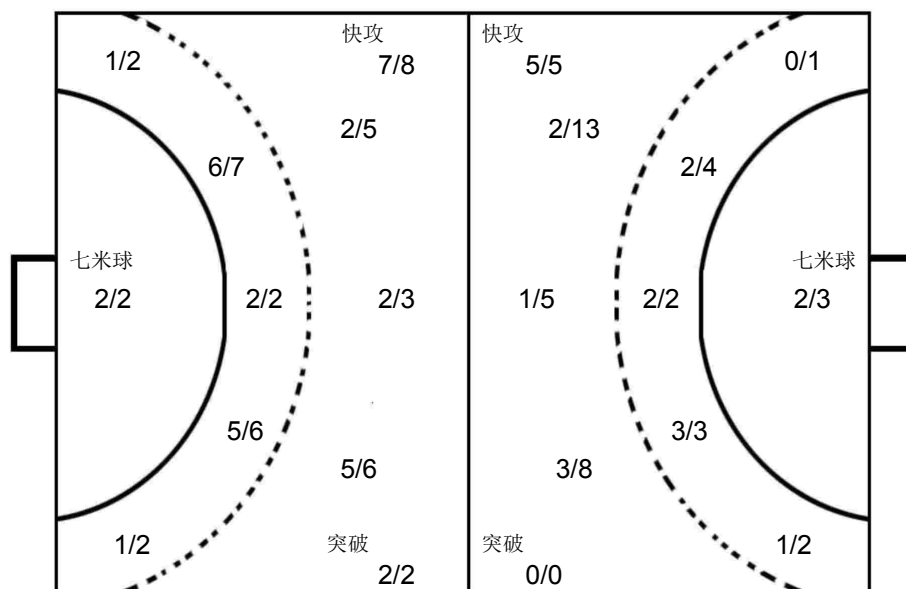

1 □□□

0/4	1/1	0/1
1/6	1/3	0/1
0/1	0/1	0/2

12 □□

1/2	0/1	0/1
0/3	2/2	1/6
0/4		0/3

天津队

1 刘宗其	2 李岳朋	4 李松浩	6 王子欣	7 张青	8 曹悦	9 吴明远	10 李帅																																																																								
<table border="1"><tr><td></td><td></td><td></td></tr><tr><td></td><td></td><td></td></tr><tr><td></td><td></td><td></td></tr></table>										<table border="1"><tr><td></td><td></td><td></td></tr><tr><td></td><td></td><td></td></tr><tr><td></td><td></td><td></td></tr></table>										<table border="1"><tr><td></td><td></td><td></td></tr><tr><td></td><td></td><td></td></tr><tr><td></td><td></td><td></td></tr></table>										<table border="1"><tr><td></td><td></td><td></td></tr><tr><td></td><td></td><td></td></tr><tr><td></td><td></td><td></td></tr></table>										<table border="1"><tr><td></td><td></td><td></td></tr><tr><td>2</td><td></td><td>3</td></tr><tr><td>3</td><td></td><td></td></tr></table>				2		3	3			<table border="1"><tr><td></td><td></td><td></td></tr><tr><td>1</td><td>1</td><td></td></tr><tr><td></td><td></td><td>1</td></tr></table>				1	1				1	<table border="1"><tr><td></td><td></td><td></td></tr><tr><td></td><td></td><td></td></tr><tr><td></td><td></td><td>1</td></tr></table>									1	<table border="1"><tr><td></td><td></td><td></td></tr><tr><td></td><td></td><td></td></tr><tr><td></td><td></td><td></td></tr></table>									
2		3																																																																													
3																																																																															
1	1																																																																														
		1																																																																													
		1																																																																													
Post - 0 Miss - 0 Block - 0	Post - 0 Miss - 0 Block - 0	Post - 0 Miss - 0 Block - 0	Post - 0 Miss - 0 Block - 0	Post - 1 Miss - 1 Block - 0	Post - 1 Miss - 1 Block - 1	Post - 0 Miss - 0 Block - 0	Post - 0 Miss - 0 Block - 0																																																																								
11 王毅	12 杨峻	13 许松	16 刘海亮	17 周群	18 王晓琪	22 魏雨童	31 田剑侠																																																																								
<table border="1"><tr><td></td><td></td><td></td></tr><tr><td></td><td></td><td></td></tr><tr><td></td><td></td><td></td></tr></table>										<table border="1"><tr><td></td><td></td><td></td></tr><tr><td></td><td></td><td></td></tr><tr><td></td><td></td><td></td></tr></table>										<table border="1"><tr><td></td><td></td><td></td></tr><tr><td>1</td><td></td><td></td></tr><tr><td></td><td></td><td></td></tr></table>				1						<table border="1"><tr><td></td><td></td><td></td></tr><tr><td></td><td></td><td></td></tr><tr><td></td><td></td><td></td></tr></table>										<table border="1"><tr><td></td><td></td><td></td></tr><tr><td>1</td><td></td><td></td></tr><tr><td></td><td></td><td></td></tr></table>				1						<table border="1"><tr><td></td><td></td><td></td></tr><tr><td></td><td></td><td></td></tr><tr><td></td><td></td><td></td></tr></table>										<table border="1"><tr><td></td><td></td><td></td></tr><tr><td></td><td></td><td></td></tr><tr><td></td><td></td><td></td></tr></table>										<table border="1"><tr><td></td><td></td><td></td></tr><tr><td></td><td></td><td></td></tr><tr><td>1</td><td></td><td>1</td></tr></table>							1		1
1																																																																															
1																																																																															
1		1																																																																													
Post - 0 Miss - 3 Block - 1	Post - 0 Miss - 0 Block - 0	Post - 2 Miss - 0 Block - 0	Post - 0 Miss - 0 Block - 0	Post - 0 Miss - 0 Block - 0	Post - 0 Miss - 0 Block - 0	Post - 0 Miss - 0 Block - 0	Post - 1 Miss - 0 Block - 1																																																																								

PHMS Pictorial Handball Match Statistics

IHF Official System

Team A					Team B					Match Number											
A 安徽队					B 上海队					17											
Played in			in the hall			on			at			Spectators									
天津			天津师范大学体育馆			2017-08-26			14:00			hours									
Half-time(30')	A	B	End of playing time		A	B	1st extra time		A	B	2nd extra time		A	B	After penalty throws		A	B			
	10	12	21		25																
Number of 7 m	A	Team time-out			Full name of players and officials						Team time-out			B	Number of 7 m						
	0/1	1	2	3							1	2	3	B							
		12:01	44:56								22:36	38:34	54:04	3/6							
No.	Team A					G	W	2'	D	DR	No.	Team B					G	W	2'	D	DR
1	郭世伟										1	张峥									
3	陈强龙					1					3	赵时俊									
5	史小帆					2					4	徐俊吉					4	1			
7	姚雄敏										6	朱世杰					1				
8	董智景					6	1	1			7	周文龙									
9	陈开勇					6		1			8	钱为玮					7				
10	严龙										9	董凯									
11	黎涛										10	吴璟					2				
12	曾献辰										11	蒋承骅						1	1		
15	曹青福临										12	周哲韬									
16	杨洋										14	沈吉磊									
17	王巨柱					2	1		1		16	朱春雷									
18	李双					3	1	1			17	贺政					2				
21	李明										18	马麟晓					9				
23	于敏清					1					19	祝君									
24	徐安格																				
B	沈强 (主教练)										A	郑益方									
C	吴翔										B	张勇军 (主教练)									
D	黄红										C	金迪琦									
E	吴台锡										D	杨时									
A	Signatures of responsables for the teams (Off.A)															B					
TP	Remarks of referees / HF Official															TP					

Signatures

Referees 程钰峰 (CHN)

周云磊 (CHN)

T.D. 门东山 (CHN)

刘书勇 (CHN)

CHA Off.

Note: Number of 7m Throws Awarded to Team A and B, Goals (G), Warnings (W), Suspensions (2'), Direct Disqualification (D), Disqualification With Report (DR) and Team Penalty (TP).

Table Officials: 隆晓磊

李志成

Statisticians: 黄岩

刘永欢

第十三届全国运动会男子手球决赛
PHMS Pictorial Handball Match Statistics

IHF Official System

竞赛技术统计

 手球
男子

 5-8名
轮次 5

 组别 X
场次 17

 天津师范大学体育馆
2017-08-26 14:00

Referees: 程钰峰 (CHN) / 周云磊 (CHN)

Result: 21:25(10:12)

Teams: 安徽队(安徽) VS 上海队(上海)

安徽		远射	近射	边射	快攻	突破	任意球	7m球	合计	%	助攻	失误	警告	2'	D+DR	安徽	比赛进程	上海
主教练: 沈强																	1st Half	
1	郭世伟	0/2	0/1						0/3	0.0						8	董智景	0 01:47 1 18 马麟晓
3	陈强龙					1/1			1/1	100	1						1 03:59 1	
5	史小帆					2/3			2/3	66.7	1	1				5	史小帆	1 04:35 2 18 马麟晓
7	姚雄敏															2 05:41 2		
8	董智景	0/1	0/1	3/6	2/2	1/1			6/11	54.5	1	1	1	1		2 07:06 3 4 徐俊吉	3 07:39 3	
9	陈开勇	0/1	6/6						6/7	85.7		2		1		3 08:52 4 6 朱世杰	3 12:01 6 8 钱为玮	
10	严龙															3 10:50 5 18 马麟晓		
11	黎涛			0/1				0/1	0/2	0.0						4 12:48 6	5 13:39 6	
12	曾献辰															5 14:40 7 4 徐俊吉	5 17:21 8 18 马麟晓	
15	曹青福临															5 18:49 9 8 钱为玮	5 20:19 10 18 马麟晓	
16	杨洋															6 22:28 10	6 23:56 10	
17	王巨柱	1/5	1/6	0/1					2/12	16.7	1	7	1		1	7 24:40 11 8 钱为玮	7 26:57 12 4 徐俊吉	
18	李双	1/2	1/1	1/1					3/4	75.0		6	1	1		8 董智景	8 27:21 12	
21	李明															9 陈开勇	9 29:02 12	
23	于敏清	1/1							1/1	100						8 董智景	10 29:48 12	
24	徐安格															2nd Half		
运动员 合计		3/12	8/15	4/9	2/2	4/5		0/1	21/44	47.7	4	17	3	3	1	10 00:20 13 8 钱为玮	10 02:15 14 4 徐俊吉	
12	曾献辰							1/2	1/2	50.0						10 02:53 15 8 钱为玮		
21	李明	2/9	4/12	4/6	1/4	1/3		1/3	13/37	35.1						9 陈开勇	11 03:07 15	
守门员 合计		2/9	4/12	4/6	1/4	1/3		2/5	14/39	35.9						11 04:07 16 17 贺政		
上海		远射	近射	边射	快攻	突破	任意球	7m球	合计	%	助攻	失误	警告	2'	D+DR	18 李双	12 04:48 16	
主教练: 张勇军																8 董智景	13 07:07 16	
1	张峥										1					17 王巨柱	14 07:56 16	
3	赵时俊			0/1				0/1	0/2	0.0	2	1				9 陈开勇	15 08:34 16	
4	徐俊吉		2/3					2/3	4/6	66.7		1	1			15 09:51 17 18 马麟晓	16 11:28 18	
6	朱世杰	0/3	0/3		0/1	1/2		1/9	1/9	11.1						16 14:45 20 18 马麟晓		
7	周文龙							0/1	0/1	0.0						17 16:22 20		
8	钱为玮		3/3	1/2	3/4			7/9	7/9	77.8	1	1				18 李双	18 17:45 20	
9	董凯															18 18:24 21 18 马麟晓		
10	吴璟		2/4					2/4	2/4	50.0						19 李双	19 18:40 21	
11	蒋承骅	0/2						0/2	0/2	0.0		2	1	1		19 19:28 22 17 贺政		
12	周哲韬															19 21:46 23 8 钱为玮		
14	沈吉磊															9 陈开勇	20 26:27 23	
16	朱春雷															20 27:59 24 10 吴璟		
17	贺政			1/3	0/1			1/1	2/5	40.0	1	1				9 陈开勇	21 28:45 24	
18	马麟晓	7/9	1/1			1/1		9/11	9/11	81.8	1	6				21 29:04 25 10 吴璟		
19	祝君																	
运动员 合计		7/14	8/14	2/6	3/6	2/3		3/6	25/49	51.0	6	12	2	1				
1	张峥	3/6	6/11	3/6	0/2	0/3		1/1	13/29	44.8	1							
12	周哲韬	2/2	1/4	1/2		1/2		5/10	5/10	50.0								
守门员 合计		5/8	7/15	4/8	0/2	1/5		1/1	18/39	46.2	1							

场上队员: 得分 / 射门

守门员: 救球 / 射门

D	取消资格	DR	取消资格+报告
---	------	----	---------

第十三届全国运动会男子手球决赛

PHMS Pictorial Handball Match Statistics

IHF Official System

个人/全队技术统计表

手球 男子 5-8名 轮次 5 组别 X 场次 17 天津师范大学体育馆 2017-08-26 14:00

号码	姓名	远射	近射	边射	快攻	突破	任意	七米	合计	%	助攻	失误	警告	2'	取消	时间
安徽队(安徽)																
(场上队员)																
1	郭世伟	0/2	0/1						0/3	0.0%						00:26:07
3	陈强龙					1/1			1/1	100%	1					00:33:17
5	史小帆					2/3			2/3	66.7%	1	1				00:26:38
7	姚雄敏									0.0%						00:00:00
8	董智景	0/1	0/1	3/6	2/2	1/1			6/11	54.5%	1	1	1	1		00:50:46
9	陈开勇	0/1	6/6						6/7	85.7%		2		1		00:38:32
10	严龙									0.0%						00:04:29
11	黎涛			0/1				0/1	0/2	0.0%						00:33:41
12	曾献辰									0.0%						00:00:34
15	曹青福临									0.0%						00:00:00
16	杨洋									0.0%						00:00:00
17	王巨柱	1/5	1/6	0/1					2/12	16.7%	1	7	1		1	00:44:22
18	李双	1/2	1/1	1/1					3/4	75.0%		6	1	1		00:56:23
21	李明									0.0%						00:59:26
23	于敏清	1/1							1/1	100%						00:45:20
24	徐安格									0.0%						00:00:00
合计		3/12	8/15	4/9	2/2	4/5		0/1	21/44	47.7%	4	17	3	3	1	
(守门员)																
12	曾献辰							1/2	1/2	50.0%						00:00:34
21	李明	2/9	4/12	4/6	1/4	1/3		1/3	13/37	35.1%						00:59:26
合计		2/9	4/12	4/6	1/4	1/3		2/5	14/39	35.9%						

场上队员：得分/射门

守门员：救球/射门

全队合计	得分	被救	射失	击柱	封球	合计	%
远射	3	5	1		3	12	25.0%
近射	8	7				15	53.3%
边射	4	4		1		9	44.4%
快攻	2					2	100.0%
突破	4	1				5	80.0%
任意							0.0%
七米		1				1	0.0%

第十三届全国运动会男子手球决赛

PHMS Pictorial Handball Match Statistics

IHF Official System

个人/全队技术统计表

 手球 男子 5-8名 轮次 5 组别 X 场次 17 天津师范大学体育馆
 2017-08-26 14:00

号码	姓名	远射	近射	边射	快攻	突破	任意	七米	合计	%	助攻	失误	警告	2'	取消	时间
上海队(上海)																
(场上队员)																
1	张崢									0.0%	1					00:50:29
3	赵时俊			0/1				0/1	0/2	0.0%	2	1				00:39:02
4	徐俊吉		2/3					2/3	4/6	66.7%		1	1			00:50:35
6	朱世杰	0/3	0/3		0/1	1/2			1/9	11.1%						01:00:00
7	周文龙							0/1	0/1	0.0%						00:00:25
8	钱为玮		3/3	1/2	3/4				7/9	77.8%	1	1				00:58:59
9	董凯									0.0%						00:00:00
10	吴璟		2/4						2/4	50.0%						00:10:05
11	蒋承骅	0/2							0/2	0.0%		2	1	1		00:35:56
12	周哲韬									0.0%						00:09:31
14	沈吉磊									0.0%						00:00:00
16	朱春雷									0.0%						00:00:00
17	贺政			1/3	0/1			1/1	2/5	40.0%	1	1				00:48:36
18	马麟晓	7/9	1/1			1/1			9/11	81.8%	1	6				00:50:19
19	祝君									0.0%						00:05:44
合计		7/14	8/14	2/6	3/6	2/3		3/6	25/49	51.0%	6	12	2	1		
(守门员)																
1	张崢	3/6	6/11	3/6	0/2	0/3		1/1	13/29	44.8%	1					00:50:29
12	周哲韬	2/2	1/4	1/2		1/2			5/10	50.0%						00:09:31
合计		5/8	7/15	4/8	0/2	1/5		1/1	18/39	46.2%	1					

场上队员：得分/射门

守门员：救球/射门

全队合计	得分	被救	射失	击柱	封球	合计	%
远射	7	2	3		2	14	50.0%
近射	8	4	2			14	57.1%
边射	2	4				6	33.3%
快攻	3	1	1	1		6	50.0%
突破	2	1				3	66.7%
任意							0.0%
七米	3	2	1			6	50.0%

第十三届全国运动会男子手球决赛

PHMS Pictorial Handball Match Statistics

IHF Official System

图式比赛技术统计表

手球
男子

5-8名
轮次 5

组别 X
场次 17

天津师范大学体育馆
2017-08-26 14:00

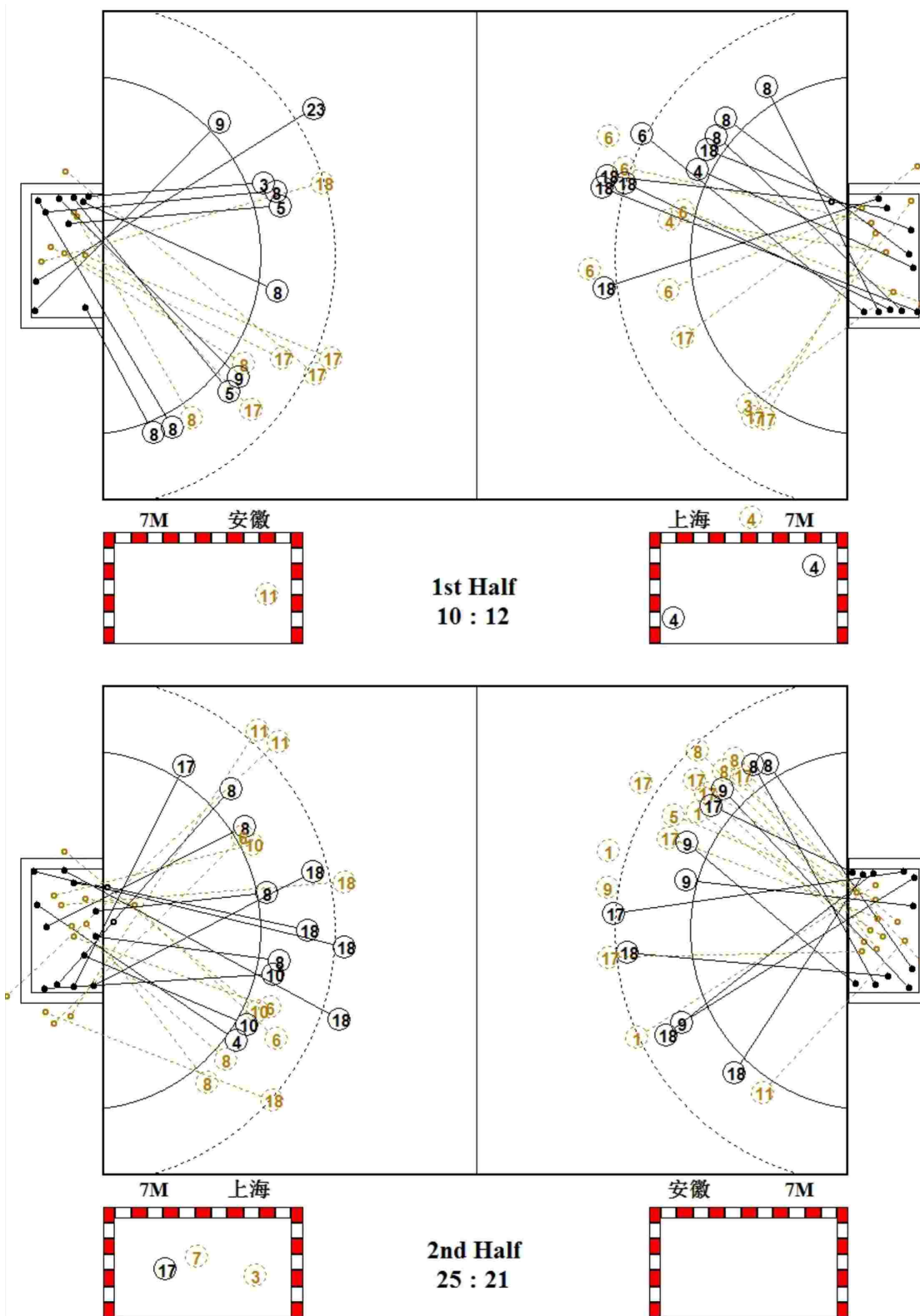

第十三届全国运动会男子手球决赛

PHMS Pictorial Handball Match Statistics

IHF Official System

图式射门区域统计

手球
男子

5-8名
轮次 5

组别 X
场次 17

天津师范大学体育馆
2017-08-26 14:00

安徽队

1 郭世伟	3 陈强龙	5 史小帆	7 姚雄敏	8 董智景	9 陈开勇	10 严龙	11 黎涛																																																																								
<table border="1"><tr><td></td><td></td><td></td></tr><tr><td></td><td></td><td></td></tr><tr><td></td><td></td><td></td></tr></table>										<table border="1"><tr><td></td><td></td><td></td></tr><tr><td></td><td></td><td>1</td></tr><tr><td></td><td></td><td></td></tr></table>						1				<table border="1"><tr><td></td><td></td><td></td></tr><tr><td></td><td></td><td>2</td></tr><tr><td></td><td></td><td></td></tr></table>						2				<table border="1"><tr><td></td><td></td><td></td></tr><tr><td></td><td></td><td></td></tr><tr><td></td><td></td><td></td></tr></table>										<table border="1"><tr><td></td><td></td><td>3</td></tr><tr><td></td><td></td><td>1</td></tr><tr><td>1</td><td></td><td>1</td></tr></table>			3			1	1		1	<table border="1"><tr><td>3</td><td></td><td>1</td></tr><tr><td></td><td></td><td>1</td></tr><tr><td></td><td></td><td>1</td></tr></table>	3		1			1			1	<table border="1"><tr><td></td><td></td><td></td></tr><tr><td></td><td></td><td></td></tr><tr><td></td><td></td><td></td></tr></table>										<table border="1"><tr><td></td><td></td><td></td></tr><tr><td></td><td></td><td></td></tr><tr><td></td><td></td><td></td></tr></table>									
		1																																																																													
		2																																																																													
		3																																																																													
		1																																																																													
1		1																																																																													
3		1																																																																													
		1																																																																													
		1																																																																													
Post - 0 Miss - 0 Block - 1	Post - 0 Miss - 0 Block - 0	Post - 0 Miss - 0 Block - 0	Post - 0 Miss - 0 Block - 0	Post - 1 Miss - 0 Block - 0	Post - 0 Miss - 0 Block - 1	Post - 0 Miss - 0 Block - 0	Post - 0 Miss - 0 Block - 0																																																																								
12 曾献辰	15 曹青福临	16 杨洋	17 王巨柱	18 李双	21 李明	23 于敏清	24 徐安格																																																																								
<table border="1"><tr><td></td><td></td><td></td></tr><tr><td></td><td></td><td></td></tr><tr><td></td><td></td><td></td></tr></table>										<table border="1"><tr><td></td><td></td><td></td></tr><tr><td></td><td></td><td></td></tr><tr><td></td><td></td><td></td></tr></table>										<table border="1"><tr><td></td><td></td><td></td></tr><tr><td></td><td></td><td></td></tr><tr><td></td><td></td><td></td></tr></table>										<table border="1"><tr><td>1</td><td></td><td></td></tr><tr><td></td><td></td><td></td></tr><tr><td>1</td><td></td><td></td></tr></table>	1						1			<table border="1"><tr><td></td><td></td><td></td></tr><tr><td>1</td><td></td><td>1</td></tr><tr><td></td><td></td><td></td></tr></table>				1		1				<table border="1"><tr><td></td><td></td><td></td></tr><tr><td></td><td></td><td></td></tr><tr><td></td><td></td><td></td></tr></table>										<table border="1"><tr><td>1</td><td></td><td></td></tr><tr><td></td><td></td><td></td></tr><tr><td></td><td></td><td></td></tr></table>	1									<table border="1"><tr><td></td><td></td><td></td></tr><tr><td></td><td></td><td></td></tr><tr><td></td><td></td><td></td></tr></table>									
1																																																																															
1																																																																															
1		1																																																																													
1																																																																															
Post - 0 Miss - 0 Block - 0	Post - 0 Miss - 0 Block - 0	Post - 0 Miss - 0 Block - 0	Post - 0 Miss - 1 Block - 1	Post - 0 Miss - 0 Block - 0	Post - 0 Miss - 0 Block - 0	Post - 0 Miss - 0 Block - 0	Post - 0 Miss - 0 Block - 0																																																																								

12 □□□		
0/1		1/1

21 □□		
1/3	1/4	1/6
2/6	3/3	2/6
1/4	1/3	1/2

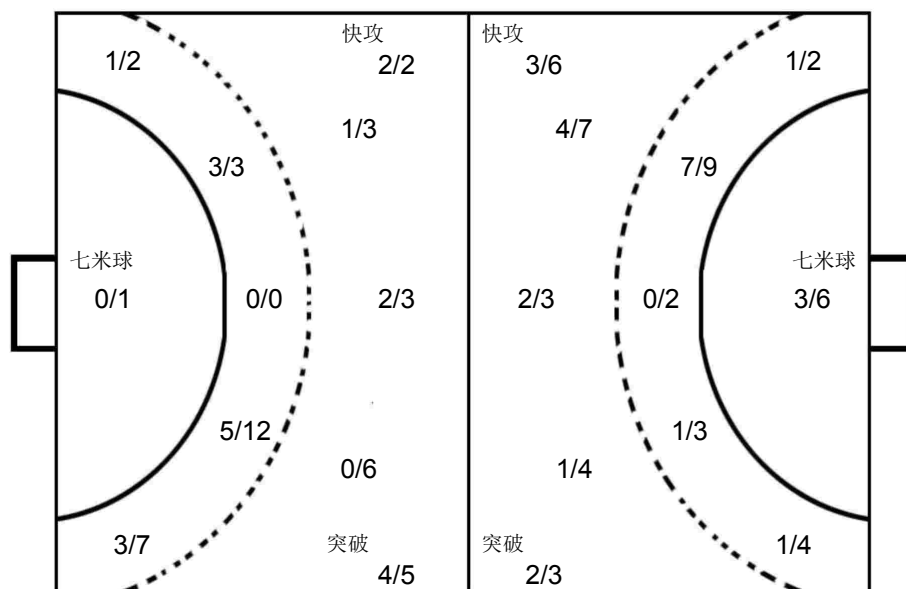

1 □□		
0/4	4/4	0/3
0/1	3/3	3/7
1/2	2/2	0/3

12 □□□		
0/1		0/1
2/2	1/1	0/1
0/2	2/2	

上海队

1 张崢	3 赵时俊	4 徐俊吉	6 朱世杰	7 周文龙	8 钱为玮	9 董凯	10 吴璟																																																																								
<table border="1"><tr><td></td><td></td><td></td></tr><tr><td></td><td></td><td></td></tr><tr><td></td><td></td><td></td></tr></table>										<table border="1"><tr><td></td><td></td><td></td></tr><tr><td></td><td></td><td></td></tr><tr><td></td><td></td><td></td></tr></table>										<table border="1"><tr><td></td><td>1</td><td>2</td></tr><tr><td></td><td></td><td></td></tr><tr><td>1</td><td></td><td></td></tr></table>		1	2				1			<table border="1"><tr><td></td><td></td><td></td></tr><tr><td></td><td></td><td></td></tr><tr><td></td><td></td><td></td></tr></table>										<table border="1"><tr><td></td><td></td><td></td></tr><tr><td></td><td></td><td></td></tr><tr><td></td><td></td><td></td></tr></table>										<table border="1"><tr><td></td><td>2</td><td>1</td></tr><tr><td>1</td><td></td><td>1</td></tr><tr><td></td><td>2</td><td></td></tr></table>		2	1	1		1		2		<table border="1"><tr><td></td><td></td><td></td></tr><tr><td></td><td></td><td></td></tr><tr><td></td><td></td><td></td></tr></table>										<table border="1"><tr><td></td><td></td><td></td></tr><tr><td></td><td></td><td></td></tr><tr><td></td><td></td><td></td></tr></table>									
	1	2																																																																													
1																																																																															
	2	1																																																																													
1		1																																																																													
	2																																																																														
Post - 0 Miss - 0 Block - 0	Post - 0 Miss - 0 Block - 0	Post - 0 Miss - 1 Block - 0	Post - 1 Miss - 1 Block - 2	Post - 0 Miss - 0 Block - 0	Post - 0 Miss - 0 Block - 0	Post - 0 Miss - 0 Block - 0	Post - 0 Miss - 1 Block - 0																																																																								
11 蒋承骅	12 周哲韬	14 沈吉磊	16 朱春雷	17 贺政	18 马麟晓	19 祝君																																																																									
<table border="1"><tr><td></td><td></td><td></td></tr><tr><td></td><td></td><td></td></tr><tr><td></td><td></td><td></td></tr></table>										<table border="1"><tr><td></td><td></td><td></td></tr><tr><td></td><td></td><td></td></tr><tr><td></td><td></td><td></td></tr></table>										<table border="1"><tr><td></td><td></td><td></td></tr><tr><td></td><td></td><td></td></tr><tr><td></td><td></td><td></td></tr></table>										<table border="1"><tr><td></td><td></td><td></td></tr><tr><td></td><td></td><td></td></tr><tr><td></td><td></td><td></td></tr></table>										<table border="1"><tr><td></td><td></td><td></td></tr><tr><td>2</td><td></td><td></td></tr><tr><td></td><td></td><td></td></tr></table>				2						<table border="1"><tr><td>1</td><td></td><td>2</td></tr><tr><td>2</td><td></td><td>3</td></tr><tr><td>1</td><td></td><td></td></tr></table>	1		2	2		3	1			<table border="1"><tr><td></td><td></td><td></td></tr><tr><td></td><td></td><td></td></tr><tr><td></td><td></td><td></td></tr></table>																			
2																																																																															
1		2																																																																													
2		3																																																																													
1																																																																															
Post - 0 Miss - 2 Block - 0	Post - 0 Miss - 0 Block - 0	Post - 0 Miss - 0 Block - 0	Post - 0 Miss - 0 Block - 0	Post - 0 Miss - 1 Block - 0	Post - 0 Miss - 1 Block - 0	Post - 0 Miss - 0 Block - 0																																																																									

Team A					Team B					Match Number											
A 香港队					B 天津队					18											
Played in			in the hall			on			at			Spectators									
天津			天津师范大学体育馆			2017-08-26			15:45			hours									
Half-time(30')	A	B	End of playing time		A	B	1st extra time		A	B	2nd extra time		A	B	After penalty throws		A	B			
	14	12	27		23																
Number of 7 m	A	Team time-out			Full name of players and officials						Team time-out			B	Number of 7 m						
	4/4	1	2	3							1	2	3	B							
			56:04								18:25	24:07	43:09	0/2							
No.	Team A					G	W	2'	D	DR	No.	Team B					G	W	2'	D	DR
1	叶冠英					1					1	刘宗其									
2	刘健斌					1					2	李岳朋					1				
3	陈梓朗						1				4	李松浩									
5	黄胜业					1					6	王子欣					2	1	1		
7	谭俊杰										7	张青					2		1		
8	李伟东										8	曹悦					9				
10	谢永辉					2					9	吴明远									
12	许文邦					4					10	李帅									
13	张伟浩										11	王毅									
18	李鑫豪							1			12	杨峻									
23	郭斯鸣					3	1				13	许松					5		1		
27	冼大维										16	刘海亮									
29	练明辉					6	1	1			17	周群					1				
31	叶仕仁					4					18	王晓琪						1	1		
33	袁晞彦					1					22	魏雨童									
40	叶冠雄					4					31	田剑侠					3				
A	杨开将										A	贾守信									
B	王涛						1				B	杜瑞军 (主教练)									
C	高梓欣										C	孟凡钢									
											E	崔嘉禄									
A											Signatures of responsables for the teams (Off.A)										B
TP	Remarks of referees / HF Official																				TP

Signatures

Referees 李兆蒙 (CHN)

张耿 (CHN)

T.D. 于中迅 (CHN)

刘书勇 (CHN)

CHA Off.

Note: Number of 7m Throws Awarded to Team A and B, Goals (G), Warnings (W), Suspensions (2'), Direct Disqualification (D), Disqualification With Report (DR) and Team Penalty (TP).

Table Officials: 鲍瑀

梅艳

Statisticians: 陈柱

黄岩

第十三届全国运动会男子手球决赛
PHMS Pictorial Handball Match Statistics

IHF Official System

竞赛技术统计

 手球
男子

 5-8名
轮次 5

 组别 X
场次 18

 天津师范大学体育馆
2017-08-26 15:45

 Referees: 李兆蒙 (CHN) / 张耿 (CHN) Result: 27:23 (14:12)
 Teams: 香港队 (香港) VS 天津队 (天津)

香港		远	近	边	快	突	任意	7m	合计	%	助攻	失误	警告	2'	D+DR	香港	比赛	天津																																																																																																																																																																																																																																																																																																																																																																																																																																	
主教练: 高梓欣		射	射	射	攻	破	球	球								进程																																																																																																																																																																																																																																																																																																																																																																																																																																			
1	叶冠英				1/1				1/1	100		1					01:32	1 13 许松																																																																																																																																																																																																																																																																																																																																																																																																																																	
2	刘健斌		1/1	0/1					1/2	50.0		1					02:43	2 17 周群																																																																																																																																																																																																																																																																																																																																																																																																																																	
3	陈梓朗											2	1				03:09	2																																																																																																																																																																																																																																																																																																																																																																																																																																	
5	黄胜业		1/1	0/2					1/3	33.3		1					06:13	3 6 王子欣																																																																																																																																																																																																																																																																																																																																																																																																																																	
7	谭俊杰										1						07:37	4 8 曹悦																																																																																																																																																																																																																																																																																																																																																																																																																																	
8	李伟东																07:59	4																																																																																																																																																																																																																																																																																																																																																																																																																																	
10	谢永辉			0/1	2/2				2/3	66.7		1					08:41	4																																																																																																																																																																																																																																																																																																																																																																																																																																	
12	许文邦							4/4	4/4	100							09:22	5 31 田剑侠																																																																																																																																																																																																																																																																																																																																																																																																																																	
13	张伟浩																10:35	5																																																																																																																																																																																																																																																																																																																																																																																																																																	
18	李鑫豪													1			11:12	6 6 王子欣																																																																																																																																																																																																																																																																																																																																																																																																																																	
23	郭斯鸣	0/1	2/3		1/1				3/5	60.0		1	1				12:32	6																																																																																																																																																																																																																																																																																																																																																																																																																																	
27	冼大维																13:09	7 31 田剑侠																																																																																																																																																																																																																																																																																																																																																																																																																																	
29	练明辉	1/2	3/3	0/1		1/1	1/1		6/8	75.0	2	3	1	1			13:46	7																																																																																																																																																																																																																																																																																																																																																																																																																																	
31	叶仕仁	0/1	2/3	1/1	1/1				4/6	66.7	1	1					15:05	8 8 曹悦																																																																																																																																																																																																																																																																																																																																																																																																																																	
33	袁晞彦		1/3						1/3	33.3							15:51	8																																																																																																																																																																																																																																																																																																																																																																																																																																	
40	叶冠雄	1/2	2/2			1/1			4/5	80.0	3	2					16:30	9 31 田剑侠																																																																																																																																																																																																																																																																																																																																																																																																																																	
运动员	合计	2/6	12/16	1/6	5/5	2/2	1/1	4/4	27/40	67.5	7	14	3	2			17:43	9																																																																																																																																																																																																																																																																																																																																																																																																																																	
1	叶冠英	2/2	3/11	2/3		0/3			7/19	36.8		1					18:20	9																																																																																																																																																																																																																																																																																																																																																																																																																																	
7	谭俊杰	3/6	2/5	4/6		0/3		1/1	10/21	47.6	1						19:10	10 7 张青																																																																																																																																																																																																																																																																																																																																																																																																																																	
守门员	合计	5/8	5/16	6/9		0/6		1/1	17/40	42.5	1	1					20:30	10																																																																																																																																																																																																																																																																																																																																																																																																																																	
<table border="1"> <thead> <tr> <th colspan="2">天津</th> <th>远</th> <th>近</th> <th>边</th> <th>快</th> <th>突</th> <th>任意</th> <th>7m</th> <th>合计</th> <th>%</th> <th>助攻</th> <th>失误</th> <th>警告</th> <th>2'</th> <th>D+DR</th> <th>香港</th> <th>比赛</th> <th>天津</th> </tr> <tr> <th colspan="2">主教练: 杜瑞军</th> <th>射</th> <th>射</th> <th>射</th> <th>攻</th> <th>破</th> <th>球</th> <th>球</th> <th></th> <th></th> <th></th> <th></th> <th></th> <th></th> <th></th> <th>进程</th> <th></th> </tr> </thead> <tbody> <tr> <td>1</td> <td>刘宗其</td> <td></td> <td></td> <td></td> <td></td> <td></td> <td></td> <td></td> <td></td> <td></td> <td></td> <td></td> <td></td> <td></td> <td></td> <td></td> <td>02:33</td> <td>12</td> </tr> <tr> <td>2</td> <td>李岳朋</td> <td>0/1</td> <td></td> <td>1/1</td> <td></td> <td></td> <td></td> <td></td> <td>1/2</td> <td>50.0</td> <td></td> <td></td> <td></td> <td></td> <td></td> <td></td> <td>04:42</td> <td>13 13 许松</td> </tr> <tr> <td>4</td> <td>李松浩</td> <td></td> <td></td> <td></td> <td></td> <td></td> <td></td> <td></td> <td></td> <td></td> <td></td> <td></td> <td></td> <td></td> <td></td> <td></td> <td>07:45</td> <td>14 8 曹悦</td> </tr> <tr> <td>6</td> <td>王子欣</td> <td></td> <td>1/2</td> <td>1/4</td> <td></td> <td></td> <td></td> <td></td> <td>2/6</td> <td>33.3</td> <td></td> <td>1</td> <td>1</td> <td>1</td> <td></td> <td></td> <td>08:48</td> <td>14</td> </tr> <tr> <td>7</td> <td>张青</td> <td>0/1</td> <td>2/3</td> <td></td> <td></td> <td></td> <td></td> <td></td> <td>2/4</td> <td>50.0</td> <td></td> <td>3</td> <td></td> <td></td> <td></td> <td></td> <td>12:51</td> <td>14</td> </tr> <tr> <td>8</td> <td>曹悦</td> <td>2/5</td> <td>4/5</td> <td></td> <td></td> <td>3/3</td> <td></td> <td>0/1</td> <td>9/14</td> <td>64.3</td> <td>2</td> <td>4</td> <td></td> <td></td> <td></td> <td></td> <td>13:35</td> <td>15 13 许松</td> </tr> <tr> <td>9</td> <td>吴明远</td> <td></td> <td></td> <td></td> <td></td> <td></td> <td></td> <td></td> <td></td> <td></td> <td></td> <td></td> <td></td> <td></td> <td></td> <td></td> <td>17:06</td> <td>16 2 李岳朋</td> </tr> <tr> <td>10</td> <td>李帅</td> <td></td> <td></td> <td></td> <td></td> <td></td> <td></td> <td></td> <td></td> <td></td> <td></td> <td></td> <td></td> <td></td> <td></td> <td></td> <td>17:11</td> <td>16</td> </tr> <tr> <td>11</td> <td>王毅</td> <td></td> <td></td> <td></td> <td></td> <td></td> <td></td> <td></td> <td></td> <td></td> <td></td> <td></td> <td></td> <td></td> <td></td> <td></td> <td>20:49</td> <td>16</td> </tr> <tr> <td>12</td> <td>杨峻</td> <td></td> <td></td> <td></td> <td></td> <td></td> <td></td> <td></td> <td></td> <td></td> <td></td> <td></td> <td></td> <td></td> <td></td> <td></td> <td>21:18</td> <td>17 8 曹悦</td> </tr> <tr> <td>13</td> <td>许松</td> <td>0/1</td> <td>1/2</td> <td>1/4</td> <td></td> <td>3/3</td> <td></td> <td></td> <td>5/10</td> <td>50.0</td> <td>1</td> <td>2</td> <td></td> <td>1</td> <td></td> <td></td> <td>21:49</td> <td>17</td> </tr> <tr> <td>16</td> <td>刘海亮</td> <td></td> <td></td> <td></td> <td></td> <td></td> <td></td> <td></td> <td></td> <td></td> <td></td> <td></td> <td></td> <td></td> <td></td> <td></td> <td>23:14</td> <td>17</td> </tr> <tr> <td>17</td> <td>周群</td> <td></td> <td>1/2</td> <td></td> <td></td> <td></td> <td></td> <td></td> <td>1/2</td> <td>50.0</td> <td></td> <td></td> <td></td> <td></td> <td></td> <td></td> <td>23:45</td> <td>18 13 许松</td> </tr> <tr> <td>18</td> <td>王晓琪</td> <td>0/1</td> <td></td> <td>0/3</td> <td></td> <td></td> <td></td> <td></td> <td>0/4</td> <td>0.0</td> <td></td> <td>1</td> <td>1</td> <td>1</td> <td></td> <td></td> <td>24:27</td> <td>18</td> </tr> <tr> <td>22</td> <td>魏雨童</td> <td></td> <td></td> <td></td> <td></td> <td></td> <td></td> <td></td> <td></td> <td></td> <td></td> <td></td> <td></td> <td></td> <td></td> <td></td> <td>25:05</td> <td>19 8 曹悦</td> </tr> <tr> <td>31</td> <td>田剑侠</td> <td>1/2</td> <td>2/3</td> <td></td> <td></td> <td></td> <td></td> <td>0/1</td> <td>3/6</td> <td>50.0</td> <td></td> <td></td> <td></td> <td></td> <td></td> <td></td> <td>25:52</td> <td>20 7 张青</td> </tr> <tr> <td>运动员</td> <td>合计</td> <td>3/11</td> <td>11/17</td> <td>3/12</td> <td></td> <td>6/6</td> <td></td> <td>0/2</td> <td>23/48</td> <td>47.9</td> <td>3</td> <td>11</td> <td>2</td> <td>4</td> <td></td> <td></td> <td>26:56</td> <td>20</td> </tr> <tr> <td>1</td> <td>刘宗其</td> <td>2/3</td> <td>2/8</td> <td>1/2</td> <td>0/2</td> <td>0/1</td> <td></td> <td>0/1</td> <td>5/17</td> <td>29.4</td> <td></td> <td></td> <td></td> <td></td> <td></td> <td></td> <td>27:08</td> <td>21 8 曹悦</td> </tr> <tr> <td>12</td> <td>杨峻</td> <td>1/2</td> <td>1/7</td> <td>2/2</td> <td>0/3</td> <td>0/1</td> <td>0/1</td> <td>0/3</td> <td>4/19</td> <td>21.1</td> <td></td> <td></td> <td></td> <td></td> <td></td> <td></td> <td>27:28</td> <td>21</td> </tr> <tr> <td>守门员</td> <td>合计</td> <td>3/5</td> <td>3/15</td> <td>3/4</td> <td>0/5</td> <td>0/2</td> <td>0/1</td> <td>0/4</td> <td>9/36</td> <td>25.0</td> <td></td> <td></td> <td></td> <td></td> <td></td> <td></td> <td>28:03</td> <td>21</td> </tr> </tbody> </table>																			天津		远	近	边	快	突	任意	7m	合计	%	助攻	失误	警告	2'	D+DR	香港	比赛	天津	主教练: 杜瑞军		射	射	射	攻	破	球	球								进程		1	刘宗其																02:33	12	2	李岳朋	0/1		1/1					1/2	50.0							04:42	13 13 许松	4	李松浩																07:45	14 8 曹悦	6	王子欣		1/2	1/4					2/6	33.3		1	1	1			08:48	14	7	张青	0/1	2/3						2/4	50.0		3					12:51	14	8	曹悦	2/5	4/5			3/3		0/1	9/14	64.3	2	4					13:35	15 13 许松	9	吴明远																17:06	16 2 李岳朋	10	李帅																17:11	16	11	王毅																20:49	16	12	杨峻																21:18	17 8 曹悦	13	许松	0/1	1/2	1/4		3/3			5/10	50.0	1	2		1			21:49	17	16	刘海亮																23:14	17	17	周群		1/2						1/2	50.0							23:45	18 13 许松	18	王晓琪	0/1		0/3					0/4	0.0		1	1	1			24:27	18	22	魏雨童																25:05	19 8 曹悦	31	田剑侠	1/2	2/3					0/1	3/6	50.0							25:52	20 7 张青	运动员	合计	3/11	11/17	3/12		6/6		0/2	23/48	47.9	3	11	2	4			26:56	20	1	刘宗其	2/3	2/8	1/2	0/2	0/1		0/1	5/17	29.4							27:08	21 8 曹悦	12	杨峻	1/2	1/7	2/2	0/3	0/1	0/1	0/3	4/19	21.1							27:28	21	守门员	合计	3/5	3/15	3/4	0/5	0/2	0/1	0/4	9/36	25.0							28:03	21
天津		远	近	边	快	突	任意	7m	合计	%	助攻	失误	警告	2'	D+DR	香港	比赛	天津																																																																																																																																																																																																																																																																																																																																																																																																																																	
主教练: 杜瑞军		射	射	射	攻	破	球	球								进程																																																																																																																																																																																																																																																																																																																																																																																																																																			
1	刘宗其																02:33	12																																																																																																																																																																																																																																																																																																																																																																																																																																	
2	李岳朋	0/1		1/1					1/2	50.0							04:42	13 13 许松																																																																																																																																																																																																																																																																																																																																																																																																																																	
4	李松浩																07:45	14 8 曹悦																																																																																																																																																																																																																																																																																																																																																																																																																																	
6	王子欣		1/2	1/4					2/6	33.3		1	1	1			08:48	14																																																																																																																																																																																																																																																																																																																																																																																																																																	
7	张青	0/1	2/3						2/4	50.0		3					12:51	14																																																																																																																																																																																																																																																																																																																																																																																																																																	
8	曹悦	2/5	4/5			3/3		0/1	9/14	64.3	2	4					13:35	15 13 许松																																																																																																																																																																																																																																																																																																																																																																																																																																	
9	吴明远																17:06	16 2 李岳朋																																																																																																																																																																																																																																																																																																																																																																																																																																	
10	李帅																17:11	16																																																																																																																																																																																																																																																																																																																																																																																																																																	
11	王毅																20:49	16																																																																																																																																																																																																																																																																																																																																																																																																																																	
12	杨峻																21:18	17 8 曹悦																																																																																																																																																																																																																																																																																																																																																																																																																																	
13	许松	0/1	1/2	1/4		3/3			5/10	50.0	1	2		1			21:49	17																																																																																																																																																																																																																																																																																																																																																																																																																																	
16	刘海亮																23:14	17																																																																																																																																																																																																																																																																																																																																																																																																																																	
17	周群		1/2						1/2	50.0							23:45	18 13 许松																																																																																																																																																																																																																																																																																																																																																																																																																																	
18	王晓琪	0/1		0/3					0/4	0.0		1	1	1			24:27	18																																																																																																																																																																																																																																																																																																																																																																																																																																	
22	魏雨童																25:05	19 8 曹悦																																																																																																																																																																																																																																																																																																																																																																																																																																	
31	田剑侠	1/2	2/3					0/1	3/6	50.0							25:52	20 7 张青																																																																																																																																																																																																																																																																																																																																																																																																																																	
运动员	合计	3/11	11/17	3/12		6/6		0/2	23/48	47.9	3	11	2	4			26:56	20																																																																																																																																																																																																																																																																																																																																																																																																																																	
1	刘宗其	2/3	2/8	1/2	0/2	0/1		0/1	5/17	29.4							27:08	21 8 曹悦																																																																																																																																																																																																																																																																																																																																																																																																																																	
12	杨峻	1/2	1/7	2/2	0/3	0/1	0/1	0/3	4/19	21.1							27:28	21																																																																																																																																																																																																																																																																																																																																																																																																																																	
守门员	合计	3/5	3/15	3/4	0/5	0/2	0/1	0/4	9/36	25.0							28:03	21																																																																																																																																																																																																																																																																																																																																																																																																																																	

场上队员: 得分 / 射门

守门员: 救球 / 射门

D	取消资格	DR	取消资格+报告
---	------	----	---------

第十三届全国运动会男子手球决赛

PHMS Pictorial Handball Match Statistics

IHF Official System

个人/全队技术统计表

手球 男子 5-8名 轮次 5 组别 X 场次 18 天津师范大学体育馆 2017-08-26 15:45

号码	姓名	远射	近射	边射	快攻	突破	任意	七米	合计	%	助攻	失误	警告	2'	取消	时间
香港队(香港)																
(场上队员)																
1	叶冠英				1/1				1/1	100%		1				00:19:15
2	刘健斌		1/1	0/1					1/2	50.0%		1				00:17:42
3	陈梓朗									0.0%		2	1			00:28:03
5	黄胜业		1/1	0/2					1/3	33.3%		1				00:36:06
7	谭俊杰									0.0%	1					00:40:45
8	李伟东									0.0%						00:22:01
10	谢永辉			0/1	2/2				2/3	66.7%		1				00:31:26
12	许文邦							4/4	4/4	100%						00:00:31
13	张伟浩									0.0%						00:00:00
18	李鑫豪									0.0%		1		1		00:30:54
23	郭斯鸣	0/1	2/3		1/1				3/5	60.0%		1	1			00:40:24
27	冼大维									0.0%						00:05:56
29	练明辉	1/2	3/3	0/1		1/1	1/1		6/8	75.0%	2	3	1	1		00:38:40
31	叶仕仁	0/1	2/3	1/1	1/1				4/6	66.7%	1	1				00:31:07
33	袁晞彦		1/3						1/3	33.3%						00:31:21
40	叶冠雄	1/2	2/2			1/1			4/5	80.0%	3	2				00:39:47
	合计	2/6	12/16	1/6	5/5	2/2	1/1	4/4	27/40	67.5%	7	14	3	2		
(守门员)																
1	叶冠英	2/2	3/11	2/3		0/3			7/19	36.8%		1				00:19:15
7	谭俊杰	3/6	2/5	4/6		0/3		1/1	10/21	47.6%	1					00:40:45
	合计	5/8	5/16	6/9		0/6		1/1	17/40	42.5%	1	1				

场上队员：得分/射门

守门员：救球/射门

全队合计	得分	被救	射失	击柱	封球	合计	%
远射	2	3			1	6	33.3%
近射	12	3	1			16	75.0%
边射	1	3	2			6	16.7%
快攻	5					5	100.0%
突破	2					2	100.0%
任意	1					1	100.0%
七米	4					4	100.0%

第十三届全国运动会男子手球决赛

PHMS Pictorial Handball Match Statistics

IHF Official System

个人/全队技术统计表

手球 男子 5-8名 轮次 5 组别 X 场次 18 天津师范大学体育馆 2017-08-26 15:45

号码	姓名	远射	近射	边射	快攻	突破	任意	七米	合计	%	助攻	失误	警告	2'	取消	时间
天津队(天津)																
(场上队员)																
1	刘宗其									0.0%						00:29:42
2	李岳朋	0/1		1/1					1/2	50.0%						00:19:37
4	李松浩									0.0%						00:00:00
6	王子欣		1/2	1/4					2/6	33.3%		1	1	1		00:46:16
7	张青	0/1	2/3						2/4	50.0%		3		1		00:50:42
8	曹悦	2/5	4/5			3/3		0/1	9/14	64.3%	2	4				01:00:00
9	吴明远									0.0%						00:00:00
10	李帅									0.0%						00:00:00
11	王毅									0.0%						00:00:00
12	杨峻									0.0%						00:30:18
13	许松	0/1	1/2	1/4		3/3			5/10	50.0%	1	2		1		01:00:00
16	刘海亮									0.0%						00:00:00
17	周群		1/2						1/2	50.0%						00:38:22
18	王晓琪	0/1		0/3					0/4	0.0%		1	1	1		00:23:03
22	魏雨童									0.0%						00:17:55
31	田剑侠	1/2	2/3					0/1	3/6	50.0%						00:43:29
	合计	3/11	11/17	3/12		6/6		0/2	23/48	47.9%	3	11	2	4		
(守门员)																
1	刘宗其	2/3	2/8	1/2	0/2	0/1		0/1	5/17	29.4%						00:29:42
12	杨峻	1/2	1/7	2/2	0/3	0/1	0/1	0/3	4/19	21.1%						00:30:18
	合计	3/5	3/15	3/4	0/5	0/2	0/1	0/4	9/36	25.0%						

场上队员：得分/射门

守门员：救球/射门

全队合计	得分	被救	射失	击柱	封球	合计	%
远射	3	5	2		1	11	27.3%
近射	11	5		1		17	64.7%
边射	3	6	1	2		12	25.0%
快攻							0.0%
突破	6					6	100.0%
任意							0.0%
七米		1	1			2	0.0%

第十三届全国运动会男子手球决赛

PHMS Pictorial Handball Match Statistics

IHF Official System

图式比赛技术统计表

手球
男子

5-8名
轮次 5

组别 X
场次 18

天津师范大学体育馆
2017-08-26 15:45

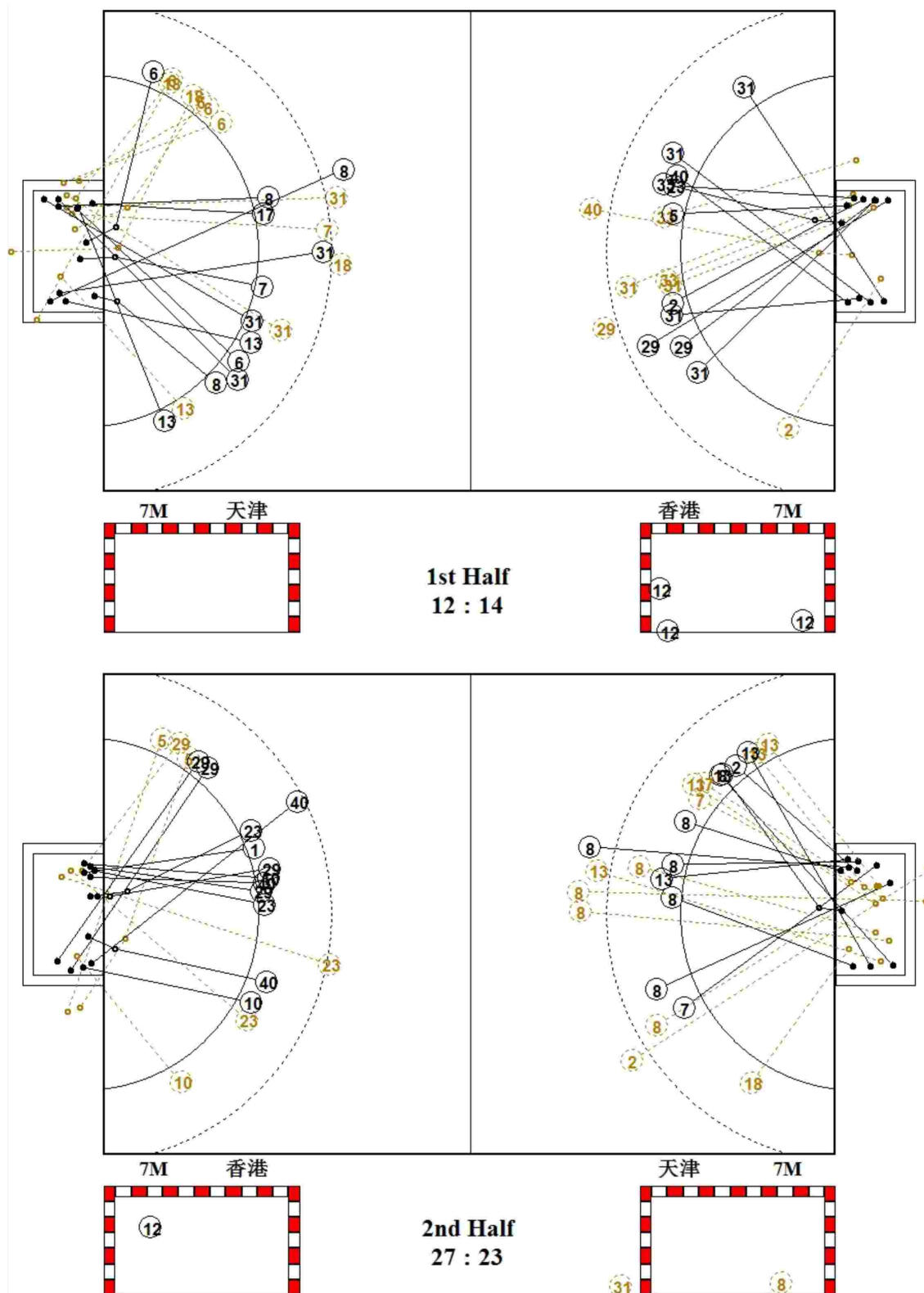

第十三届全国运动会男子手球决赛

PHMS Pictorial Handball Match Statistics

IHF Official System

图式射门区域统计

手球
男子

5-8名
轮次 5

组别 X
场次 18

天津师范大学体育馆
2017-08-26 15:45

香港队

1 叶冠英	2 刘健斌	3 陈梓朗	5 黄胜业	7 谭俊杰	8 李伟东	10 谢永辉	12 许文邦																																																			
<table border="1"><tr><td></td><td></td><td></td></tr><tr><td></td><td></td><td>1</td></tr></table>						1	<table border="1"><tr><td></td><td></td><td></td></tr><tr><td>1</td><td></td><td></td></tr></table>				1			<table border="1"><tr><td></td><td></td><td></td></tr><tr><td></td><td></td><td></td></tr></table>							<table border="1"><tr><td></td><td></td><td></td></tr><tr><td></td><td></td><td>1</td></tr></table>						1	<table border="1"><tr><td></td><td></td><td></td></tr><tr><td></td><td></td><td></td></tr></table>							<table border="1"><tr><td></td><td></td><td></td></tr><tr><td></td><td></td><td></td></tr></table>							<table border="1"><tr><td></td><td></td><td></td></tr><tr><td>1</td><td></td><td>1</td></tr></table>				1		1	<table border="1"><tr><td>1</td><td></td><td></td></tr><tr><td>1</td><td></td><td></td></tr><tr><td>1</td><td></td><td>1</td></tr></table>	1			1			1		1
		1																																																								
1																																																										
		1																																																								
1		1																																																								
1																																																										
1																																																										
1		1																																																								
Post - 0 Miss - 0 Block - 0	Post - 0 Miss - 0 Block - 0	Post - 0 Miss - 0 Block - 0	Post - 0 Miss - 2 Block - 0	Post - 0 Miss - 0 Block - 0	Post - 0 Miss - 0 Block - 0	Post - 0 Miss - 0 Block - 0	Post - 0 Miss - 0 Block - 0																																																			
13 张伟浩	18 李鑫豪	23 郭斯鸣	27 冼大维	29 练明辉	31 叶仕仁	33 袁晔彦	40 叶冠雄																																																			
<table border="1"><tr><td></td><td></td><td></td></tr><tr><td></td><td></td><td></td></tr></table>							<table border="1"><tr><td></td><td></td><td></td></tr><tr><td></td><td></td><td></td></tr></table>							<table border="1"><tr><td></td><td></td><td></td></tr><tr><td></td><td></td><td></td></tr></table>							<table border="1"><tr><td></td><td></td><td></td></tr><tr><td></td><td></td><td></td></tr></table>							<table border="1"><tr><td>2</td><td></td><td></td></tr><tr><td>2</td><td></td><td></td></tr><tr><td></td><td>1</td><td>1</td></tr></table>	2			2				1	1	<table border="1"><tr><td></td><td></td><td>1</td></tr><tr><td>1</td><td></td><td>2</td></tr></table>			1	1		2	<table border="1"><tr><td></td><td></td><td></td></tr><tr><td></td><td></td><td></td></tr></table>							<table border="1"><tr><td></td><td></td><td></td></tr><tr><td></td><td></td><td></td></tr></table>						
2																																																										
2																																																										
	1	1																																																								
		1																																																								
1		2																																																								
Post - 0 Miss - 0 Block - 0	Post - 0 Miss - 0 Block - 0	Post - 0 Miss - 0 Block - 0	Post - 0 Miss - 0 Block - 0	Post - 0 Miss - 0 Block - 1	Post - 0 Miss - 0 Block - 0	Post - 0 Miss - 1 Block - 0	Post - 0 Miss - 0 Block - 0																																																			

1 □□□

0/1	1/1	0/1
1/4		4/6
1/3	0/2	0/1

7 □□□

0/1		2/3
3/4	2/3	1/4
0/3		2/3

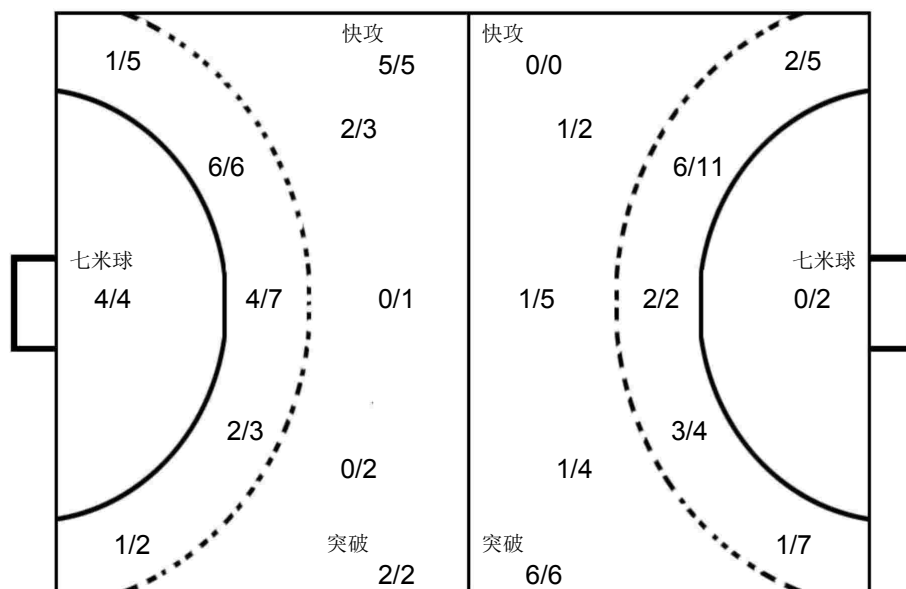

1 □□□

0/1		1/2
1/5		0/2
2/5	1/1	0/1

12 □□□

0/2		
1/2		2/2
0/4	0/2	1/7

天津队

1 刘宗其	2 李岳朋	4 李松浩	6 王子欣	7 张青	8 曹悦	9 吴明远	10 李帅																																																			
<table border="1"><tr><td></td><td></td><td></td></tr><tr><td></td><td></td><td></td></tr></table>							<table border="1"><tr><td></td><td></td><td></td></tr><tr><td>1</td><td></td><td></td></tr></table>				1			<table border="1"><tr><td></td><td></td><td></td></tr><tr><td></td><td></td><td></td></tr></table>							<table border="1"><tr><td></td><td></td><td></td></tr><tr><td></td><td></td><td>1</td></tr></table>						1	<table border="1"><tr><td></td><td></td><td></td></tr><tr><td>1</td><td>1</td><td></td></tr></table>				1	1		<table border="1"><tr><td>2</td><td></td><td></td></tr><tr><td>1</td><td></td><td>1</td></tr><tr><td>3</td><td>1</td><td>1</td></tr></table>	2			1		1	3	1	1	<table border="1"><tr><td></td><td></td><td></td></tr><tr><td></td><td></td><td></td></tr></table>							<table border="1"><tr><td></td><td></td><td></td></tr><tr><td></td><td></td><td></td></tr></table>						
1																																																										
		1																																																								
1	1																																																									
2																																																										
1		1																																																								
3	1	1																																																								
Post - 0 Miss - 0 Block - 0	Post - 0 Miss - 1 Block - 0	Post - 0 Miss - 0 Block - 0	Post - 2 Miss - 0 Block - 0	Post - 0 Miss - 0 Block - 0	Post - 0 Miss - 1 Block - 0	Post - 0 Miss - 0 Block - 0	Post - 0 Miss - 0 Block - 0																																																			
11 王毅	12 杨峻	13 许松	16 刘海亮	17 周群	18 王晓琪	22 魏雨童	31 田剑侠																																																			
<table border="1"><tr><td></td><td></td><td></td></tr><tr><td></td><td></td><td></td></tr></table>							<table border="1"><tr><td></td><td></td><td></td></tr><tr><td></td><td></td><td></td></tr></table>							<table border="1"><tr><td></td><td></td><td>1</td></tr><tr><td>1</td><td></td><td>2</td></tr><tr><td>1</td><td></td><td></td></tr></table>			1	1		2	1			<table border="1"><tr><td></td><td></td><td></td></tr><tr><td></td><td></td><td></td></tr></table>							<table border="1"><tr><td></td><td></td><td></td></tr><tr><td></td><td></td><td></td></tr></table>							<table border="1"><tr><td></td><td></td><td></td></tr><tr><td></td><td></td><td></td></tr></table>							<table border="1"><tr><td></td><td></td><td></td></tr><tr><td></td><td></td><td></td></tr></table>							<table border="1"><tr><td></td><td></td><td>1</td></tr><tr><td>1</td><td></td><td>1</td></tr></table>			1	1		1
		1																																																								
1		2																																																								
1																																																										
		1																																																								
1		1																																																								
Post - 0 Miss - 0 Block - 0	Post - 0 Miss - 0 Block - 0	Post - 0 Miss - 0 Block - 0	Post - 0 Miss - 0 Block - 0	Post - 0 Miss - 0 Block - 0	Post - 1 Miss - 1 Block - 1	Post - 0 Miss - 0 Block - 0	Post - 0 Miss - 1 Block - 0																																																			

Team A					Team B					Match Number											
A 山东队					B 广东队					19											
Played in			in the hall			on			at			Spectators									
天津			天津师范大学体育馆			2017-08-26			17:30			hours									
Half-time(30')	A	B	End of playing time		A	B	1st extra time		A	B	2nd extra time		A	B	After penalty throws		A	B			
	10	10	20		20	23		23	28		27										
Number of 7 m	A	Team time-out			Full name of players and officials						Team time-out			B	Number of 7 m						
	5/6	1	2	3							1	2	3	B							
		14:22	45:50						19:17	35:47	54:11	4/6									
No.	Team A					G	W	2'	D	DR	No.	Team B					G	W	2'	D	DR
3	尹杰										1	王帅									
4	田瑞										2	孙江山					1				
5	潘翔					4	1	1			3	曲汝洋					7				
6	李朝鹏										4	李卓洋					4				
8	王炳华										5	侯生升					4				
9	赵鑫					8					6	邓志贵									
11	宋朋强					2					7	付文博					4				
12	崔剑										8	于彦江					3	1			
13	刘晓					1		1			9	徐庆									
15	张继伟							2			11	房友屯									
16	于性哲										12	王雨									
17	王旭东					1		1			15	张建杰									
18	于亚男					1	1	1			16	马跃									
19	李语庆					2					17	李中洲					2		2		
20	杜在超					4		2			26	姚雪岩									
21	翟乾坤					5	1				84	王伟					2	1	1		
A	王志峰										B	王锋 (主教练)									
B	王鸿斌 (主教练)										C	刘康伶									
C	刘桂妮										D	张广建									
D	邢建刚										E	王永存									
A	Signatures of responsables for the teams (Off.A)																		B		
TP	Remarks of referees / HF Official																			TP	

Signatures

Referees PETER. HORVATH (HUN)

BALAZS. MARTON (HUN)

T.D. 李长海 (CHN)

李刚 (CHN)

CHA Off.

Note: Number of 7m Throws Awarded to Team A and B, Goals (G), Warnings (W), Suspensions (2'), Direct Disqualification (D), Disqualification With Report (DR) and Team Penalty (TP).

Table Officials: 隆晓磊

刘宇阳

Statisticians: 刘永欢

陈柱

第十三届全国运动会男子手球决赛

PHMS Pictorial Handball Match Statistics

IHF Official System

竞赛技术统计

 手球 半决赛 组别 X 天津师范大学体育馆
 男子 轮次 5 场次 19 2017-08-26 17:30

 Referees: PETER. HORVATH (HUN) / BALAZS. MARTON (HUN) Result: 28:27(10:10)
 Teams: 山东队(山东) VS 广东队(广东)

山东		远射	近射	边射	快攻	突破	任意球	7m球	合计	%	助攻	失误	警告	2'	D+DR	山东	比赛进程	广东
主教练: 王鸿斌																	1st Half	
3	尹杰															0	00:37	1 3 曲汝洋
4	田瑞															0	01:26	2 5 侯生升
5	潘翔			1/1	1/1		1/1	1/1	4/4	100		1	1	1		9	赵鑫	1 02:11 2
6	李朝鹏															11	宋朋强	2 04:16 2
8	王炳华															2	05:30	3 2 孙江山
9	赵鑫	3/12	3/4	0/1		2/2			8/19	42.1		2				2	08:23	4 17 李中洲
11	宋朋强	1/4	0/1			1/1			2/6	33.3	1	2				2	09:50	5 84 王伟
12	崔剑															13	刘晓	3 10:39 5
13	刘晓	0/1	1/1	0/1					1/3	33.3				1		3	11:19	6 3 曲汝洋
15	张继伟													2		3	14:15	7 8 于彦江
16	于性哲															5	潘翔	4 17:29 7
17	王旭东			0/1	1/1			1/2	1/2	50.0		2		1		9	赵鑫	5 19:06 8
18	于亚男		0/1			1/1		1/2	1/2	50.0	1		1	1		17	王旭东	6 23:05 8
19	李语庆				1/1			1/1	2/2	100						6	24:17	9 4 李卓洋
20	杜在超	4/6						4/6	4/6	66.7		1		2		21	翟乾坤	7 25:22 9
21	翟乾坤	1/1	1/1	0/1				3/4	5/7	71.4			1			21	翟乾坤	8 27:08 9
运动员 合计		9/24	5/8	1/5	3/3	4/4	1/1	5/6	28/51	54.9	2	8	3	8		9	赵鑫	9 29:05 9
16	于性哲	2/7	5/17	3/6	1/3	1/2		2/6	14/41	34.1						9	赵鑫	9 29:36 10 8 于彦江
守门员 合计		2/7	5/17	3/6	1/3	1/2		2/6	14/41	34.1						10	30:00	10
主教练: 王锋																	2nd Half	
1	王帅															20	杜在超	11 00:51 10
2	孙江山			0/1				1/2	1/3	33.3						21	翟乾坤	12 03:32 10
3	曲汝洋	2/5	4/8		1/2			7/15	46.7		2					5	潘翔	12 04:00 11 17 李中洲
4	李卓洋	2/3	2/3					4/6	66.7							5	潘翔	13 04:49 11
5	侯生升		2/4	1/1	1/1			4/6	66.7			1				14	05:33	11
6	邓志贵															14	06:18	12 5 侯生升
7	付文博	0/1	1/1			0/1		3/3	4/6	66.7	1	1				14	08:08	13 7 付文博
8	于彦江		1/1	2/5				3/6	50.0			2	1			9	赵鑫	15 08:47 13
9	徐庆															9	赵鑫	16 09:46 13
11	房友屯															17	12:08	13
12	王雨															17	12:36	14 8 于彦江
15	张建杰															17	14:03	15 3 曲汝洋
16	马跃										1					18	14:13	15
17	李中洲	1/2	0/1			1/1		0/1	2/5	40.0	1	2		2		18	15:14	16 3 曲汝洋
26	姚雪岩															18	16:44	17 4 李卓洋
84	王伟		2/2					2/2	100					1		18	17:49	18 3 曲汝洋
运动员 合计		5/11	12/20	3/7	2/3	1/2		4/6	27/49	55.1	3	10	2	3		21	翟乾坤	19 22:37 18
1	王帅							0/2	0/2	0.0						18	于亚男	20 25:37 18
16	马跃	8/17	3/8	3/4	0/3	0/4	0/1	1/4	15/41	36.6	1					20	26:05	19 5 侯生升
守门员 合计		8/17	3/8	3/4	0/3	0/4	0/1	1/6	15/43	34.9	1					20	28:43	20 5 侯生升

场上队员: 得分 / 射门		守门员: 救球 / 射门	
D	取消资格	DR	取消资格+报告

第十三届全国运动会男子手球决赛
PHMS Pictorial Handball Match Statistics

IHF Official System

个人/全队技术统计表

 手球 半决赛 组别 X 天津师范大学体育馆
 男子 轮次 5 场次 19 2017-08-26 17:30

号码	姓名	远射	近射	边射	快攻	突破	任意	七米	合计	%	助攻	失误	警告	2'	取消	时间
山东队(山东)																
(场上队员)																
3	尹杰									0.0%						00:00:00
4	田瑞									0.0%						00:00:00
5	潘翔			1/1	1/1		1/1	1/1	4/4	100%	1	1	1			00:53:34
6	李朝鹏									0.0%						00:00:00
8	王炳华									0.0%						00:00:00
9	赵鑫	3/12	3/4	0/1		2/2			8/19	42.1%	2					00:49:32
11	宋朋强	1/4	0/1			1/1			2/6	33.3%	1	2				01:05:22
12	崔剑									0.0%						00:00:00
13	刘晓	0/1	1/1	0/1					1/3	33.3%				1		00:28:20
15	张继伟									0.0%				2		00:26:18
16	于性哲									0.0%						01:20:00
17	王旭东			0/1	1/1				1/2	50.0%	2			1		01:05:59
18	于亚男		0/1			1/1			1/2	50.0%	1		1	1		00:34:53
19	李语庆				1/1			1/1	2/2	100%						00:05:50
20	杜在超	4/6							4/6	66.7%	1			2		00:42:50
21	翟乾坤	1/1	1/1	0/1				3/4	5/7	71.4%			1			01:09:51
	合计	9/24	5/8	1/5	3/3	4/4	1/1	5/6	28/51	54.9%	2	8	3	8		
(守门员)																
16	于性哲	2/7	5/17	3/6	1/3	1/2		2/6	14/41	34.1%						01:20:00
	合计	2/7	5/17	3/6	1/3	1/2		2/6	14/41	34.1%						

场上队员：得分/射门

守门员：救球/射门

全队合计	得分	被救	射失	击柱	封球	合计	%
远射	9	8	3		4	24	37.5%
近射	5	3				8	62.5%
边射	1	3	1			5	20.0%
快攻	3					3	100.0%
突破	4					4	100.0%
任意	1					1	100.0%
七米	5	1				6	83.3%

第十三届全国运动会男子手球决赛
PHMS Pictorial Handball Match Statistics

IHF Official System

个人/全队技术统计表

 手球 半决赛 组别 X 天津师范大学体育馆
 男子 轮次 5 场次 19 2017-08-26 17:30

号码	姓名	远射	近射	边射	快攻	突破	任意	七米	合计	%	助攻	失误	警告	2'	取消	时间
广东队(广东)																
(场上队员)																
1	王帅									0.0%						00:00:58
2	孙江山			0/1				1/2	1/3	33.3%						00:12:33
3	曲汝洋	2/5	4/8		1/2				7/15	46.7%		2				01:06:51
4	李卓洋	2/3	2/3						4/6	66.7%						01:07:09
5	侯生升		2/4	1/1	1/1				4/6	66.7%		1				01:09:43
6	邓志贵									0.0%						00:00:00
7	付云博	0/1	1/1			0/1		3/3	4/6	66.7%	1	1				00:26:15
8	于彦江		1/1	2/5					3/6	50.0%		2	1			01:11:15
9	徐庆									0.0%						00:09:59
11	房友屯									0.0%						00:00:00
12	王雨									0.0%						00:00:00
15	张建杰									0.0%						00:00:00
16	马跃									0.0%	1					01:19:02
17	李中洲	1/2	0/1			1/1		0/1	2/5	40.0%	1	2		2		01:10:29
26	姚雪岩									0.0%						00:00:00
84	王伟		2/2						2/2	100%		2	1	1		01:03:38
	合计	5/11	12/20	3/7	2/3	1/2		4/6	27/49	55.1%	3	10	2	3		
(守门员)																
1	王帅							0/2	0/2	0.0%						00:00:58
16	马跃	8/17	3/8	3/4	0/3	0/4	0/1	1/4	15/41	36.6%	1					01:19:02
	合计	8/17	3/8	3/4	0/3	0/4	0/1	1/6	15/43	34.9%	1					

场上队员：得分/射门

守门员：救球/射门

全队合计	得分	被救	射失	击柱	封球	合计	%
远射	5	2	1	2	1	11	45.5%
近射	12	5	3			20	60.0%
边射	3	3		1		7	42.9%
快攻	2	1				3	66.7%
突破	1	1				2	50.0%
任意							0.0%
七米	4	2				6	66.7%

第十三届全国运动会男子手球决赛

PHMS Pictorial Handball Match Statistics

IHF Official System

图式比赛技术统计表

手球
男子

半决赛
轮次 5

组别 X
场次 19

天津师范大学体育馆
2017-08-26 17:30

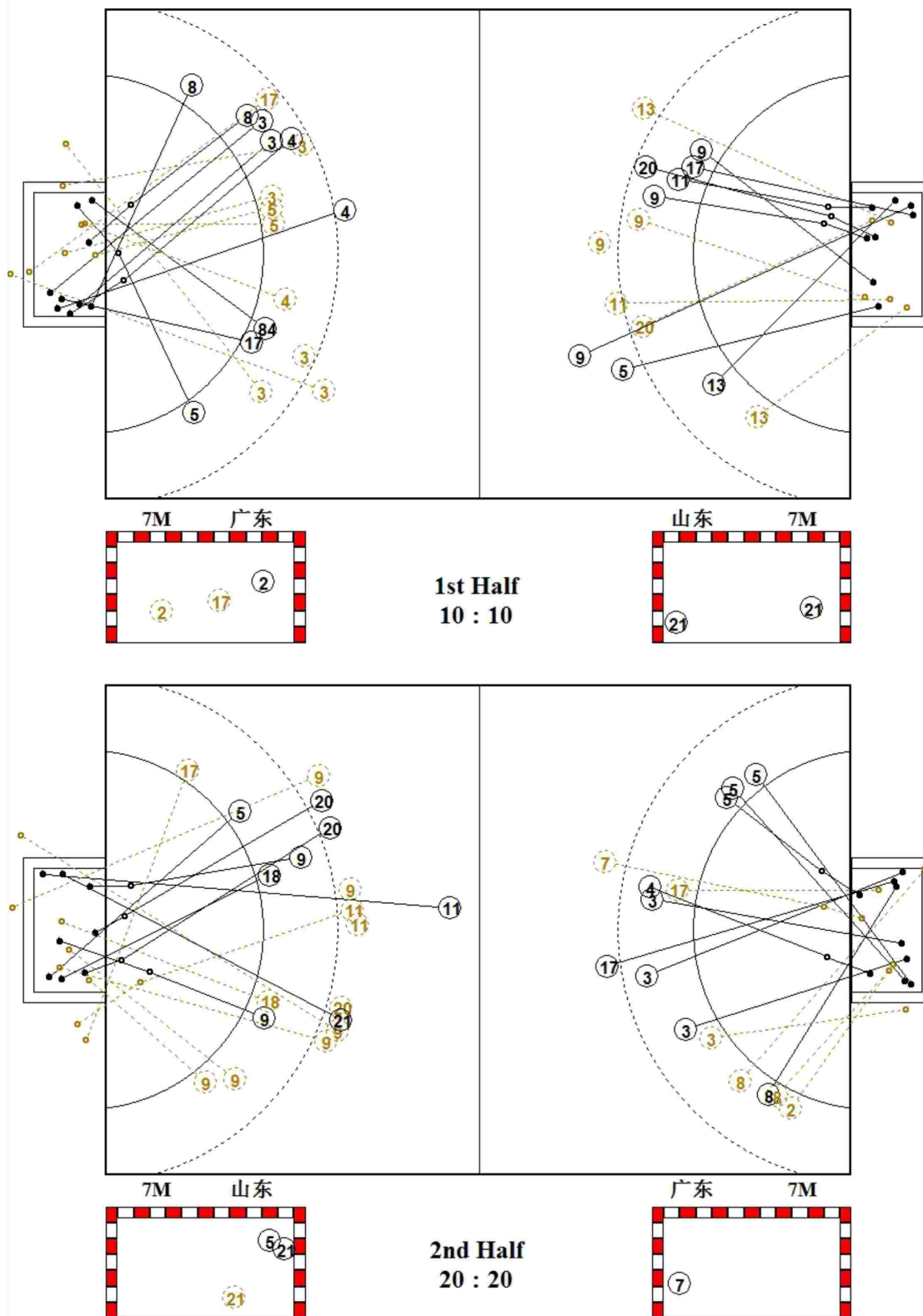

第十三届全国运动会男子手球决赛

PHMS Pictorial Handball Match Statistics

IHF Official System

PICTORIAL MATCH STATISTICS

HANDBALL
男子

半决赛
ROUND 5

GROUP X
MATCH 19

天津师范大学体育馆
2017-08-26 17:30

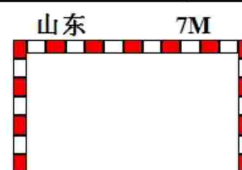
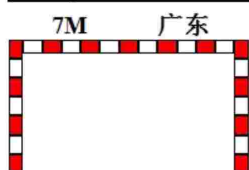
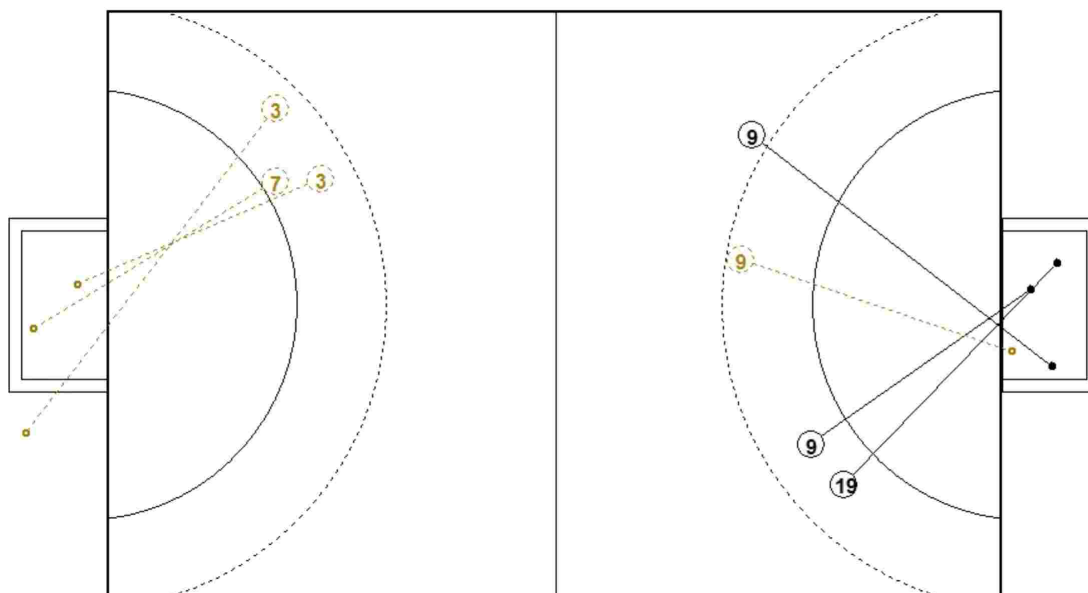

Extra 1-1
20 : 23

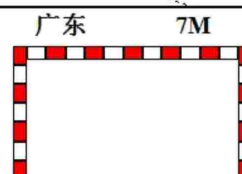
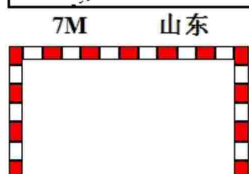
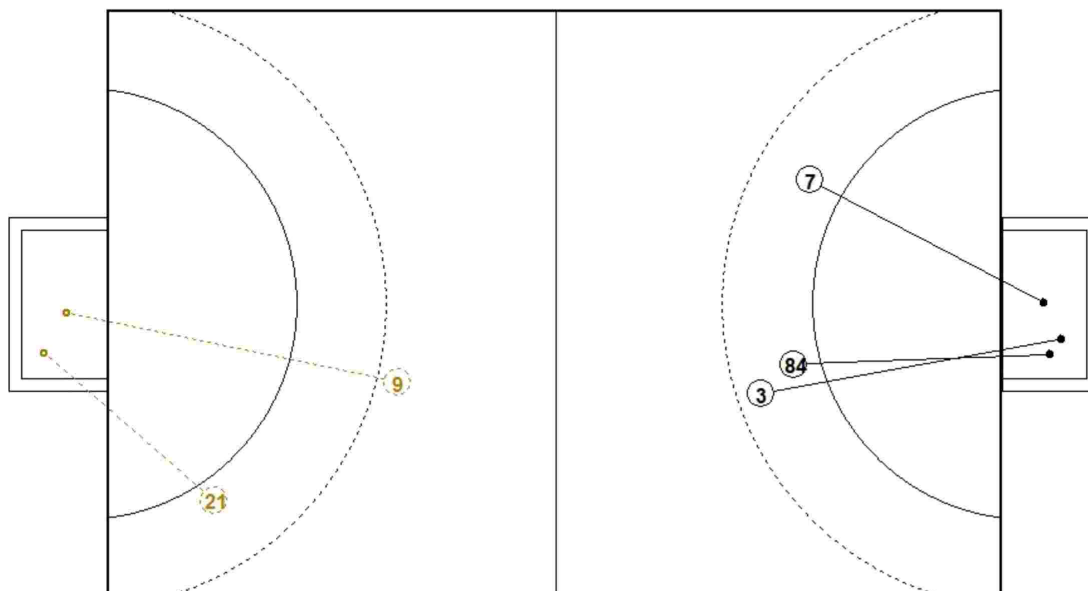

Extra 1-2
23 : 23

第十三届全国运动会男子手球决赛

PHMS Pictorial Handball Match Statistics

IHF Official System

PICTORIAL MATCH STATISTICS

HANDBALL
男子

半决赛
ROUND 5

GROUP X
MATCH 19

天津师范大学体育馆
2017-08-26 17:30

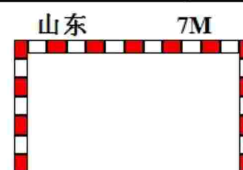
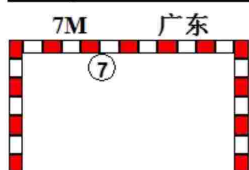
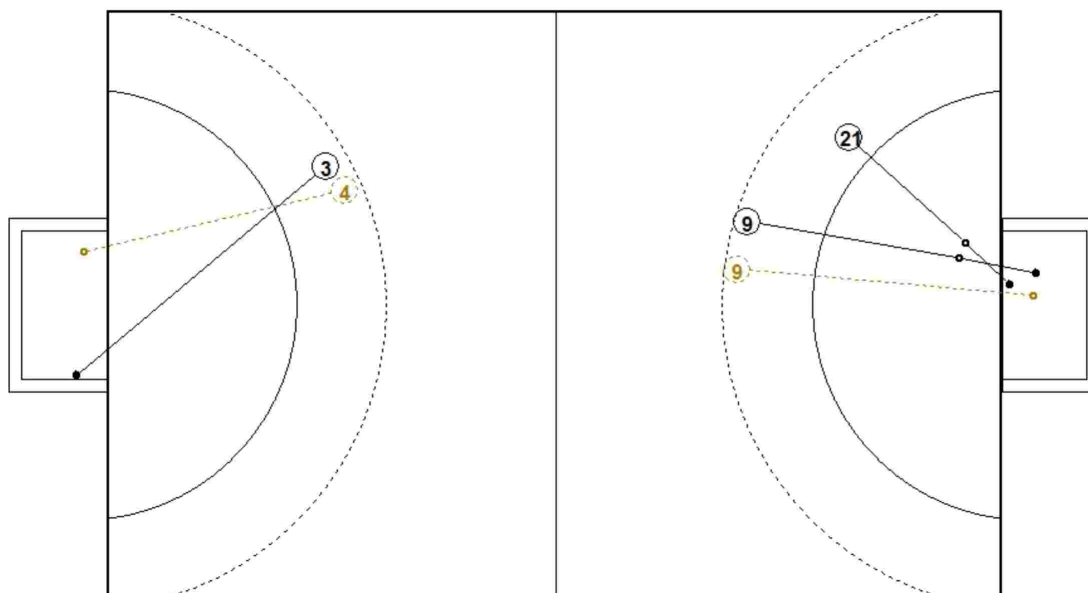

Extra 2-1
25 : 25

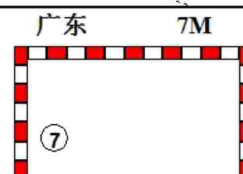
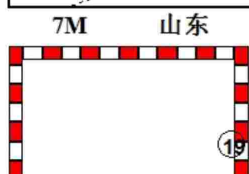
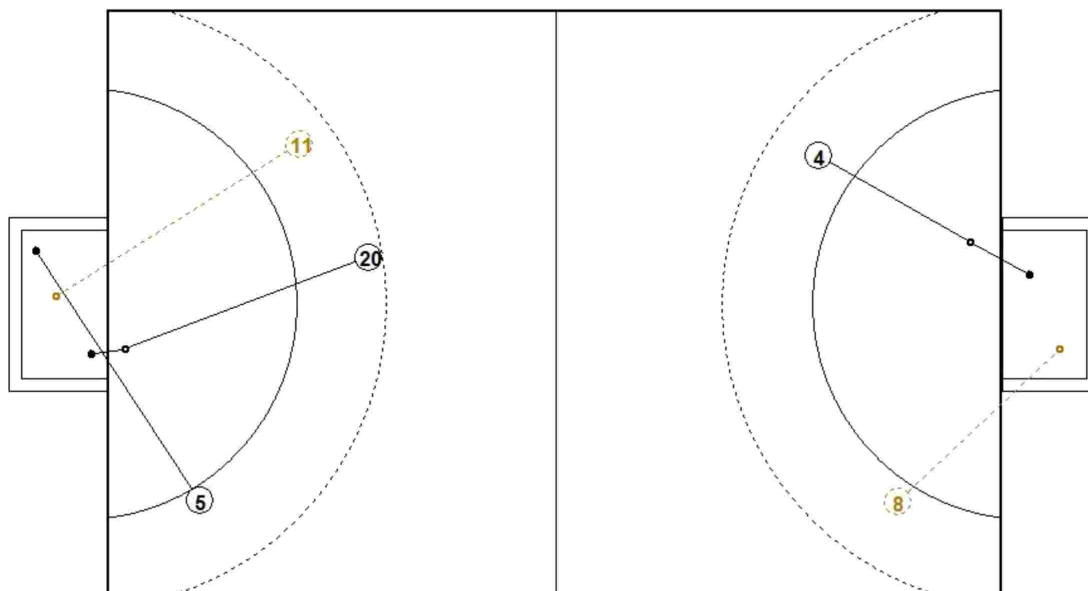

Extra 2-2
28 : 27

第十三届全国运动会男子手球决赛

PHMS Pictorial Handball Match Statistics

IHF Official System

图式射门区域统计

手球
男子

半决赛
轮次 5

组别 X
场次 19

天津师范大学体育馆
2017-08-26 17:30

山东队

3 尹杰	4 田瑞	5 潘翔	6 李朝鹏	8 王炳华	9 赵鑫	11 宋朋强	12 崔剑																																																																								
<table border="1"><tr><td></td><td></td><td></td></tr><tr><td></td><td></td><td></td></tr><tr><td></td><td></td><td></td></tr></table>										<table border="1"><tr><td></td><td></td><td></td></tr><tr><td></td><td></td><td></td></tr><tr><td></td><td></td><td></td></tr></table>										<table border="1"><tr><td>1</td><td></td><td>2</td></tr><tr><td></td><td></td><td>1</td></tr><tr><td></td><td></td><td></td></tr></table>	1		2			1				<table border="1"><tr><td></td><td></td><td></td></tr><tr><td></td><td></td><td></td></tr><tr><td></td><td></td><td></td></tr></table>										<table border="1"><tr><td></td><td></td><td></td></tr><tr><td></td><td></td><td></td></tr><tr><td></td><td></td><td></td></tr></table>										<table border="1"><tr><td>1</td><td></td><td></td></tr><tr><td>1</td><td>2</td><td>1</td></tr><tr><td></td><td>1</td><td>2</td></tr></table>	1			1	2	1		1	2	<table border="1"><tr><td></td><td></td><td>1</td></tr><tr><td></td><td></td><td></td></tr><tr><td>1</td><td></td><td></td></tr></table>			1				1			<table border="1"><tr><td></td><td></td><td></td></tr><tr><td></td><td></td><td></td></tr><tr><td></td><td></td><td></td></tr></table>									
1		2																																																																													
		1																																																																													
1																																																																															
1	2	1																																																																													
	1	2																																																																													
		1																																																																													
1																																																																															
Post - 0 Miss - 0 Block - 0	Post - 0 Miss - 0 Block - 0	Post - 0 Miss - 0 Block - 0	Post - 0 Miss - 0 Block - 0	Post - 0 Miss - 0 Block - 0	Post - 0 Miss - 2 Block - 2	Post - 0 Miss - 1 Block - 1	Post - 0 Miss - 0 Block - 0																																																																								
13 刘晓	15 张继伟	16 于性哲	17 王旭东	18 于亚男	19 李语庆	20 杜在超	21 翟乾坤																																																																								
<table border="1"><tr><td>1</td><td></td><td></td></tr><tr><td></td><td></td><td></td></tr><tr><td></td><td></td><td></td></tr></table>	1									<table border="1"><tr><td></td><td></td><td></td></tr><tr><td></td><td></td><td></td></tr><tr><td></td><td></td><td></td></tr></table>										<table border="1"><tr><td></td><td></td><td></td></tr><tr><td></td><td></td><td></td></tr><tr><td></td><td></td><td></td></tr></table>										<table border="1"><tr><td>1</td><td></td><td></td></tr><tr><td></td><td></td><td></td></tr><tr><td></td><td></td><td></td></tr></table>	1									<table border="1"><tr><td></td><td></td><td></td></tr><tr><td>1</td><td></td><td></td></tr><tr><td></td><td></td><td></td></tr></table>				1						<table border="1"><tr><td>1</td><td></td><td></td></tr><tr><td></td><td></td><td>1</td></tr><tr><td></td><td></td><td></td></tr></table>	1					1				<table border="1"><tr><td></td><td></td><td></td></tr><tr><td></td><td>1</td><td></td></tr><tr><td>2</td><td>1</td><td></td></tr></table>					1		2	1		<table border="1"><tr><td></td><td></td><td>1</td></tr><tr><td></td><td></td><td>2</td></tr><tr><td>1</td><td>1</td><td></td></tr></table>			1			2	1	1	
1																																																																															
1																																																																															
1																																																																															
1																																																																															
		1																																																																													
	1																																																																														
2	1																																																																														
		1																																																																													
		2																																																																													
1	1																																																																														
Post - 0 Miss - 0 Block - 0	Post - 0 Miss - 0 Block - 0	Post - 0 Miss - 0 Block - 0	Post - 0 Miss - 1 Block - 0	Post - 0 Miss - 0 Block - 0	Post - 0 Miss - 0 Block - 0	Post - 0 Miss - 0 Block - 1	Post - 0 Miss - 0 Block - 0																																																																								

16 □□□

0/3	1/3	1/6
2/11	3/4	3/5
0/2	2/3	2/4

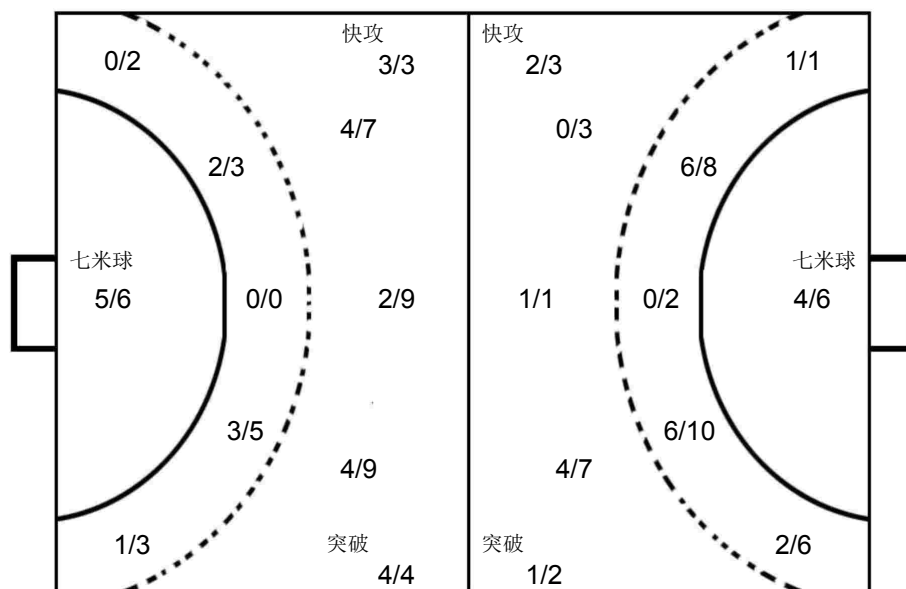

1 □□

		0/1
		0/1

16 □□

1/5		1/4
2/5	5/8	1/5
2/6	1/4	2/4

广东队

1 王帅	2 孙江山	3 曲汝洋	4 李卓洋	5 侯生升	6 邓志贵	7 付云博	8 于彦江																																																																								
<table border="1"><tr><td></td><td></td><td></td></tr><tr><td></td><td></td><td></td></tr><tr><td></td><td></td><td></td></tr></table>										<table border="1"><tr><td></td><td></td><td>1</td></tr><tr><td></td><td></td><td></td></tr><tr><td></td><td></td><td></td></tr></table>			1							<table border="1"><tr><td>2</td><td>1</td><td>2</td></tr><tr><td>2</td><td></td><td></td></tr><tr><td></td><td></td><td></td></tr></table>	2	1	2	2						<table border="1"><tr><td>1</td><td></td><td></td></tr><tr><td>2</td><td></td><td></td></tr><tr><td></td><td></td><td>1</td></tr></table>	1			2					1	<table border="1"><tr><td></td><td></td><td>2</td></tr><tr><td></td><td></td><td>1</td></tr><tr><td>1</td><td></td><td></td></tr></table>			2			1	1			<table border="1"><tr><td></td><td></td><td></td></tr><tr><td></td><td></td><td></td></tr><tr><td></td><td></td><td></td></tr></table>										<table border="1"><tr><td></td><td>1</td><td></td></tr><tr><td>2</td><td>1</td><td></td></tr><tr><td></td><td></td><td></td></tr></table>		1		2	1					<table border="1"><tr><td></td><td></td><td></td></tr><tr><td>1</td><td></td><td></td></tr><tr><td>1</td><td>1</td><td></td></tr></table>				1			1	1	
		1																																																																													
2	1	2																																																																													
2																																																																															
1																																																																															
2																																																																															
		1																																																																													
		2																																																																													
		1																																																																													
1																																																																															
	1																																																																														
2	1																																																																														
1																																																																															
1	1																																																																														
Post - 0 Miss - 0 Block - 0	Post - 0 Miss - 0 Block - 0	Post - 1 Miss - 4 Block - 1	Post - 0 Miss - 0 Block - 0	Post - 0 Miss - 0 Block - 0	Post - 0 Miss - 0 Block - 0	Post - 0 Miss - 0 Block - 0	Post - 1 Miss - 0 Block - 0																																																																								
9 徐庆	11 房友屯	12 王雨	15 张建杰	16 马跃	17 李中洲	26 姚雪岩	84 王伟																																																																								
<table border="1"><tr><td></td><td></td><td></td></tr><tr><td></td><td></td><td></td></tr><tr><td></td><td></td><td></td></tr></table>										<table border="1"><tr><td></td><td></td><td></td></tr><tr><td></td><td></td><td></td></tr><tr><td></td><td></td><td></td></tr></table>										<table border="1"><tr><td></td><td></td><td></td></tr><tr><td></td><td></td><td></td></tr><tr><td></td><td></td><td></td></tr></table>										<table border="1"><tr><td></td><td></td><td></td></tr><tr><td></td><td></td><td></td></tr><tr><td></td><td></td><td></td></tr></table>										<table border="1"><tr><td></td><td></td><td></td></tr><tr><td></td><td></td><td></td></tr><tr><td></td><td></td><td></td></tr></table>										<table border="1"><tr><td>2</td><td></td><td></td></tr><tr><td></td><td></td><td></td></tr><tr><td></td><td></td><td></td></tr></table>	2									<table border="1"><tr><td></td><td></td><td></td></tr><tr><td></td><td></td><td></td></tr><tr><td></td><td></td><td></td></tr></table>										<table border="1"><tr><td></td><td></td><td>1</td></tr><tr><td></td><td></td><td>1</td></tr><tr><td></td><td></td><td></td></tr></table>			1			1			
2																																																																															
		1																																																																													
		1																																																																													
Post - 0 Miss - 0 Block - 0	Post - 0 Miss - 0 Block - 0	Post - 0 Miss - 0 Block - 0	Post - 0 Miss - 0 Block - 0	Post - 0 Miss - 0 Block - 0	Post - 1 Miss - 0 Block - 0	Post - 0 Miss - 0 Block - 0	Post - 0 Miss - 0 Block - 0																																																																								

第十三届全国运动会男子手球决赛

PHMS Pictorial Handball Match Statistics

IHF Official System

比赛进程表

 手球 半决赛 组别 X
 男子 轮次 5 场次 19
 天津奥林匹克体育中心 2017-08-26 17:30

时间	队员	动作	比分	队员	动作			
山东队			上半时			广东队		
00:37	16 于性哲	被射入	0-1	3 曲汝洋	近射 得分			
01:20	11 宋朋强	右远射 被救		16 马跃	挡住球			
01:26	16 于性哲	被射入	0-2	5 侯生升	一传快攻 得分			
01:28				16 马跃	助攻			
02:11	9 赵鑫	近射 得分	1-2	16 马跃	被射入			
03:34				17 李中洲	右远射 击柱			
04:16	11 宋朋强	突破 得分	2-2	16 马跃	被射入			
04:26				3 曲汝洋	顶贴 失误			
04:56	18 于亚男	使被罚7M球		17 李中洲	造7M			
04:58	18 于亚男	警告						
05:30	16 于性哲	被射入	2-3	2 孙江山	7M球 得分			
06:21	9 赵鑫	中远射 被封		84 王伟	封球			
06:55	5 潘翔	警告						
07:23				3 曲汝洋	左远射 射失			
07:34	17 王旭东	运球失误						
08:23	16 于性哲	被射入	2-4	17 李中洲	突破 得分			
08:26	11 宋朋强	顶贴 失误						
09:11	13 刘晓	左远射 被救		16 马跃	挡住球			
09:46	16 于性哲	挡住球		5 侯生升	近射 被救			
09:50	16 于性哲	被射入	2-5	84 王伟	近射 得分			
10:39	13 刘晓	近射 得分	3-5	16 马跃	被射入			
11:19	16 于性哲	被射入	3-6	3 曲汝洋	近射 得分			
12:01				84 王伟	警告			
12:21	9 赵鑫	运球失误						
13:05	21 翟乾坤	使被罚7M球		3 曲汝洋	造7M			
13:05	21 翟乾坤	警告						
13:40	16 于性哲	挡住球		2 孙江山	7M球 被救			
14:06	13 刘晓	右边射 被救		16 马跃	挡住球			
14:15	16 于性哲	被射入	3-7	8 于彦江	近射 得分			
14:22		球队暂停						
14:59	9 赵鑫	中远射 被救		16 马跃	挡住球			
15:17				3 曲汝洋	近射 射失			
15:53		裁判暂停						
15:53	13 刘晓	罚出场2分钟						
16:41				8 于彦江	警告			
17:29	5 潘翔	任意球 得分	4-7	16 马跃	被射入			
17:57	16 于性哲	被射入	4-8	4 李卓洋	右远射 得分			
18:46		裁判暂停						
19:06	9 赵鑫	突破 得分	5-8	16 马跃	被射入			
19:08				3 曲汝洋	移动 失误			
19:17					球队暂停			

第十三届全国运动会男子手球决赛
PHMS Pictorial Handball Match Statistics

IHF Official System

比赛进程表

 手球 半决赛 组别 X
 男子 轮次 5 场次 19
 天津奥林匹克体育中心 2017-08-26 17:30

时间	队员	动作	比分	队员	动作			
山东队			上半时			广东队		
19:57	11 宋朋强	断球	5-8	3 曲汝洋	传球失误			
21:01	20 杜在超	右远射 被救		16 马跃	挡住球			
21:44				3 曲汝洋	右远射 击柱			
22:00	9 赵鑫	传球失误						
22:49	15 张继伟	封球		3 曲汝洋	左远射 被封			
23:01	11 宋朋强	断球		8 于彦江	传球失误			
23:05	17 王旭东	一传快攻 得分	6-8	16 马跃	被射入			
23:06	11 宋朋强	助攻						
24:01		裁判暂停						
24:17	16 于性哲	被射入	6-9	4 李卓洋	右远射 得分			
24:56	11 宋朋强	造7M		8 于彦江	使被罚7M球			
25:22	21 翟乾坤	7M球 得分	7-9	16 马跃	被射入			
26:00		裁判暂停						
26:42	16 于性哲	挡住球		5 侯生升	近射 被救			
26:51		裁判暂停						
26:51				84 王伟	罚出场2分钟			
26:55	9 赵鑫	造7M		4 李卓洋	使被罚7M球			
27:04		裁判暂停						
27:08	21 翟乾坤	7M球 得分	8-9	1 王帅	被射入			
27:24	15 张继伟	使被罚7M球		17 李中洲	造7M			
27:42		裁判暂停						
27:42	15 张继伟	罚出场2分钟						
27:44	16 于性哲	挡住球		17 李中洲	7M球 被救			
28:06		裁判暂停						
28:06	17 王旭东	罚出场2分钟						
28:20	16 于性哲	挡住球		4 李卓洋	近射 被救			
29:05	20 杜在超	左远射 得分	9-9	16 马跃	被射入			
29:33	16 于性哲	挡住球		3 曲汝洋	近射 被救			
29:36	16 于性哲	被射入	9-10	8 于彦江	右边射 得分			
30:00	9 赵鑫	右远射 得分	10-10	16 马跃	被射入			

第十三届全国运动会男子手球决赛
PHMS Pictorial Handball Match Statistics

IHF Official System

比赛进程表

 手球 半决赛 组别 X
 男子 轮次 5 场次 19
 天津奥林匹克体育中心 2017-08-26 17:30

时间	队员	动作	比分	队员	动作
山东队			广东队		
00:34	20 杜在超	左远射 被封	10-10	8 于彦江	封球
00:51	20 杜在超	右远射 得分	11-10	16 马跃	被射入
01:49	17 王旭东	造犯规		84 王伟	进攻犯规
02:31	9 赵鑫	左边射 被救		16 马跃	挡住球
02:41				8 于彦江	右边射 击柱
03:15	20 杜在超	造7M		5 侯生升	使被罚7M球
03:32	21 翟乾坤	7M球 得分	12-10	16 马跃	被射入
04:00	16 于性哲	被射入	12-11	17 李中洲	中远射 得分
04:35	11 宋朋强	造7M		17 李中洲	使被罚7M球
04:42		裁判暂停			
04:49	5 潘翔	7M球 得分	13-11	1 王帅	被射入
05:29	5 潘翔	断球		8 于彦江	传球失误
05:33	5 潘翔	一传快攻 得分	14-11	16 马跃	被射入
05:47					球队暂停
06:18	16 于性哲	被射入	14-12	5 侯生升	近射 得分
06:19		裁判暂停			
06:20	5 潘翔	罚出场2分钟			
06:51	17 王旭东	侵区			
08:02	17 王旭东	使被罚7M球		17 李中洲	造7M
08:03		裁判暂停			
08:08	16 于性哲	被射入	14-13	7 付云博	7M球 得分
08:37		裁判暂停			
08:39				17 李中洲	罚出场2分钟
08:47	9 赵鑫	近射 得分	15-13	16 马跃	被射入
09:26	18 于亚男	断球		5 侯生升	传球失误
09:27		裁判暂停			
09:46	9 赵鑫	近射 得分	16-13	16 马跃	被射入
10:52	15 张继伟	造犯规		84 王伟	进攻犯规
11:36		裁判暂停			
12:08	20 杜在超	右远射 得分	17-13	16 马跃	被射入
12:36	16 于性哲	被射入	17-14	8 于彦江	右边射 得分
13:19	9 赵鑫	造7M		8 于彦江	使被罚7M球
13:41	21 翟乾坤	7M球 被救		16 马跃	挡住球
14:03	16 于性哲	被射入	17-15	3 曲汝洋	近射 得分
14:13	11 宋朋强	中远射 得分	18-15	16 马跃	被射入
14:51		裁判暂停			
14:51	20 杜在超	罚出场2分钟			
15:14	16 于性哲	被射入	18-16	3 曲汝洋	近射 得分
15:50		球队暂停			
16:20	17 王旭东	右边射 射失			
16:44	16 于性哲	被射入	18-17	4 李卓洋	近射 得分

第十三届全国运动会男子手球决赛

PHMS Pictorial Handball Match Statistics

IHF Official System

比赛进程表

手球 半决赛 组别 X 八件型池八子牌月
男子 轮次 5 场次 19 馆
2017-08-26 17:30

时间	队员	动作	比分	队员	动作
山东队			广东队		
17:45			18-17	9 徐庆	抢球
17:49	16 于性哲	被射入	18-18	3 曲汝洋	短传快攻 得分
18:50	9 赵鑫	左远射 射失			
19:20				3 曲汝洋	传球失误
20:48	11 宋朋强	中远射 被封		17 李中洲	封球
21:04	9 赵鑫	左远射 被救		16 马跃	挡住球
21:37	16 于性哲	挡住球		2 孙江山	右边射 被救
22:12		裁判暂停			
22:37	21 翟乾坤	左远射 得分	19-18	16 马跃	被射入
23:17				3 曲汝洋	近射 射失
23:30		裁判暂停			
24:03	9 赵鑫	近射 被救		16 马跃	挡住球
24:11					球队暂停
24:57	16 于性哲	挡住球		8 于彦江	右边射 被救
25:37	18 于亚男	突破 得分	20-18	16 马跃	被射入
25:41				17 李中洲	顶贴 失误
26:05	16 于性哲	被射入	20-19	5 侯生升	左边射 得分
26:54	9 赵鑫	右远射 射失			
27:08	16 于性哲	挡住球		17 李中洲	近射 被救
27:55	18 于亚男	近射 被救		16 马跃	挡住球
28:43	16 于性哲	被射入	20-20	5 侯生升	近射 得分
29:21	9 赵鑫	中远射 被封		8 于彦江	封球
29:34	11 宋朋强	中远射 射失			
29:51		裁判暂停			
30:00	16 于性哲	挡住球		7 付文博	左远射 被救
30:00		裁判暂停			

第十三届全国运动会男子手球决赛

PHMS Pictorial Handball Match Statistics

IHF Official System

比赛进程表

手球 半决赛 组别 X
男子 轮次 5 场次 19
天津奥林匹克体育中心 2017-08-26 17:30

时间	队员	动作	比分	队员	动作			
山东队			决胜期 1-1			广东队		
00:00		裁判暂停	20-20					
00:38	9 赵鑫	左远射 得分	21-20	16 马跃	被射入			
00:42		裁判暂停						
01:01				17 李中洲	四步			
01:40	9 赵鑫	突破 得分	22-20	16 马跃	被射入			
01:43				8 于彦江	移动 失误			
01:59				3 曲汝洋	近射 射失			
02:42	9 赵鑫	中远射 被救		16 马跃	挡住球			
02:49	16 于性哲	挡住球		3 曲汝洋	一传快攻 被救			
02:53				17 李中洲	助攻			
03:34	16 于性哲	挡住球		7 付文博	突破 被救			
03:40	19 李语庆	一传快攻 得分	23-20	16 马跃	被射入			
03:43	18 于亚男	助攻						
04:14				17 李中洲	传球失误			
04:35		裁判暂停						
04:58	5 潘翔	进攻犯规		4 李卓洋	造犯规			
05:00		裁判暂停						

第十三届全国运动会男子手球决赛

PHMS Pictorial Handball Match Statistics

IHF Official System

比赛进程表

手球 半决赛 组别 X 八件型池八子牌月
男子 轮次 5 场次 19 馆
2017-08-26 17:30

时间	队员	动作	比分	队员	动作			
山东队			决胜期 1-2			广东队		
00:00		裁判暂停	23-20					
00:54	16 于性哲	被射入	23-21	7 付文博	近射 得分			
01:56	21 翟乾坤	左边射 被救		16 马跃	挡住球			
02:32	16 于性哲	被射入	23-22	84 王伟	近射 得分			
02:34				7 付文博	助攻			
03:22		裁判暂停						
03:48	9 赵鑫	左远射 被救		16 马跃	挡住球			
04:22	11 宋朋强	其它失误						
04:55		裁判暂停						
05:00	16 于性哲	被射入	23-23	3 曲汝洋	右远射 得分			

第十三届全国运动会男子手球决赛

PHMS Pictorial Handball Match Statistics

IHF Official System

比赛进程表

手球 半决赛 组别 X
男子 轮次 5 场次 19
八津卅卅八手球月 馆
2017-08-26 17:30

时间	队员	动作	比分	队员	动作
山东队			广东队		
决胜期 2-1					
00:33	21 翟乾坤	近射 得分	24-23	16 马跃	被射入
01:03	16 于性哲	挡住球		4 李卓洋	右远射 被救
01:40	20 杜在超	进攻犯规		84 王伟	造犯规
02:37	15 张继伟	使被罚7M球		7 付文博	造7M
02:37		裁判暂停			
02:37	15 张继伟	罚出场2分钟			
02:41	16 于性哲	被射入	24-24	7 付文博	7M球 得分
03:27		裁判暂停			
03:27				17 李中洲	罚出场2分钟
03:52	9 赵鑫	中远射 被救		16 马跃	挡住球
04:31	16 于性哲	被射入	24-25	3 曲汝洋	右远射 得分
04:57	9 赵鑫	左远射 得分	25-25	16 马跃	被射入
04:59		裁判暂停			

第十三届全国运动会男子手球决赛

PHMS Pictorial Handball Match Statistics

IHF Official System

比赛进程表

手球 半决赛 组别 X 八件型池八子牌日
男子 轮次 5 场次 19 馆
2017-08-26 17:30

时间	队员	动作	比分	队员	动作
山东队		决胜期E 2-2		广东队	
00:35	20 杜在超	造犯规	25-25	7 付文博	进攻犯规
00:55	20 杜在超	造7M		17 李中洲	使被罚7M球
01:12		裁判暂停			
01:15	19 李语庆	7M球 得分	26-25	16 马跃	被射入
01:32	18 于亚男	使被罚7M球		17 李中洲	造7M
01:52		裁判暂停			
01:52	18 于亚男	罚出场2分钟			
02:00	16 于性哲	被射入	26-26	7 付文博	7M球 得分
02:34	20 杜在超	中远射 得分	27-26	16 马跃	被射入
03:26		裁判暂停			
03:26	20 杜在超	罚出场2分钟			
03:36	16 于性哲	挡住球		8 于彦江	右边射 被救
04:15	11 宋朋强	近射 被救		16 马跃	挡住球
04:27	16 于性哲	被射入	27-27	4 李卓洋	近射 得分
04:58	5 潘翔	左边射 得分	28-27	16 马跃	被射入
05:00		裁判暂停			

Team A					Team B					Match Number											
A 北京队					B 江苏队					20											
Played in			in the hall			on			at			Spectators									
天津			天津师范大学体育馆			2017-08-26			19:15			hours									
Half-time(30')	A	B	End of playing time		A	B	1st extra time		A	B	2nd extra time		A	B	After penalty throws		A	B			
	11	15			22	25															
Number of 7 m	A	Team time-out			Full name of players and officials						Team time-out			B	Number of 7 m						
		1	2	3							1	2	3								
	3/4	05:55	35:58								19:41	49:17	54:21	3/4							
No.	Team A					G	W	2'	D	DR	No.	Team B					G	W	2'	D	DR
1	王洸										1	徐畅									
7	马昌震										4	张家纬					2	1	1		
8	王鹏										5	闫亮					3				
9	刘振					6	1				6	赵晨					8				
10	成亚					3	1	1			7	徐奕飞					1				
16	刘迈科										8	周小坚					1				
21	胡瀛					2	1	1			9	王杰缘					3	1			
22	王超										10	郝可鑫					3		1		
23	王军程										12	王权									
25	马明辉										13	叶强									
29	杜龙飞										15	李安					4				
39	张骥					5					17	王伟强									
66	解建飞					1					18	赵楠									
77	朱昕晨					2		1			19	张志宇									
83	潘天							1			20	顾艳超									
99	蒋维一					3		1			21	刘江							2		
A	安福田										A	闫威名 (主教练)									
B	郑永利 (主教练)										C	雷纳德									
C	孟辉										D	贾淑君									
E	王长林										E	王建国									
A	Signatures of responsables for the teams (Off.A)										B										
TP	Remarks of referees / HF Official										TP										

Signatures

Referees ALEXEI. COVALCIUC (MDA)

IGOR. COVALCIUC (MDA)

T.D. 李长海 (CHN)

李刚 (CHN)

CHA Off.

Note: Number of 7m Throws Awarded to Team A and B, Goals (G), Warnings (W), Suspensions (2'), Direct Disqualification (D), Disqualification With Report (DR) and Team Penalty (TP).

Table Officials: 鲍瑀

李志成

Statisticians: 黄岩

陈柱

第十三届全国运动会男子手球决赛
PHMS Pictorial Handball Match Statistics

IHF Official System

竞赛技术统计

 手球
男子

 半决赛
轮次 5

 组别 X
场次 20

 天津师范大学体育馆
2017-08-26 19:15

Referees: ALEXEI. COVALCIUC (MDA) / IGOR. COVALCIUC (MDA)

Result: 22:25(11:15)

Teams: 北京队(北京) VS 江苏队(江苏)

北京		远射	近射	边射	快攻	突破	任意球	7m球	合计	%	助攻	失误	警告	2'	D+DR
主教练: 郑永利															
1	王澍														
7	马昌震														
8	王鹏														
9	刘振	3/8	2/3					1/1	6/12	50.0			1		
10	成亚	0/1	2/2	1/1					3/4	75.0		3	1	1	
16	刘迈科														
21	胡瀛		1/2	1/1					2/3	66.7		2	1	1	
22	王超														
23	王军程														
25	马明辉														
29	杜龙飞														
39	张骥	3/10						2/3	5/13	38.5	2	2			
66	解建飞			1/3					1/3	33.3					
77	朱昕晨	2/7					0/1		2/8	25.0	2	2		1	
83	潘天													1	
99	蒋维一		2/3		1/1				3/4	75.0		1		1	
运动员 合计		8/26	7/10	3/5	1/1	0/1		3/4	22/47	46.8	4	10	3	5	
1	王澍	2/7	2/5		0/1		0/1	1/3	5/17	29.4					
16	刘迈科	4/11	2/3		0/4			0/1	6/19	31.6					
守门员 合计		6/18	4/8		0/5		0/1	1/4	11/36	30.6					

江苏		远射	近射	边射	快攻	突破	任意球	7m球	合计	%	助攻	失误	警告	2'	D+DR
主教练: 闫威名															
1	徐畅														
4	张家纬	2/6	0/2						2/8	25.0		1	1	1	
5	闫亮		1/1		2/2				3/3	100					
6	赵晨	7/11					1/1		8/12	66.7	3	2			
7	徐奕飞		1/1						1/1	100					
8	周小坚		1/1						1/1	100	1				
9	王杰缘		1/3		2/3				3/6	50.0			1		
10	郝可鑫	3/6							3/6	50.0				1	
12	王权											1			
13	叶强														
15	李安	0/1		0/2	1/1			3/4	4/8	50.0		2			
17	王伟强														
18	赵楠														
19	张志宇	0/1							0/1	0.0					
20	顾艳超														
21	刘江				0/1				0/1	0.0				2	
运动员 合计		12/25	4/8	0/2	5/7		1/1	3/4	25/47	53.2	5	5	2	4	
12	王权	7/15	2/9	1/4	0/1	1/1		0/3	11/33	33.3	1				
守门员 合计		7/15	2/9	1/4	0/1	1/1		0/3	11/33	33.3	1				

北京	比赛进程	江苏
1st Half		
9 刘振	1 01:22 0	
	1 02:06 1 6 赵晨	
	1 03:16 2 15 李安	
	1 04:50 3 15 李安	
	1 05:42 4 5 闫亮	
	1 06:33 5 5 闫亮	
39 张骥	2 07:42 5 5	
39 张骥	3 09:17 5 5	
9 刘振	4 10:18 5 5	
	4 10:53 6 10 郝可鑫	
39 张骥	5 11:44 6 6	
	5 12:57 7 15 李安	
	5 14:48 8 6 赵晨	
	5 15:37 9 9 王杰缘	
39 张骥	6 16:16 9 9	
99 蒋维一	7 16:57 9 9	
10 成亚	8 17:46 9 9	
10 成亚	9 19:31 9 9	
	9 21:26 10 4 张家纬	
9 刘振	10 22:25 10 10	
	10 23:06 11 6 赵晨	
39 张骥	11 23:58 11 11	
	11 24:48 12 6 赵晨	
	11 27:24 13 9 王杰缘	
	11 29:26 14 6 赵晨	
	11 30:00 15 5 闫亮	
2nd Half		
	11 01:48 16 7 徐奕飞	
	11 04:48 17 4 张家纬	
	11 05:38 18 10 郝可鑫	
9 刘振	12 06:52 18 18	
	12 07:28 19 10 郝可鑫	
77 朱昕晨	13 07:59 19 19	
	13 09:47 20 6 赵晨	
10 成亚	14 11:44 20 20	
	14 12:22 21 6 赵晨	
	14 13:51 22 6 赵晨	
	14 15:30 23 8 周小坚	
9 刘振	15 16:14 23 23	
	15 18:05 24 15 李安	
9 刘振	16 18:51 24 24	
99 蒋维一	17 19:53 24 24	
77 朱昕晨	18 20:56 24 24	
66 解建飞	19 22:42 24 24	
21 胡瀛	20 23:45 24 24	
21 胡瀛	21 25:21 24 24	
	21 27:37 25 9 王杰缘	
99 蒋维一	22 30:00 25 25	

场上队员: 得分 / 射门

守门员: 救球 / 射门

D	取消资格	DR	取消资格+报告
---	------	----	---------

第十三届全国运动会男子手球决赛
PHMS Pictorial Handball Match Statistics

IHF Official System

个人/全队技术统计表

 手球 半决赛 组别 X 天津师范大学体育馆
 男子 轮次 5 场次 20 2017-08-26 19:15

号码	姓名	远射	近射	边射	快攻	突破	任意	七米	合计	%	助攻	失误	警告	2'	取消	时间
北京队(北京)																
(场上队员)																
1	王澍									0.0%						00:25:20
7	马昌震									0.0%						00:00:00
8	王鹏									0.0%						00:16:41
9	刘振	3/8	2/3					1/1	6/12	50.0%			1			00:37:59
10	成亚	0/1	2/2	1/1					3/4	75.0%	3		1	1		00:49:20
16	刘迈科									0.0%						00:34:40
21	胡瀛		1/2	1/1					2/3	66.7%	2		1	1		01:00:00
22	王超									0.0%						00:00:40
23	王军程									0.0%						00:00:00
25	马明辉									0.0%						00:00:00
29	杜龙飞									0.0%						00:00:03
39	张骥	3/10						2/3	5/13	38.5%	2	2				00:40:30
66	解建飞			1/3					1/3	33.3%						00:56:09
77	朱昕晨	2/7				0/1			2/8	25.0%	2	2		1		00:20:54
83	潘天									0.0%				1		00:22:53
99	蒋维一		2/3		1/1				3/4	75.0%		1		1		00:52:41
	合计	8/26	7/10	3/5	1/1	0/1		3/4	22/47	46.8%	4	10	3	5		
(守门员)																
1	王澍	2/7	2/5		0/1		0/1	1/3	5/17	29.4%						00:25:20
16	刘迈科	4/11	2/3		0/4			0/1	6/19	31.6%						00:34:40
	合计	6/18	4/8		0/5		0/1	1/4	11/36	30.6%						

场上队员：得分/射门

守门员：救球/射门

全队合计	得分	被救	射失	击柱	封球	合计	%
远射	8	7	2	3	6	26	30.8%
近射	7	2	1			10	70.0%
边射	3	1		1		5	60.0%
快攻	1					1	100.0%
突破		1				1	0.0%
任意							0.0%
七米	3			1		4	75.0%

第十三届全国运动会男子手球决赛

PHMS Pictorial Handball Match Statistics

IHF Official System

个人/全队技术统计表

 手球 半决赛 组别 X 天津师范大学体育馆
 男子 轮次 5 场次 20 2017-08-26 19:15

号码	姓名	远射	近射	边射	快攻	突破	任意	七米	合计	%	助攻	失误	警告	2'	取消	时间
江苏队(江苏)																
(场上队员)																
1	徐畅									0.0%						00:00:00
4	张家纬	2/6	0/2						2/8	25.0%		1	1	1		00:47:18
5	闫亮		1/1		2/2				3/3	100%						00:26:26
6	赵晨	7/11					1/1		8/12	66.7%	3	2				00:49:34
7	徐奕飞		1/1						1/1	100%						00:03:25
8	周小坚		1/1						1/1	100%	1					00:59:59
9	王杰缘		1/3		2/3				3/6	50.0%			1			00:56:34
10	郝可鑫	3/6							3/6	50.0%				1		00:34:09
12	王权									0.0%	1					01:00:00
13	叶强									0.0%						00:00:00
15	李安	0/1		0/2	1/1			3/4	4/8	50.0%		2				01:00:00
17	王伟强									0.0%						00:00:00
18	赵楠									0.0%						00:00:00
19	张志宇	0/1							0/1	0.0%						00:13:15
20	顾艳超									0.0%						00:01:06
21	刘江				0/1				0/1	0.0%				2		00:07:19
	合计	12/25	4/8	0/2	5/7		1/1	3/4	25/47	53.2%	5	5	2	4		
(守门员)																
12	王权	7/15	2/9	1/4	0/1	1/1		0/3	11/33	33.3%	1					01:00:00
	合计	7/15	2/9	1/4	0/1	1/1		0/3	11/33	33.3%	1					

场上队员：得分/射门

守门员：救球/射门

全队合计	得分	被救	射失	击柱	封球	合计	%
远射	12	6	3		4	25	48.0%
近射	4	4				8	50.0%
边射			2			2	0.0%
快攻	5		1	1		7	71.4%
突破							0.0%
任意	1					1	100.0%
七米	3	1				4	75.0%

第十三届全国运动会男子手球决赛

PHMS Pictorial Handball Match Statistics

IHF Official System

图式比赛技术统计表

手球
男子

半决赛
轮次 5

组别 X
场次 20

天津师范大学体育馆
2017-08-26 19:15

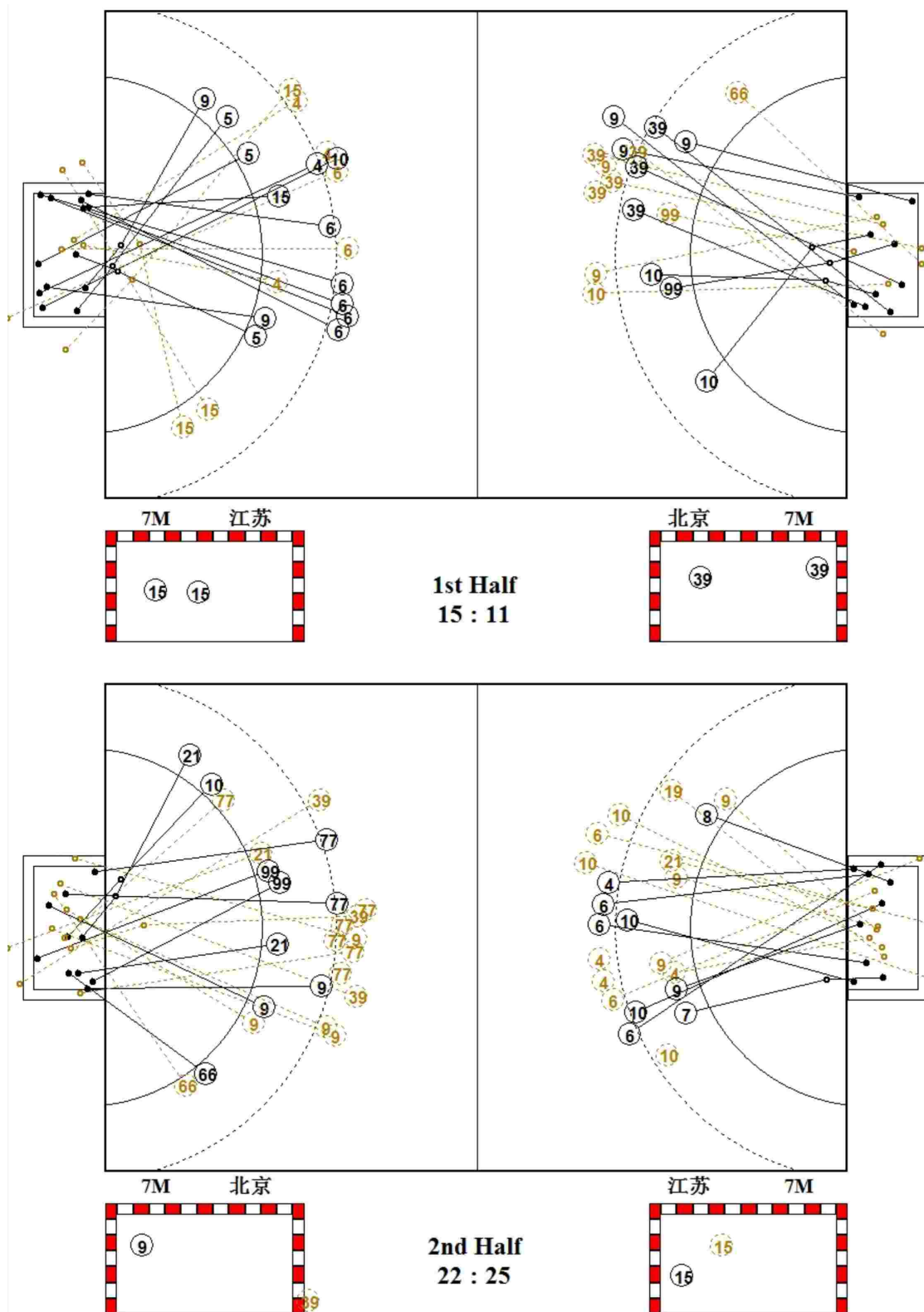

第十三届全国运动会男子手球决赛

PHMS Pictorial Handball Match Statistics

IHF Official System

图式射门区域统计

手球
男子

半决赛
轮次 5

组别 X
场次 20

天津师范大学体育馆
2017-08-26 19:15

北京队

1 王澍	7 马昌震	8 王鹏	9 刘振	10 成亚	16 刘迈科	21 胡瀛	22 王超																																																																								
<table border="1"><tr><td></td><td></td><td></td></tr><tr><td></td><td></td><td></td></tr><tr><td></td><td></td><td></td></tr></table>										<table border="1"><tr><td></td><td></td><td></td></tr><tr><td></td><td></td><td></td></tr><tr><td></td><td></td><td></td></tr></table>										<table border="1"><tr><td></td><td></td><td></td></tr><tr><td></td><td></td><td></td></tr><tr><td></td><td></td><td></td></tr></table>										<table border="1"><tr><td>2</td><td></td><td>1</td></tr><tr><td></td><td></td><td></td></tr><tr><td>2</td><td></td><td>1</td></tr></table>	2		1				2		1	<table border="1"><tr><td></td><td></td><td></td></tr><tr><td></td><td>2</td><td>1</td></tr><tr><td></td><td></td><td></td></tr></table>					2	1				<table border="1"><tr><td></td><td></td><td></td></tr><tr><td></td><td></td><td></td></tr><tr><td></td><td></td><td></td></tr></table>										<table border="1"><tr><td></td><td></td><td></td></tr><tr><td>1</td><td></td><td></td></tr><tr><td></td><td>1</td><td></td></tr></table>				1				1		<table border="1"><tr><td></td><td></td><td></td></tr><tr><td></td><td></td><td></td></tr><tr><td></td><td></td><td></td></tr></table>									
2		1																																																																													
2		1																																																																													
	2	1																																																																													
1																																																																															
	1																																																																														
Post - 0 Miss - 0 Block - 0	Post - 0 Miss - 0 Block - 0	Post - 0 Miss - 0 Block - 0	Post - 1 Miss - 0 Block - 1	Post - 0 Miss - 0 Block - 0	Post - 0 Miss - 0 Block - 0	Post - 0 Miss - 1 Block - 0	Post - 0 Miss - 0 Block - 0																																																																								
23 王军程	25 马明辉	29 杜龙飞	39 张骥	66 解建飞	77 朱昕晨	83 潘天	99 蒋维一																																																																								
<table border="1"><tr><td></td><td></td><td></td></tr><tr><td></td><td></td><td></td></tr><tr><td></td><td></td><td></td></tr></table>										<table border="1"><tr><td></td><td></td><td></td></tr><tr><td></td><td></td><td></td></tr><tr><td></td><td></td><td></td></tr></table>										<table border="1"><tr><td></td><td></td><td></td></tr><tr><td></td><td></td><td></td></tr><tr><td></td><td></td><td></td></tr></table>										<table border="1"><tr><td>1</td><td></td><td>2</td></tr><tr><td></td><td></td><td>1</td></tr><tr><td></td><td></td><td>1</td></tr></table>	1		2			1			1	<table border="1"><tr><td></td><td></td><td></td></tr><tr><td>1</td><td></td><td></td></tr><tr><td></td><td></td><td></td></tr></table>				1						<table border="1"><tr><td></td><td></td><td></td></tr><tr><td></td><td></td><td>1</td></tr><tr><td></td><td></td><td>1</td></tr></table>						1			1	<table border="1"><tr><td></td><td></td><td></td></tr><tr><td></td><td></td><td></td></tr><tr><td></td><td></td><td></td></tr></table>										<table border="1"><tr><td>1</td><td>1</td><td></td></tr><tr><td></td><td></td><td></td></tr><tr><td>1</td><td></td><td></td></tr></table>	1	1					1		
1		2																																																																													
		1																																																																													
		1																																																																													
1																																																																															
		1																																																																													
		1																																																																													
1	1																																																																														
1																																																																															
Post - 0 Miss - 0 Block - 0	Post - 0 Miss - 0 Block - 0	Post - 0 Miss - 0 Block - 0	Post - 2 Miss - 2 Block - 1	Post - 1 Miss - 0 Block - 0	Post - 1 Miss - 0 Block - 4	Post - 0 Miss - 0 Block - 0	Post - 0 Miss - 0 Block - 0																																																																								

1 □□

1/3		0/2
0/2	3/4	0/2
0/2	1/1	0/1

16 □□□

0/1	0/1	
1/5	3/4	1/1
0/1	1/2	0/4

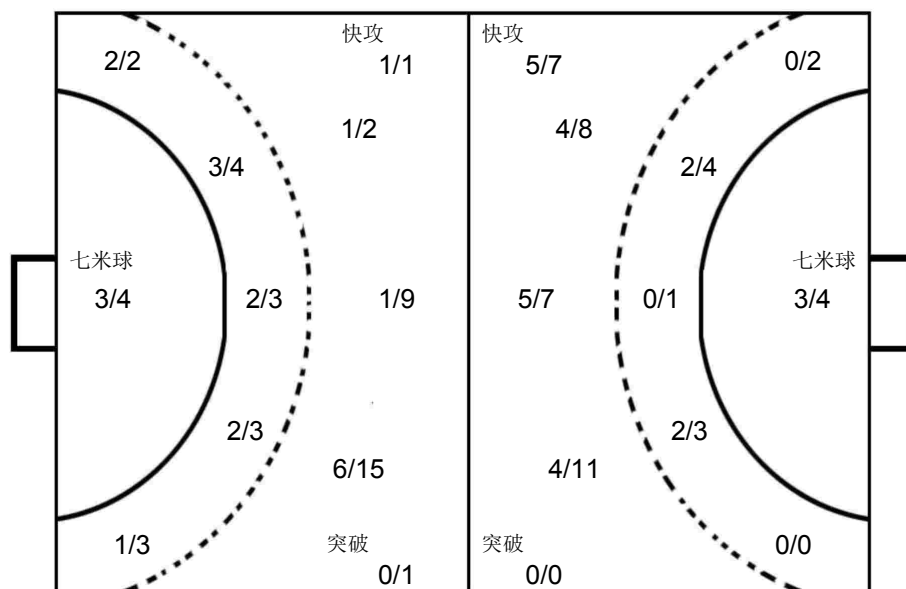

12 □□

0/4	1/2	1/4
2/4	4/6	2/5
0/3	1/2	0/3

江苏队

1 徐畅	4 张家纬	5 闫亮	6 赵晨	7 徐奕飞	8 周小坚	9 王杰缘	10 郝可鑫																																																																								
<table border="1"><tr><td></td><td></td><td></td></tr><tr><td></td><td></td><td></td></tr><tr><td></td><td></td><td></td></tr></table>										<table border="1"><tr><td>1</td><td></td><td></td></tr><tr><td></td><td></td><td></td></tr><tr><td>1</td><td></td><td></td></tr></table>	1						1			<table border="1"><tr><td></td><td>1</td><td></td></tr><tr><td>1</td><td>1</td><td></td></tr><tr><td></td><td></td><td></td></tr></table>		1		1	1					<table border="1"><tr><td></td><td></td><td>2</td></tr><tr><td>1</td><td></td><td>1</td></tr><tr><td>1</td><td></td><td>3</td></tr></table>			2	1		1	1		3	<table border="1"><tr><td></td><td></td><td></td></tr><tr><td></td><td></td><td>1</td></tr><tr><td></td><td></td><td></td></tr></table>						1				<table border="1"><tr><td></td><td></td><td></td></tr><tr><td>1</td><td></td><td></td></tr><tr><td></td><td></td><td></td></tr></table>				1						<table border="1"><tr><td></td><td></td><td></td></tr><tr><td>1</td><td></td><td></td></tr><tr><td>1</td><td>1</td><td></td></tr></table>				1			1	1		<table border="1"><tr><td></td><td></td><td></td></tr><tr><td>1</td><td></td><td></td></tr><tr><td></td><td></td><td>1</td></tr></table>				1					1
1																																																																															
1																																																																															
	1																																																																														
1	1																																																																														
		2																																																																													
1		1																																																																													
1		3																																																																													
		1																																																																													
1																																																																															
1																																																																															
1	1																																																																														
1																																																																															
		1																																																																													
Post - 0 Miss - 0 Block - 0	Post - 0 Miss - 0 Block - 3	Post - 0 Miss - 0 Block - 0	Post - 0 Miss - 1 Block - 0	Post - 0 Miss - 0 Block - 0	Post - 0 Miss - 0 Block - 0	Post - 1 Miss - 0 Block - 0	Post - 0 Miss - 1 Block - 1																																																																								
12 王权	13 叶强	15 李安	17 王伟强	18 赵楠	19 张志宇	20 顾艳超	21 刘江																																																																								
<table border="1"><tr><td></td><td></td><td></td></tr><tr><td></td><td></td><td></td></tr><tr><td></td><td></td><td></td></tr></table>										<table border="1"><tr><td></td><td></td><td></td></tr><tr><td></td><td></td><td></td></tr><tr><td></td><td></td><td></td></tr></table>										<table border="1"><tr><td></td><td></td><td></td></tr><tr><td>2</td><td>1</td><td></td></tr><tr><td></td><td></td><td>1</td></tr></table>				2	1				1	<table border="1"><tr><td></td><td></td><td></td></tr><tr><td></td><td></td><td></td></tr><tr><td></td><td></td><td></td></tr></table>										<table border="1"><tr><td></td><td></td><td></td></tr><tr><td></td><td></td><td></td></tr><tr><td></td><td></td><td></td></tr></table>										<table border="1"><tr><td></td><td></td><td></td></tr><tr><td></td><td></td><td></td></tr><tr><td></td><td></td><td></td></tr></table>										<table border="1"><tr><td></td><td></td><td></td></tr><tr><td></td><td></td><td></td></tr><tr><td></td><td></td><td></td></tr></table>										<table border="1"><tr><td></td><td></td><td></td></tr><tr><td></td><td></td><td></td></tr><tr><td></td><td></td><td></td></tr></table>									
2	1																																																																														
		1																																																																													
Post - 0 Miss - 0 Block - 0	Post - 0 Miss - 0 Block - 0	Post - 0 Miss - 3 Block - 0	Post - 0 Miss - 0 Block - 0	Post - 0 Miss - 0 Block - 0	Post - 0 Miss - 0 Block - 0	Post - 0 Miss - 0 Block - 0	Post - 0 Miss - 1 Block - 0																																																																								

第十三届全国运动会男子手球决赛
PHMS Pictorial Handball Match Statistics

IHF Official System

比赛进程表

手球 男子 半决赛 轮次 5 组别 X 场次 20 八件四世八子牌月 馆 2017-08-26 19:15

时间	队员	动作	比分	队员	动作
北京队			上半时		
00:43	66 解建飞	封球	0-0	4 张家纬	右远射 被封
01:22	9 刘振	左远射 得分	1-0	12 王权	被射入
02:06	16 刘迈科	被射入	1-1	6 赵晨	左远射 得分
02:39	39 张骥	助攻			
02:42	99 蒋维一	近射 被救		12 王权	挡住球
02:51	9 刘振	使被罚7M球		5 闫亮	造7M
02:52	9 刘振	警告			
03:16	1 王泷	被射入	1-2	15 李安	7M球 得分
04:18	9 刘振	左远射 被封		8 周小坚	封球
04:28	39 张骥	左远射 被封		5 闫亮	封球
04:46	21 胡瀛	其它失误			
04:50	16 刘迈科	被射入	1-3	15 李安	一传快攻 得分
04:52				6 赵晨	助攻
05:37	39 张骥	进攻犯规		9 王杰缘	造犯规
05:42	16 刘迈科	被射入	1-4	5 闫亮	短传快攻 得分
05:55		球队暂停			
06:25	9 刘振	中远射 被救		12 王权	挡住球
06:33	16 刘迈科	被射入	1-5	5 闫亮	短传快攻 得分
07:17	66 解建飞	造7M		4 张家纬	使被罚7M球
07:18				4 张家纬	警告
07:42	39 张骥	7M球 得分	2-5	12 王权	被射入
08:25				6 赵晨	传球失误
08:35		裁判暂停			
08:35				4 张家纬	罚出场2分钟
09:05	10 成亚	造7M		5 闫亮	使被罚7M球
09:17	39 张骥	7M球 得分	3-5	12 王权	被射入
09:50				15 李安	右远射 射失
10:18	9 刘振	近射 得分	4-5	12 王权	被射入
10:27				9 王杰缘	警告
10:53	16 刘迈科	被射入	4-6	10 郝可鑫	右远射 得分
11:44	39 张骥	左远射 得分	5-6	12 王权	被射入
12:15				6 赵晨	右远射 射失
12:27	39 张骥	左远射 射失			
12:37	10 成亚	使被罚7M球		15 李安	造7M
12:39	10 成亚	警告			
12:57	1 王泷	被射入	5-7	15 李安	7M球 得分
13:39	66 解建飞	左边射 击柱			
13:52	21 胡瀛	传球失误			
14:48	1 王泷	被射入	5-8	6 赵晨	任意球 得分
15:28	39 张骥	接球失误			
15:37	1 王泷	被射入	5-9	9 王杰缘	一传快攻 得分

第十三届全国运动会男子手球决赛
PHMS Pictorial Handball Match Statistics

IHF Official System

比赛进程表

 手球 半决赛 组别 X
 男子 轮次 5 场次 20
 天津奥林匹克体育中心 2017-08-26 19:15

时间	队员	动作	比分	队员	动作
北京队			上半时		
16:16	39 张骥	左远射 得分	6-9	12 王权	被射入
16:54	99 蒋维一	抢球		4 张家纬	接球失误
16:57	99 蒋维一	一传快攻 得分	7-9	12 王权	被射入
17:04		裁判暂停			
17:36				15 李安	左边射 射失
17:46	10 成亚	近射 得分	8-9	12 王权	被射入
18:23	21 胡瀛	警告			
18:48	1 王洸	挡住球		4 张家纬	右远射 被救
18:50	1 王洸	挡住球		4 张家纬	近射 被救
19:31	10 成亚	近射 得分	9-9	12 王权	被射入
19:33	39 张骥	助攻			
19:41					球队暂停
20:04	1 王洸	挡住球		6 赵晨	中远射 被救
20:57	39 张骥	左远射 击柱			
21:26	1 王洸	被射入	9-10	4 张家纬	右远射 得分
22:25	9 刘振	左远射 得分	10-10	12 王权	被射入
23:06	1 王洸	被射入	10-11	6 赵晨	中远射 得分
23:58	39 张骥	左远射 得分	11-11	12 王权	被射入
24:29		裁判暂停			
24:30	83 潘天	罚出场2分钟			
24:48	1 王洸	被射入	11-12	6 赵晨	中远射 得分
25:26	10 成亚	传球失误			
26:01				15 李安	左边射 射失
26:48		裁判暂停			
27:14	10 成亚	中远射 被救		12 王权	挡住球
27:24	1 王洸	被射入	11-13	9 王杰缘	近射 得分
27:29				6 赵晨	助攻
28:10		裁判暂停			
28:46	39 张骥	左远射 被救		12 王权	挡住球
29:11		裁判暂停			
29:13	77 朱昕晨	罚出场2分钟			
29:26	1 王洸	被射入	11-14	6 赵晨	左远射 得分
29:56	99 蒋维一	进攻犯规		9 王杰缘	造犯规
30:00		裁判暂停			
30:00	1 王洸	被射入	11-15	5 闫亮	近射 得分
30:00				8 周小坚	助攻

第十三届全国运动会男子手球决赛
PHMS Pictorial Handball Match Statistics

IHF Official System

比赛进程表

 手球 半决赛 组别 X
 男子 轮次 5 场次 20
 天津奥体中心体育馆
 2017-08-26 19:15

时间	队员	动作	比分	队员	动作
北京队			江苏队		
00:00			11-15		
01:03	9 刘振	左远射 被救		12 王权	挡住球
01:10		裁判暂停			
01:13	1 王洸	挡住球		9 王杰缘	近射 被救
01:42	39 张骥	左远射 被救		12 王权	挡住球
01:48	1 王洸	被射入	11-16	7 徐突飞	近射 得分
03:06	77 朱昕晨	传球失误			
03:38	83 潘天	封球		4 张家纬	中远射 被封
03:51	9 刘振	造7M		4 张家纬	使被罚7M球
04:15	39 张骥	7M球 击柱			
04:48	1 王洸	被射入	11-17	4 张家纬	左远射 得分
05:21	10 成亚	进攻犯规		10 郝可鑫	造犯规
05:38	16 刘迈科	被射入	11-18	10 郝可鑫	中远射 得分
05:58		球队暂停			
06:45				9 王杰缘	短传快攻 击柱
06:52	9 刘振	近射 得分	12-18	12 王权	被射入
07:28	16 刘迈科	被射入	12-19	10 郝可鑫	右远射 得分
07:59	77 朱昕晨	中远射 得分	13-19	12 王权	被射入
08:34	66 解建飞	封球		10 郝可鑫	右远射 被封
09:05	77 朱昕晨	中远射 被封		6 赵晨	封球
09:47	16 刘迈科	被射入	13-20	6 赵晨	右远射 得分
10:15		裁判暂停			
10:15				10 郝可鑫	罚出场2分钟
10:36	9 刘振	中远射 击柱			
11:11	16 刘迈科	挡住球		9 王杰缘	近射 被救
11:13				6 赵晨	助攻
11:44	10 成亚	右边射 得分	14-20	12 王权	被射入
12:22	16 刘迈科	被射入	14-21	6 赵晨	中远射 得分
12:57	10 成亚	传球失误		21 刘江	断球
13:00				21 刘江	一传快攻 射失
13:16	21 胡瀛	近射 射失			
13:51	16 刘迈科	被射入	14-22	6 赵晨	中远射 得分
14:26	66 解建飞	左边射 被救		12 王权	挡住球
14:59		裁判暂停			
15:07	99 蒋维一	罚出场2分钟			
15:23	16 刘迈科	挡住球		10 郝可鑫	左远射 被救
15:25	16 刘迈科	挡住球		4 张家纬	近射 被救
15:30	16 刘迈科	被射入	14-23	8 周小坚	近射 得分
16:05	77 朱昕晨	造7M		9 王杰缘	使被罚7M球
16:06		裁判暂停			
16:14	9 刘振	7M球 得分	15-23	12 王权	被射入

第十三届全国运动会男子手球决赛

PHMS Pictorial Handball Match Statistics

IHF Official System

比赛进程表

 手球 半决赛 组别 X
 男子 轮次 5 场次 20
 八津卅卅八子卅卅月 馆
 2017-08-26 19:15

时间	队员	动作	比分	队员	动作
北京队			江苏队		
16:43	66 解建飞	封球	15-23	4 张家纬	右远射 被封
17:06				10 郝可鑫	左远射 射失
17:20	77 朱昕晨	进攻犯规		10 郝可鑫	造犯规
17:57		裁判暂停			
18:00	10 成亚	使被罚7M球		15 李安	造7M
18:00	10 成亚	罚出场2分钟			
18:05	16 刘迈科	被射入	15-24	15 李安	7M球 得分
18:36		裁判暂停			
18:38				21 刘江	罚出场2分钟
18:51	9 刘振	左远射 得分	16-24	12 王权	被射入
18:53	77 朱昕晨	助攻			
19:17					球队暂停
19:35				15 李安	侵区
19:49	77 朱昕晨	突破 被救		12 王权	挡住球
19:53	99 蒋维一	近射 得分	17-24	12 王权	被射入
20:45				15 李安	接球失误
20:56	77 朱昕晨	右远射 得分	18-24	12 王权	被射入
21:23	16 刘迈科	挡住球		19 张志宇	左远射 被救
22:14		裁判暂停			
22:16				21 刘江	罚出场2分钟
22:39	9 刘振	近射 被救		12 王权	挡住球
22:42	66 解建飞	左边射 得分	19-24	12 王权	被射入
23:12		裁判暂停			
23:37	16 刘迈科	挡住球		6 赵晨	右远射 被救
23:45	21 胡瀛	近射 得分	20-24	12 王权	被射入
23:47	77 朱昕晨	助攻			
24:21					球队暂停
24:32	99 蒋维一	造犯规		6 赵晨	进攻犯规
25:07	77 朱昕晨	中远射 击柱			
25:21	21 胡瀛	右边射 得分	21-24	12 王权	被射入
25:59		裁判暂停			
26:04	21 胡瀛	罚出场2分钟			
26:22	16 刘迈科	挡住球		6 赵晨	左远射 被救
26:35	77 朱昕晨	左远射 被封		8 周小坚	封球
27:16	77 朱昕晨	中远射 被封		8 周小坚	封球
27:28	39 张骥	中远射 被救		12 王权	挡住球
27:37	16 刘迈科	被射入	21-25	9 王杰缘	一传快攻 得分
27:41				12 王权	助攻
28:26	39 张骥	右远射 射失			
29:00	99 蒋维一	使被罚7M球		4 张家纬	造7M
29:09		裁判暂停			

第十三届全国运动会男子手球决赛

PHMS Pictorial Handball Match Statistics

IHF Official System

比赛进程表

手球 半决赛 组别 X 八件型也八子件月
男子 轮次 5 场次 20 馆
2017-08-26 19:15

时间	队员	动作	比分	队员	动作
北京队			江苏队		
29:17	1 王洸	挡住球	21-25	15 李安	7M球 被救
29:27		裁判暂停			
29:27	77 朱昕晨	中远射 被封		6 赵晨	封球
29:58		裁判暂停			
30:00	9 刘振	左远射 被救		12 王权	挡住球
30:00	99 蒋维一	近射 得分	22-25	12 王权	被射入

PHMS Pictorial Handball Match Statistics

IHF Official System

Team A					Team B					Match Number								
A 安徽队					B 天津队					21								
Played in			in the hall			on			at			Spectators						
天津			天津师范大学体育馆			2017-08-28			14:00			hours						
Half-time(30')	A	B	End of playing time		A	B	1st extra time		A	B	2nd extra time		A	B	After penalty throws		A	B
	11	13	26 30															
Number of 7 m	A	Team time-out			Full name of players and officials						Team time-out			B	Number of 7 m			
	4/4	1	2	3							1	2	3	2/4				
		22:03	38:15						24:19	40:55	56:18							

No.	Team A	G	W	2'	D	DR	No.	Team B	G	W	2'	D	DR
1	郭世伟	3					1	刘宗其					
3	陈强龙	1					2	李岳朋					
5	史小帆	1					4	李松浩					
7	姚雄敏						6	王子欣	2	1			
8	董智景	9		1			7	张青	7	1	1		
9	陈开勇	2					8	曹悦	3	1	1		
10	严龙	3		1			9	吴明远					
11	黎涛	2		1			10	李帅					
12	曾献辰						11	王毅	1				
15	曹青福临						12	杨峻					
16	杨洋						13	许松	8				
18	李双	5	1	1			16	刘海亮					
21	李明						17	周群	3		1		
23	于敏清						18	王晓琪					
24	徐安格						22	魏雨童	1				
							31	田剑侠	5				
B	沈强 (主教练)						A	贾守信					
C	吴翔						B	杜瑞军 (主教练)					
D	黄红						C	孟凡钢					
E	吴台锡						E	崔嘉禄					
A	Signatures of responsables for the teams (Off.A)												B
TP	Remarks of referees / HF Official												TP

Referees	程钰峰 (CHN)	周云磊 (CHN)	
T.D.	于中迅 (CHN)	刘书勇 (CHN)	
CHA Off.			

Note: Number of 7m Throws Awarded to Team A and B, Goals (G), Warnings (W), Suspensions (2'), Direct Disqualification (D), Disqualification With Report (DR) and Team Penalty (TP).

Table Officials: 隆晓磊 梅艳 Statisticians: 黄岩 刘永欢



第十三届全国运动会男子手球决赛
PHMS Pictorial Handball Match Statistics

IHF Official System

竞赛技术统计

 手球
男子

 7-8名
轮次 6

 组别 X
场次 21

 天津师范大学体育馆
2017-08-28 14:00

Referees: 程钰峰 (CHN) / 周云磊 (CHN)

Result: 26:30(11:13)

Teams: 安徽队(安徽) VS 天津队(天津)

安徽		远射	近射	边射	快攻	突破	任意球	7m球	合计	%	助攻	失误	警告	2'	D+DR
主教练: 沈强															
1	郭世伟	1/5	1/1			1/1			3/7	42.9		4			
3	陈强龙		1/1						1/1	100					
5	史小帆		1/2						1/2	50.0					
7	姚雄敏											1			
8	董智景	3/3	2/2	2/3	1/2			1/1	9/11	81.8	3		1		
9	陈开勇				1/2		1/1		2/3	66.7	1				
10	严龙							3/3	3/3	100	1			1	
11	黎涛	1/2	0/1	1/1					2/4	50.0		2		1	
12	曾献辰														
15	曹青福临														
16	杨洋														
18	李双	2/3	1/2	0/1		2/2			5/8	62.5	1	2	1	1	
21	李明											1			
23	于敏清											1			
24	徐安格														
运动员	合计	7/13	6/9	3/5	2/4	3/3	1/1	4/4	26/39	66.7	1	16	1	4	
21	李明	4/9	6/21	1/5	1/3	0/2		1/3	13/43	30.2		1			
守门员	合计	4/9	6/21	1/5	1/3	0/2		1/3	13/43	30.2		1			
天津		远射	近射	边射	快攻	突破	任意球	7m球	合计	%	助攻	失误	警告	2'	D+DR
主教练: 杜瑞军															
1	刘宗其														
2	李岳朋														
4	李松浩														
6	王子欣		1/2	1/3					2/5	40.0			1		
7	张青	2/4	4/6					1/2	7/12	58.3	1	2	1	1	
8	曹悦	2/3	1/3			0/1		0/1	3/8	37.5		2	1	1	
9	吴明远														
10	李帅														
11	王毅							1/1	1/1	100					
12	杨峻														
13	许松	1/2	2/2	3/3	2/4				8/11	72.7		1			
16	刘海亮														
17	周群		3/3						3/3	100				1	
18	王晓琪														
22	魏雨童		1/1						1/1	100					
31	田剑侠	0/5	3/5			2/2			5/12	41.7	3	1			
运动员	合计	5/14	15/22	4/6	2/4	2/3		2/4	30/53	56.6	4	6	3	3	
1	刘宗其	0/2	1/3	0/1					1/6	16.7					
12	杨峻	2/7	1/5	1/3	1/3	0/3	0/1	0/4	5/26	19.2					
守门员	合计	2/9	2/8	1/4	1/3	0/3	0/1	0/4	6/32	18.8					

安徽	比赛进程	天津
1st Half		
0	00:49	1 31 田剑侠
3	02:20	1
1	05:31	2 13 许松
2	05:54	2
2	06:59	3 7 张青
3	07:11	3
11	黎涛	3 07:11 3
3	09:09	4 13 许松
8	董智景	4 09:53 4
4	10:24	5 31 田剑侠
4	10:24	5 31 田剑侠
5	13:33	5
8	董智景	6 15:27 5
6	16:29	6 17 周群
6	17:36	7 31 田剑侠
6	18:40	8 13 许松
10	严龙	7 20:05 8
7	22:03	9 13 许松
1	郭世伟	8 22:28 9
8	23:15	10 17 周群
8	24:34	11 31 田剑侠
1	郭世伟	9 25:30 11
9	26:57	12 7 张青
9	27:38	13 6 王子欣
10	严龙	10 28:06 13
9	陈开勇	11 30:00 13
2nd Half		
	11 02:23	14 7 张青
	11 04:15	15 13 许松
	11 05:29	16 13 许松
	11 08:07	17 8 曹悦
8	董智景	12 08:40 17
10	严龙	13 10:02 17
9	陈开勇	14 10:51 17
14	11:13	18 7 张青
8	董智景	15 11:25 18
15	12:02	19 8 曹悦
15	15:43	20 31 田剑侠
15	16:12	21 13 许松
8	董智景	16 16:57 21
16	17:25	22 7 张青
1	郭世伟	17 17:41 22
8	董智景	18 18:40 22
18	19:14	23 17 周群
19	19:46	23
19	20:46	24 11 王毅
18	李双	20 21:25 24
20	22:22	25 13 许松
8	董智景	21 22:58 25
21	23:42	26 8 曹悦
21	24:50	27 7 张青
18	李双	22 25:09 27
11	黎涛	23 26:03 27
23	27:16	28 6 王子欣
18	李双	24 27:58 28
24	28:12	29 22 魏雨童
18	李双	25 28:29 29
8	董智景	26 28:53 29
26	29:21	30 7 张青

场上队员: 得分 / 射门

守门员: 救球 / 射门

D	取消资格	DR	取消资格+报告
---	------	----	---------

第十三届全国运动会男子手球决赛

PHMS Pictorial Handball Match Statistics

IHF Official System

个人/全队技术统计表

手球 男子 7-8名 轮次 6 组别 X 场次 21 天津师范大学体育馆 2017-08-28 14:00

号码	姓名	远射	近射	边射	快攻	突破	任意	七米	合计	%	助攻	失误	警告	2'	取消	时间
安徽队(安徽)																
(场上队员)																
1	郭世伟	1/5	1/1			1/1			3/7	42.9%		4				00:44:46
3	陈强龙		1/1						1/1	100%						00:37:35
5	史小帆		1/2						1/2	50.0%						00:24:10
7	姚雄敏									0.0%		1				00:02:27
8	董智景	3/3	2/2	2/3	1/2			1/1	9/11	81.8%		3		1		01:00:00
9	陈开勇				1/2		1/1		2/3	66.7%		1				00:45:50
10	严龙							3/3	3/3	100%		1		1		00:11:04
11	黎涛	1/2	0/1	1/1					2/4	50.0%		2		1		00:31:47
12	曾献辰									0.0%						00:00:00
15	曹青福临									0.0%						00:00:00
16	杨洋									0.0%						00:00:00
18	李双	2/3	1/2	0/1		2/2			5/8	62.5%	1	2	1	1		01:00:00
21	李明									0.0%		1				01:00:00
23	于敏清									0.0%		1				00:41:23
24	徐安格									0.0%						00:00:00
合计		7/13	6/9	3/5	2/4	3/3	1/1	4/4	26/39	66.7%	1	16	1	4		
(守门员)																
21	李明	4/9	6/21	1/5	1/3	0/2		1/3	13/43	30.2%		1				01:00:00
合计		4/9	6/21	1/5	1/3	0/2		1/3	13/43	30.2%		1				

场上队员： 得分/射门

守门员： 救球/射门

全队合计	得分	被救	射失	击柱	封球	合计	%
远射	7	2	2	2		13	53.8%
近射	6	2		1		9	66.7%
边射	3	1		1		5	60.0%
快攻	2	1		1		4	50.0%
突破	3					3	100.0%
任意	1					1	100.0%
七米	4					4	100.0%

第十三届全国运动会男子手球决赛

PHMS Pictorial Handball Match Statistics

IHF Official System

个人/全队技术统计表

手球 男子 7-8名 轮次 6 组别 X 场次 21 天津师范大学体育馆 2017-08-28 14:00

号码	姓名	远射	近射	边射	快攻	突破	任意	七米	合计	%	助攻	失误	警告	2'	取消	时间
天津队(天津)																
(场上队员)																
1	刘宗其									0.0%						00:13:50
2	李岳朋									0.0%						00:15:33
4	李松浩									0.0%						00:00:01
6	王子欣		1/2	1/3					2/5	40.0%			1			01:00:00
7	张青	2/4	4/6					1/2	7/12	58.3%	1	2	1	1		00:59:38
8	曹悦	2/3	1/3			0/1		0/1	3/8	37.5%		2	1	1		01:00:00
9	吴明远									0.0%						00:00:00
10	李帅									0.0%						00:00:00
11	王毅							1/1	1/1	100%						00:00:34
12	杨峻									0.0%						00:46:10
13	许松	1/2	2/2	3/3	2/4				8/11	72.7%		1				01:00:00
16	刘海亮									0.0%						00:00:00
17	周群		3/3						3/3	100%				1		00:55:57
18	王晓琪									0.0%						00:00:00
22	魏雨童		1/1						1/1	100%						00:03:32
31	田剑侠	0/5	3/5			2/2			5/12	41.7%	3	1				00:44:03
	合计	5/14	15/22	4/6	2/4	2/3		2/4	30/53	56.6%	4	6	3	3		
(守门员)																
1	刘宗其	0/2	1/3	0/1					1/6	16.7%						00:13:50
12	杨峻	2/7	1/5	1/3	1/3	0/3	0/1	0/4	5/26	19.2%						00:46:10
	合计	2/9	2/8	1/4	1/3	0/3	0/1	0/4	6/32	18.8%						

场上队员：得分/射门

守门员：救球/射门

全队合计	得分	被救	射失	击柱	封球	合计	%
远射	5	4	3		2	14	35.7%
近射	15	6		1		22	68.2%
边射	4	1		1		6	66.7%
快攻	2	1	1			4	50.0%
突破	2			1		3	66.7%
任意							0.0%
七米	2	1		1		4	50.0%

第十三届全国运动会男子手球决赛

图式比赛技术统计表

手球
男子

7-8名
轮次 6

组别 X
场次 21

天津师范大学体育馆
2017-08-28 14:00

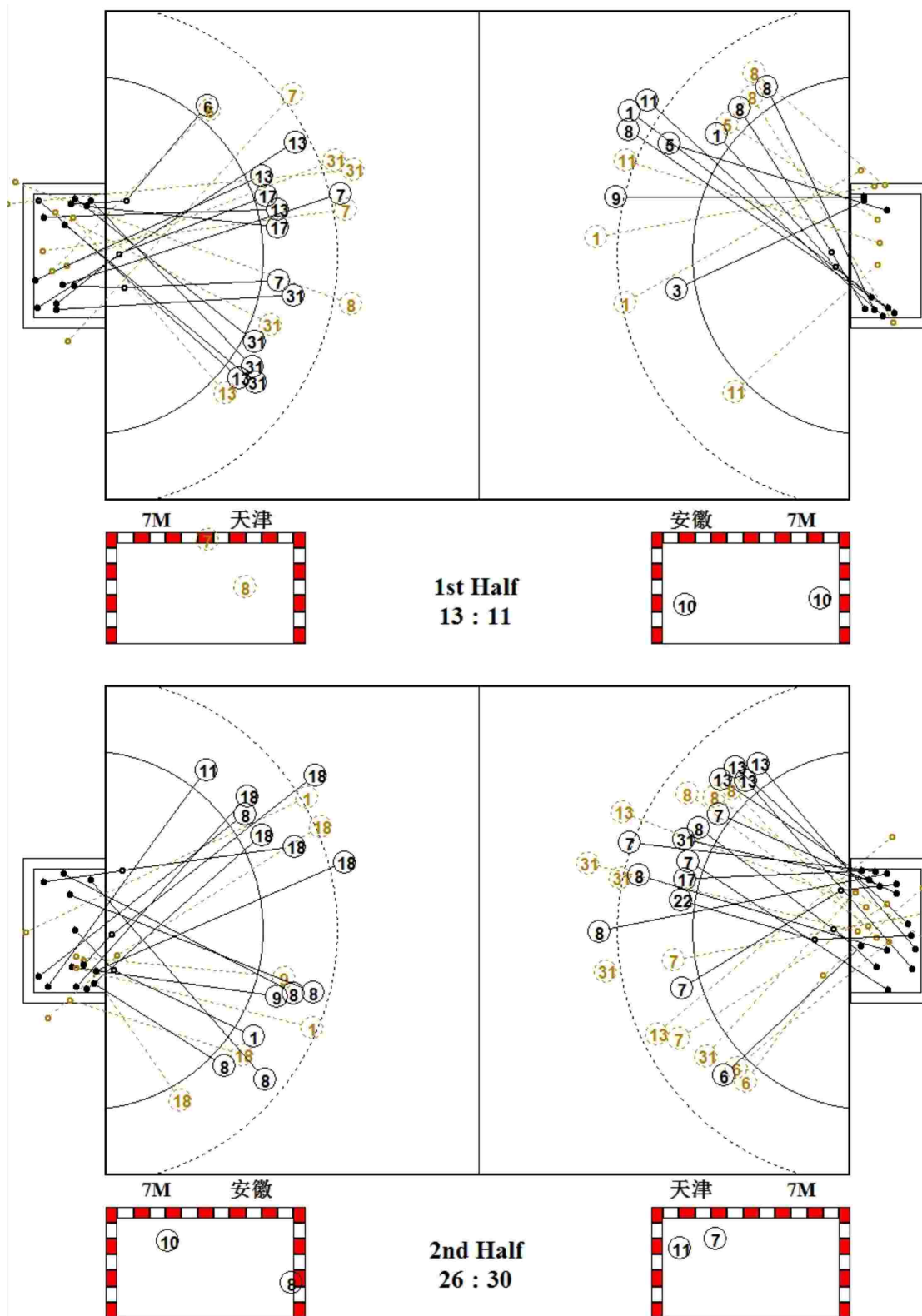

第十三届全国运动会男子手球决赛

PHMS Pictorial Handball Match Statistics

IHF Official System

图式射门区域统计

手球
男子

7-8名
轮次 6

组别 X
场次 21

天津师范大学体育馆
2017-08-28 14:00

安徽队

1 郭世伟	3 陈强龙	5 史小帆	7 姚雄敏	8 董智景	9 陈开勇	10 严龙	11 黎涛																																																						
<table border="1"><tr><td></td><td>1</td><td>1</td></tr><tr><td></td><td></td><td>1</td></tr></table>		1	1			1	<table border="1"><tr><td></td><td></td><td></td></tr><tr><td>1</td><td></td><td></td></tr></table>				1			<table border="1"><tr><td></td><td></td><td></td></tr><tr><td>1</td><td></td><td></td></tr></table>				1			<table border="1"><tr><td></td><td></td><td></td></tr><tr><td></td><td></td><td></td></tr></table>							<table border="1"><tr><td>1</td><td></td><td></td></tr><tr><td></td><td></td><td>5</td></tr><tr><td>1</td><td></td><td>2</td></tr></table>	1					5	1		2	<table border="1"><tr><td></td><td></td><td></td></tr><tr><td>1</td><td></td><td></td></tr><tr><td>1</td><td></td><td></td></tr></table>				1			1			<table border="1"><tr><td>1</td><td></td><td></td></tr><tr><td>1</td><td></td><td>1</td></tr></table>	1			1		1	<table border="1"><tr><td>1</td><td></td><td></td></tr><tr><td></td><td></td><td>1</td></tr></table>	1					1
	1	1																																																											
		1																																																											
1																																																													
1																																																													
1																																																													
		5																																																											
1		2																																																											
1																																																													
1																																																													
1																																																													
1		1																																																											
1																																																													
		1																																																											
Post - 2 Miss - 1 Block - 0	Post - 0 Miss - 0 Block - 0	Post - 0 Miss - 0 Block - 0	Post - 0 Miss - 0 Block - 0	Post - 2 Miss - 0 Block - 0	Post - 0 Miss - 0 Block - 0	Post - 0 Miss - 0 Block - 0	Post - 0 Miss - 0 Block - 0																																																						
12 曾献辰	15 曹青福临	16 杨洋	18 李双	21 李明	23 于敏清	24 徐安格																																																							
<table border="1"><tr><td></td><td></td><td></td></tr><tr><td></td><td></td><td></td></tr></table>							<table border="1"><tr><td></td><td></td><td></td></tr><tr><td></td><td></td><td></td></tr></table>							<table border="1"><tr><td></td><td></td><td></td></tr><tr><td></td><td></td><td></td></tr></table>							<table border="1"><tr><td></td><td></td><td>1</td></tr><tr><td>1</td><td></td><td></td></tr><tr><td>3</td><td></td><td></td></tr></table>			1	1			3			<table border="1"><tr><td></td><td></td><td></td></tr><tr><td></td><td></td><td></td></tr></table>							<table border="1"><tr><td></td><td></td><td></td></tr><tr><td></td><td></td><td></td></tr></table>							<table border="1"><tr><td></td><td></td><td></td></tr><tr><td></td><td></td><td></td></tr></table>																
		1																																																											
1																																																													
3																																																													
Post - 0 Miss - 0 Block - 0	Post - 0 Miss - 0 Block - 0	Post - 0 Miss - 0 Block - 0	Post - 1 Miss - 1 Block - 0	Post - 0 Miss - 0 Block - 0	Post - 0 Miss - 0 Block - 0	Post - 0 Miss - 0 Block - 0																																																							

21 □□

0/8	2/5	1/4
1/6	3/4	2/7
2/4	2/3	0/2

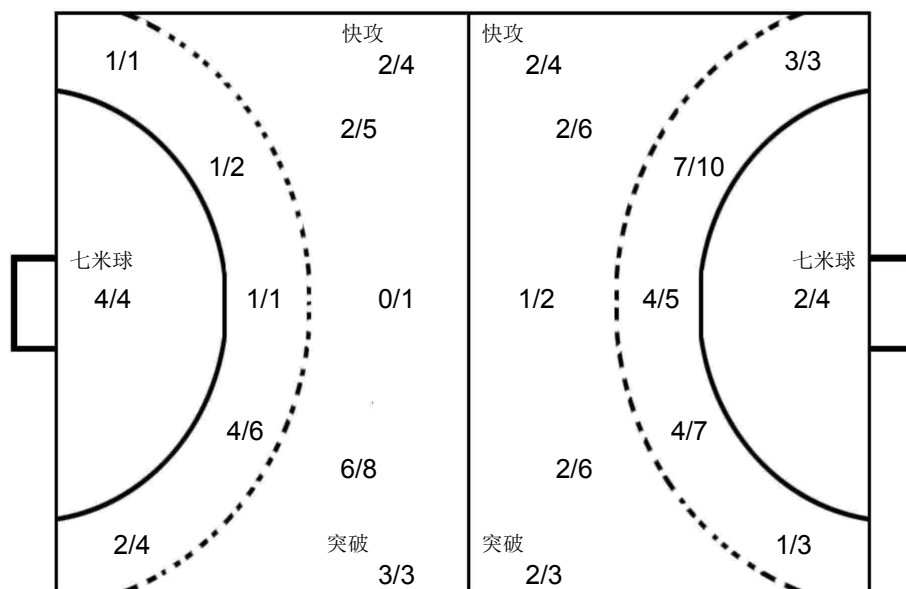

1 □□□

0/1	1/1	0/2
0/1		0/1

12 □□

0/3		0/1
3/6	1/2	0/6
1/6		0/2

天津队

1 刘宗其	2 李岳朋	4 李松浩	6 王子欣	7 张青	8 曹悦	9 吴明远	10 李帅																																																			
<table border="1"><tr><td></td><td></td><td></td></tr><tr><td></td><td></td><td></td></tr></table>							<table border="1"><tr><td></td><td></td><td></td></tr><tr><td></td><td></td><td></td></tr></table>							<table border="1"><tr><td></td><td></td><td></td></tr><tr><td></td><td></td><td></td></tr></table>							<table border="1"><tr><td></td><td></td><td>1</td></tr><tr><td></td><td></td><td>1</td></tr></table>			1			1	<table border="1"><tr><td>3</td><td></td><td></td></tr><tr><td>3</td><td></td><td>1</td></tr></table>	3			3		1	<table border="1"><tr><td>1</td><td>1</td><td>1</td></tr><tr><td></td><td></td><td></td></tr></table>	1	1	1				<table border="1"><tr><td></td><td></td><td></td></tr><tr><td></td><td></td><td></td></tr></table>							<table border="1"><tr><td></td><td></td><td></td></tr><tr><td></td><td></td><td></td></tr></table>									
		1																																																								
		1																																																								
3																																																										
3		1																																																								
1	1	1																																																								
Post - 0 Miss - 0 Block - 0	Post - 0 Miss - 0 Block - 0	Post - 0 Miss - 0 Block - 0	Post - 1 Miss - 0 Block - 0	Post - 2 Miss - 1 Block - 0	Post - 1 Miss - 1 Block - 0	Post - 0 Miss - 0 Block - 0	Post - 0 Miss - 0 Block - 0																																																			
11 王毅	12 杨峻	13 许松	16 刘海亮	17 周群	18 王晓琪	22 魏雨童	31 田剑侠																																																			
<table border="1"><tr><td>1</td><td></td><td></td></tr><tr><td></td><td></td><td></td></tr></table>	1						<table border="1"><tr><td></td><td></td><td></td></tr><tr><td></td><td></td><td></td></tr></table>							<table border="1"><tr><td>2</td><td>2</td><td>3</td></tr><tr><td>1</td><td></td><td></td></tr></table>	2	2	3	1			<table border="1"><tr><td></td><td></td><td></td></tr><tr><td></td><td></td><td></td></tr></table>							<table border="1"><tr><td>1</td><td></td><td></td></tr><tr><td>1</td><td></td><td>1</td></tr></table>	1			1		1	<table border="1"><tr><td></td><td></td><td></td></tr><tr><td></td><td></td><td></td></tr></table>							<table border="1"><tr><td></td><td>1</td><td></td></tr><tr><td></td><td></td><td></td></tr></table>		1					<table border="1"><tr><td>1</td><td></td><td></td></tr><tr><td></td><td></td><td>2</td></tr><tr><td>1</td><td></td><td>1</td></tr></table>	1					2	1		1
1																																																										
2	2	3																																																								
1																																																										
1																																																										
1		1																																																								
	1																																																									
1																																																										
		2																																																								
1		1																																																								
Post - 0 Miss - 0 Block - 0	Post - 0 Miss - 0 Block - 0	Post - 0 Miss - 1 Block - 0	Post - 0 Miss - 0 Block - 0	Post - 0 Miss - 0 Block - 0	Post - 0 Miss - 0 Block - 0	Post - 0 Miss - 0 Block - 0	Post - 0 Miss - 1 Block - 2																																																			

Team A				Team B				Match Number						
A 上海队				B 香港队				22						
Played in		in the hall		on		at		Spectators						
天津		天津师范大学体育馆		2017-08-28		15:45		hours						
Half-time(30')	A	B	End of playing time	A	B	1st extra time	A	B	2nd extra time	A	B	After penalty throws	A	B
	15	12	29	26										
Number of 7 m	A	Team time-out			Full name of players and officials			Team time-out			B	Number of 7 m		
	4/5	1	2	3				1	2	3	4/6			
		19:34	36:34	57:53				13:35	51:22					

No.	Team A	G	W	2'	D	DR	No.	Team B	G	W	2'	D	DR
1	张峥						1	叶冠英					
2	张文斌						2	刘健斌	3				
3	赵时俊	2					3	陈梓朗	1				
4	徐俊吉	7					5	黄胜业	3				
6	朱世杰	2	1	1			7	谭俊杰					
7	周文龙						8	李伟东		1			
8	钱为玮	4		2			10	谢永辉	6				
9	董凯	1					12	许文邦	4				
10	吴璟						13	张伟浩		1			
11	蒋承骅						18	李鑫豪					
12	周哲韬						23	郭斯鸣	1				
14	沈吉磊	8					27	冼大维					
16	朱春雷						29	练明辉	1				
17	贺政	5					31	叶仕仁	1				
18	马麟晓		1				33	袁晞彦	4				
19	祝君						40	叶冠雄	2				
A	郑益方						A	杨开将					
B	张勇军 (主教练)						B	王涛					
C	金迪琦						C	高梓欣					
D	杨时												
A	Signatures of responsables for the teams (Off.A)												B
TP	Remarks of referees / HF Official												TP

Signatures

Referees	李兆蒙 (CHN)	张耿 (CHN)	
T.D.	门东山 (CHN)	刘书勇 (CHN)	
CHA Off.			

Note: Number of 7m Throws Awarded to Team A and B, Goals (G), Warnings (W), Suspensions (2'), Direct Disqualification (D), Disqualification With Report (DR) and Team Penalty (TP).

Table Officials: 鲍瑀

李志成

Statisticians: 刘永欢

黄岩

第十三届全国运动会男子手球决赛
PHMS Pictorial Handball Match Statistics

IHF Official System

竞赛技术统计

 手球
男子

 5-6名
轮次 6

 组别 X
场次 22

 天津师范大学体育馆
2017-08-28 15:45

Referees: 李兆蒙 (CHN) / 张耿 (CHN)

Result: 29:26(15:12)

Teams: 上海队(上海) VS 香港队(香港)

上海		远射	近射	边射	快攻	突破	任意球	7m球	合计	%	助攻	失误	警告	2'	D+DR	上海	比赛进程	香港	
主教练: 张勇军																	1st Half		
1	张崢																0 01:33	1 40 叶冠雄	
2	张文斌																0 02:11	2 3 陈梓朗	
3	赵时俊			2/4				2/4	50.0		1					4	徐俊吉	1 03:32	2
4	徐俊吉		5/5		1/2			1/2	7/9	77.8						6	朱世杰	2 04:29	2
6	朱世杰	1/1	0/1		1/1			2/3	66.7		6	1	1			4	徐俊吉	3 06:00	2
7	周文龙															6	朱世杰	4 06:47	2
8	钱为玮	1/3	0/2	3/7				4/12	33.3	1	2			2		4	徐俊吉	5 07:30	3 33 袁晞彦
9	董凯							1/1	1/1	100						5	徐俊吉	5 08:02	3
10	吴璟			0/1				0/1	0.0							5	贺政	5 09:08	4 12 许文邦
11	蒋承骅											2				6	贺政	6 11:15	4
12	周哲韬											1				6	沈吉磊	6 14:12	5 5 黄胜业
14	沈吉磊	5/8	2/2				1/1	8/11	72.7		2					17	贺政	7 14:52	5
16	朱春雷															17	贺政	8 15:45	5
17	贺政			1/3	2/2			2/2	5/7	71.4		1				14	沈吉磊	9 17:08	5
18	马麟晓	0/2					0/1	0/3	0.0		4	1				9	沈吉磊	9 17:23	6 10 谢永辉
19	祝君															10	沈吉磊	10 17:52	6
运动员 合计		7/14	7/10	6/15	4/5		1/2	4/5	29/51	56.9	2	18	2	3		10	沈吉磊	10 18:56	7 5 黄胜业
1	张崢	1/1	3/5	0/3	1/1	0/1		0/4	5/15	33.3						10	沈吉磊	10 19:30	8 12 许文邦
12	周哲韬	1/2	4/9	0/3	2/9	2/2		2/2	11/27	40.7	1					8	钱为玮	11 20:27	8
守门员 合计		2/3	7/14	0/6	3/10	2/3		2/6	16/42	38.1	1					11	沈吉磊	11 22:56	9 12 许文邦
香港																14	沈吉磊	12 23:50	9
主教练: 高梓欣																8	钱为玮	12 24:44	10 33 袁晞彦
1	叶冠英										1					13	贺政	13 25:45	10
2	刘健斌			2/3	1/1			3/4	75.0	1	1					14	贺政	14 27:36	10
3	陈梓朗		0/1		1/1			1/2	50.0							14	沈吉磊	14 28:23	11 33 袁晞彦
5	黄胜业			1/1	2/4			3/5	60.0		2					15	沈吉磊	15 28:57	11
7	谭俊杰										1					15	沈吉磊	15 29:12	12 10 谢永辉
8	李伟东												1			2nd Half			
10	谢永辉	1/1	2/2	2/3	1/2			6/8	75.0	1	1					15	沈吉磊	15 02:12	13 10 谢永辉
12	许文邦		0/1					4/6	4/7	57.1		3				16	沈吉磊	16 02:56	13
13	张伟浩												1			17	钱为玮	17 04:09	13
18	李鑫豪															17	钱为玮	17 05:00	14 10 谢永辉
23	郭斯鸣				1/1			1/1	100		3					17	钱为玮	17 05:45	15 5 黄胜业
27	冼大维															17	钱为玮	17 06:27	16 2 刘健斌
29	练明辉	0/1		1/2				1/3	33.3	1	2					17	钱为玮	17 07:48	17 29 练明辉
31	叶仕仁	0/3	1/4			0/1		1/8	12.5		3					17	钱为玮	17 08:26	18 10 谢永辉
33	袁晞彦		3/6		1/1			4/7	57.1		1					18	董凯	18 09:28	18
40	叶冠雄		1/2		0/1	1/2		2/5	40.0	1	2					19	赵时俊	19 11:02	18
运动员 合计		1/5	7/16	6/9	7/11	1/3		4/6	26/50	52.0	6	19	2			19	沈吉磊	19 11:42	19 2 刘健斌
1	叶冠英	0/4	2/6	2/4	0/2		0/1	1/2	5/19	26.3	1					14	沈吉磊	20 12:13	19
7	谭俊杰	2/5	0/3	6/10	0/2			0/3	8/23	34.8	1					4	徐俊吉	21 12:26	19
守门员 合计		2/9	2/9	8/14	0/4		0/1	1/5	13/42	31.0	2					14	沈吉磊	22 13:54	19
																14	沈吉磊	23 14:37	19
																14	沈吉磊	24 15:49	19
																24	沈吉磊	24 16:15	20 33 袁晞彦
																24	沈吉磊	24 17:22	21 10 谢永辉
																4	徐俊吉	25 17:45	21
																25	沈吉磊	25 18:45	22 40 叶冠雄
																3	赵时俊	26 19:42	22
																4	徐俊吉	27 22:03	22
																4	徐俊吉	28 22:14	22
																28	沈吉磊	28 24:04	23 12 许文邦
																8	钱为玮	28 26:20	24 2 刘健斌
																29	沈吉磊	29 28:00	24
																29	沈吉磊	29 28:20	25 31 叶仕仁
																29	沈吉磊	29 29:51	26 23 郭斯鸣

场上队员: 得分 / 射门

守门员: 救球 / 射门

D	取消资格	DR	取消资格+报告
---	------	----	---------

第十三届全国运动会男子手球决赛

PHMS Pictorial Handball Match Statistics

IHF Official System

个人/全队技术统计表

手球 男子 5-6名 轮次 6 组别 X 场次 22 天津师范大学体育馆 2017-08-28 15:45

号码	姓名	远射	近射	边射	快攻	突破	任意	七米	合计	%	助攻	失误	警告	2'	取消	时间
上海队(上海)																
(场上队员)																
1	张崢									0.0%						00:24:15
2	张文斌									0.0%						00:00:00
3	赵时俊			2/4					2/4	50.0%	1					00:20:01
4	徐俊吉		5/5		1/2			1/2	7/9	77.8%						01:00:00
6	朱世杰	1/1	0/1		1/1				2/3	66.7%	6	1	1			00:46:50
7	周文龙									0.0%						00:00:00
8	钱为玮	1/3	0/2	3/7					4/12	33.3%	1	2		2		00:59:54
9	董凯							1/1	1/1	100%						00:00:19
10	吴璟			0/1					0/1	0.0%						00:18:33
11	蒋承骅									0.0%		2				00:23:51
12	周哲韬									0.0%	1					00:35:45
14	沈吉磊	5/8	2/2			1/1			8/11	72.7%		2				00:30:52
16	朱春雷									0.0%						00:00:00
17	贺政			1/3	2/2			2/2	5/7	71.4%		1				00:38:11
18	马麟晓	0/2					0/1		0/3	0.0%		4	1			01:00:00
19	祝君									0.0%						00:00:00
	合计	7/14	7/10	6/15	4/5		1/2	4/5	29/51	56.9%	2	18	2	3		
(守门员)																
1	张崢	1/1	3/5	0/3	1/1	0/1		0/4	5/15	33.3%						00:24:15
12	周哲韬	1/2	4/9	0/3	2/9	2/2		2/2	11/27	40.7%	1					00:35:45
	合计	2/3	7/14	0/6	3/10	2/3		2/6	16/42	38.1%	1					

场上队员：得分/射门

守门员：救球/射门

全队合计	得分	被救	射失	击柱	封球	合计	%
远射	7	2	3		2	14	50.0%
近射	7	2	1			10	70.0%
边射	6	8	1			15	40.0%
快攻	4			1		5	80.0%
突破							0.0%
任意	1		1			2	50.0%
七米	4	1				5	80.0%

第十三届全国运动会男子手球决赛

PHMS Pictorial Handball Match Statistics

IHF Official System

个人/全队技术统计表

手球 男子 5-6名 轮次 6 组别 X 场次 22 天津师范大学体育馆 2017-08-28 15:45

号码	姓名	远射	近射	边射	快攻	突破	任意	七米	合计	%	助攻	失误	警告	2'	取消	时间
香港队(香港)																
(场上队员)																
1	叶冠英									0.0%	1					00:25:15
2	刘健斌			2/3	1/1				3/4	75.0%	1	1				00:27:43
3	陈梓朗		0/1		1/1				1/2	50.0%		1				00:06:49
5	黄胜业			1/1	2/4				3/5	60.0%		2				00:30:14
7	谭俊杰									0.0%	1					00:34:45
8	李伟东									0.0%			1			00:24:30
10	谢永辉	1/1	2/2	2/3	1/2				6/8	75.0%	1	1				00:52:47
12	许文邦		0/1					4/6	4/7	57.1%		3				00:14:19
13	张伟浩									0.0%			1			00:06:58
18	李鑫豪									0.0%						00:18:53
23	郭斯鸣				1/1				1/1	100%		3				00:38:38
27	冼大维									0.0%						00:00:00
29	练明辉	0/1		1/2					1/3	33.3%	1	2				00:26:45
31	叶仕仁	0/3	1/4			0/1			1/8	12.5%		3				00:42:25
33	袁晞彦		3/6		1/1				4/7	57.1%		1				00:33:47
40	叶冠雄		1/2		0/1	1/2			2/5	40.0%	1	2				00:32:54
	合计	1/5	7/16	6/9	7/11	1/3		4/6	26/50	52.0%	6	19	2			
(守门员)																
1	叶冠英	0/4	2/6	2/4	0/2		0/1	1/2	5/19	26.3%	1					00:25:15
7	谭俊杰	2/5	0/3	6/10	0/2			0/3	8/23	34.8%	1					00:34:45
	合计	2/9	2/9	8/14	0/4		0/1	1/5	13/42	31.0%	2					

场上队员：得分/射门

守门员：救球/射门

全队合计	得分	被救	射失	击柱	封球	合计	%
远射	1	2			2	5	20.0%
近射	7	7	2			16	43.8%
边射	6		2	1		9	66.7%
快攻	7	3		1		11	63.6%
突破	1	2				3	33.3%
任意							0.0%
七米	4	2				6	66.7%

第十三届全国运动会男子手球决赛

PHMS Pictorial Handball Match Statistics

IHF Official System

图式比赛技术统计表

手球
男子

5-6名
轮次 6

组别 X
场次 22

天津师范大学体育馆
2017-08-28 15:45

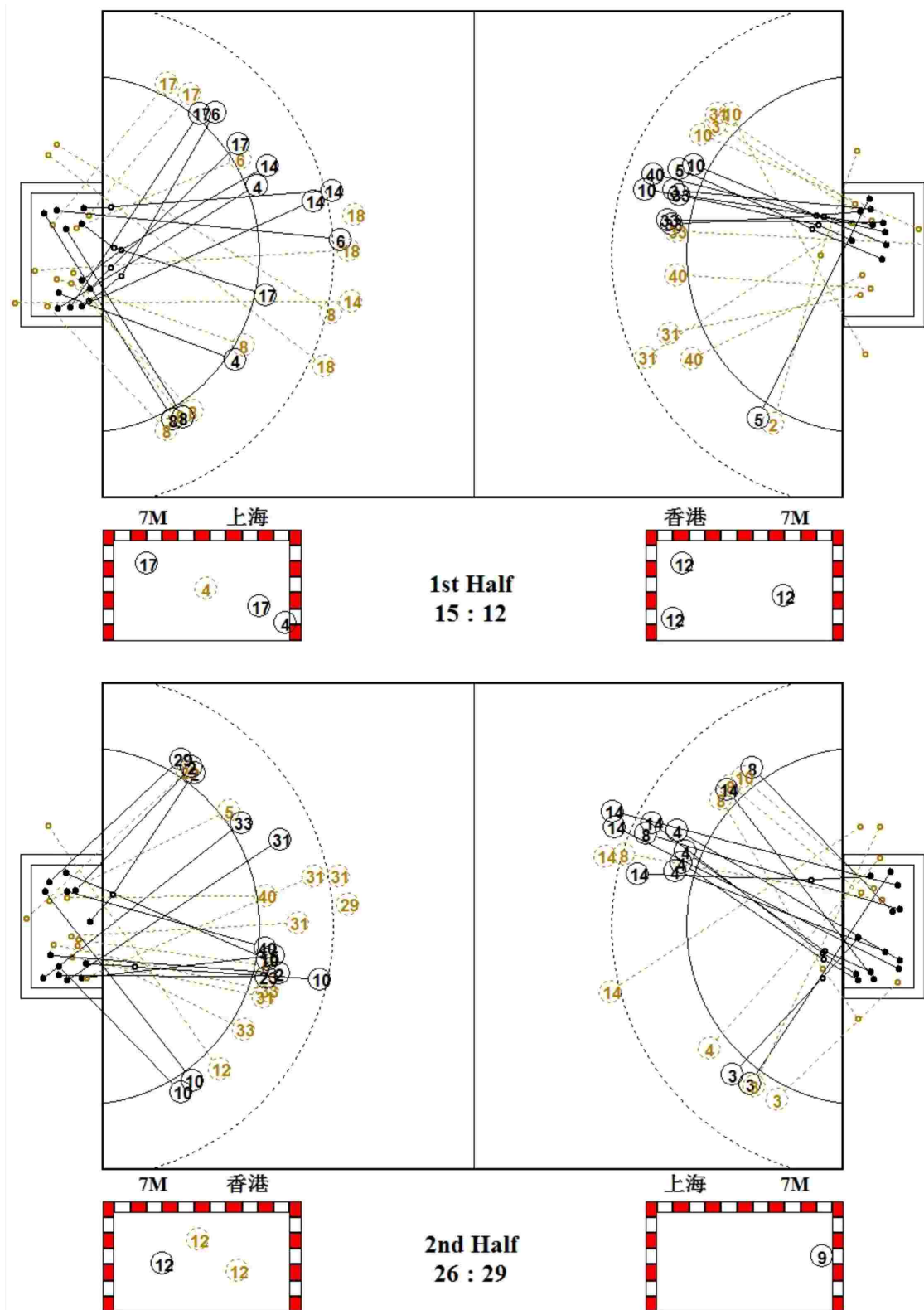

第十三届全国运动会男子手球决赛

PHMS Pictorial Handball Match Statistics

IHF Official System

图式射门区域统计

手球
男子

5-6名
轮次 6

组别 X
场次 22

天津师范大学体育馆
2017-08-28 15:45

上海队

1 张峥	2 张文斌	3 赵时俊	4 徐俊吉	6 朱世杰	7 周文龙	8 钱为玮	9 董凯																																																																								
<table border="1"><tr><td></td><td></td><td></td></tr><tr><td></td><td></td><td></td></tr><tr><td></td><td></td><td></td></tr></table>										<table border="1"><tr><td></td><td></td><td></td></tr><tr><td></td><td></td><td></td></tr><tr><td></td><td></td><td></td></tr></table>										<table border="1"><tr><td>1</td><td></td><td></td></tr><tr><td></td><td></td><td></td></tr><tr><td></td><td>1</td><td></td></tr></table>	1							1		<table border="1"><tr><td></td><td></td><td>1</td></tr><tr><td>2</td><td></td><td>2</td></tr><tr><td></td><td></td><td>2</td></tr></table>			1	2		2			2	<table border="1"><tr><td></td><td></td><td></td></tr><tr><td></td><td></td><td>1</td></tr><tr><td>1</td><td></td><td></td></tr></table>						1	1			<table border="1"><tr><td></td><td></td><td></td></tr><tr><td></td><td></td><td></td></tr><tr><td></td><td></td><td></td></tr></table>										<table border="1"><tr><td></td><td>2</td><td>1</td></tr><tr><td></td><td></td><td>1</td></tr><tr><td></td><td></td><td></td></tr></table>		2	1			1				<table border="1"><tr><td></td><td></td><td></td></tr><tr><td></td><td></td><td></td></tr><tr><td></td><td></td><td>1</td></tr></table>									1
1																																																																															
	1																																																																														
		1																																																																													
2		2																																																																													
		2																																																																													
		1																																																																													
1																																																																															
	2	1																																																																													
		1																																																																													
		1																																																																													
Post - 0 Miss - 0 Block - 0	Post - 0 Miss - 0 Block - 0	Post - 0 Miss - 1 Block - 0	Post - 1 Miss - 0 Block - 0	Post - 0 Miss - 0 Block - 0	Post - 0 Miss - 0 Block - 0	Post - 0 Miss - 2 Block - 0	Post - 0 Miss - 0 Block - 0																																																																								
10 吴璟	11 蒋承骅	12 周哲韬	14 沈吉磊	16 朱春雷	17 贺政	18 马麟晓	19 祝君																																																																								
<table border="1"><tr><td></td><td></td><td></td></tr><tr><td></td><td></td><td></td></tr><tr><td></td><td></td><td></td></tr></table>										<table border="1"><tr><td></td><td></td><td></td></tr><tr><td></td><td></td><td></td></tr><tr><td></td><td></td><td></td></tr></table>										<table border="1"><tr><td></td><td></td><td></td></tr><tr><td></td><td></td><td></td></tr><tr><td></td><td></td><td></td></tr></table>										<table border="1"><tr><td>1</td><td></td><td>1</td></tr><tr><td>1</td><td></td><td>1</td></tr><tr><td>2</td><td></td><td>2</td></tr></table>	1		1	1		1	2		2	<table border="1"><tr><td></td><td></td><td></td></tr><tr><td></td><td></td><td></td></tr><tr><td></td><td></td><td></td></tr></table>										<table border="1"><tr><td>1</td><td></td><td></td></tr><tr><td>1</td><td></td><td>1</td></tr><tr><td>1</td><td></td><td>1</td></tr></table>	1			1		1	1		1	<table border="1"><tr><td></td><td></td><td></td></tr><tr><td></td><td></td><td></td></tr><tr><td></td><td></td><td></td></tr></table>										<table border="1"><tr><td></td><td></td><td></td></tr><tr><td></td><td></td><td></td></tr><tr><td></td><td></td><td></td></tr></table>									
1		1																																																																													
1		1																																																																													
2		2																																																																													
1																																																																															
1		1																																																																													
1		1																																																																													
Post - 0 Miss - 0 Block - 0	Post - 0 Miss - 0 Block - 0	Post - 0 Miss - 0 Block - 0	Post - 0 Miss - 2 Block - 1	Post - 0 Miss - 0 Block - 0	Post - 0 Miss - 0 Block - 0	Post - 0 Miss - 1 Block - 1	Post - 0 Miss - 0 Block - 0																																																																								

1 □□

0/2	1/1	0/1
0/2	1/1	2/5
1/2	0/1	

12 □□□

0/1	1/1	1/2
2/9	2/4	1/2
2/5	1/2	1/1

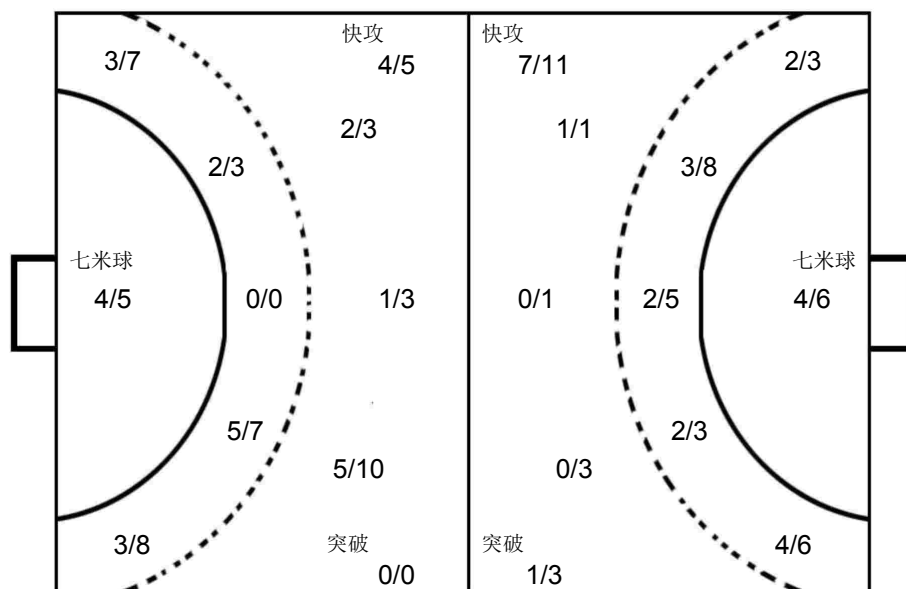

1 □□□

0/1		1/2
1/4	1/1	1/4
0/2		1/5

7 □□□

1/3	1/3	1/3
3/4	1/1	0/4
1/3	0/1	0/1

香港队

1 叶冠英	2 刘健斌	3 陈祥朗	5 黄胜业	7 谭俊杰	8 李伟东	10 谢永辉	12 许文邦																																																																								
<table border="1"><tr><td></td><td></td><td></td></tr><tr><td></td><td></td><td></td></tr><tr><td></td><td></td><td></td></tr></table>										<table border="1"><tr><td>1</td><td></td><td></td></tr><tr><td></td><td></td><td>1</td></tr><tr><td></td><td>1</td><td></td></tr></table>	1					1		1		<table border="1"><tr><td></td><td></td><td></td></tr><tr><td>1</td><td></td><td></td></tr><tr><td></td><td></td><td></td></tr></table>				1						<table border="1"><tr><td></td><td></td><td></td></tr><tr><td>1</td><td>1</td><td></td></tr><tr><td>1</td><td></td><td></td></tr></table>				1	1		1			<table border="1"><tr><td></td><td></td><td></td></tr><tr><td></td><td></td><td></td></tr><tr><td></td><td></td><td></td></tr></table>										<table border="1"><tr><td></td><td></td><td></td></tr><tr><td></td><td></td><td></td></tr><tr><td></td><td></td><td></td></tr></table>										<table border="1"><tr><td></td><td></td><td>1</td></tr><tr><td>2</td><td>1</td><td>1</td></tr><tr><td>1</td><td></td><td></td></tr></table>			1	2	1	1	1			<table border="1"><tr><td>1</td><td></td><td></td></tr><tr><td>1</td><td></td><td>1</td></tr><tr><td>1</td><td></td><td></td></tr></table>	1			1		1	1		
1																																																																															
		1																																																																													
	1																																																																														
1																																																																															
1	1																																																																														
1																																																																															
		1																																																																													
2	1	1																																																																													
1																																																																															
1																																																																															
1		1																																																																													
1																																																																															
Post - 0 Miss - 0 Block - 0	Post - 0 Miss - 1 Block - 0	Post - 0 Miss - 0 Block - 0	Post - 0 Miss - 0 Block - 0	Post - 0 Miss - 0 Block - 0	Post - 0 Miss - 0 Block - 0	Post - 1 Miss - 1 Block - 0	Post - 0 Miss - 1 Block - 0																																																																								
13 张伟浩	18 李鑫豪	23 郭斯鸣	27 冼大维	29 练明辉	31 叶仕仁	33 袁晔彦	40 叶冠雄																																																																								
<table border="1"><tr><td></td><td></td><td></td></tr><tr><td></td><td></td><td></td></tr><tr><td></td><td></td><td></td></tr></table>										<table border="1"><tr><td></td><td></td><td></td></tr><tr><td></td><td></td><td></td></tr><tr><td></td><td></td><td></td></tr></table>										<table border="1"><tr><td></td><td></td><td></td></tr><tr><td>1</td><td></td><td></td></tr><tr><td></td><td></td><td></td></tr></table>				1						<table border="1"><tr><td></td><td></td><td></td></tr><tr><td></td><td></td><td></td></tr><tr><td></td><td></td><td></td></tr></table>										<table border="1"><tr><td></td><td></td><td>1</td></tr><tr><td></td><td></td><td></td></tr><tr><td></td><td></td><td></td></tr></table>			1							<table border="1"><tr><td></td><td></td><td></td></tr><tr><td>1</td><td></td><td></td></tr><tr><td></td><td></td><td></td></tr></table>				1						<table border="1"><tr><td>1</td><td></td><td></td></tr><tr><td>1</td><td></td><td></td></tr><tr><td>1</td><td>1</td><td></td></tr></table>	1			1			1	1		<table border="1"><tr><td></td><td></td><td></td></tr><tr><td>1</td><td></td><td>1</td></tr><tr><td></td><td></td><td></td></tr></table>				1		1			
1																																																																															
		1																																																																													
1																																																																															
1																																																																															
1																																																																															
1	1																																																																														
1		1																																																																													
Post - 0 Miss - 0 Block - 0	Post - 0 Miss - 0 Block - 0	Post - 0 Miss - 0 Block - 0	Post - 0 Miss - 0 Block - 0	Post - 1 Miss - 0 Block - 1	Post - 0 Miss - 0 Block - 1	Post - 0 Miss - 1 Block - 0	Post - 0 Miss - 0 Block - 0																																																																								

PHMS Pictorial Handball Match Statistics

IHF Official System

Team A					Team B					Match Number											
A 广东队					B 北京队					23											
Played in			in the hall			on			at			Spectators									
天津			天津师范大学体育馆			2017-08-28			17:30			hours									
Half-time(30')	A	B	End of playing time		A	B	1st extra time		A	B	2nd extra time		A	B	After penalty throws		A	B			
	8	13			17	23															
Number of 7 m	A	Team time-out			Full name of players and officials						Team time-out			B	Number of 7 m						
	2/3	1	2	3							1	2	3	B							
		19:46	55:16								25:34	42:44		4/4							
No.	Team A					G	W	2'	D	DR	No.	Team B					G	W	2'	D	DR
1	王帅										1	王洸									
2	孙江山										7	马昌震									
3	曲汝洋					3					8	王鹏									
4	李卓洋					2					9	刘振					5				
5	侯生升										10	成亚					2				
6	邓志贵					1					16	刘迈科									
7	付云博					2					21	胡瀛					2	1			
8	于彦江					5					22	王超									
9	徐庆										23	王军程					2				
11	房友屯										25	马明辉									
12	王雨										29	杜龙飞									
15	张建杰										39	张骥					8				
16	马跃										66	解建飞					1	1			
17	李中洲					2	1	1			77	朱昕晨					2				
26	姚雪岩										83	潘天									
84	王伟					2	1				99	蒋维一					1		1		
B	王锋 (主教练)										A	安福田									
C	刘康伶										B	郑永利 (主教练)									
D	张广建										C	孟辉									
E	王永存										E	王长林									
A	Signatures of responsables for the teams (Off.A)															B					
TP	Remarks of referees / HF Official															TP					

Signatures

Referees IGOR. COVALCIUC (MDA)

ALEXEI. COVALCIUC (MDA)

T.D. 李长海 (CHN)

李刚 (CHN)

CHA Off.

Note: Number of 7m Throws Awarded to Team A and B, Goals (G), Warnings (W), Suspensions (2'), Direct Disqualification (D), Disqualification With Report (DR) and Team Penalty (TP).

Table Officials: 鲍瑀

刘宇阳

Statisticians: 陈柱

黄岩

第十三届全国运动会男子手球决赛
PHMS Pictorial Handball Match Statistics

IHF Official System

竞赛技术统计

 手球
男子

 3-4名
轮次 6

 组别 X
场次 23

 天津师范大学体育馆
2017-08-28 17:30

Referees: IGOR. COVALCIUC (MDA) / ALEXEI. COVALCIUC (MDA)

Result: 17:23 (8:13)

Teams: 广东队(广东) VS 北京队(北京)

广东		远	近	边	快	突	任意	7m	合计	%	助攻	失误	警告	2'	D+DR	广东	比赛 进程	北京
主教练: 王锋		射	射	射	攻	破	球	球										
1	王帅																	
2	孙江山																	
3	曲汝洋	1/3	1/3	1/1	0/1				3/8	37.5	1	2						
4	李卓洋	2/4		0/1					2/5	40.0		4						
5	侯生升			0/1					0/1	0.0								
6	邓志贵		0/1	1/2					1/3	33.3		1						
7	付文博				0/1			2/3	2/4	50.0	1	2						
8	于彦江	1/1		3/6		1/1			5/8	62.5		1						
9	徐庆																	
11	房友屯																	
12	王雨																	
15	张建杰																	
16	马跃																	
17	李中洲	0/2	1/1			1/1			2/4	50.0	1	4	1	1				
26	姚雪岩																	
84	王伟		1/1		1/1				2/2	100			1					
运动员 合计		4/10	3/6	5/11	1/3	2/2		2/3	17/35	48.6	3	14	2	1				
1	王帅		0/3	1/2		1/1			2/6	33.3								
16	马跃	4/12	1/3	1/3	0/1	0/1	0/1	0/4	6/25	24.0								
守门员 合计		4/12	1/6	2/5	0/1	1/2	0/1	0/4	8/31	25.8								

北京		远	近	边	快	突	任意	7m	合计	%	助攻	失误	警告	2'	D+DR	广东	比赛 进程	北京
主教练: 郑永利		射	射	射	攻	破	球	球										
1	王洸																	
7	马昌震																	
8	王鹏																	
9	刘振	4/6	0/1	1/1					5/8	62.5		2						
10	成亚	1/3		1/1	0/1				2/5	40.0	1							
16	刘迈科																	
21	胡瀛	1/1	0/1		1/1				2/3	66.7			1					
22	王超																	
23	王军程	1/3					1/2		2/5	40.0		1						
25	马明辉																	
29	杜龙飞																	
39	张骥	1/3	3/4	0/1		0/1		4/4	8/13	61.5		3						
66	解建飞	0/1		1/2					1/3	33.3			1					
77	朱昕晨	0/1	1/1			1/1			2/3	66.7	1	2						
83	潘天																	
99	蒋维一	0/1	1/1						1/2	50.0				1				
运动员 合计		8/19	5/8	3/5	1/2	1/2	1/2	4/4	23/42	54.8	2	8	2	1				
1	王洸							0/1	0/1	0.0								
16	刘迈科	5/9	2/5	5/10	2/3	0/2		1/2	15/31	48.4								
守门员 合计		5/9	2/5	5/10	2/3	0/2		1/3	15/32	46.9								

场上队员: 得分 / 射门

守门员: 救球 / 射门

D	取消资格	DR	取消资格+报告
---	------	----	---------

第十三届全国运动会男子手球决赛

PHMS Pictorial Handball Match Statistics

IHF Official System

个人/全队技术统计表

手球 男子 3-4名 轮次 6 组别 X 场次 23 天津师范大学体育馆 2017-08-28 17:30

号码	姓名	远射	近射	边射	快攻	突破	任意	七米	合计	%	助攻	失误	警告	2'	取消	时间
广东队(广东)																
(场上队员)																
1	王帅									0.0%						00:12:17
2	孙江山									0.0%						00:03:17
3	曲汝洋	1/3	1/3	1/1	0/1				3/8	37.5%	1	2				00:51:01
4	李卓洋	2/4		0/1					2/5	40.0%		4				00:40:53
5	侯生升			0/1					0/1	0.0%						00:04:08
6	邓志贵		0/1	1/2					1/3	33.3%		1				00:55:12
7	付云博				0/1			2/3	2/4	50.0%	1	2				00:30:00
8	于彦江	1/1		3/6		1/1			5/8	62.5%		1				00:59:44
9	徐庆									0.0%						00:06:54
11	房友屯									0.0%						00:00:00
12	王雨									0.0%						00:00:00
15	张建杰									0.0%						00:00:00
16	马跃									0.0%						00:47:43
17	李中洲	0/2	1/1			1/1			2/4	50.0%	1	4	1	1		00:49:24
26	姚雪岩									0.0%						00:00:00
84	王伟		1/1		1/1				2/2	100%			1			00:58:40
	合计	4/10	3/6	5/11	1/3	2/2		2/3	17/35	48.6%	3	14	2	1		
(守门员)																
1	王帅		0/3	1/2		1/1			2/6	33.3%						00:12:17
16	马跃	4/12	1/3	1/3	0/1	0/1	0/1	0/4	6/25	24.0%						00:47:43
	合计	4/12	1/6	2/5	0/1	1/2	0/1	0/4	8/31	25.8%						

场上队员：得分/射门

守门员：救球/射门

全队合计	得分	被救	射失	击柱	封球	合计	%
远射	4	5			1	10	40.0%
近射	3	2		1		6	50.0%
边射	5	5	1			11	45.5%
快攻	1	2				3	33.3%
突破	2					2	100.0%
任意							0.0%
七米	2	1				3	66.7%

第十三届全国运动会男子手球决赛

PHMS Pictorial Handball Match Statistics

IHF Official System

个人/全队技术统计表

手球 男子 3-4名 轮次 6 组别 X 场次 23 天津师范大学体育馆 2017-08-28 17:30

号码	姓名	远射	近射	边射	快攻	突破	任意	七米	合计	%	助攻	失误	警告	2'	取消	时间
北京队(北京)																
(场上队员)																
1	王洸									0.0%						00:00:27
7	马昌震									0.0%						00:00:02
8	王鹏									0.0%						00:10:05
9	刘振	4/6	0/1	1/1					5/8	62.5%		2				00:31:06
10	成亚	1/3		1/1	0/1				2/5	40.0%	1					00:48:33
16	刘迈科									0.0%						00:59:33
21	胡瀛	1/1	0/1		1/1				2/3	66.7%			1			00:41:32
22	王超									0.0%						00:27:54
23	王军程	1/3					1/2		2/5	40.0%		1				00:08:34
25	马明辉									0.0%						00:19:32
29	杜龙飞									0.0%						00:00:00
39	张骥	1/3	3/4	0/1		0/1		4/4	8/13	61.5%		3				00:39:54
66	解建飞	0/1		1/2					1/3	33.3%			1			00:35:09
77	朱昕晨	0/1	1/1			1/1			2/3	66.7%	1	2				00:11:58
83	潘天									0.0%						00:22:08
99	蒋维一	0/1	1/1						1/2	50.0%				1		00:58:53
	合计	8/19	5/8	3/5	1/2	1/2	1/2	4/4	23/42	54.8%	2	8	2	1		
(守门员)																
1	王洸							0/1	0/1	0.0%						00:00:27
16	刘迈科	5/9	2/5	5/10	2/3	0/2		1/2	15/31	48.4%						00:59:33
	合计	5/9	2/5	5/10	2/3	0/2		1/3	15/32	46.9%						

场上队员：得分/射门

守门员：救球/射门

全队合计	得分	被救	射失	击柱	封球	合计	%
远射	8	4	2	1	4	19	42.1%
近射	5	1	2			8	62.5%
边射	3	2				5	60.0%
快攻	1		1			2	50.0%
突破	1	1				2	50.0%
任意	1		1			2	50.0%
七米	4					4	100.0%

第十三届全国运动会男子手球决赛

PHMS Pictorial Handball Match Statistics

IHF Official System

图式比赛技术统计表

手球
男子

3-4名
轮次 6

组别 X
场次 23

天津师范大学体育馆
2017-08-28 17:30

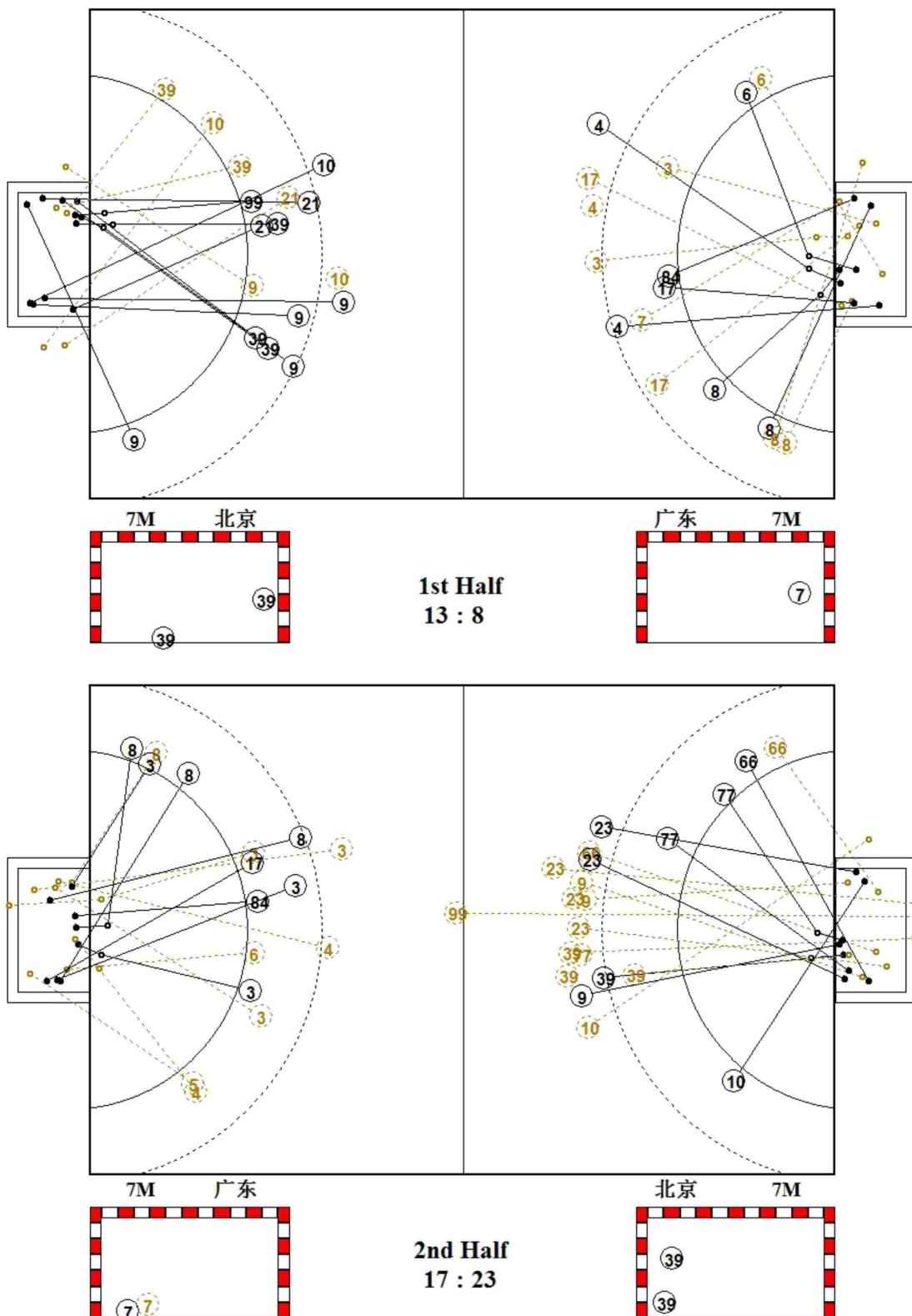

第十三届全国运动会男子手球决赛

PHMS Pictorial Handball Match Statistics

IHF Official System

图式射门区域统计

手球
男子

3-4名
轮次 6

组别 X
场次 23

天津师范大学体育馆
2017-08-28 17:30

广东队

1 王帅	2 孙江山	3 曲汝洋	4 李卓洋	5 侯生升	6 邓志贵	7 付文博	8 于彦江																																																																											
<table border="1"><tr><td></td><td></td><td></td></tr><tr><td></td><td></td><td></td></tr><tr><td></td><td></td><td></td></tr></table>										<table border="1"><tr><td></td><td></td><td></td></tr><tr><td></td><td></td><td></td></tr><tr><td></td><td></td><td></td></tr></table>										<table border="1"><tr><td></td><td></td><td></td></tr><tr><td>1</td><td></td><td></td></tr><tr><td></td><td>1</td><td>1</td></tr></table>				1				1	1	<table border="1"><tr><td></td><td></td><td></td></tr><tr><td></td><td></td><td>1</td></tr><tr><td></td><td></td><td>1</td></tr></table>						1			1	<table border="1"><tr><td></td><td></td><td></td></tr><tr><td></td><td></td><td></td></tr><tr><td></td><td></td><td></td></tr></table>										<table border="1"><tr><td></td><td></td><td></td></tr><tr><td></td><td></td><td></td></tr><tr><td></td><td>1</td><td></td></tr></table>								1		<table border="1"><tr><td></td><td></td><td></td></tr><tr><td></td><td></td><td>1</td></tr><tr><td>1</td><td></td><td></td></tr></table>						1	1			<table border="1"><tr><td></td><td></td><td></td></tr><tr><td></td><td></td><td></td></tr><tr><td>2</td><td></td><td>1</td></tr><tr><td></td><td>2</td><td></td></tr></table>							2		1		2	
1																																																																																		
	1	1																																																																																
		1																																																																																
		1																																																																																
	1																																																																																	
		1																																																																																
1																																																																																		
2		1																																																																																
	2																																																																																	
Post - 0 Miss - 0 Block - 0	Post - 0 Miss - 0 Block - 0	Post - 1 Miss - 0 Block - 0	Post - 0 Miss - 0 Block - 1	Post - 0 Miss - 0 Block - 0	Post - 0 Miss - 0 Block - 0	Post - 0 Miss - 0 Block - 0	Post - 0 Miss - 1 Block - 0																																																																											
9 徐庆	11 房友屯	12 王雨	15 张建杰	16 马跃	17 李中洲	26 姚雪岩	84 王伟																																																																											
<table border="1"><tr><td></td><td></td><td></td></tr><tr><td></td><td></td><td></td></tr><tr><td></td><td></td><td></td></tr></table>										<table border="1"><tr><td></td><td></td><td></td></tr><tr><td></td><td></td><td></td></tr><tr><td></td><td></td><td></td></tr></table>										<table border="1"><tr><td></td><td></td><td></td></tr><tr><td></td><td></td><td></td></tr><tr><td></td><td></td><td></td></tr></table>										<table border="1"><tr><td></td><td></td><td></td></tr><tr><td></td><td></td><td></td></tr><tr><td></td><td></td><td></td></tr></table>										<table border="1"><tr><td></td><td></td><td></td></tr><tr><td></td><td></td><td></td></tr><tr><td></td><td></td><td></td></tr></table>										<table border="1"><tr><td></td><td></td><td></td></tr><tr><td>1</td><td></td><td></td></tr><tr><td></td><td></td><td>1</td></tr></table>				1					1	<table border="1"><tr><td></td><td></td><td></td></tr><tr><td></td><td></td><td></td></tr><tr><td></td><td></td><td></td></tr></table>										<table border="1"><tr><td></td><td></td><td></td></tr><tr><td></td><td></td><td></td></tr><tr><td>1</td><td>1</td><td></td></tr></table>							1	1				
1																																																																																		
		1																																																																																
1	1																																																																																	
Post - 0 Miss - 0 Block - 0	Post - 0 Miss - 0 Block - 0	Post - 0 Miss - 0 Block - 0	Post - 0 Miss - 0 Block - 0	Post - 0 Miss - 0 Block - 0	Post - 0 Miss - 0 Block - 0	Post - 0 Miss - 0 Block - 0	Post - 0 Miss - 0 Block - 0																																																																											

1 □□

		0/1
		1/2
		1/3

16 □□

0/2		1/2
1/4		2/4
1/5	0/2	1/6

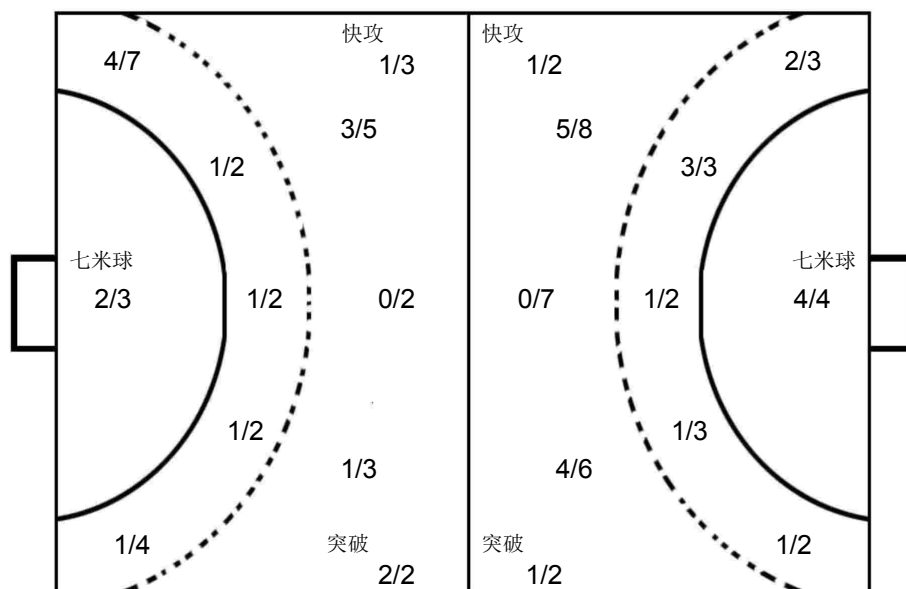

1 □□

0/1		

16 □□□

1/1	1/1	1/1
2/6		2/5
3/4	2/7	3/6

北京队

1 王澍	7 马昌震	8 王鹏	9 刘振	10 成亚	16 刘迈科	21 胡瀛	22 王超																																																																								
<table border="1"><tr><td></td><td></td><td></td></tr><tr><td></td><td></td><td></td></tr><tr><td></td><td></td><td></td></tr></table>										<table border="1"><tr><td></td><td></td><td></td></tr><tr><td></td><td></td><td></td></tr><tr><td></td><td></td><td></td></tr></table>										<table border="1"><tr><td></td><td></td><td></td></tr><tr><td></td><td></td><td></td></tr><tr><td></td><td></td><td></td></tr></table>										<table border="1"><tr><td></td><td></td><td></td></tr><tr><td>1</td><td></td><td>1</td></tr><tr><td></td><td>1</td><td>1</td></tr></table>				1		1		1	1	<table border="1"><tr><td></td><td></td><td></td></tr><tr><td>1</td><td></td><td></td></tr><tr><td></td><td></td><td></td></tr></table>				1						<table border="1"><tr><td></td><td></td><td></td></tr><tr><td></td><td></td><td></td></tr><tr><td></td><td></td><td></td></tr></table>										<table border="1"><tr><td></td><td></td><td></td></tr><tr><td></td><td></td><td>1</td></tr><tr><td>1</td><td></td><td></td></tr></table>						1	1			<table border="1"><tr><td></td><td></td><td></td></tr><tr><td></td><td></td><td></td></tr><tr><td></td><td></td><td></td></tr></table>									
1		1																																																																													
	1	1																																																																													
1																																																																															
		1																																																																													
1																																																																															
Post - 0 Miss - 0 Block - 0	Post - 0 Miss - 0 Block - 0	Post - 0 Miss - 0 Block - 0	Post - 0 Miss - 1 Block - 0	Post - 0 Miss - 2 Block - 1	Post - 0 Miss - 0 Block - 0	Post - 0 Miss - 1 Block - 0	Post - 0 Miss - 0 Block - 0																																																																								
23 王军程	25 马明辉	29 杜龙飞	39 张骥	66 解建飞	77 朱昕晨	83 潘天	99 蒋维一																																																																								
<table border="1"><tr><td></td><td></td><td></td></tr><tr><td></td><td></td><td></td></tr><tr><td>1</td><td></td><td>1</td></tr></table>							1		1	<table border="1"><tr><td></td><td></td><td></td></tr><tr><td></td><td></td><td></td></tr><tr><td></td><td></td><td></td></tr></table>										<table border="1"><tr><td></td><td></td><td></td></tr><tr><td></td><td></td><td></td></tr><tr><td></td><td></td><td></td></tr></table>										<table border="1"><tr><td></td><td></td><td></td></tr><tr><td>1</td><td></td><td>2</td></tr><tr><td>2</td><td></td><td>3</td></tr></table>				1		2	2		3	<table border="1"><tr><td></td><td></td><td></td></tr><tr><td></td><td></td><td></td></tr><tr><td></td><td></td><td>1</td></tr></table>									1	<table border="1"><tr><td></td><td></td><td></td></tr><tr><td></td><td></td><td></td></tr><tr><td></td><td>1</td><td>1</td></tr></table>								1	1	<table border="1"><tr><td></td><td></td><td></td></tr><tr><td></td><td></td><td></td></tr><tr><td></td><td></td><td></td></tr></table>										<table border="1"><tr><td></td><td></td><td></td></tr><tr><td></td><td></td><td></td></tr><tr><td></td><td></td><td>1</td></tr></table>									1
1		1																																																																													
1		2																																																																													
2		3																																																																													
		1																																																																													
	1	1																																																																													
		1																																																																													
Post - 0 Miss - 1 Block - 1	Post - 0 Miss - 0 Block - 0	Post - 0 Miss - 0 Block - 0	Post - 1 Miss - 0 Block - 1	Post - 0 Miss - 0 Block - 0	Post - 0 Miss - 0 Block - 1	Post - 0 Miss - 0 Block - 0	Post - 0 Miss - 1 Block - 0																																																																								

第十三届全国运动会男子手球决赛

PHMS Pictorial Handball Match Statistics

IHF Official System

比赛进程表

手球 男子 3-4名 轮次 6 组别 X 场次 23 八件四世八子件月 馆 2017-08-28 17:30

时间	队员	动作	比分	队员	动作
广东队			上半时	北京队	
00:40	16 马跃	被射入	0-1	9 刘振	左远射 得分
01:21	8 于彦江	右边射 被救		16 刘迈科	挡住球
01:40				21 胡瀛	警告
01:59	17 李中洲	助攻			
02:02	84 王伟	近射 得分	1-1	16 刘迈科	被射入
02:43	16 马跃	被射入	1-2	39 张骥	近射 得分
03:32	17 李中洲	右远射 被救		16 刘迈科	挡住球
04:01	16 马跃	被射入	1-3	39 张骥	7M球 得分
04:12	3 曲汝洋	使被罚7M球		10 成亚	造7M
04:38	4 李卓洋	左远射 得分	2-3	16 刘迈科	被射入
05:23	8 于彦江	造犯规		9 刘振	进攻犯规
06:10	4 李卓洋	左远射 被封		66 解建飞	封球
06:33				66 解建飞	警告
06:35		裁判暂停			
07:01	17 李中洲	造7M		39 张骥	使被罚7M球
07:23		裁判暂停			
07:28	7 付文博	7M球 得分	3-3	16 刘迈科	被射入
08:14	16 马跃	被射入	3-4	10 成亚	右远射 得分
08:46	4 李卓洋	右远射 得分	4-4	16 刘迈科	被射入
09:37				9 刘振	近射 射失
10:21	4 李卓洋	进攻犯规		21 胡瀛	造犯规
11:18	16 马跃	被射入	4-5	21 胡瀛	右远射 得分
12:05	8 于彦江	右边射 得分	5-5	16 刘迈科	被射入
12:34				39 张骥	传球失误
12:41		裁判暂停			
13:18	17 李中洲	左远射 被救		16 刘迈科	挡住球
13:49	84 王伟	使被罚7M球		99 蒋维一	造7M
13:51	84 王伟	警告			
14:03	16 马跃	被射入	5-6	39 张骥	7M球 得分
14:32	3 曲汝洋	四步			
15:17		裁判暂停			
15:17	17 李中洲	警告			
15:46	16 马跃	被射入	5-7	9 刘振	左远射 得分
16:27	6 邓志贵	左边射 被救		16 刘迈科	挡住球
16:29	3 曲汝洋	助攻			
16:45	1 王帅	挡住球		39 张骥	右边射 被救
17:57	3 曲汝洋	中远射 被救		16 刘迈科	挡住球
18:08	7 付文博	断球		39 张骥	快攻 传球失误
18:26	7 付文博	一传快攻 被救		16 刘迈科	挡住球
18:59	1 王帅	挡住球		39 张骥	突破 被救
19:01		裁判暂停			

第十三届全国运动会男子手球决赛

PHMS Pictorial Handball Match Statistics

IHF Official System

比赛进程表

手球 男子 3-4名 轮次 6 组别 X 场次 23 八件型世八子件月 馆 2017-08-28 17:30

时间	队员	动作	比分	队员	动作			
广东队			上半时			北京队		
19:02	7 付云博	快攻 四步	5-7					
19:43	1 王帅	被射入	5-8	99 蒋维一	近射 得分			
19:46				10 成亚	助攻			
19:46		球队暂停						
20:18	17 李中洲	突破 得分	6-8	16 刘迈科	被射入			
20:57	8 于彦江	造犯规		77 朱昕晨	进攻犯规			
21:09	17 李中洲	其它失误						
21:53				21 胡瀛	近射 射失			
22:06	17 李中洲	其它失误						
22:17				10 成亚	短传快攻 射失			
22:52	6 邓志贵	左边射 得分	7-8	16 刘迈科	被射入			
22:54	7 付云博	助攻						
23:32	1 王帅	被射入	7-9	9 刘振	左边射 得分			
23:34				77 朱昕晨	助攻			
24:26	8 于彦江	右边射 射失						
24:37	84 王伟	封球		10 成亚	中远射 被封			
25:12	3 曲汝洋	断球		39 张骥	传球失误			
25:15	3 曲汝洋	一传快攻 被救		16 刘迈科	挡住球			
25:34					球队暂停			
26:00	1 王帅	被射入	7-10	39 张骥	近射 得分			
27:06	6 邓志贵	接球失误						
28:01	1 王帅	被射入	7-11	39 张骥	近射 得分			
28:36	17 李中洲	运球失误						
28:43	16 马跃	被射入	7-12	21 胡瀛	一传快攻 得分			
29:27	8 于彦江	突破 得分	8-12	16 刘迈科	被射入			
29:54	16 马跃	被射入	8-13	9 刘振	左远射 得分			
30:00		裁判暂停						

第十三届全国运动会男子手球决赛

PHMS Pictorial Handball Match Statistics

IHF Official System

比赛进程表

手球 男子 3-4名 轮次 6 组别 X 场次 23 八件四世八子牌月 馆 2017-08-28 17:30

时间	队员	动作	比分	队员	动作
广东队			北京队		
下半场			下半场		
00:30	3 曲汝洋	传球失误	8-13		
01:23				9 刘振	其它失误
01:33	3 曲汝洋	近射 击柱			
01:37	6 邓志贵	近射 被救		16 刘迈科	挡住球
02:26	16 马跃	被射入	8-14	39 张骥	右远射 得分
02:55	17 李中洲	近射 得分	9-14	16 刘迈科	被射入
03:29	16 马跃	挡住球		9 刘振	左远射 被救
04:03	17 李中洲	造7M		66 解建飞	使被罚7M球
04:25	7 付文博	7M球 得分	10-14	1 王泷	被射入
04:59	16 马跃	挡住球		66 解建飞	左远射 被救
05:07	4 李卓洋	传球失误			
05:57				39 张骥	中远射 击柱
06:36	84 王伟	封球		39 张骥	右远射 被封
06:46	84 王伟	封球		77 朱昕晨	中远射 被封
06:58	16 马跃	被射入	10-15	9 刘振	右远射 得分
07:38	8 于彦江	右边射 得分	11-15	16 刘迈科	被射入
07:46				99 蒋维一	中远射 射失
08:10	17 李中洲	接球失误			
08:26	8 于彦江	使被罚7M球		99 蒋维一	造7M
08:47	16 马跃	被射入	11-16	39 张骥	7M球 得分
09:36	8 于彦江	侵区			
10:22				10 成亚	右远射 射失
10:38	8 于彦江	右边射 被救		16 刘迈科	挡住球
11:11	84 王伟	封球		23 王军程	中远射 被封
11:39	7 付文博	传球失误			
12:44					球队暂停
13:16	16 马跃	被射入	11-17	23 王军程	任意球 得分
13:46	5 侯生升	左边射 被救		16 刘迈科	挡住球
14:39	16 马跃	被射入	11-18	66 解建飞	左边射 得分
15:09		裁判暂停			
15:15				99 蒋维一	罚出场2分钟
15:28	3 曲汝洋	右远射 被救		16 刘迈科	挡住球
15:42	3 曲汝洋	右远射 得分	12-18	16 刘迈科	被射入
16:41				23 王军程	任意球 射失
17:25	16 马跃	挡住球		23 王军程	中远射 被救
18:19	3 曲汝洋	近射 得分	13-18	16 刘迈科	被射入
18:55	16 马跃	被射入	13-19	10 成亚	右边射 得分
19:08	4 李卓洋	进攻犯规		21 胡瀛	造犯规
19:58	16 马跃	挡住球		9 刘振	中远射 被救
20:13	8 于彦江	右边射 得分	14-19	16 刘迈科	被射入
20:57	16 马跃	挡住球		66 解建飞	左边射 被救

第十三届全国运动会男子手球决赛
PHMS Pictorial Handball Match Statistics

IHF Official System

比赛进程表

手球 男子 3-4名 轮次 6 组别 X 场次 23 天津奥林匹克体育中心 2017-08-28 17:30

时间	队员	动作	比分	队员	动作			
广东队			下半场			北京队		
21:08	4 李卓洋	四步	14-19					
21:51	16 马跃	被射入	14-20	77 朱昕晨	突破 得分			
22:20	3 曲汝洋	近射 被救		16 刘迈科	挡住球			
23:22		裁判暂停						
23:25	17 李中洲	使被罚7M球		10 成亚	造7M			
23:25	17 李中洲	罚出场2分钟						
23:30	16 马跃	被射入	14-21	39 张骥	7M球 得分			
24:15	4 李卓洋	左边射 被救		16 刘迈科	挡住球			
24:50	16 马跃	挡住球		39 张骥	近射 被救			
25:16		球队暂停						
25:43	4 李卓洋	中远射 被救		16 刘迈科	挡住球			
26:30	16 马跃	被射入	14-22	77 朱昕晨	近射 得分			
27:01	8 于彦江	右远射 得分	15-22	16 刘迈科	被射入			
27:48				77 朱昕晨	其它失误			
28:07	3 曲汝洋	右边射 得分	16-22	16 刘迈科	被射入			
28:28	8 于彦江	断球		23 王军程	传球失误			
28:36	84 王伟	短传快攻 得分	17-22	16 刘迈科	被射入			
29:03	16 马跃	被射入	17-23	23 王军程	左远射 得分			
29:34		裁判暂停						
29:43	84 王伟	造7M		99 蒋维一	使被罚7M球			
29:52	7 付云博	7M球 被救		16 刘迈科	挡住球			
29:59		裁判暂停						

Team A					Team B					Match Number											
A 山东队					B 江苏队					24											
Played in			in the hall			on			at			Spectators									
天津			天津师范大学体育馆			2017-08-28			19:15			hours									
Half-time(30')	A	B	End of playing time		A	B	1st extra time		A	B	2nd extra time		A	B	After penalty throws		A	B			
	5	11			13	23															
Number of 7 m	A	Team time-out			Full name of players and officials						Team time-out			B	Number of 7 m						
	2/3	1	2	3							1	2	3	B							
		16:09	46:02								22:03	50:04	55:00	2/3							
No.	Team A					G	W	2'	D	DR	No.	Team B					G	W	2'	D	DR
3	尹杰										1	徐畅									
4	田瑞					1					4	张家纬									
5	潘翔					1		1			5	闫亮						1			
6	李朝鹏							1			6	赵晨					5	1	1		
8	王炳华										7	徐奕飞									
9	赵鑫					2	1	1			8	周小坚					3		1		
11	宋朋强					1					9	王杰缘					3		1		
12	崔剑										10	郝可鑫									
13	刘晓					1	1				12	王权									
15	张继伟										13	叶强									
16	于性哲										15	李安					5				
17	王旭东							1			17	王伟强									
18	于亚男						1	1			18	赵楠									
19	李语庆										19	张志宇					1				
20	杜在超					4					20	顾艳超					6	1			
21	翟乾坤					3					21	刘江									
A	王志峰										A	闫威名 (主教练)									
B	王鸿斌 (主教练)										C	雷纳德									
C	刘桂妮										D	贾淑君									
D	邢建刚										E	王建国									
A	Signatures of responsables for the teams (Off.A)																			B	
TP	Remarks of referees / HF Official																			TP	

Signatures

Referees BALAZS. MARTON (HUN)

PETER. HORVATH (HUN)

T.D. 李长海 (CHN)

李刚 (CHN)

CHA Off.

Note: Number of 7m Throws Awarded to Team A and B, Goals (G), Warnings (W), Suspensions (2'), Direct Disqualification (D), Disqualification With Report (DR) and Team Penalty (TP).

Table Officials: 隆晓磊

李志成

Statisticians: 刘永欢

陈柱

第十三届全国运动会男子手球决赛
PHMS Pictorial Handball Match Statistics

IHF Official System

竞赛技术统计

 手球
男子

 决赛
轮次 6

 组别 X
场次 24

 天津师范大学体育馆
2017-08-28 19:15

Referees: BALAZS. MARTON (HUN) / PETER. HORVATH (HUN)

Result: 13:23 (5:11)

Teams: 山东队(山东) VS 江苏队(江苏)

山东		远	近	边	快	突	任意	7m	合计	%	助攻	失误	警告	2'	D+DR	山东	比赛 进程	江苏
主教练: 王鸿斌		射	射	射	攻	破	球	球										
3	尹杰											1						
4	田瑞				1/1				1/1	100		2						
5	潘翔				0/1			1/1	1/2	50.0		1		1				
6	李朝鹏	0/2			0/1		0/1		0/4	0.0		2						
8	王炳华																	
9	赵鑫	2/6							2/6	33.3	2	1	1	1				
11	宋朋强	0/3			0/1	1/2			1/6	16.7								
12	崔剑																	
13	刘晓	0/2	0/1			1/1			1/4	25.0		2	1					
15	张继伟																	
16	于性哲							0/1	0/1	0.0								
17	王旭东	0/1	0/1	0/1					0/3	0.0		2		1				
18	于亚男	0/2	0/1						0/3	0.0		1	1	1				
19	李语庆			0/1					0/1	0.0								
20	杜在超	2/4	0/1		1/2	1/1			4/8	50.0		1						
21	翟乾坤	0/1		1/3	1/1			1/1	3/6	50.0		1						
运动员 合计		4/21	0/4	1/5	3/7	3/4	0/1	2/3	13/45	28.9	2	14	3	5				
12	崔剑			0/1		0/1	0/1	0/1	0/4	0.0								
16	于性哲	4/10	3/6	0/1	1/4	2/7	2/2	1/2	13/32	40.6								
守门员 合计		4/10	3/6	0/2	1/4	2/8	2/3	1/3	13/36	36.1								

江苏		远	近	边	快	突	任意	7m	合计	%	助攻	失误	警告	2'	D+DR	山东	比赛 进程	江苏
主教练: 闫威名		射	射	射	攻	破	球	球										
1	徐畅																	
4	张家纬	0/2	0/1						0/3	0.0	2	3						
5	闫亮										1		1					
6	赵晨	2/5	1/2		1/1		1/2		5/10	50.0	1	1	1	1				
7	徐奕飞																	
8	周小坚		1/1		1/1	1/1			3/3	100	2	4		1				
9	王杰缘	0/2	0/1		1/1			2/2	3/6	50.0		1		1				
10	郝可鑫											1						
12	王权																	
13	叶强																	
15	李安	1/1	1/1	2/2	0/1	1/2		0/1	5/8	62.5		1						
17	王伟强																	
18	赵楠																	
19	张志宇	1/1							1/1	100	1	2						
20	顾艳超	2/3				4/5	0/1		6/9	66.7			1					
21	刘江																	
运动员 合计		6/14	3/6	2/2	3/4	6/8	1/3	2/3	23/40	57.5	7	13	3	3				
12	王权	11/15	1/1	1/2	2/5	1/4	1/1	0/2	17/30	56.7								
13	叶强																	
守门员 合计		11/15	1/1	1/2	2/5	1/4	1/1	0/2	17/30	56.7								

场上队员: 得分 / 射门

守门员: 救球 / 射门

D	取消资格	DR	取消资格+报告
---	------	----	---------

第十三届全国运动会男子手球决赛

PHMS Pictorial Handball Match Statistics

IHF Official System

个人/全队技术统计表

手球 男子 决赛 轮次 6 组别 X 场次 24 天津师范大学体育馆 2017-08-28 19:15

号码	姓名	远射	近射	边射	快攻	突破	任意	七米	合计	%	助攻	失误	警告	2'	取消	时间
山东队(山东)																
(场上队员)																
3	尹杰									0.0%		1				00:16:34
4	田瑞				1/1				1/1	100%		2				00:16:24
5	潘翔				0/1			1/1	1/2	50.0%		1		1		00:35:23
6	李朝鹏	0/2			0/1		0/1		0/4	0.0%		2		1		00:15:10
8	王炳华									0.0%						00:00:00
9	赵鑫	2/6							2/6	33.3%	2	1	1	1		00:32:55
11	宋朋强	0/3			0/1	1/2			1/6	16.7%						00:29:25
12	崔剑									0.0%						00:04:25
13	刘晓	0/2	0/1			1/1			1/4	25.0%		2		1		00:34:36
15	张继伟									0.0%						00:23:27
16	于性哲							0/1	0/1	0.0%						00:55:35
17	王旭东	0/1	0/1	0/1					0/3	0.0%		2		1		00:43:34
18	于亚男	0/2	0/1						0/3	0.0%		1		1	1	00:41:29
19	李语庆			0/1					0/1	0.0%						00:08:45
20	杜在超	2/4	0/1		1/2	1/1			4/8	50.0%		1				00:23:33
21	翟乾坤	0/1		1/3	1/1			1/1	3/6	50.0%		1				00:37:39
合计		4/21	0/4	1/5	3/7	3/4	0/1	2/3	13/45	28.9%	2	14	3	5		
(守门员)																
12	崔剑			0/1		0/1	0/1	0/1	0/4	0.0%						00:04:25
16	于性哲	4/10	3/6	0/1	1/4	2/7	2/2	1/2	13/32	40.6%						00:55:35
合计		4/10	3/6	0/2	1/4	2/8	2/3	1/3	13/36	36.1%						

场上队员：得分/射门

守门员：救球/射门

全队合计	得分	被救	射失	击柱	封球	合计	%
远射	4	11	1		5	21	19.0%
近射		1	1	1	1	4	0.0%
边射	1	1	3			5	20.0%
快攻	3	2	2			7	42.9%
突破	3	1				4	75.0%
任意		1				1	0.0%
七米	2			1		3	66.7%

第十三届全国运动会男子手球决赛
PHMS Pictorial Handball Match Statistics

IHF Official System

个人/全队技术统计表

手球 男子 决赛 轮次 6 组别 X 场次 24 天津师范大学体育馆 2017-08-28 19:15

号码	姓名	远射	近射	边射	快攻	突破	任意	七米	合计	%	助攻	失误	警告	2'	取消	时间
江苏队(江苏)																
(场上队员)																
1	徐畅									0.0%						00:00:00
4	张家纬	0/2	0/1						0/3	0.0%	2	3				00:46:44
5	闫亮									0.0%	1		1			00:14:14
6	赵晨	2/5	1/2		1/1		1/2		5/10	50.0%	1	1	1	1		01:00:00
7	徐奕飞									0.0%						00:00:00
8	周小坚		1/1		1/1	1/1			3/3	100%	2	4		1		00:43:14
9	王杰缘	0/2	0/1		1/1			2/2	3/6	50.0%		1		1		01:00:00
10	郝可鑫									0.0%		1				00:11:32
12	王权									0.0%						00:58:39
13	叶强									0.0%						00:01:21
15	李安	1/1	1/1	2/2	0/1	1/2		0/1	5/8	62.5%		1				00:59:41
17	王伟强									0.0%						00:00:00
18	赵楠									0.0%						00:00:00
19	张志宇	1/1							1/1	100%	1	2				00:13:23
20	顾艳超	2/3				4/5	0/1		6/9	66.7%			1			00:38:20
21	刘江									0.0%						00:11:45
合计		6/14	3/6	2/2	3/4	6/8	1/3	2/3	23/40	57.5%	7	13	3	3		
(守门员)																
12	王权	11/15	1/1	1/2	2/5	1/4	1/1	0/2	17/30	56.7%						00:58:39
13	叶强									0.0%						00:01:21
合计		11/15	1/1	1/2	2/5	1/4	1/1	0/2	17/30	56.7%						

场上队员：得分/射门

守门员：救球/射门

全队合计	得分	被救	射失	击柱	封球	合计	%
远射	6	4	1		3	14	42.9%
近射	3	3				6	50.0%
边射	2					2	100.0%
快攻	3	1				4	75.0%
突破	6	2				8	75.0%
任意	1	2				3	33.3%
七米	2	1				3	66.7%

图式比赛技术统计表

手球
男子

决赛
轮次 6

组别 X
场次 24

天津师范大学体育馆
2017-08-28 19:15

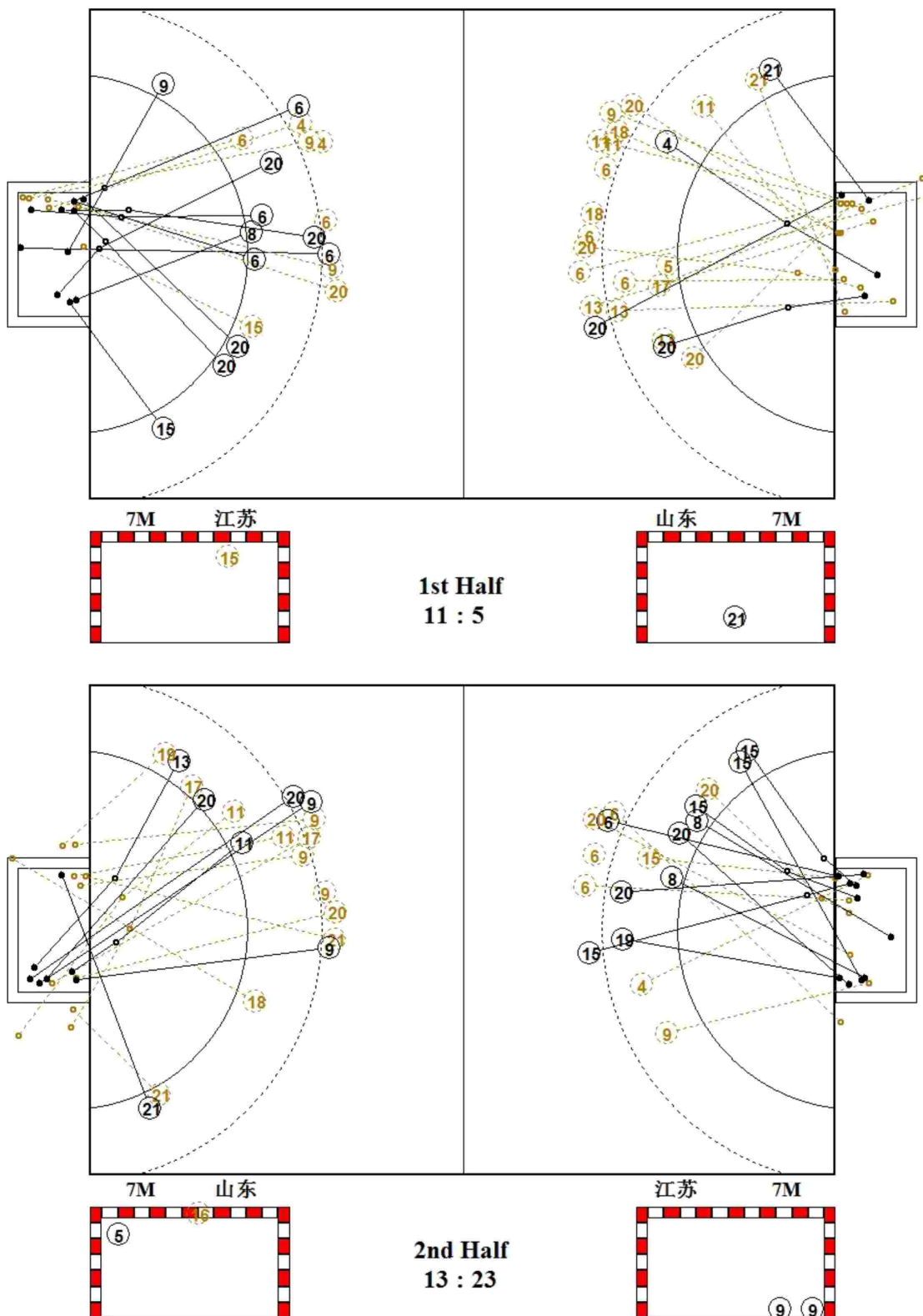

第十三届全国运动会男子手球决赛

PHMS Pictorial Handball Match Statistics

IHF Official System

图式射门区域统计

手球
男子

决赛
轮次 6

组别 X
场次 24

天津师范大学体育馆
2017-08-28 19:15

山东队

3 尹杰 <table border="1"><tr><td></td><td></td><td></td></tr><tr><td></td><td></td><td></td></tr><tr><td></td><td></td><td></td></tr></table> Post - 0 Miss - 0 Block - 0										4 田瑞 <table border="1"><tr><td></td><td></td><td></td></tr><tr><td></td><td>1</td><td></td></tr><tr><td></td><td></td><td></td></tr></table> Post - 0 Miss - 0 Block - 0					1					5 潘翔 <table border="1"><tr><td></td><td>1</td><td></td></tr><tr><td></td><td></td><td></td></tr><tr><td></td><td></td><td></td></tr></table> Post - 0 Miss - 1 Block - 0		1								6 李朝鹏 <table border="1"><tr><td></td><td></td><td></td></tr><tr><td></td><td></td><td></td></tr><tr><td></td><td></td><td></td></tr></table> Post - 0 Miss - 0 Block - 2										8 王炳华 <table border="1"><tr><td></td><td></td><td></td></tr><tr><td></td><td></td><td></td></tr><tr><td></td><td></td><td></td></tr></table> Post - 0 Miss - 0 Block - 0										9 赵鑫 <table border="1"><tr><td></td><td>1</td><td></td></tr><tr><td></td><td></td><td></td></tr><tr><td></td><td>1</td><td></td></tr></table> Post - 0 Miss - 1 Block - 1		1						1		11 宋朋强 <table border="1"><tr><td></td><td></td><td></td></tr><tr><td></td><td></td><td></td></tr><tr><td></td><td>1</td><td></td></tr></table> Post - 0 Miss - 1 Block - 1								1		12 崔剑 <table border="1"><tr><td></td><td></td><td></td></tr><tr><td></td><td></td><td></td></tr><tr><td></td><td></td><td></td></tr></table> Post - 0 Miss - 0 Block - 0									
	1																																																																														
	1																																																																														
	1																																																																														
	1																																																																														
	1																																																																														
13 刘晓 <table border="1"><tr><td>1</td><td></td><td></td></tr><tr><td></td><td></td><td></td></tr><tr><td></td><td></td><td></td></tr></table> Post - 0 Miss - 0 Block - 1	1									15 张继伟 <table border="1"><tr><td></td><td></td><td></td></tr><tr><td></td><td></td><td></td></tr><tr><td></td><td></td><td></td></tr></table> Post - 0 Miss - 0 Block - 0										16 于性哲 <table border="1"><tr><td></td><td></td><td></td></tr><tr><td></td><td></td><td></td></tr><tr><td></td><td></td><td></td></tr></table> Post - 1 Miss - 0 Block - 0										17 王旭东 <table border="1"><tr><td></td><td></td><td></td></tr><tr><td></td><td></td><td></td></tr><tr><td></td><td></td><td></td></tr></table> Post - 0 Miss - 2 Block - 0										18 于亚男 <table border="1"><tr><td></td><td></td><td></td></tr><tr><td></td><td></td><td></td></tr><tr><td></td><td></td><td></td></tr></table> Post - 1 Miss - 0 Block - 1										19 李语庆 <table border="1"><tr><td></td><td></td><td></td></tr><tr><td></td><td></td><td></td></tr><tr><td></td><td></td><td></td></tr></table> Post - 0 Miss - 1 Block - 0										20 杜在超 <table border="1"><tr><td></td><td>1</td><td></td></tr><tr><td></td><td>1</td><td>1</td></tr><tr><td></td><td>1</td><td></td></tr></table> Post - 0 Miss - 0 Block - 0		1			1	1		1		21 翟乾坤 <table border="1"><tr><td></td><td>1</td><td></td></tr><tr><td></td><td></td><td>1</td></tr><tr><td></td><td>1</td><td></td></tr></table> Post - 0 Miss - 1 Block - 0		1				1		1	
1																																																																															
	1																																																																														
	1	1																																																																													
	1																																																																														
	1																																																																														
		1																																																																													
	1																																																																														

12 □□

0/2		0/2

16 □□□

	0/2	3/4
1/3		3/6
2/6	2/3	2/8

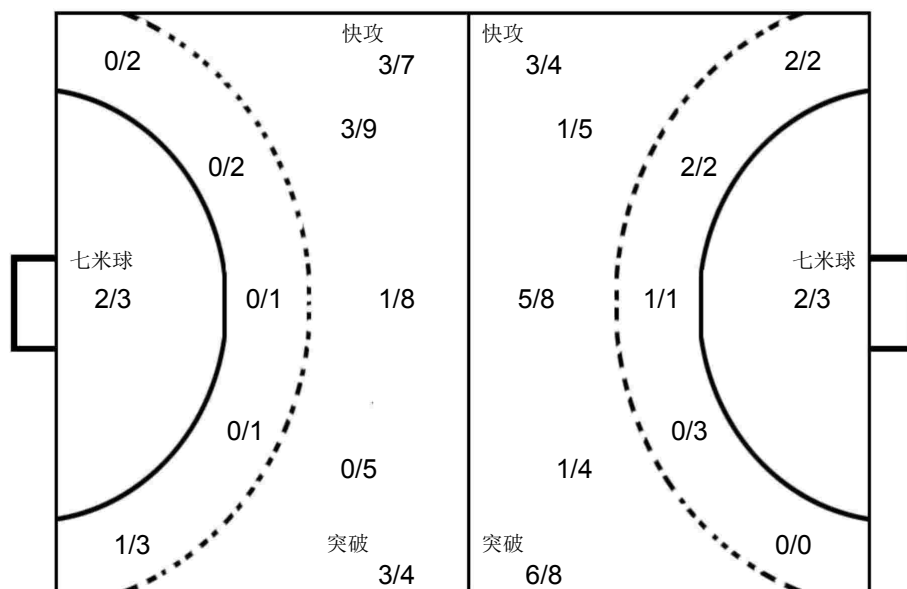

12 □□

0/4		1/1
3/5	0/1	1/3
4/7	3/4	5/5

13 □□

江苏队

1 徐畅 <table border="1"><tr><td></td><td></td><td></td></tr><tr><td></td><td></td><td></td></tr><tr><td></td><td></td><td></td></tr></table> Post - 0 Miss - 0 Block - 0										4 张家伟 <table border="1"><tr><td></td><td></td><td></td></tr><tr><td></td><td></td><td></td></tr><tr><td></td><td></td><td></td></tr></table> Post - 0 Miss - 0 Block - 1										5 闫亮 <table border="1"><tr><td></td><td></td><td></td></tr><tr><td></td><td></td><td></td></tr><tr><td></td><td></td><td></td></tr></table> Post - 0 Miss - 0 Block - 0										6 赵晨 <table border="1"><tr><td></td><td>1</td><td>1</td></tr><tr><td></td><td></td><td></td></tr><tr><td>1</td><td></td><td>2</td></tr></table> Post - 0 Miss - 1 Block - 2		1	1				1		2	7 徐奕飞 <table border="1"><tr><td></td><td></td><td></td></tr><tr><td></td><td></td><td></td></tr><tr><td></td><td></td><td></td></tr></table> Post - 0 Miss - 0 Block - 0										8 周小坚 <table border="1"><tr><td></td><td>1</td><td></td></tr><tr><td></td><td></td><td>1</td></tr><tr><td>1</td><td></td><td></td></tr></table> Post - 0 Miss - 0 Block - 0		1				1	1			9 王杰缘 <table border="1"><tr><td></td><td></td><td></td></tr><tr><td></td><td></td><td></td></tr><tr><td></td><td>1</td><td>2</td></tr></table> Post - 0 Miss - 0 Block - 0								1	2	10 郝可鑫 <table border="1"><tr><td></td><td></td><td></td></tr><tr><td></td><td></td><td></td></tr><tr><td></td><td></td><td></td></tr></table> Post - 0 Miss - 0 Block - 0									
	1	1																																																																													
1		2																																																																													
	1																																																																														
		1																																																																													
1																																																																															
	1	2																																																																													
12 王权 <table border="1"><tr><td></td><td></td><td></td></tr><tr><td></td><td></td><td></td></tr><tr><td></td><td></td><td></td></tr></table> Post - 0 Miss - 0 Block - 0										13 叶强 <table border="1"><tr><td></td><td></td><td></td></tr><tr><td></td><td></td><td></td></tr><tr><td></td><td></td><td></td></tr></table> Post - 0 Miss - 0 Block - 0										15 李安 <table border="1"><tr><td></td><td></td><td>1</td></tr><tr><td></td><td></td><td></td></tr><tr><td>4</td><td></td><td></td></tr></table> Post - 0 Miss - 0 Block - 0			1				4			17 王伟强 <table border="1"><tr><td></td><td></td><td></td></tr><tr><td></td><td></td><td></td></tr><tr><td></td><td></td><td></td></tr></table> Post - 0 Miss - 0 Block - 0										18 赵楠 <table border="1"><tr><td></td><td></td><td></td></tr><tr><td></td><td></td><td></td></tr><tr><td></td><td></td><td></td></tr></table> Post - 0 Miss - 0 Block - 0										19 张志宇 <table border="1"><tr><td></td><td></td><td></td></tr><tr><td></td><td></td><td></td></tr><tr><td></td><td></td><td>1</td></tr></table> Post - 0 Miss - 0 Block - 0									1	20 顾艳超 <table border="1"><tr><td></td><td>2</td><td></td></tr><tr><td></td><td></td><td>1</td></tr><tr><td></td><td></td><td>3</td></tr></table> Post - 0 Miss - 0 Block - 0		2				1			3	21 刘江 <table border="1"><tr><td></td><td></td><td></td></tr><tr><td></td><td></td><td></td></tr><tr><td></td><td></td><td></td></tr></table> Post - 0 Miss - 0 Block - 0									
		1																																																																													
4																																																																															
		1																																																																													
	2																																																																														
		1																																																																													
		3																																																																													

第十三届全国运动会男子手球决赛
PHMS Pictorial Handball Match Statistics

IHF Official System

比赛进程表

手球 男子 决赛 轮次 6 组别 X 场次 24 八件四世八子件月 馆 2017-08-28 19:15

时间	队员	动作	比分	队员	动作			
山东队			上半时			江苏队		
00:37	6 李朝鹏	接球失误	0-0					
01:07	18 于亚男	断球		4 张家纬	传球失误			
01:12	4 田瑞	一传快攻 得分	1-0	12 王权	被射入			
01:50		裁判暂停						
01:51	6 李朝鹏	罚出场2分钟						
02:04	15 张继伟	封球		4 张家纬	右远射 被封			
02:13	3 尹杰	快攻 侵区						
02:40	15 张继伟	封球		6 赵晨	中远射 被封			
02:51	16 于性哲	挡住球		6 赵晨	近射 被救			
03:30				5 闫亮	警告			
04:18	13 刘晓	右远射 被救		12 王权	挡住球			
04:27	16 于性哲	被射入	1-1	20 顾艳超	中远射 得分			
05:09	6 李朝鹏	中远射 被封		5 闫亮	封球			
05:38	18 于亚男	中远射 被封		8 周小坚	封球			
05:46	13 刘晓	近射 被封		6 赵晨	封球			
06:20	13 刘晓	警告						
06:35		裁判暂停						
07:00	15 张继伟	造犯规		8 周小坚	进攻犯规			
07:33	18 于亚男	左远射 被救		12 王权	挡住球			
07:43	6 李朝鹏	造失误		8 周小坚	快攻 运球失误			
07:53	6 李朝鹏	一传快攻 被救		12 王权	挡住球			
07:55				6 赵晨	警告			
08:21	6 李朝鹏	左远射 被封		8 周小坚	封球			
08:29	4 田瑞	进攻犯规		9 王杰缘	造犯规			
09:10	16 于性哲	被射入	1-2	20 顾艳超	突破 得分			
09:12	15 张继伟	顶贴 失误						
09:45	6 李朝鹏	进攻犯规		4 张家纬	造犯规			
10:21	16 于性哲	被射入	1-3	6 赵晨	中远射 得分			
10:51	13 刘晓	接球失误						
11:00				15 李安	快攻 运球失误			
11:14	18 于亚男	警告						
11:57	4 田瑞	进攻犯规		9 王杰缘	造犯规			
12:20	16 于性哲	挡住球		9 王杰缘	中远射 被救			
13:17	6 李朝鹏	任意球 被救		12 王权	挡住球			
13:56		裁判暂停						
14:05	18 于亚男	使被罚7M球		4 张家纬	造7M			
14:05	18 于亚男	罚出场2分钟						
14:10	16 于性哲	挡住球		15 李安	7M球 被救			
14:55	5 潘翔	运球失误						
15:00	16 于性哲	挡住球		15 李安	一传快攻 被救			
15:08				5 闫亮	助攻			

第十三届全国运动会男子手球决赛

PHMS Pictorial Handball Match Statistics

IHF Official System

比赛进程表

手球 男子 决赛 轮次 6 组别 X 场次 24 八津卅卅八子卅卅月 馆 2017-08-28 19:15

时间	队员	动作	比分	队员	动作
山东队			上半时		
15:43	21 翟乾坤	左边射 被救	1-3	12 王权	挡住球
15:52	16 于性哲	被射入	1-4	6 赵晨	短传快攻 得分
15:54				4 张家纬	助攻
16:09		球队暂停			
16:40	13 刘晓	右远射 被救		12 王权	挡住球
16:43	17 王旭东	近射 射失			
17:16	16 于性哲	被射入	1-5	6 赵晨	近射 得分
17:18				8 周小坚	助攻
17:29	9 赵鑫	四步			
17:39	16 于性哲	被射入	1-6	9 王杰缘	一传快攻 得分
17:41				8 周小坚	助攻
17:57	13 刘晓	接球失误			
18:25				4 张家纬	传球失误
18:33	5 潘翔	短传快攻 射失			
18:37	9 赵鑫	助攻			
19:16	16 于性哲	挡住球		20 顾艳超	中远射 被救
19:52	20 杜在超	近射 被救		12 王权	挡住球
20:03	16 于性哲	被射入	1-7	8 周小坚	一传快攻 得分
20:13				4 张家纬	助攻
20:21	11 宋朋强	突破 被救		12 王权	挡住球
20:51	11 宋朋强	左远射 被封		8 周小坚	封球
21:40	9 赵鑫	警告			
22:03					球队暂停
22:11	16 于性哲	挡住球		4 张家纬	右远射 被救
22:34		裁判暂停			
22:37	20 杜在超	突破 得分	2-7	12 王权	被射入
22:39				20 顾艳超	警告
23:03	16 于性哲	被射入	2-8	20 顾艳超	突破 得分
23:05	11 宋朋强	顶贴 失误			
23:09	11 宋朋强	左远射 被救		12 王权	挡住球
23:44	20 杜在超	右远射 得分	3-8	12 王权	被射入
24:20	15 张继伟	断球		10 郝可鑫	传球失误
25:12	20 杜在超	中远射 被救		12 王权	挡住球
25:57	16 于性哲	被射入	3-9	20 顾艳超	突破 得分
26:23	9 赵鑫	左远射 被救		12 王权	挡住球
26:54				8 周小坚	接球失误
27:03	21 翟乾坤	短传快攻 得分	4-9	12 王权	被射入
27:50		裁判暂停			
28:06	16 于性哲	被射入	4-10	6 赵晨	右远射 得分
28:20	9 赵鑫	造7M		8 周小坚	使被罚7M球
28:46	21 翟乾坤	7M球 得分	5-10	12 王权	被射入

第十三届全国运动会男子手球决赛

PHMS Pictorial Handball Match Statistics

IHF Official System

比赛进程表

手球 男子 决赛 轮次 6 组别 X 场次 24 天津奥林匹克体育中心 2017-08-28 19:15

时间	队员	动作	比分	队员	动作			
山东队			上半时			江苏队		
29:11	16 于性哲	挡住球	5-10	9 王杰缘	右远射 被救			
29:19	20 杜在超	短传快攻 被救		12 王权	挡住球			
29:53	16 于性哲	被射入	5-11	15 李安	左边射 得分			
29:55				6 赵晨	助攻			
29:57		裁判暂停						

第十三届全国运动会男子手球决赛

PHMS Pictorial Handball Match Statistics

IHF Official System

比赛进程表

手球 男子 决赛 轮次 6 组别 X 场次 24 天津奥体中心体育馆 2017-08-28 19:15

时间	队员	动作	比分	队员	动作
山东队			江苏队		
下半场					
00:00		裁判暂停	5-11		
00:54		裁判暂停			
00:59				6 赵晨	左远射 射失
01:55	20 杜在超	右远射 得分	6-11	12 王权	被射入
02:38	16 于性哲	挡住球		6 赵晨	任意球 被救
02:49	18 于亚男	接球失误			
03:43	16 于性哲	挡住球		15 李安	突破 被救
03:59	17 王旭东	快攻 进攻犯规		6 赵晨	造犯规
04:35	16 于性哲	挡住球		9 王杰缘	近射 被救
05:23	17 王旭东	右远射 被救		12 王权	挡住球
06:04		裁判暂停			
06:11	9 赵鑫	使被罚7M球		20 顾艳超	造7M
06:11	9 赵鑫	罚出场2分钟			
06:13	16 于性哲	被射入	6-12	9 王杰缘	7M球 得分
07:05	21 翟乾坤	传球失误			
07:23	16 于性哲	挡住球		4 张家纬	近射 被救
08:01	21 翟乾坤	中远射 被救		12 王权	挡住球
08:16	17 王旭东	抢球		8 周小坚	快攻 接球失误
08:25	17 王旭东	右边射 射失			
09:11	16 于性哲	被射入	6-13	15 李安	突破 得分
09:30	21 翟乾坤	左边射 射失			
10:14		裁判暂停			
10:17	17 王旭东	罚出场2分钟			
10:25		裁判暂停			
10:26	9 赵鑫	使被罚7M球		20 顾艳超	造7M
10:28	12 崔剑	被射入	6-14	9 王杰缘	7M球 得分
11:14		裁判暂停			
11:14				8 周小坚	罚出场2分钟
11:35		裁判暂停			
12:02	9 赵鑫	右远射 射失			
12:55	16 于性哲	被射入	6-15	20 顾艳超	中远射 得分
13:08	18 于亚男	近射 击柱			
13:10	9 赵鑫	助攻			
13:50	16 于性哲	挡住球		20 顾艳超	突破 被救
13:58	11 宋朋强	短传快攻 射失			
14:49	16 于性哲	被射入	6-16	15 李安	中远射 得分
15:25	13 刘晓	突破 得分	7-16	12 王权	被射入
15:45	16 于性哲	被射入	7-17	15 李安	近射 得分
15:48				19 张志宇	助攻
16:02		球队暂停			
16:33	11 宋朋强	右远射 被救		12 王权	挡住球

第十三届全国运动会男子手球决赛
PHMS Pictorial Handball Match Statistics

IHF Official System

比赛进程表

手球 男子 决赛 轮次 6 组别 X 场次 24 天津奥体中心体育馆 2017-08-28 19:15

时间	队员	动作	比分	队员	动作
山东队			江苏队		
17:19		裁判暂停	7-17		
17:34	5 潘翔	封球		6 赵晨	左远射 被封
17:40	20 杜在超	短传快攻 得分	8-17	12 王权	被射入
18:15	12 崔剑	被射入	8-18	15 李安	左边射 得分
18:42	20 杜在超	中远射 被救		12 王权	挡住球
19:14	5 潘翔	造犯规		4 张家纬	进攻犯规
19:20		裁判暂停			
19:48	9 赵鑫	右远射 得分	9-18	12 王权	被射入
20:04					球队暂停
20:21	12 崔剑	被射入	9-19	20 顾艳超	突破 得分
20:30	20 杜在超	进攻犯规		19 张志宇	造犯规
21:07	5 潘翔	造犯规		6 赵晨	进攻犯规
21:15		裁判暂停			
21:15	21 翟乾坤	造7M		9 王杰缘	使被罚7M球
21:15				9 王杰缘	罚出场2分钟
21:20	5 潘翔	7M球 得分	10-19	12 王权	被射入
22:20	12 崔剑	被射入	10-20	6 赵晨	任意球 得分
22:44	9 赵鑫	中远射 被封		5 闫亮	封球
22:47	21 翟乾坤	左边射 得分	11-20	12 王权	被射入
23:34	16 于性哲	被射入	11-21	19 张志宇	中远射 得分
24:03	9 赵鑫	中远射 得分	12-21	12 王权	被射入
25:00					球队暂停
25:10				19 张志宇	传球失误
25:32	17 王旭东	进攻犯规		15 李安	造犯规
26:19	16 于性哲	被射入	12-22	8 周小坚	突破 得分
26:37	11 宋朋强	突破 得分	13-22	12 王权	被射入
27:08	9 赵鑫	造犯规		19 张志宇	进攻犯规
27:15		裁判暂停			
27:17				6 赵晨	罚出场2分钟
27:41	9 赵鑫	右远射 被救		12 王权	挡住球
28:10				9 王杰缘	侵区
28:23	19 李语庆	右边射 射失			
28:54		裁判暂停			
28:58	5 潘翔	罚出场2分钟			
29:11	16 于性哲	挡住球		20 顾艳超	任意球 被救
29:15	16 于性哲	被射入	13-23	8 周小坚	近射 得分
29:53	21 翟乾坤	造7M		9 王杰缘	使被罚7M球
29:57		裁判暂停			
30:00	16 于性哲	7M球 击柱			